



**LIGHT^{MY}
BRICKS**



**LEGO® IMPERIAL LIGHT CRUISER
#75315 LIGHT KIT
INSTALLATION GUIDE**

Light My Bricks



LEGO® STAR WARS IMPERIAL LIGHT CRUISER #75315 LIGHT KIT INSTALLATION GUIDE

Hi There!

We're here to help you get started on the LEGO® Star Wars Imperial Light Cruiser (75315) Light Kit.

This PDF details the instructions for the LED light kit only. If you are wishing to purchase this product, please [click here](#) to view the product page.

If you run into any issues, please refer to the troubleshooting section towards the end of this guide.

Have fun and enjoy!



PACKAGE CONTENTS:



- 4 x Green 30cm Large Bit Light
- 3 x Cool White 30cm Large Bit Light
- 4 x White 30cm Bit Light
- 2 x White 15cm Bit Light
- 2 x Cool White 30cm Bit Light
- 2 x Red 30cm Bit Light



- 2 x 2-Port Expansion Board
- 2 x 6-Port Expansion Board
- 1 x 12-Port Expansion Board
- 3 x Adhesive Squares



- 1 x Gun Effects Board
- 1 x Pulse Effects Board



- 4 x 5cm Connecting Cable
- 2 x 15cm Connecting Cable



- 1 x USB Power Cable
(Power Source not Included)

LEGO PIECES:



- 6 x Tile 1x2 - Trans Black
- 2 x Plate 2x2 - Dark Grey
- 2 x Plate 1x8 - Dark Grey
- 6 x Plate 1x2 - Trans Clear
- 2 x Round Plate 1x1 - Trans Red
- 4 x Round Plate 1x1 - Trans Clear

Contents

Before You Begin	5
Blueprint	8
Instructions	9
Final Product	32
Troubleshooting	33
Contact	38

Before You Begin

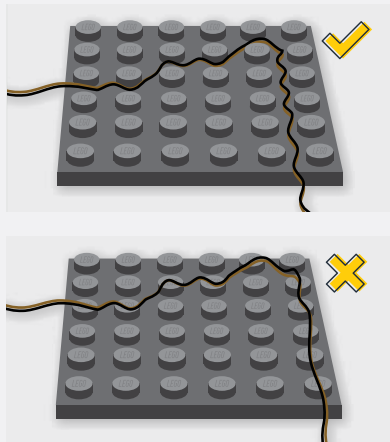

Laying cables in between and underneath bricks

Cables can fit in between and underneath LEGO® bricks, plates, and tiles providing they are laid correctly between the LEGO® studs. Do NOT forcefully join LEGO® together around cables; instead ensure they are laying comfortably in between each stud.

CAUTION: Forcing LEGO® to connect over a cable can result in damaging the cable and light.



Connecting Cable Connectors To Expansion Boards

Take extra care when inserting connectors to ports of Expansion Boards. Connectors can be inserted only one way. With the expansion board facing up, look for the soldered “=” symbol on the left side of the port. The connector side with the wires exposed should be facing toward the soldered “=” symbol as you insert into the port. If a plug won’t fit easily into a port connector, do not force it.

Incorrectly inserting the connector can result in bent pins inside the port or possible overheating of the expansion board when connected.

Before You Begin



Connecting Cable Connectors To Strip Lights

Take extra care when inserting connectors to ports on the Strip Lights. Connectors can be inserted only one way. With the Strip Light facing up, ensure the side of the connector with the wires exposed is facing down. If a plug won't fit easily into a port connector, don't force it. Doing so will damage the plug and the connector.

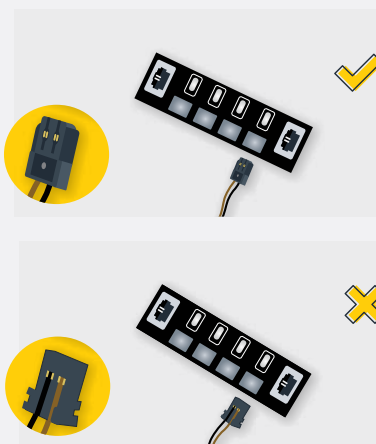

Connecting Micro Cable Connectors To Micro Expansion Board Ports

Take extra care when inserting the micro connectors to micro ports of Micro Expansion Boards. Connecting Micro Bit Lights to Micro Expansion Boards is similar to connecting lights and cables to Strip Lights. With the expansion board facing up, ensure the side of the connector with the wires exposed is facing down. If a plug won't fit easily into a port connector, do not force it. Use your fingernail to push the plastic part of the connector to the micro port.

Before You Begin

Installing Bit Lights Under Lego® Bricks And Plates

When installing Bit Lights under LEGO® pieces, ensure they are placed the correct way up (Yellow LED component exposed). You can either place them directly on top of LEGO® studs or in between.





BLUEPRINT

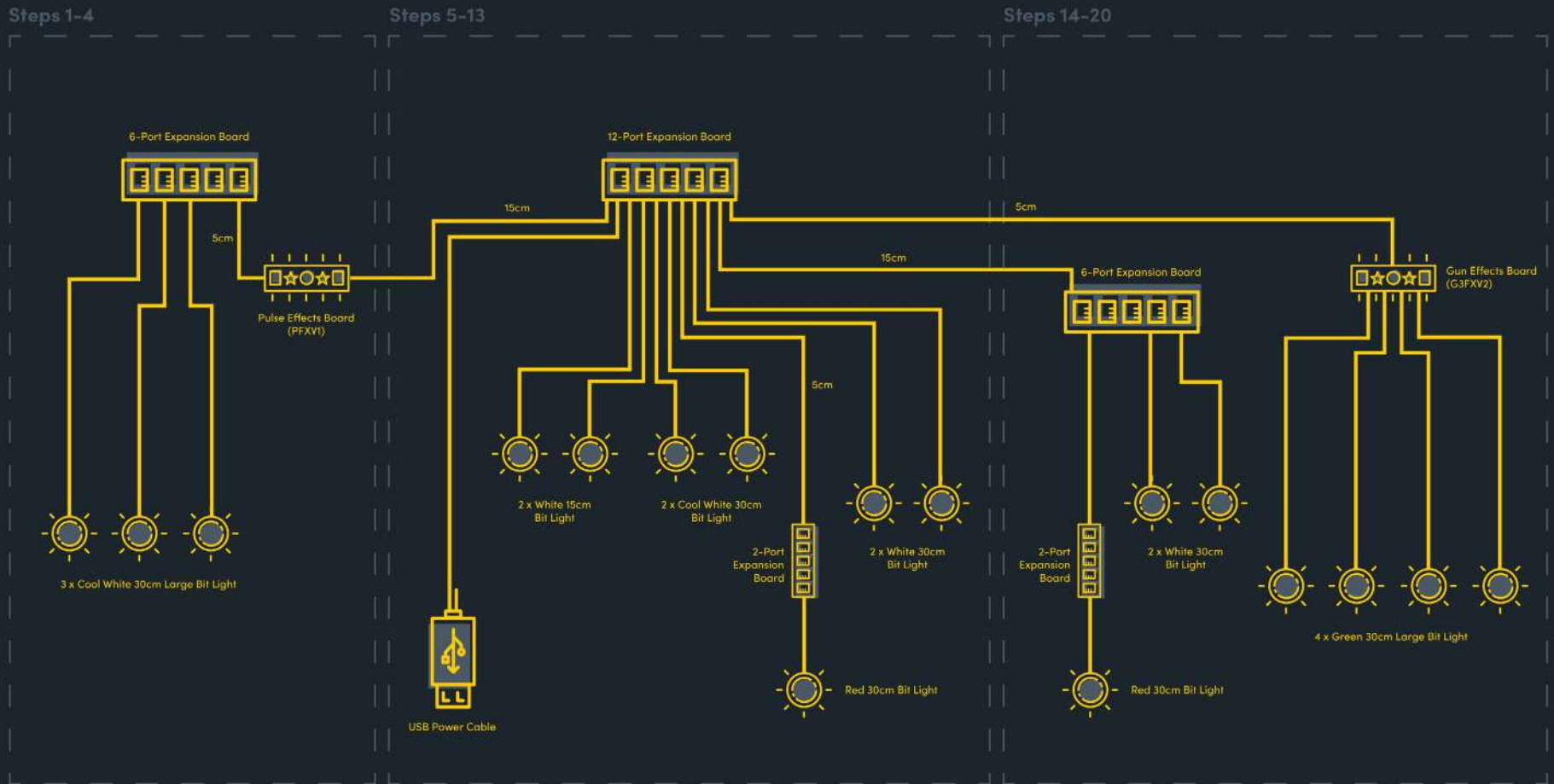



INSTRUCTIONS

To ensure a smooth installation of your light kit, please read and follow each step carefully. If you run into any issues, please refer to the online troubleshooting guide.

1

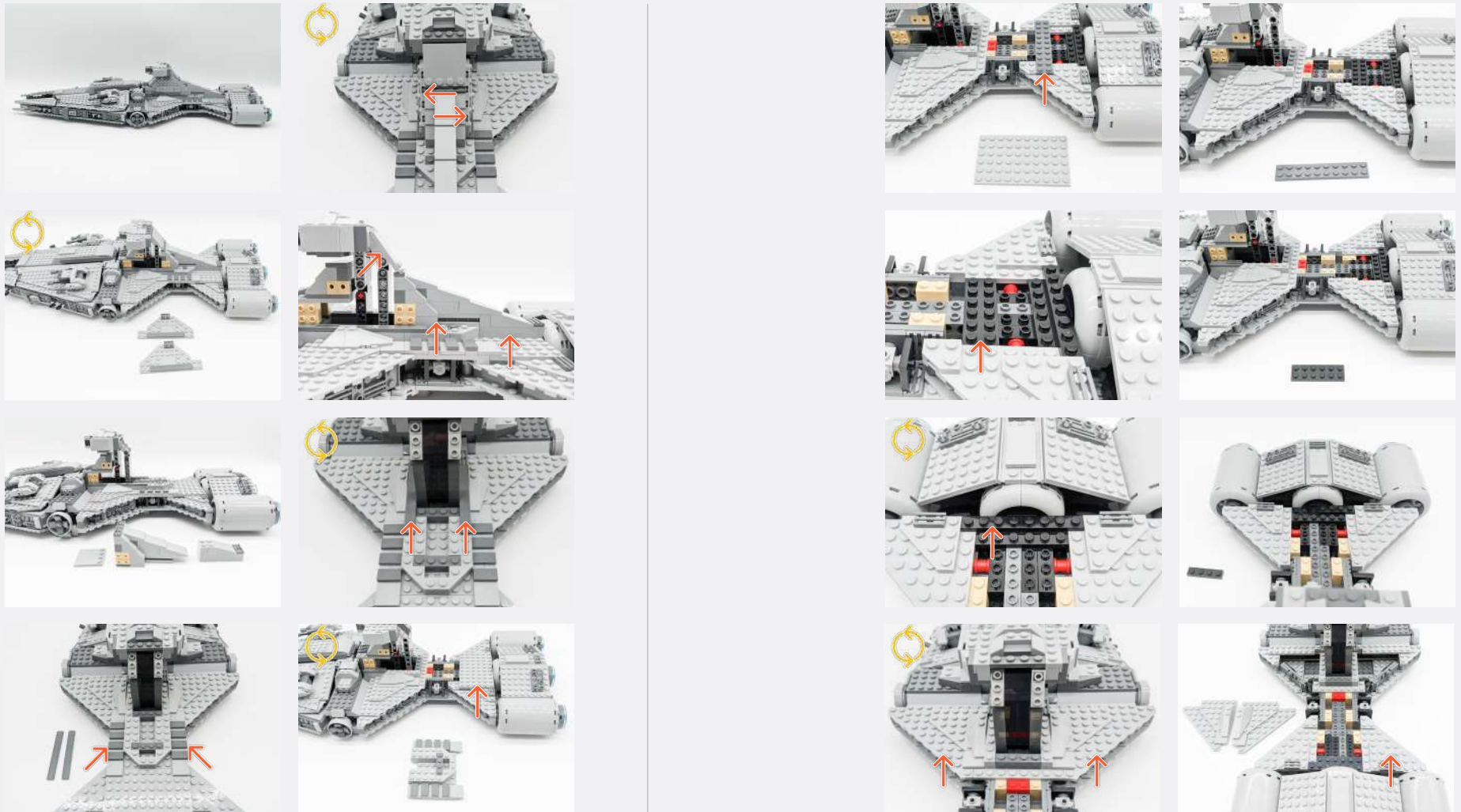

Legend

- DISCONNECT
- CONNECT / RECONNECT
- ↻ TURN / FLIP
- DIRECTIONAL
- ↻↻ TWIST / BRAID
- ✳ POWER ON TEST
- 📝 NOTE ICON

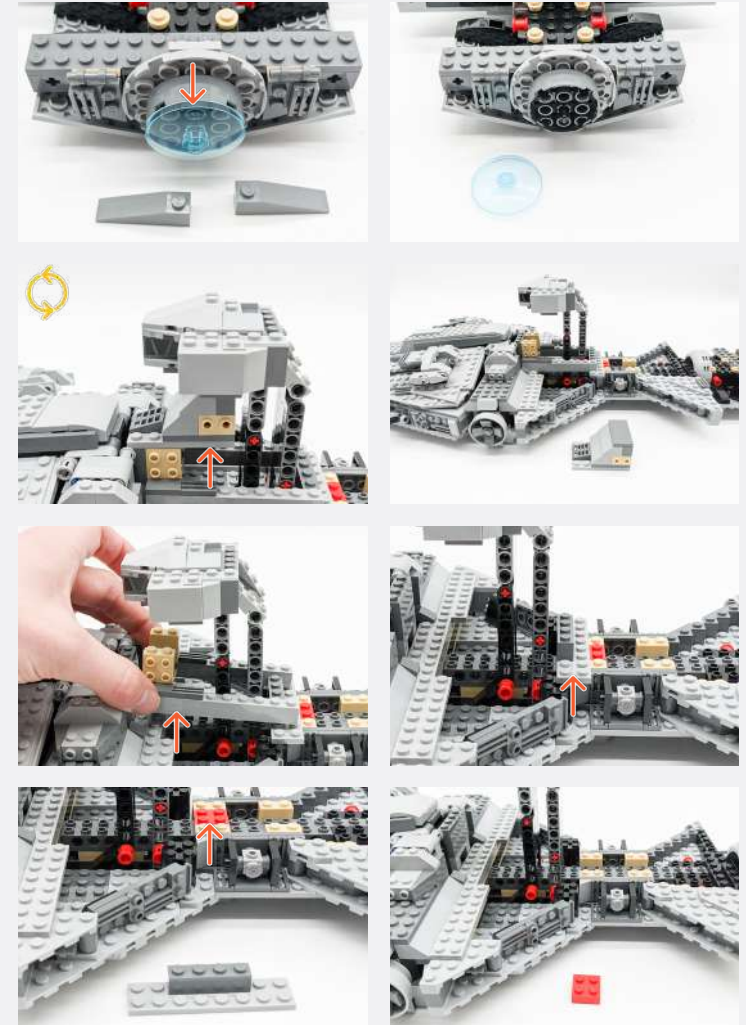

Legend → DISCONNECT → CONNECT / RECONNECT ↻ TURN / FLIP → DIRECTIONAL ↺ TWIST / BRAID ✨ POWER ON TEST 📝 NOTE ICON

2

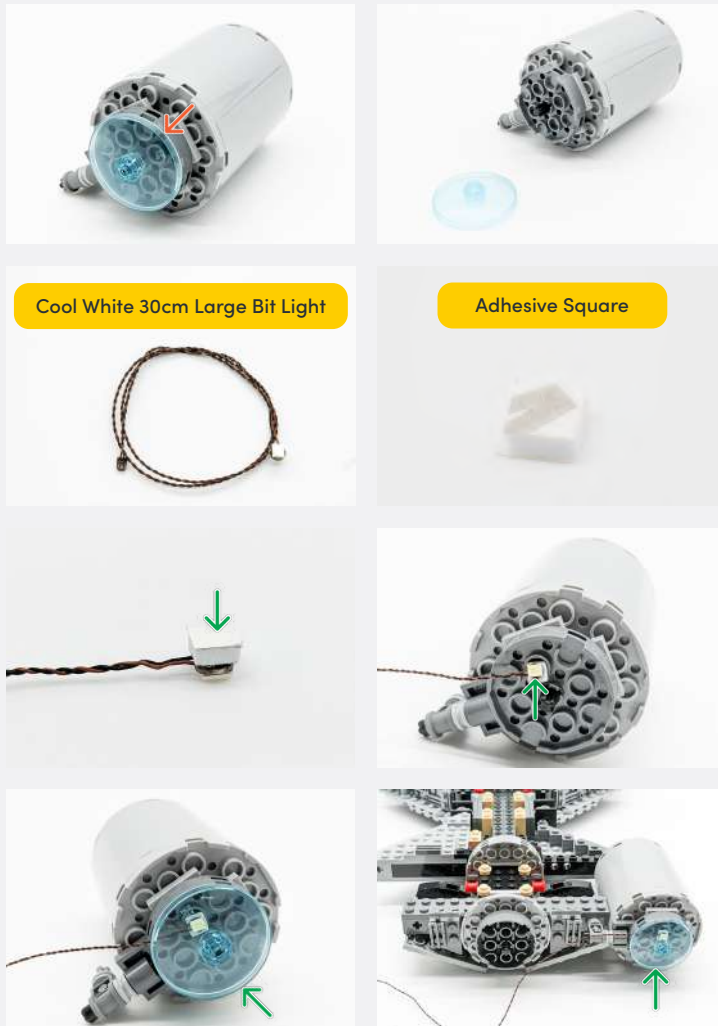

3

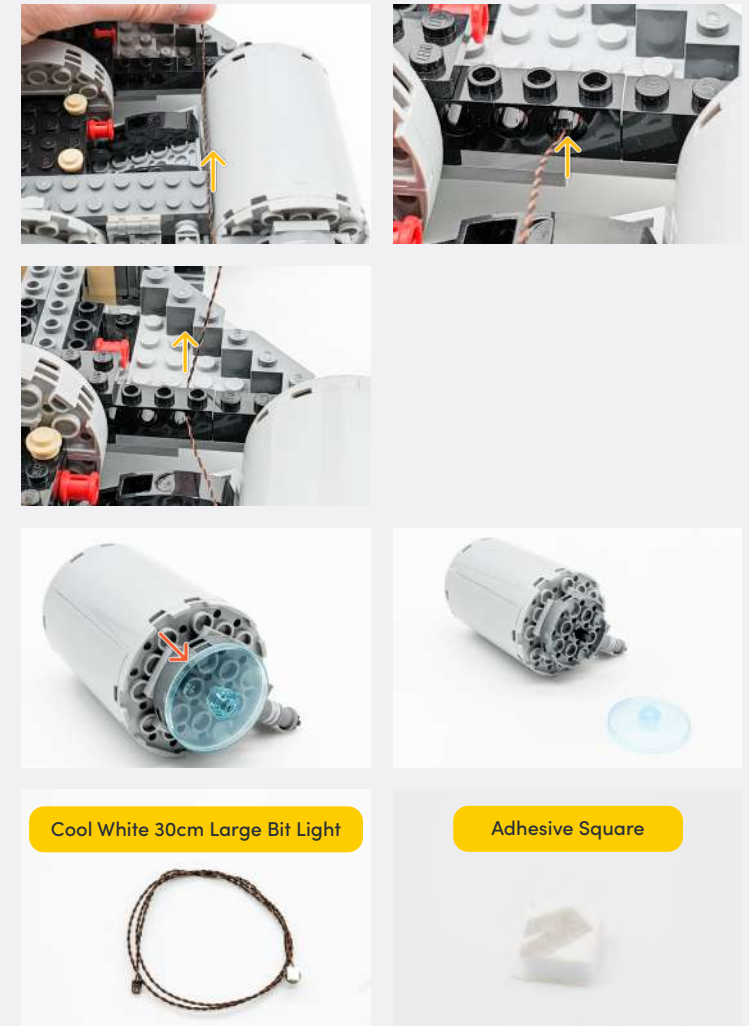

Legend

- DISCONNECT
- CONNECT / RECONNECT
- ↻ TURN / FLIP
- DIRECTIONAL
- ↻ TWIST / BRAID
- ✳ POWER ON TEST
- 📝 NOTE ICON



4

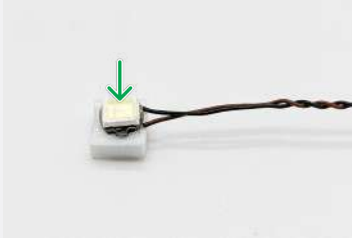

Legend → DISCONNECT → CONNECT / RECONNECT ↻ TURN / FLIP → DIRECTIONAL ↻ TWIST / BRAID * POWER ON TEST 📝 NOTE ICON

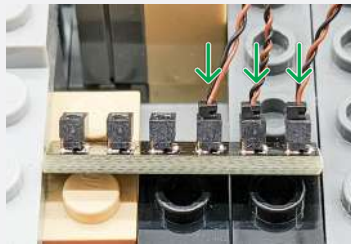

5cm Connecting Cable

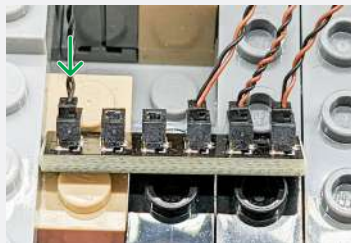

Pulse Effects Board



✍️ Connect the 5cm Connecting Cable to the 'OUT' port of the Pulse Effects Board.

Push the switch to the left.

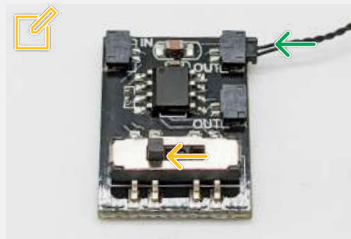

15cm Connecting Cable



✍️ Connect the 15cm Connecting Cable to the 'IN' port of the Pulse Effects Board.

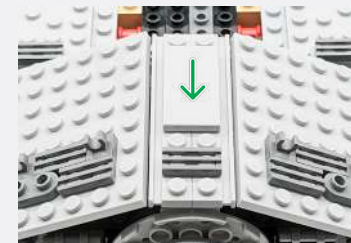
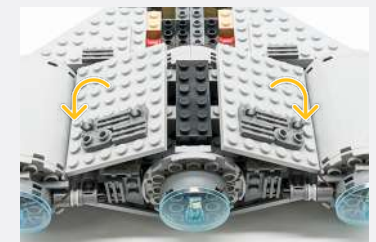
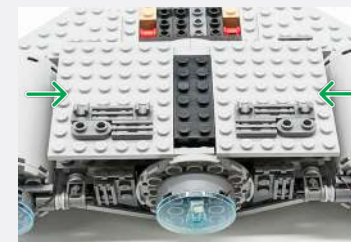
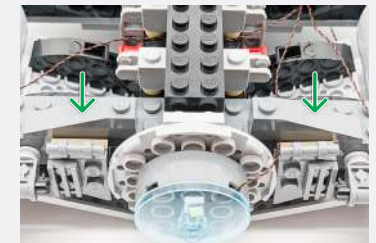
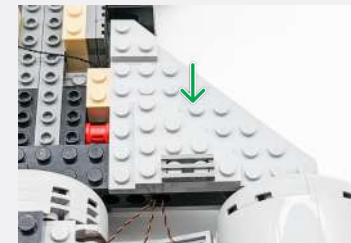
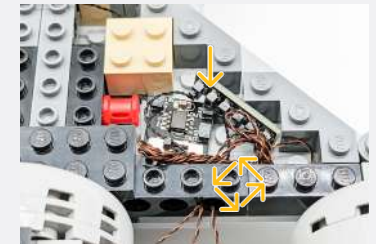
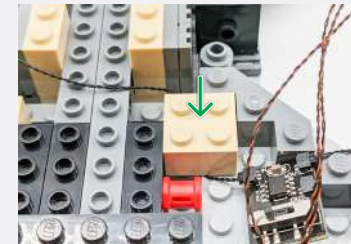
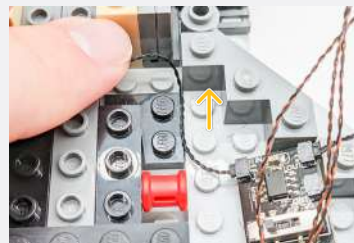

Legend

- DISCONNECT
- CONNECT / RECONNECT
- TURN / FLIP
- DIRECTIONAL
- TWIST / BRAID
- POWER ON TEST
- NOTE ICON

If you experience any issues with the lights not working and suspect an issue with a component, please try a different port on the expansion board to verify where the fault lies (with the light or expansion board). To correct any issues with expansion board ports, please view the section addressing expansion board issues in our troubleshooting section.

5

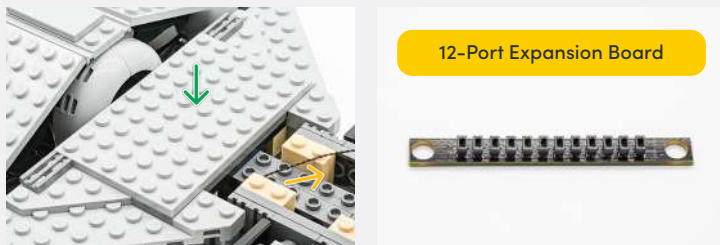
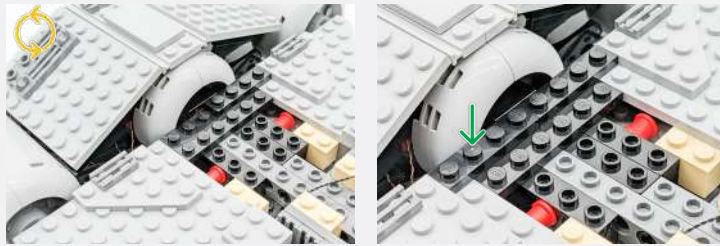

12-Port Expansion Board

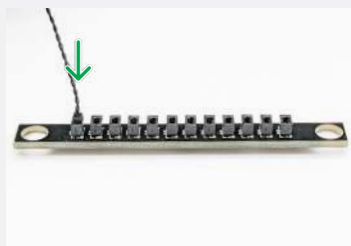

USB Power Cable



Connect the other end to a USB Power Bank, USB Wall Adaptor, or USB to AA Battery Pack (sold separately)

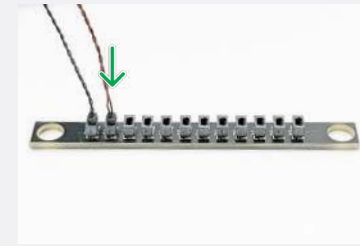

6

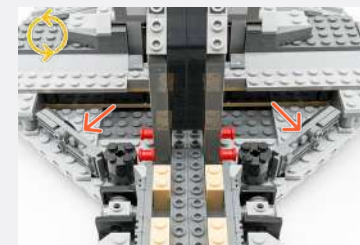

Legend DISCONNECT CONNECT / RECONNECT TURN / FLIP DIRECTIONAL TWIST / BRAID POWER ON TEST NOTE ICON

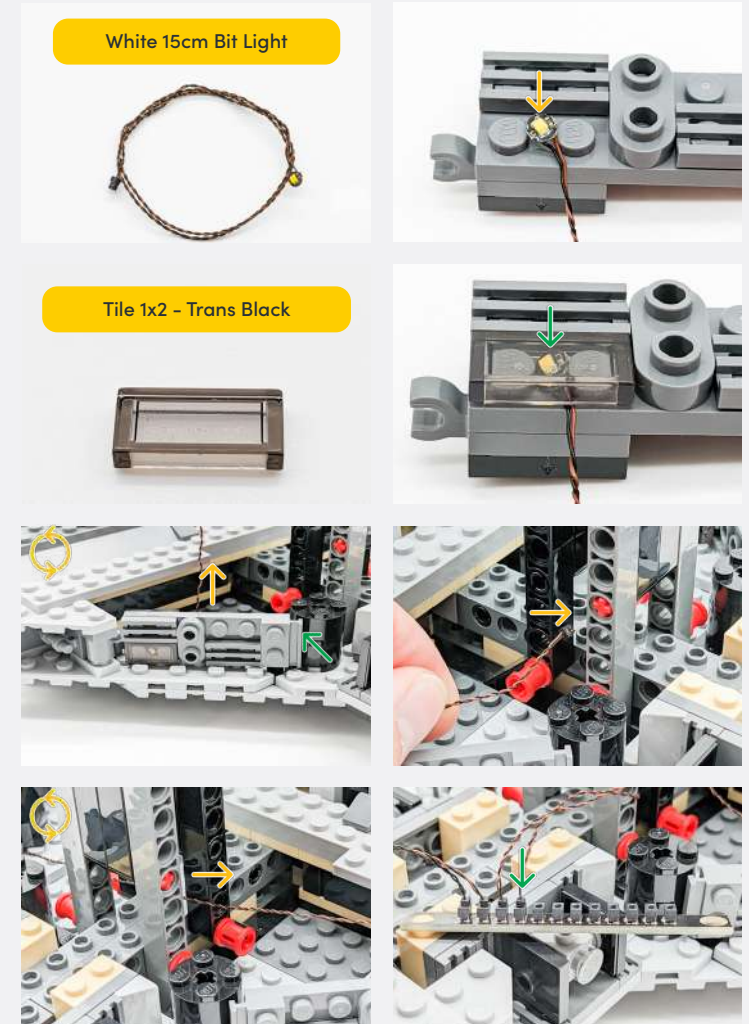
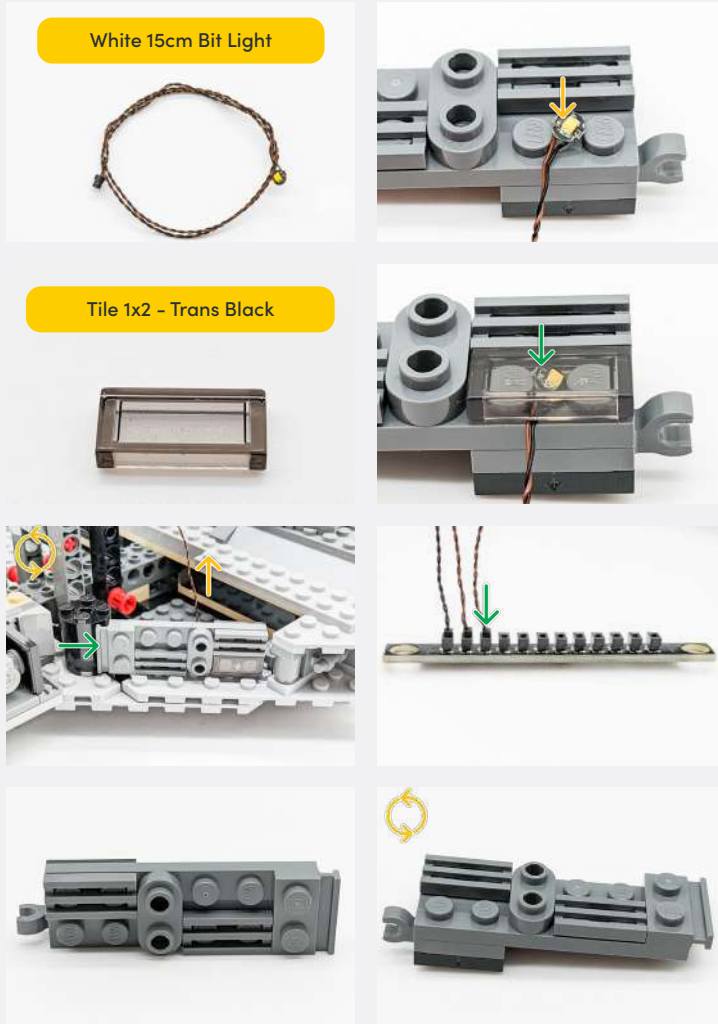

Legend → DISCONNECT → CONNECT / RECONNECT ↻ TURN / FLIP → DIRECTIONAL ↻ TWIST / BRAID * POWER ON TEST 📝 NOTE ICON

7

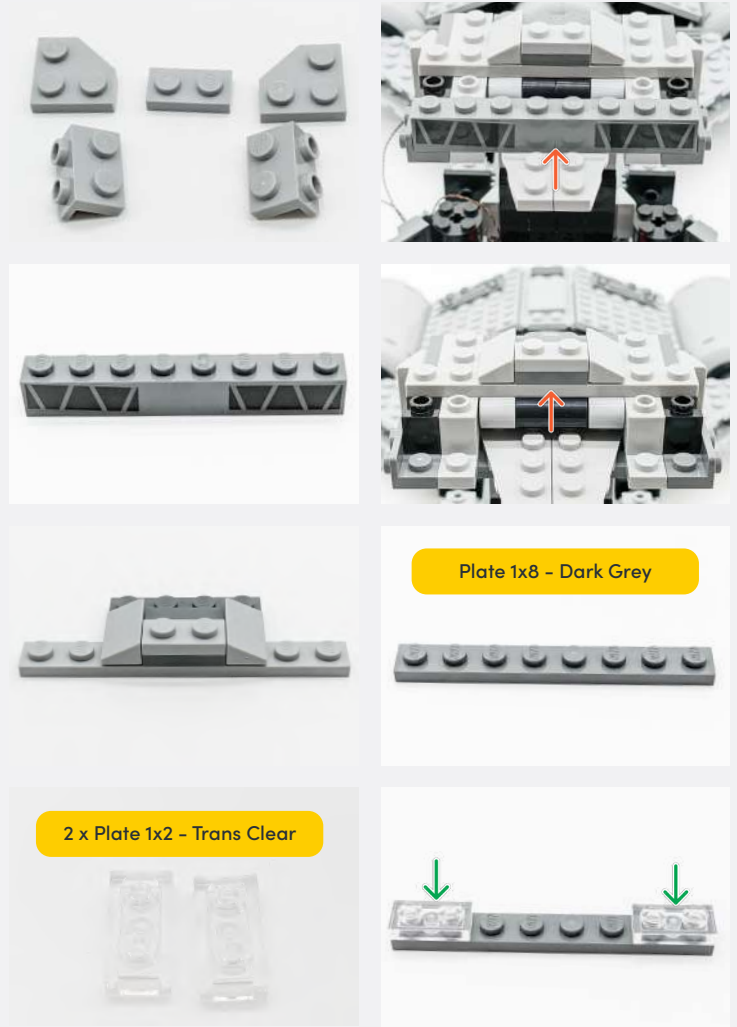
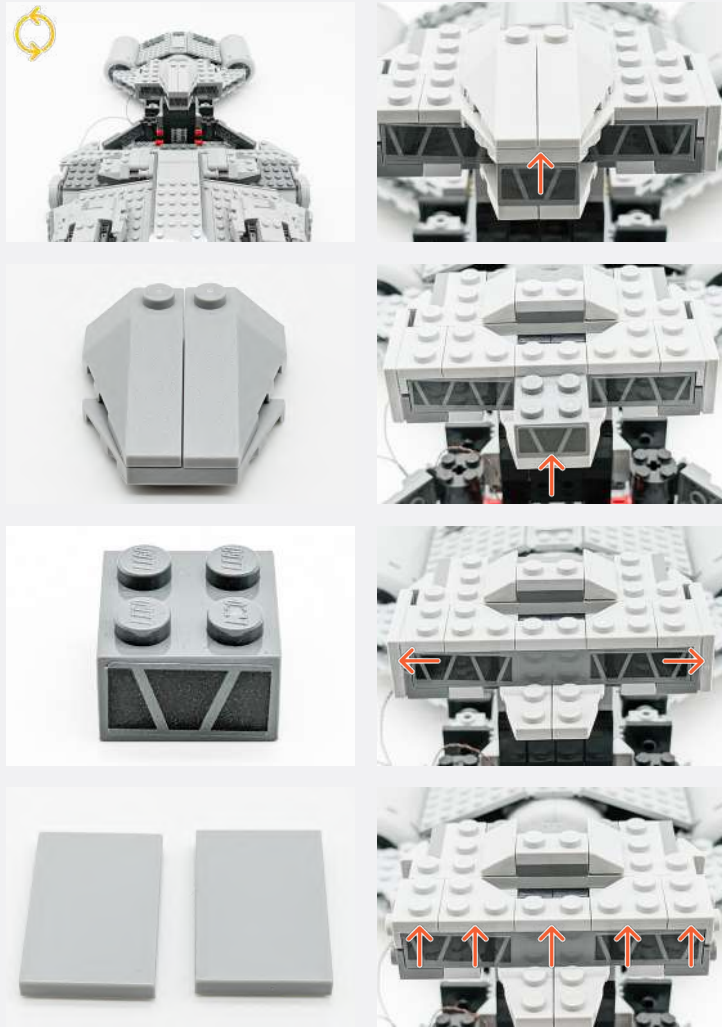

Legend

- DISCONNECT
- CONNECT / RECONNECT
- ↻ TURN / FLIP
- DIRECTIONAL
- ↻↻ TWIST / BRAID
- ✳ POWER ON TEST
- 📝 NOTE ICON

Cool White 30cm Bit Light	
Plate 1x2 - Trans Clear	
Cool White 30cm Bit Light	
Plate 1x2 - Trans Clear	

8

Plate 1x8 - Dark Grey	
Plate 2x2 - Dark Grey	
2 x Plate 1x2 - Trans Clear	Plate 2x2 - Dark Grey

Legend → DISCONNECT → CONNECT / RECONNECT ↻ TURN / FLIP → DIRECTIONAL ↻ TWIST / BRAID * POWER ON TEST 📝 NOTE ICON

If you experience any issues with the lights not working and suspect an issue with a component, please try a different port on the expansion board to verify where the fault lies (with the light or expansion board). To correct any issues with expansion board ports, please view the section addressing expansion board issues in our troubleshooting section.

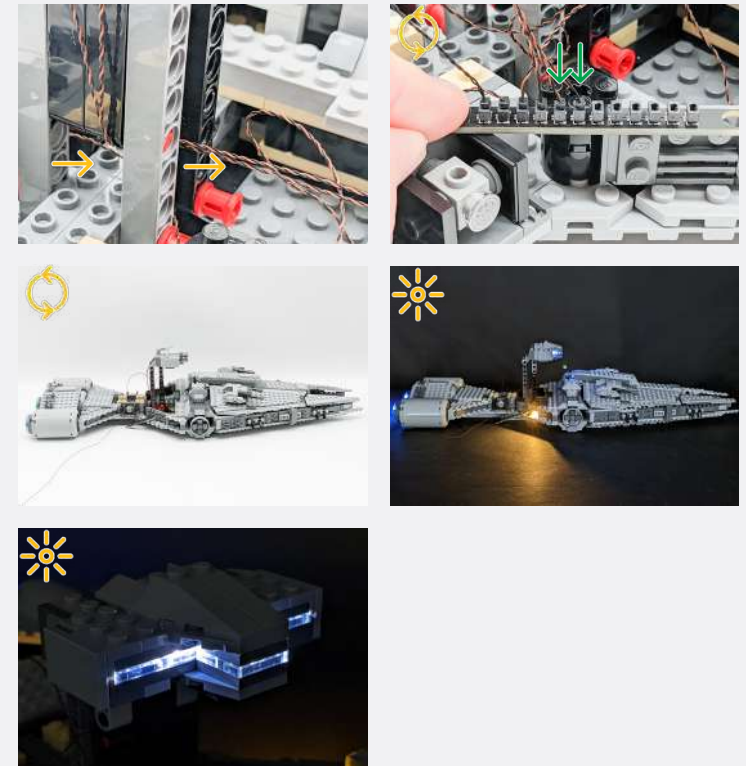
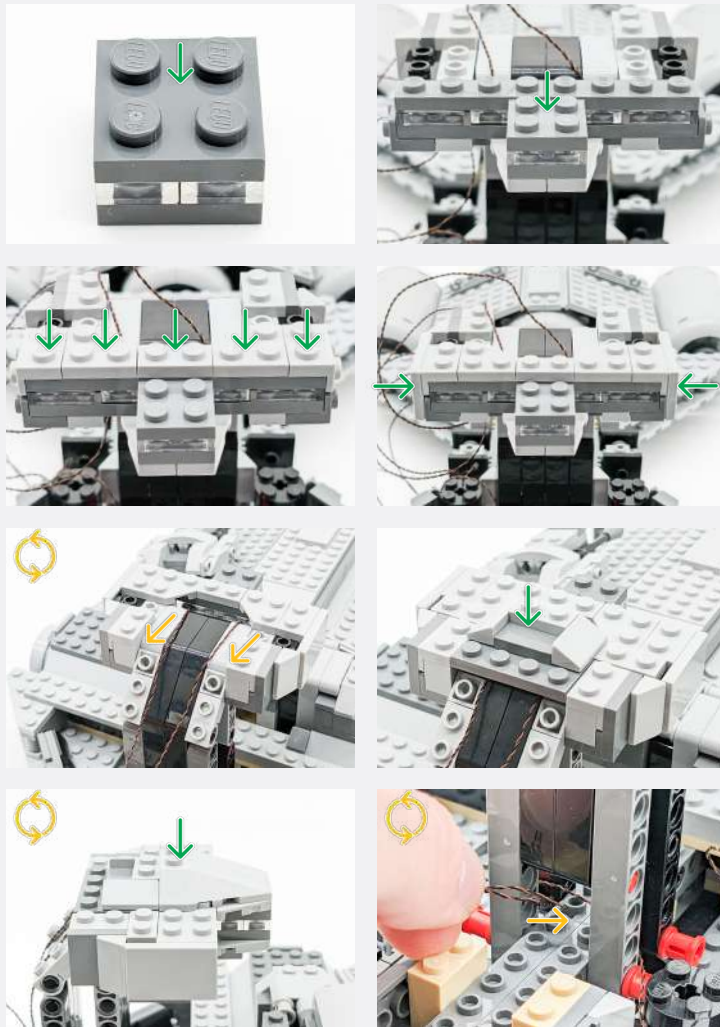

Legend DISCONNECT CONNECT / RECONNECT TURN / FLIP DIRECTIONAL TWIST / BRAID POWER ON TEST NOTE ICON

9

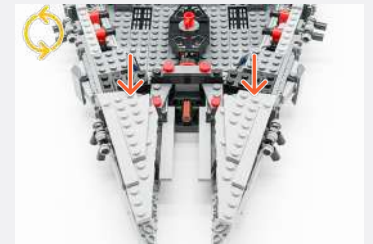
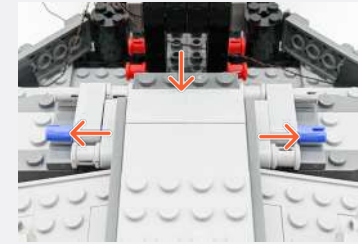
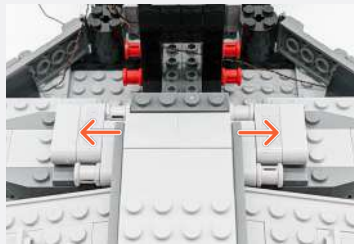

Legend

- DISCONNECT
- CONNECT / RECONNECT
- ↻ TURN / FLIP
- DIRECTIONAL
- ↻↻ TWIST / BRAID
- ✳ POWER ON TEST
- 📝 NOTE ICON

10

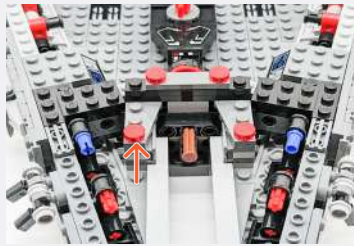

Red 30cm Bit Light

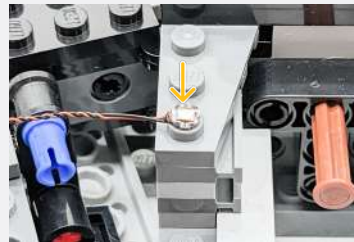

Trans Red Round Plate 1x1

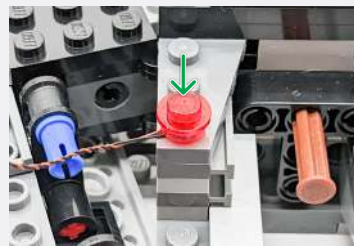

2-Port Expansion Board

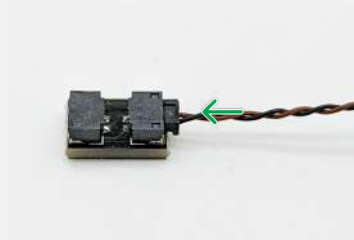

5cm Connecting Cable

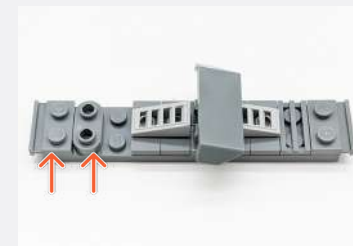
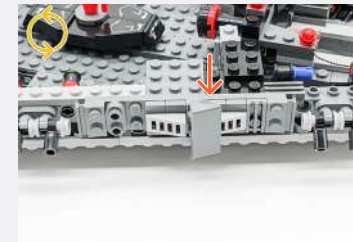
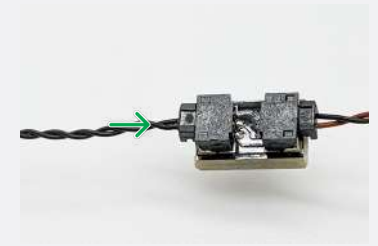

White 30cm Bit Light

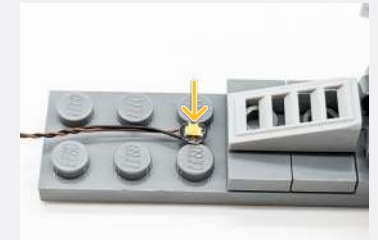

Legend

- DISCONNECT
- CONNECT / RECONNECT
- TURN / FLIP
- DIRECTIONAL
- TWIST / BRAID
- POWER ON TEST
- NOTE ICON

11

Tile 1x2 - Trans Black

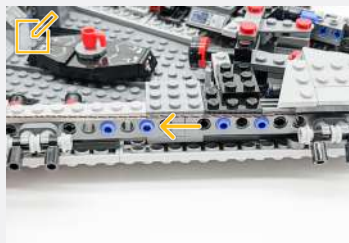
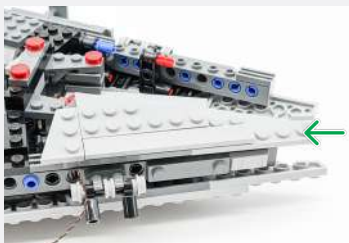
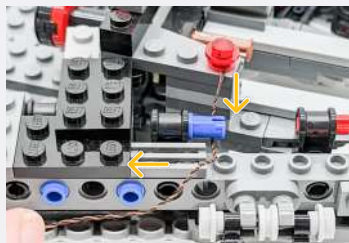

Run the cable of the Red 30cm Bit Light along the Technic Bricks on the side of the ship before reconnecting the piece from step 10.

12

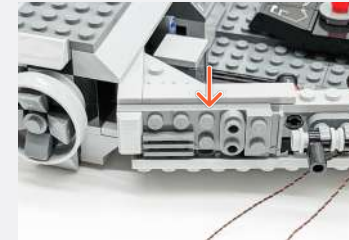

White 30cm Bit Light



Tile 1x2 - Trans Black



Legend

- DISCONNECT
- CONNECT / RECONNECT
- ↻ TURN / FLIP
- DIRECTIONAL
- ↔ TWIST / BRAID
- ✳ POWER ON TEST
- 📝 NOTE ICON

13

Run both Bit Light cables from step 10 along the Technic Brick on the side of the ship before reconnecting the piece from step 12.

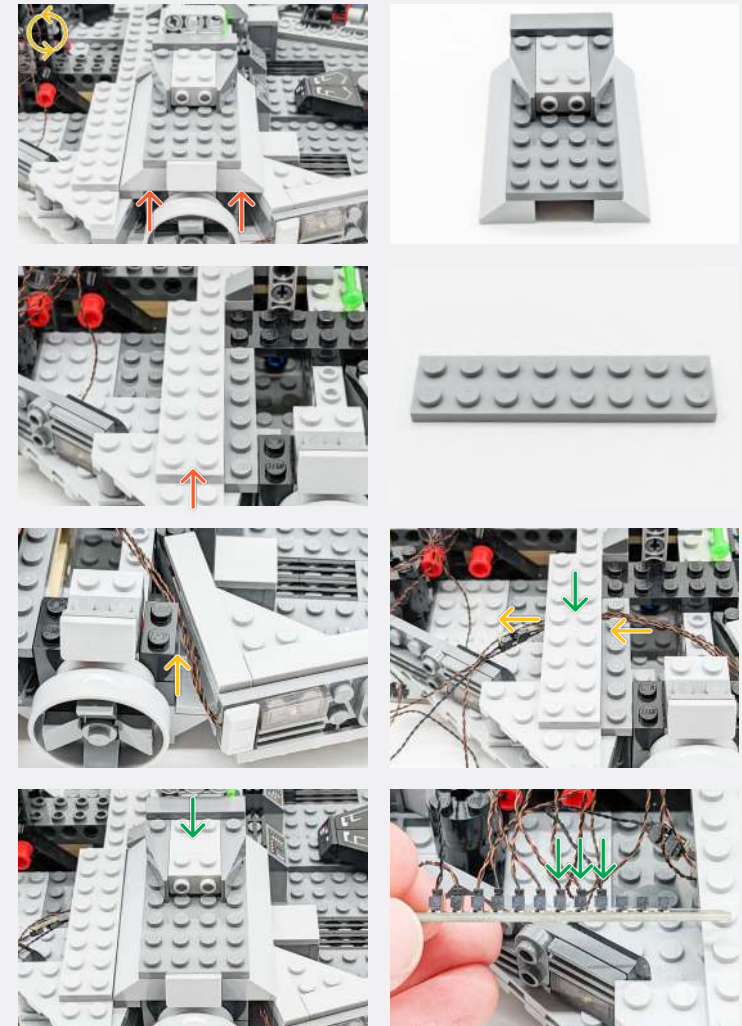

Legend

- DISCONNECT
- CONNECT / RECONNECT
- TURN / FLIP
- DIRECTIONAL
- TWIST / BRAID
- POWER ON TEST
- NOTE ICON

📌 If you experience any issues with the lights not working and suspect an issue with a component, please try a different port on the expansion board to verify where the fault lies (with the light or expansion board). To correct any issues with expansion board ports, please view the section addressing expansion board issues in our troubleshooting section.

14

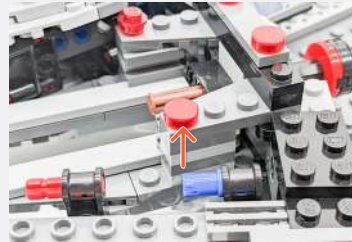

Red 30cm Bit Light



Trans Red Round Plate 1x1



2-Port Expansion Board

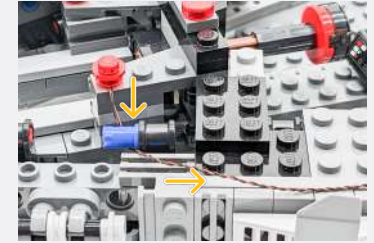

5cm Connecting Cable

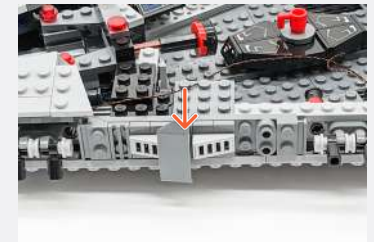
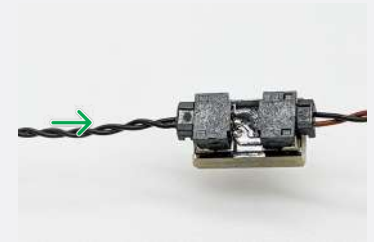
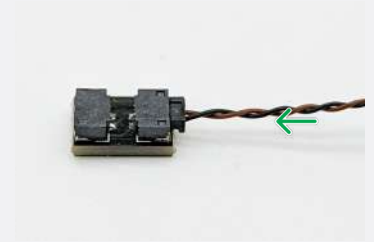

Legend

- DISCONNECT
- CONNECT / RECONNECT
- TURN / FLIP
- DIRECTIONAL
- TWIST / BRAID
- POWER ON TEST
- NOTE ICON

15



White 30cm Bit Light



Tile 1x2 - Trans Black



Thread the cable from the Red 30cm Bit Light from step 14 under the piece before reconnecting it.

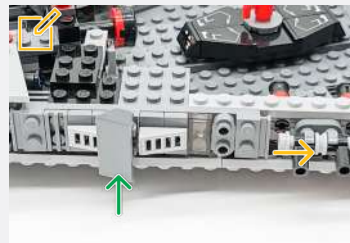

16

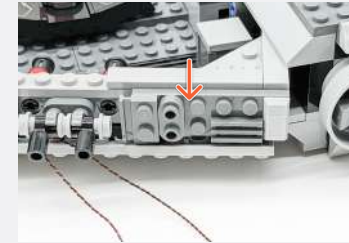

White 30cm Bit Light



Tile 1x2 - Trans Black



Legend

- DISCONNECT
- CONNECT / RECONNECT
- TURN / FLIP
- DIRECTIONAL
- TWIST / BRAID
- POWER ON TEST
- NOTE ICON

17

Run both cables from step 14 and 15 along the Technic Brick on the side of the ship before reconnecting the piece from step 16.

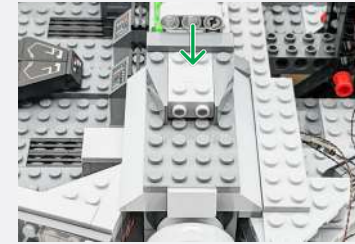
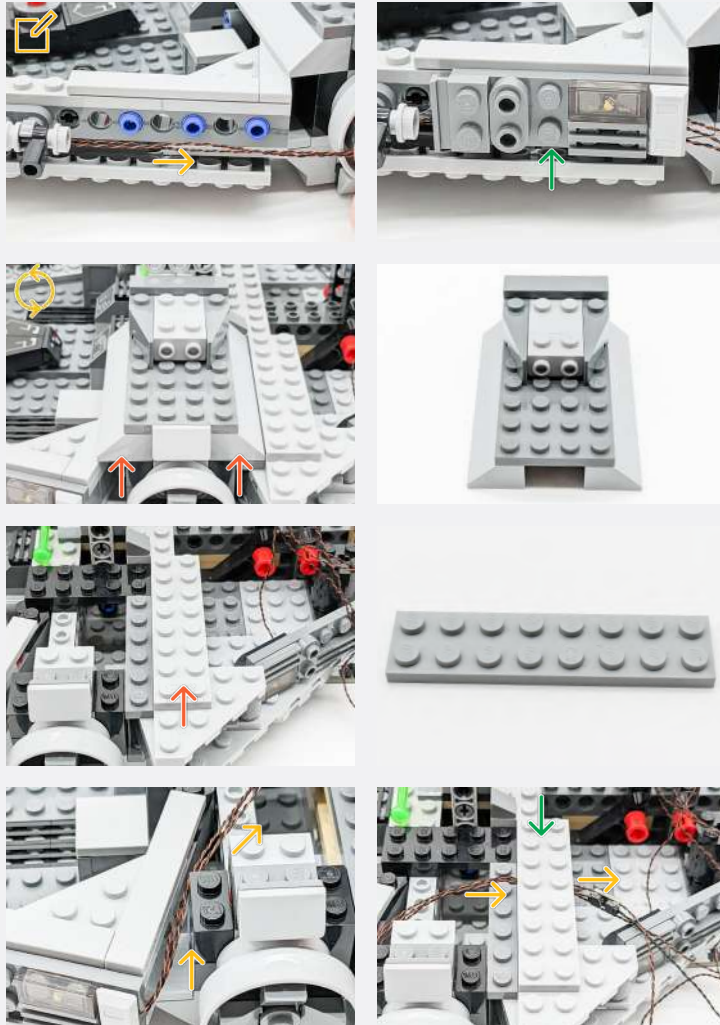

6-Port Expansion Board

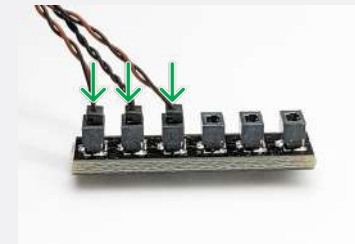

15cm Connecting Cable



Thread the 15cm Connecting Cable to the opposite side

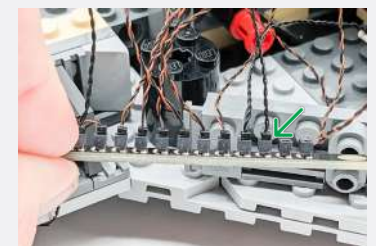
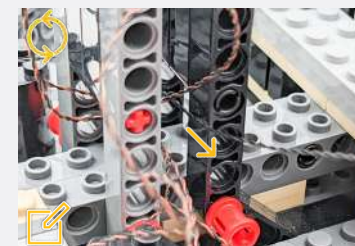
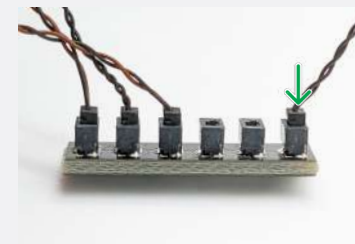

Legend

- DISCONNECT
- CONNECT / RECONNECT
- TURN / FLIP
- DIRECTIONAL
- TWIST / BRAID
- POWER ON TEST
- NOTE ICON

📌 If you experience any issues with the lights not working and suspect an issue with a component, please try a different port on the expansion board to verify where the fault lies (with the light or expansion board). To correct any issues with expansion board ports, please view the section addressing expansion board issues in our troubleshooting section.

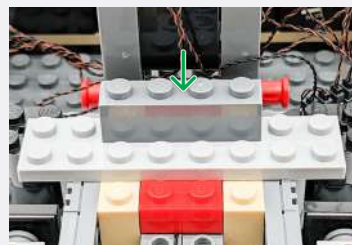
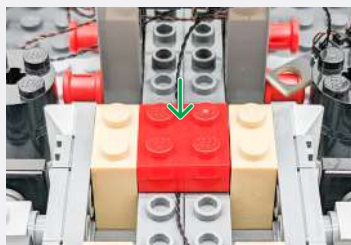
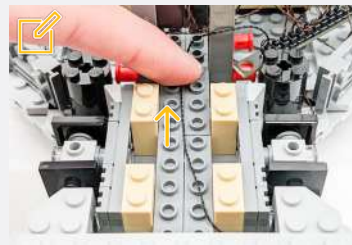

📌 Pull the Connecting Cable from the back of the ship in between the studs

18

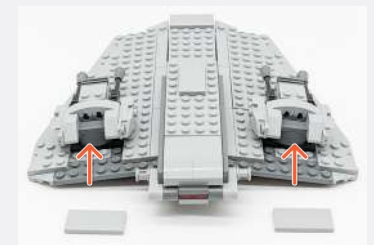

Legend

- DISCONNECT
- CONNECT / RECONNECT
- TURN / FLIP
- DIRECTIONAL
- TWIST / BRAID
- POWER ON TEST
- NOTE ICON

19

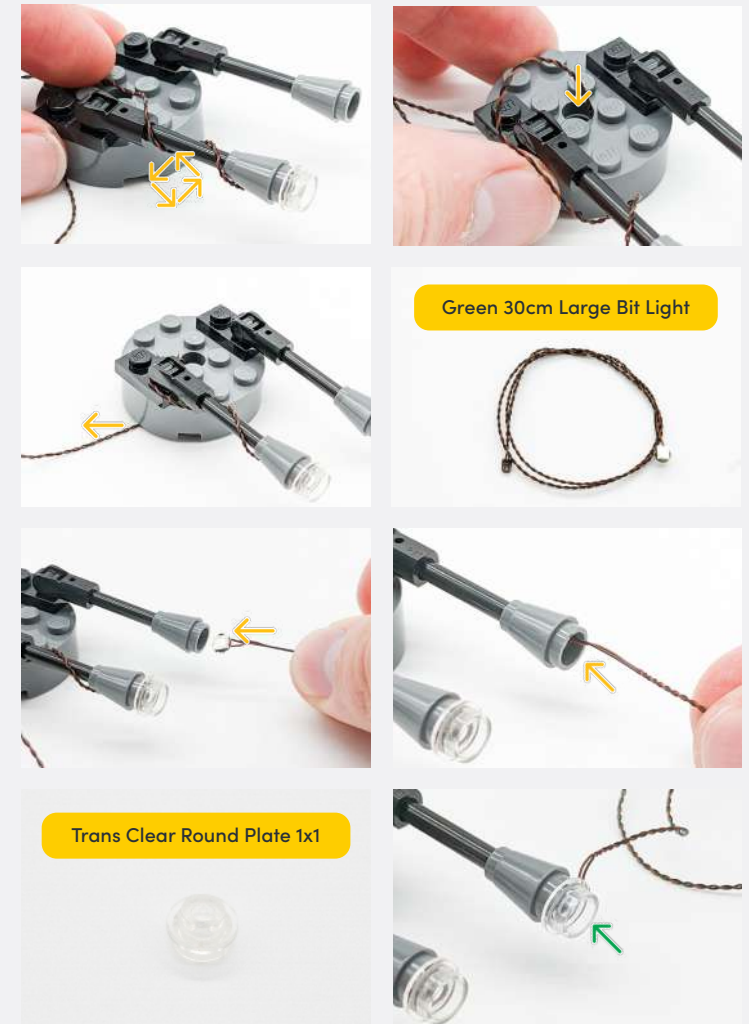

Legend → DISCONNECT → CONNECT / RECONNECT ↻ TURN / FLIP → DIRECTIONAL ↻ TWIST / BRAID * POWER ON TEST 📝 NOTE ICON

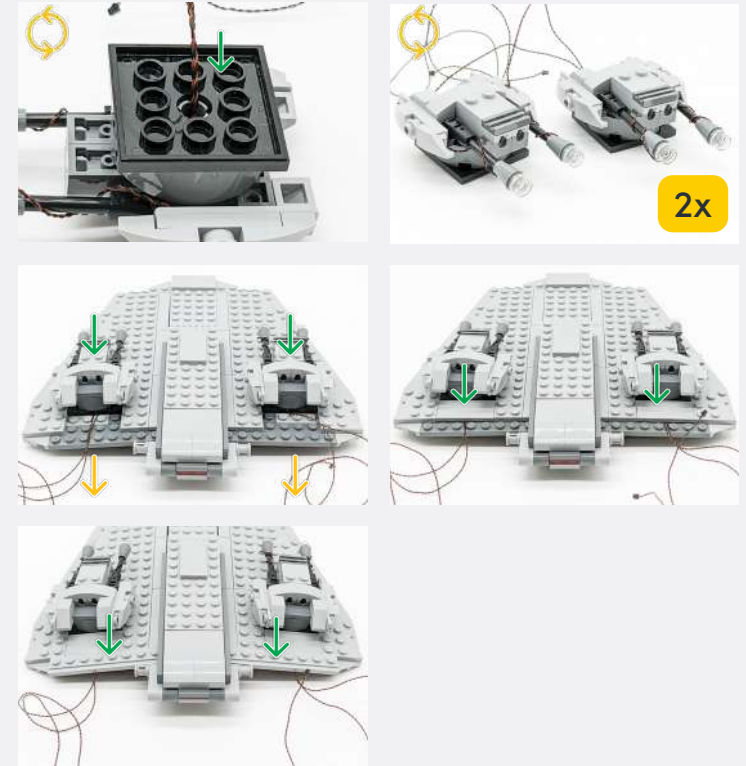
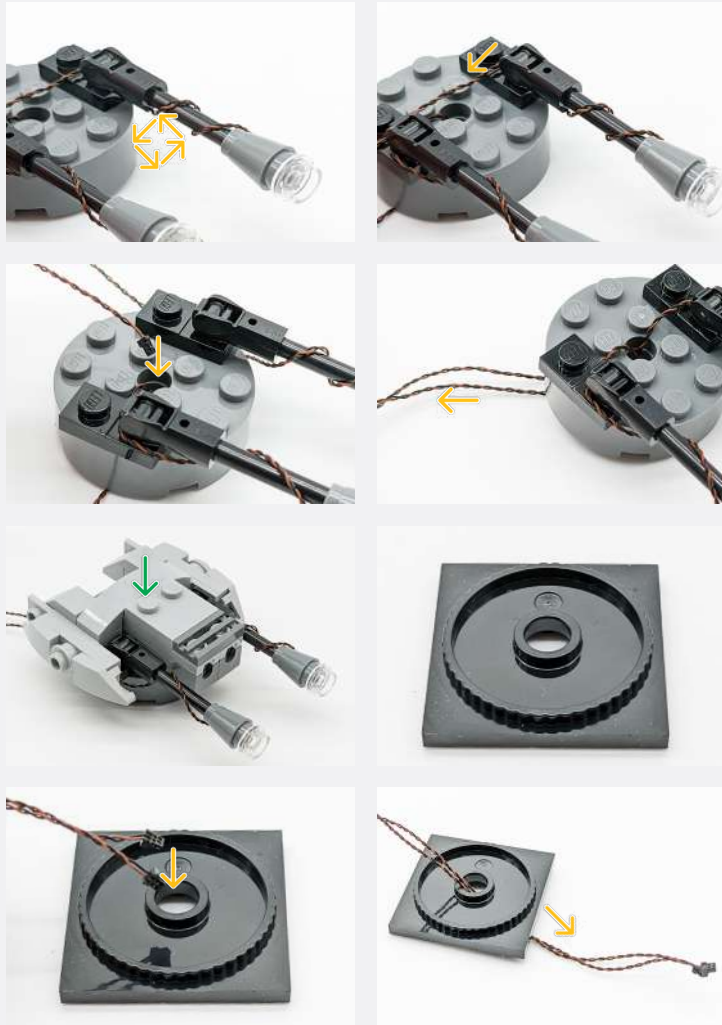

Legend → DISCONNECT → CONNECT / RECONNECT ↻ TURN / FLIP → DIRECTIONAL ↻ TWIST / BRAID ✨ POWER ON TEST 📝 NOTE ICON

20

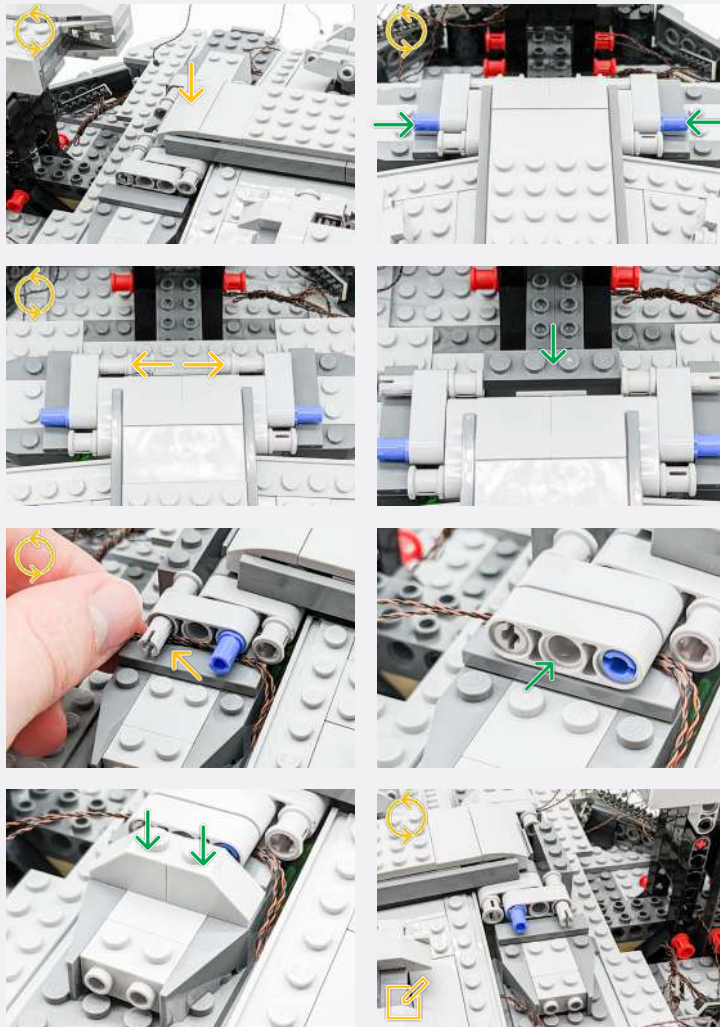

Repeat the threading of the Cool White 30cm Large Bit Lights on the opposite side

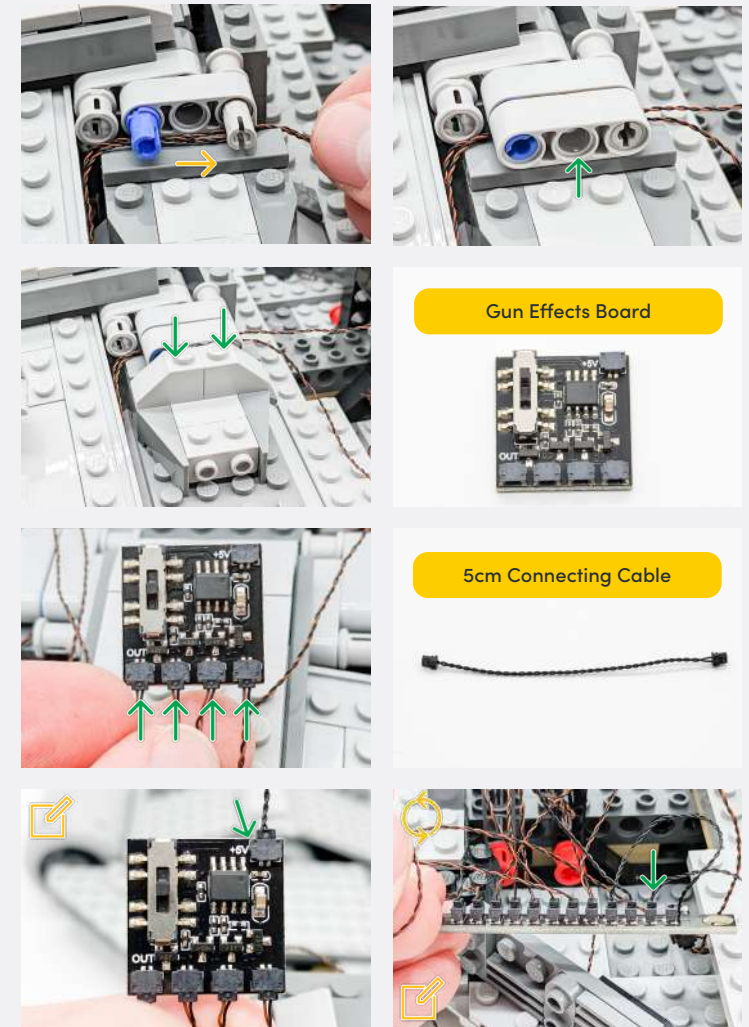

Gun Effects Board



5cm Connecting Cable



Connect the 5cm Connecting Cable to the '+5V' port on the Gun Effects Board

Connect the other end to the 12-Port Expansion Board.

Legend

- DISCONNECT
- CONNECT / RECONNECT
- TURN / FLIP
- DIRECTIONAL
- TWIST / BRAID
- POWER ON TEST
- NOTE ICON

If you experience any issues with the lights not working and suspect an issue with a component, please try a different port on the expansion board to verify where the fault lies (with the light or expansion board). To correct any issues with expansion board ports, please view the section addressing expansion board issues in our troubleshooting section.

When twisting the cables, exclude the USB Power Cable and thread it under the piece shown in the second image.

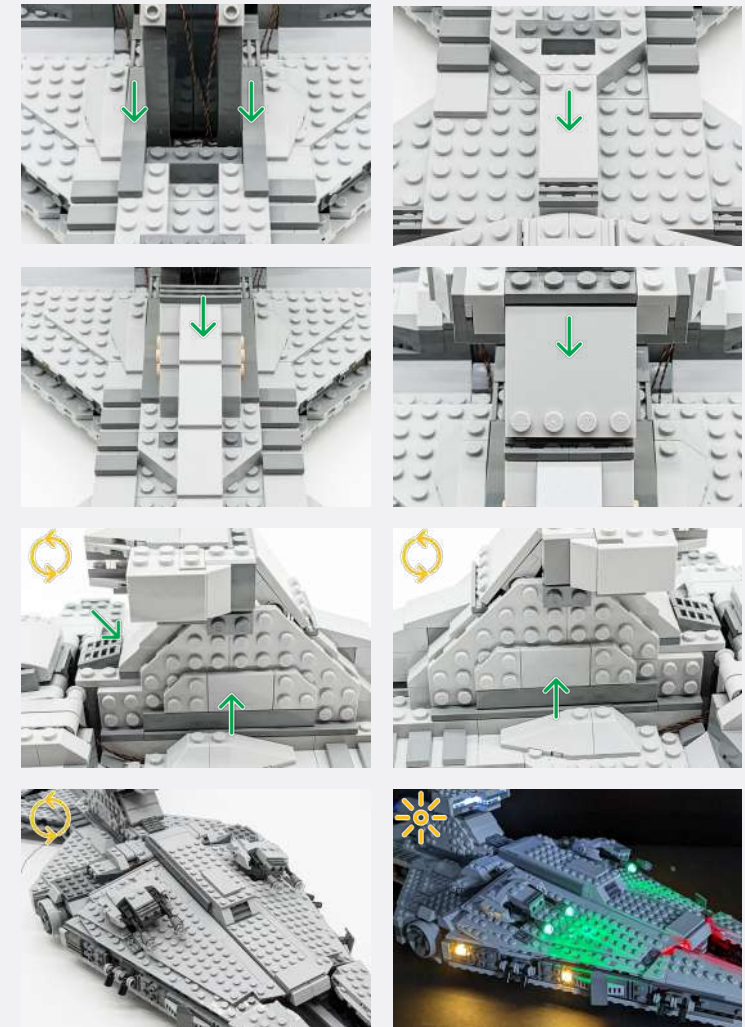
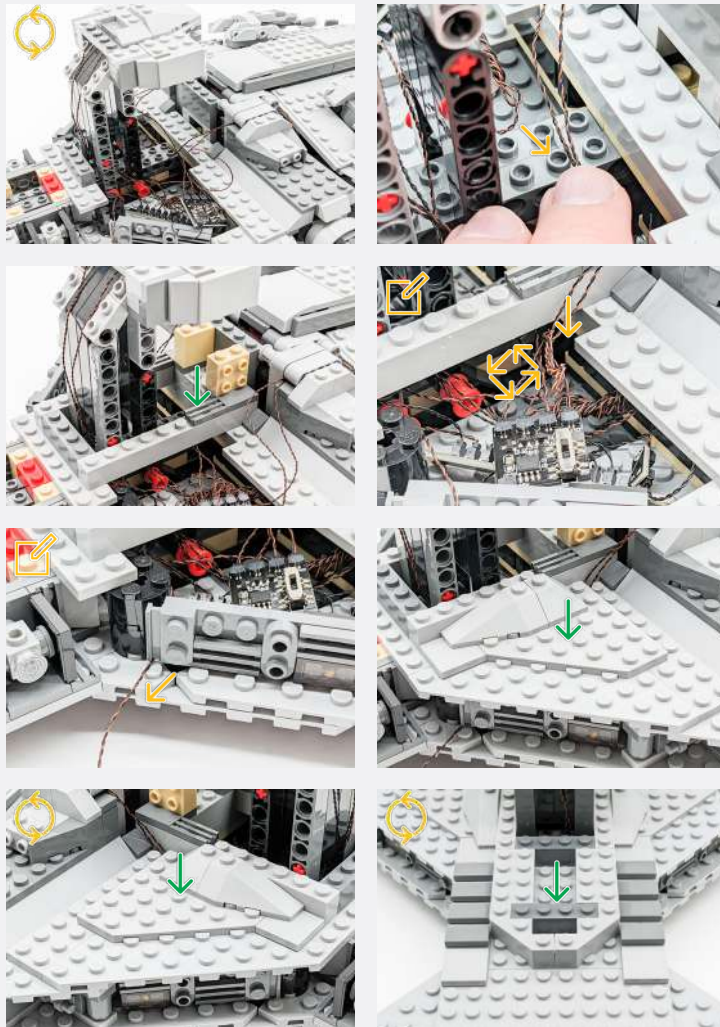

Legend DISCONNECT CONNECT / RECONNECT TURN / FLIP DIRECTIONAL TWIST / BRAID POWER ON TEST NOTE ICON

FINAL PRODUCT

This finally completes installation of the Light My Bricks Star Wars Imperial Light Cruiser Light Kit.





TROUBLESHOOTING

Light My Bricks lighting kits contain individual components that are very small and can be easily damaged if not handled correctly.

To prevent unnecessary damage to components, we highly recommend that the User Guide section, **“Important things to note”** is read carefully. Follow the handling procedures in the User Guide to help prevent faults and damages to your Light My Bricks components.

If you are experiencing issues with your Light My Bricks set, watch our troubleshooting video [here](#) or read on for a list of common causes to help you troubleshoot.

Troubleshooting

Firstly, ensure that the batteries have power using a battery charge gauge.

If the batteries have no power, replace the batteries.

If the batteries still have power, check to see if the batteries have been inserted correctly into the battery pack.

Check For CR2032 Batteries Using The Flat Battery Pack

Inside the battery pack is a symbol indicating which side the (round) CR2032 battery should be inserted. Check that the “+” side of the battery pack has the battery with the “+” symbol facing downwards.

On the opposite side, the “-” side of the battery pack should have the battery flipped upside down, that is the “+” symbol facing upwards.

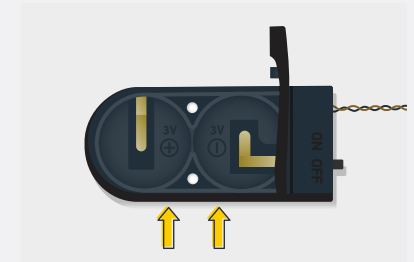

Troubleshooting

Check For Cr2032 Batteries Using The Round Battery Pack

Inside the battery pack is a symbol indicating which side the (round) CR2032 battery should be inserted. In this case, for the stacked battery pack, ensure that BOTH batteries have the “+” symbol facing upwards.

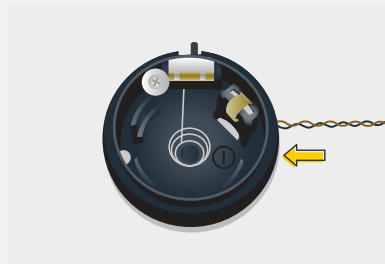

Check for AA batteries using the AA battery pack

Inside the battery pack are symbols indicating which direction the AA battery should be inserted. The flat side of the battery should be paired with the spring side of the battery pack.

If the batteries have been installed correctly and your kit still isn't operating correctly, the next step is to check the wiring.

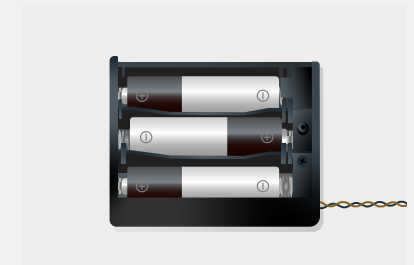
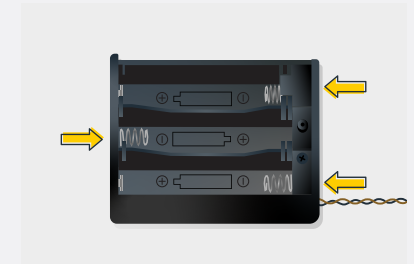

Troubleshooting

Check Your Wires

In order for Light My Bricks components to fit in between and underneath LEGO® bricks, the components need to be very small. Due to this nature, Light My Bricks components can be easily damaged when not handled correctly.

Be careful when removing unpacked components out of the packaging and ensure not to forcibly pull at the wires as this can damage the soldering that attach the wires to the LEDs.

If the wiring is detached from the LED itself, the light will not operate.

When connecting lights to your LEGO set, check that there are no pinched wires underneath or in between bricks and plates. When the wires are pinched and the exposed wires are touching each other, this can cause a crosswire and the lights to not function correctly.

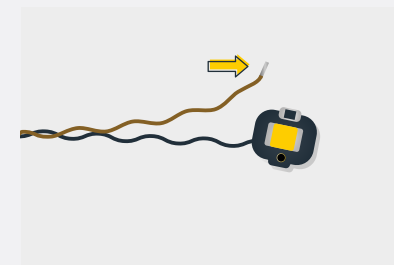
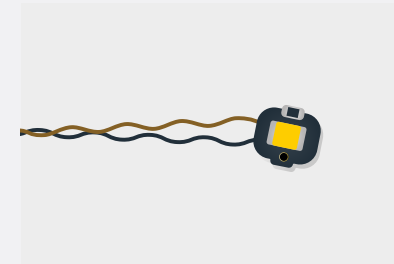

Troubleshooting

Check Your Expansion Board Ports/ Strip Light Ports / Effects Board Ports

It is important to note that connectors can only be inserted to the expansion board, strip light, or effects board ports in one direction.

Forcibly inserting connectors in the incorrect direction will result in damaging the pins inside each of the ports on your component board.

Not only will a light connected to the damaged port not work, but if the pins inside the port are bent to a point they are touching each other, this can result in all other lights in the system to stop working. This is a short circuit.

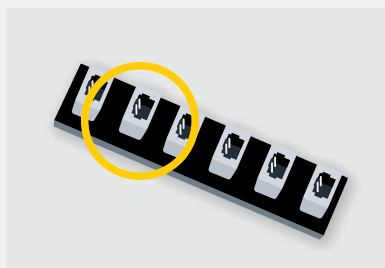
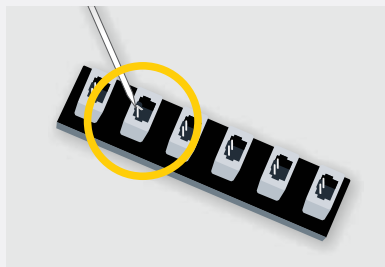

A short circuit can also result in overheating of the board, cable or batteries. If you suspect a short circuit, **DISCONNECT POWER IMMEDIATELY**. Batteries can fail, catch fire, or even explode if left connected to a short circuit for too long.

If you suspect you have a faulty component due to a bent pin, try the following steps:

If you look carefully inside each of the ports, each port contains 2 small pins that should be straight. You will be able to identify a faulty port if it has any bent pins.

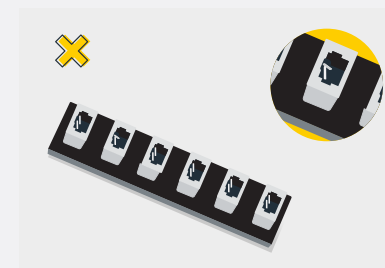
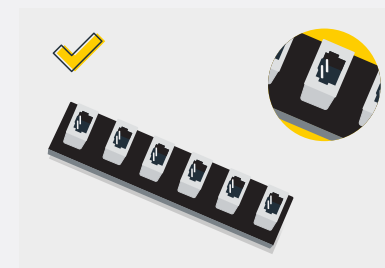
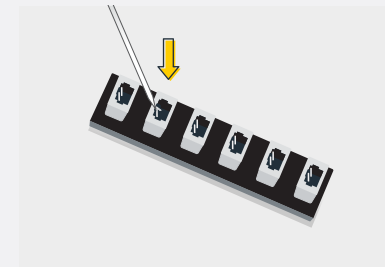



CONTACT US

If you have an enquiry regarding the online shop, our products or a general enquiry please refer to our Frequently Asked Questions webpage here.

Alternatively, you can contact our Customer Services team by visiting our online support portal here.

support.lightmybricks.com

We thank you for purchasing this product and hope you enjoy!



lightmybricks.com