

LIGHT KIT INSTALLATION GUIDE

BOUTIQUE HOTEL

FOR LEGO
SET
#10297



CONTENTS



03

Getting Started

- 04** Legend
- 05** Component Handling
- 06** Blueprint

08

Instructions

- 25** LMB Bag 2
- 53** LMB Bag 1
- 131** LMB Bag 3
- 167** LMB Bag 4
- 229** LMB Bag 5
- 283** LMB Bag 6

324

Final Product

- 325** Package Contents
- 328** Contact & Troubleshooting

GETTING STARTED



Bold, beautiful and bright, Light My Bricks elevates your favourite LEGO set from knick-knack to statement piece. Create a talking point at home or in the office that speaks to your passions with Light My Bricks. To learn more, click below.

[Learn More](#)



Audacieux, beau et lumineux, Light My Bricks élève votre ensemble LEGO préféré du statut de bibelot à celui de pièce maîtresse. Que ce soit à la maison ou au bureau, partagez votre passion des LEGO avec Light My Bricks. Cliquez ci-dessous pour en savoir plus.

[En savoir plus](#)



Audace, bello e luminoso, Light My Bricks eleva il tuo set LEGO preferito da soprammobile a pezzo di tendenza. Crea un punto di discussione a casa o in ufficio che parli alle tue passioni con Light My Bricks. Per saperne di più, clicca qui sotto.

[Ulteriori Informazioni](#)



Mutig, schön und hell – Light My Bricks verwandelt Ihr Lieblings-LEGO-Set von einem schnickschnack in ein statement-stück. Schaffen sie einen gesprächspunkt zu hause oder im büro, der Ihre leidenschaften widerspiegelt, mit Light My Bricks. Um mehr zu erfahren, klicken sie unten.

[Mehr erfahren](#)



Audaz, hermoso y brillante, Light My Bricks eleva tu set LEGO favorito de una chuchería a una pieza llamativa. Crea un tema de conversación en casa o en la oficina que hable de tus pasiones con Light My Bricks. Para obtener más información, haga clic a continuación.

[Más información](#)



大胆、美丽而明亮，Light My Bricks 将你喜爱的乐高套装从小摆件提升为引人注目的装饰品。在家或办公室打造一个能表达你激情的话题，了解更多，请点击下方。

[了解更多](#)



LEGEND

Rotate Set



Retournez L'ensemble
Ruota Set
Set Drehen
Rotar Conjunto
旋转套件

Add Part



Ajoutez une Pièce
Aggiungi Parte
Teil Hinzufügen
Agregar Pieza
添加零件

Click



Cliquez
Clic
Klicken
Clic
点击

Pinch/Fold



Pincez/Pliez
Pizzicare/Piegare
Kneifen/Falten
Pellizcar/Doblar
折叠

Pull Cable



Tirez le Cable
Tirare il Cavo
Kabel Ziehen
Tirar del Cable
拉动电缆

Repeat Step



Répétez
Ripetere
Wiederholen
Repetir
重复

Sticker



Autocollant
Adesivo
Aufkleber
Pegatina
贴纸

Power On Test



Test de mise sous tension
Test di Potenza
Stromtest
Prueba de Energía
电源测试

Disconnect Power

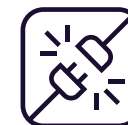

Débranchez L'alimentation
Scollegare L'alimentazione
Strom Trennen
Desconectar la Energía
断开电源

Troubleshoot



Dépanner
Risolvere
Fehlerbehebung
Solución de Problemas
故障排除

COMPONENT HANDLING

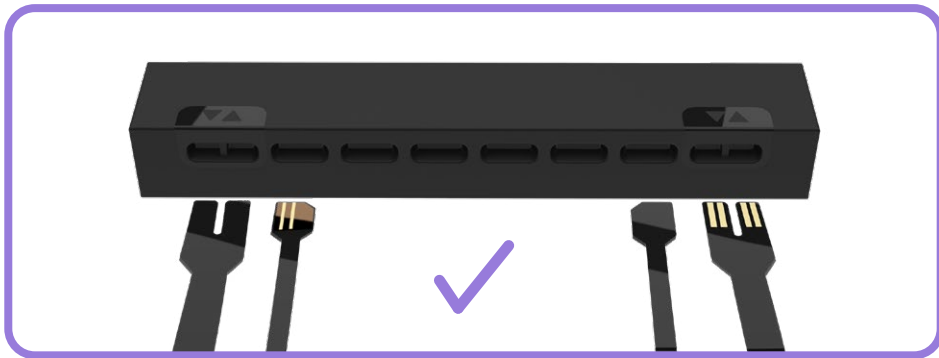
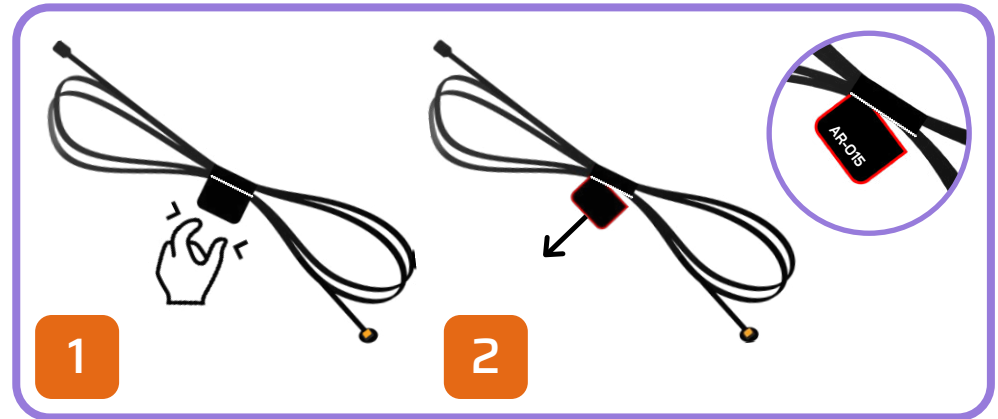
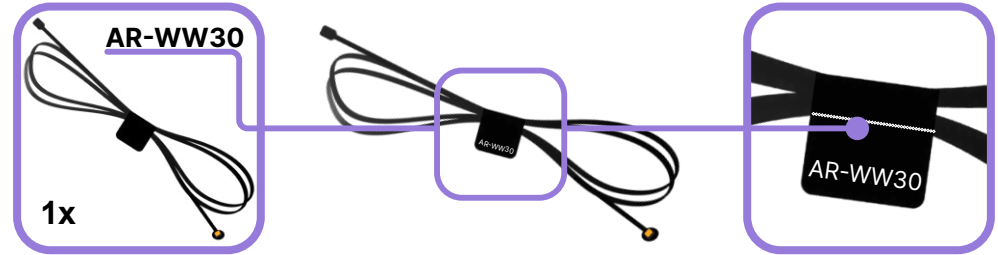
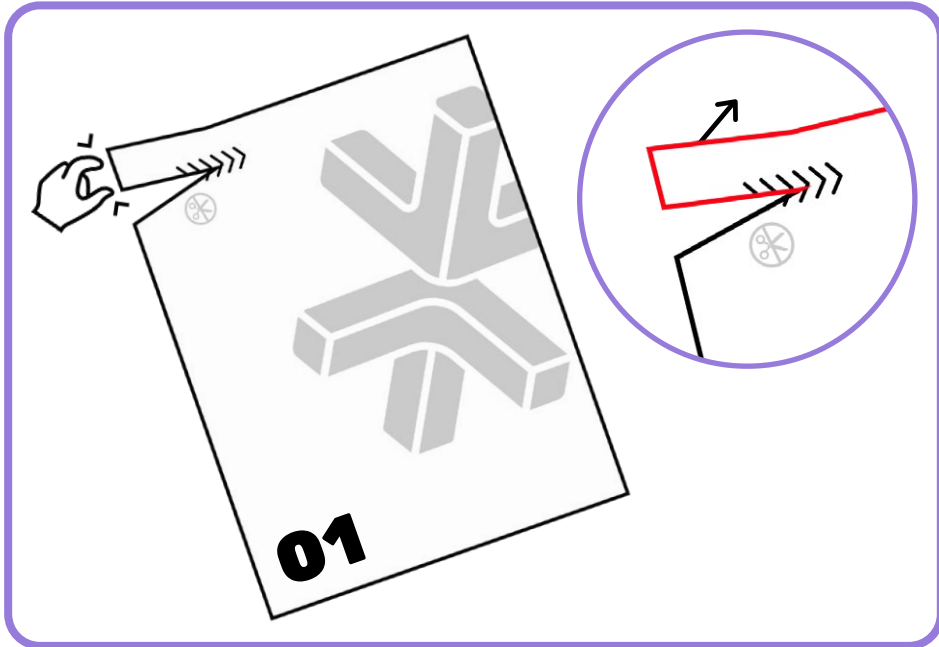

BLUEPRINT

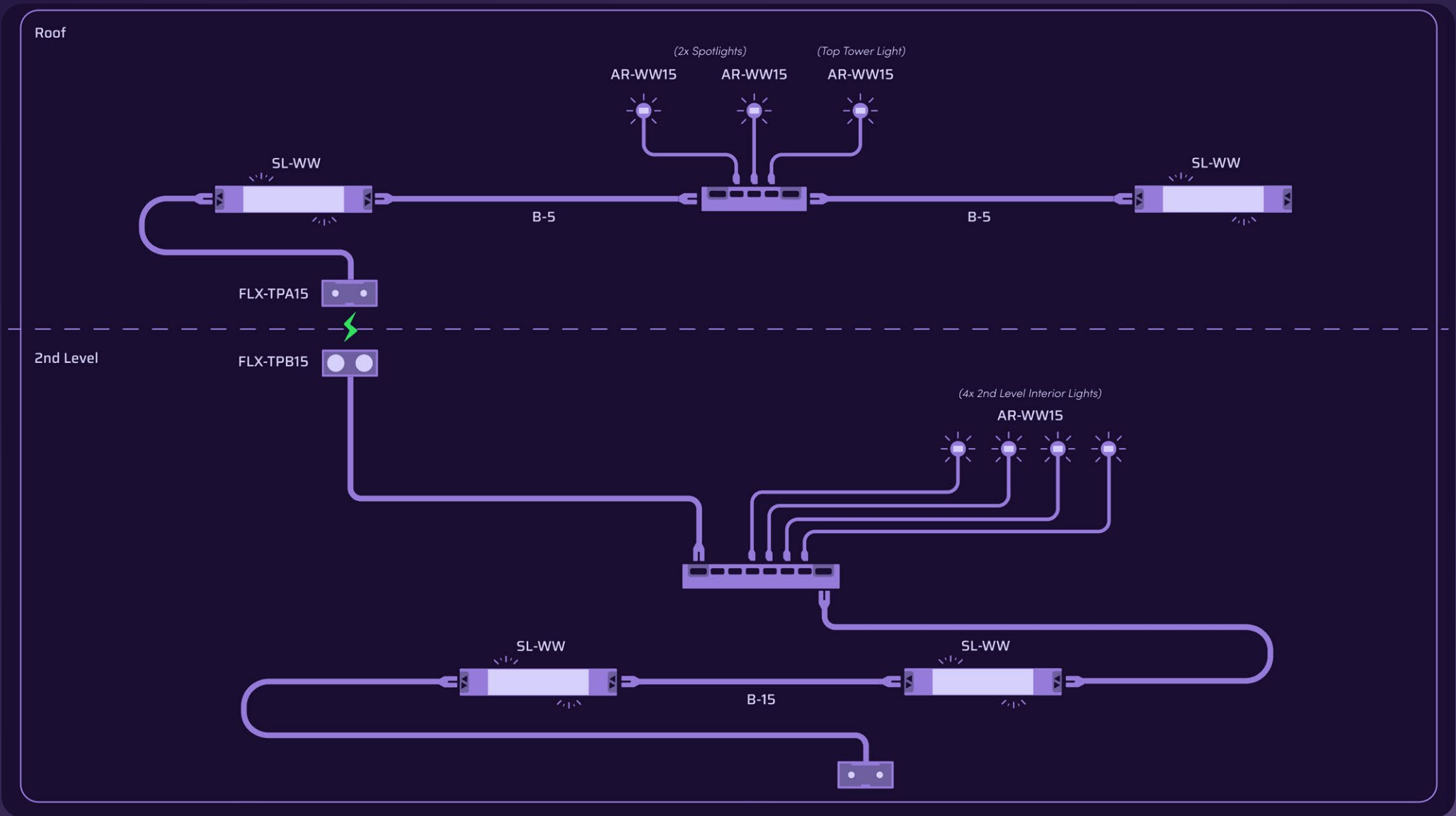

BLUEPRINT

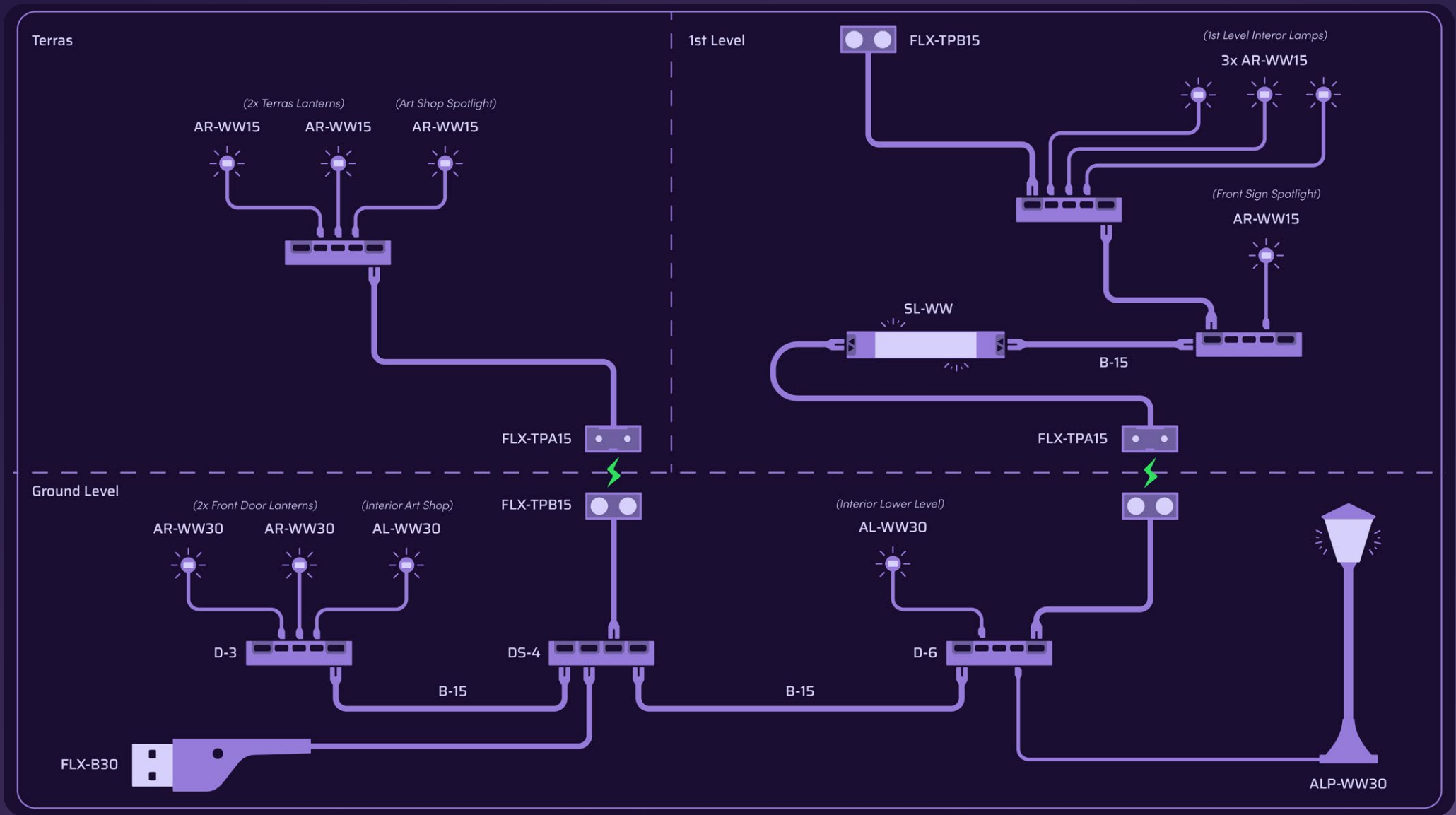

1



2



3



4



5

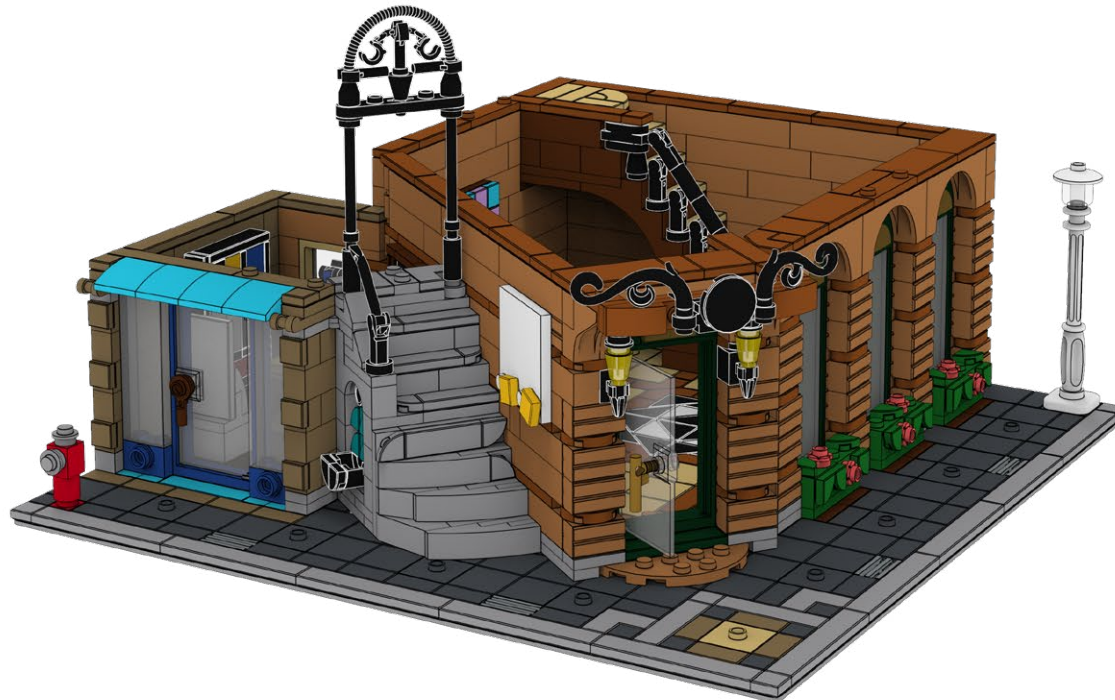

6



7



8



9

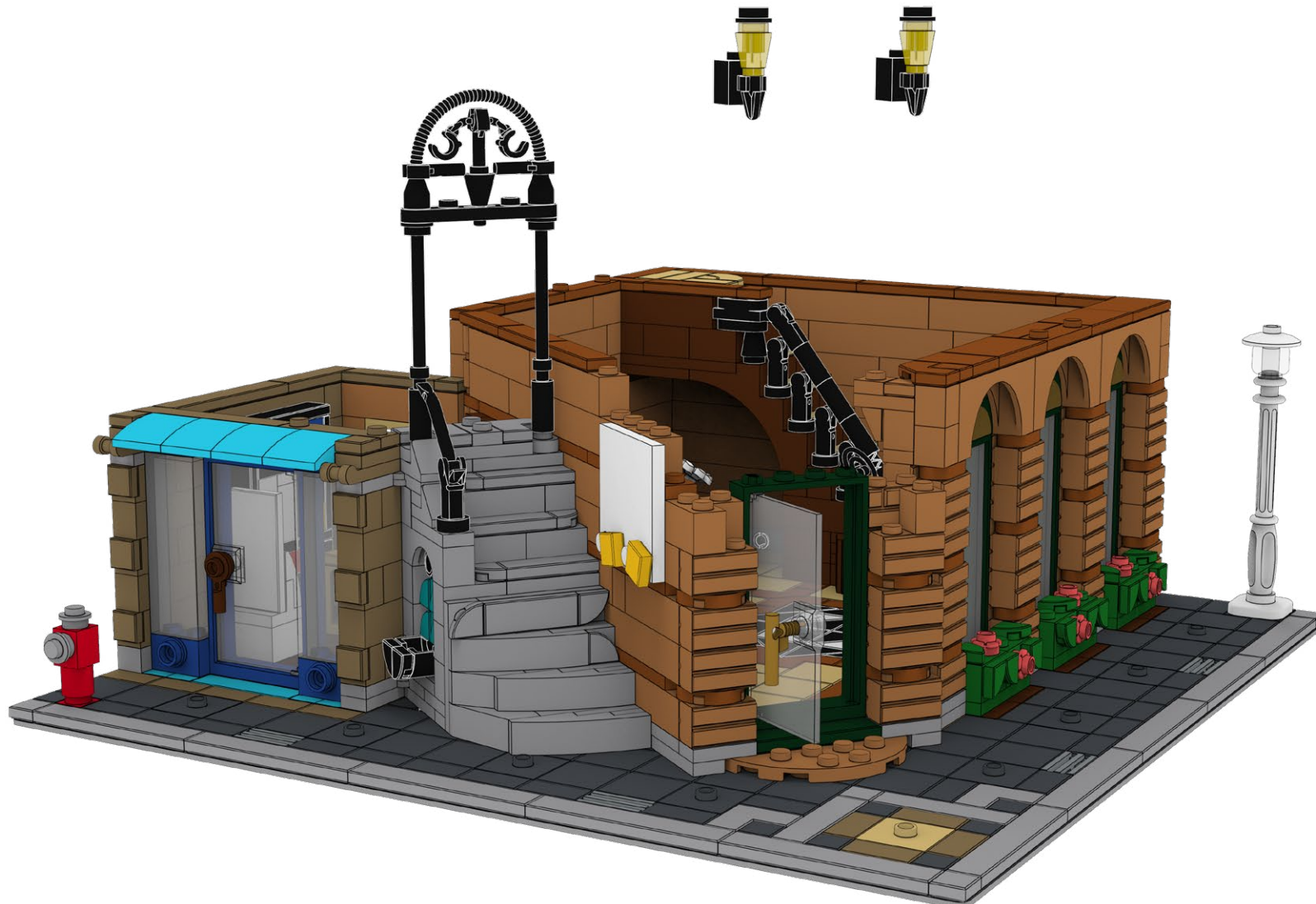

10



11



12

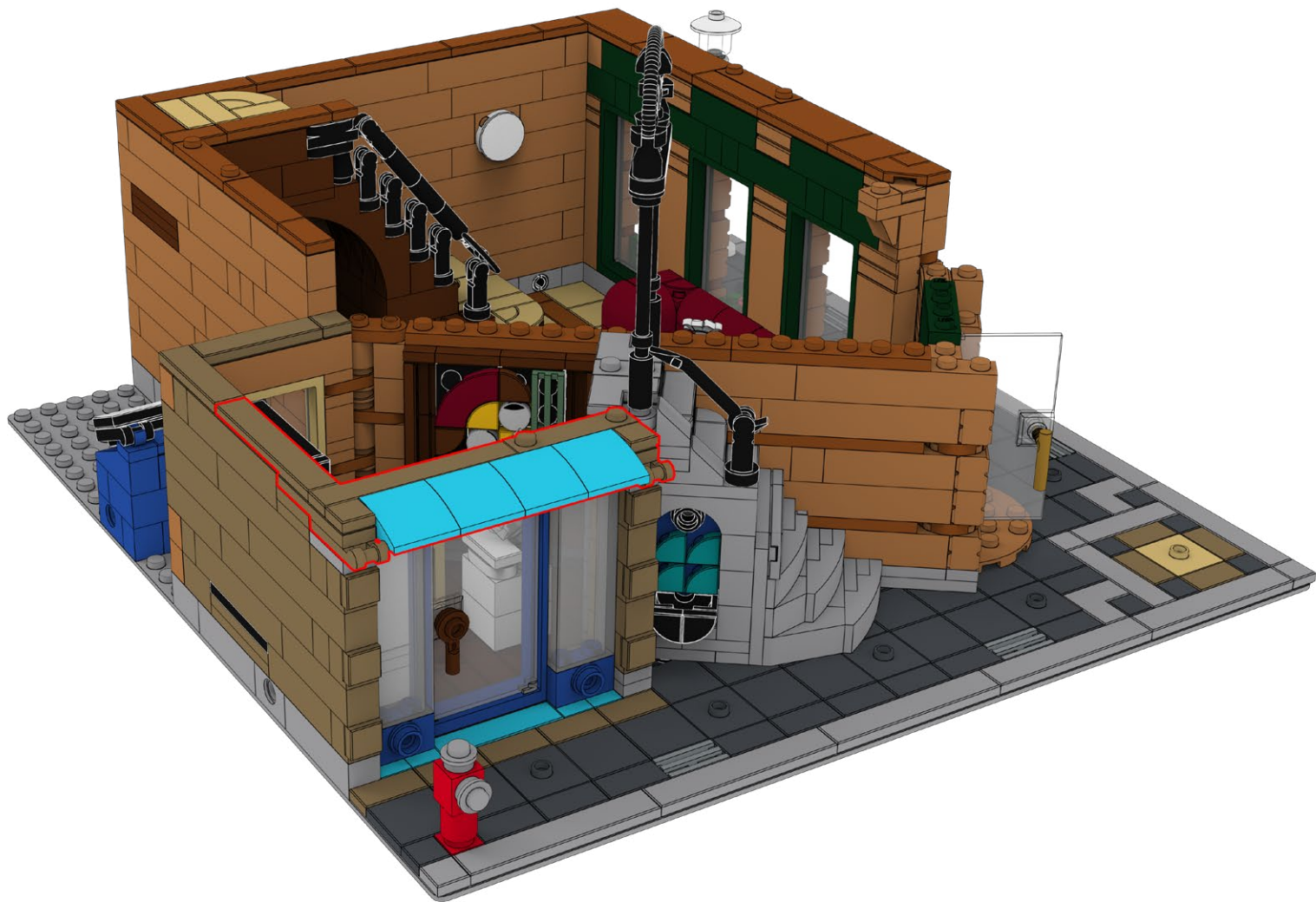

13

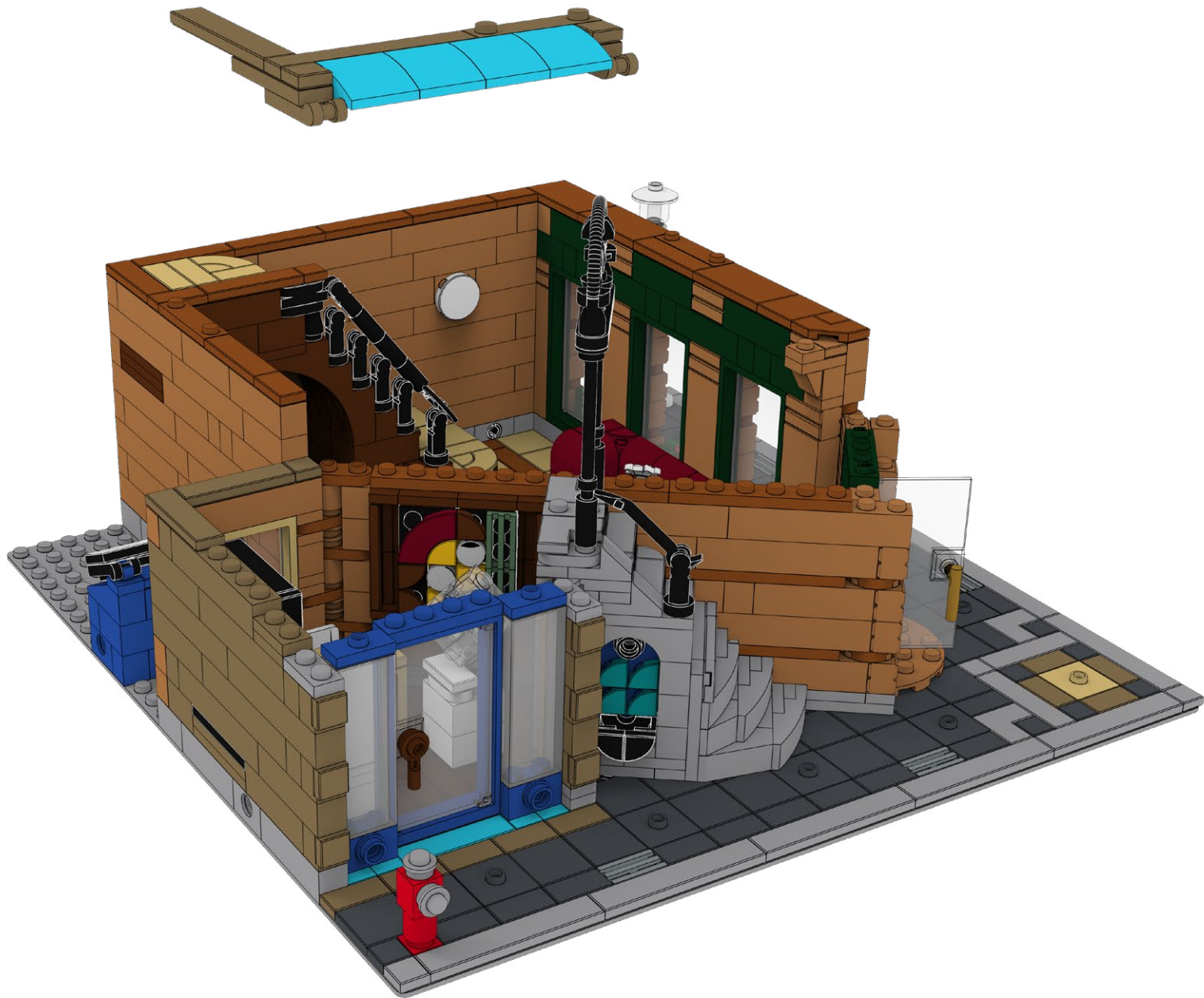

14



15

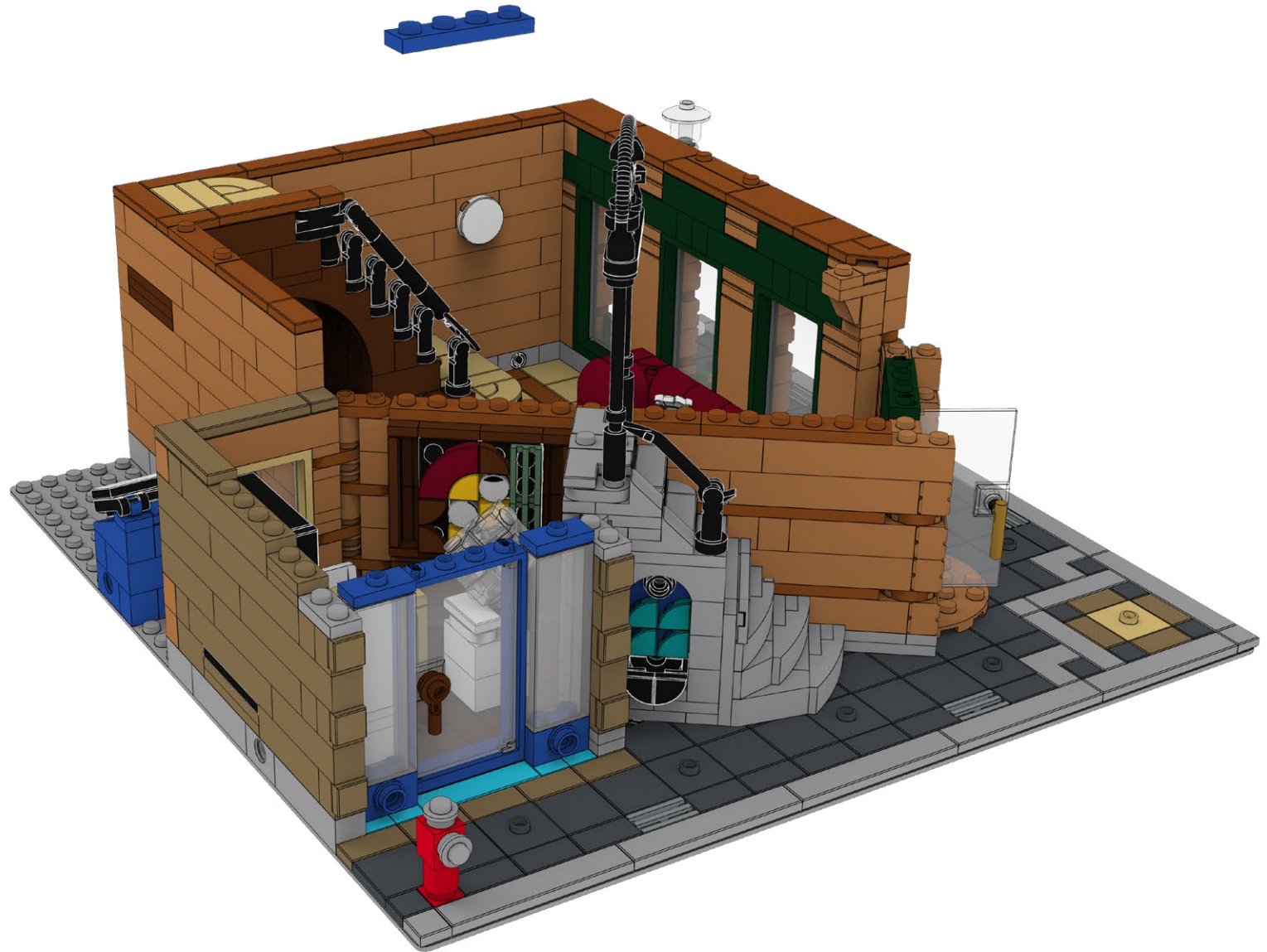

16



17





HOLD UP!

You might notice some bags aren't in order, as well as left over pieces, but that's ok! We're changing the way you build LEGO!

ATTENDEZ!

Vous remarquerez peut-être que certains sacs, ainsi que certaines pièces, ne sont pas dans le bon ordre. Mais pas de panique! Nous changeons simplement la façon avec laquelle vous construisez vos LEGO!

ASPETTA!

Potresti notare che alcuni sacchetti non sono in ordine, così come i pezzi avanzati, ma va bene così! Stiamo cambiando il modo in cui costruisci i LEGO!

HALT!

Sie werden möglicherweise bemerken, dass einige tüten durcheinander sind und teile übrig bleiben, aber das ist in Ordnung! Wir ändern die art und weise, wie Sie LEGO bauen!

¡ESPERA!

Es posible que notes que algunas bolsas están fuera de servicio, así como piezas sobrantes, ¡pero está bien! ¡Estamos cambiando la forma en que construyes LEGO!

暫停!

你可能会注意到一些袋子顺序错乱, 以及一些剩余的部件, 但没关系! 我们正在改变你搭建乐高的方式!

Open LMB Bag 02

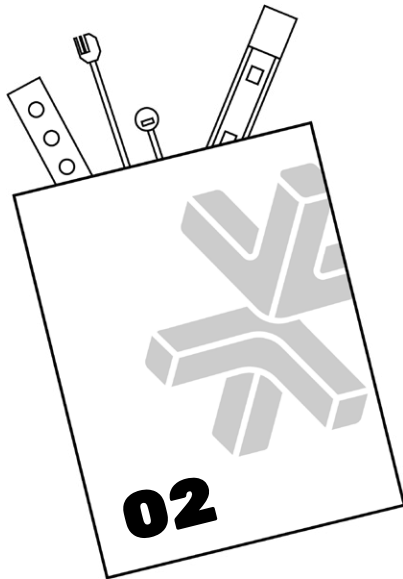

18

1

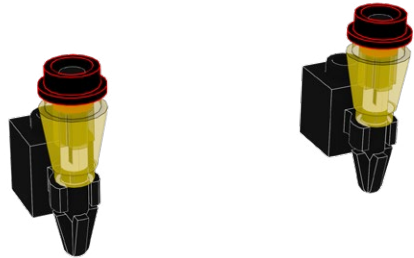

2

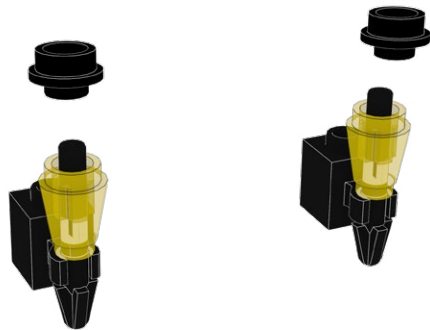

19

1

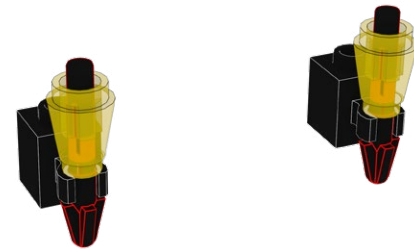

2

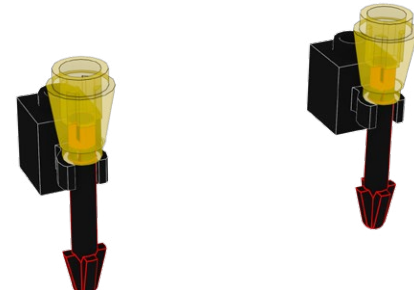

20

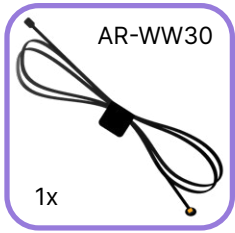

1

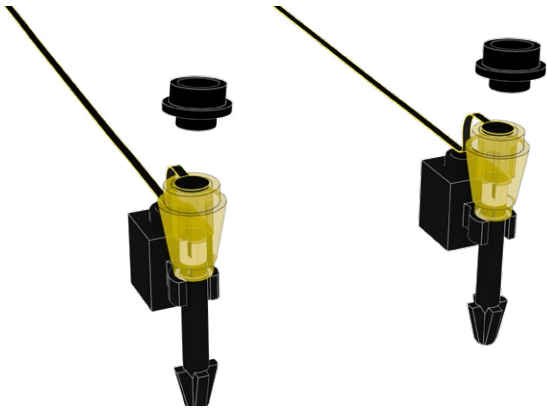

2

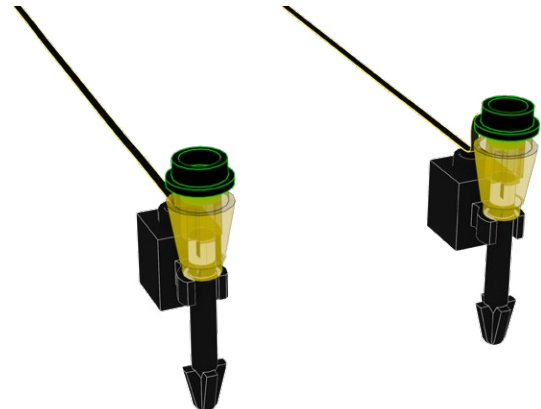

21



22



23

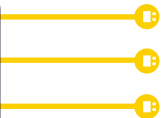

24



25

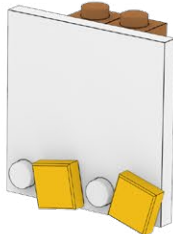

26



27

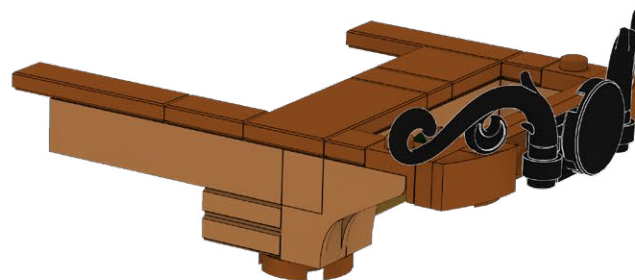

28



29



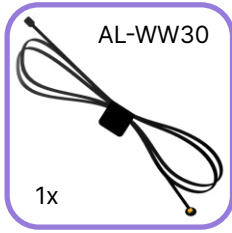

1

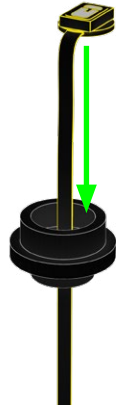

2

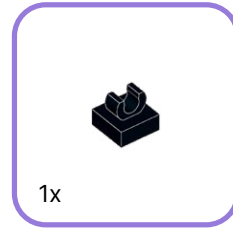

1



2

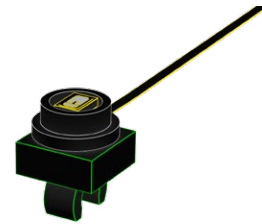

32

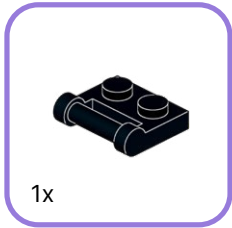

1

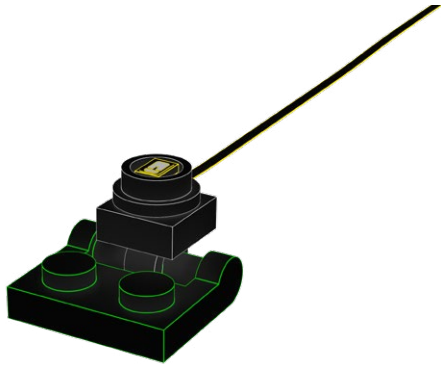

2



33



1

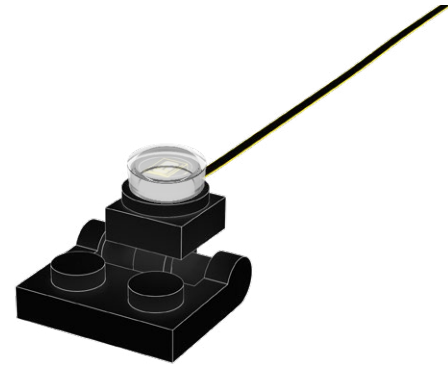

2



34

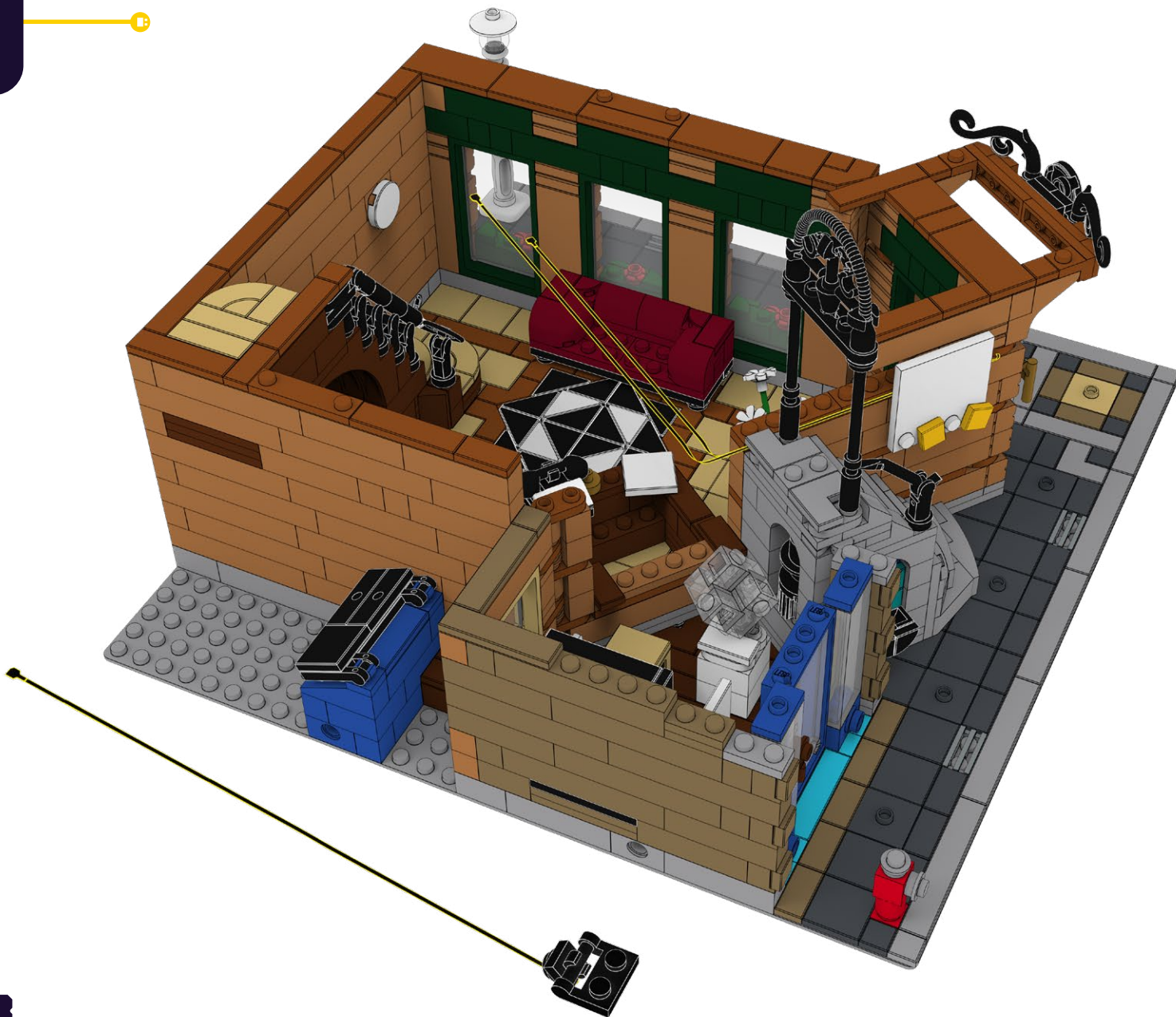

35



36



37



38

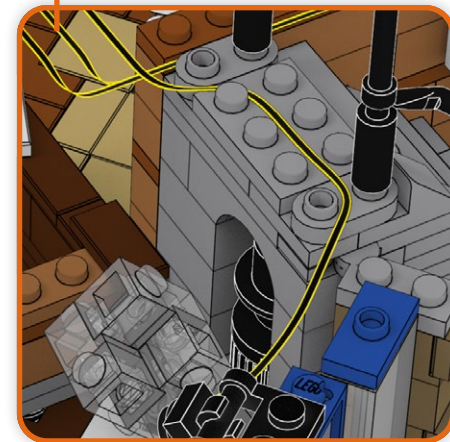

39



40



41

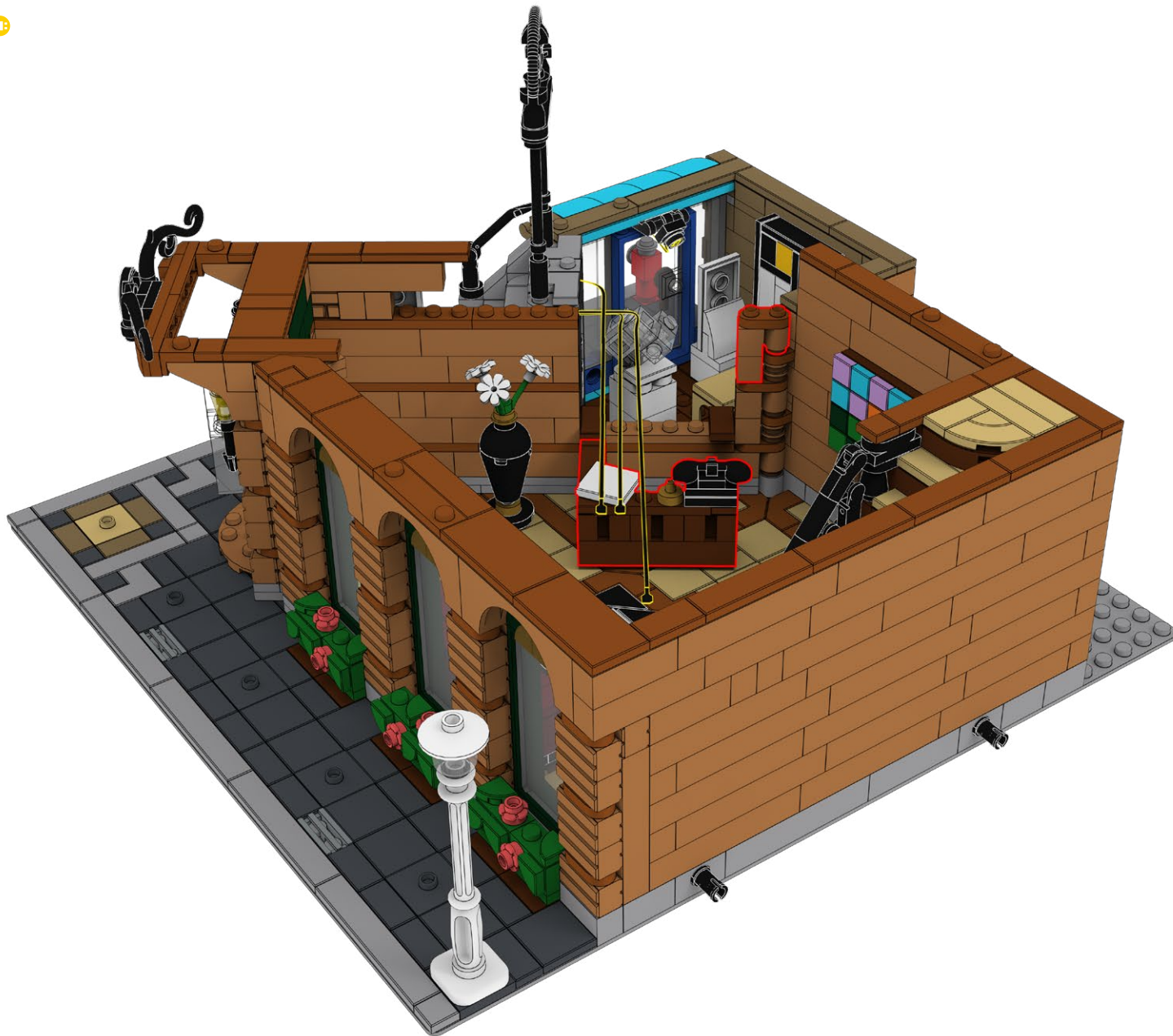

42



43

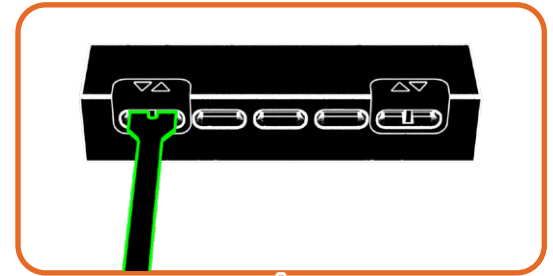
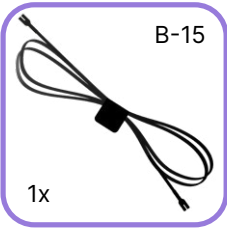
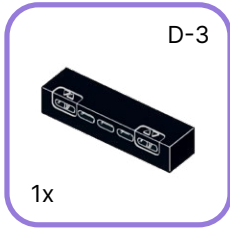

1

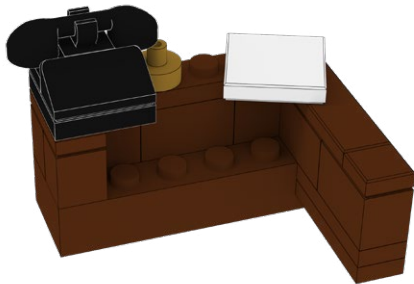

2

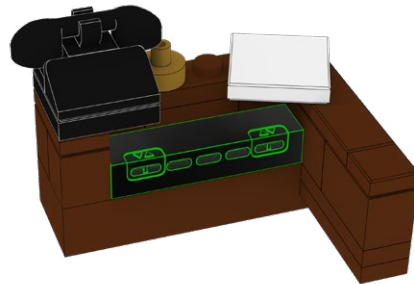

2

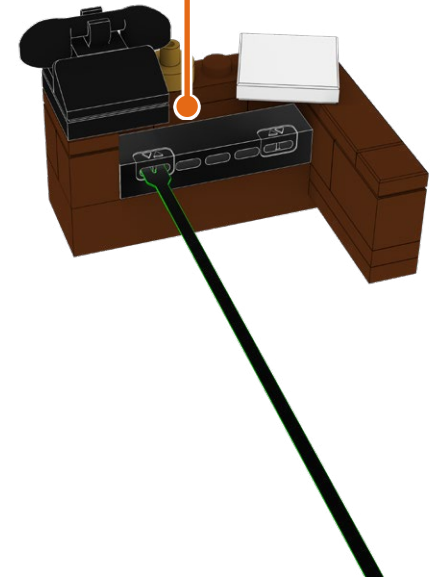

44

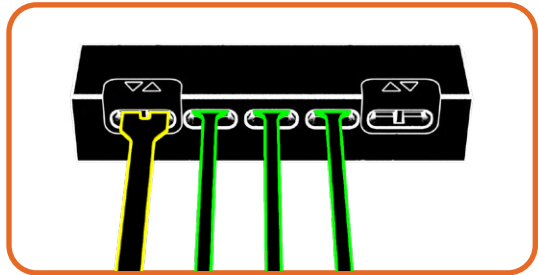

45



46



47





HOLD UP!

You might notice some bags aren't in order, as well as left over pieces, but that's ok! We're changing the way you build LEGO!

ATTENDEZ!

Vous remarquerez peut-être que certains sacs, ainsi que certaines pièces, ne sont pas dans le bon ordre. Mais pas de panique! Nous changeons simplement la façon avec laquelle vous construisez vos LEGO!

ASPETTA!

Potresti notare che alcuni sacchetti non sono in ordine, così come i pezzi avanzati, ma va bene così! Stiamo cambiando il modo in cui costruisci i LEGO!

HALT!

Sie werden möglicherweise bemerken, dass einige tüten durcheinander sind und teile übrig bleiben, aber das ist in Ordnung! Wir ändern die art und weise, wie Sie LEGO bauen!

¡ESPERA!

Es posible que notes que algunas bolsas están fuera de servicio, así como piezas sobrantes, ¡pero está bien! ¡Estamos cambiando la forma en que construyes LEGO!

暫停!

你可能会注意到一些袋子顺序错乱, 以及一些剩余的部件, 但没关系! 我们正在改变你搭建乐高的方式!

Open LMB Bag 01

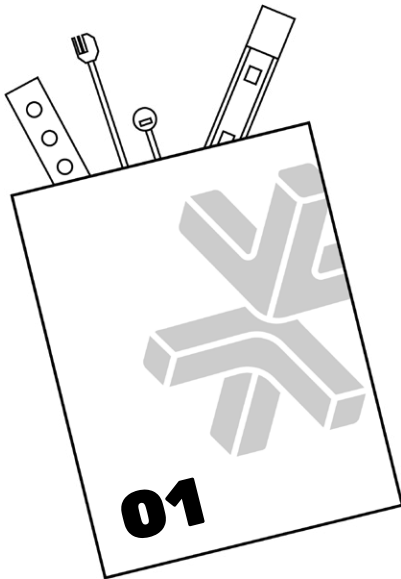

4



4.1

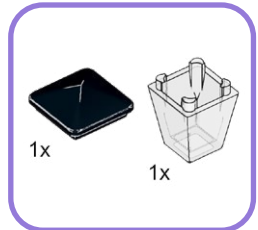

48



49

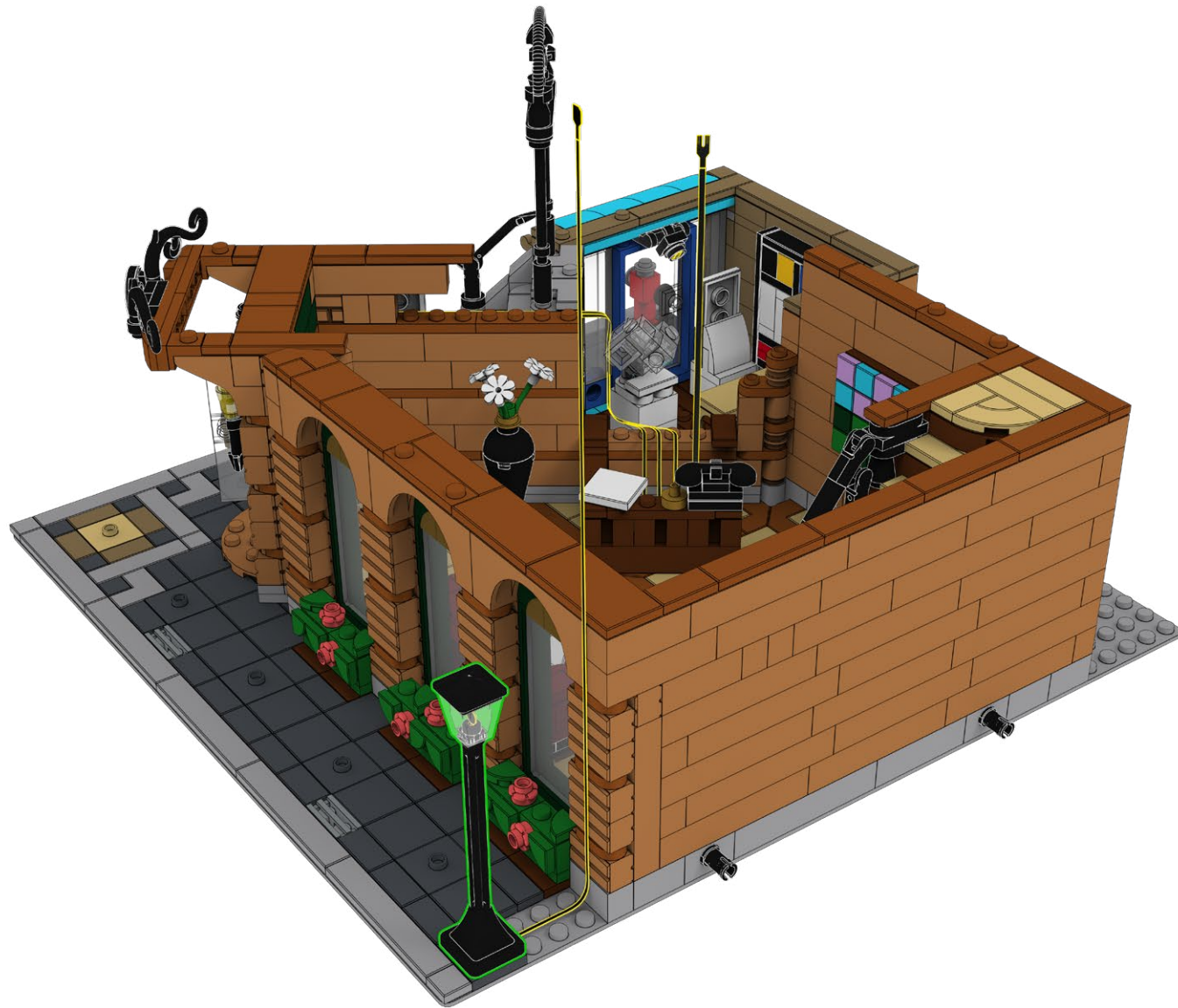

50



51

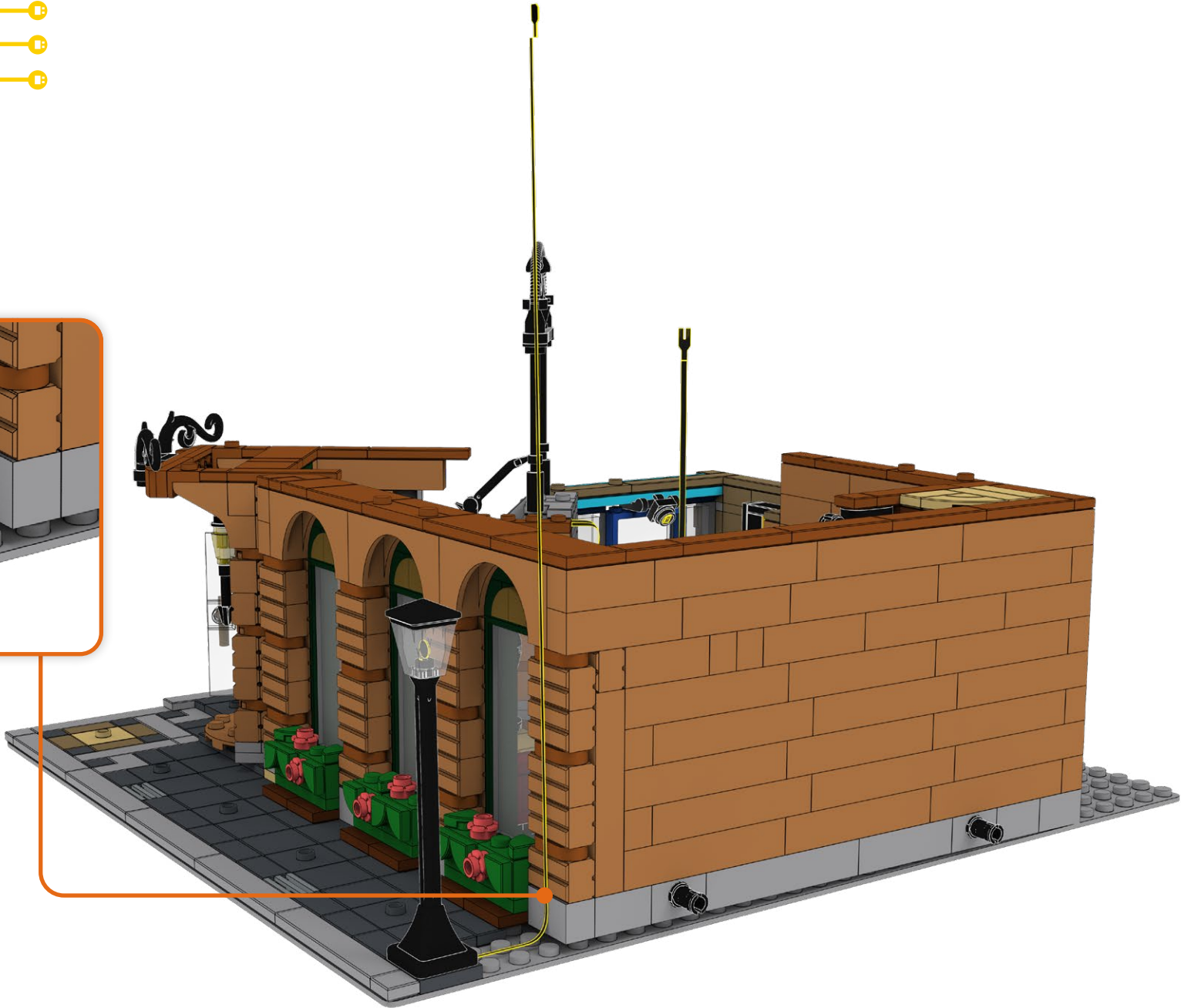
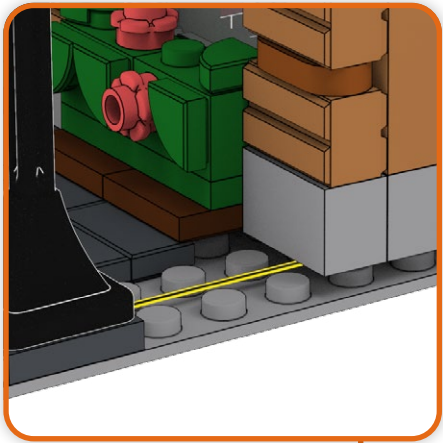

52

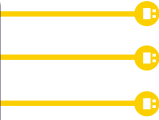

53



54



55



56

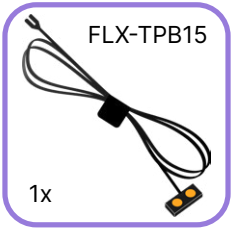

57



58



59



60

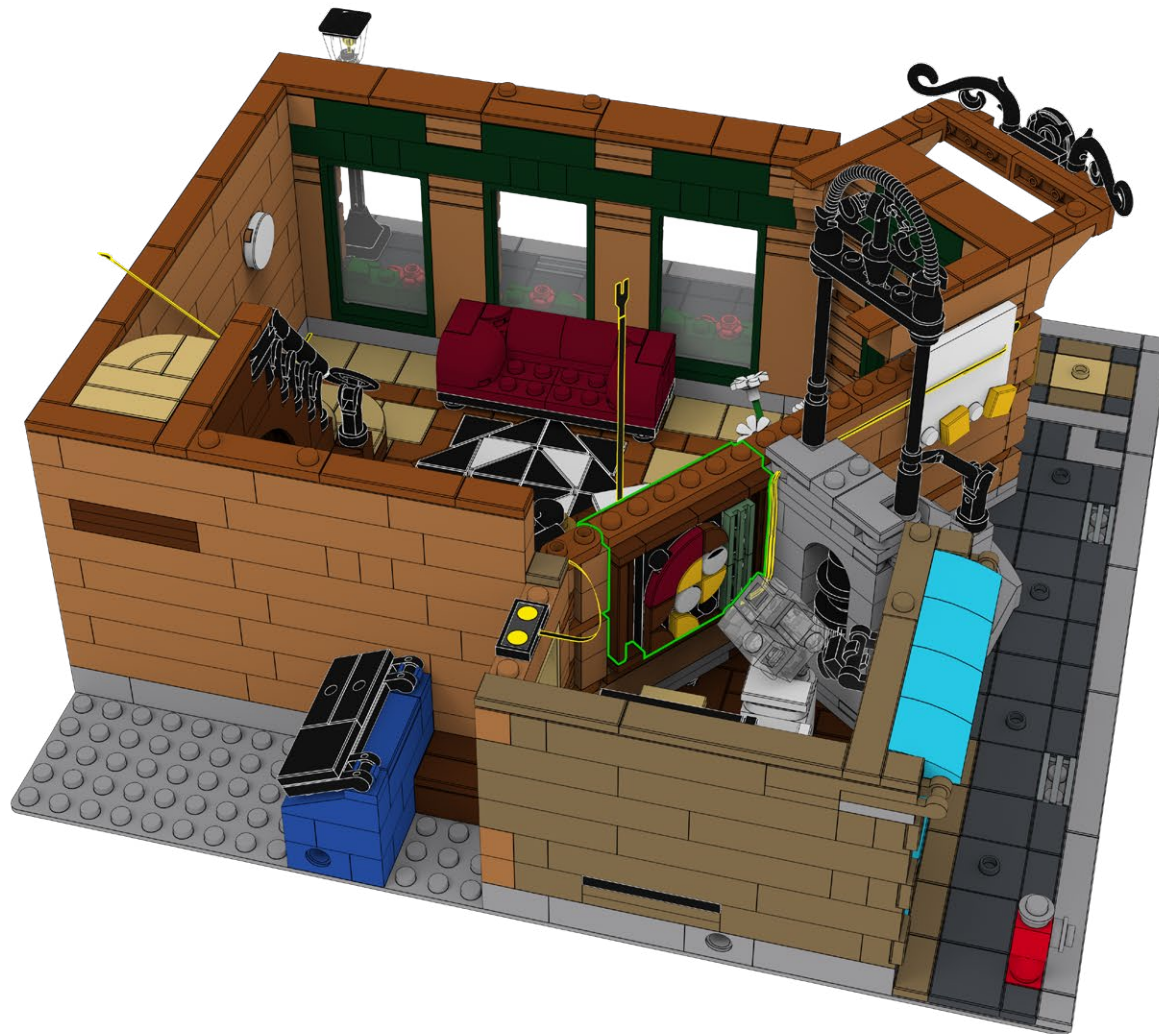

61

E-1x2



1x



62

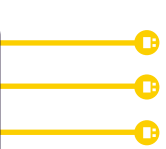

63



64



65

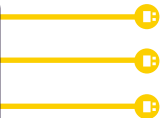

66



67



68



69

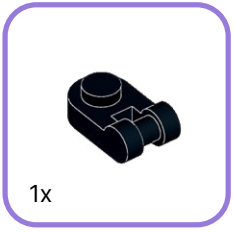
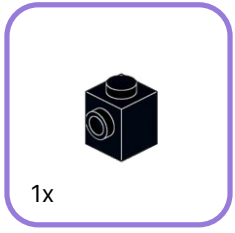

1

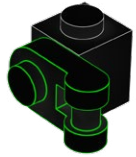

70

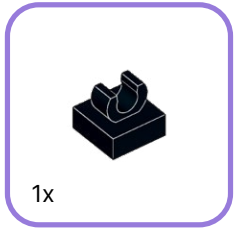

1

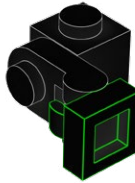

2

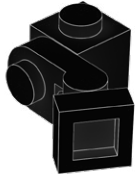

71

AL-WW30

1x

1x

1

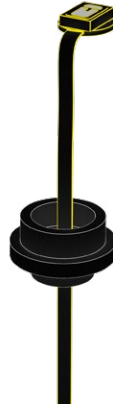

2



72

Astro Cap Clear

1x

1

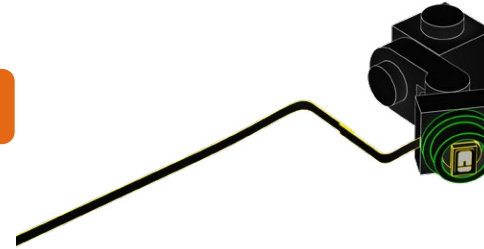

2

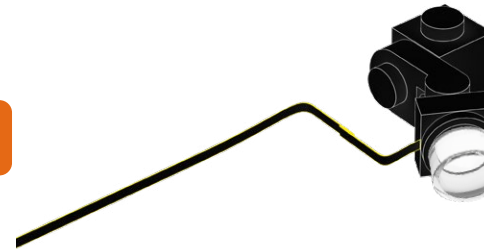

73



74

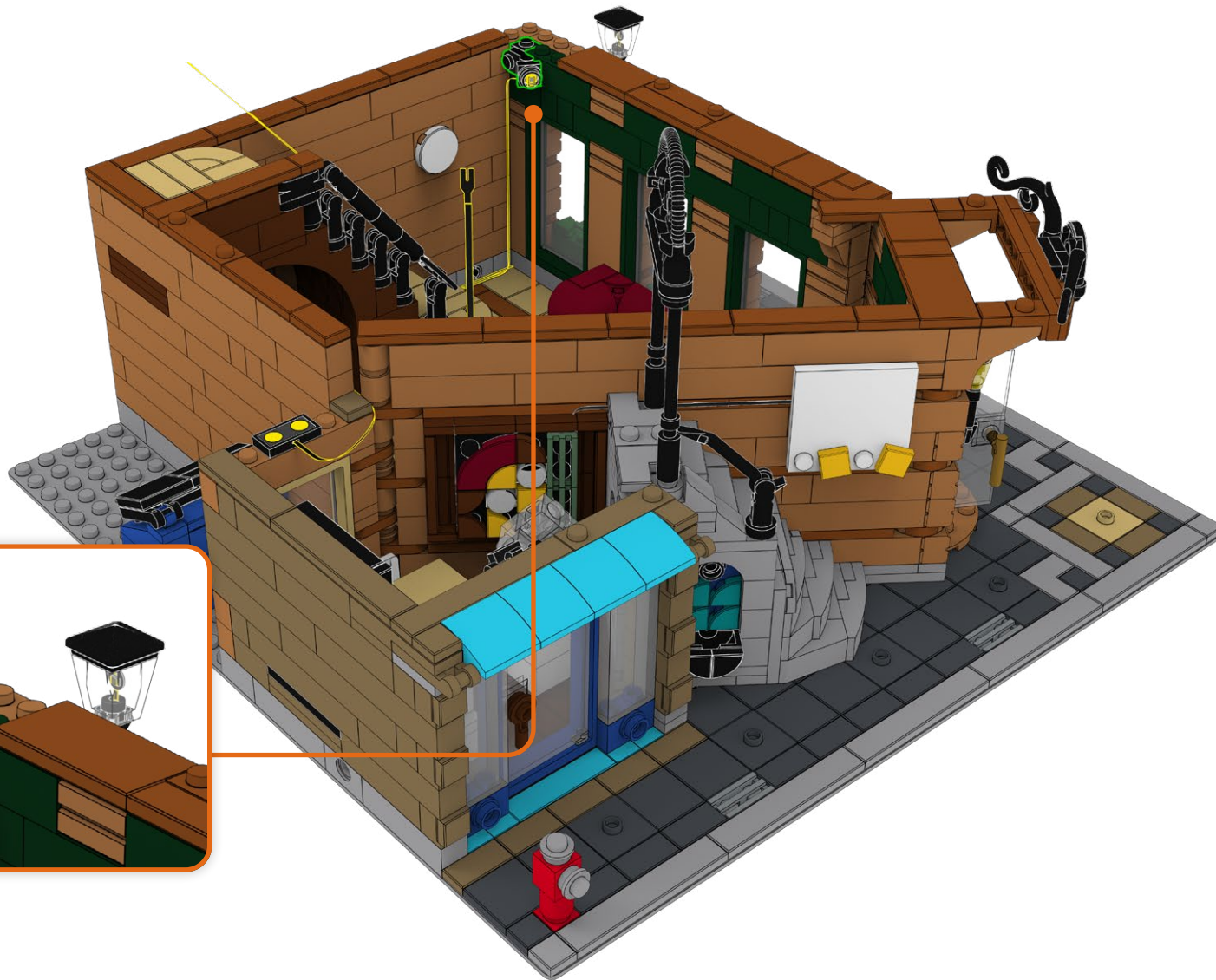

75



76



77



78



79



80



81

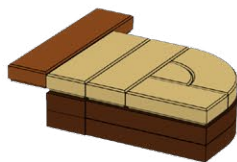

82

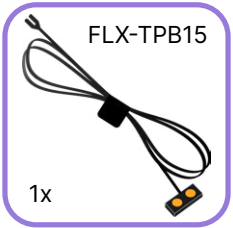

83





85



86



87



88



89

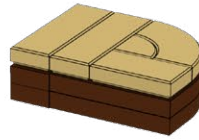

90



91

D-3



1x

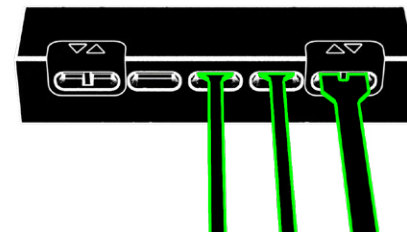

92

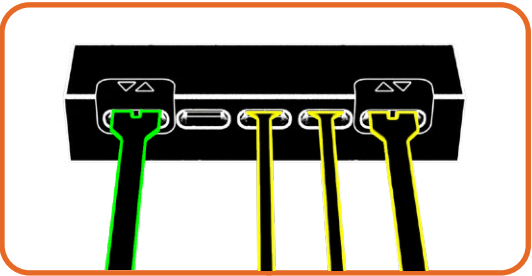
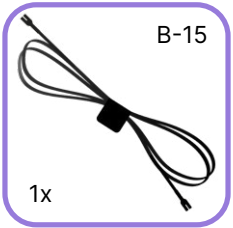

93

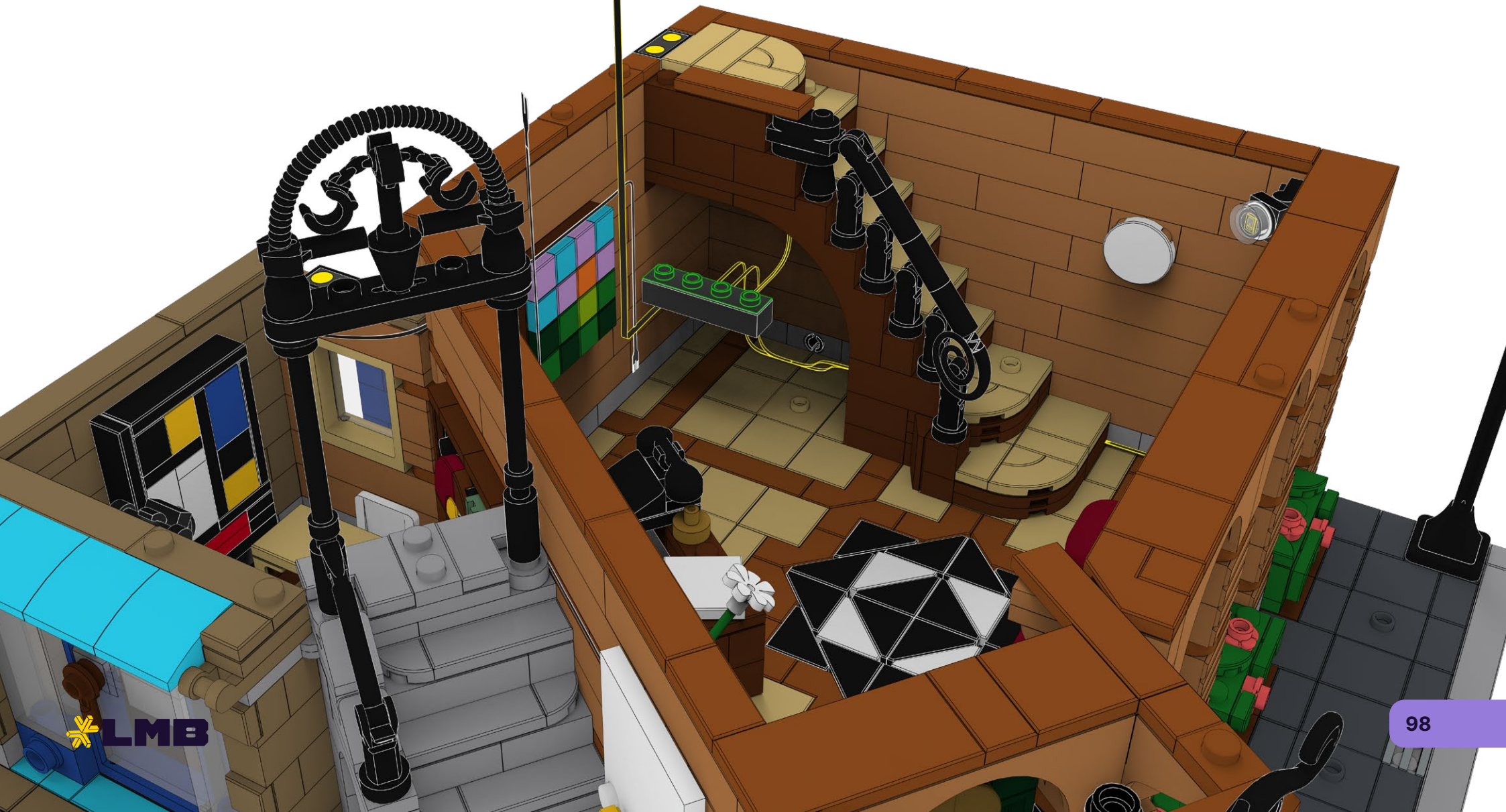
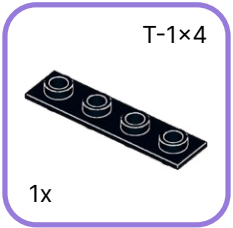

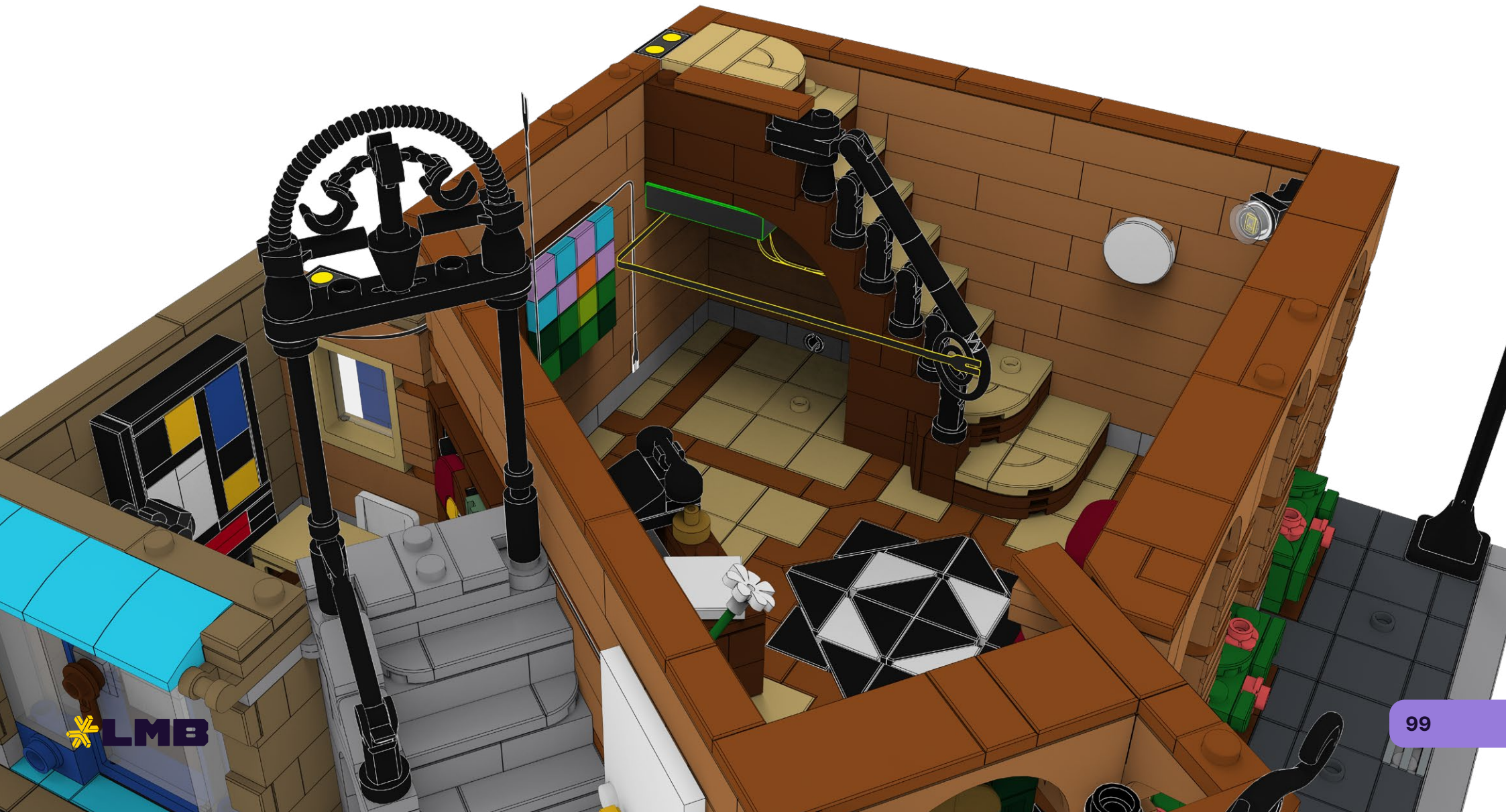

95



96



97



98



99

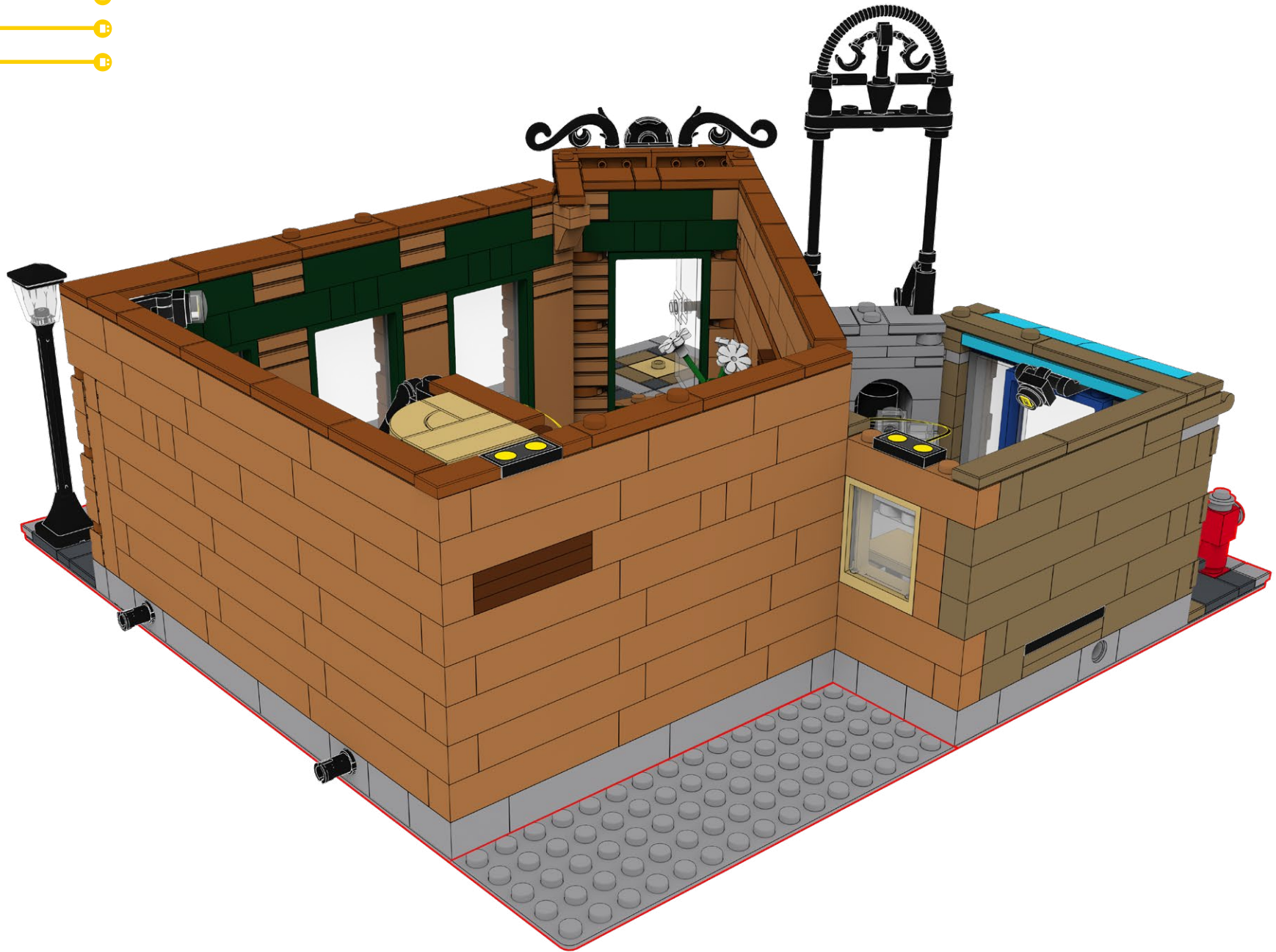

100



101

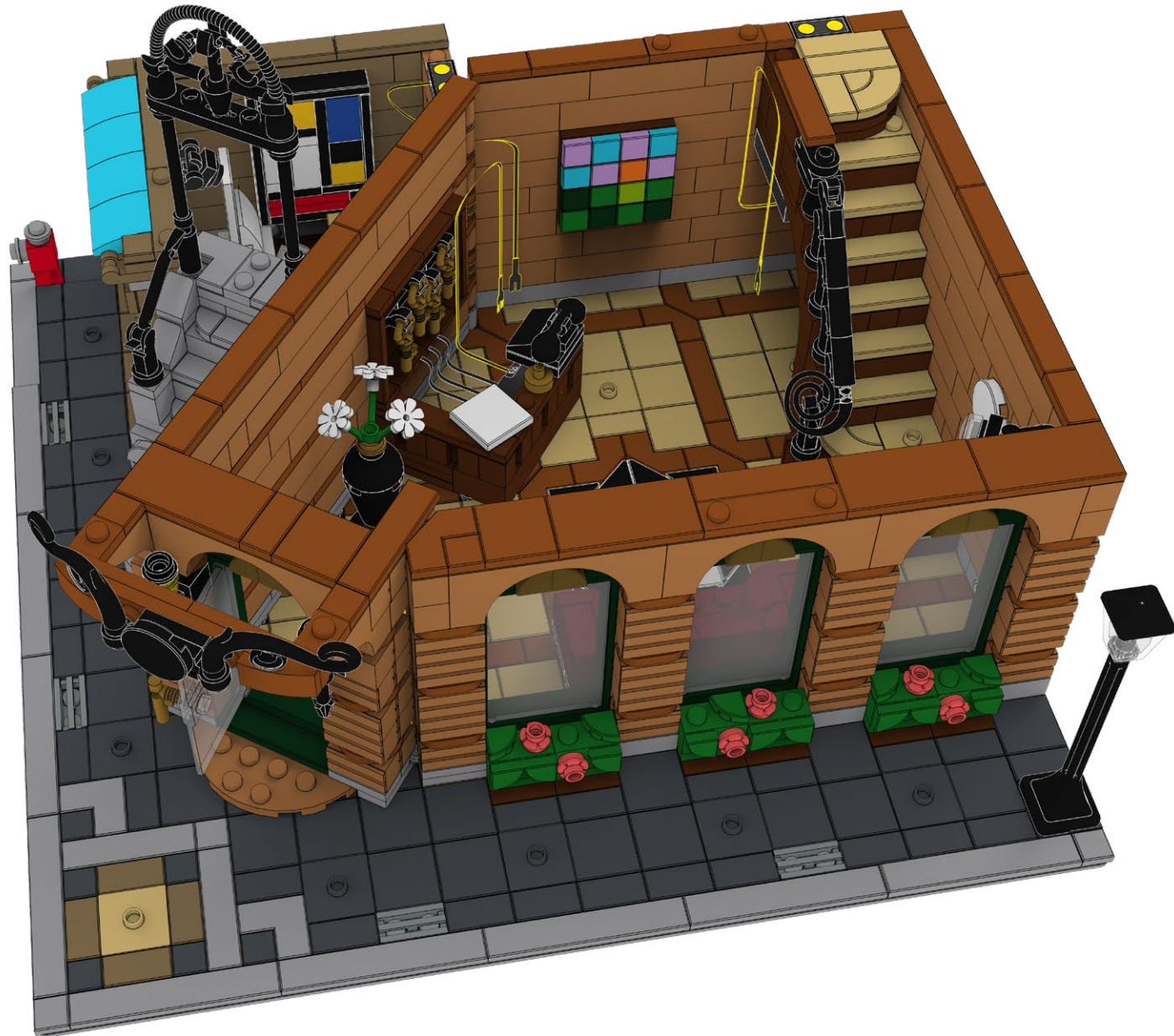

102



103



104

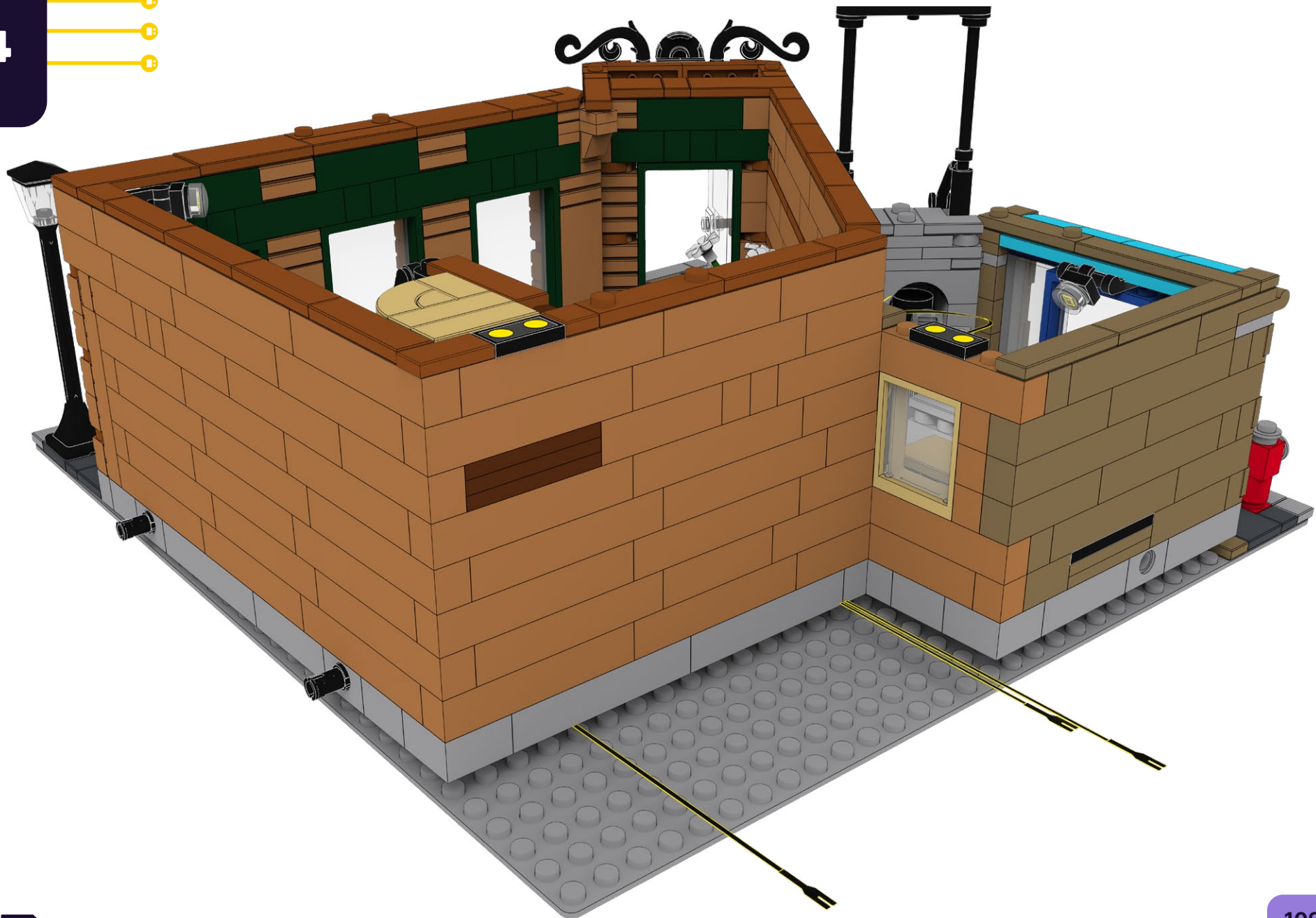

105

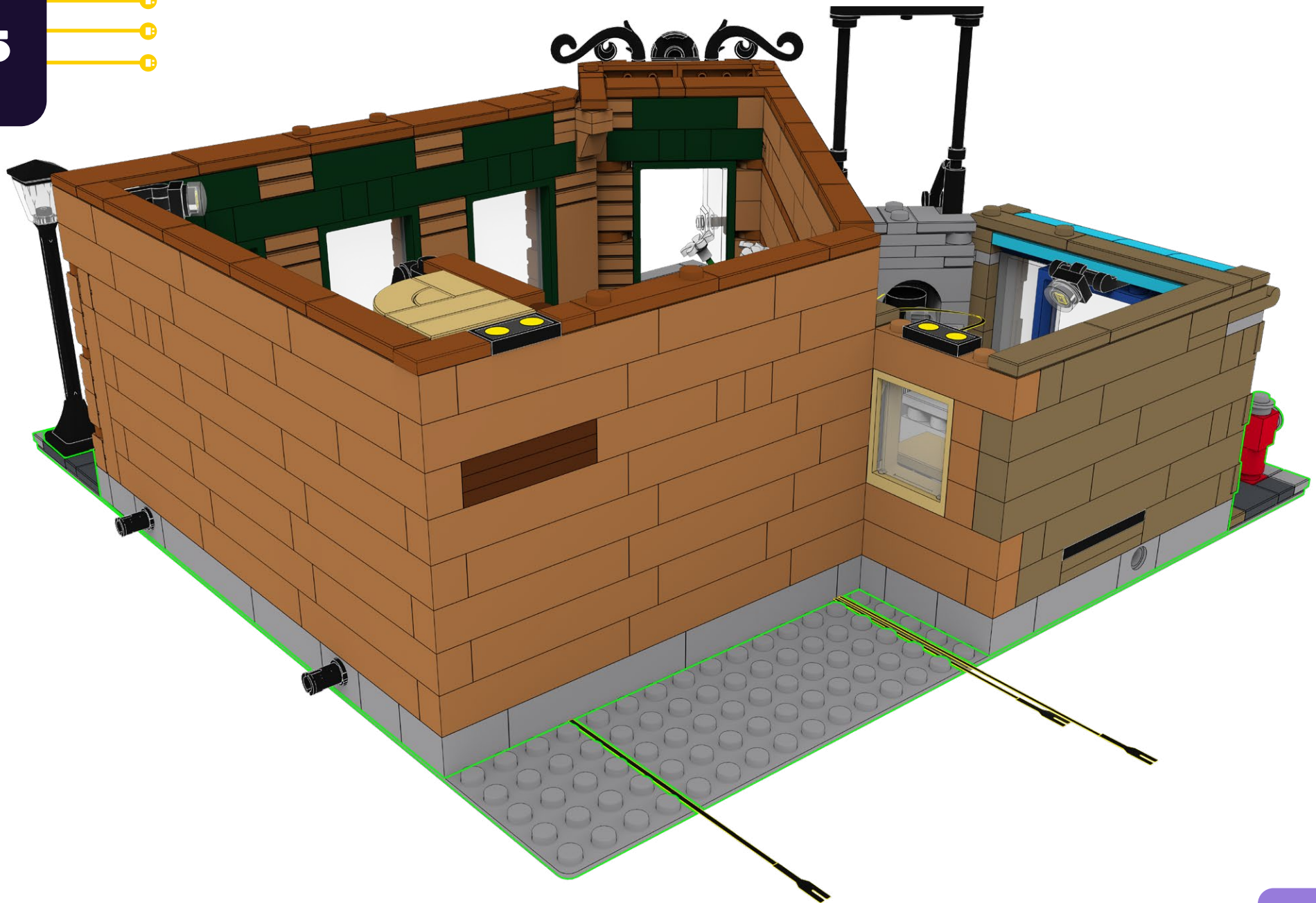

106

1

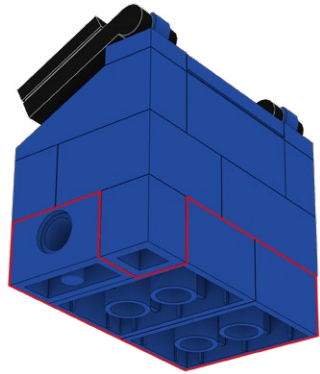

2

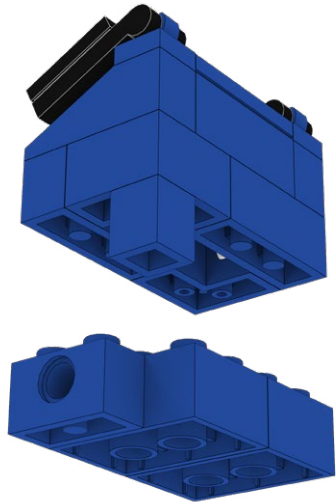

107

1

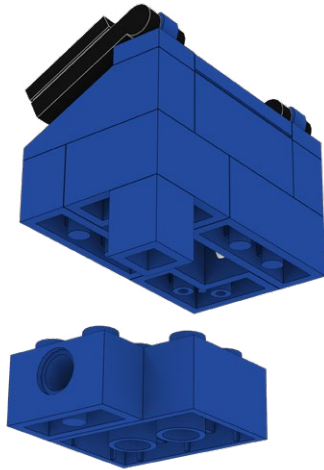

2

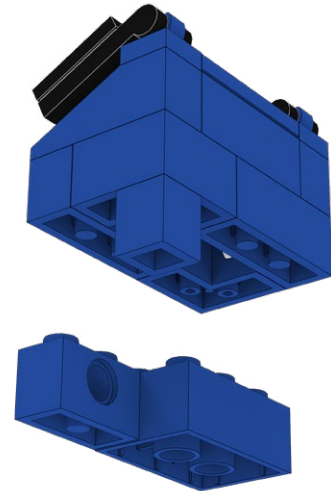

108

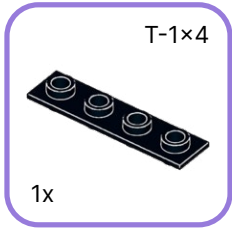

1

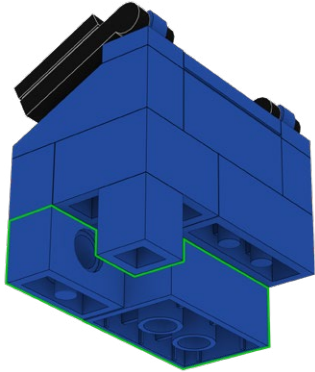

2

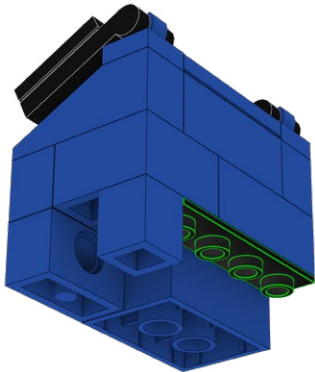

109

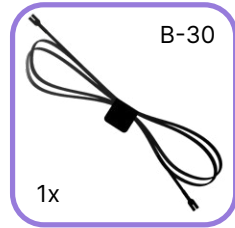
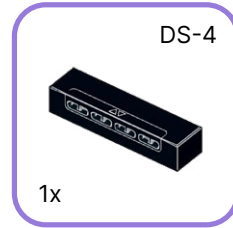

1

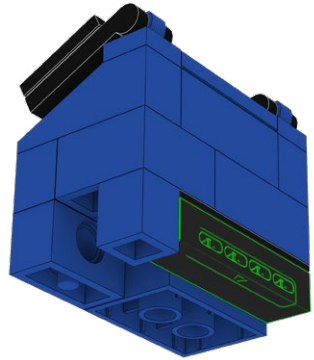

2

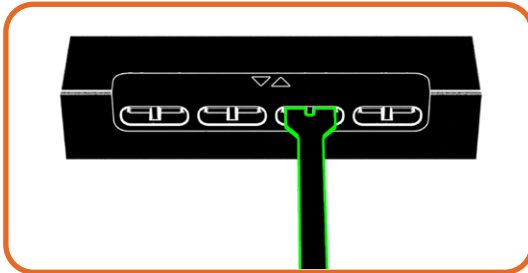
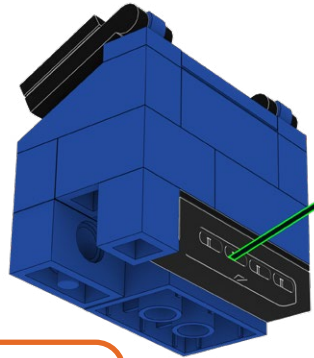

110

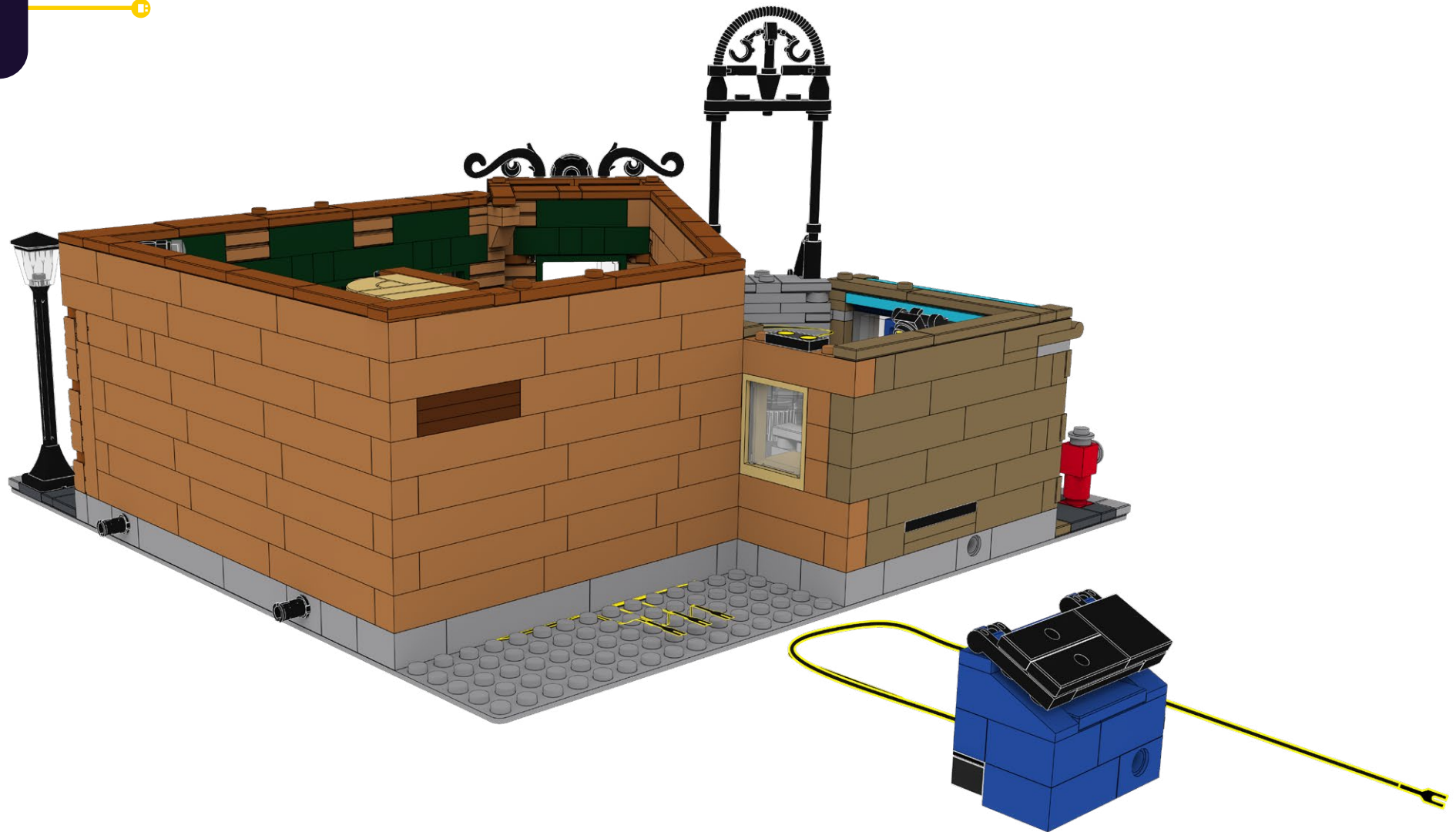

111

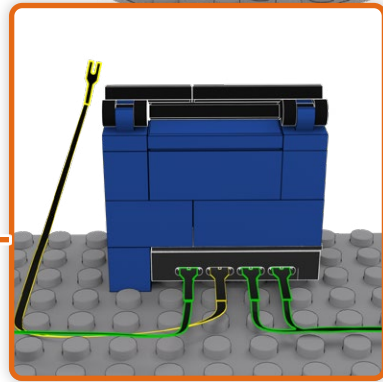
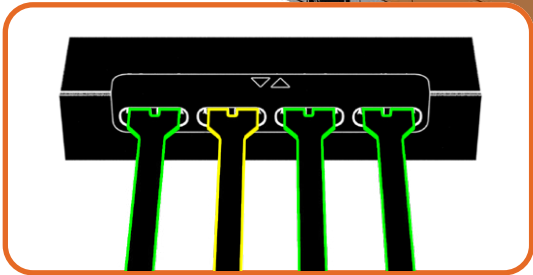
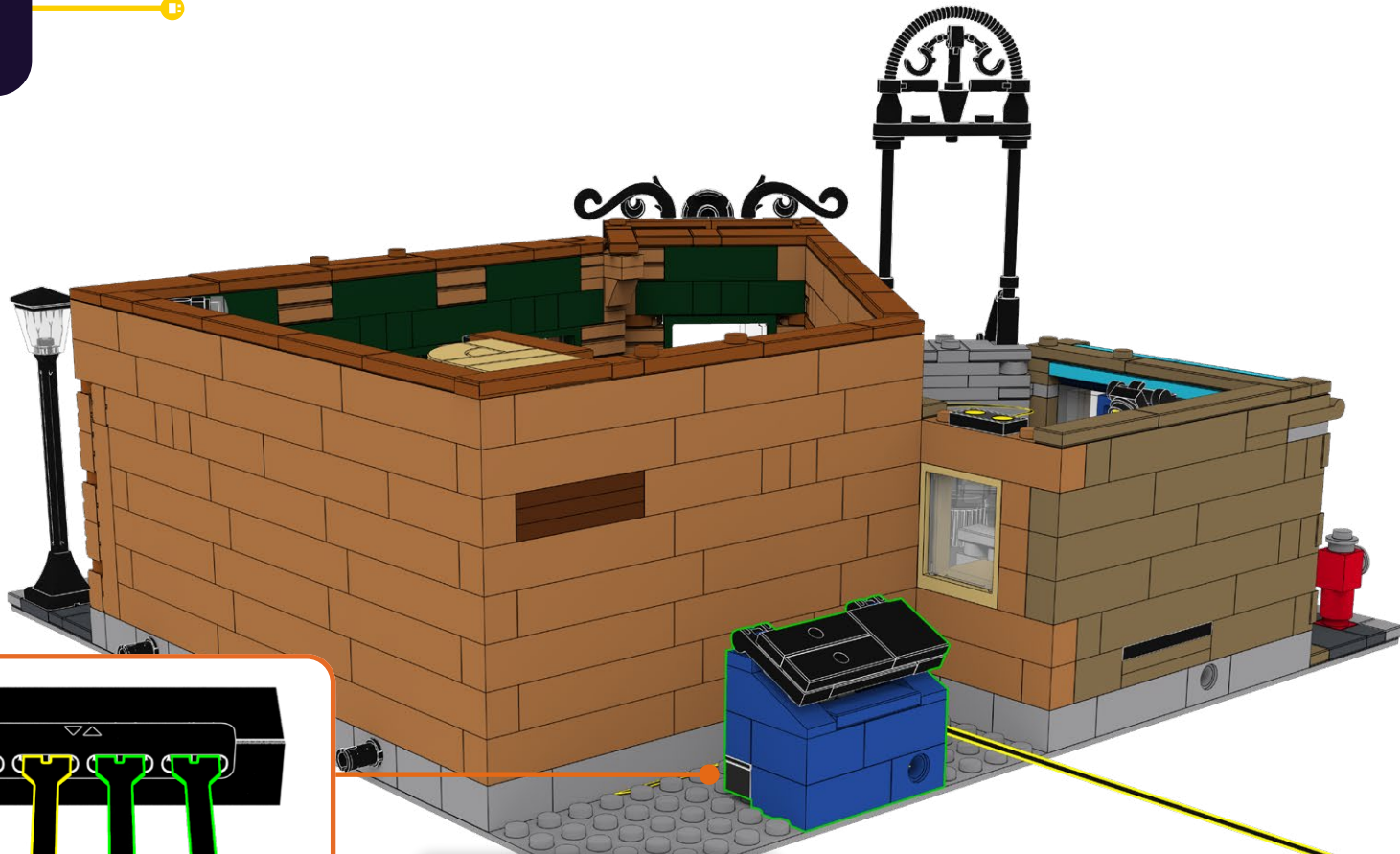

112

FLX-C

1x

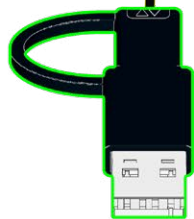

113

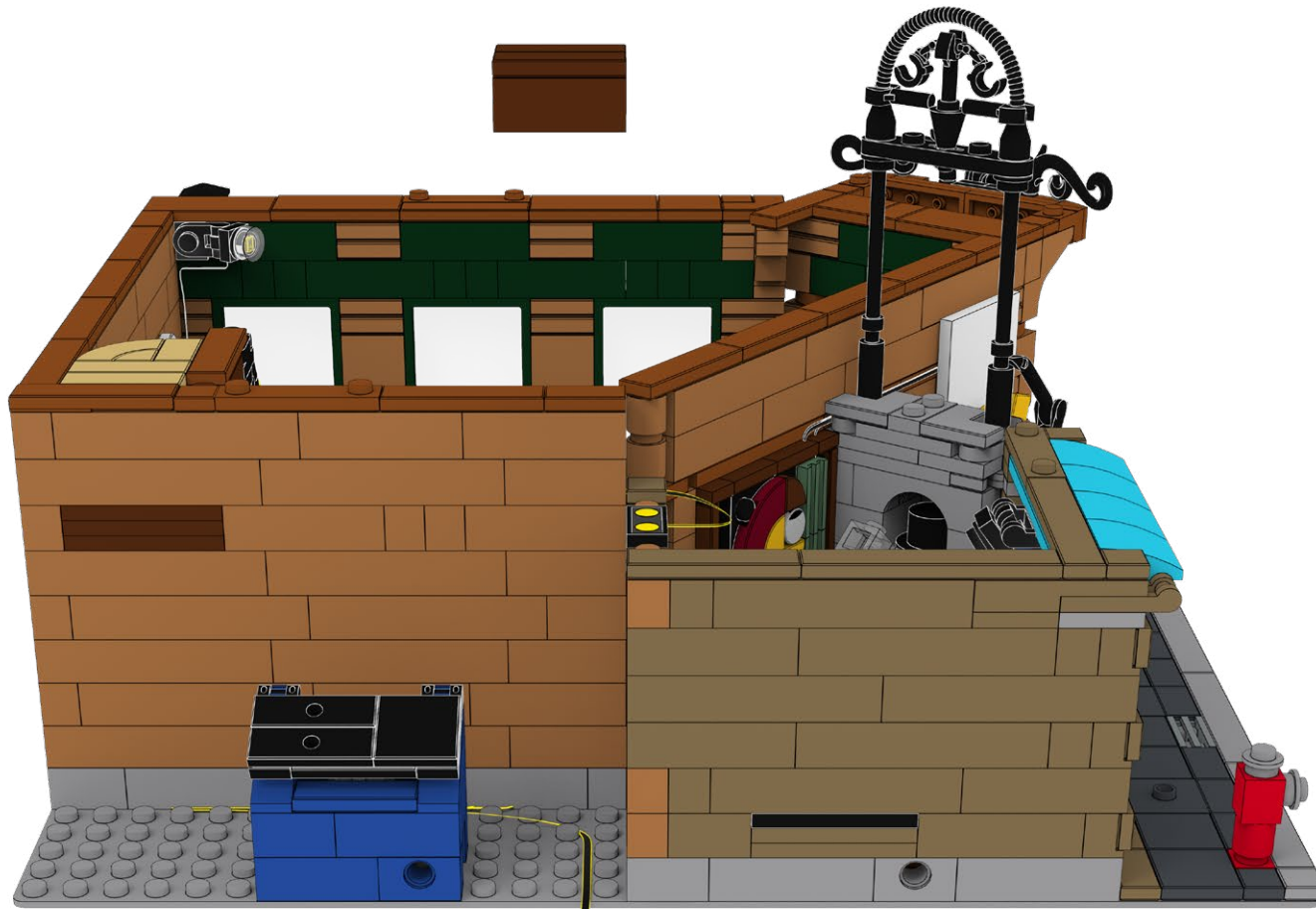

114

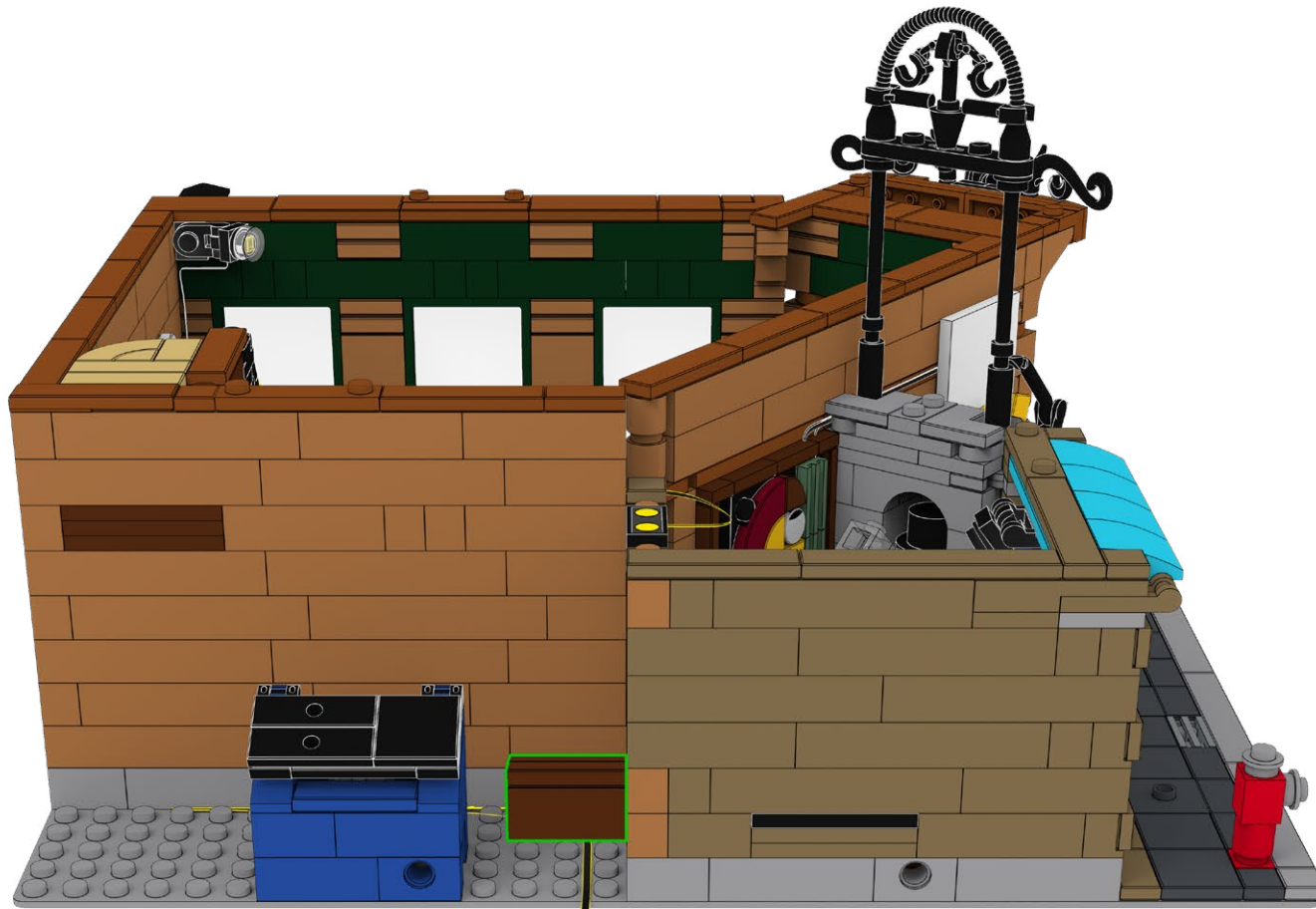

115



116



Power on Test
Test de mise sous tension
Test di Potenza
Stromtest
Prueba de Energía
电源测试



117



118

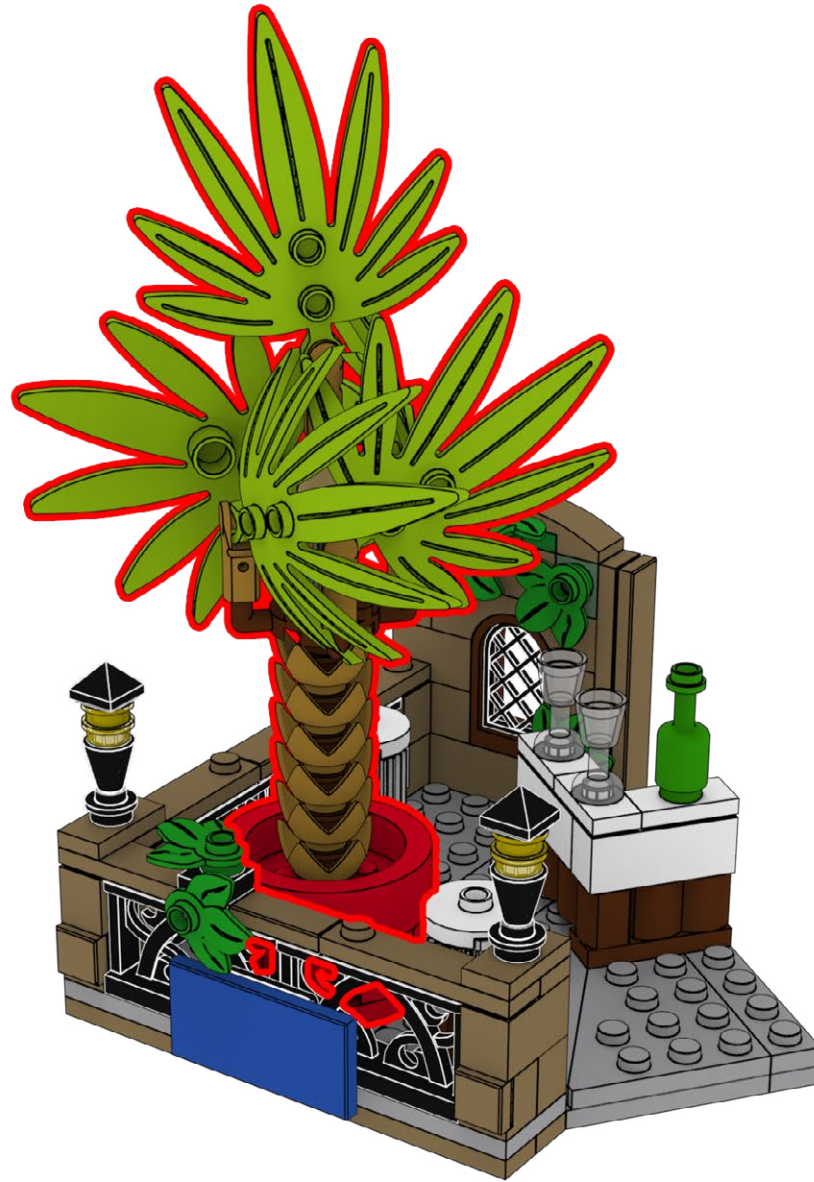

119



120



121

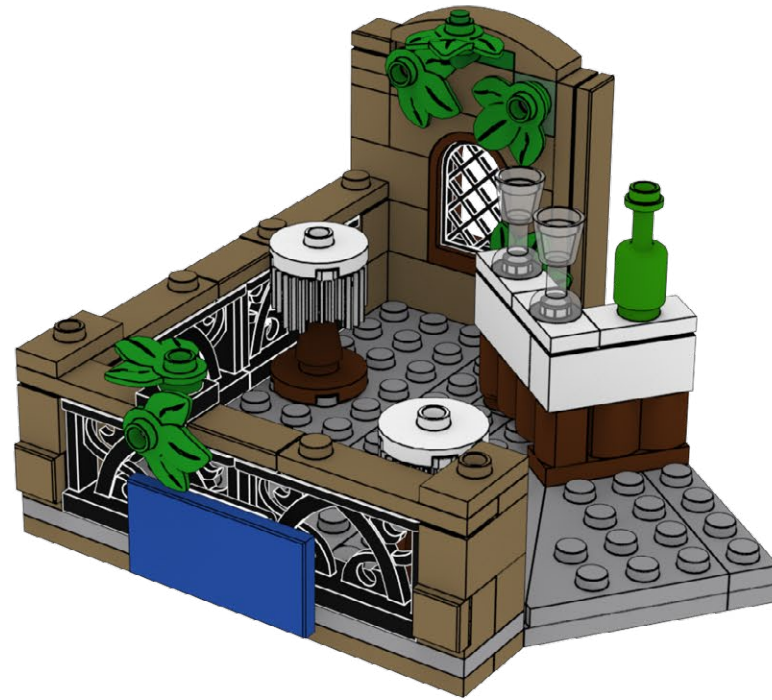

122

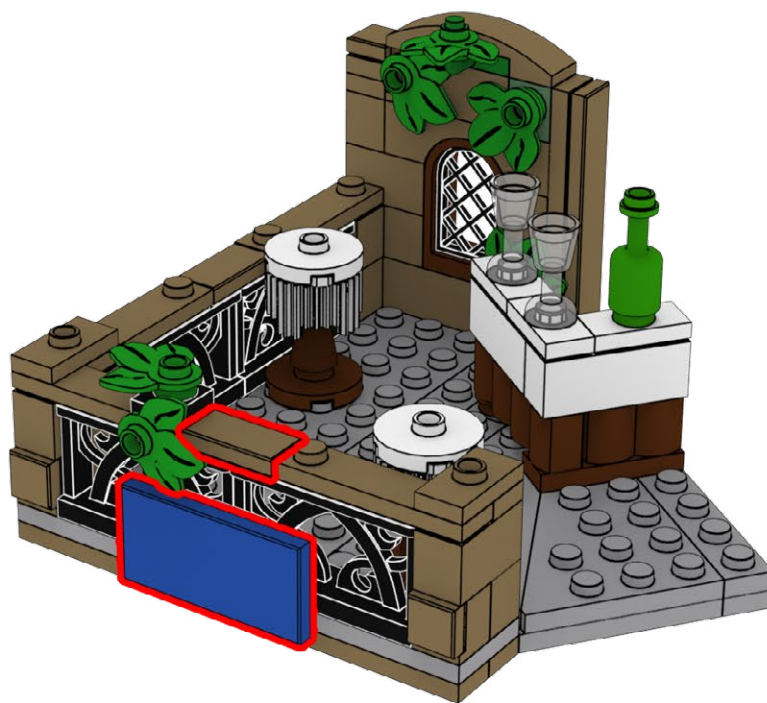

123



124

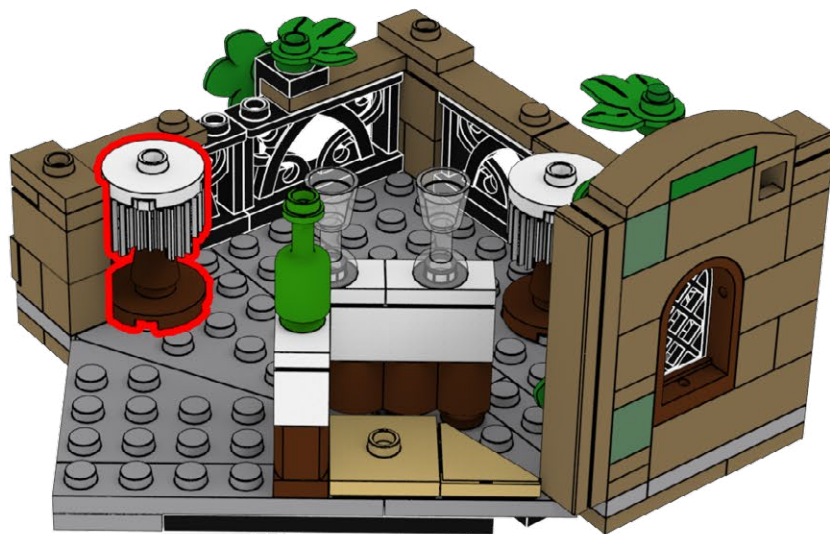

125



126

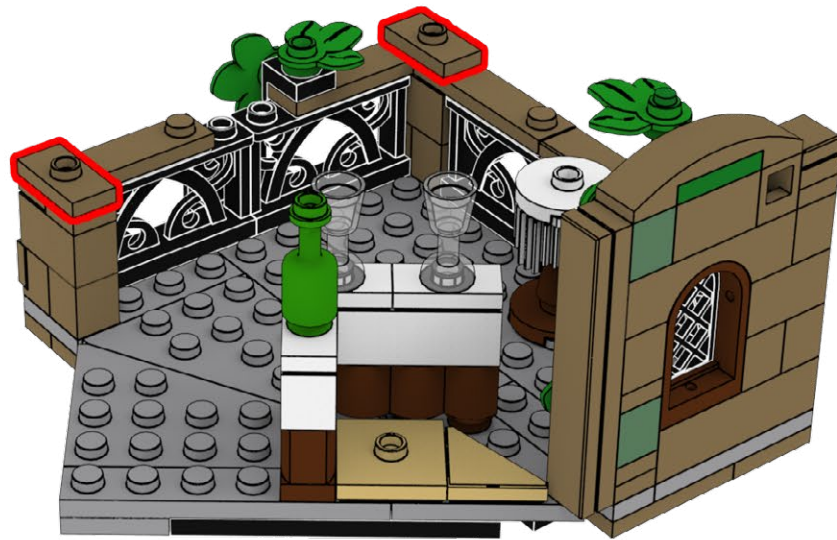

127





HOLD UP!

You might notice some bags aren't in order, as well as left over pieces, but that's ok! We're changing the way you build LEGO!

ATTENDEZ!

Vous remarquerez peut-être que certains sacs, ainsi que certaines pièces, ne sont pas dans le bon ordre. Mais pas de panique! Nous changeons simplement la façon avec laquelle vous construisez vos LEGO!

ASPETTA!

Potresti notare che alcuni sacchetti non sono in ordine, così come i pezzi avanzati, ma va bene così! Stiamo cambiando il modo in cui costruisci i LEGO!

HALT!

Sie werden möglicherweise bemerken, dass einige tüten durcheinander sind und teile übrig bleiben, aber das ist in Ordnung! Wir ändern die art und weise, wie Sie LEGO bauen!

¡ESPERA!

Es posible que notes que algunas bolsas están fuera de servicio, así como piezas sobrantes, ¡pero está bien! ¡Estamos cambiando la forma en que construyes LEGO!

暫停!

你可能会注意到一些袋子顺序错乱, 以及一些剩余的部件, 但没关系! 我们正在改变你搭建乐高的方式!

Open LMB Bag 03

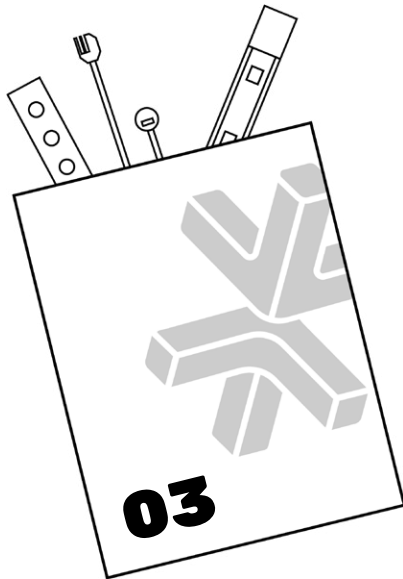

128

1



2



129

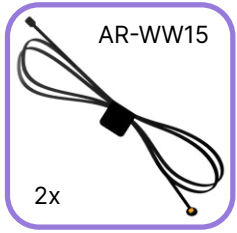

1



2



130

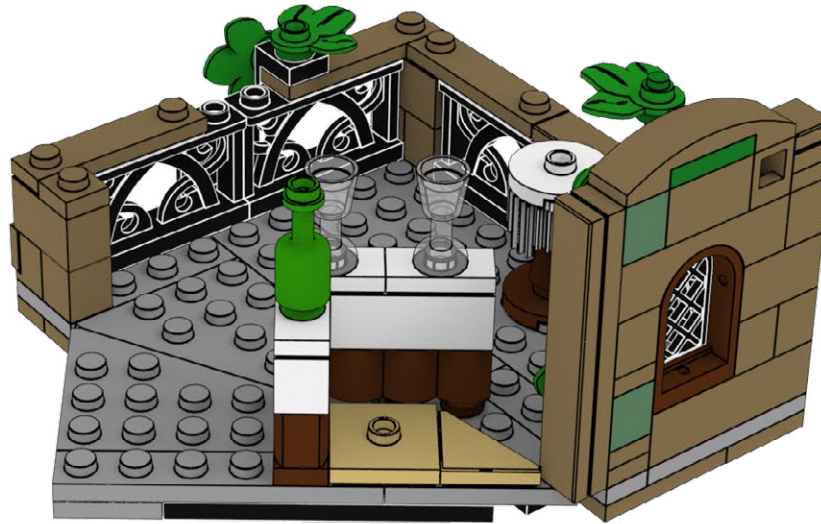
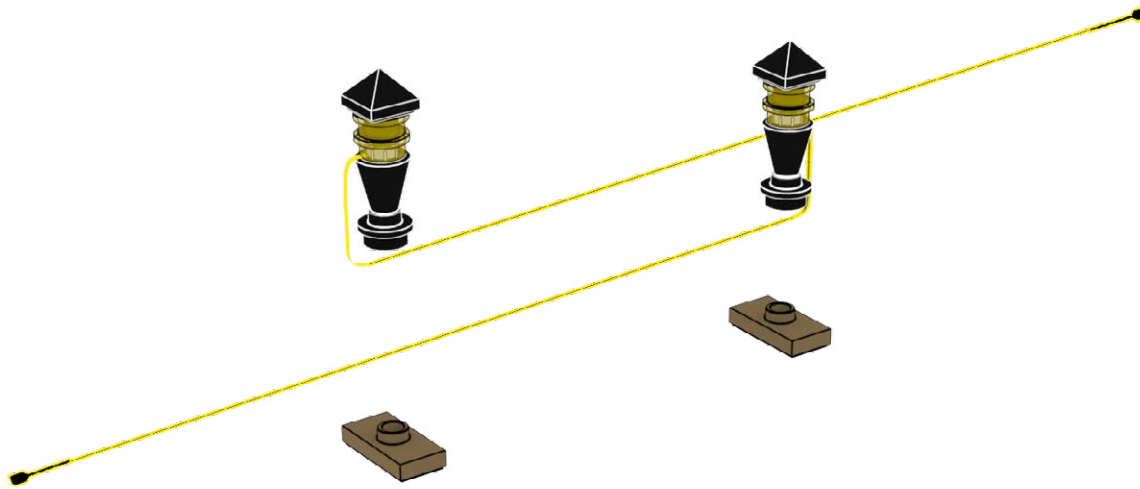

131

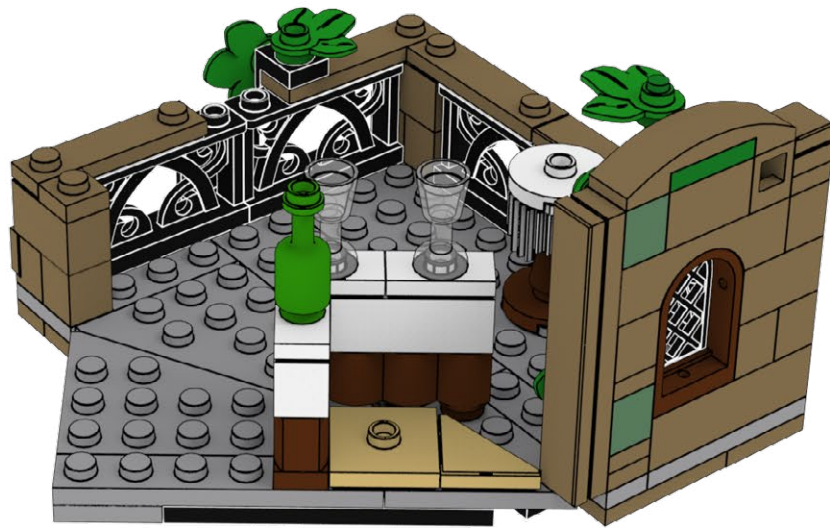
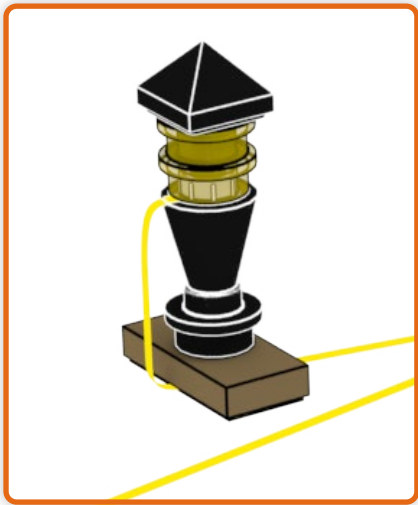
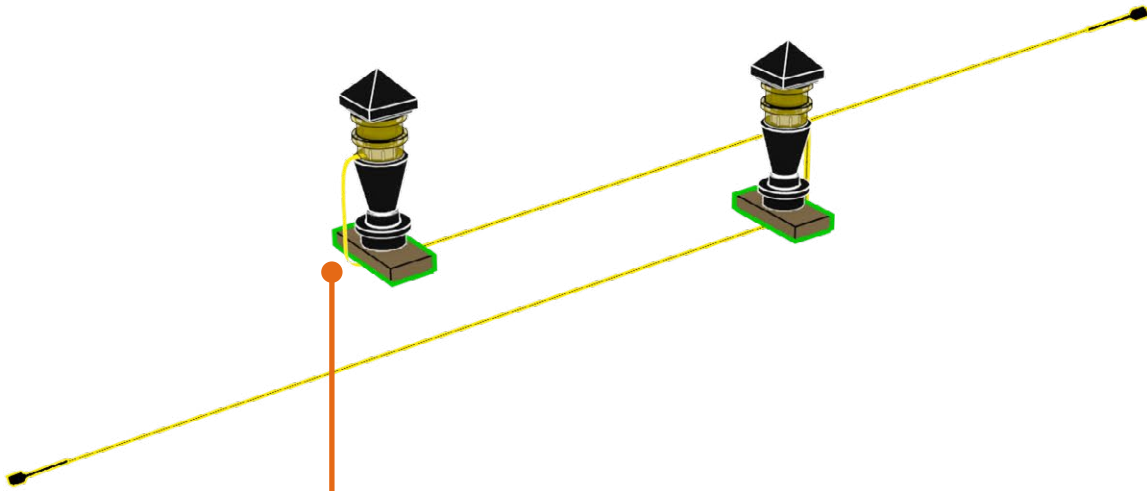

132

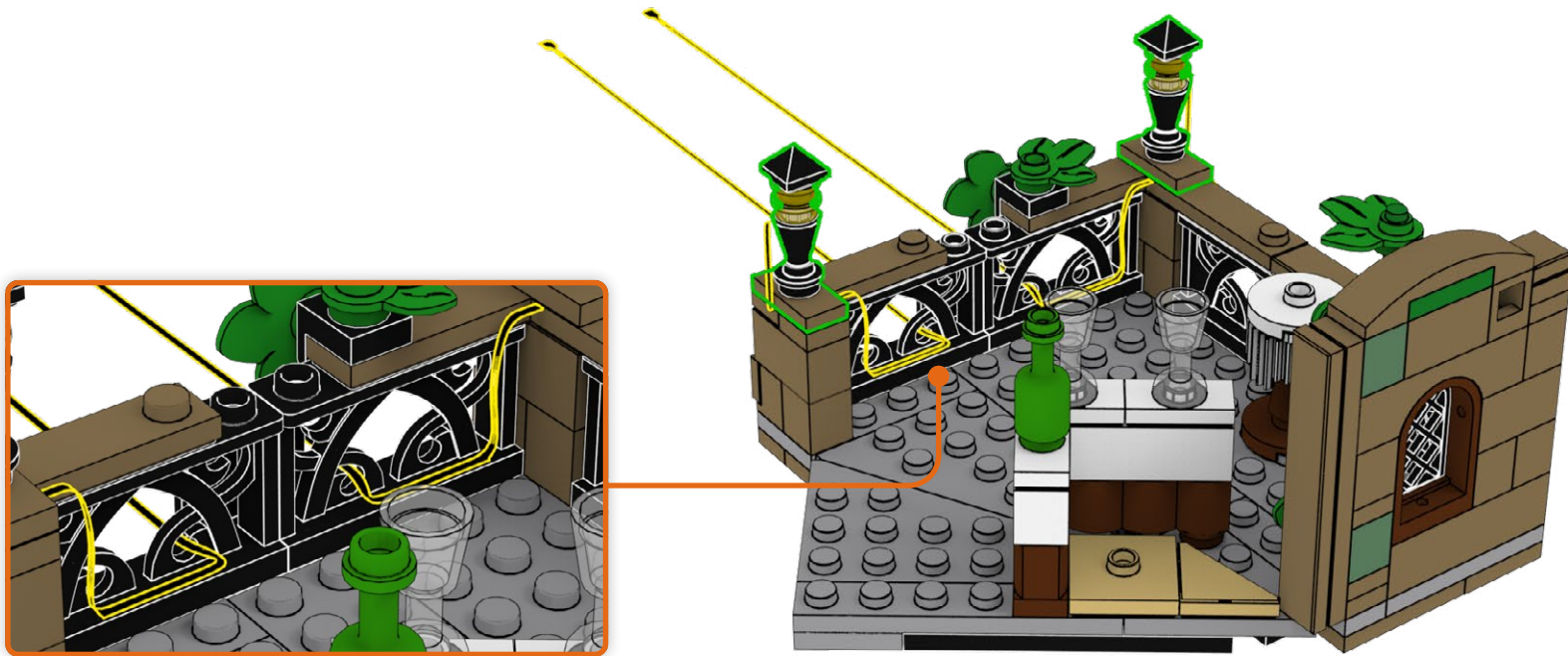

133

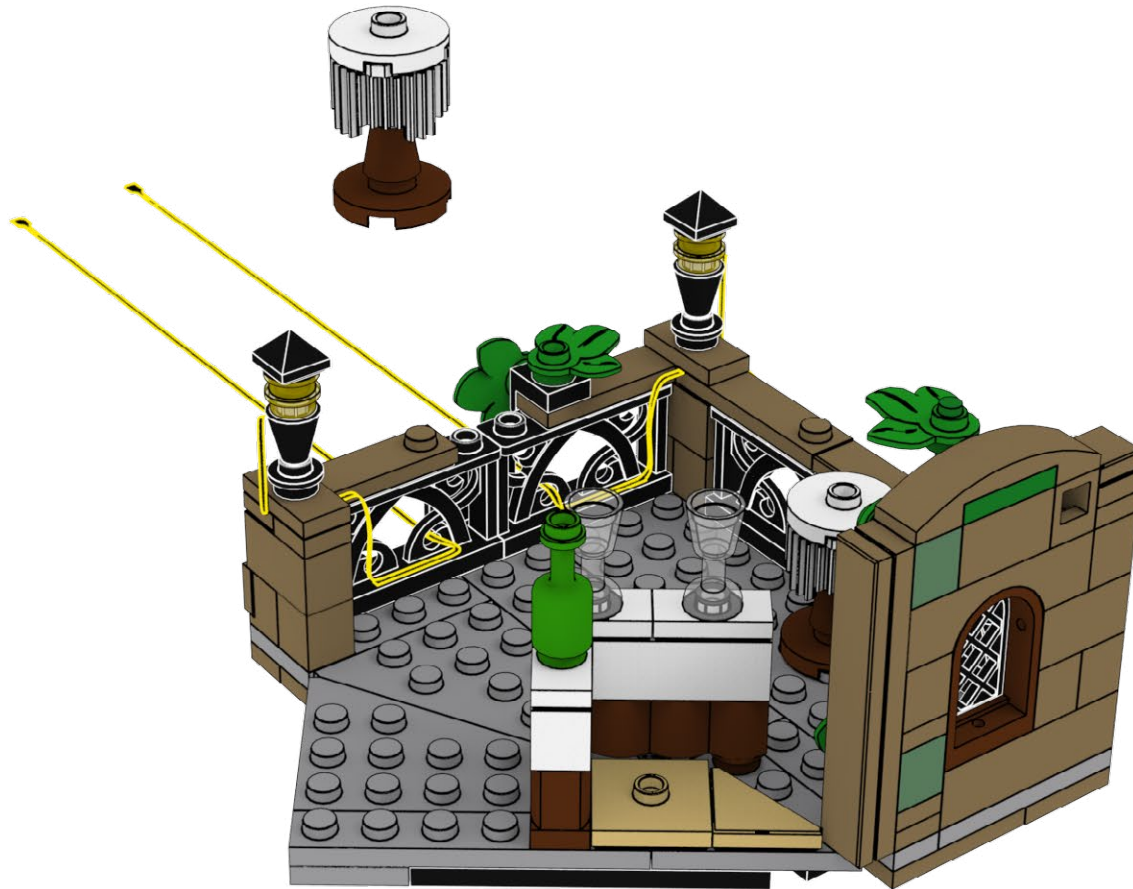

134

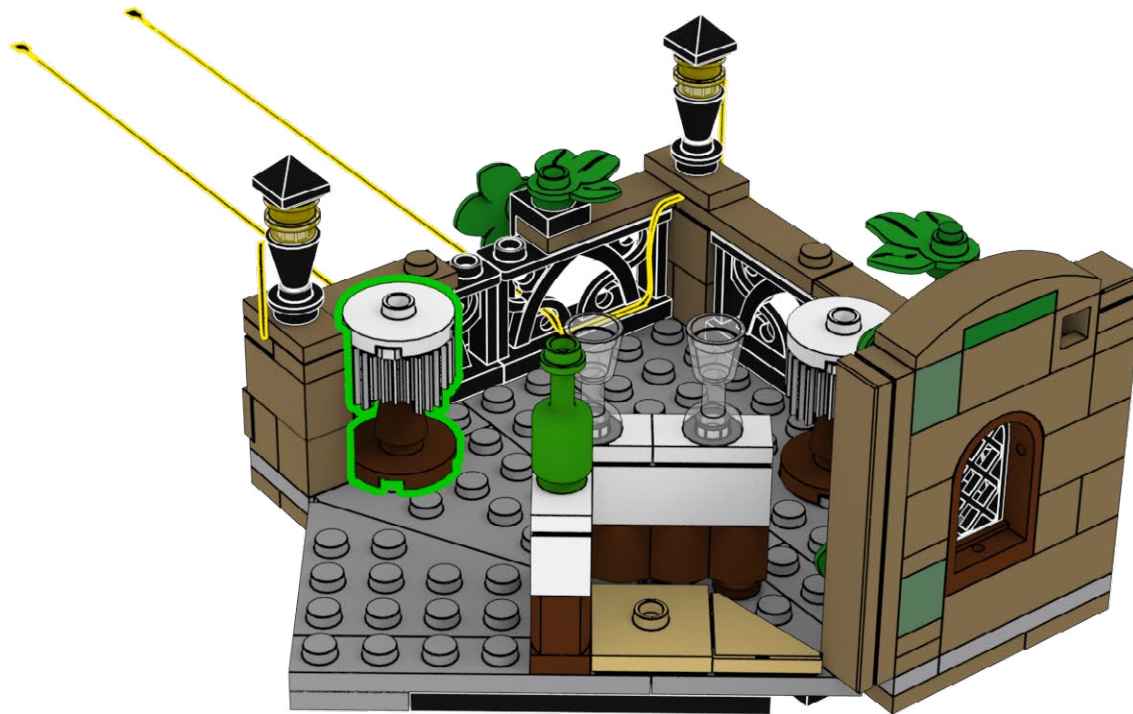

135

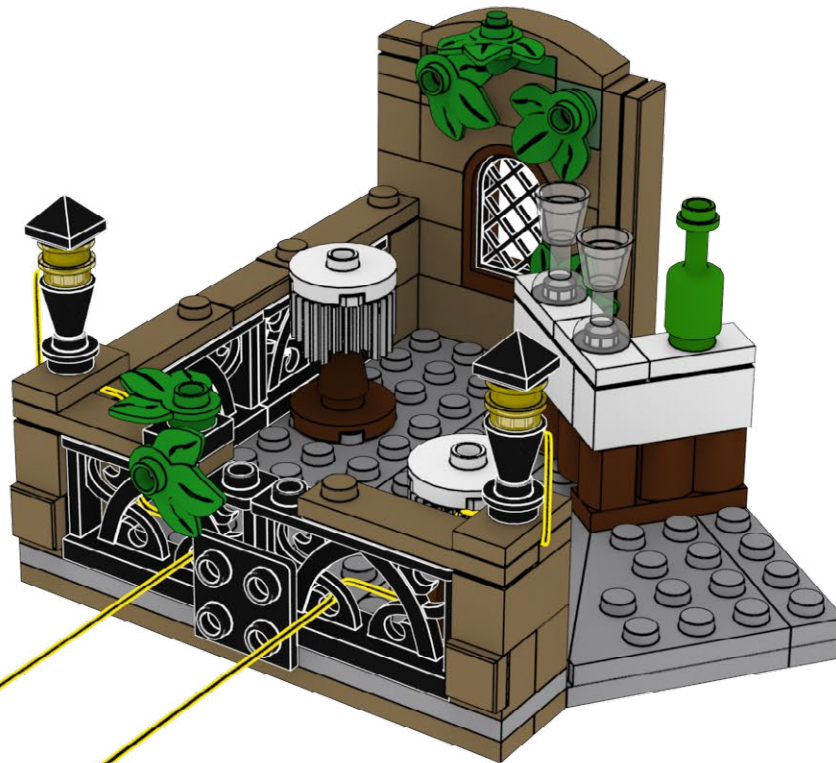

136

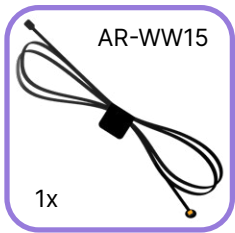

1

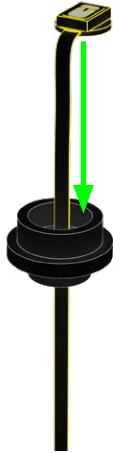

2



137

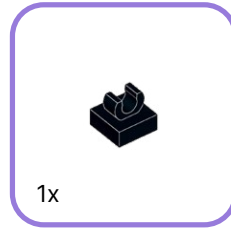

1

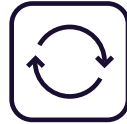
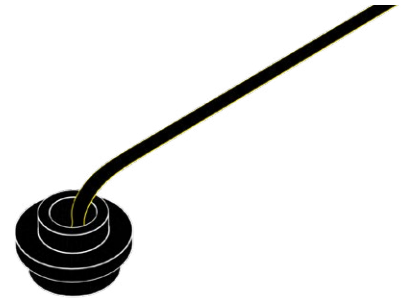

2

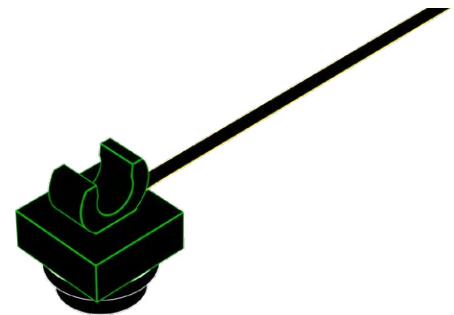

138

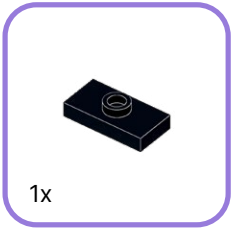
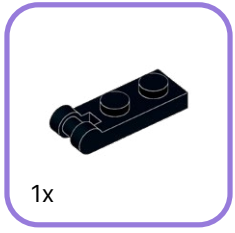

1

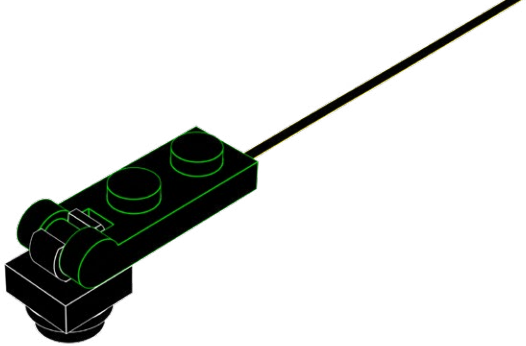

2

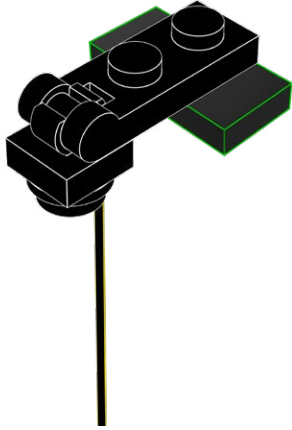

139

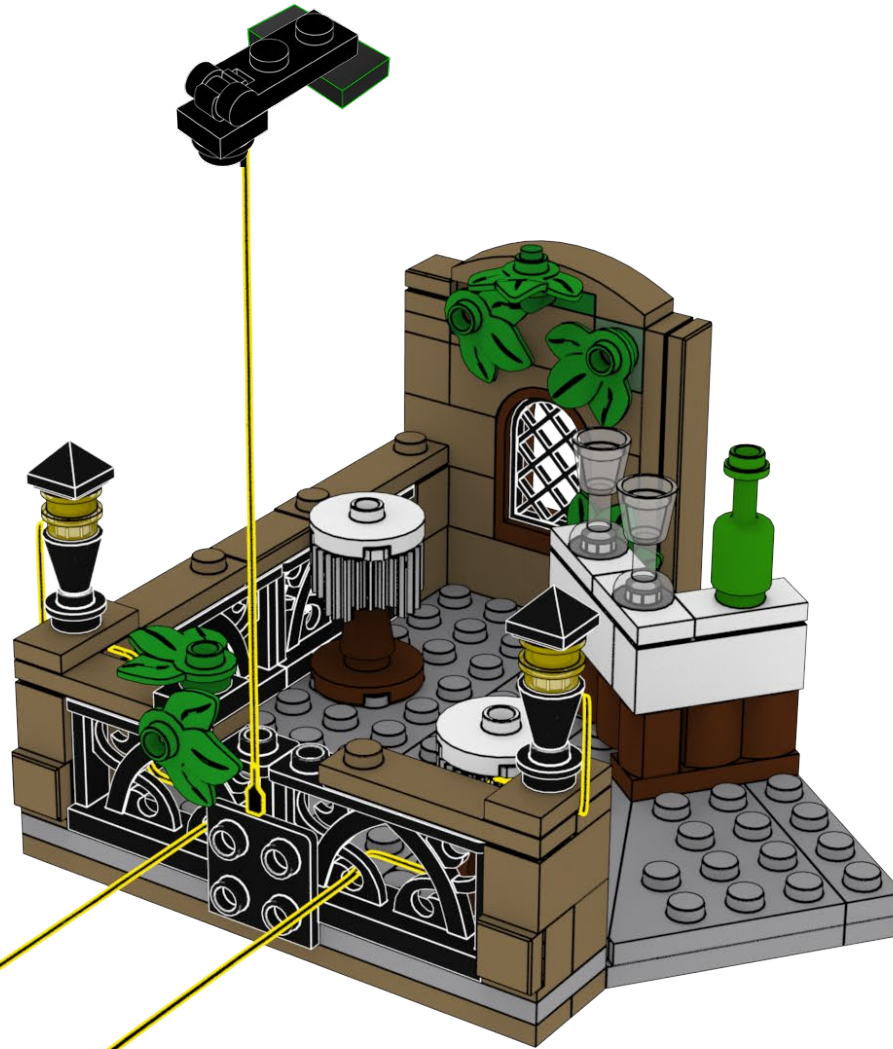

140

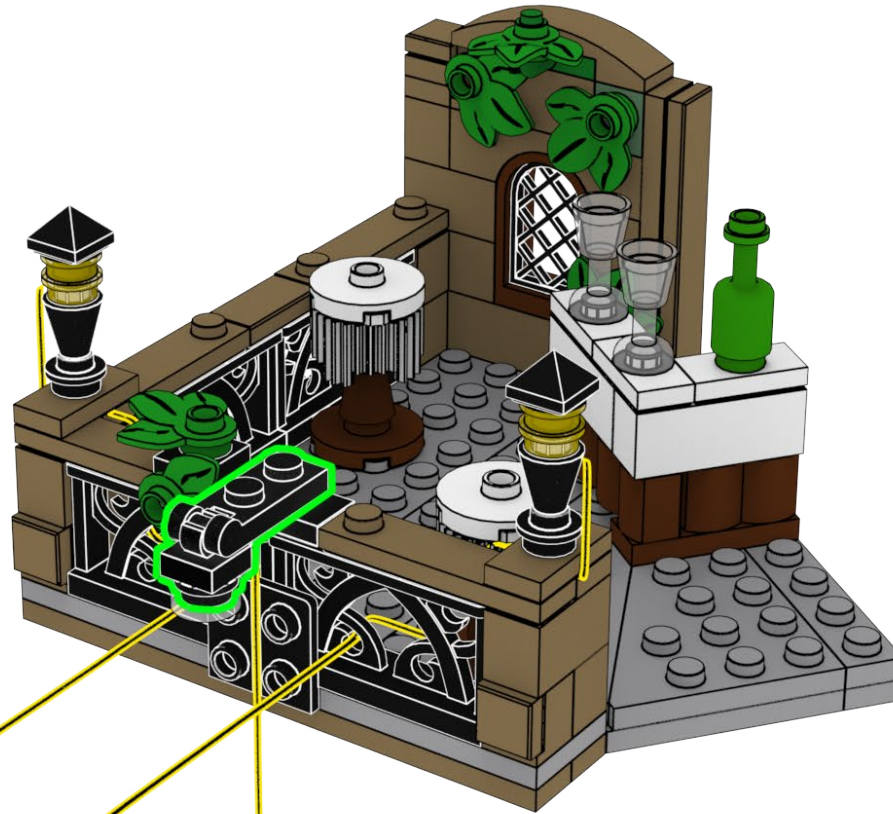

141

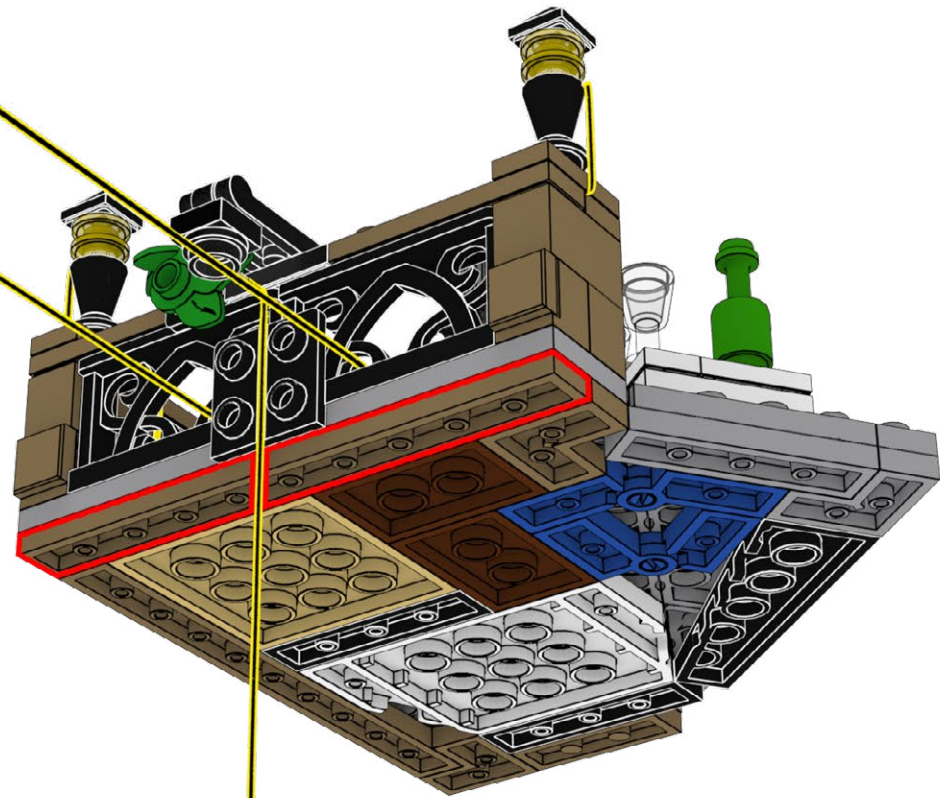

142

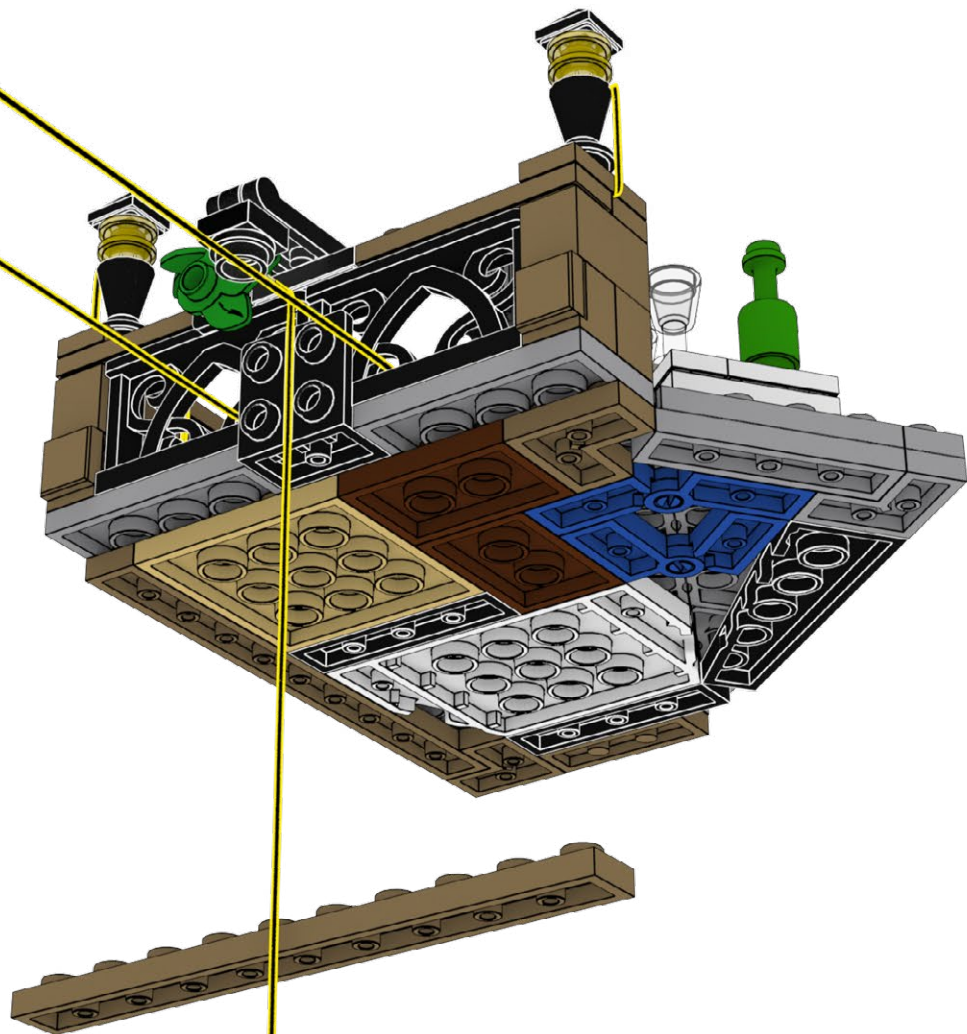
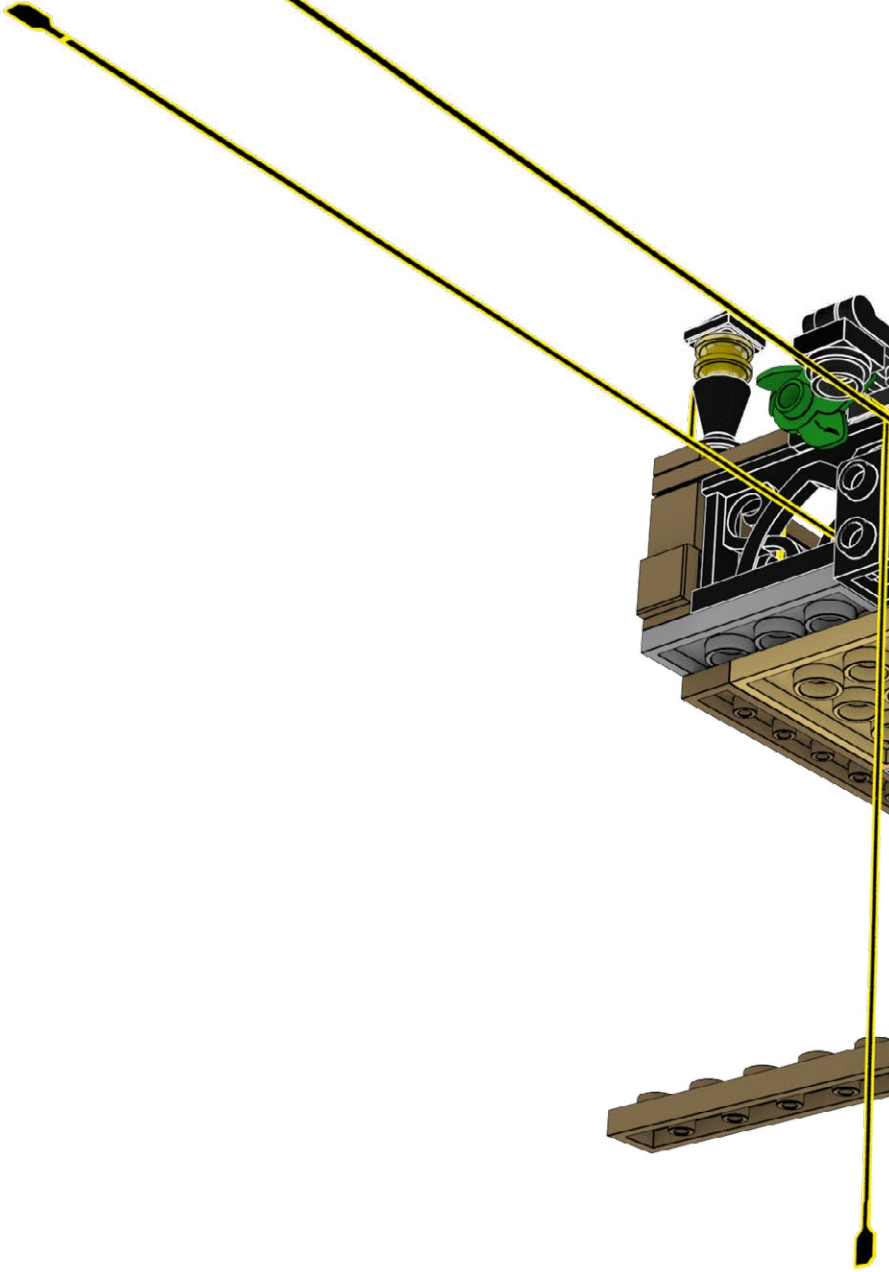
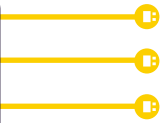

143

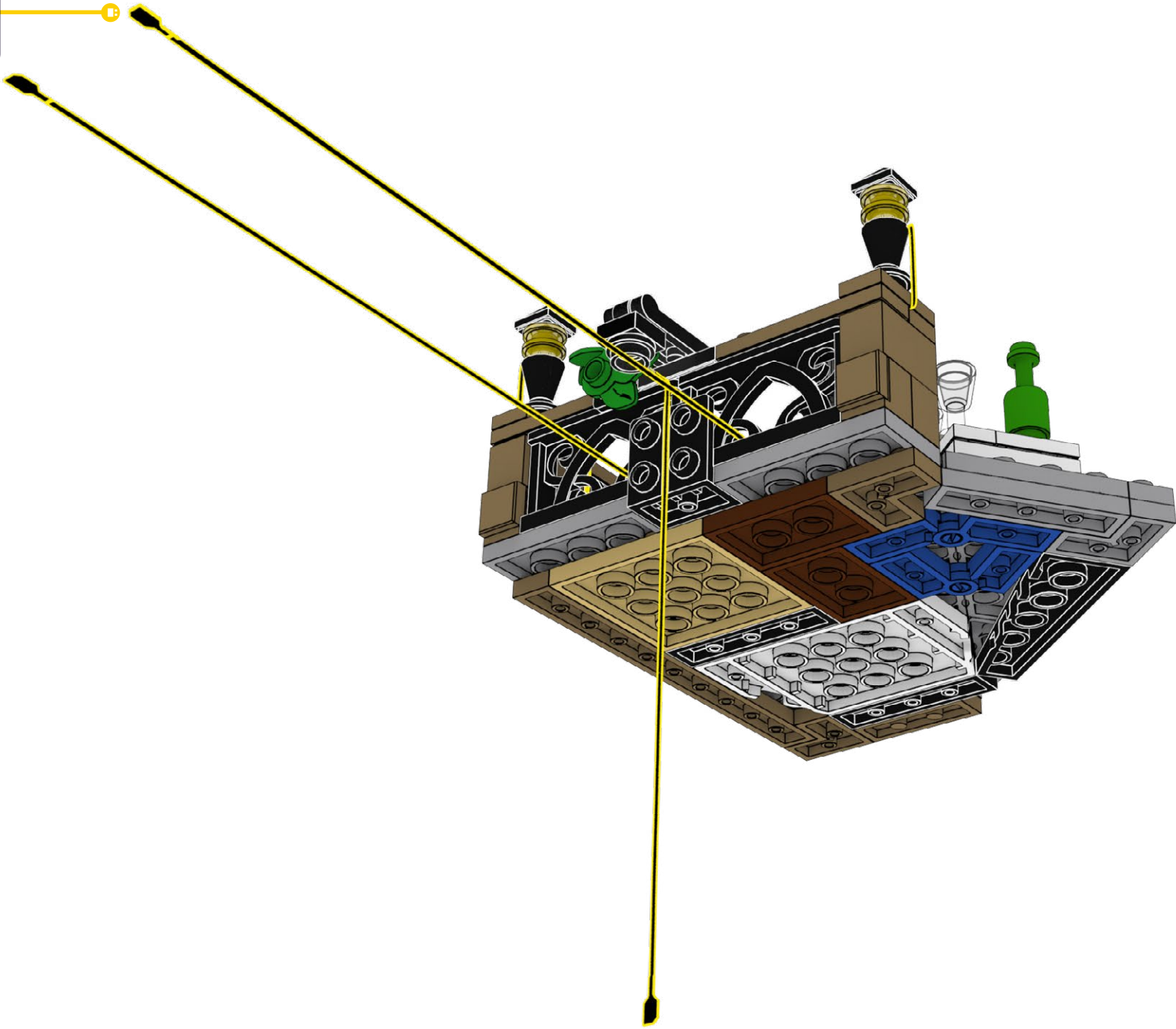
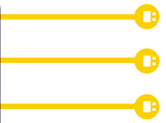

144

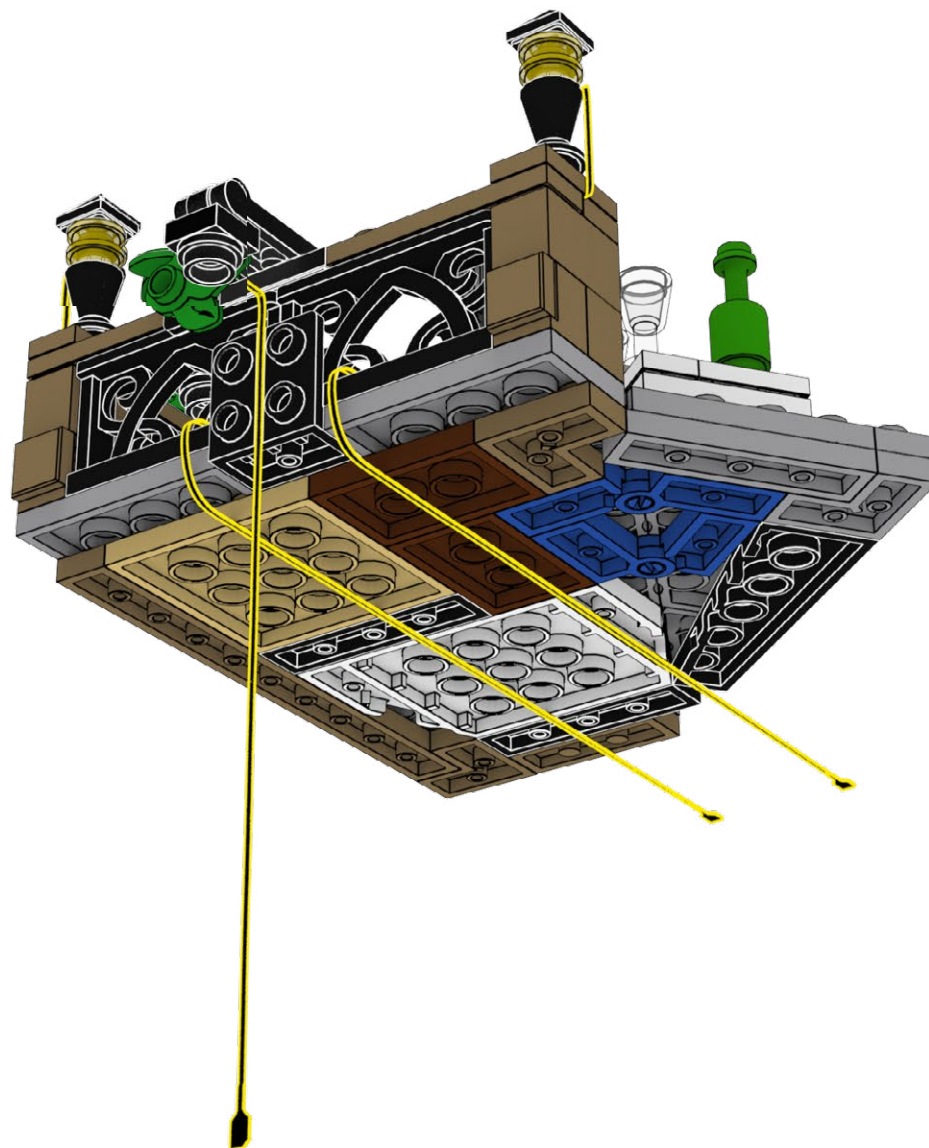
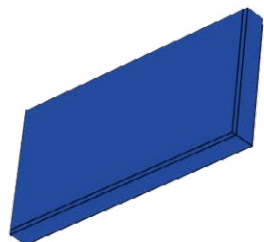

145

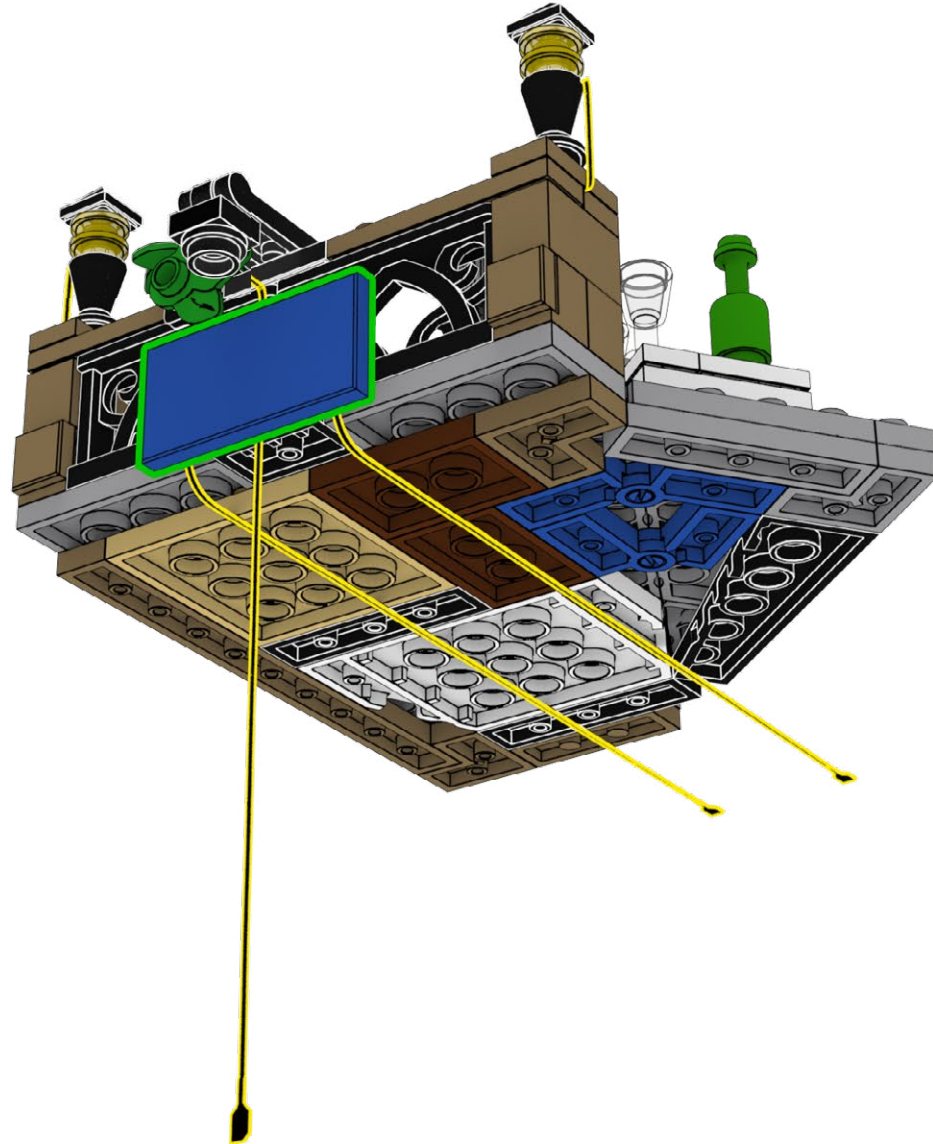

146

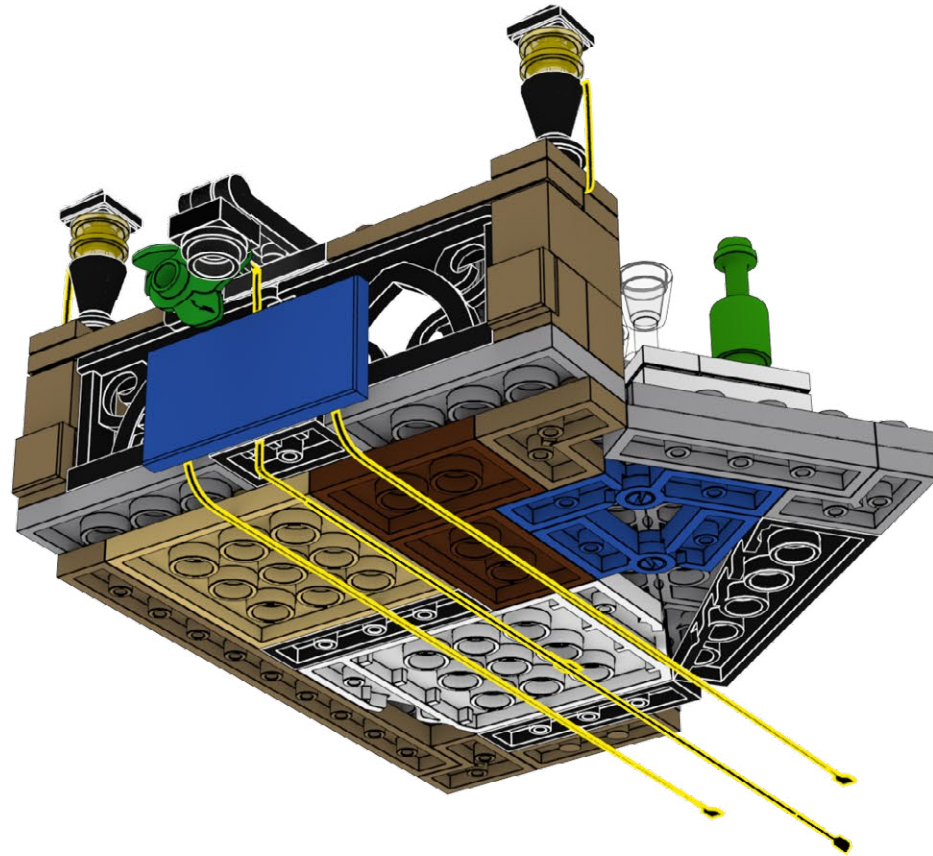

147

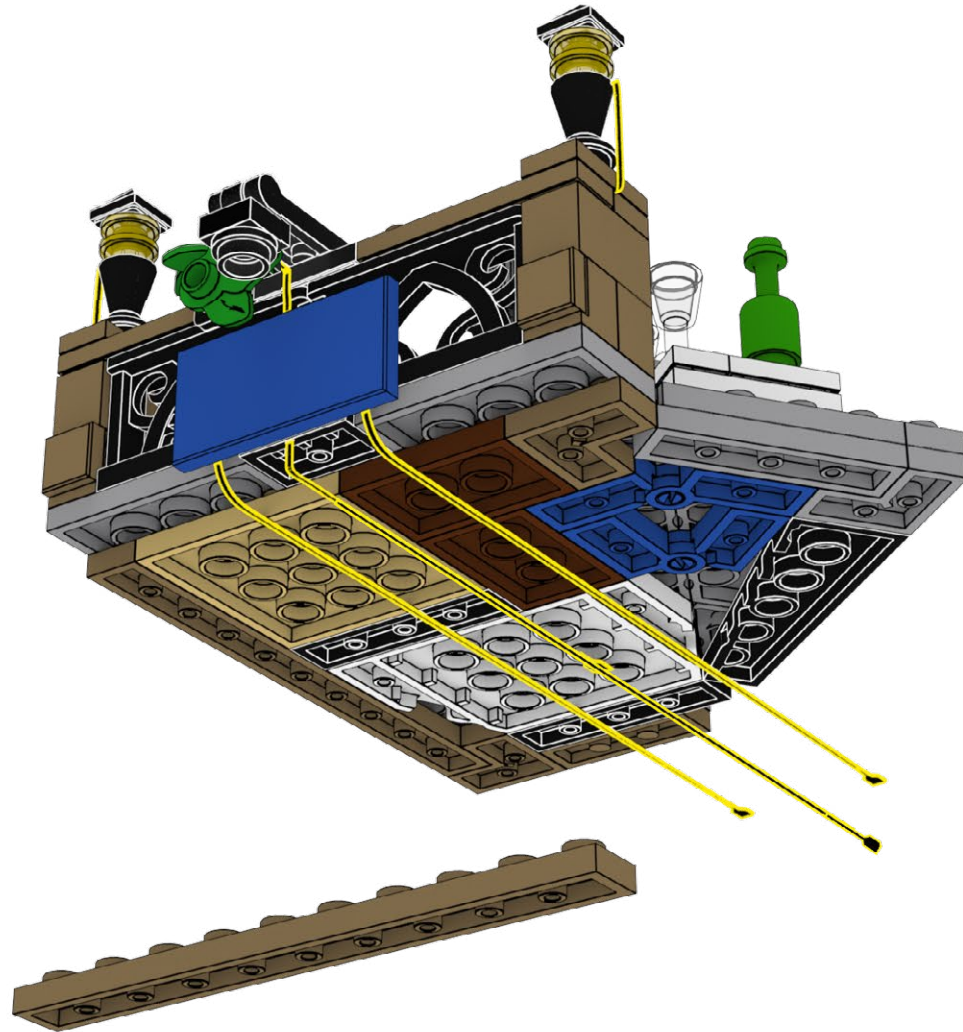

148

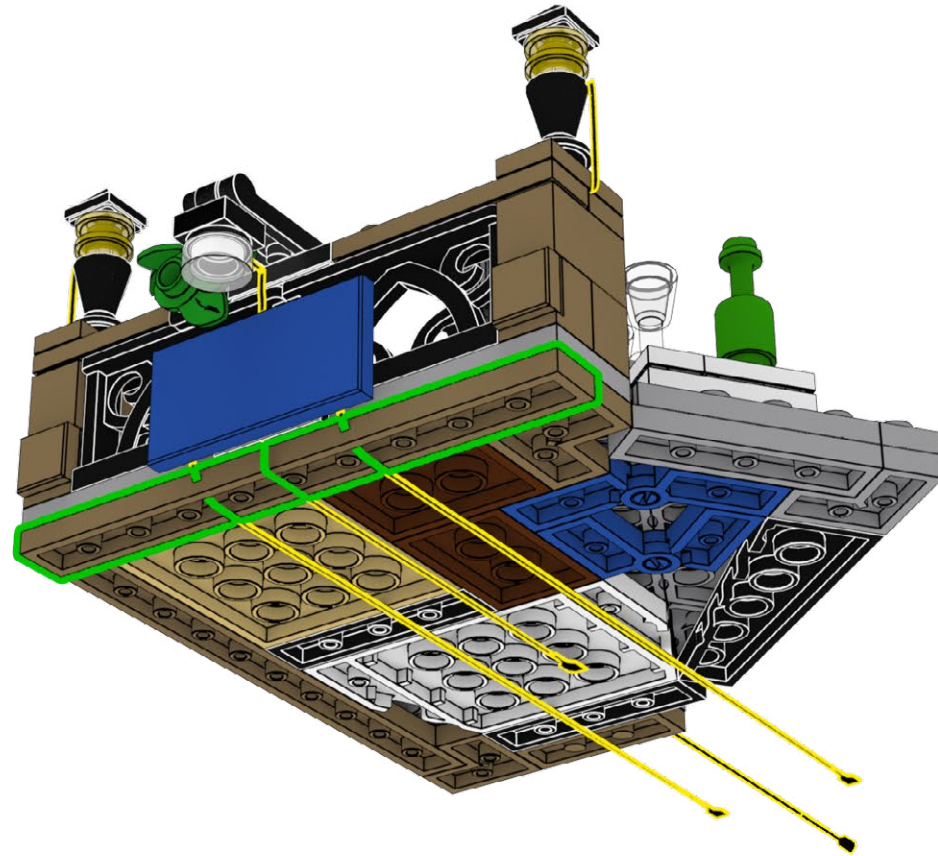

149

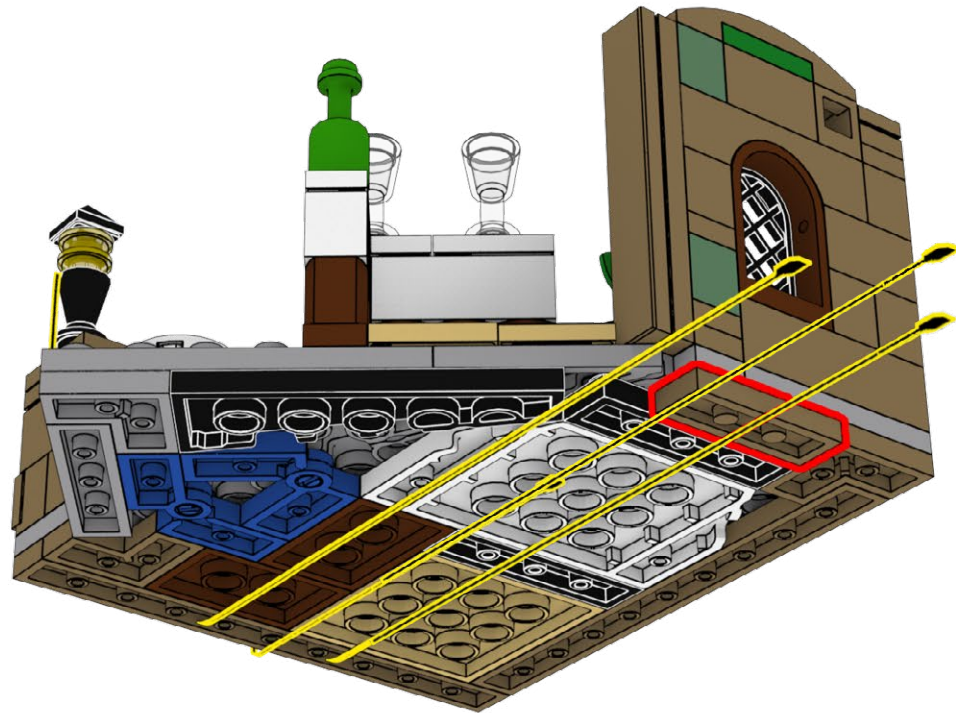

150

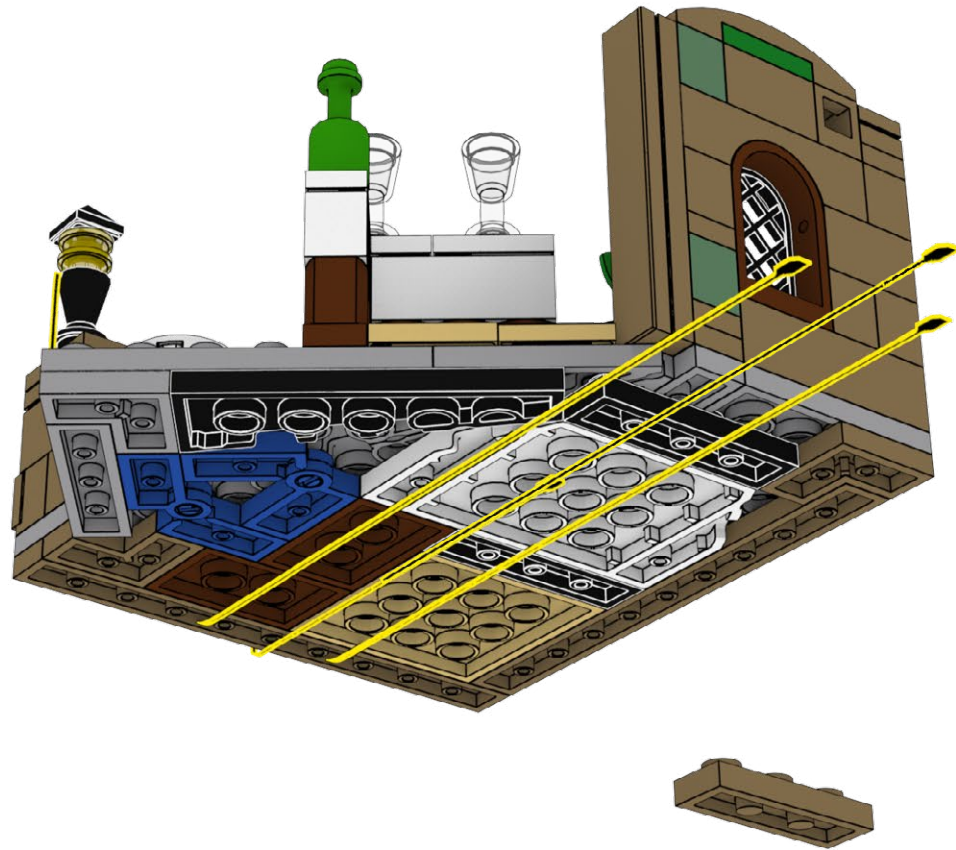

151

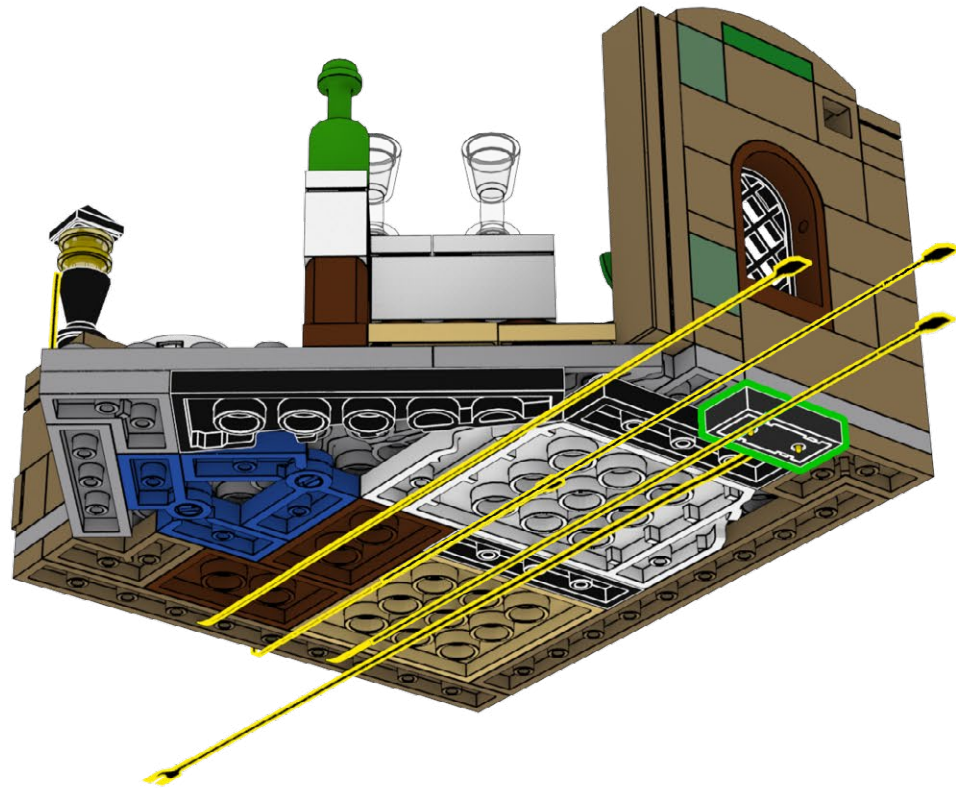
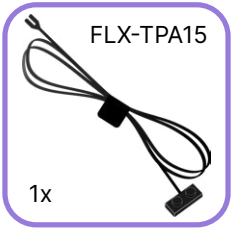

152

D-3



1x

T-1x4



1x

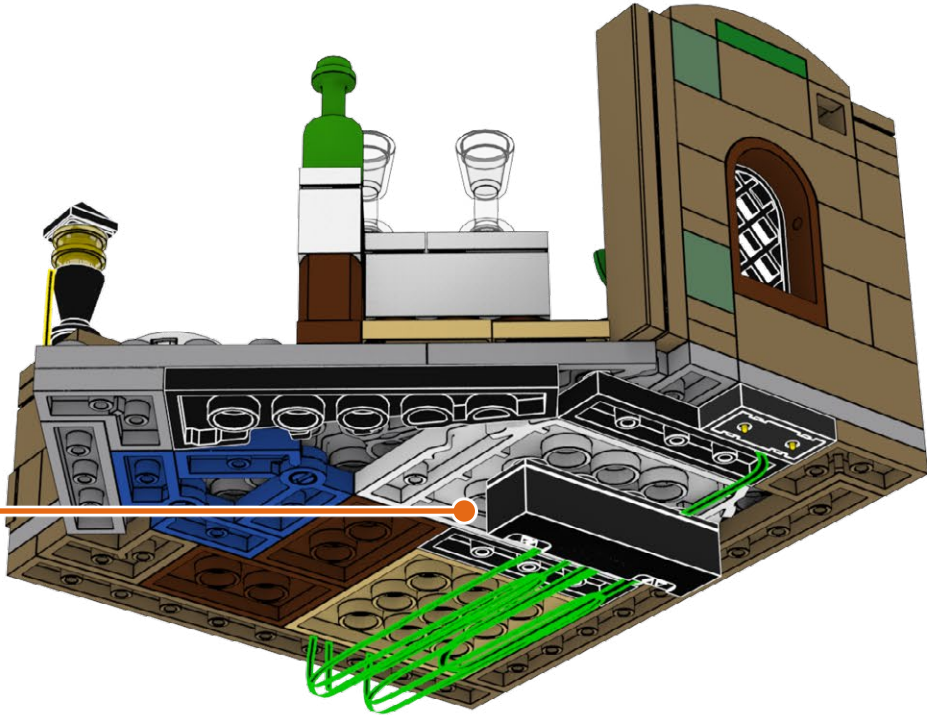
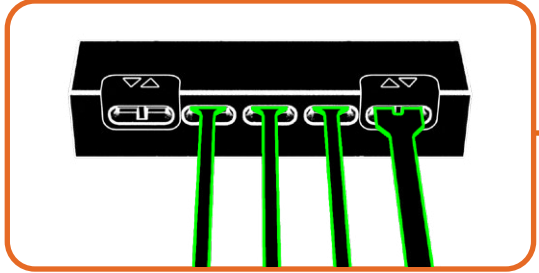
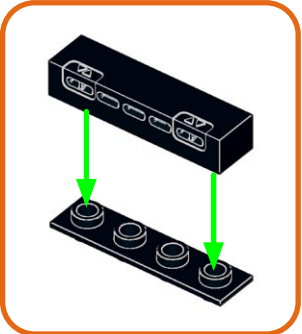

153

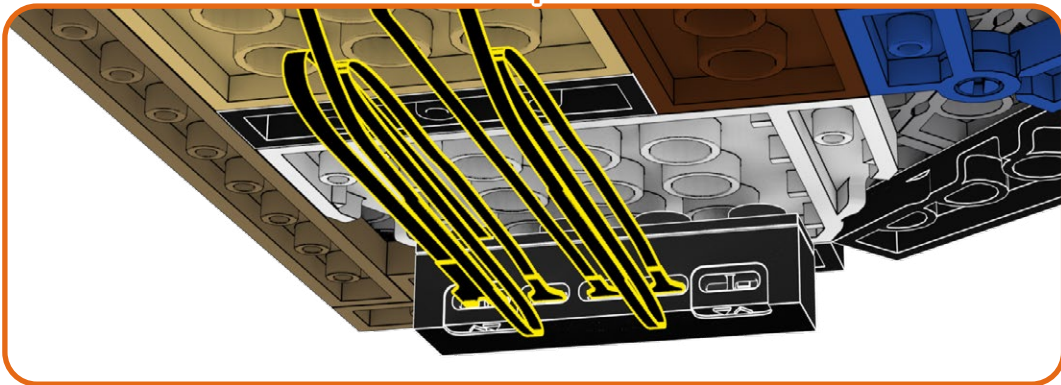
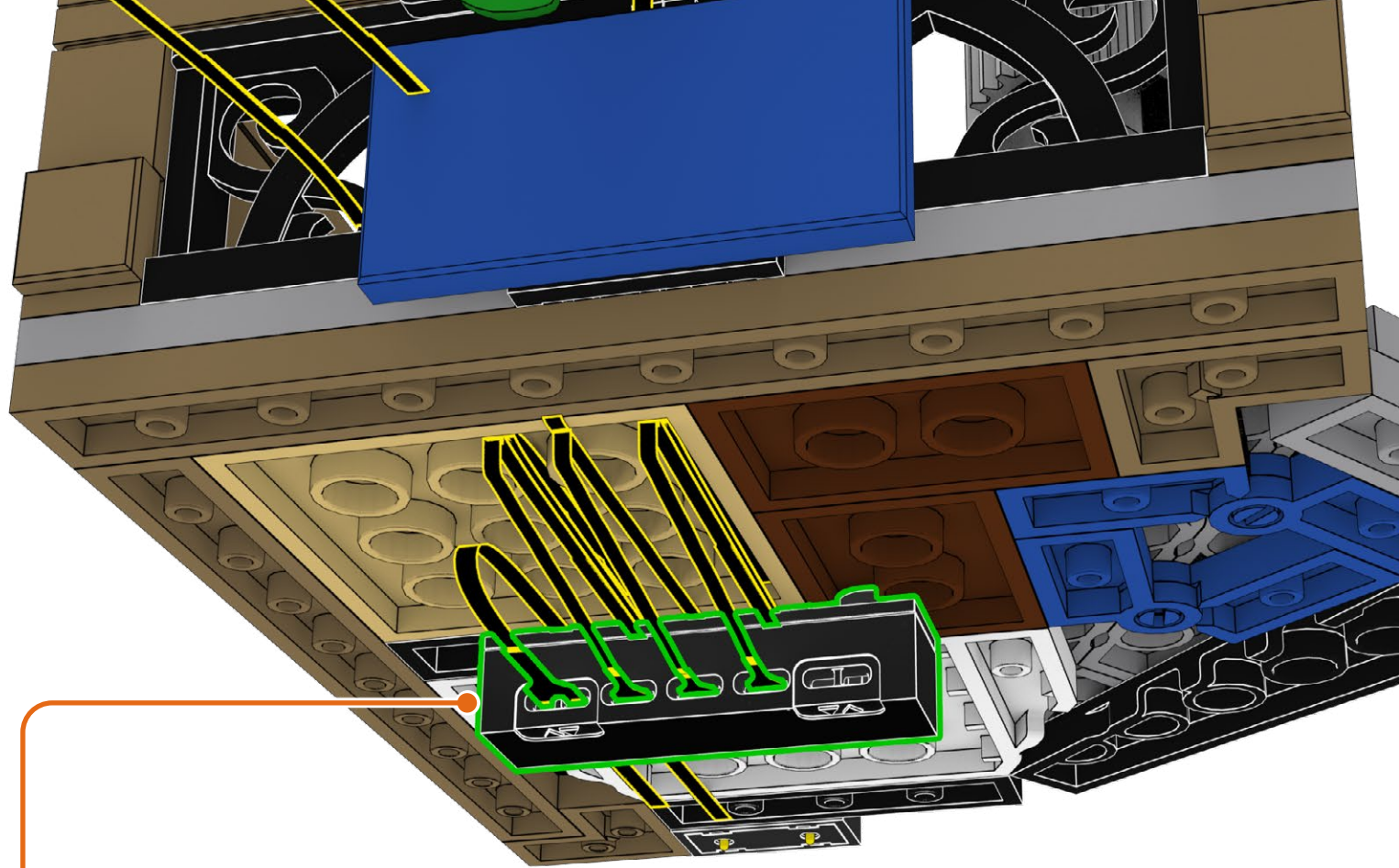

154

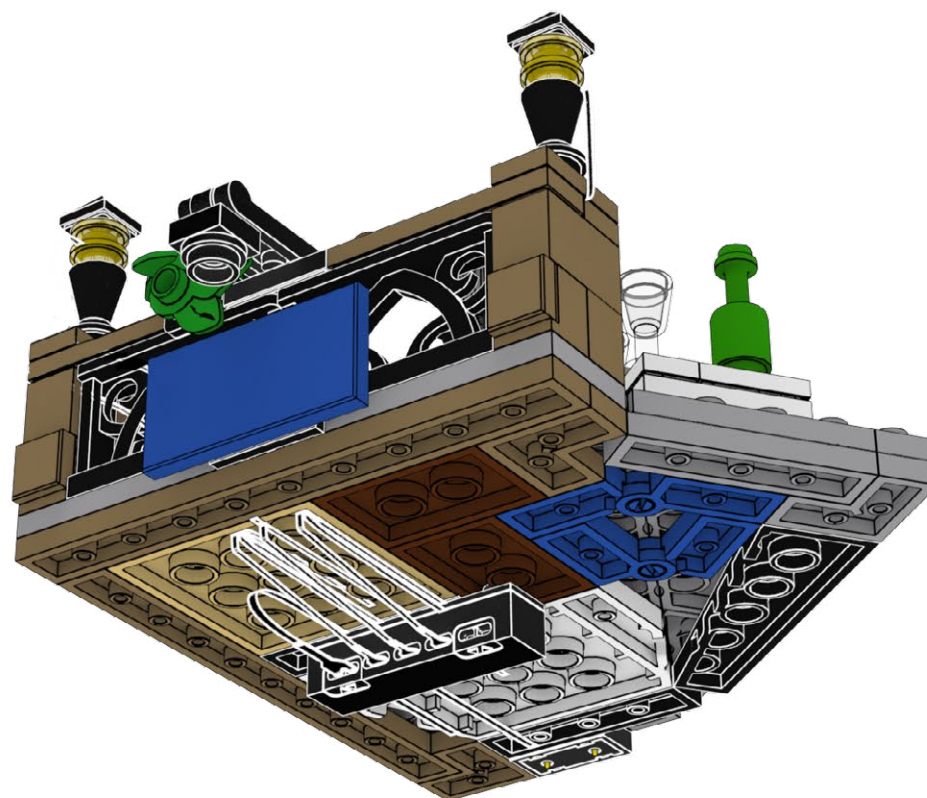

155

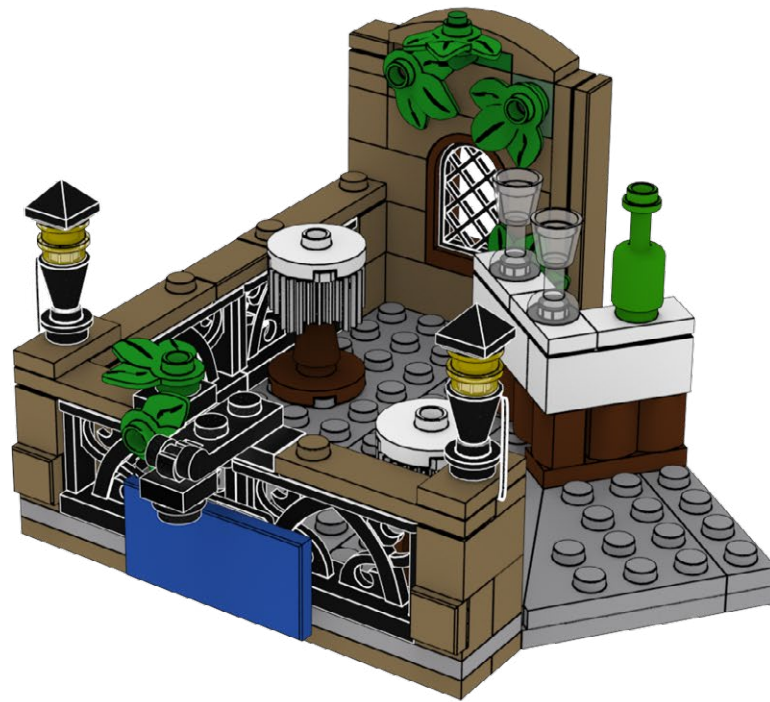

156



157



158



159



Power on Test
Test de mise sous tension
Test di Potenza
Stromtest
Prueba de Energía
电源测试



160

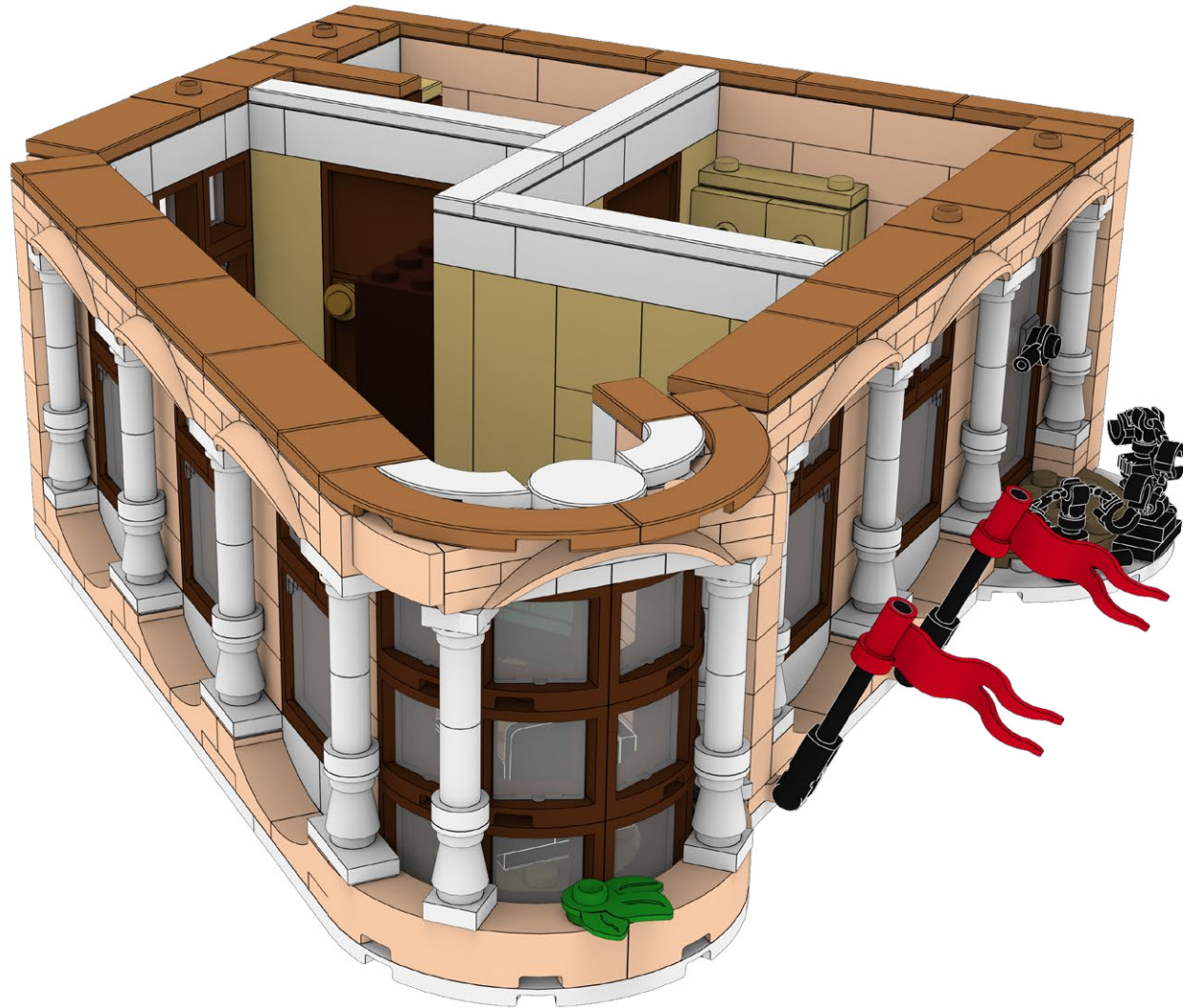

161

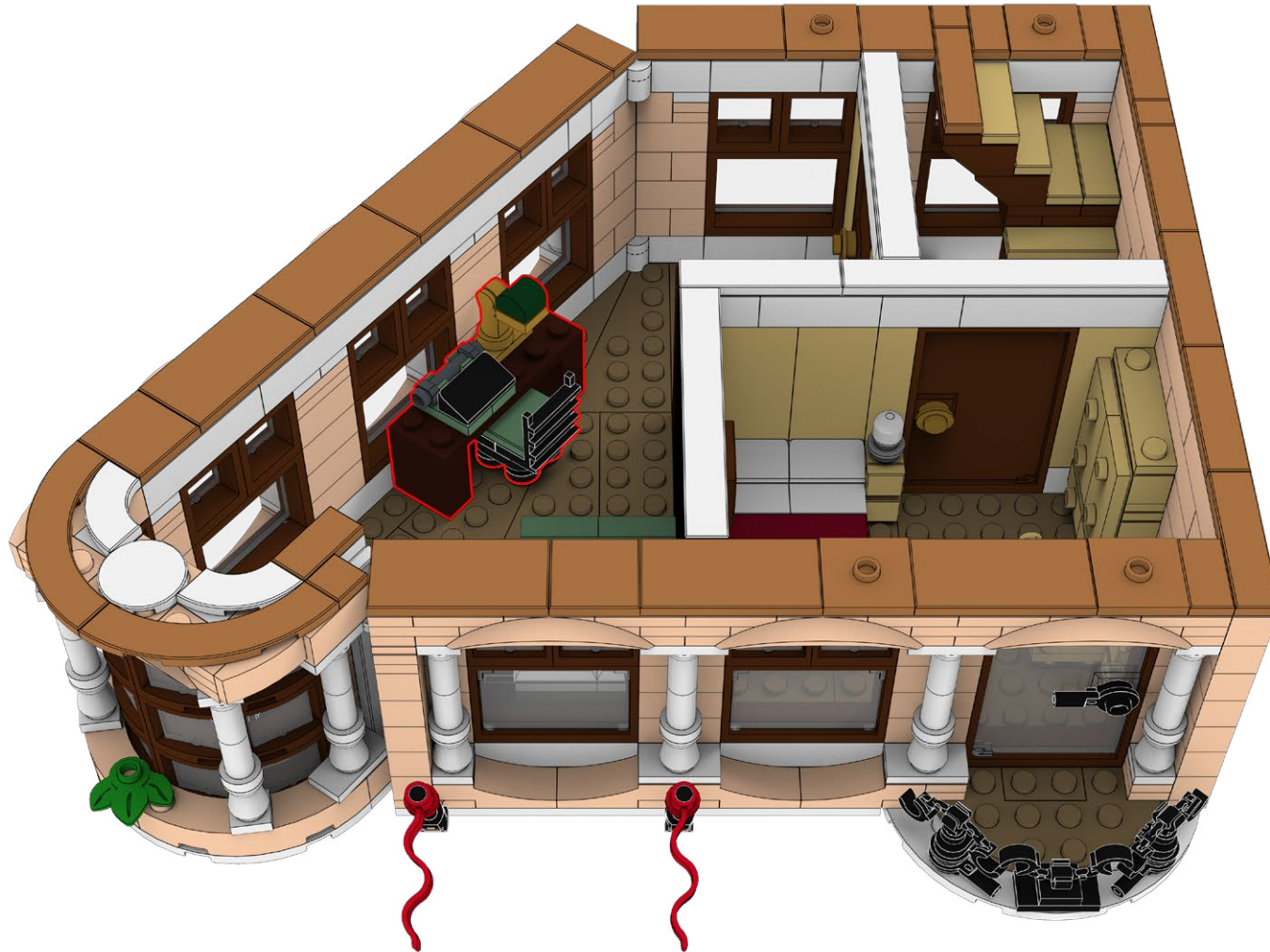

162

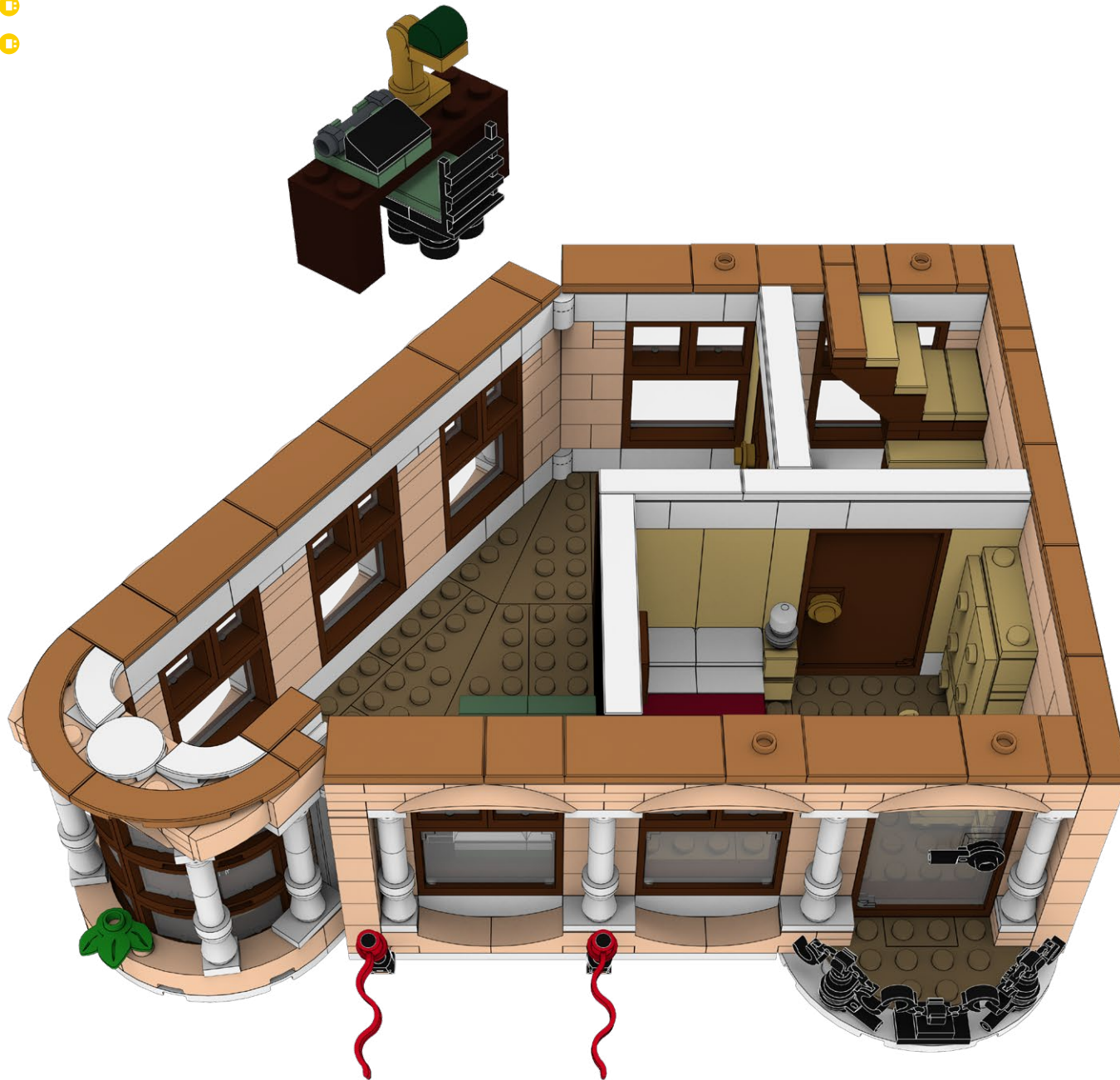

163

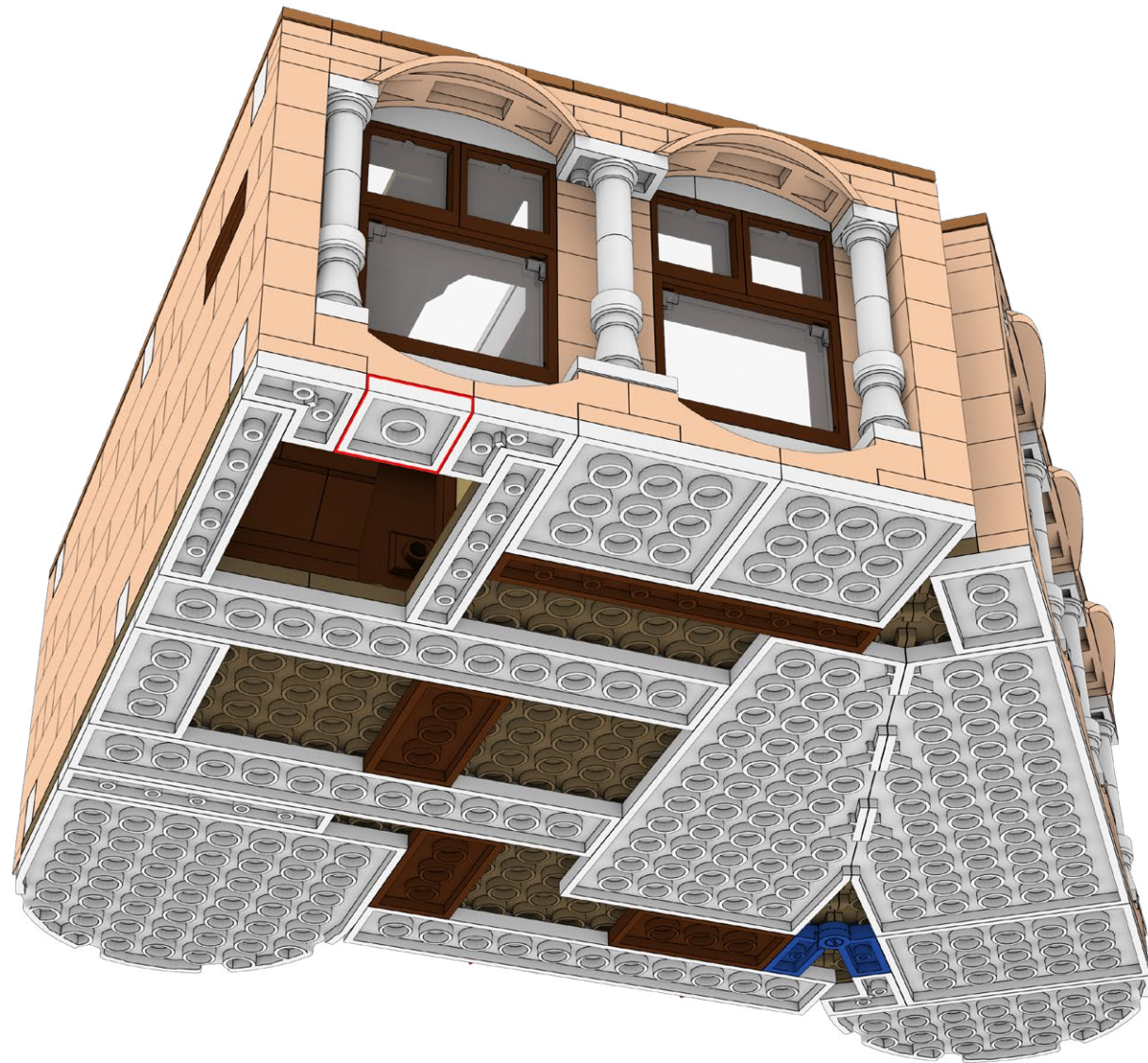

164

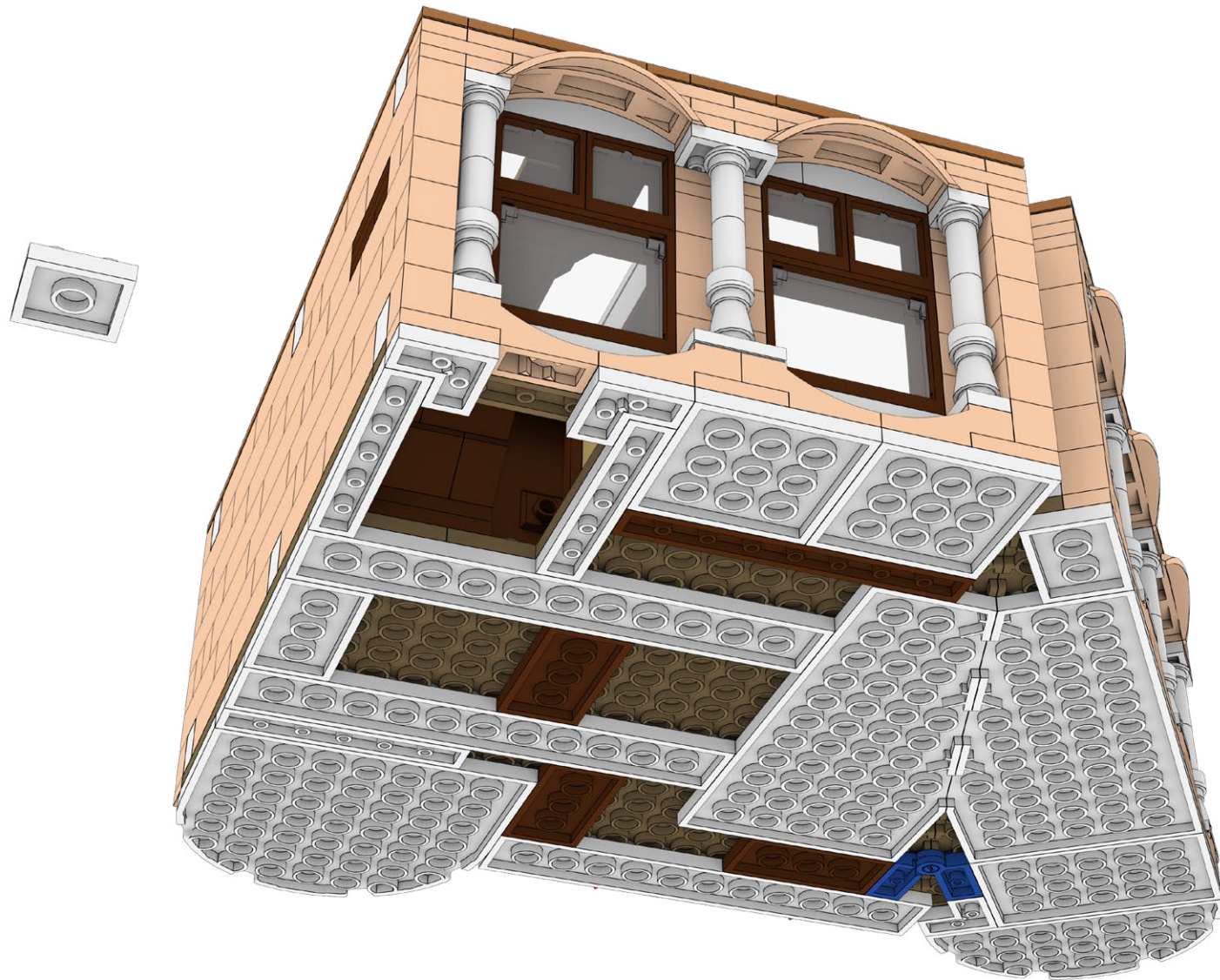

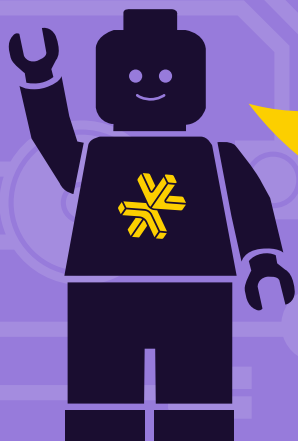

HOLD UP!

You might notice some bags aren't in order, as well as left over pieces, but that's ok! We're changing the way you build LEGO!

ATTENDEZ!

Vous remarquerez peut-être que certains sacs, ainsi que certaines pièces, ne sont pas dans le bon ordre. Mais pas de panique! Nous changeons simplement la façon avec laquelle vous construisez vos LEGO!

ASPETTA!

Potresti notare che alcuni sacchetti non sono in ordine, così come i pezzi avanzati, ma va bene così! Stiamo cambiando il modo in cui costruisci i LEGO!

HALT!

Sie werden möglicherweise bemerken, dass einige tüten durcheinander sind und teile übrig bleiben, aber das ist in Ordnung! Wir ändern die art und weise, wie Sie LEGO bauen!

¡ESPERA!

Es posible que notes que algunas bolsas están fuera de servicio, así como piezas sobrantes, ¡pero está bien! ¡Estamos cambiando la forma en que construyes LEGO!

暫停!

你可能会注意到一些袋子顺序错乱, 以及一些剩余的部件, 但没关系! 我们正在改变你搭建乐高的方式!

Open LMB Bag 04

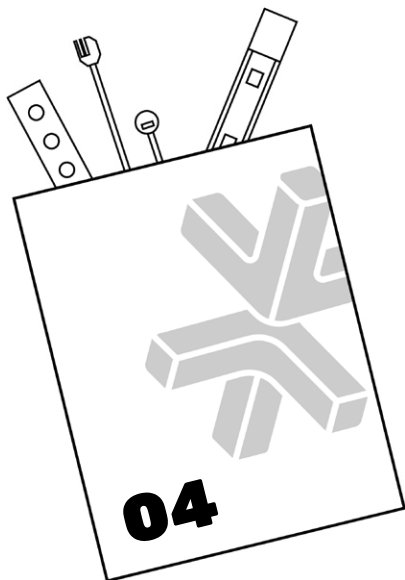

165

FLX-TPA15

1x

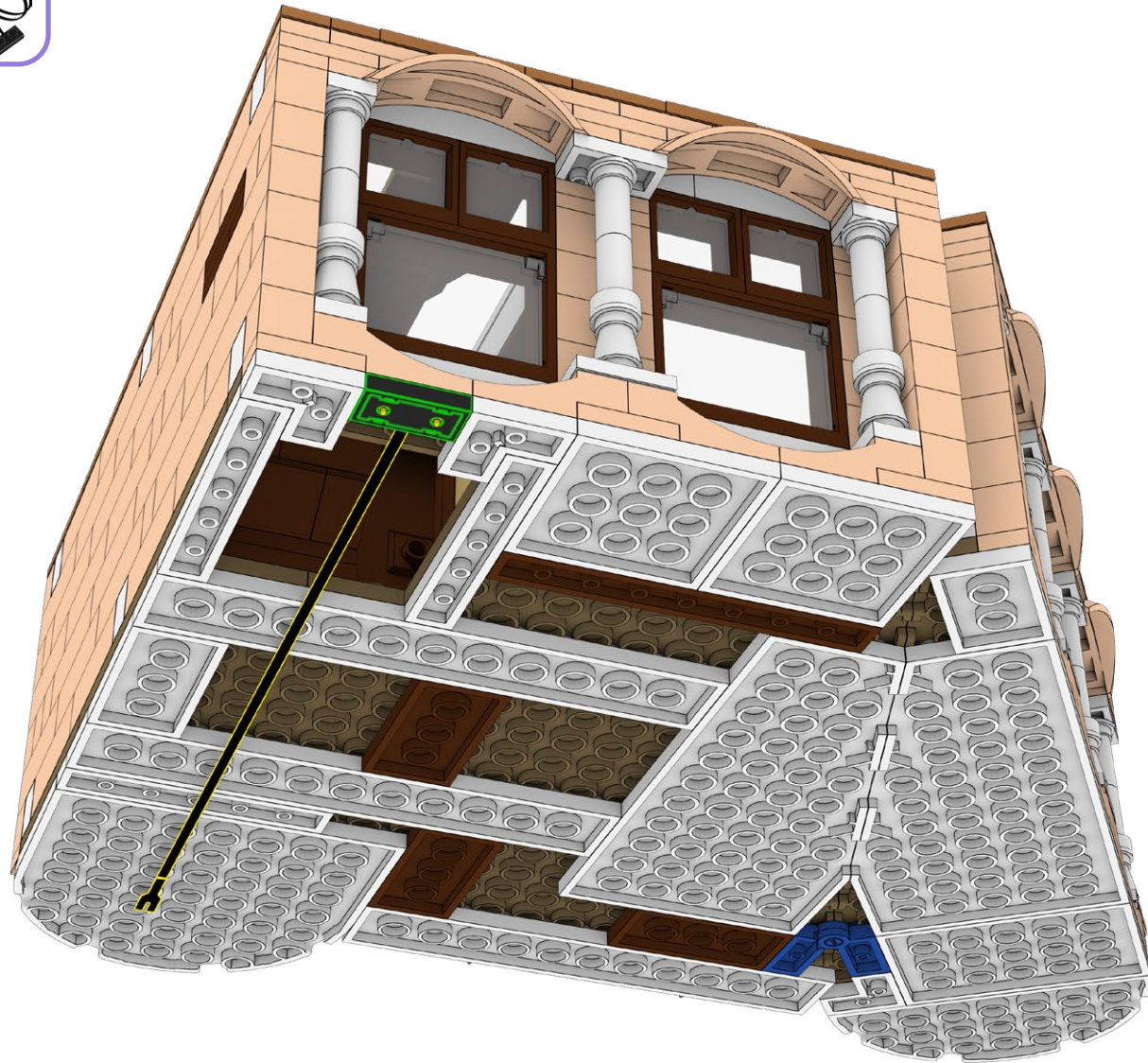

166

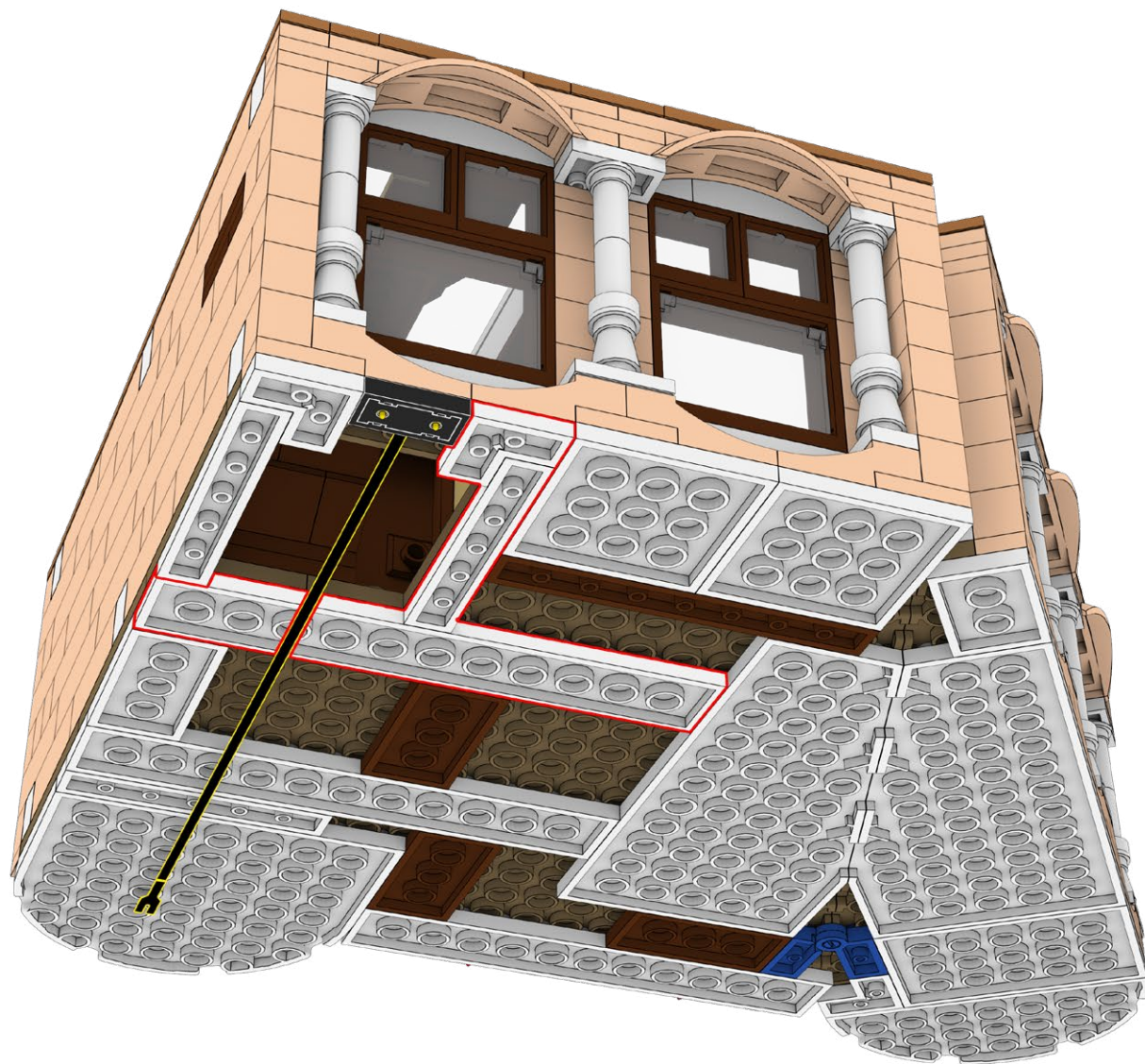

167

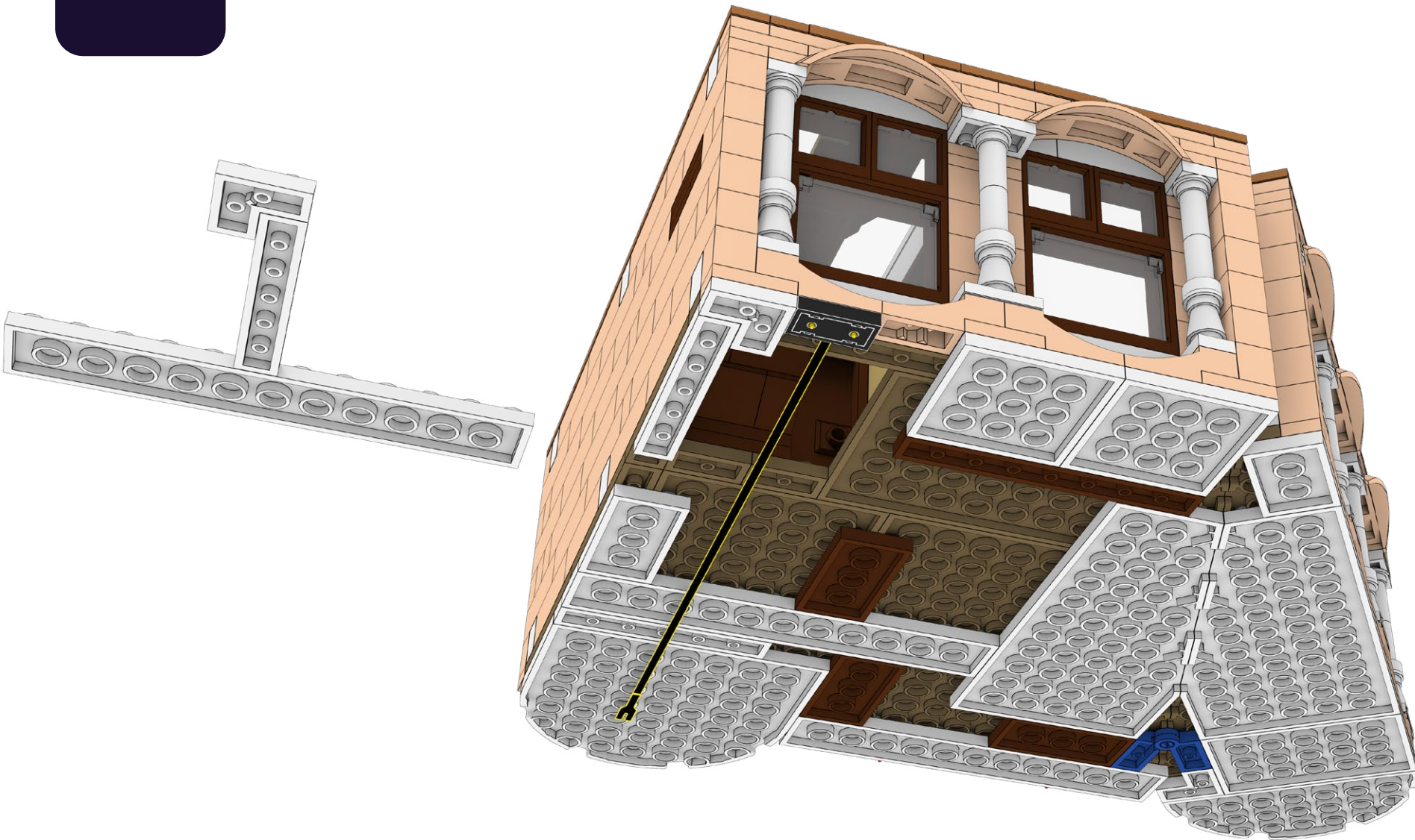

168

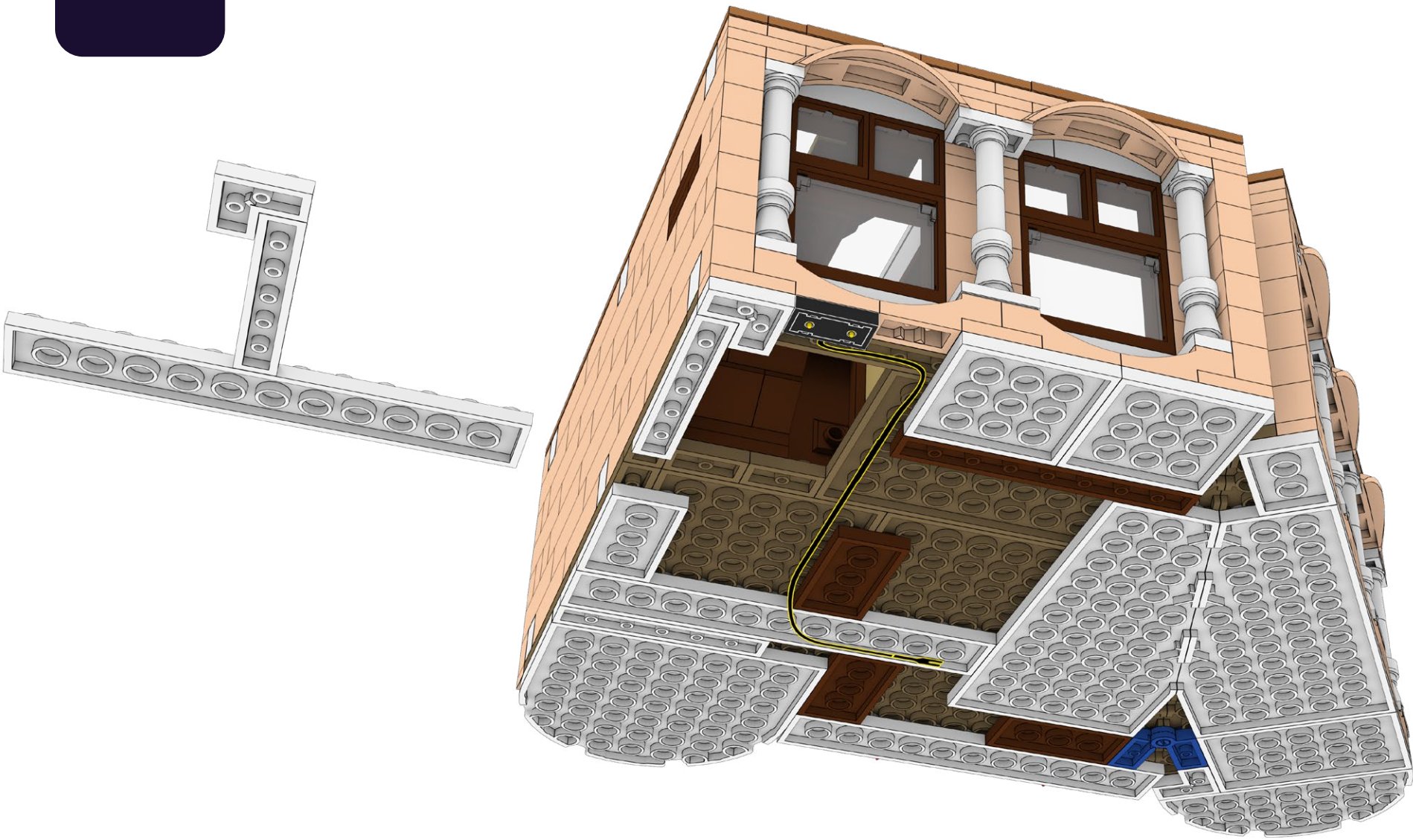

169

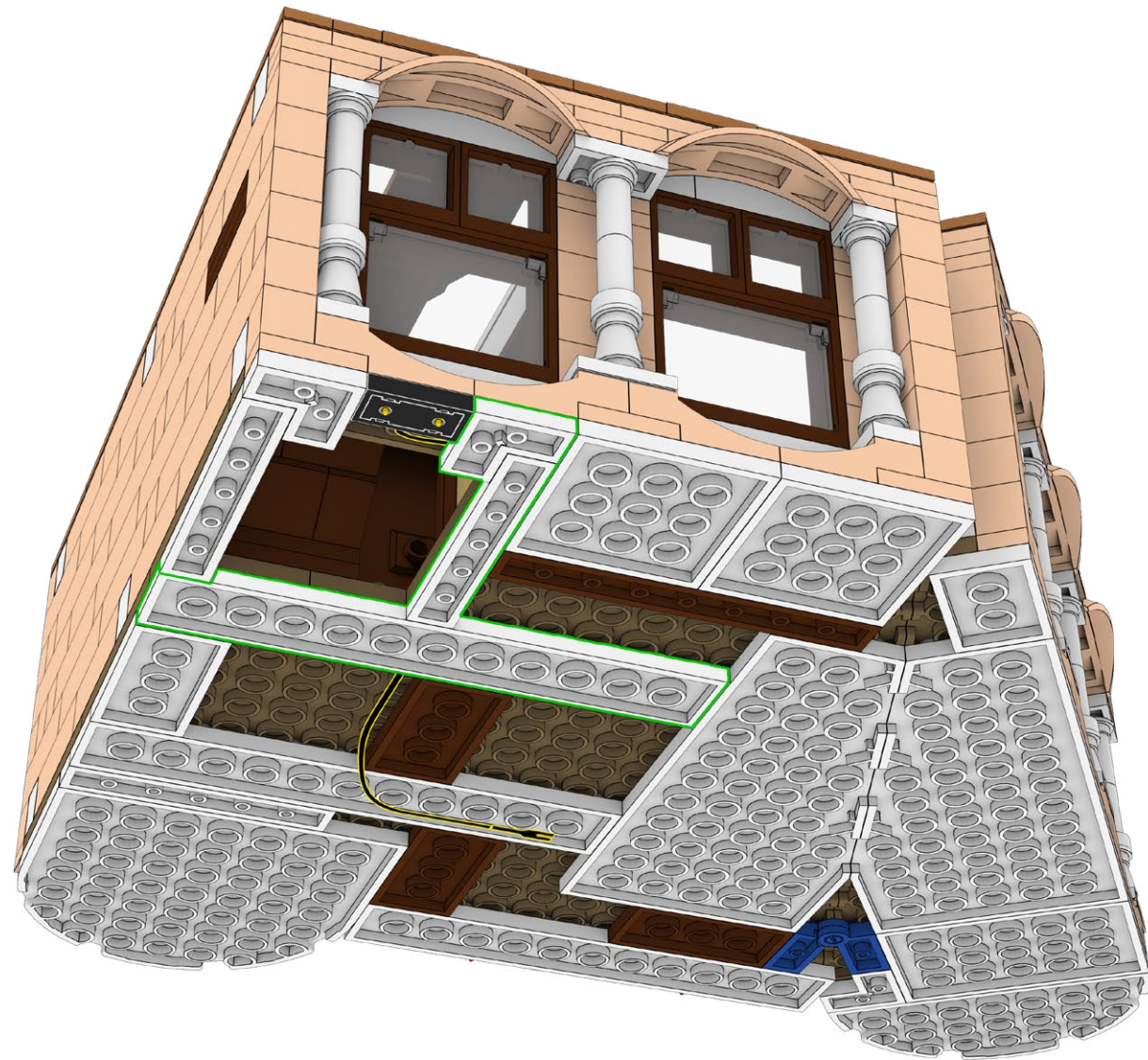

170

ML-WW

1x

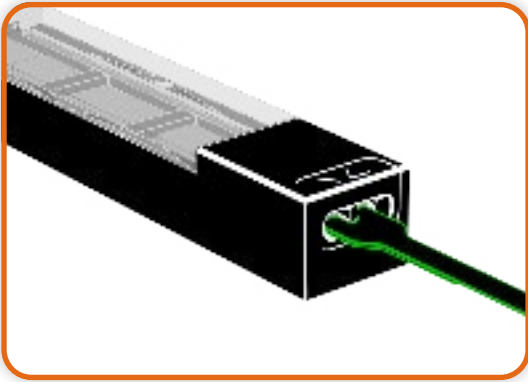
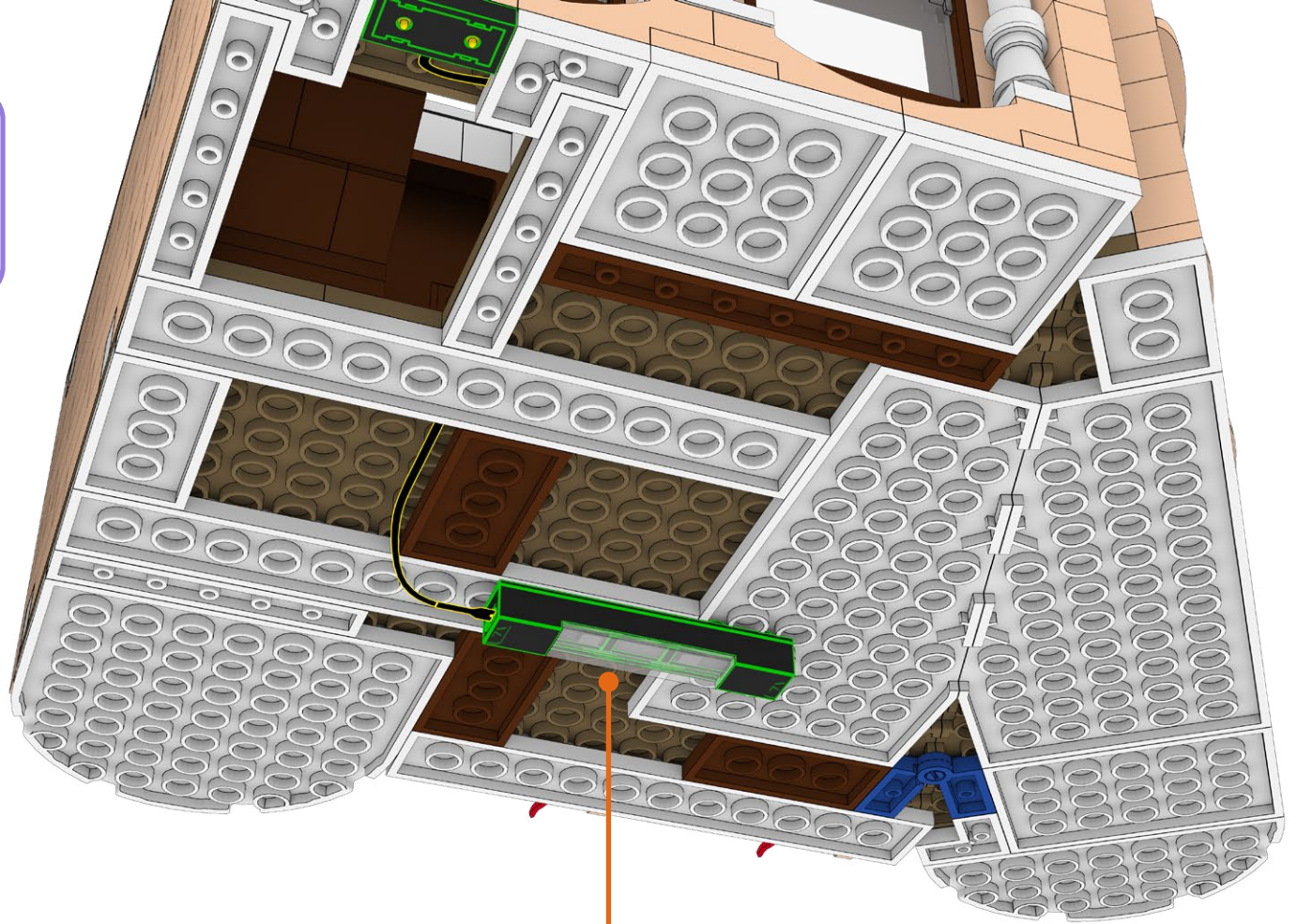

171

B-5
1x

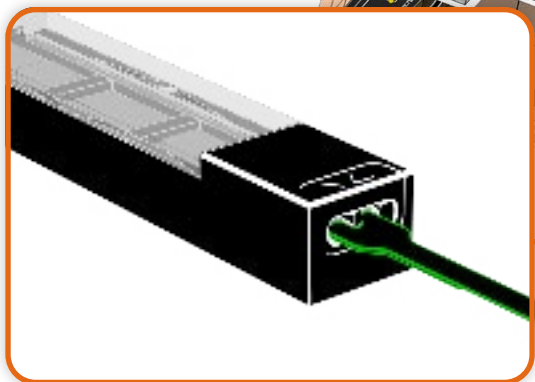
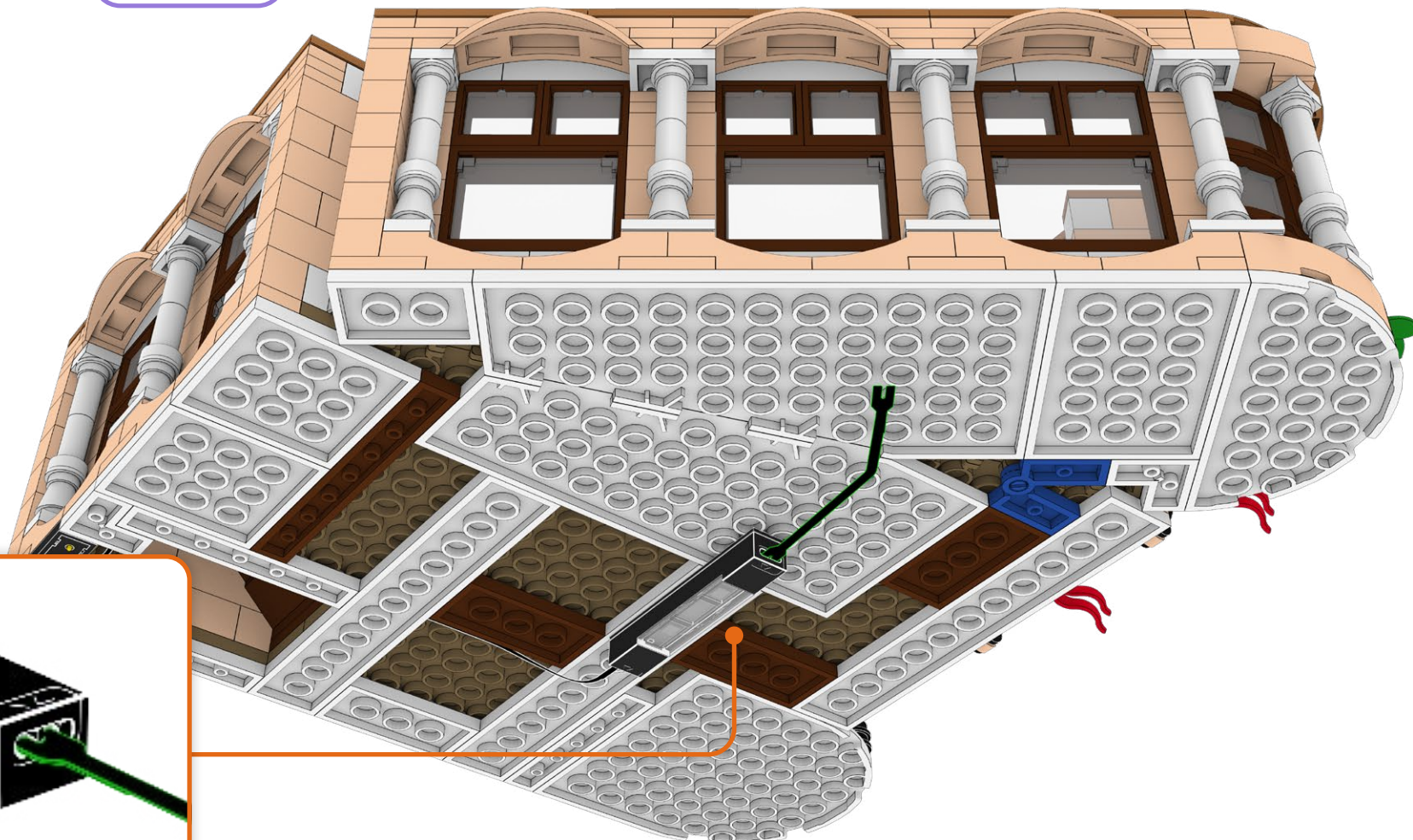

172

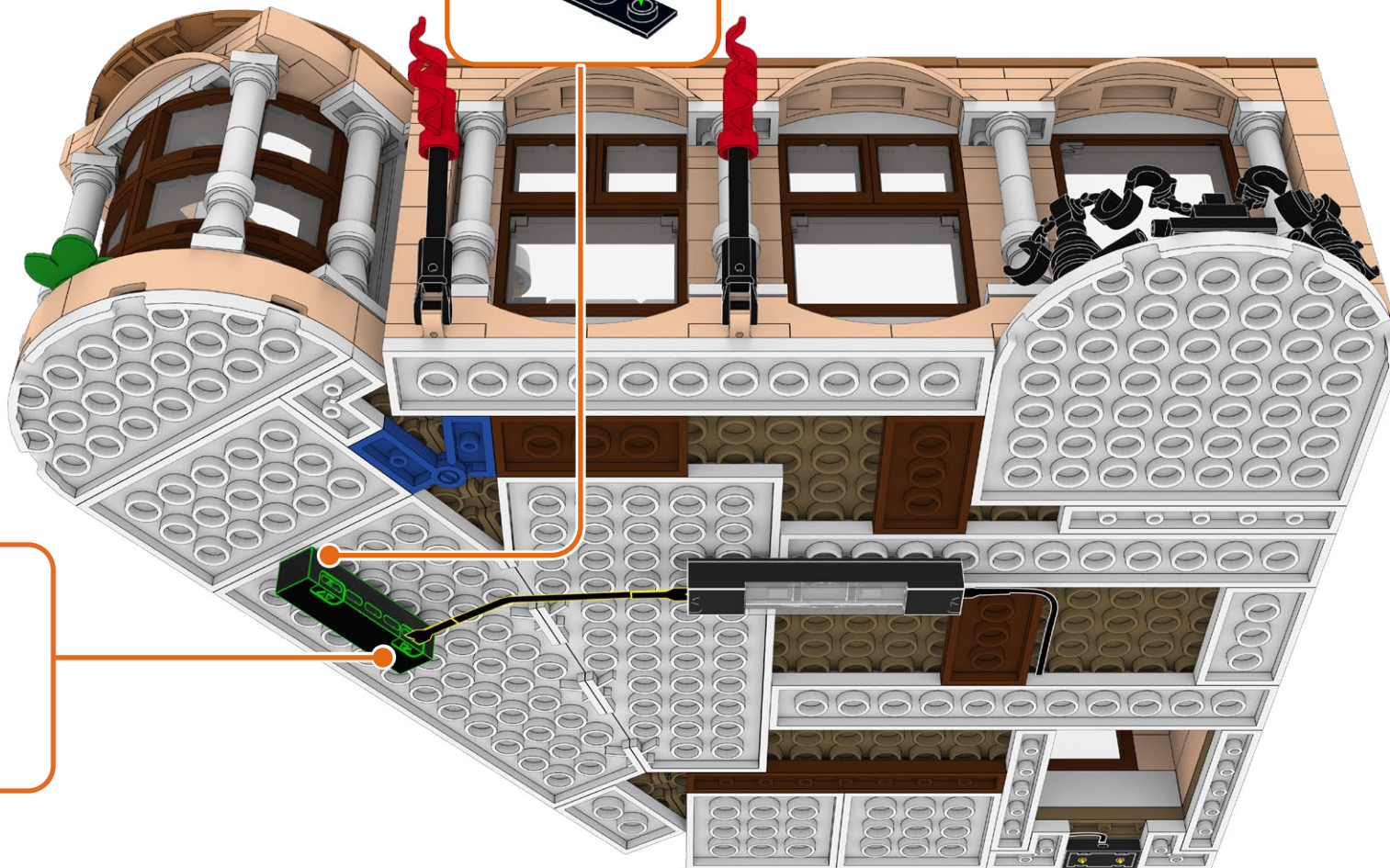
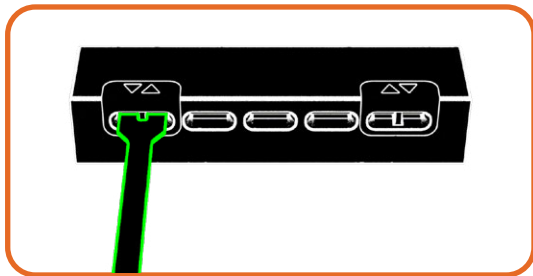
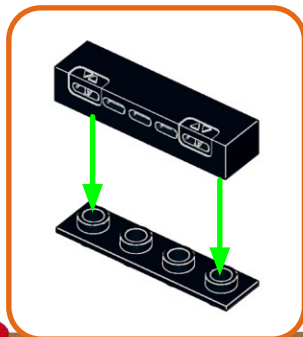
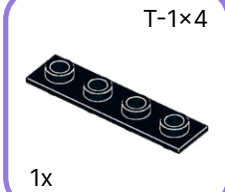
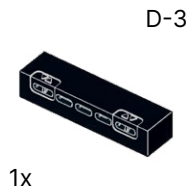

173

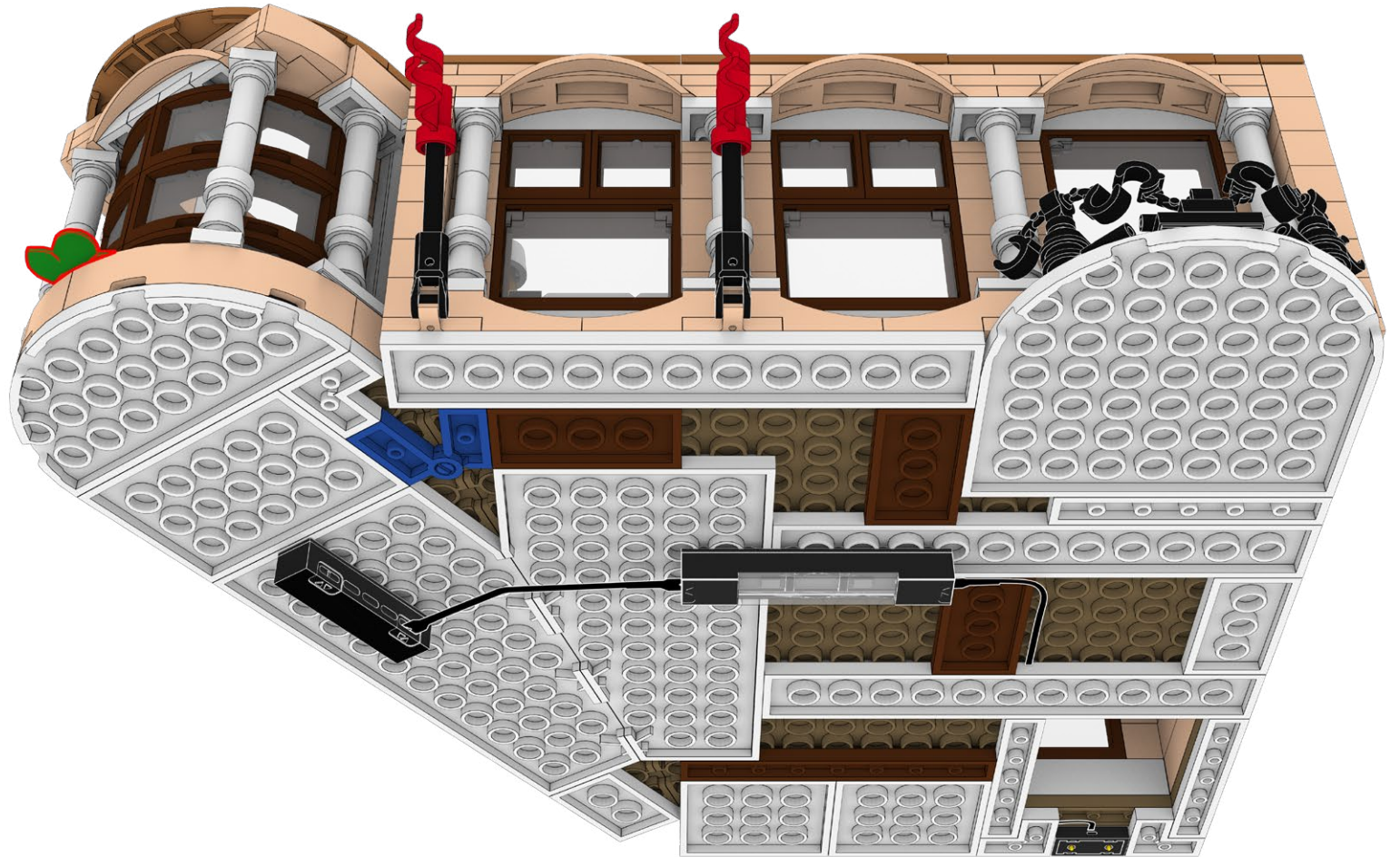

174

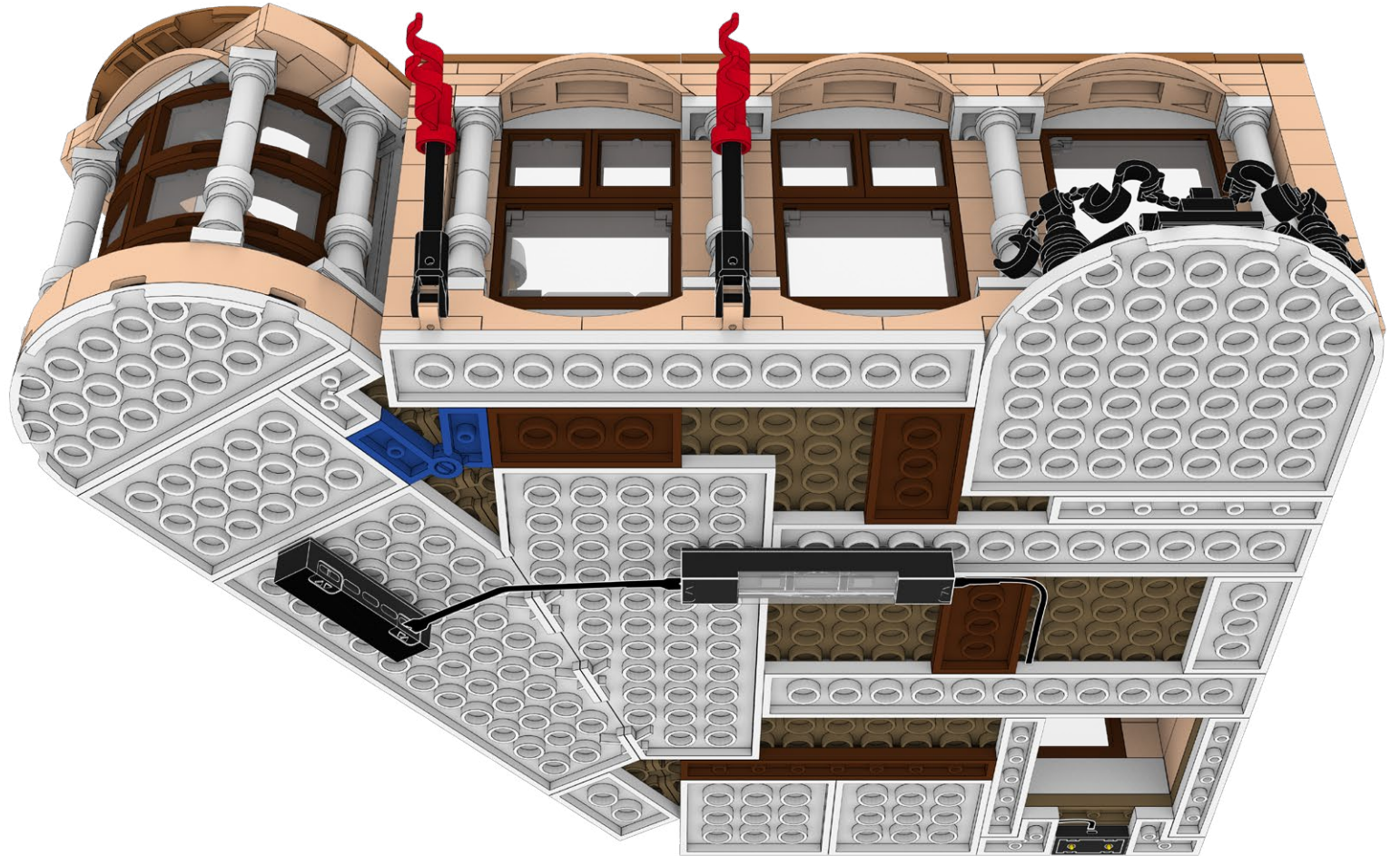

175

AR-WW15

1x

1x

1

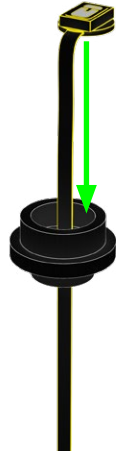

2



176

1x

1x

1

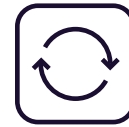

2

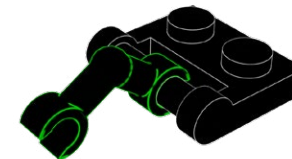

177

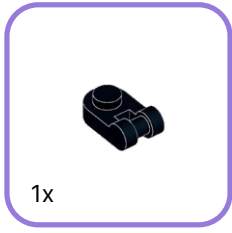

1

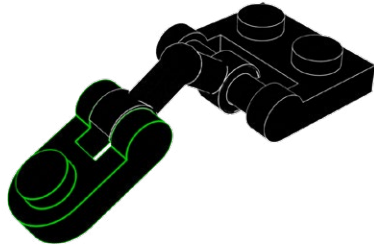

2

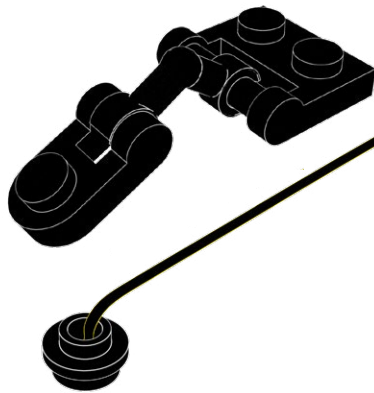

178

1

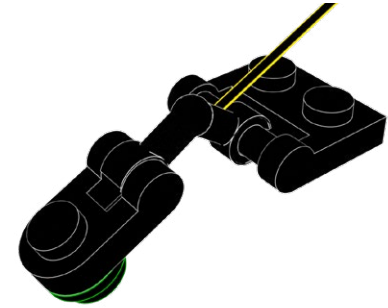

2

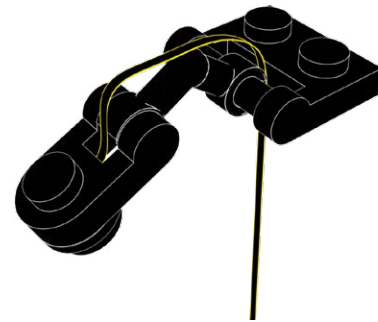

179

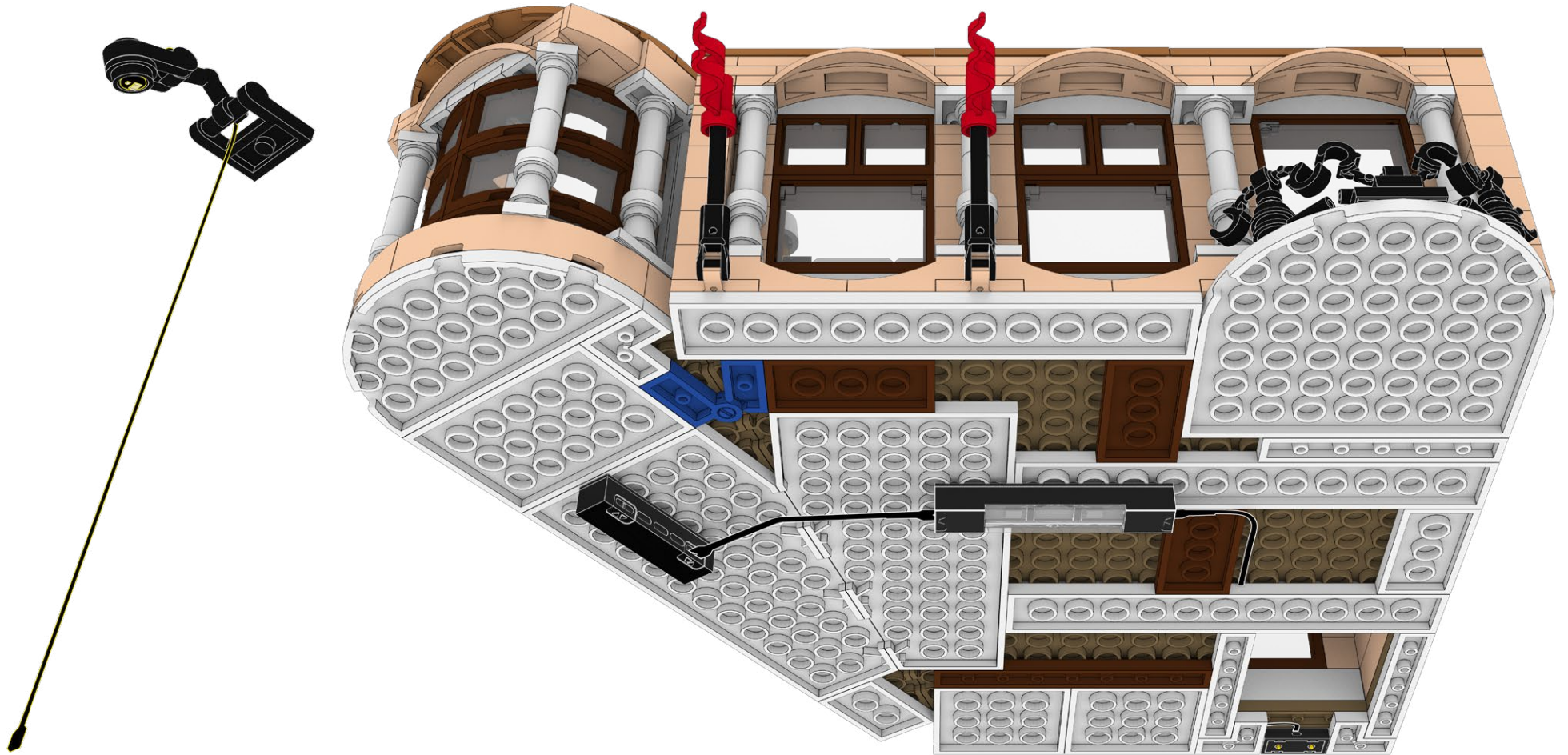

180

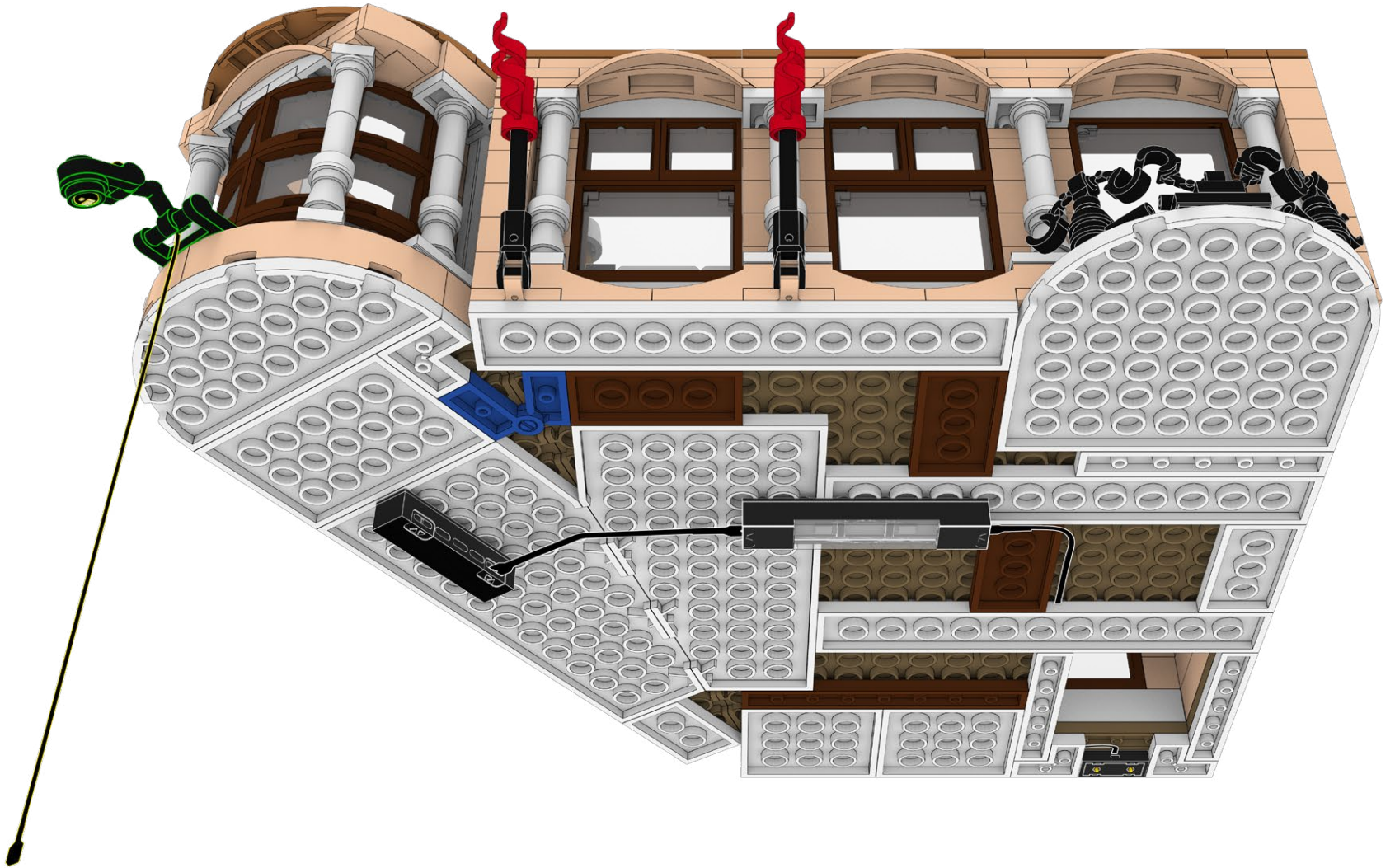

181

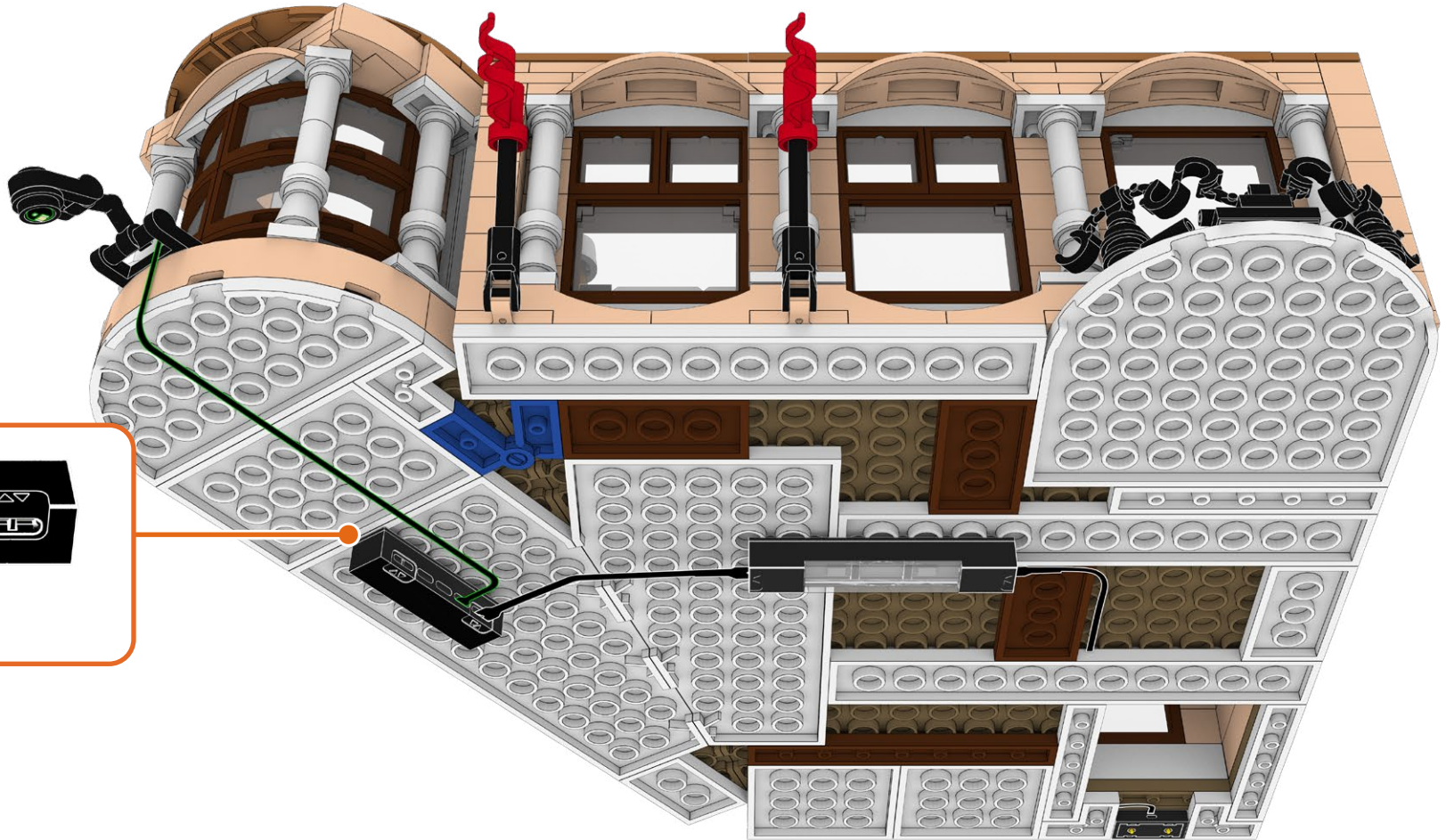

182

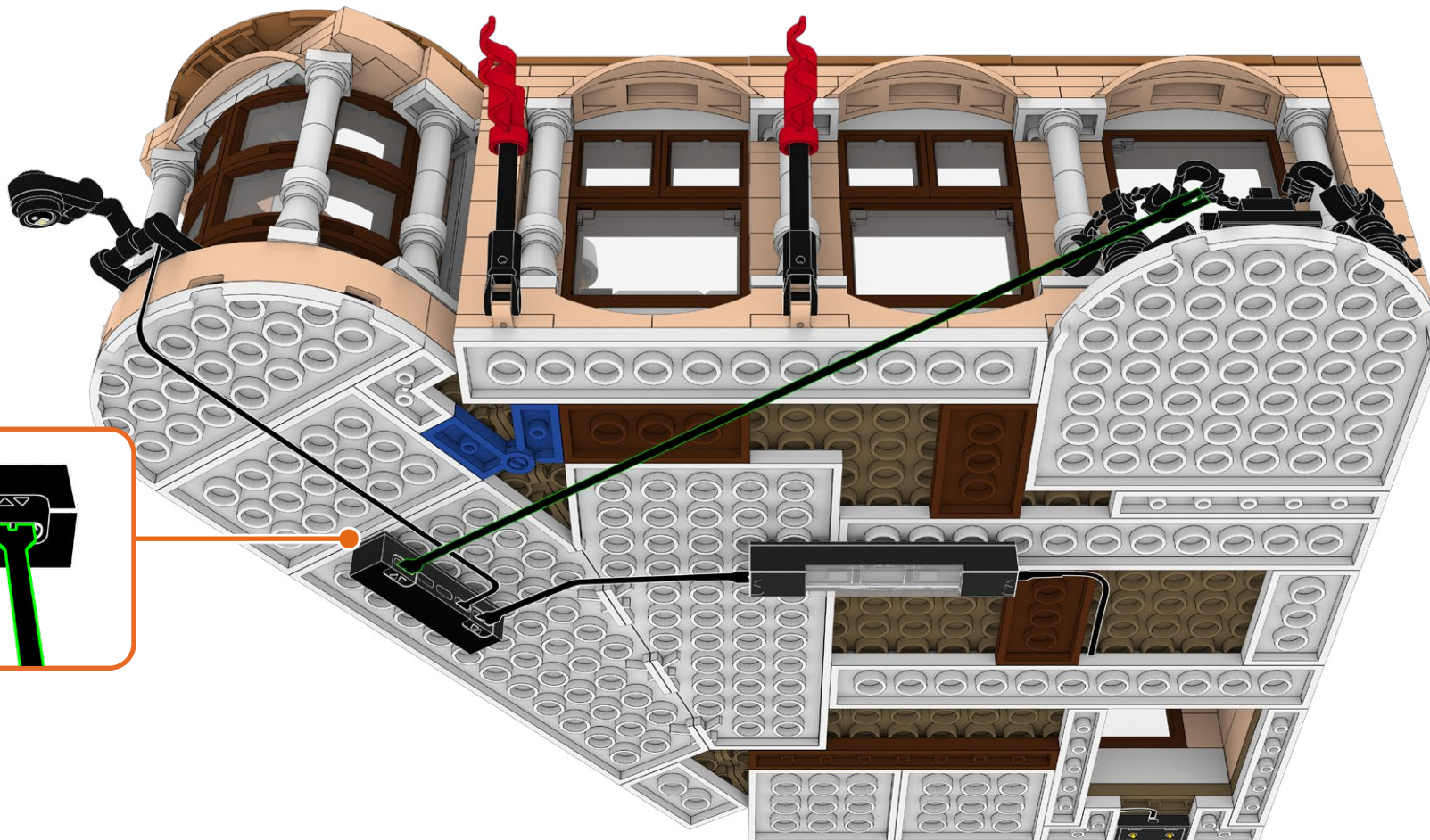
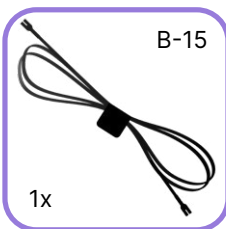

183

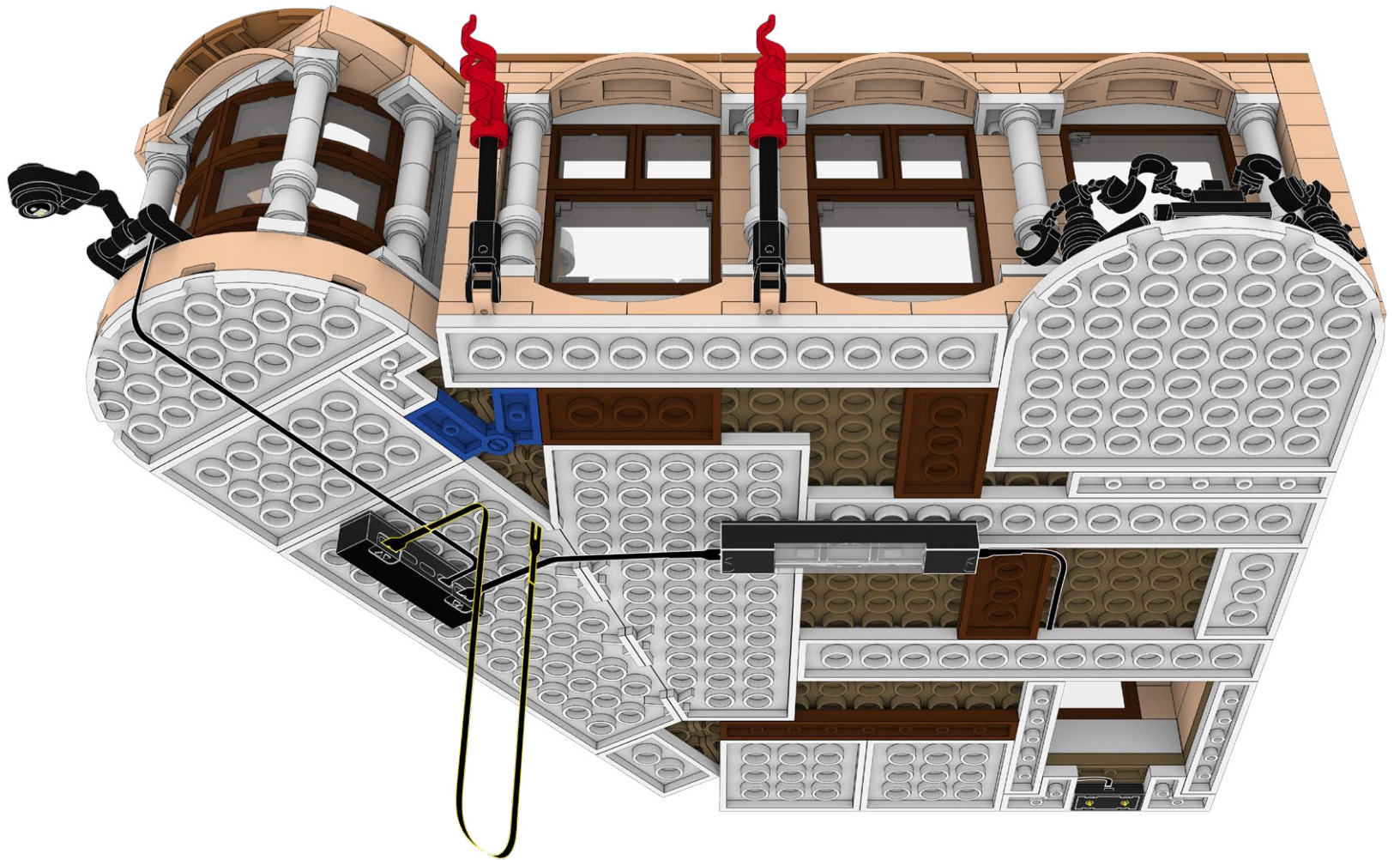

184

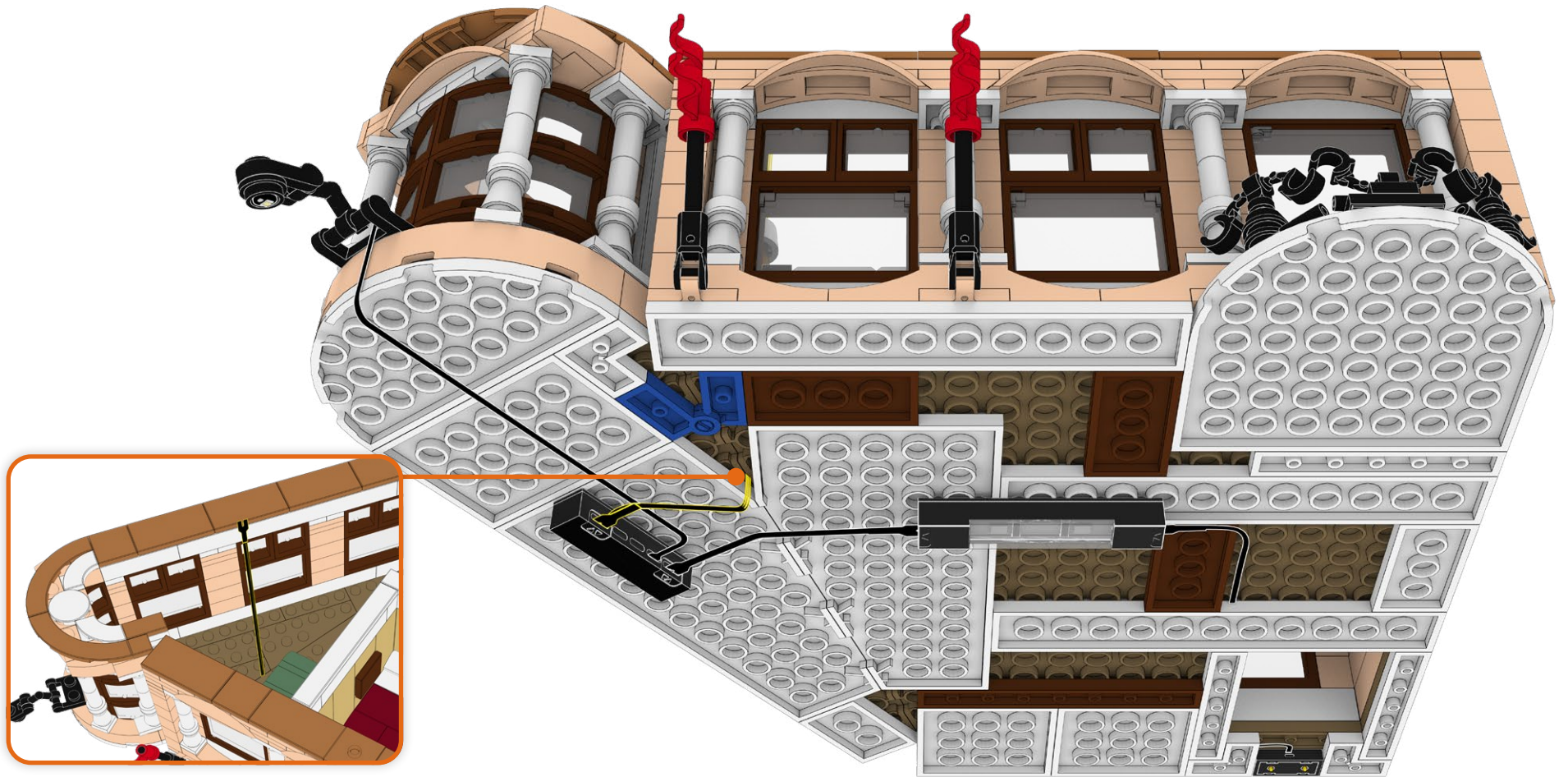

185

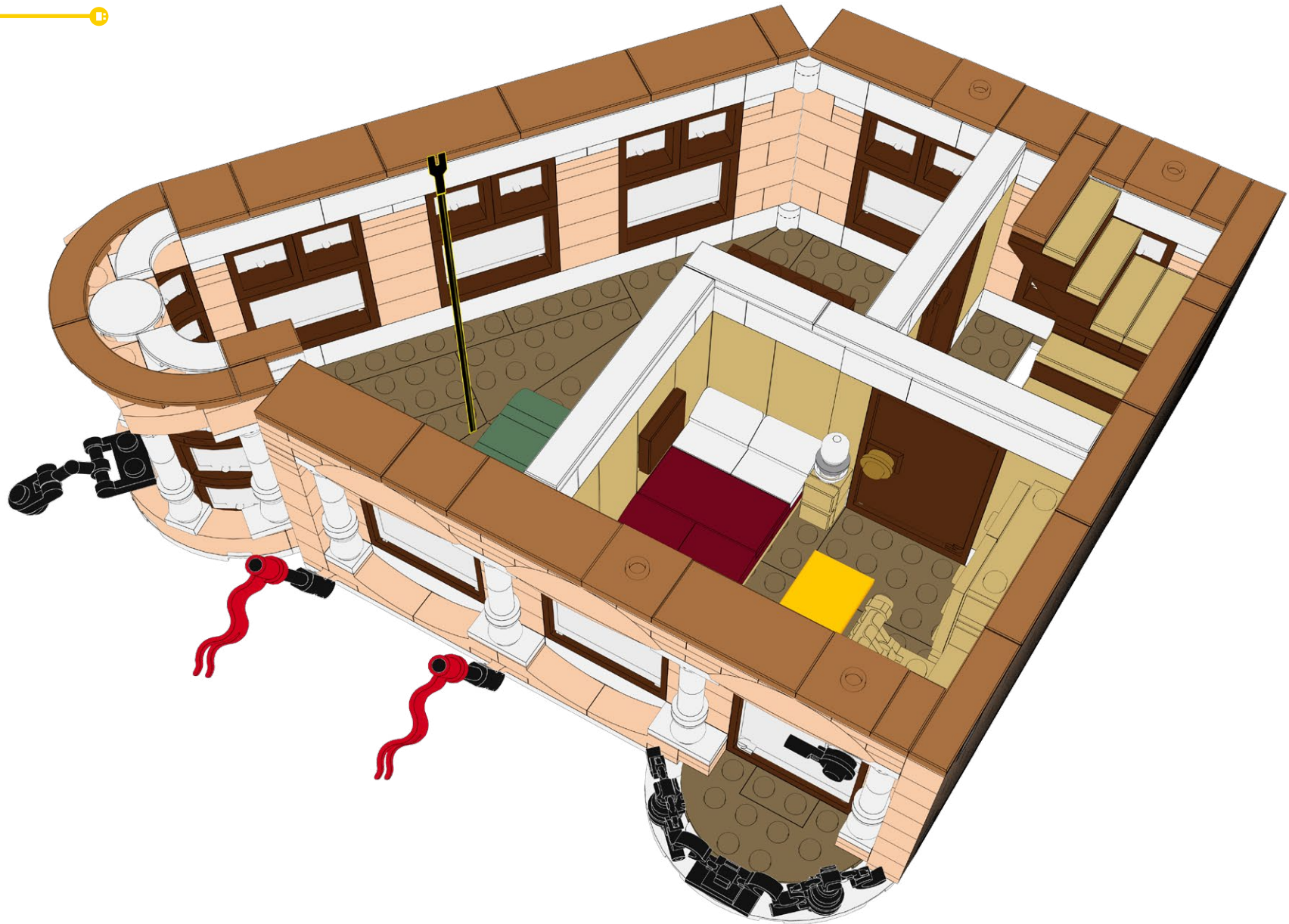

186

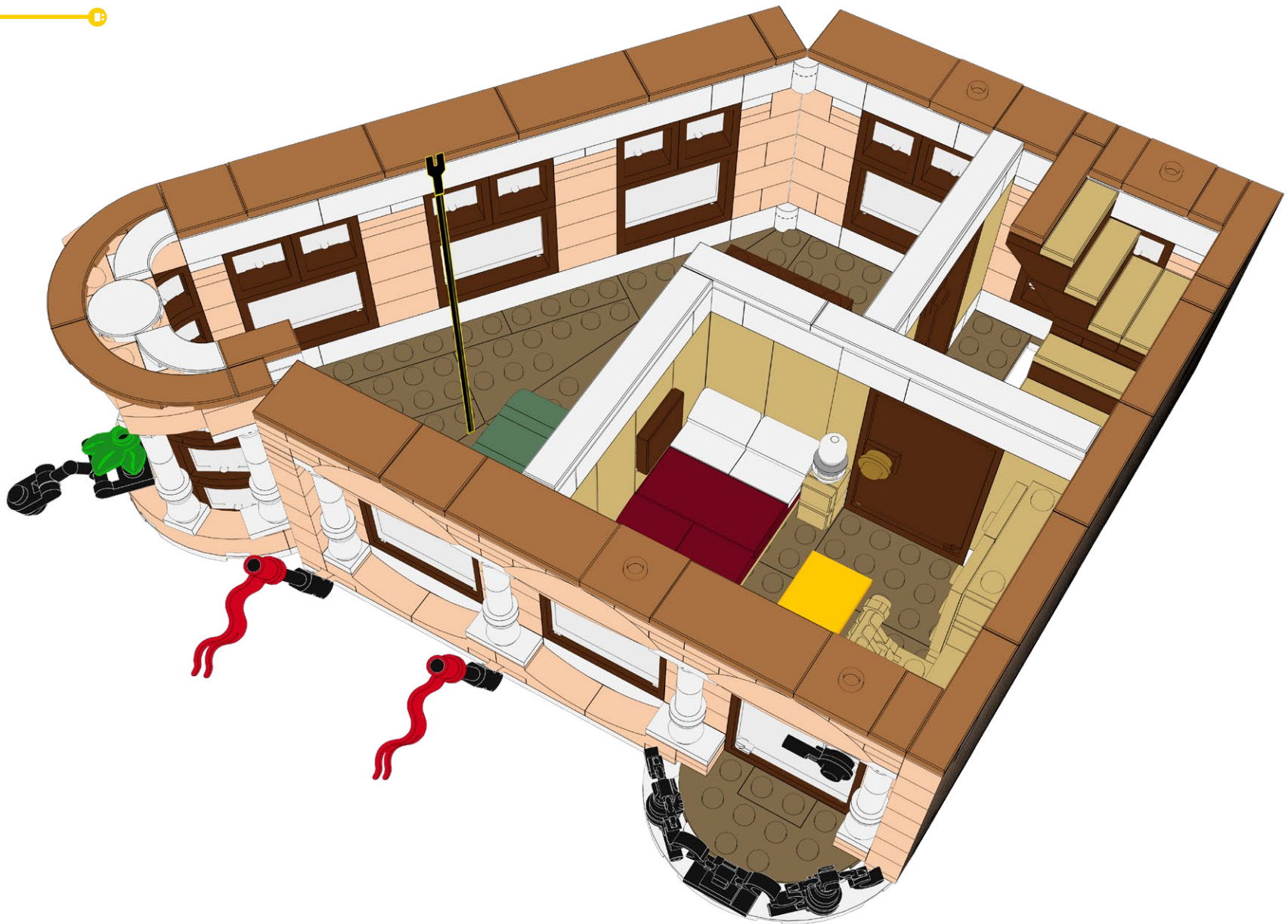

187

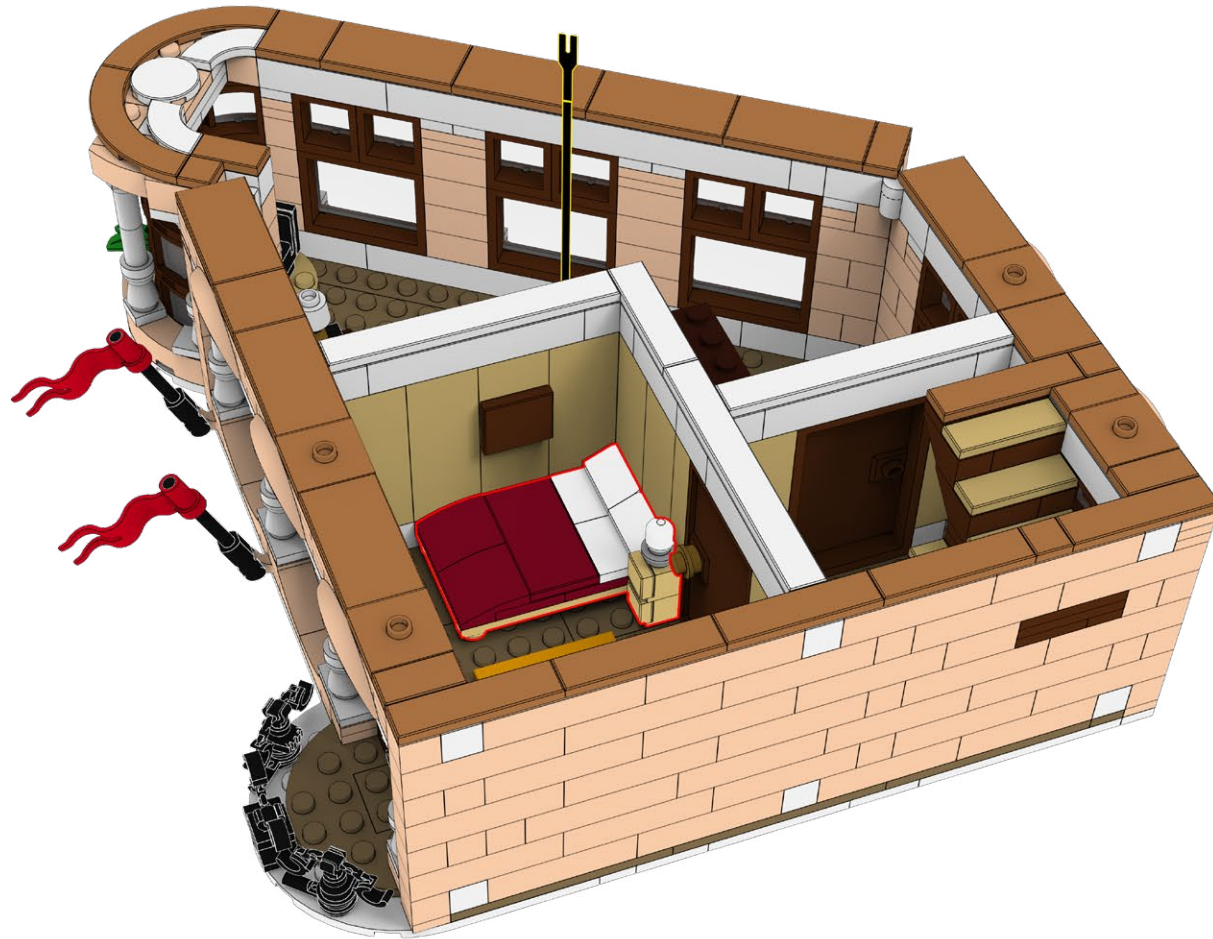

188

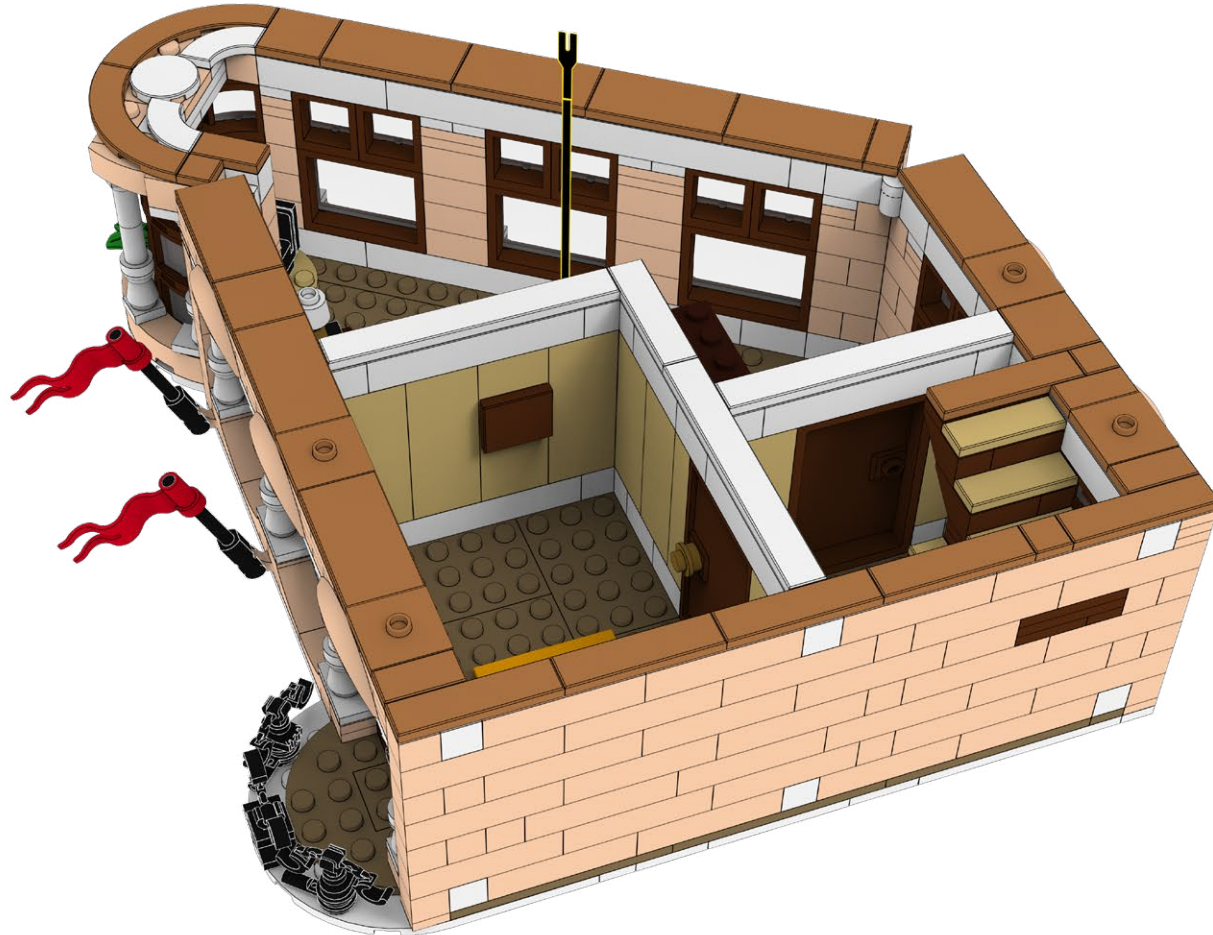
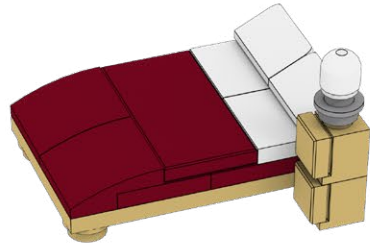

189

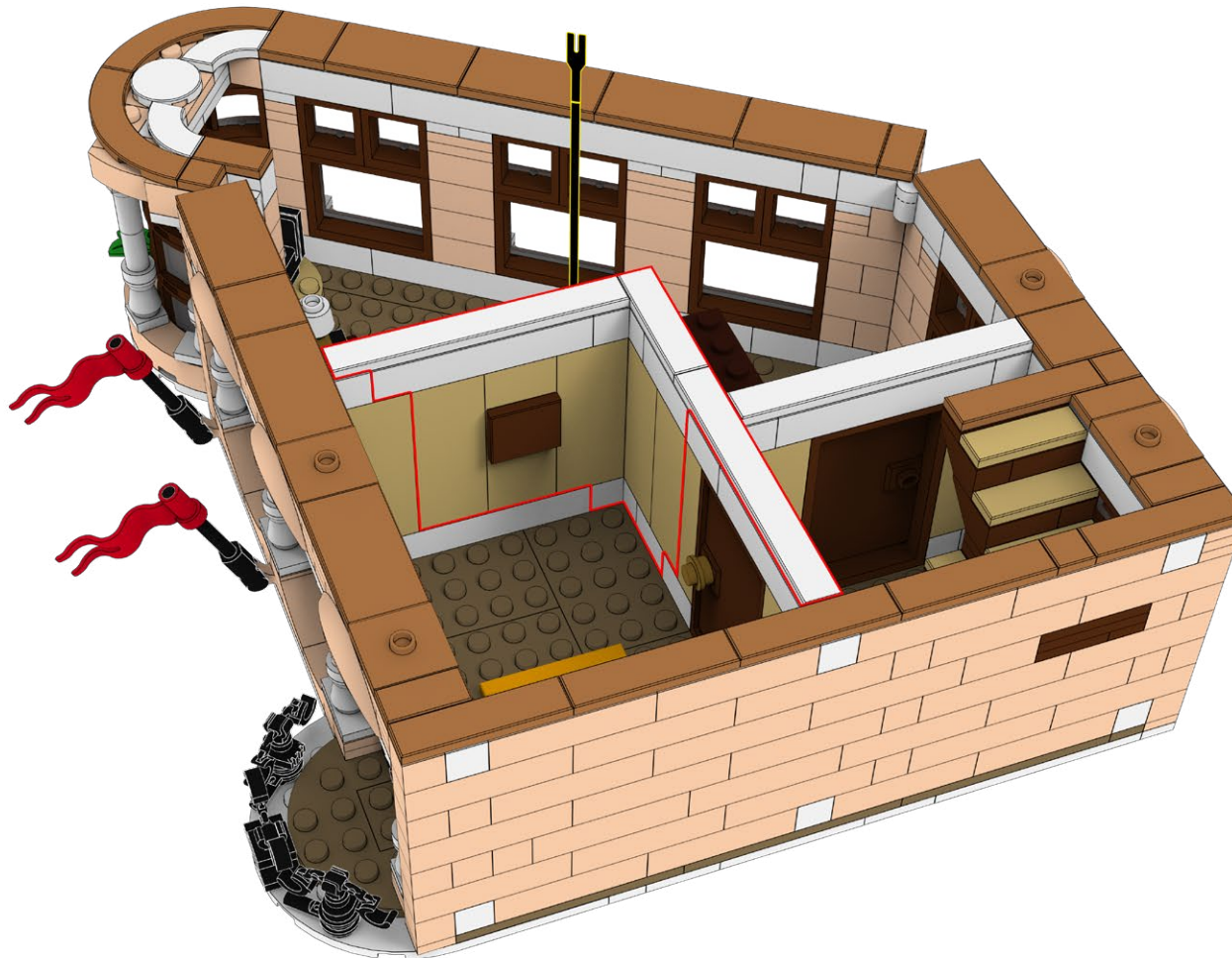

190





1

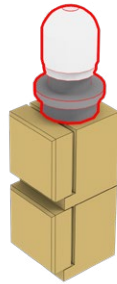

2

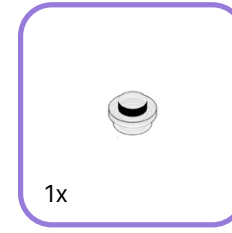
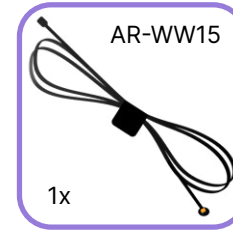
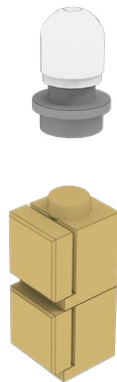

1

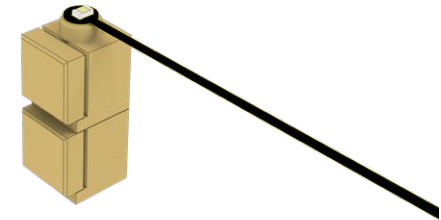

2

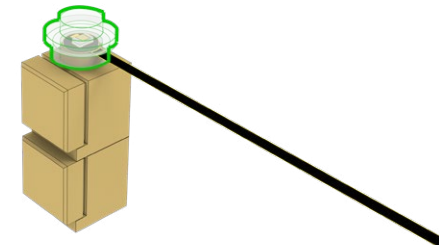

1

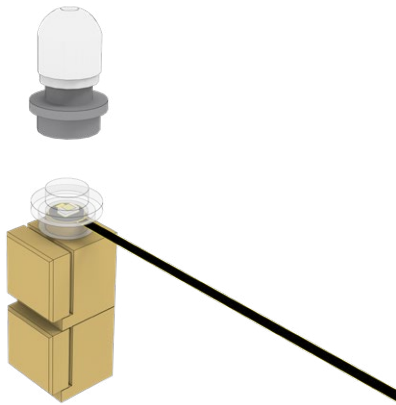

2

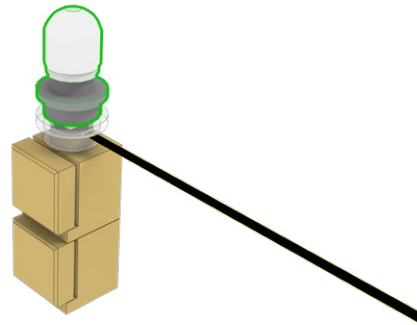

3

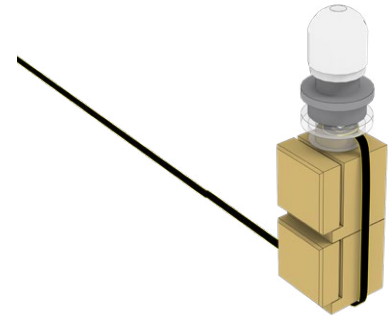

194

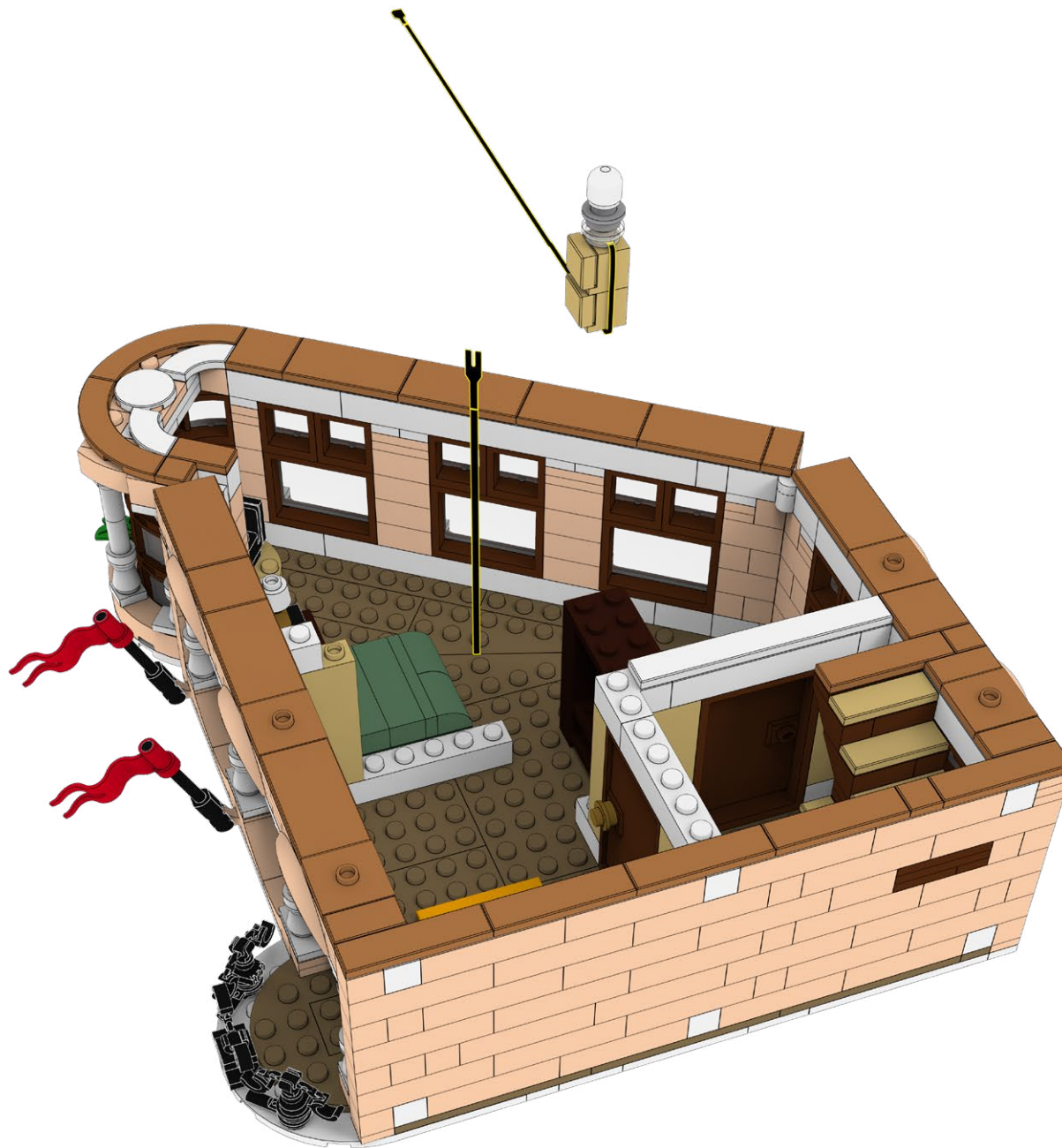

195

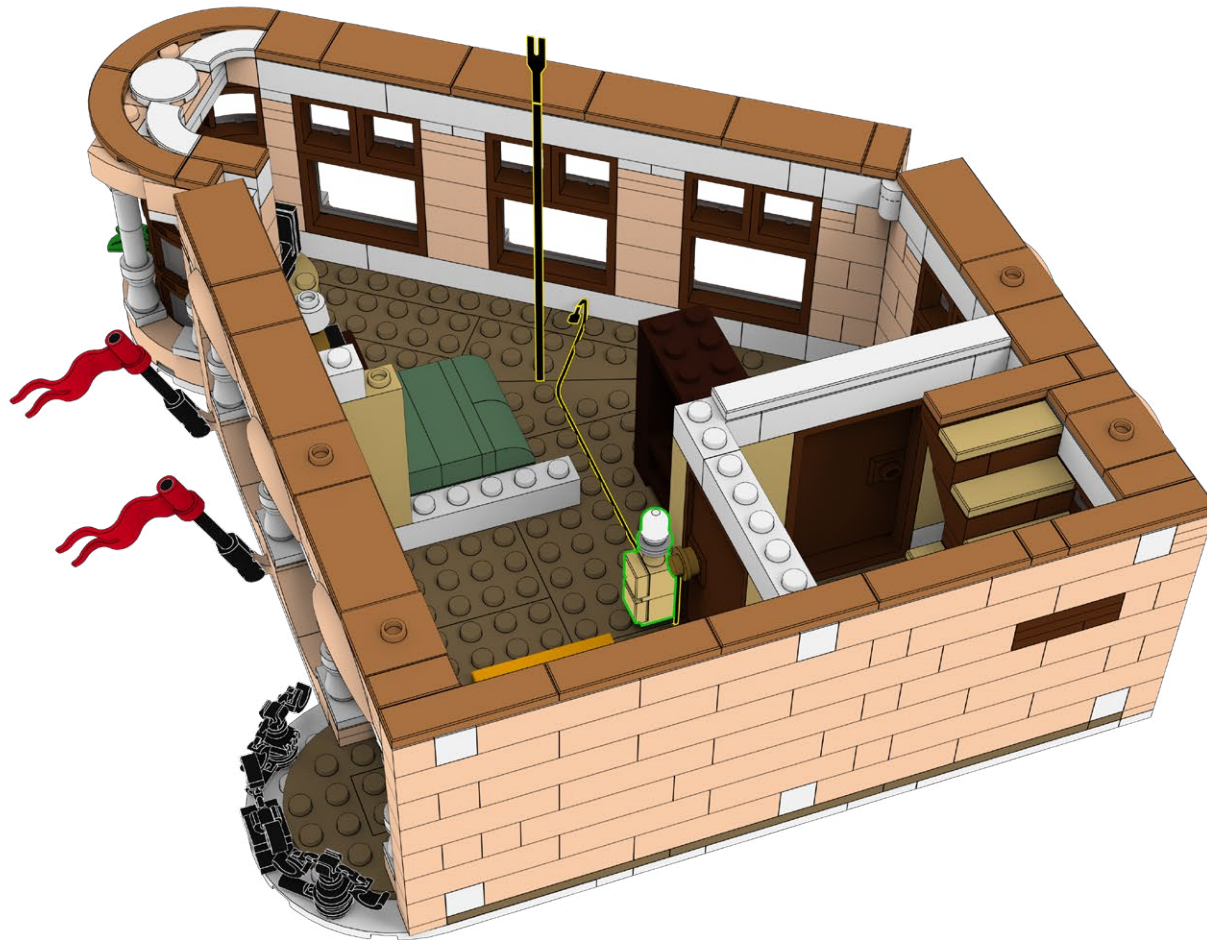

196

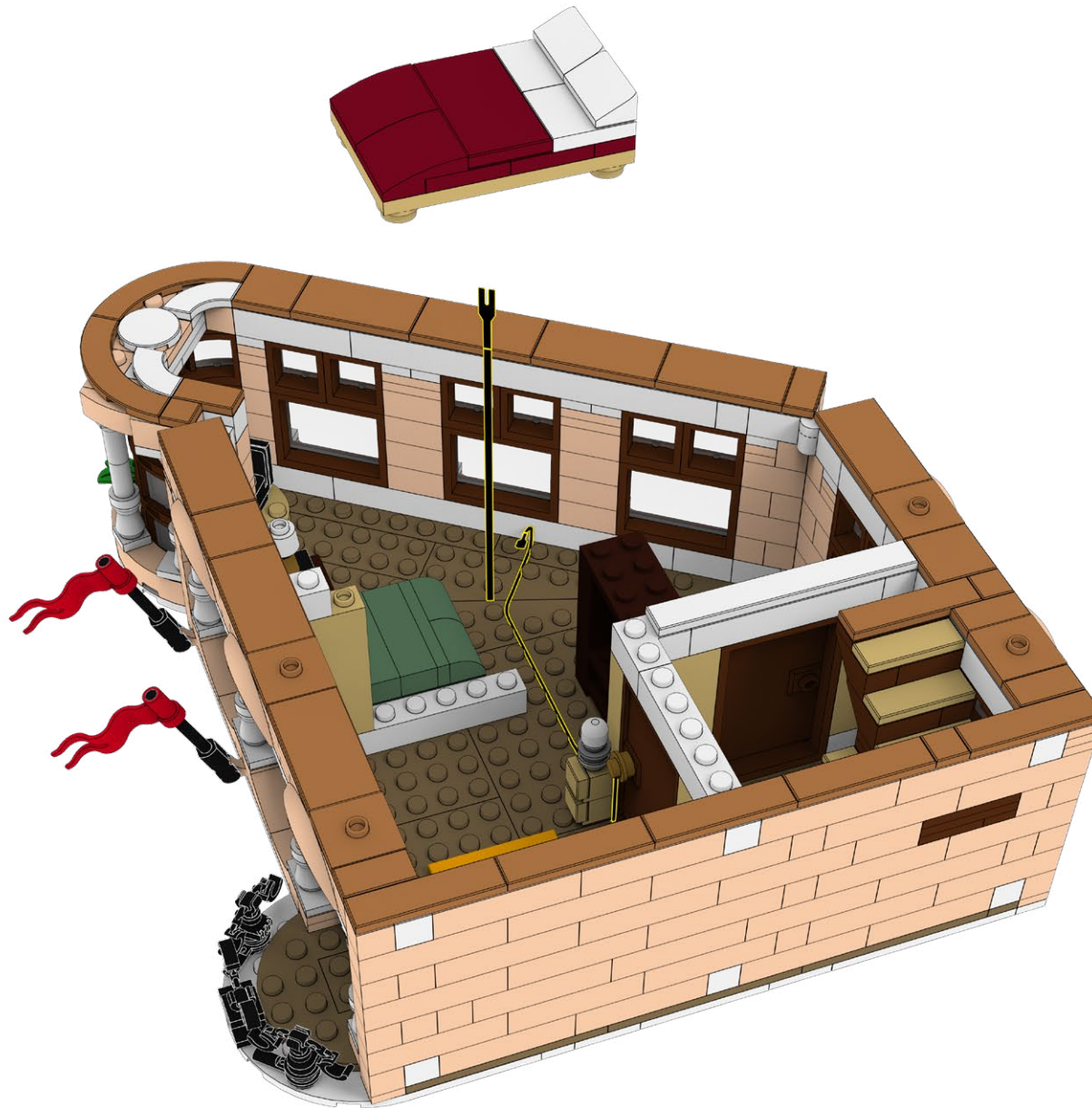

197

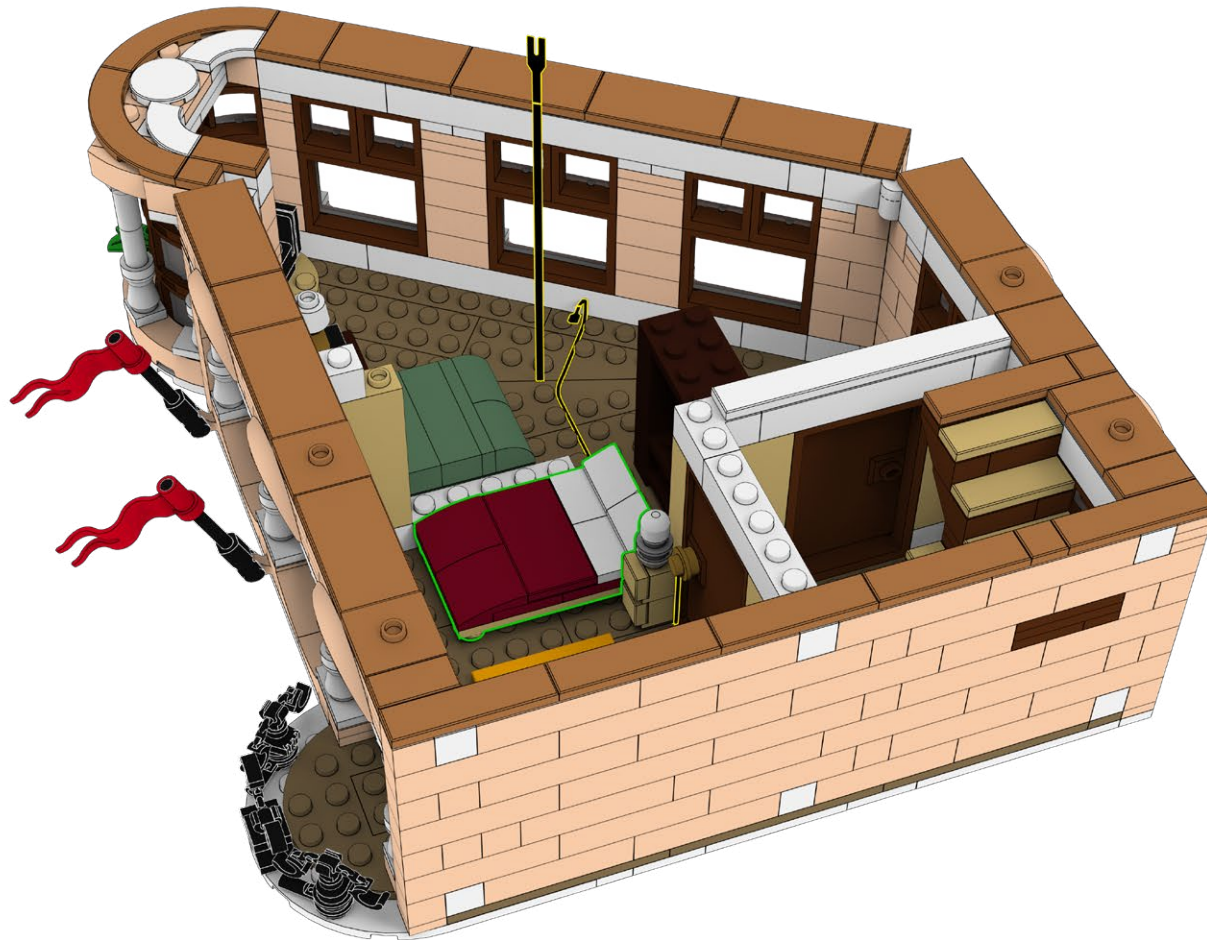

198

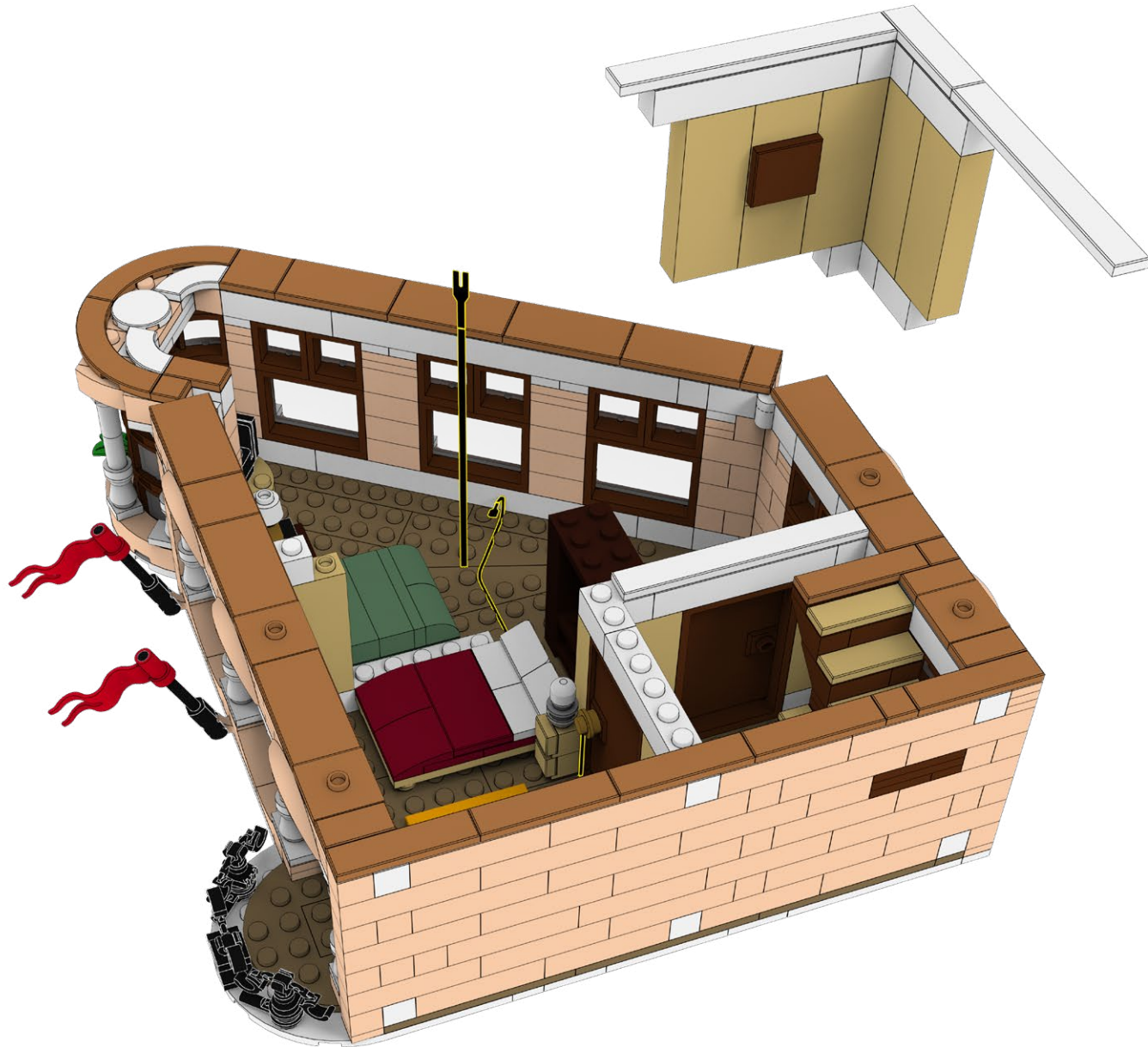

199

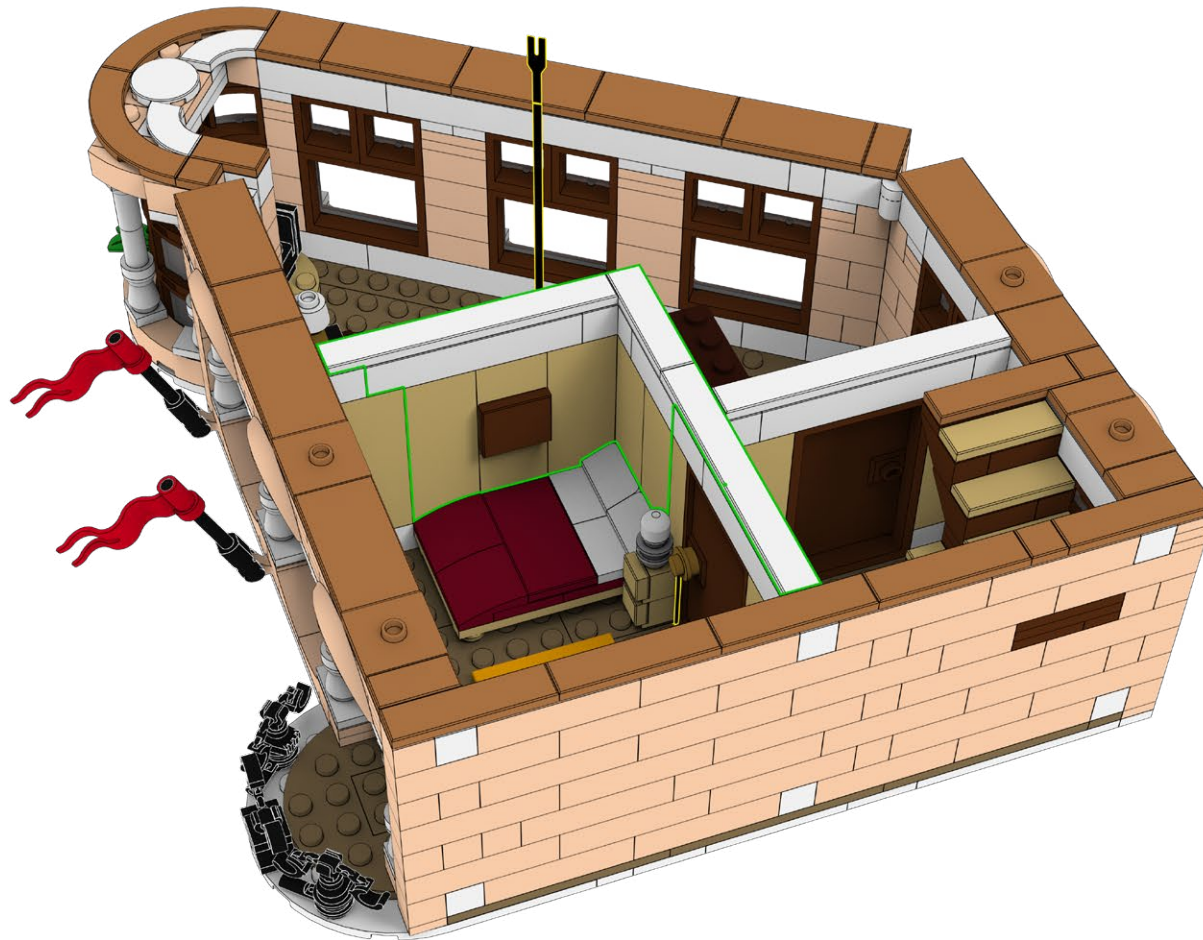

200

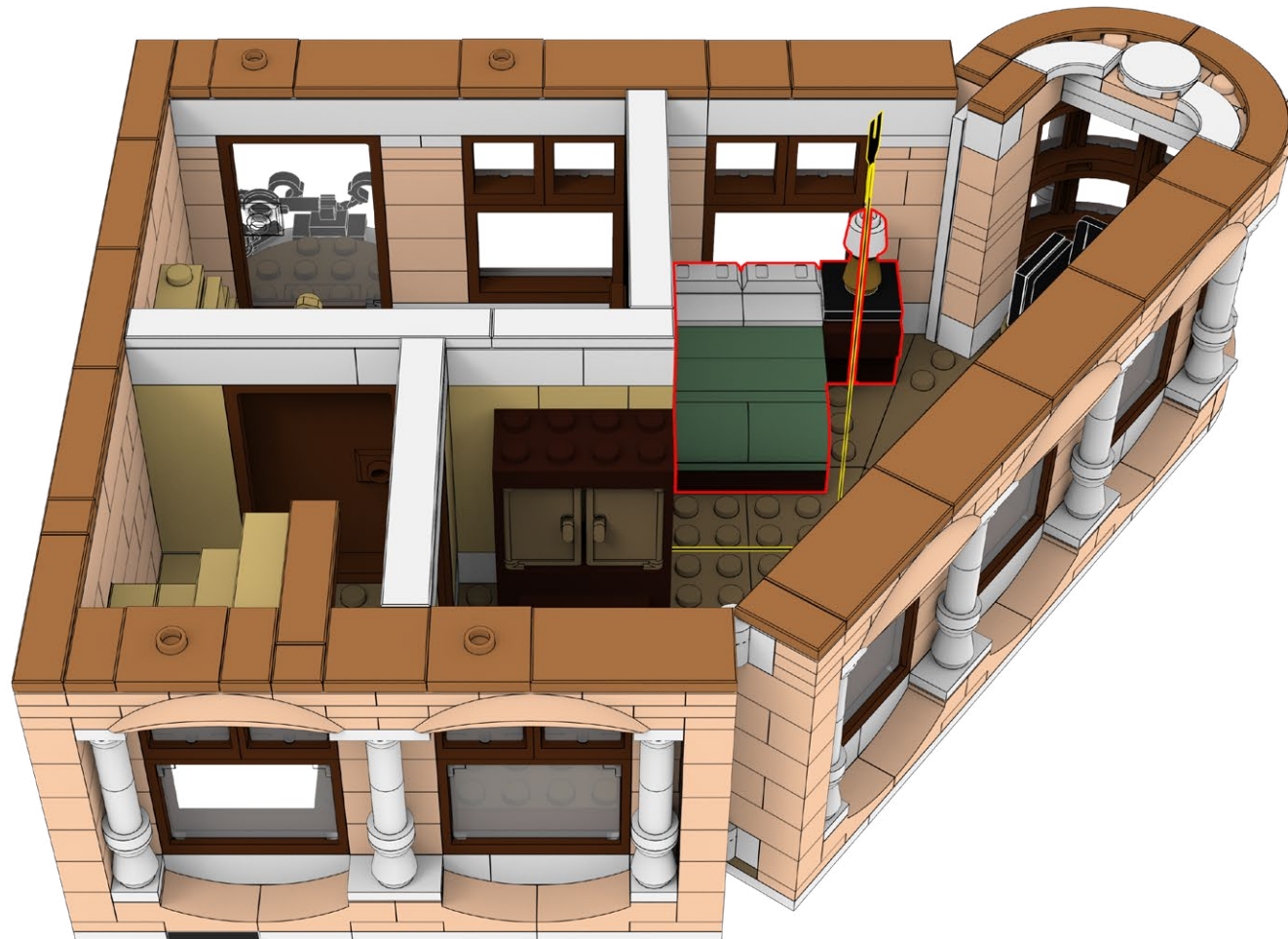

201

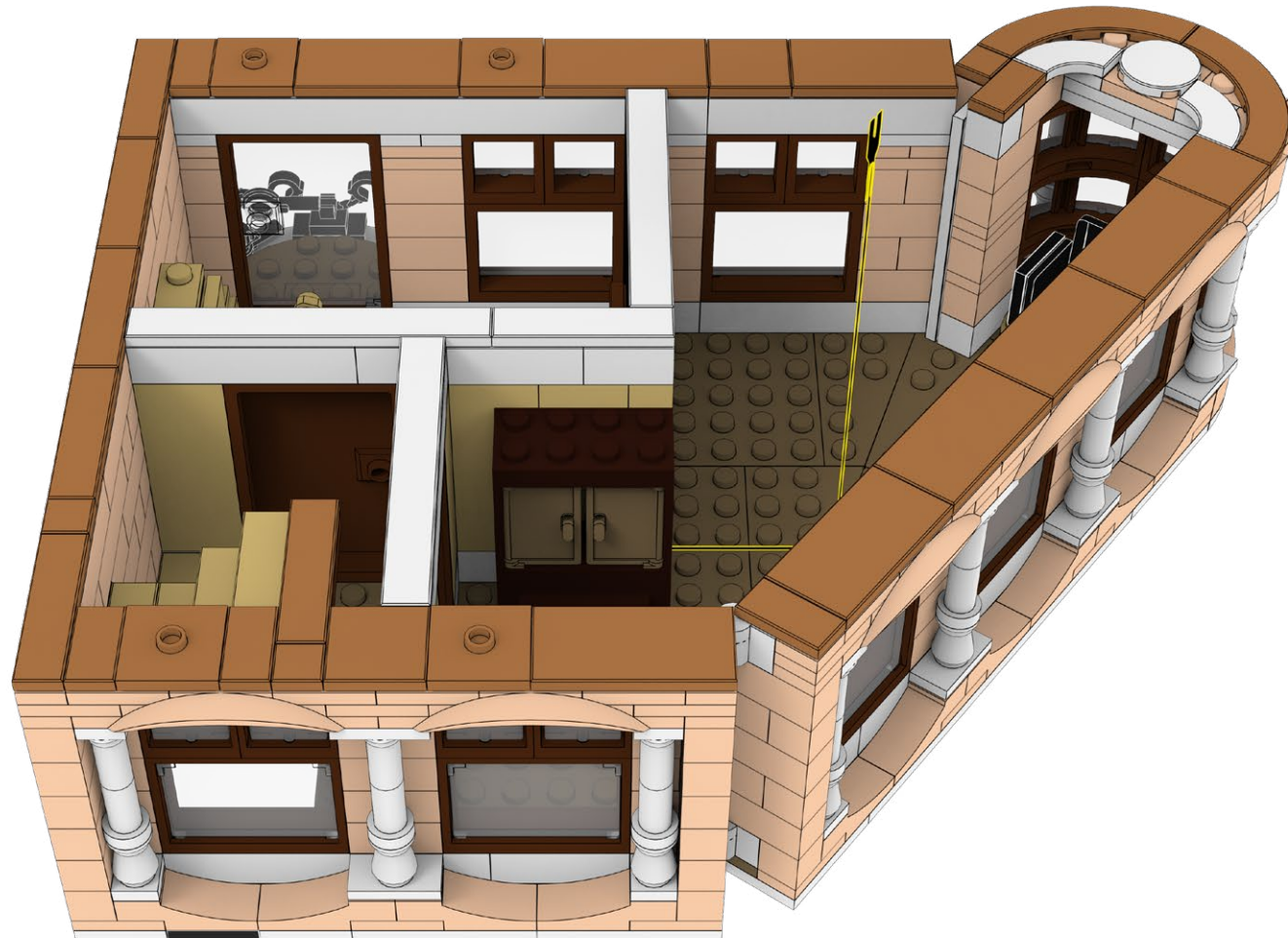
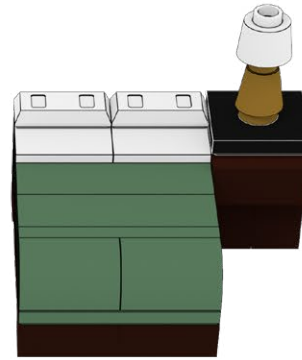

202

1

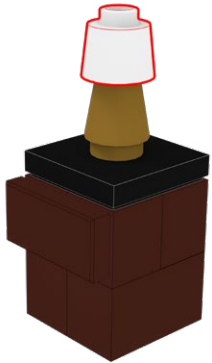

2

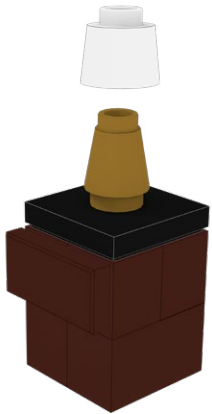

203

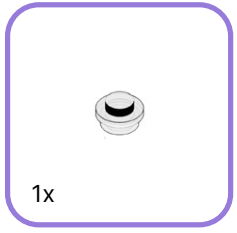
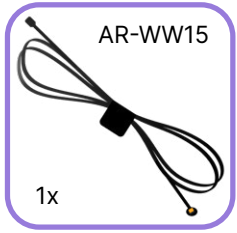

1

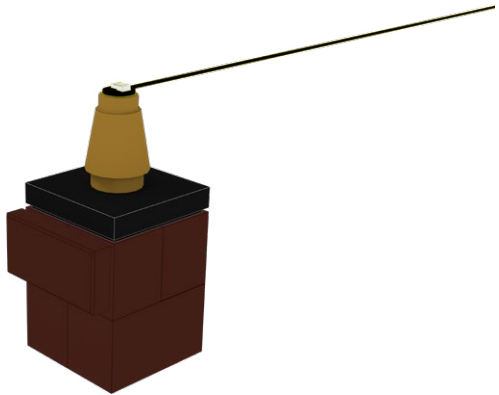

2

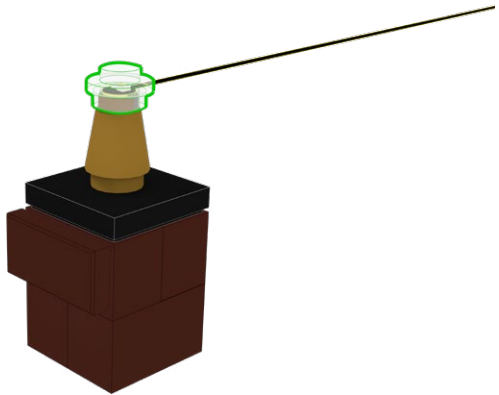

204

1



2



3



205

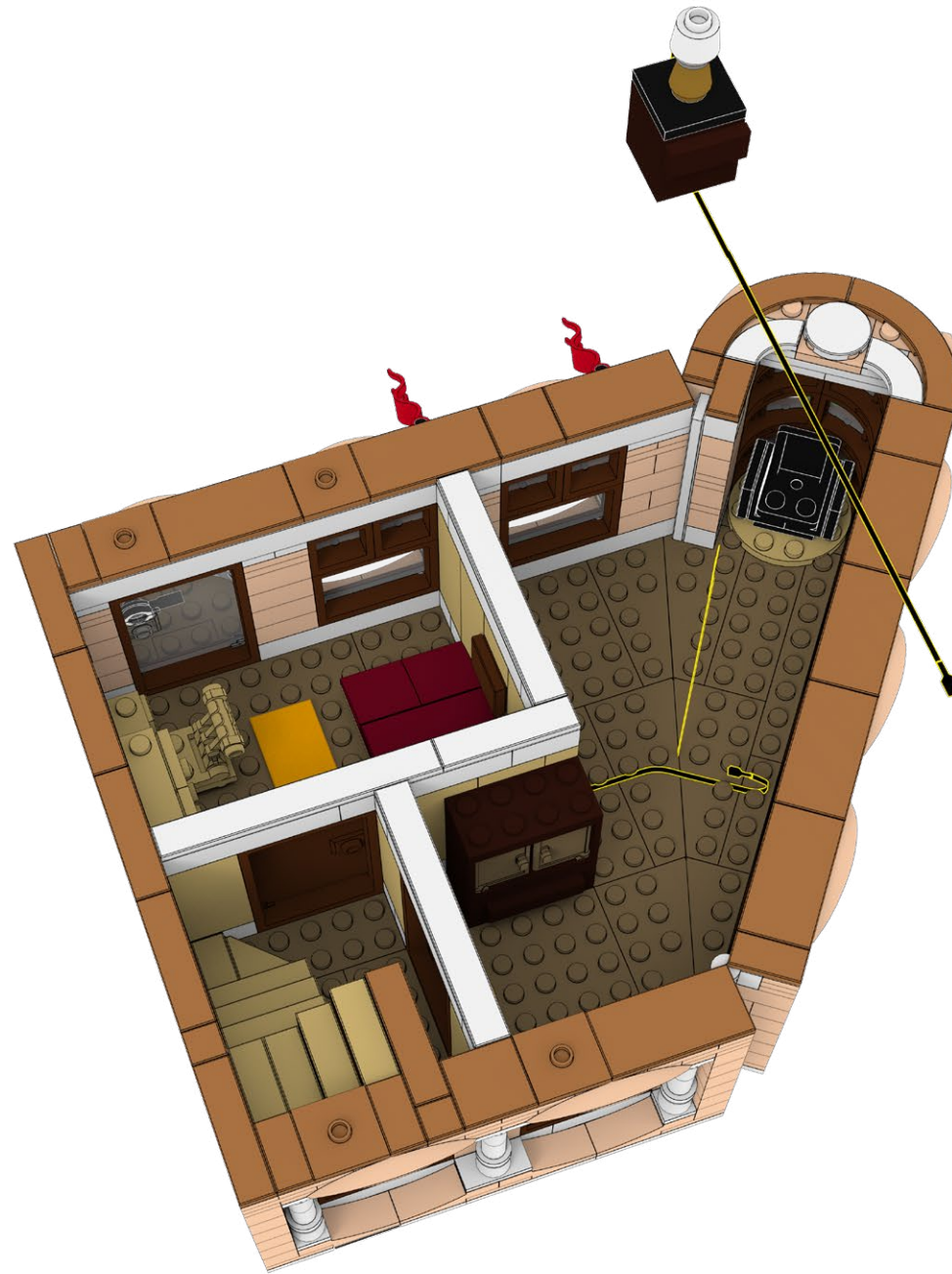

206



207



208



209

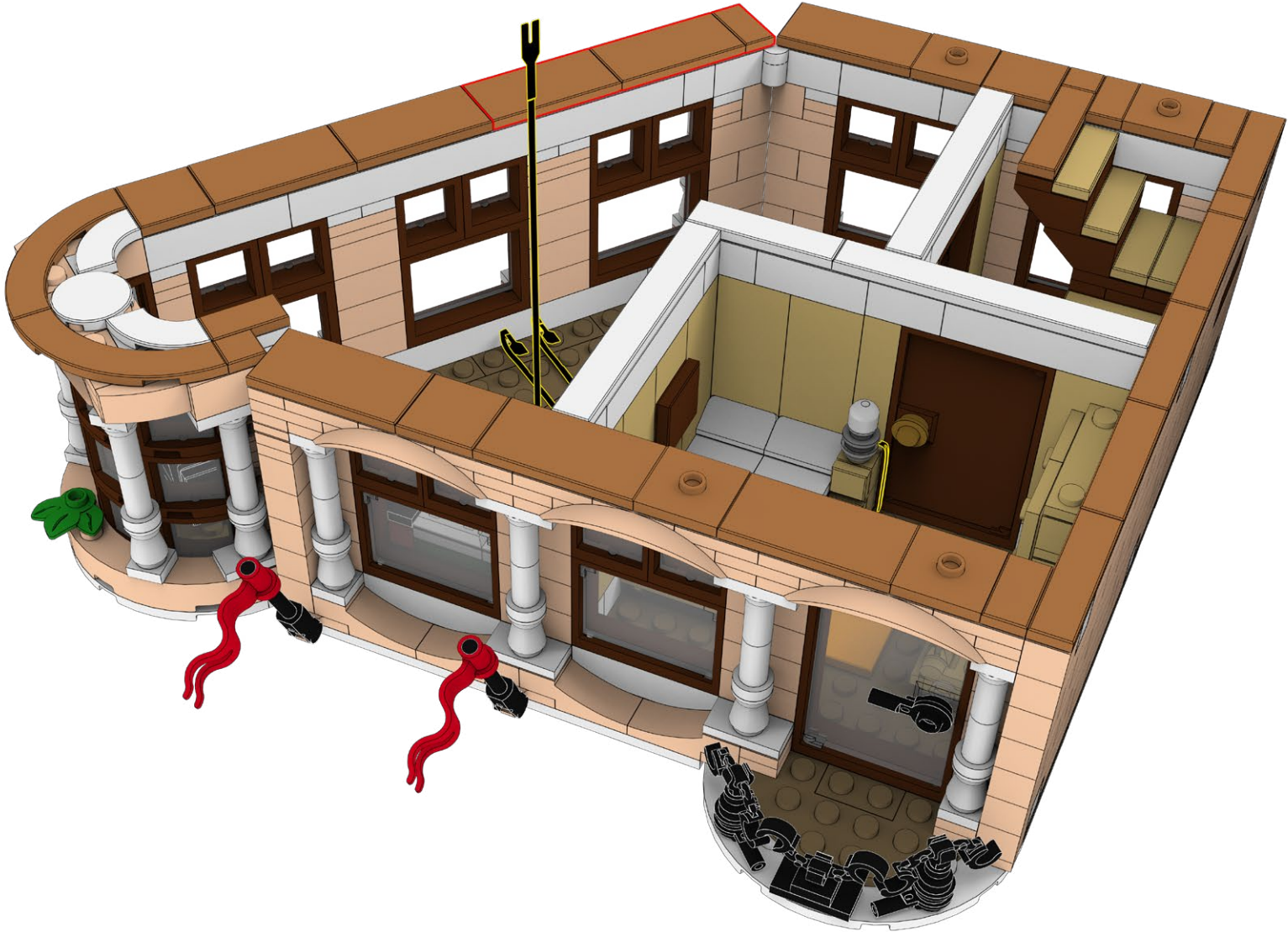

210

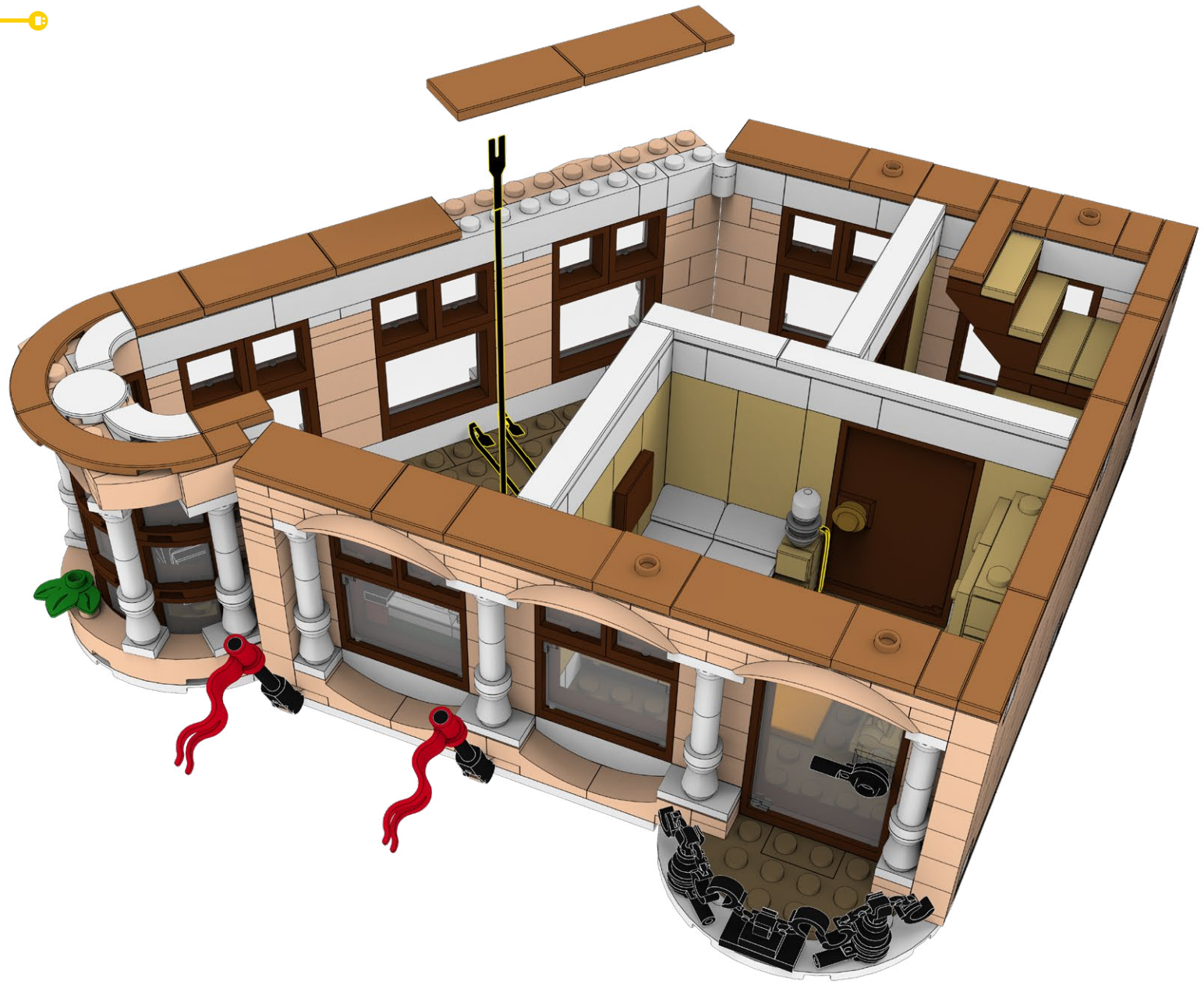

211

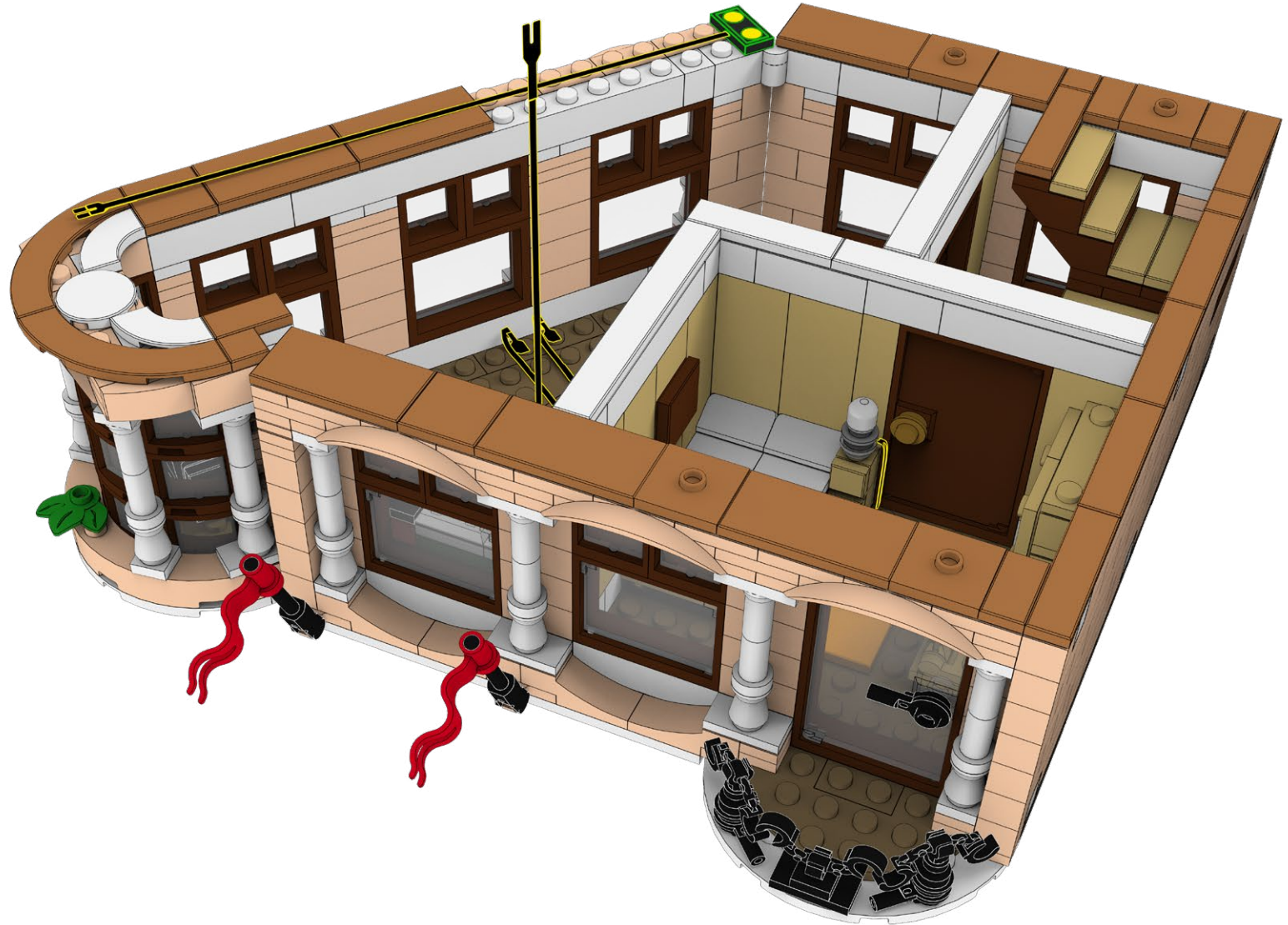
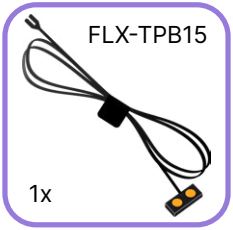

212

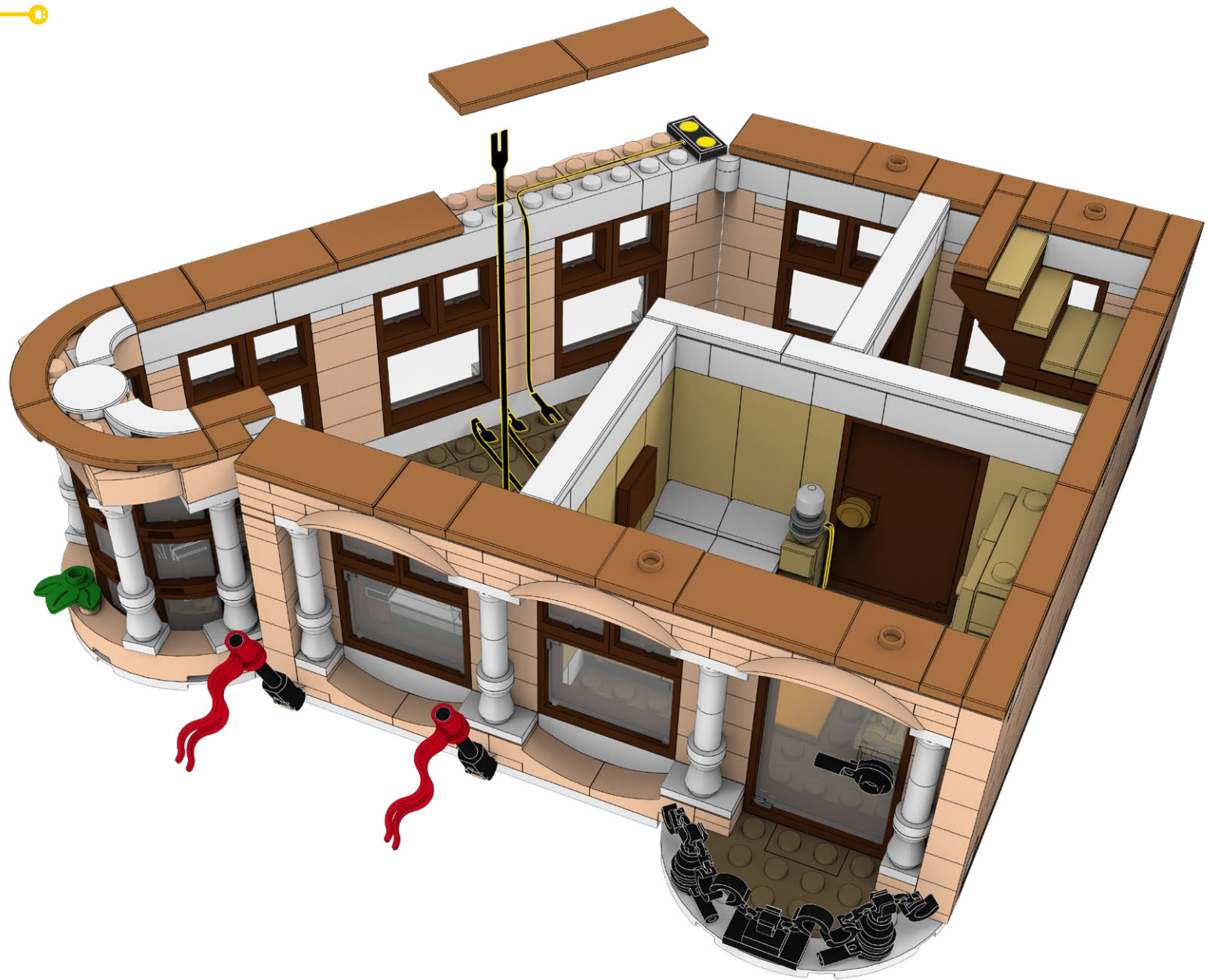

213

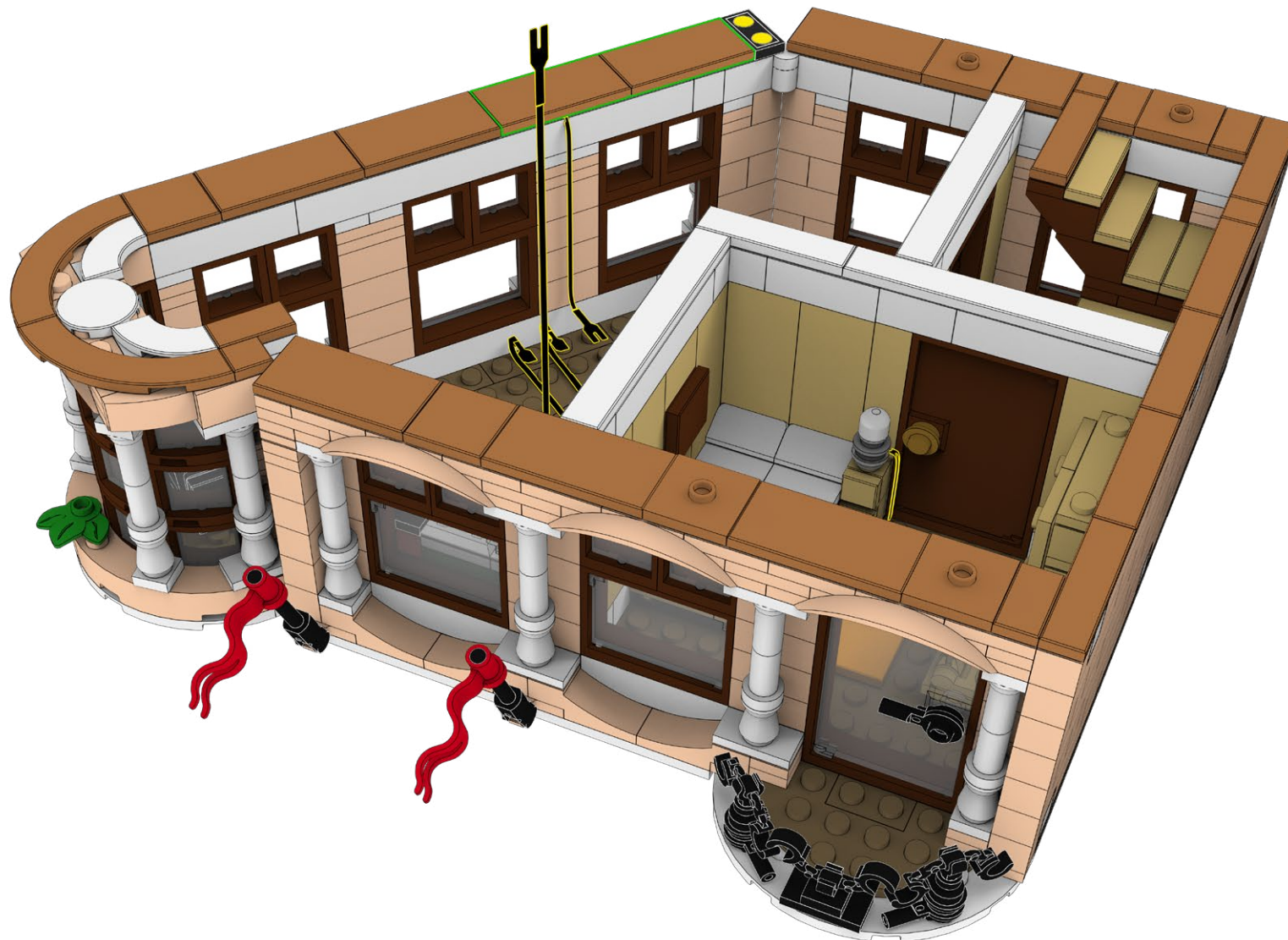

214

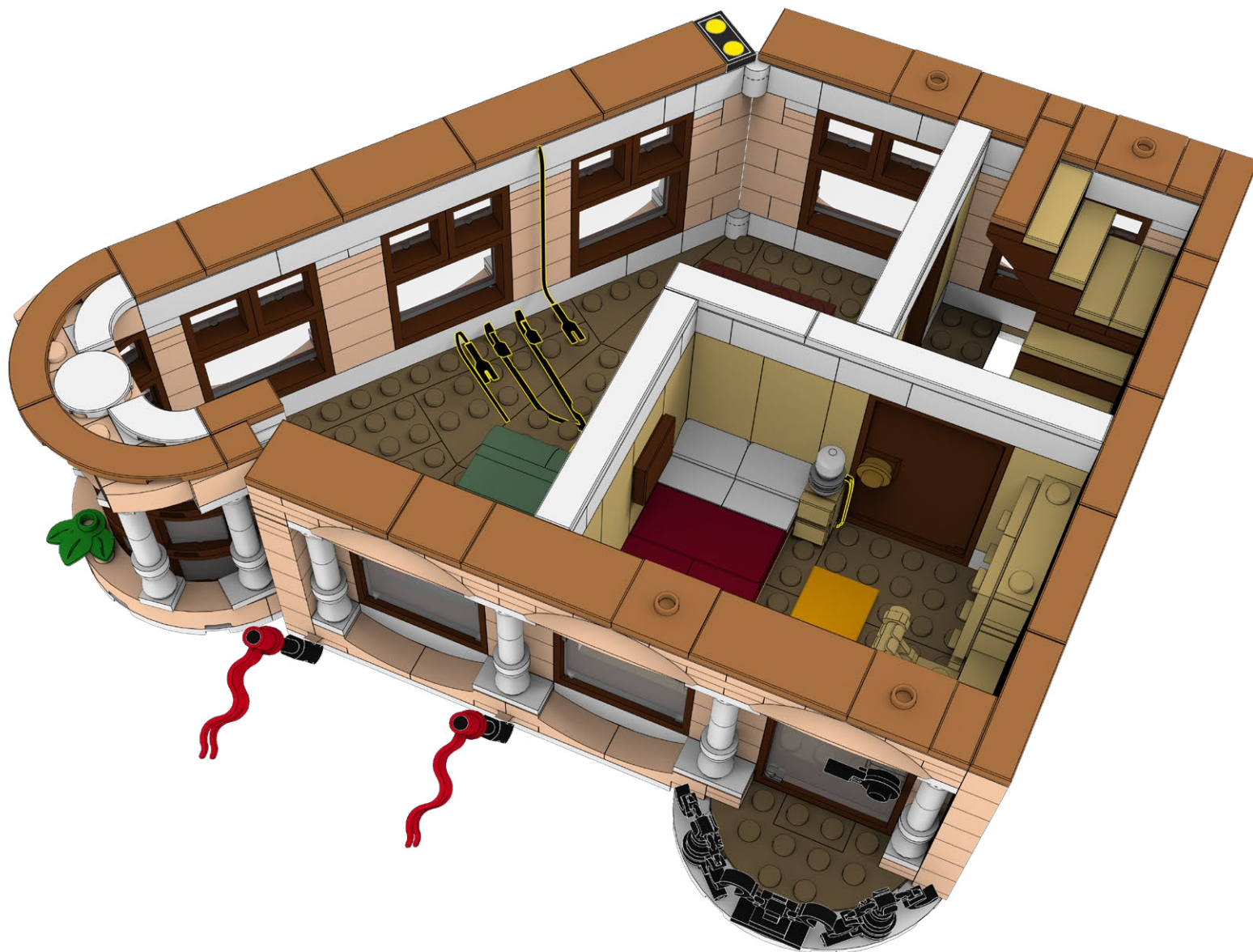

215

1

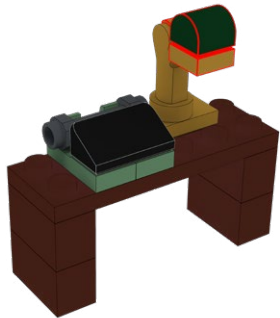

2

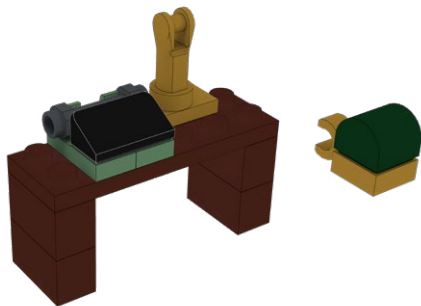

216

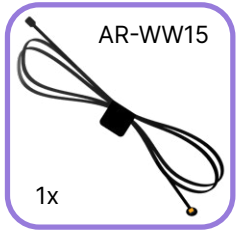

1

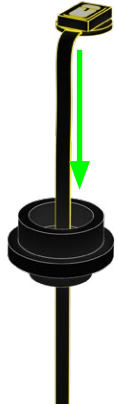

2



217

1

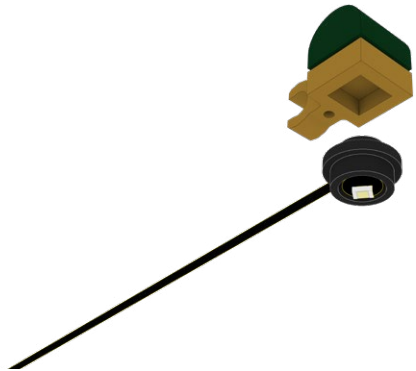

2

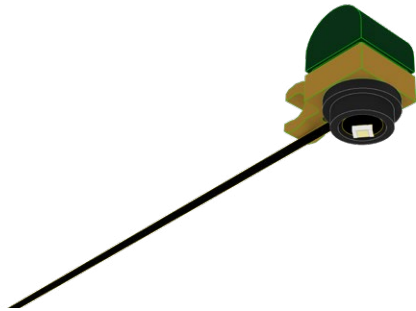

218

1

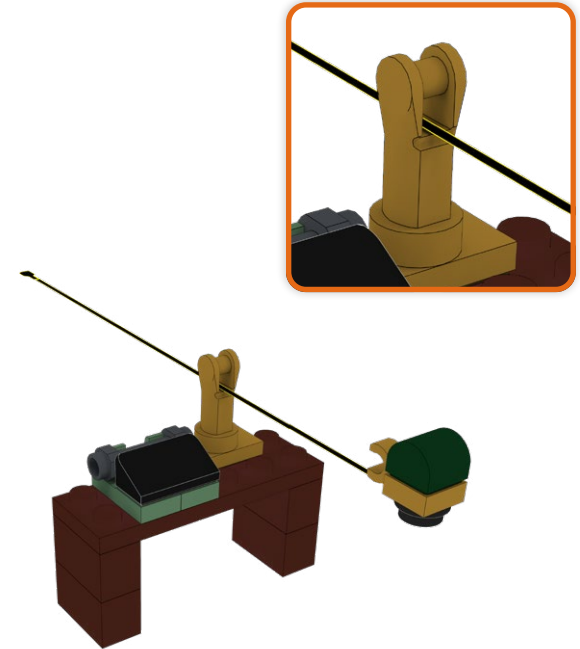

2

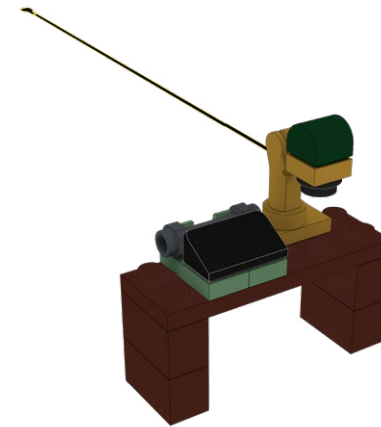

219



1

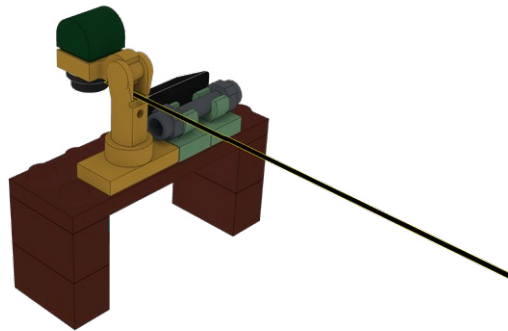

2

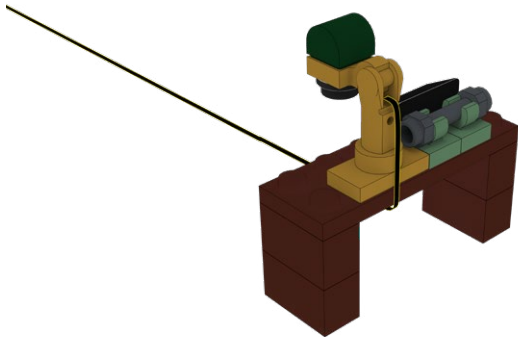

220

1

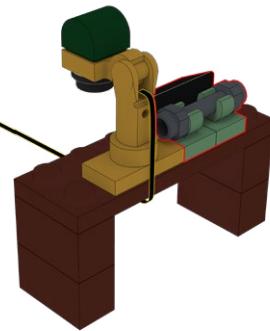

2

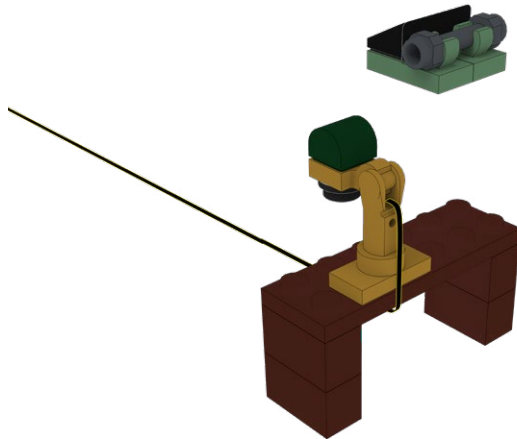

221

1

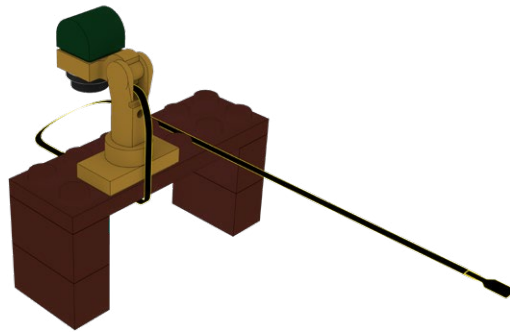

2

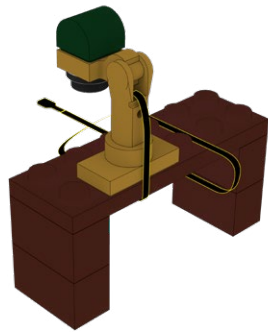

222

1

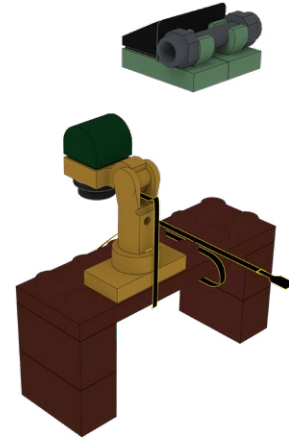

2

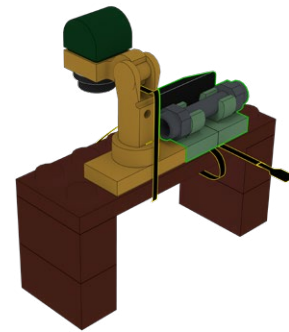

223

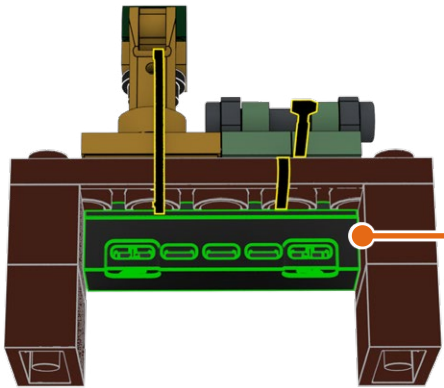
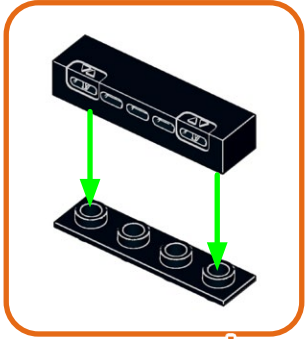
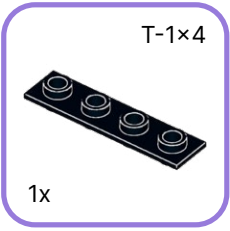
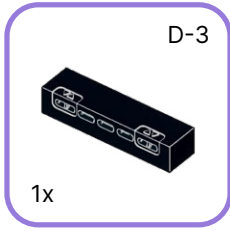

224

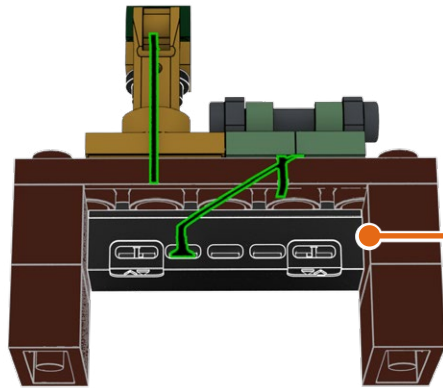
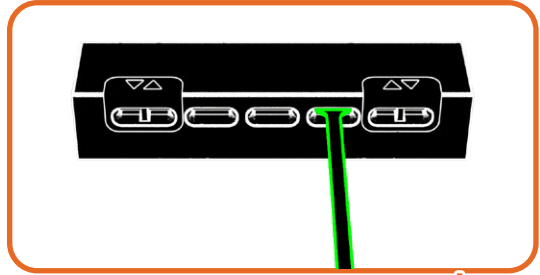

225

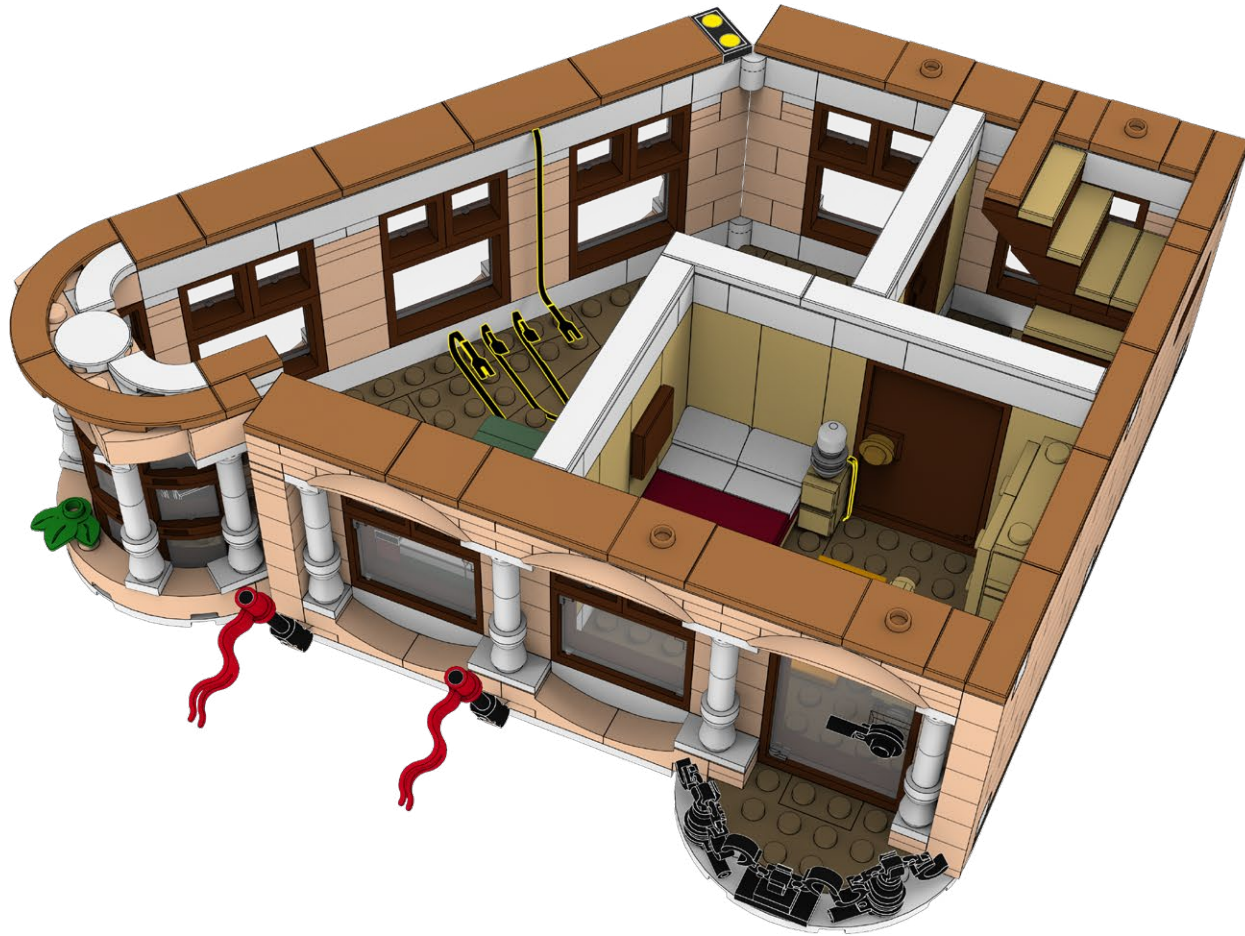
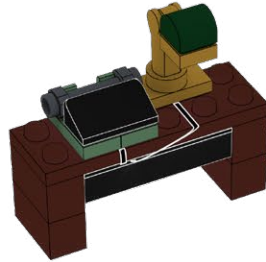

226

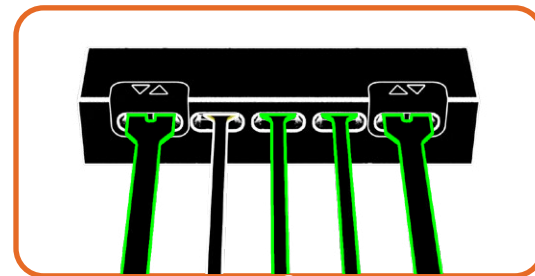
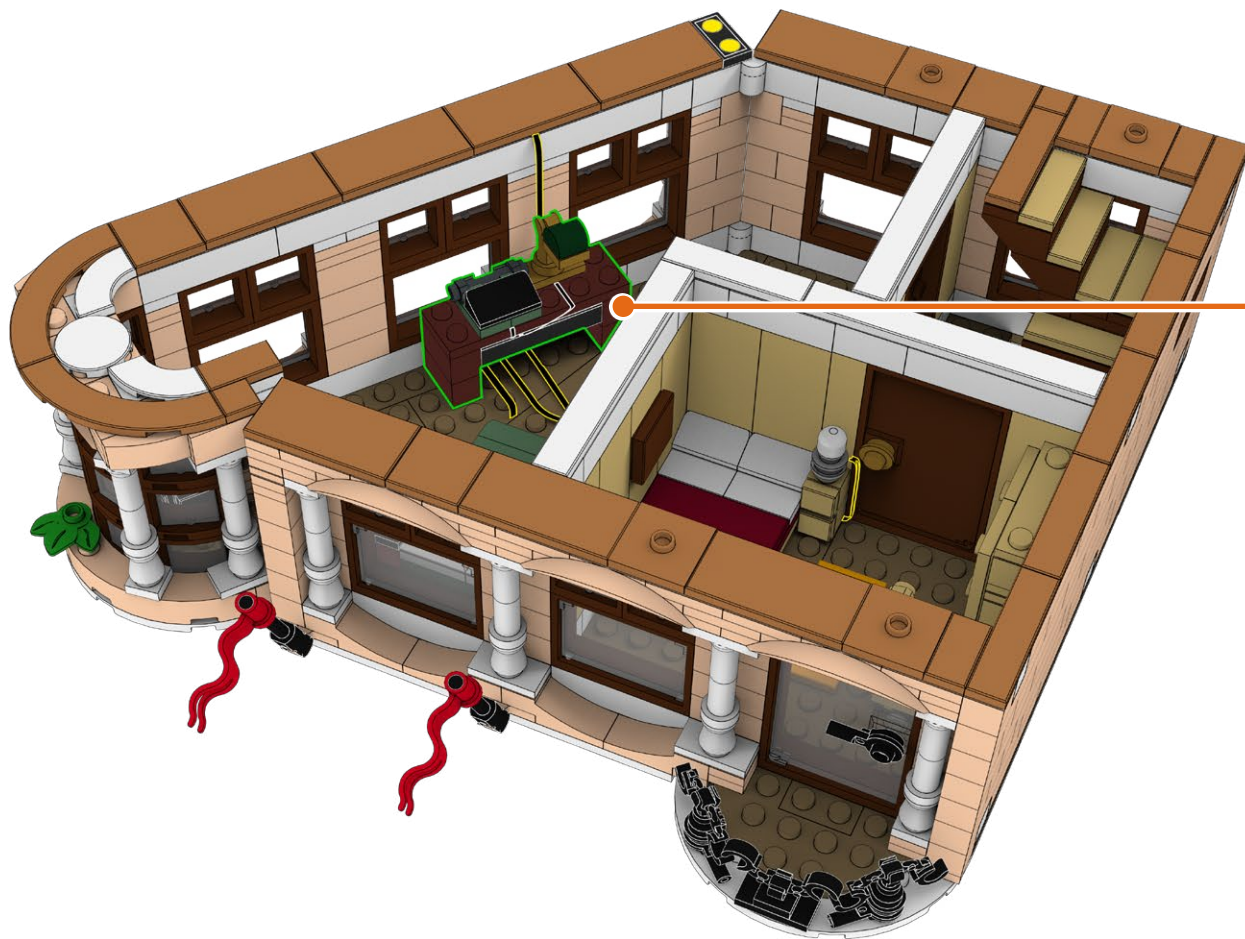

227

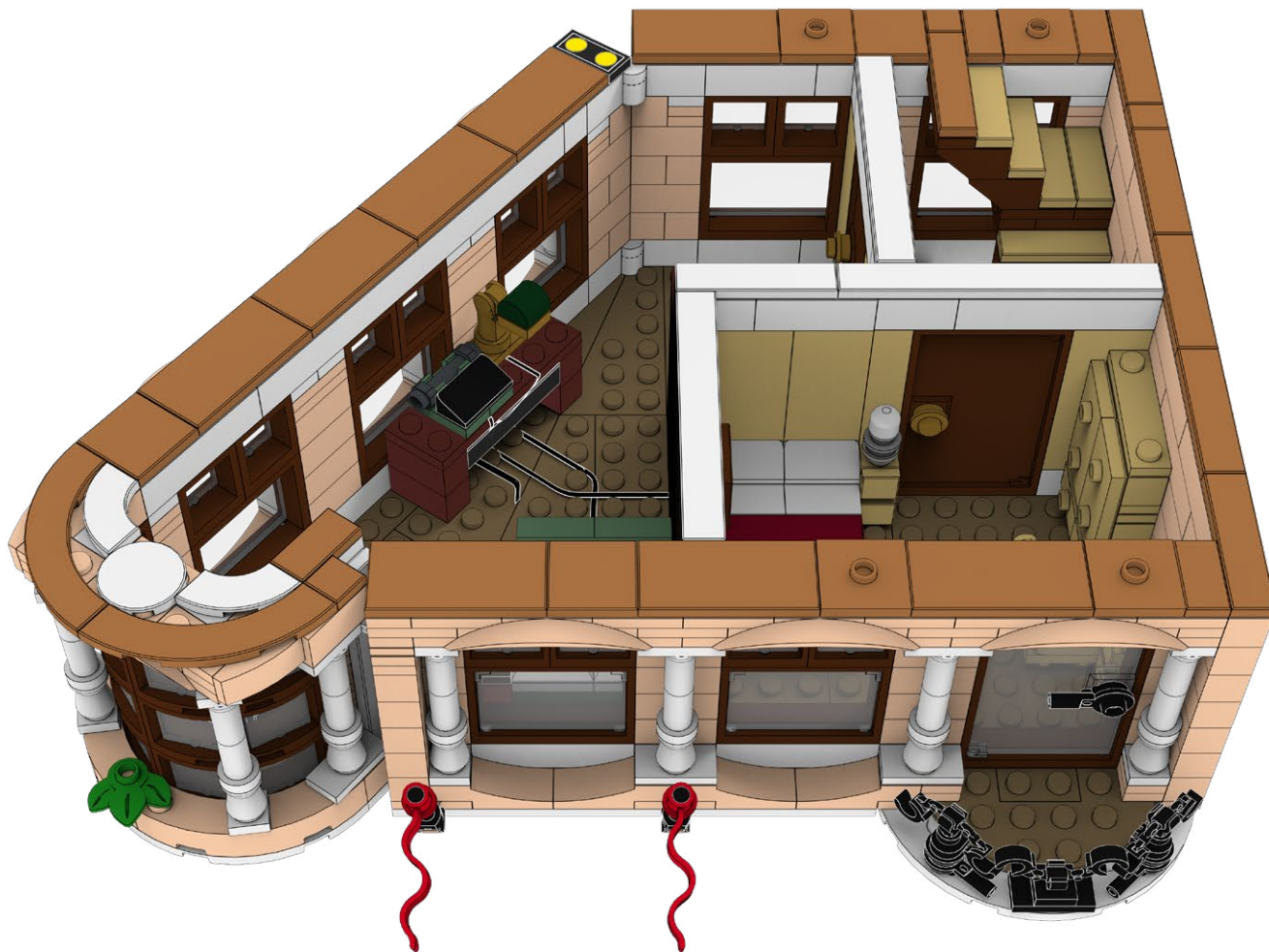

228

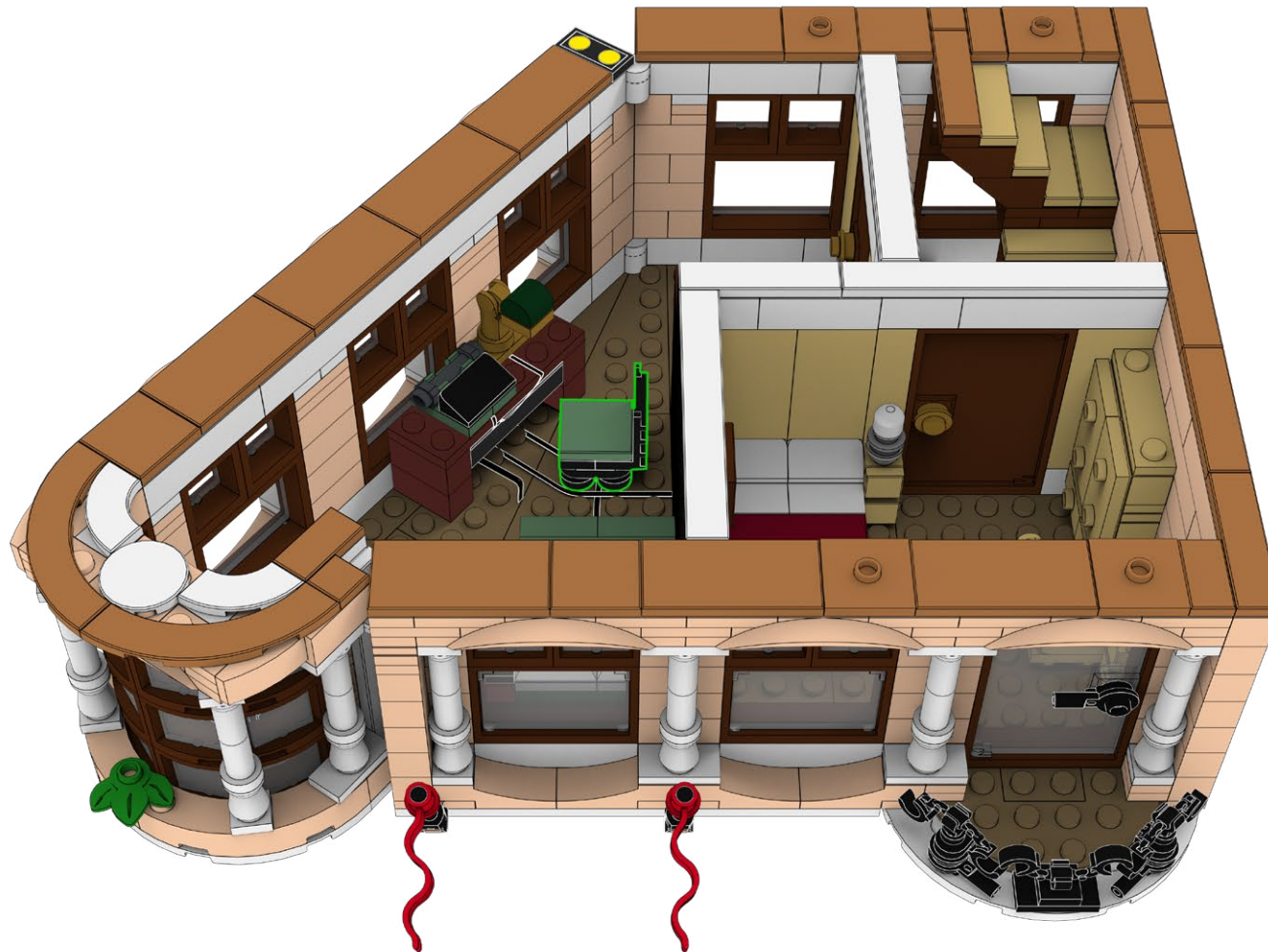

229



230



231



Power on Test
Test de mise sous tension
Test di Potenza
Stromtest
Prueba de Energía
电源测试



232



233

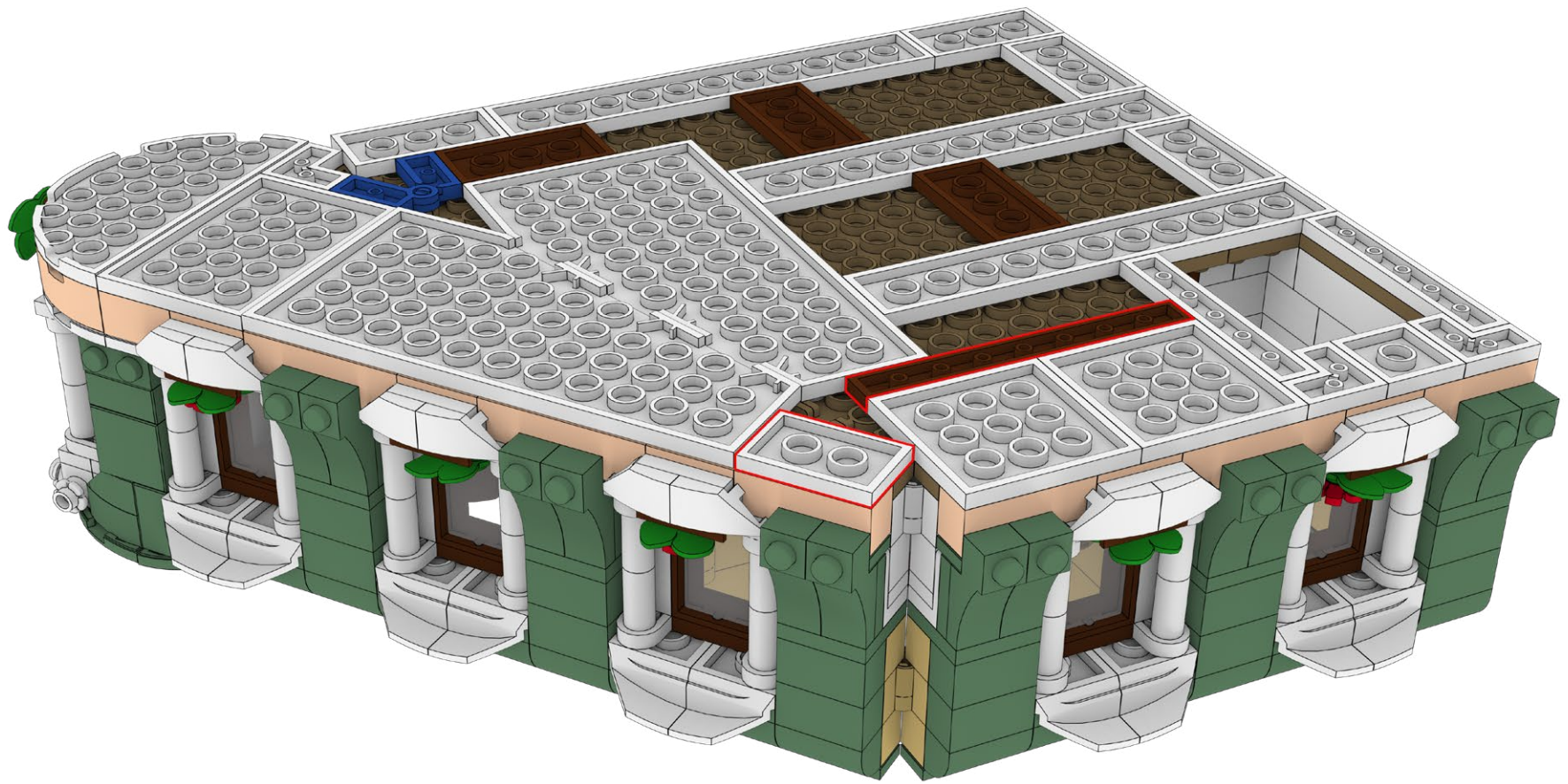

234

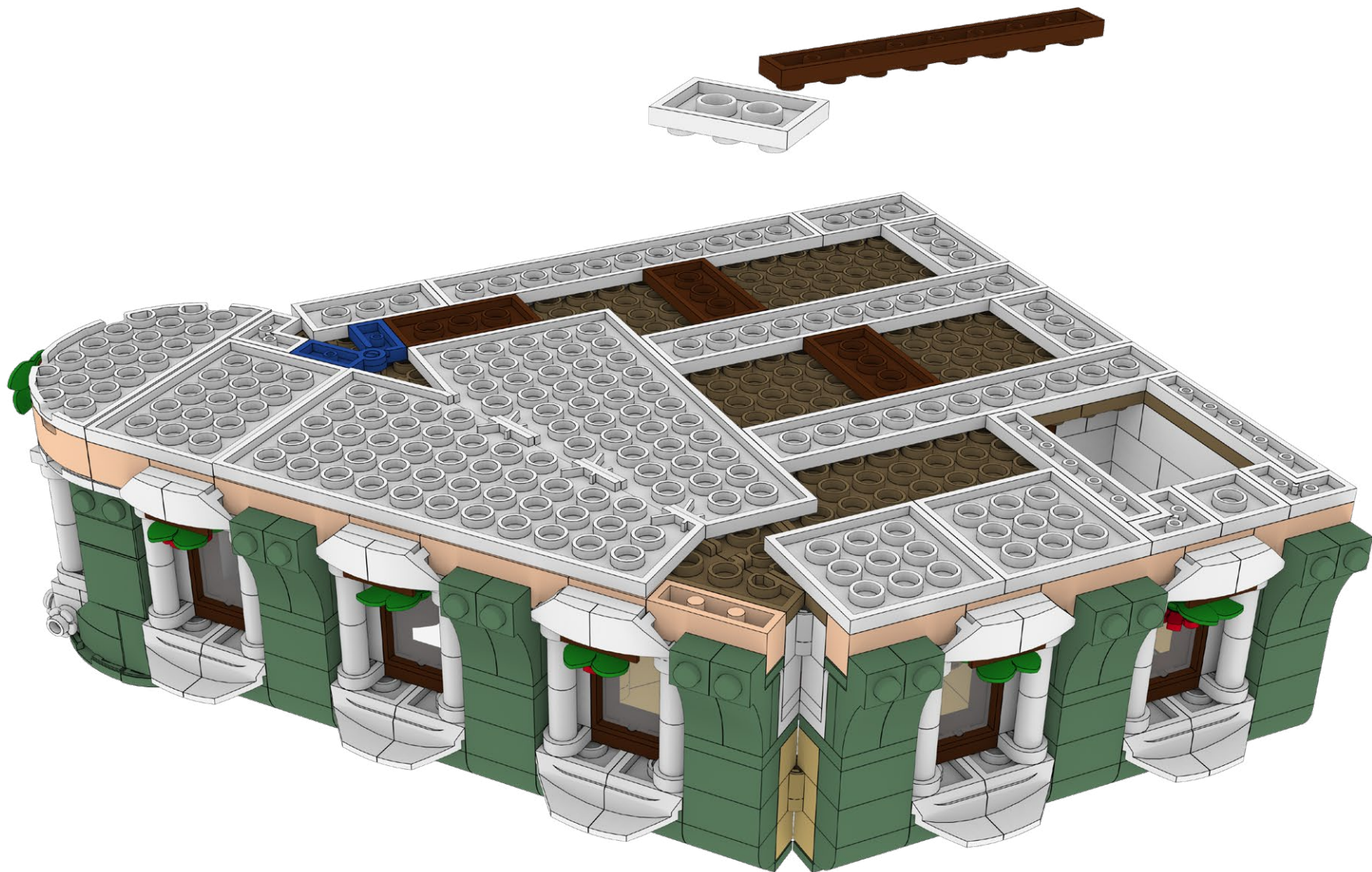

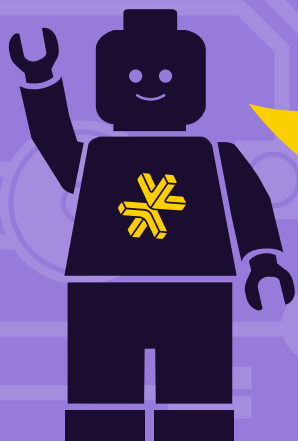

HOLD UP!

You might notice some bags aren't in order, as well as left over pieces, but that's ok! We're changing the way you build LEGO!

ATTENDEZ!

Vous remarquerez peut-être que certains sacs, ainsi que certaines pièces, ne sont pas dans le bon ordre. Mais pas de panique! Nous changeons simplement la façon avec laquelle vous construisez vos LEGO!

ASPETTA!

Potresti notare che alcuni sacchetti non sono in ordine, così come i pezzi avanzati, ma va bene così! Stiamo cambiando il modo in cui costruisci i LEGO!

HALT!

Sie werden möglicherweise bemerken, dass einige tüten durcheinander sind und teile übrig bleiben, aber das ist in Ordnung! Wir ändern die art und weise, wie Sie LEGO bauen!

¡ESPERA!

Es posible que notes que algunas bolsas están fuera de servicio, así como piezas sobrantes, ¡pero está bien! ¡Estamos cambiando la forma en que construyes LEGO!

暫停!

你可能会注意到一些袋子顺序错乱, 以及一些剩余的部件, 但没关系! 我们正在改变你搭建乐高的方式!

Open LMB Bag 05

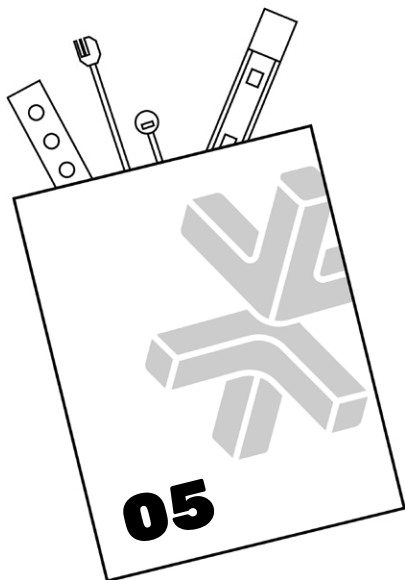

235

FLX-TPA15

1x

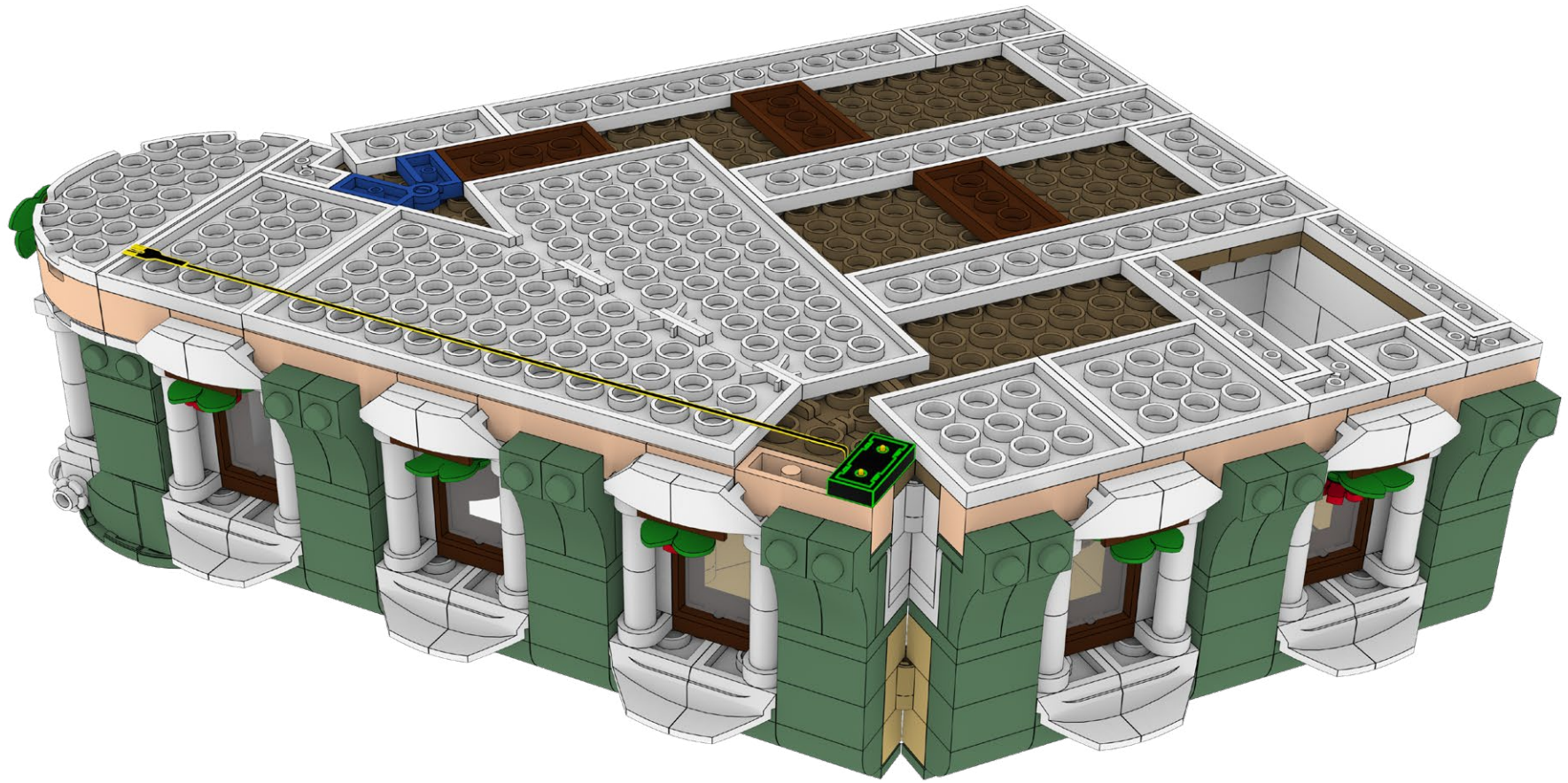

236

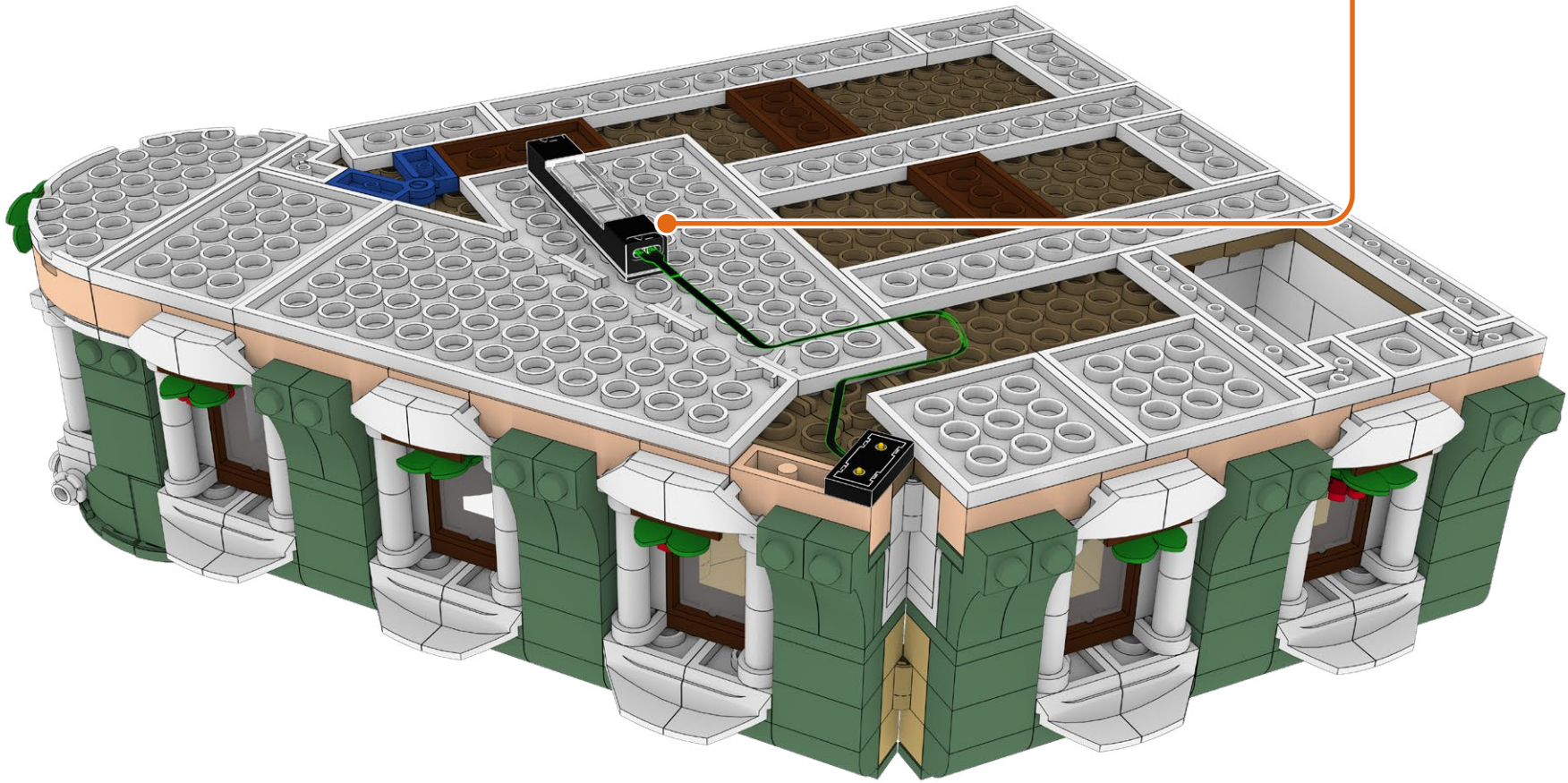
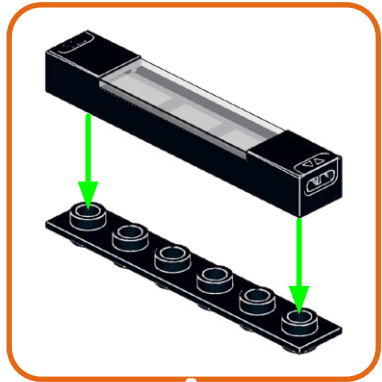
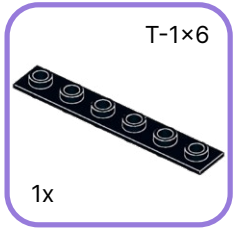

237

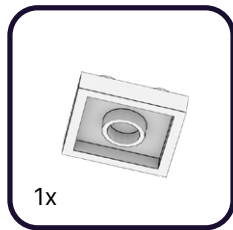
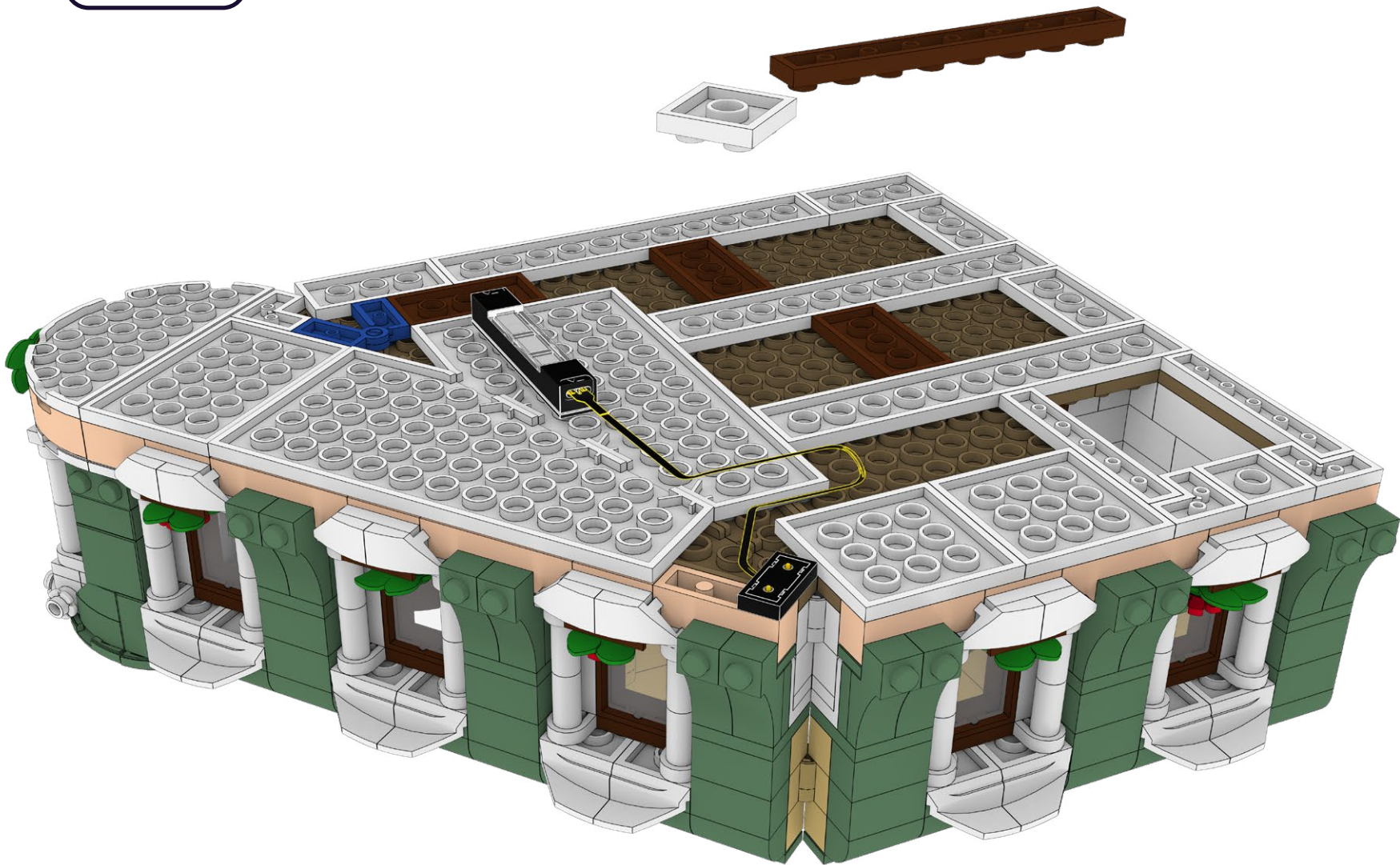
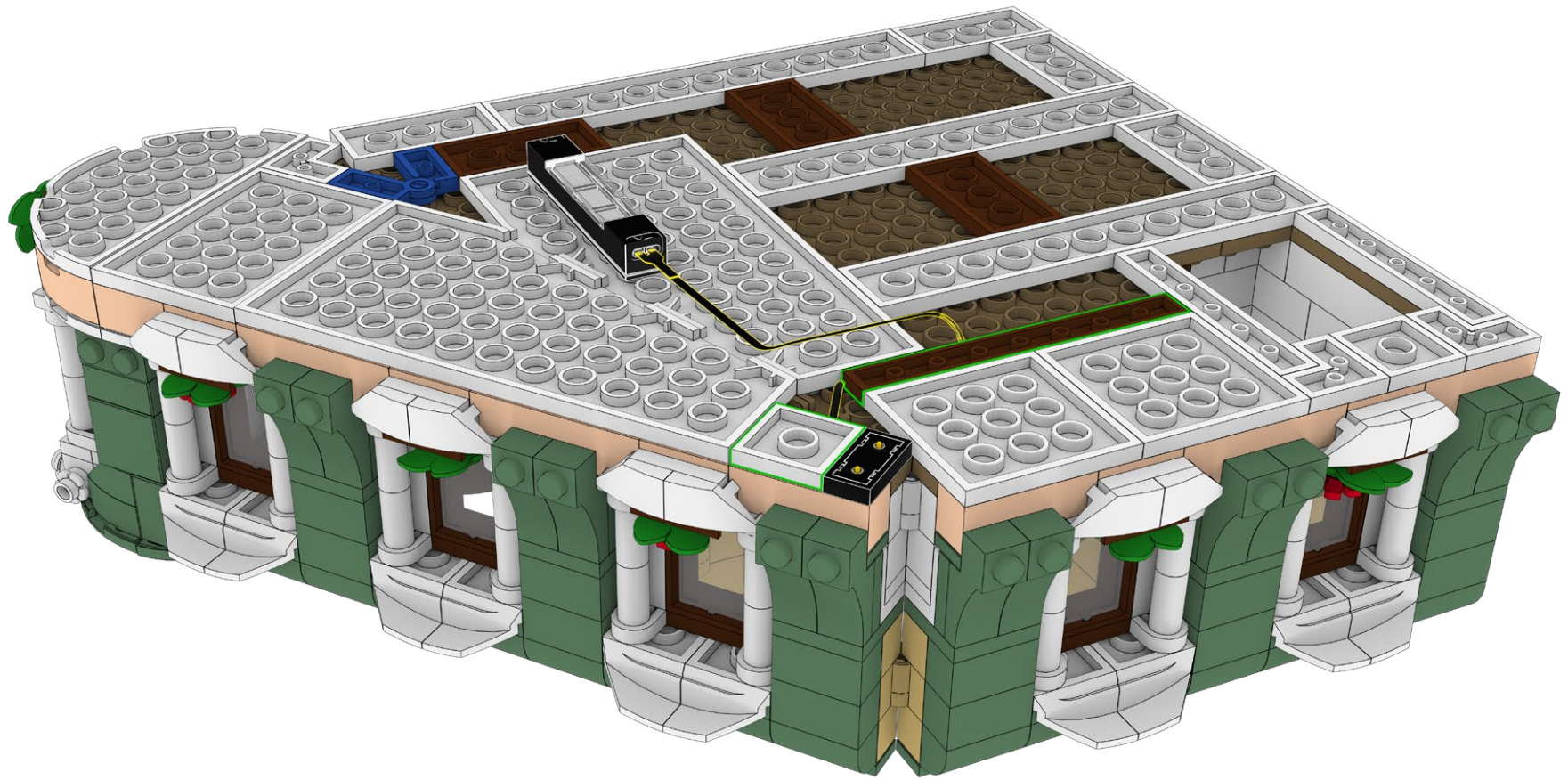

Plate 2x2 - White
Was previously disconnected in
step 164



238



239

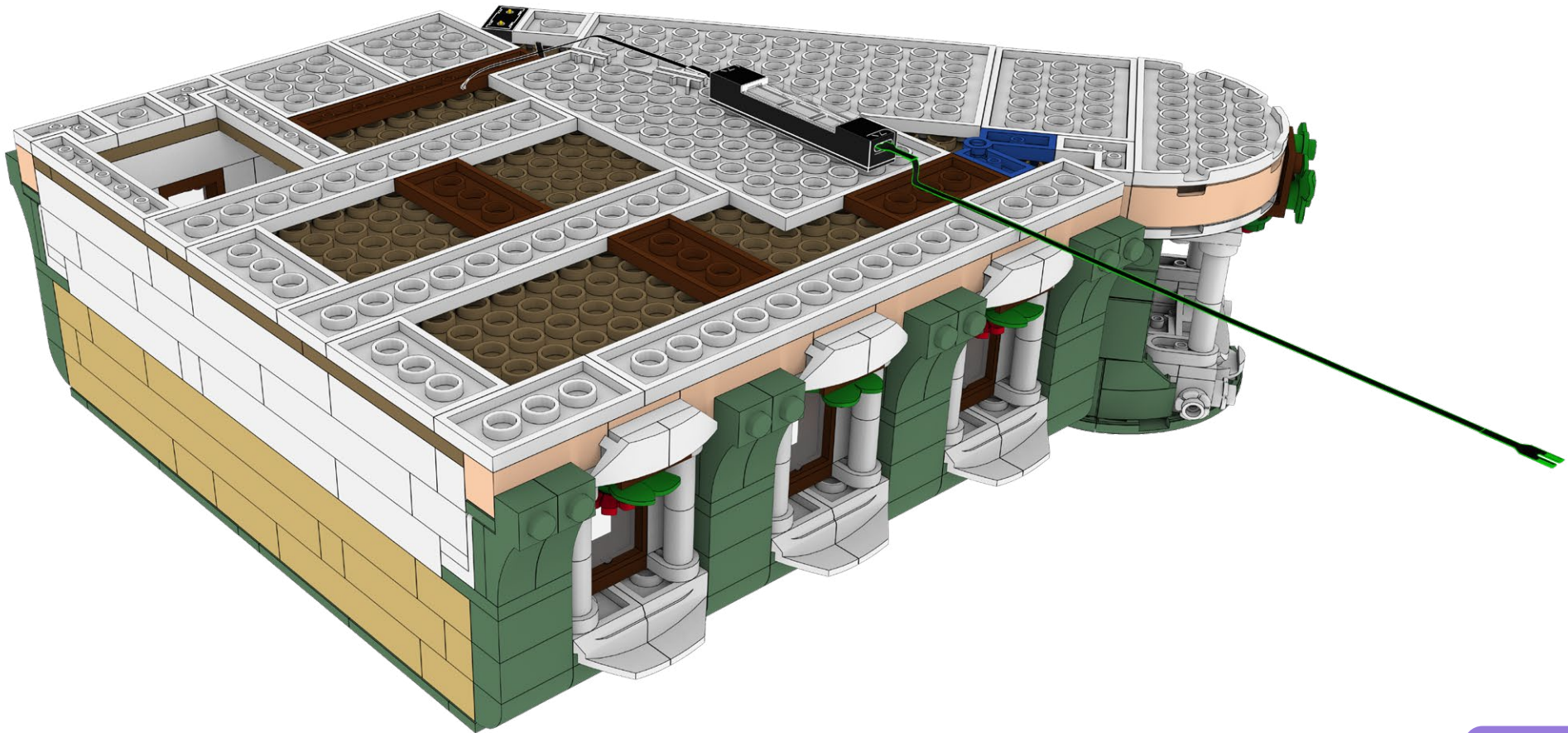
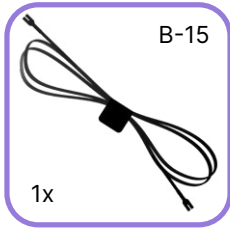

240

ML-WW



1x

T-1x6



1x

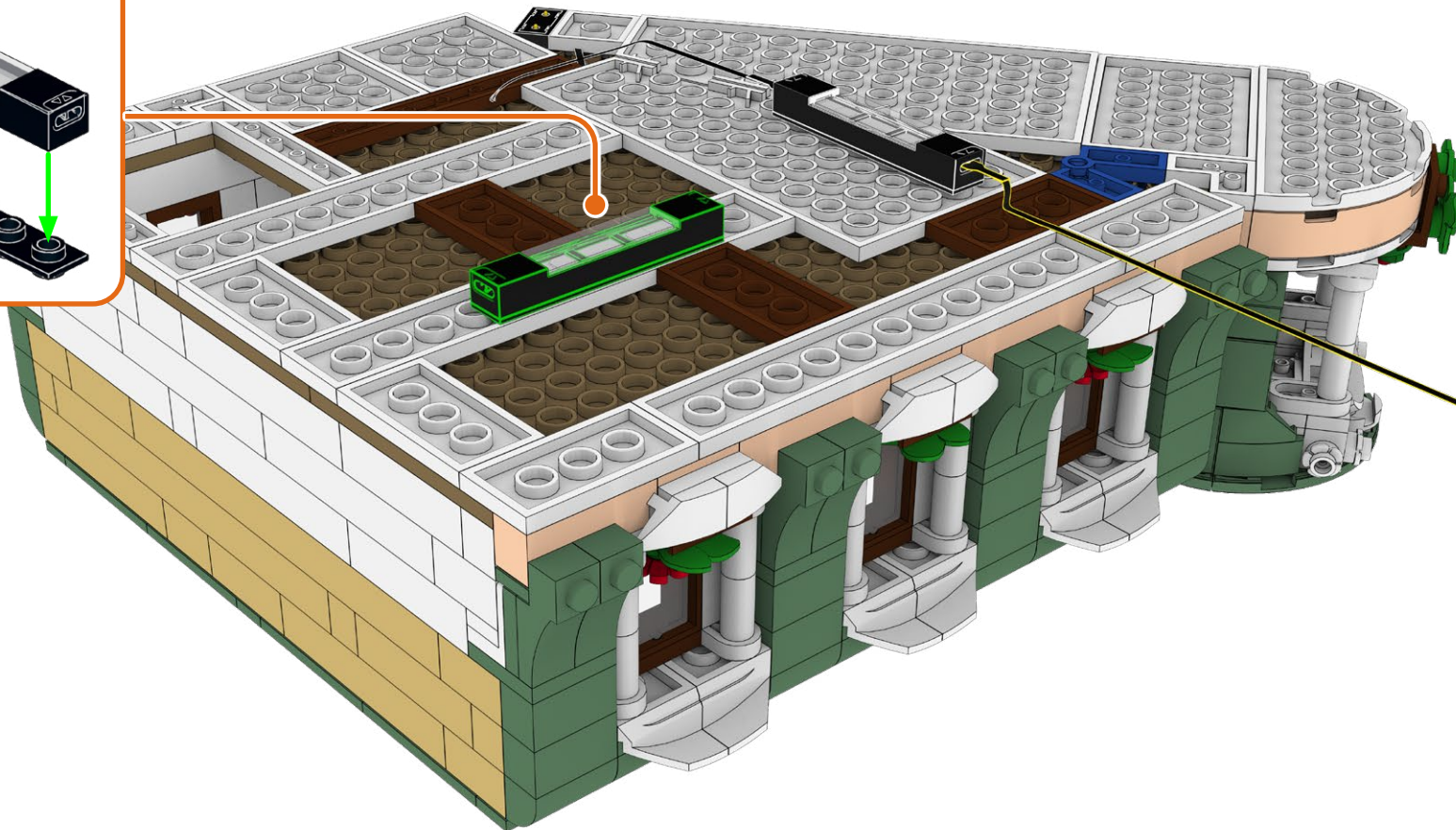
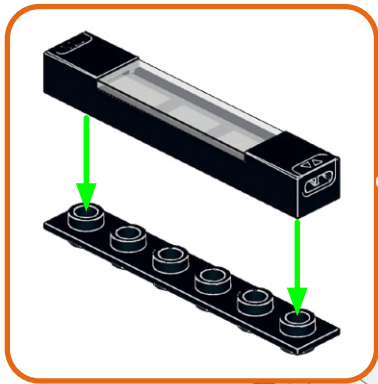

241

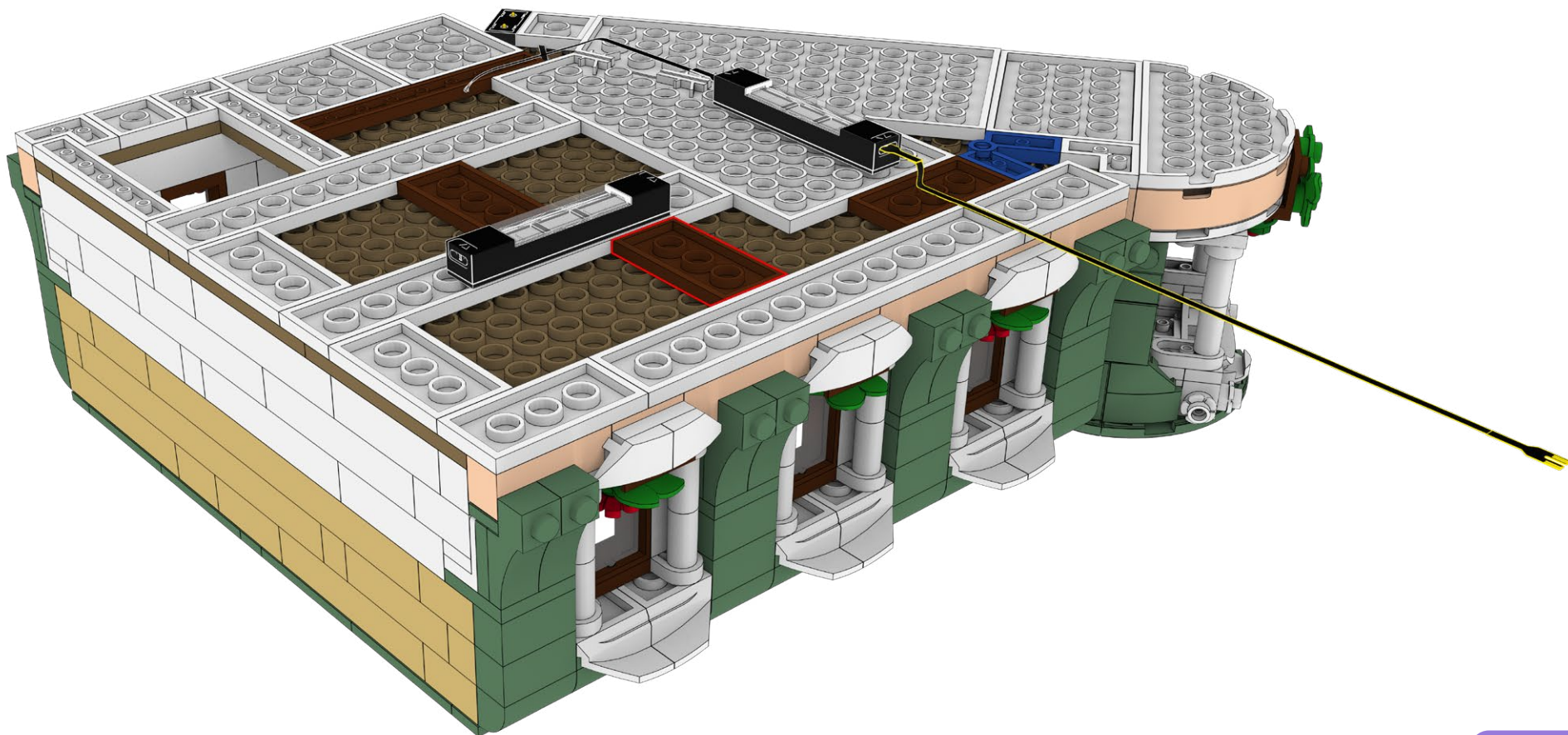

242

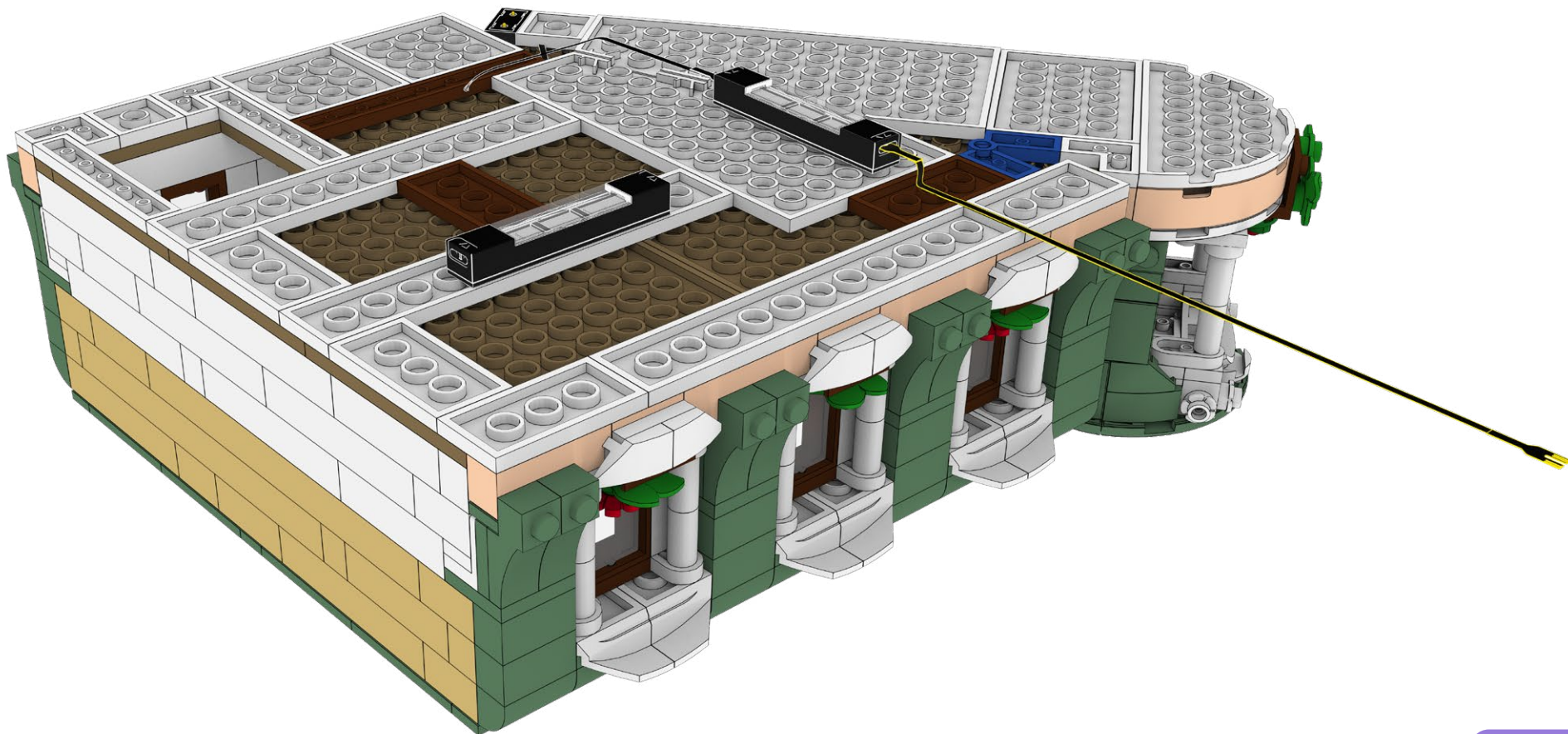

243

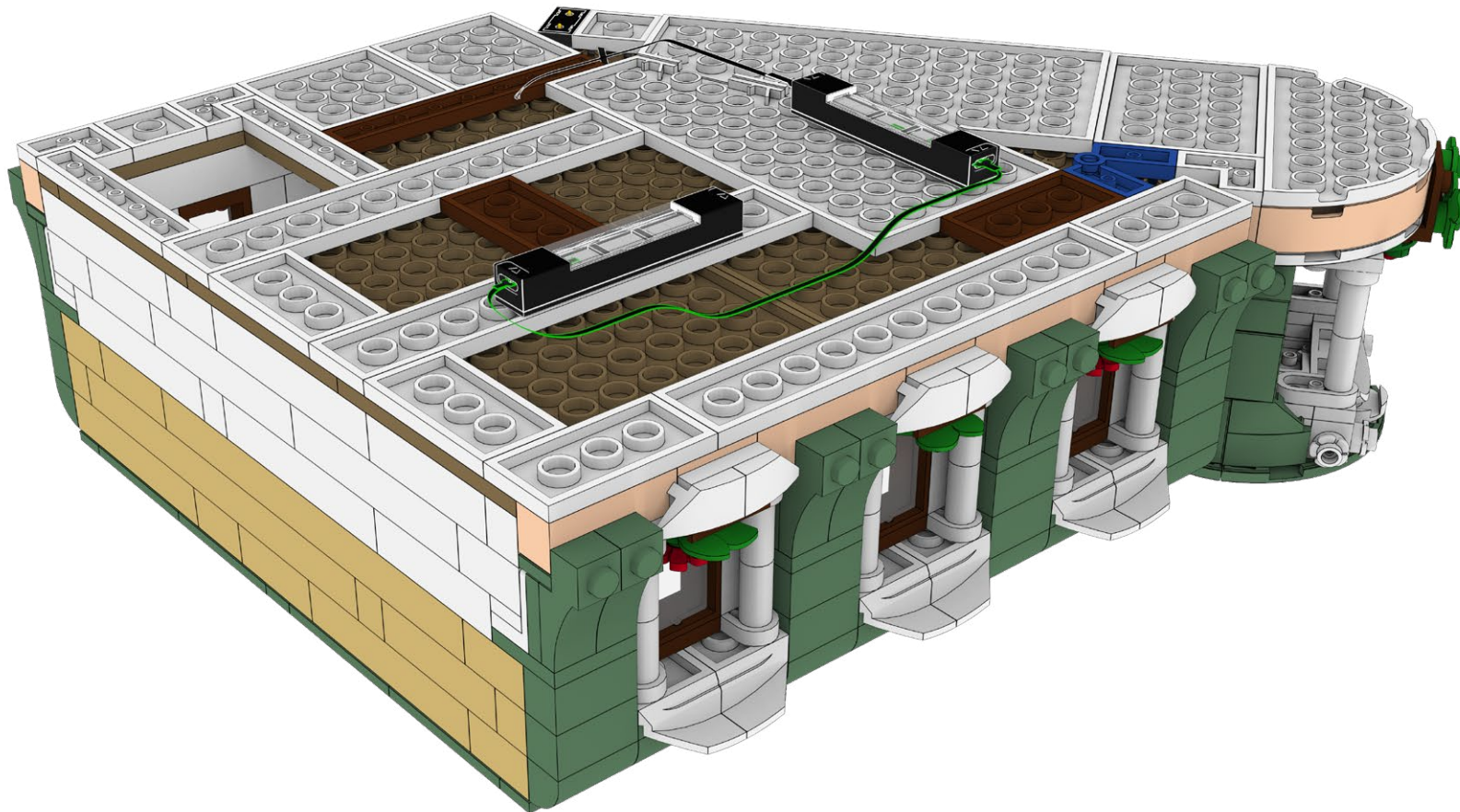

244

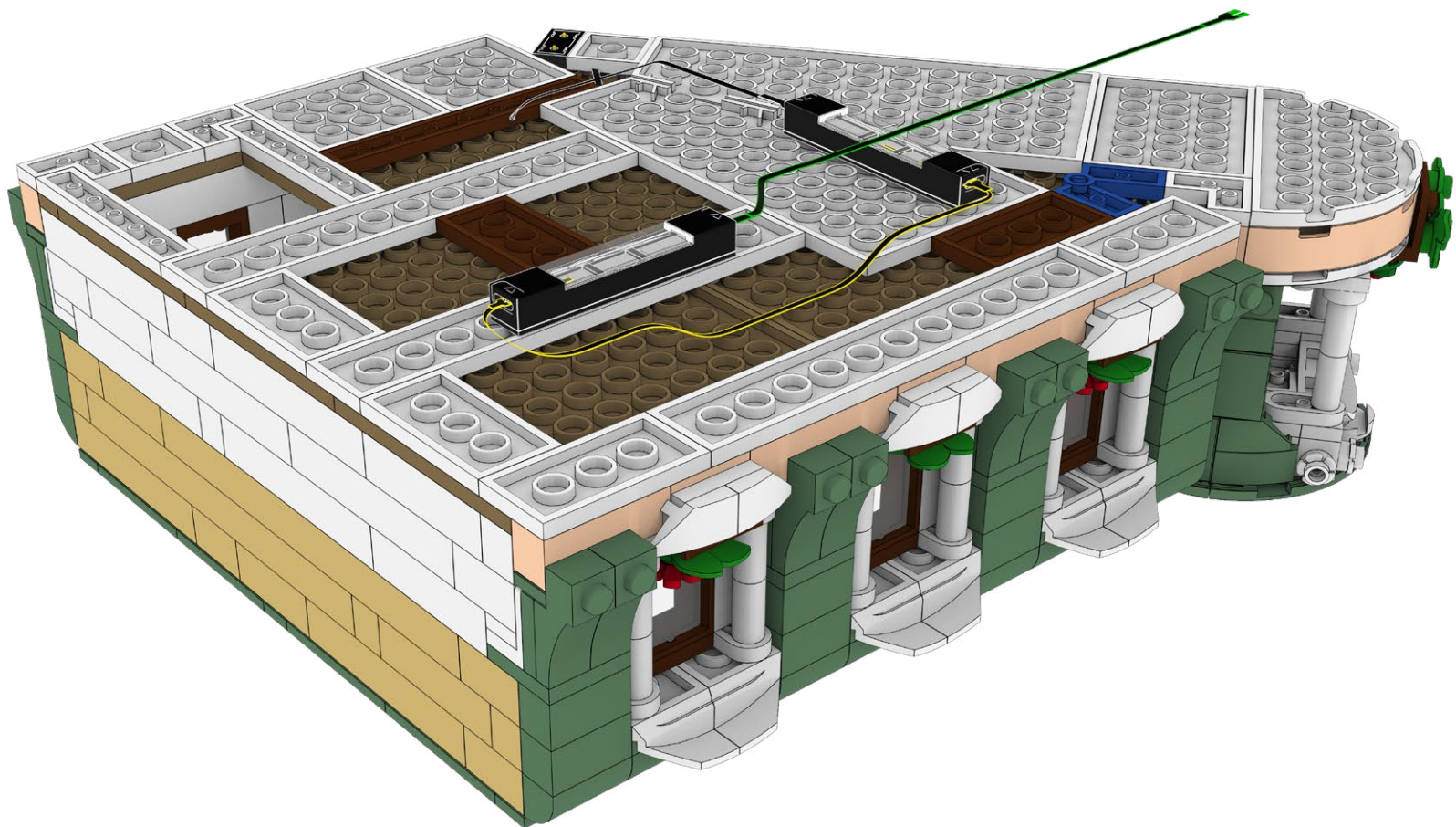
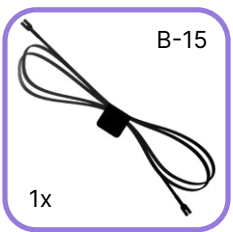

245

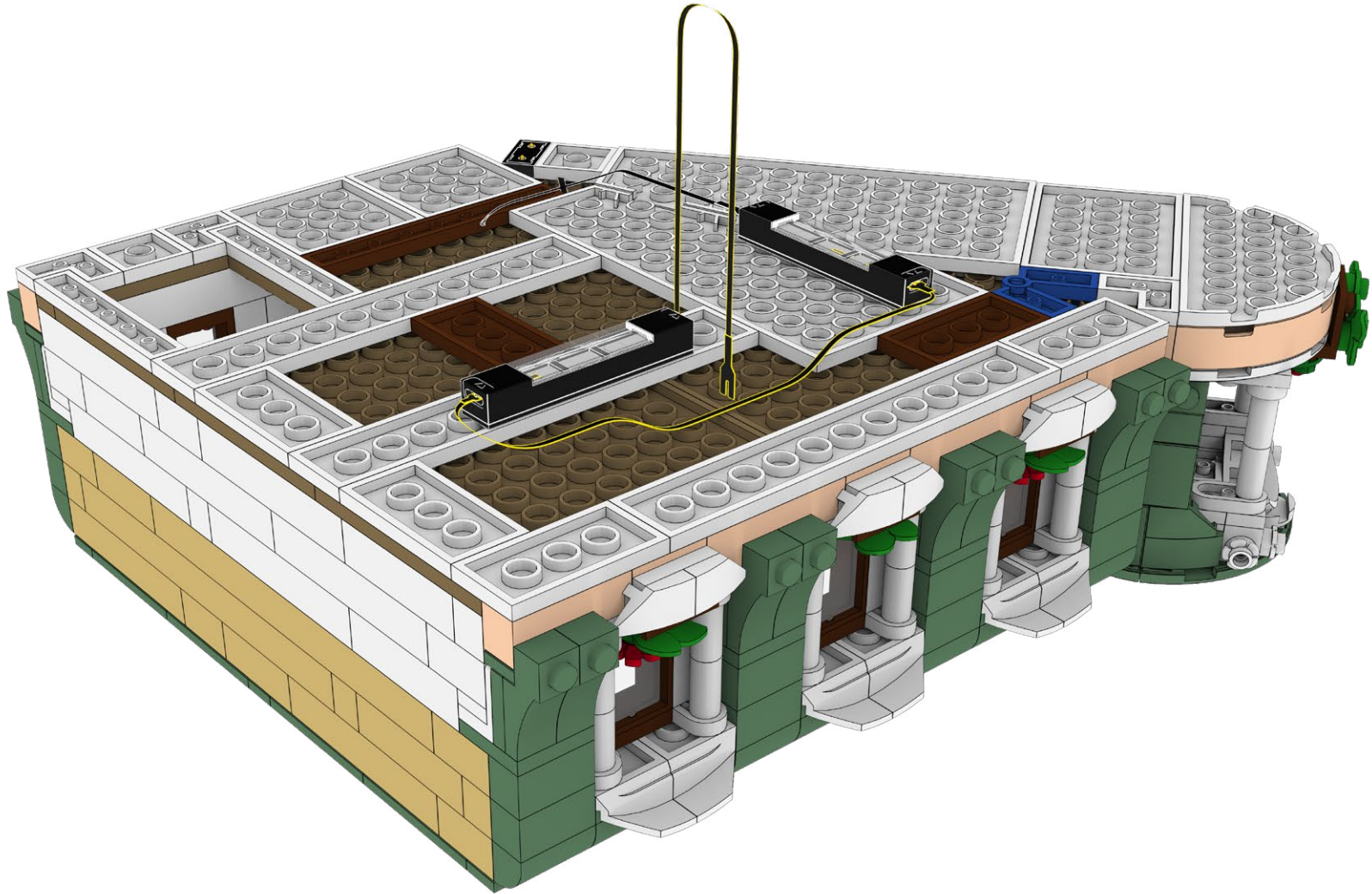

246

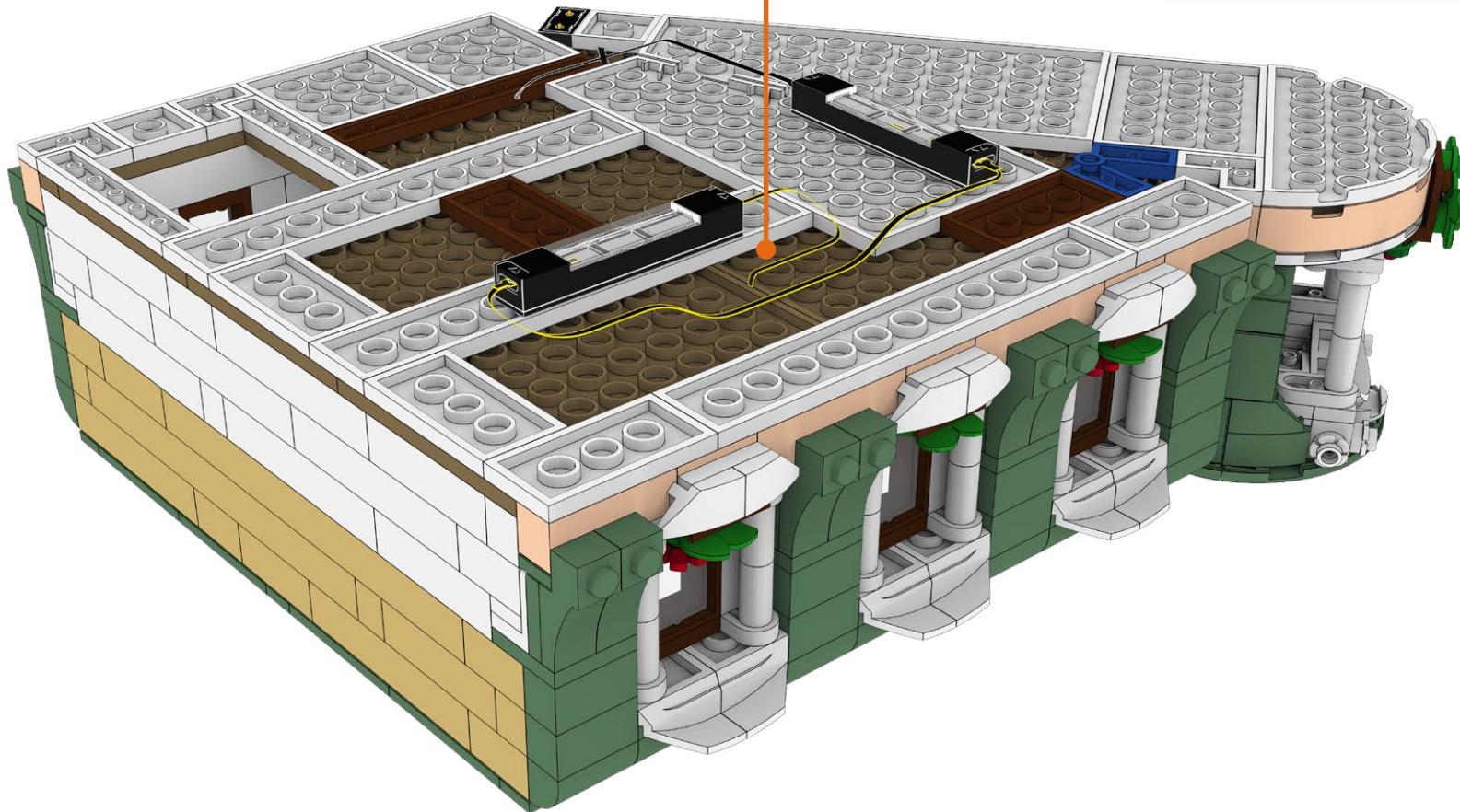

247

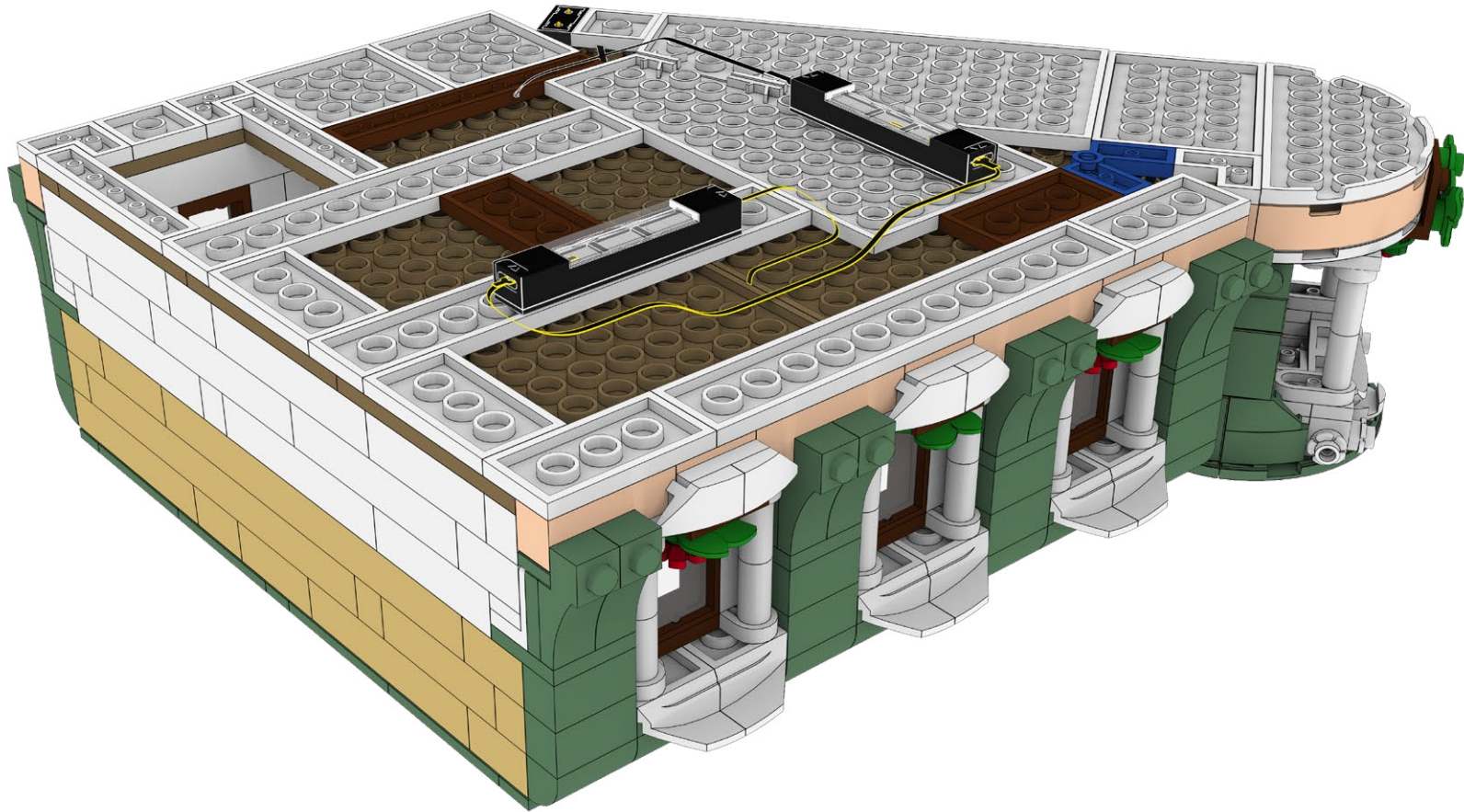
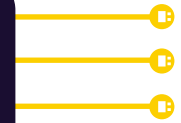

248

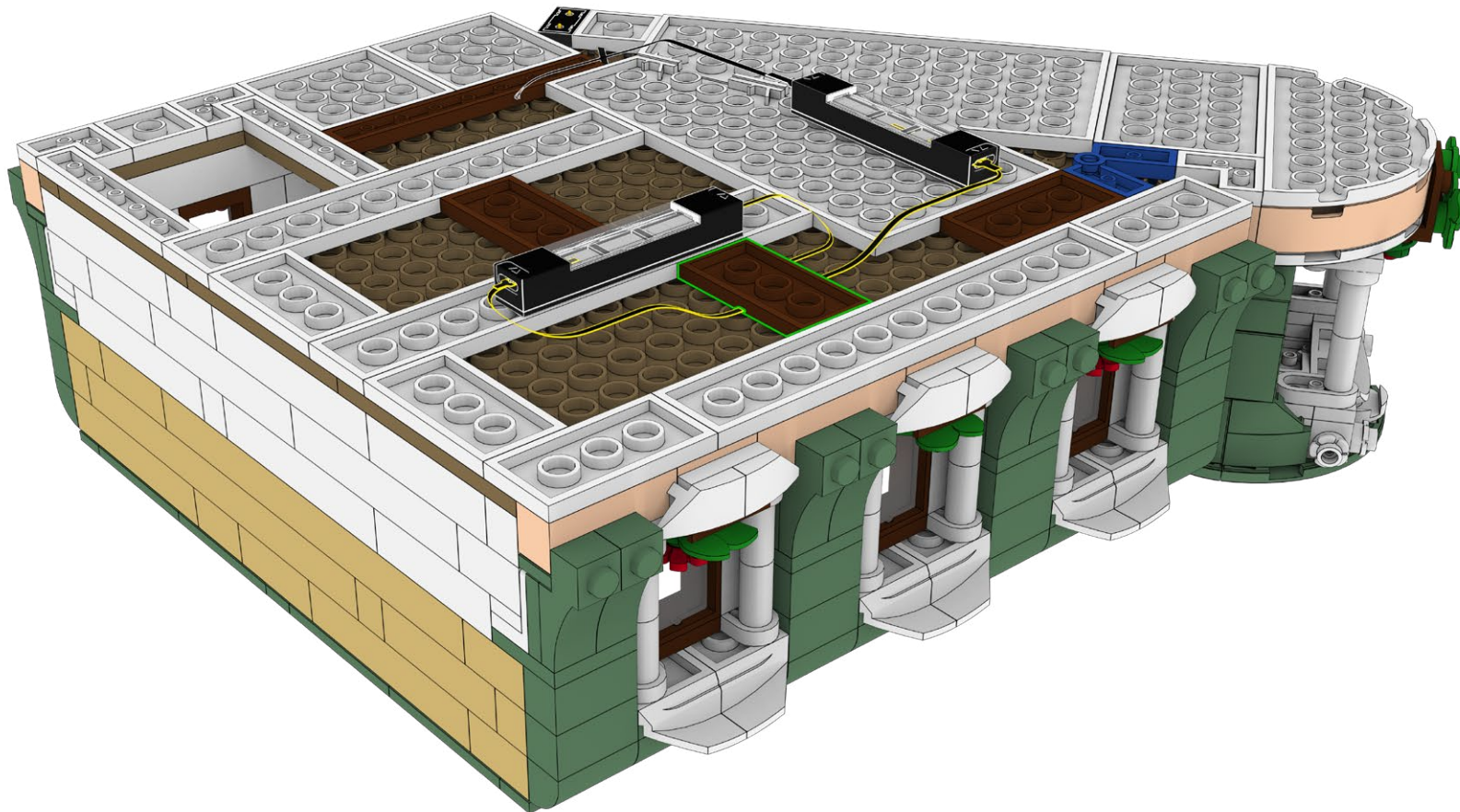

249

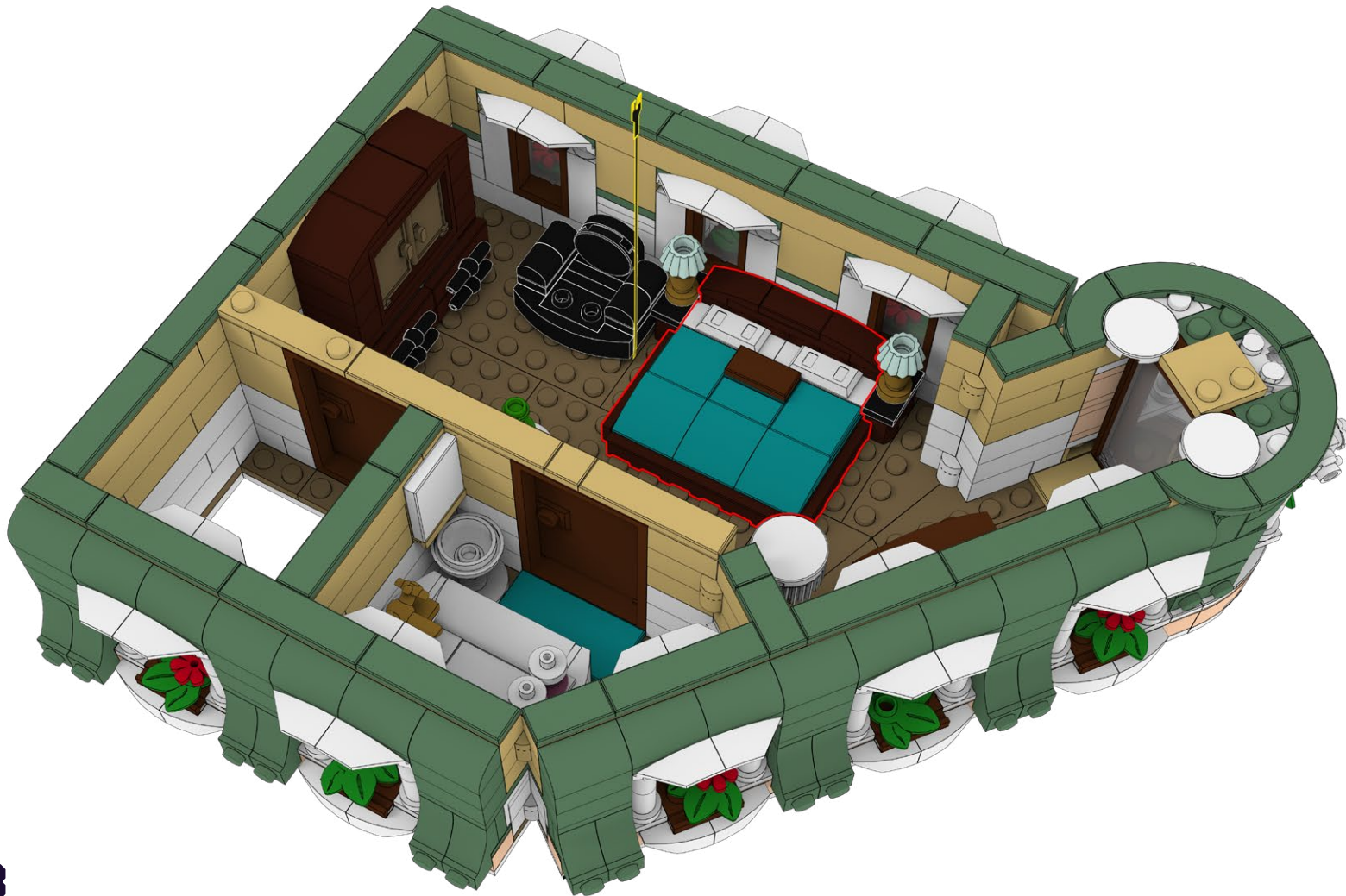

250

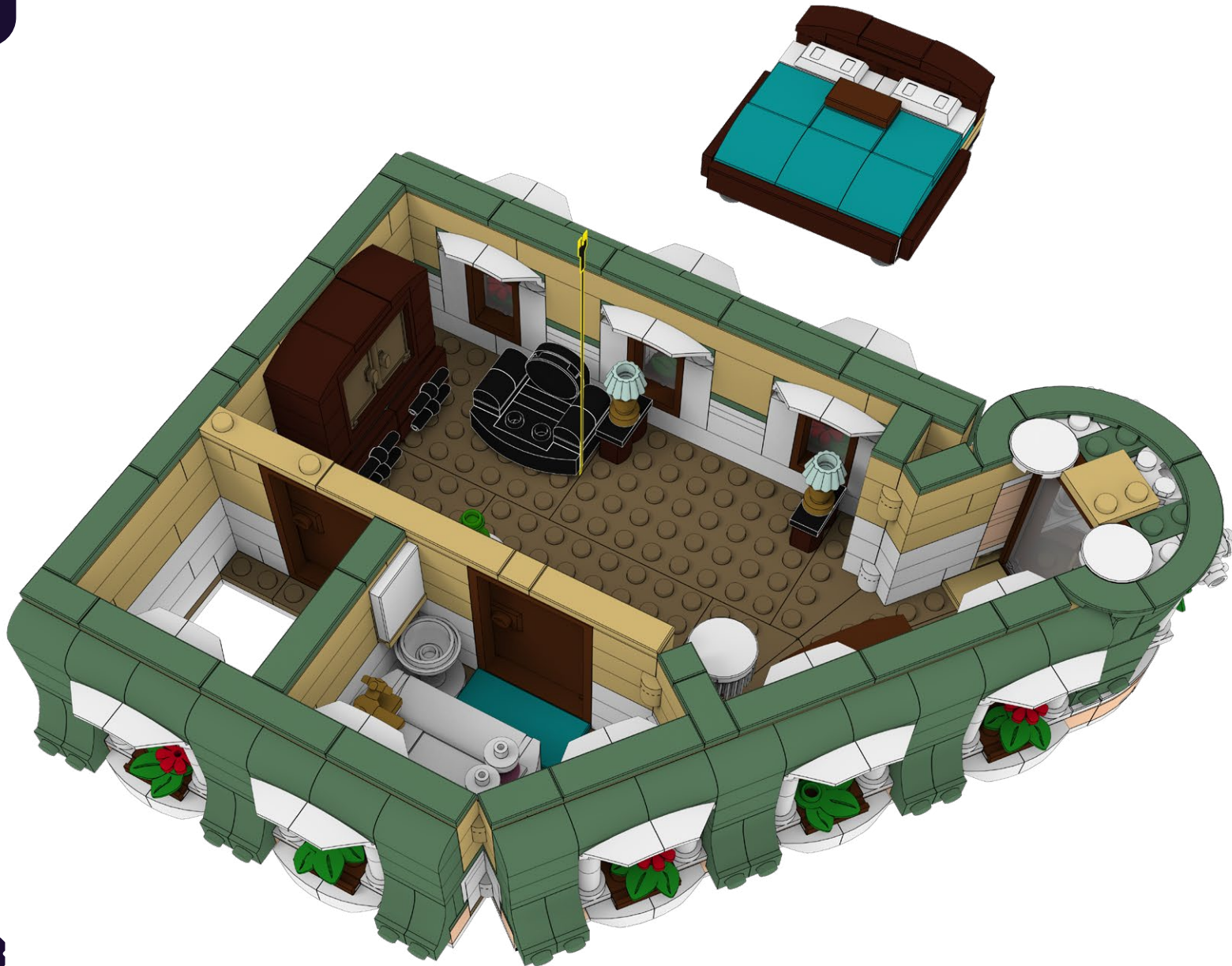

251



252



253

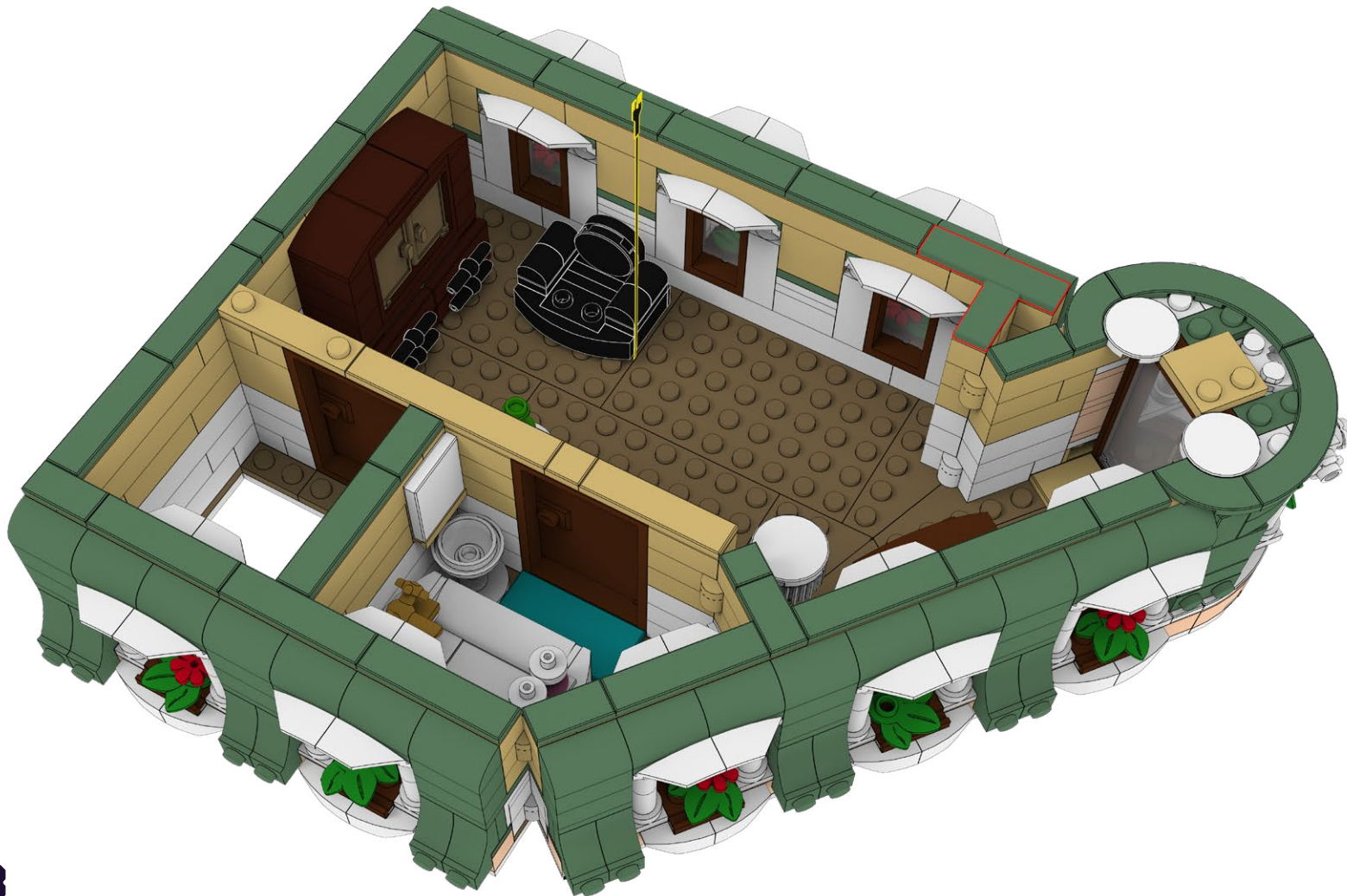

254

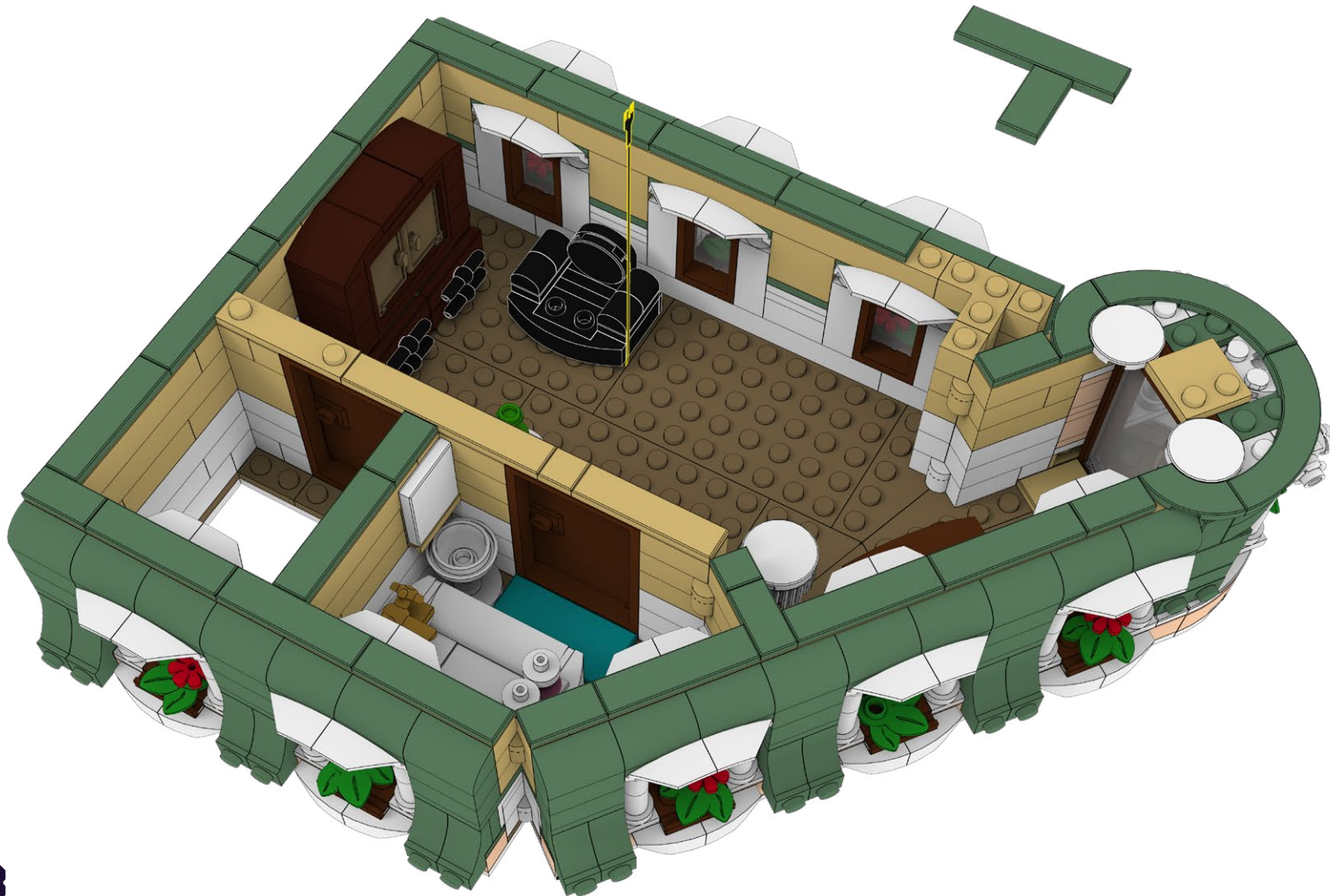

255

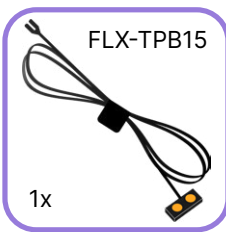

256



257

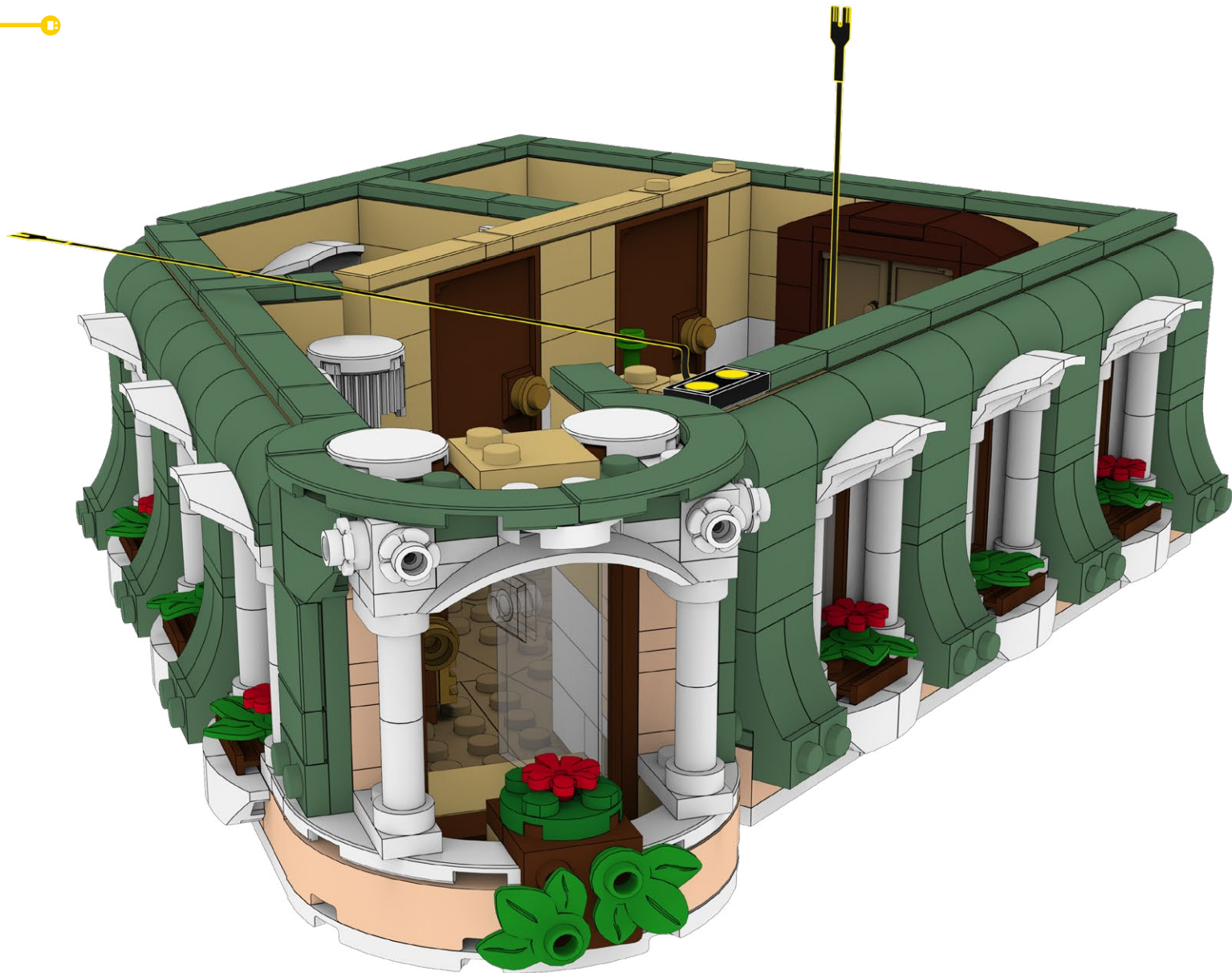

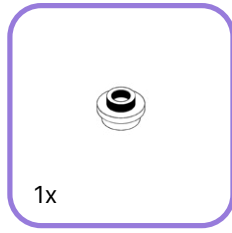
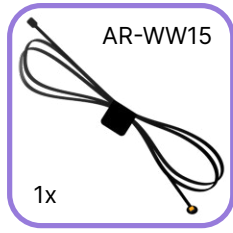
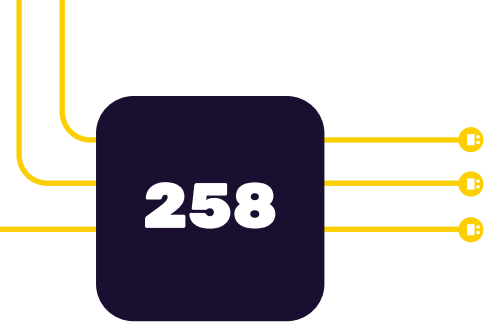

1

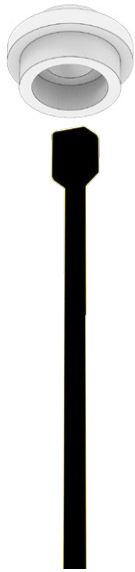

2

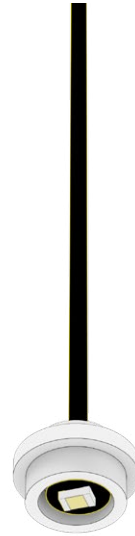

3



259



260

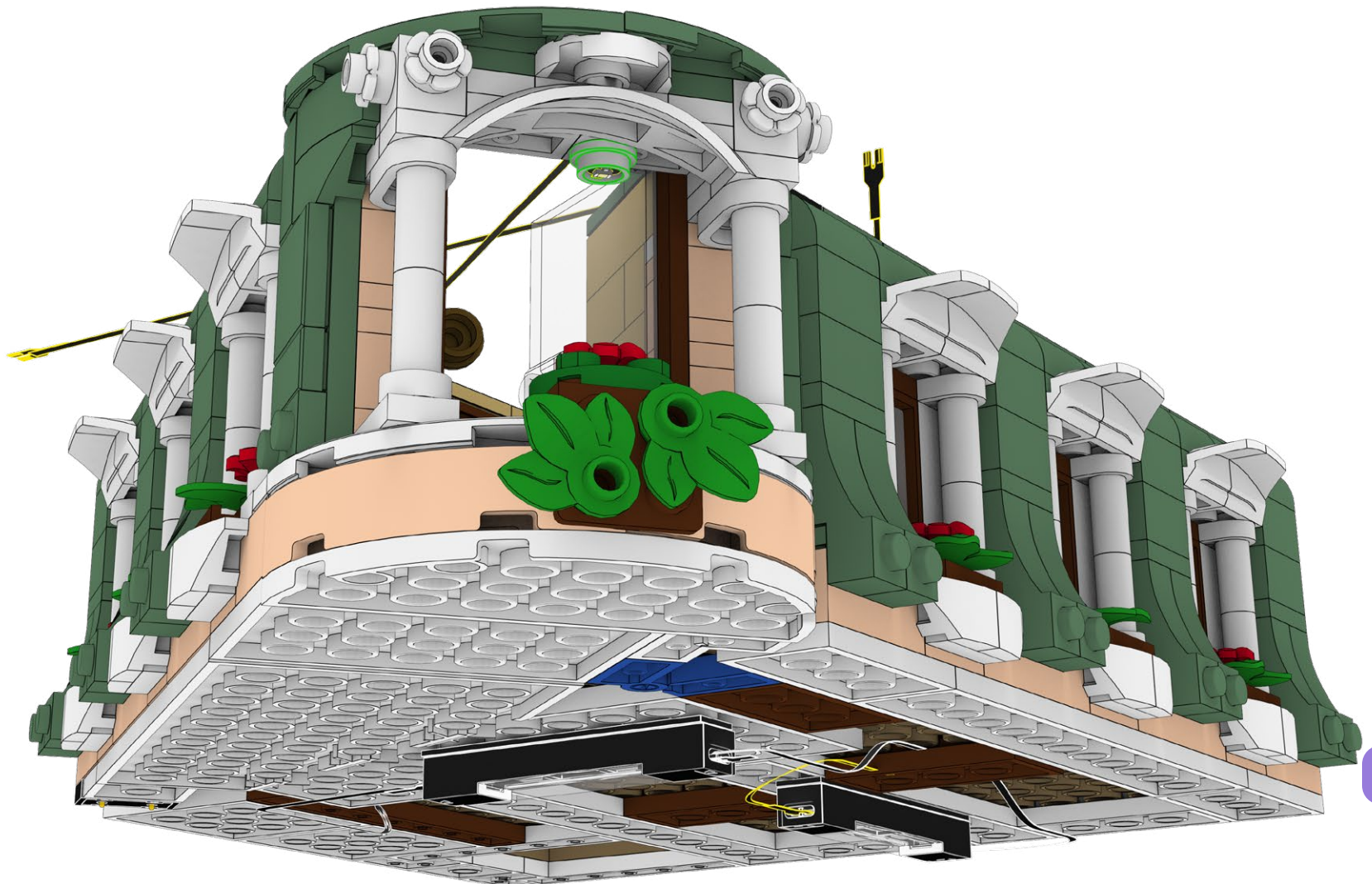

261





263



264



265





267



268



269

1

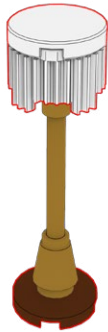

2



270

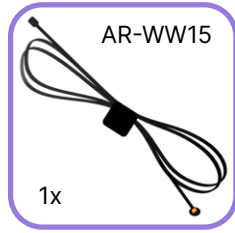
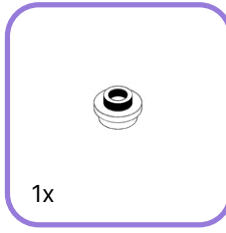

1



2



271

1



2

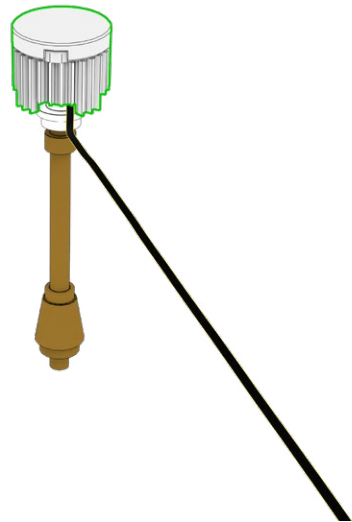

272

1

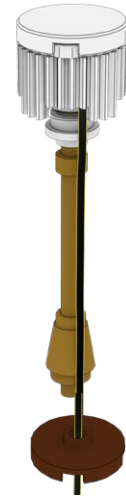

2



273

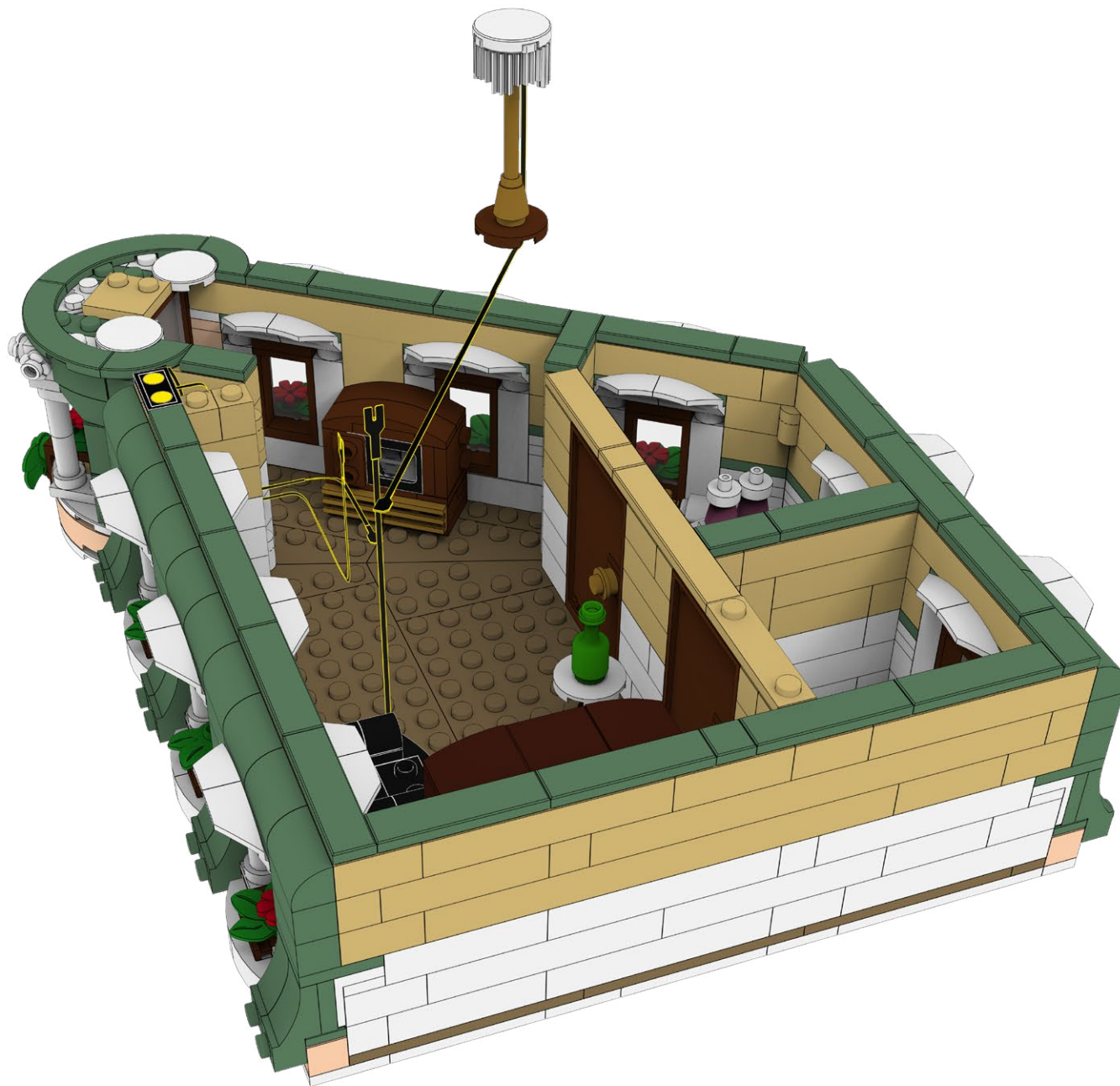

274



275

1



2



276

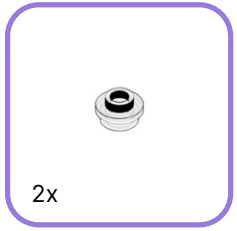
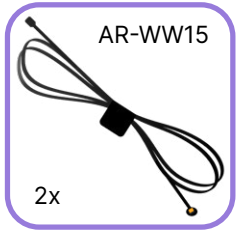

1



2



3



277



278

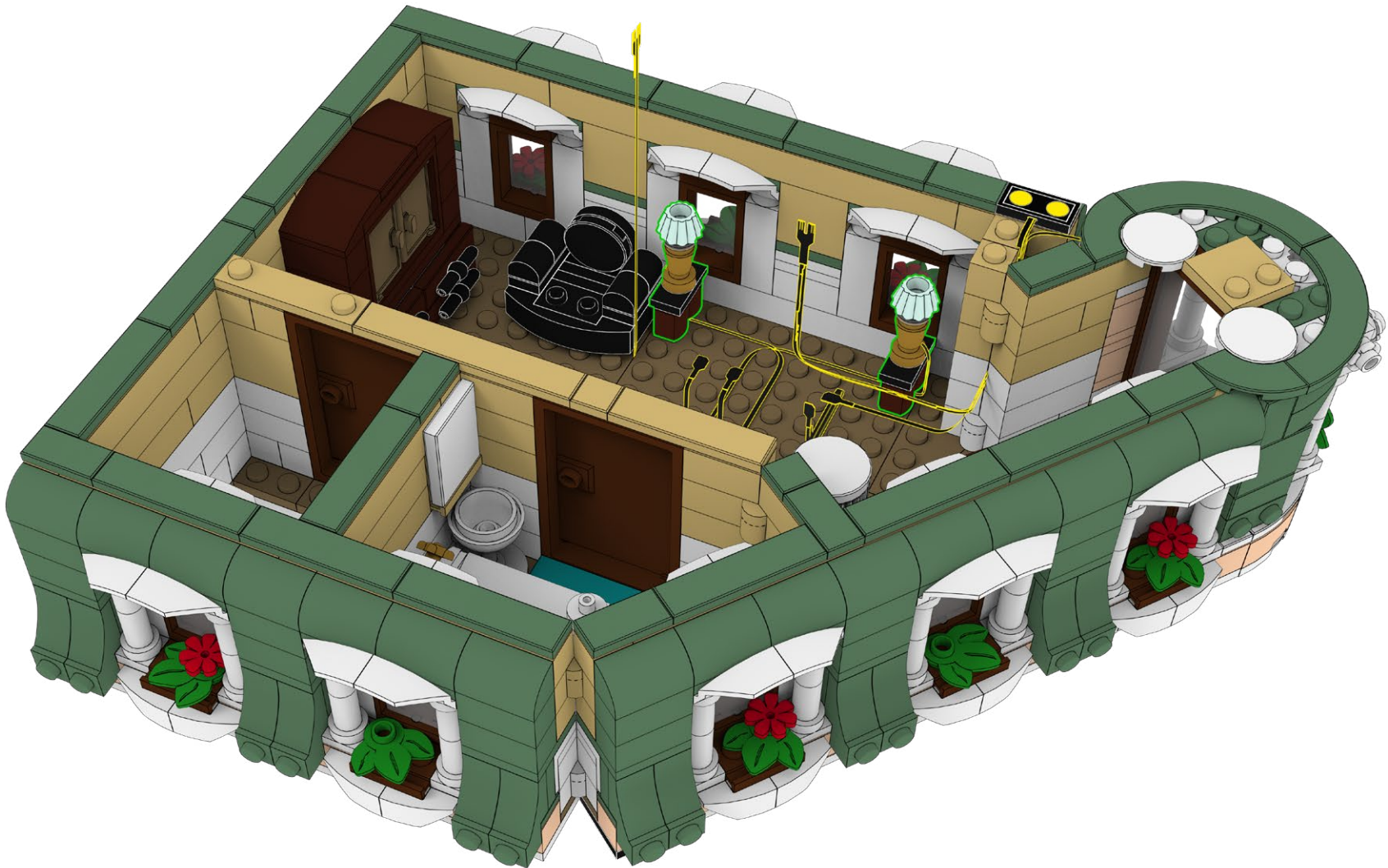

279

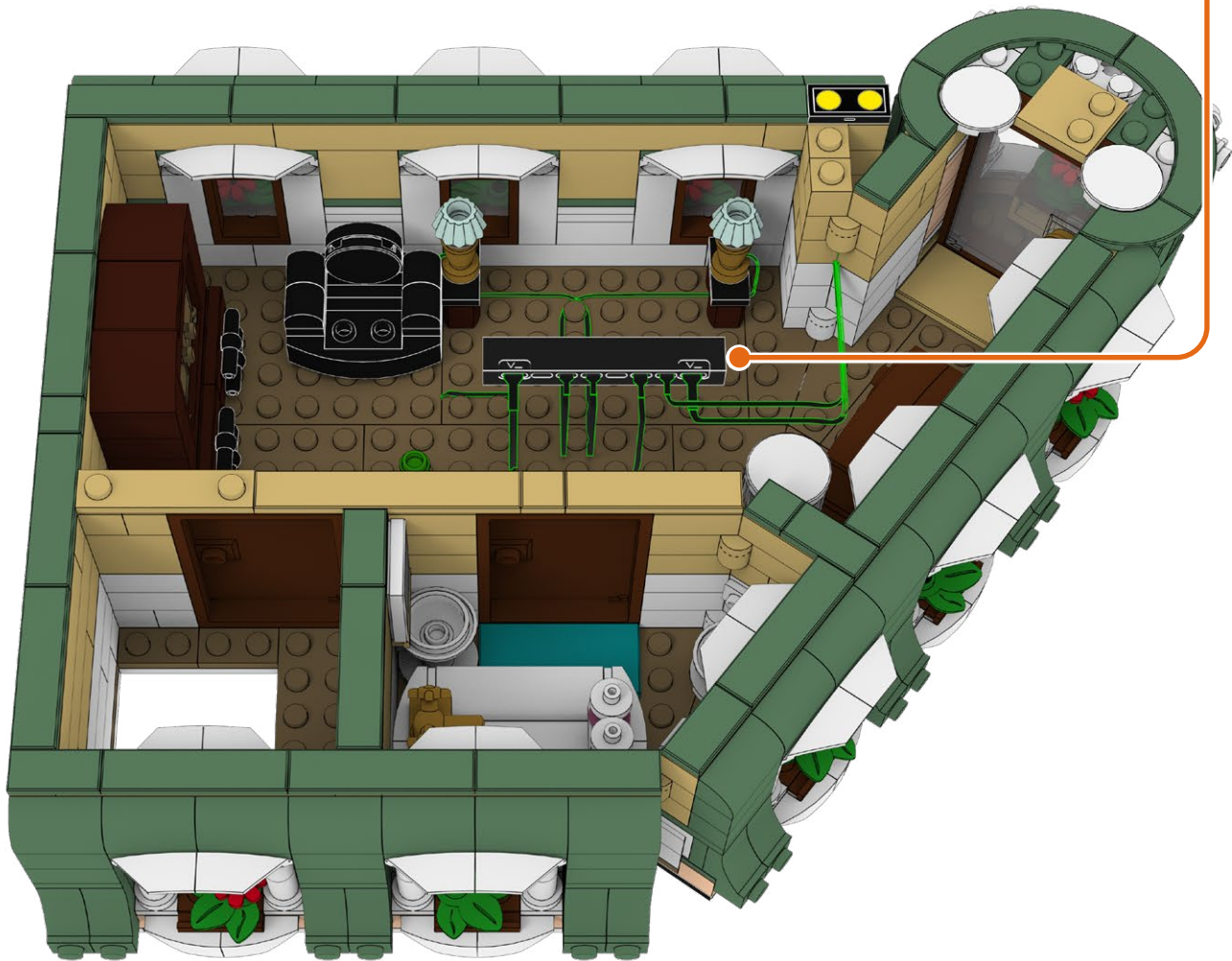
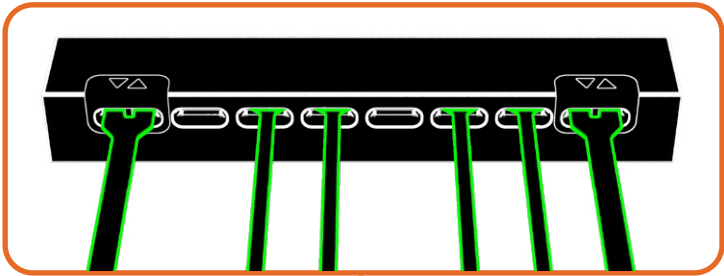
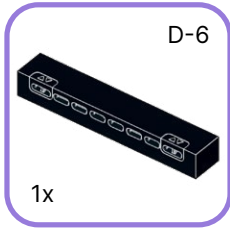

280



281

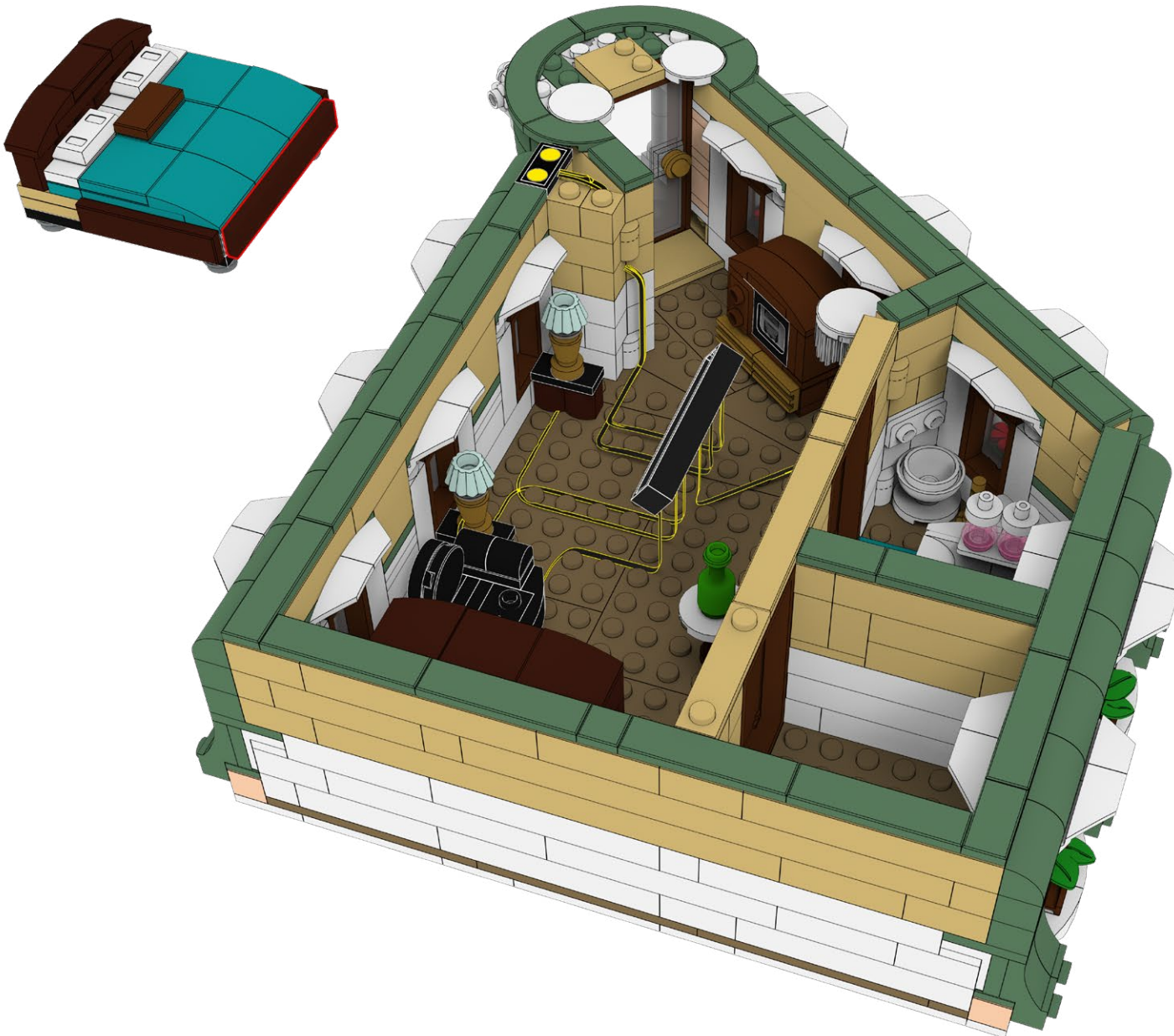

282

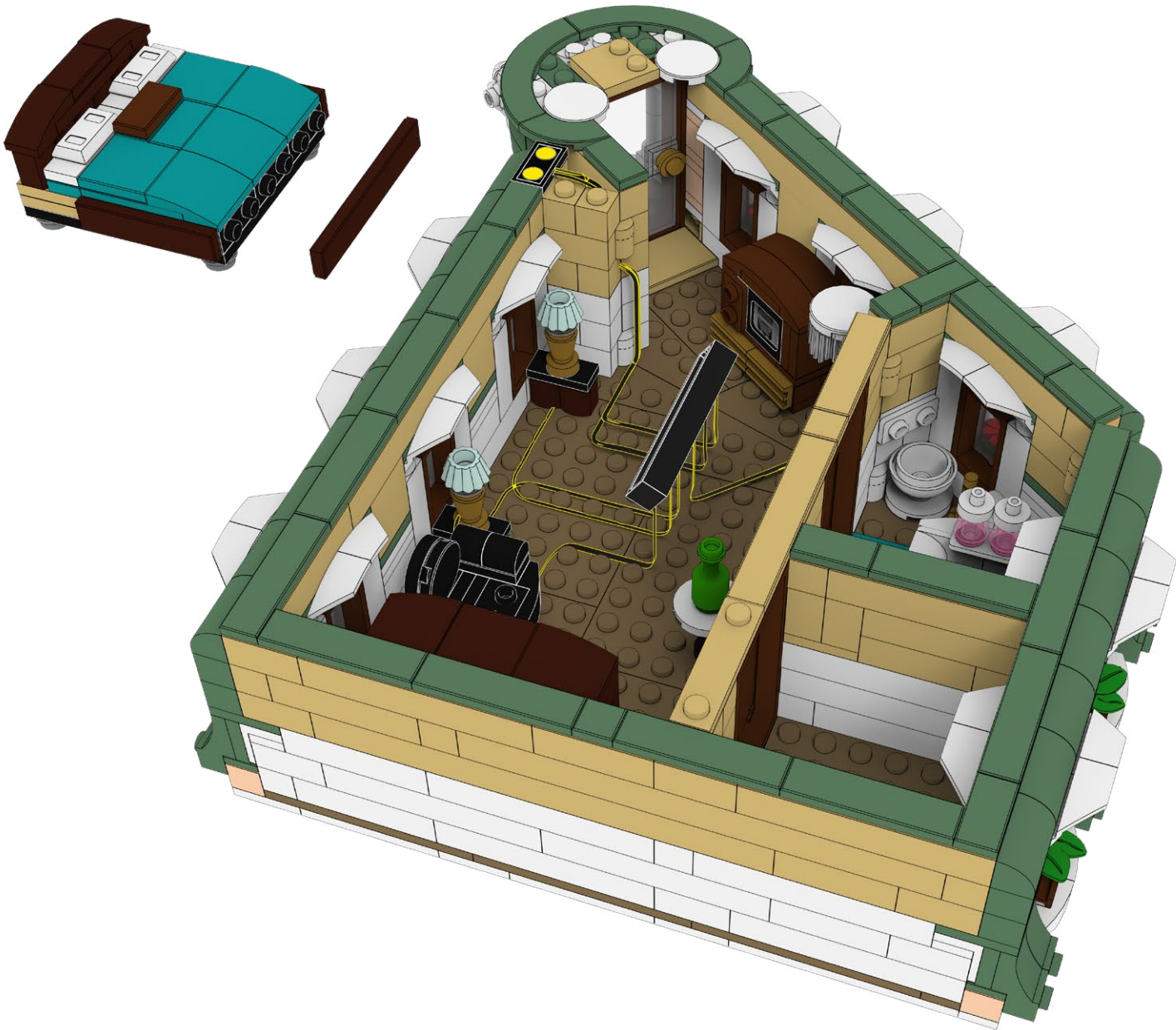

283



284



285

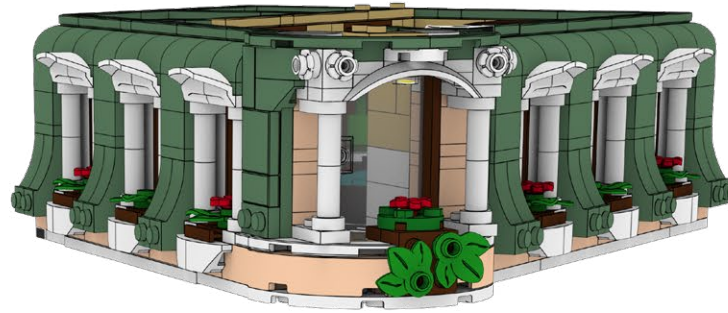

286



287

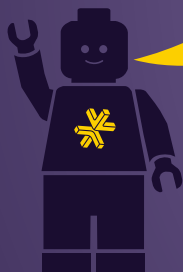

Power on Test
Test de mise sous tension
Test di Potenza
Stromtest
Prueba de Energía
电源测试



288

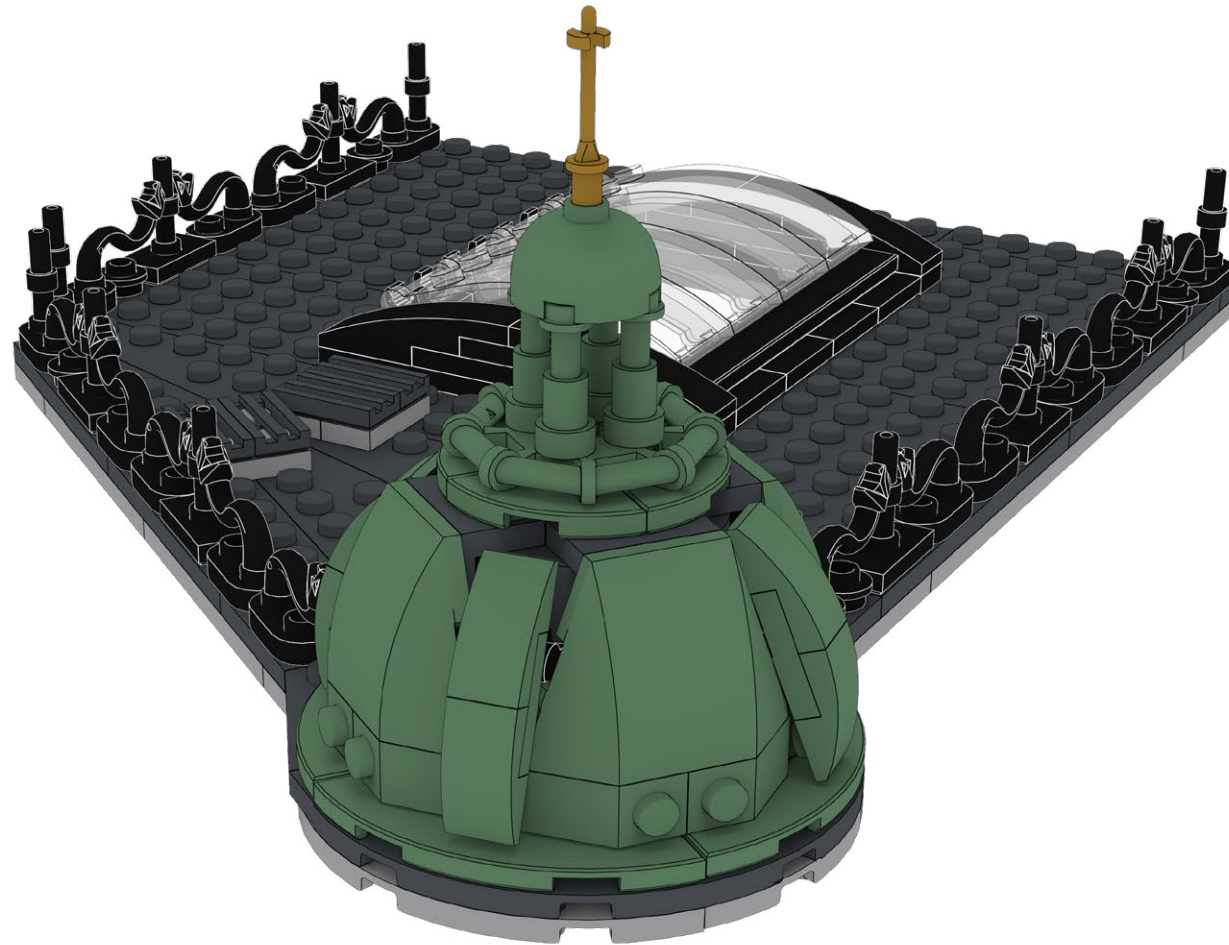

289

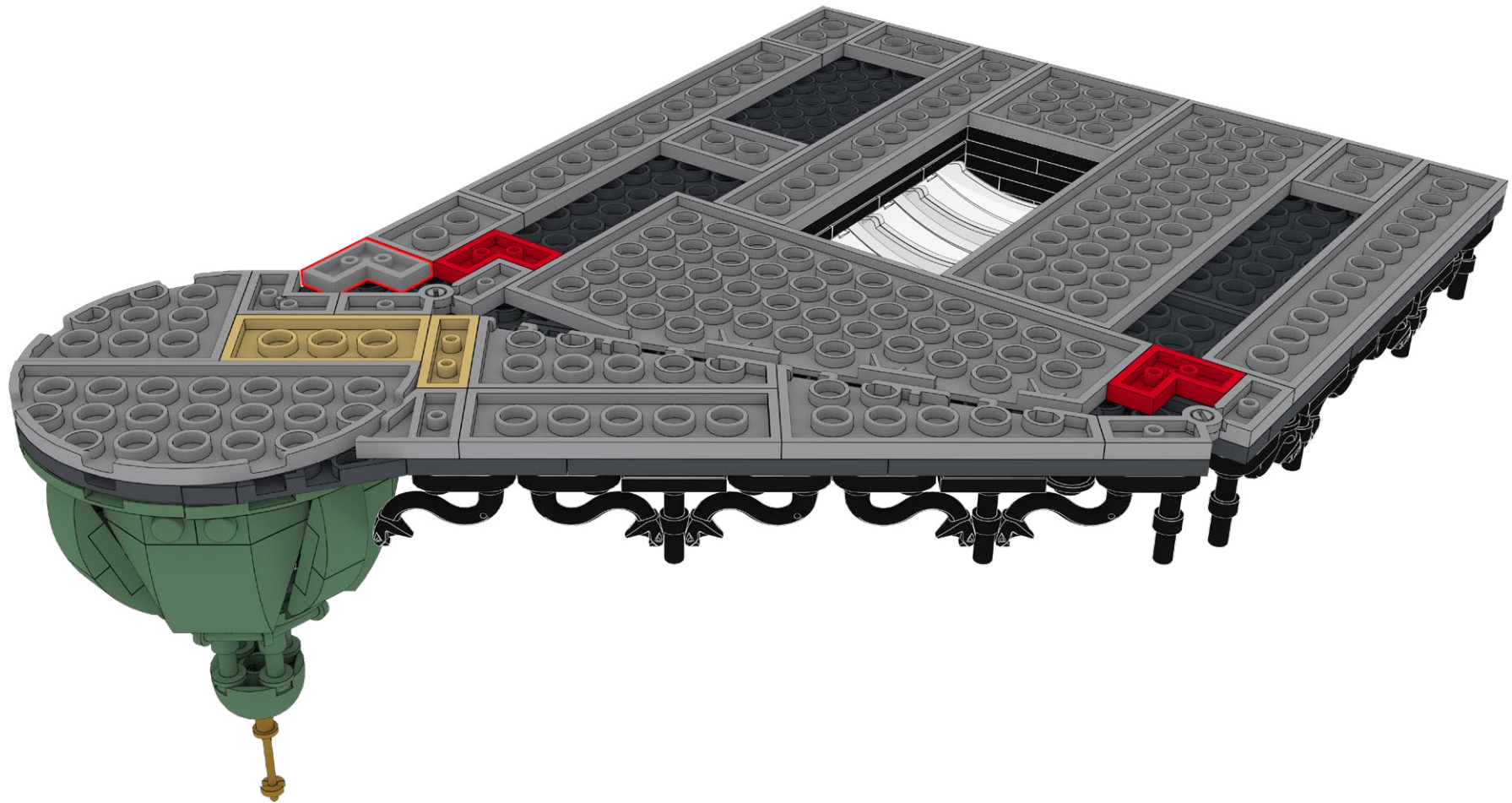

290

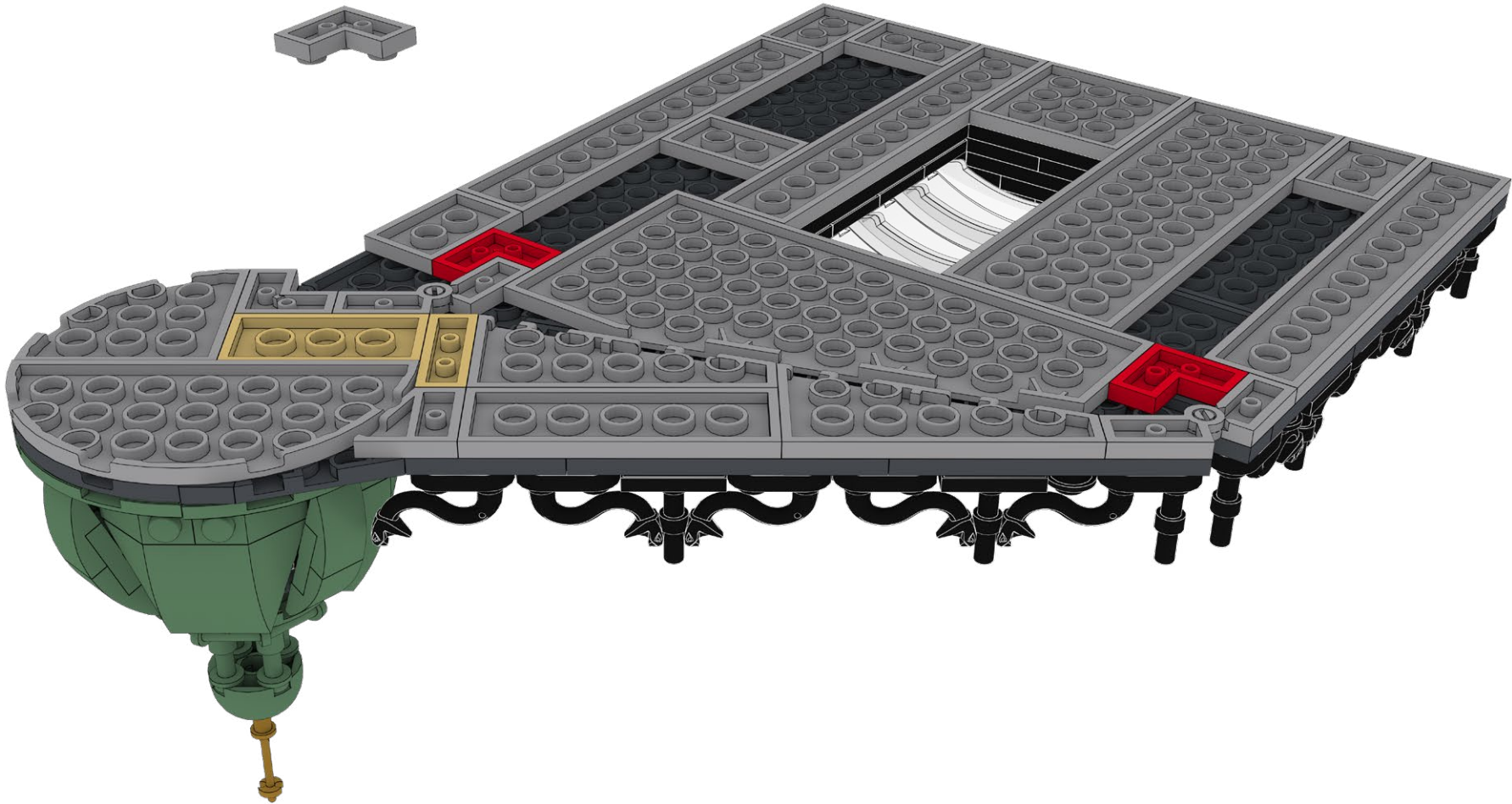

**HOLD UP!**

You might notice some bags aren't in order, as well as left over pieces, but that's ok! We're changing the way you build LEGO!

ATTENDEZ!

Vous remarquerez peut-être que certains sacs, ainsi que certaines pièces, ne sont pas dans le bon ordre. Mais pas de panique! Nous changeons simplement la façon avec laquelle vous construisez vos LEGO!

ASPETTA!

Potresti notare che alcuni sacchetti non sono in ordine, così come i pezzi avanzati, ma va bene così! Stiamo cambiando il modo in cui costruisci i LEGO!

HALT!

Sie werden möglicherweise bemerken, dass einige tüten durcheinander sind und teile übrig bleiben, aber das ist in Ordnung! Wir ändern die art und weise, wie Sie LEGO bauen!

¡ESPERA!

Es posible que notes que algunas bolsas están fuera de servicio, así como piezas sobrantes, ¡pero está bien! ¡Estamos cambiando la forma en que construyes LEGO!

暫停!

你可能会注意到一些袋子顺序错乱, 以及一些剩余的部件, 但没关系! 我们正在改变你搭建乐高的方式!

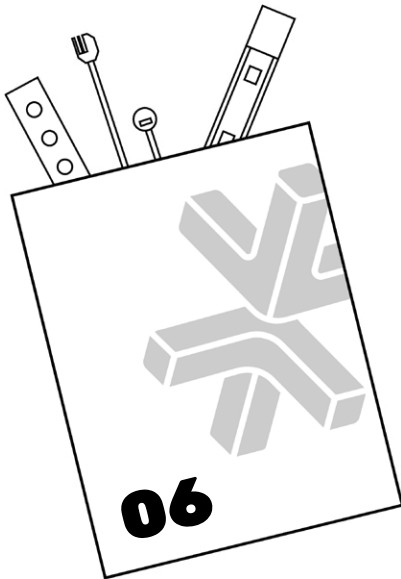
Open LMB Bag 06

291

FLX-TPA15

1x

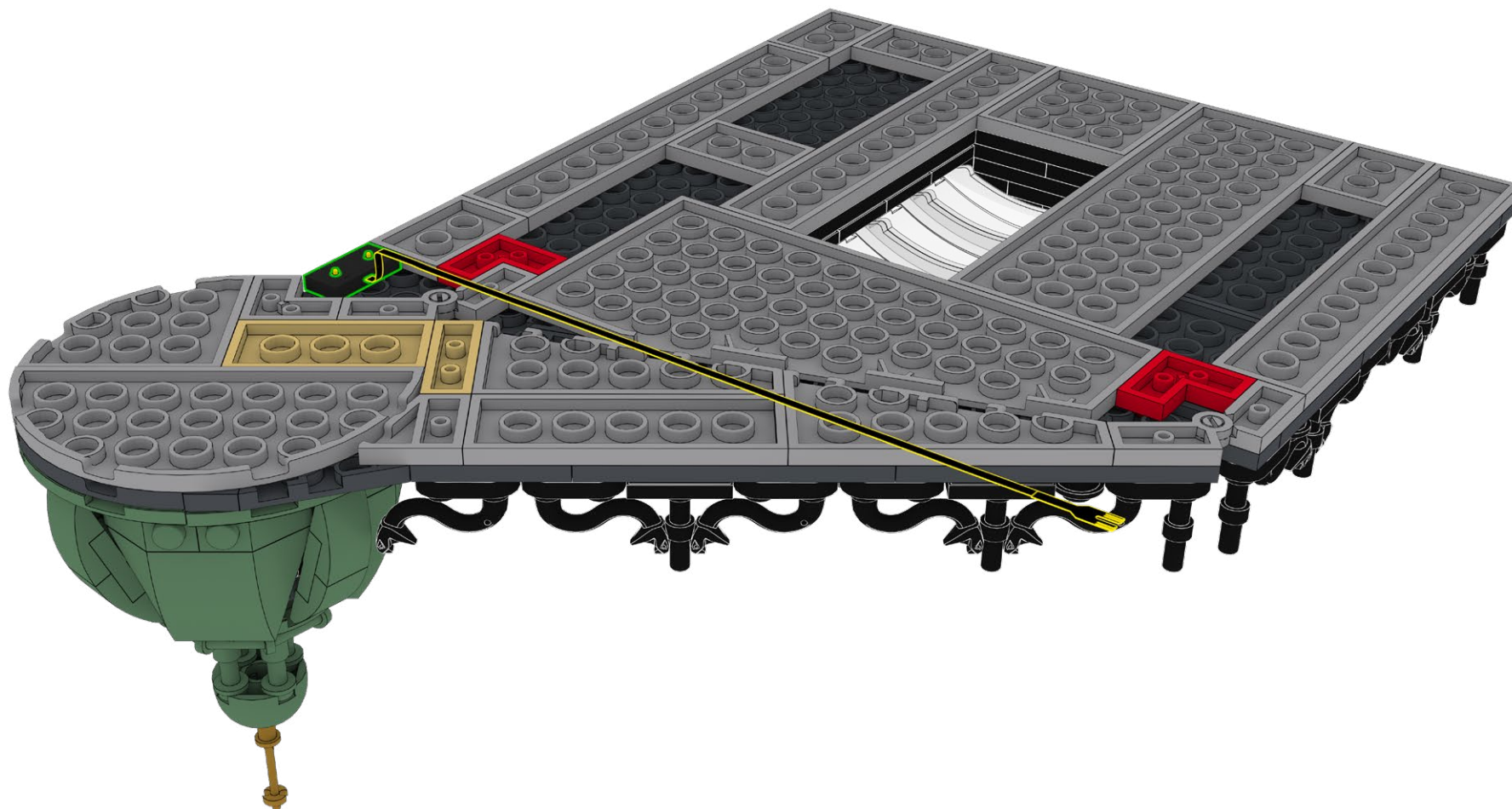

292

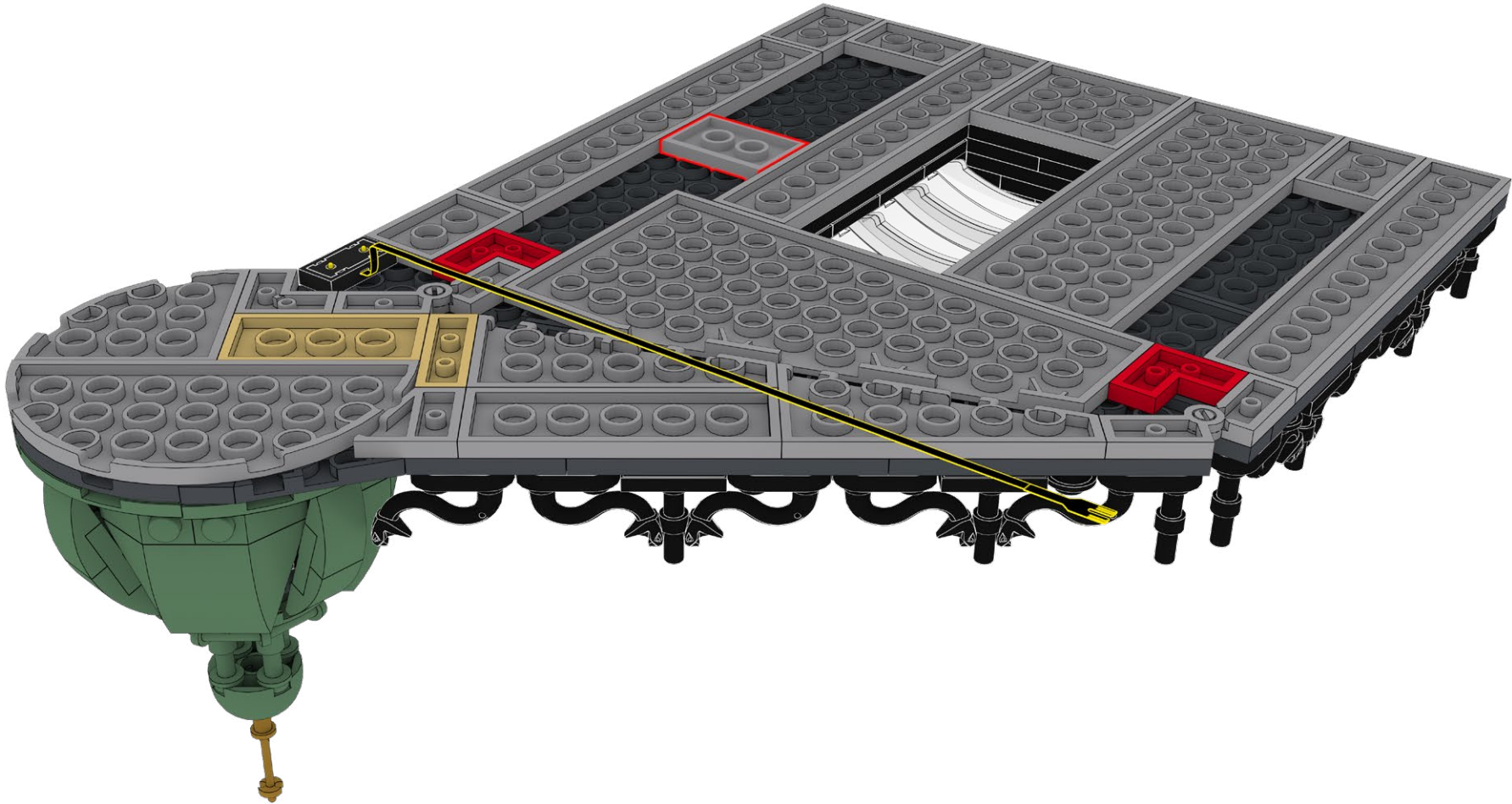

293

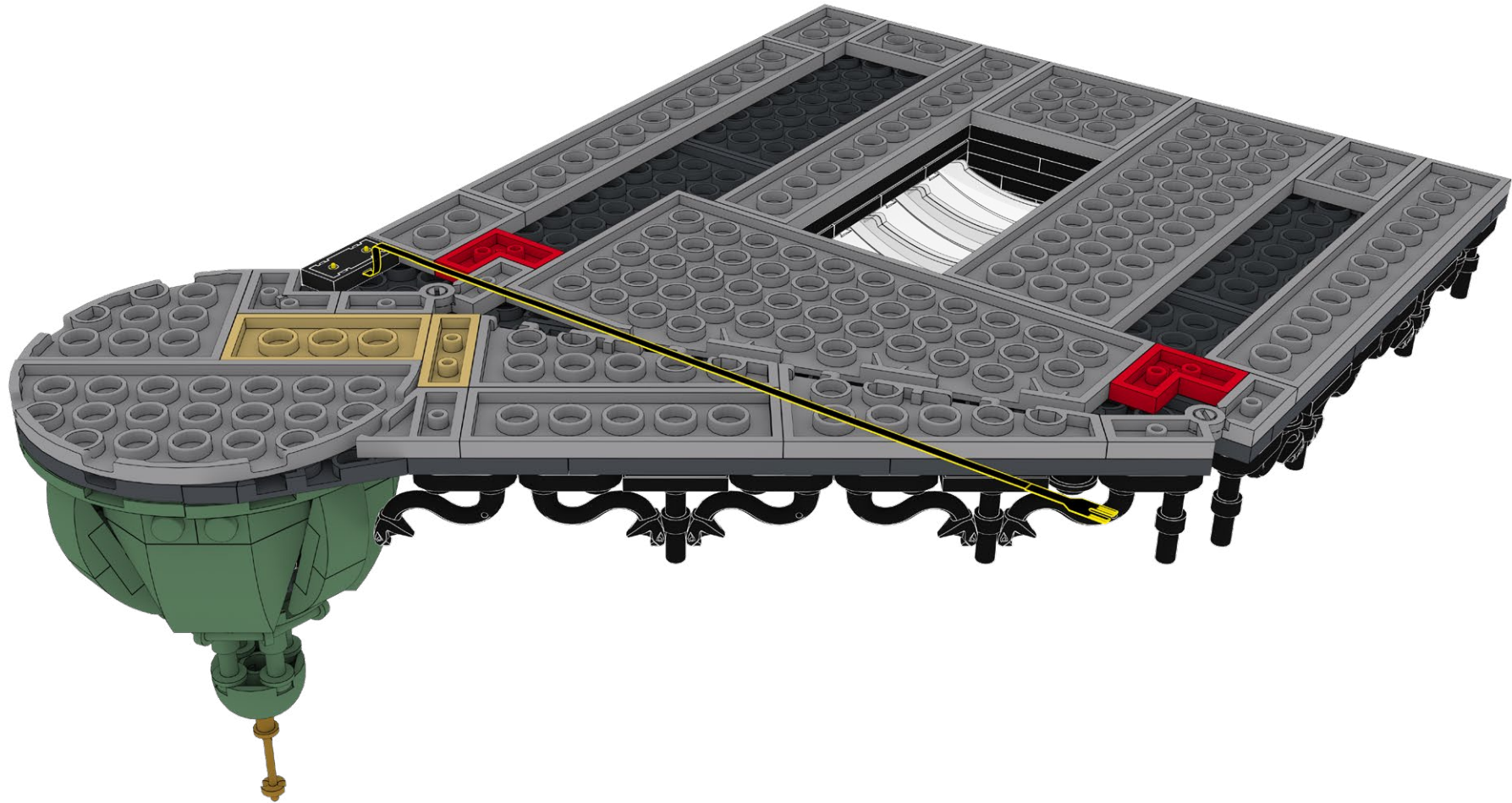

294

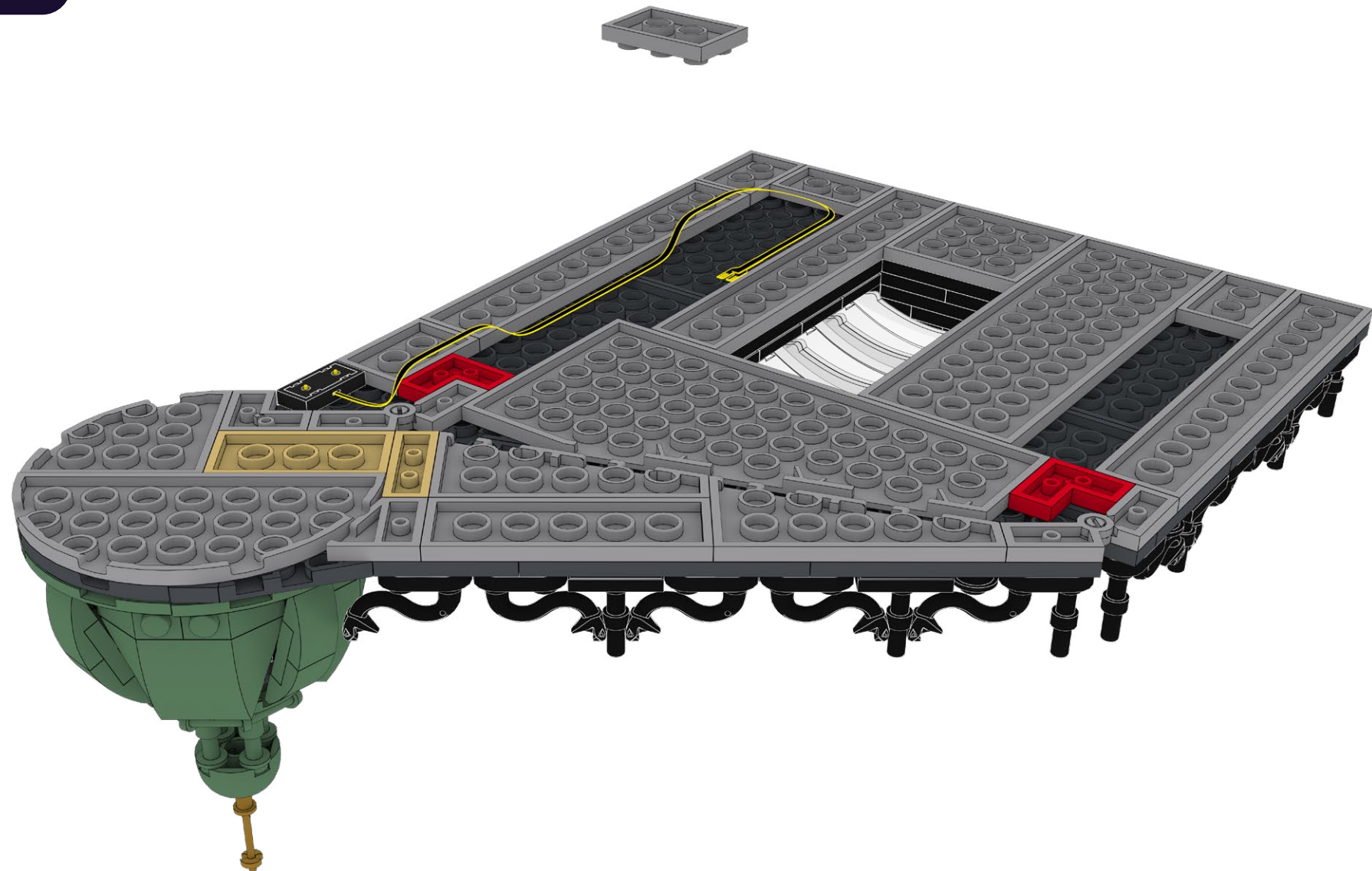

295

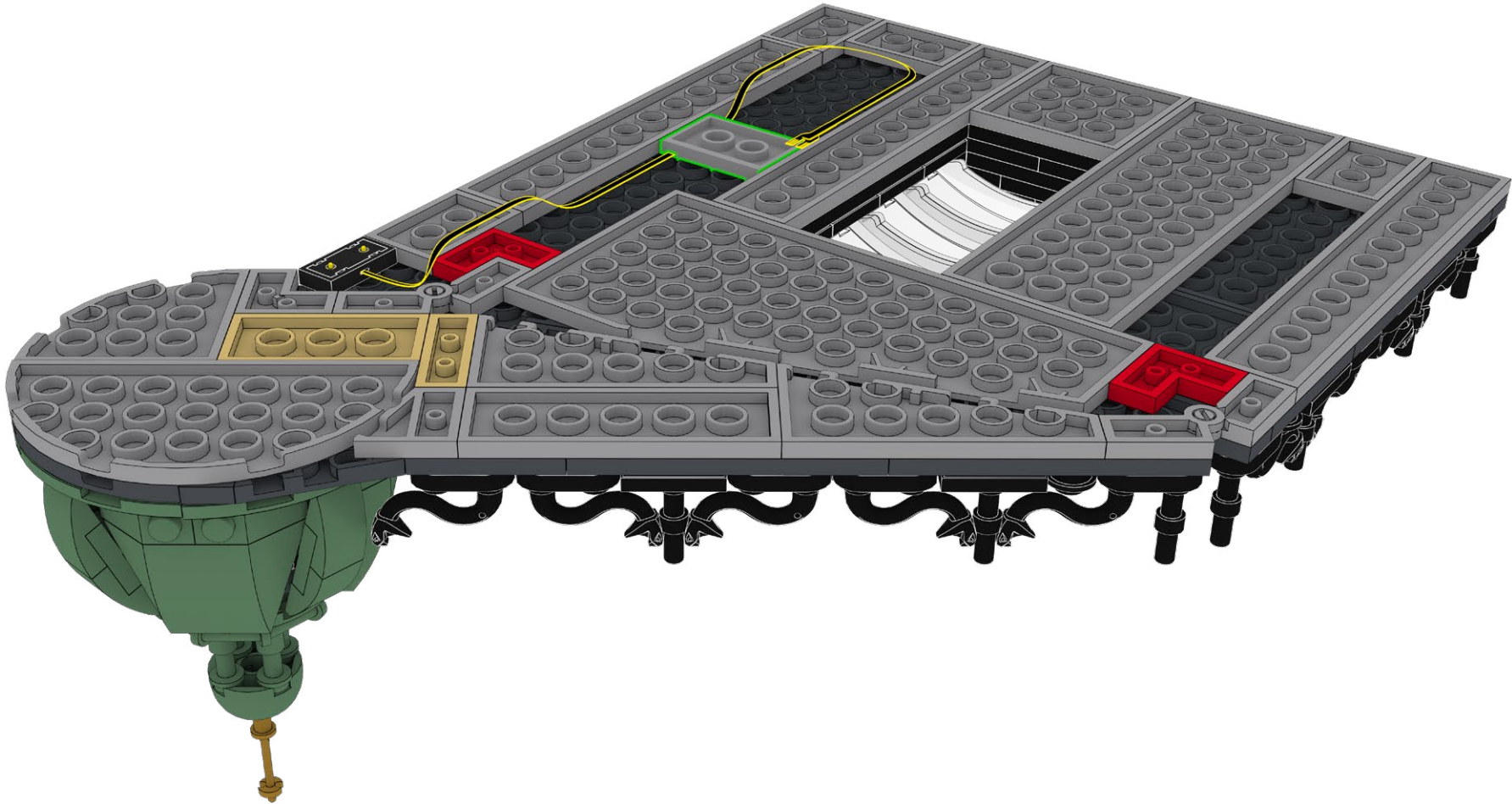

296

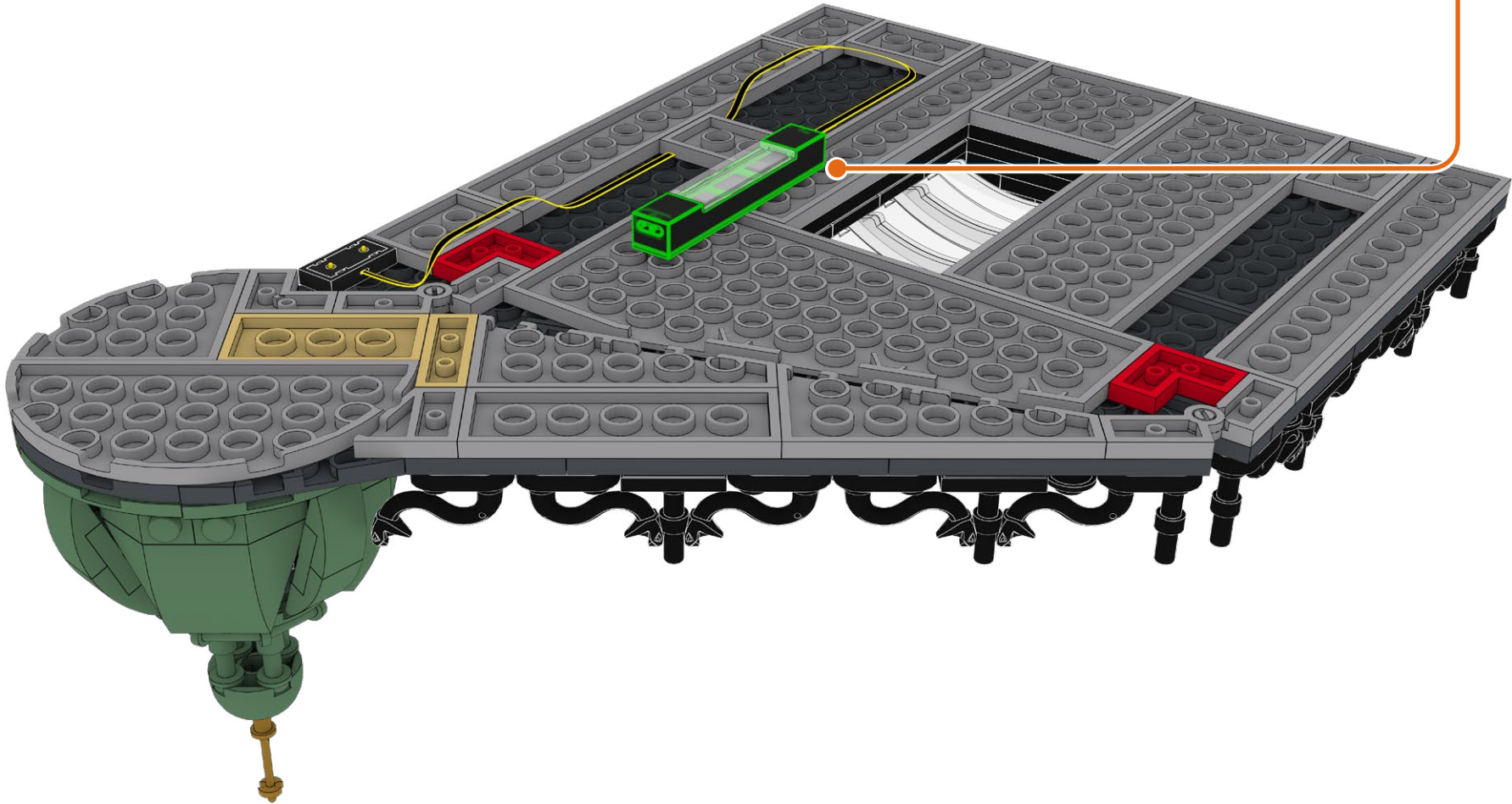
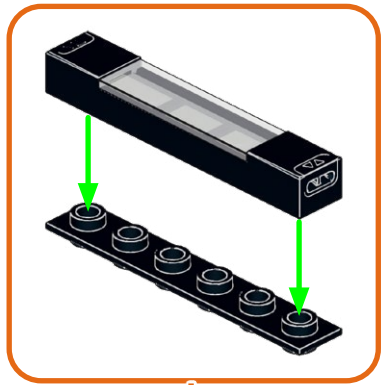
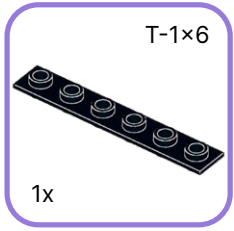

297

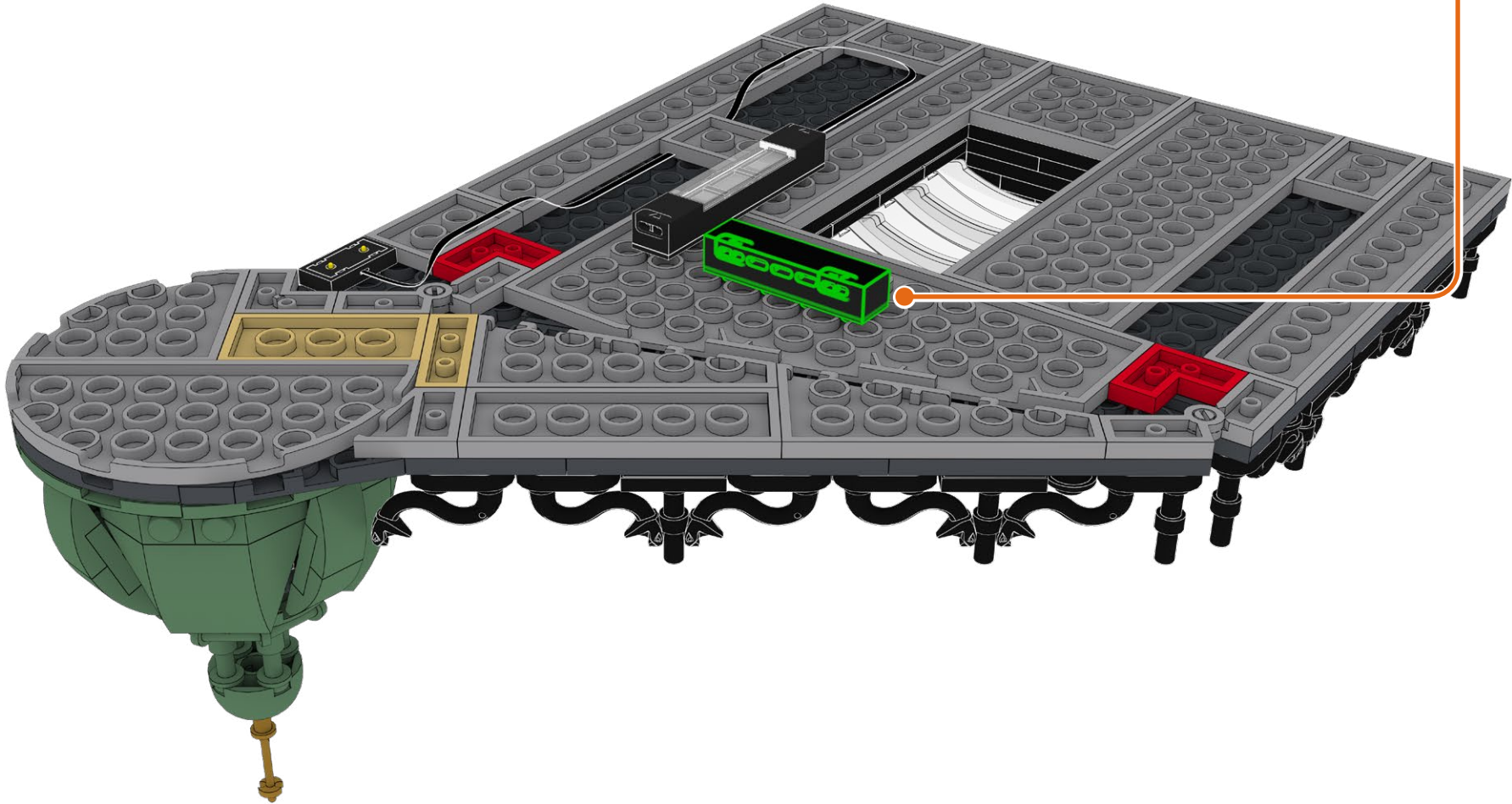
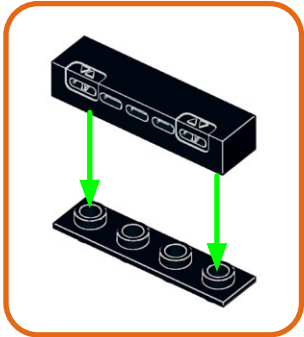
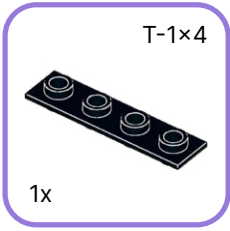
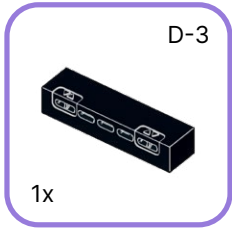

298

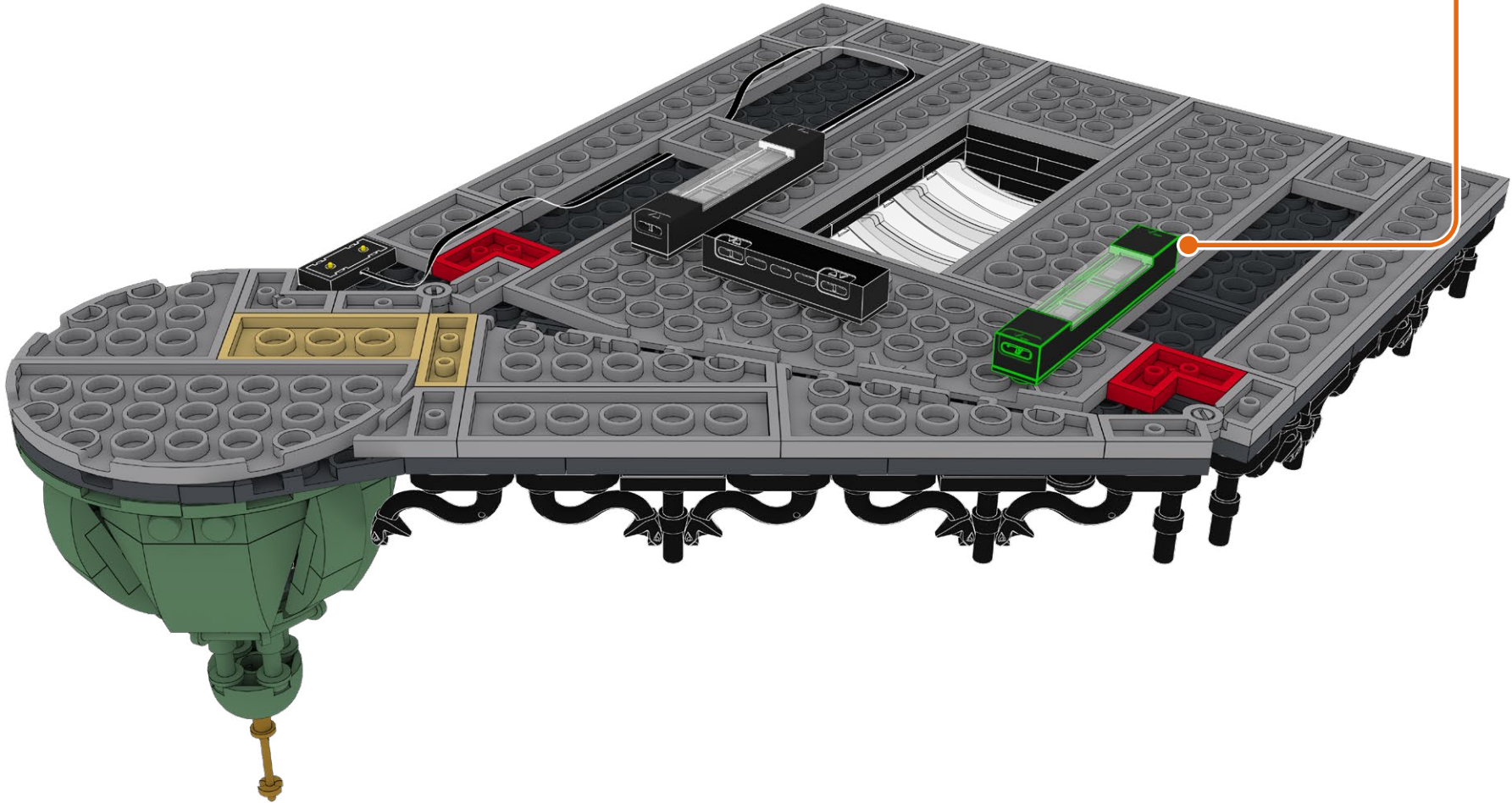
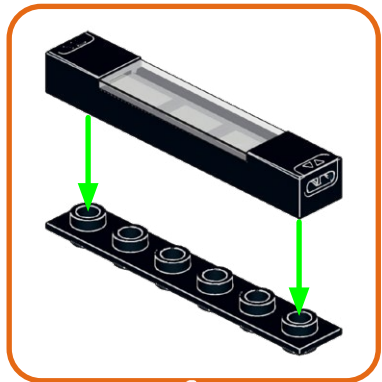
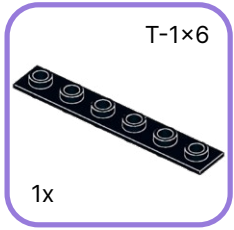

299

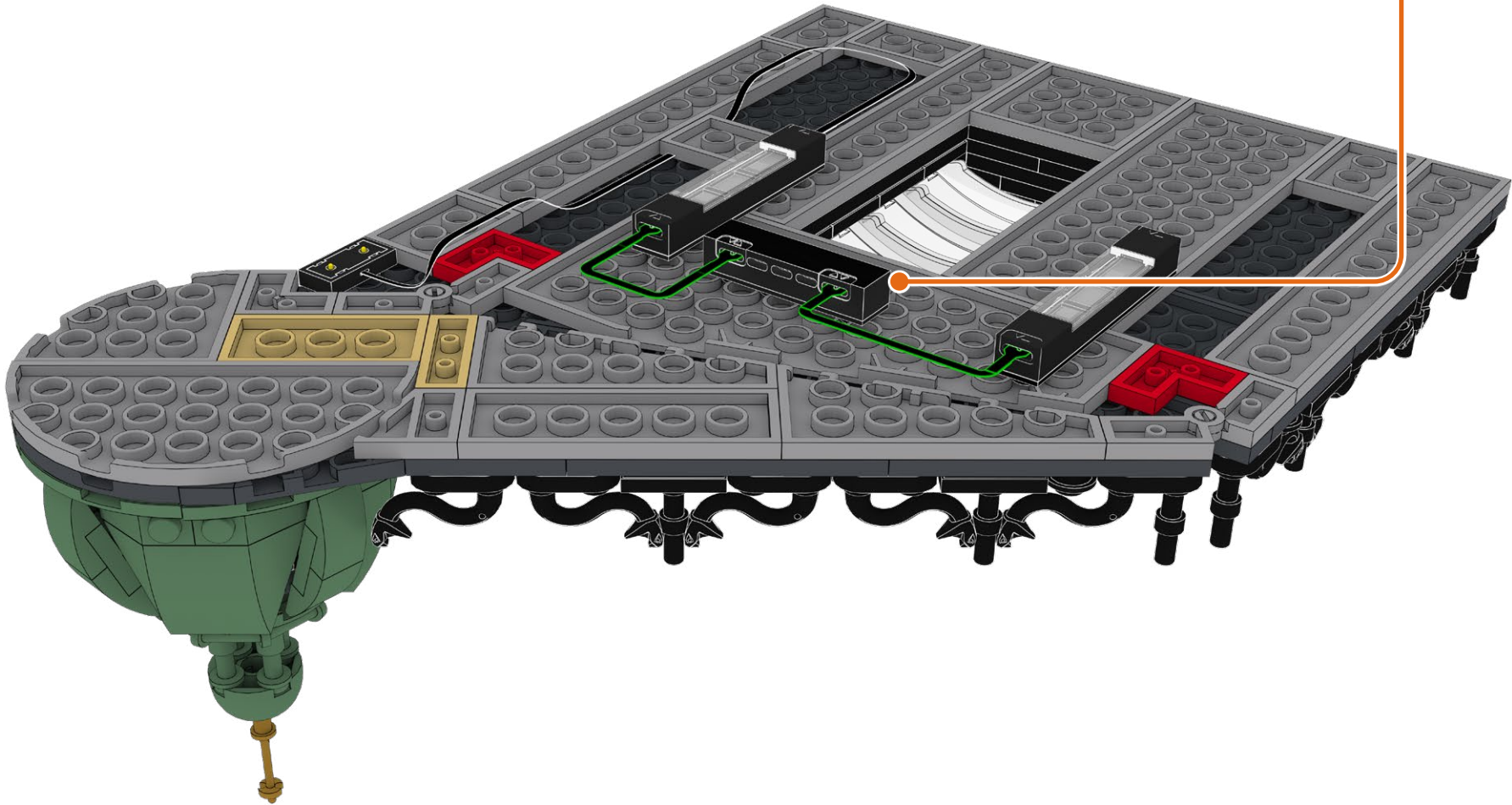
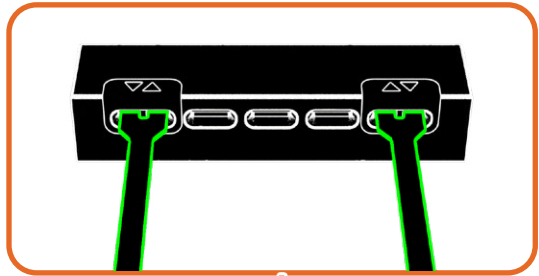
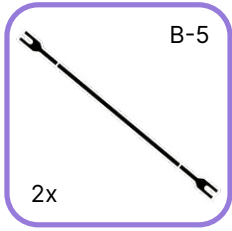

300

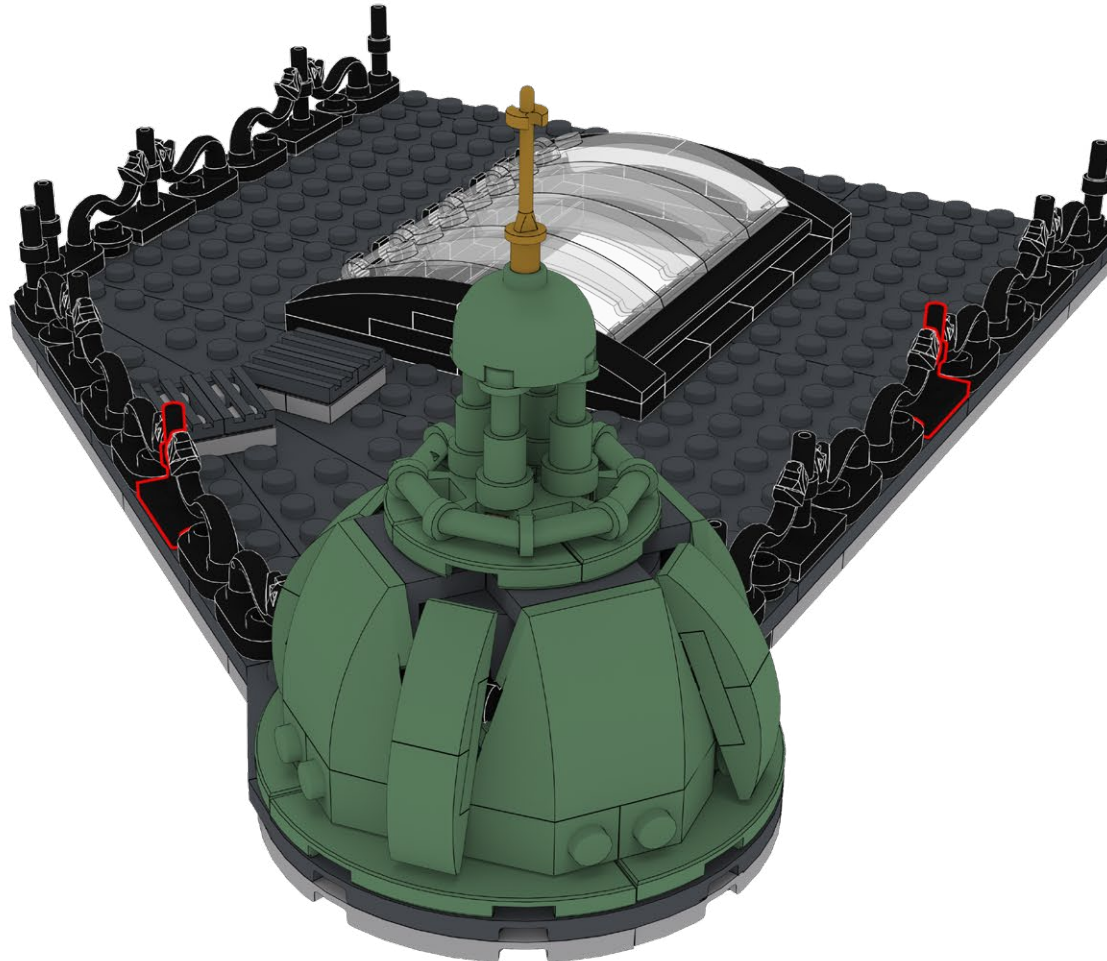

301

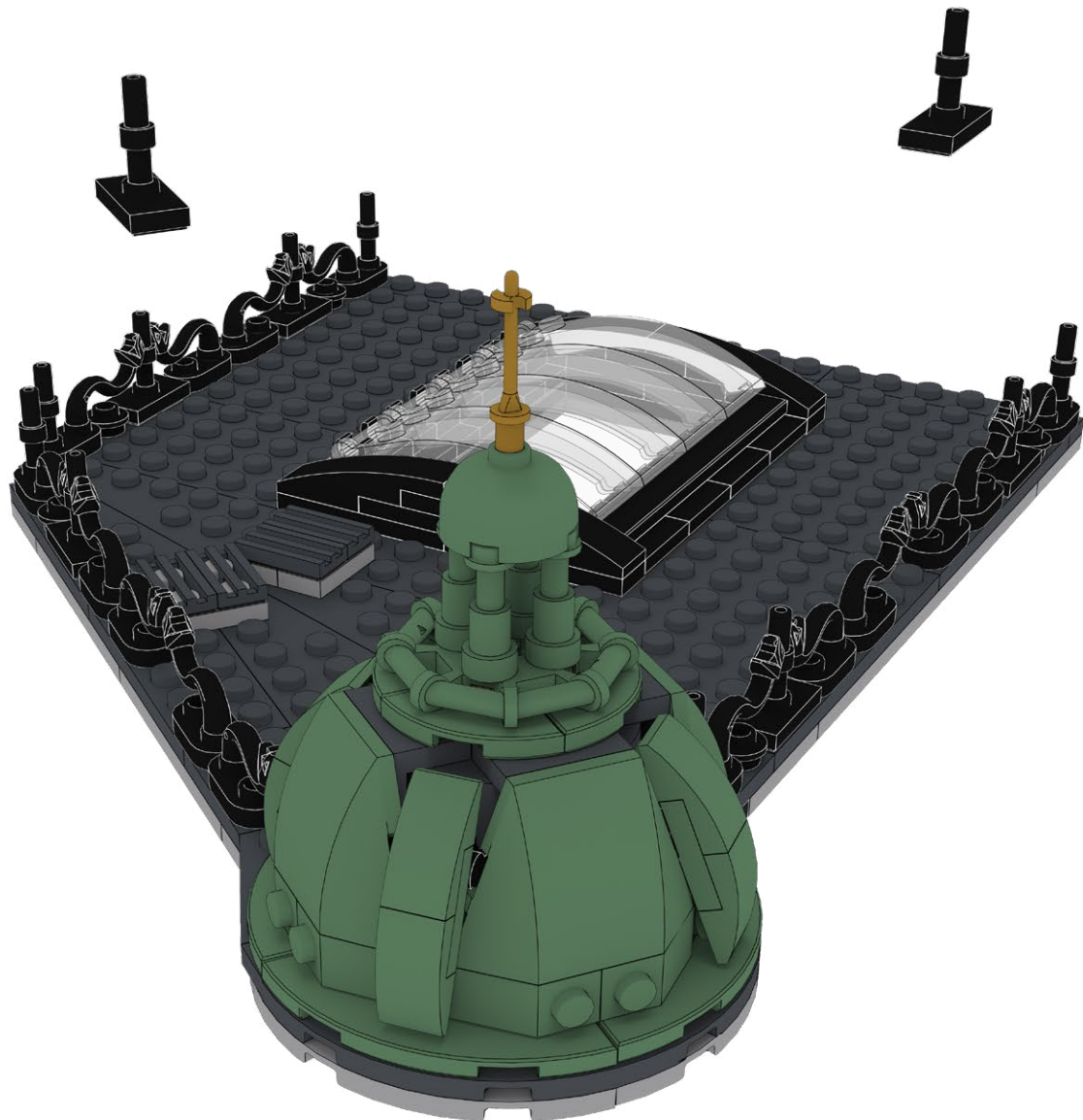

302

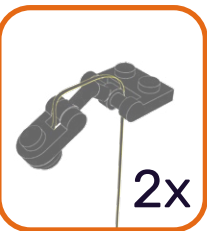
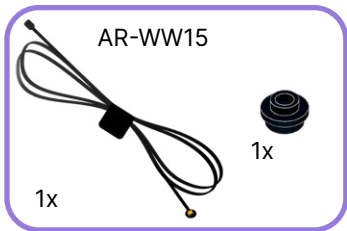

1

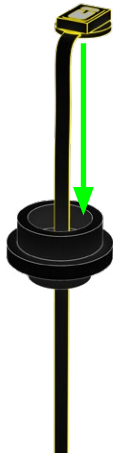

2



303

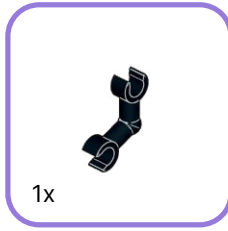
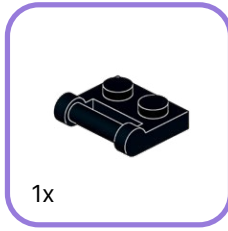

1

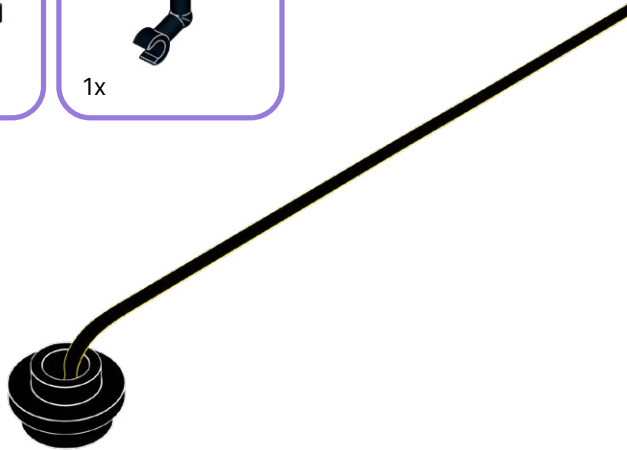

2

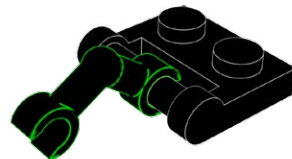

304

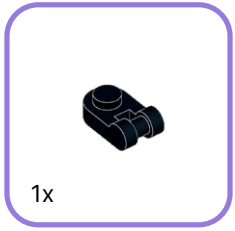

1x

1

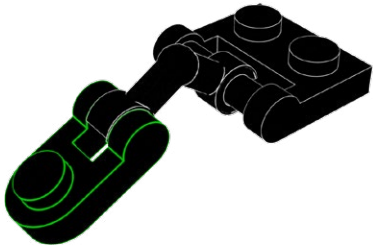

2

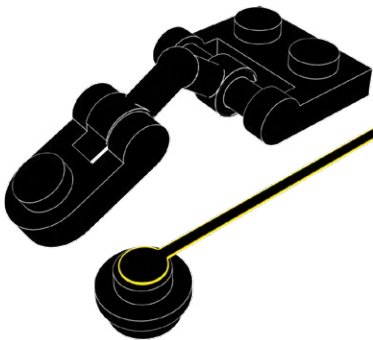

305



1

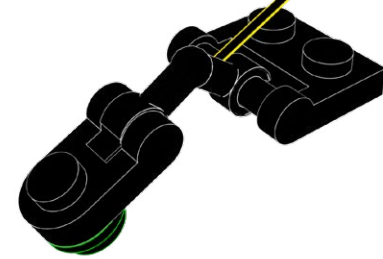

2

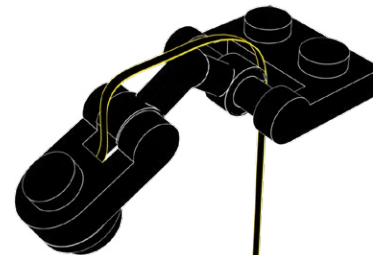

2x

306

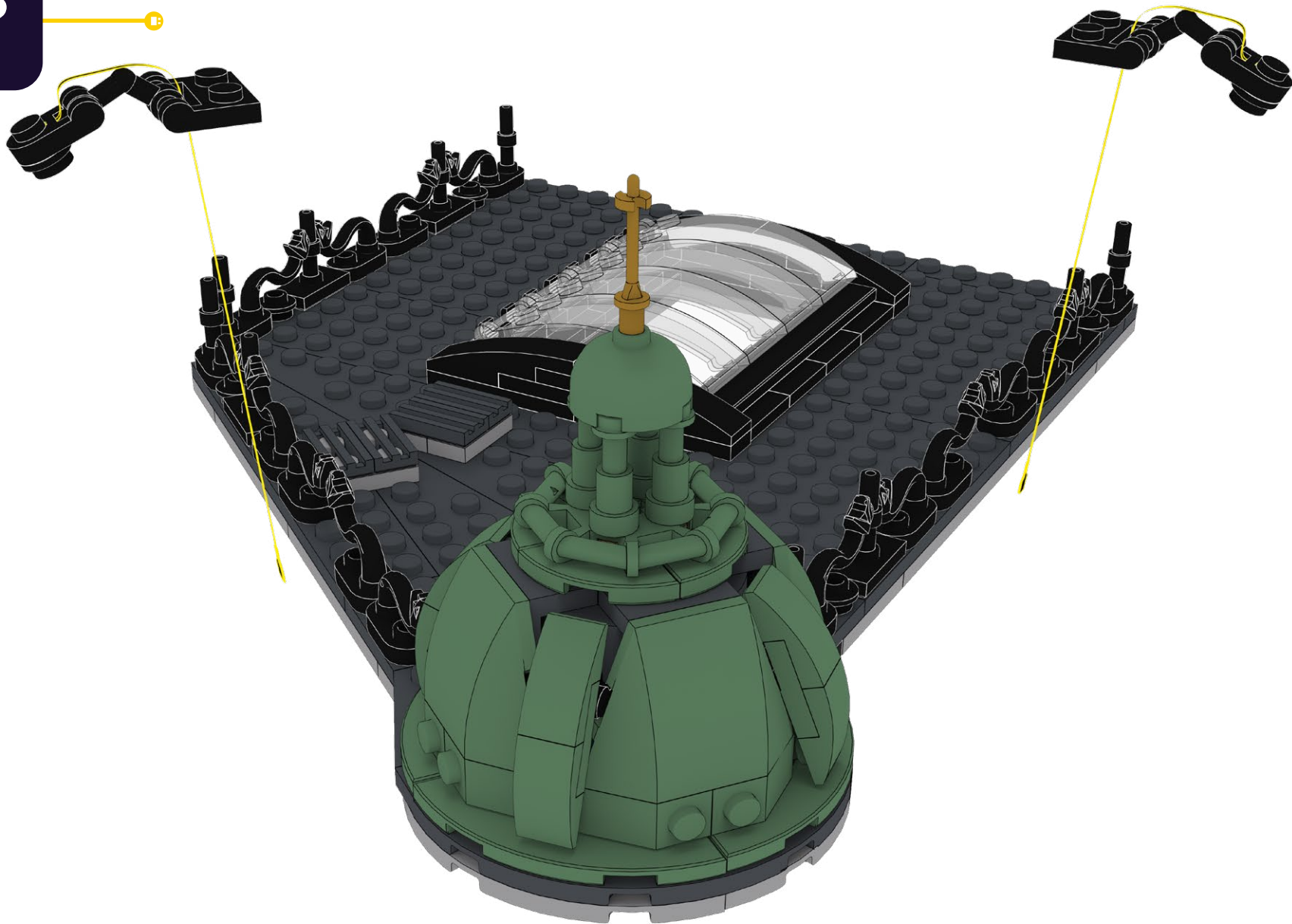

307

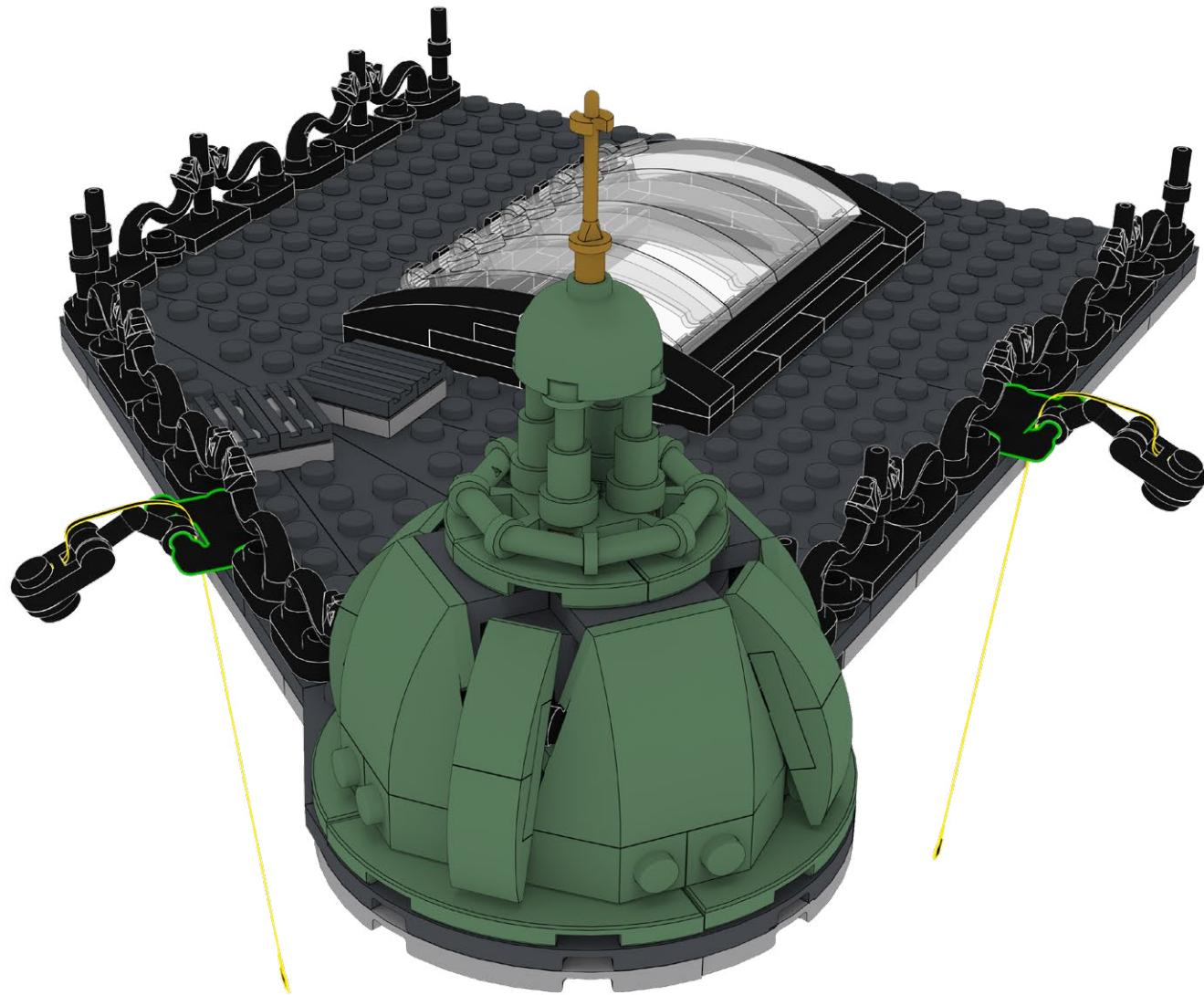

308

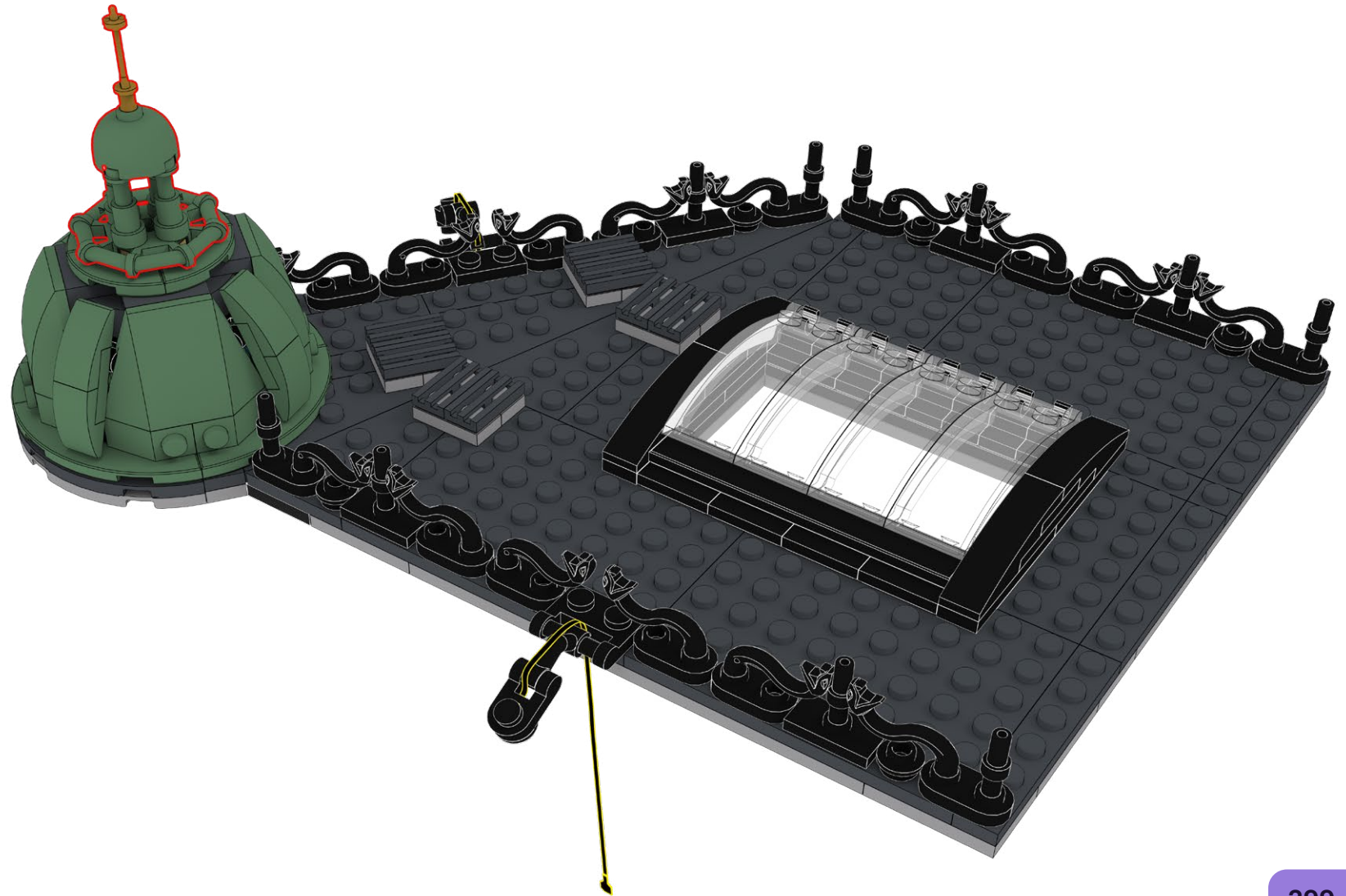

309

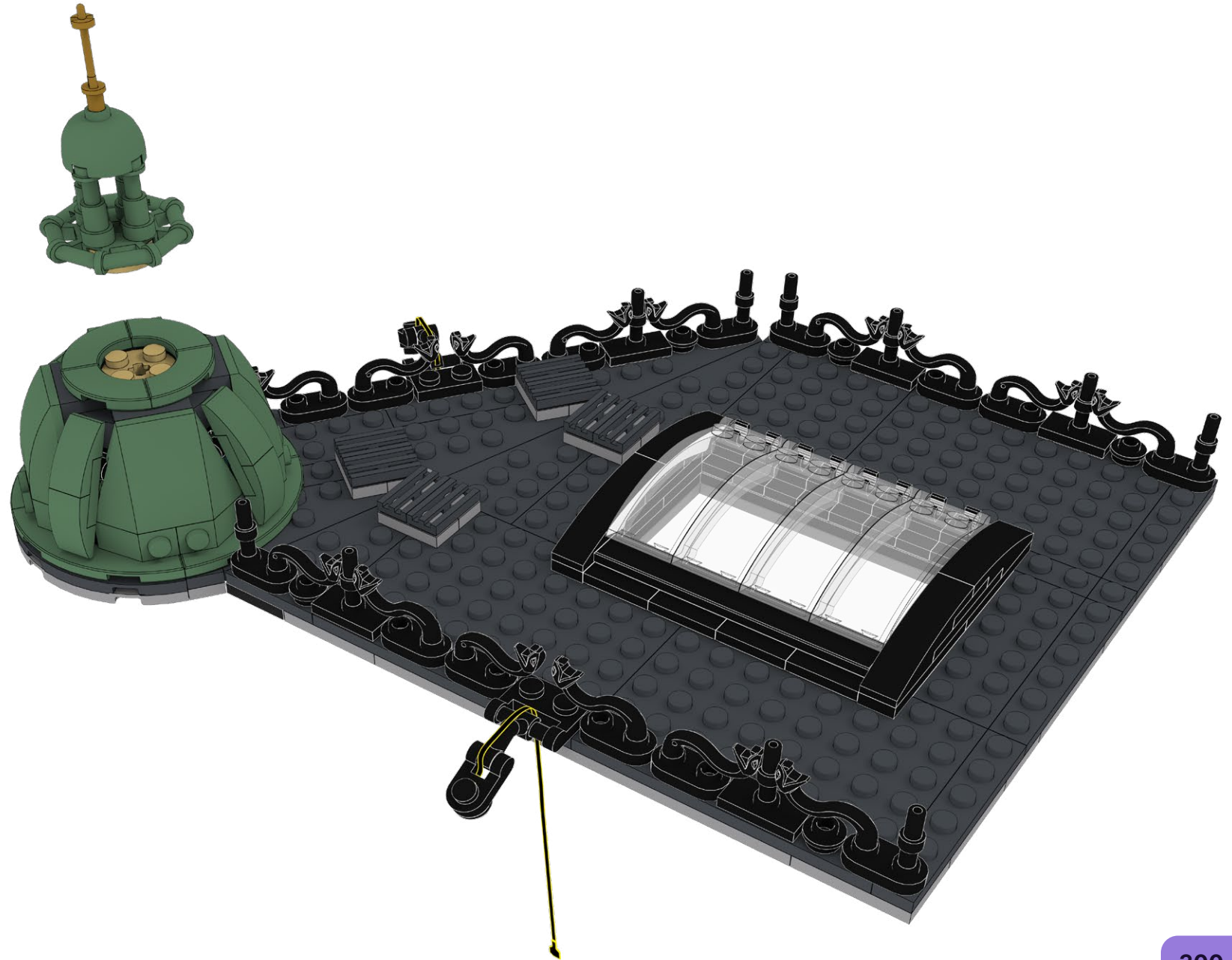

310

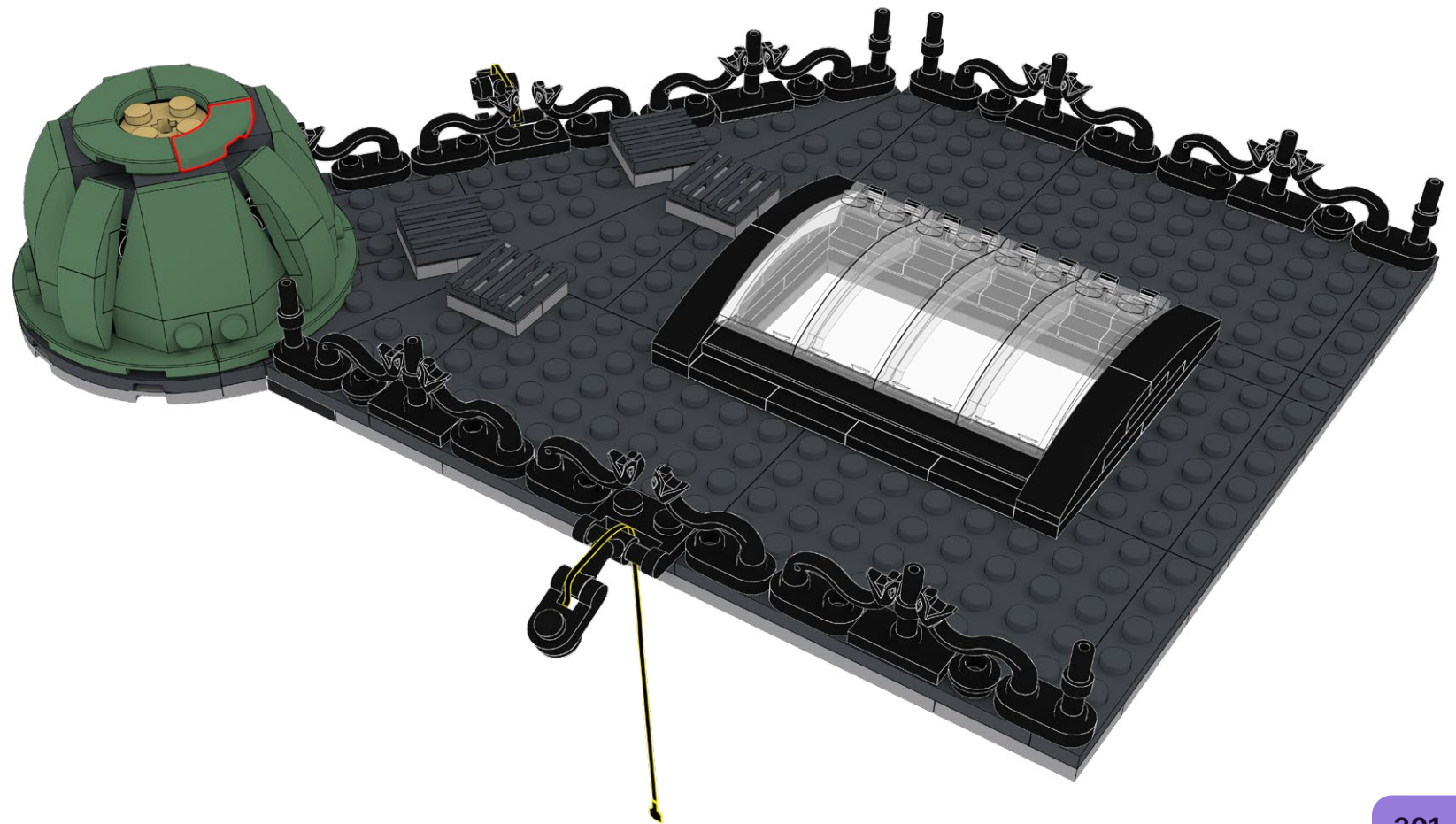

311



312

AR-WW15

1x

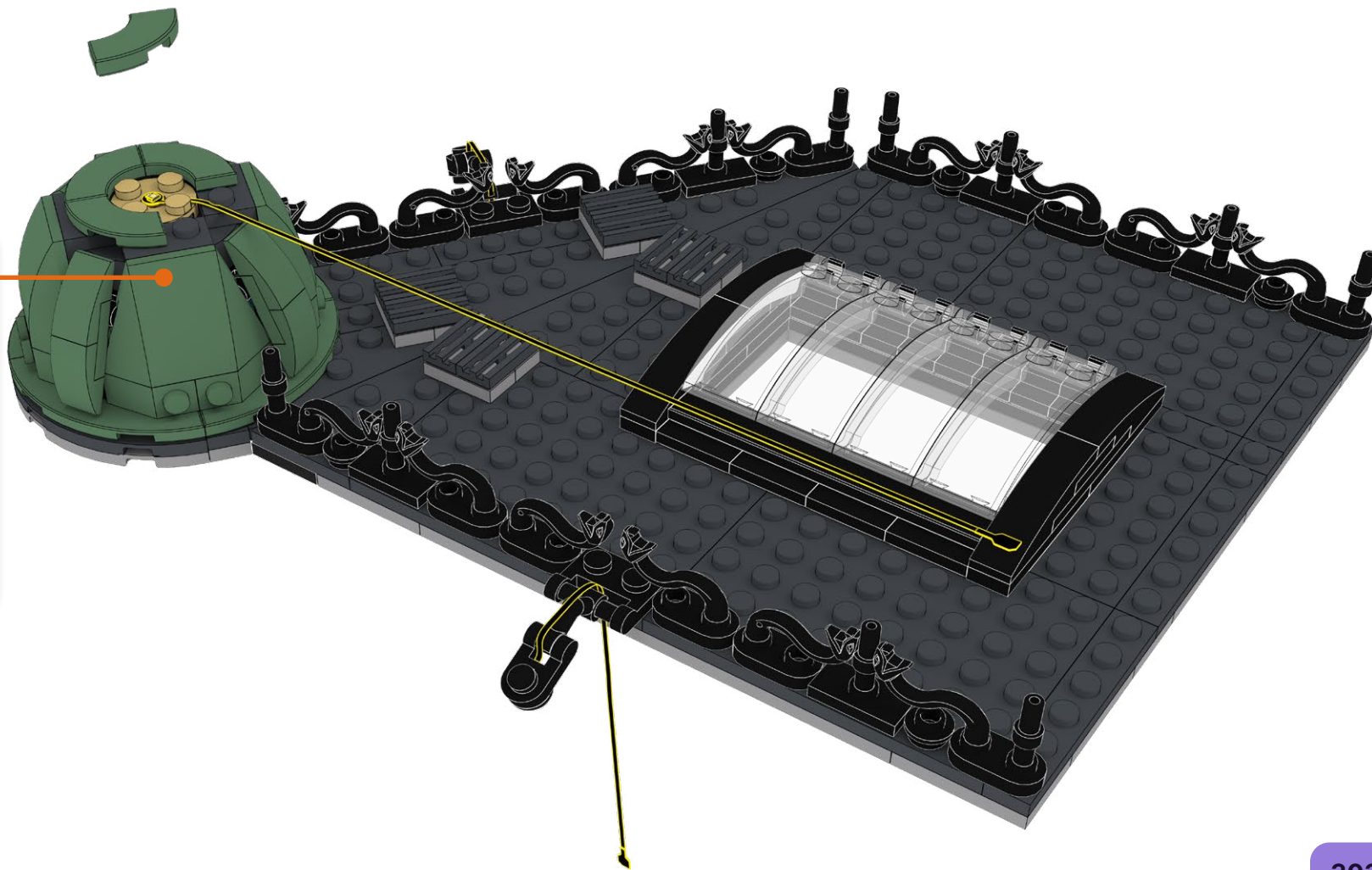
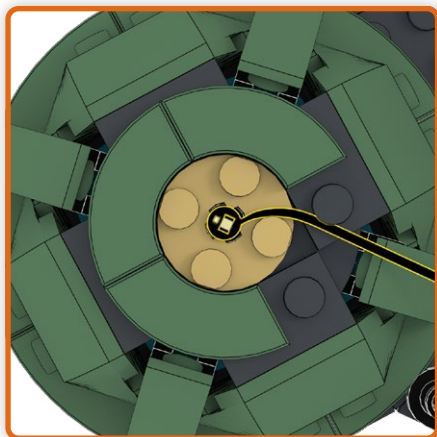

313

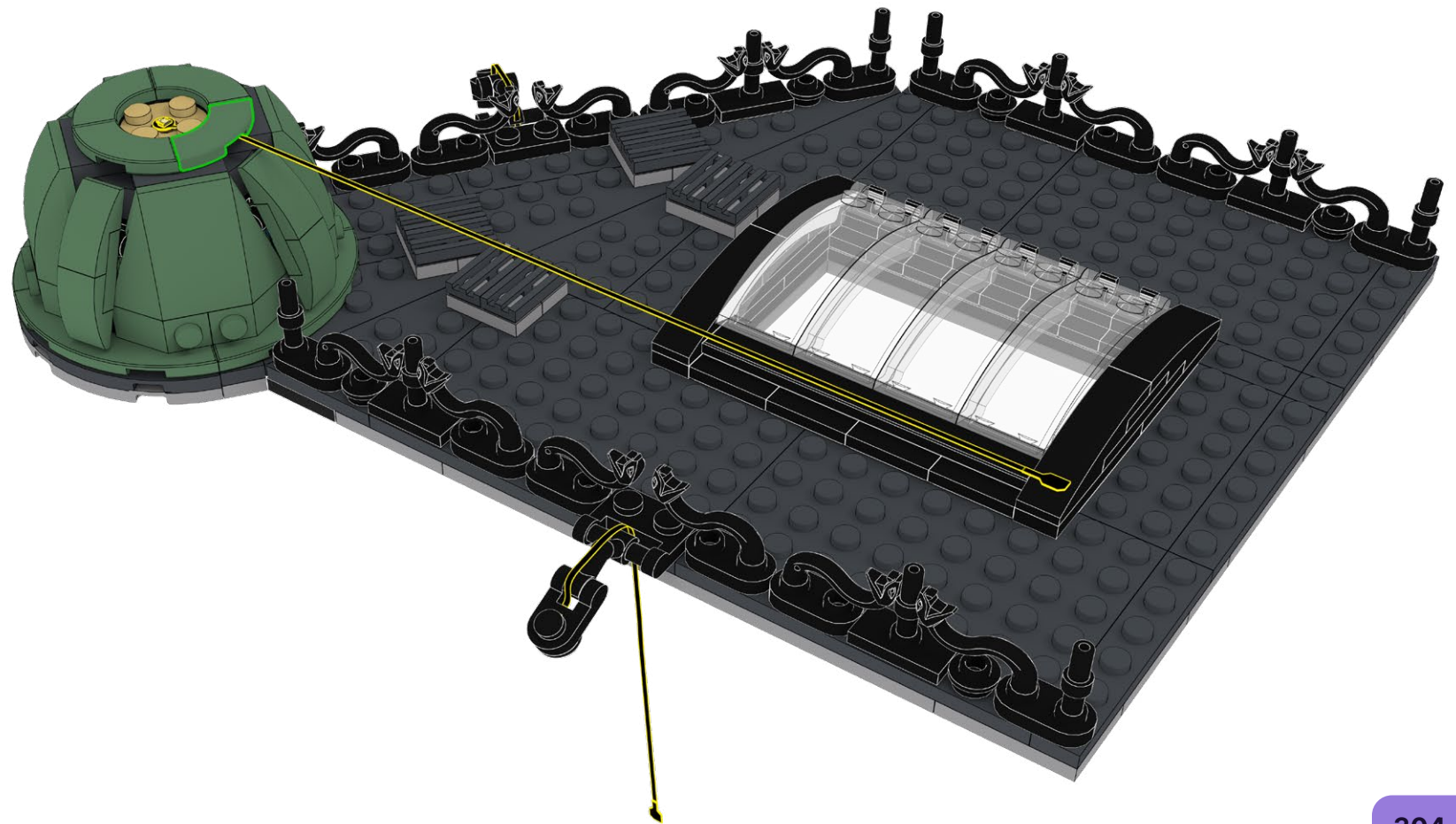

314

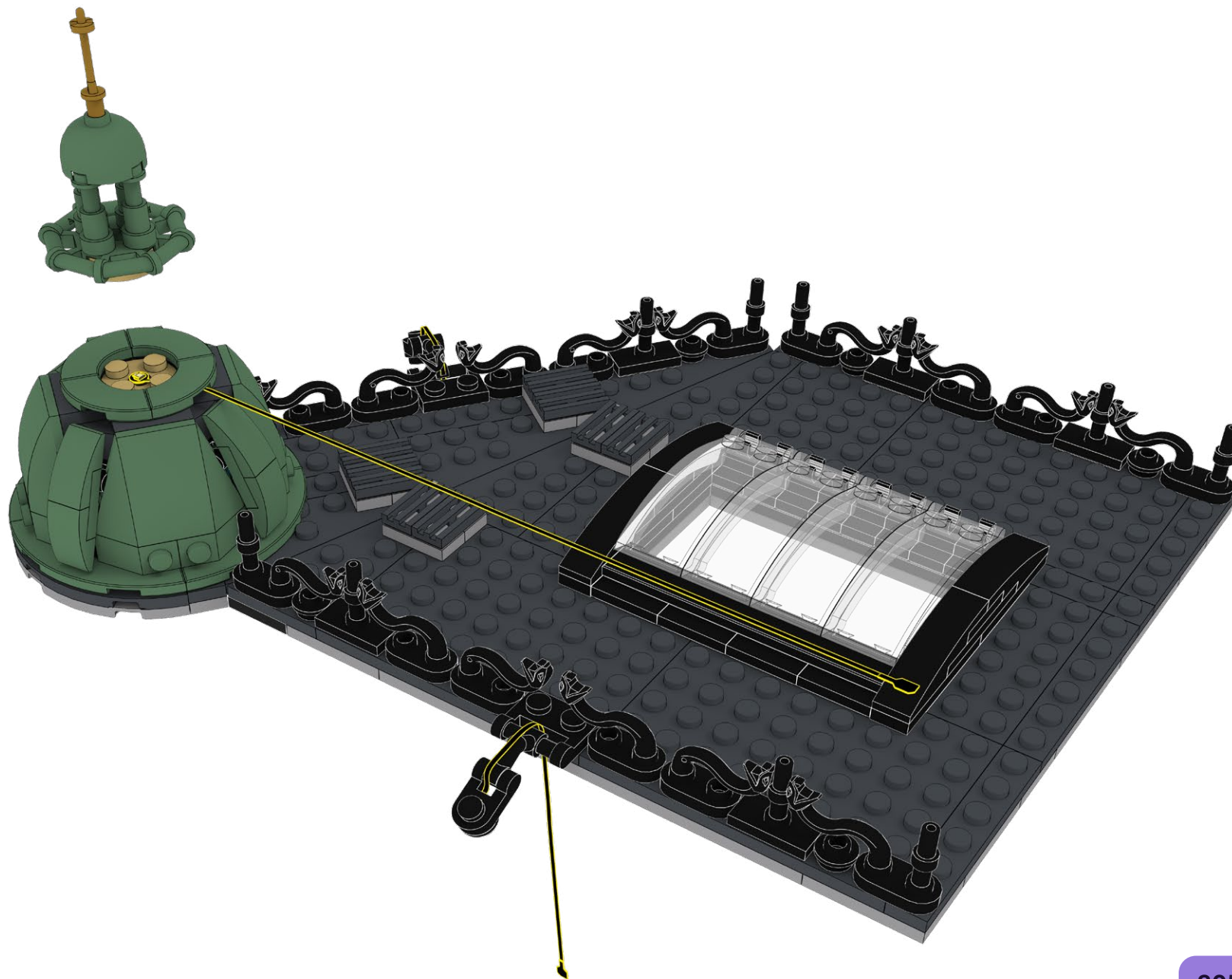

315

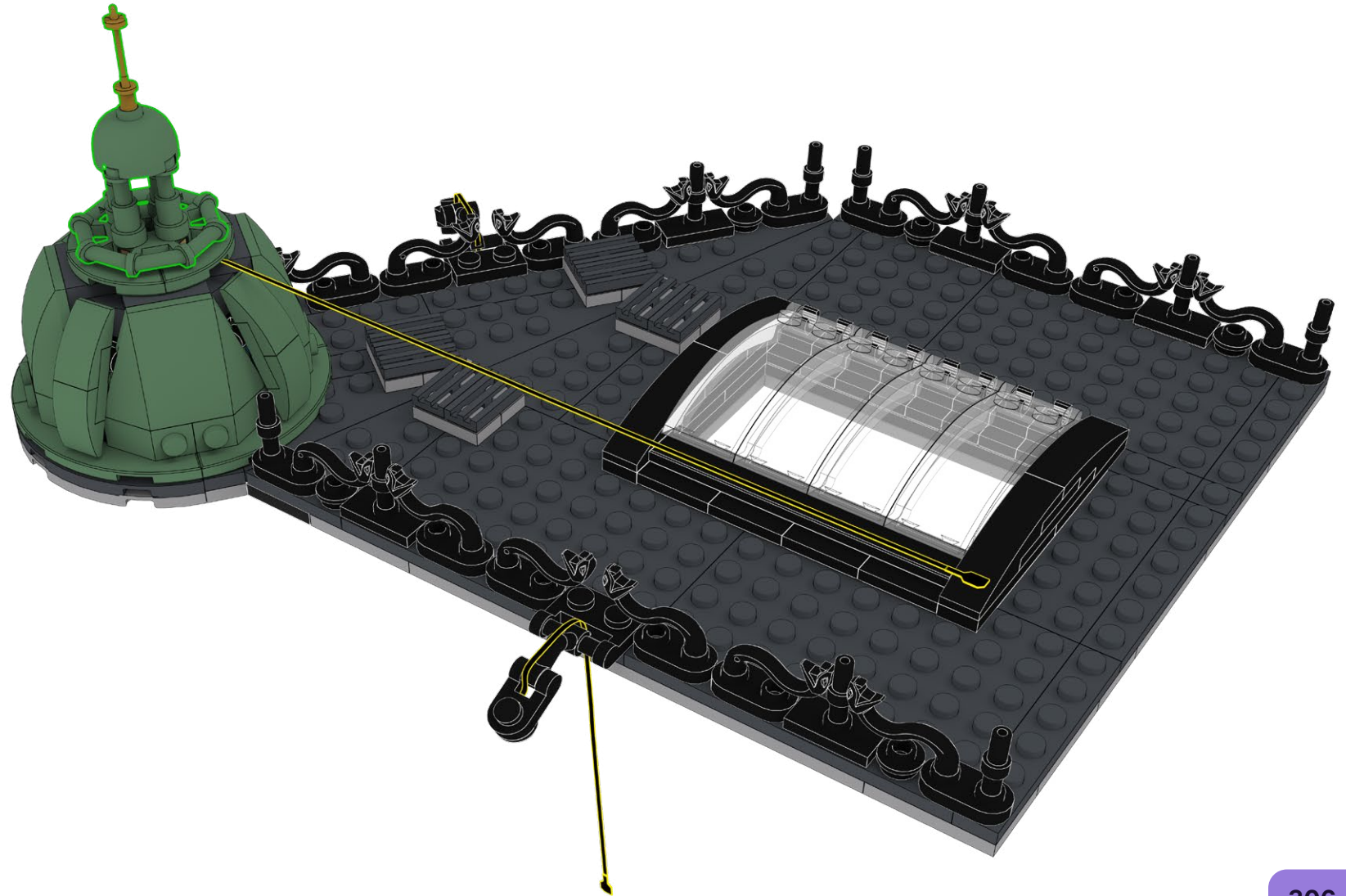

316

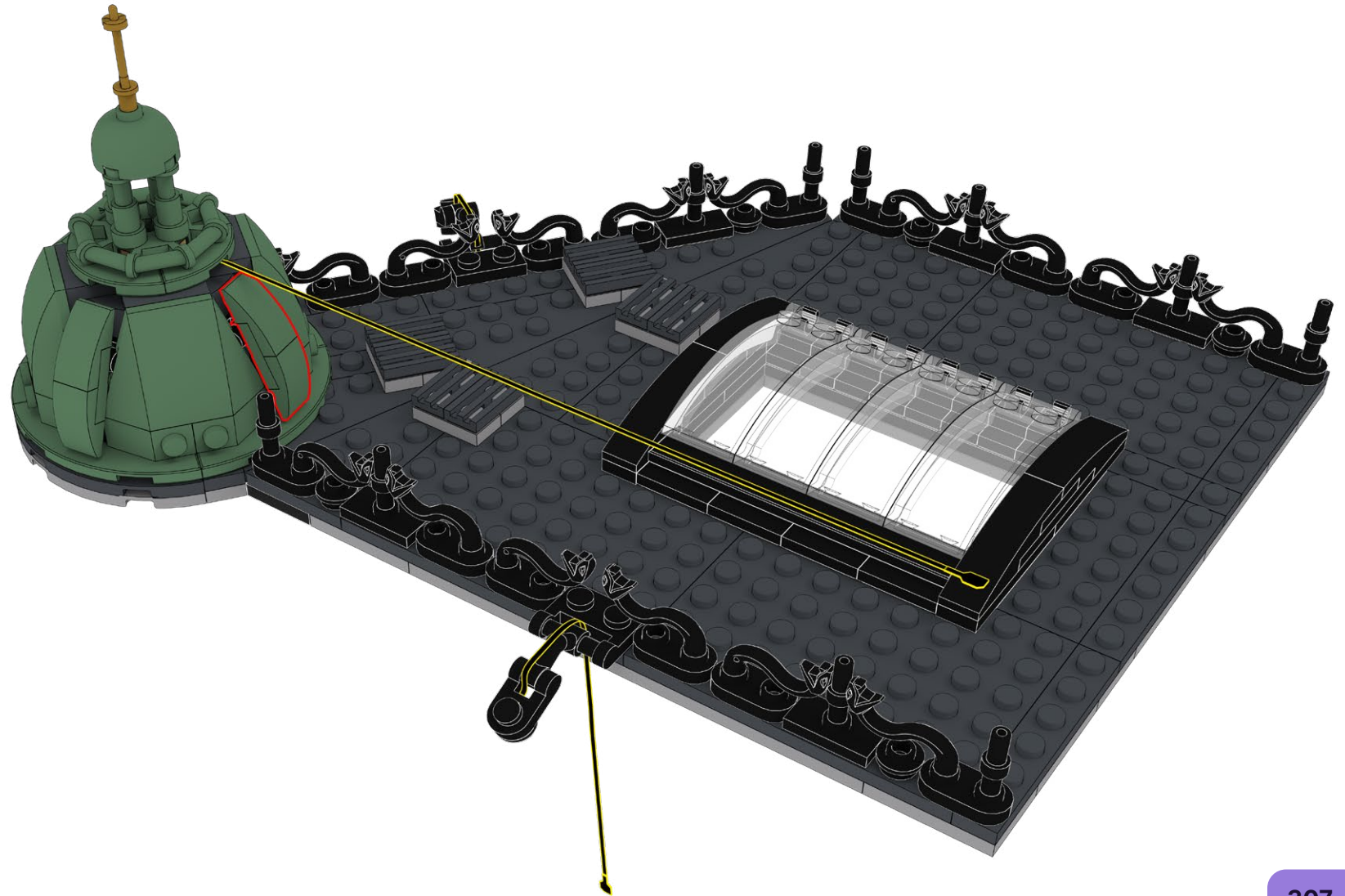

317

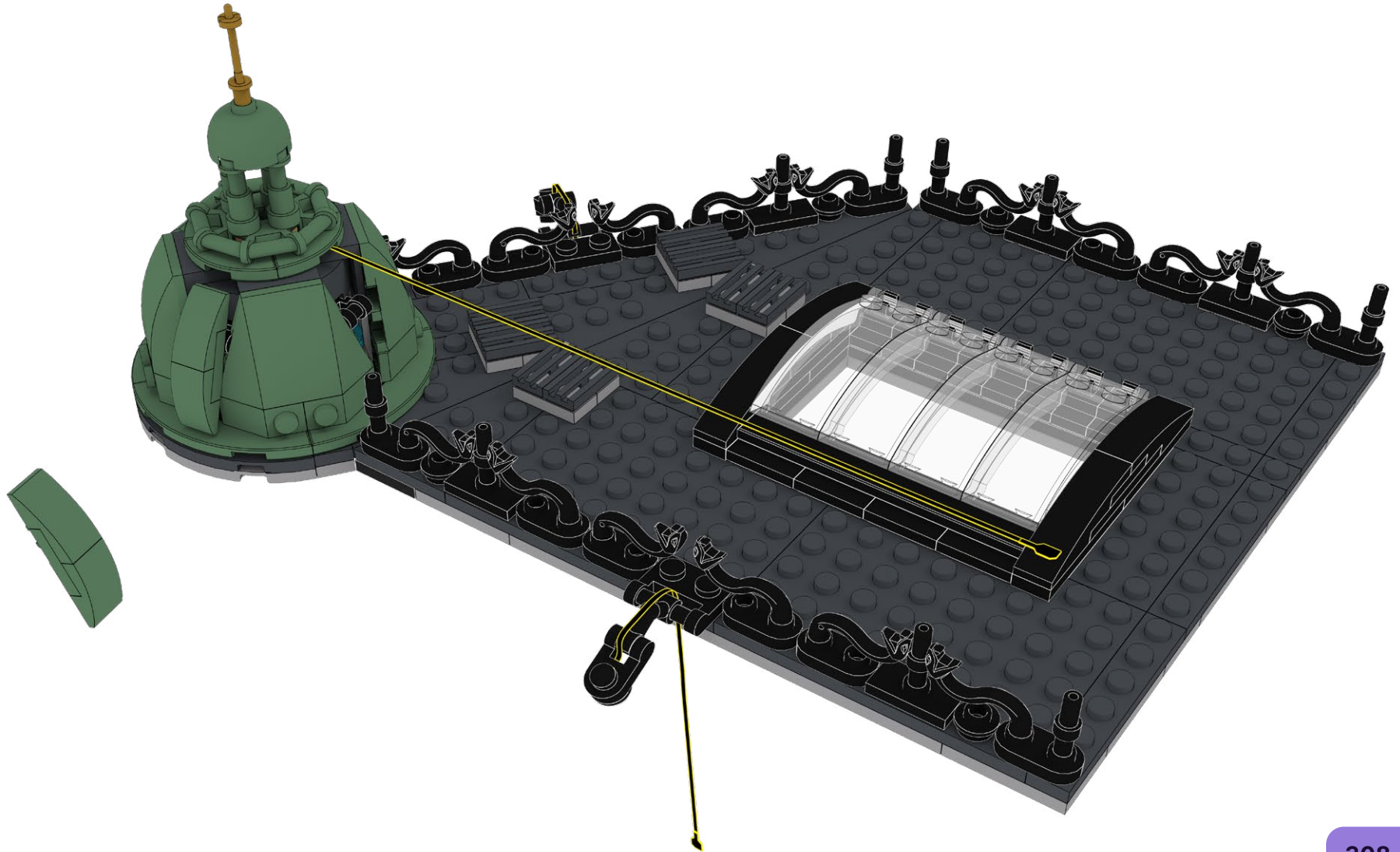

318

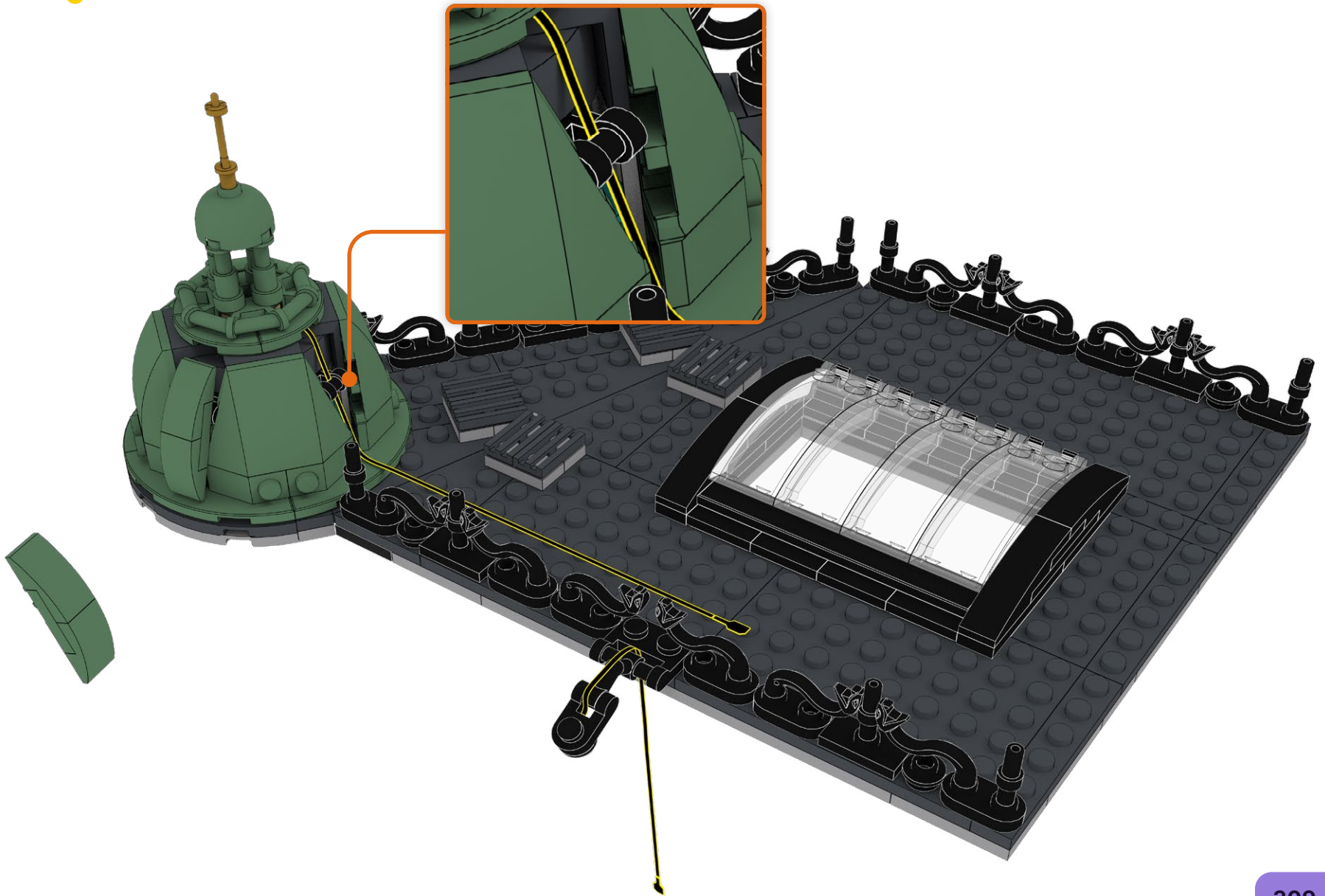

319

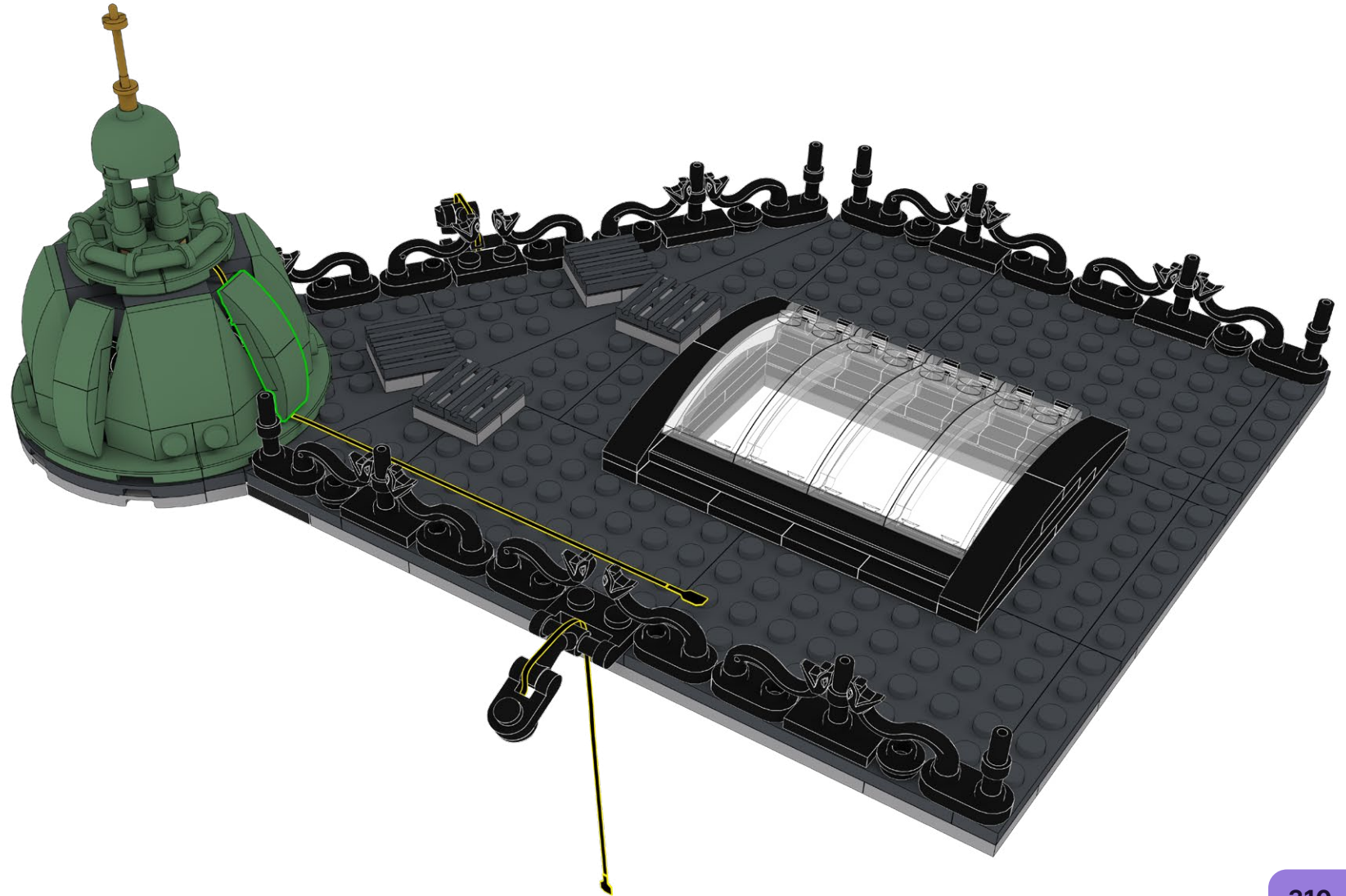

320

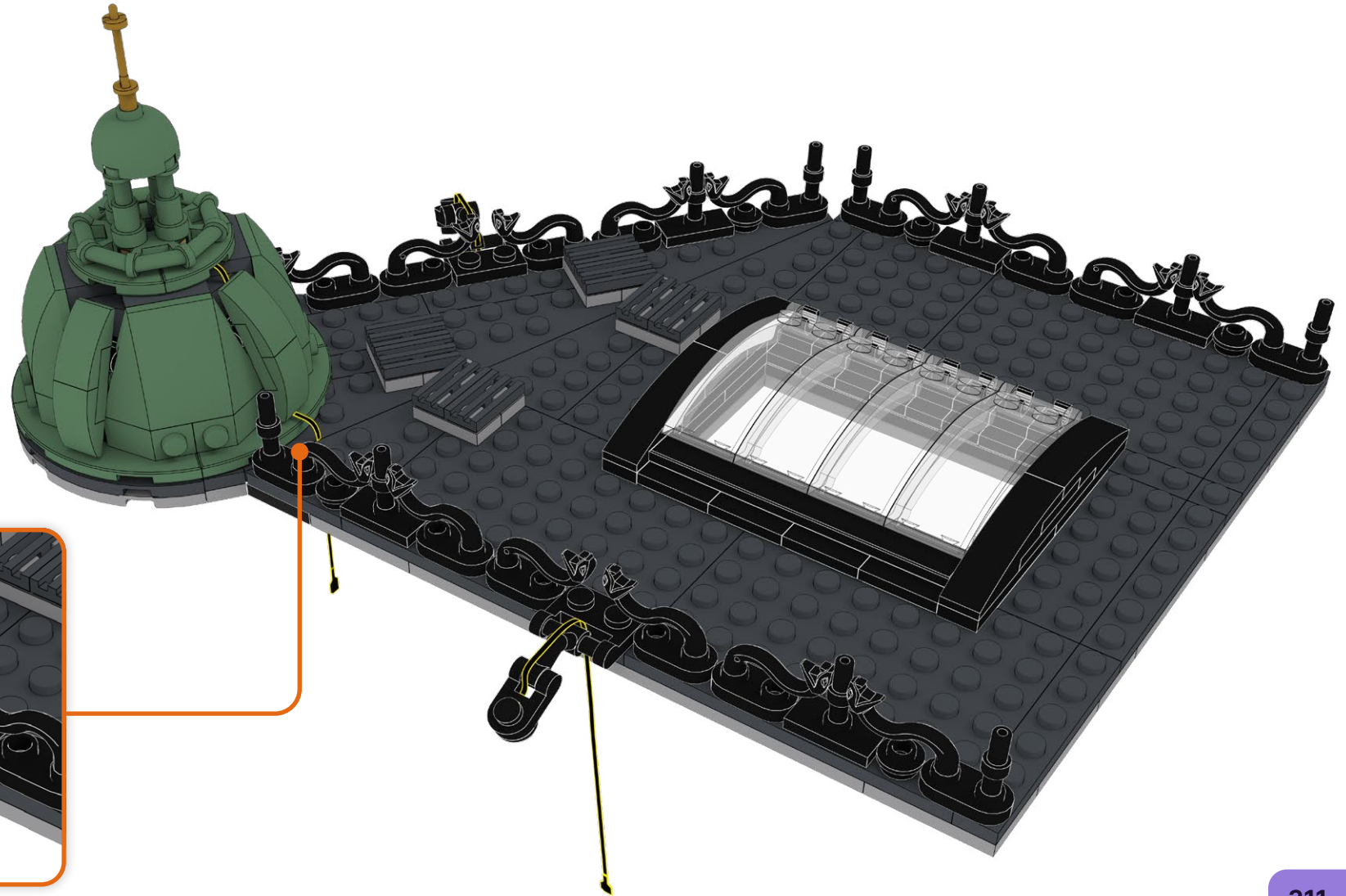

321

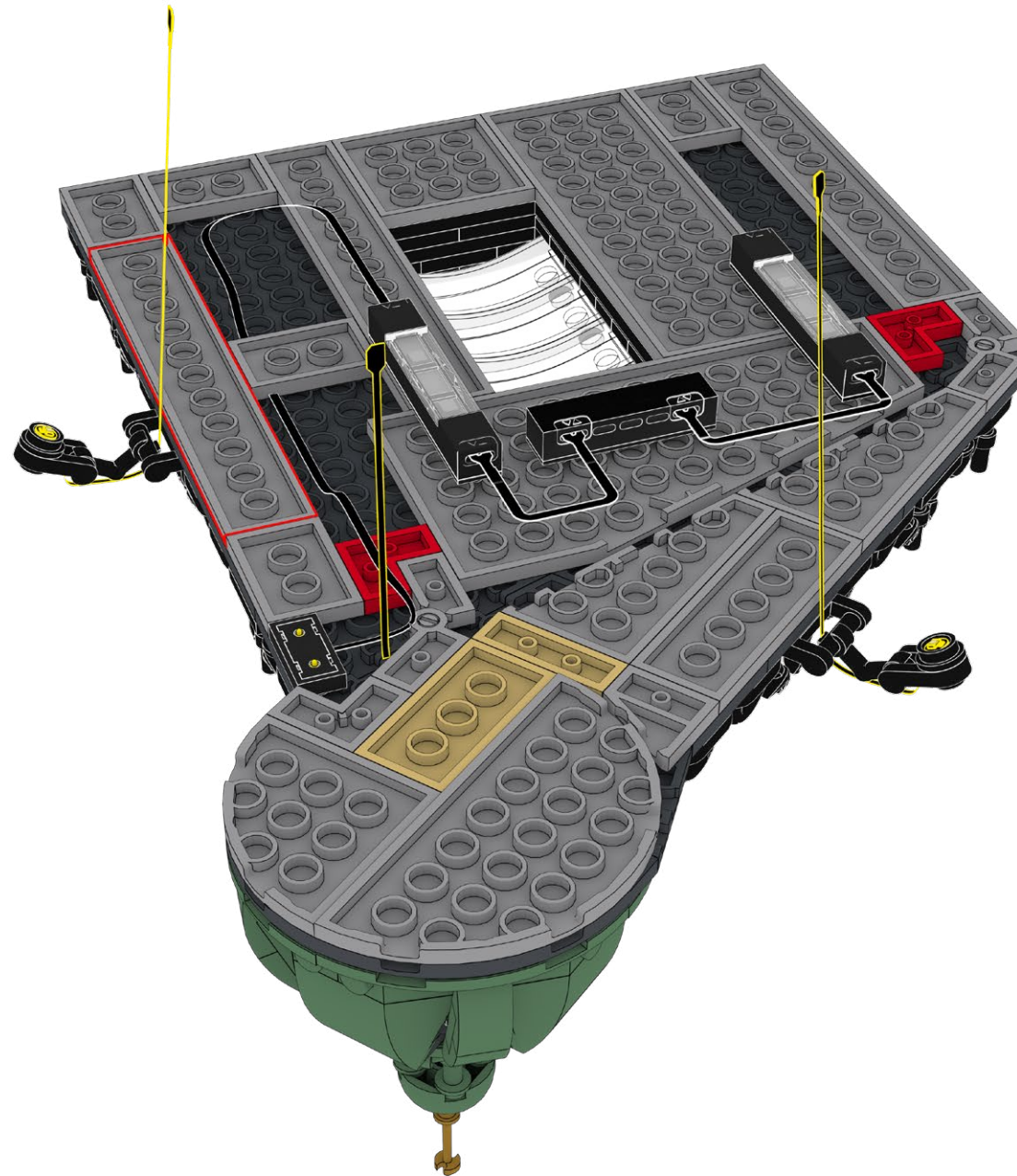

322

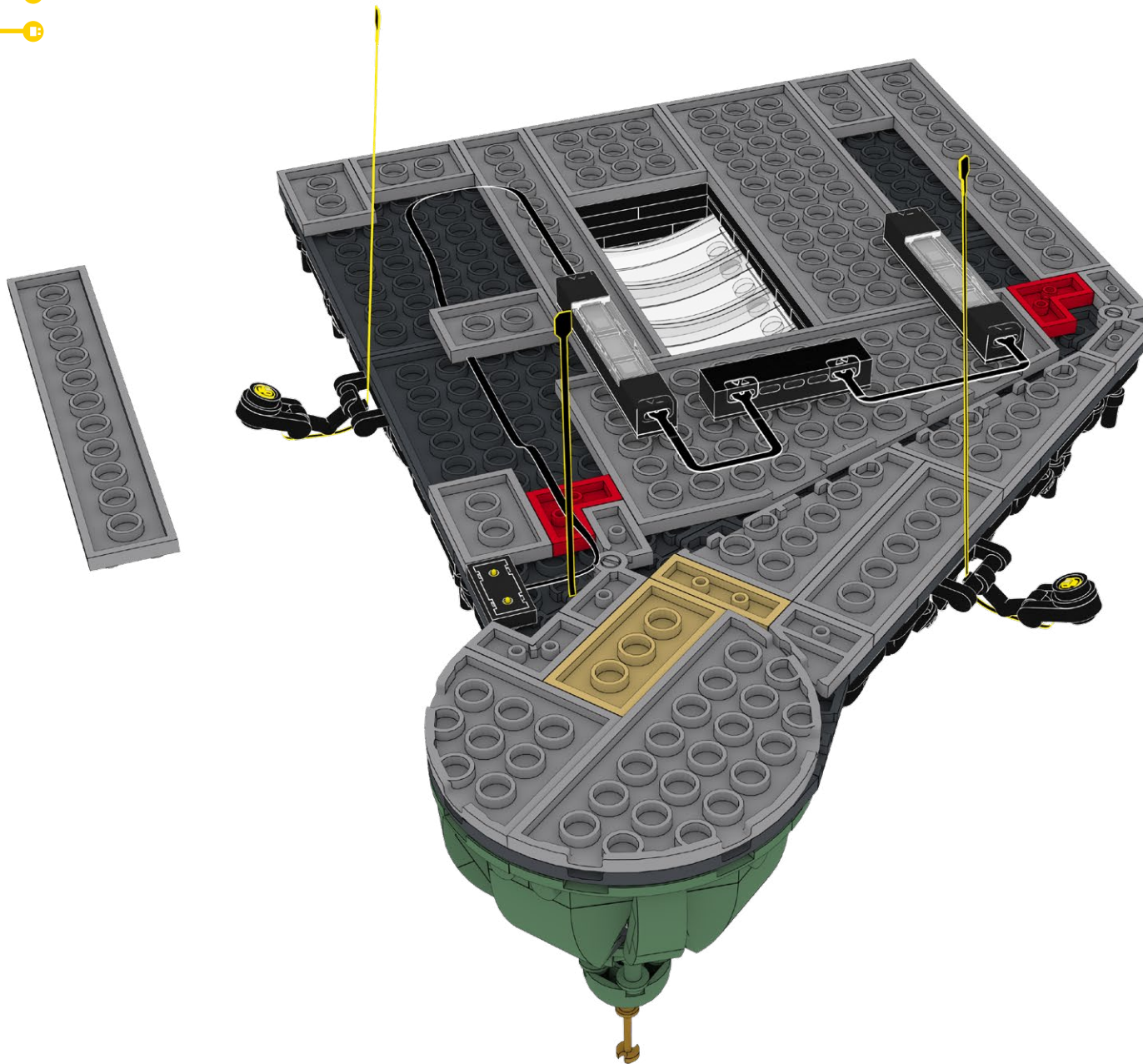

323

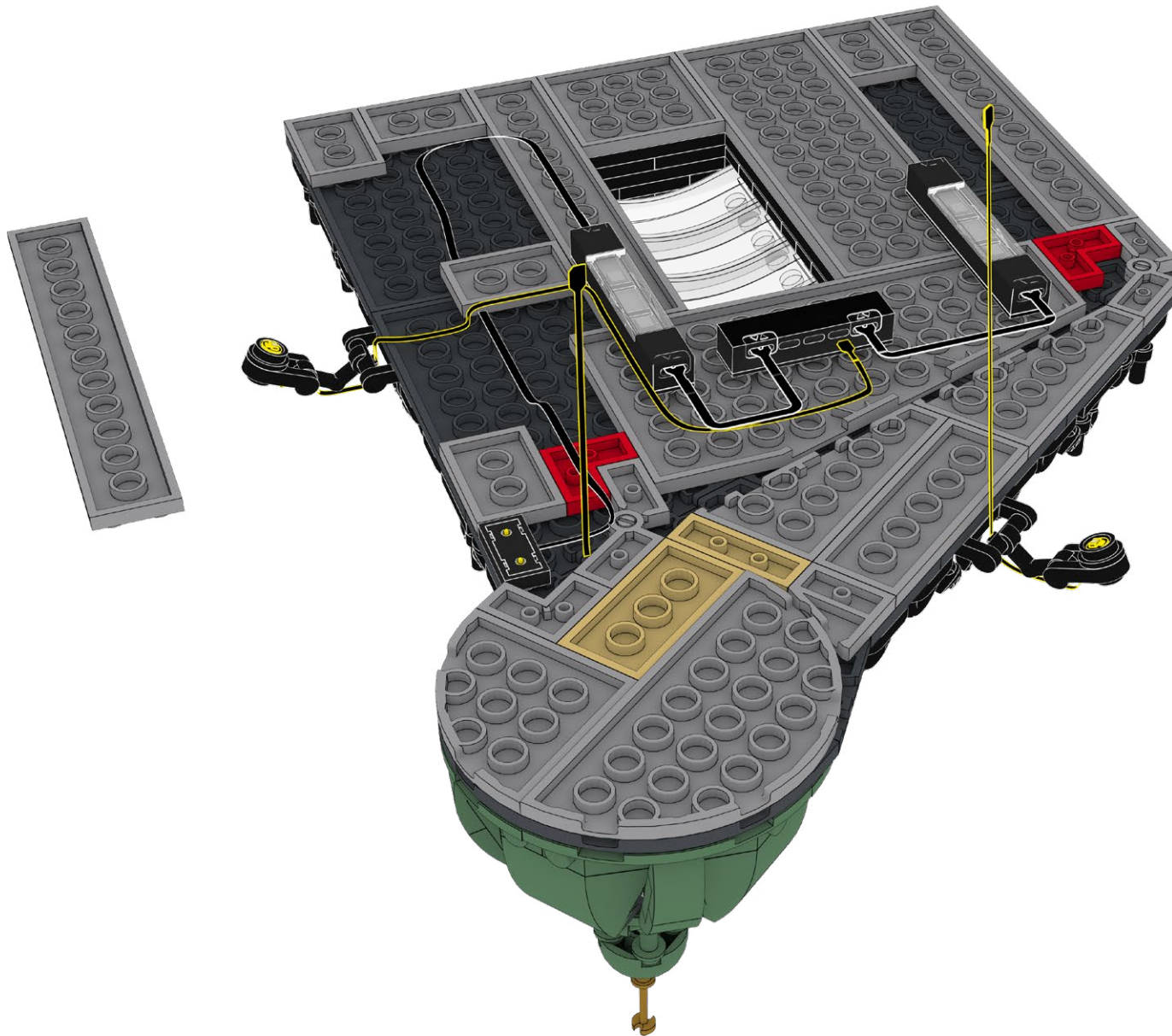

324

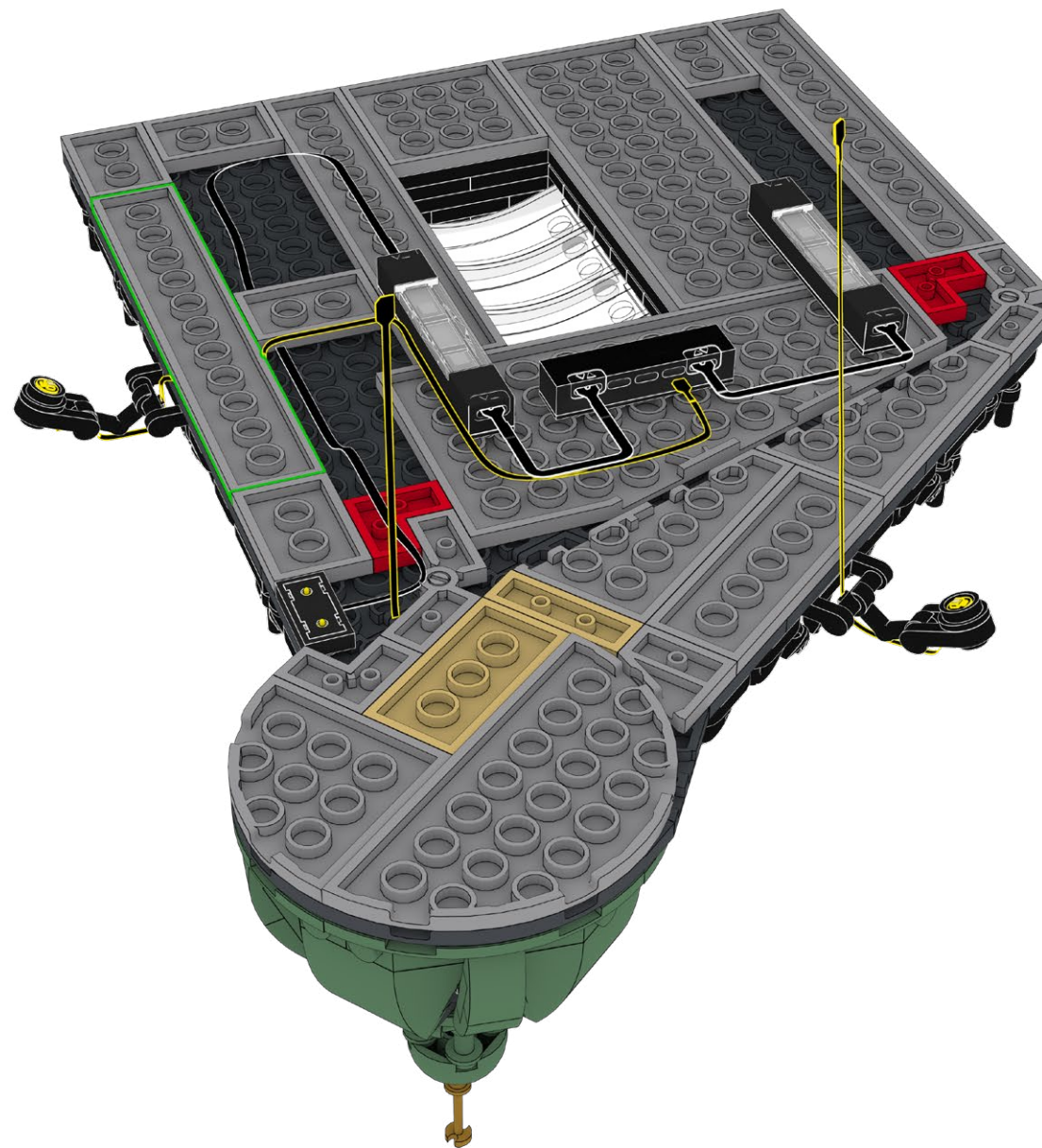

325

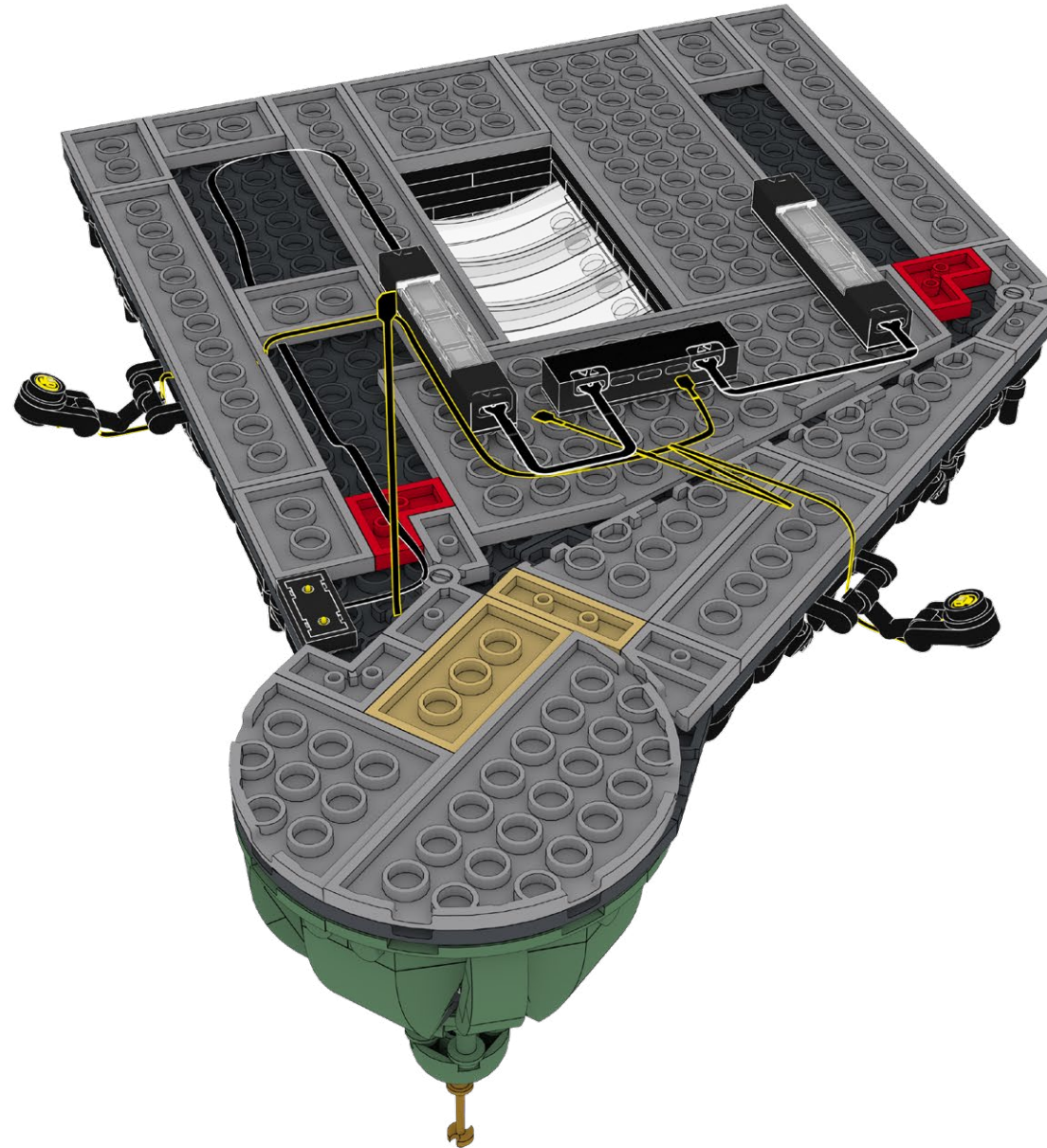

326

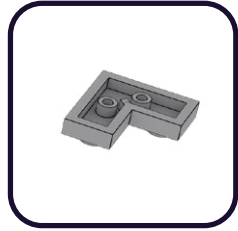
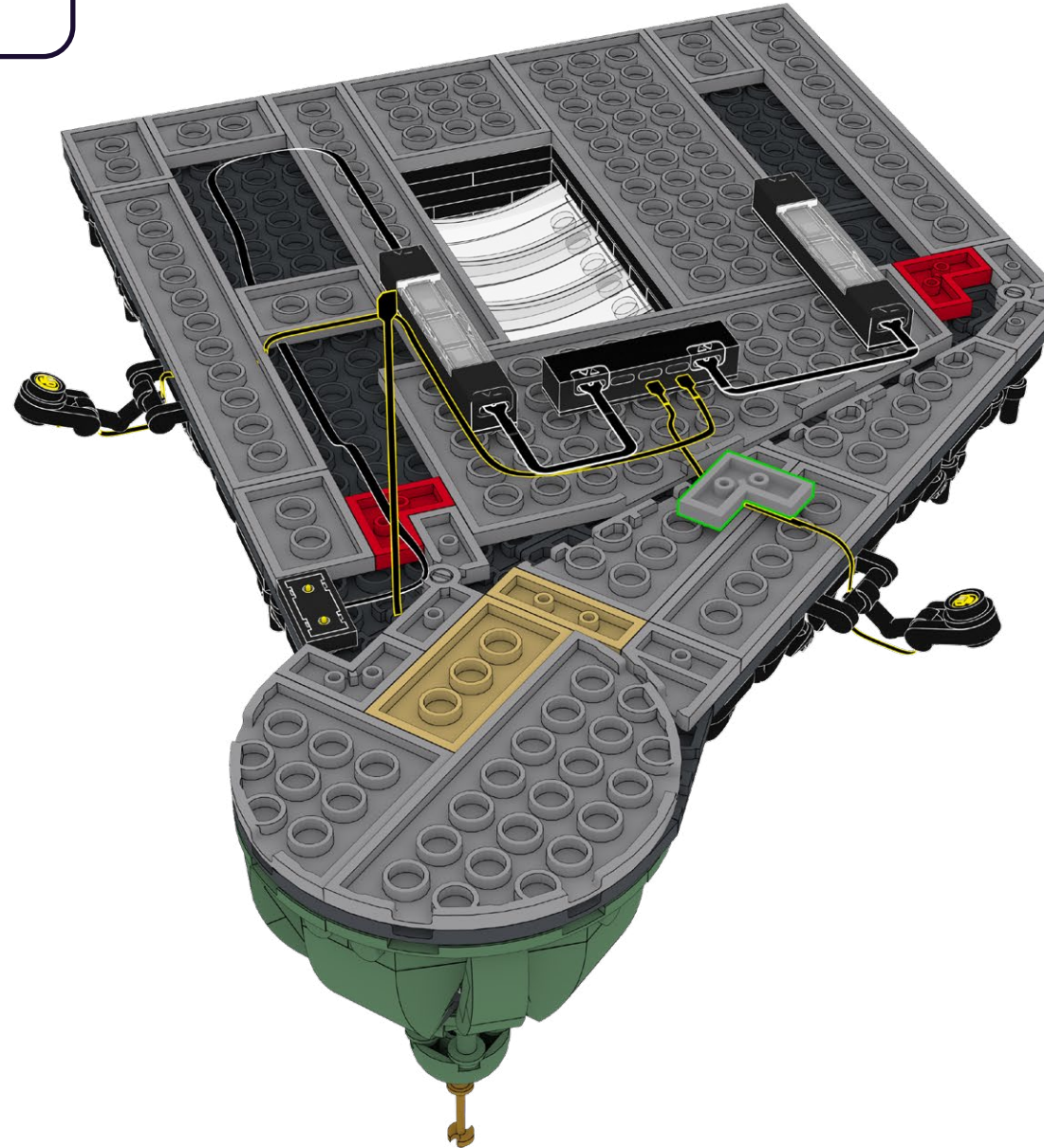
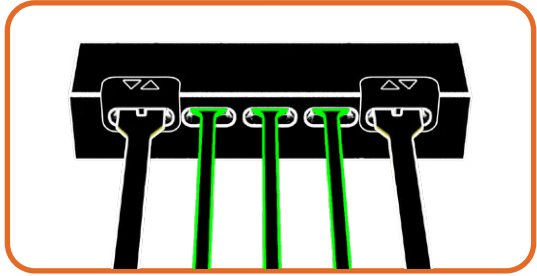
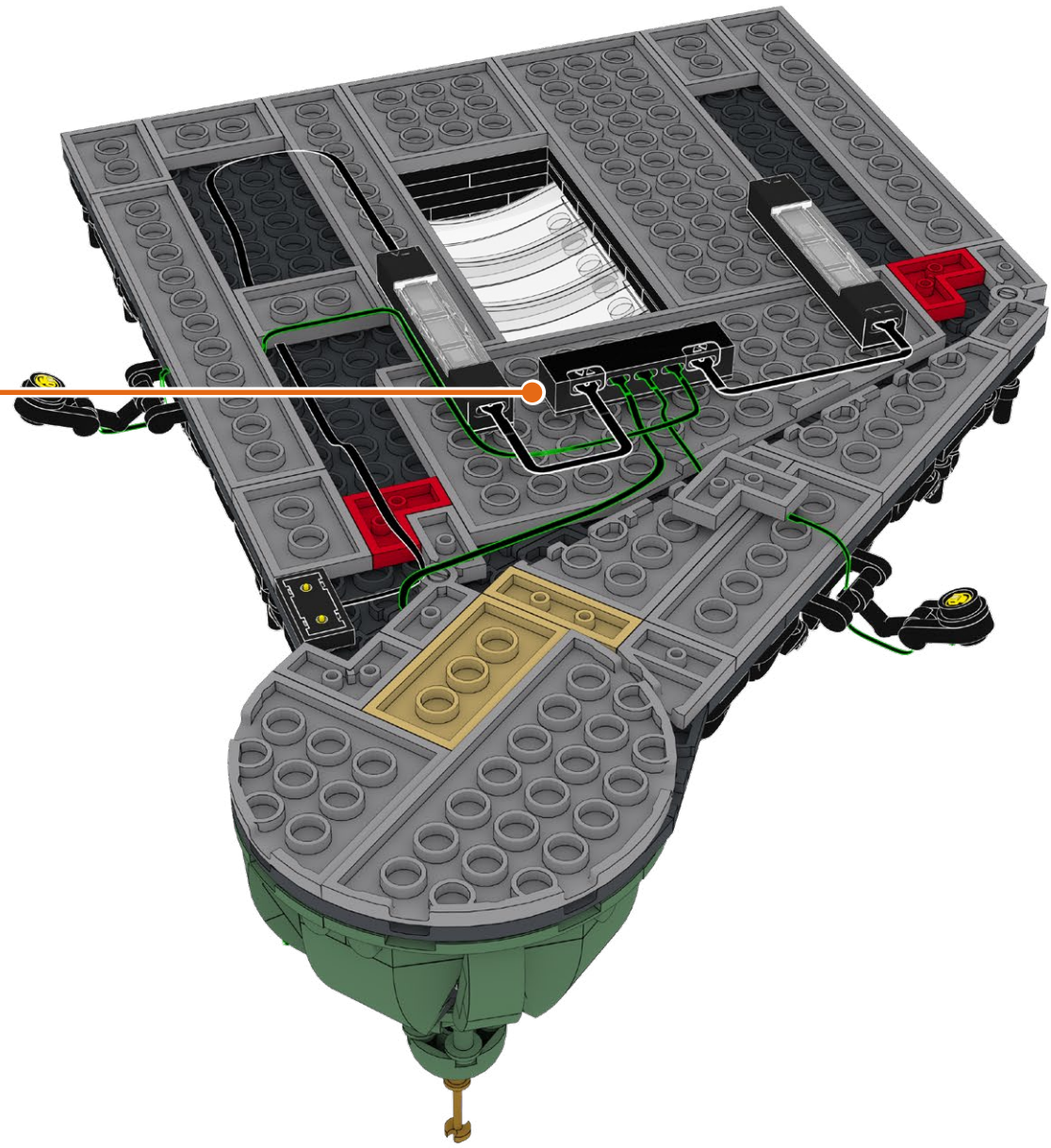

Plate 2x2 - White
Previously disconnected in step
290



327



328

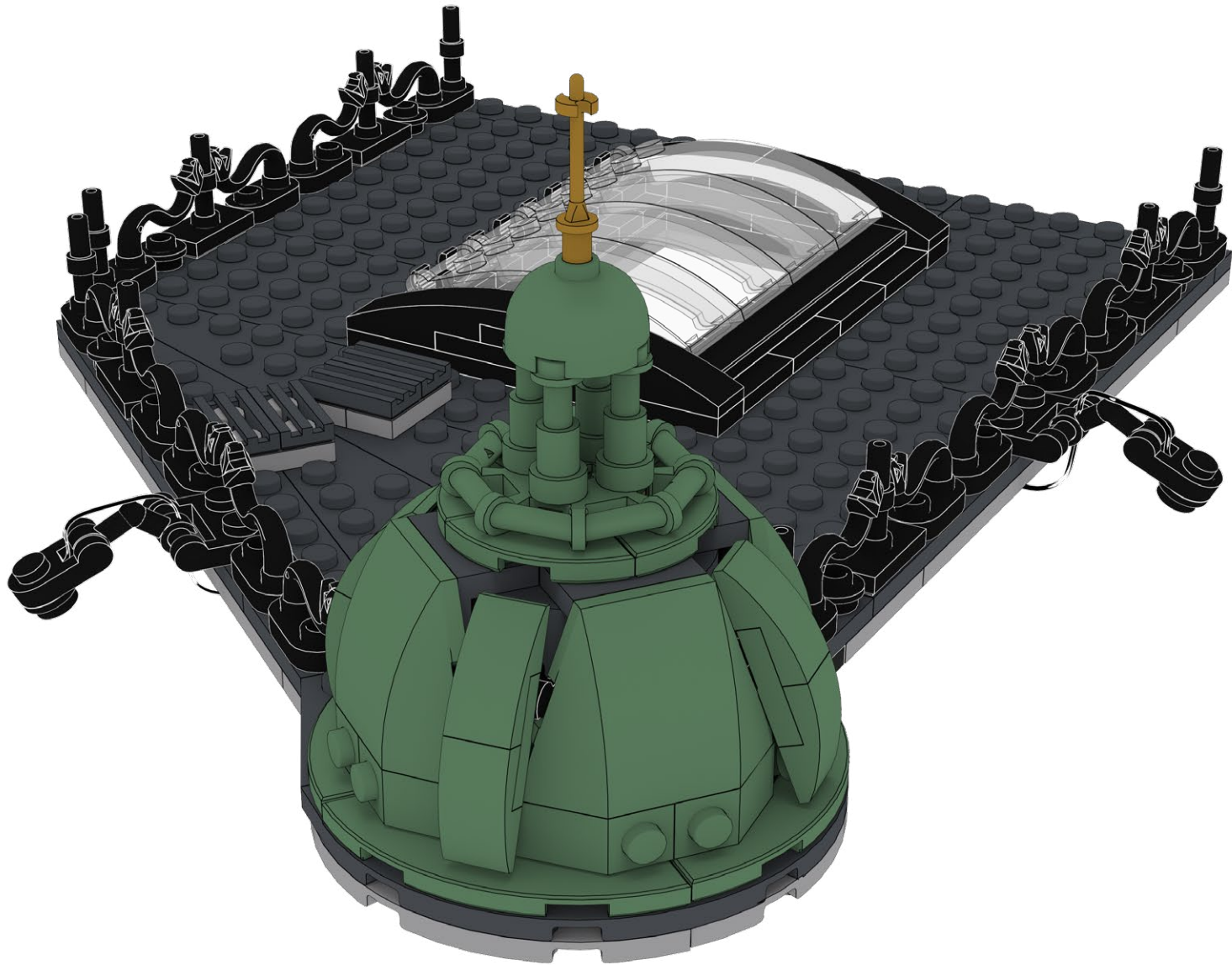

329



330



331



332



FINAL PRODUCT



PACKAGE CONTENTS



2x AR-WW30
Astro Light Regular
Warm White 30cm

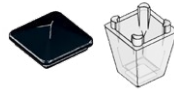

1x Astro Lamp Cap



6x T-1x4
Tether 1x4



14x AR-WW15
Astro Light Regular
Warm White 15cm



1x Astro Cap Clear



5x T-1x6
Tether 1x6



2x AL-WW30
Astro Light Large
Warm White 30cm



6x D-3
Dock 3

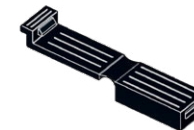

1x E-1x2
Eclipse



5x ML-WW
Meteor Light Warm
White



1x D-6
Dock 6



1x ALP-30
Astro Lamp Post Warm
White - 30cm



1x DS-4
Splitter Dock

PACKAGE CONTENTS



1x B-30
Belt 30cm



5x B-15
Belt 15cm



3x B-5
Belt 5cm



4x FLX-TPA15
Flux Touch Plates (A)
15cm



4x FLX-TPB15
Flux Touch Plates (B)
15cm



1x FLX-C
Flux Converter

PACKAGE CONTENTS



7x Plate, Round 1×1 with Open Stud - Black



2x Plate, Round 1×1 with Open Stud - White



3x Arm Skeleton, Bent with Clips (Horizontal Grip) Black



5x Plate, Round 1×1 - Trans Clear

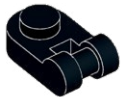

4x Plate, Modified 1×1 Rounded with Handle on End - Black

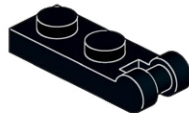

1x Plate, Modified 1×2 with Bar Handle on End - Black



3x Tile, Modified 1×1 with Open O Clip - Black

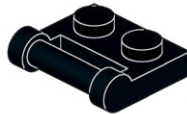

4x Plate, Modified 1×2 with Bar Handle on Side - Black

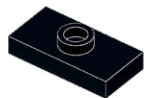

1x Plate, Modified 1×2 with 1 Stud with Groove and Bottom Stud Holder (Jumper) -Black



1x Brick, Modified with Stud on Side - Black

CONTACT US

Click below for customer support, or general inquiries.

Cliquez ci-dessous pour accéder au support client ou aux renseignements généraux.

Clicca qui sotto per l'assistenza clienti o per richieste generali.

Contact Us



Contactez-nous



Contattaci



Klicken sie unten für kundensupport oder allgemeine anfragen.

Haga clic a continuación para atención al cliente o consultas generales.

点击下方获取客户支持或一般咨询。

Kontaktieren sie uns



Contáctanos



联系我们



TROUBLESHOOTING

If you're stuck, scan the QR code for troubleshooting.

Se sei bloccato, scansiona il codice QR per la risoluzione dei problemi.

Wenn Sie nicht weiterkommen, scannen Sie den QR-Code zur Fehlerbehebung.

Si vous êtes bloqué, scannez le code QR pour le dépannage

Si está atascado, escanee el código QR para solucionar el problema.

如果遇到问题, 请扫描二维码进行故障排除

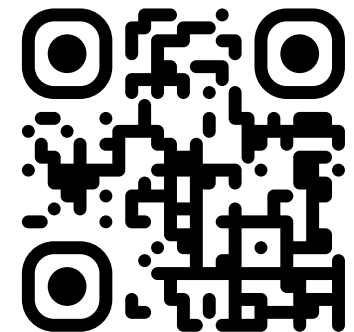



LIGHTMYBRICKS

lightmybricks.com



LEGO® is a trademark of the LEGO Group of companies, which does not sponsor, authorize or endorse this product. All LEGO® sets featured in images are sold separately. This is not a LEGO® product. The LEGO Group is not liable for any loss, injury or damage arising from the use or misuse of this product. ©2024 Light My Bricks Pty Ltd. All rights reserved. www.lightmybricks.com

Our components are designed and packaged in Australia by Light My Bricks Pty Ltd. Components are manufactured in China. 3fl bldg C, Shuanghuan Quanxin Technology Information Industry Park Baolong Street, Longgang District, Shenzhen, China. Imported in Australia by Light My Bricks Pty Ltd, 5/26 Rushdale St, Knoxfield, VIC, 3180, Australia.

WARNING: CHOKING HAZARD - Small parts. Not for children under 3 years.

AVERTISSEMENT : RISQUE D'ÉTOUFFEMENT - Petites pièces. Ne convient pas aux enfants de moins de 3 ans.

ATTENZIONE: PERICOLO DI SOFFOCAMENTO - Piccole parti. Non adatto a bambini di età inferiore a 3 anni.

WARNUNG: ERSTICKUNGSGEFAHR - Kleine Teile. Nicht für Kinder unter 3 Jahren geeignet.

ADVERTENCIA: PELIGRO DE ASFIXIA - Piezas pequeñas. No son apto para niños menores de 3 años.

警告：窒息危险 - 小零件。不适合3岁以下儿童。