



LIGHT KIT INSTALLATION GUIDE

**THE LEGEND OF ZELDA
GREAT DEKU TREE (OOT)**

FOR LEGO
SET
#77092



03

Getting Started

- 04 Legend
- 05 Component Handling
- 06 Blueprint

07

Instructions

- 07 LEGO Bag 1 - LMB Bag 04
- 34 LEGO Bag 2
- 62 LEGO Bag 3
- 80 LEGO Bag 4 - LMB Bag 01
- 100 LEGO Bag 5
- 112 LEGO Bag 6
- 122 LEGO Bag 7 & 9 - LMB Bag 02
- 142 LEGO Bag 22
- 171 LMB Bag 03
- 202 LEGO Bag 8
- 227 LEGO Bag 10, 14 & 23
- 277 LEGO Bag 13
- 290 LEGO Bag 16
- 302 LEGO Bag 17, 20 & 21

358

Final Product

- 359 Package Contents
- 361 Contact & Troubleshooting

GETTING STARTED

Bold, beautiful and bright, Light My Bricks elevates your favourite LEGO set from knick-knack to statement piece. Create a talking point at home or in the office that speaks to your passions with Light My Bricks. To learn more, click below.

[Learn More](#)



Audacieux, beau et lumineux, Light My Bricks élève votre ensemble LEGO préféré du statut de bibelot à celui de pièce maîtresse. Que ce soit à la maison ou au bureau, partagez votre passion des LEGO avec Light My Bricks. Cliquez ci-dessous pour en savoir plus.

[En savoir plus](#)



Audace, bello e luminoso, Light My Bricks eleva il tuo set LEGO preferito da soprammobile a pezzo di tendenza. Crea un punto di discussione a casa o in ufficio che parli alle tue passioni con Light My Bricks. Per saperne di più, clicca qui sotto.

[Ulteriori Informazioni](#)



Mutig, schön und hell – Light My Bricks verwandelt Ihr Lieblings-LEGO-Set von einem schnickschnack in ein statement-stück. Schaffen sie einen gesprächspunkt zu hause oder im büro, der Ihre leidenschaften widerspiegelt, mit Light My Bricks. Um mehr zu erfahren, klicken sie unten.

[Mehr erfahren](#)



Audaz, hermoso y brillante, Light My Bricks eleva tu set LEGO favorito de una chuchería a una pieza llamativa. Crea un tema de conversación en casa o en la oficina que hable de tus pasiones con Light My Bricks. Para obtener más información, haga clic a continuación.

[Más información](#)



大胆、美丽而明亮，Light My Bricks 将你喜爱的乐高套装从小摆件提升为引人注目的装饰品。在家或办公室打造一个能表达你激情的话题，了解更多，请点击下方。

[了解更多](#)



LEGEND

Rotate Set



Retournez L'ensemble
Ruota Set
Set Drehen
Rotar Conjunto
旋转套件

Add Part



Ajoutez une Pièce
Aggiungi Parte
Teil Hinzufügen
Agregar Pieza
添加零件

Click



Cliquez
Clic
Klicken
Clic
点击

Pinch/Fold



Pincez/Pliez
Pizzicare/Piegare
Kneifen/Falten
Pellizcar/Doblar
折叠

Pull Cable



Tirez le Cable
Tirare il Cavo
Kabel Ziehen
Tirar del Cable
拉动电缆

Repeat Step



Répétez
Ripetere
Wiederholen
Repetir
重复

Sticker



Autocollant
Adesivo
Aufkleber
Pegatina
贴纸

Power On Test



Test de mise sous tension
Test di Potenza
Stromtest
Prueba de Energía
电源测试

Disconnect Power



Débranchez L'alimentation
Scollegare L'alimentazione
Strom Trennen
Desconectar la Energía
断开电源

Troubleshoot



Dépanner
Risolvere
Fehlerbehebung
Solución de Problemas
故障排除

COMPONENT HANDLING

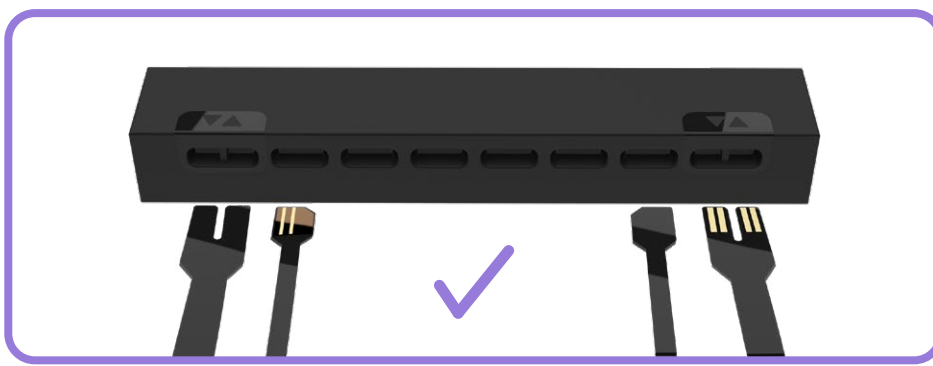
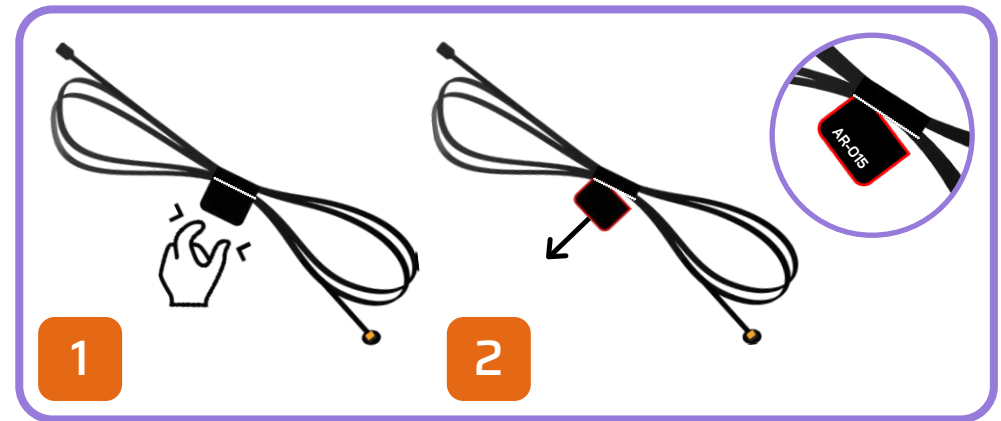
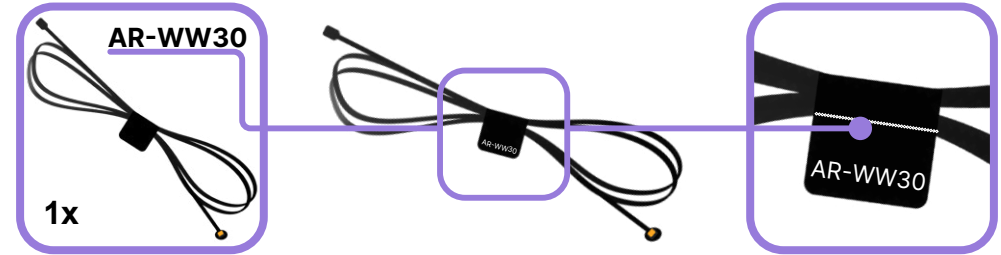
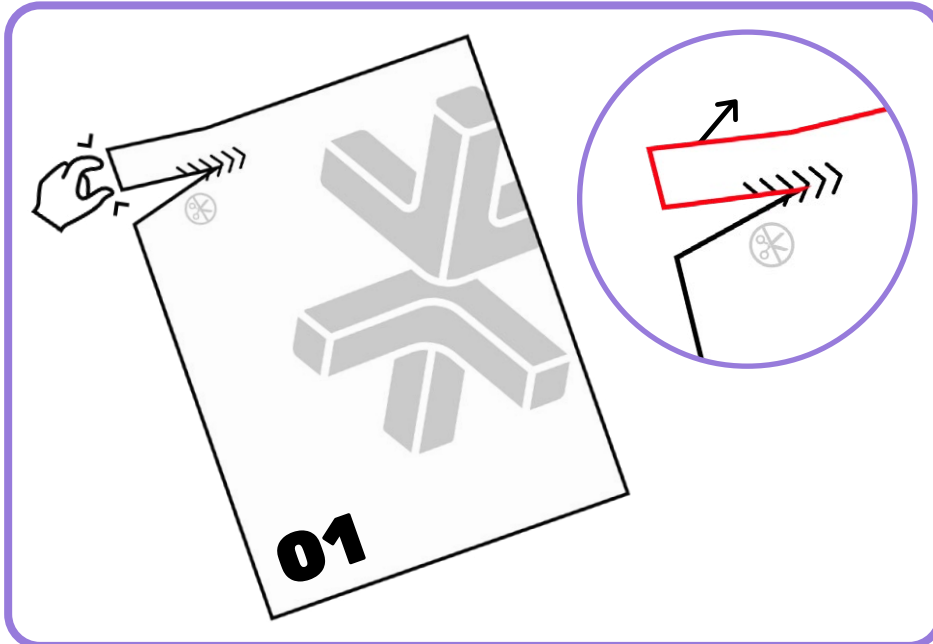

BLUEPRINT

Deku Tree

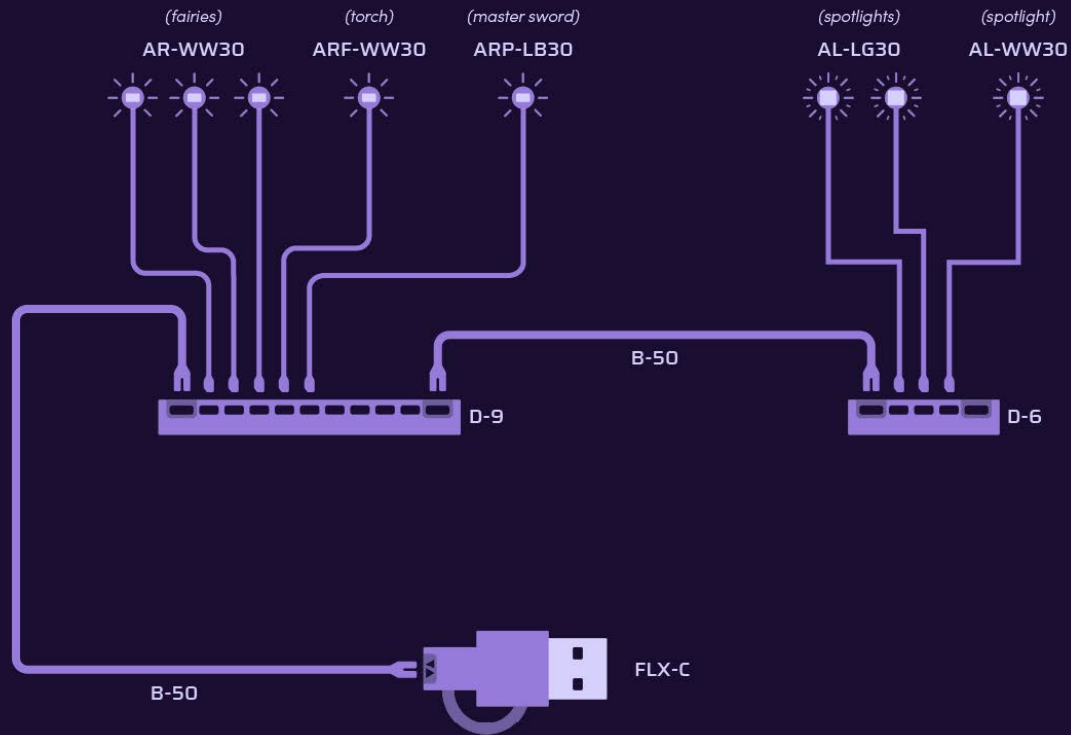

Link's House

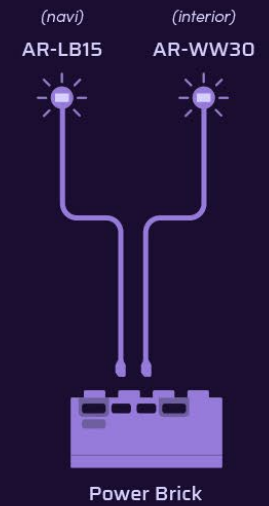



HOLD UP!

You might notice some bags aren't in order, as well as left over pieces, but that's ok! We're changing the way you build LEGO!

ATTENDEZ!

Vous remarquerez peut-être que certains sacs, ainsi que certaines pièces, ne sont pas dans le bon ordre. Mais pas de panique! Nous changeons simplement la façon avec laquelle vous construisez vos LEGO!

ASPETTA!

Potresti notare che alcuni sacchetti non sono in ordine, così come i pezzi avanzati, ma va bene così! Stiamo cambiando il modo in cui costruisci i LEGO!

HALT!

Sie werden möglicherweise bemerken, dass einige tüten durcheinander sind und teile übrig bleiben, aber das ist in Ordnung! Wir ändern die art und weise, wie Sie LEGO bauen!

¡ESPERA!

Es posible que notes que algunas bolsas están fuera de servicio, así como piezas sobrantes, ¡pero está bien! ¡Estamos cambiando la forma en que construyes LEGO!

暫停!

你可能会注意到一些袋子顺序错乱, 以及一些剩余的部件, 但没关系! 我们正在改变你搭建乐高的方式!

Open LEGO® Bag 1

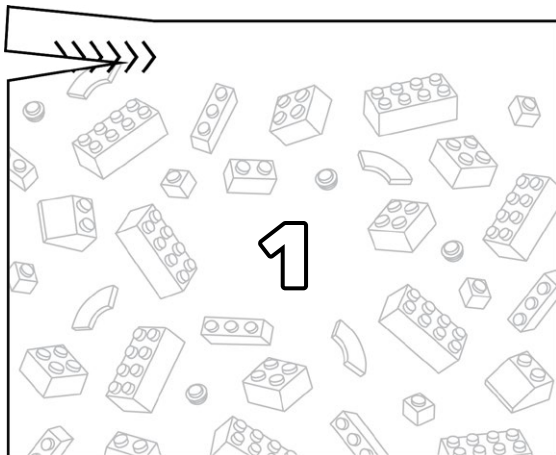

Open LMB Bag 04

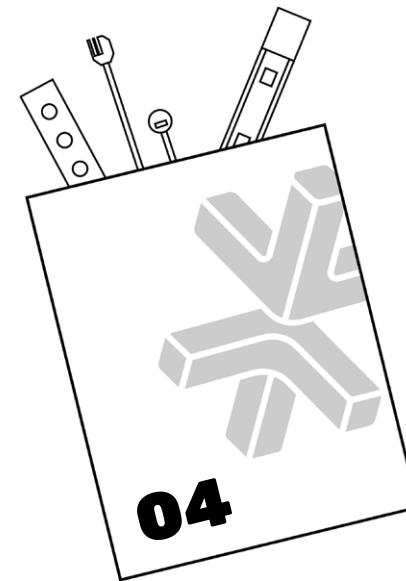



1

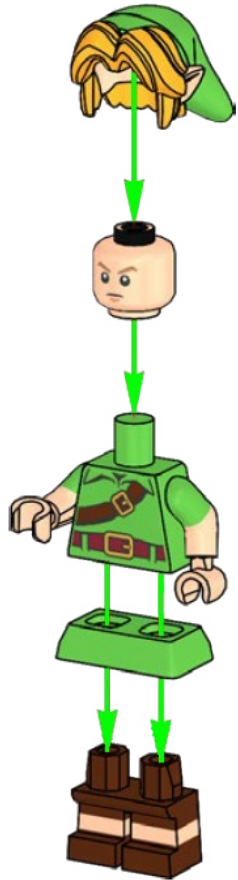

2



2

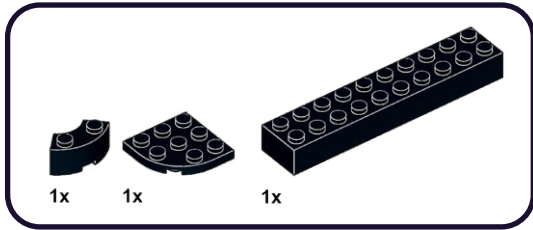

1

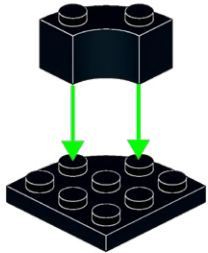

2

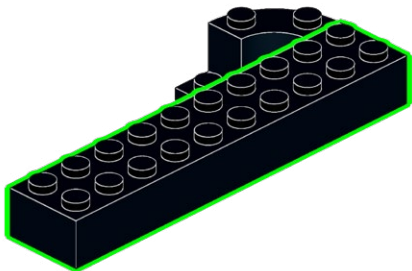

3

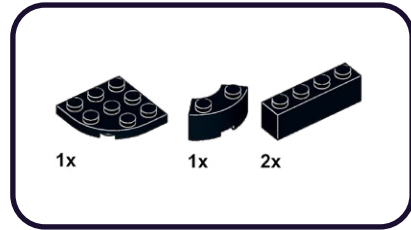

1

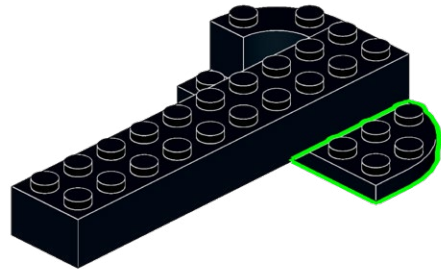

2

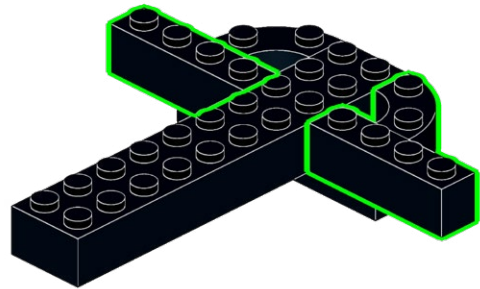

4

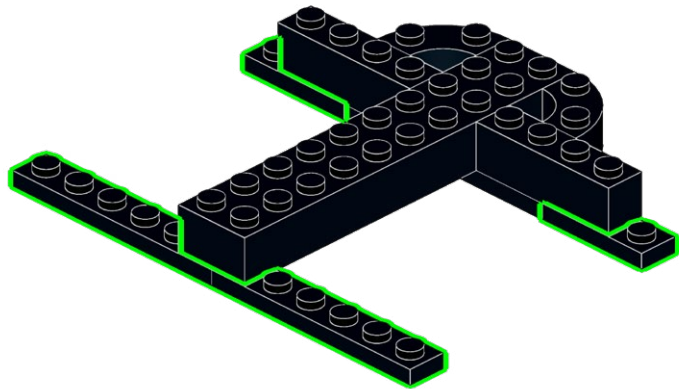
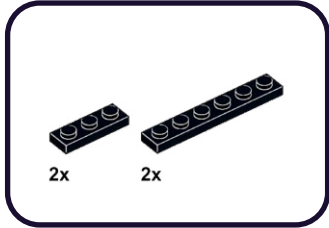

5

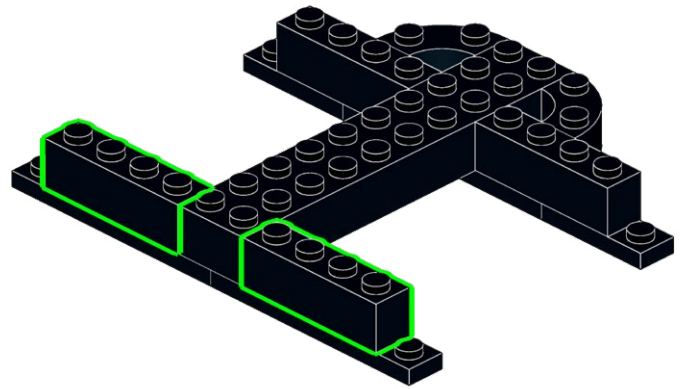
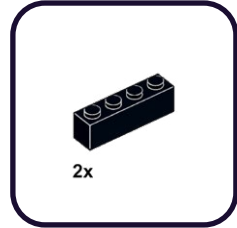

6

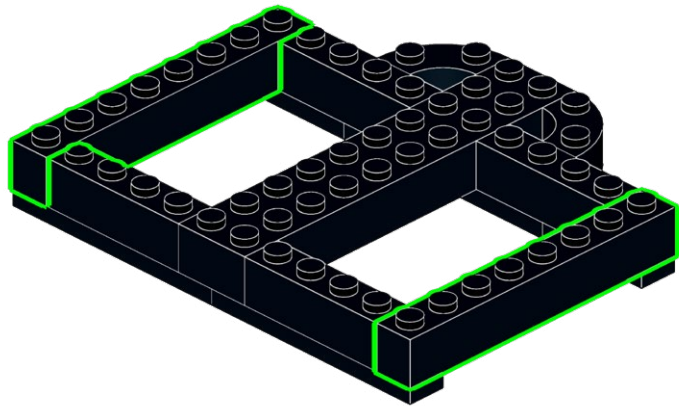
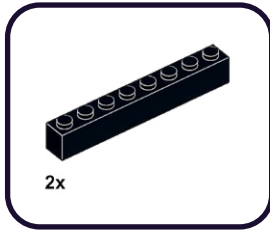

7

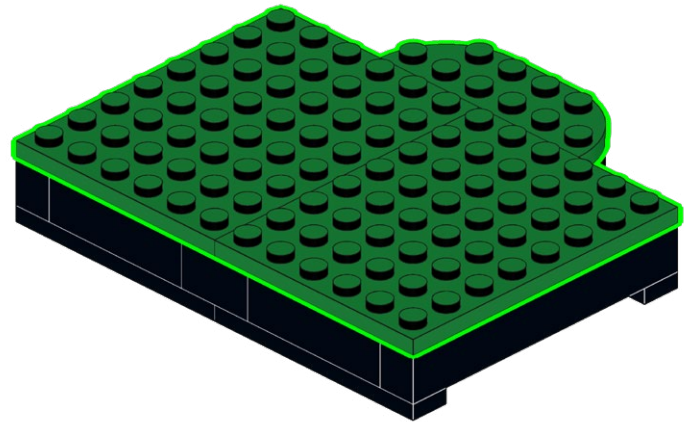
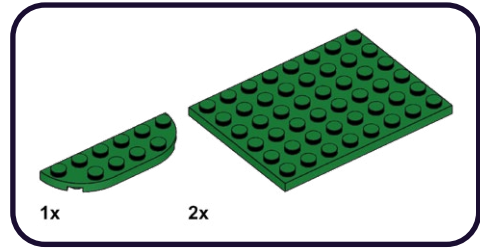

8

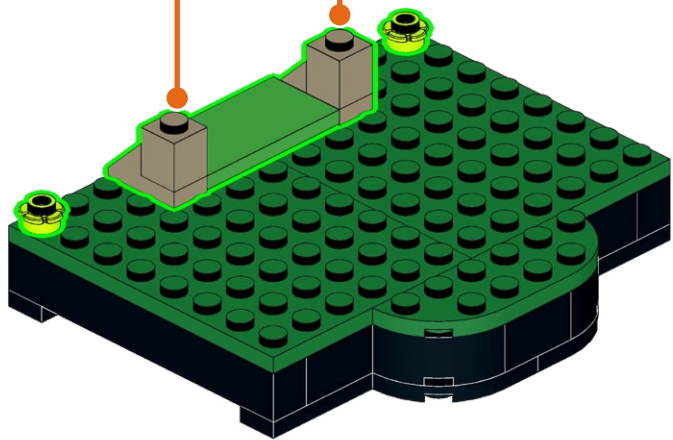
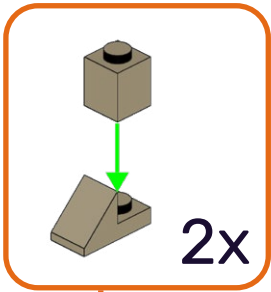
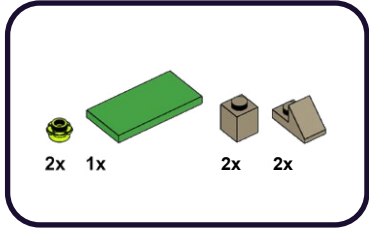

9

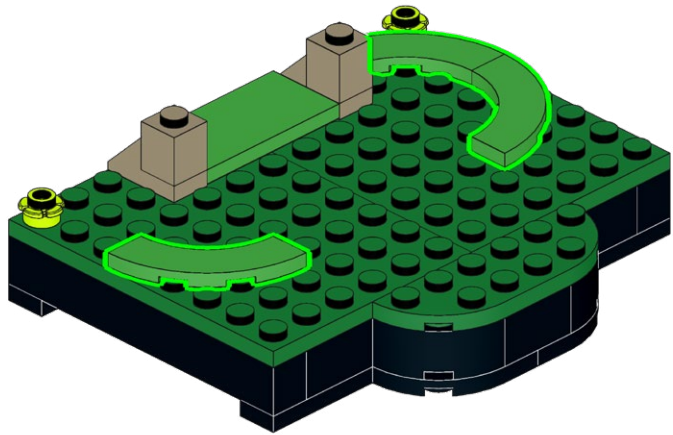
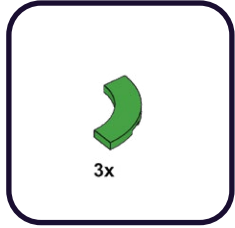

10

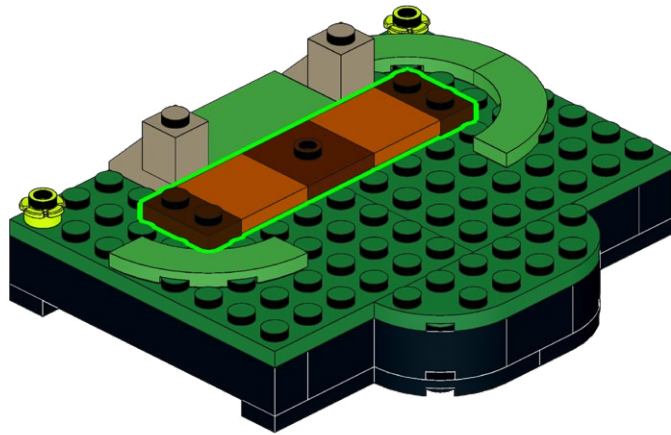
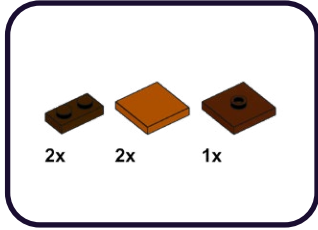

11

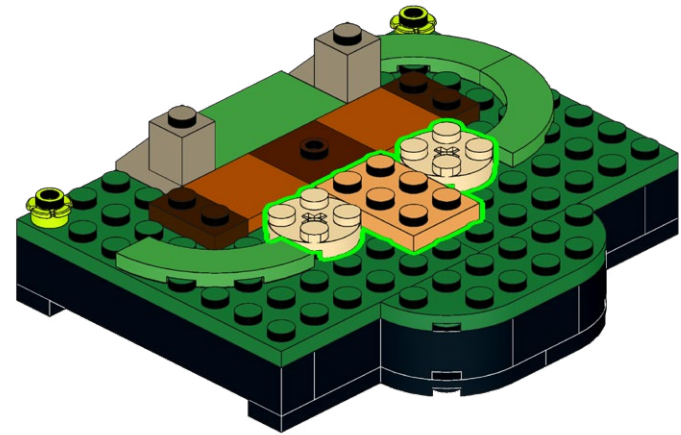
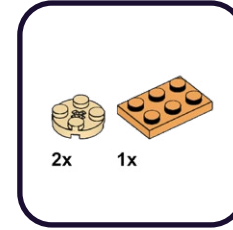

12

2x 4x

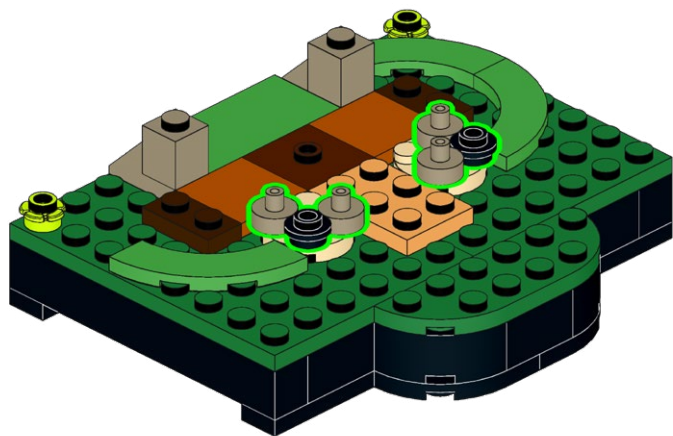

13

2x 2x 1x

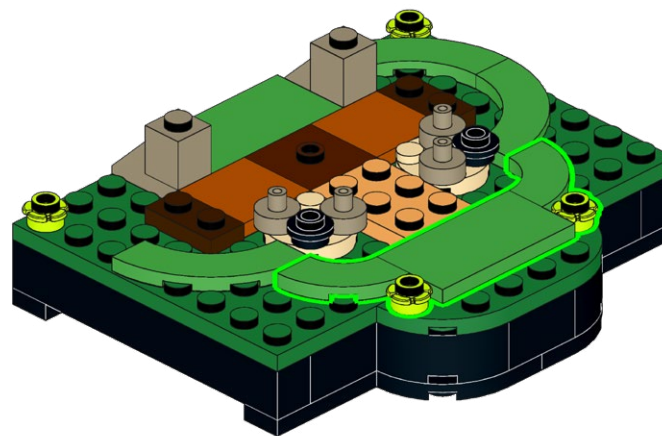

14

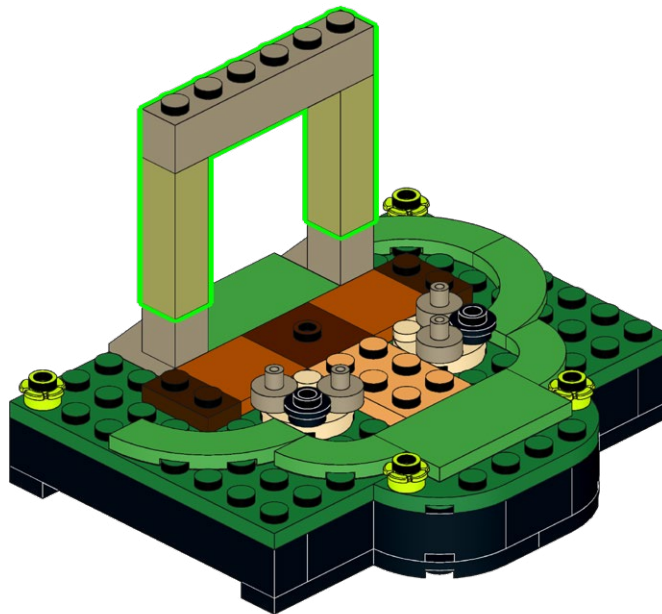
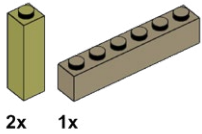

15

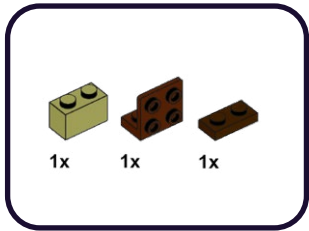

1

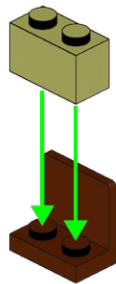

2

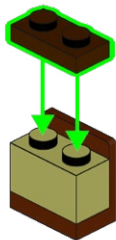

16

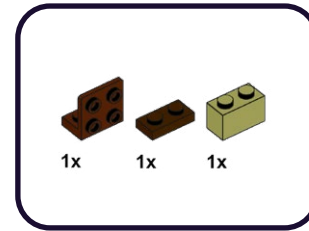

1

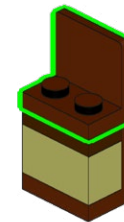

2

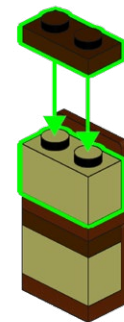

17

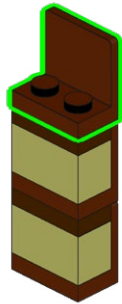
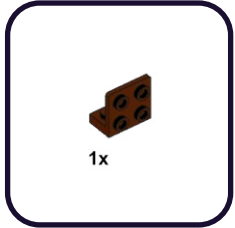

18

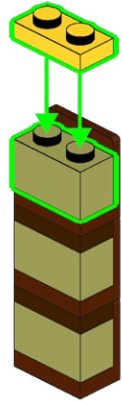
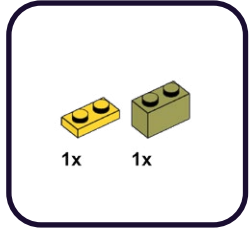

19

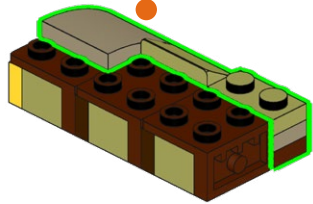
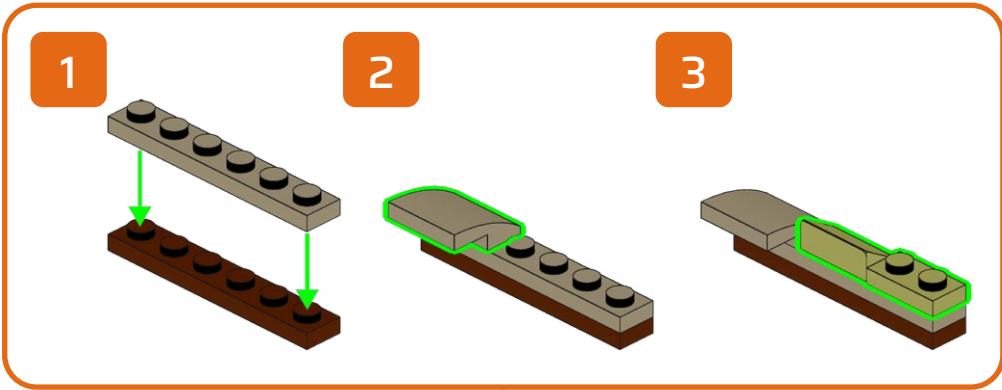
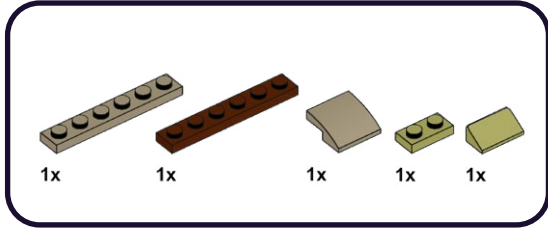

20

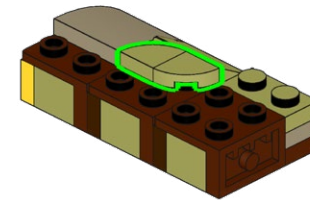
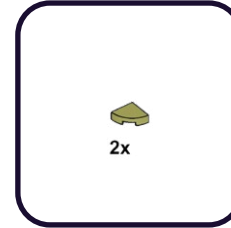

21

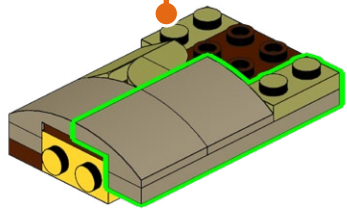
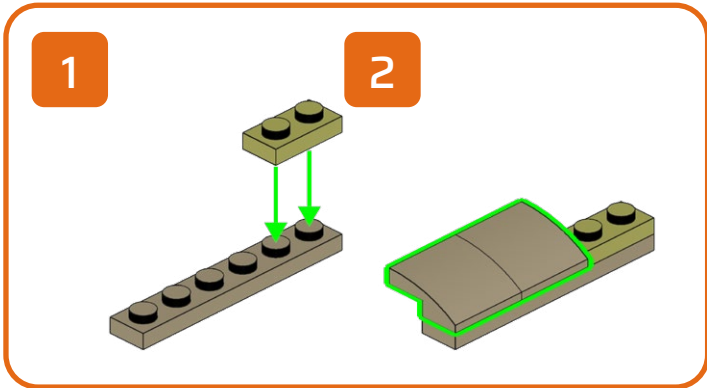
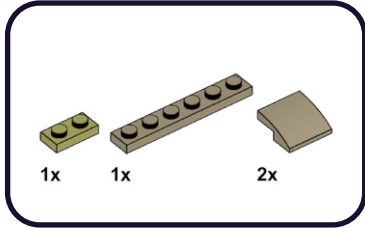

22

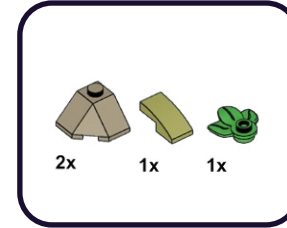

1

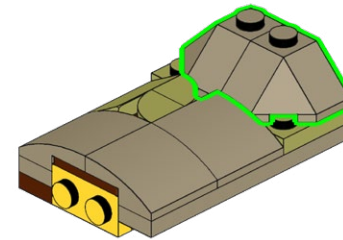

2

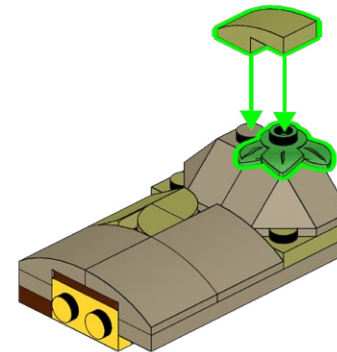

23

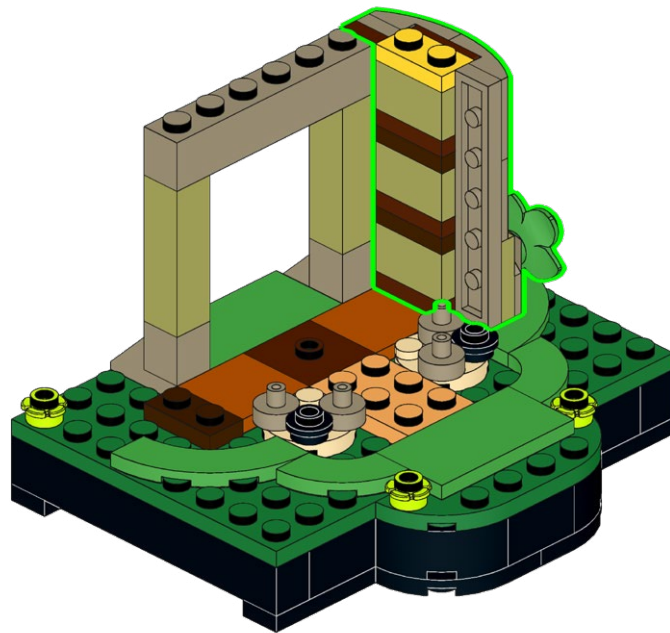

24

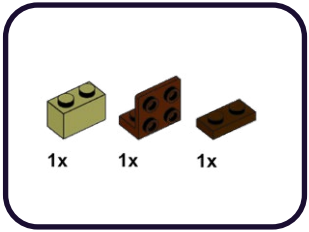

1

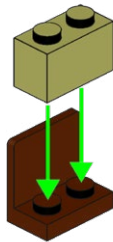

2

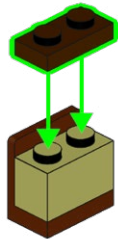

25

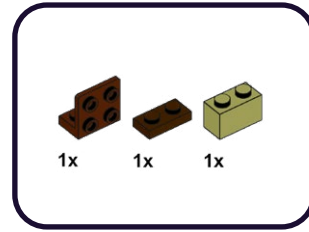

1

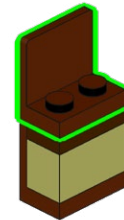

2

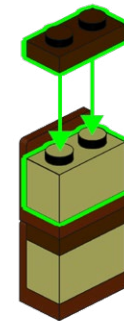

26

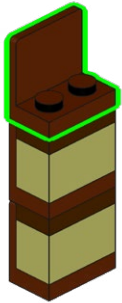
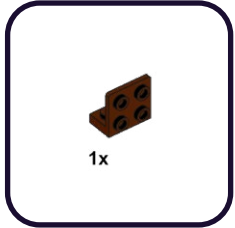

27

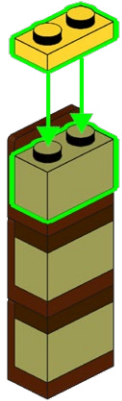
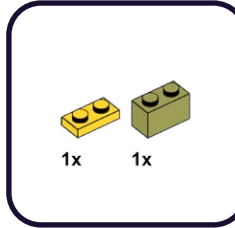

28

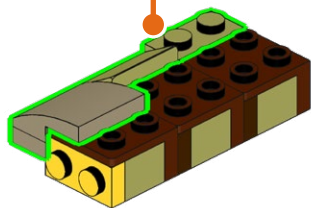
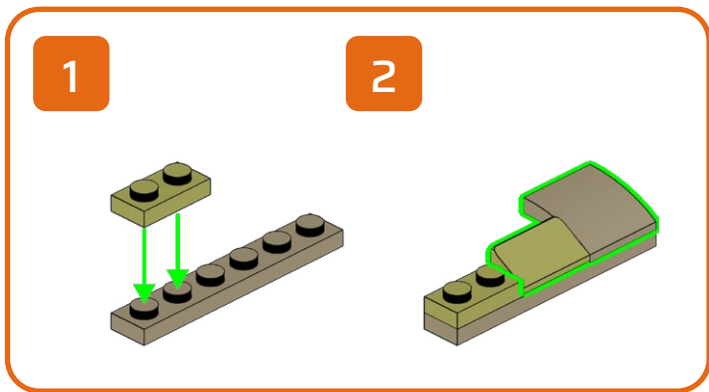
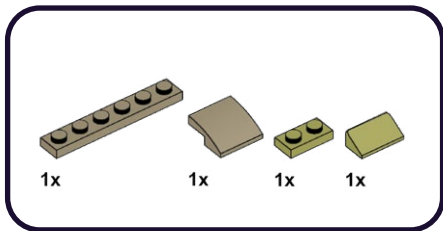

29

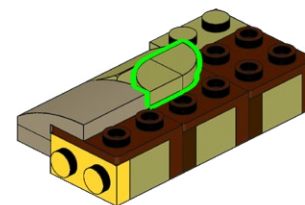
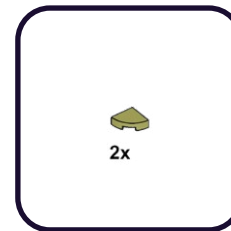

30



31

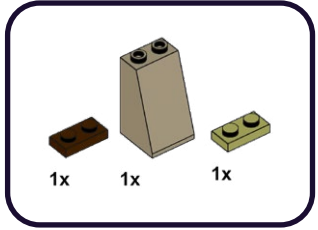

1

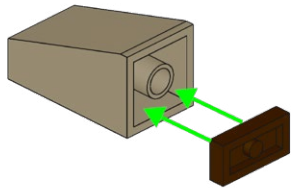

2

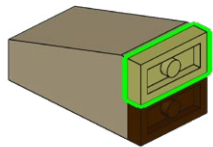

32

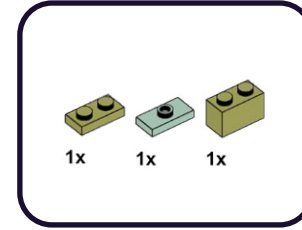

1

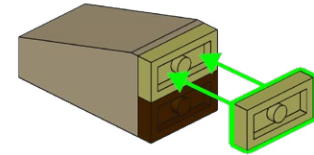

2

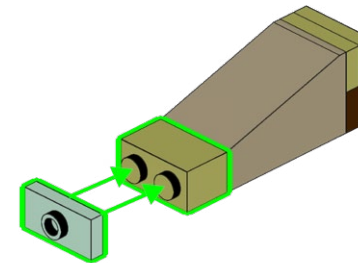
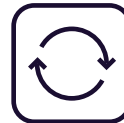

2x

33

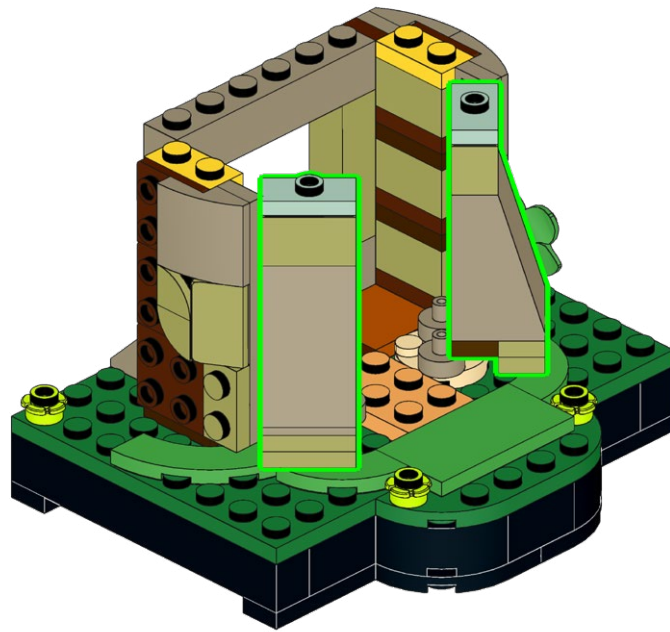

34

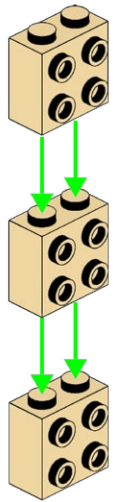
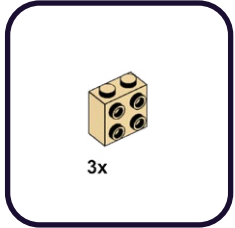

35

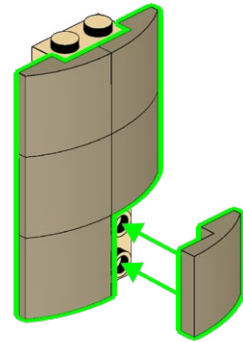
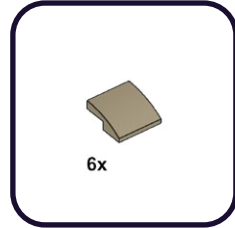

36

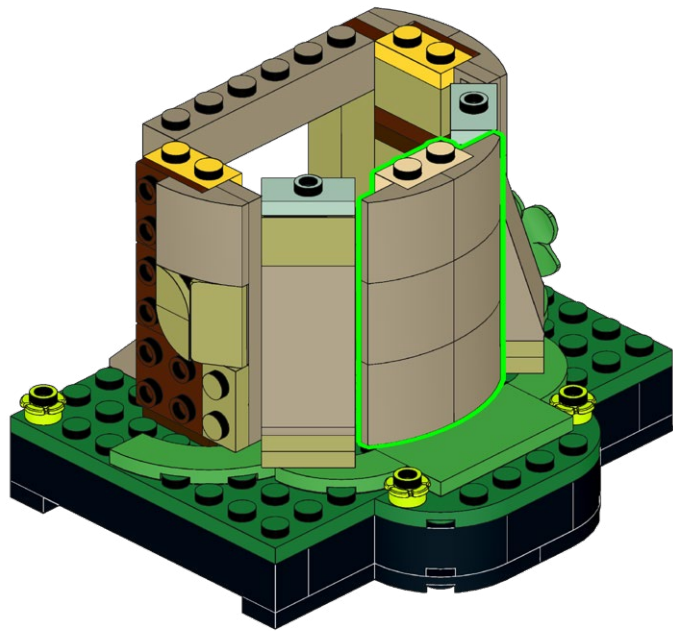

37

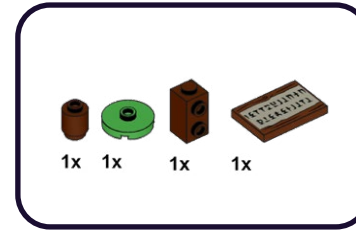

1

2

3

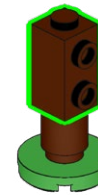
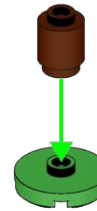

38

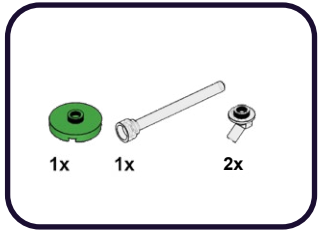

1

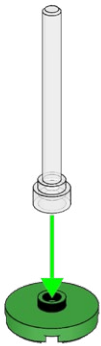

2

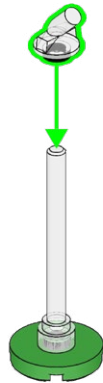

3



39

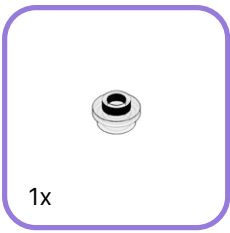
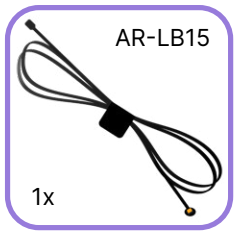

1

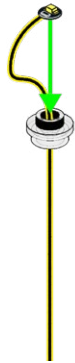

2



40

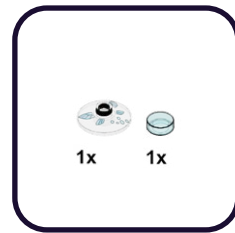

1

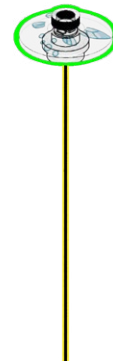

2

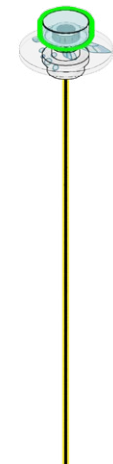

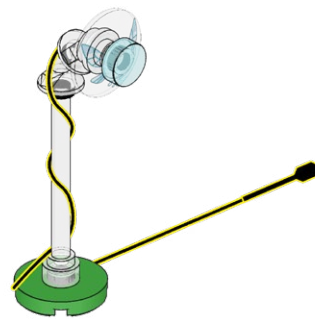
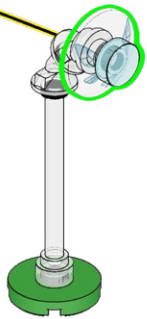
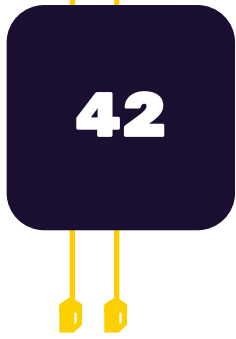

43

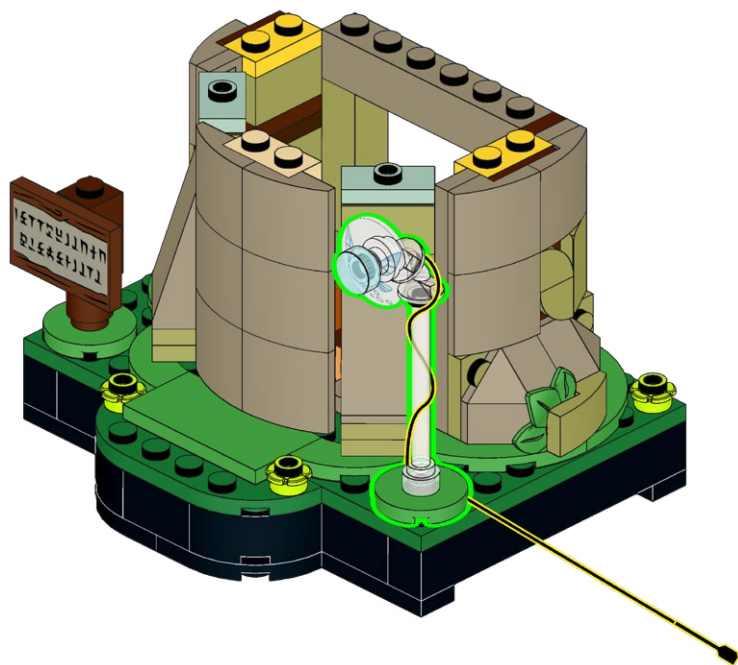

44

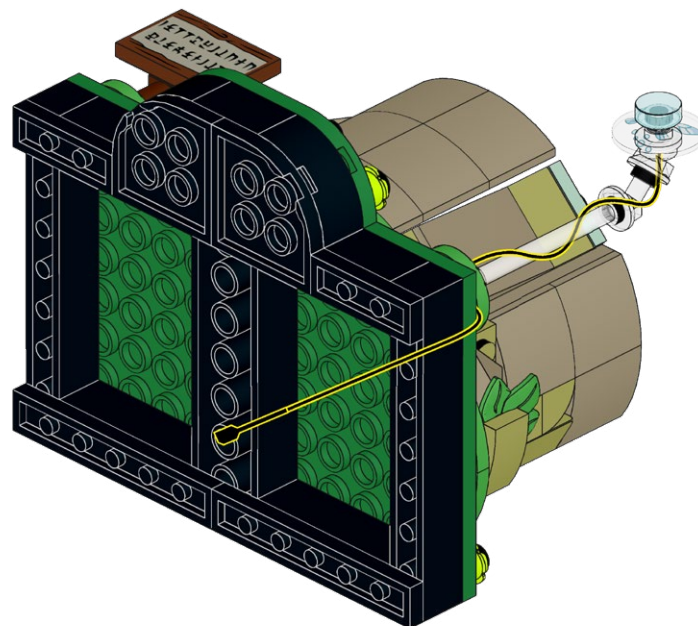
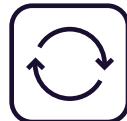

45

46



1x

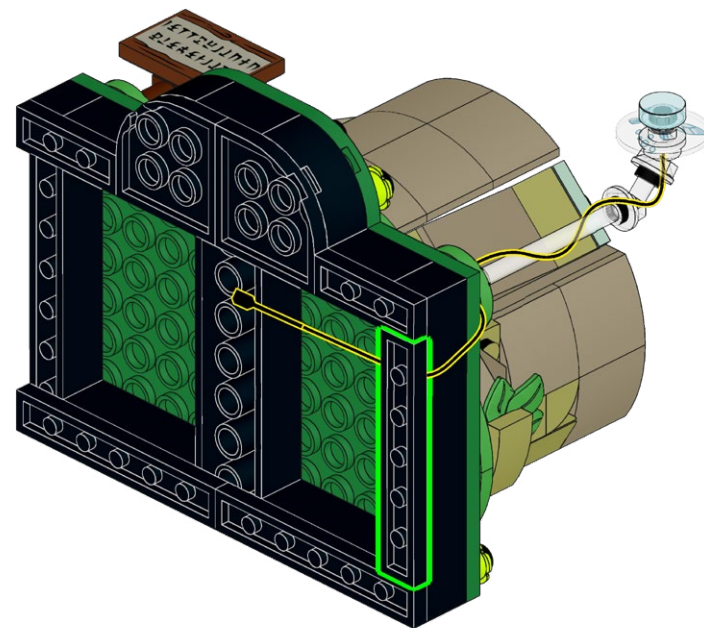
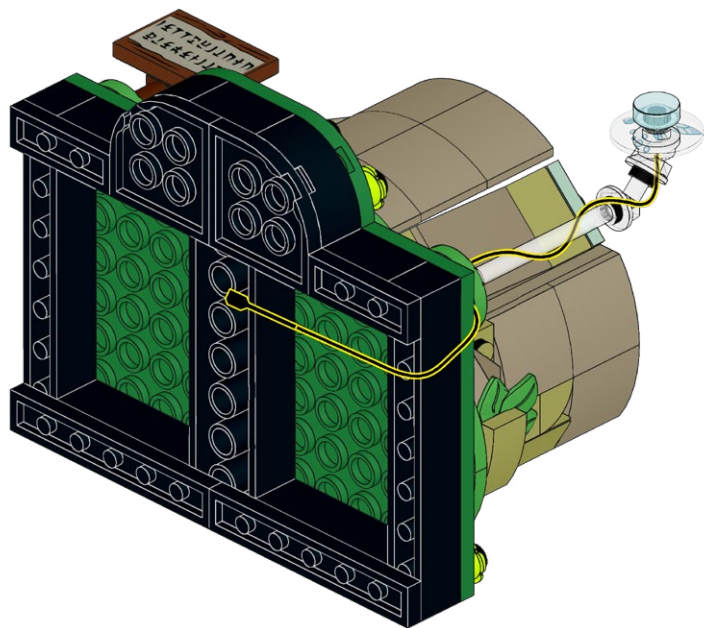

**HOLD UP!**

You might notice some bags aren't in order, as well as left over pieces, but that's ok! We're changing the way you build LEGO!

ATTENDEZ!

Vous remarquerez peut-être que certains sacs, ainsi que certaines pièces, ne sont pas dans le bon ordre. Mais pas de panique! Nous changeons simplement la façon avec laquelle vous construisez vos LEGO!

ASPETTA!

Potresti notare che alcuni sacchetti non sono in ordine, così come i pezzi avanzati, ma va bene così! Stiamo cambiando il modo in cui costruisci i LEGO!

HALT!

Sie werden möglicherweise bemerken, dass einige tüten durcheinander sind und teile übrig bleiben, aber das ist in Ordnung! Wir ändern die art und weise, wie Sie LEGO bauen!

¡ESPERA!

Es posible que notes que algunas bolsas están fuera de servicio, así como piezas sobrantes, ¡pero está bien! ¡Estamos cambiando la forma en que construyes LEGO!

暫停!

你可能会注意到一些袋子顺序错乱, 以及一些剩余的部件, 但没关系! 我们正在改变你搭建乐高的方式!

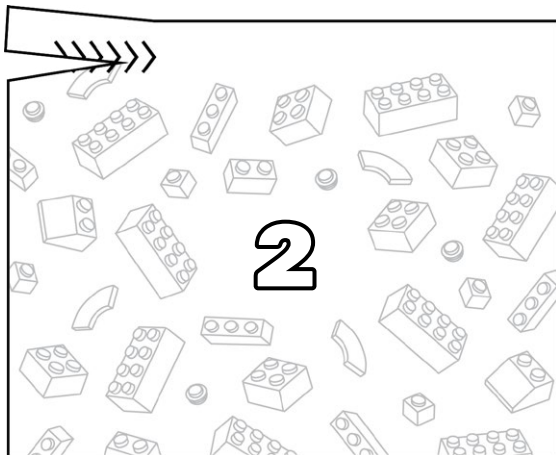
Open LEGO® Bag 2

1

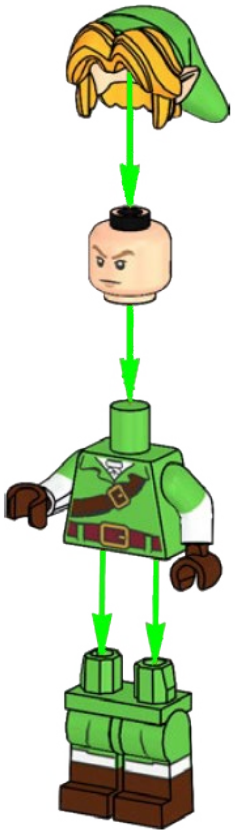

2



48

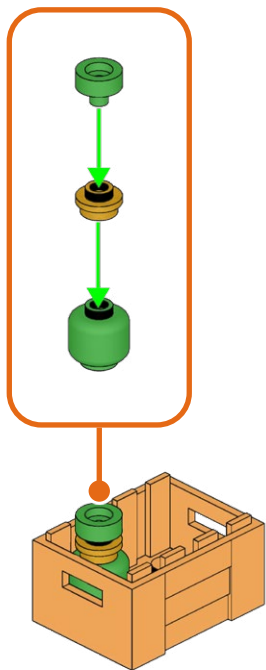
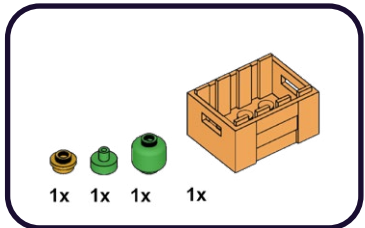

49

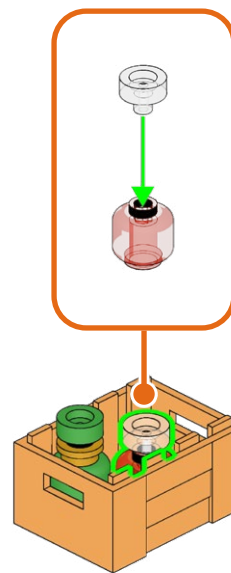
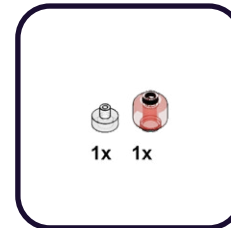

50

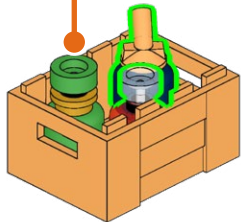
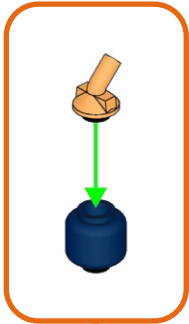

51

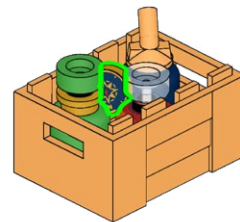
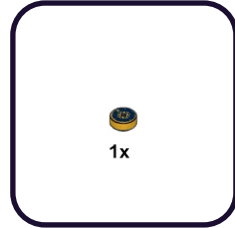

52

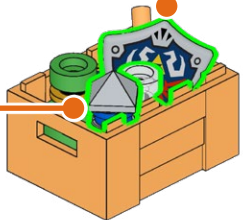
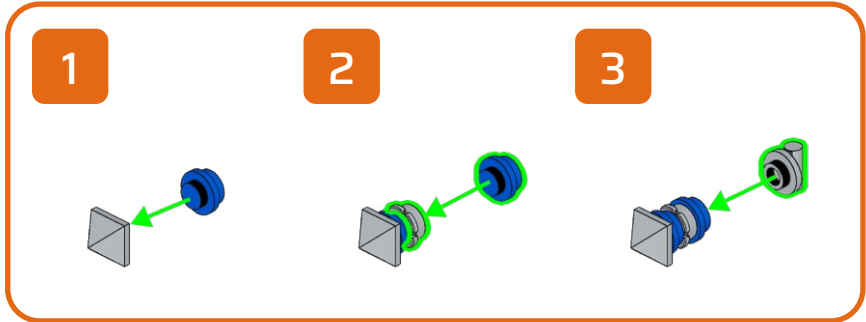
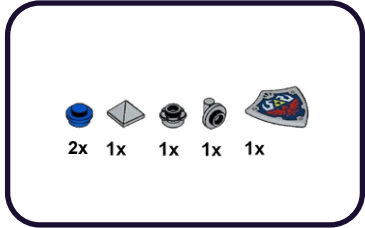

53

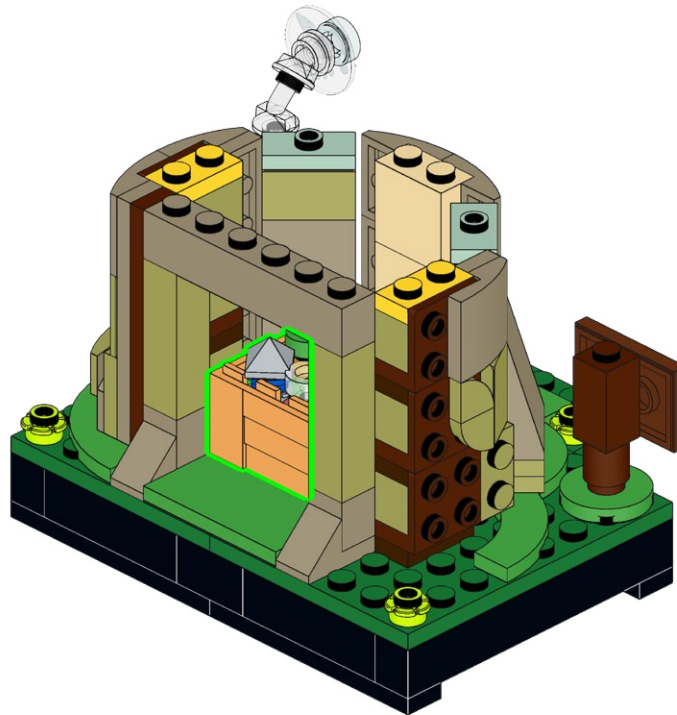

54

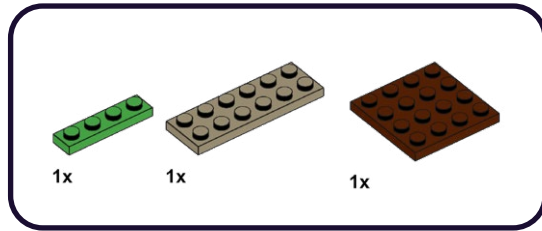

1

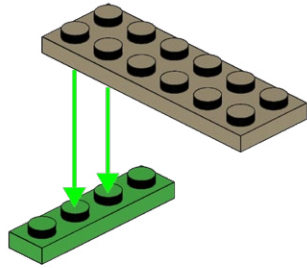

2

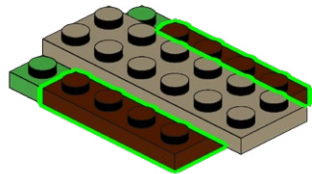

55

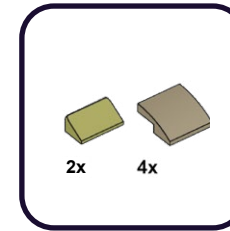

1

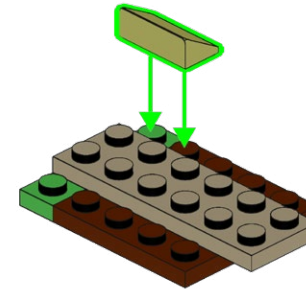

2

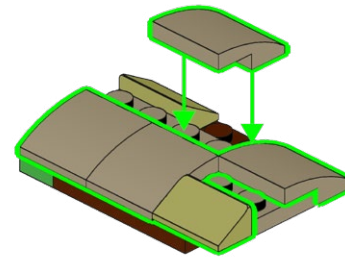

56

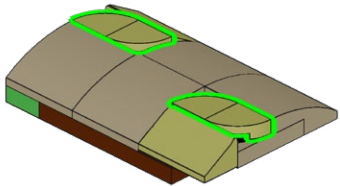
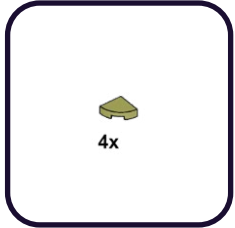

57

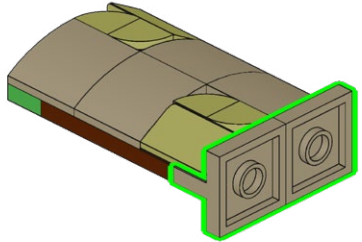
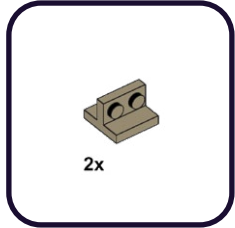

58

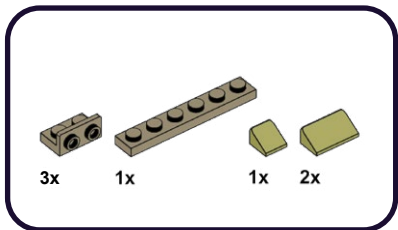

-
-
-

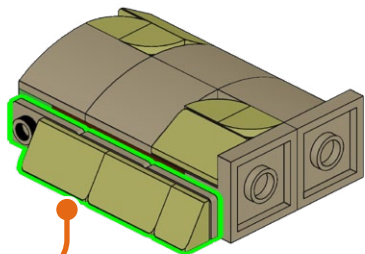

59

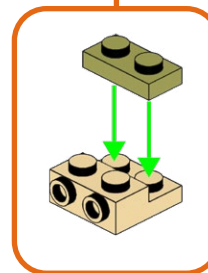
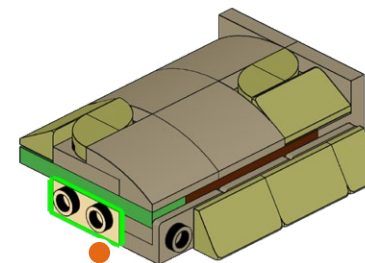
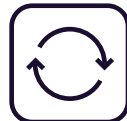
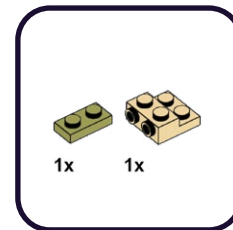

60

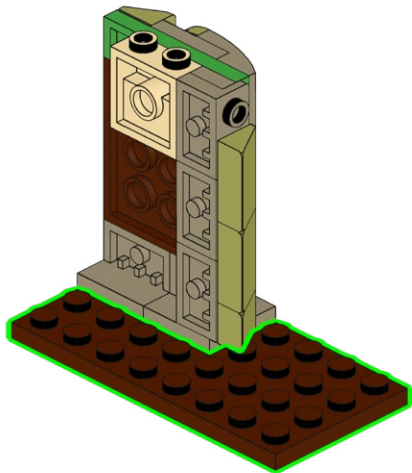
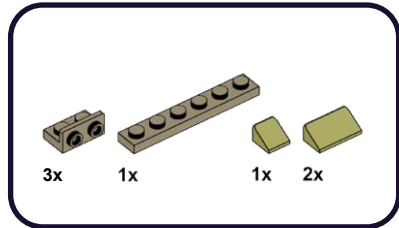

61

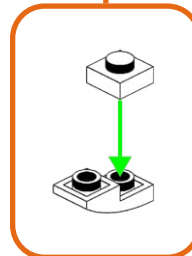
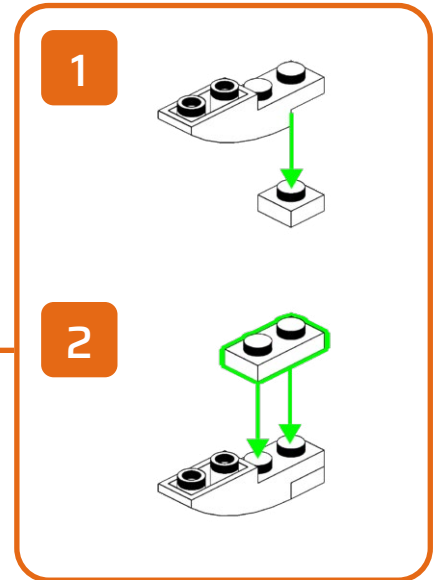
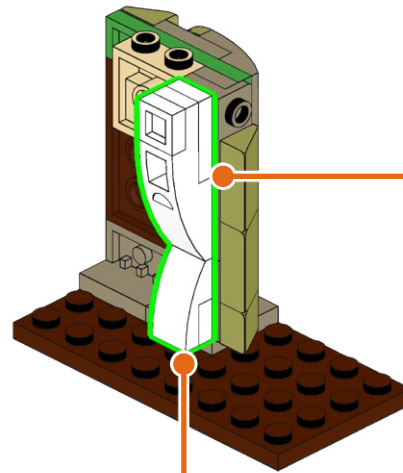
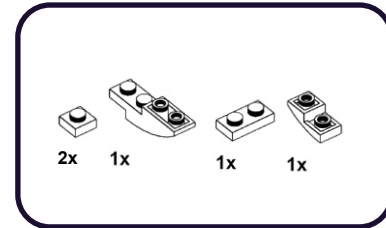

62

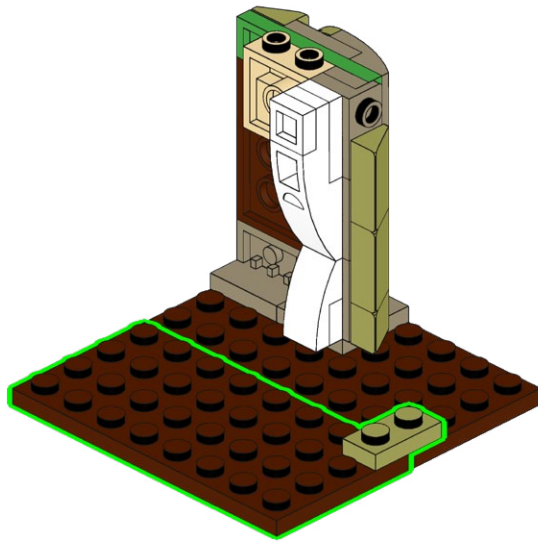
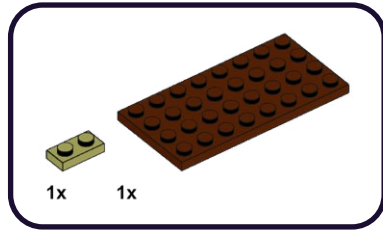

63

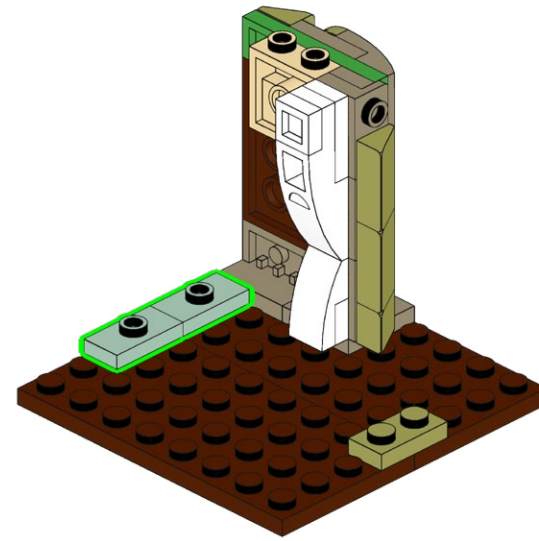
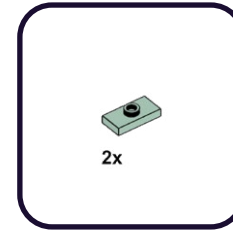

64

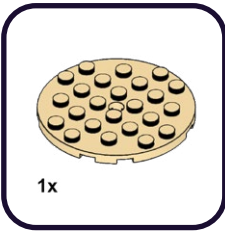
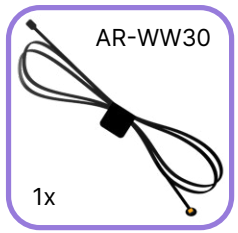

1

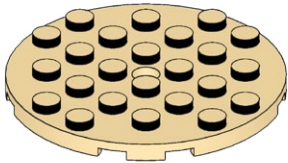

2

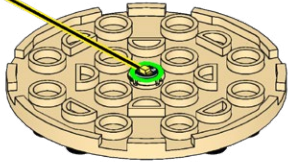

65

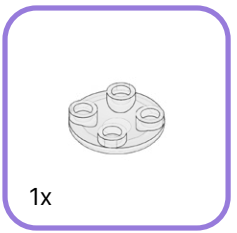
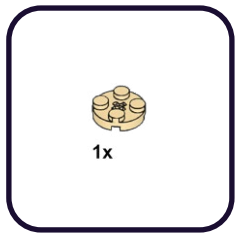

1

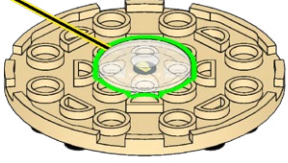

2

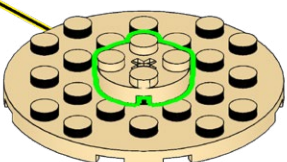

66

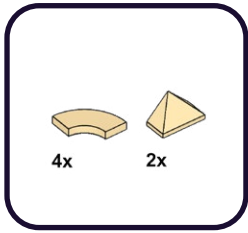

1

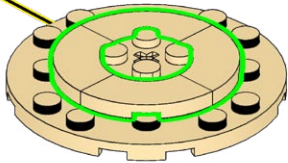

2

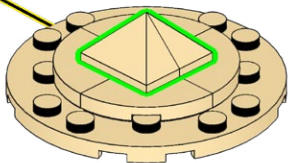

67

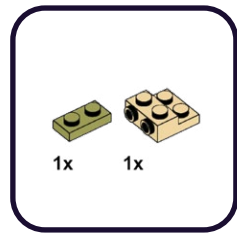

1

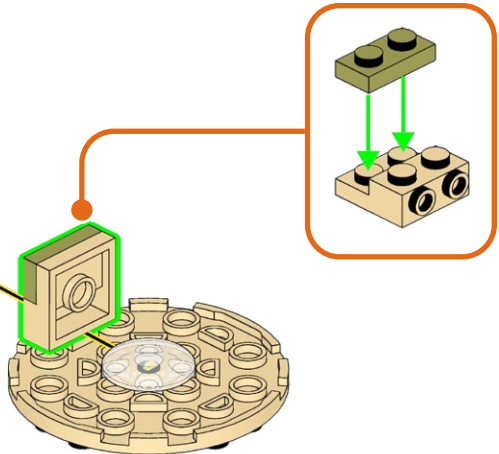

2

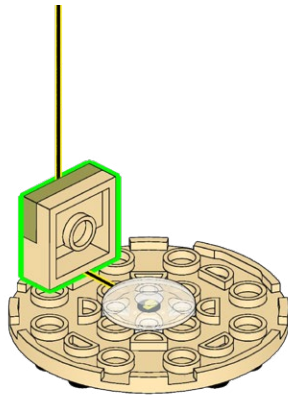

68

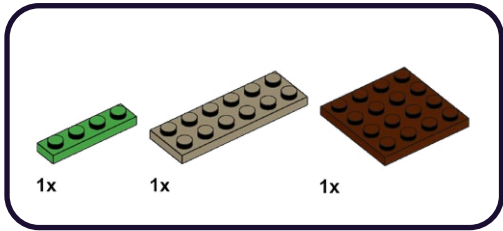

1

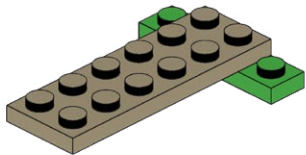

2

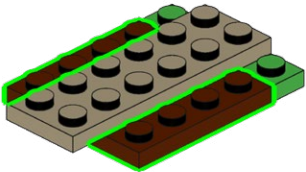

69

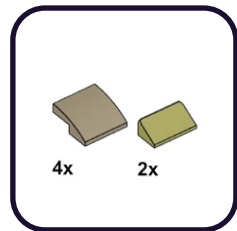

1

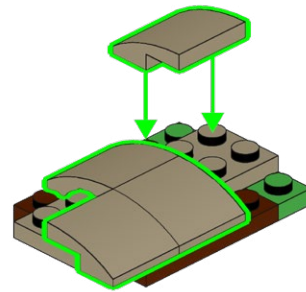

2

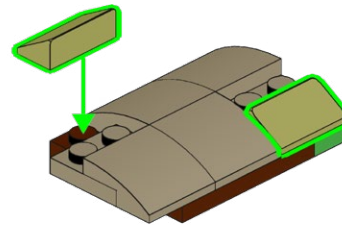

70

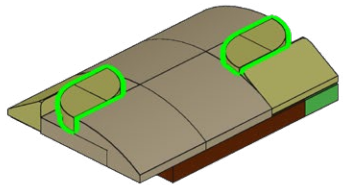
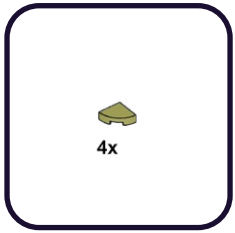

71

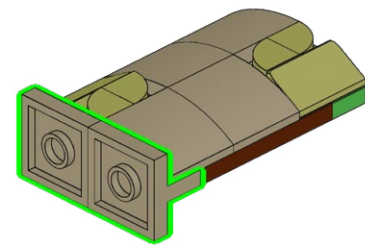
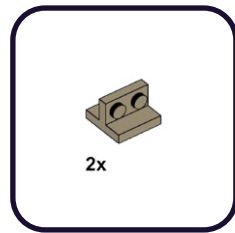

72

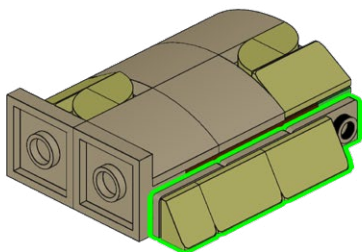
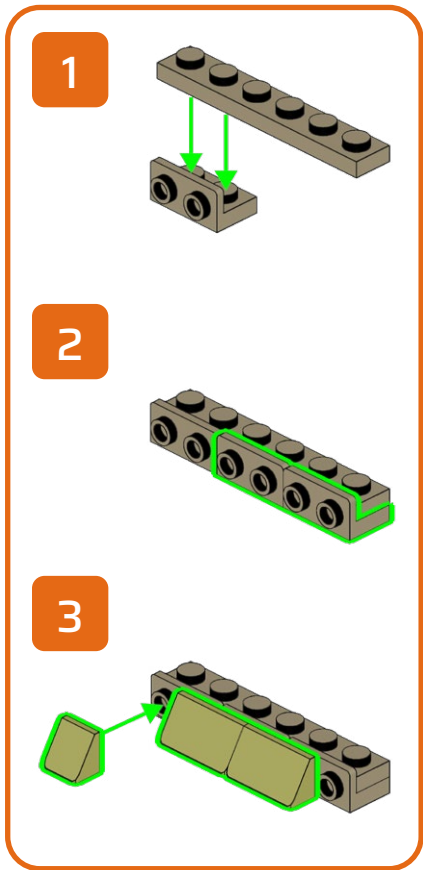
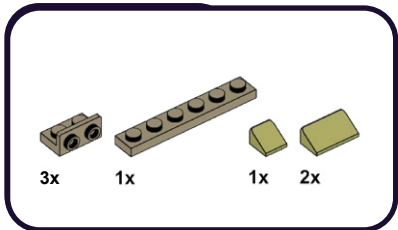

73

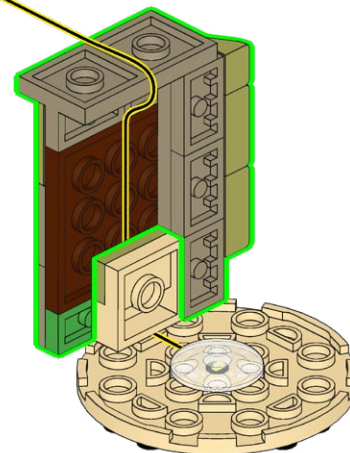

74

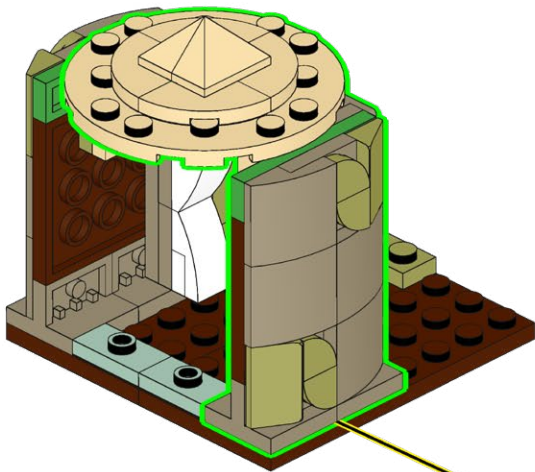

75

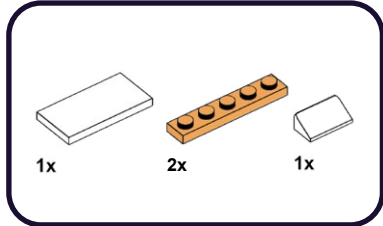

- 1
- 2
- 3

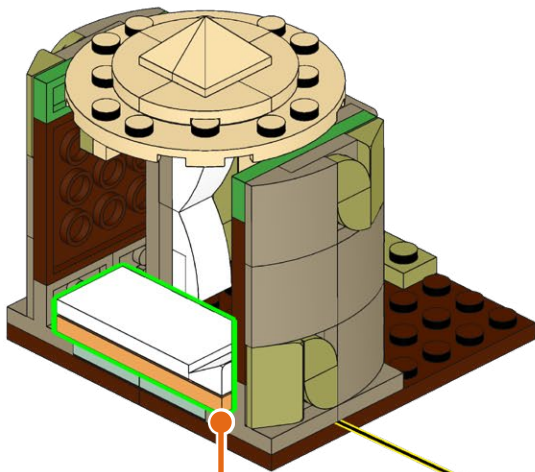

76

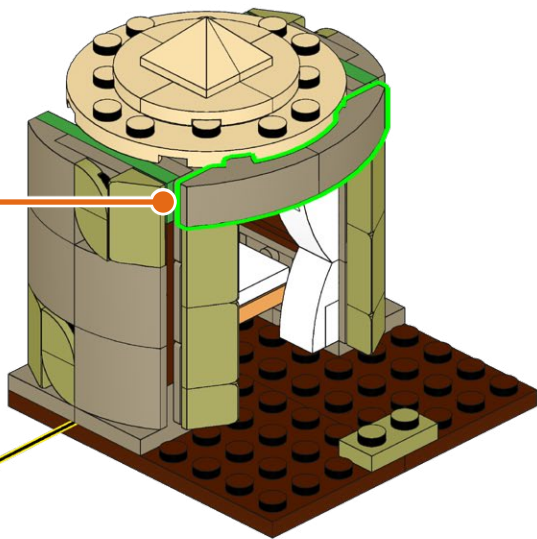
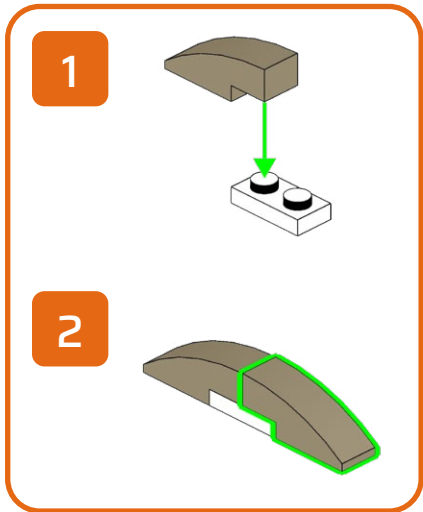
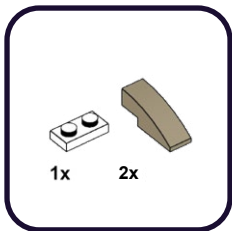

77

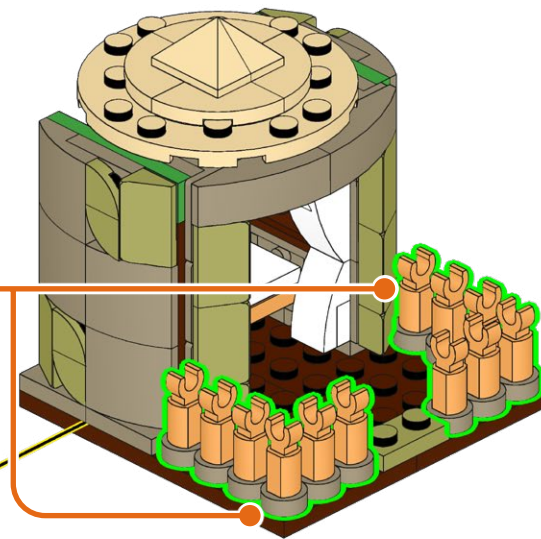
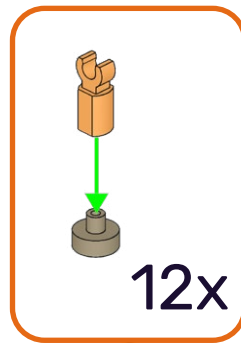
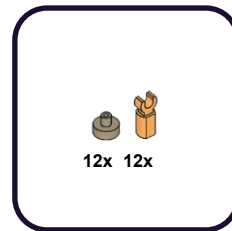

78

4x

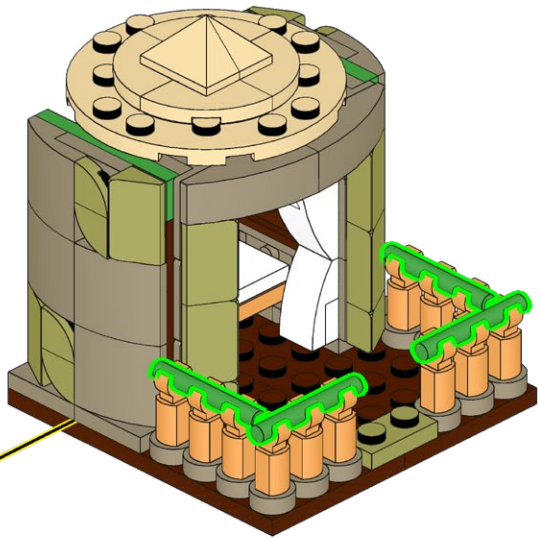

79

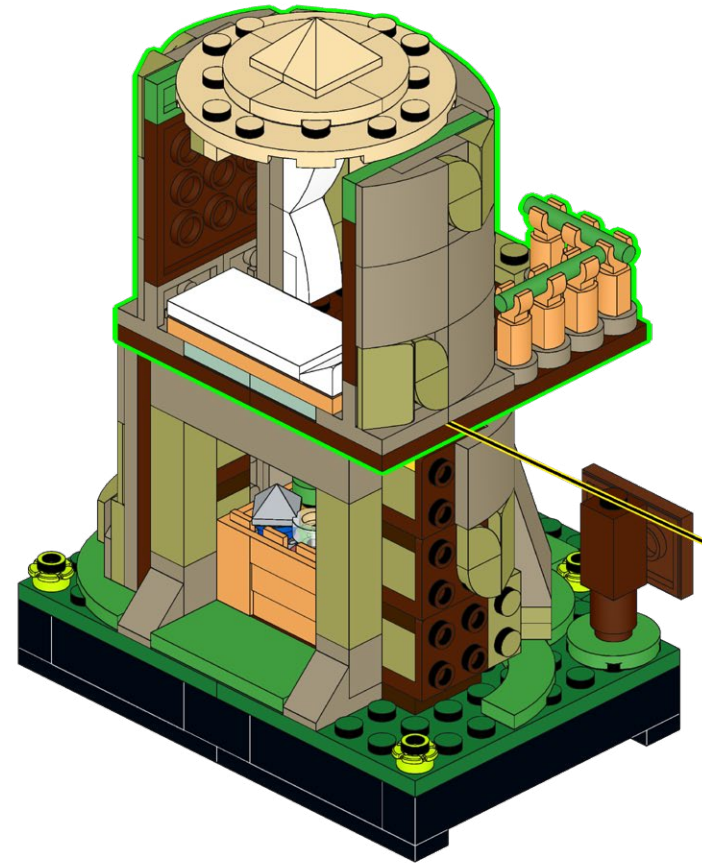

80



81

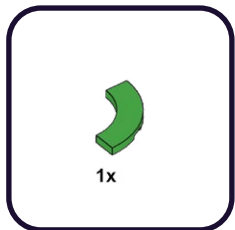

82

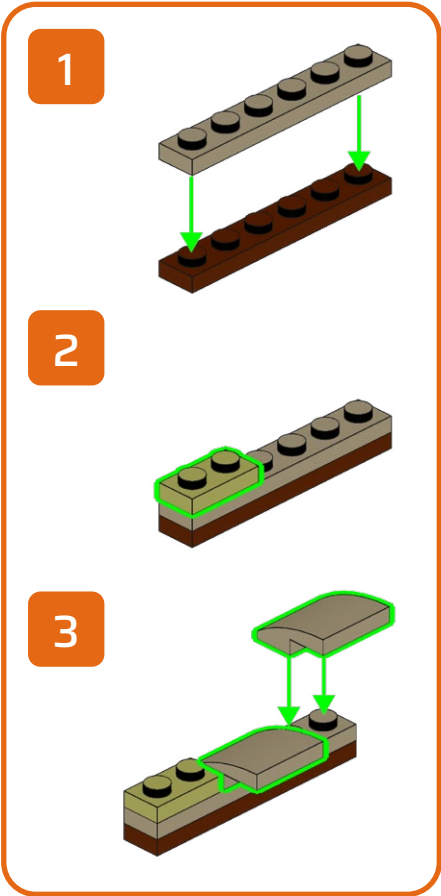
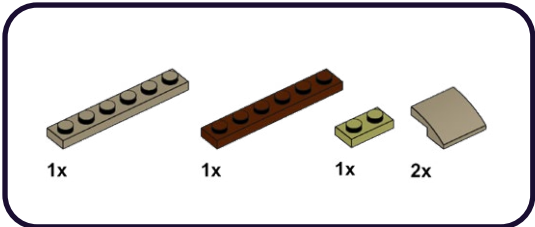

83



2x



84



1x

1x

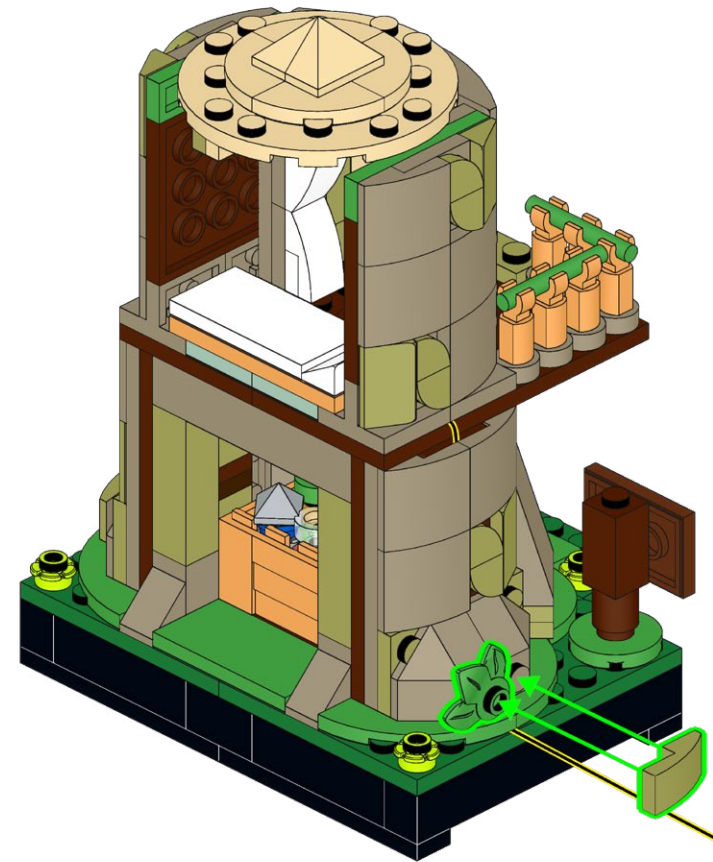

85

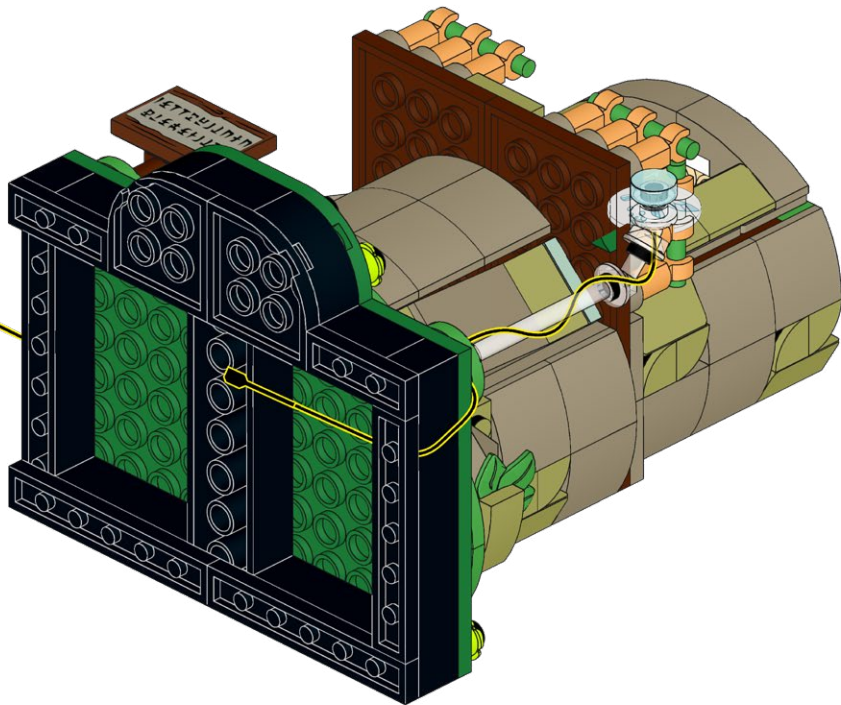

86

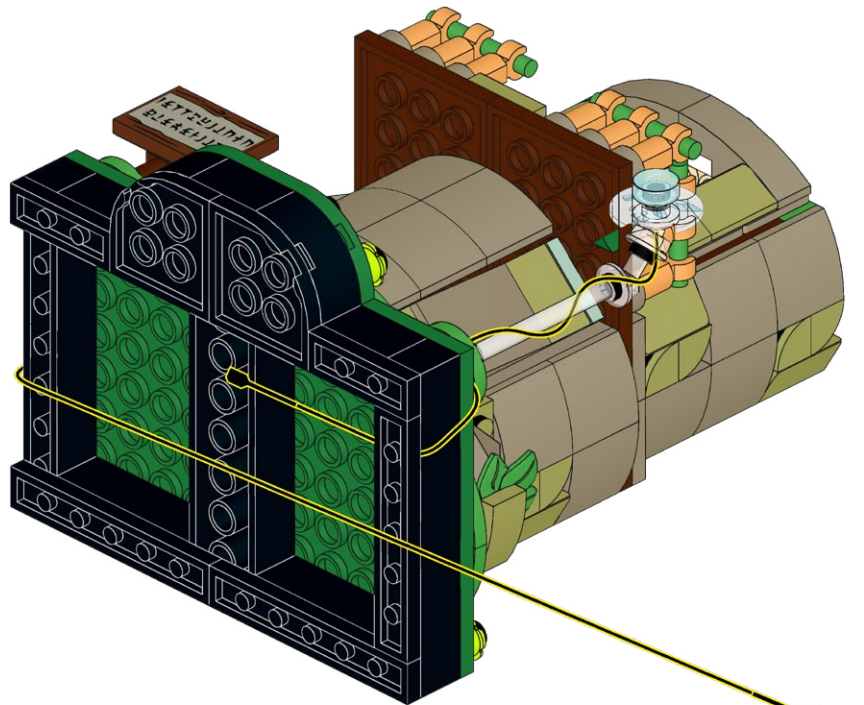

87

1x

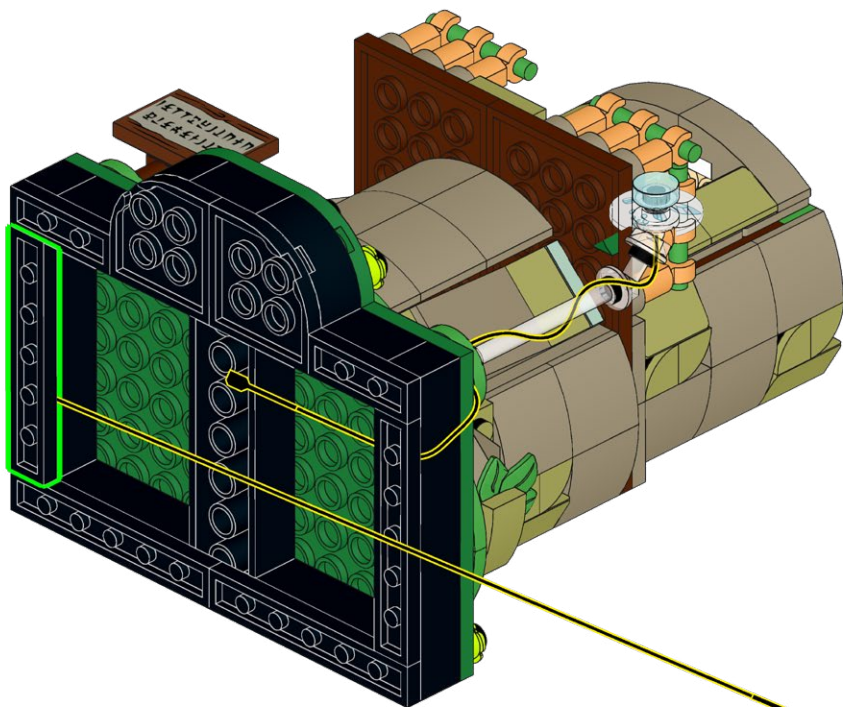
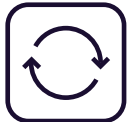

88

1x

PB-2.0

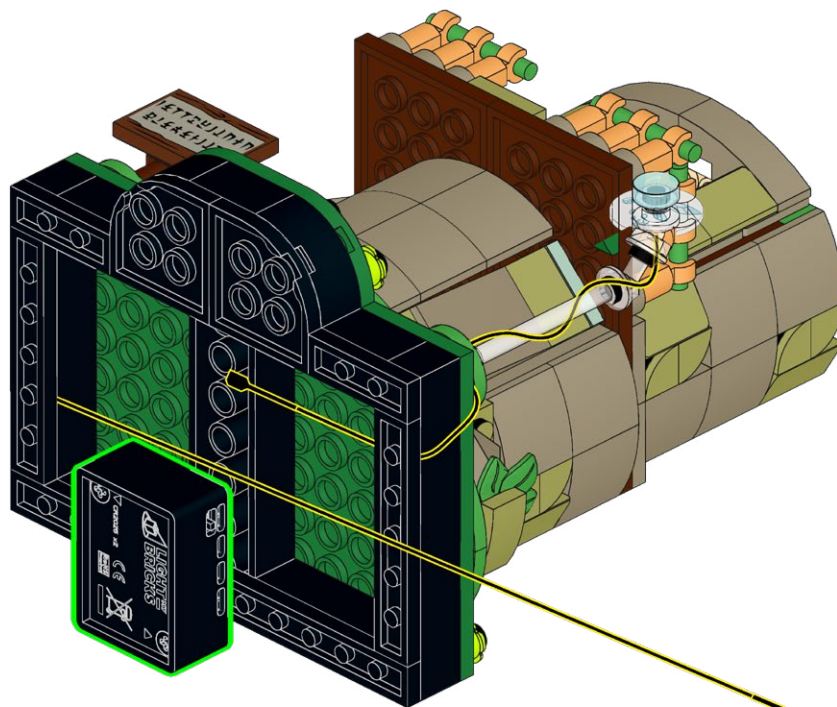

89

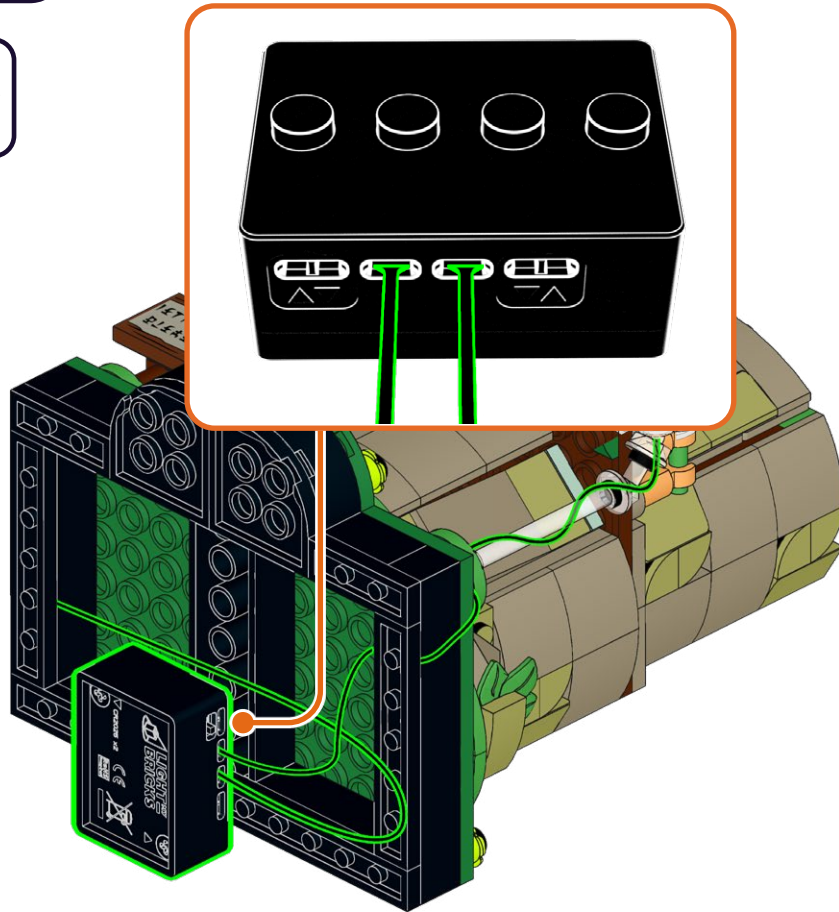

90

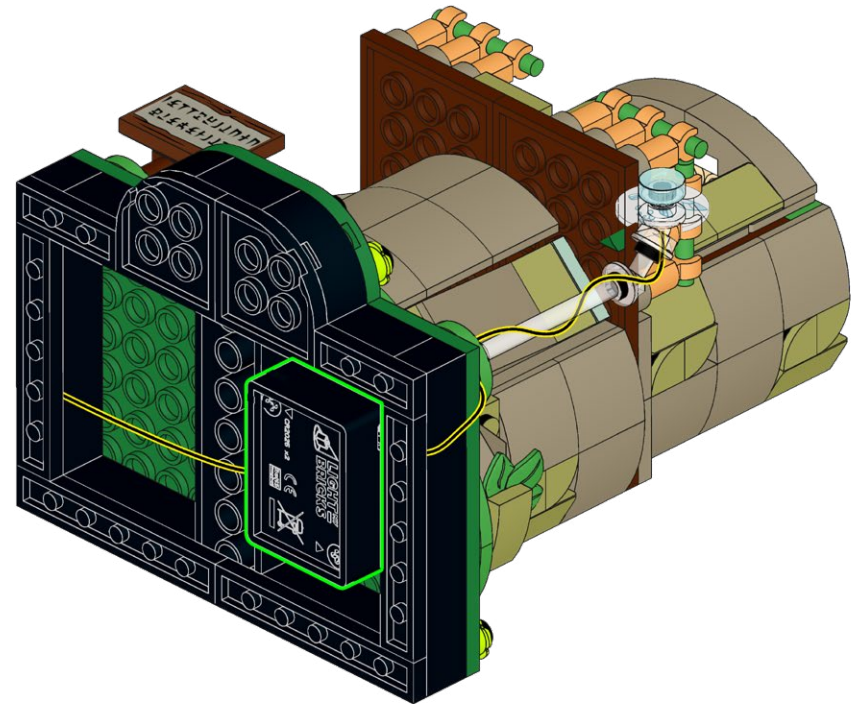

91

1x

1x

1x

1

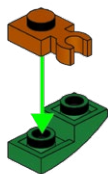

2

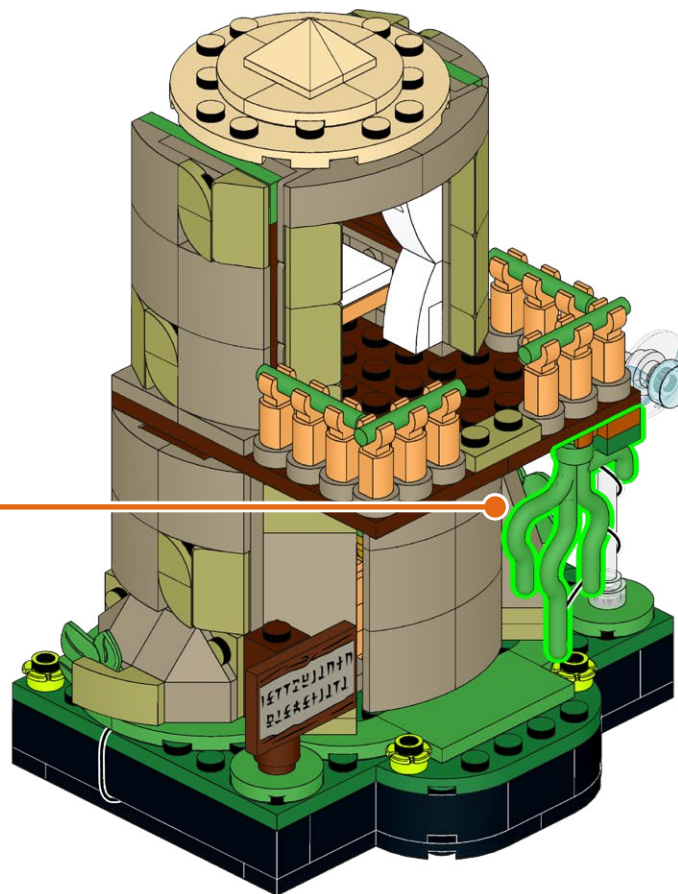

92

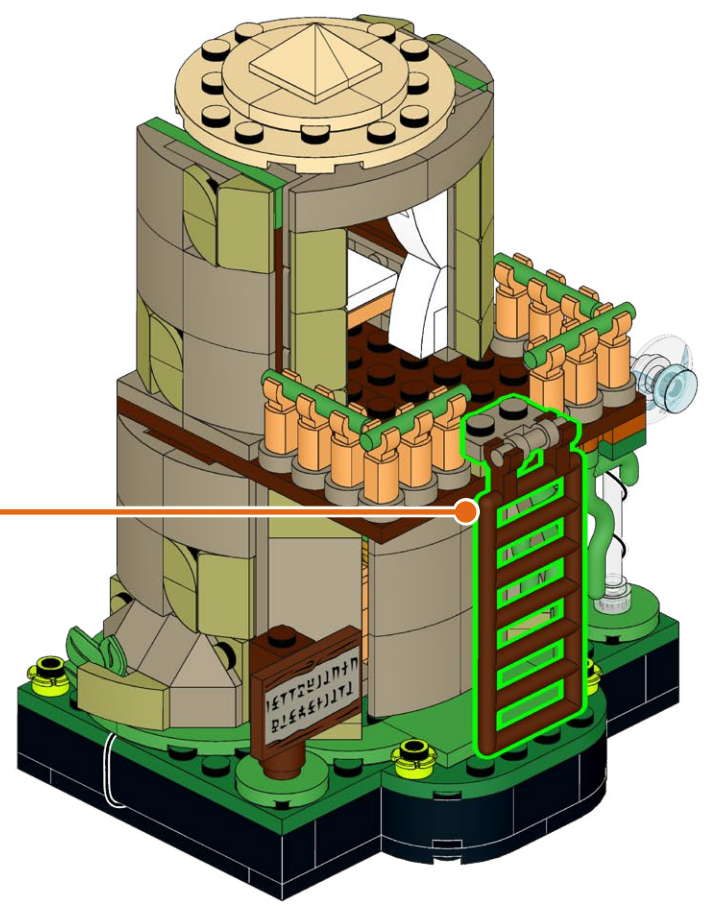
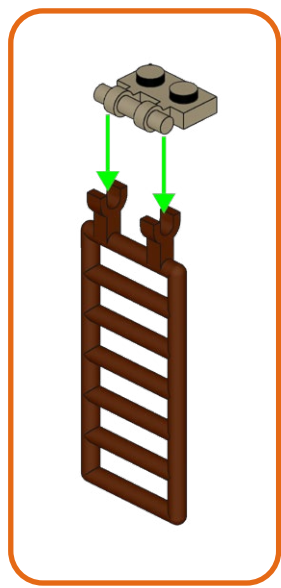
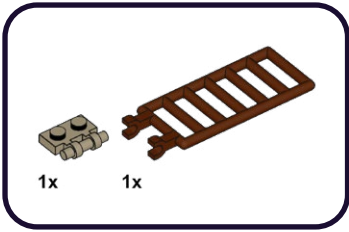

93



Power on Test
Test de mise sous tension
Test di Potenza
Stromtest
Prueba de Energía
电源测试



**HOLD UP!**

You might notice some bags aren't in order, as well as left over pieces, but that's ok! We're changing the way you build LEGO!

ATTENDEZ!

Vous remarquerez peut-être que certains sacs, ainsi que certaines pièces, ne sont pas dans le bon ordre. Mais pas de panique! Nous changeons simplement la façon avec laquelle vous construisez vos LEGO!

ASPETTA!

Potresti notare che alcuni sacchetti non sono in ordine, così come i pezzi avanzati, ma va bene così! Stiamo cambiando il modo in cui costruisci i LEGO!

HALT!

Sie werden möglicherweise bemerken, dass einige tüten durcheinander sind und teile übrig bleiben, aber das ist in Ordnung! Wir ändern die art und weise, wie Sie LEGO bauen!

¡ESPERA!

Es posible que notes que algunas bolsas están fuera de servicio, así como piezas sobrantes, ¡pero está bien! ¡Estamos cambiando la forma en que construyes LEGO!

暫停!

你可能会注意到一些袋子顺序错乱, 以及一些剩余的部件, 但没关系! 我们正在改变你搭建乐高的方式!

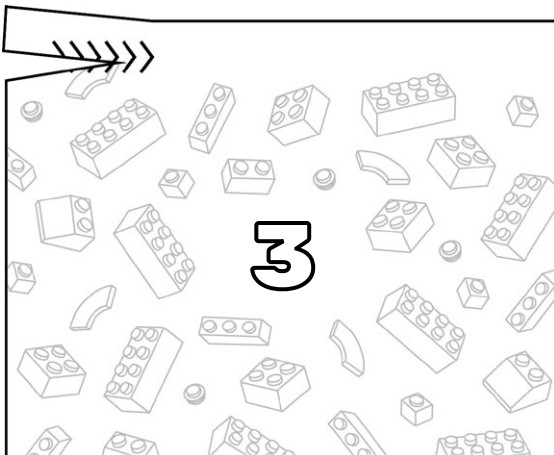
Open LEGO® Bag 3

1

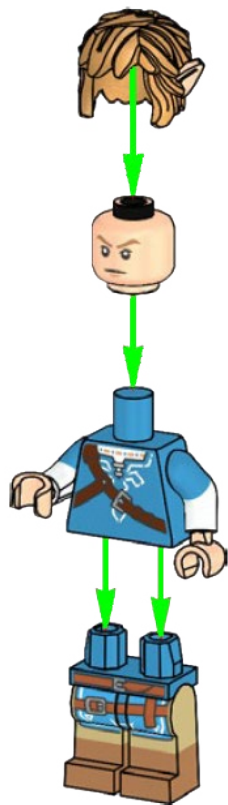

2



95

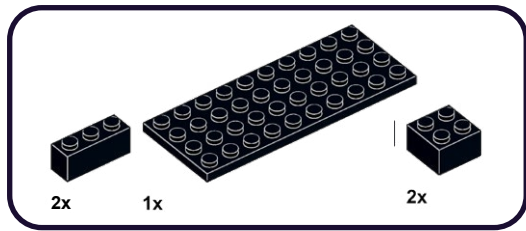

1

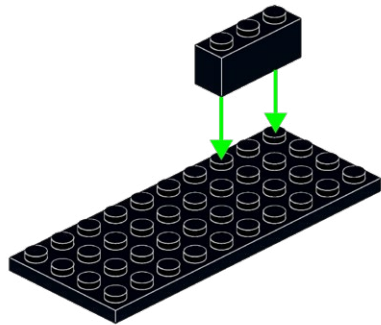

2

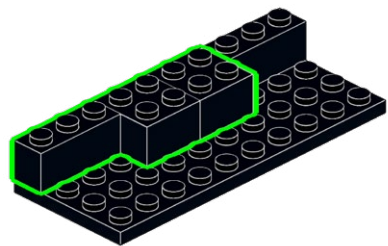

96

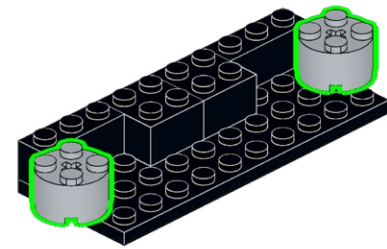
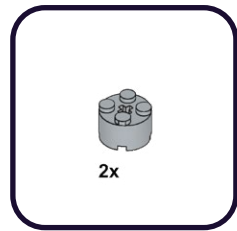

97

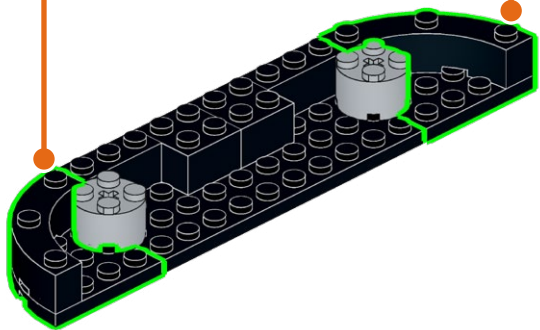
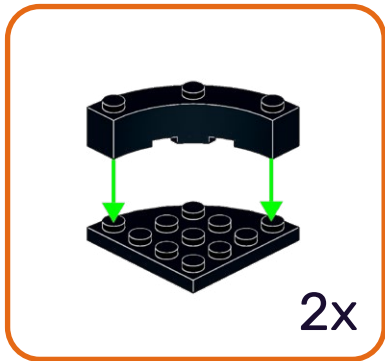
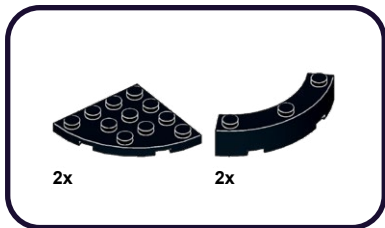

98

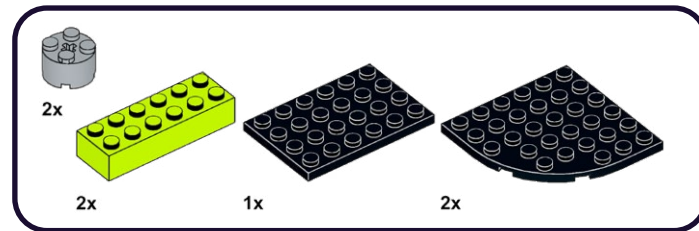

1

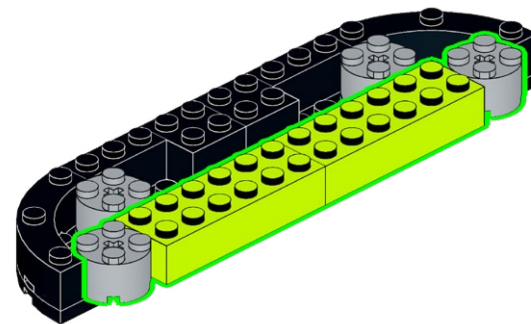

2

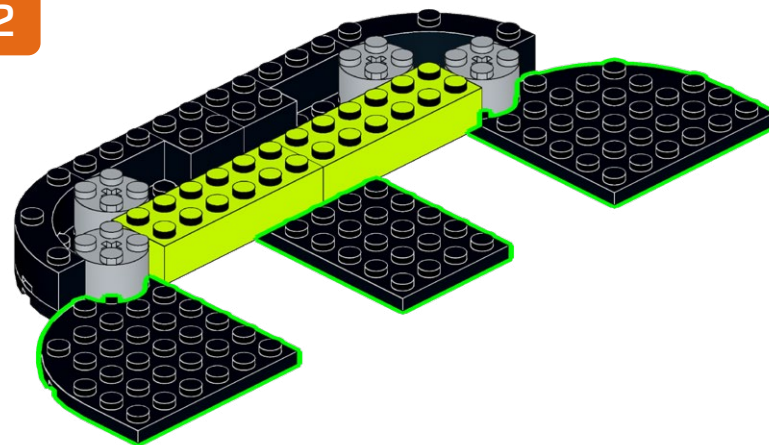

99

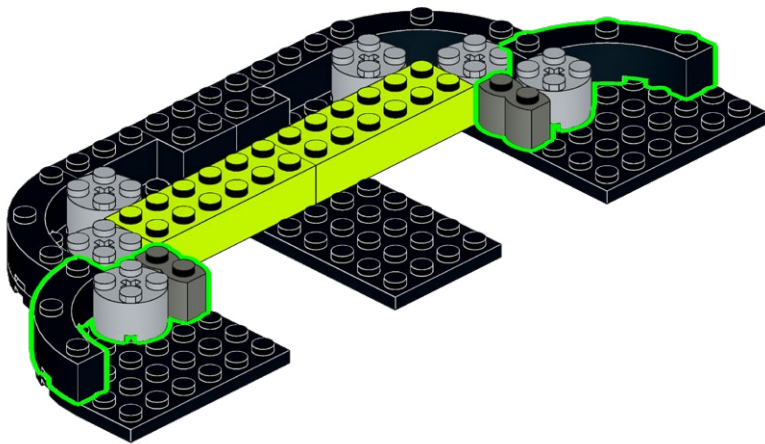
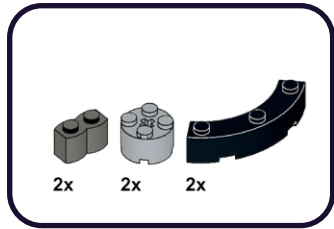

100

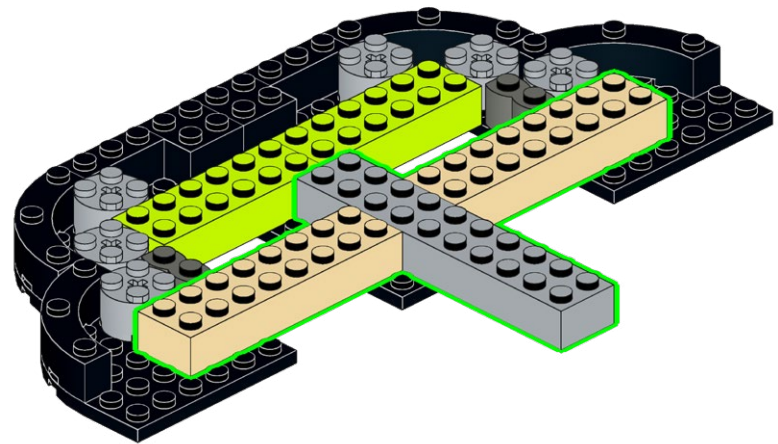
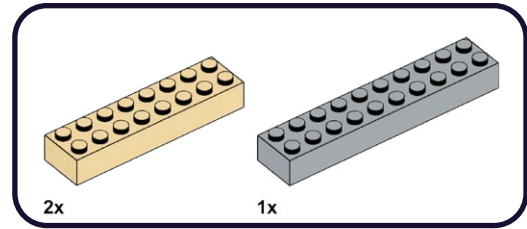

101

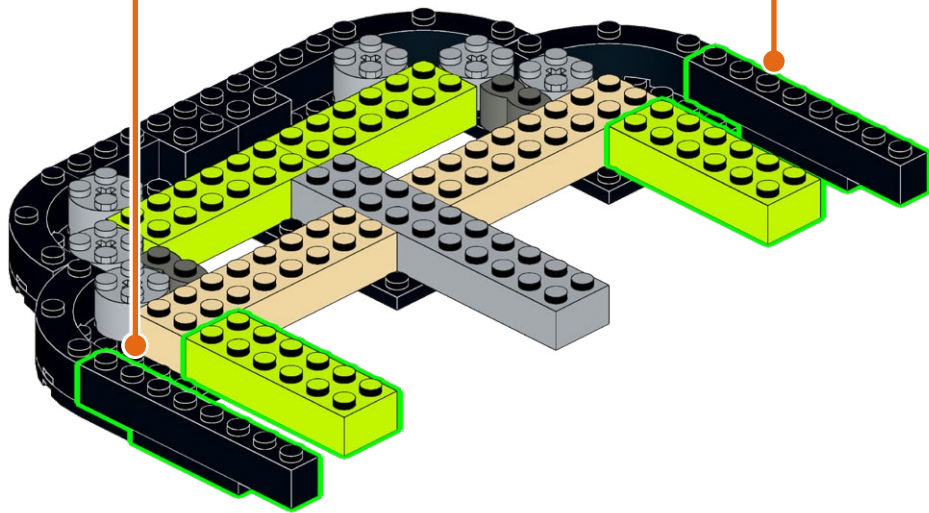
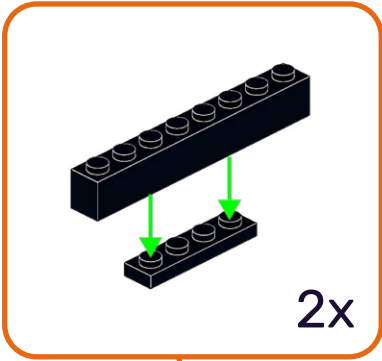
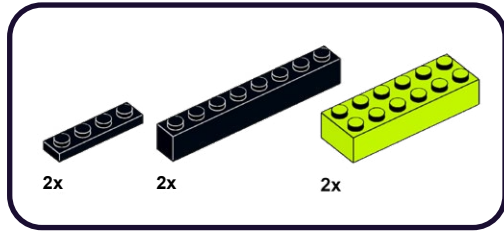

102

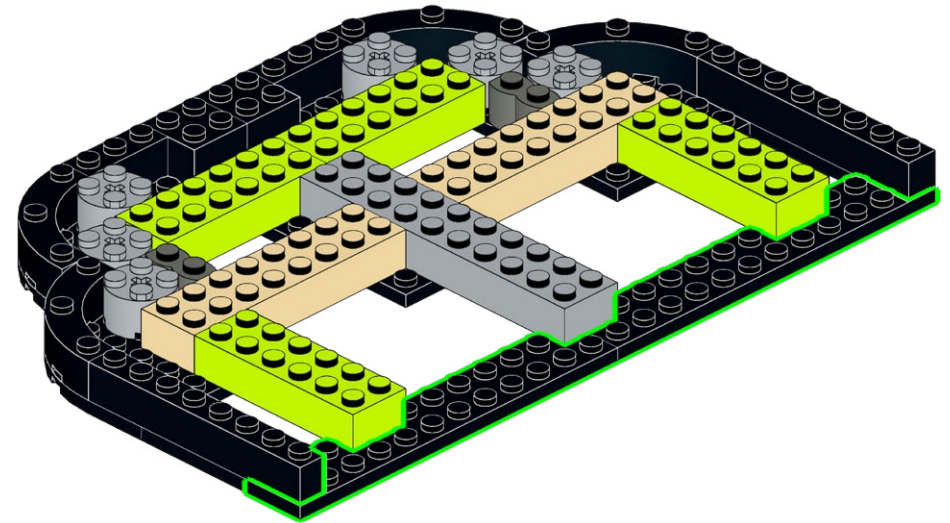
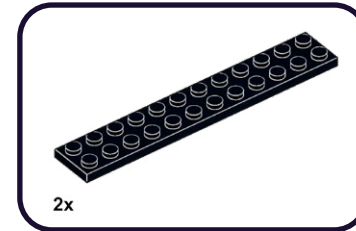

103

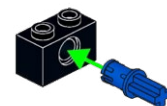
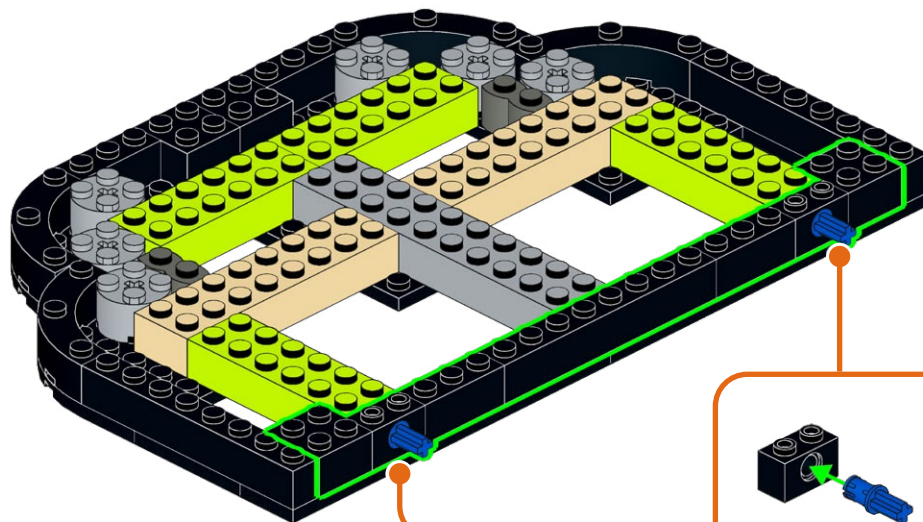
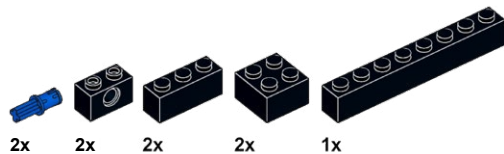

2x

104

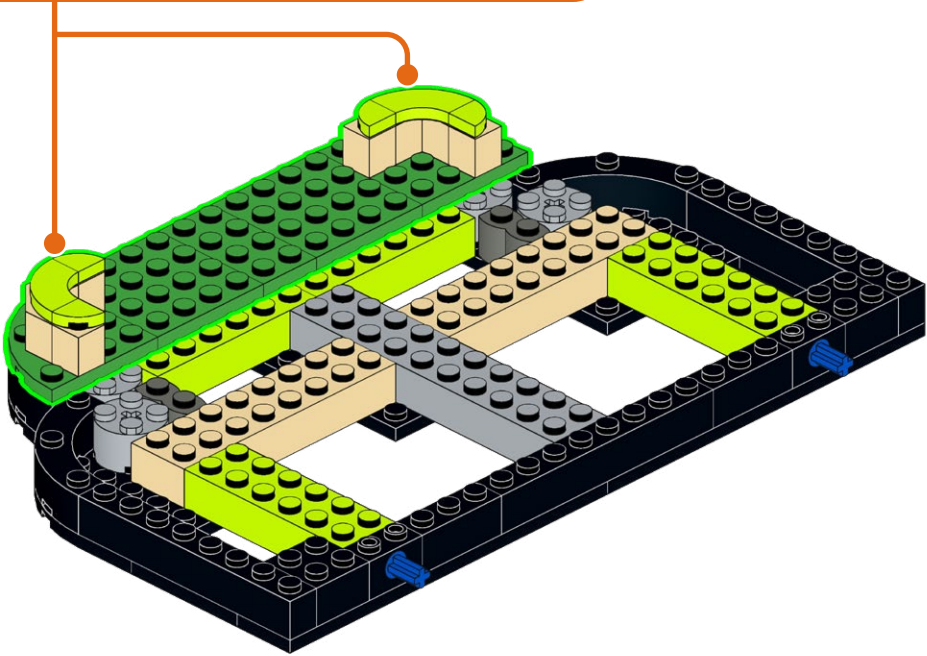
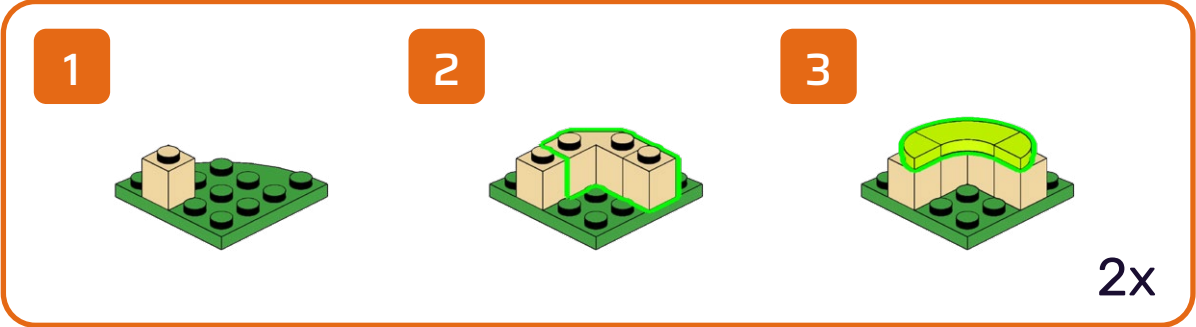
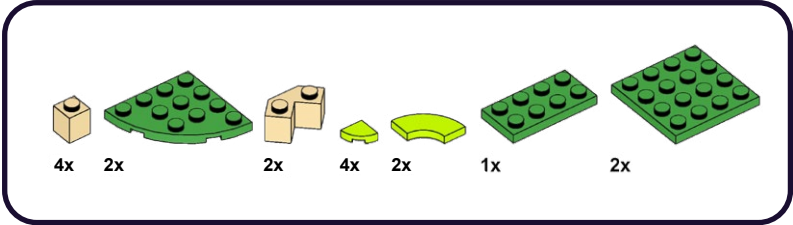

105

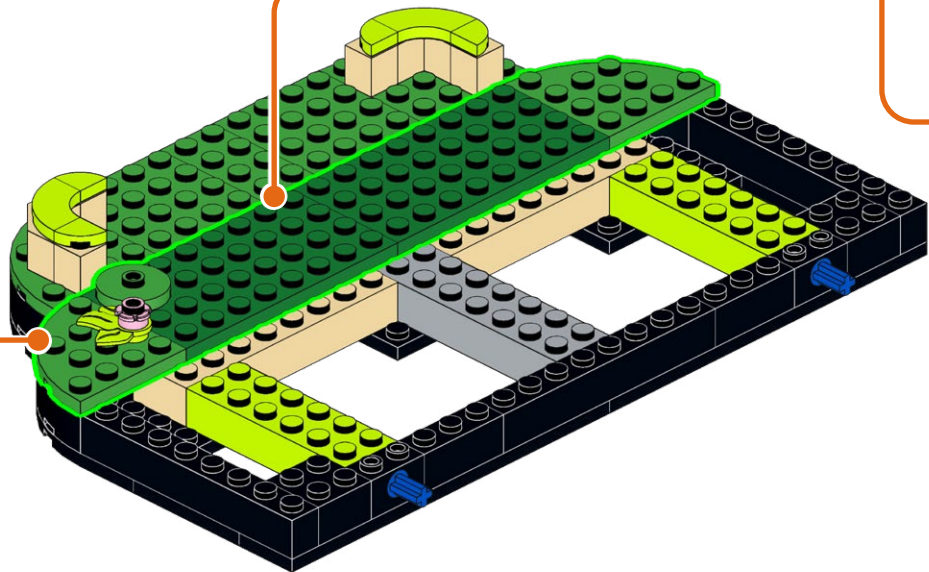
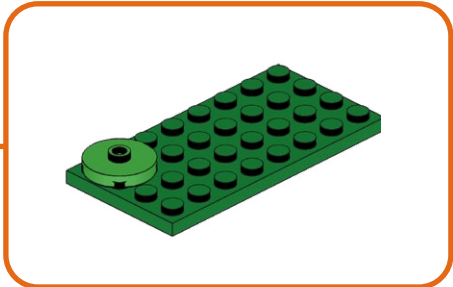
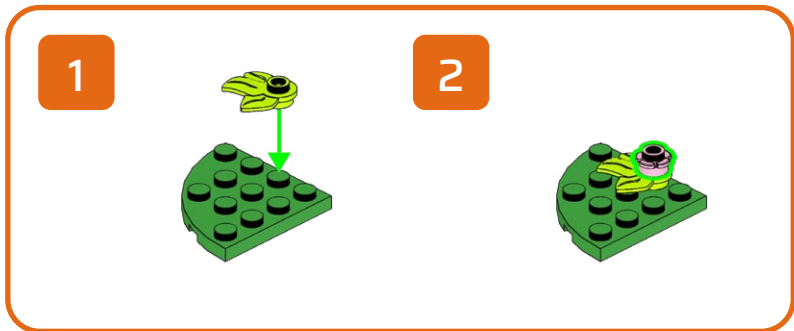
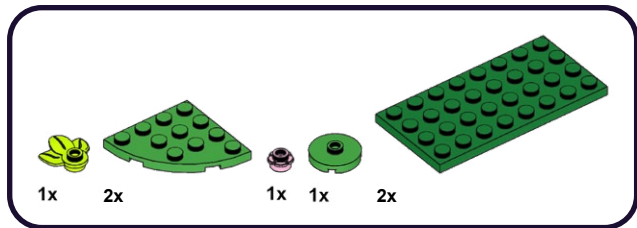

106

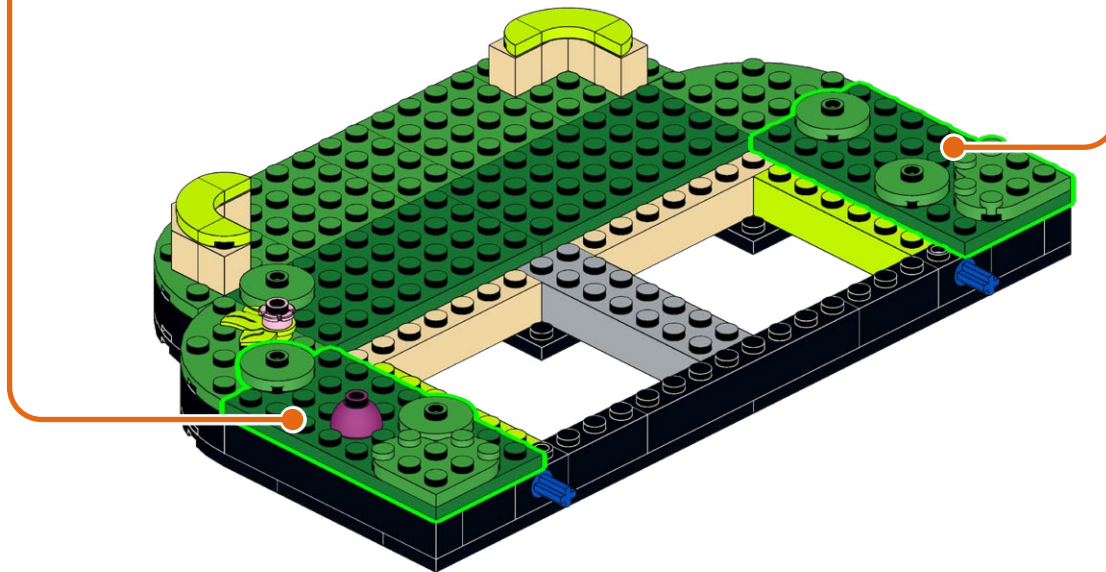
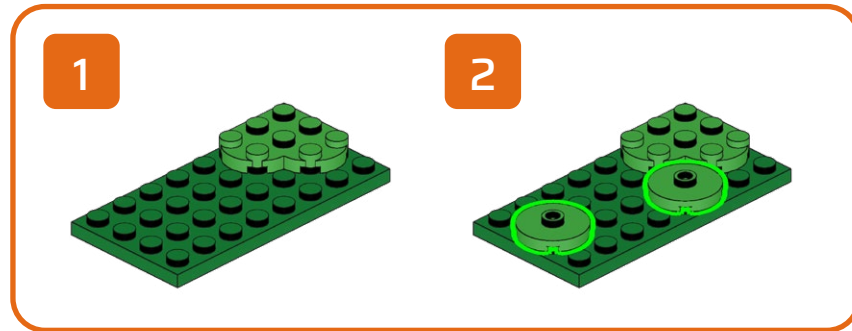
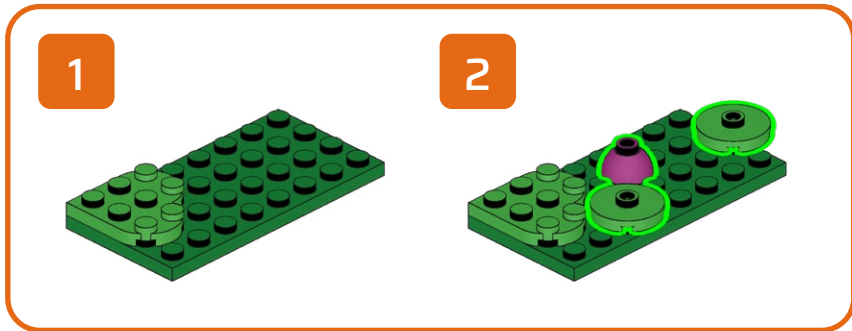
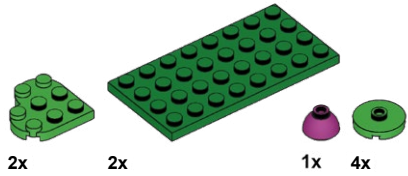

107

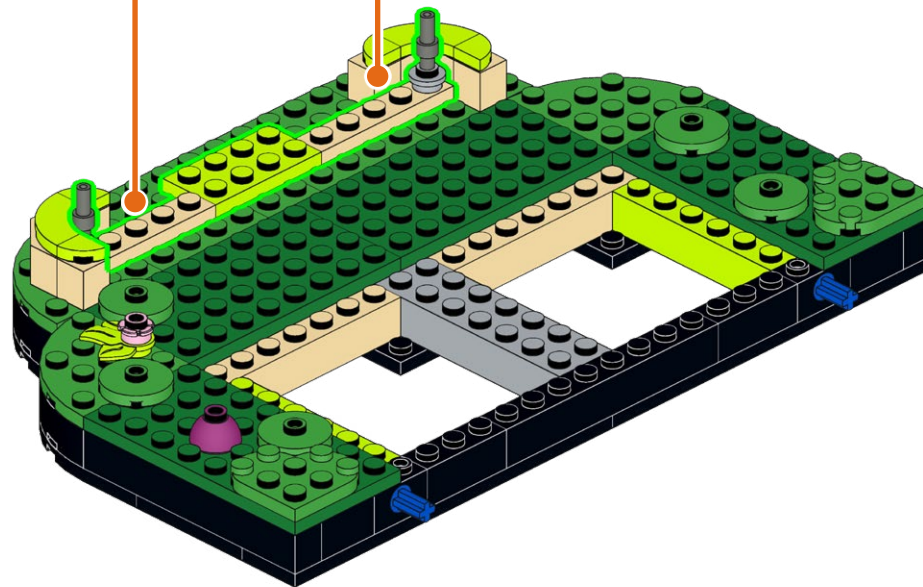
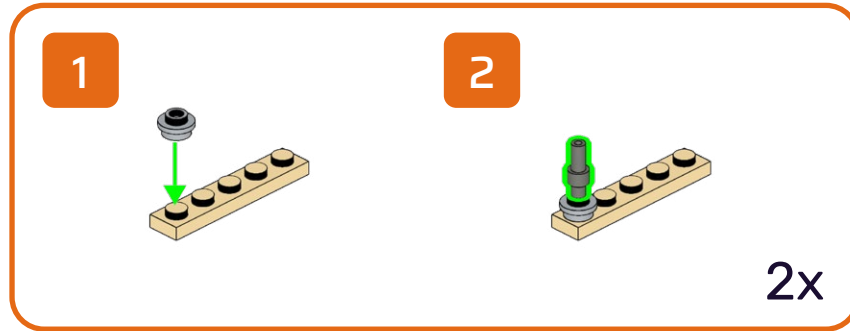
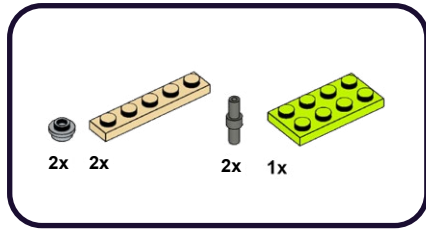

108

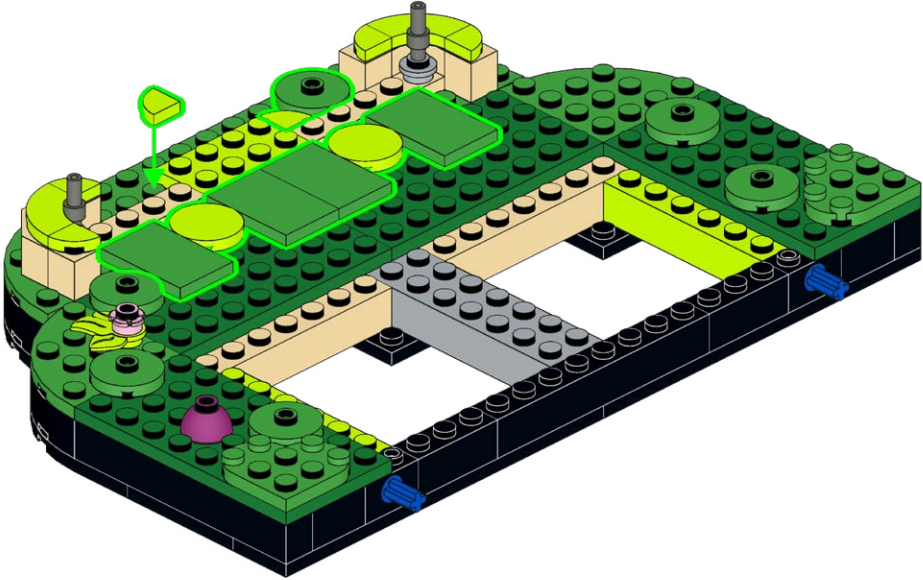
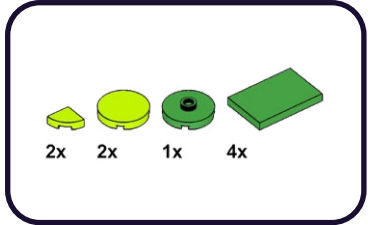

109



1

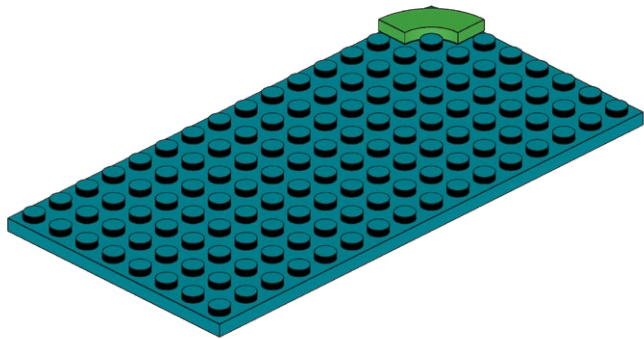
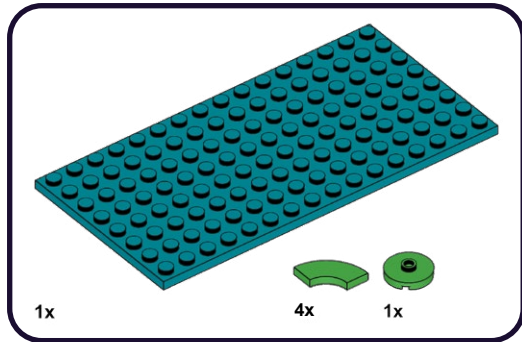

2

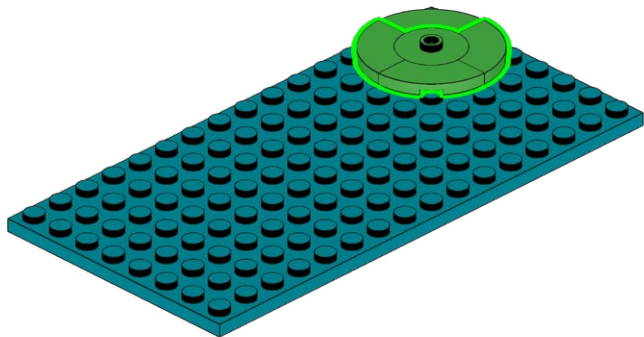

110

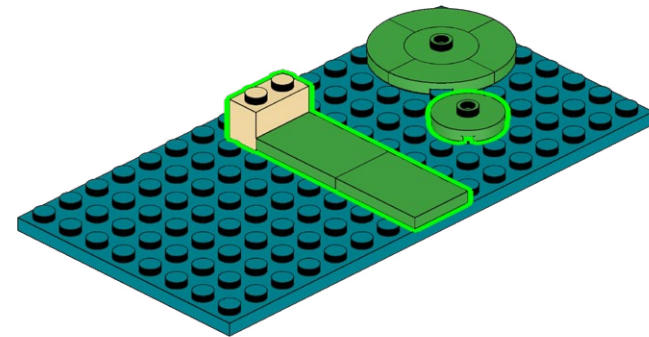
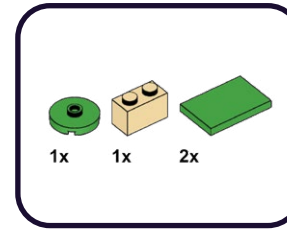

111

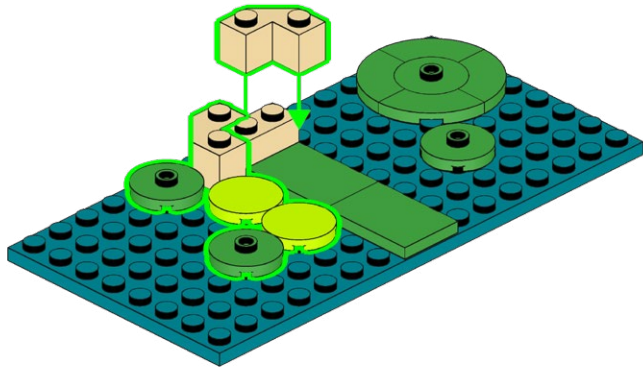
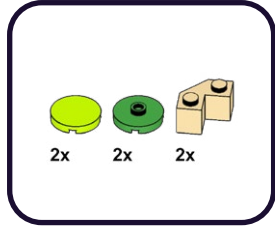

112

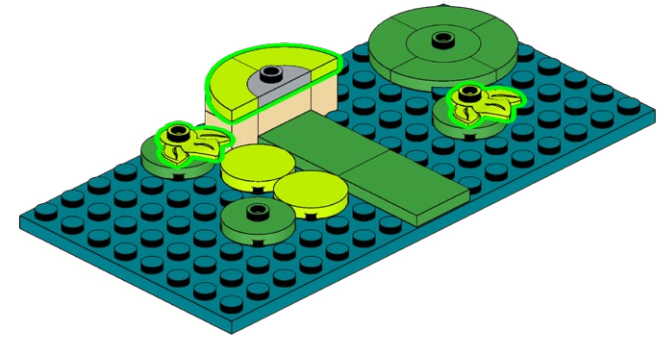
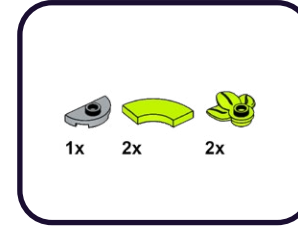

113

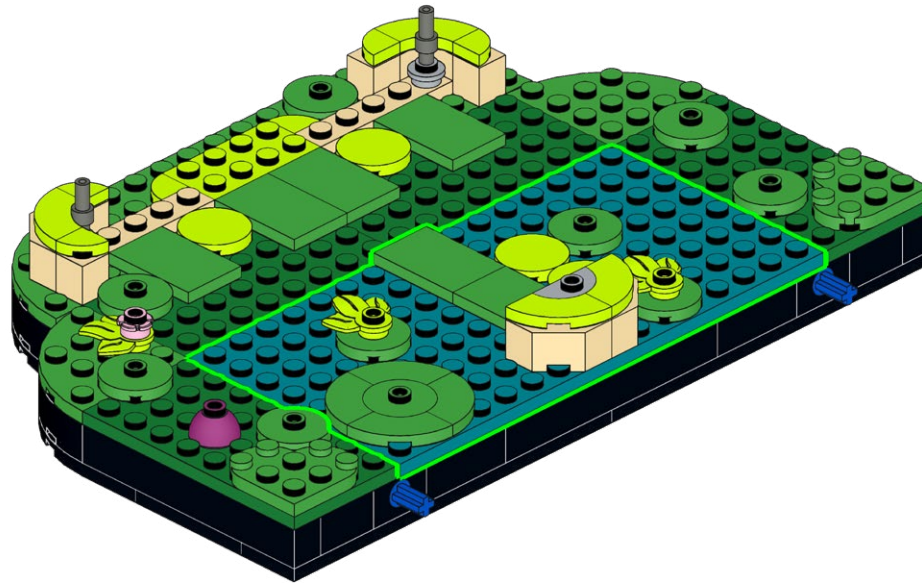

114

2x 2x

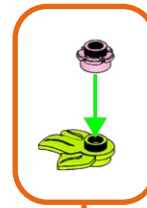
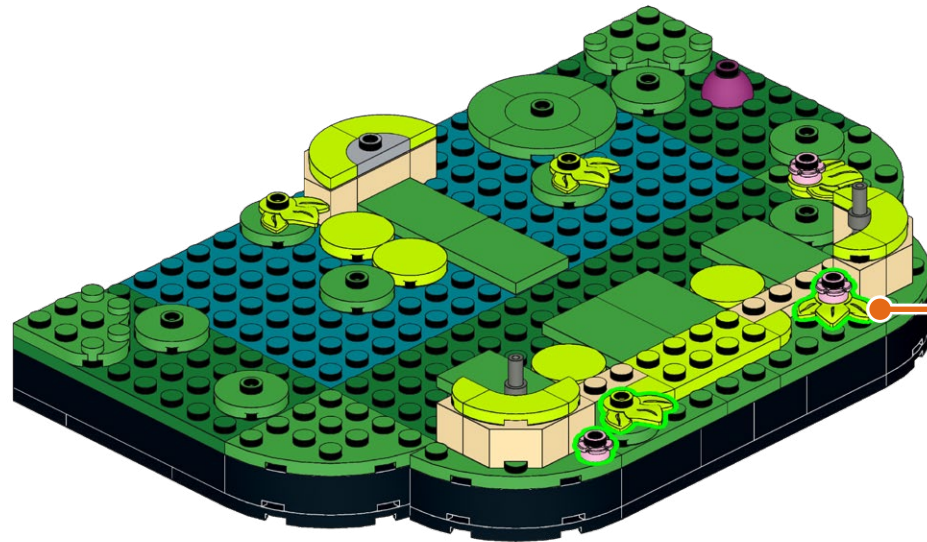

115

- 1x
- 1x
- 2x
- 1x
- 1x
- 1x
- 1x
- 1x
- 1x

1



2



1



2

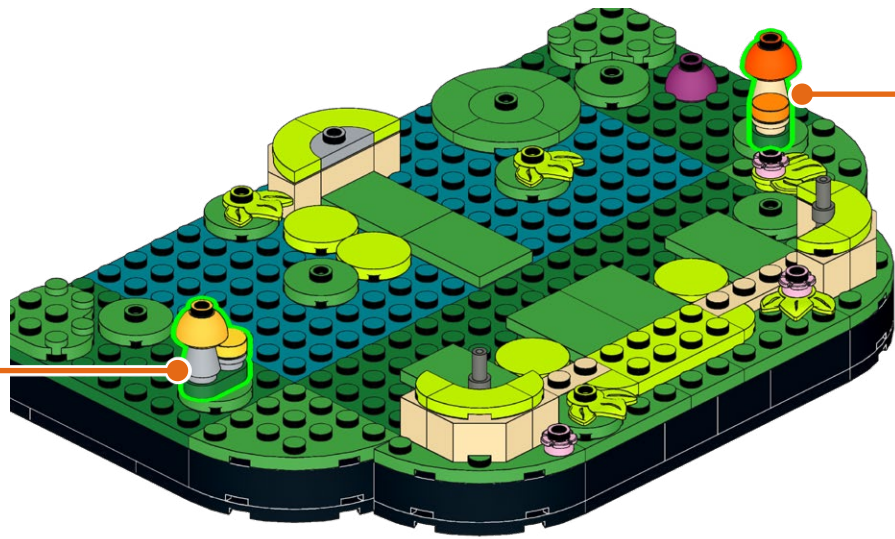

116

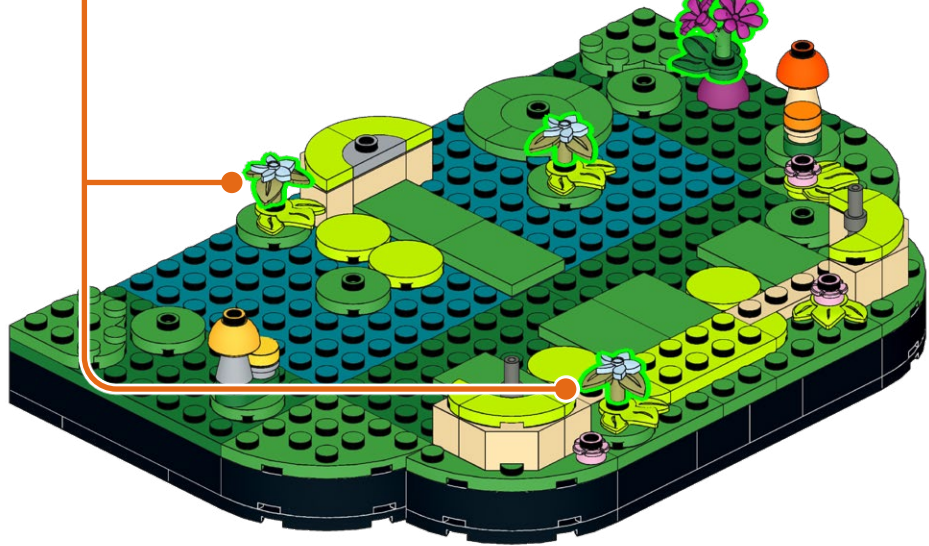
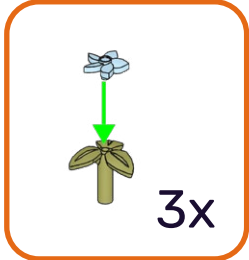
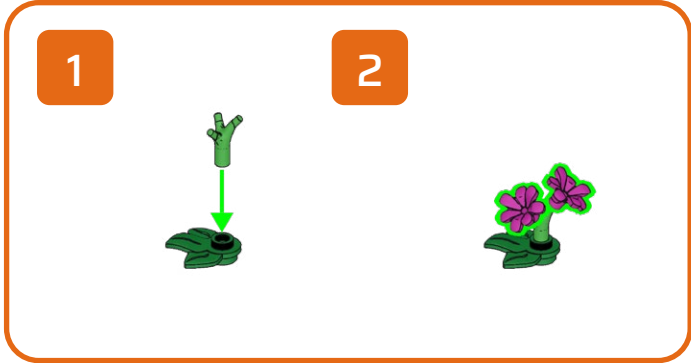
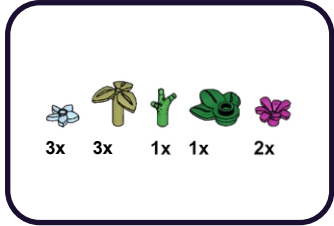



HOLD UP!

You might notice some bags aren't in order, as well as left over pieces, but that's ok! We're changing the way you build LEGO!

ATTENDEZ!

Vous remarquerez peut-être que certains sacs, ainsi que certaines pièces, ne sont pas dans le bon ordre. Mais pas de panique! Nous changeons simplement la façon avec laquelle vous construisez vos LEGO!

ASPETTA!

Potresti notare che alcuni sacchetti non sono in ordine, così come i pezzi avanzati, ma va bene così! Stiamo cambiando il modo in cui costruisci i LEGO!

HALT!

Sie werden möglicherweise bemerken, dass einige tüten durcheinander sind und teile übrig bleiben, aber das ist in Ordnung! Wir ändern die art und weise, wie Sie LEGO bauen!

¡ESPERA!

Es posible que notes que algunas bolsas están fuera de servicio, así como piezas sobrantes, ¡pero está bien! ¡Estamos cambiando la forma en que construyes LEGO!

暫停!

你可能会注意到一些袋子顺序错乱, 以及一些剩余的部件, 但没关系! 我们正在改变你搭建乐高的方式!

Open LEGO® Bag 4

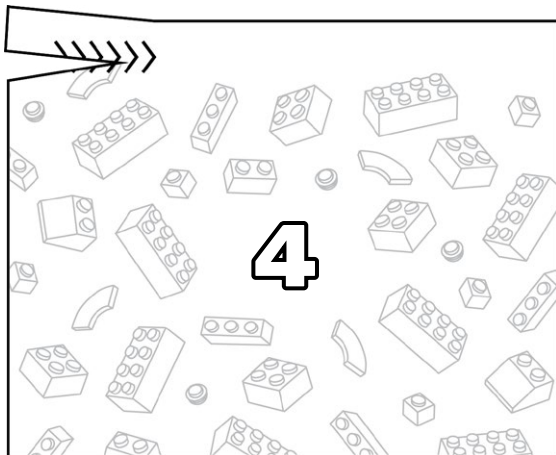

Open LMB Bag 01

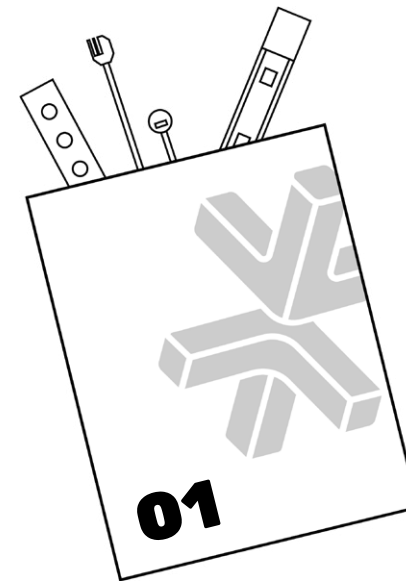

117

1

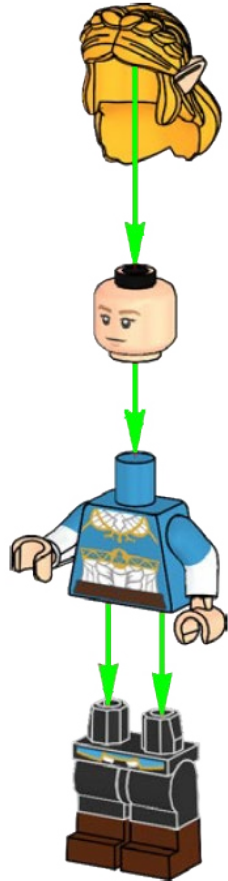

2



118

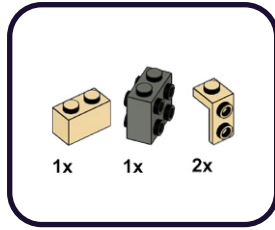

1

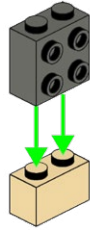

2

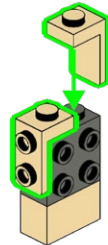

119

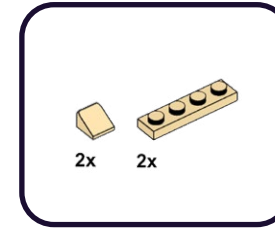

1

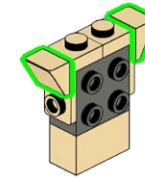

2

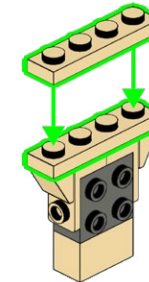

120

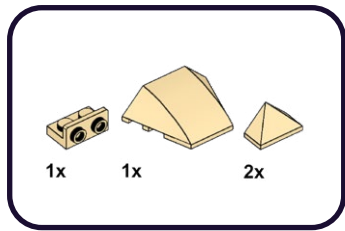

1

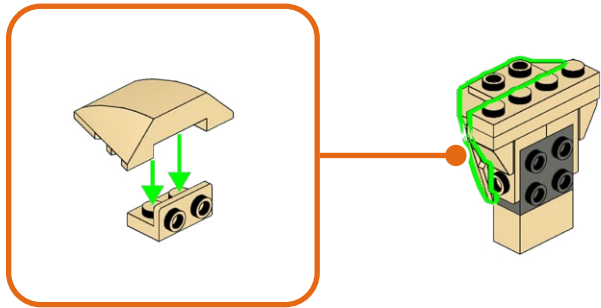

2

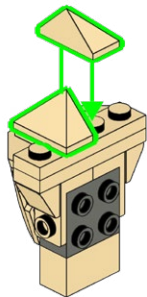

121

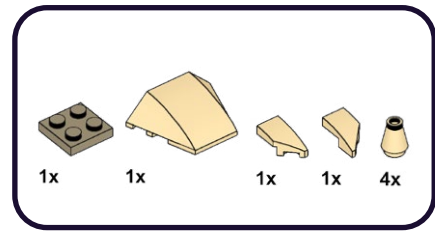

1



1

2

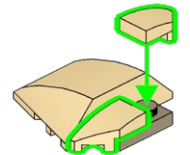

2

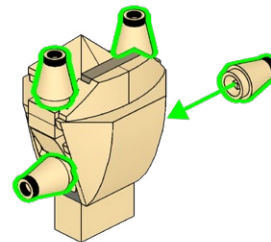

122

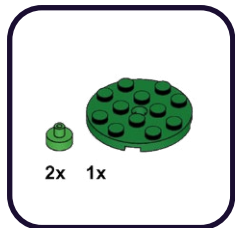

1

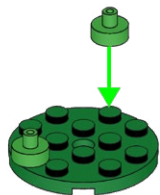

2

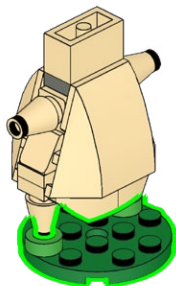

123

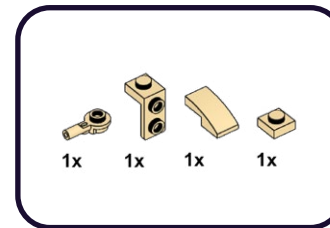

1

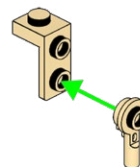

2

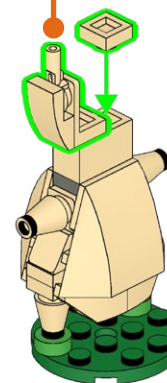

124

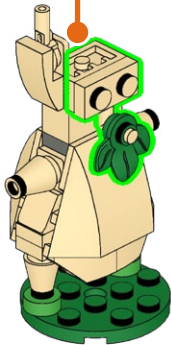
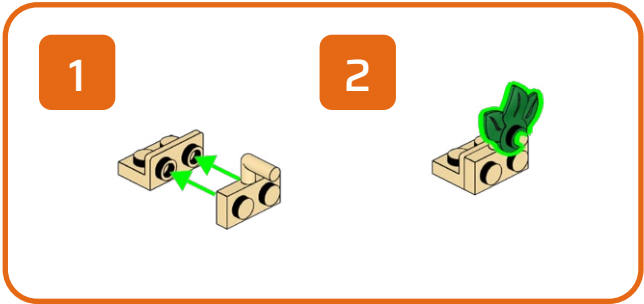
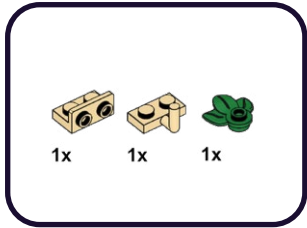

125

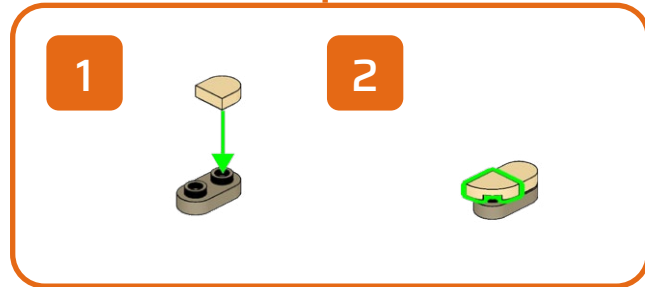
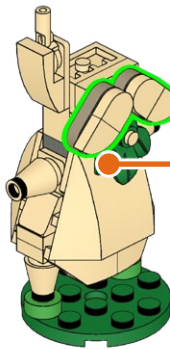
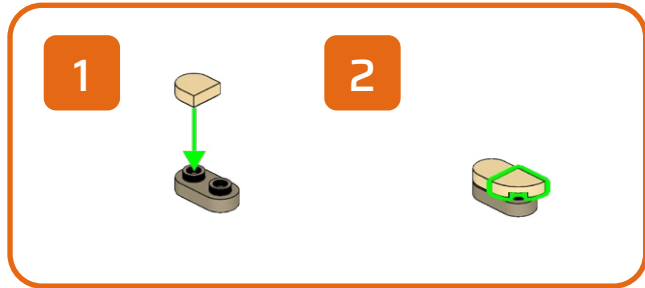
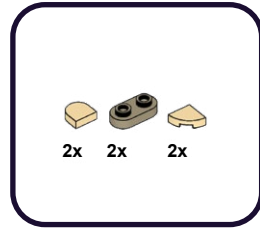

126

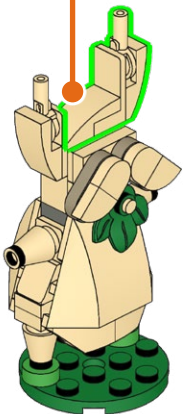
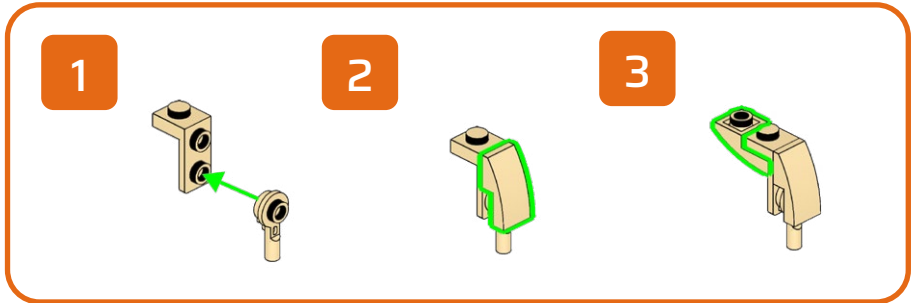
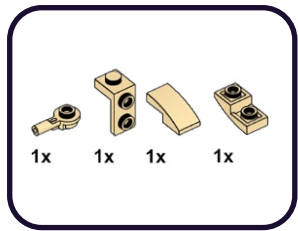

127

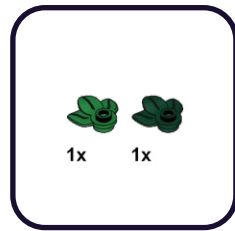

128

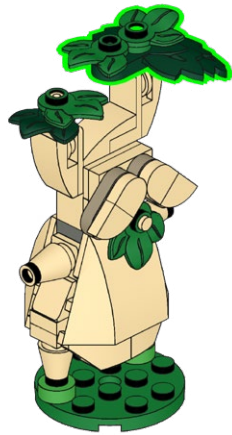
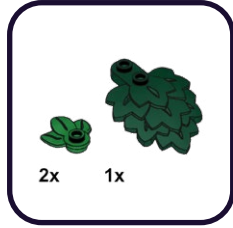

129

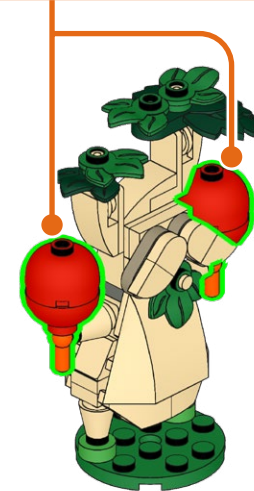
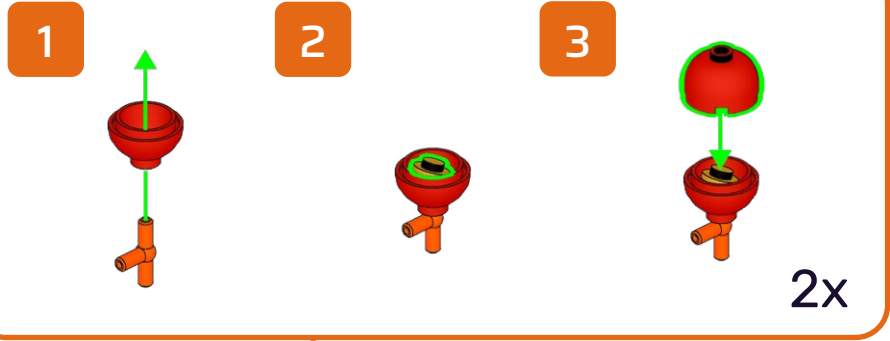
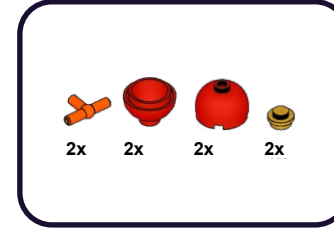

130

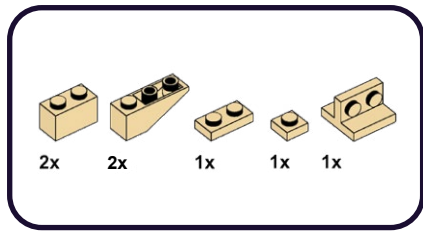

1

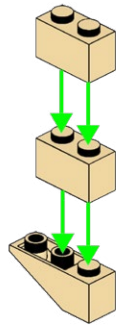

2

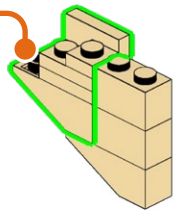
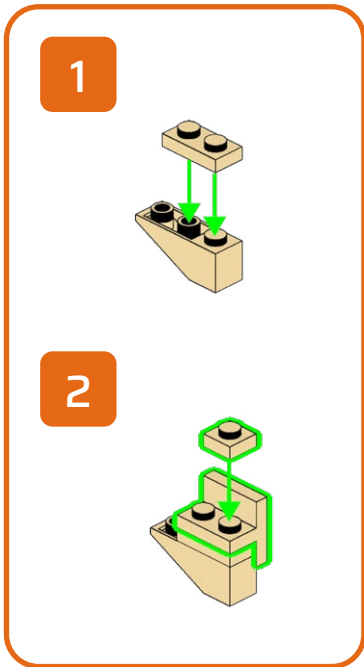

131

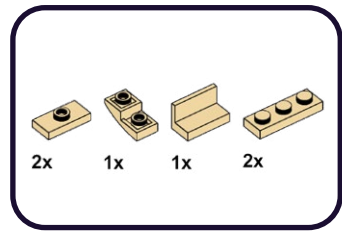

3

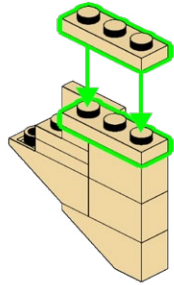

4

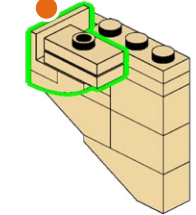
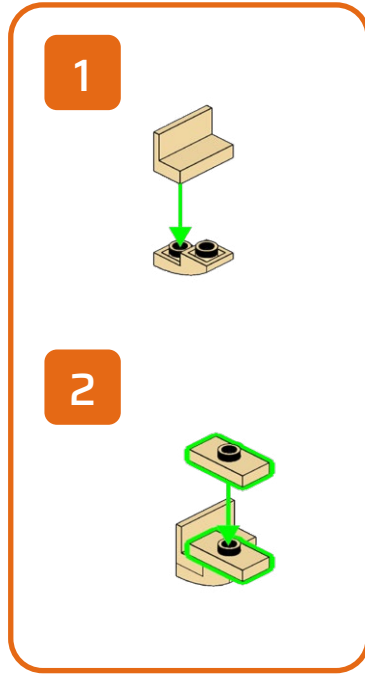

132

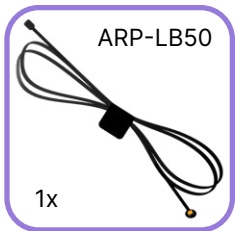

133

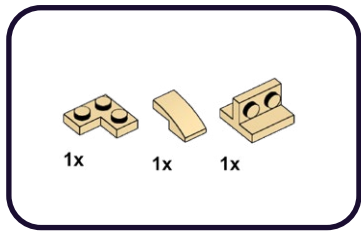

1

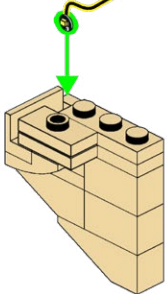

2

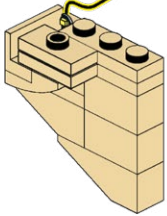

3

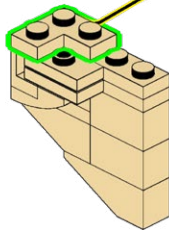

4

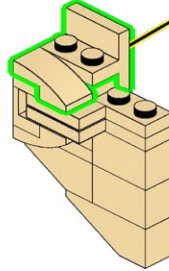

134

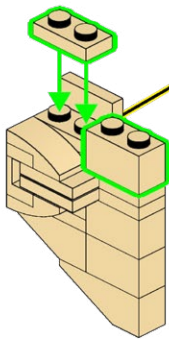
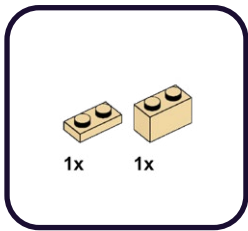

135

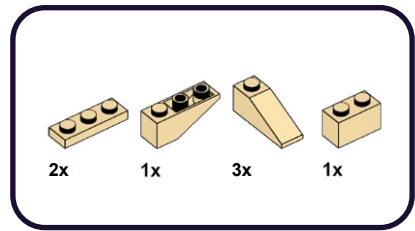

1

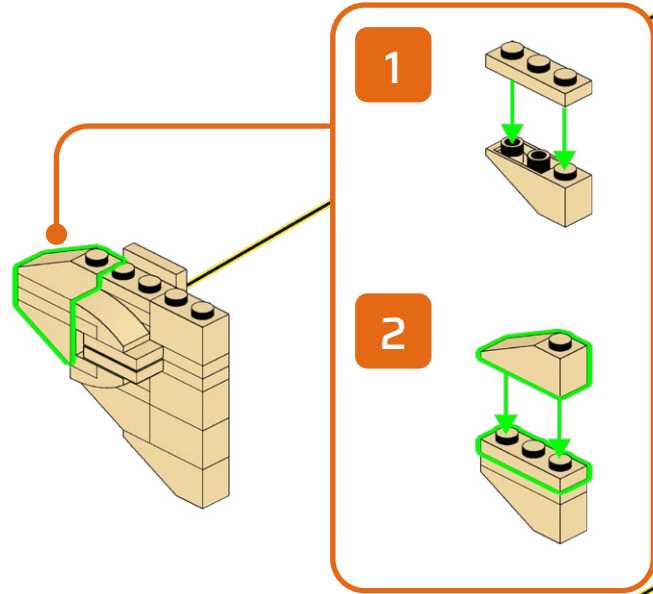

3

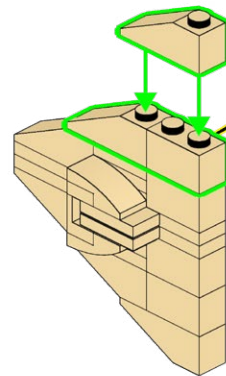

136

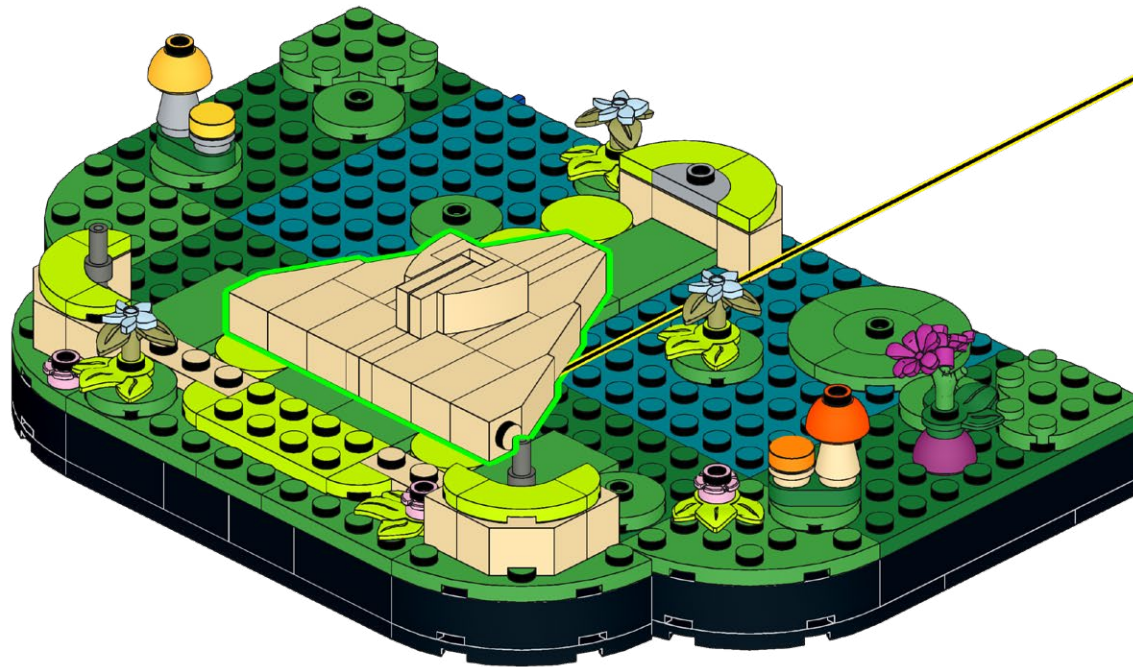

137

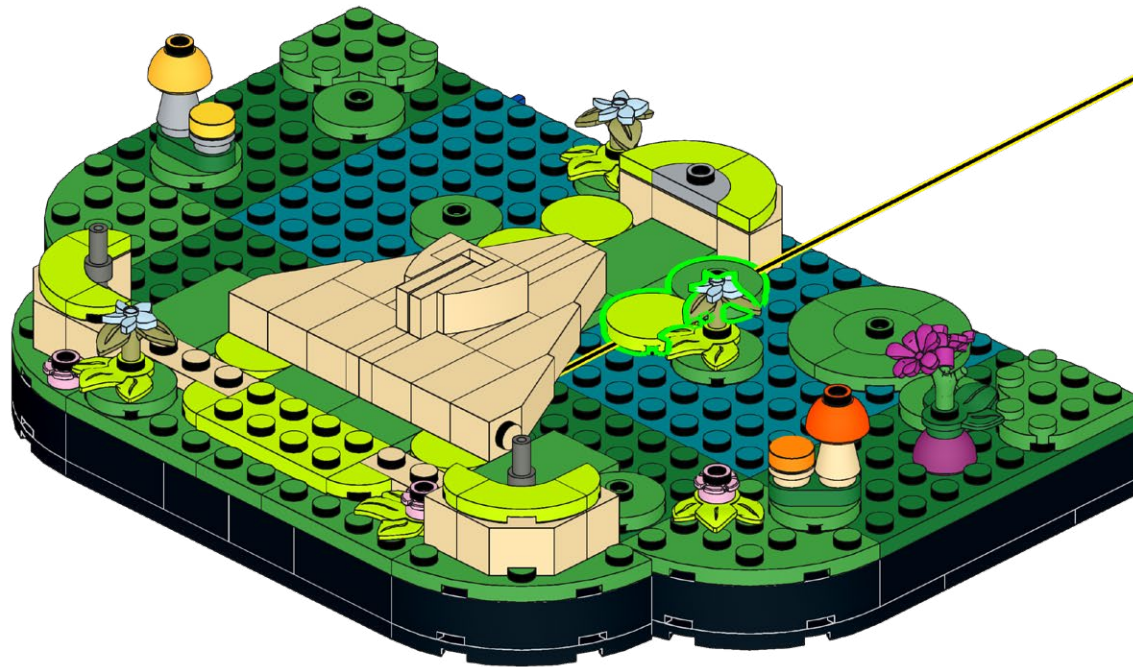
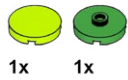

138



6x

4x



3x



2x

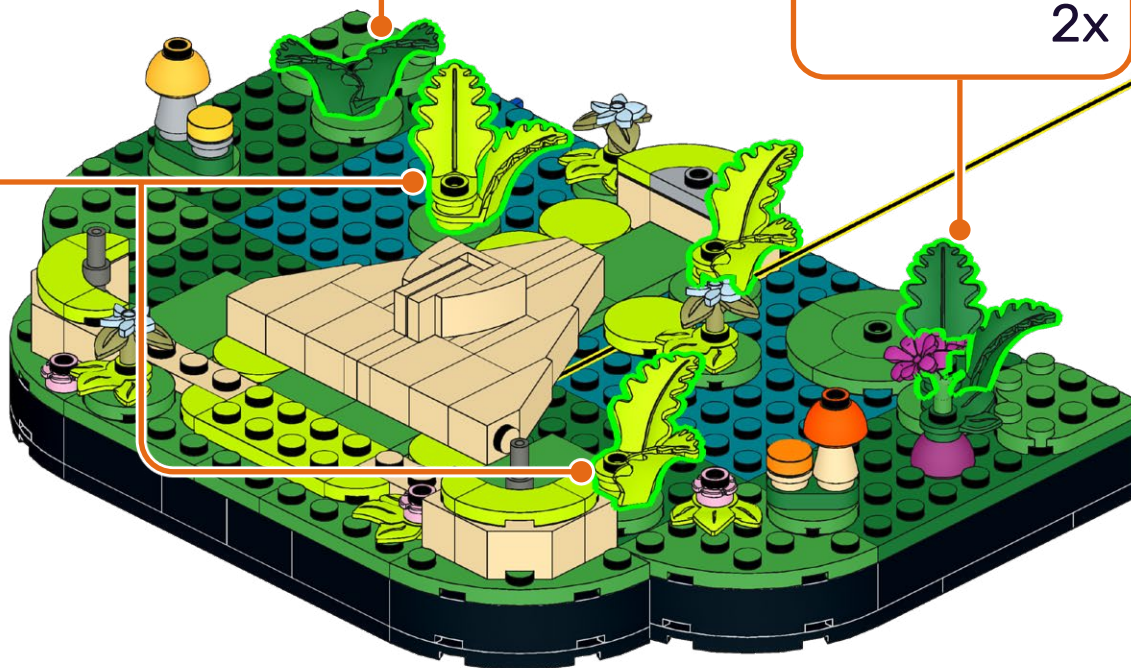

139

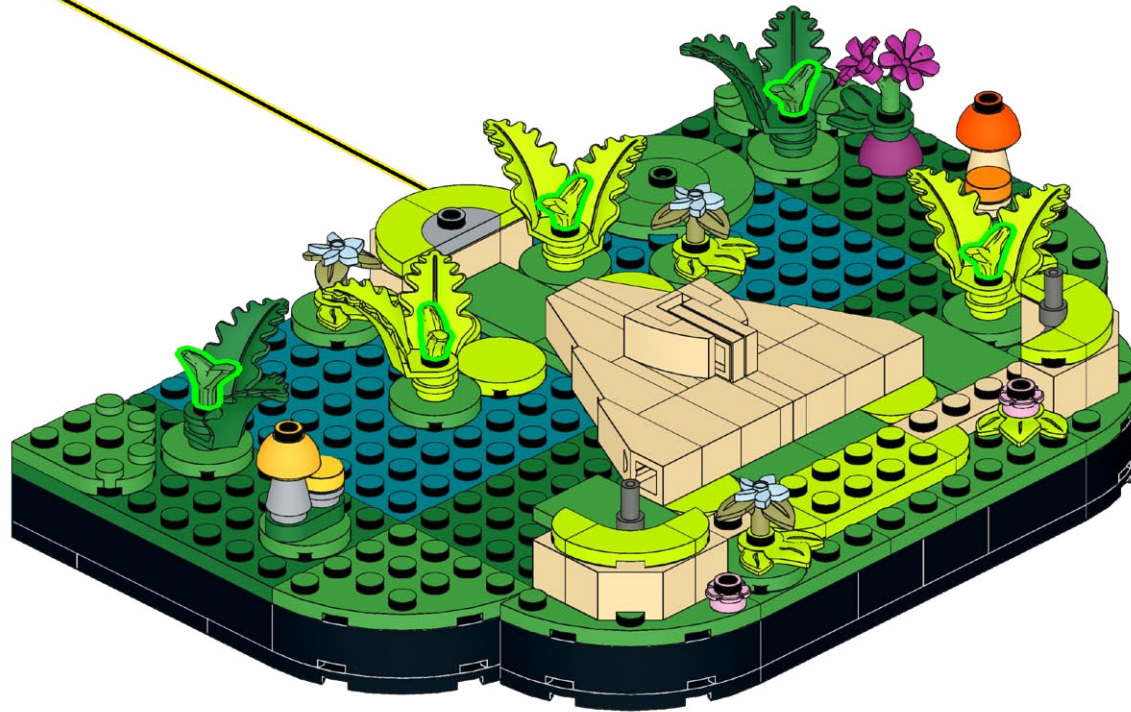
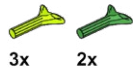

140

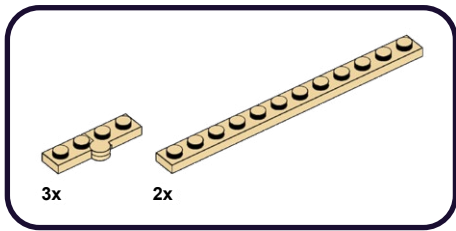

1

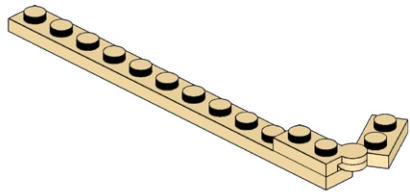

2

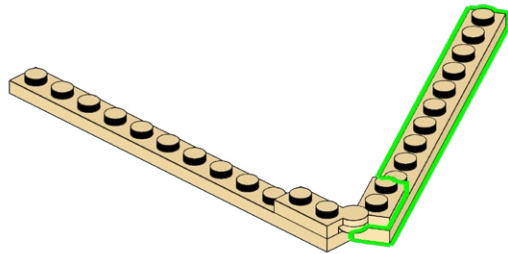

3

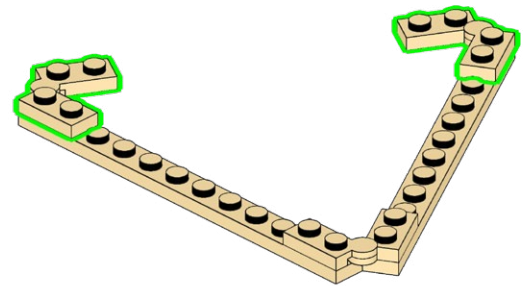

141

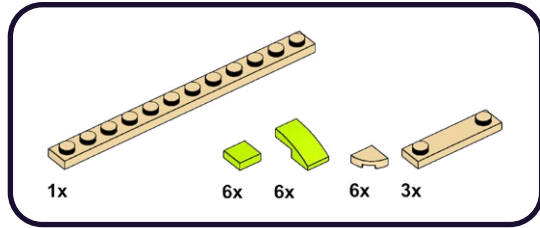

1

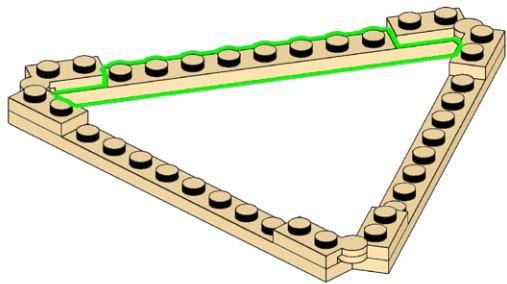

2

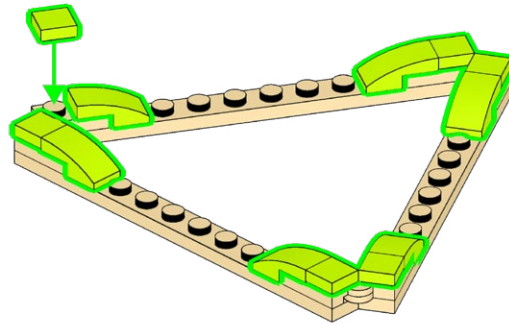

3

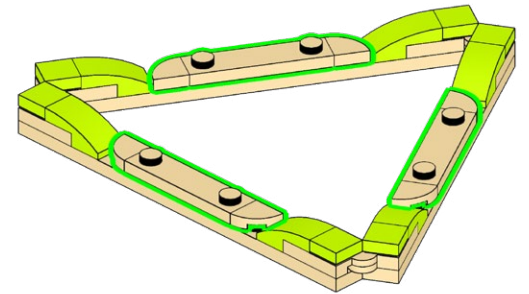

142

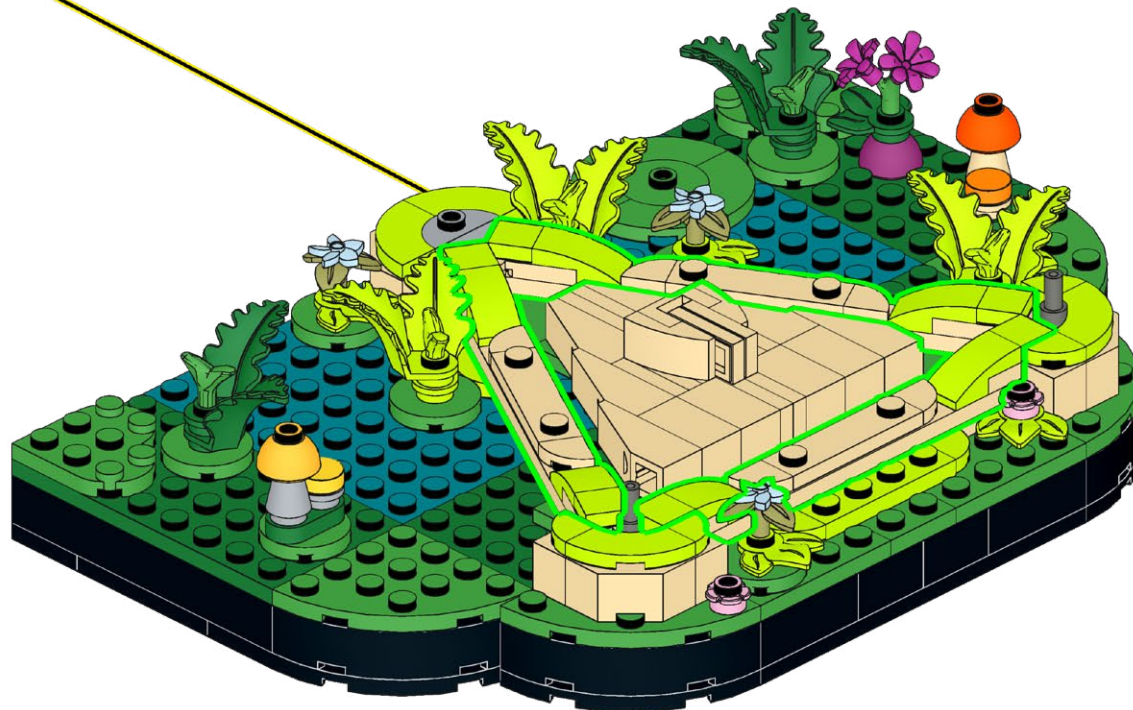

143

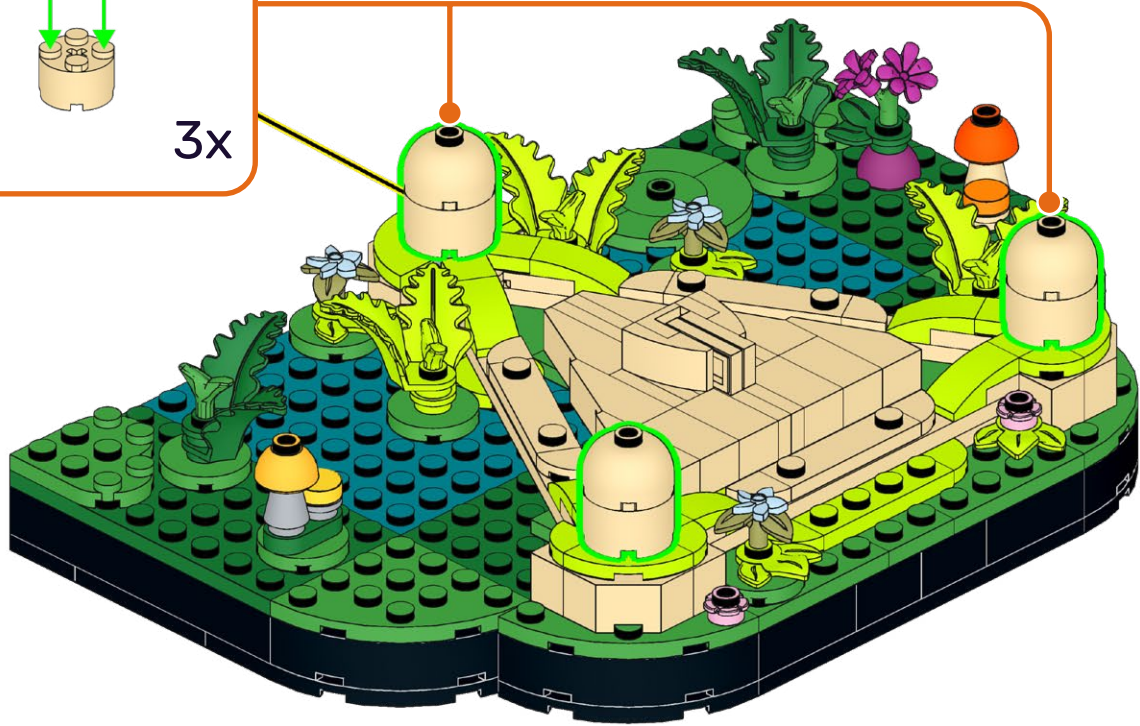
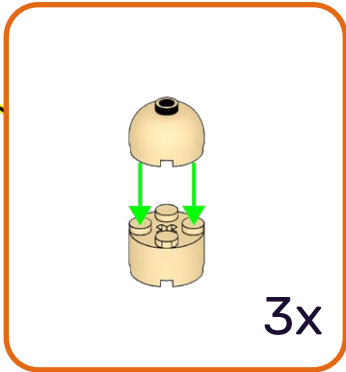
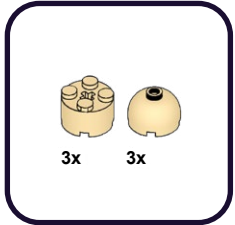

144

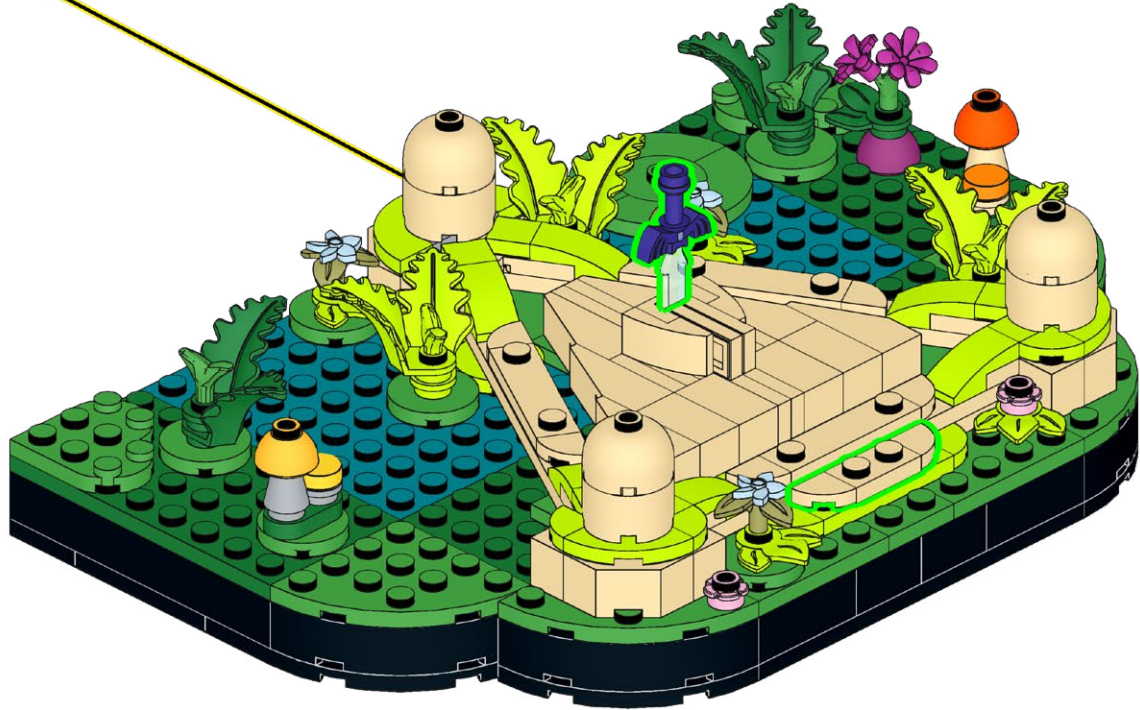
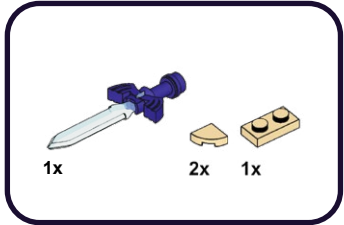

**HOLD UP!**

You might notice some bags aren't in order, as well as left over pieces, but that's ok! We're changing the way you build LEGO!

ATTENDEZ!

Vous remarquerez peut-être que certains sacs, ainsi que certaines pièces, ne sont pas dans le bon ordre. Mais pas de panique! Nous changeons simplement la façon avec laquelle vous construisez vos LEGO!

ASPETTA!

Potresti notare che alcuni sacchetti non sono in ordine, così come i pezzi avanzati, ma va bene così! Stiamo cambiando il modo in cui costruisci i LEGO!

HALT!

Sie werden möglicherweise bemerken, dass einige tüten durcheinander sind und teile übrig bleiben, aber das ist in Ordnung! Wir ändern die art und weise, wie Sie LEGO bauen!

¡ESPERA!

Es posible que notes que algunas bolsas están fuera de servicio, así como piezas sobrantes, ¡pero está bien! ¡Estamos cambiando la forma en que construyes LEGO!

暫停!

你可能会注意到一些袋子顺序错乱, 以及一些剩余的部件, 但没关系! 我们正在改变你搭建乐高的方式!

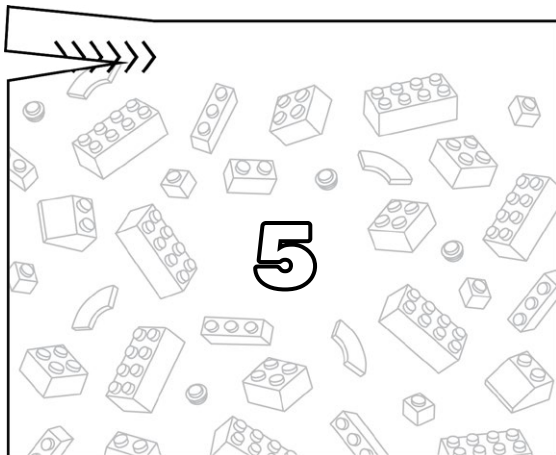
Open LEGO® Bag 5

145

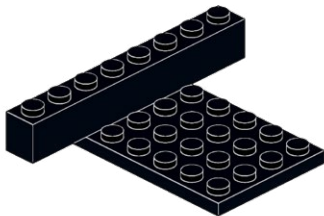
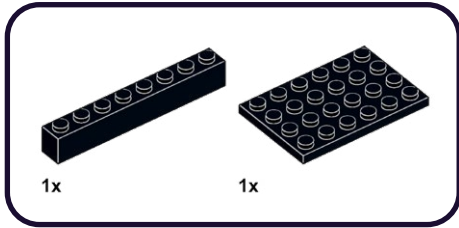

146

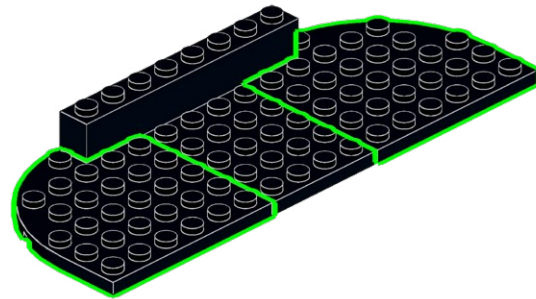
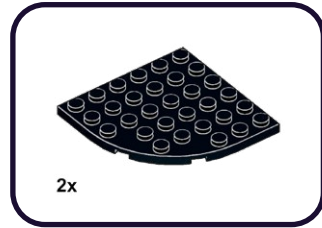

147

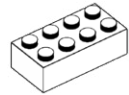

2x

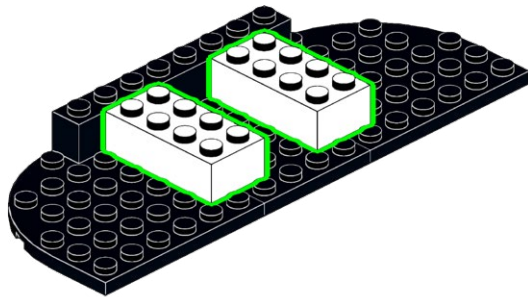

148



2x



2x

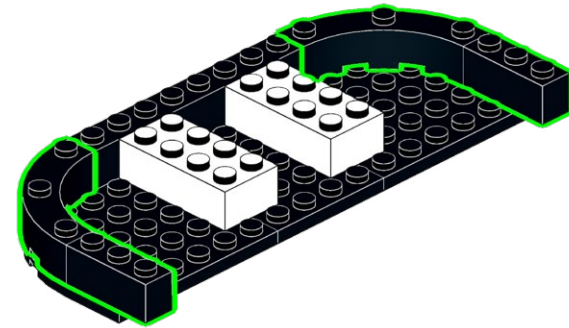

149

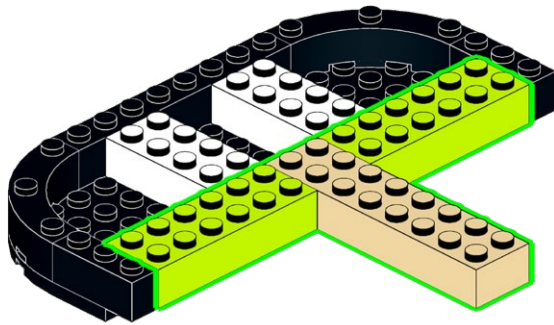
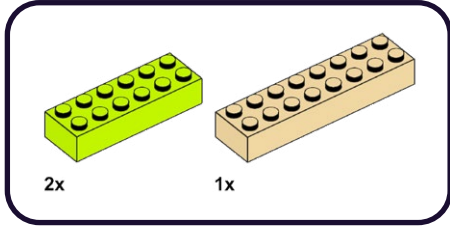

150

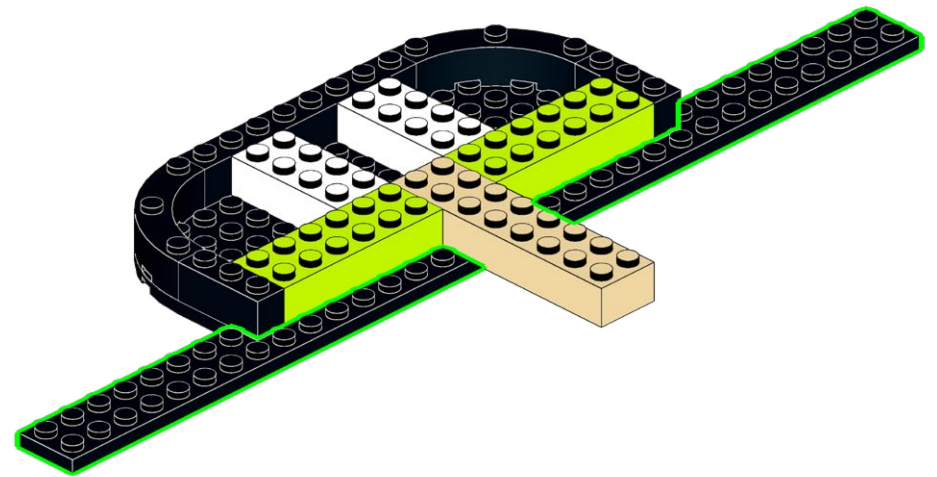
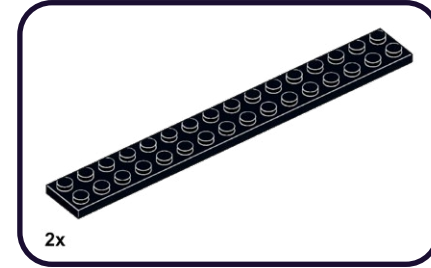

151

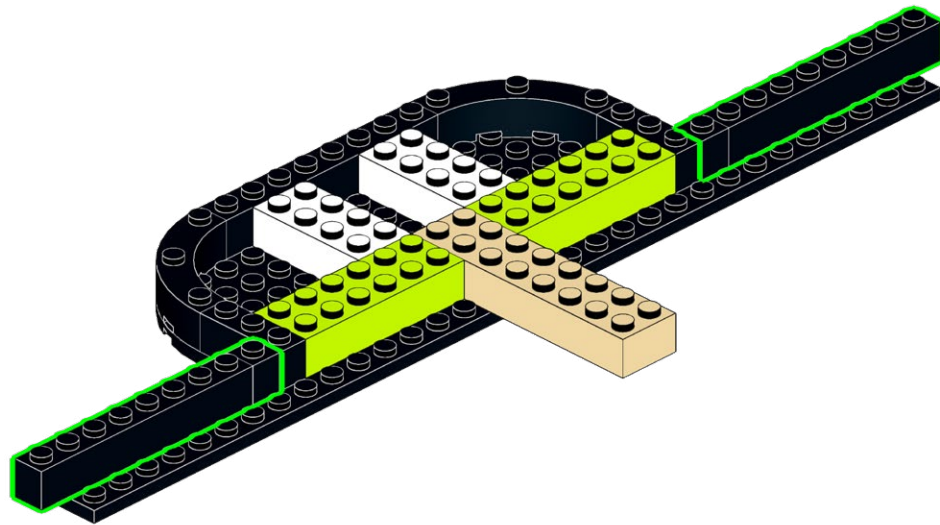
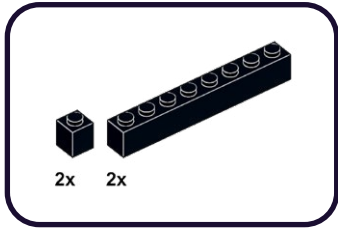

152

2x

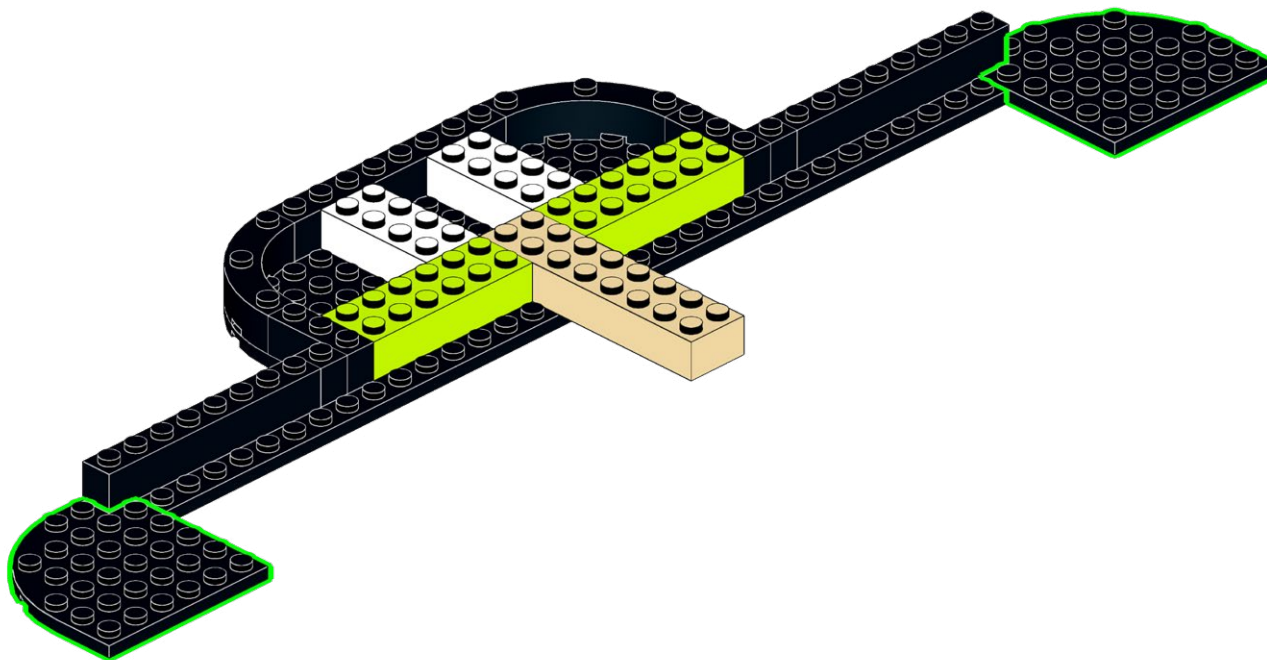

153

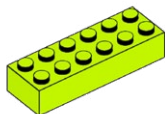

4x

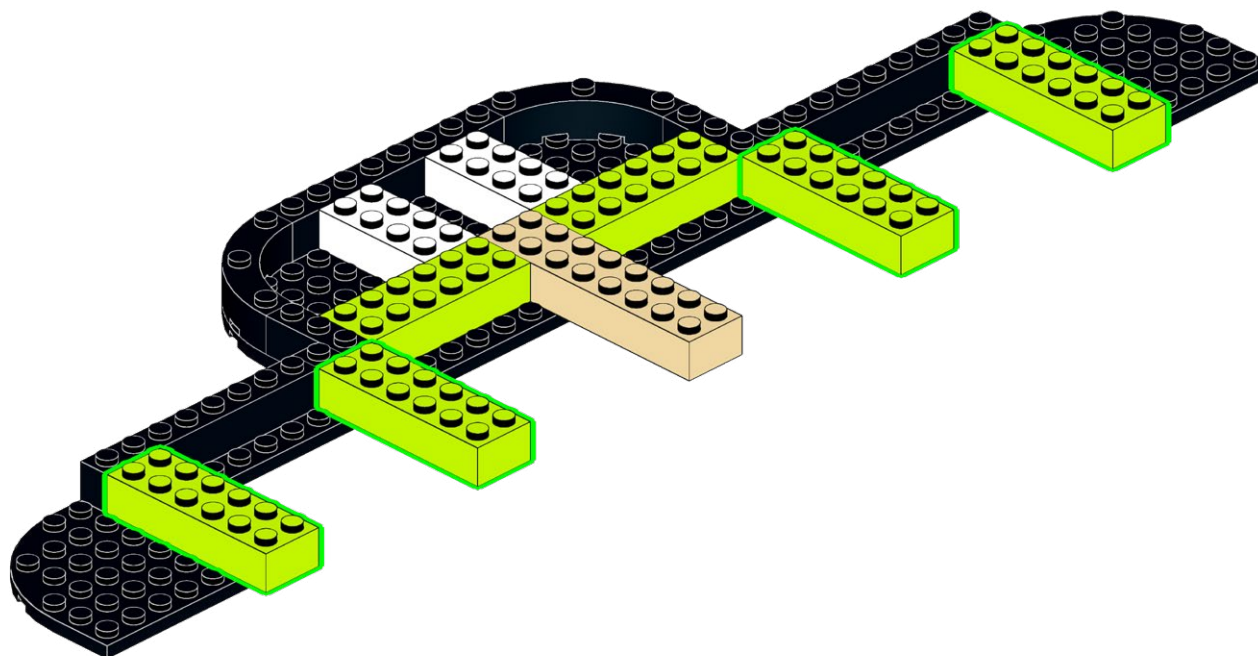

154

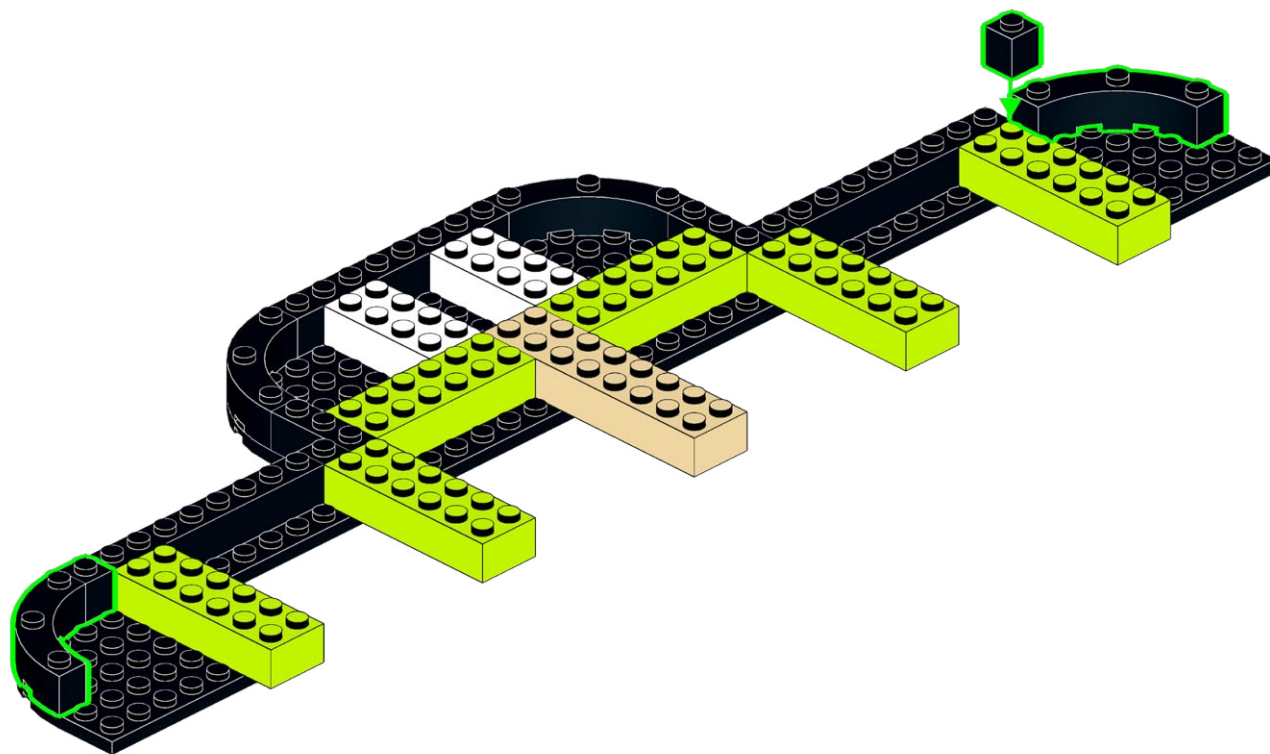
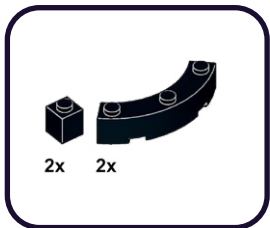

155

2x

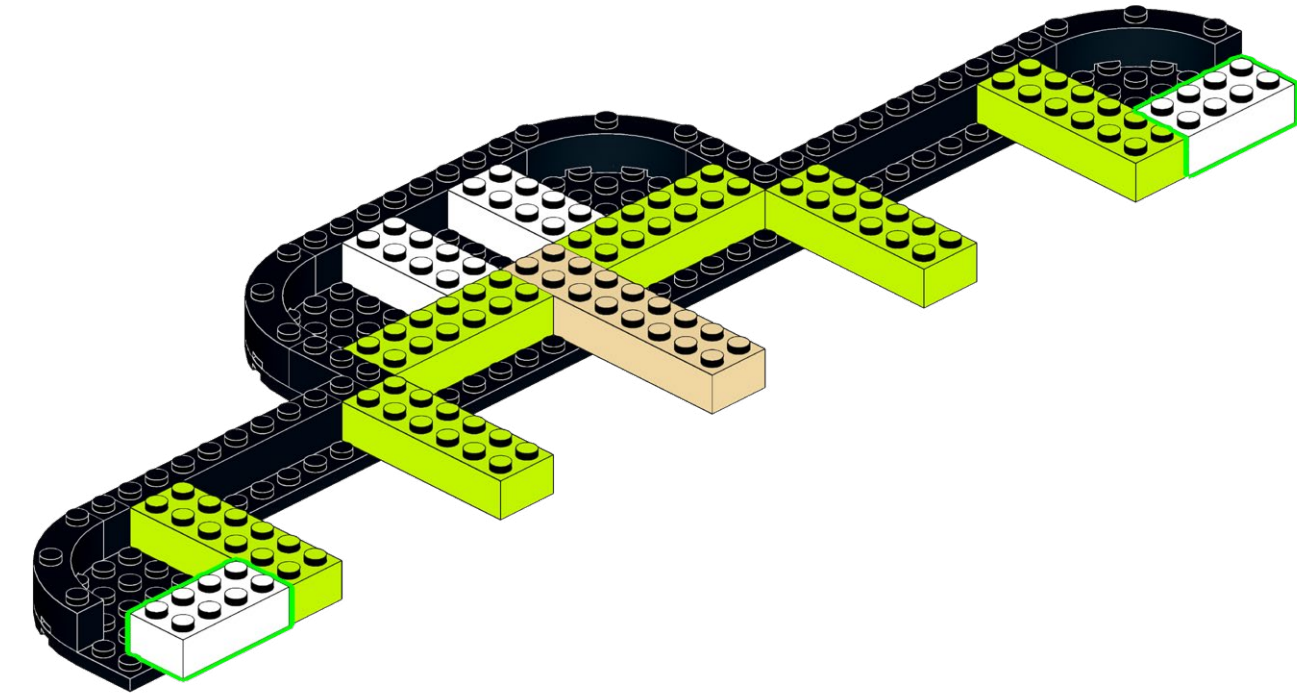

156

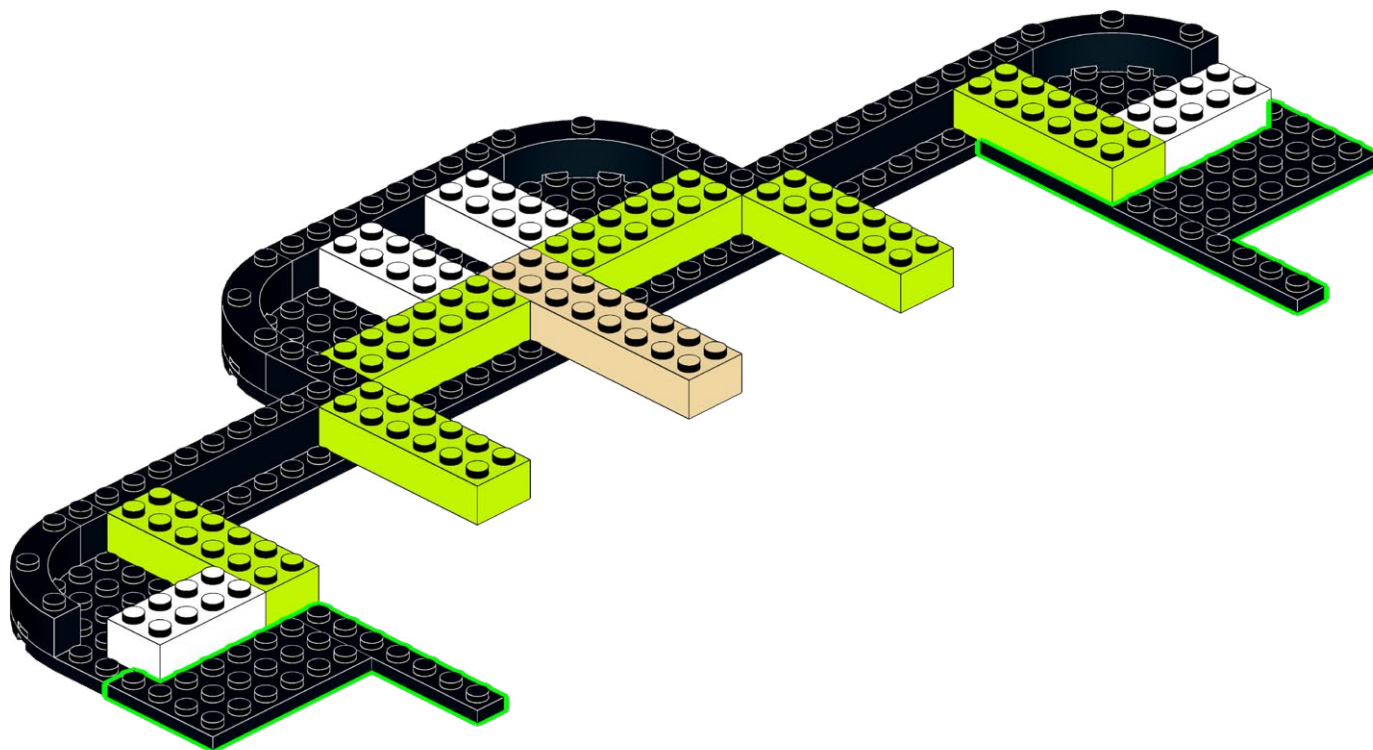
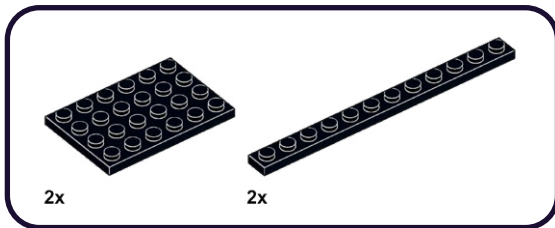

157

3x

5x

1

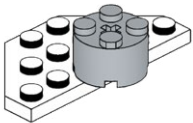

2

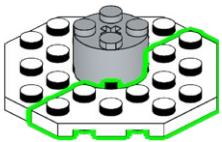

2x

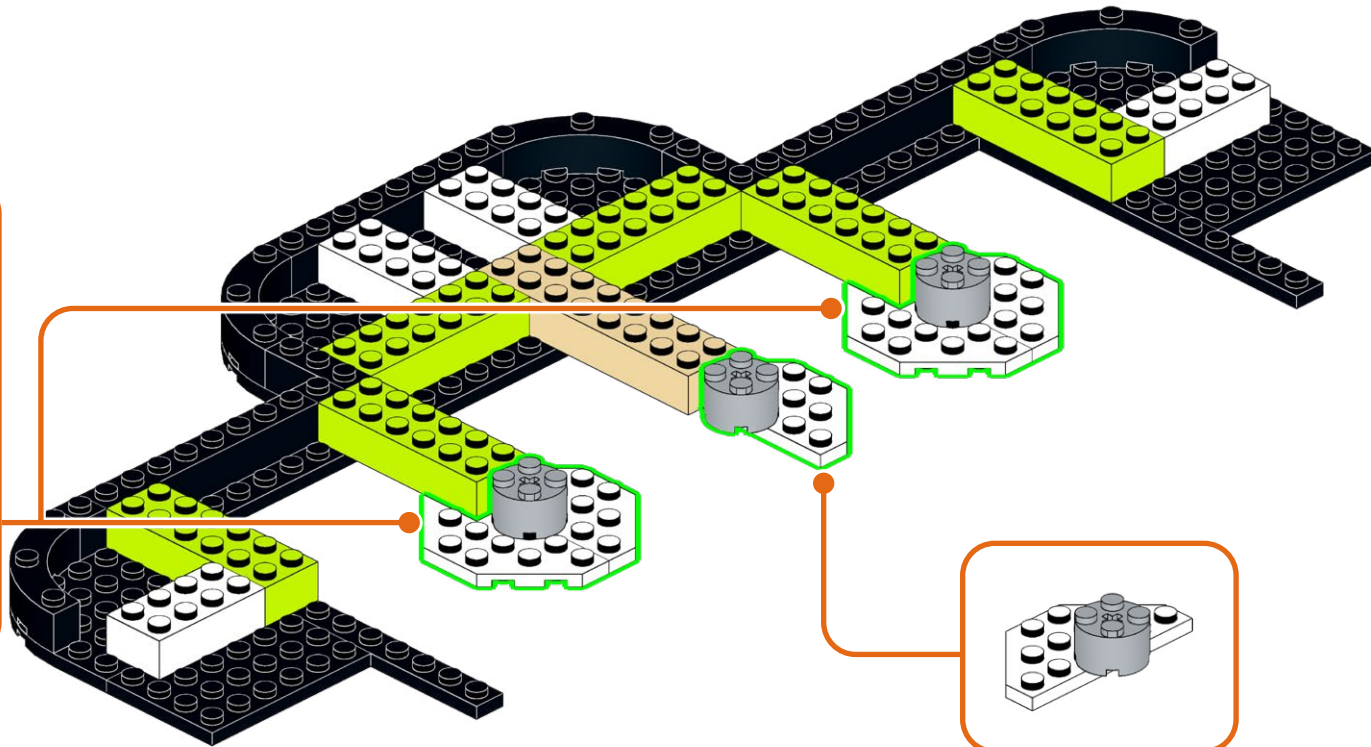

158

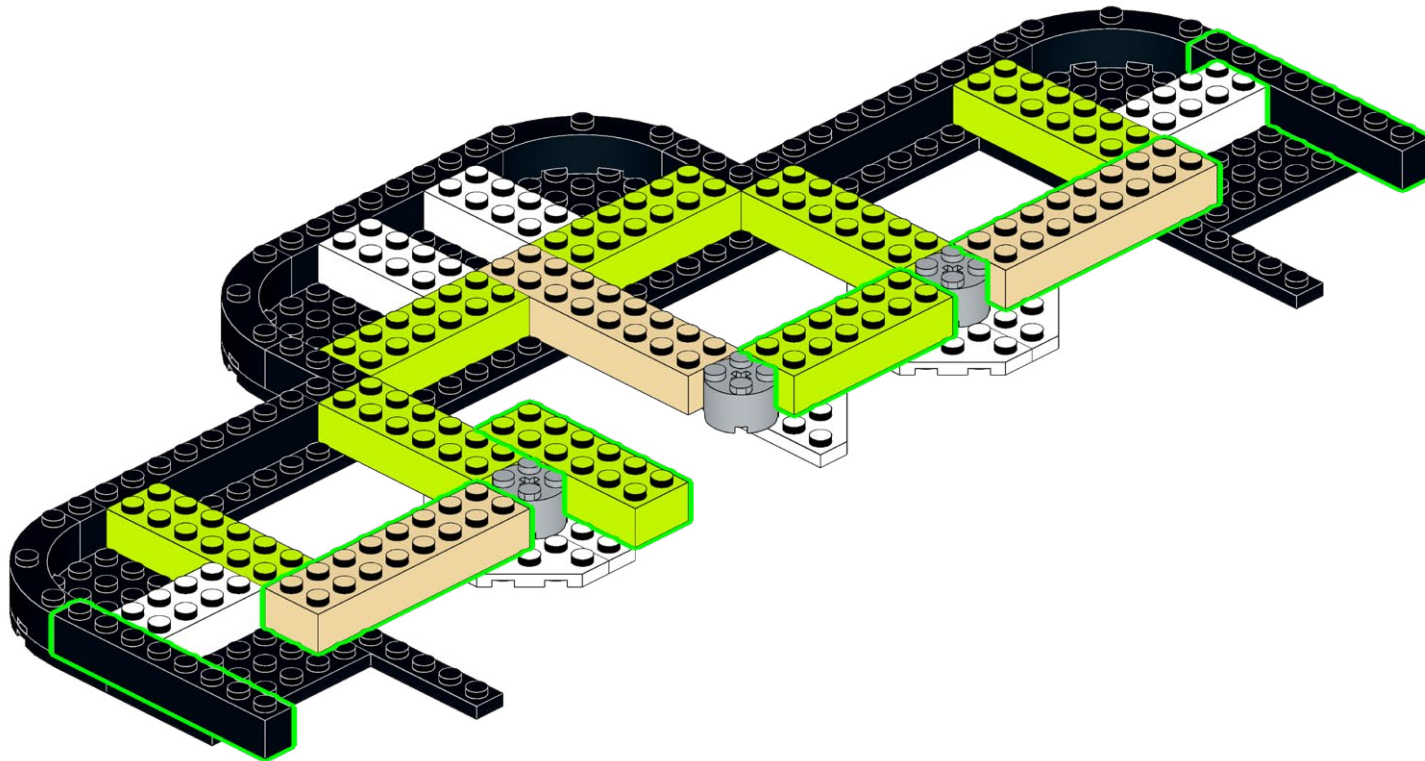
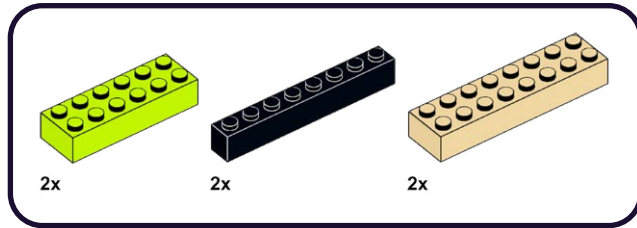

**HOLD UP!**

You might notice some bags aren't in order, as well as left over pieces, but that's ok! We're changing the way you build LEGO!

ATTENDEZ!

Vous remarquerez peut-être que certains sacs, ainsi que certaines pièces, ne sont pas dans le bon ordre. Mais pas de panique! Nous changeons simplement la façon avec laquelle vous construisez vos LEGO!

ASPETTA!

Potresti notare che alcuni sacchetti non sono in ordine, così come i pezzi avanzati, ma va bene così! Stiamo cambiando il modo in cui costruisci i LEGO!

HALT!

Sie werden möglicherweise bemerken, dass einige tüten durcheinander sind und teile übrig bleiben, aber das ist in Ordnung! Wir ändern die art und weise, wie Sie LEGO bauen!

¡ESPERA!

Es posible que notes que algunas bolsas están fuera de servicio, así como piezas sobrantes, ¡pero está bien! ¡Estamos cambiando la forma en que construyes LEGO!

暫停!

你可能会注意到一些袋子顺序错乱, 以及一些剩余的部件, 但没关系! 我们正在改变你搭建乐高的方式!

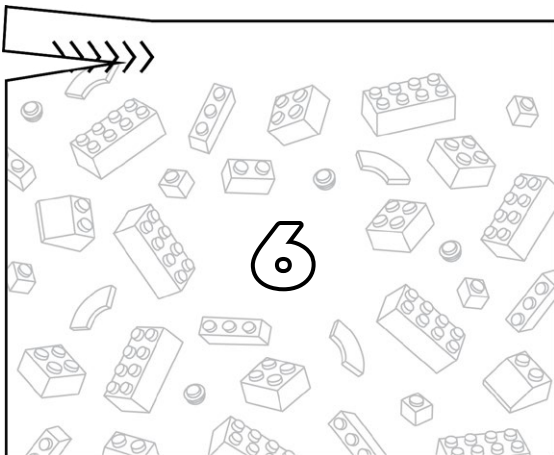
Open LEGO® Bag 6

159

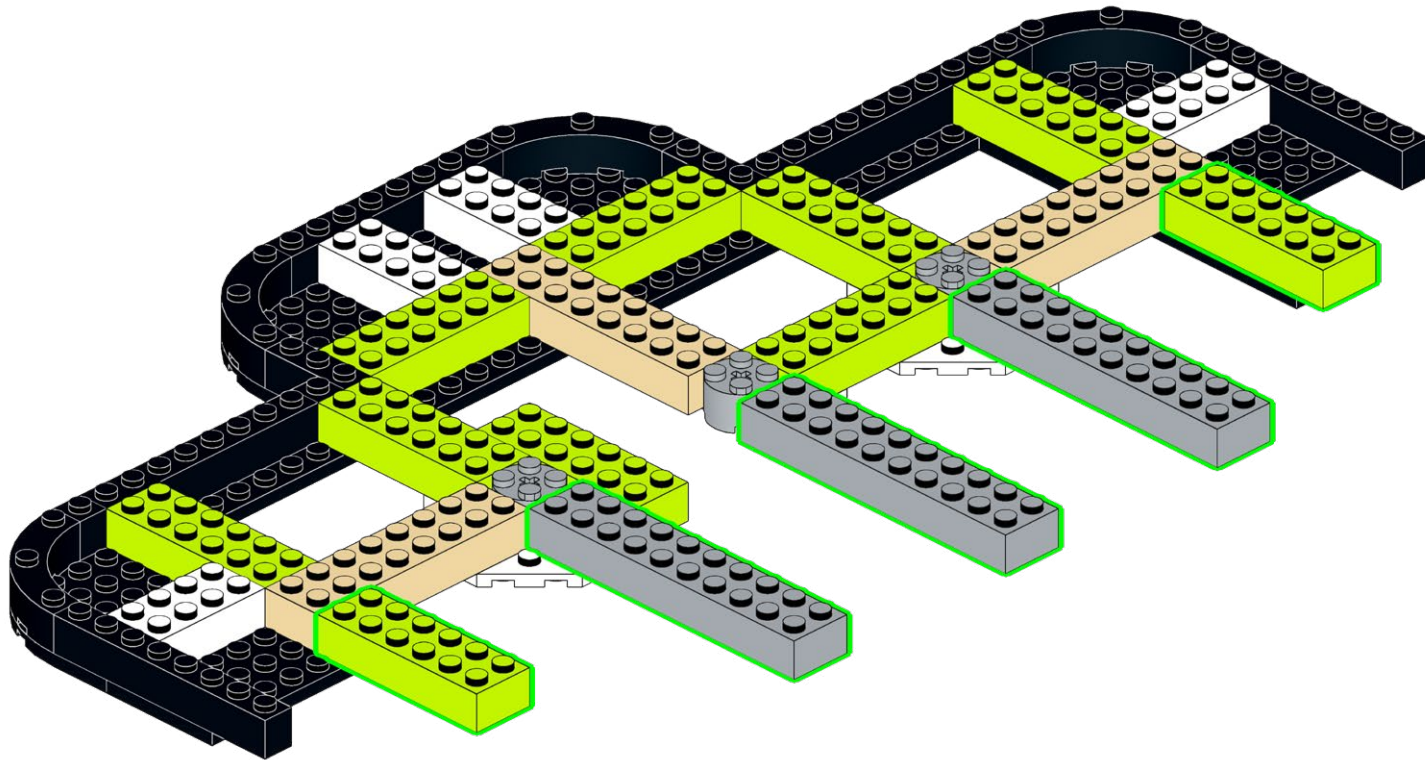
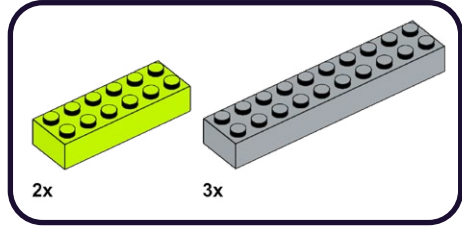

160

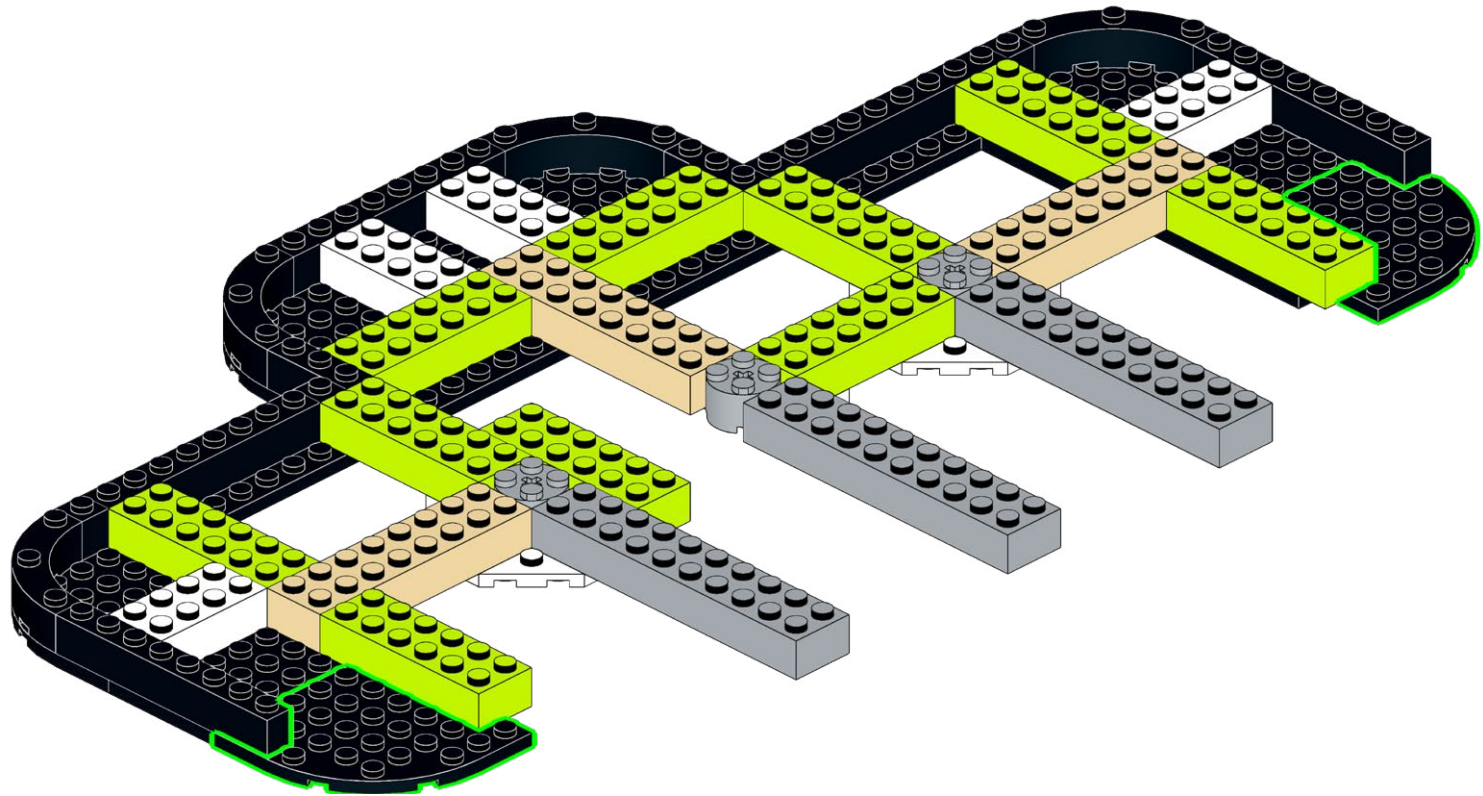
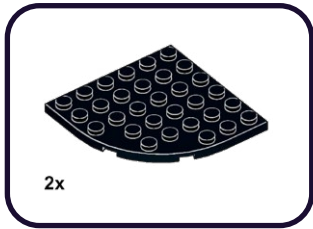

161

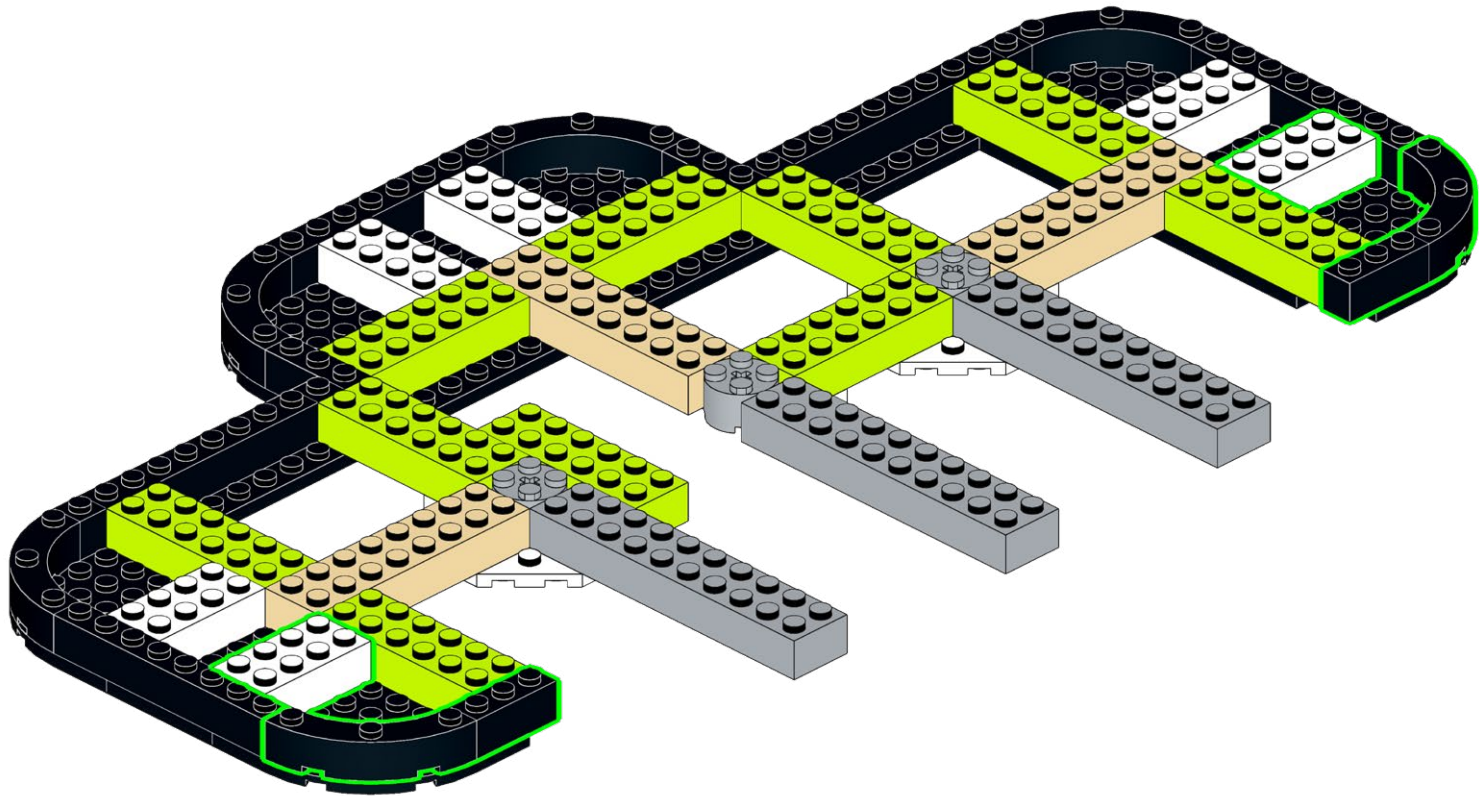
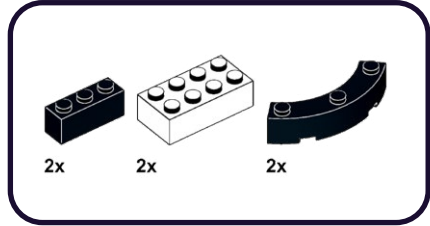

162

2x

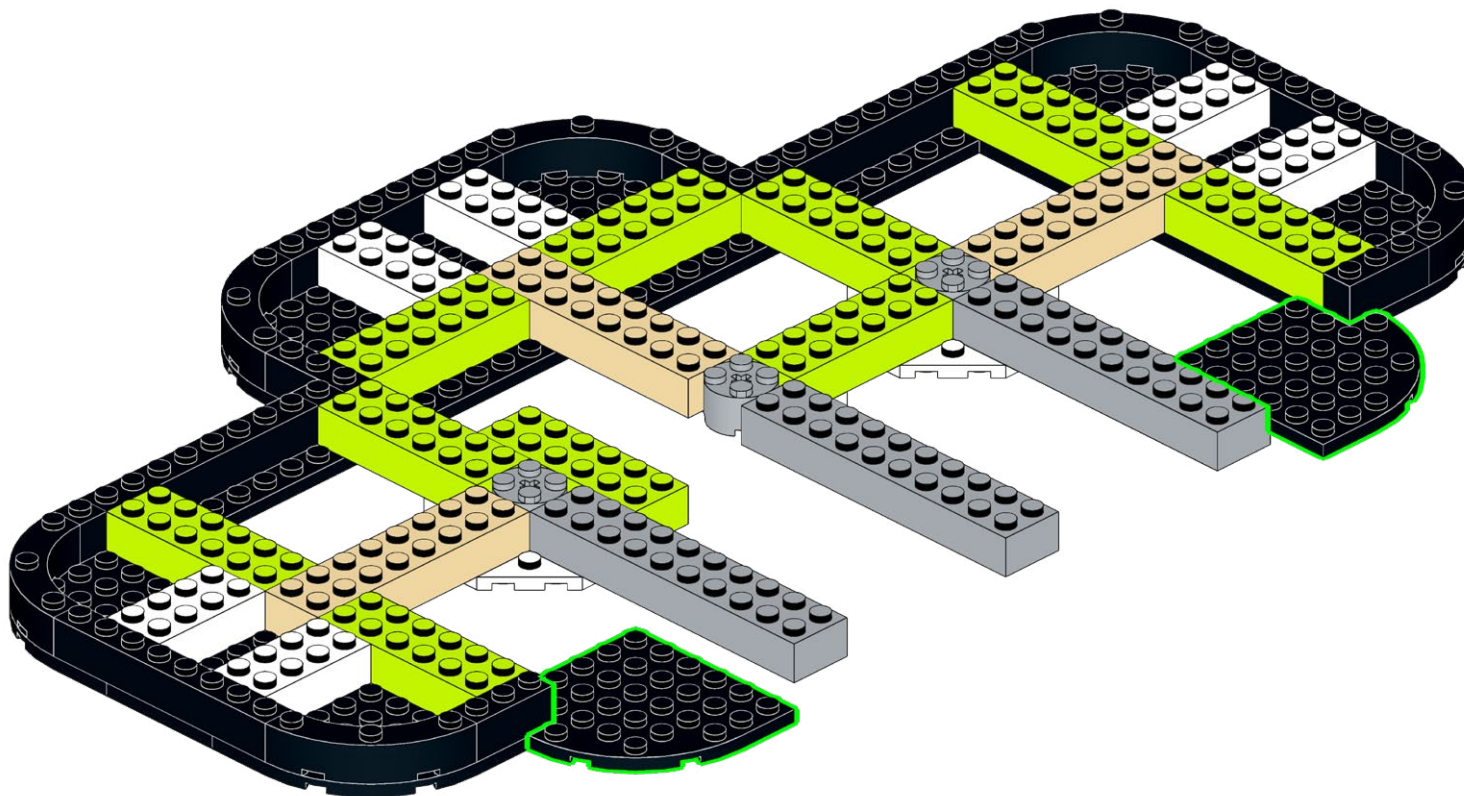

163

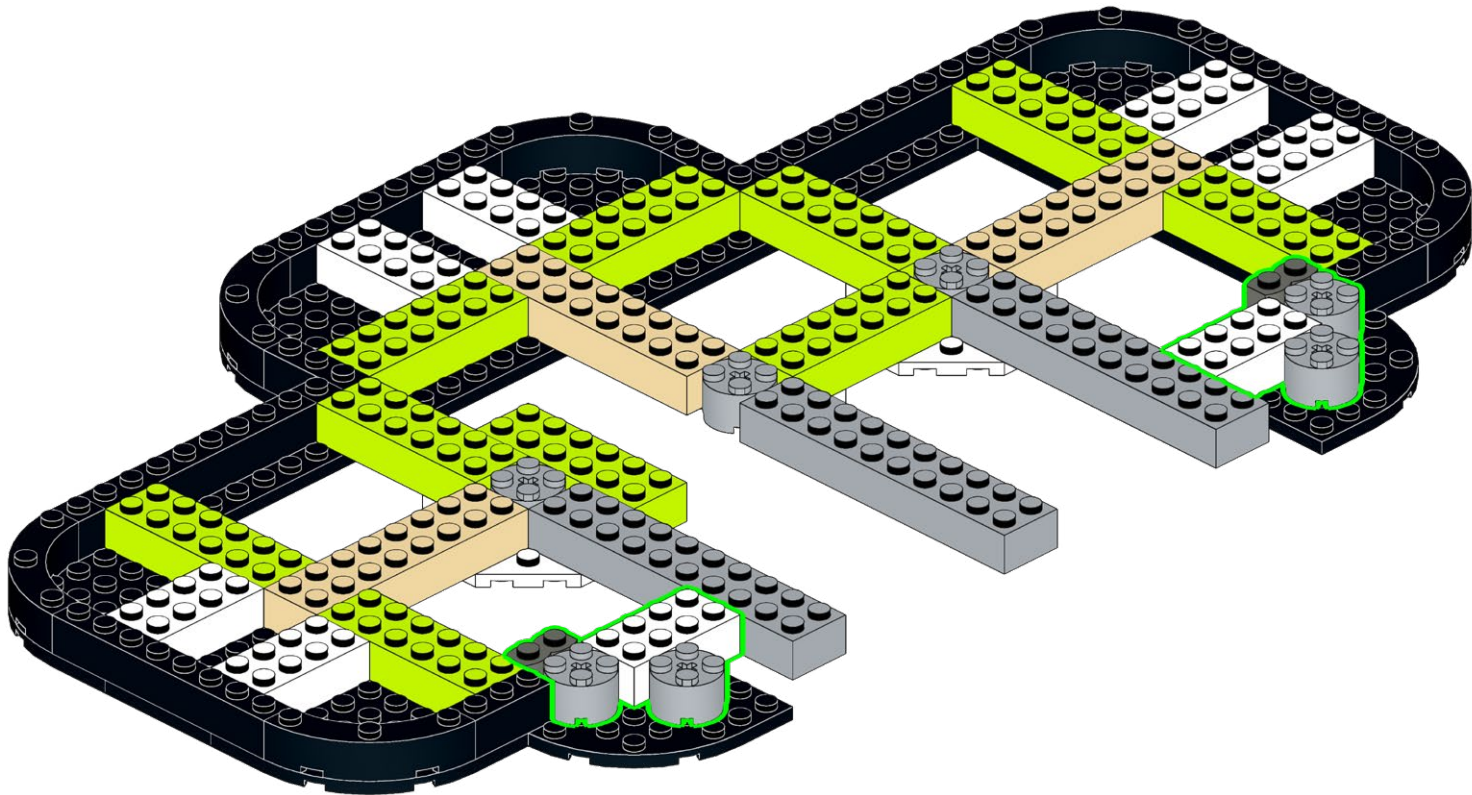
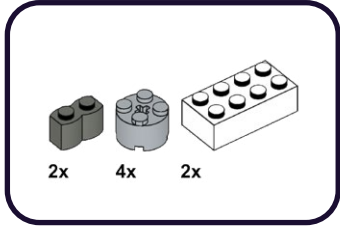

164

4x

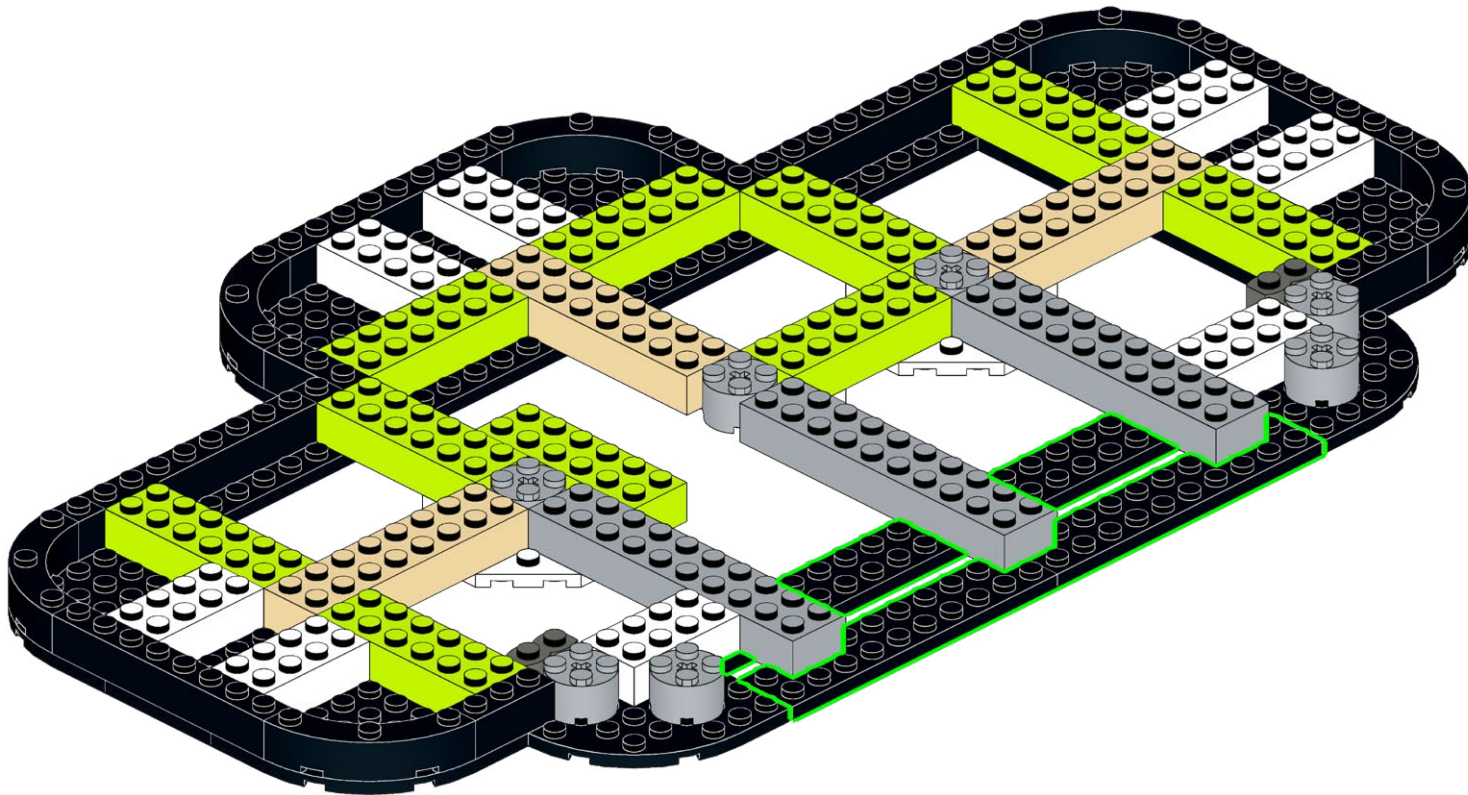

165

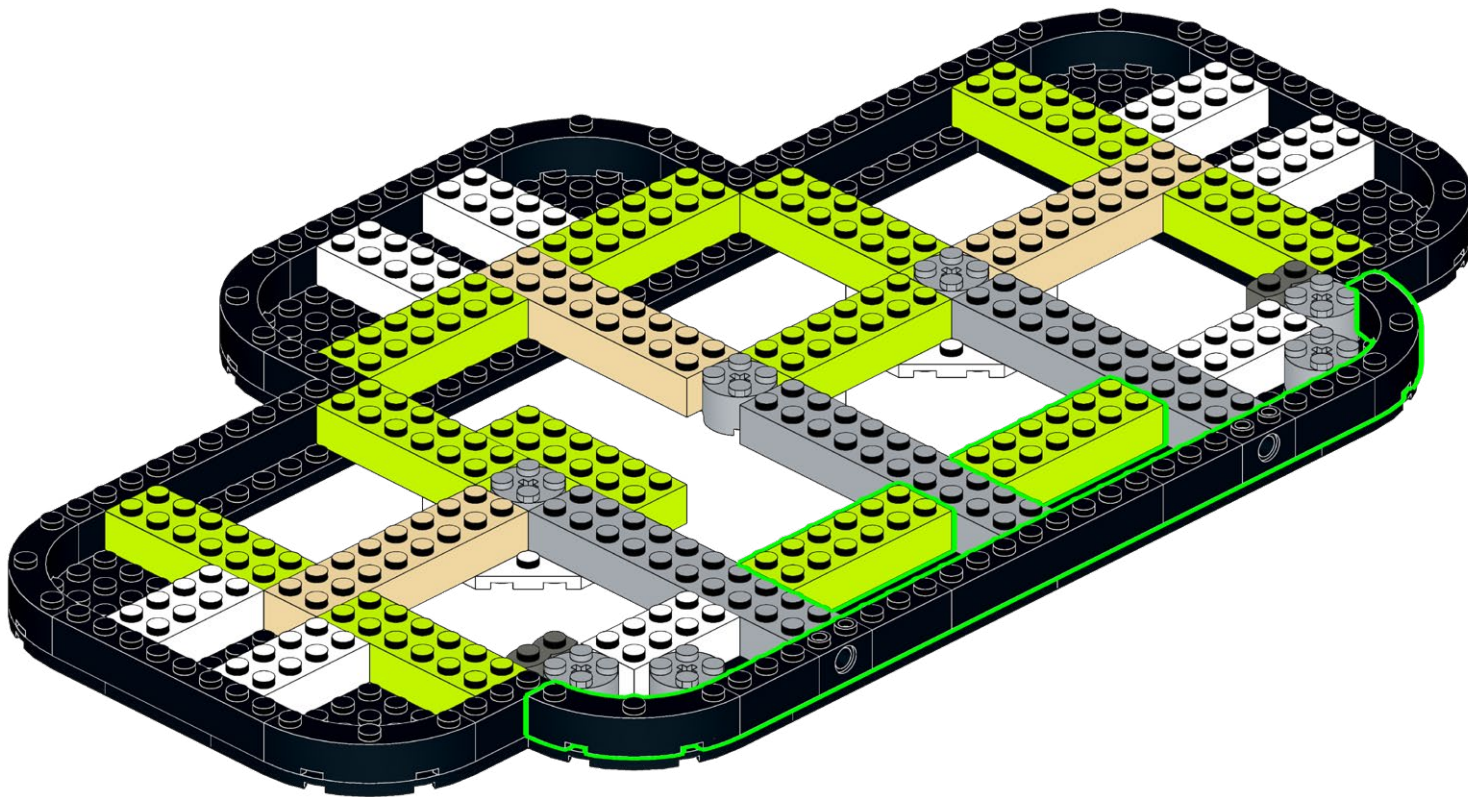
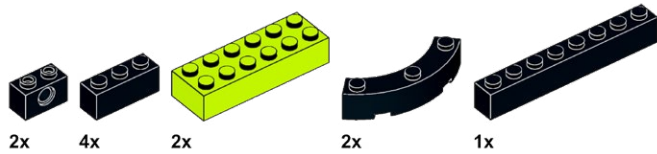

166

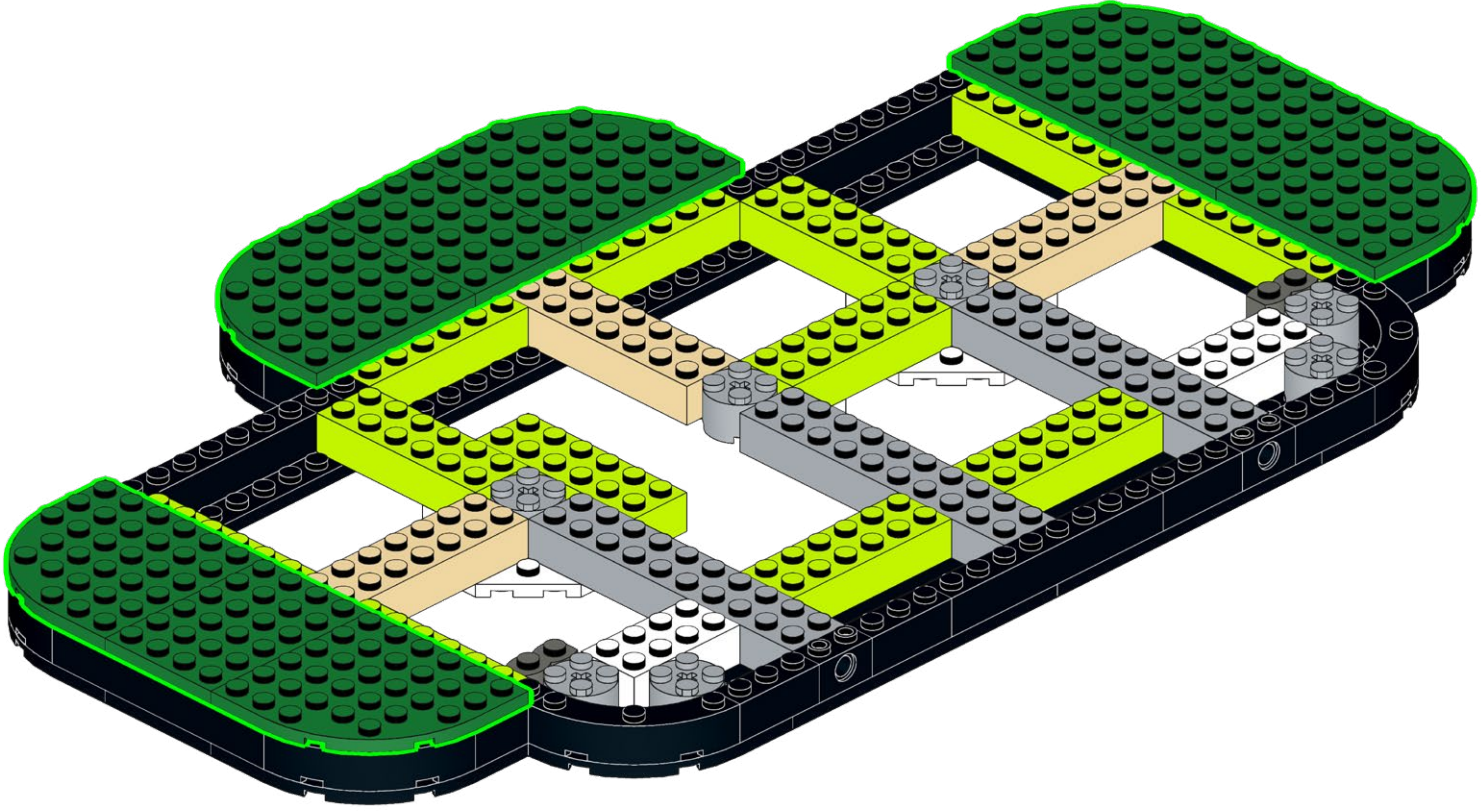
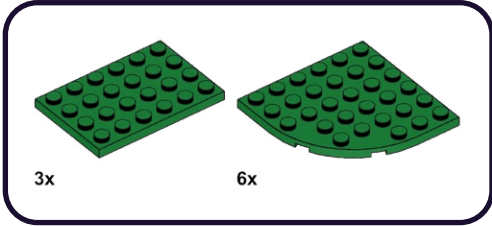

167

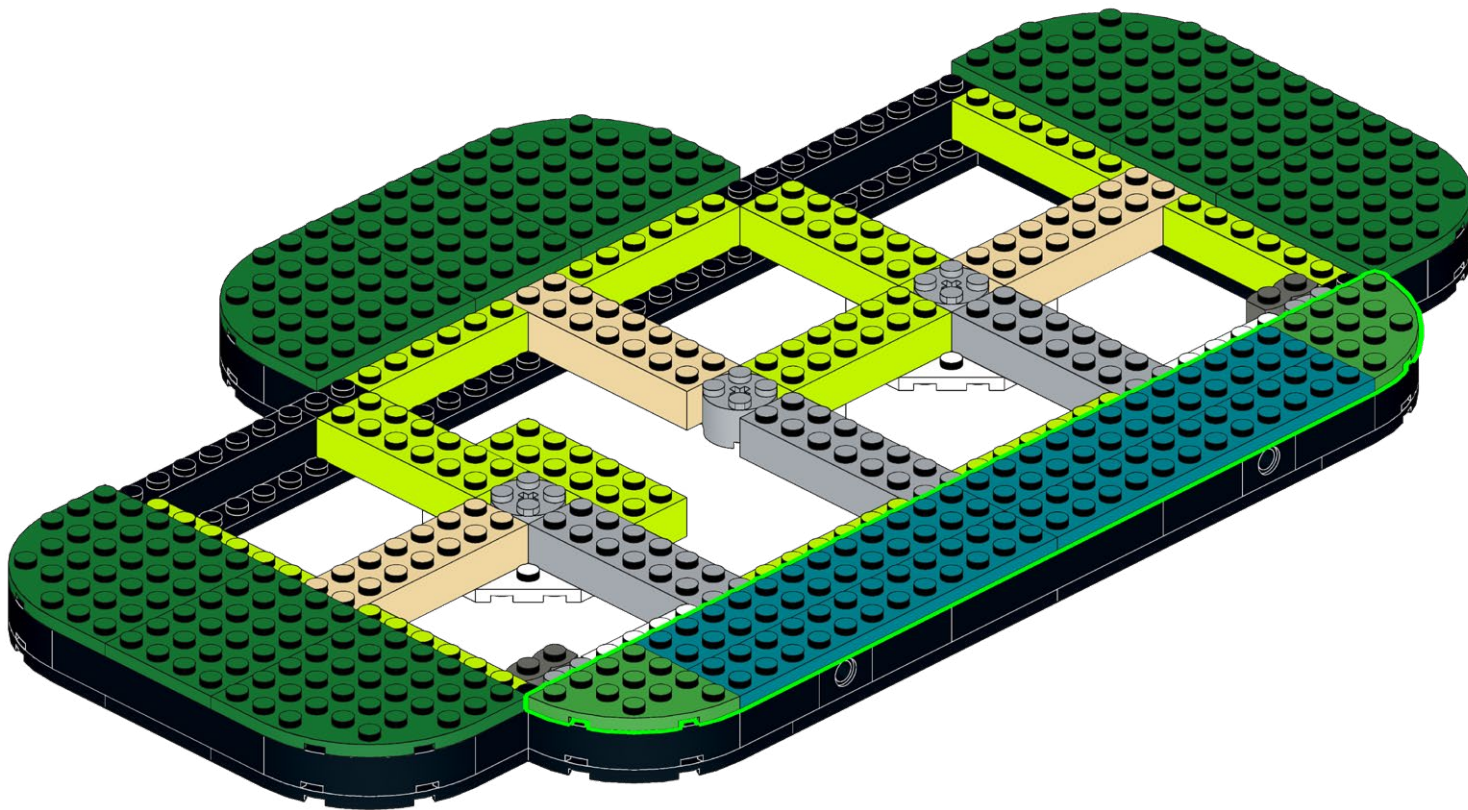
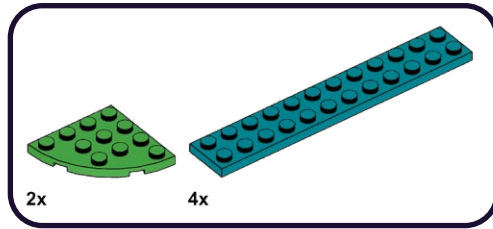

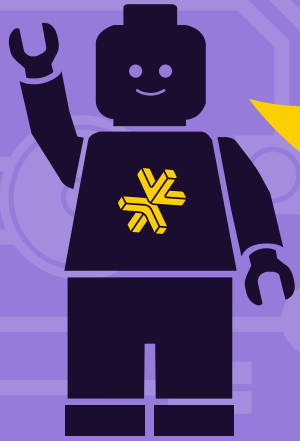

HOLD UP!

You might notice some bags aren't in order, as well as left over pieces, but that's ok! We're changing the way you build LEGO!

ATTENDEZ!

Vous remarquerez peut-être que certains sacs, ainsi que certaines pièces, ne sont pas dans le bon ordre. Mais pas de panique! Nous changeons simplement la façon avec laquelle vous construisez vos LEGO!

ASPETTA!

Potresti notare che alcuni sacchetti non sono in ordine, così come i pezzi avanzati, ma va bene così! Stiamo cambiando il modo in cui costruisci i LEGO!

HALT!

Sie werden möglicherweise bemerken, dass einige tüten durcheinander sind und teile übrig bleiben, aber das ist in Ordnung! Wir ändern die art und weise, wie Sie LEGO bauen!

¡ESPERA!

Es posible que notes que algunas bolsas están fuera de servicio, así como piezas sobrantes, ¡pero está bien! ¡Estamos cambiando la forma en que construyes LEGO!

暫停!

你可能会注意到一些袋子顺序错乱, 以及一些剩余的部件, 但没关系! 我们正在改变你搭建乐高的方式!

Open LEGO® Bags 7 & 9

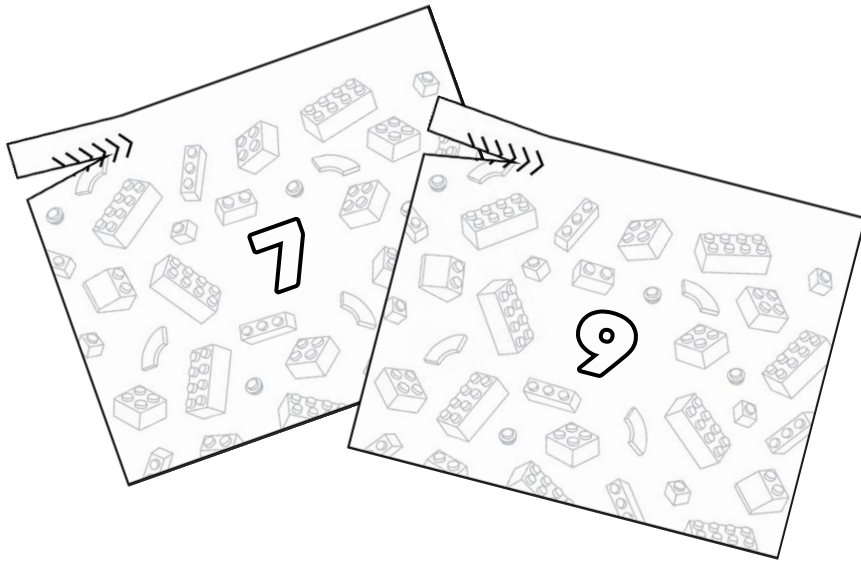

Open LMB Bag 02

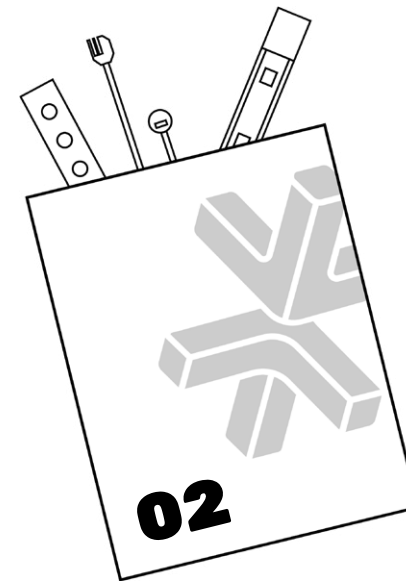

168

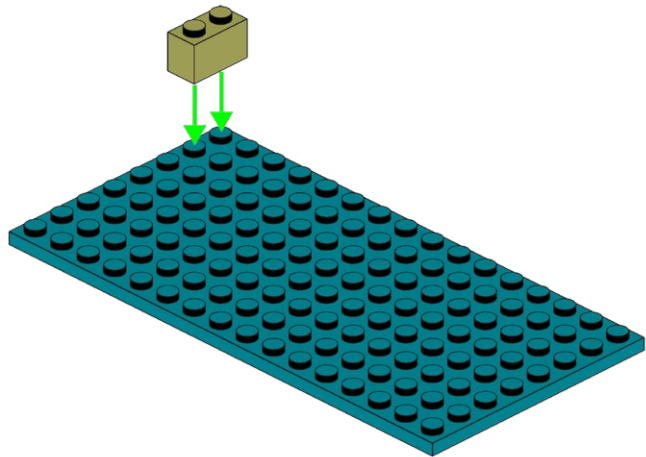
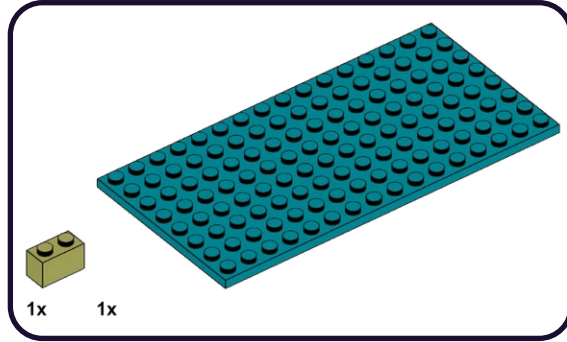

169

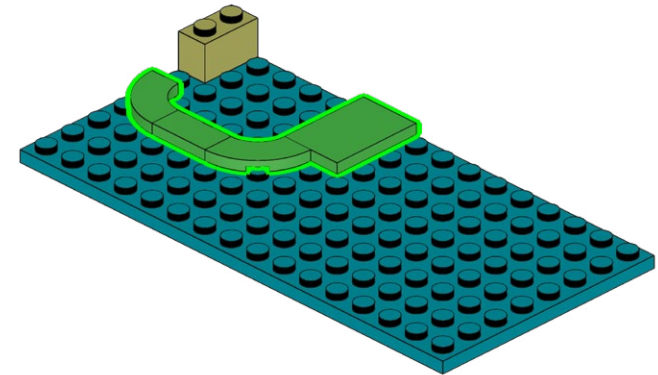
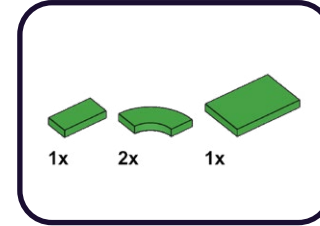

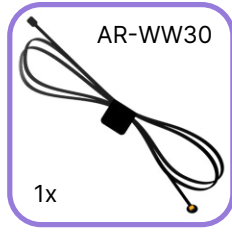
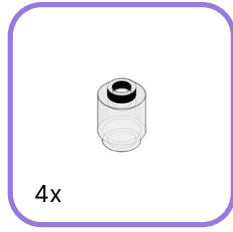
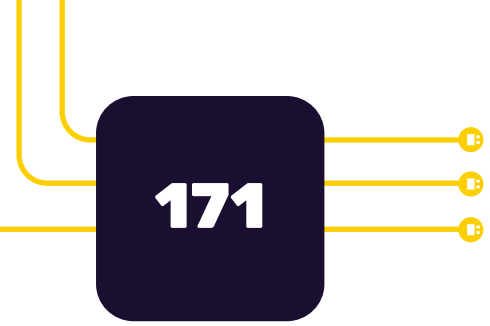

1



2



3



173

1x

1x

1

2

3

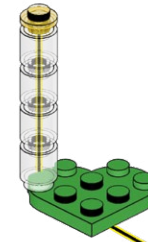
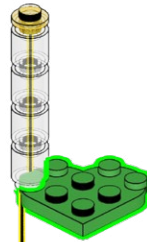

174

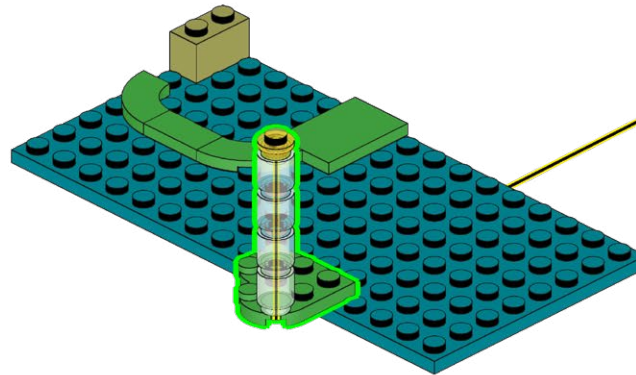

175

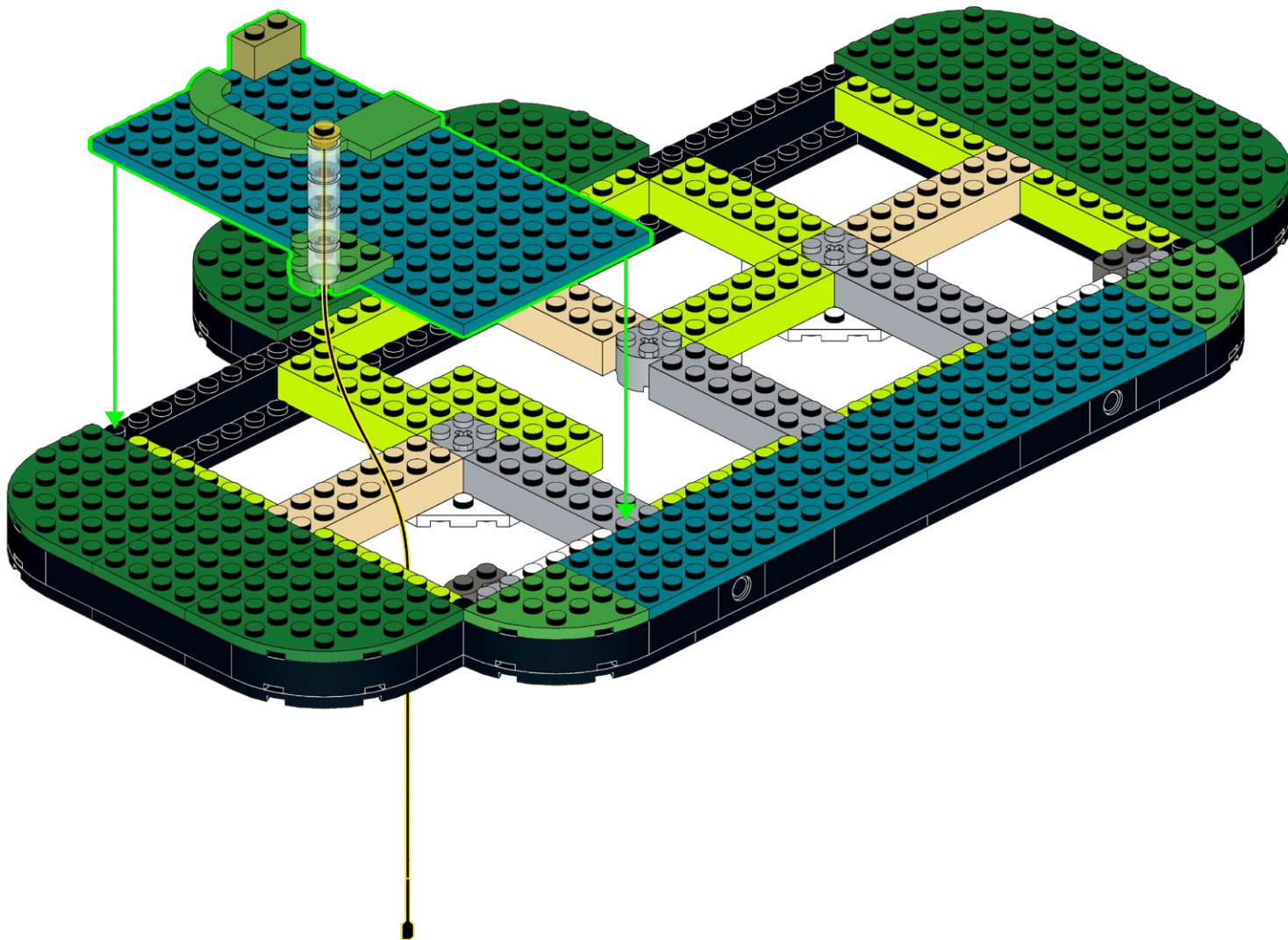

176

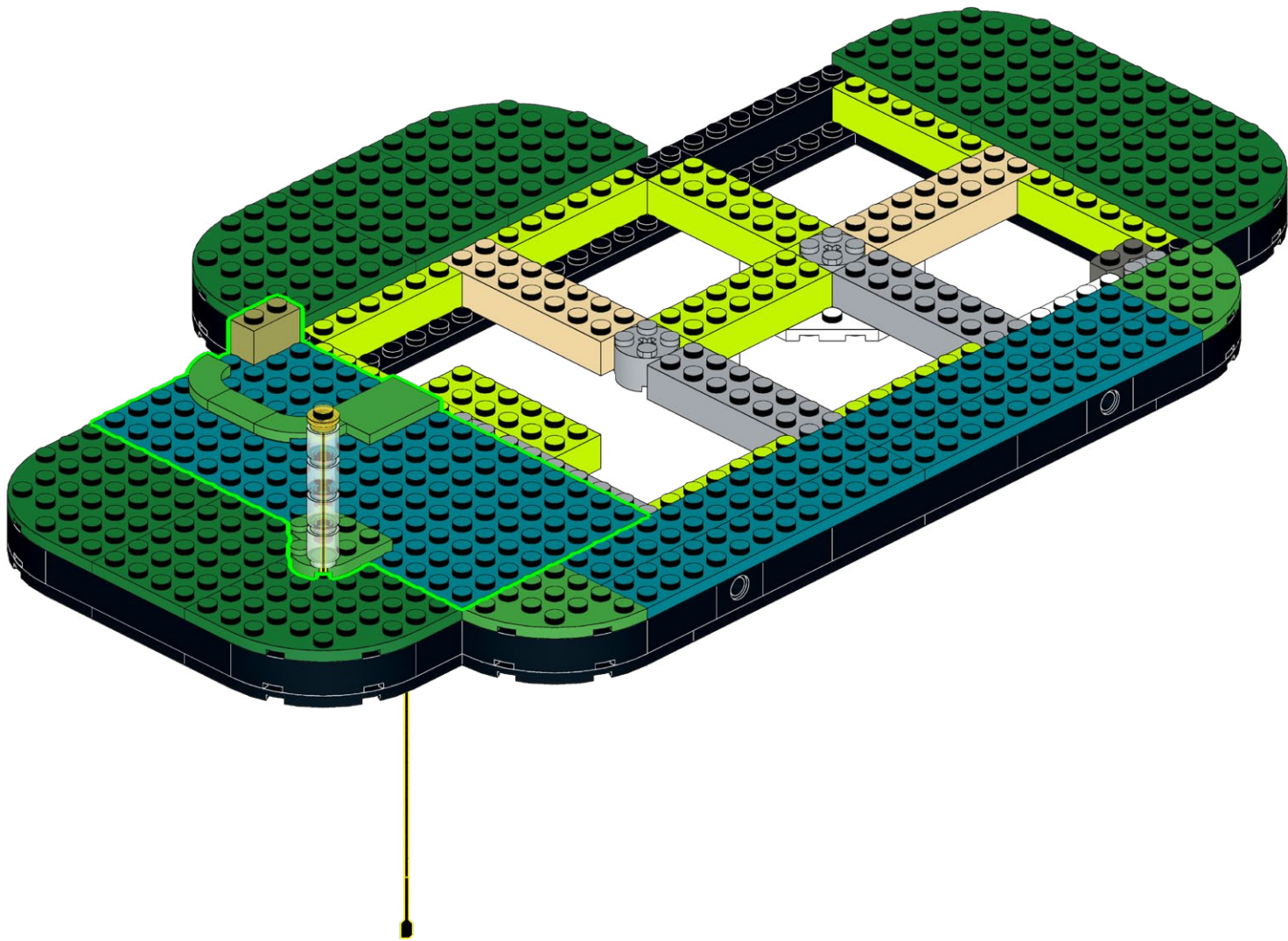

178

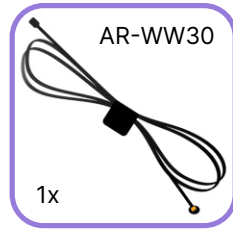
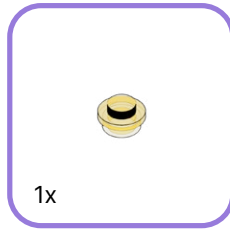
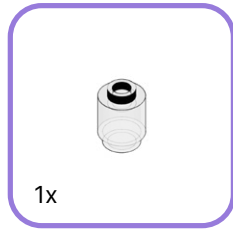

1



2



3



179

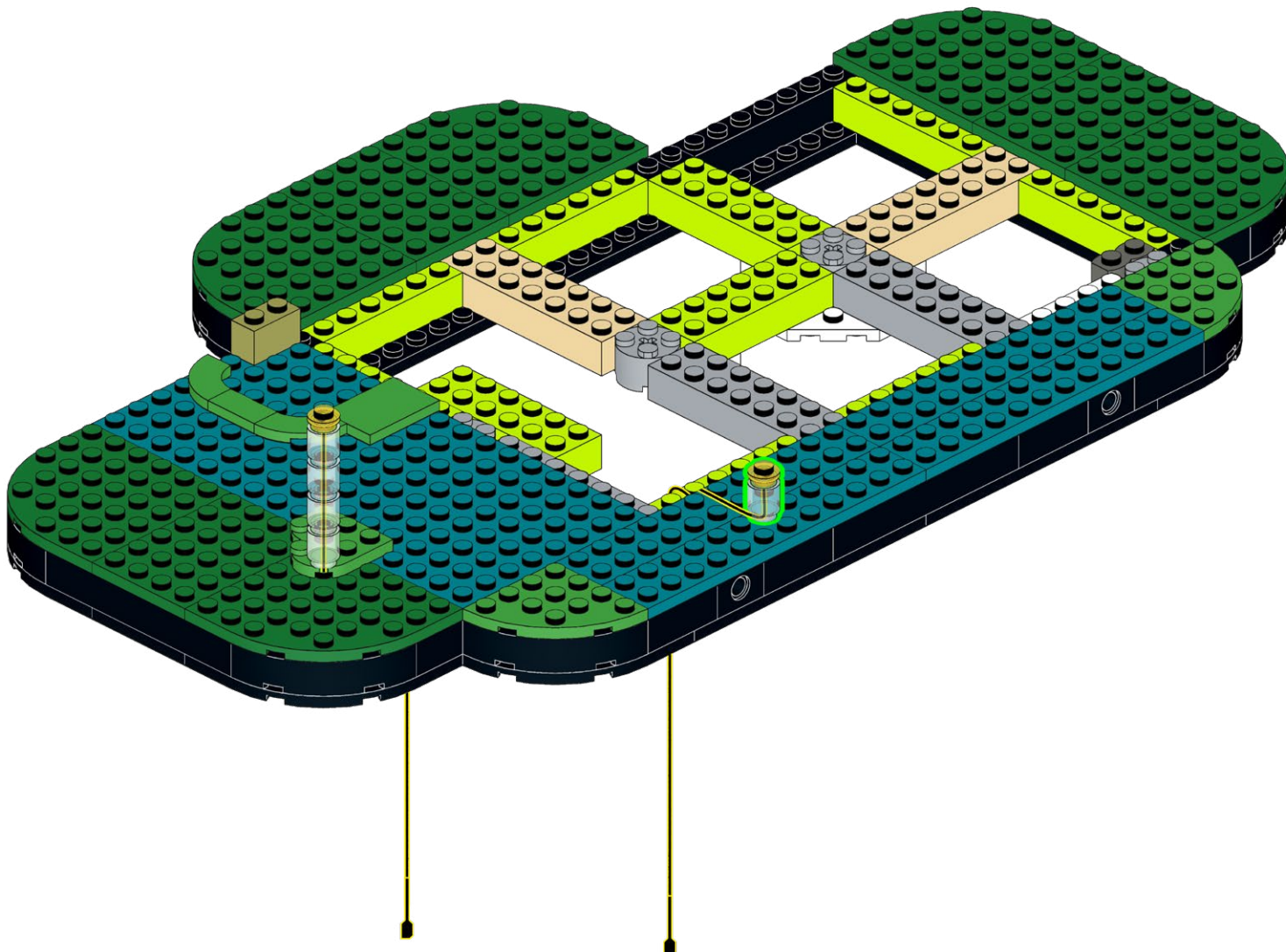

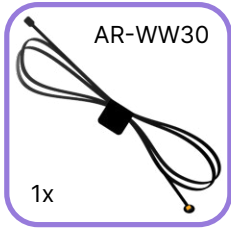
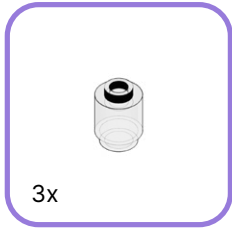

1



2



3



183

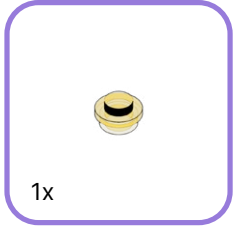

184

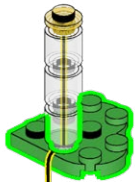
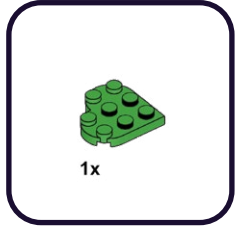

185

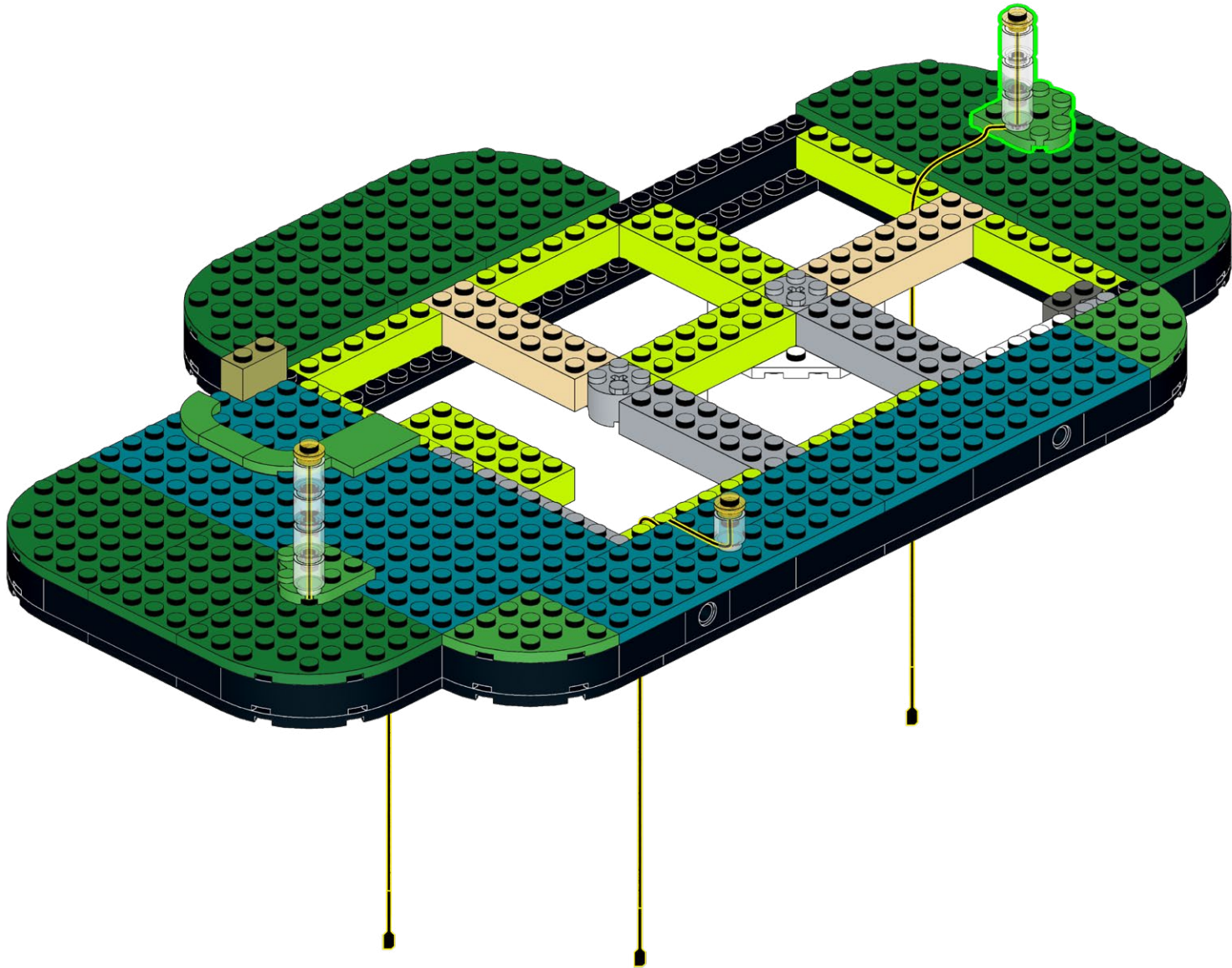

187

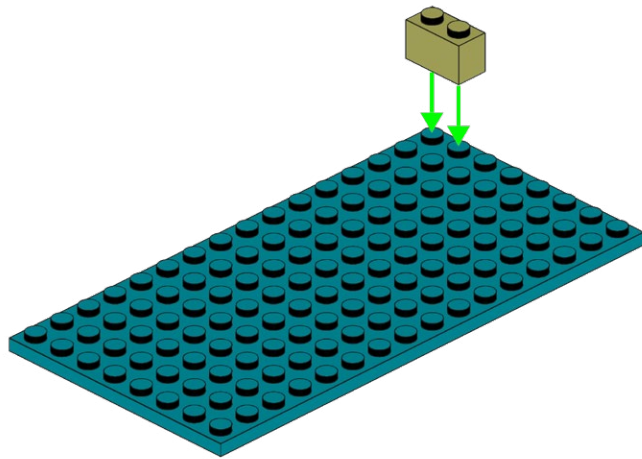
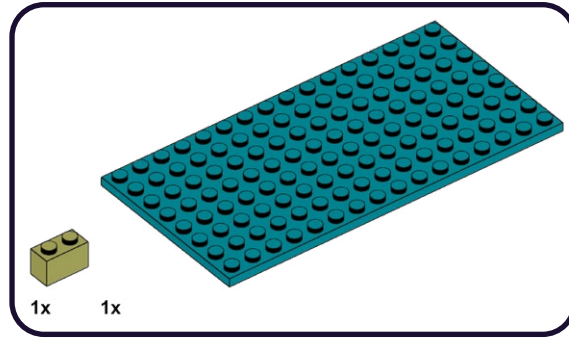

188

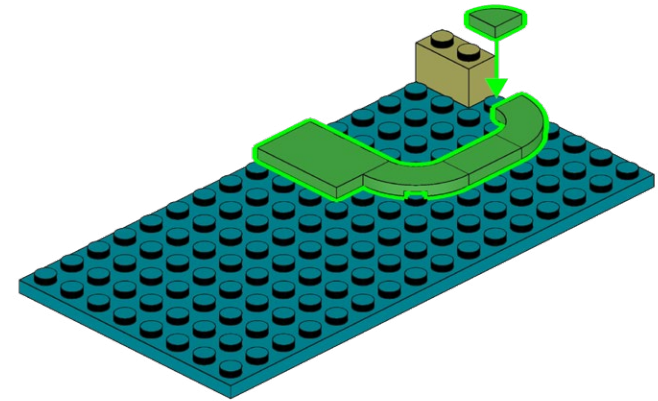
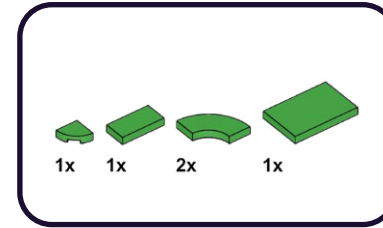

189

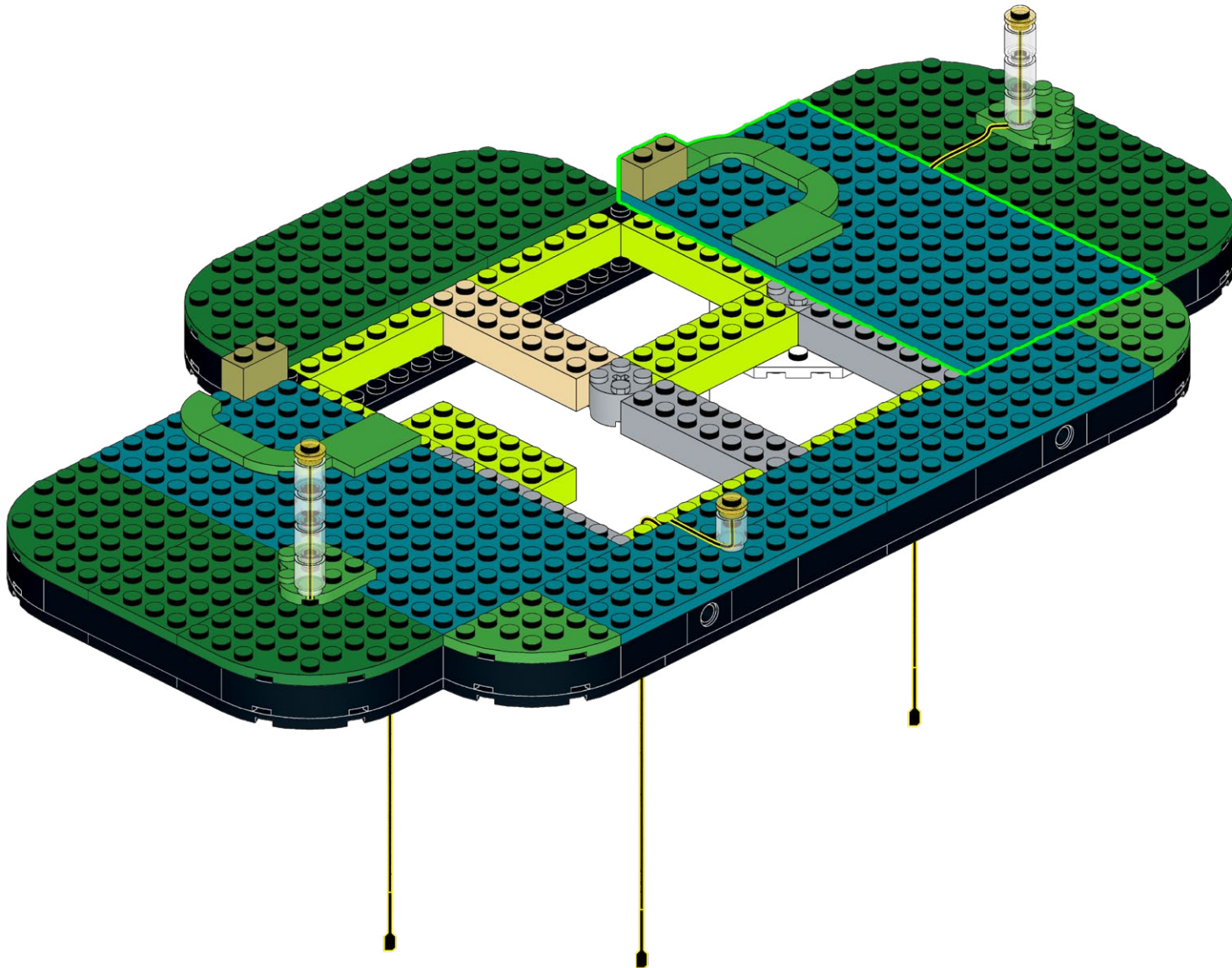

190

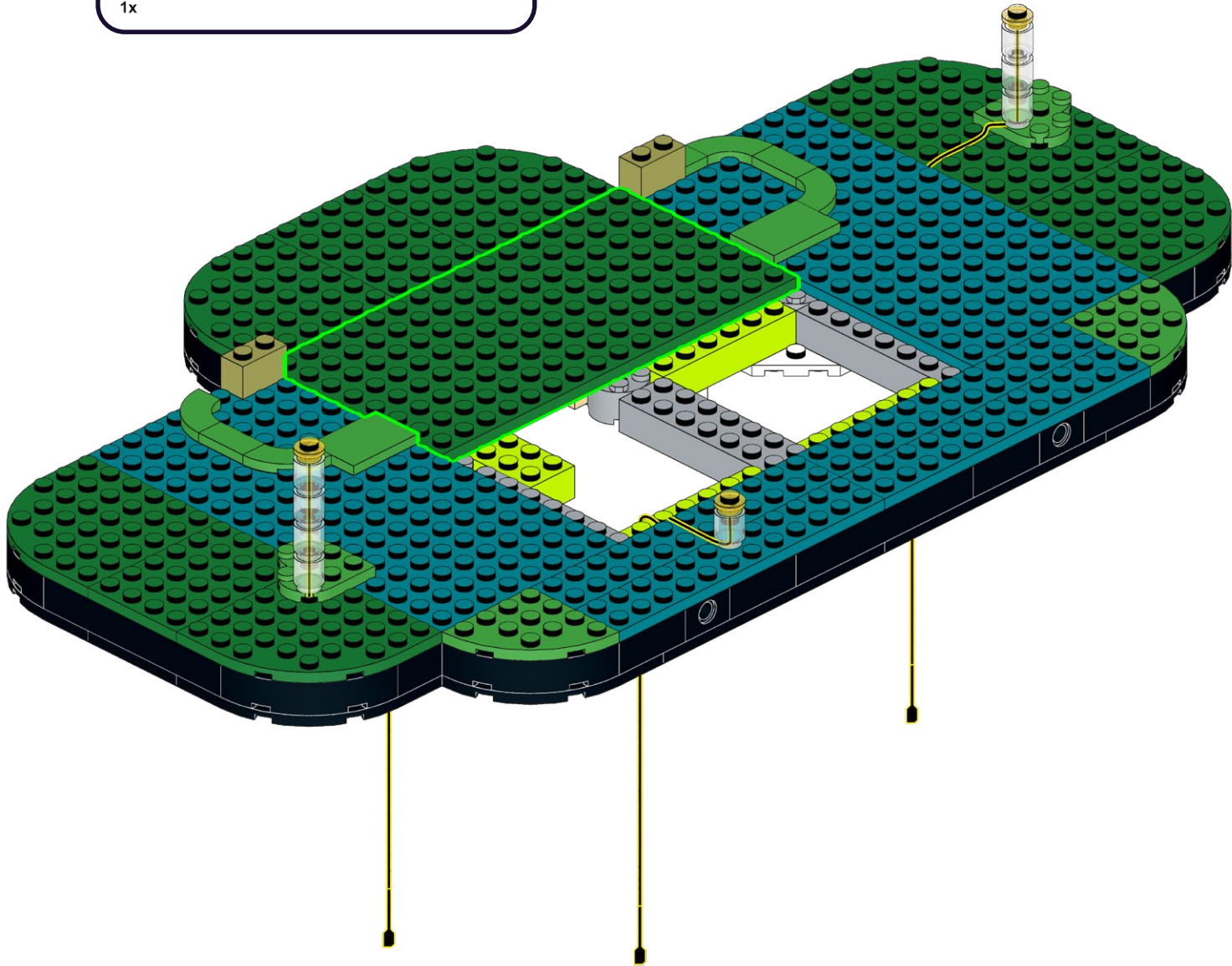
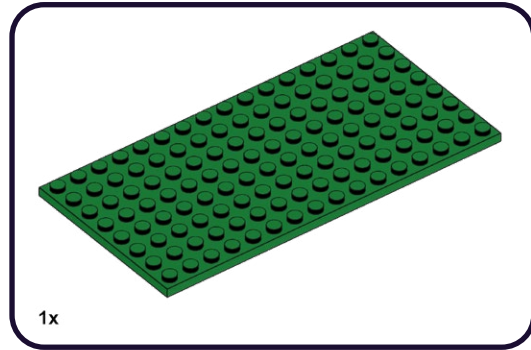

191

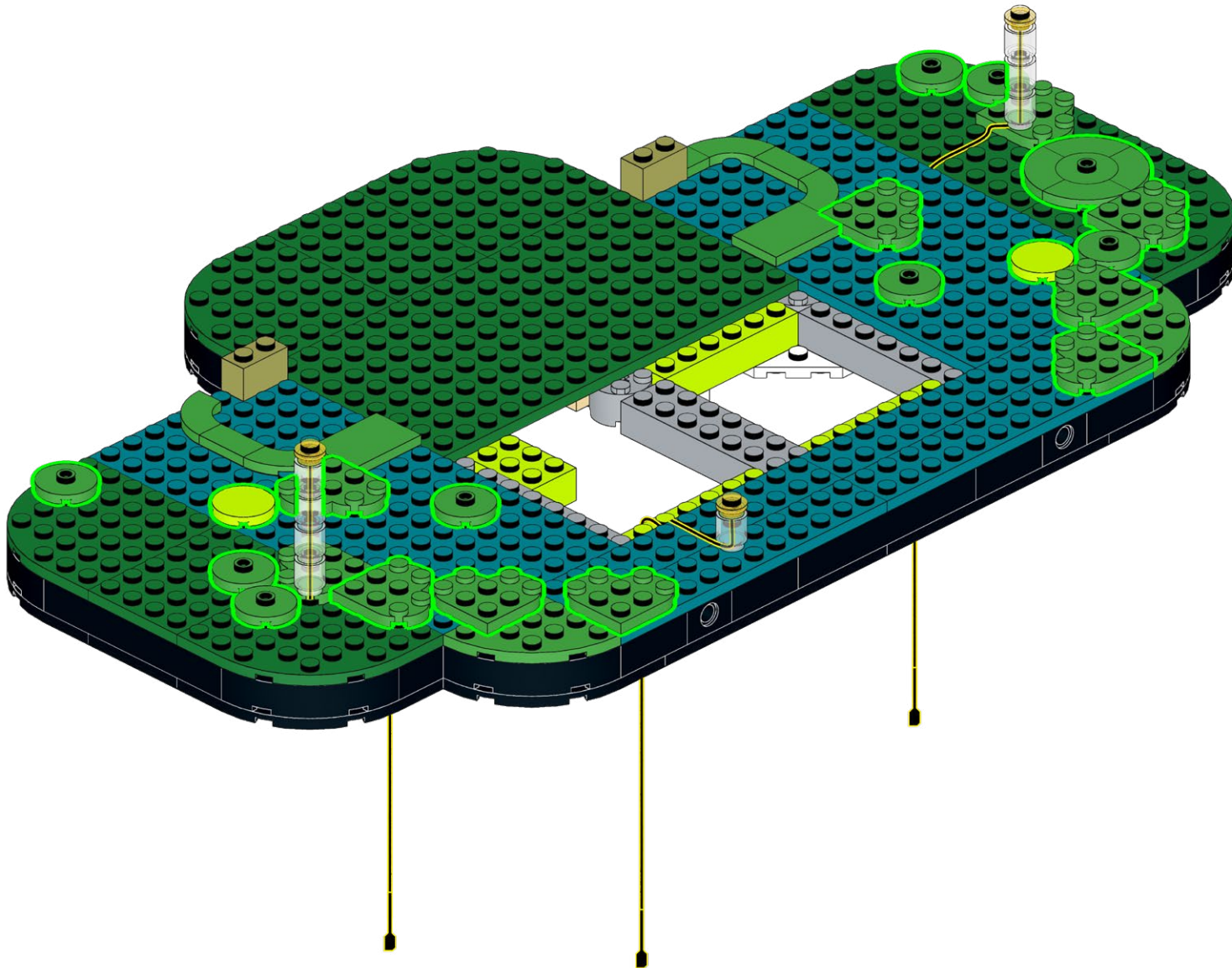
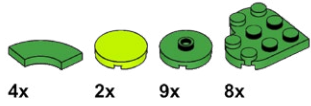

192

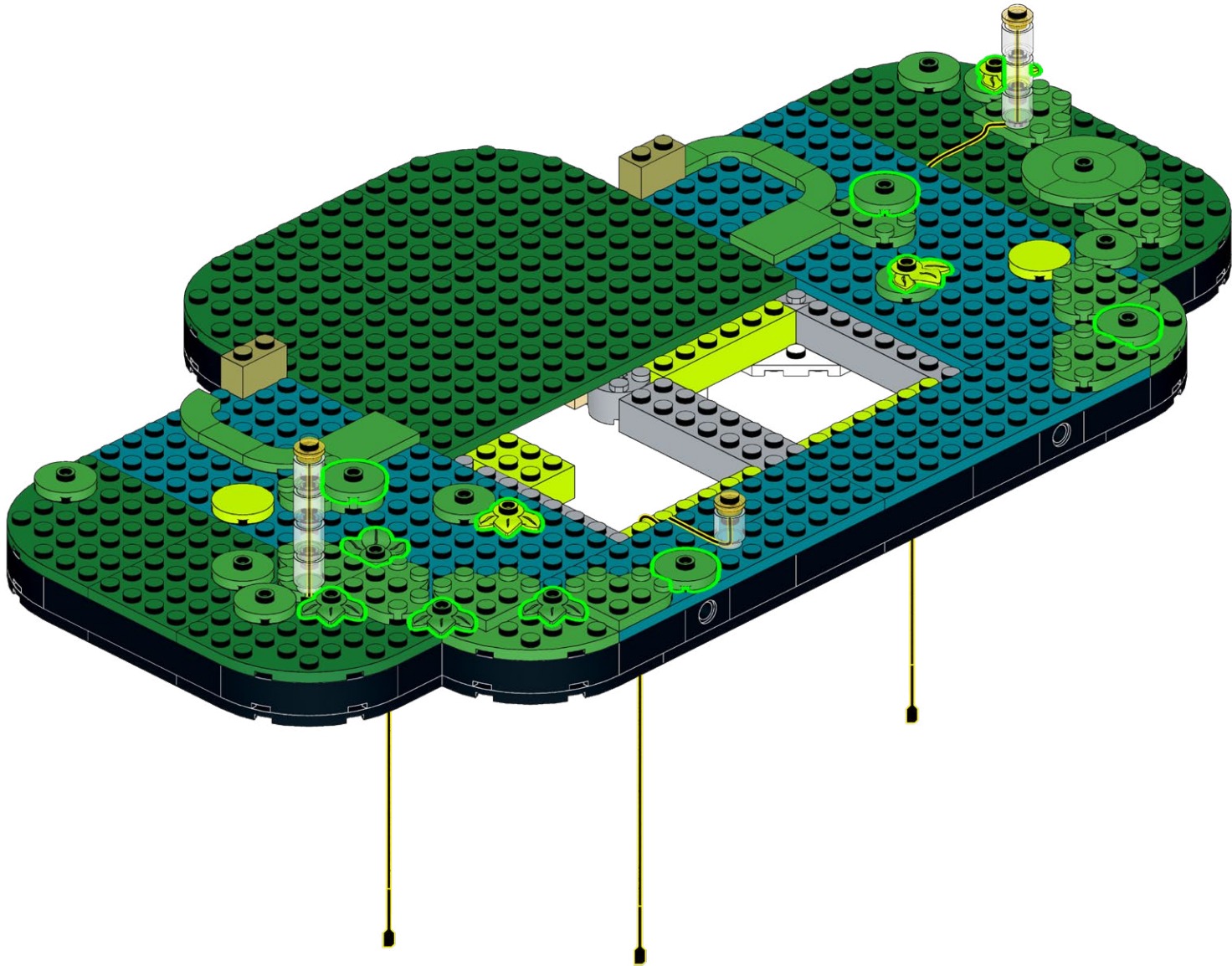

193



14x



7x

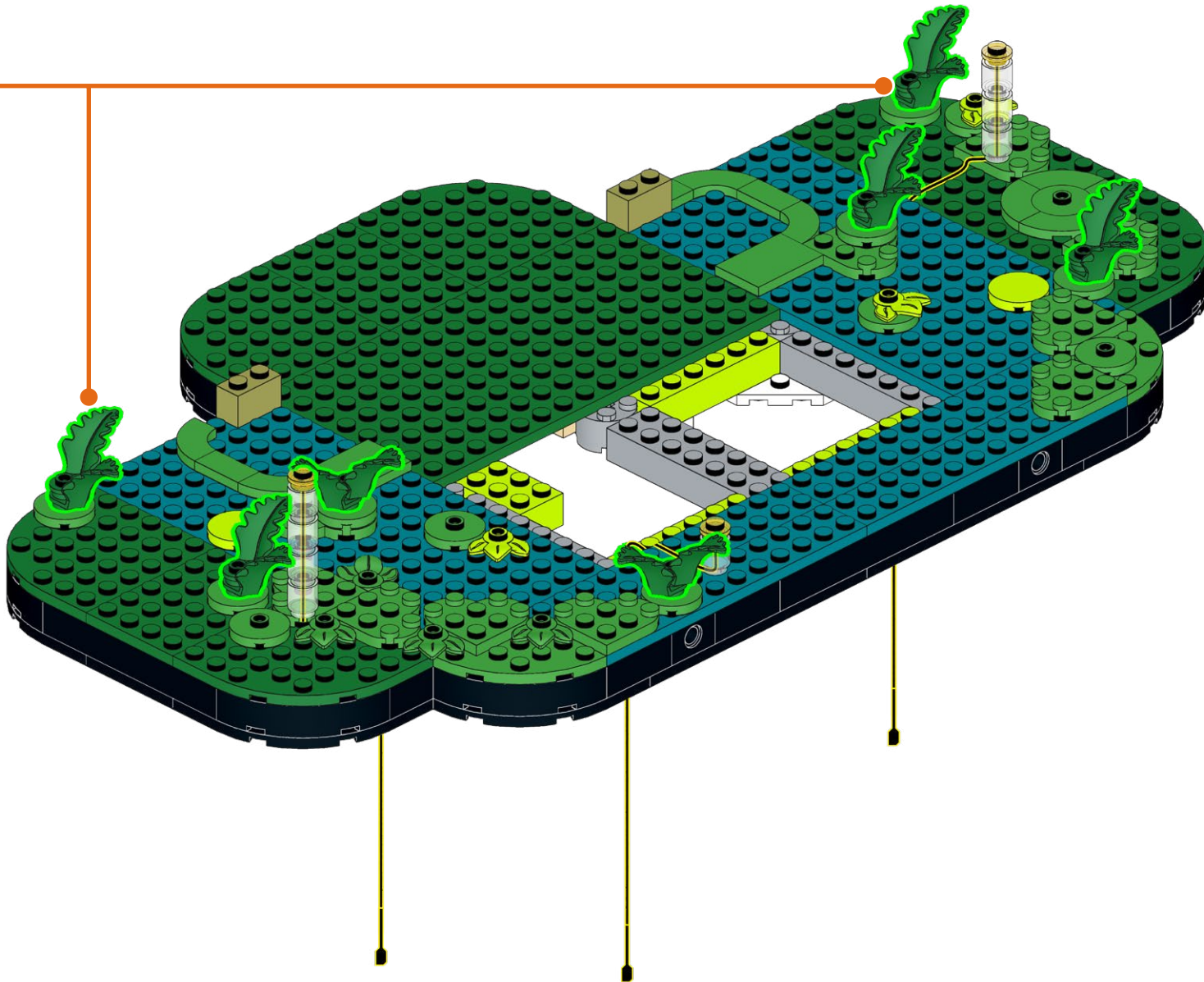

194



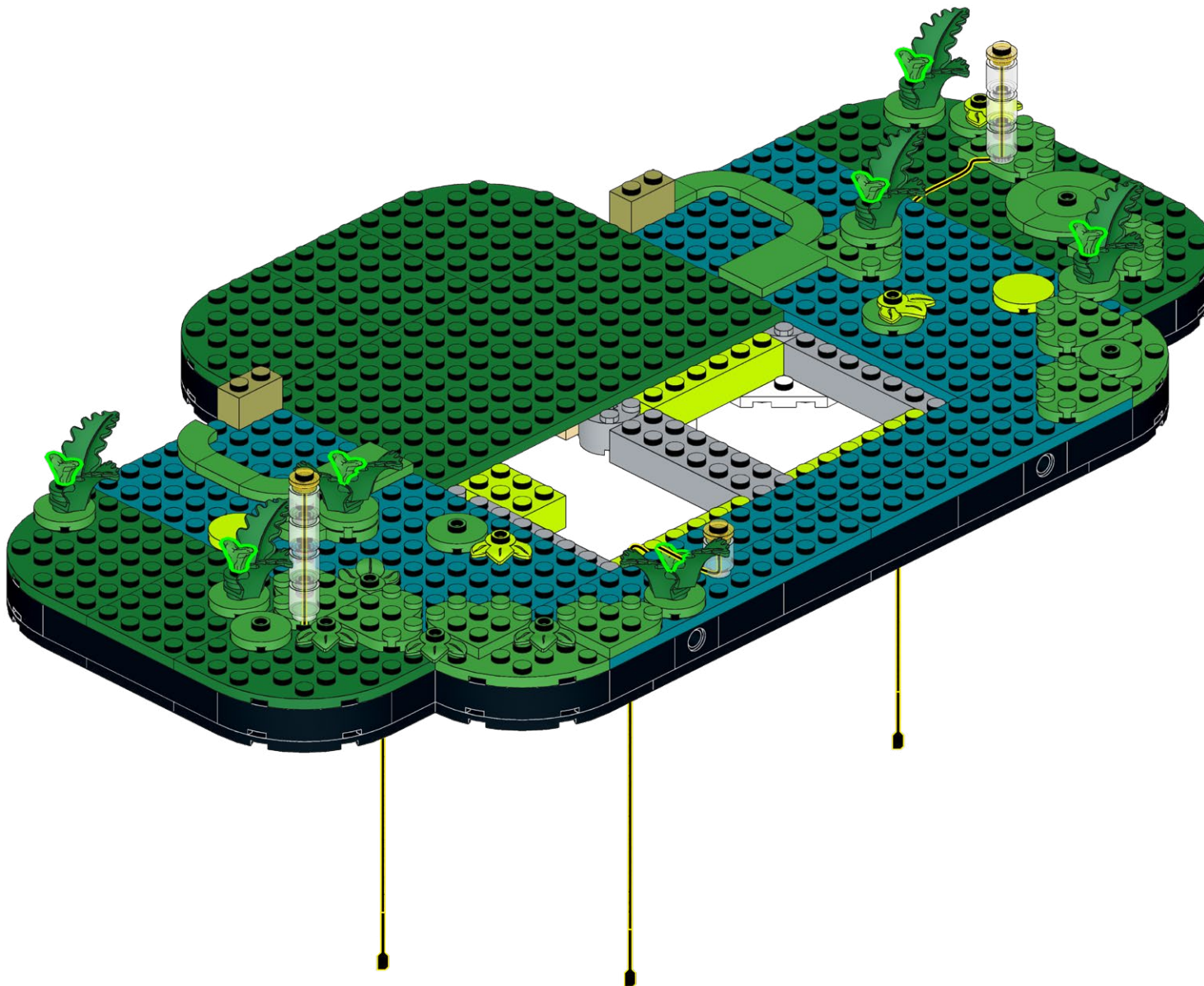

7x

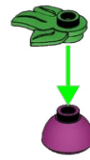
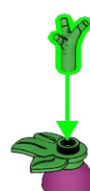

195

- 1x 
- 1x 
- 1x 
- 2x 
- 1x 
- 1x 
- 1x 
- 1x 
- 1x 

- 
- 
- 

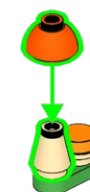
- 
- 

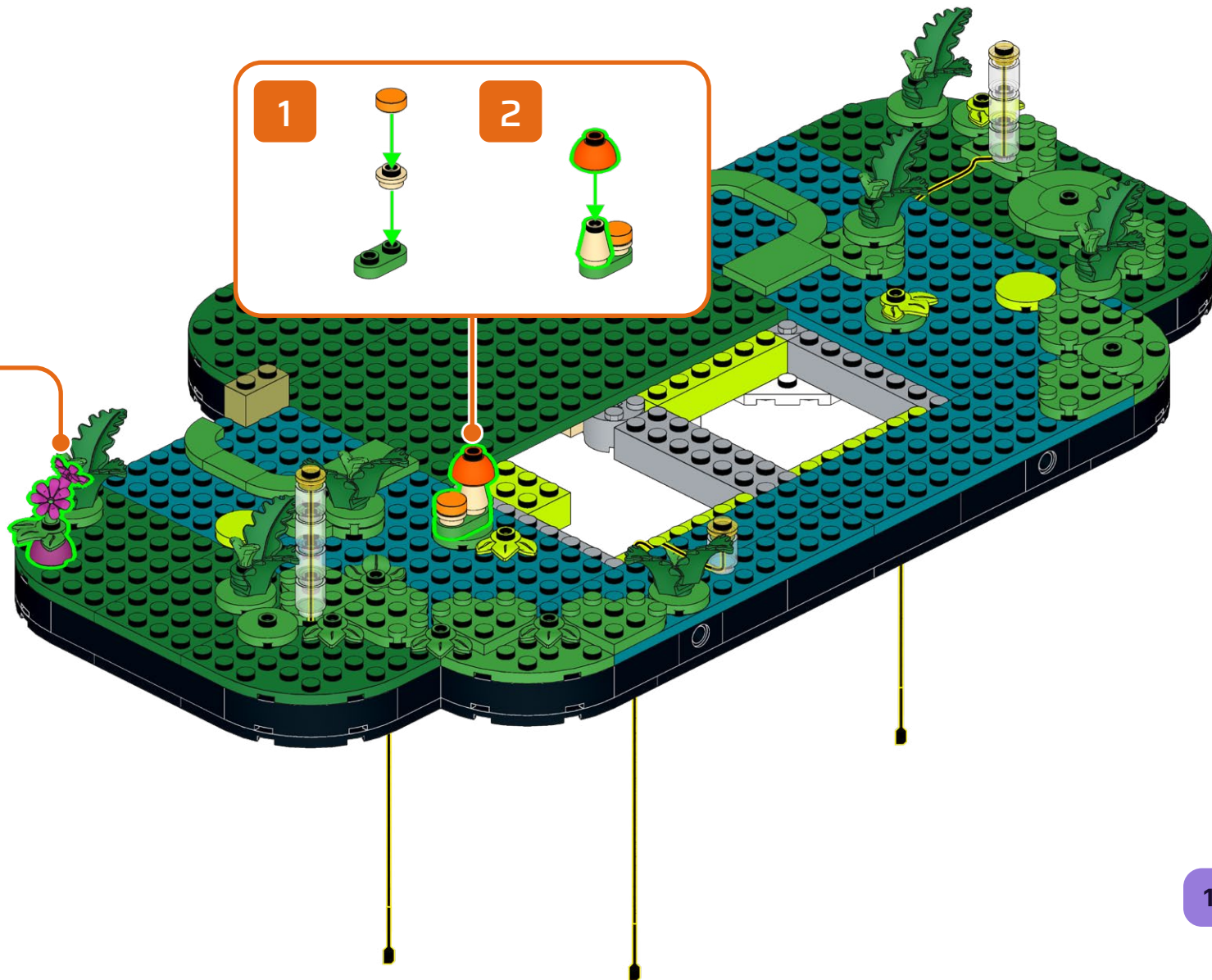

**HOLD UP!**

You might notice some bags aren't in order, as well as left over pieces, but that's ok! We're changing the way you build LEGO!

ATTENDEZ!

Vous remarquerez peut-être que certains sacs, ainsi que certaines pièces, ne sont pas dans le bon ordre. Mais pas de panique! Nous changeons simplement la façon avec laquelle vous construisez vos LEGO!

ASPETTA!

Potresti notare che alcuni sacchetti non sono in ordine, così come i pezzi avanzati, ma va bene così! Stiamo cambiando il modo in cui costruisci i LEGO!

HALT!

Sie werden möglicherweise bemerken, dass einige tüten durcheinander sind und teile übrig bleiben, aber das ist in Ordnung! Wir ändern die art und weise, wie Sie LEGO bauen!

¡ESPERA!

Es posible que notes que algunas bolsas están fuera de servicio, así como piezas sobrantes, ¡pero está bien! ¡Estamos cambiando la forma en que construyes LEGO!

暫停!

你可能会注意到一些袋子顺序错乱, 以及一些剩余的部件, 但没关系! 我们正在改变你搭建乐高的方式!

Open LEGO® Bag 22

197

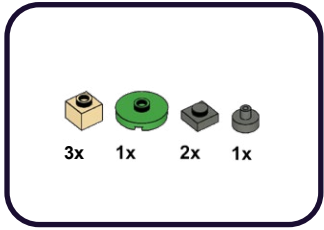

1

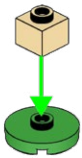

2

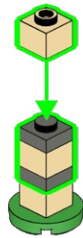

3

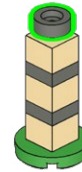

199

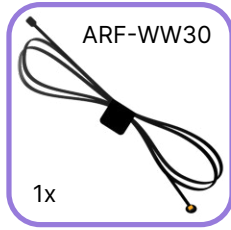
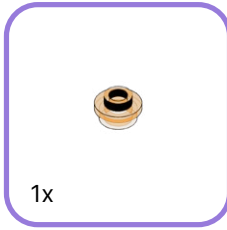
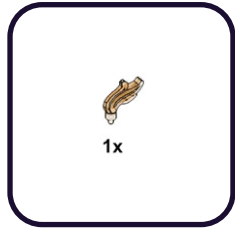

1



2



3



4

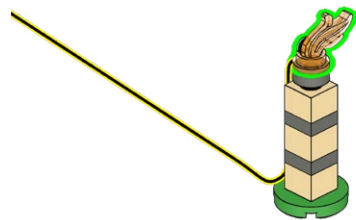

200

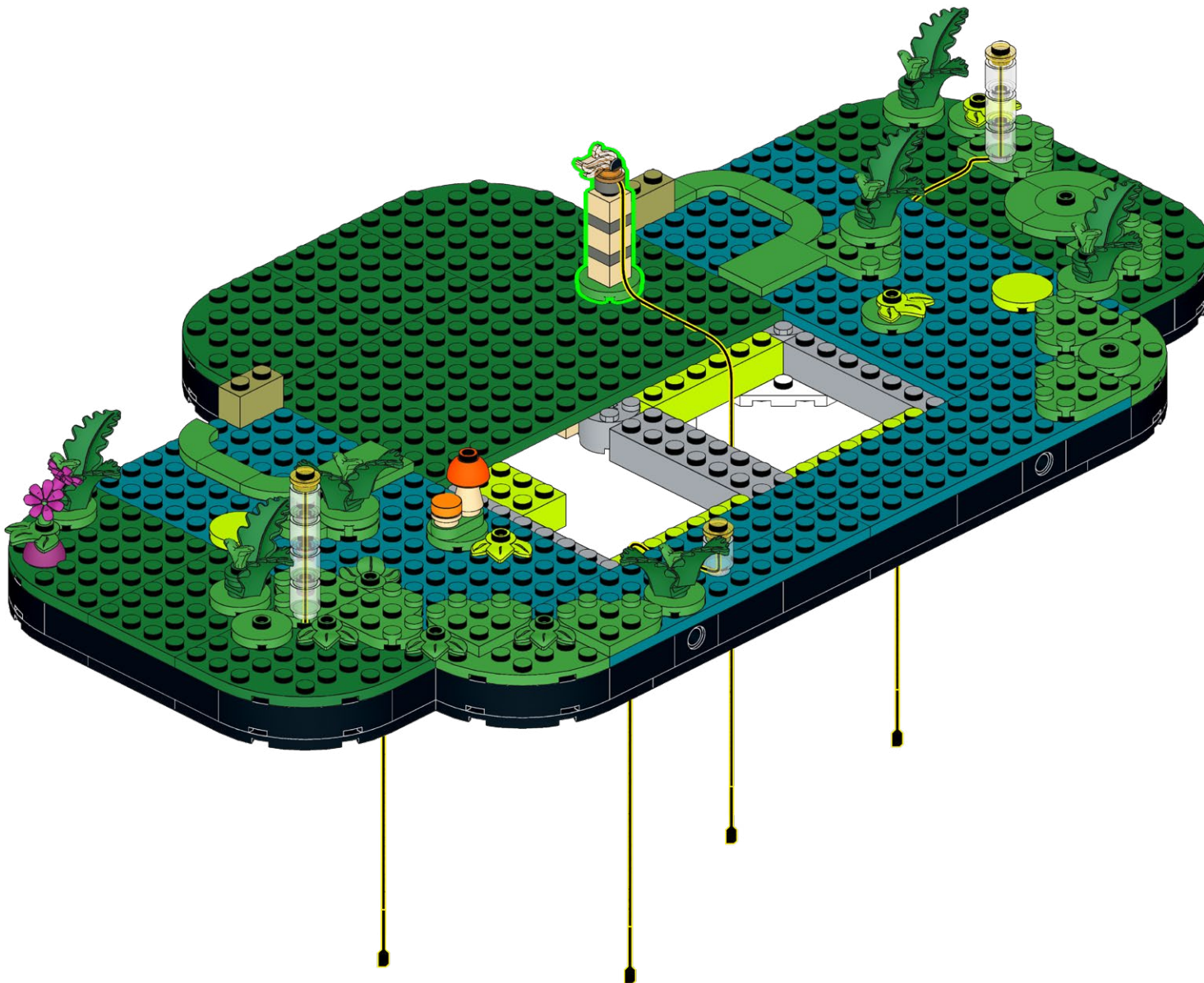

201

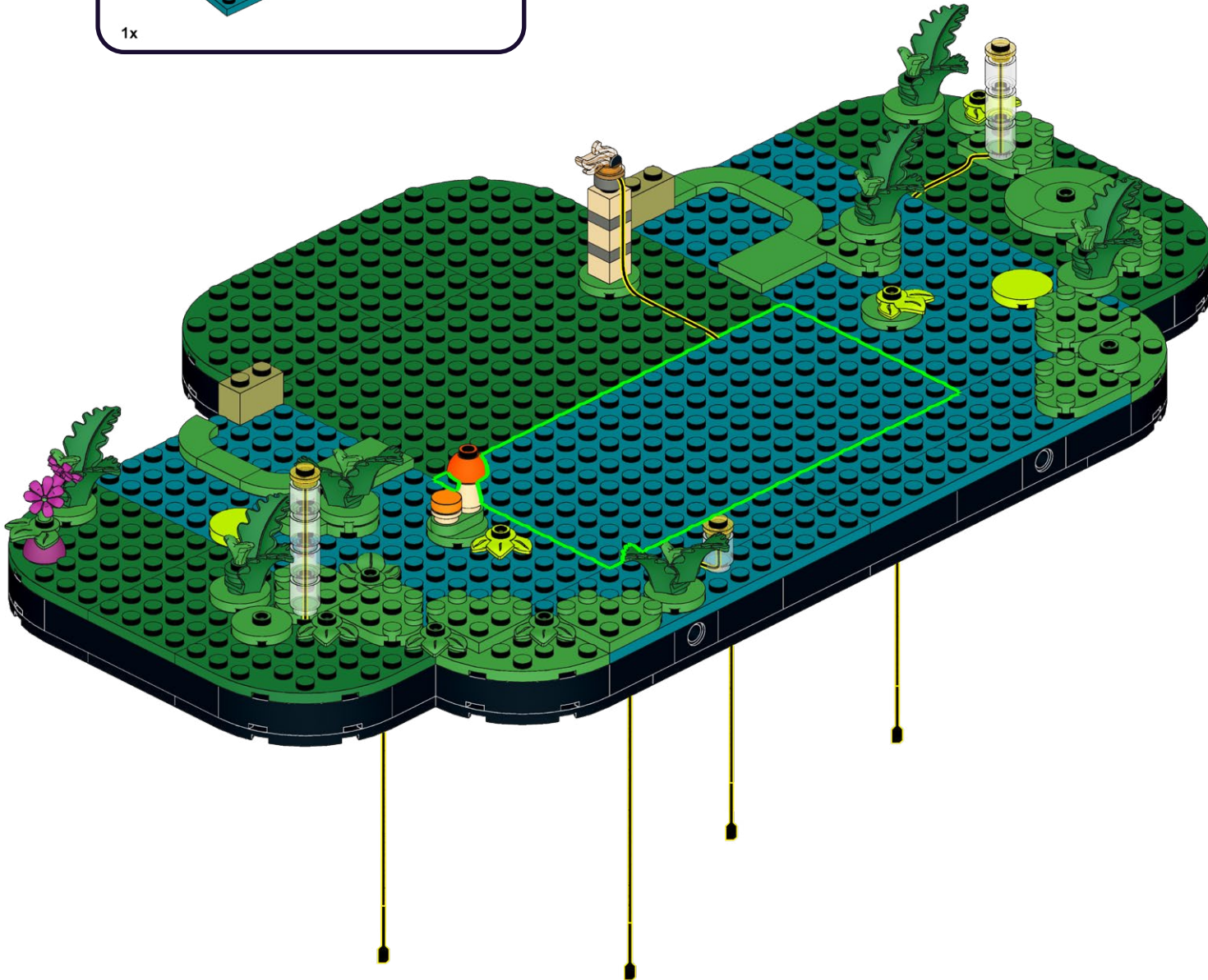
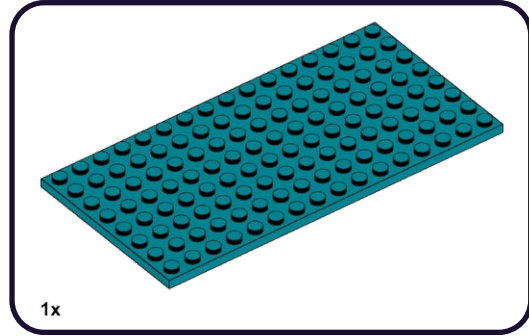

202

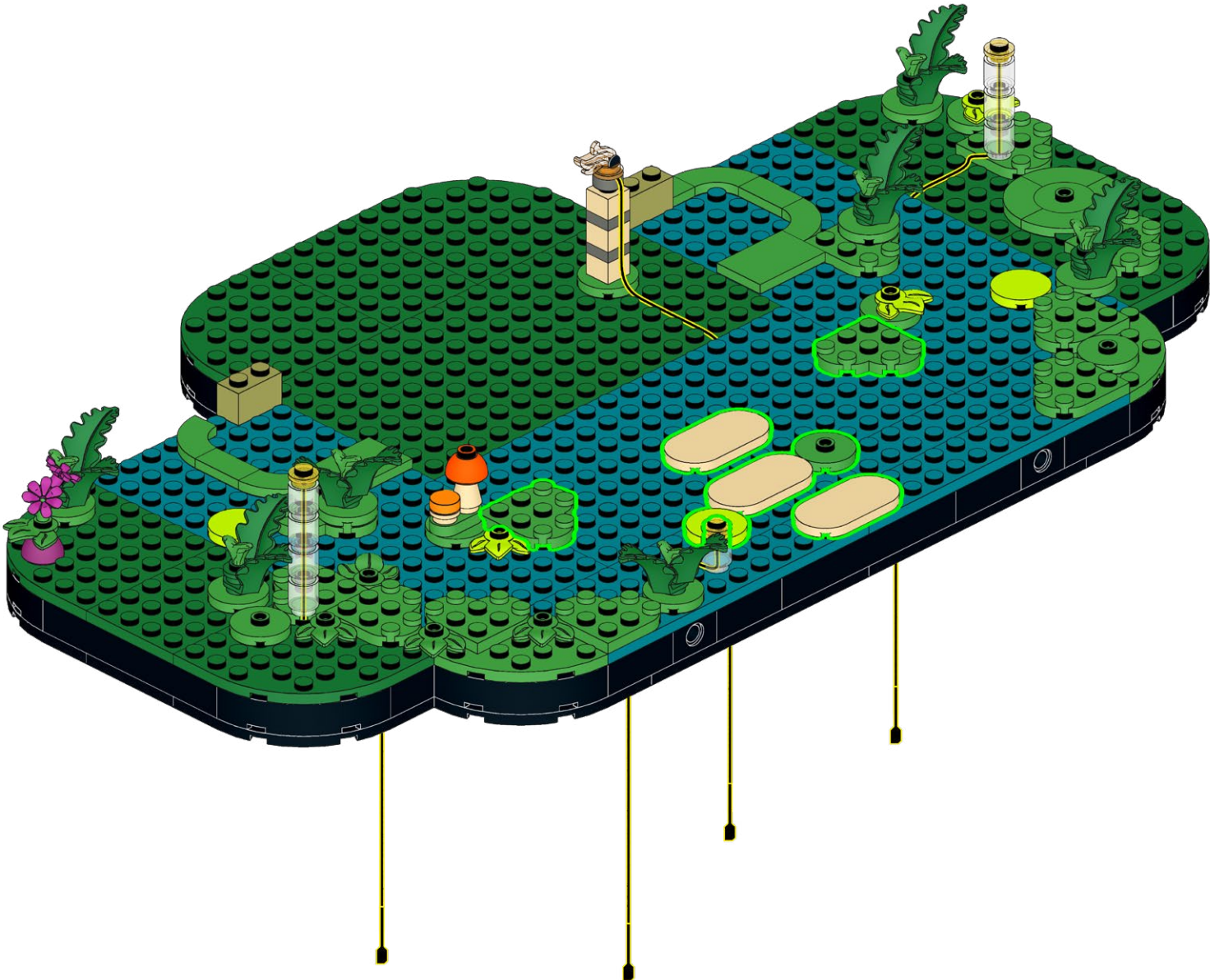
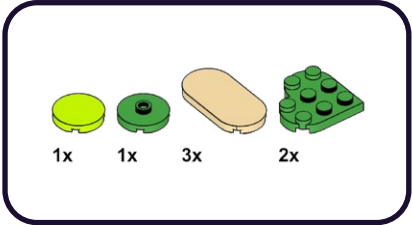

203

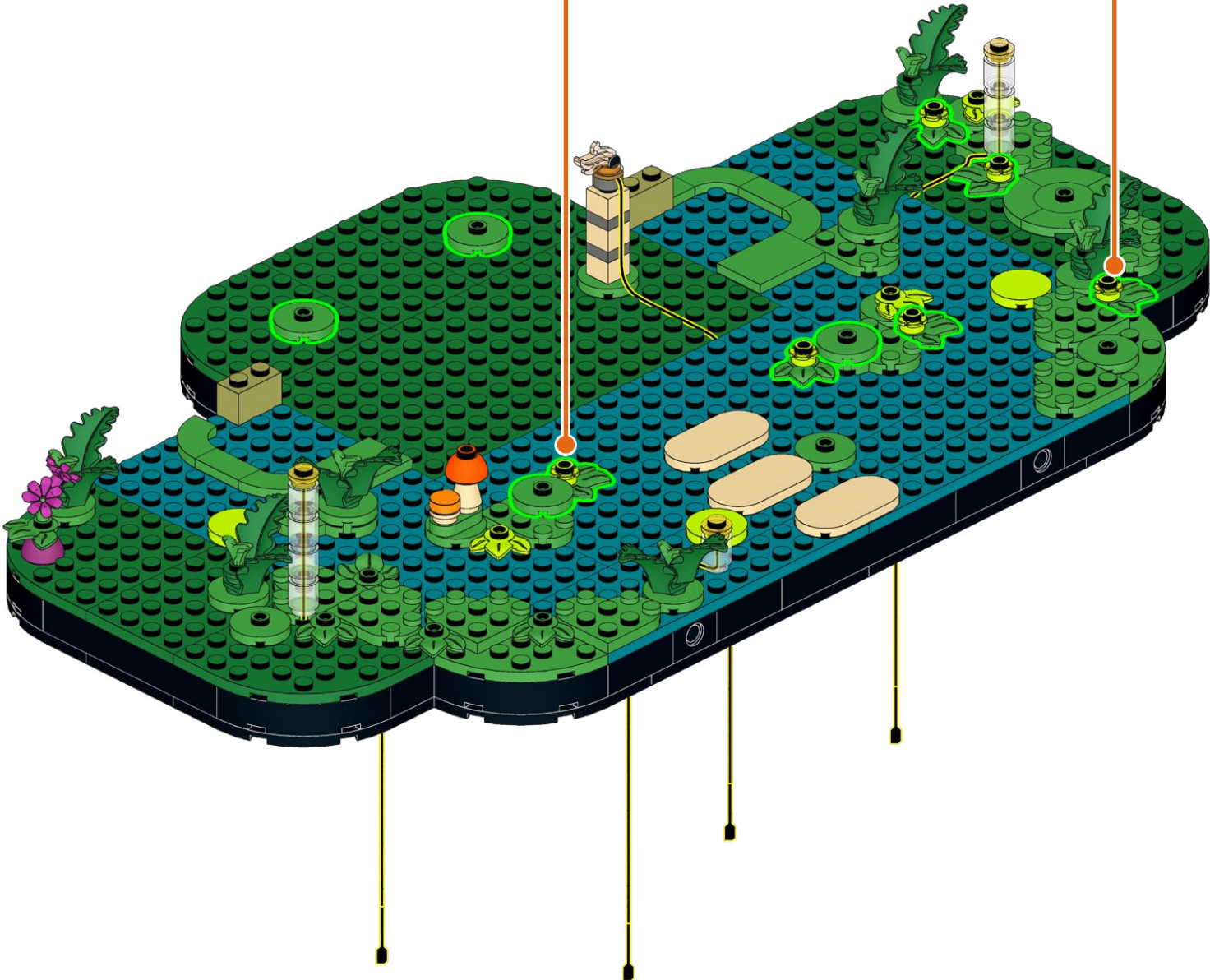
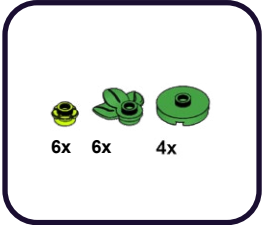

204

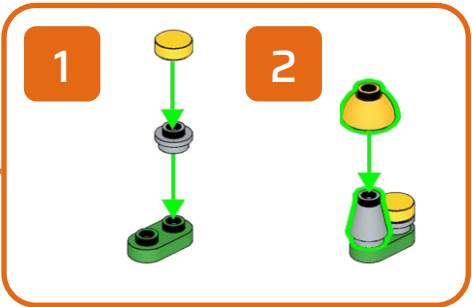
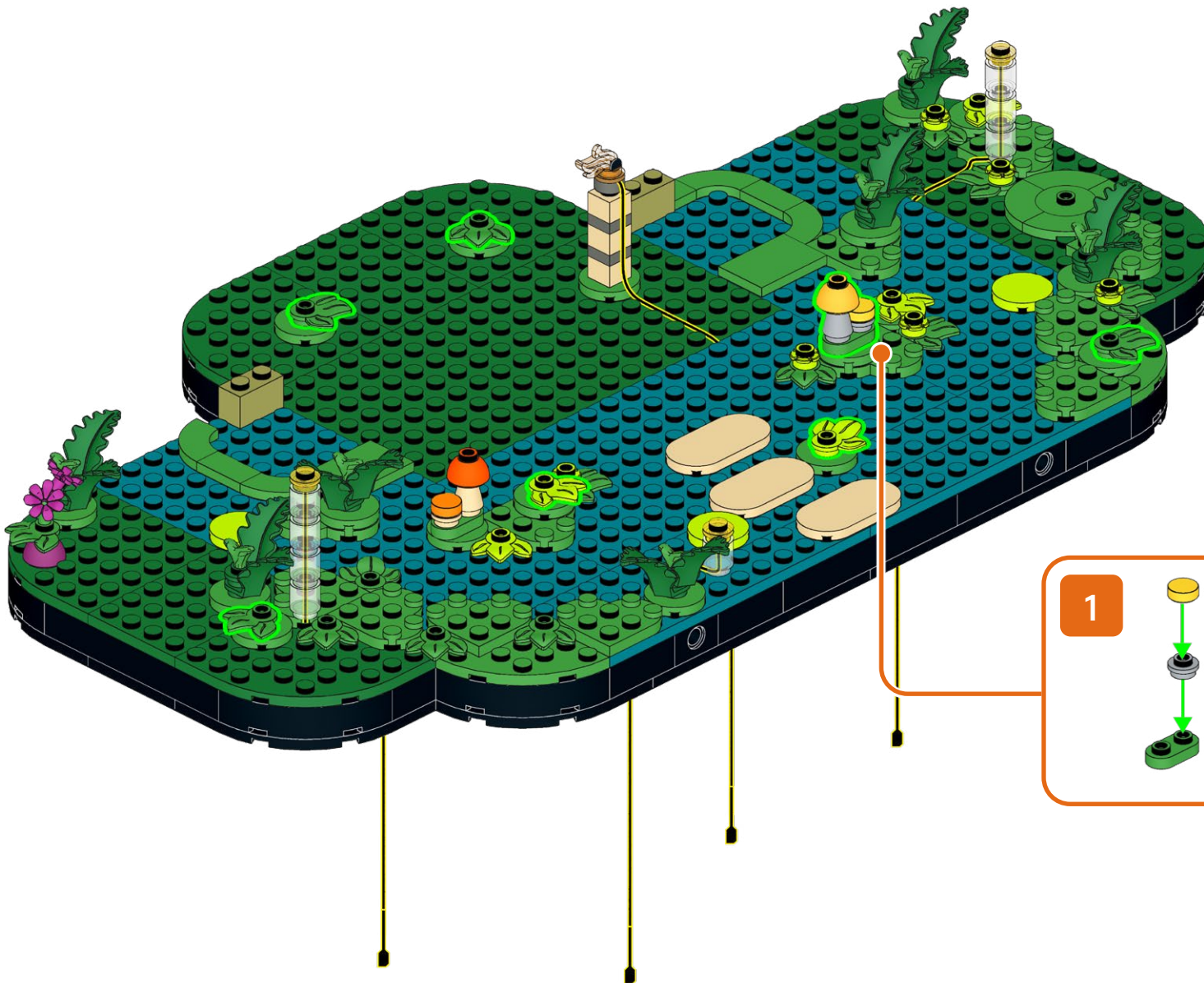

205

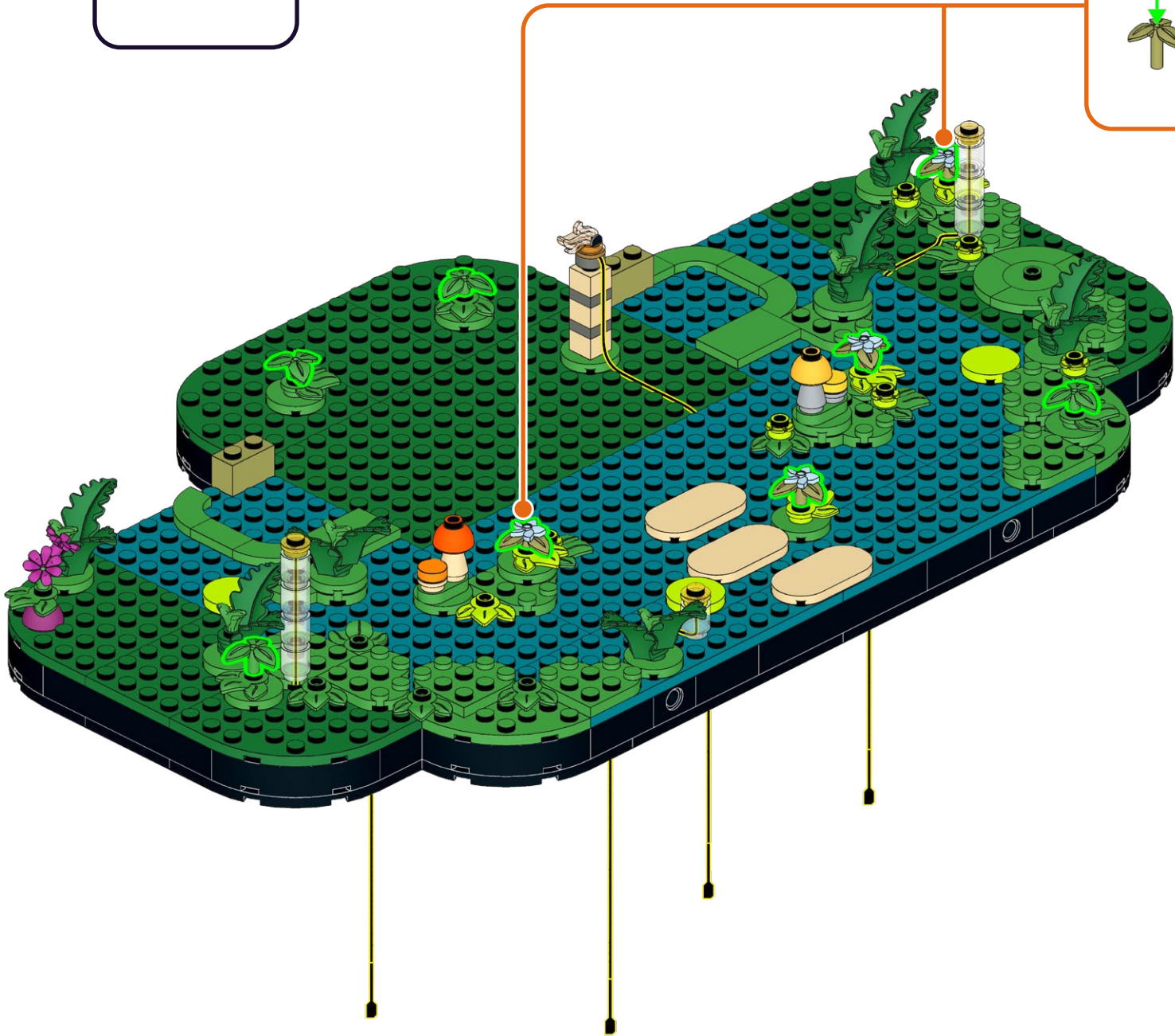
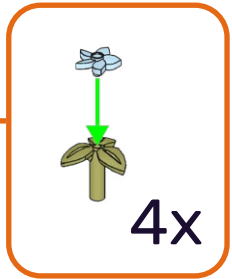
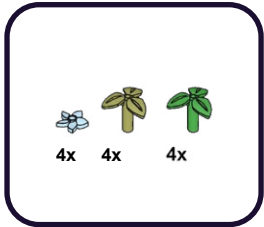

206

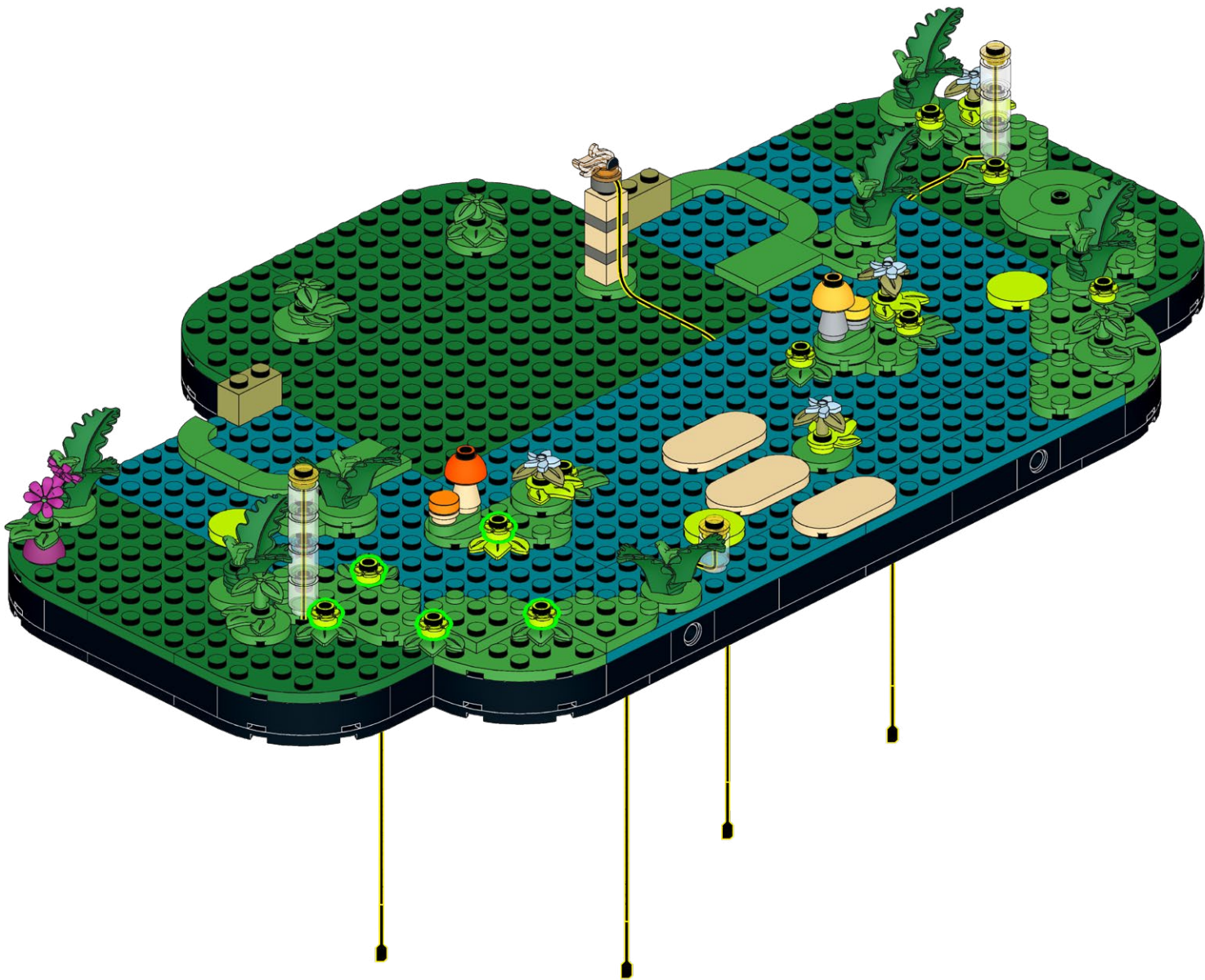

207

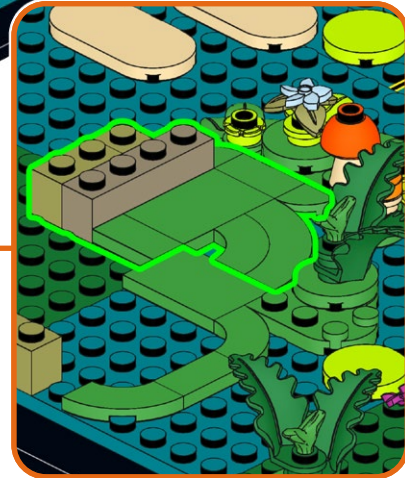
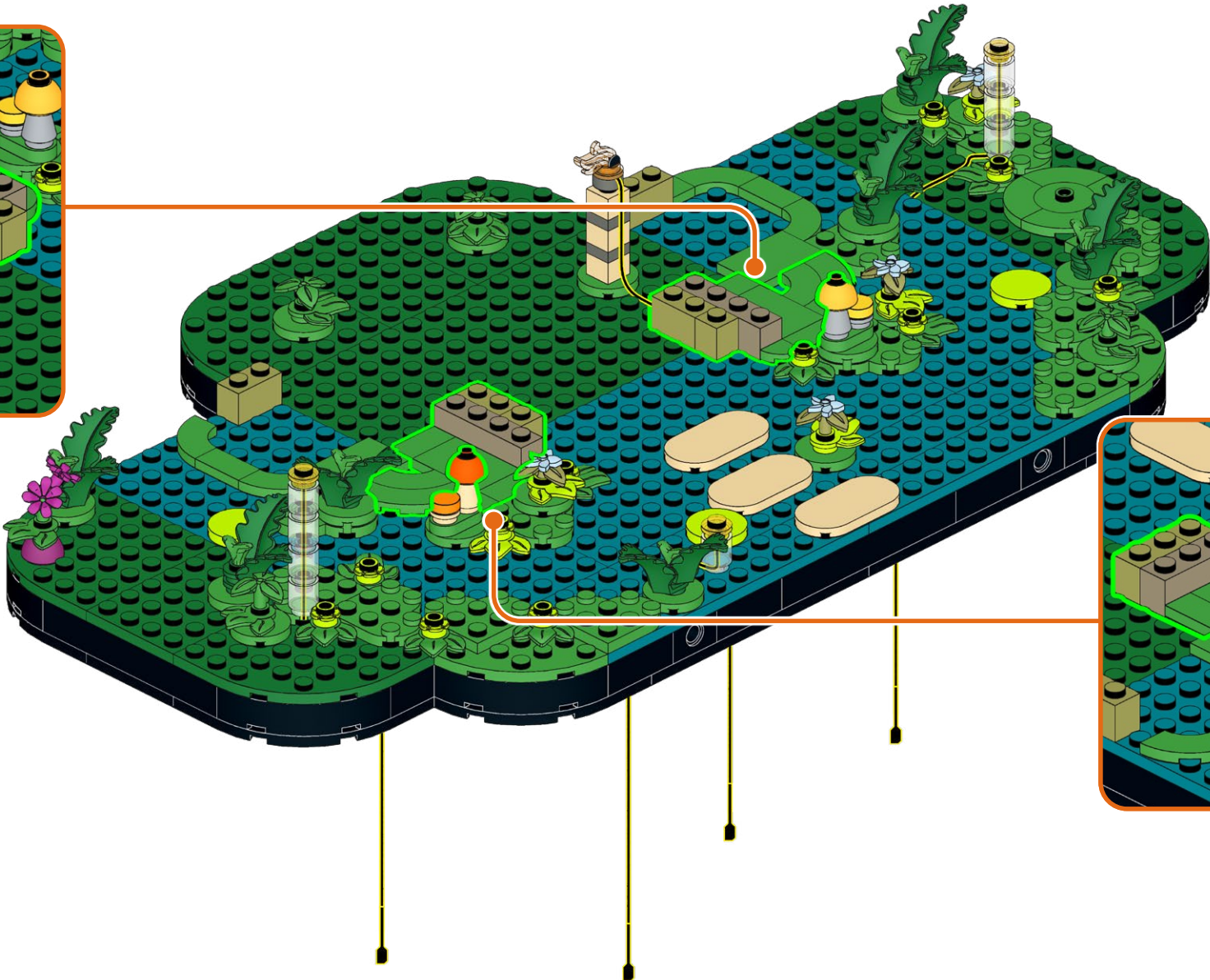
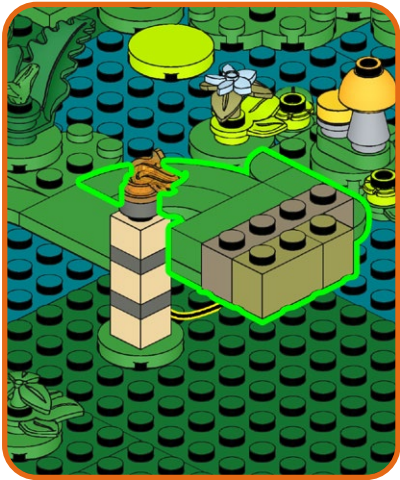
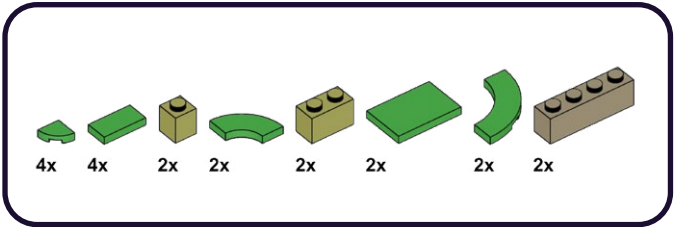

208

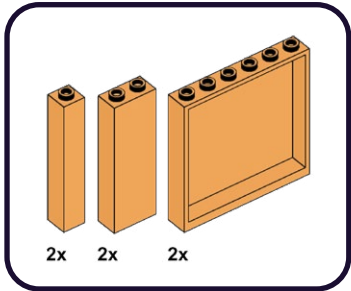

209

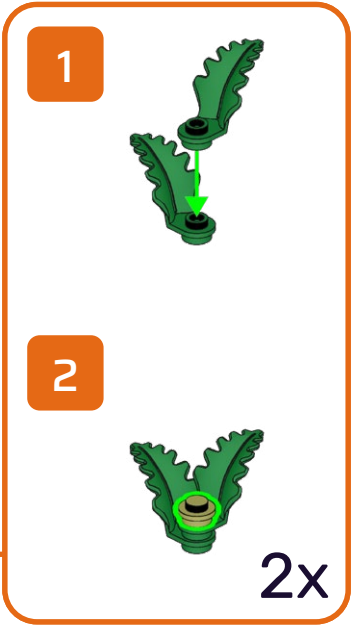
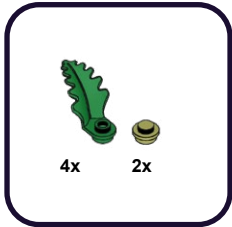

210

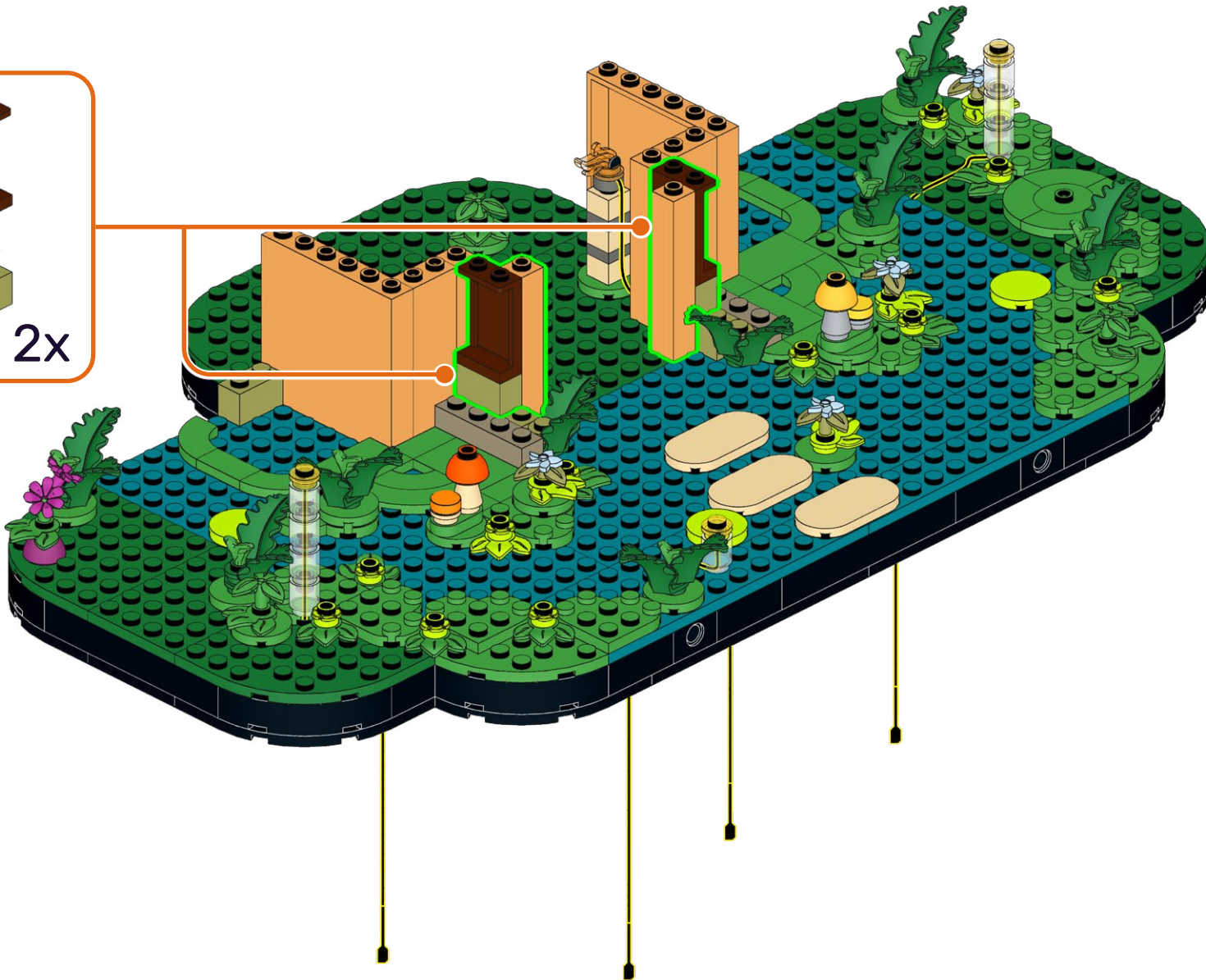
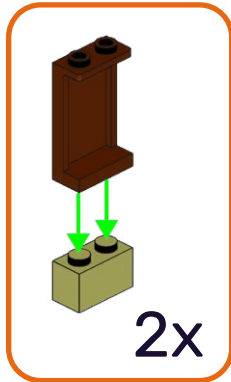
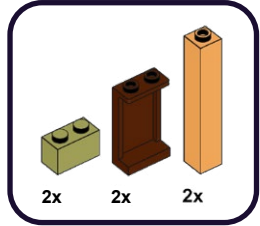

211

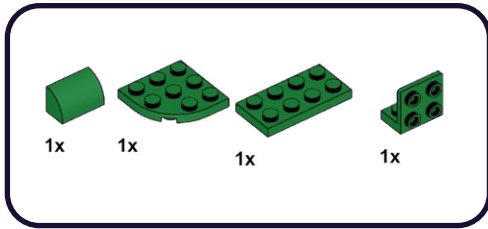

1

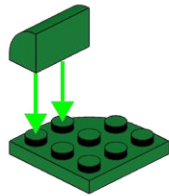

2

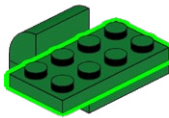

2

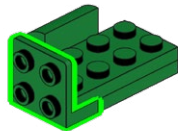

212

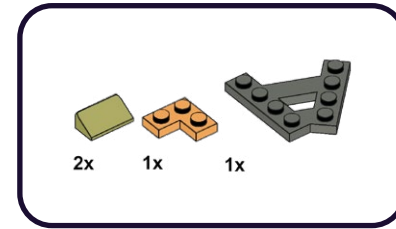

1

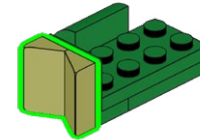

2

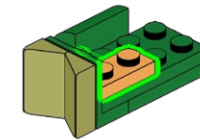

2

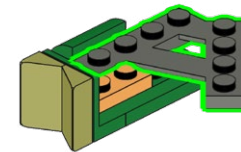

213



214

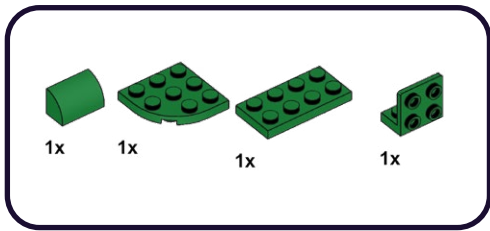

1

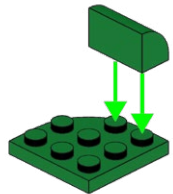

2

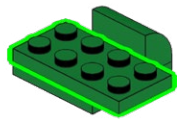

2

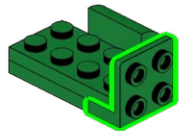

215

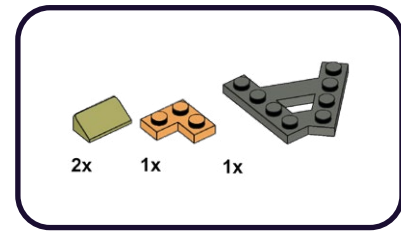

1

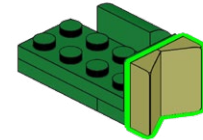

2

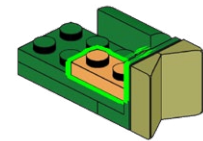

2

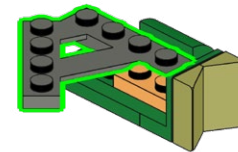

216



217

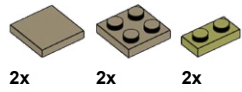

1

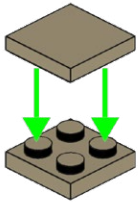

2

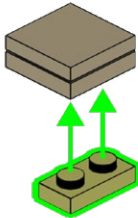

2x

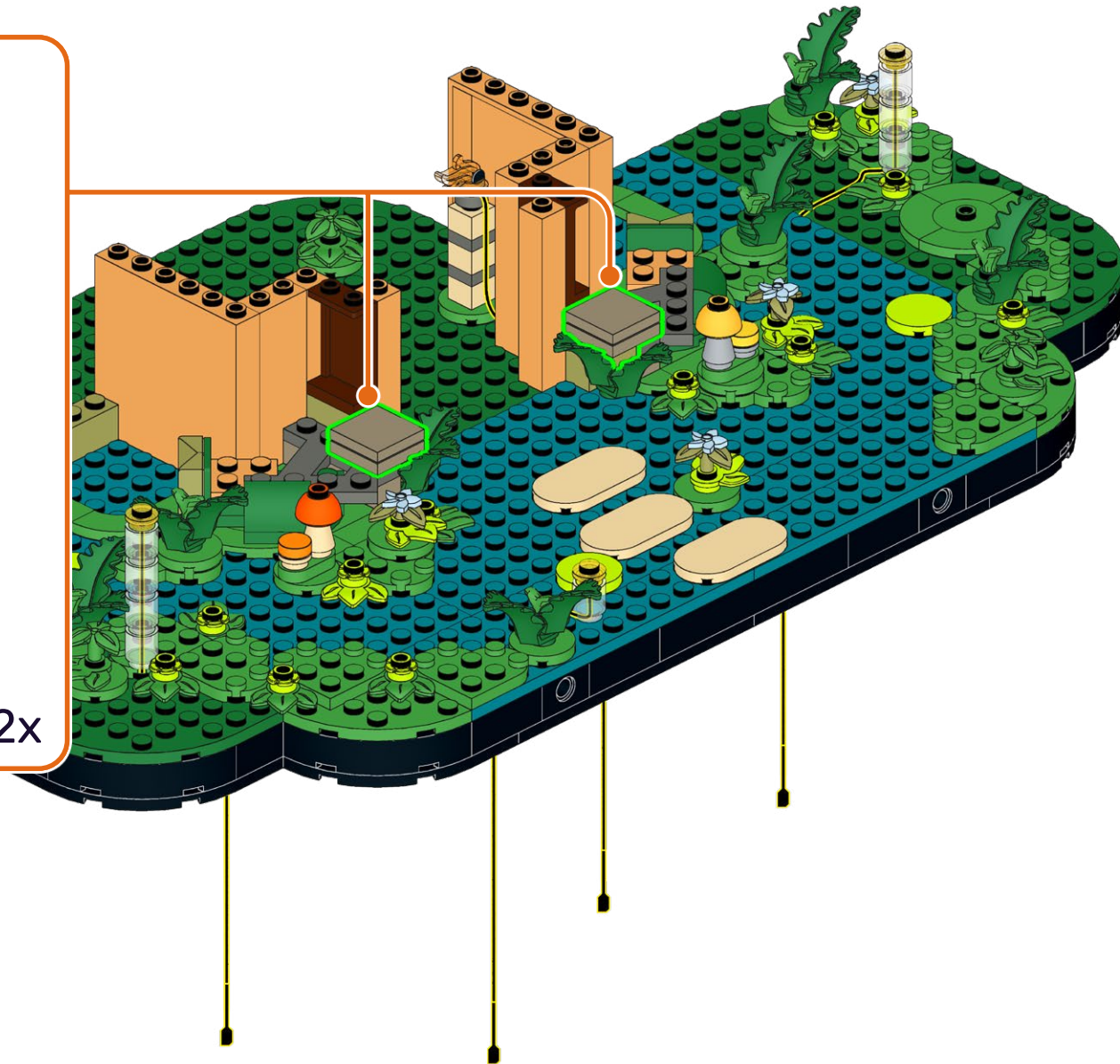

218

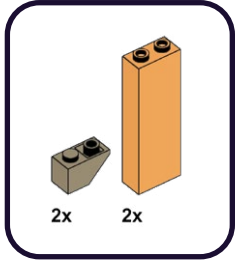

219

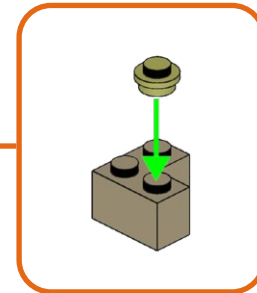
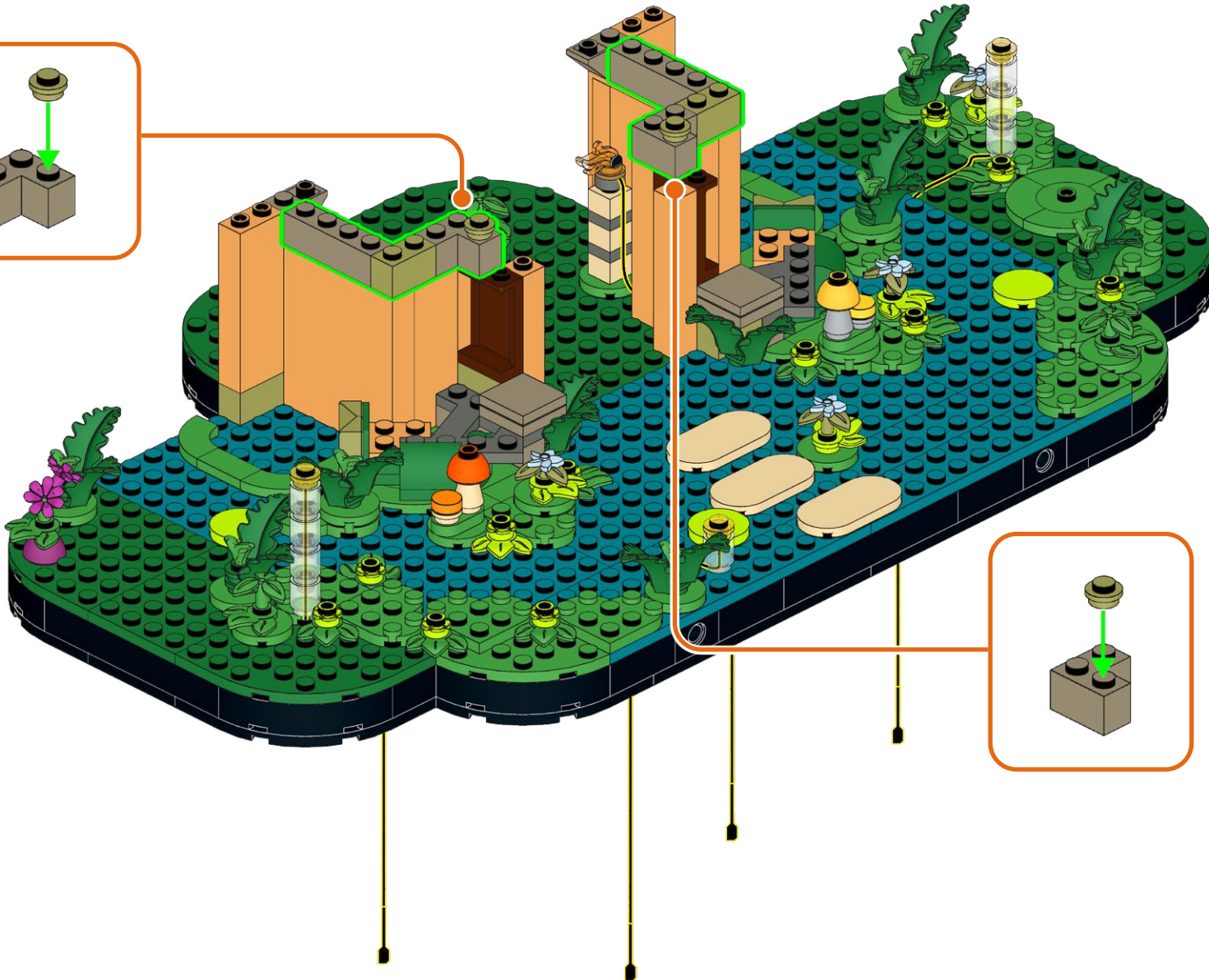
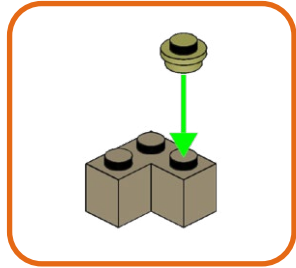
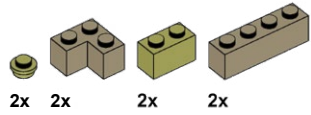

220

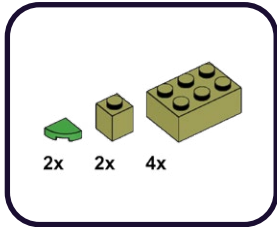

221

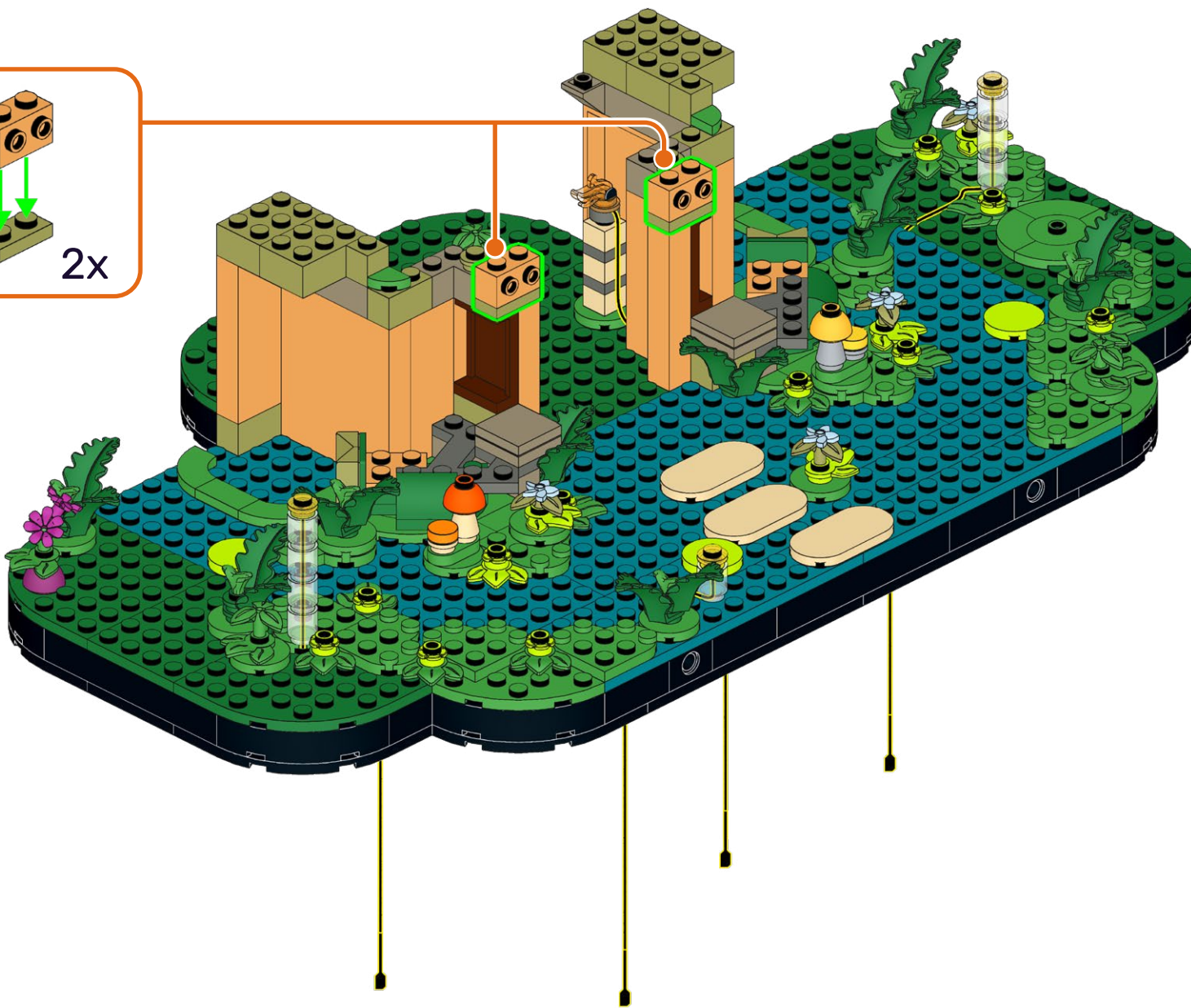
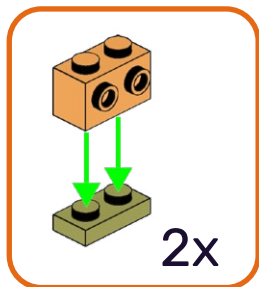
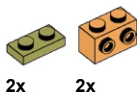

222

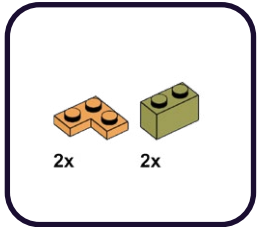

223

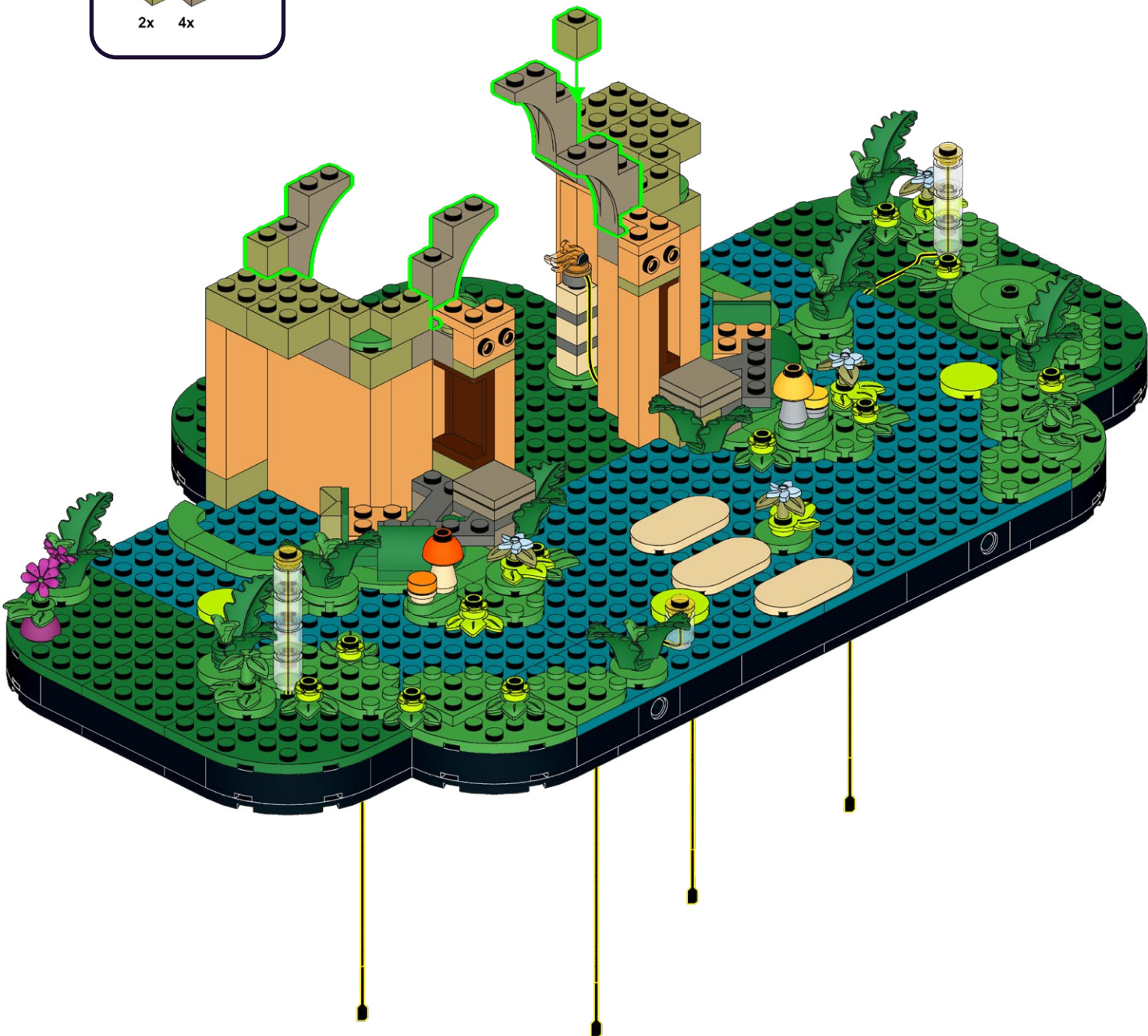
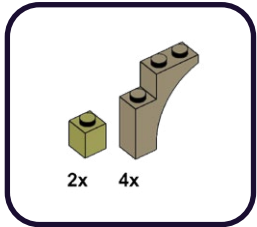

224

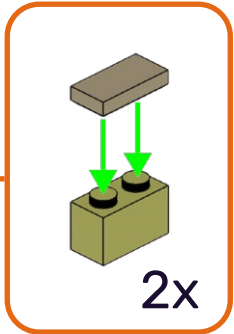
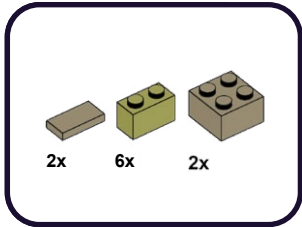

225

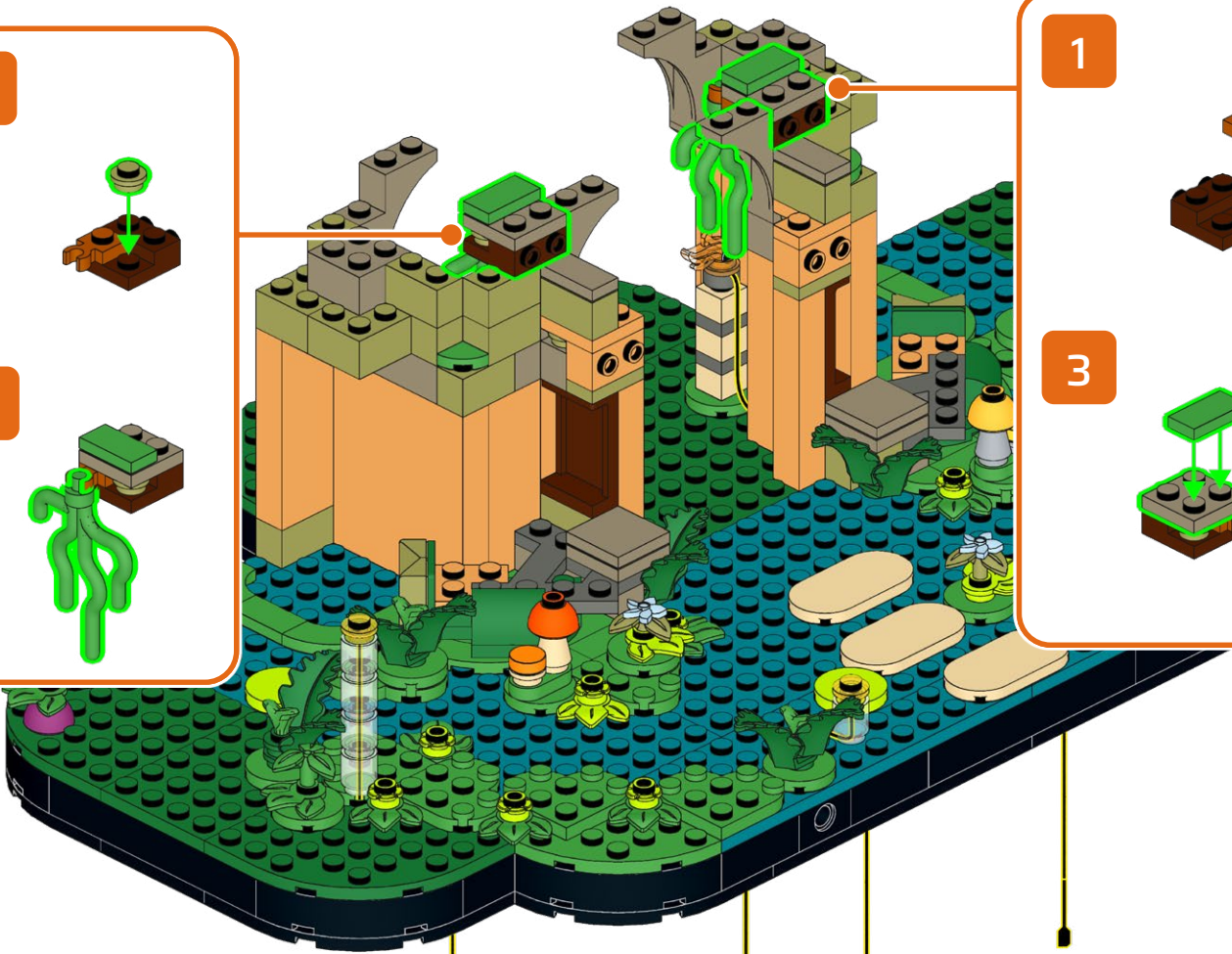
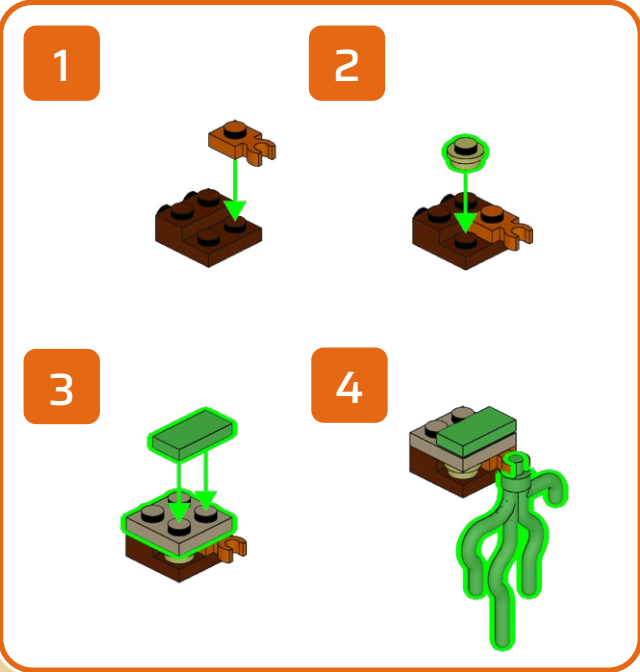
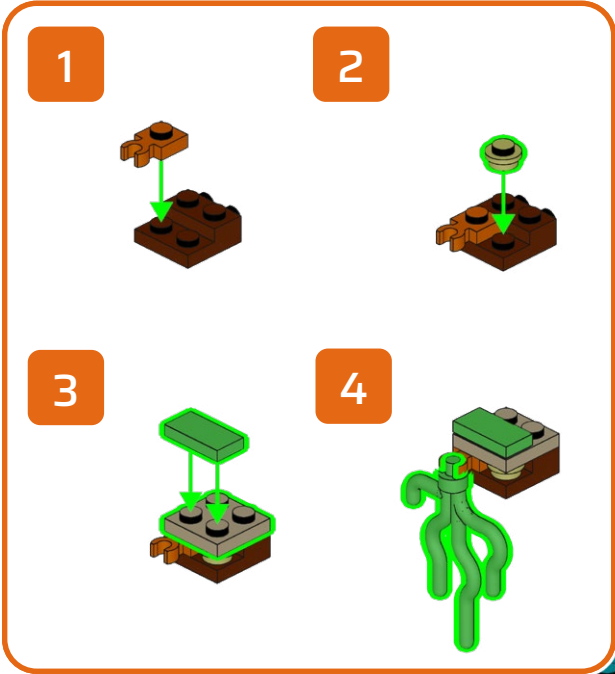
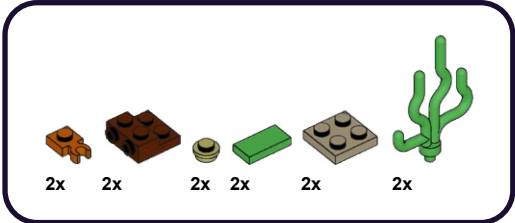

226

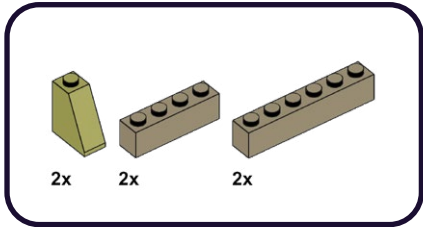

227





HOLD UP!

You might notice some bags aren't in order, as well as left over pieces, but that's ok! We're changing the way you build LEGO!

ATTENDEZ!

Vous remarquerez peut-être que certains sacs, ainsi que certaines pièces, ne sont pas dans le bon ordre. Mais pas de panique! Nous changeons simplement la façon avec laquelle vous construisez vos LEGO!

ASPETTA!

Potresti notare che alcuni sacchetti non sono in ordine, così come i pezzi avanzati, ma va bene così! Stiamo cambiando il modo in cui costruisci i LEGO!

HALT!

Sie werden möglicherweise bemerken, dass einige tüten durcheinander sind und teile übrig bleiben, aber das ist in Ordnung! Wir ändern die art und weise, wie Sie LEGO bauen!

¡ESPERA!

Es posible que notes que algunas bolsas están fuera de servicio, así como piezas sobrantes, ¡pero está bien! ¡Estamos cambiando la forma en que construyes LEGO!

暫停!

你可能会注意到一些袋子顺序错乱, 以及一些剩余的部件, 但没关系! 我们正在改变你搭建乐高的方式!

Open LMB Bag 03

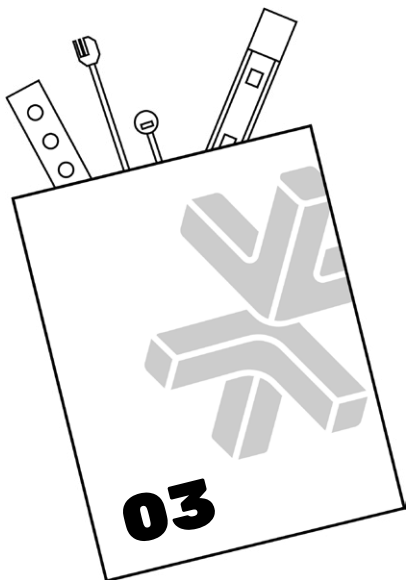

228

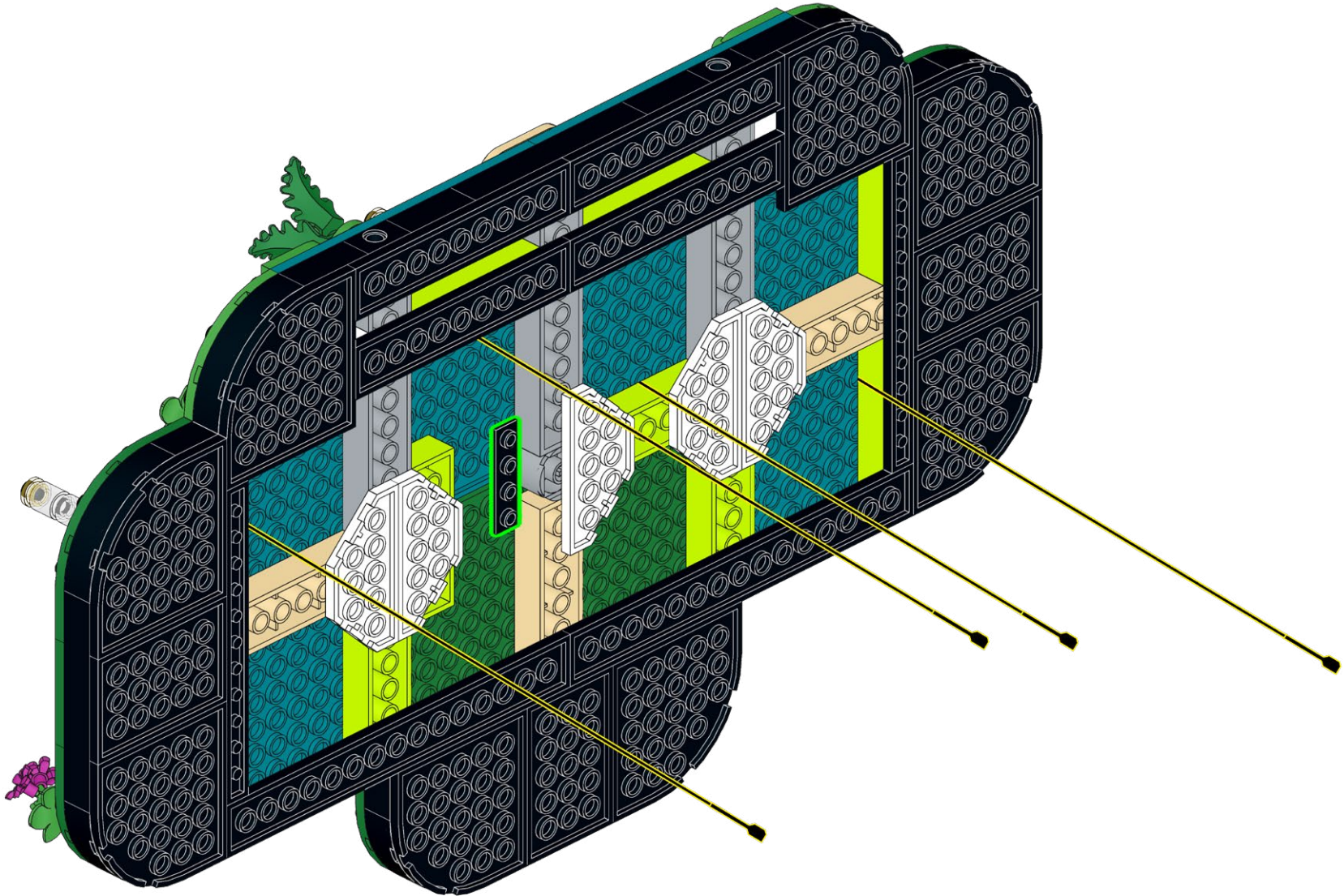
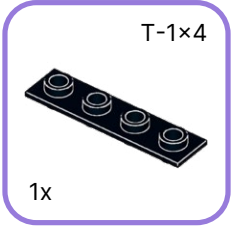

229

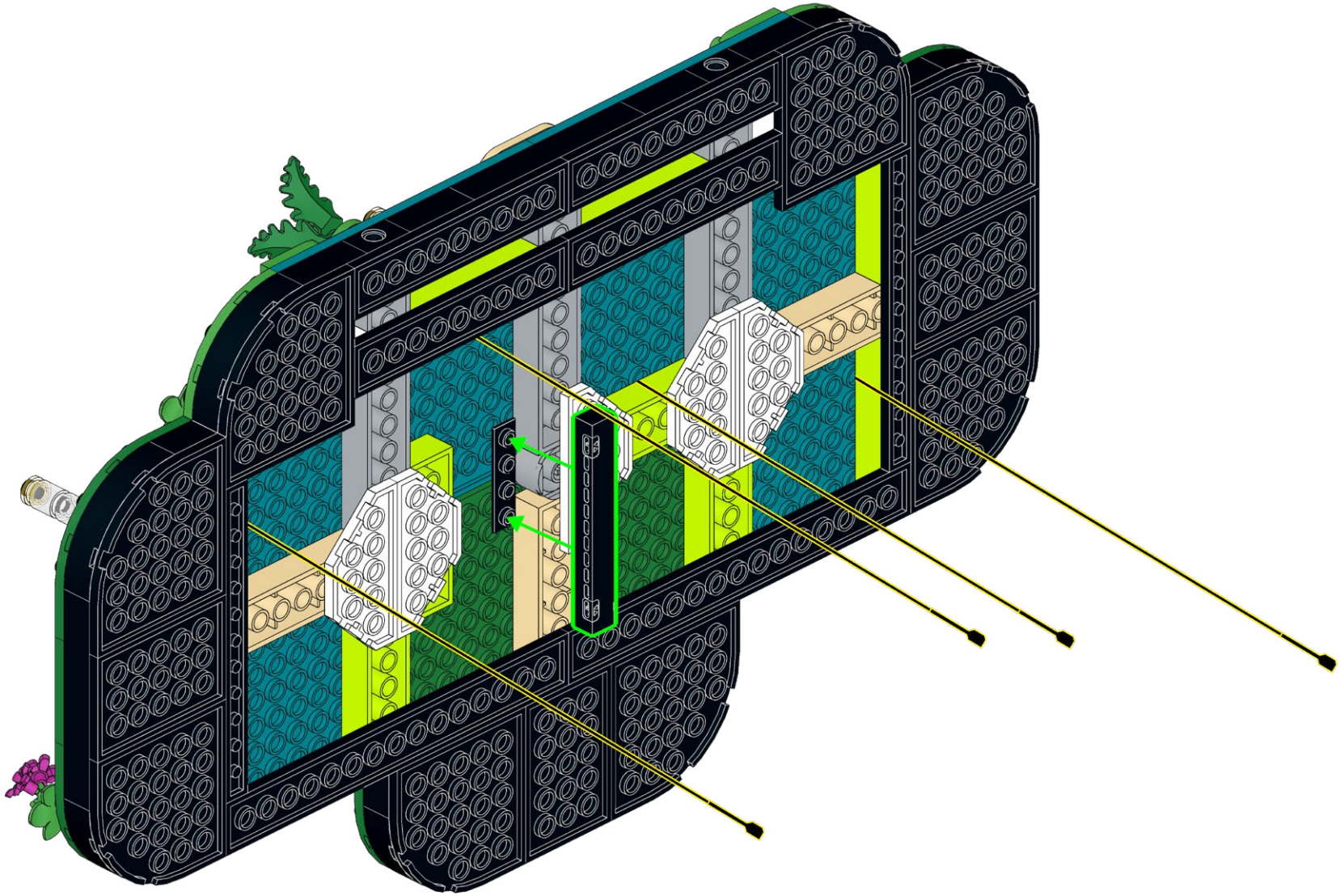
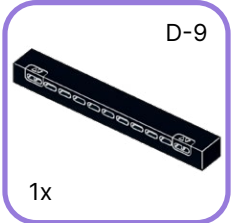

230

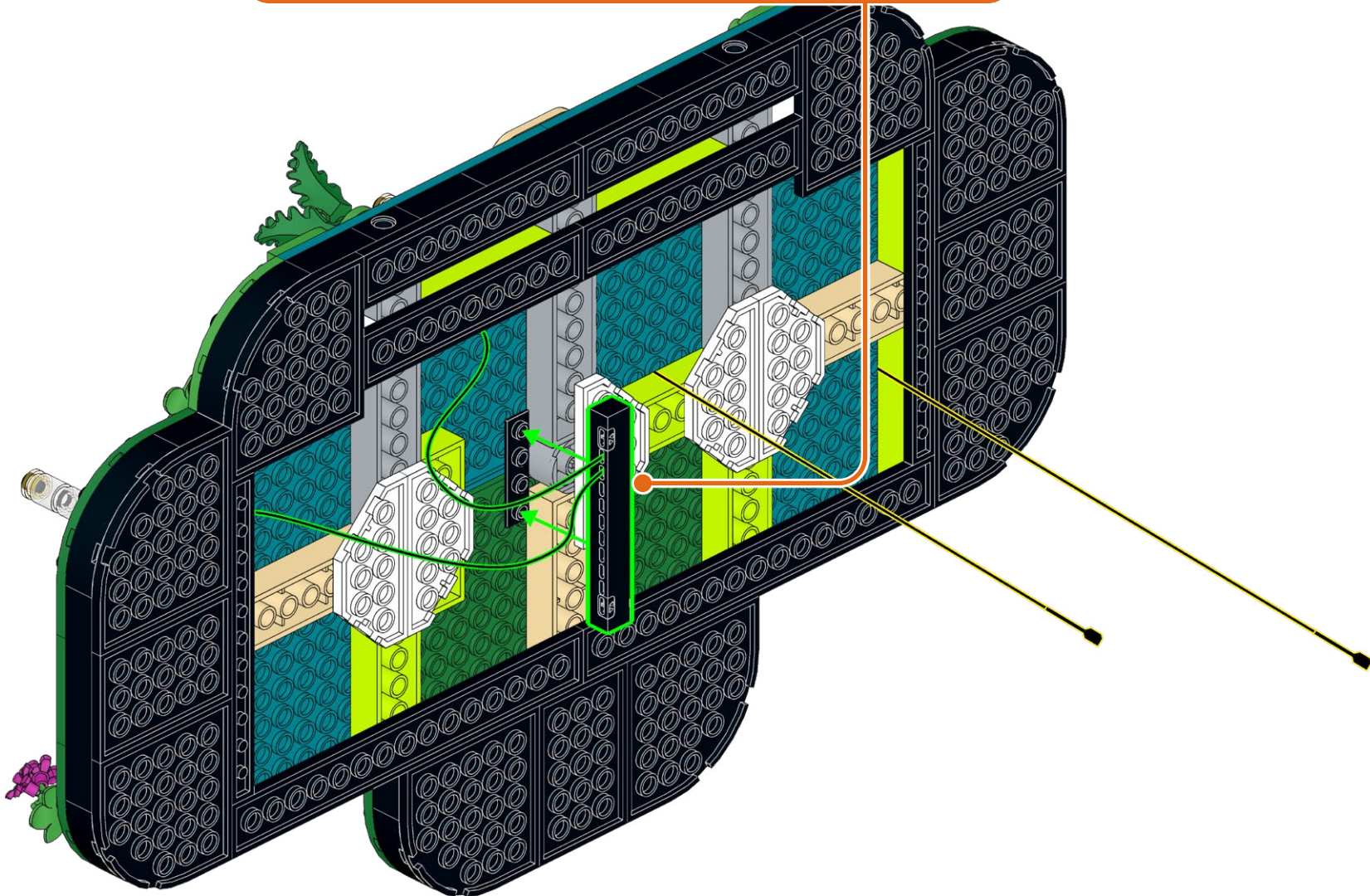
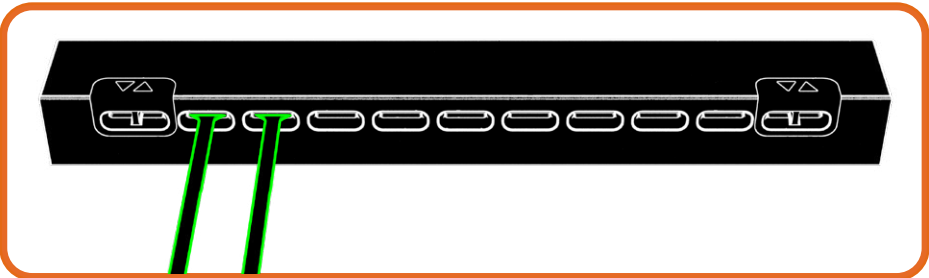

231

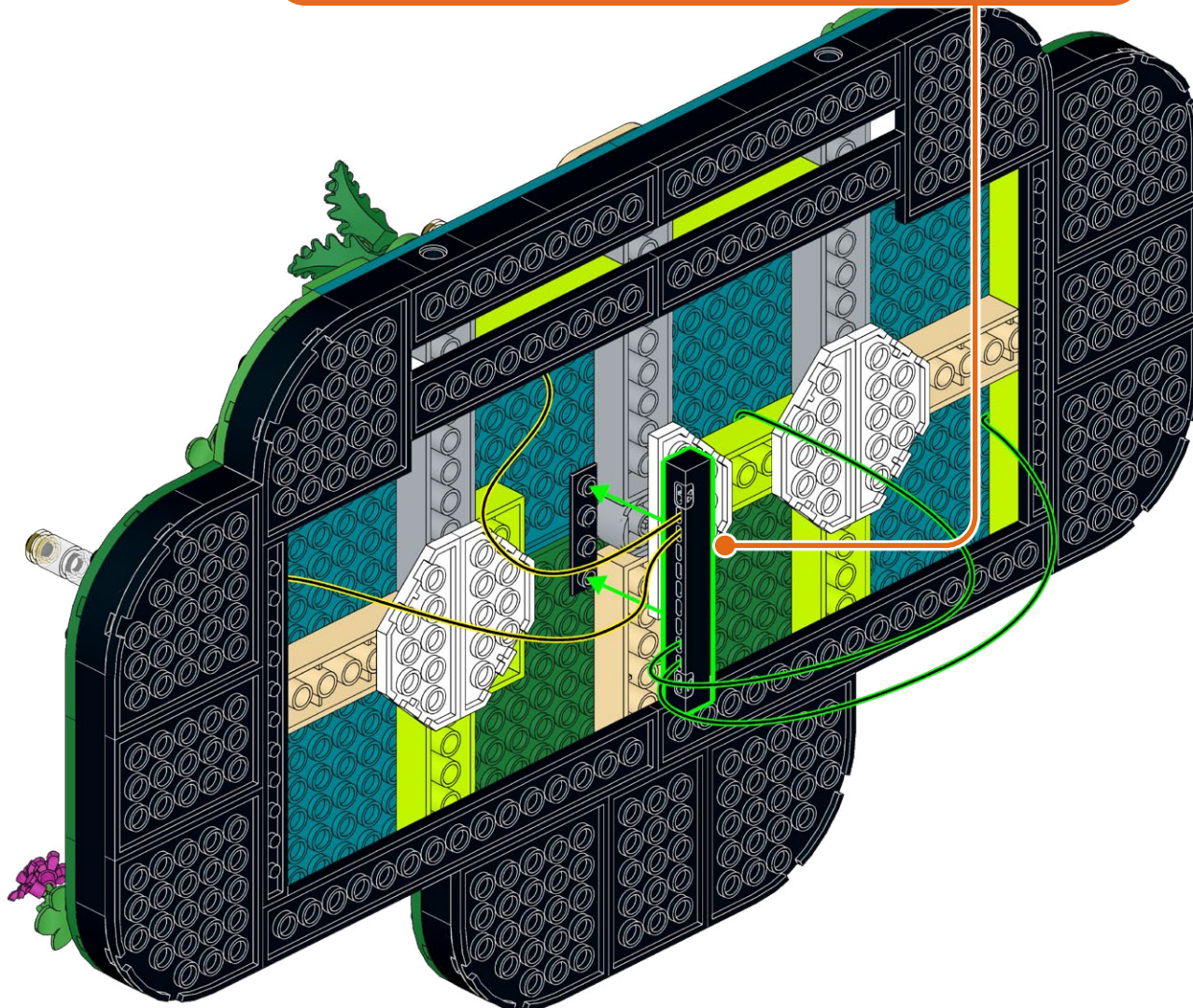
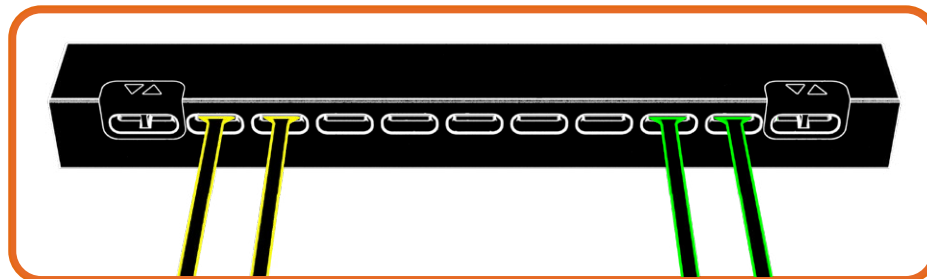

232

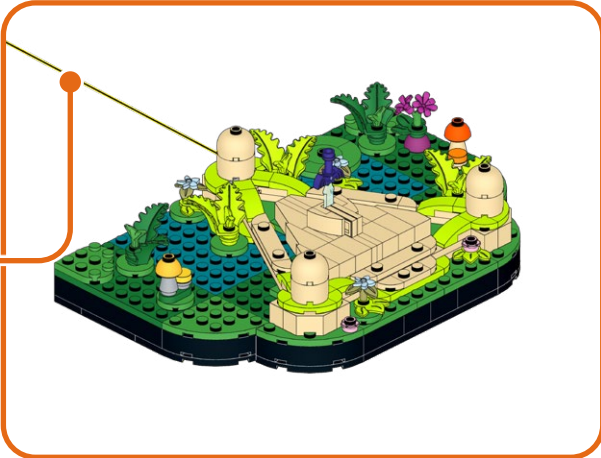
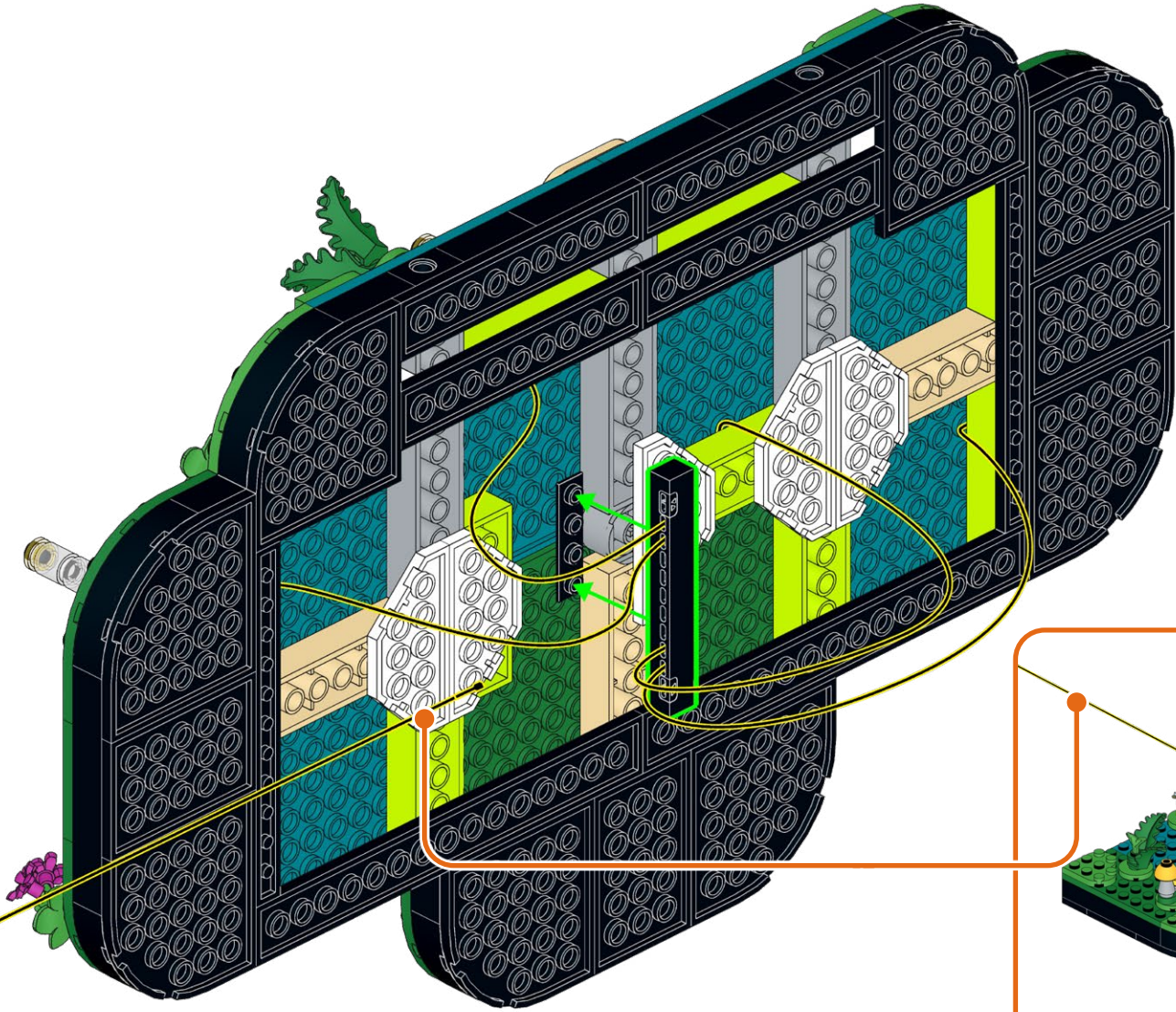

233

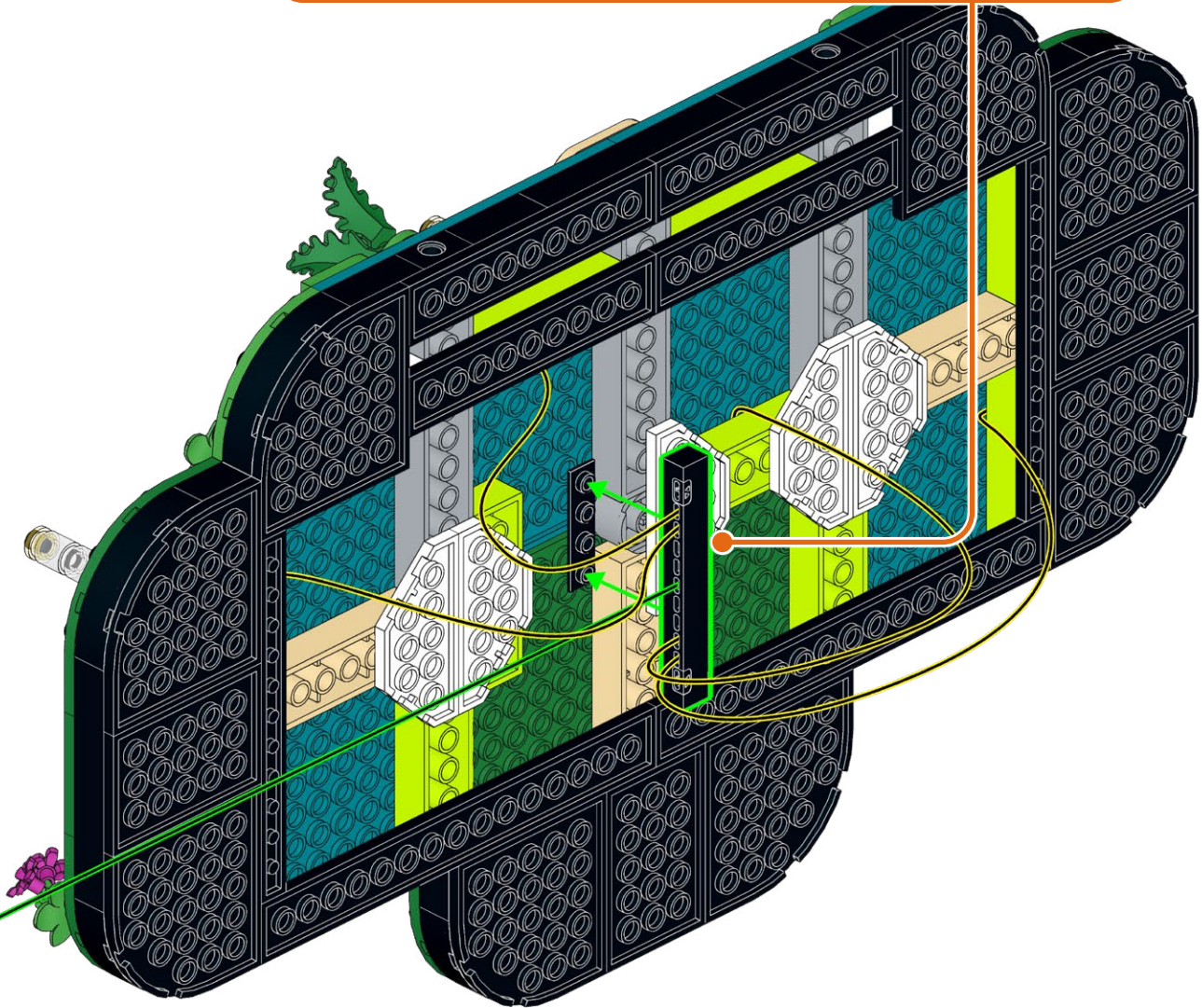
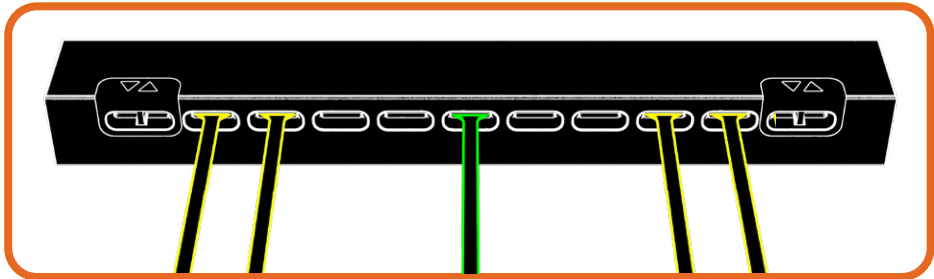

234

B-50

1x

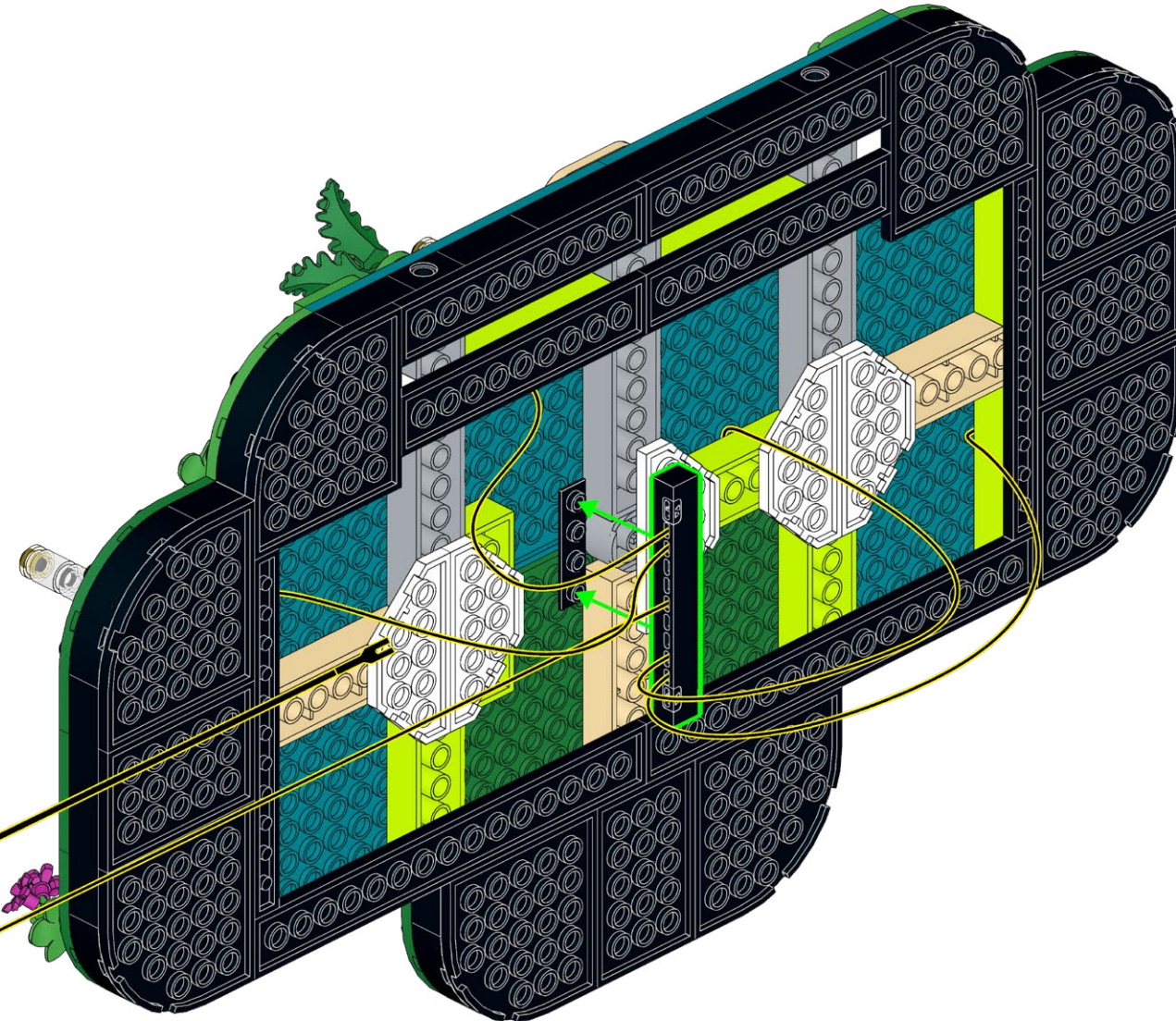

235

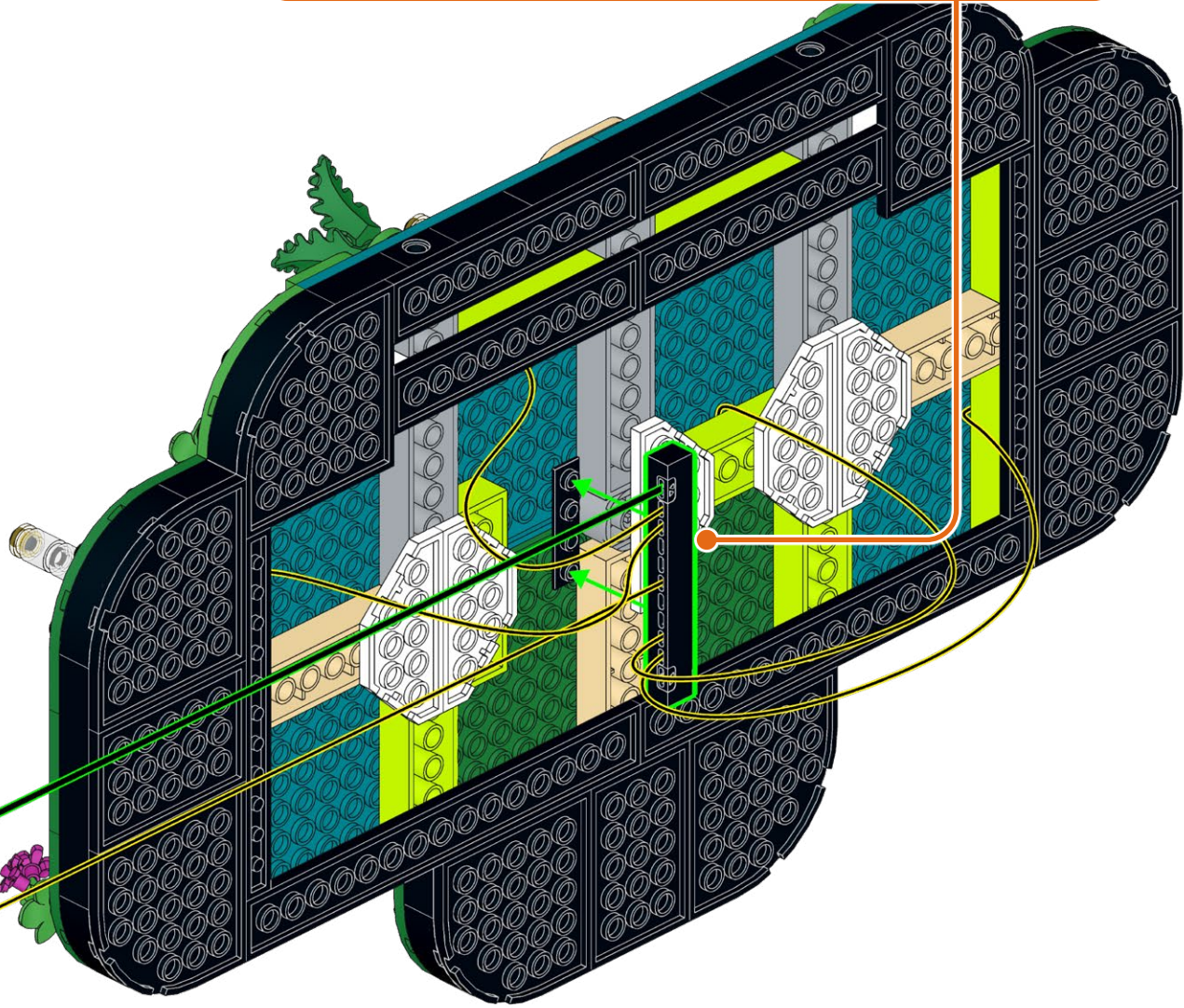
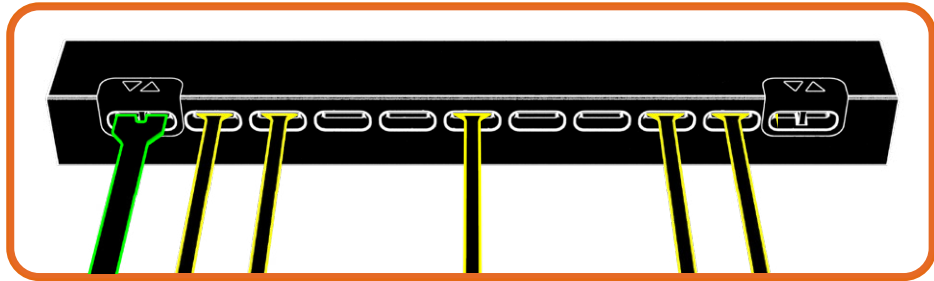

236

B-50

1x

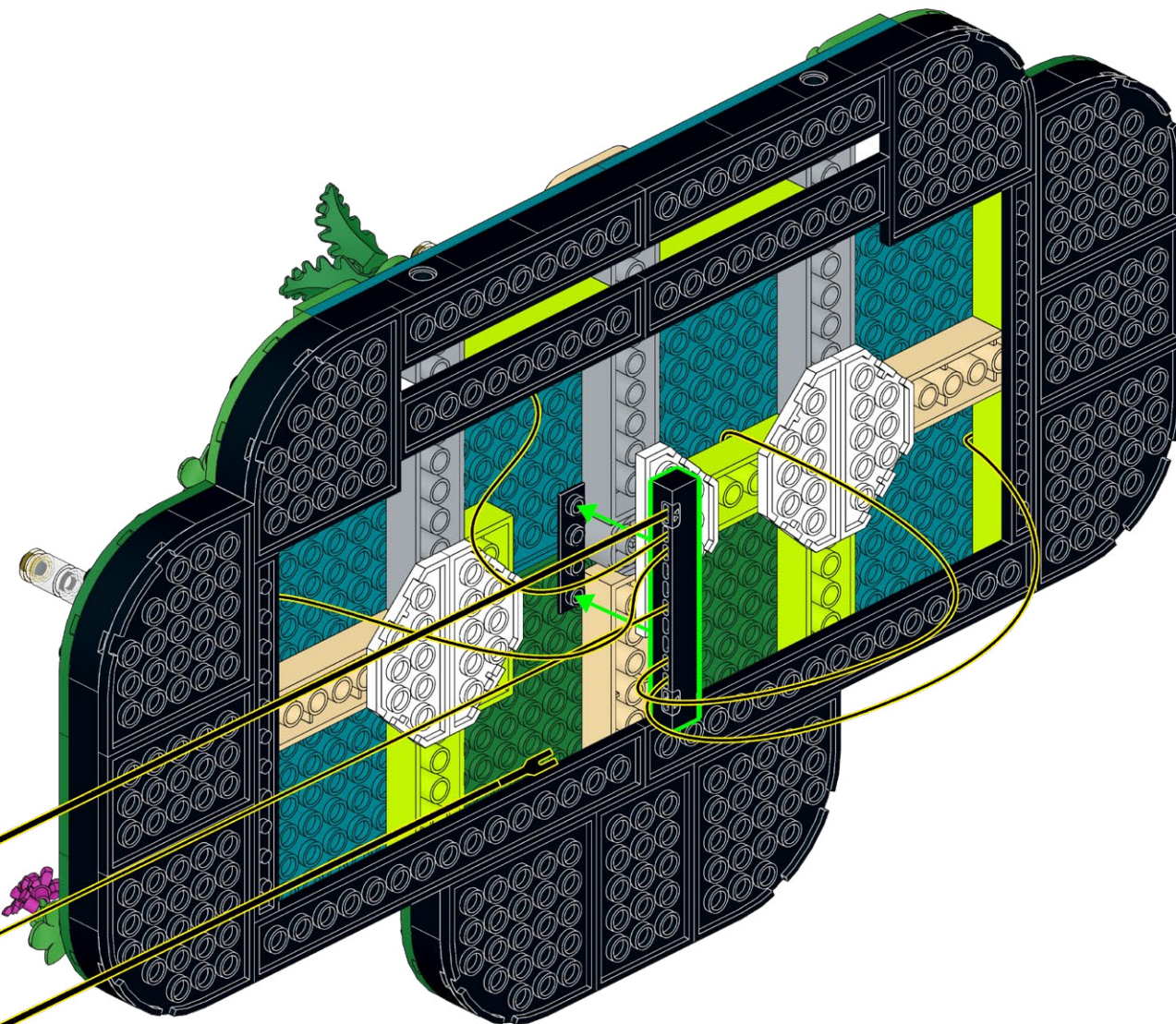

237

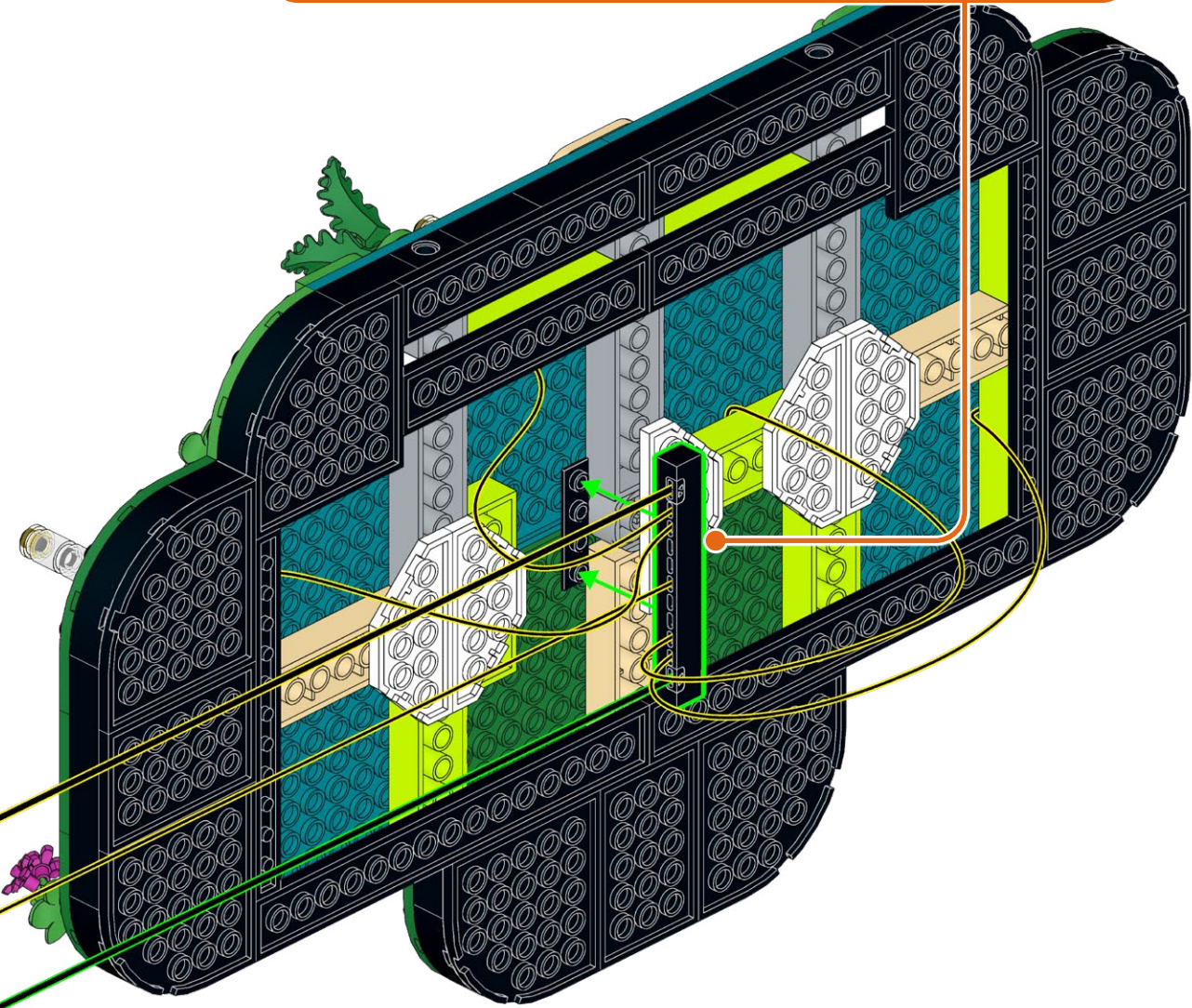
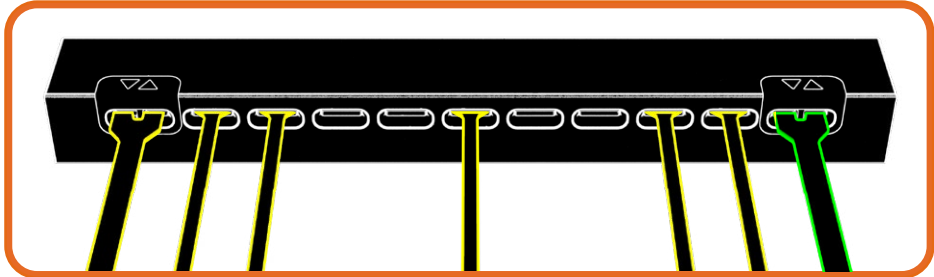

238

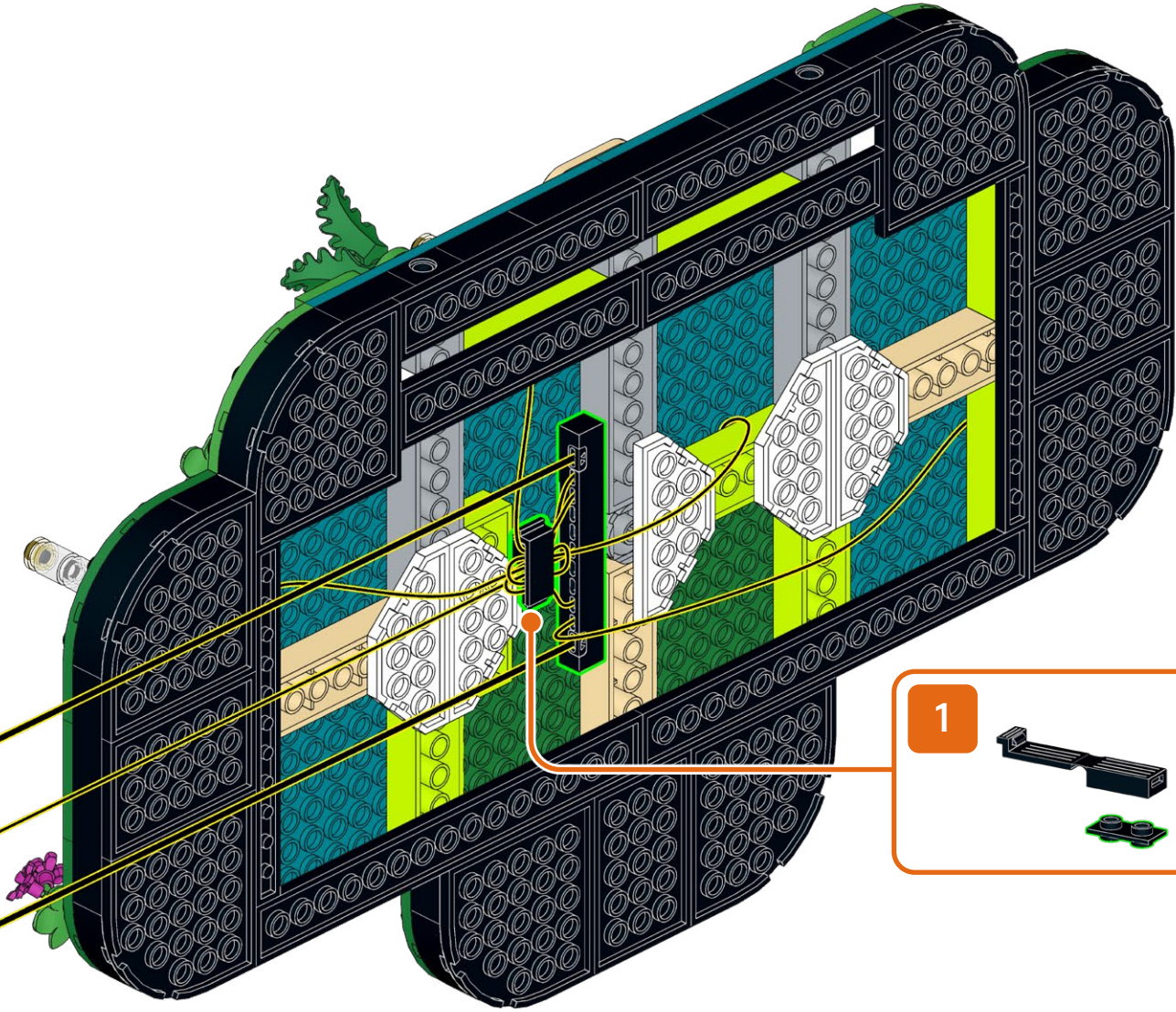

239

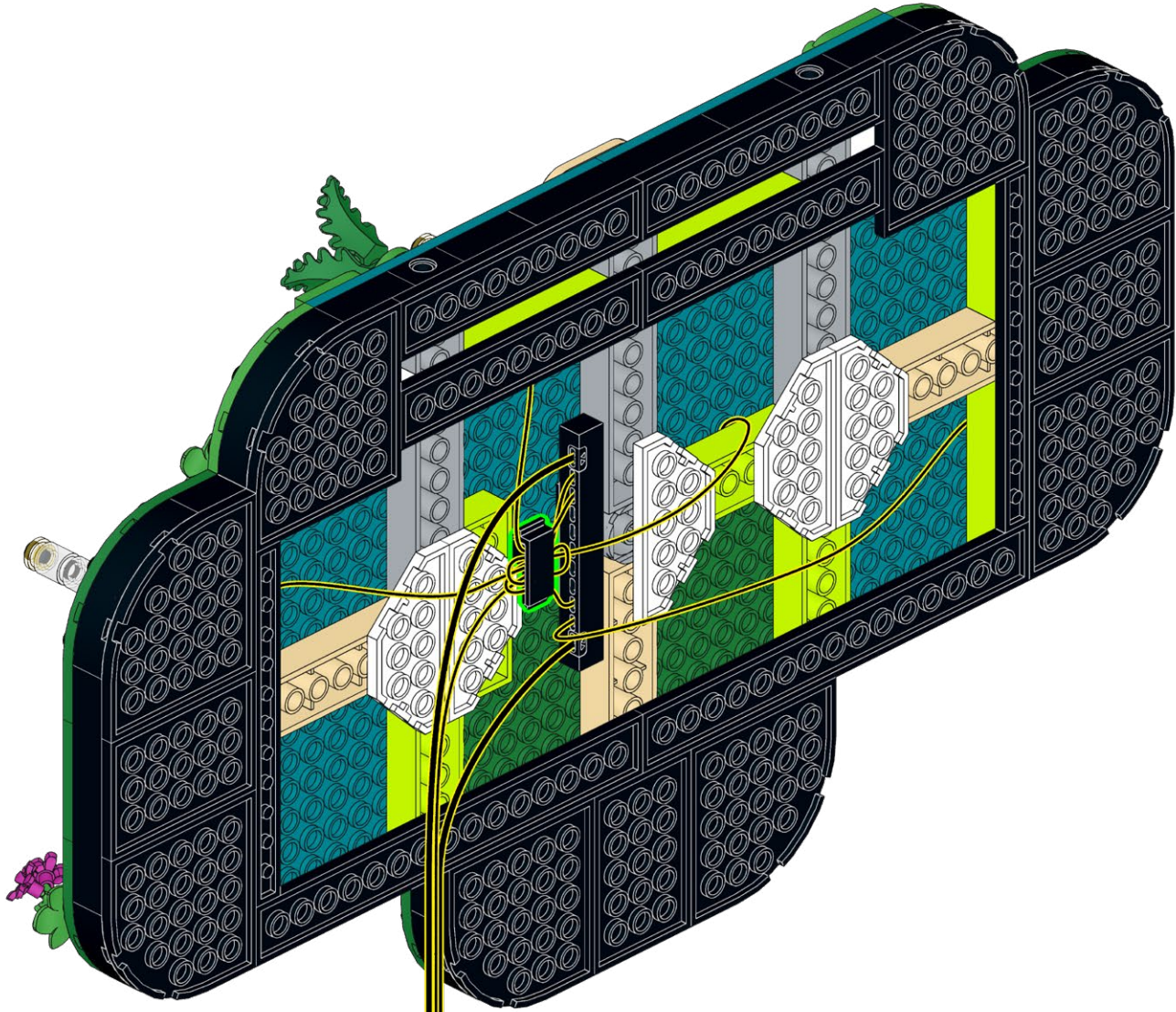

240



241

FLX-C

1x

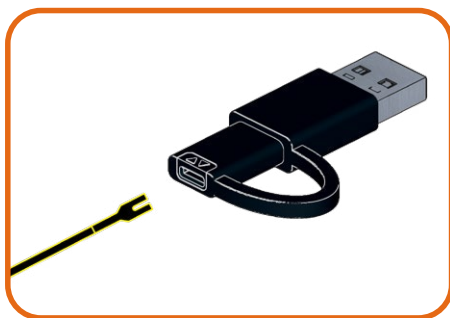
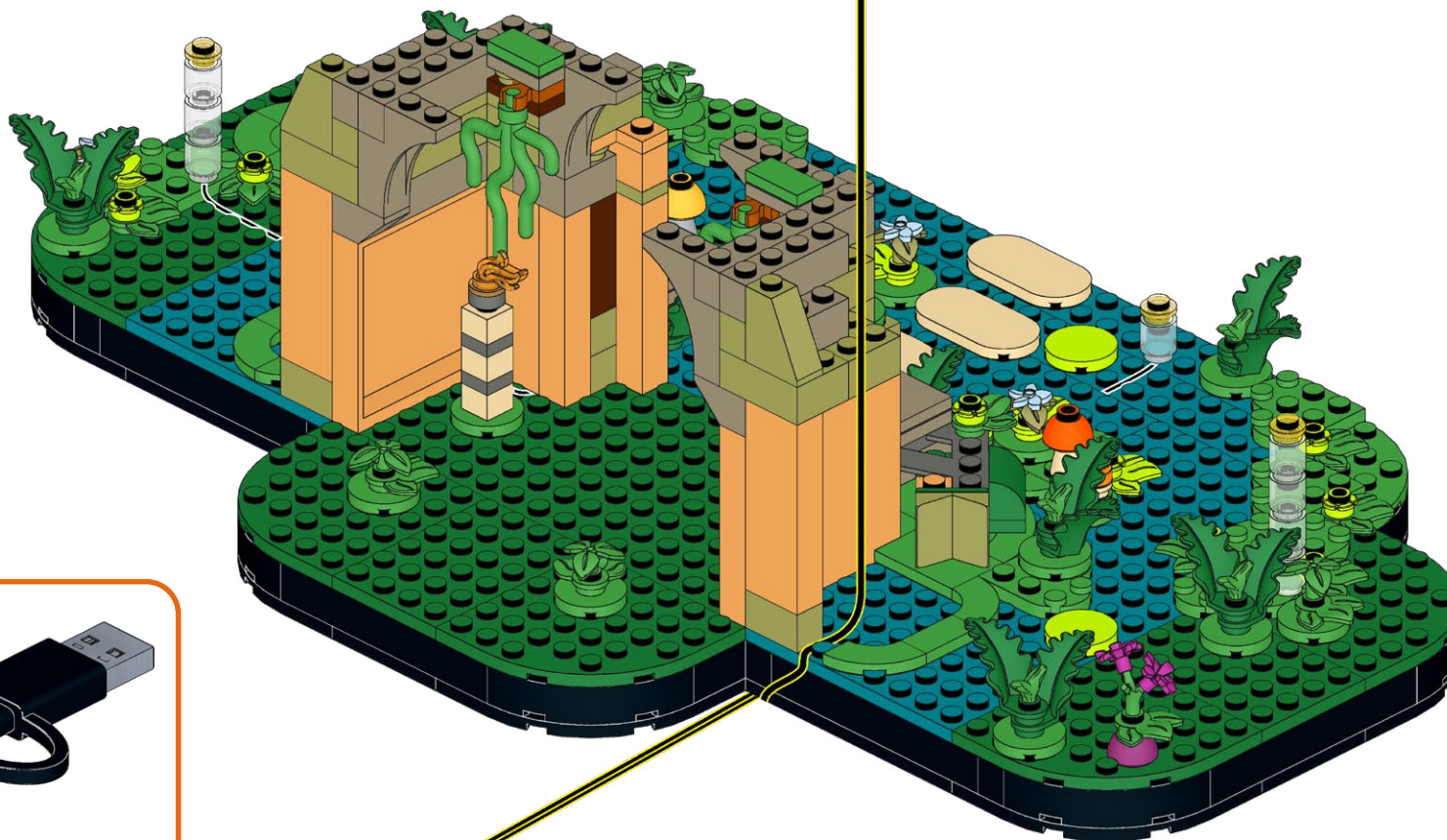

242



1x

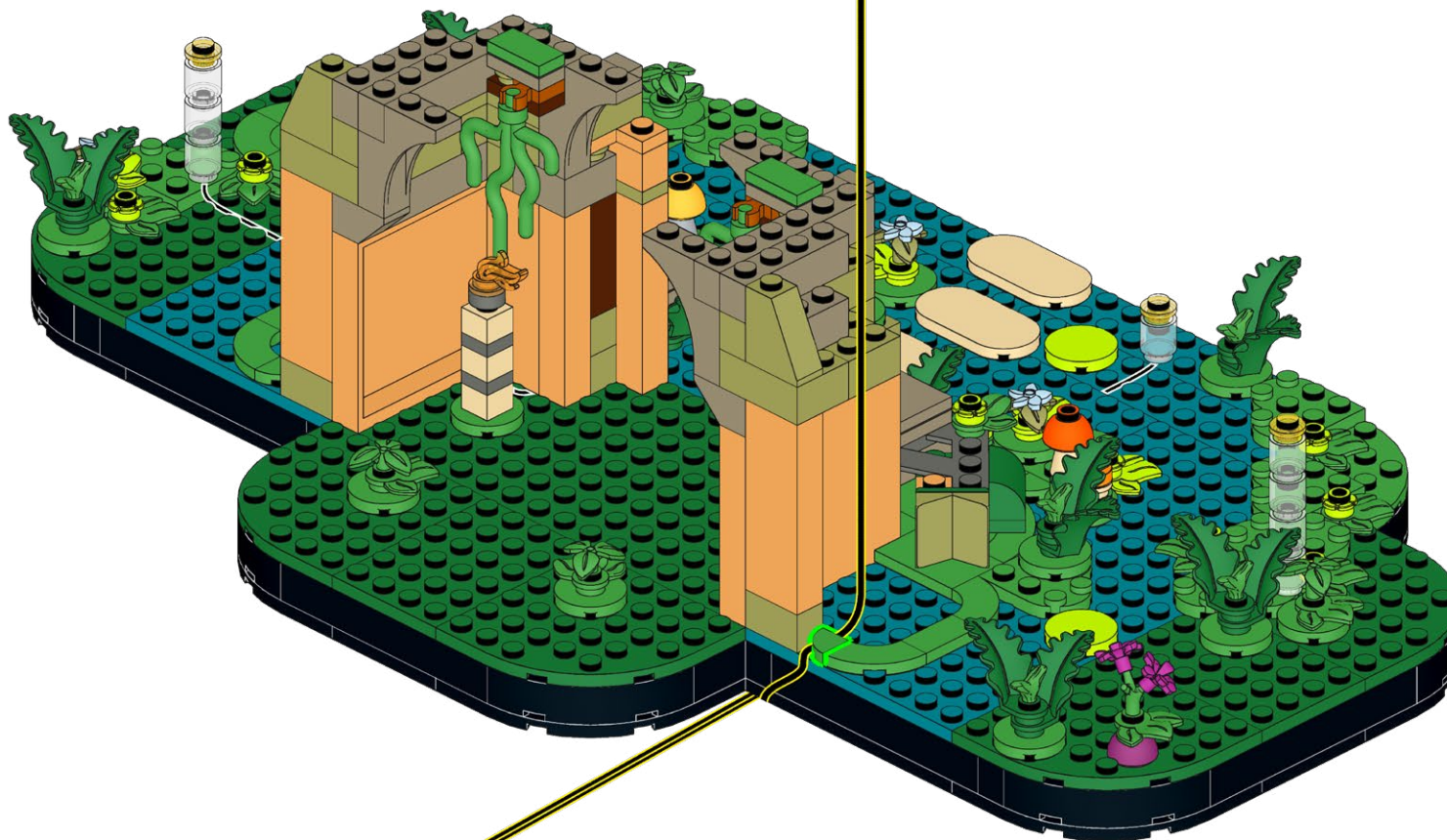

243

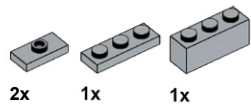

1



2

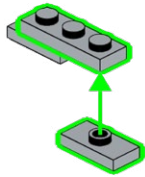

3

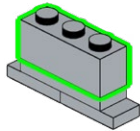

244

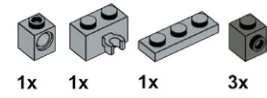

1

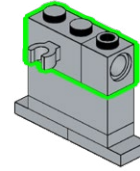

2

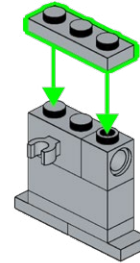

3

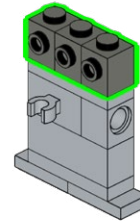

245

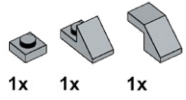

1

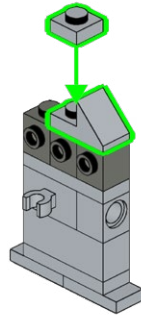

2

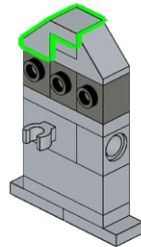

246



1

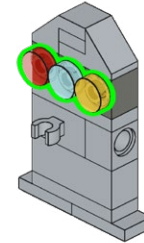

2



247



248

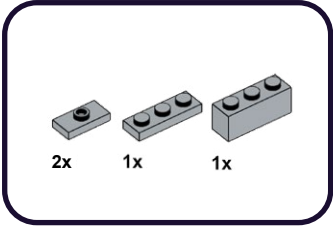

1



2

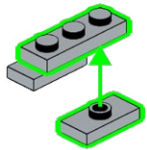

3

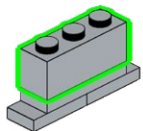

249

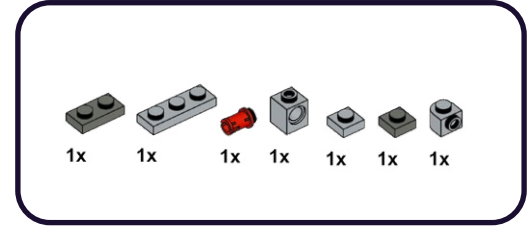

1

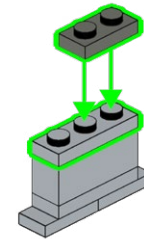

2

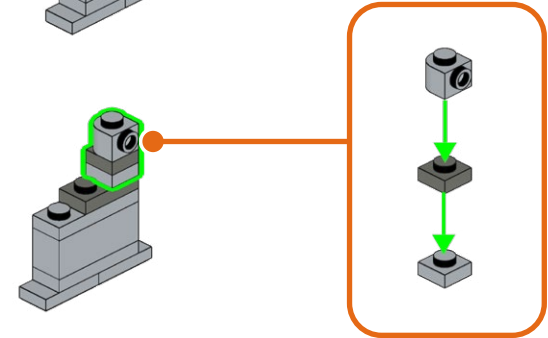

3

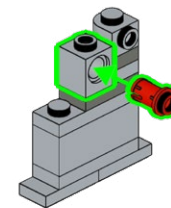

250

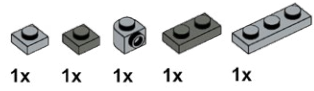

1

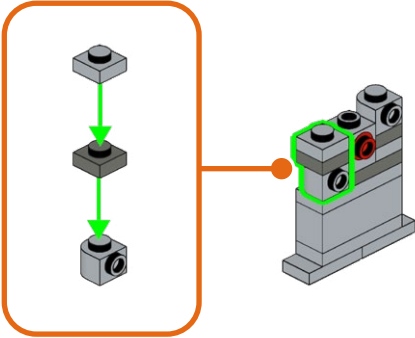

2

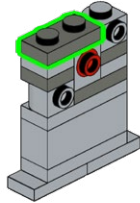

3

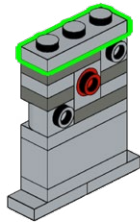

251

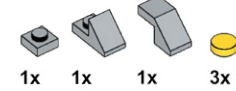

1

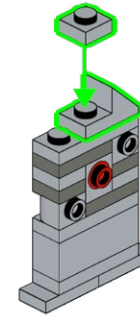

2

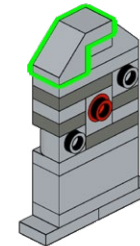

3

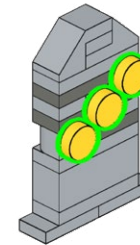

252



253

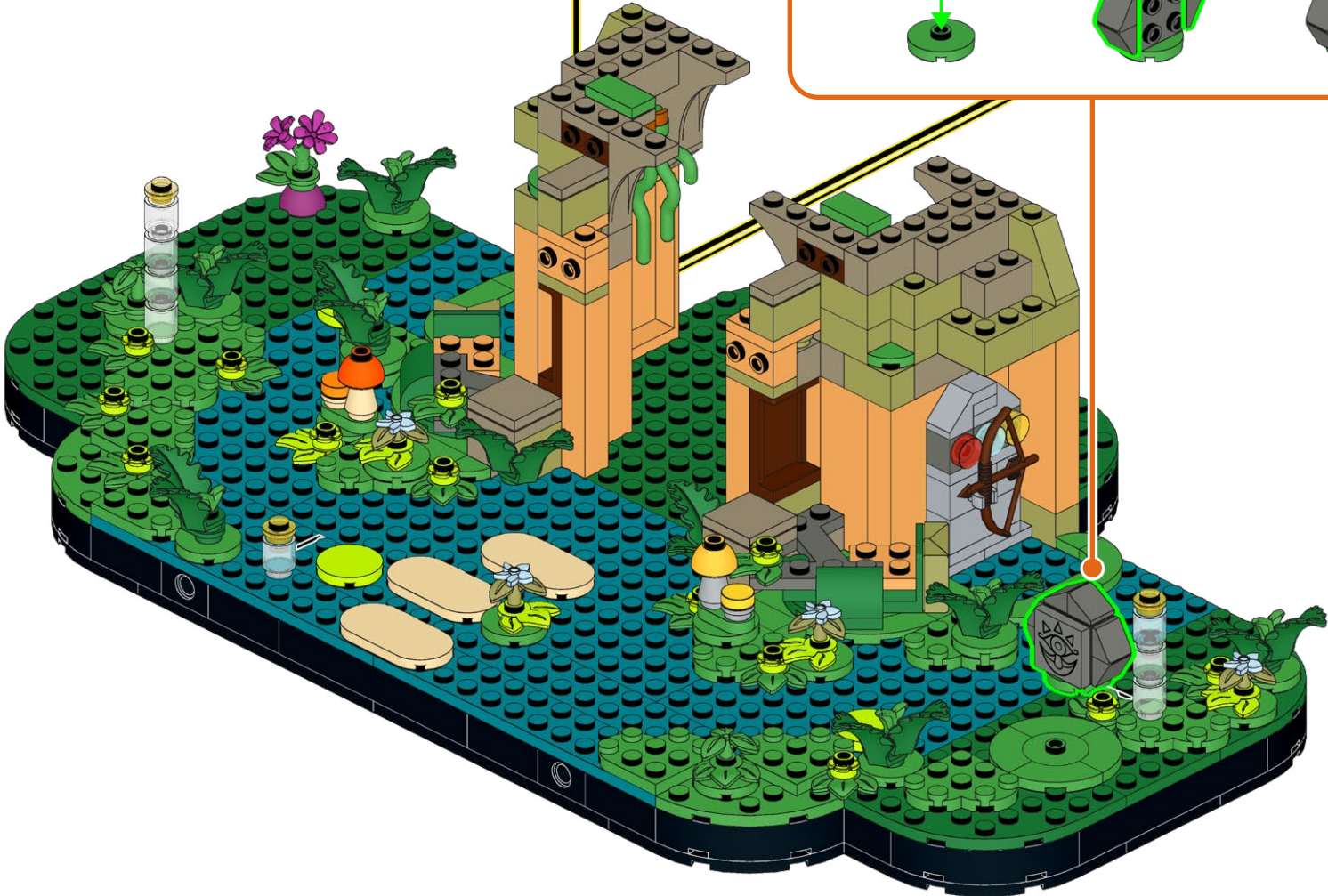
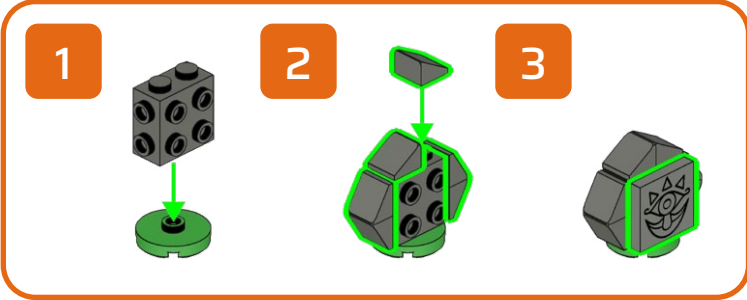
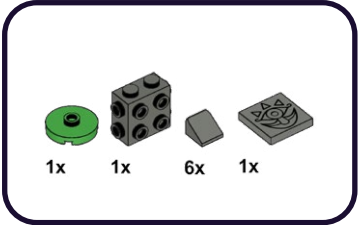

254

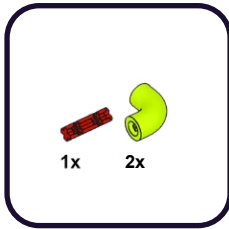
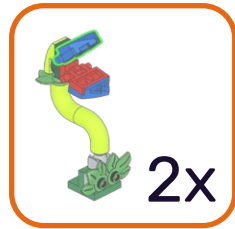

1

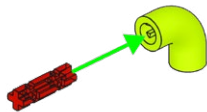

2

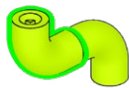

255

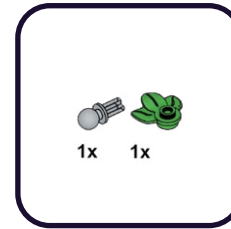

1

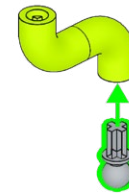

2



256

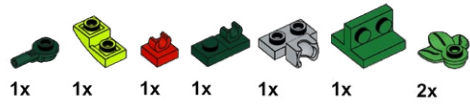

1

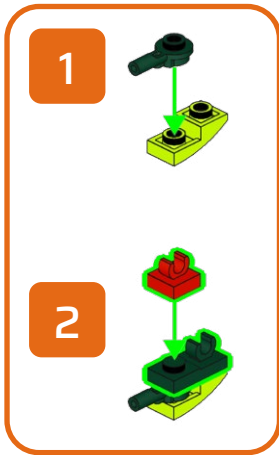

2

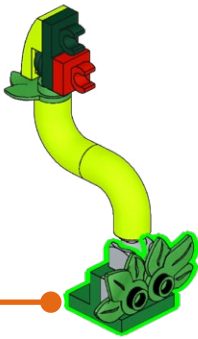
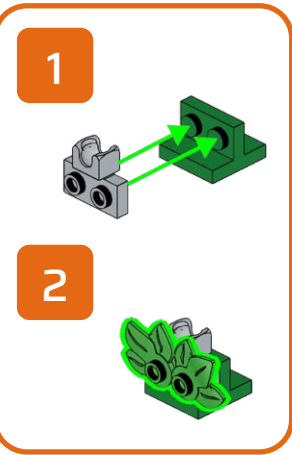

257

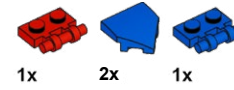

1

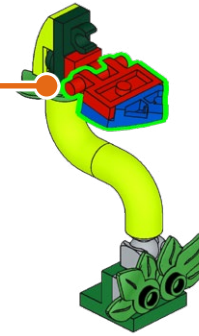
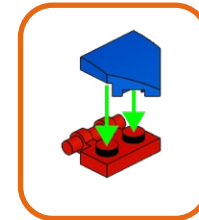

2

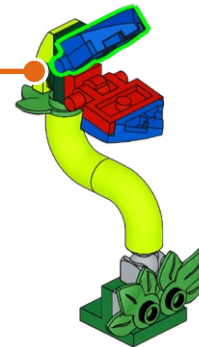
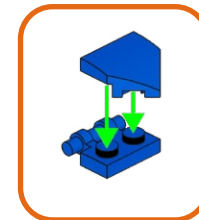

2x

258



259

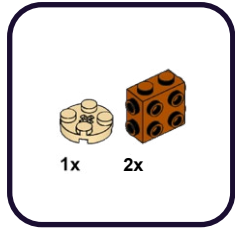

1



2



260

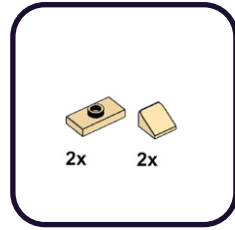

1

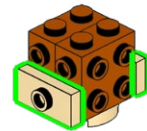

2

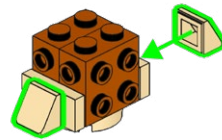

261

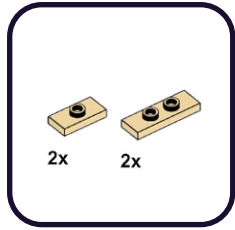

1

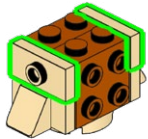

2

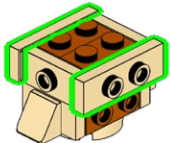

262

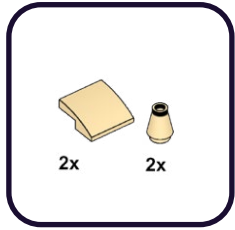

1

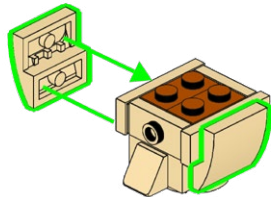

2

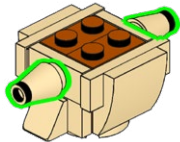

263

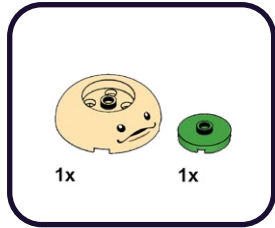

1

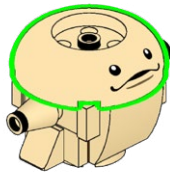

2

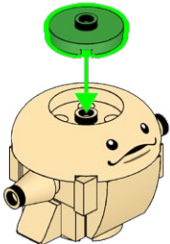

264

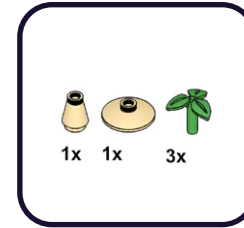

1

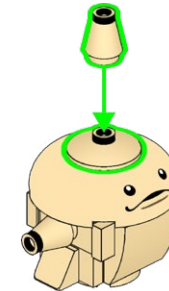

2

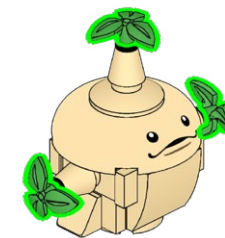

265



266

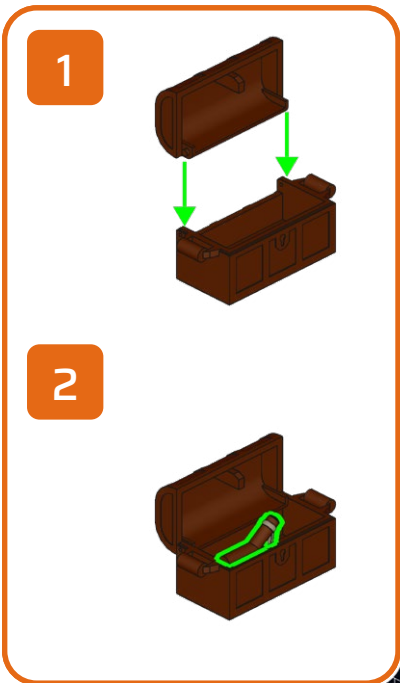
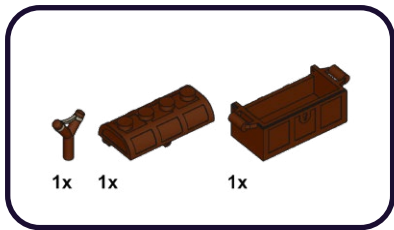

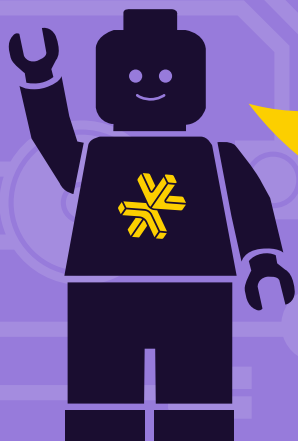
**HOLD UP!**

You might notice some bags aren't in order, as well as left over pieces, but that's ok! We're changing the way you build LEGO!

ATTENDEZ!

Vous remarquerez peut-être que certains sacs, ainsi que certaines pièces, ne sont pas dans le bon ordre. Mais pas de panique! Nous changeons simplement la façon avec laquelle vous construisez vos LEGO!

ASPETTA!

Potresti notare che alcuni sacchetti non sono in ordine, così come i pezzi avanzati, ma va bene così! Stiamo cambiando il modo in cui costruisci i LEGO!

HALT!

Sie werden möglicherweise bemerken, dass einige tüten durcheinander sind und teile übrig bleiben, aber das ist in Ordnung! Wir ändern die art und weise, wie Sie LEGO bauen!

¡ESPERA!

Es posible que notes que algunas bolsas están fuera de servicio, así como piezas sobrantes, ¡pero está bien! ¡Estamos cambiando la forma en que construyes LEGO!

暫停!

你可能会注意到一些袋子顺序错乱, 以及一些剩余的部件, 但没关系! 我们正在改变你搭建乐高的方式!

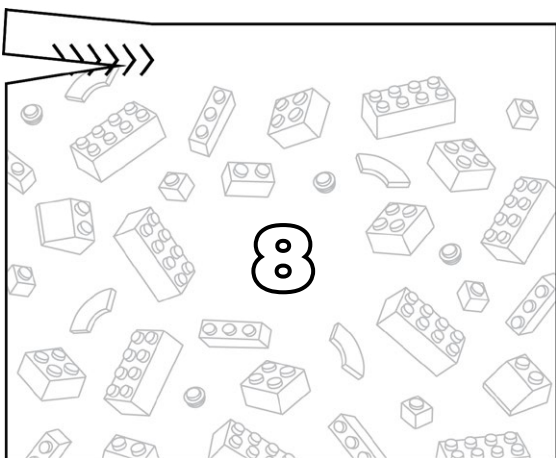
Open LEGO® Bag 8

267

2x



268

2x

2x

2x

269

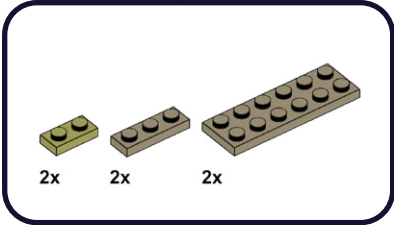

270



271

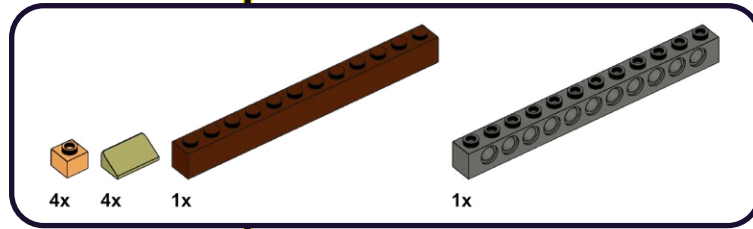

272

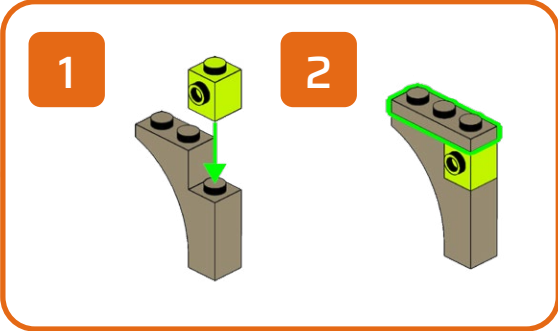
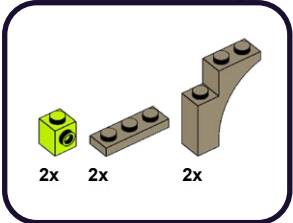

2

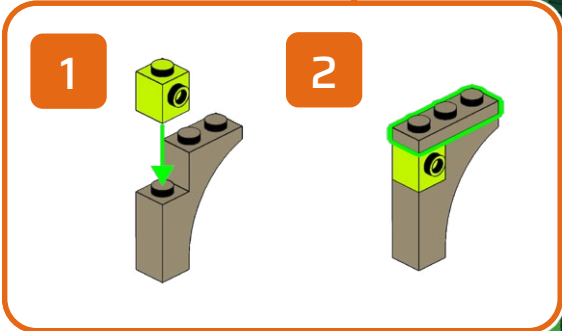
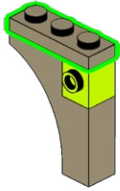

2

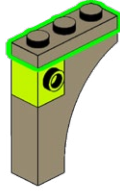

273

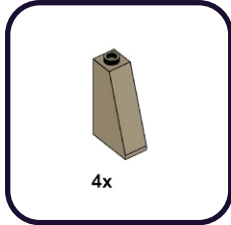

274

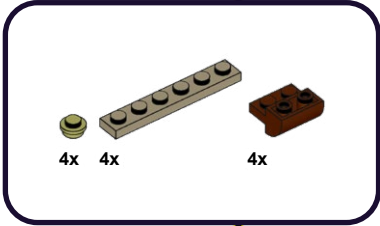

1

2

3

2x



275

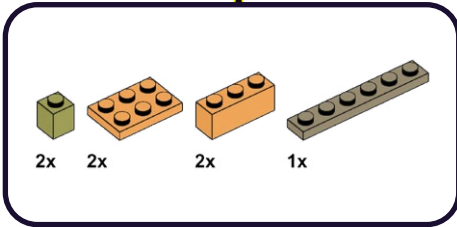

276

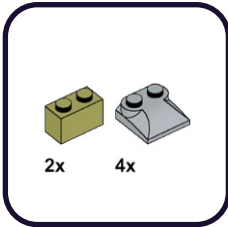

277

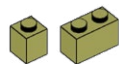

2x 2x



278

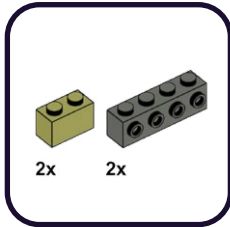

279

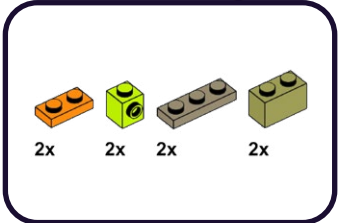

280

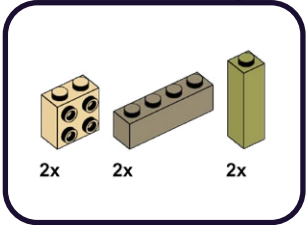

281

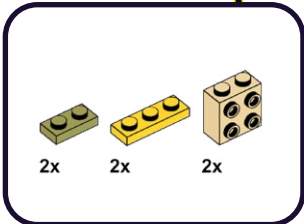

282

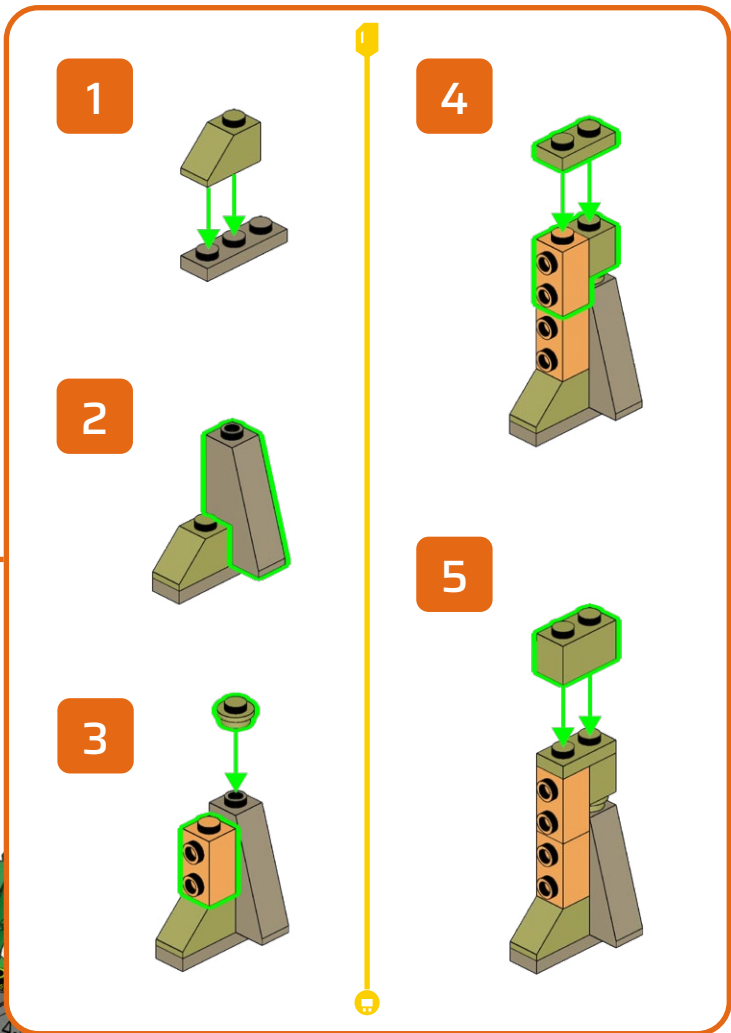
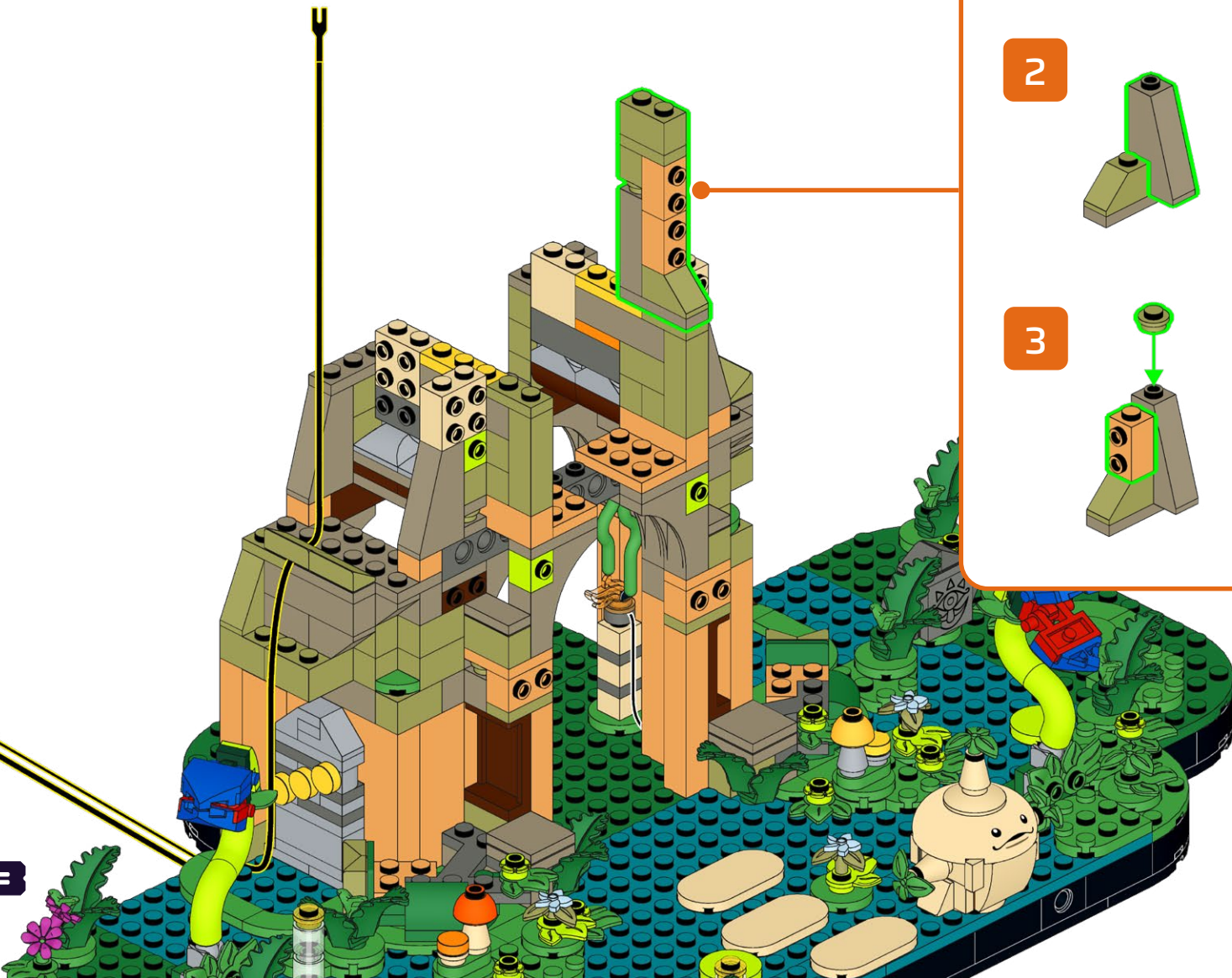
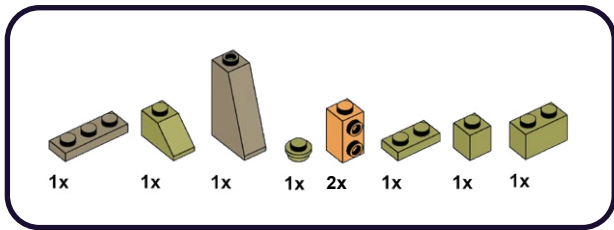

283

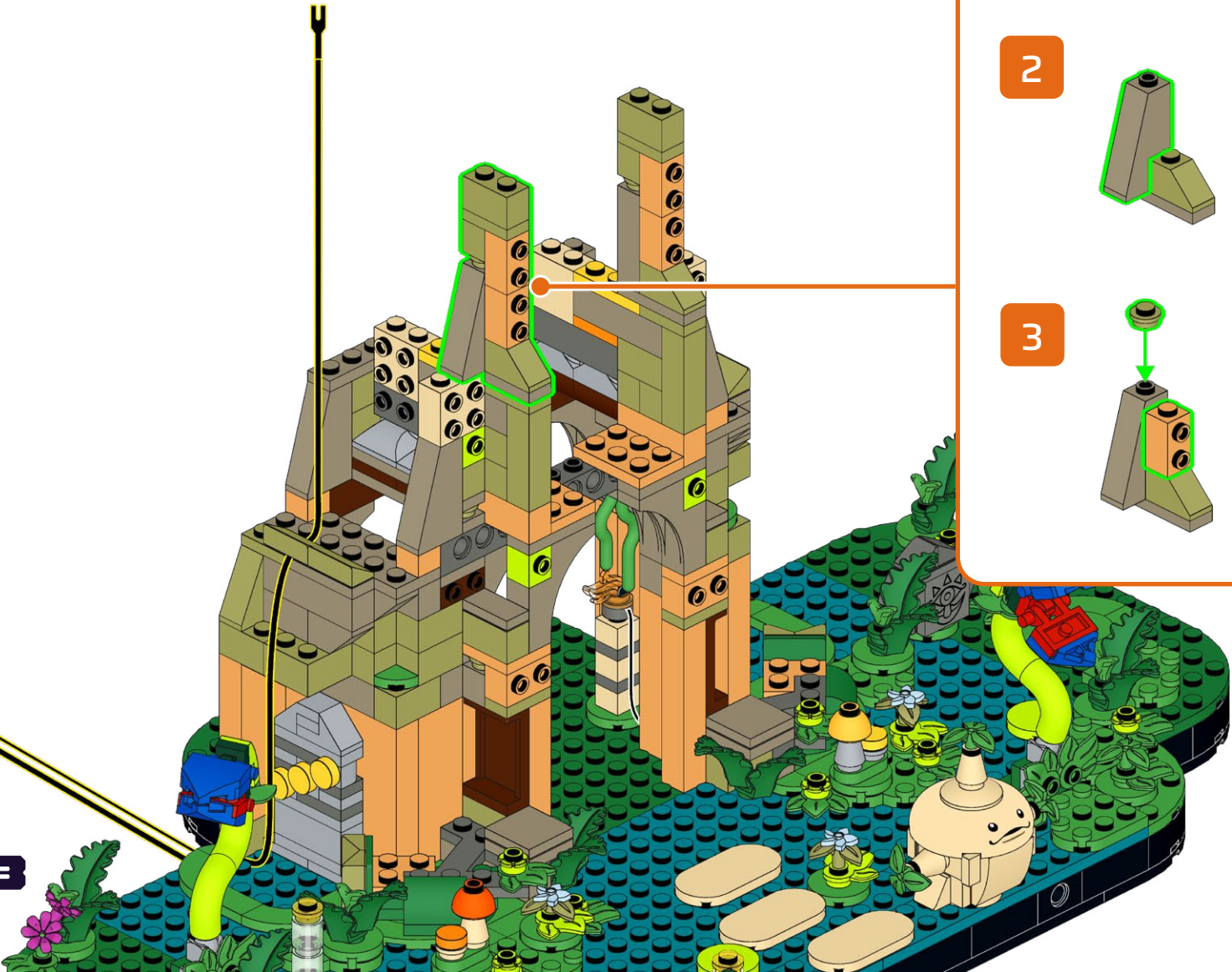
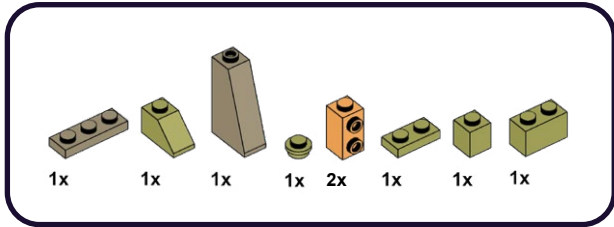

1. A grey 1x3 Technic brick with a hole is placed on top of a grey 1x2 Technic brick with a hole.

2. A grey 1x3 Technic brick with a hole is placed on top of the assembly from step 1.

3. A grey 1x2 Technic brick with a hole is placed on top of the assembly from step 2.

4. An orange 1x2 Technic brick with a hole is placed on top of the assembly from step 3.

5. A grey 1x2 Technic brick is placed on top of the assembly from step 4.

284

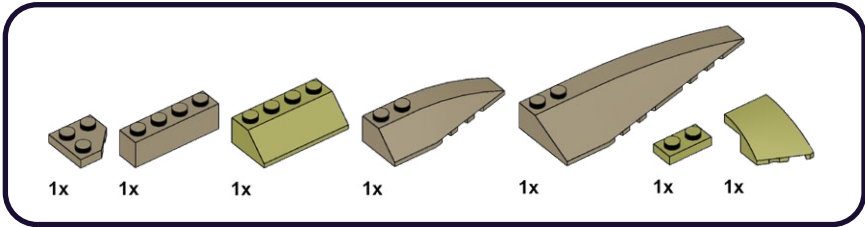

- 1
- 2
- 3
- 4
- 5

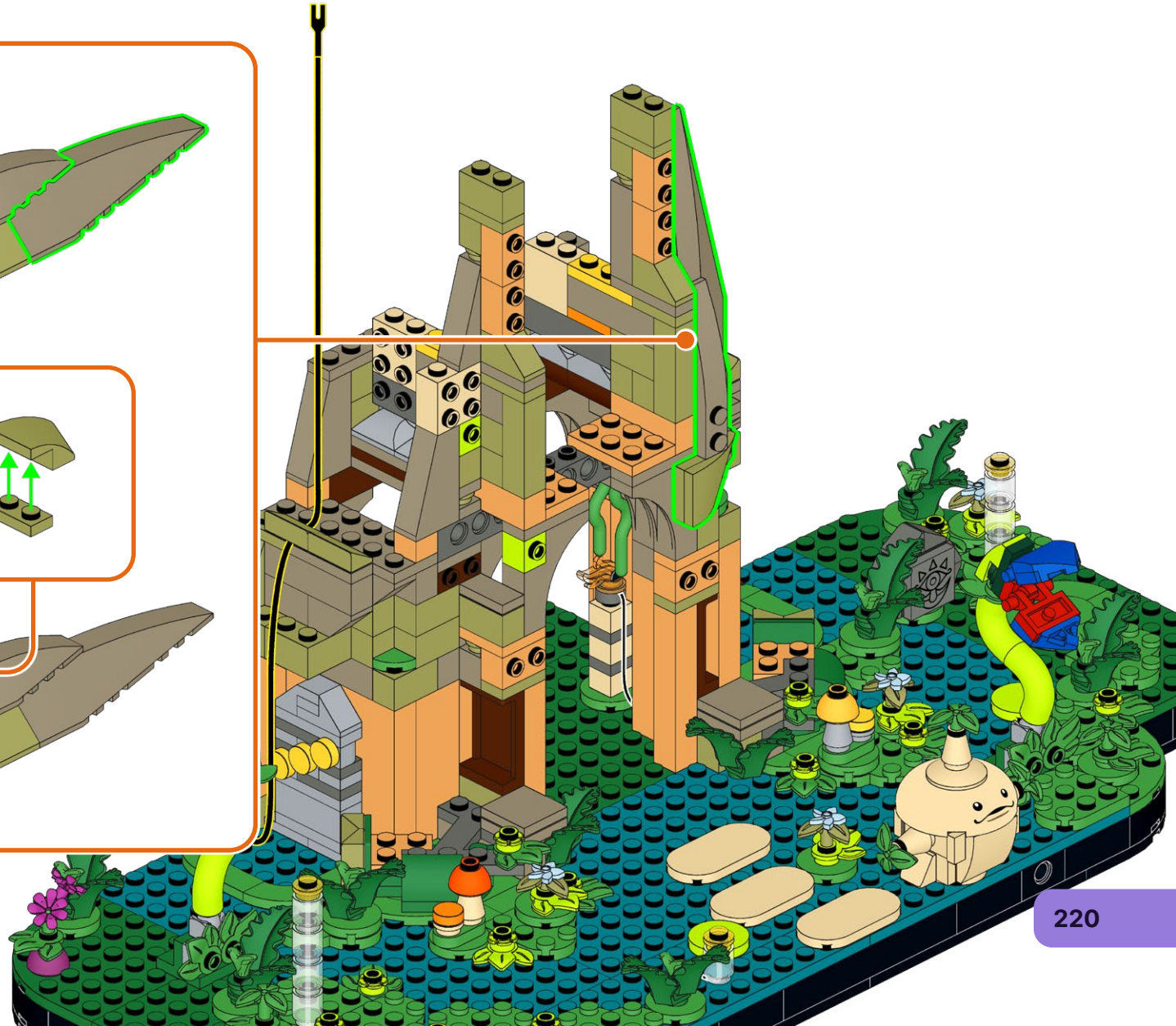

285

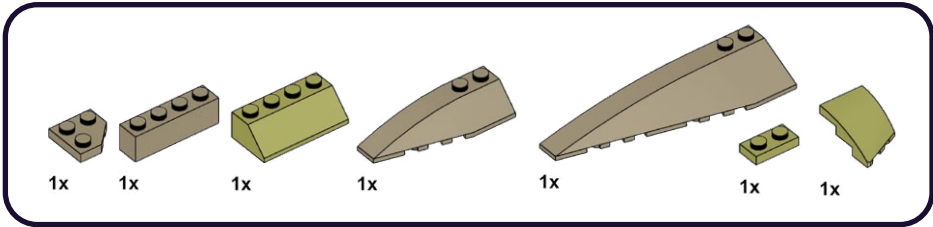

1 2 3 4 5



286

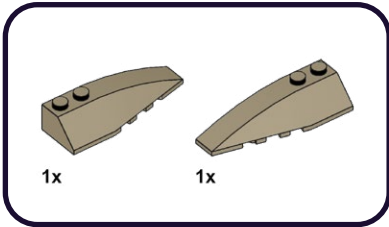

287

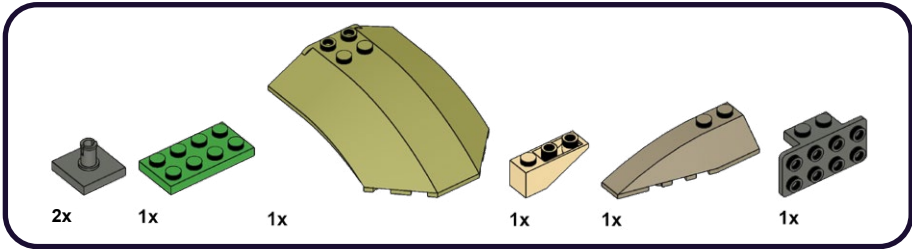

1 2 3 4 5



288

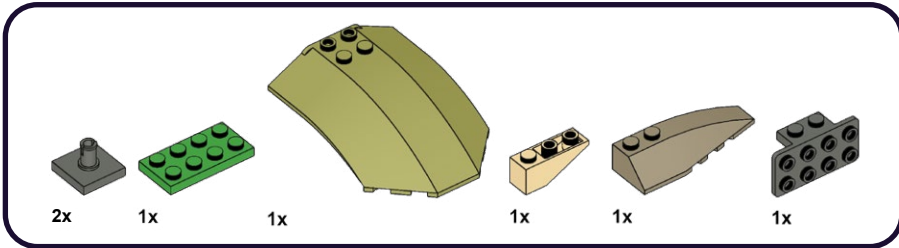

1 2 3 4 5

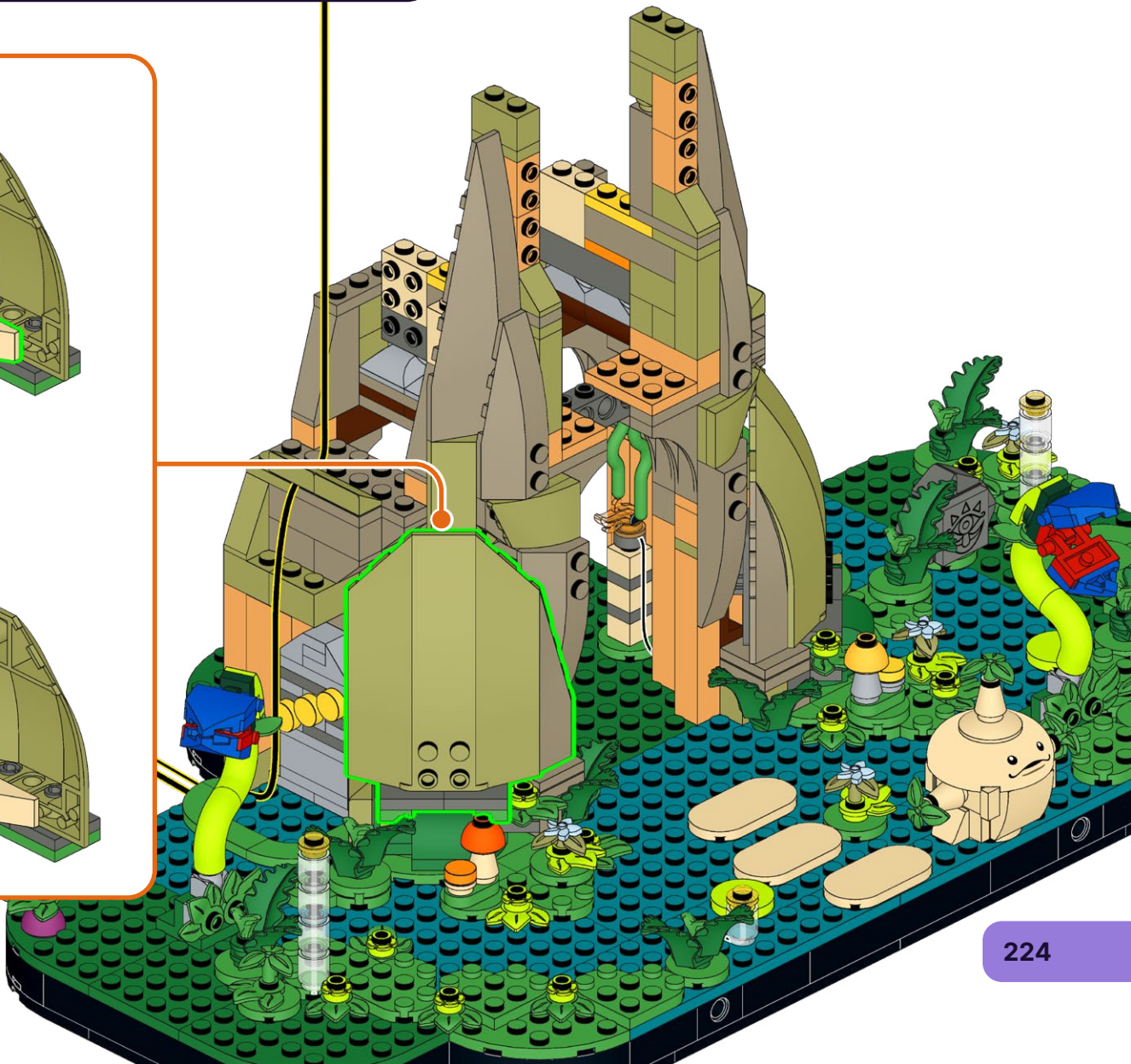

289

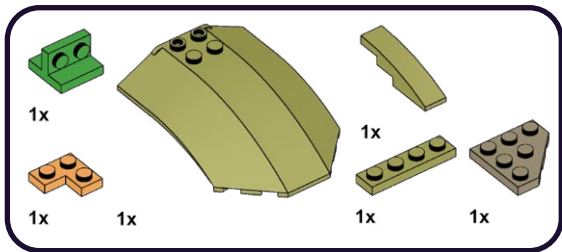

1

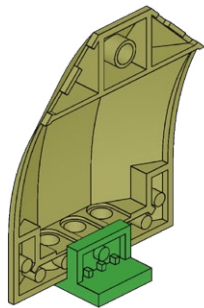

2

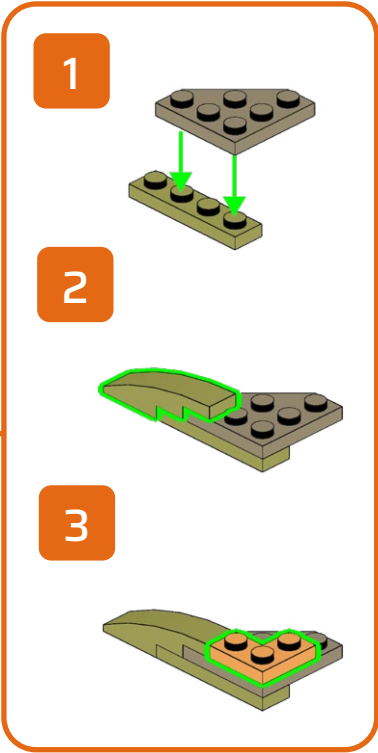
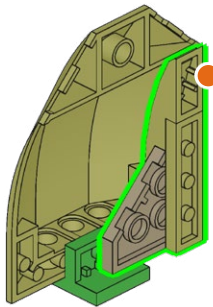

290

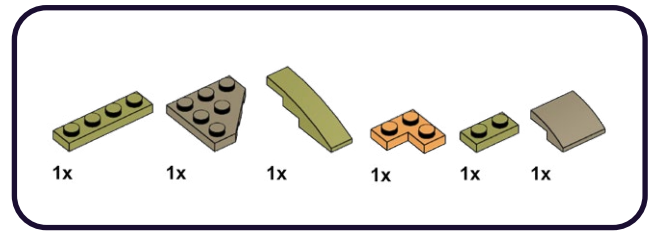

3

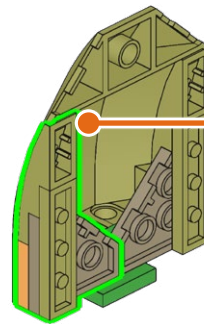

4

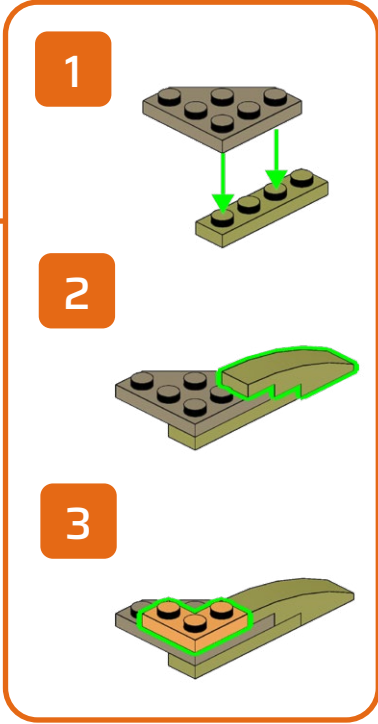
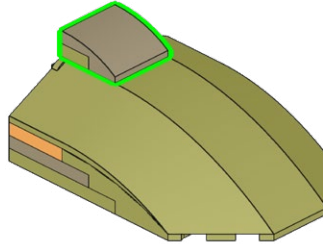

2x

291

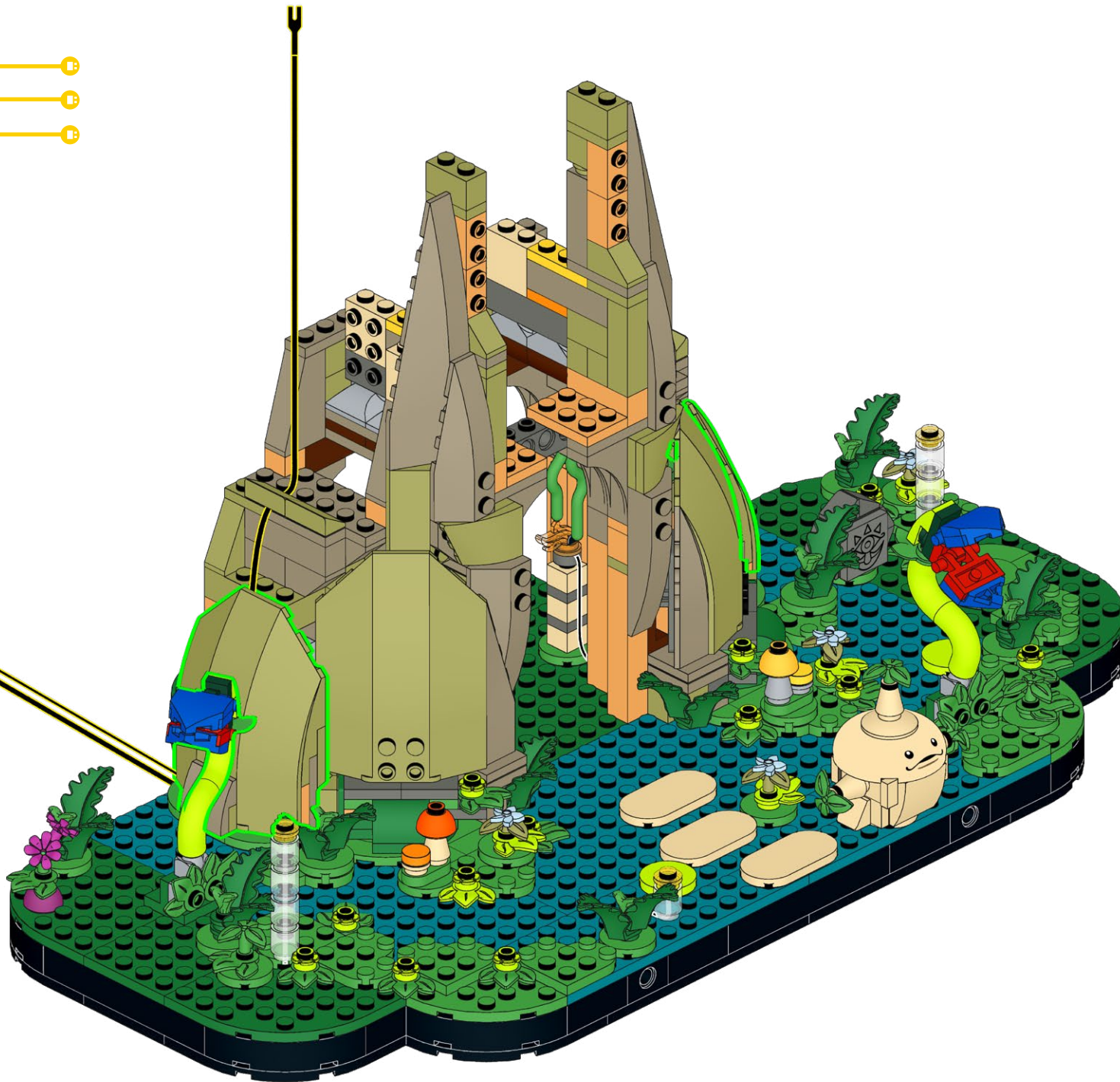

**HOLD UP!**

You might notice some bags aren't in order, as well as left over pieces, but that's ok! We're changing the way you build LEGO!

ATTENDEZ!

Vous remarquerez peut-être que certains sacs, ainsi que certaines pièces, ne sont pas dans le bon ordre. Mais pas de panique! Nous changeons simplement la façon avec laquelle vous construisez vos LEGO!

ASPETTA!

Potresti notare che alcuni sacchetti non sono in ordine, così come i pezzi avanzati, ma va bene così! Stiamo cambiando il modo in cui costruisci i LEGO!

HALT!

Sie werden möglicherweise bemerken, dass einige tüten durcheinander sind und teile übrig bleiben, aber das ist in Ordnung! Wir ändern die art und weise, wie Sie LEGO bauen!

¡ESPERA!

Es posible que notes que algunas bolsas están fuera de servicio, así como piezas sobrantes, ¡pero está bien! ¡Estamos cambiando la forma en que construyes LEGO!

暫停!

你可能会注意到一些袋子顺序错乱, 以及一些剩余的部件, 但没关系! 我们正在改变你搭建乐高的方式!

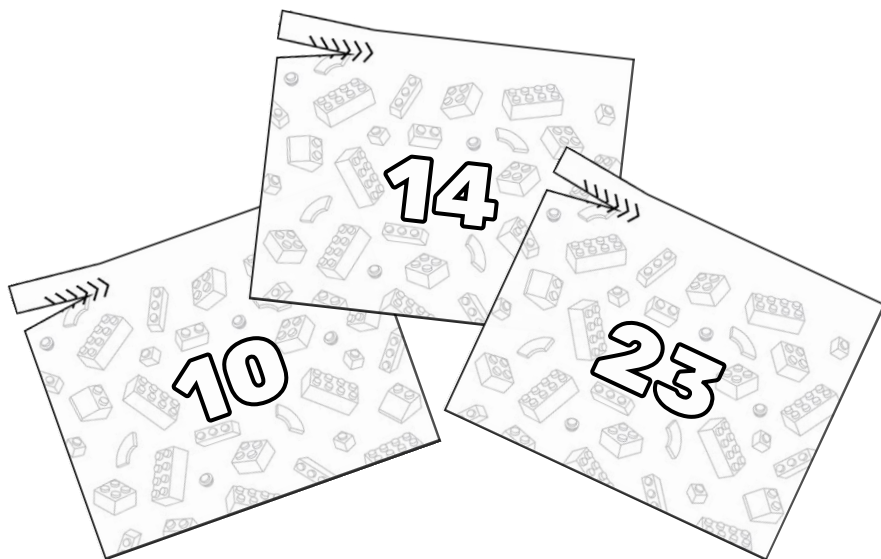
Open LEGO® Bags 10, 14 & 23

292

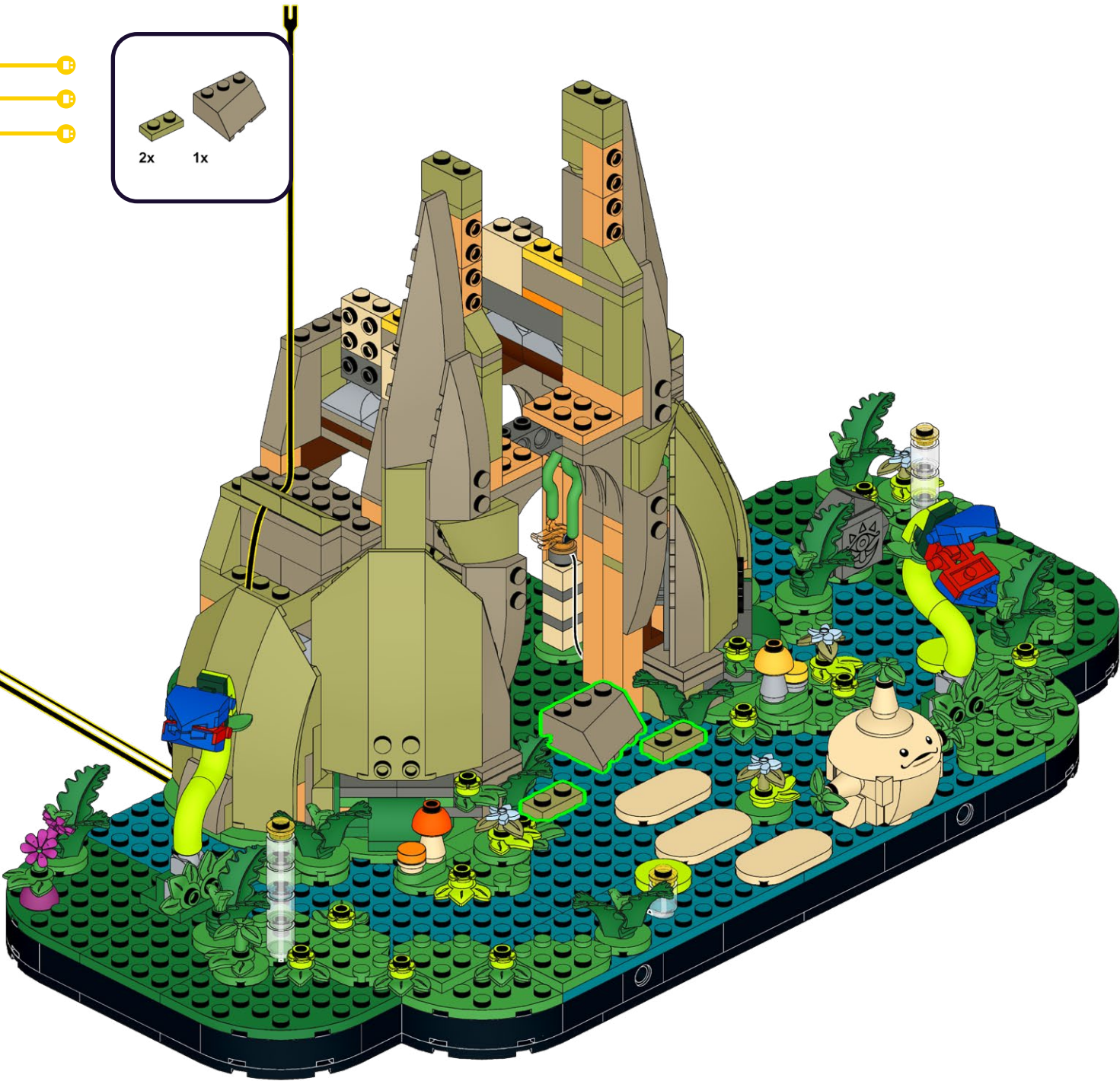
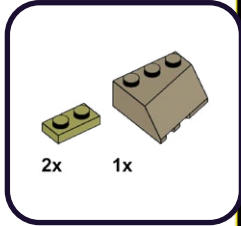

293

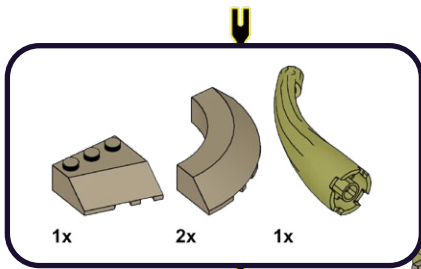

294

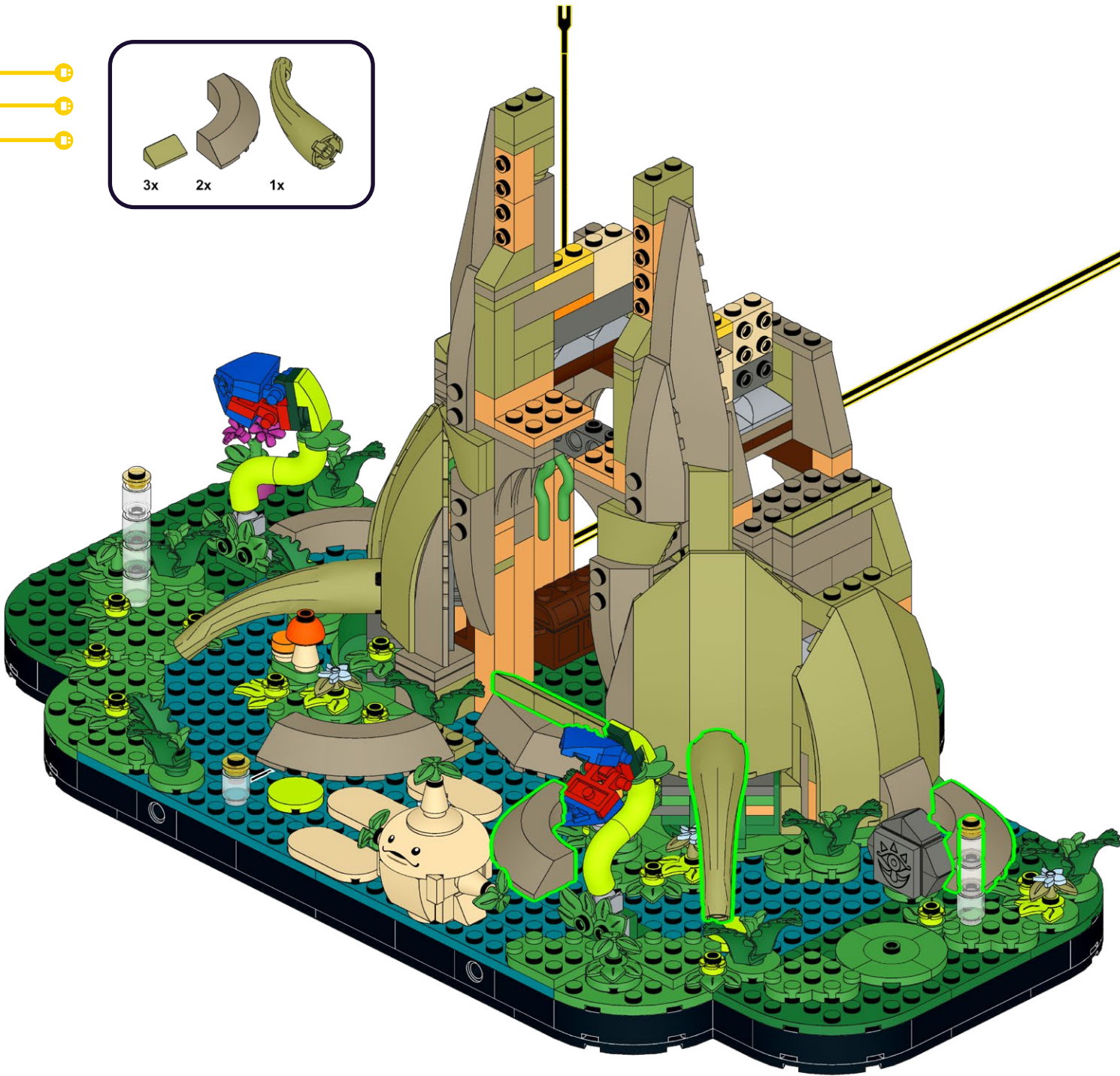
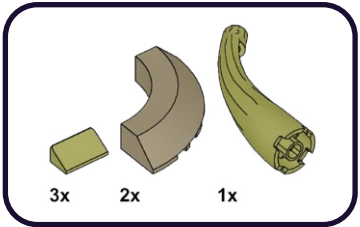

295

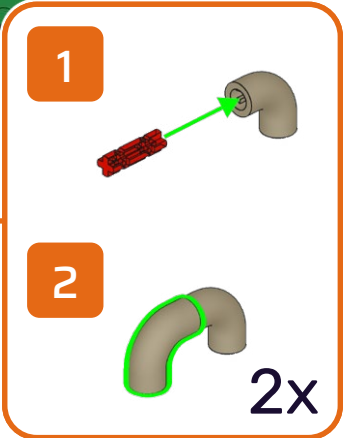
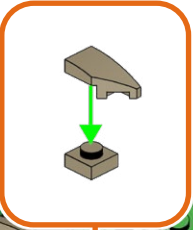
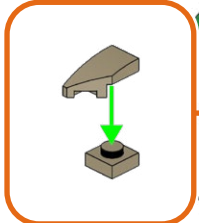
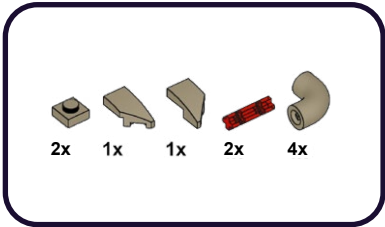

296

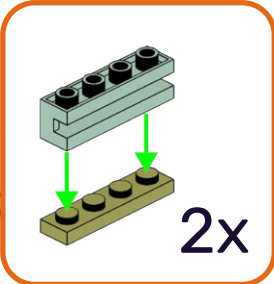
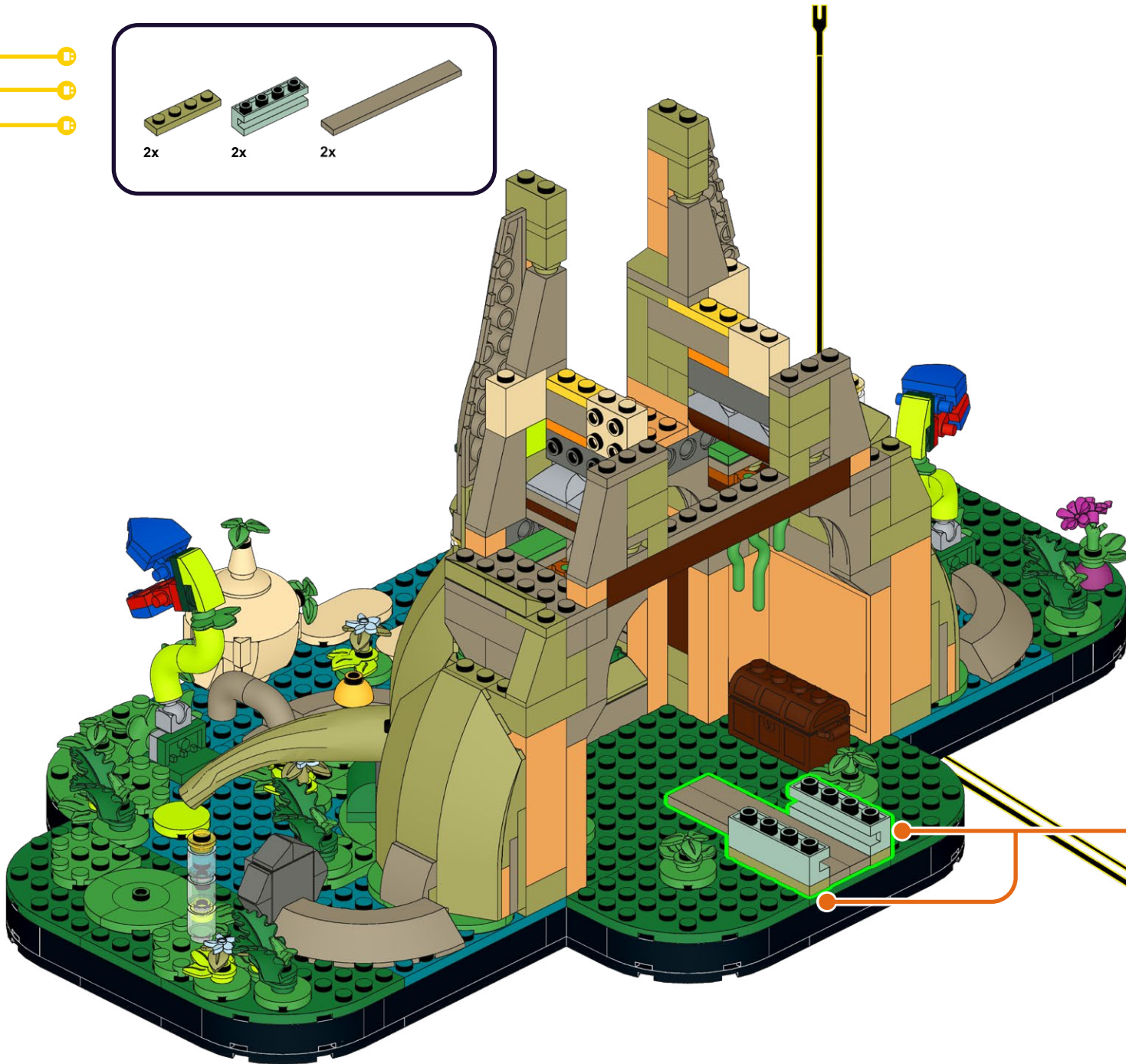
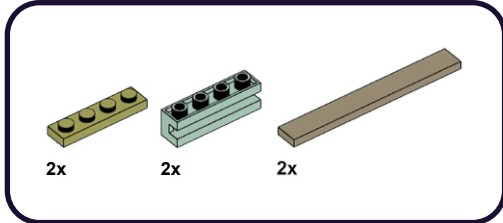

297

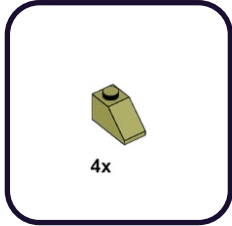

298

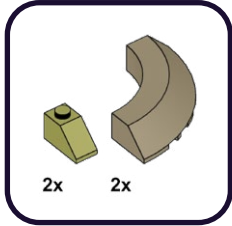

299

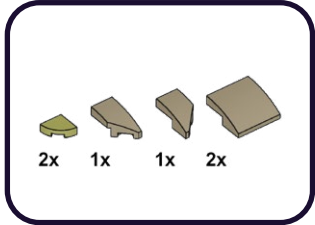

300

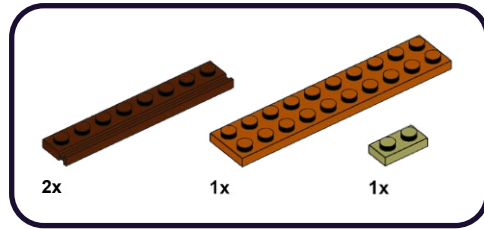

1

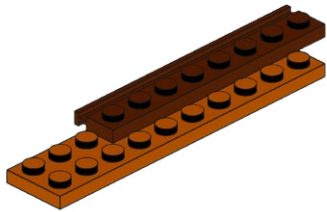

2

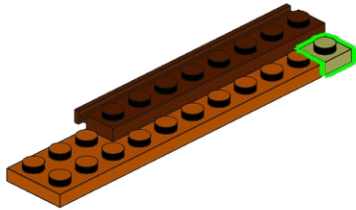

3

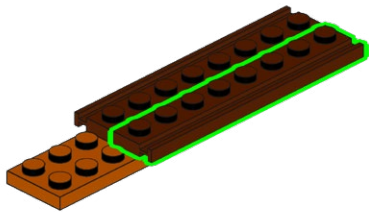

301

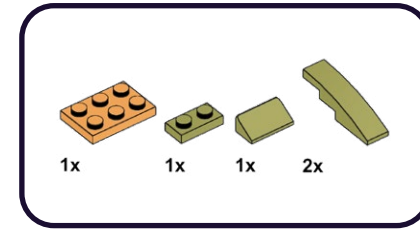

1

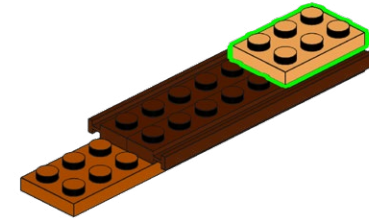

2

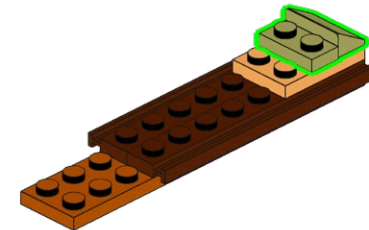

3

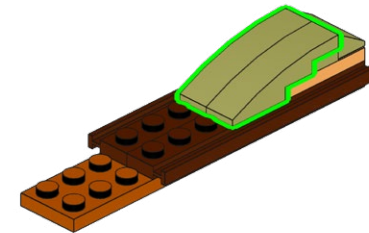

302

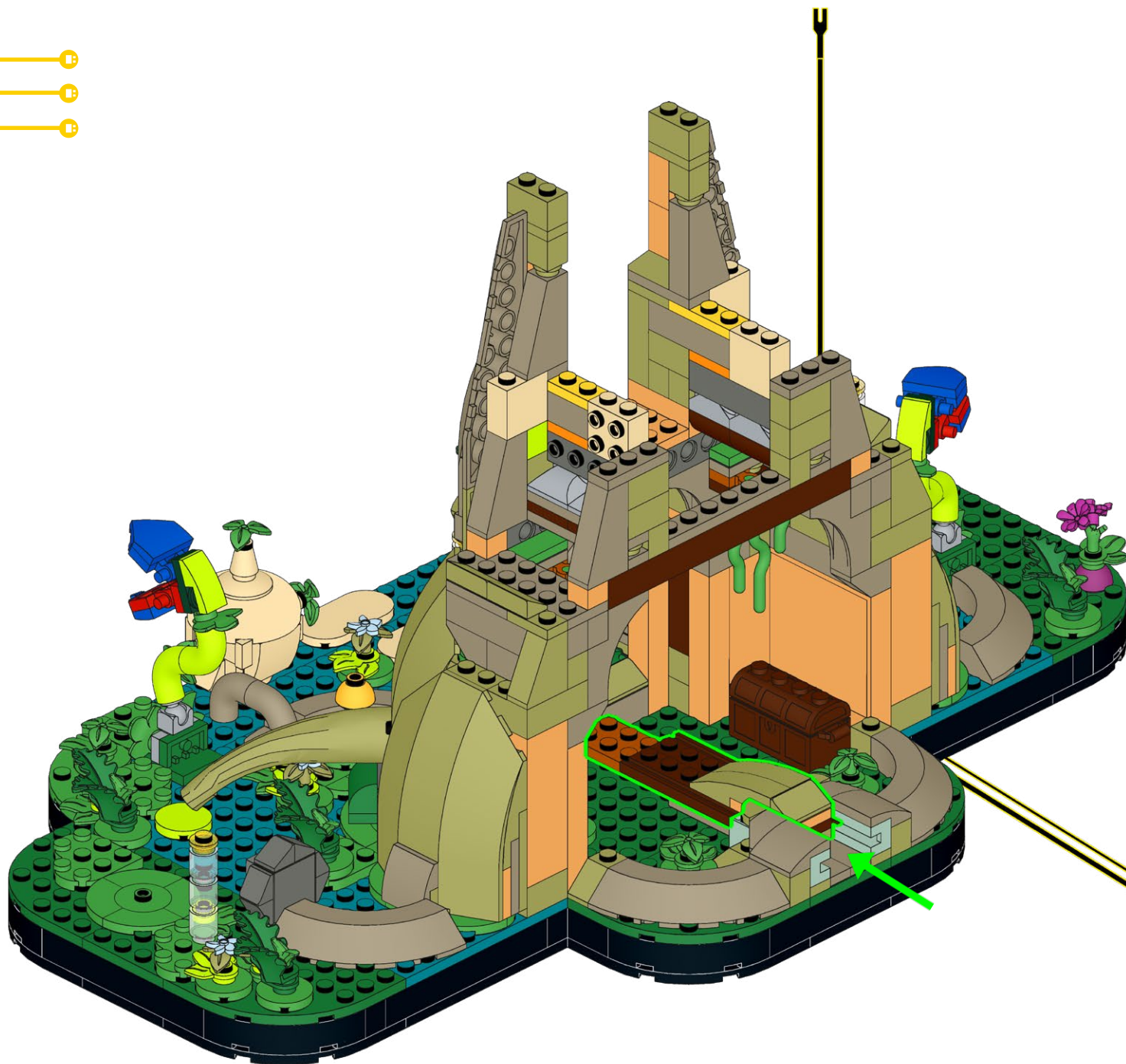

303

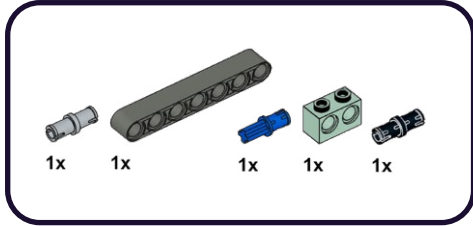

1

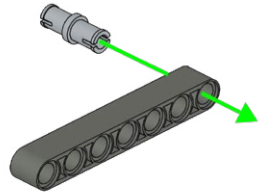

2

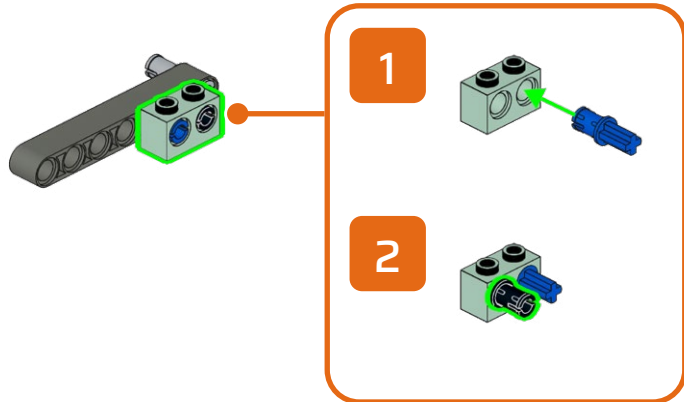

304

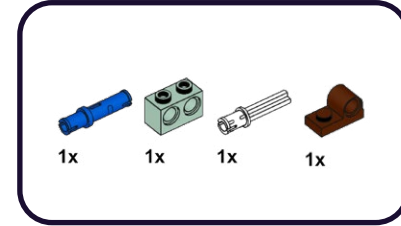

1

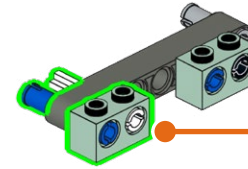

2

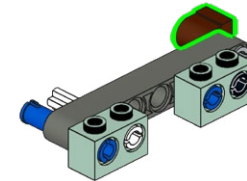

305

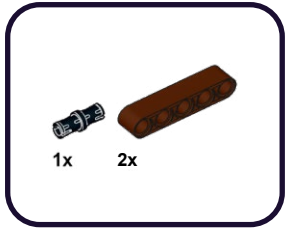

1

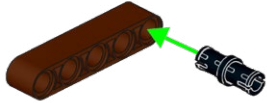

2

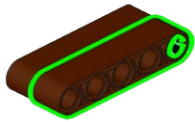

306

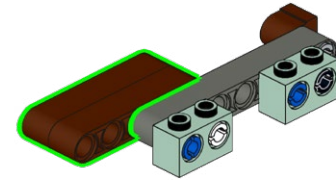

307

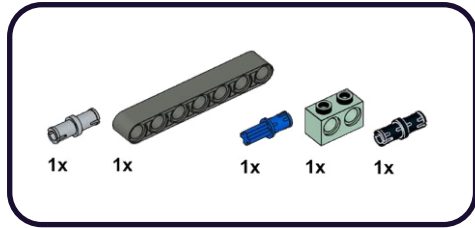

1

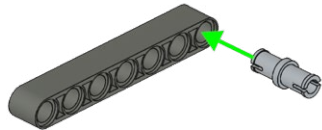

2

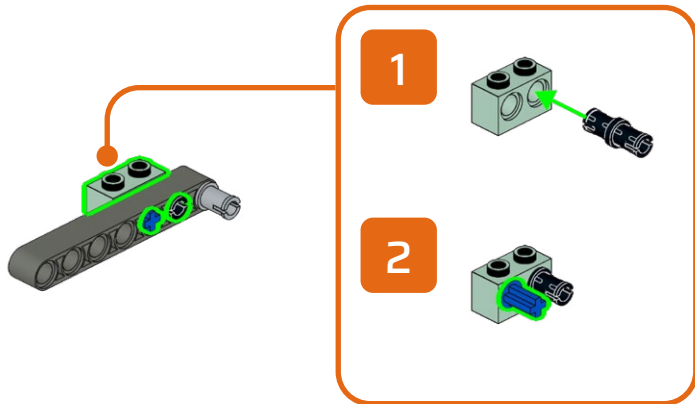

308

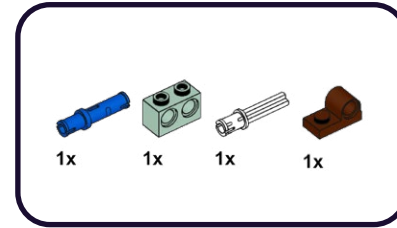

1

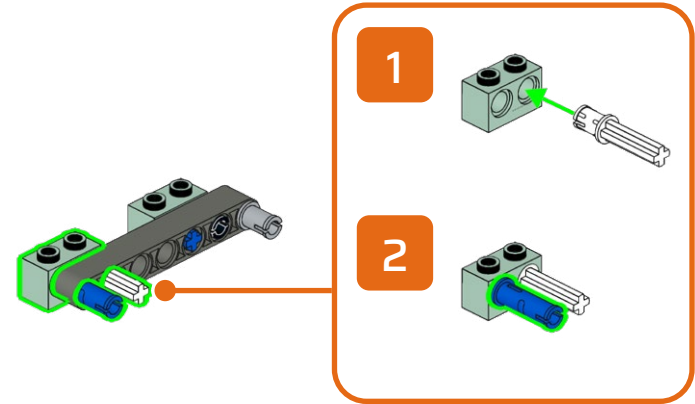

2

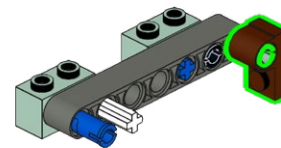

309

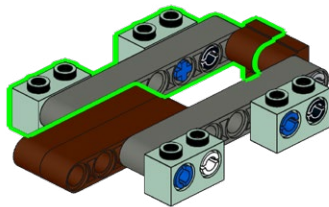

310

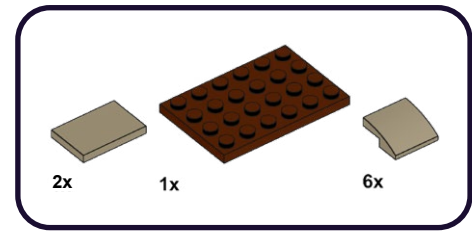

1

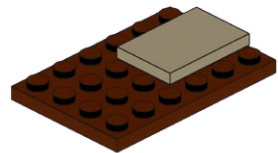

2

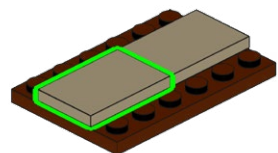

3

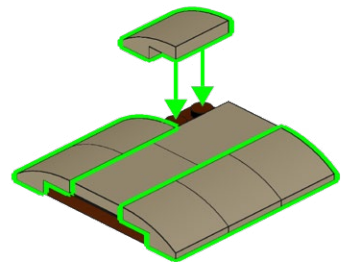

311

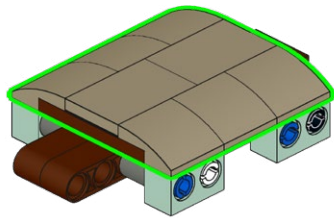

312

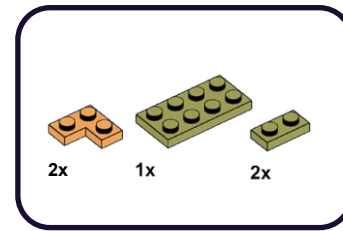

1

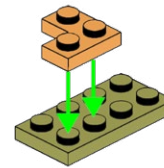

2

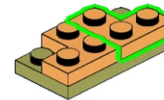

3

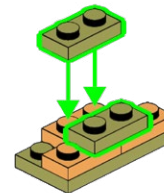

313

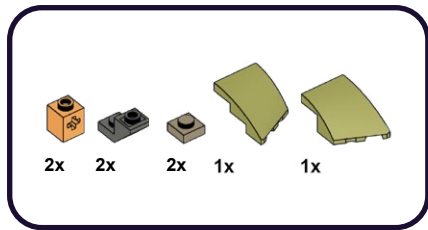

1

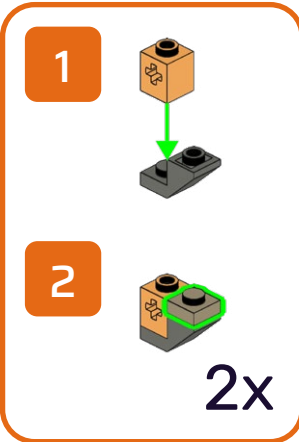
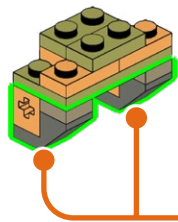

2

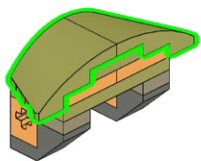

3

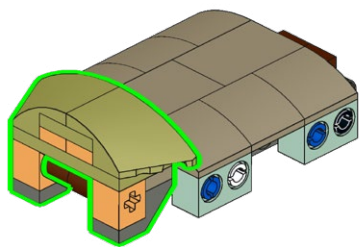

314

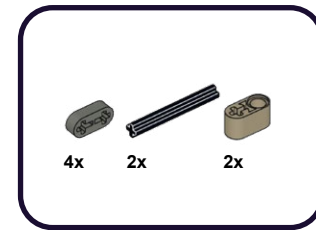

1



2

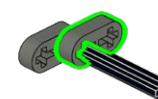

3

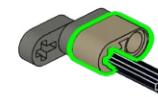

2x

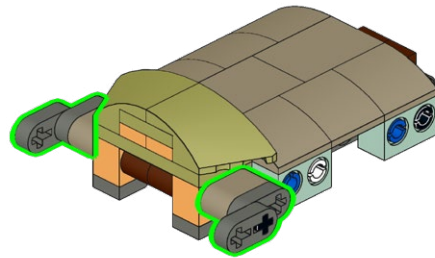

316

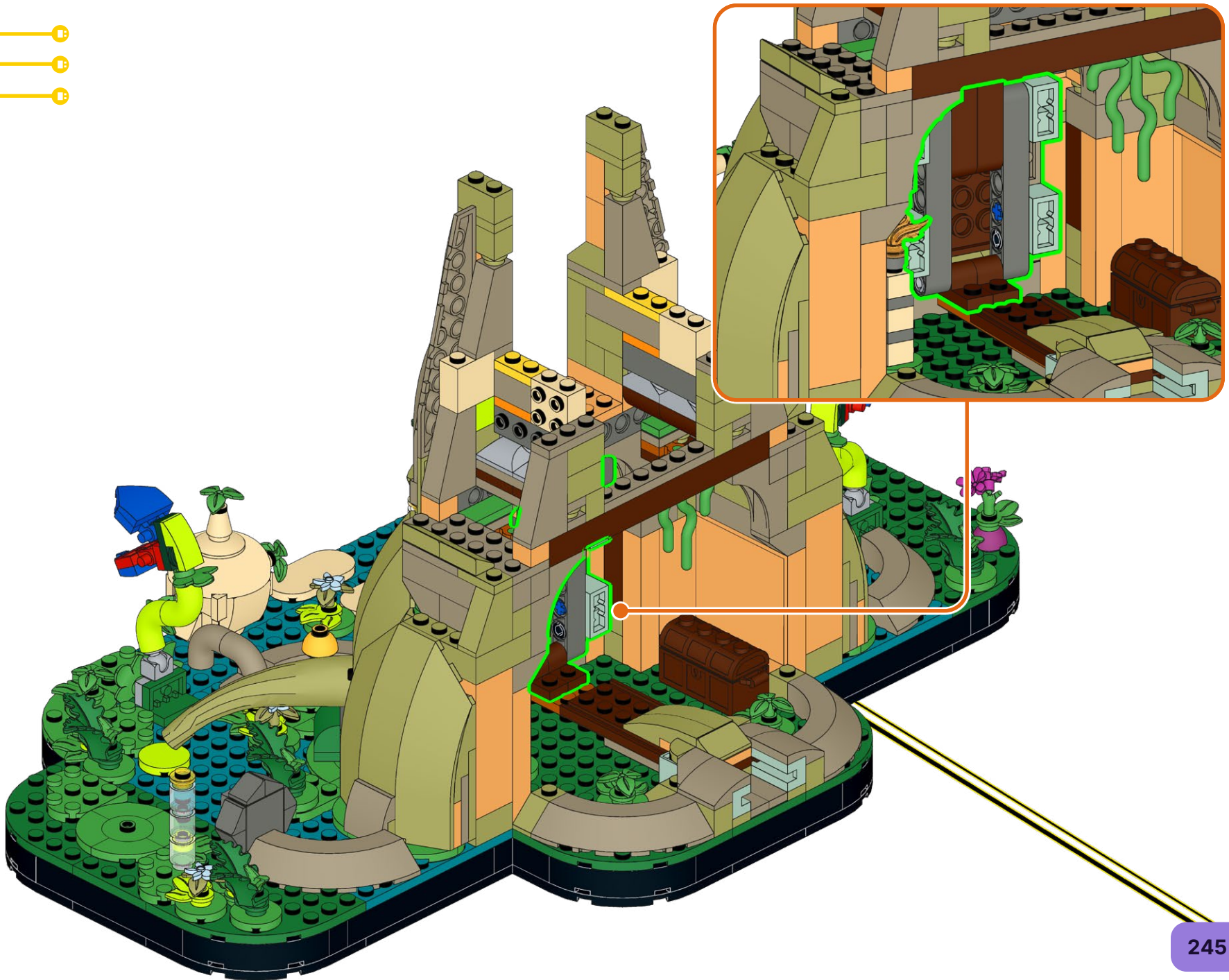

317

1x



318

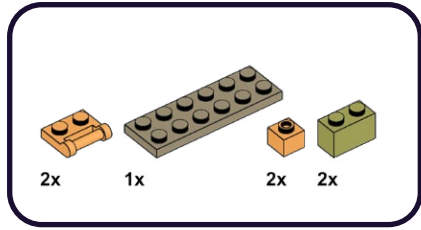

1

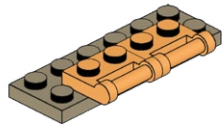

2

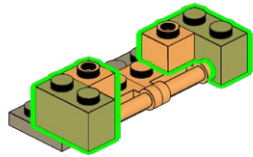

319

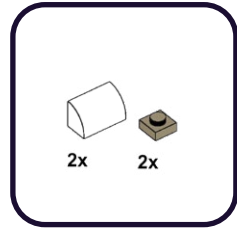

1

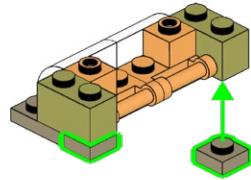

2

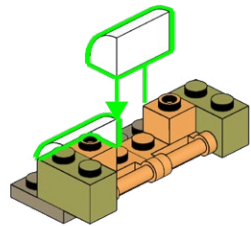

320

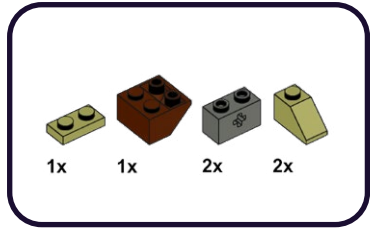

1

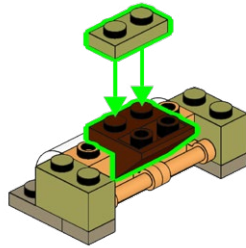

2

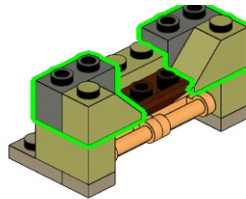

321

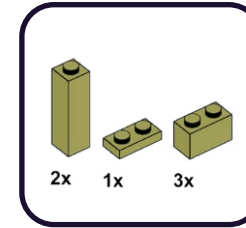

1

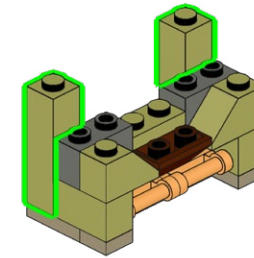

2

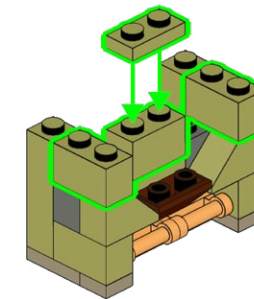

322

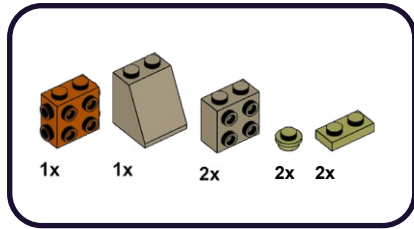

1

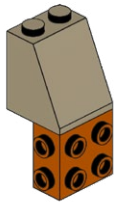

2

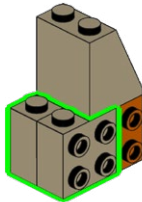

3

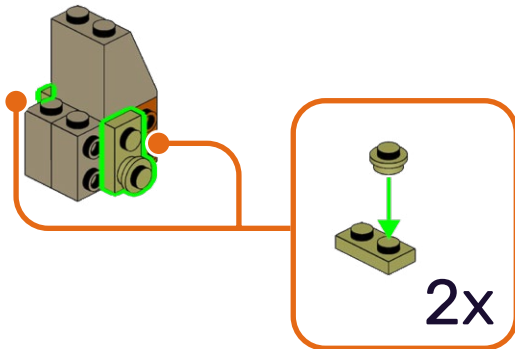

323

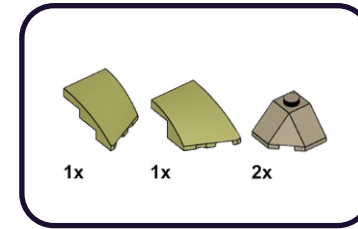

1

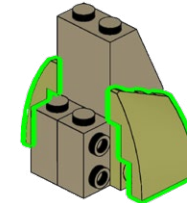

2

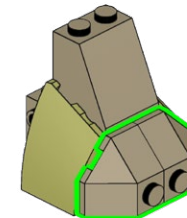

324

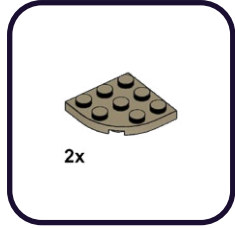

1

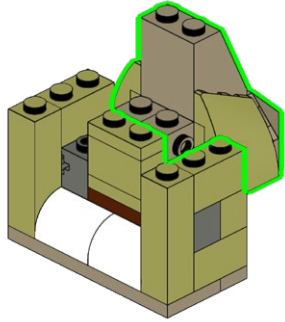

2

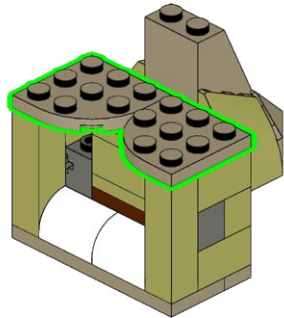

325

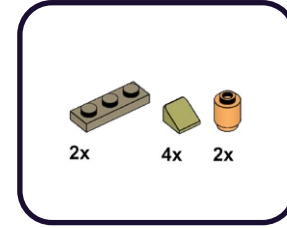

1

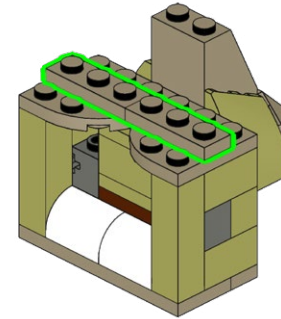

2

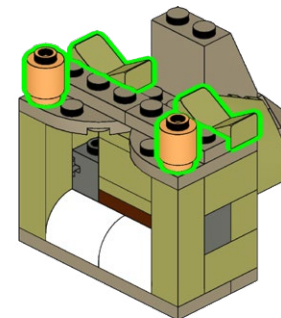

326

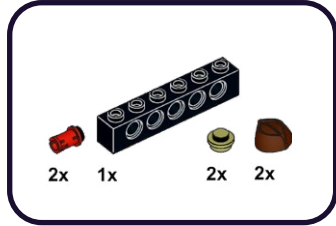

1

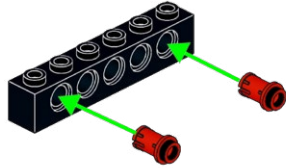

2

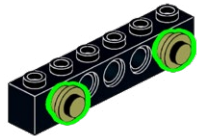

3

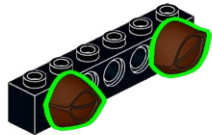

327

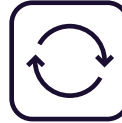
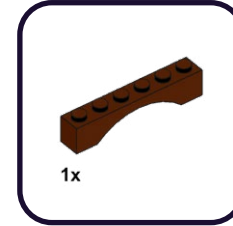

1

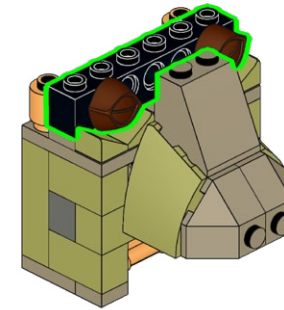

2

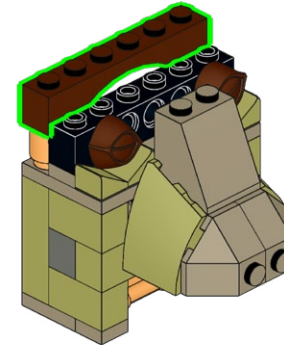

328

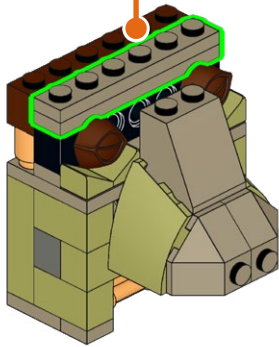
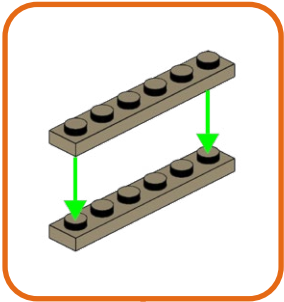
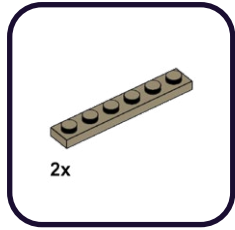

329

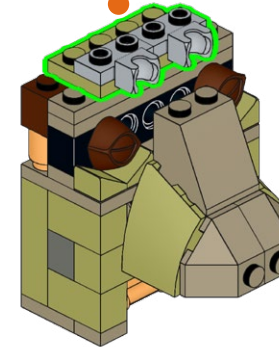
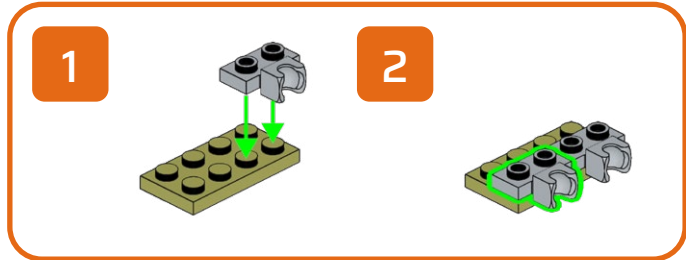
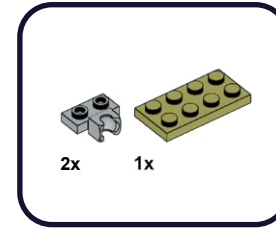

330

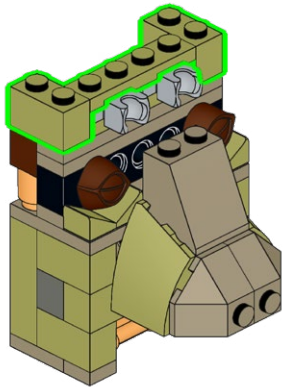
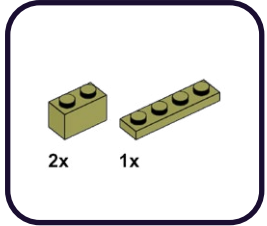

331

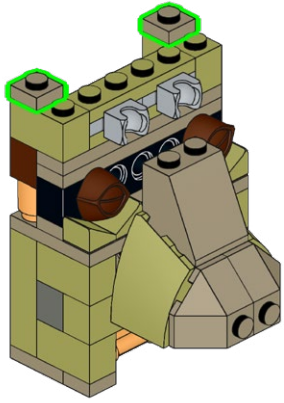
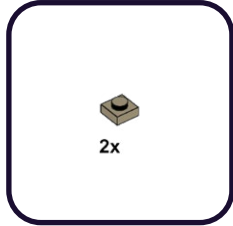

333

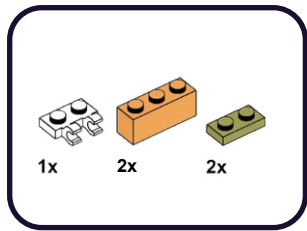

1

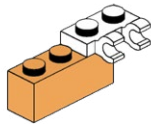

2

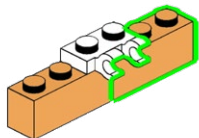

3

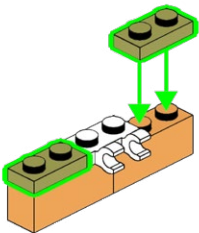

334

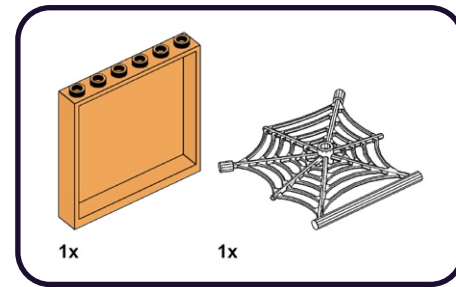

1

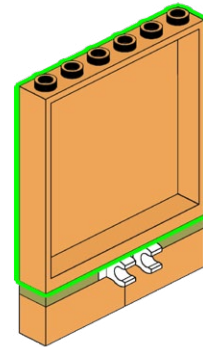

2

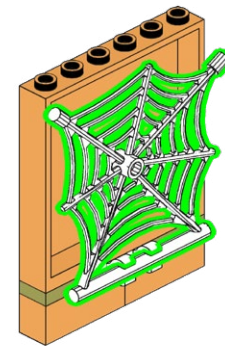

335



336

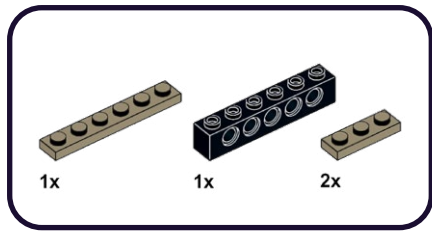

1

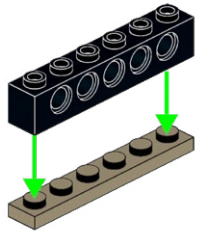

2

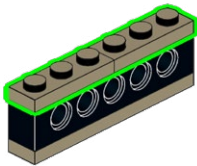

337

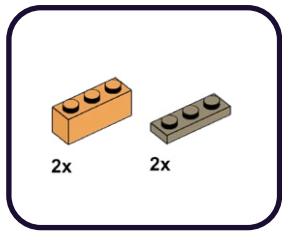

1

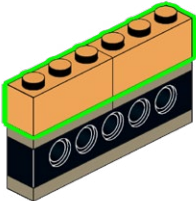

2

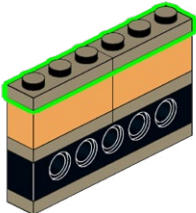

338

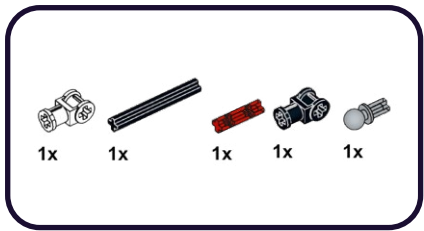

1



1



1

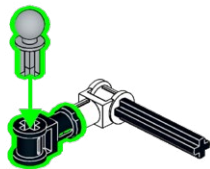

339

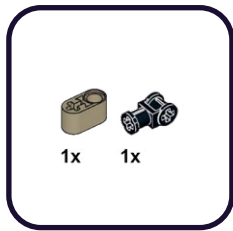

1

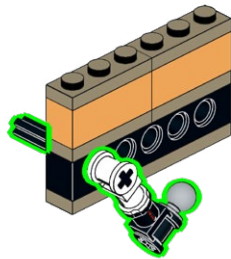

2

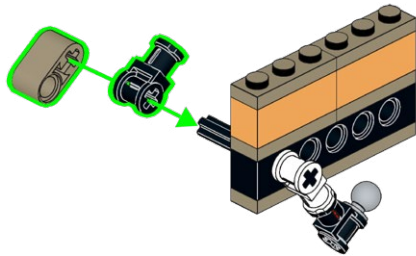

340

1x

1x

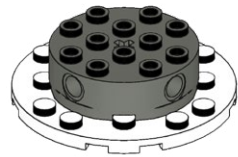
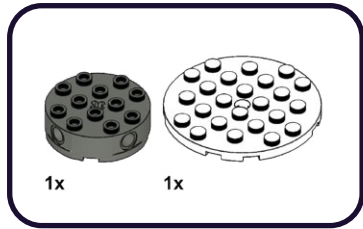

341

1x

2x

1x

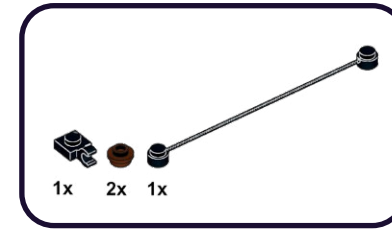

1



2

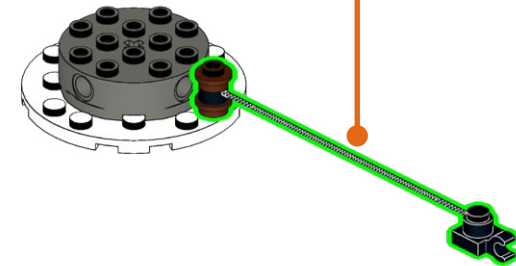
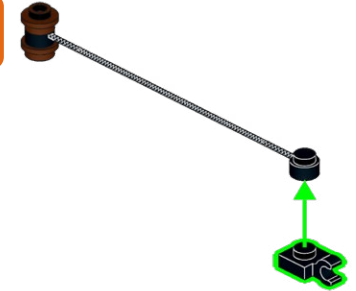

342

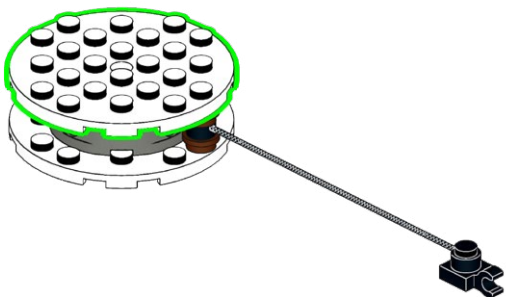
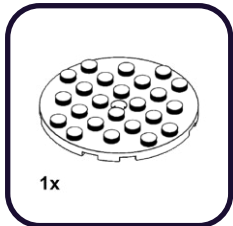

343

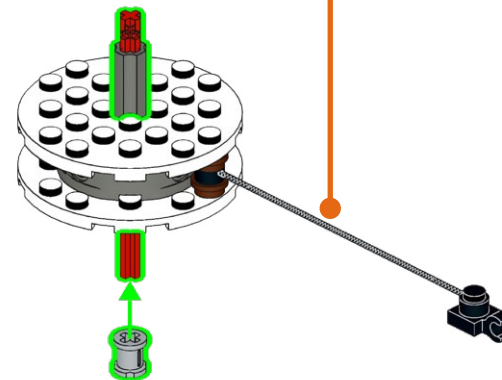
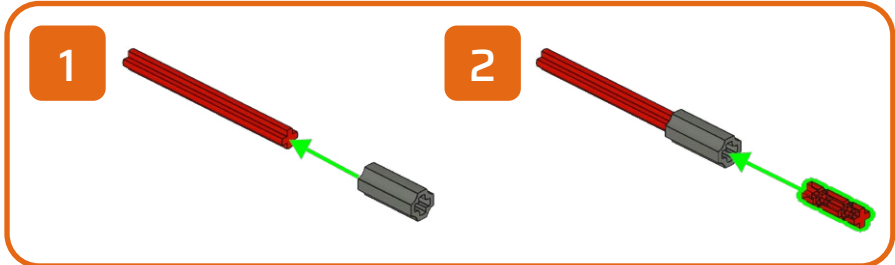
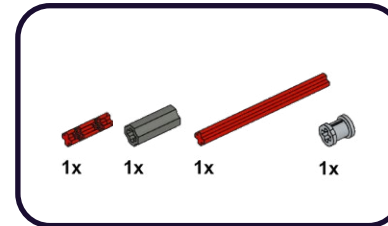

344

1x

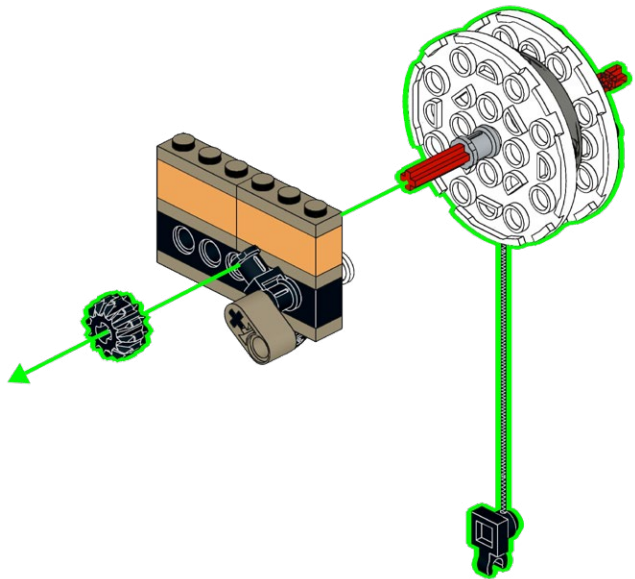

345

1x

1x

2x

1x

1

1

1

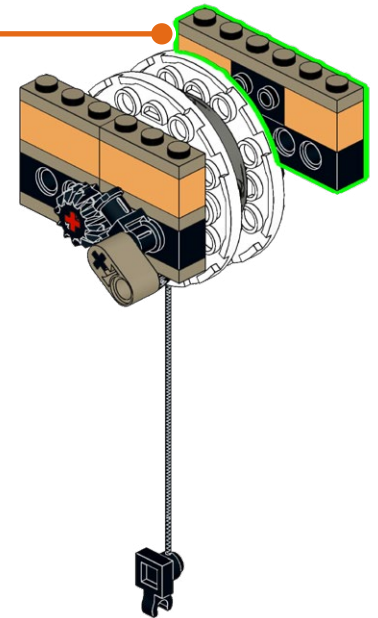
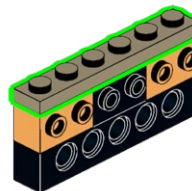
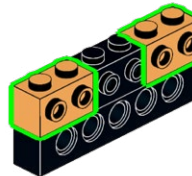
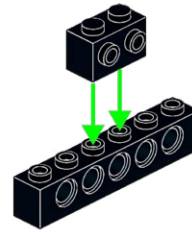

346



347

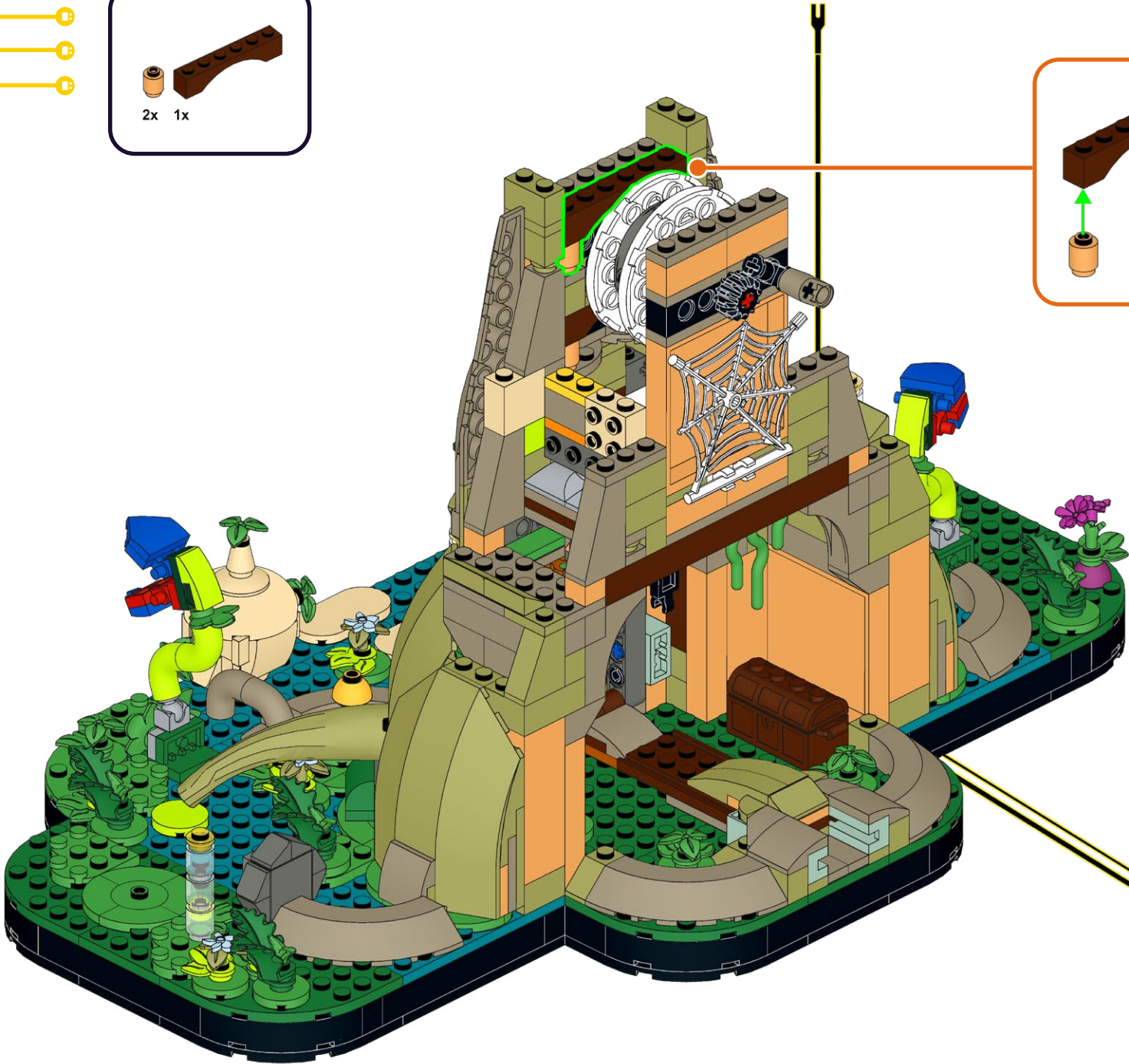
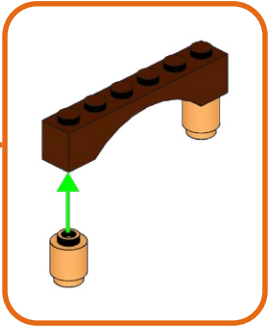
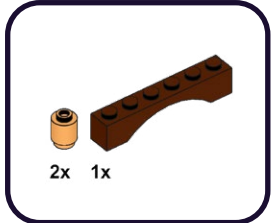

348

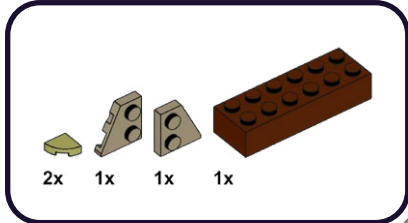

349

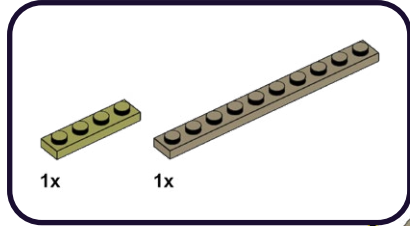

350

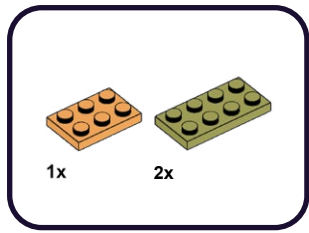

1

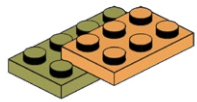

2

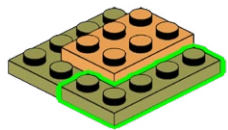

351

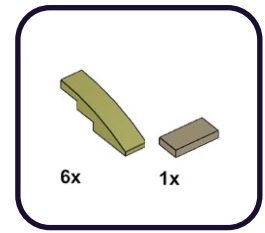

1

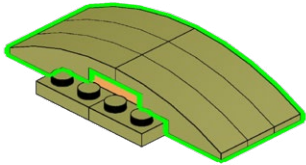

2

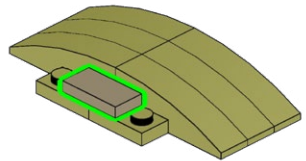

352



353

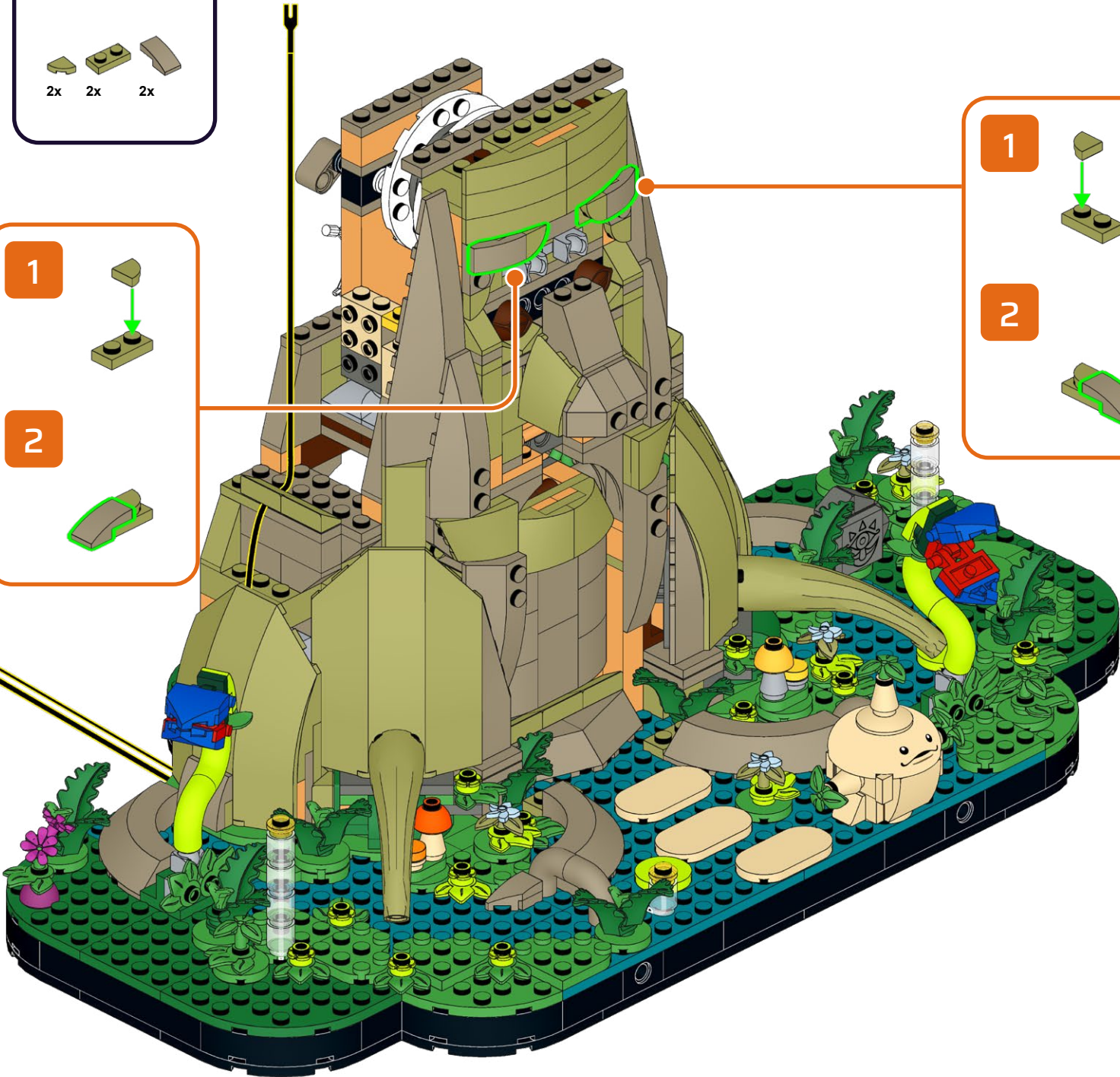
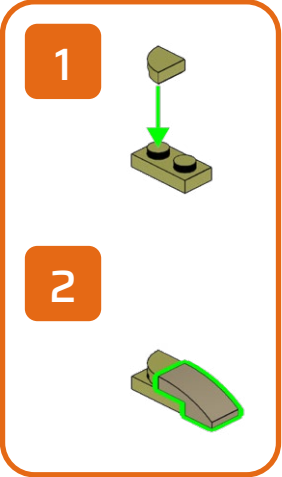
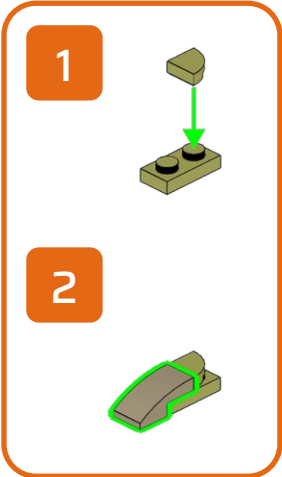
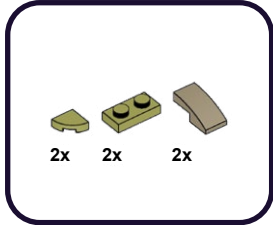

354

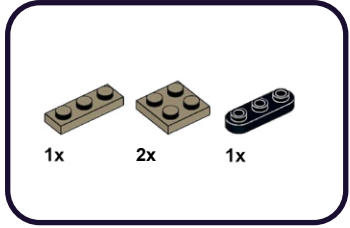

1

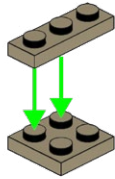

2

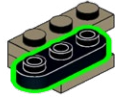

2

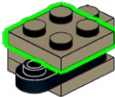

355

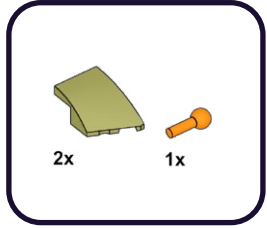

1

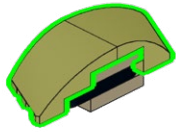

2

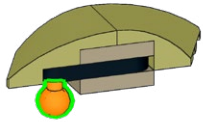

357

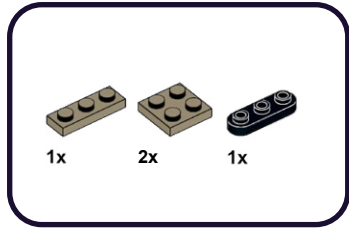

1

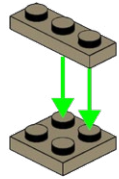

2

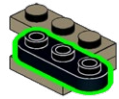

2

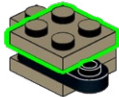

358

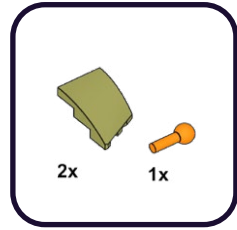

1

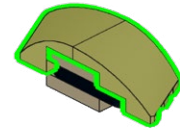

2

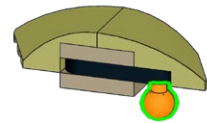
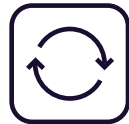

359



360

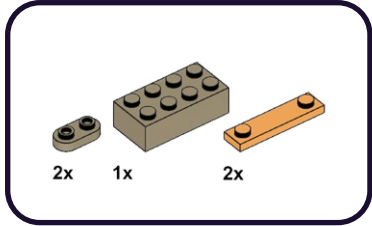

1

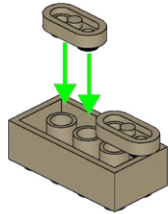

2

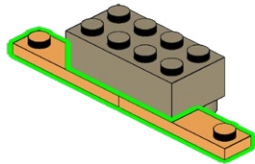

361

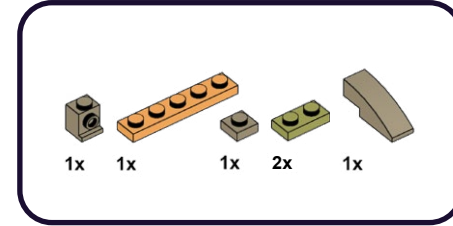

1

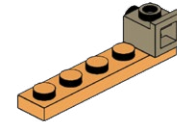

1

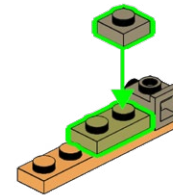

1

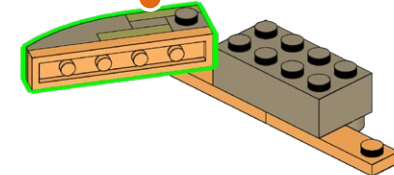
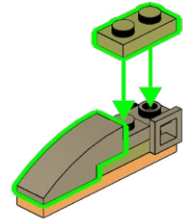

362

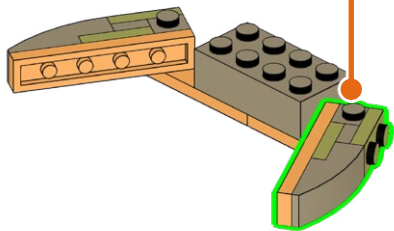
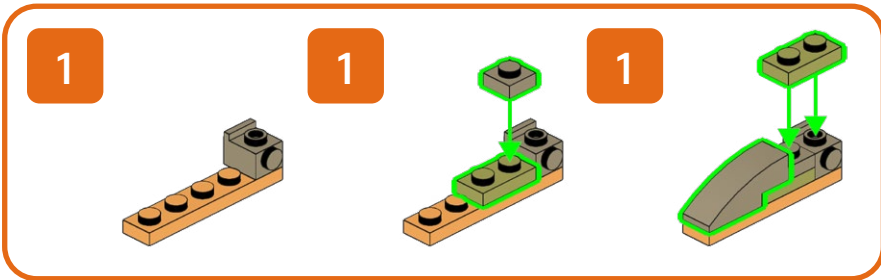
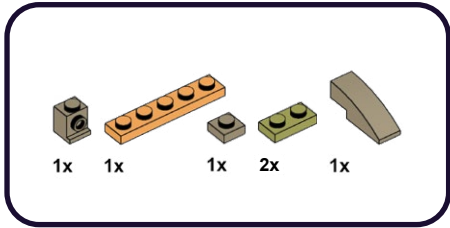

363

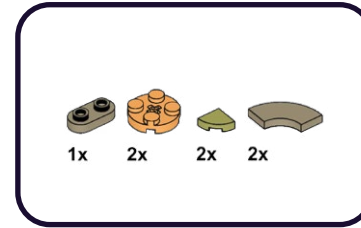

1

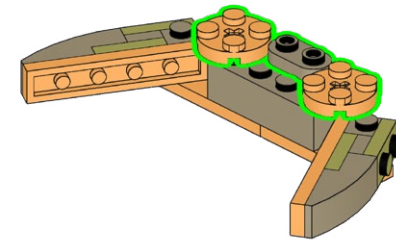

2

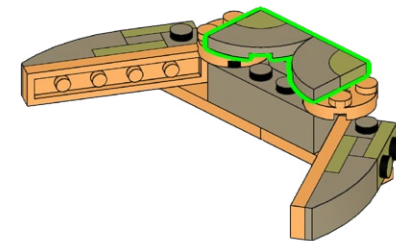

364

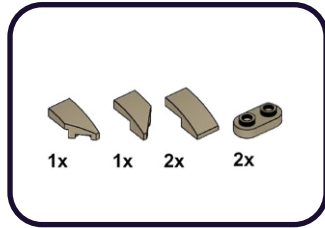

1

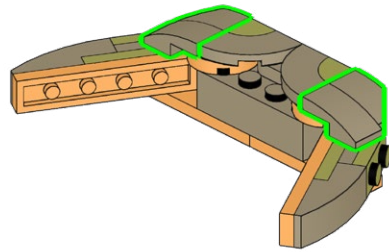

2

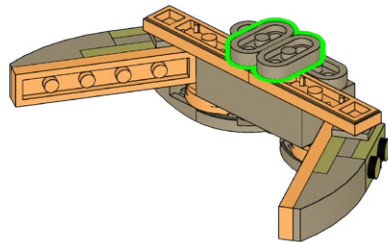

365

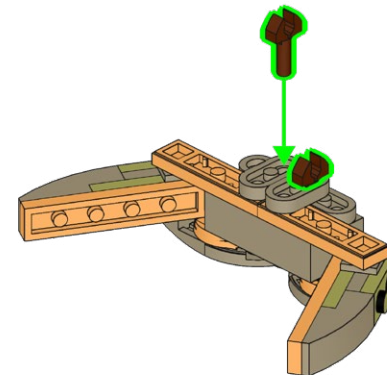
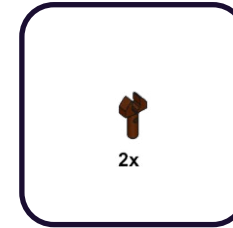

366



**HOLD UP!**

You might notice some bags aren't in order, as well as left over pieces, but that's ok! We're changing the way you build LEGO!

ATTENDEZ!

Vous remarquerez peut-être que certains sacs, ainsi que certaines pièces, ne sont pas dans le bon ordre. Mais pas de panique! Nous changeons simplement la façon avec laquelle vous construisez vos LEGO!

ASPETTA!

Potresti notare che alcuni sacchetti non sono in ordine, così come i pezzi avanzati, ma va bene così! Stiamo cambiando il modo in cui costruisci i LEGO!

HALT!

Sie werden möglicherweise bemerken, dass einige tüten durcheinander sind und teile übrig bleiben, aber das ist in Ordnung! Wir ändern die art und weise, wie Sie LEGO bauen!

¡ESPERA!

Es posible que notes que algunas bolsas están fuera de servicio, así como piezas sobrantes, ¡pero está bien! ¡Estamos cambiando la forma en que construyes LEGO!

暫停!

你可能会注意到一些袋子顺序错乱, 以及一些剩余的部件, 但没关系! 我们正在改变你搭建乐高的方式!

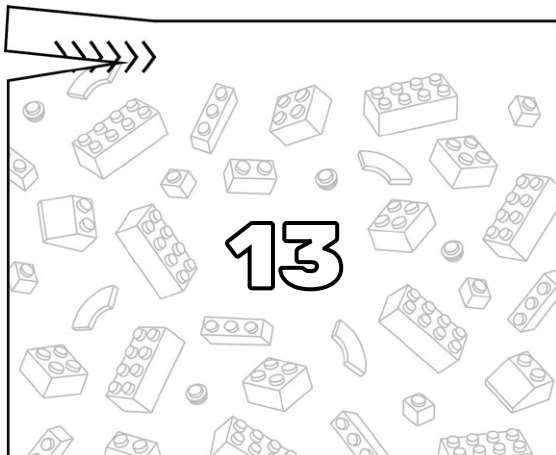
Open LEGO® Bag 13

367

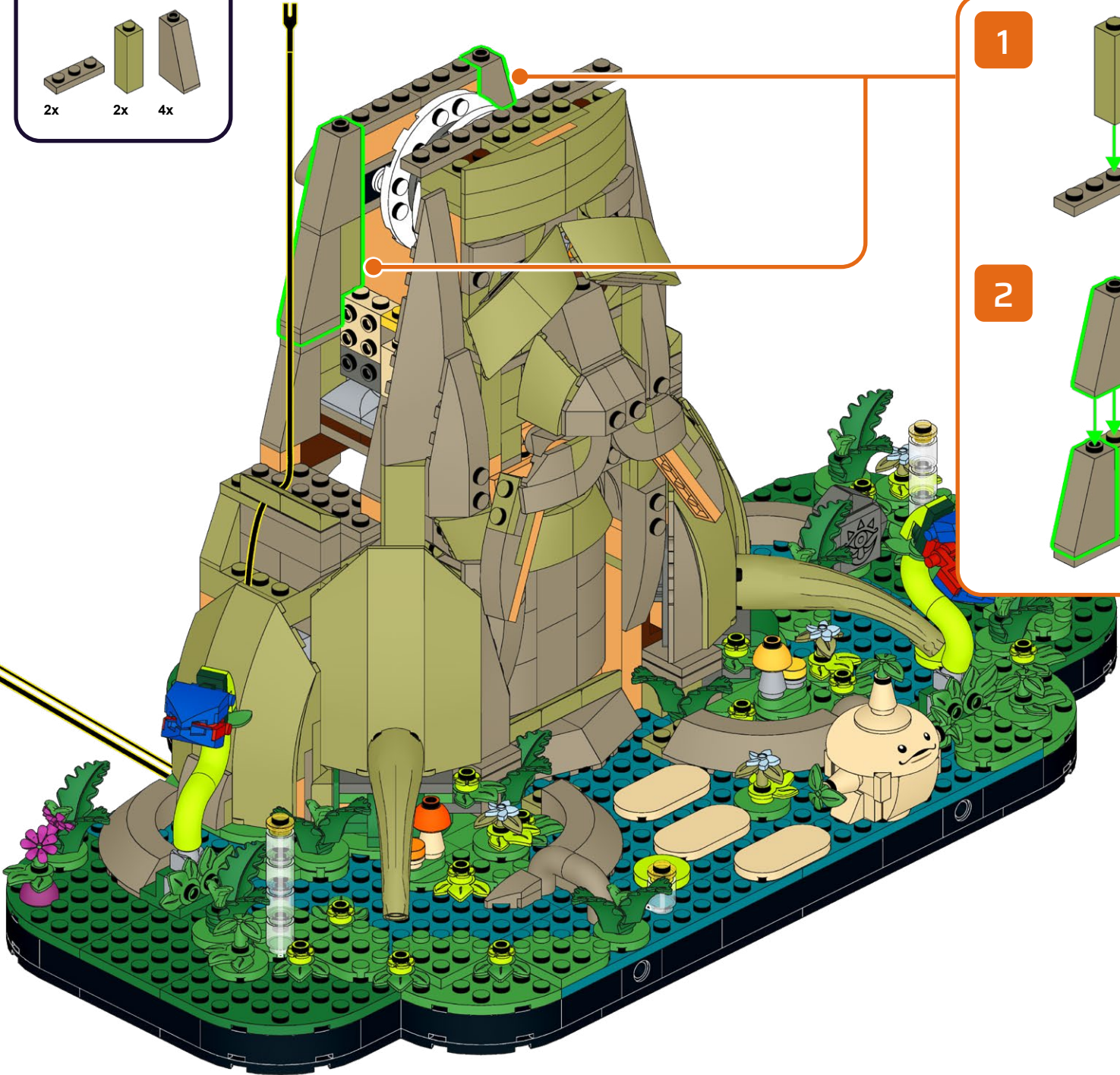
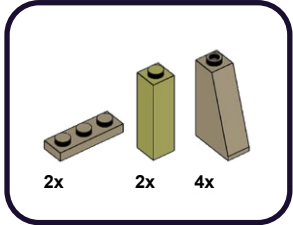

1

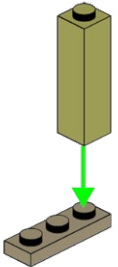

2

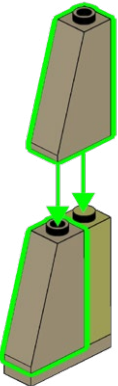

2x

368

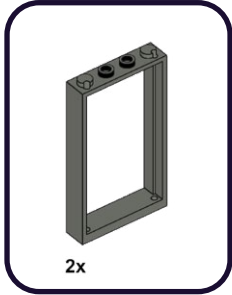

369



370

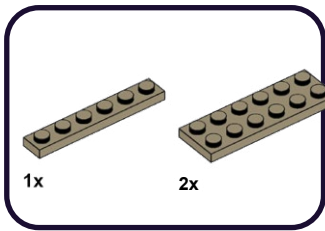

1

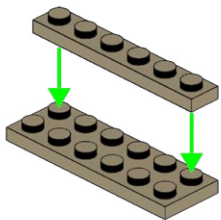

2

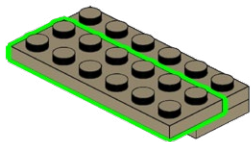

371

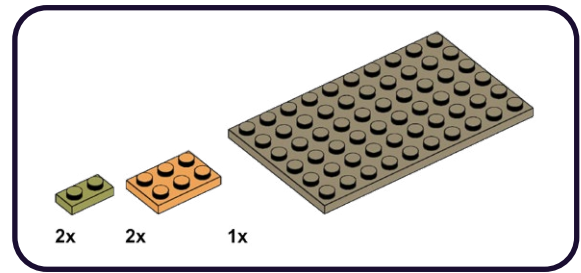

1

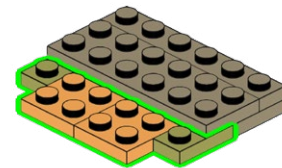

2

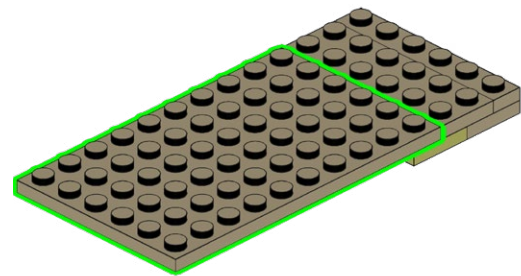

372

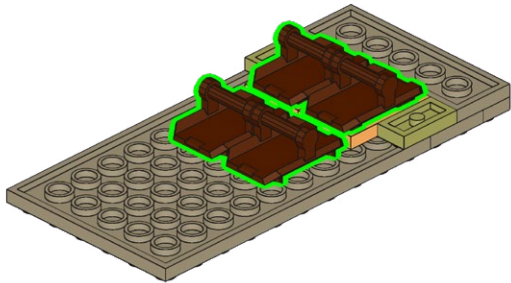
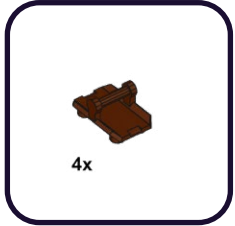

373

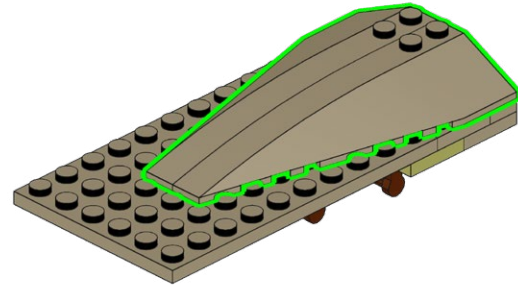
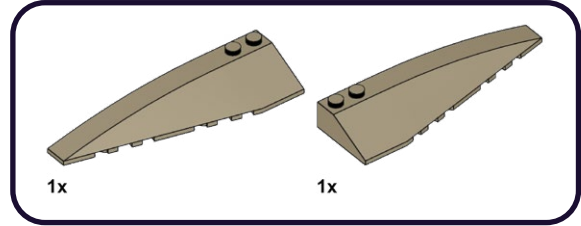

374

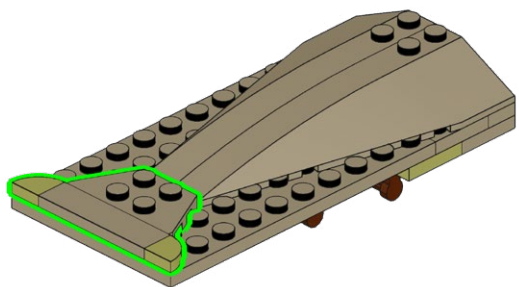
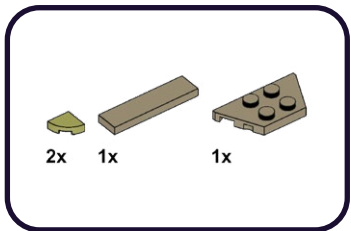

375

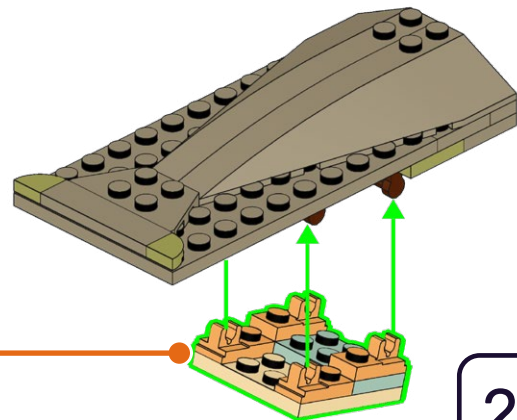
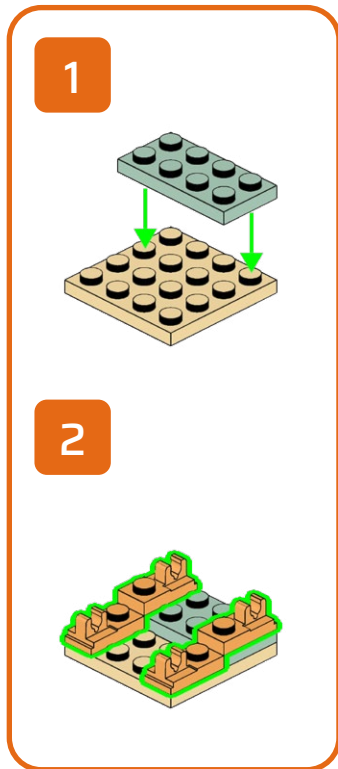
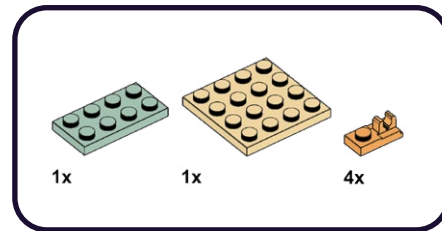

2x

376



377

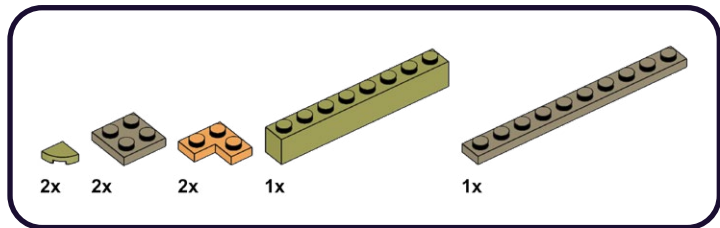

378

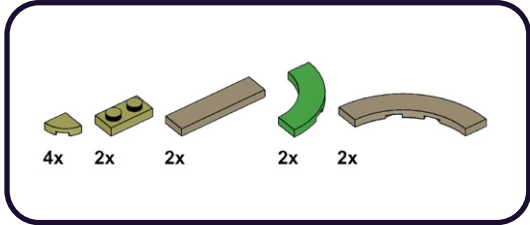

379

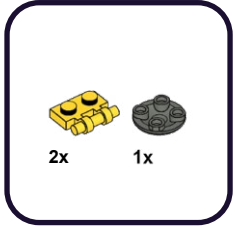

1

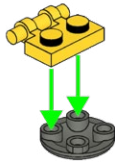

2

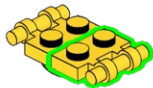

380

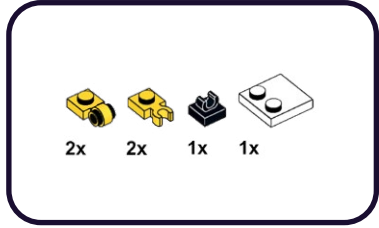

1

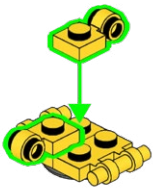

2

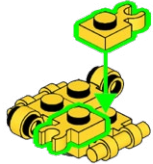

3

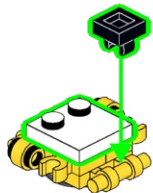

381

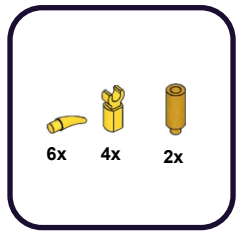

1

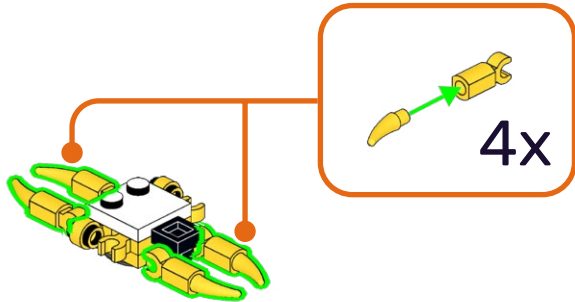

2

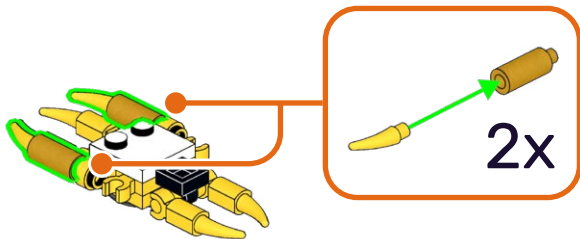

382

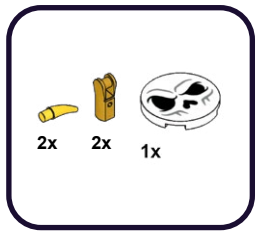

1

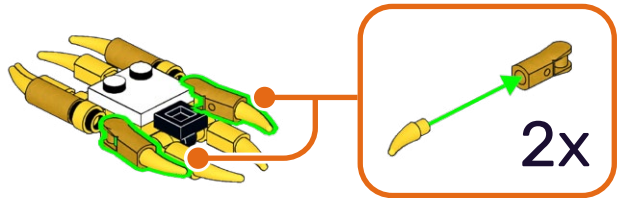

2

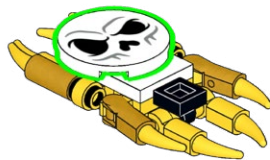

383



**HOLD UP!**

You might notice some bags aren't in order, as well as left over pieces, but that's ok! We're changing the way you build LEGO!

ATTENDEZ!

Vous remarquerez peut-être que certains sacs, ainsi que certaines pièces, ne sont pas dans le bon ordre. Mais pas de panique! Nous changeons simplement la façon avec laquelle vous construisez vos LEGO!

ASPETTA!

Potresti notare che alcuni sacchetti non sono in ordine, così come i pezzi avanzati, ma va bene così! Stiamo cambiando il modo in cui costruisci i LEGO!

HALT!

Sie werden möglicherweise bemerken, dass einige tüten durcheinander sind und teile übrig bleiben, aber das ist in Ordnung! Wir ändern die art und weise, wie Sie LEGO bauen!

¡ESPERA!

Es posible que notes que algunas bolsas están fuera de servicio, así como piezas sobrantes, ¡pero está bien! ¡Estamos cambiando la forma en que construyes LEGO!

暫停!

你可能会注意到一些袋子顺序错乱, 以及一些剩余的部件, 但没关系! 我们正在改变你搭建乐高的方式!

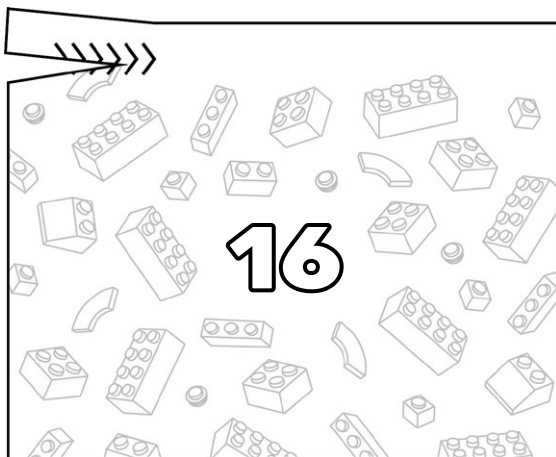
Open LEGO® Bag 16

384

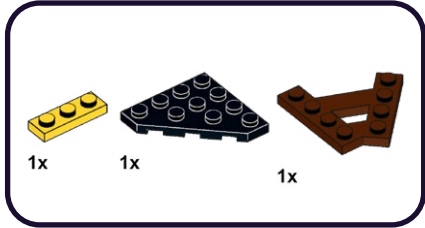

1



2



385

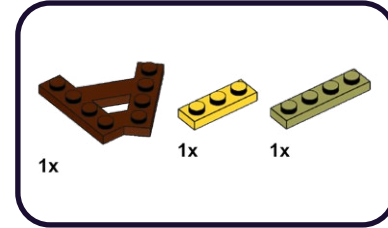

1

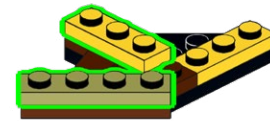

2

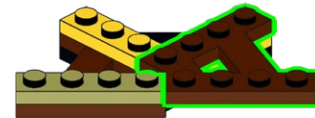

386

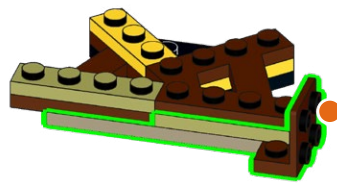
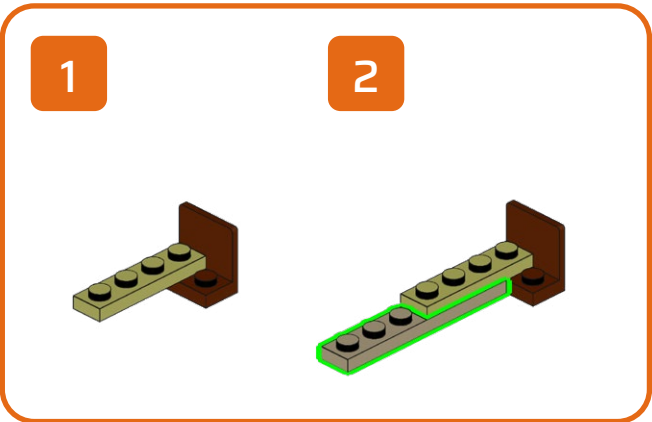
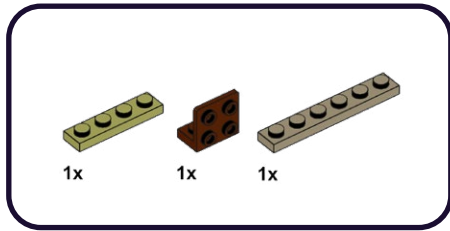

387

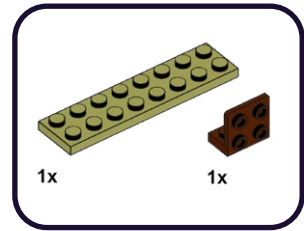

1

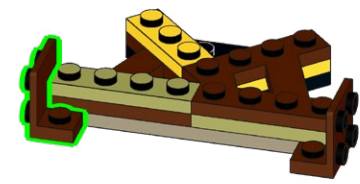

2

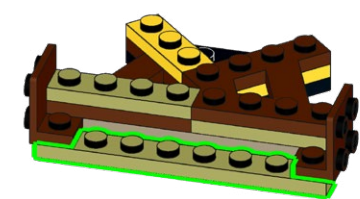

388

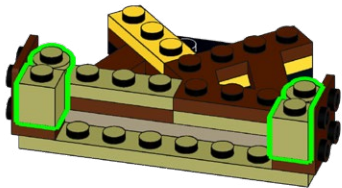
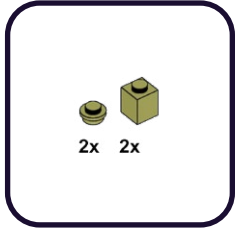

389

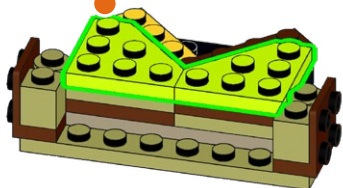
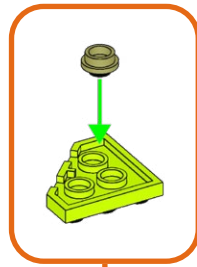
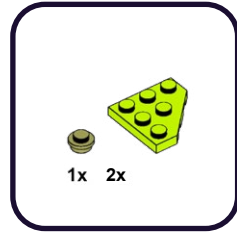

390

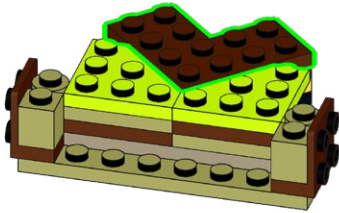
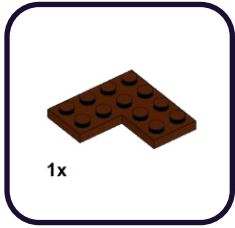

391

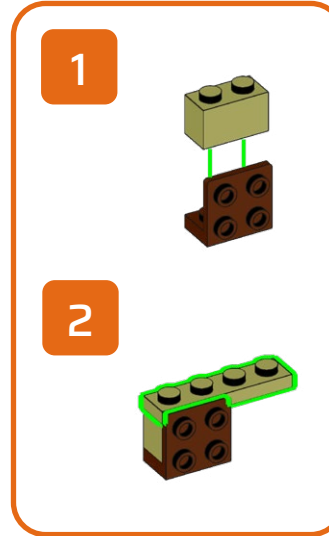
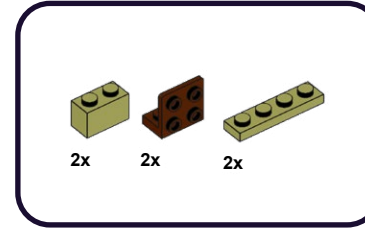

2

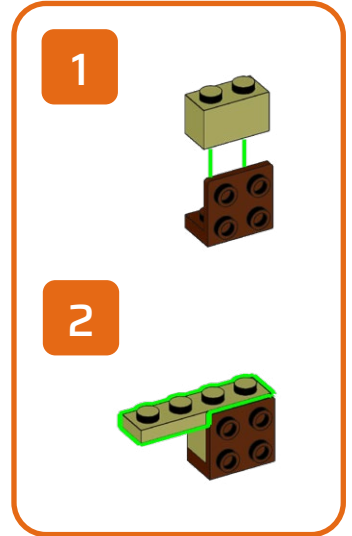
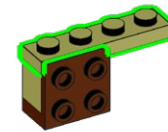

2

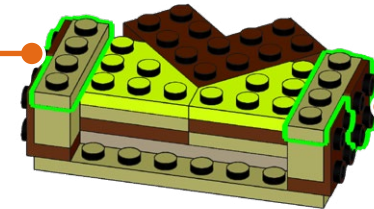
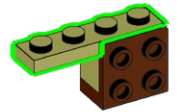

392

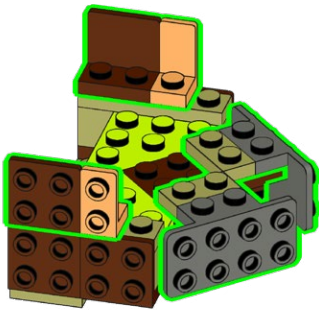
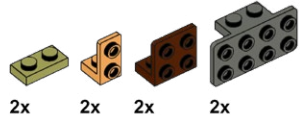

393

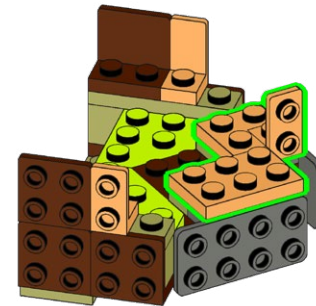
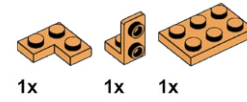

394

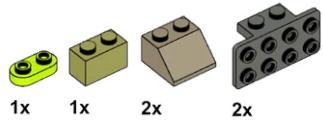

1

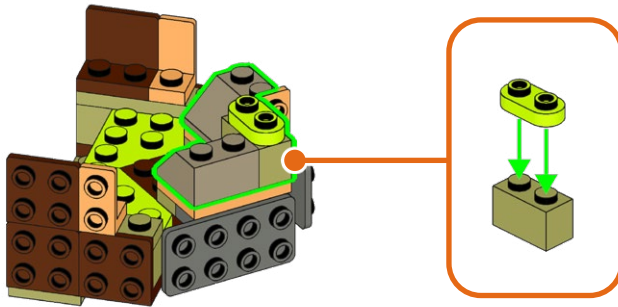

2

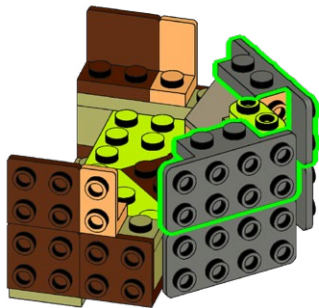

395

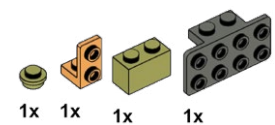

1

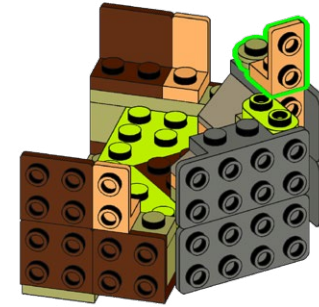

2

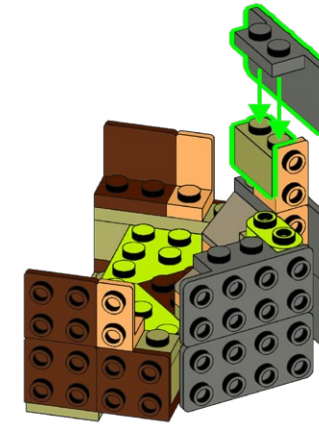

396

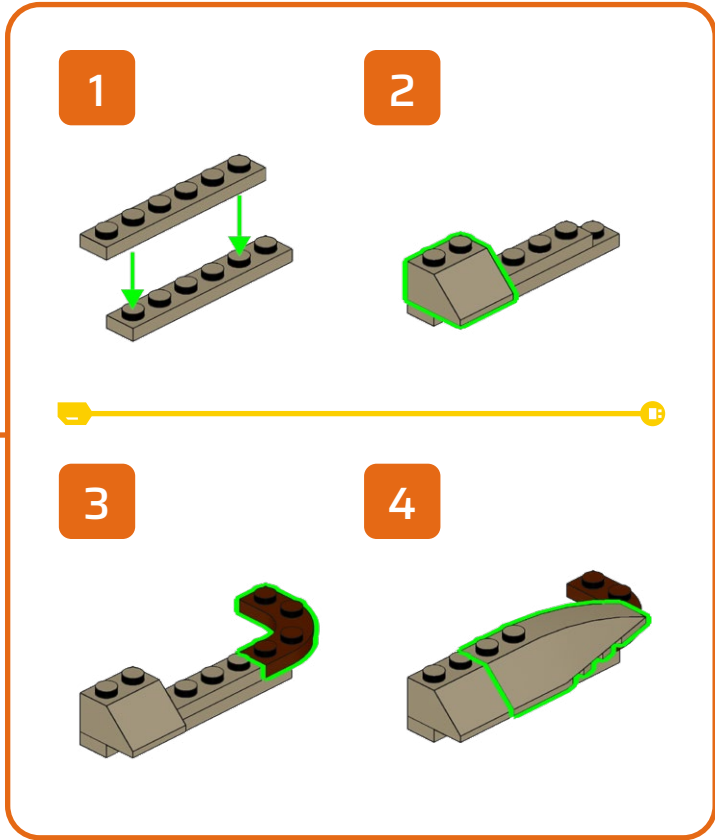
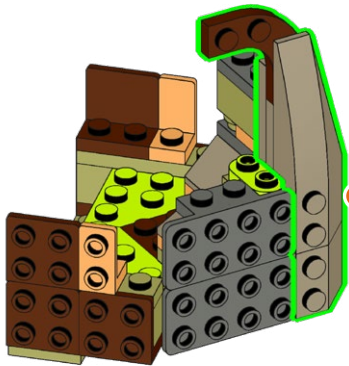
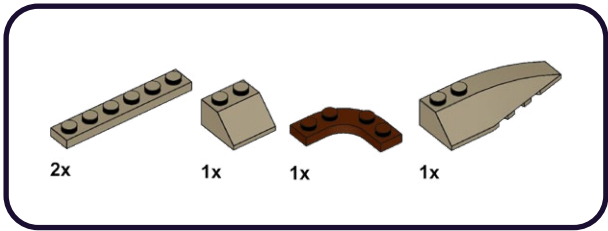

397

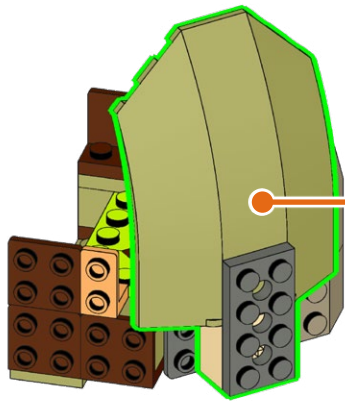
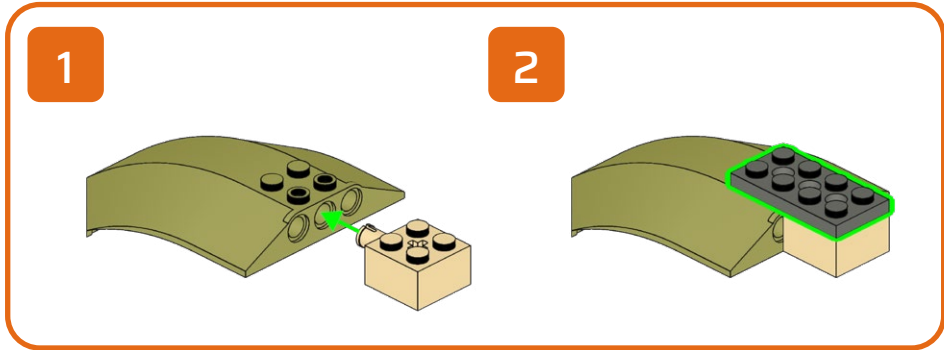
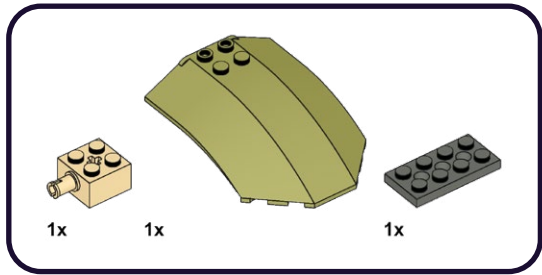

398

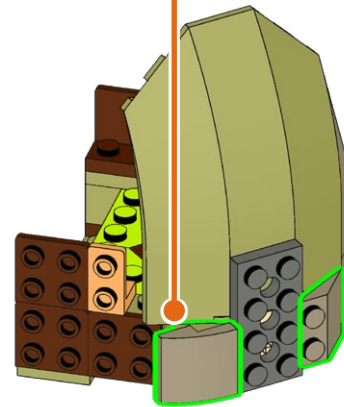
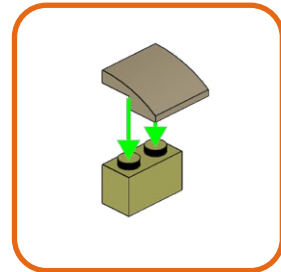
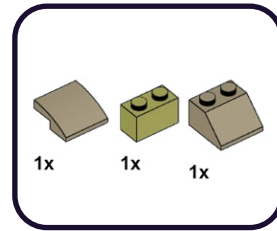

399

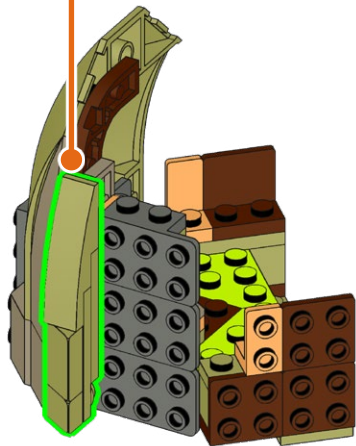
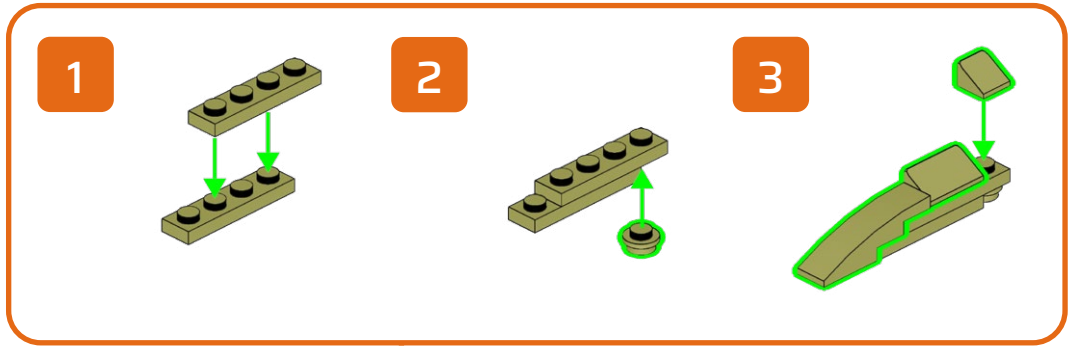
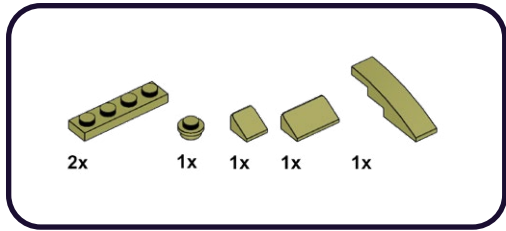

400

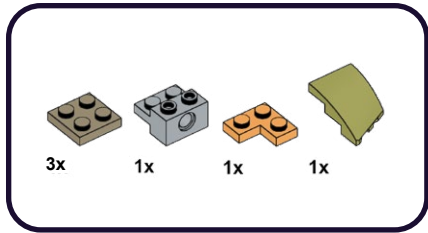

1

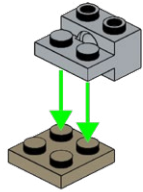

2

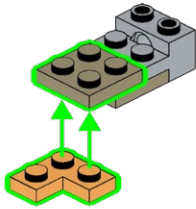

2

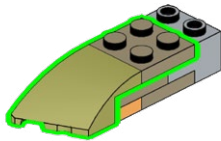

401

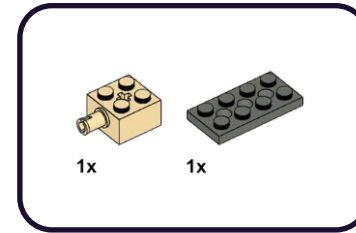

1

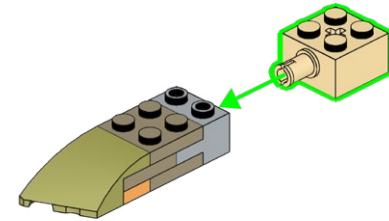

2

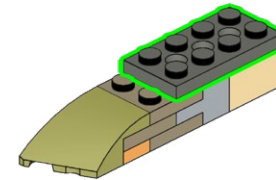

402

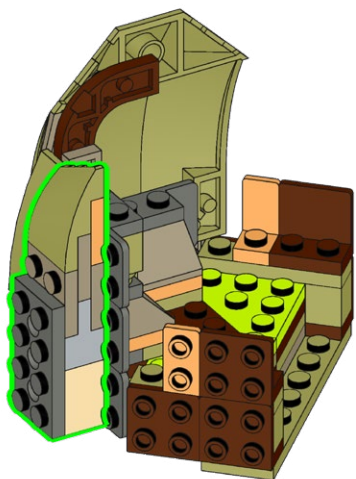

403

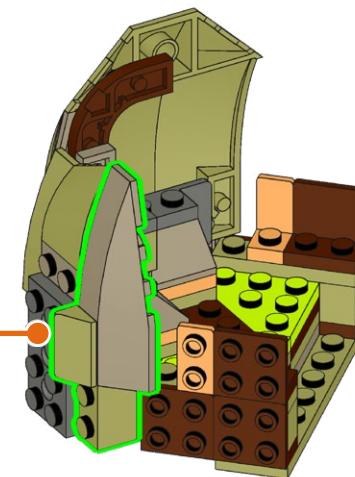
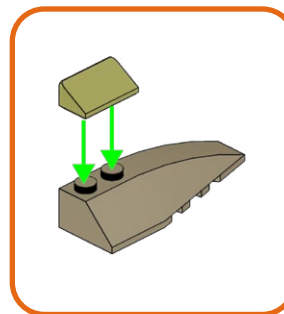
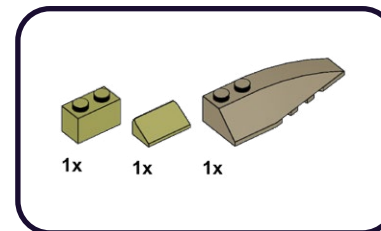

**HOLD UP!**

You might notice some bags aren't in order, as well as left over pieces, but that's ok! We're changing the way you build LEGO!

ATTENDEZ!

Vous remarquerez peut-être que certains sacs, ainsi que certaines pièces, ne sont pas dans le bon ordre. Mais pas de panique! Nous changeons simplement la façon avec laquelle vous construisez vos LEGO!

ASPETTA!

Potresti notare che alcuni sacchetti non sono in ordine, così come i pezzi avanzati, ma va bene così! Stiamo cambiando il modo in cui costruisci i LEGO!

HALT!

Sie werden möglicherweise bemerken, dass einige tüten durcheinander sind und teile übrig bleiben, aber das ist in Ordnung! Wir ändern die art und weise, wie Sie LEGO bauen!

¡ESPERA!

Es posible que notes que algunas bolsas están fuera de servicio, así como piezas sobrantes, ¡pero está bien! ¡Estamos cambiando la forma en que construyes LEGO!

暫停!

你可能会注意到一些袋子顺序错乱, 以及一些剩余的部件, 但没关系! 我们正在改变你搭建乐高的方式!

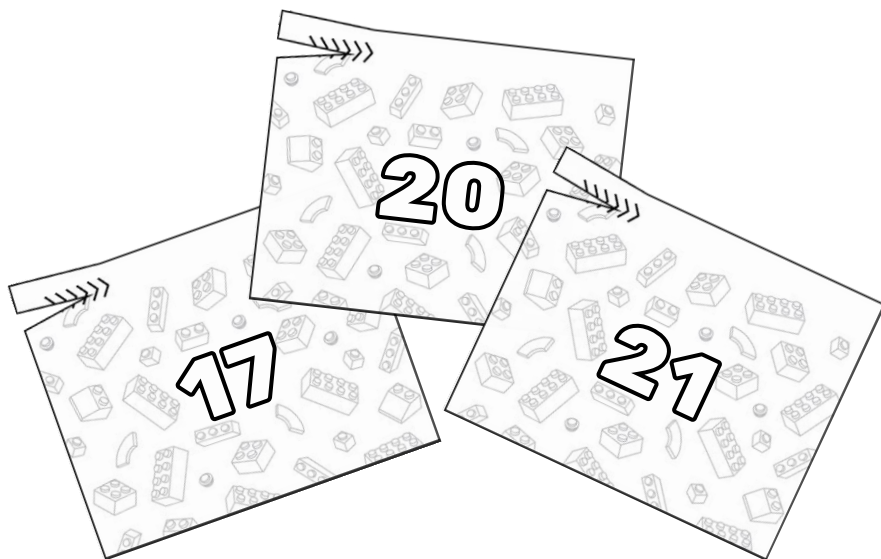
Open LEGO® Bags 17, 20 & 21

404

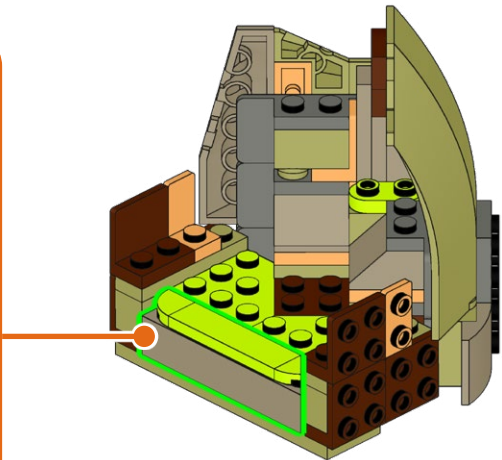
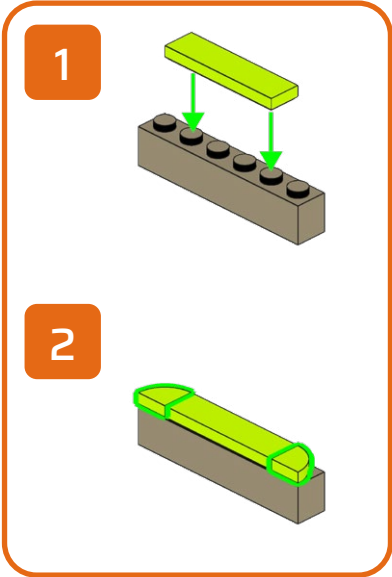
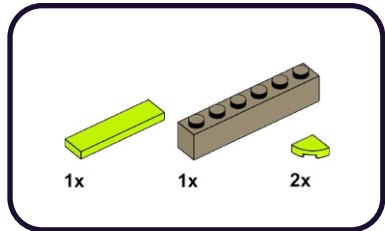

405

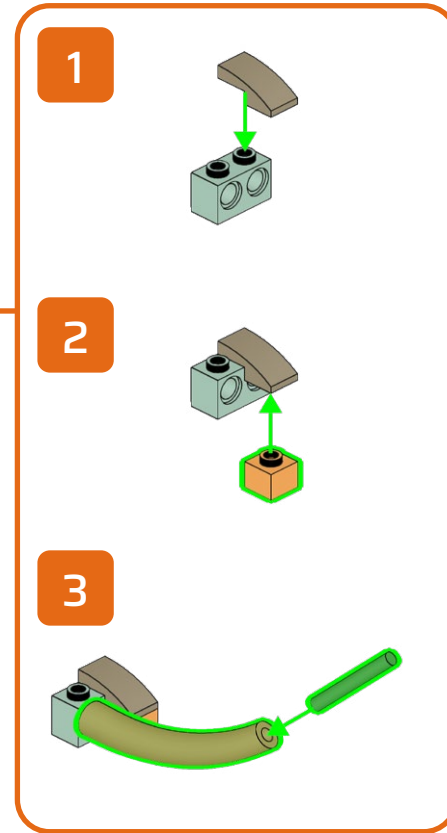
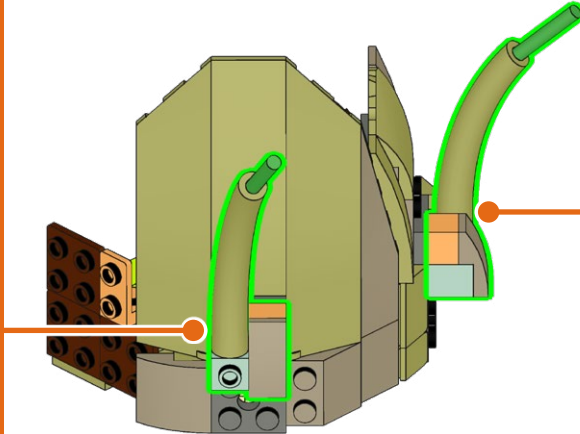
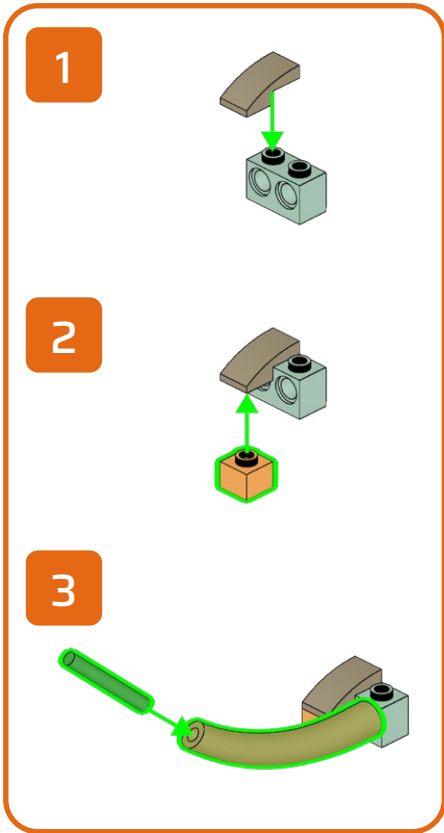
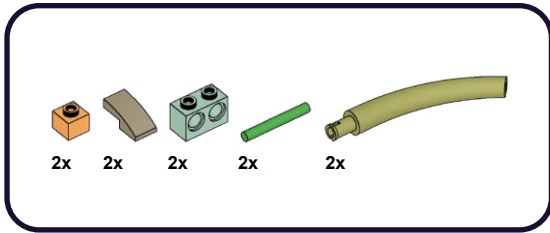

406

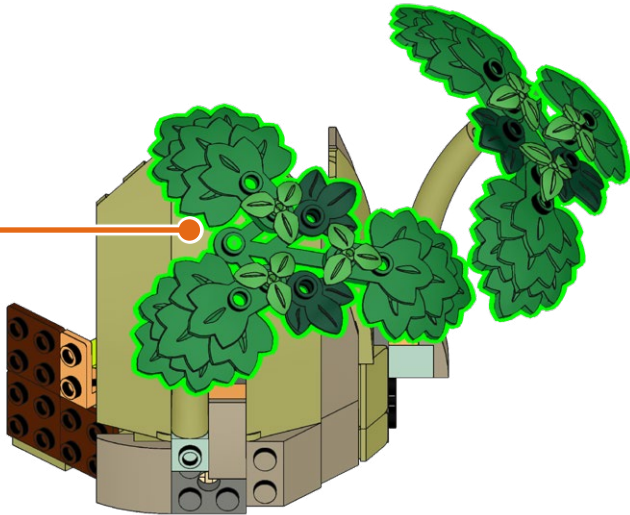
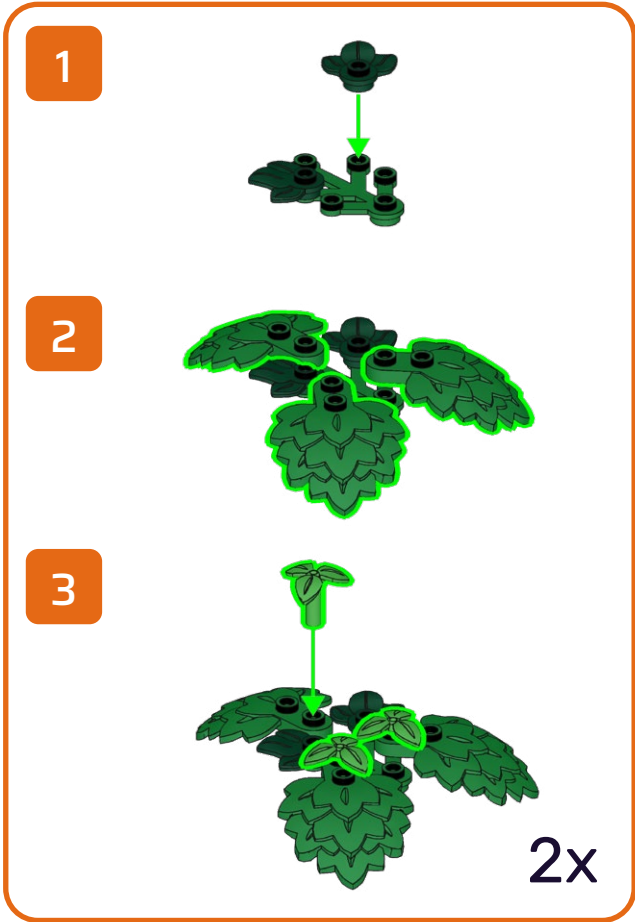
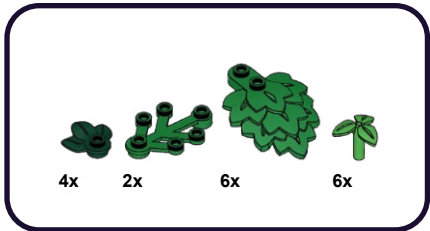

407

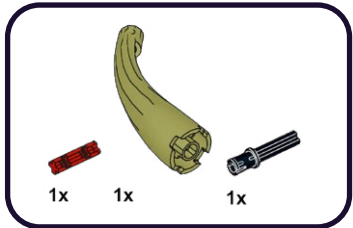

1

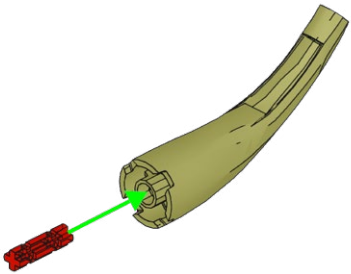

2

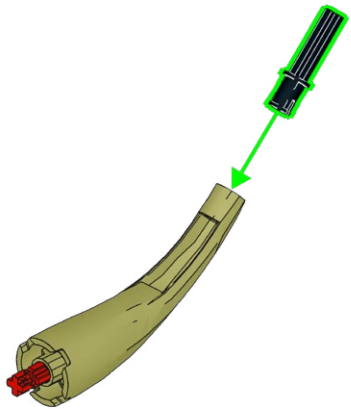

408

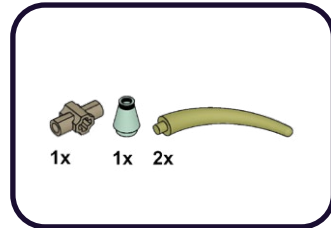

1

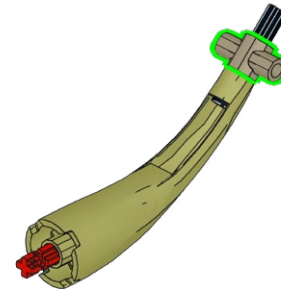

2

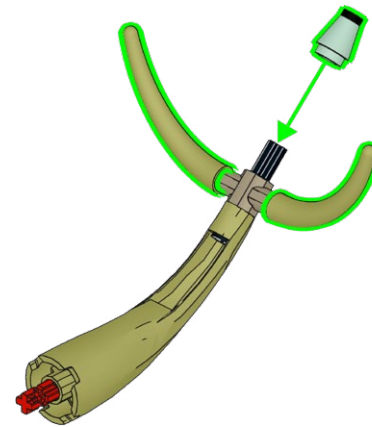

409



1x 1x

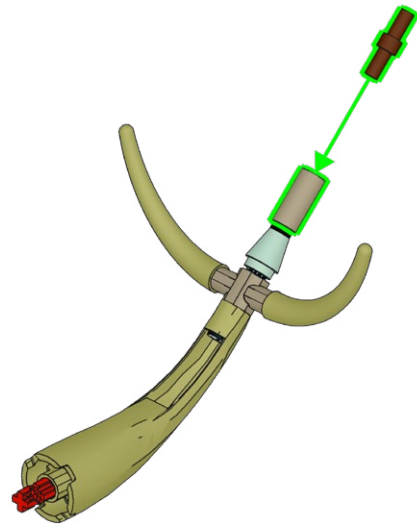

410



2x

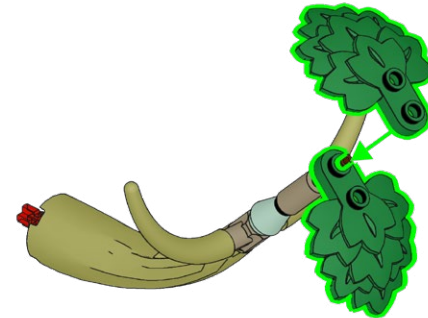

411

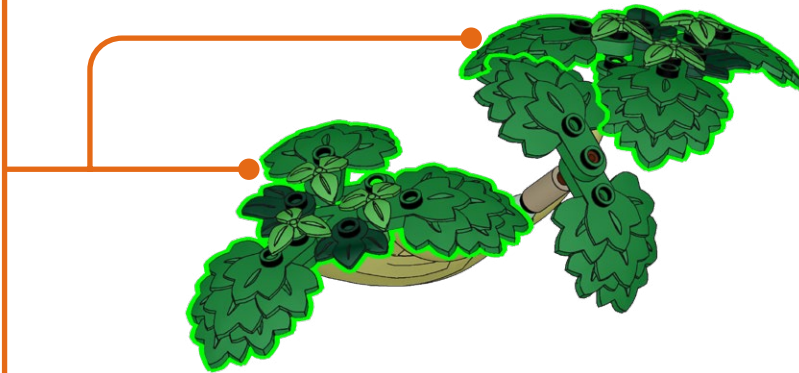
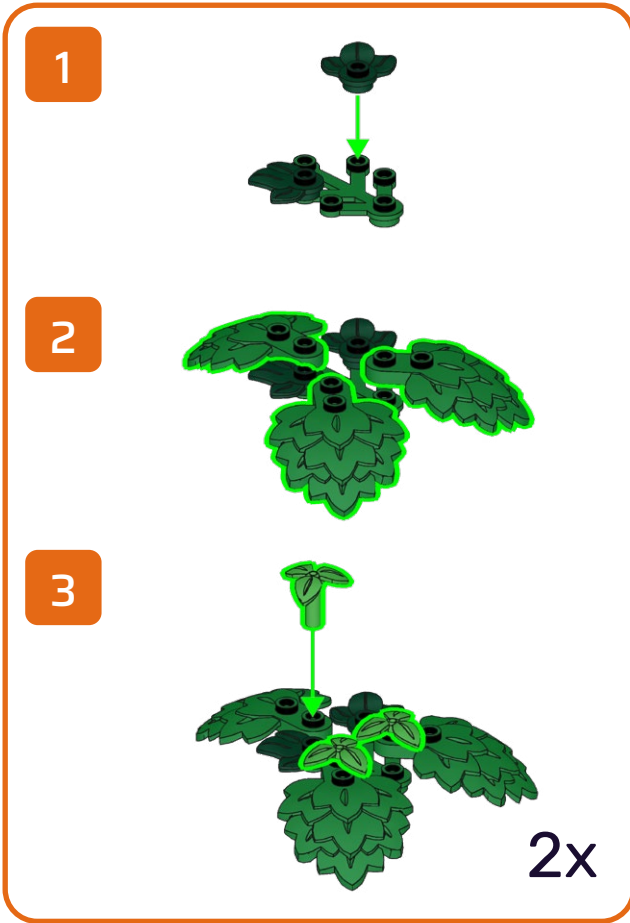
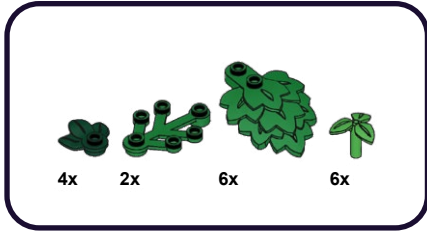

412

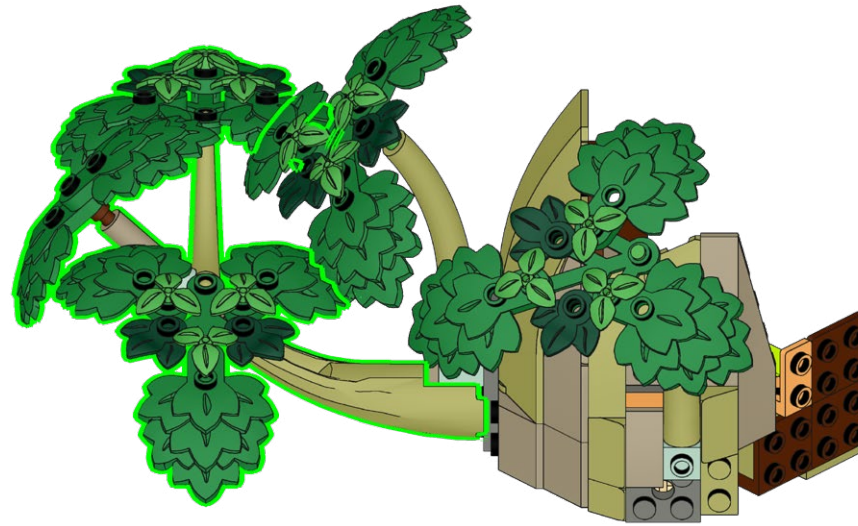

413

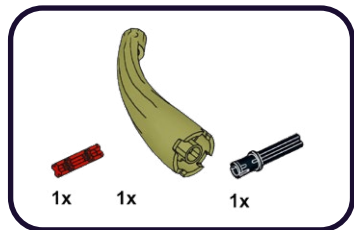

1

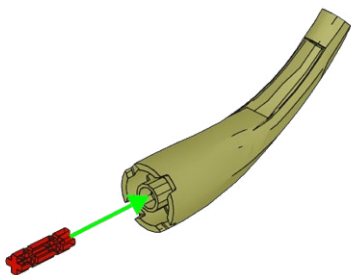

2

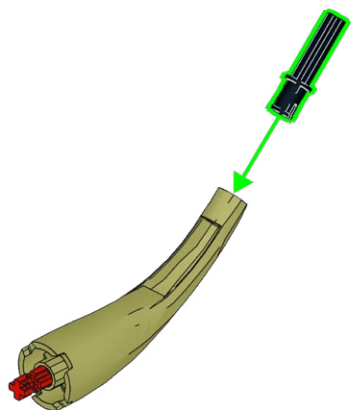

414

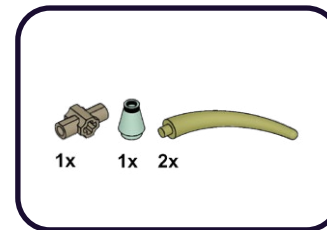

1

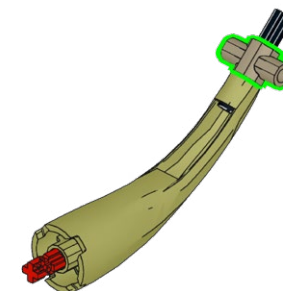

2

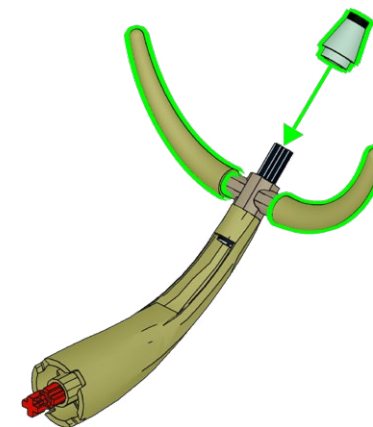

415



1x 1x

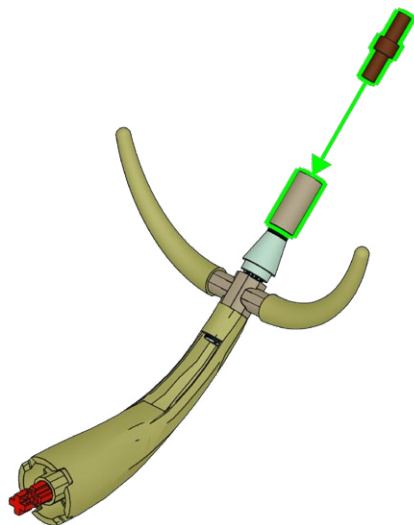

416



2x

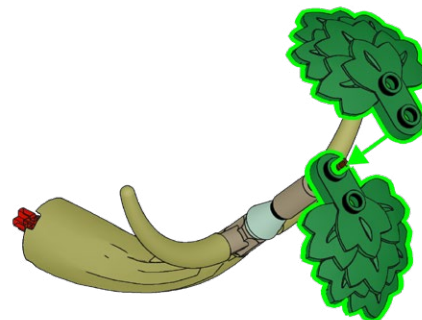
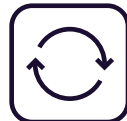

417

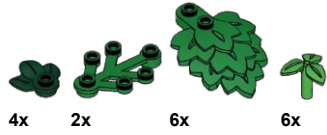

1

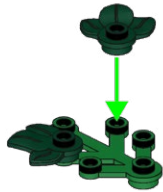

2



3

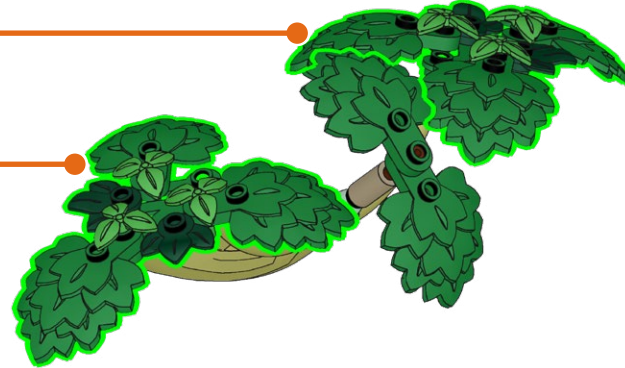
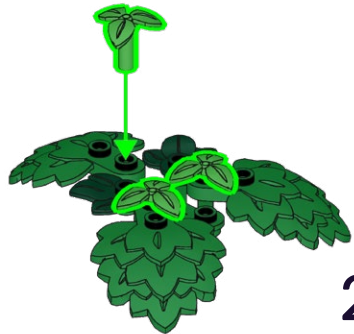

418

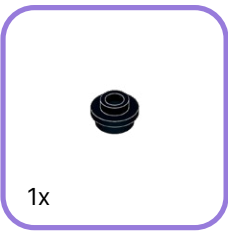
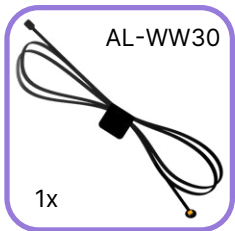

1



2



419

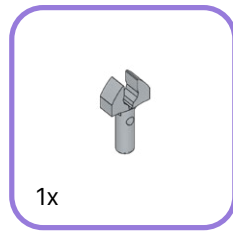
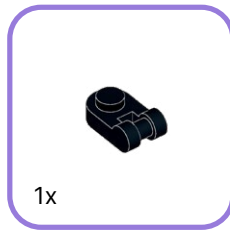

1



2



420



421

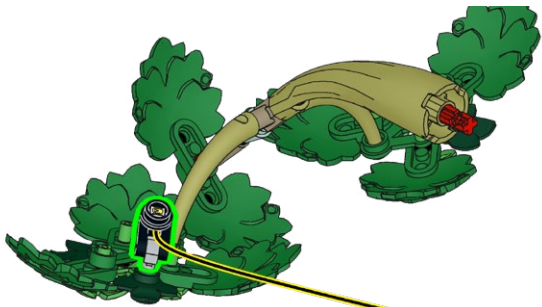

422

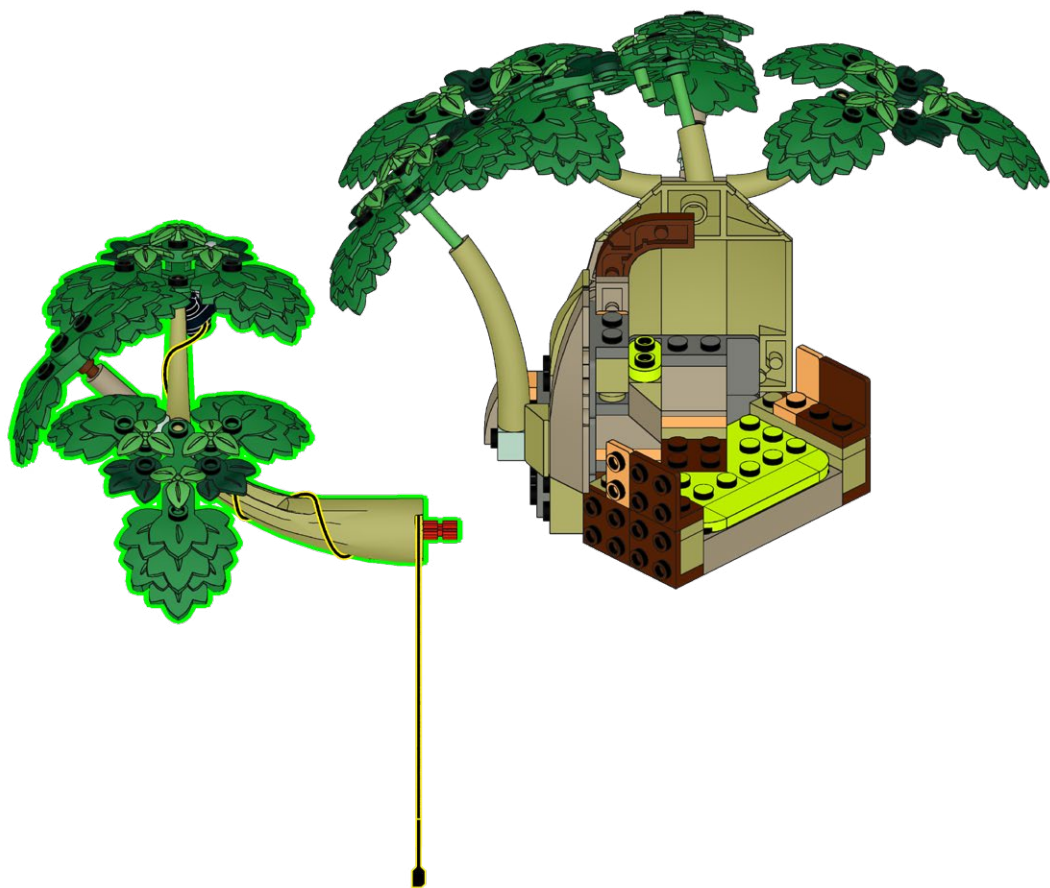

423



424

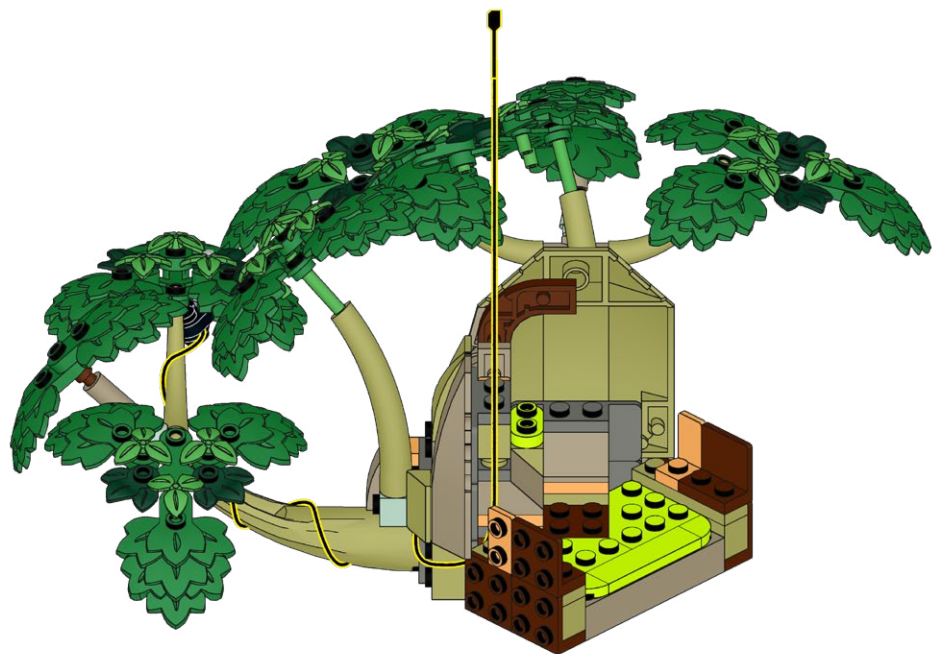

425

1x

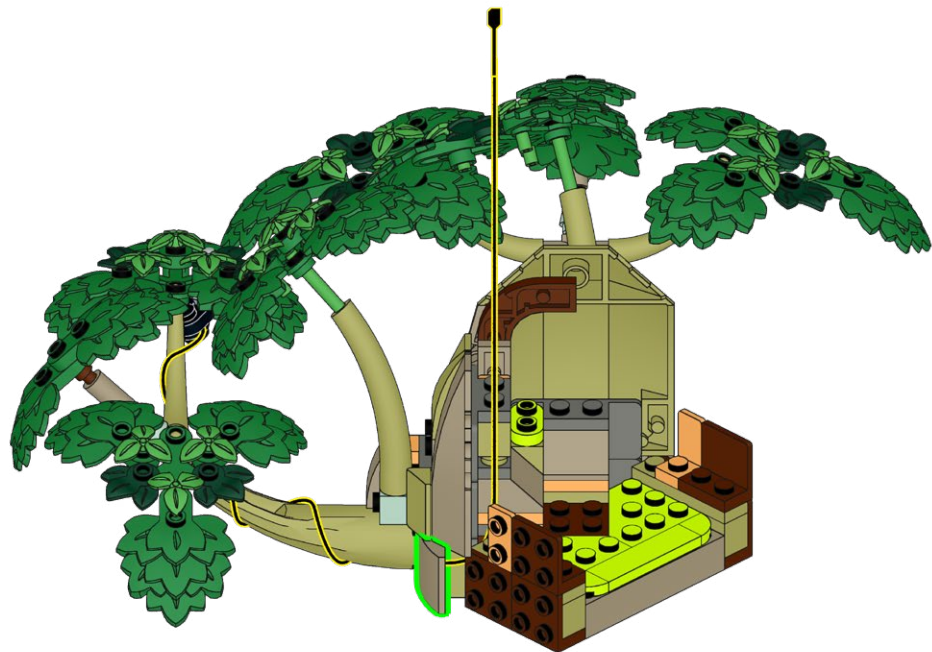

426

D-3

1x

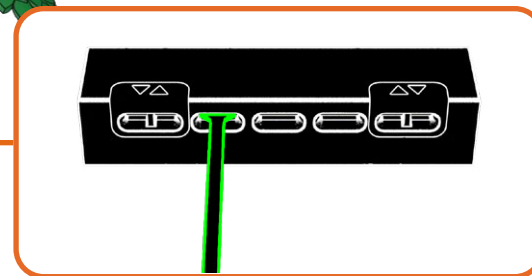
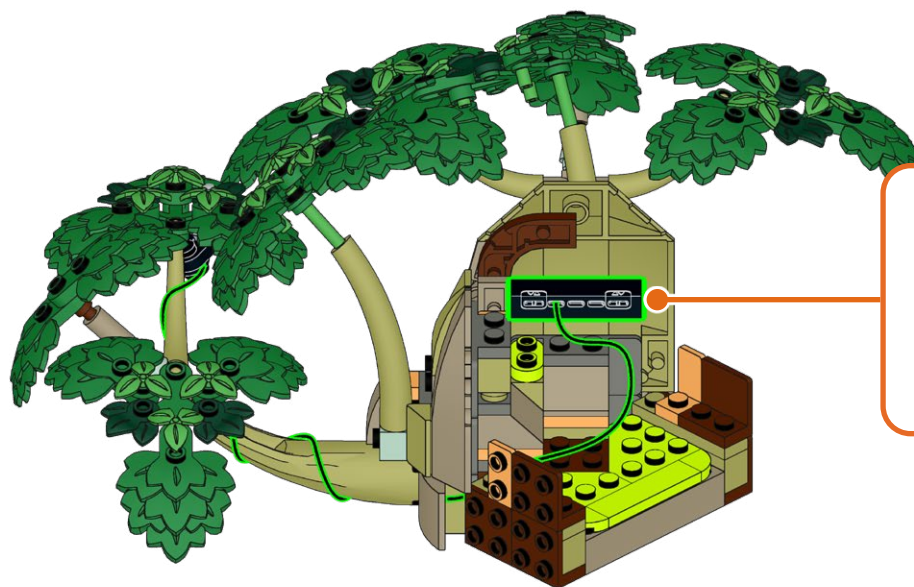

427

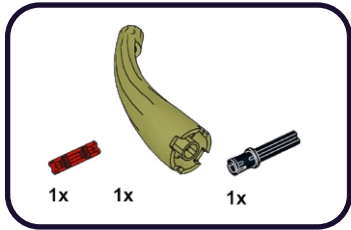

1

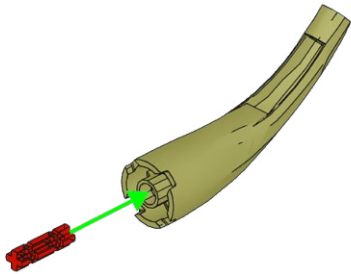

2

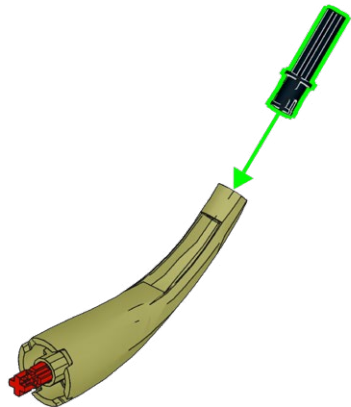

428

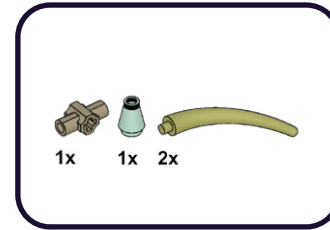

1

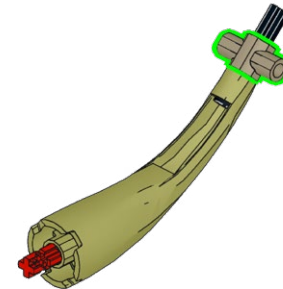

2

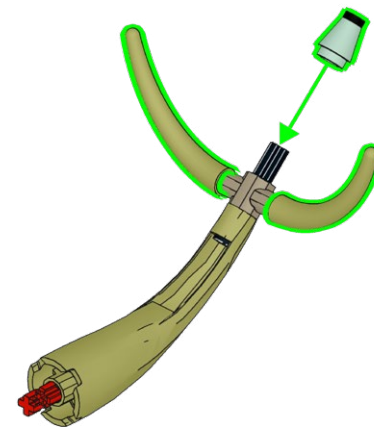

429



1x 1x

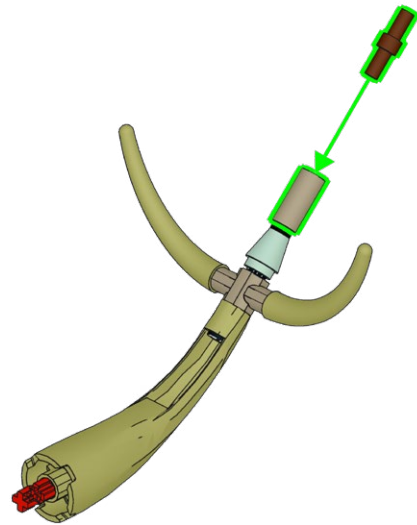

430



2x

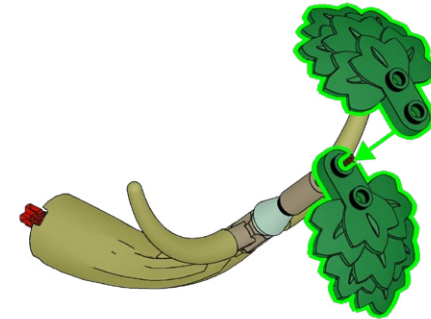

431

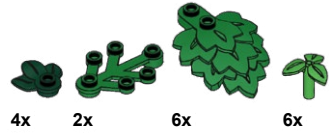

1

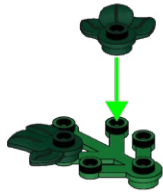

2



3

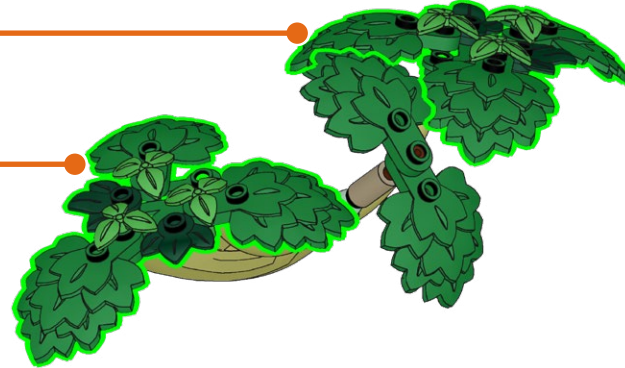
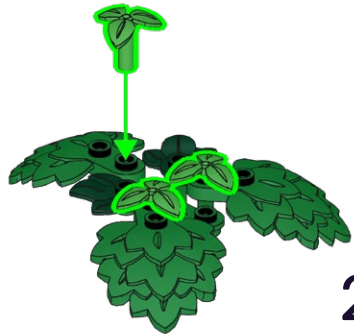

432

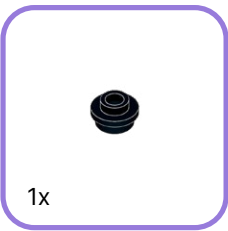
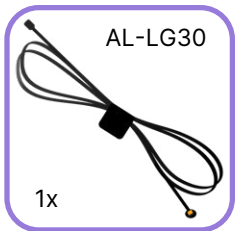

433

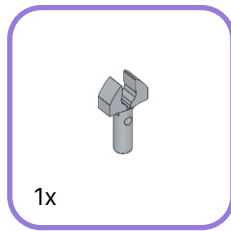
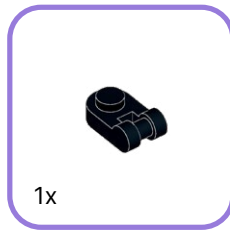

1

1

2

2



434



435

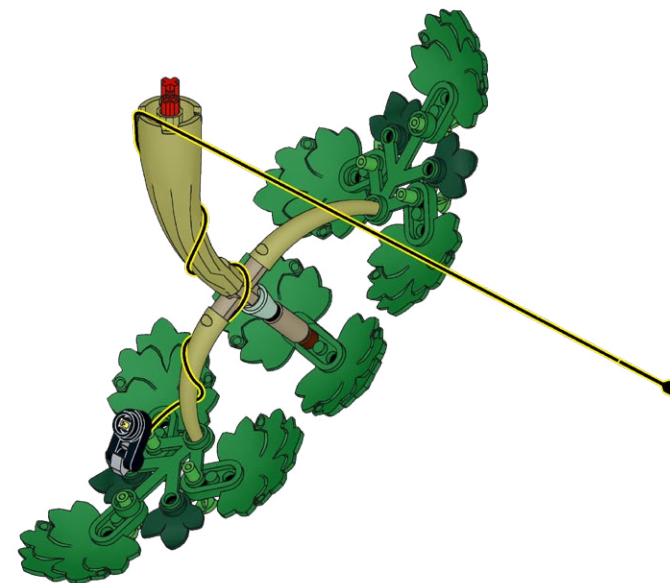
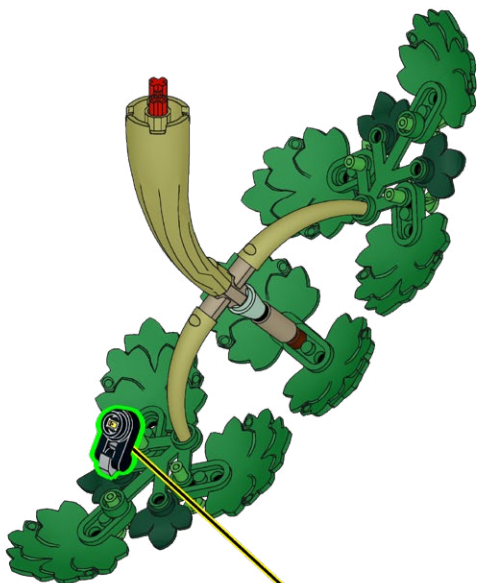

436

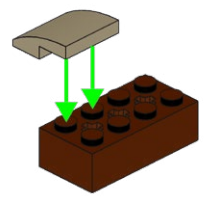
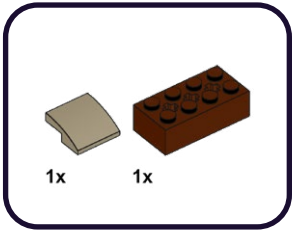

437

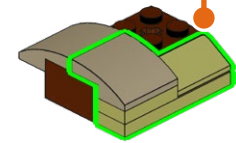
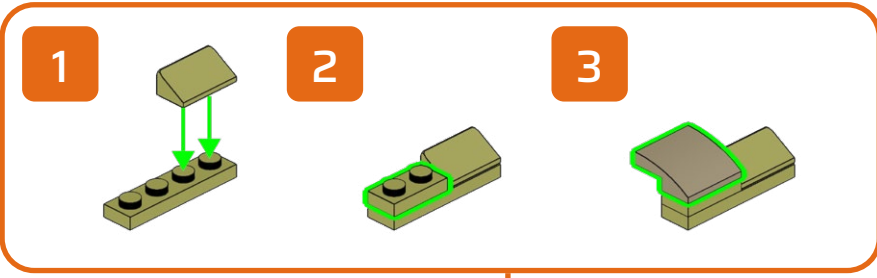
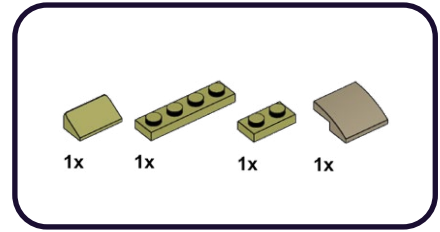

438

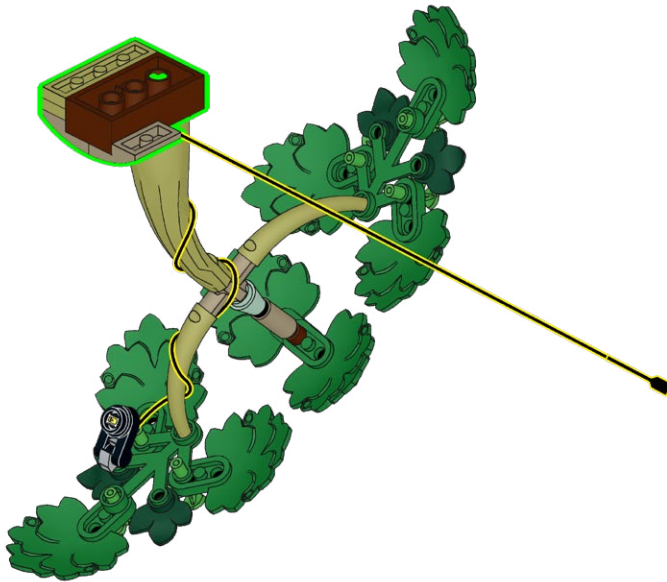

439

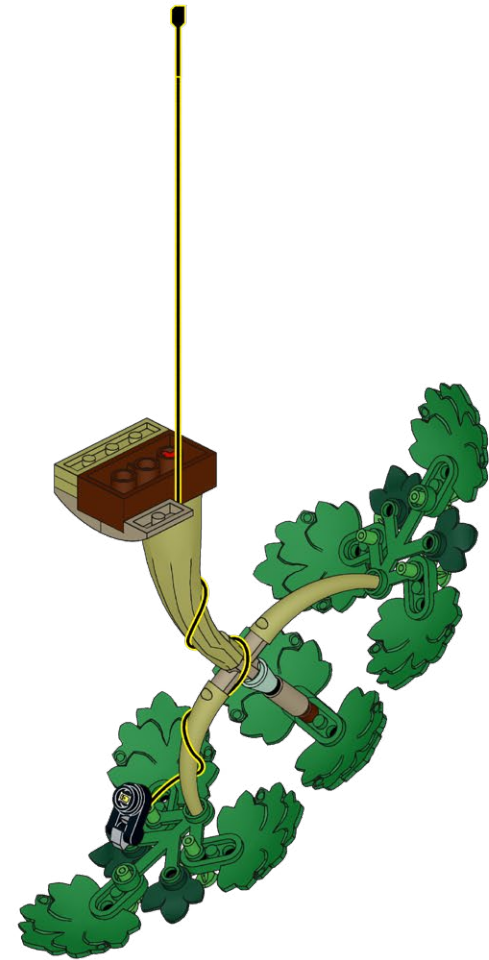

440

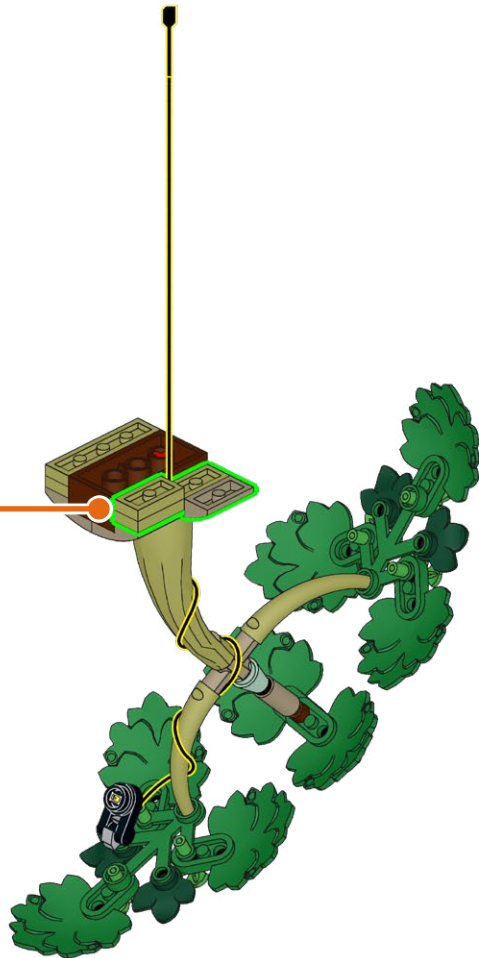
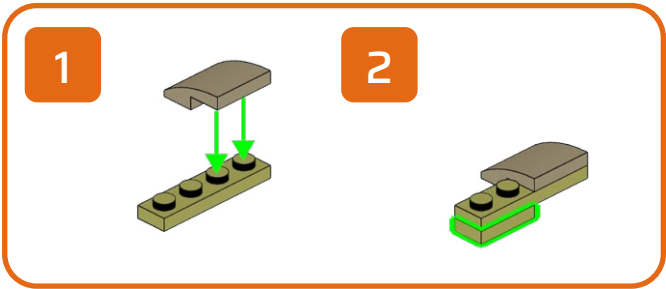
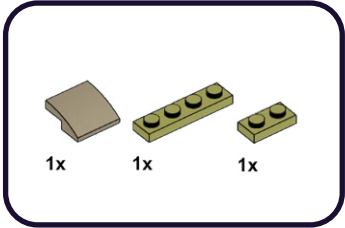

441



442

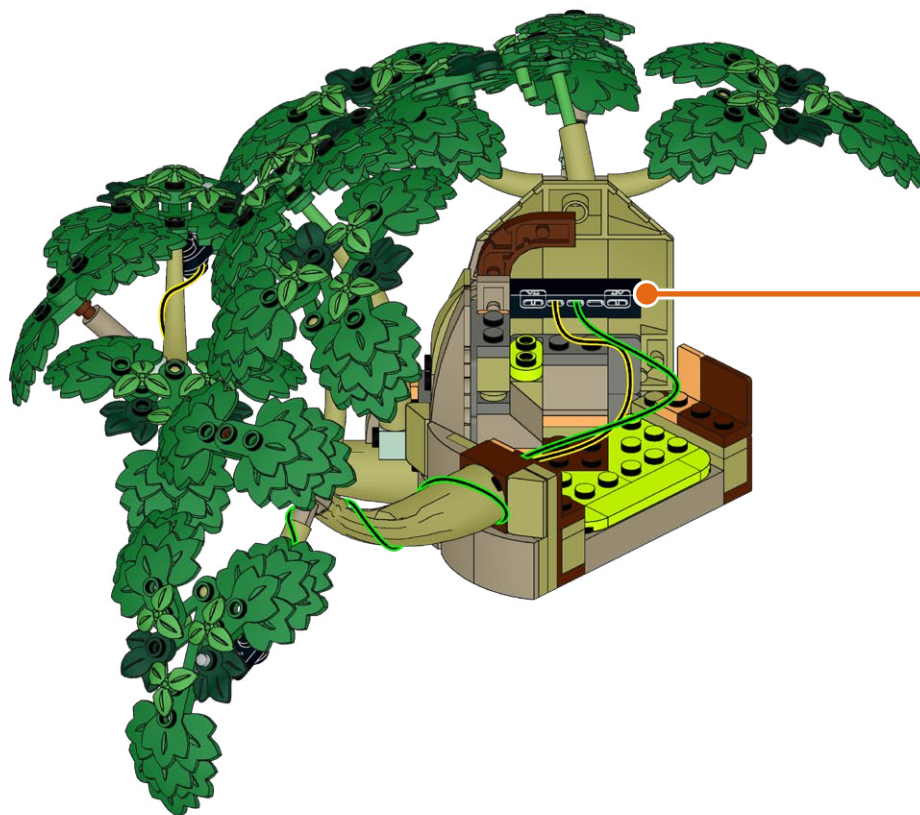

443

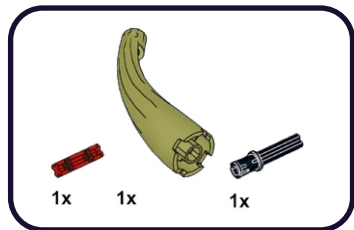

1

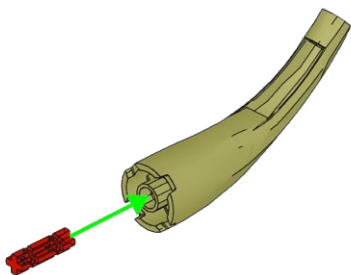

2

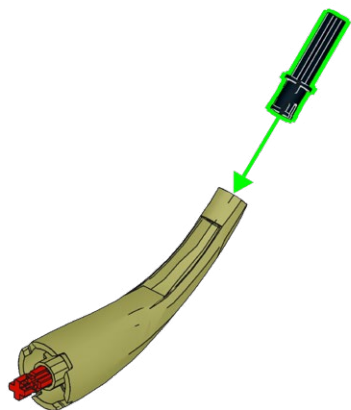

444

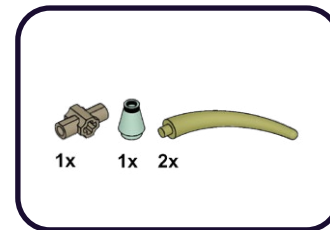

1

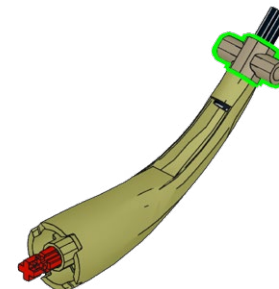

2

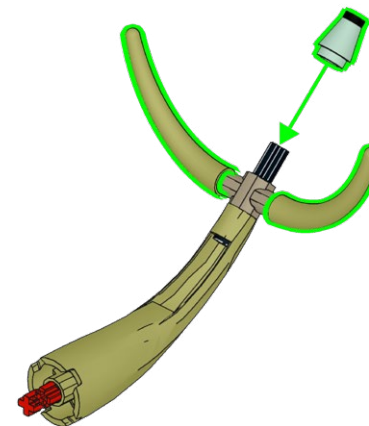

445

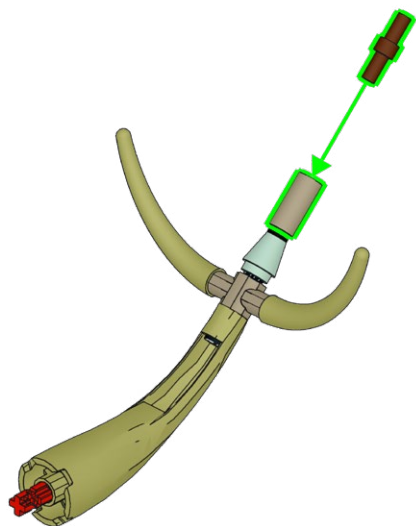

446

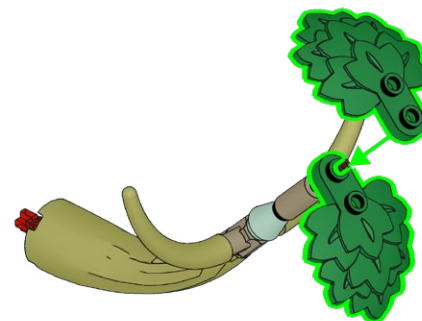
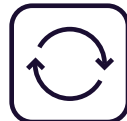

447

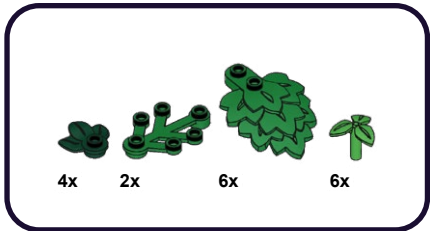

1

2

3

2x

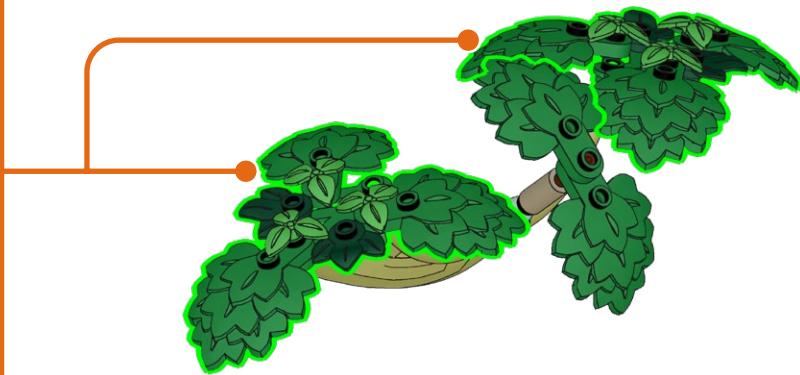

448

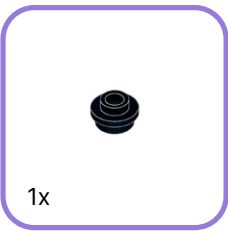
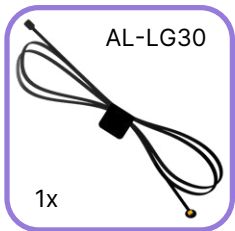

449

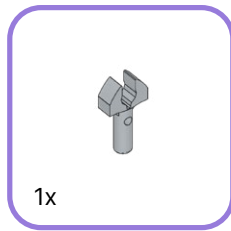
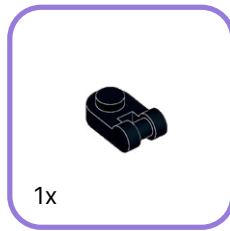

1

1

2

2



450

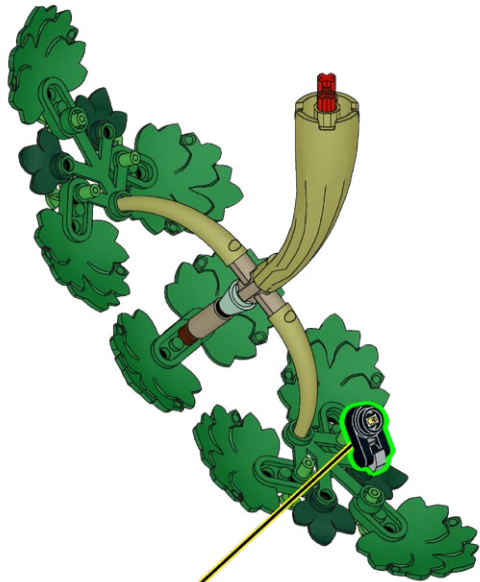

451

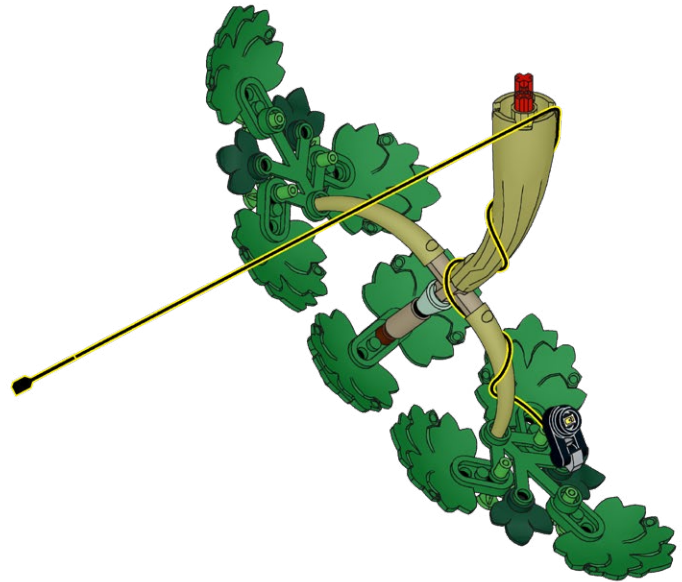

452

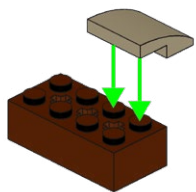
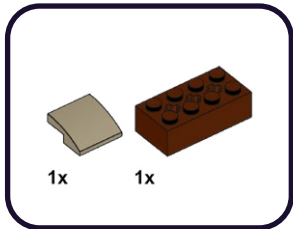

453

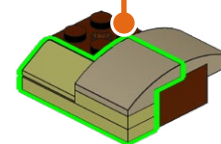
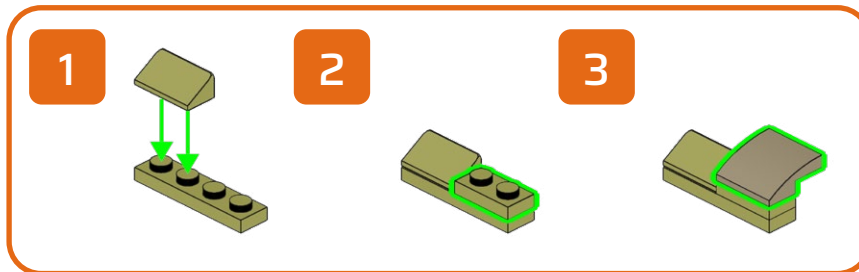
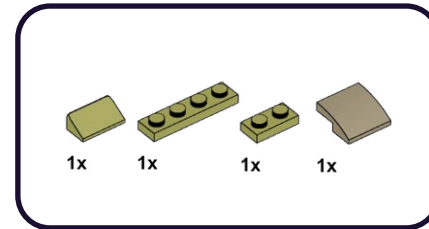

454

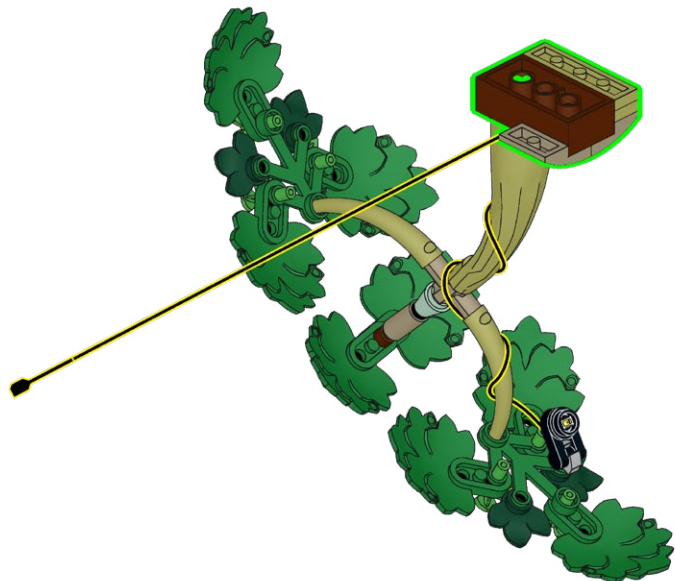

455

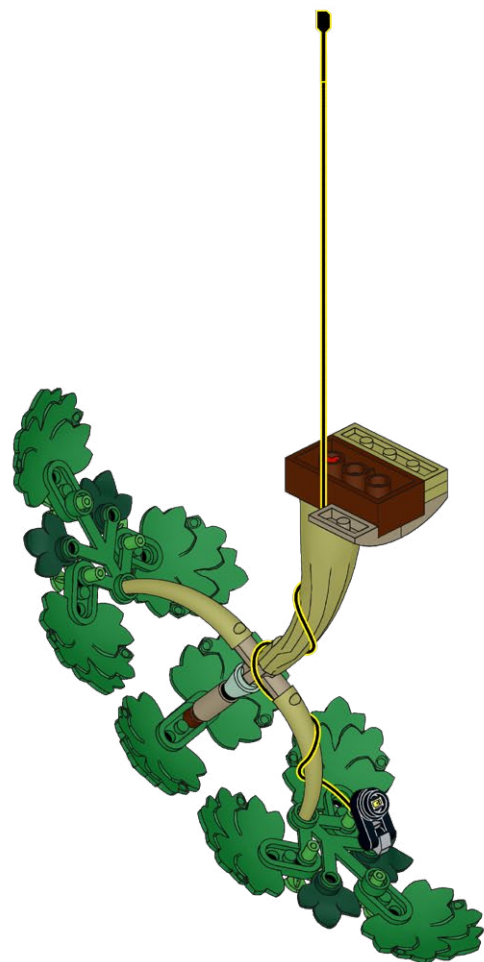

456

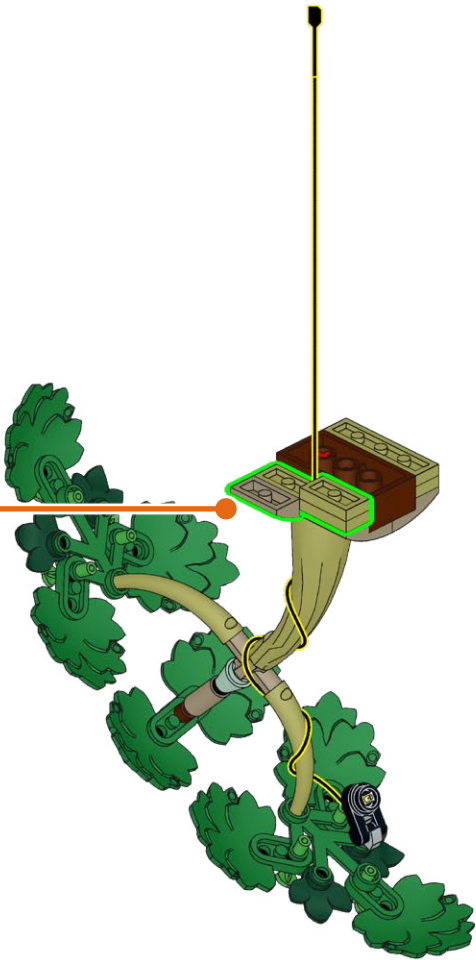
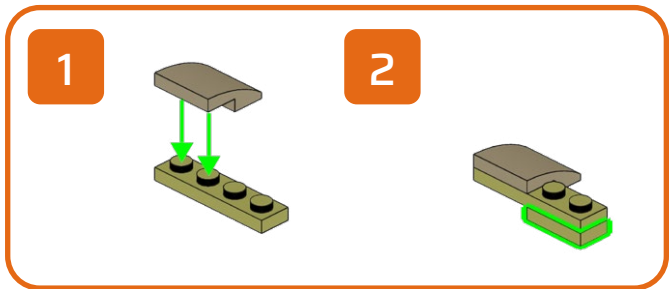
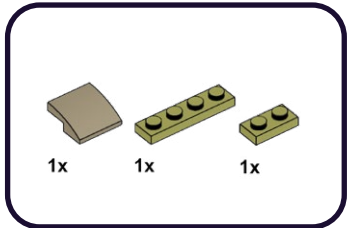

457



458



459

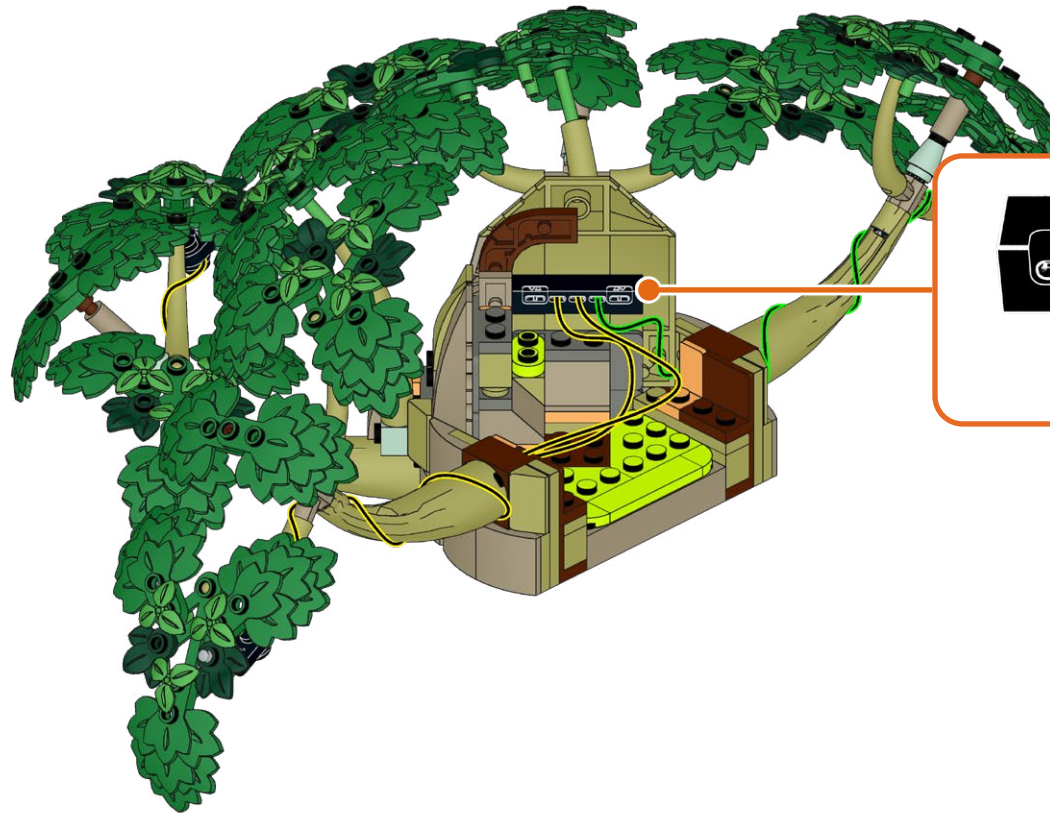

460



461



462



463



464

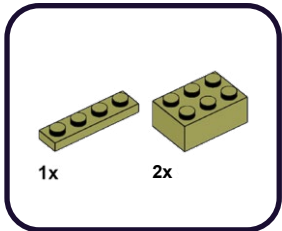

1

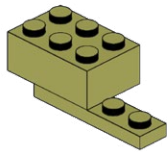

2

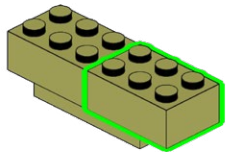

465

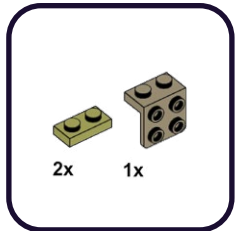

1

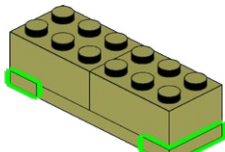

2

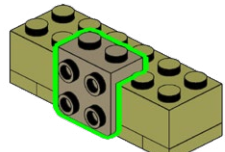

466

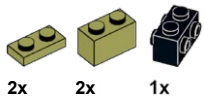

2x 2x 1x

467

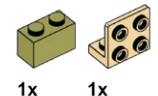

1x 1x

1

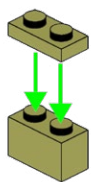

2

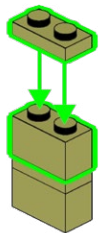

3

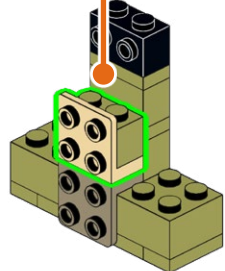
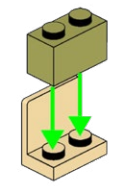
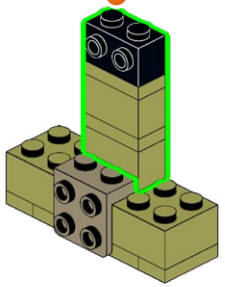
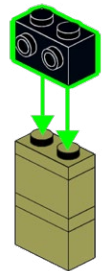

468

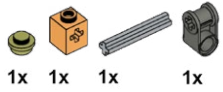

1

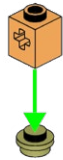

2

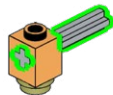

3



469

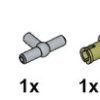

1

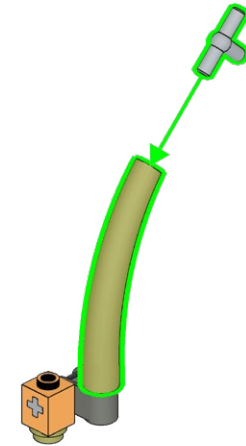

2

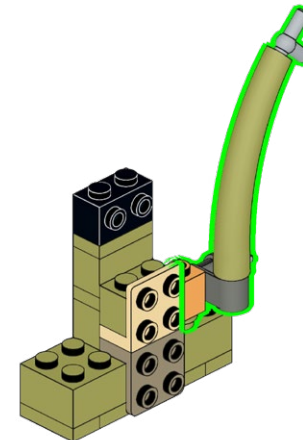
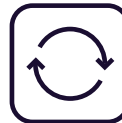

470

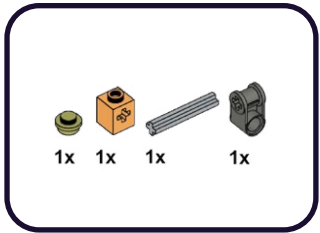

1

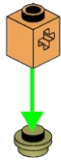

2

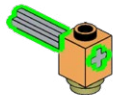

3



471

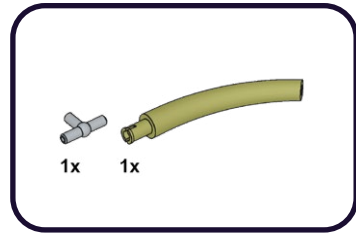

1

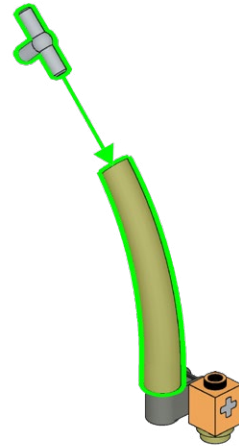

2

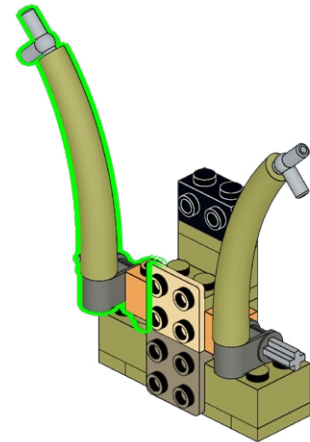
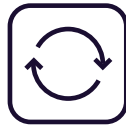

472

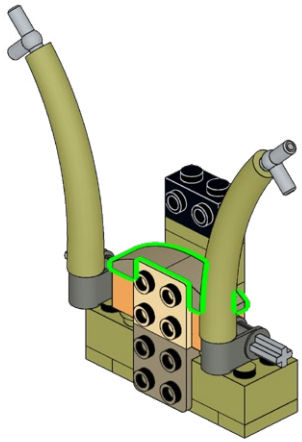
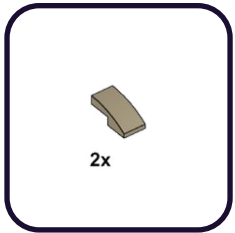

473

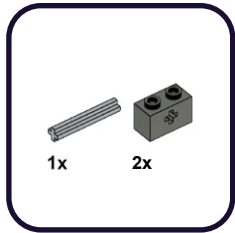

1

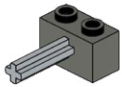

2

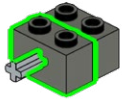

474

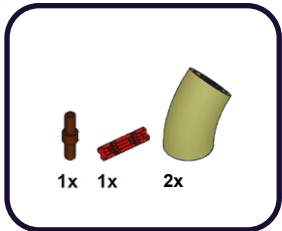

1

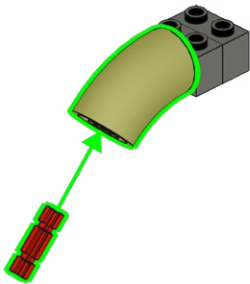

2

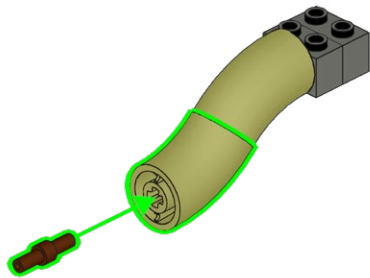

475

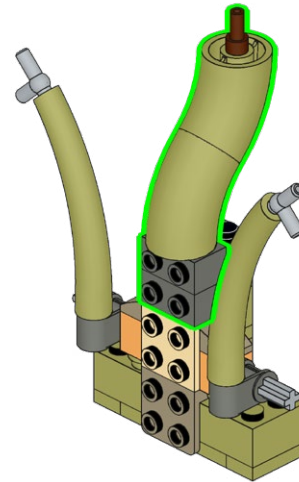

476

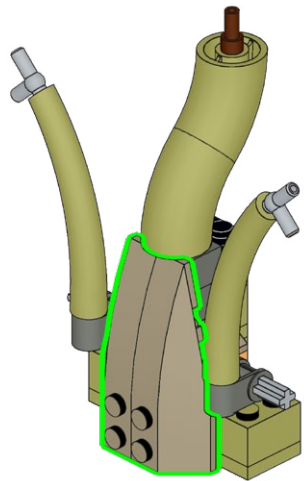
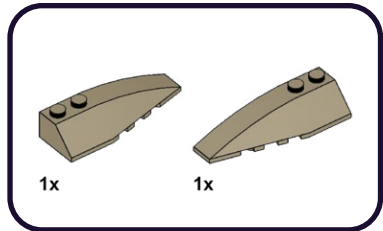

477

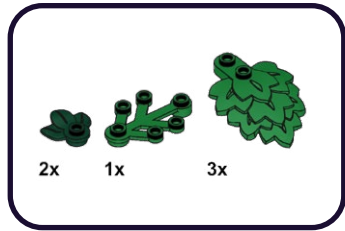

1

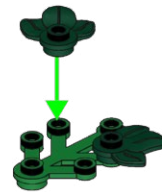

2



478

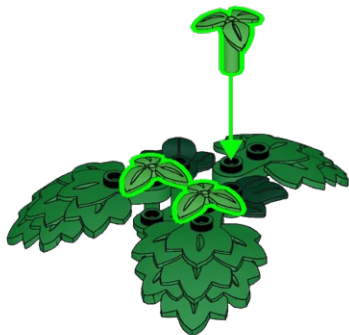
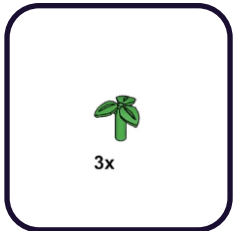

3x

479



480



481



482

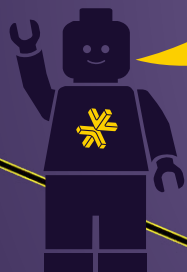

Power on Test
Test de mise sous tension
Test di Potenza
Stromtest
Prueba de Energía
电源测试

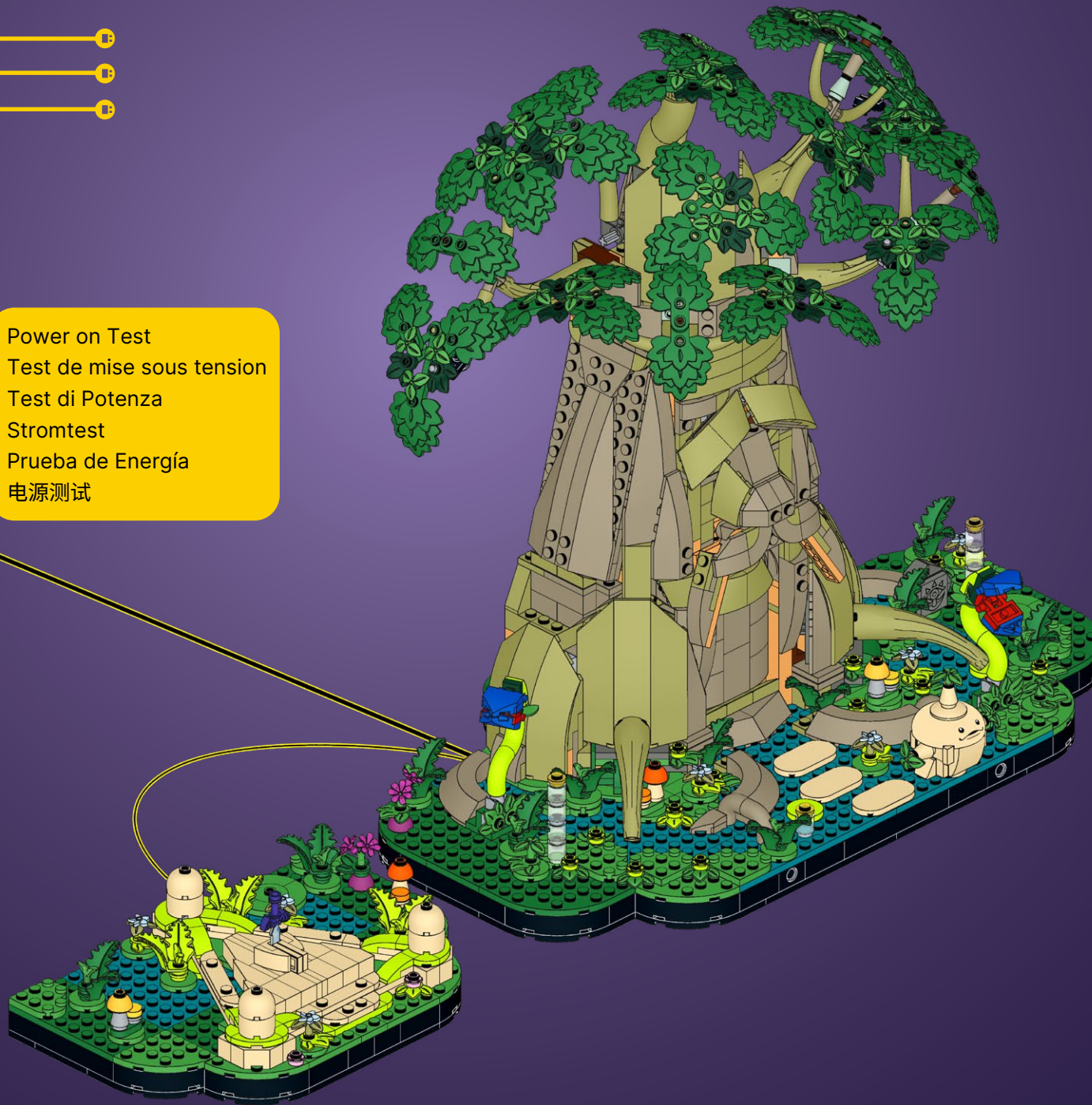

483



484



FINAL PRODUCT



PACKAGE CONTENTS



4x AR-WW30
Astro Light Regular
Warm White 30cm



1x ARF-WW30
Astro Light Regular
Flickering
Warm White 30cm



1x AR-V30
Astro Light Regular
Violet 30cm



1x AR-LB15
Astro Light Regular
Light Blue 15cm



1x ARP-LB50
Astro Light Regular
Pulsing
Light Blue 50cm



1x AL-WW30
Astro Light Large
Warm White 30cm



2x AL-LG30
Astro Light Large
Light Green 30cm



2x B-50
Belt 50cm



1x D-3
Dock-3



1x D-9
Dock-9

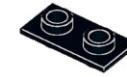

1x T-1x2
Tether 1x2



1x T-1x4
Tether 1x4

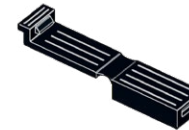

1x E-1x2
Eclipse 1x2



1x FLX-C
Flux Converter



1x Power Brick

PACKAGE CONTENTS



3x Round Plate 1x1
Trans Yellow



1x Round Plate 2x2 with
Rounded Bottom (Boat
Stud)
Trans-Clear



3x Round Plate 1x1 with
Open Stud
Black



1x Plate 1x2
Light Bluish Gray



1x Round Plate 1x1 with
Open Stud
Trans Orange



2x Modified Brick 1x1 with
Stud on Side
Light Bluish Gray



2x Round Plate 1x1 with
Open Stud
Trans Clear



8x Round Brick 1x1
Open Stud
Trans-Clear



3x Round Plate 1x1 with
Bar Handle
Black



3x Bar 1L with Clip
Mechanical Claw - Cut
Edges and Hole on Side
Light Bluish Gray

CONTACT US

Click below for customer support, or general inquiries.

Cliquez ci-dessous pour accéder au support client ou aux renseignements généraux.

Clicca qui sotto per l'assistenza clienti o per richieste generali.

Contact Us



Contactez-nous



Contattaci



Klicken sie unten für kundensupport oder allgemeine anfragen.

Haga clic a continuación para atención al cliente o consultas generales.

点击下方获取客户支持或一般咨询。

Kontaktieren sie uns



Contáctanos



联系我们



TROUBLESHOOTING

If you're stuck, scan the QR code for troubleshooting.

Se sei bloccato, scansiona il codice QR per la risoluzione dei problemi.

Wenn Sie nicht weiterkommen, scannen Sie den QR-Code zur Fehlerbehebung.

Si vous êtes bloqué, scannez le code QR pour le dépannage

Si está atascado, escanee el código QR para solucionar el problema.

如果遇到问题, 请扫描二维码进行故障排除

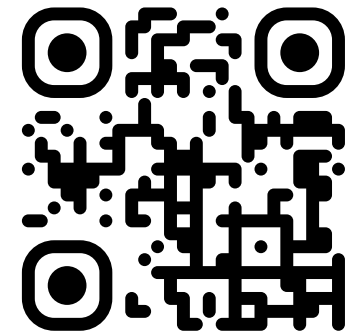



LIGHT MY BRICKS

lightmybricks.com



LEGO® is a trademark of the LEGO Group of companies, which does not sponsor, authorize or endorse this product. All LEGO® sets featured in images are sold separately. This is not a LEGO® product. The LEGO Group is not liable for any loss, injury or damage arising from the use or misuse of this product. ©2024 Light My Bricks Pty Ltd. All rights reserved. www.lightmybricks.com

Our components are designed and packaged in Australia by Light My Bricks Pty Ltd. Components are manufactured in China. 3fl bldg C, Shuanghuan Quanxin Technology Information Industry Park Baolong Street, Longgang District, Shenzhen, China. Imported in Australia by Light My Bricks Pty Ltd, 5/26 Rushdale St, Knoxfield, VIC, 3180, Australia.

WARNING: CHOKING HAZARD - Small parts. Not for children under 3 years.

AVERTISSEMENT : RISQUE D'ÉTOUFFEMENT - Petites pièces. Ne convient pas aux enfants de moins de 3 ans.

ATTENZIONE: PERICOLO DI SOFFOCAMENTO - Piccole parti. Non adatto a bambini di età inferiore a 3 anni.

WARNUNG: ERSTICKUNGSGEFAHR - Kleine Teile. Nicht für Kinder unter 3 Jahren geeignet.

ADVERTENCIA: PELIGRO DE ASFIXIA - Piezas pequeñas. No son apto para niños menores de 3 años.

警告：窒息危险 - 小零件。不适合3岁以下儿童。