

LIGHT KIT INSTALLATION GUIDE

**THE LEGEND OF ZELDA
GREAT DEKU TREE 2 IN 1**

FOR LEGO
SET
#77092



CONTENTS



03

Getting Started

- 04** Legend
- 05** Component Handling
- 06** Blueprint

07

Instructions

- 07** LEGO Bag 1 - LMB Bag 04
- 34** LEGO Bag 2
- 62** LEGO Bag 3
- 80** LEGO Bag 4 - LMB Bag 01
- 100** LEGO Bag 5
- 112** LEGO Bag 6
- 122** LEGO Bag 7 & 12
- 173** LEGO Bag 8
- 197** LEGO Bag 9
- 205** LEGO Bag 10 & 11 - LMB Bag 03
- 238** LEGO Bag 13
- 248** LEGO Bag 14 & 15
- 283** LEGO Bag 19
- 297** LEGO Bag 20
- 300** LEGO Bag 16
- 312** LEGO Bag 17 & 18 - LMB Bag 03

372

Final Product

- 373** Package Contents
- 375** Contact & Troubleshooting

GETTING STARTED



Bold, beautiful and bright, Light My Bricks elevates your favourite LEGO set from knick-knack to statement piece. Create a talking point at home or in the office that speaks to your passions with Light My Bricks. To learn more, click below.

[Learn More](#)



Audacieux, beau et lumineux, Light My Bricks élève votre ensemble LEGO préféré du statut de bibelot à celui de pièce maîtresse. Que ce soit à la maison ou au bureau, partagez votre passion des LEGO avec Light My Bricks. Cliquez ci-dessous pour en savoir plus.

[En savoir plus](#)



Audace, bello e luminoso, Light My Bricks eleva il tuo set LEGO preferito da soprammobile a pezzo di tendenza. Crea un punto di discussione a casa o in ufficio che parli alle tue passioni con Light My Bricks. Per saperne di più, clicca qui sotto.

[Ulteriori Informazioni](#)



Mutig, schön und hell – Light My Bricks verwandelt Ihr Lieblings-LEGO-Set von einem schnickschnack in ein statement-stück. Schaffen sie einen gesprächspunkt zu hause oder im büro, der Ihre leidenschaften widerspiegelt, mit Light My Bricks. Um mehr zu erfahren, klicken sie unten.

[Mehr erfahren](#)



Audaz, hermoso y brillante, Light My Bricks eleva tu set LEGO favorito de una chuchería a una pieza llamativa. Crea un tema de conversación en casa o en la oficina que hable de tus pasiones con Light My Bricks. Para obtener más información, haga clic a continuación.

[Más información](#)



大胆、美丽而明亮，Light My Bricks 将你喜爱的乐高套装从小摆件提升为引人注目的装饰品。在家或办公室打造一个能表达你激情的话题，了解更多，请点击下方。

[了解更多](#)



LEGEND

Rotate Set



Retournez L'ensemble
Ruota Set
Set Drehen
Rotar Conjunto
旋转套件

Add Part



Ajoutez une Pièce
Aggiungi Parte
Teil Hinzufügen
Agregar Pieza
添加零件

Click



Cliquez
Clic
Klicken
Clic
点击

Pinch/Fold



Pincez/Pliez
Pizzicare/Piegare
Kneifen/Falten
Pellizcar/Doblar
折叠

Pull Cable



Tirez le Cable
Tirare il Cavo
Kabel Ziehen
Tirar del Cable
拉动电缆

Repeat Step



Répétez
Ripetere
Wiederholen
Repetir
重复

Sticker



Autocollant
Adesivo
Aufkleber
Pegatina
贴纸

Power On Test



Test de mise sous tension
Test di Potenza
Stromtest
Prueba de Energía
电源测试

Disconnect Power

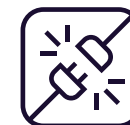

Débranchez L'alimentation
Scollegare L'alimentazione
Strom Trennen
Desconectar la Energía
断开电源

Troubleshoot



Dépanner
Risolvere
Fehlerbehebung
Solución de Problemas
故障排除

COMPONENT HANDLING

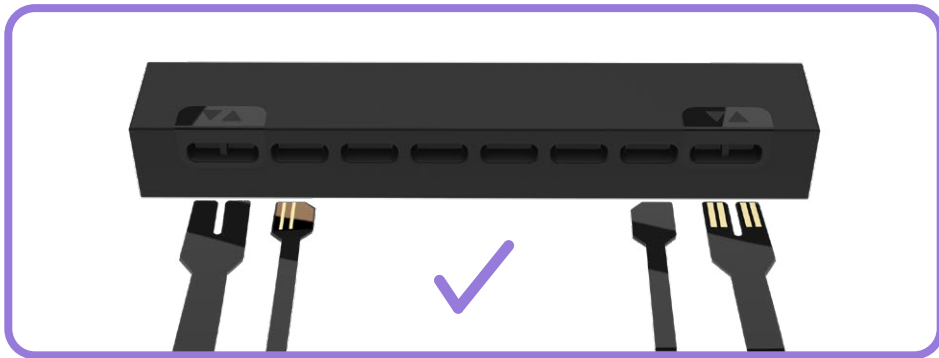
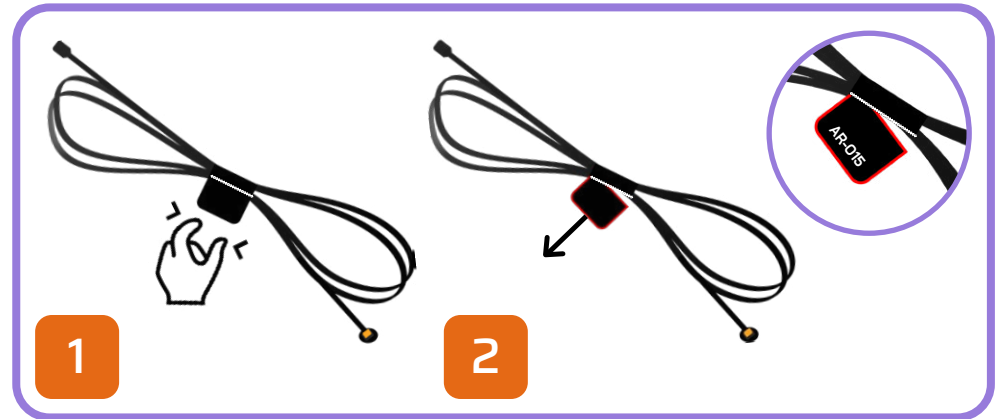
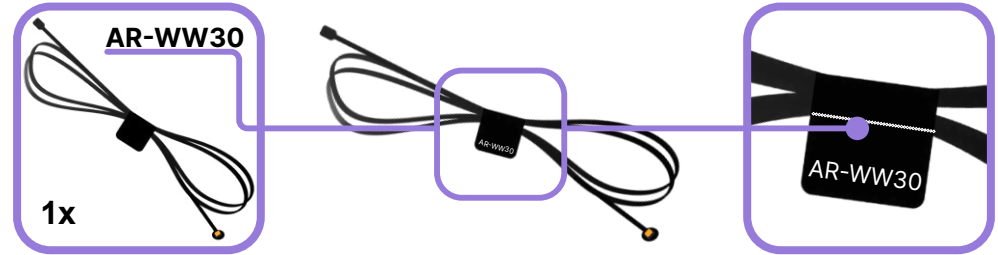
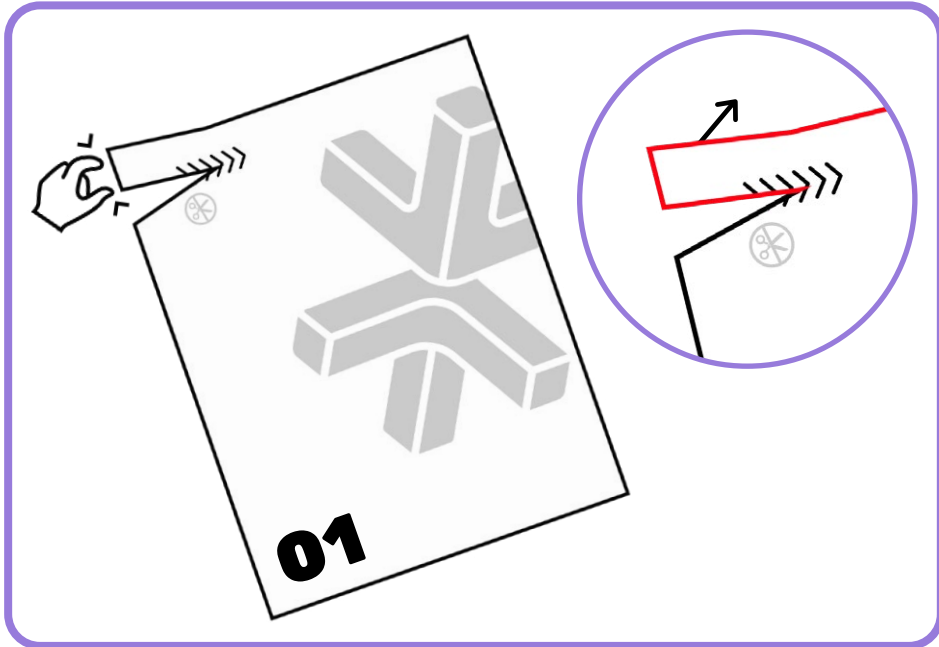

BLUEPRINT

Deku Tree

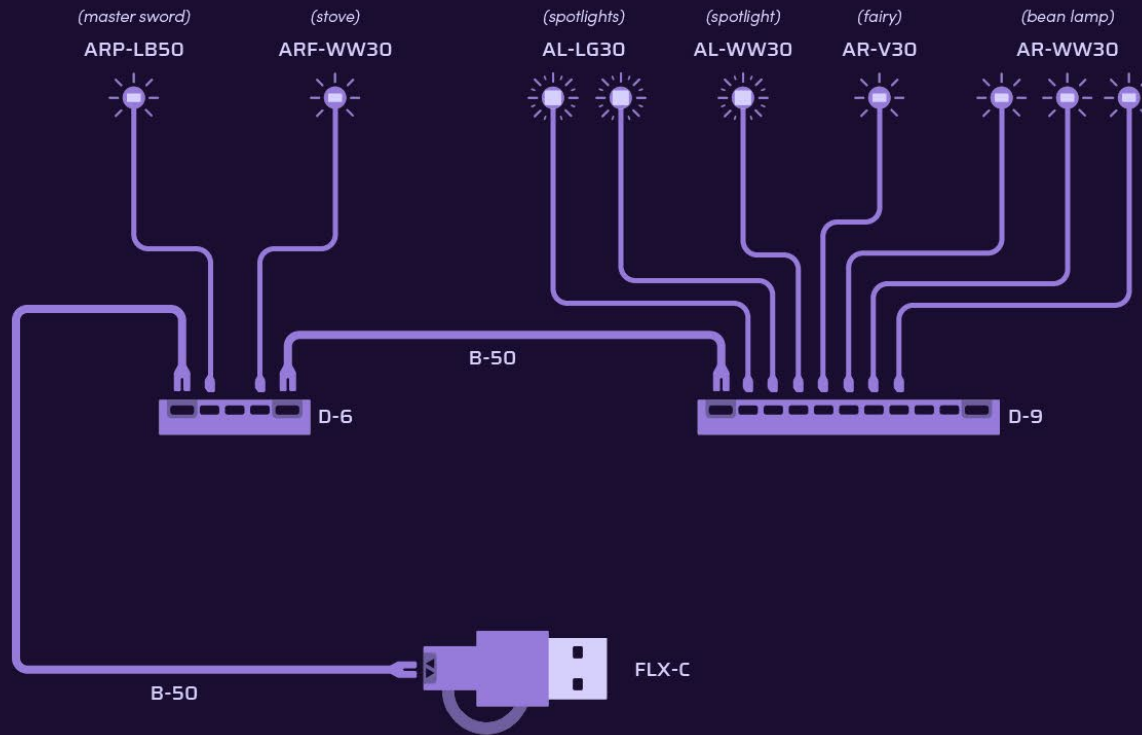

Link's House

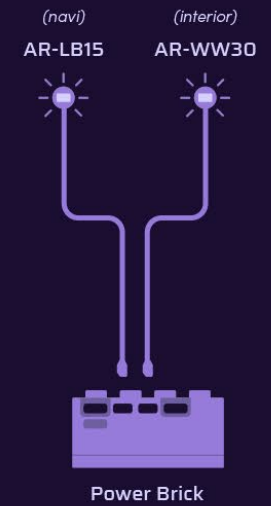



HOLD UP!

You might notice some bags aren't in order, as well as left over pieces, but that's ok! We're changing the way you build LEGO!

ATTENDEZ!

Vous remarquerez peut-être que certains sacs, ainsi que certaines pièces, ne sont pas dans le bon ordre. Mais pas de panique! Nous changeons simplement la façon avec laquelle vous construisez vos LEGO!

ASPETTA!

Potresti notare che alcuni sacchetti non sono in ordine, così come i pezzi avanzati, ma va bene così! Stiamo cambiando il modo in cui costruisci i LEGO!

HALT!

Sie werden möglicherweise bemerken, dass einige tüten durcheinander sind und teile übrig bleiben, aber das ist in Ordnung! Wir ändern die art und weise, wie Sie LEGO bauen!

¡ESPERA!

Es posible que notes que algunas bolsas están fuera de servicio, así como piezas sobrantes, ¡pero está bien! ¡Estamos cambiando la forma en que construyes LEGO!

暫停!

你可能会注意到一些袋子顺序错乱, 以及一些剩余的部件, 但没关系! 我们正在改变你搭建乐高的方式!

Open LEGO® Bag 1

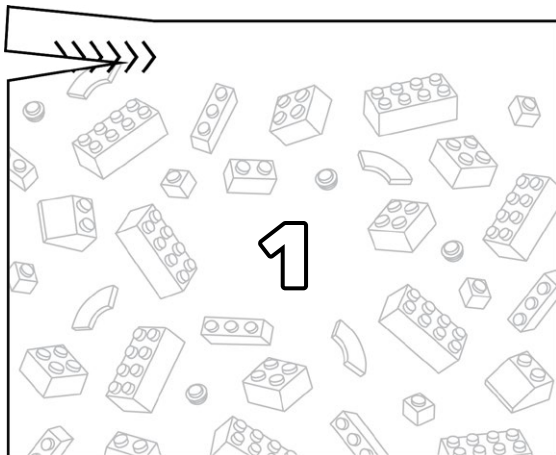

Open LMB Bag 04

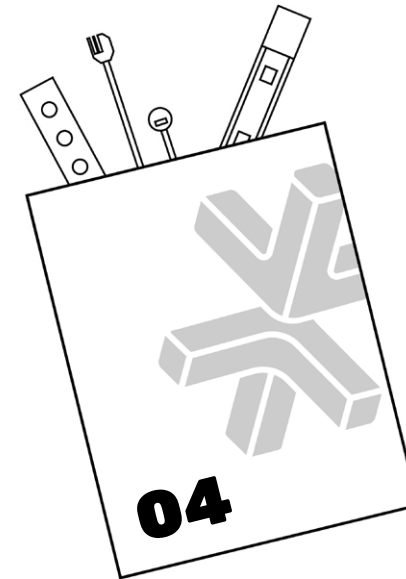



1

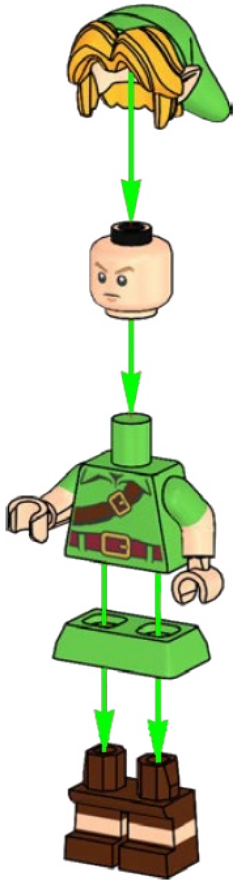

2



2

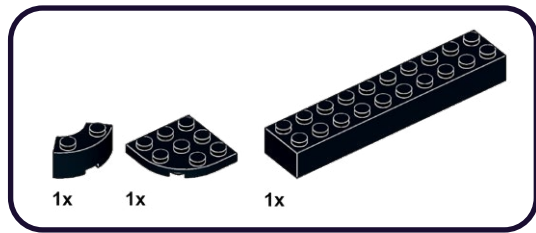

1

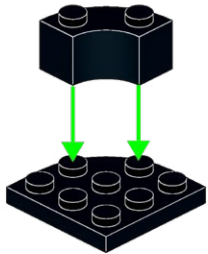

2

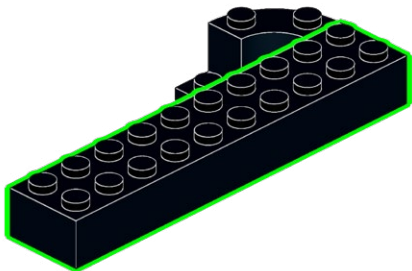

3

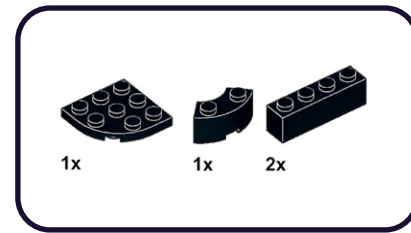

1

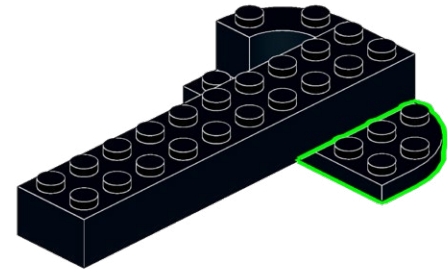

2

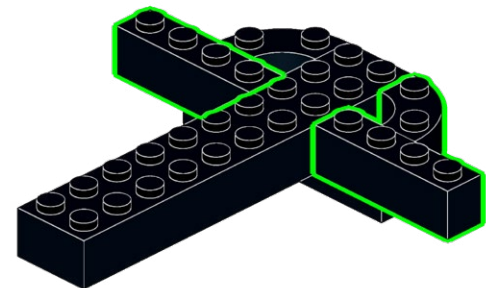

4

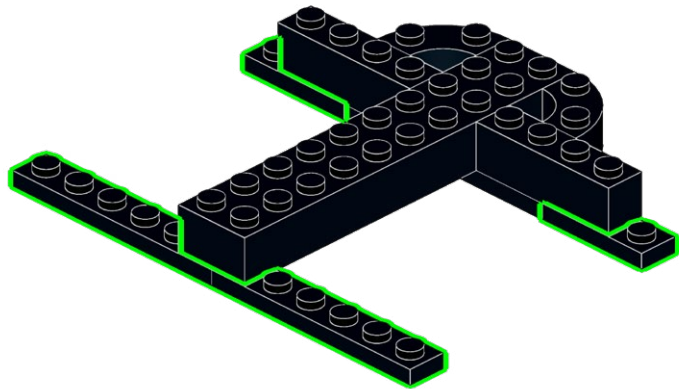
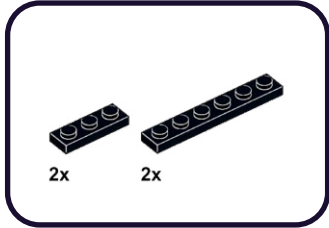

5

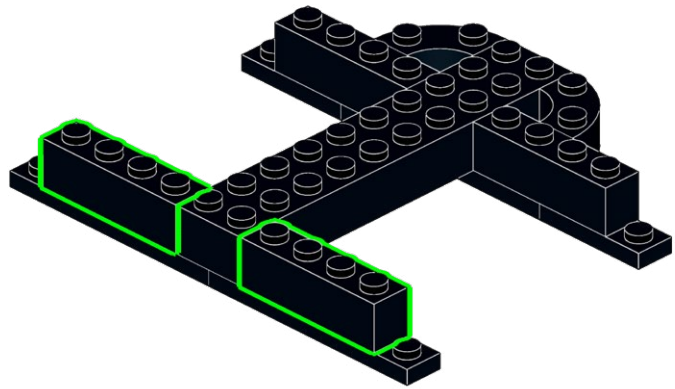
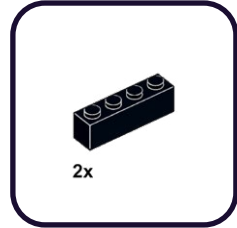

6

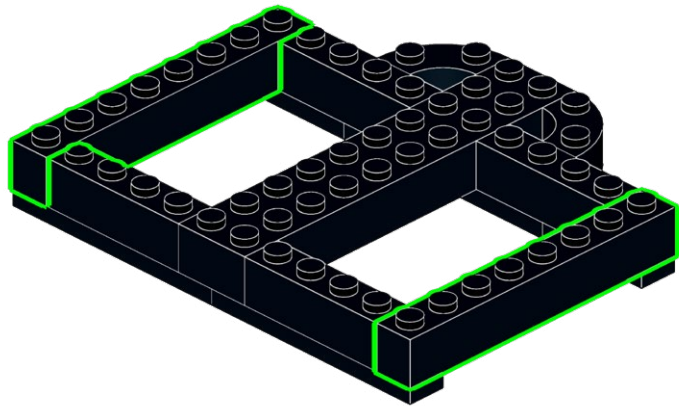
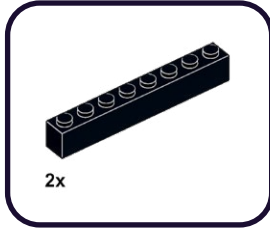

7

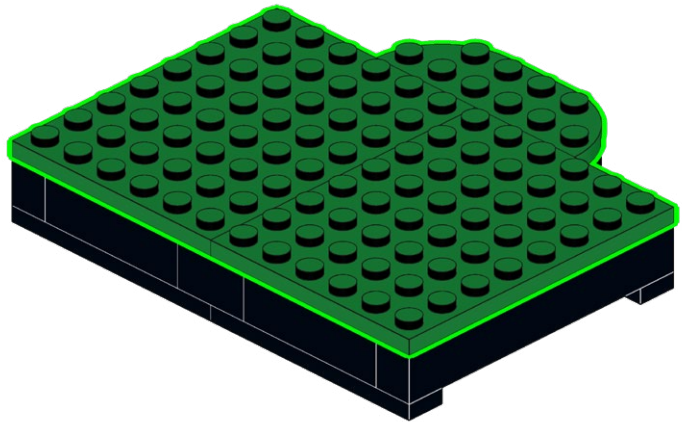
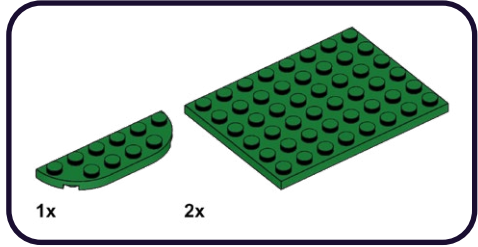

8

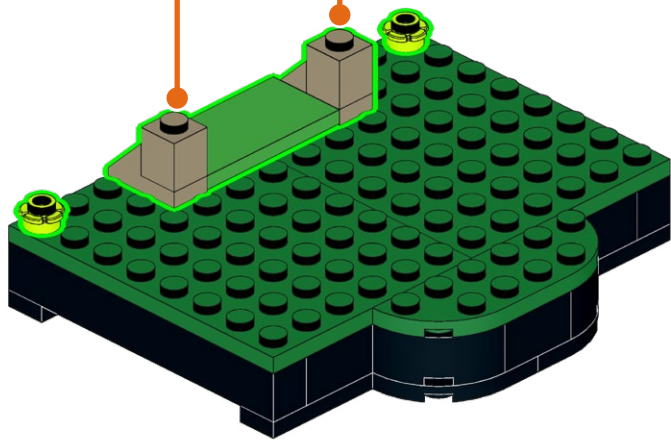
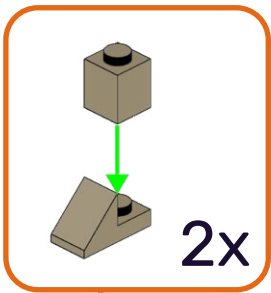
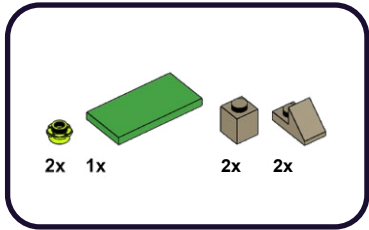

9

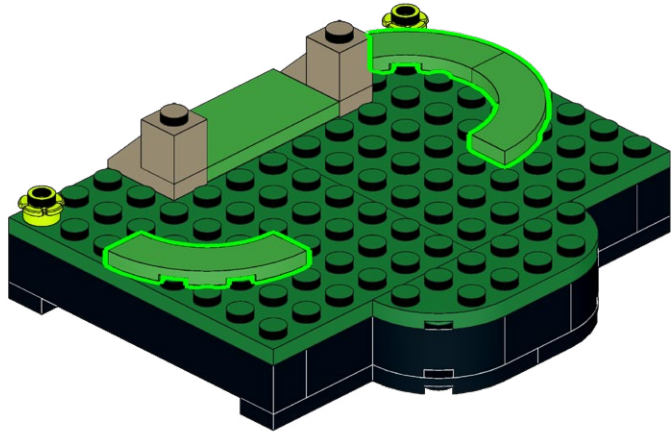
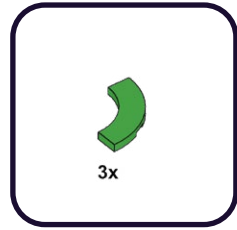

10

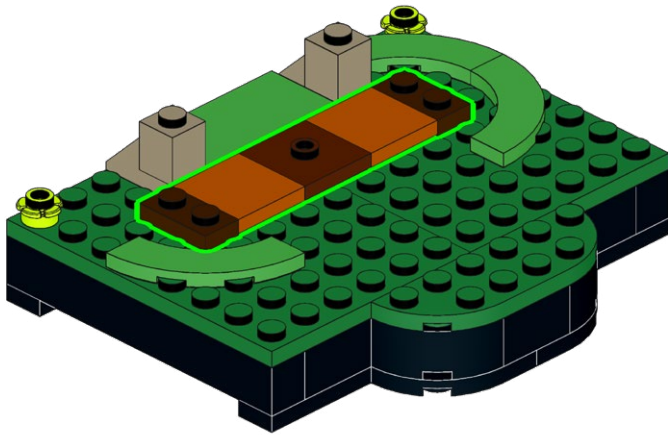
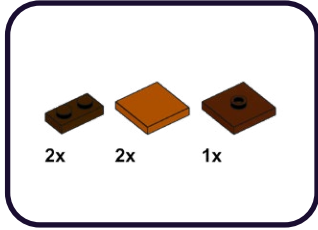

11

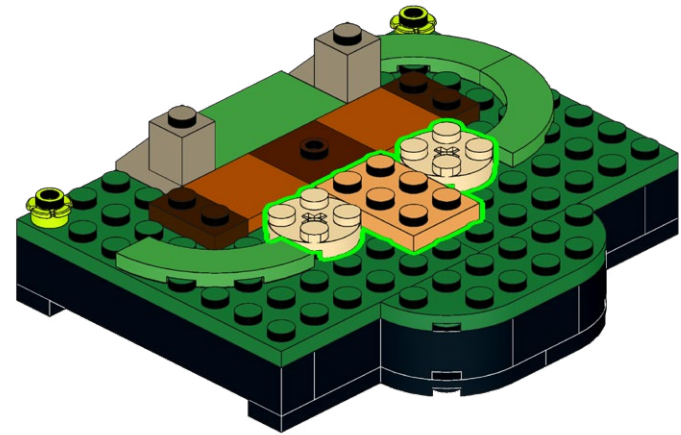
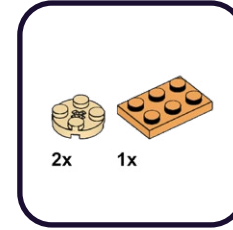

12

2x 4x

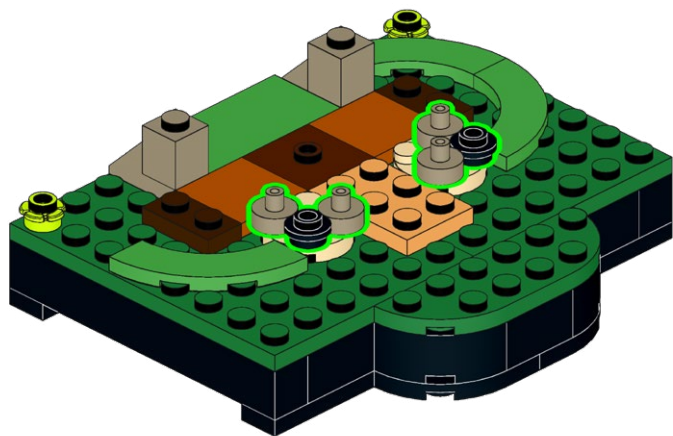

13

2x 2x 1x

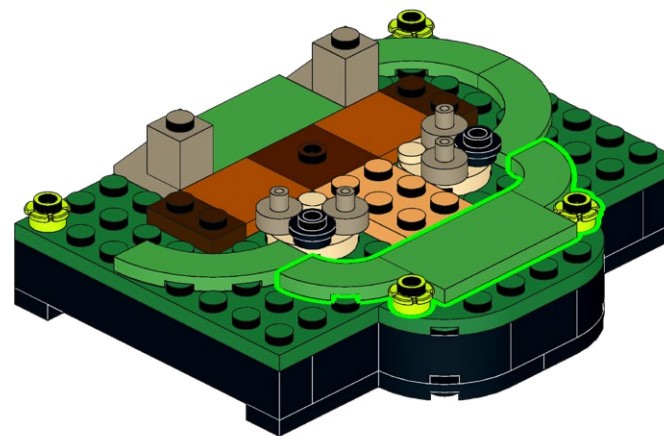

14

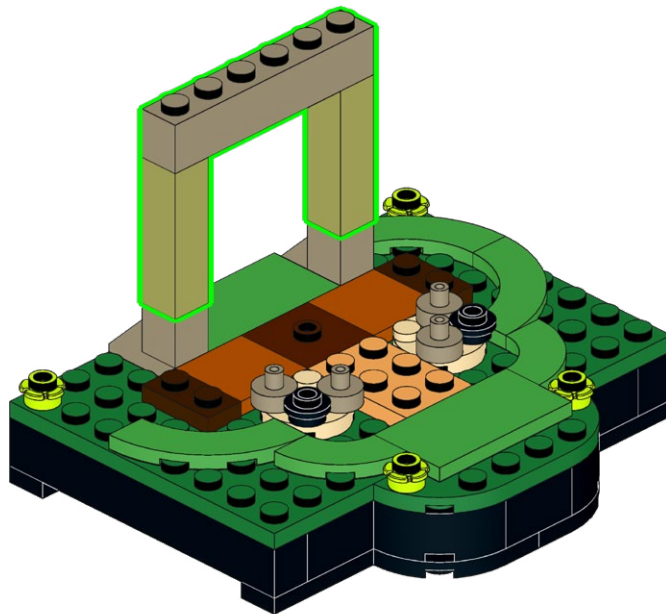
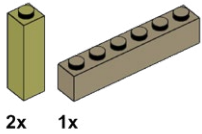

15

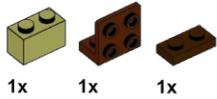

1

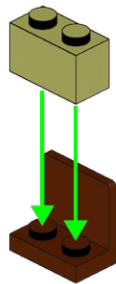

2

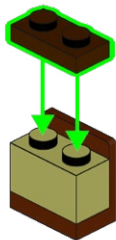

16

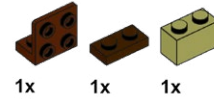

1

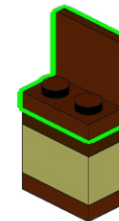

2

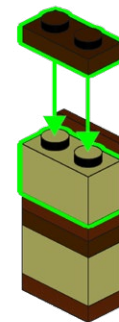

17

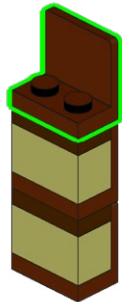
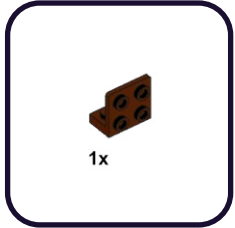

18

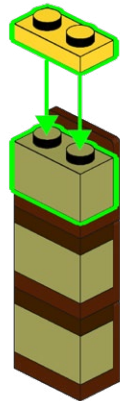
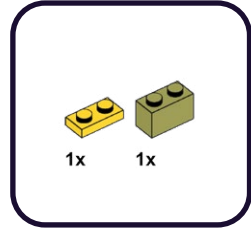

19

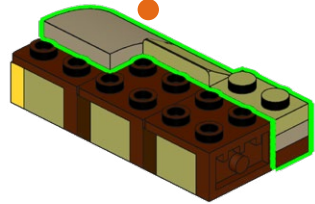
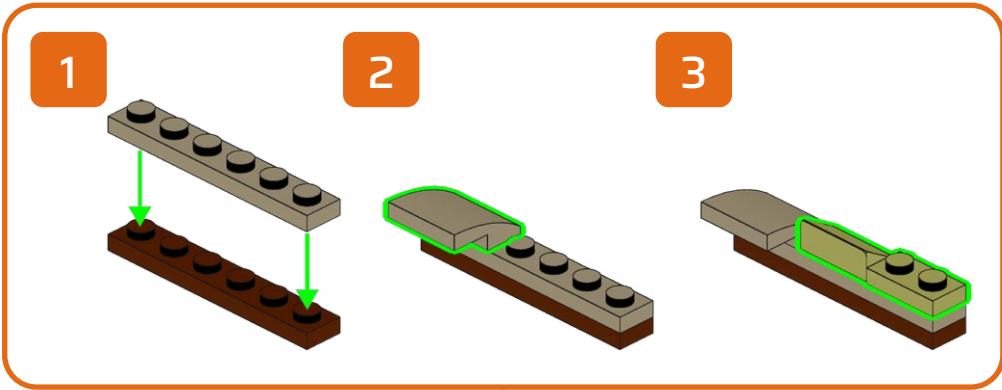
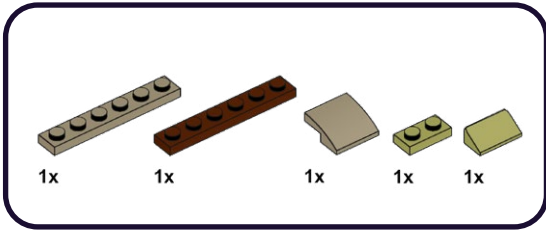

20

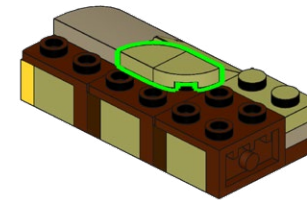
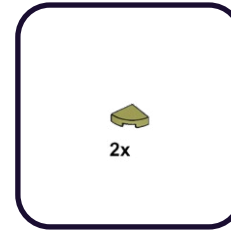

21

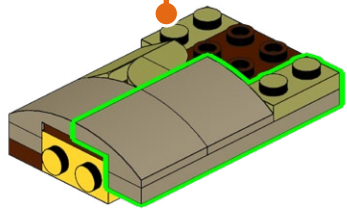
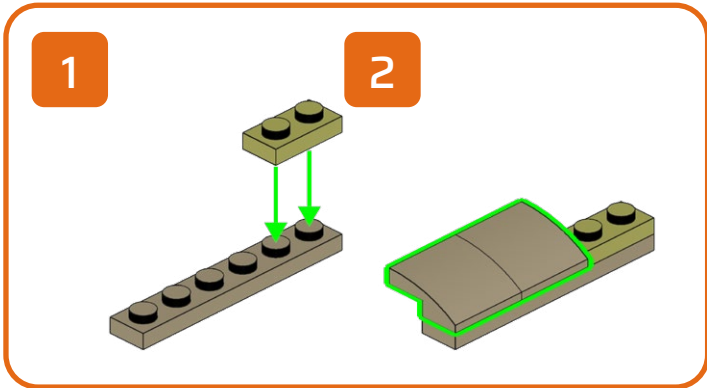
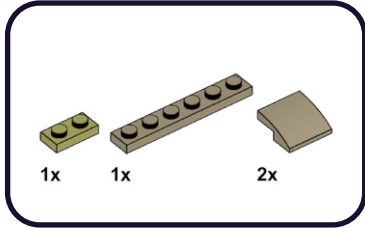

22

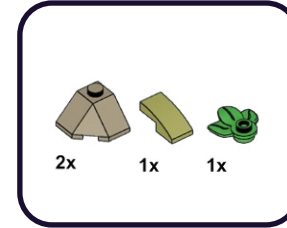

1

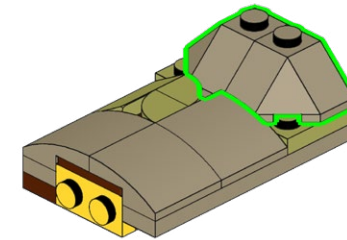

2

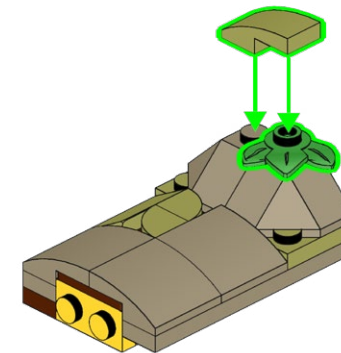

23

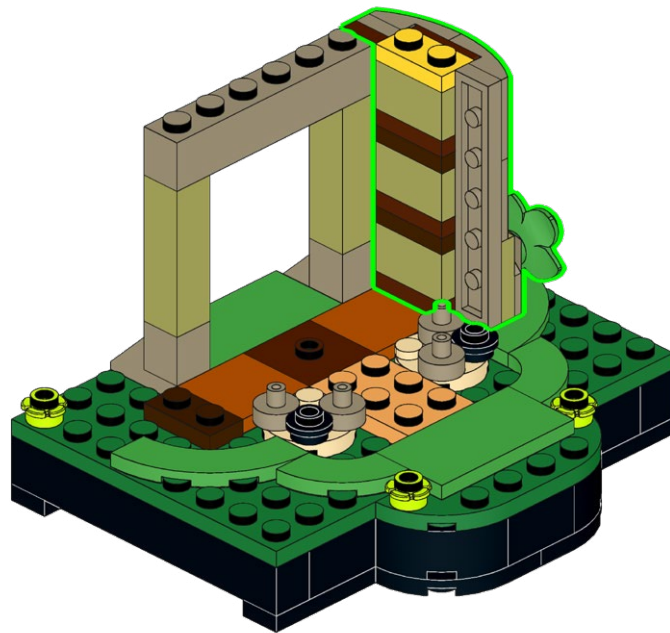

24

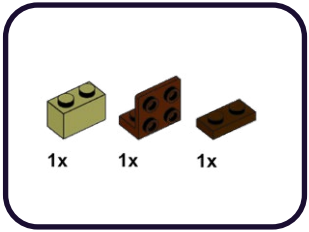

1

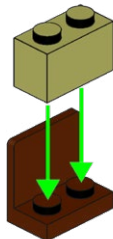

2

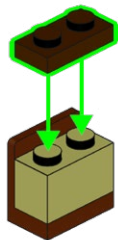

25

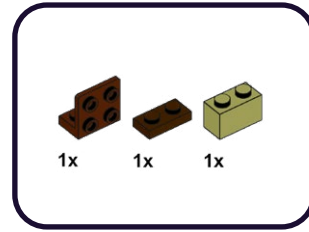

1

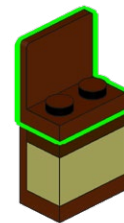

2

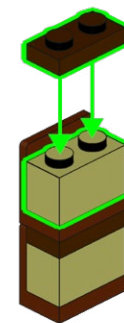

26

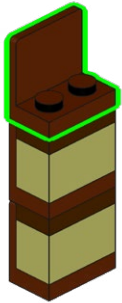
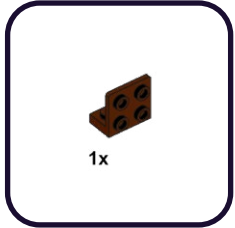

27

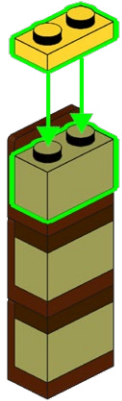
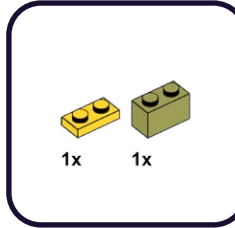

28

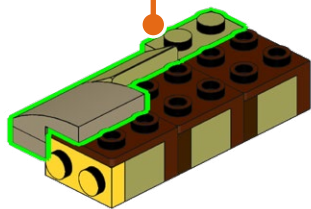
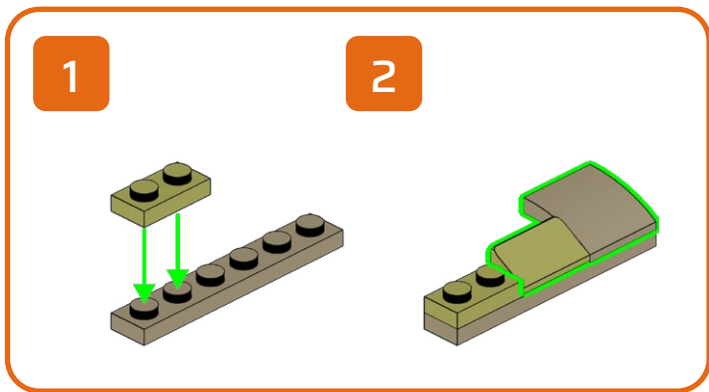
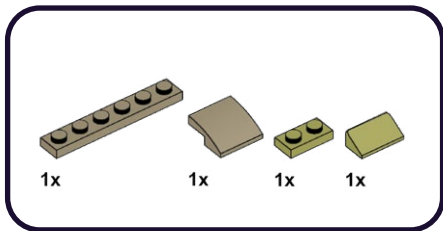

29

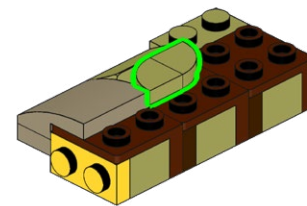
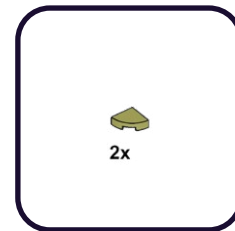

30



31

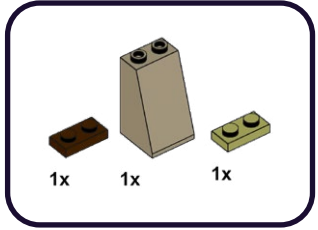

1

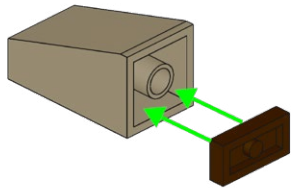

2

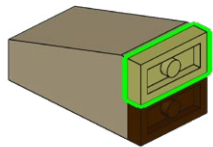

32

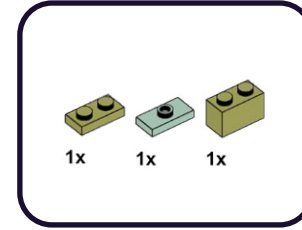

1

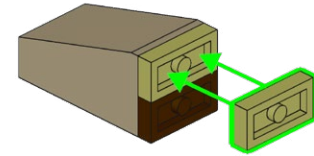

2

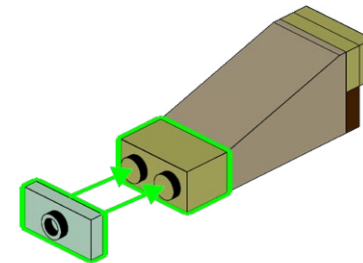
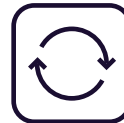

2x

33

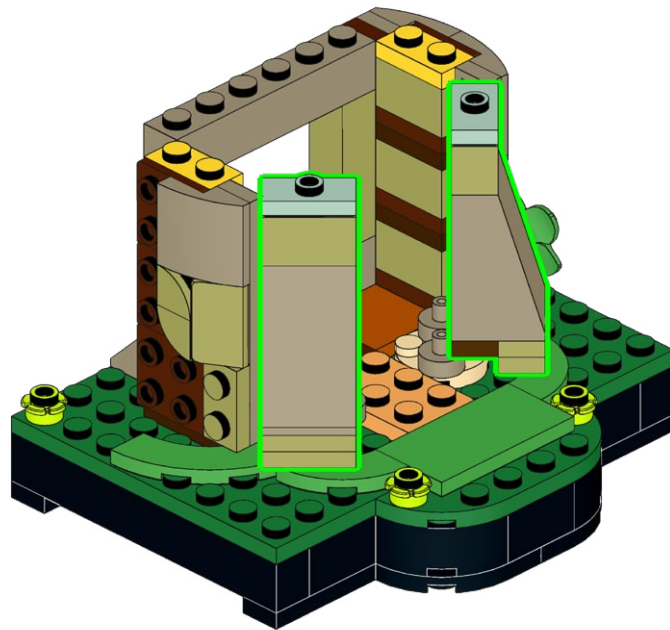

34

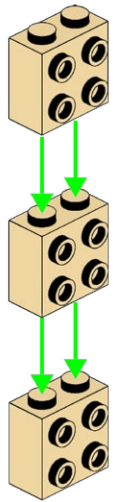
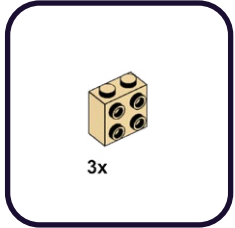

35

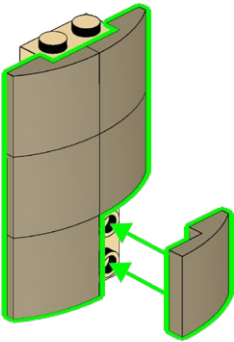
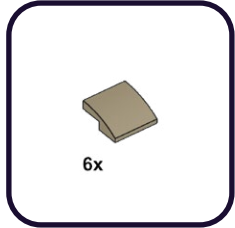

36

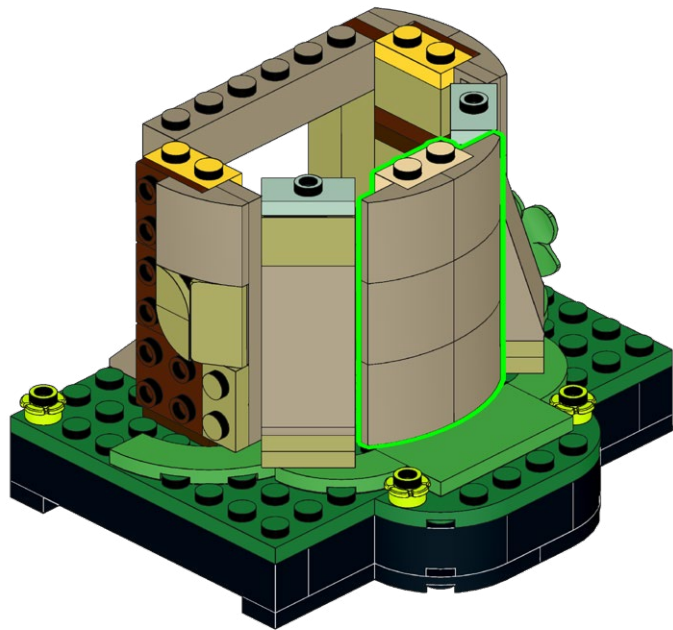

37

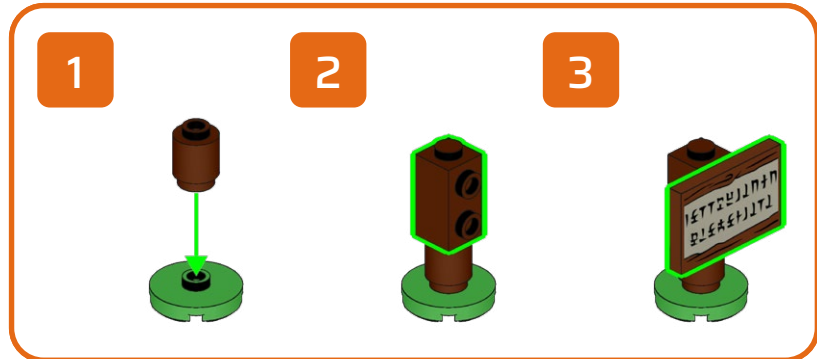
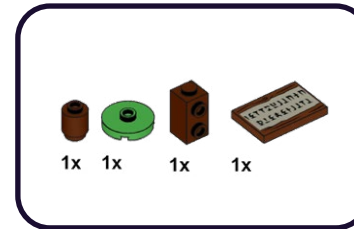

38

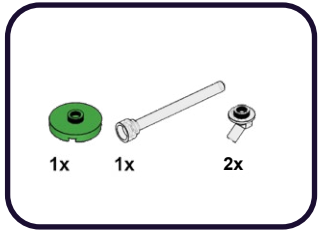

1

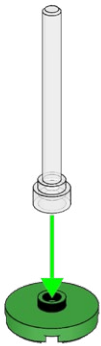

2

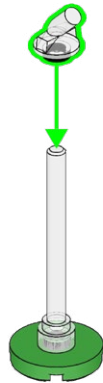

3



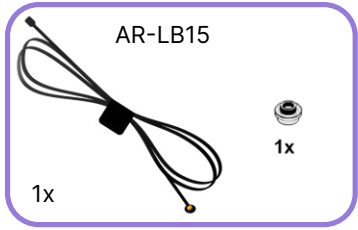

1



2

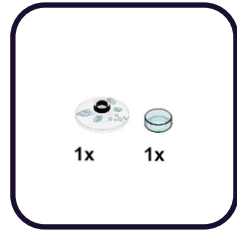

1



2



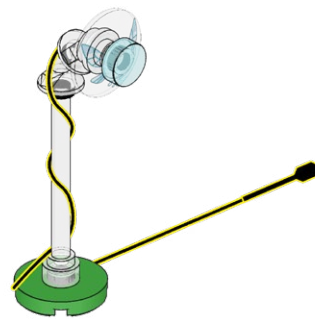
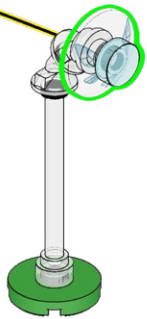
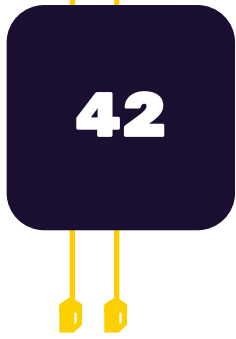

43

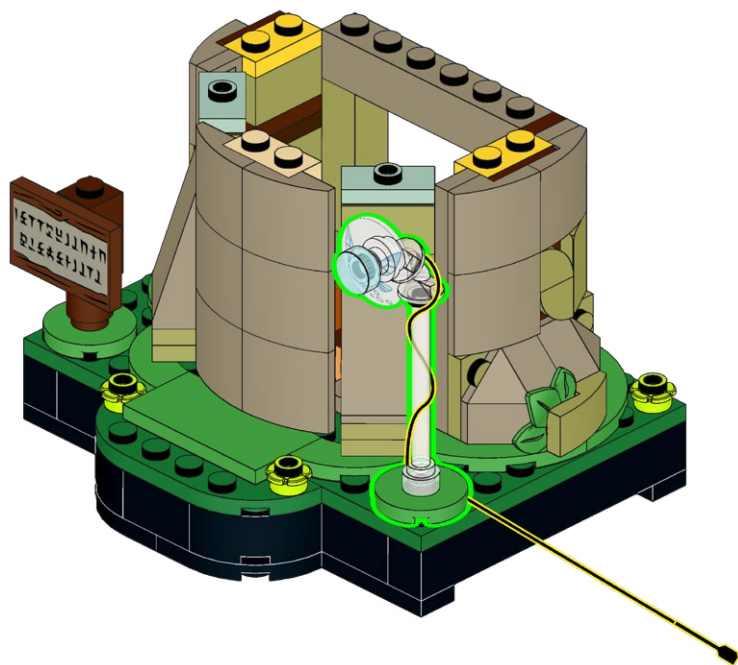

44

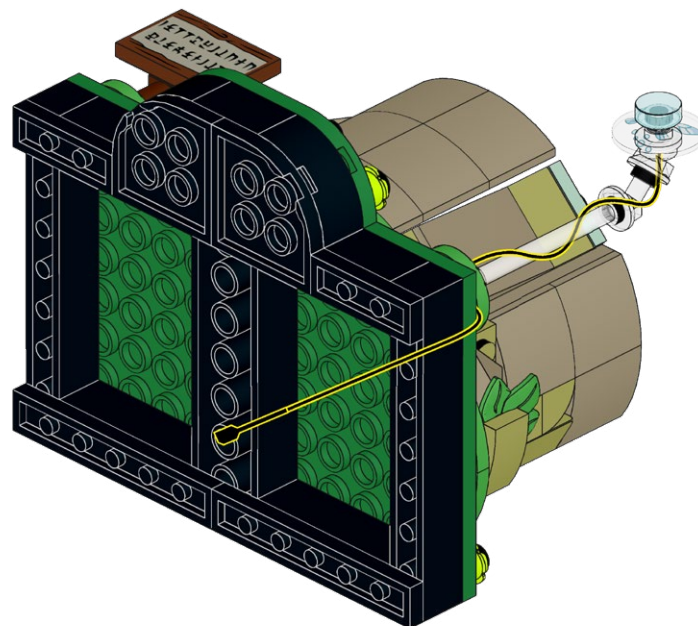
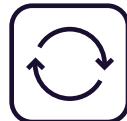

45

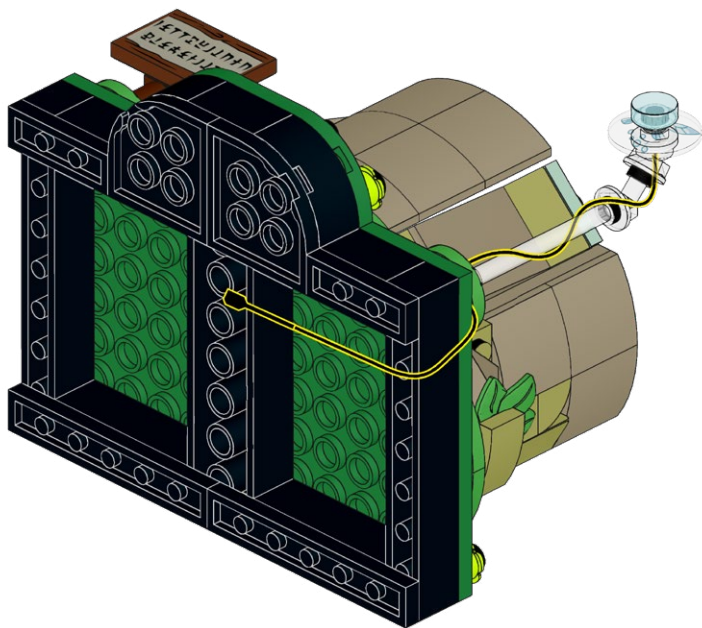

46

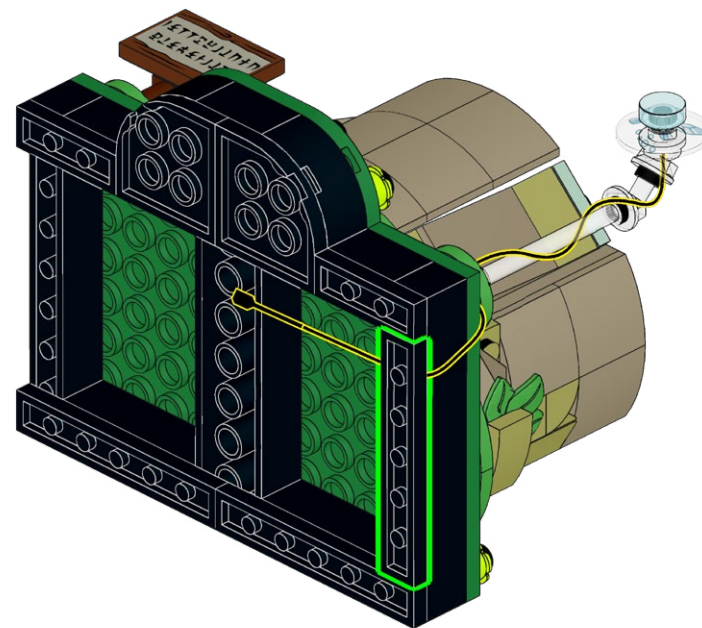
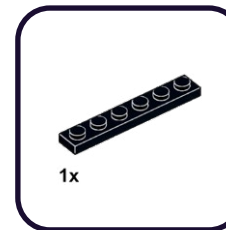

**HOLD UP!**

You might notice some bags aren't in order, as well as left over pieces, but that's ok! We're changing the way you build LEGO!

ATTENDEZ!

Vous remarquerez peut-être que certains sacs, ainsi que certaines pièces, ne sont pas dans le bon ordre. Mais pas de panique! Nous changeons simplement la façon avec laquelle vous construisez vos LEGO!

ASPETTA!

Potresti notare che alcuni sacchetti non sono in ordine, così come i pezzi avanzati, ma va bene così! Stiamo cambiando il modo in cui costruisci i LEGO!

HALT!

Sie werden möglicherweise bemerken, dass einige tüten durcheinander sind und teile übrig bleiben, aber das ist in Ordnung! Wir ändern die art und weise, wie Sie LEGO bauen!

¡ESPERA!

Es posible que notes que algunas bolsas están fuera de servicio, así como piezas sobrantes, ¡pero está bien! ¡Estamos cambiando la forma en que construyes LEGO!

暫停!

你可能会注意到一些袋子顺序错乱, 以及一些剩余的部件, 但没关系! 我们正在改变你搭建乐高的方式!

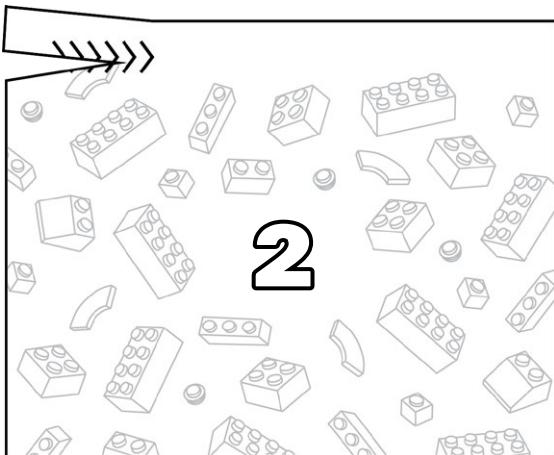
Open LEGO® Bag 2

47

1

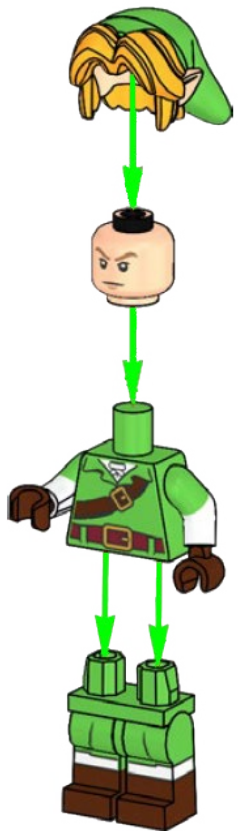

2



48

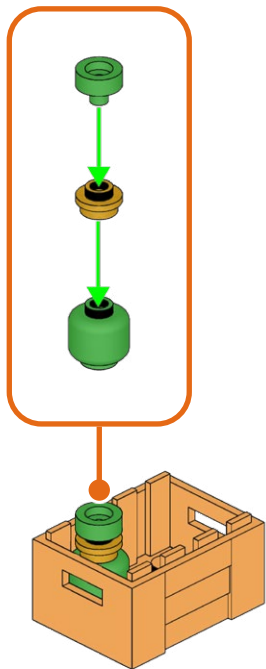
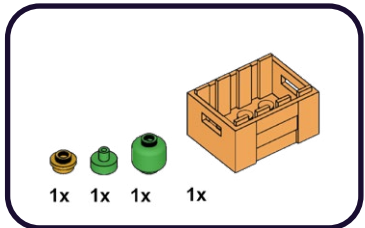

49

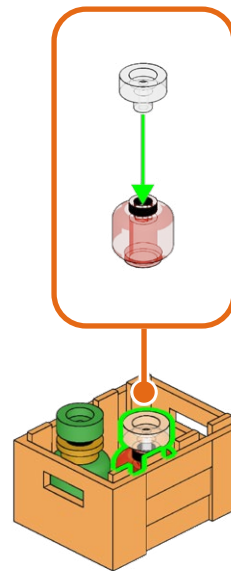
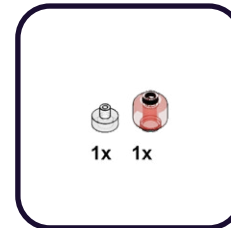

50

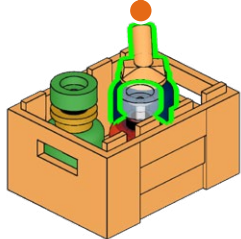
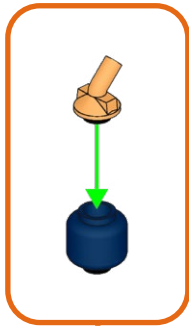

51

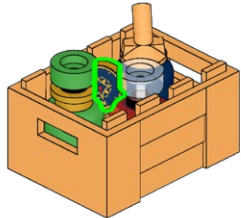
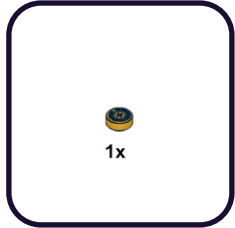

52

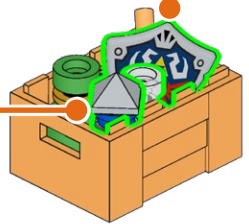
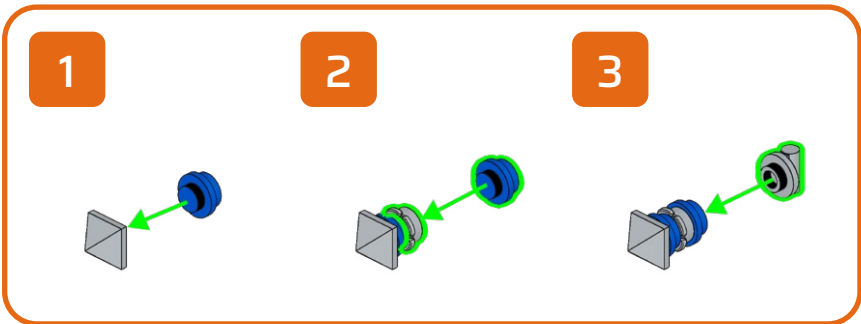
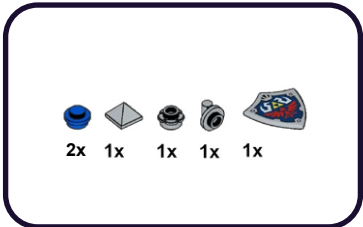

53

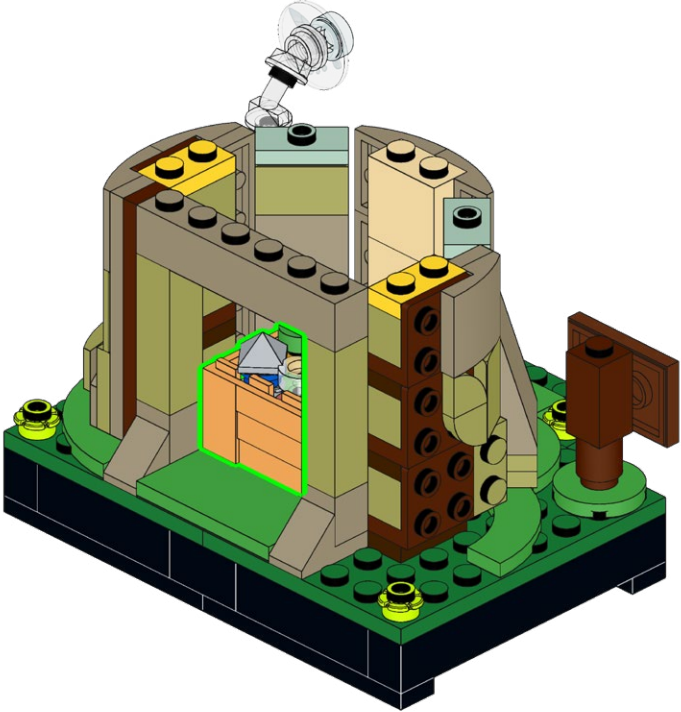

54

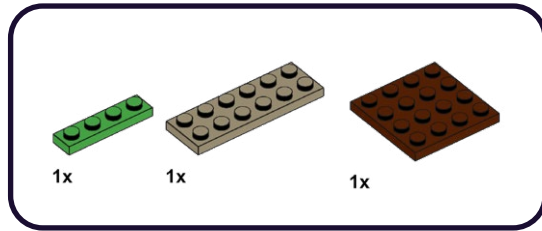

1

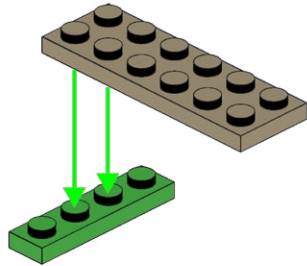

2

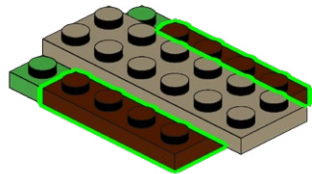

55

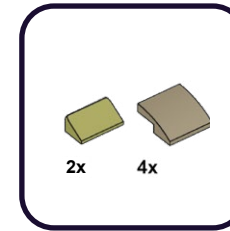

1

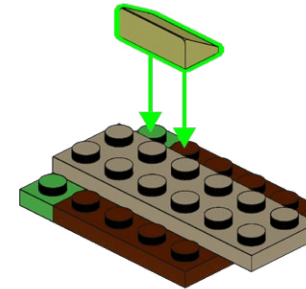

2

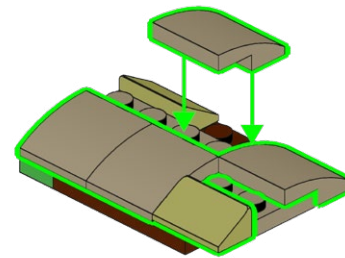

56

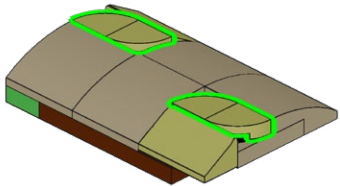
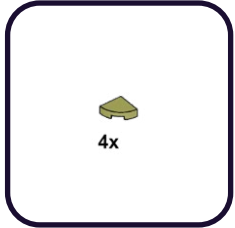

57

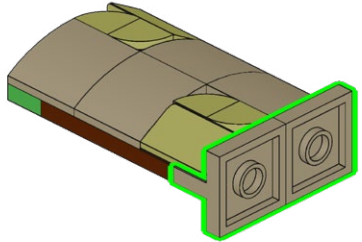
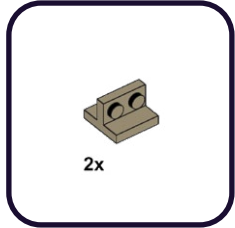

58

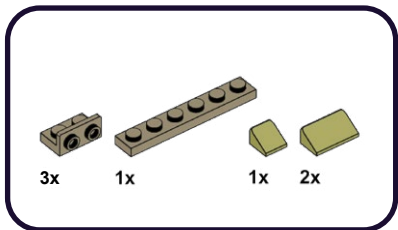

-
-
-

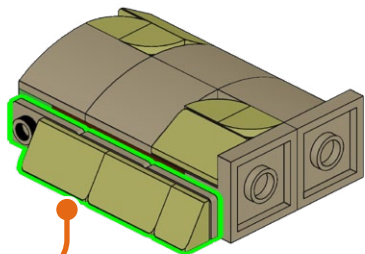

59

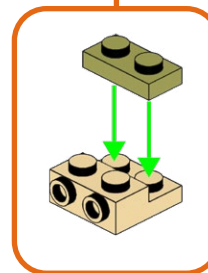
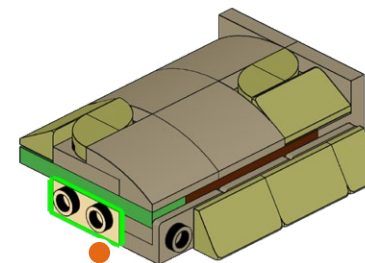
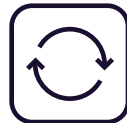
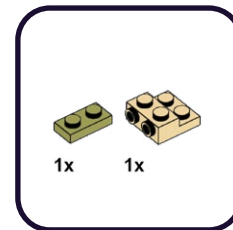

60

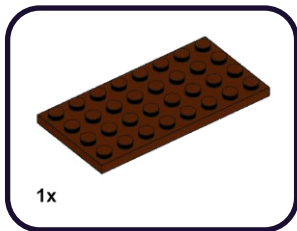

1x

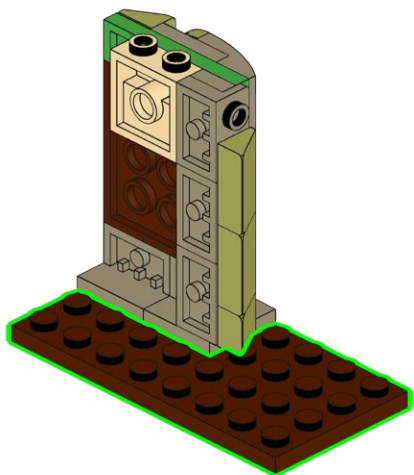

61

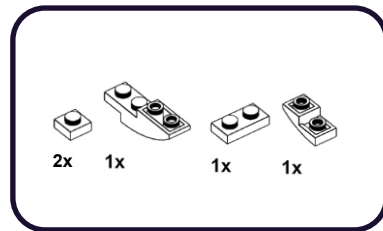

2x

1x

1x

1x

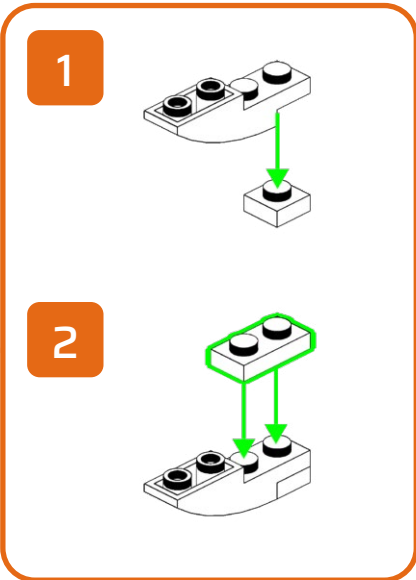
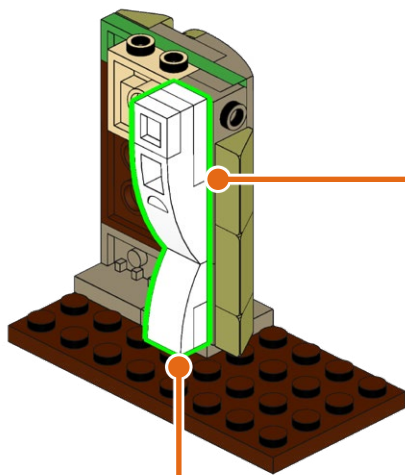

1

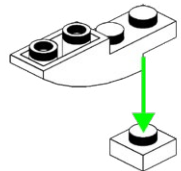

2

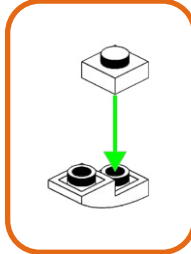
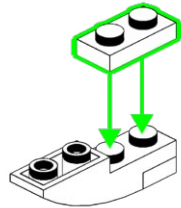

62

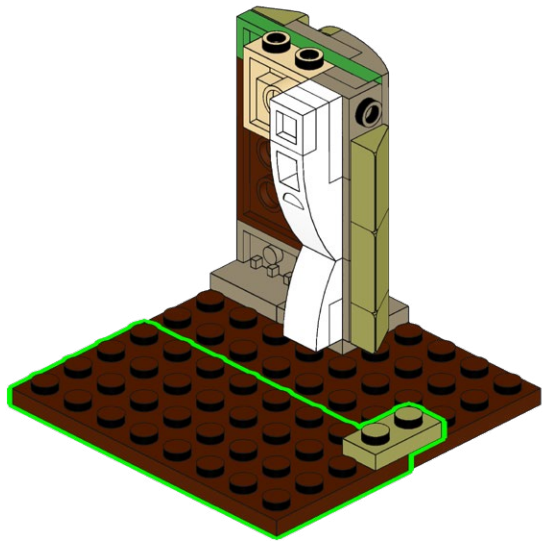
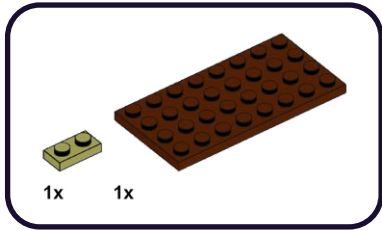

63

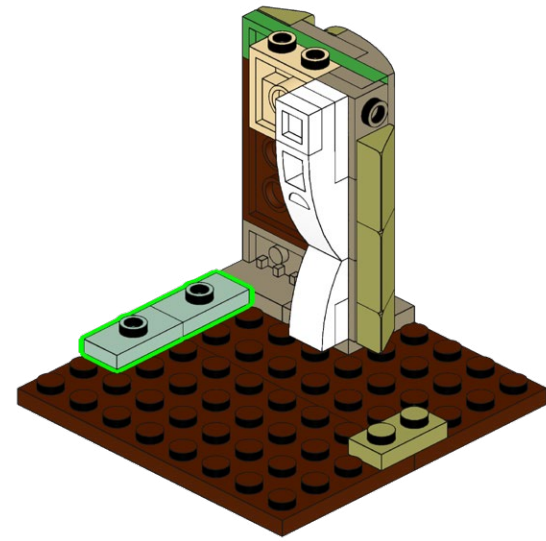
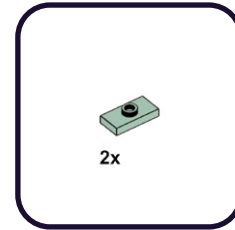

64

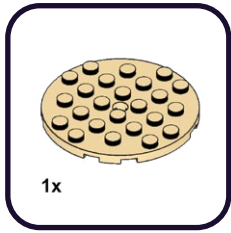
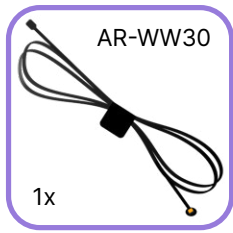

1

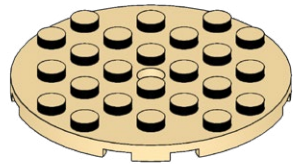

2

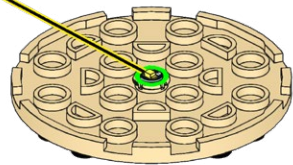

65

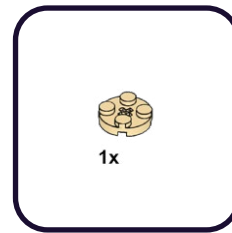
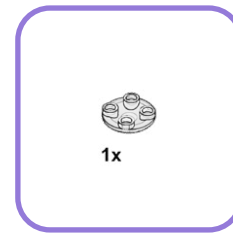

1

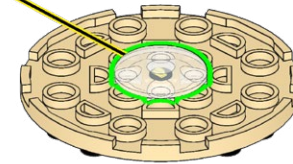

2

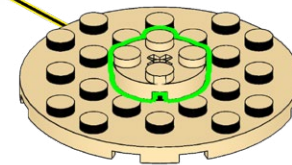
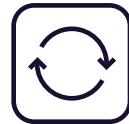

66

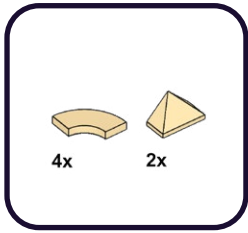

1

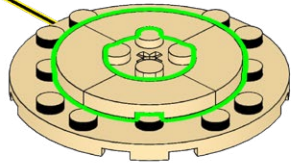

2

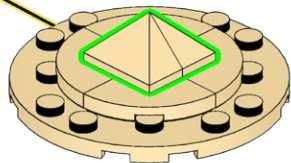

67

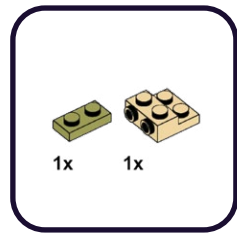

1

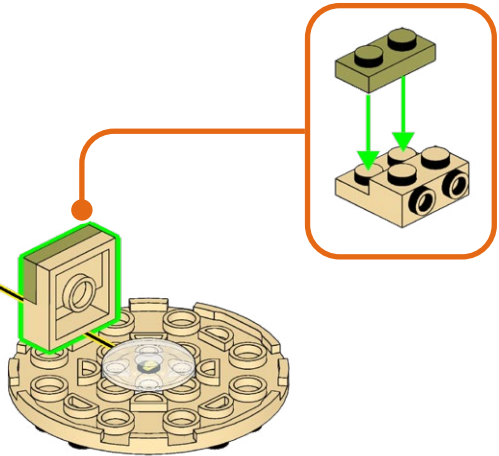

2

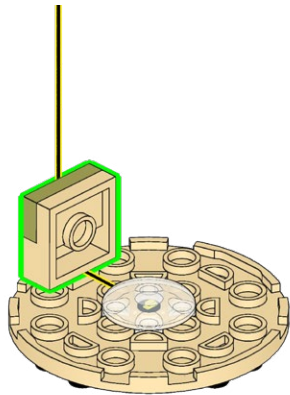

68

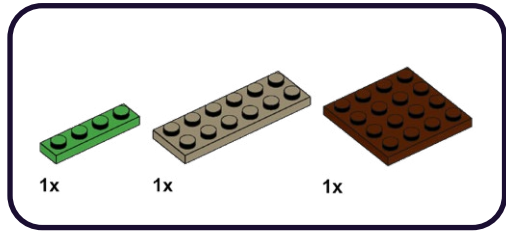

1

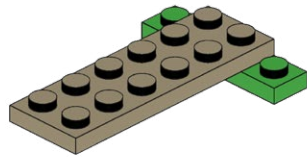

2

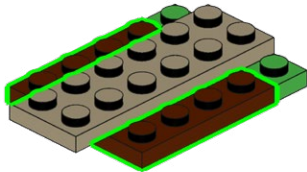

69

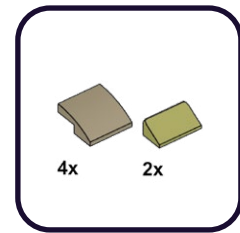

1

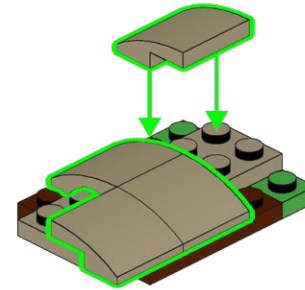

2

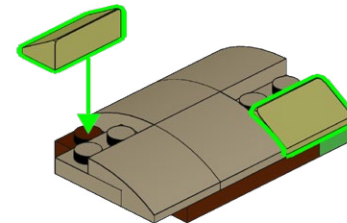

70

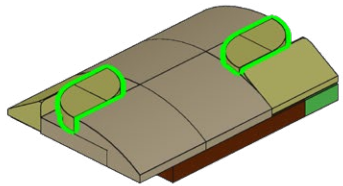
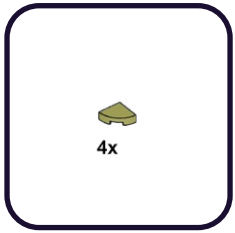

71

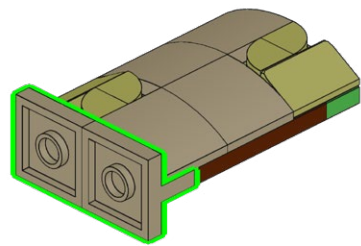
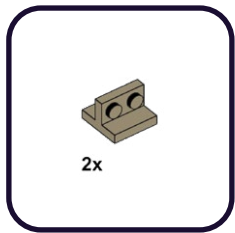

72

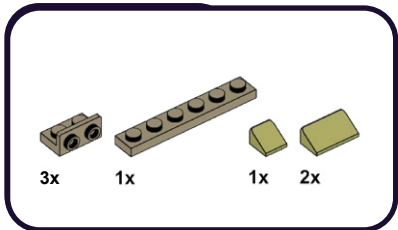

-
-
-

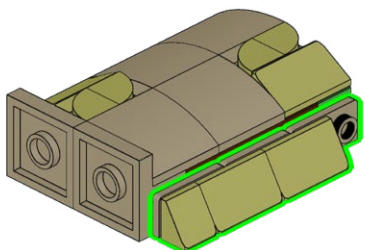

73

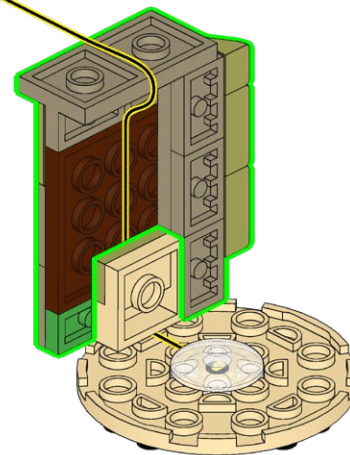

74

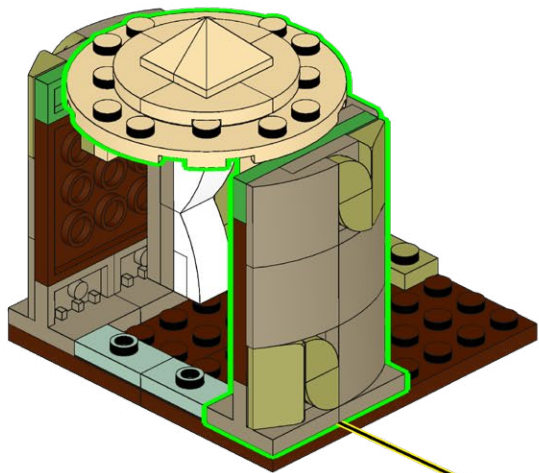

75

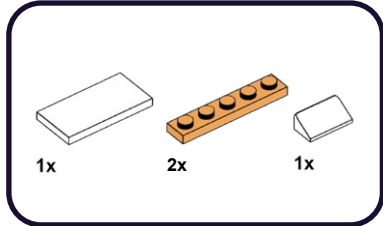

- 1
- 2
- 3

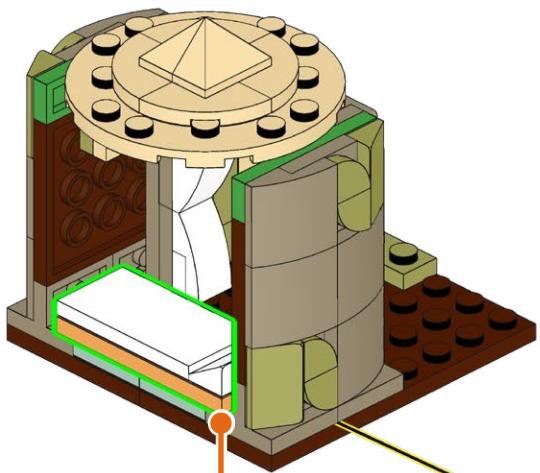

76

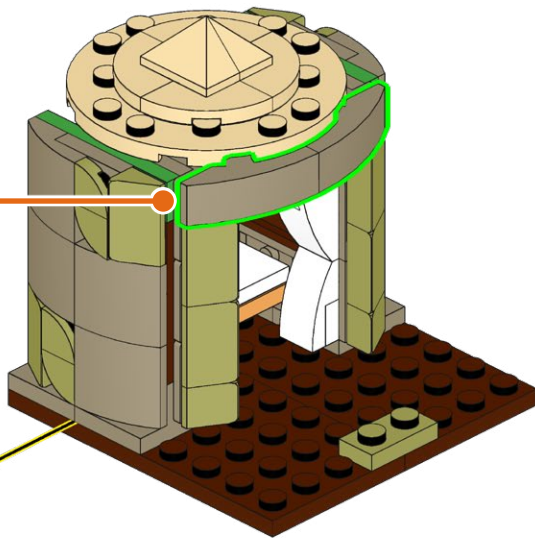
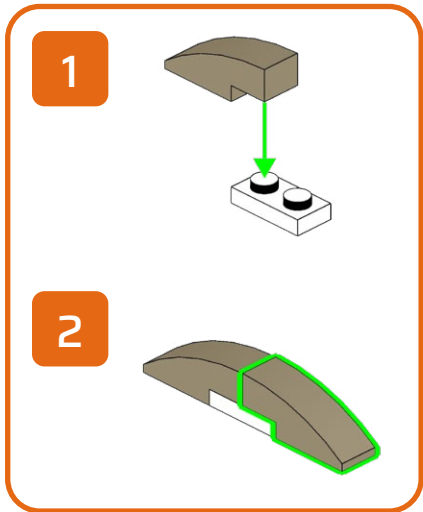
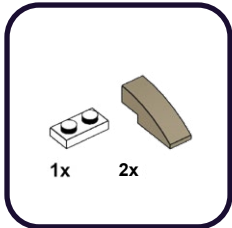

77

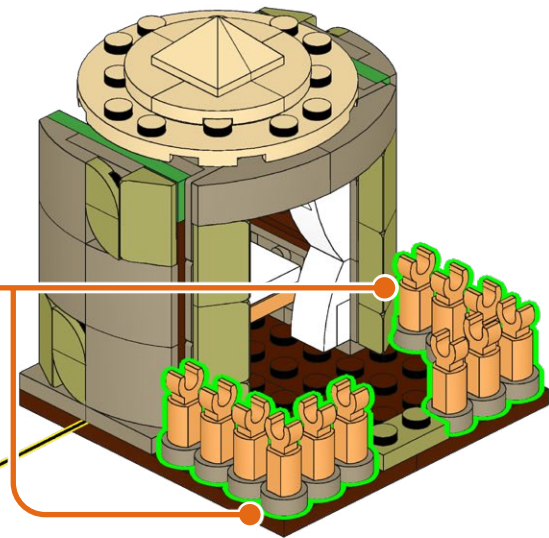
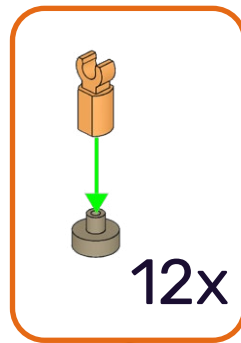
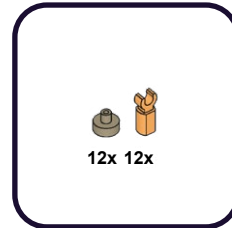

78

4x

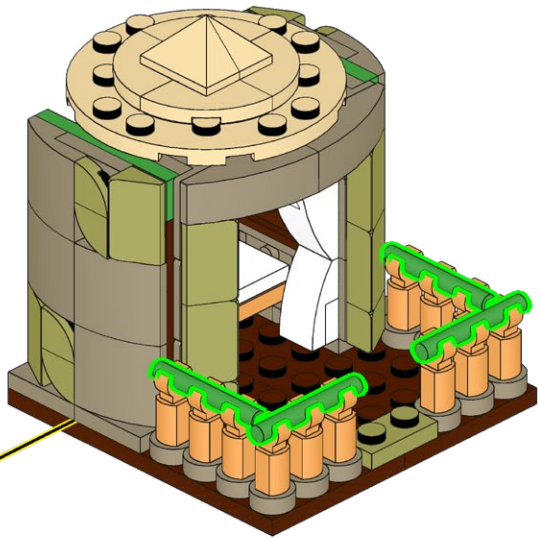

79

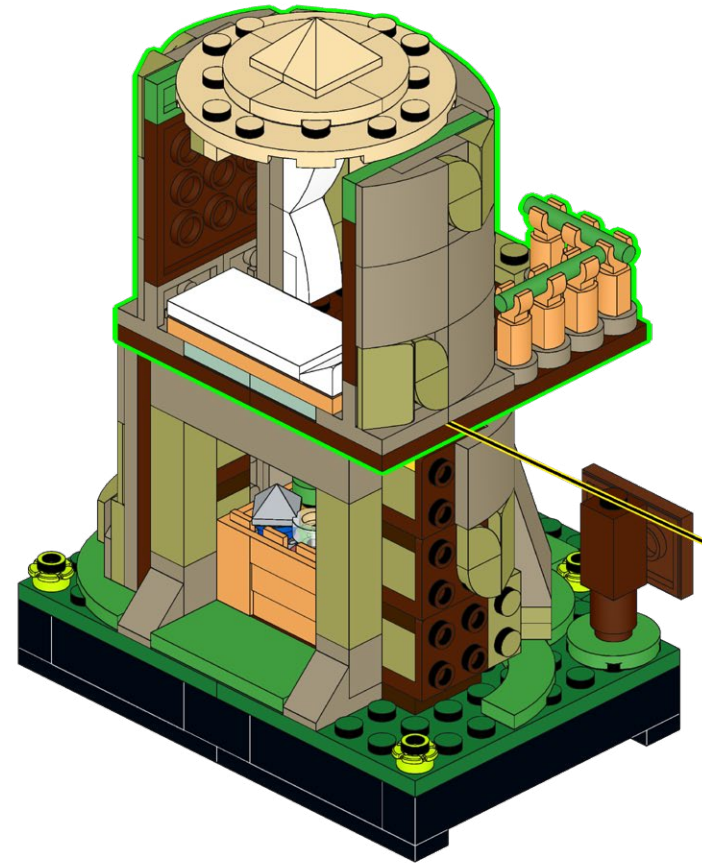
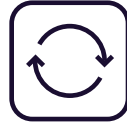

80



81

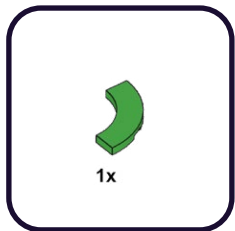

82

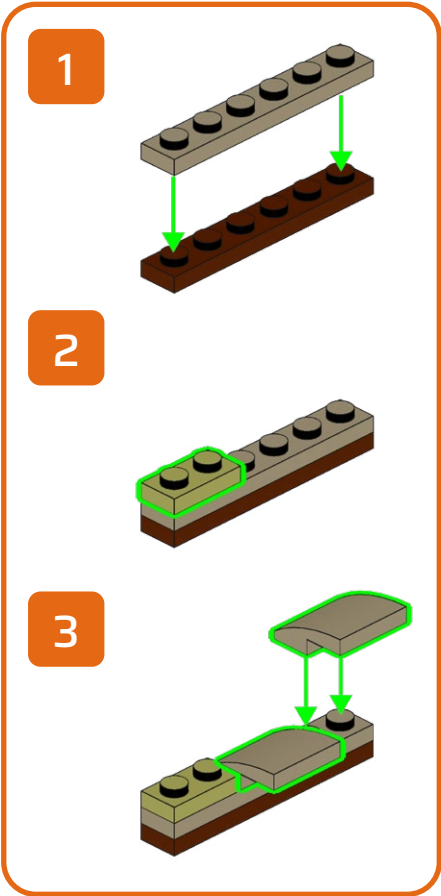
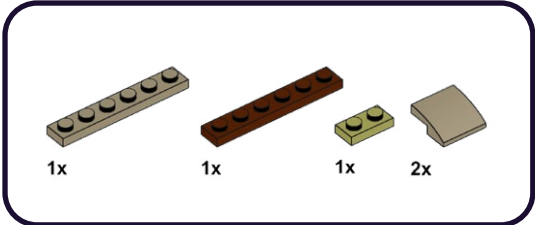

83



2x



84



1x

1x

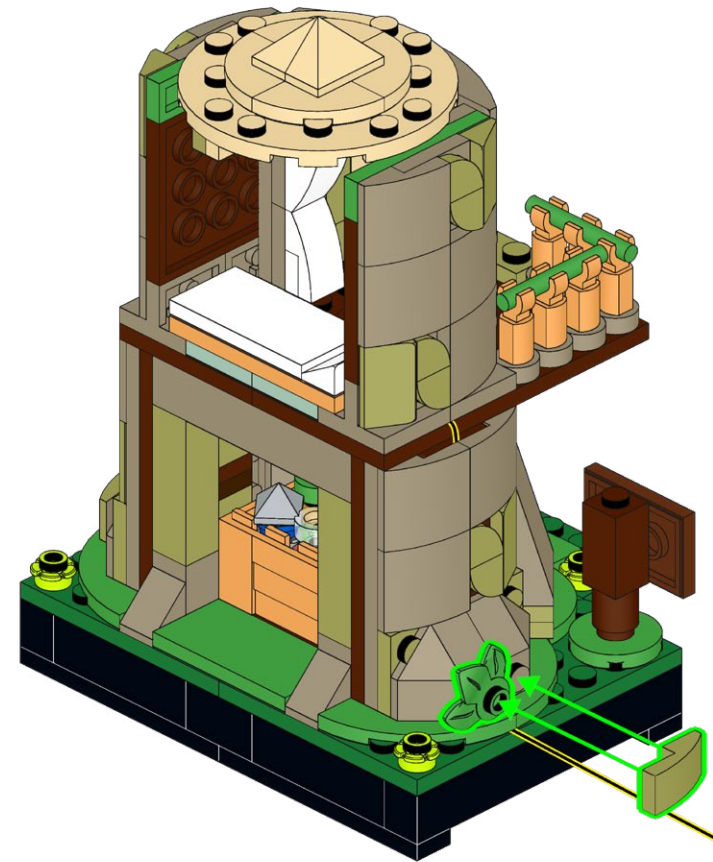

85

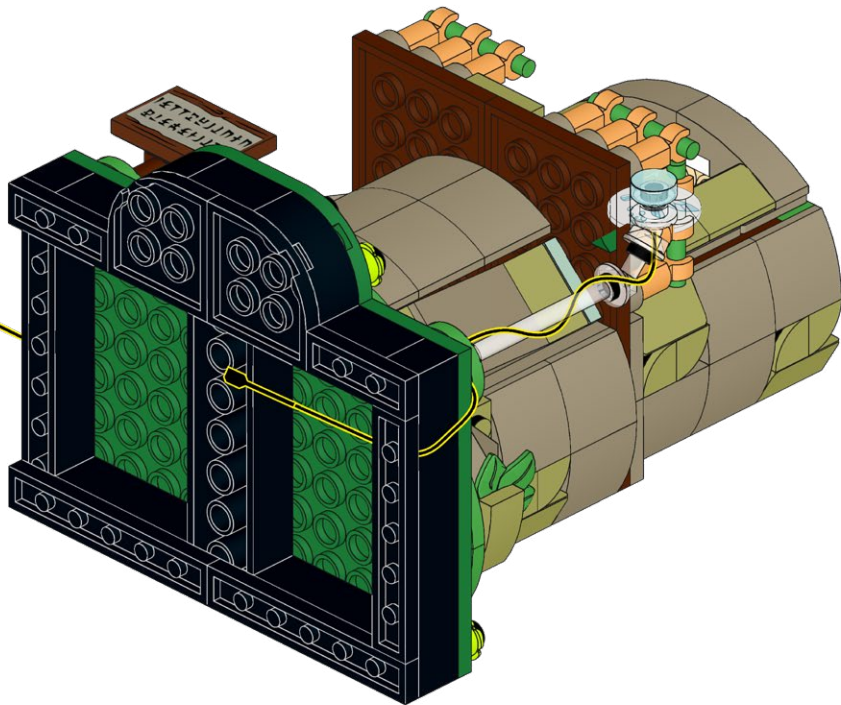

86

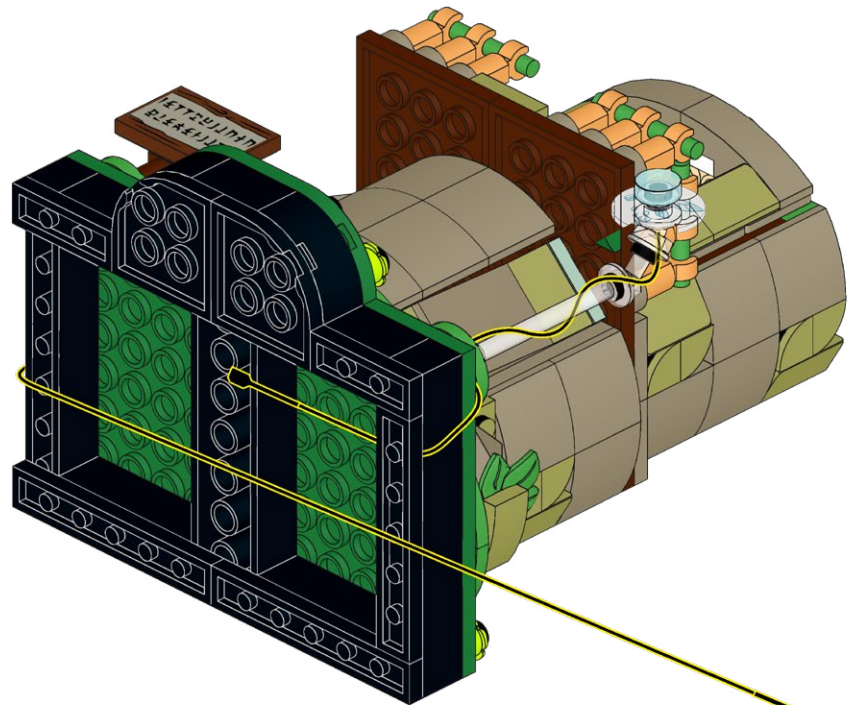

87

1x

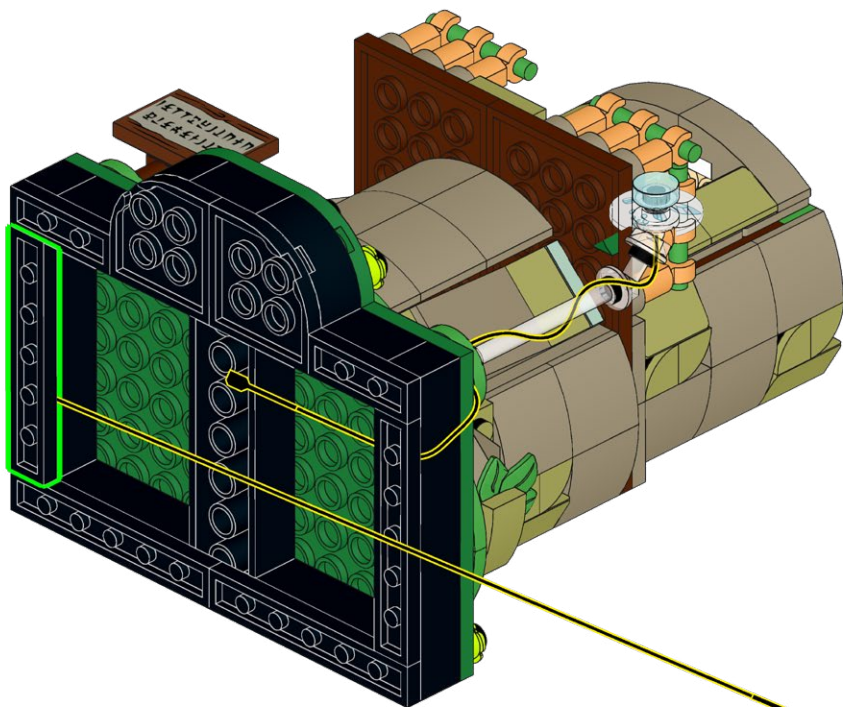

88

1x



PB-2.0

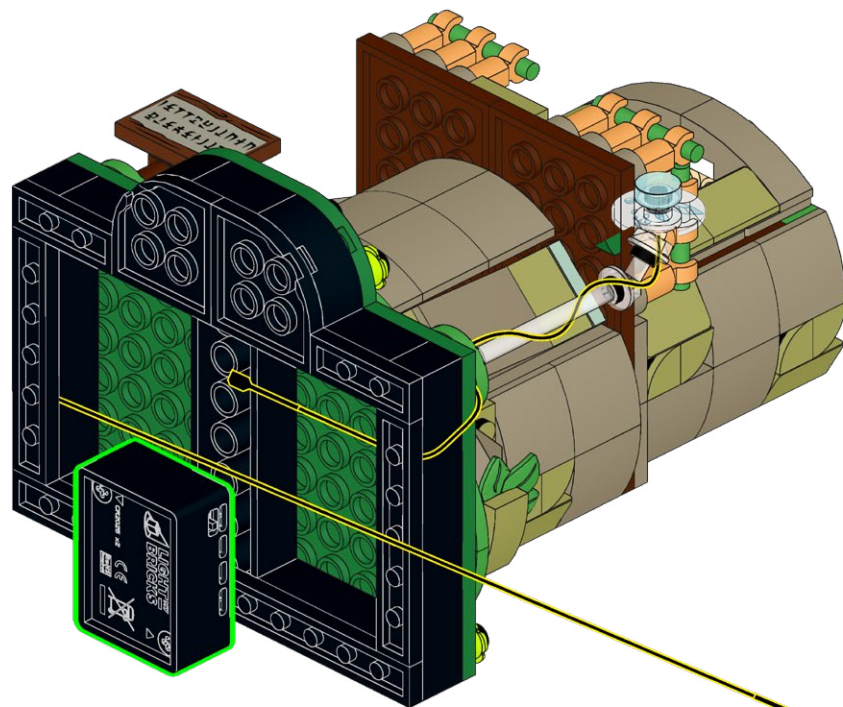

89

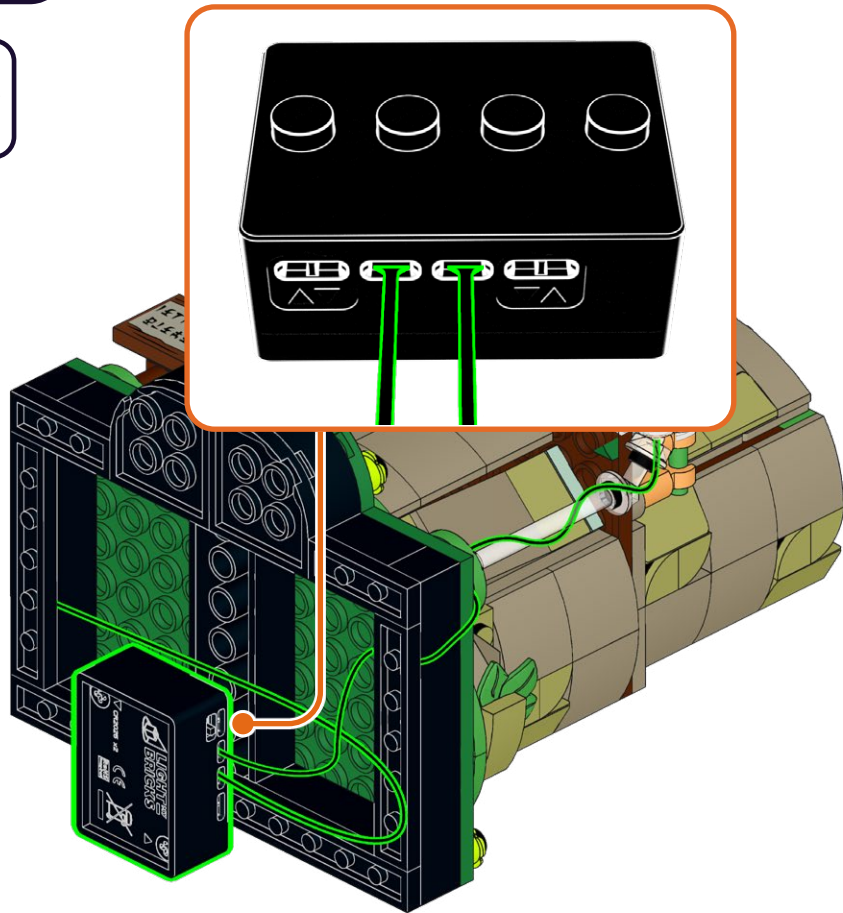

90

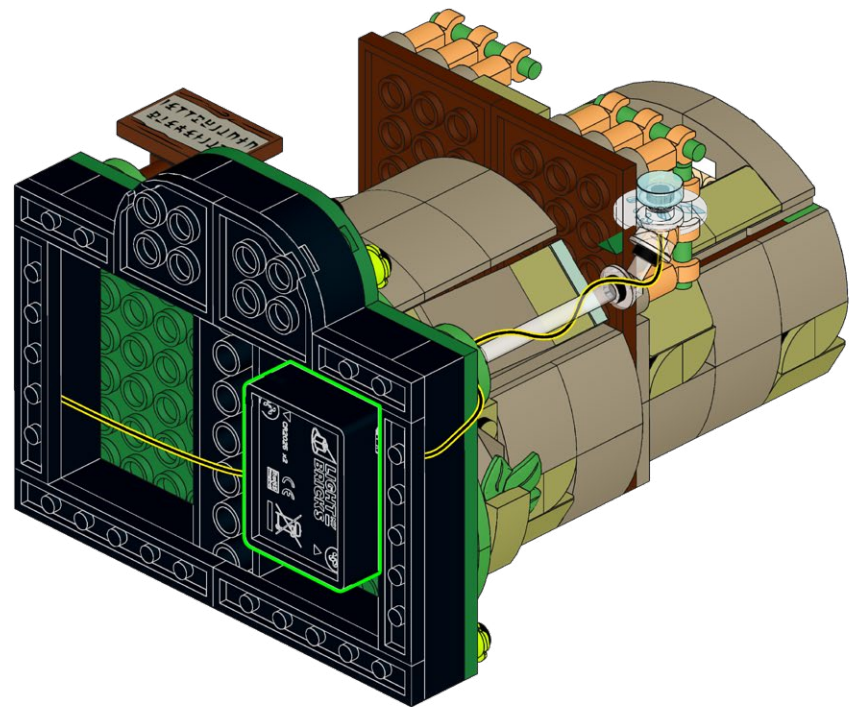

91

1x

1x

1x

1

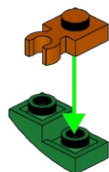

2

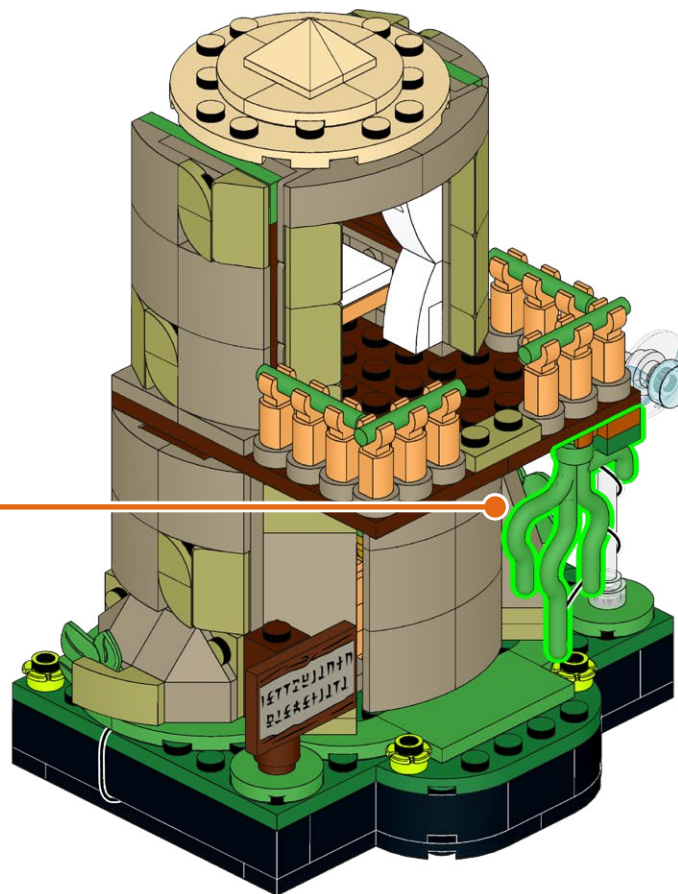
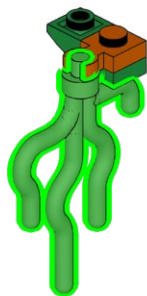

92

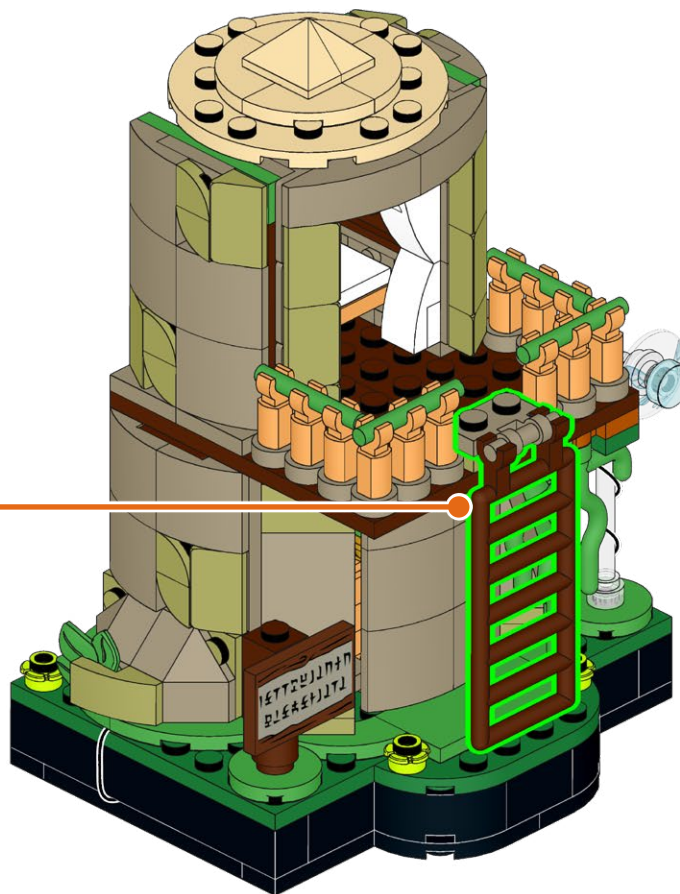
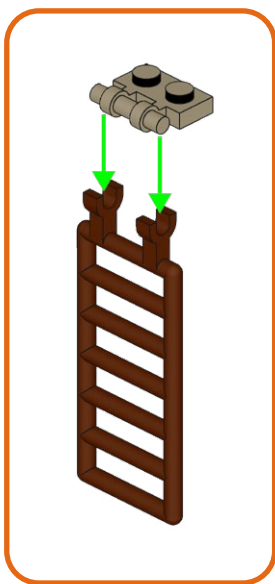

93



Power on Test
Test de mise sous tension
Test di Potenza
Stromtest
Prueba de Energía
电源测试



**HOLD UP!**

You might notice some bags aren't in order, as well as left over pieces, but that's ok! We're changing the way you build LEGO!

ATTENDEZ!

Vous remarquerez peut-être que certains sacs, ainsi que certaines pièces, ne sont pas dans le bon ordre. Mais pas de panique! Nous changeons simplement la façon avec laquelle vous construisez vos LEGO!

ASPETTA!

Potresti notare che alcuni sacchetti non sono in ordine, così come i pezzi avanzati, ma va bene così! Stiamo cambiando il modo in cui costruisci i LEGO!

HALT!

Sie werden möglicherweise bemerken, dass einige tüten durcheinander sind und teile übrig bleiben, aber das ist in Ordnung! Wir ändern die art und weise, wie Sie LEGO bauen!

¡ESPERA!

Es posible que notes que algunas bolsas están fuera de servicio, así como piezas sobrantes, ¡pero está bien! ¡Estamos cambiando la forma en que construyes LEGO!

暫停!

你可能会注意到一些袋子顺序错乱, 以及一些剩余的部件, 但没关系! 我们正在改变你搭建乐高的方式!

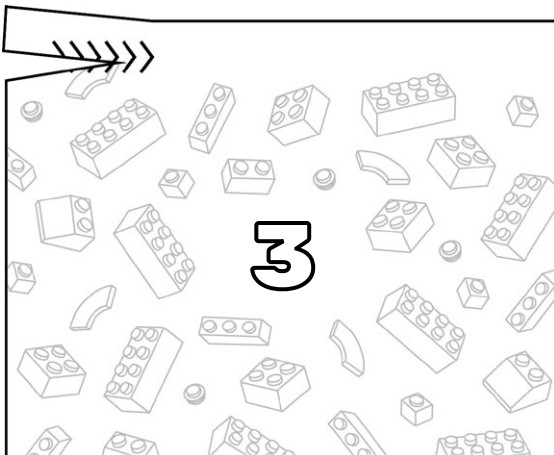
Open LEGO® Bag 3

1

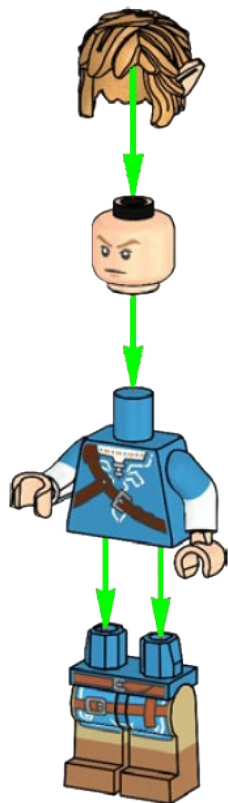

2



95

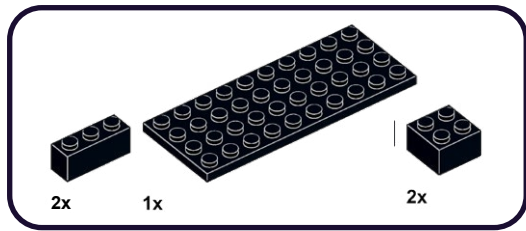

1

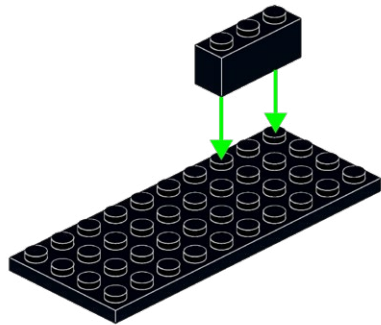

2

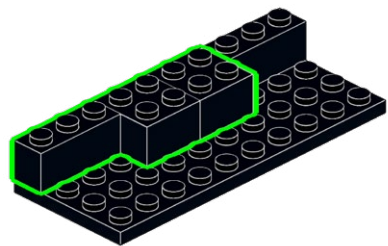

96

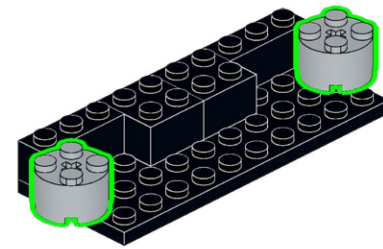
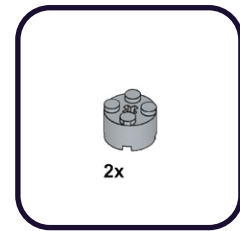

97



2x

2x

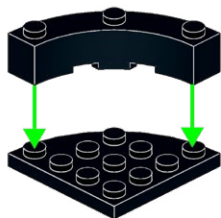

2x

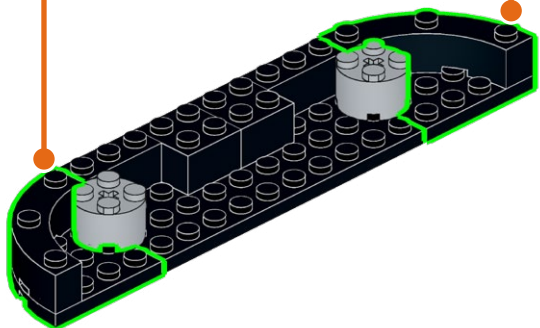

98



2x

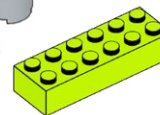

2x



1x



2x

1

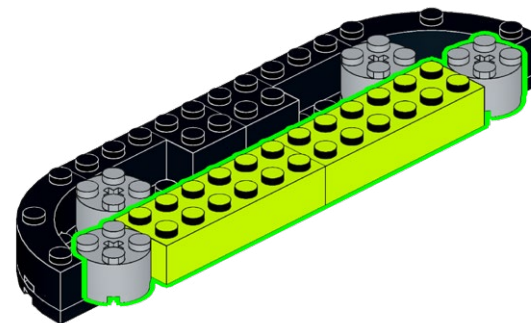

2

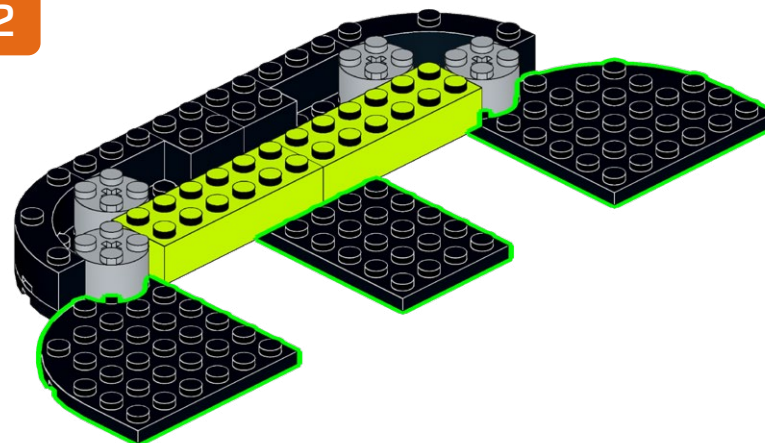

99

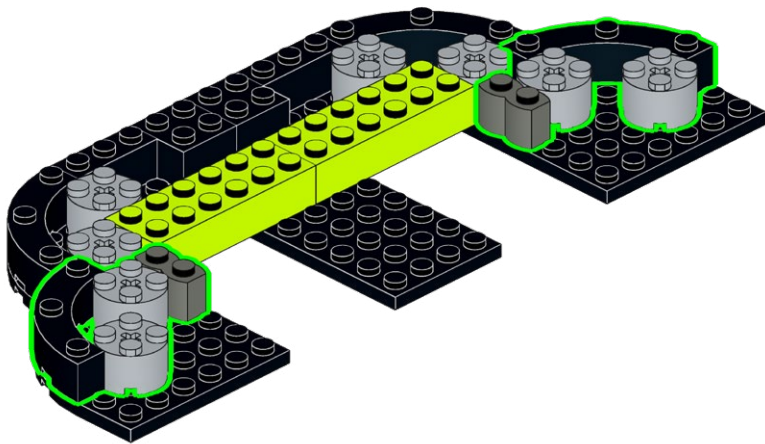
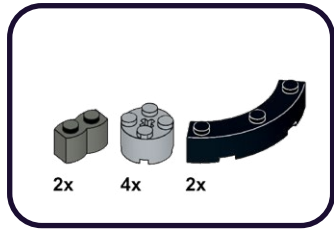

100

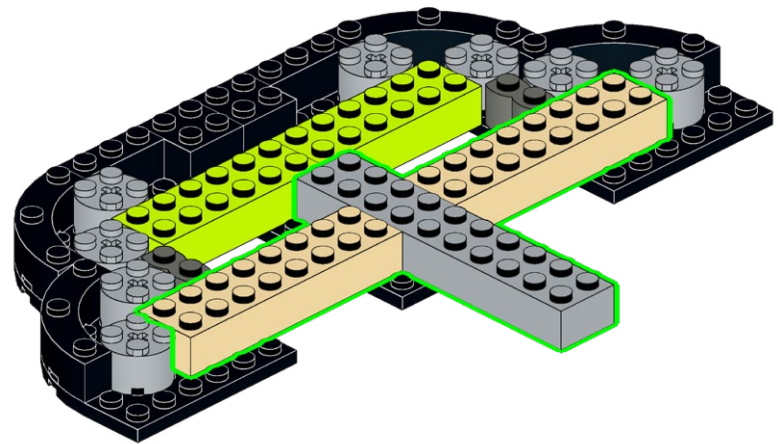
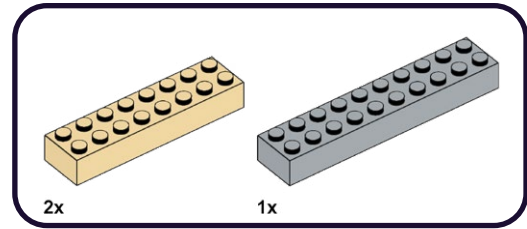

101

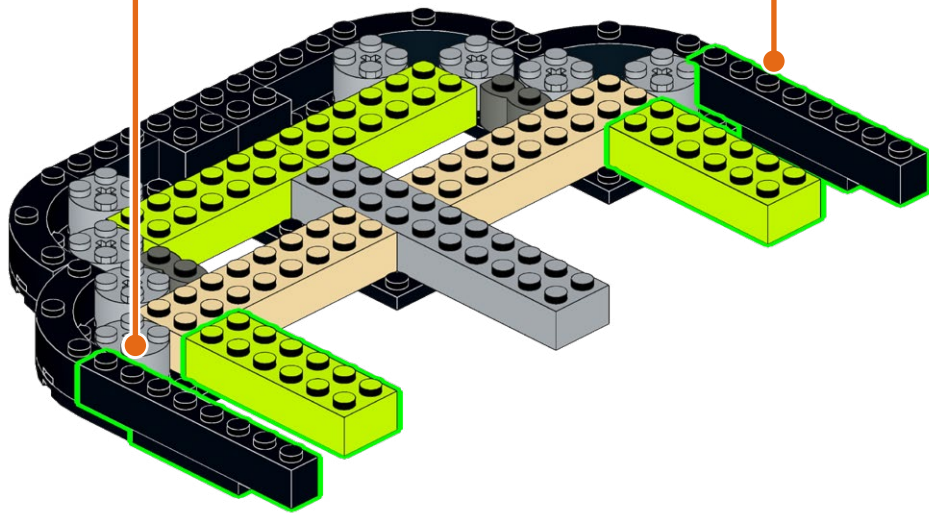
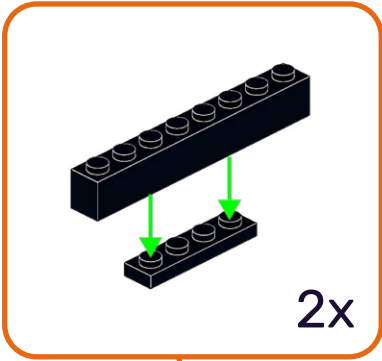
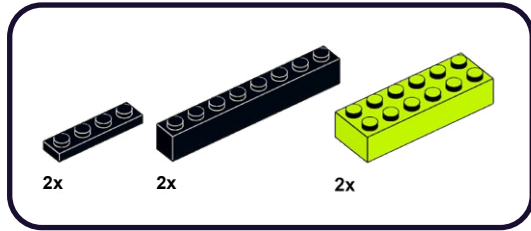

102

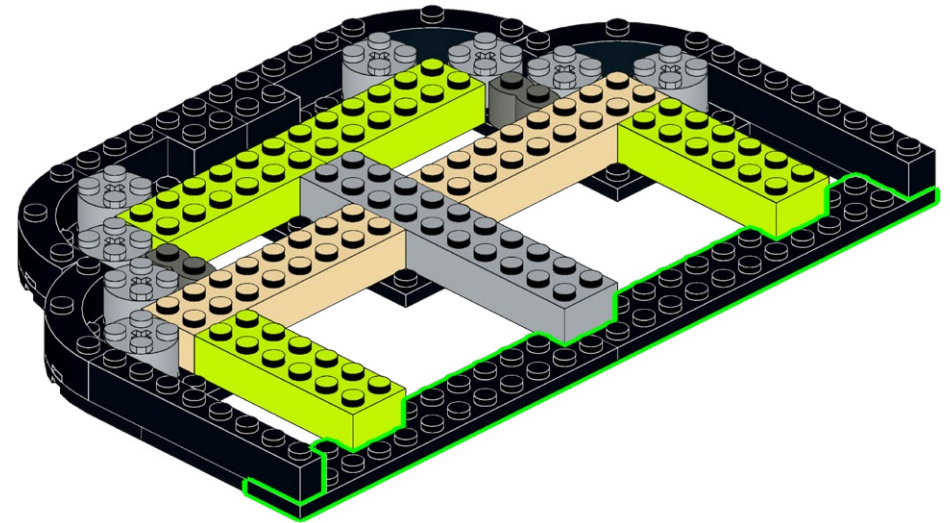
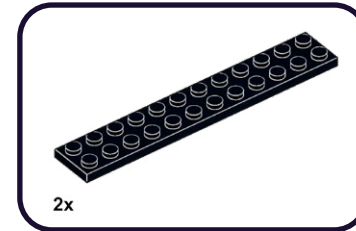

103

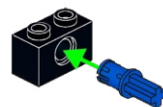
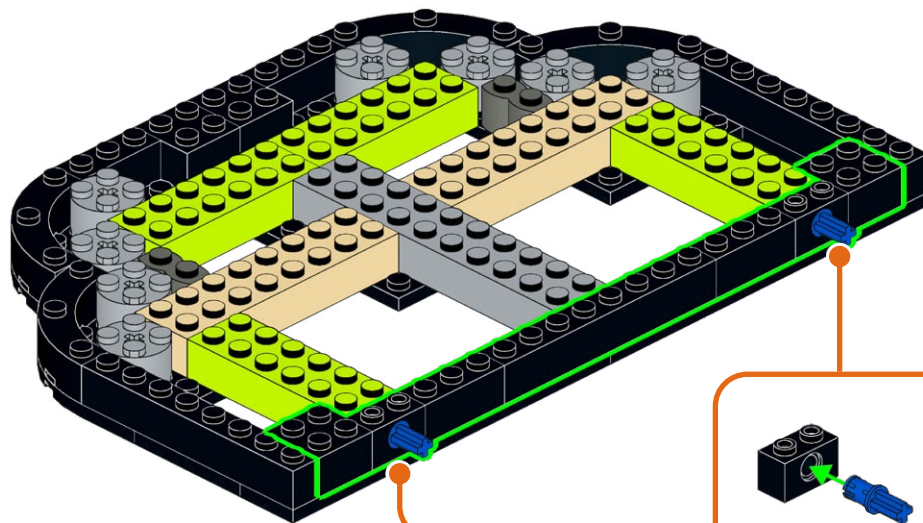
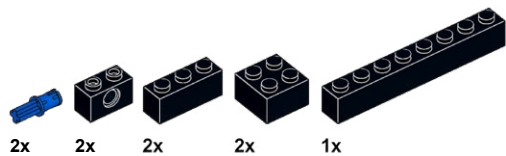

2x

104

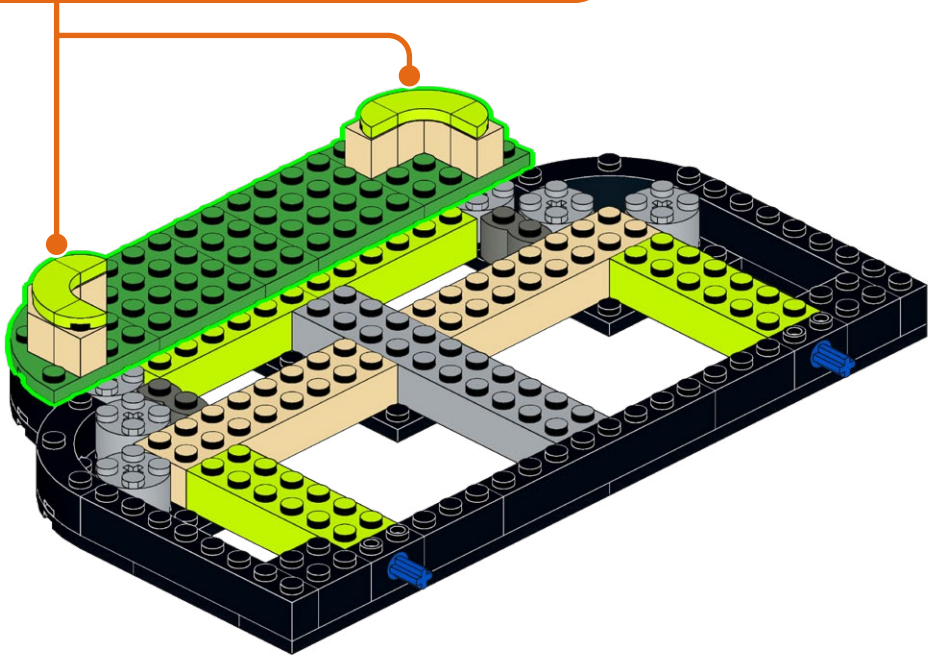
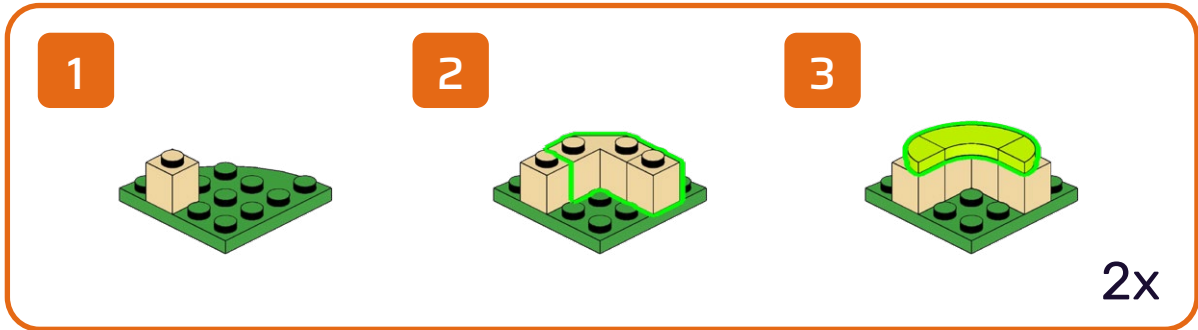
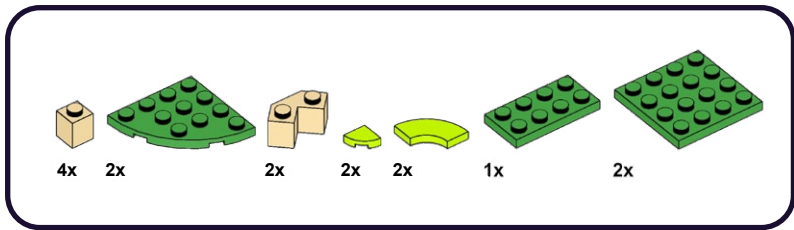

105

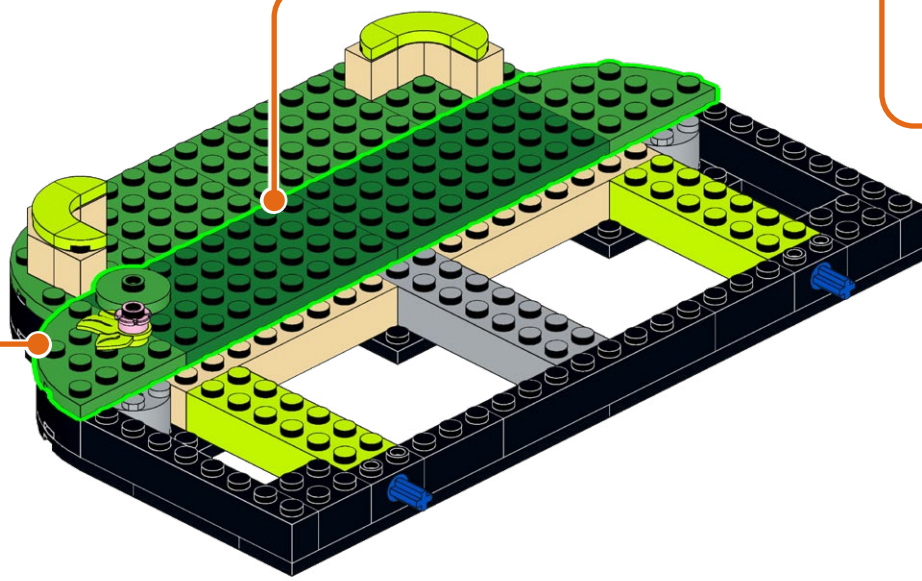
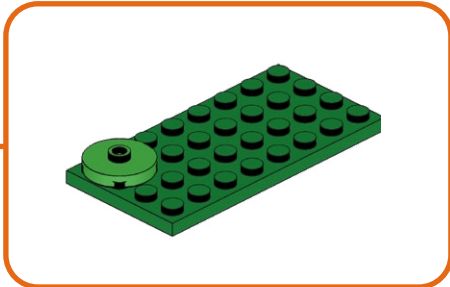
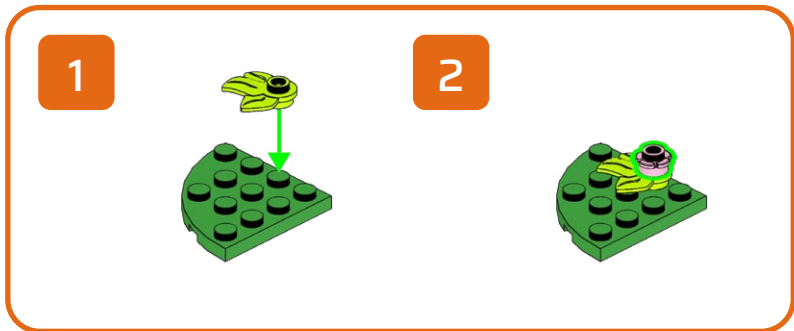
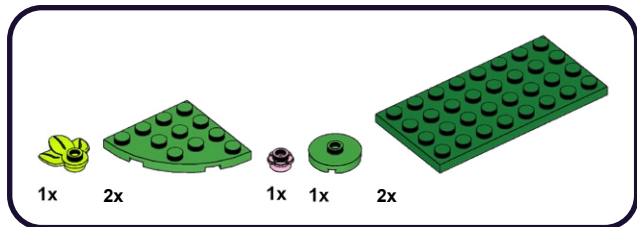

106

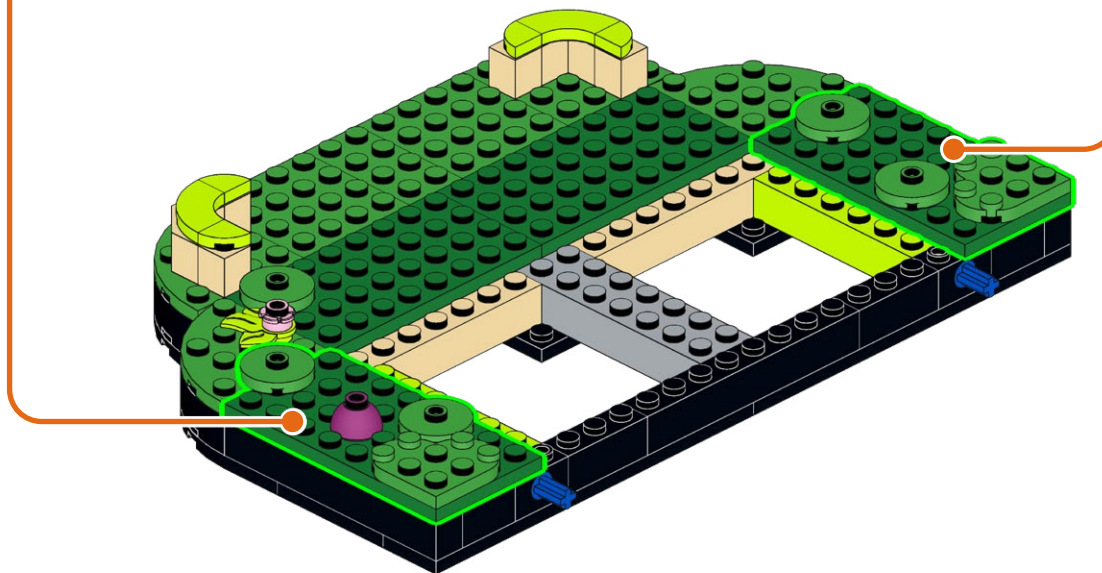
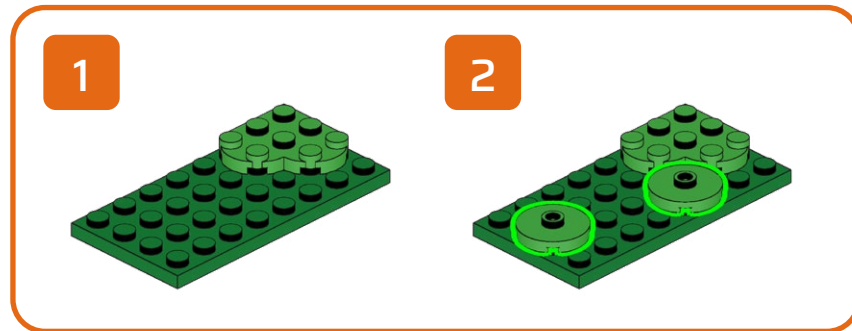
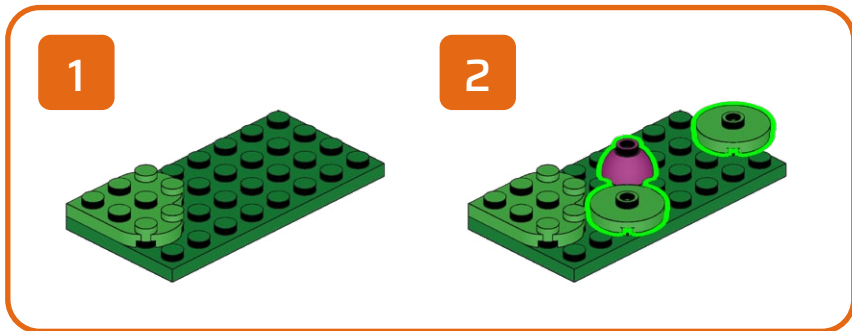
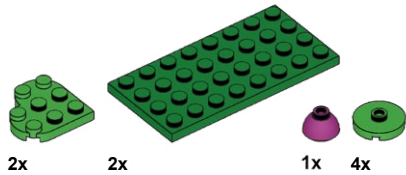

107

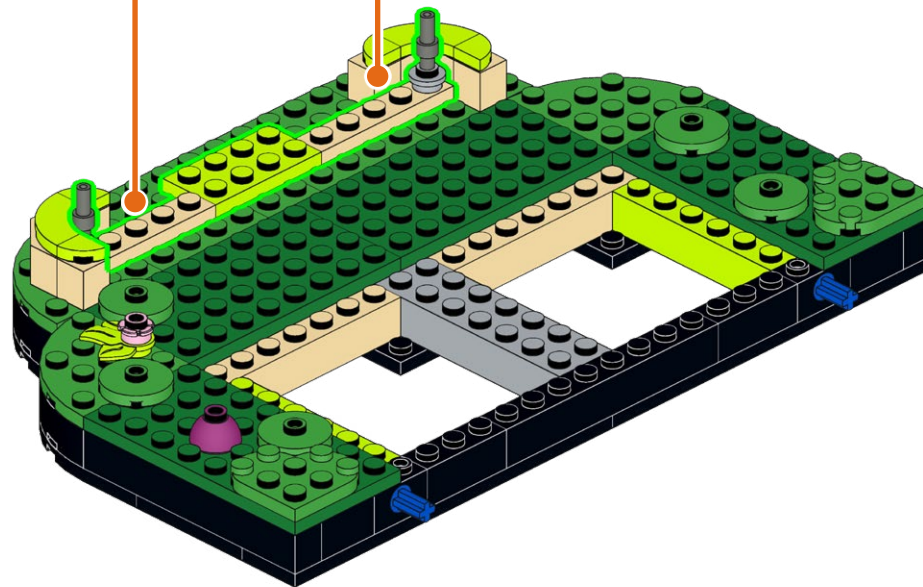
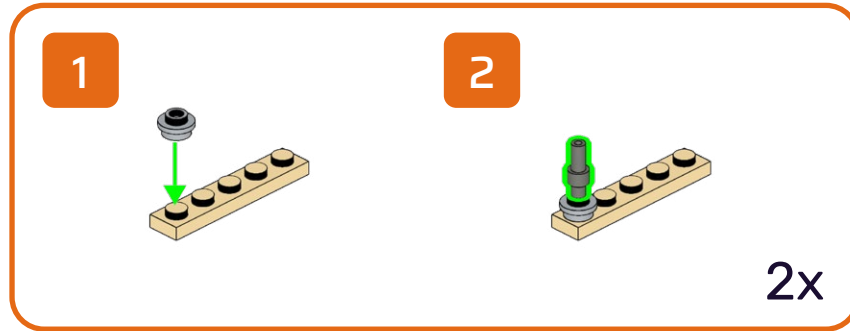
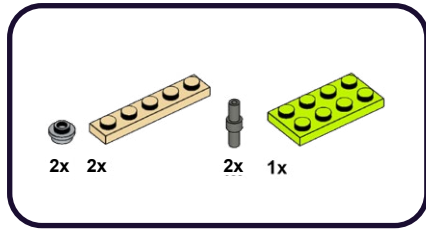

108

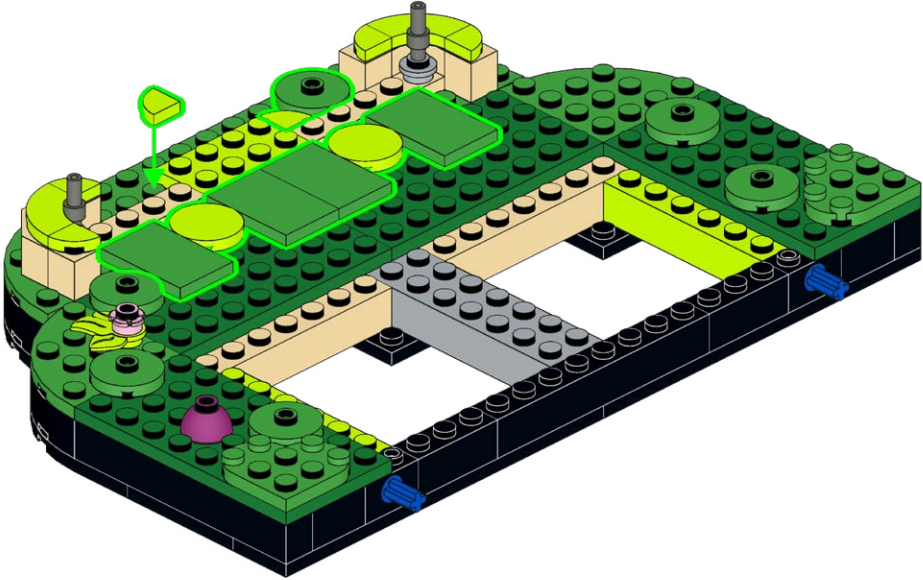
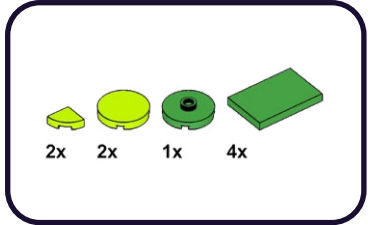

109

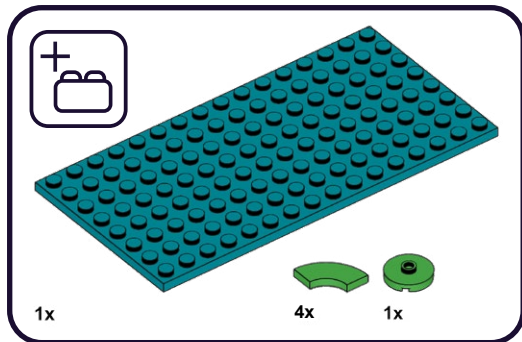

1

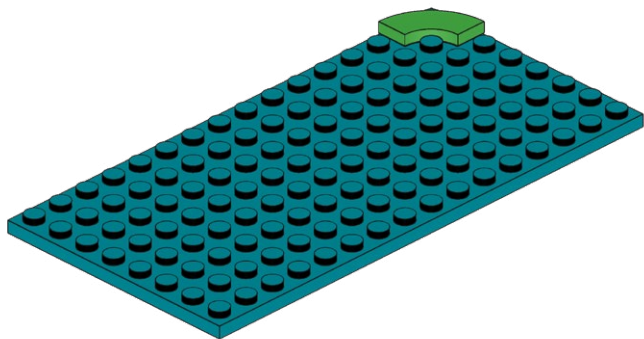

2

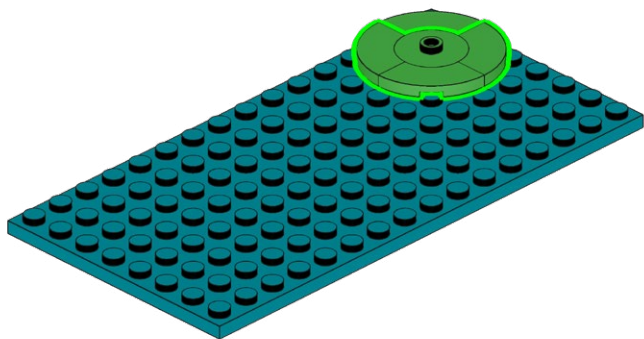

110

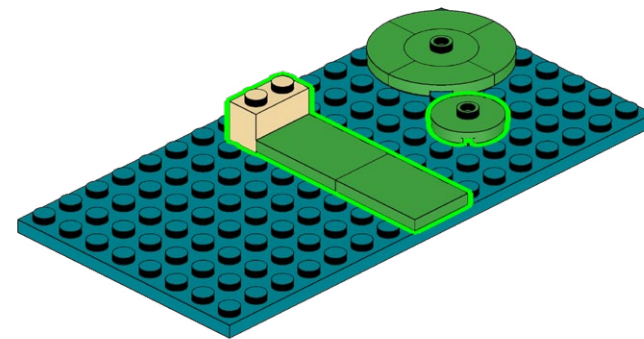
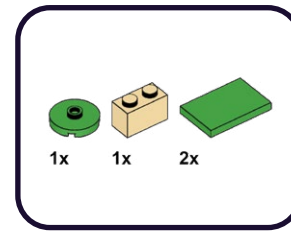

111

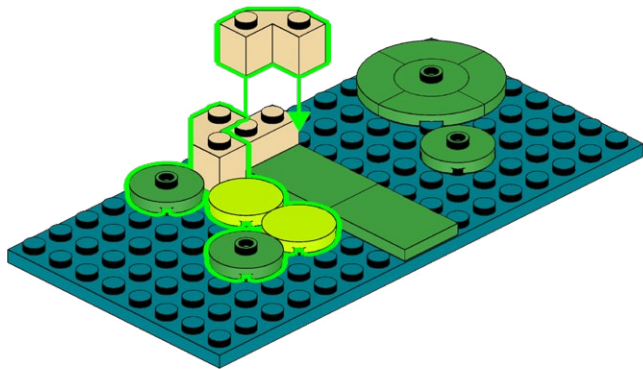
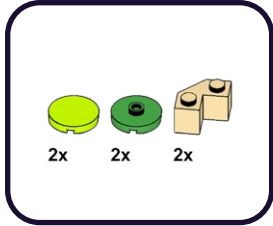

112

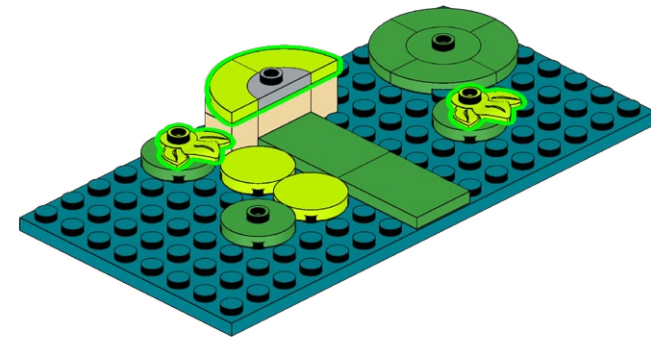
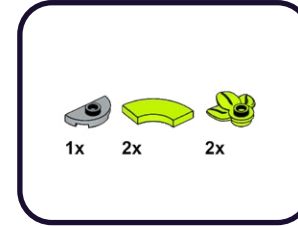

113

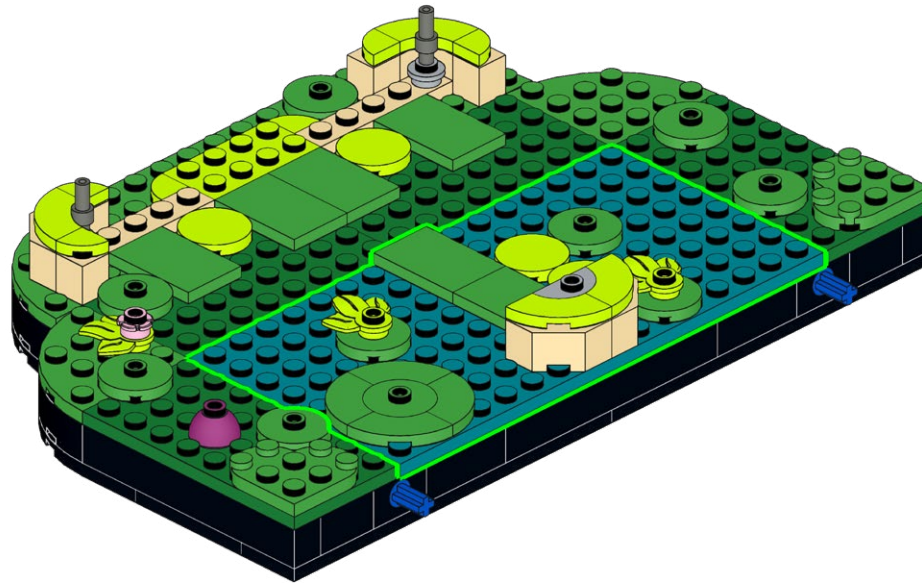

114

2x 2x

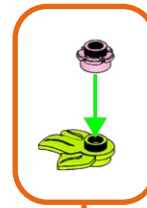
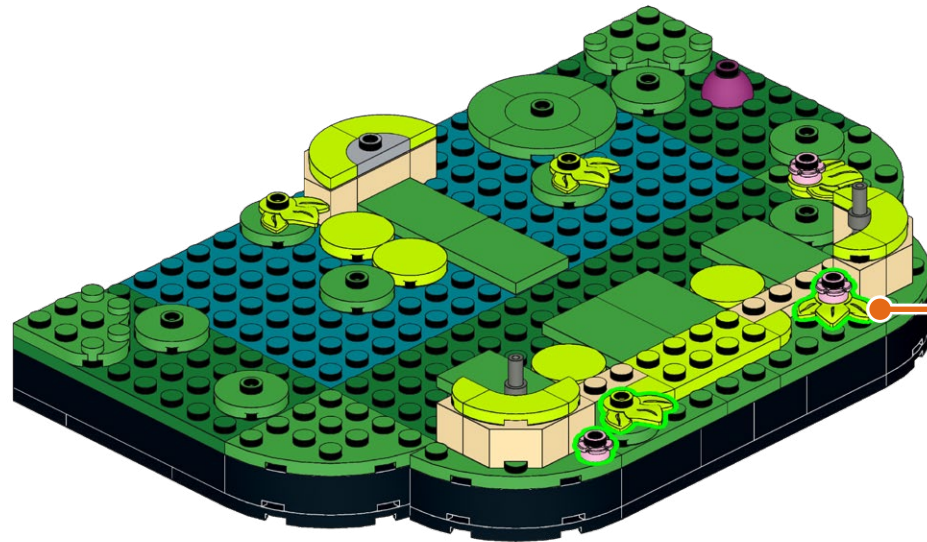

115

- 1x
- 1x
- 2x
- 1x
- 1x
- 1x
- 1x
- 1x
- 1x



116

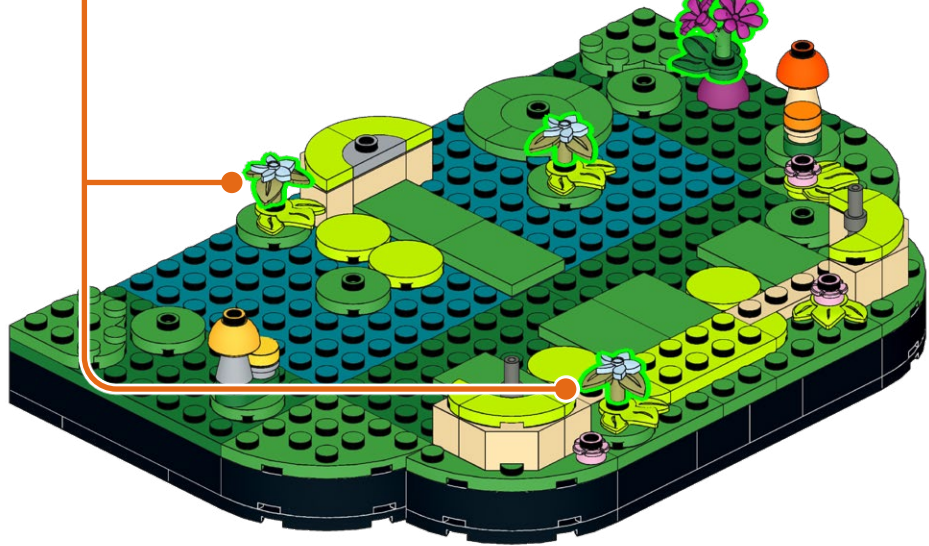
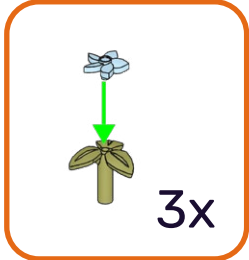
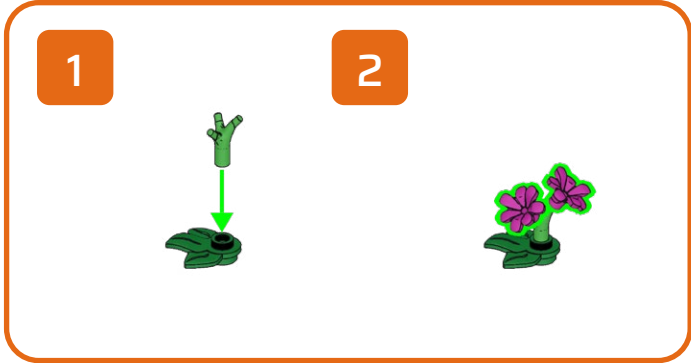
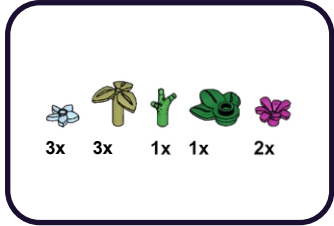

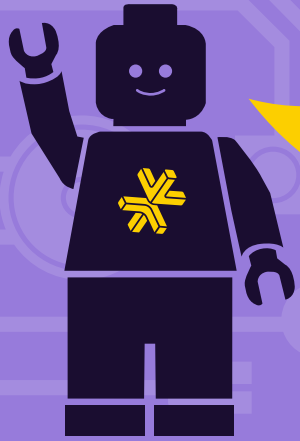

HOLD UP!

You might notice some bags aren't in order, as well as left over pieces, but that's ok! We're changing the way you build LEGO!

ATTENDEZ!

Vous remarquerez peut-être que certains sacs, ainsi que certaines pièces, ne sont pas dans le bon ordre. Mais pas de panique! Nous changeons simplement la façon avec laquelle vous construisez vos LEGO!

ASPETTA!

Potresti notare che alcuni sacchetti non sono in ordine, così come i pezzi avanzati, ma va bene così! Stiamo cambiando il modo in cui costruisci i LEGO!

HALT!

Sie werden möglicherweise bemerken, dass einige tüten durcheinander sind und teile übrig bleiben, aber das ist in Ordnung! Wir ändern die art und weise, wie Sie LEGO bauen!

¡ESPERA!

Es posible que notes que algunas bolsas están fuera de servicio, así como piezas sobrantes, ¡pero está bien! ¡Estamos cambiando la forma en que construyes LEGO!

暫停!

你可能会注意到一些袋子顺序错乱, 以及一些剩余的部件, 但没关系! 我们正在改变你搭建乐高的方式!

Open LEGO® Bag 4

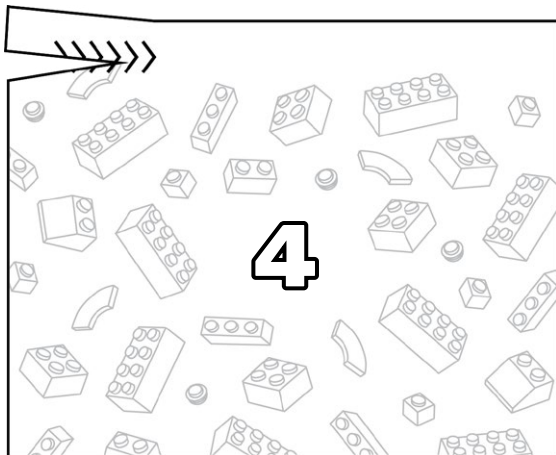

Open LMB Bag 01

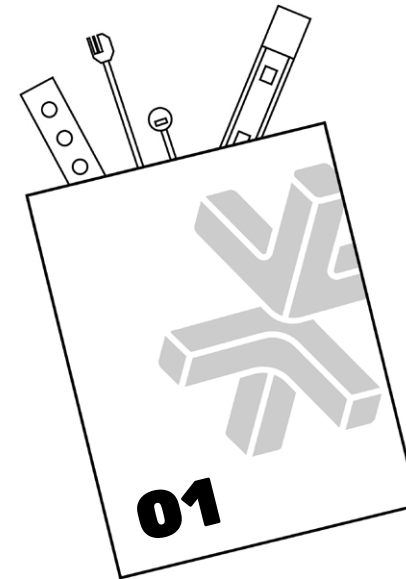

117

1

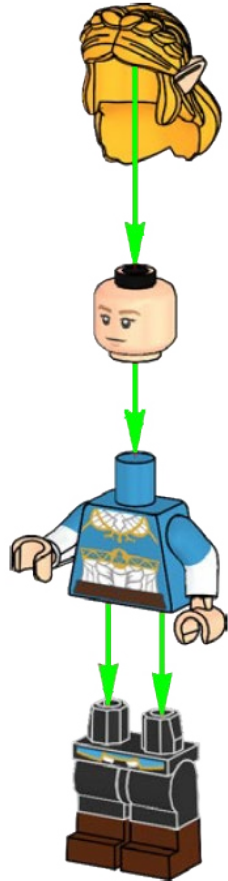

2



118

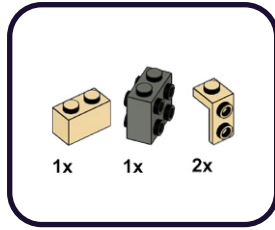

1

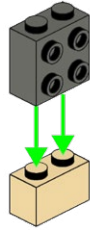

2

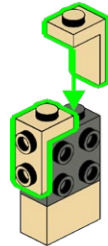

119

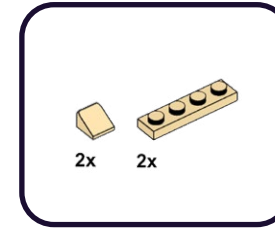

1

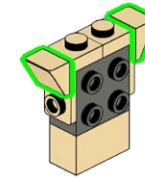

2

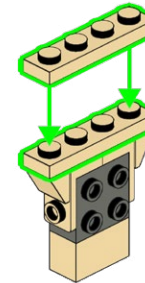

120

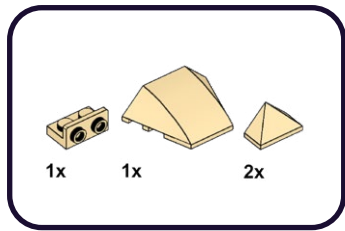

1

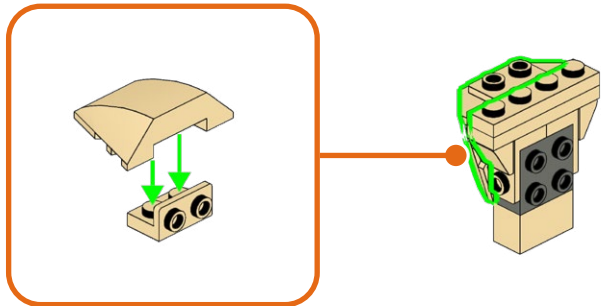

2

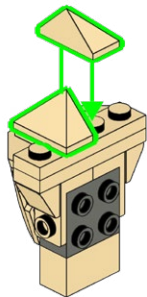

121

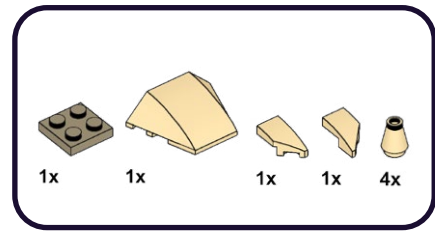

1

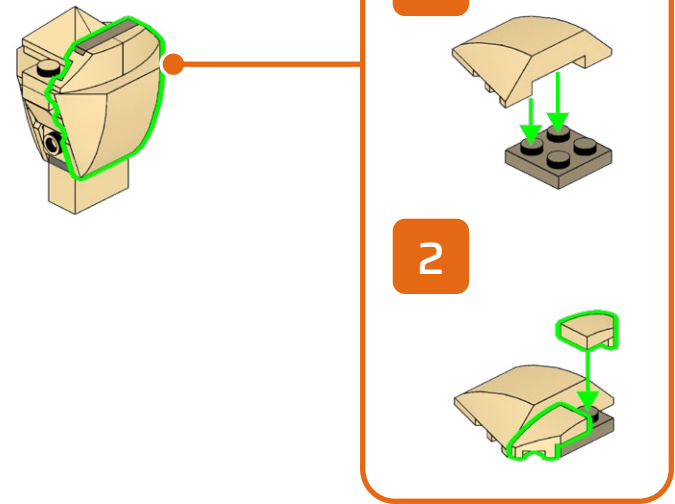

2

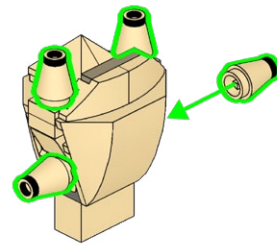

122

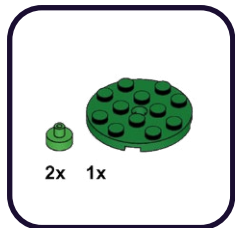

1

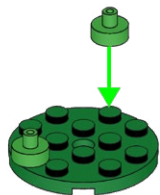

2

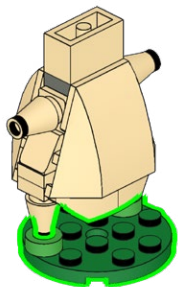

123

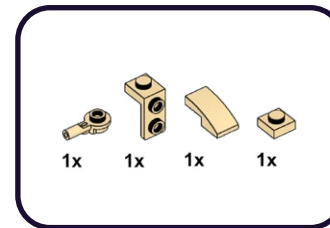

1

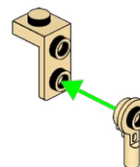

2

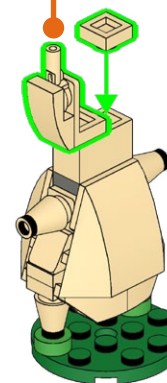

124

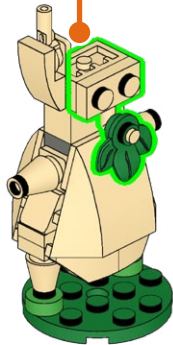
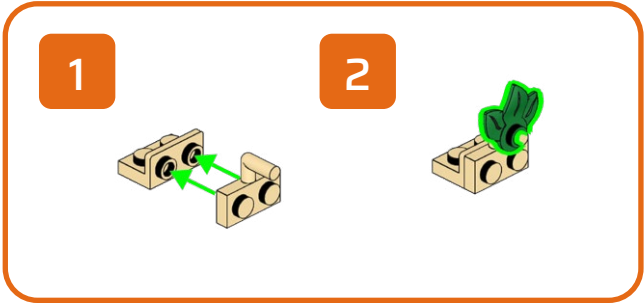
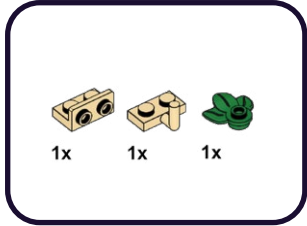

125

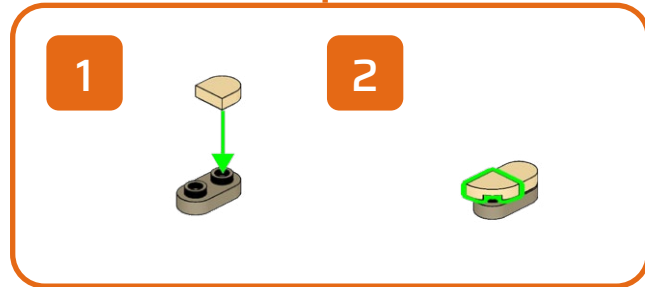
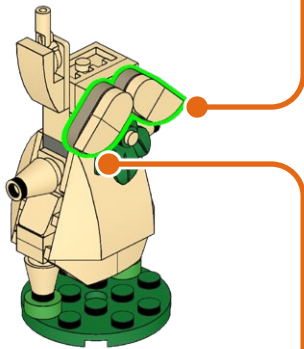
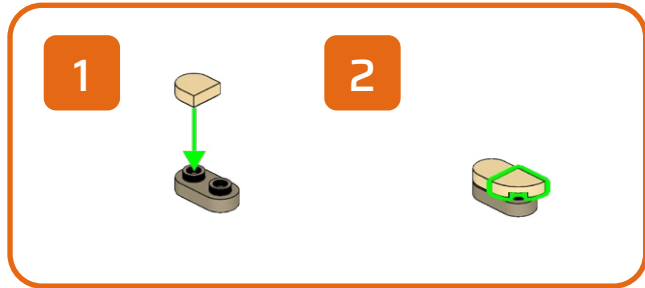
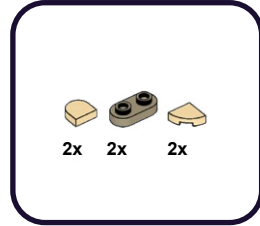

126

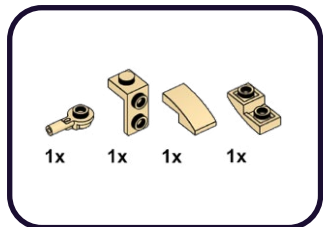

127

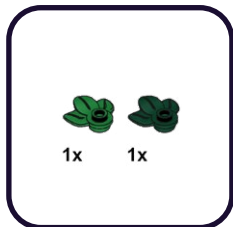

1

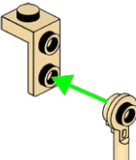

2



3

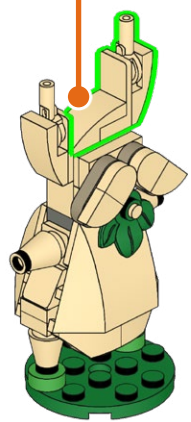
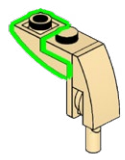

128

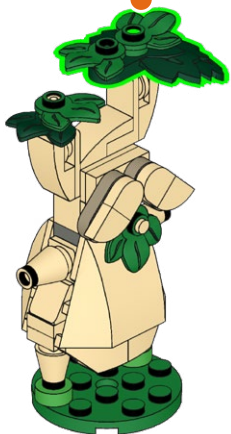
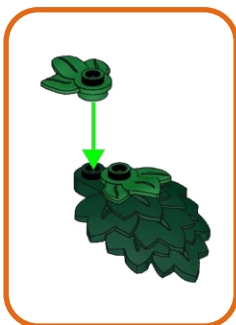
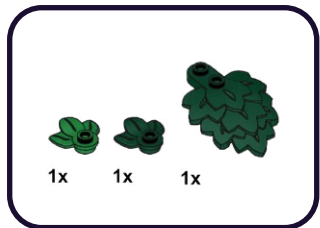

129

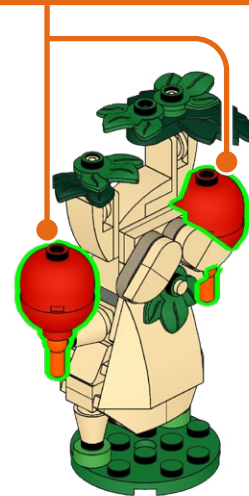
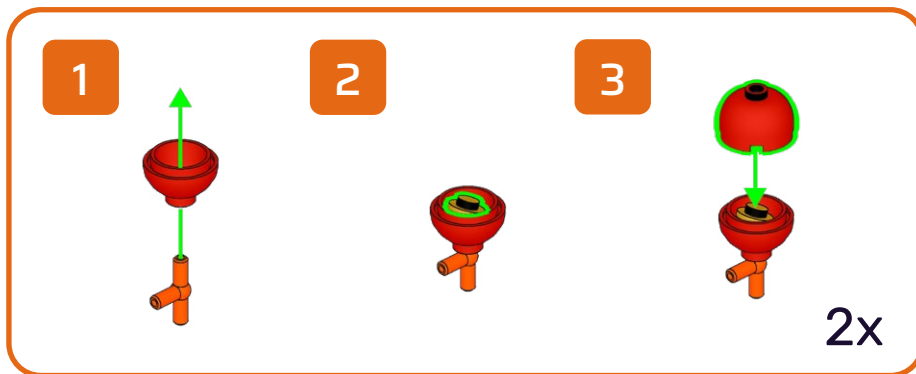
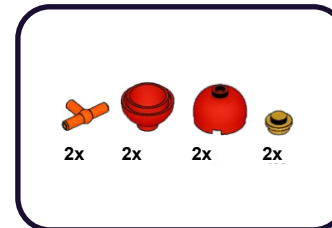

130

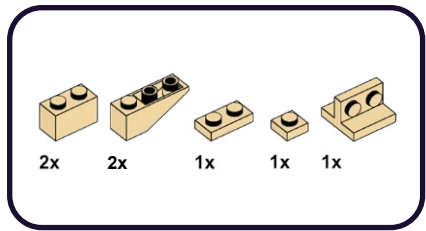

1

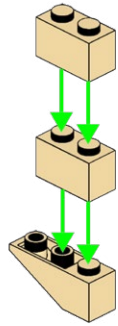

2

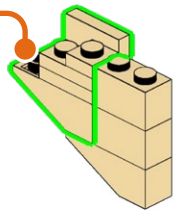
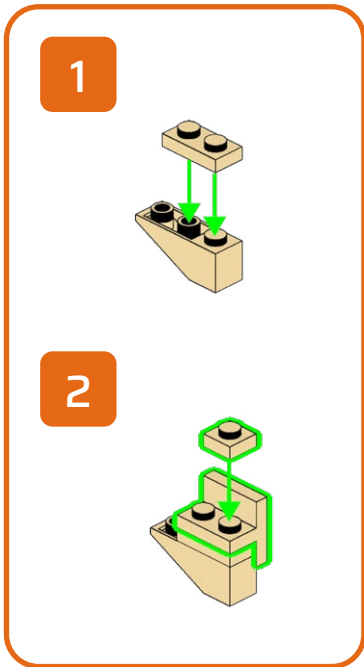

131

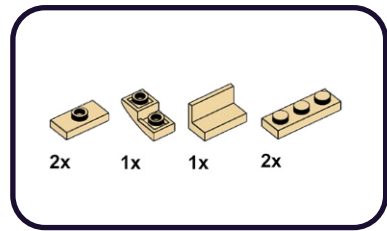

1

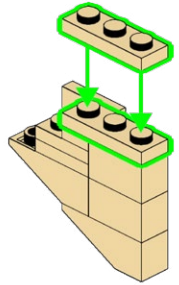

2

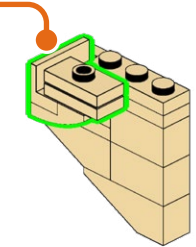
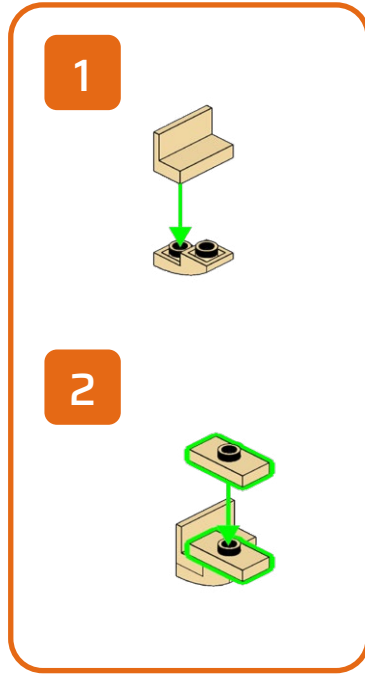

132

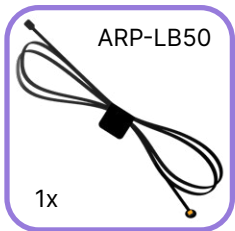

1

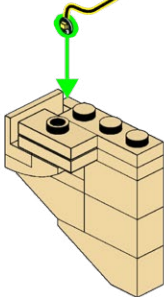

2

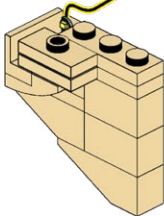

133

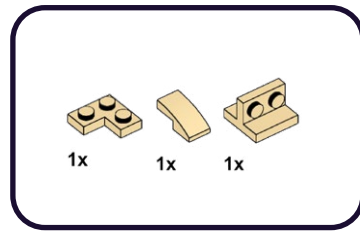

1

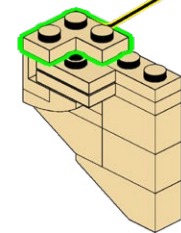

2

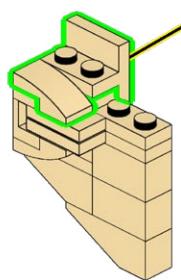

134

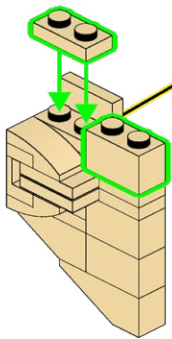
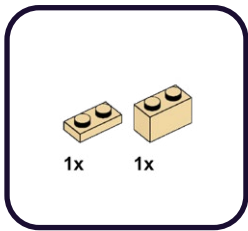

135

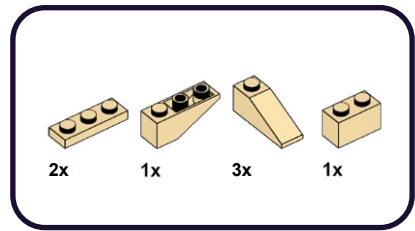

1

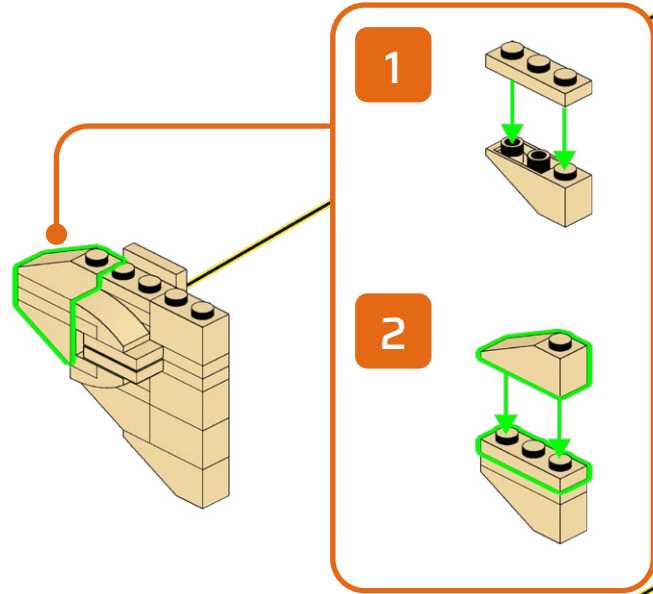

3

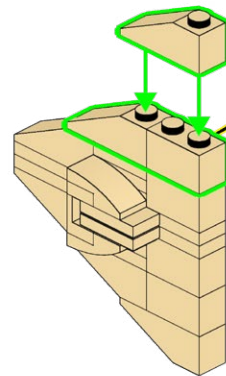

136

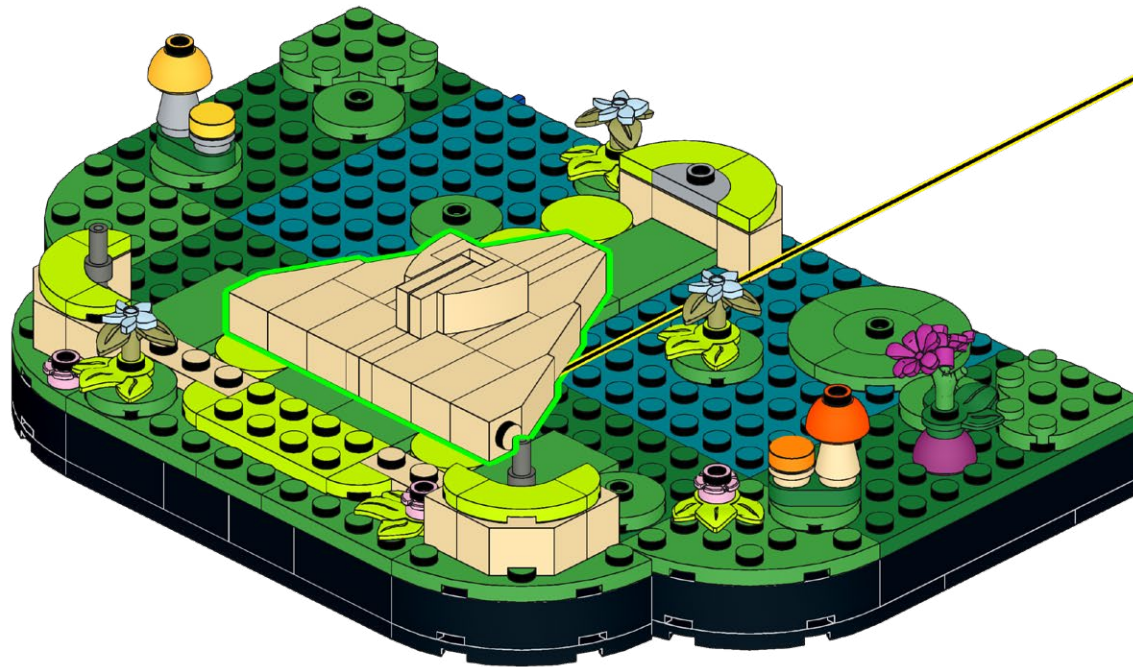

137

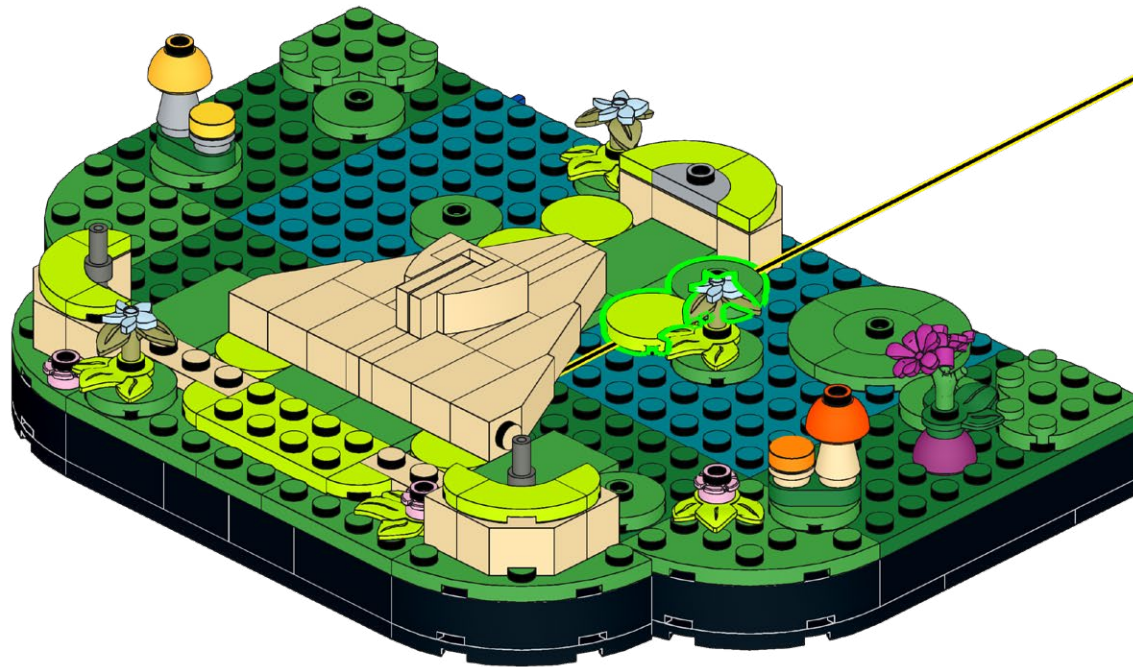
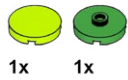

138



4x

4x



3x



2x

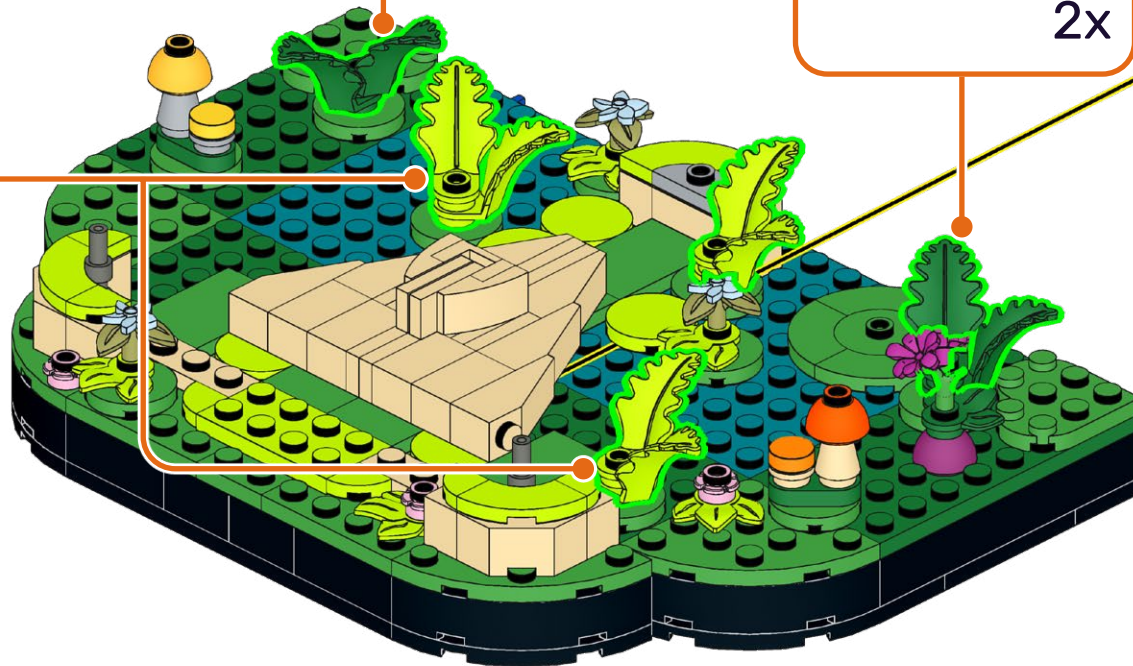

139

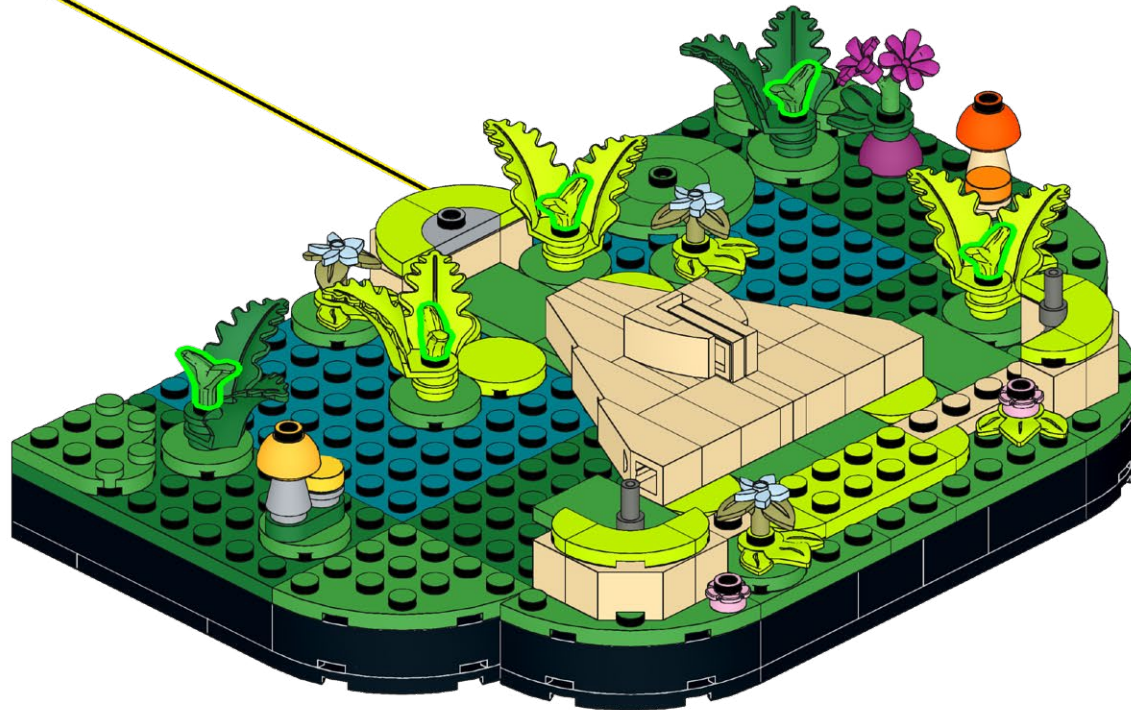
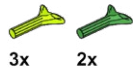

140

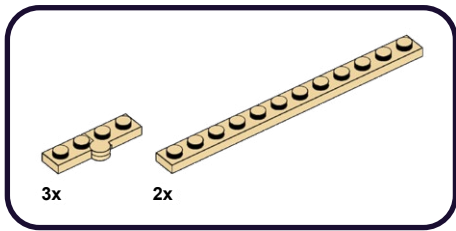

1

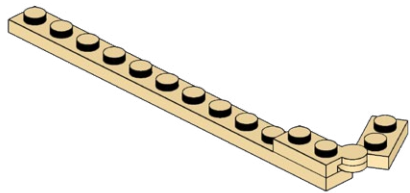

2

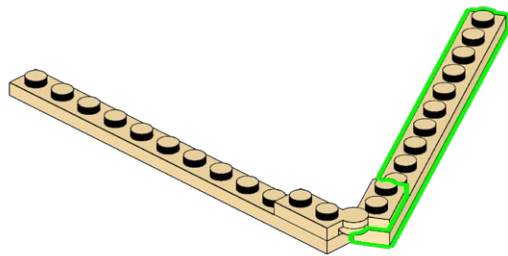

3

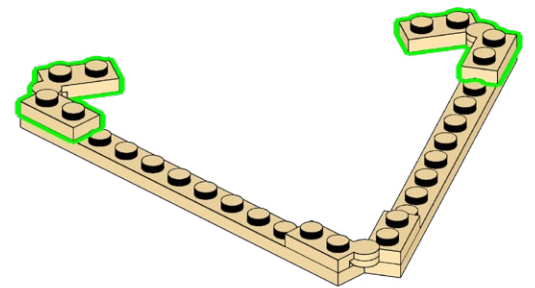

141

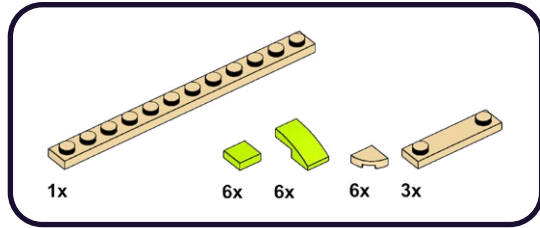

1

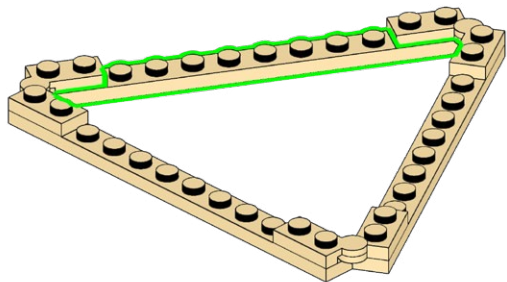

2

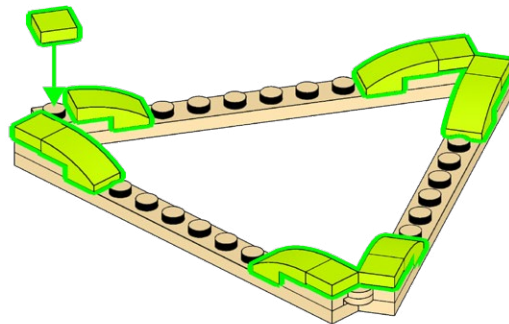

3

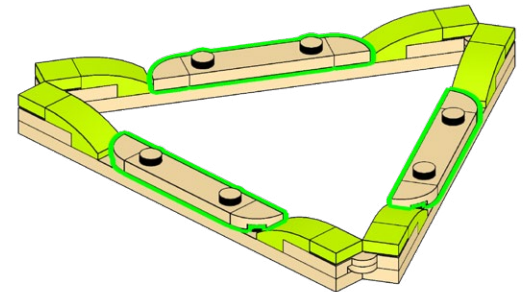

142

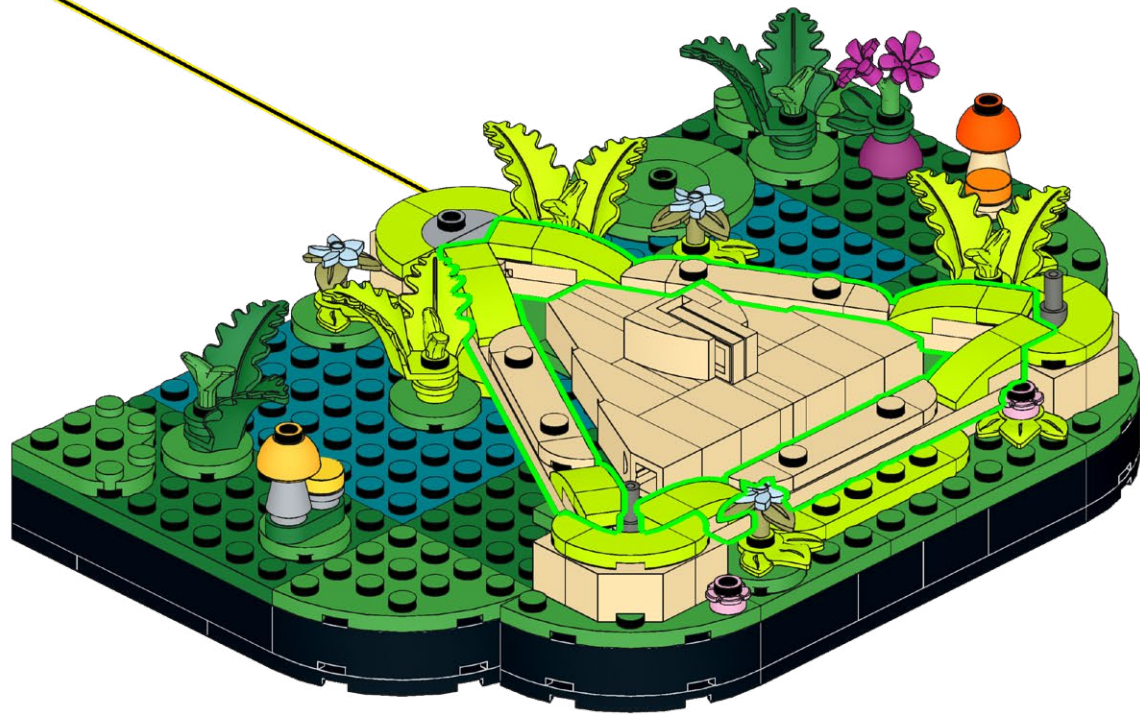

143

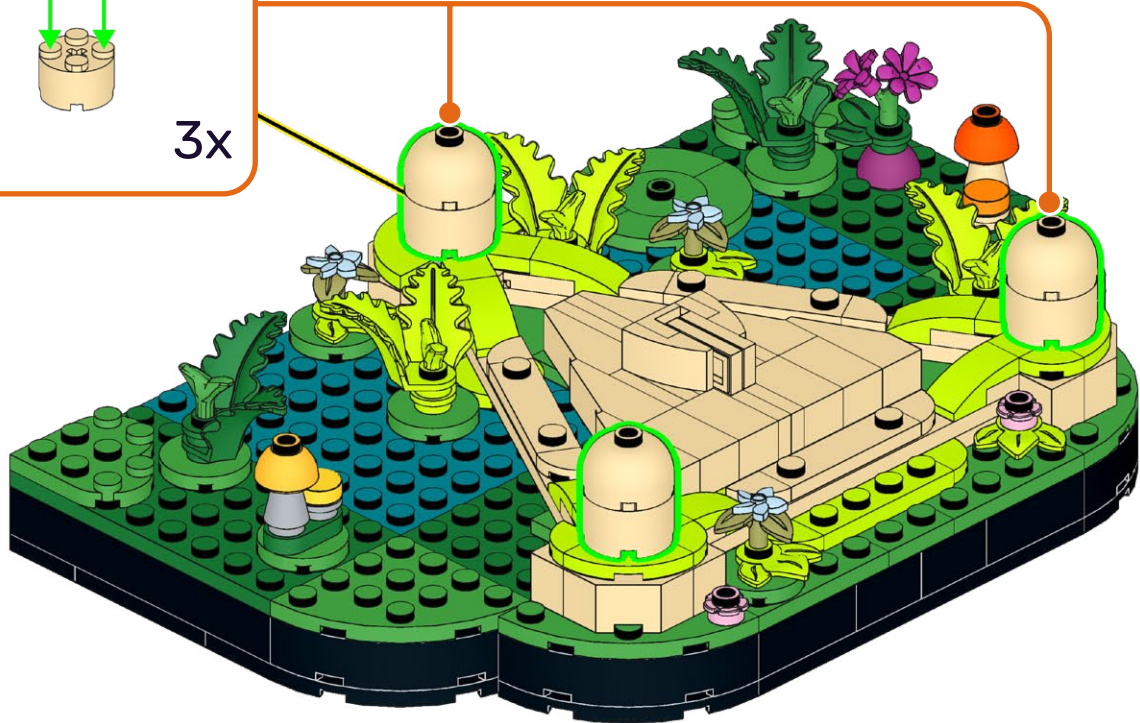
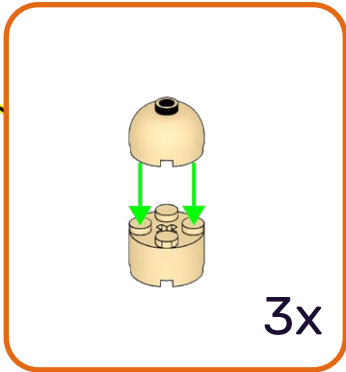
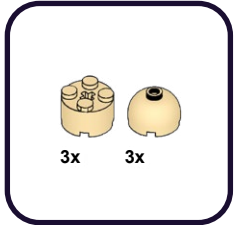

144

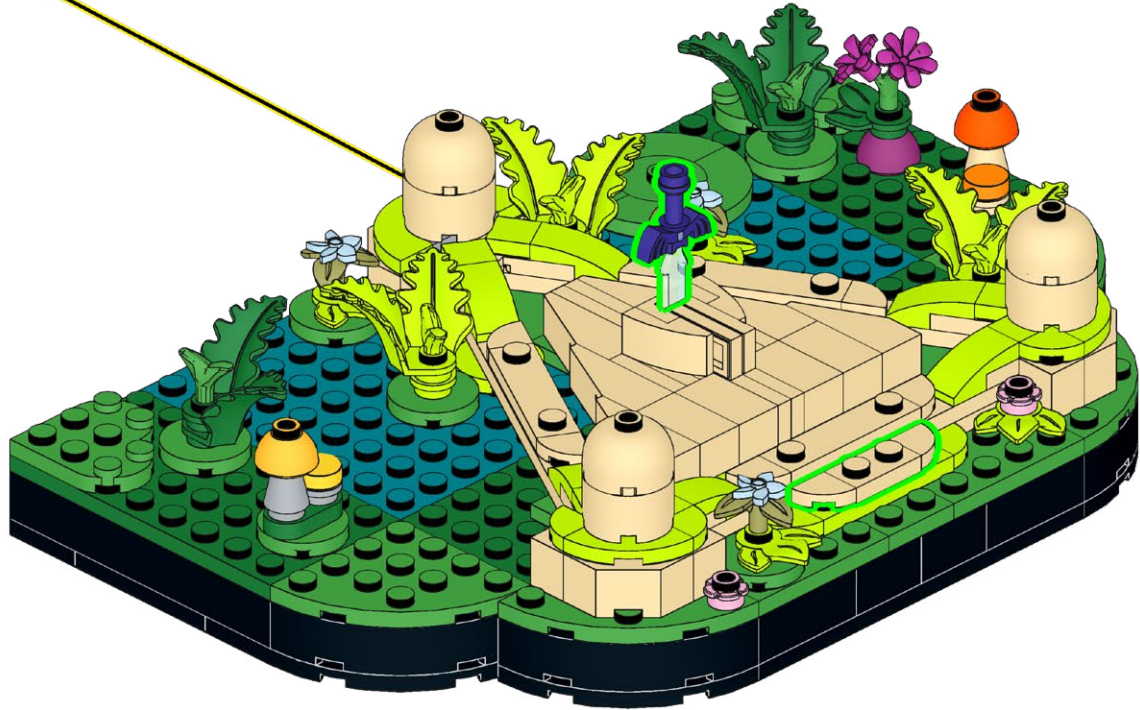
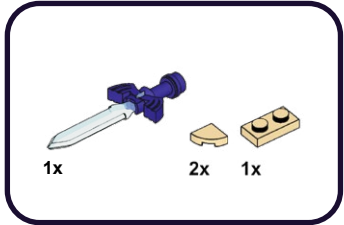

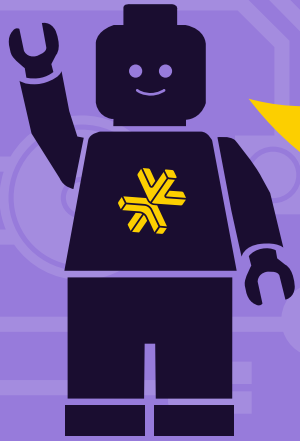
**HOLD UP!**

You might notice some bags aren't in order, as well as left over pieces, but that's ok! We're changing the way you build LEGO!

ATTENDEZ!

Vous remarquerez peut-être que certains sacs, ainsi que certaines pièces, ne sont pas dans le bon ordre. Mais pas de panique! Nous changeons simplement la façon avec laquelle vous construisez vos LEGO!

ASPETTA!

Potresti notare che alcuni sacchetti non sono in ordine, così come i pezzi avanzati, ma va bene così! Stiamo cambiando il modo in cui costruisci i LEGO!

HALT!

Sie werden möglicherweise bemerken, dass einige tüten durcheinander sind und teile übrig bleiben, aber das ist in Ordnung! Wir ändern die art und weise, wie Sie LEGO bauen!

¡ESPERA!

Es posible que notes que algunas bolsas están fuera de servicio, así como piezas sobrantes, ¡pero está bien! ¡Estamos cambiando la forma en que construyes LEGO!

暫停!

你可能会注意到一些袋子顺序错乱, 以及一些剩余的部件, 但没关系! 我们正在改变你搭建乐高的方式!

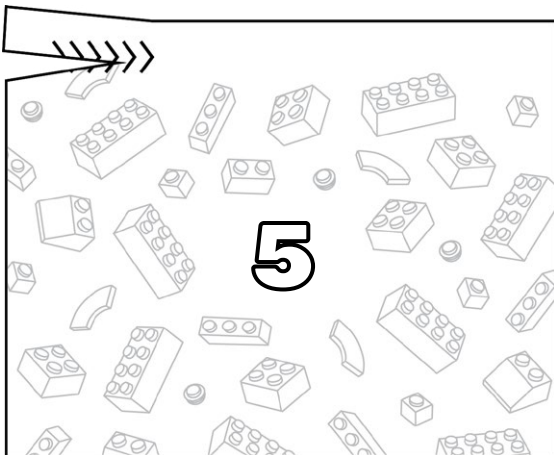
Open LEGO® Bag 5

145

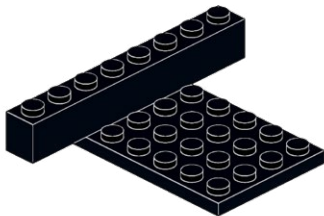
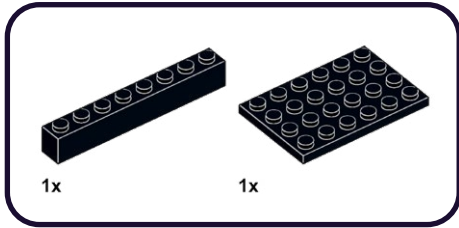

146

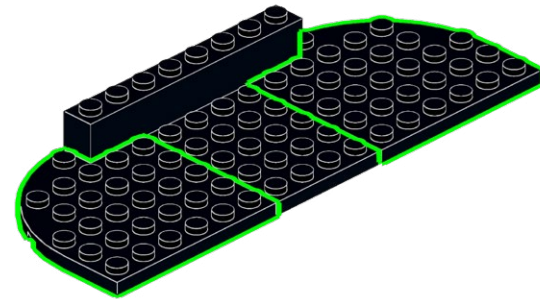
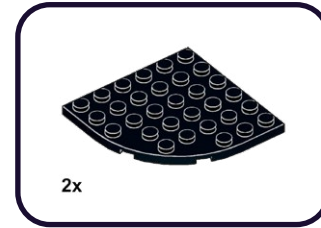

147

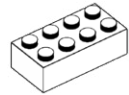

2x

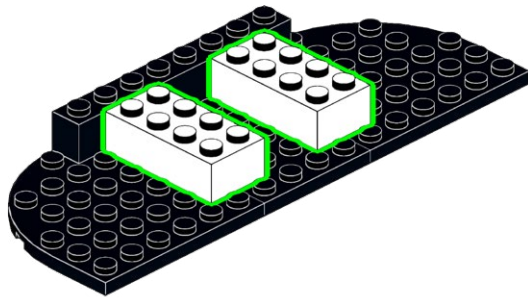

148



2x



2x

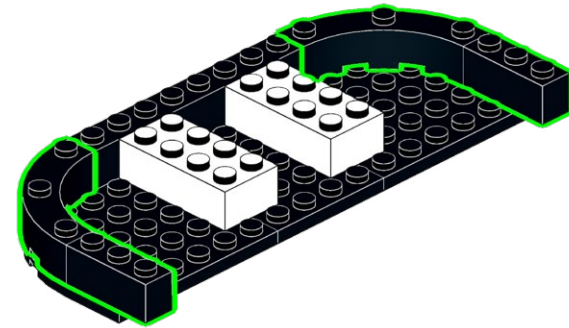

149

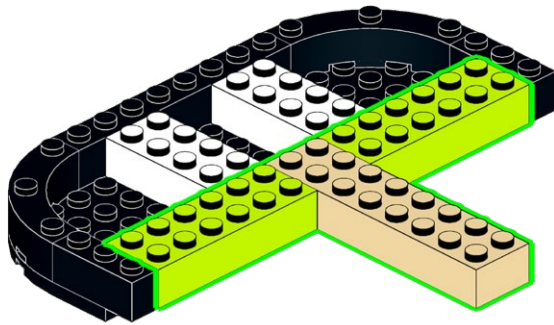
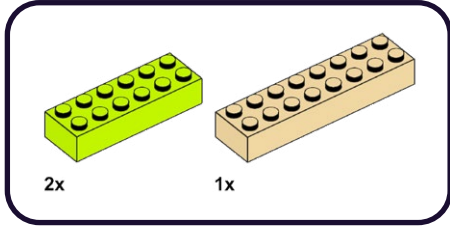

150

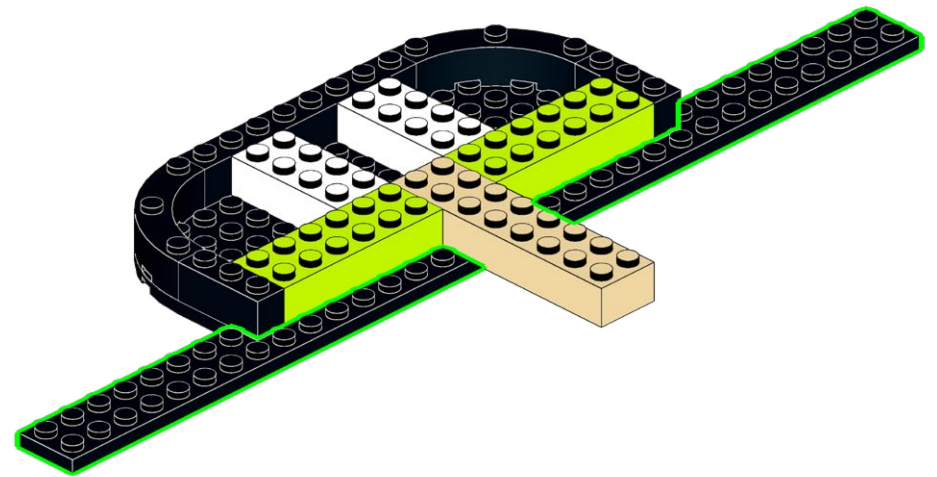
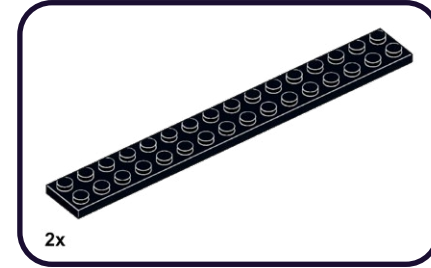

151

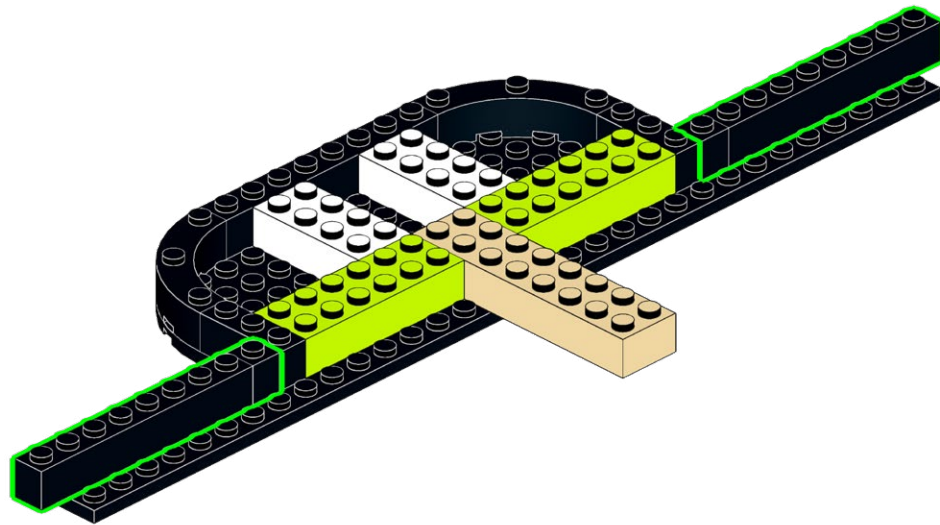
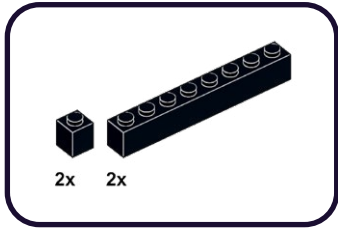

152

2x

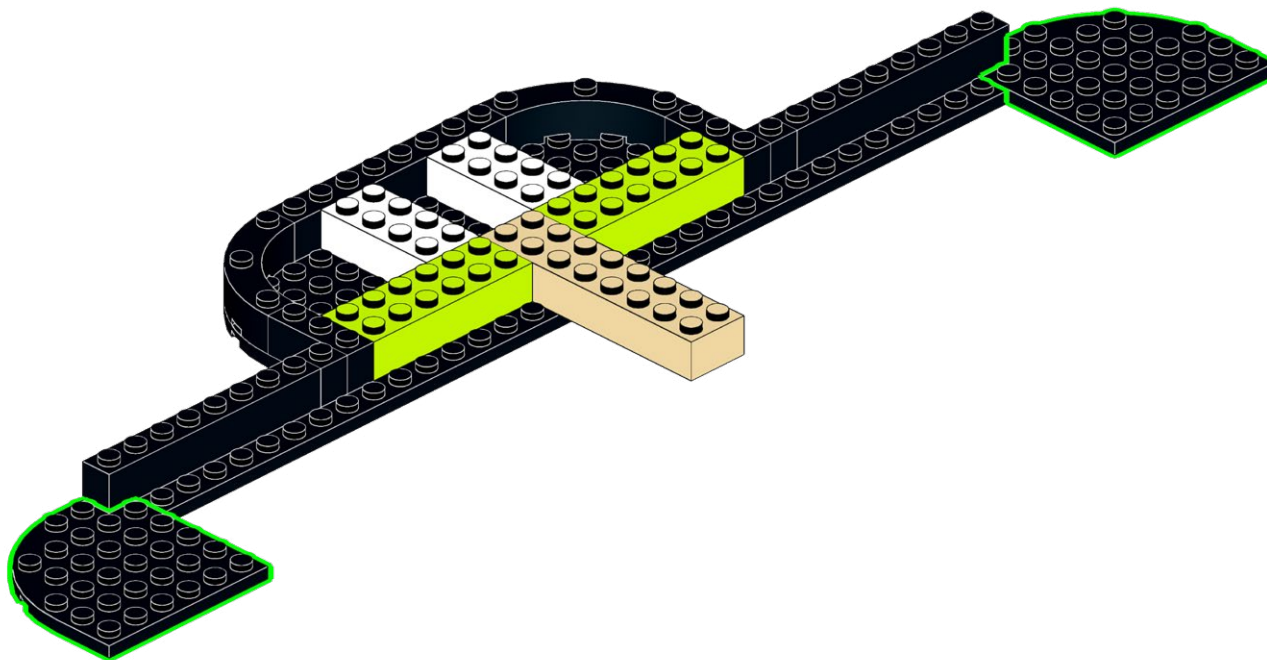

153

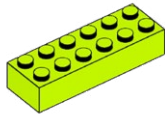

4x

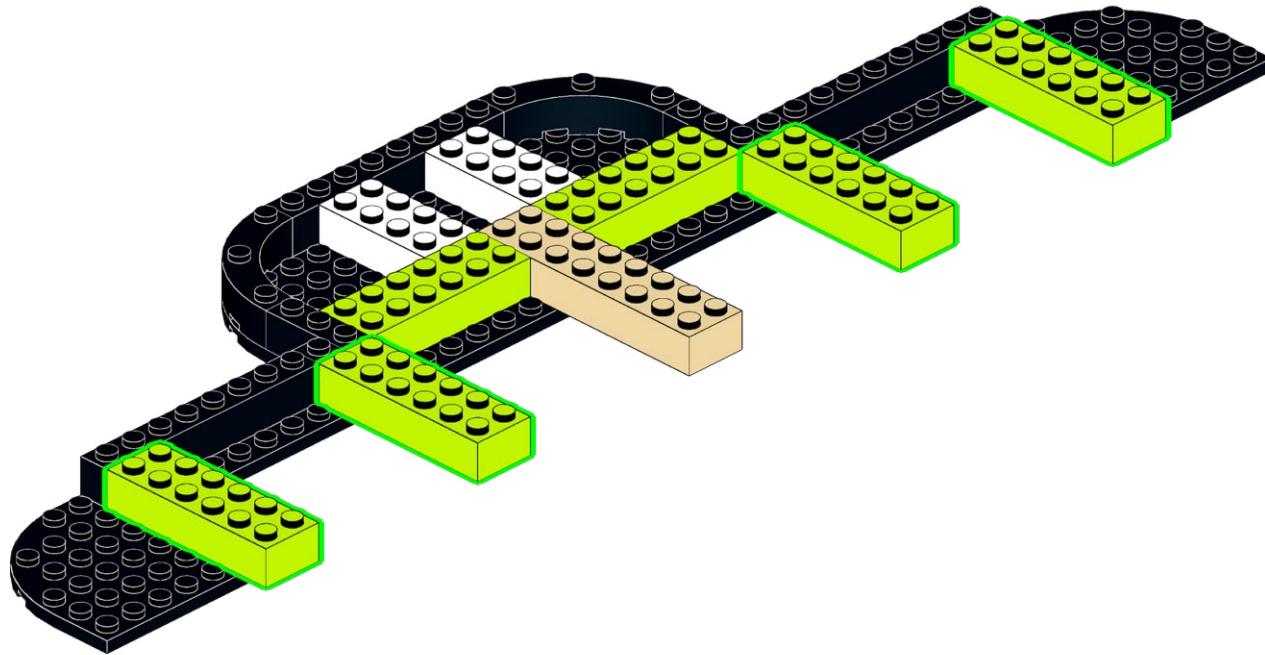

154

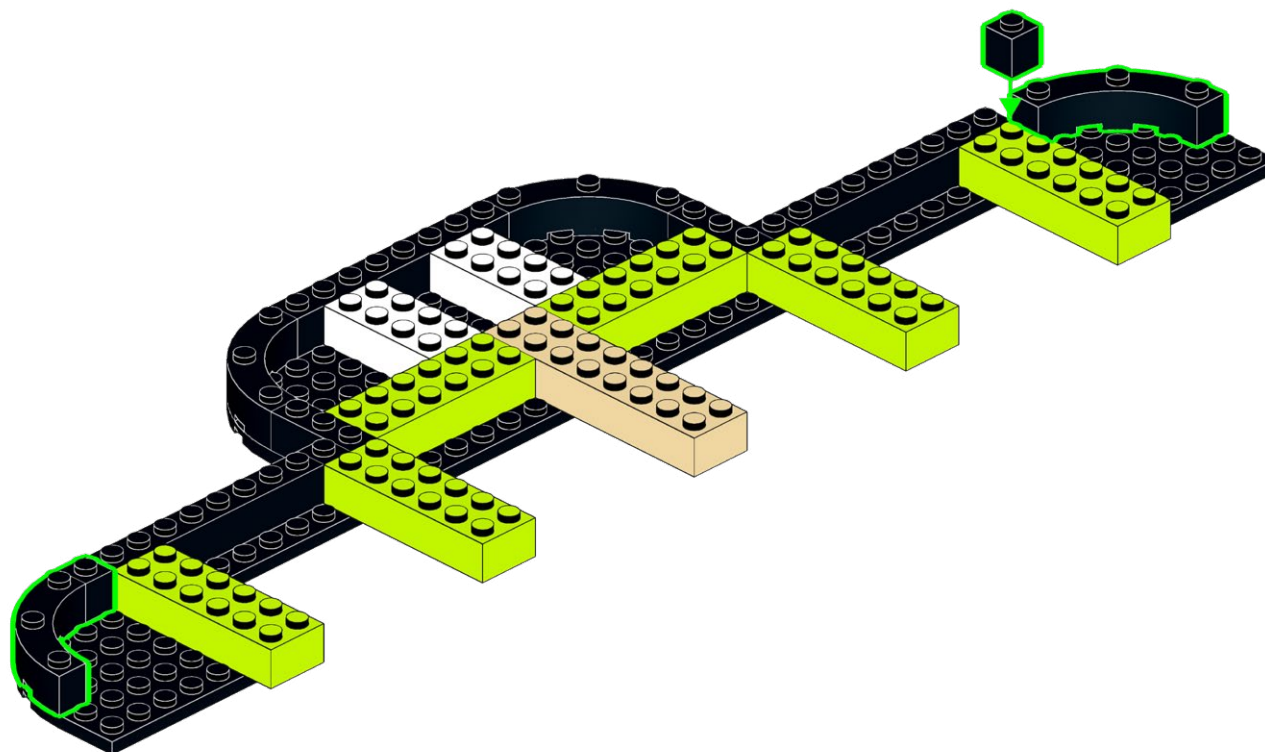
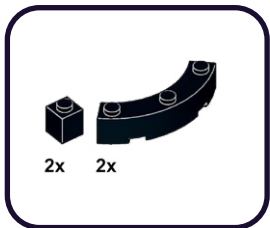

155

2x

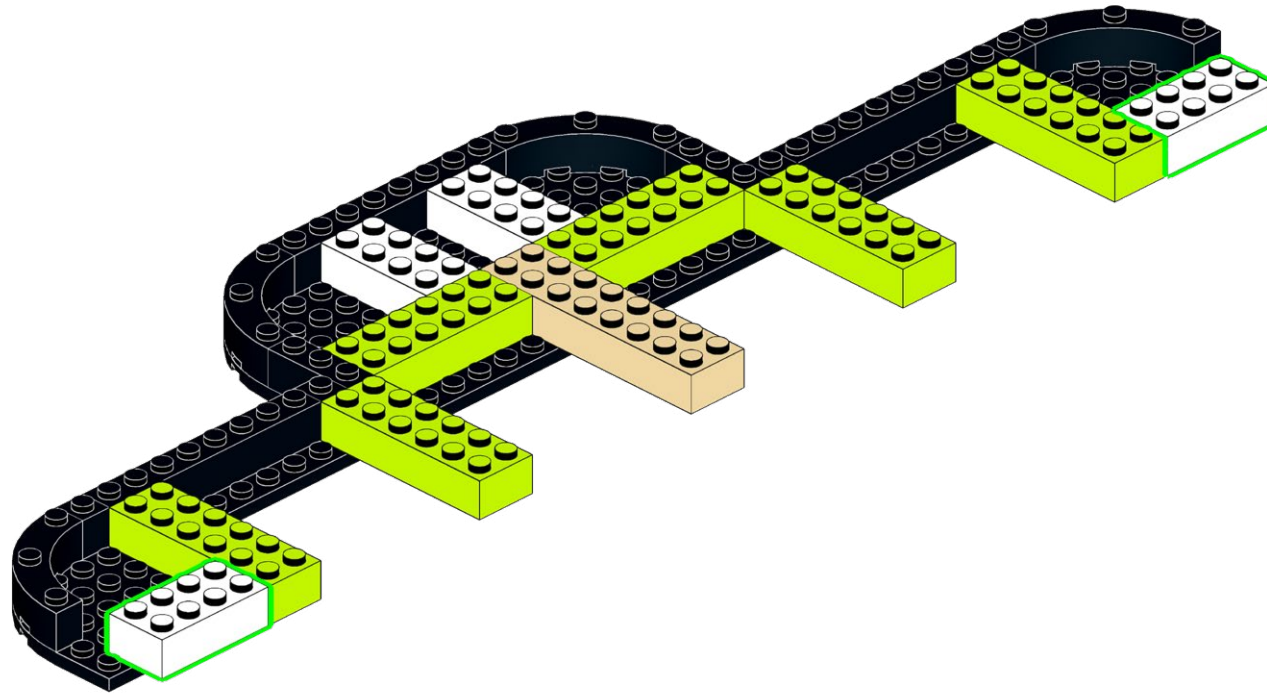
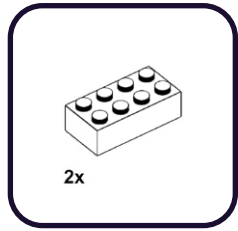

156

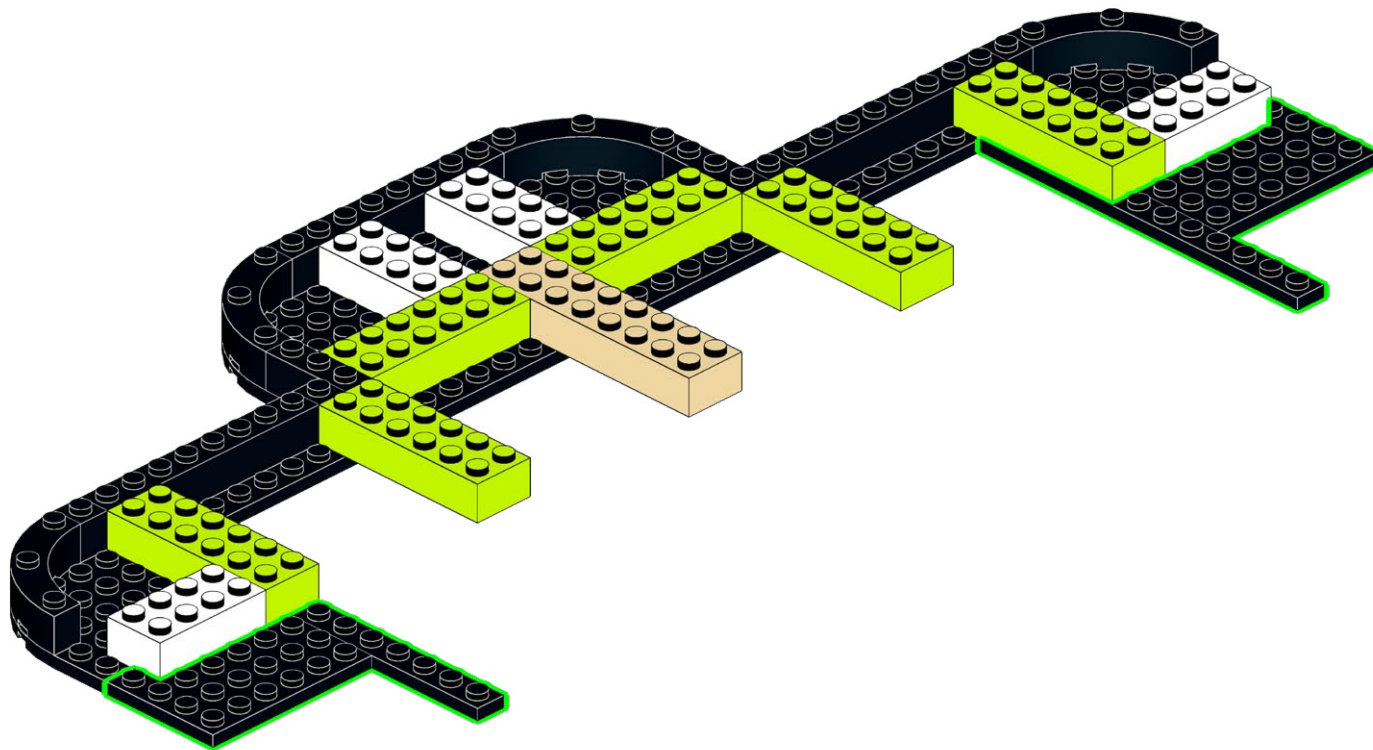
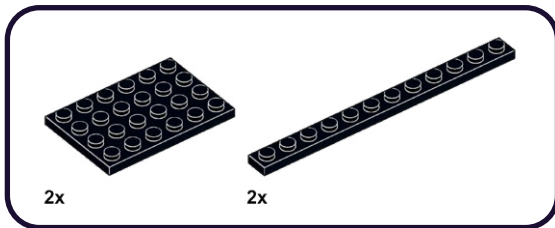

157

3x

3x

1

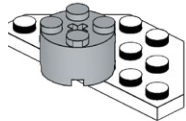

2

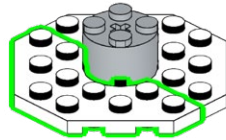

3x

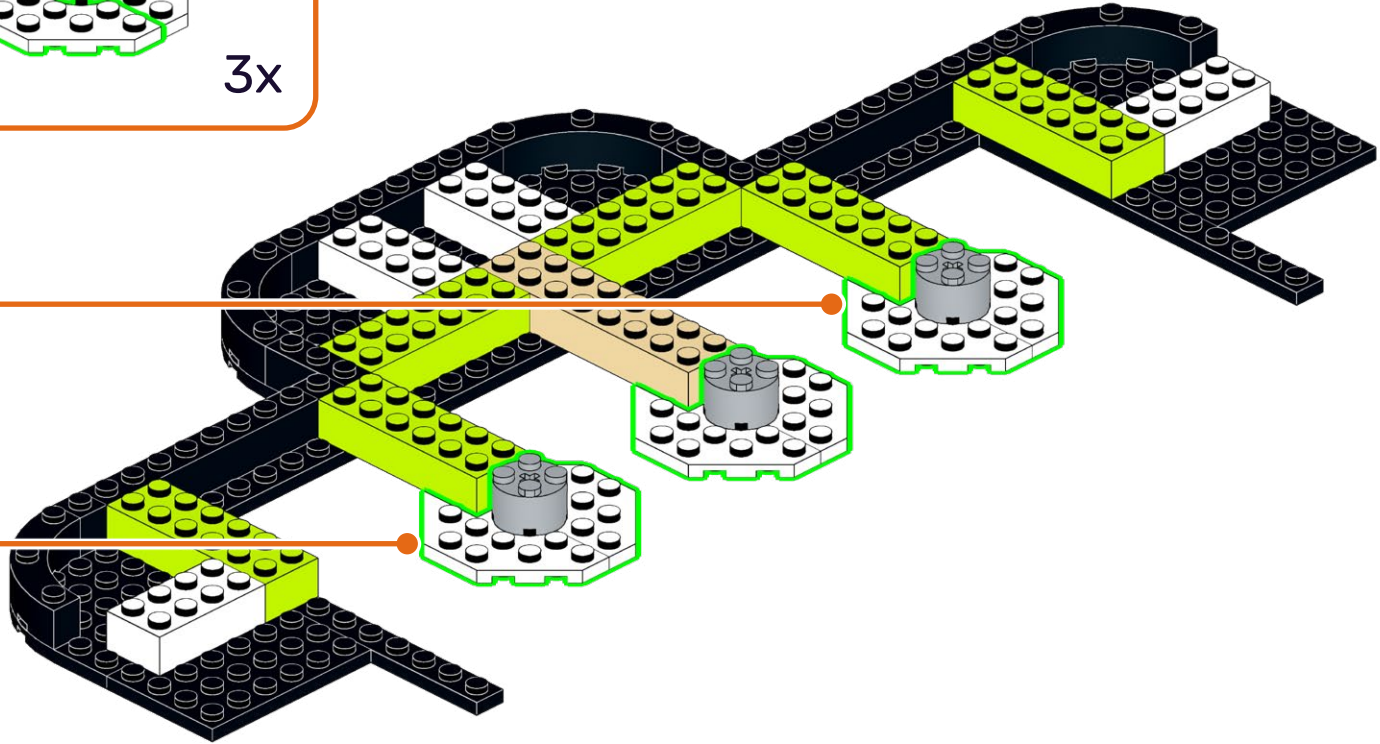

158

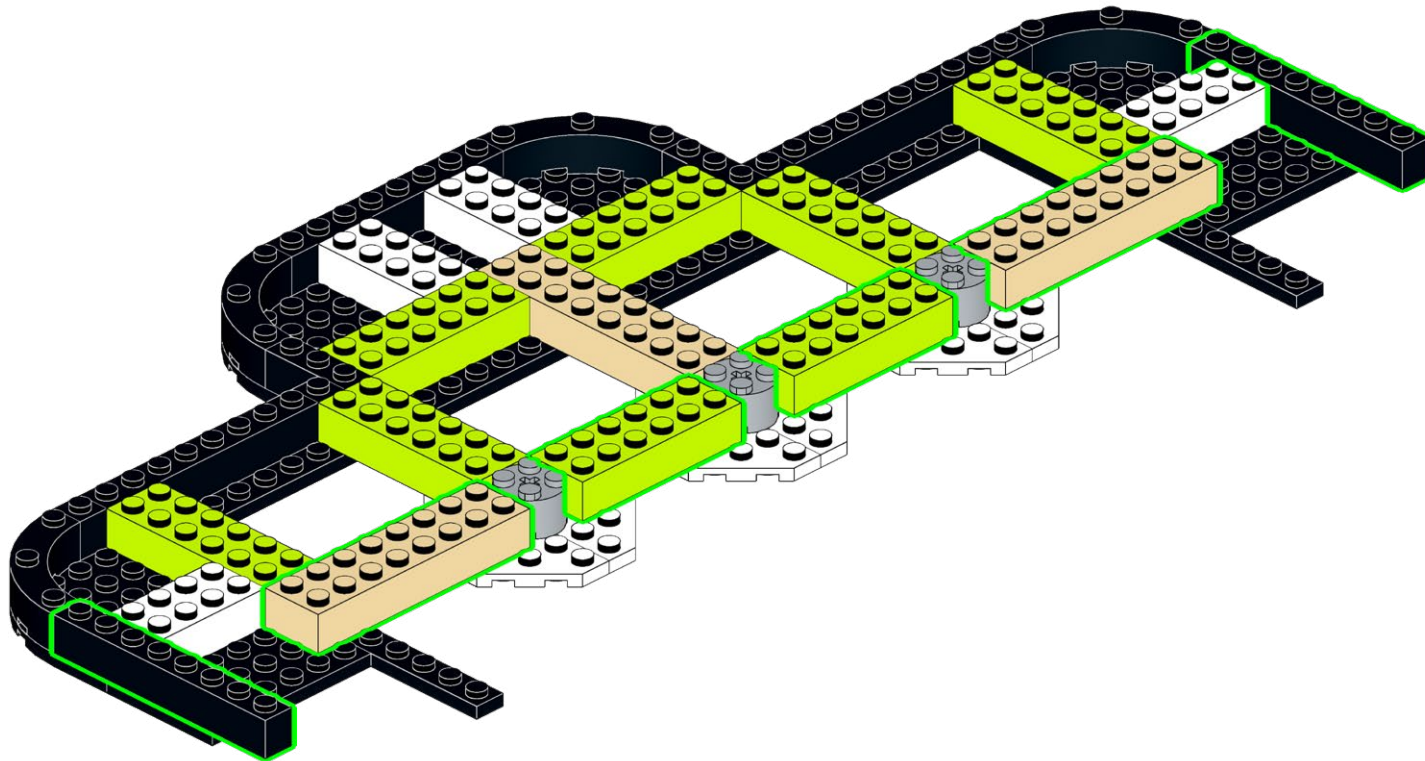
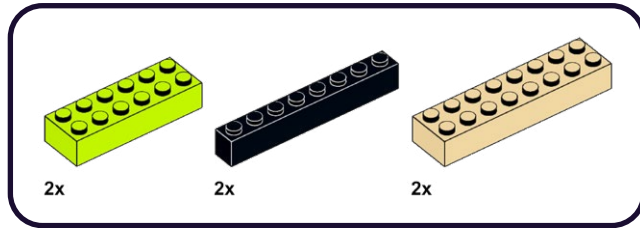

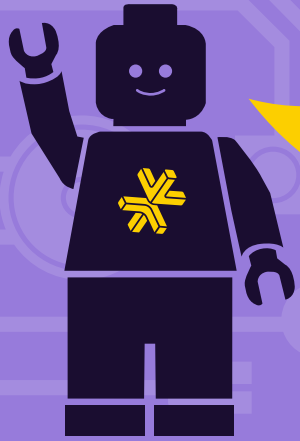
**HOLD UP!**

You might notice some bags aren't in order, as well as left over pieces, but that's ok! We're changing the way you build LEGO!

ATTENDEZ!

Vous remarquerez peut-être que certains sacs, ainsi que certaines pièces, ne sont pas dans le bon ordre. Mais pas de panique! Nous changeons simplement la façon avec laquelle vous construisez vos LEGO!

ASPETTA!

Potresti notare che alcuni sacchetti non sono in ordine, così come i pezzi avanzati, ma va bene così! Stiamo cambiando il modo in cui costruisci i LEGO!

HALT!

Sie werden möglicherweise bemerken, dass einige tüten durcheinander sind und teile übrig bleiben, aber das ist in Ordnung! Wir ändern die art und weise, wie Sie LEGO bauen!

¡ESPERA!

Es posible que notes que algunas bolsas están fuera de servicio, así como piezas sobrantes, ¡pero está bien! ¡Estamos cambiando la forma en que construyes LEGO!

暫停!

你可能会注意到一些袋子顺序错乱, 以及一些剩余的部件, 但没关系! 我们正在改变你搭建乐高的方式!

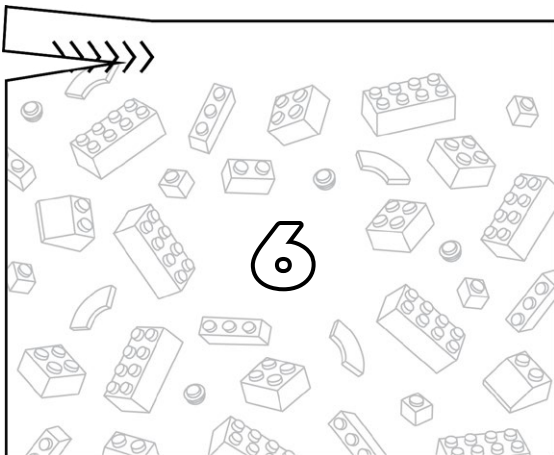
Open LEGO® Bag 6

159

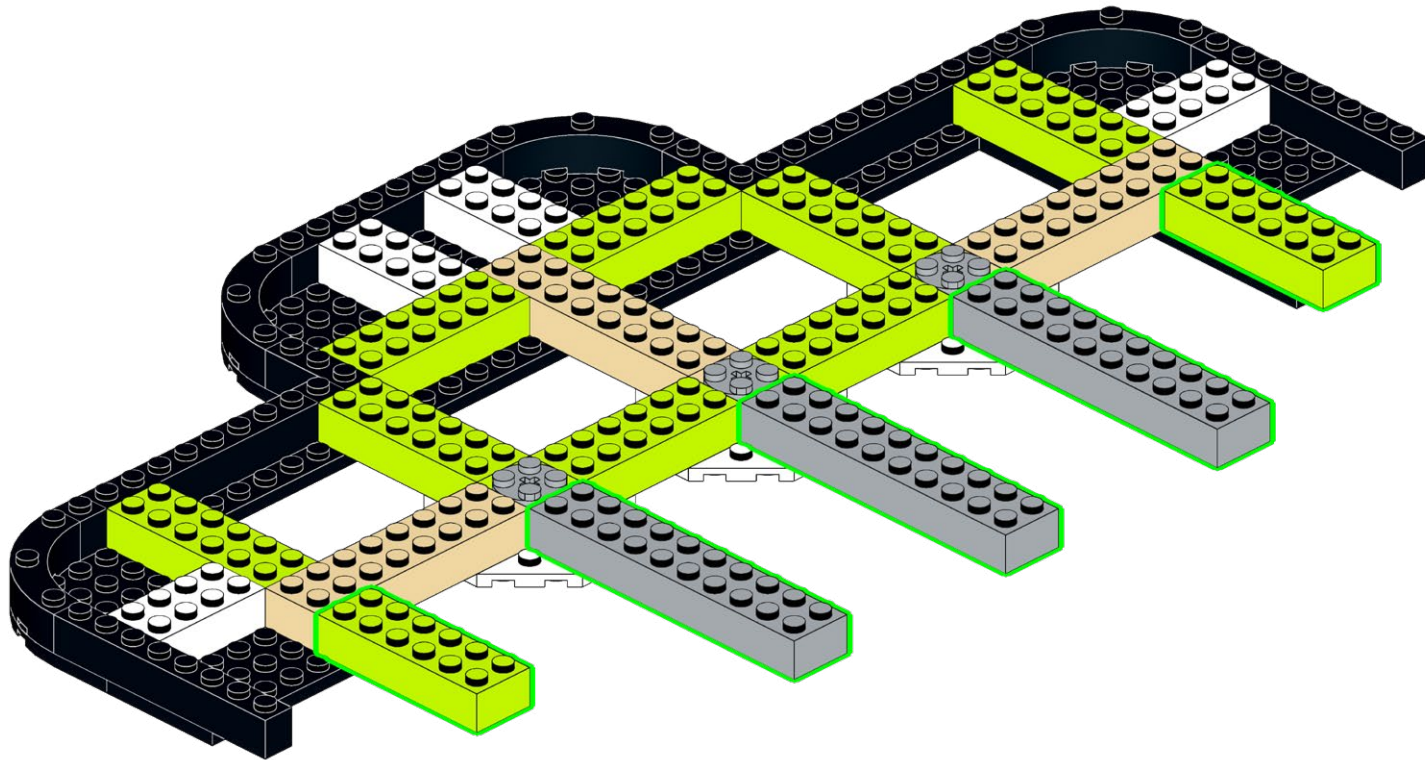
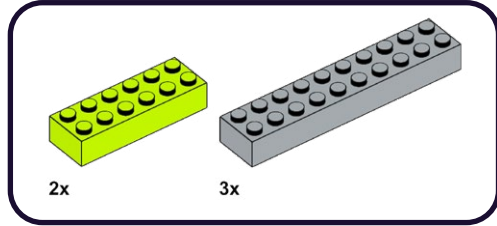

160

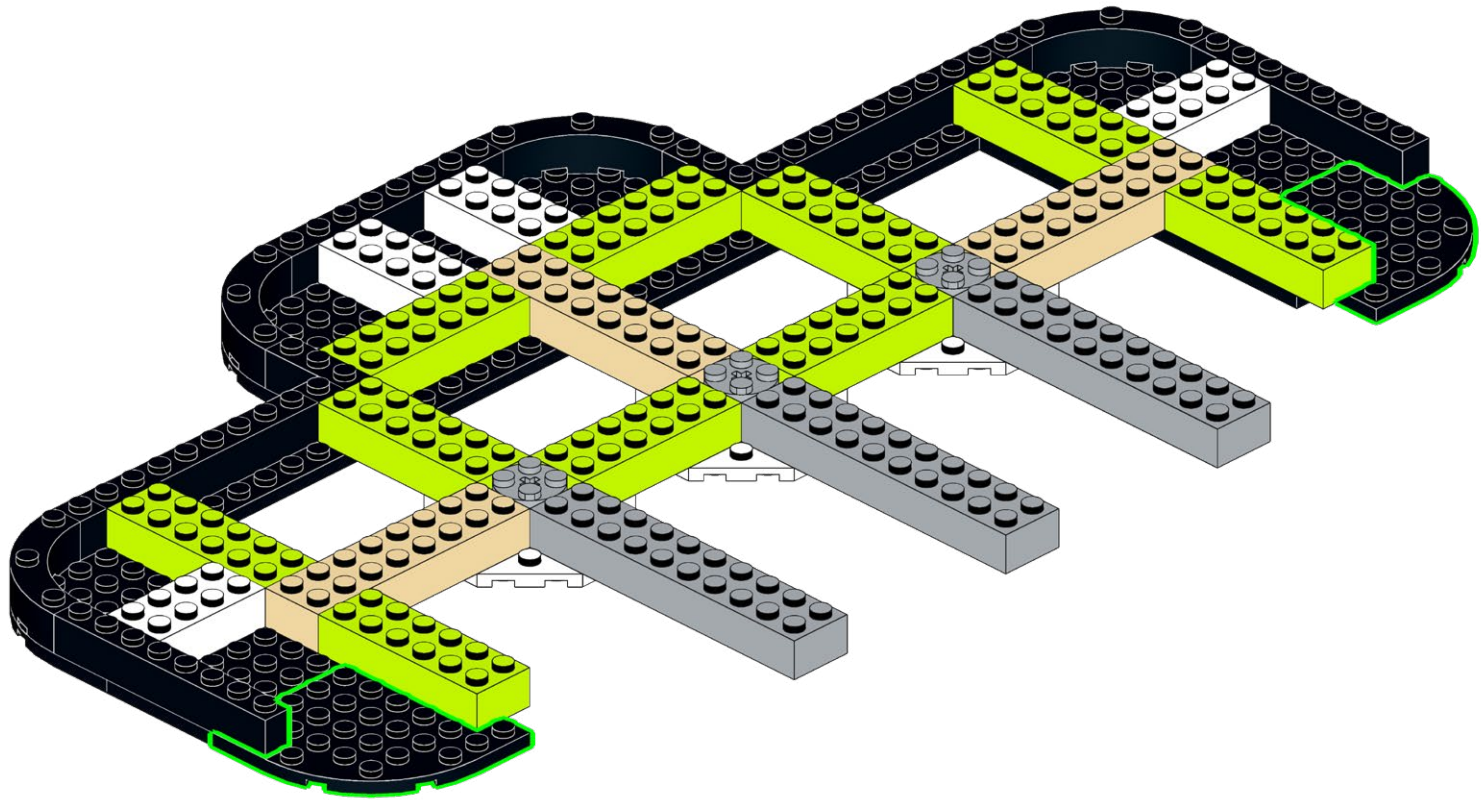
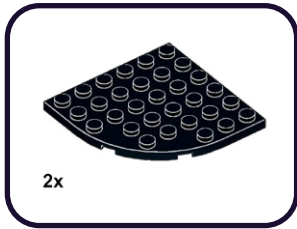

161

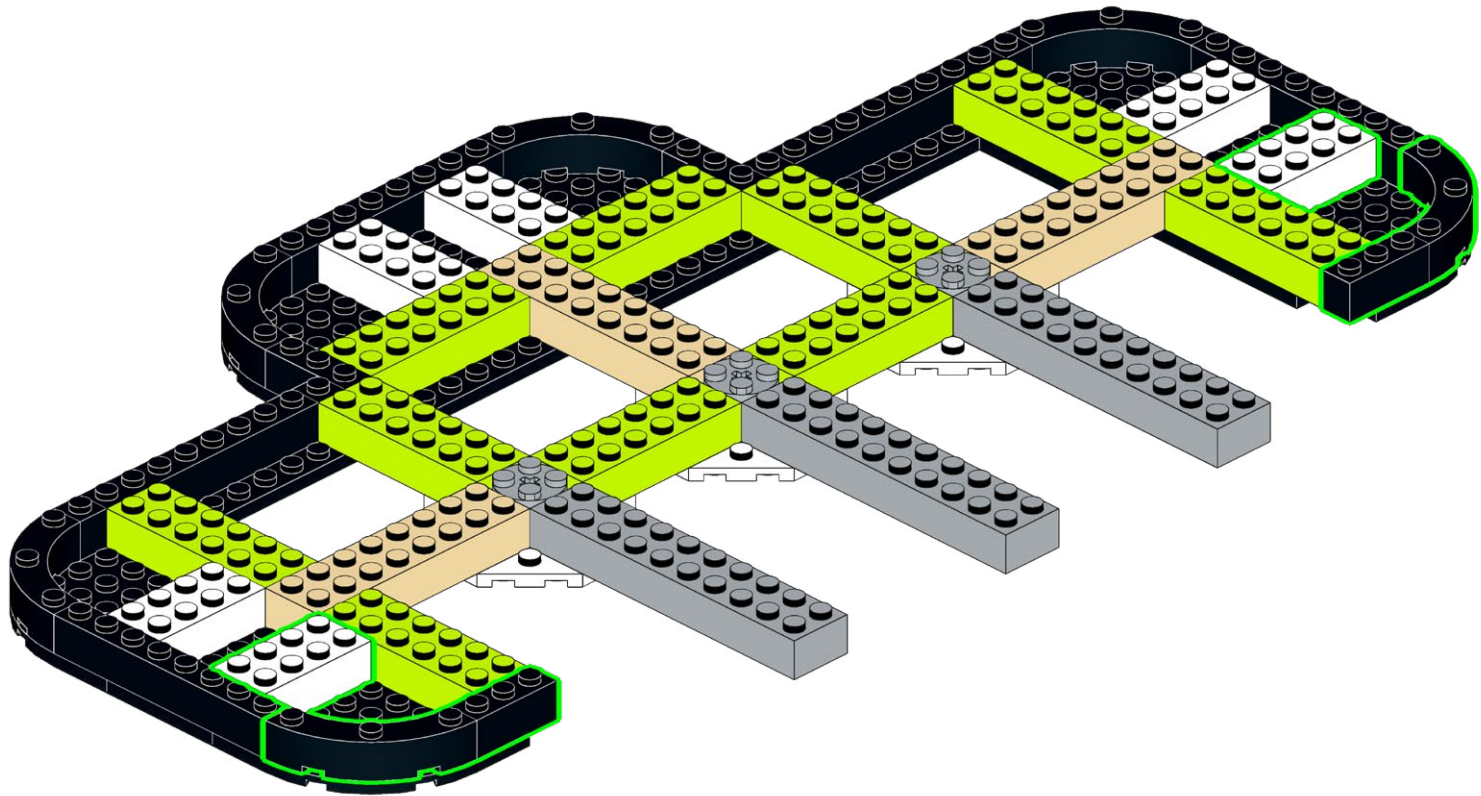
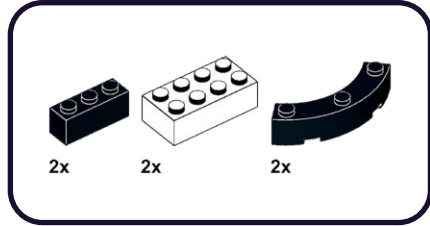

162



2x

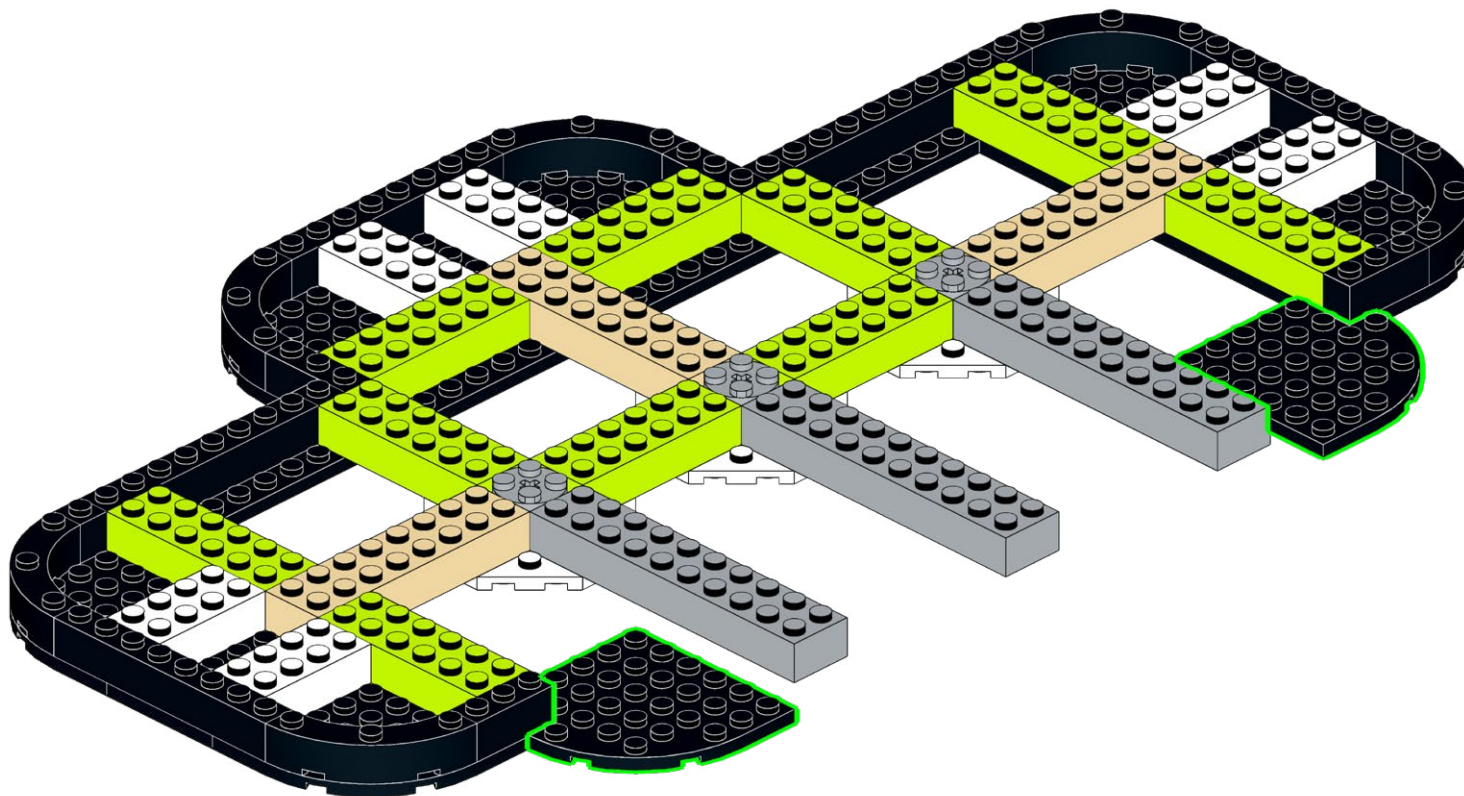

163

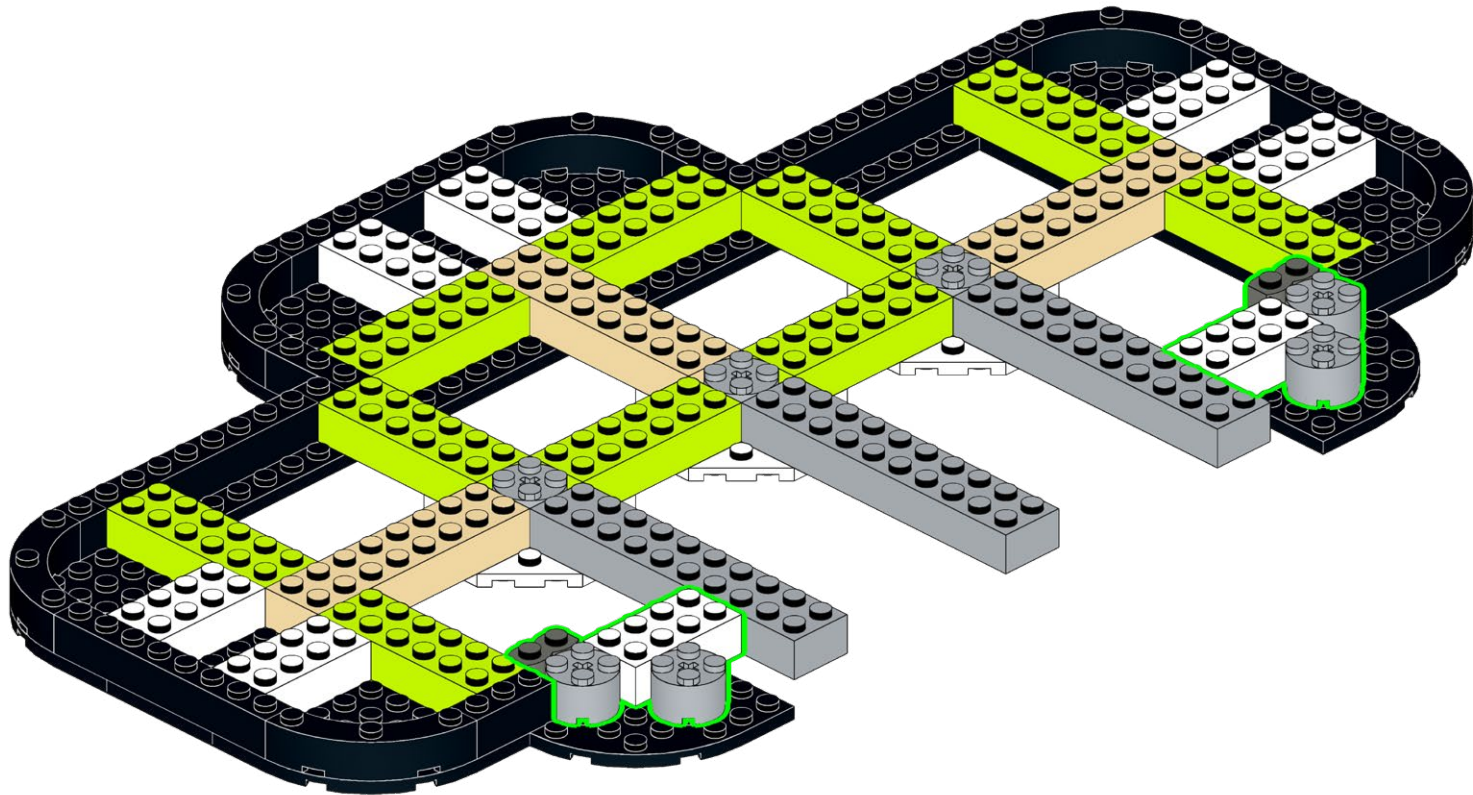
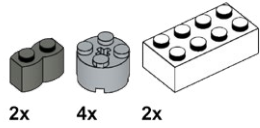

164

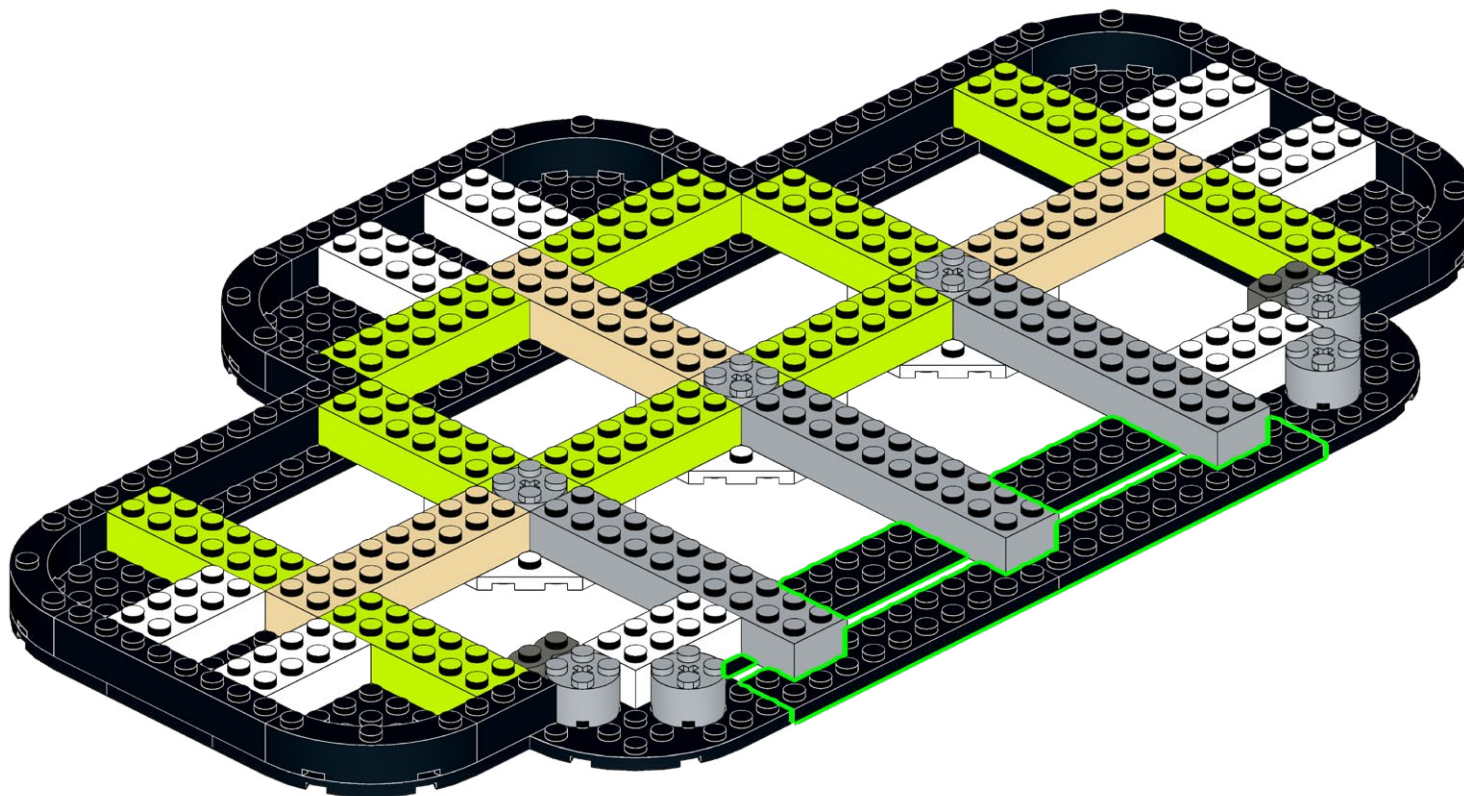
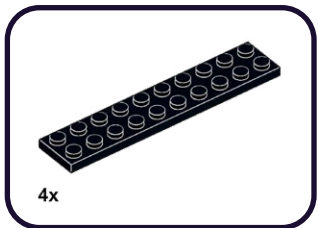

165

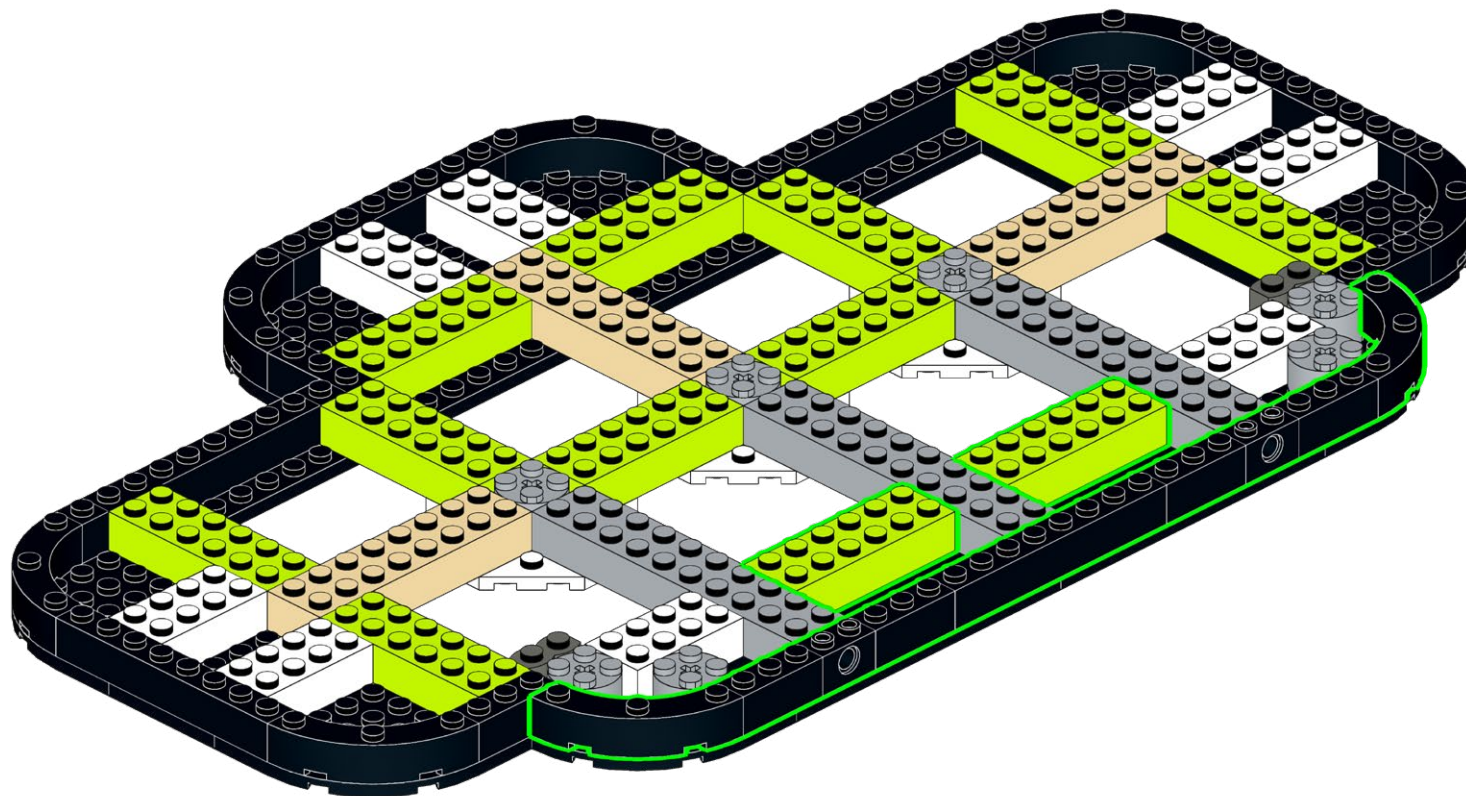
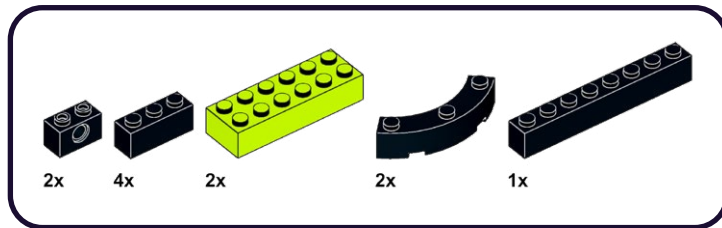

166

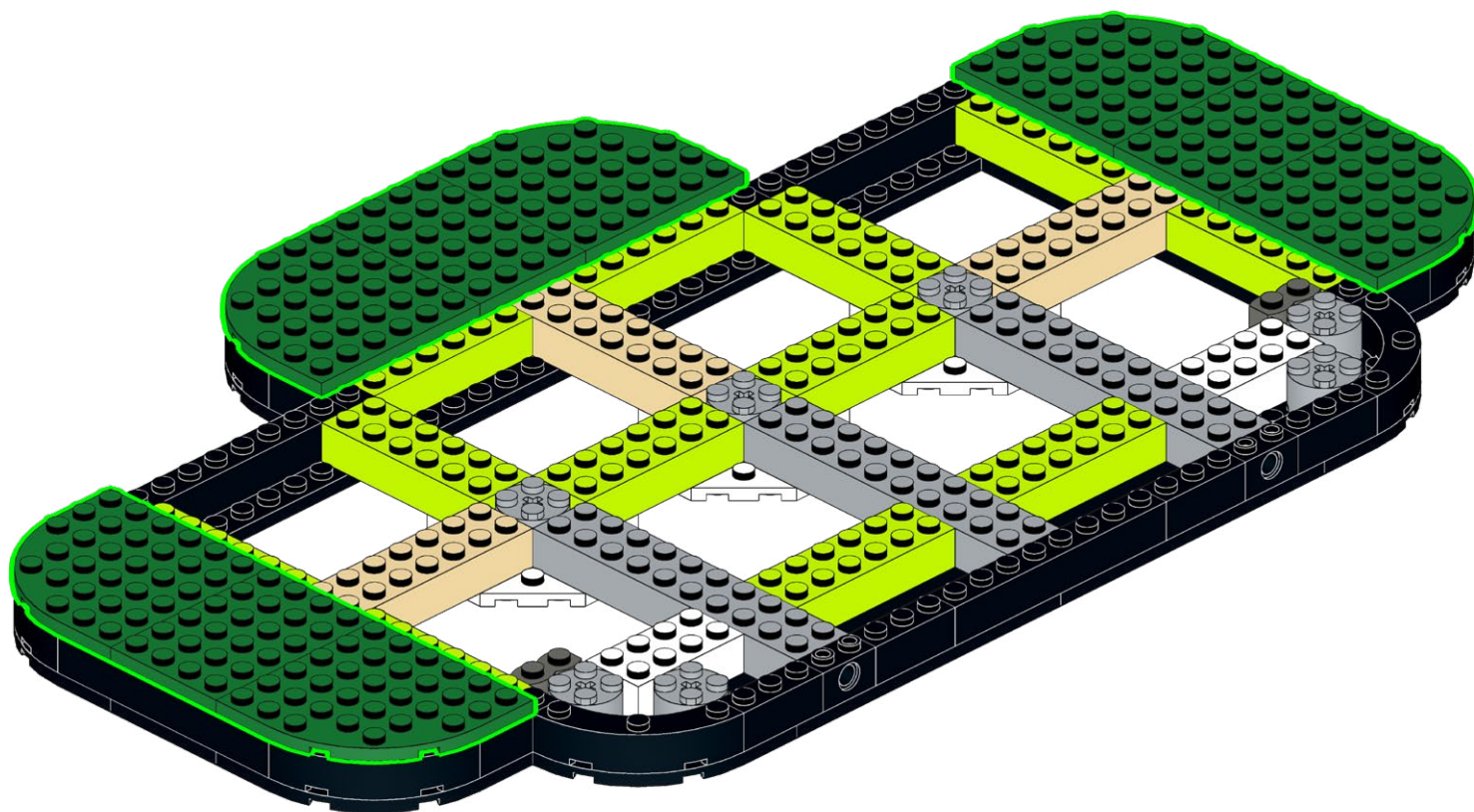
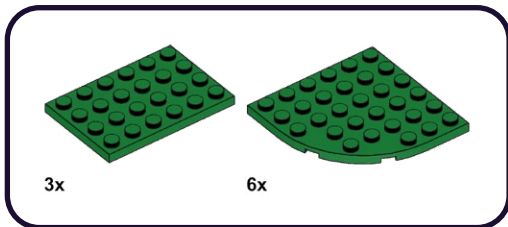

167

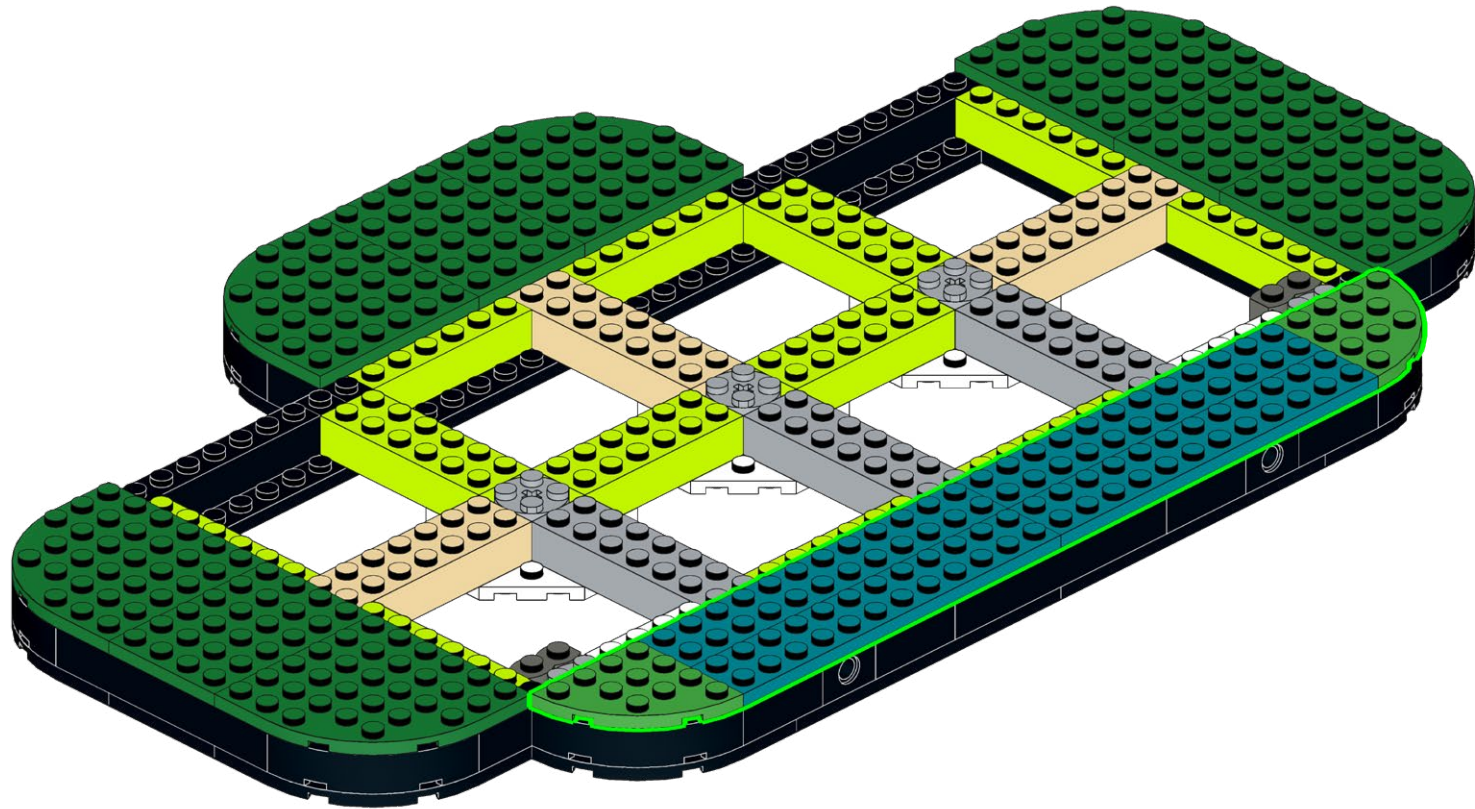
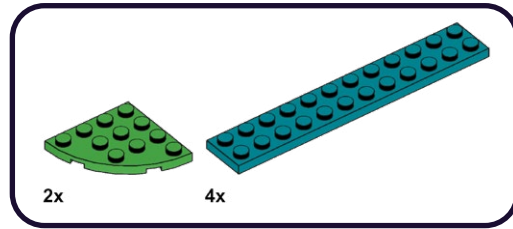

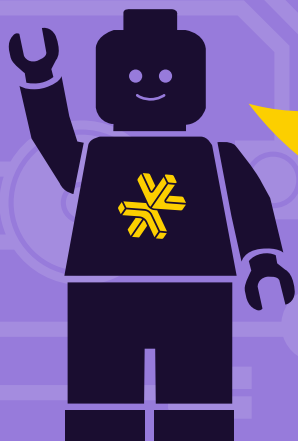
**HOLD UP!**

You might notice some bags aren't in order, as well as left over pieces, but that's ok! We're changing the way you build LEGO!

ATTENDEZ!

Vous remarquerez peut-être que certains sacs, ainsi que certaines pièces, ne sont pas dans le bon ordre. Mais pas de panique! Nous changeons simplement la façon avec laquelle vous construisez vos LEGO!

ASPETTA!

Potresti notare che alcuni sacchetti non sono in ordine, così come i pezzi avanzati, ma va bene così! Stiamo cambiando il modo in cui costruisci i LEGO!

HALT!

Sie werden möglicherweise bemerken, dass einige tüten durcheinander sind und teile übrig bleiben, aber das ist in Ordnung! Wir ändern die art und weise, wie Sie LEGO bauen!

¡ESPERA!

Es posible que notes que algunas bolsas están fuera de servicio, así como piezas sobrantes, ¡pero está bien! ¡Estamos cambiando la forma en que construyes LEGO!

暫停!

你可能会注意到一些袋子顺序错乱, 以及一些剩余的部件, 但没关系! 我们正在改变你搭建乐高的方式!

Open LEGO® Bags 7 & 12

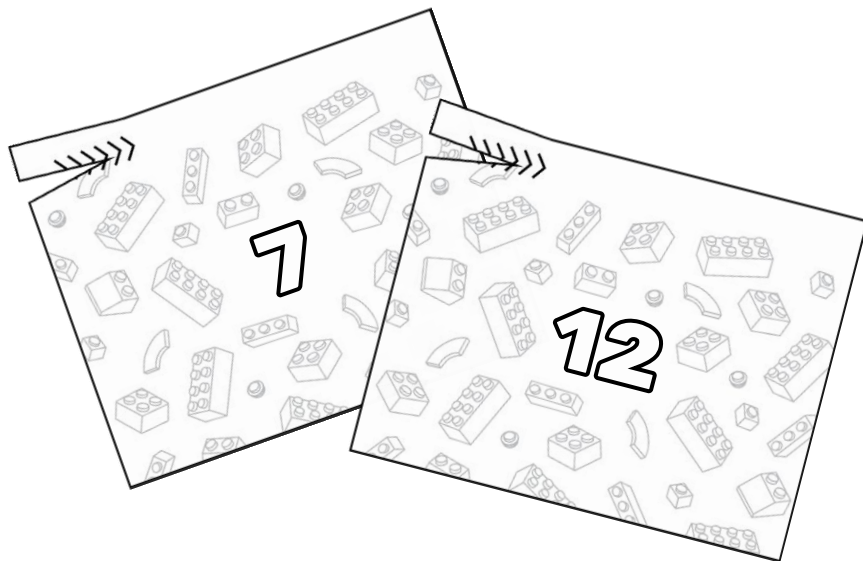

168

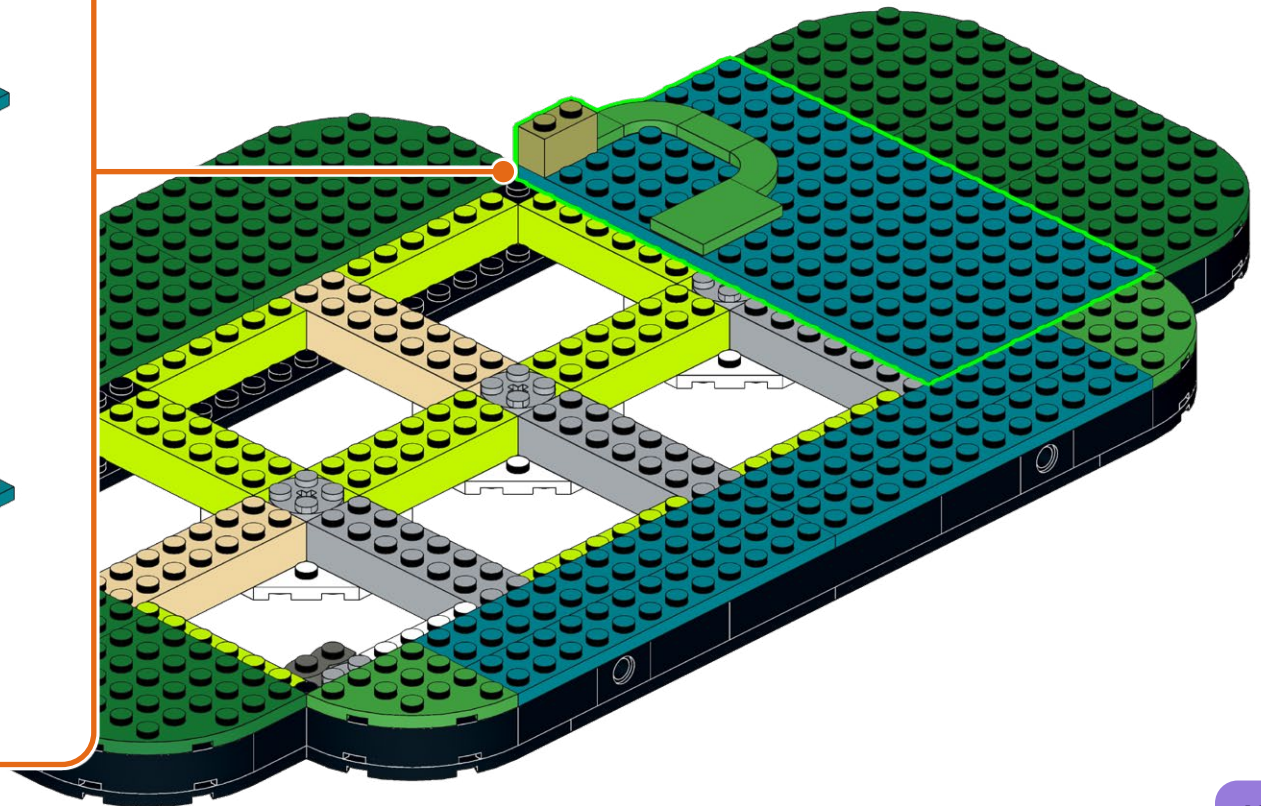
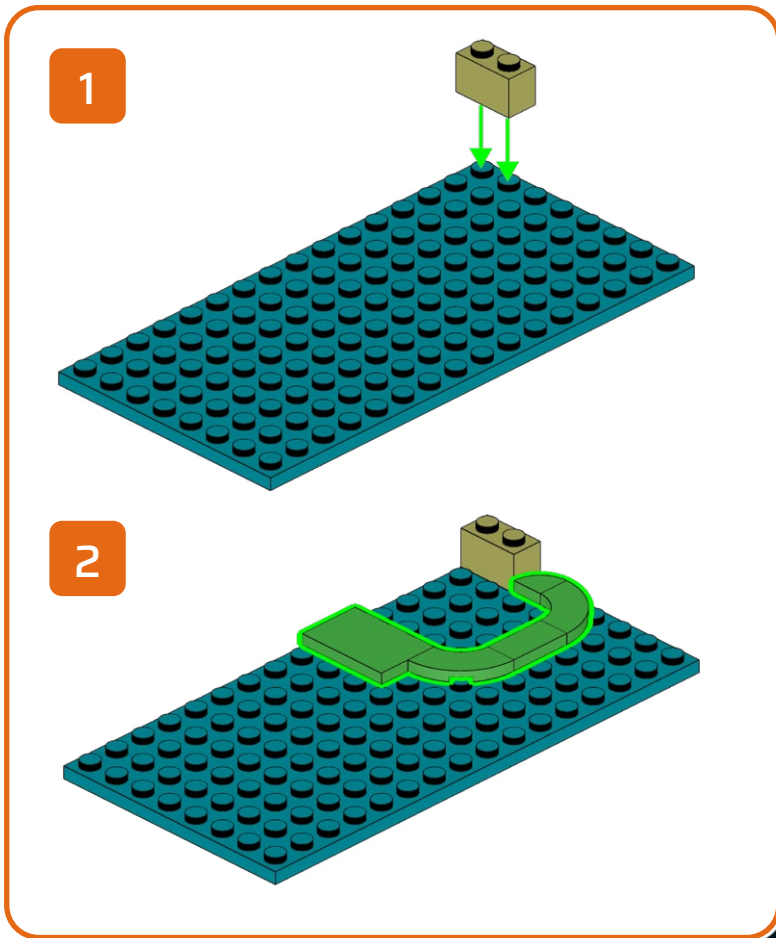
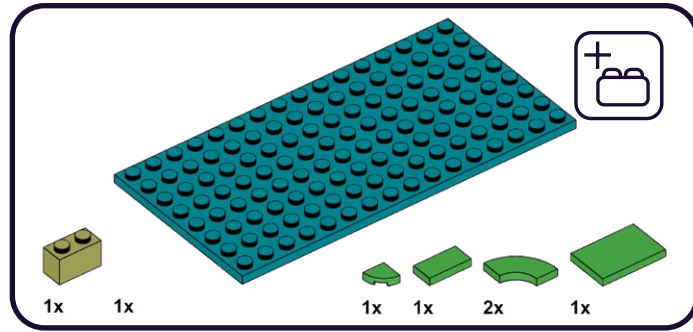

169

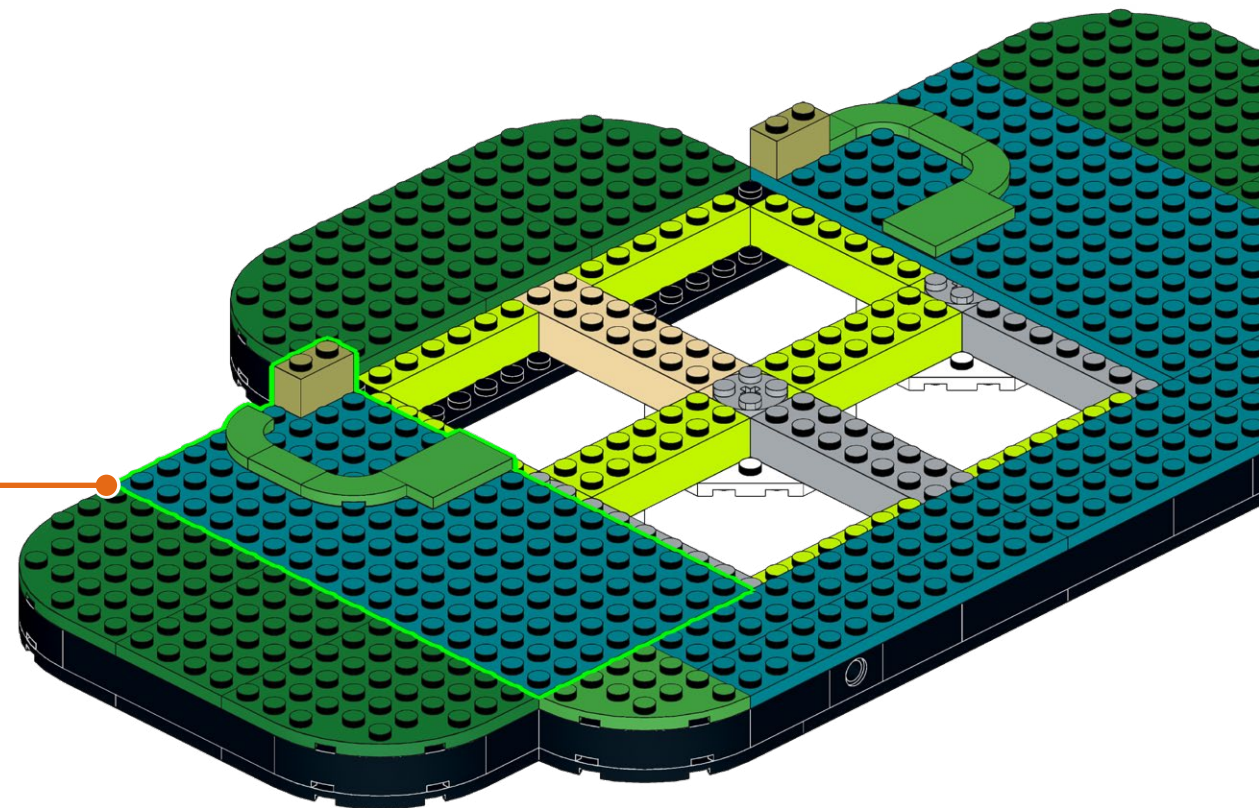
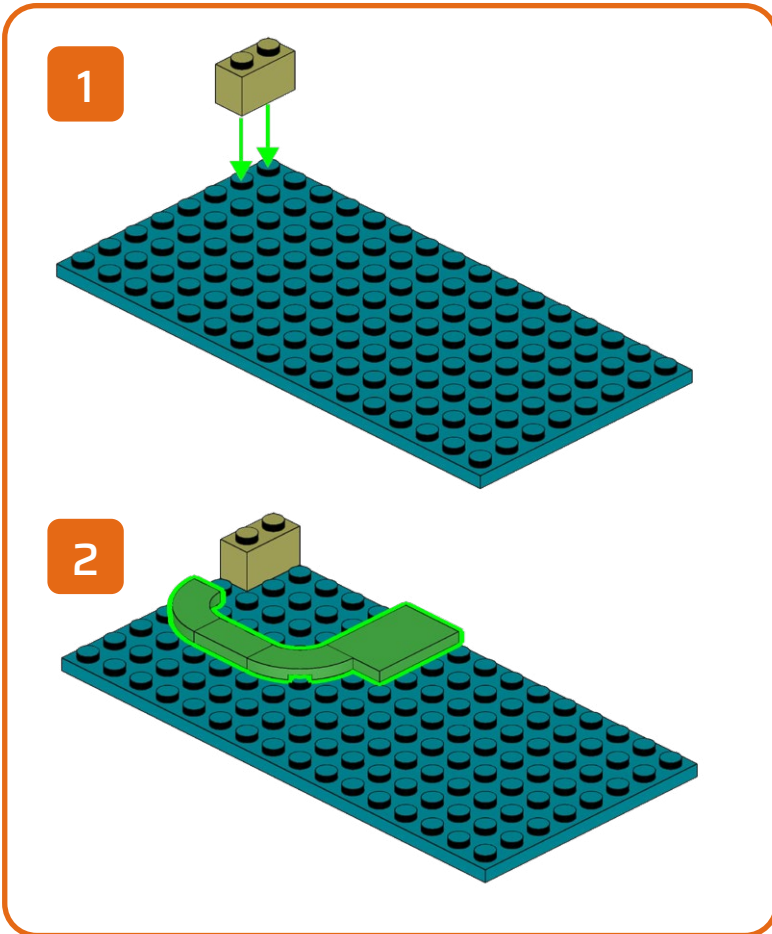
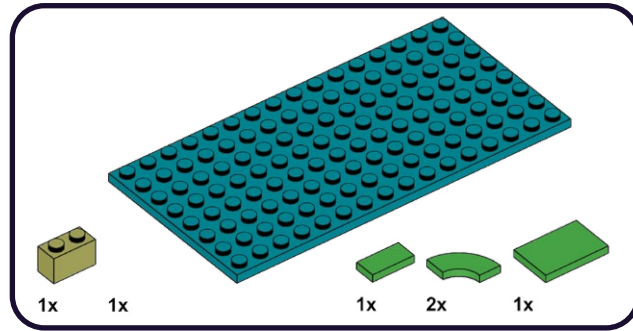

170

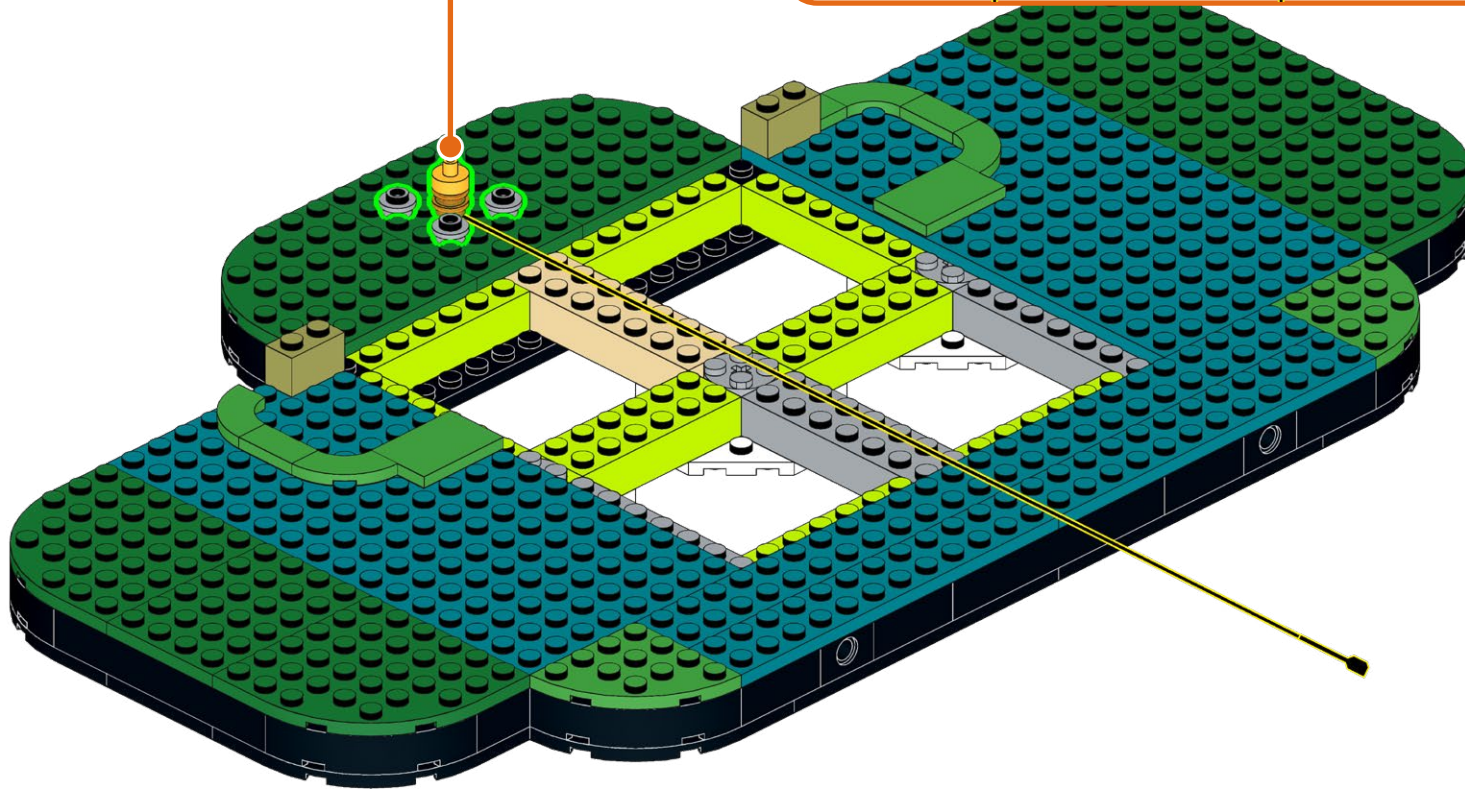
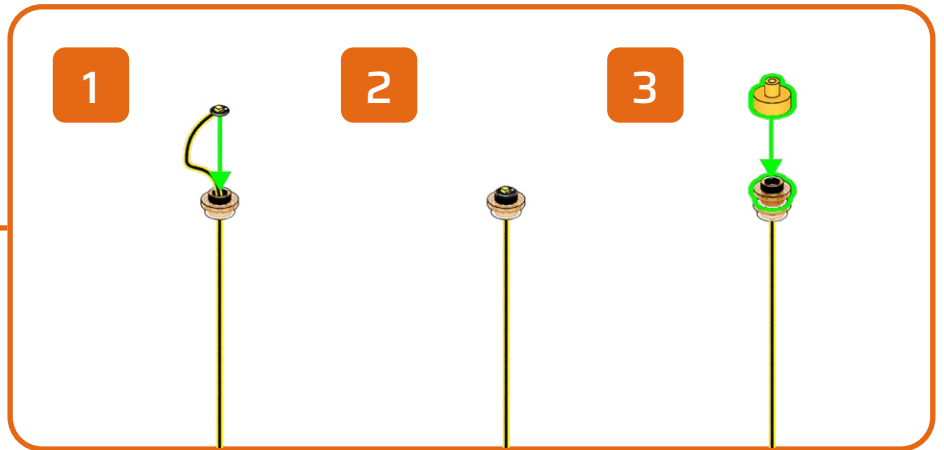
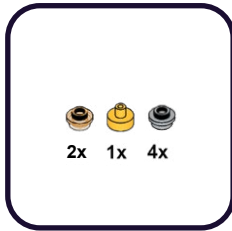
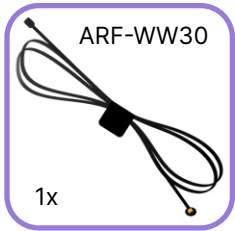

171

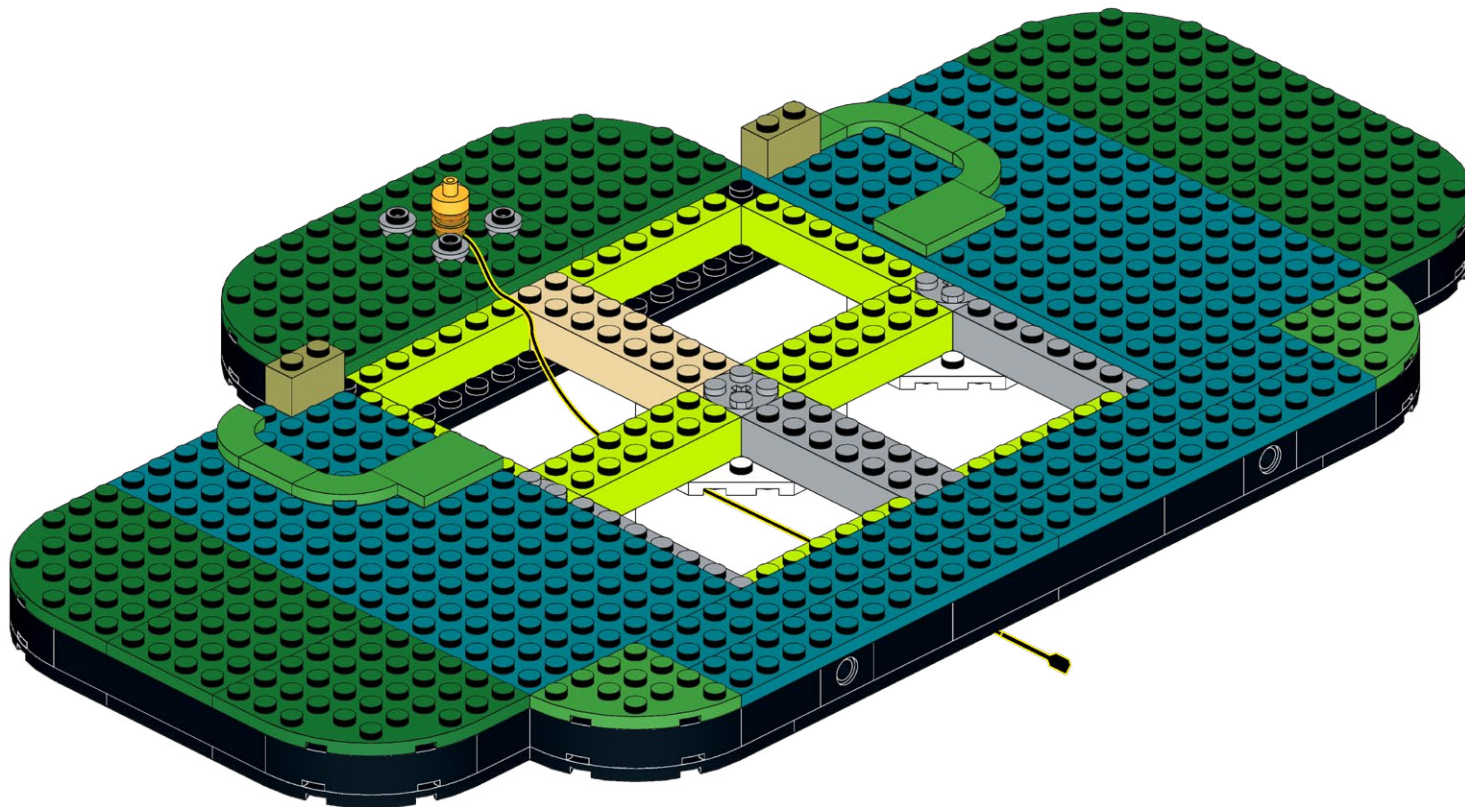

172

4x

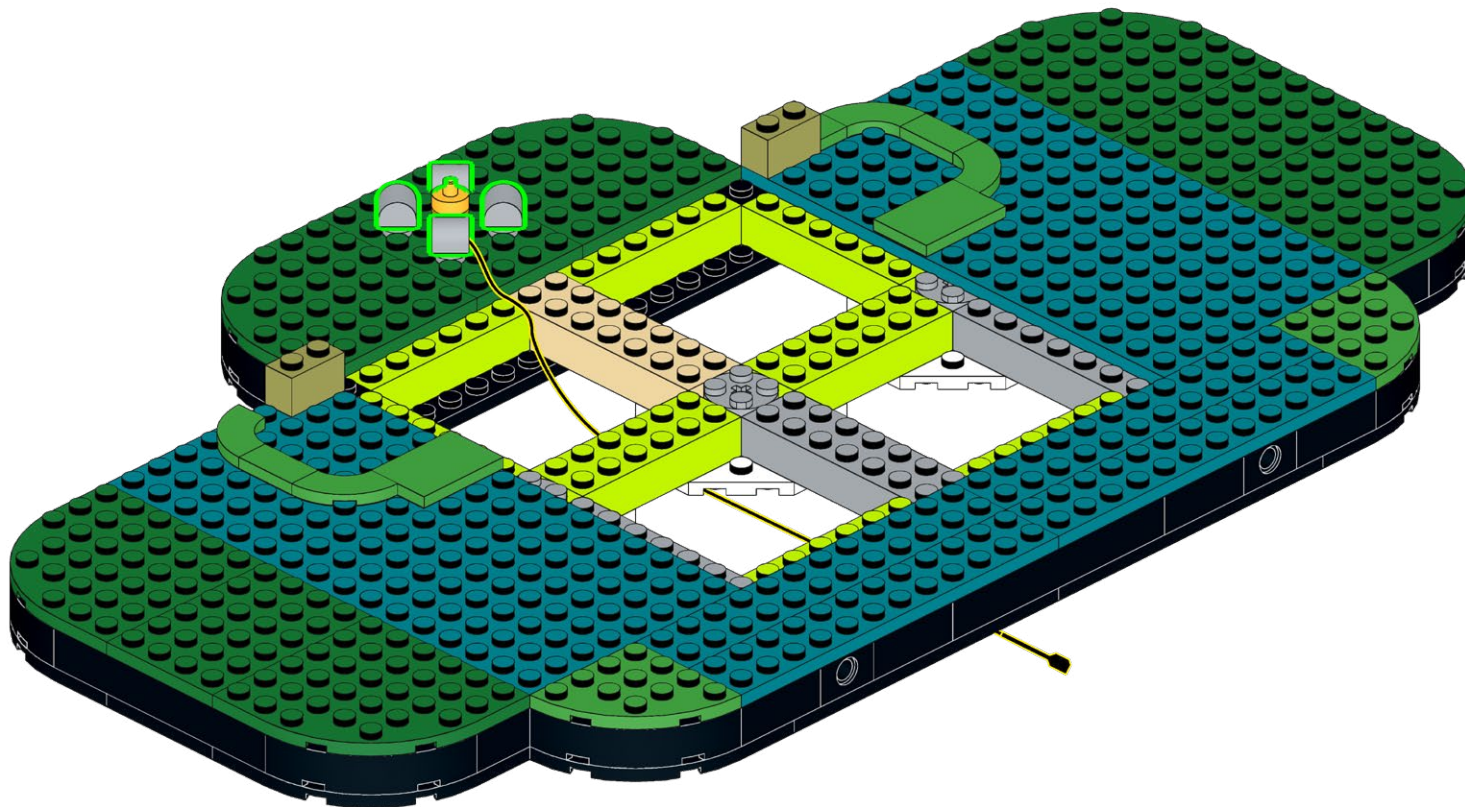

173



1

2

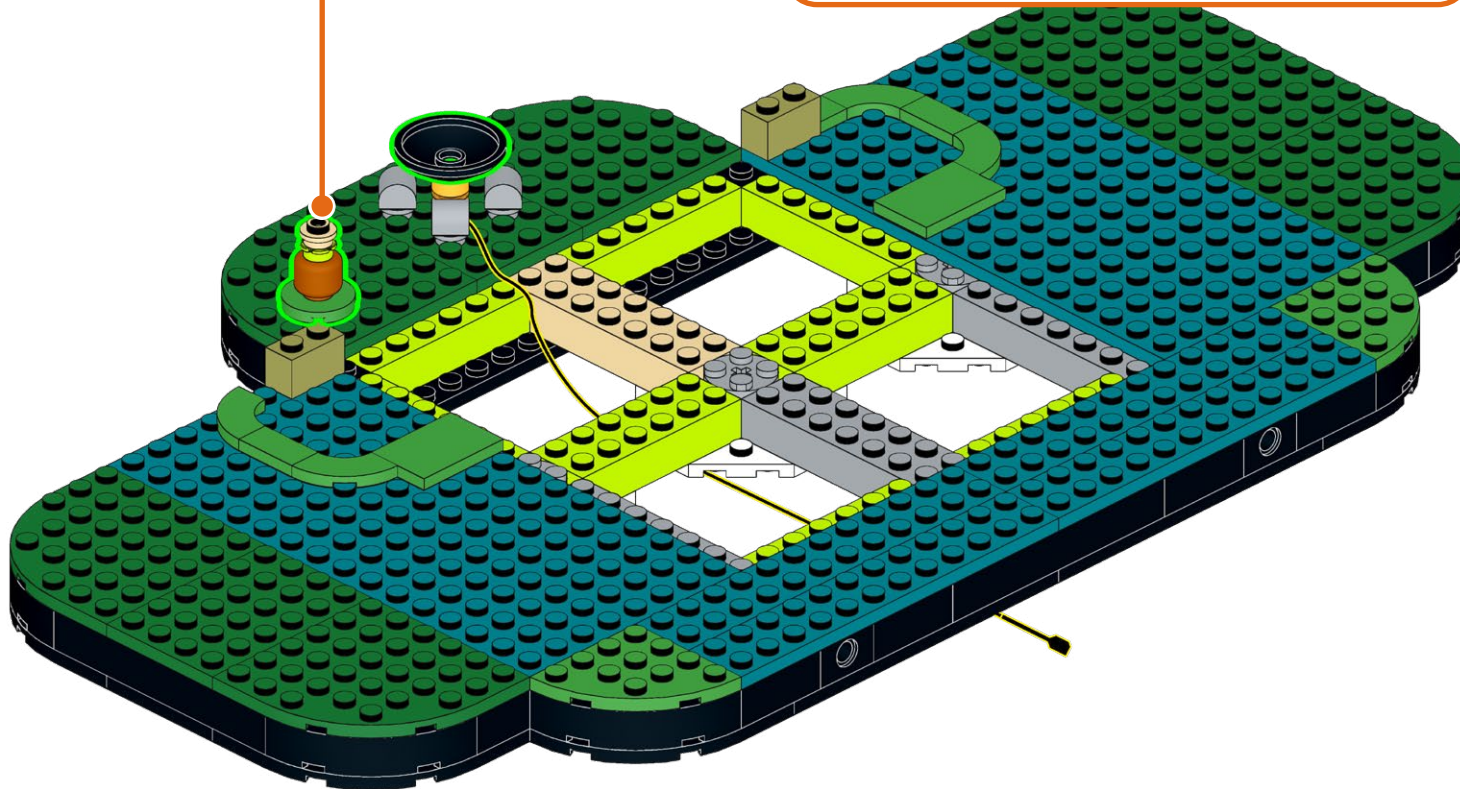
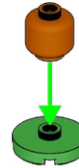

174

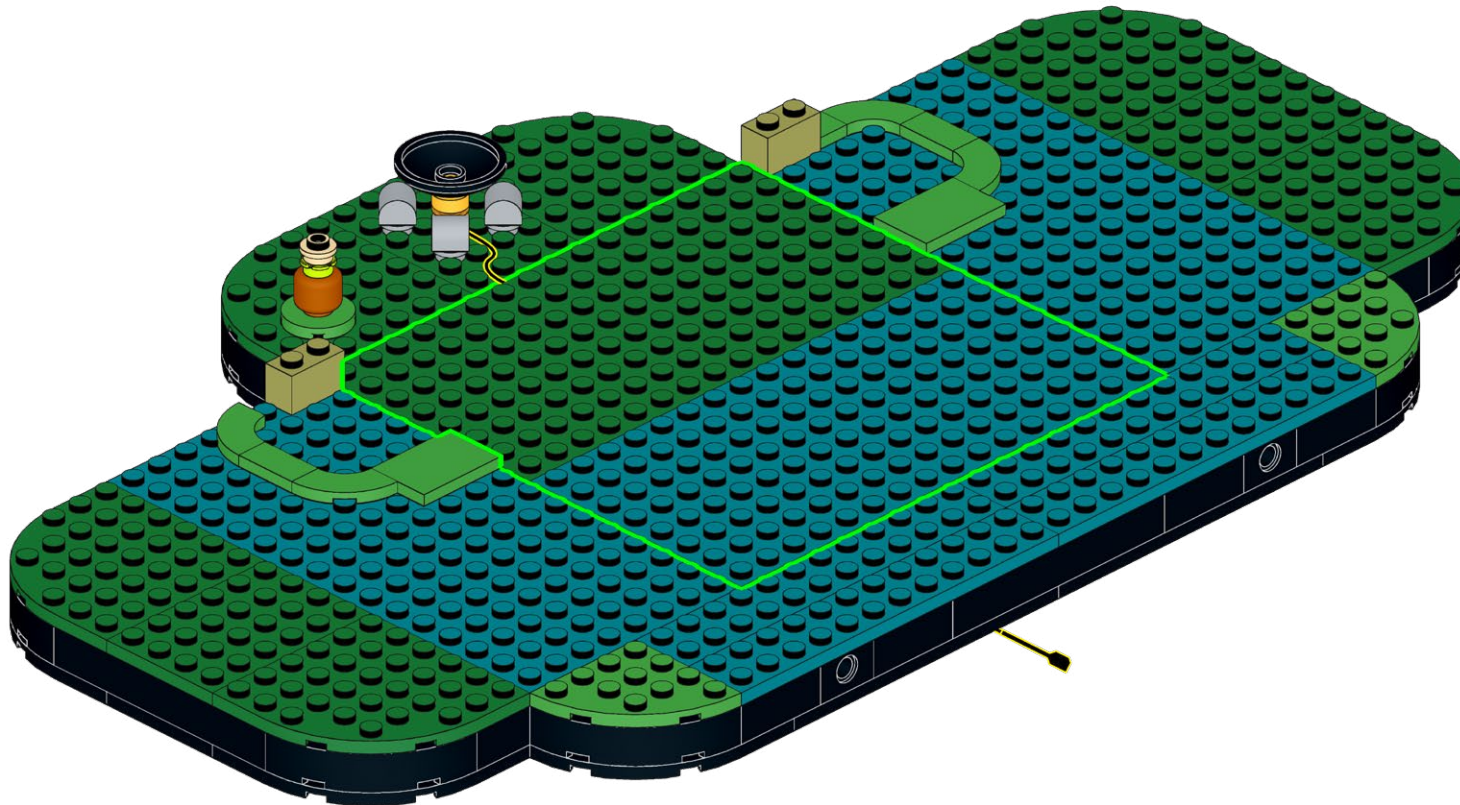
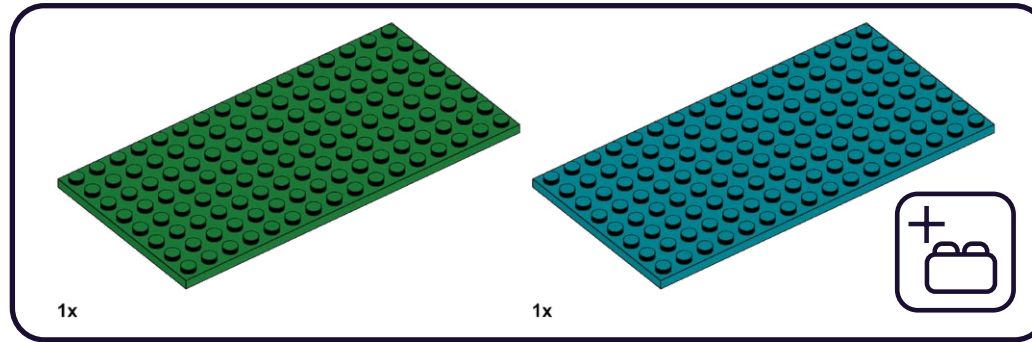

175



1x



D-3

1x



T-1x4

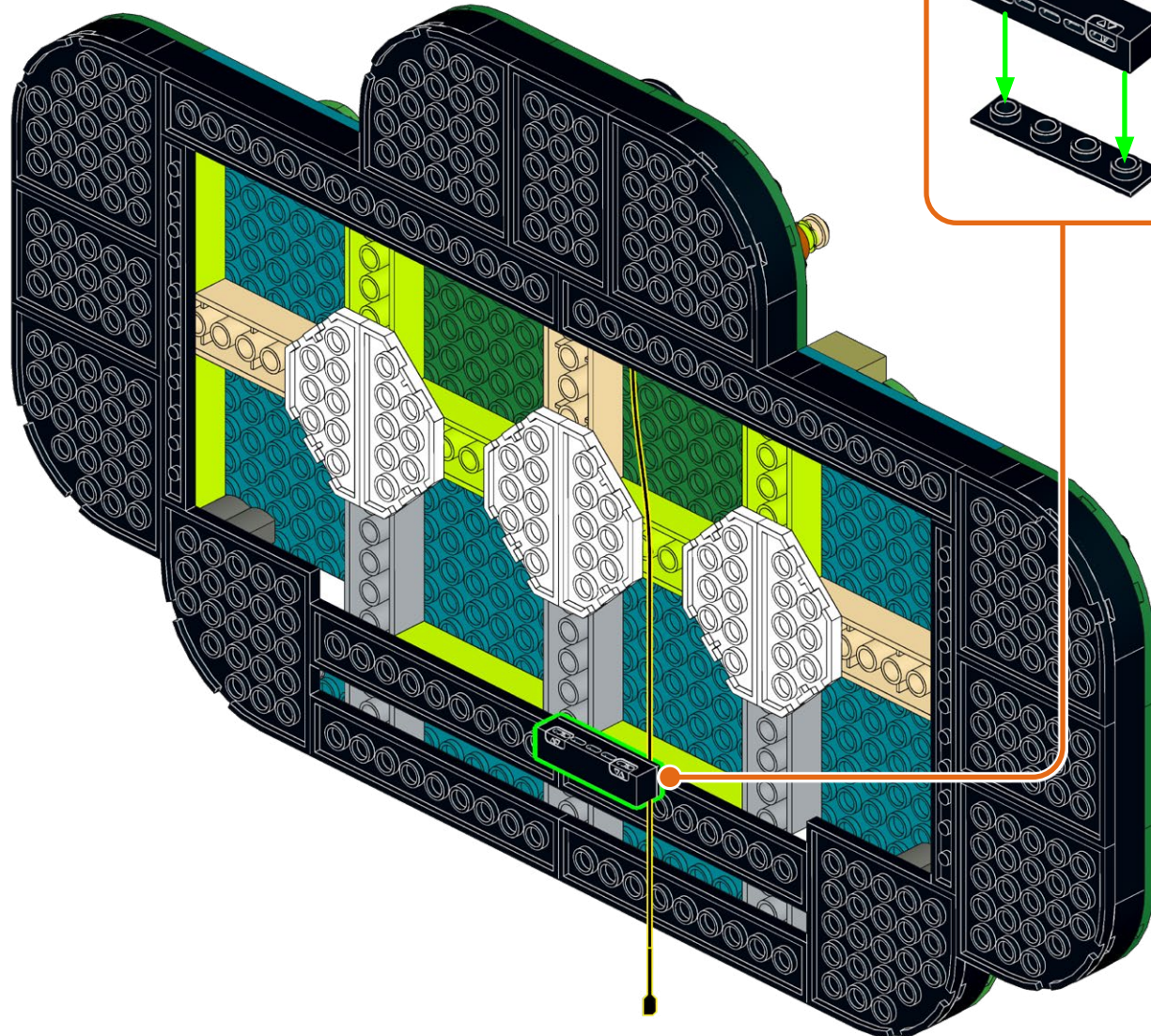

176

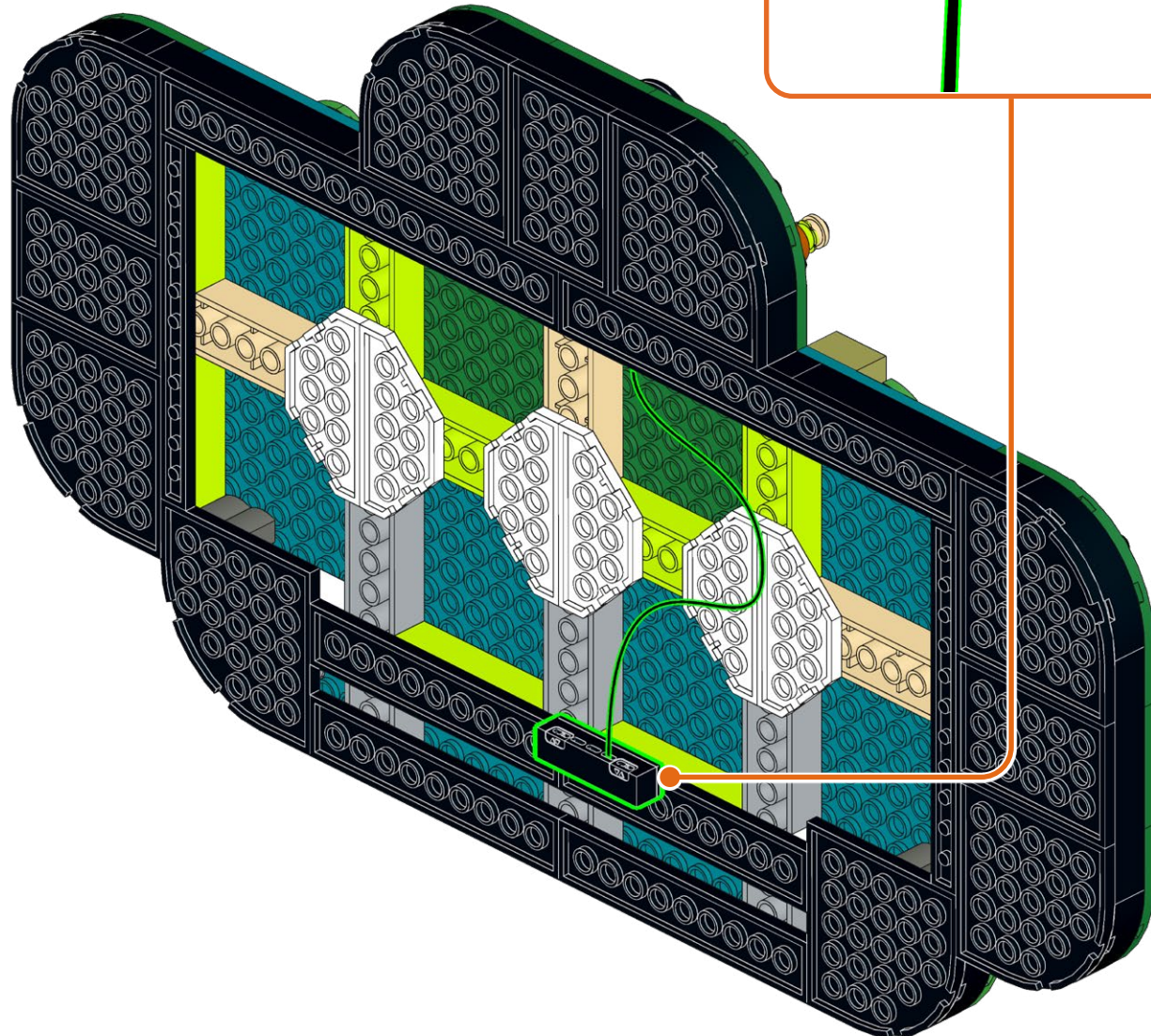

177

B-50

1x

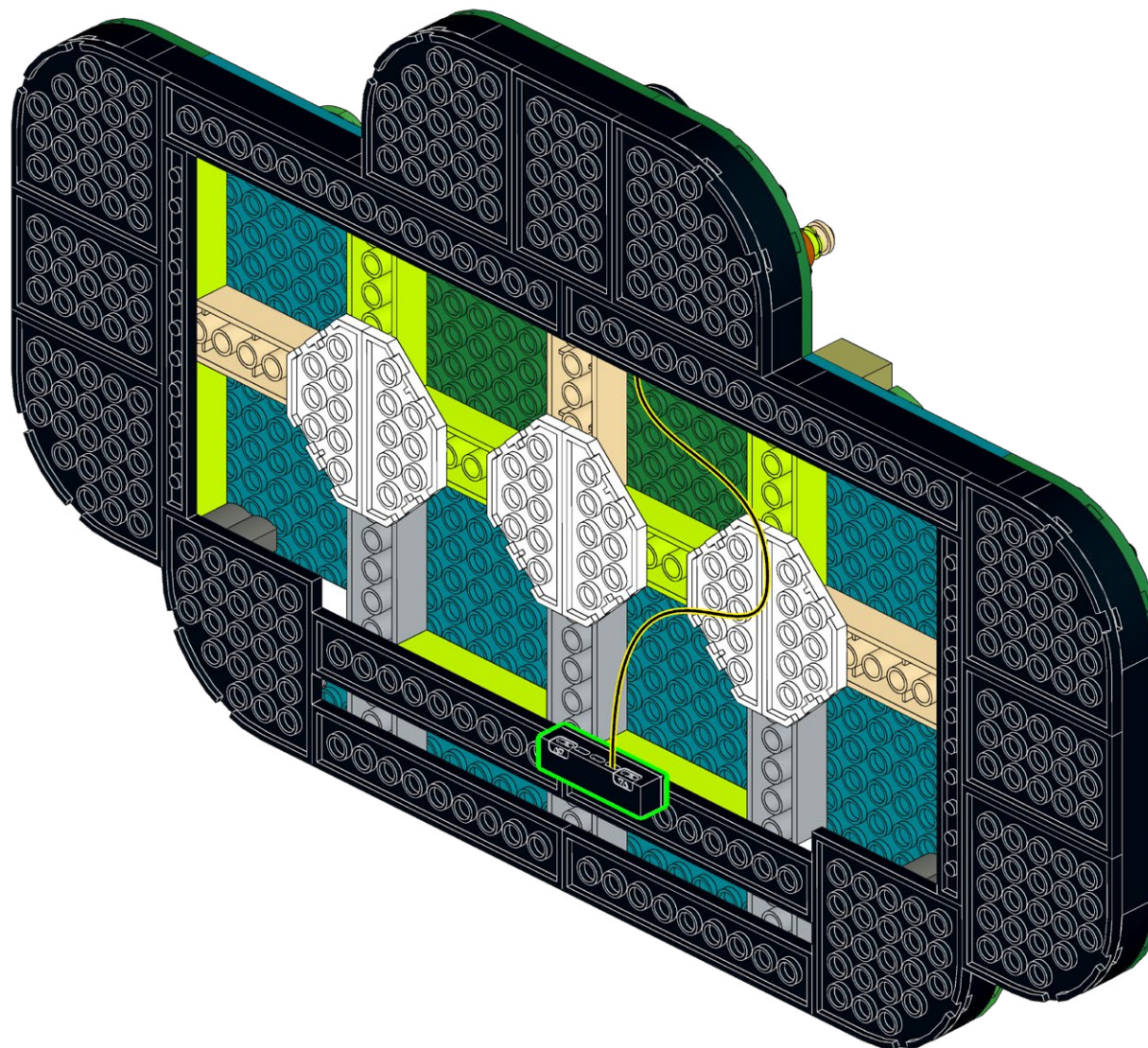

178

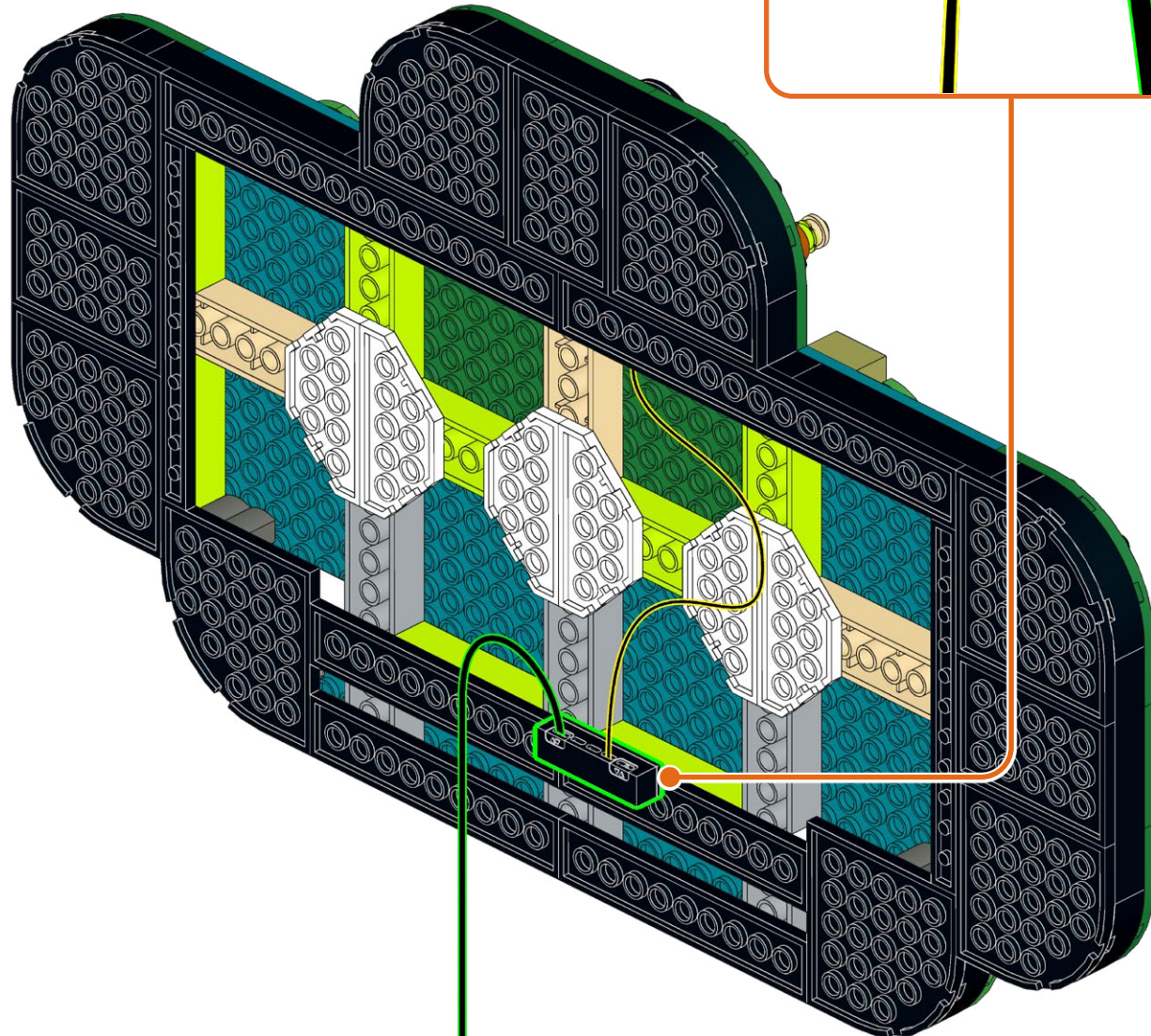

179

B-50

1x

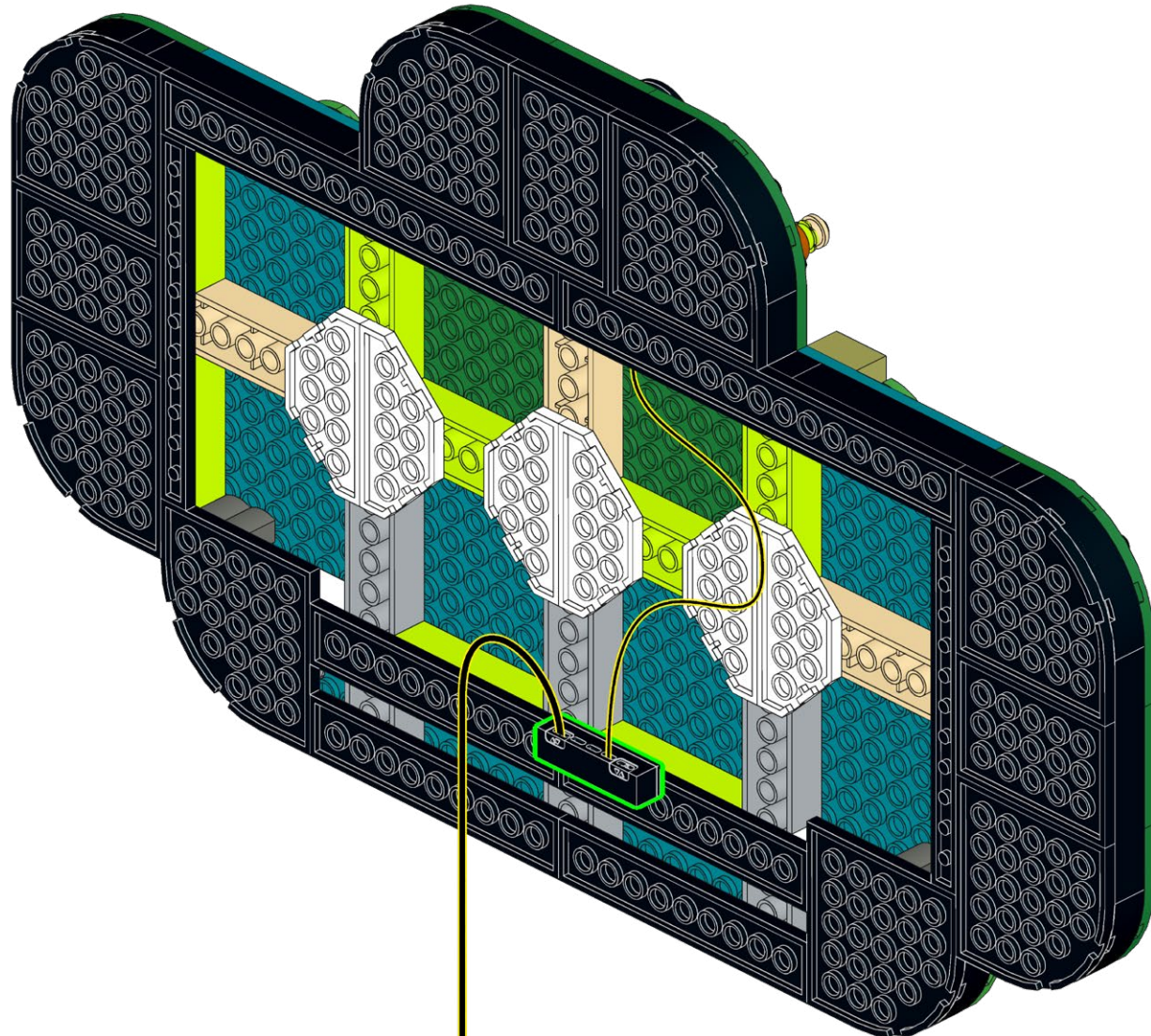

180

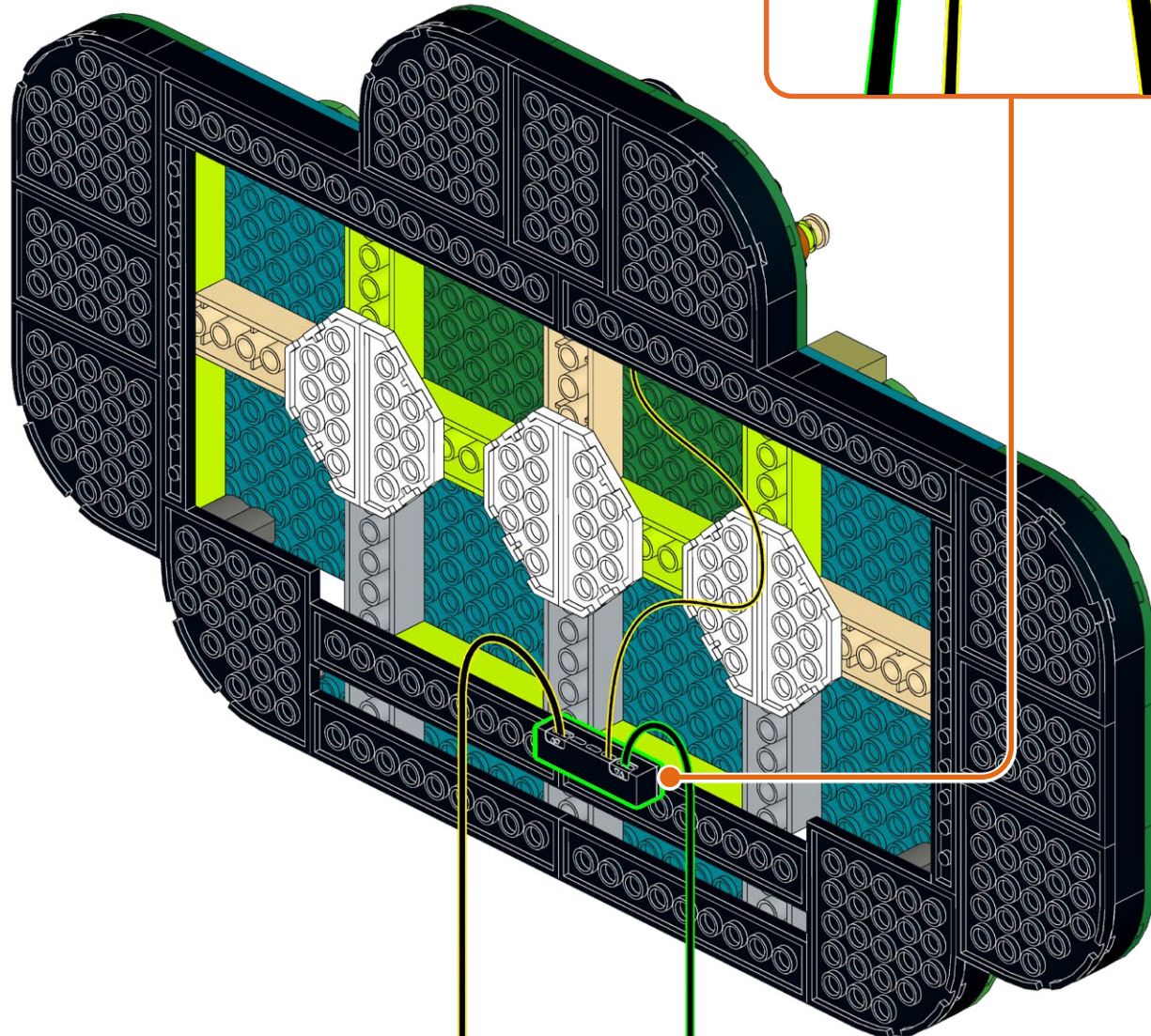

181

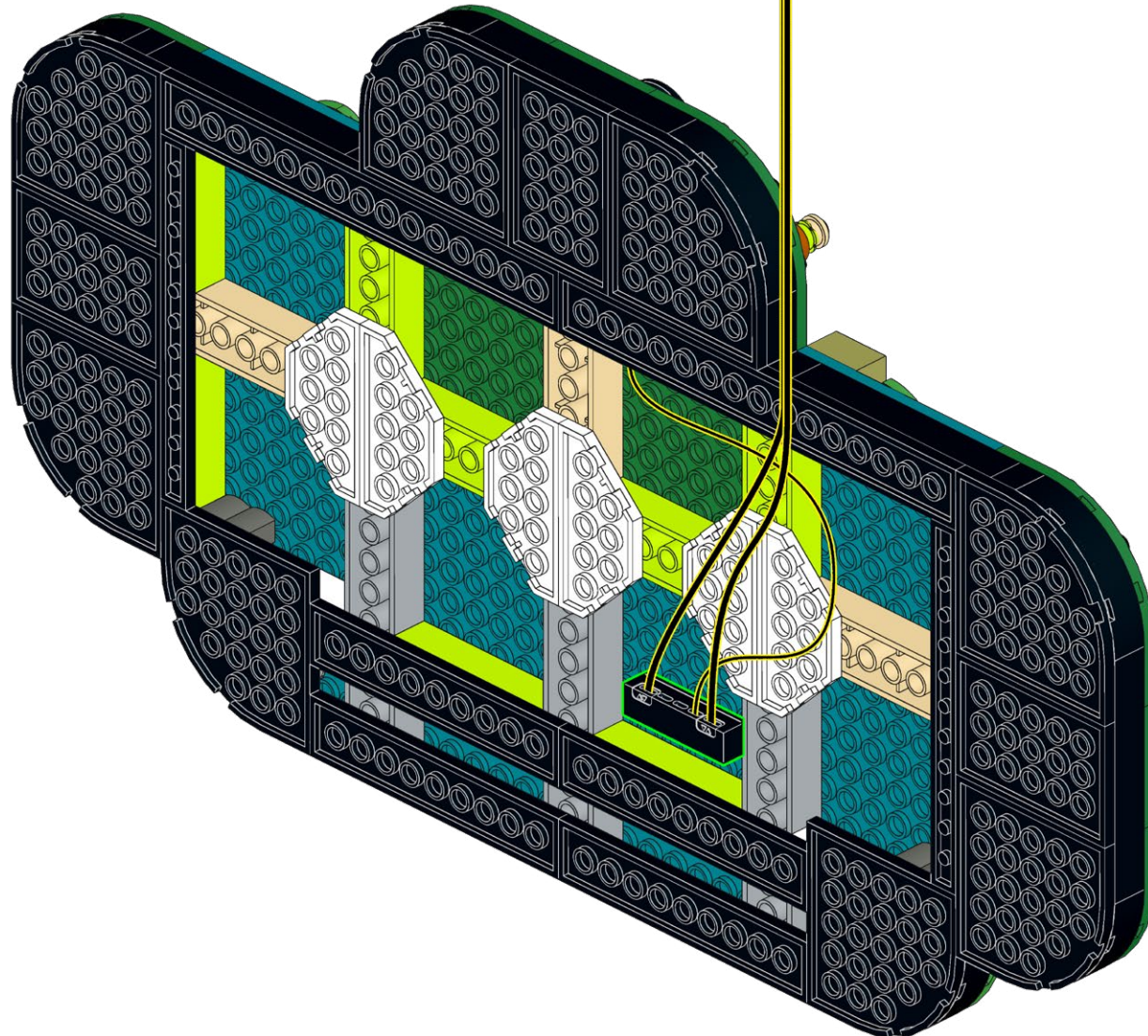

182

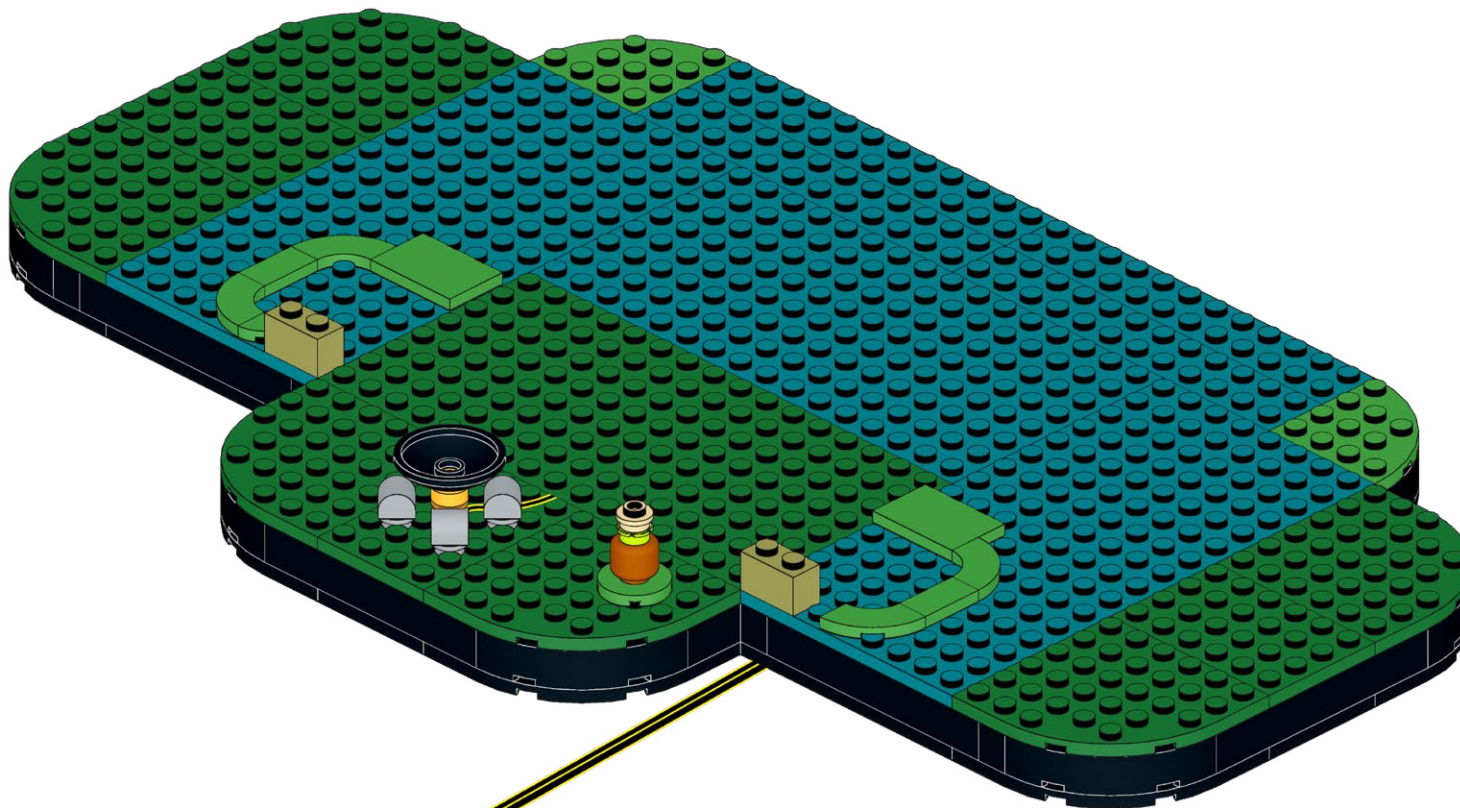

183

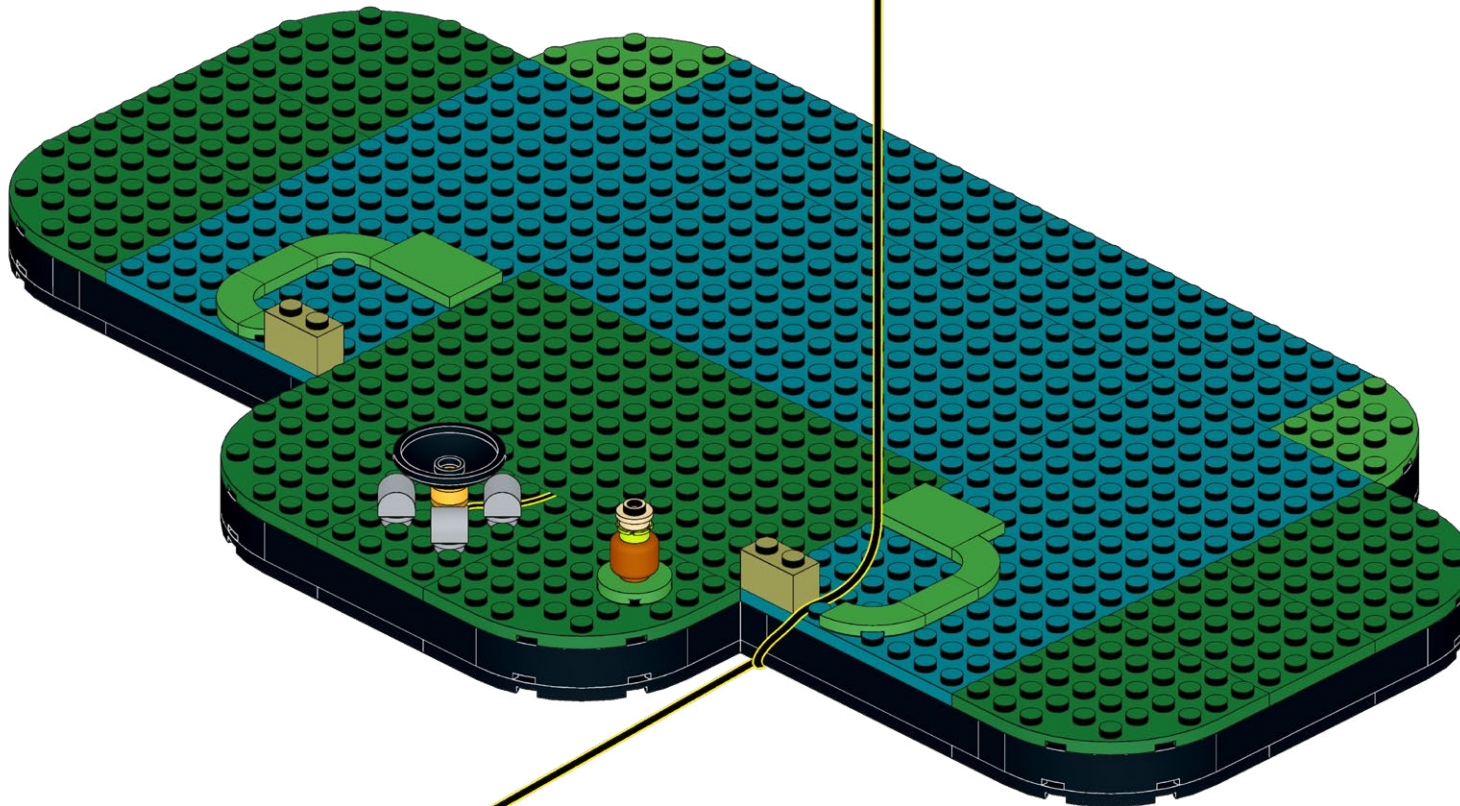

184

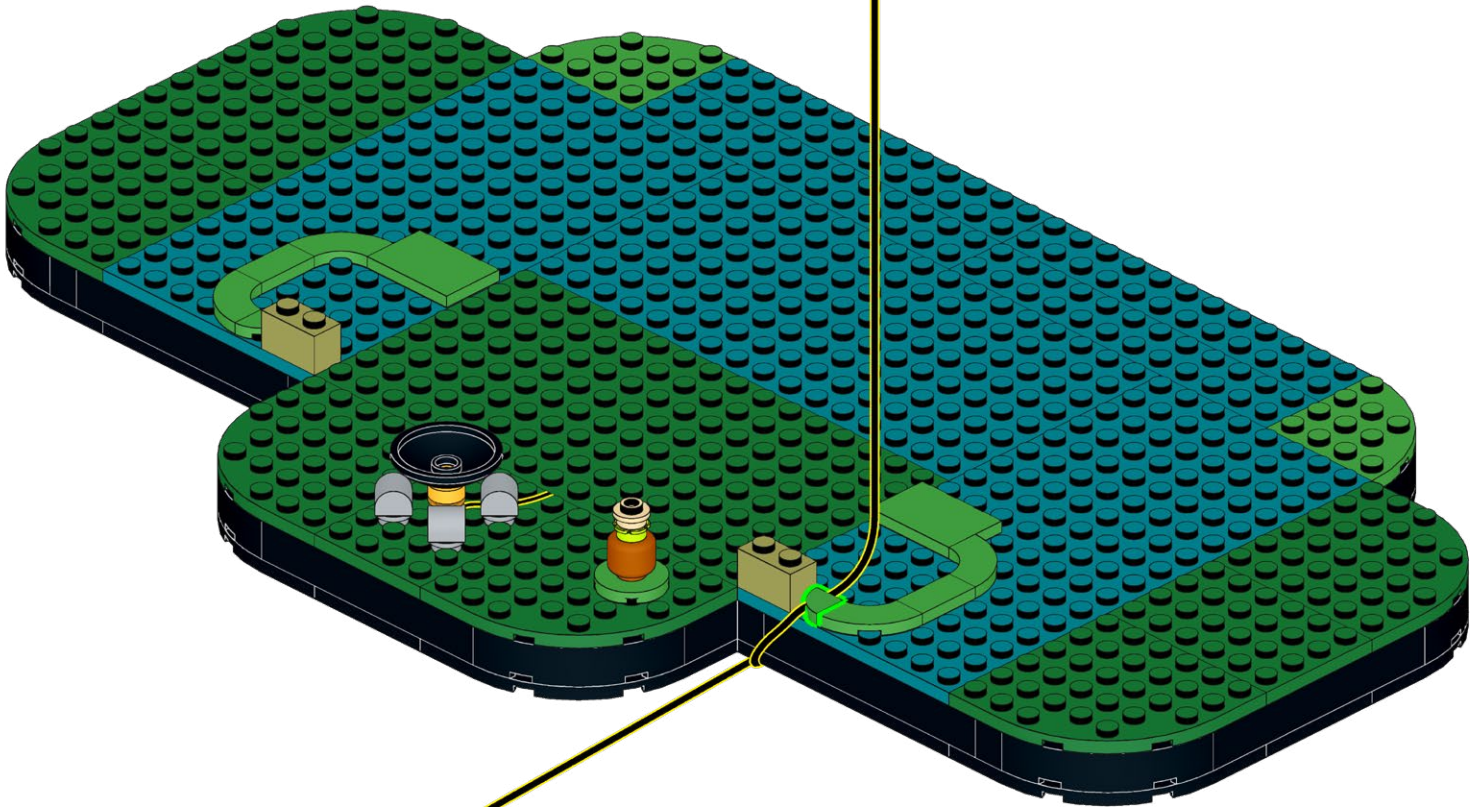
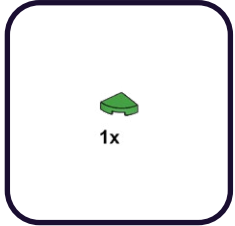

186

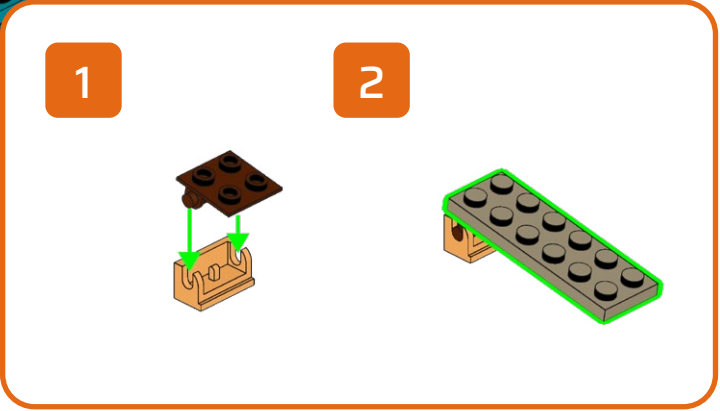
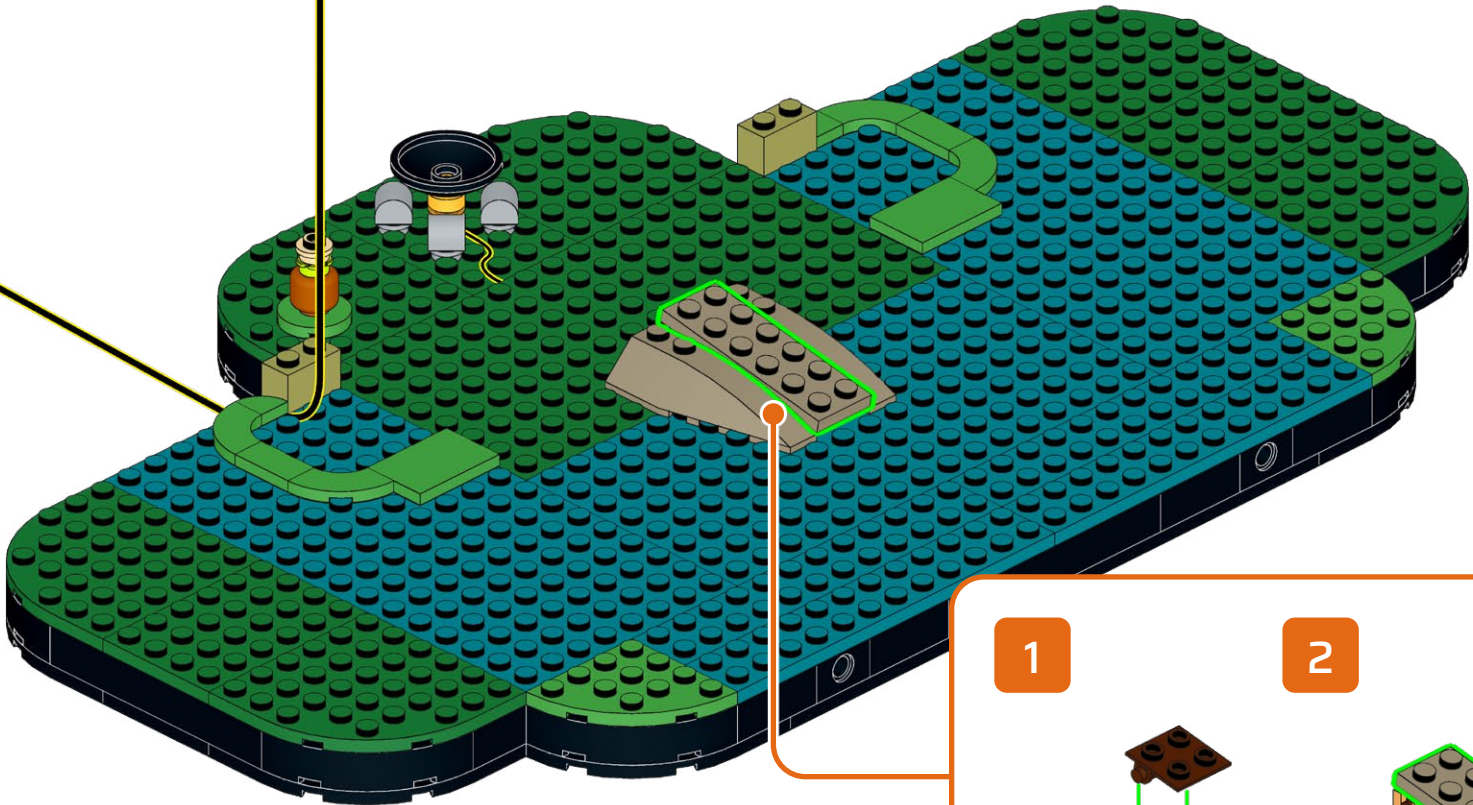
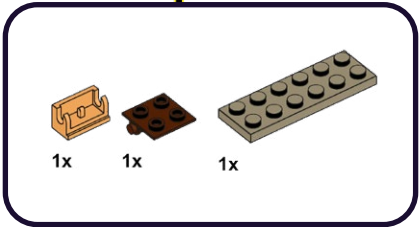

187

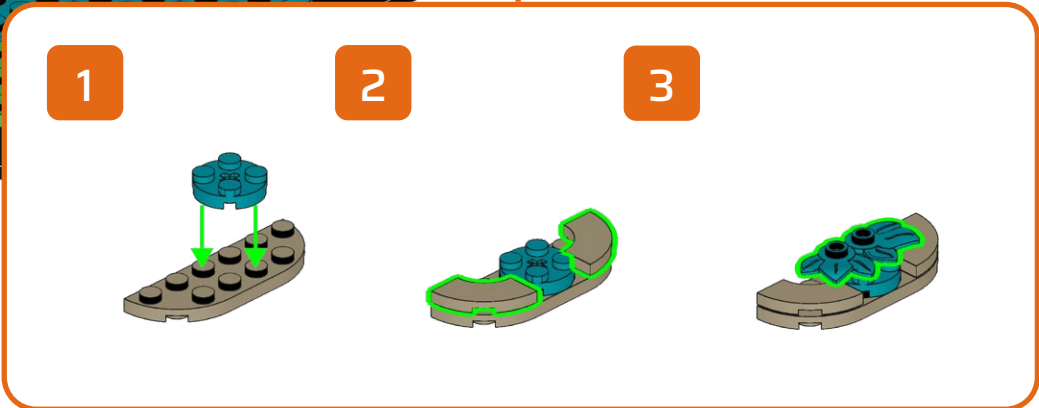
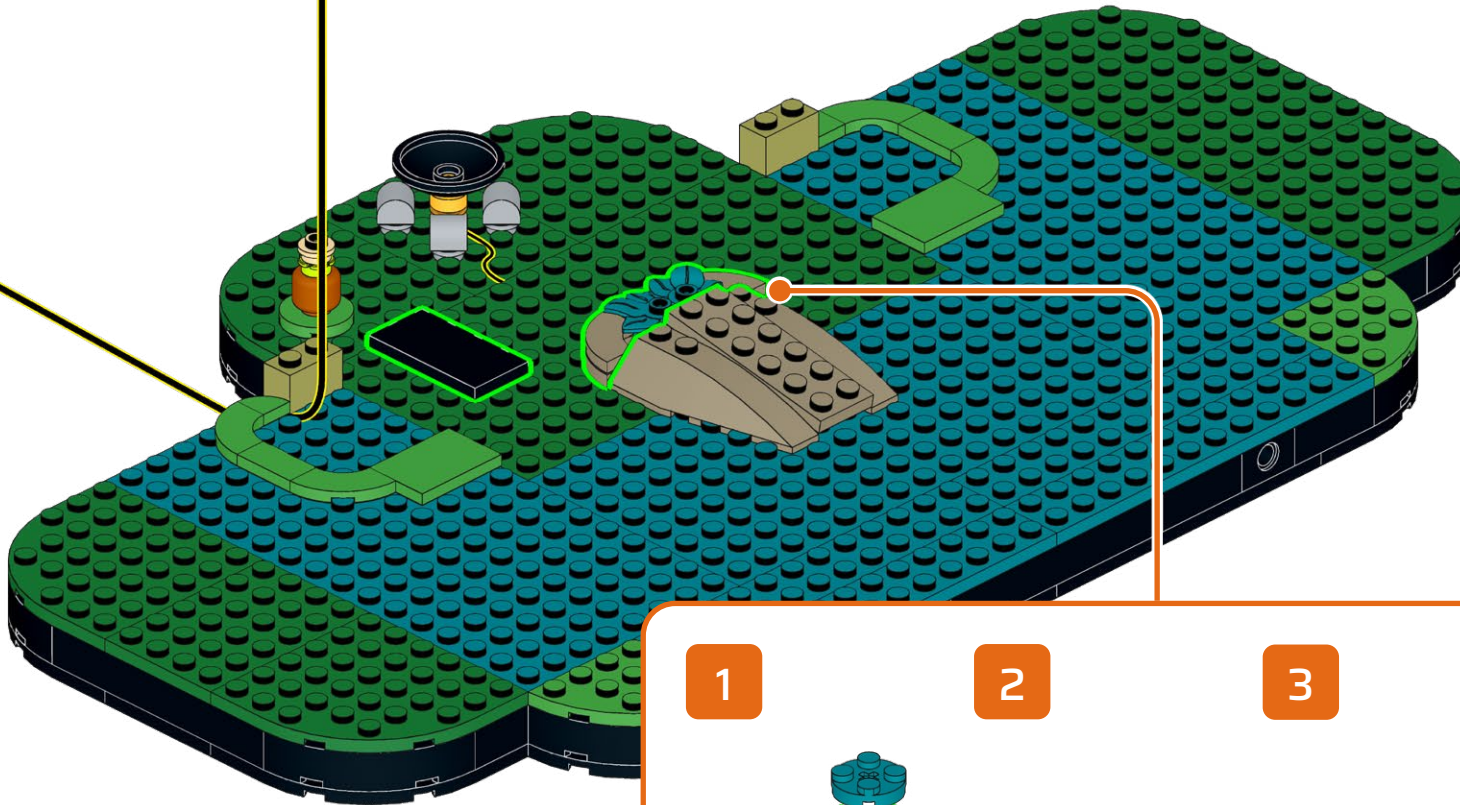
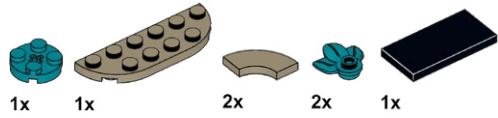

188

4x 4x

4x

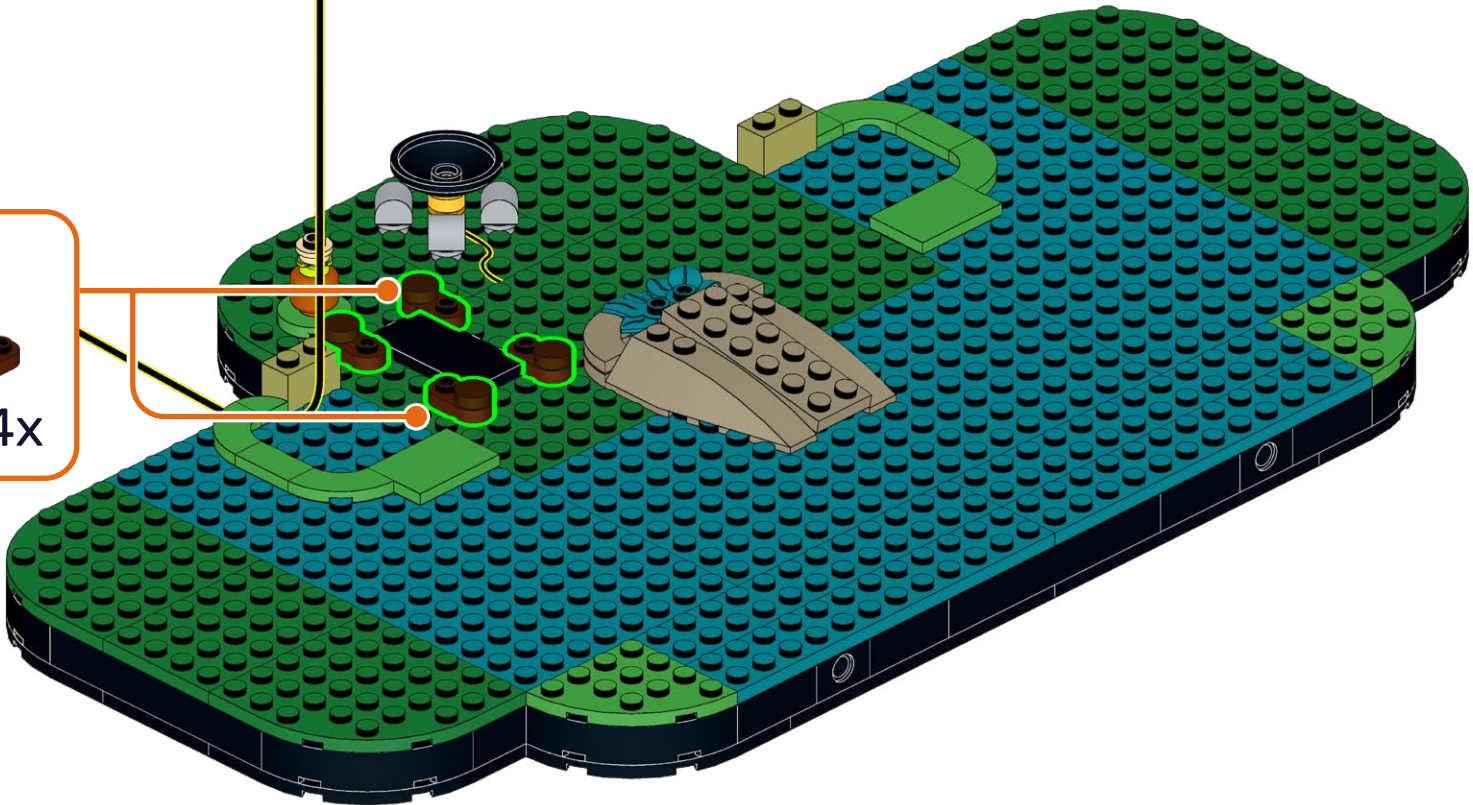

189

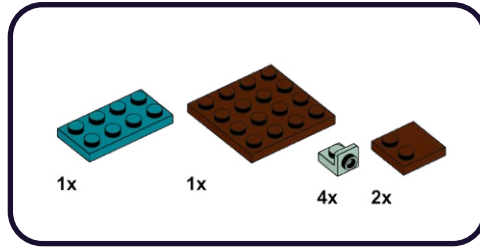

1

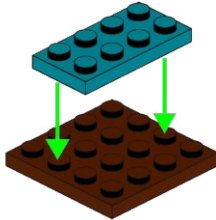

2

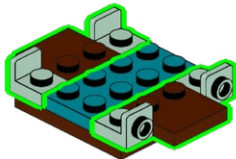

190

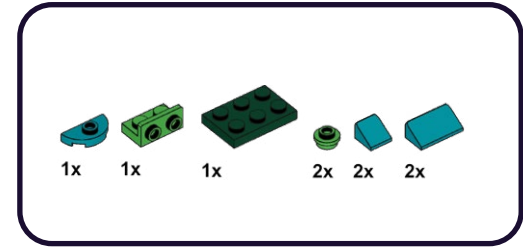

1

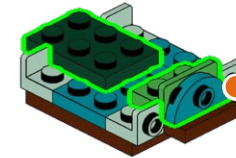
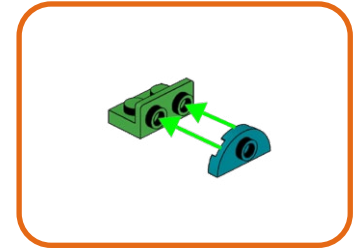

2

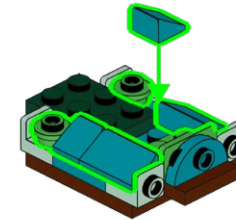

191

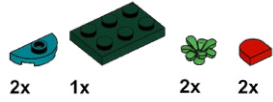

1

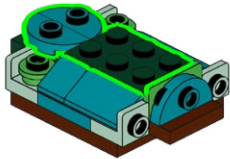

2

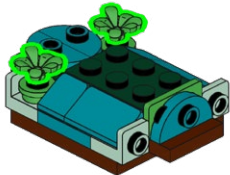

3

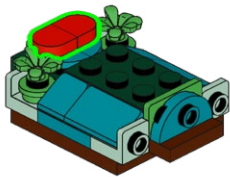

192



1

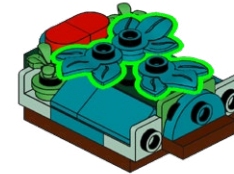

2

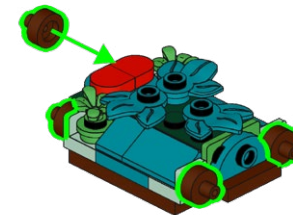

3

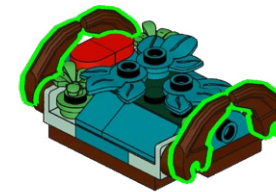

193

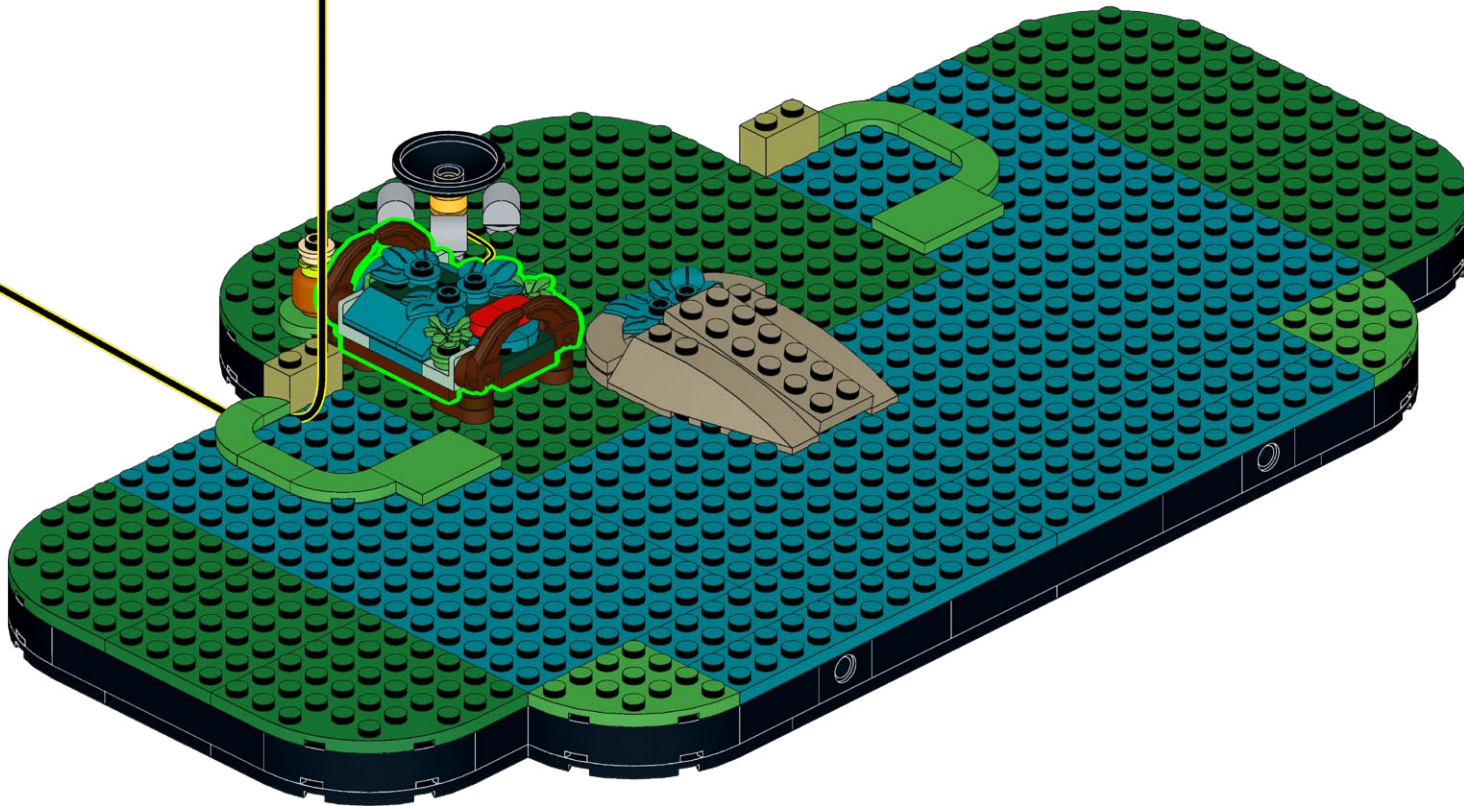

194

1x 1x 3x

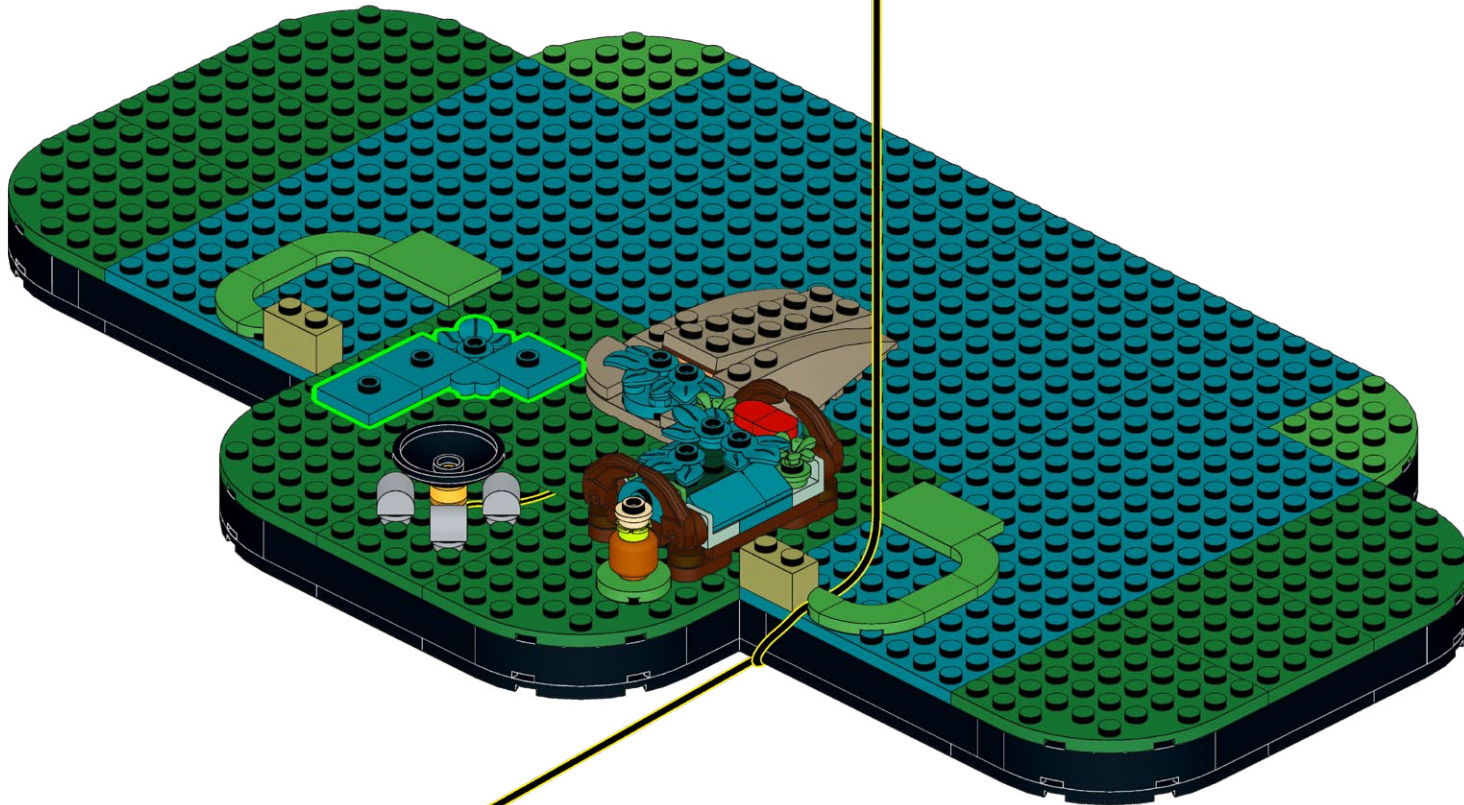

195

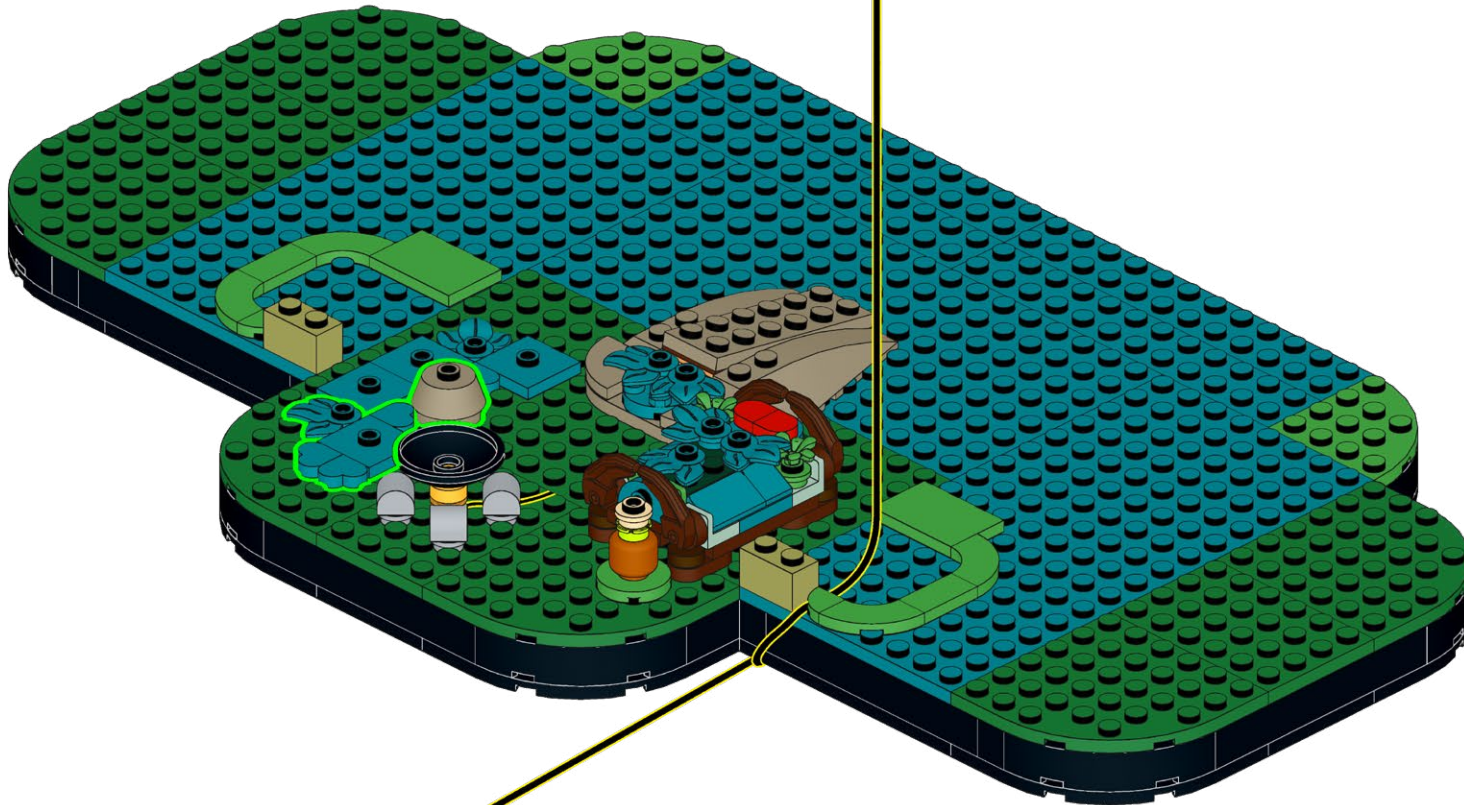
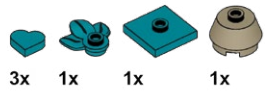

196

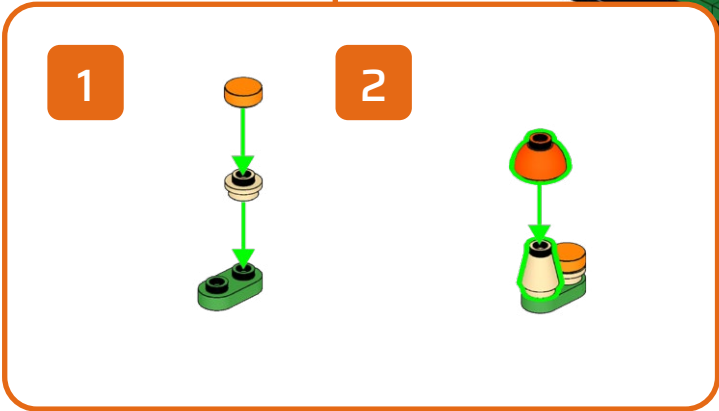
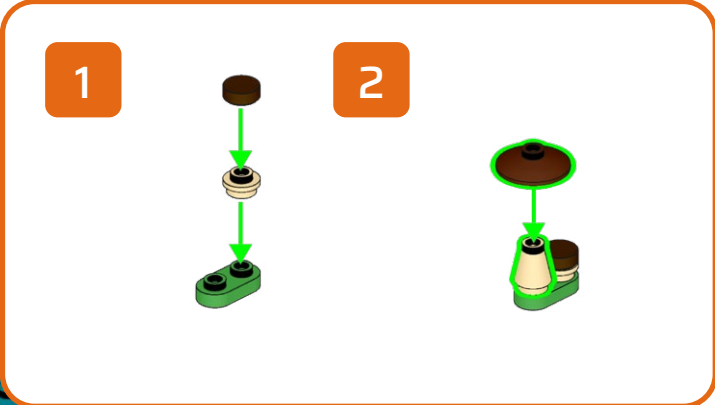
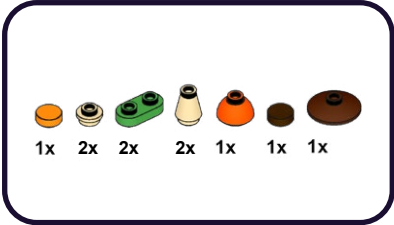

197

1x 2x 2x 2x 1x 1x 1x

1

2

1

2

198

- 1x [Grey Pin]
- 1x [Grey Technic Connector]
- 1x [Grey Technic Brick]
- 1x [Green Technic Leaf]
- 1x [Reddish-brown Technic Piece]

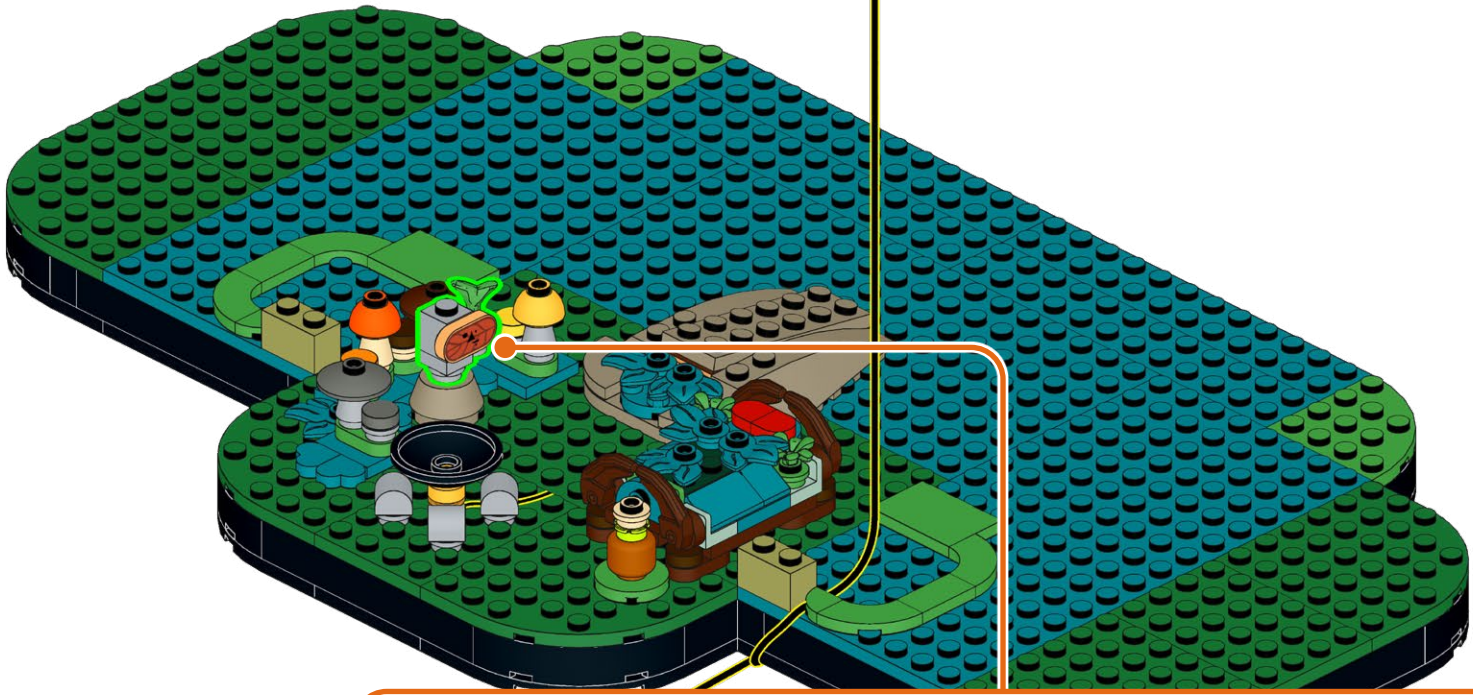

1 2 3 4

-
-
-
-

199

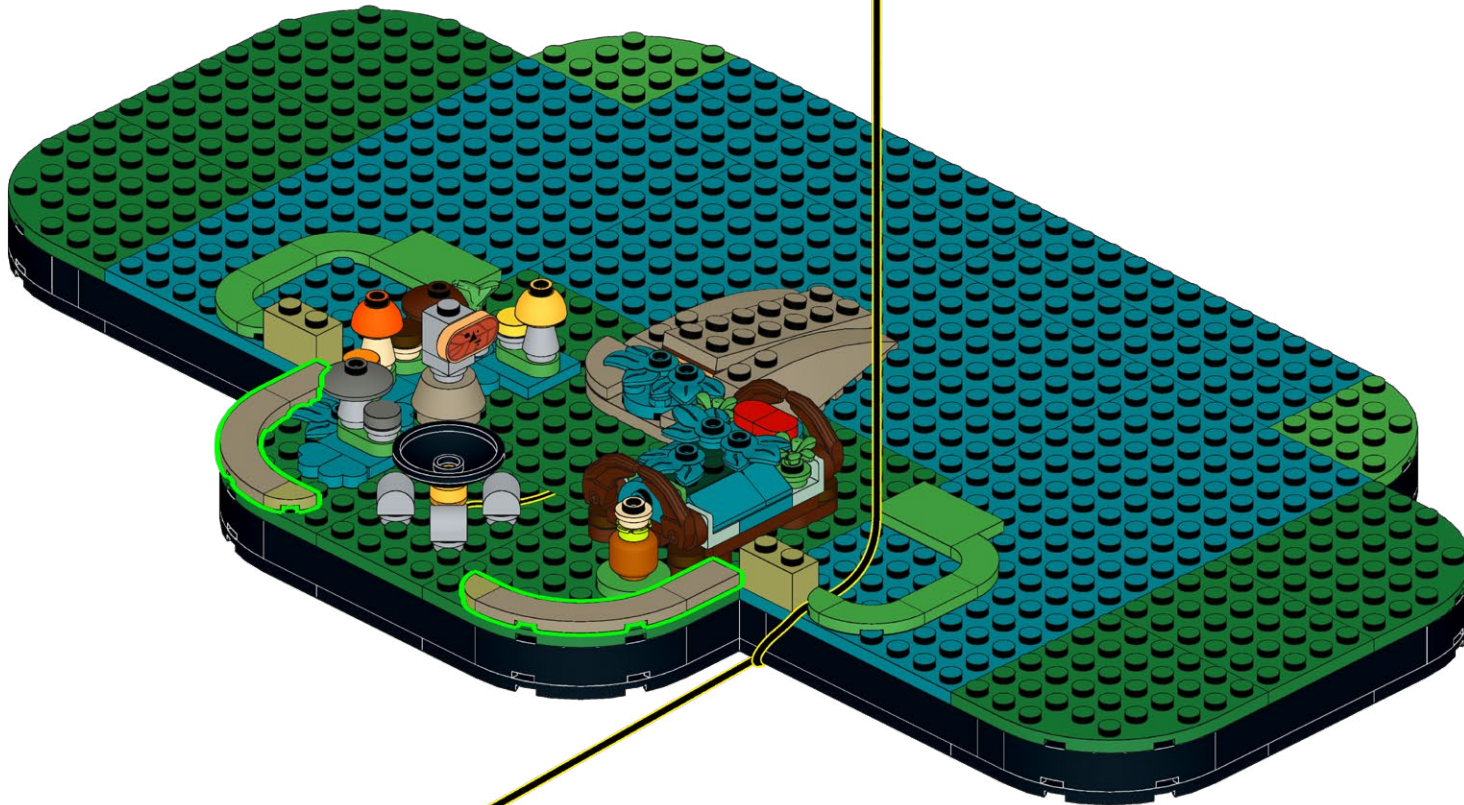
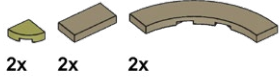

200

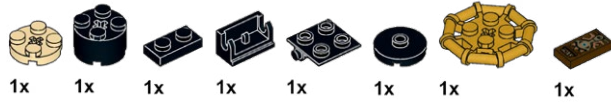

1

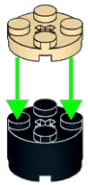

2

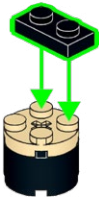

3

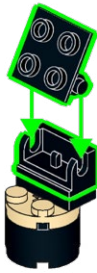

4

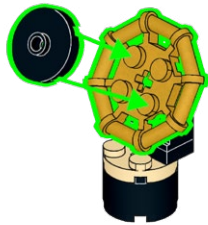

5



201

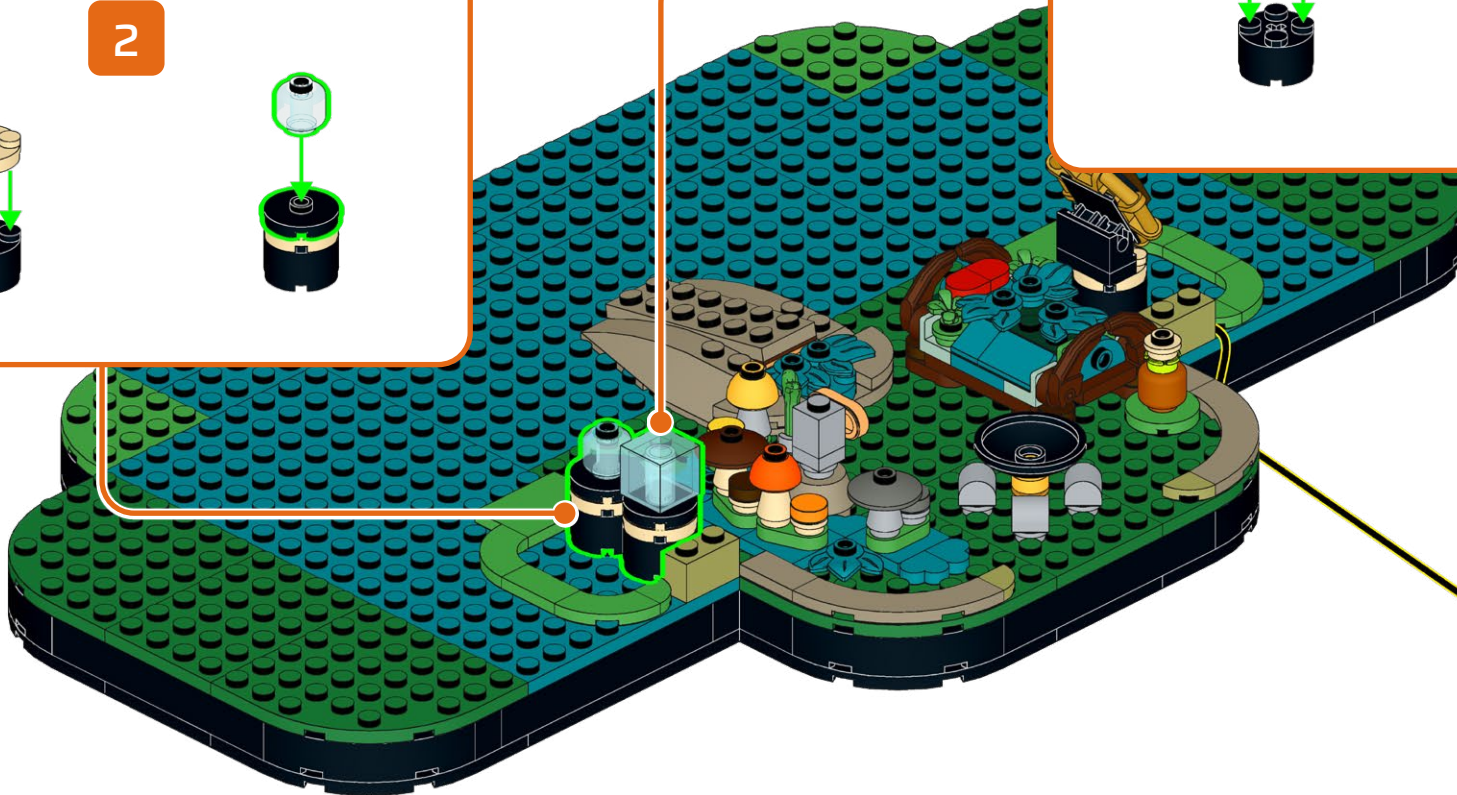
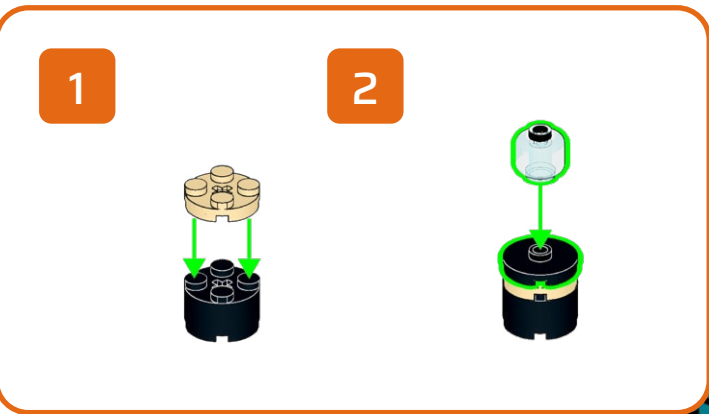
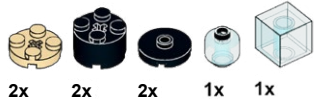

202

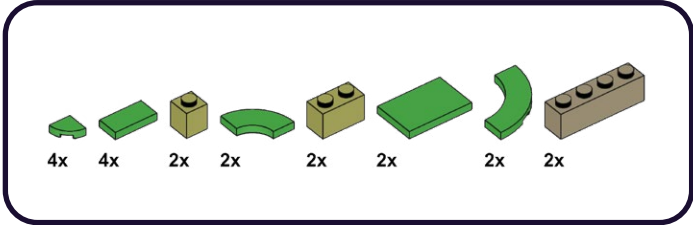

203

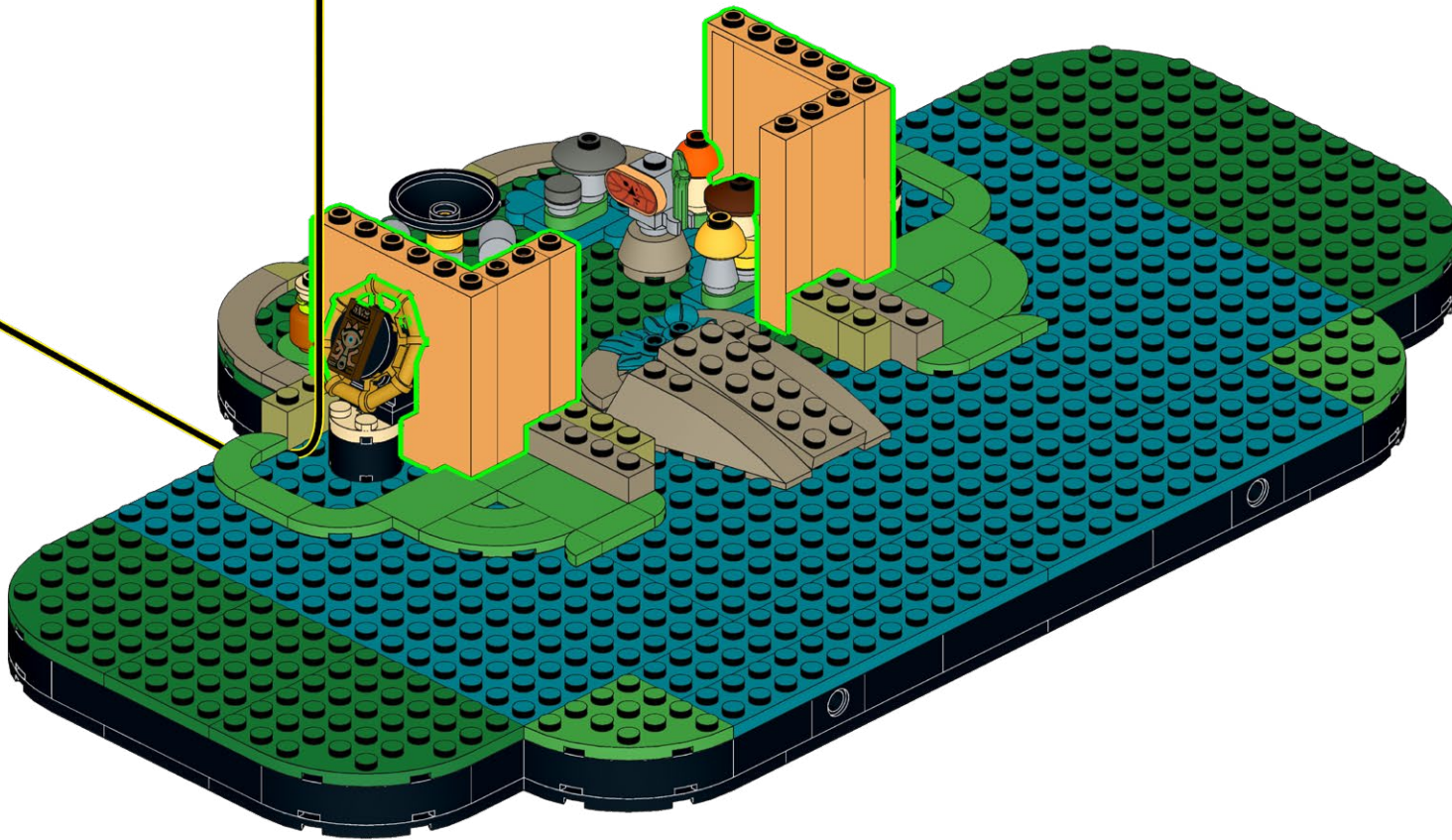
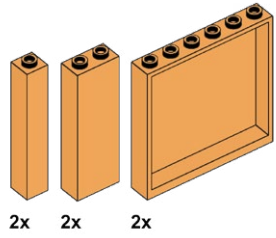

204

2x 4x



2x

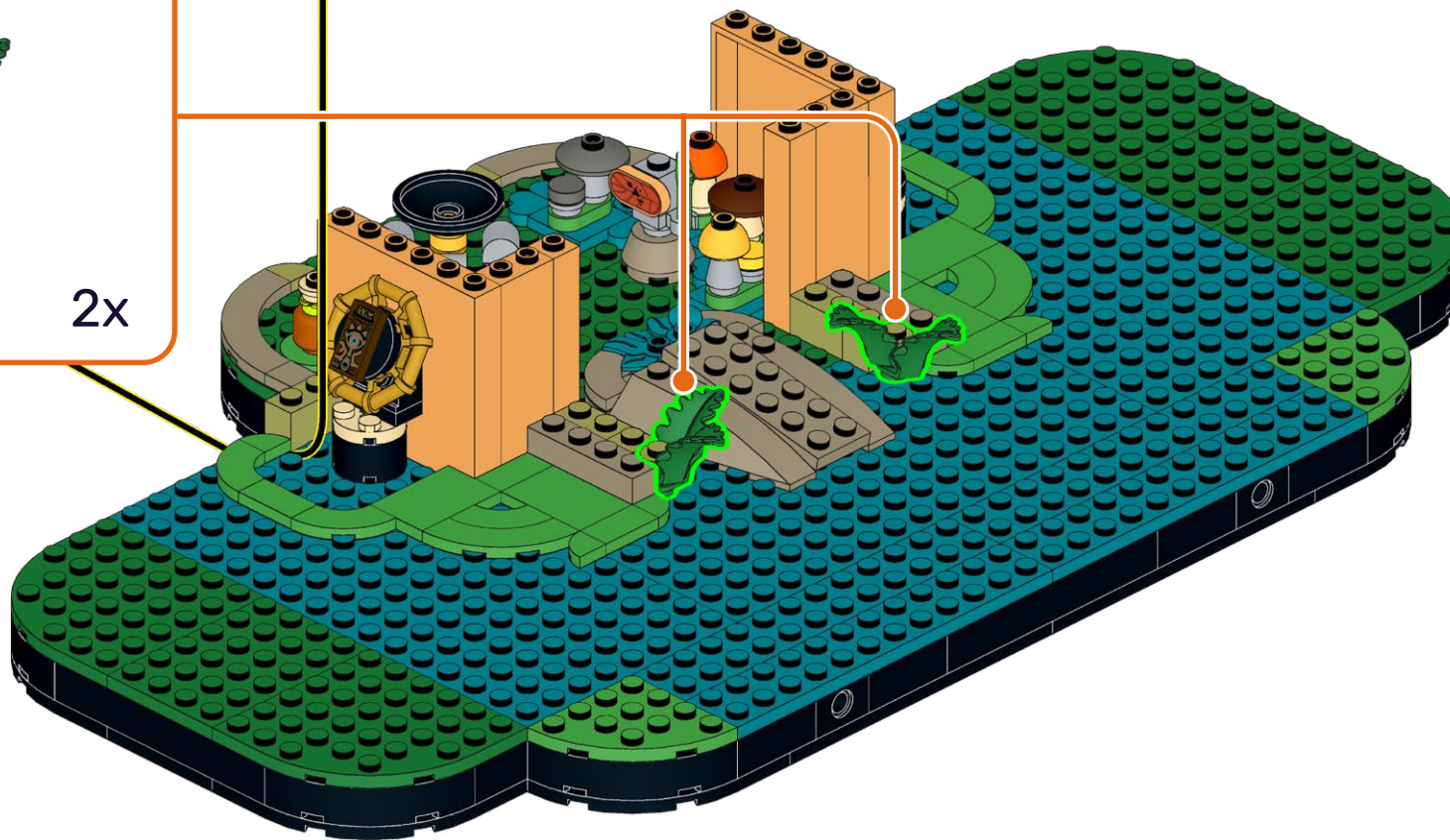

205

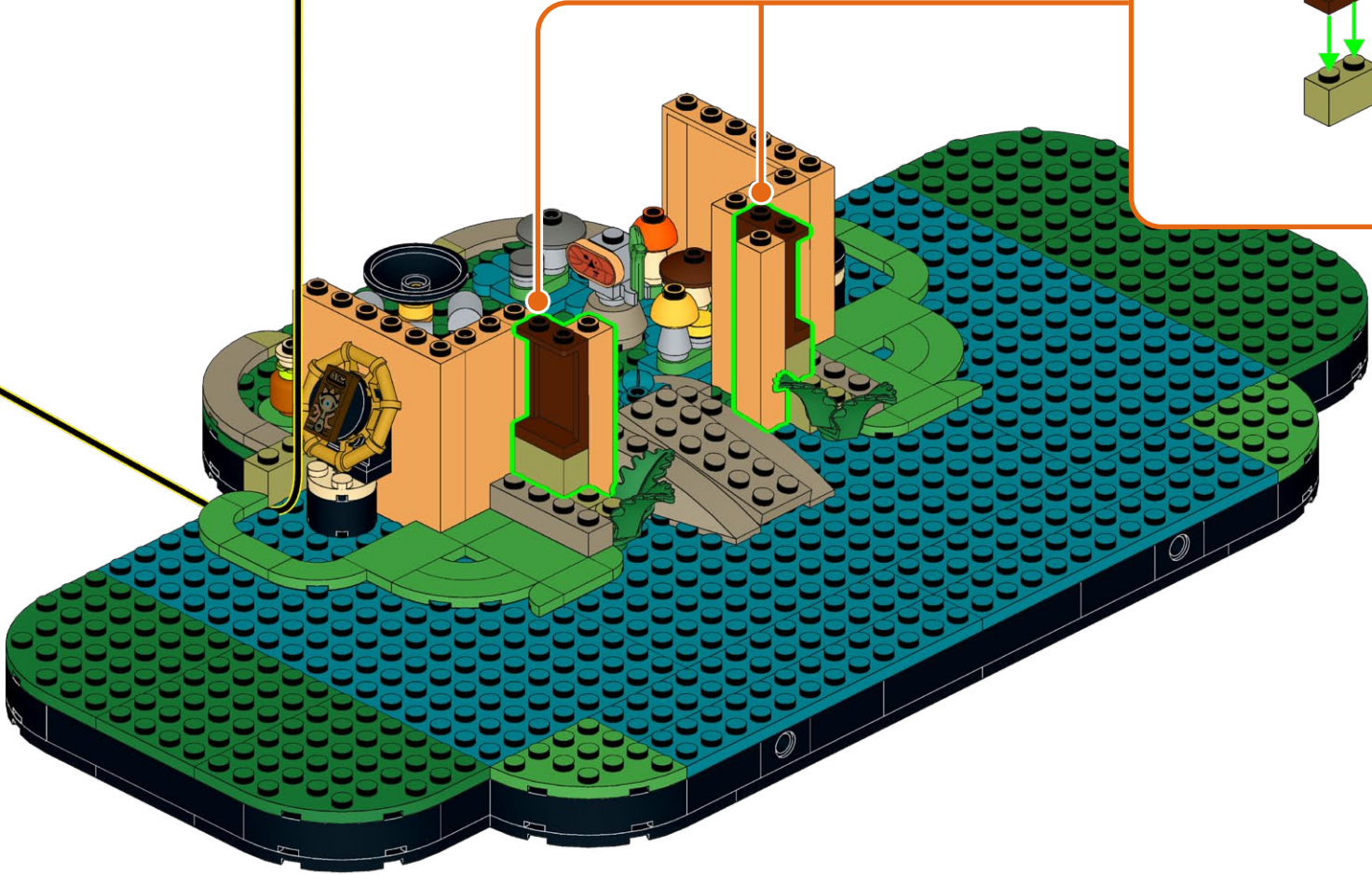
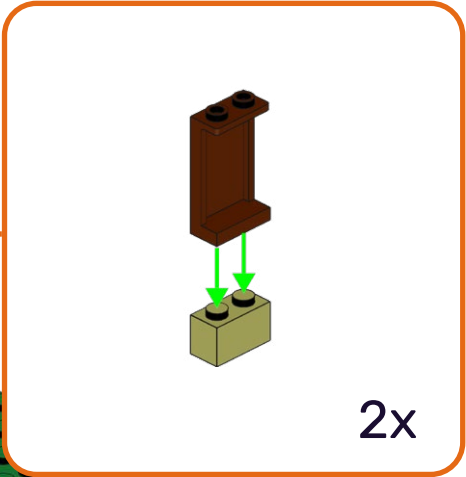
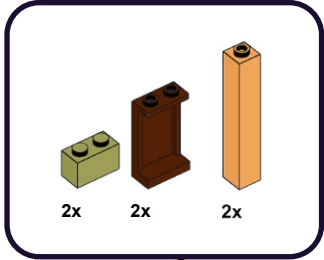

206

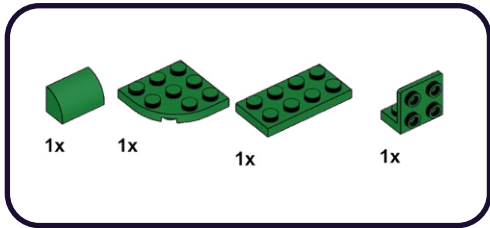

1

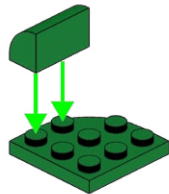

2

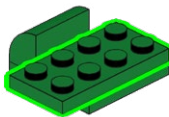

3

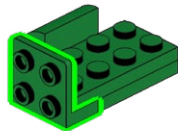

207

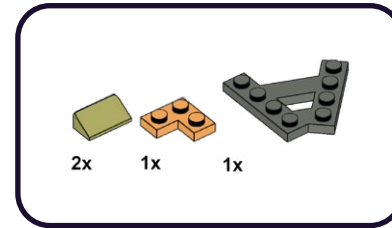

1

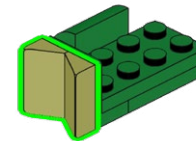

2

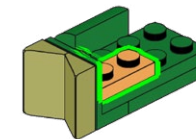

3

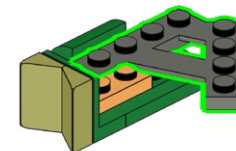

208

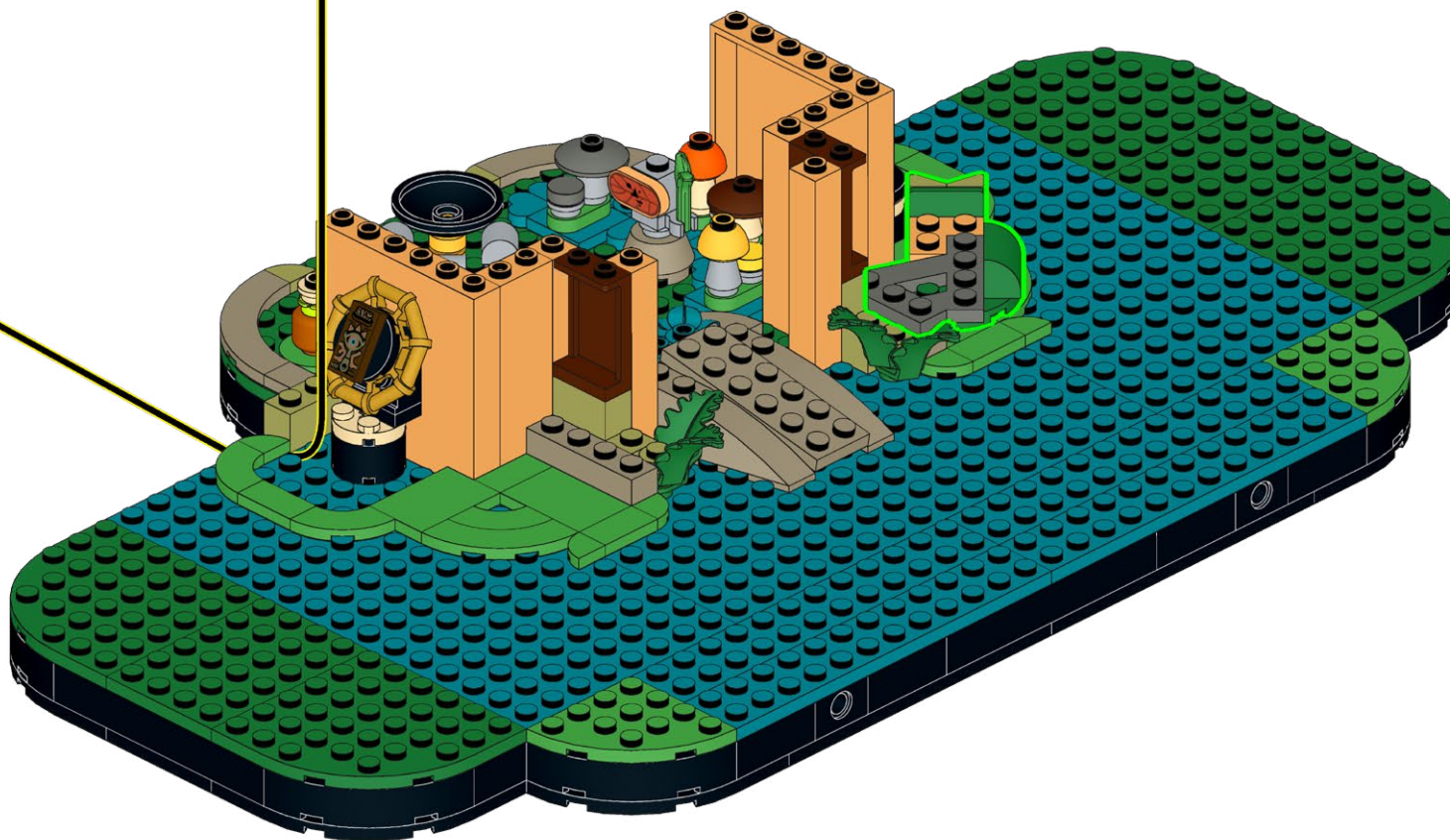

209

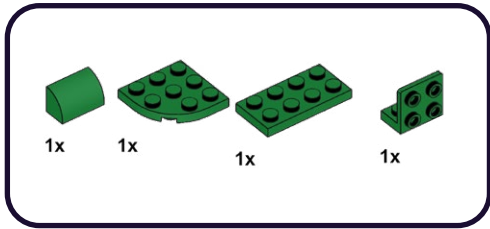

1

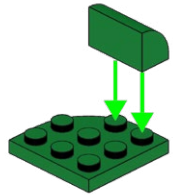

2

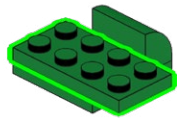

3

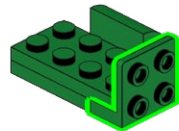

210

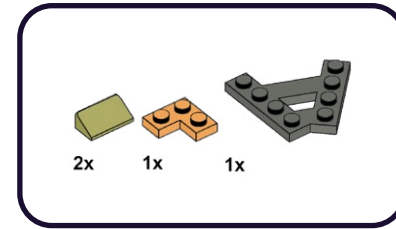

1

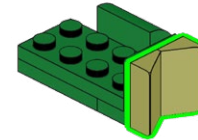

2

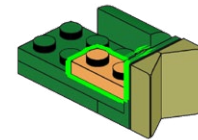

3

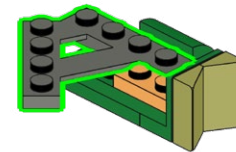

211

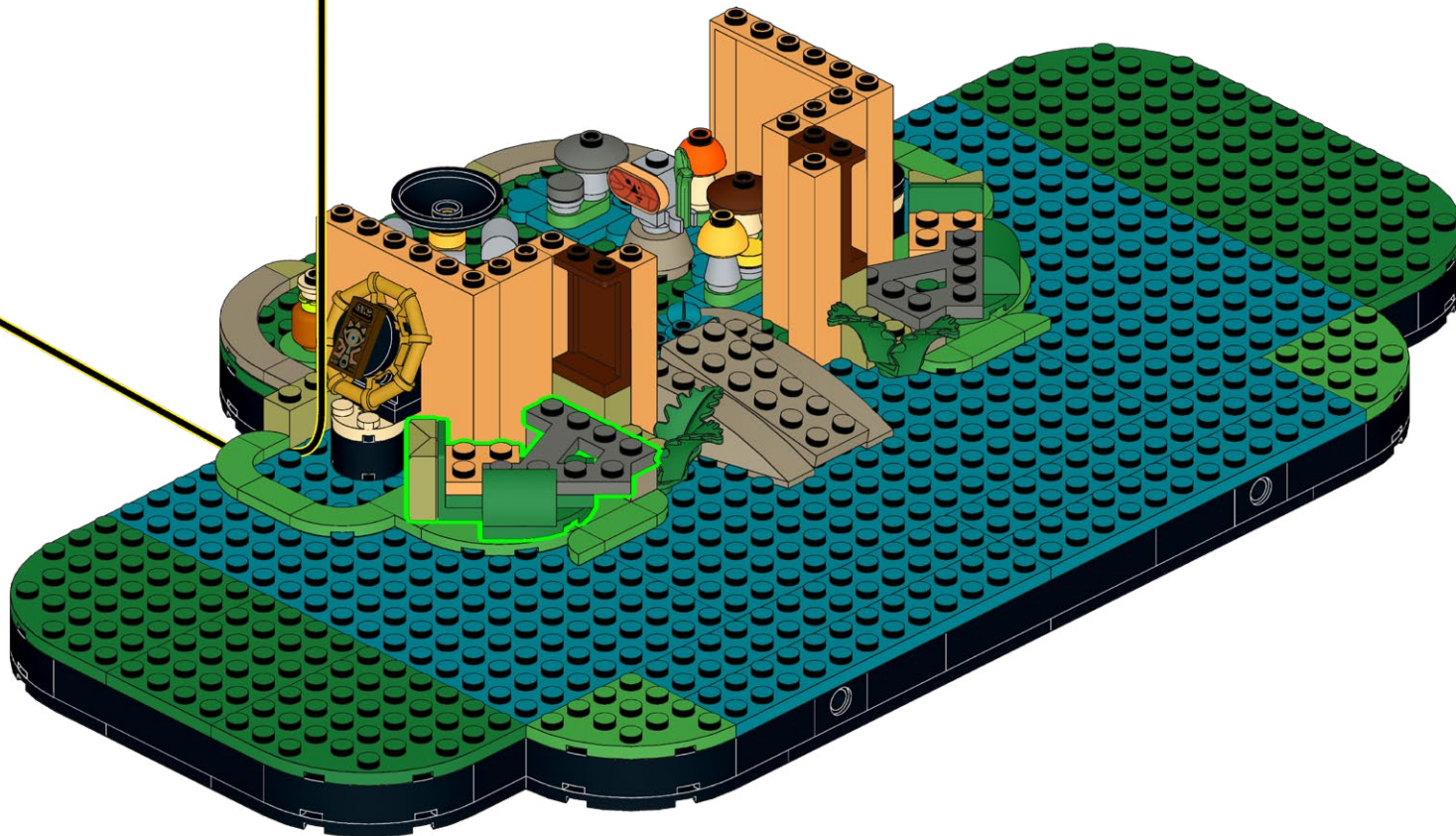

212

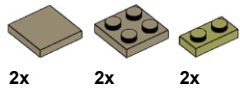

1

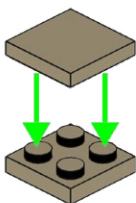

2

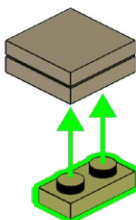

2x

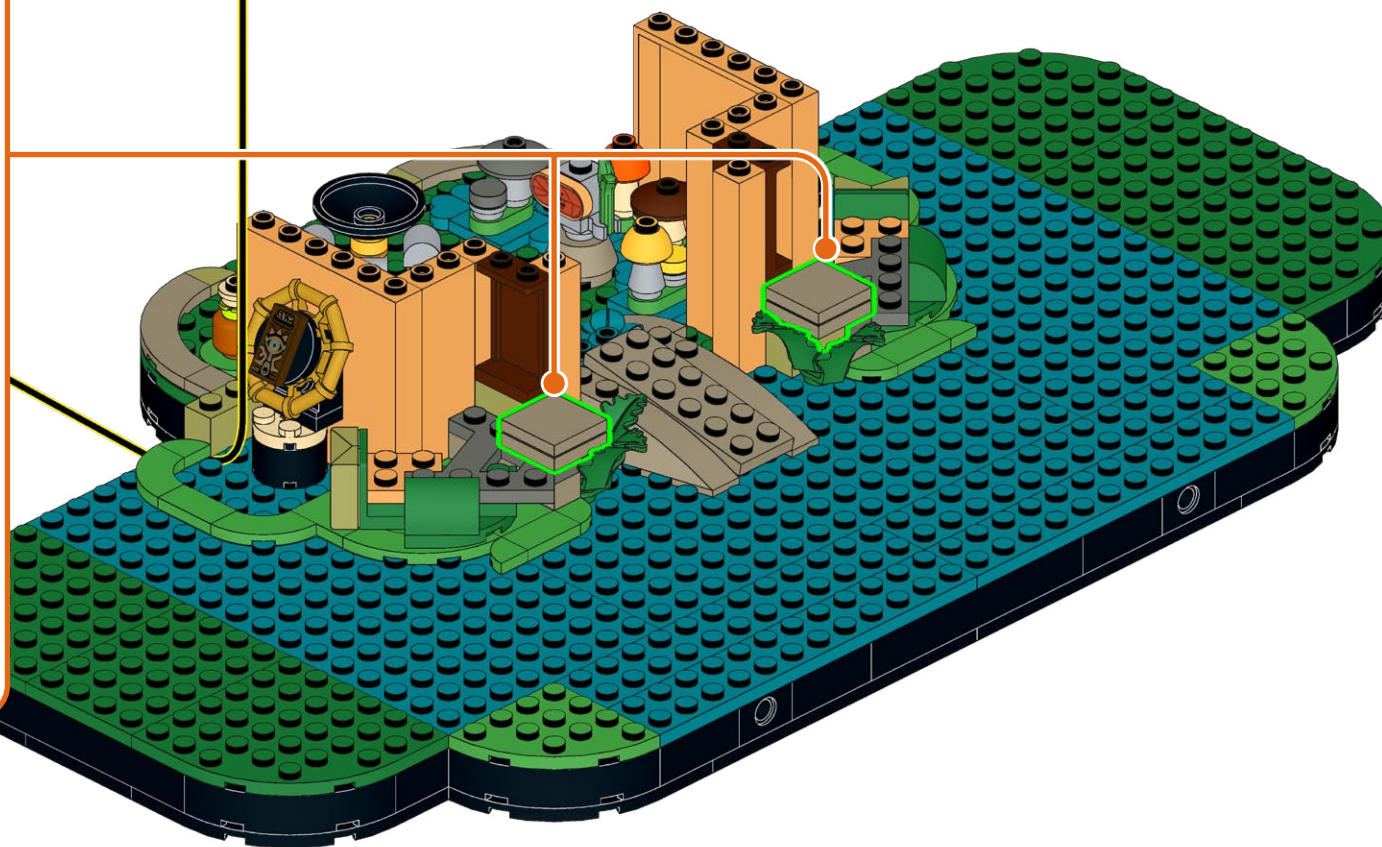

213

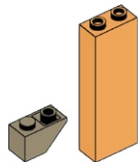

2x

2x

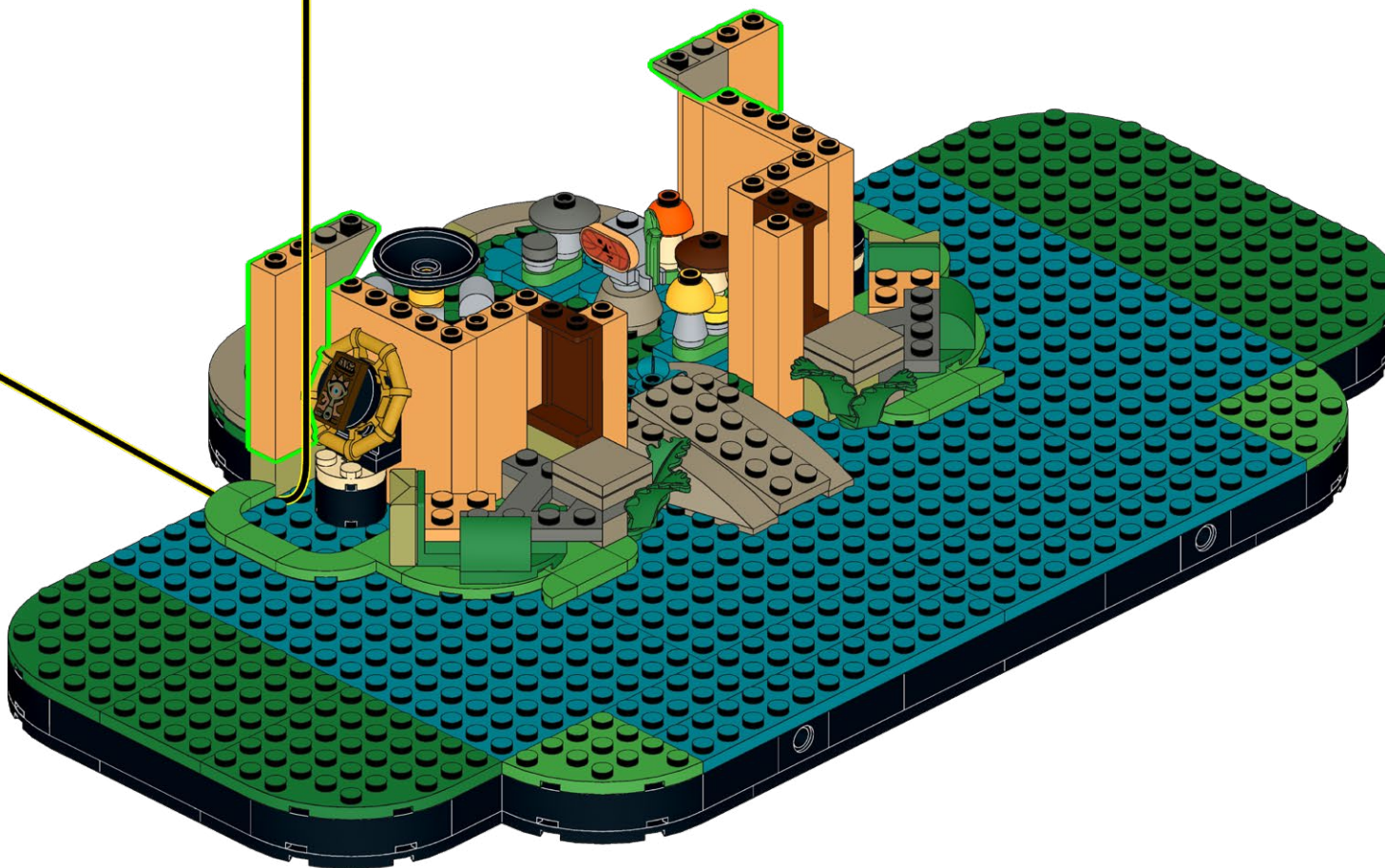

214

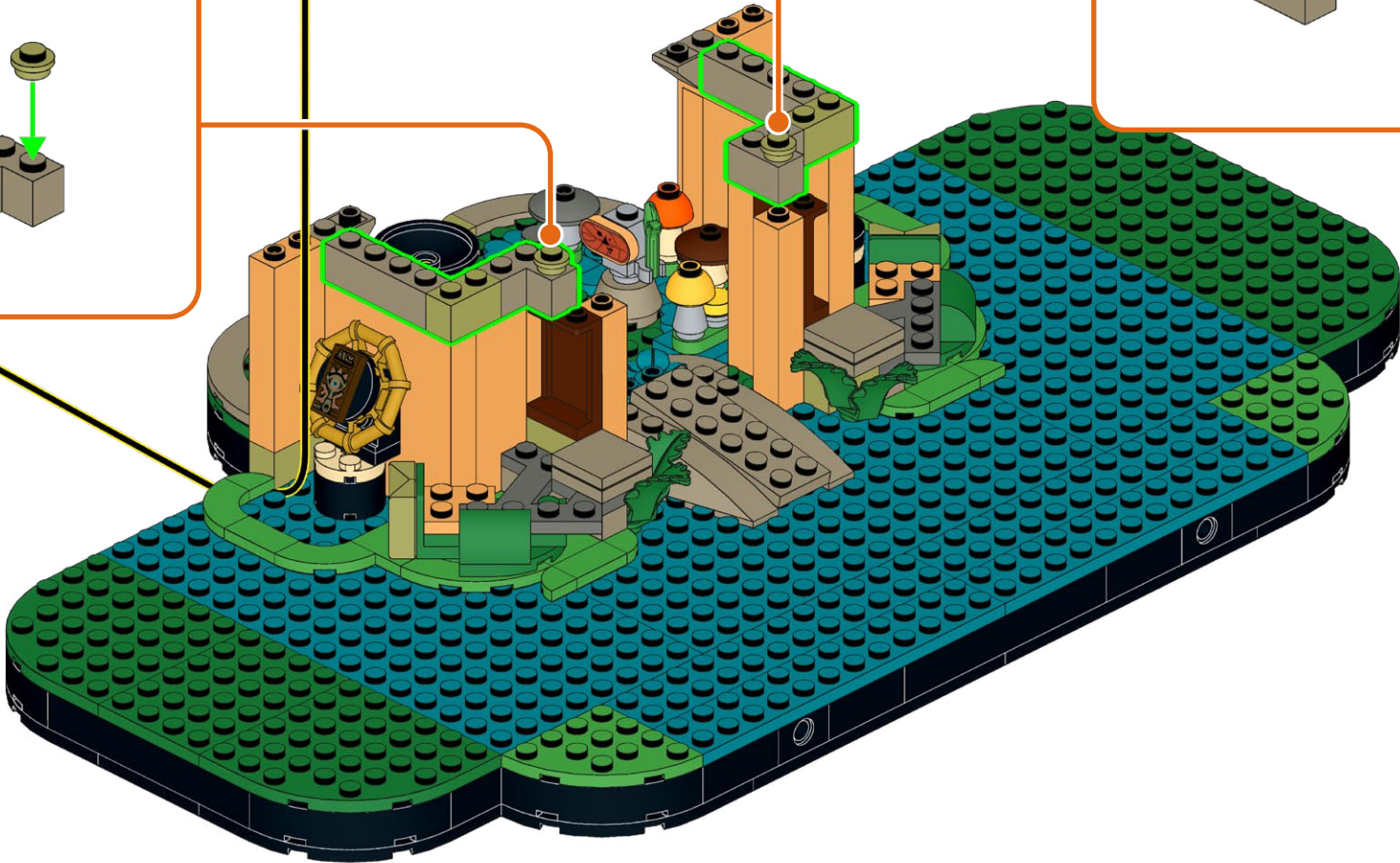
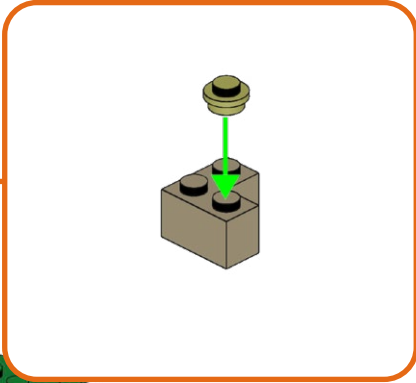
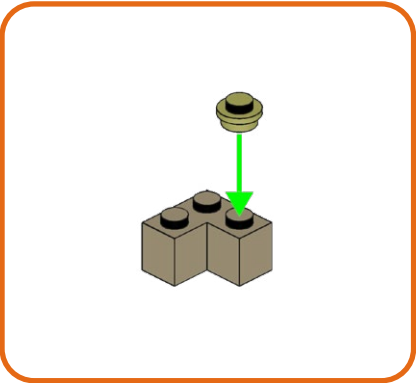
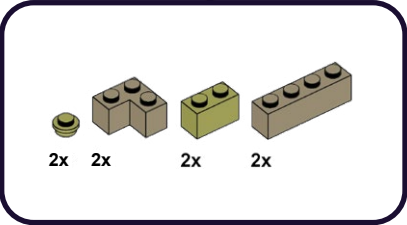

215

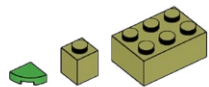

2x 2x 4x

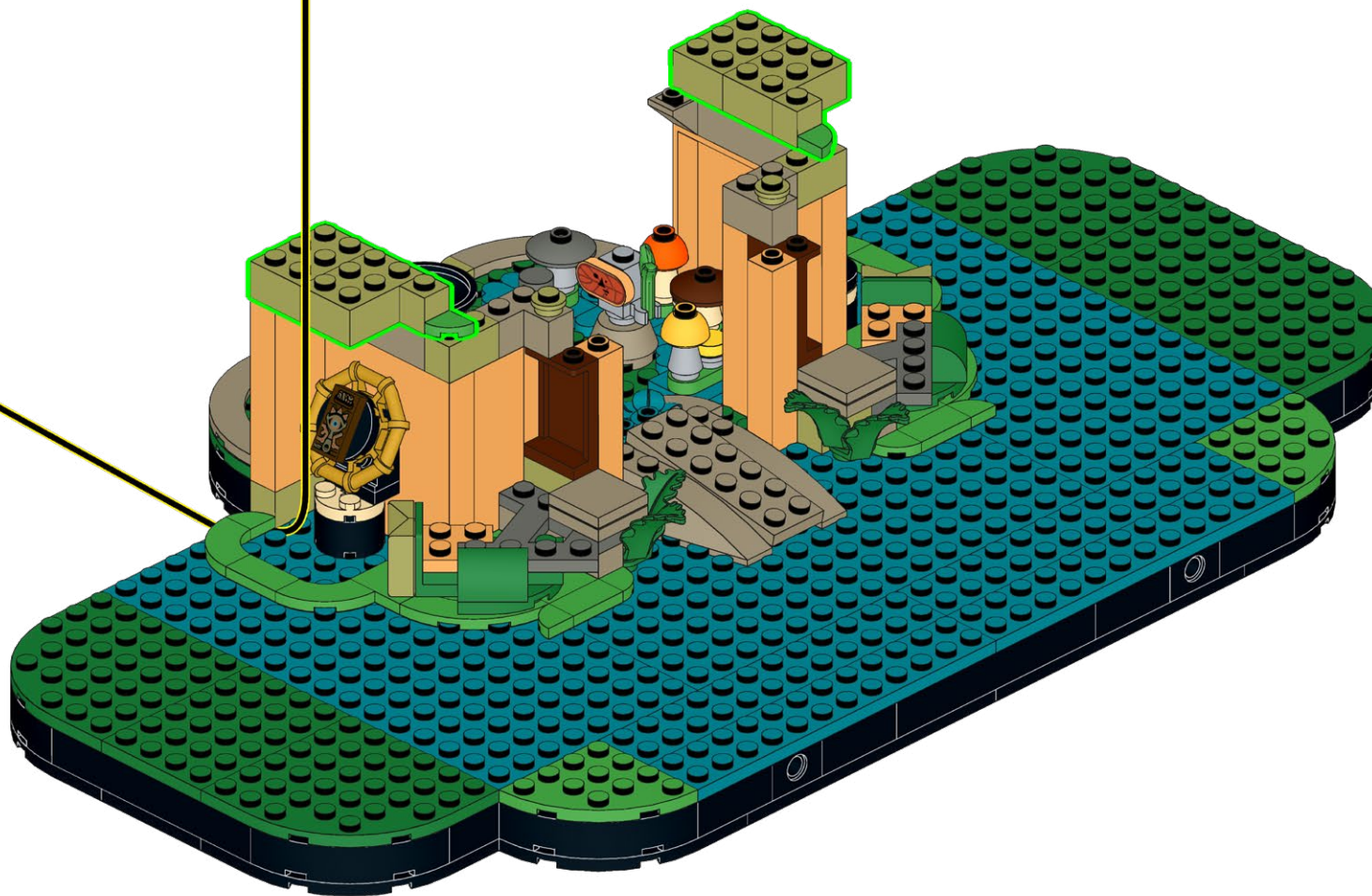

216

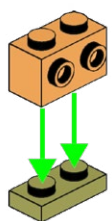
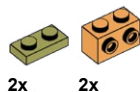

2x

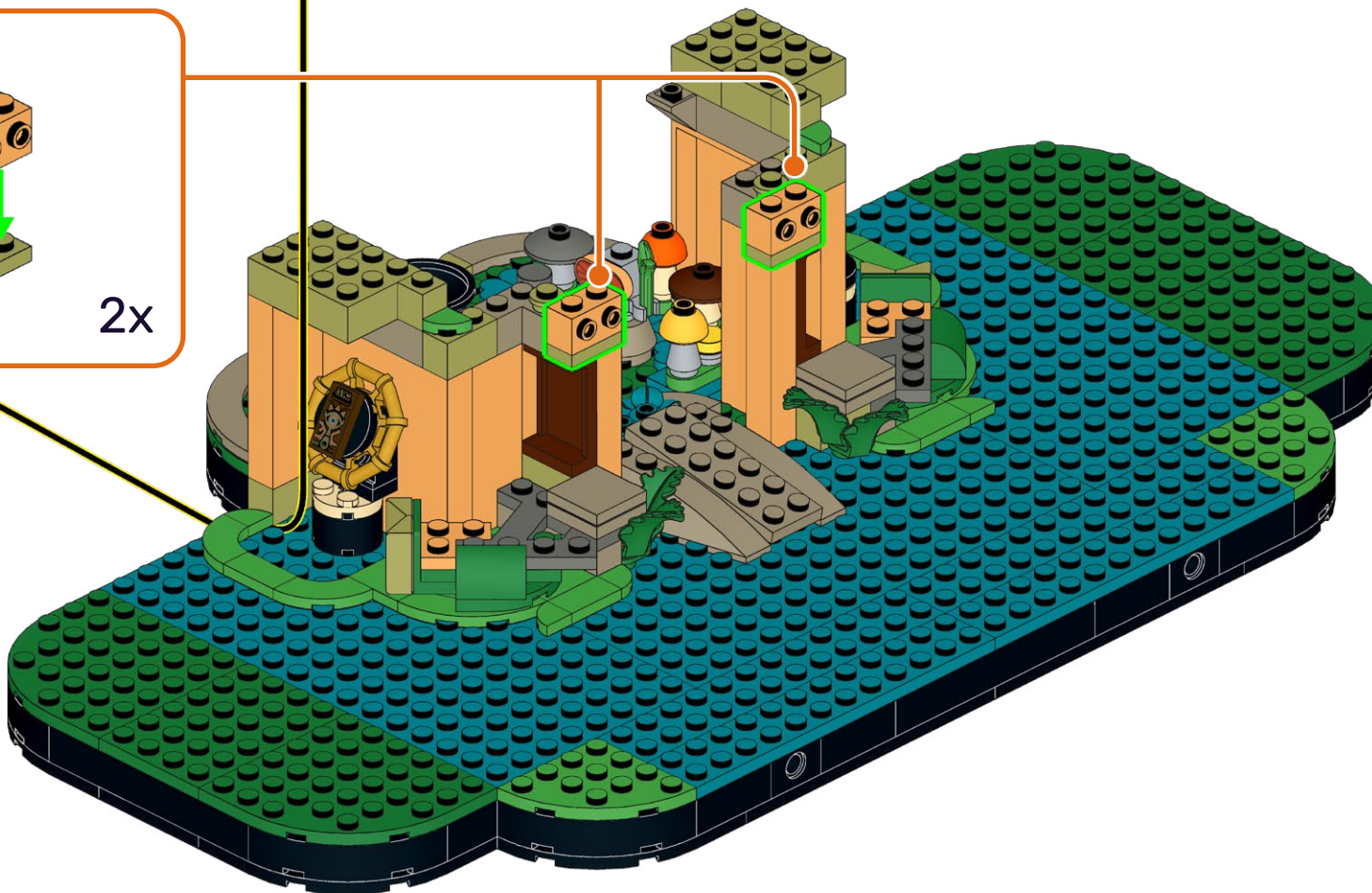

217

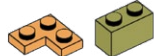

2x

2x

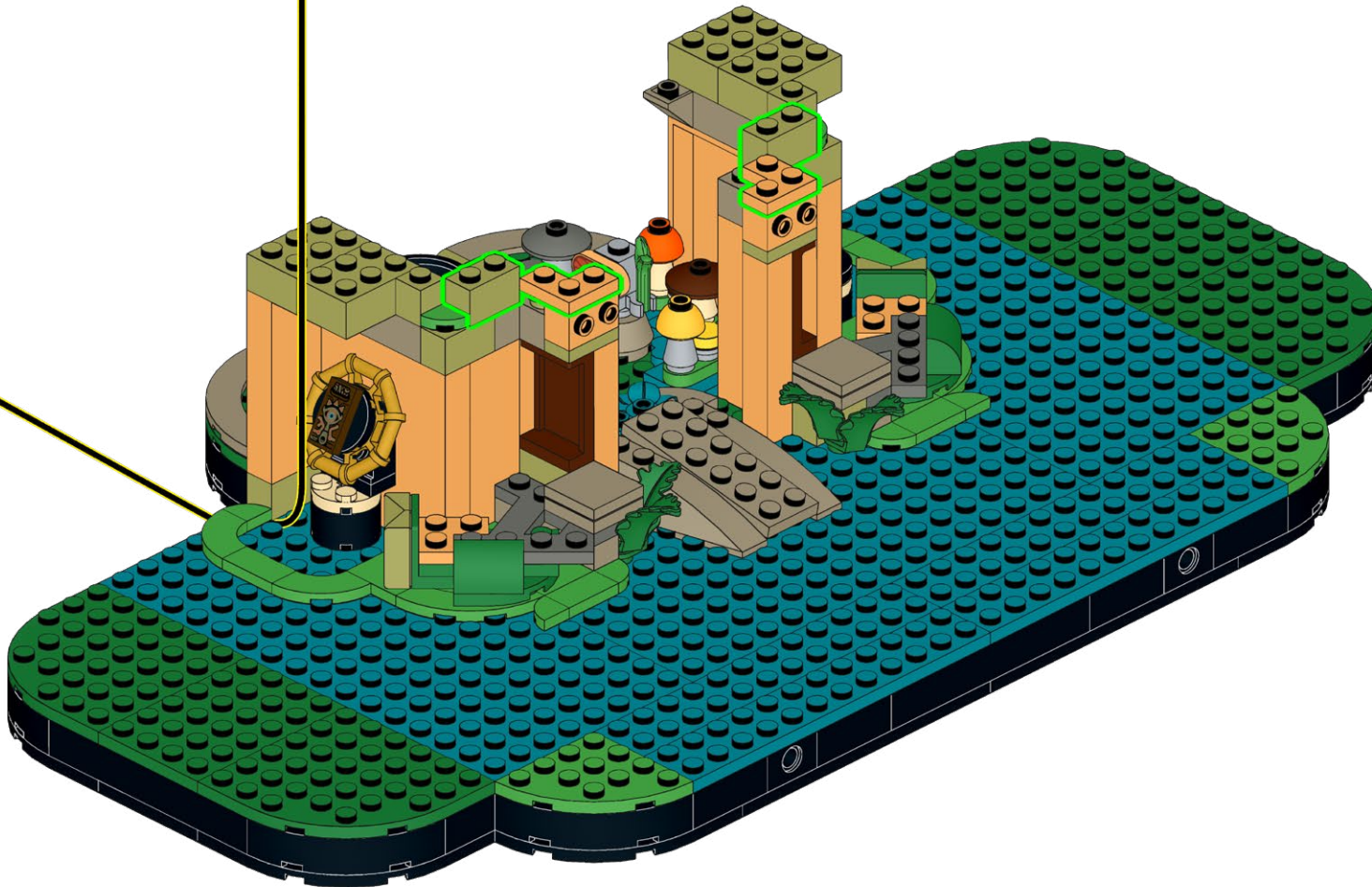

218

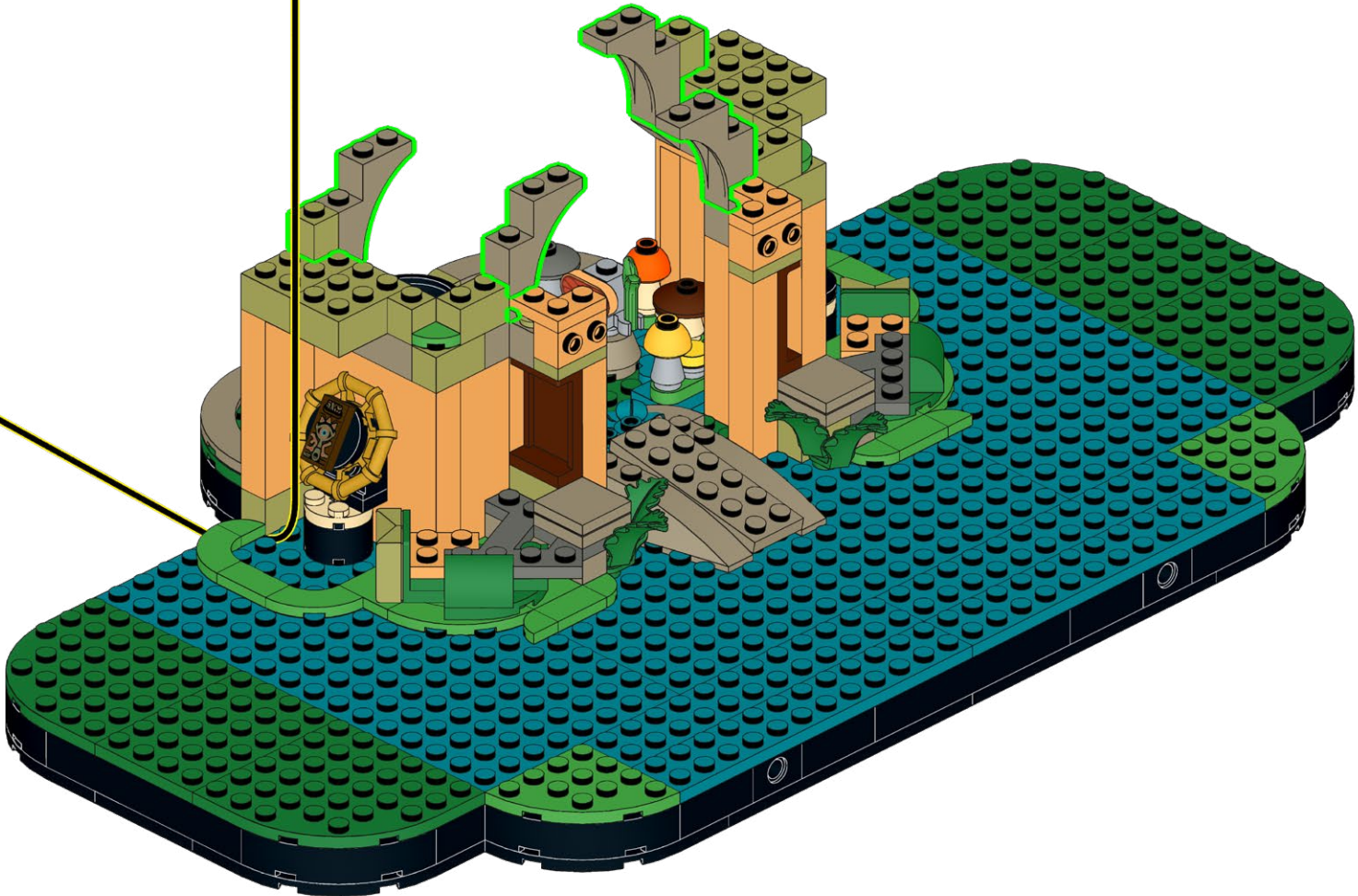
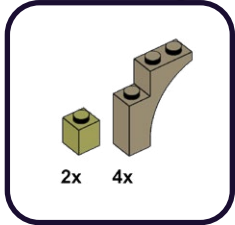

219

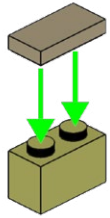
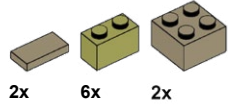

2x

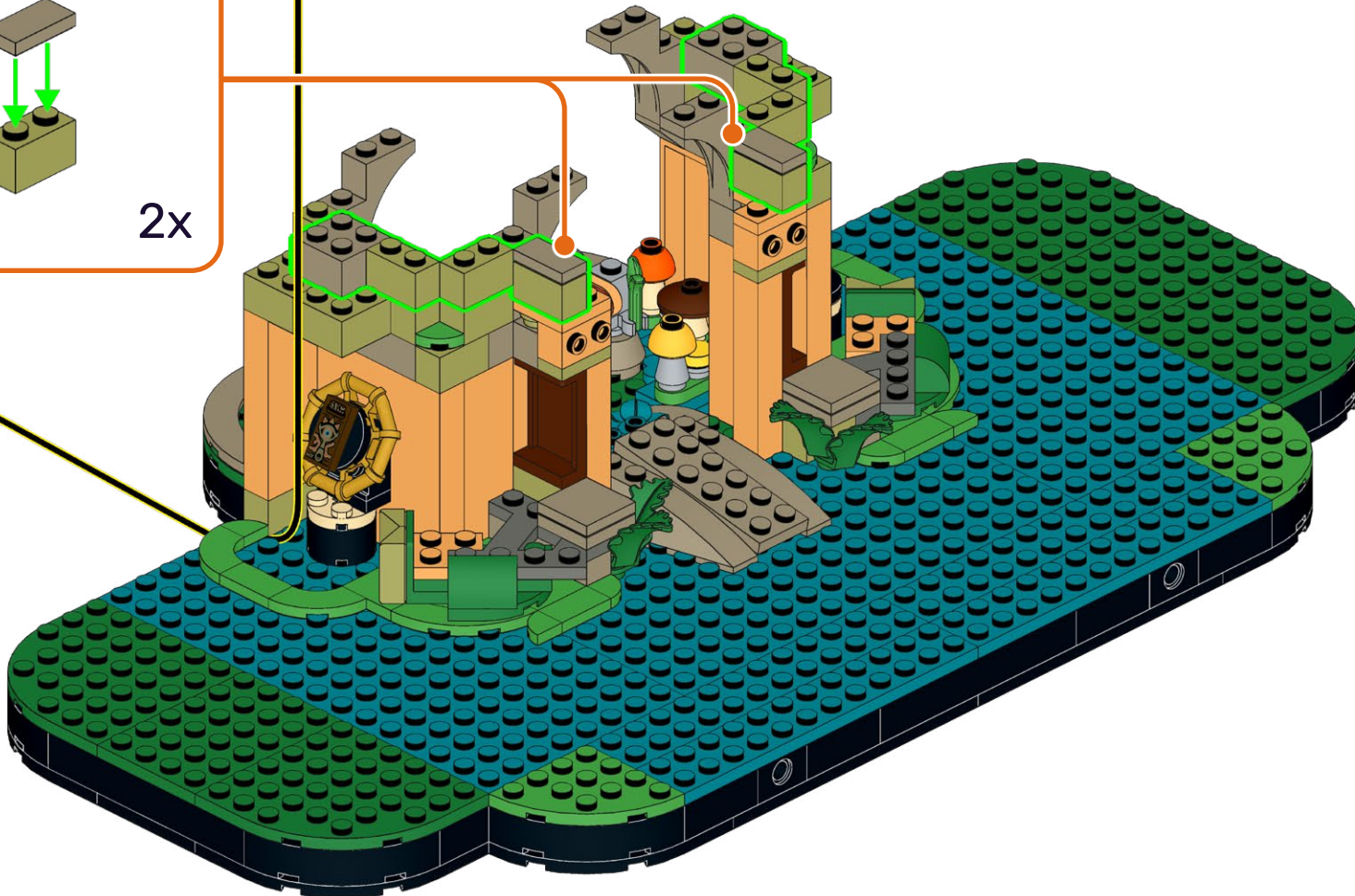

220

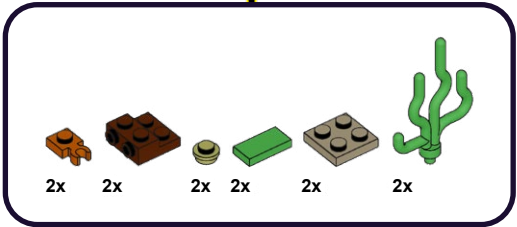

1

2

3

4

1

2

3

4

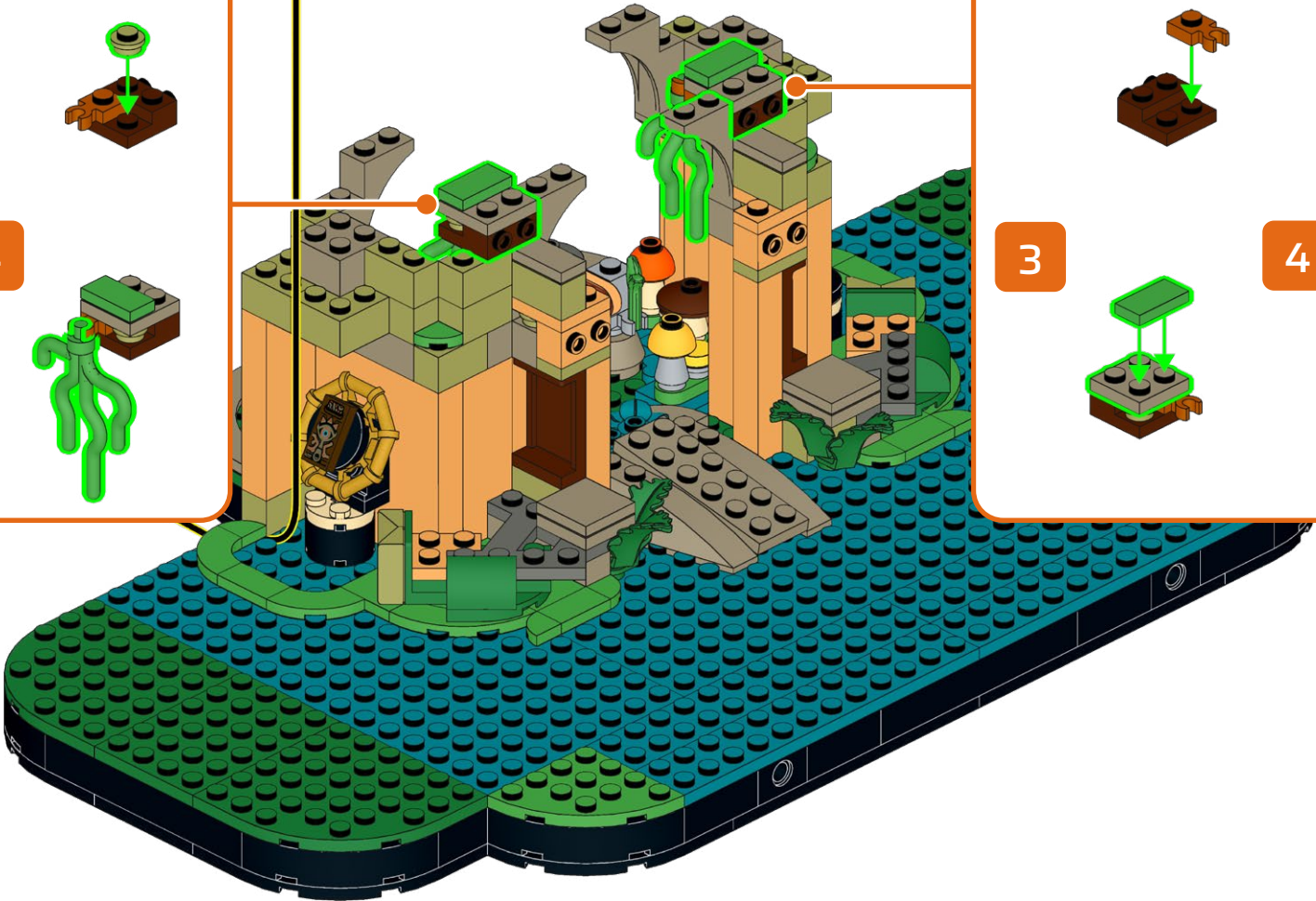

221



2x

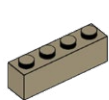

2x

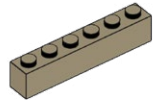

2x

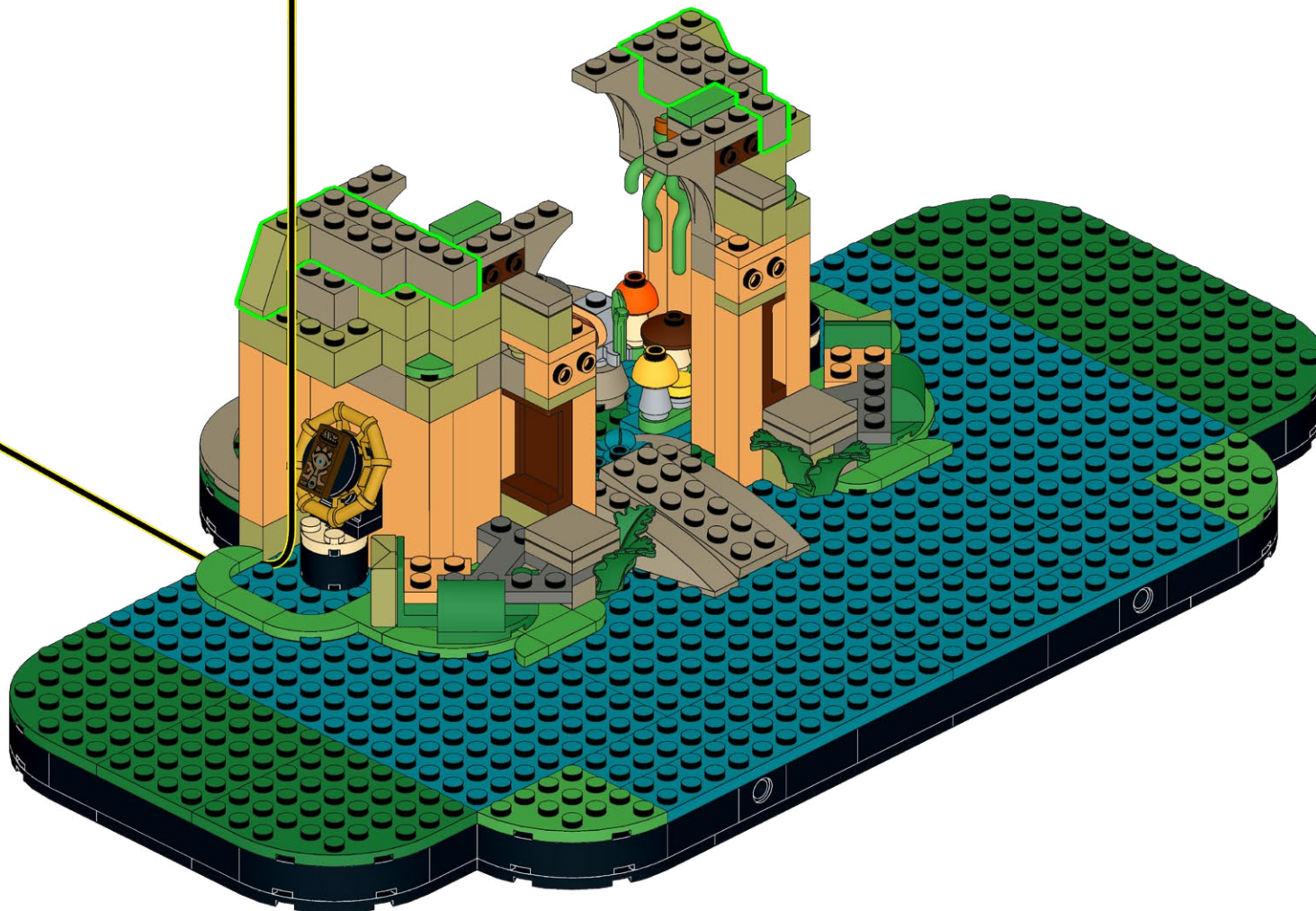

**HOLD UP!**

You might notice some bags aren't in order, as well as left over pieces, but that's ok! We're changing the way you build LEGO!

ATTENDEZ!

Vous remarquerez peut-être que certains sacs, ainsi que certaines pièces, ne sont pas dans le bon ordre. Mais pas de panique! Nous changeons simplement la façon avec laquelle vous construisez vos LEGO!

ASPETTA!

Potresti notare che alcuni sacchetti non sono in ordine, così come i pezzi avanzati, ma va bene così! Stiamo cambiando il modo in cui costruisci i LEGO!

HALT!

Sie werden möglicherweise bemerken, dass einige tüten durcheinander sind und teile übrig bleiben, aber das ist in Ordnung! Wir ändern die art und weise, wie Sie LEGO bauen!

¡ESPERA!

Es posible que notes que algunas bolsas están fuera de servicio, así como piezas sobrantes, ¡pero está bien! ¡Estamos cambiando la forma en que construyes LEGO!

暫停!

你可能会注意到一些袋子顺序错乱, 以及一些剩余的部件, 但没关系! 我们正在改变你搭建乐高的方式!

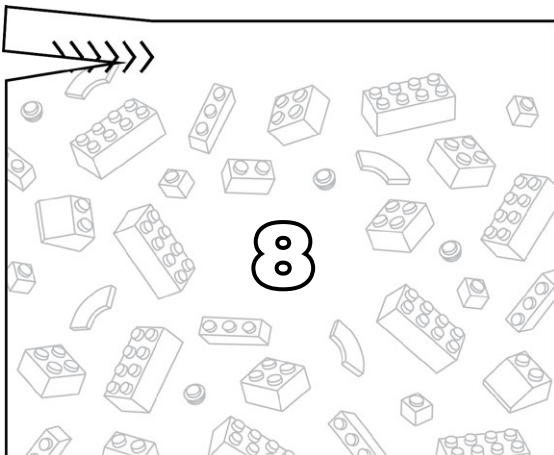
Open LEGO® Bag 8

222



2x

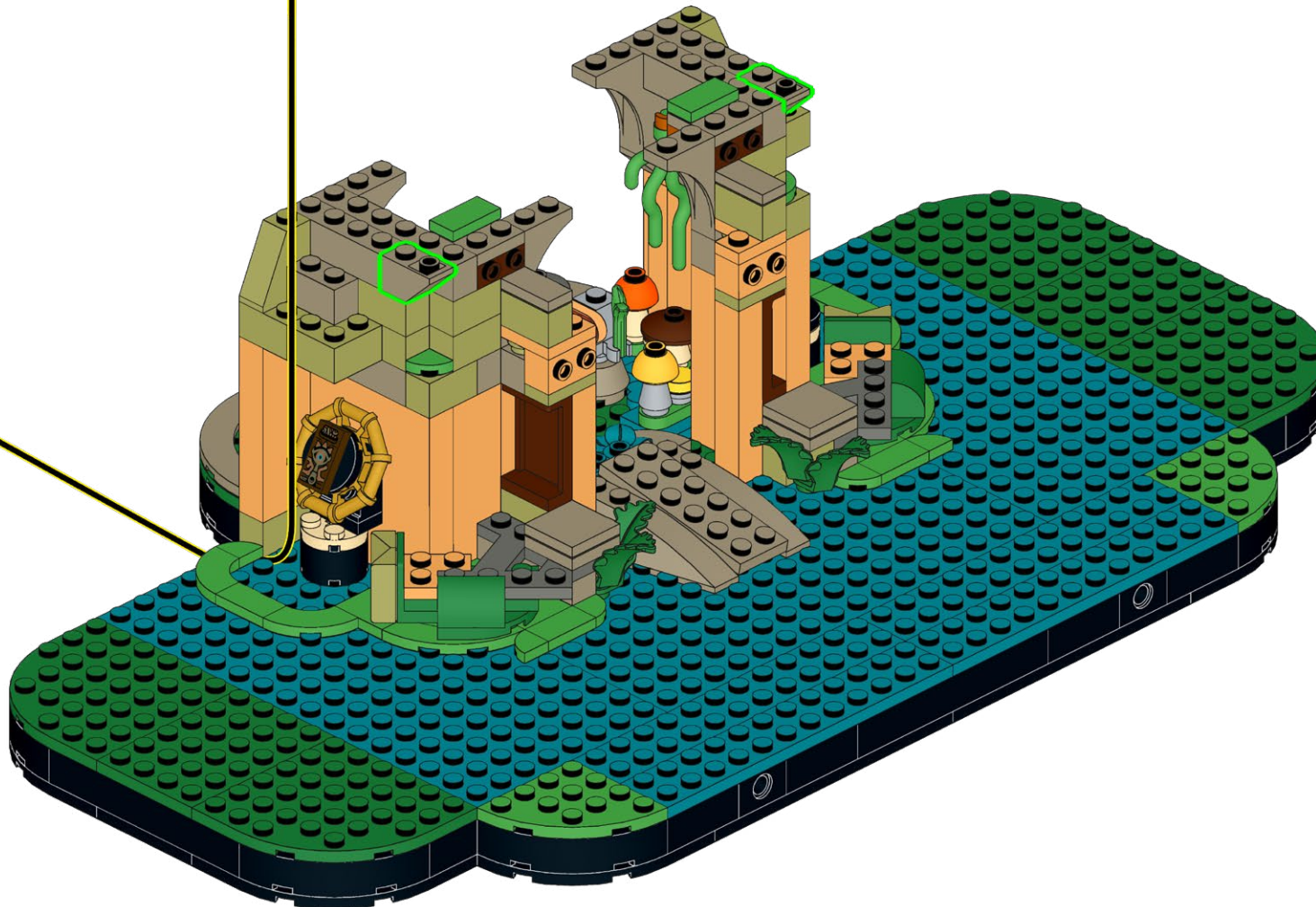

223

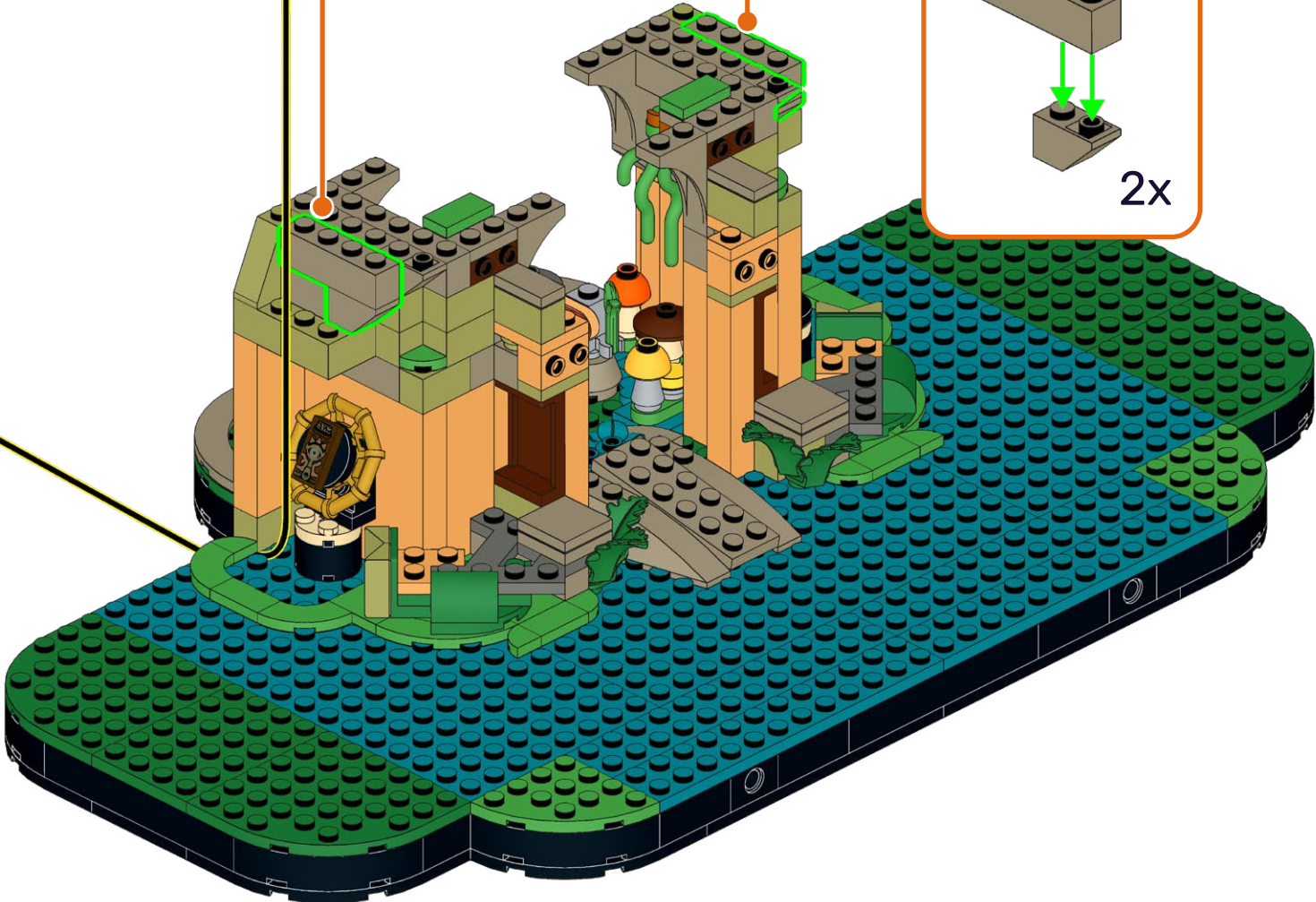
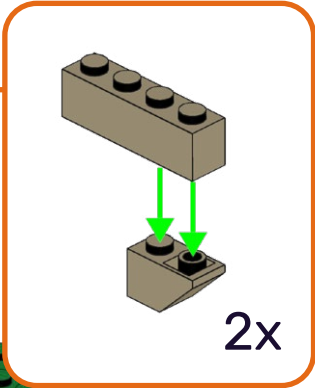
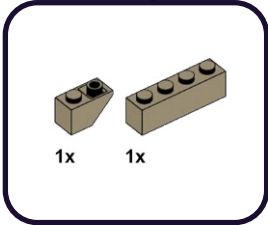

224

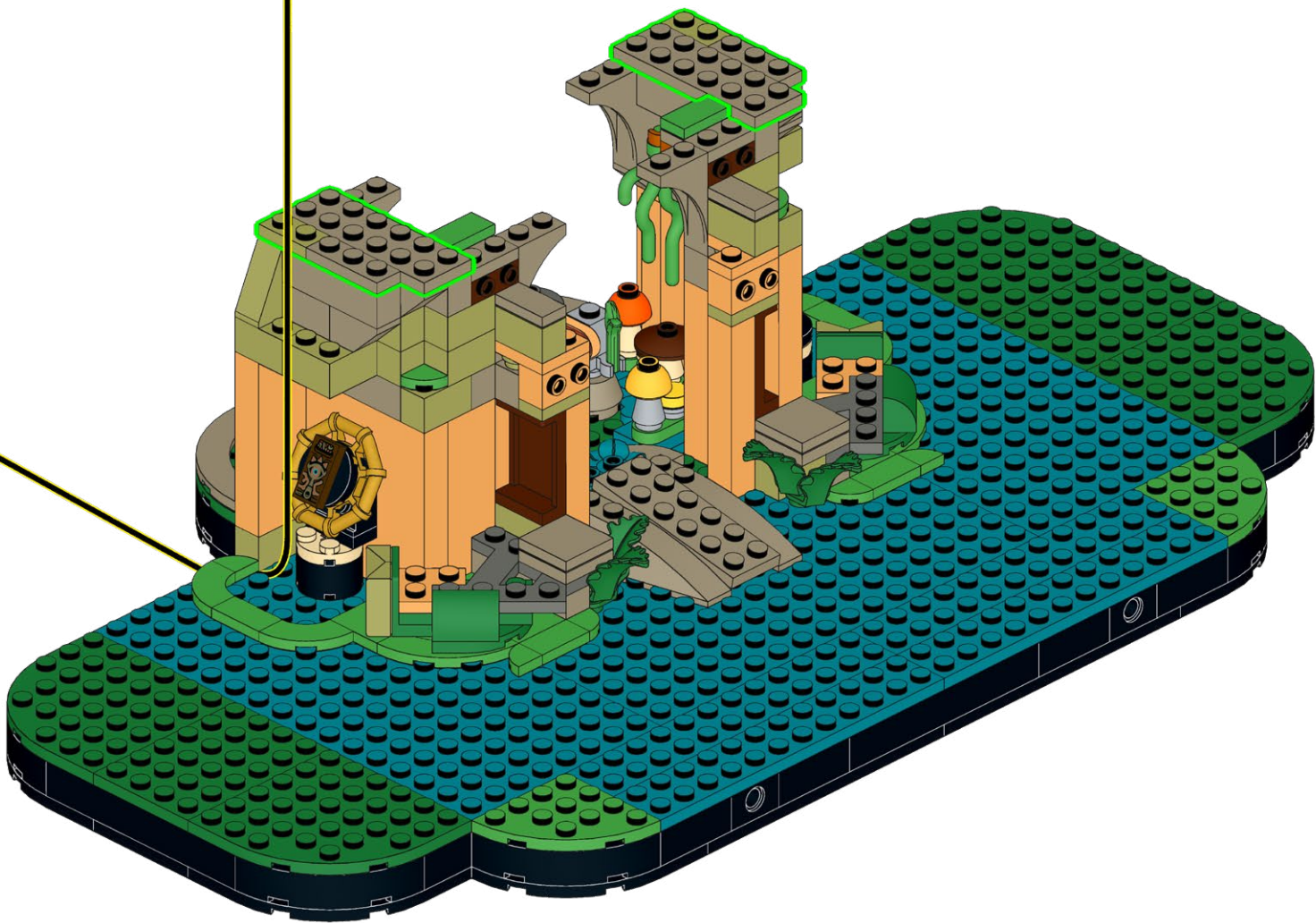
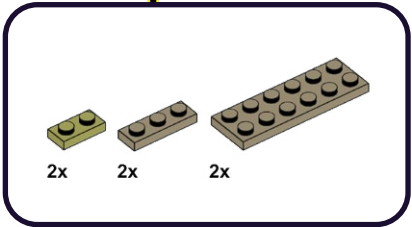

225

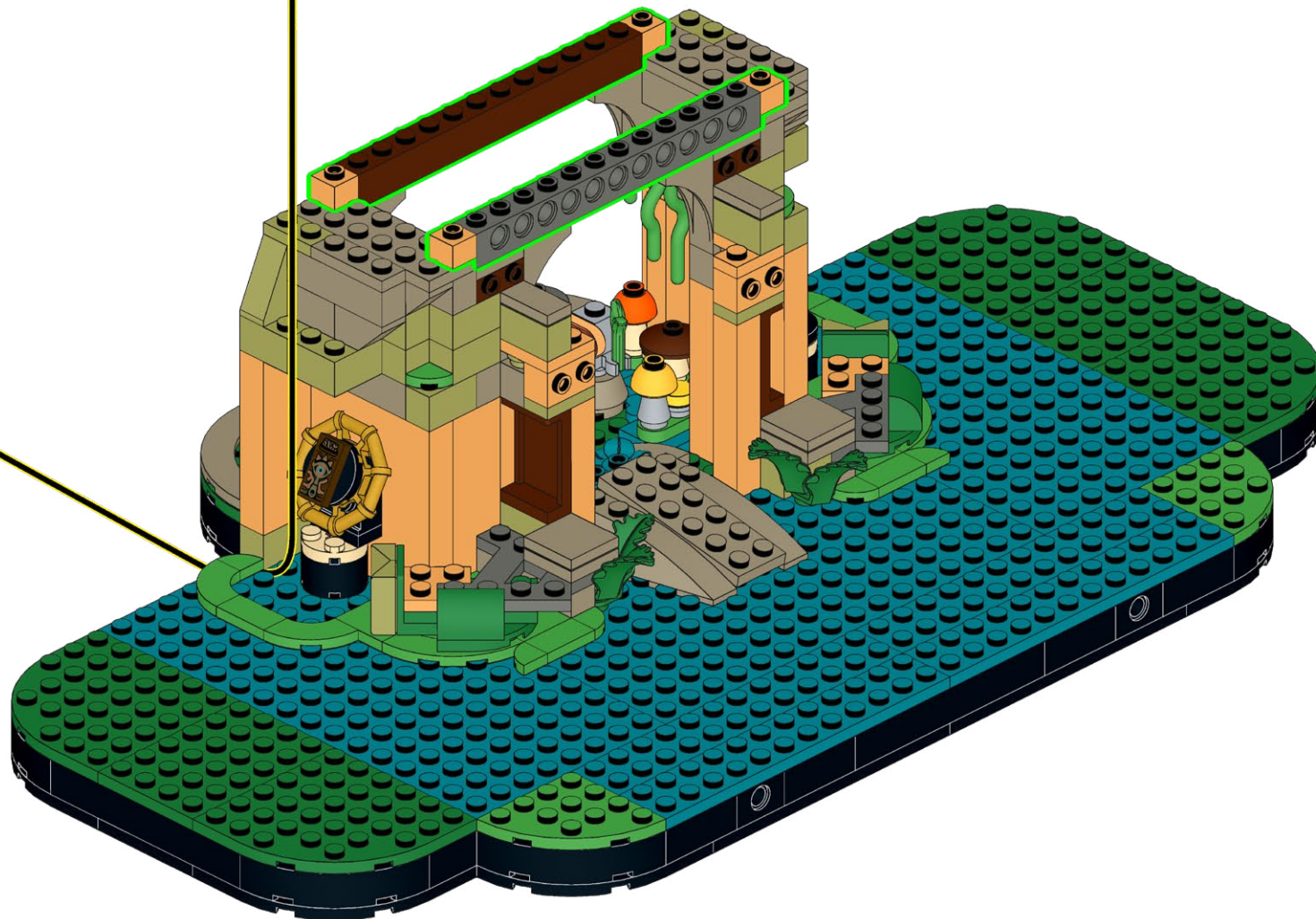
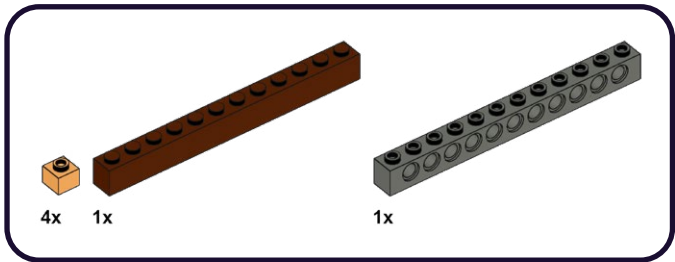

226

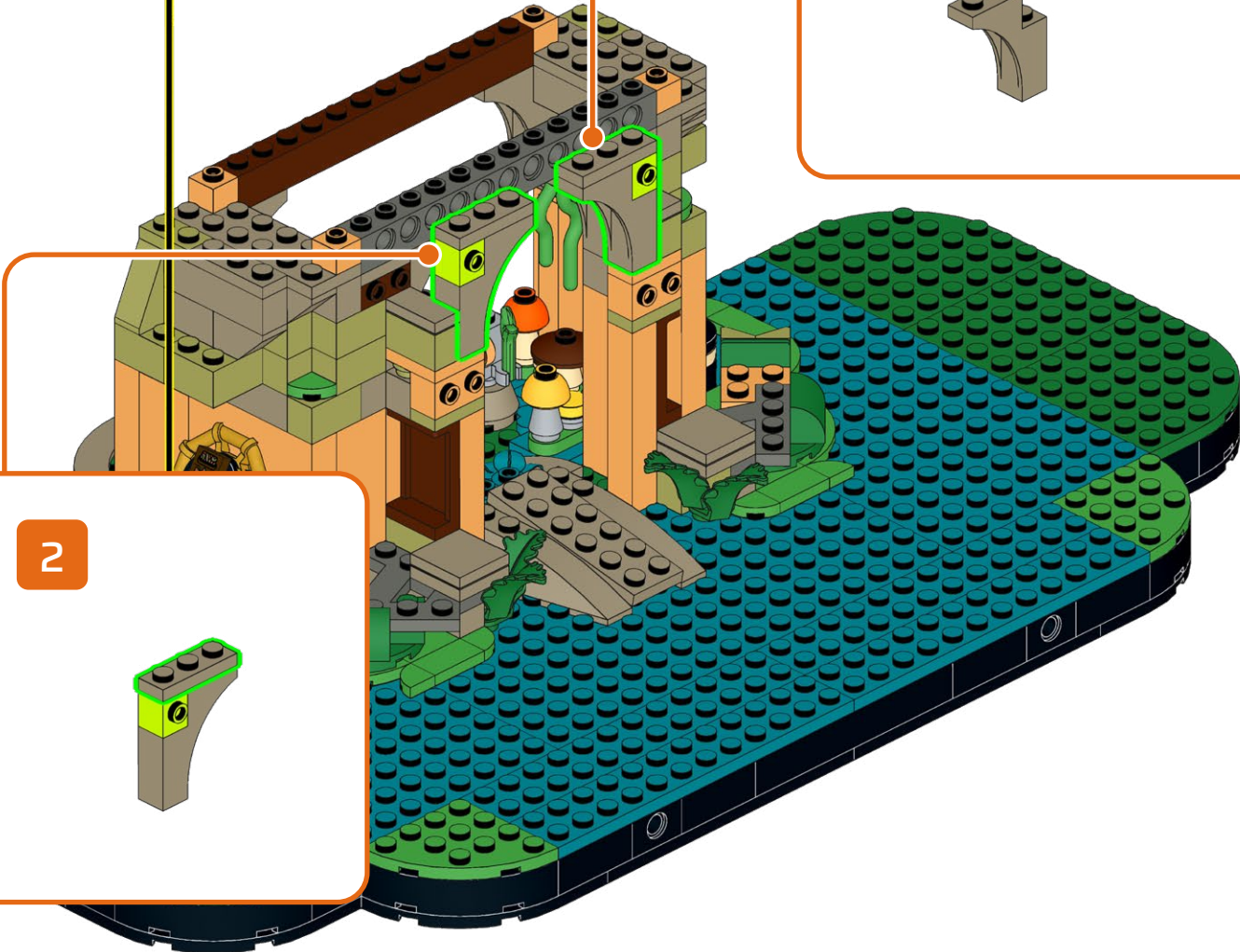
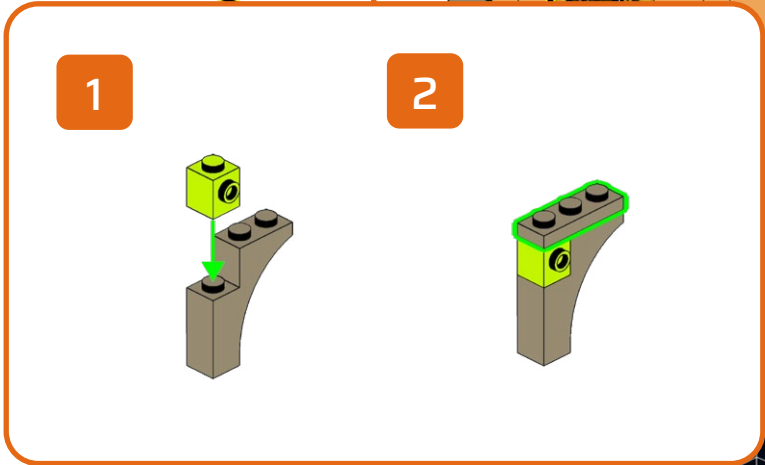
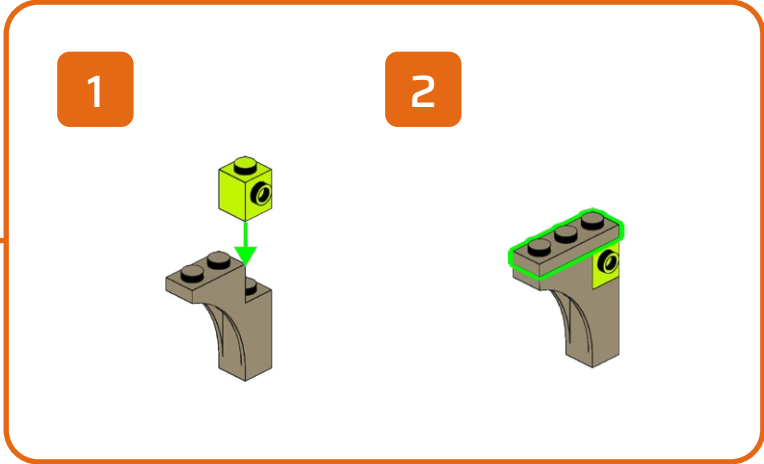
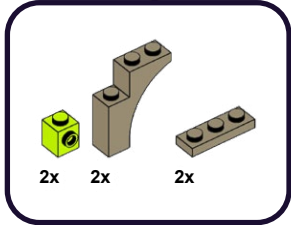

227

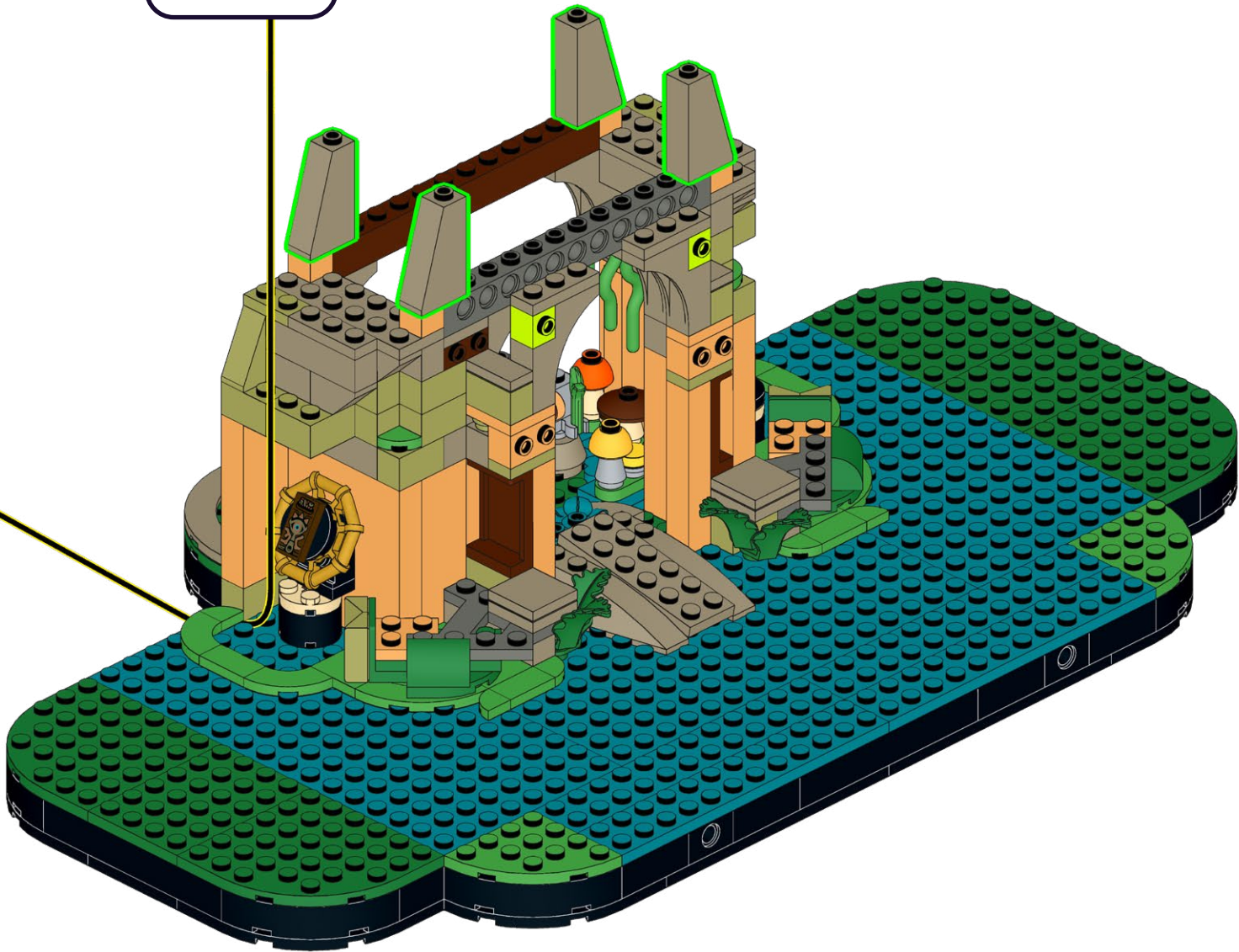
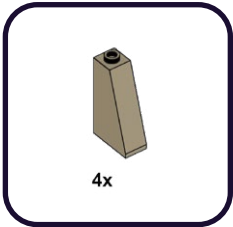

228

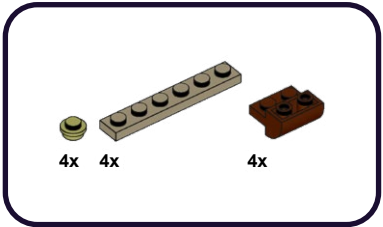

1

2

3

2x

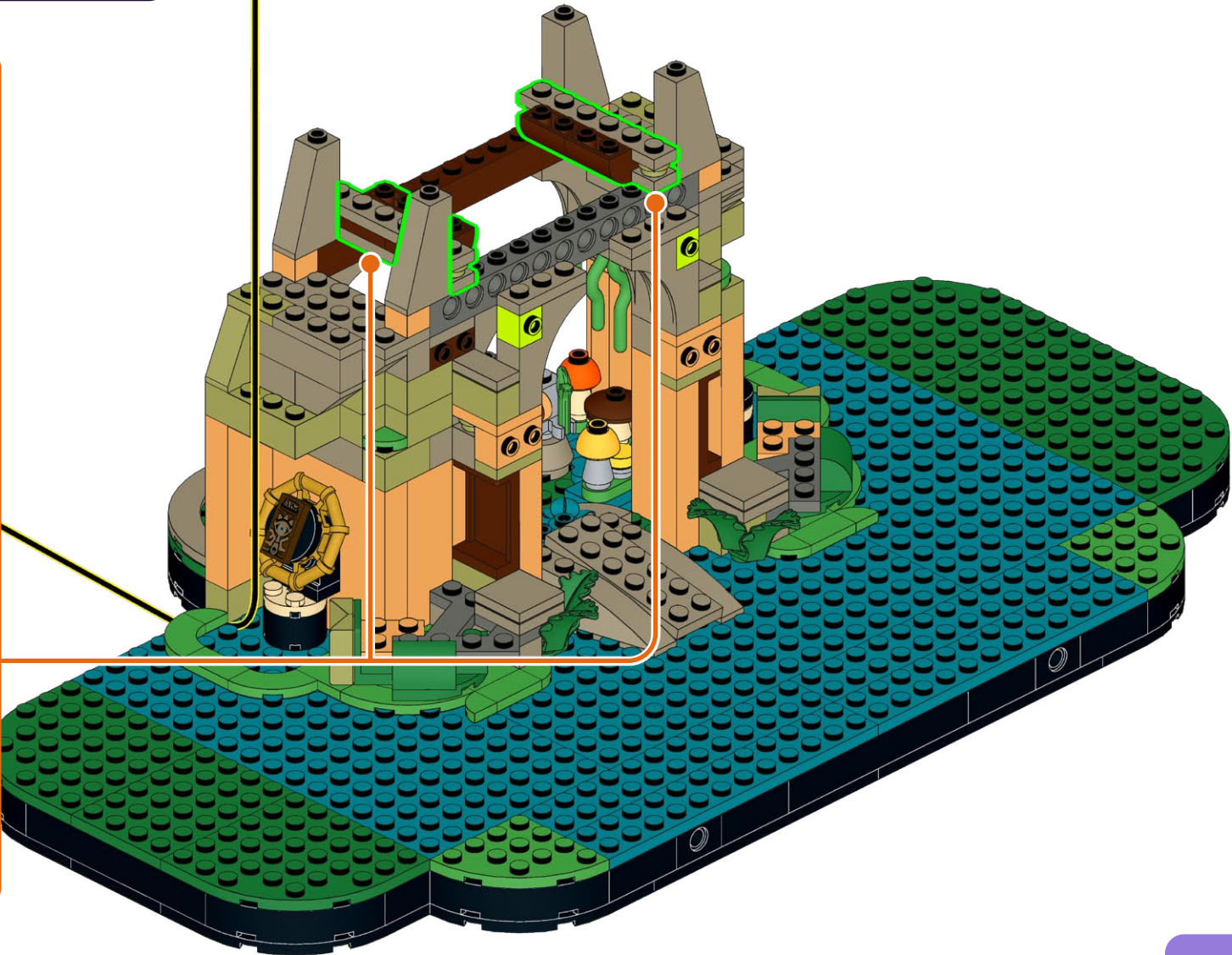

229

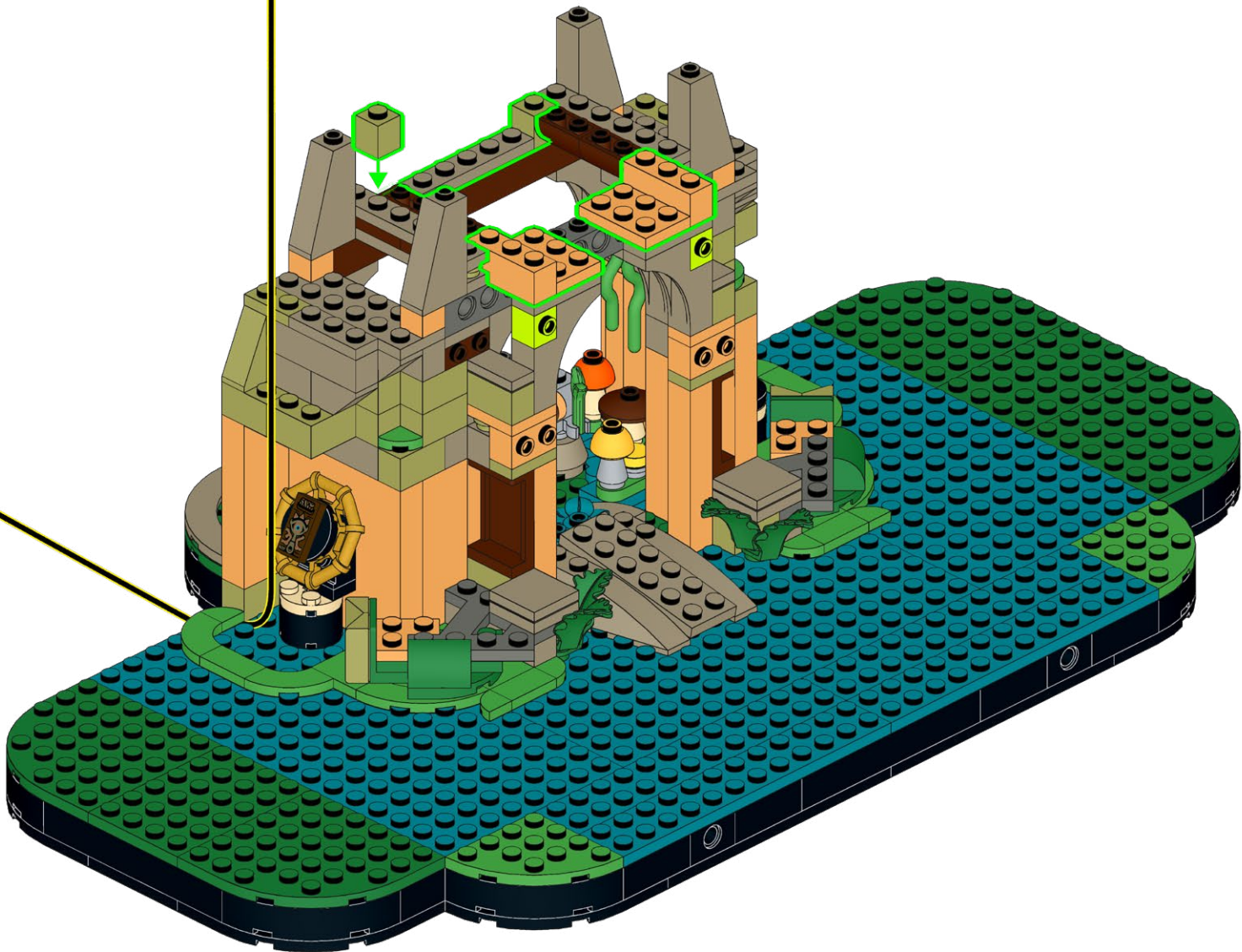
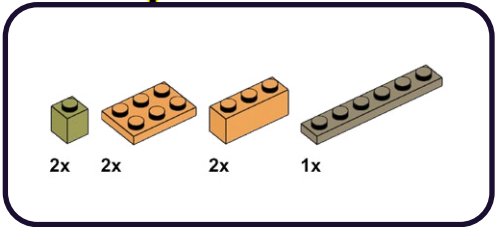

230

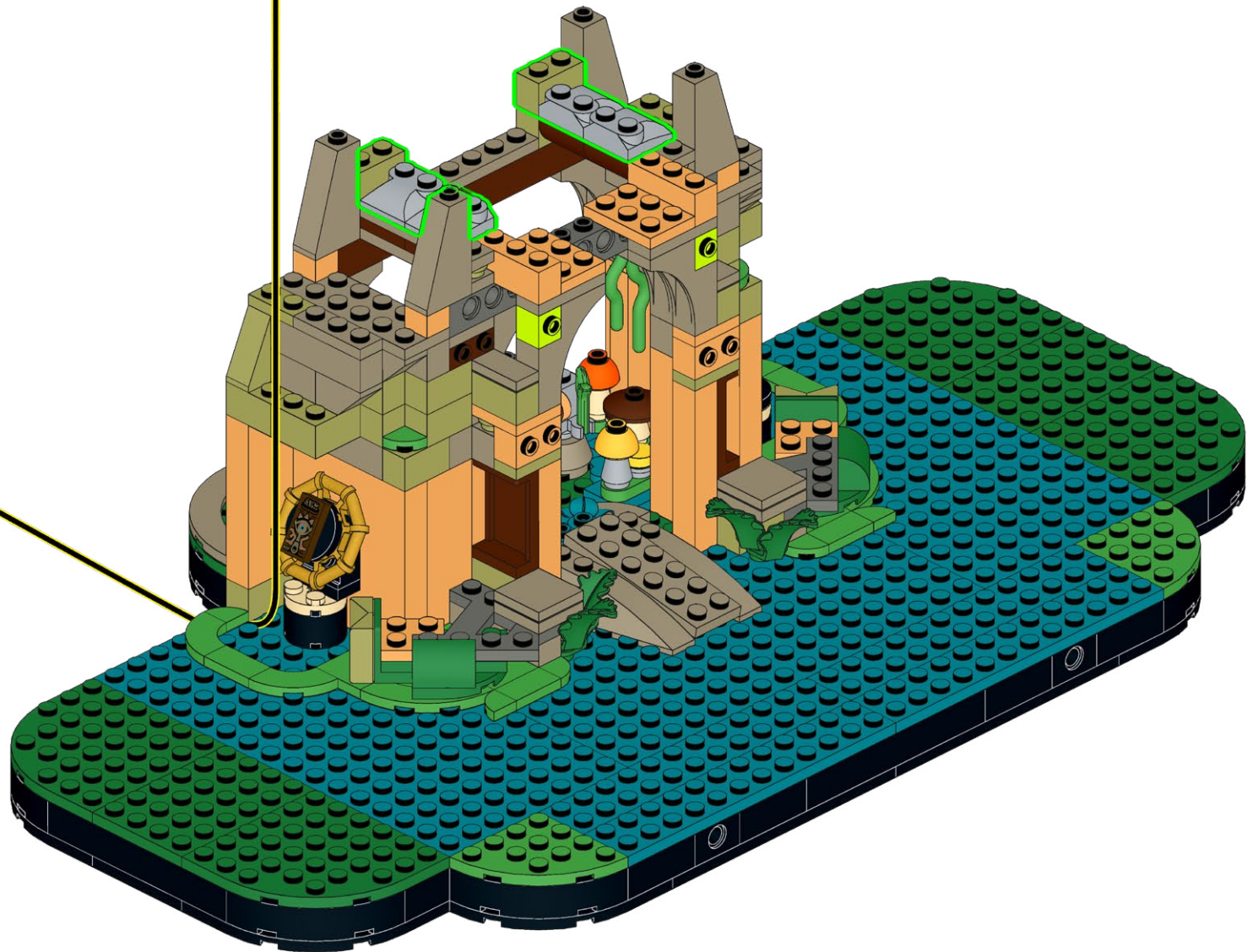
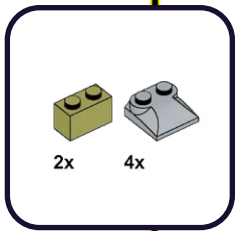

231

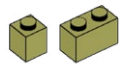

2x 2x

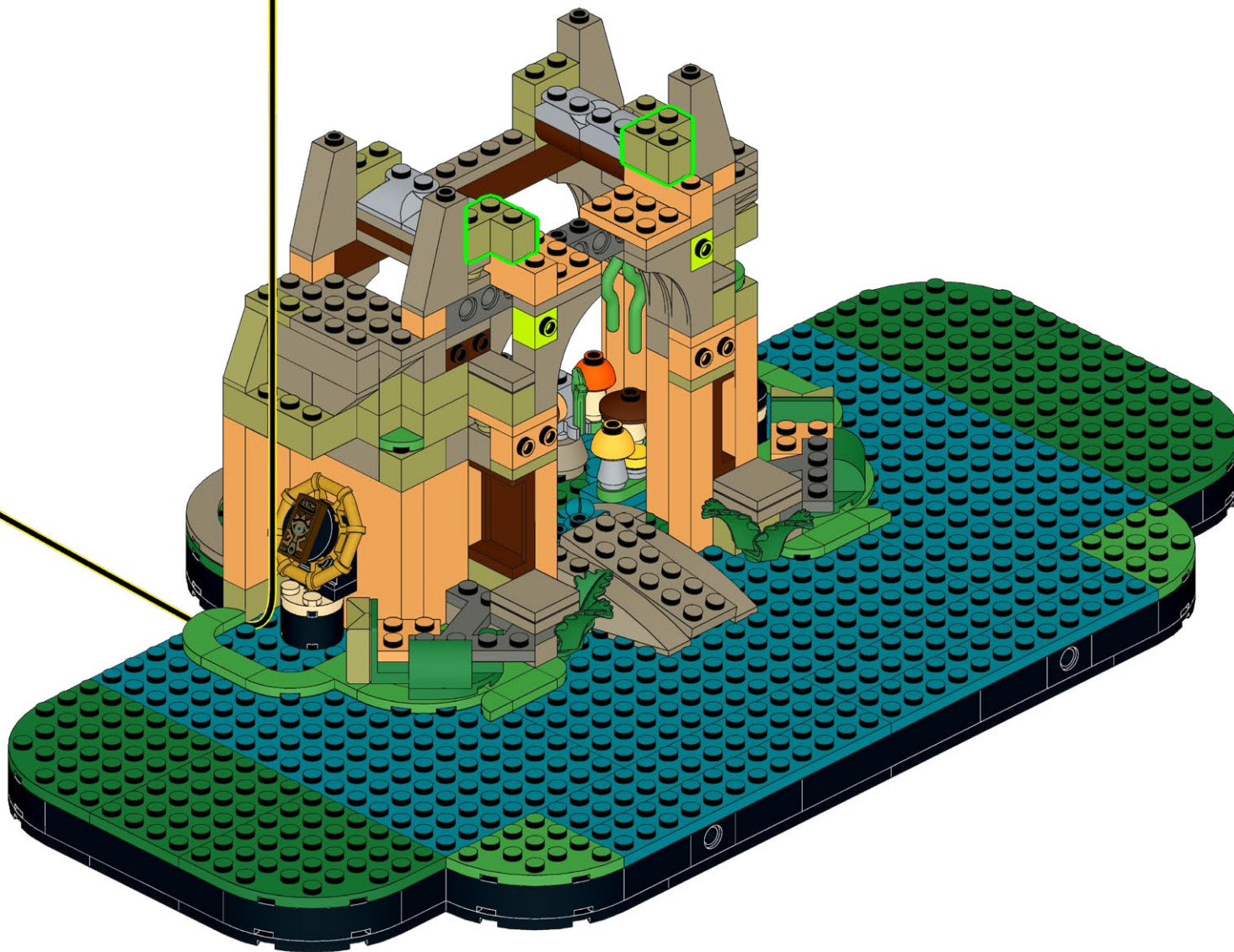

232

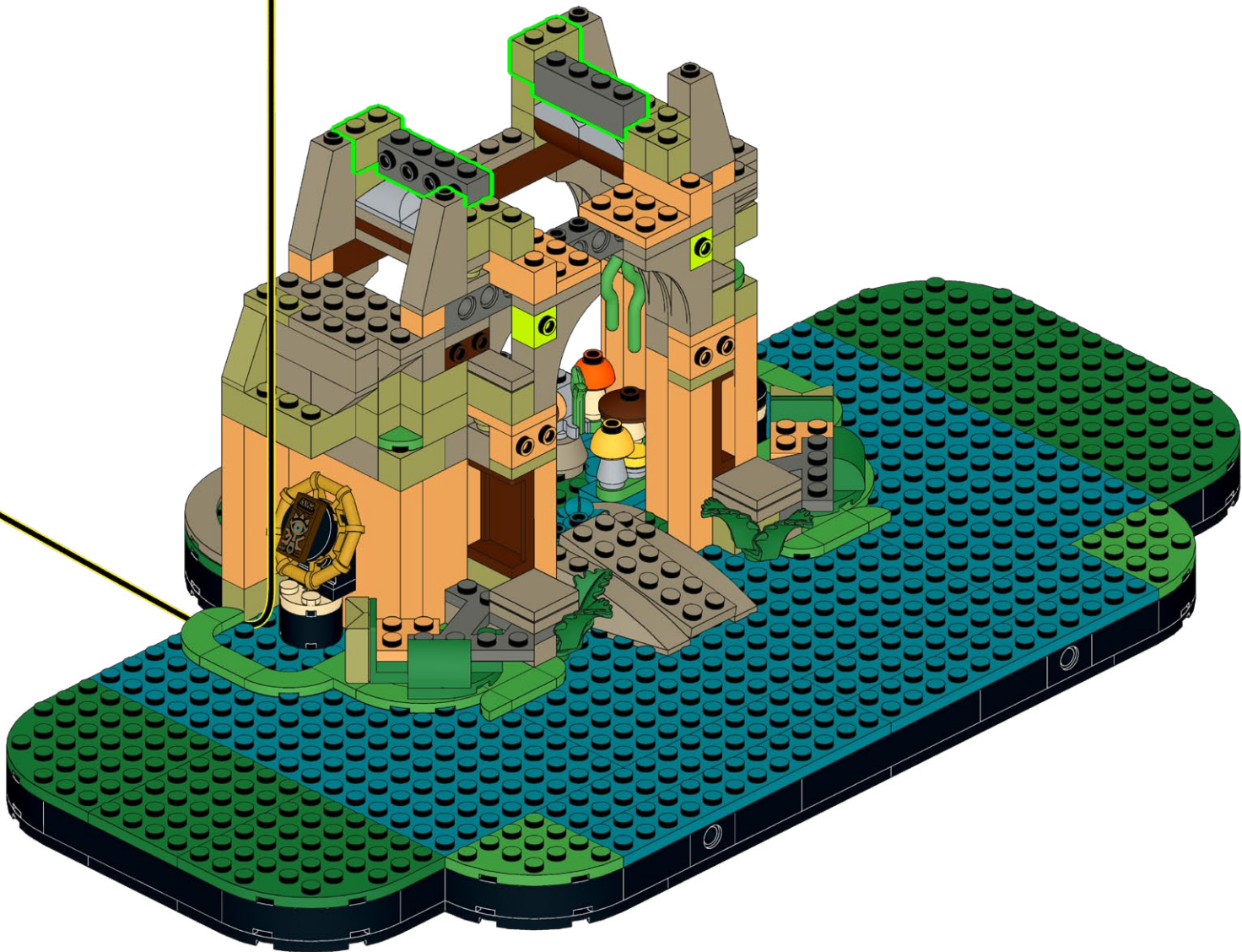
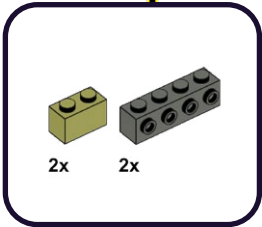

233

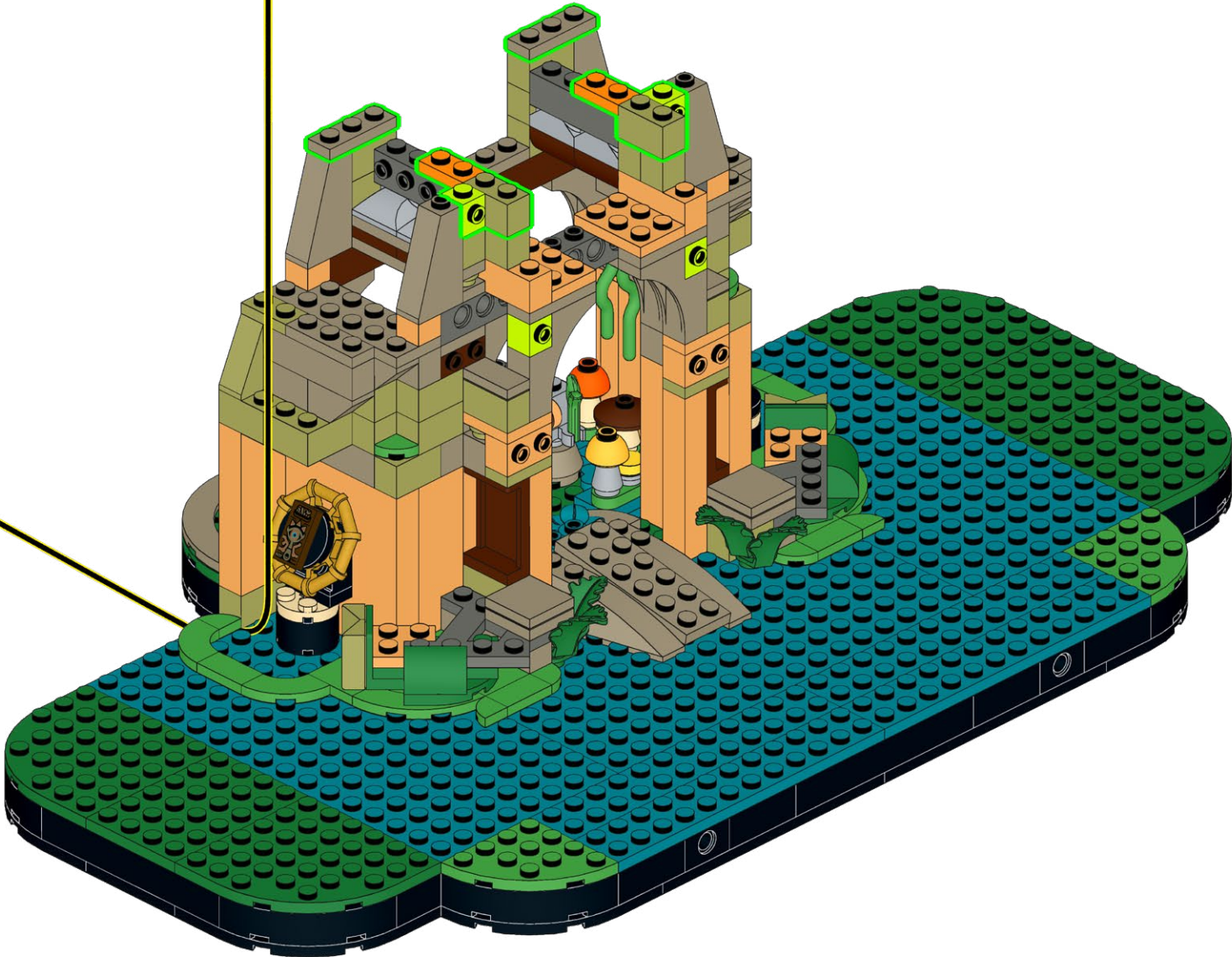
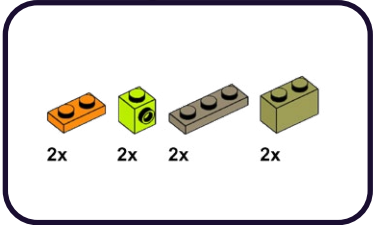

234

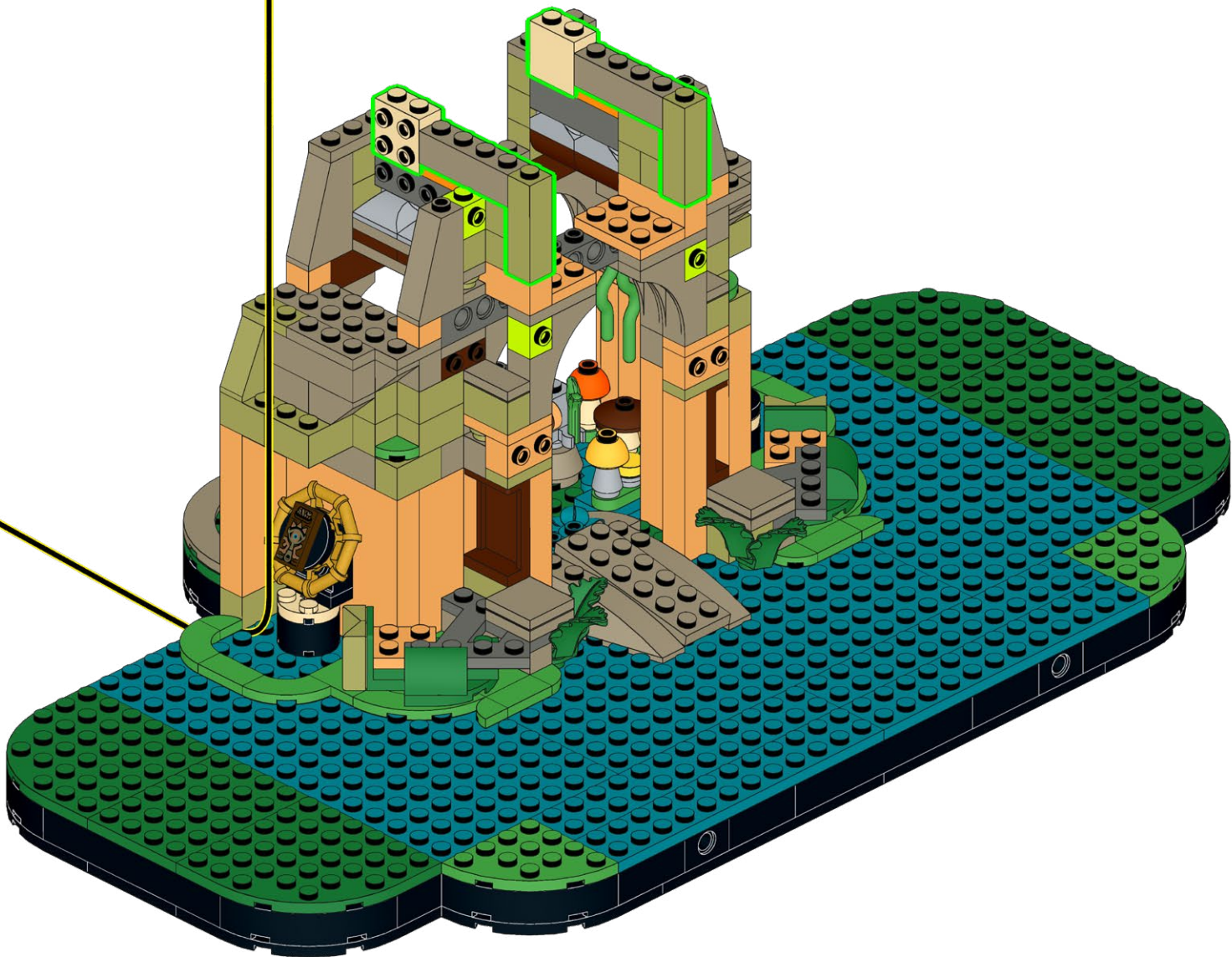
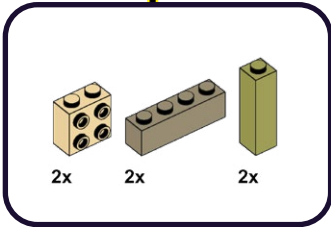

235

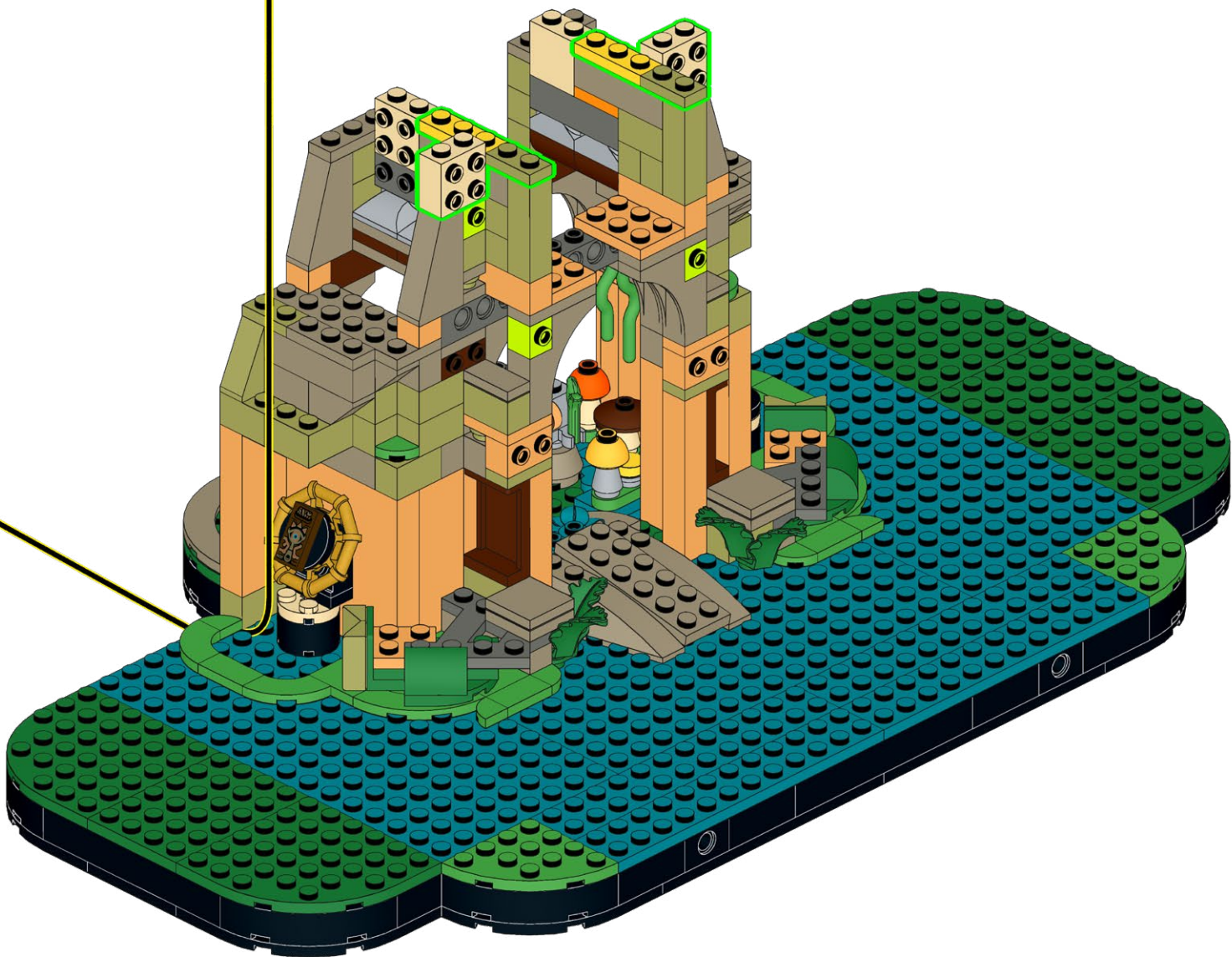
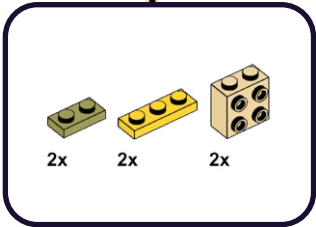

236

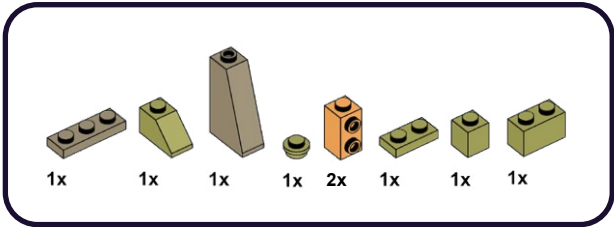

1

2

3

4

5

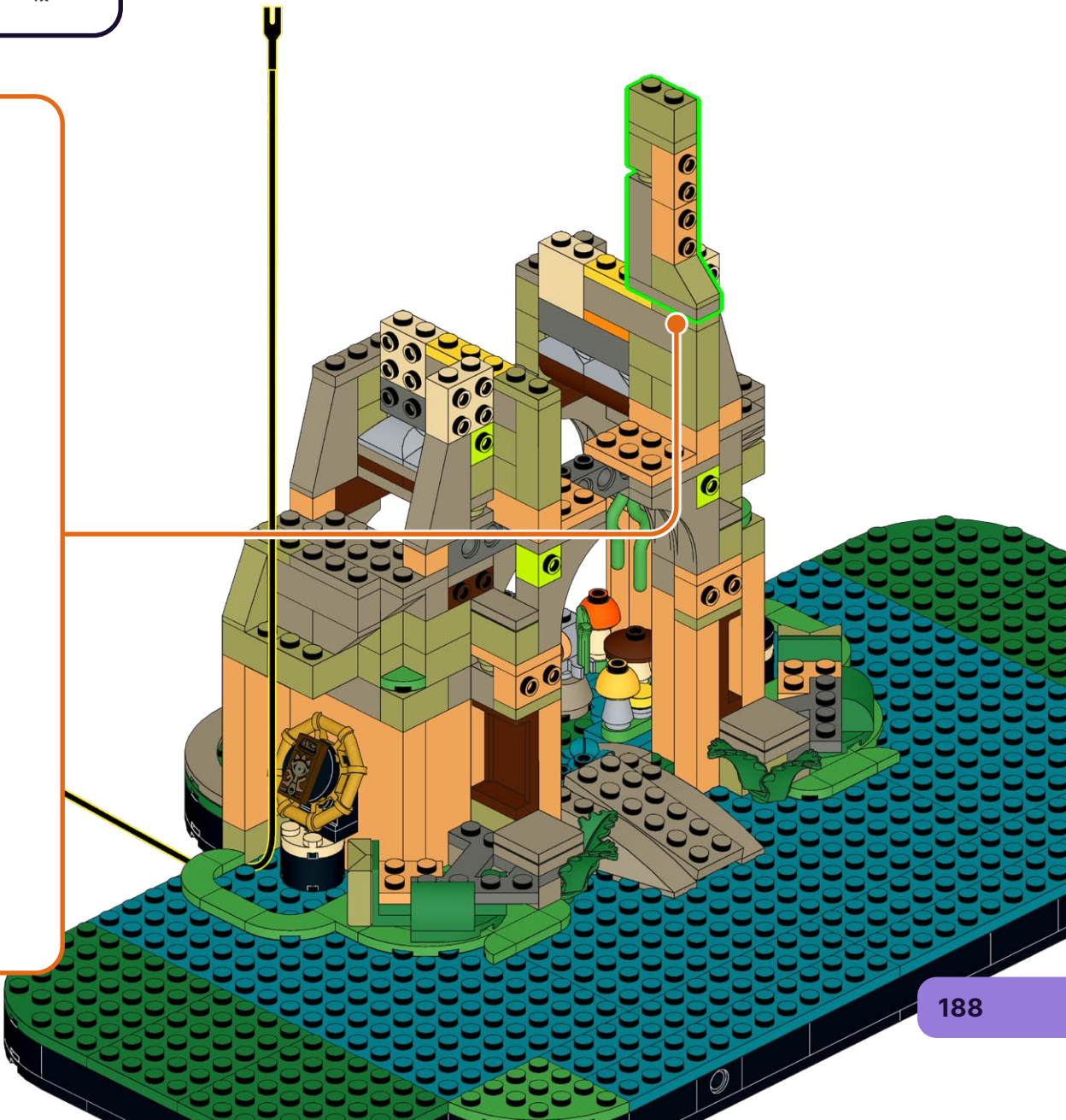

237

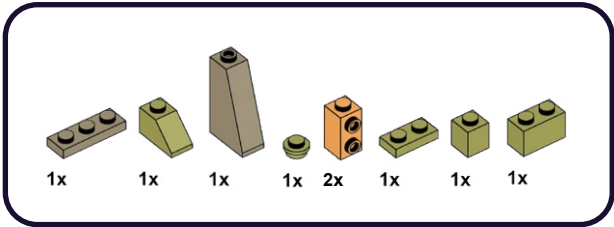

1

2

3

4

5

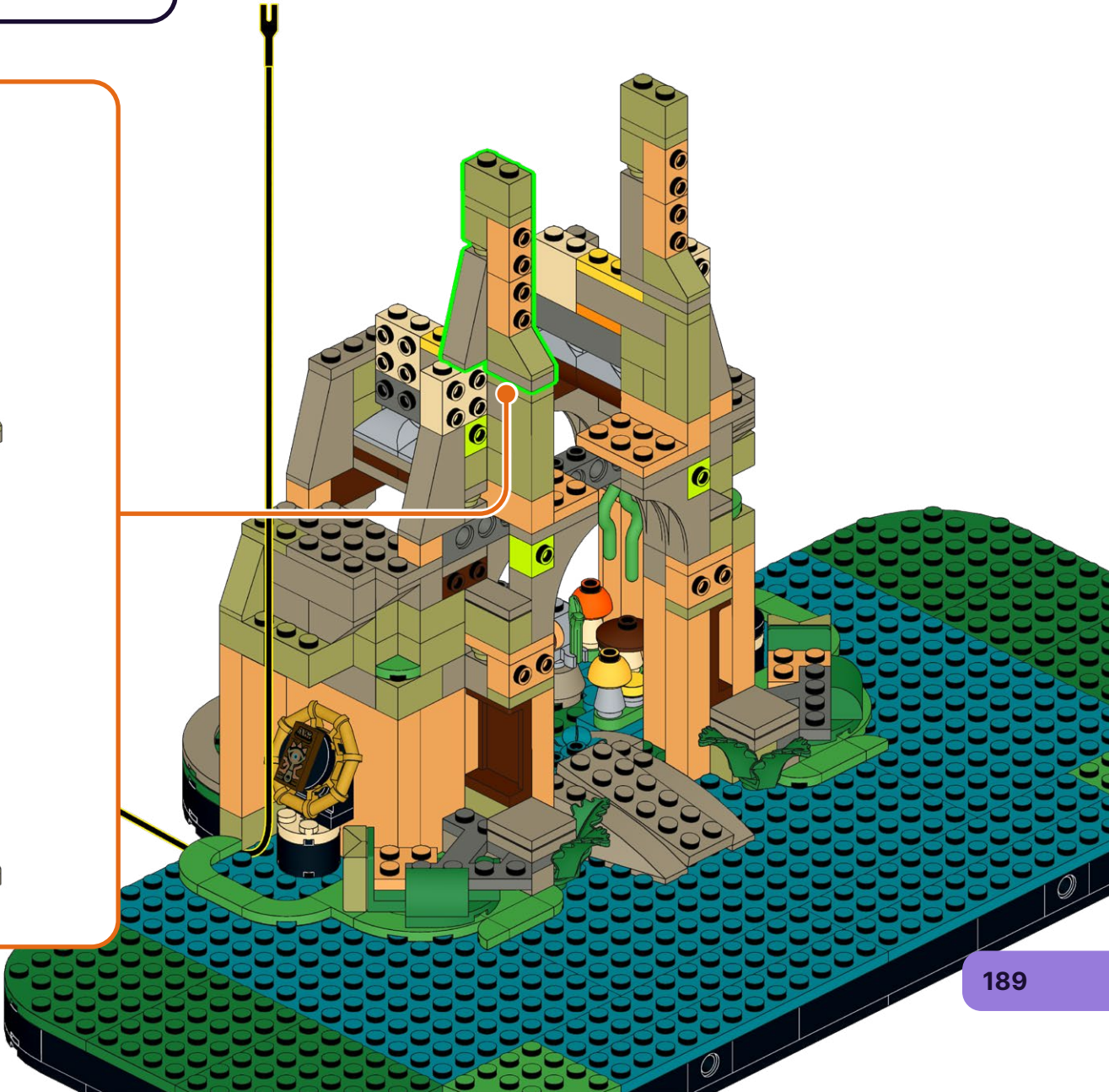

238

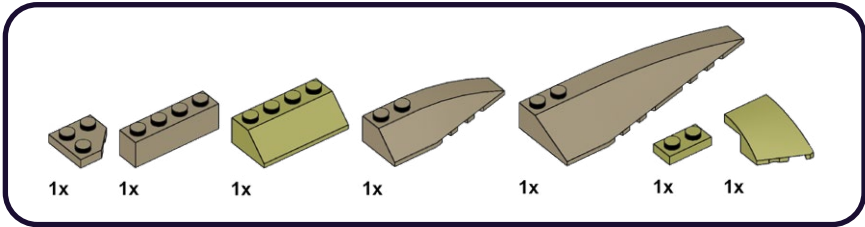

1

2

3

4

5

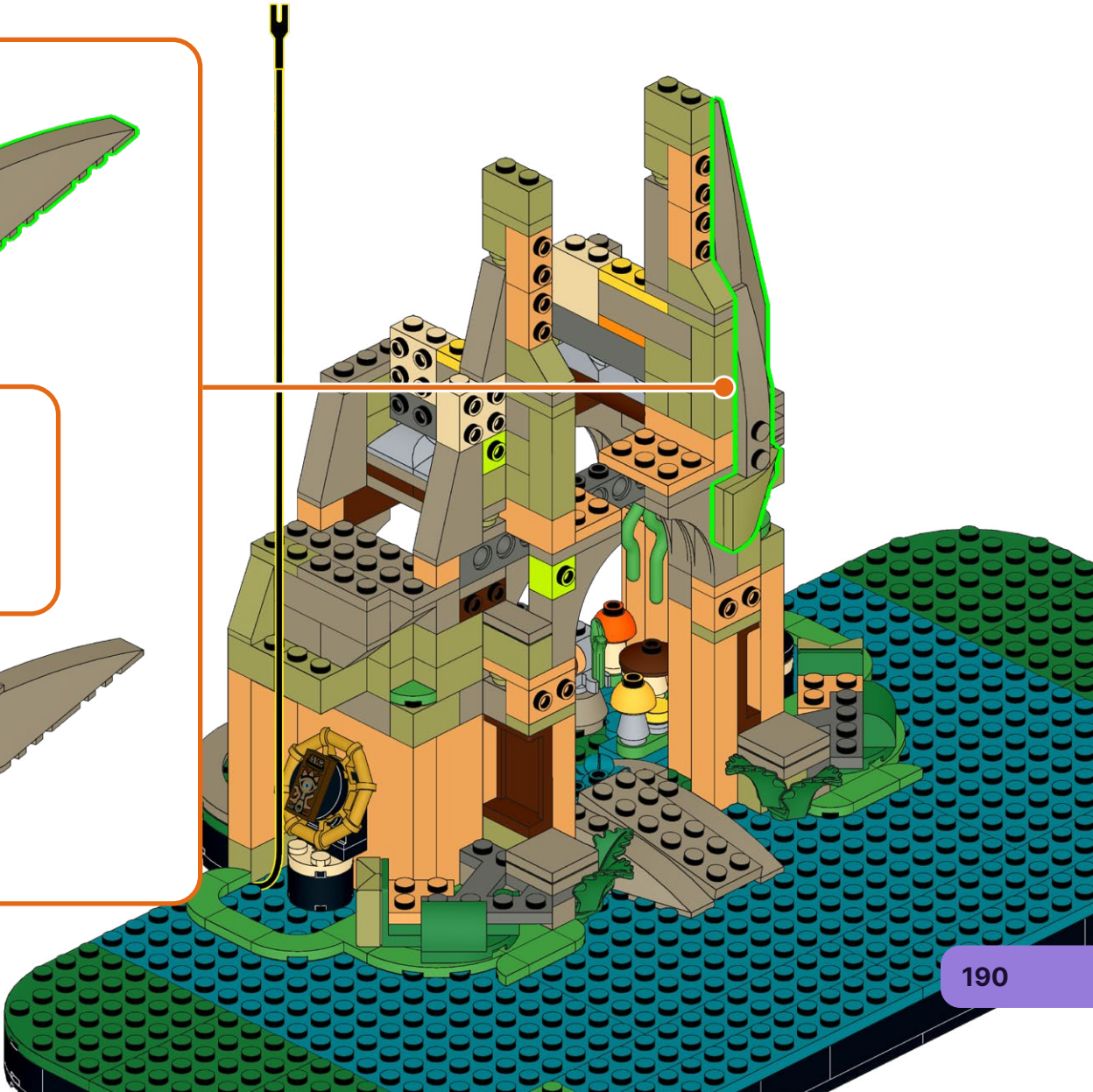

239

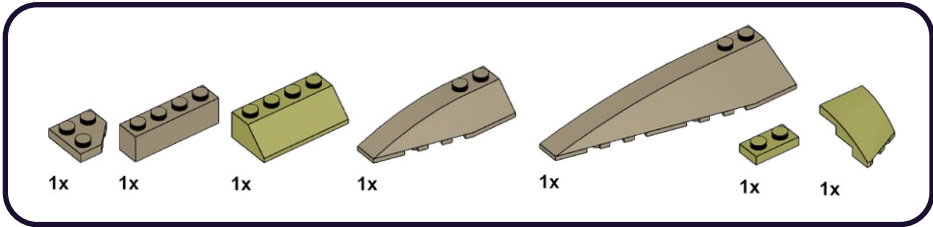

1

2

3

4

5

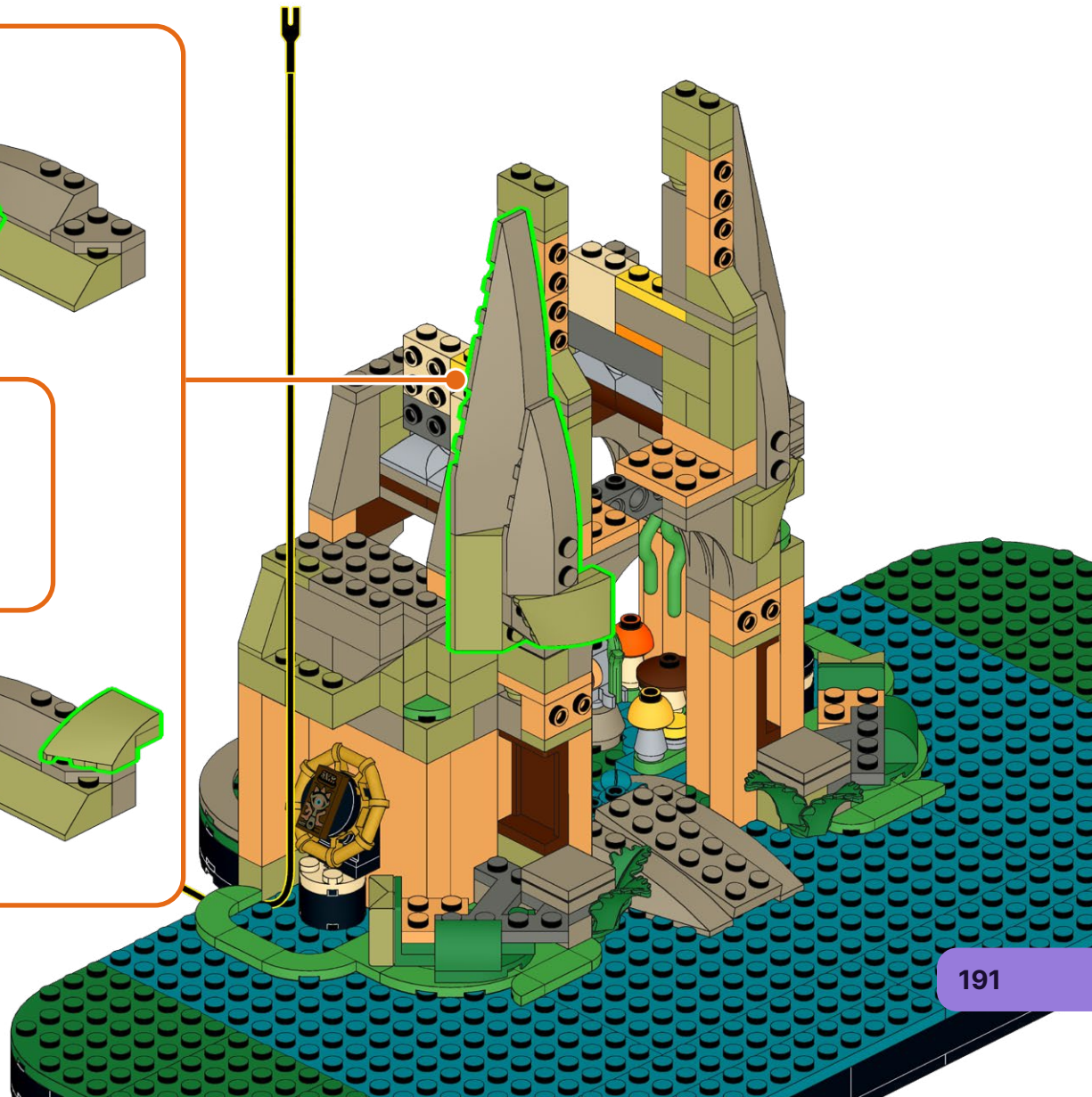

240

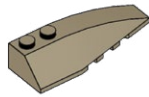

1x

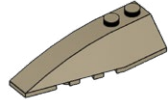

1x

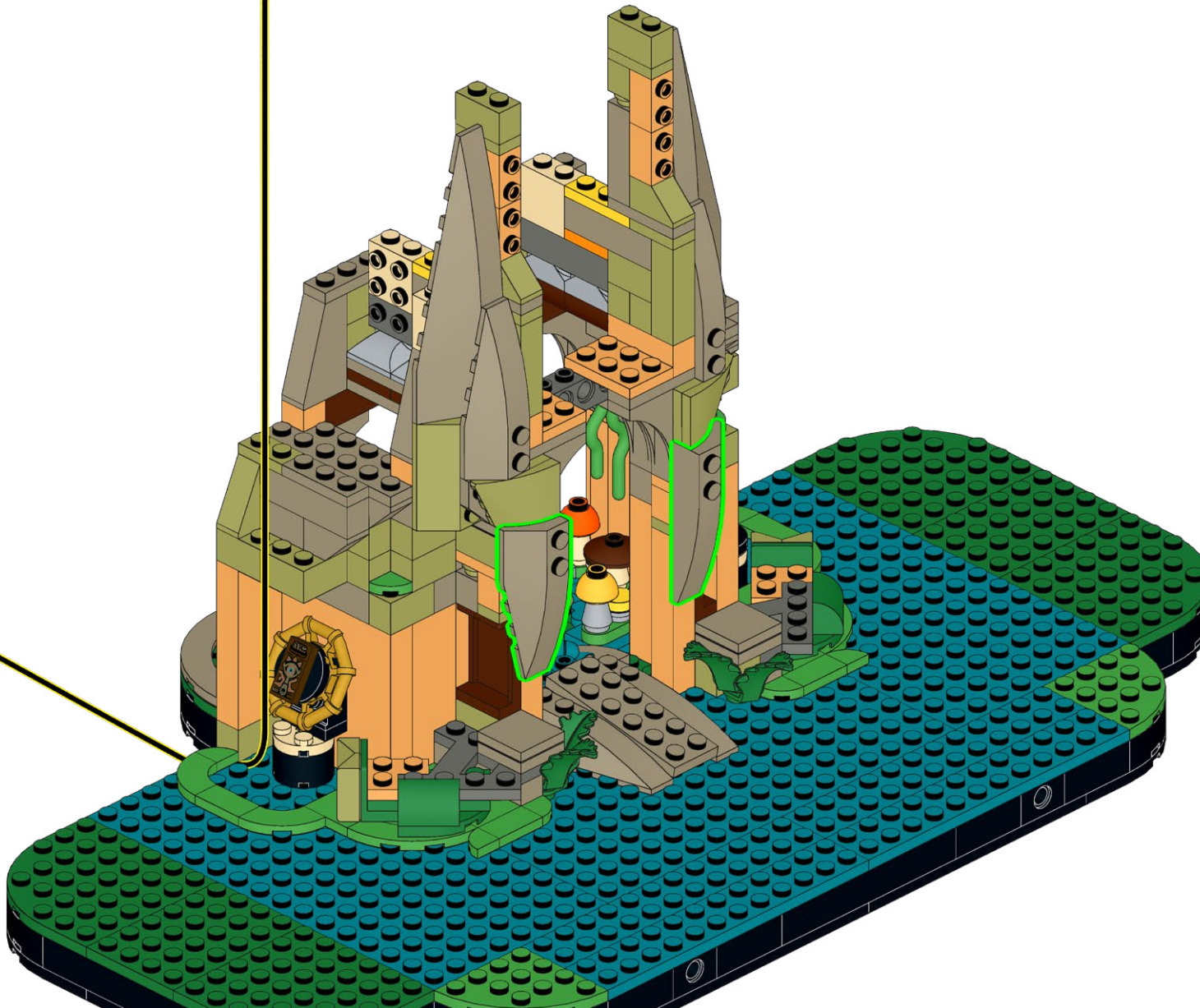

241

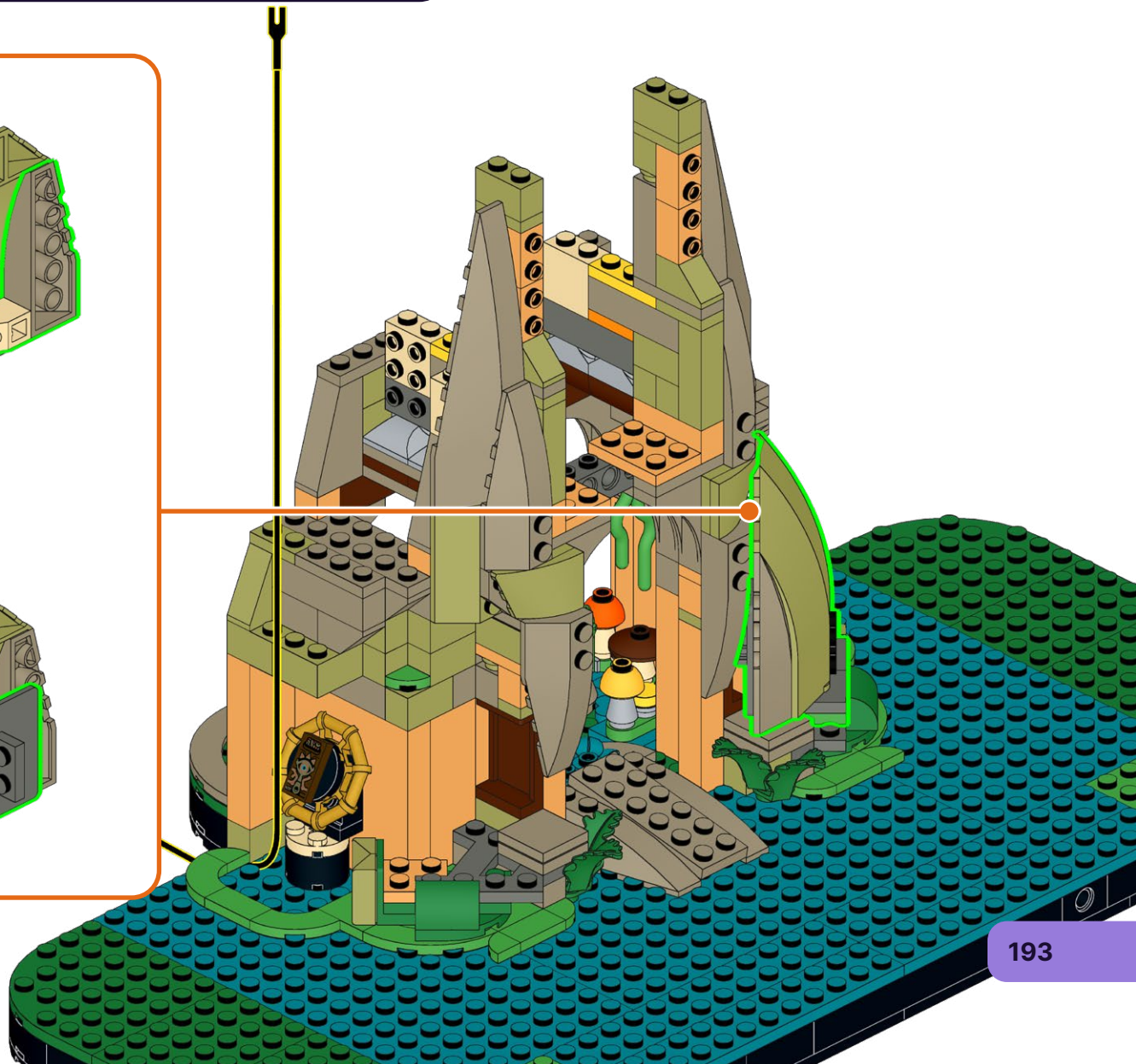
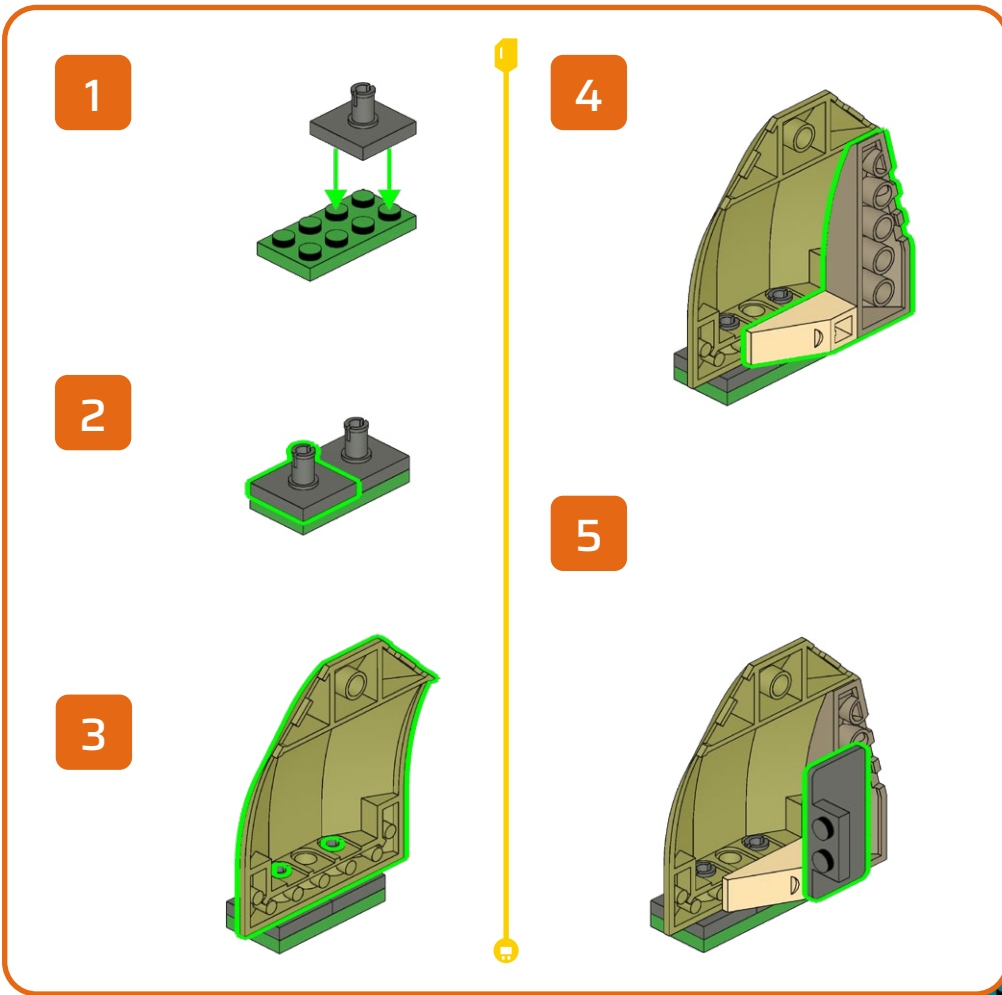
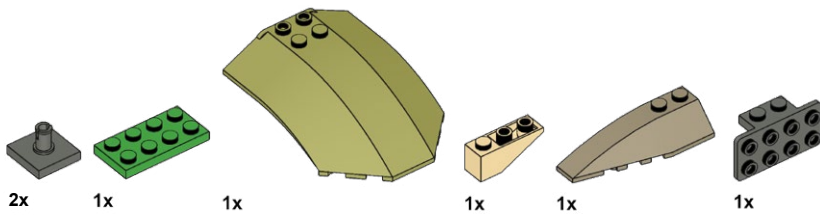

242

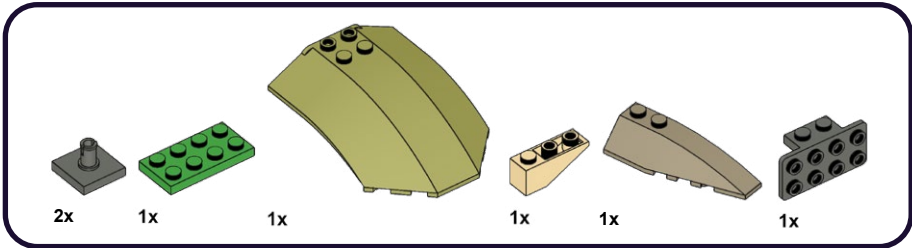

1

2

3

4

5

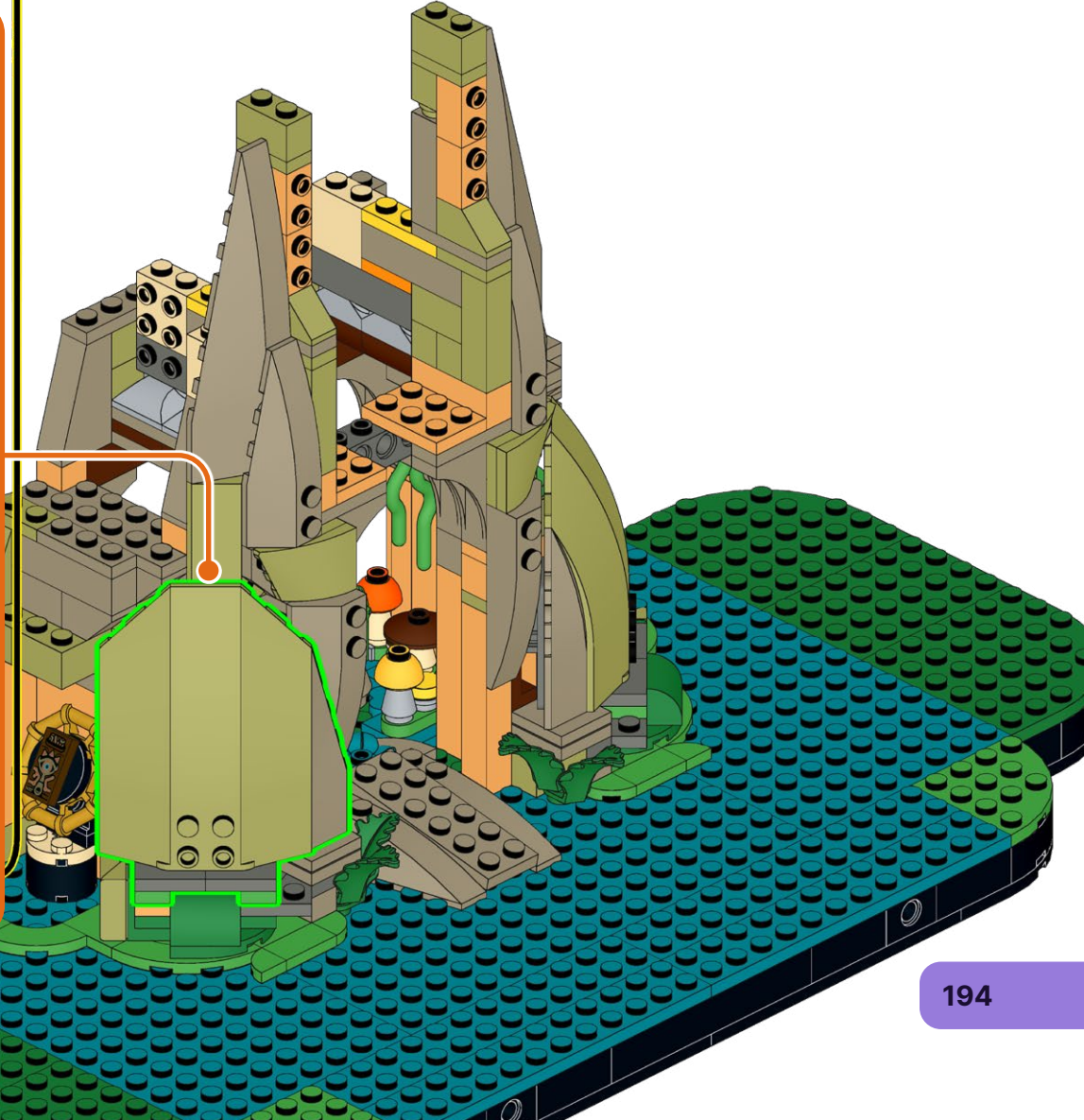

243

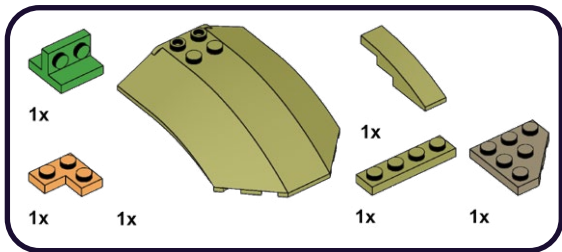

1

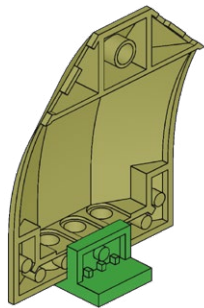

2

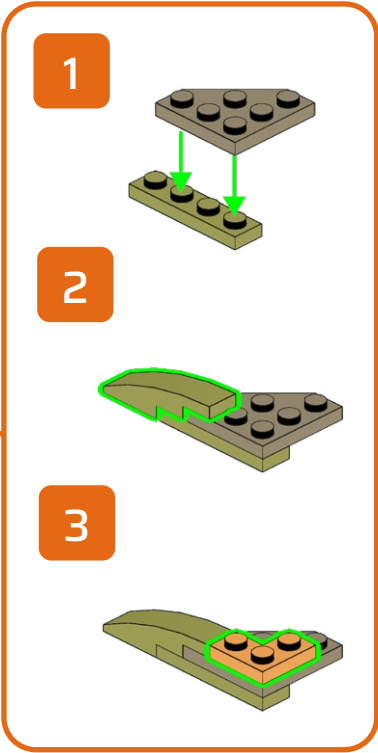
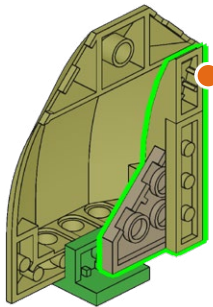

244

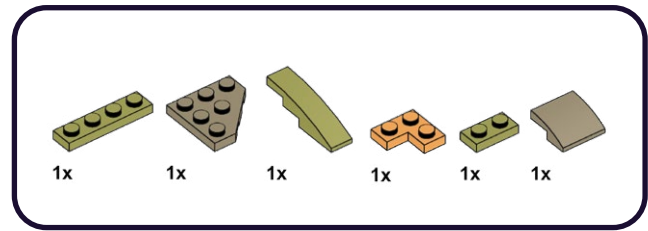

1

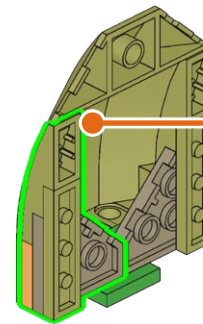

2

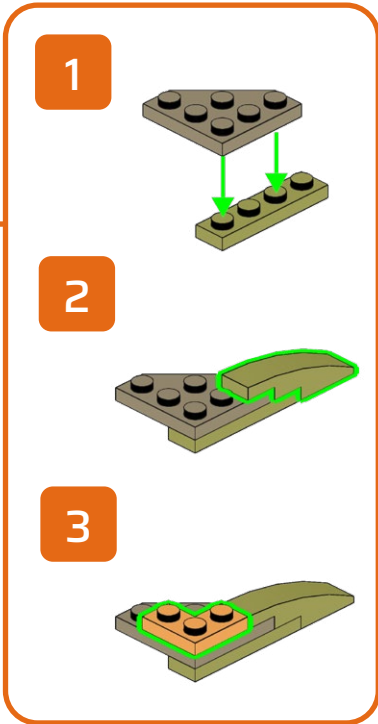
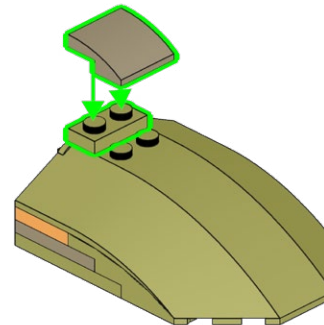
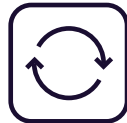

2x

245

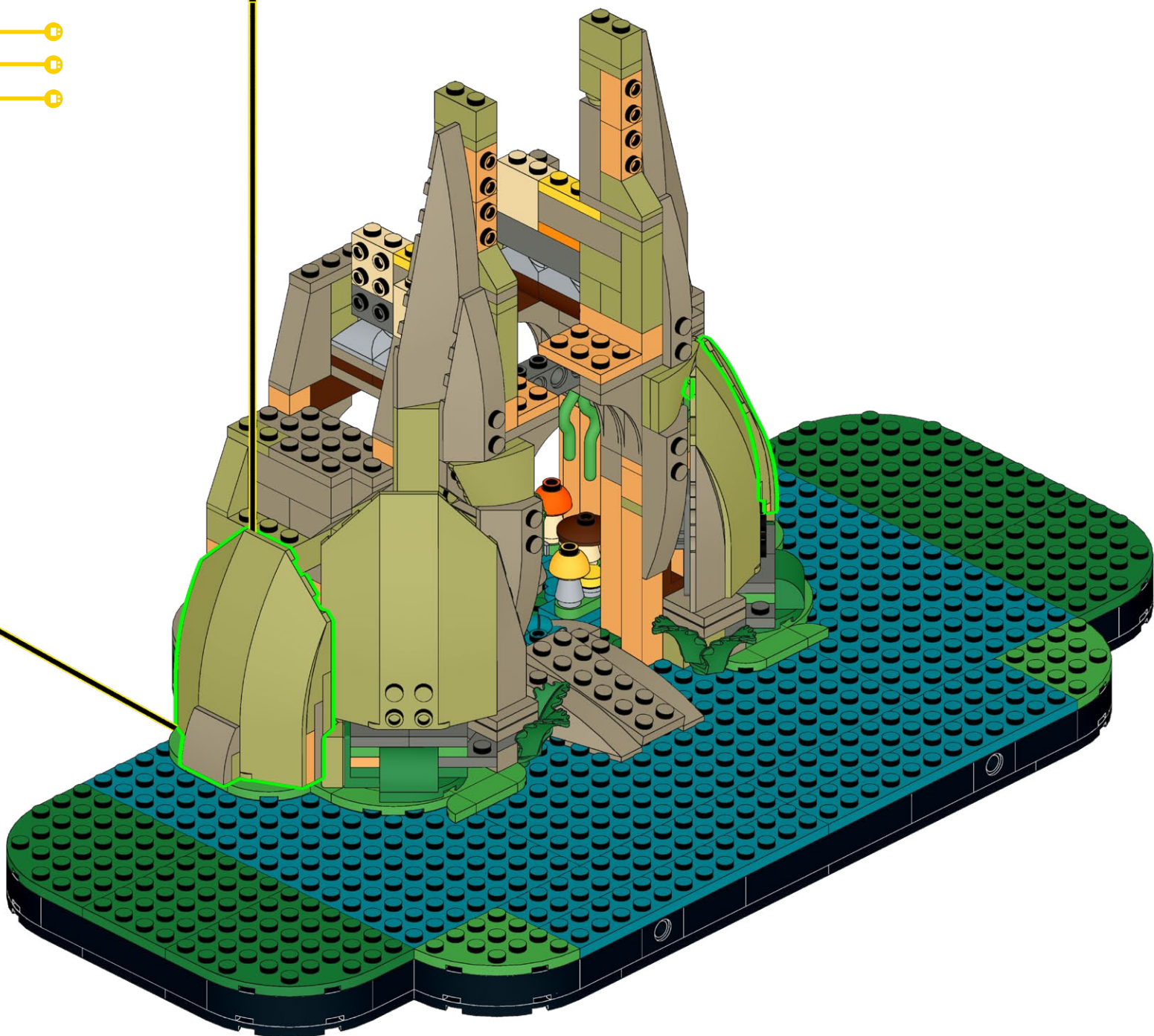

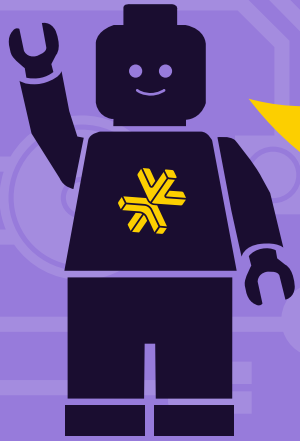
**HOLD UP!**

You might notice some bags aren't in order, as well as left over pieces, but that's ok! We're changing the way you build LEGO!

ATTENDEZ!

Vous remarquerez peut-être que certains sacs, ainsi que certaines pièces, ne sont pas dans le bon ordre. Mais pas de panique! Nous changeons simplement la façon avec laquelle vous construisez vos LEGO!

ASPETTA!

Potresti notare che alcuni sacchetti non sono in ordine, così come i pezzi avanzati, ma va bene così! Stiamo cambiando il modo in cui costruisci i LEGO!

HALT!

Sie werden möglicherweise bemerken, dass einige tüten durcheinander sind und teile übrig bleiben, aber das ist in Ordnung! Wir ändern die art und weise, wie Sie LEGO bauen!

¡ESPERA!

Es posible que notes que algunas bolsas están fuera de servicio, así como piezas sobrantes, ¡pero está bien! ¡Estamos cambiando la forma en que construyes LEGO!

暫停!

你可能会注意到一些袋子顺序错乱, 以及一些剩余的部件, 但没关系! 我们正在改变你搭建乐高的方式!

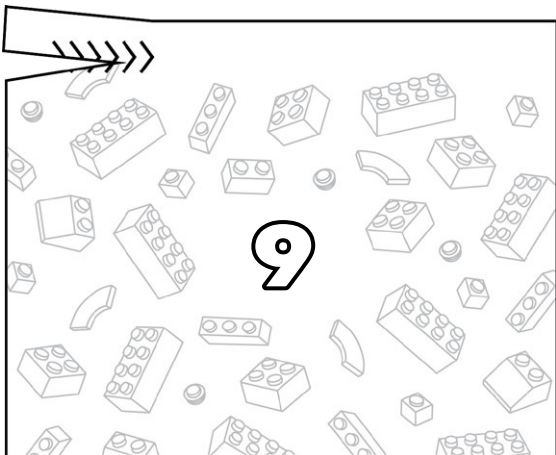
Open LEGO® Bag 9

246

4x 2x 9x 12x

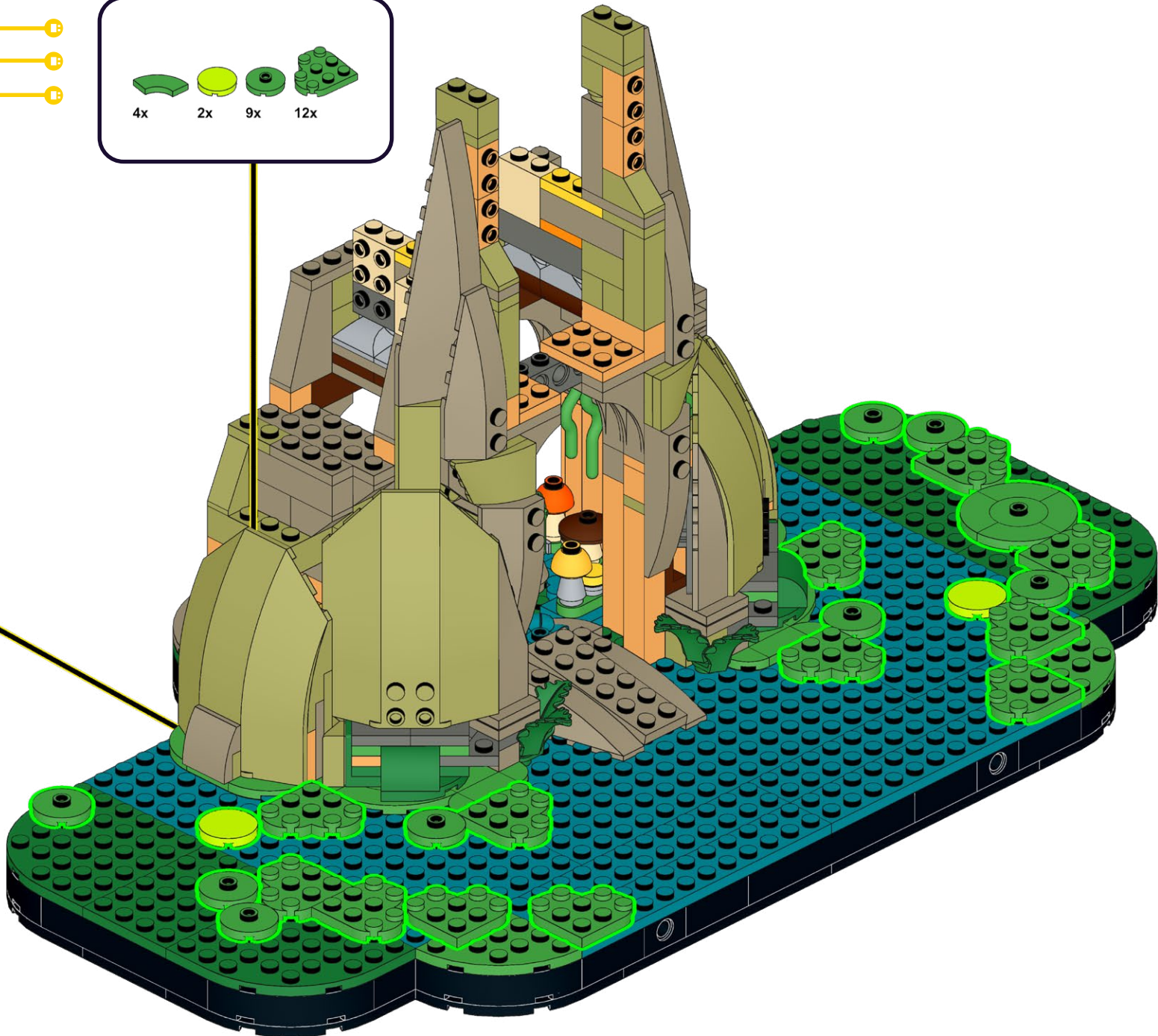

247

1x 7x 3x

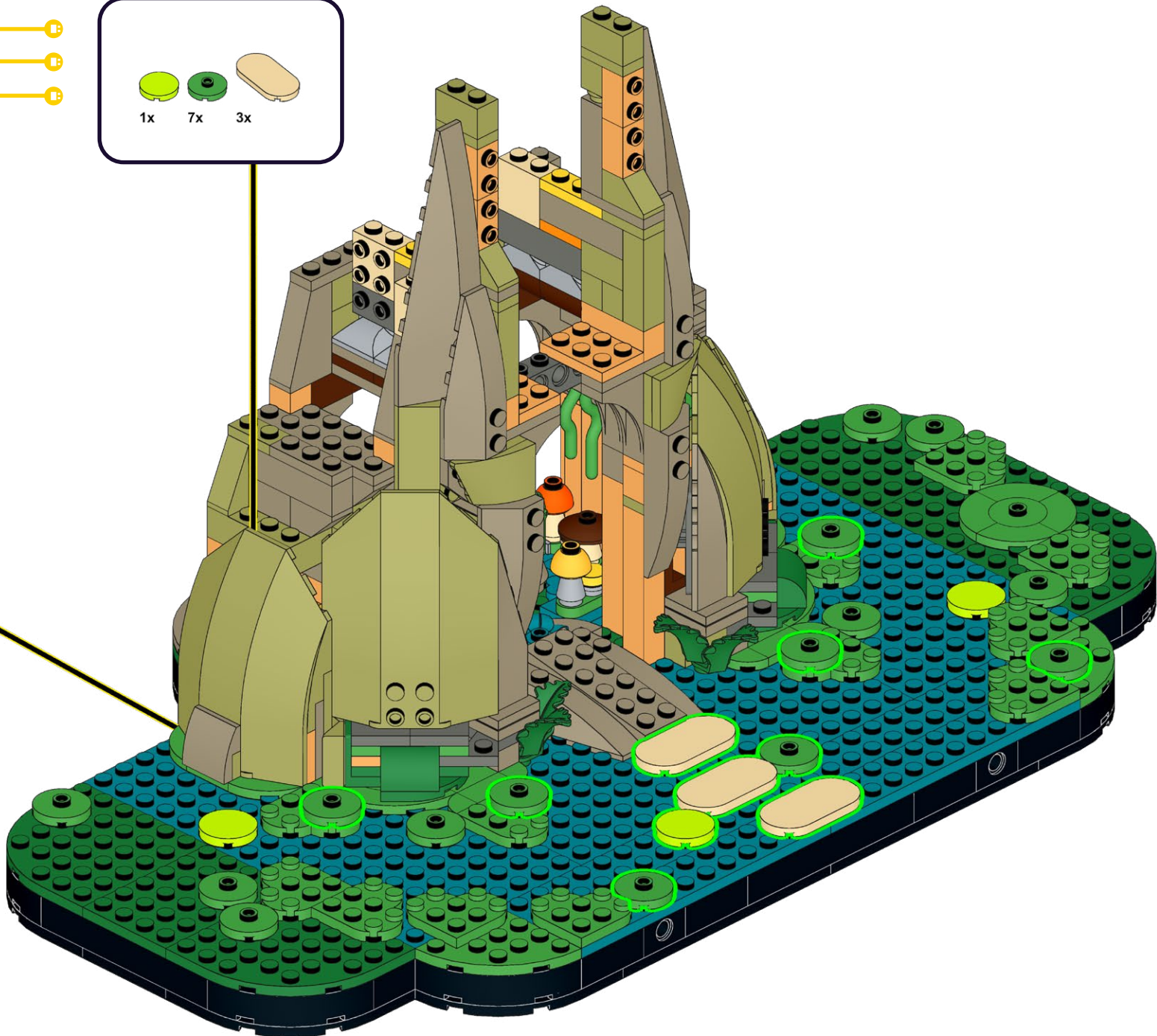
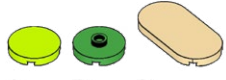

248



4x

5x

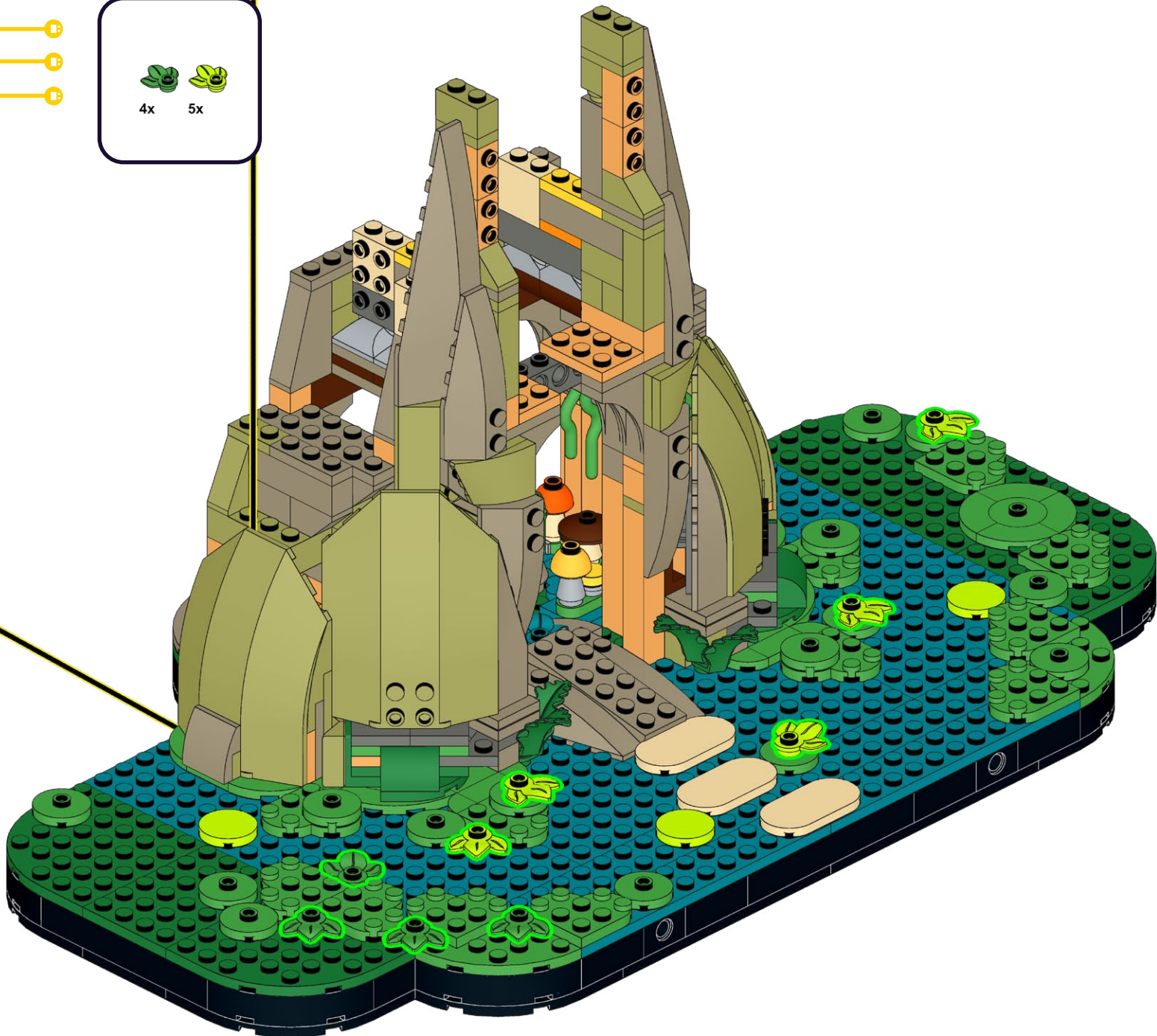





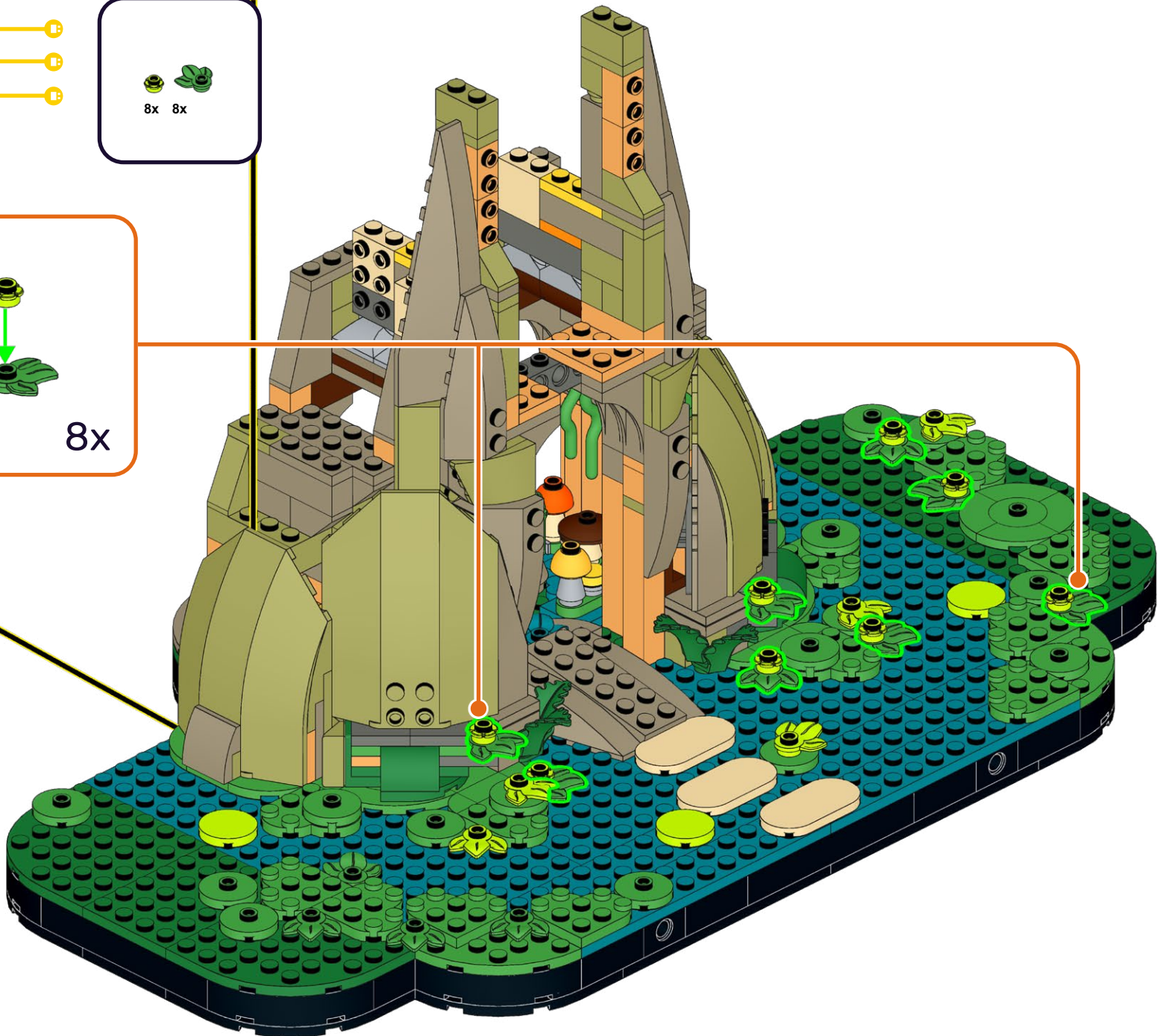
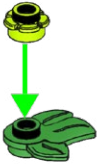

249



8x 8x



8x





250

- 1x 
- 1x 
- 1x 
- 2x 
- 4x 
- 4x 

1  → 

2  → 

3 

 →  4x

251

1x 1x 2x 1x 1x 1x 1x 1x 1x 14x

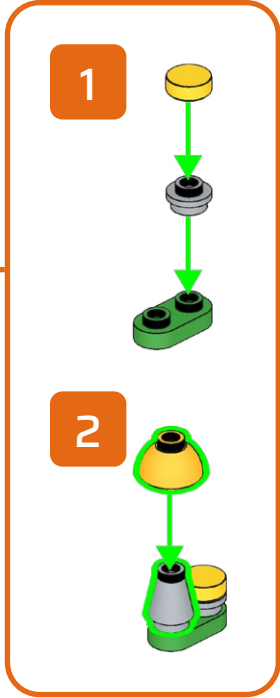
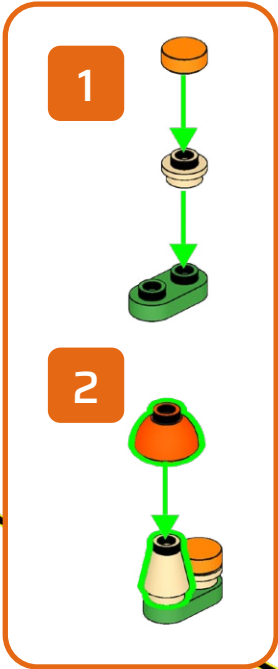

252

7x





HOLD UP!

You might notice some bags aren't in order, as well as left over pieces, but that's ok! We're changing the way you build LEGO!

ATTENDEZ!

Vous remarquerez peut-être que certains sacs, ainsi que certaines pièces, ne sont pas dans le bon ordre. Mais pas de panique! Nous changeons simplement la façon avec laquelle vous construisez vos LEGO!

ASPETTA!

Potresti notare che alcuni sacchetti non sono in ordine, così come i pezzi avanzati, ma va bene così! Stiamo cambiando il modo in cui costruisci i LEGO!

HALT!

Sie werden möglicherweise bemerken, dass einige tüten durcheinander sind und teile übrig bleiben, aber das ist in Ordnung! Wir ändern die art und weise, wie Sie LEGO bauen!

¡ESPERA!

Es posible que notes que algunas bolsas están fuera de servicio, así como piezas sobrantes, ¡pero está bien! ¡Estamos cambiando la forma en que construyes LEGO!

暫停!

你可能会注意到一些袋子顺序错乱, 以及一些剩余的部件, 但没关系! 我们正在改变你搭建乐高的方式!

Open LEGO® Bags 10 & 11

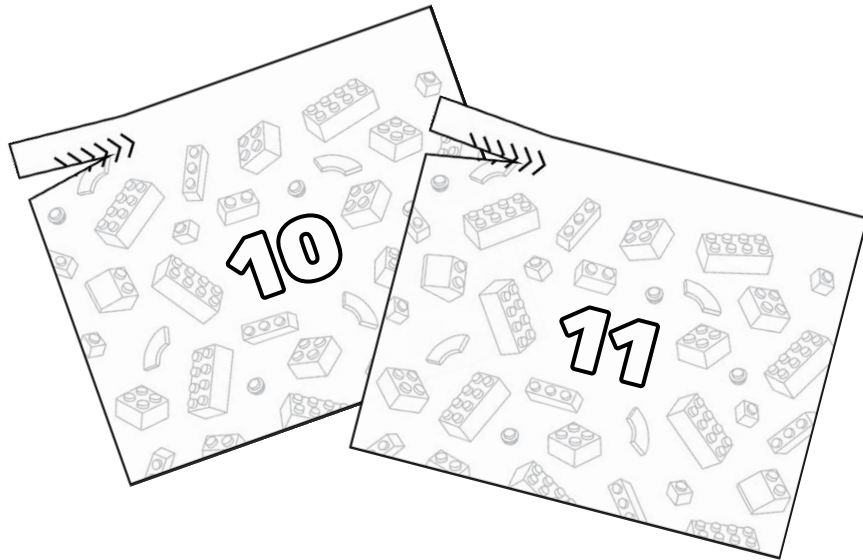

Open LMB Bag 03

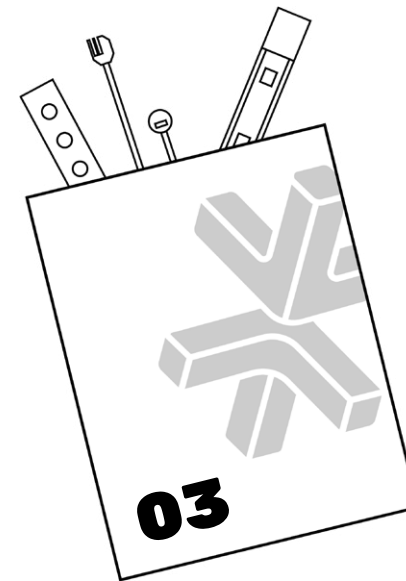

253

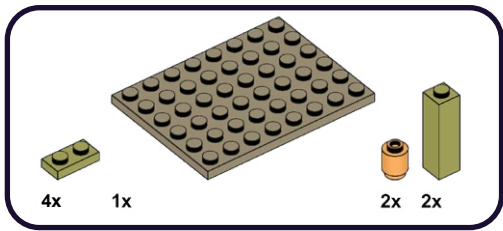

1

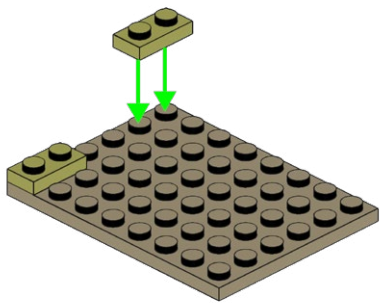

2

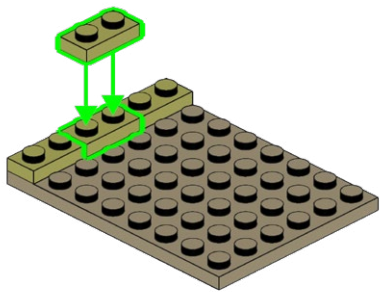

3

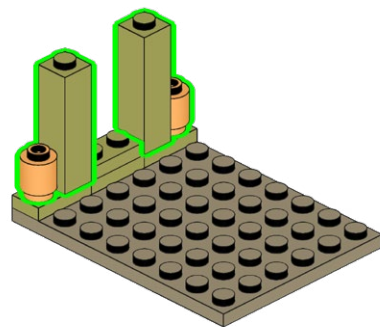

254

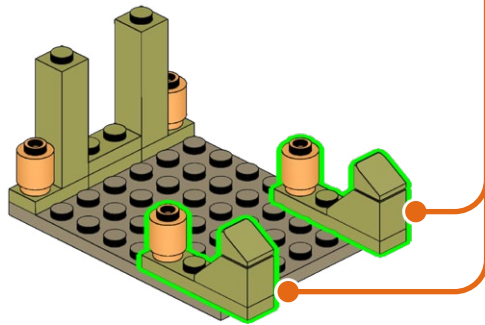
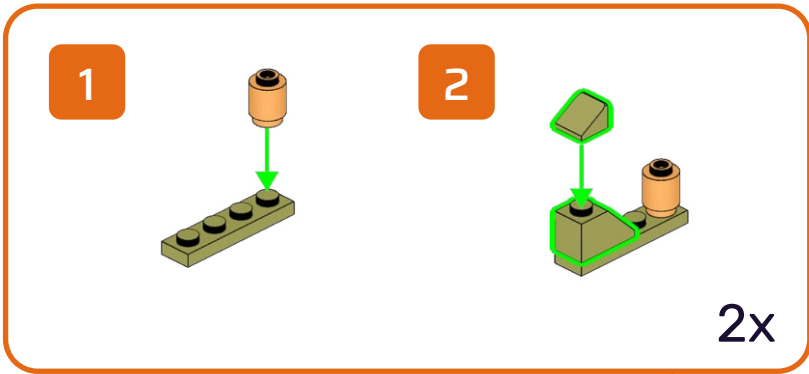
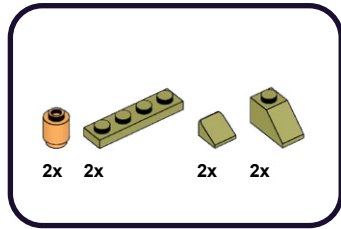

255

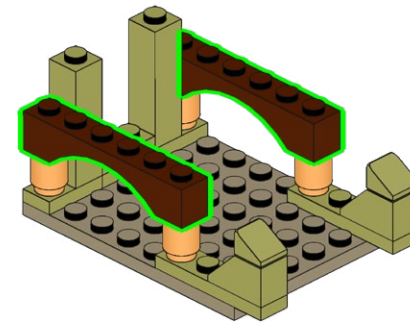
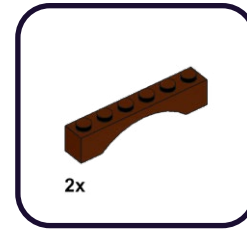

256

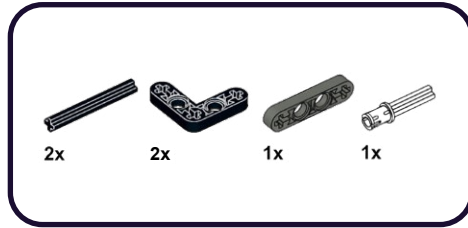

1



2



3

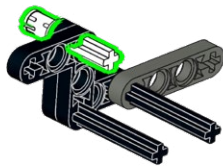

257

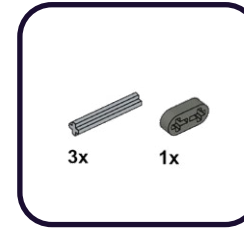

1

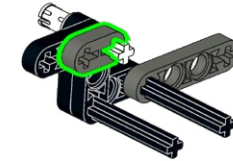

2

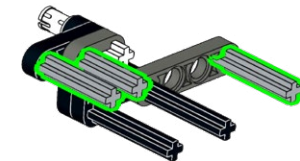

258

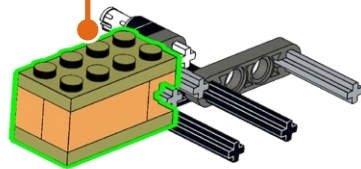
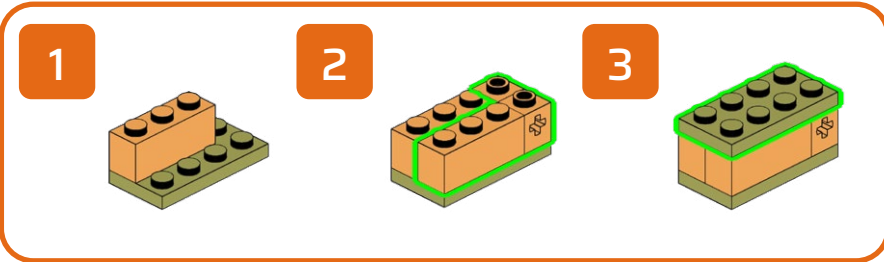
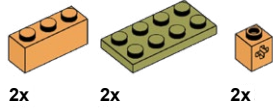

259

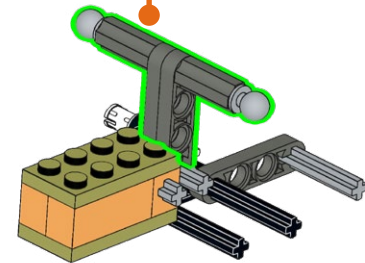
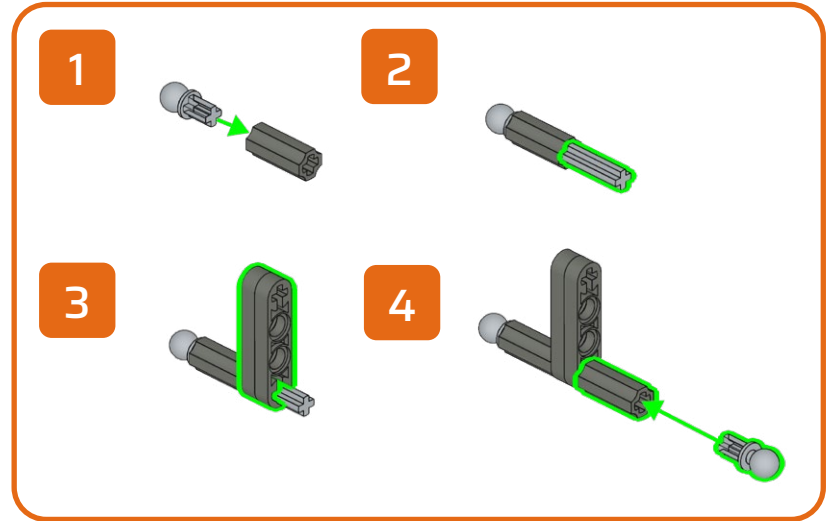
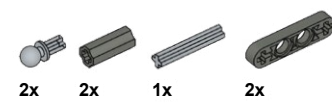

260

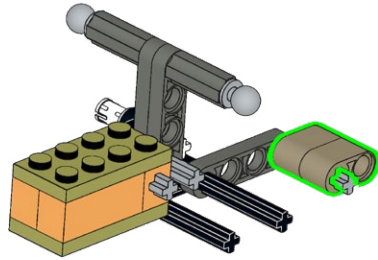
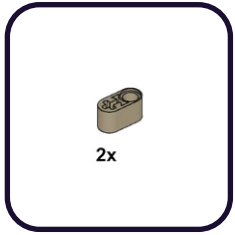

261

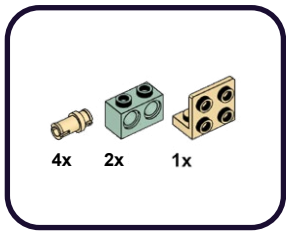

1

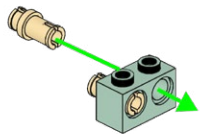

2

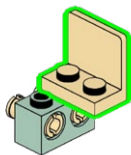

3

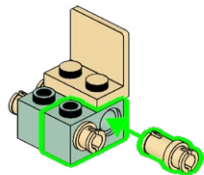

262

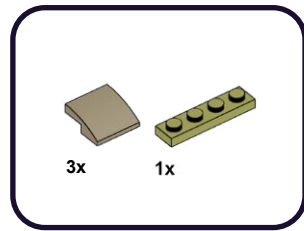

1

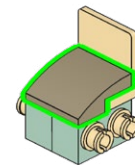

2

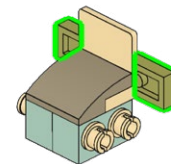

3

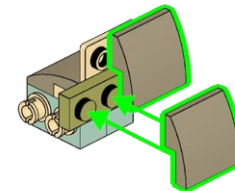
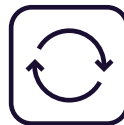

263

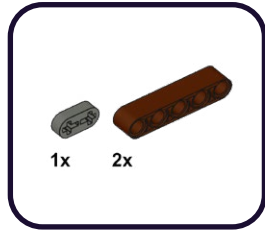

1

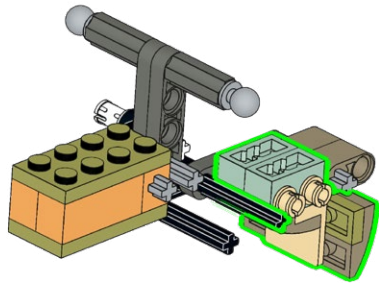

2

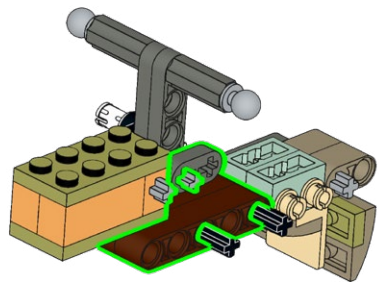

264

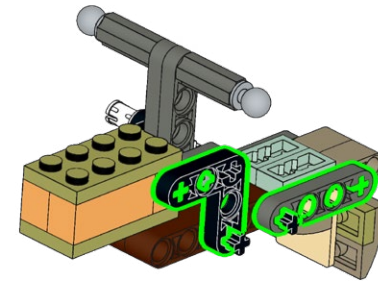
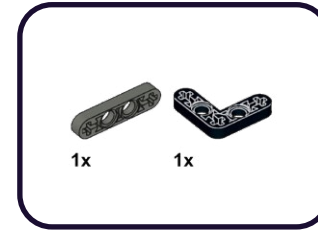

265

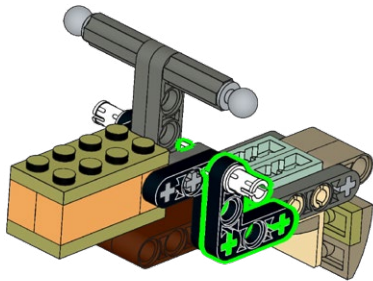
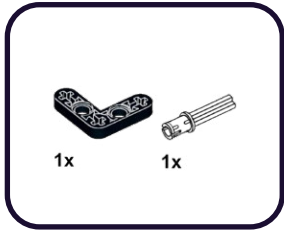

266

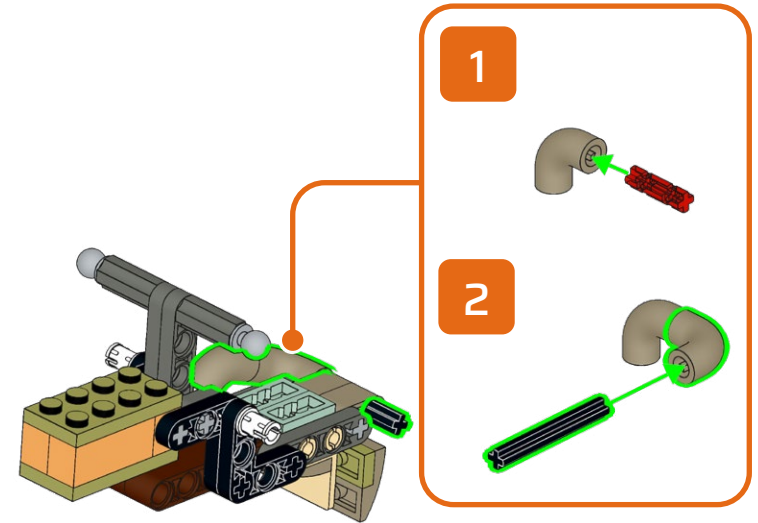
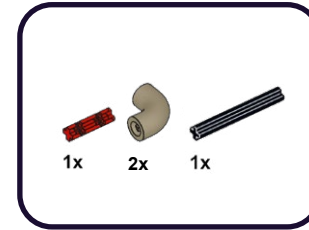

267

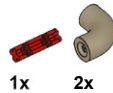

1

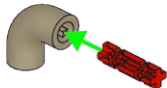

2

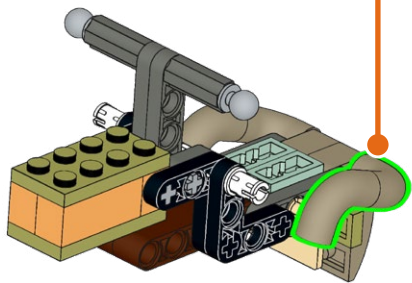
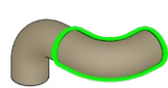

268

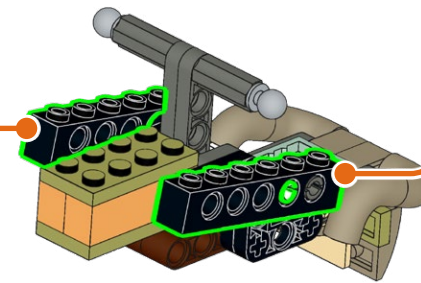
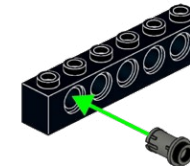
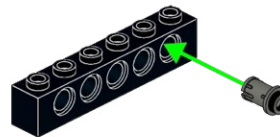
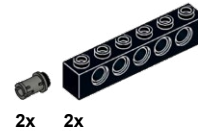

269



1

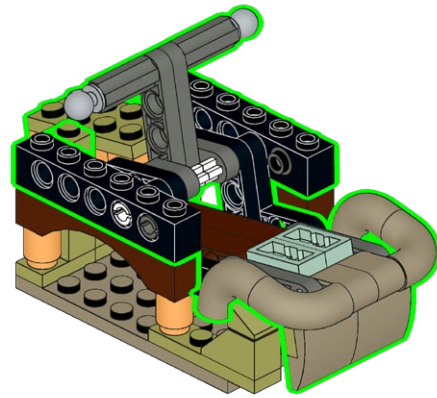
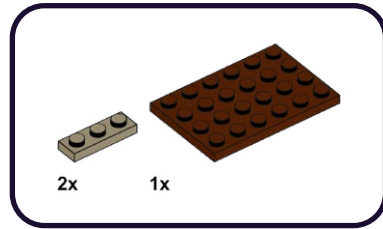

2

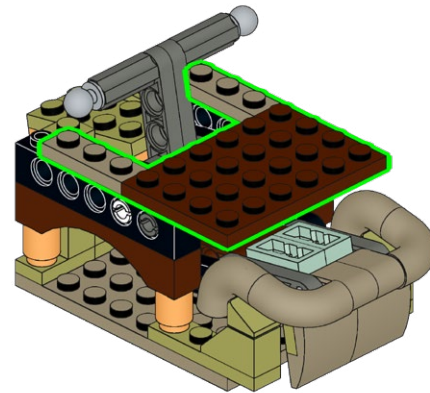

270

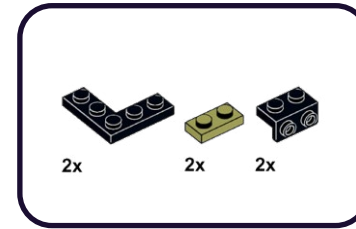

1

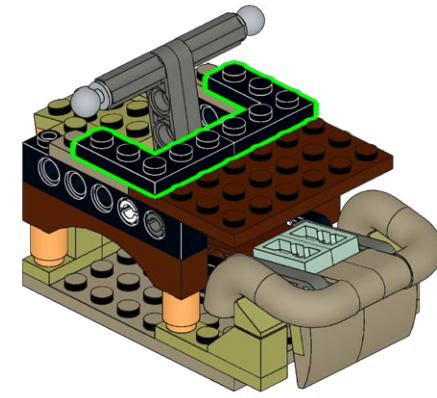

2

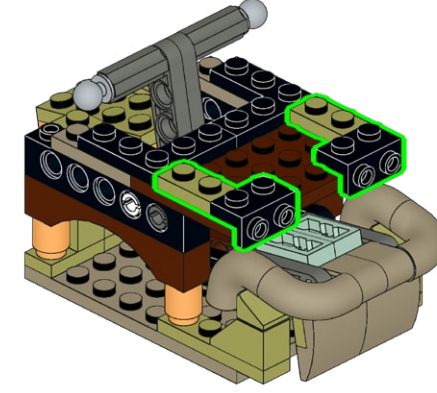

271

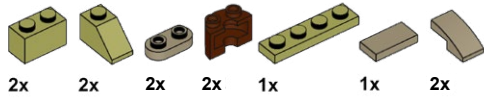

1

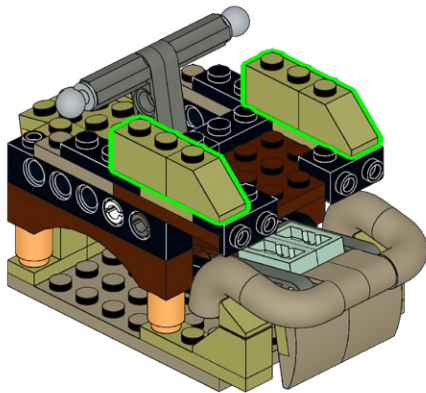

2

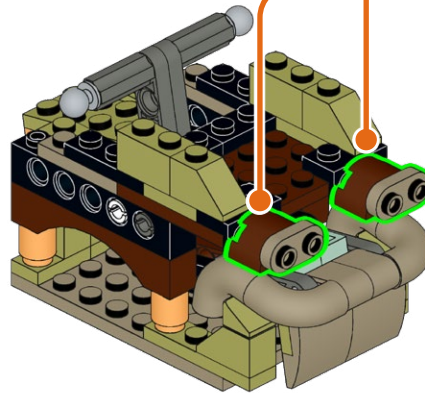
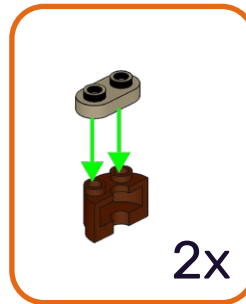

3

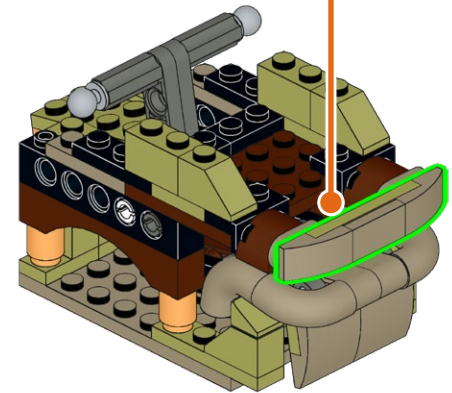
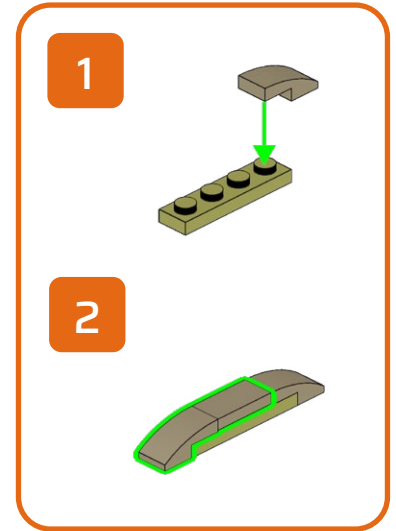

272

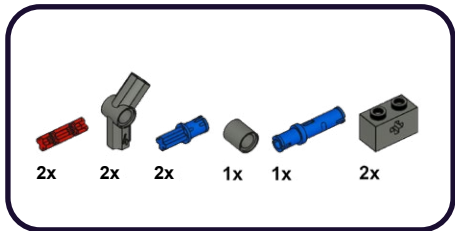

1

2

3

4

5

6

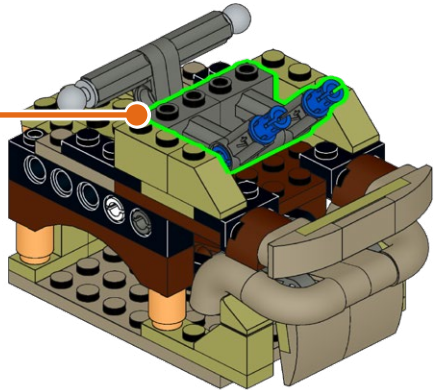

273

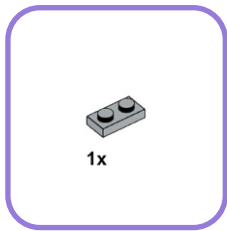
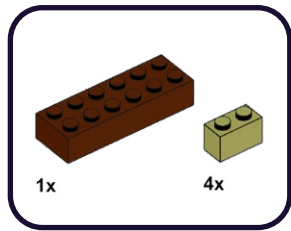

1

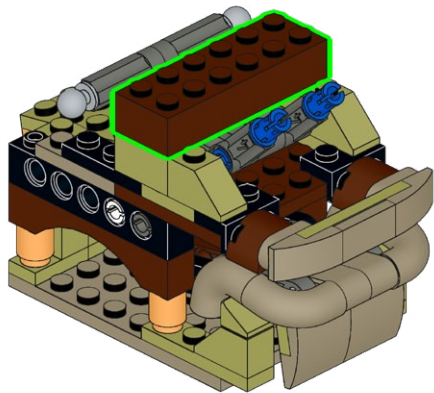

2

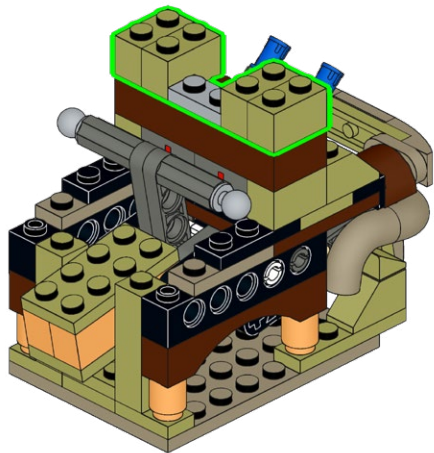
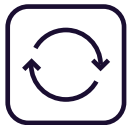

274

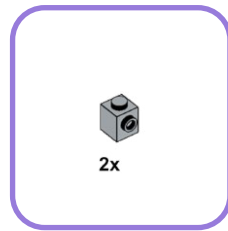
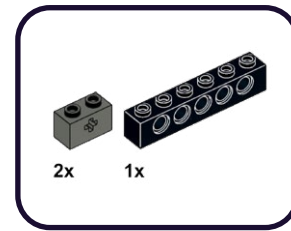

1

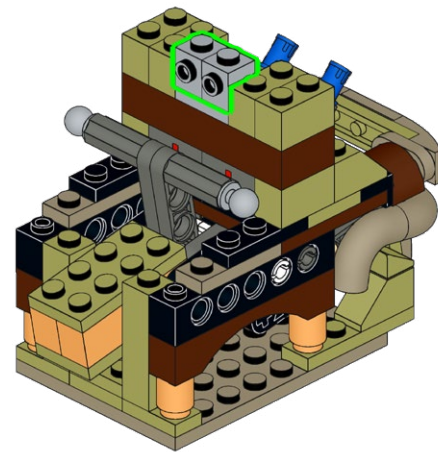

2

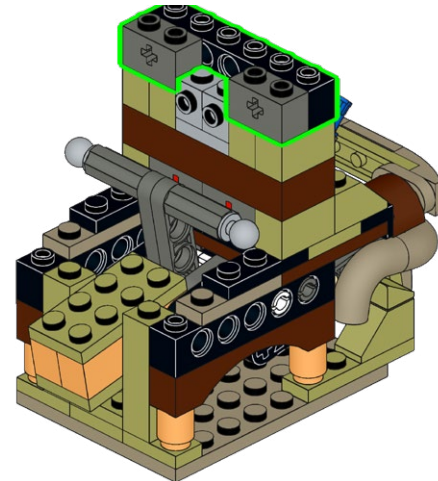

275

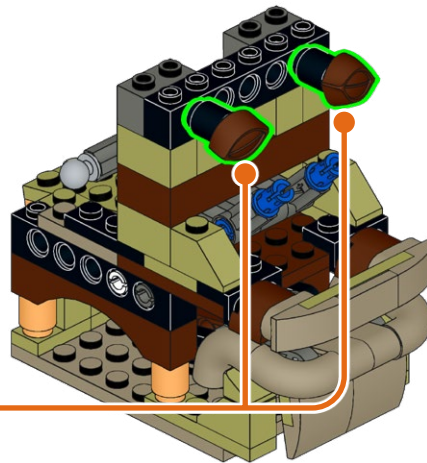
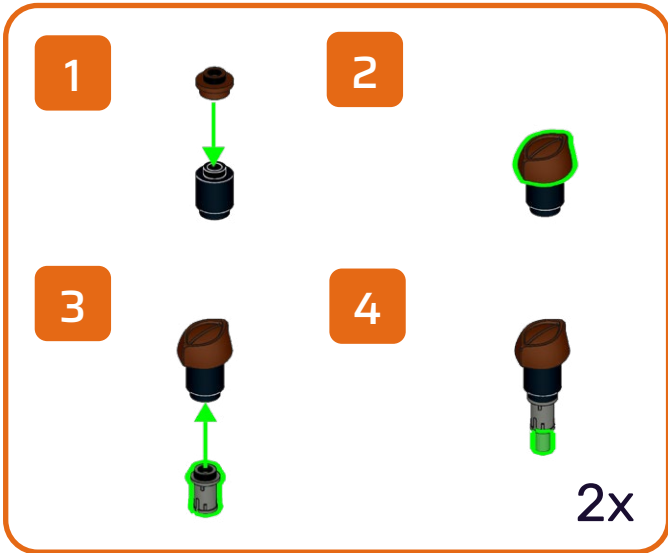
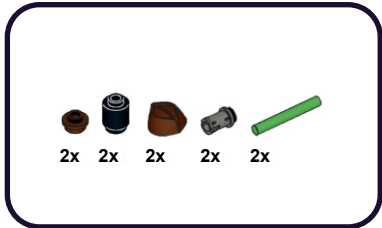

276

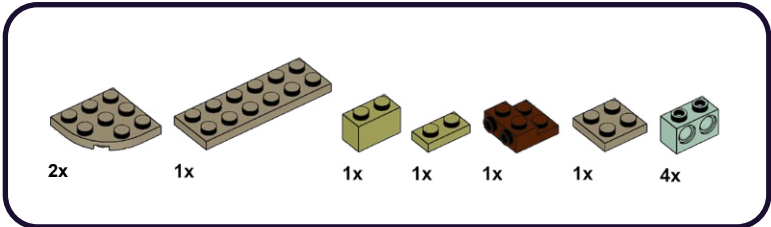

1 2 3 4 5 6

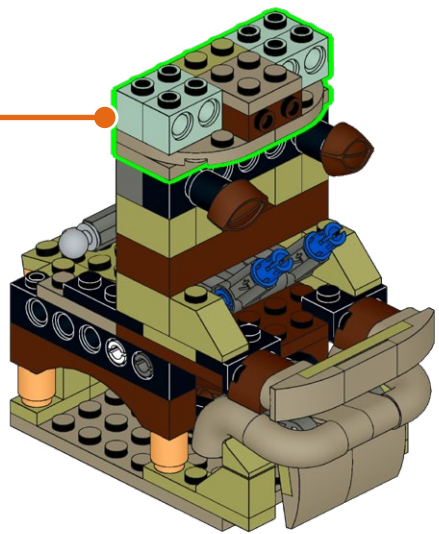

277



278

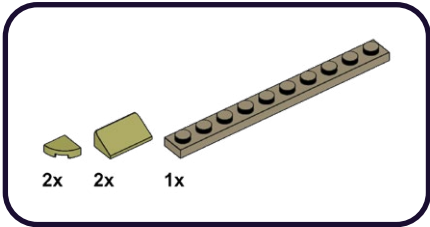

279

- 1x
- 2x
- 2x
- 2x
- 2x
- 1x
- 2x

1

2

3

4

1

2

3

4

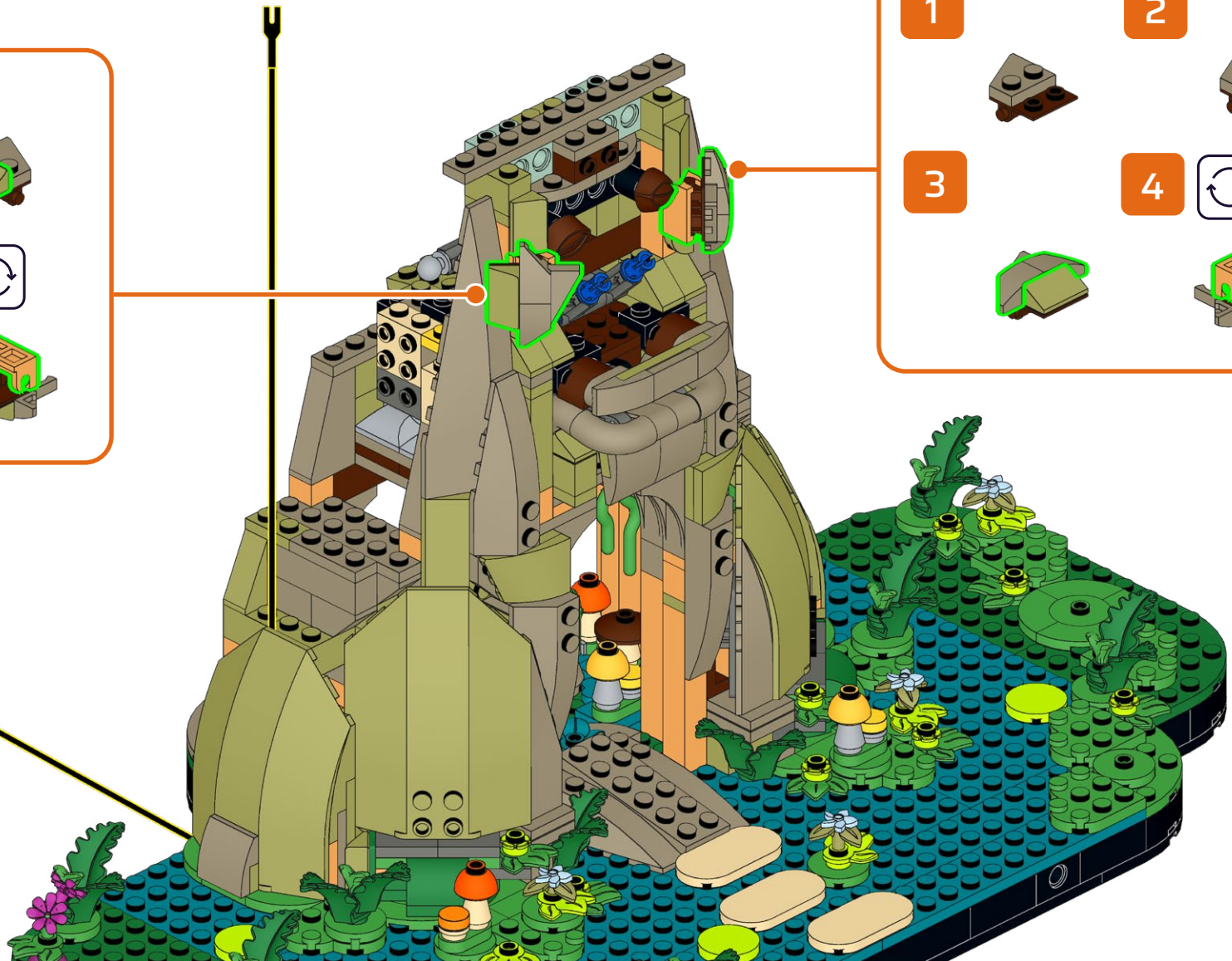

280

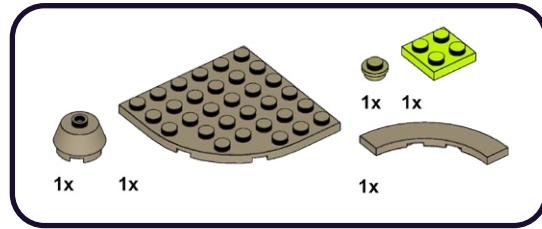

1

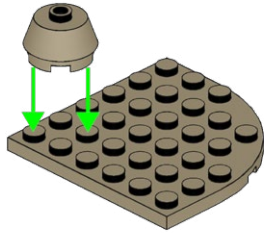

2

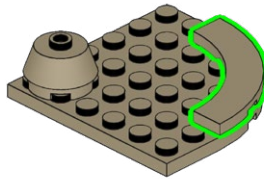

3

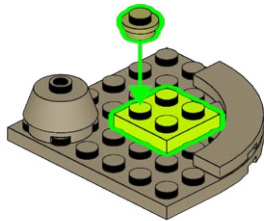

281

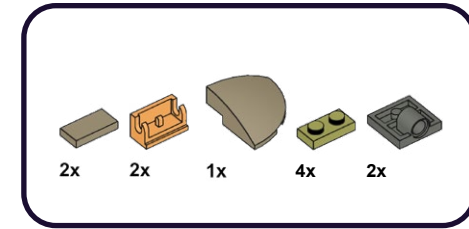

1

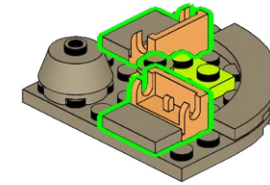

2

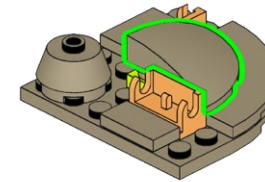

3

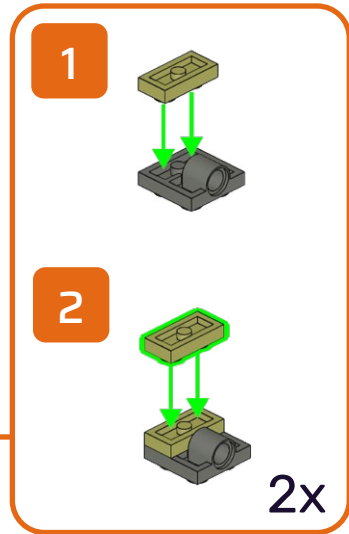
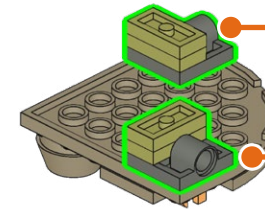

282

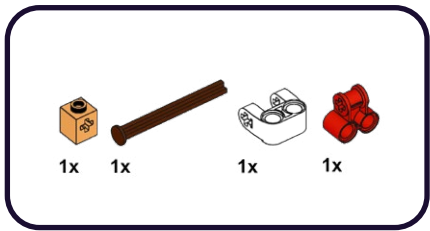

1

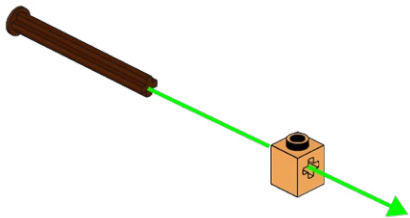

2

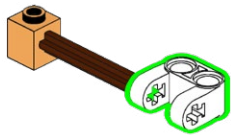

3

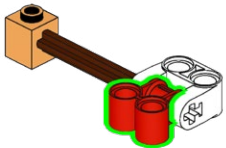

283

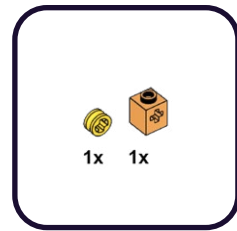

1

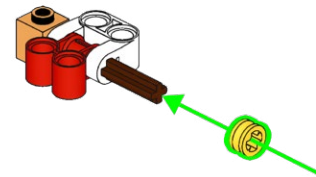

2

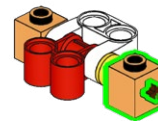

284

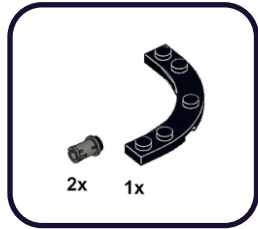

1

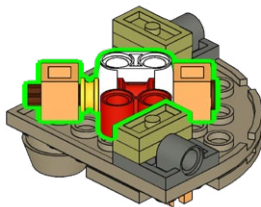

2

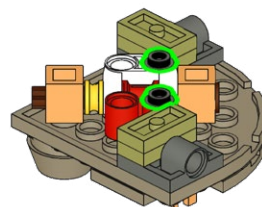

3

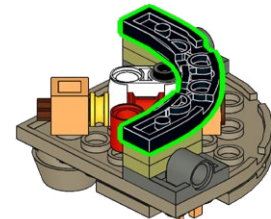

285

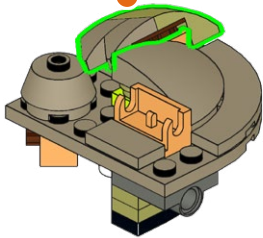
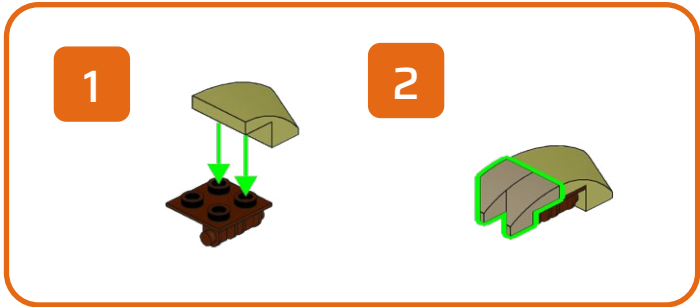
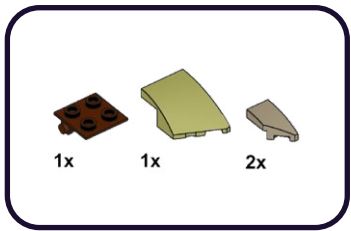

286

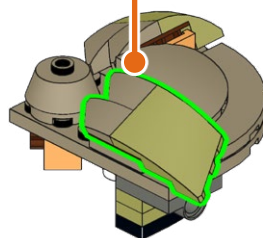
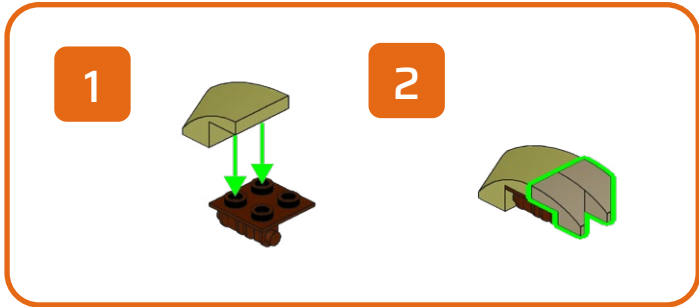
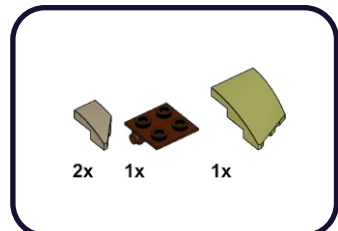

287



LMB

288

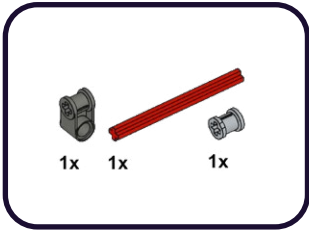

1

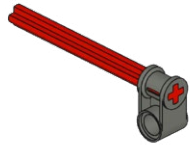

2

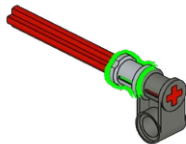

289

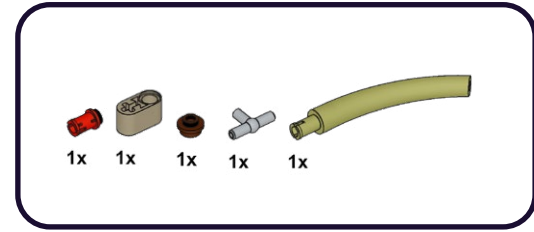

1

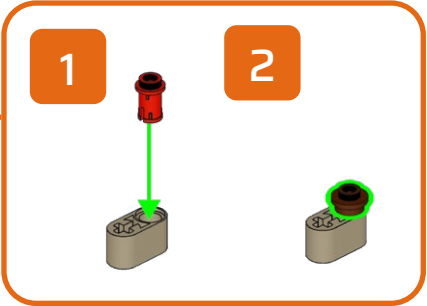
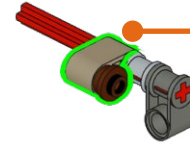

2

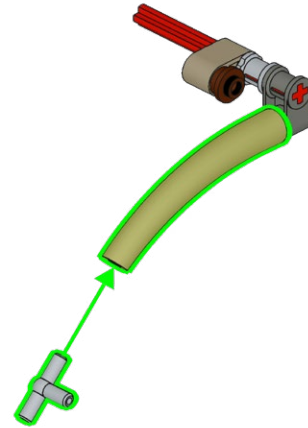

290

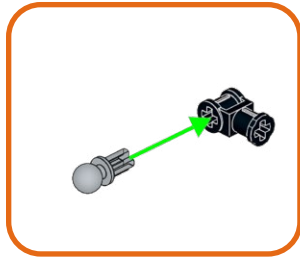
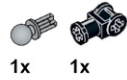

291

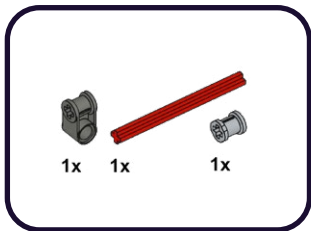

1

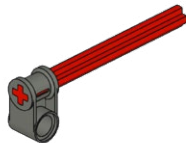

2

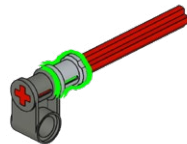

292

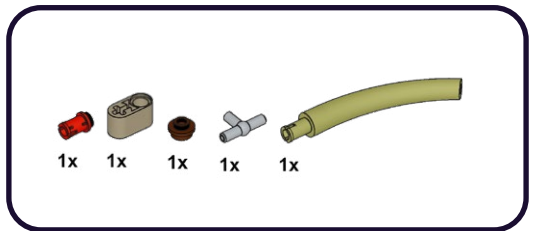

1

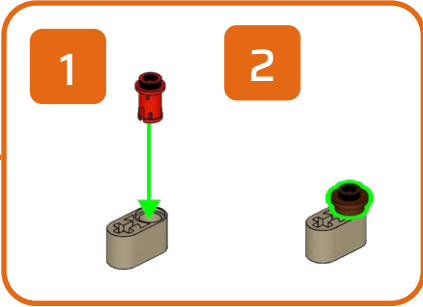
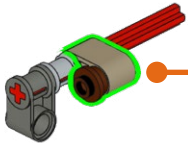

2

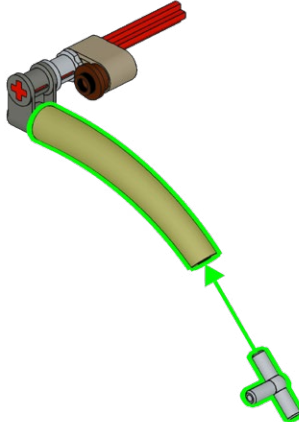

293



1x 1x

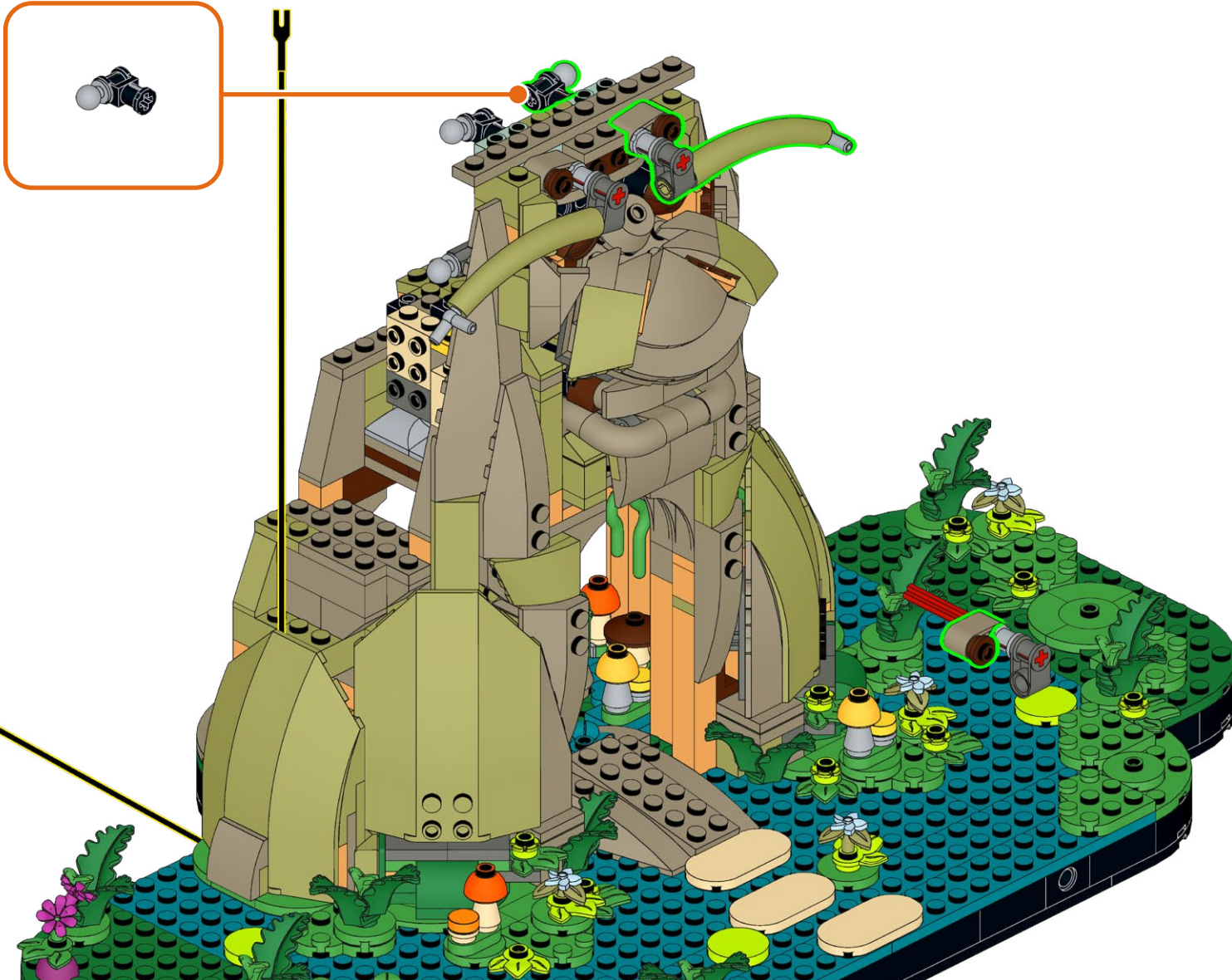

294

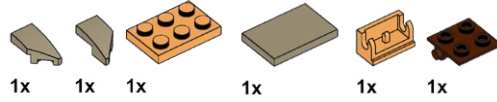

1

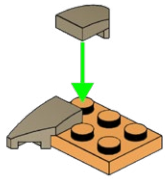

2

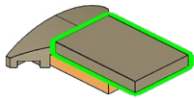

3

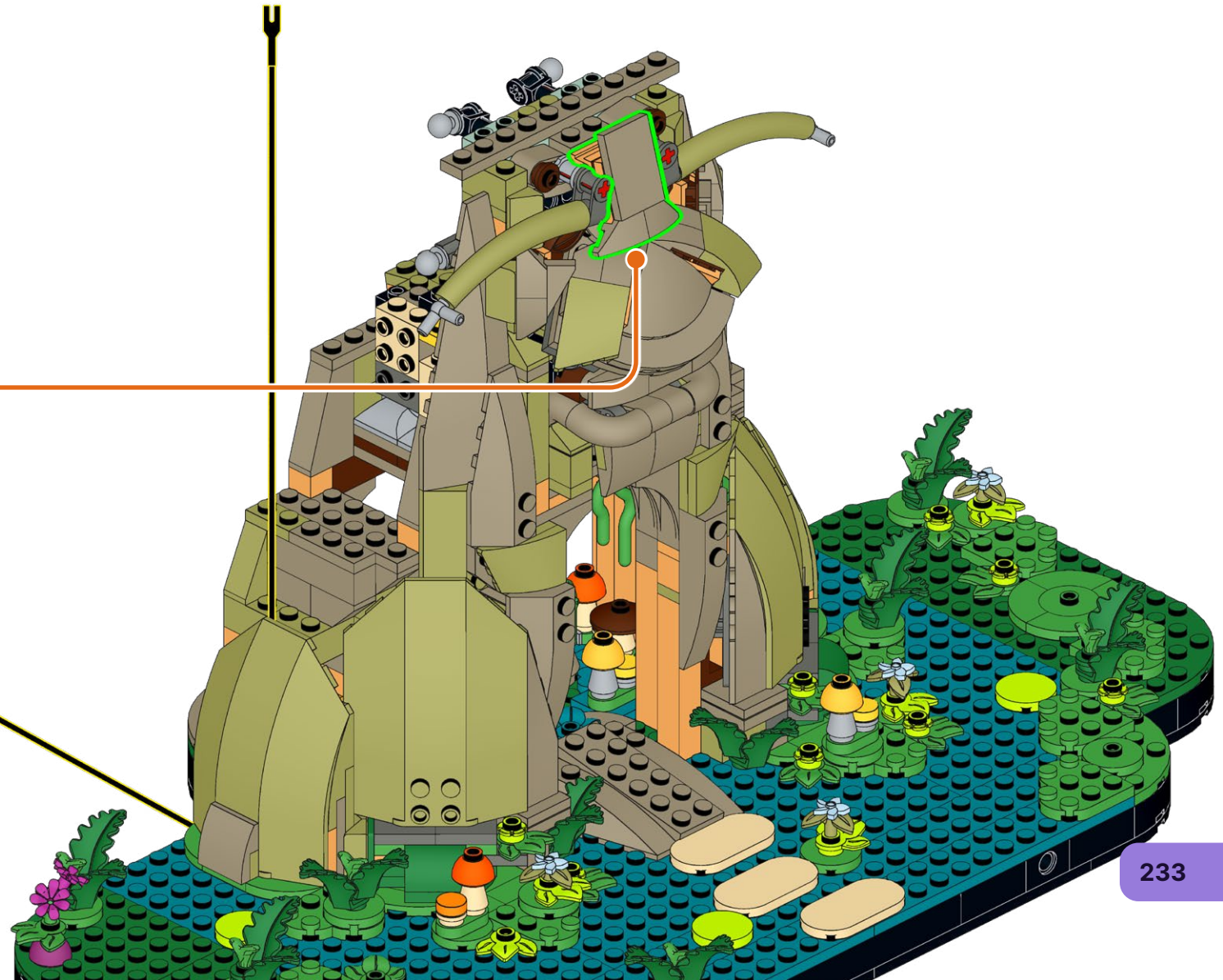
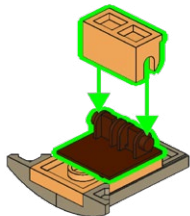

295

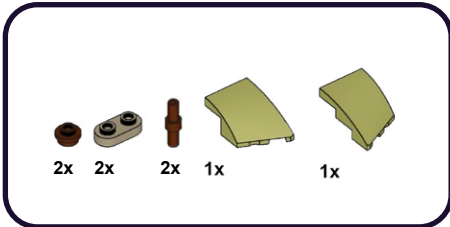

1

2

3

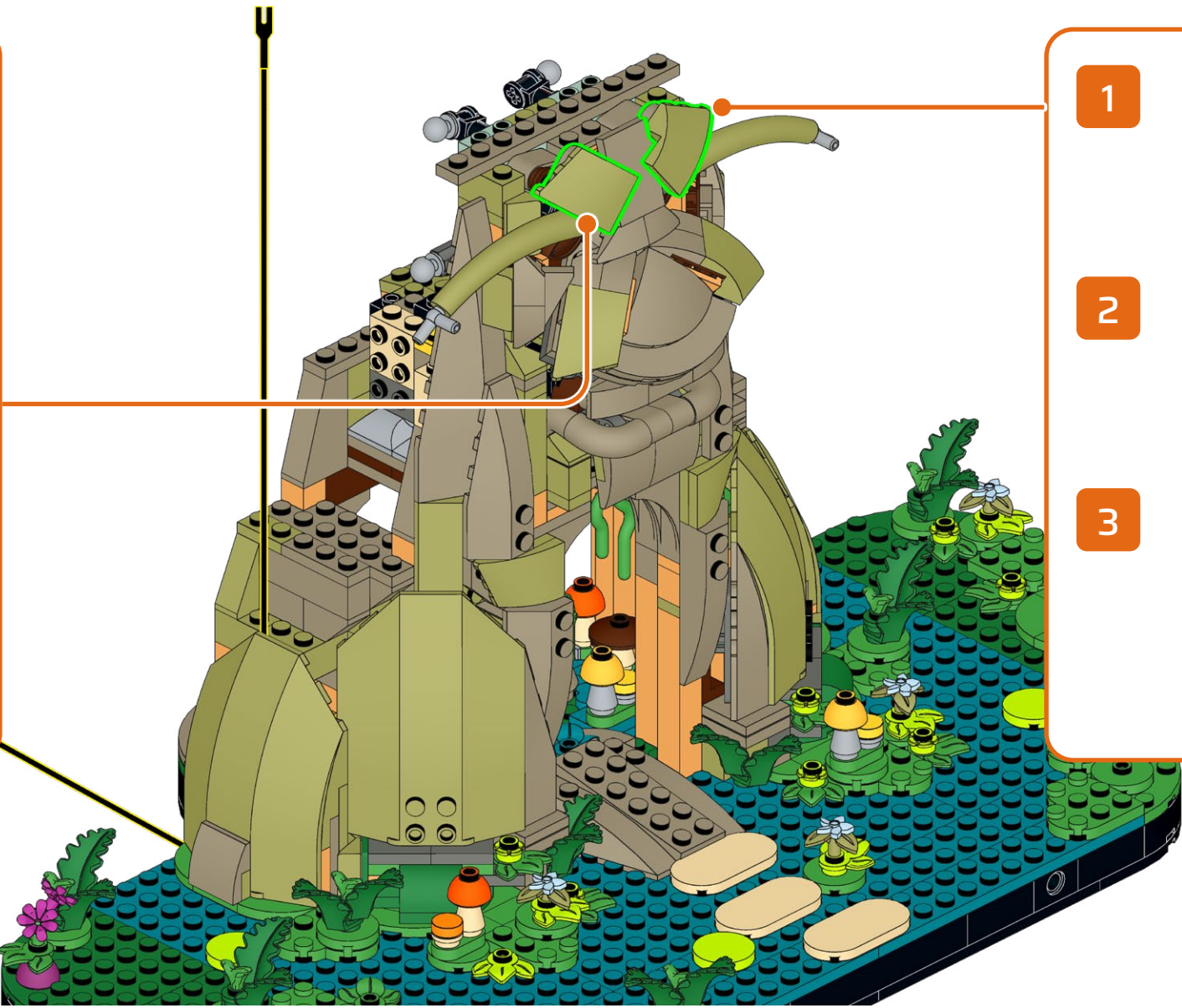

1

2

3

296

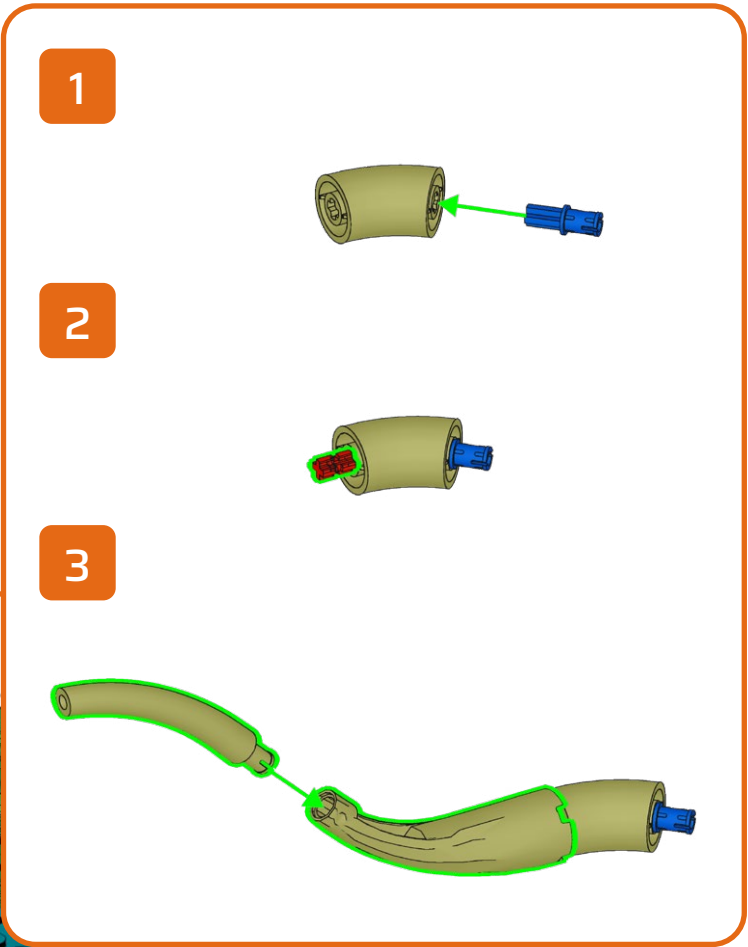
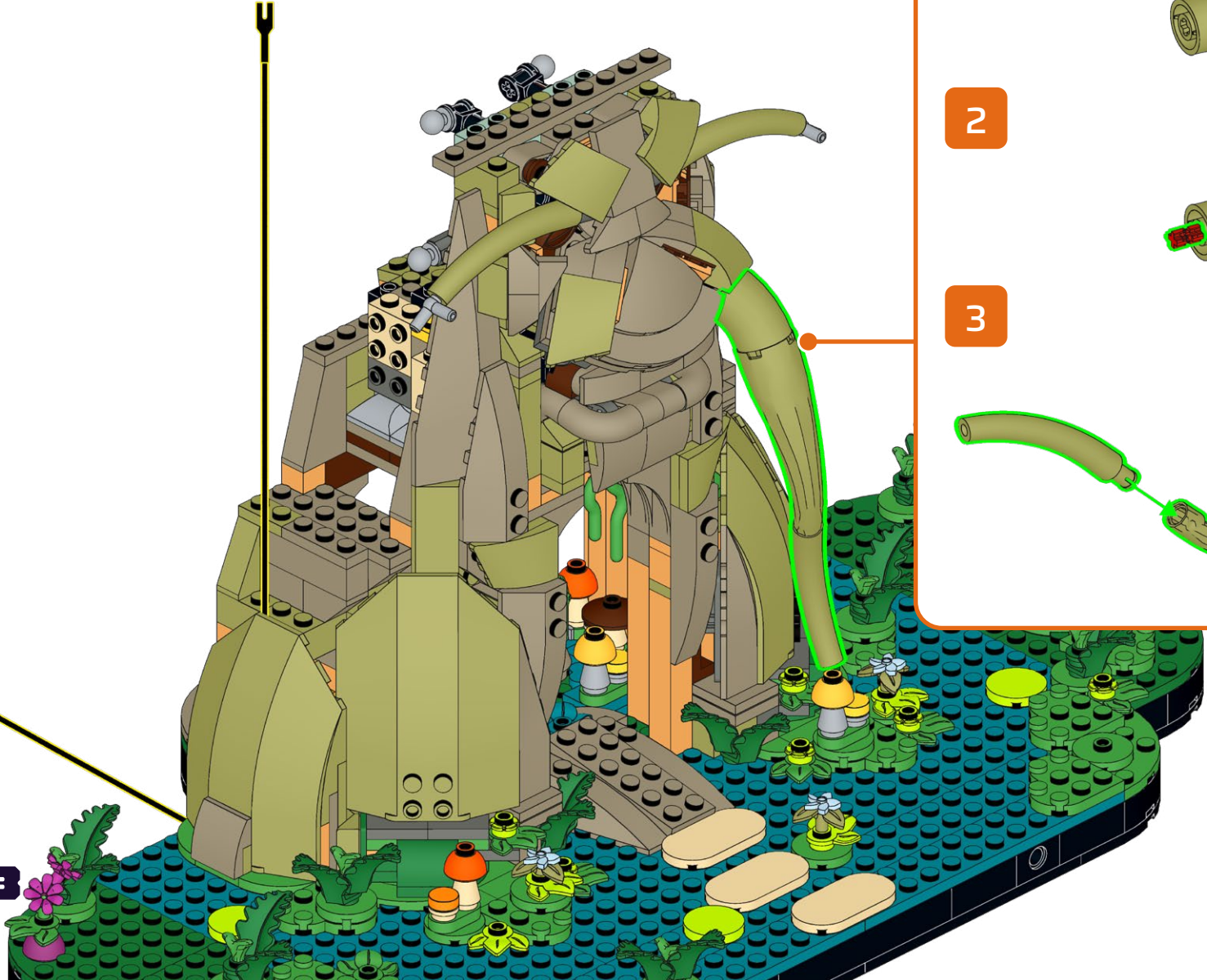
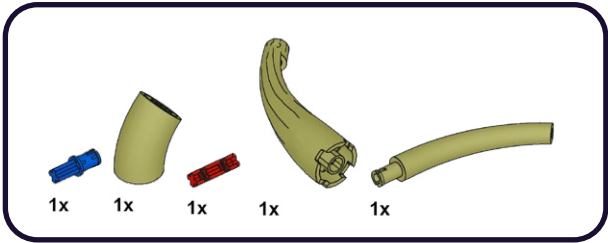

297

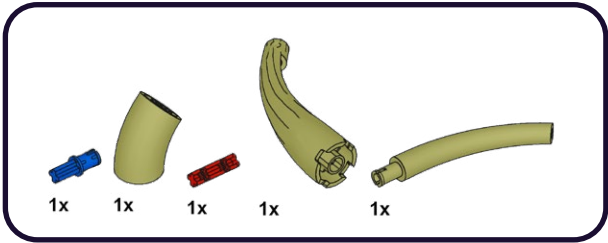

1

2

3

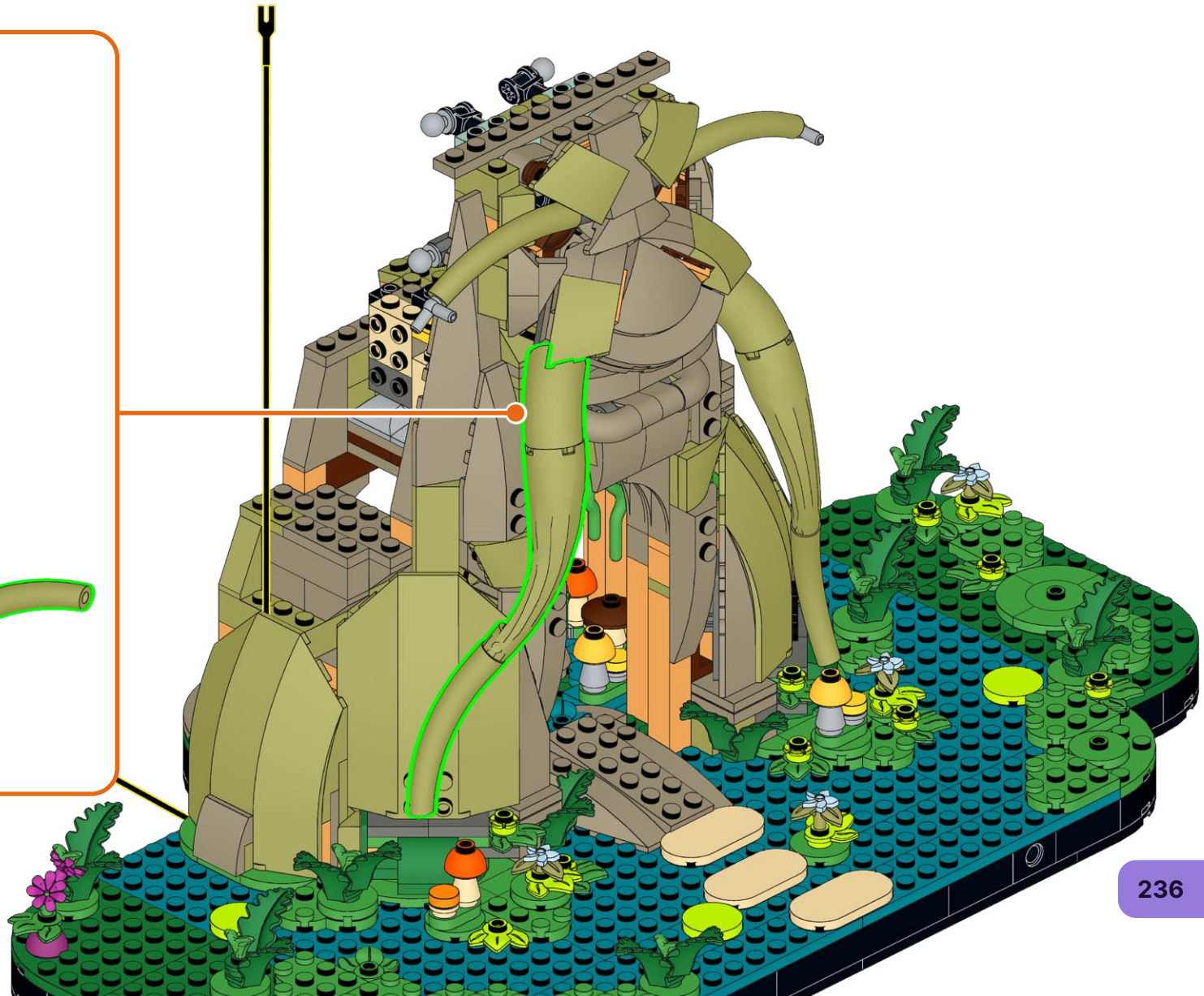

298

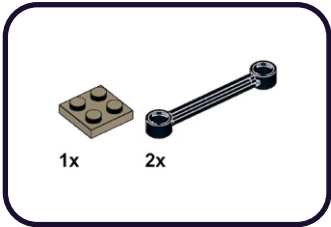

**HOLD UP!**

You might notice some bags aren't in order, as well as left over pieces, but that's ok! We're changing the way you build LEGO!

ATTENDEZ!

Vous remarquerez peut-être que certains sacs, ainsi que certaines pièces, ne sont pas dans le bon ordre. Mais pas de panique! Nous changeons simplement la façon avec laquelle vous construisez vos LEGO!

ASPETTA!

Potresti notare che alcuni sacchetti non sono in ordine, così come i pezzi avanzati, ma va bene così! Stiamo cambiando il modo in cui costruisci i LEGO!

HALT!

Sie werden möglicherweise bemerken, dass einige tüten durcheinander sind und teile übrig bleiben, aber das ist in Ordnung! Wir ändern die art und weise, wie Sie LEGO bauen!

¡ESPERA!

Es posible que notes que algunas bolsas están fuera de servicio, así como piezas sobrantes, ¡pero está bien! ¡Estamos cambiando la forma en que construyes LEGO!

暫停!

你可能会注意到一些袋子顺序错乱, 以及一些剩余的部件, 但没关系! 我们正在改变你搭建乐高的方式!

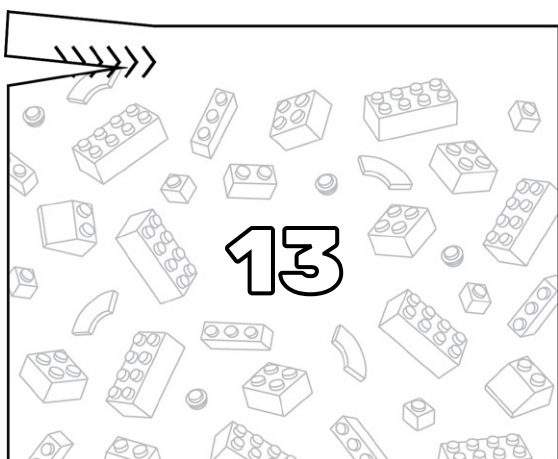
Open LEGO® Bag 13

299

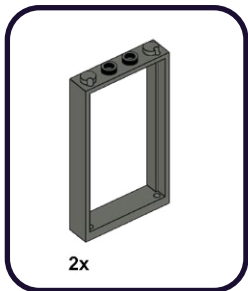

300

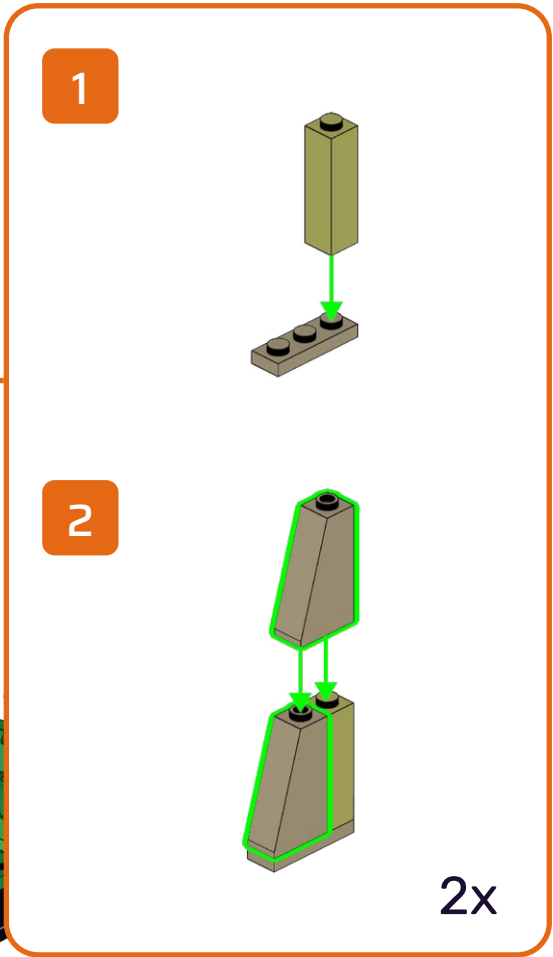
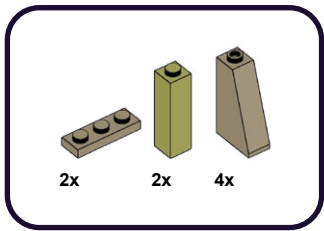

301

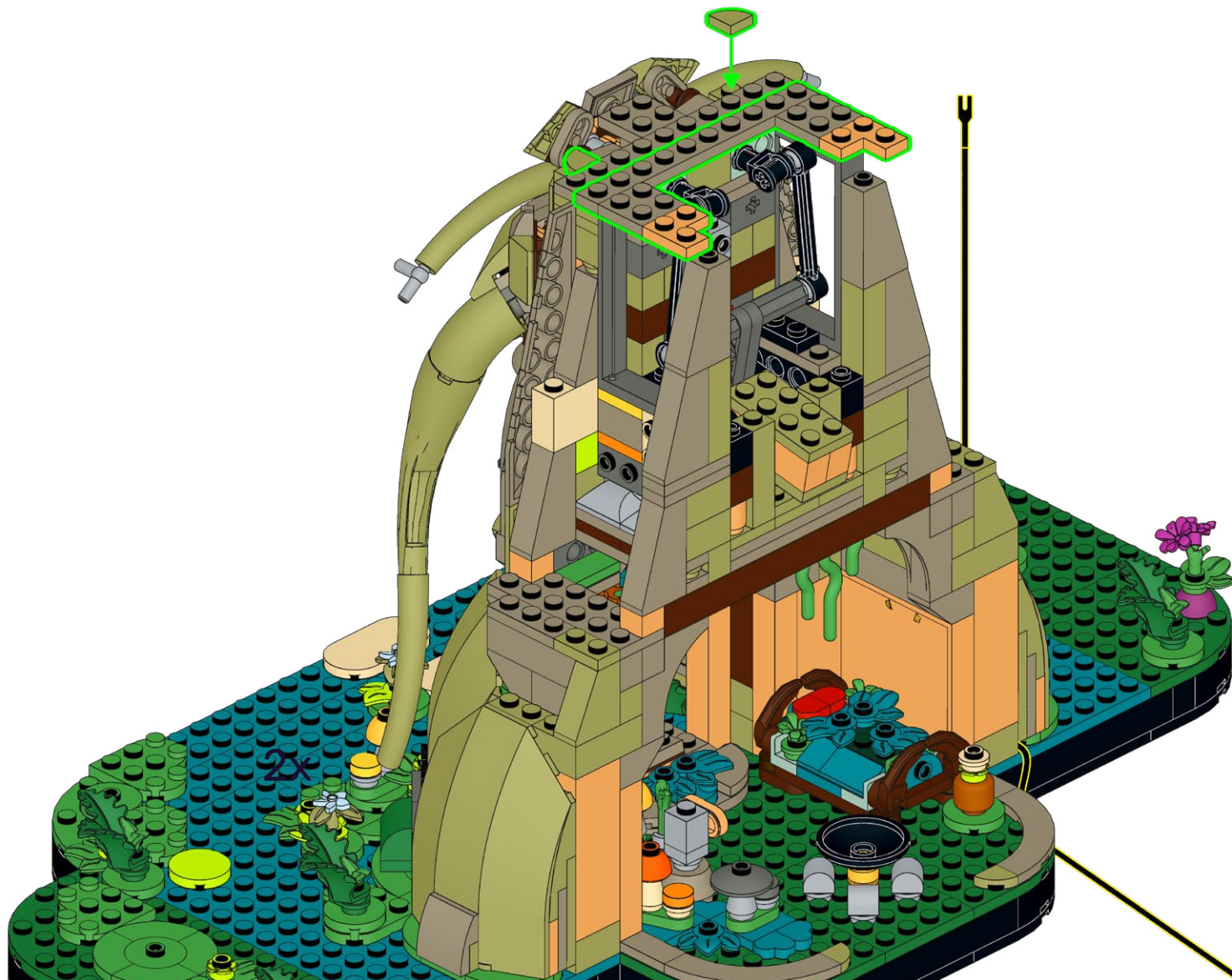
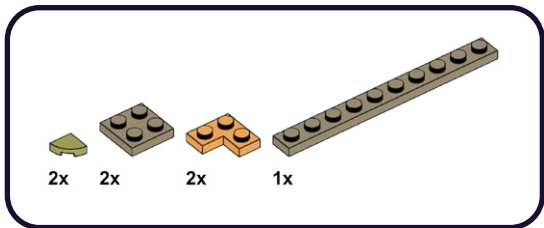

302

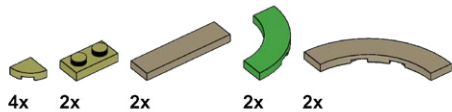

303



2x

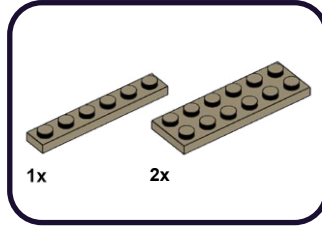

1x

2x

304

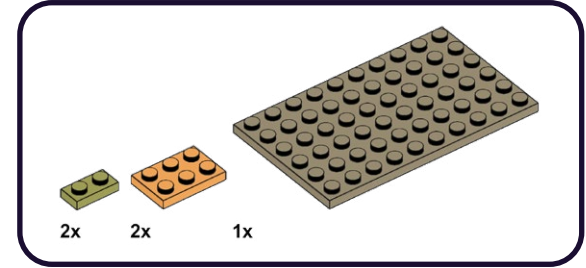

2x

2x

1x

1

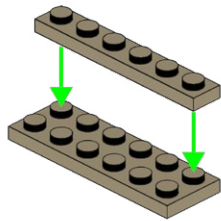

2

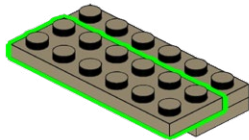

1

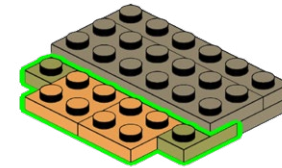

2

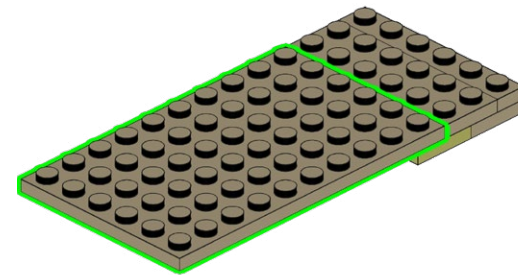

305

4x

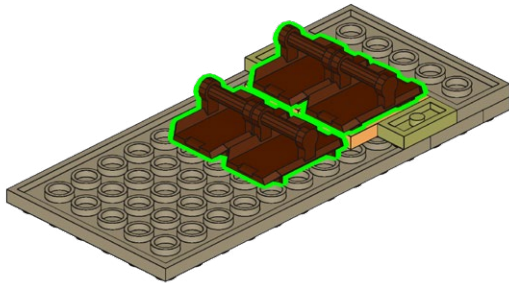

306

1x

1x

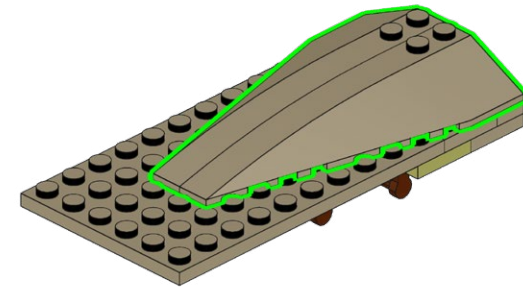

307

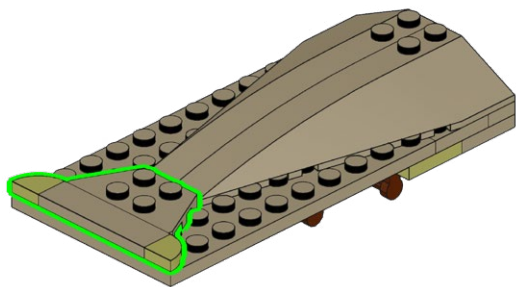
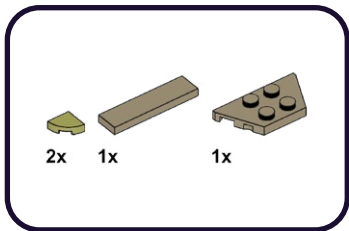

308

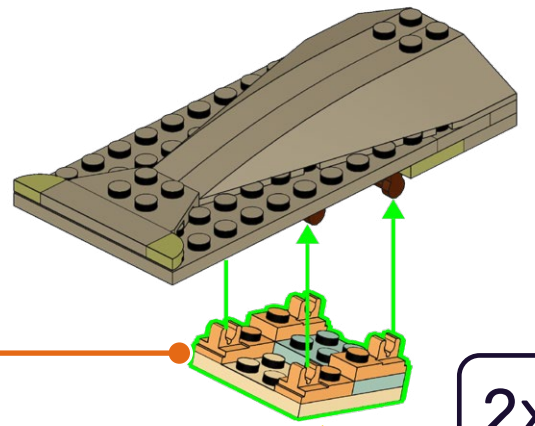
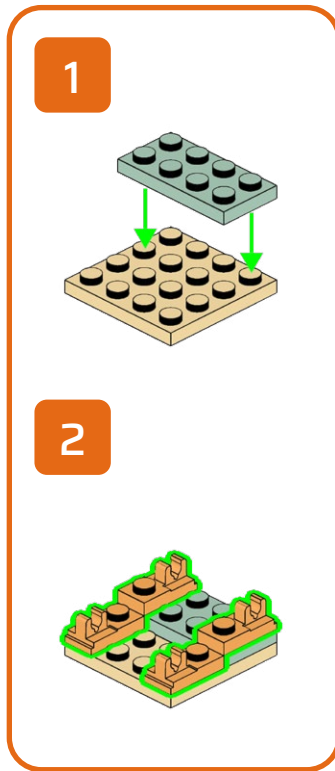
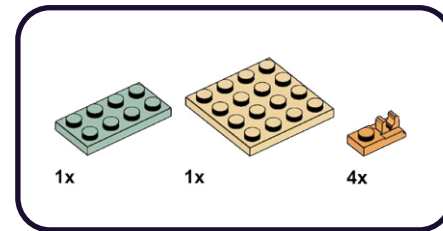

To be used later
 A utiliser plus tard
 Da utilizzare dopo
 Zur späteren Verwendung
 Para ser utilizado más tarde
 稍后使用

309



310

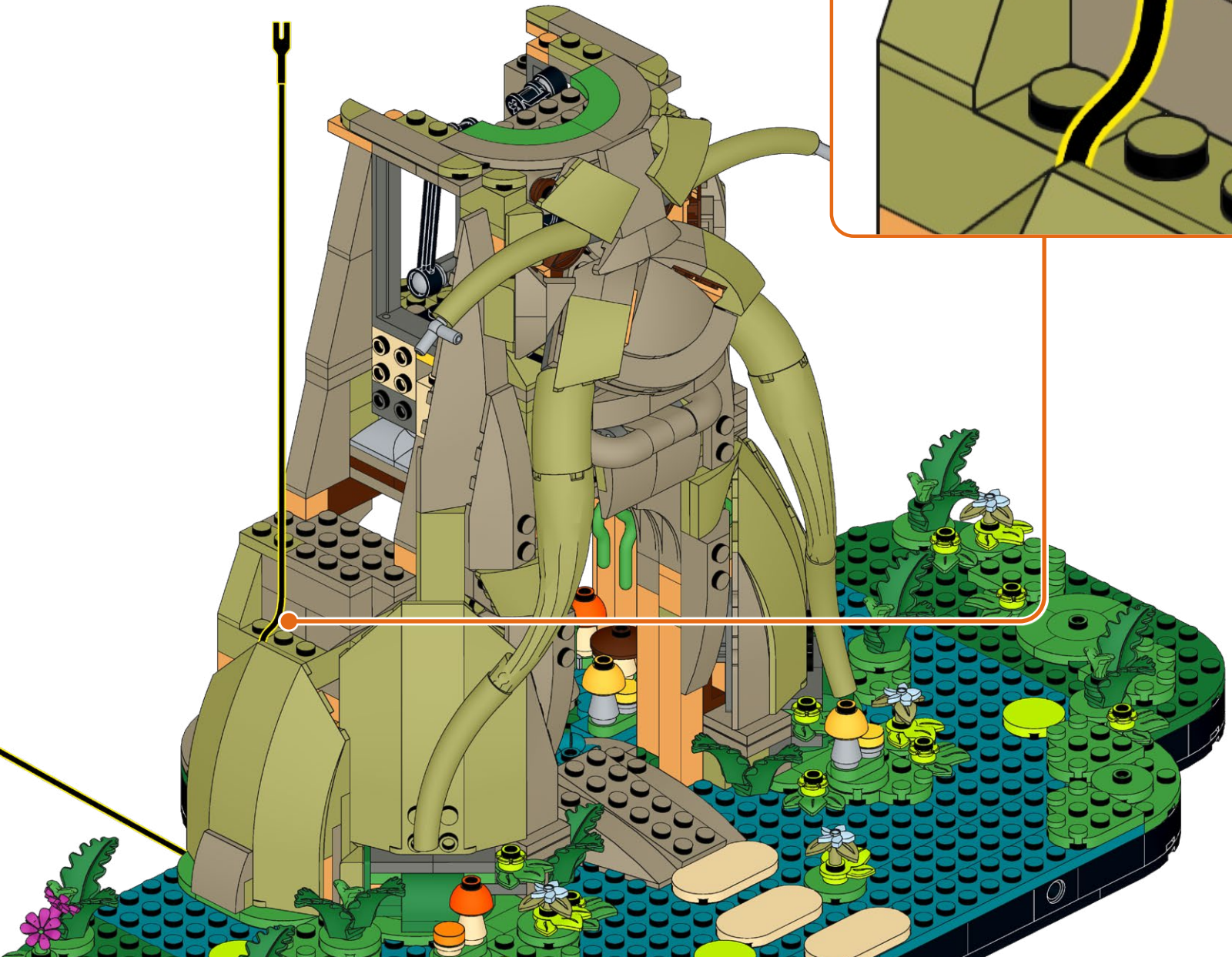

**HOLD UP!**

You might notice some bags aren't in order, as well as left over pieces, but that's ok! We're changing the way you build LEGO!

ATTENDEZ!

Vous remarquerez peut-être que certains sacs, ainsi que certaines pièces, ne sont pas dans le bon ordre. Mais pas de panique! Nous changeons simplement la façon avec laquelle vous construisez vos LEGO!

ASPETTA!

Potresti notare che alcuni sacchetti non sono in ordine, così come i pezzi avanzati, ma va bene così! Stiamo cambiando il modo in cui costruisci i LEGO!

HALT!

Sie werden möglicherweise bemerken, dass einige tüten durcheinander sind und teile übrig bleiben, aber das ist in Ordnung! Wir ändern die art und weise, wie Sie LEGO bauen!

¡ESPERA!

Es posible que notes que algunas bolsas están fuera de servicio, así como piezas sobrantes, ¡pero está bien! ¡Estamos cambiando la forma en que construyes LEGO!

暫停!

你可能会注意到一些袋子顺序错乱, 以及一些剩余的部件, 但没关系! 我们正在改变你搭建乐高的方式!

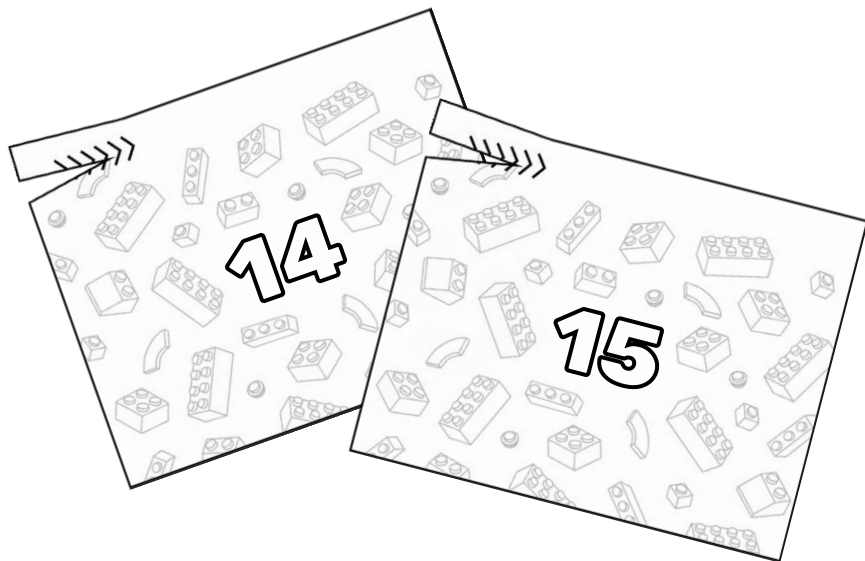
Open LEGO® Bags 14 & 15

311

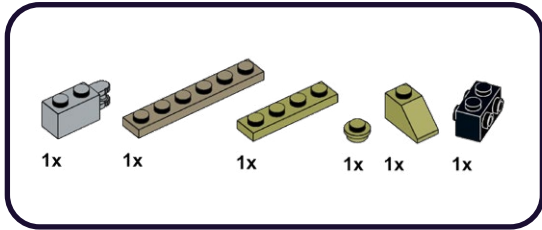

1

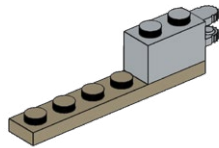

2

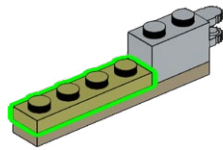

3

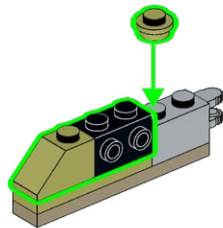

312

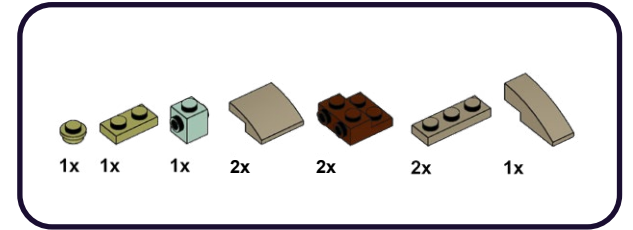

1

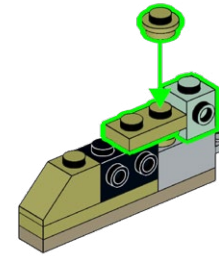

2

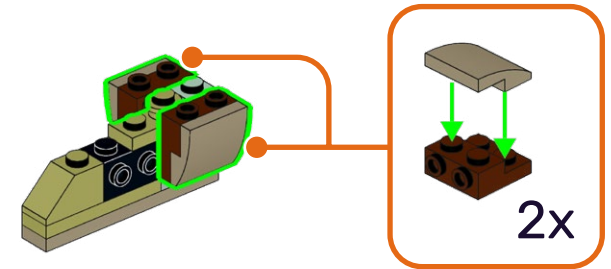

3

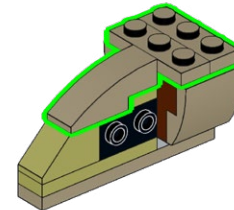

313

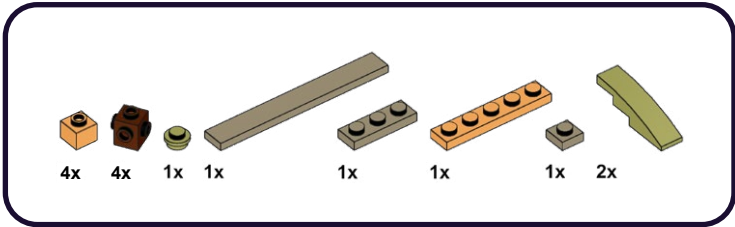

1

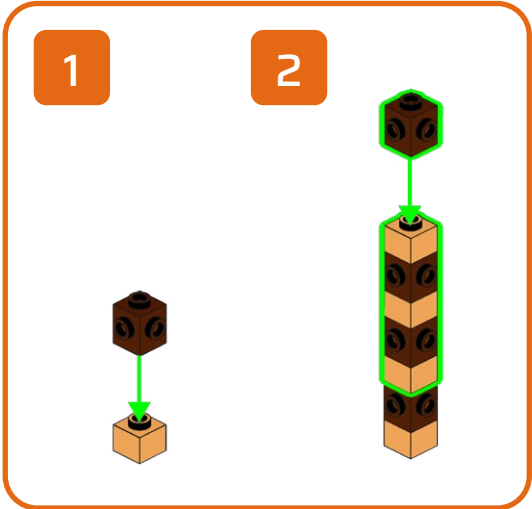

2

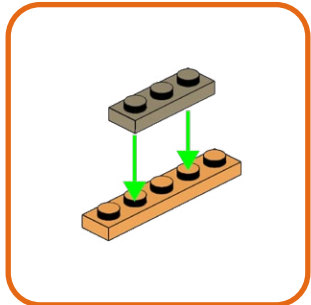

3

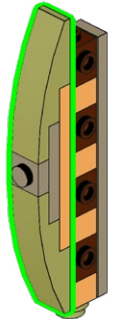
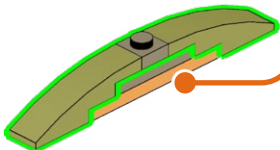

314

315

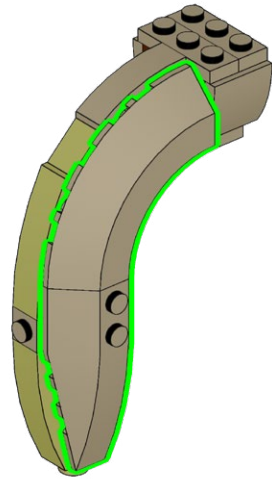
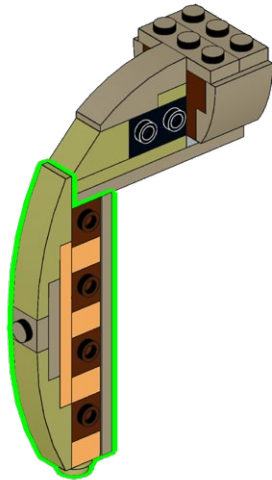
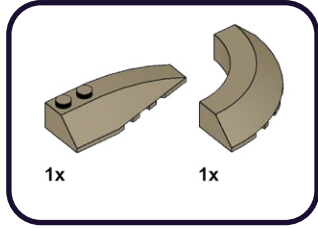

316

1x

1x

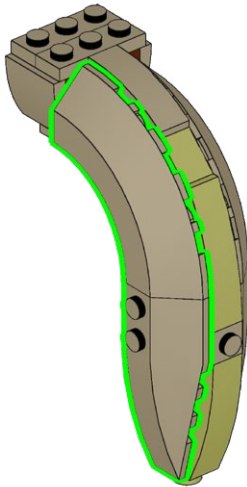

317

1x

1x

1x

1x

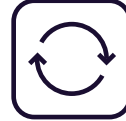

1

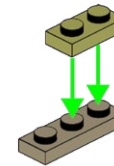

2

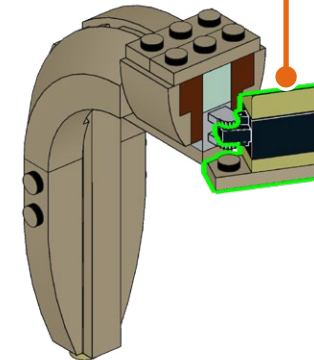
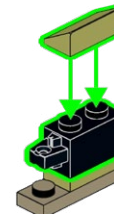

318



319

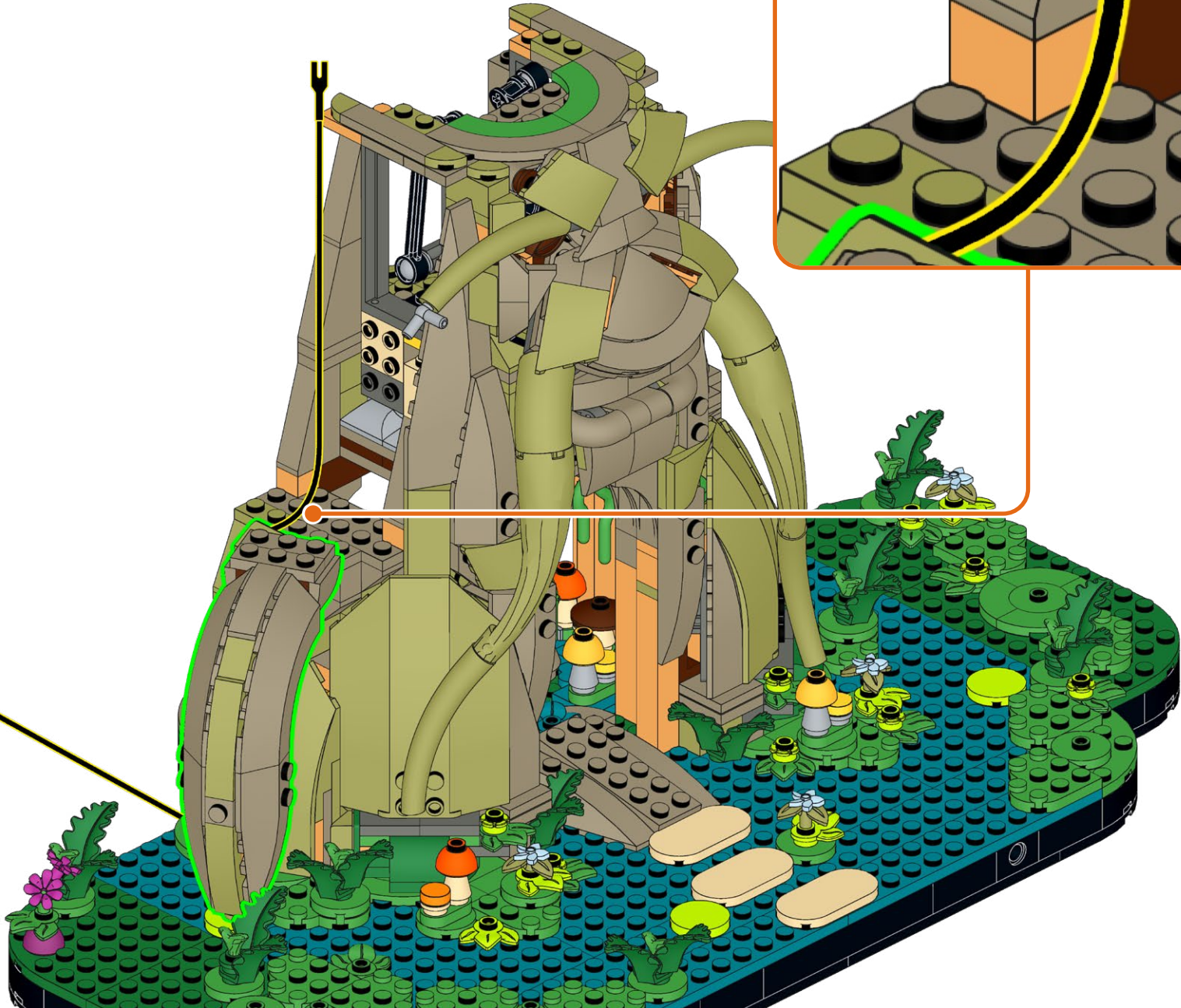

320

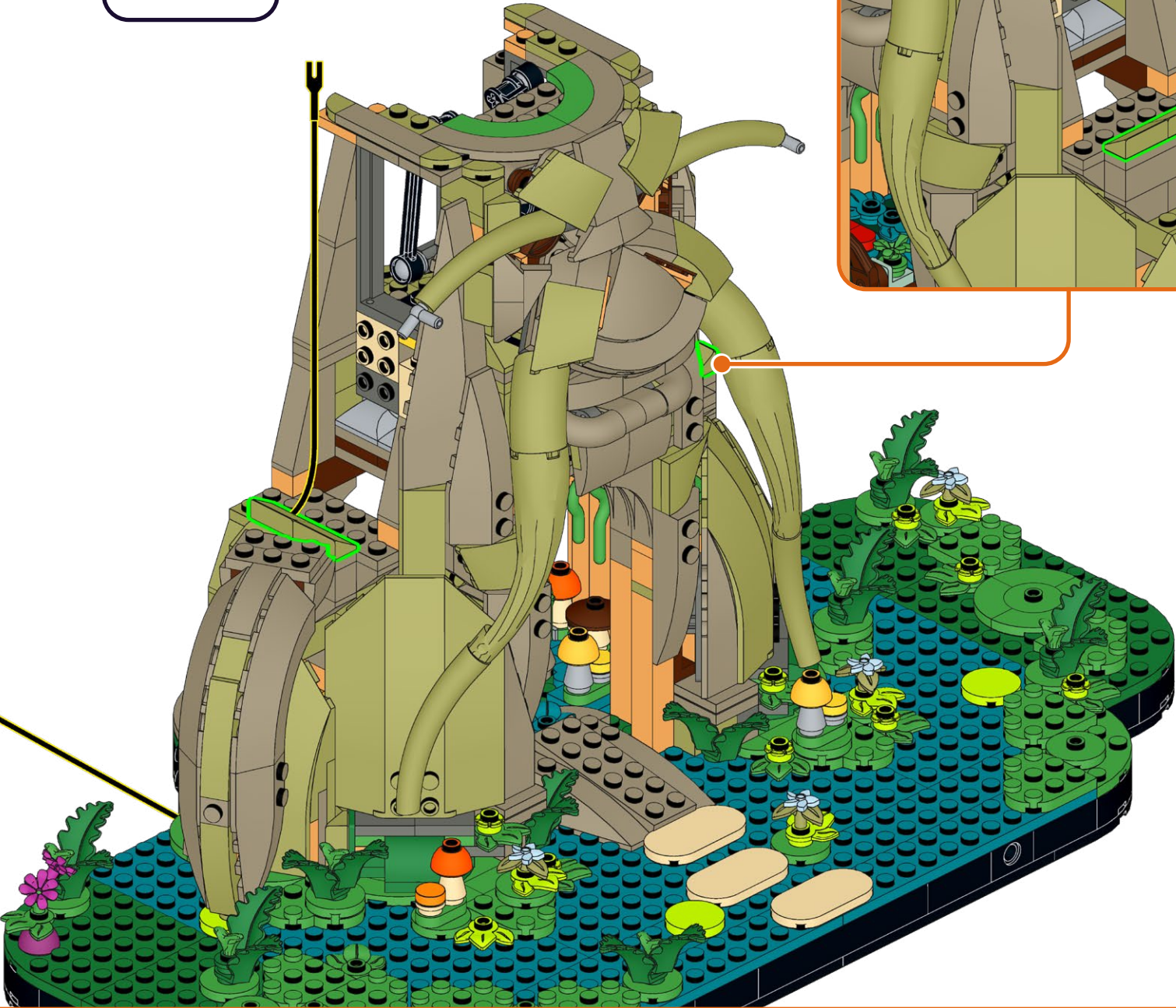
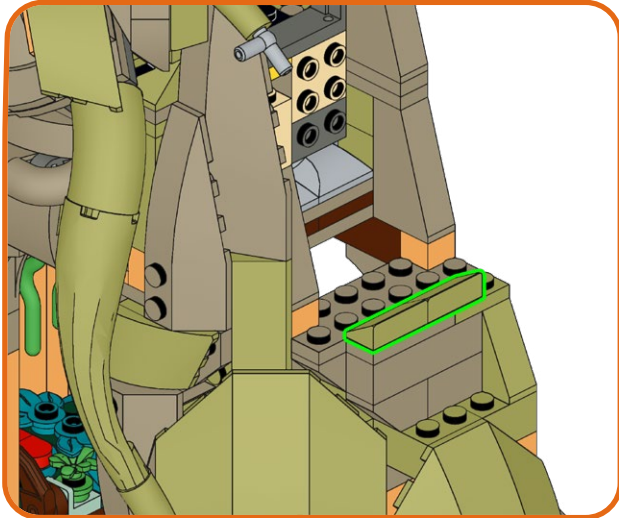
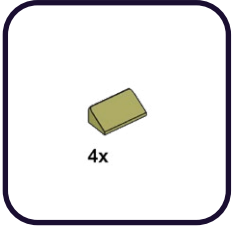

321



322



323

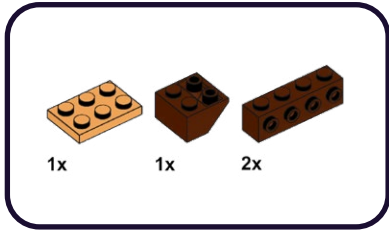

1

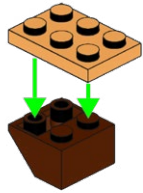

2

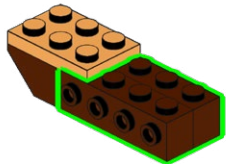

324

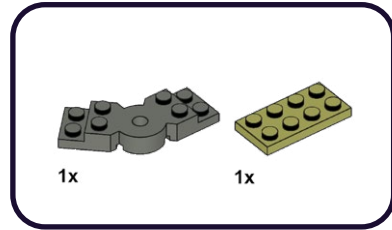

1

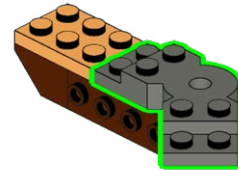

2

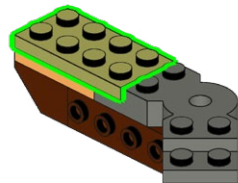

325

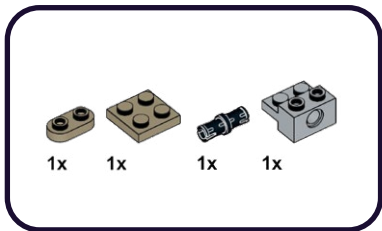

1

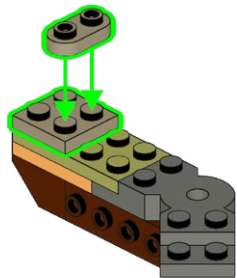

2

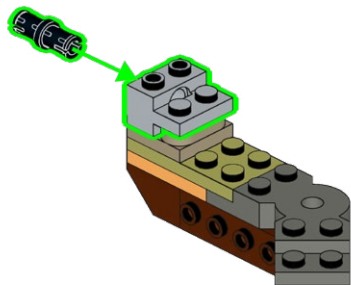

326

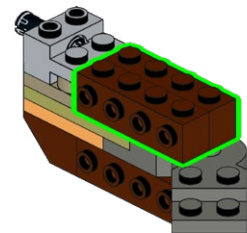
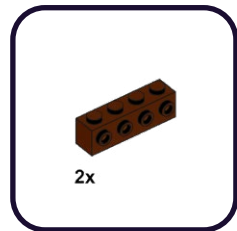

327

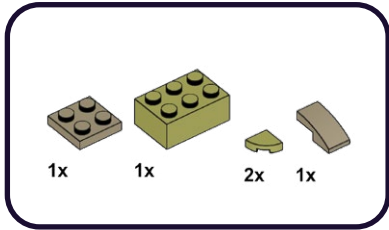

1

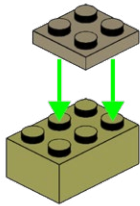

2

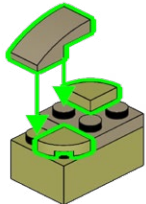

328

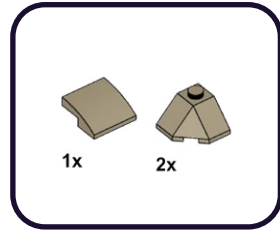

1

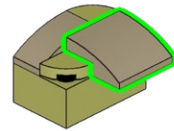

2

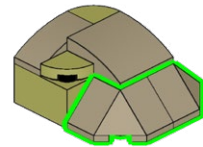

329

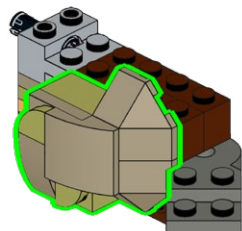

330

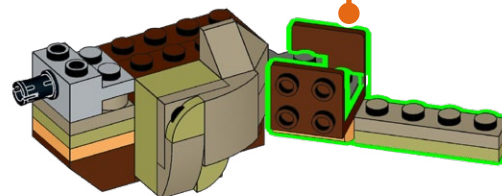
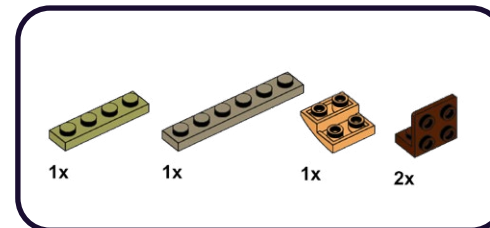

1

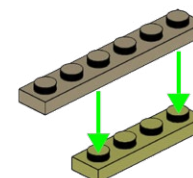

2

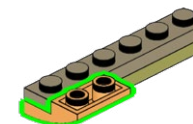

3

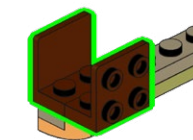

331

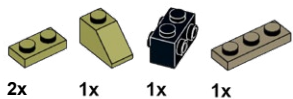

1

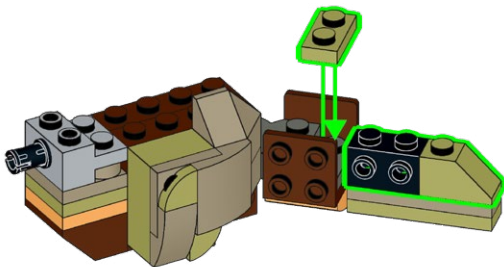

2

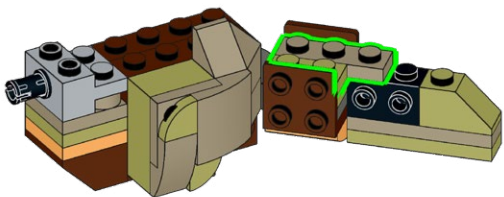

332

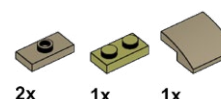

1

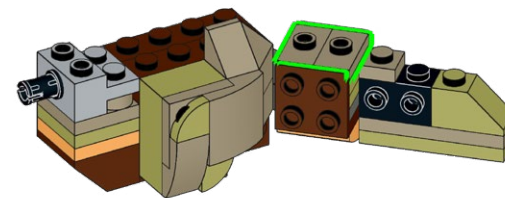

2

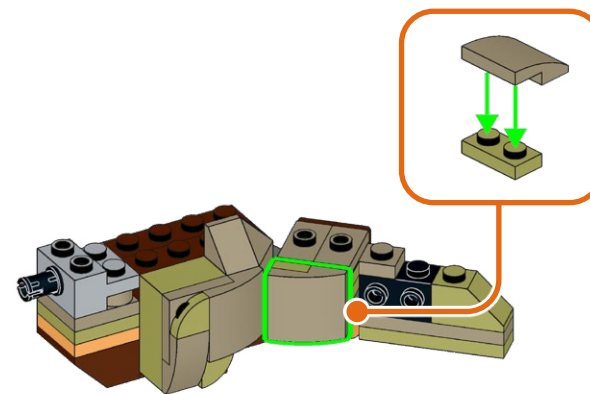

333

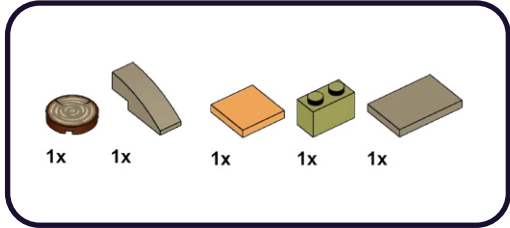

1

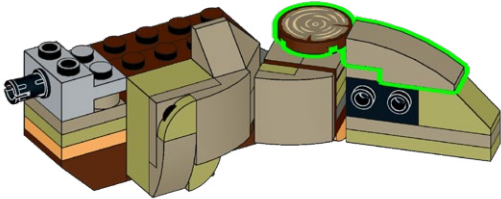

2

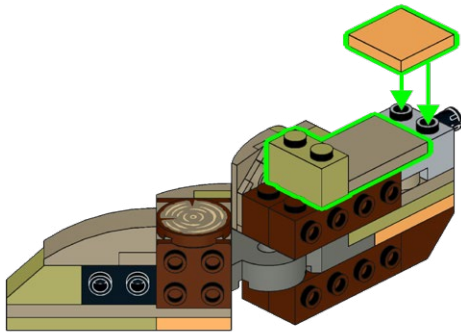

334

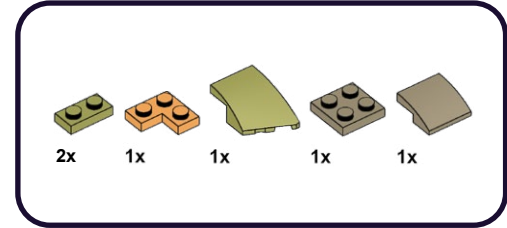

1

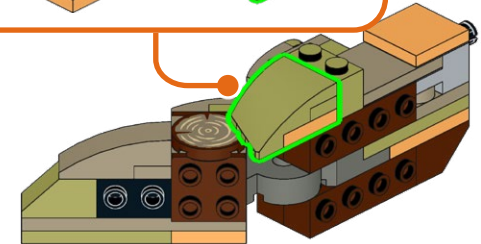
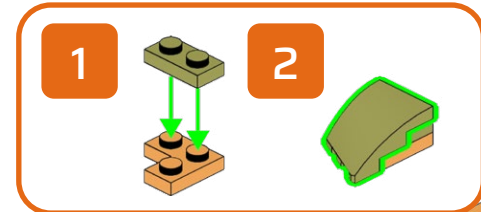

2

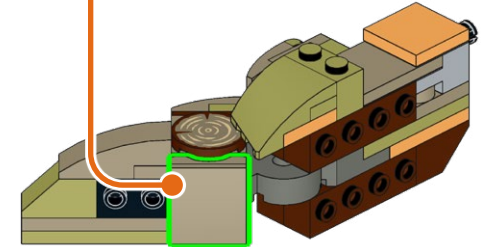
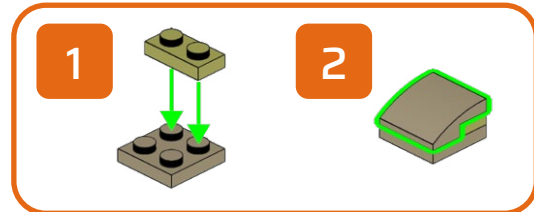

335

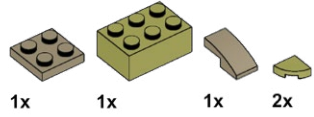

1

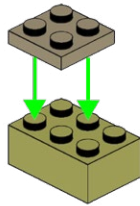

2

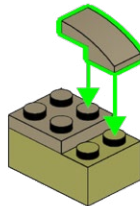

3

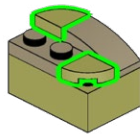

336

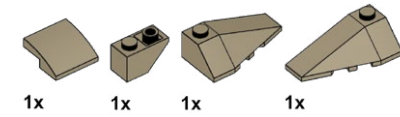

1

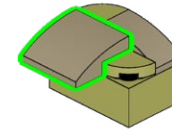

2

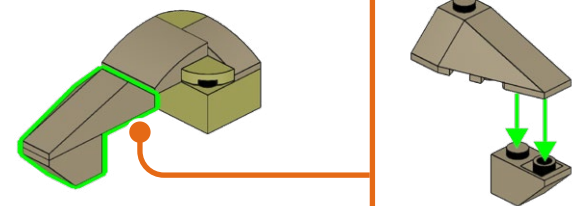

3

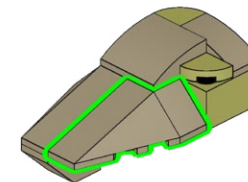

337

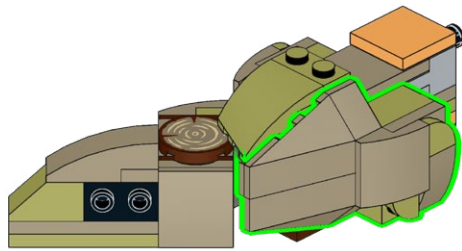

338

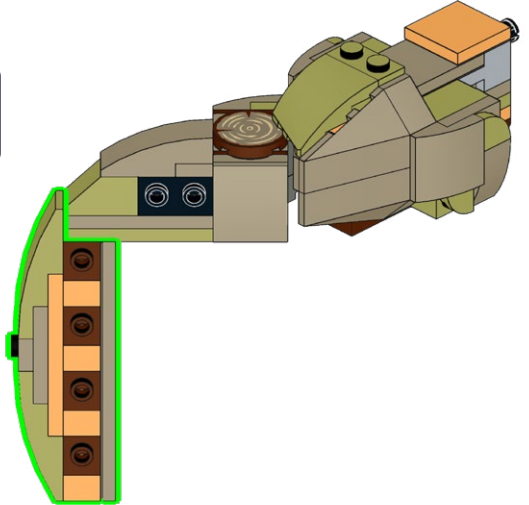
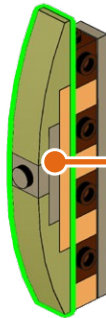
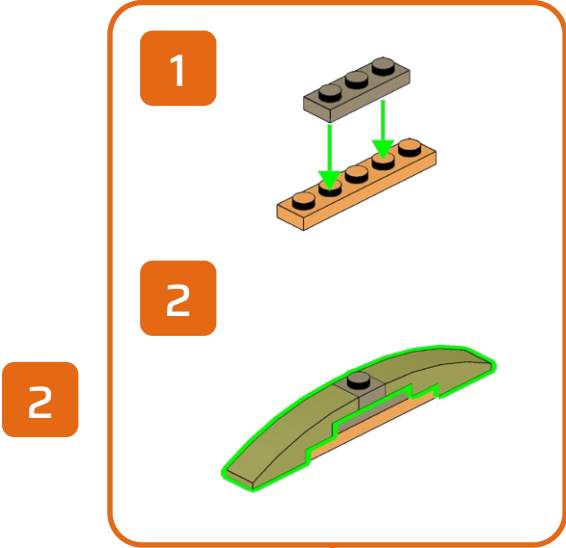
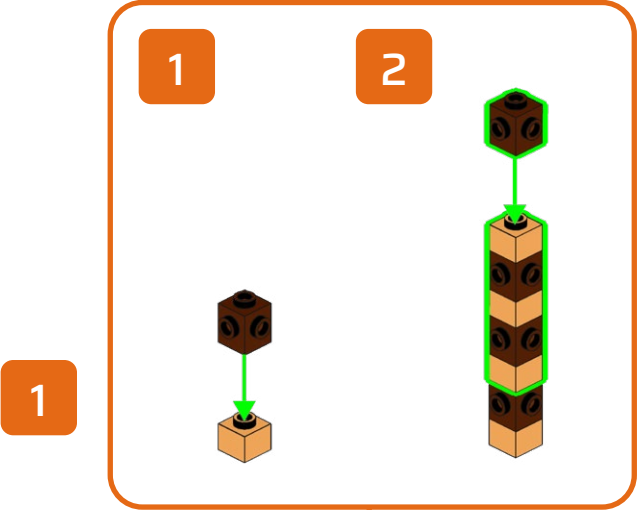
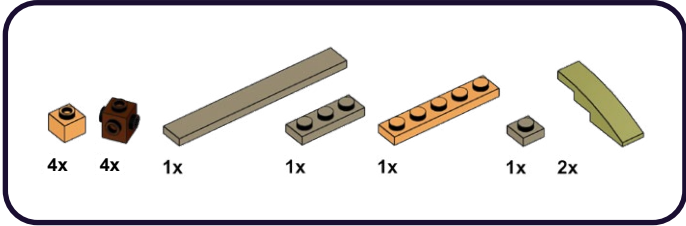

339

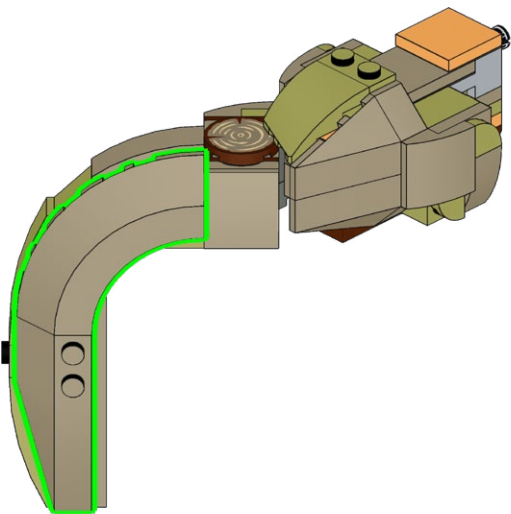
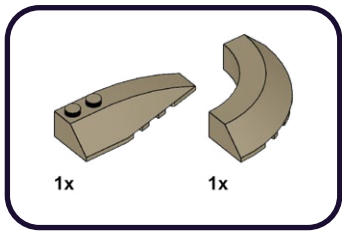

340

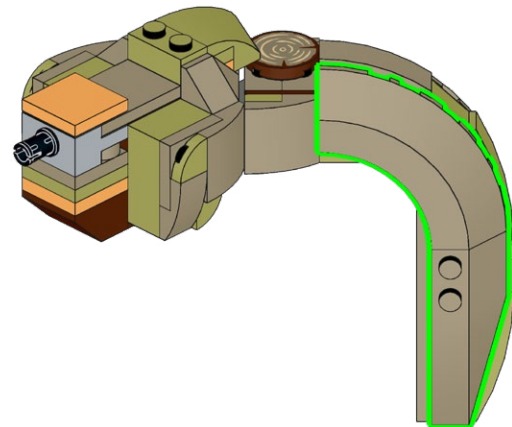
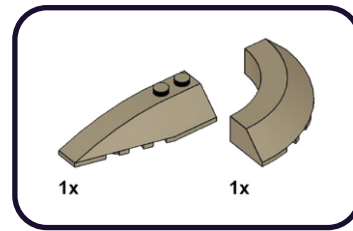

341

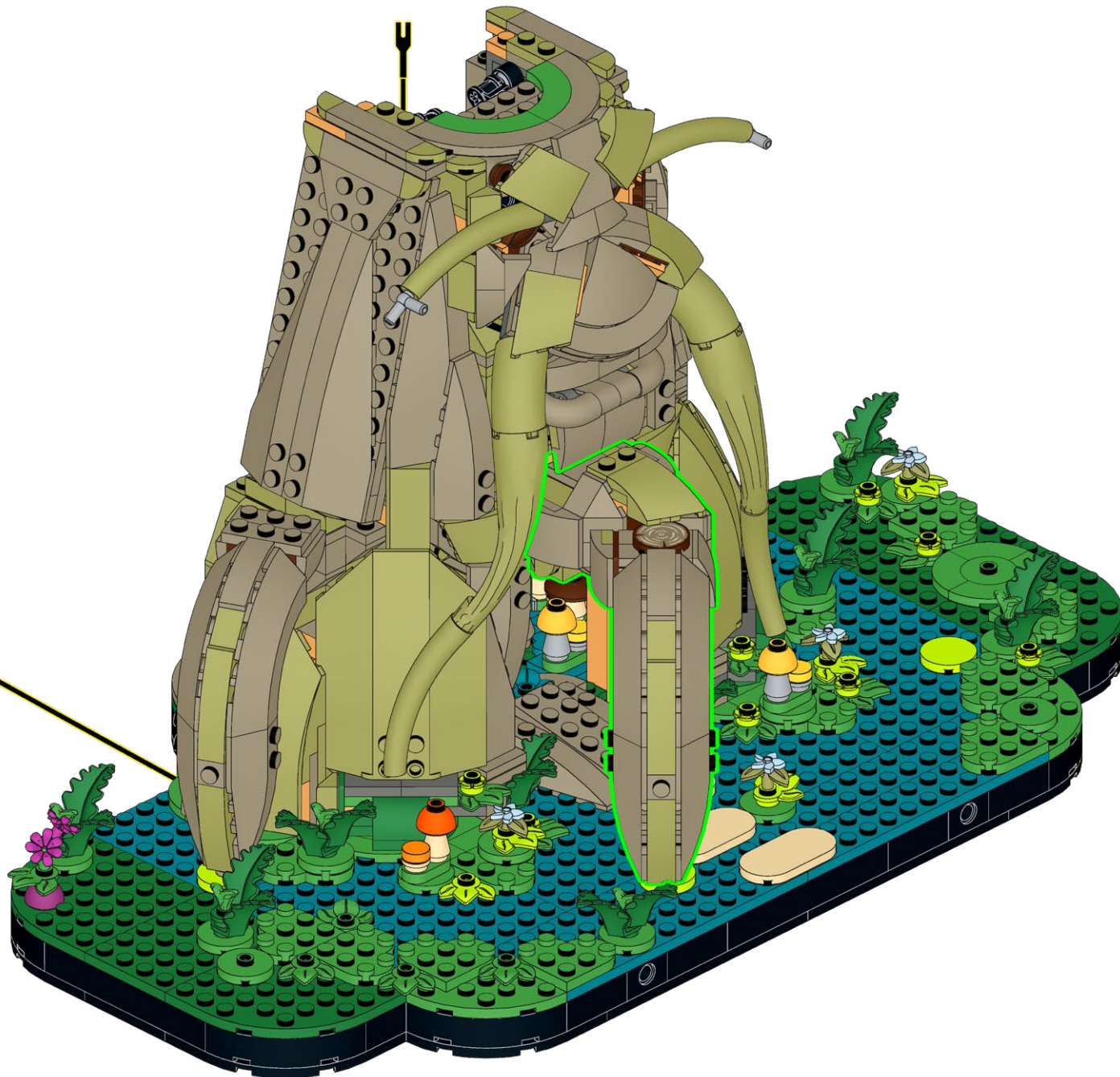

342

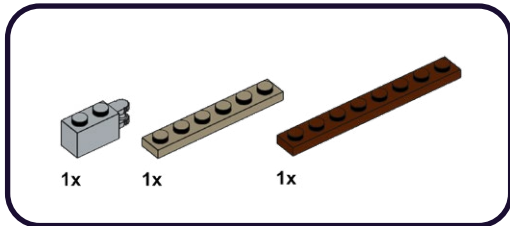

1

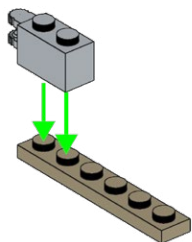

2

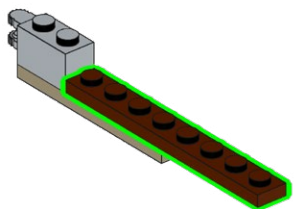

343

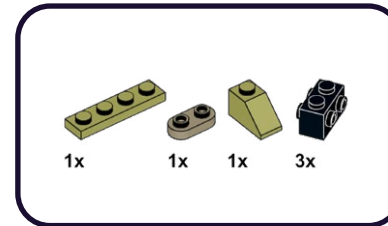

1

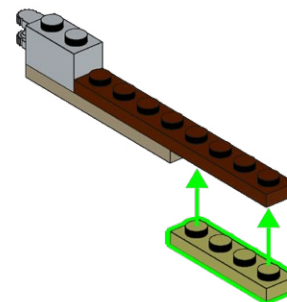

2

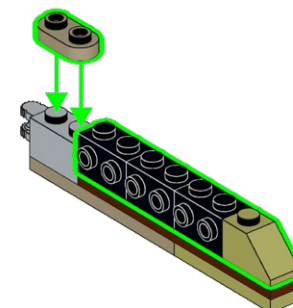

344

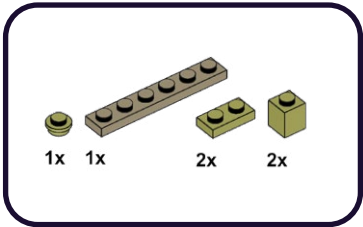

1

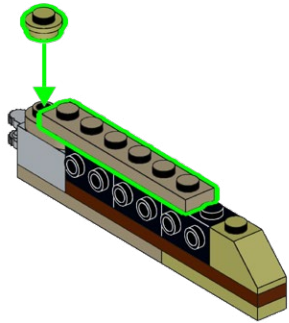

2

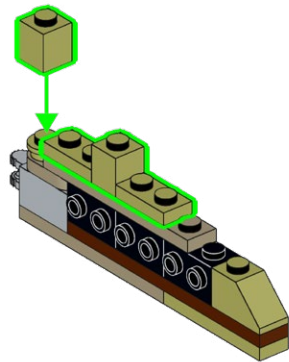

345

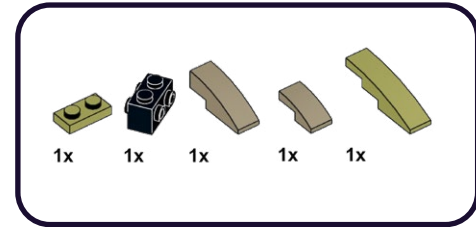

1

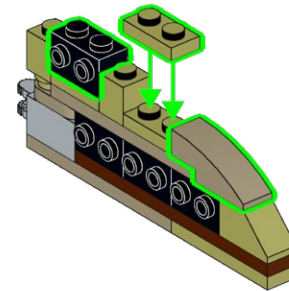

2

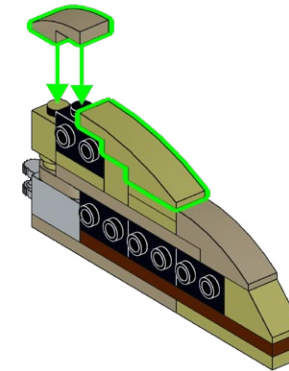

346

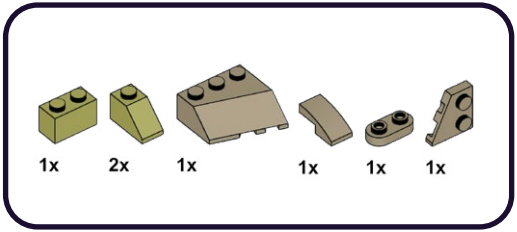

347

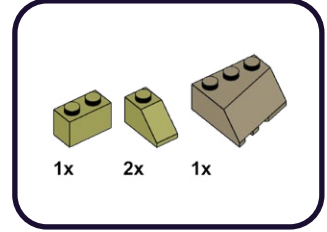

1

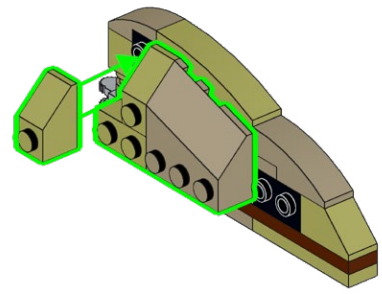

2

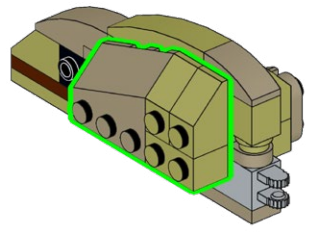
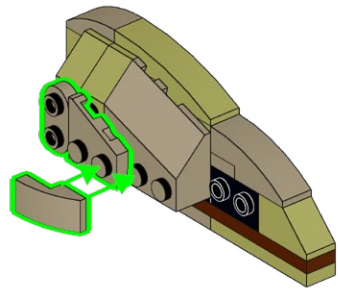

348

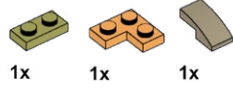

1



2

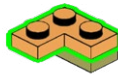

3

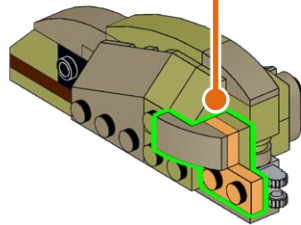
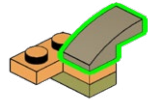

349

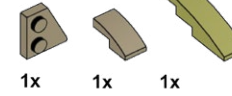

1

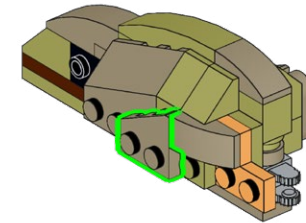

2

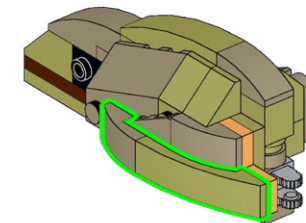

350

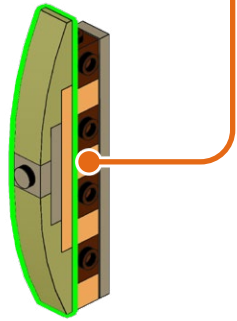
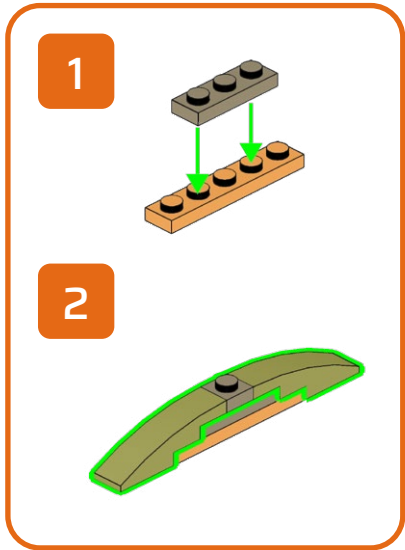
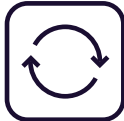
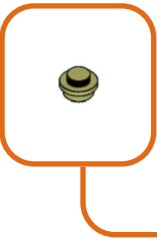
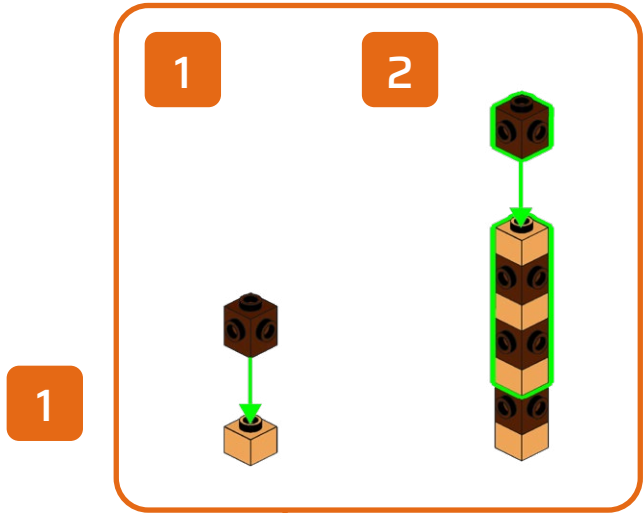
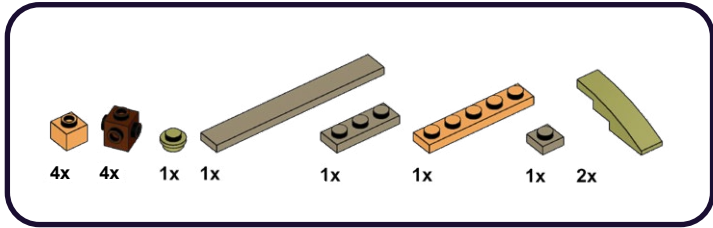

3

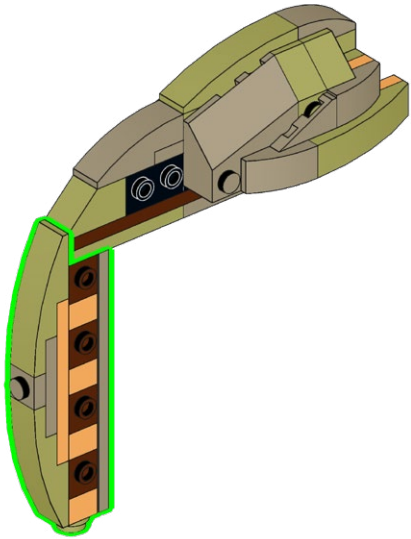

351

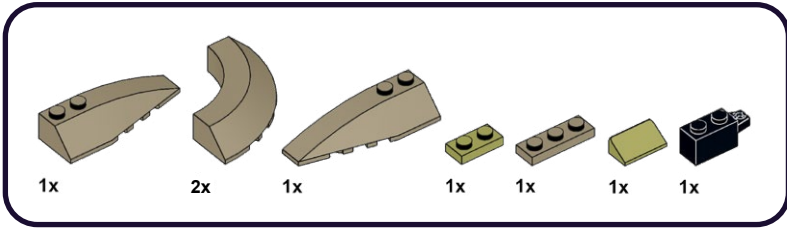

1

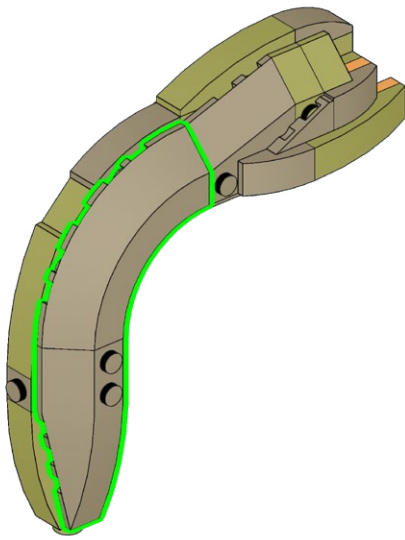

2

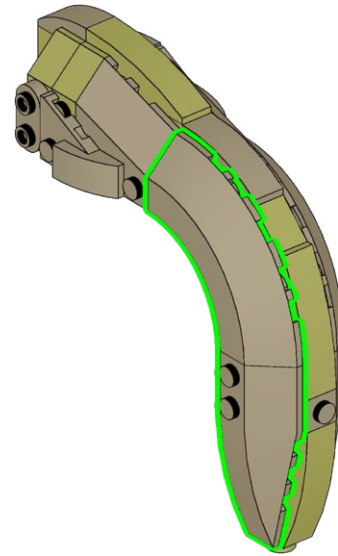

3

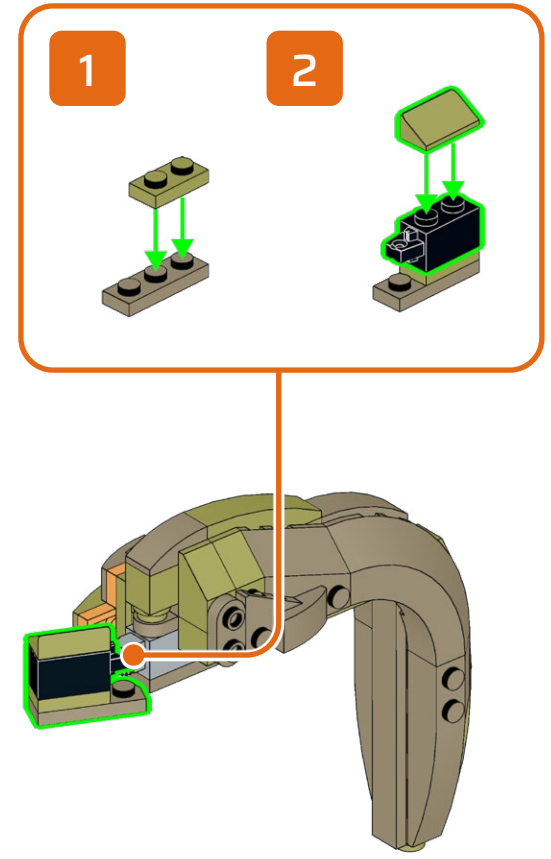
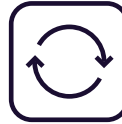

352

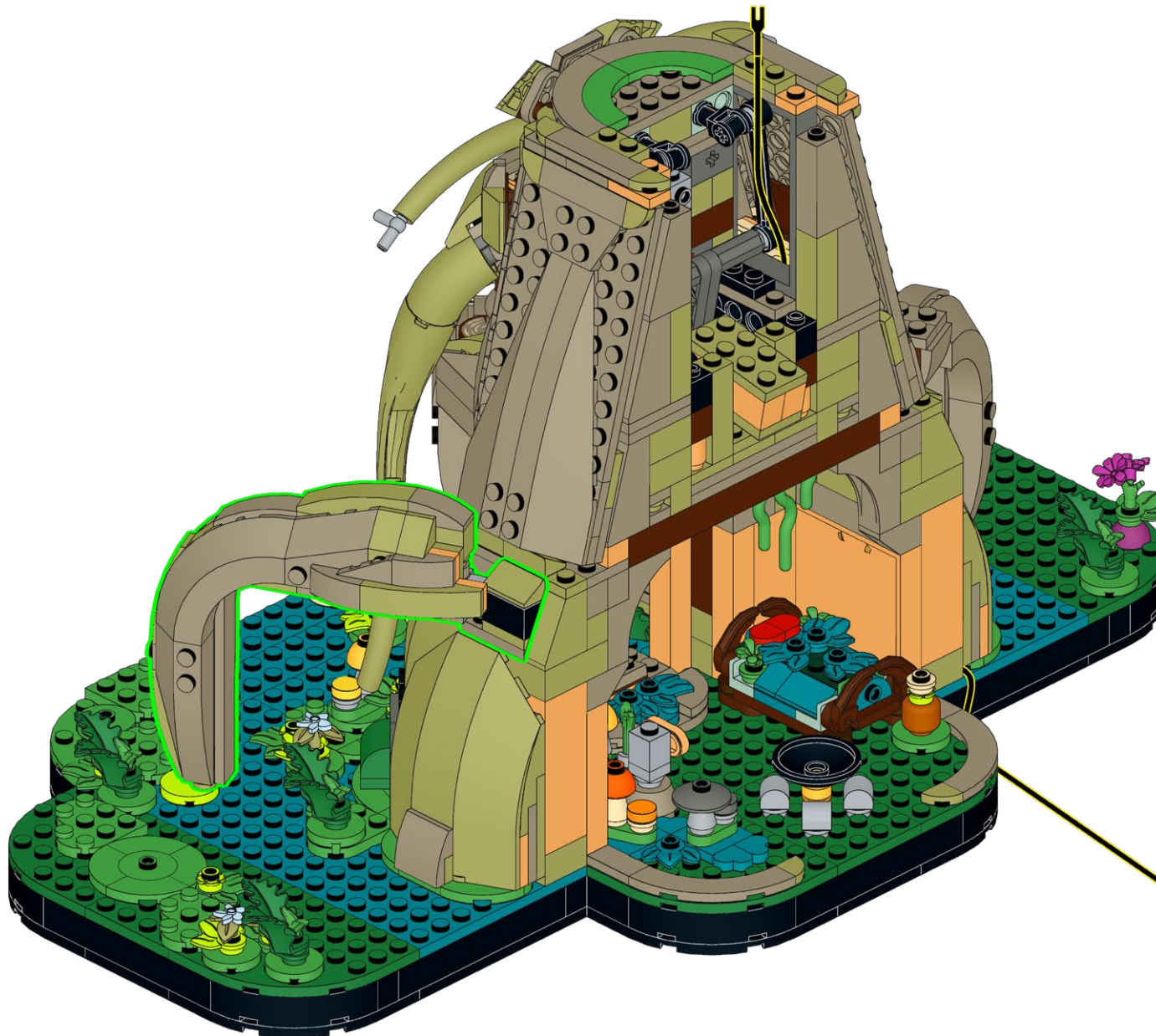

353

-  5x
-  1x
-  4x

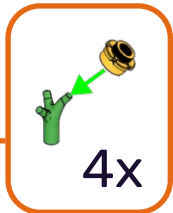

354

- 1x
- 1x
- 1x
- 1x
- 1x

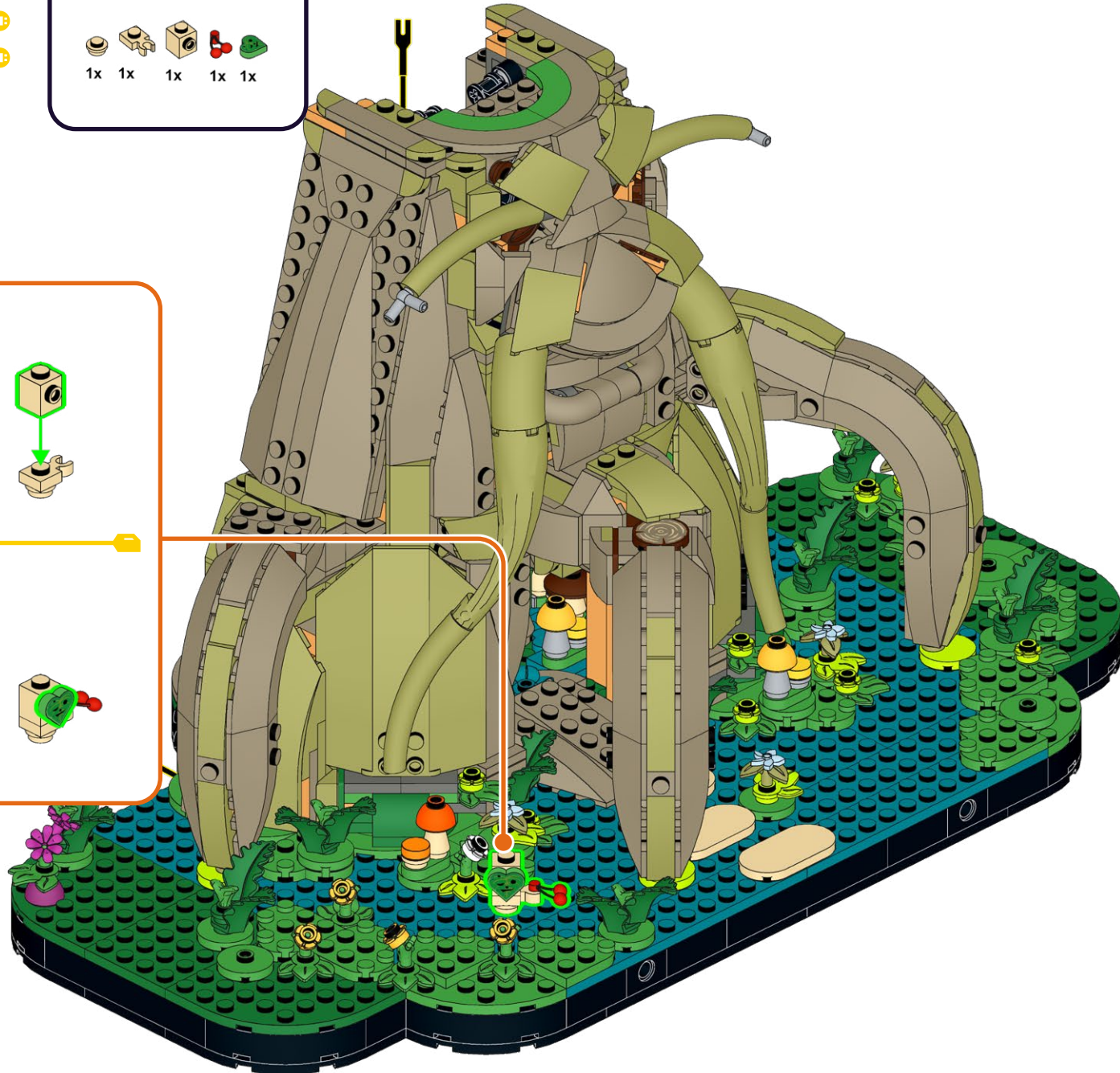
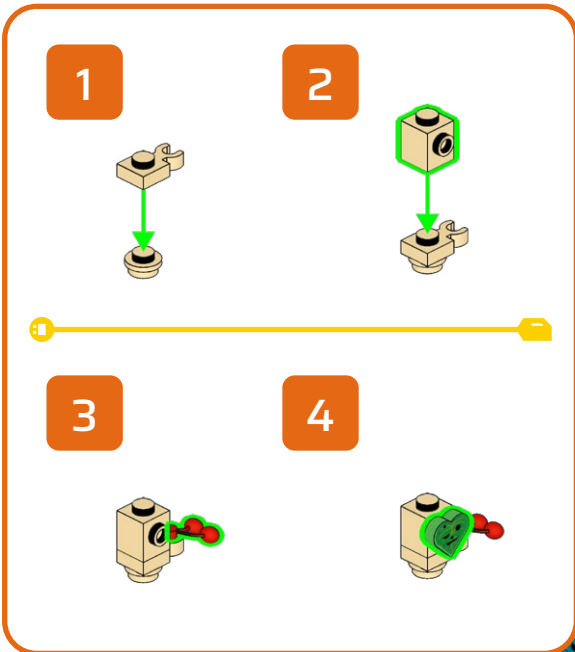

355

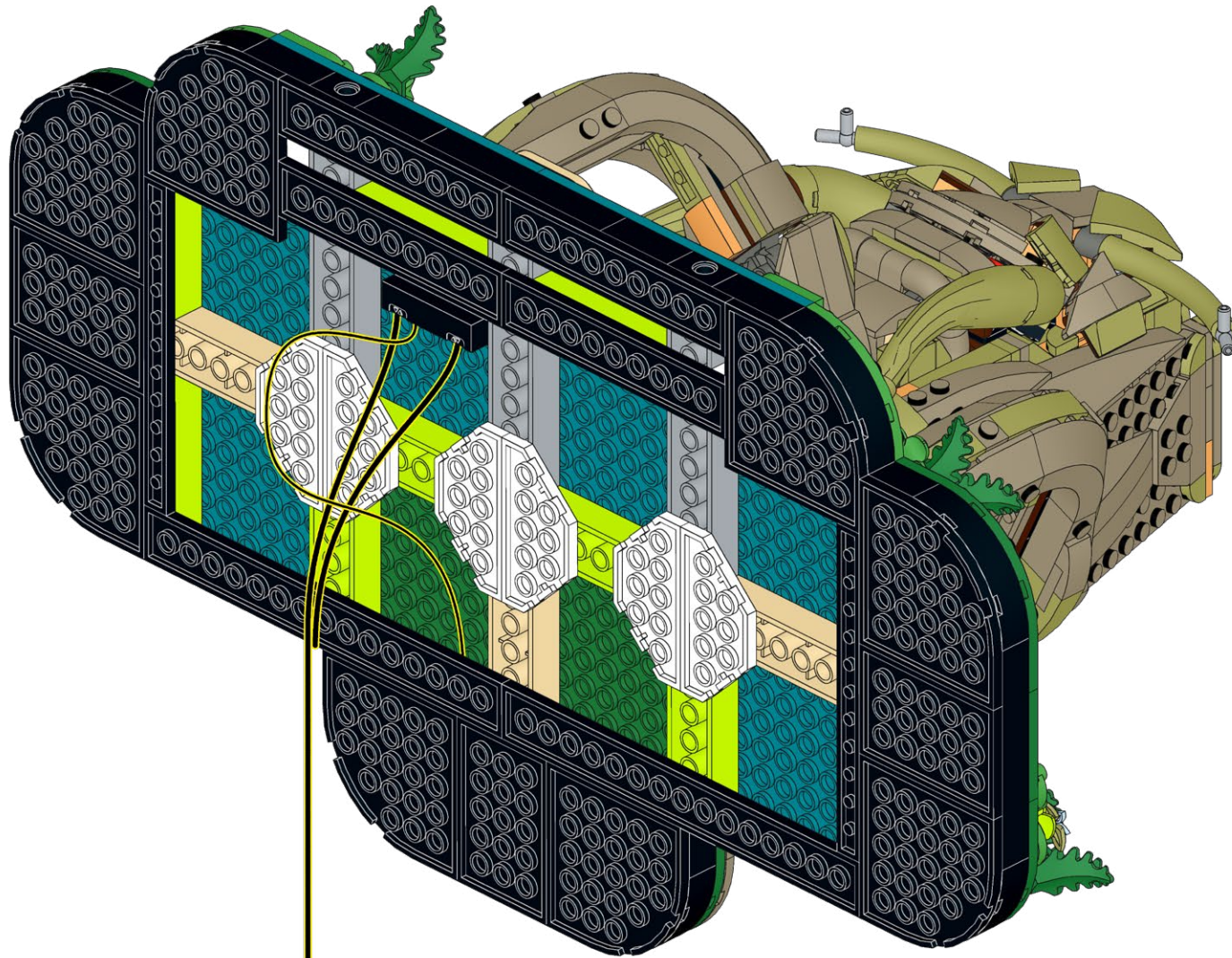

356



357

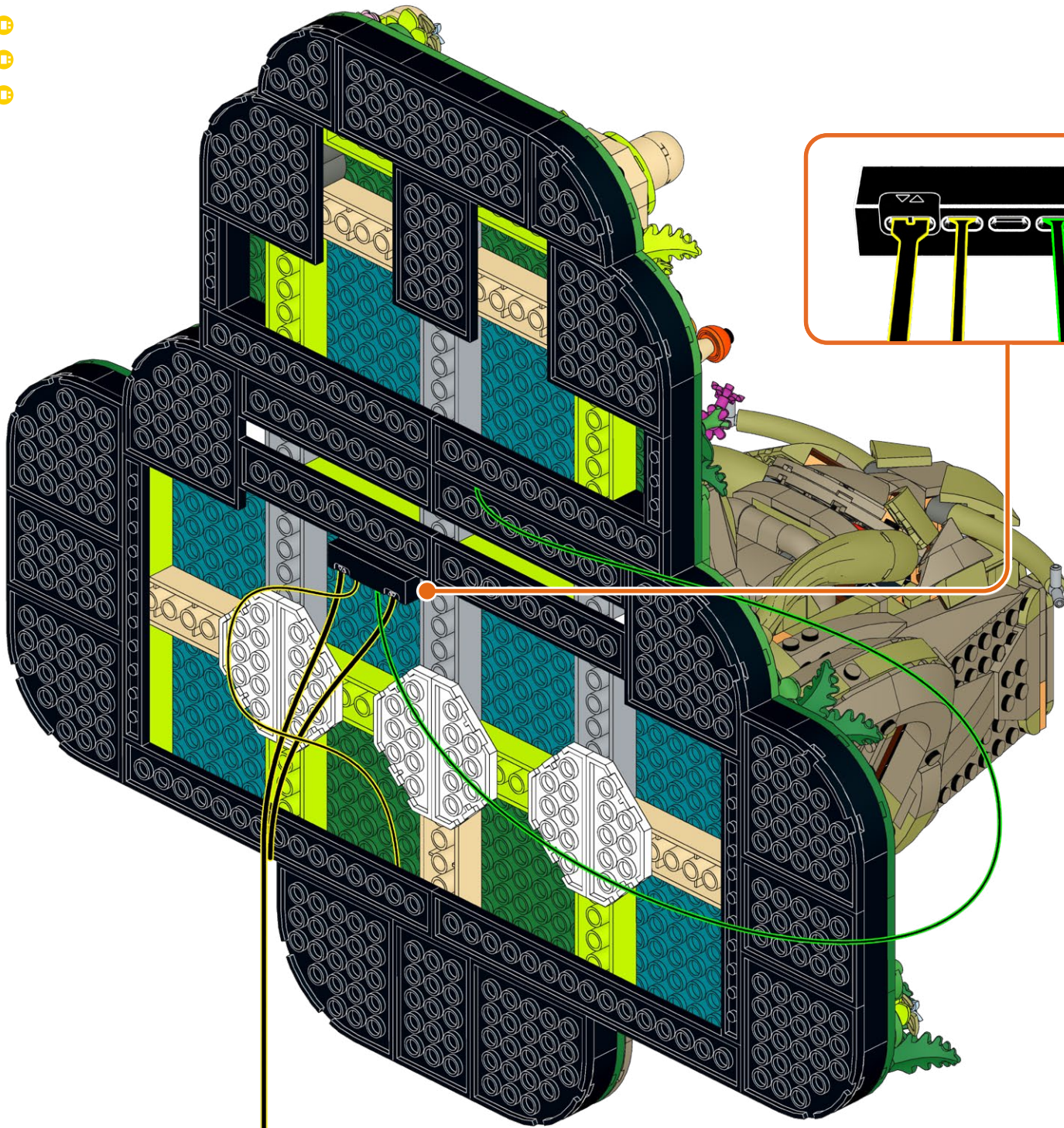

358

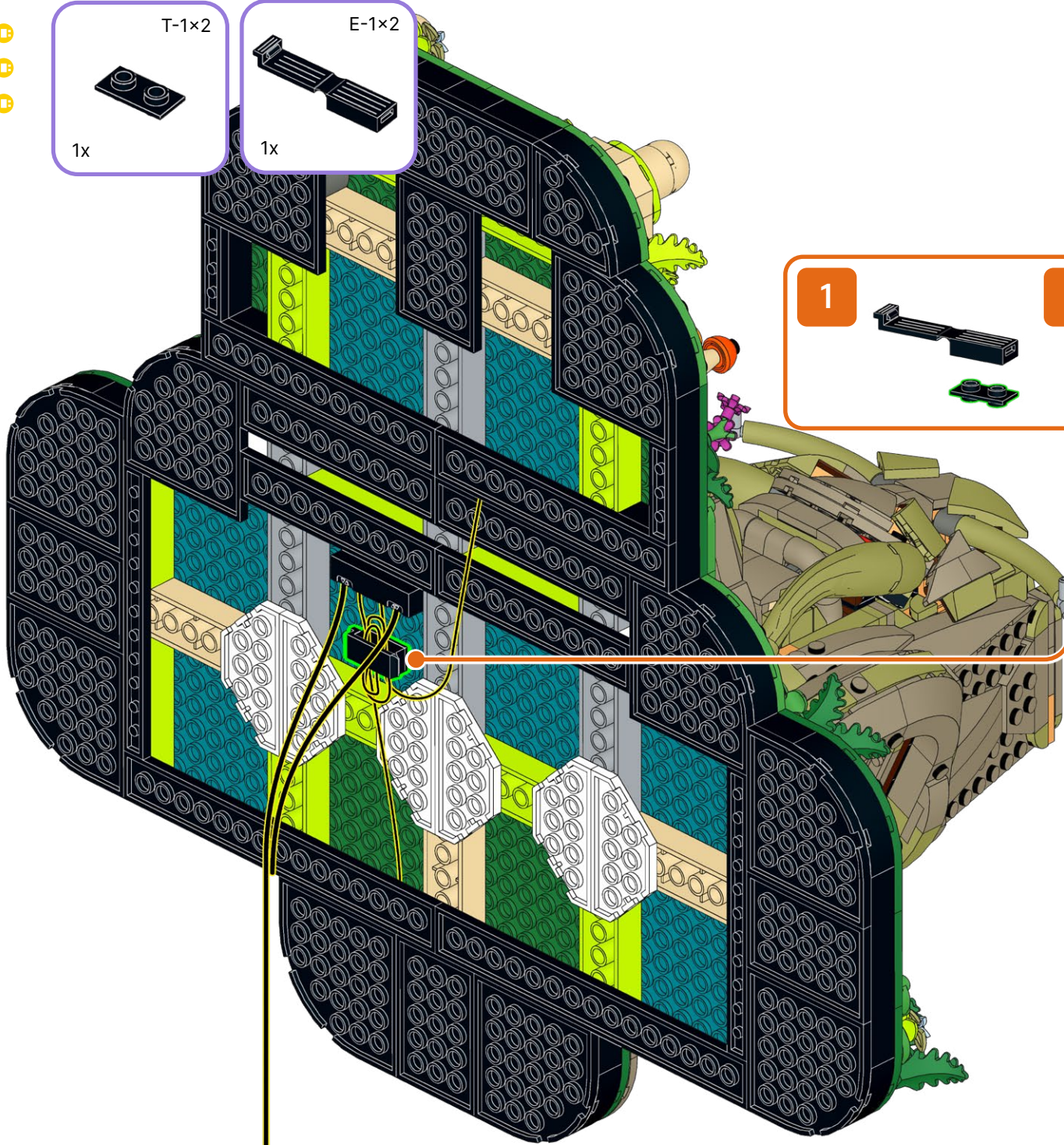
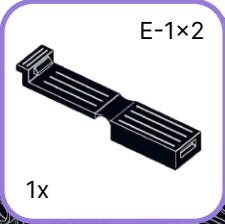
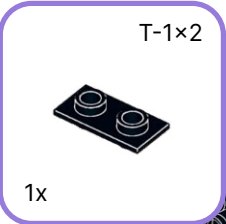

359

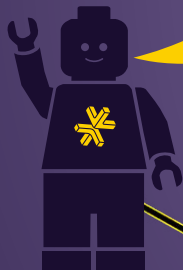

Power on Test
Test de mise sous tension
Test di Potenza
Stromtest
Prueba de Energía
电源测试



**HOLD UP!**

You might notice some bags aren't in order, as well as left over pieces, but that's ok! We're changing the way you build LEGO!

ATTENDEZ!

Vous remarquerez peut-être que certains sacs, ainsi que certaines pièces, ne sont pas dans le bon ordre. Mais pas de panique! Nous changeons simplement la façon avec laquelle vous construisez vos LEGO!

ASPETTA!

Potresti notare che alcuni sacchetti non sono in ordine, così come i pezzi avanzati, ma va bene così! Stiamo cambiando il modo in cui costruisci i LEGO!

HALT!

Sie werden möglicherweise bemerken, dass einige tüten durcheinander sind und teile übrig bleiben, aber das ist in Ordnung! Wir ändern die art und weise, wie Sie LEGO bauen!

¡ESPERA!

Es posible que notes que algunas bolsas están fuera de servicio, así como piezas sobrantes, ¡pero está bien! ¡Estamos cambiando la forma en que construyes LEGO!

暫停!

你可能会注意到一些袋子顺序错乱, 以及一些剩余的部件, 但没关系! 我们正在改变你搭建乐高的方式!

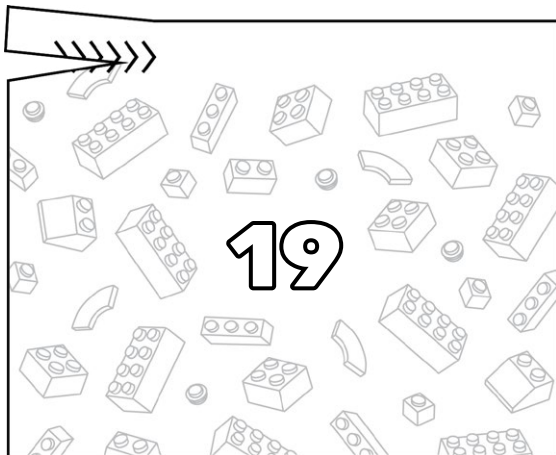
Open LEGO® Bag 19

360

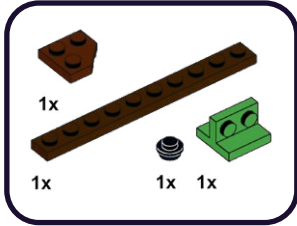

1

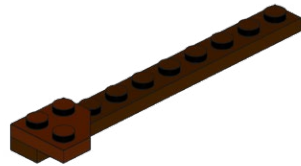

2

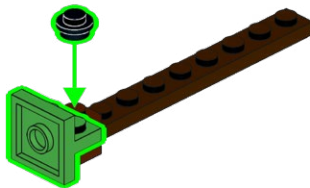

361

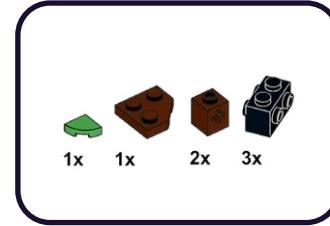

1

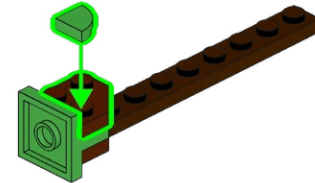

2

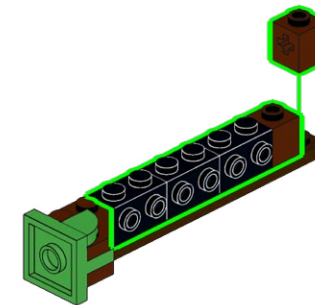

362

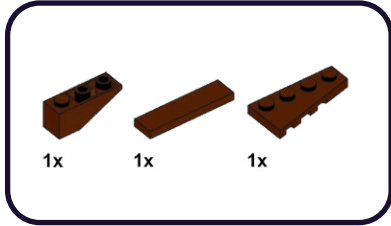

1

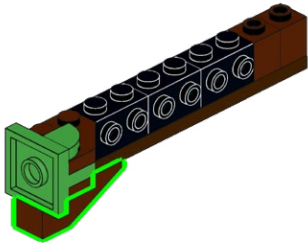

2

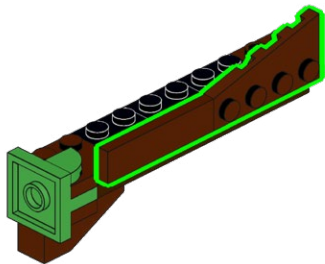

363

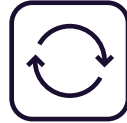
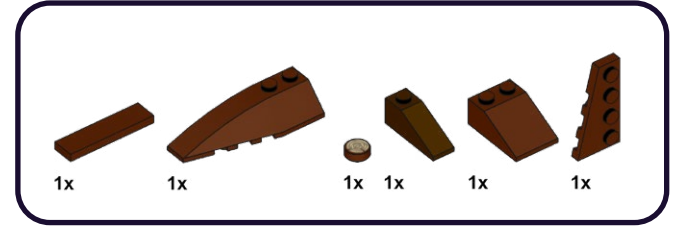

1

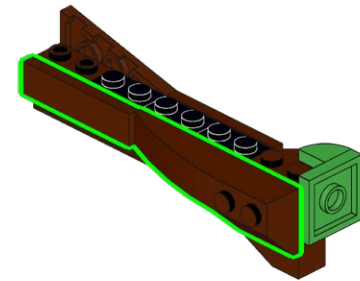

2

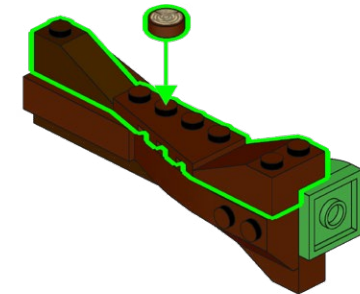

364



1

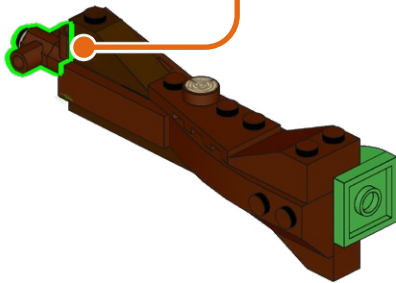
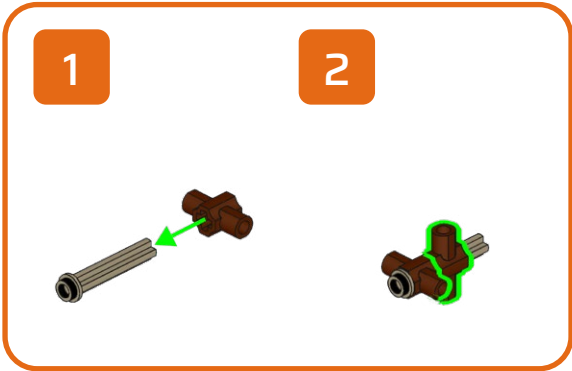

2



3



2x

365

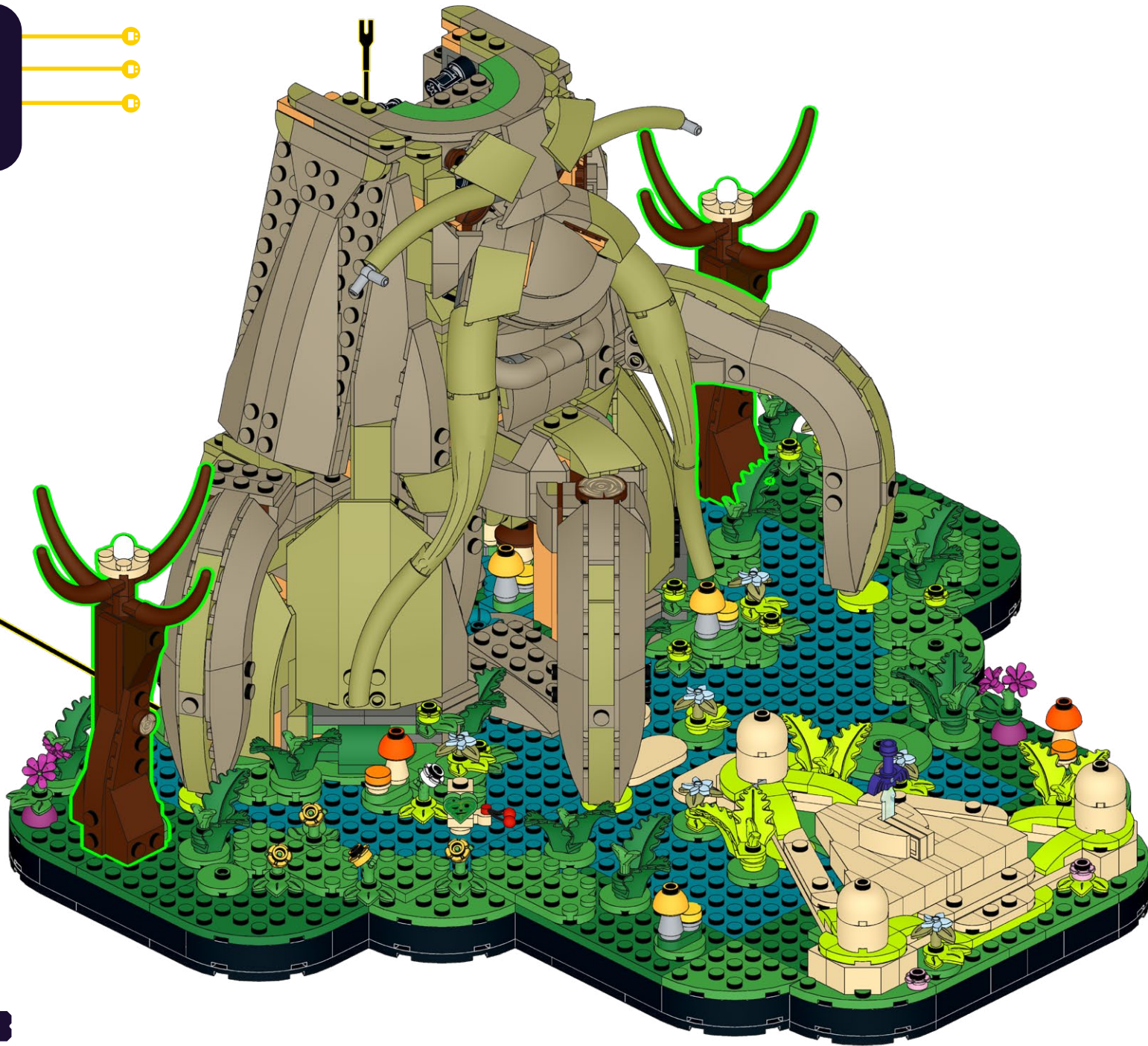

366

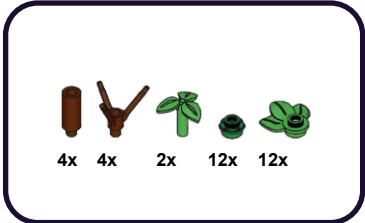

1

2

3

4

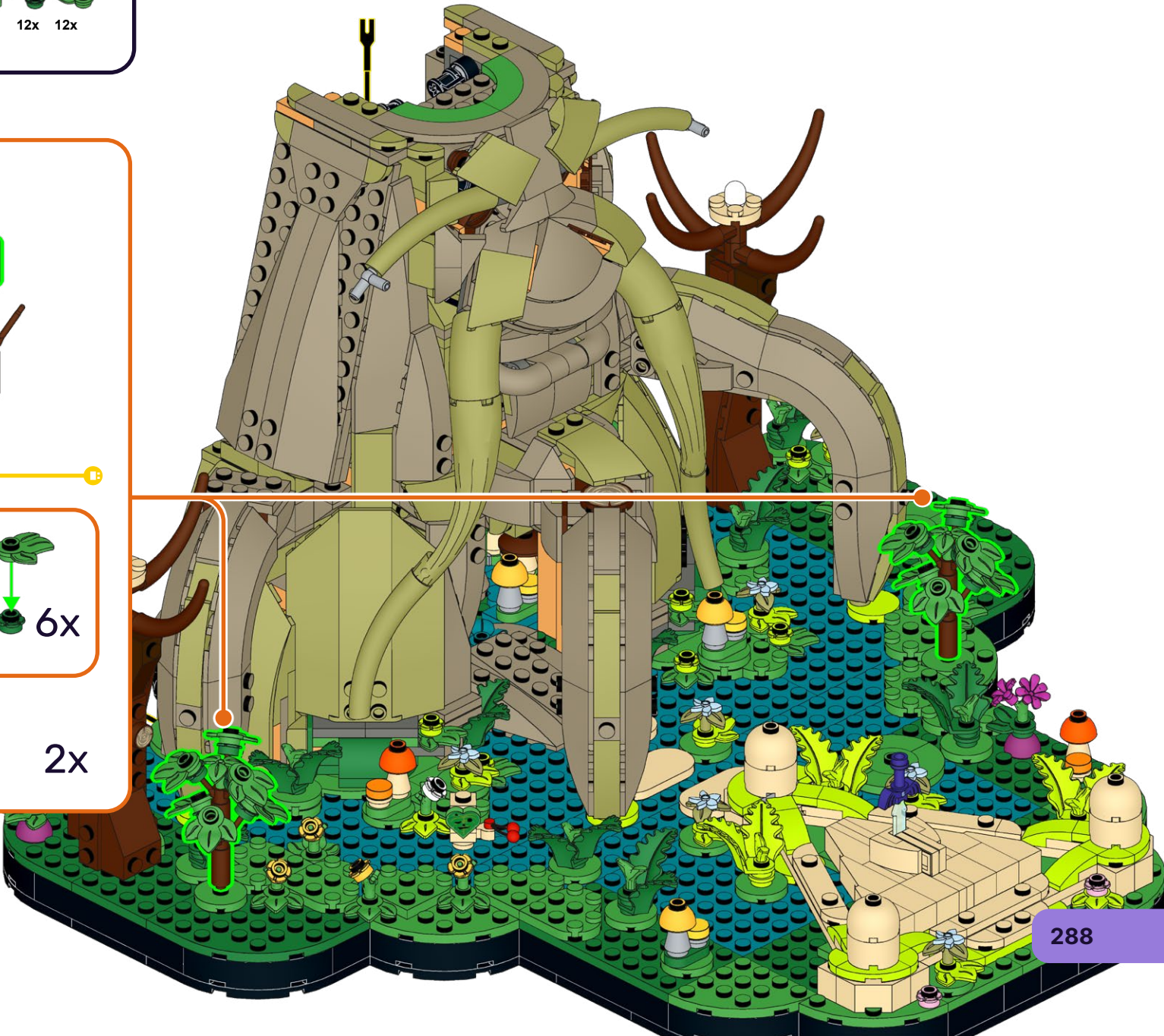

367

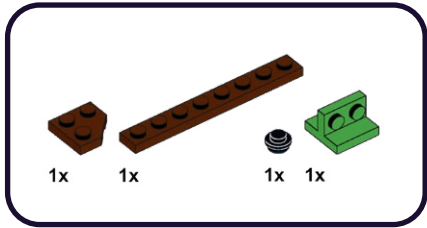

1

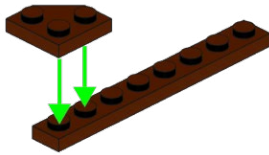

2

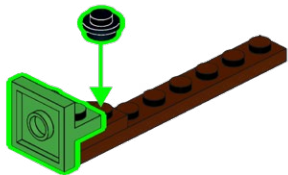

368

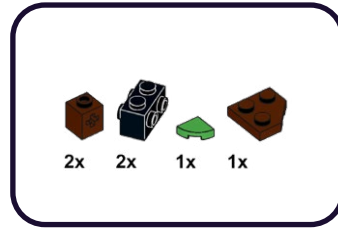

1

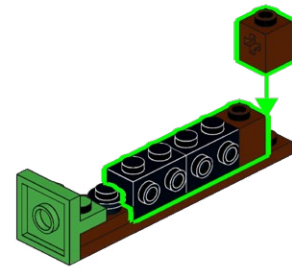

2

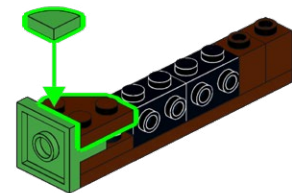

369

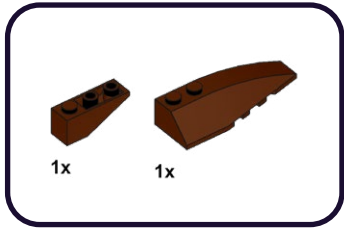

1

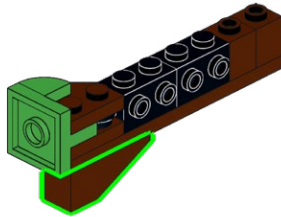

2

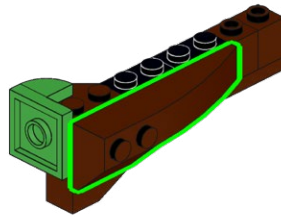

370

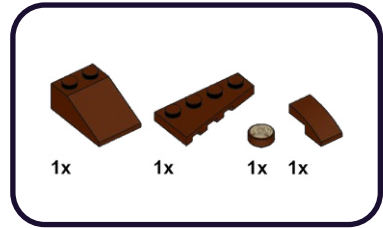

1

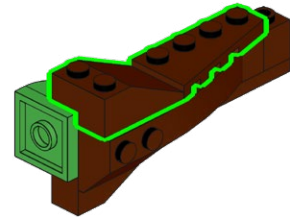

2

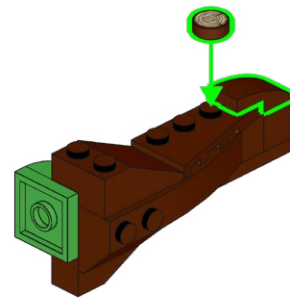

371

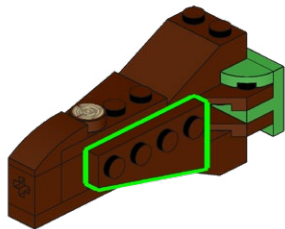
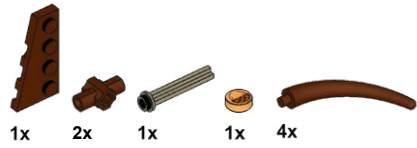

2

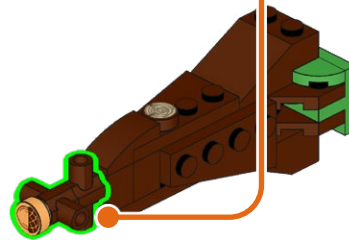
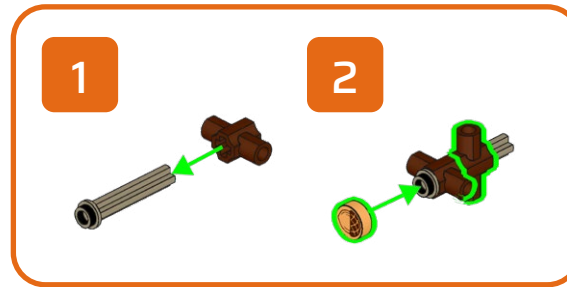

3

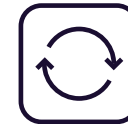

372

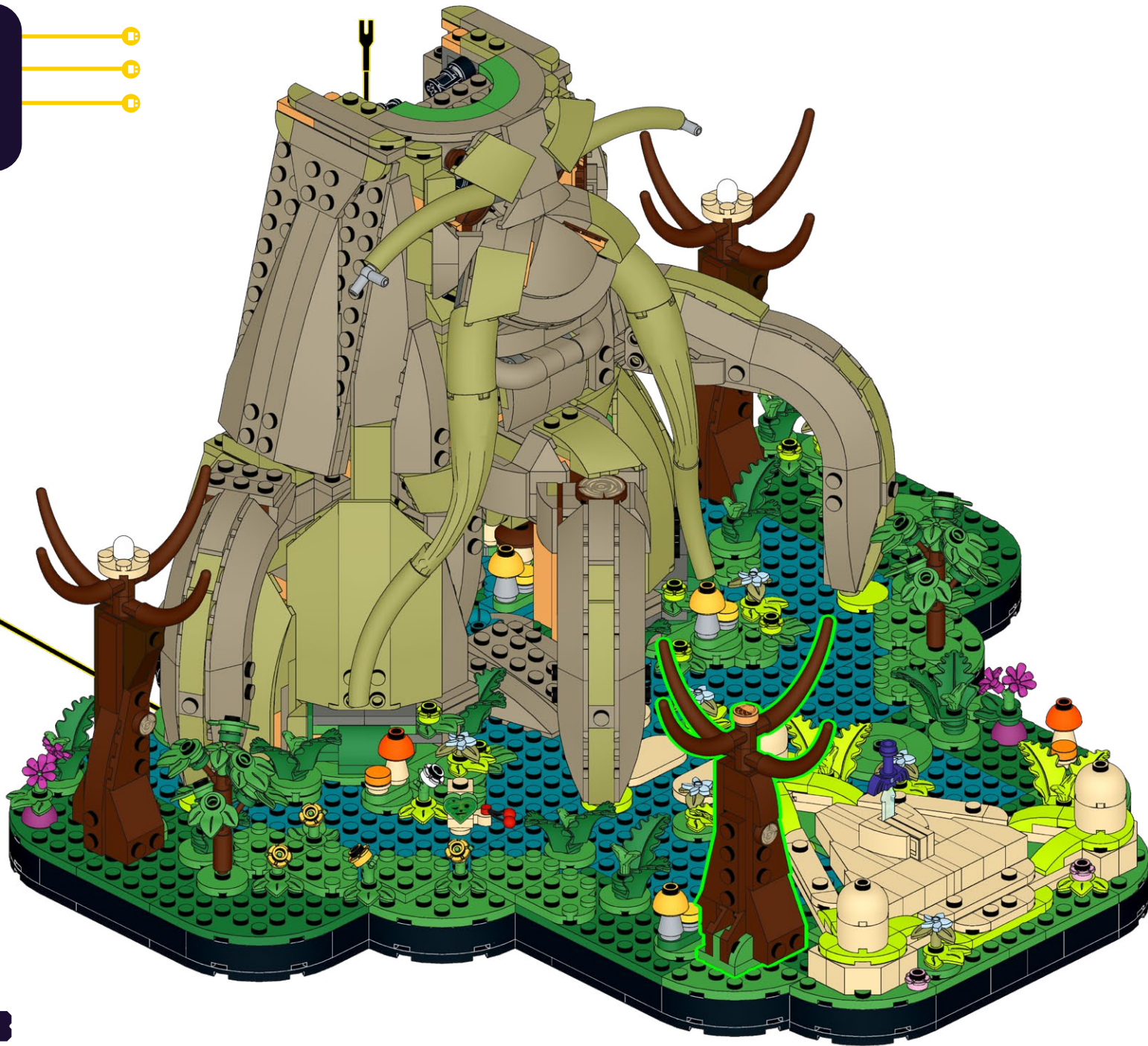

373

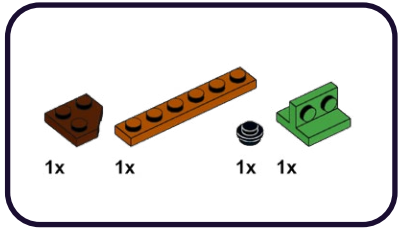

1

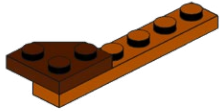

2

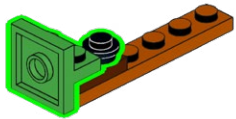

374

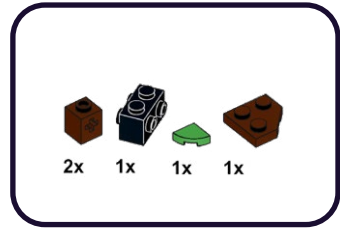

1

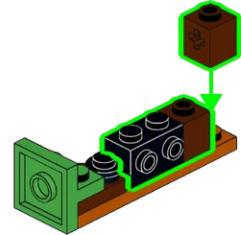

2

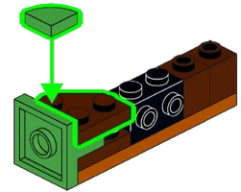

375

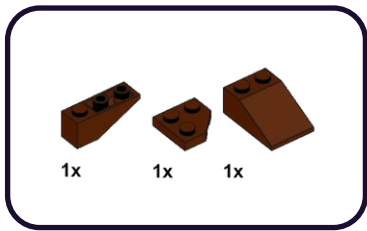

1

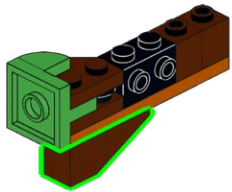

2

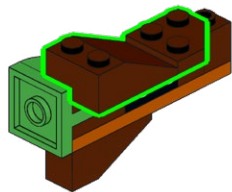

376

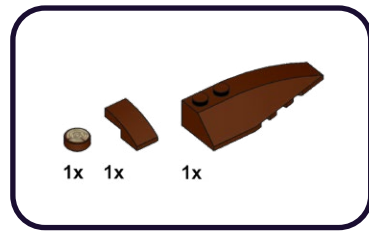

1

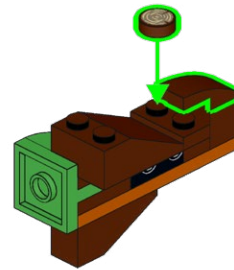

2

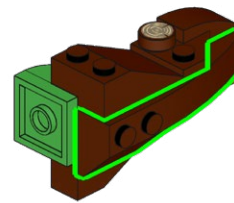

377

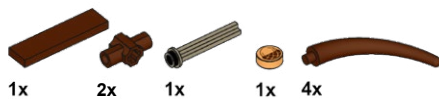

1

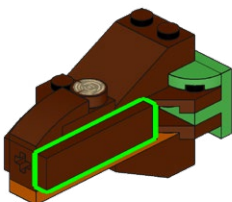

2

1

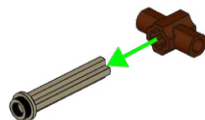

2

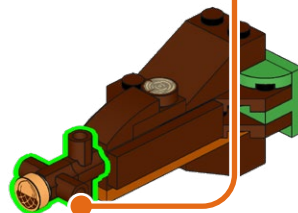
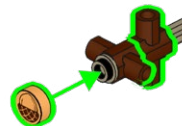

3



378

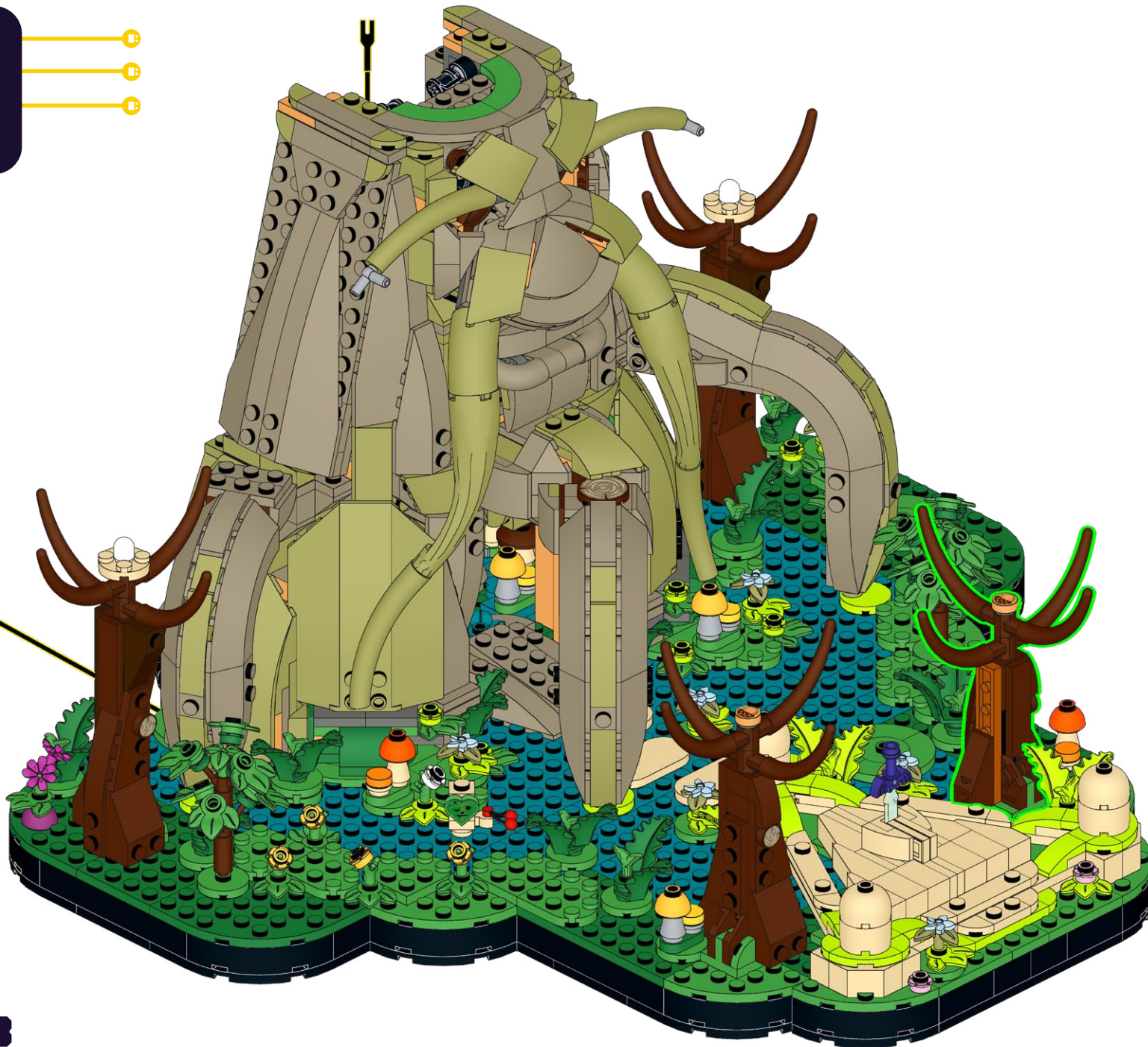

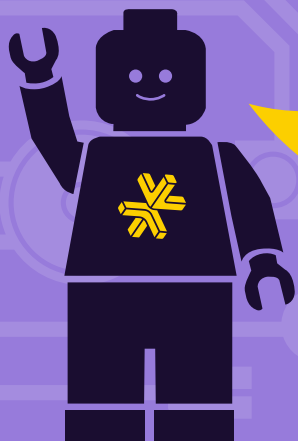
**HOLD UP!**

You might notice some bags aren't in order, as well as left over pieces, but that's ok! We're changing the way you build LEGO!

ATTENDEZ!

Vous remarquerez peut-être que certains sacs, ainsi que certaines pièces, ne sont pas dans le bon ordre. Mais pas de panique! Nous changeons simplement la façon avec laquelle vous construisez vos LEGO!

ASPETTA!

Potresti notare che alcuni sacchetti non sono in ordine, così come i pezzi avanzati, ma va bene così! Stiamo cambiando il modo in cui costruisci i LEGO!

HALT!

Sie werden möglicherweise bemerken, dass einige tüten durcheinander sind und teile übrig bleiben, aber das ist in Ordnung! Wir ändern die art und weise, wie Sie LEGO bauen!

¡ESPERA!

Es posible que notes que algunas bolsas están fuera de servicio, así como piezas sobrantes, ¡pero está bien! ¡Estamos cambiando la forma en que construyes LEGO!

暫停!

你可能会注意到一些袋子顺序错乱, 以及一些剩余的部件, 但没关系! 我们正在改变你搭建乐高的方式!

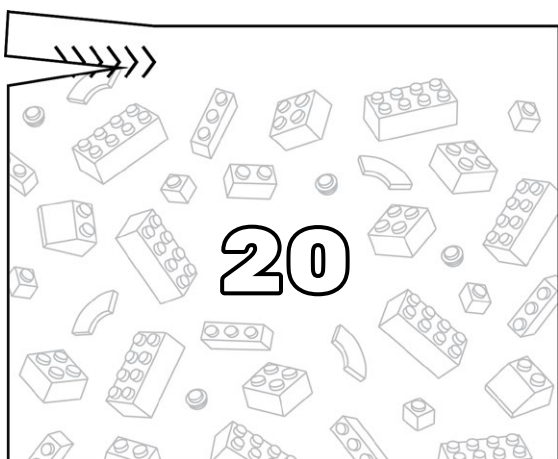
Open LEGO® Bag 20

379

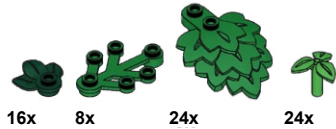

1

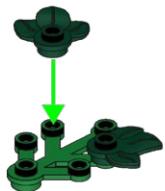

2



3



8x



380

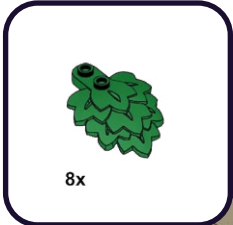

**HOLD UP!**

You might notice some bags aren't in order, as well as left over pieces, but that's ok! We're changing the way you build LEGO!

ATTENDEZ!

Vous remarquerez peut-être que certains sacs, ainsi que certaines pièces, ne sont pas dans le bon ordre. Mais pas de panique! Nous changeons simplement la façon avec laquelle vous construisez vos LEGO!

ASPETTA!

Potresti notare che alcuni sacchetti non sono in ordine, così come i pezzi avanzati, ma va bene così! Stiamo cambiando il modo in cui costruisci i LEGO!

HALT!

Sie werden möglicherweise bemerken, dass einige tüten durcheinander sind und teile übrig bleiben, aber das ist in Ordnung! Wir ändern die art und weise, wie Sie LEGO bauen!

¡ESPERA!

Es posible que notes que algunas bolsas están fuera de servicio, así como piezas sobrantes, ¡pero está bien! ¡Estamos cambiando la forma en que construyes LEGO!

暫停!

你可能会注意到一些袋子顺序错乱, 以及一些剩余的部件, 但没关系! 我们正在改变你搭建乐高的方式!

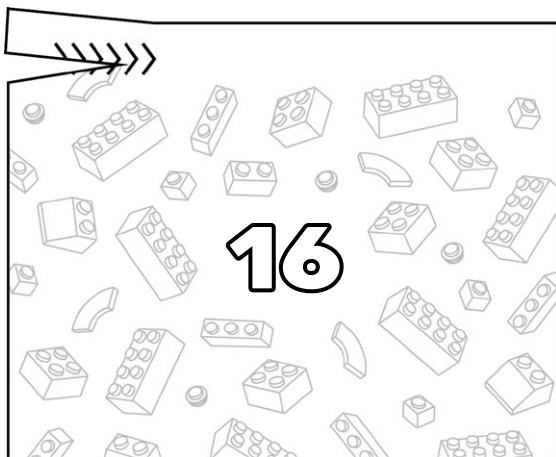
Open LEGO® Bag 16

381

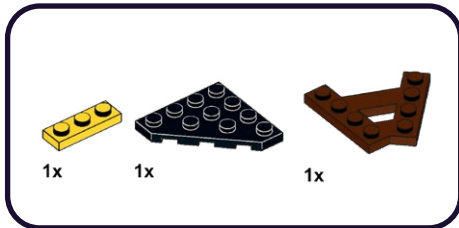

1



2



382

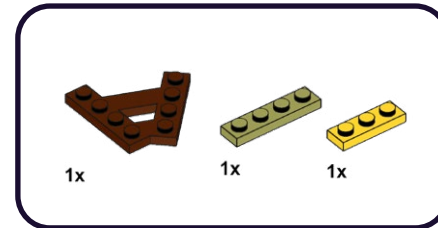

1

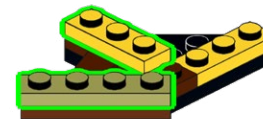

2



383

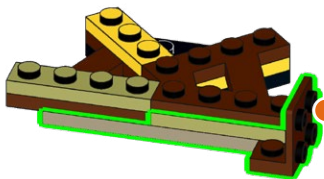
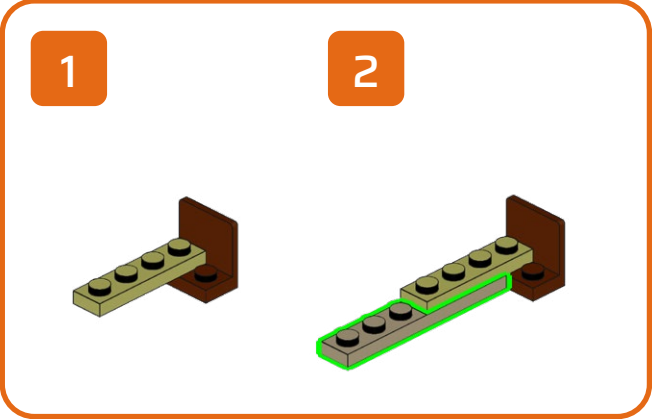
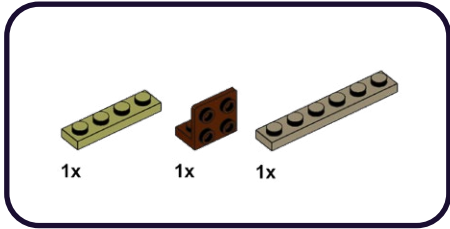

384

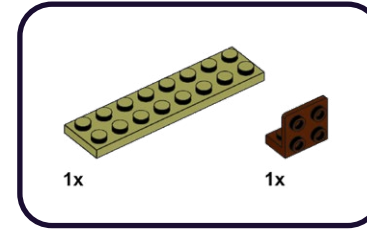

1

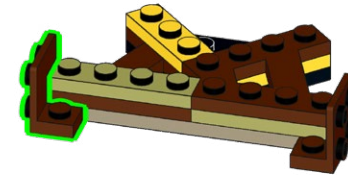

2

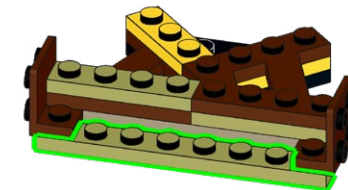

385



2x 2x

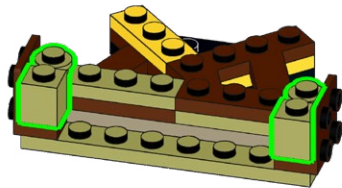

386

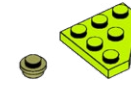

1x 2x

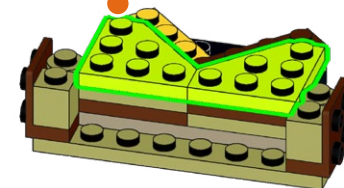
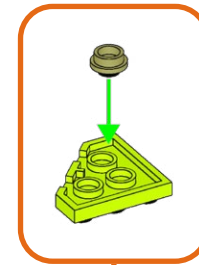

387

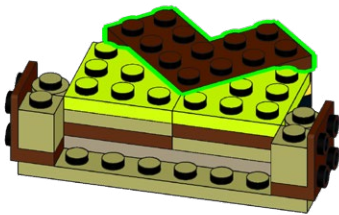
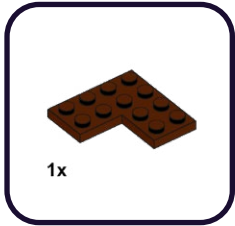

388

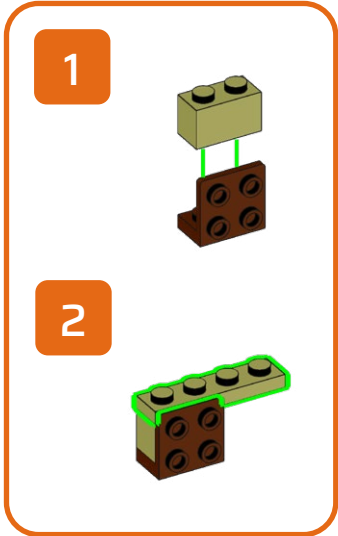
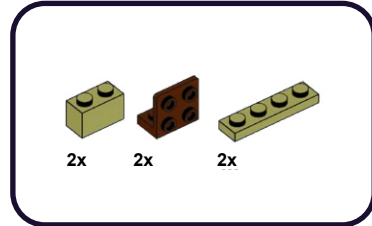

2

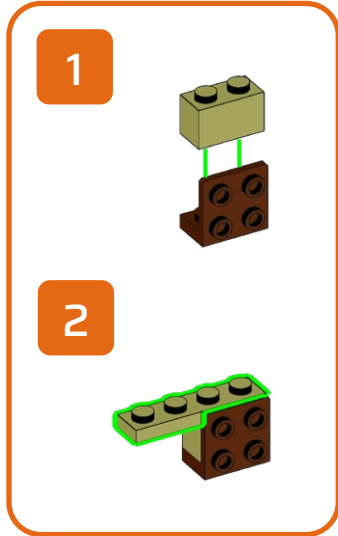
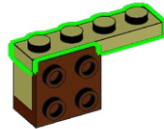

2

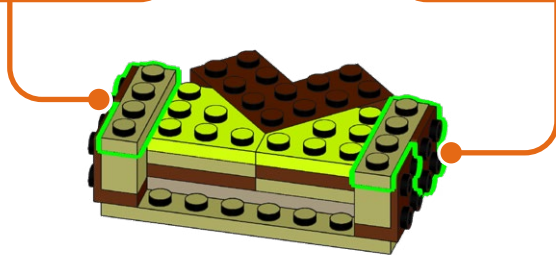
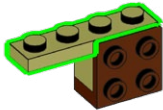

389

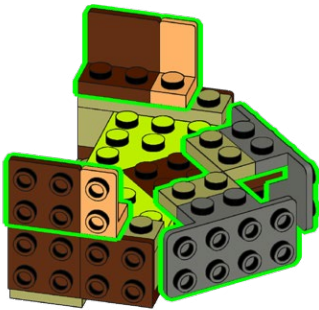
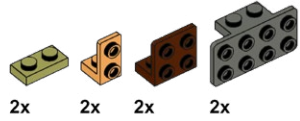

390

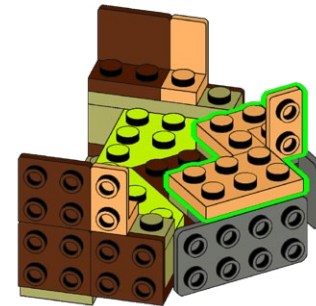
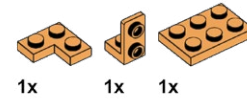

391

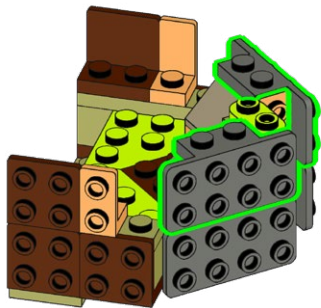
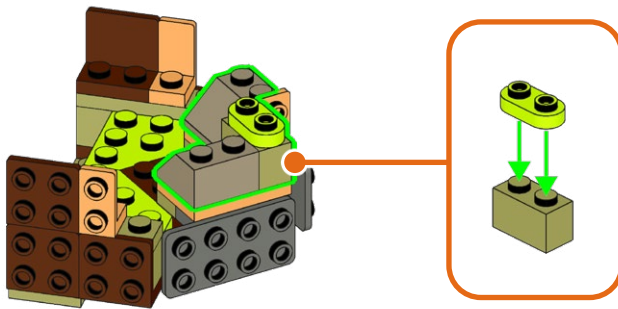
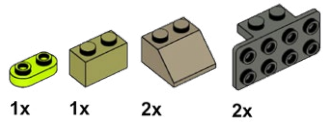

392

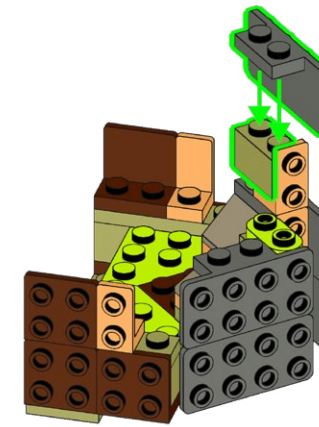
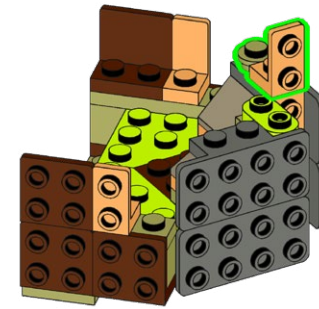
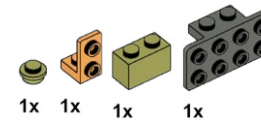

393

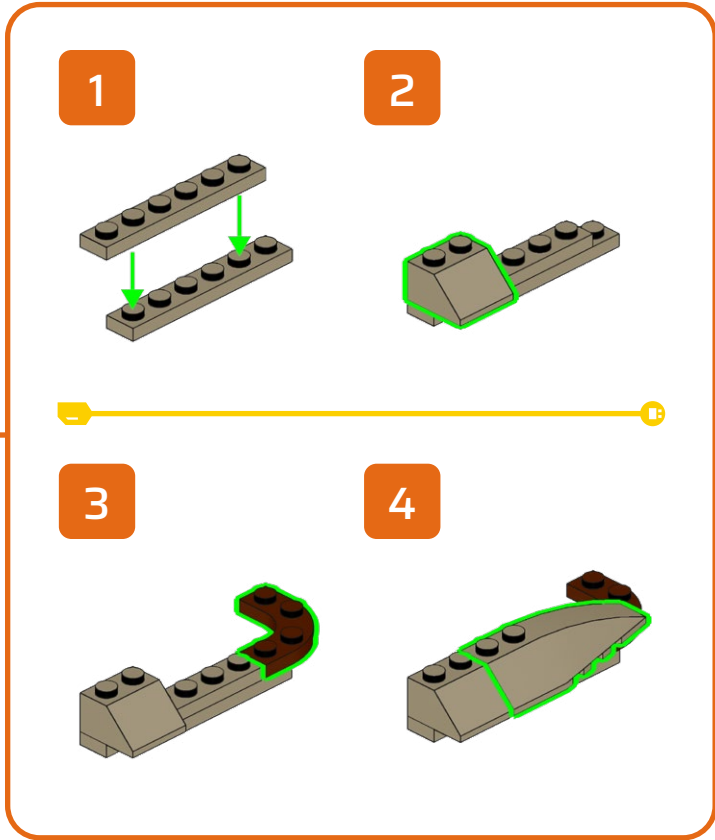
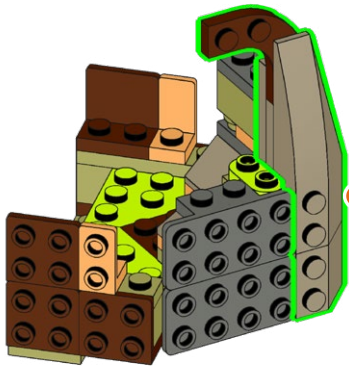
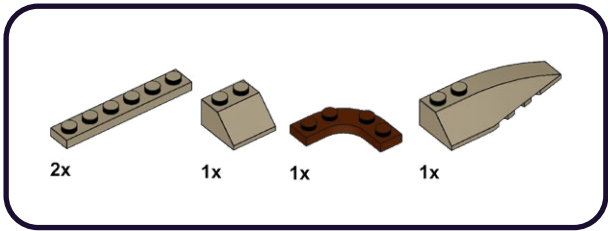

394

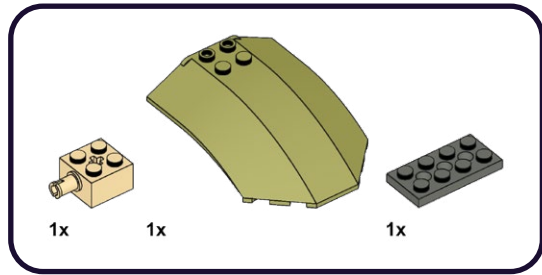

395

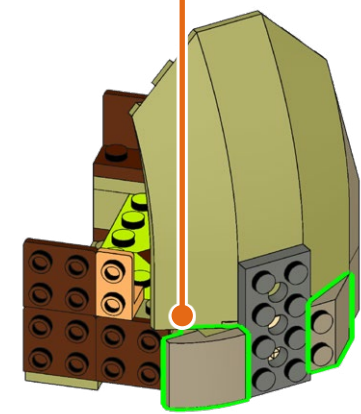
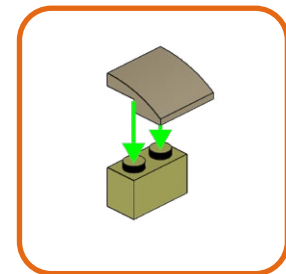
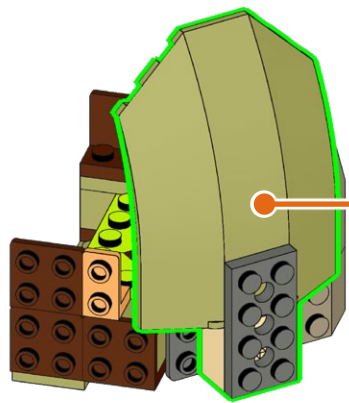
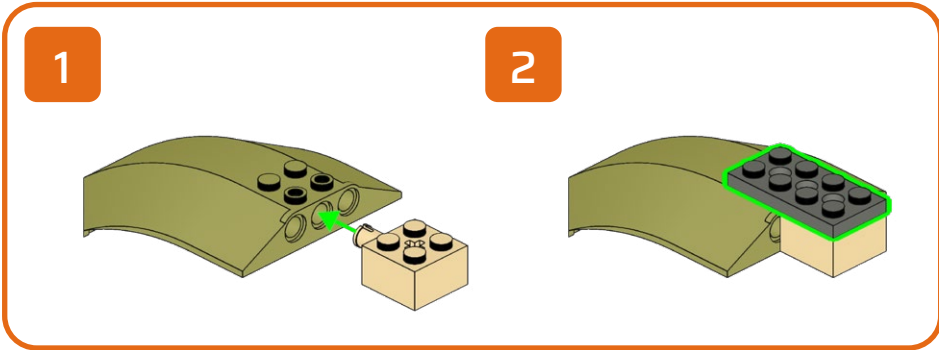
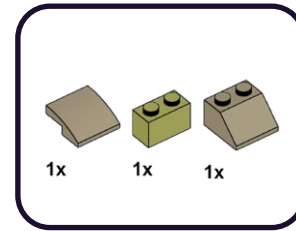

396

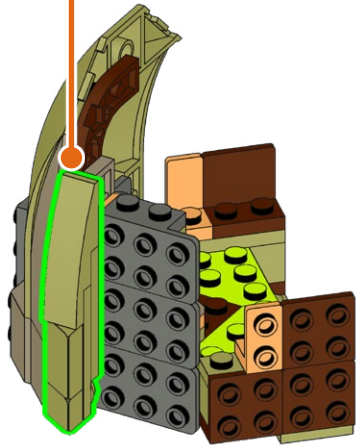
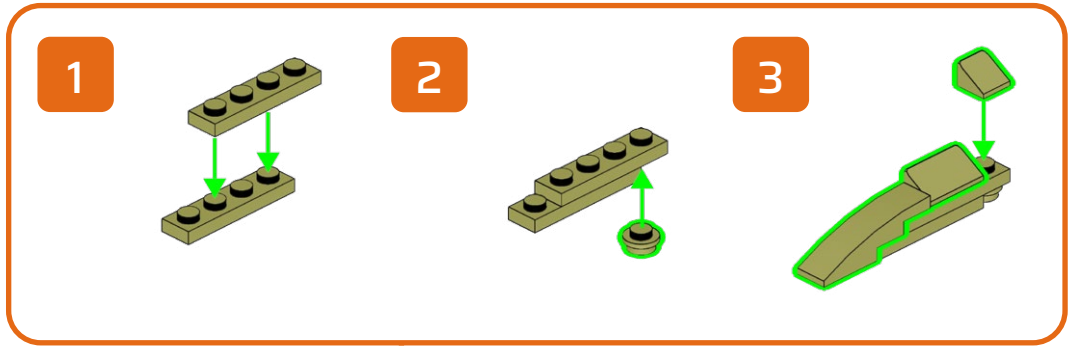
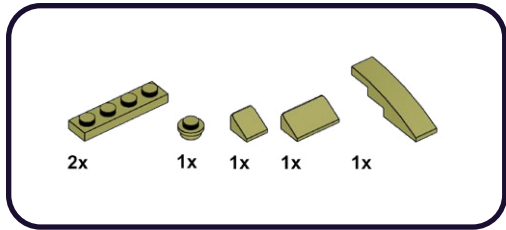

397

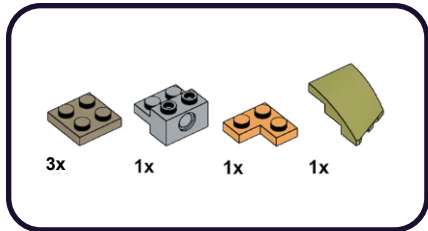

1

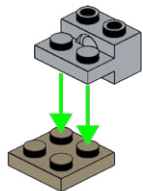

2

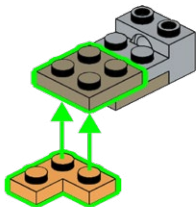

3

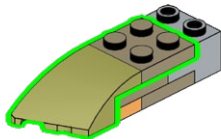

398

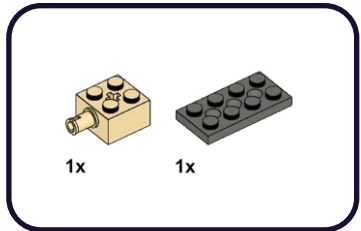

1

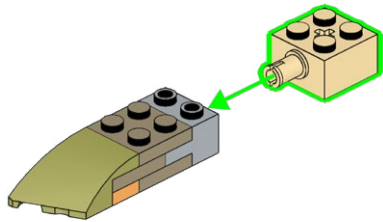

2

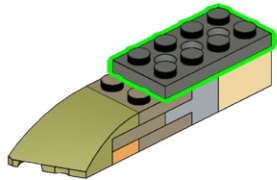

399

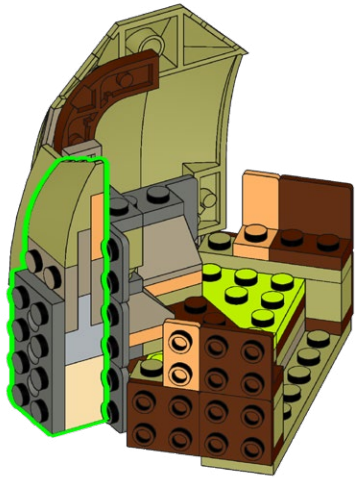

400

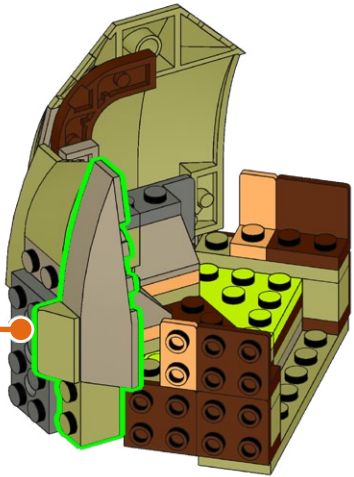
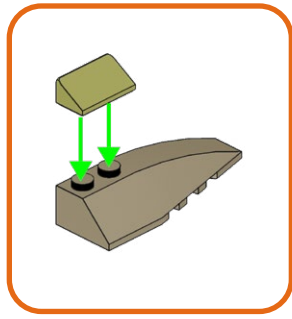
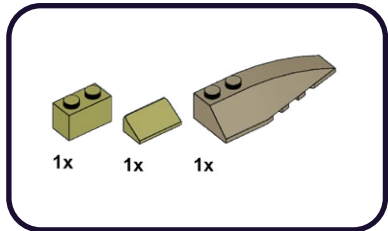

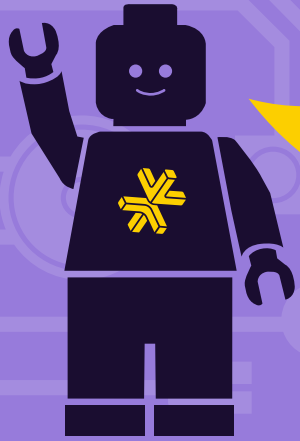
**HOLD UP!**

You might notice some bags aren't in order, as well as left over pieces, but that's ok! We're changing the way you build LEGO!

ATTENDEZ!

Vous remarquerez peut-être que certains sacs, ainsi que certaines pièces, ne sont pas dans le bon ordre. Mais pas de panique! Nous changeons simplement la façon avec laquelle vous construisez vos LEGO!

ASPETTA!

Potresti notare che alcuni sacchetti non sono in ordine, così come i pezzi avanzati, ma va bene così! Stiamo cambiando il modo in cui costruisci i LEGO!

HALT!

Sie werden möglicherweise bemerken, dass einige tüten durcheinander sind und teile übrig bleiben, aber das ist in Ordnung! Wir ändern die art und weise, wie Sie LEGO bauen!

¡ESPERA!

Es posible que notes que algunas bolsas están fuera de servicio, así como piezas sobrantes, ¡pero está bien! ¡Estamos cambiando la forma en que construyes LEGO!

暫停!

你可能会注意到一些袋子顺序错乱, 以及一些剩余的部件, 但没关系! 我们正在改变你搭建乐高的方式!

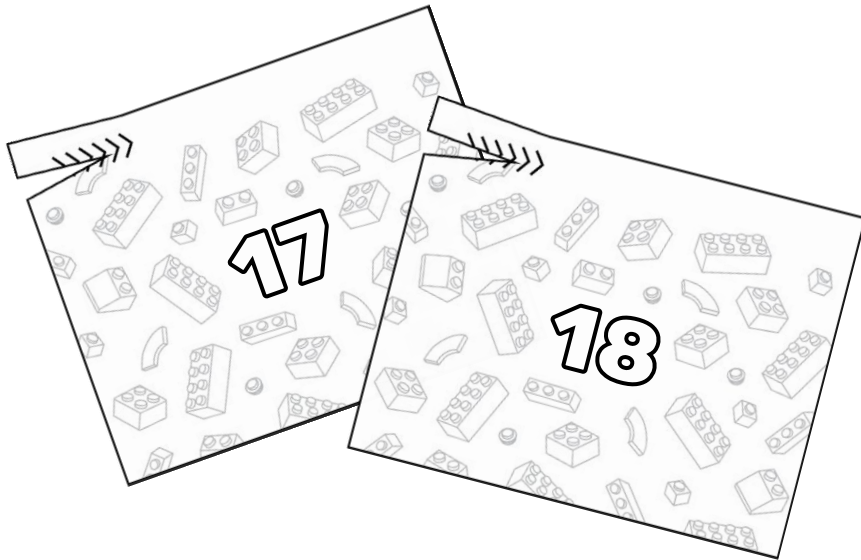
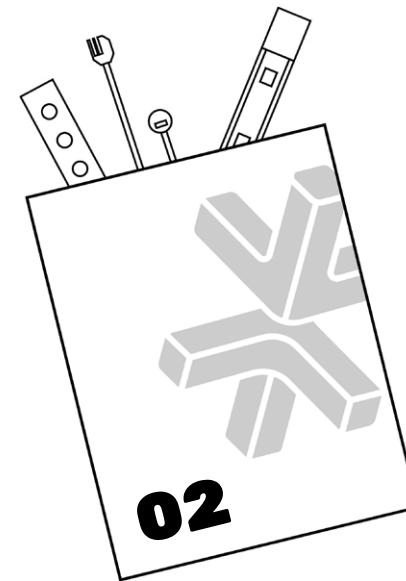
Open LEGO® Bags 17 & 18**Open LMB Bag 02**

401

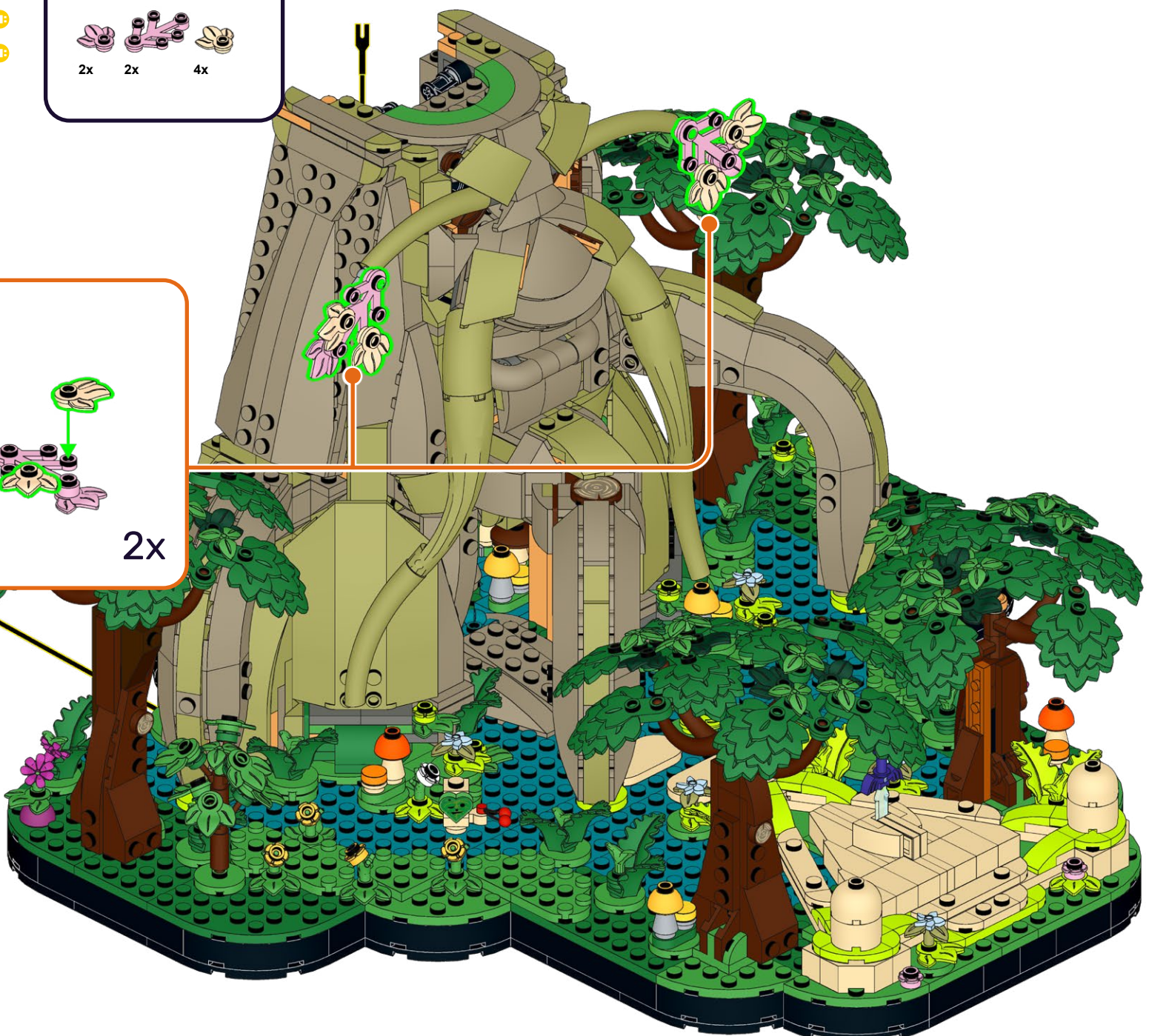
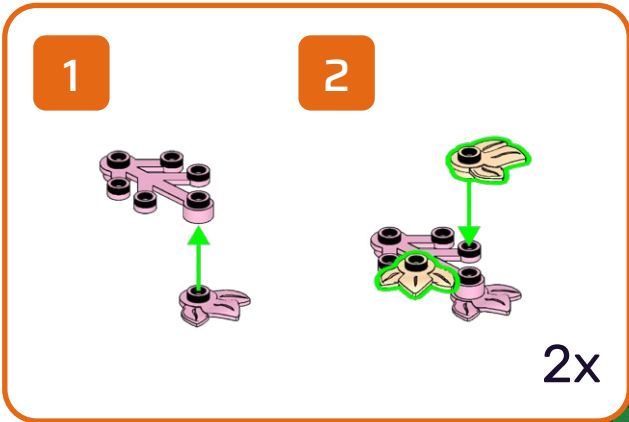
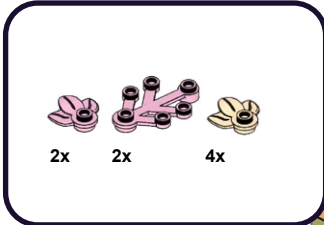

402

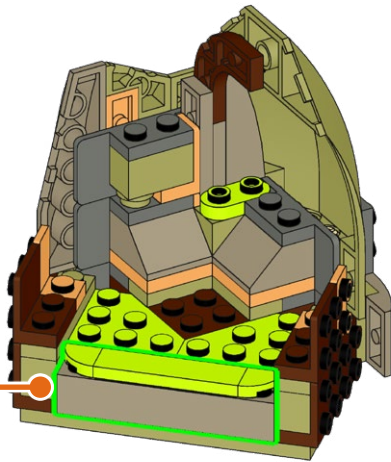
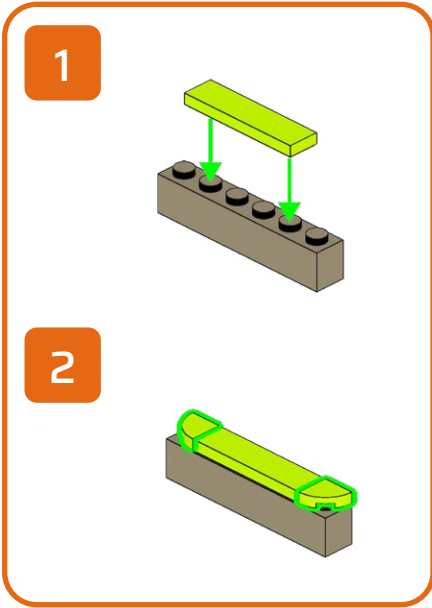
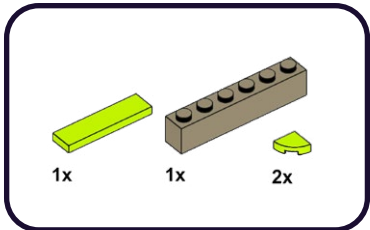

403

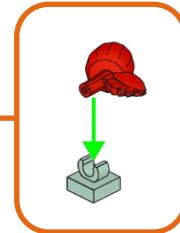
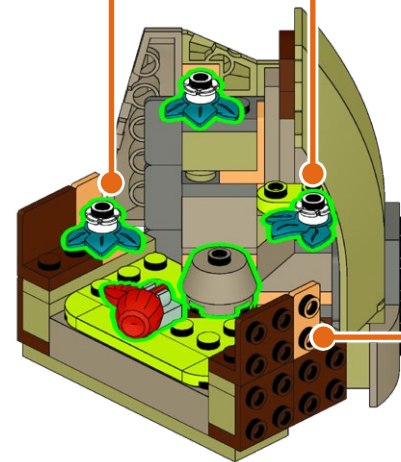
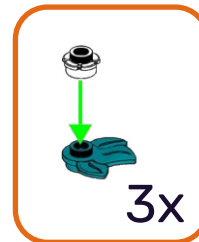
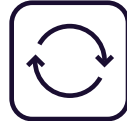
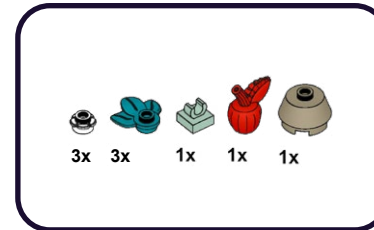

404

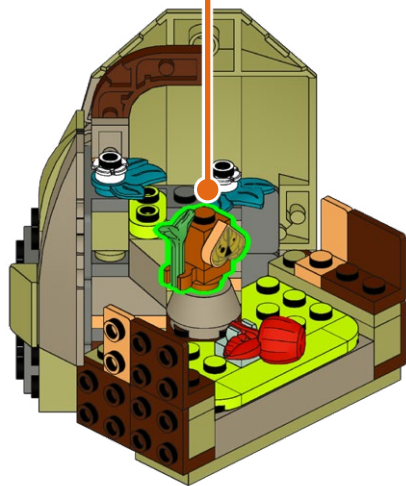
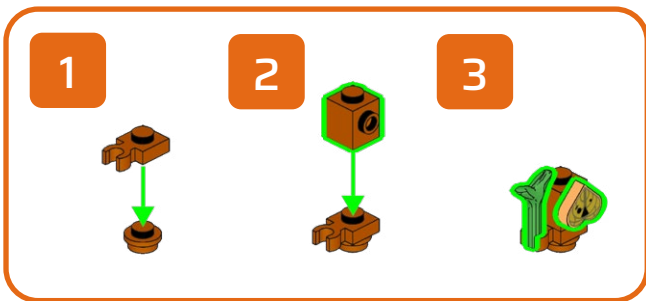

405

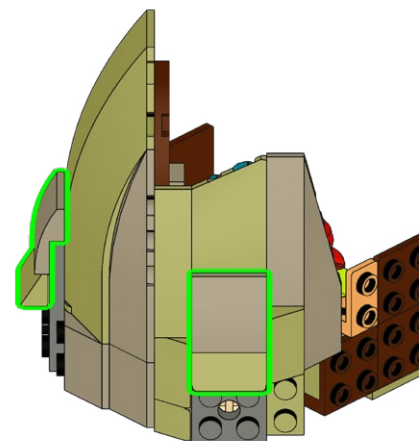
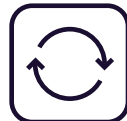
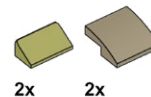

406

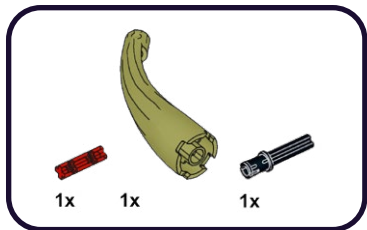

1

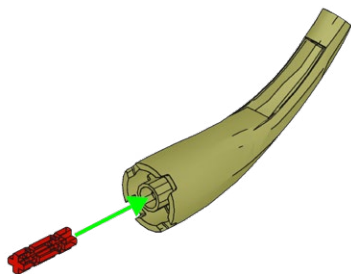

2

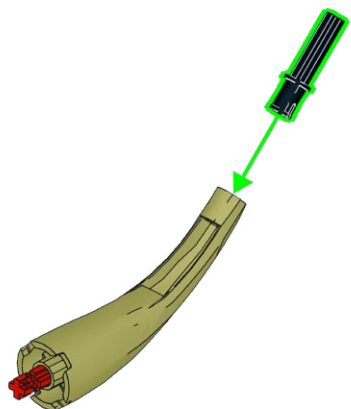

407

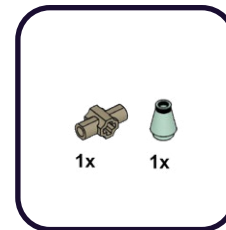

1

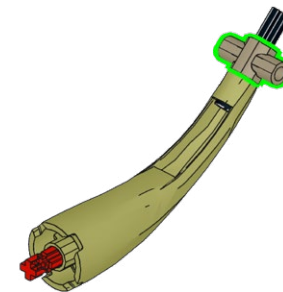

2

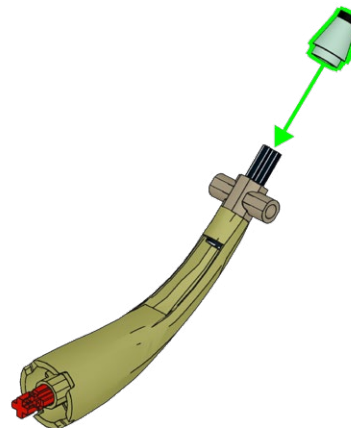

408

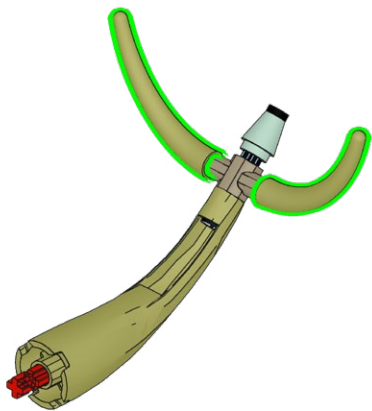
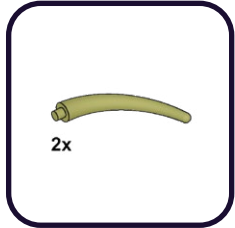

409

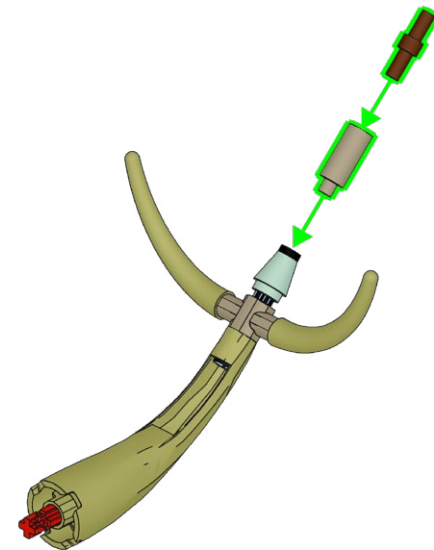
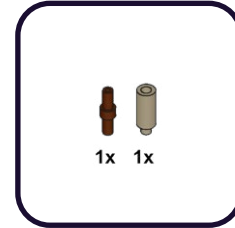

410

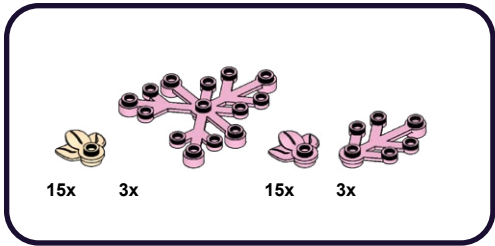

1

2

3

4

5

3x

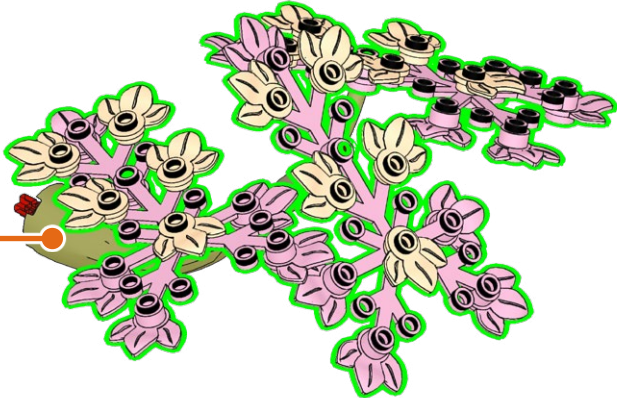

411

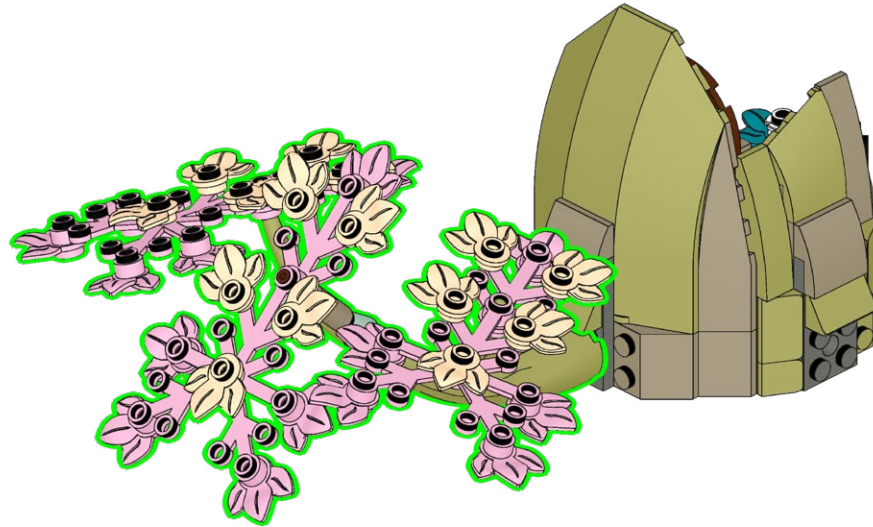

412

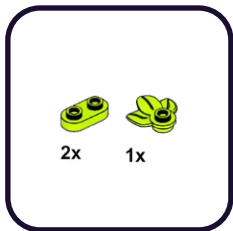
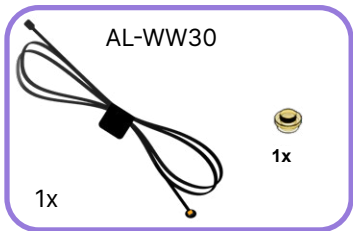

1

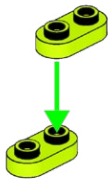

2

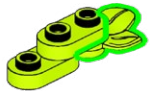

3

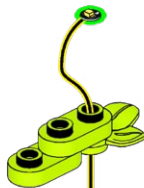

4

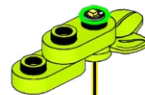

5

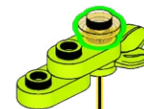

413

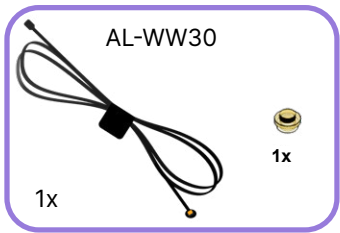

1

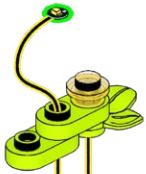

2

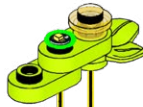

3

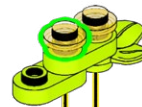

414

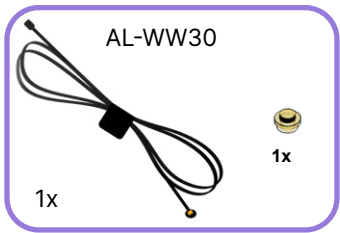

1

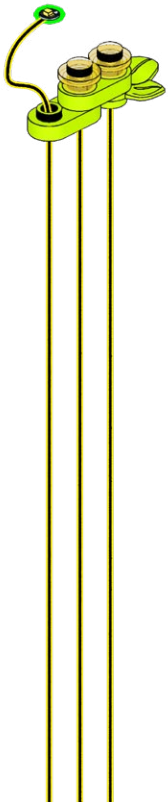

2

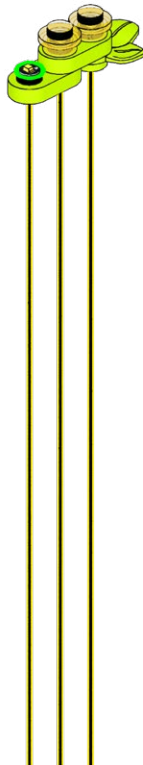

3

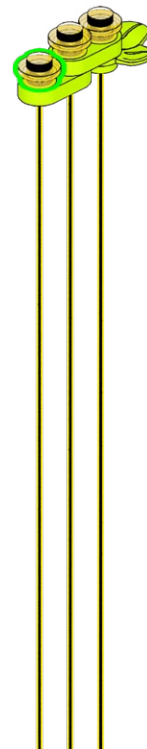

415

3x 1x

1



2



3

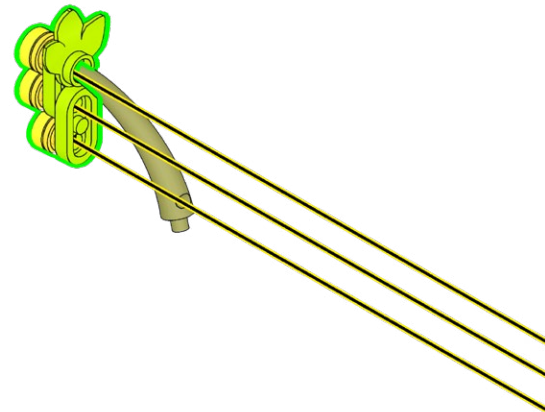

416

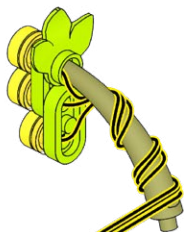

417

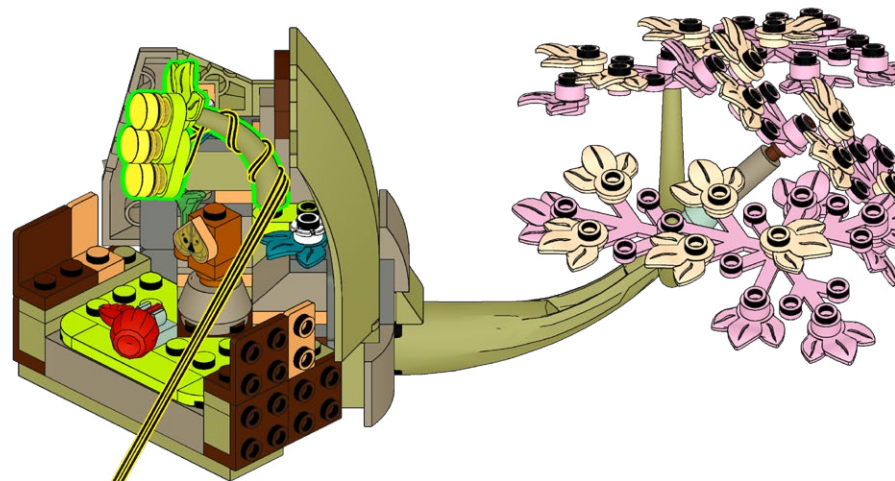
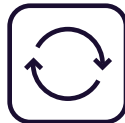

418

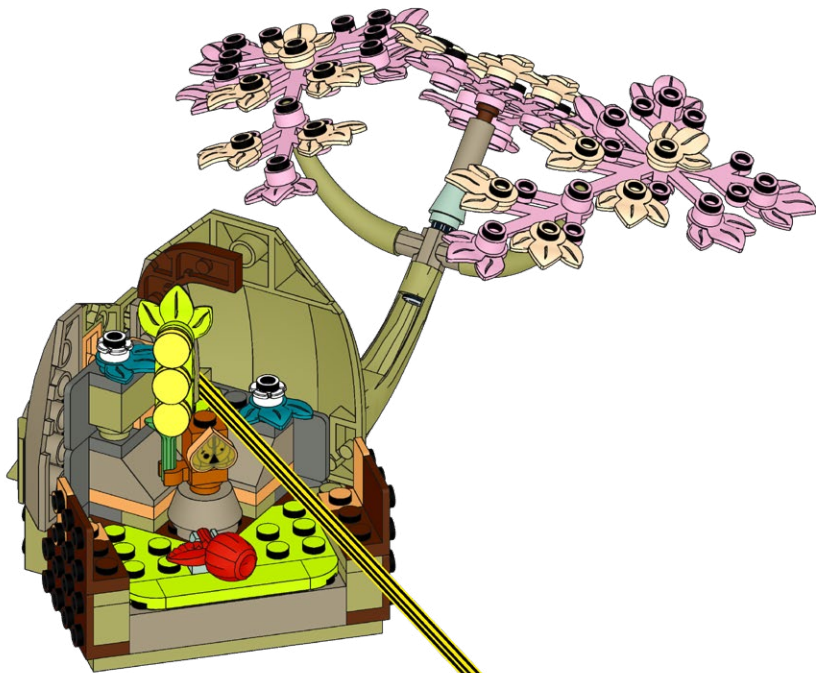

419

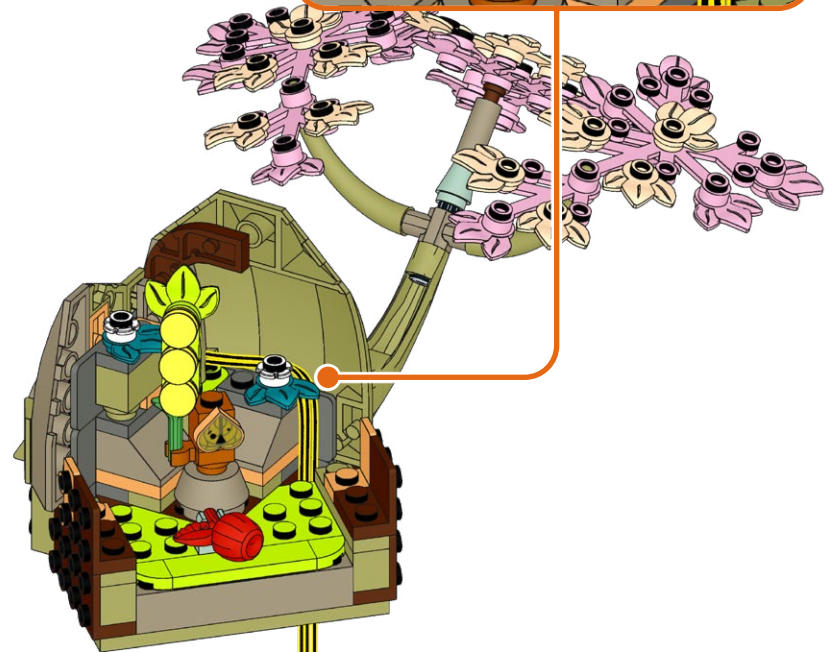
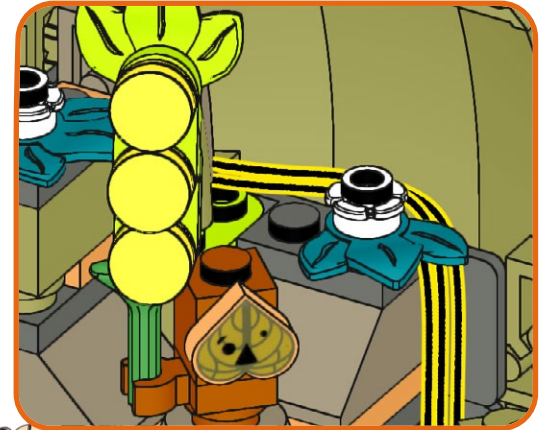

420

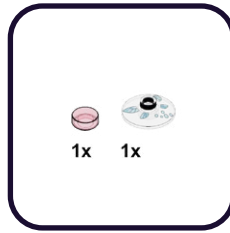
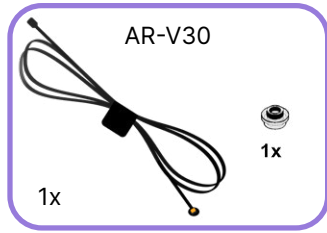

1



2



3



421

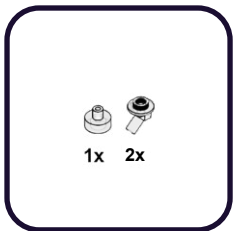

422

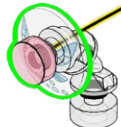
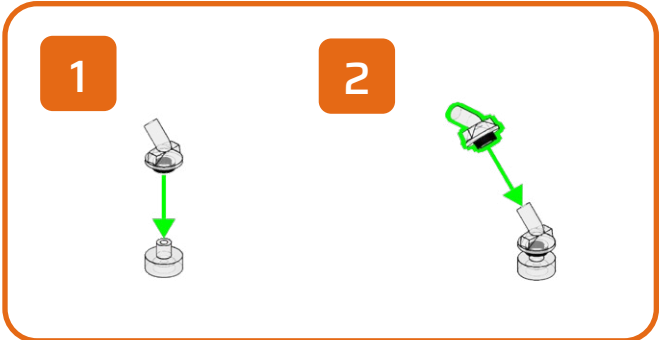

423

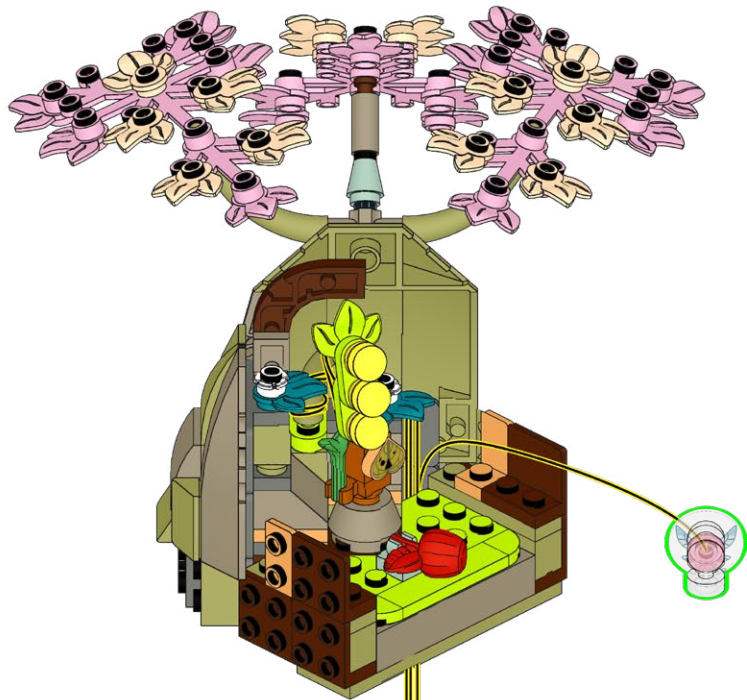

424

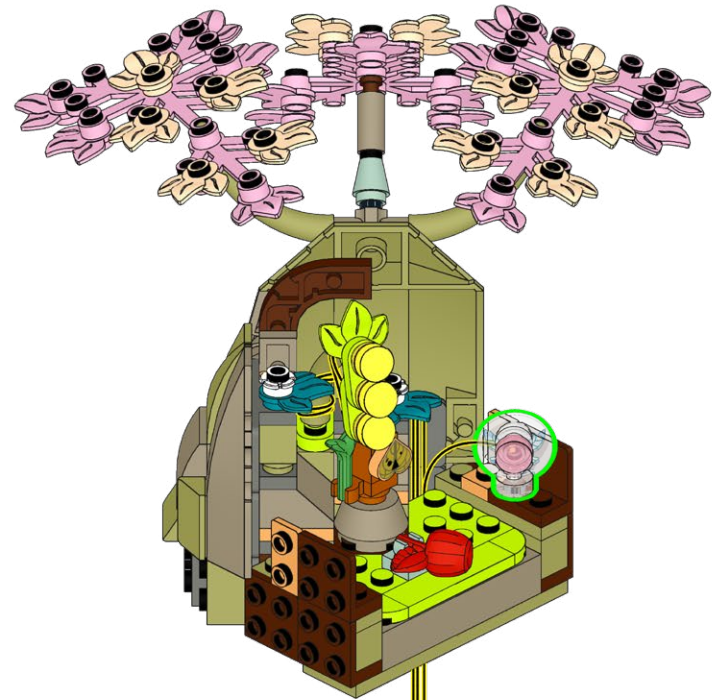

425

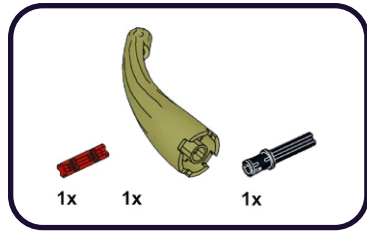

1

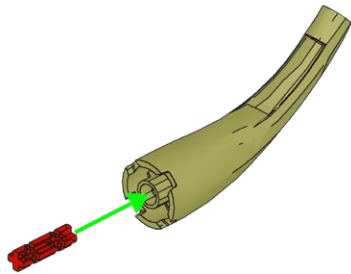

2

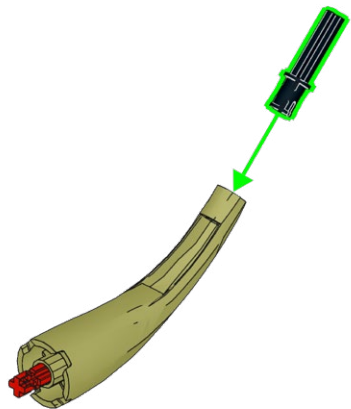

426

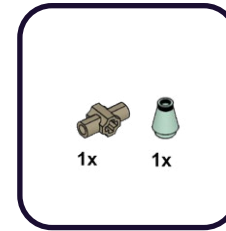

1

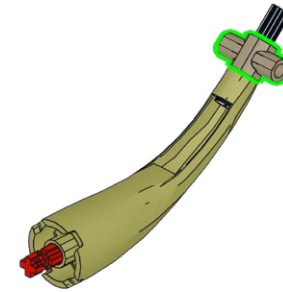

2

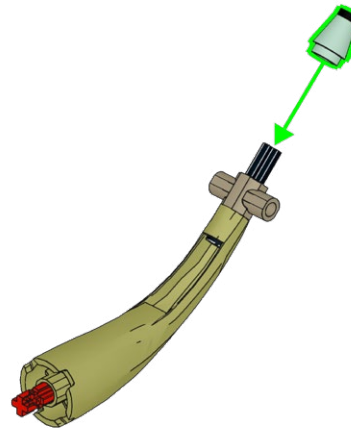

427

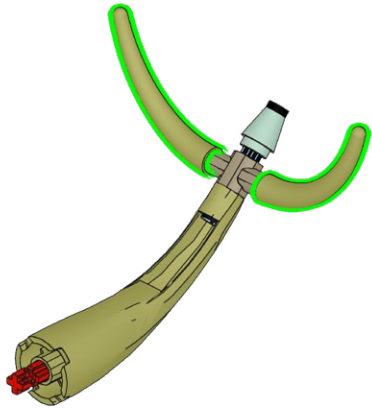
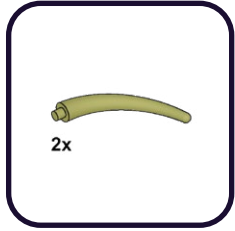

428

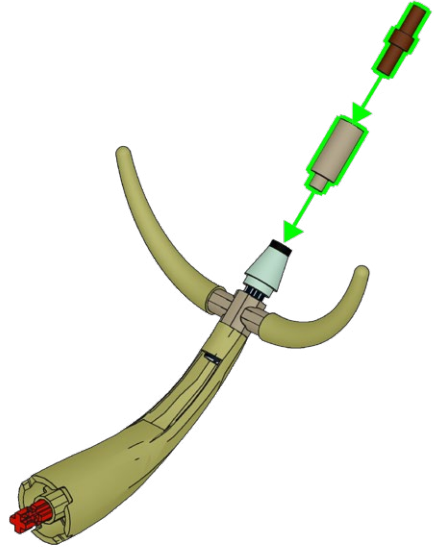
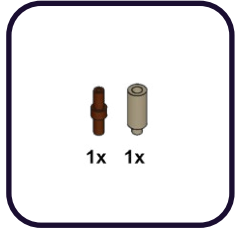

429

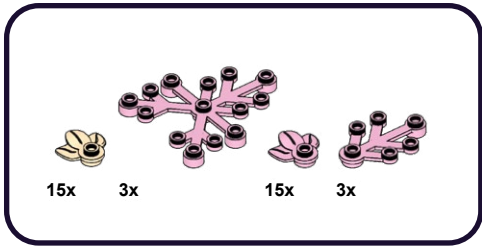

1

2

3

4

5

3x

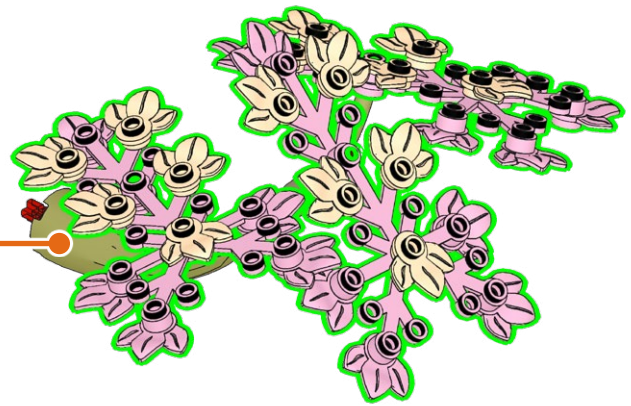

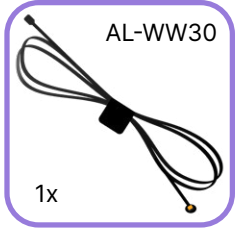

1



2

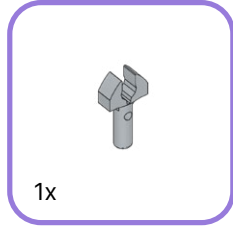
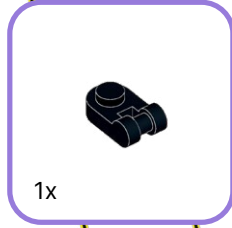
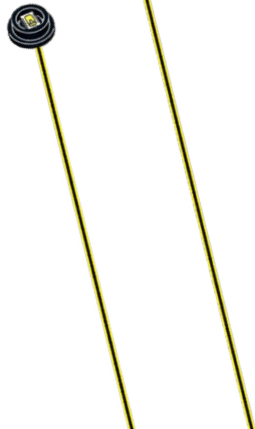

1



2

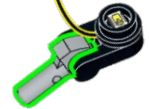

432

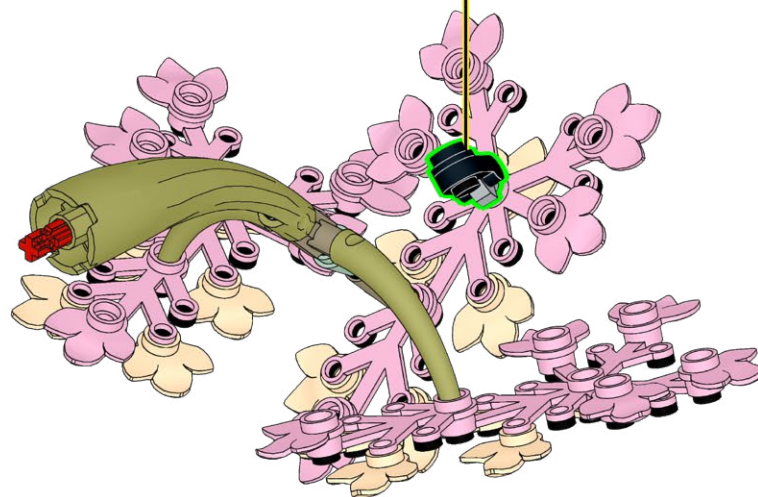

433

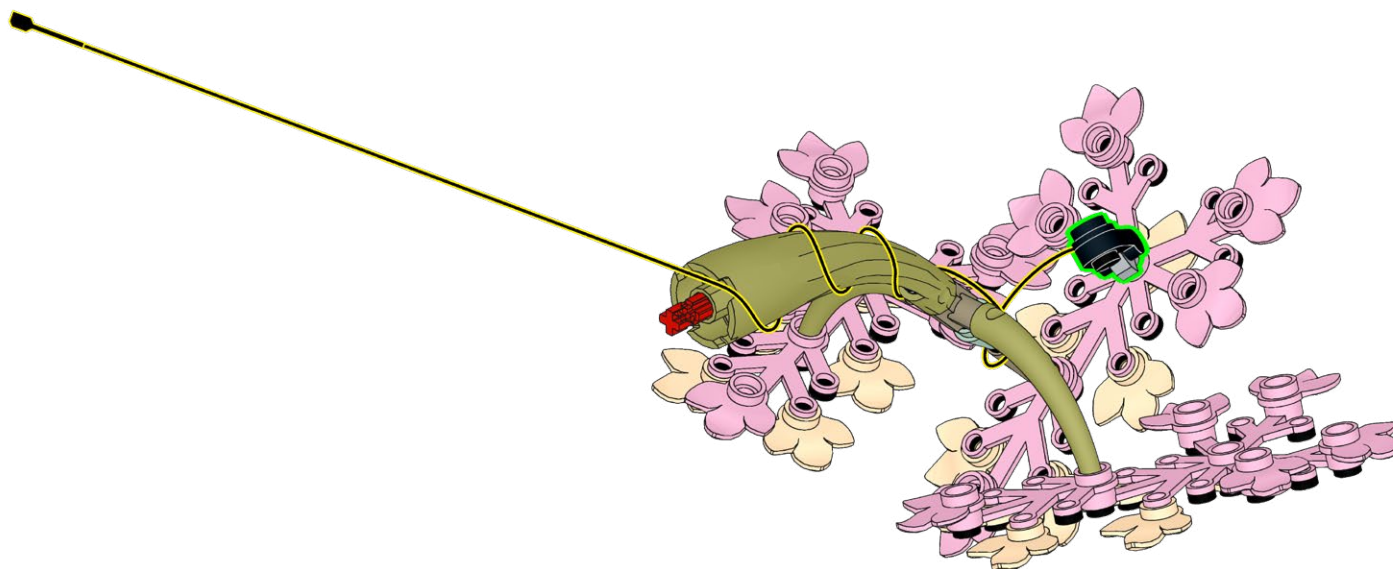

434

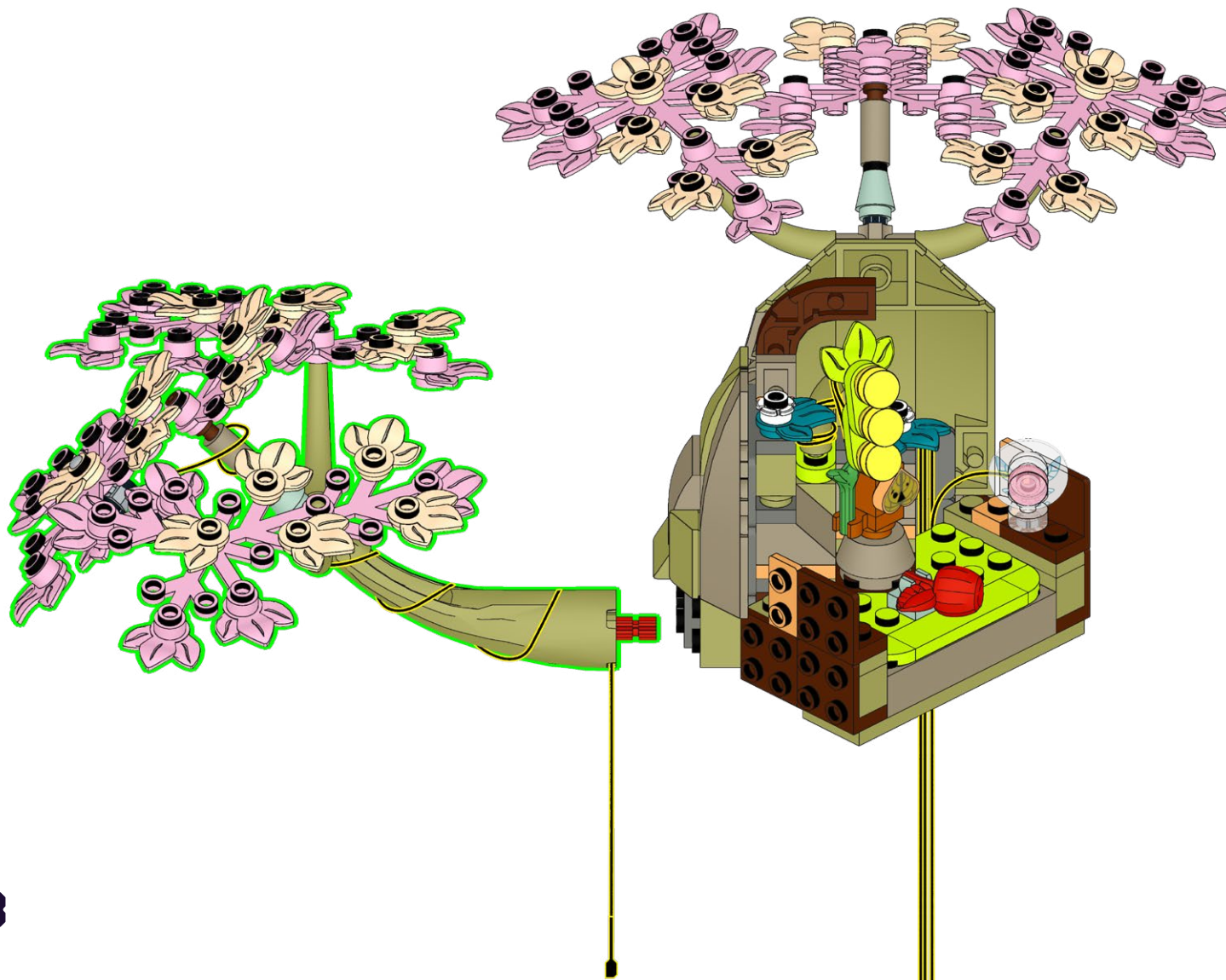

435

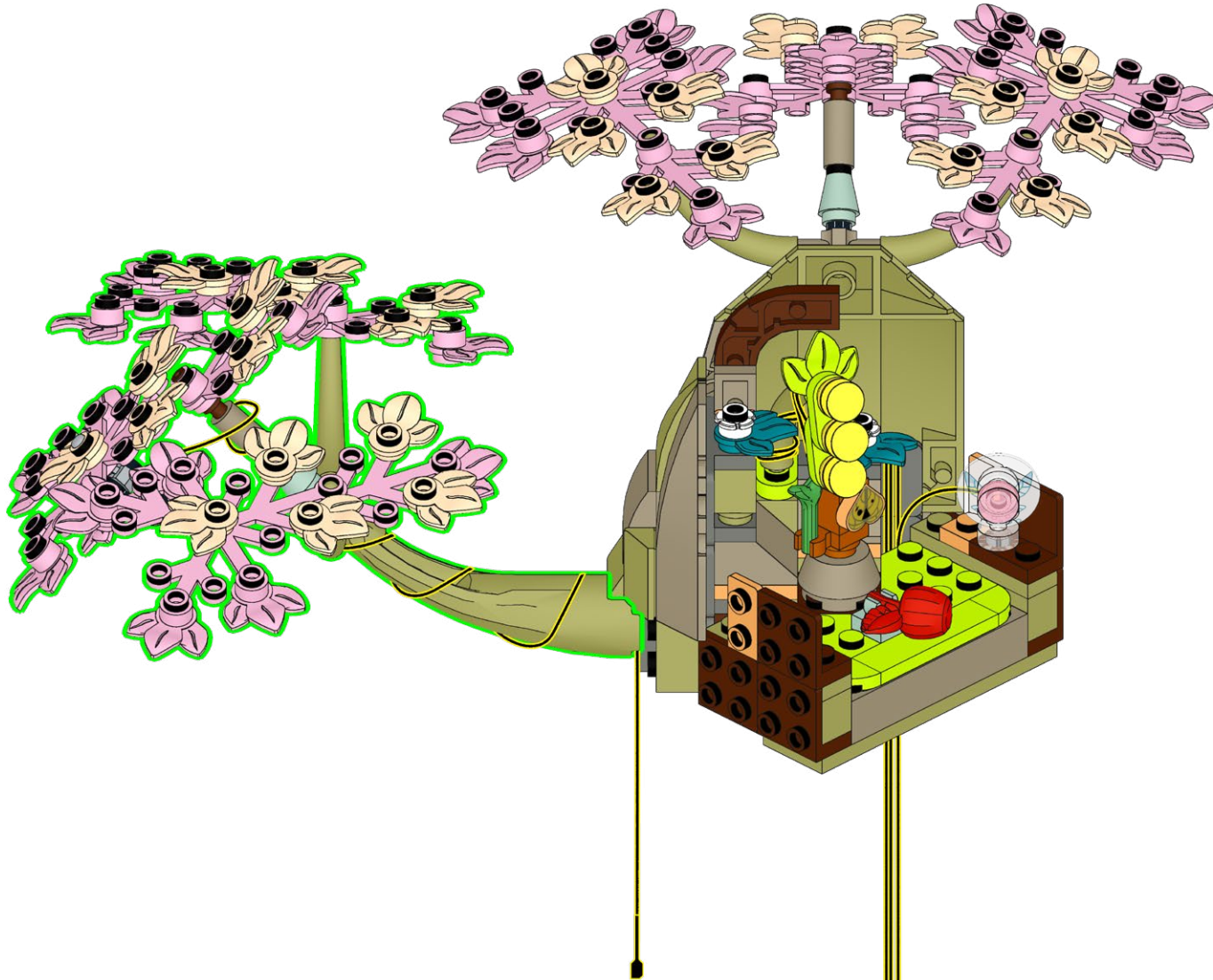

436

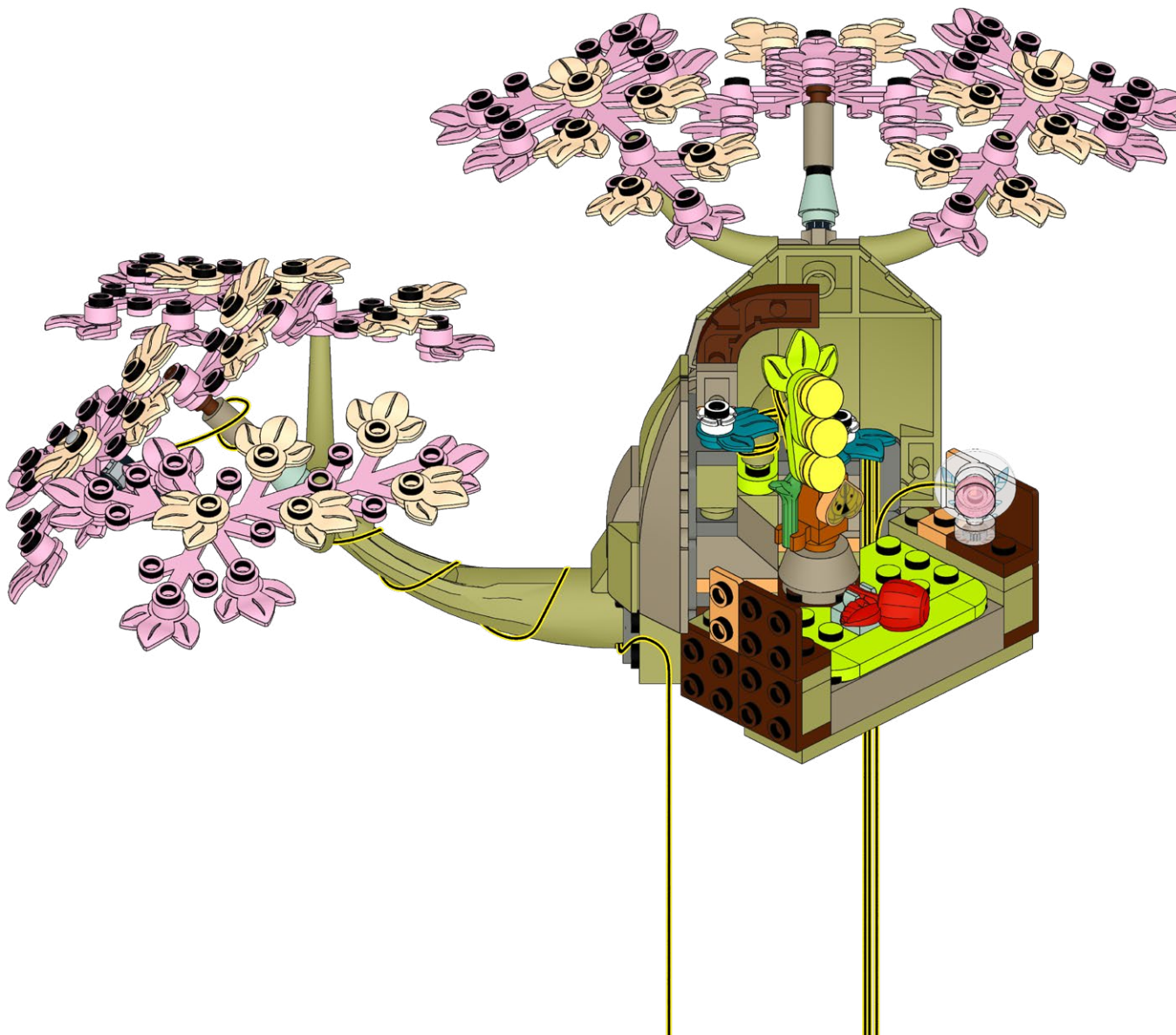

437

1x

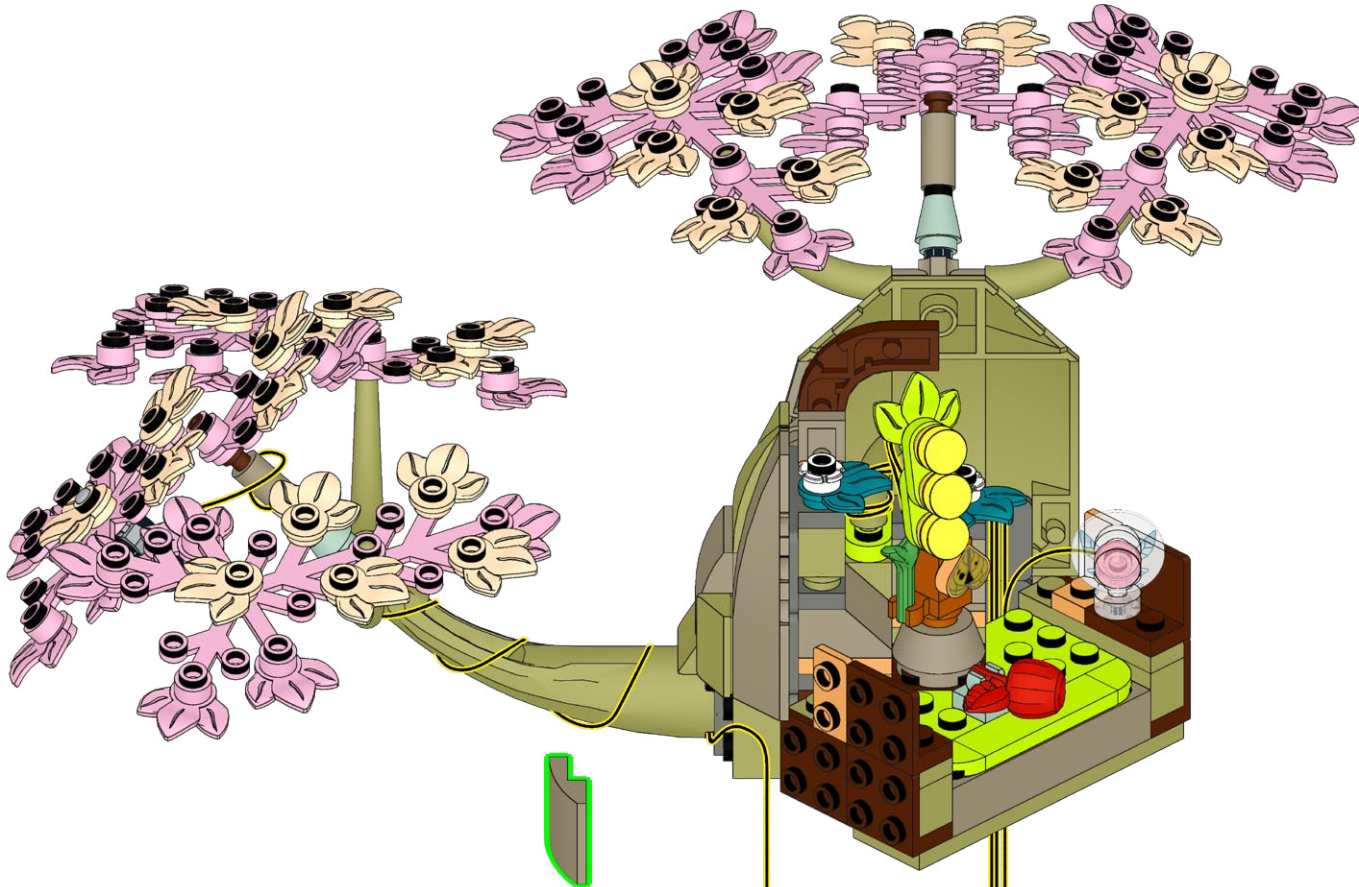

438

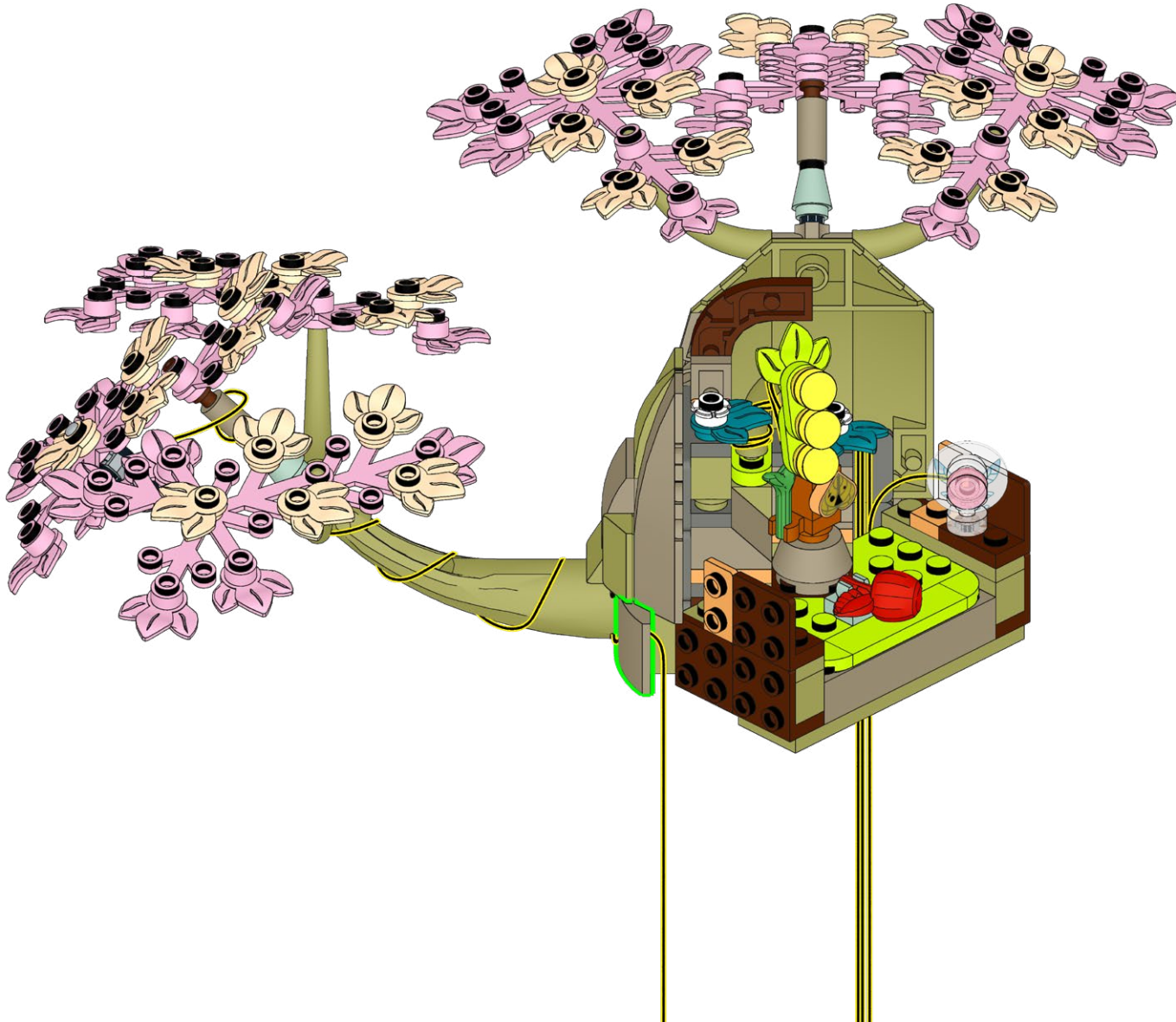

439

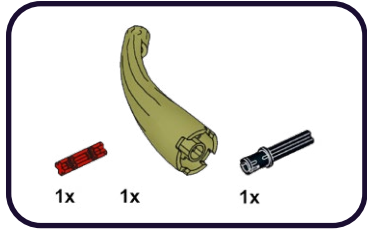

1

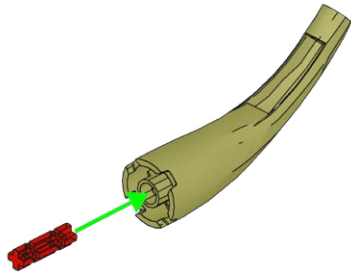

2

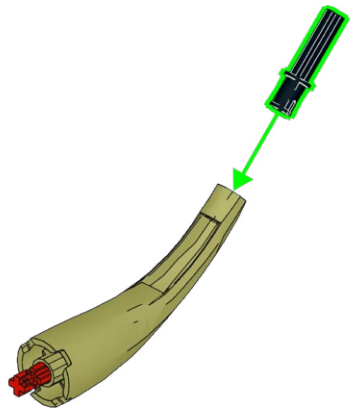

440

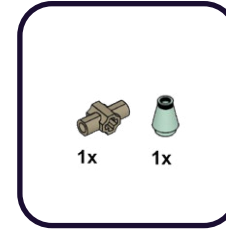

1

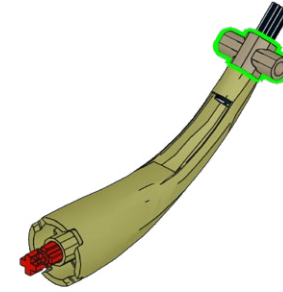

2

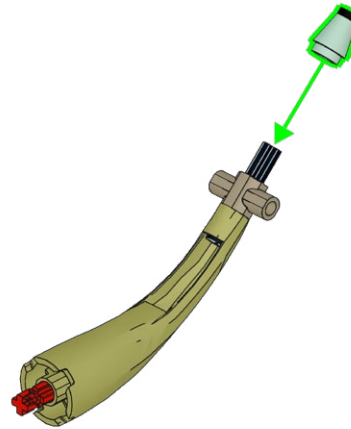

441

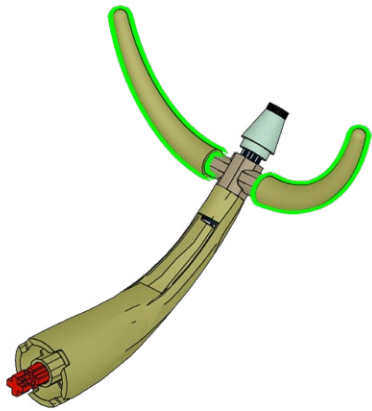
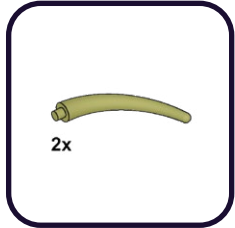

442

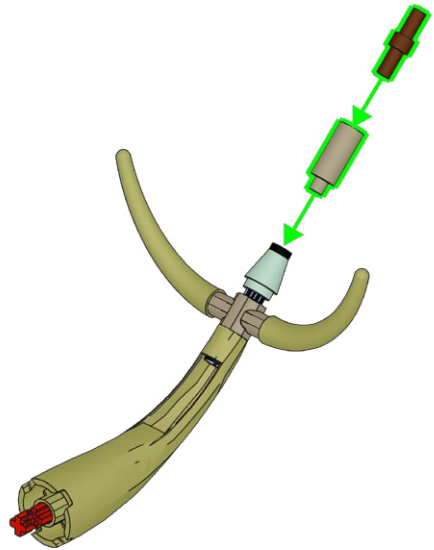
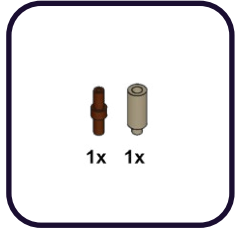

443

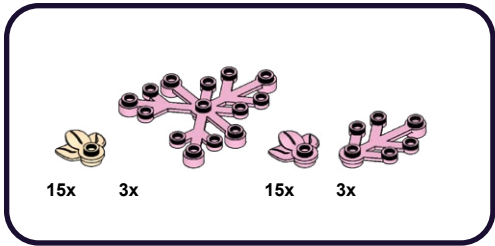

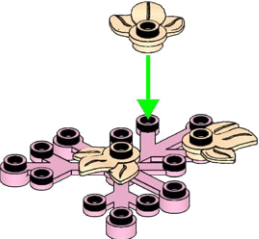
1 

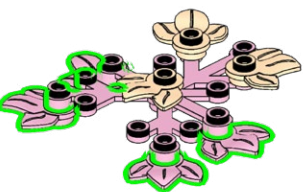
2 

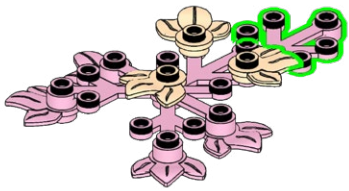
3 

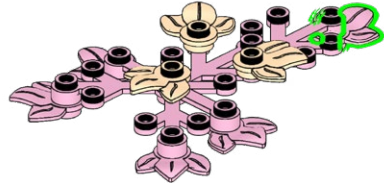
4 

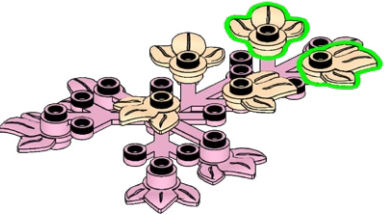
5 

3x

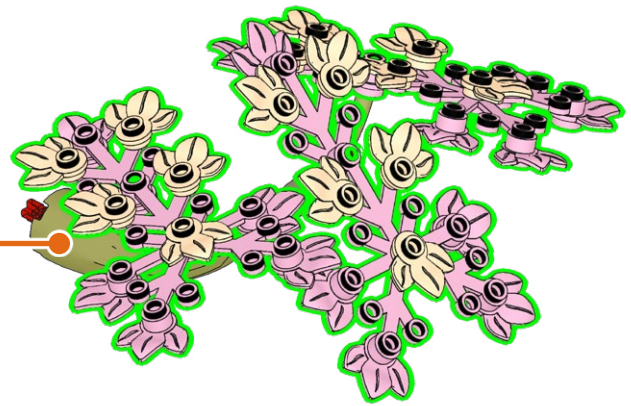

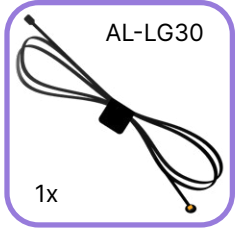

1



2

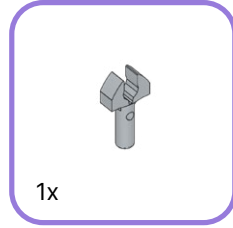
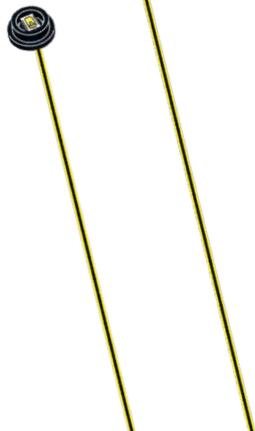

1



2

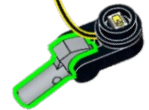

446

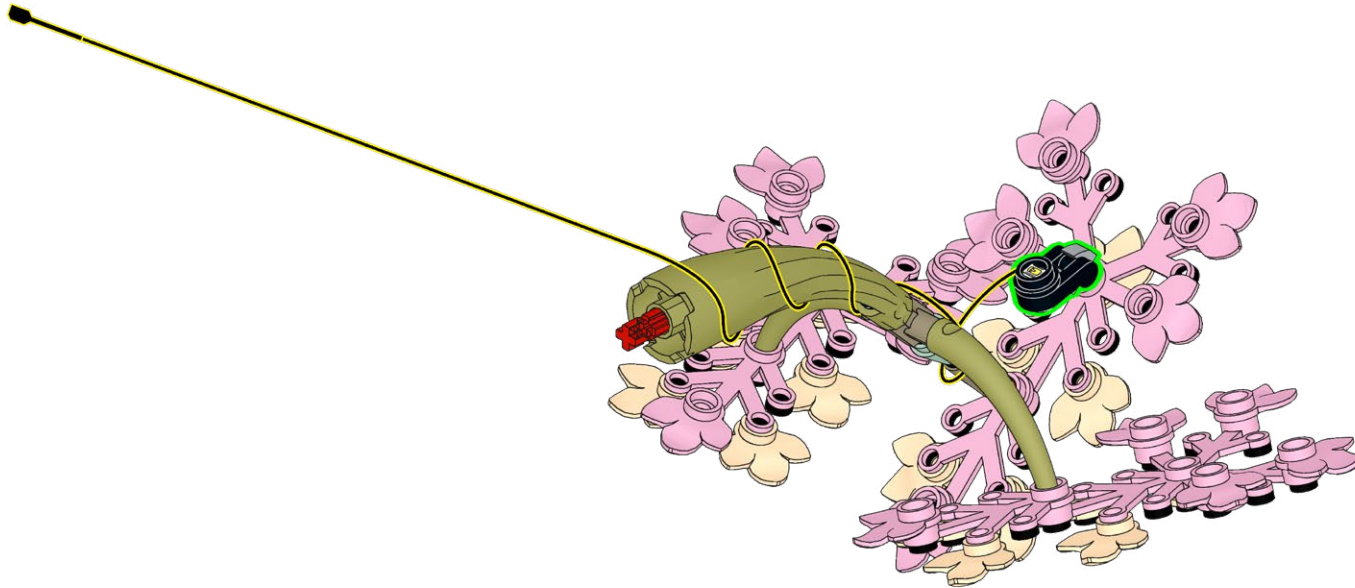

447

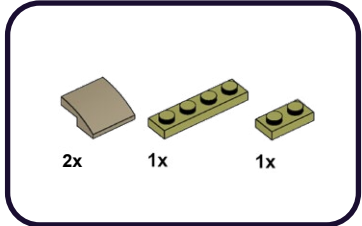

1

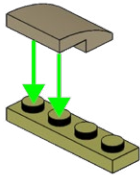

2

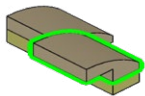

3

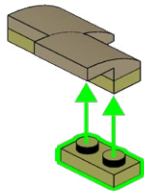

448

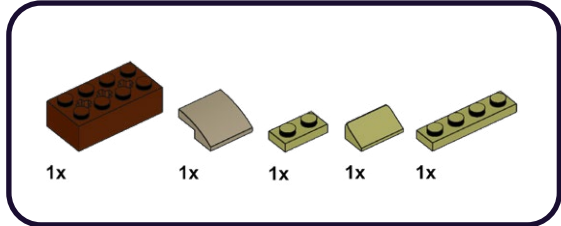

1

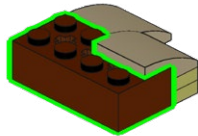

2

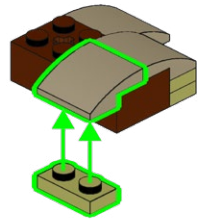

3

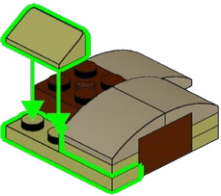

449

450

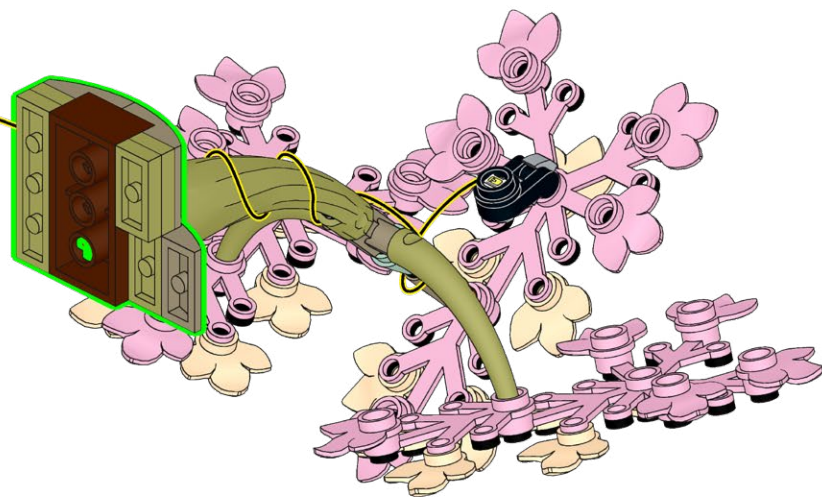
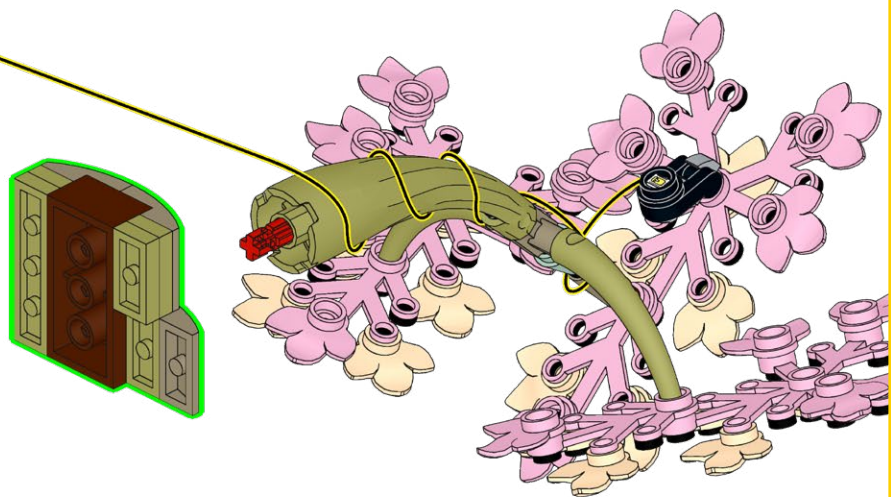

451

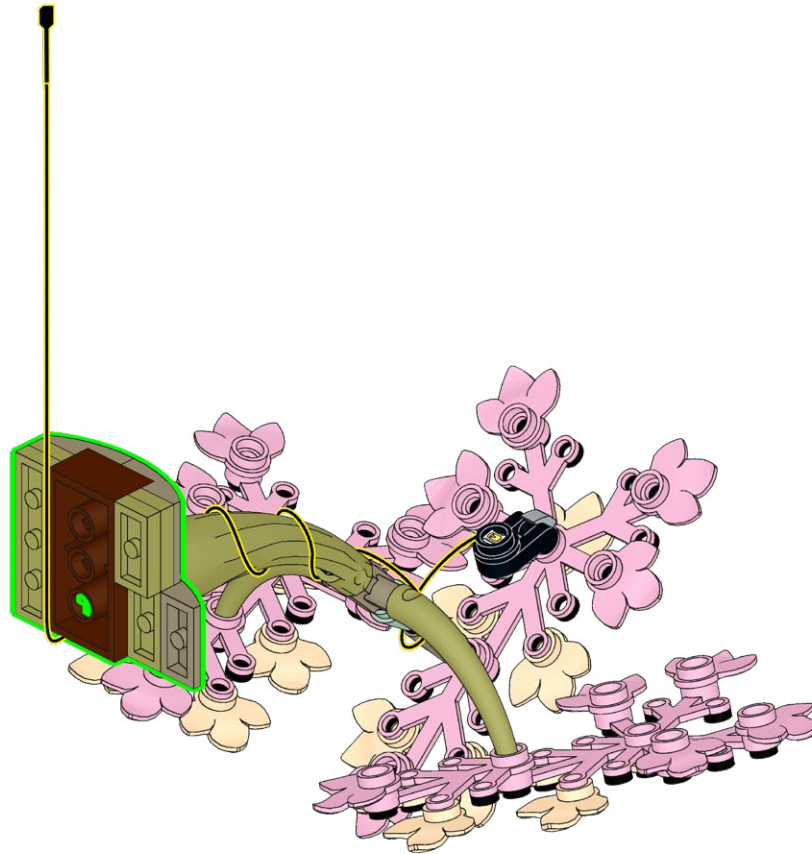

452

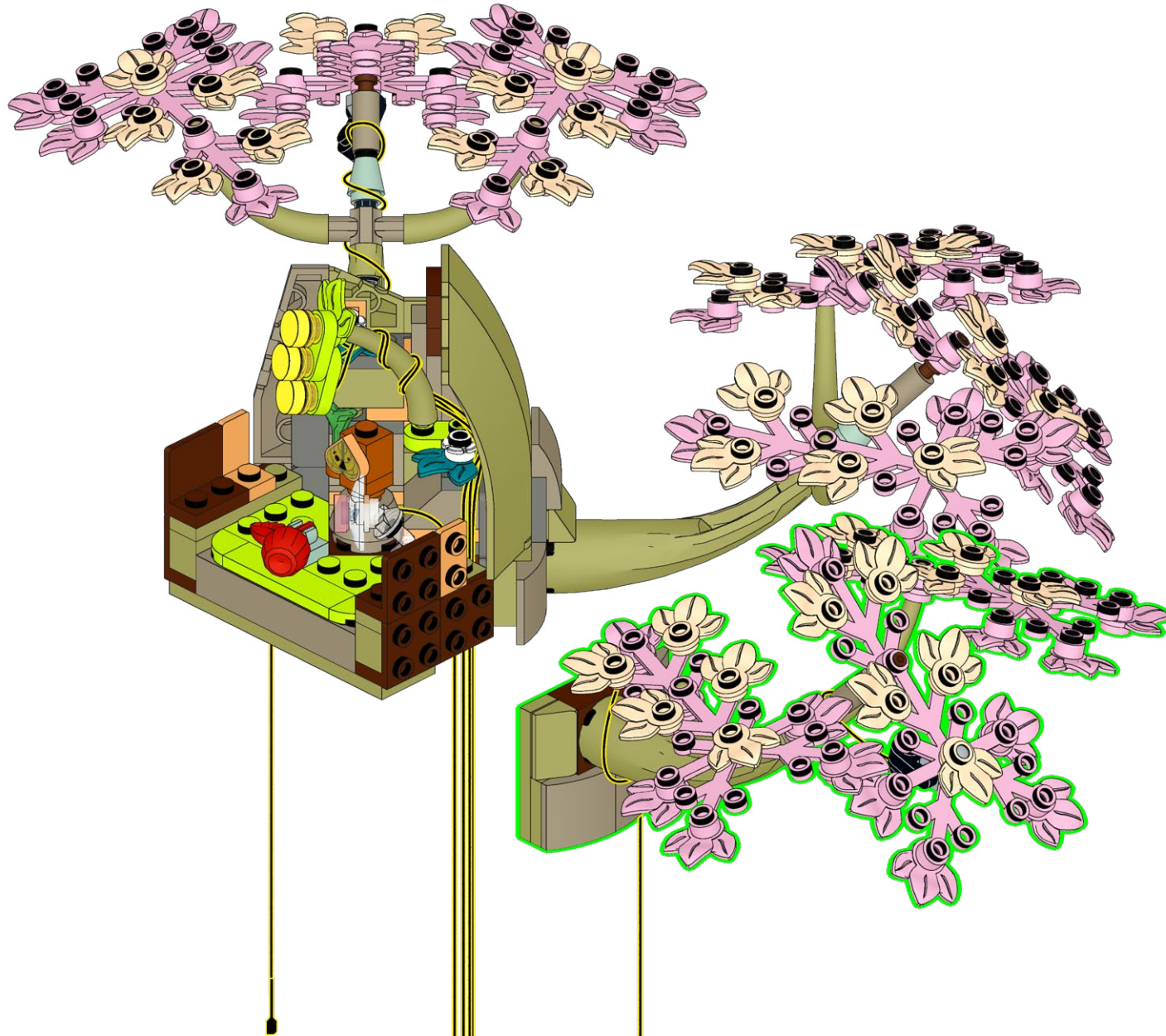

453

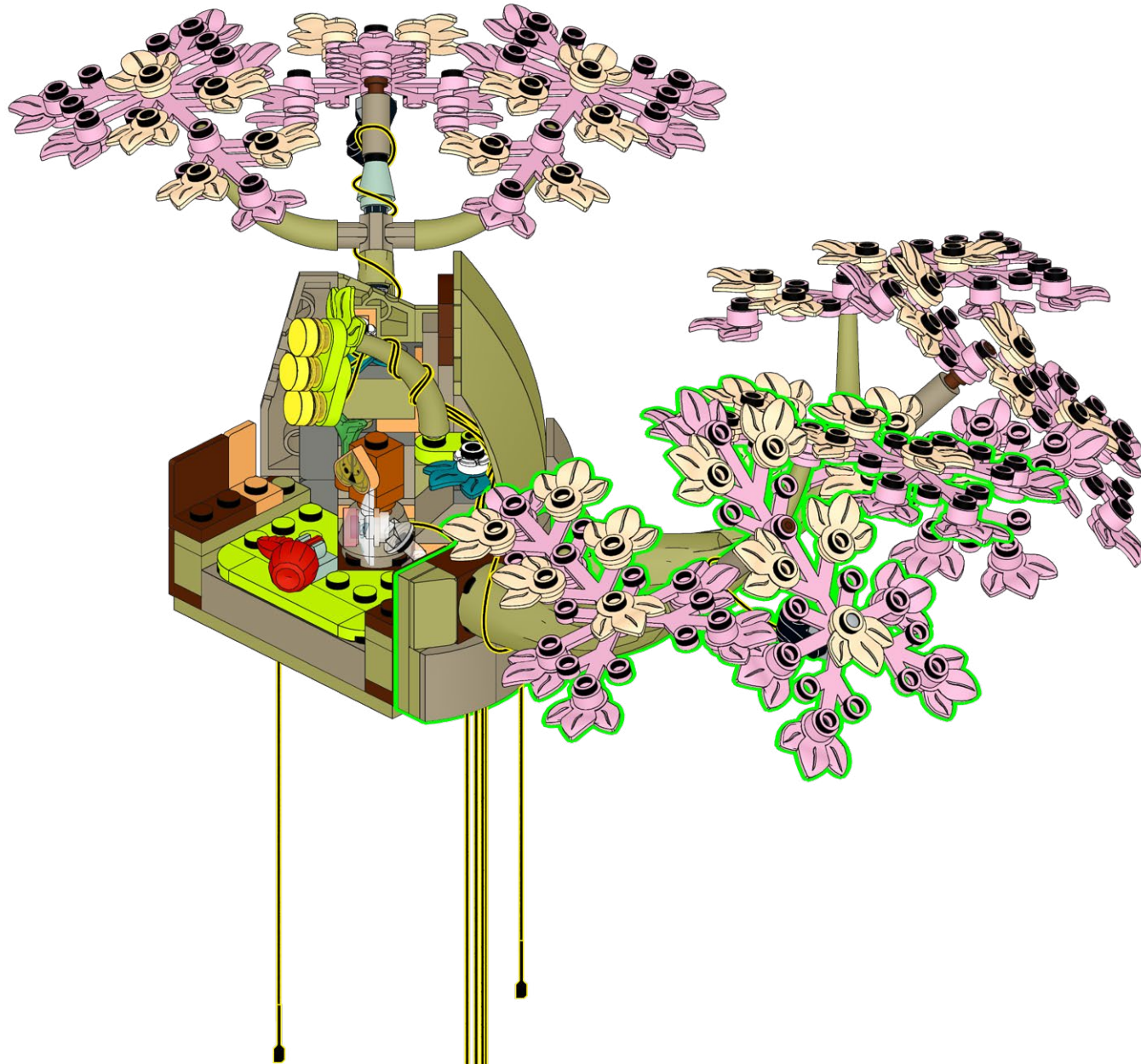

454

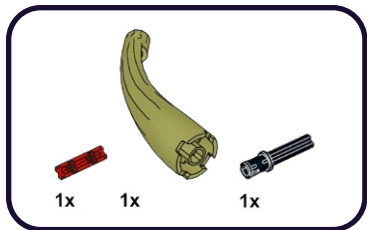

1

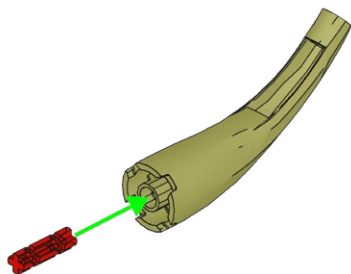

2

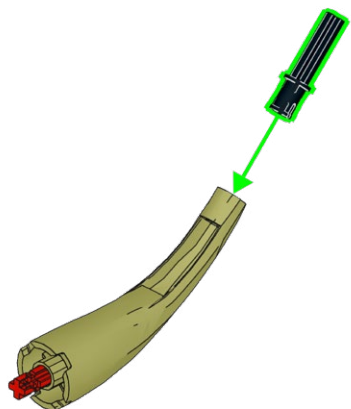

455

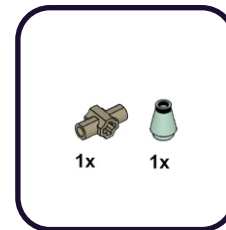

1

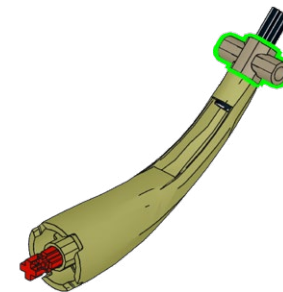

2

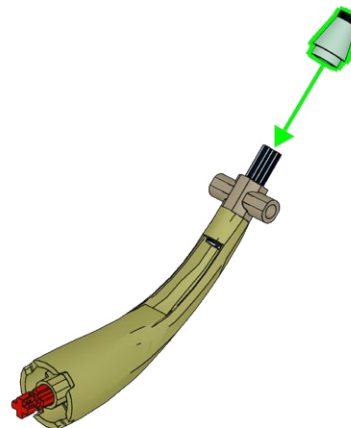

456

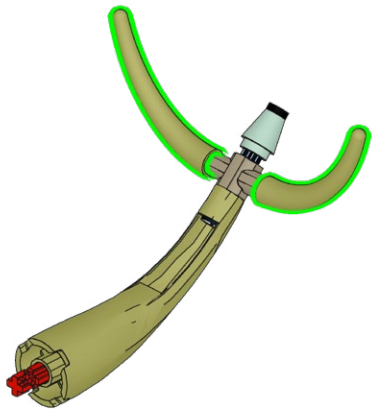
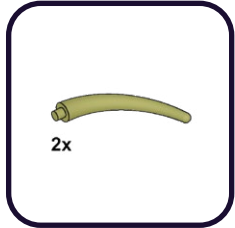

457

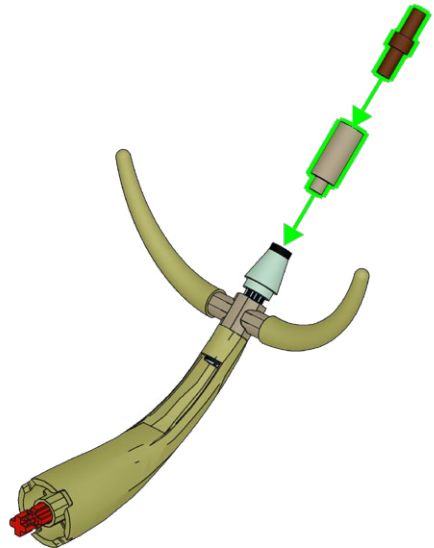
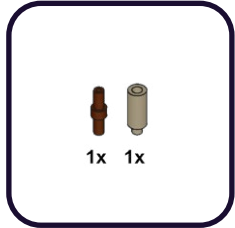

458

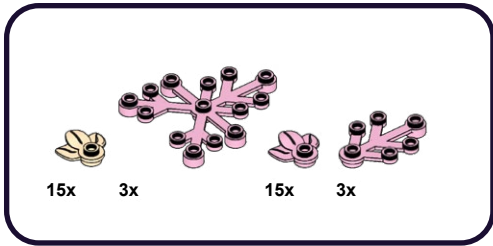

1

2

3

4

5

3x



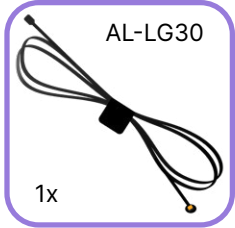

1



2

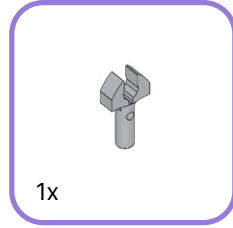

1



2

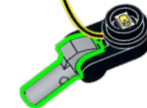

461

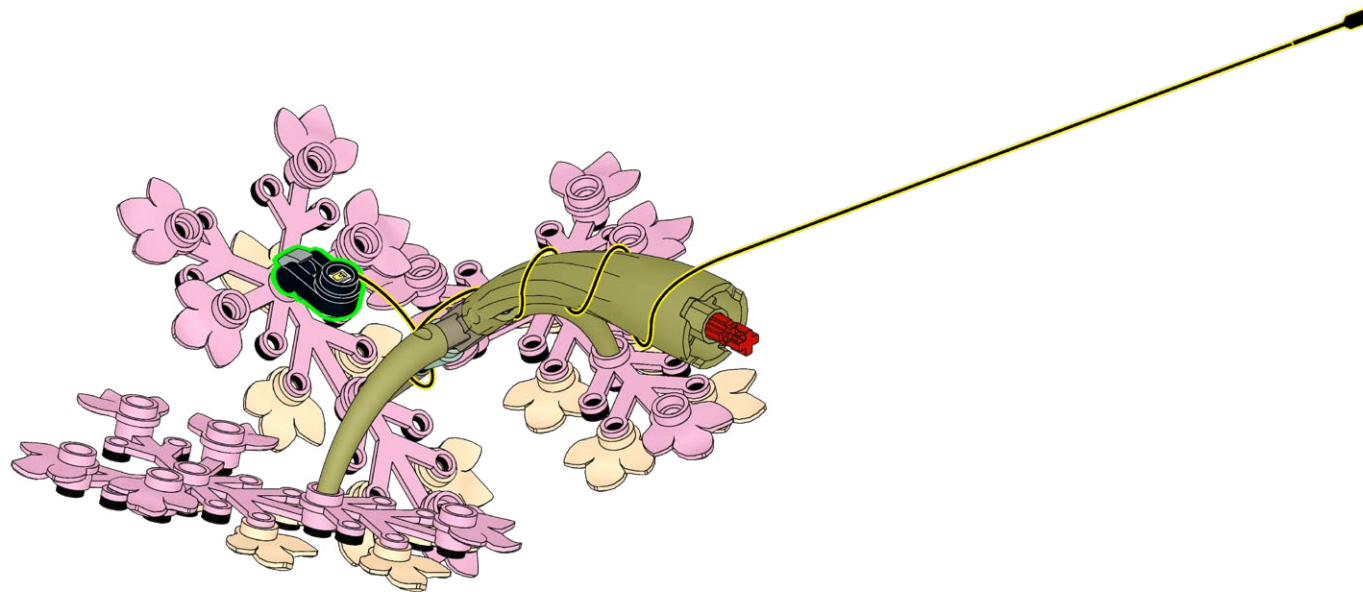

462

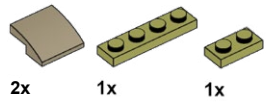

1

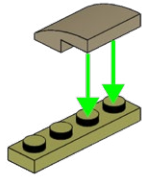

2

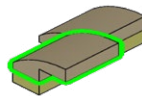

3

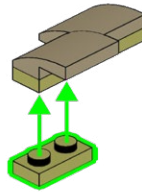

463

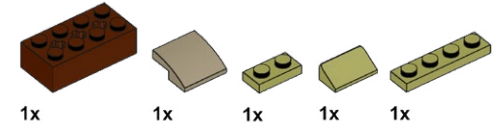

1

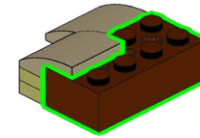

2

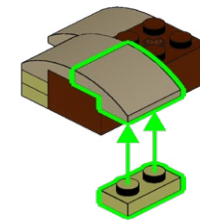

3

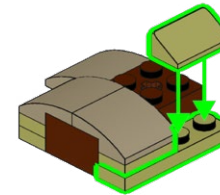

464

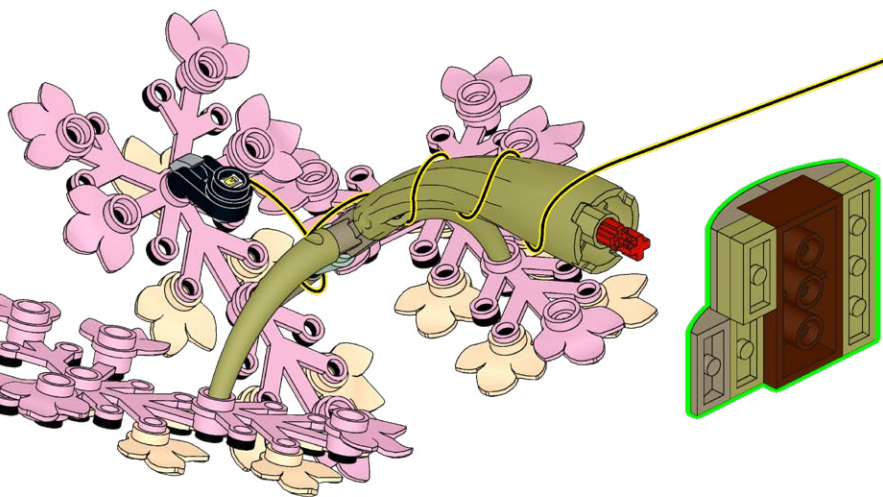

465

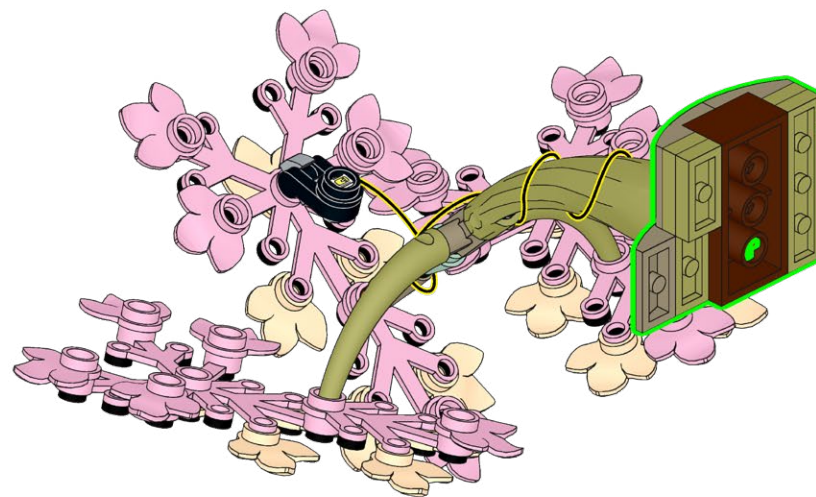

466

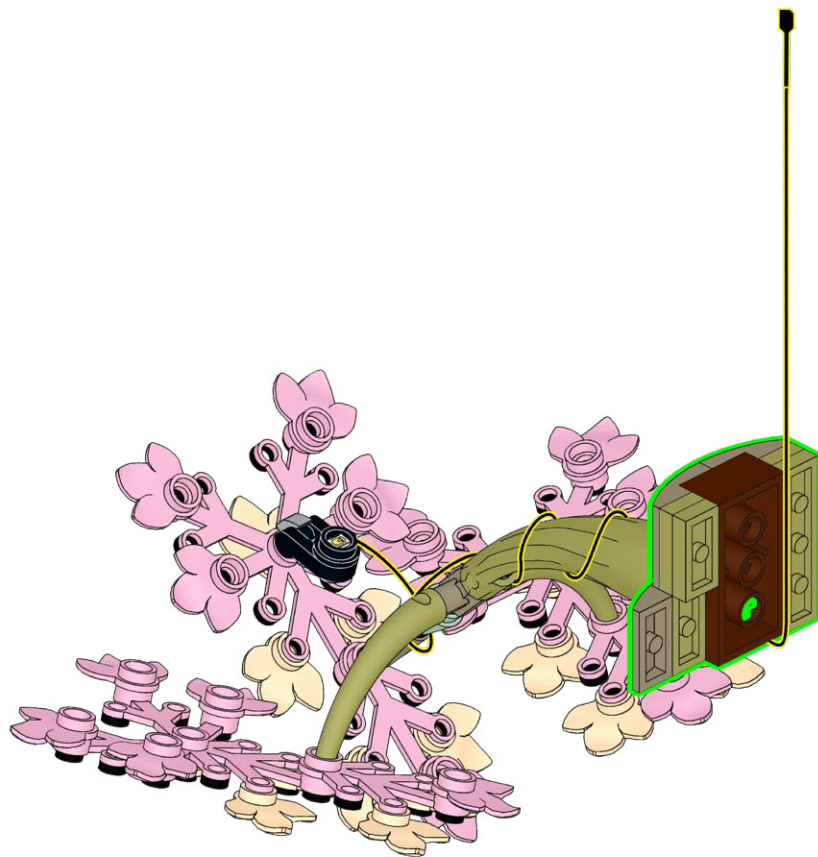

467

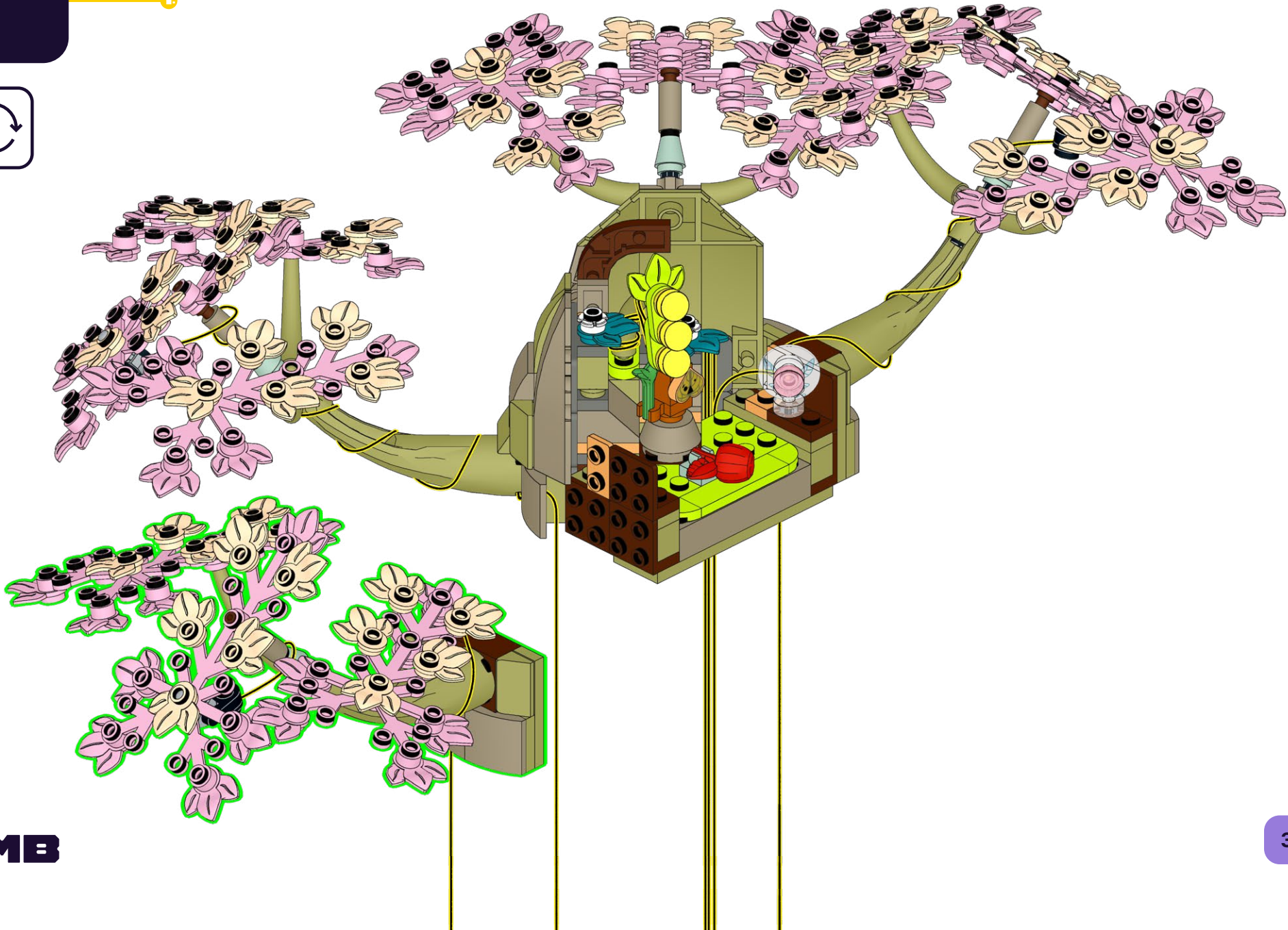

468



469

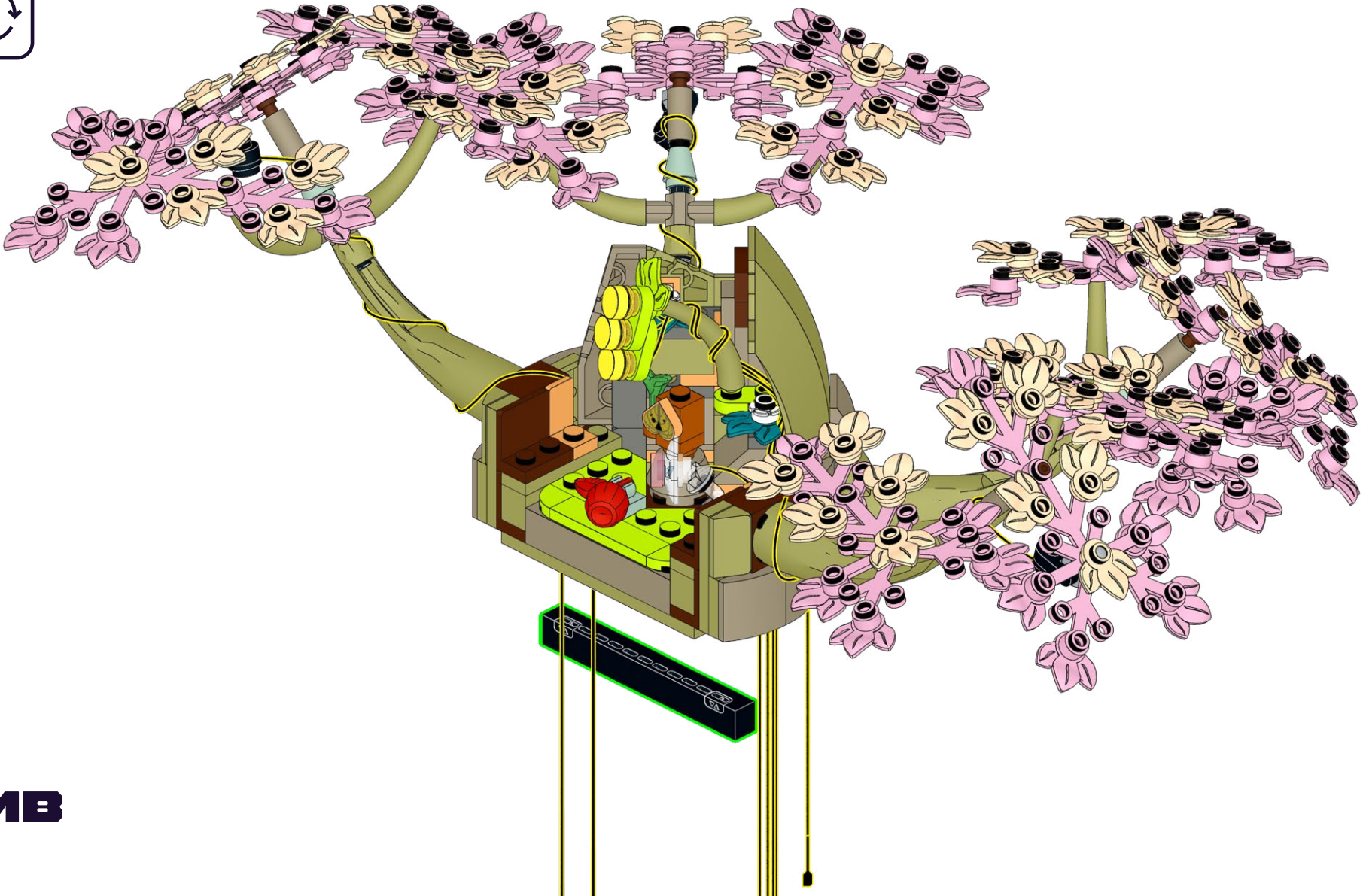
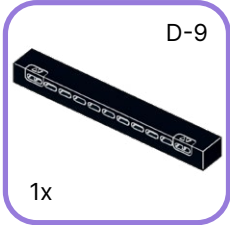

470

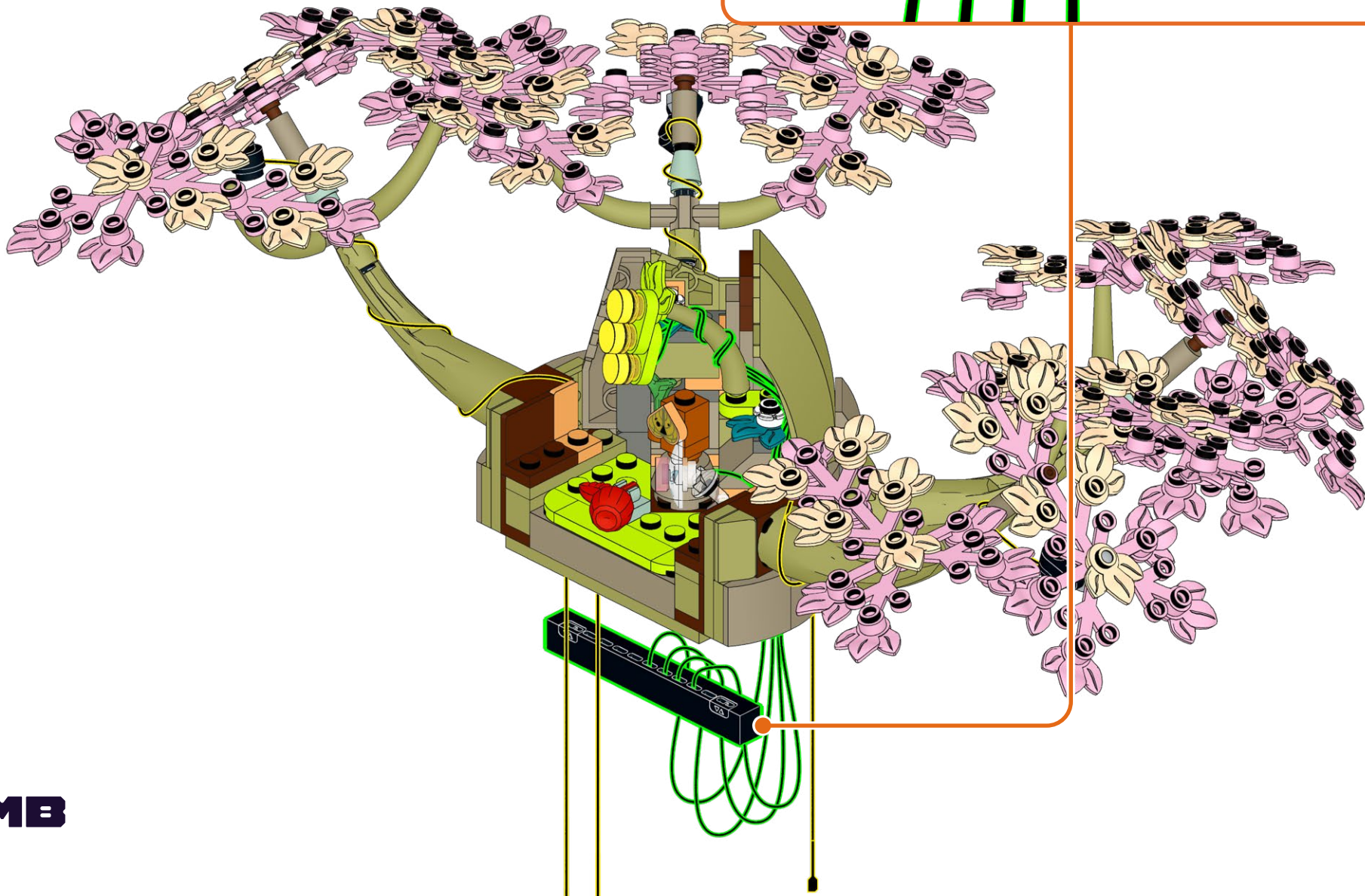

471

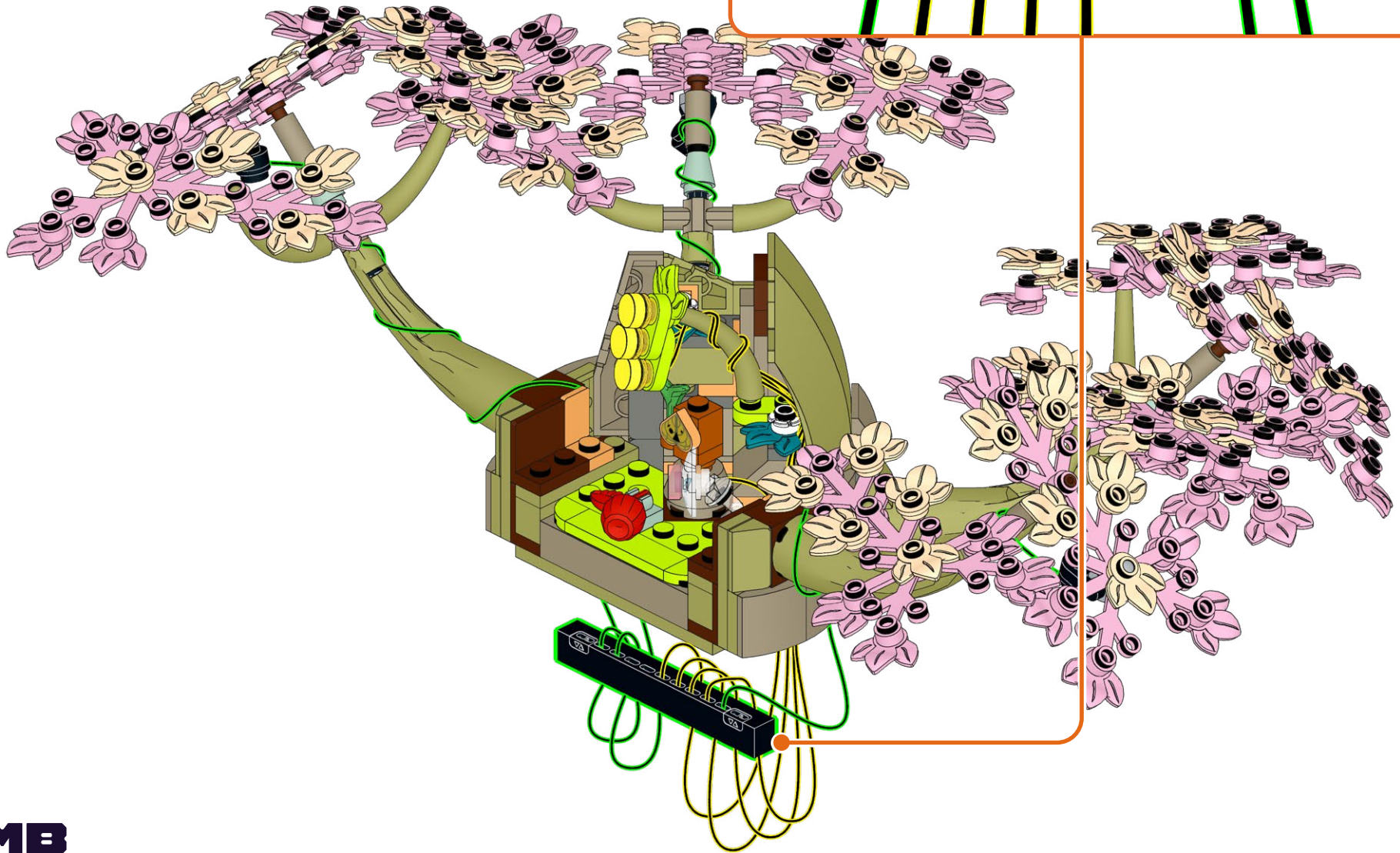

472



473



474



475

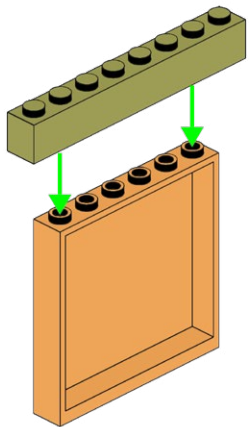
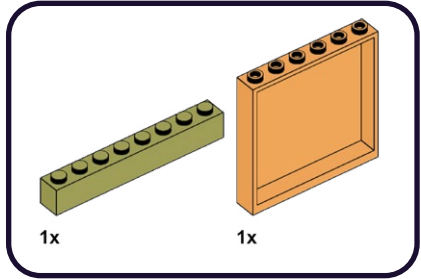

476

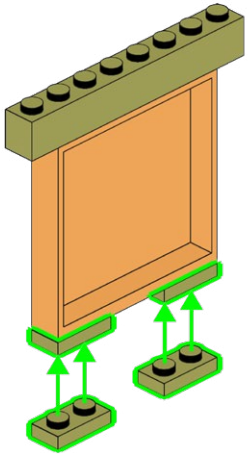
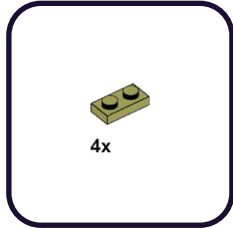

477



478



479



480



Power on Test
Test de mise sous tension
Test di Potenza
Stromtest
Prueba de Energía
电源测试



481



FINAL PRODUCT



PACKAGE CONTENTS



4x AR-WW30
Astro Light Regular
Warm White 30cm



1x ARF-WW30
Astro Light Regular
Flickering
Warm White 30cm



1x AR-V30
Astro Light Regular
Violet 30cm



1x AR-LB15
Astro Light Regular
Light Blue 15cm



1x ARP-LB50
Astro Light Regular
Pulsing
Light Blue 50cm



1x AL-WW30
Astro Light Large
Warm White 30cm



2x AL-LG30
Astro Light Large
Light Green 30cm



2x B-50
Belt 50cm



1x D-3
Dock-3



1x D-9
Dock-9

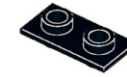

1x T-1x2
Tether 1x2



1x T-1x4
Tether 1x4

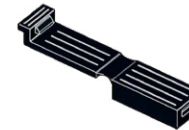

1x E-1x2
Eclipse 1x2



1x FLX-C
Flux Converter



1x Power Brick

PACKAGE CONTENTS



3x Round Plate 1x1
Trans Yellow



1x Round Plate 2x2 with
Rounded Bottom (Boat
Stud)
Trans-Clear



3x Round Plate 1x1 with
Open Stud
Black



1x Plate 1x2
Light Bluish Gray



1x Round Plate 1x1 with
Open Stud
Trans Orange



2x Modified Brick 1x1 with
Stud on Side
Light Bluish Gray



2x Round Plate 1x1 with
Open Stud
Trans Clear



8x Round Brick 1x1
Open Stud
Trans-Clear



3x Round Plate 1x1 with
Bar Handle
Black



3x Bar 1L with Clip
Mechanical Claw - Cut
Edges and Hole on Side
Light Bluish Gray

CONTACT US

Click below for customer support, or general inquiries.

Cliquez ci-dessous pour accéder au support client ou aux renseignements généraux.

Clicca qui sotto per l'assistenza clienti o per richieste generali.

Contact Us



Contactez-nous



Contattaci



Klicken sie unten für kundensupport oder allgemeine anfragen.

Haga clic a continuación para atención al cliente o consultas generales.

点击下方获取客户支持或一般咨询。

Kontaktieren sie uns



Contáctanos



联系我们



TROUBLESHOOTING

If you're stuck, scan the QR code for troubleshooting.

Se sei bloccato, scansiona il codice QR per la risoluzione dei problemi.

Wenn Sie nicht weiterkommen, scannen Sie den QR-Code zur Fehlerbehebung.

Si vous êtes bloqué, scannez le code QR pour le dépannage

Si está atascado, escanee el código QR para solucionar el problema.

如果遇到问题, 请扫描二维码进行故障排除

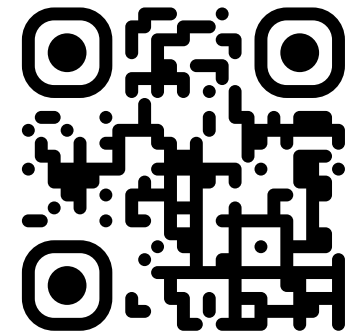



LIGHTMYBRICKS

lightmybricks.com



LEGO® is a trademark of the LEGO Group of companies, which does not sponsor, authorize or endorse this product. All LEGO® sets featured in images are sold separately. This is not a LEGO® product. The LEGO Group is not liable for any loss, injury or damage arising from the use or misuse of this product. ©2024 Light My Bricks Pty Ltd. All rights reserved. www.lightmybricks.com

Our components are designed and packaged in Australia by Light My Bricks Pty Ltd. Components are manufactured in China. 3fl bldg C, Shuanghuan Quanxin Technology Information Industry Park Baolong Street, Longgang District, Shenzhen, China. Imported in Australia by Light My Bricks Pty Ltd, 5/26 Rushdale St, Knoxfield, VIC, 3180, Australia.

WARNING: CHOKING HAZARD - Small parts. Not for children under 3 years.

AVERTISSEMENT : RISQUE D'ÉTOUFFEMENT - Petites pièces. Ne convient pas aux enfants de moins de 3 ans.

ATTENZIONE: PERICOLO DI SOFFOCAMENTO - Piccole parti. Non adatto a bambini di età inferiore a 3 anni.

WARNUNG: ERSTICKUNGSGEFAHR - Kleine Teile. Nicht für Kinder unter 3 Jahren geeignet.

ADVERTENCIA: PELIGRO DE ASFIXIA - Piezas pequeñas. No son apto para niños menores de 3 años.

警告：窒息危险 - 小零件。不适合3岁以下儿童。