

LIGHT KIT INSTALLATION GUIDE

**STAR WARS™ X-WING
STARFIGHTER™**

FOR LEGO
SET
#75355

CONTENTS



03

Getting Started

- 04 Legend
- 05 Component Handling
- 06 Blueprint

07

Instructions

- 07 LEGO Bag 1
- 48 LEGO Bag 2 - LMB Bag 02
- 99 LEGO Bag 3
- 131 LEGO Bag 4
- 172 LMB Bag 01
- 220 LEGO Bag 5 - LMB Bag 03
- 254 LEGO Bag 10
- 260 LEGO Bag 6
- 320 LEGO Bag 7
- 381 LEGO Bag 8
- 442 LEGO Bag 9

526

Final Product

- 527 Package Contents
- 539 Contact & Troubleshooting

GETTING STARTED



Bold, beautiful and bright, Light My Bricks elevates your favourite LEGO set from knick-knack to statement piece. Create a talking point at home or in the office that speaks to your passions with Light My Bricks. To learn more, click below.

[Learn More](#)



Audacieux, beau et lumineux, Light My Bricks élève votre ensemble LEGO préféré du statut de bibelot à celui de pièce maîtresse. Que ce soit à la maison ou au bureau, partagez votre passion des LEGO avec Light My Bricks. Cliquez ci-dessous pour en savoir plus.

[En savoir plus](#)



Audace, bello e luminoso, Light My Bricks eleva il tuo set LEGO preferito da soprammobile a pezzo di tendenza. Crea un punto di discussione a casa o in ufficio che parli alle tue passioni con Light My Bricks. Per saperne di più, clicca qui sotto.

[Ulteriori Informazioni](#)



Mutig, schön und hell – Light My Bricks verwandelt Ihr Lieblings-LEGO-Set von einem schnickschnack in ein statement-stück. Schaffen sie einen gesprächspunkt zu hause oder im büro, der Ihre leidenschaften widerspiegelt, mit Light My Bricks. Um mehr zu erfahren, klicken sie unten.

[Mehr erfahren](#)



Audaz, hermoso y brillante, Light My Bricks eleva tu set LEGO favorito de una chuchería a una pieza llamativa. Crea un tema de conversación en casa o en la oficina que hable de tus pasiones con Light My Bricks. Para obtener más información, haga clic a continuación.

[Más información](#)



大胆、美丽而明亮，Light My Bricks 将你喜爱的乐高套装从小摆件提升为引人注目的装饰品。在家或办公室打造一个能表达你激情的话题，了解更多，请点击下方。

[了解更多](#)



LEGEND

Rotate Set



Retournez L'ensemble
Ruota Set
Set Drehen
Rotar Conjunto
旋转套件

Add Part



Ajoutez une Pièce
Aggiungi Parte
Teil Hinzufügen
Agregar Pieza
添加零件

Click



Cliquez
Clic
Klicken
Clic
点击

Pinch/Fold



Pincez/Pliez
Pizzicare/Piegare
Kneifen/Falten
Pellizcar/Doblar
折叠

Pull Cable



Tirez le Cable
Tirare il Cavo
Kabel Ziehen
Tirar del Cable
拉动电缆

Repeat Step



Répétez
Ripetere
Wiederholen
Repetir
重复

Sticker



Autocollant
Adesivo
Aufkleber
Pegatina
贴纸

Power On Test



Test de mise sous tension
Test di Potenza
Stromtest
Prueba de Energía
电源测试

Disconnect Power



Débranchez L'alimentation
Scollegare L'alimentazione
Strom Trennen
Desconectar la Energía
断开电源

Troubleshoot



Dépanner
Risolvere
Fehlerbehebung
Solución de Problemas
故障排除

COMPONENT HANDLING

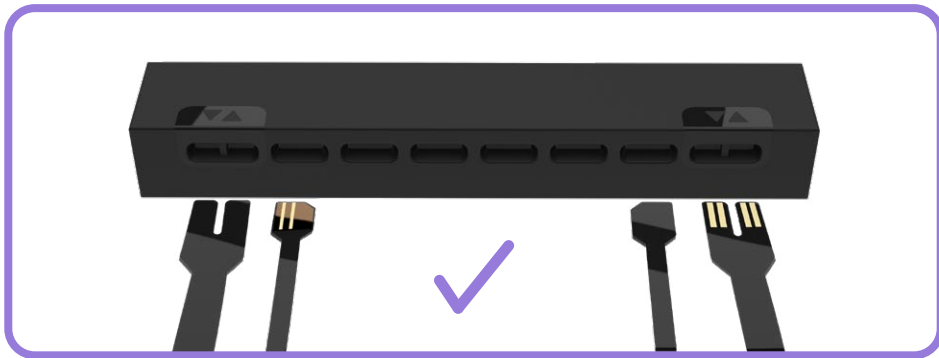
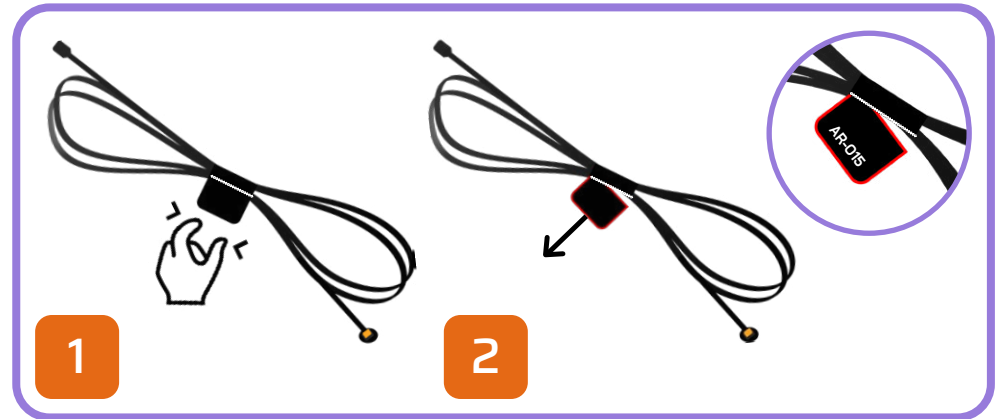
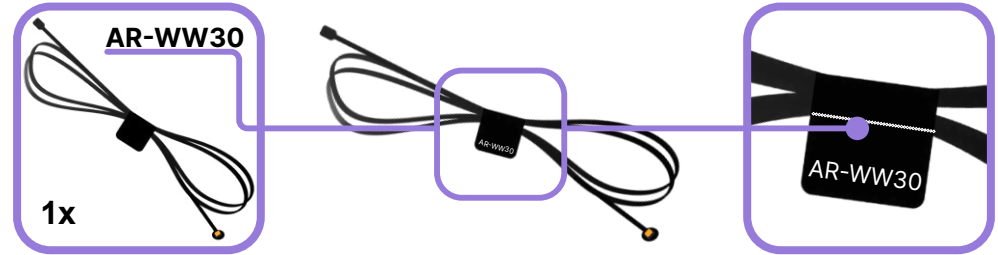
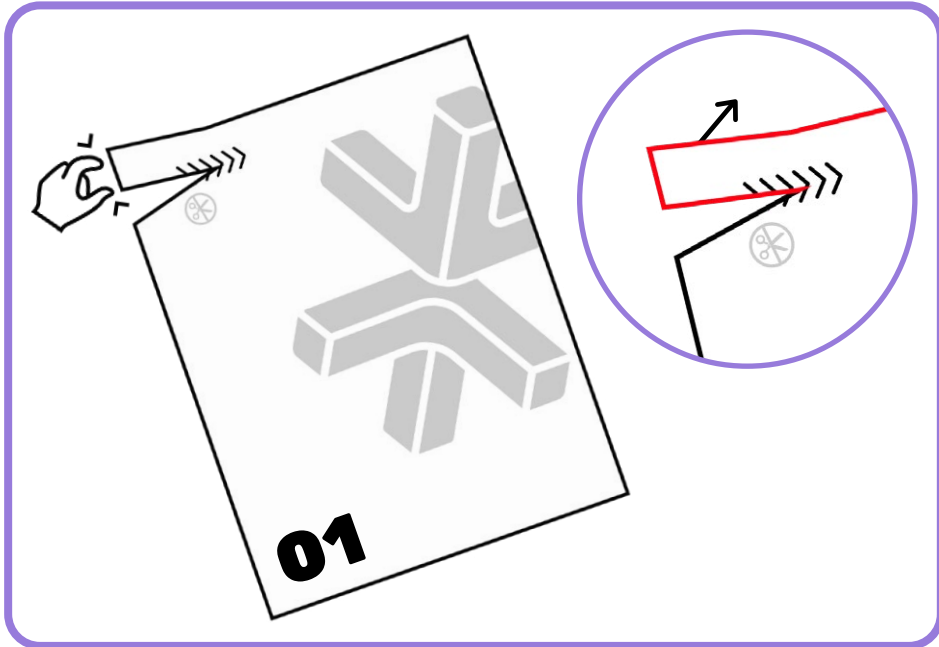

BLUEPRINT

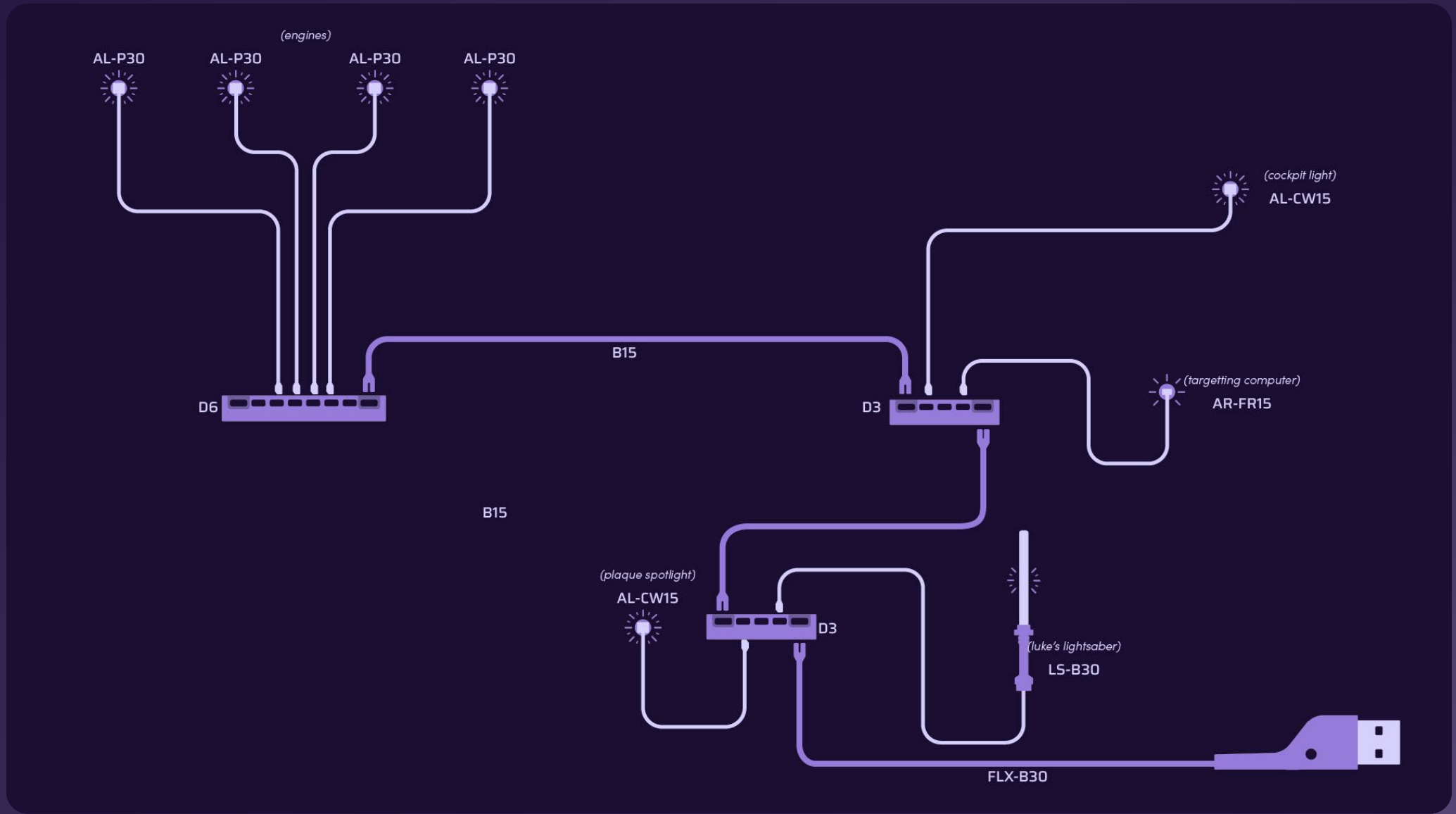

**HOLD UP!**

You might notice some bags aren't in order, as well as left over pieces, but that's ok! We're changing the way you build LEGO!

ATTENDEZ!

Vous remarquerez peut-être que certains sacs, ainsi que certaines pièces, ne sont pas dans le bon ordre. Mais pas de panique! Nous changeons simplement la façon avec laquelle vous construisez vos LEGO!

ASPETTA!

Potresti notare che alcuni sacchetti non sono in ordine, così come i pezzi avanzati, ma va bene così! Stiamo cambiando il modo in cui costruisci i LEGO!

HALT!

Sie werden möglicherweise bemerken, dass einige tüten durcheinander sind und teile übrig bleiben, aber das ist in Ordnung! Wir ändern die art und weise, wie Sie LEGO bauen!

¡ESPERA!

Es posible que notes que algunas bolsas están fuera de servicio, así como piezas sobrantes, ¡pero está bien! ¡Estamos cambiando la forma en que construyes LEGO!

暫停!

你可能会注意到一些袋子顺序错乱, 以及一些剩余的部件, 但没关系! 我们正在改变你搭建乐高的方式!

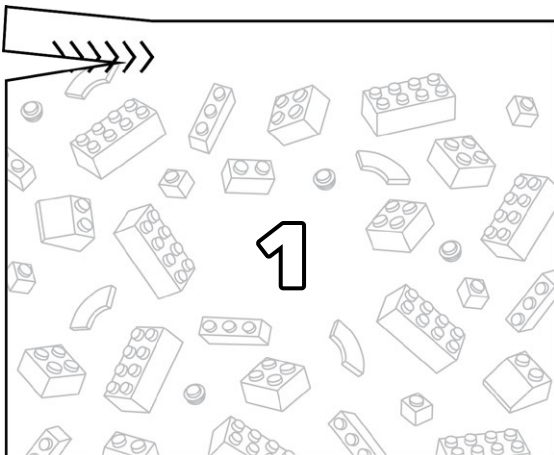
Open LEGO® Bag 1

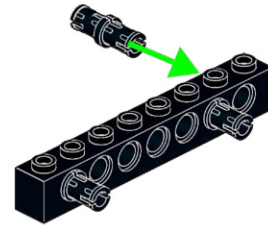
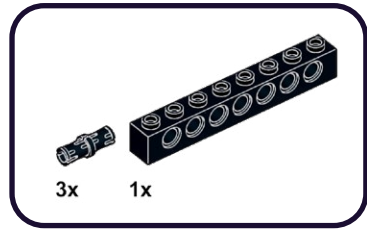

2

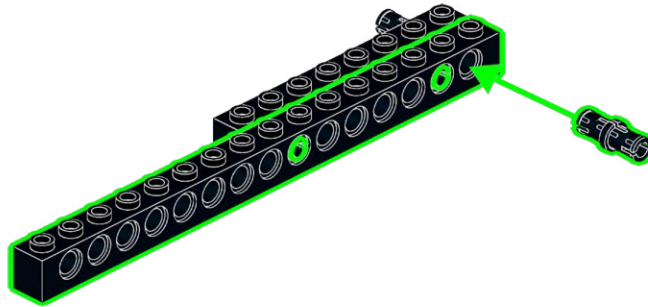

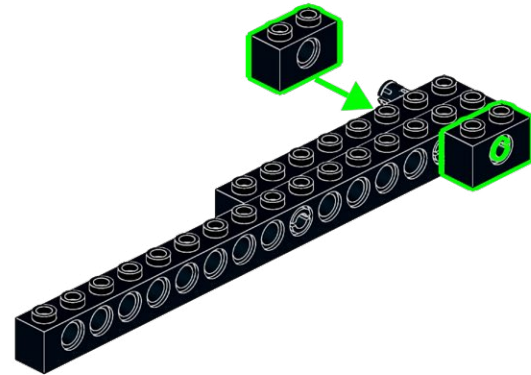

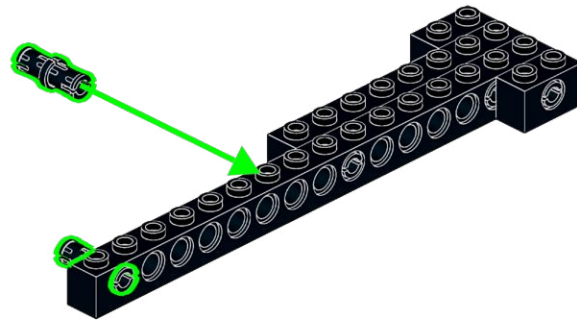
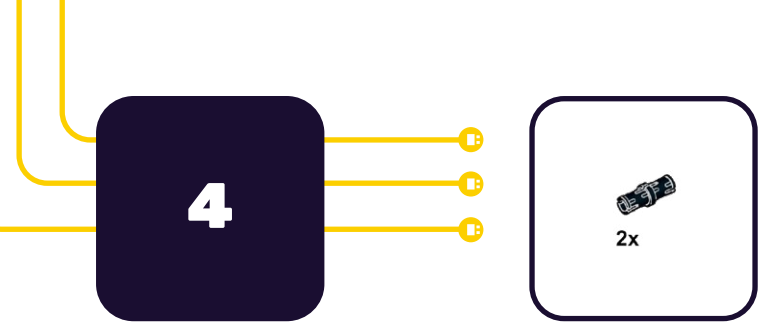

5

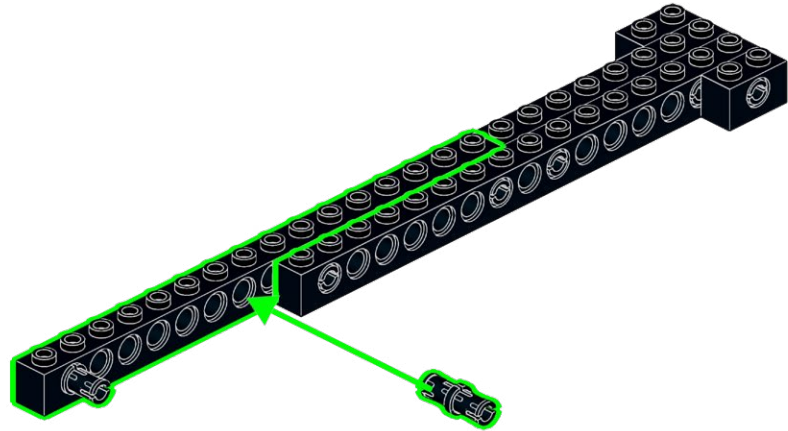

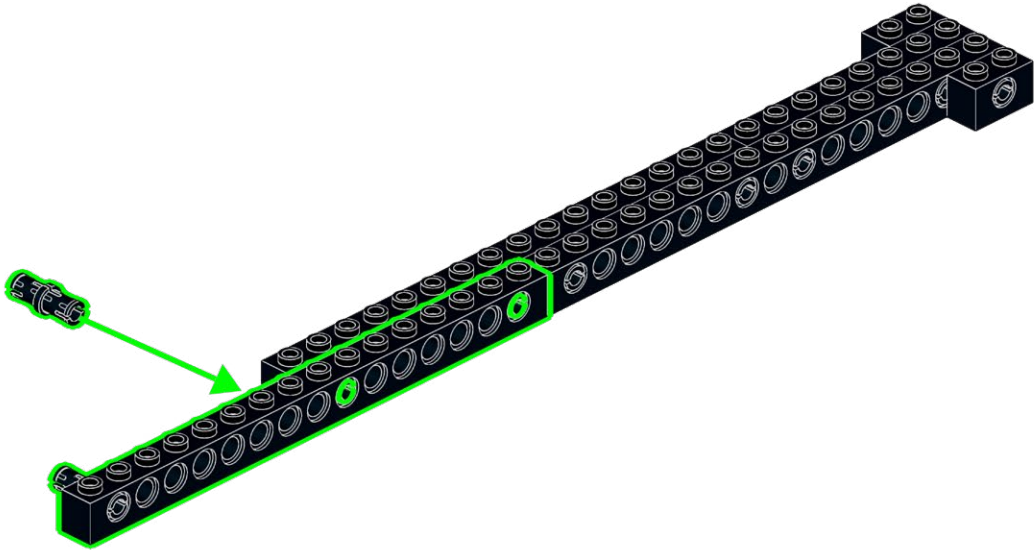
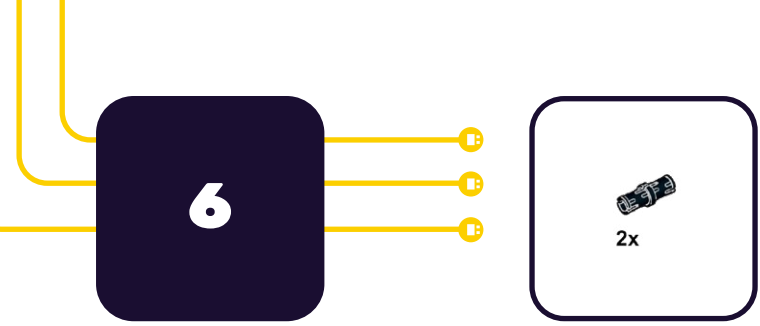

7

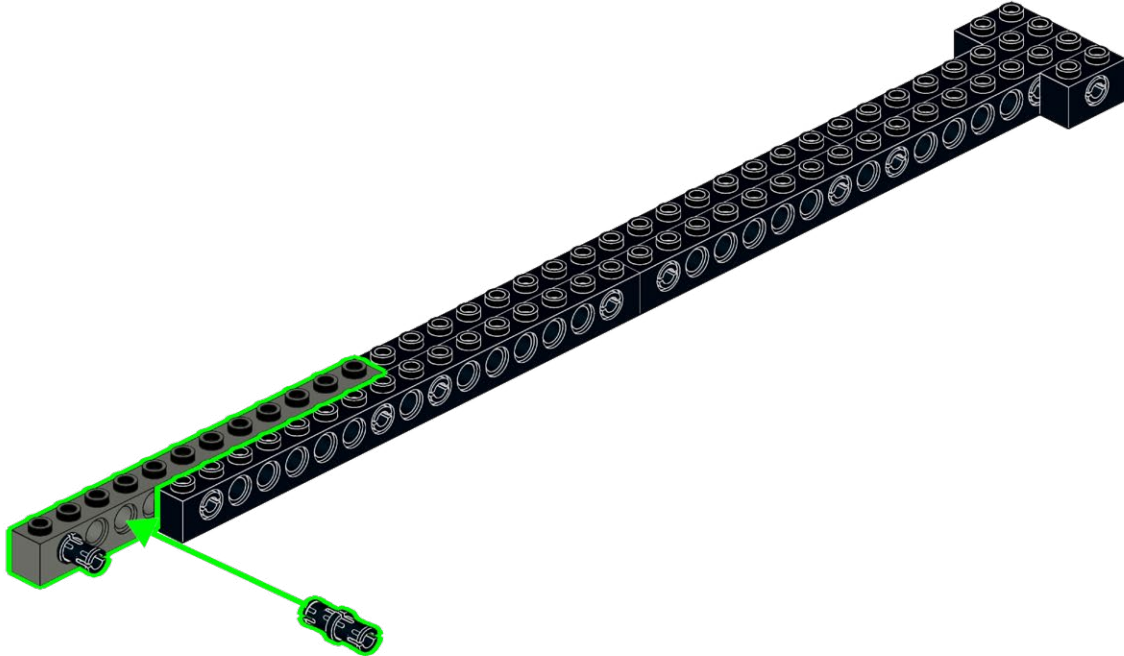
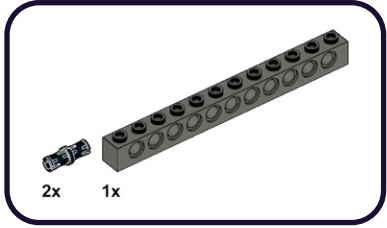

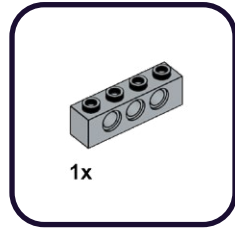
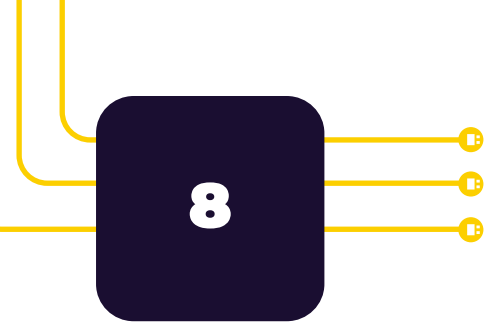

9

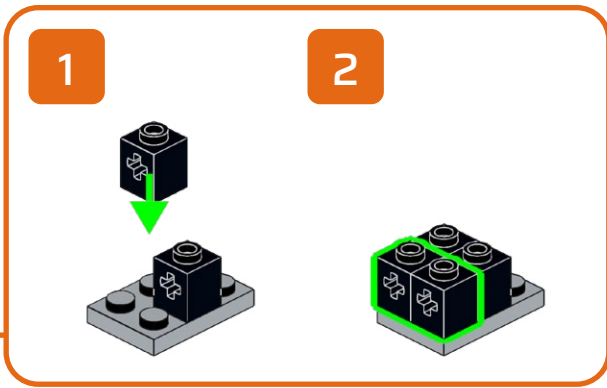
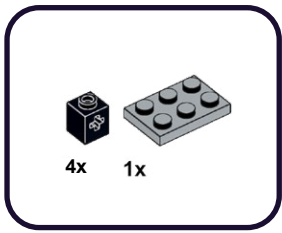

10

2x

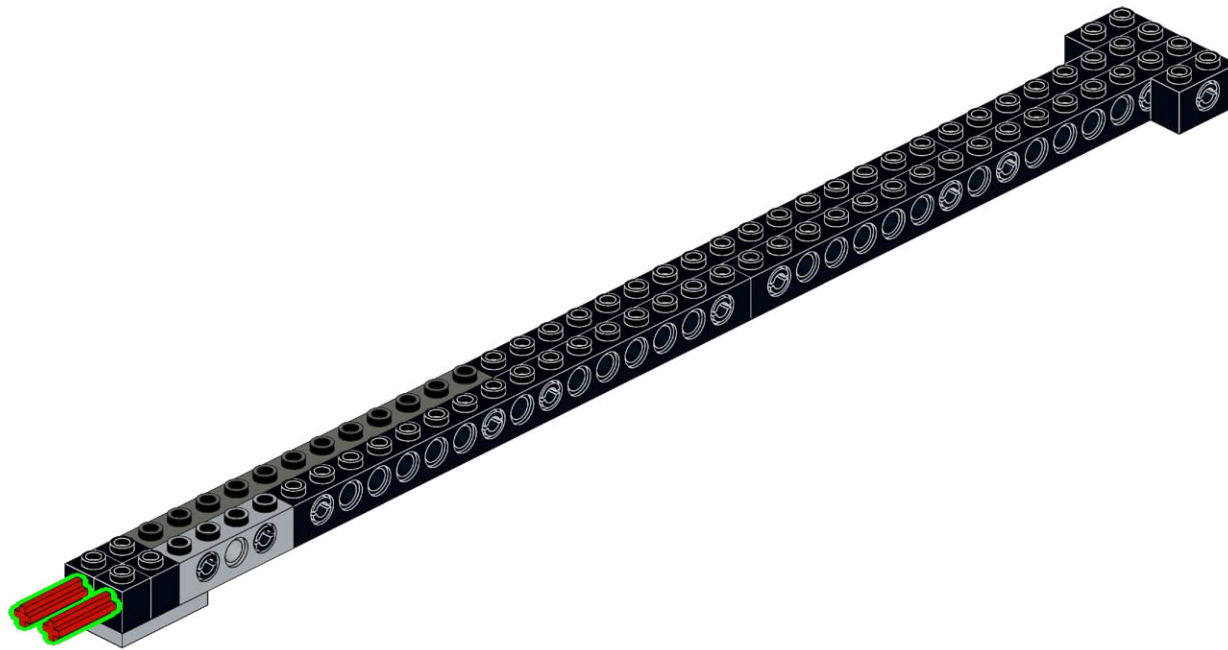

11

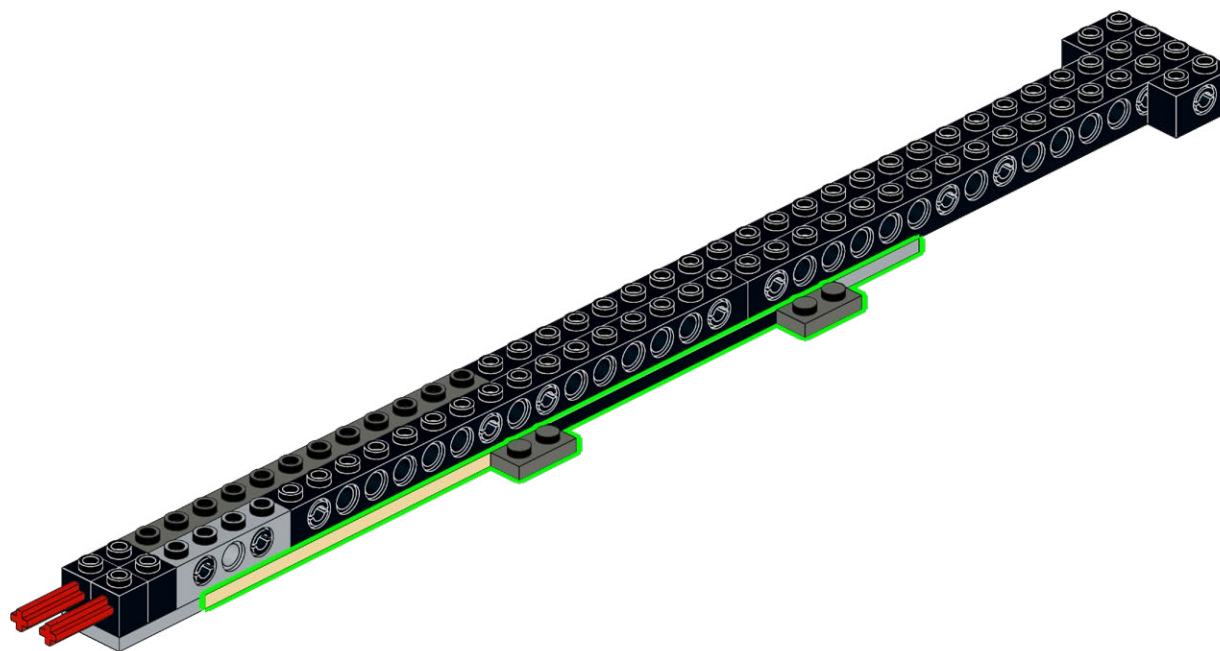

12

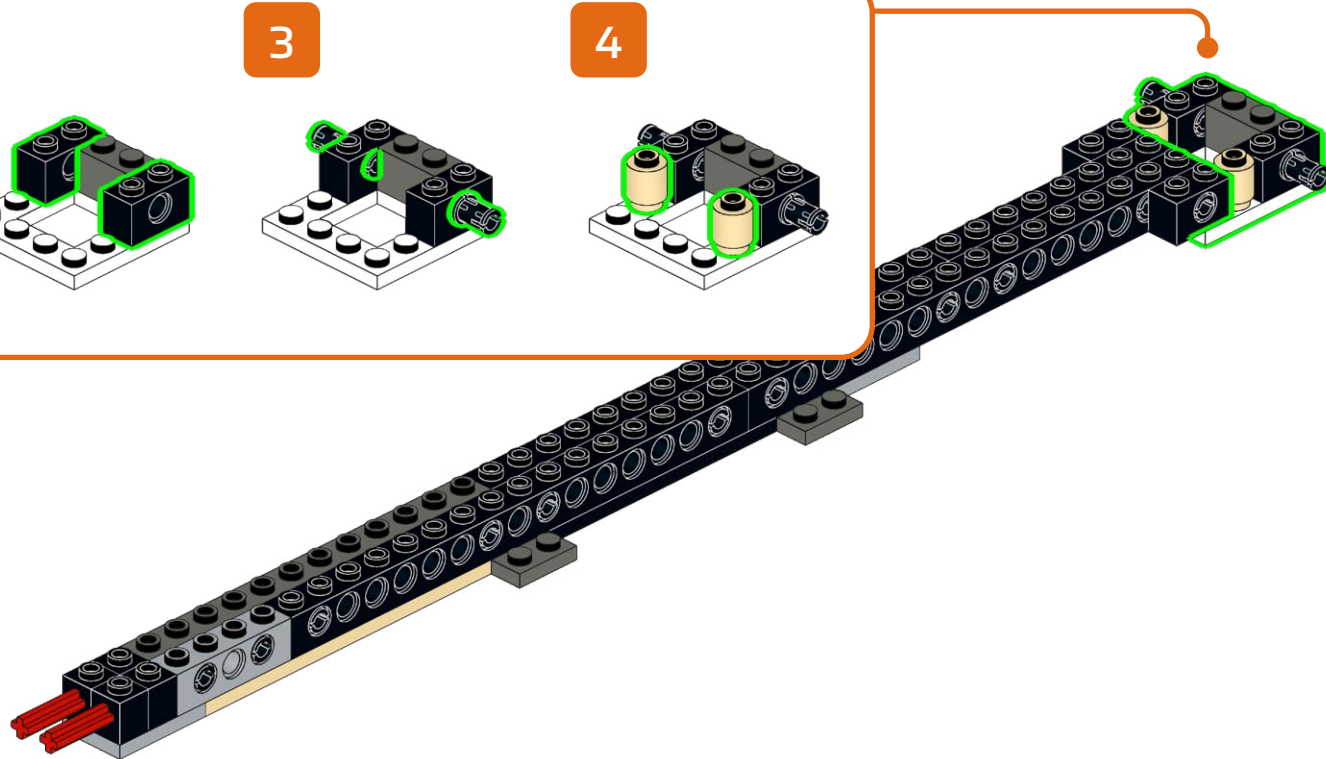
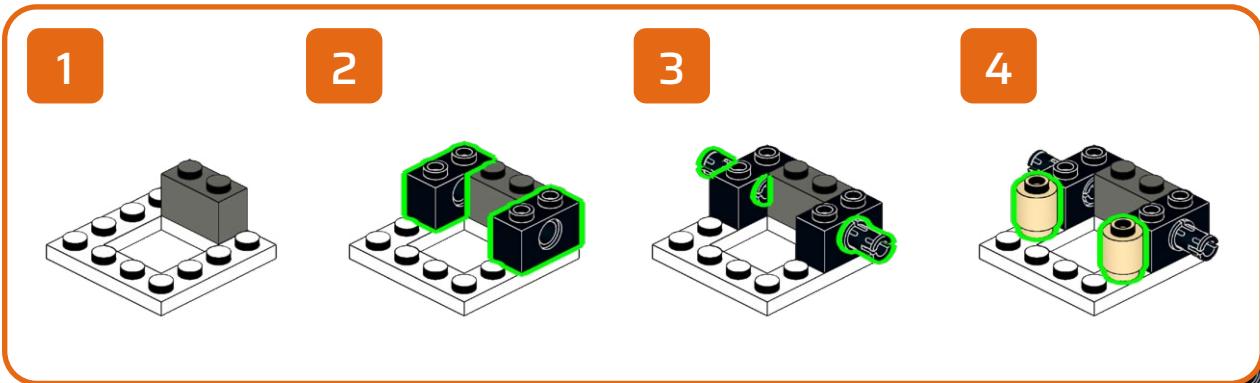
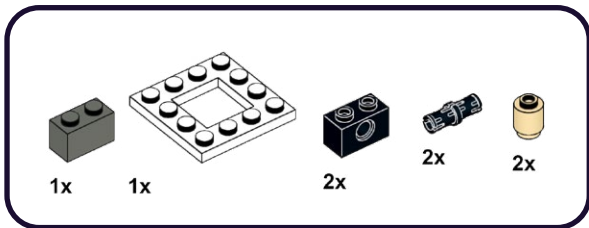

13

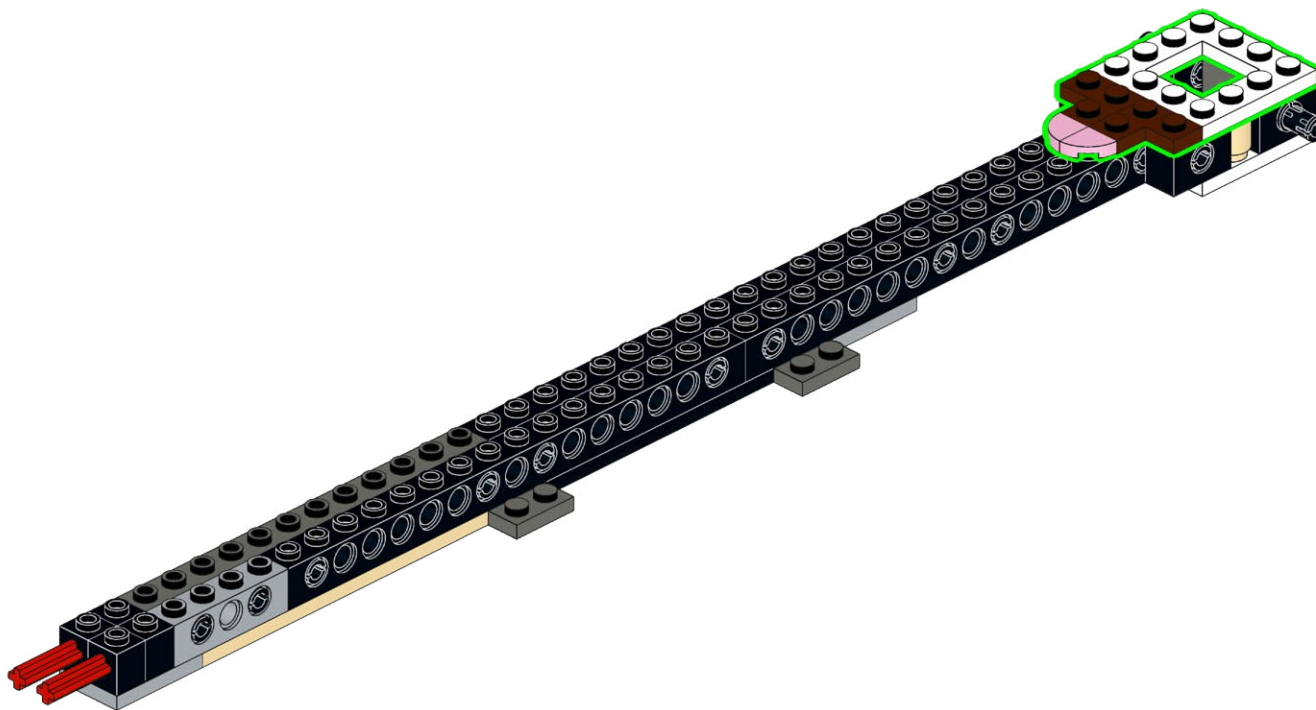
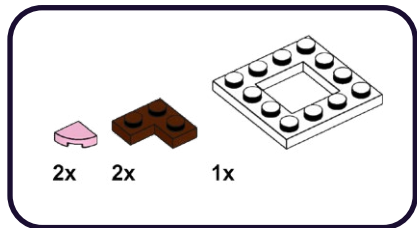

14

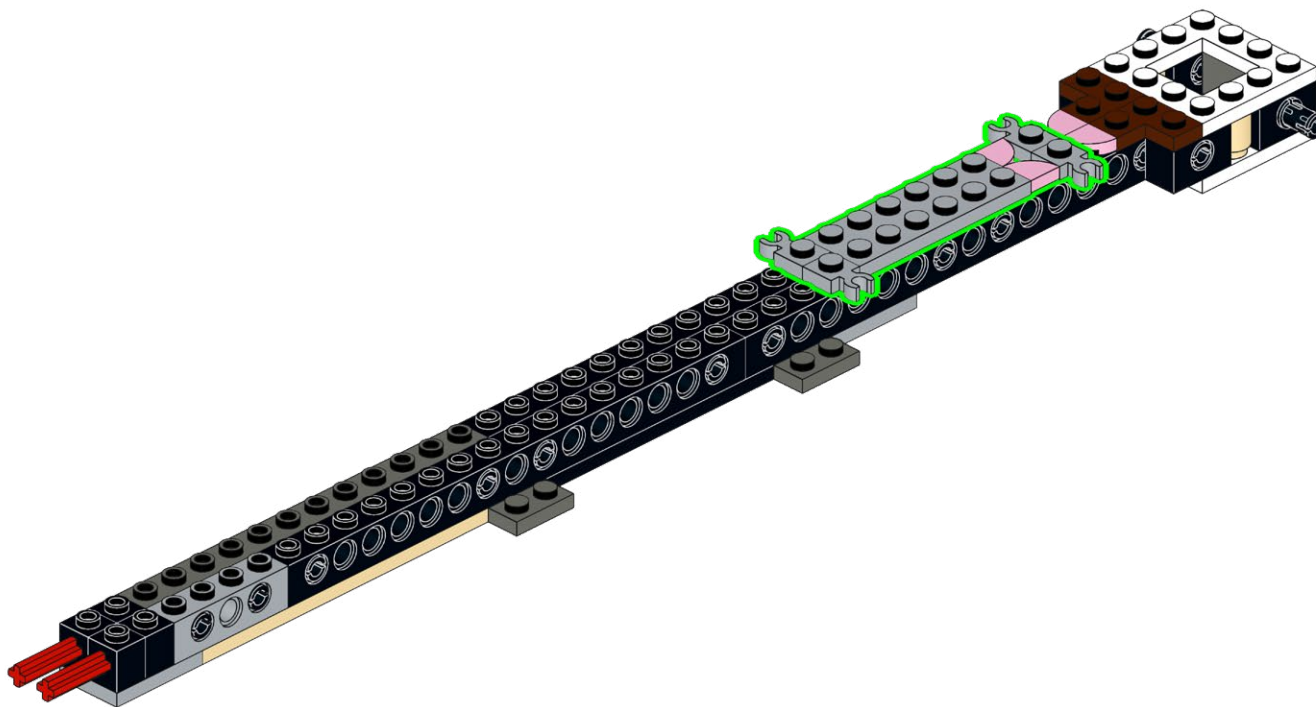
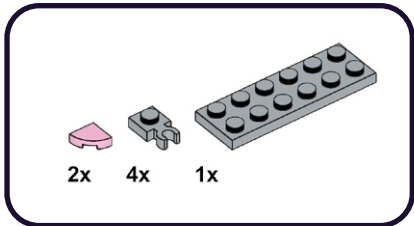

15

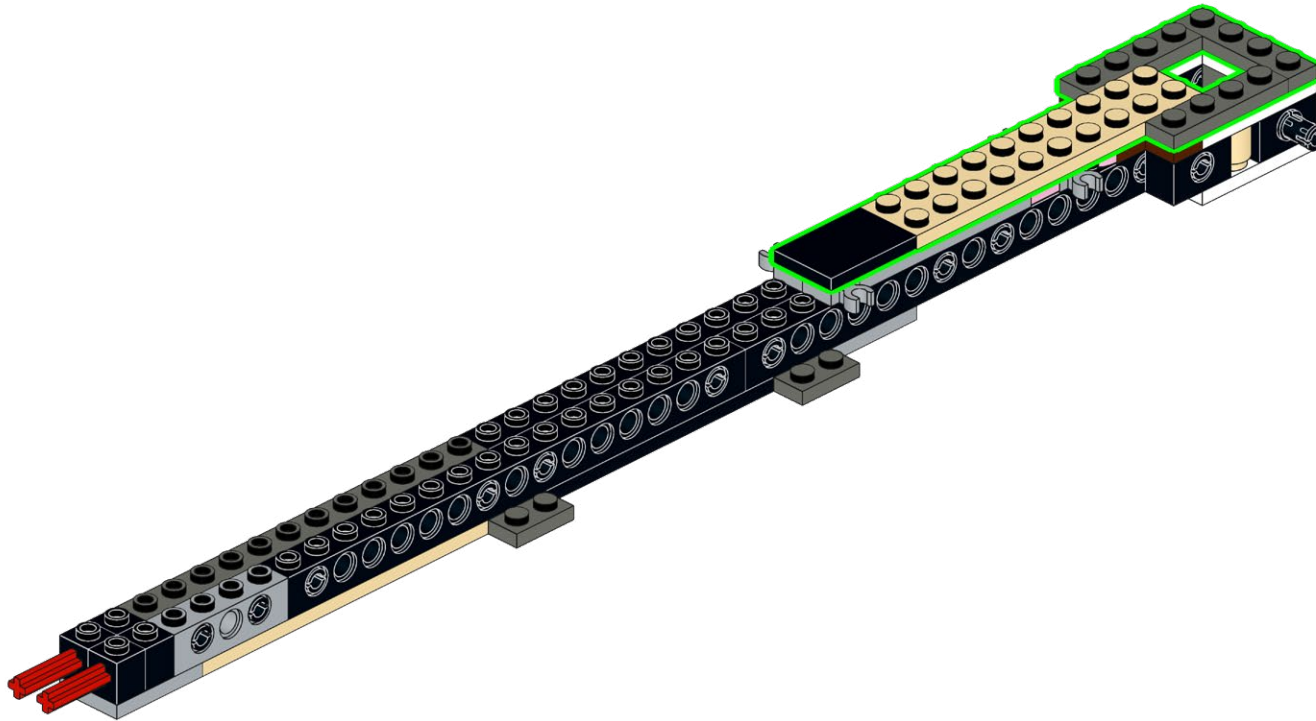
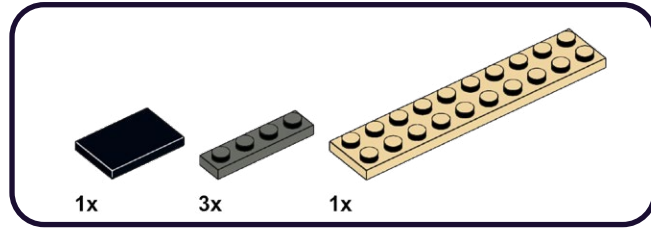

16

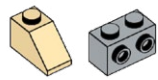

2x

2x

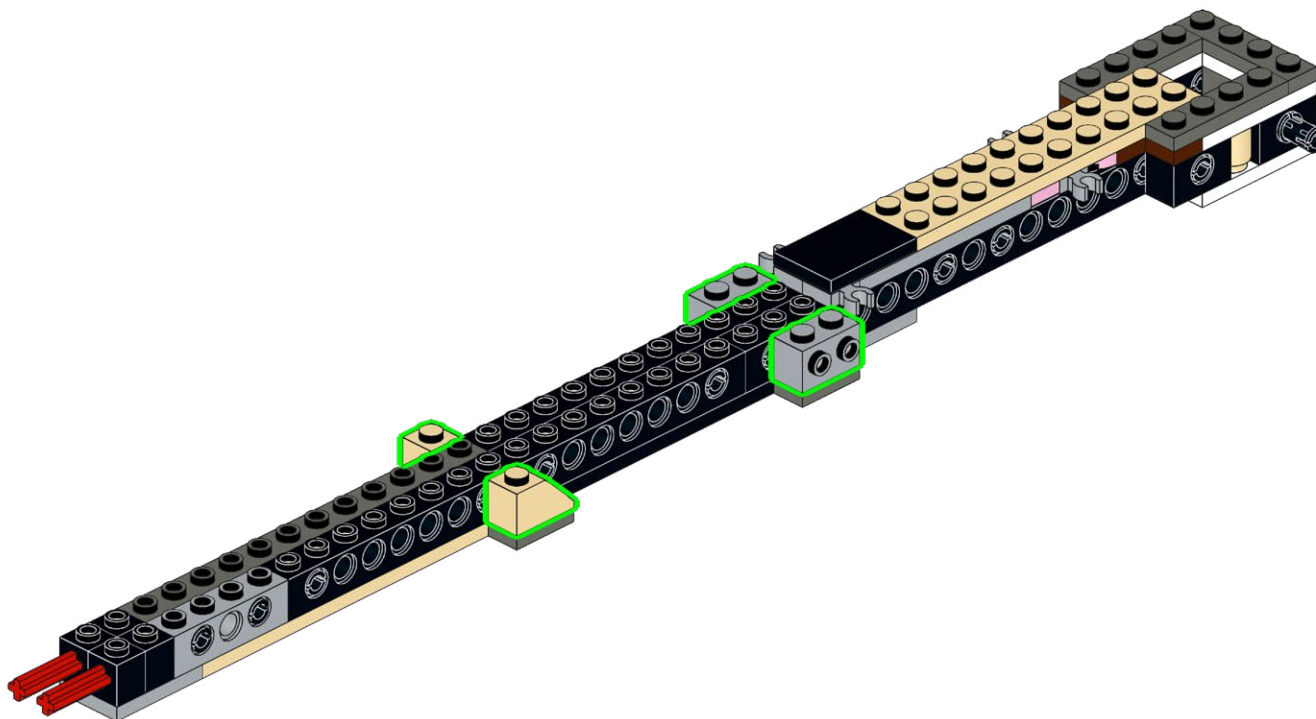

17

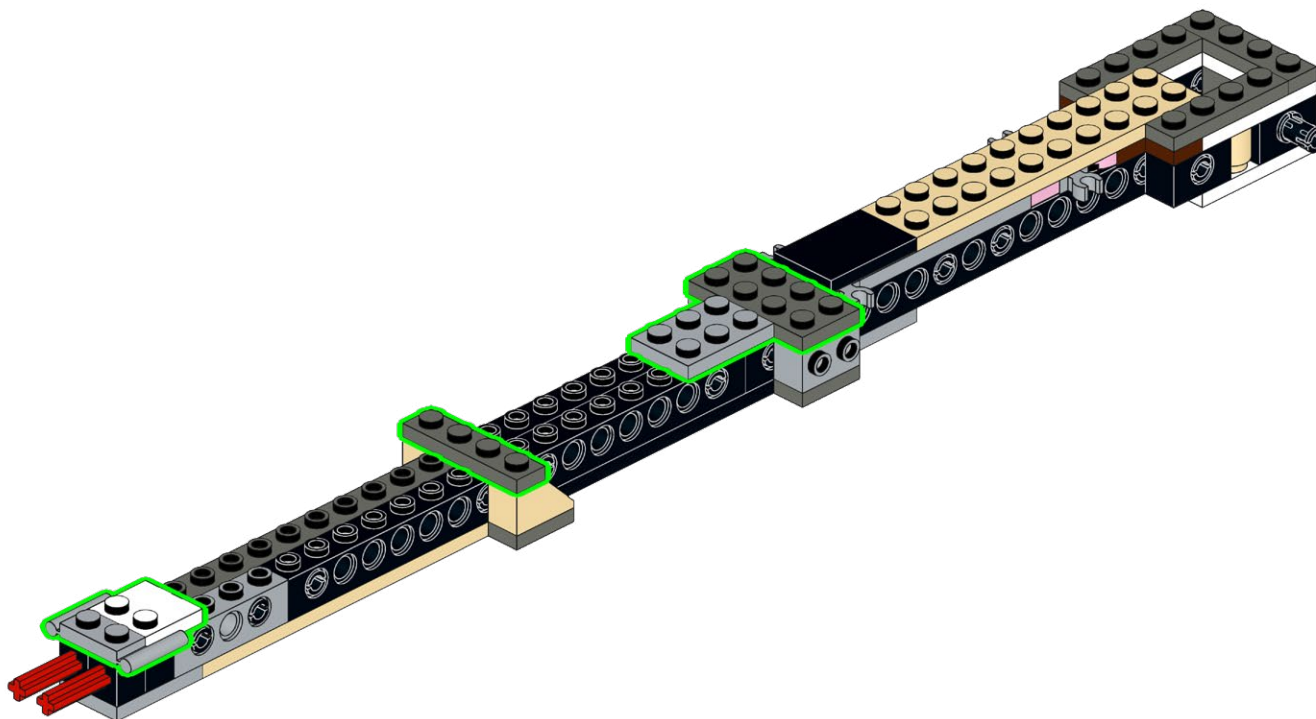
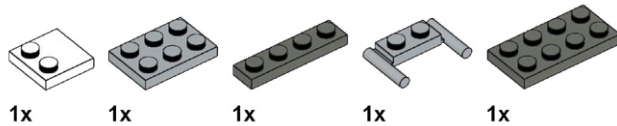

18

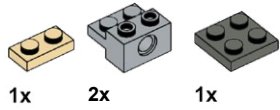

1

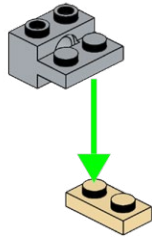

2

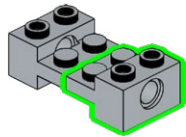

3

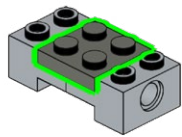

19

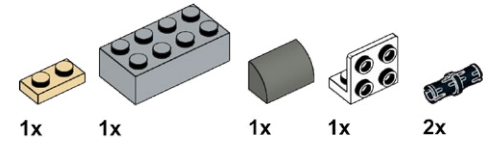

1

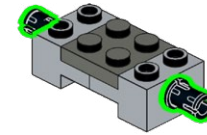

2

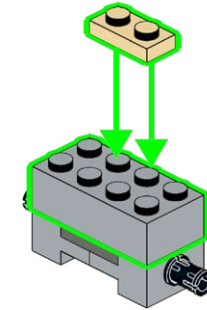

3

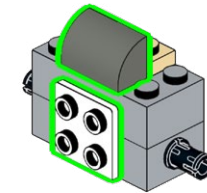

20

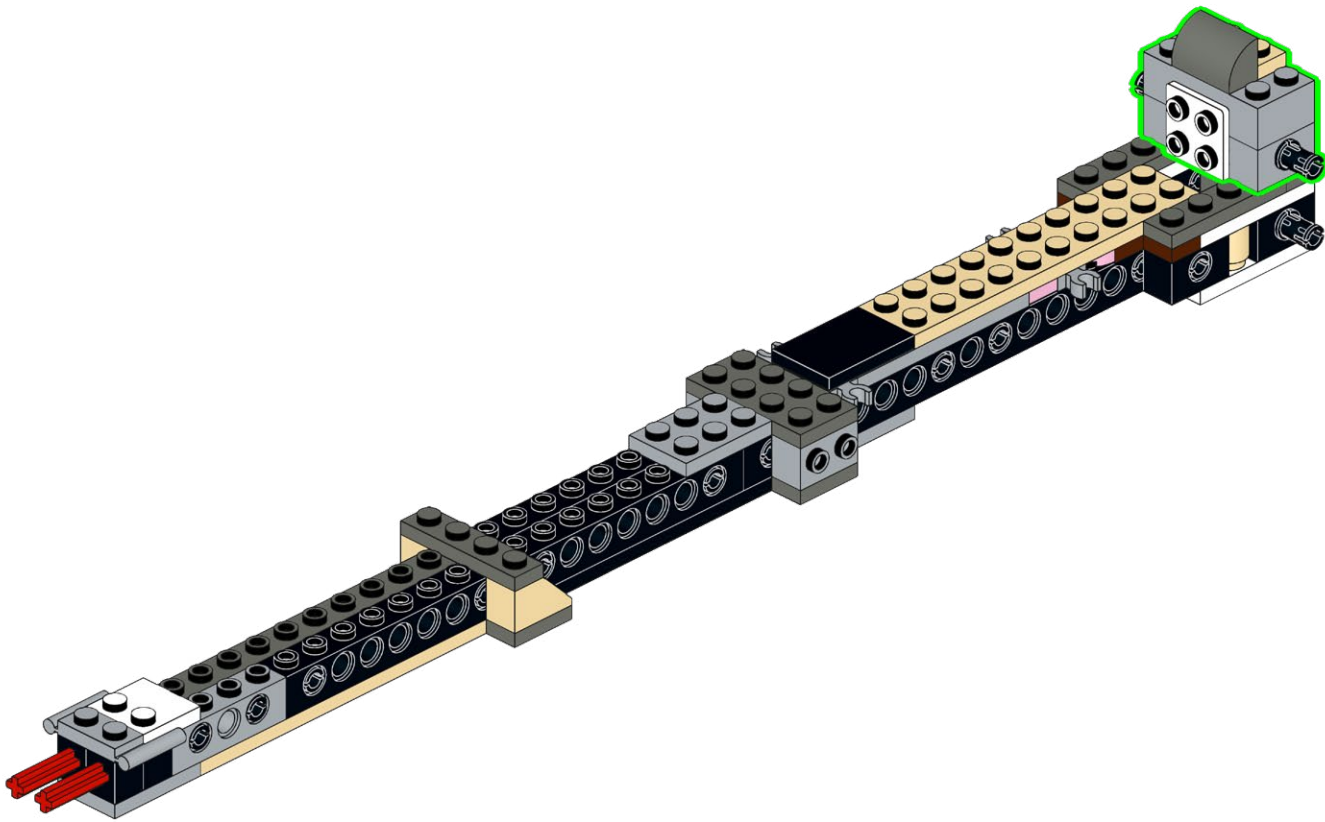

21



2x



2x



1x



1x

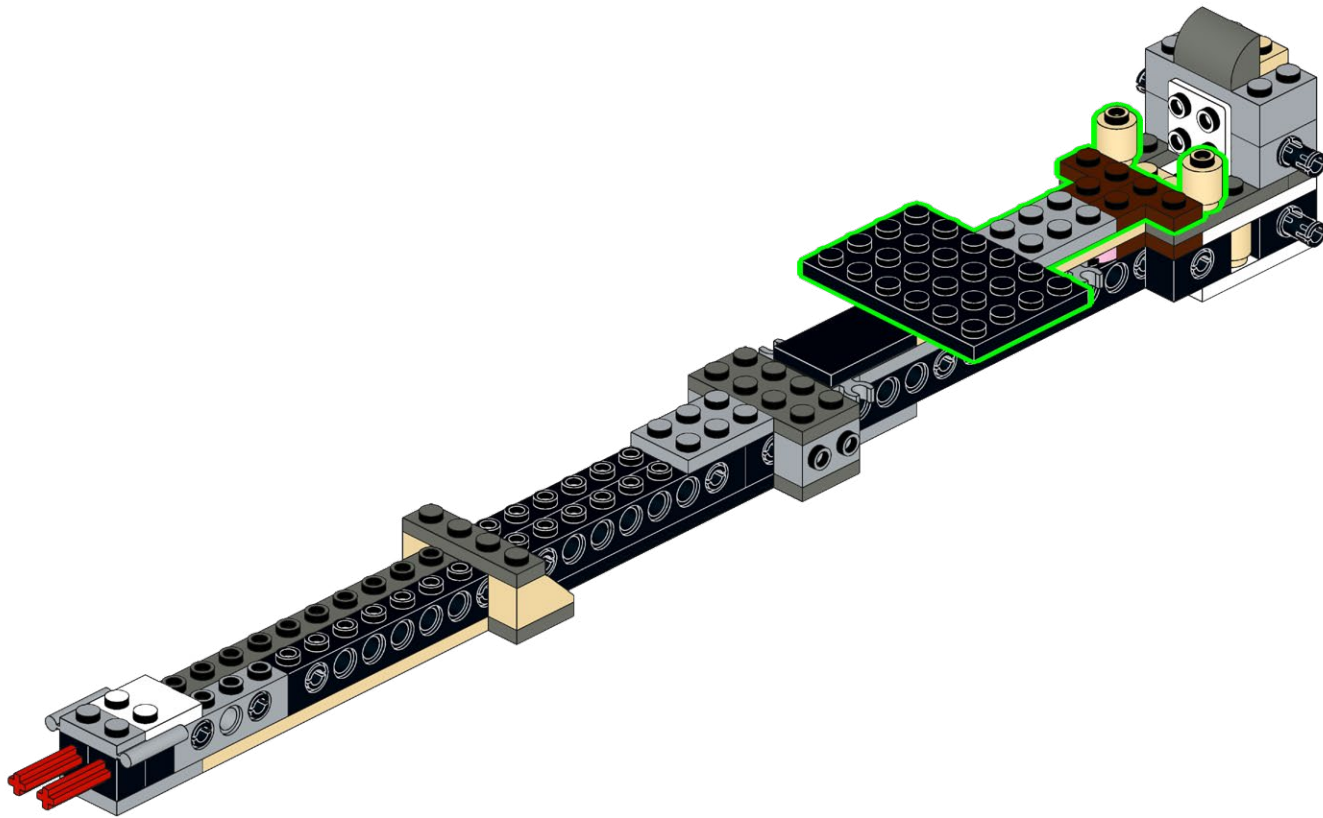

22

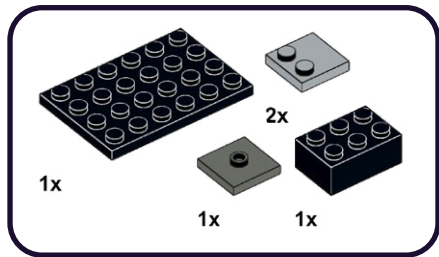

1

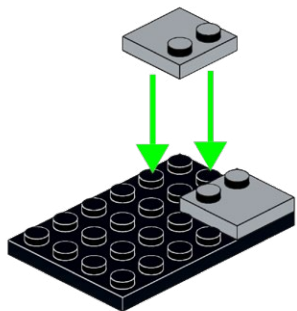

2

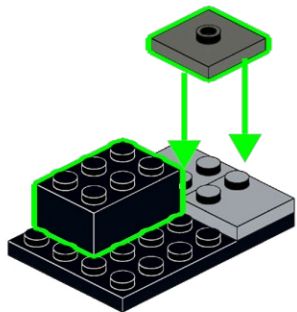

23

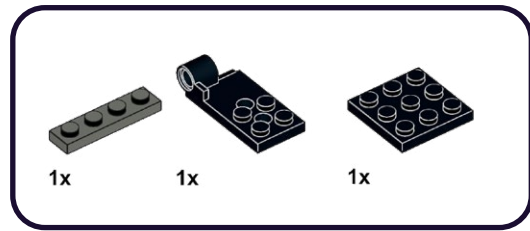

1

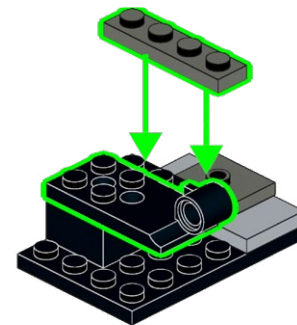

2

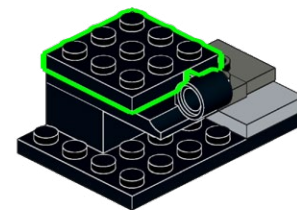

24



1x

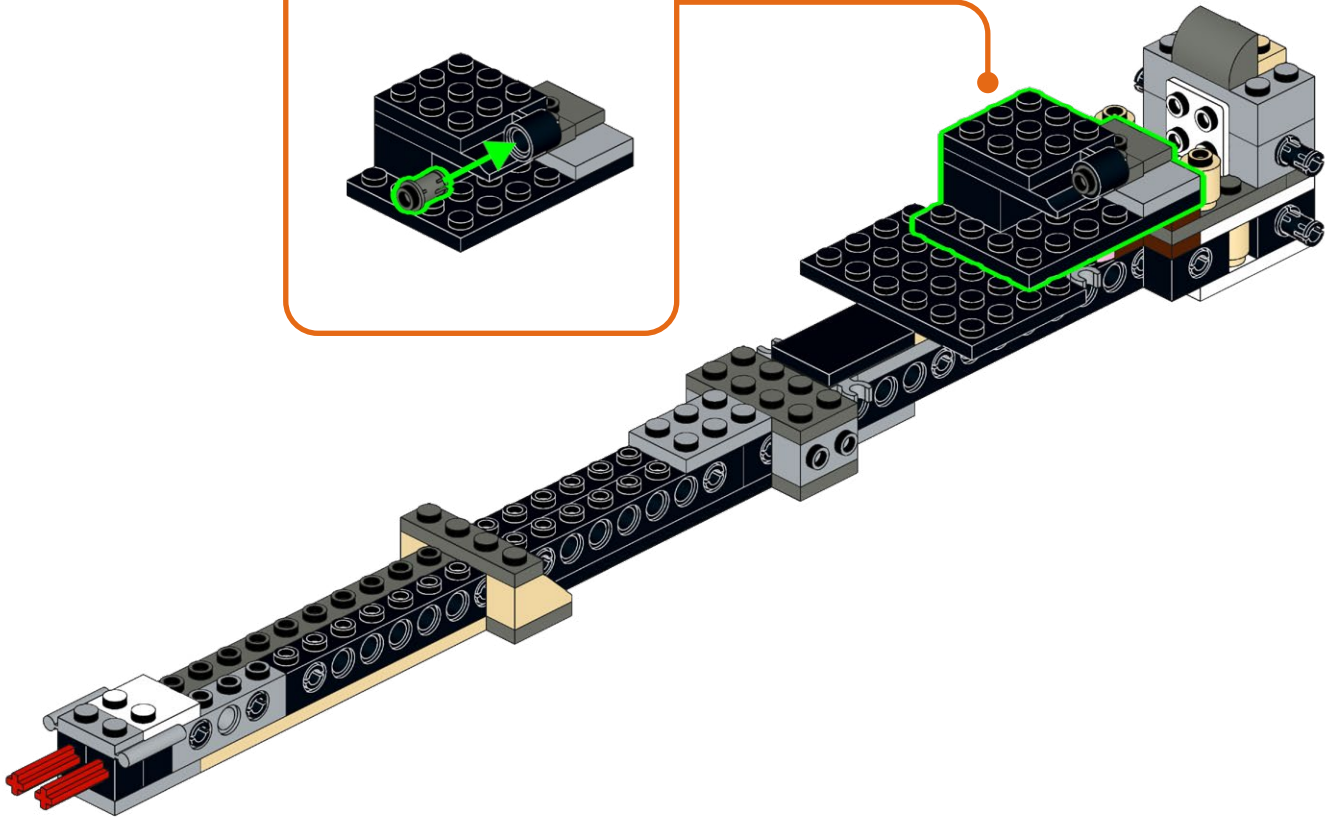
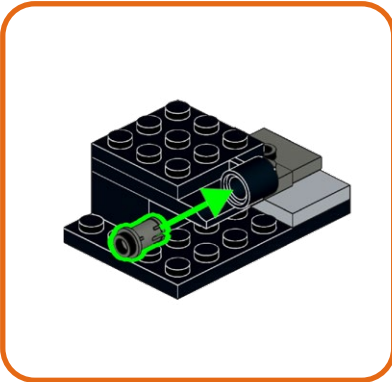

25

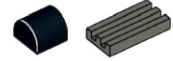

4x 3x

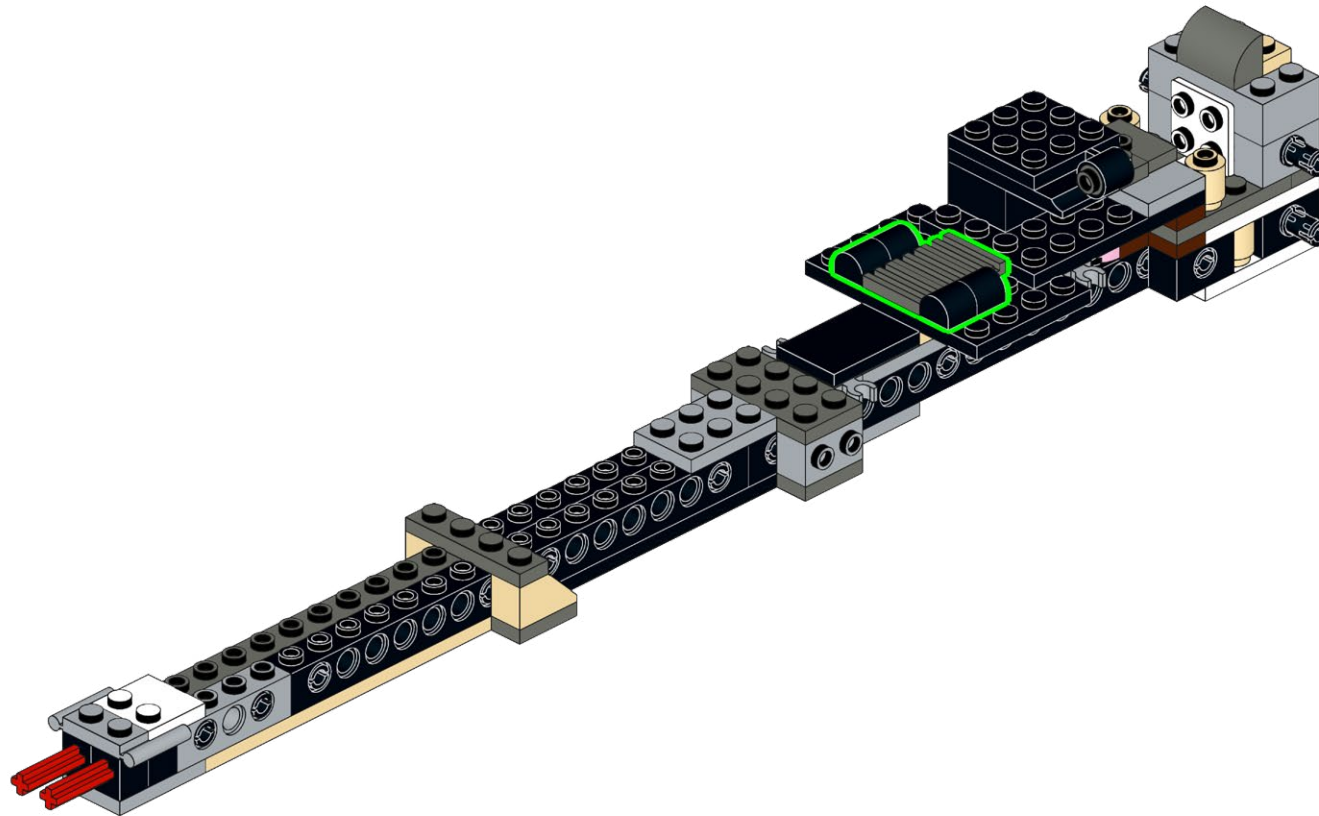

26

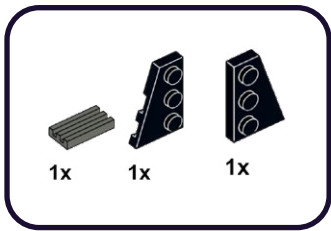

1

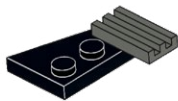

2

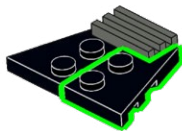

27

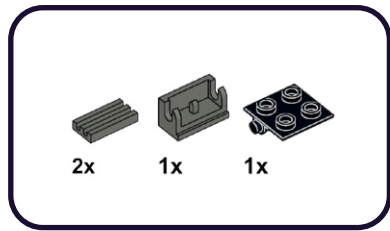

1

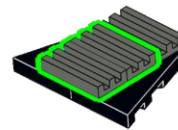

2

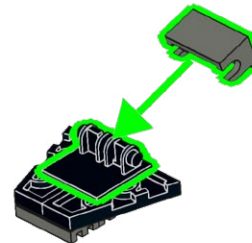

28

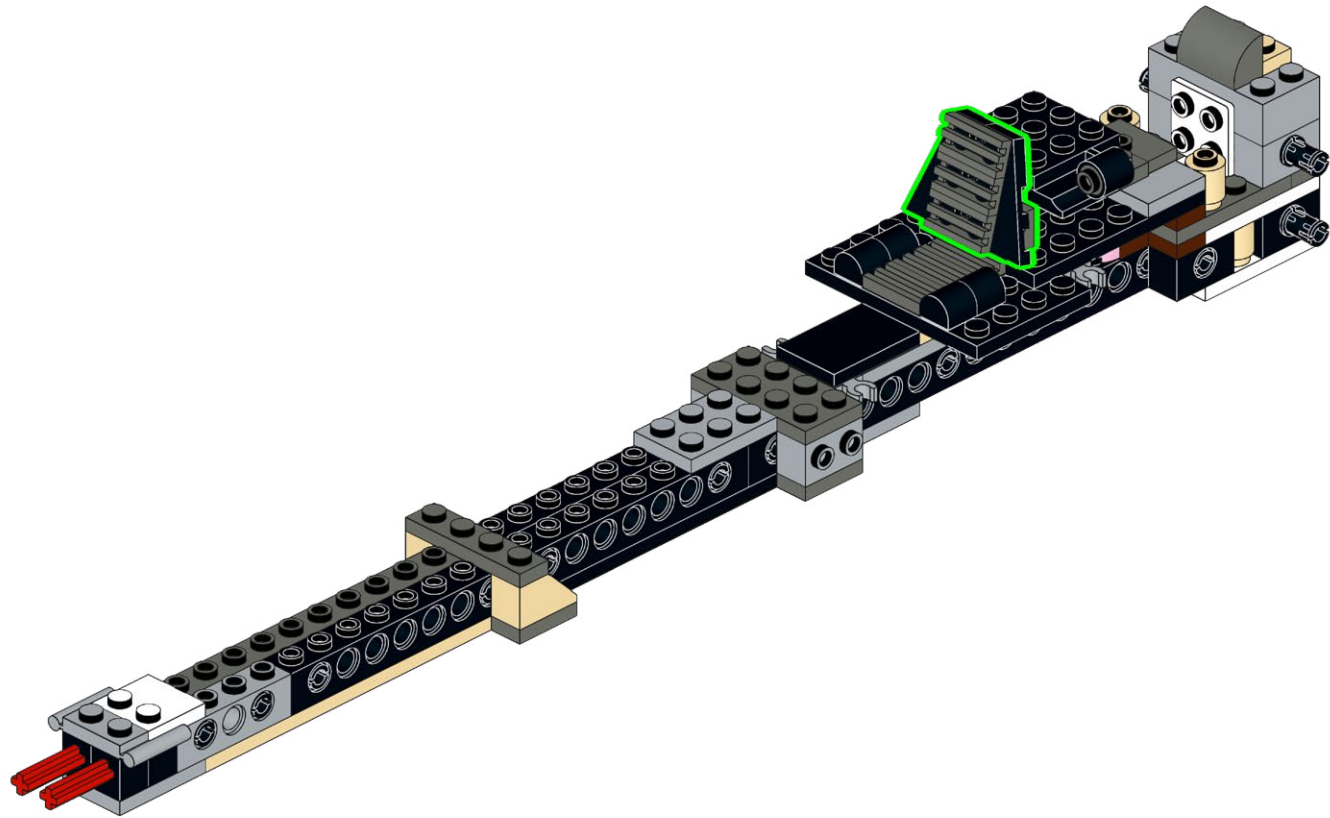

29

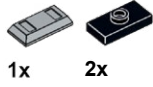

1

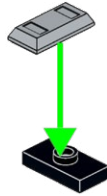

2

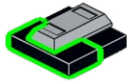

2x

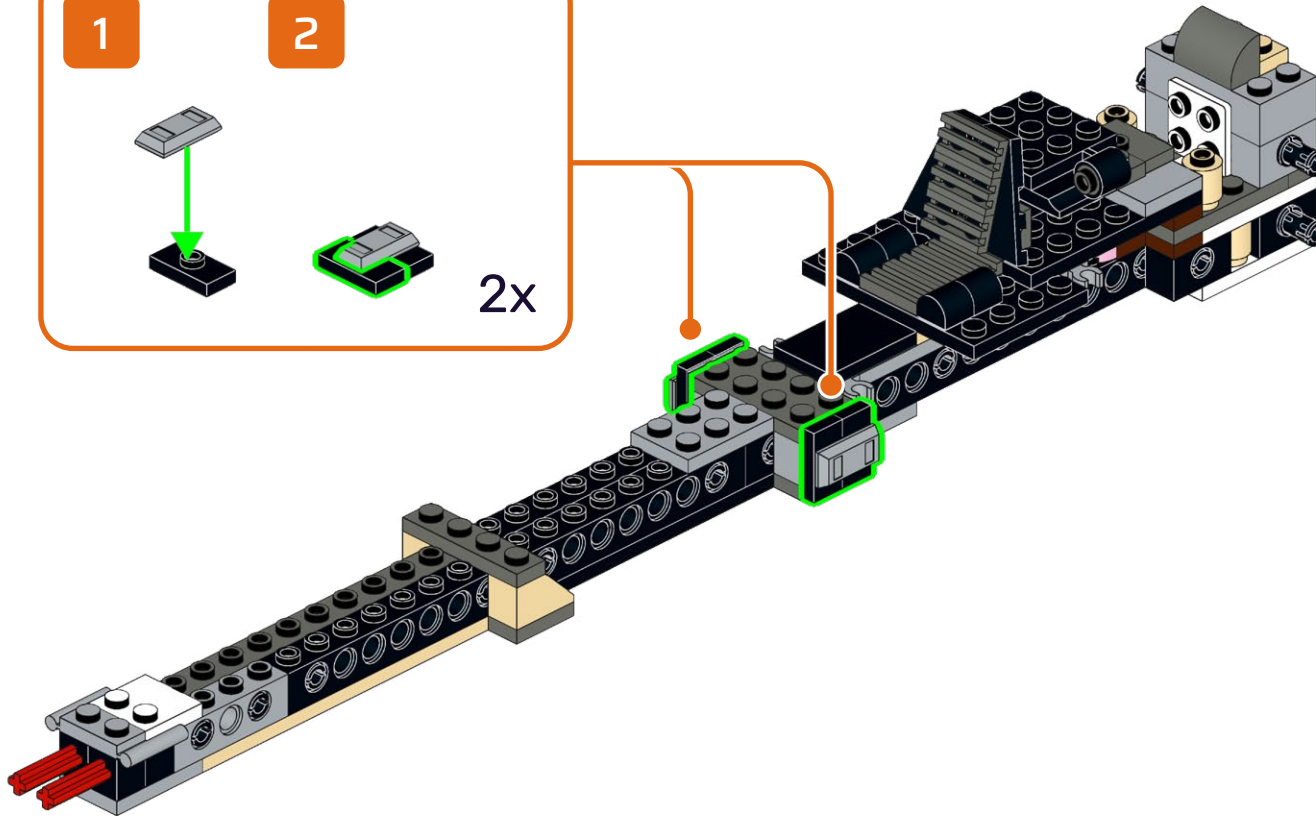

30



1x

2x

1x

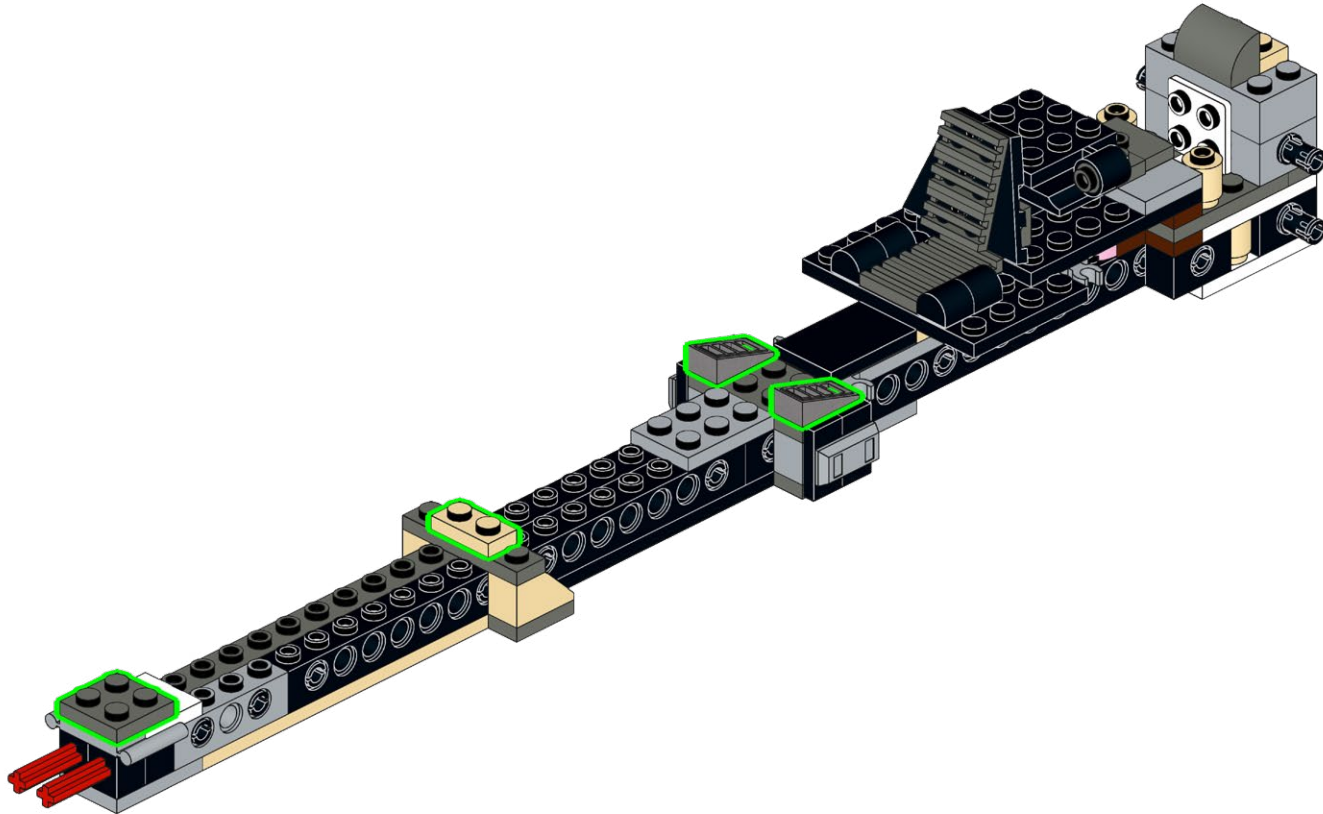

31

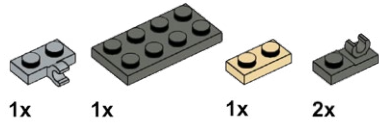

1

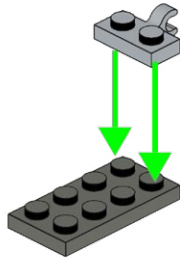

2

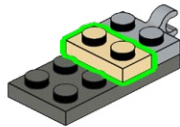

3

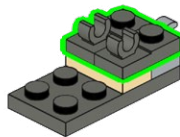

32



1

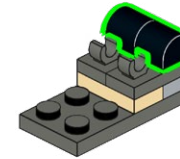

2

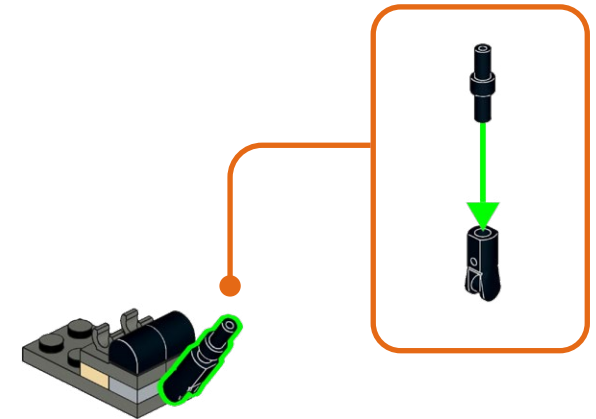

33

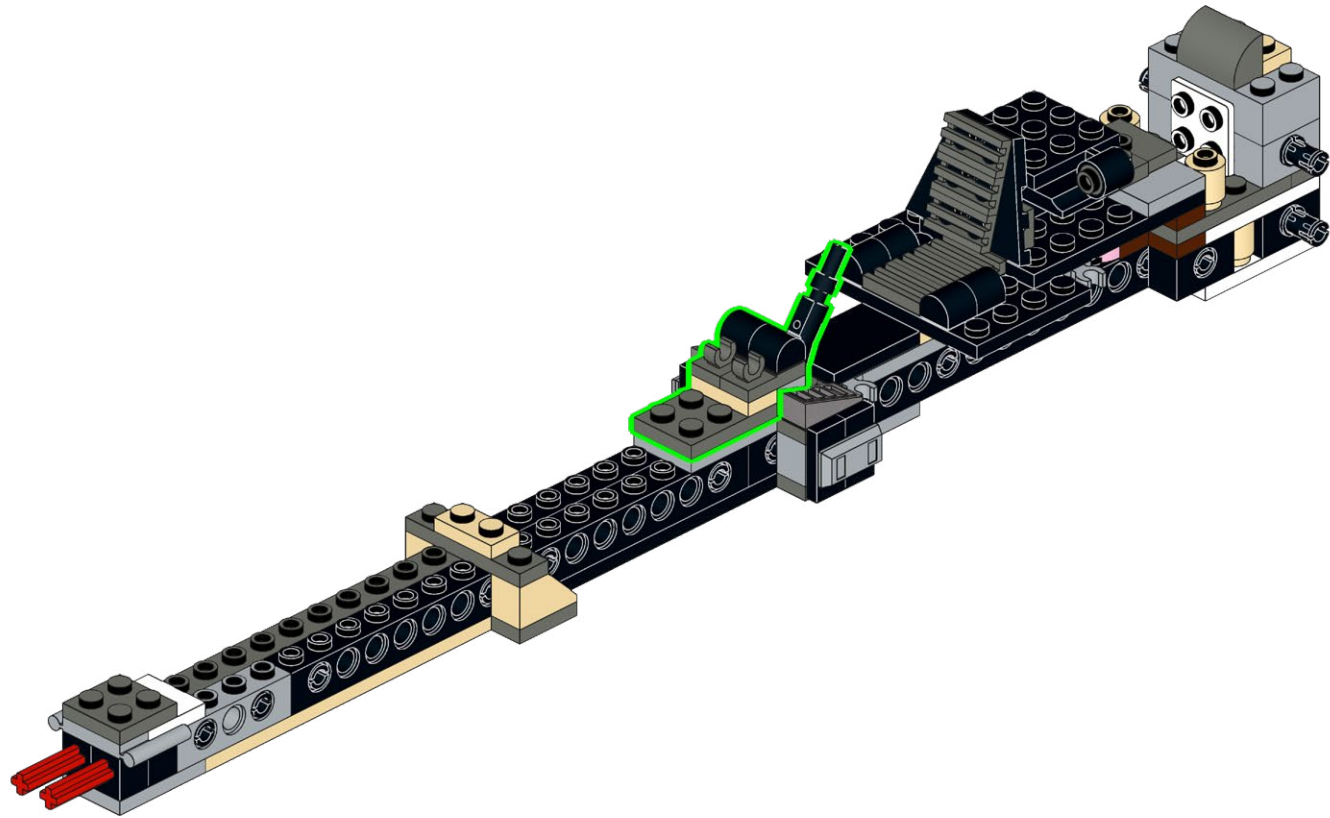

34

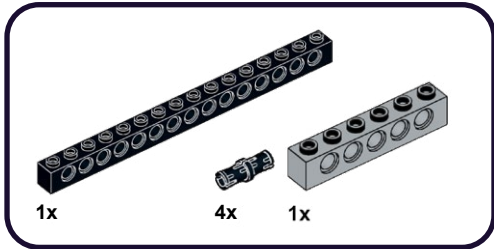

1

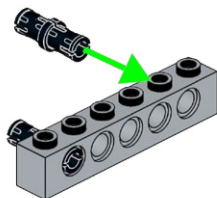

2

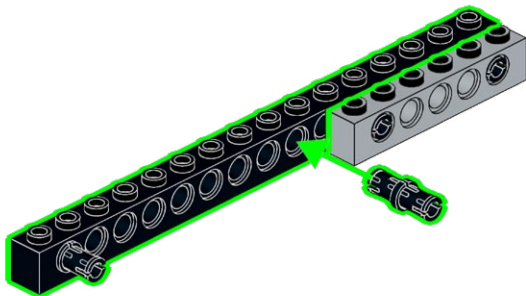

35

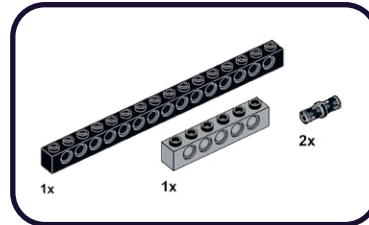

1

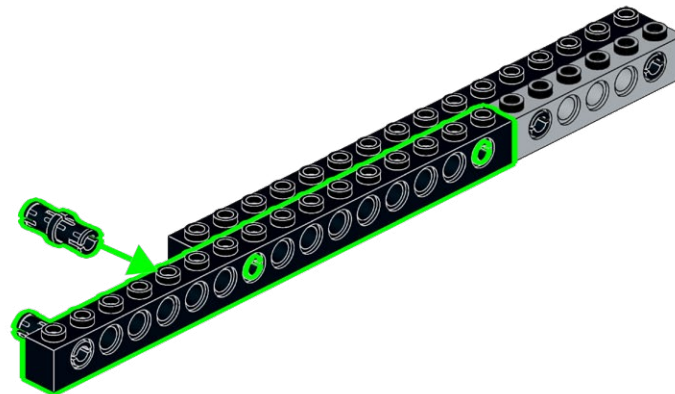

2

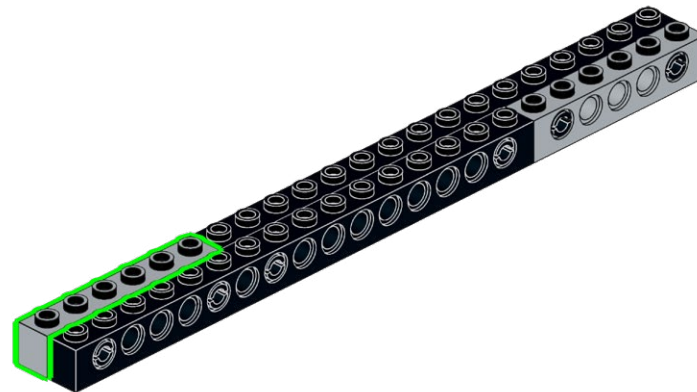

36

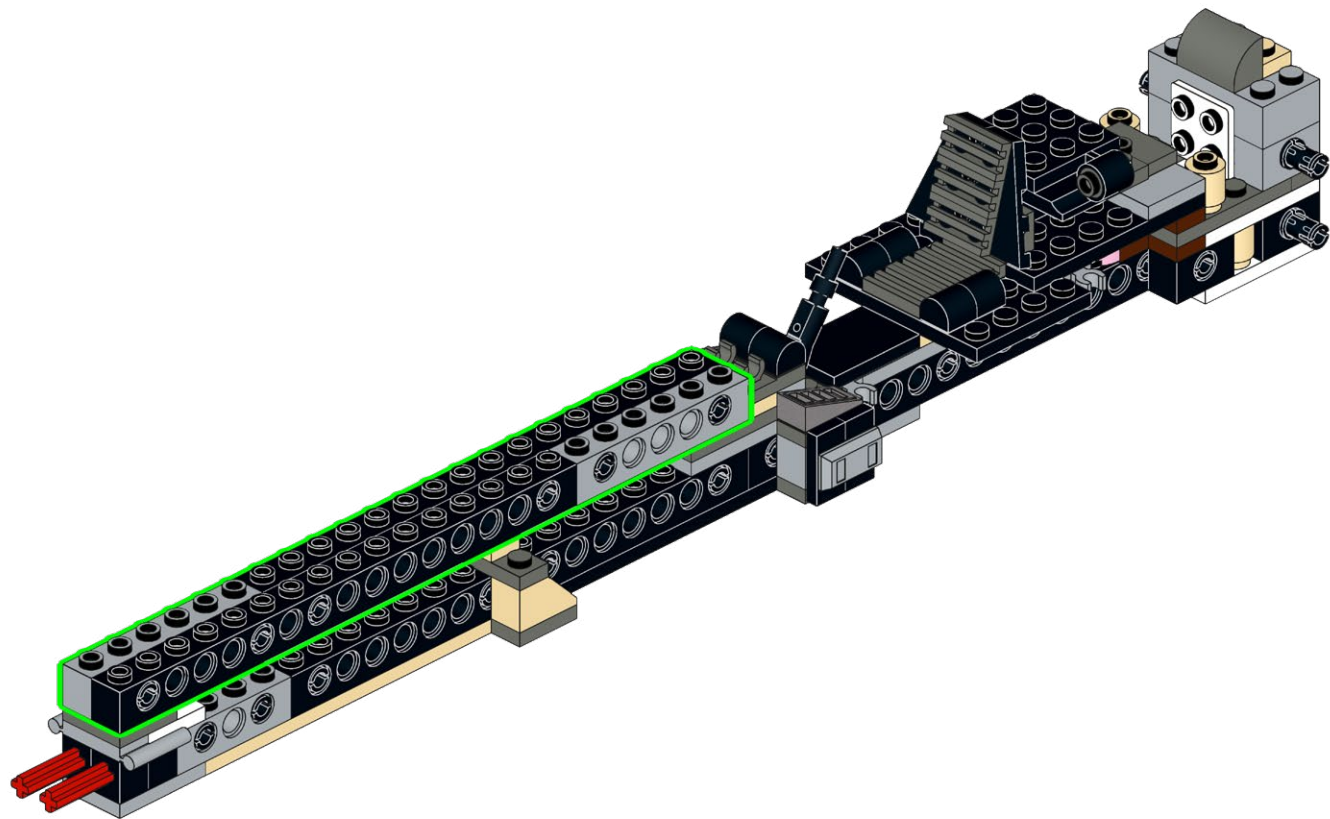

37

2x

2x

4x

1

2

2x

38

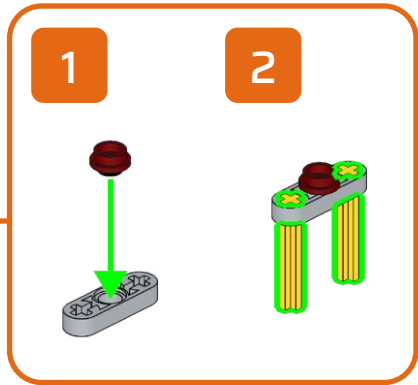
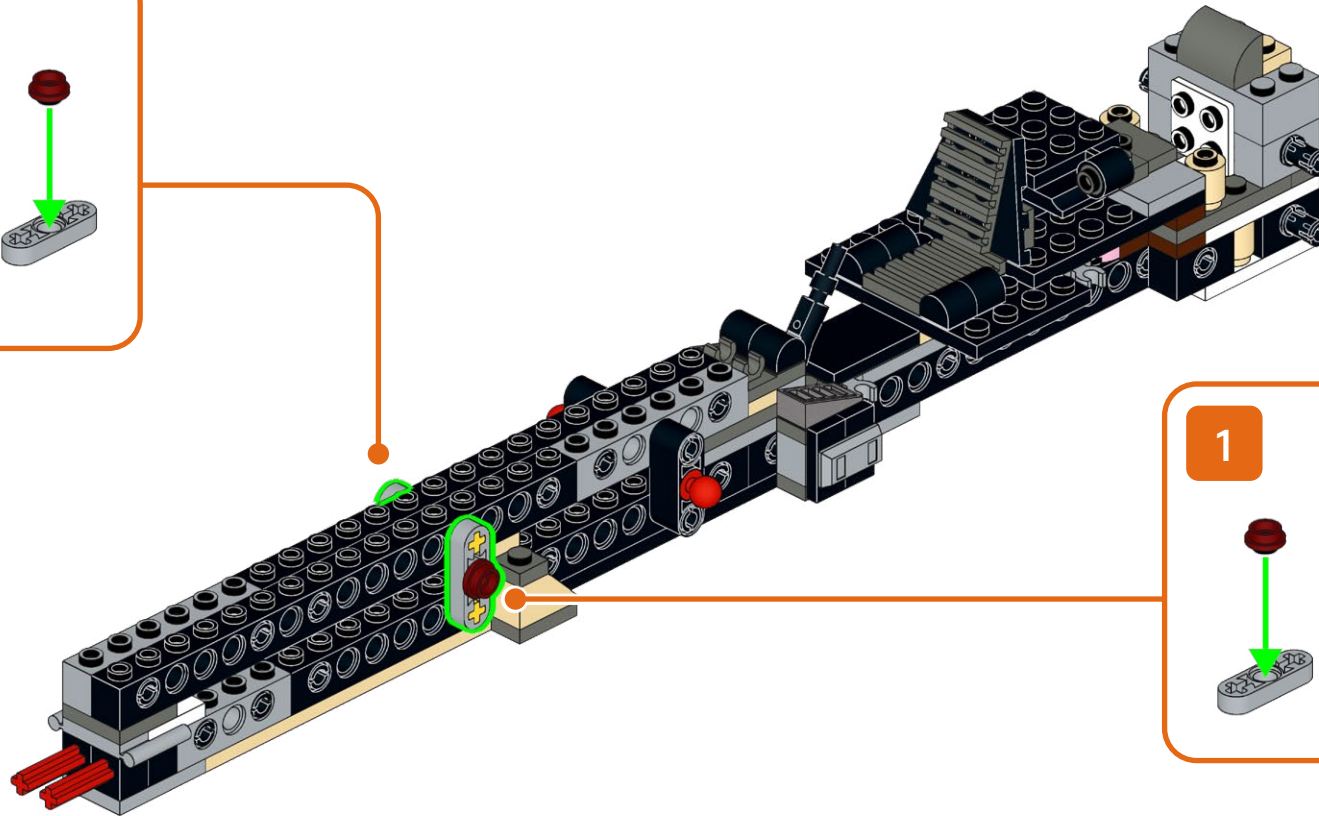
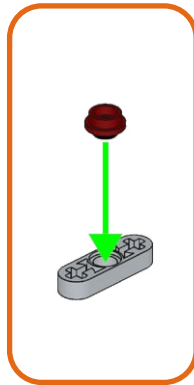
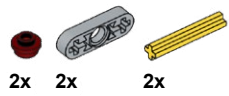

39

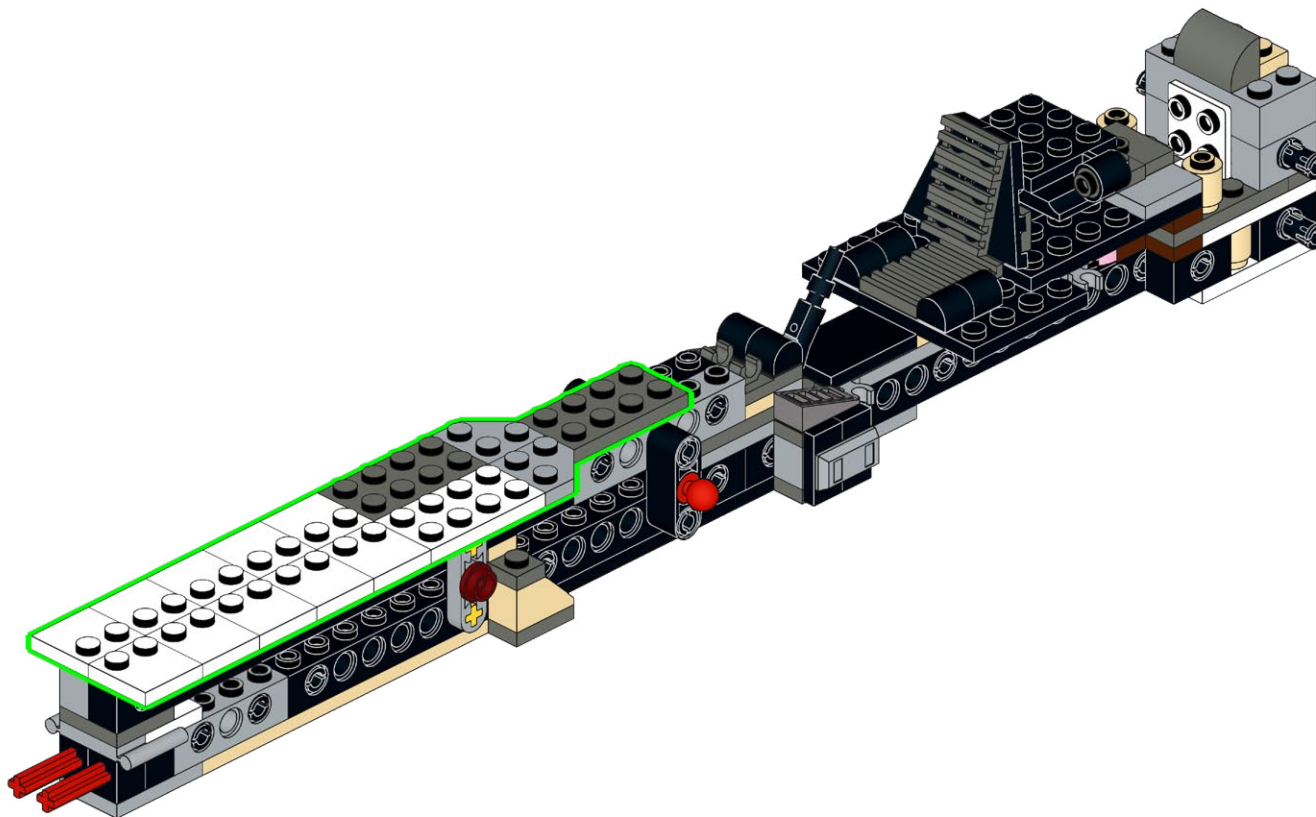
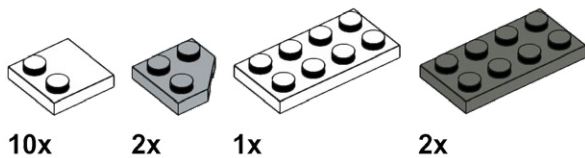

40

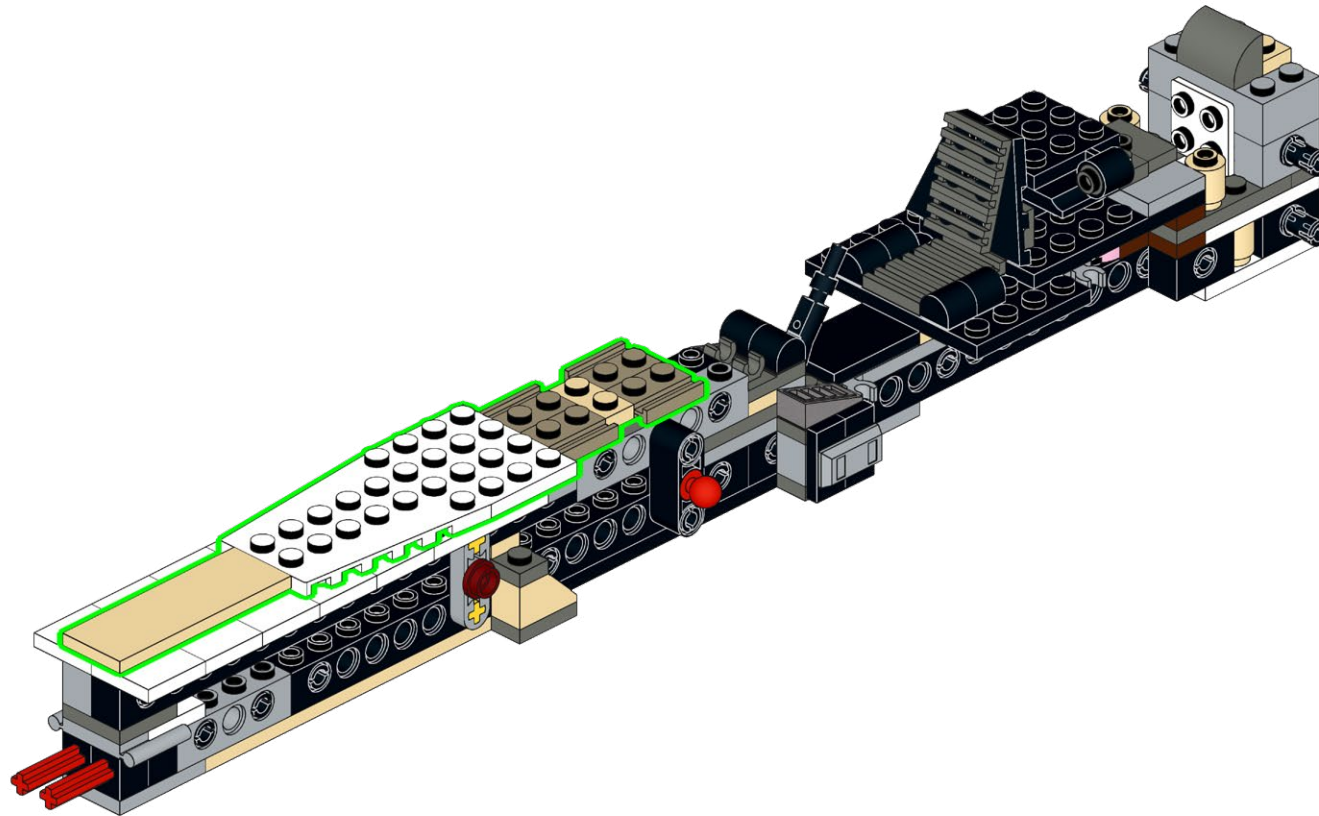
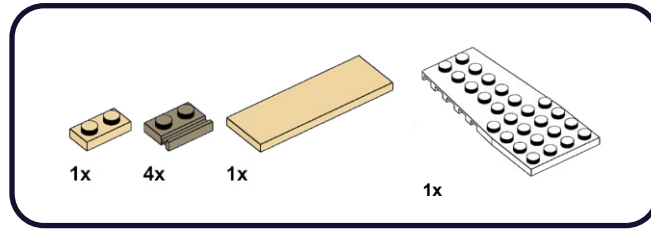

41

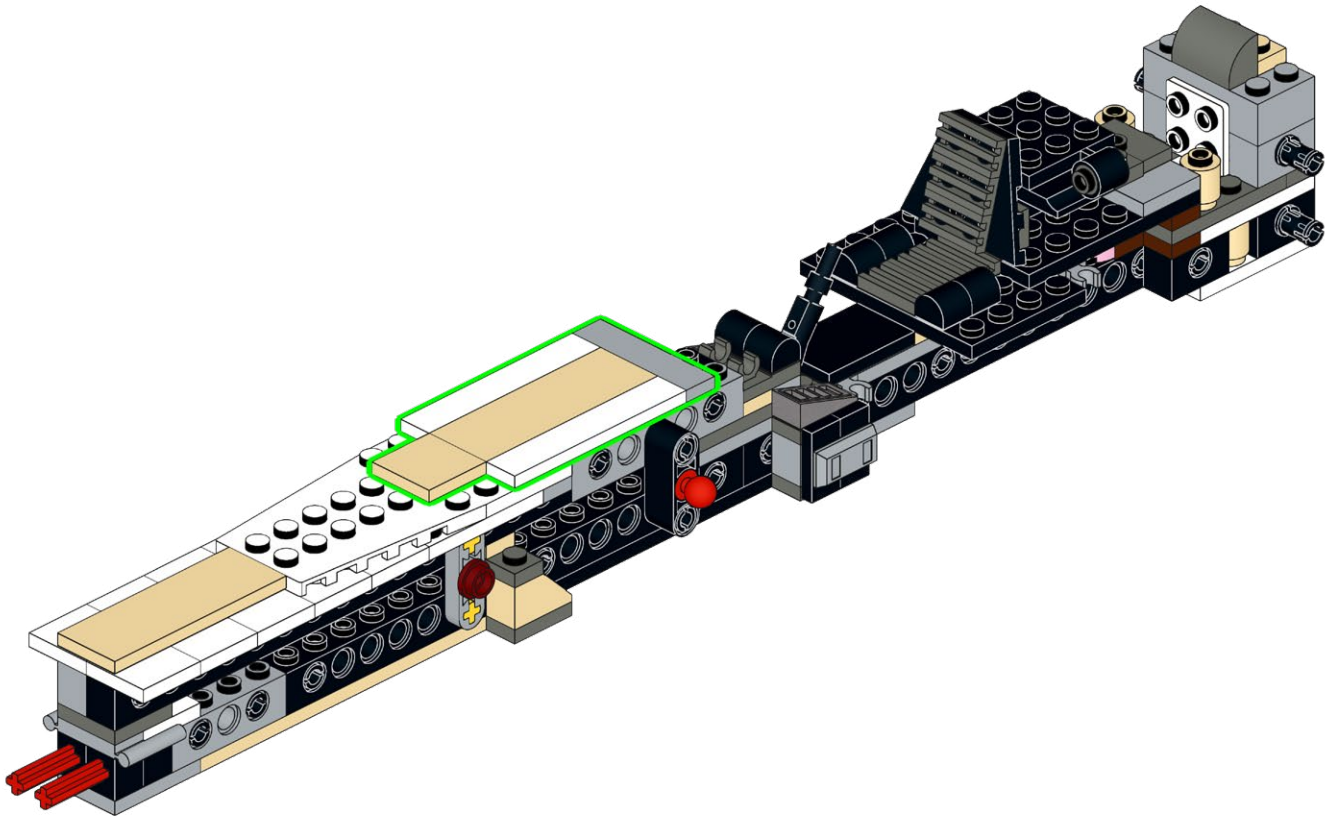
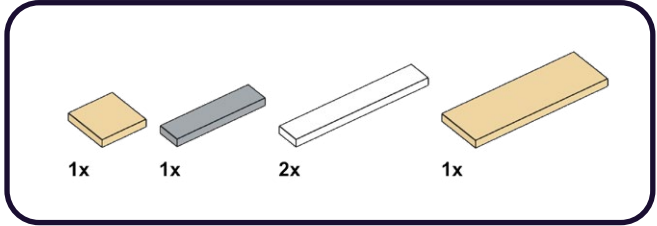

42

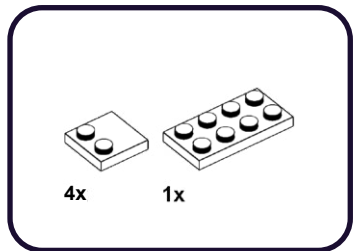

1

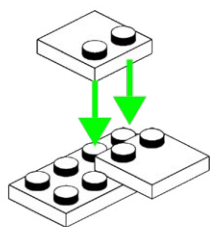

2

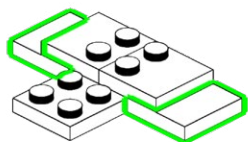

43

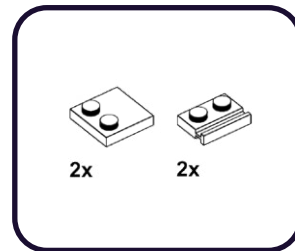

1

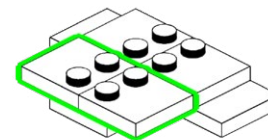

2

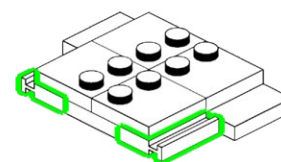

44

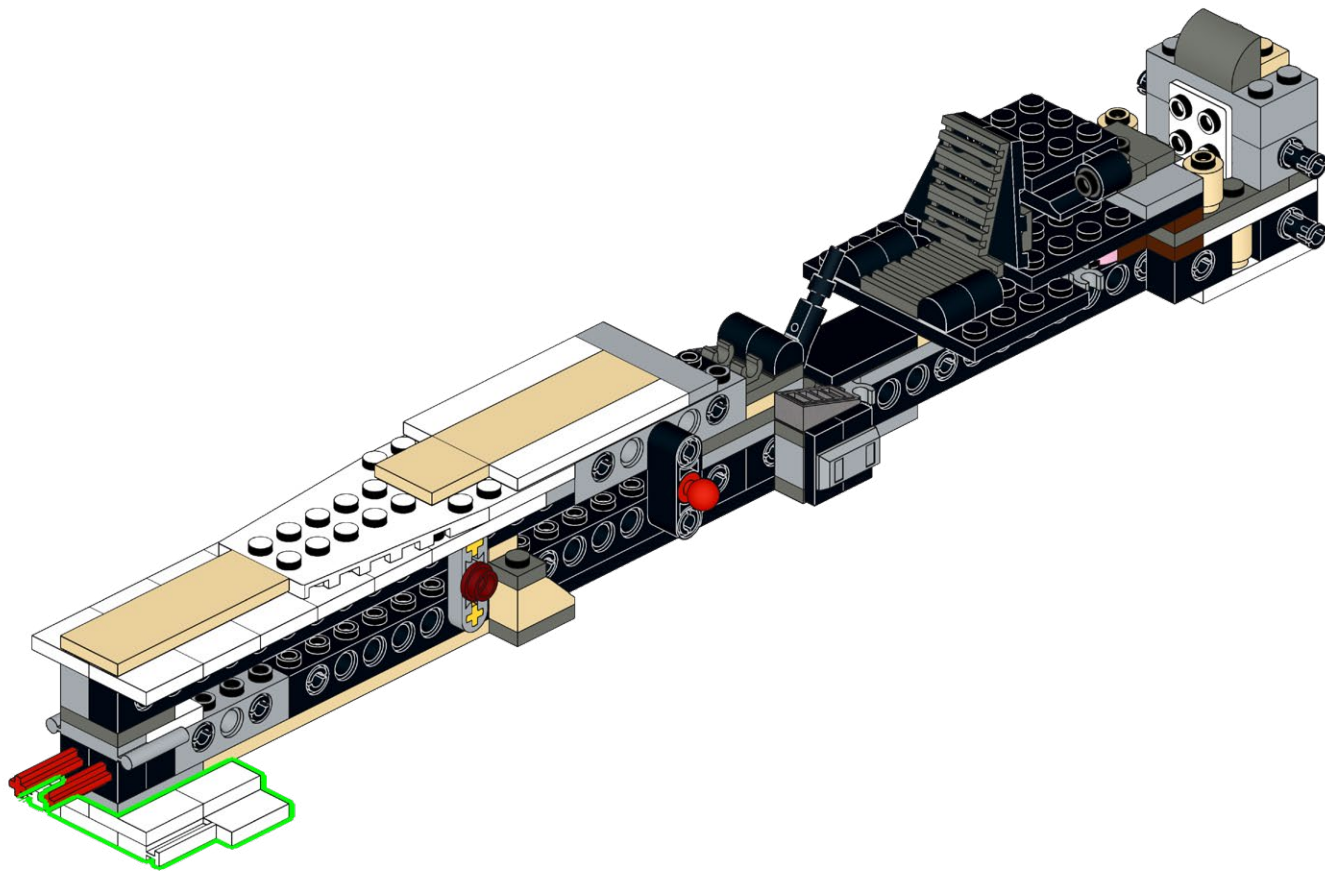

45

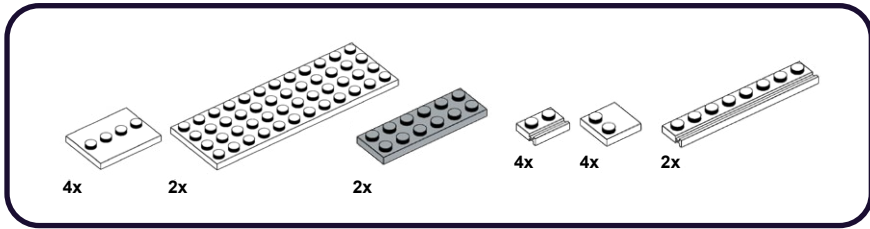

1

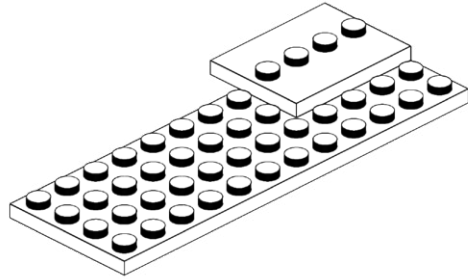

2

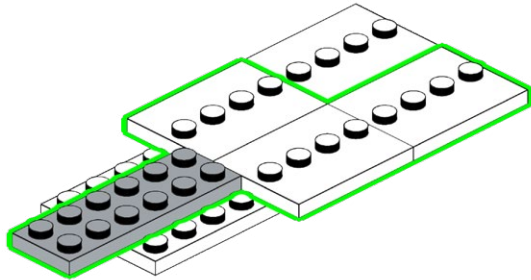

3

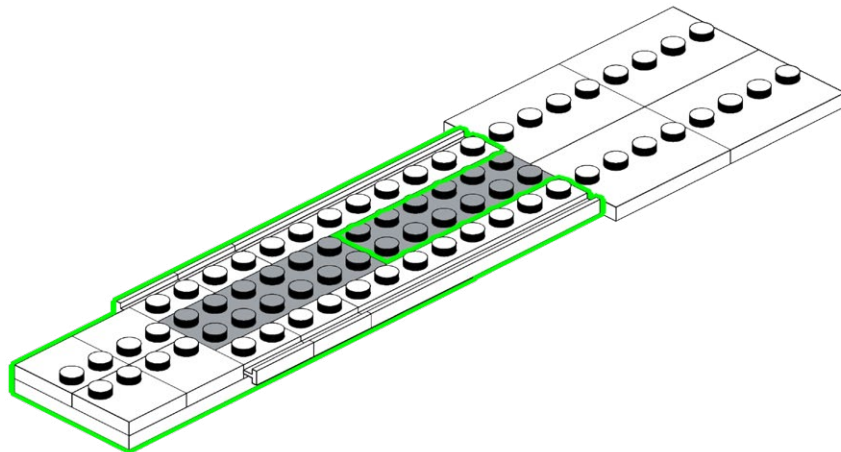

46

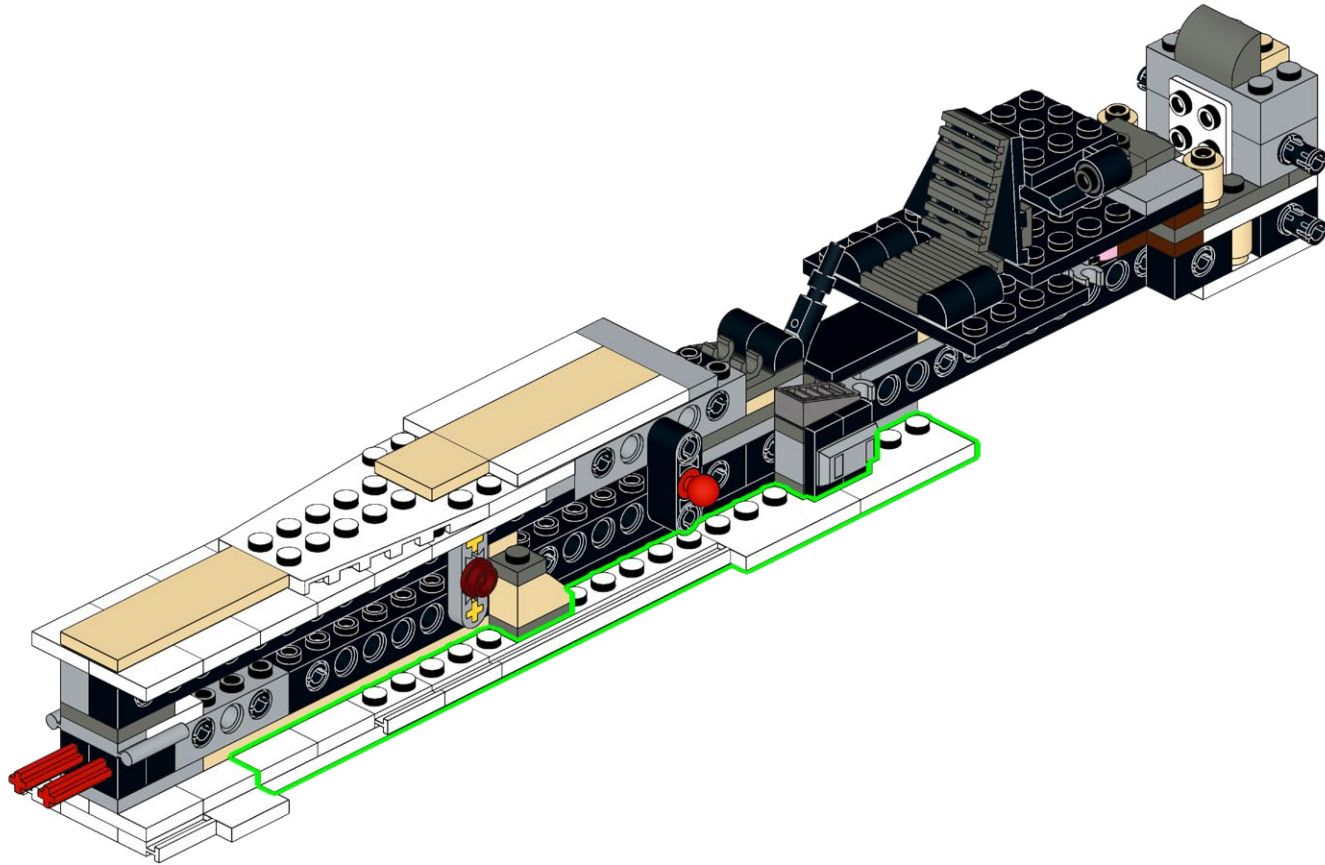



HOLD UP!

You might notice some bags aren't in order, as well as left over pieces, but that's ok! We're changing the way you build LEGO!

ATTENDEZ!

Vous remarquerez peut-être que certains sacs, ainsi que certaines pièces, ne sont pas dans le bon ordre. Mais pas de panique! Nous changeons simplement la façon avec laquelle vous construisez vos LEGO!

ASPETTA!

Potresti notare che alcuni sacchetti non sono in ordine, così come i pezzi avanzati, ma va bene così! Stiamo cambiando il modo in cui costruisci i LEGO!

HALT!

Sie werden möglicherweise bemerken, dass einige tüten durcheinander sind und teile übrig bleiben, aber das ist in Ordnung! Wir ändern die art und weise, wie Sie LEGO bauen!

¡ESPERA!

Es posible que notes que algunas bolsas están fuera de servicio, así como piezas sobrantes, ¡pero está bien! ¡Estamos cambiando la forma en que construyes LEGO!

暫停!

你可能会注意到一些袋子顺序错乱, 以及一些剩余的部件, 但没关系! 我们正在改变你搭建乐高的方式!

Open LEGO® Bag 2

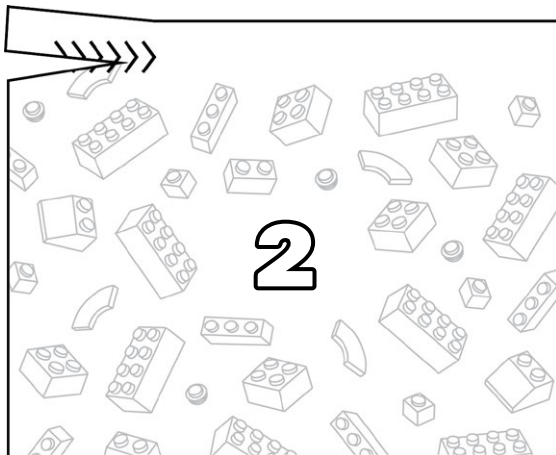

Open LMB Bags 02

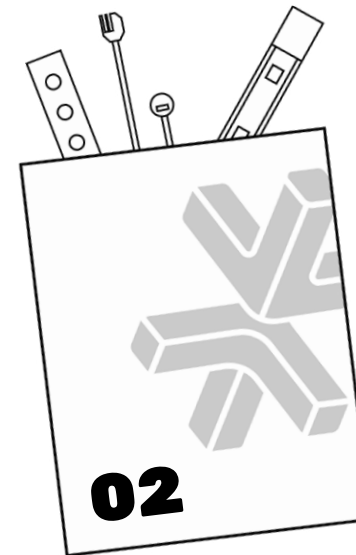

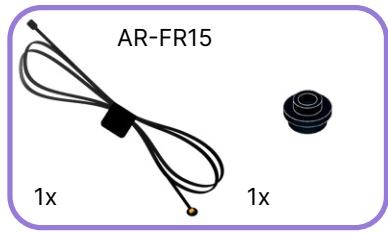

1



2

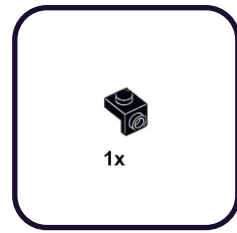
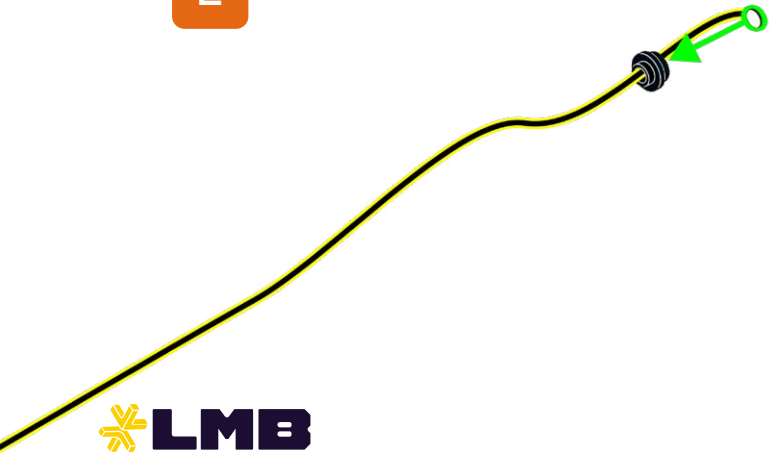

1



2

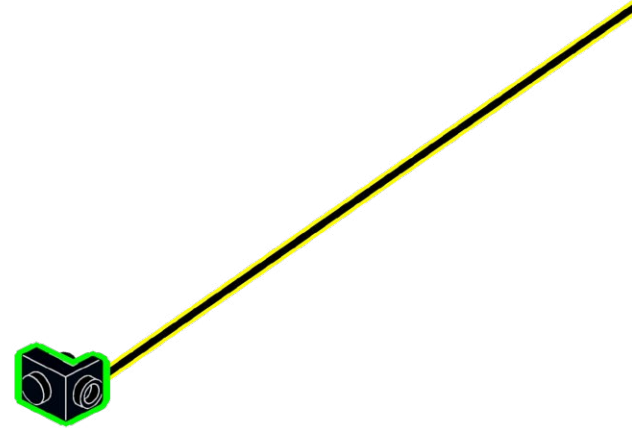

49

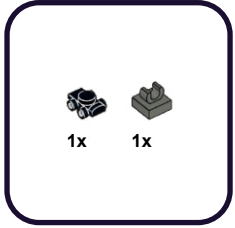

1



2



50

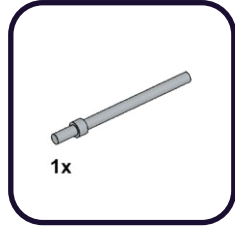

1

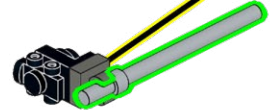

2

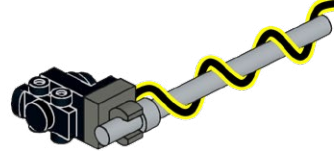

51

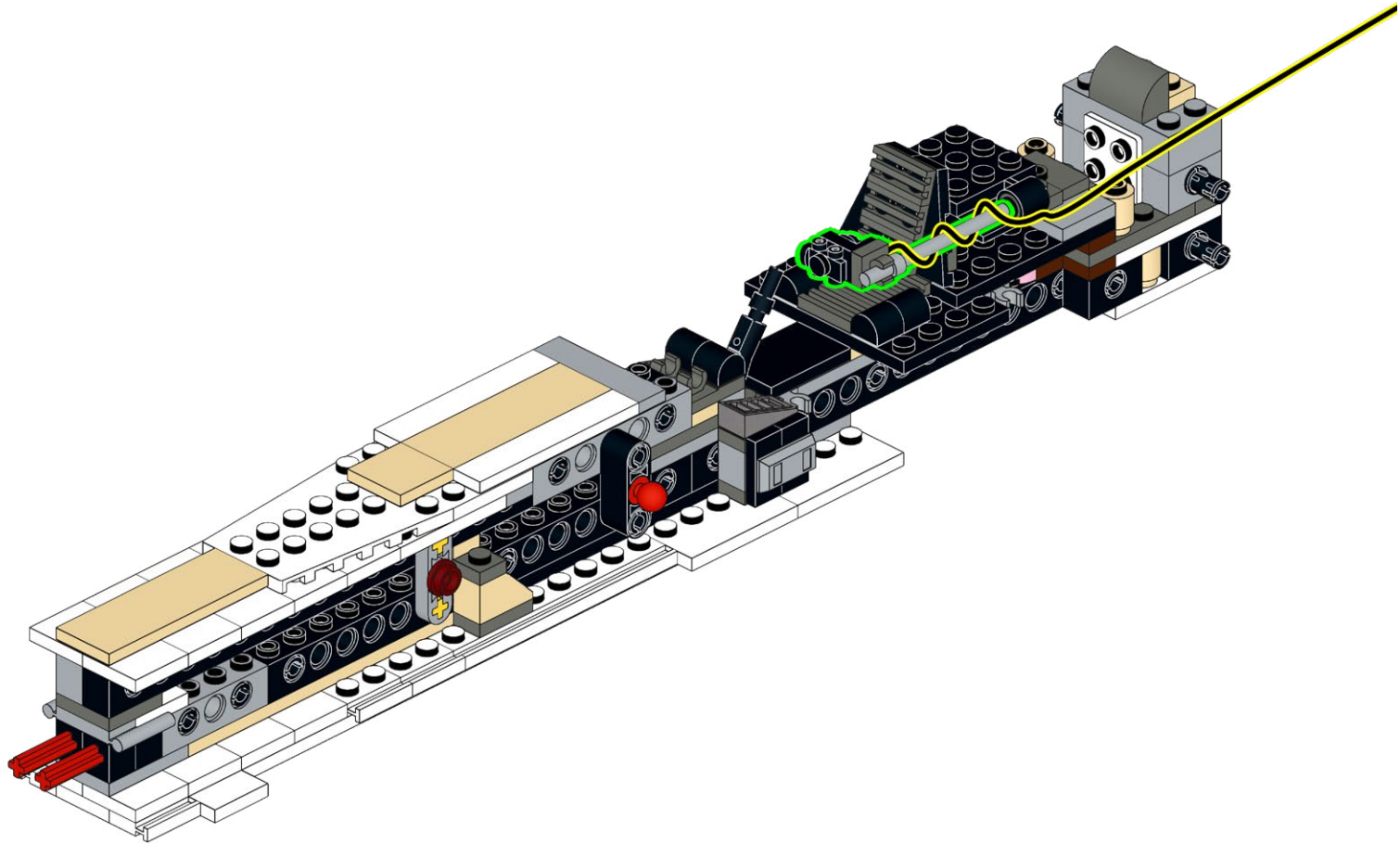

52

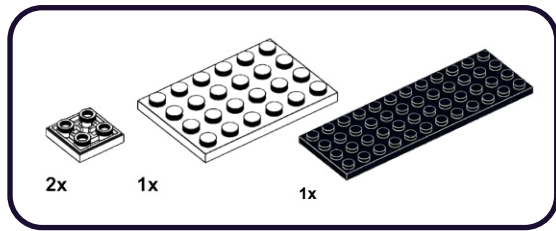

1

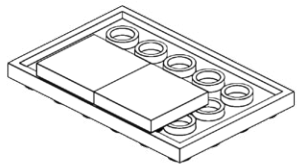

2

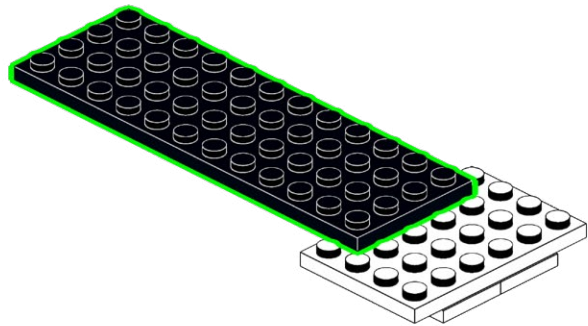

53

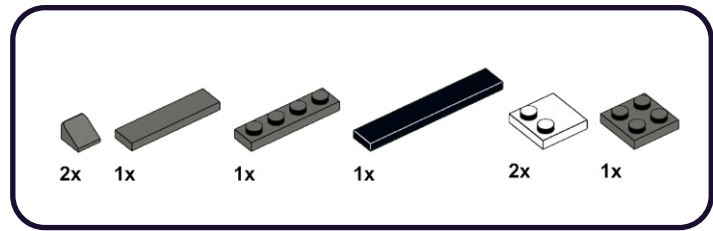

1

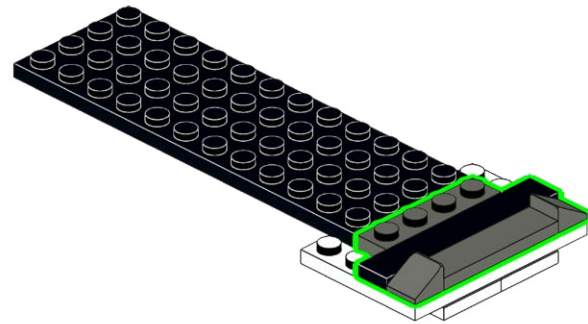

2

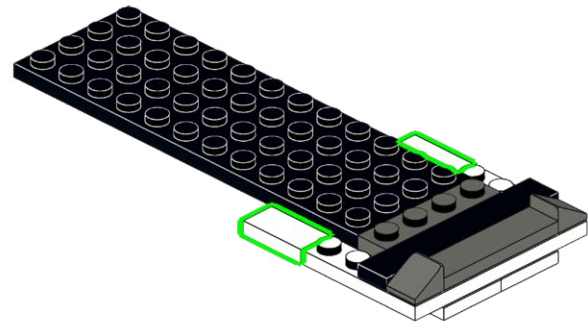

54

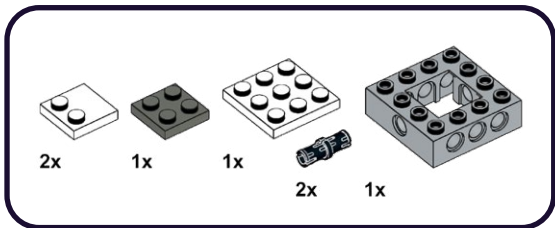

1

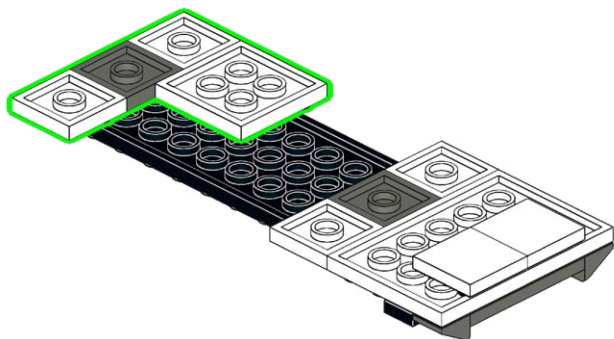

2

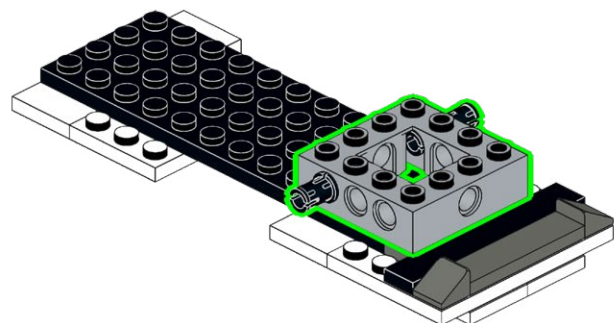

55

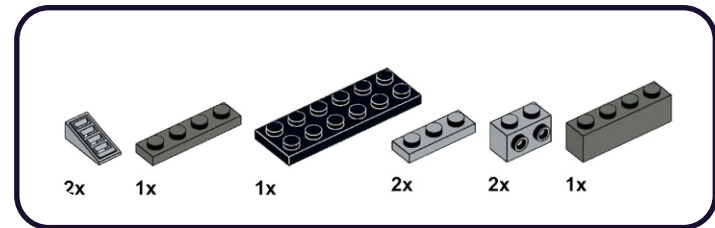

1

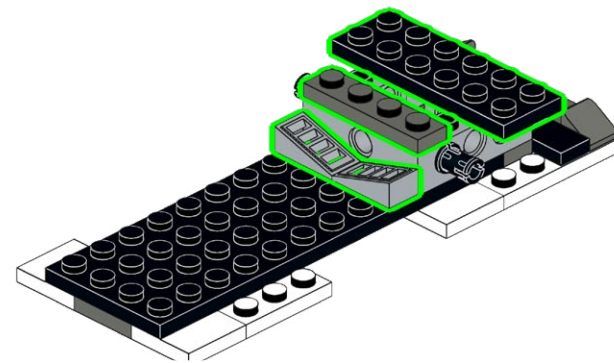

2

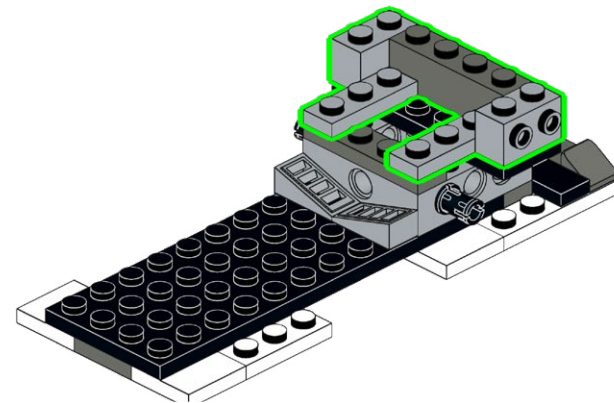

56

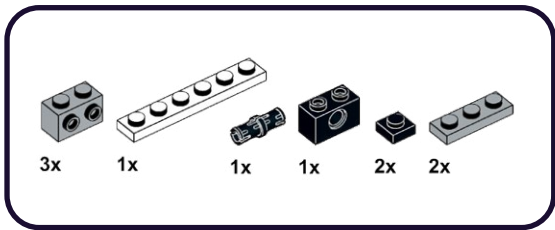

1

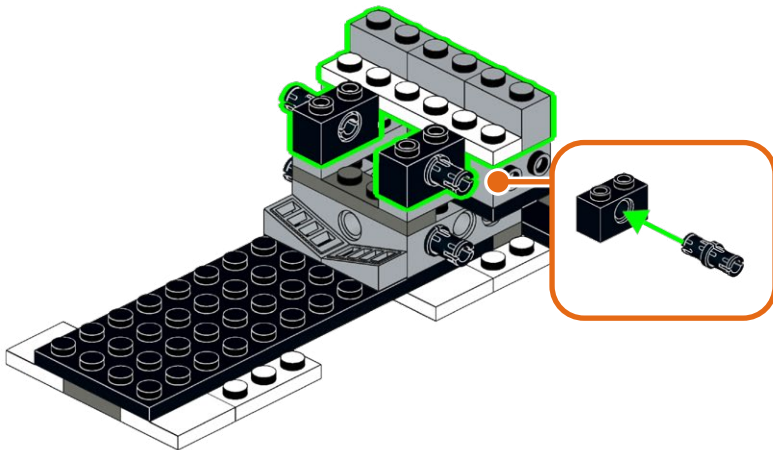

2

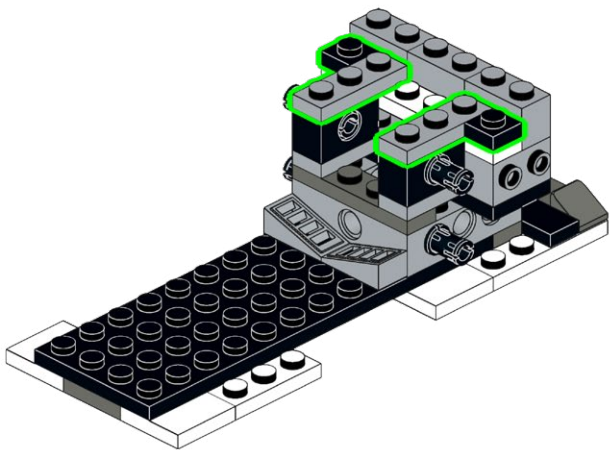

57

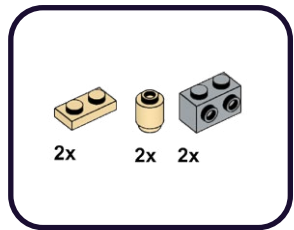

1

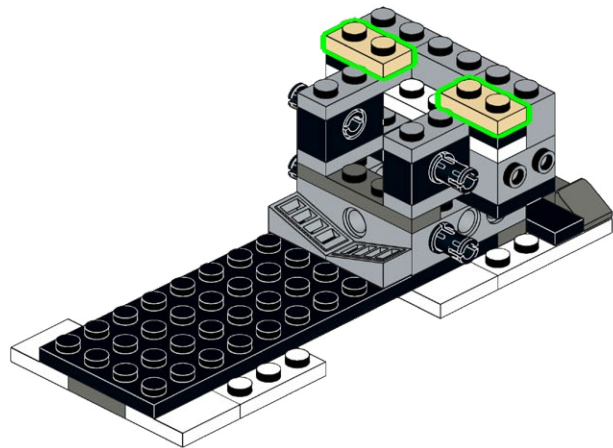

2

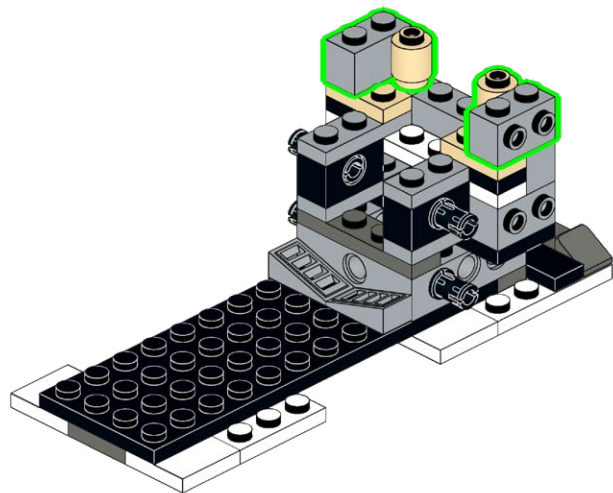

58

2x

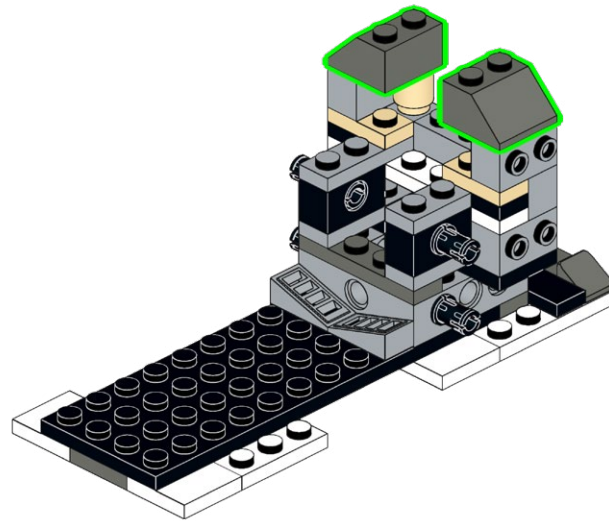

59

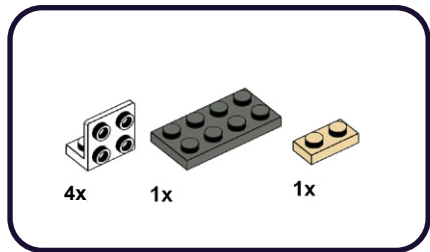

1

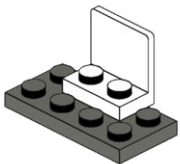

2

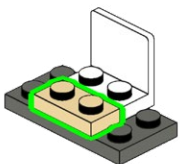

60

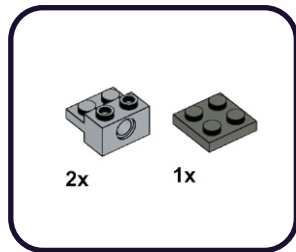

1

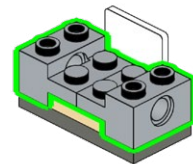

2

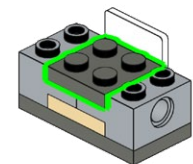

61



1

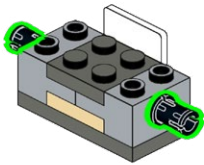

62

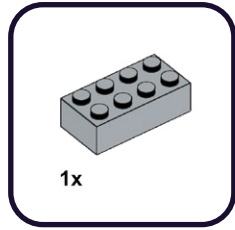

1

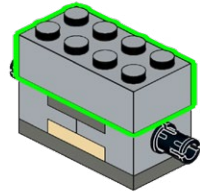

63

1

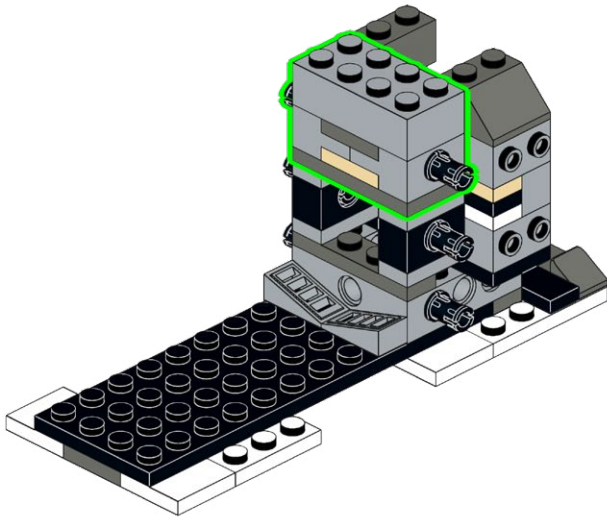

64

1

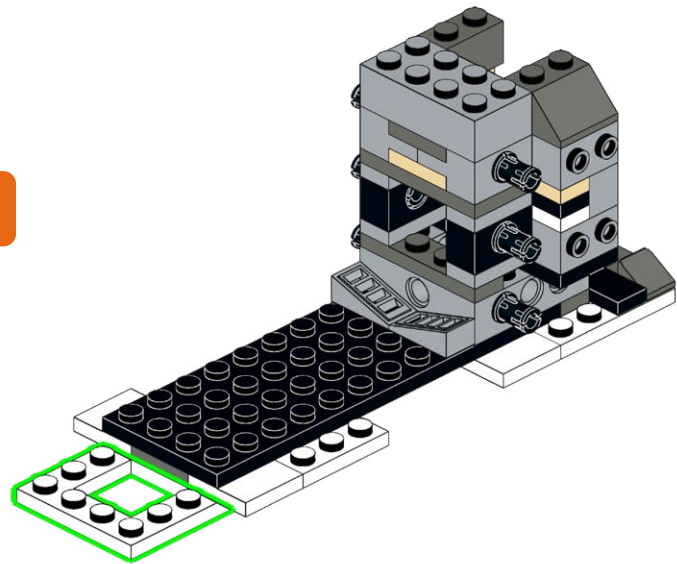
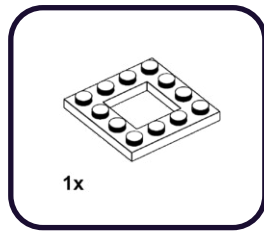

65

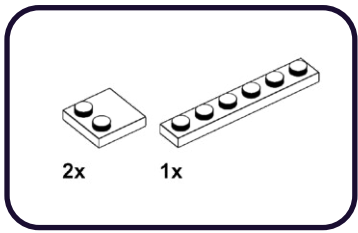

1

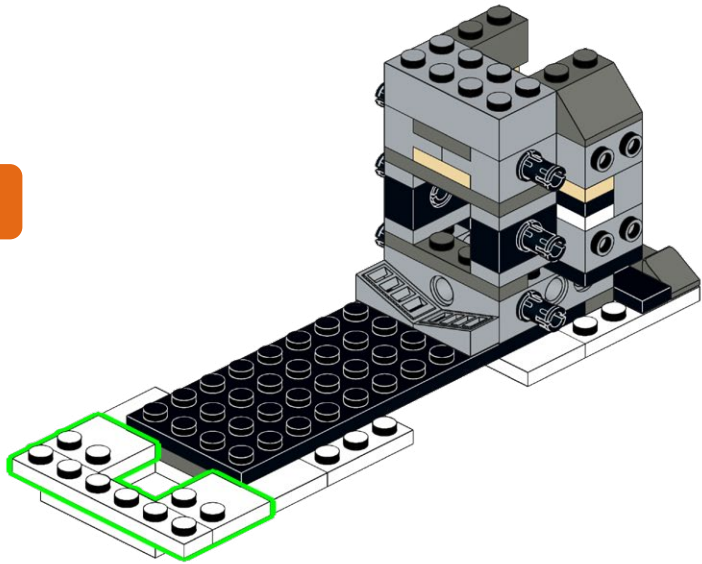

66

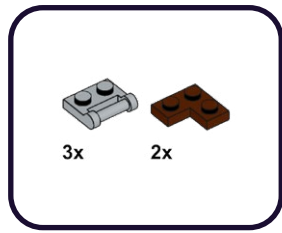

1

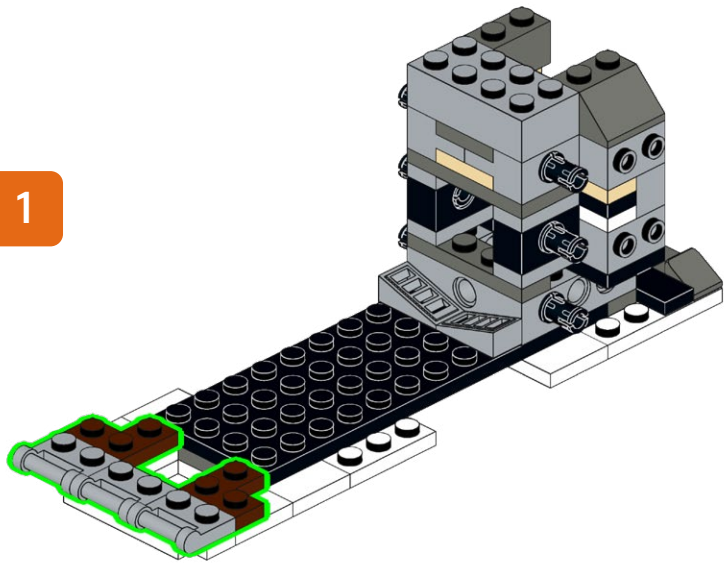

67

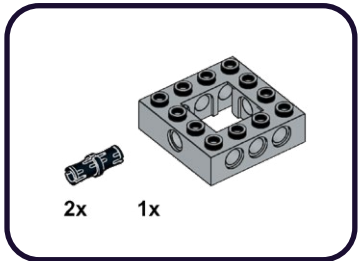

1

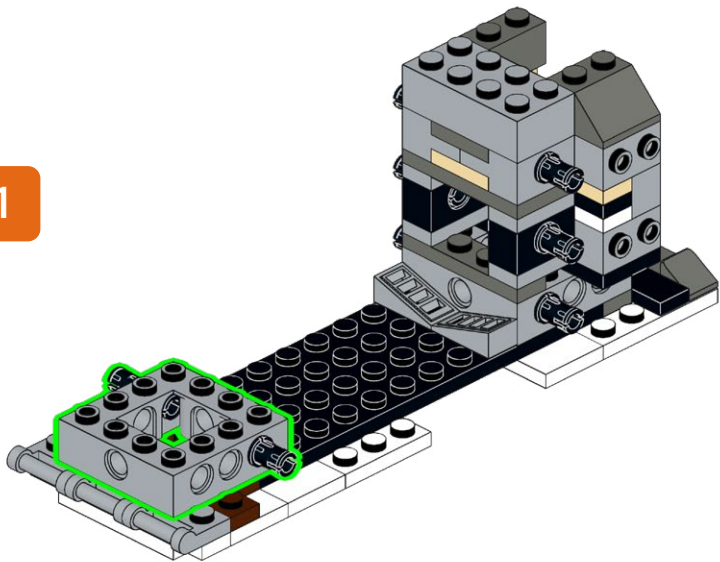

68

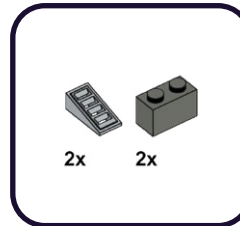

1

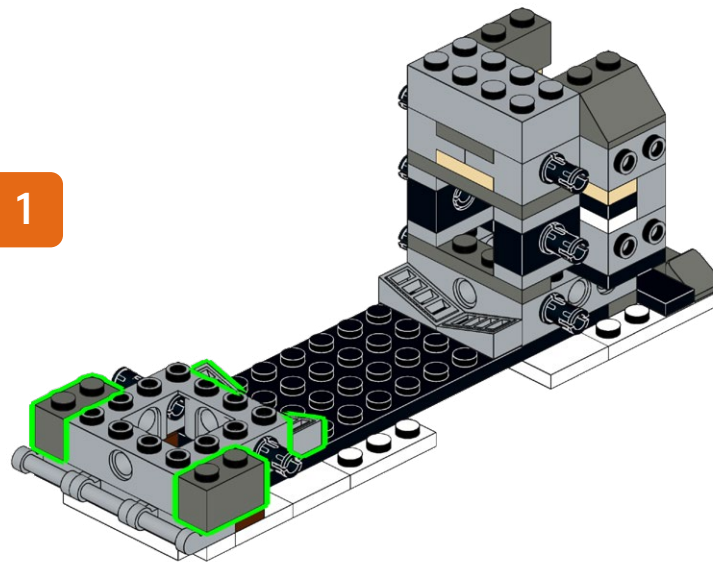

69

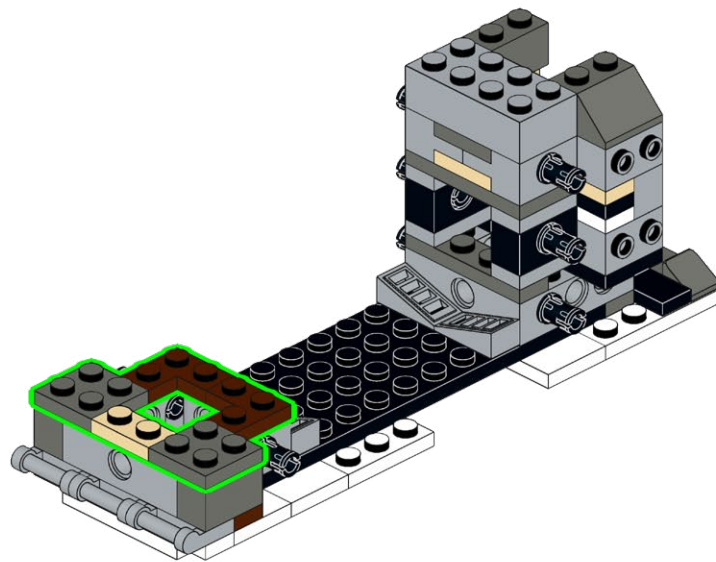
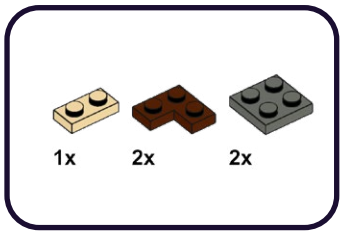

70

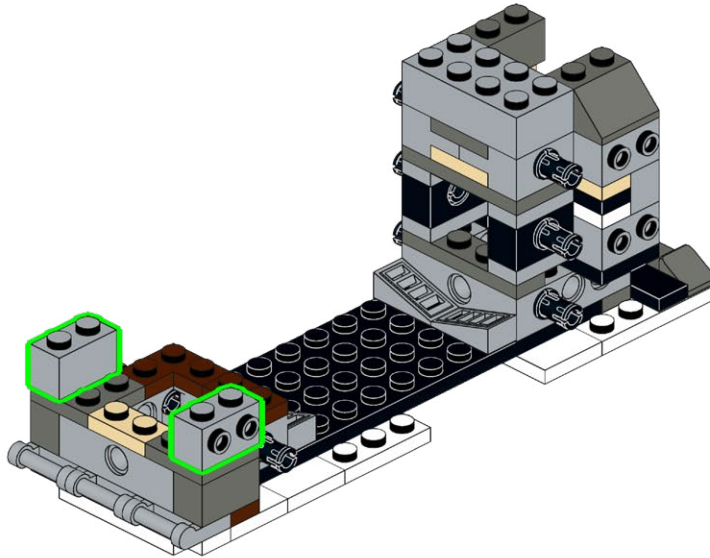
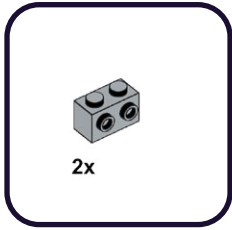

71

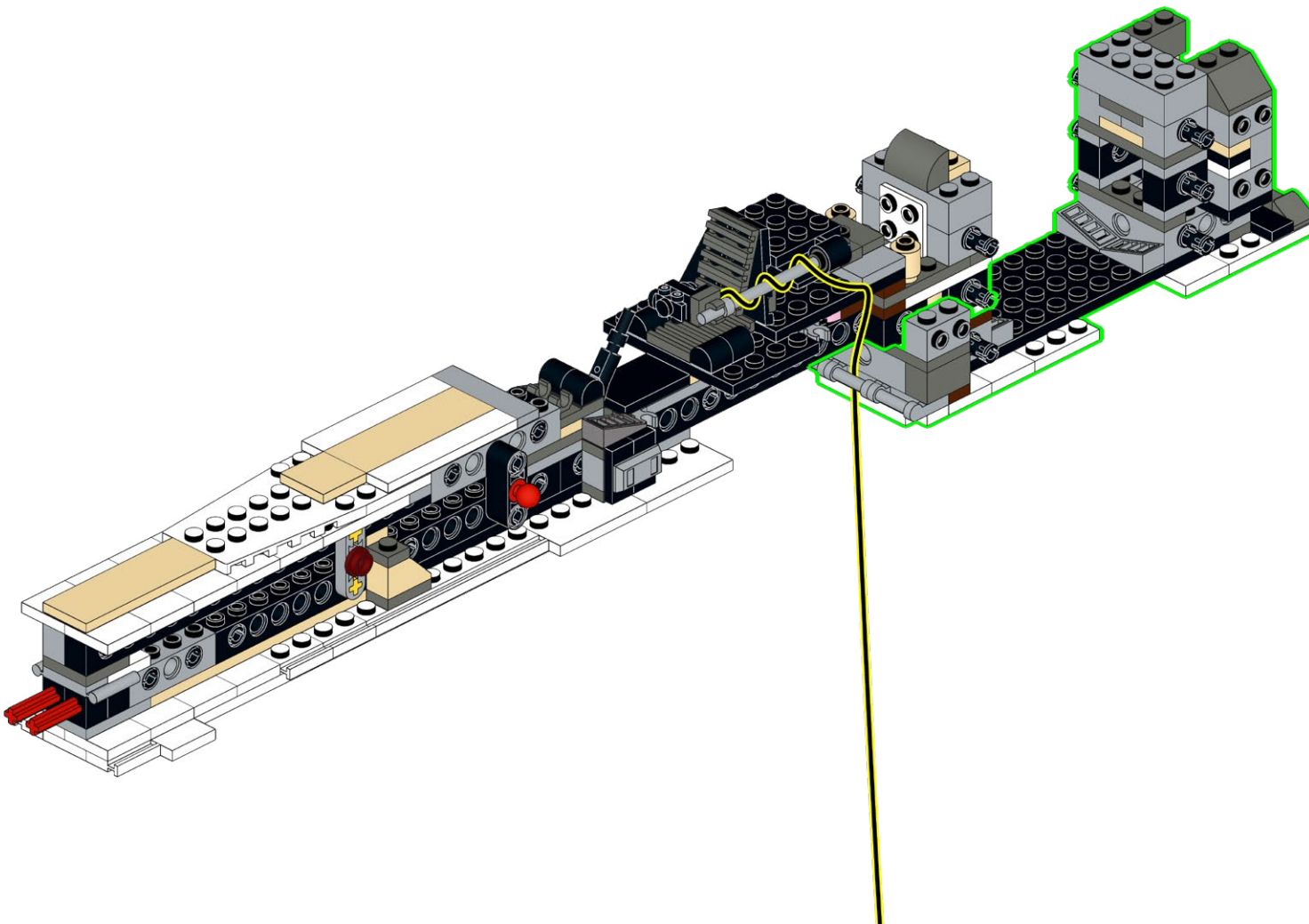

72

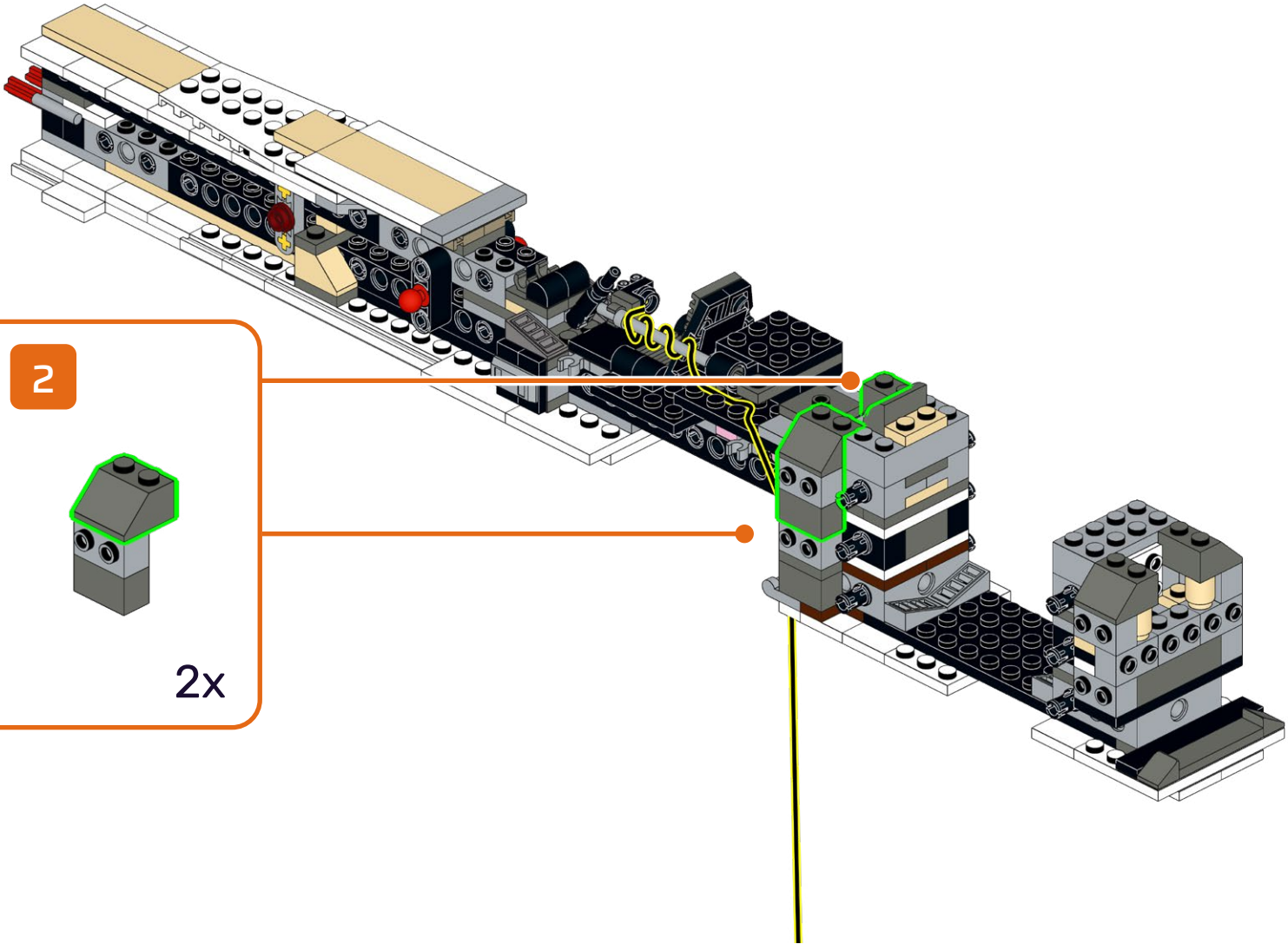
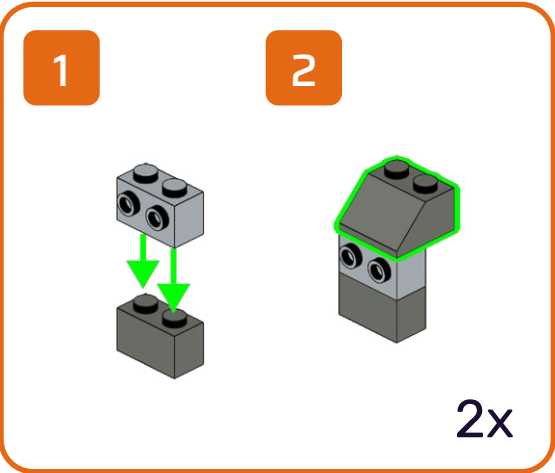
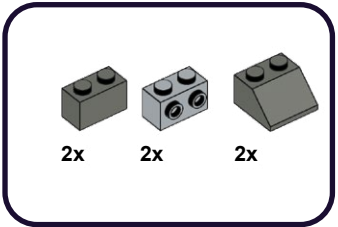

73

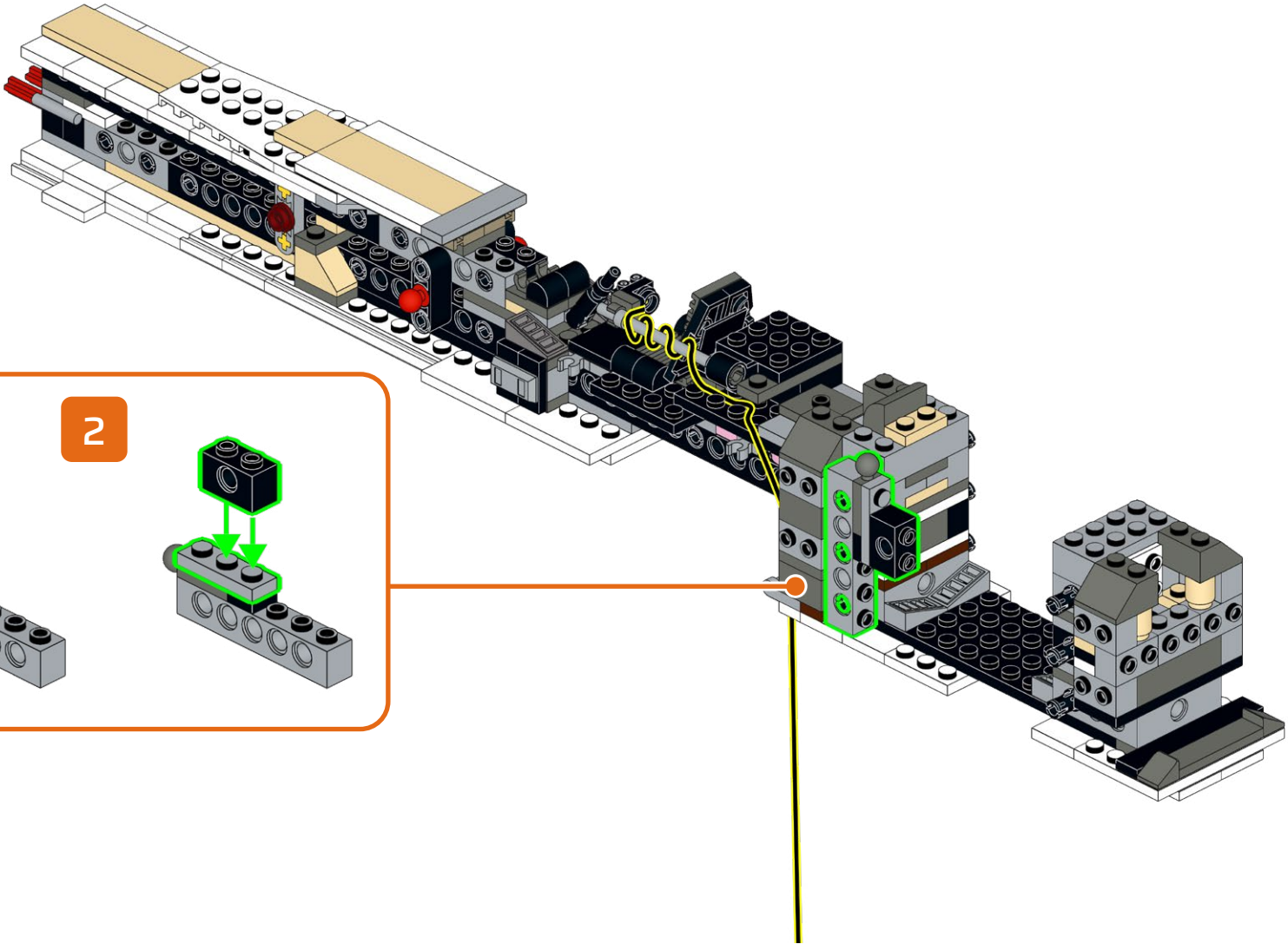
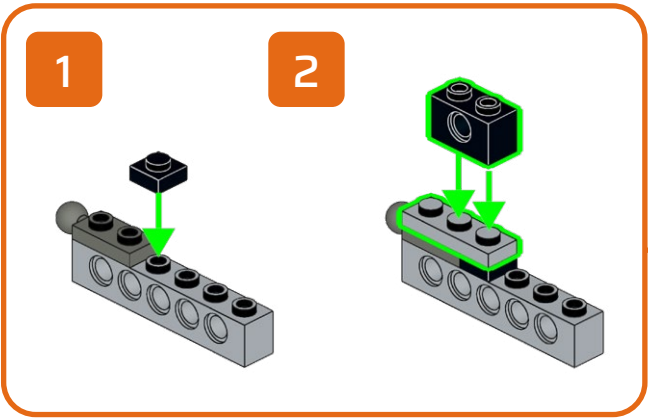
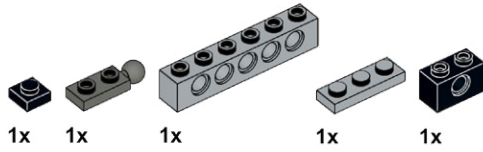

74

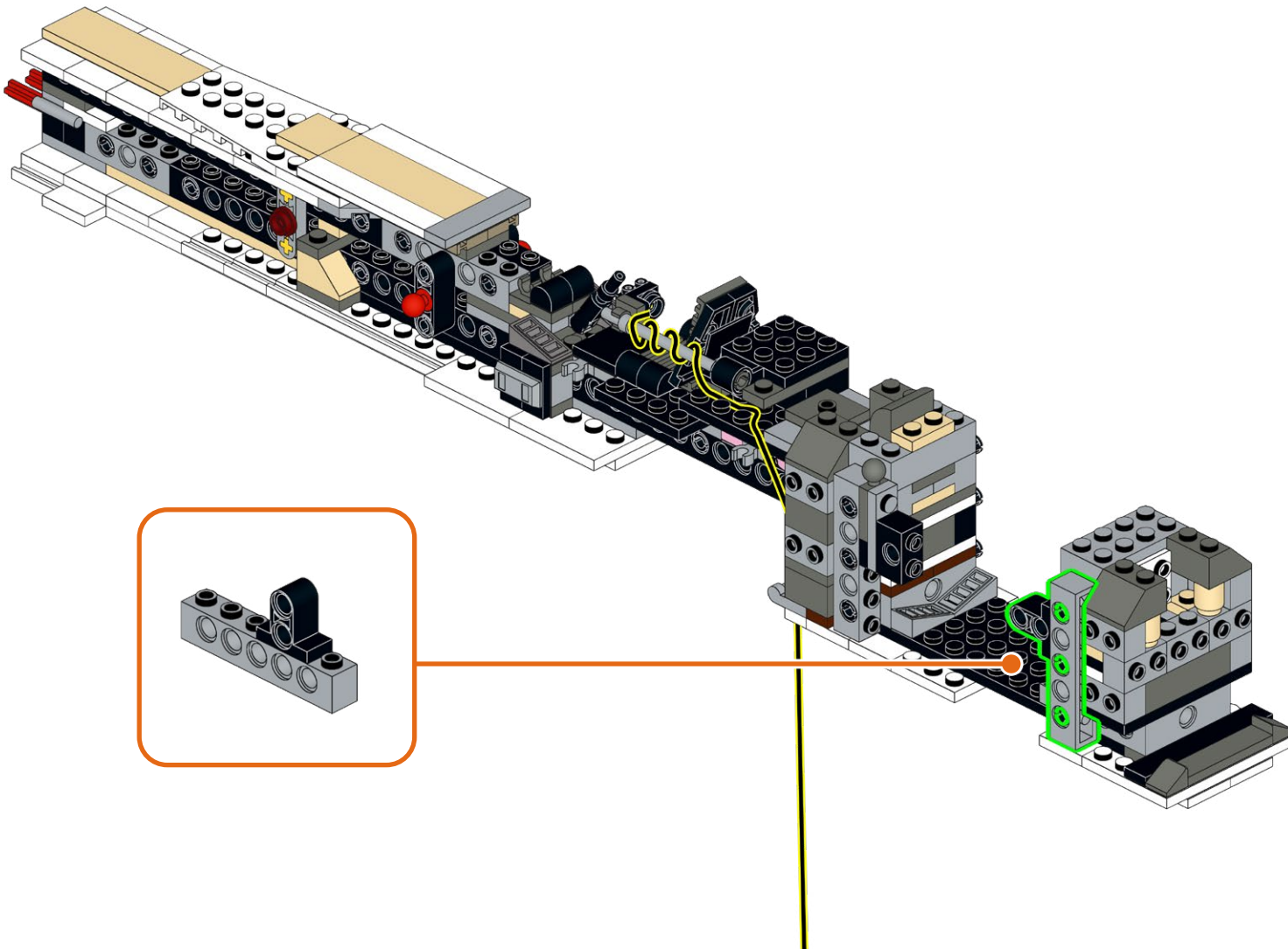
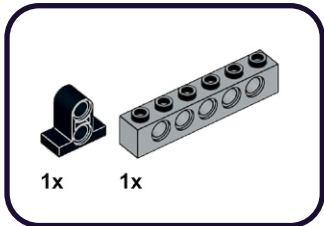

75

4x

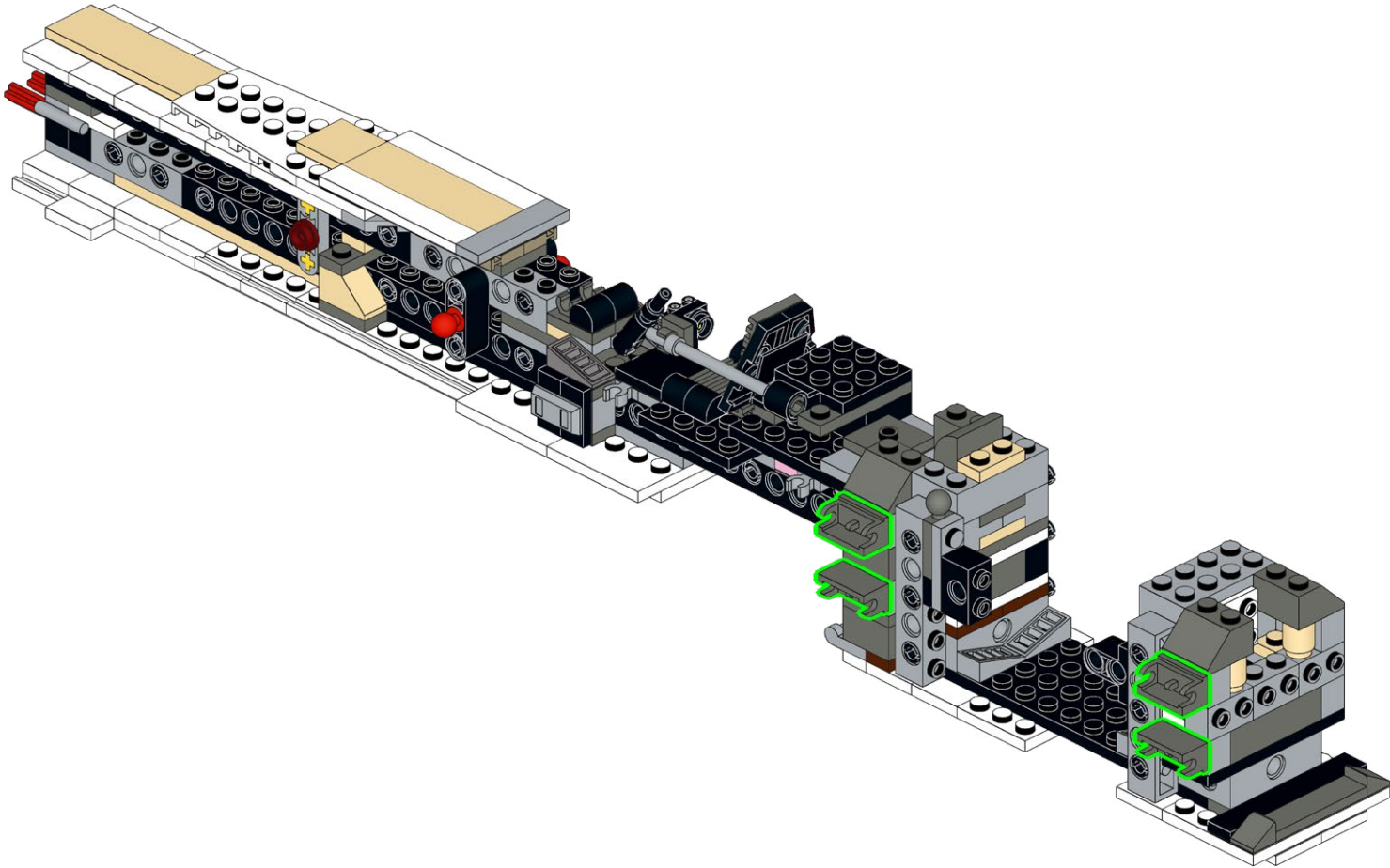

76

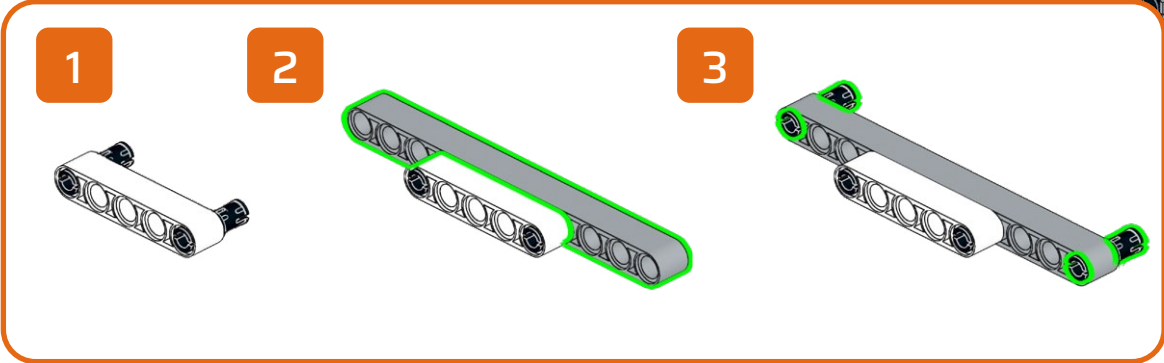
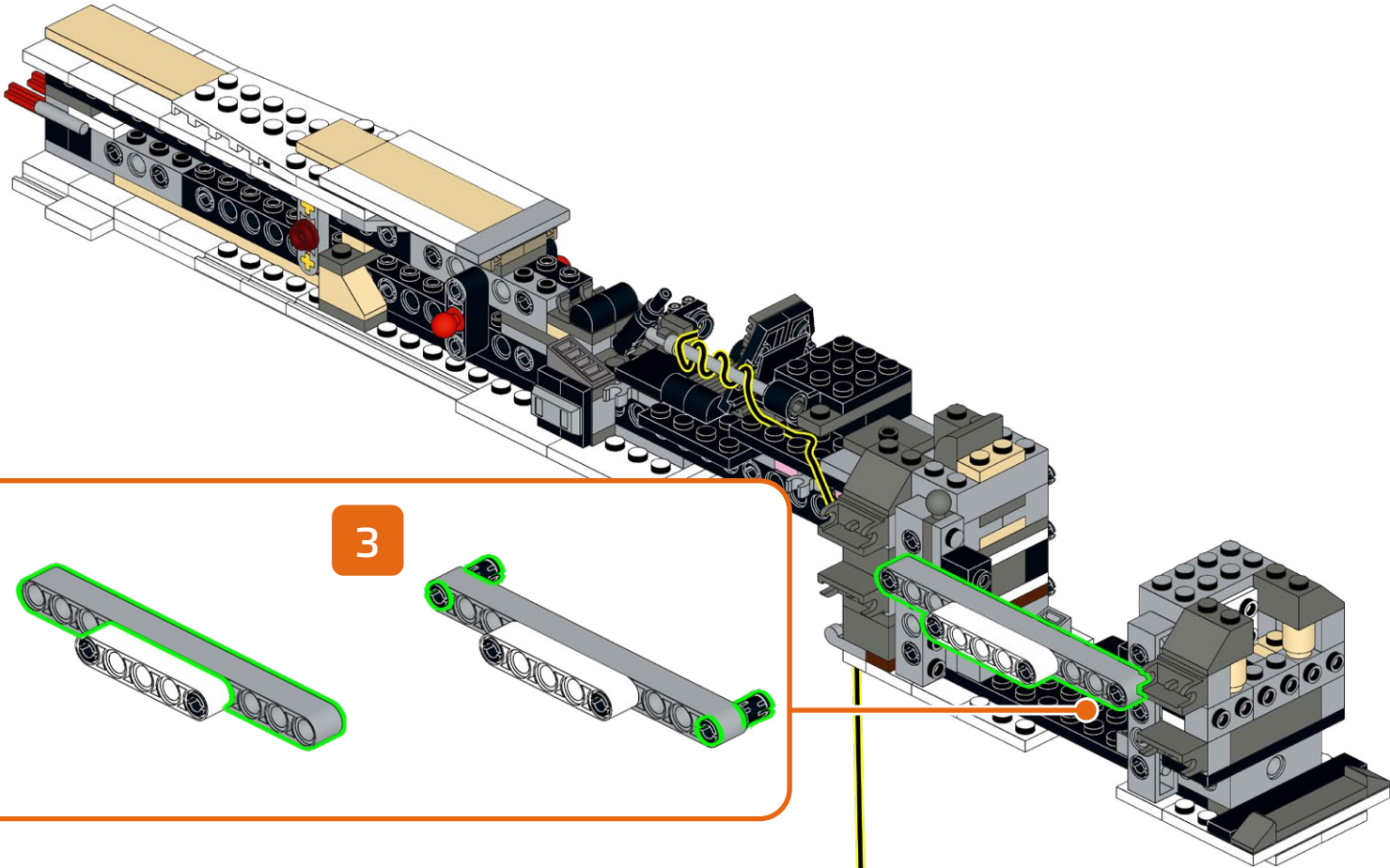
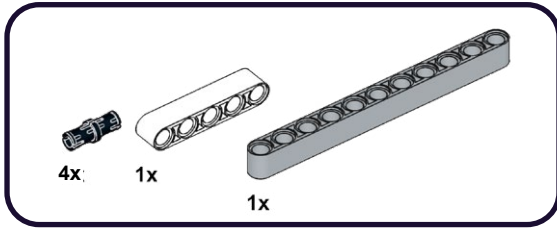

77

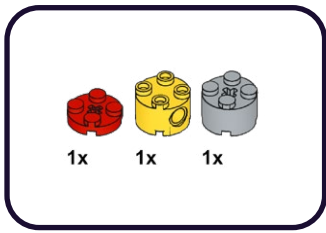

1

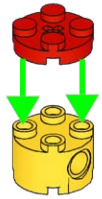

2



78

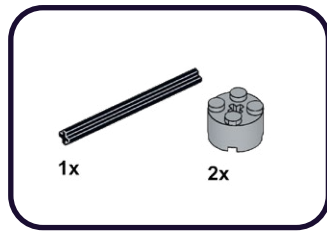

1

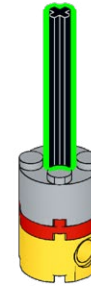

2

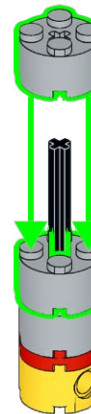

79

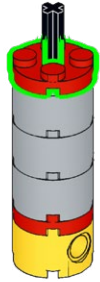
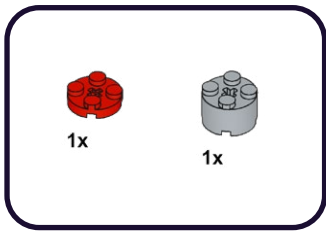

80

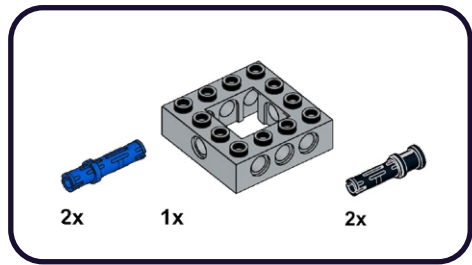

1

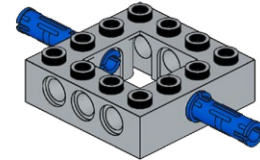

2

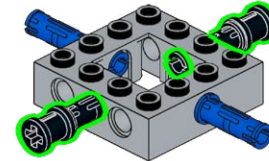

81

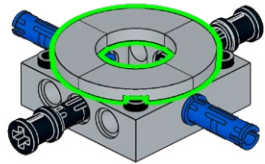
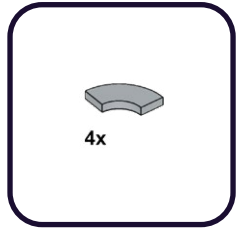

82

1

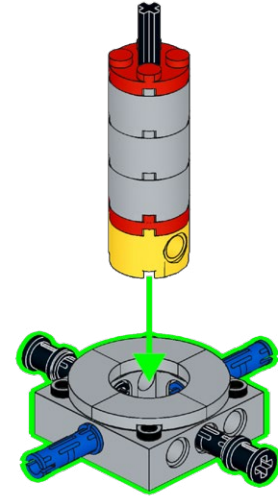

2

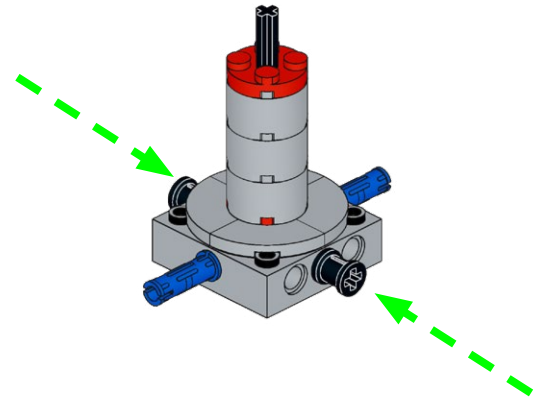

83

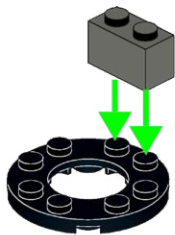
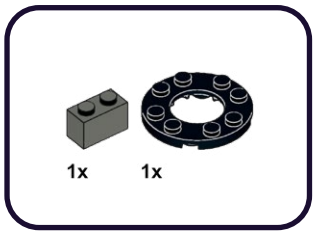

84

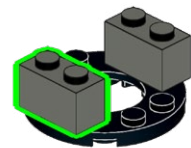
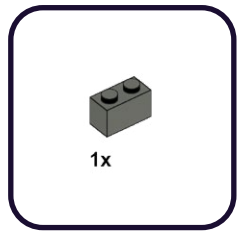

85

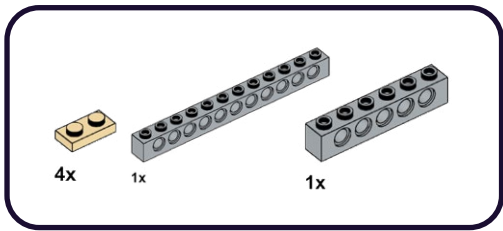

1

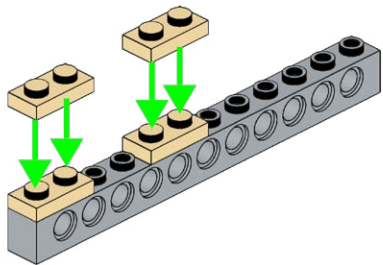

2

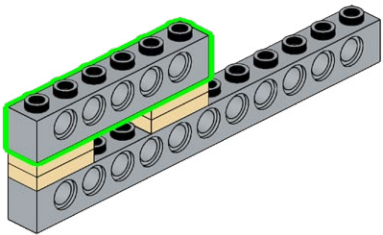

86

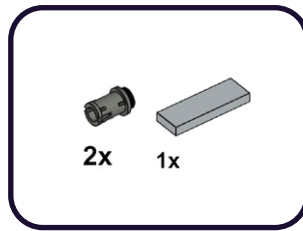

1

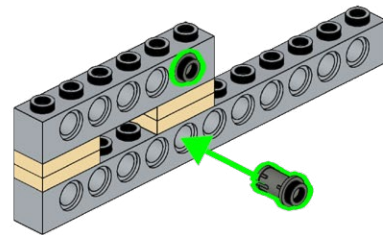

2

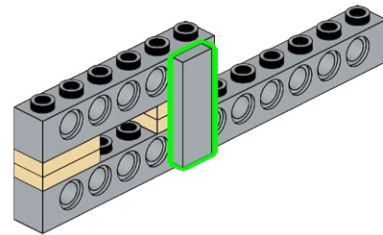

2x

87

4x



1

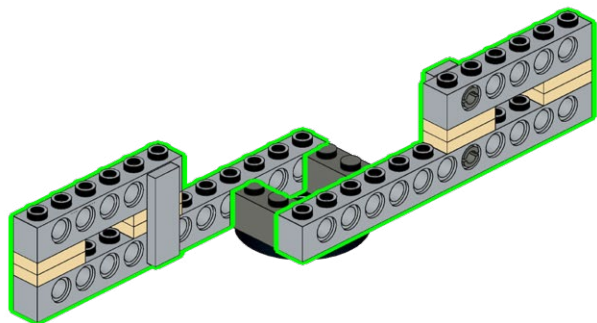

2

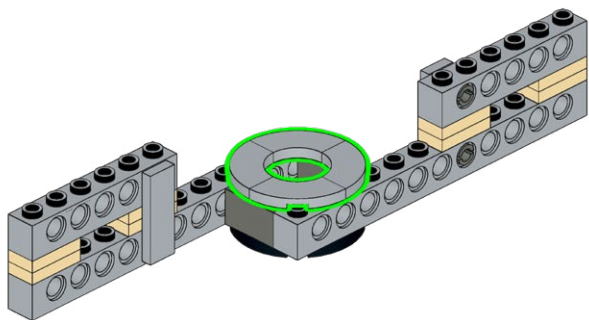

88

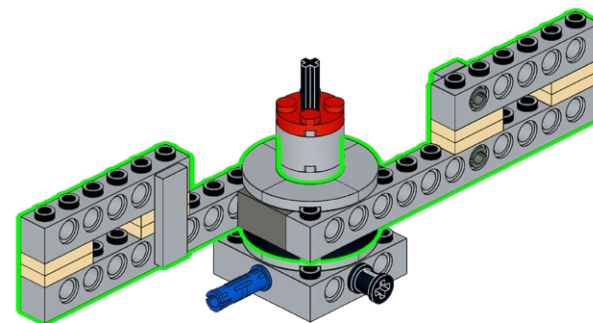

89

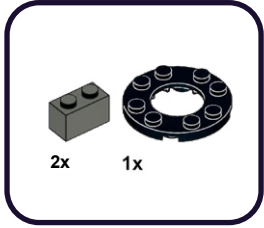

1

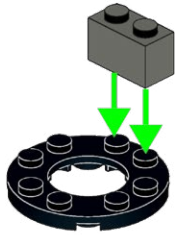

2

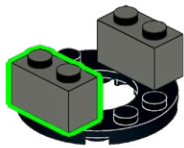

90

1

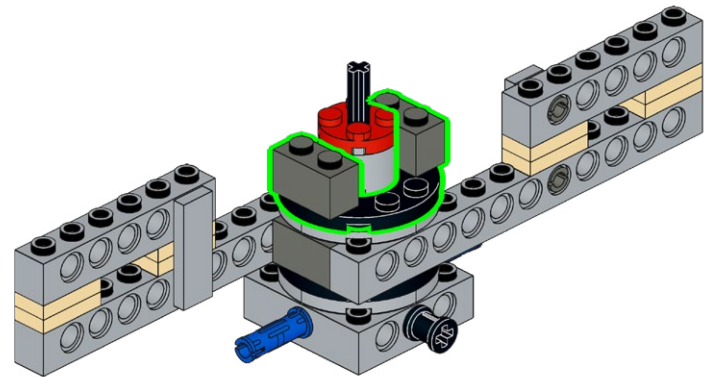

91

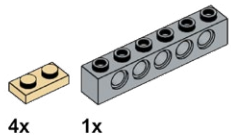

1

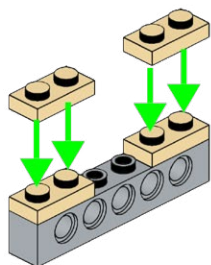

2

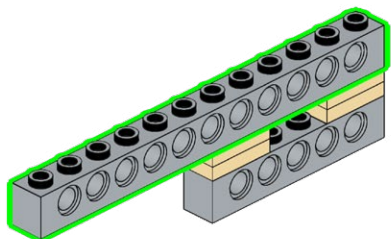

92

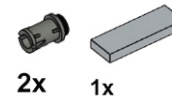

1

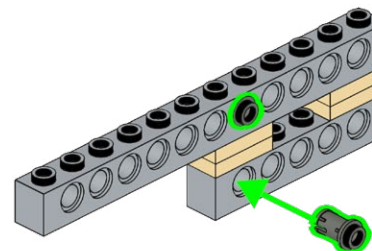

2

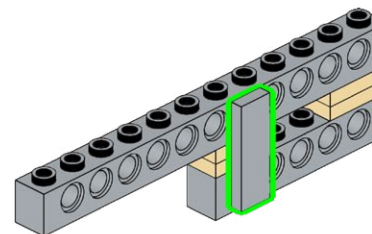

2x

93

94

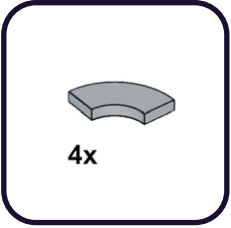

1

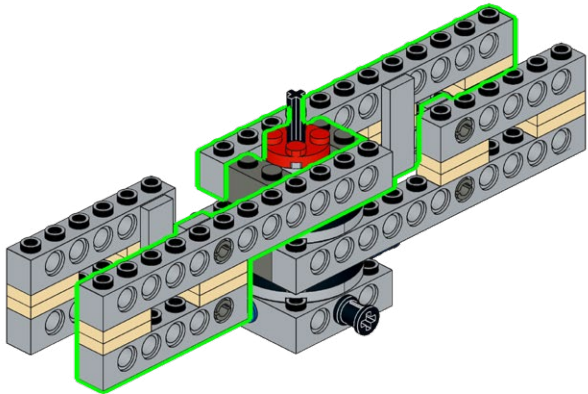

1

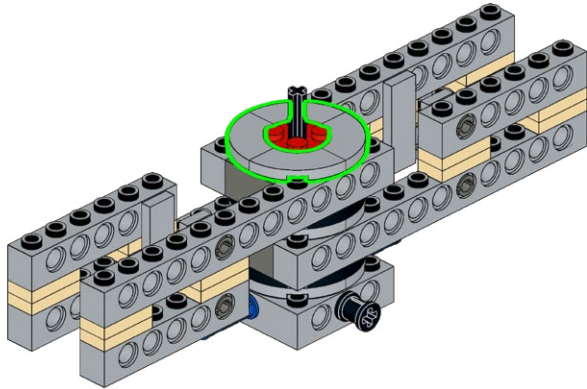

95

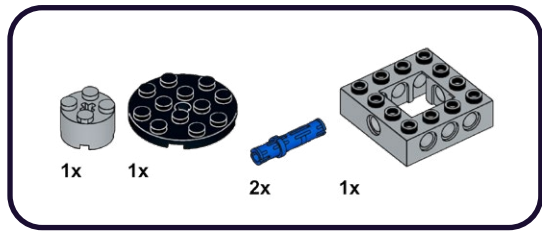

1

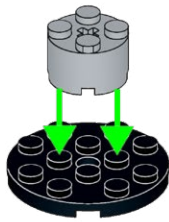

2

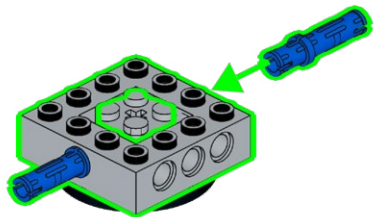

96

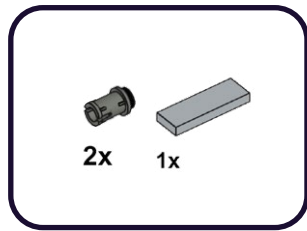

1

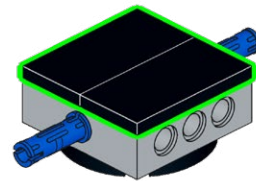

2

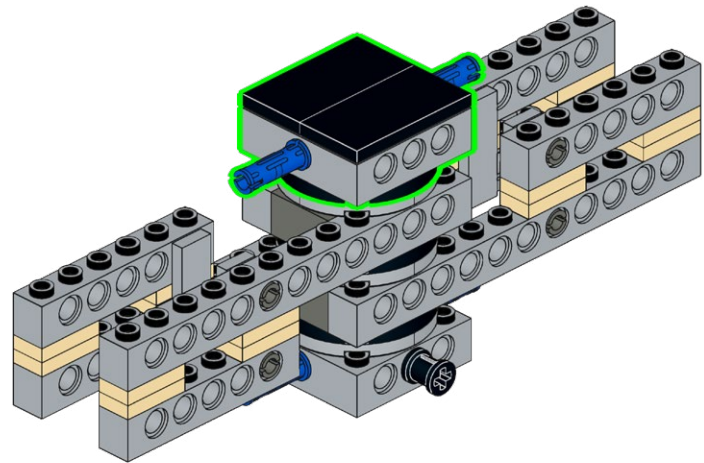

97

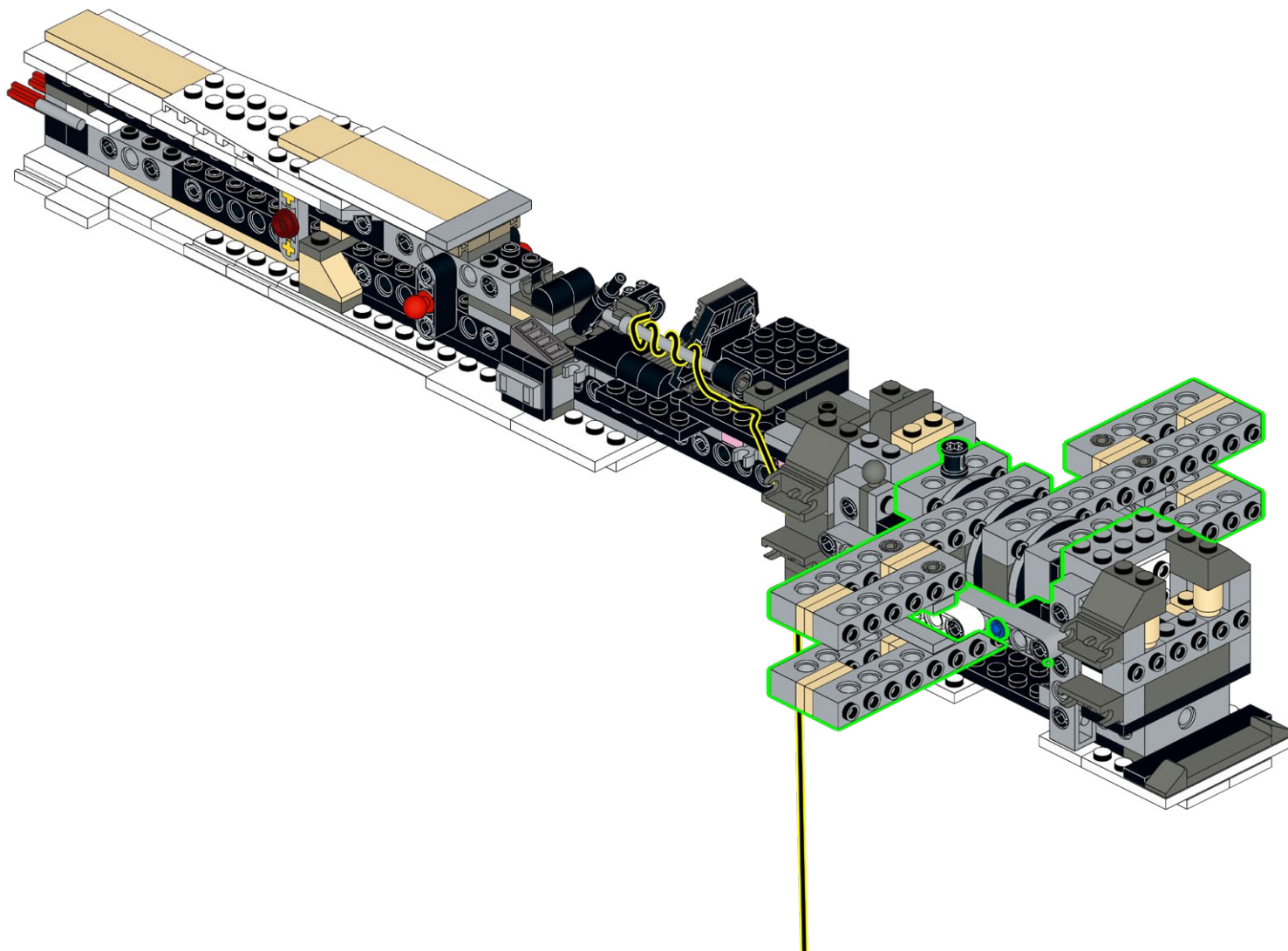

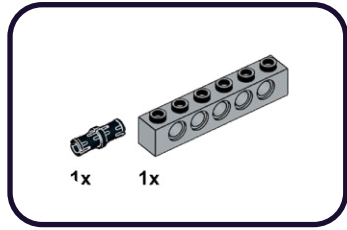

1

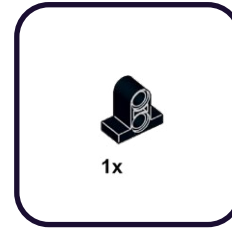
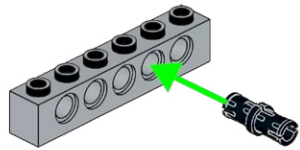

1

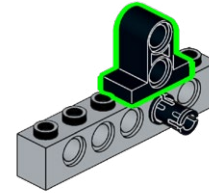

100

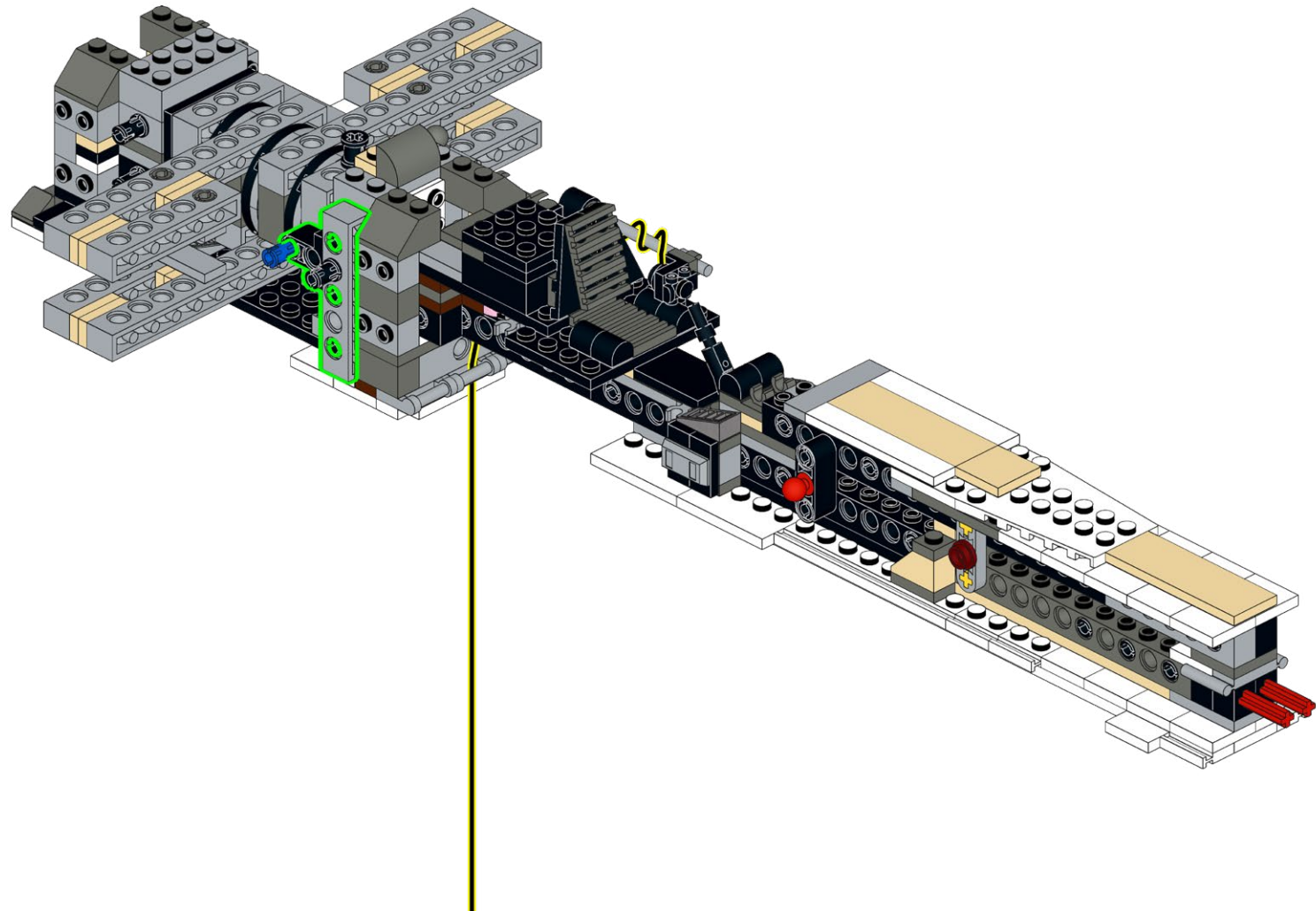

101

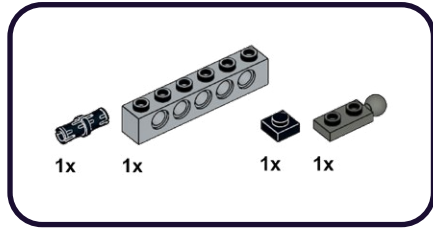

1

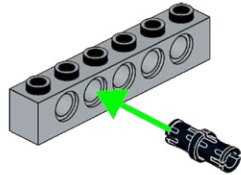

2

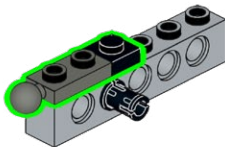

102

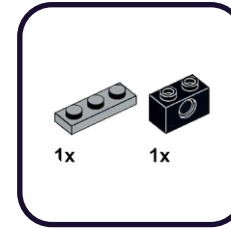

1

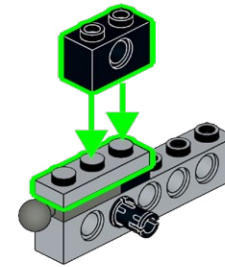

103

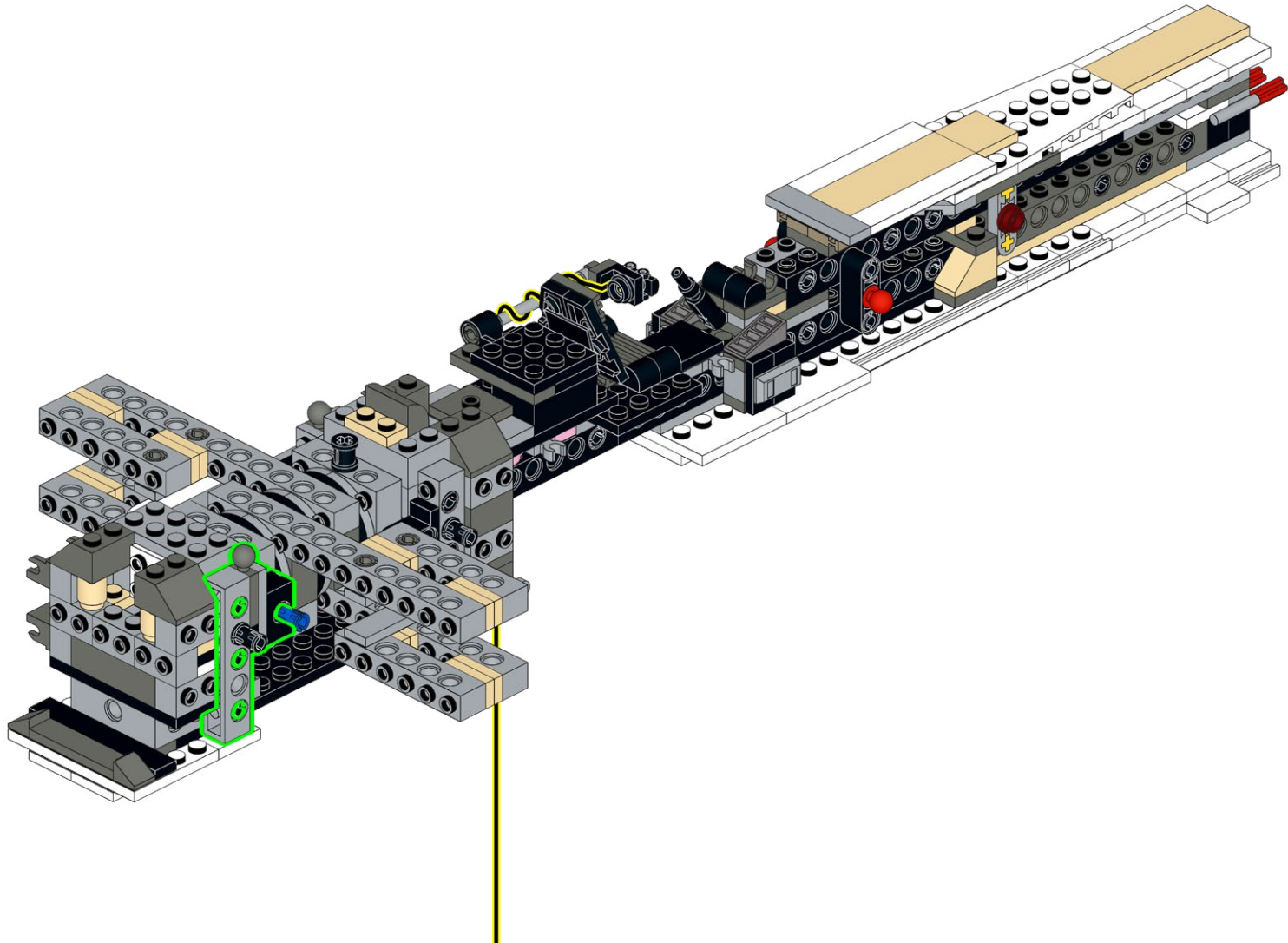

104

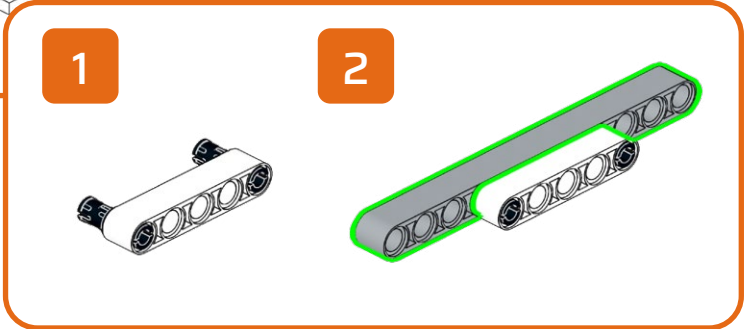
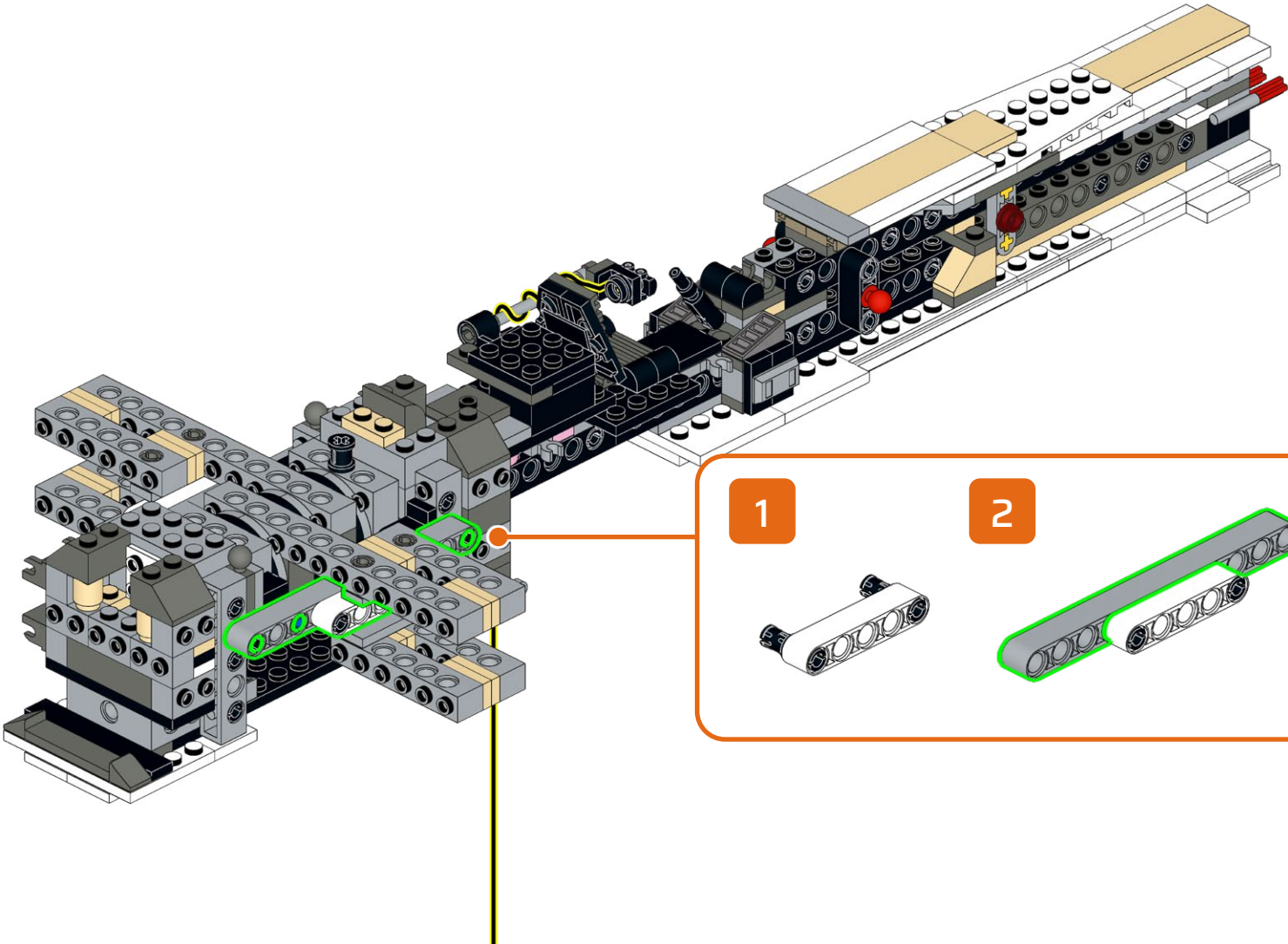
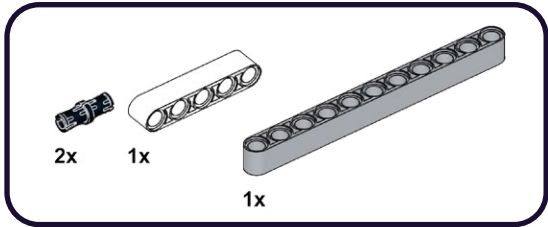

105



4x

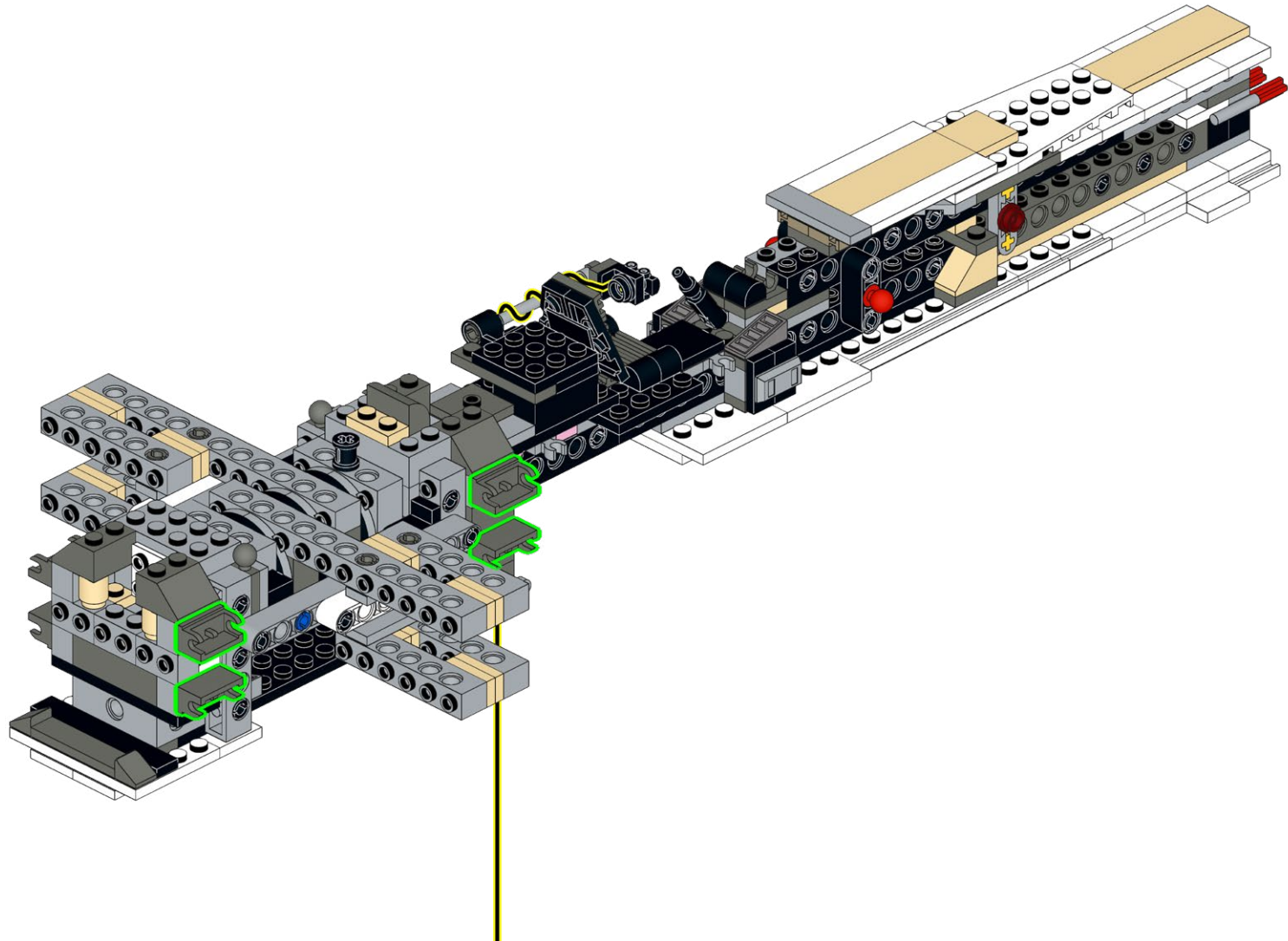

106

2x

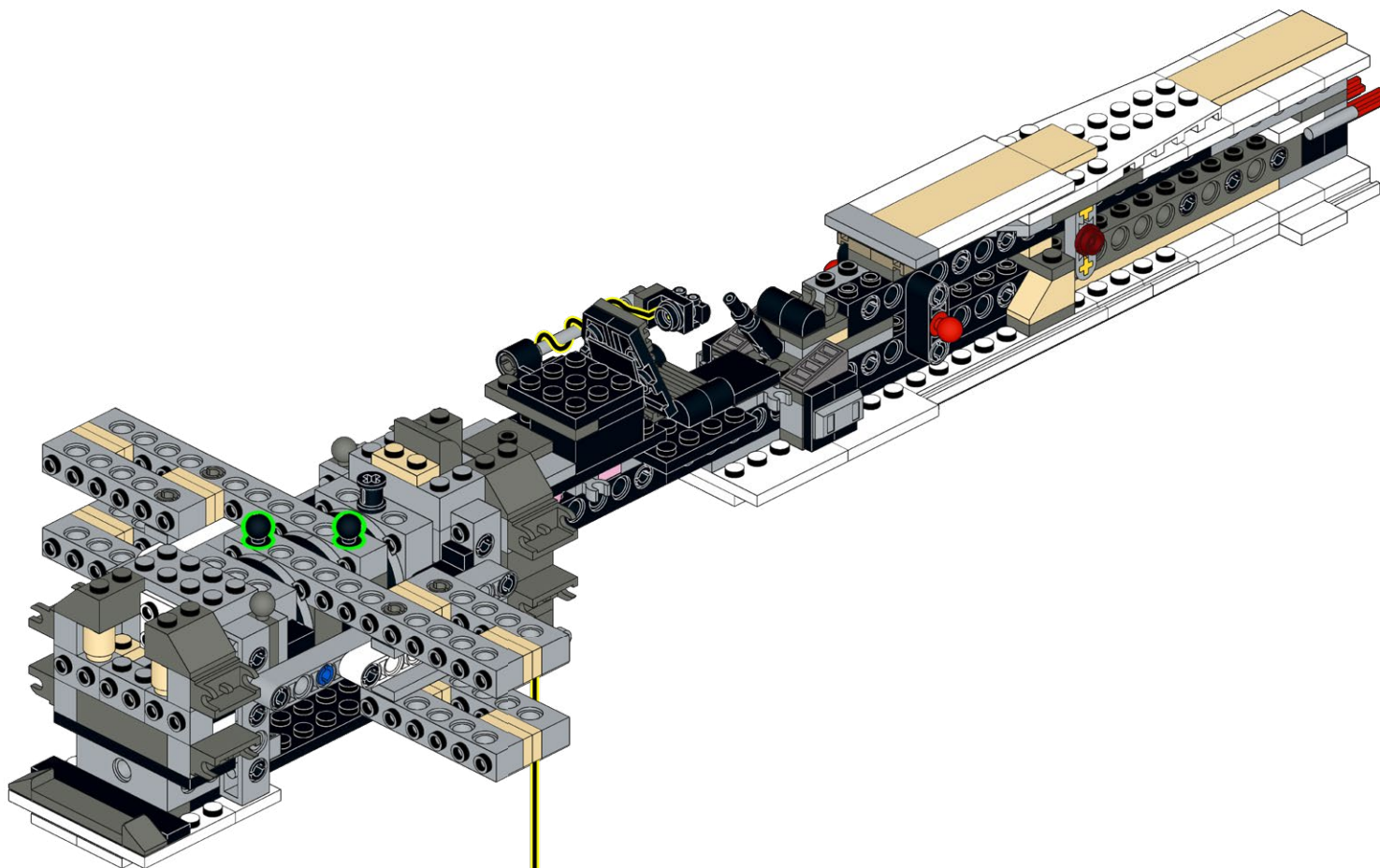

107

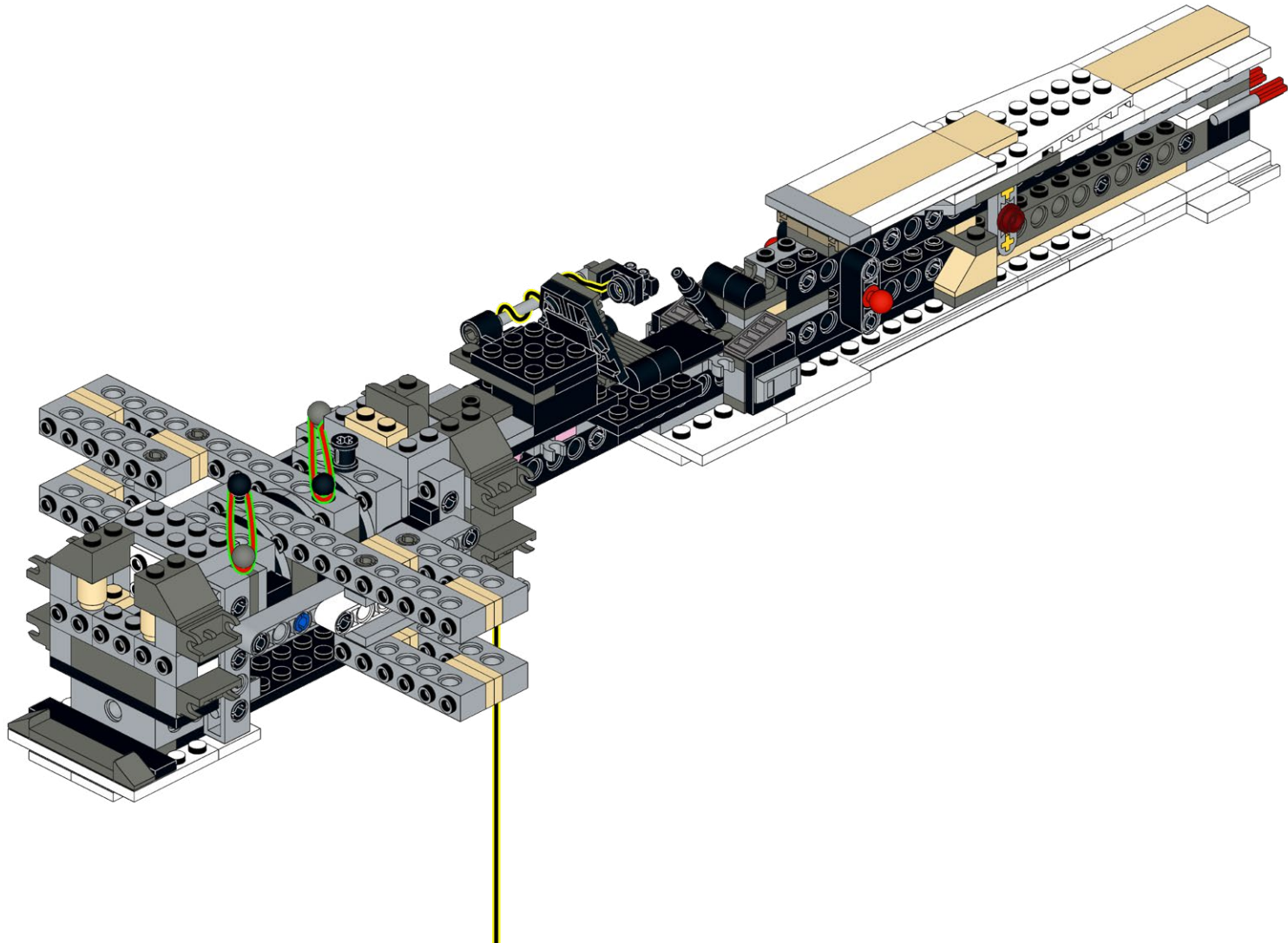

108

4x

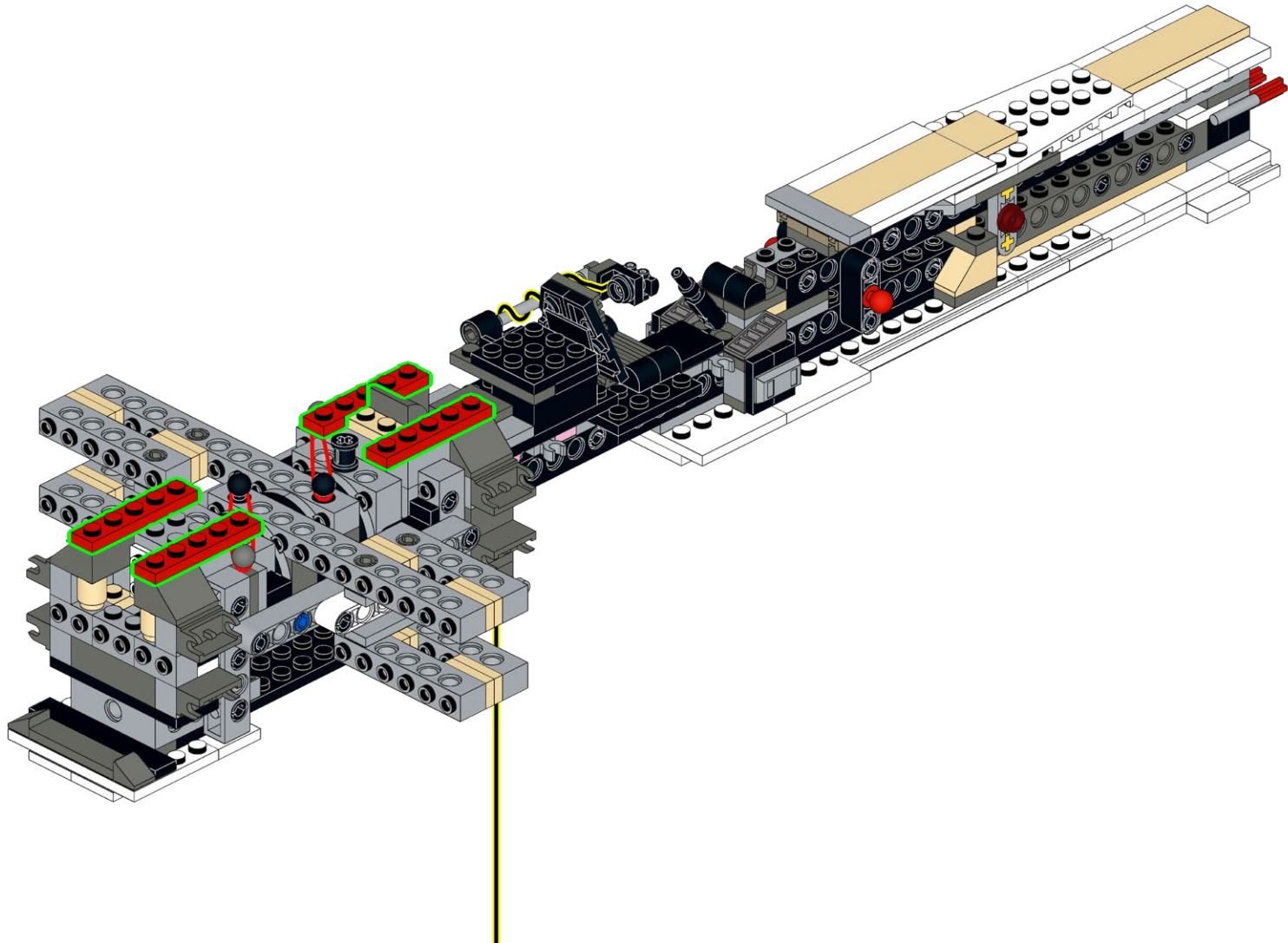

109



1x



1x

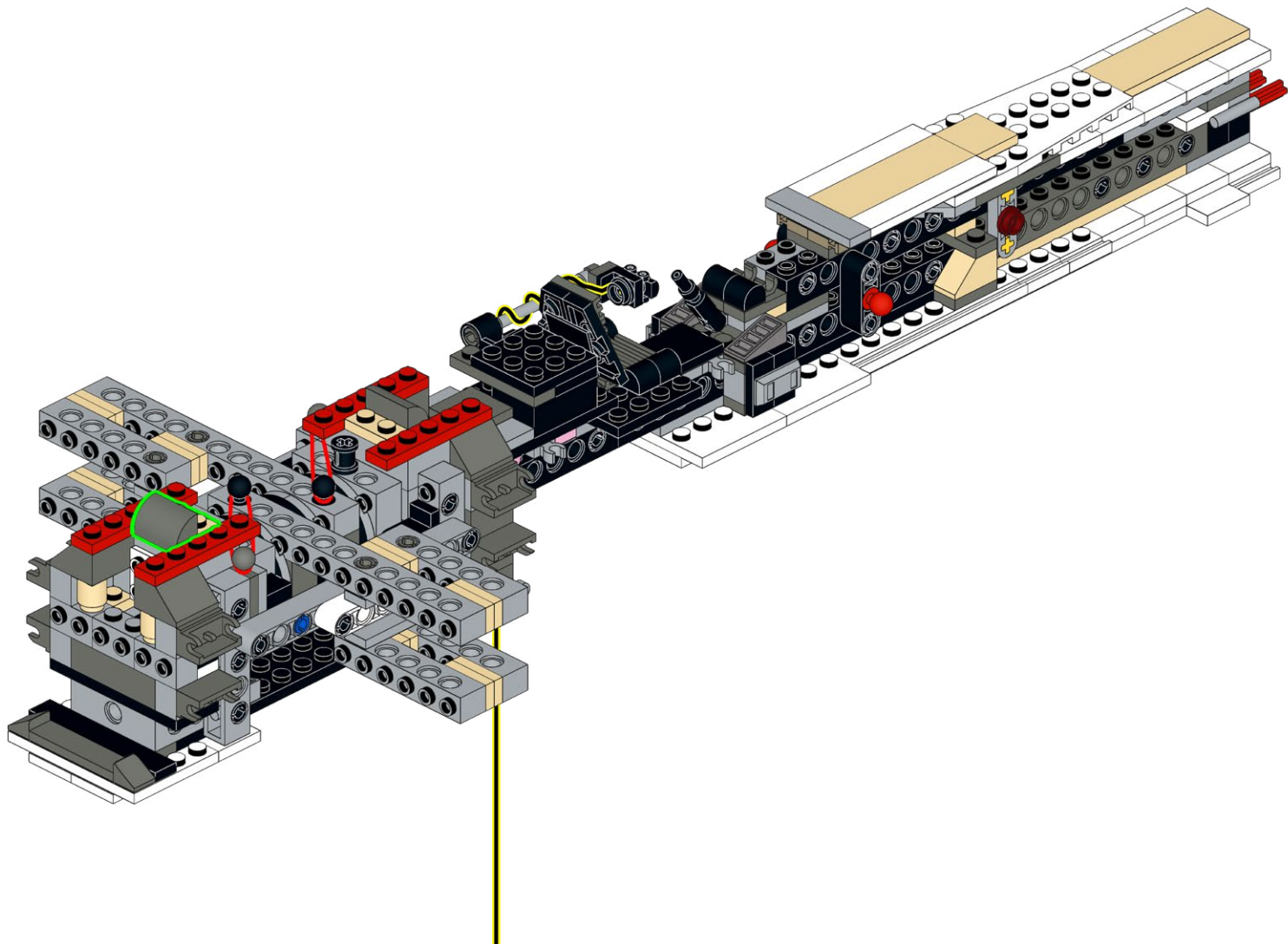

110

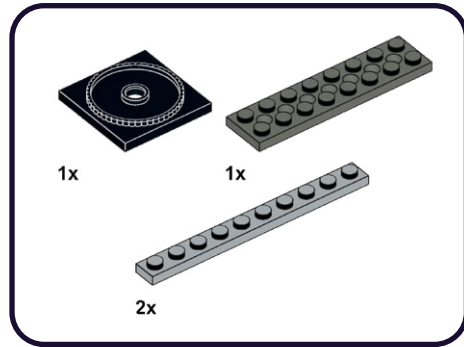

1



2



111

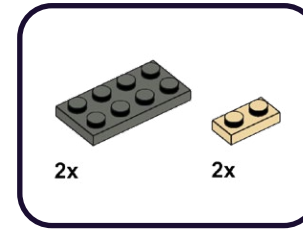

1

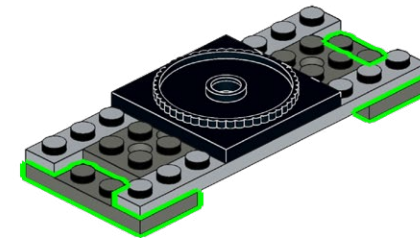

2



2x

112

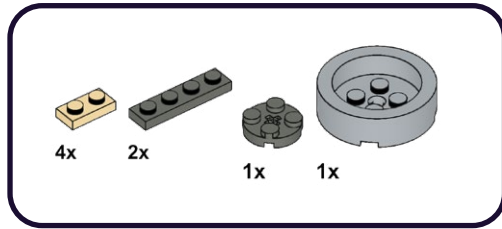

1

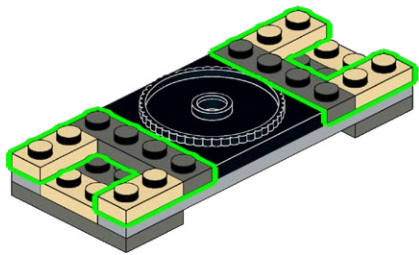

2

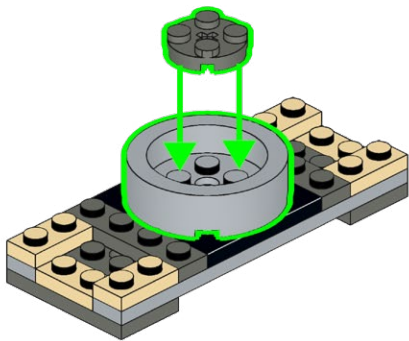

113

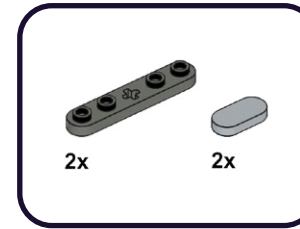

1

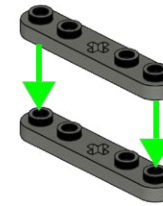

2

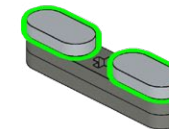

114

1x

1

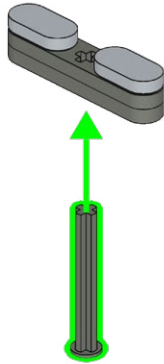

2

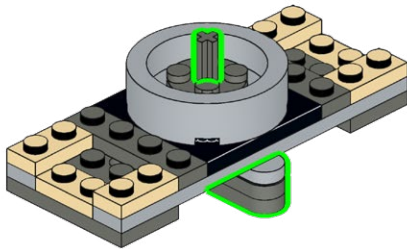

115

1x

1

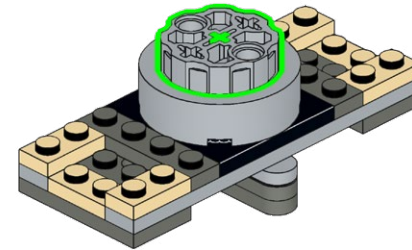

116

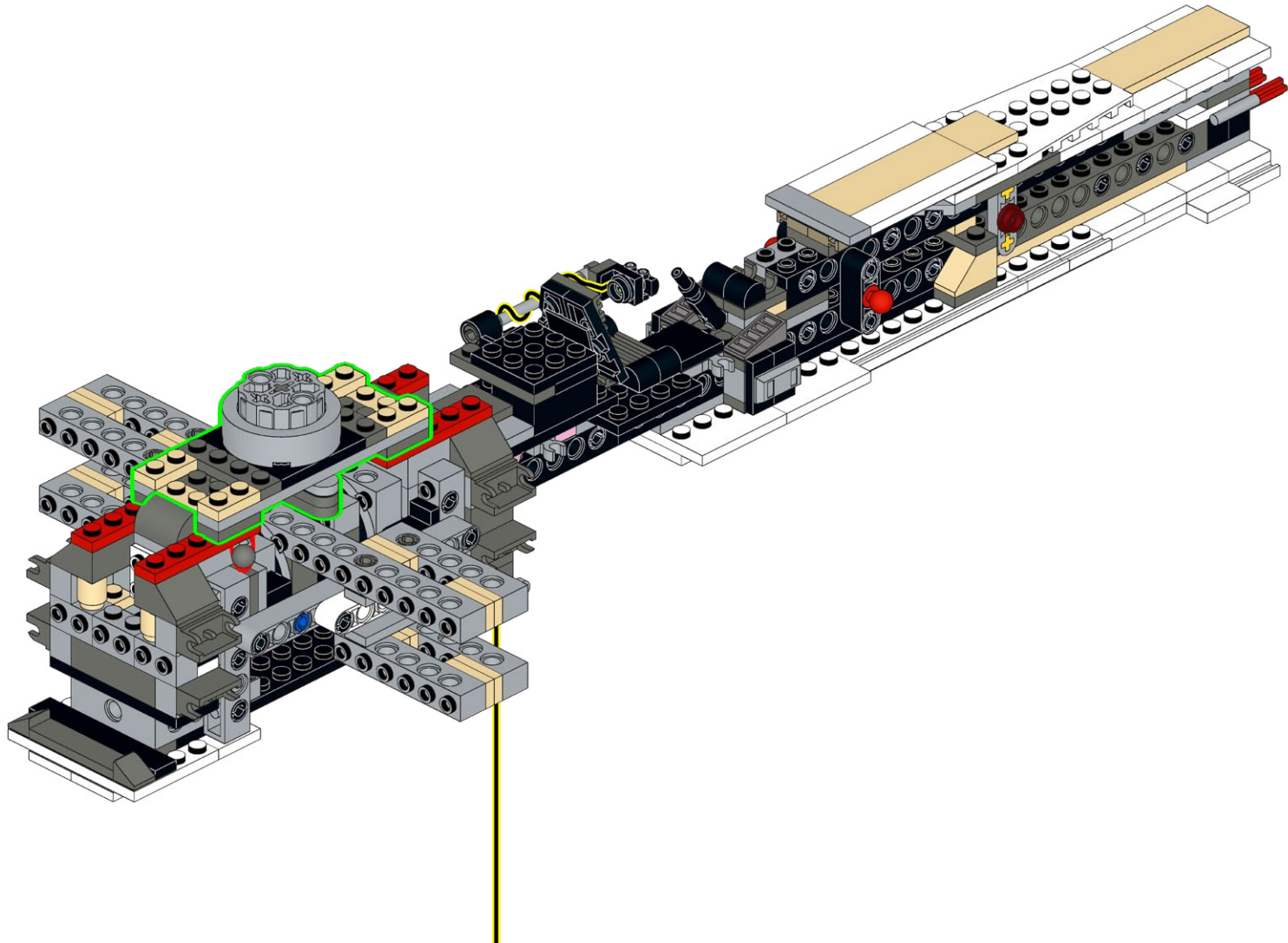

117

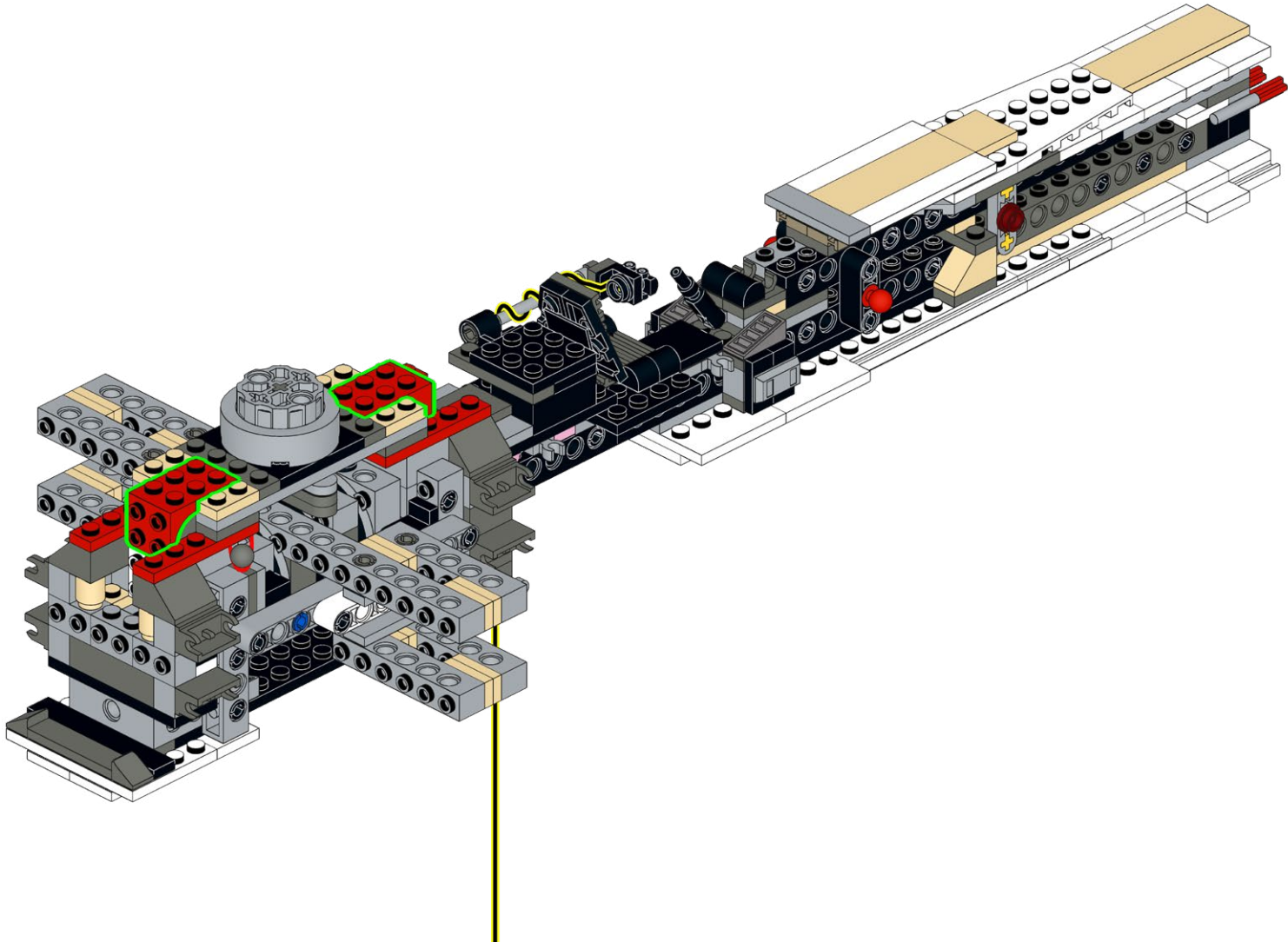
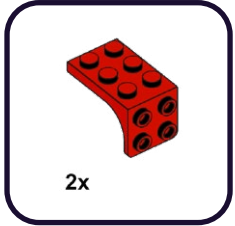

118

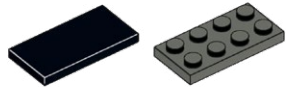

2x

2x

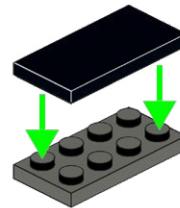
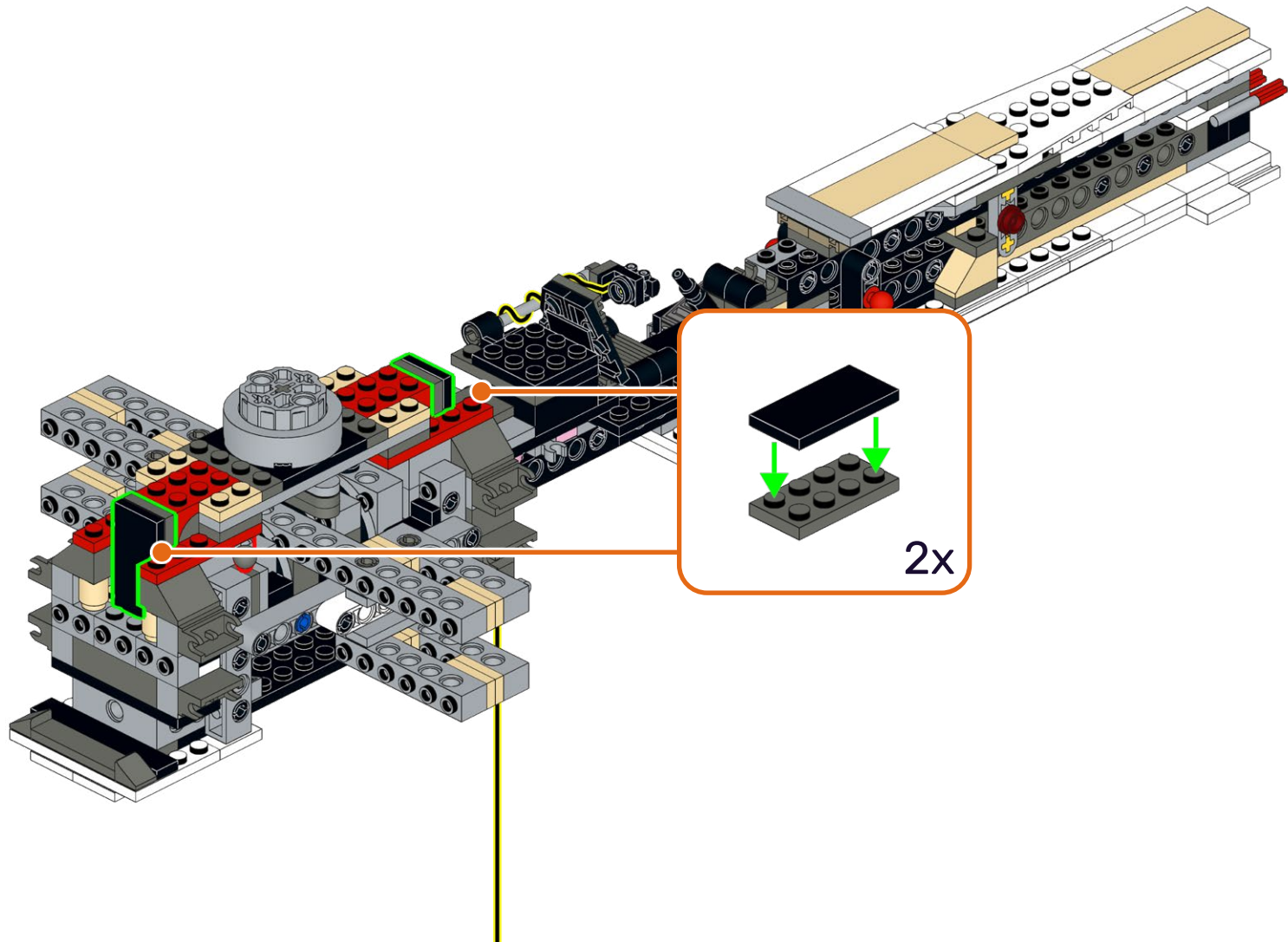

2x

119

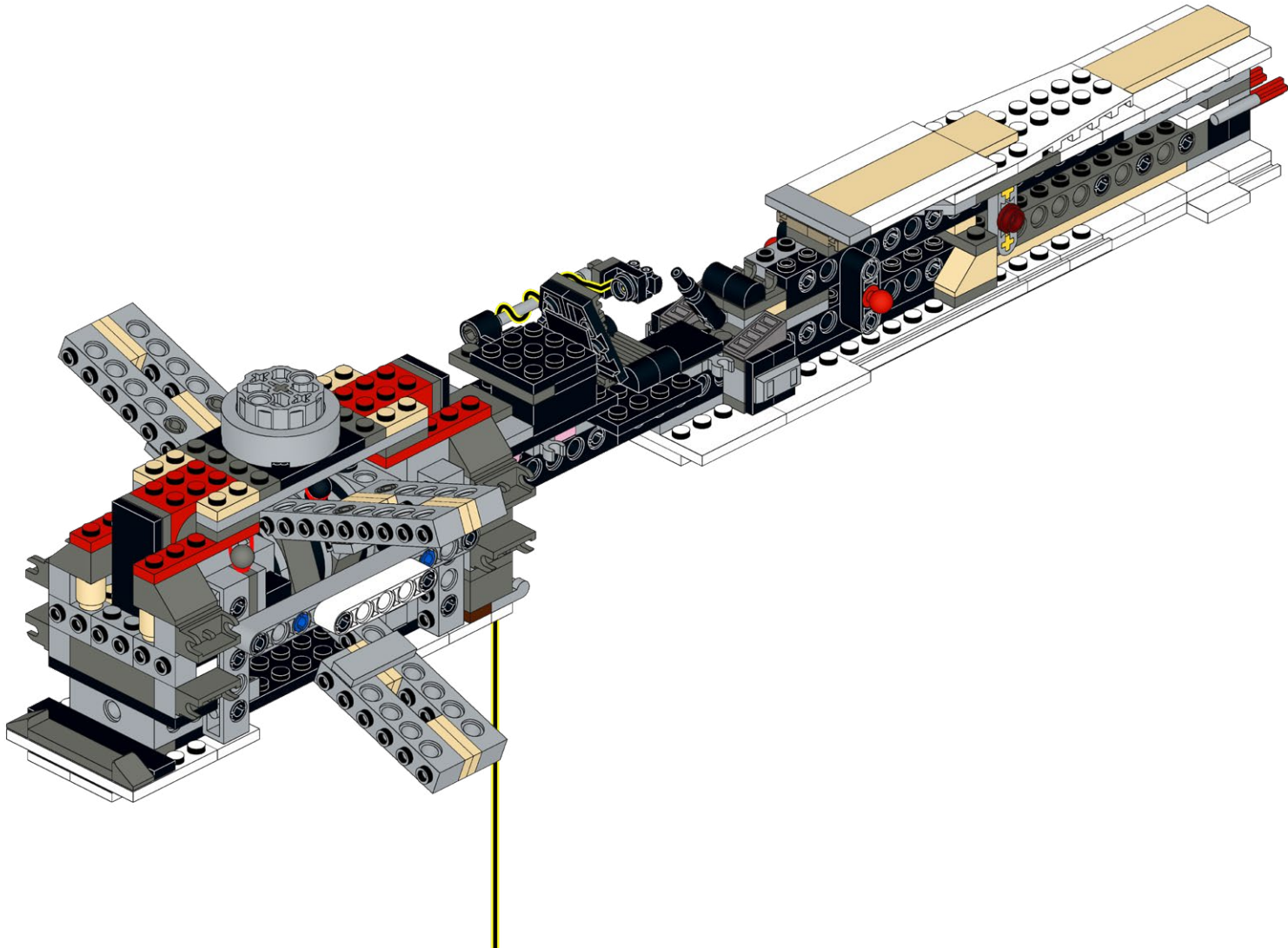

120

2x

2x

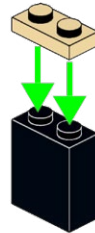

2x

121

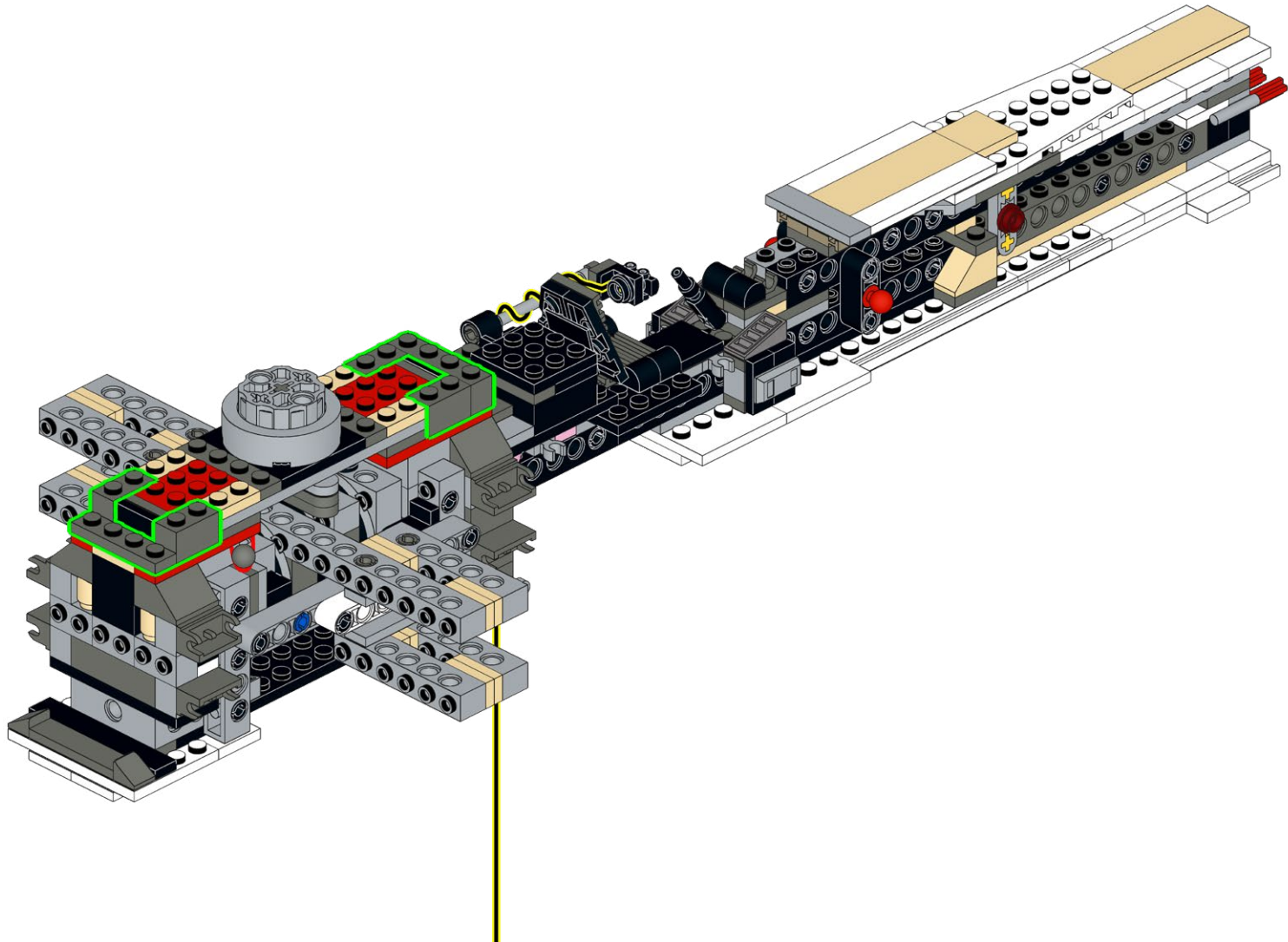
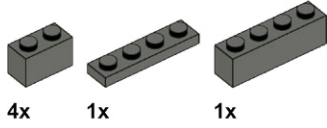

**HOLD UP!**

You might notice some bags aren't in order, as well as left over pieces, but that's ok! We're changing the way you build LEGO!

ATTENDEZ!

Vous remarquerez peut-être que certains sacs, ainsi que certaines pièces, ne sont pas dans le bon ordre. Mais pas de panique! Nous changeons simplement la façon avec laquelle vous construisez vos LEGO!

ASPETTA!

Potresti notare che alcuni sacchetti non sono in ordine, così come i pezzi avanzati, ma va bene così! Stiamo cambiando il modo in cui costruisci i LEGO!

HALT!

Sie werden möglicherweise bemerken, dass einige tüten durcheinander sind und teile übrig bleiben, aber das ist in Ordnung! Wir ändern die art und weise, wie Sie LEGO bauen!

¡ESPERA!

Es posible que notes que algunas bolsas están fuera de servicio, así como piezas sobrantes, ¡pero está bien! ¡Estamos cambiando la forma en que construyes LEGO!

暫停!

你可能会注意到一些袋子顺序错乱, 以及一些剩余的部件, 但没关系! 我们正在改变你搭建乐高的方式!

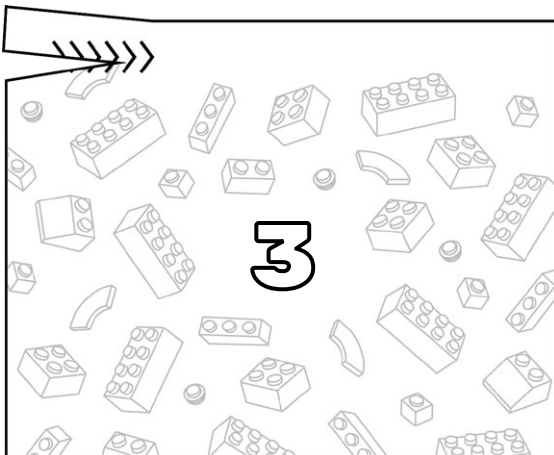
Open LEGO® Bag 3

122

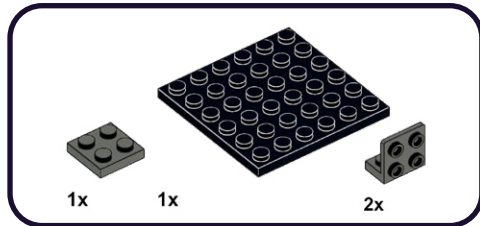

1

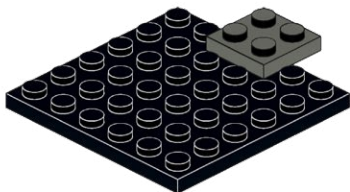

2

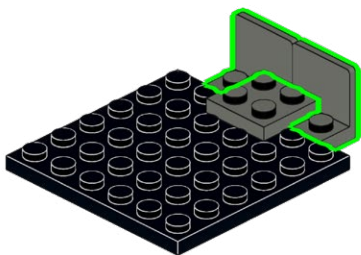

123

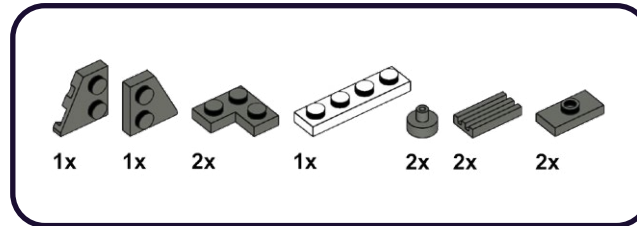

1

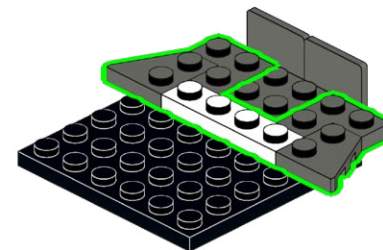

2

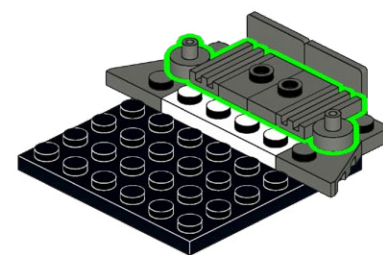

124

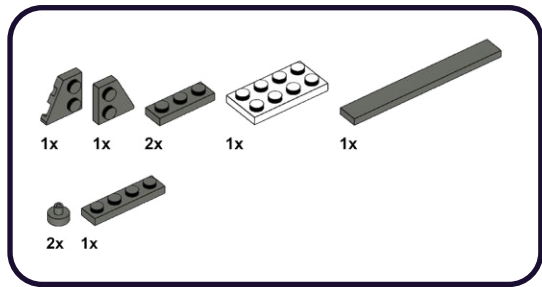

1

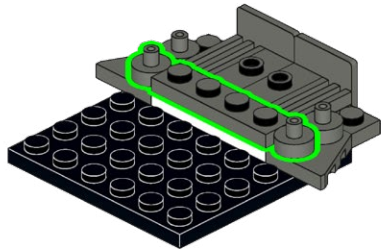

2

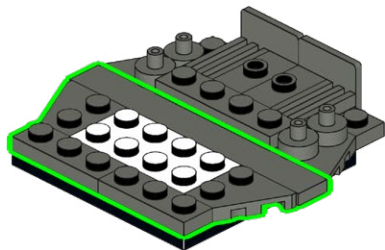

125

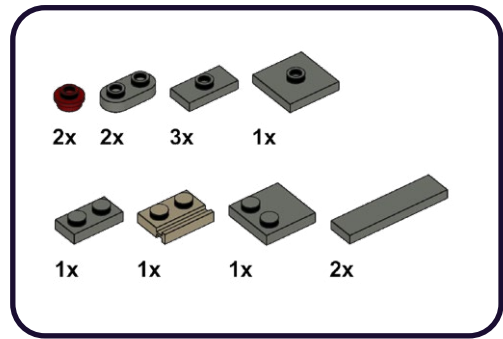

1

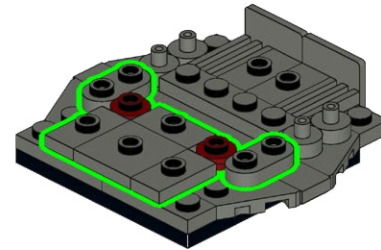

2

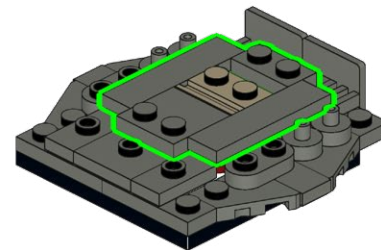

126

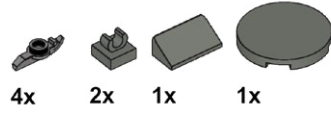

4x 2x 1x 1x

1

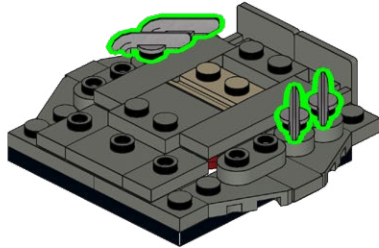

2

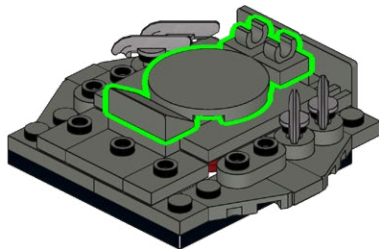

127

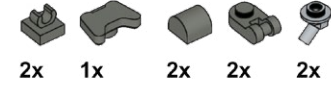

2x 1x 2x 2x 2x

1

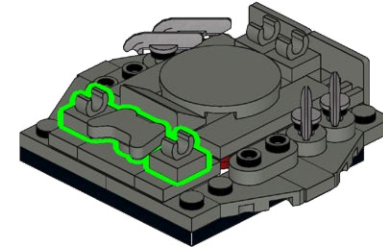

2

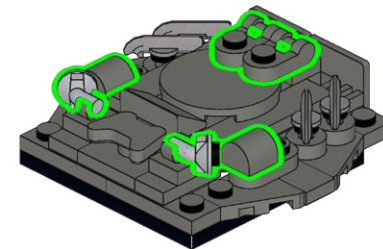

128

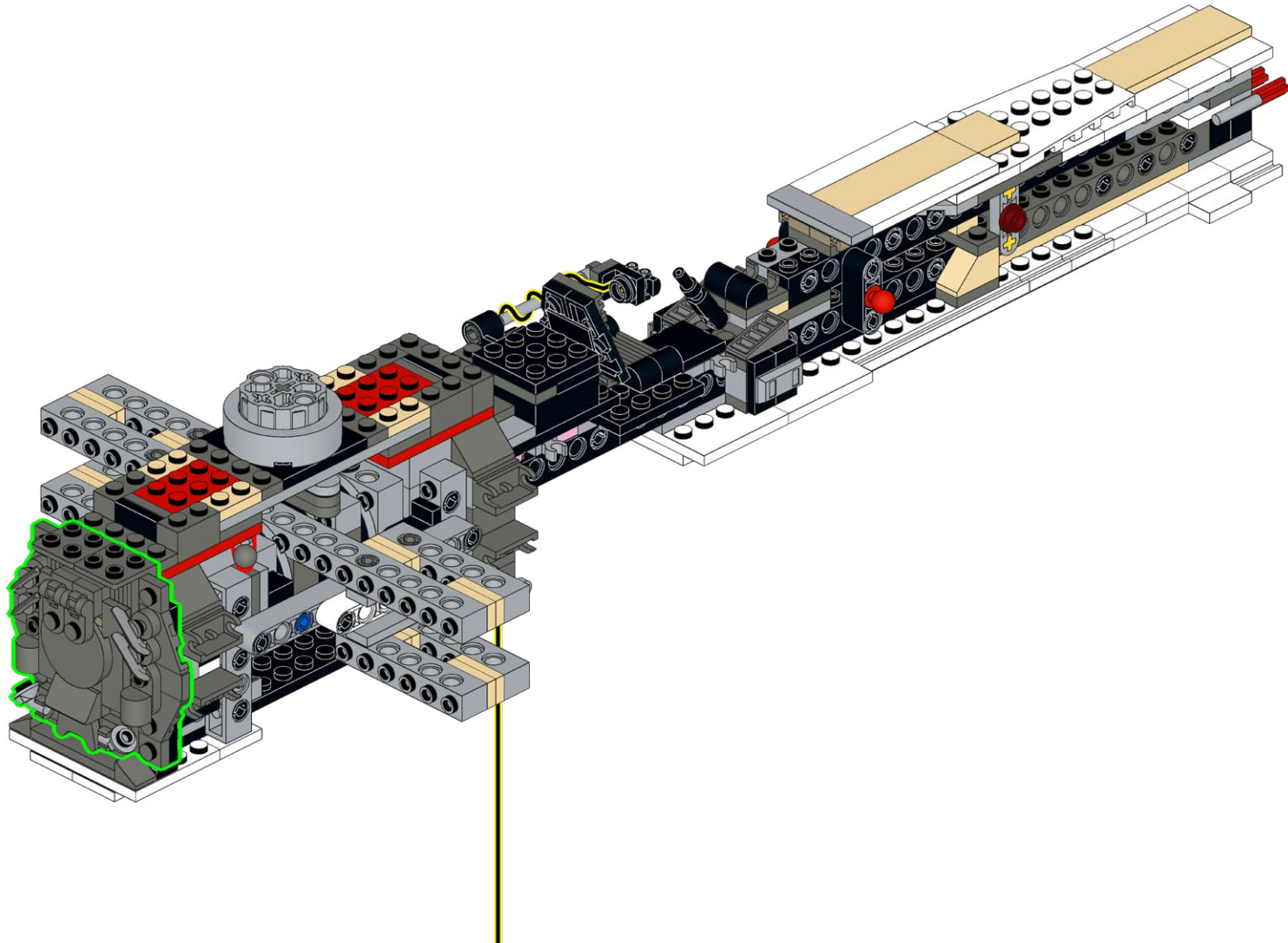

129

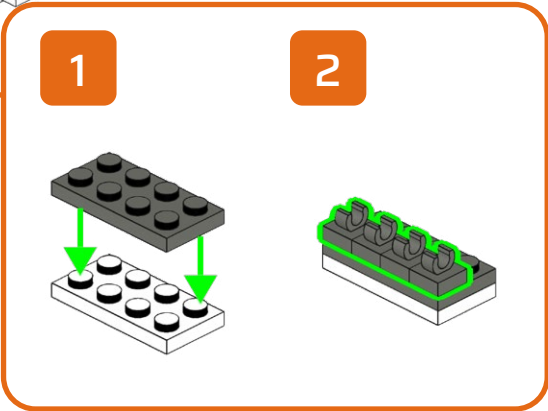
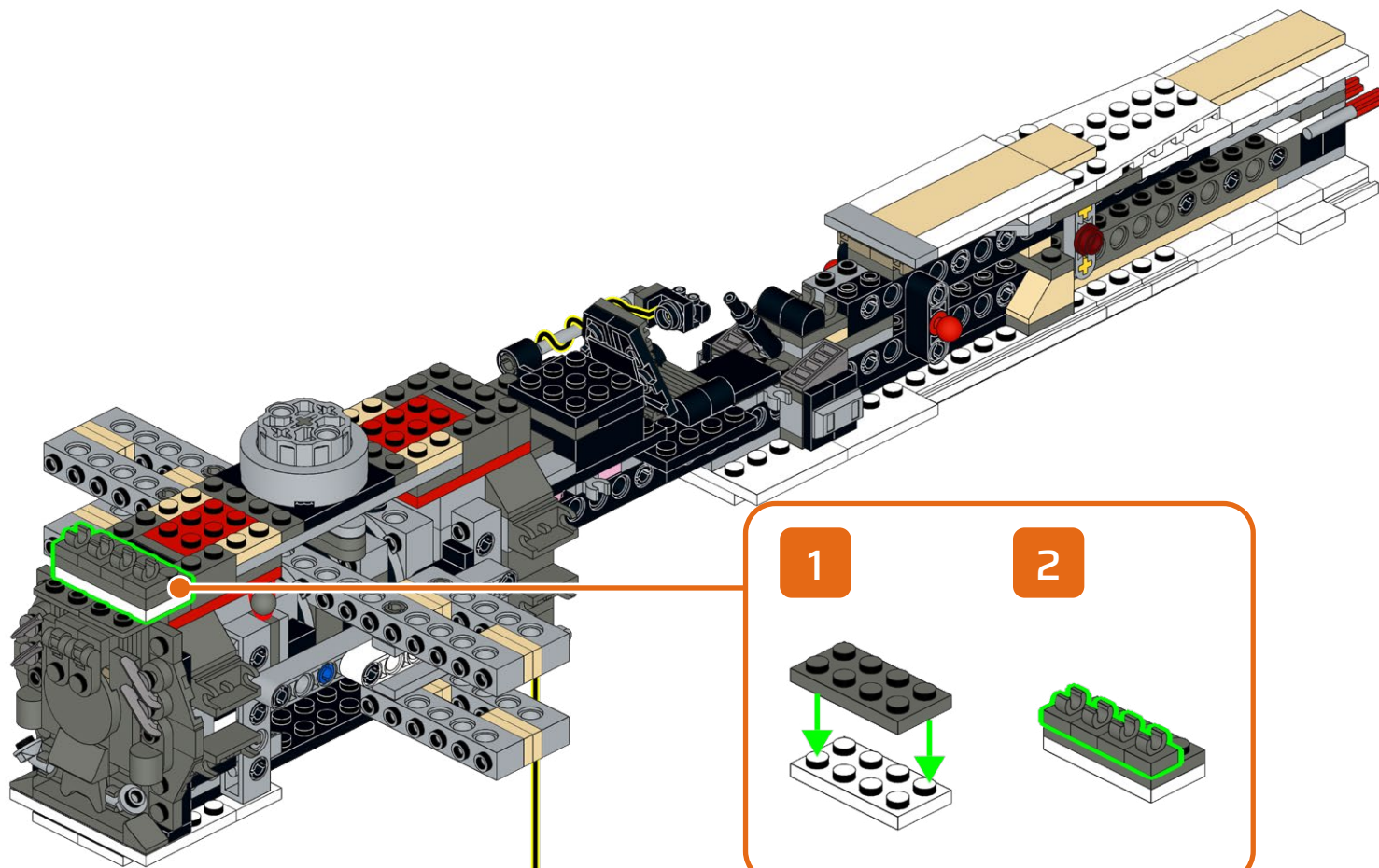
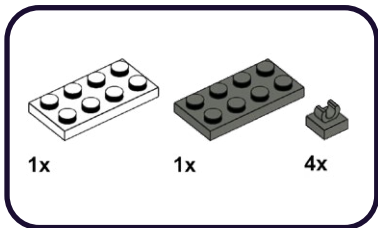

130

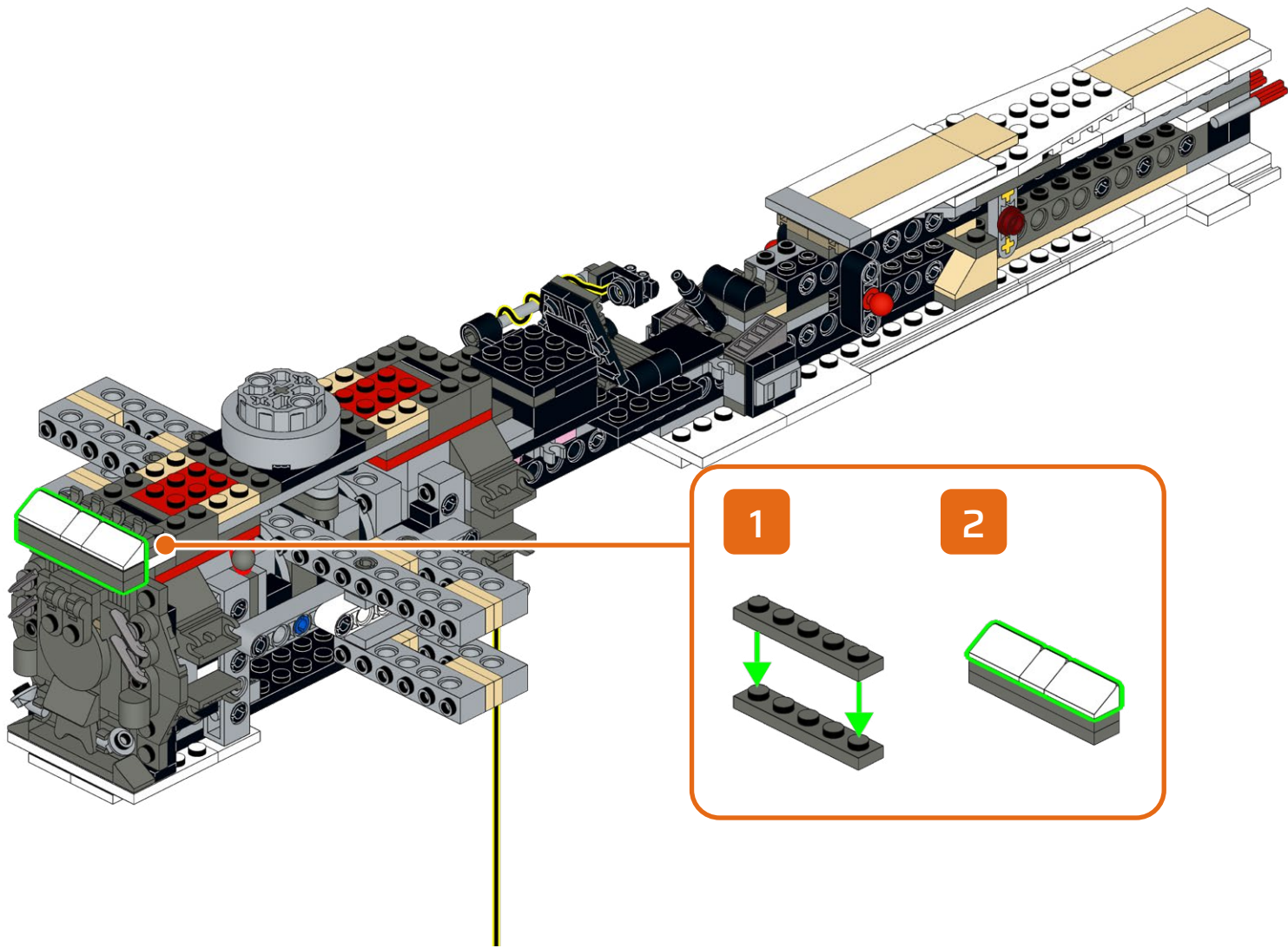
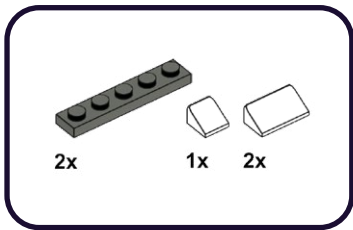

131

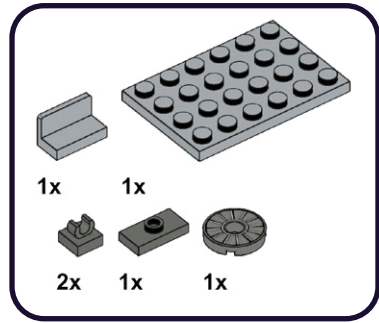

1

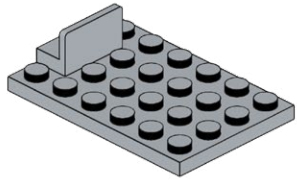

2

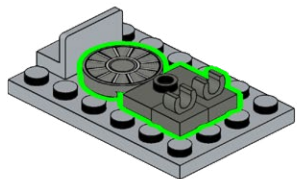

132

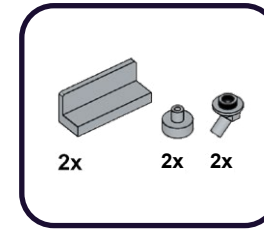

1

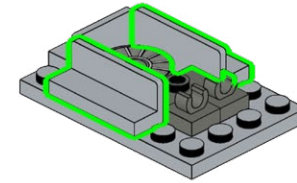

2

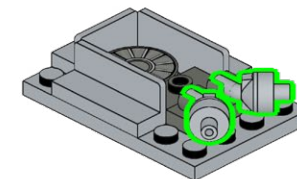

2x

133

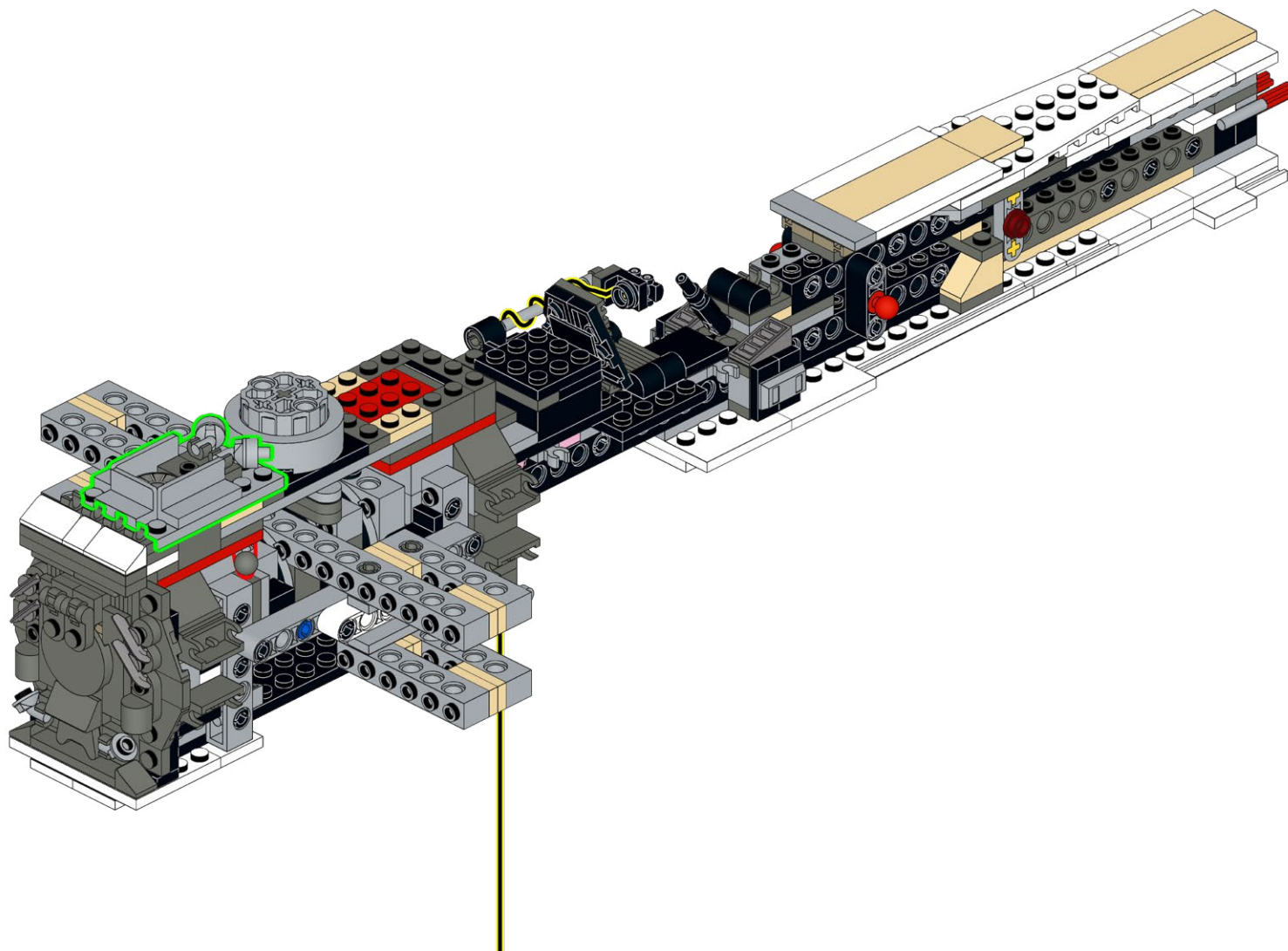

134

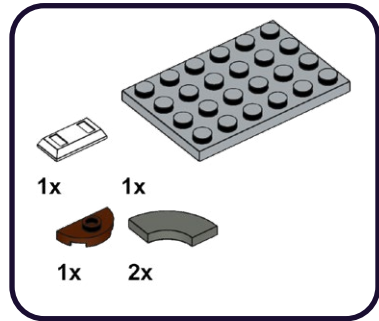

1

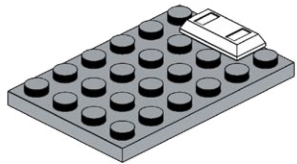

2

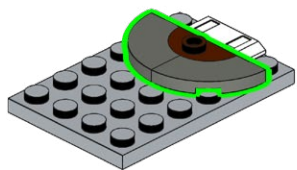

135

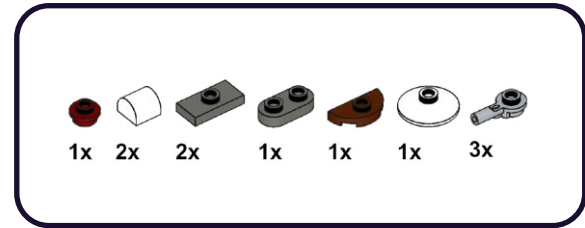

1

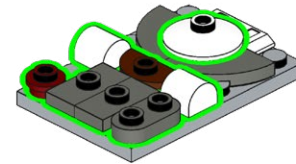

2

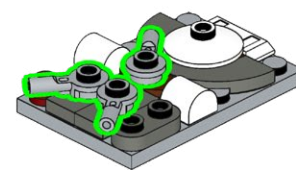

136

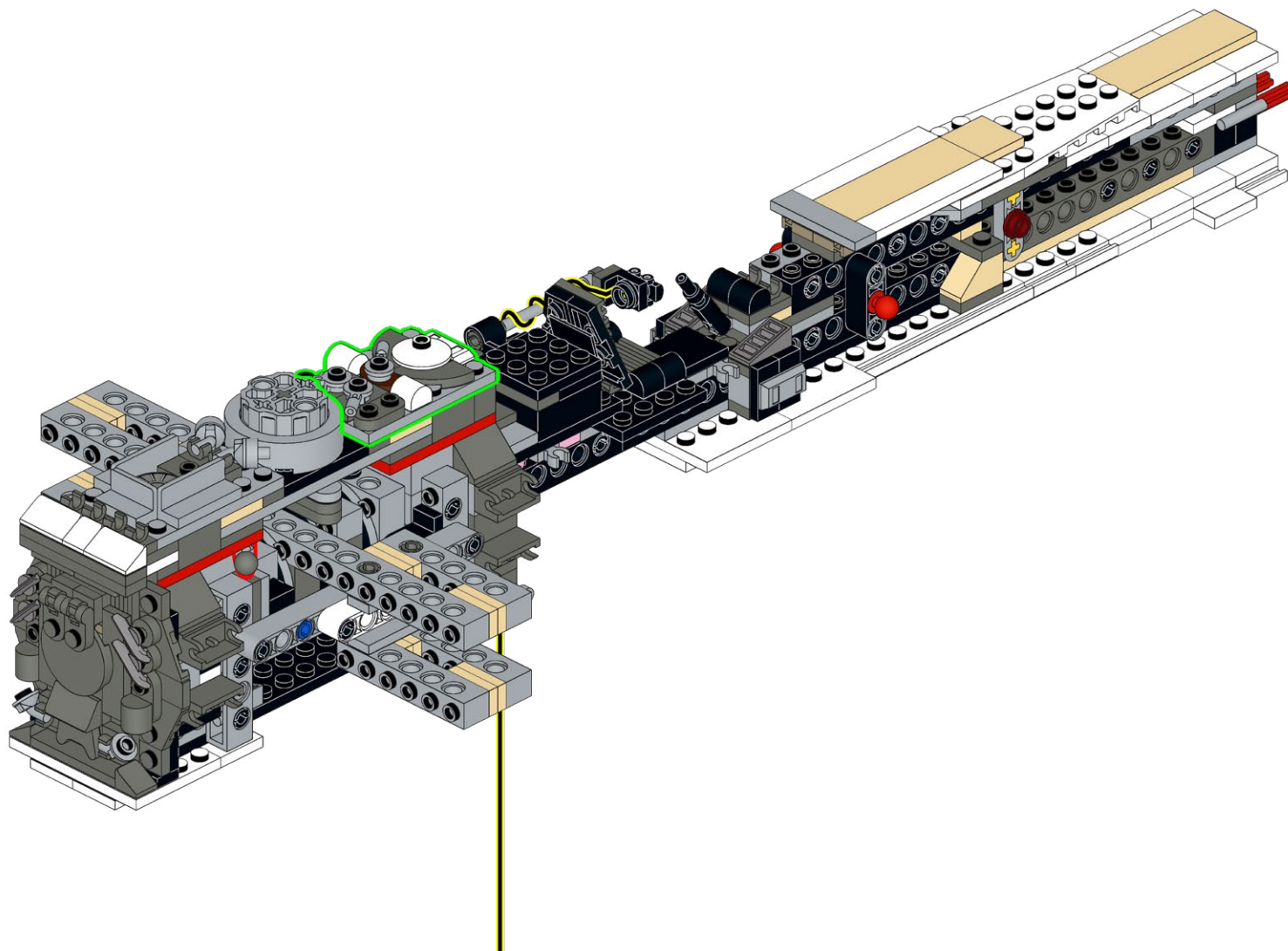

137

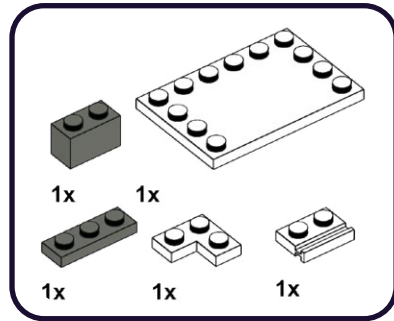

1

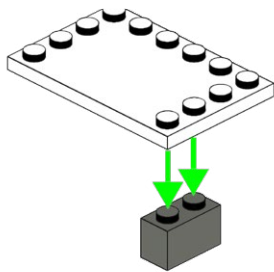

2

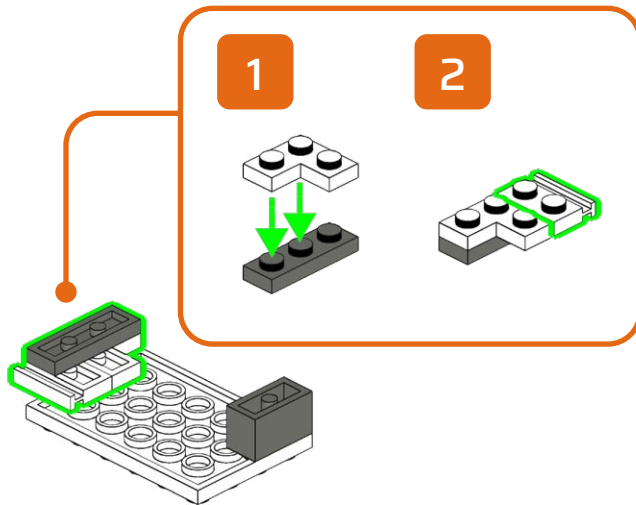

138

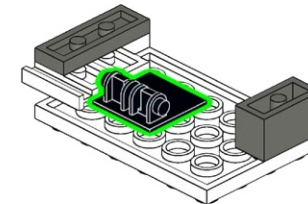
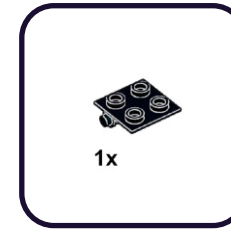

139

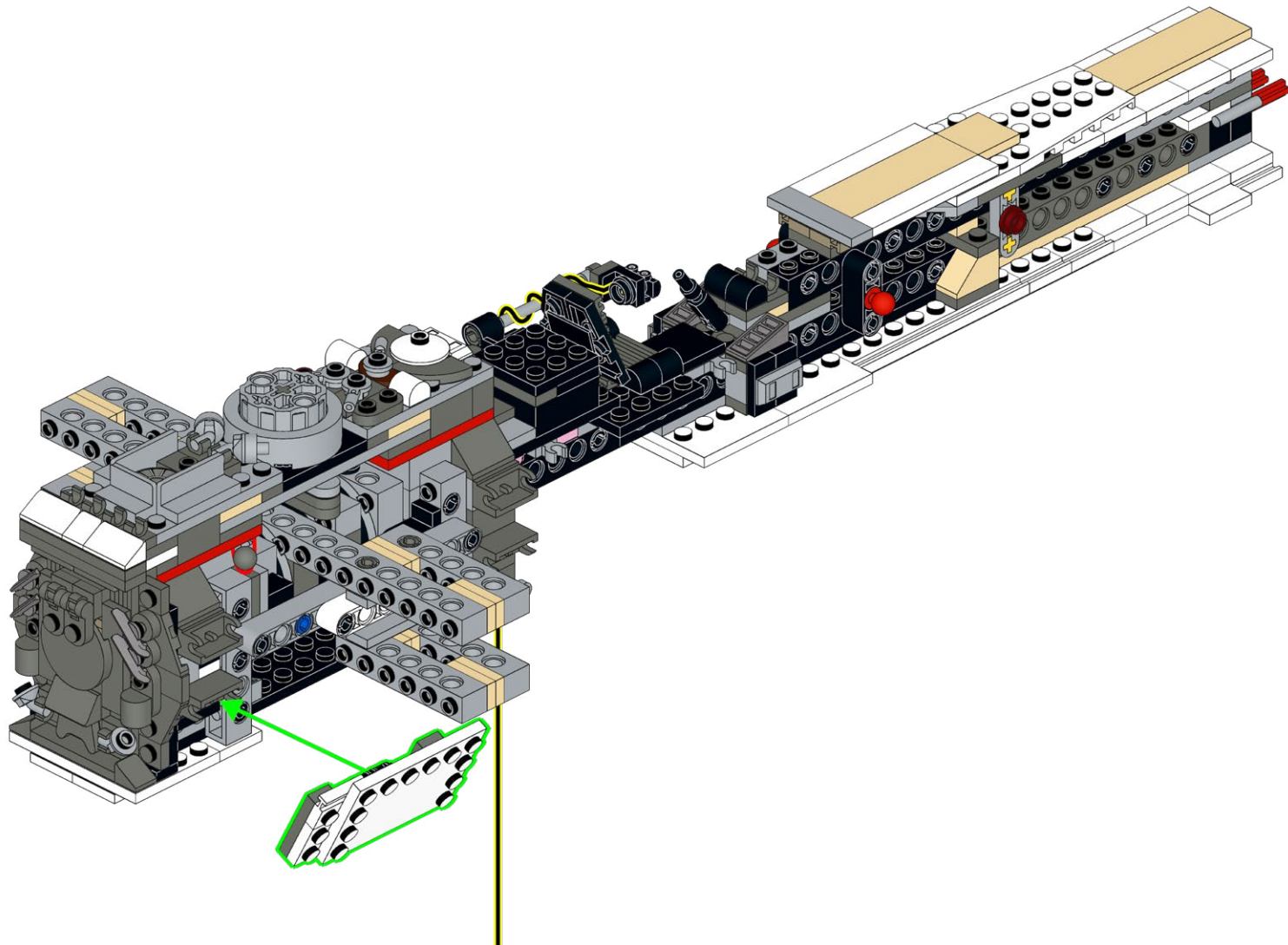

140

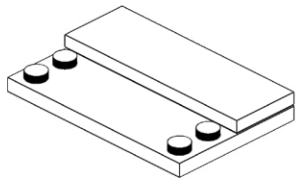
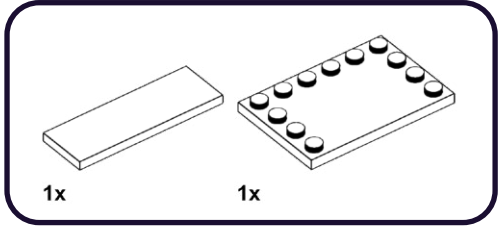

141

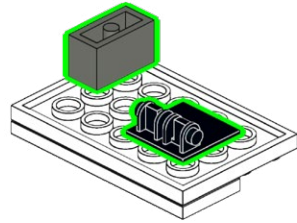
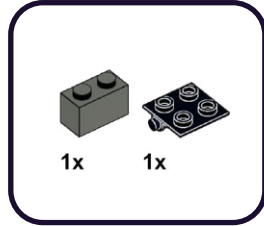

142

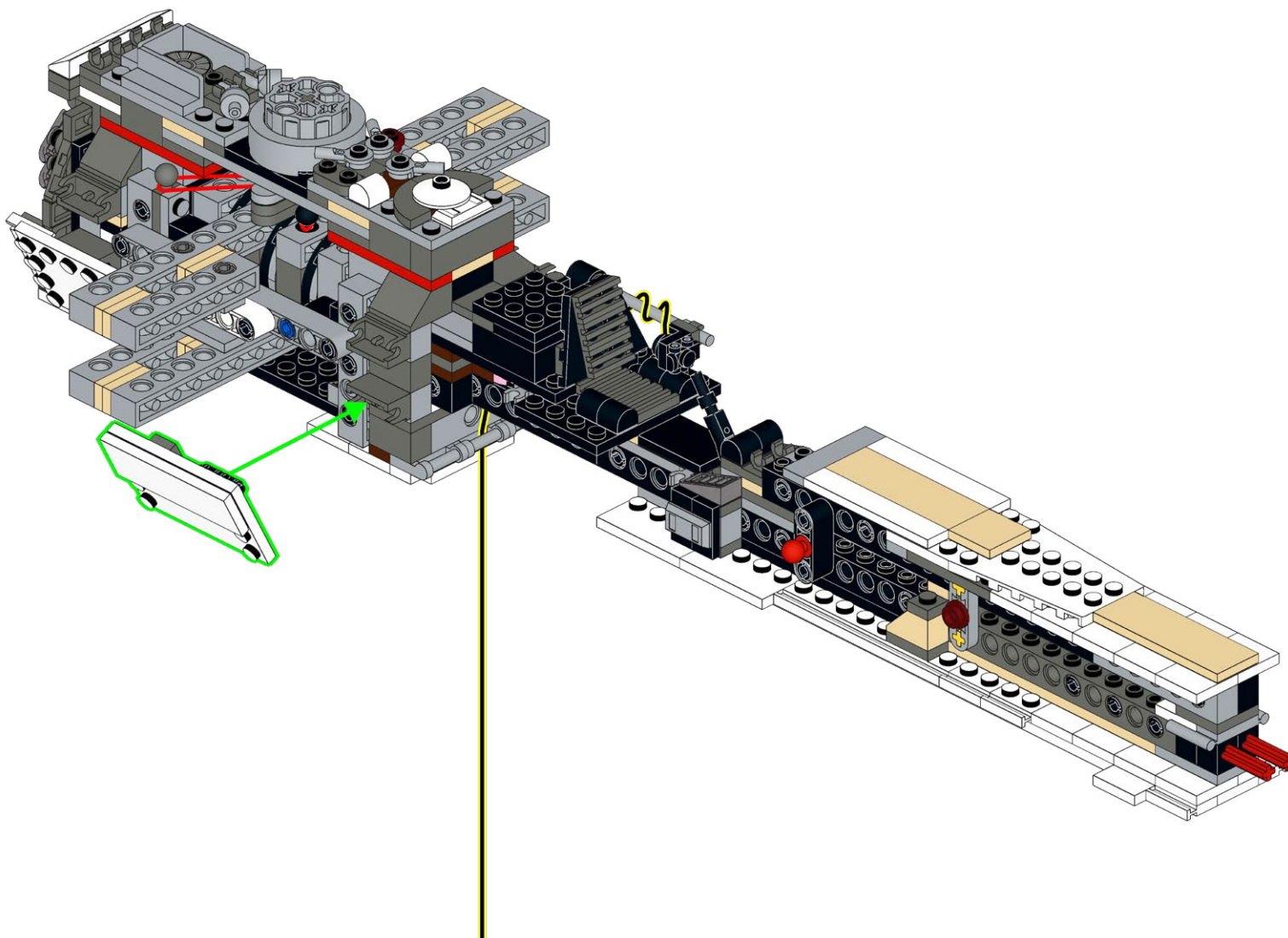

143

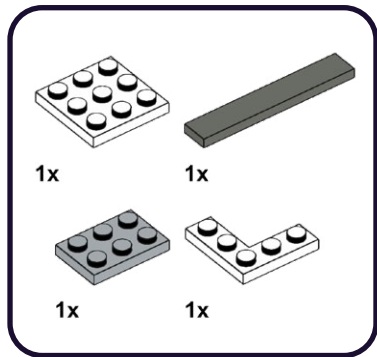

1

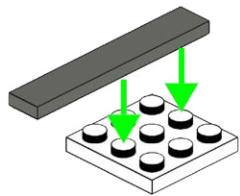

2

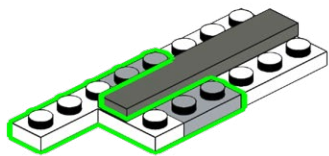

144

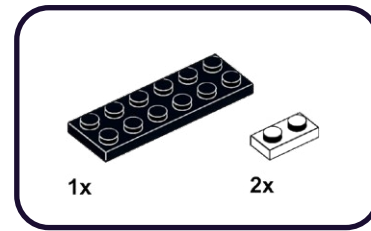

1

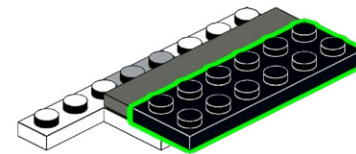

2

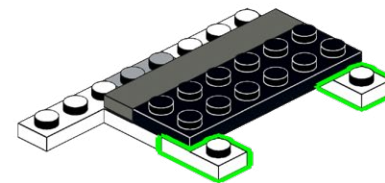

145

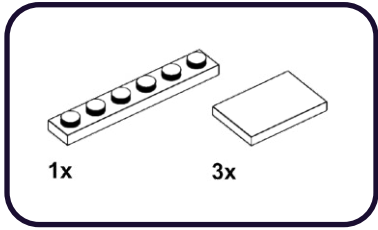

1

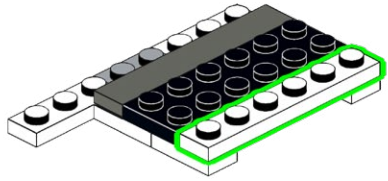

2

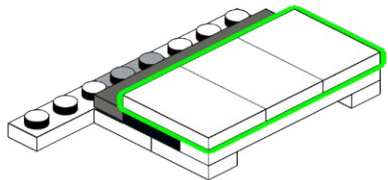

146

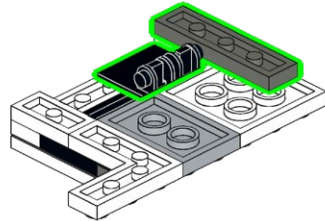
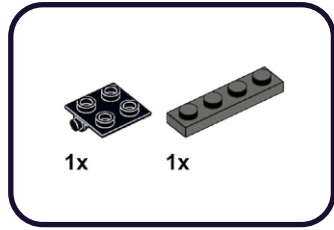

147

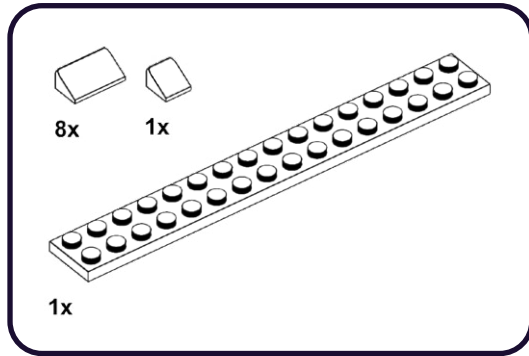

1

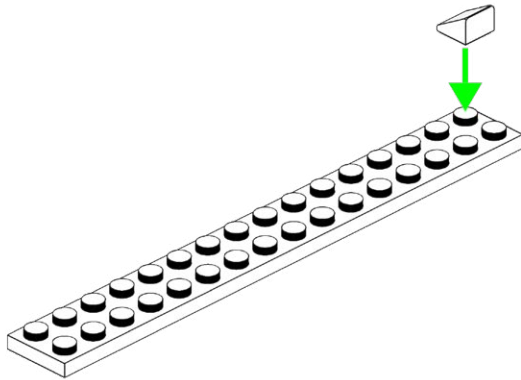

2

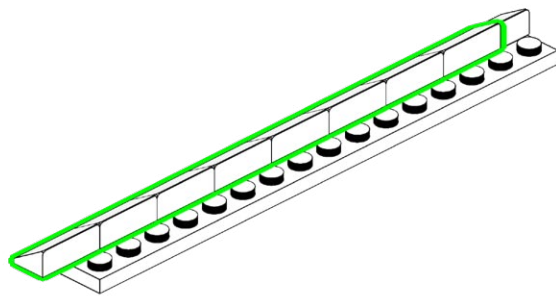

148

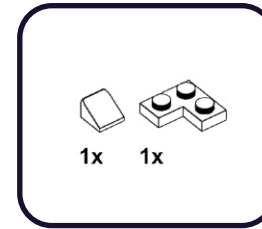

1

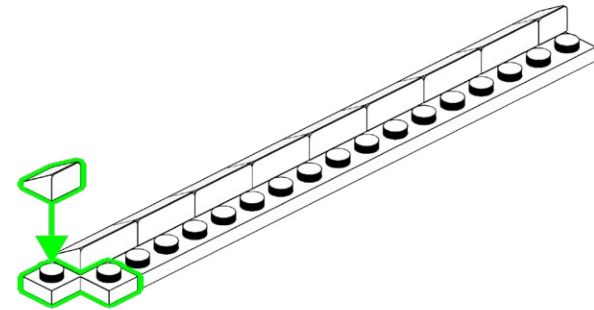

2

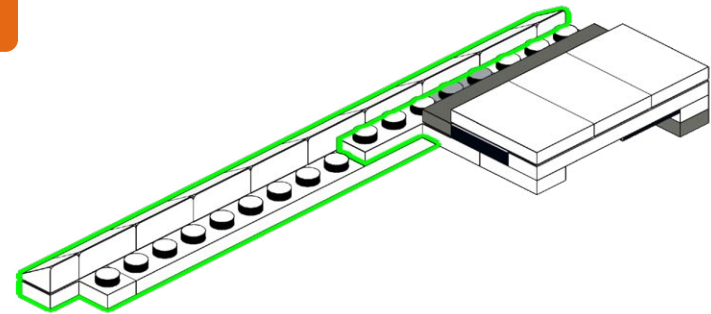

149

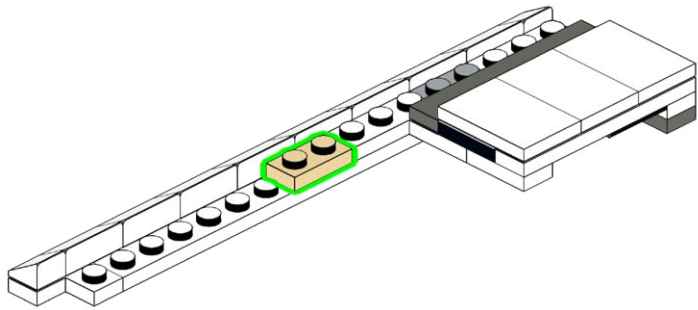
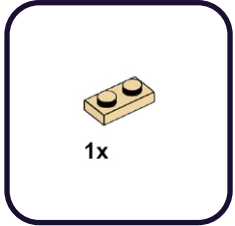

150

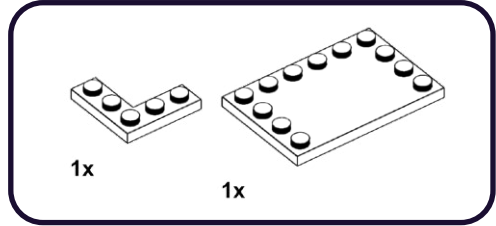

1

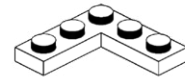

2

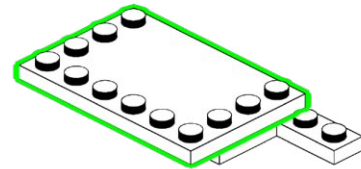

151

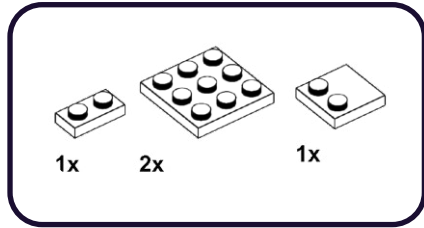

1

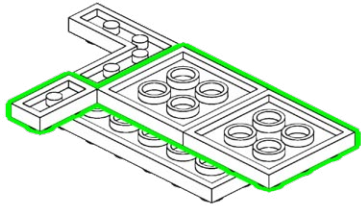

2

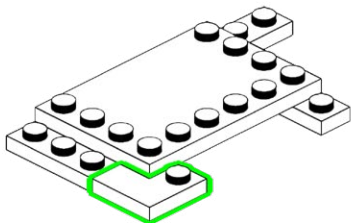

152

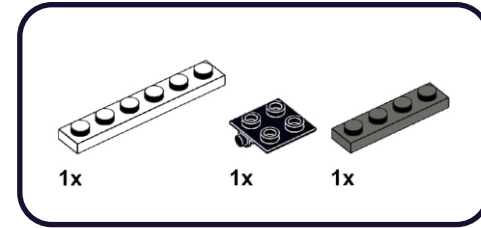

1

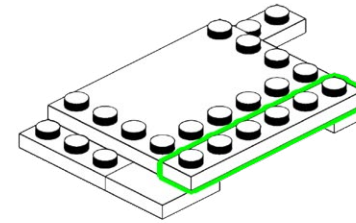

2

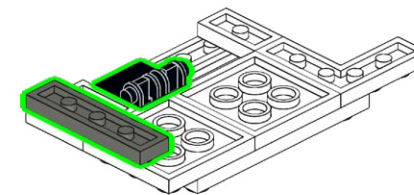

153

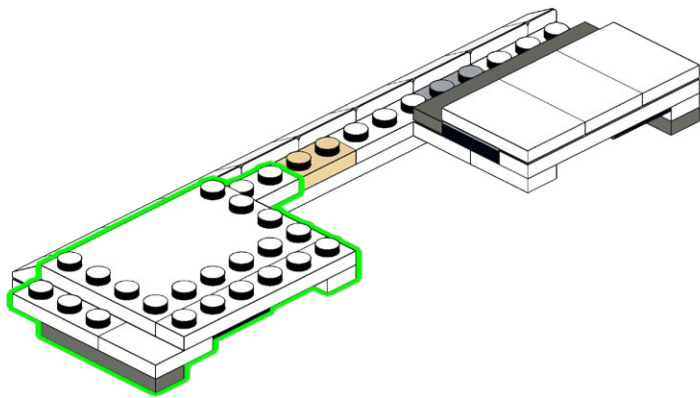

154

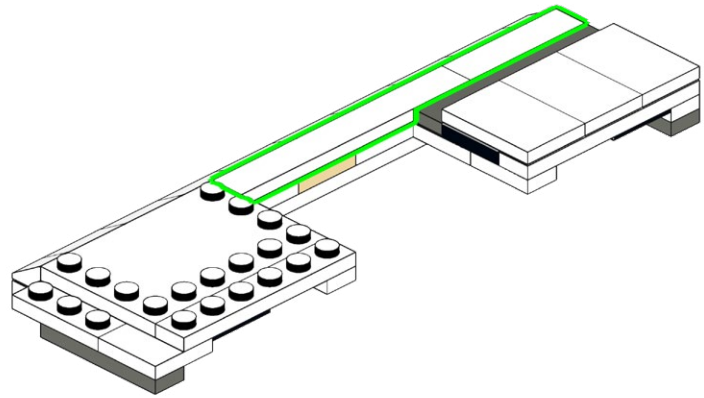
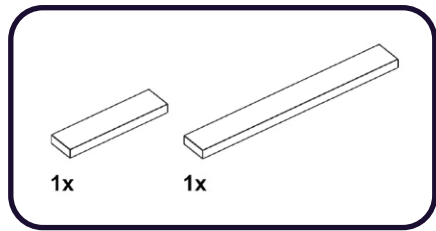

155

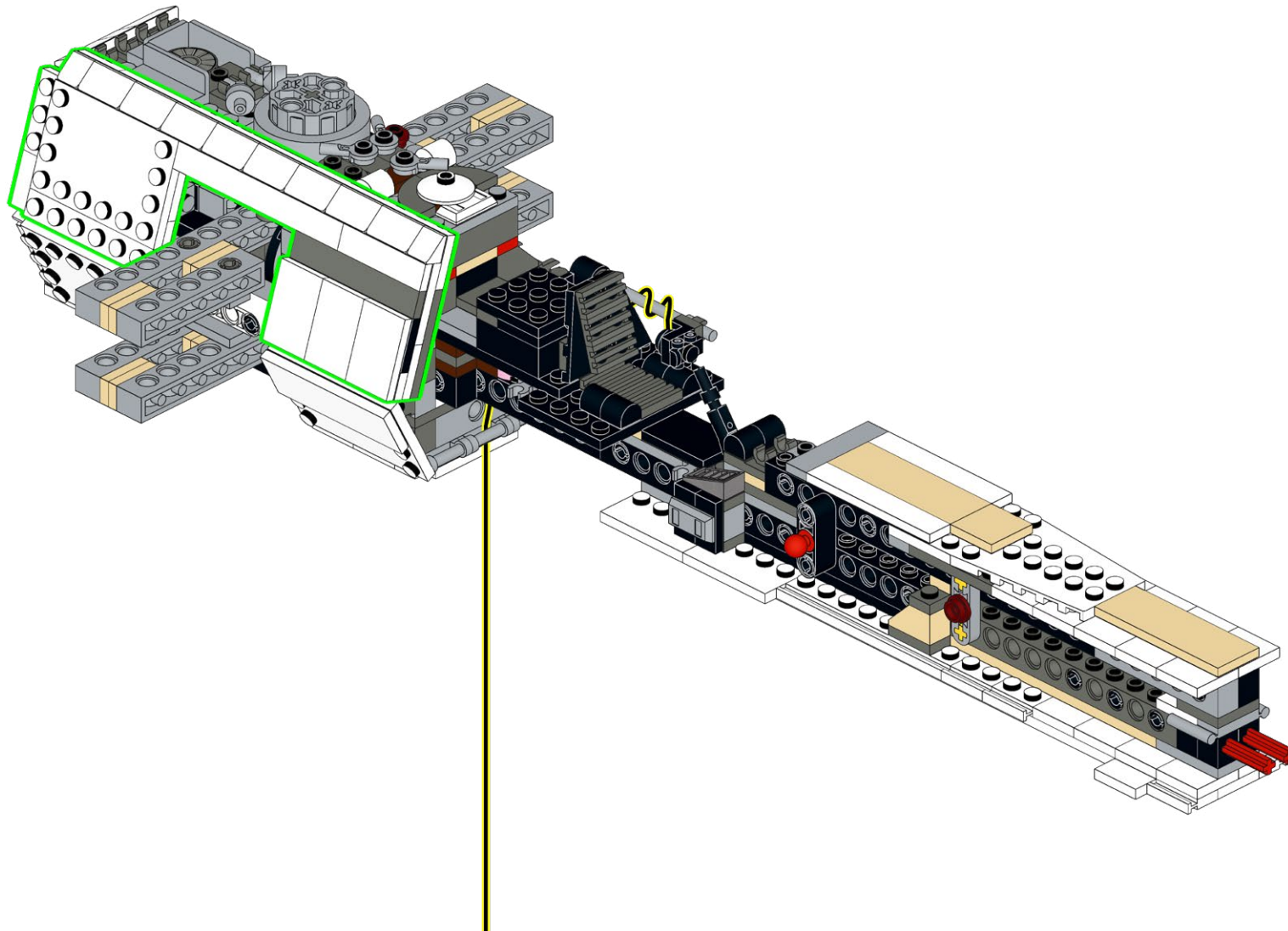

156

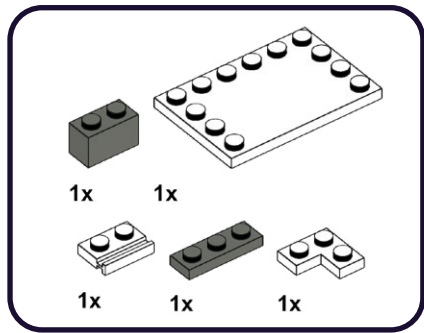

1

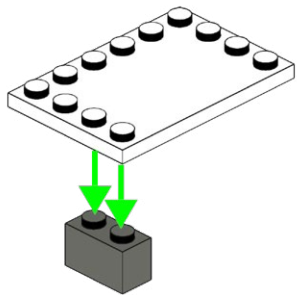

1

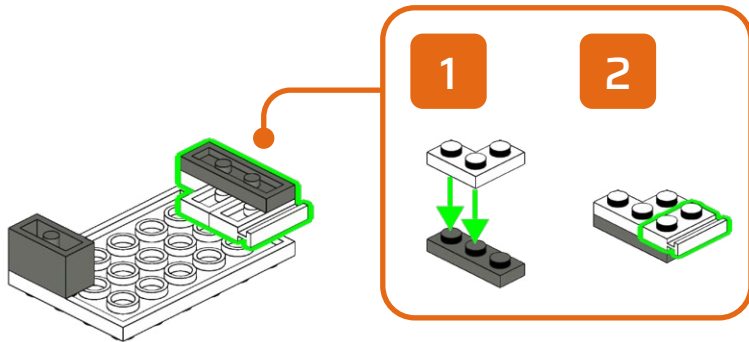

157

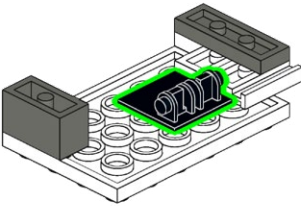
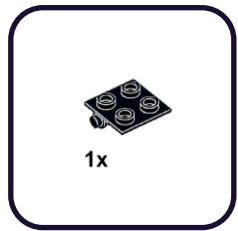

158

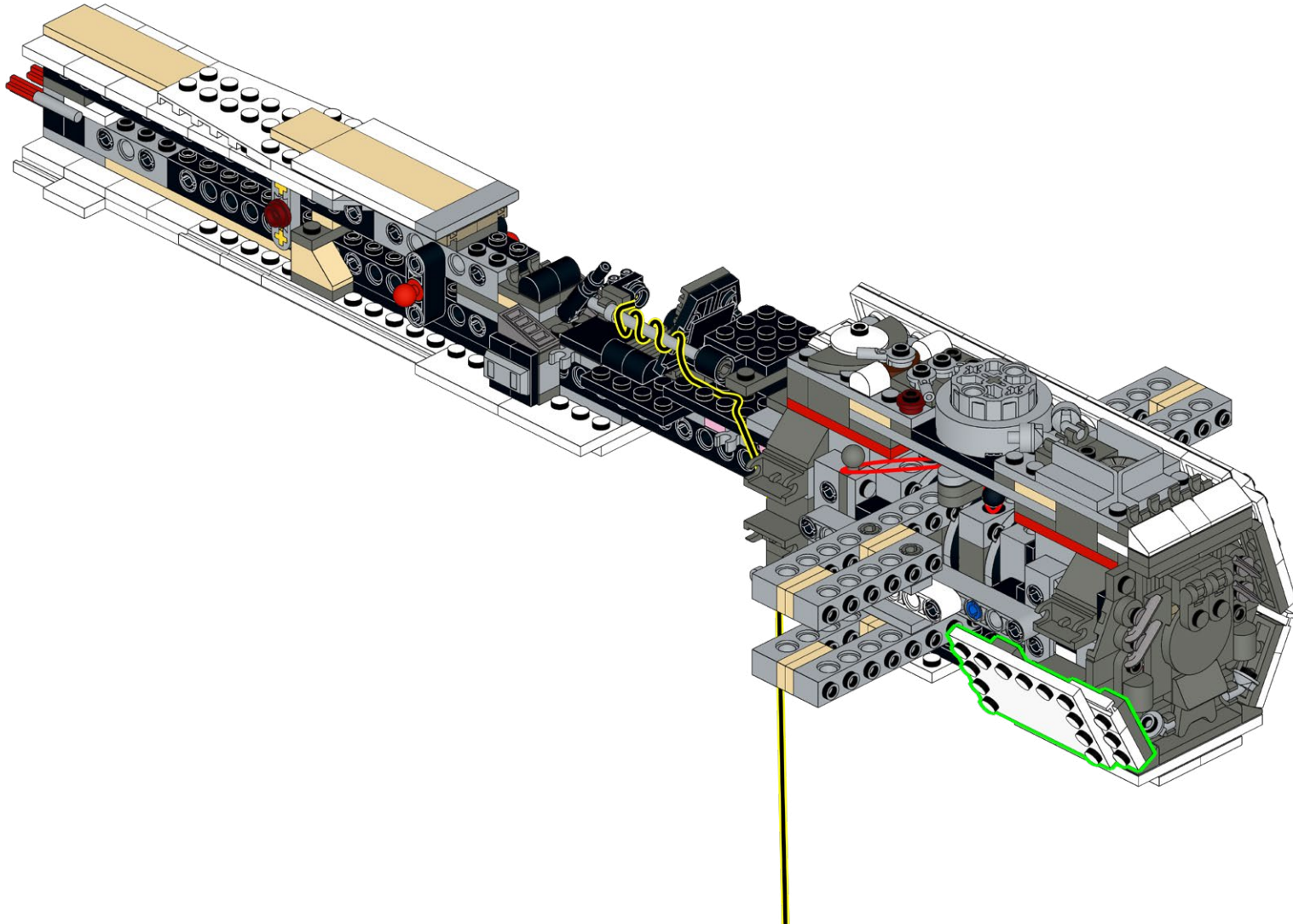

159

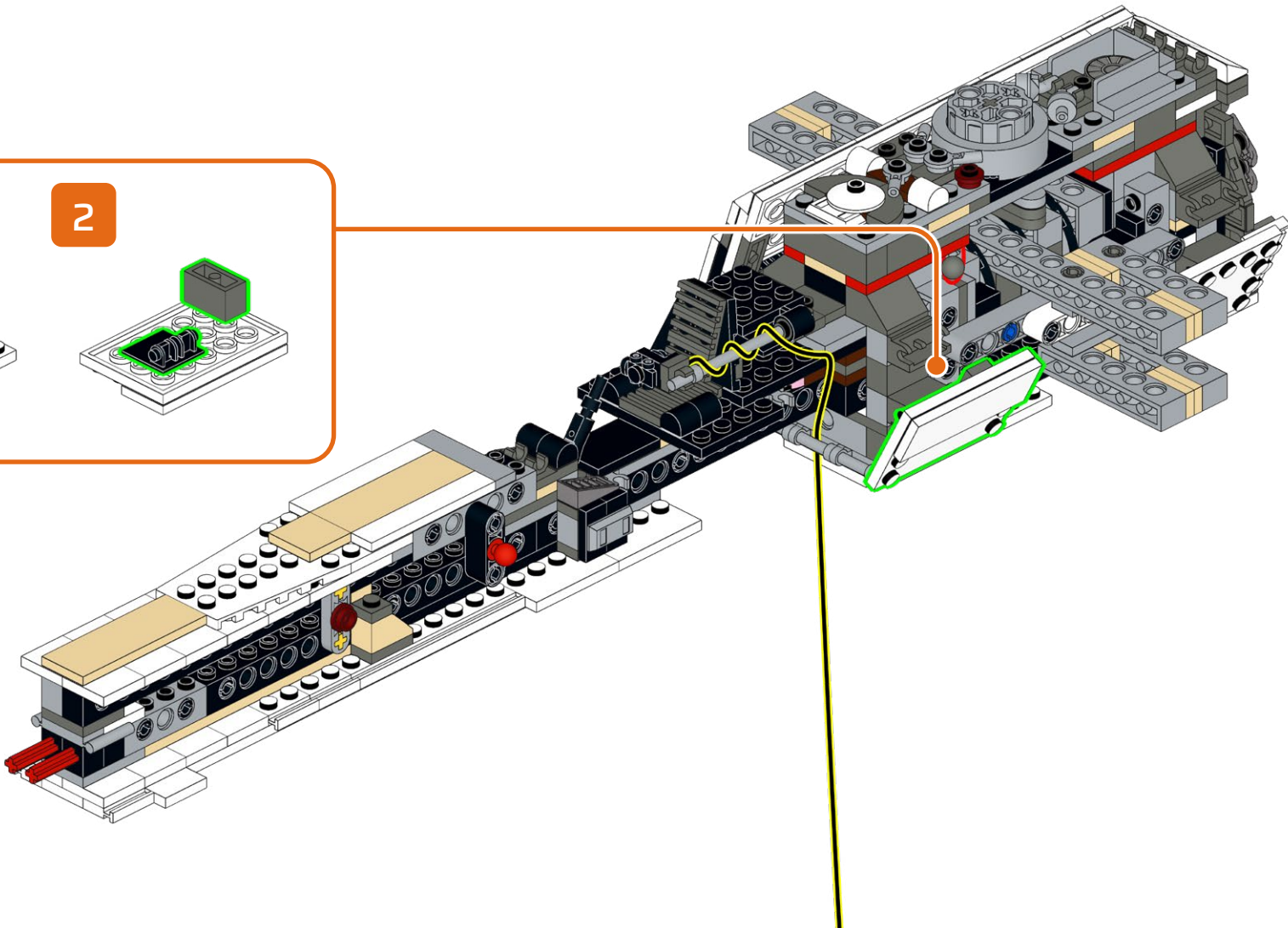
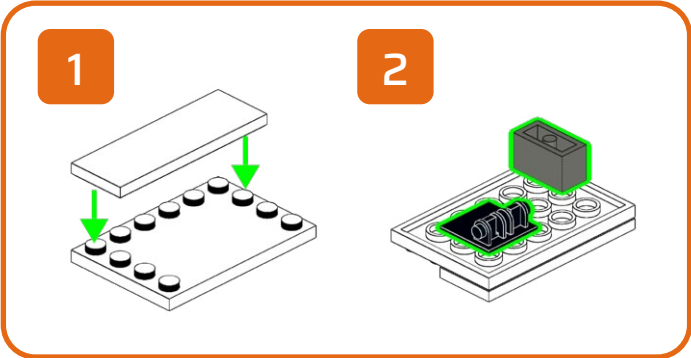
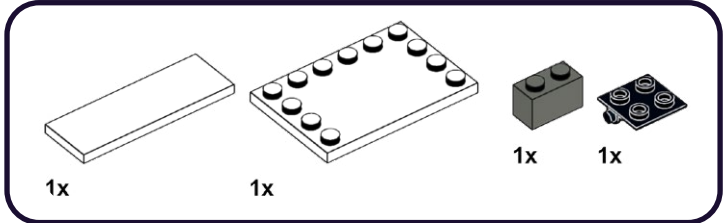

160

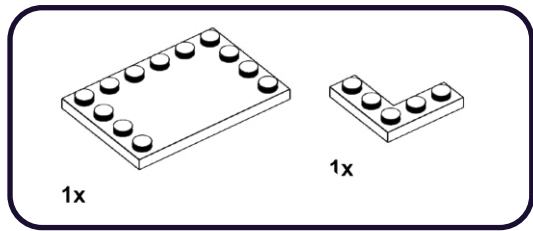

1

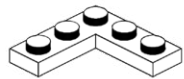

2

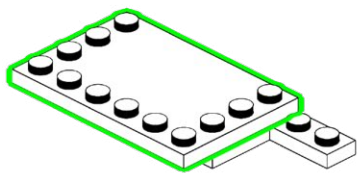

161

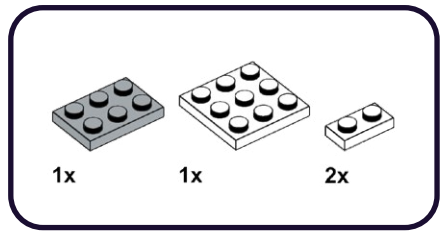

1

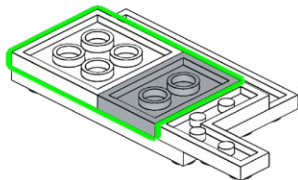

2

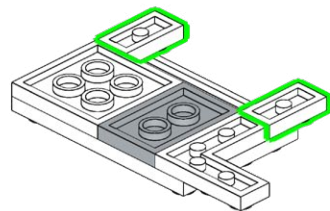

162

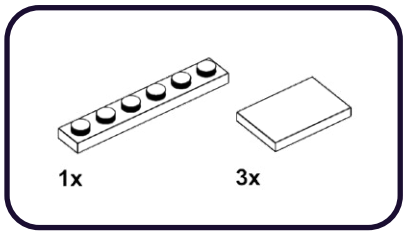

1

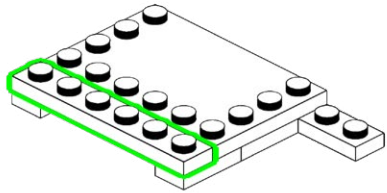

2

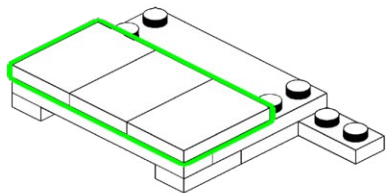

163

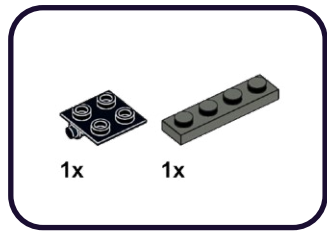

1

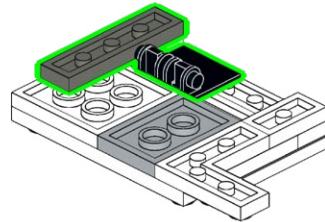

164

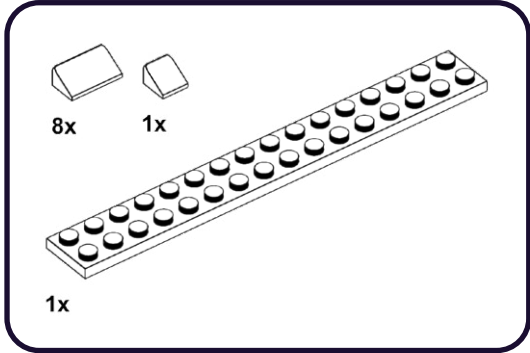

1

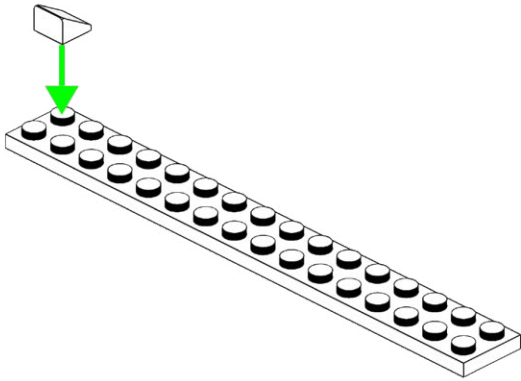

2

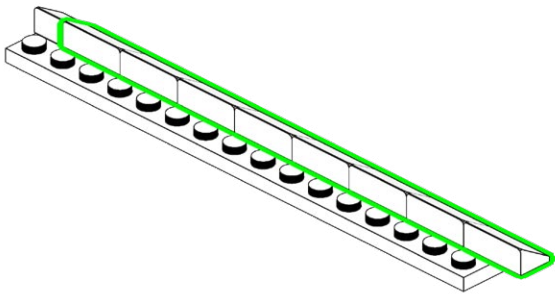

165

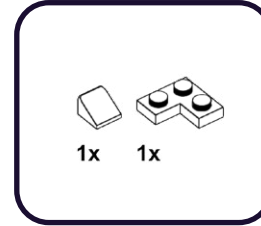

1

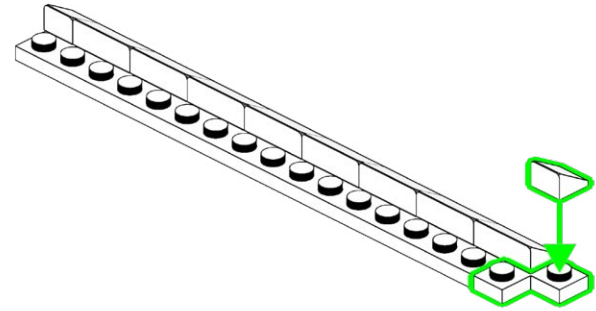

2

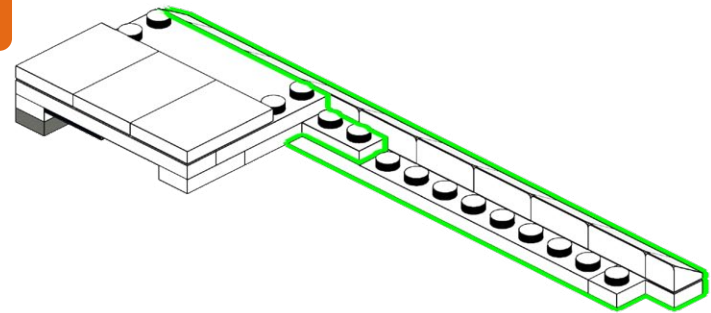

166

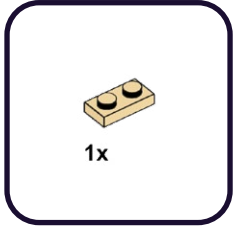

1

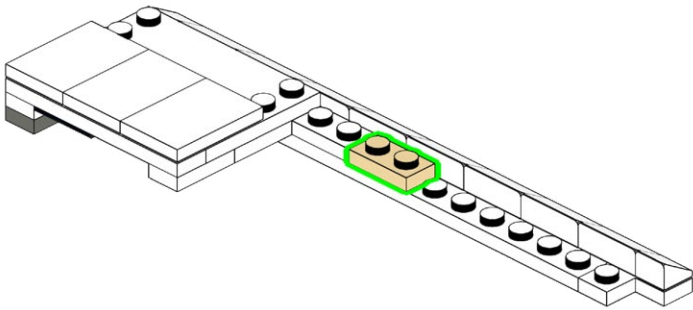

167

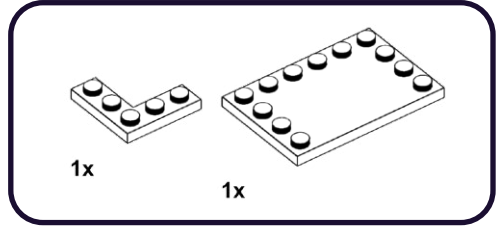

1

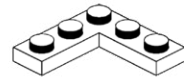

2

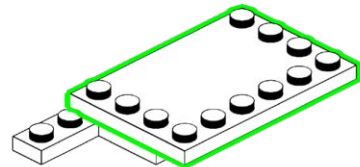

168

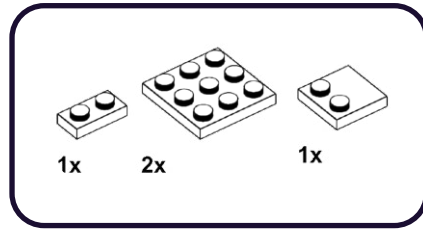

1

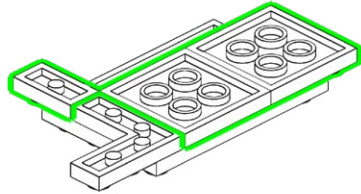

2

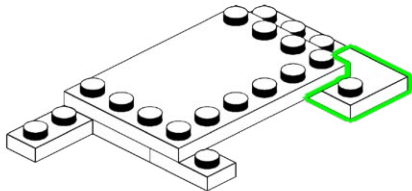

169

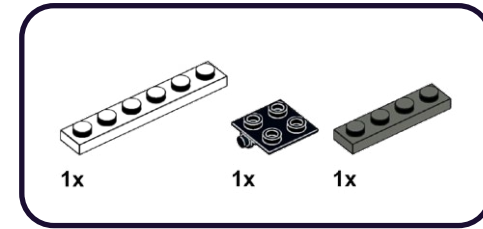

1

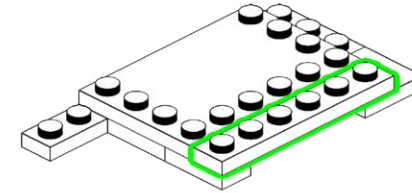

2

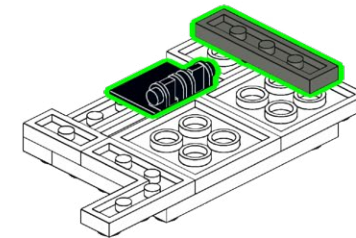

170

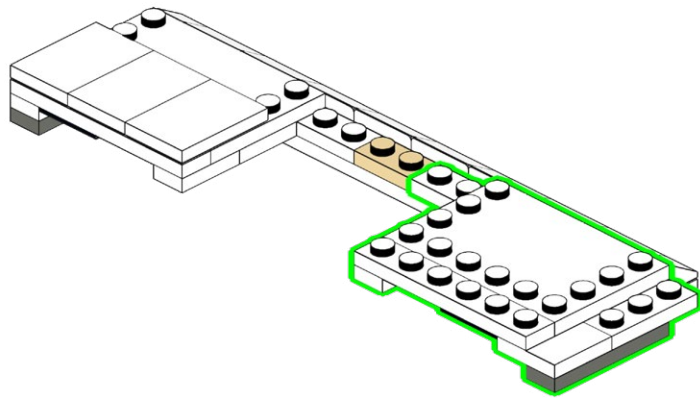

171

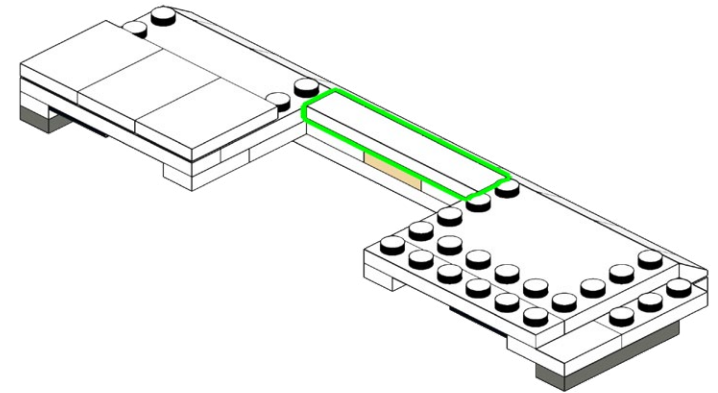
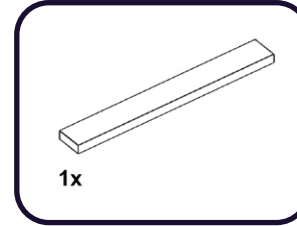

172

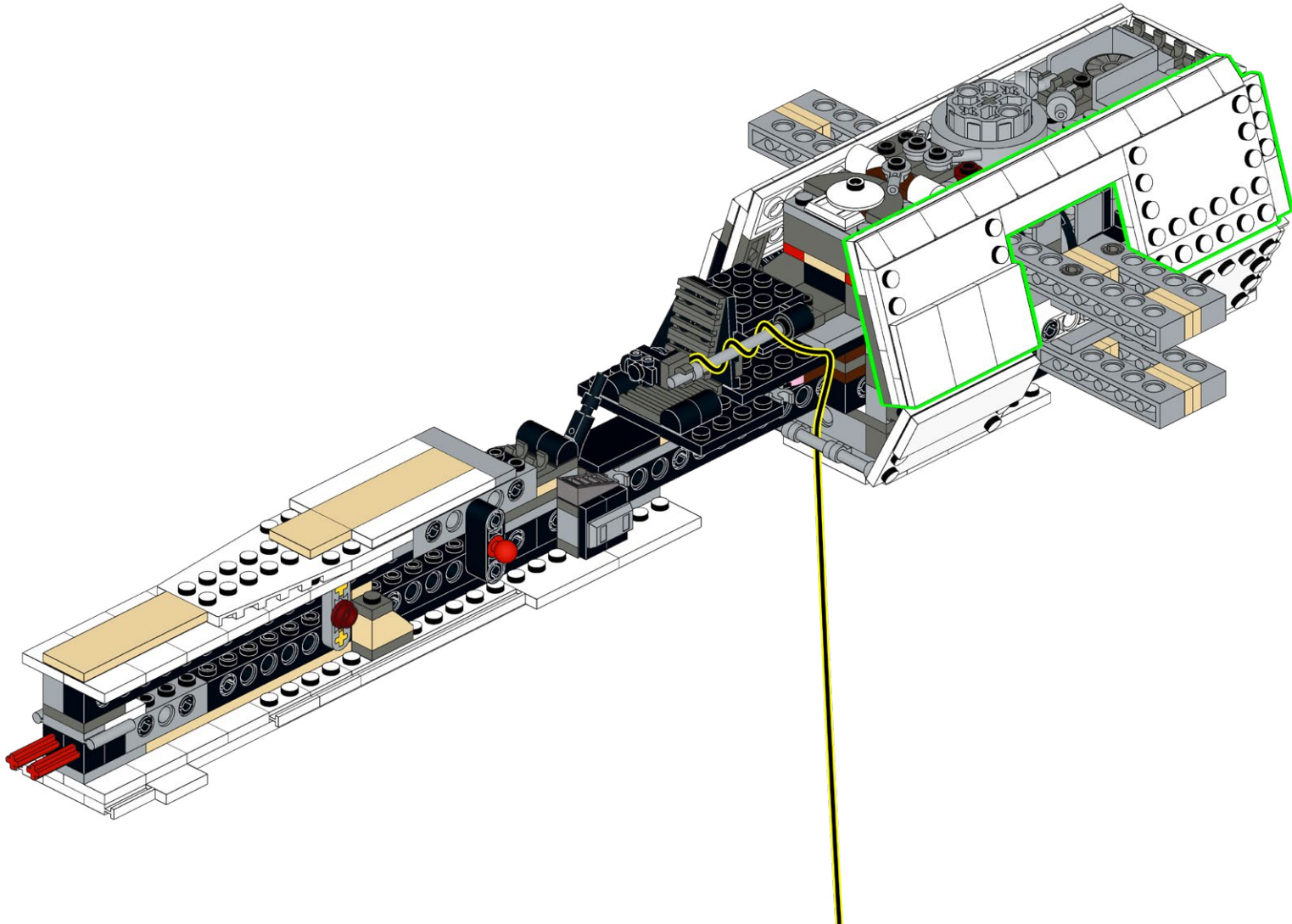

**HOLD UP!**

You might notice some bags aren't in order, as well as left over pieces, but that's ok! We're changing the way you build LEGO!

ATTENDEZ!

Vous remarquerez peut-être que certains sacs, ainsi que certaines pièces, ne sont pas dans le bon ordre. Mais pas de panique! Nous changeons simplement la façon avec laquelle vous construisez vos LEGO!

ASPETTA!

Potresti notare che alcuni sacchetti non sono in ordine, così come i pezzi avanzati, ma va bene così! Stiamo cambiando il modo in cui costruisci i LEGO!

HALT!

Sie werden möglicherweise bemerken, dass einige tüten durcheinander sind und teile übrig bleiben, aber das ist in Ordnung! Wir ändern die art und weise, wie Sie LEGO bauen!

¡ESPERA!

Es posible que notes que algunas bolsas están fuera de servicio, así como piezas sobrantes, ¡pero está bien! ¡Estamos cambiando la forma en que construyes LEGO!

暫停!

你可能会注意到一些袋子顺序错乱, 以及一些剩余的部件, 但没关系! 我们正在改变你搭建乐高的方式!

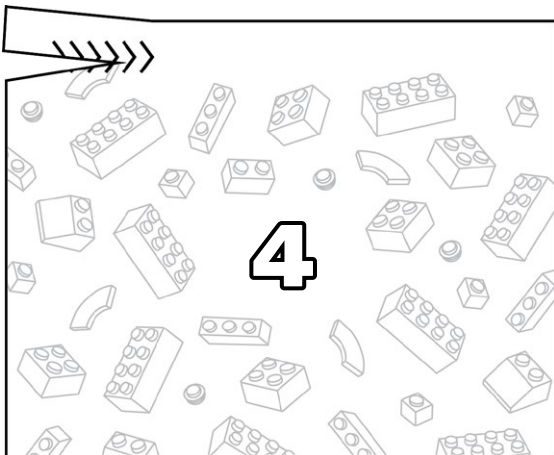
Open LEGO® Bag 4

173

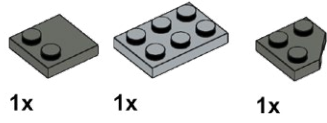

1

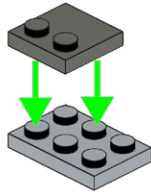

2

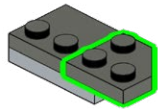

174

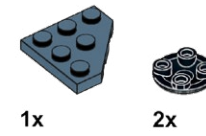

1

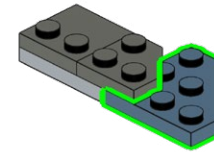

2

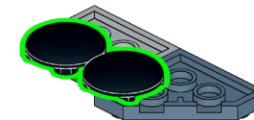

175

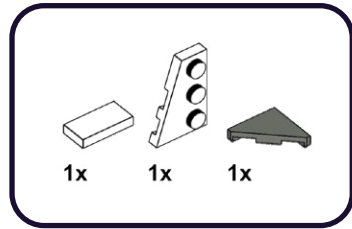

1

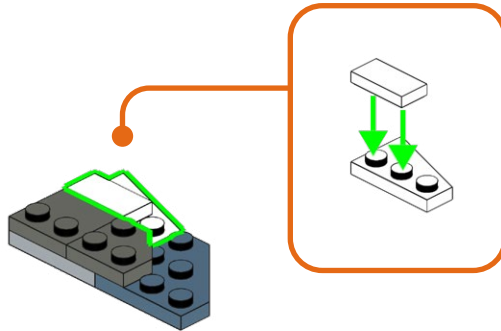

2

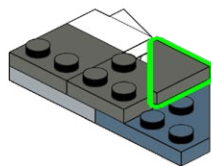

176

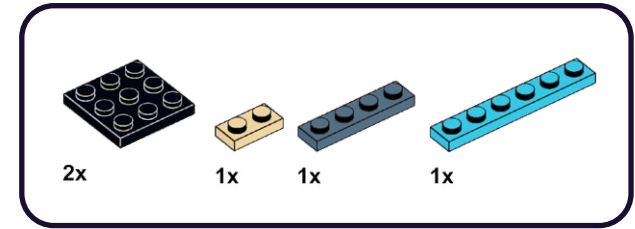

1

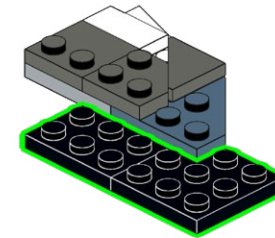

2

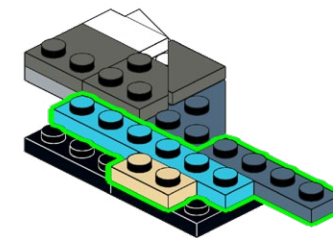

177

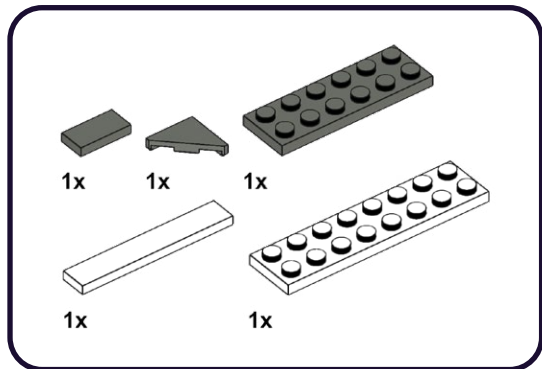

1

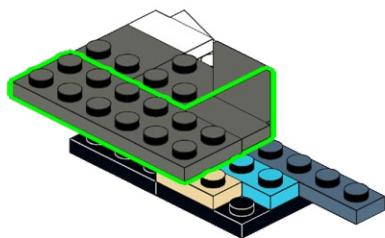

2

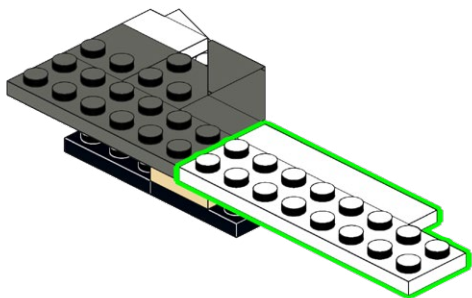

178

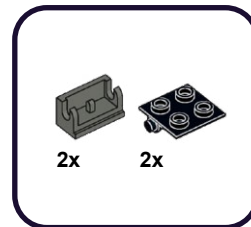

1

2

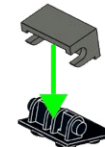

2x

1

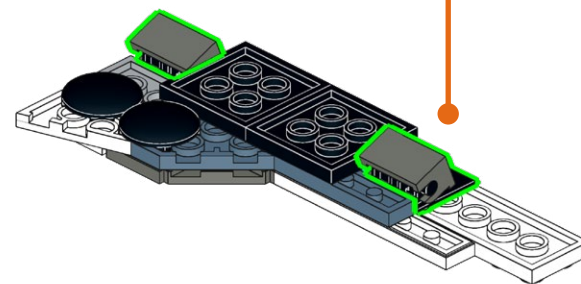

179

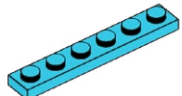

1x

1

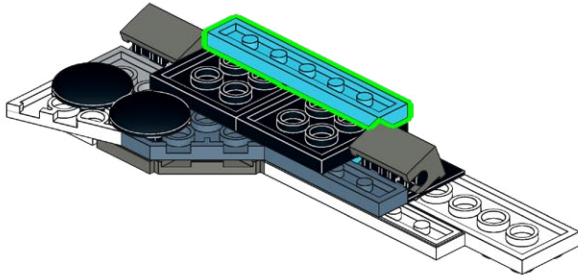

180

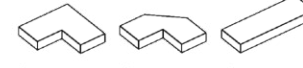

1x

1x

1x

1

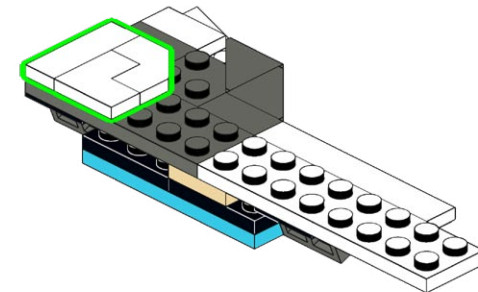

181

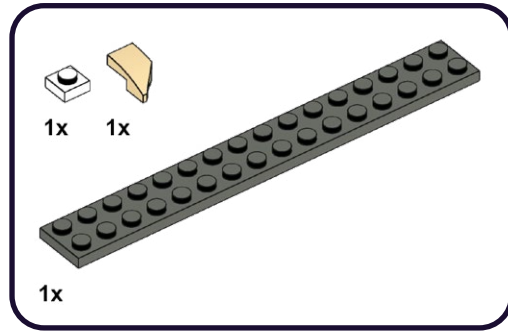

1

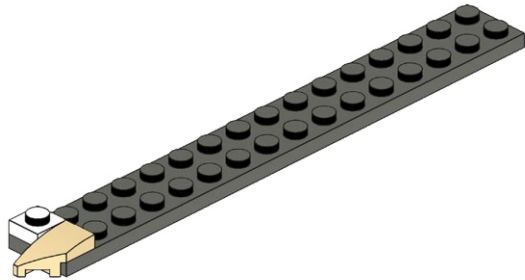

182

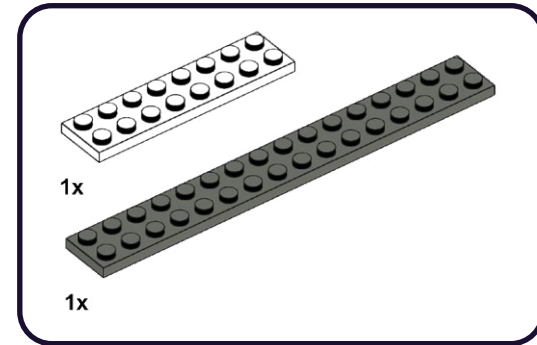

1

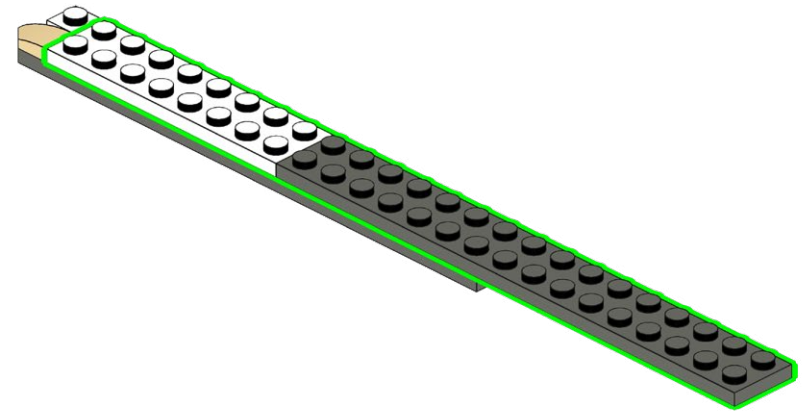

183

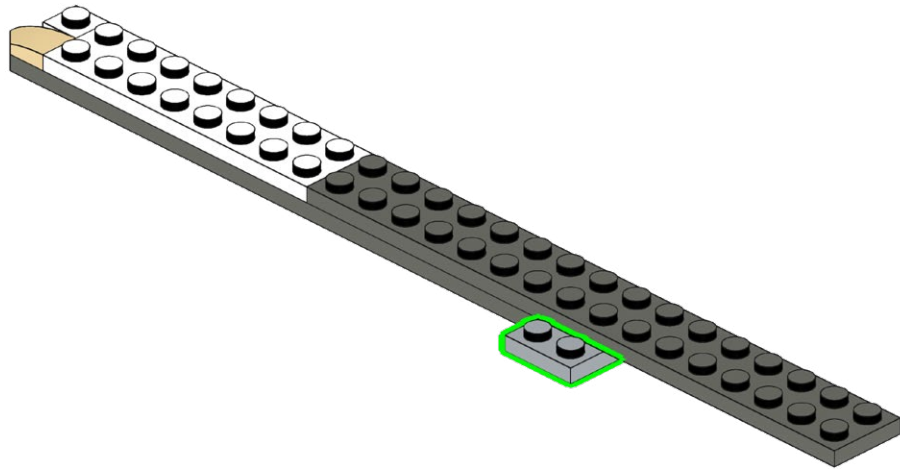
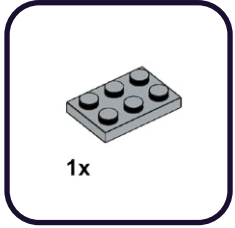

184

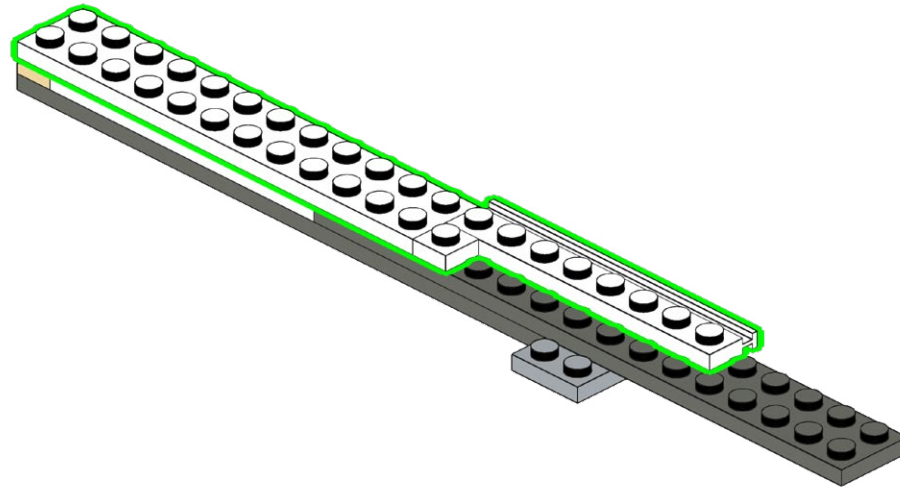
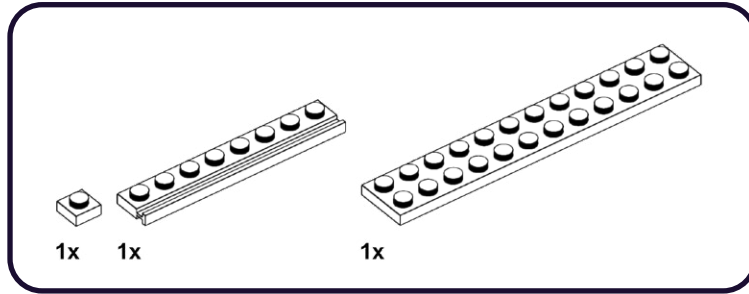

185

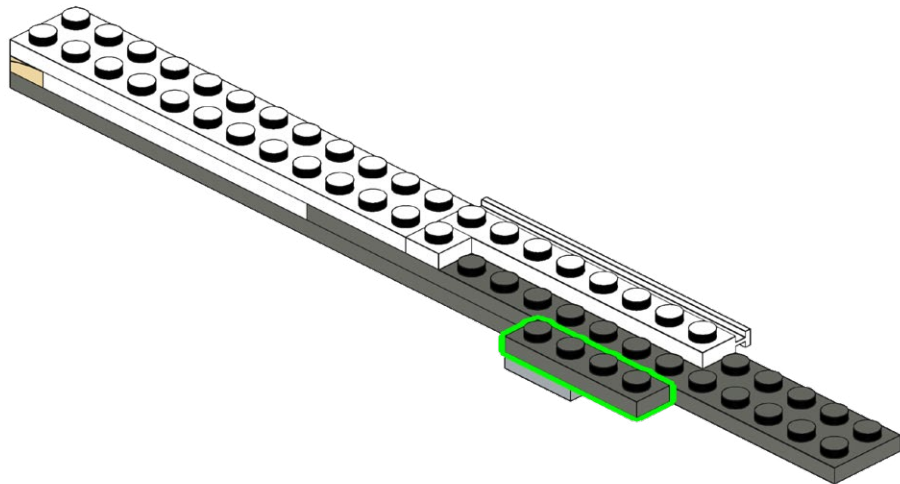
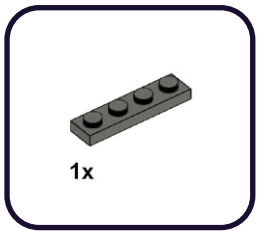

186

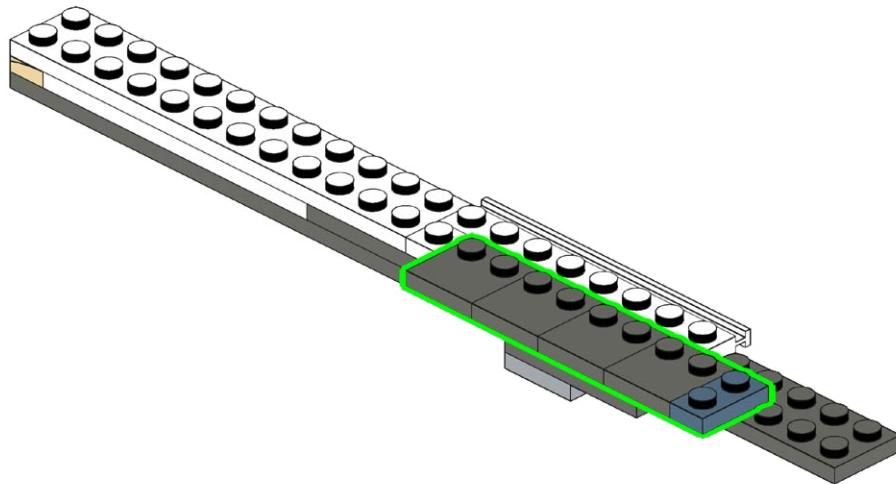
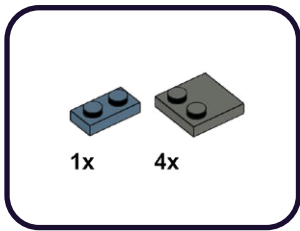

187

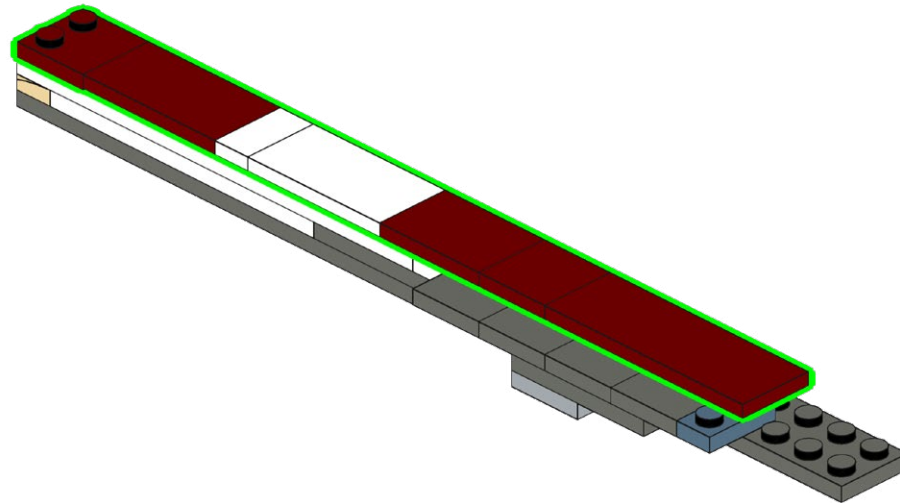
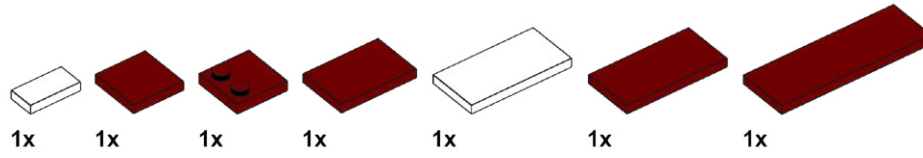

188

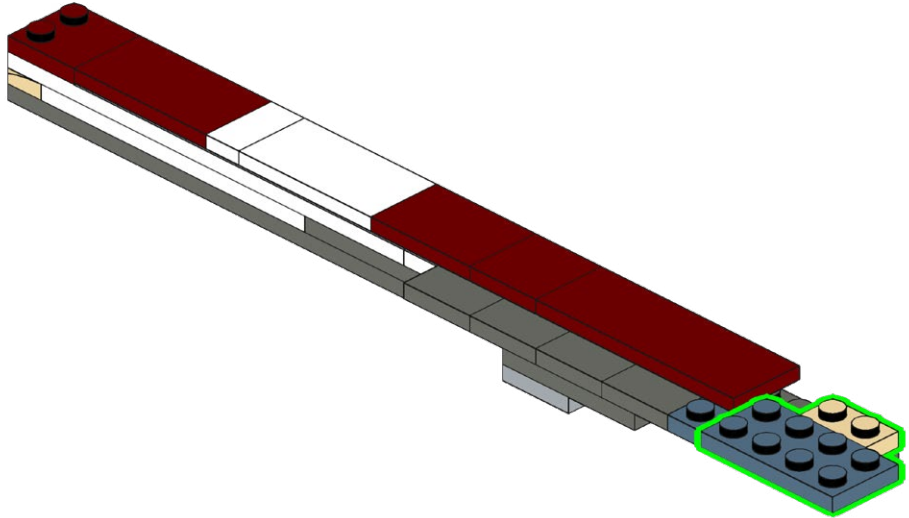
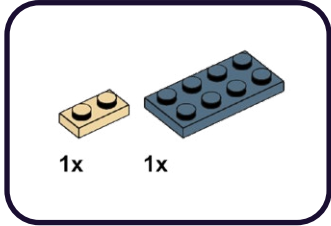

189

1x

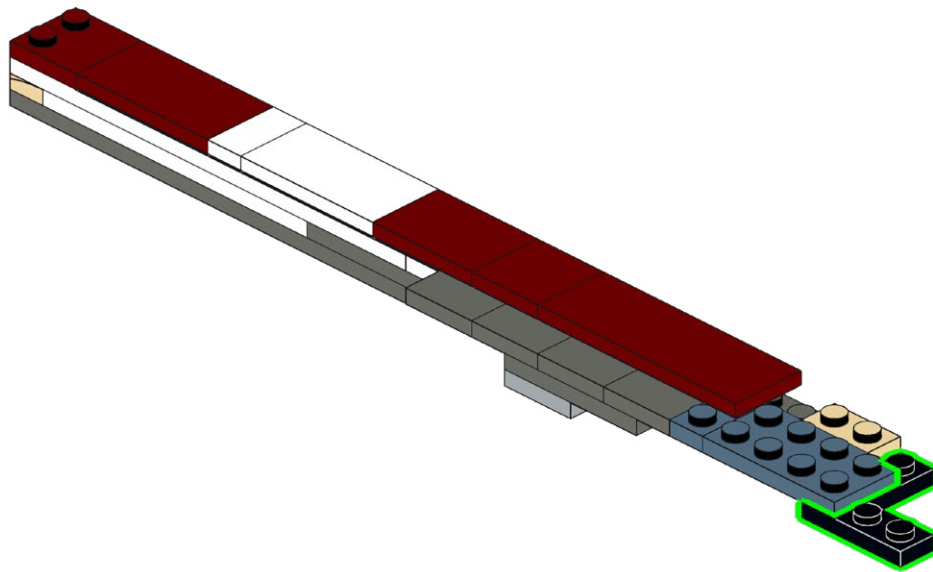

190

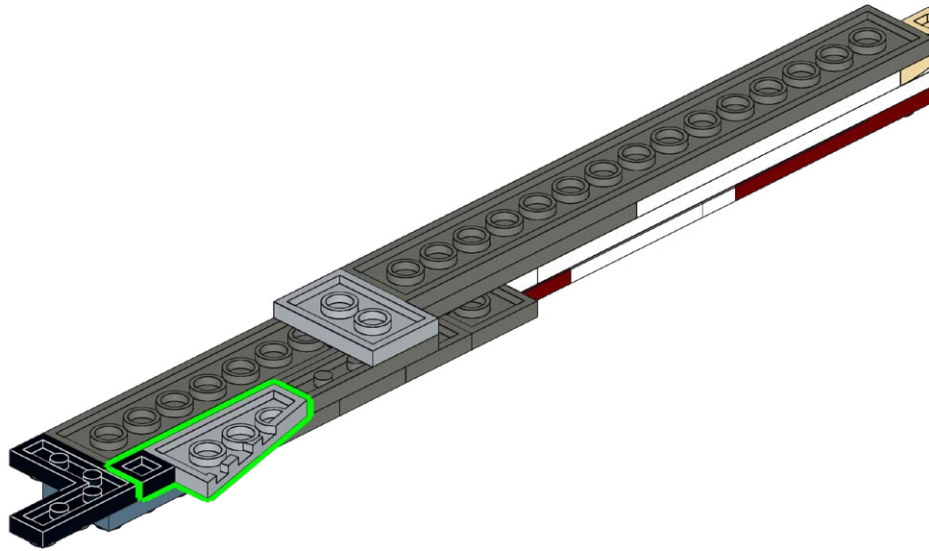
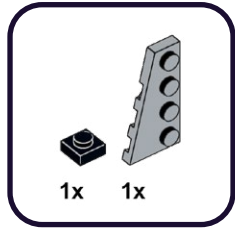

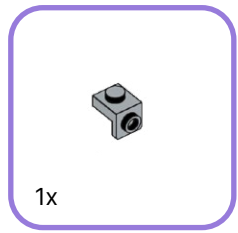
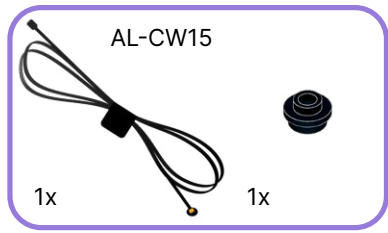

1

1

2

2

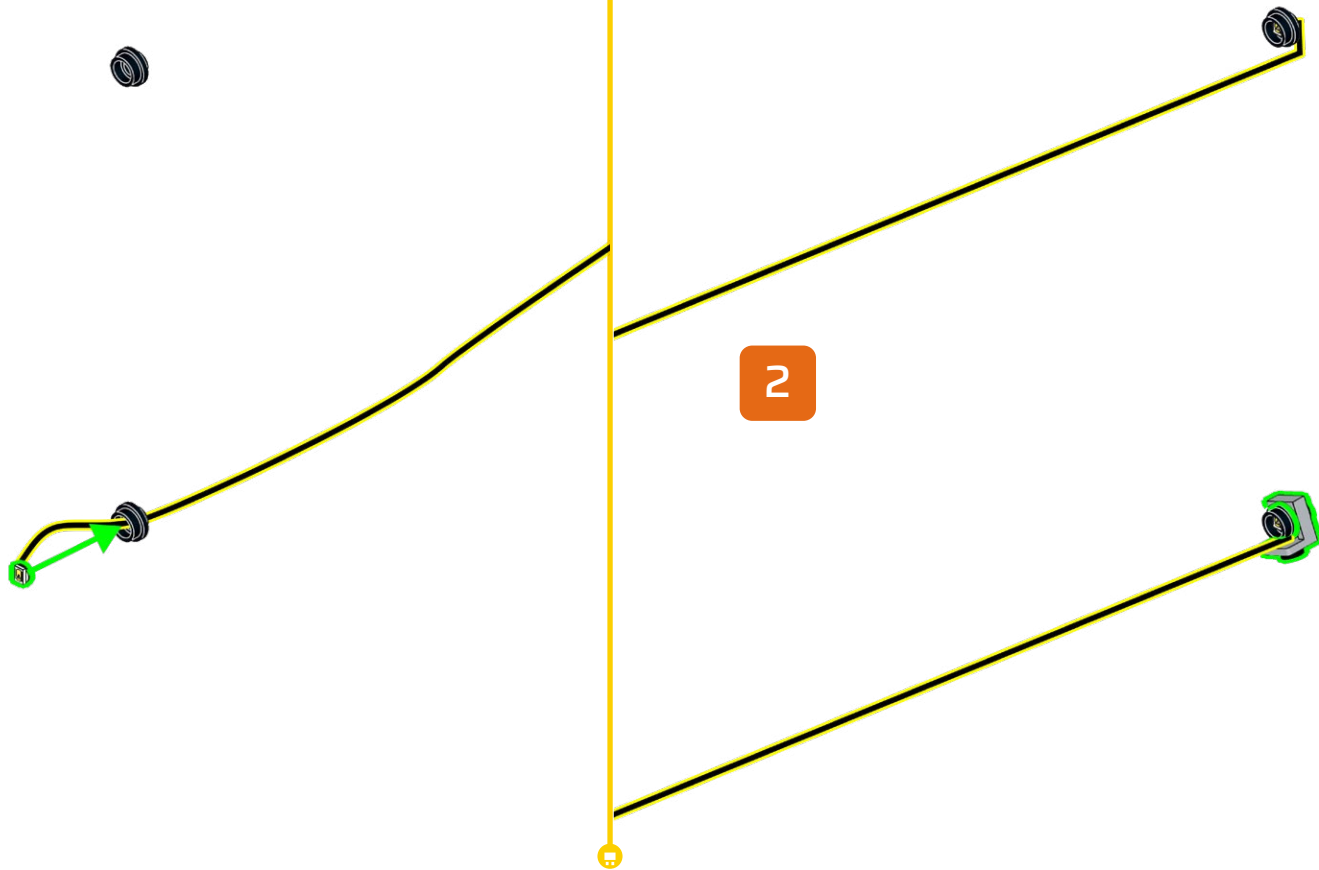

193

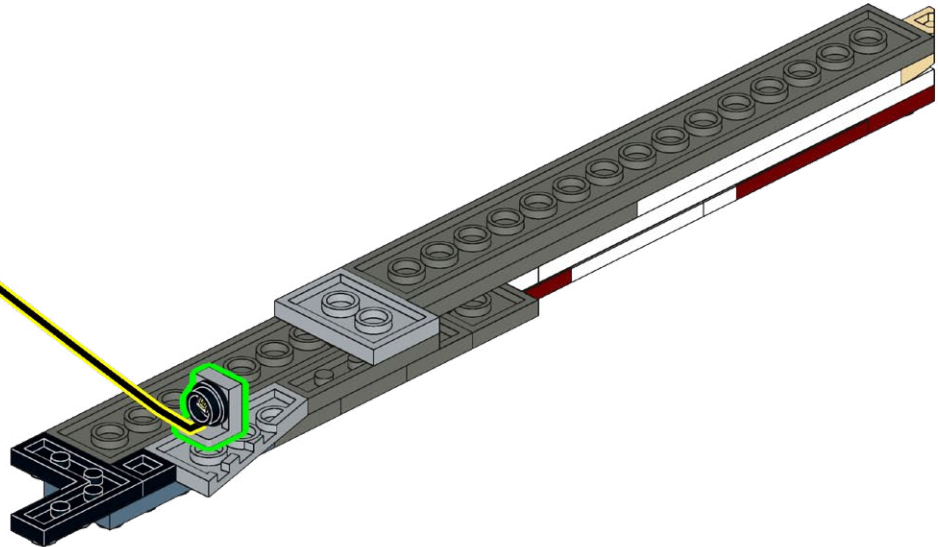
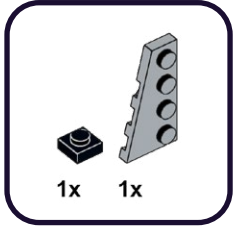

194

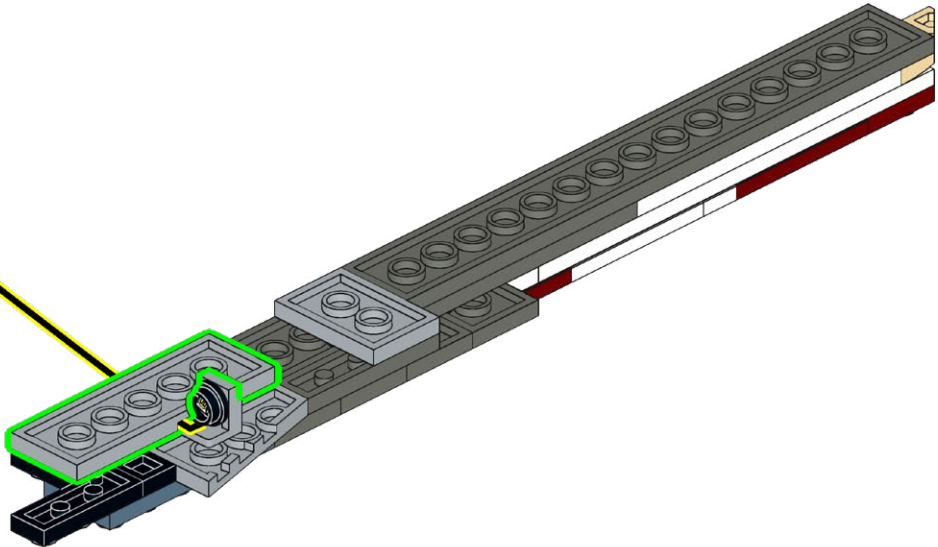
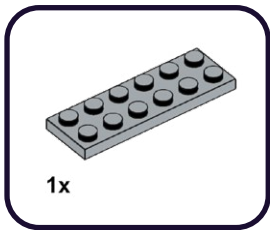

195

1x

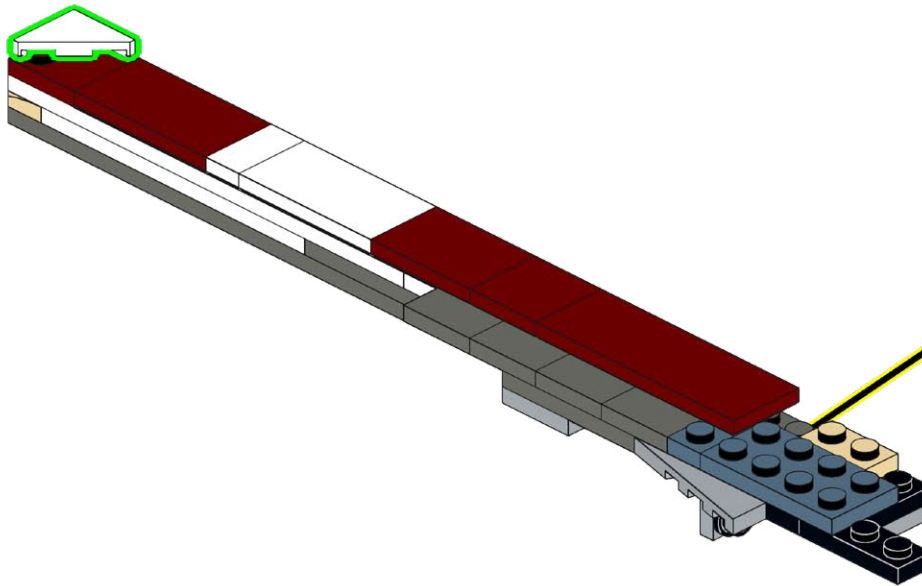

196

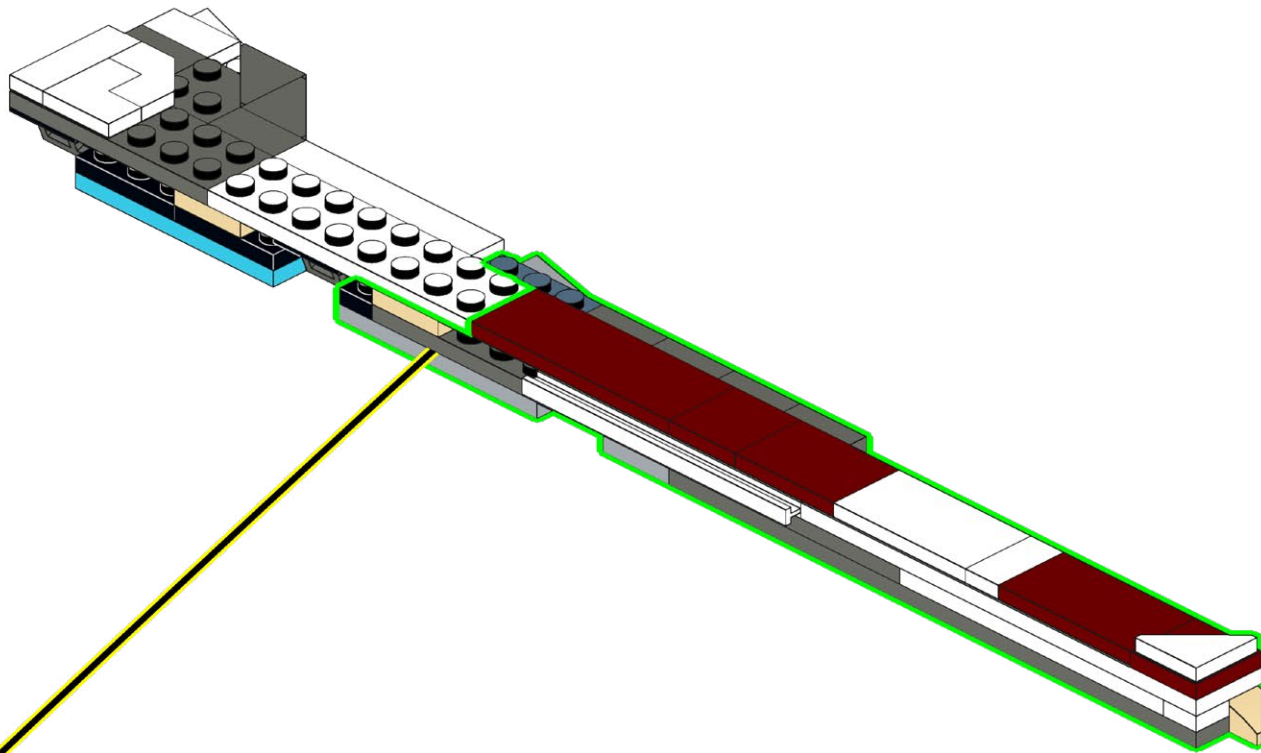
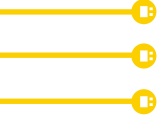

197

1x

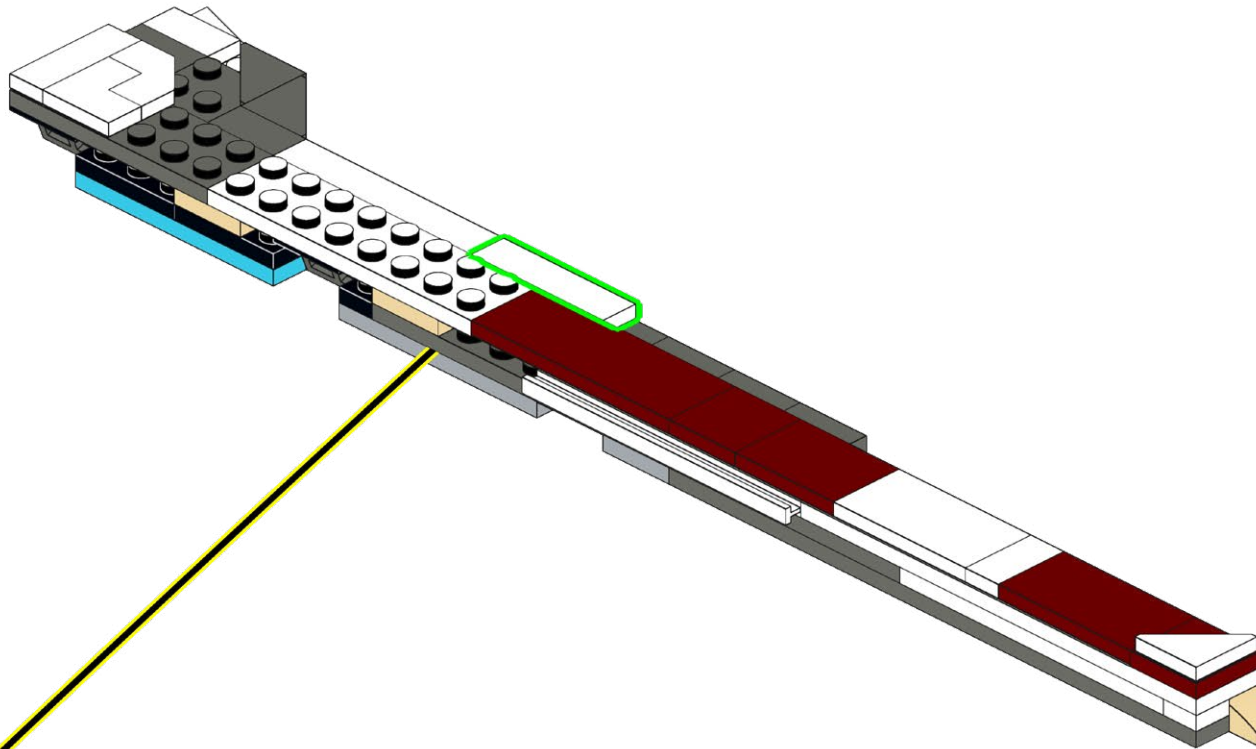

198

2x

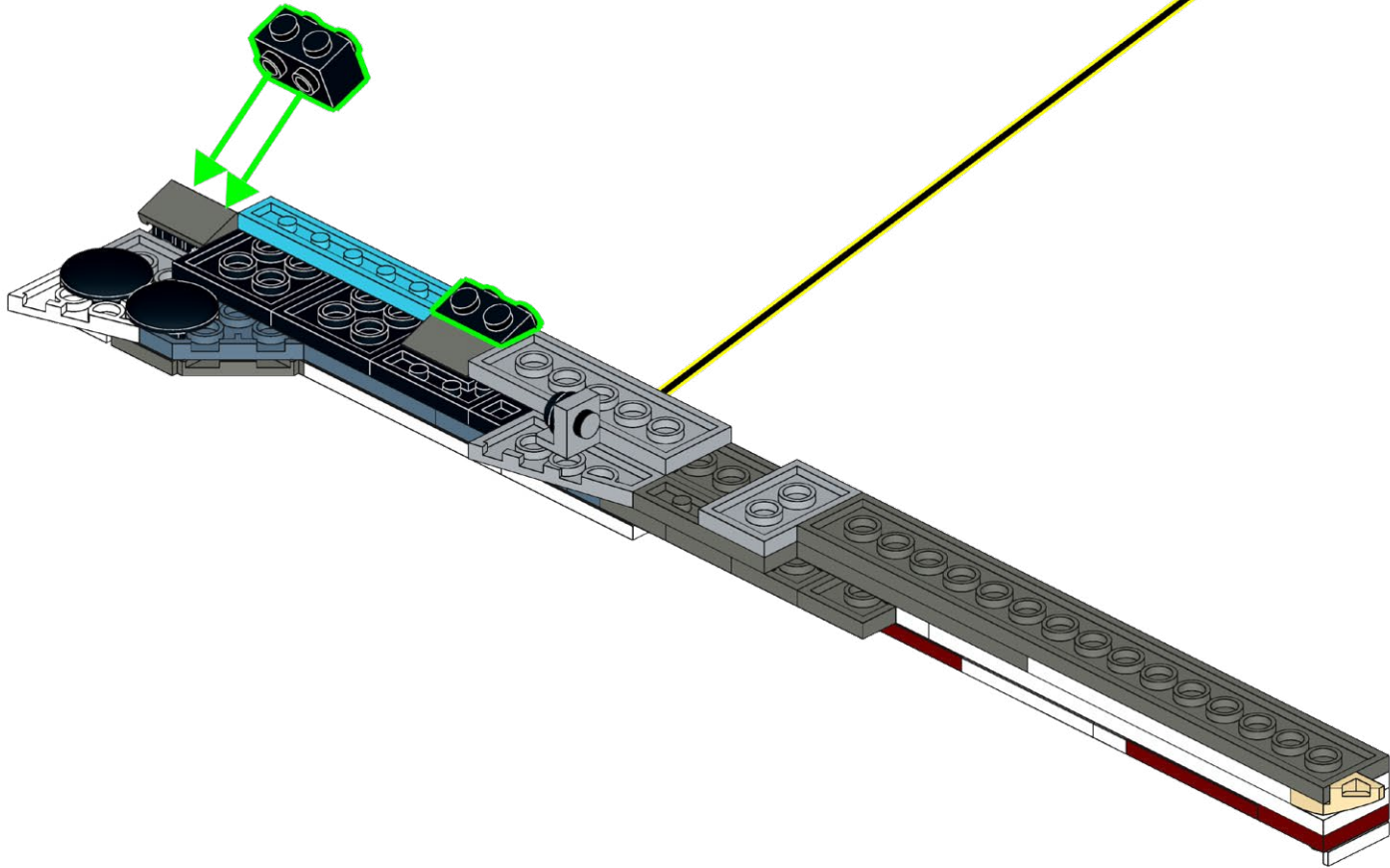

199

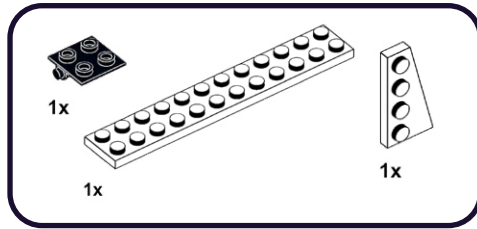

1

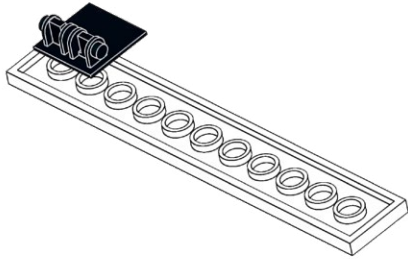

2

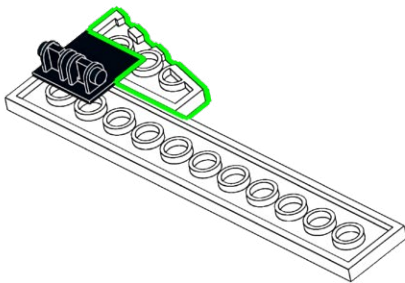

200

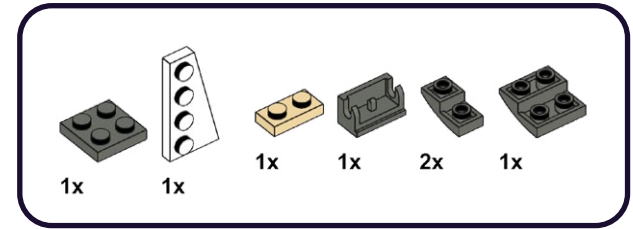

1

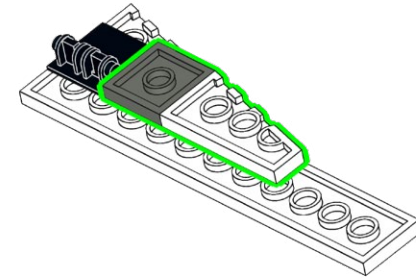

2

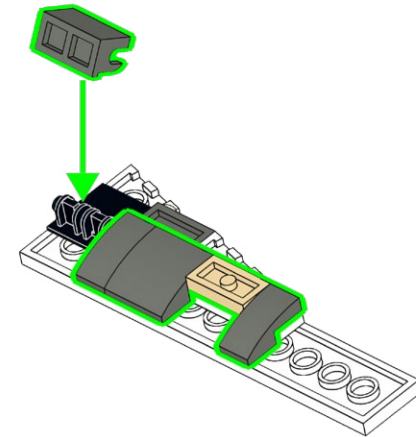

201

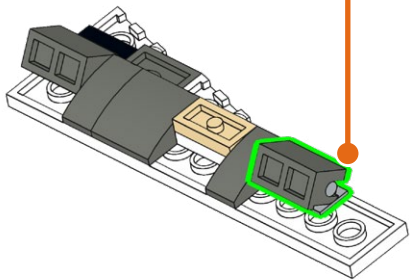
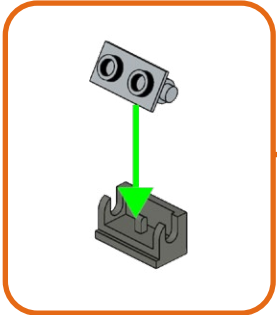
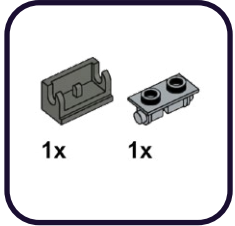

202

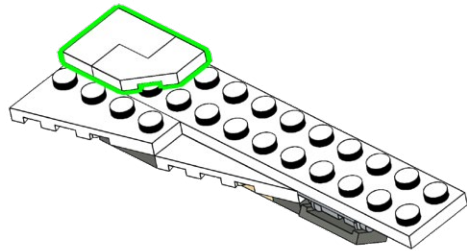
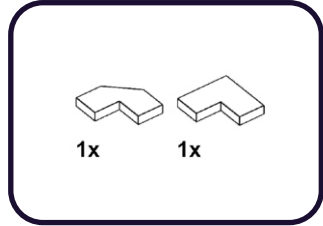

203

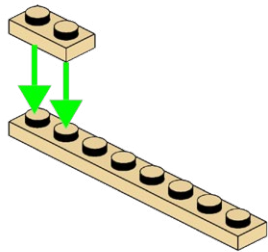
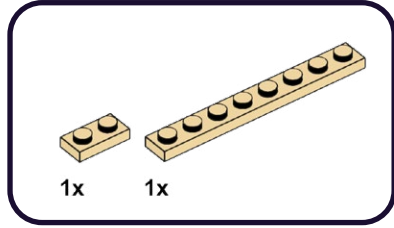

204

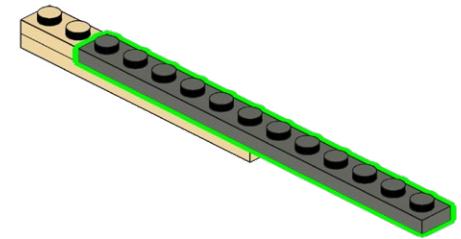
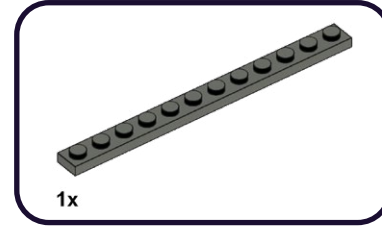

205

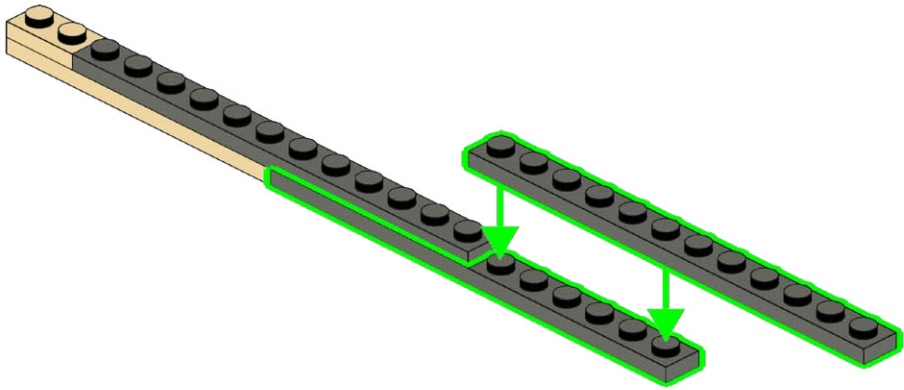
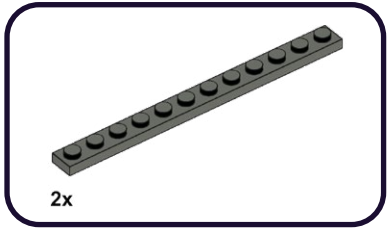

206

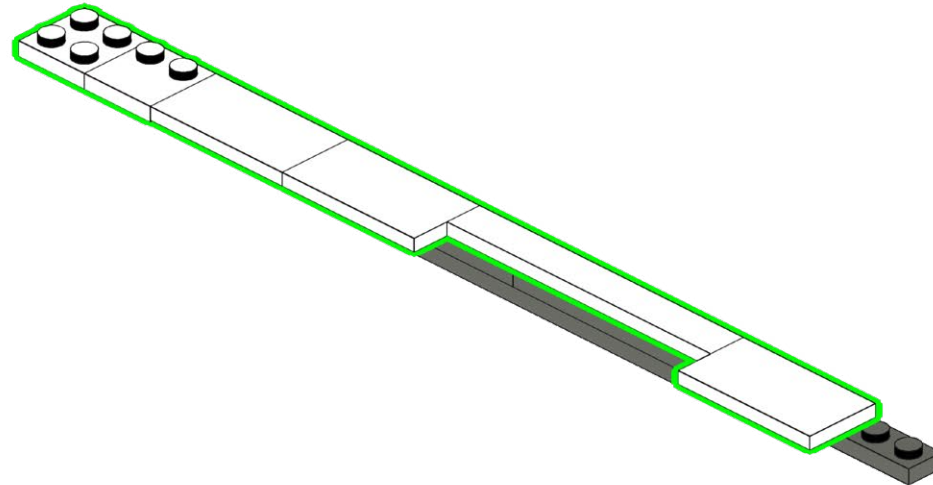
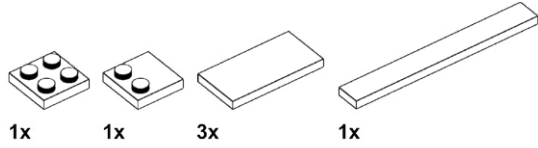

207

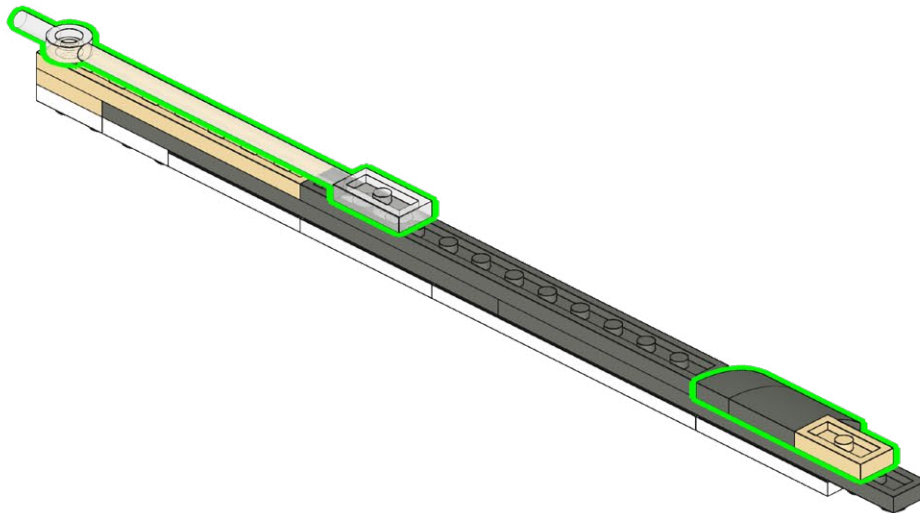
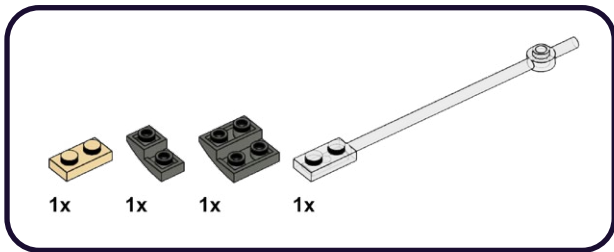

208

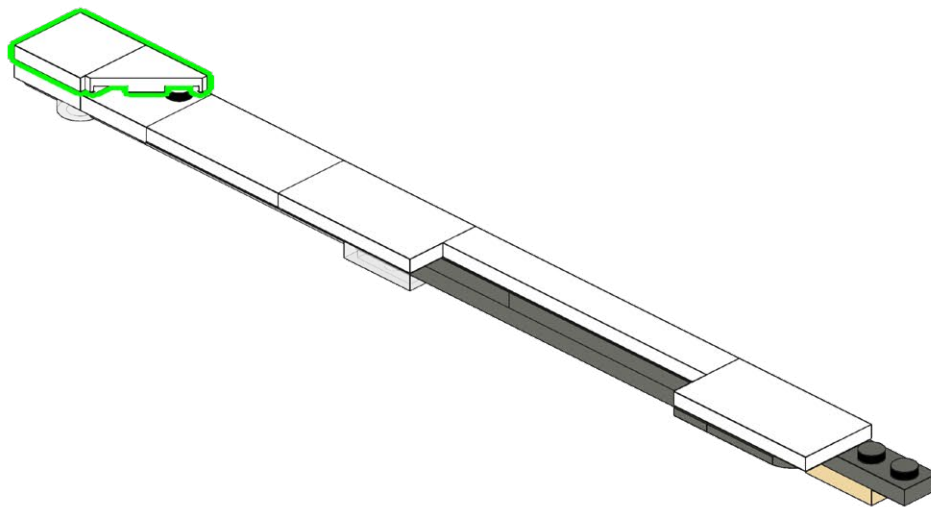
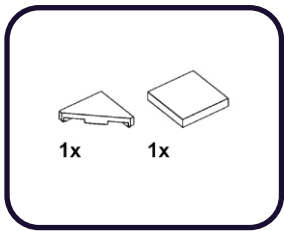

209

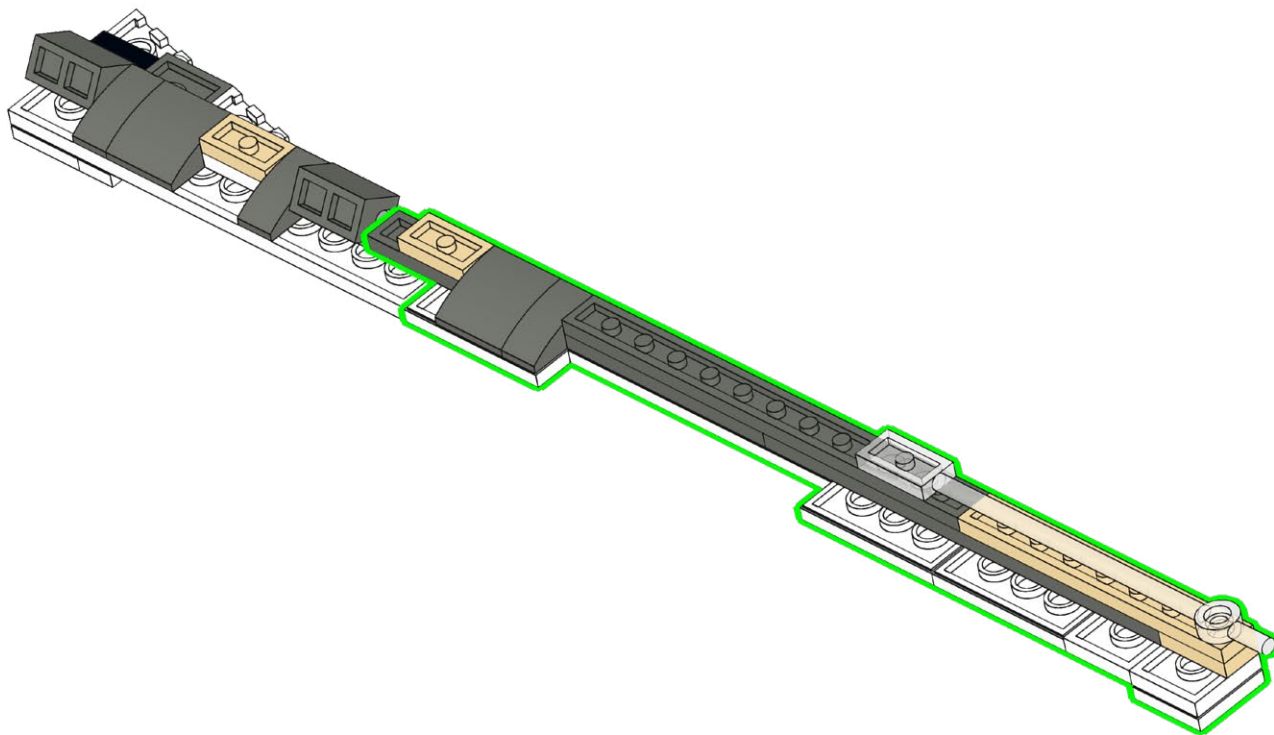

210

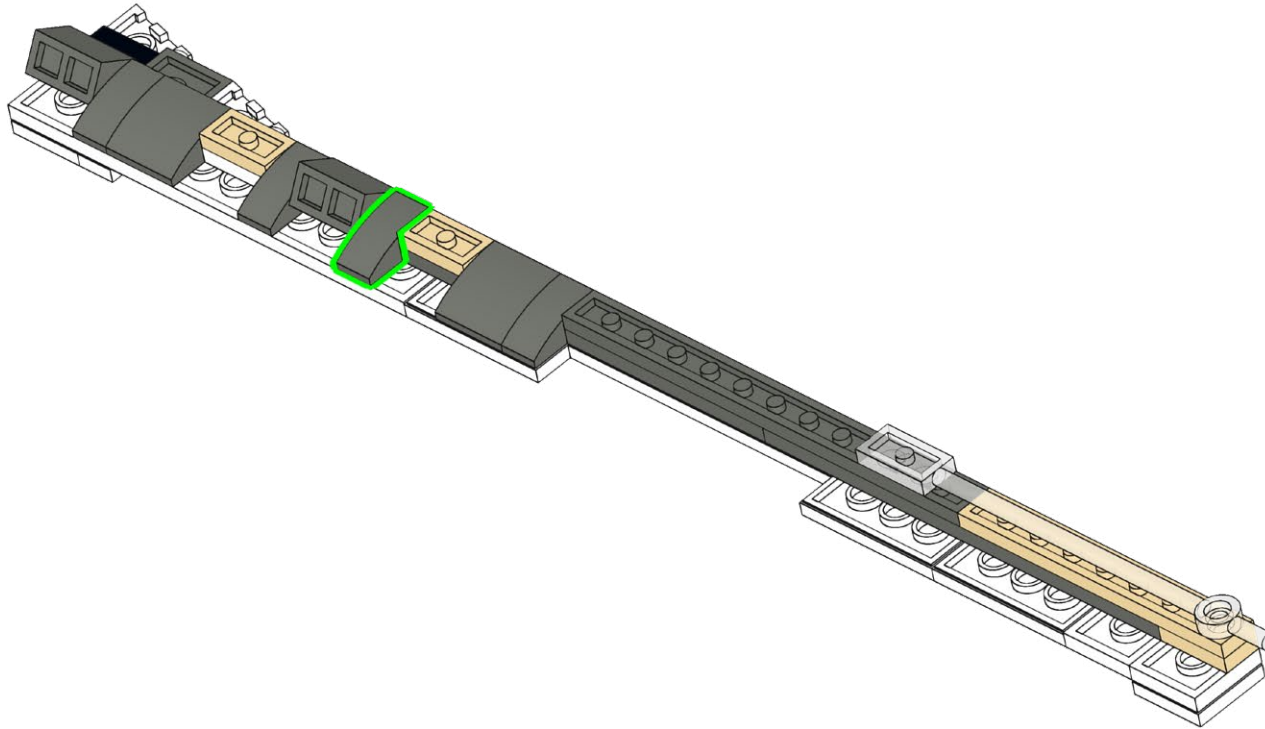
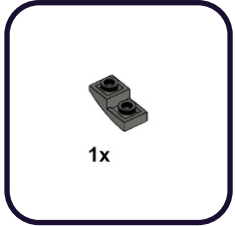

211

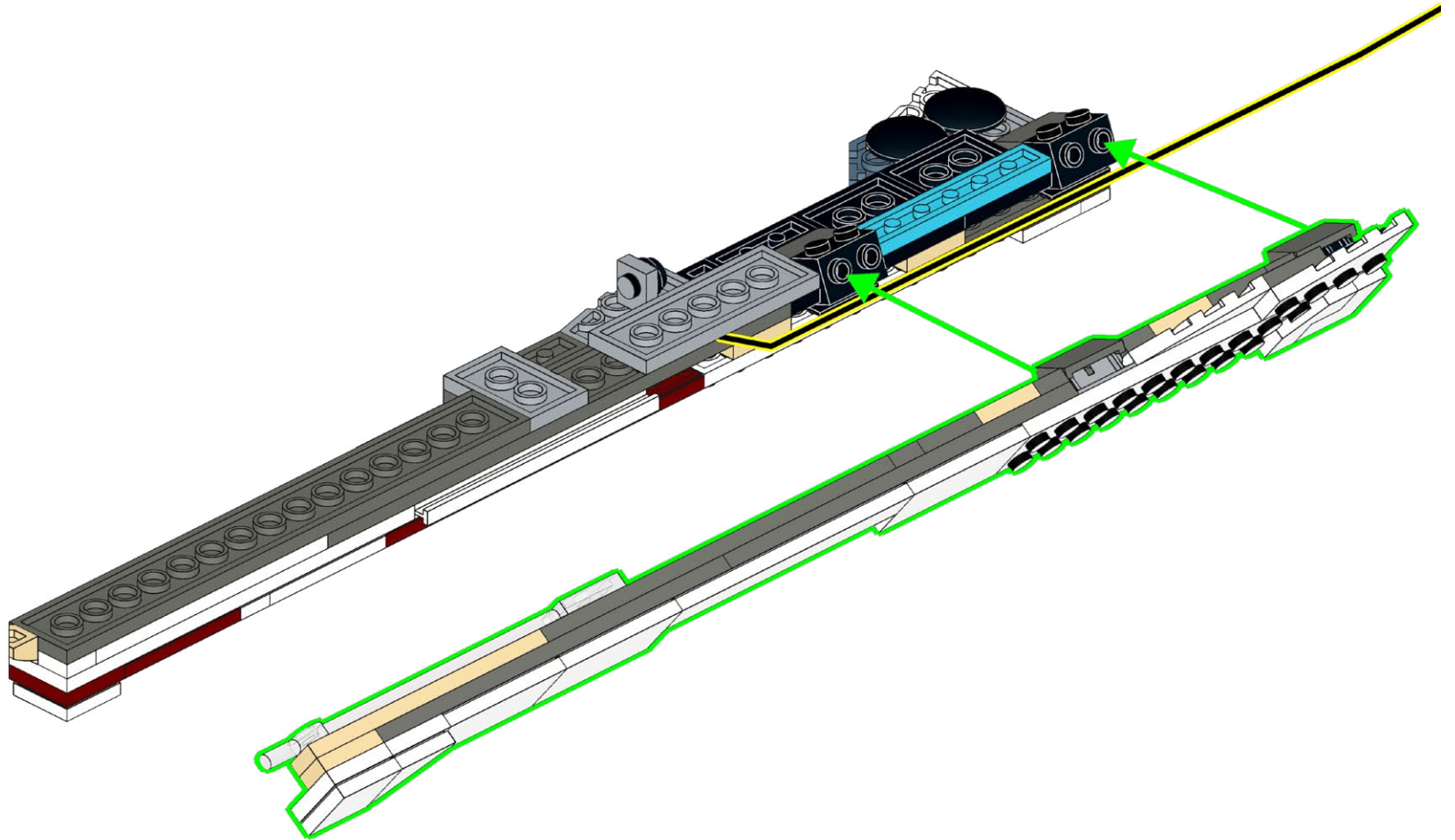

212

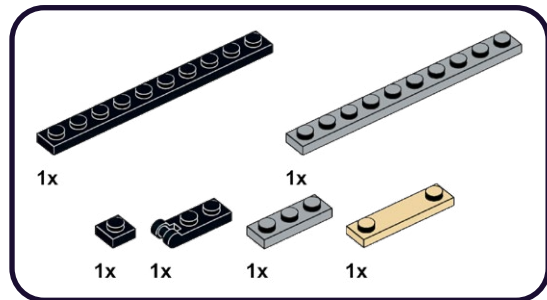

1

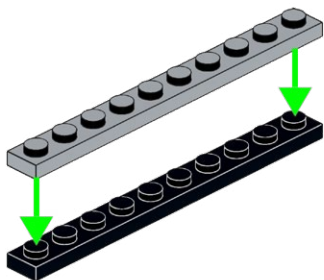

2

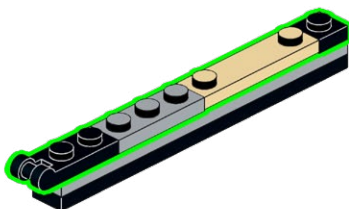

213

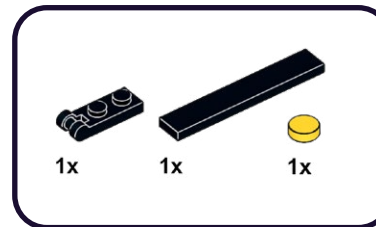

1

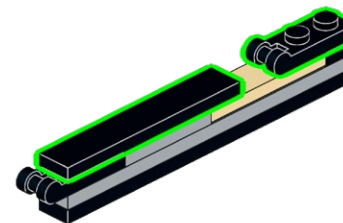

2

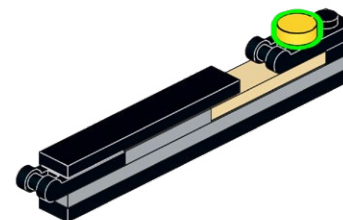

214

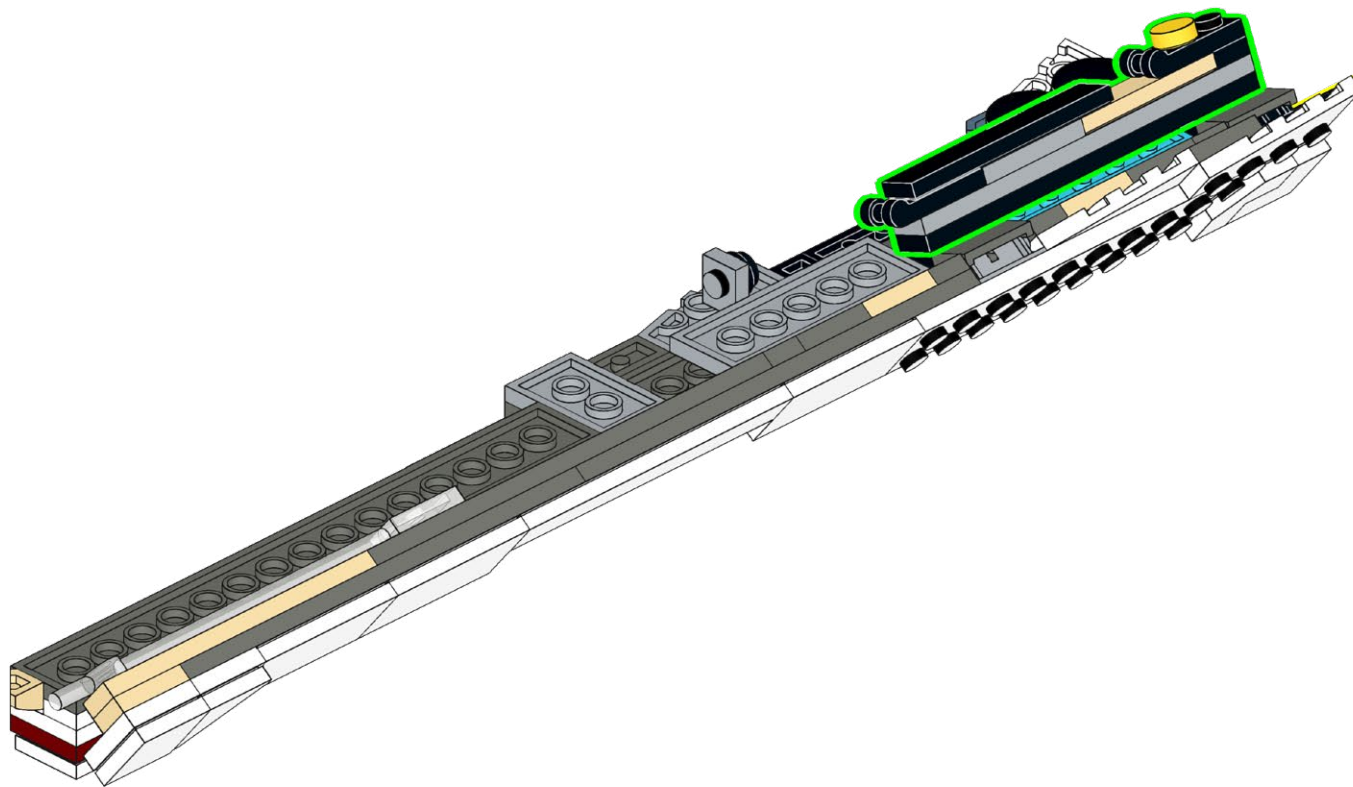

215

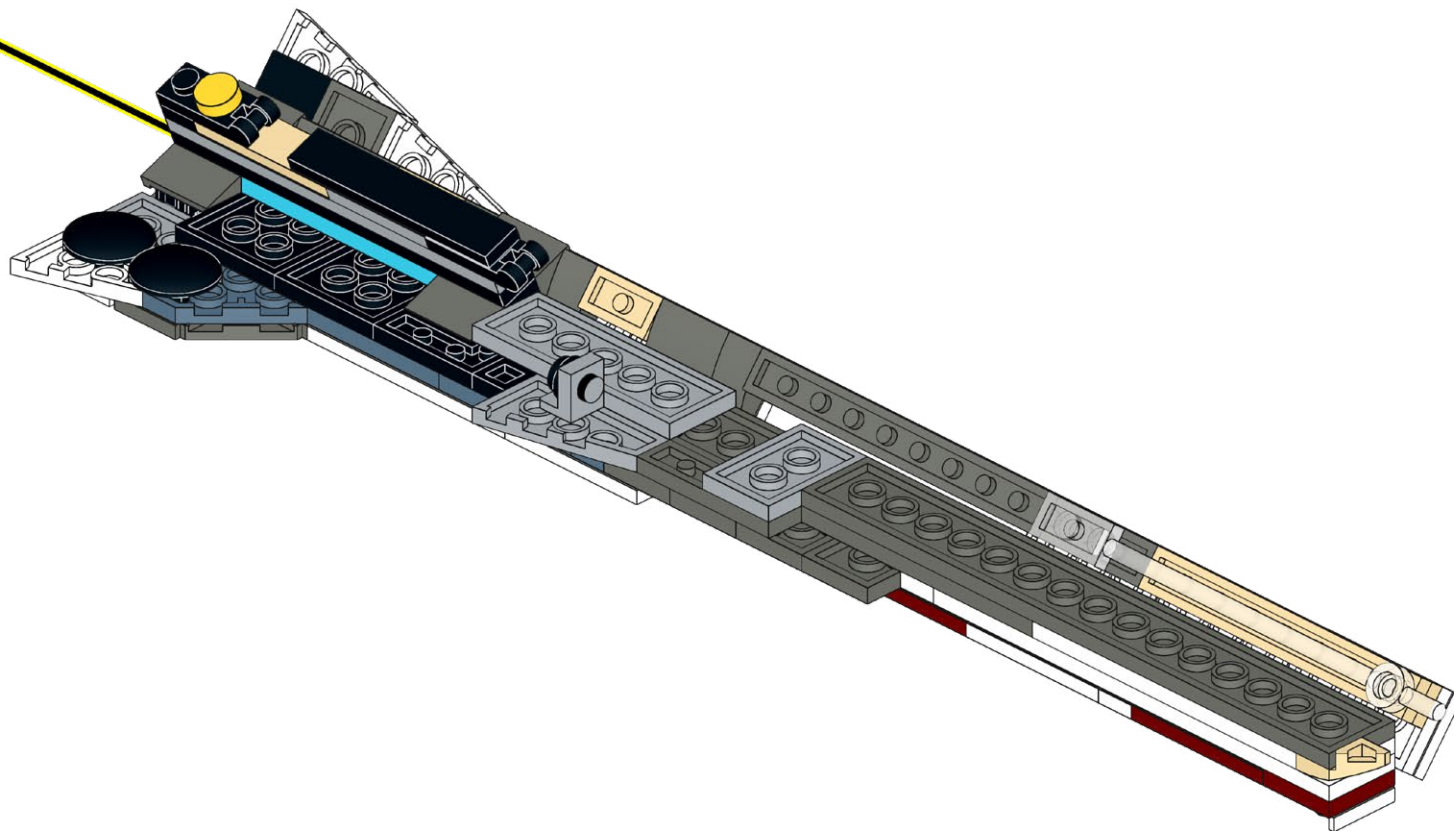

216

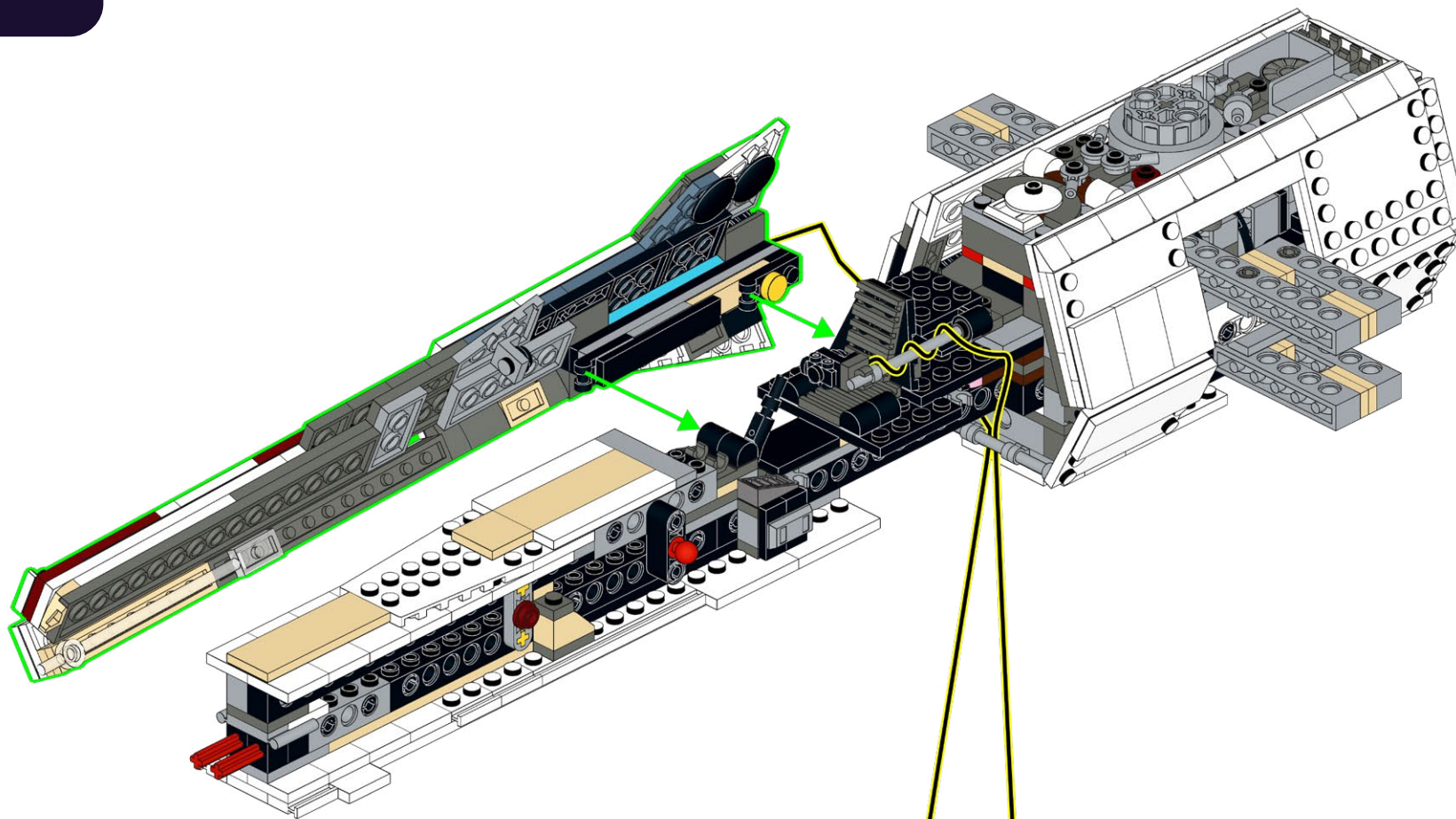

217

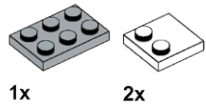

1



2

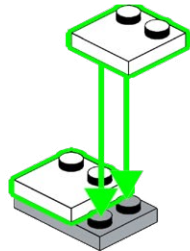

218

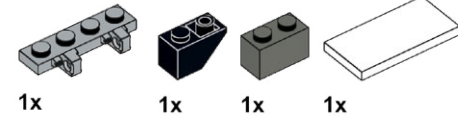

1

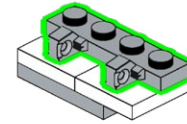

2

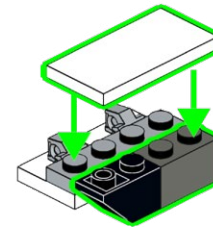

219

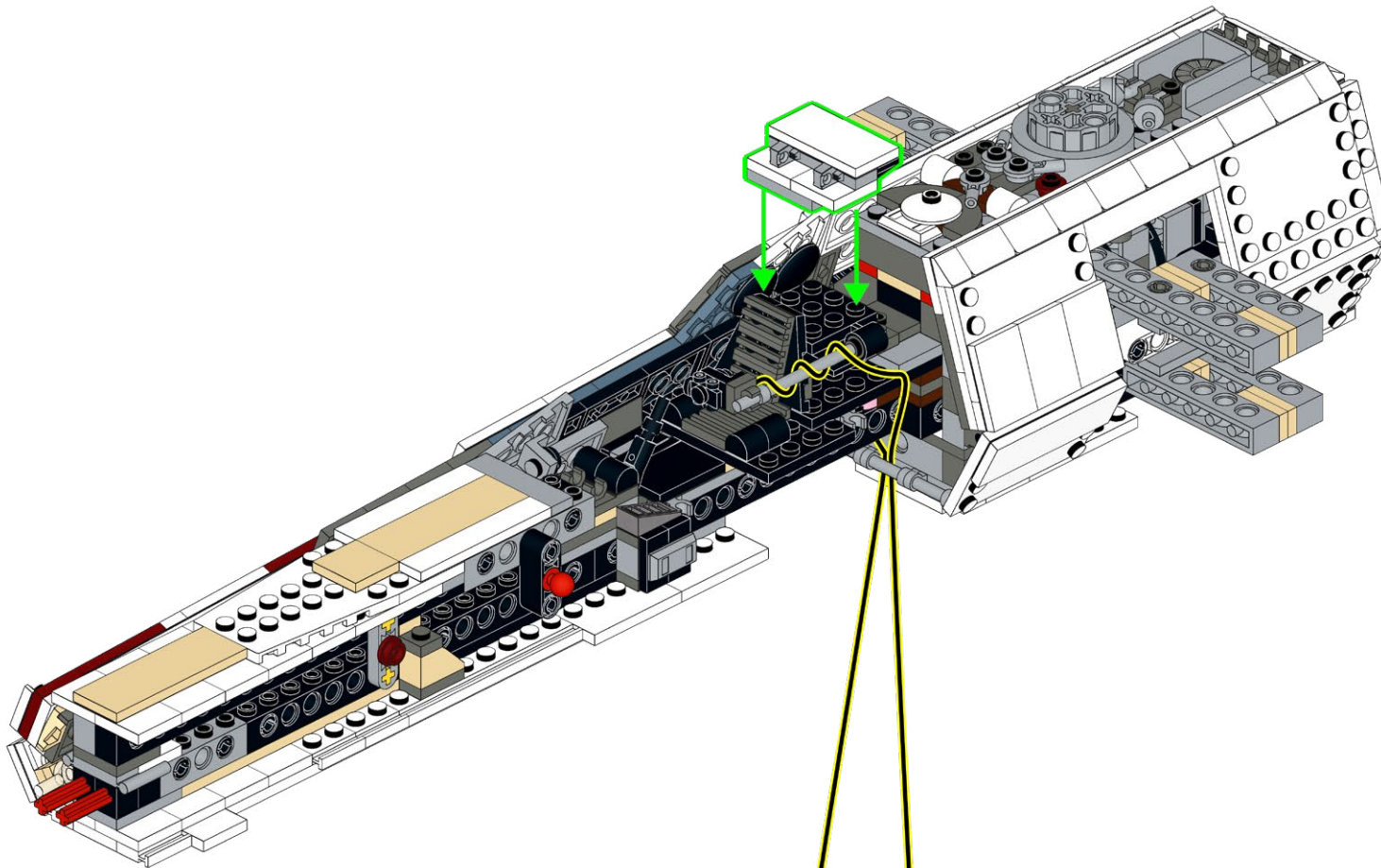

220

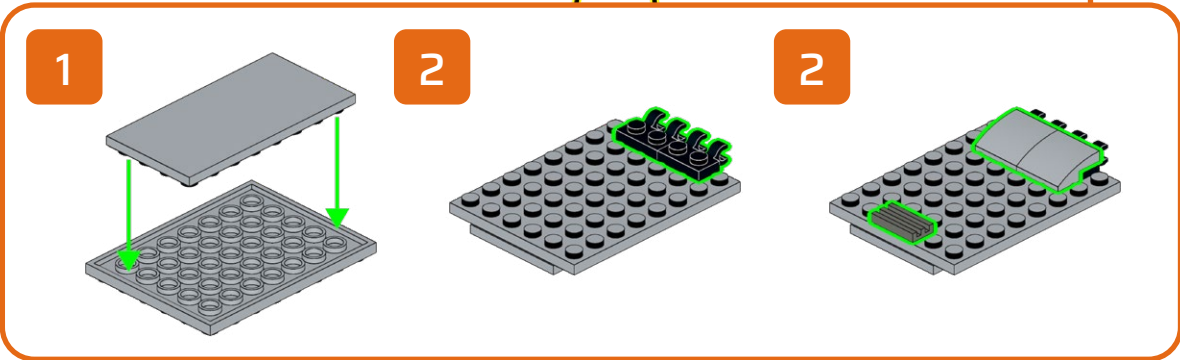
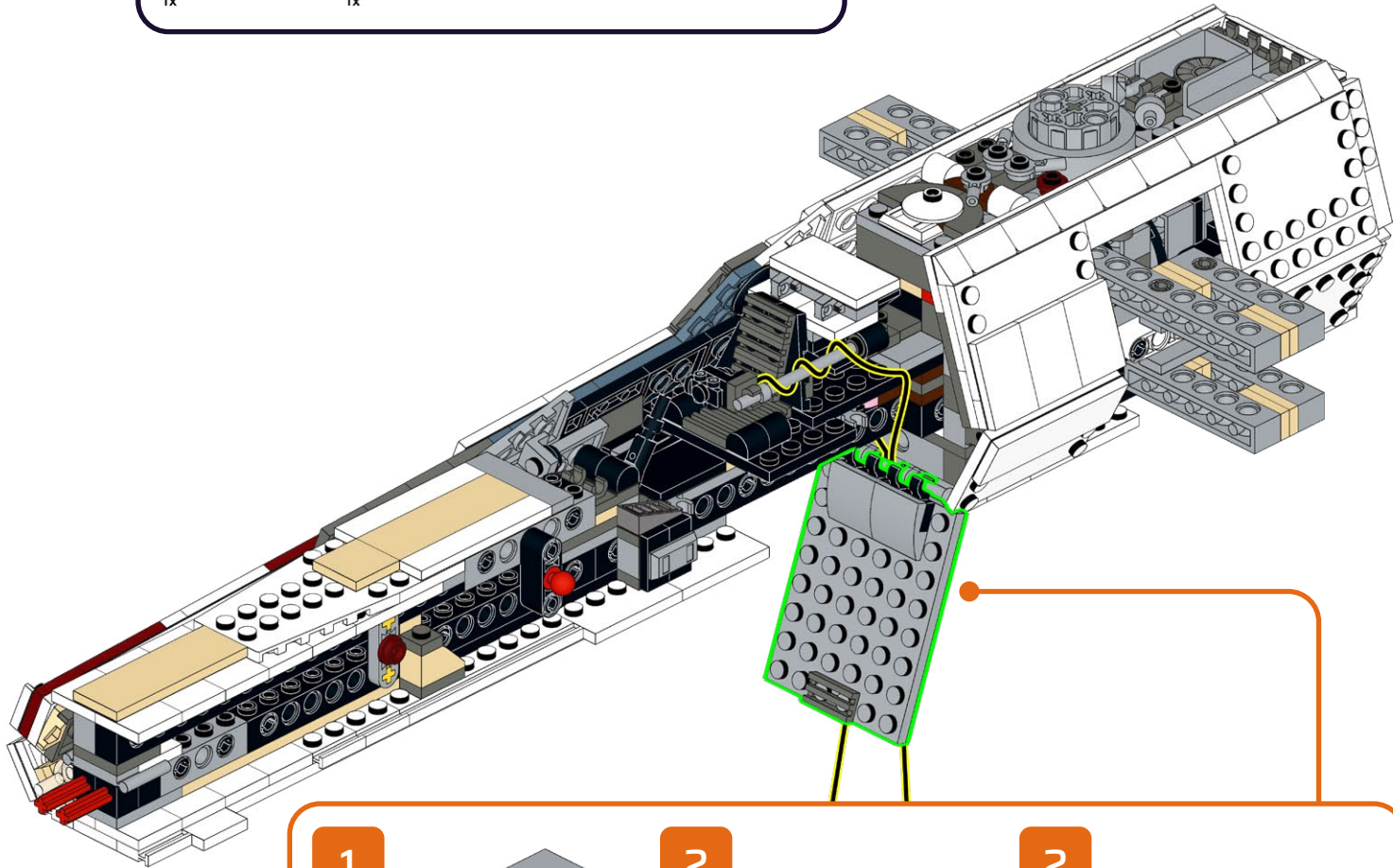
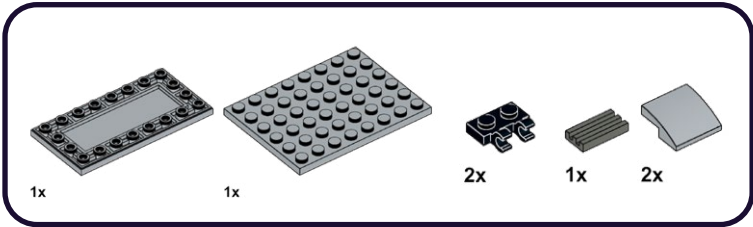

221

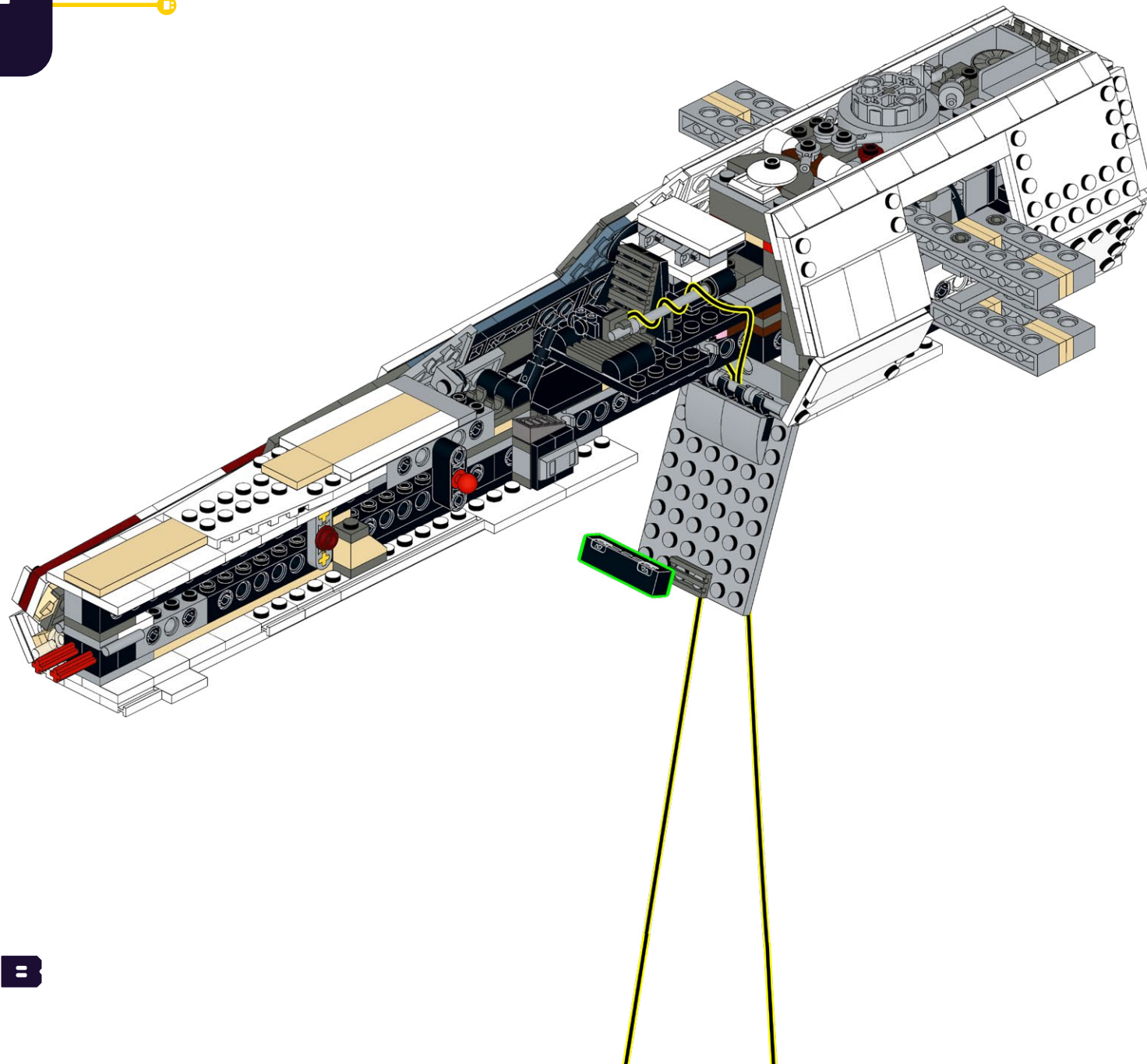

222

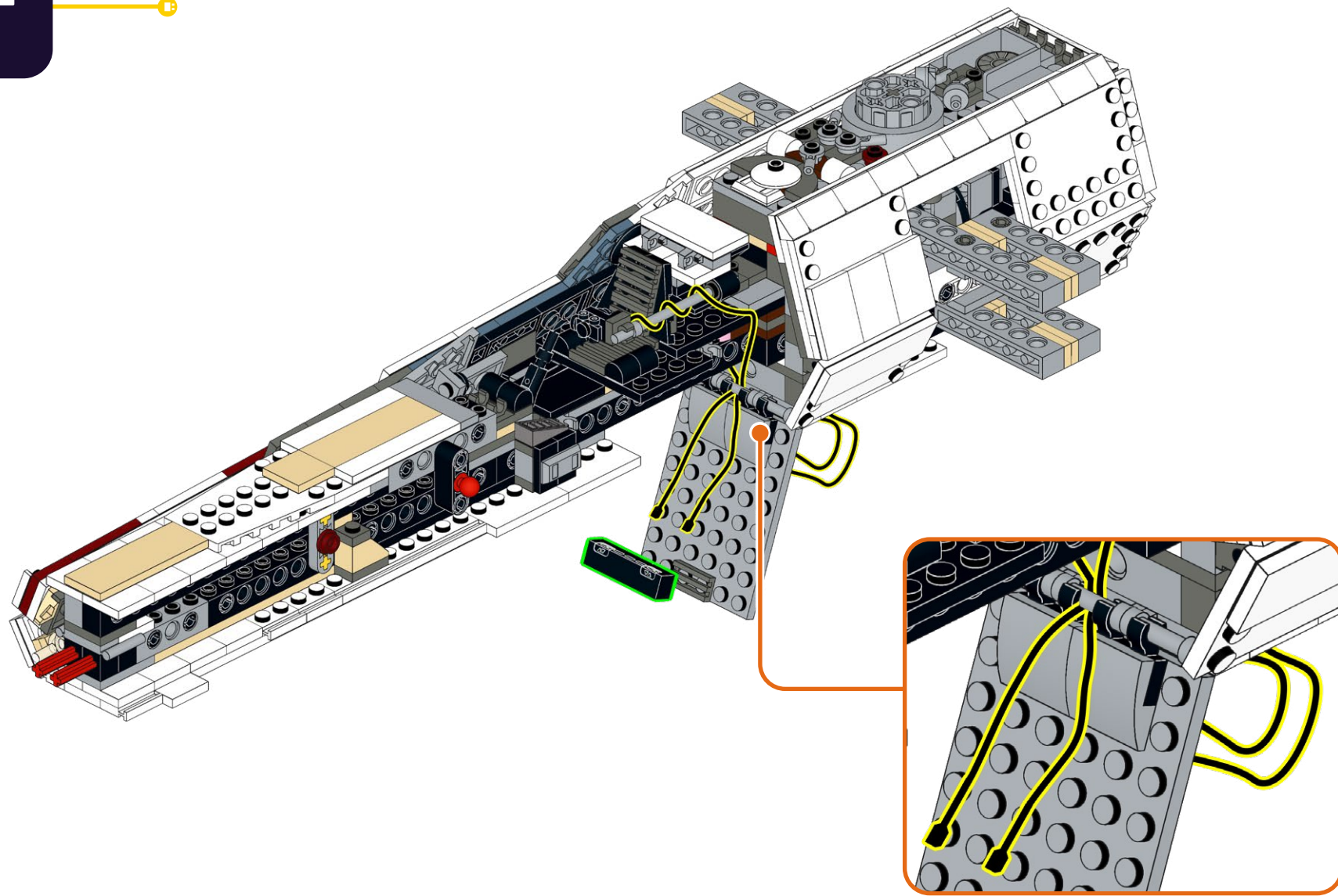

223

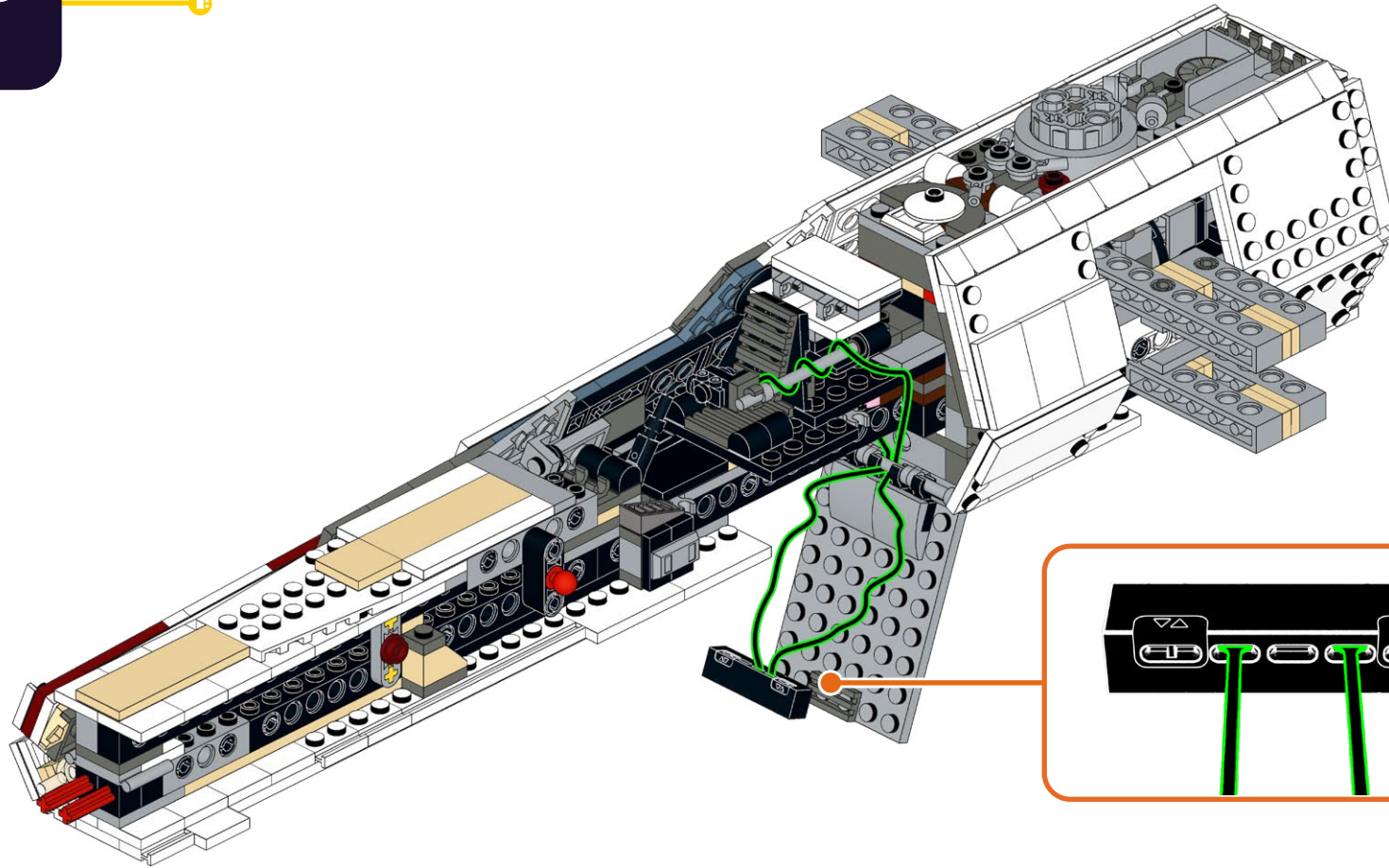



HOLD UP!

You might notice some bags aren't in order, as well as left over pieces, but that's ok! We're changing the way you build LEGO!

ATTENDEZ!

Vous remarquerez peut-être que certains sacs, ainsi que certaines pièces, ne sont pas dans le bon ordre. Mais pas de panique! Nous changeons simplement la façon avec laquelle vous construisez vos LEGO!

ASPETTA!

Potresti notare che alcuni sacchetti non sono in ordine, così come i pezzi avanzati, ma va bene così! Stiamo cambiando il modo in cui costruisci i LEGO!

HALT!

Sie werden möglicherweise bemerken, dass einige tüten durcheinander sind und teile übrig bleiben, aber das ist in Ordnung! Wir ändern die art und weise, wie Sie LEGO bauen!

¡ESPERA!

Es posible que notes que algunas bolsas están fuera de servicio, así como piezas sobrantes, ¡pero está bien! ¡Estamos cambiando la forma en que construyes LEGO!

暫停!

你可能会注意到一些袋子顺序错乱, 以及一些剩余的部件, 但没关系! 我们正在改变你搭建乐高的方式!

Open LMB Bag 01

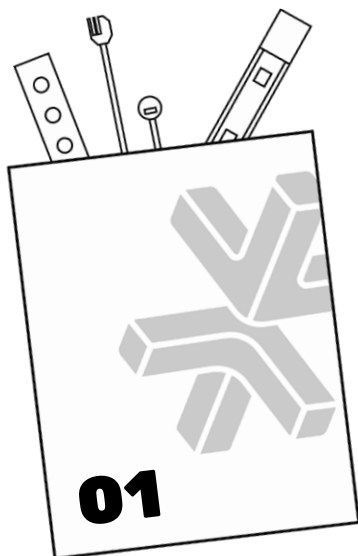

224

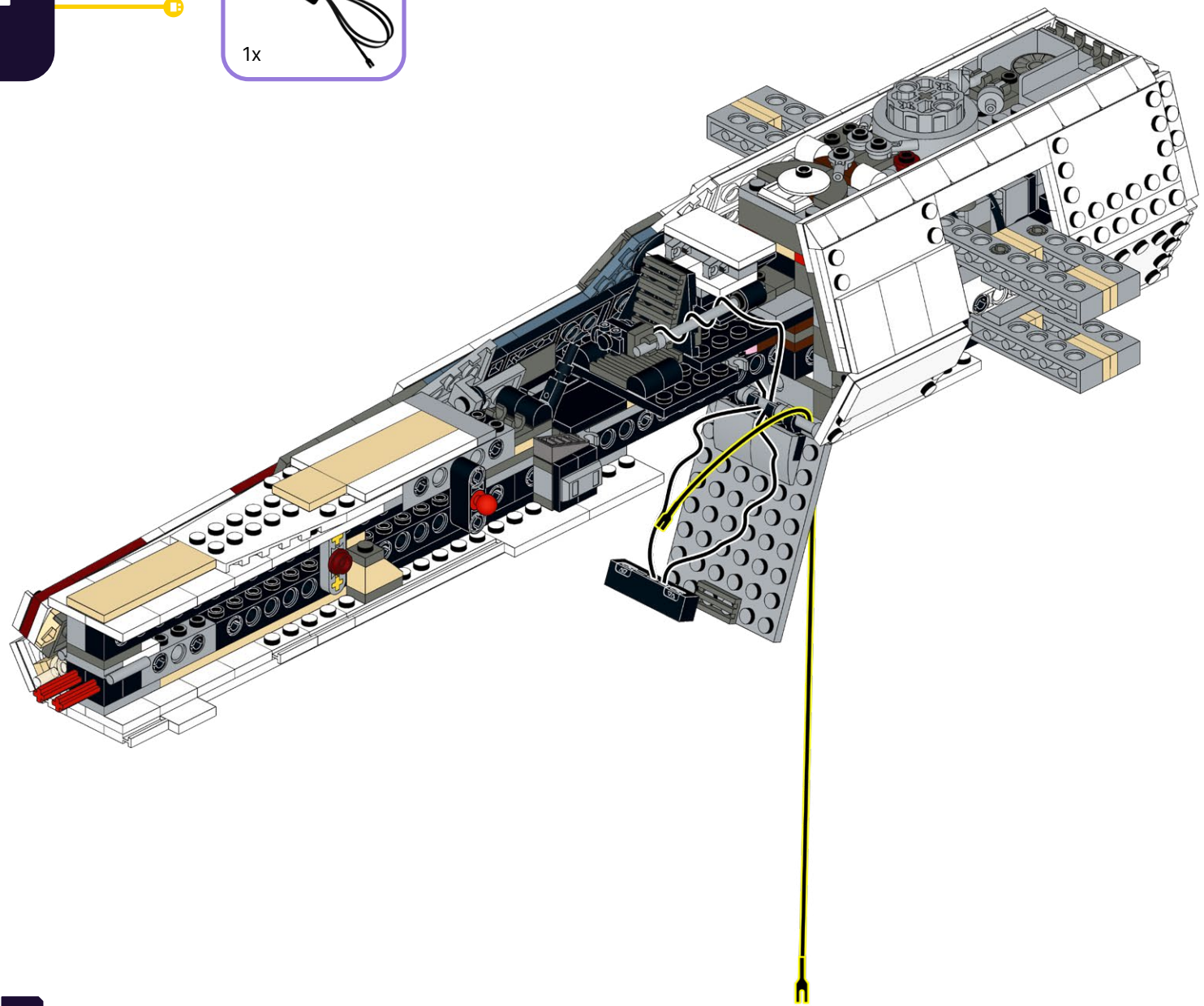
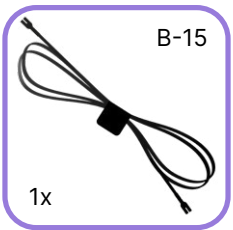

225

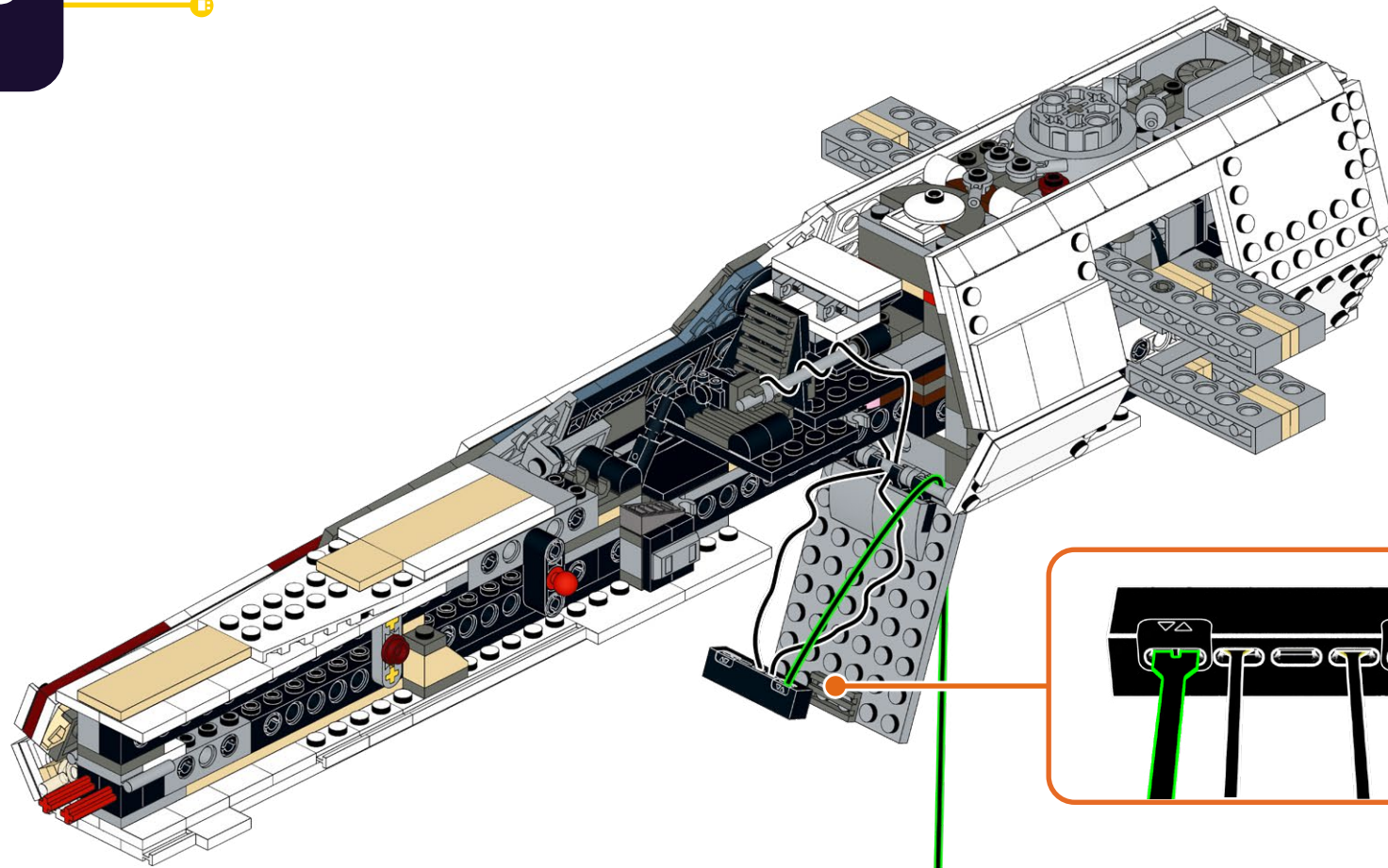

226

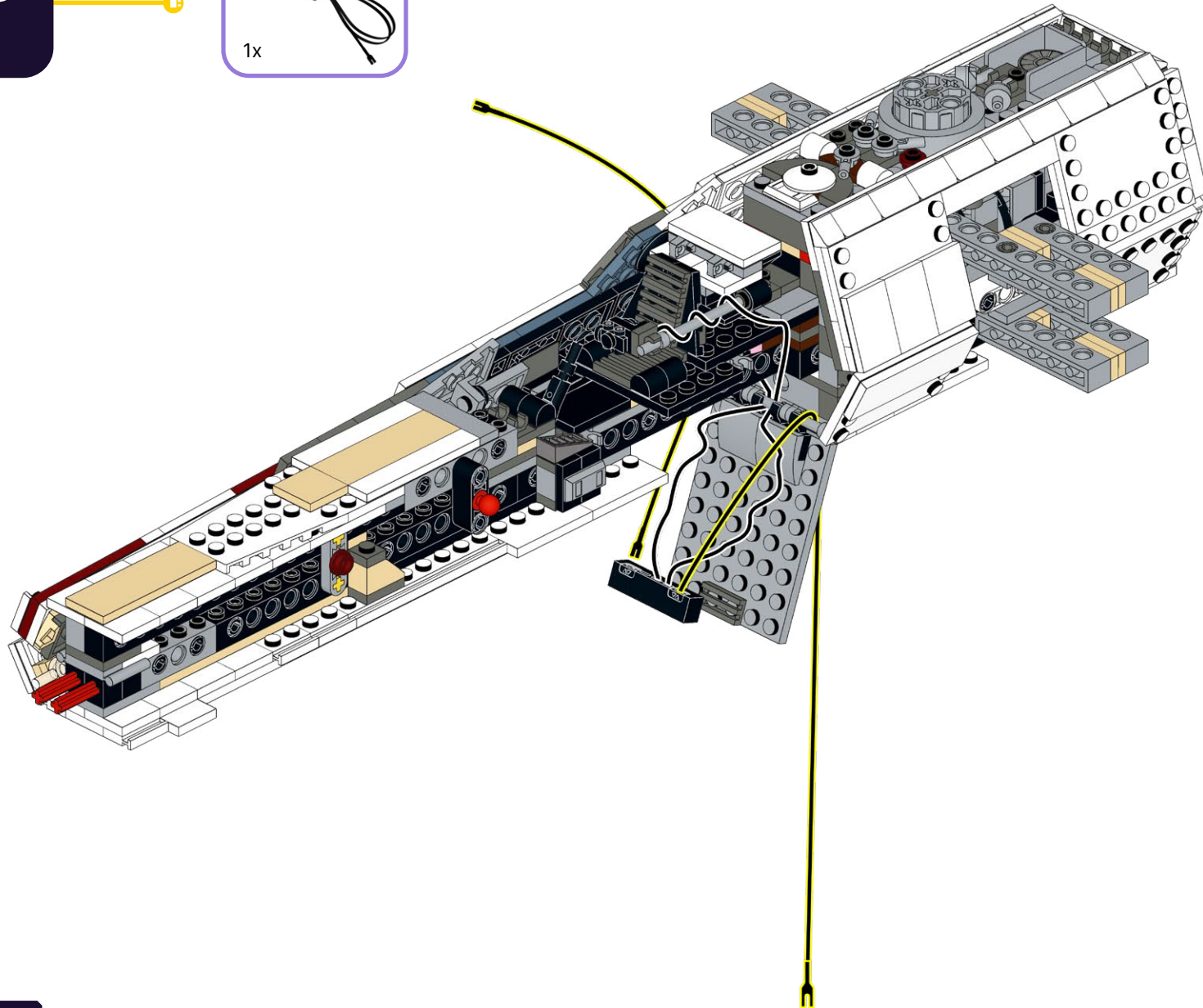
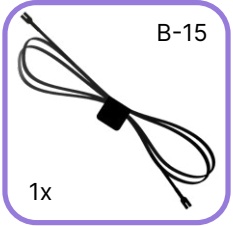

227

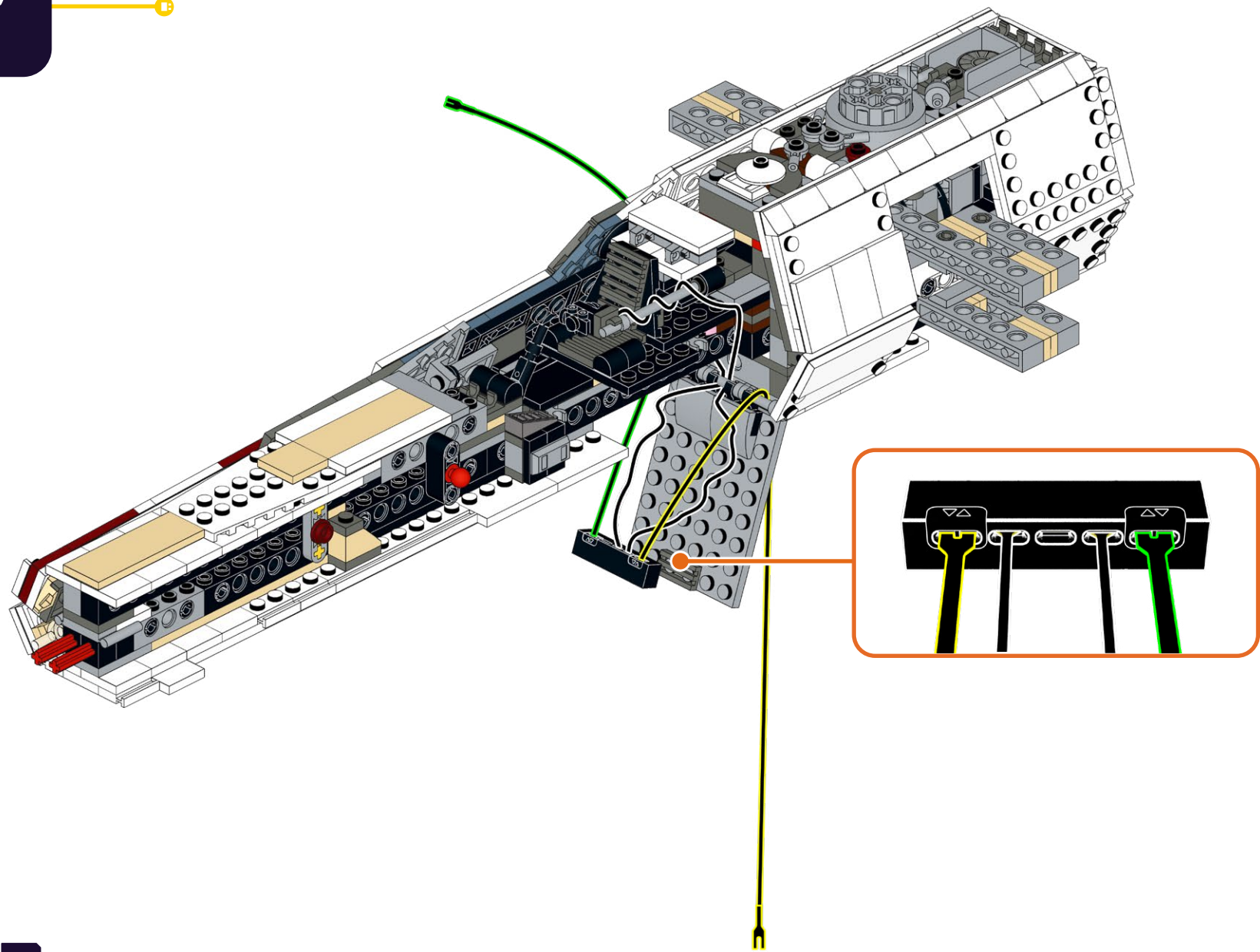

228

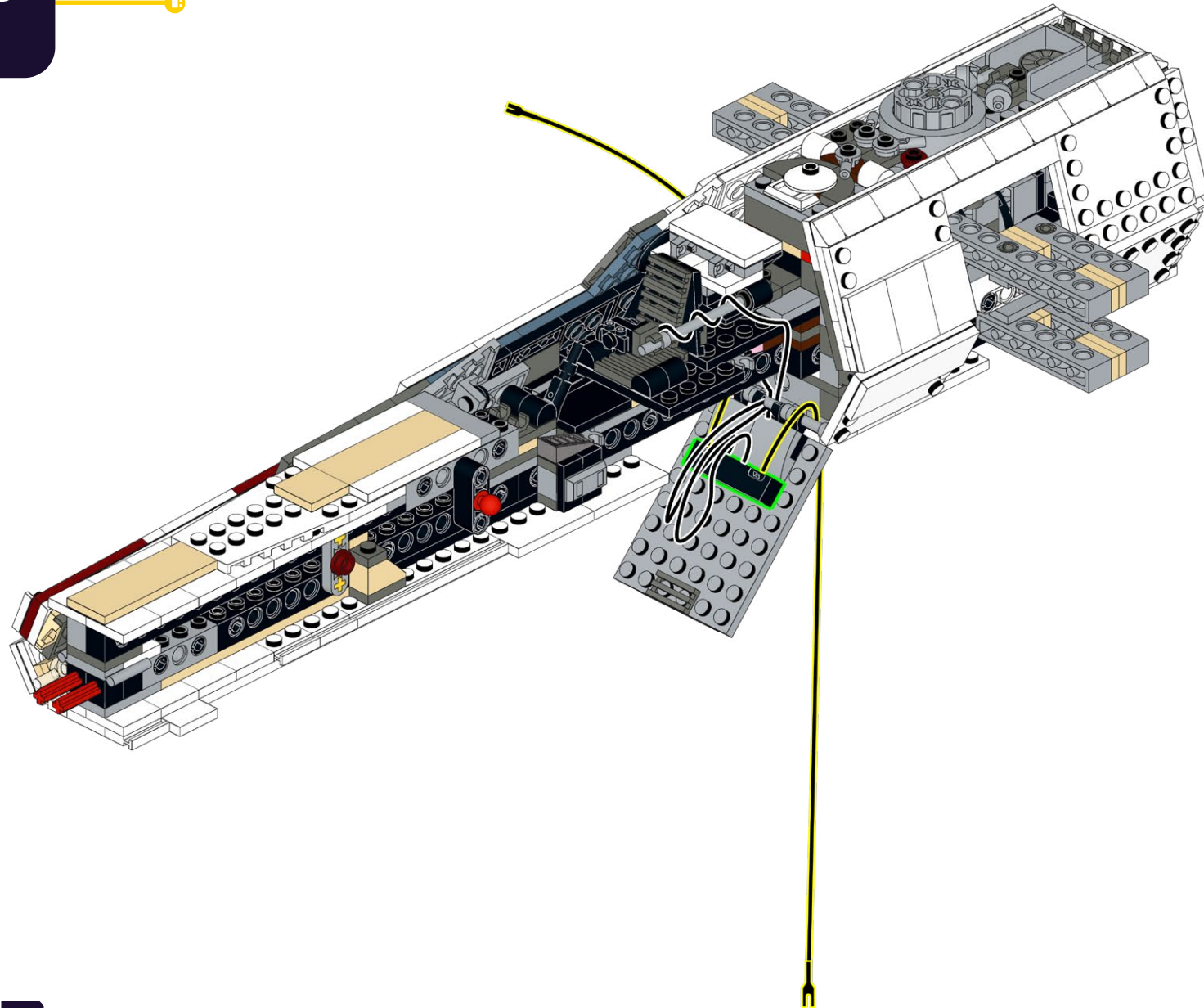

229

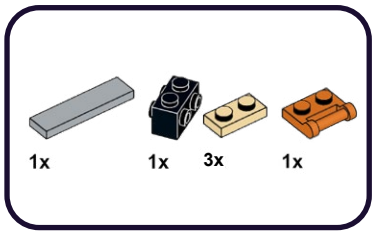

1

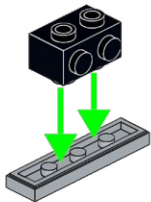

2

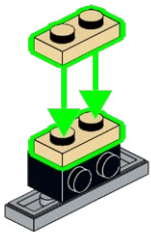

2

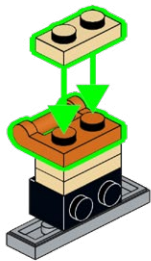

230

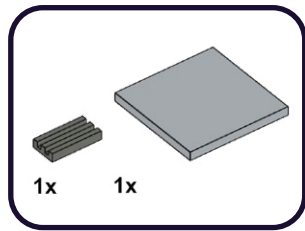

1

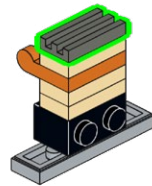

2

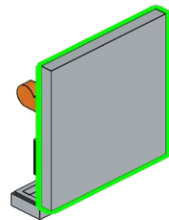

2

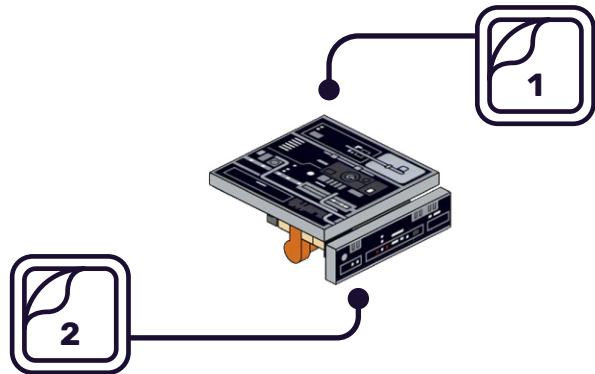

231

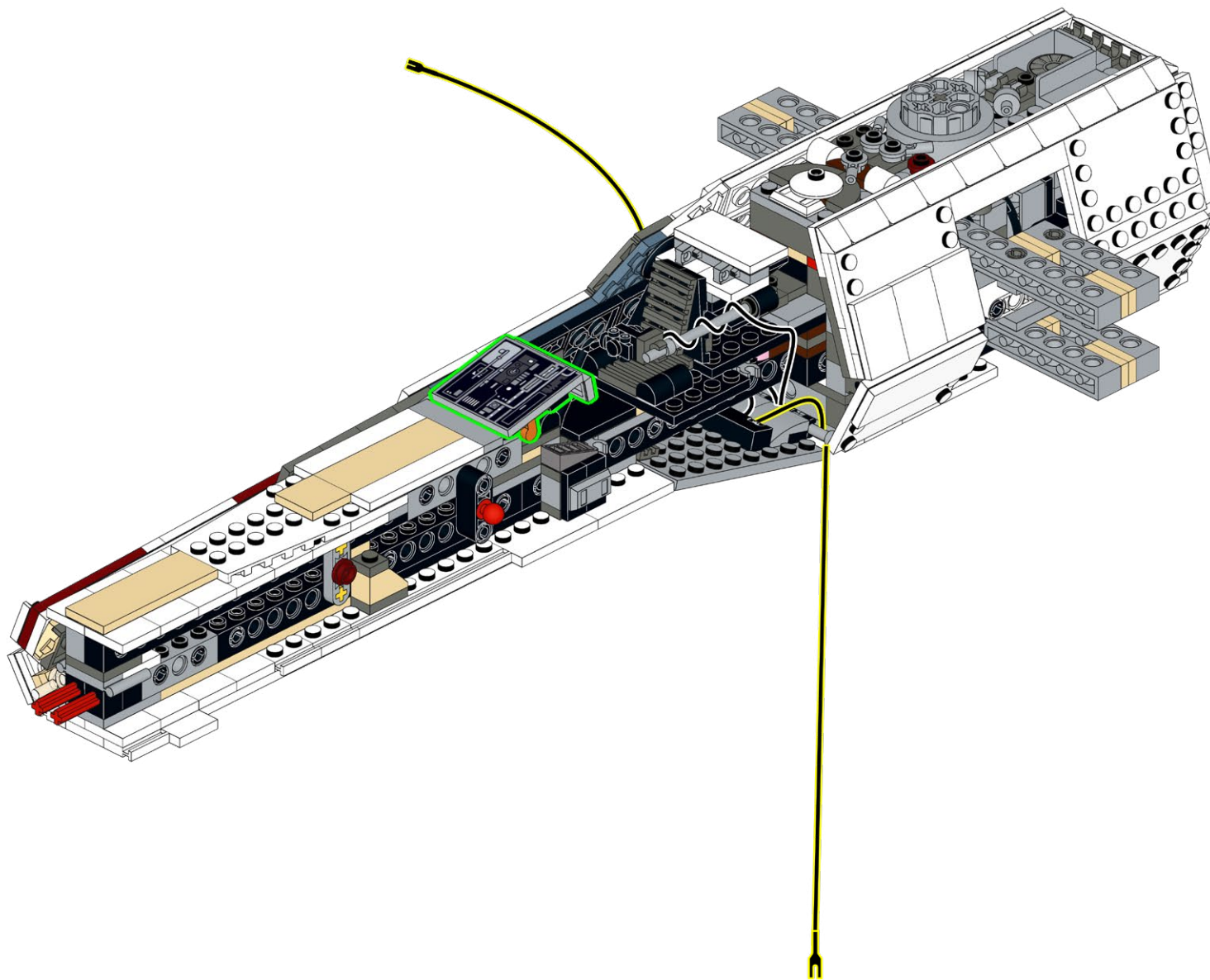

232

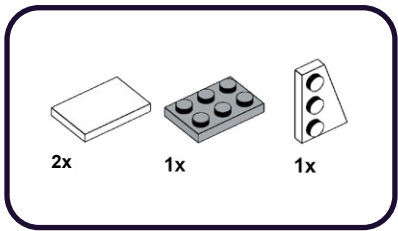

1

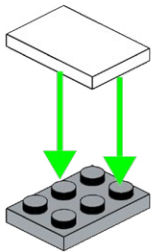

2

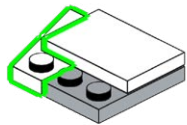

2

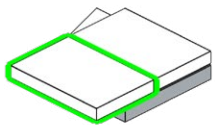

233

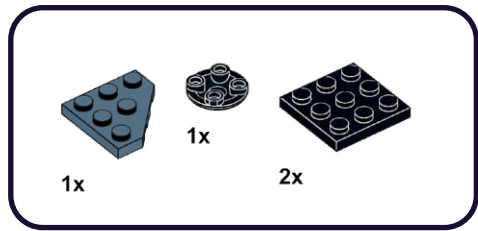

1

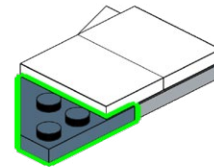

2

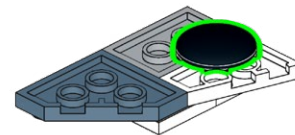

2

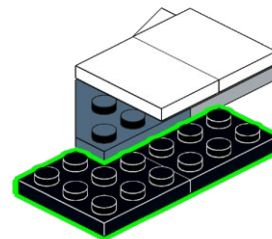

234

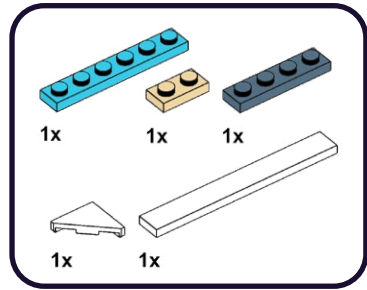

1

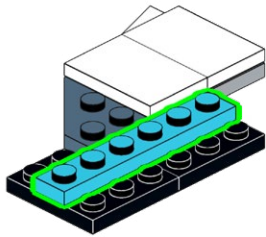

2

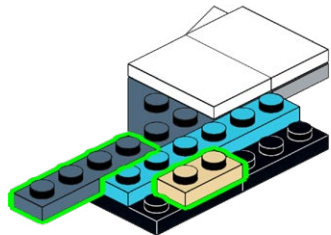

2

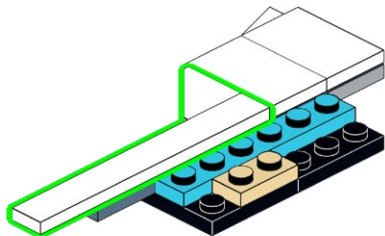

235

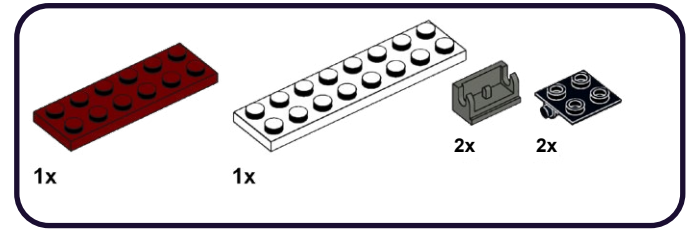

1

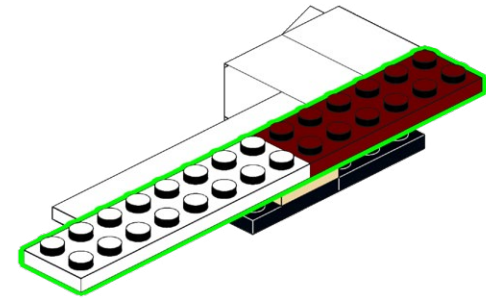

2

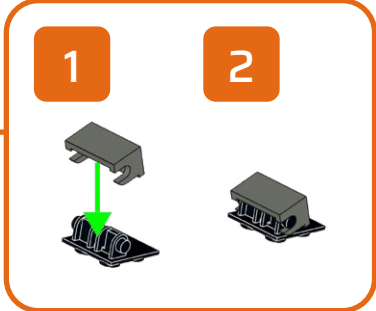
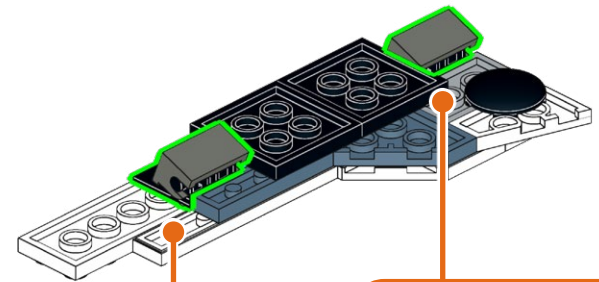

236

1x

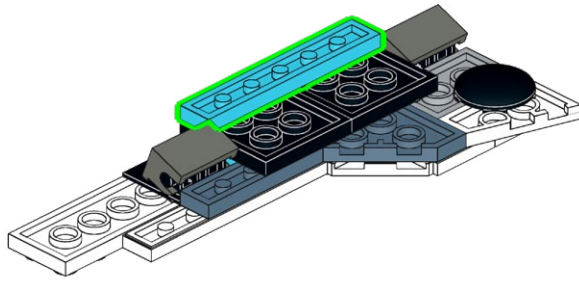
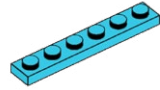

237

1x

1x

1x

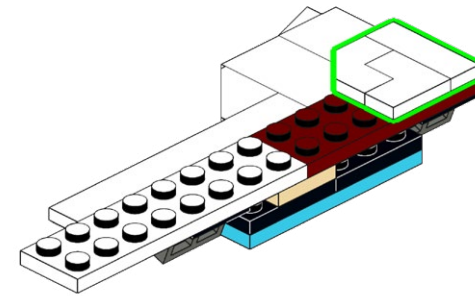

238

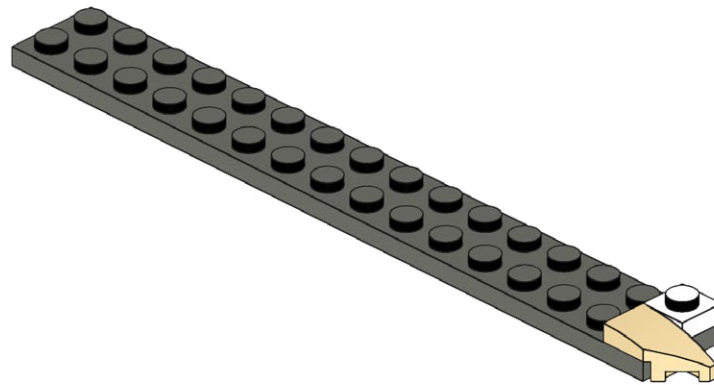
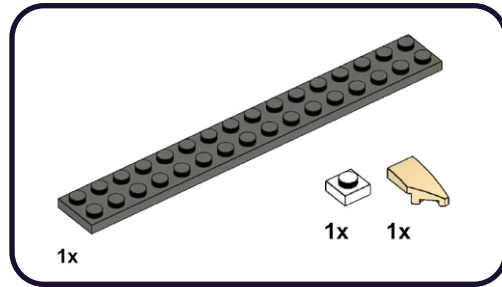

239

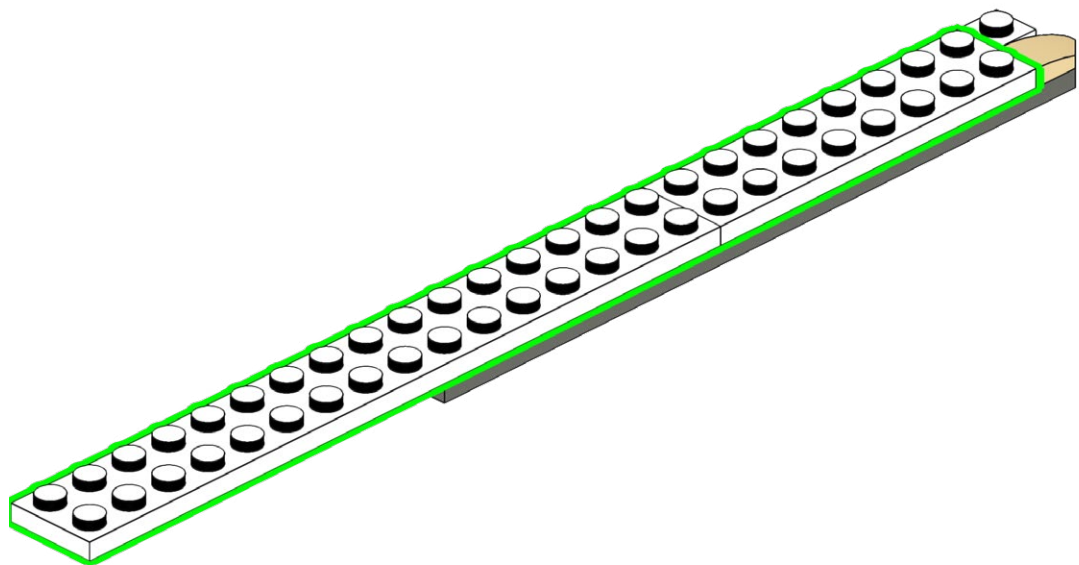
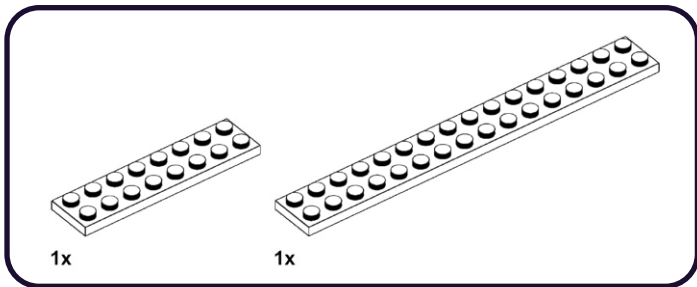

240

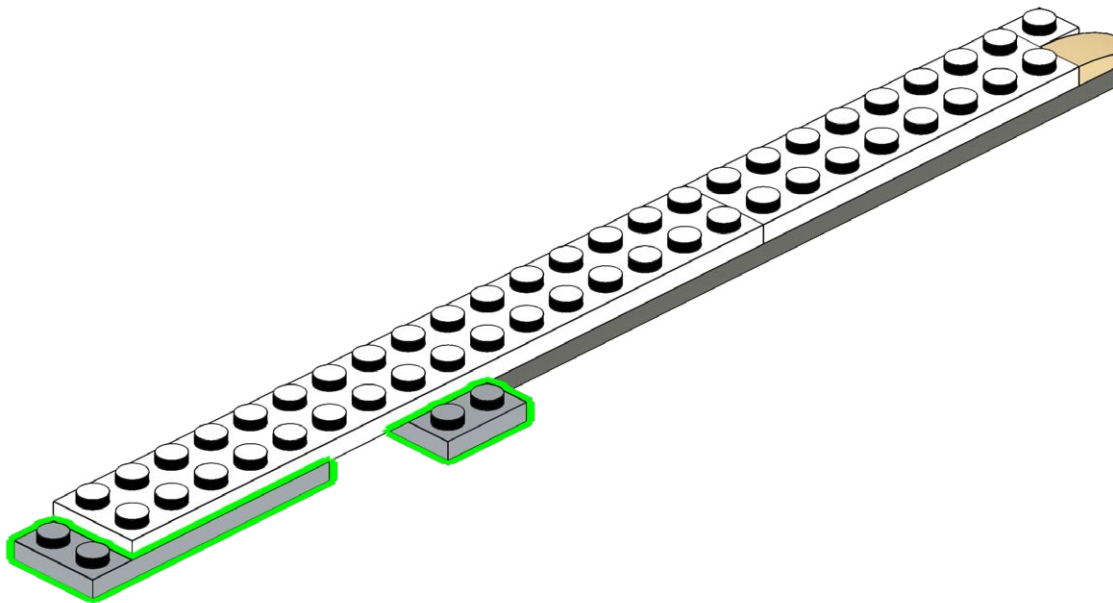
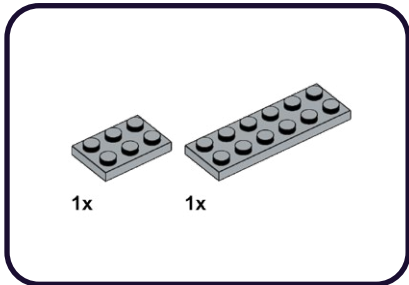

241

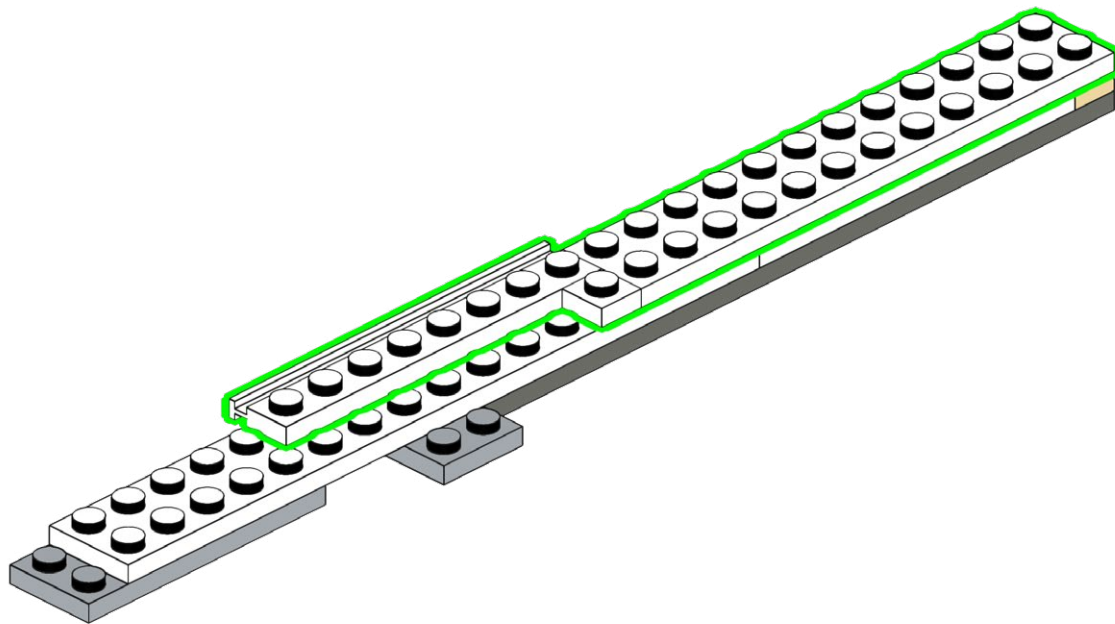
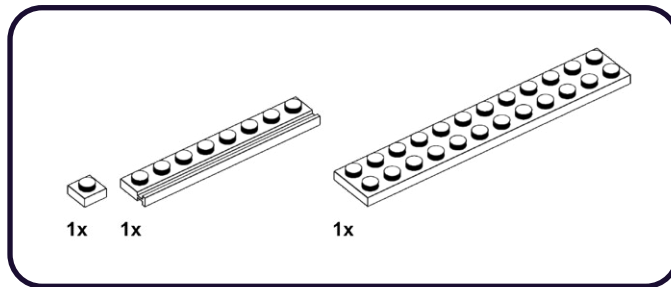

242

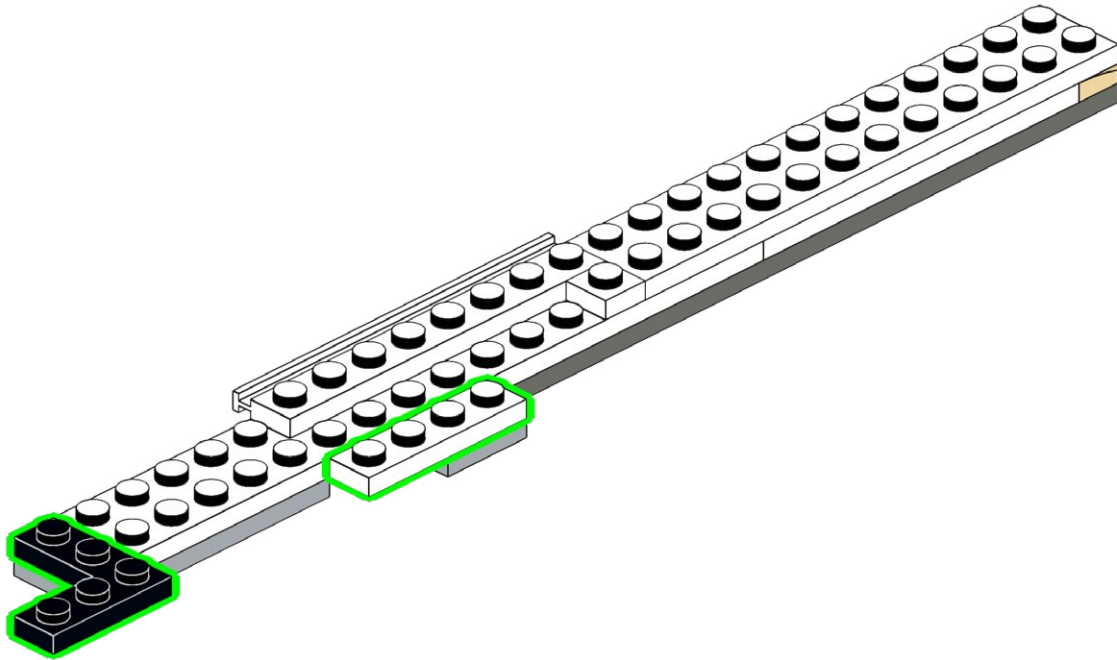
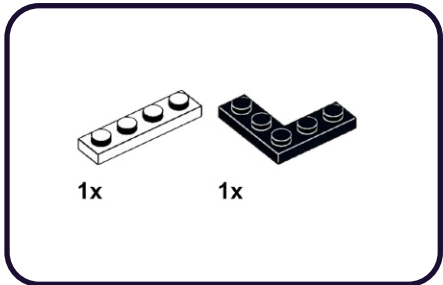

243

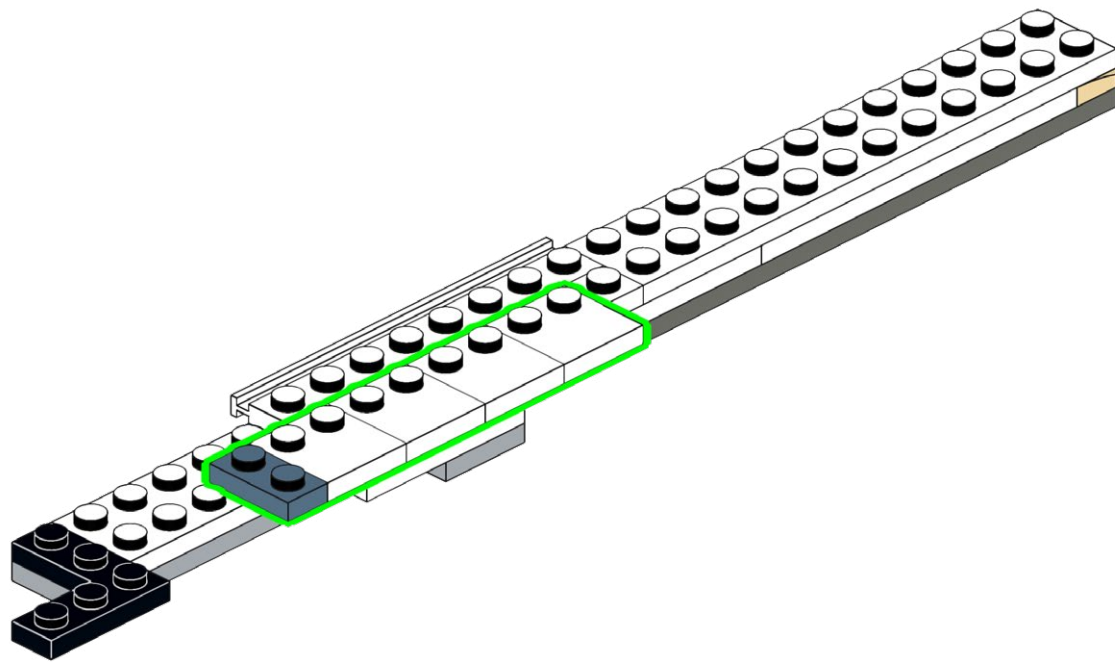
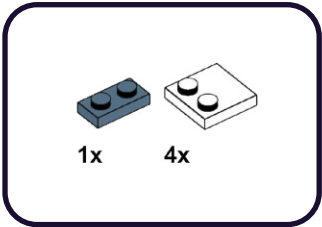

244

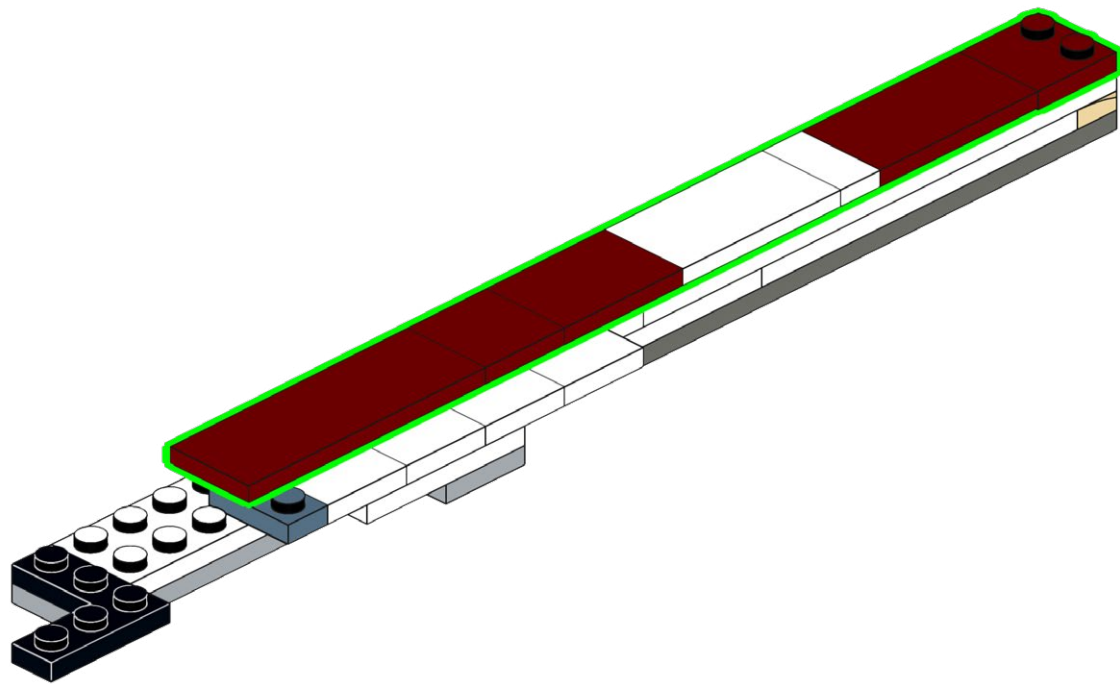
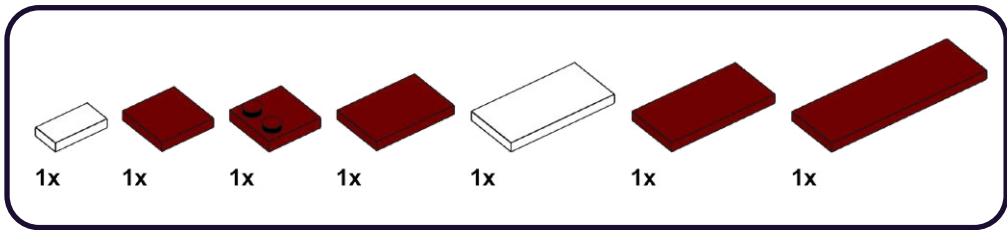

245

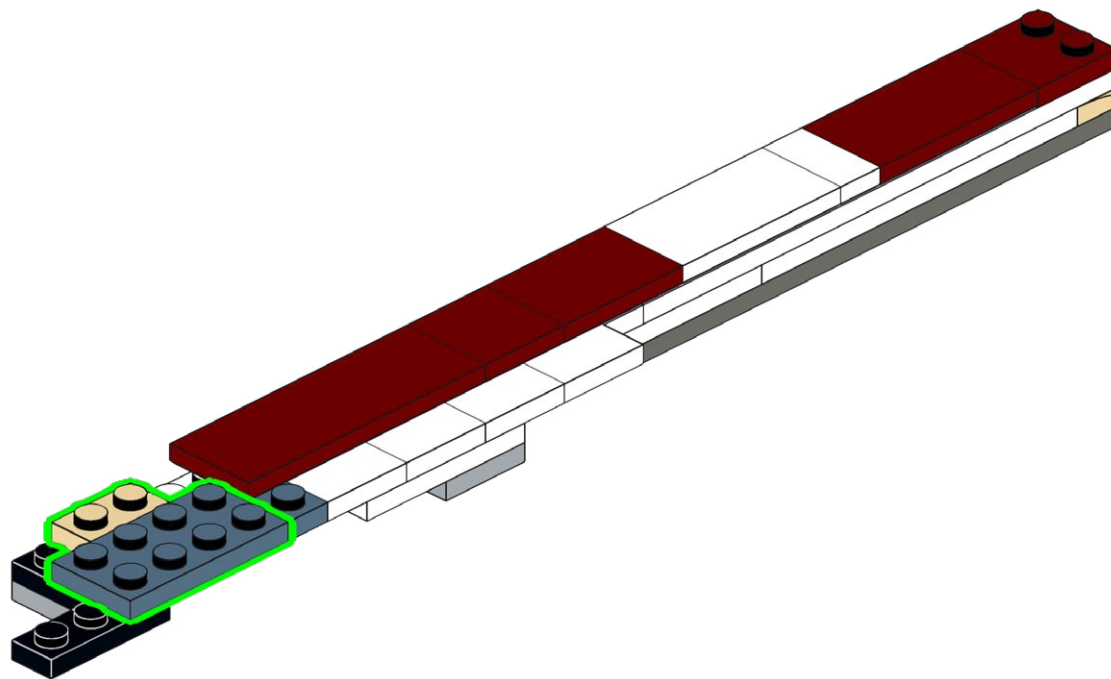
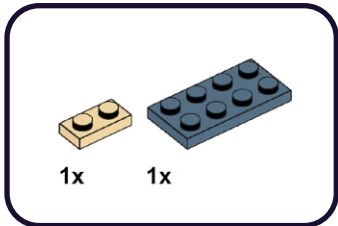

246

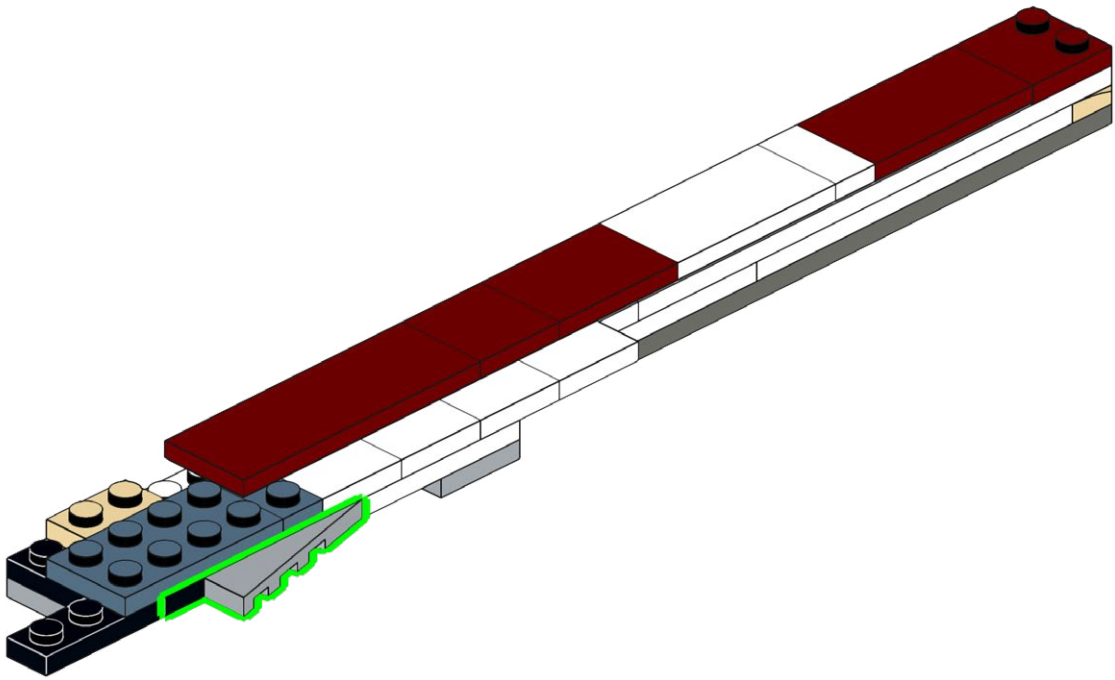
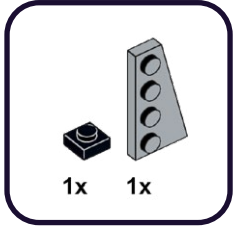

247

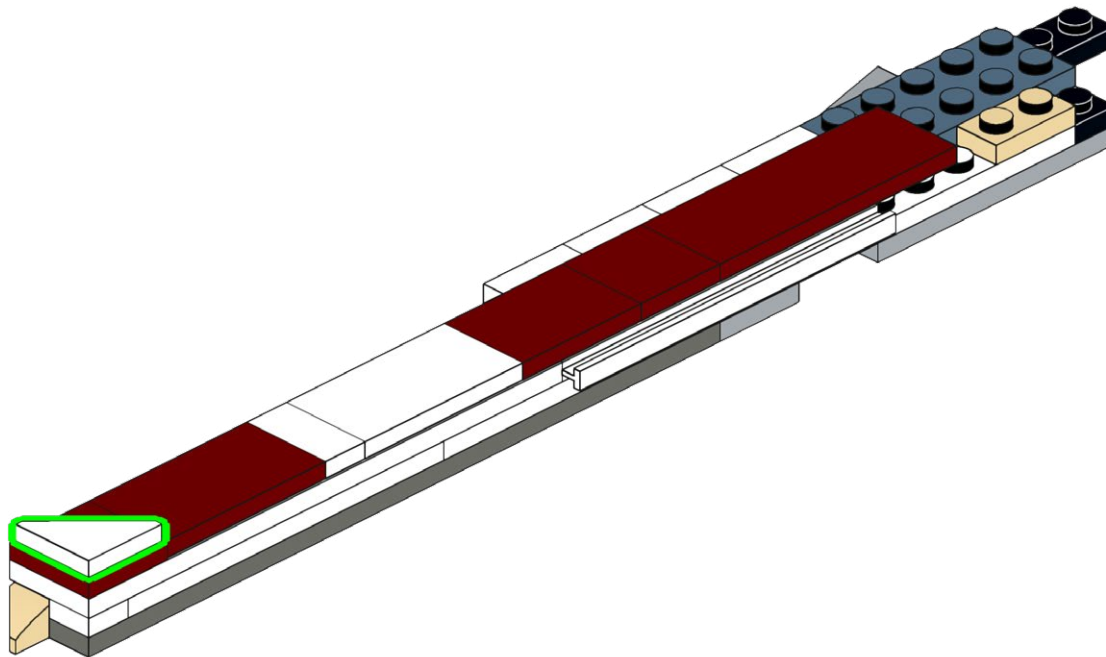
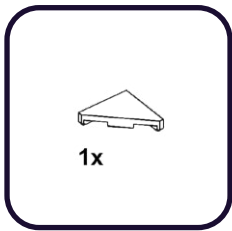

248

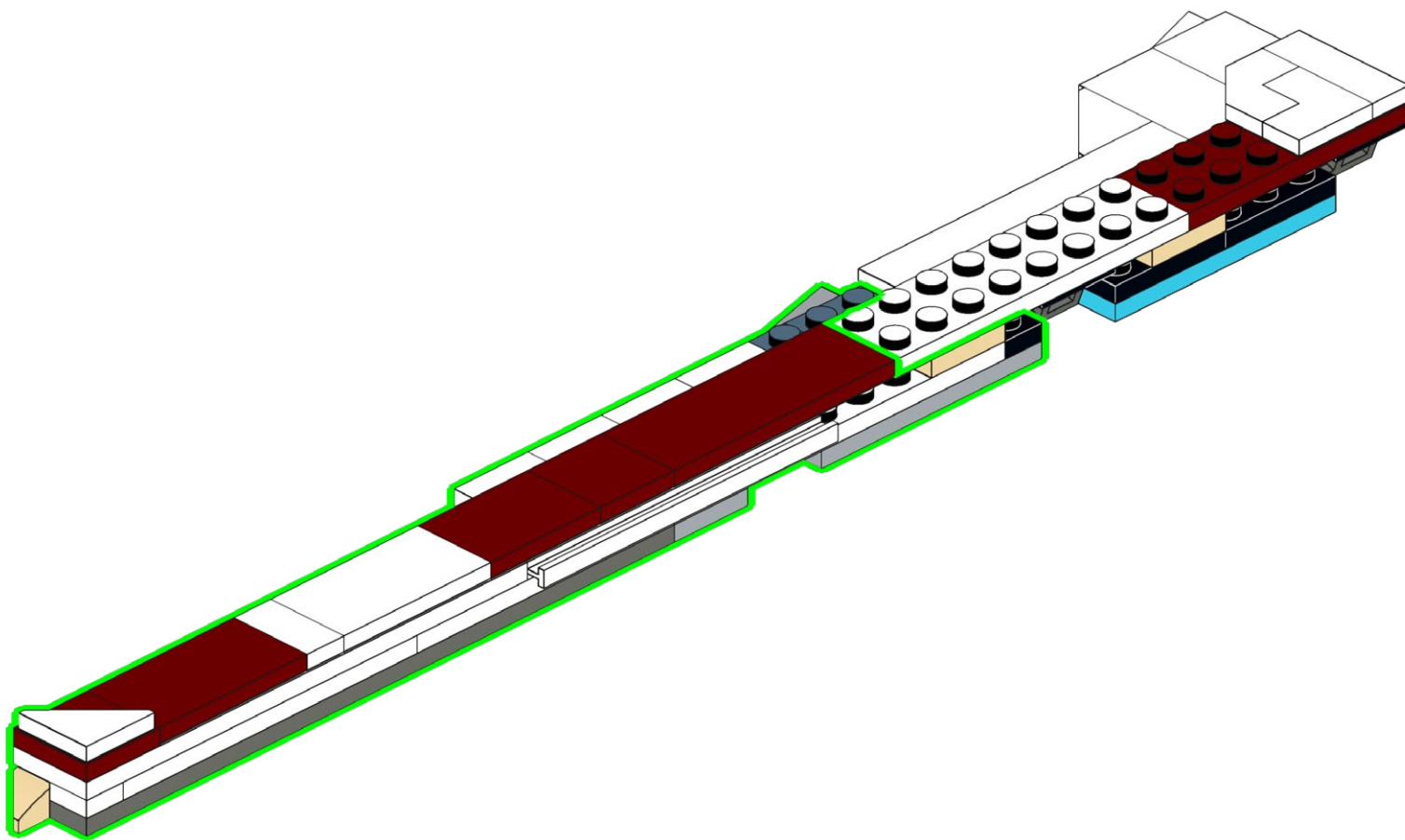

249

1x

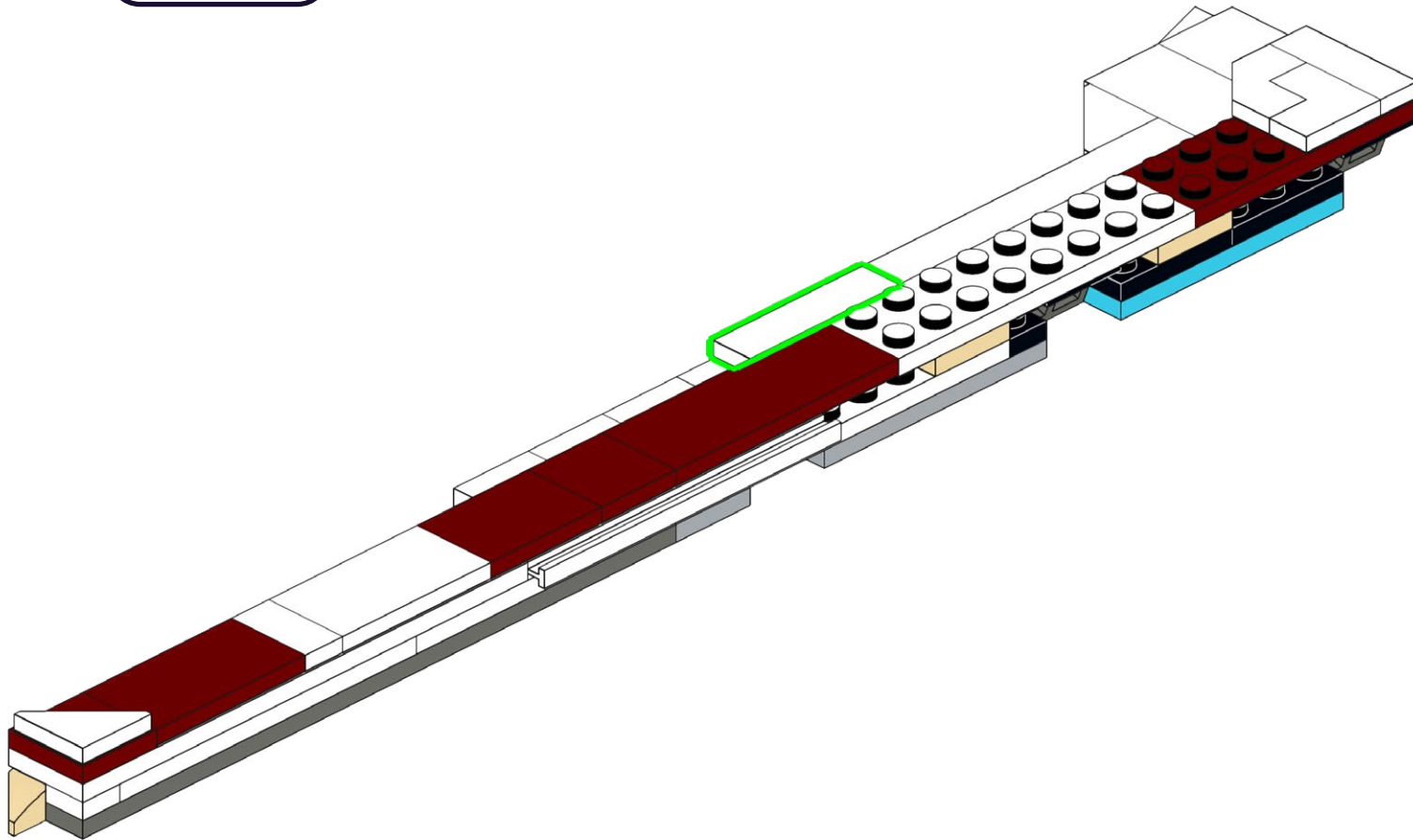

250

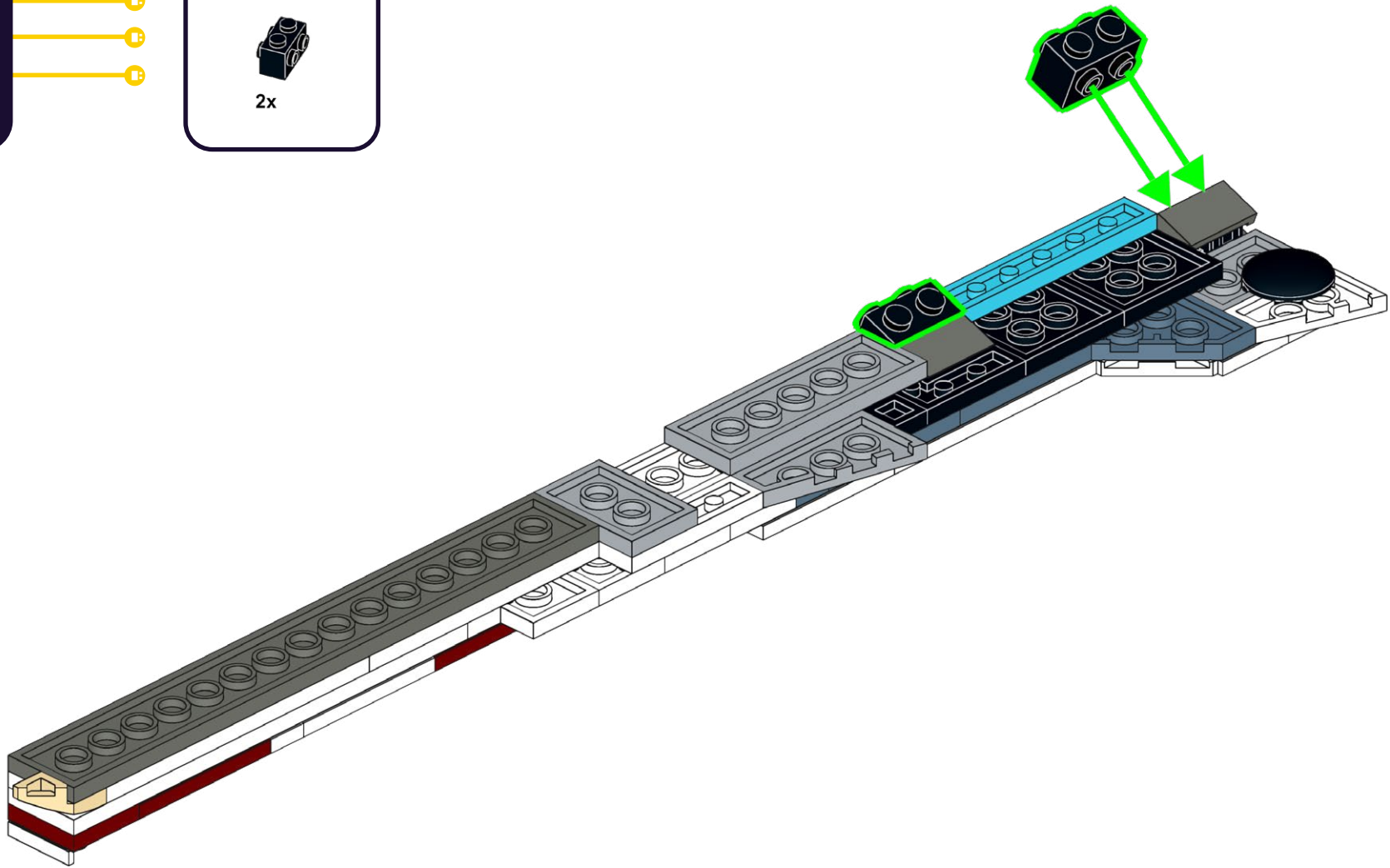

251

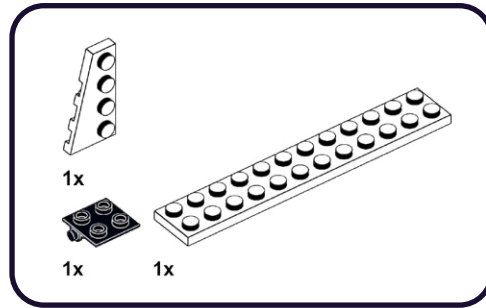

1

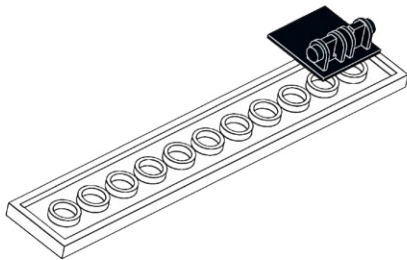

2

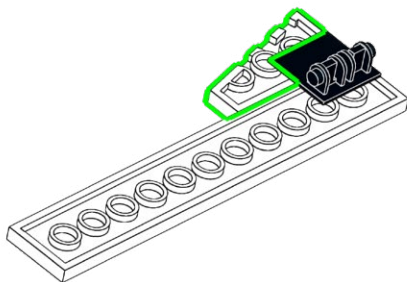

252

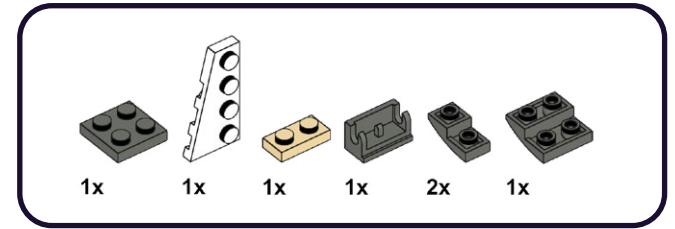

1

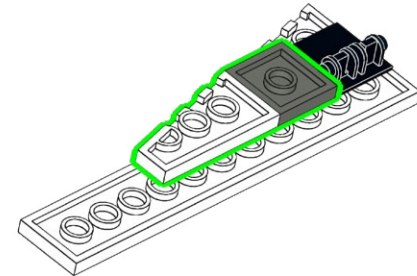

2

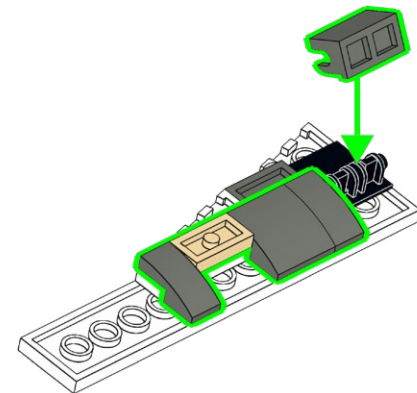

253

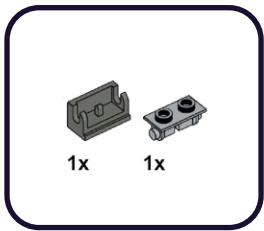

1

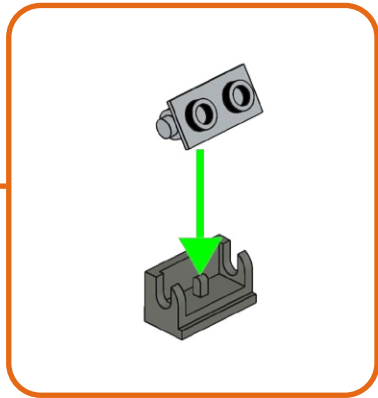
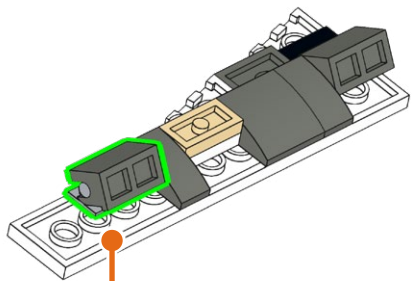

254

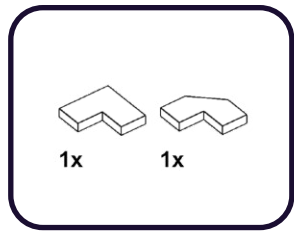

1

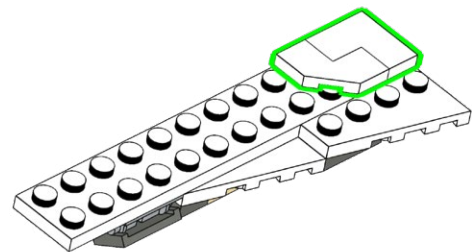

255

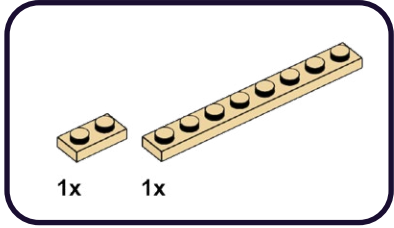

1

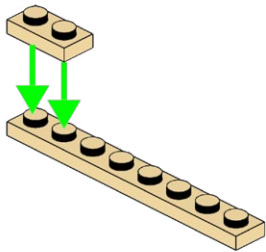

256

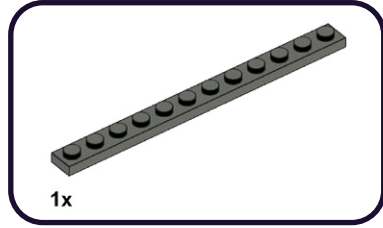

1

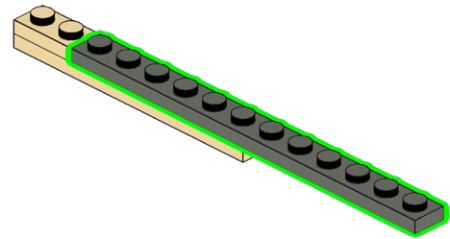

257

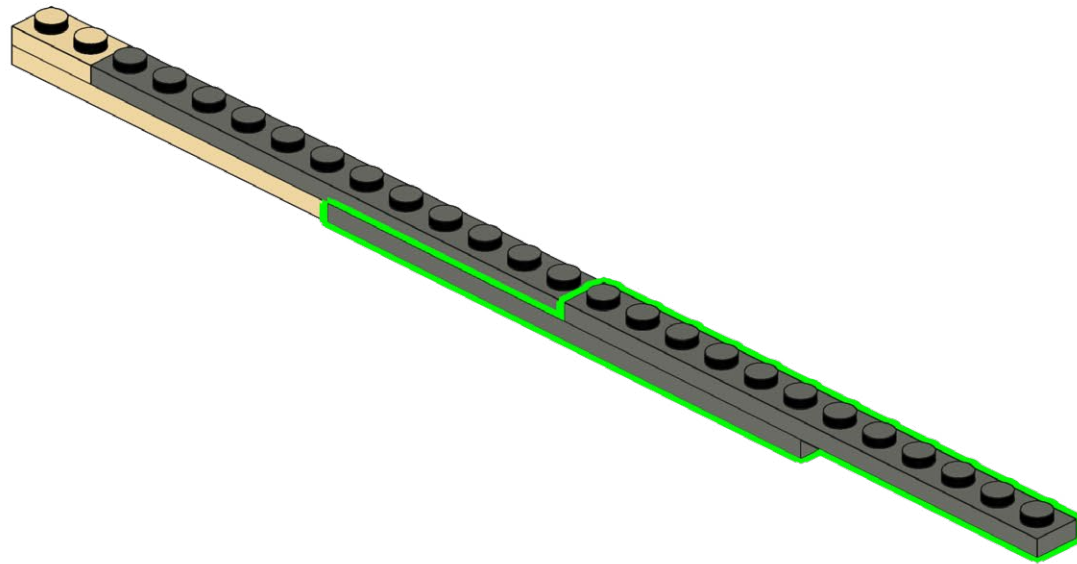
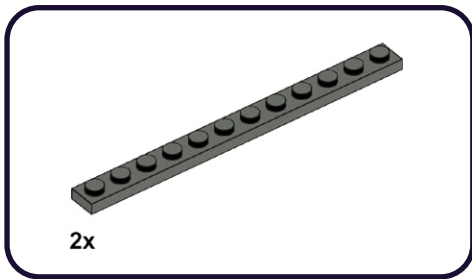

258

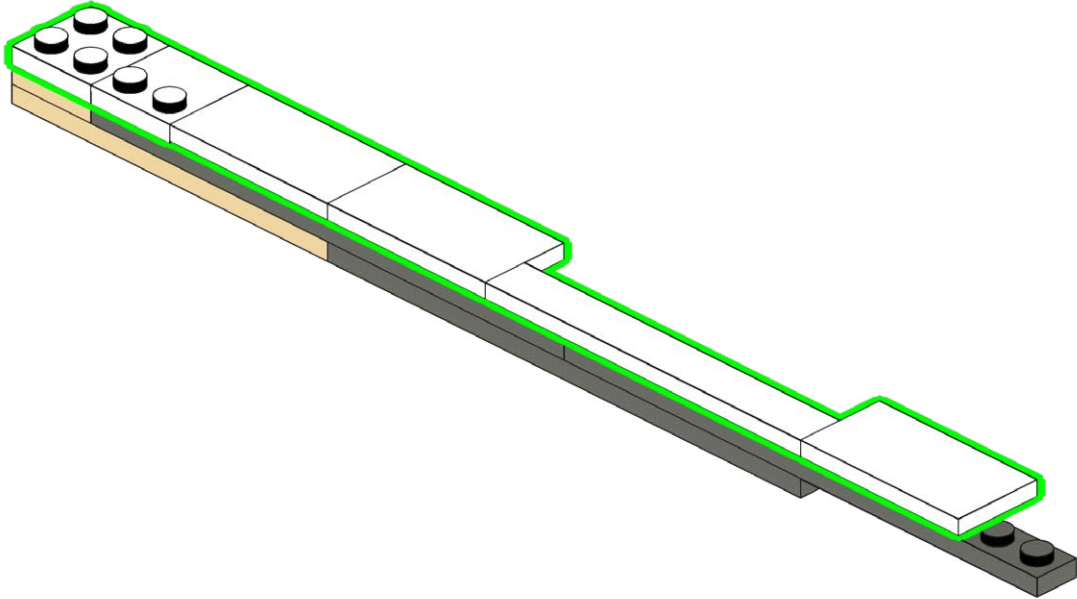
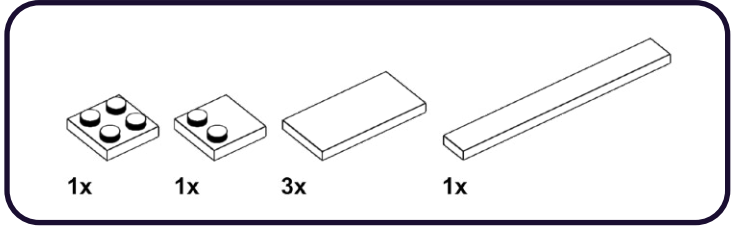

259

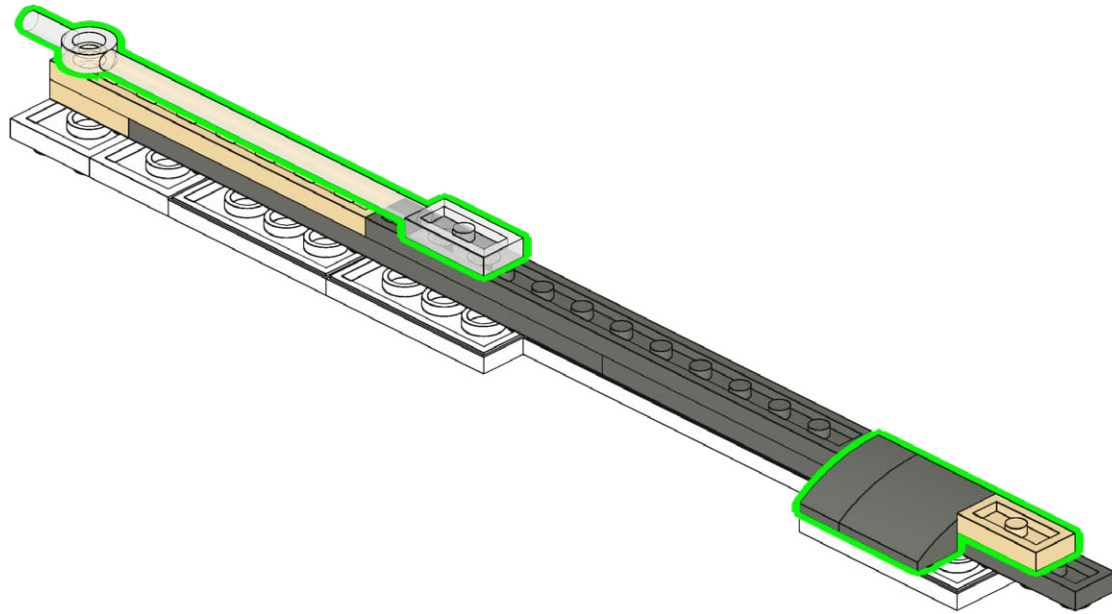
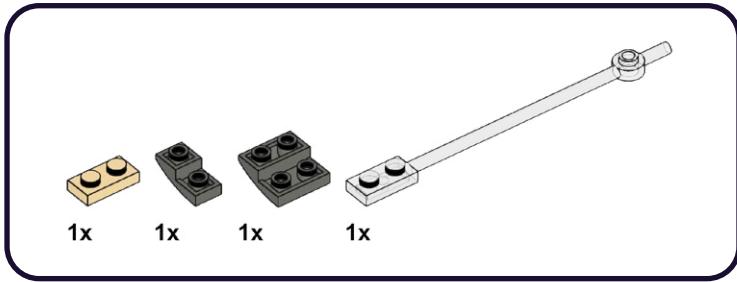

260

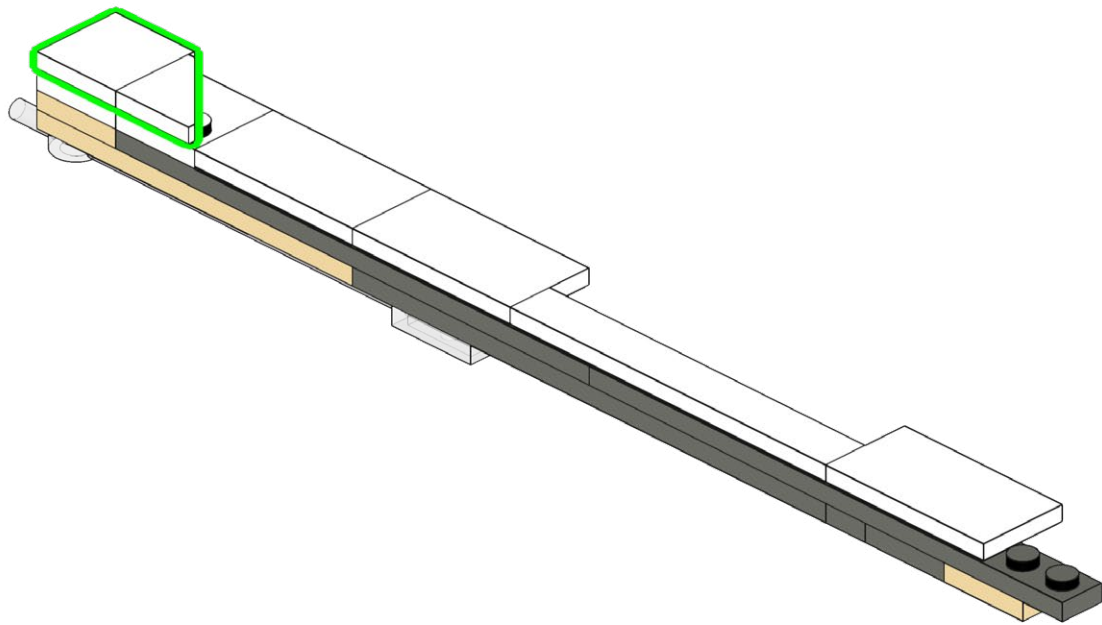
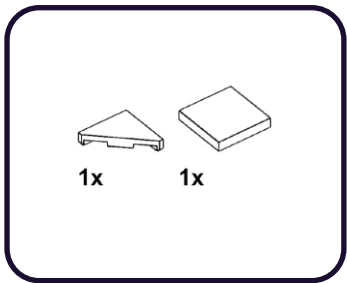

261

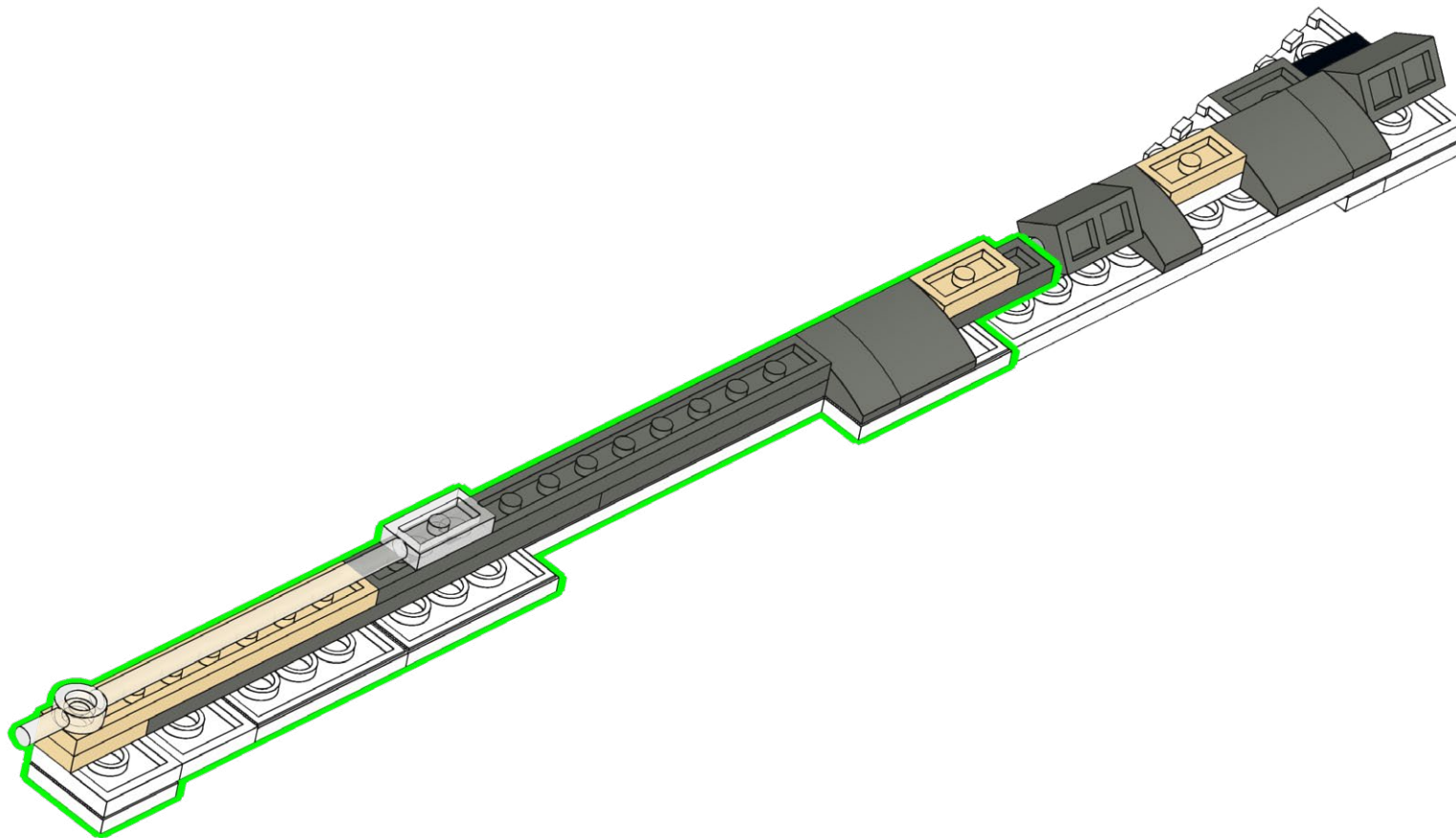

262

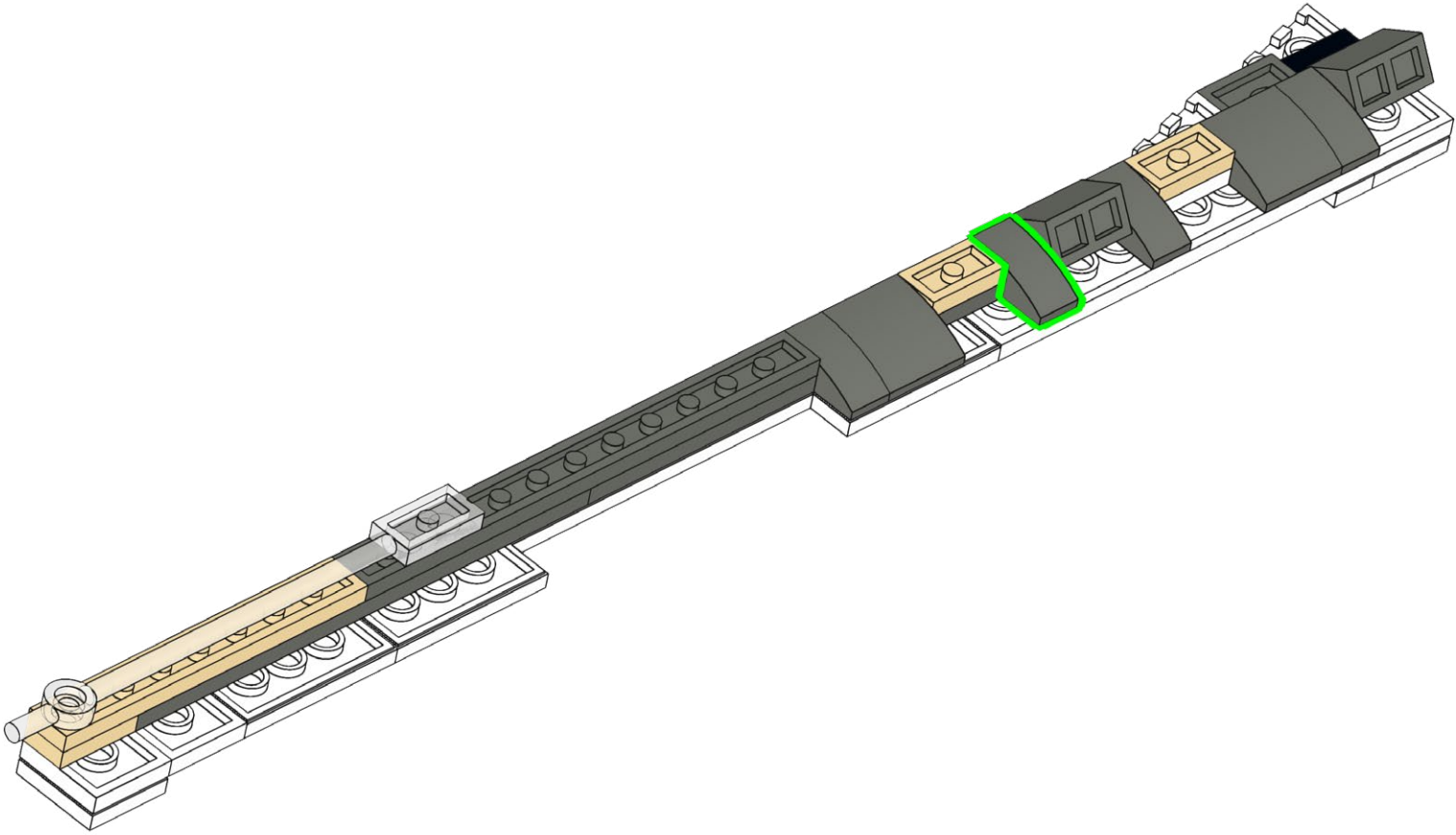
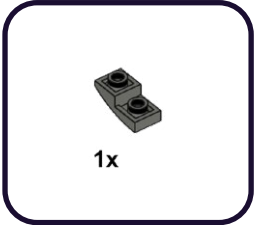

263



1x

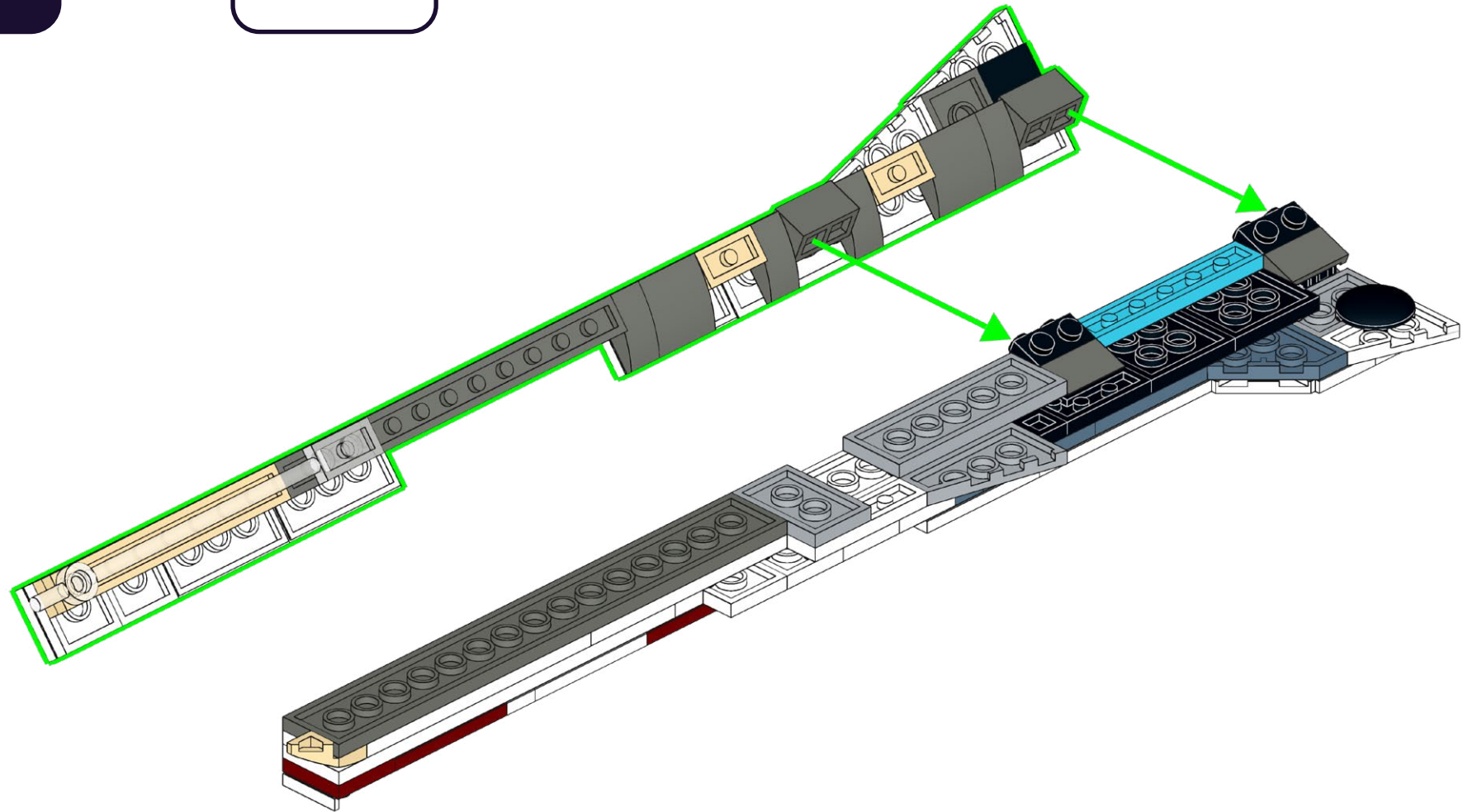

264

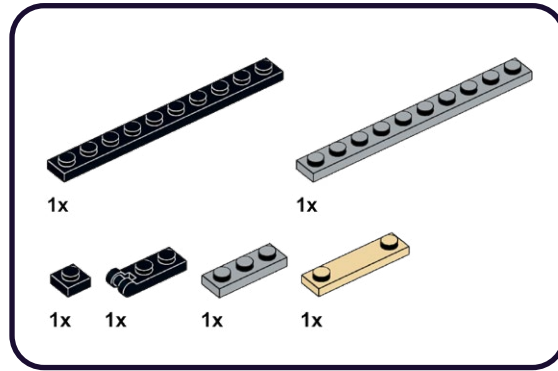

1

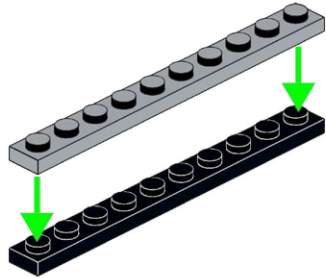

2

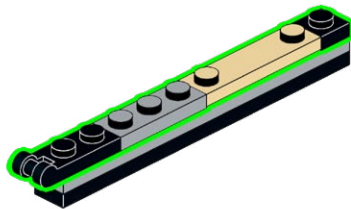

265

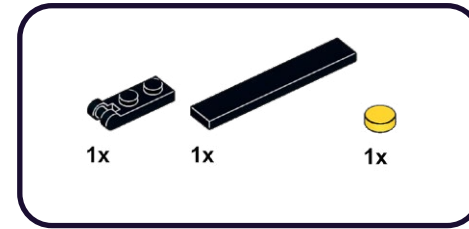

1

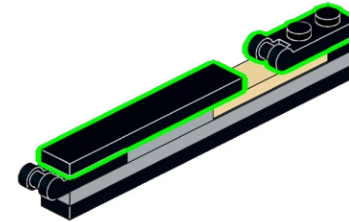

2

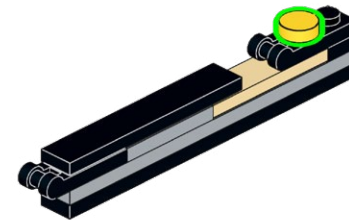

266

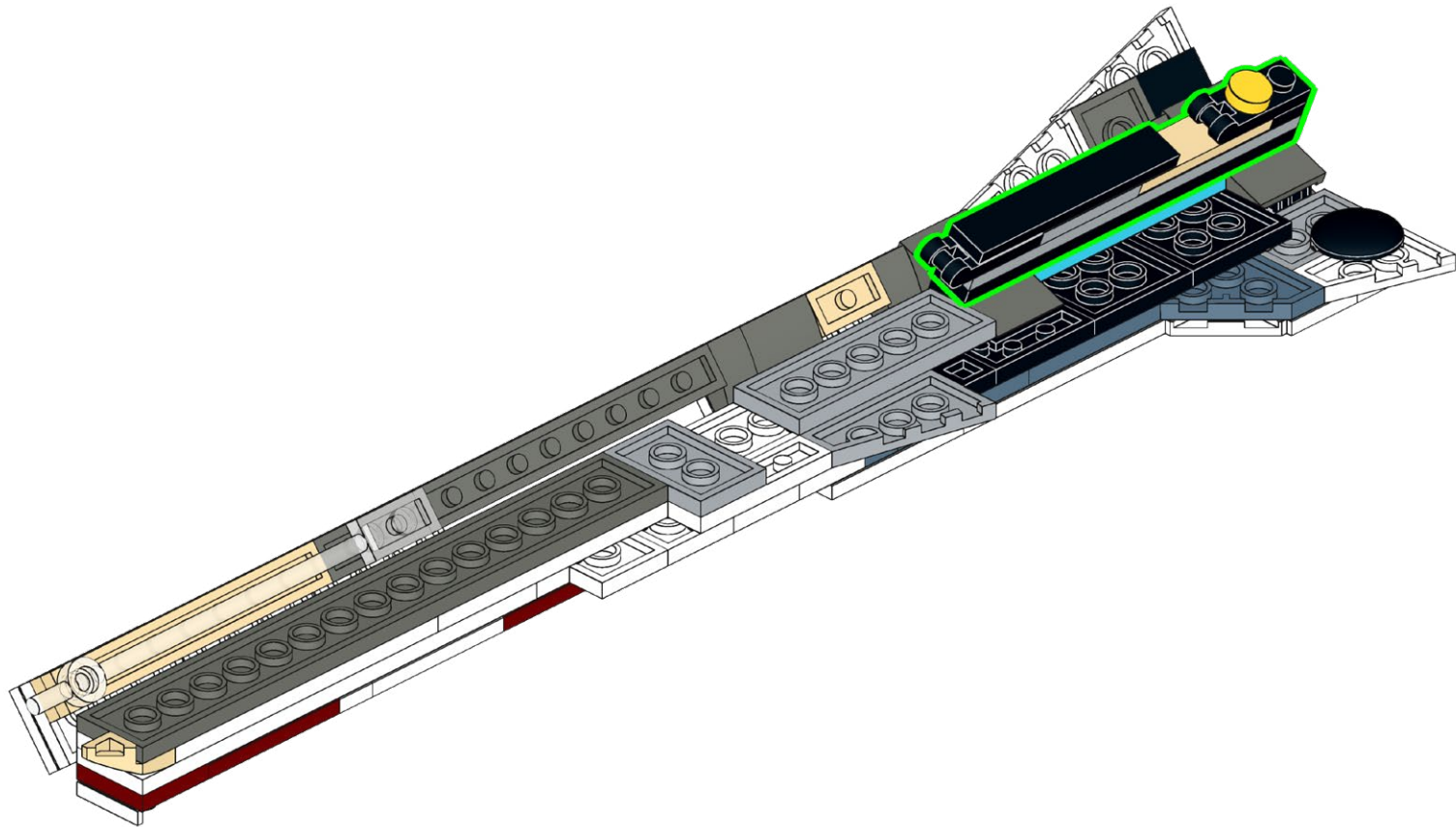

267

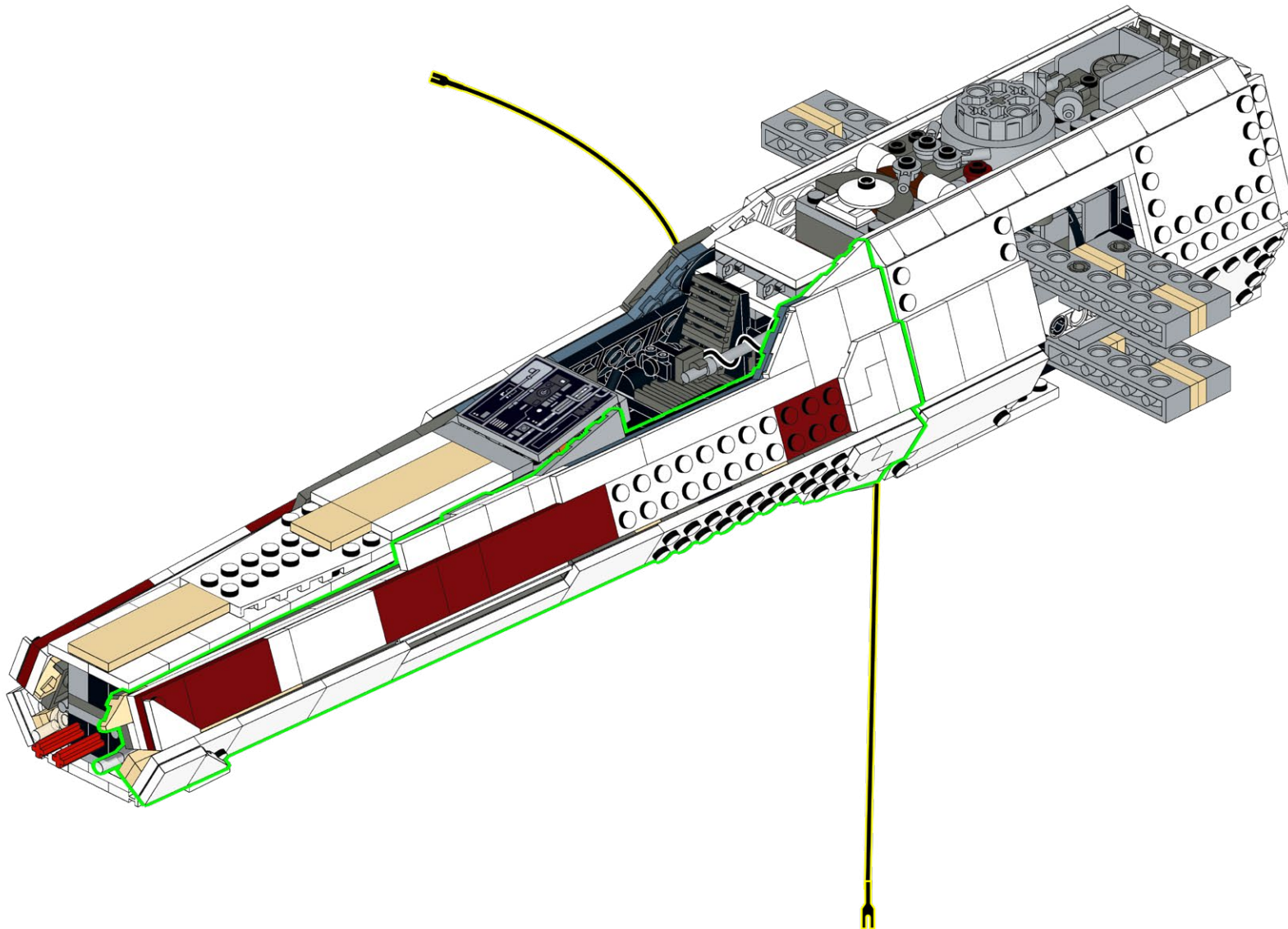

268

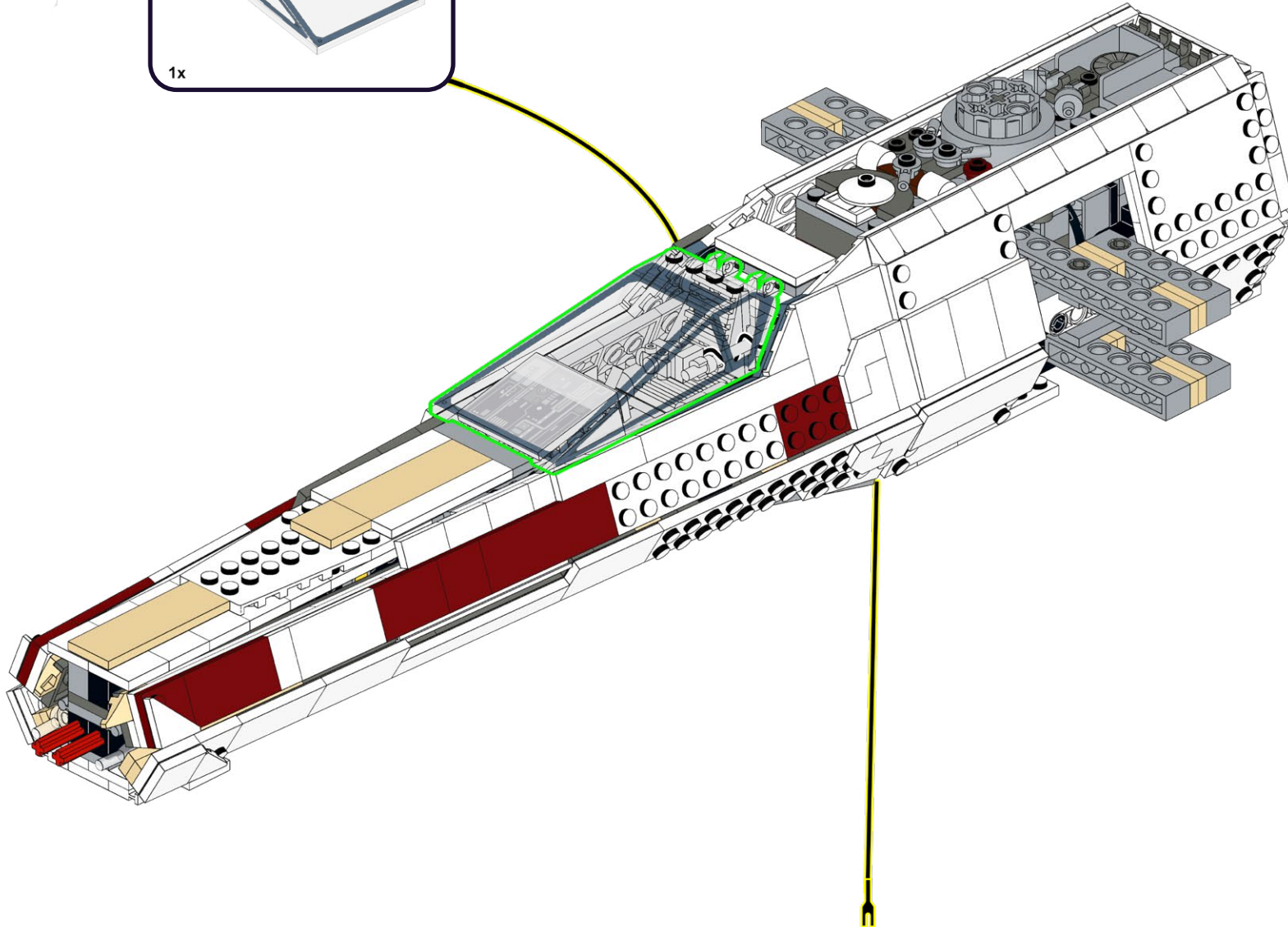
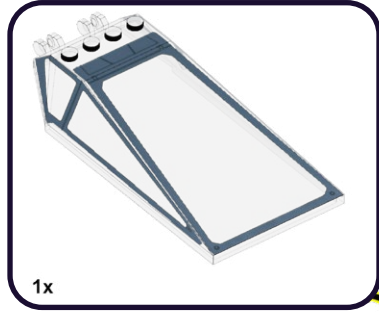

269

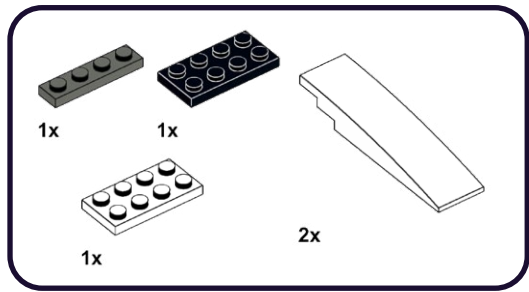

1

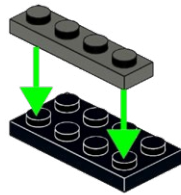

2

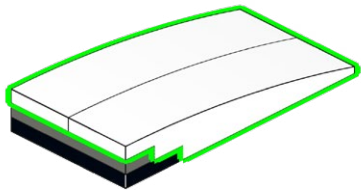

2

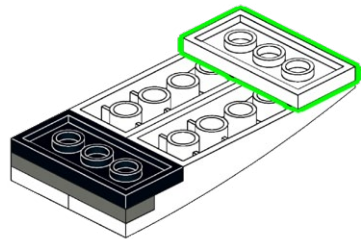

270

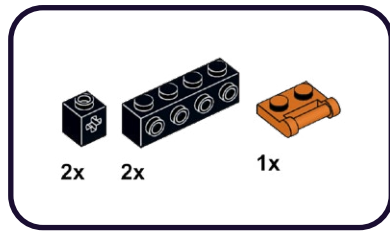

1

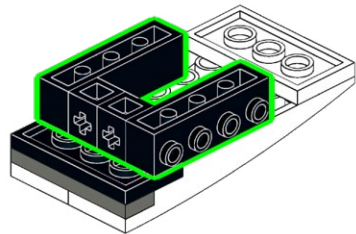

2

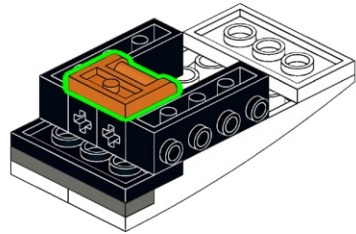

271

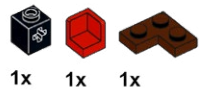

1x 1x 1x

1

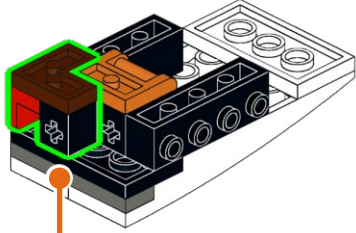

1

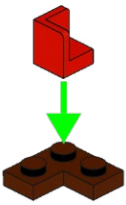

2

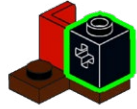

272

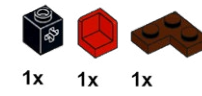

1x 1x 1x

1

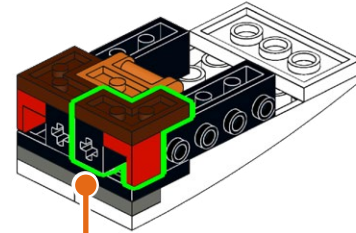

1

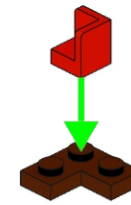

2

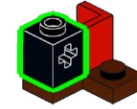

273

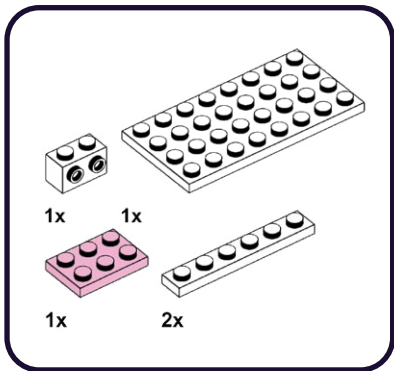

1

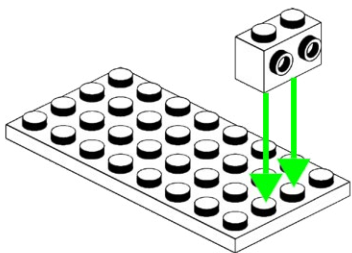

2

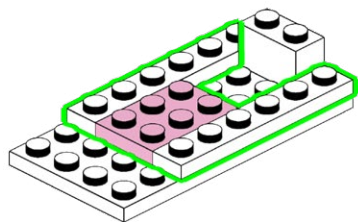

274

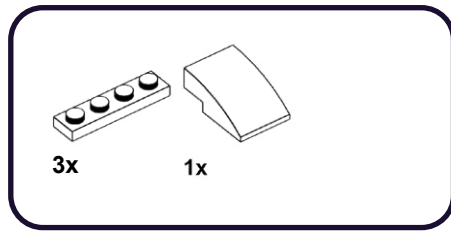

1

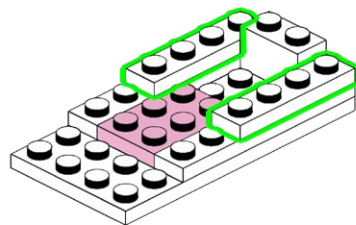

2

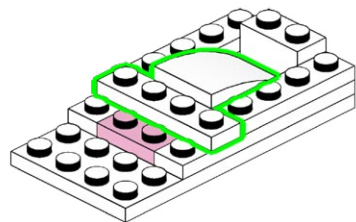

275

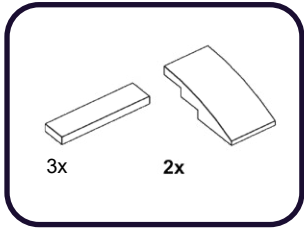

1

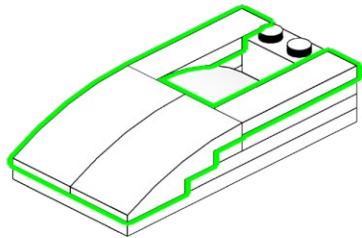

2

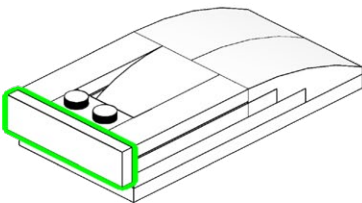

276

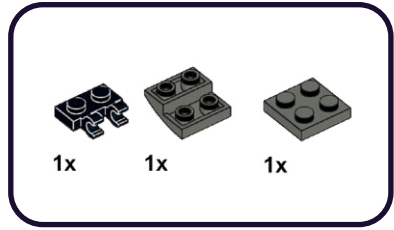

1

2

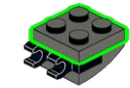
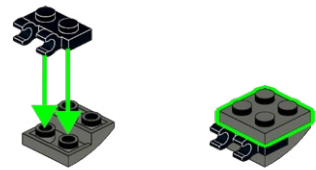

1

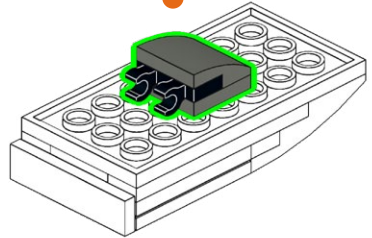

277

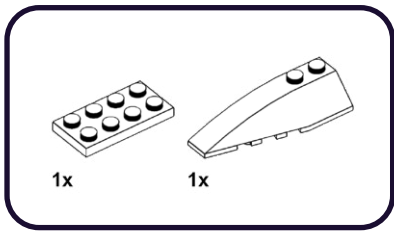

1

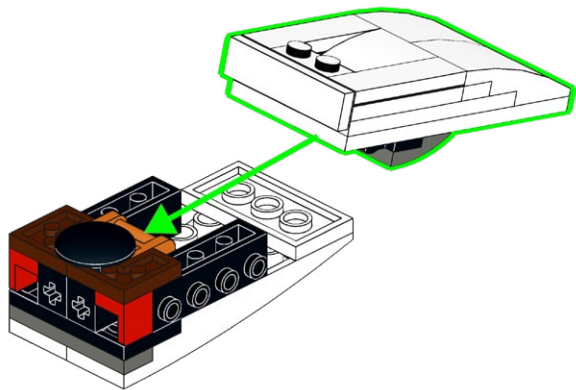

2

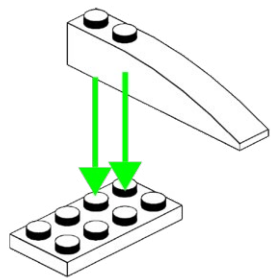

278

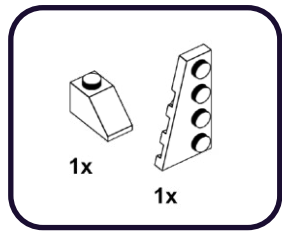

1

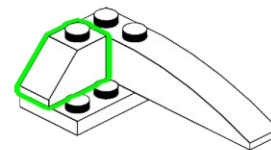

2

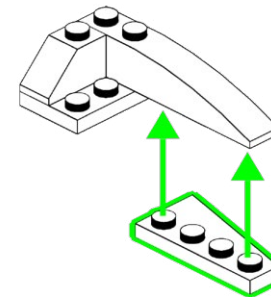

279

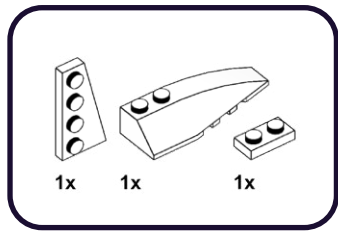

1

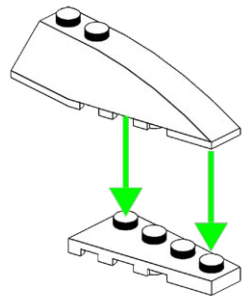

2

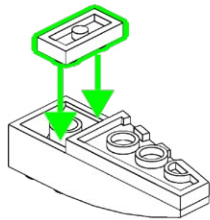

280

1

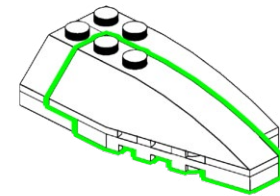

1

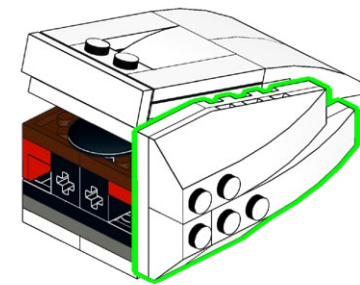

281

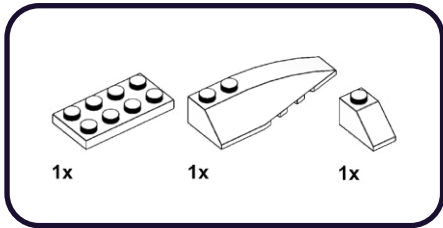

1

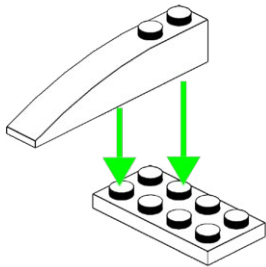

2

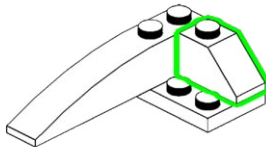

282

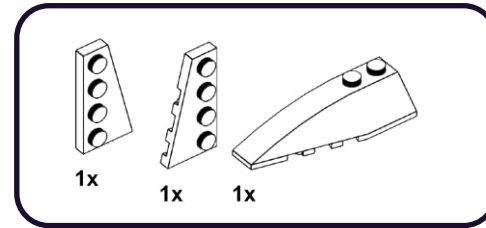

1

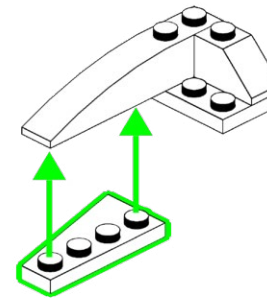

2

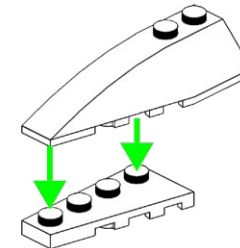

283

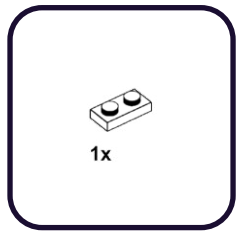

1

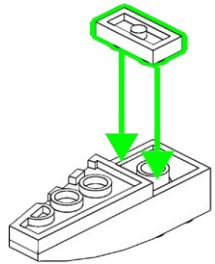

2

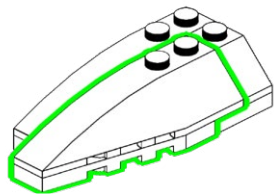

284

1

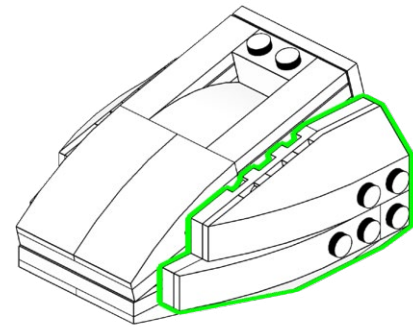

285

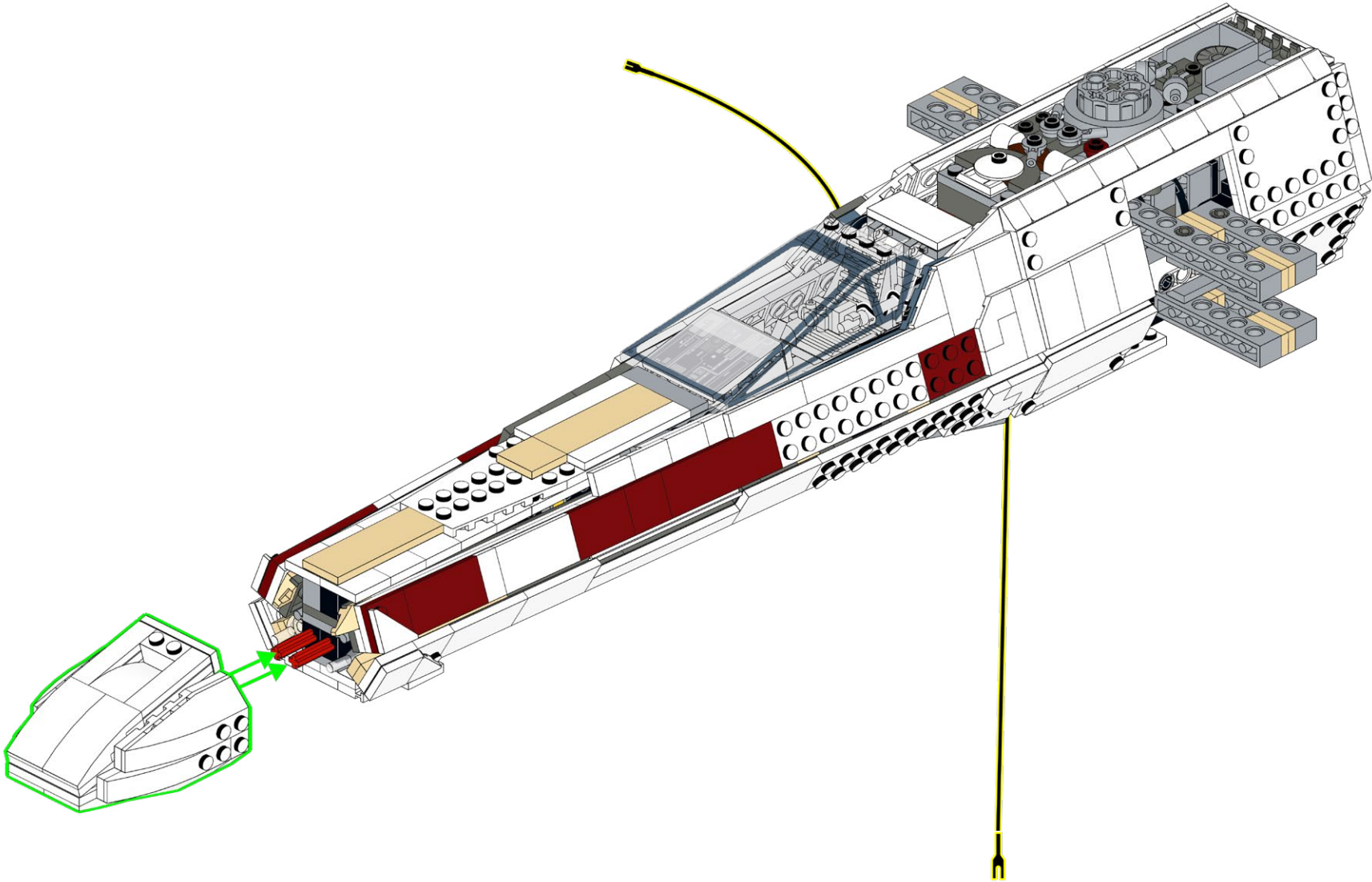

286

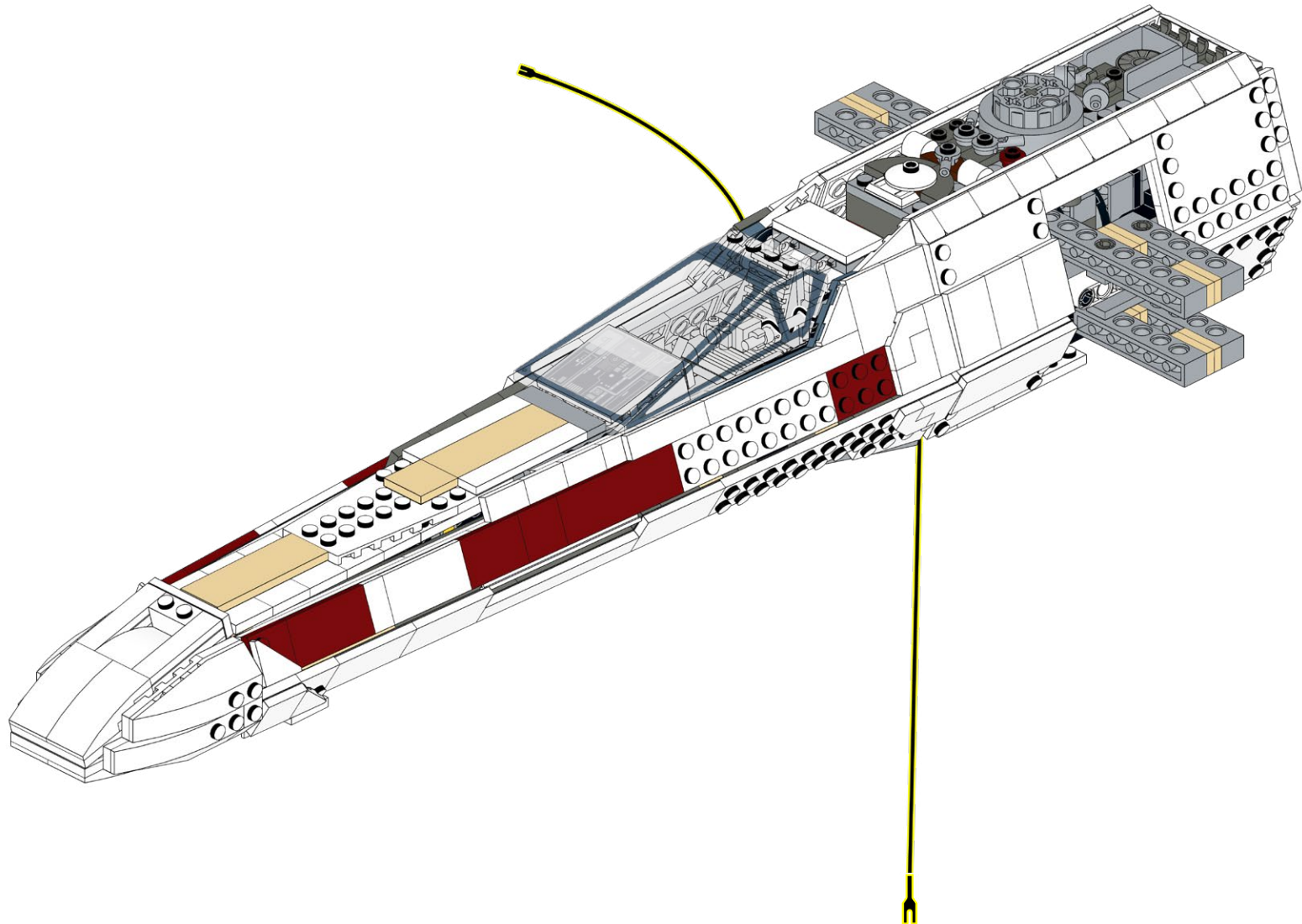

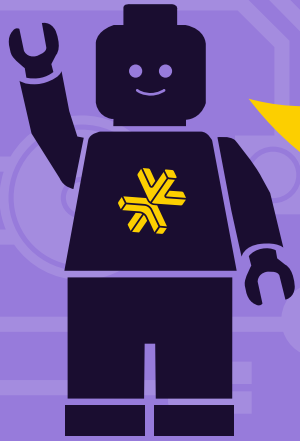
**HOLD UP!**

You might notice some bags aren't in order, as well as left over pieces, but that's ok! We're changing the way you build LEGO!

ATTENDEZ!

Vous remarquerez peut-être que certains sacs, ainsi que certaines pièces, ne sont pas dans le bon ordre. Mais pas de panique! Nous changeons simplement la façon avec laquelle vous construisez vos LEGO!

ASPETTA!

Potresti notare che alcuni sacchetti non sono in ordine, così come i pezzi avanzati, ma va bene così! Stiamo cambiando il modo in cui costruisci i LEGO!

HALT!

Sie werden möglicherweise bemerken, dass einige tüten durcheinander sind und teile übrig bleiben, aber das ist in Ordnung! Wir ändern die art und weise, wie Sie LEGO bauen!

¡ESPERA!

Es posible que notes que algunas bolsas están fuera de servicio, así como piezas sobrantes, ¡pero está bien! ¡Estamos cambiando la forma en que construyes LEGO!

暫停!

你可能会注意到一些袋子顺序错乱, 以及一些剩余的部件, 但没关系! 我们正在改变你搭建乐高的方式!

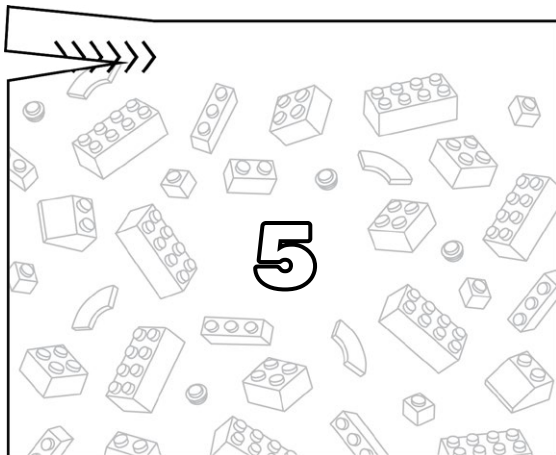
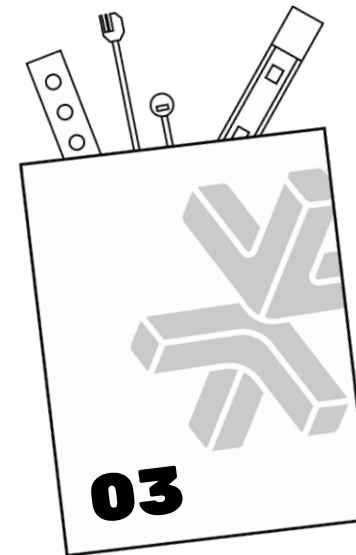
Open LEGO® Bag 5**Open LMB Bags 03**

287

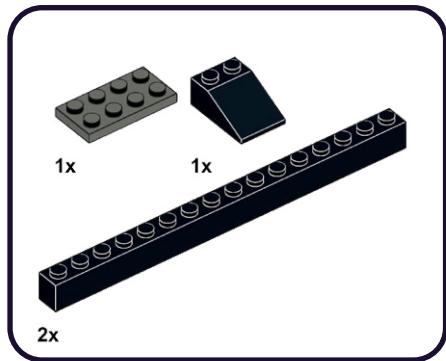

1

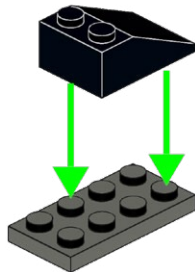

2

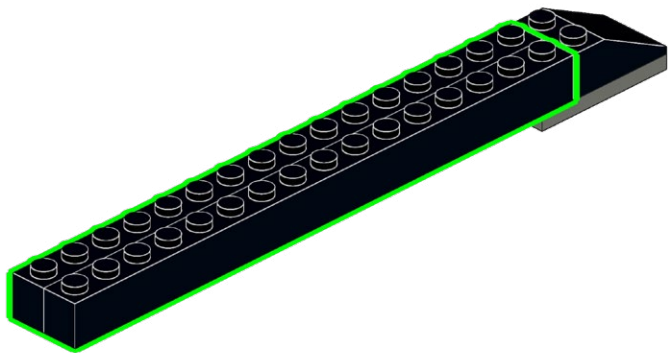

288

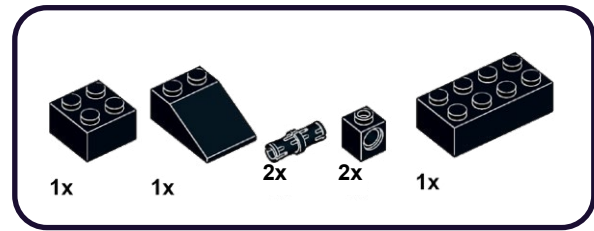

1

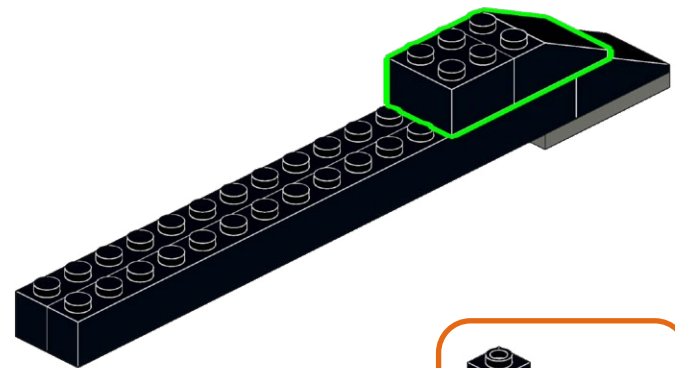

2

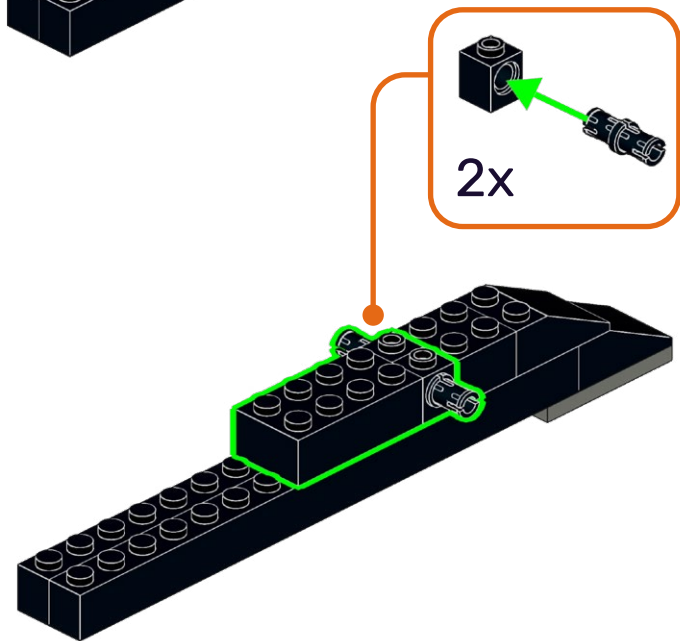

289

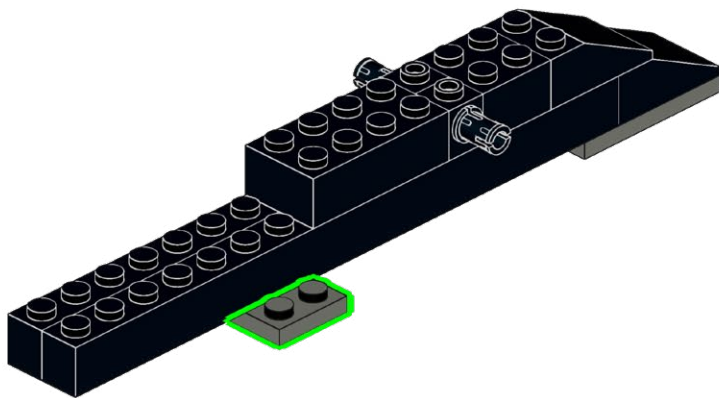
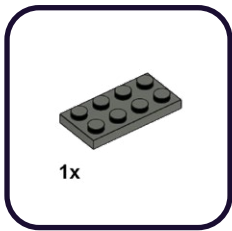

290

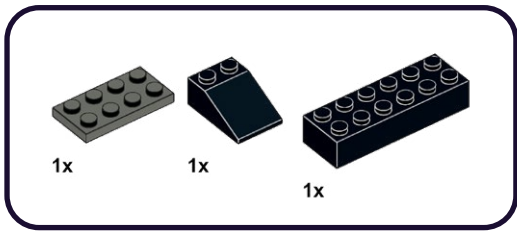

1

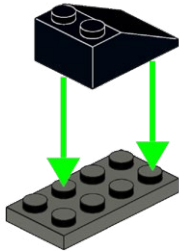

2

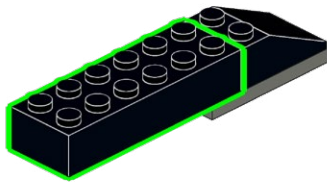

291

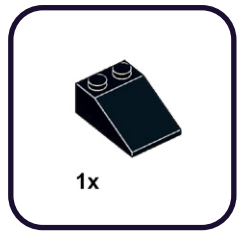

1

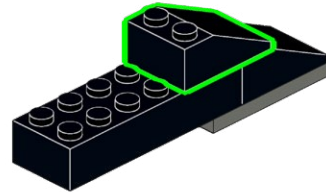

2x

292

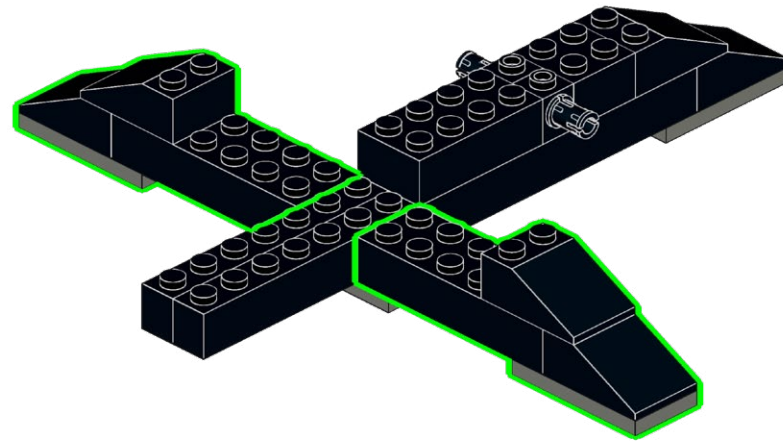

293

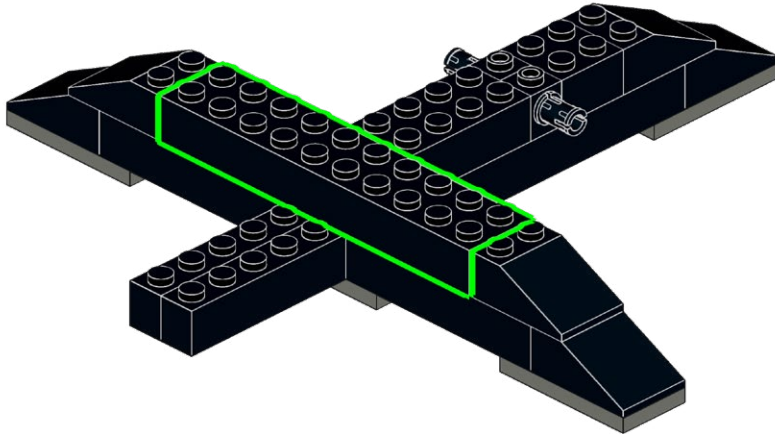
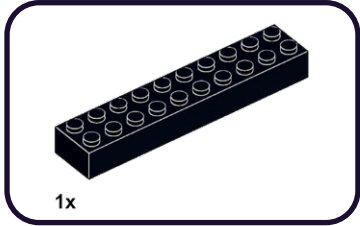

294

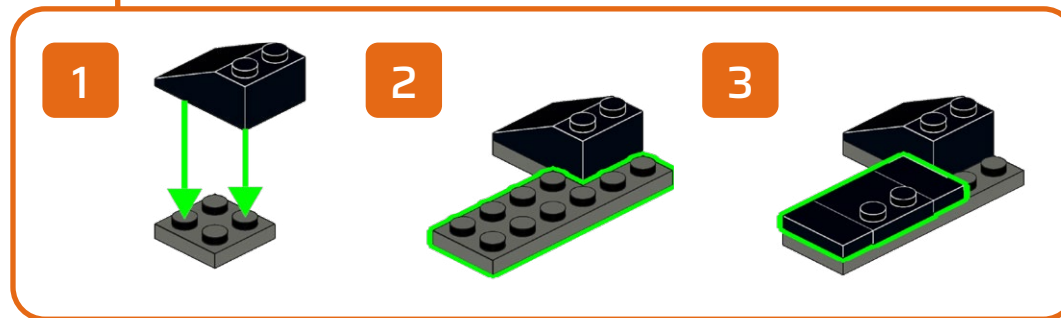
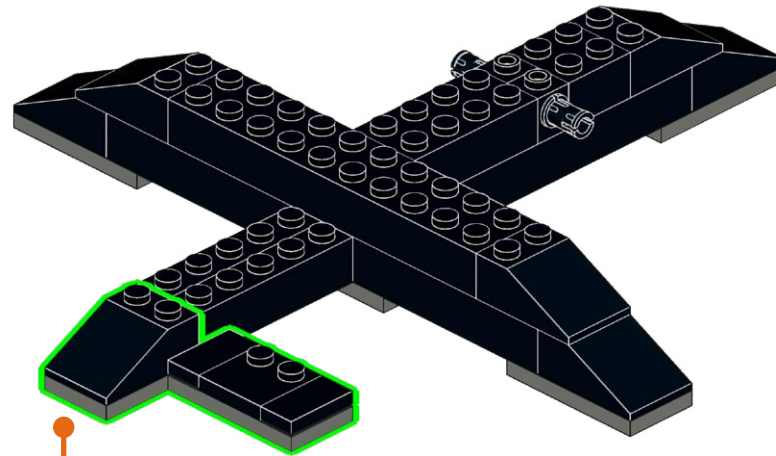
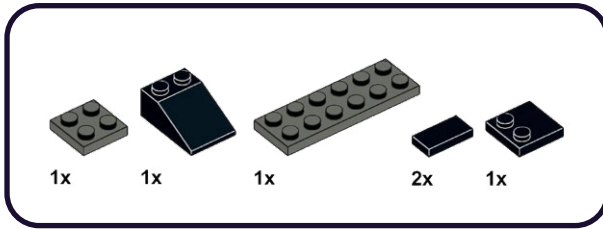

295

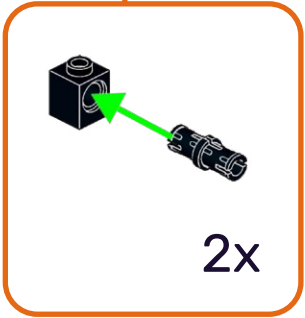
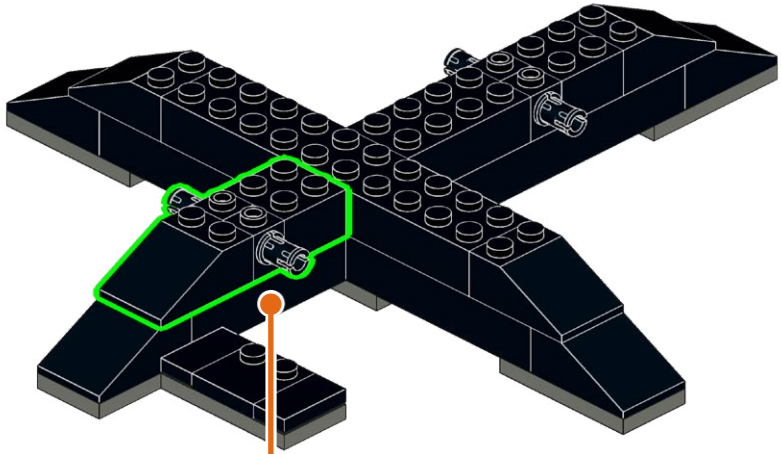
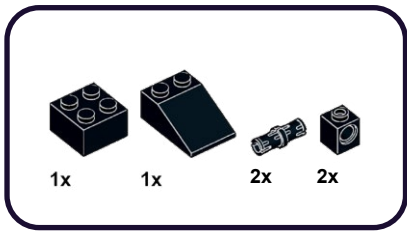

296

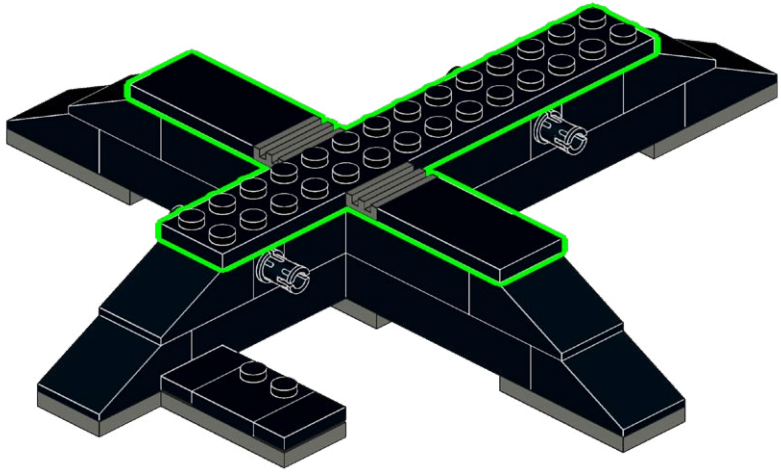
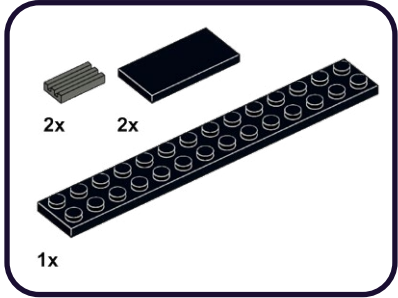

297

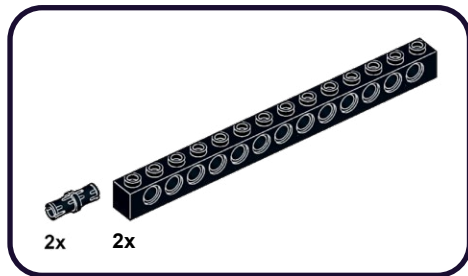

1

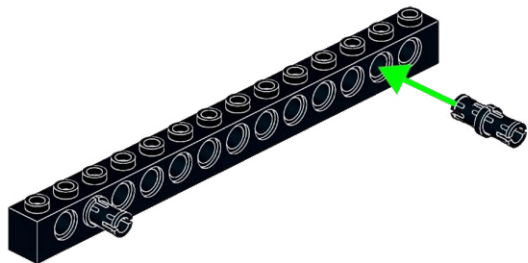

2

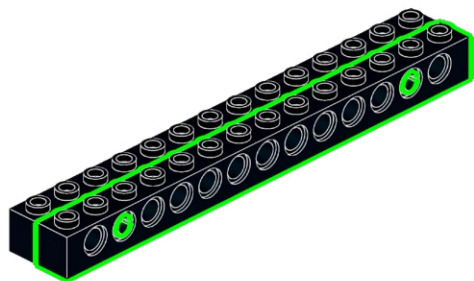

298

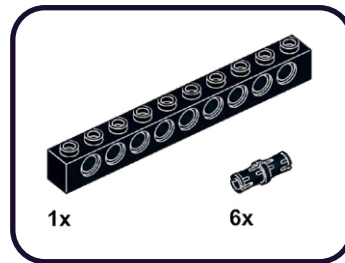

1

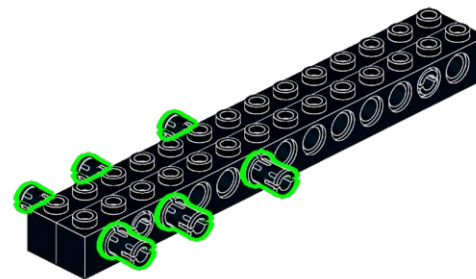

2

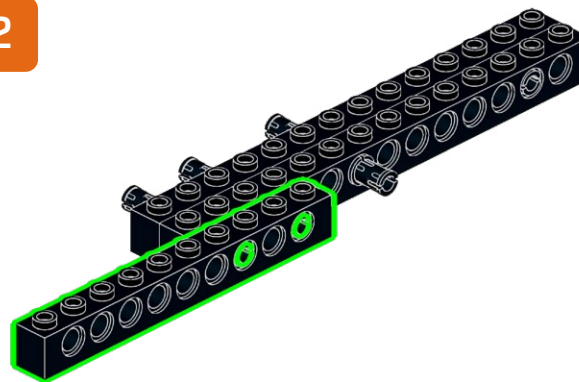

299

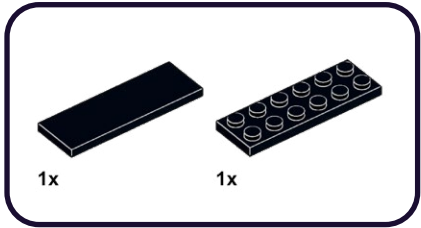

1

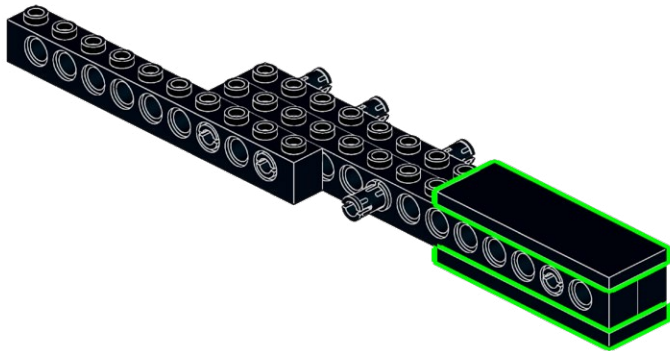

300

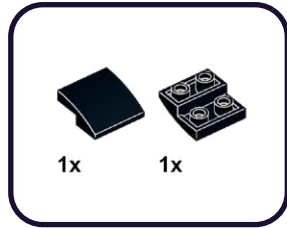

1

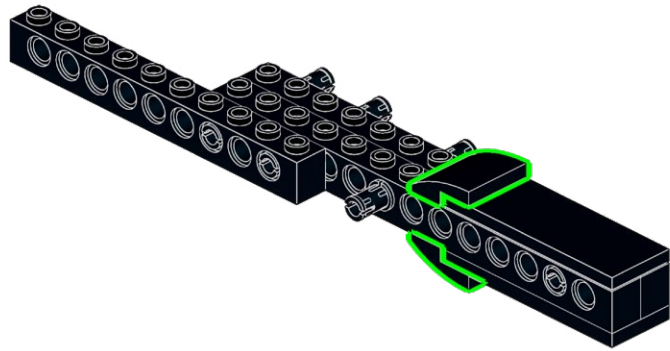

301

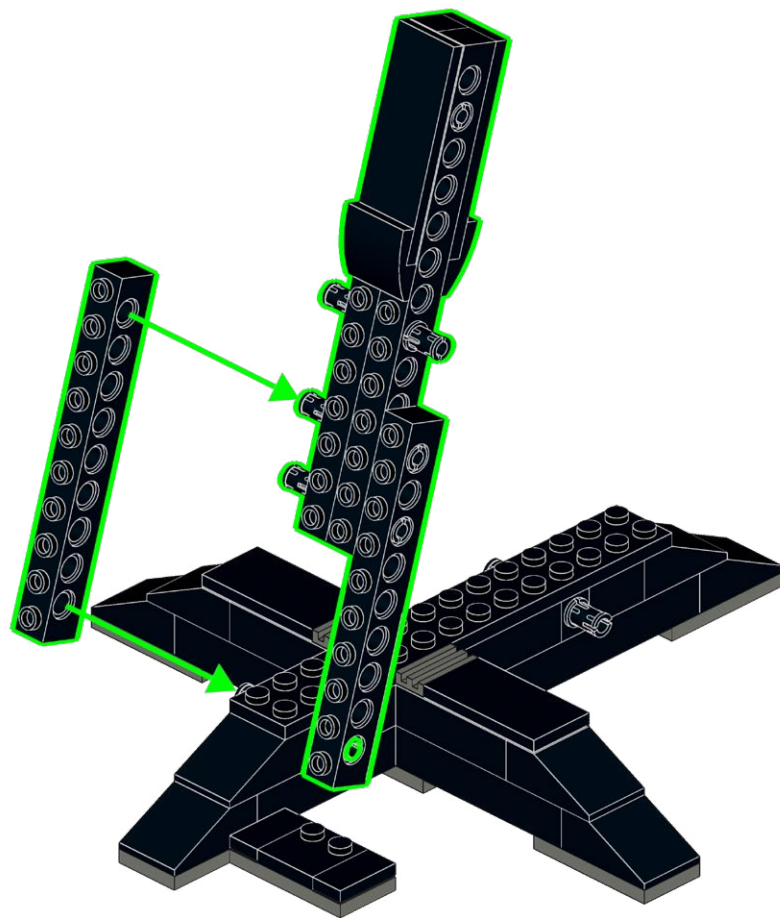
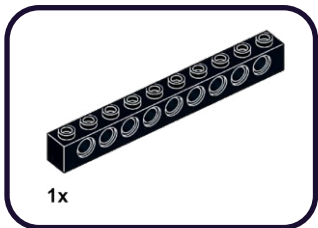

302

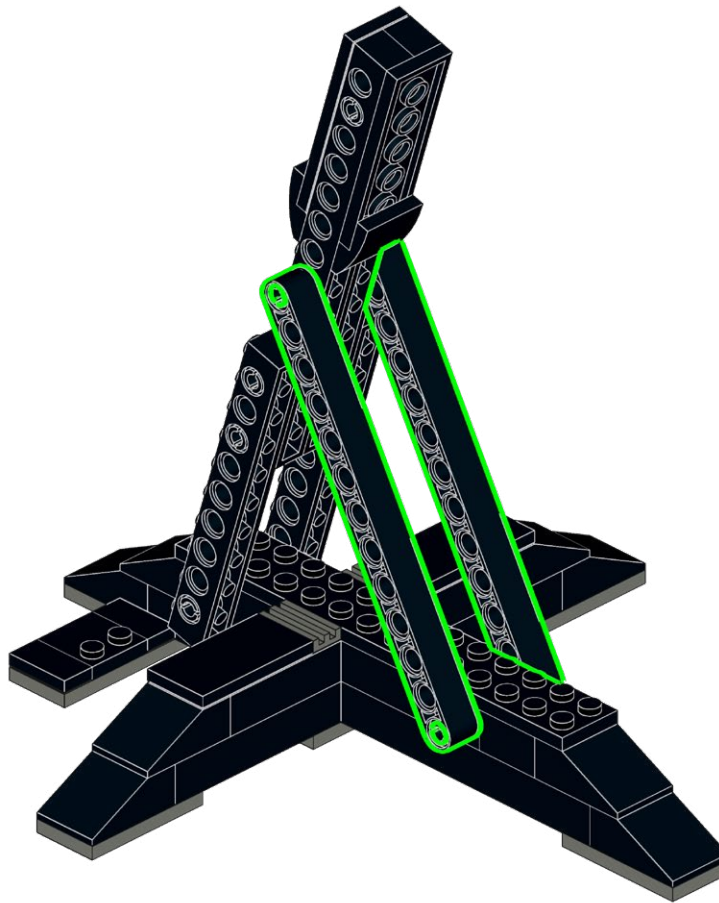
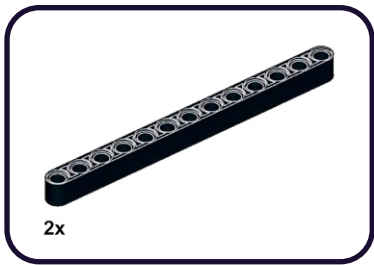

303

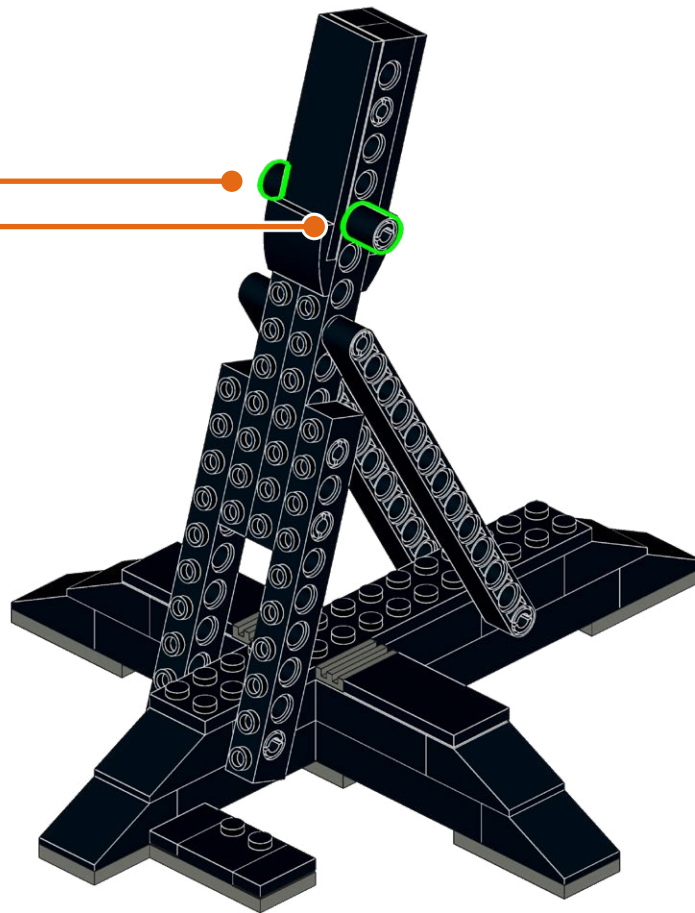

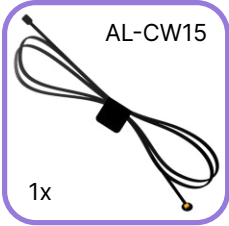
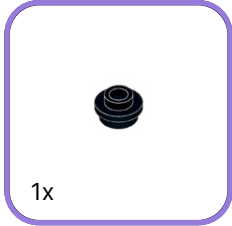

1



2

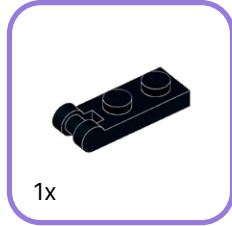

1



2



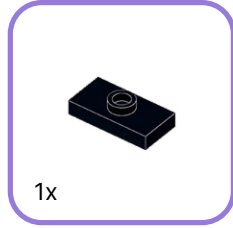
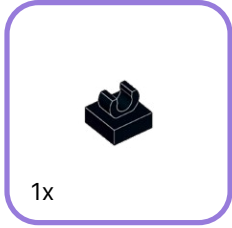

1

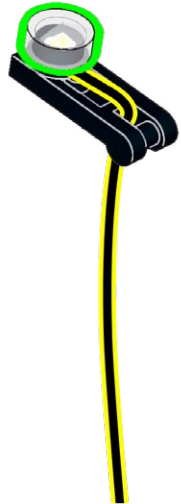

2

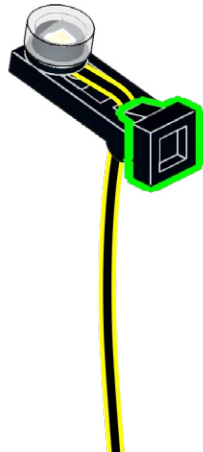

1

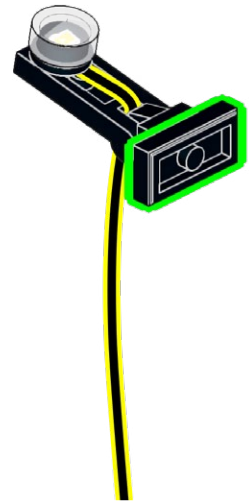

308

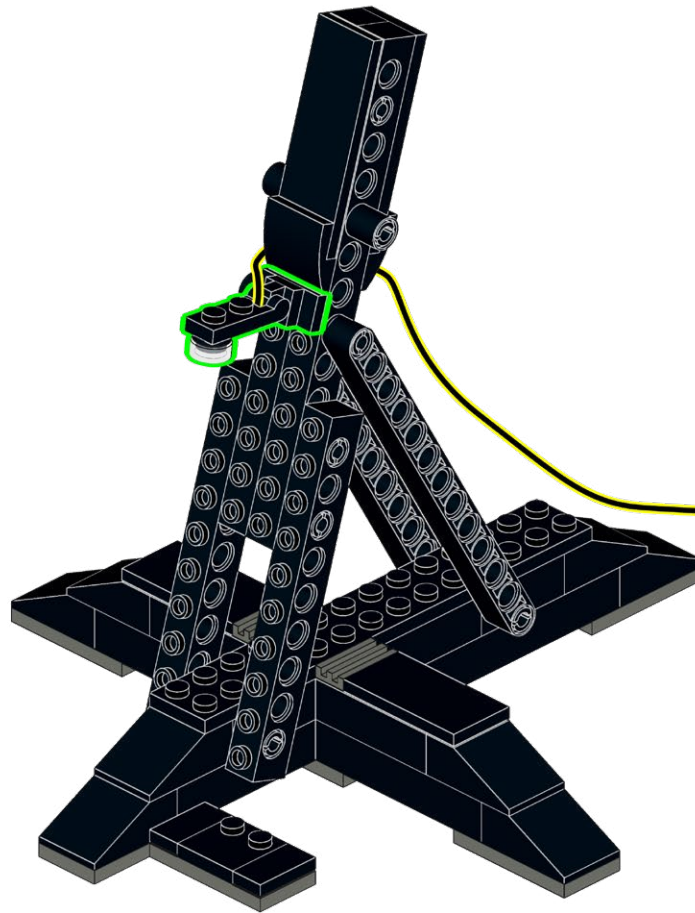

309

1

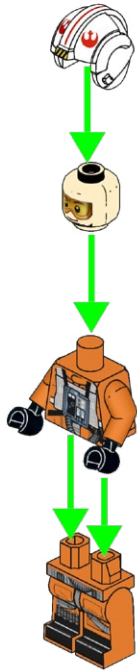

310

1

2

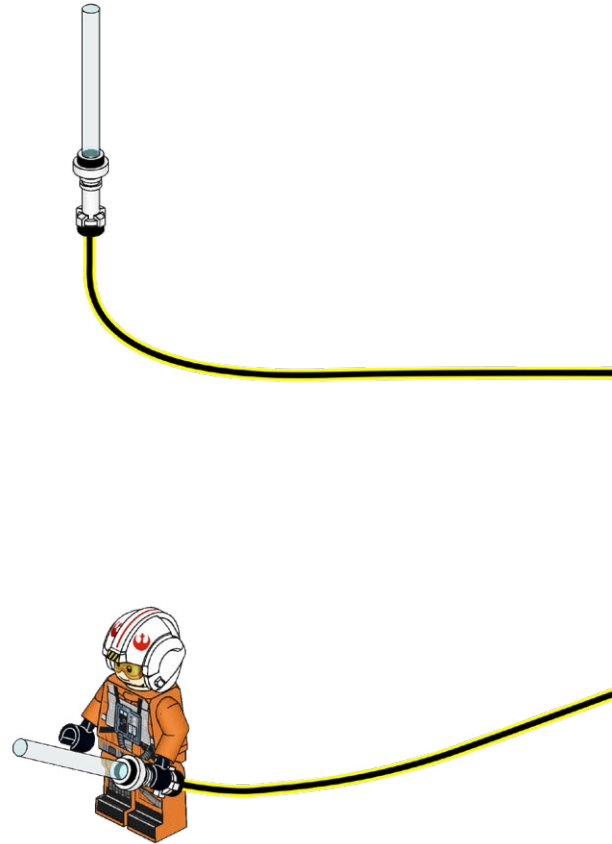
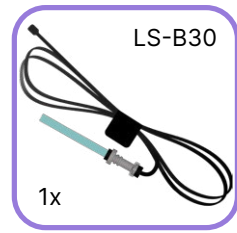

311

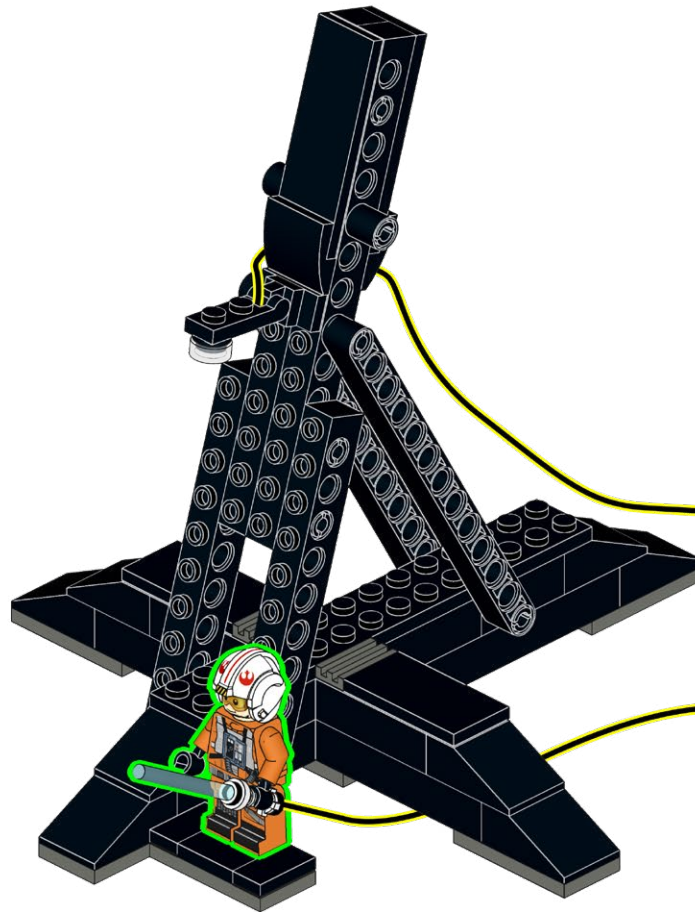

312

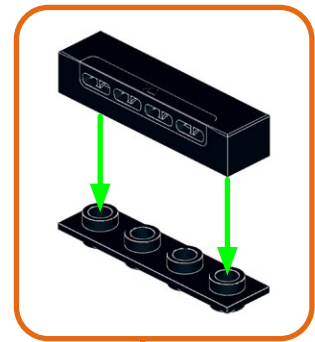
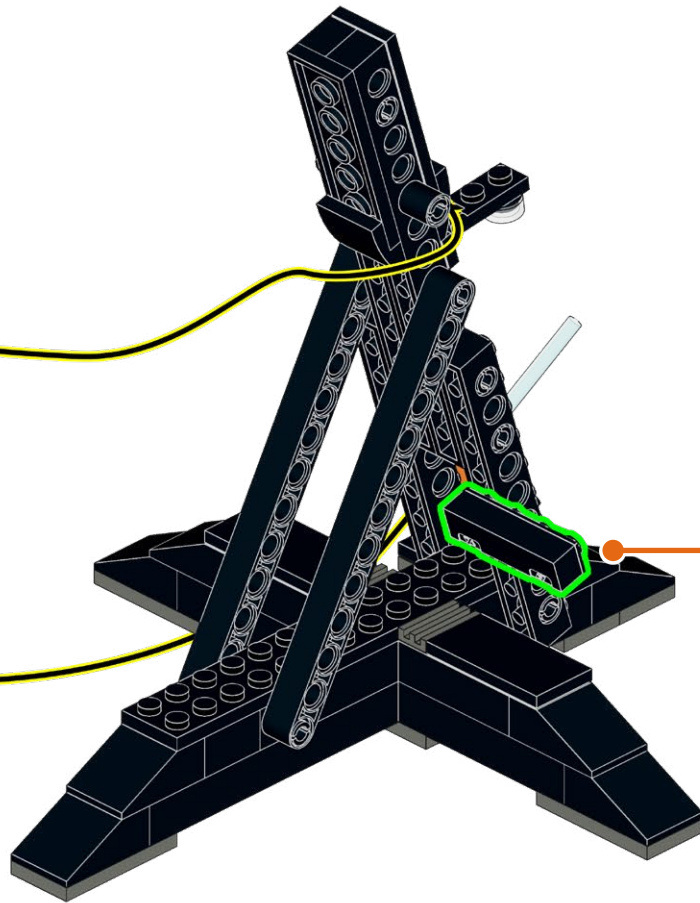
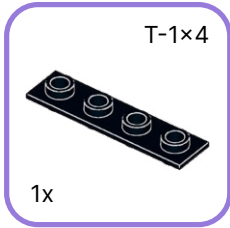
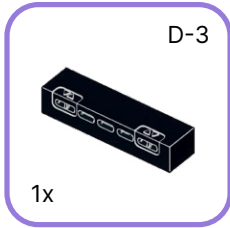

313

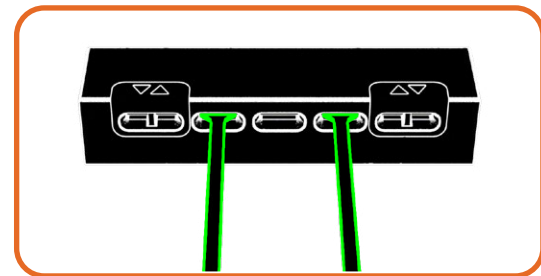
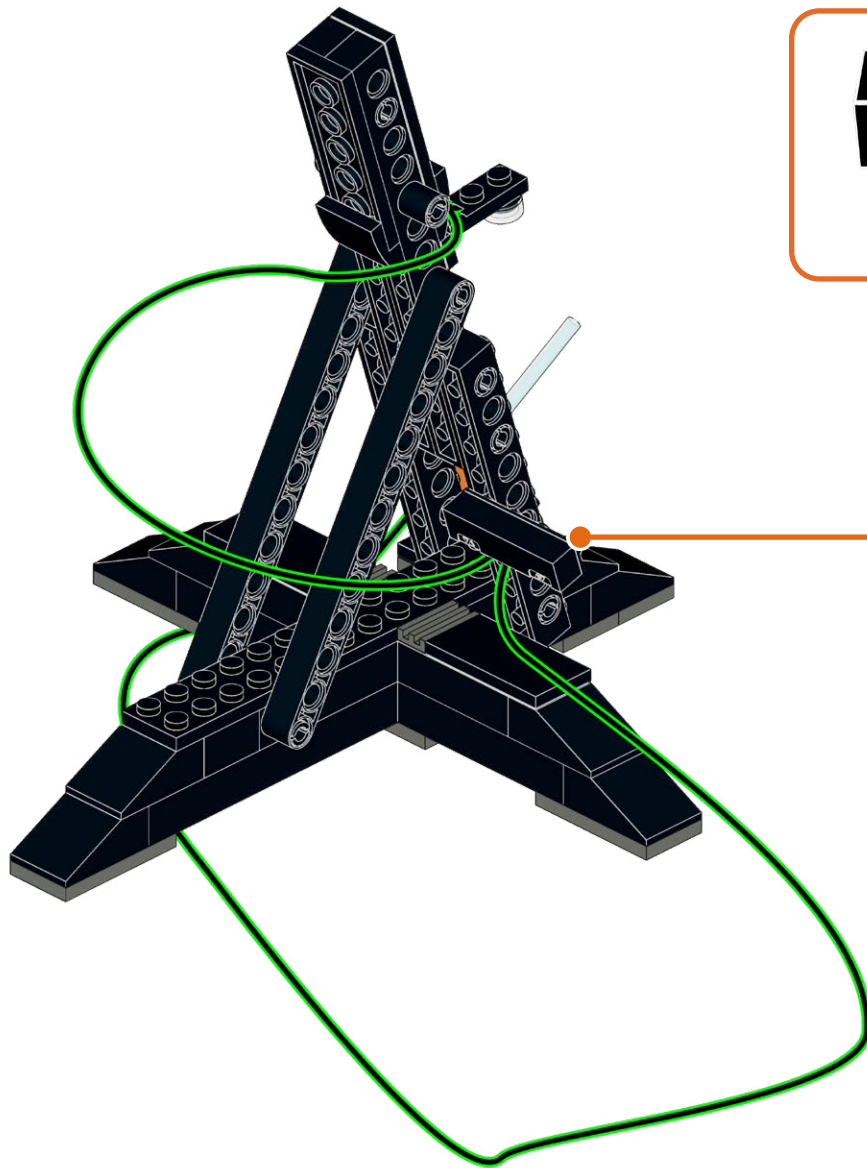

314

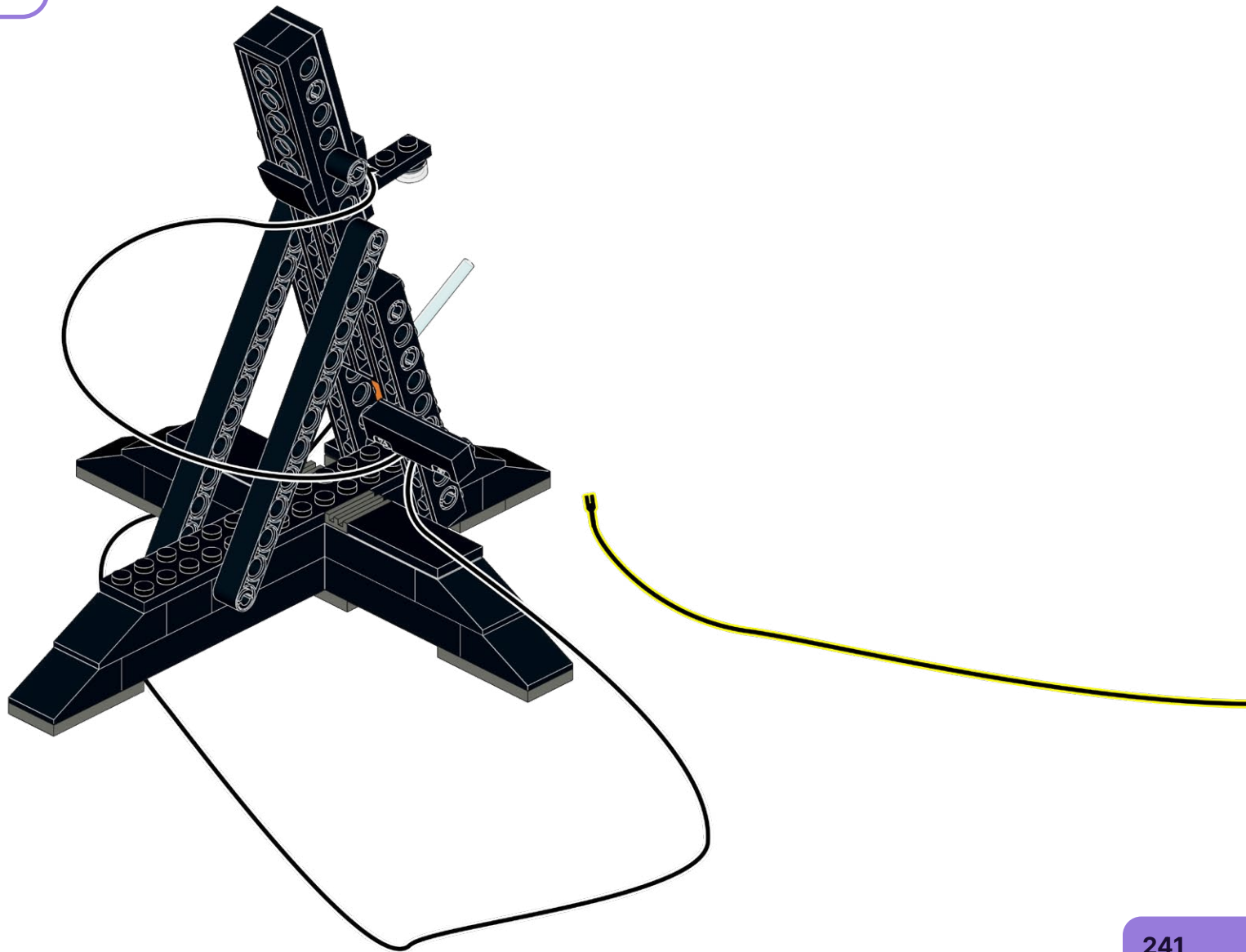

315

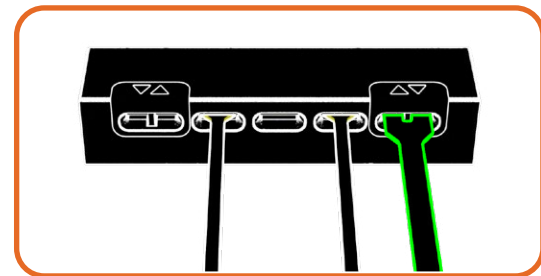
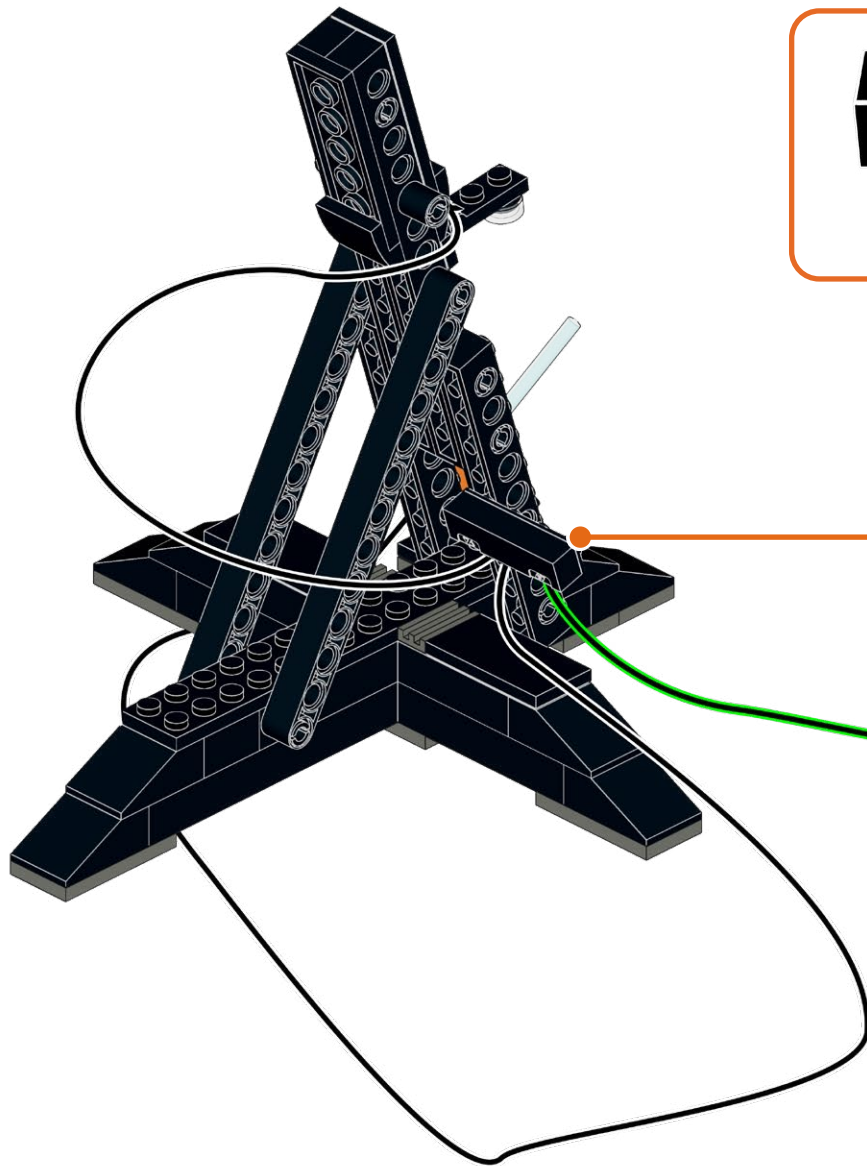

316

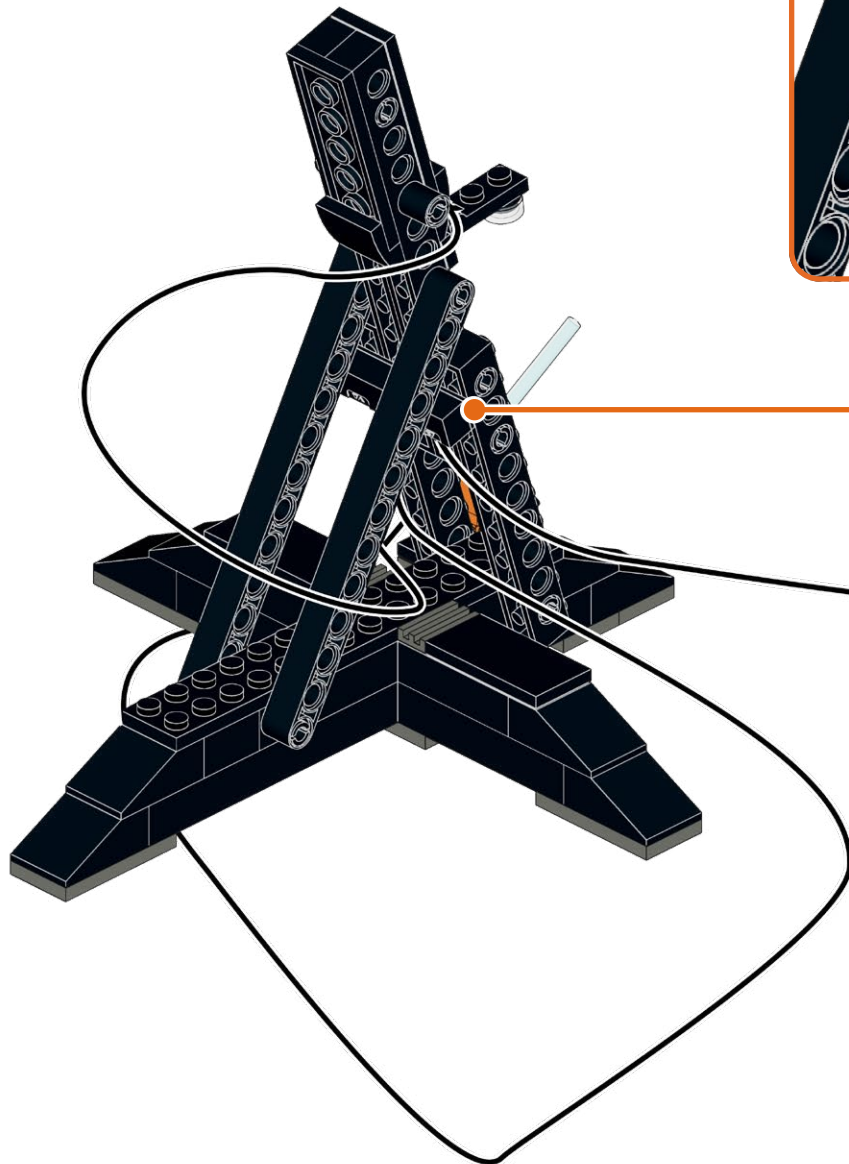

317

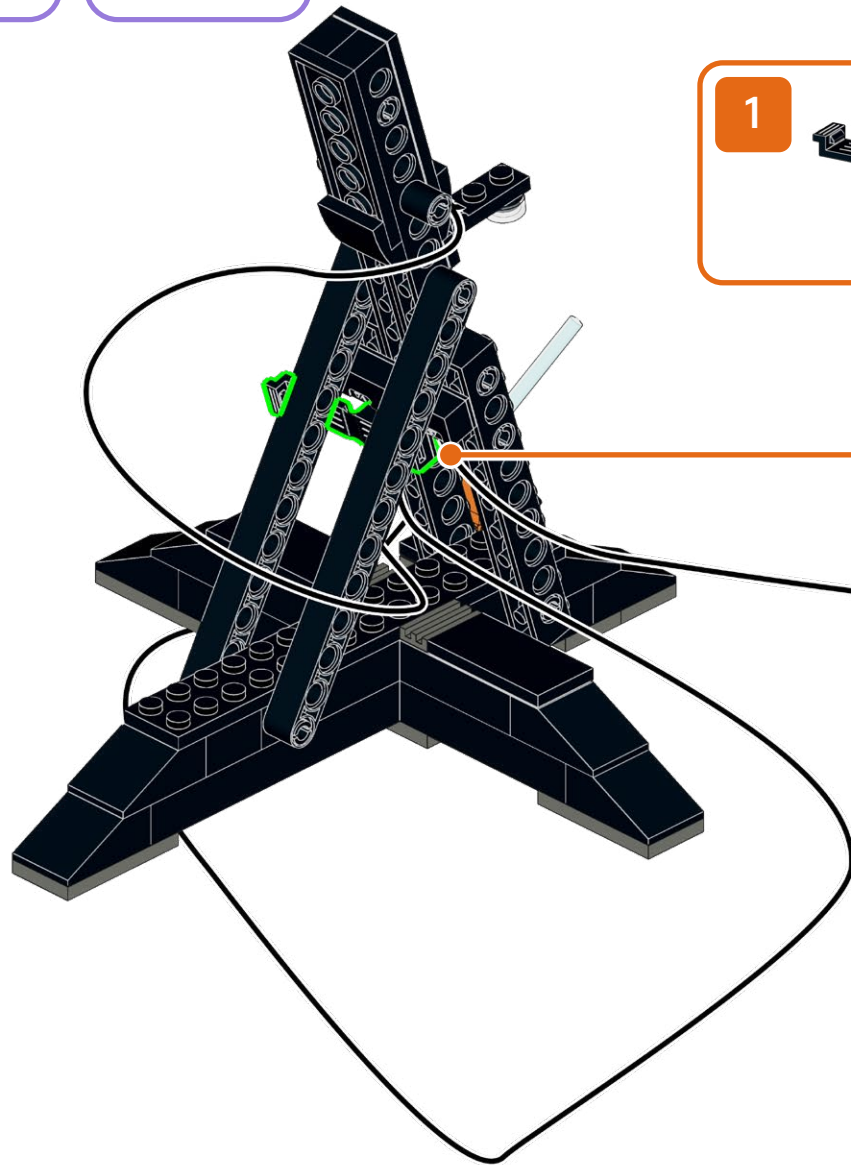
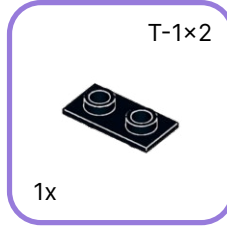
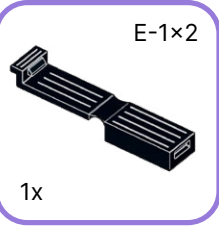

318

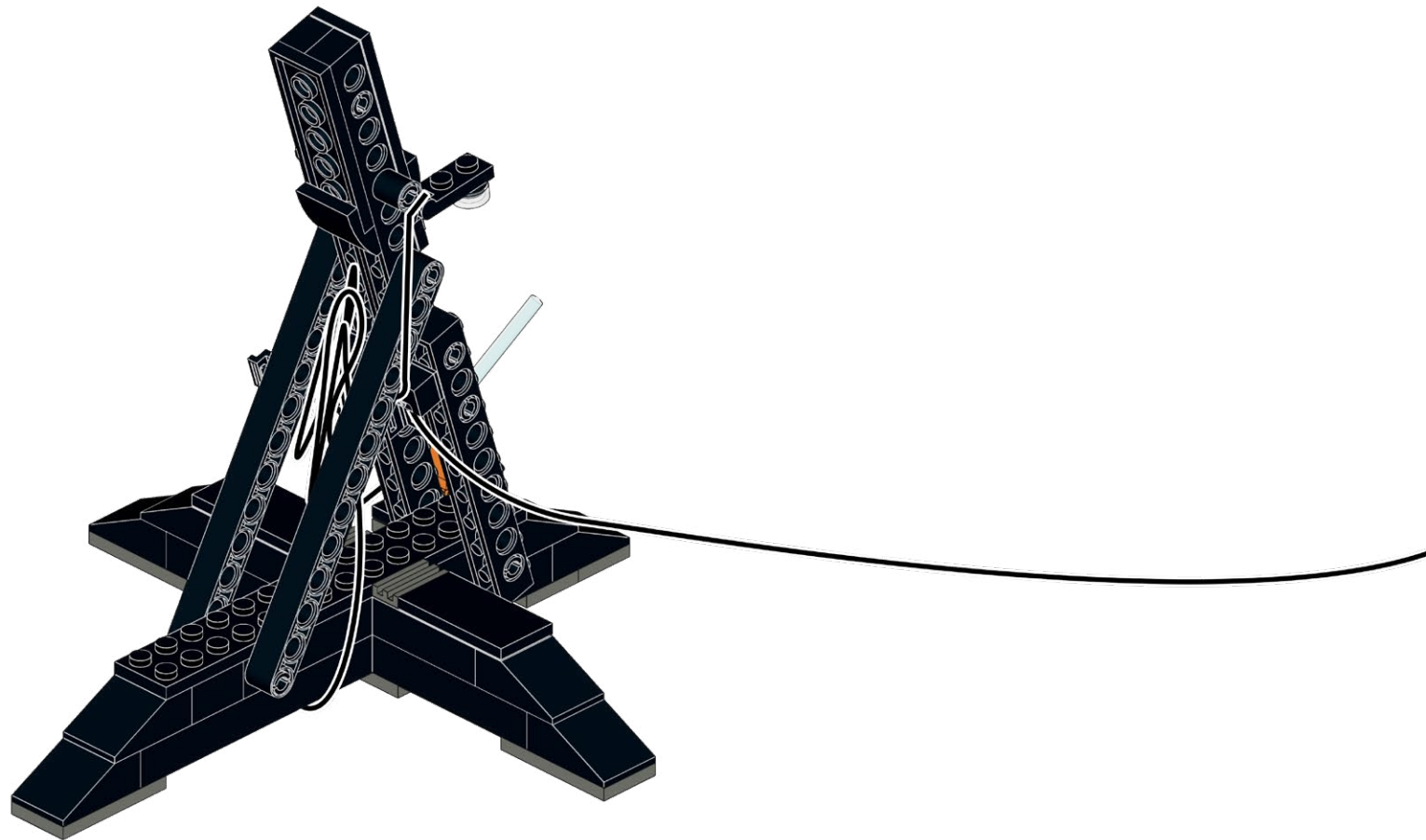

319

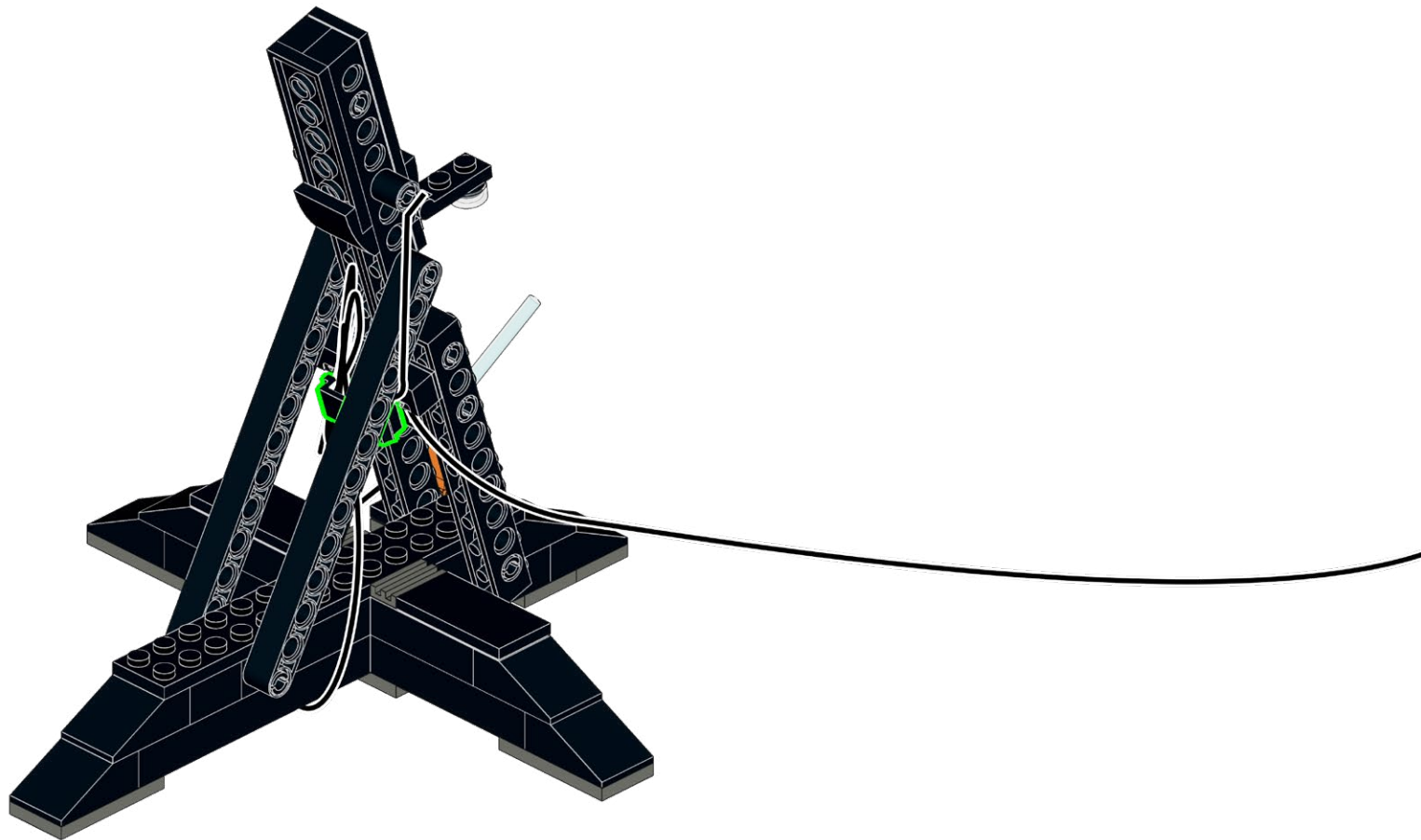

320



321

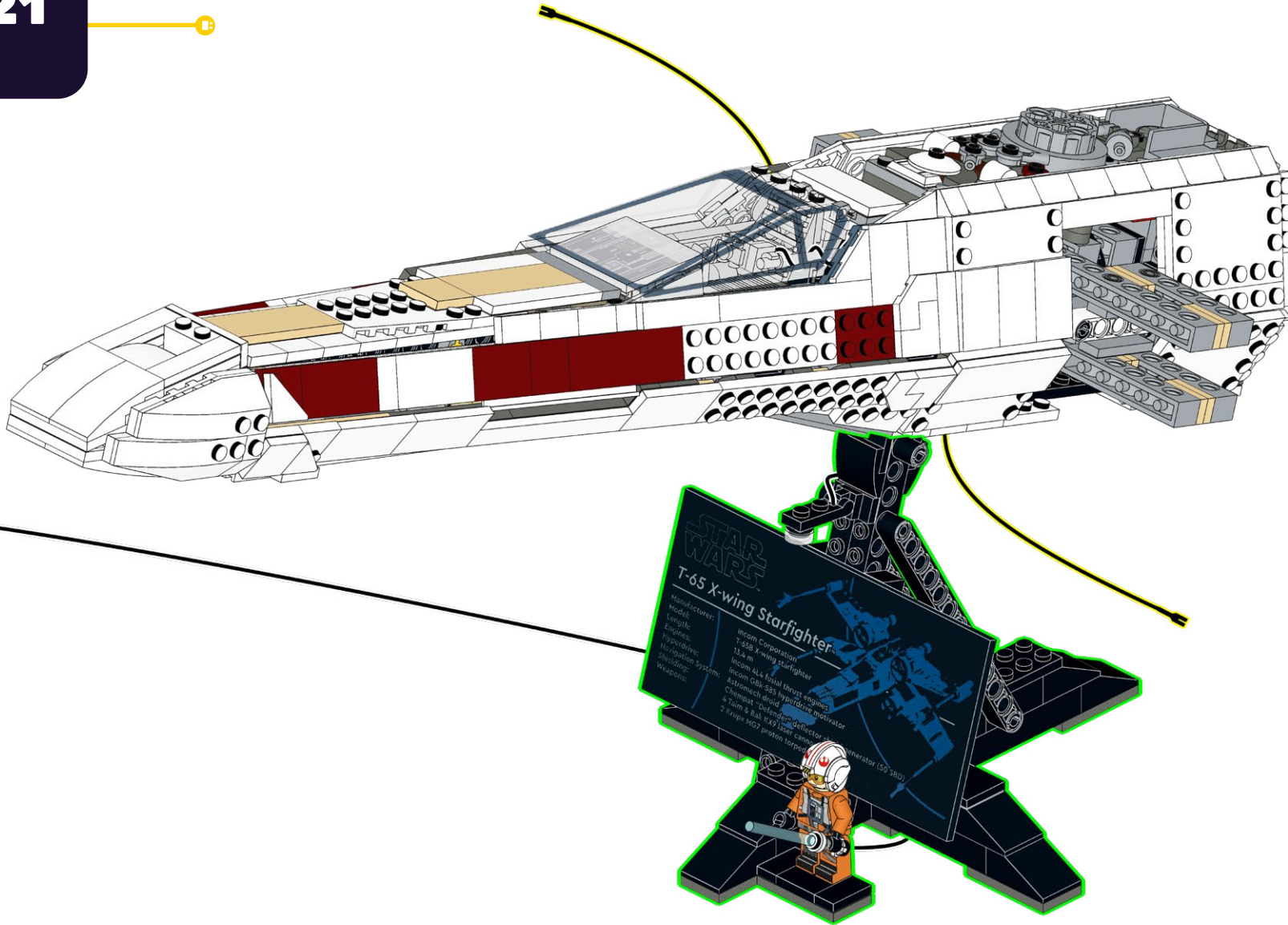

322

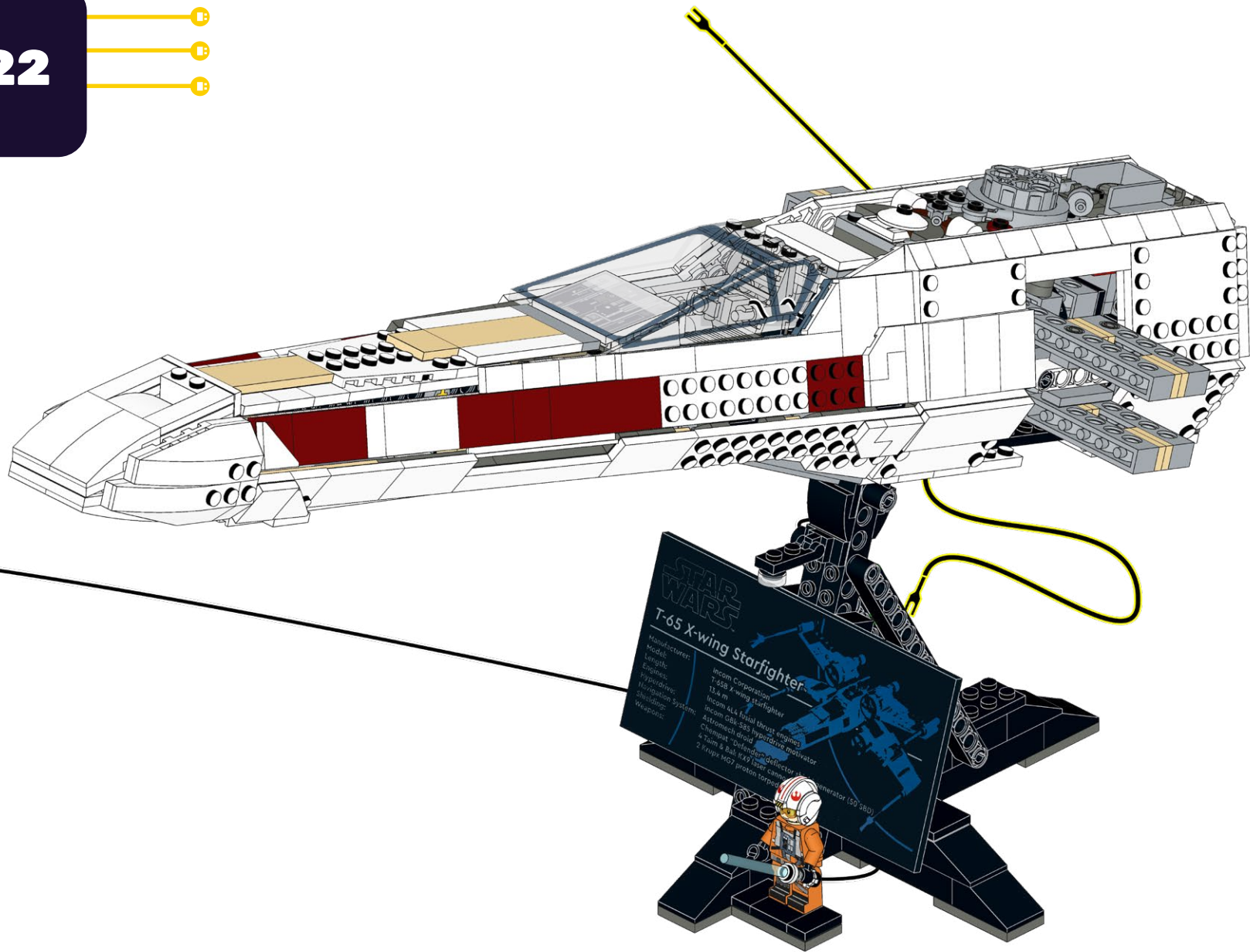

323

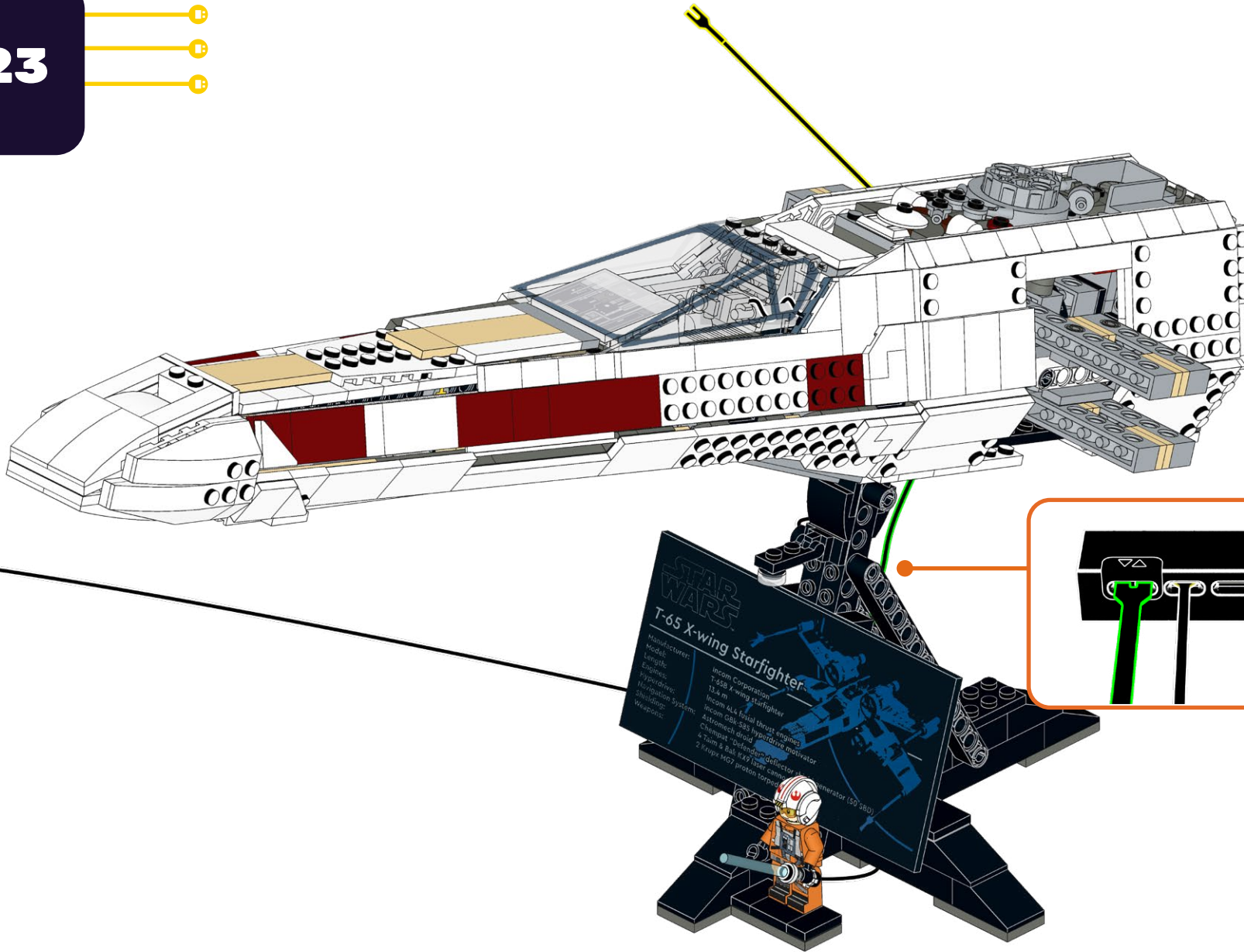

| STAR WARS | |
|-------------------------|--------------------------------|
| T-65 X-wing Starfighter | |
| Manufacturer: | Incom Corporation |
| Model: | T-65 X-wing starfighter |
| Length: | 13.4 m |
| Capacity: | Incom AL-4 dual thrust engines |
| Propulsion System: | Astromech droid |
| Armaments: | 4 Twin & Blaster cannons |
| Weapons: | 2 Heavy MG7 proton torpedoes |



324



1x 2x 1x

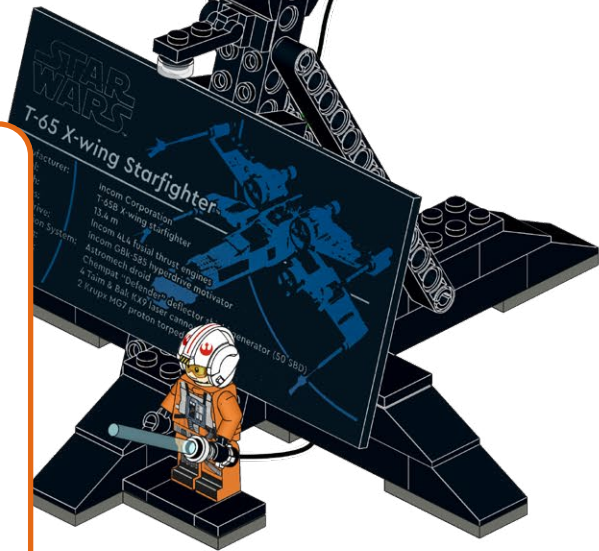
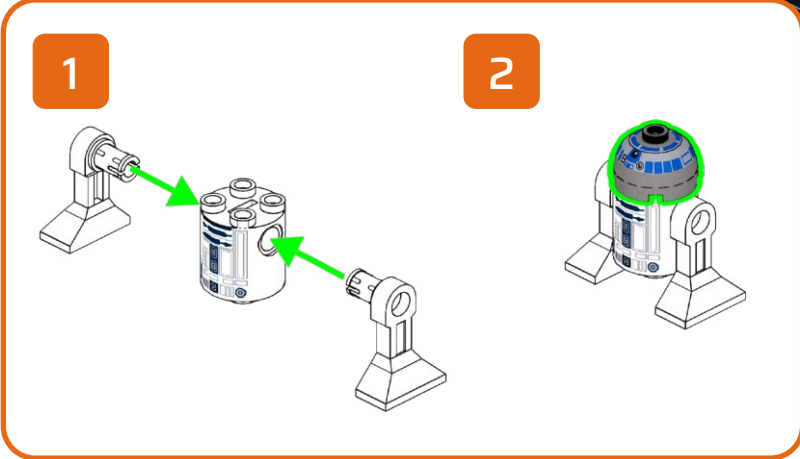
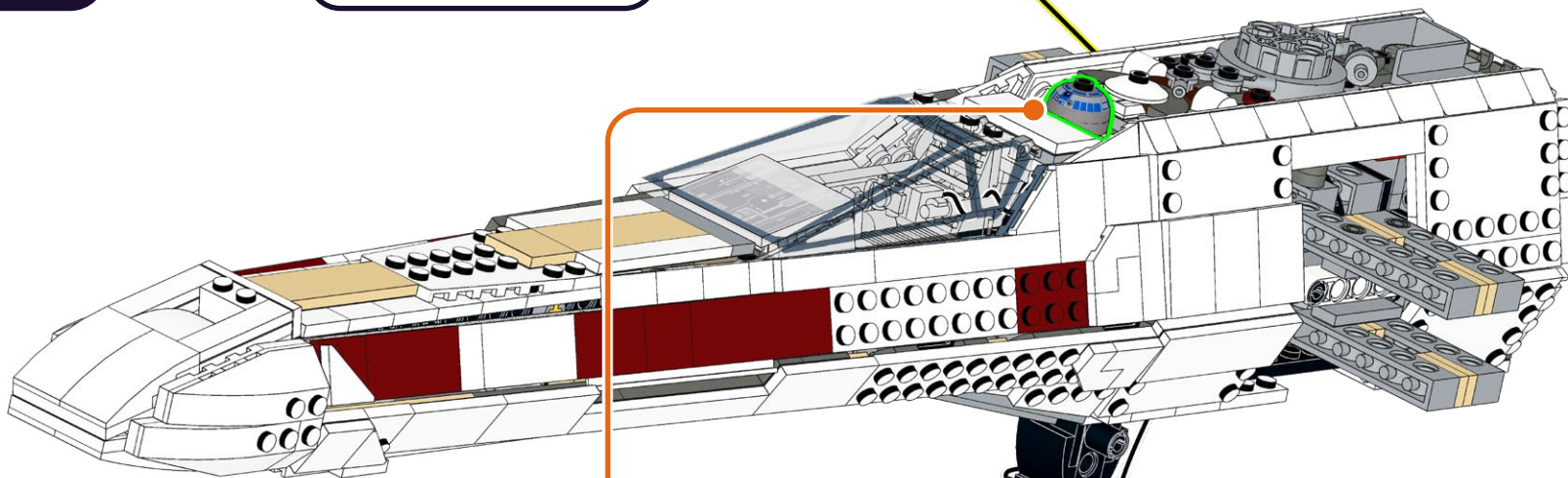

STAR WARS
T-65 X-wing Starfighter

Manufacturer: Incom Corporation
Length: 13.5 m
Incom AL-4 total thrust engines
Armament: 4 x 132mm laser cannons
4 x Twin & Blaster laser cannons
2 x Heavy MG7 proton torpedoes
Generator (22 380)

325

D-6



1x

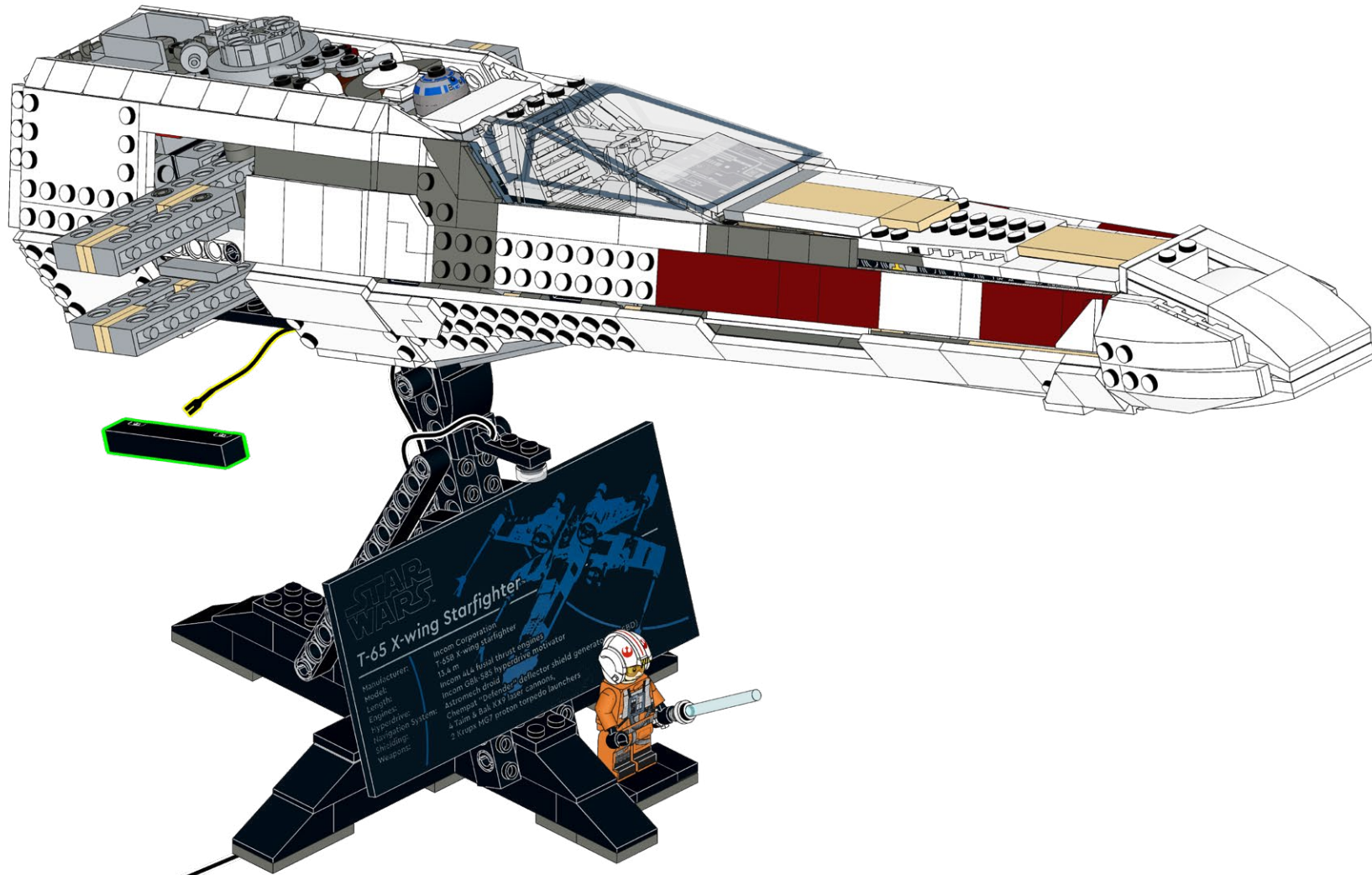

326

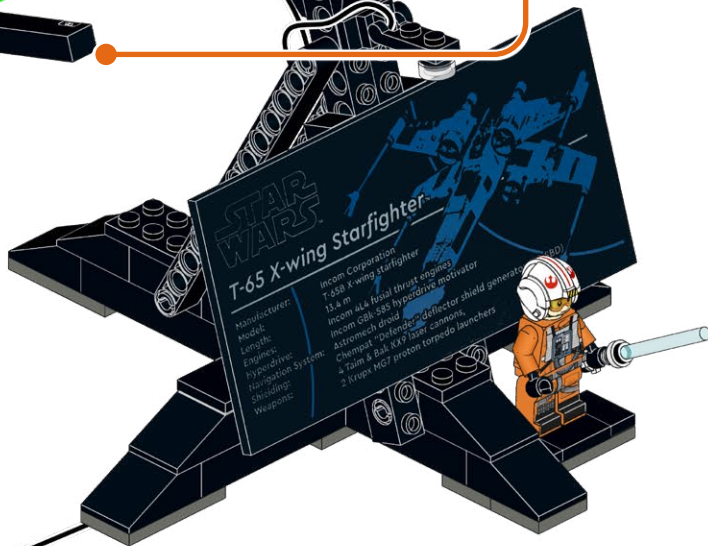
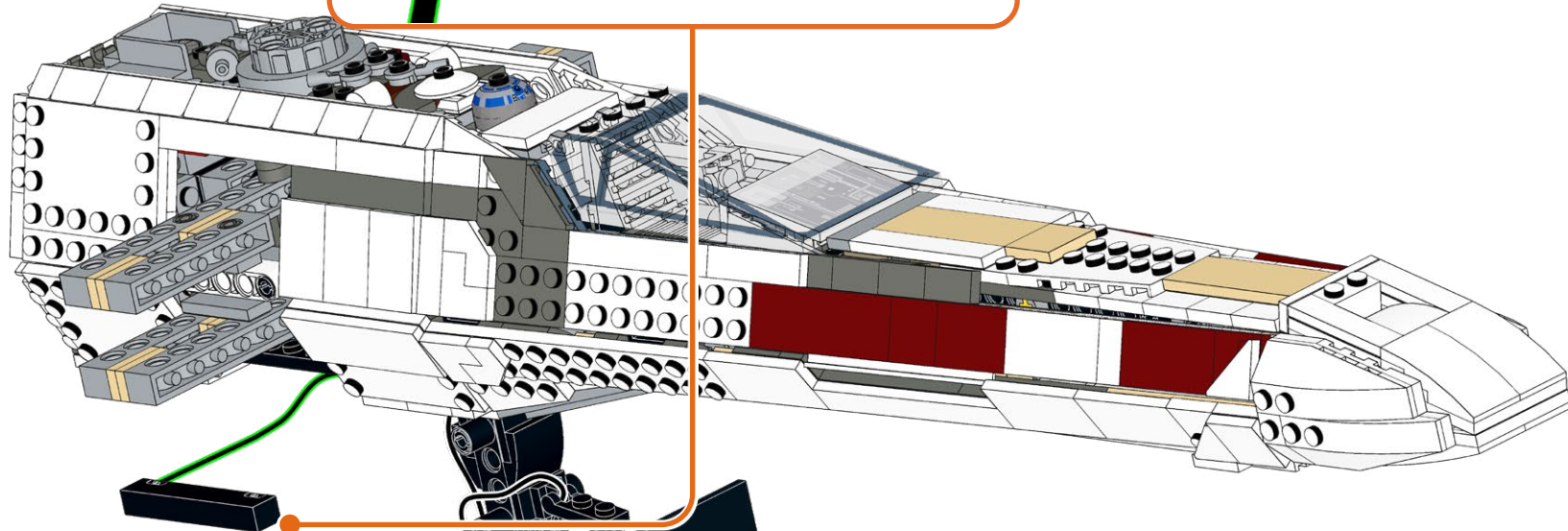
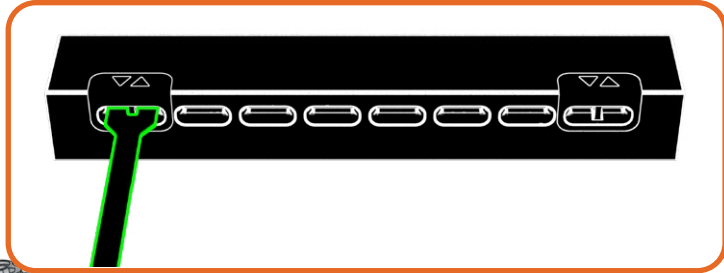

**HOLD UP!**

You might notice some bags aren't in order, as well as left over pieces, but that's ok! We're changing the way you build LEGO!

ATTENDEZ!

Vous remarquerez peut-être que certains sacs, ainsi que certaines pièces, ne sont pas dans le bon ordre. Mais pas de panique! Nous changeons simplement la façon avec laquelle vous construisez vos LEGO!

ASPETTA!

Potresti notare che alcuni sacchetti non sono in ordine, così come i pezzi avanzati, ma va bene così! Stiamo cambiando il modo in cui costruisci i LEGO!

HALT!

Sie werden möglicherweise bemerken, dass einige tüten durcheinander sind und teile übrig bleiben, aber das ist in Ordnung! Wir ändern die art und weise, wie Sie LEGO bauen!

¡ESPERA!

Es posible que notes que algunas bolsas están fuera de servicio, así como piezas sobrantes, ¡pero está bien! ¡Estamos cambiando la forma en que construyes LEGO!

暫停!

你可能会注意到一些袋子顺序错乱, 以及一些剩余的部件, 但没关系! 我们正在改变你搭建乐高的方式!

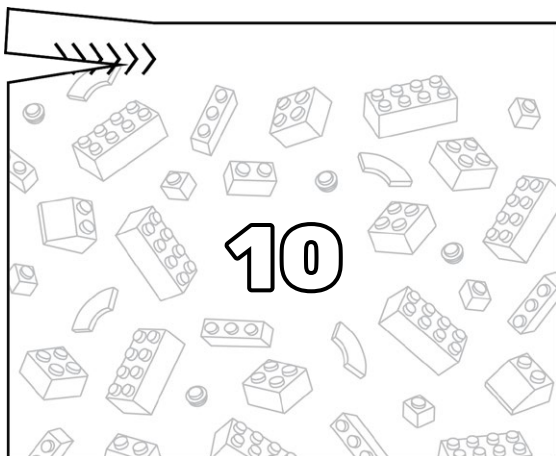
Open LEGO® Bag 10

327

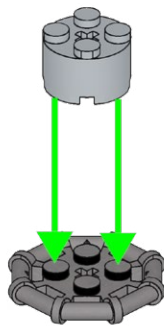
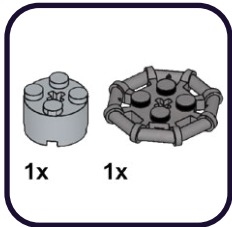
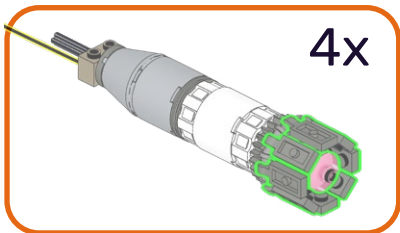

328

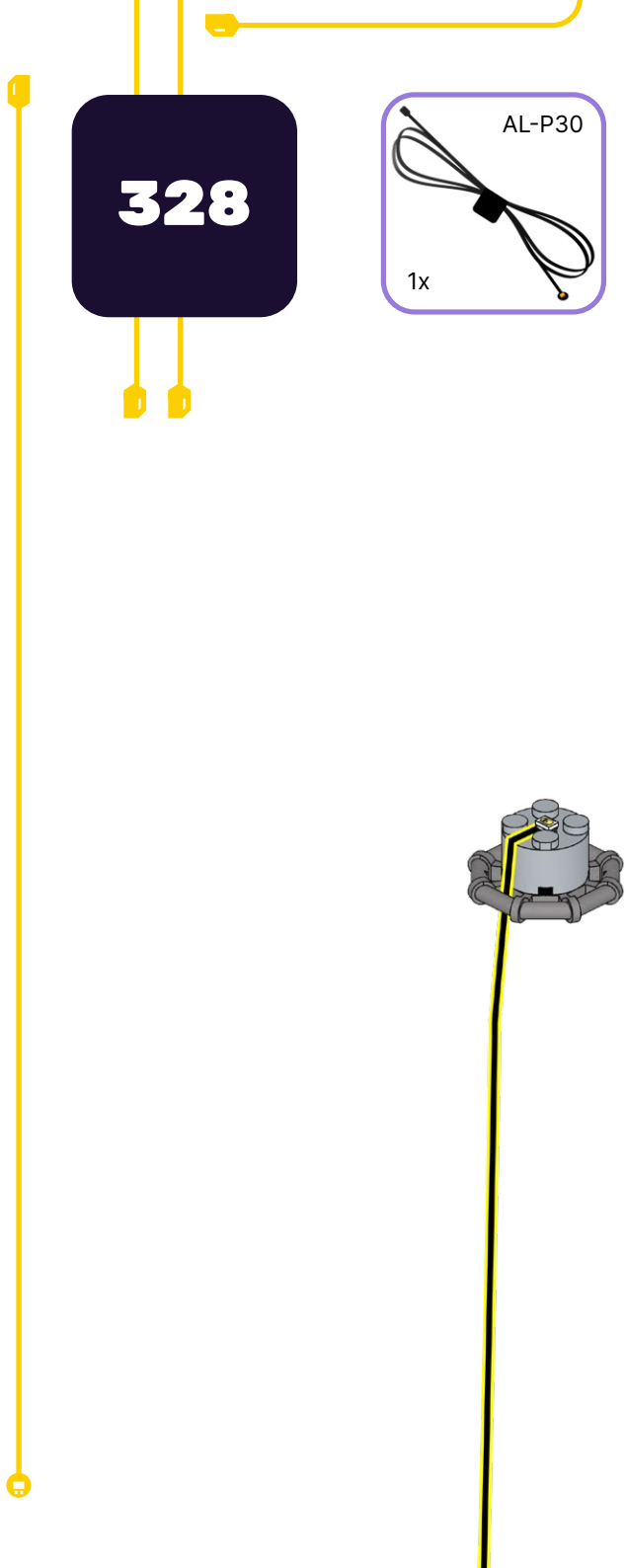
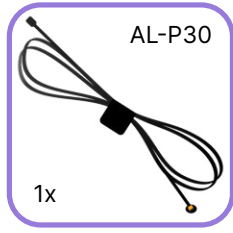

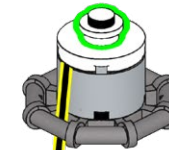
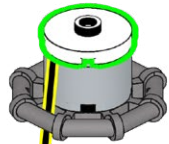
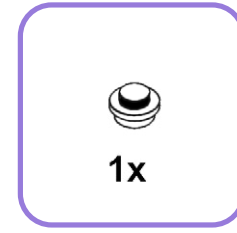
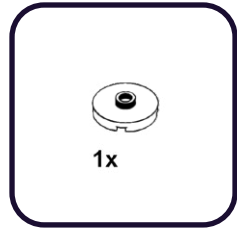

331

1x

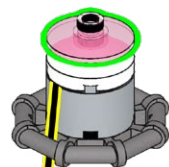
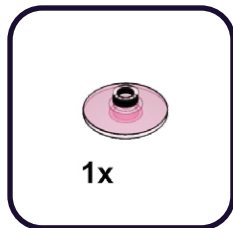

332

1x

1x

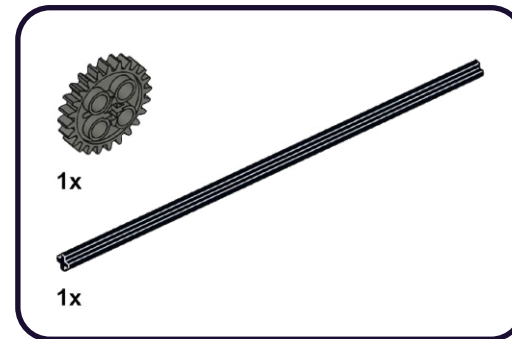

1

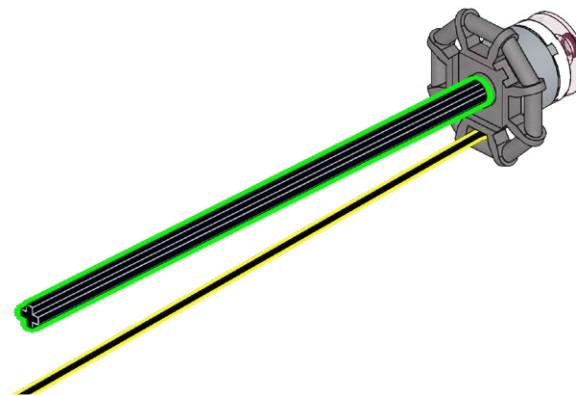

2



333

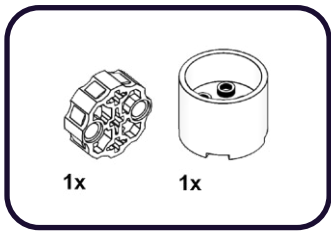

1

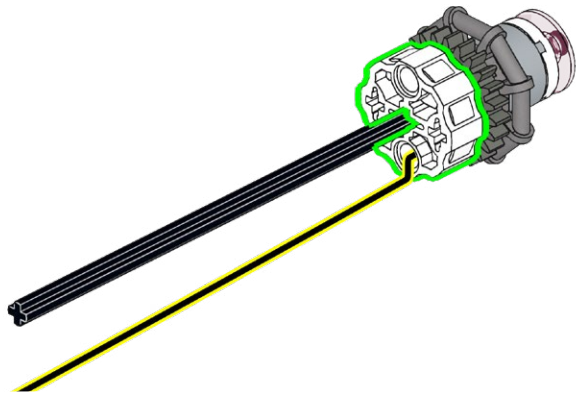

2

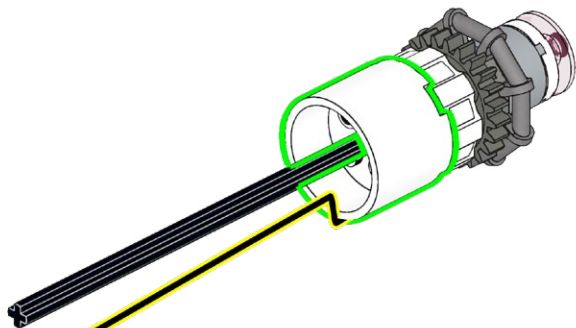

334

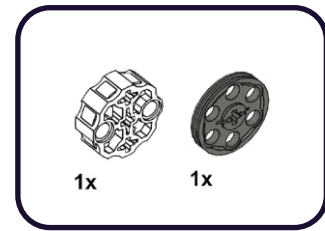

1

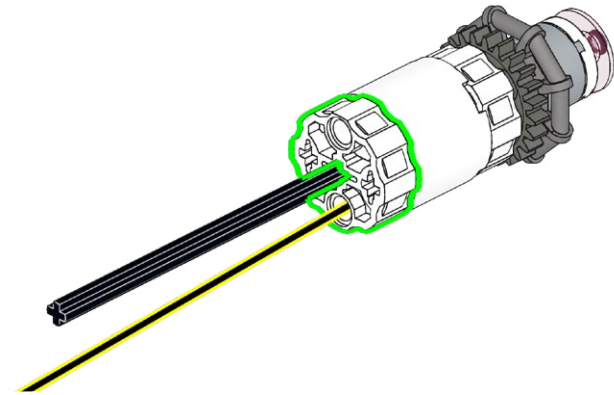

2

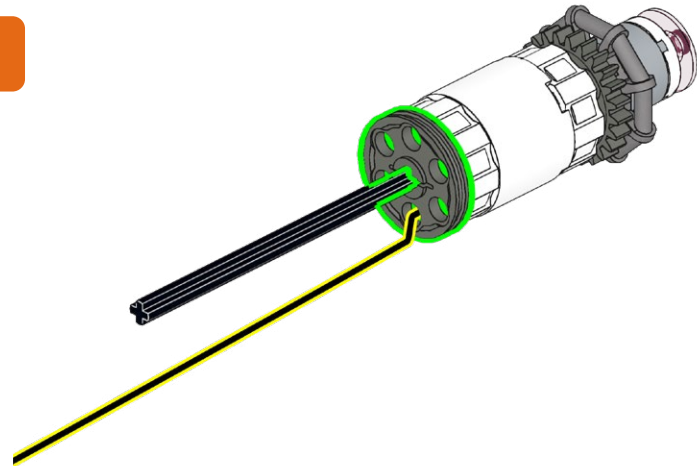

335

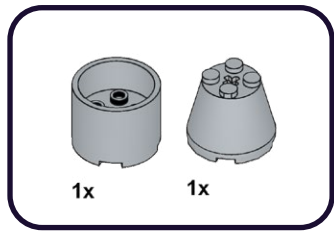

1

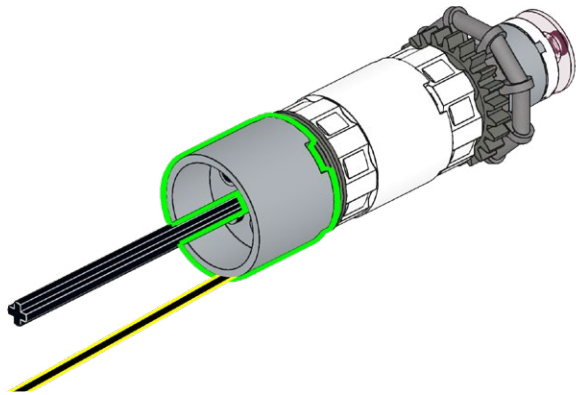

2

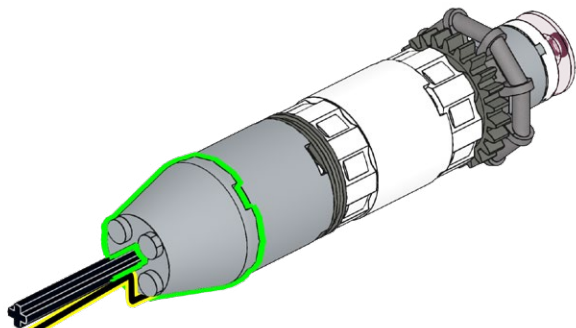

336

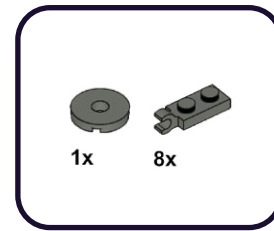

1

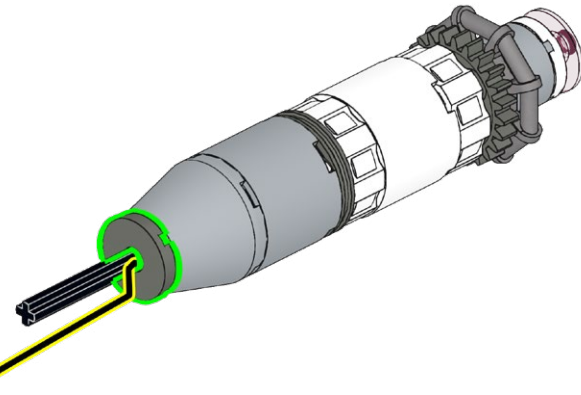

2

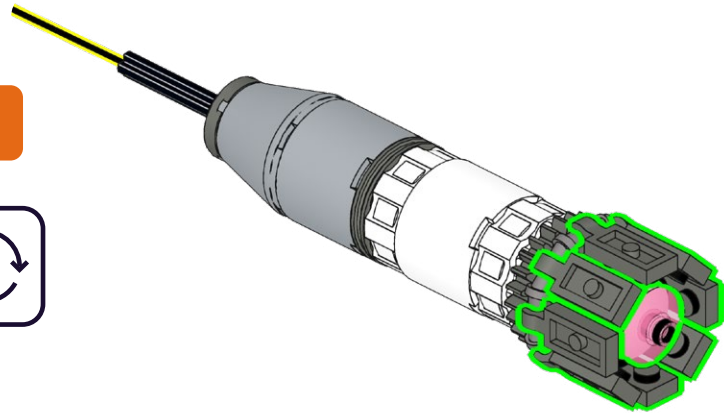

4x

**HOLD UP!**

You might notice some bags aren't in order, as well as left over pieces, but that's ok! We're changing the way you build LEGO!

ATTENDEZ!

Vous remarquerez peut-être que certains sacs, ainsi que certaines pièces, ne sont pas dans le bon ordre. Mais pas de panique! Nous changeons simplement la façon avec laquelle vous construisez vos LEGO!

ASPETTA!

Potresti notare che alcuni sacchetti non sono in ordine, così come i pezzi avanzati, ma va bene così! Stiamo cambiando il modo in cui costruisci i LEGO!

HALT!

Sie werden möglicherweise bemerken, dass einige tüten durcheinander sind und teile übrig bleiben, aber das ist in Ordnung! Wir ändern die art und weise, wie Sie LEGO bauen!

¡ESPERA!

Es posible que notes que algunas bolsas están fuera de servicio, así como piezas sobrantes, ¡pero está bien! ¡Estamos cambiando la forma en que construyes LEGO!

暫停!

你可能会注意到一些袋子顺序错乱, 以及一些剩余的部件, 但没关系! 我们正在改变你搭建乐高的方式!

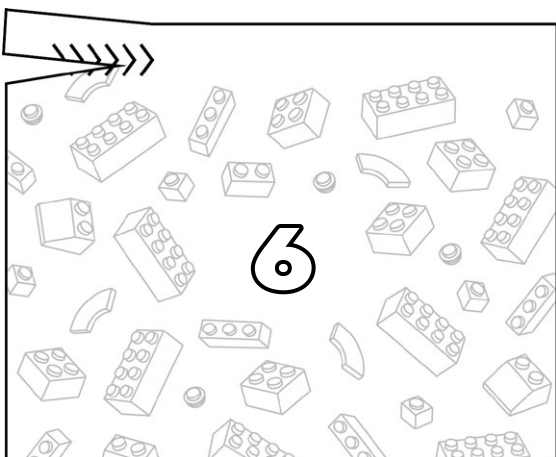
Open LEGO® Bag 6

337

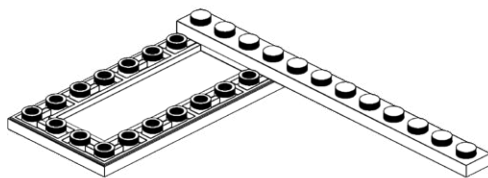
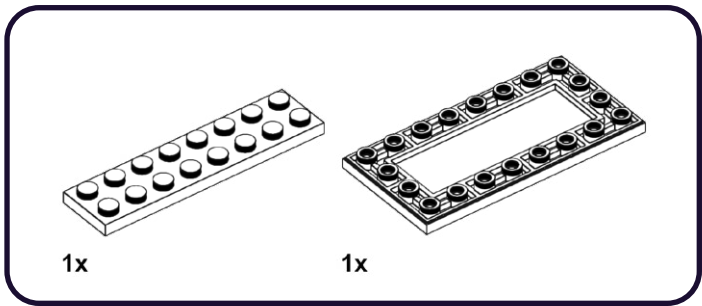

338

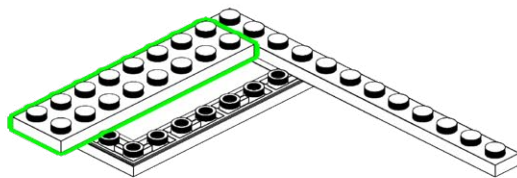
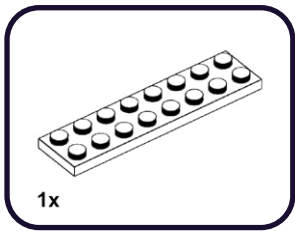

339

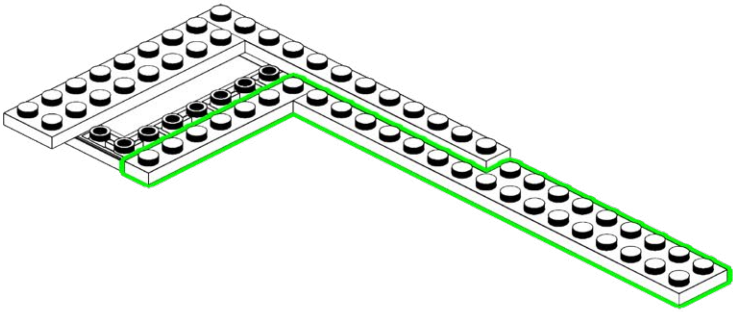
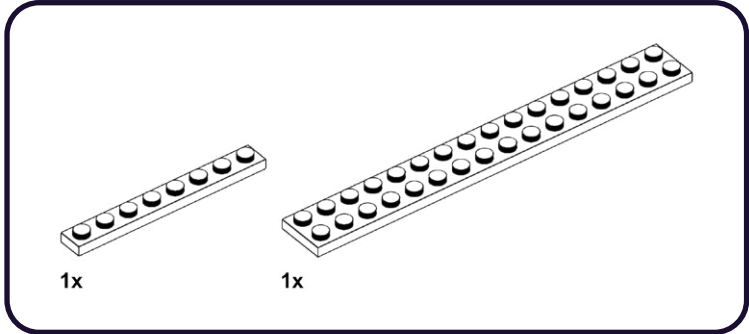

340

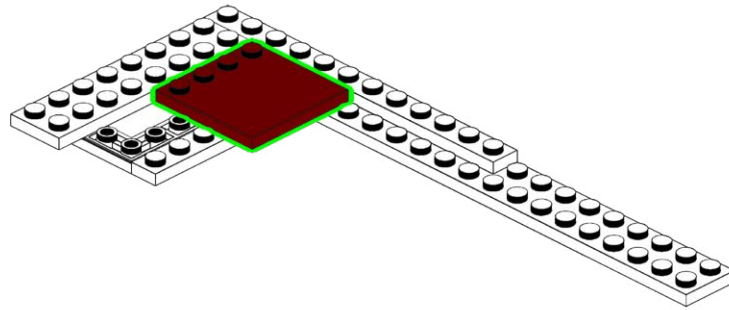
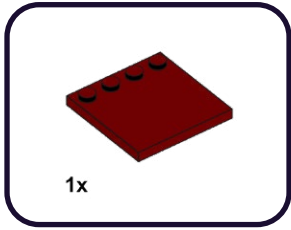

341

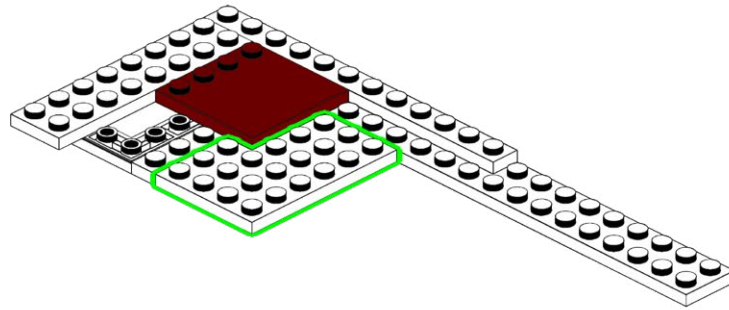
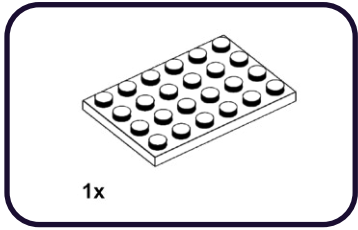

342

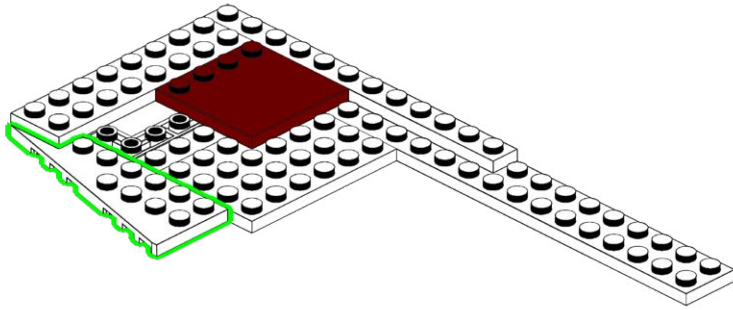
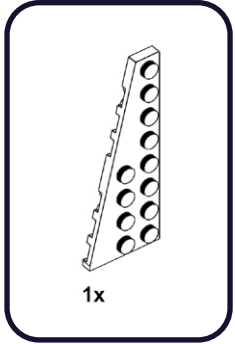

343

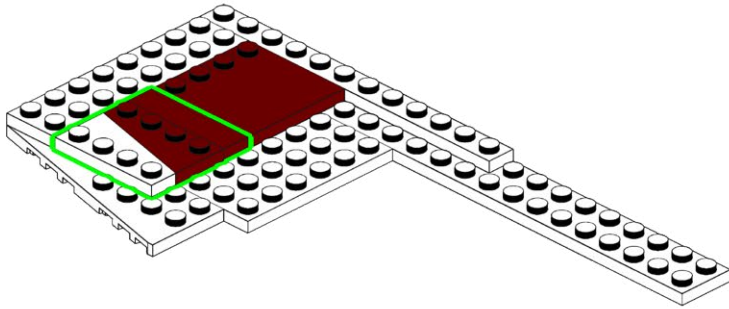
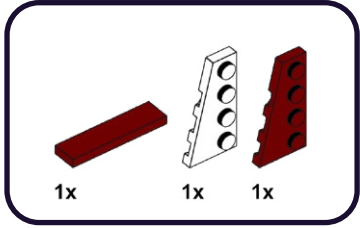

344

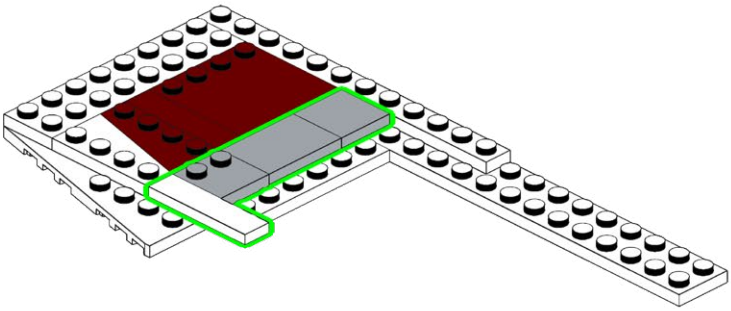
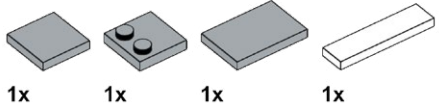

345

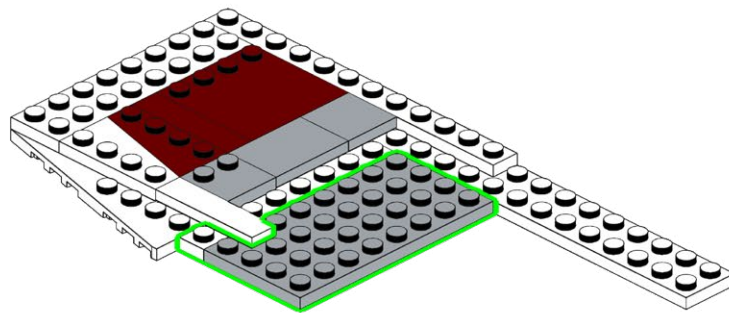
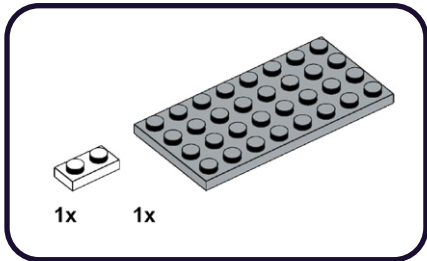

346

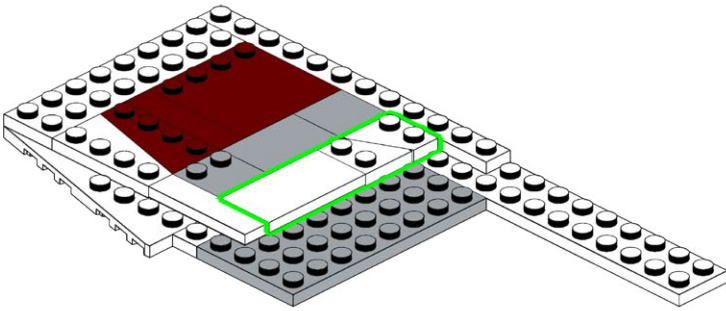
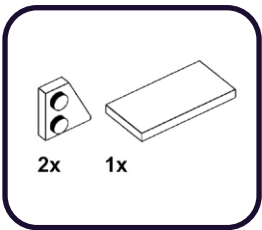

347

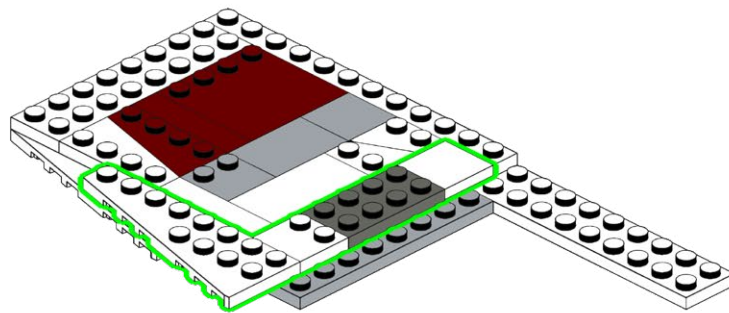
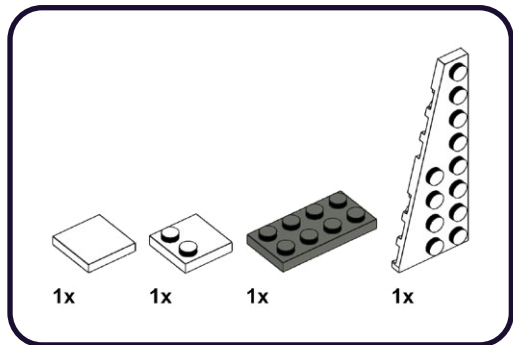

348

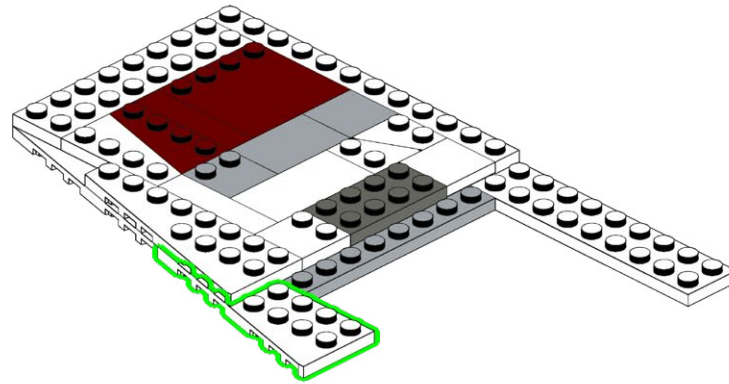
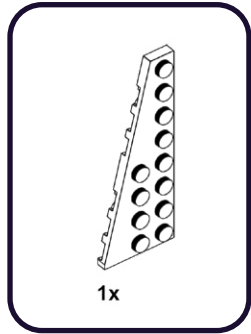

349

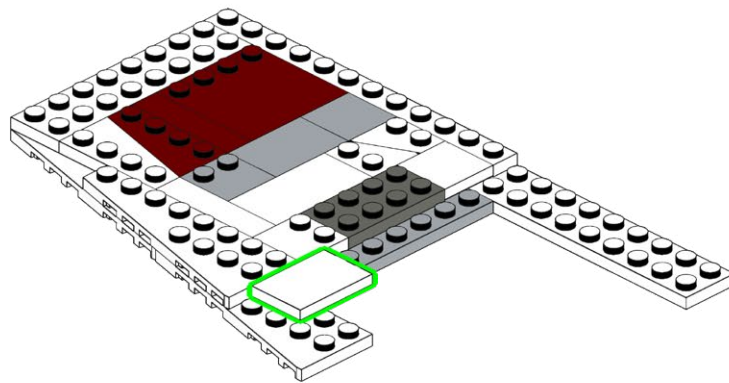
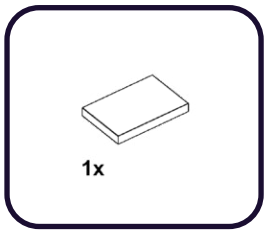

350

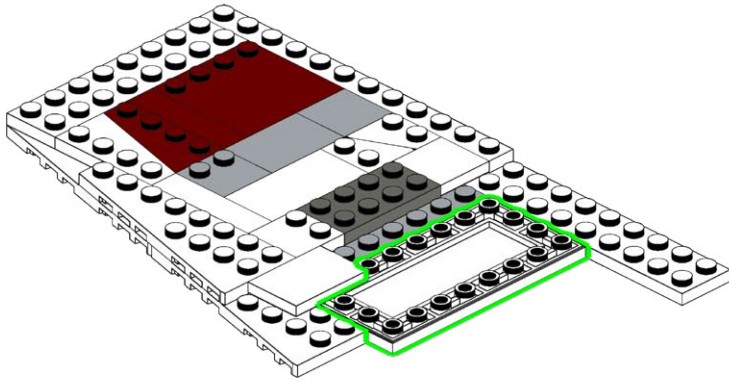
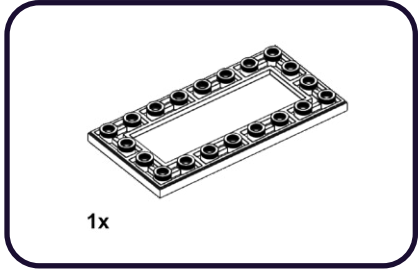

351

1x

1x

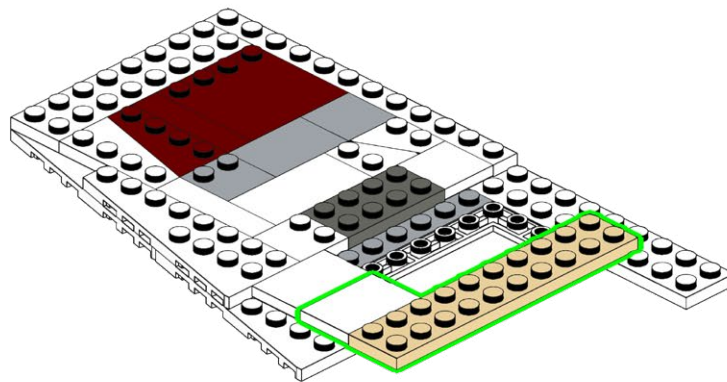

352

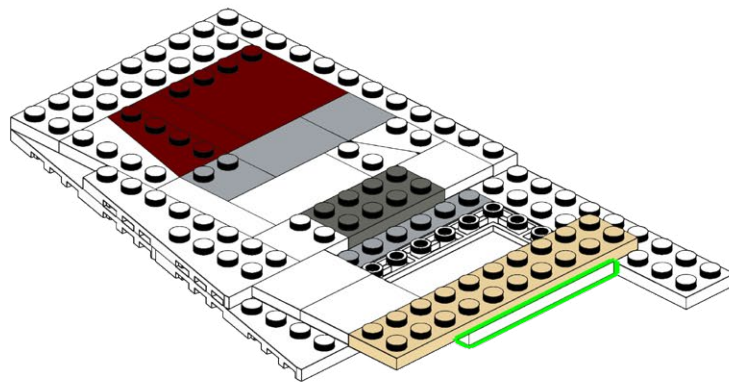
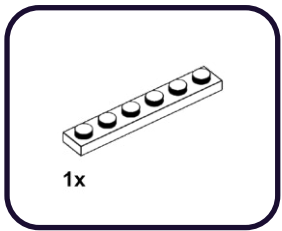

353

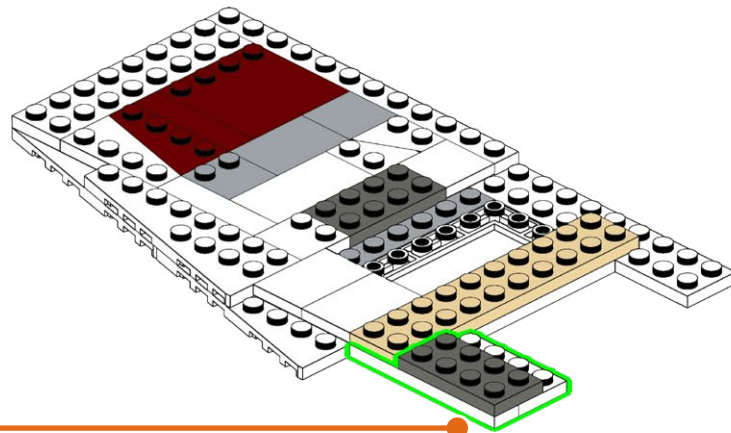
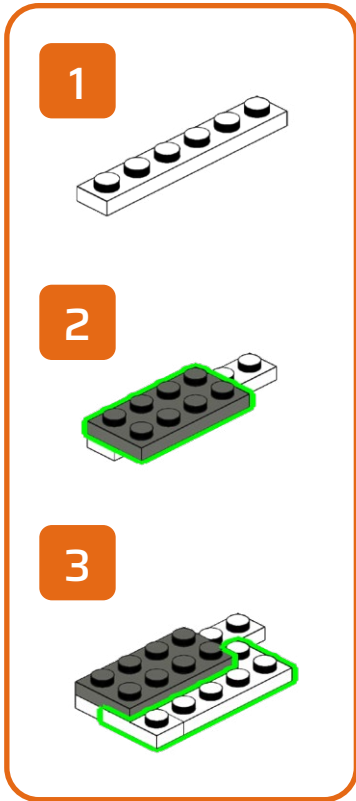
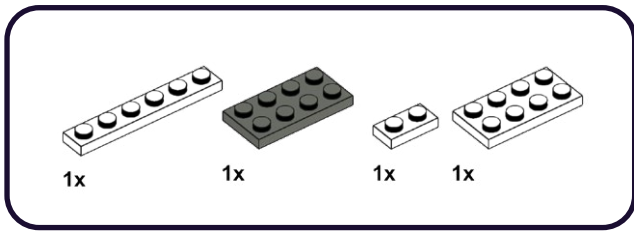

354

1x

1x

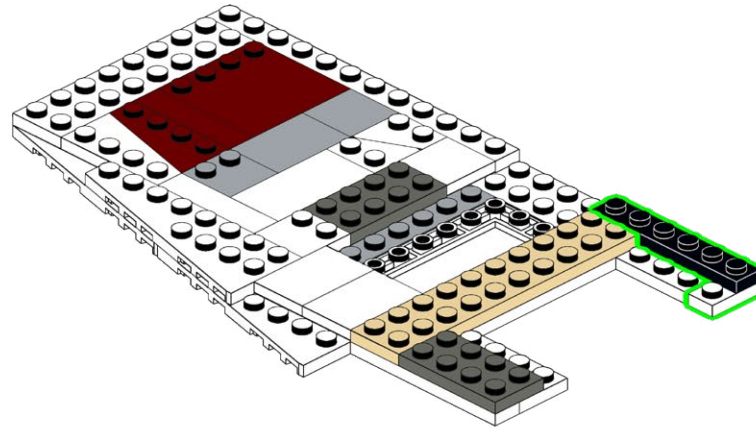

355

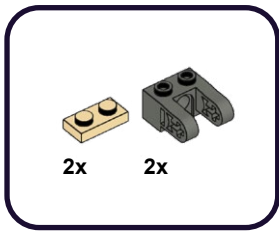

1

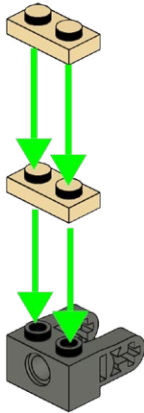

2

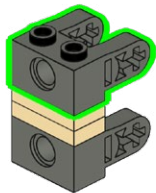

356

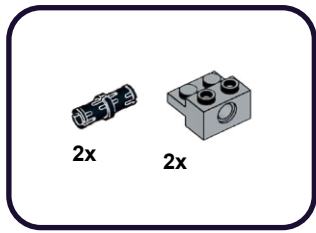

1

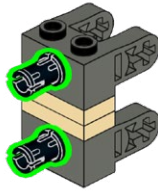

2

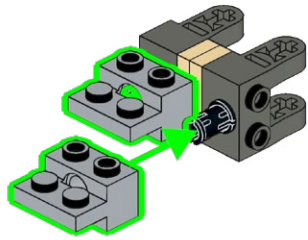

357

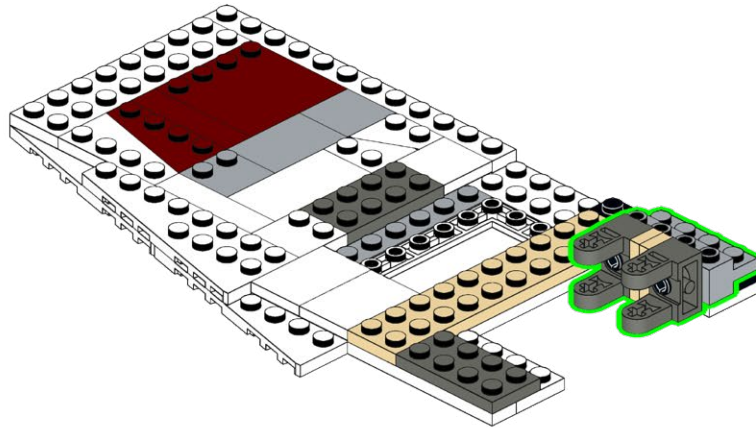

358

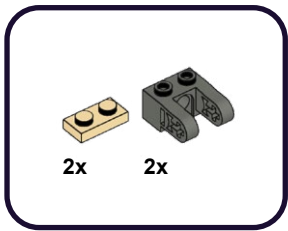

1

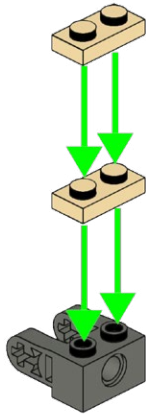

2

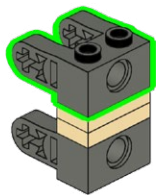

359

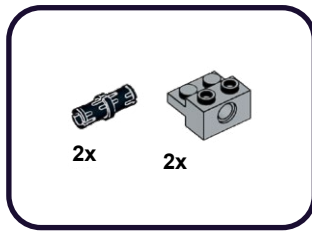

1

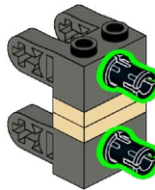

2

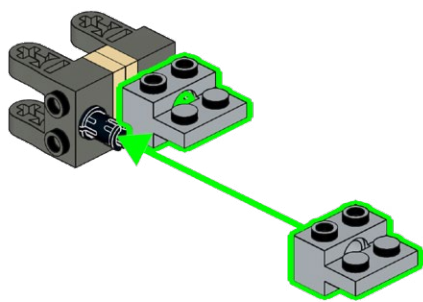

360

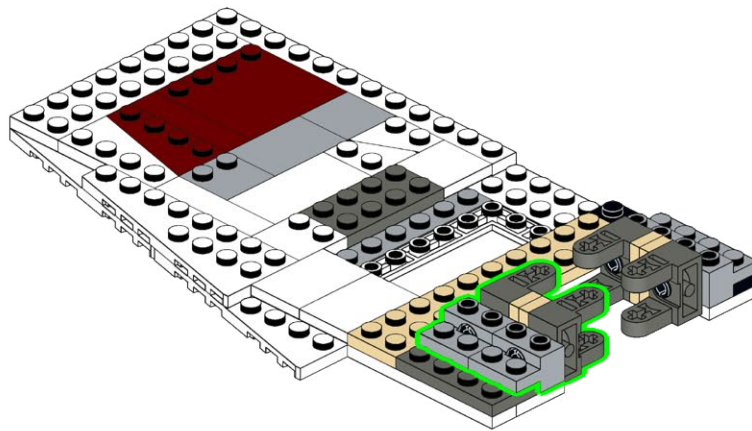

361

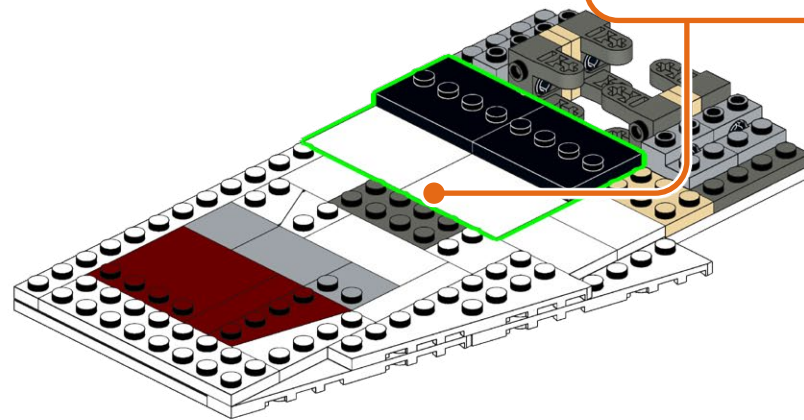
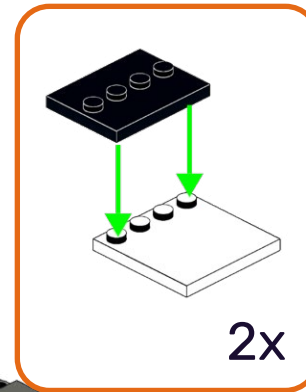
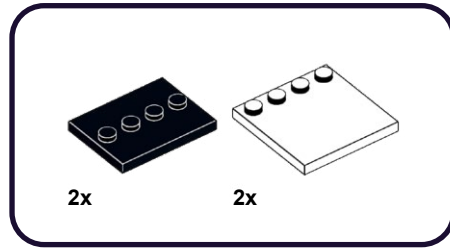

362



1x

1x

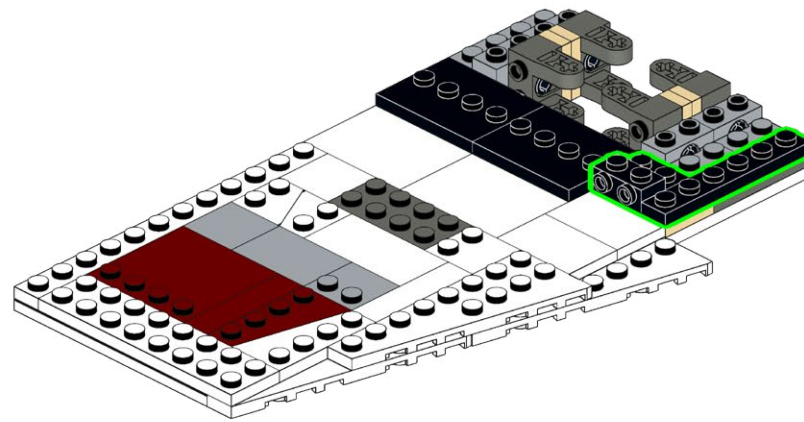

363

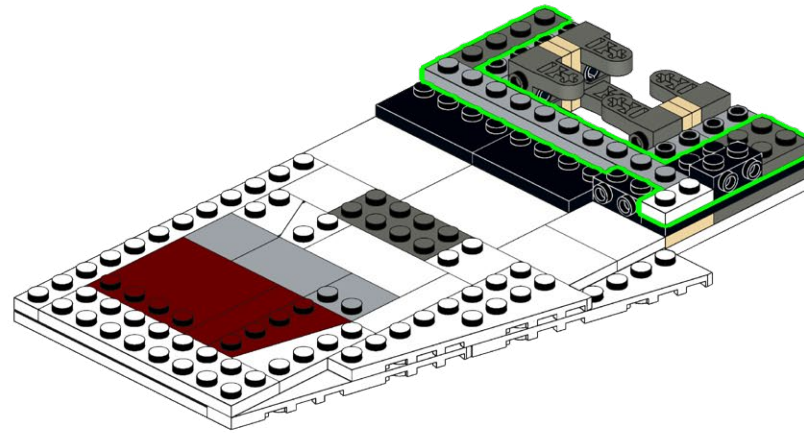
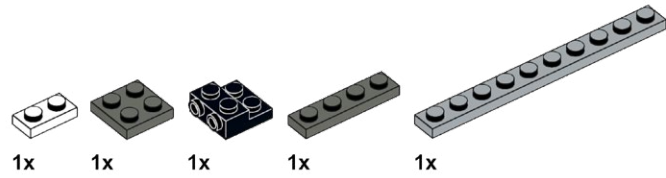

364

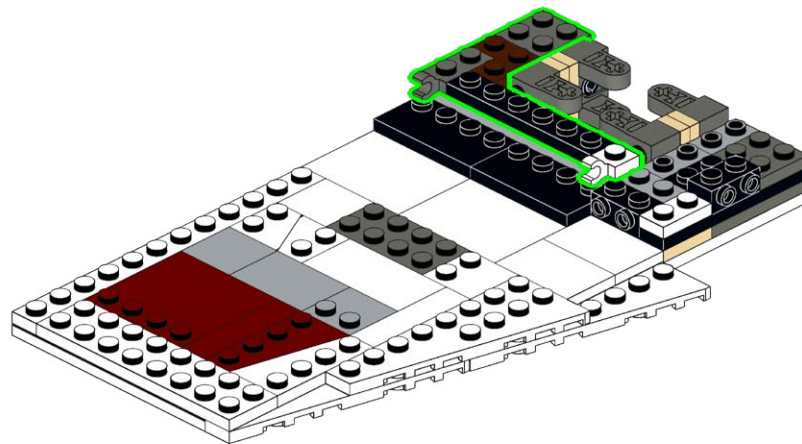
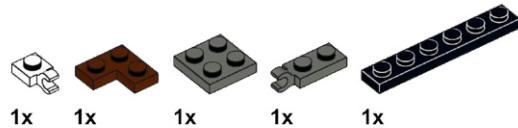

365

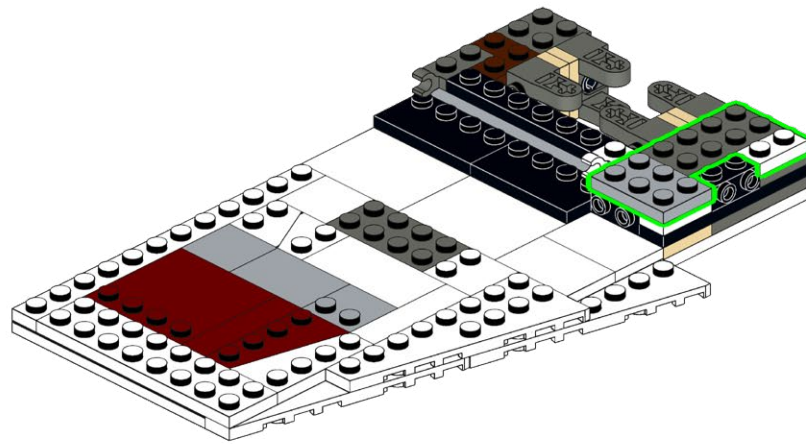
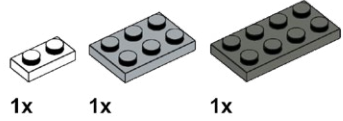

366

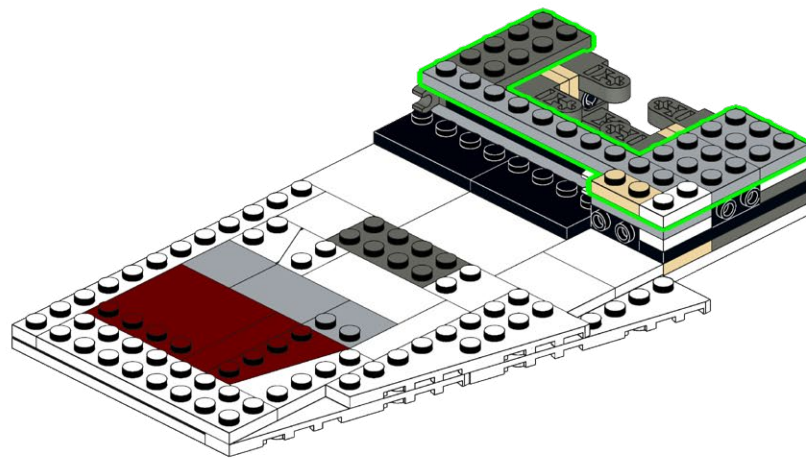
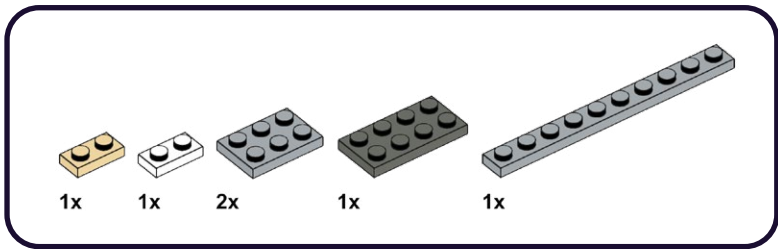

367

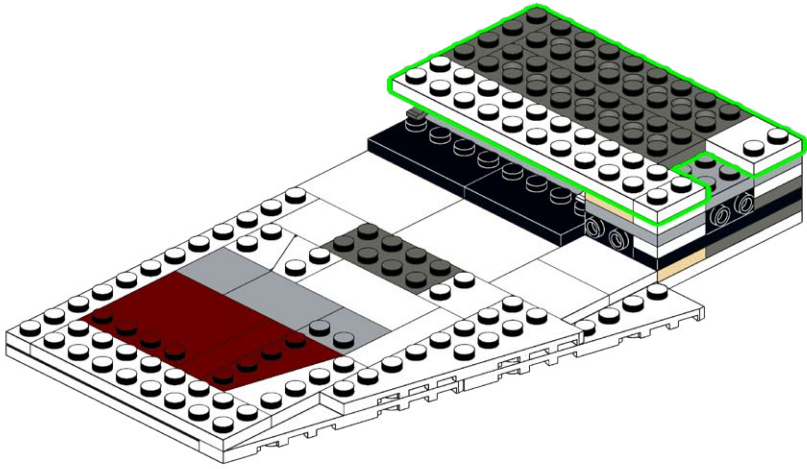
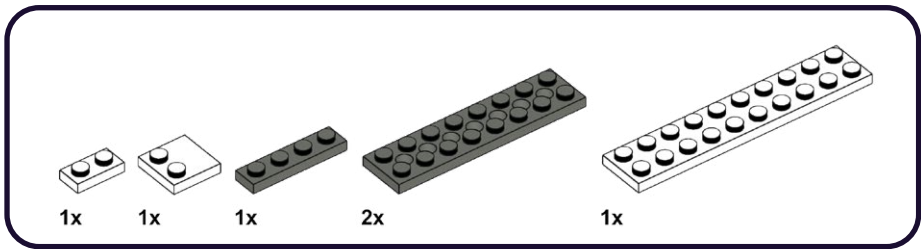

368

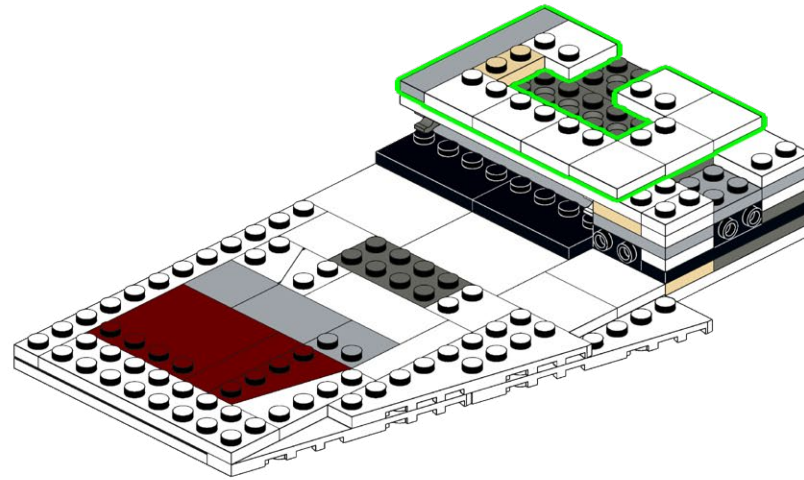
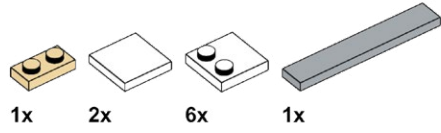

369

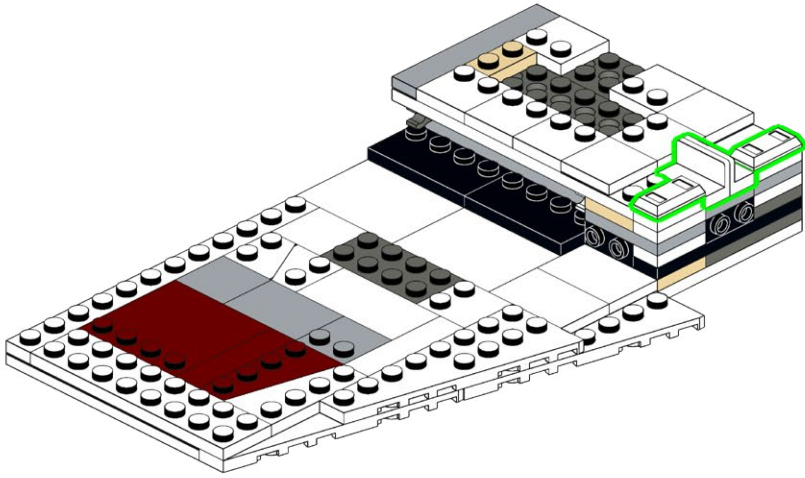
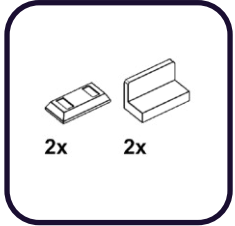

370

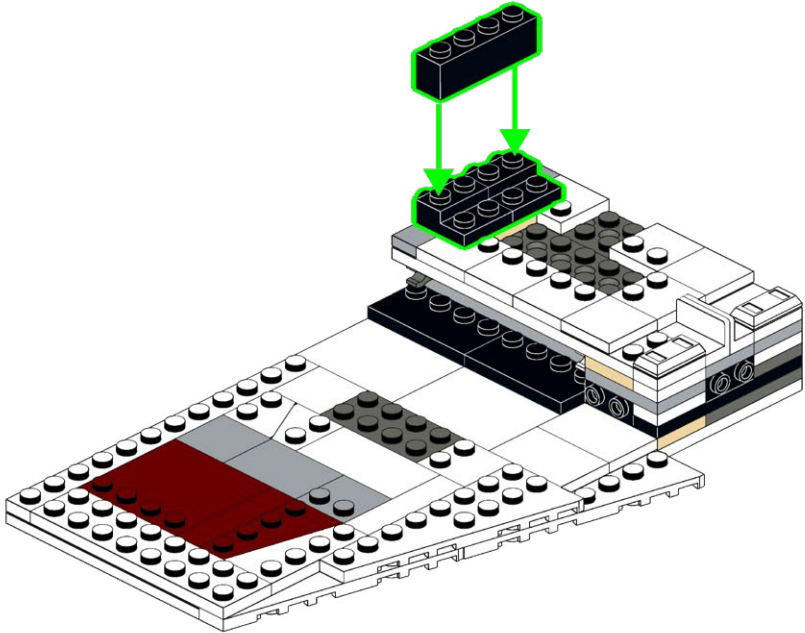
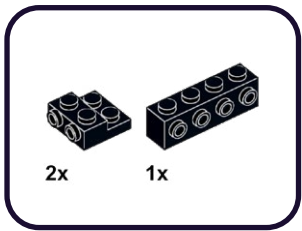

371



1x

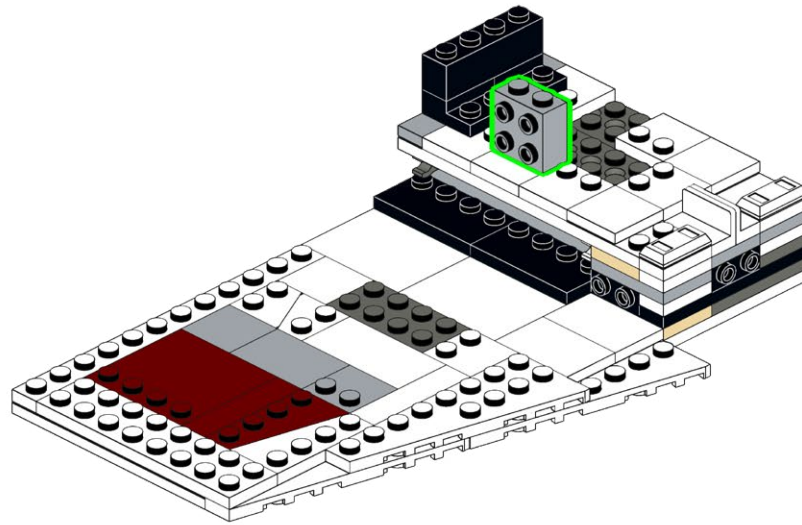

372

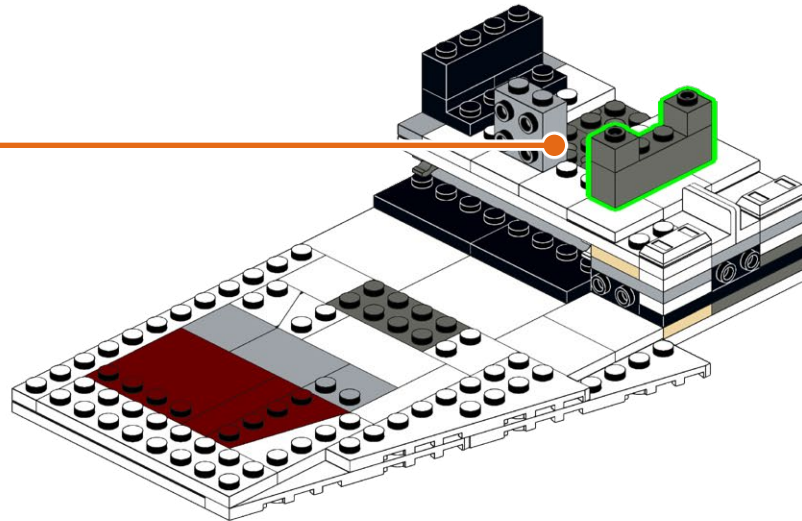
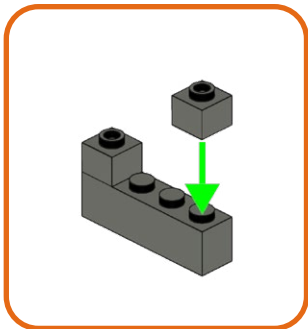
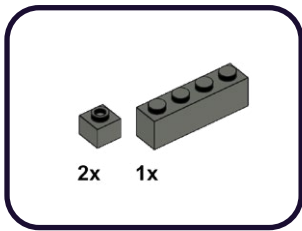

373

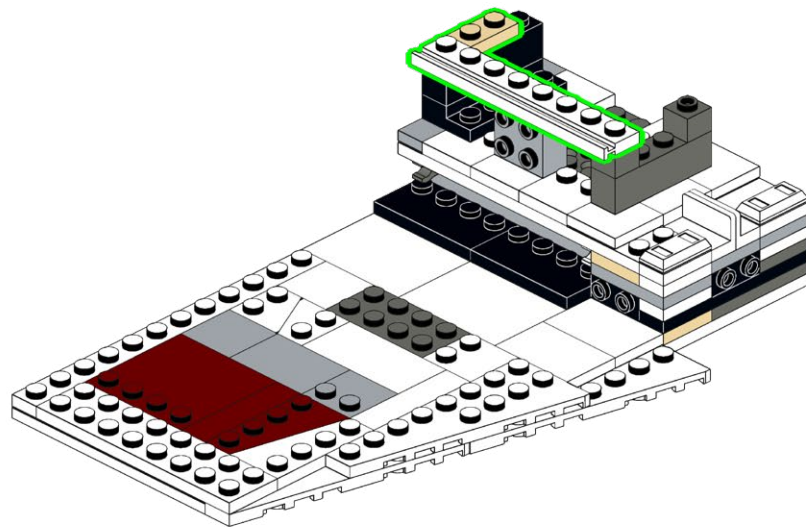
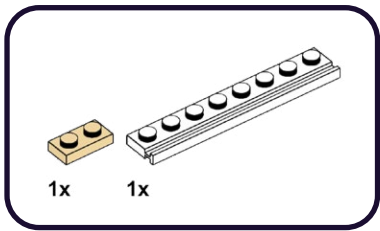

374

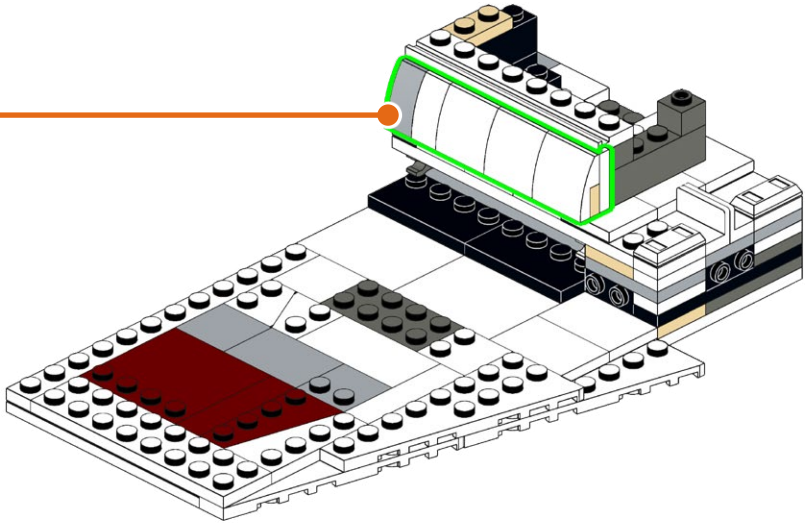
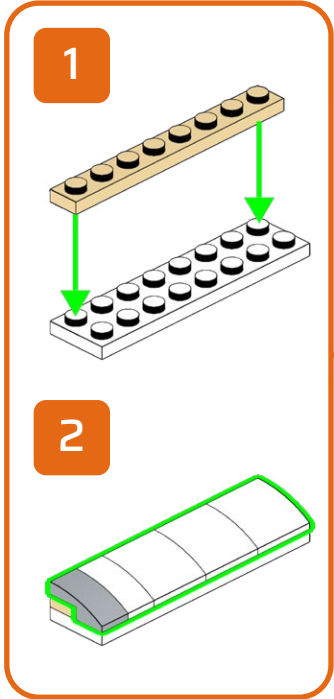
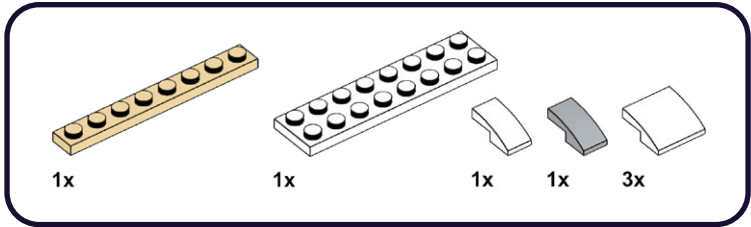

375

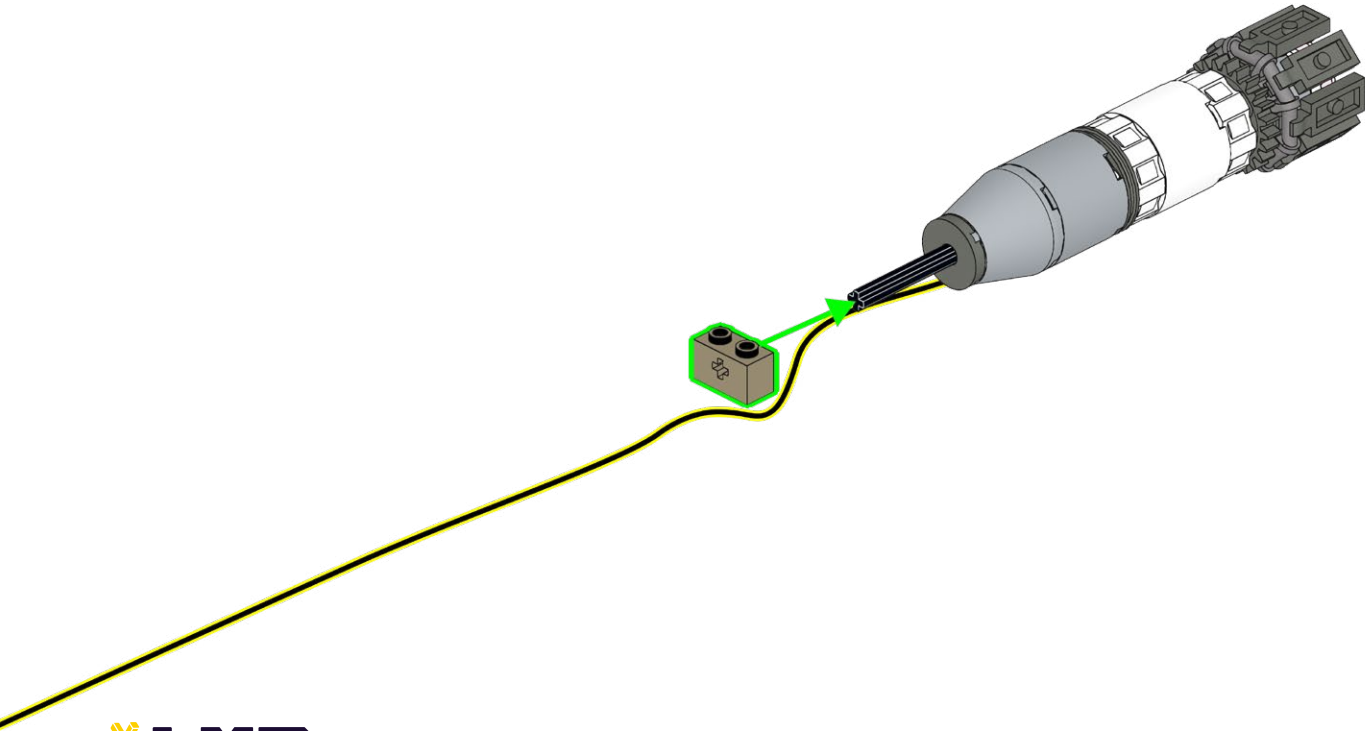
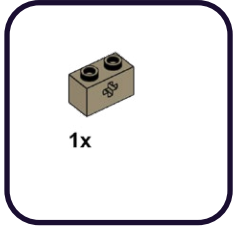

376

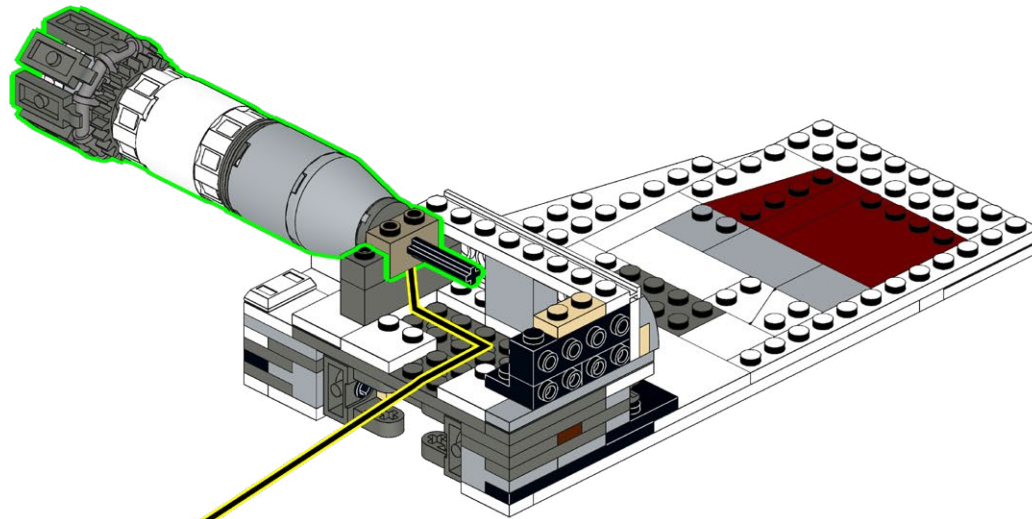

377



1x



1x

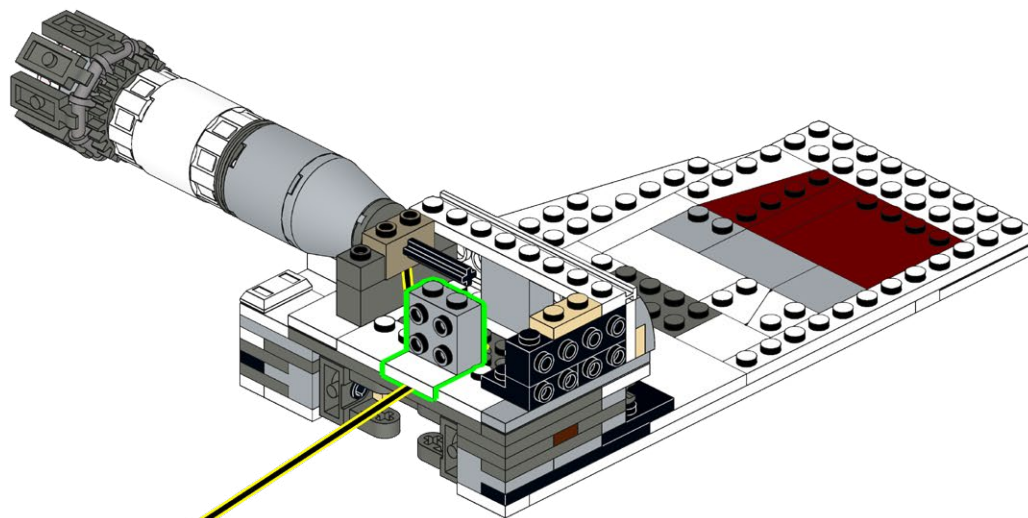

378

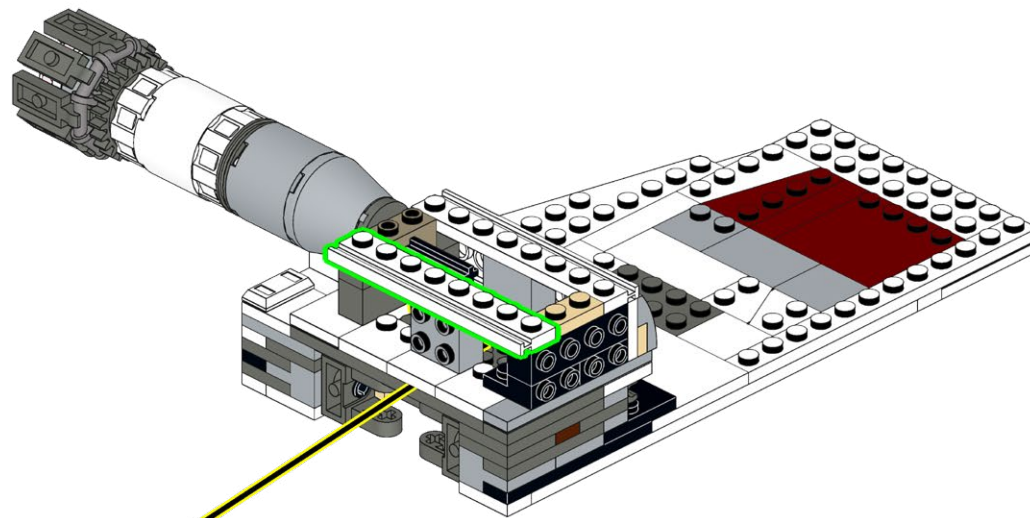
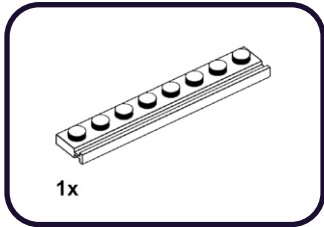

379

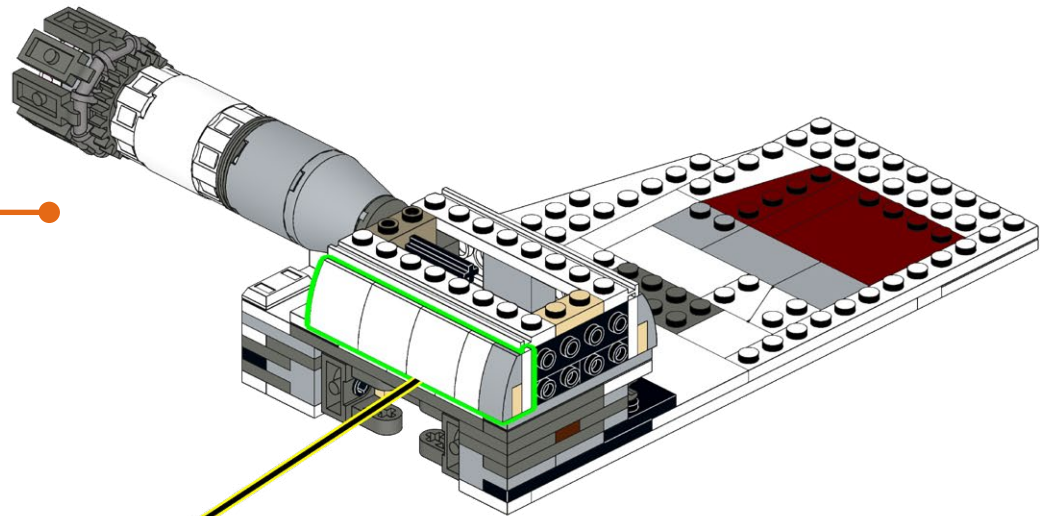
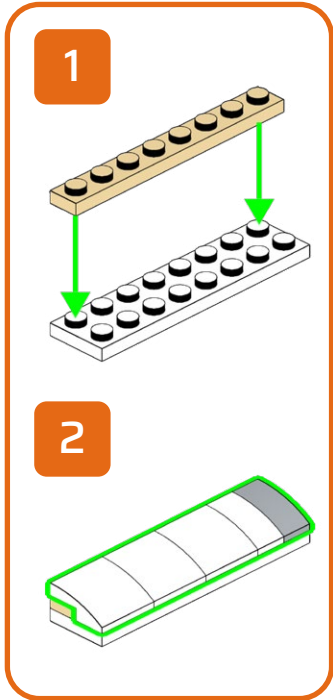
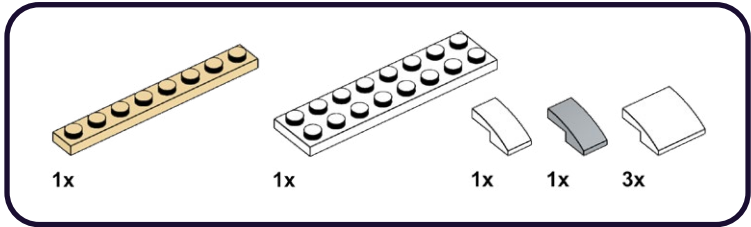

380

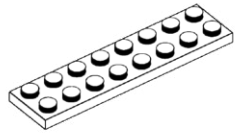

1x

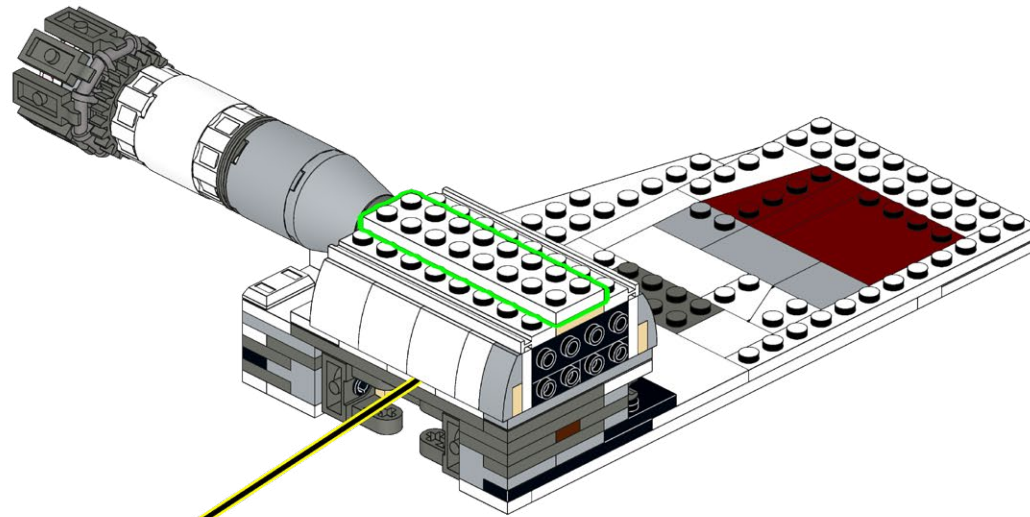

381

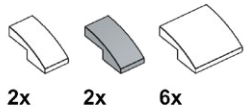

2x

2x

6x

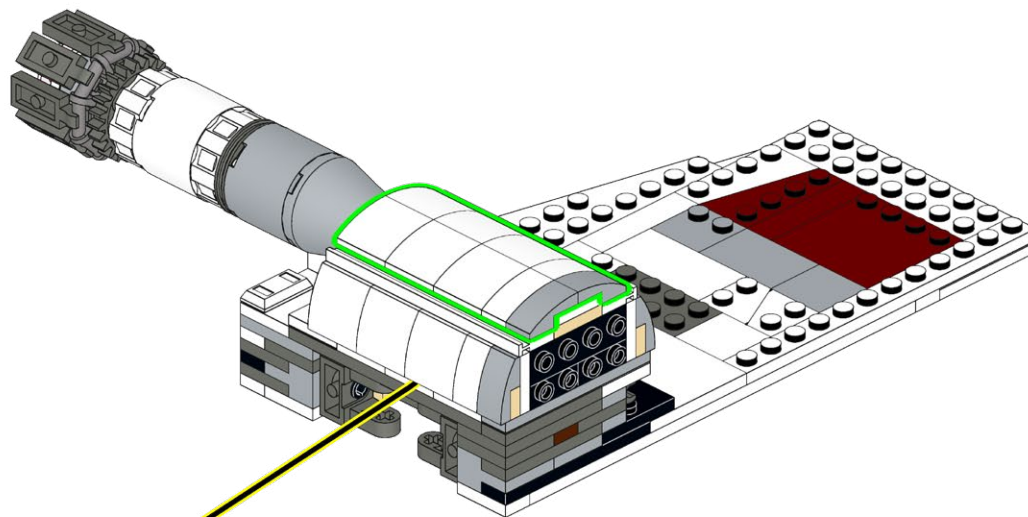

382

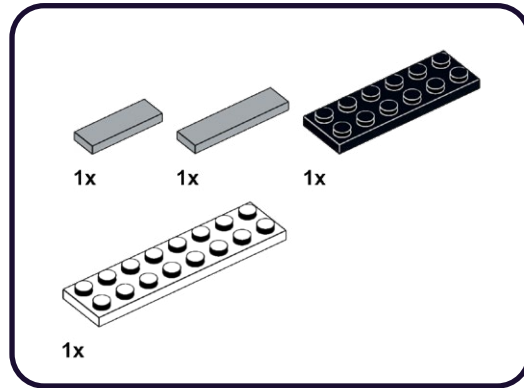

1

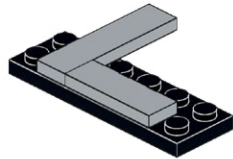

2

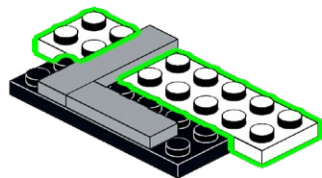

383

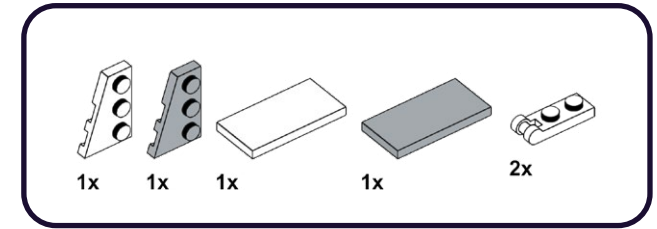

1

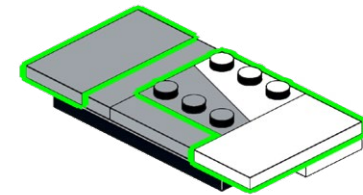

2

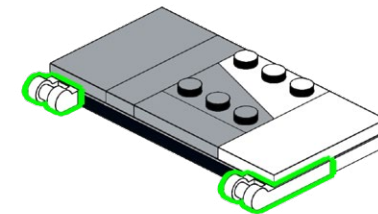

384

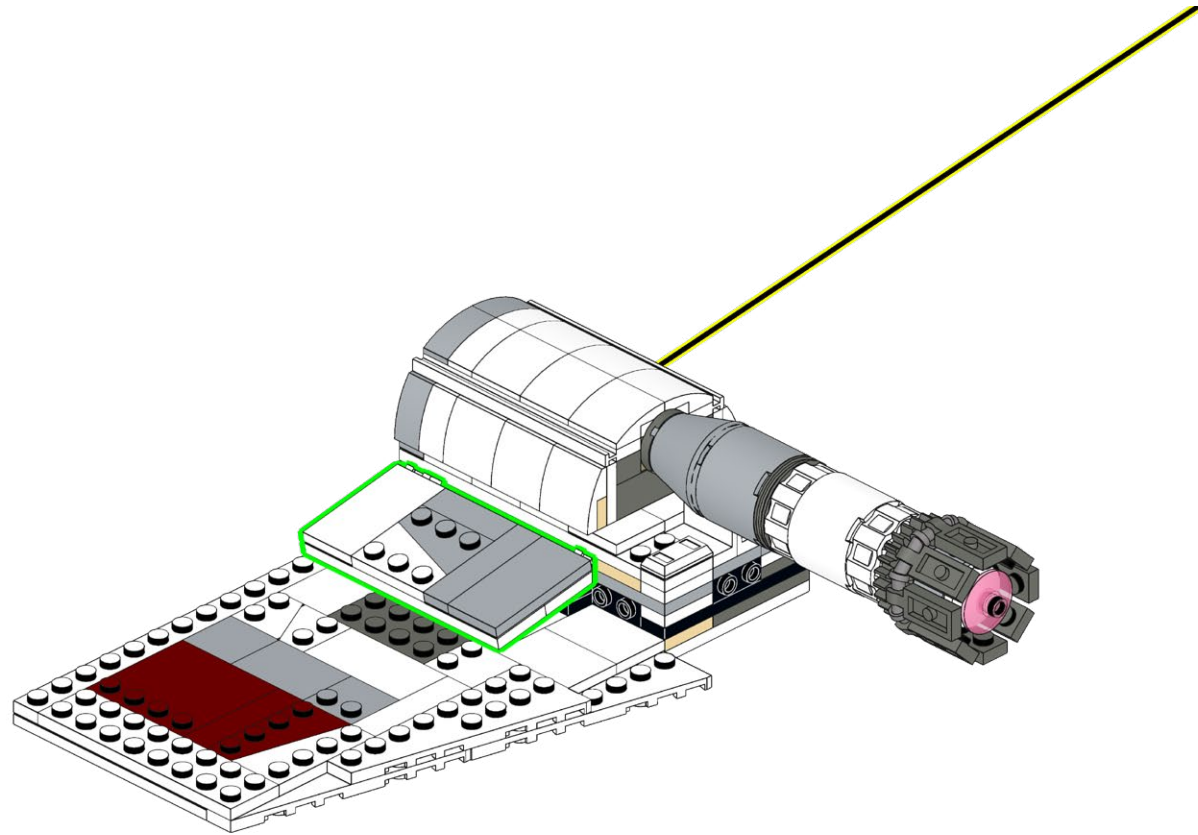

385

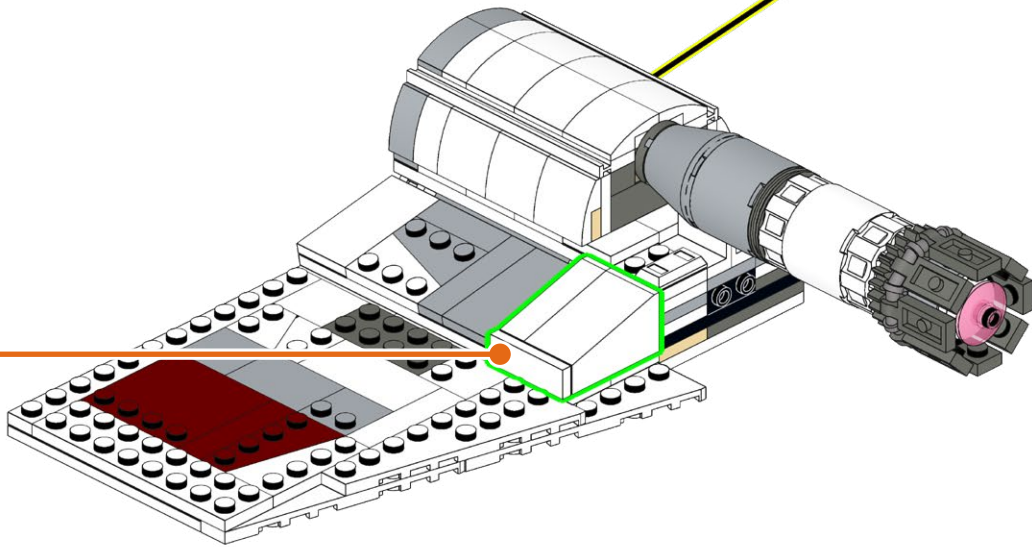
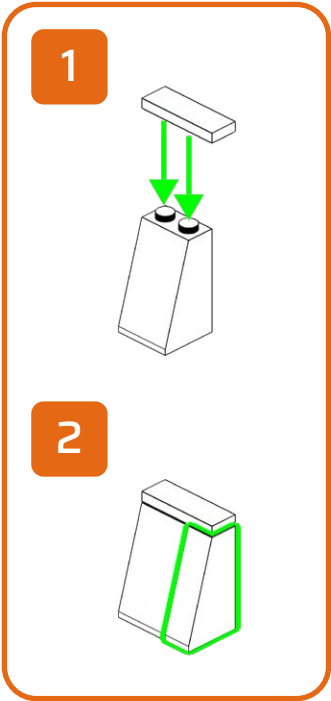
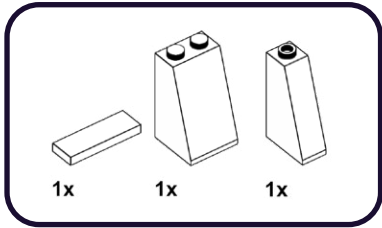

386

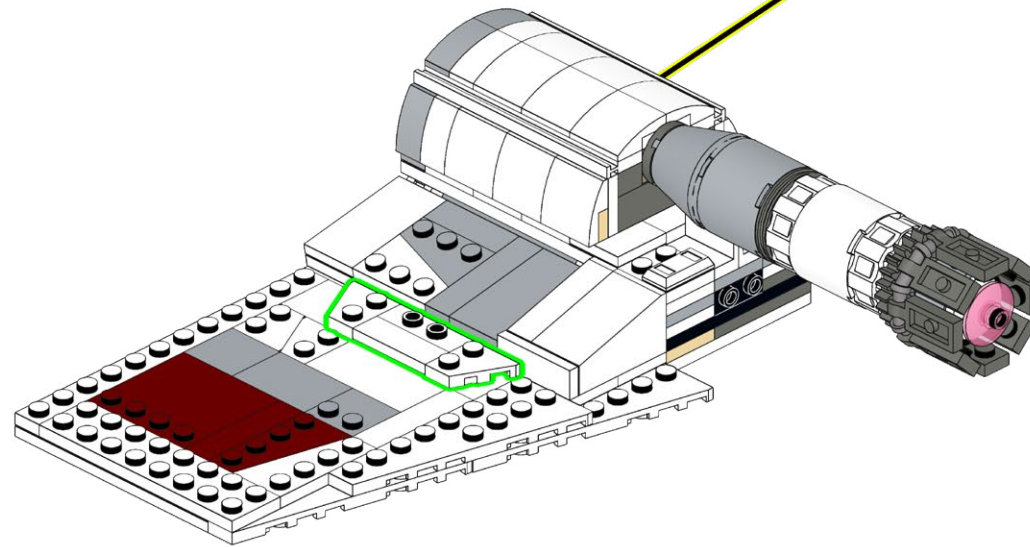
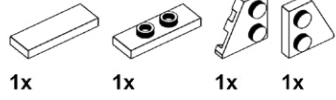

387

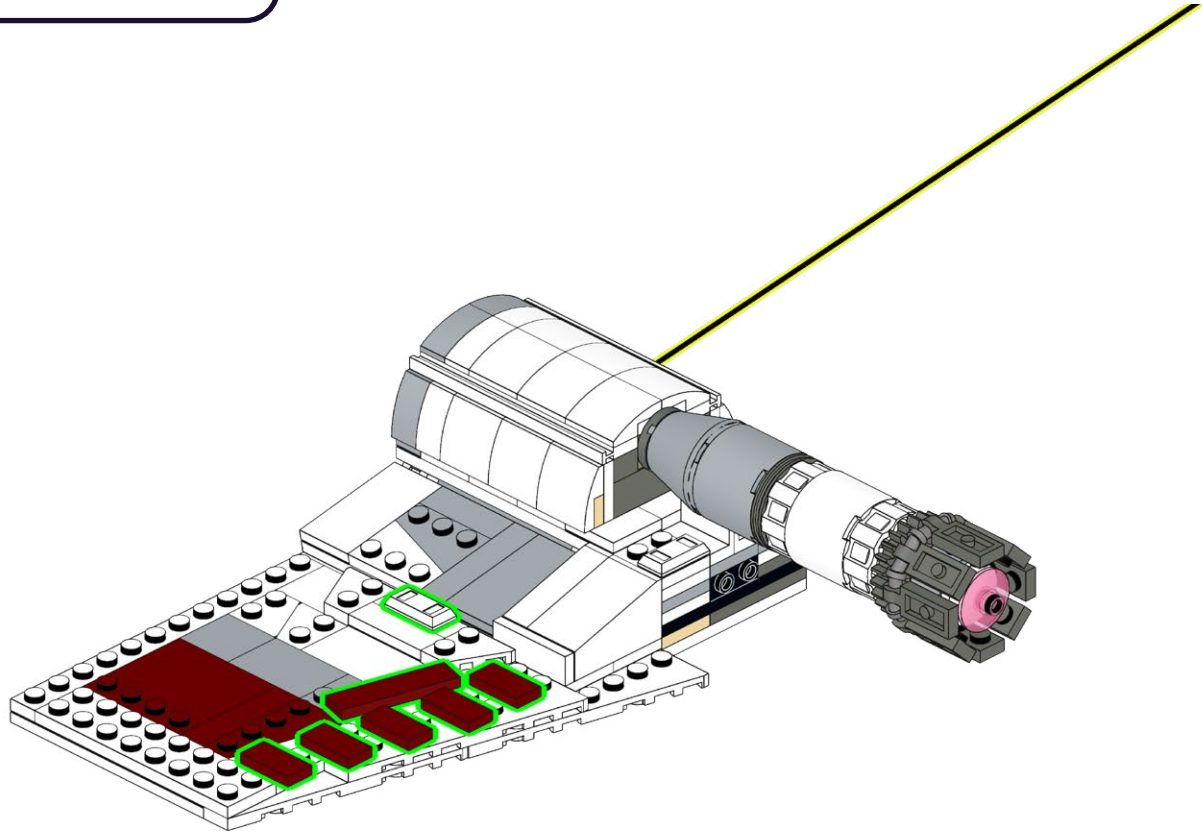
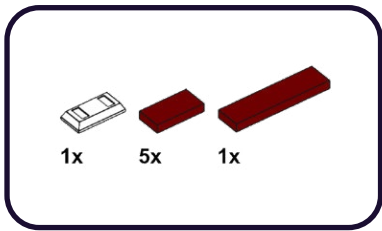

388

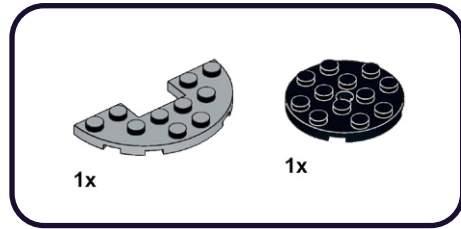

1

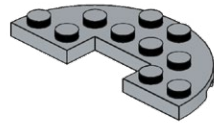

2

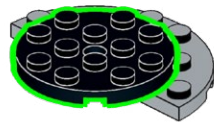

389

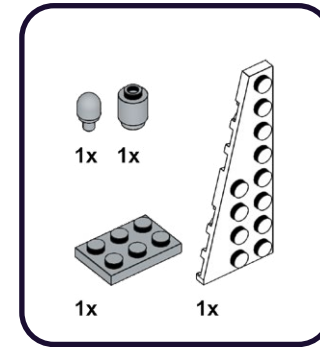

1

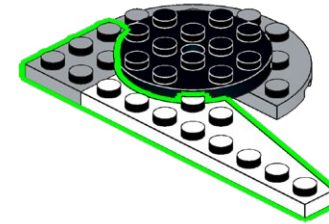

2

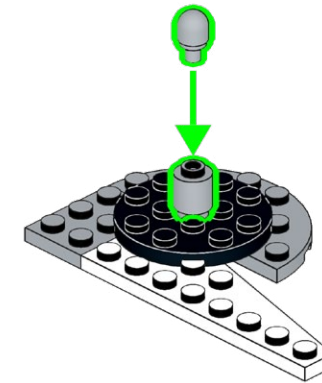

390

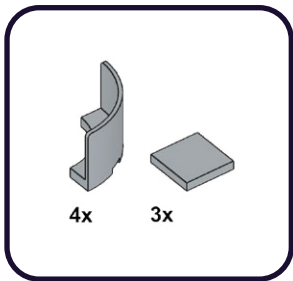

1

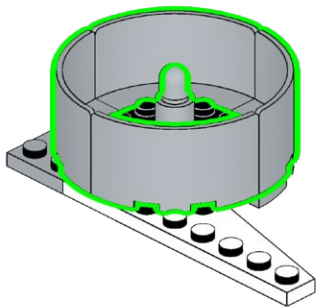

2

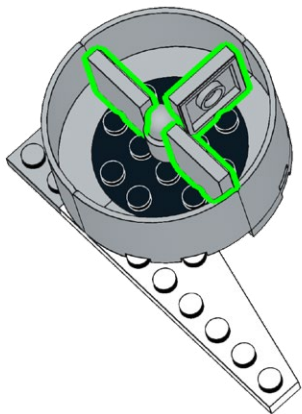

391

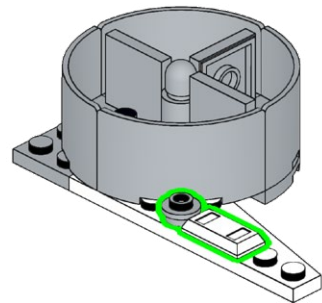
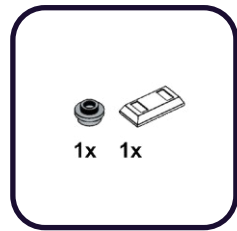

392

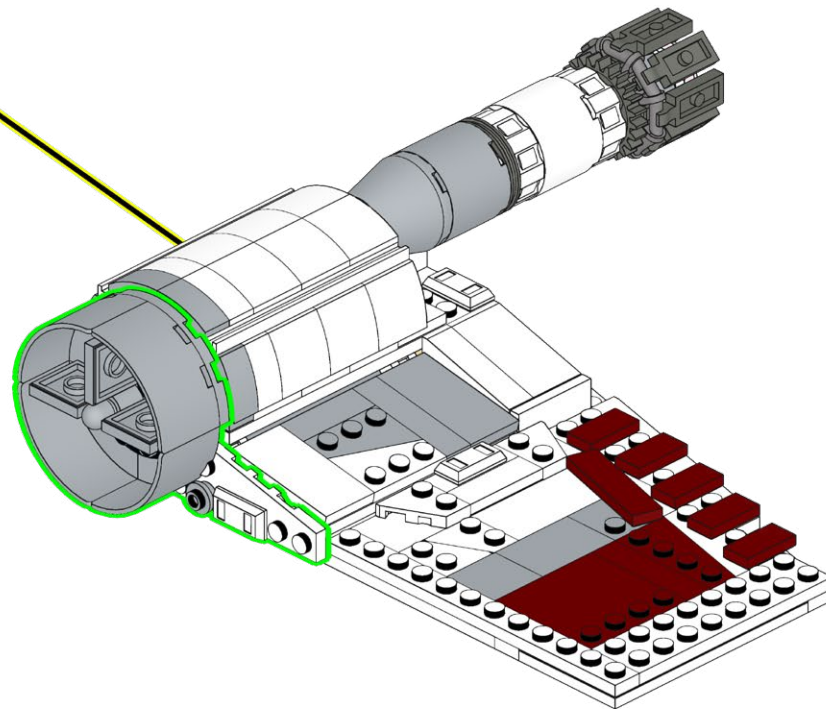

393

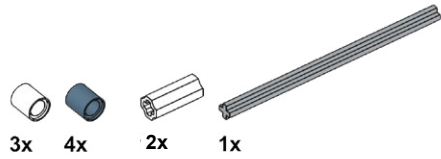

1

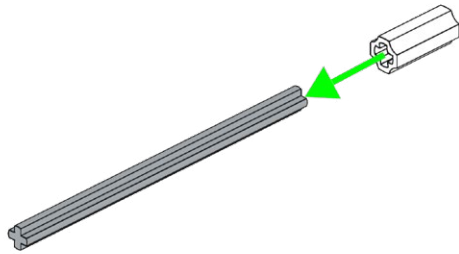

2

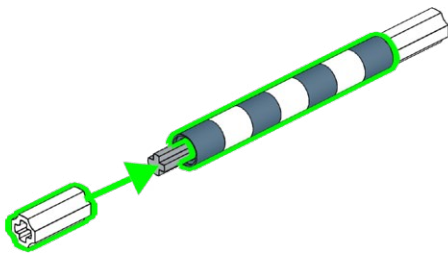

394

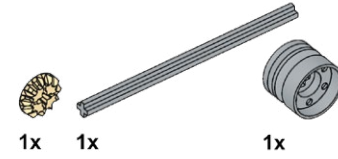

1

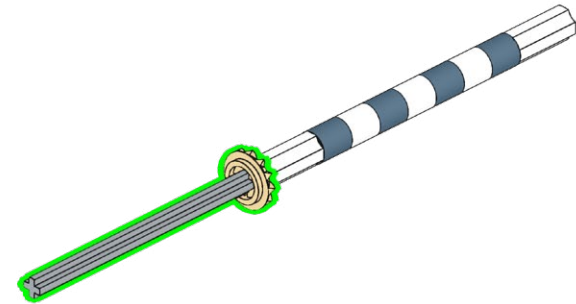

2

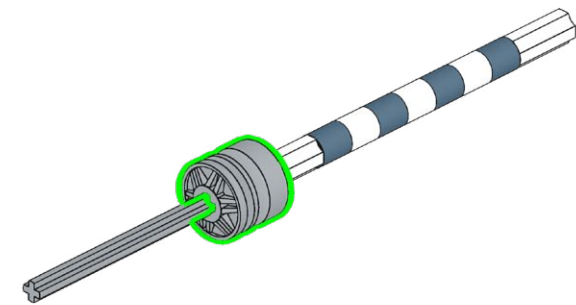

395

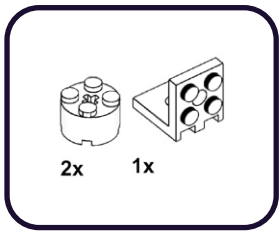

1

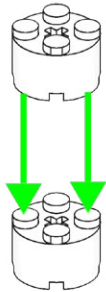

2

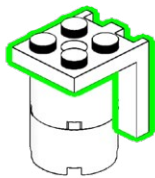

396

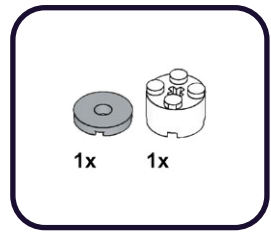

1

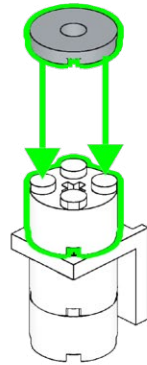

2

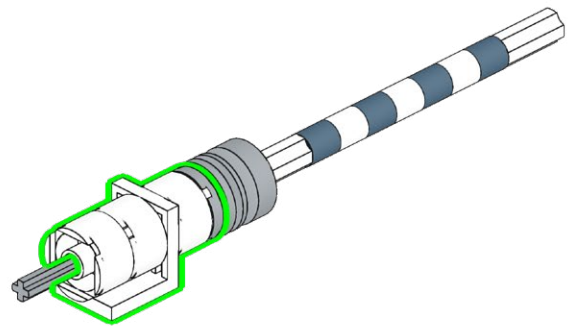

397

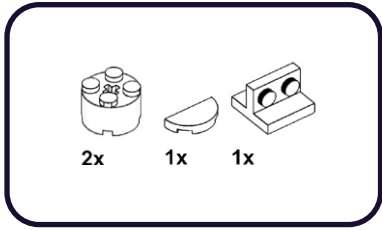

1

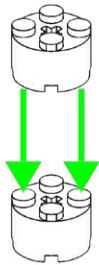

2

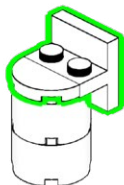

398

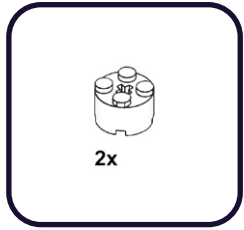

1

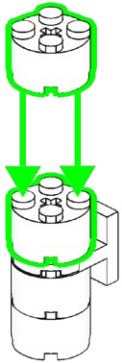

2

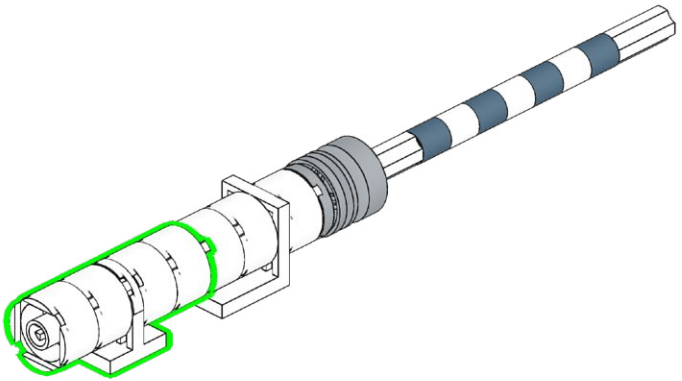

399

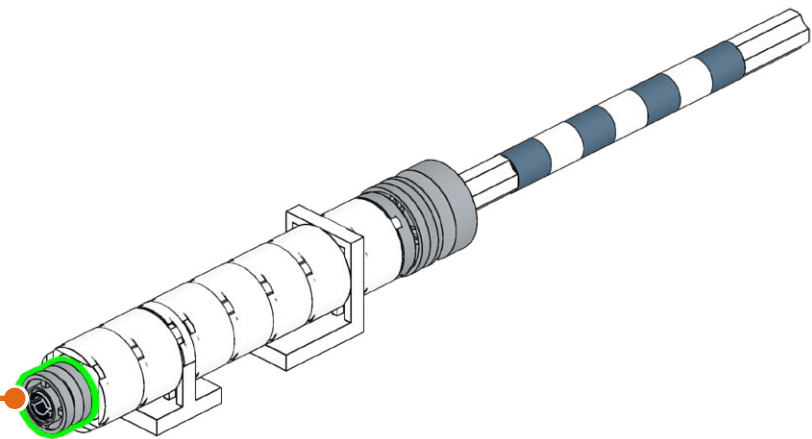
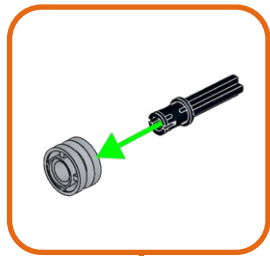
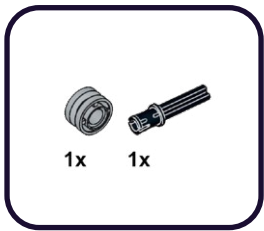

400

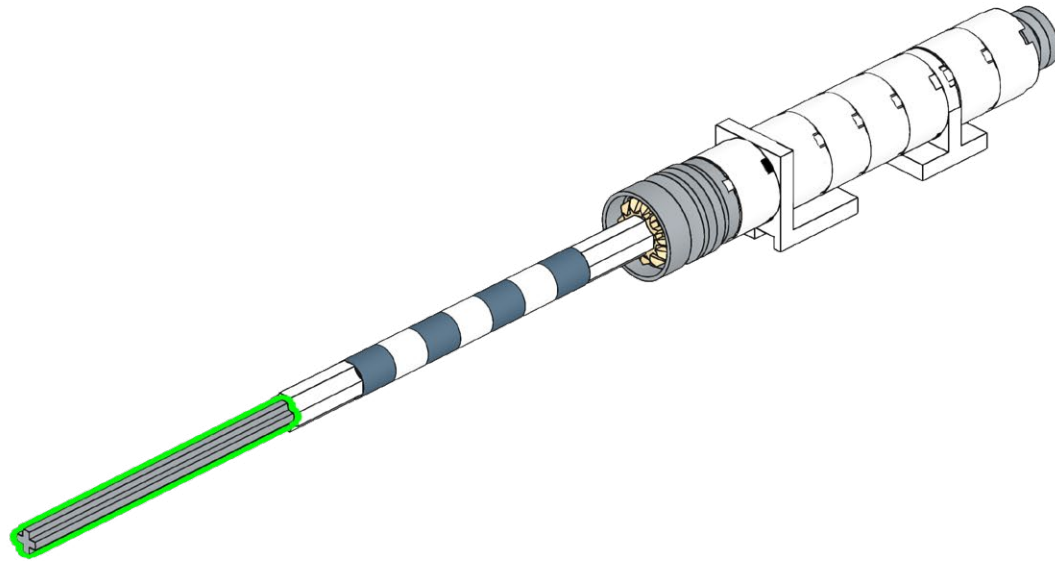
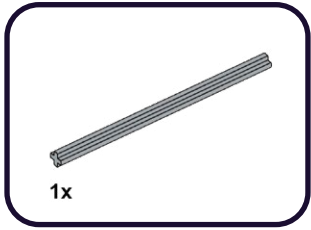
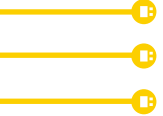

401

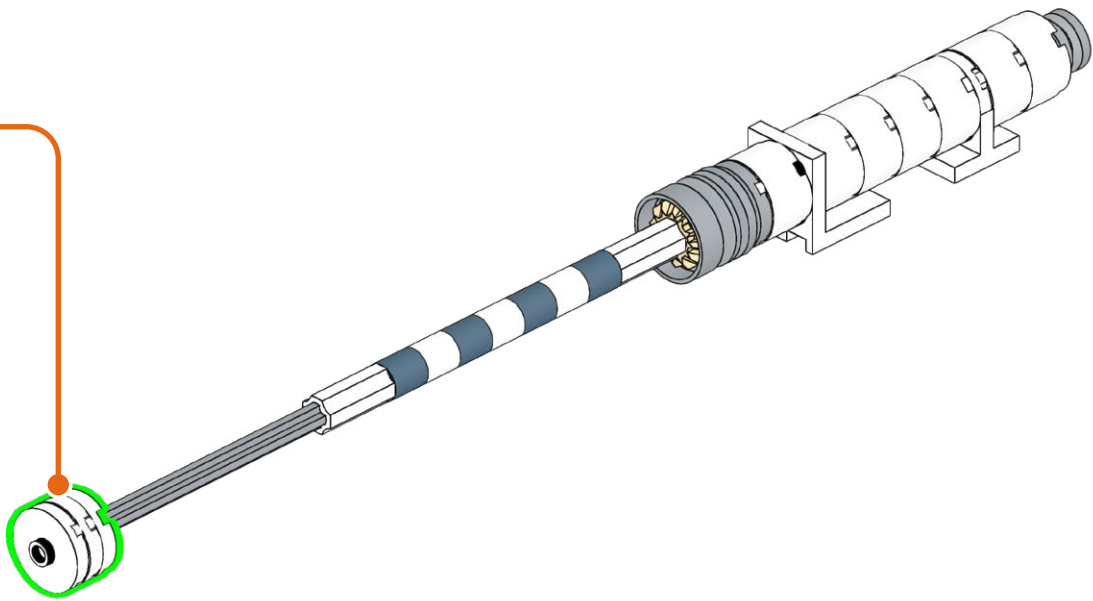
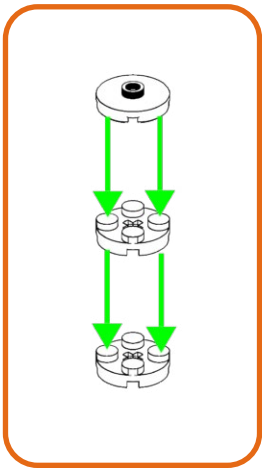
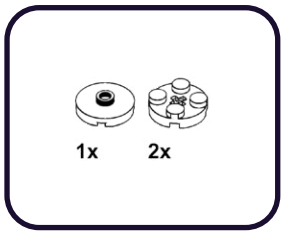

402

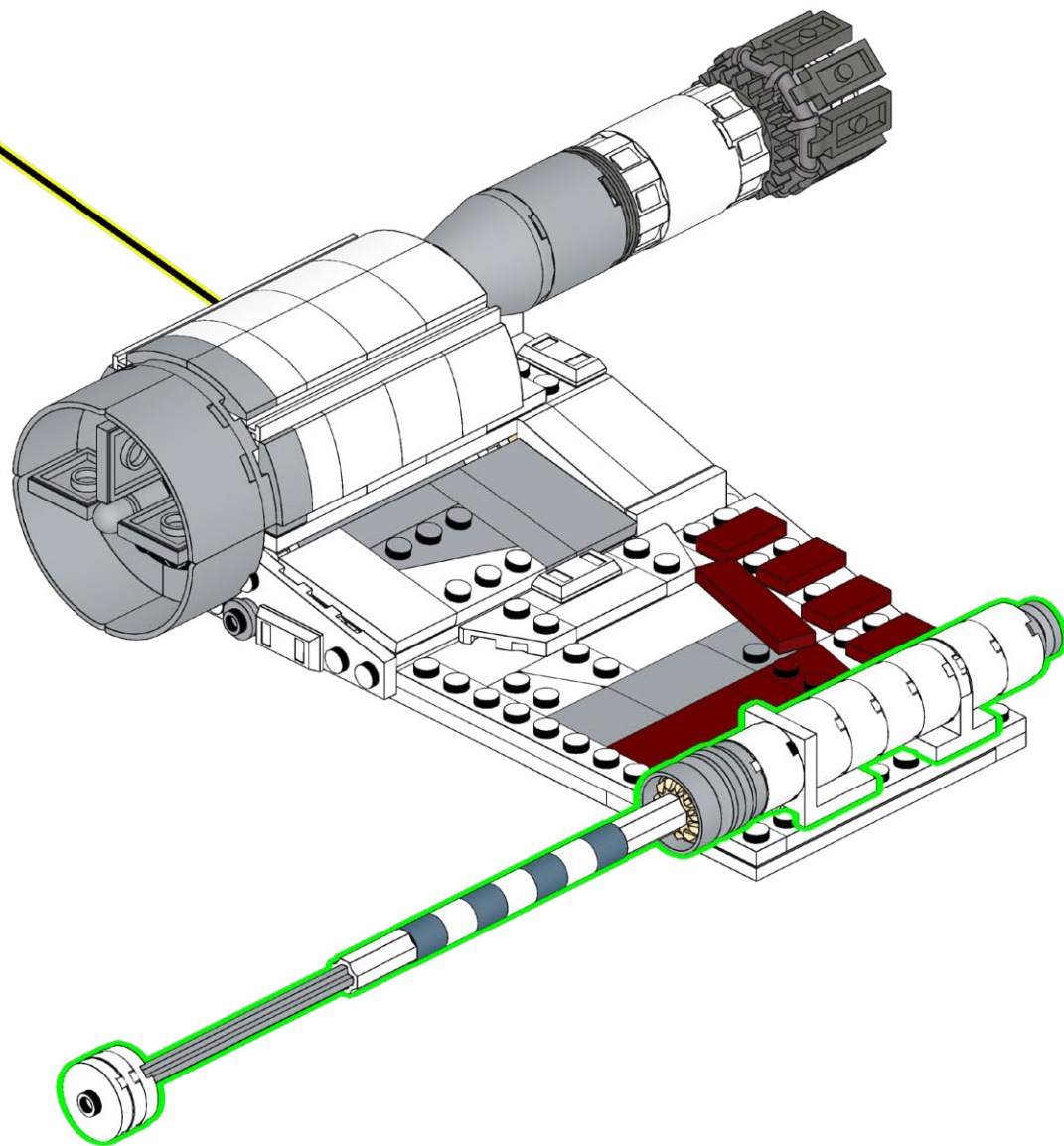

403

4x

4



4x

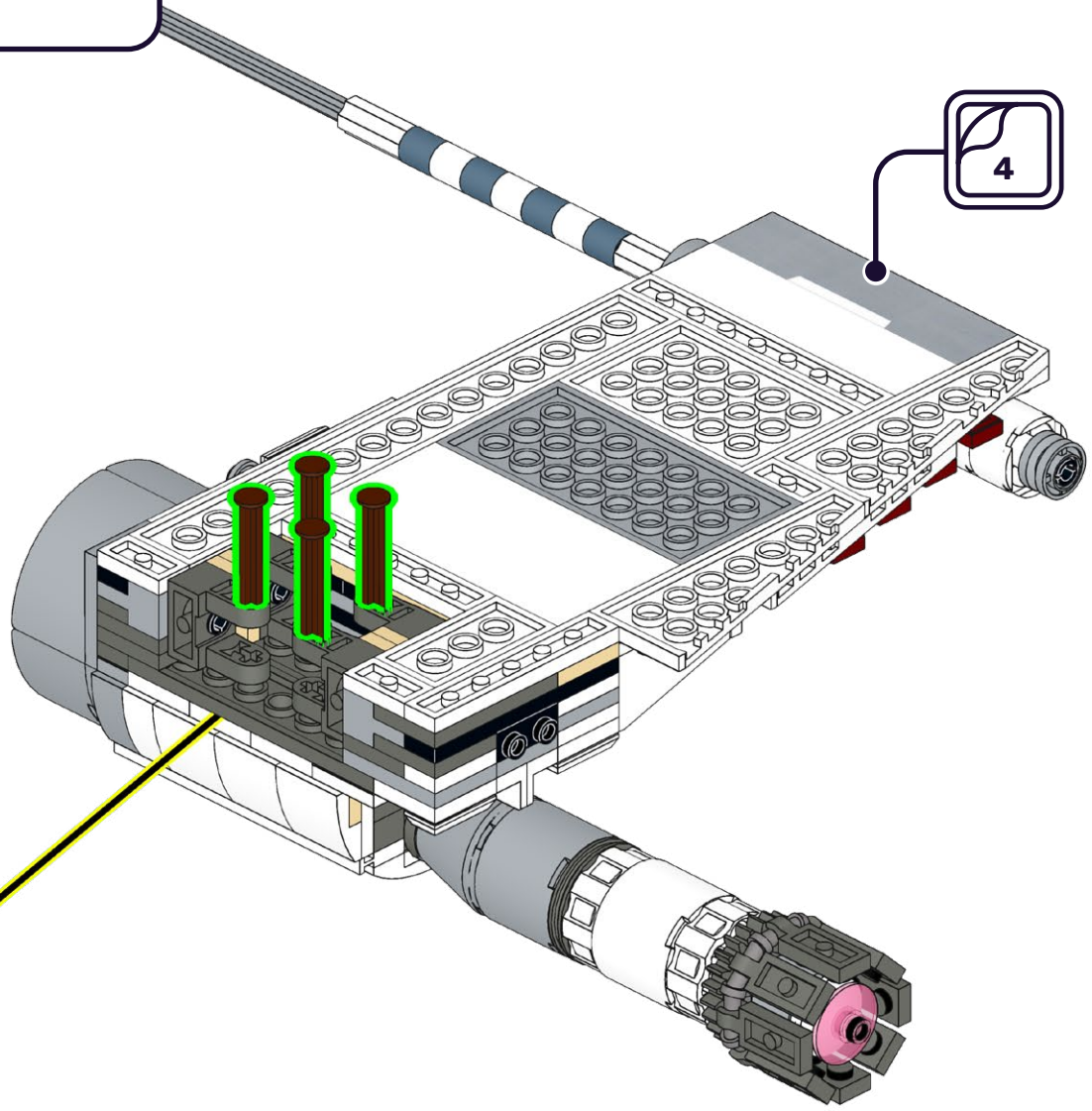
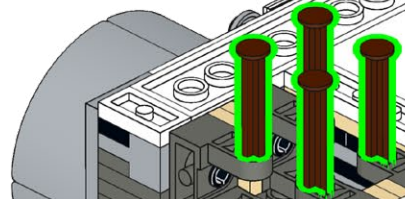

**HOLD UP!**

You might notice some bags aren't in order, as well as left over pieces, but that's ok! We're changing the way you build LEGO!

ATTENDEZ!

Vous remarquerez peut-être que certains sacs, ainsi que certaines pièces, ne sont pas dans le bon ordre. Mais pas de panique! Nous changeons simplement la façon avec laquelle vous construisez vos LEGO!

ASPETTA!

Potresti notare che alcuni sacchetti non sono in ordine, così come i pezzi avanzati, ma va bene così! Stiamo cambiando il modo in cui costruisci i LEGO!

HALT!

Sie werden möglicherweise bemerken, dass einige tüten durcheinander sind und teile übrig bleiben, aber das ist in Ordnung! Wir ändern die art und weise, wie Sie LEGO bauen!

¡ESPERA!

Es posible que notes que algunas bolsas están fuera de servicio, así como piezas sobrantes, ¡pero está bien! ¡Estamos cambiando la forma en que construyes LEGO!

暫停!

你可能会注意到一些袋子顺序错乱, 以及一些剩余的部件, 但没关系! 我们正在改变你搭建乐高的方式!

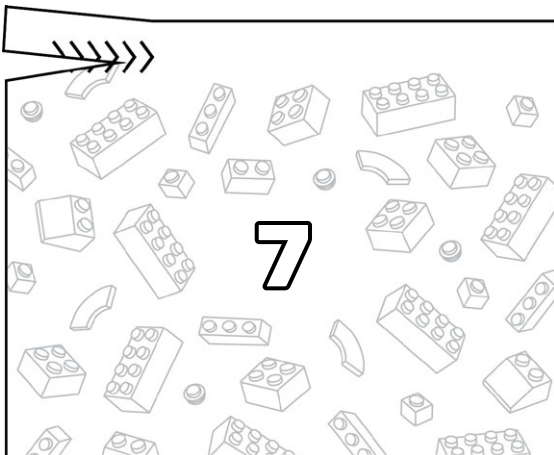
Open LEGO® Bag 7

404

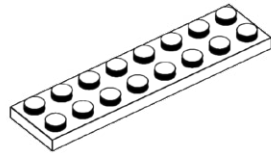

1x

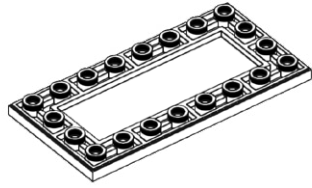

1x

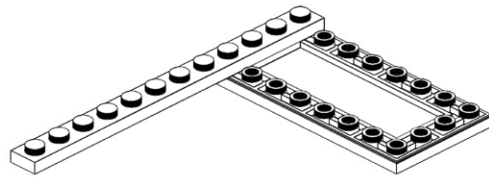

405

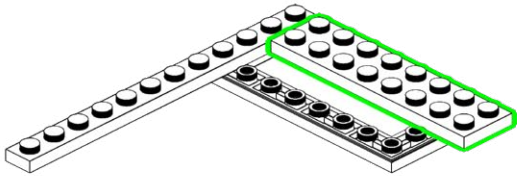
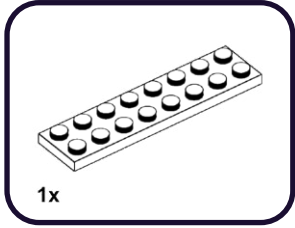

406

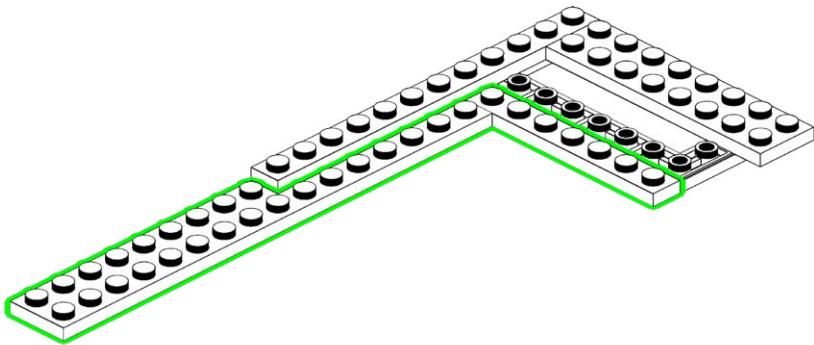
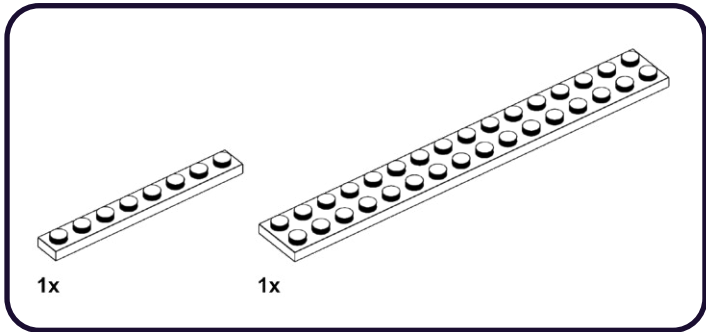

407

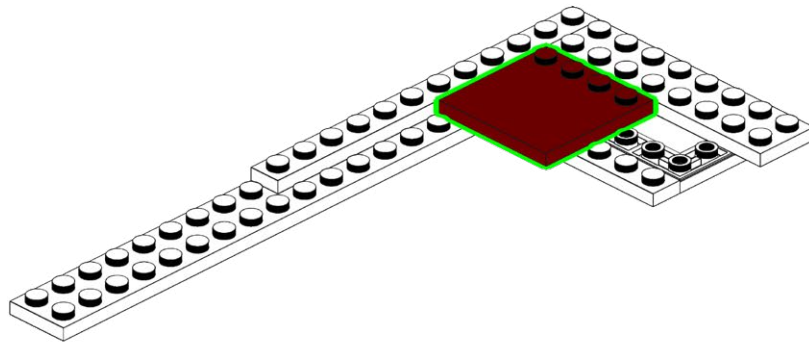
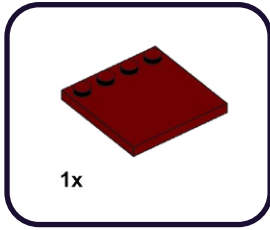

408

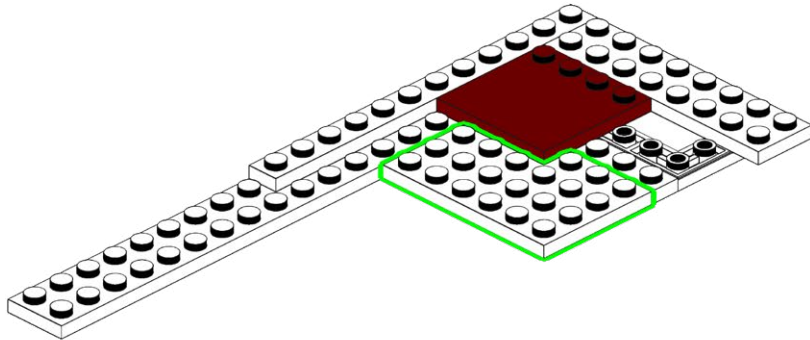
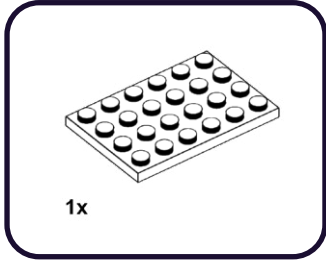

409

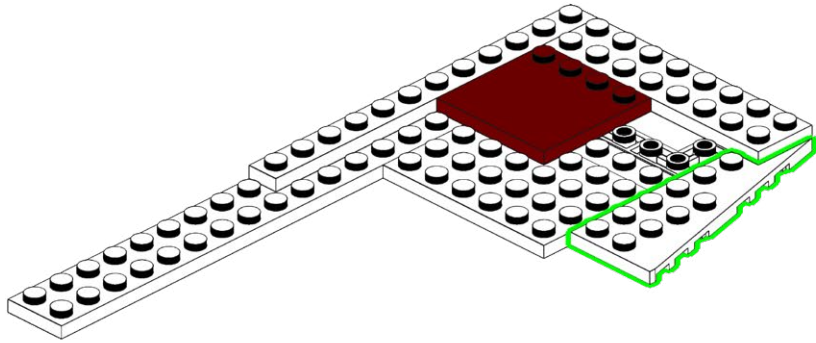
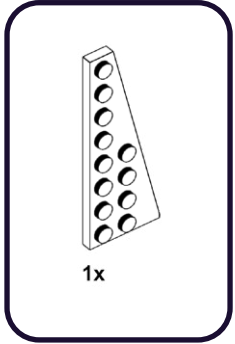

410

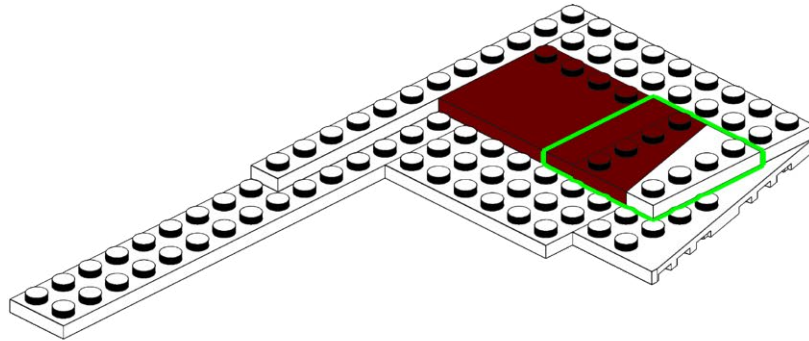
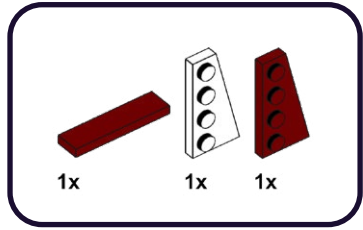

411

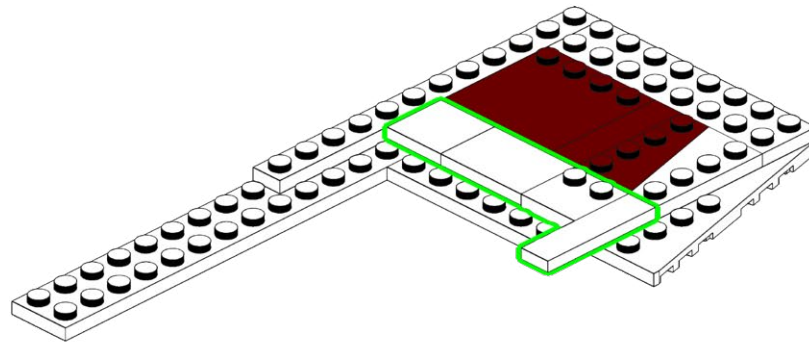
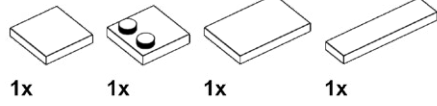

412

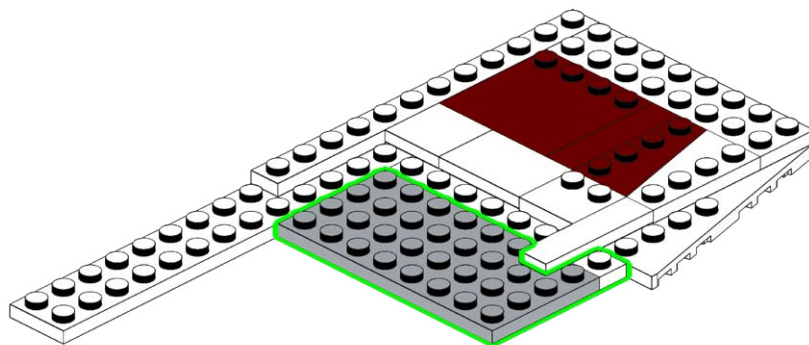
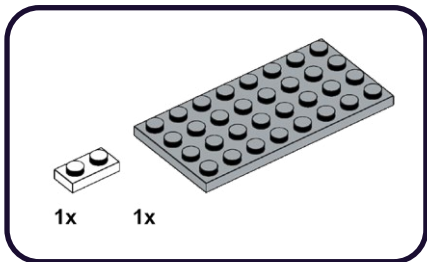

413

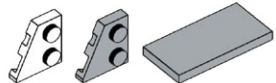

1x 1x 1x

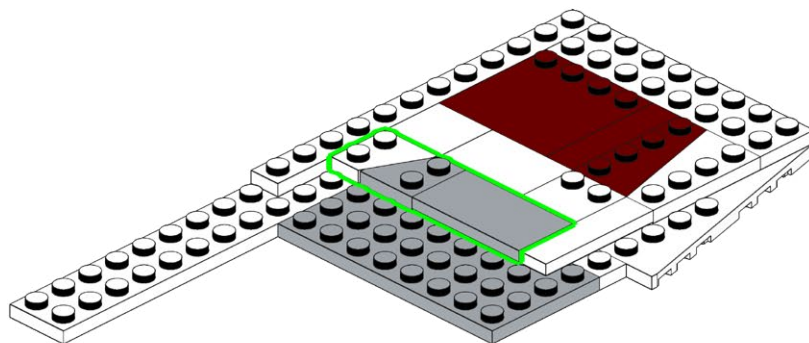

414

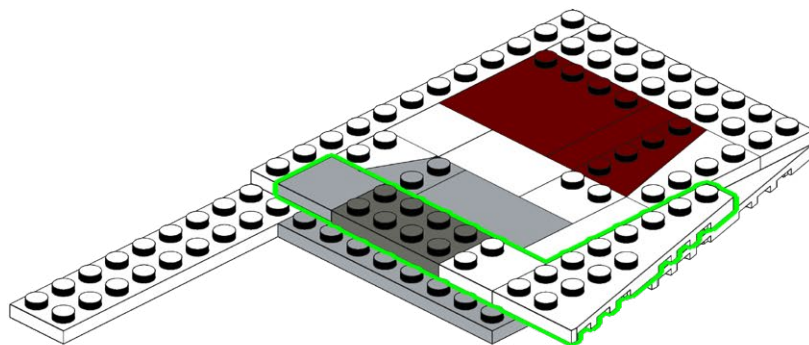
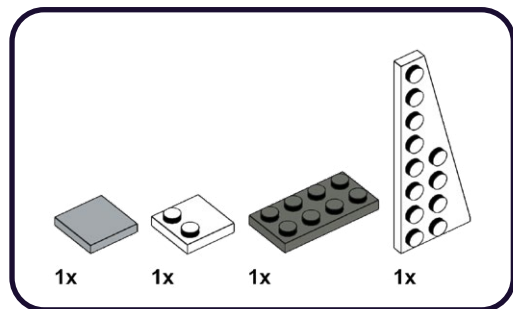

415

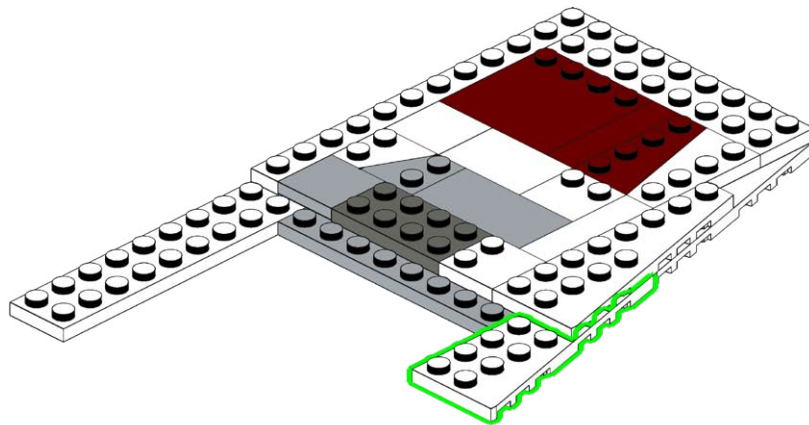
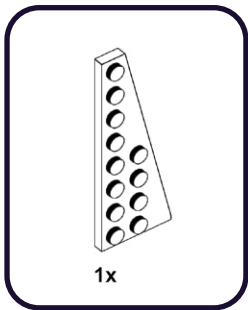

416

1x

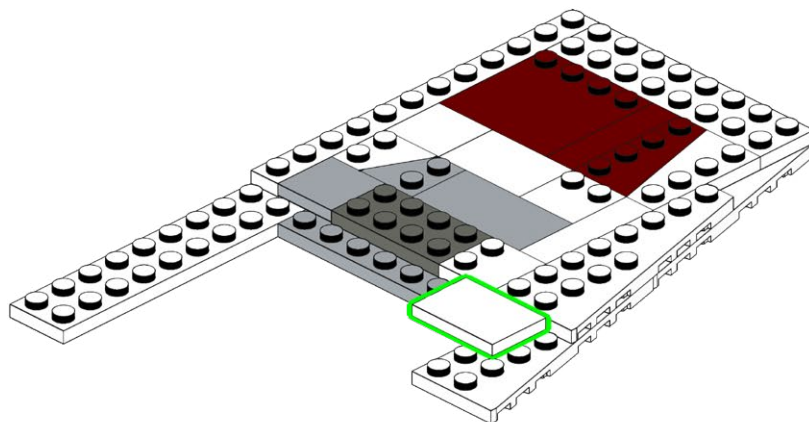

417

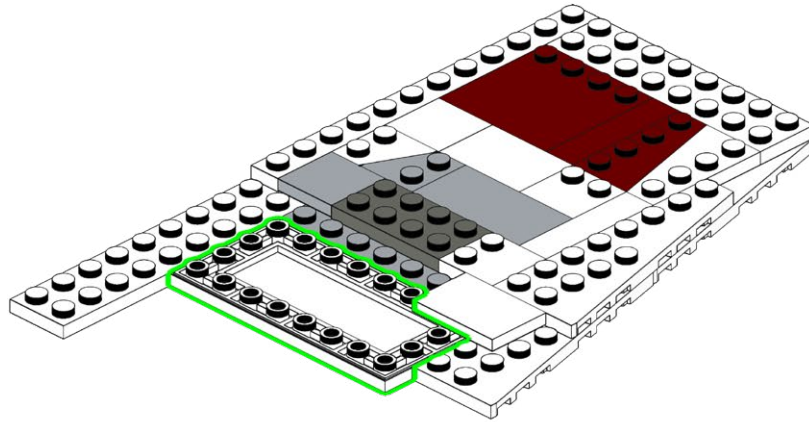
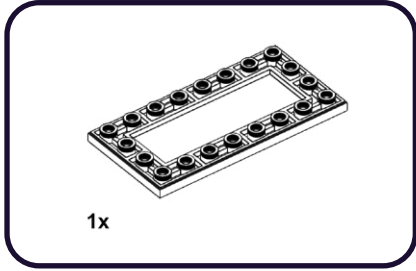

418

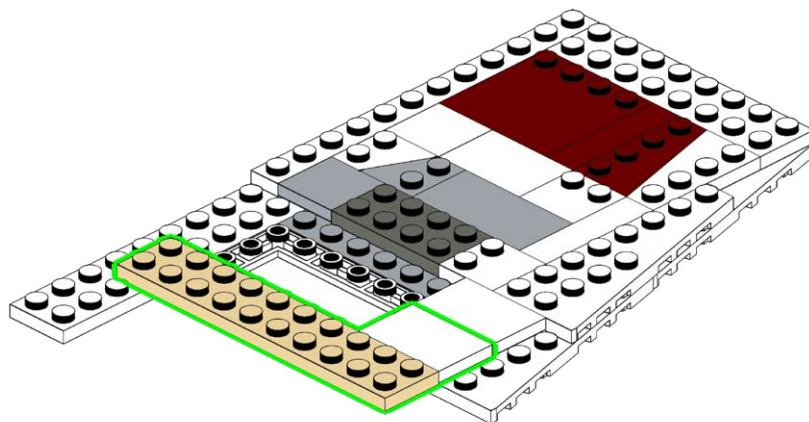
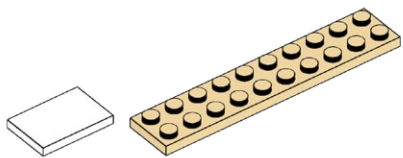

419

1x

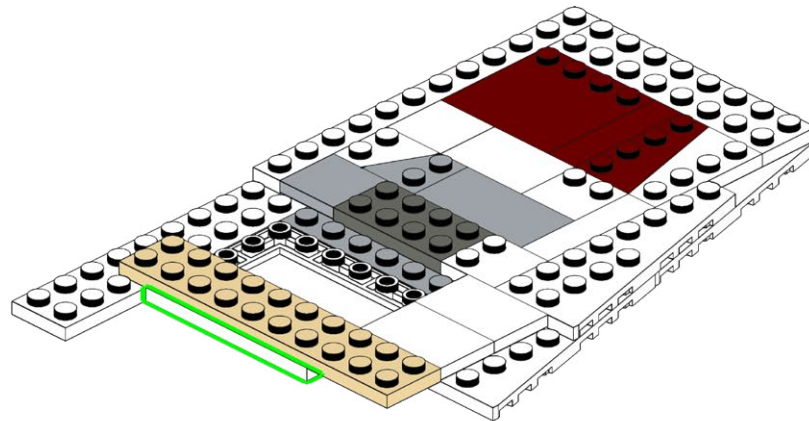

420

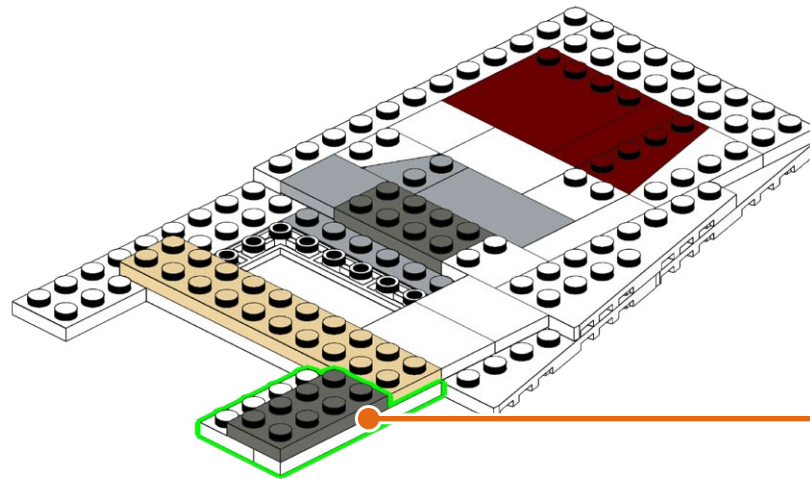
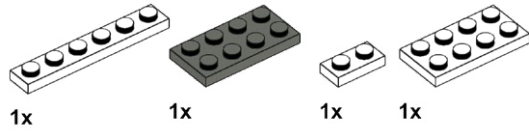

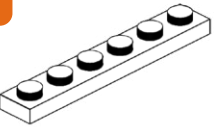
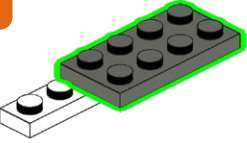
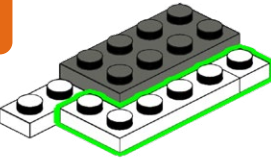
- 1 
- 2 
- 3 

421

1x

1x

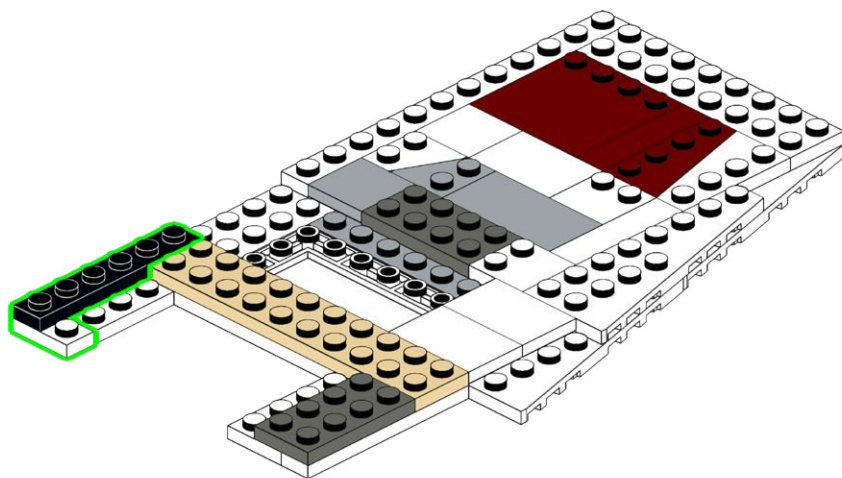

422

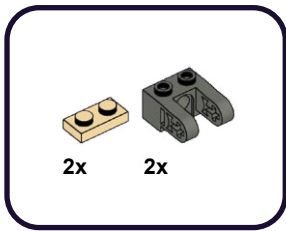

1

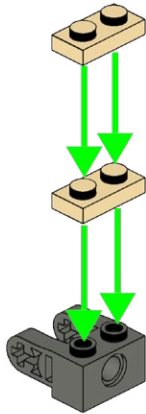

2

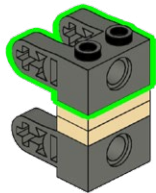

423

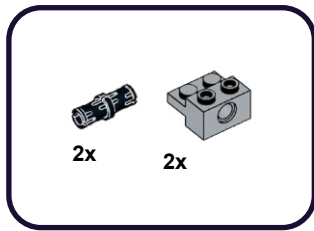

1

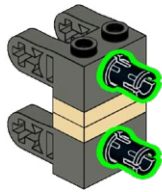

2

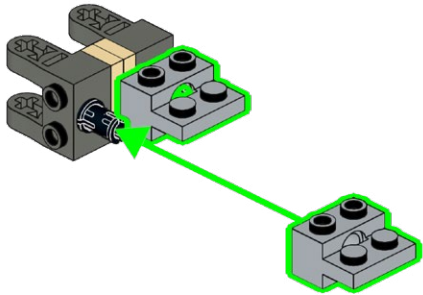

424

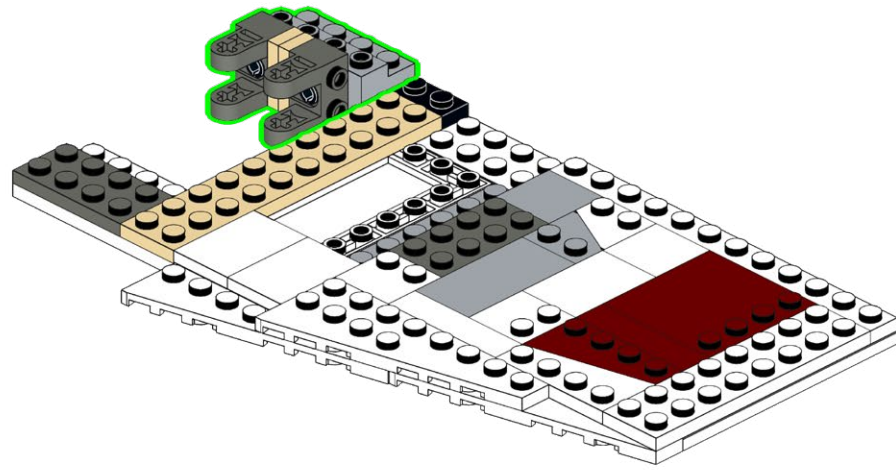

425

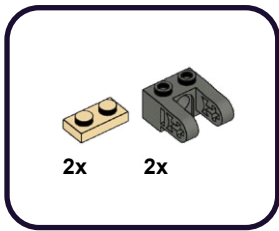

1

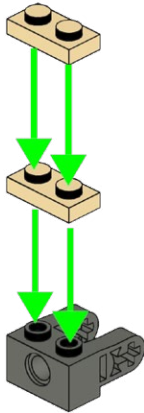

2

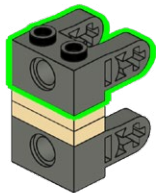

426

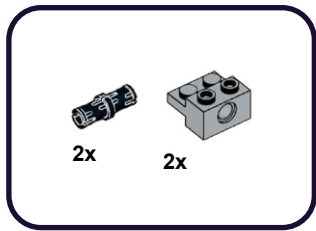

1

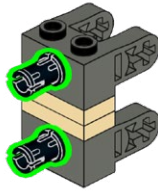

2

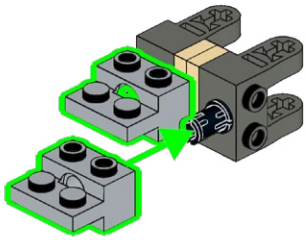

427

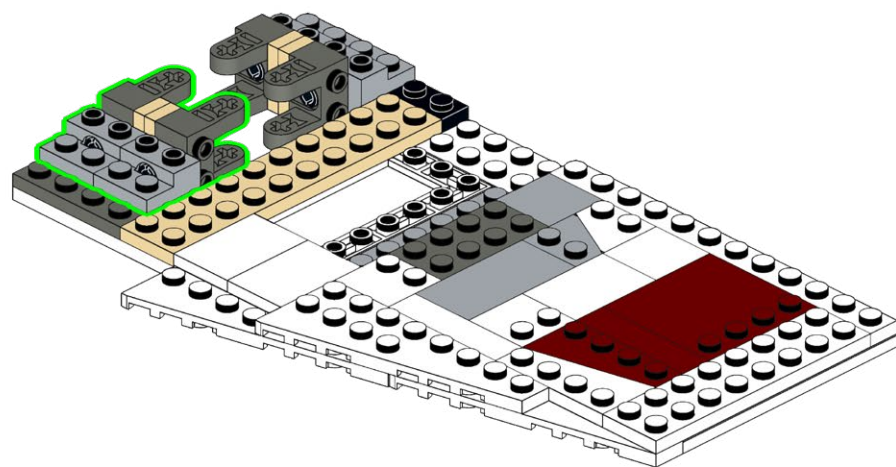

428

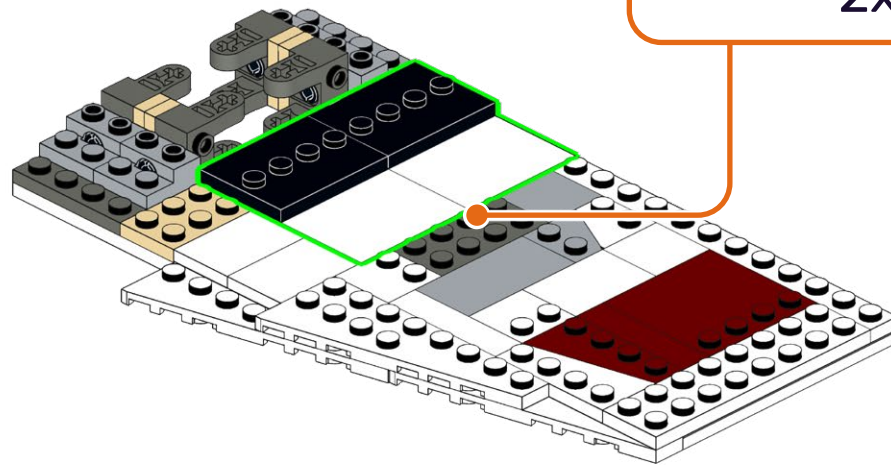
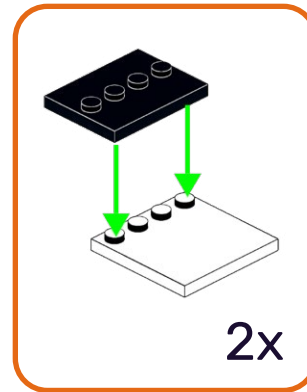
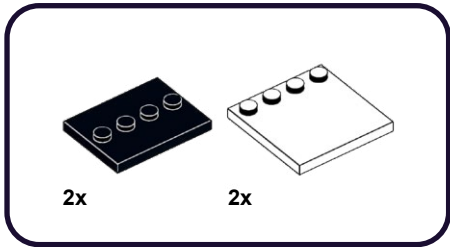

429

1x

1x

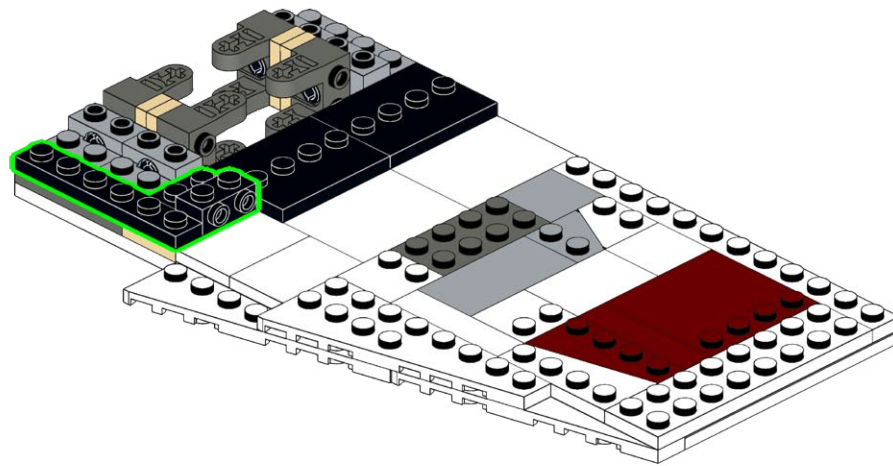

430

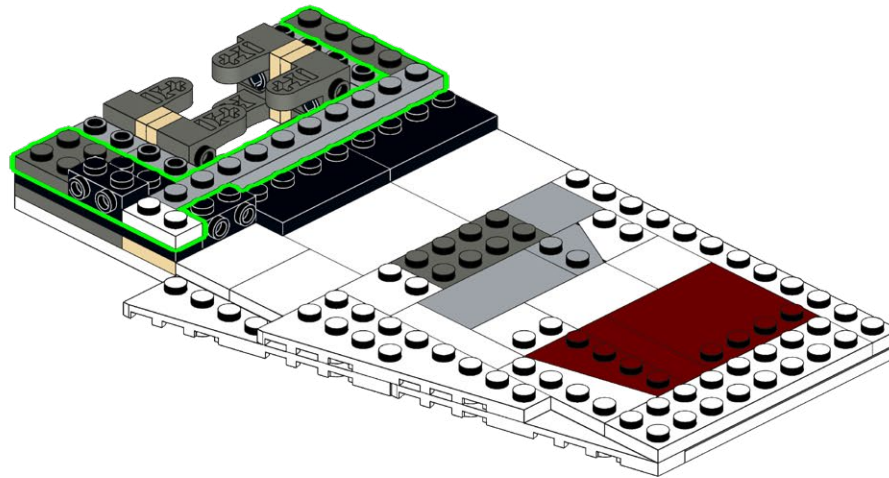
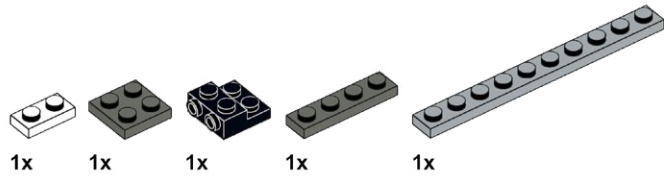

431

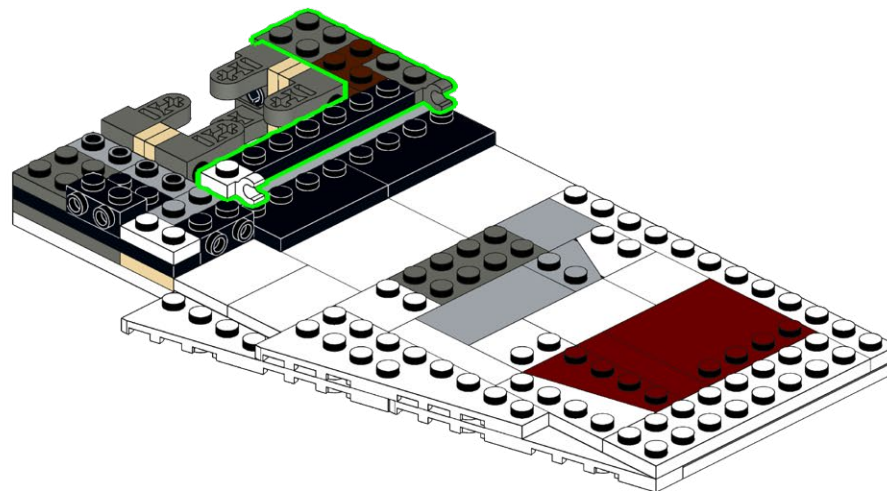
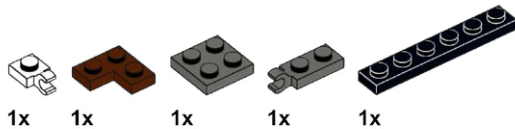

432

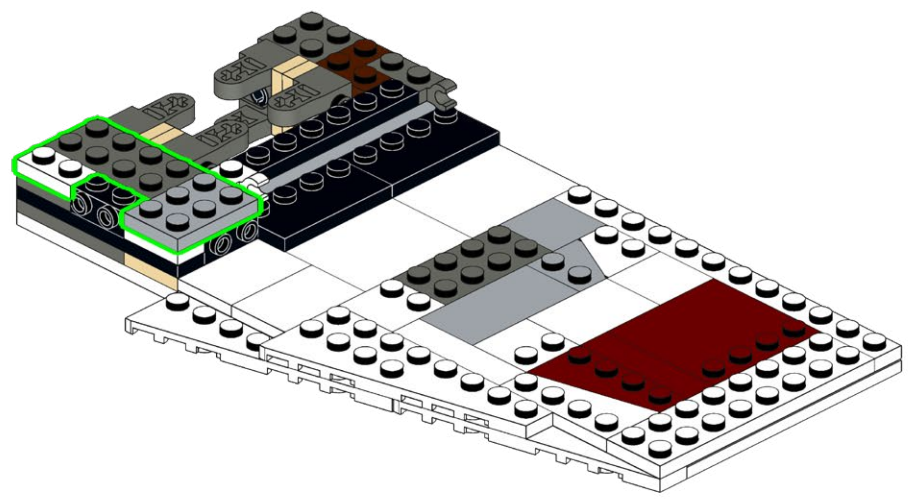
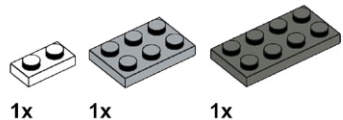

433

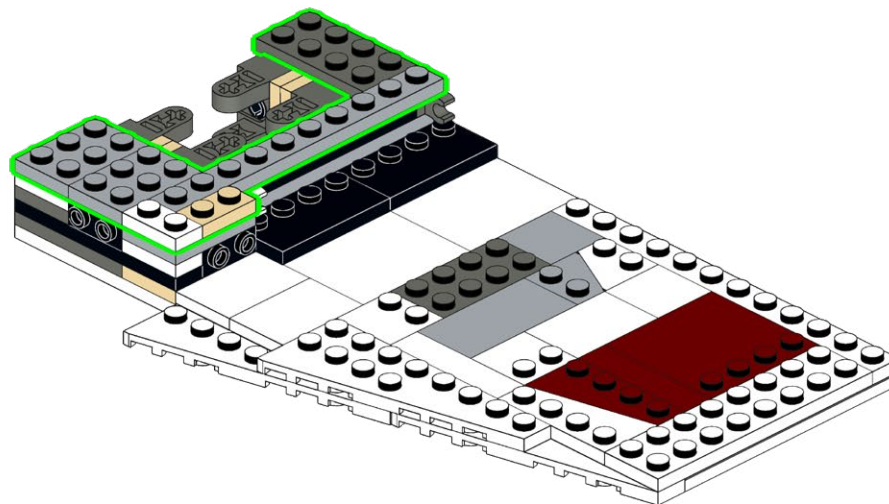
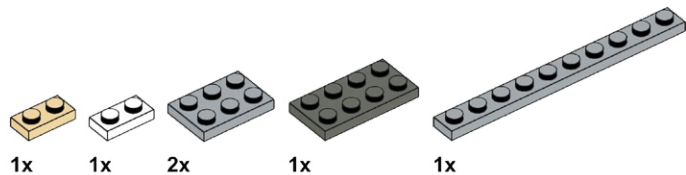

434

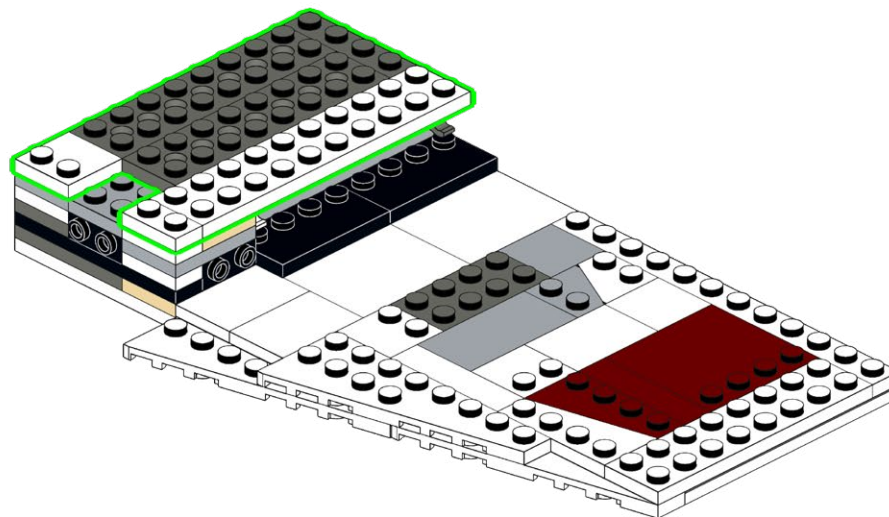
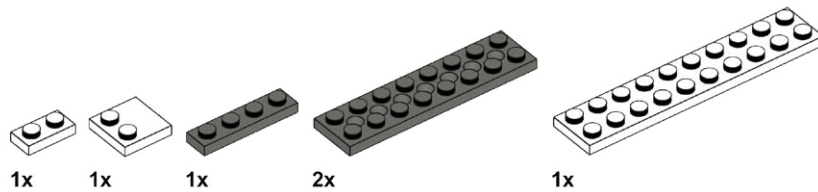

435

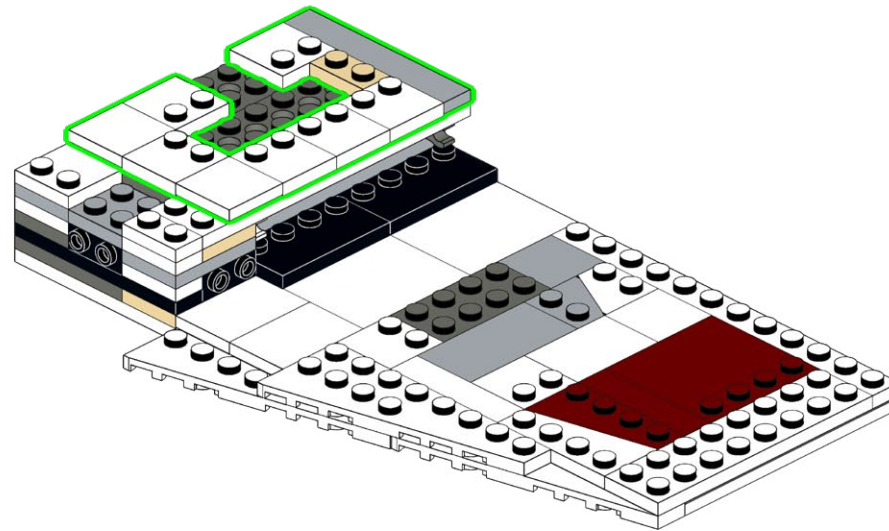
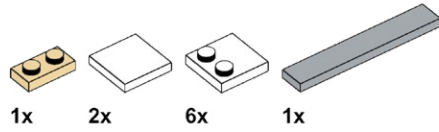

436

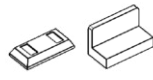

2x

2x

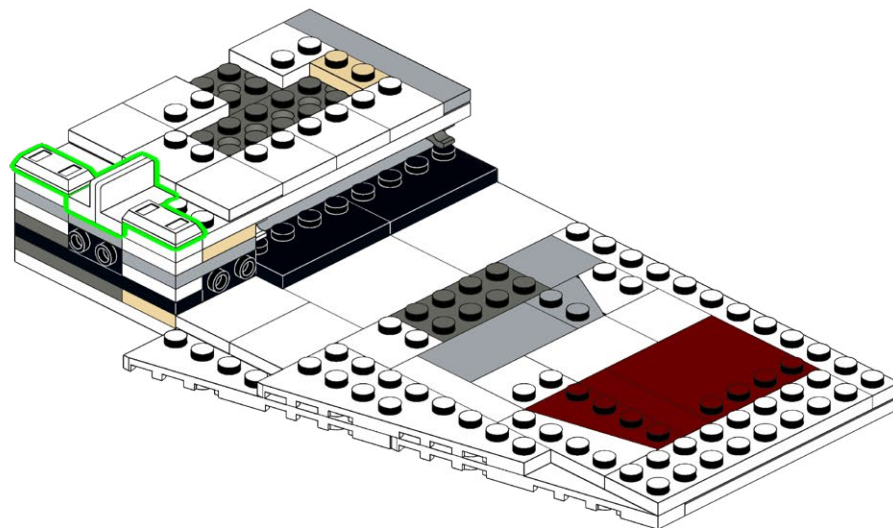

437

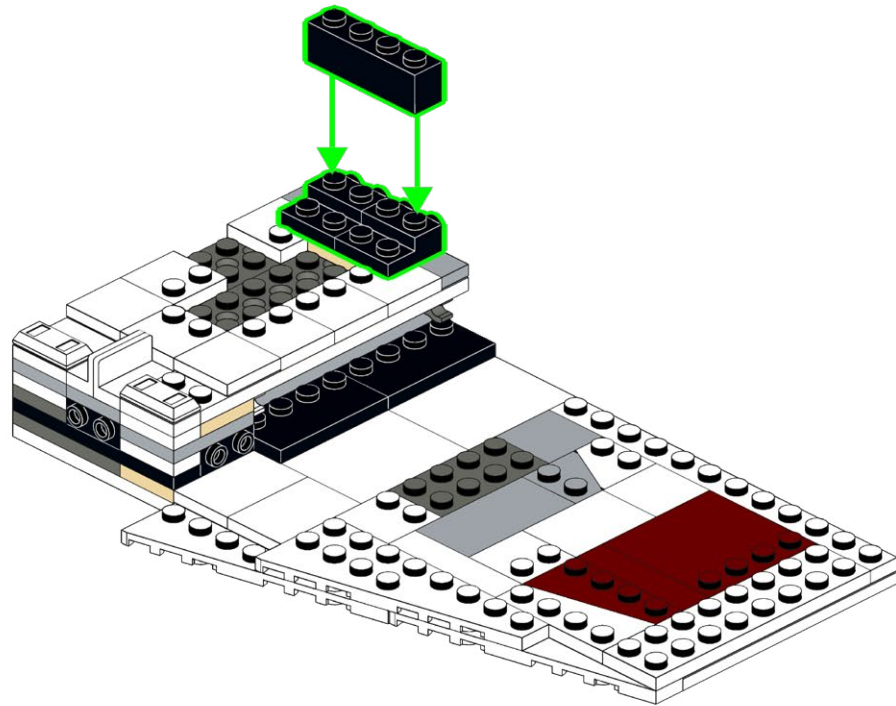
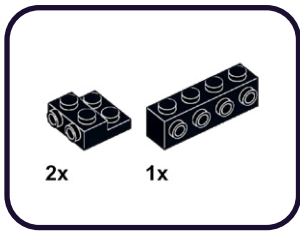

438



1x

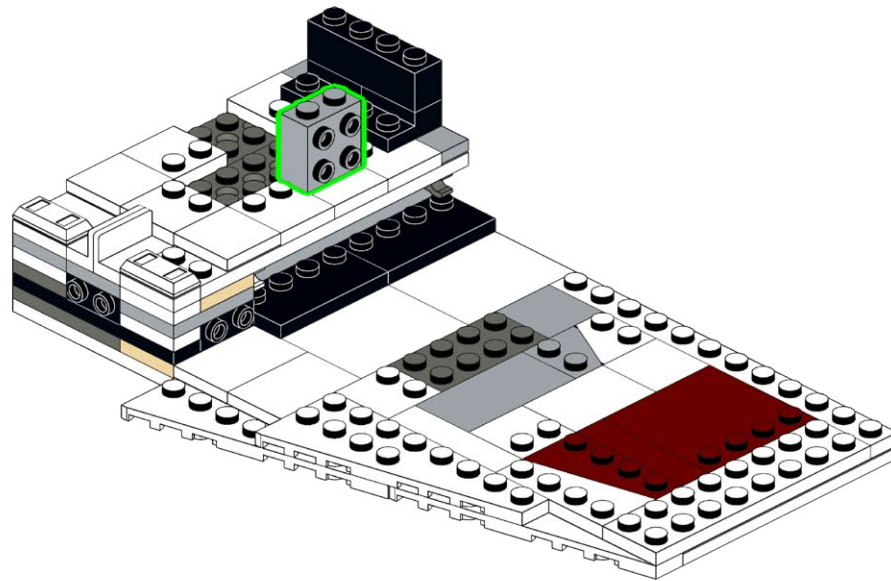

439

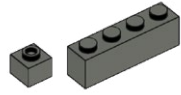

2x 1x

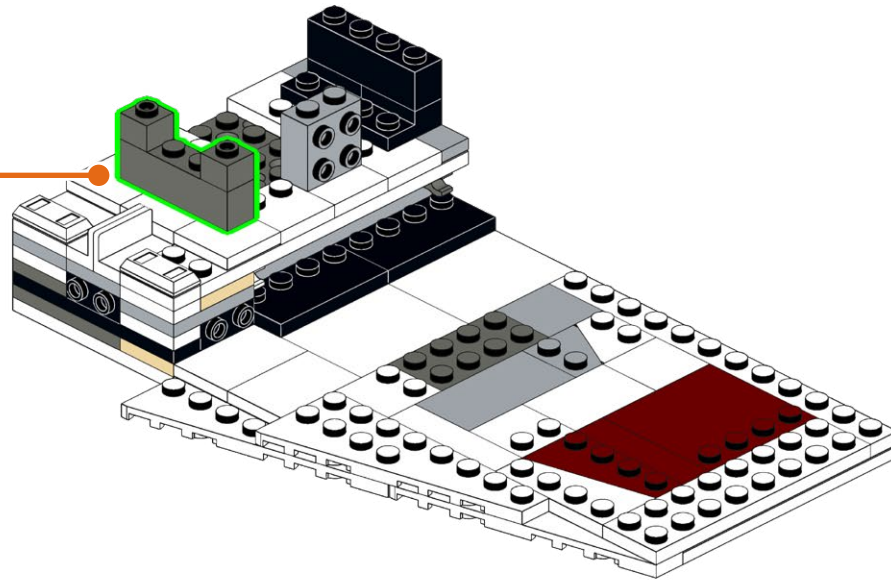
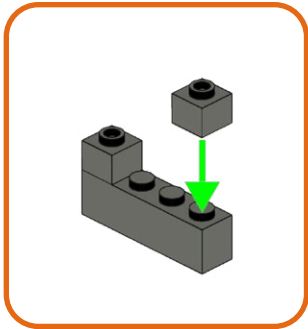

440

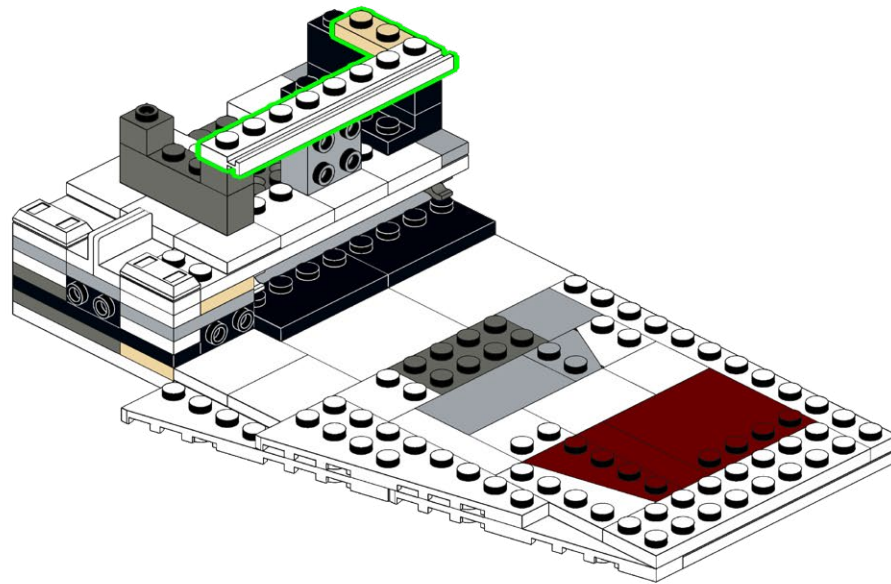
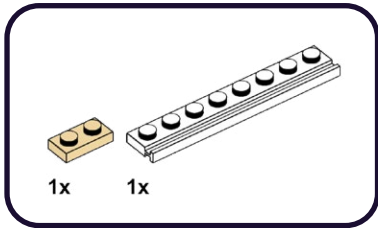

441

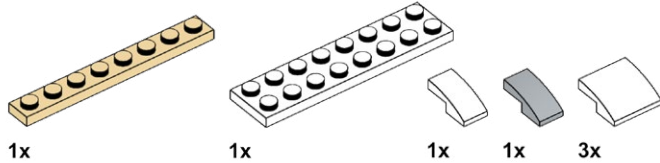

1

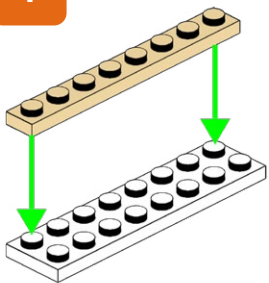

2

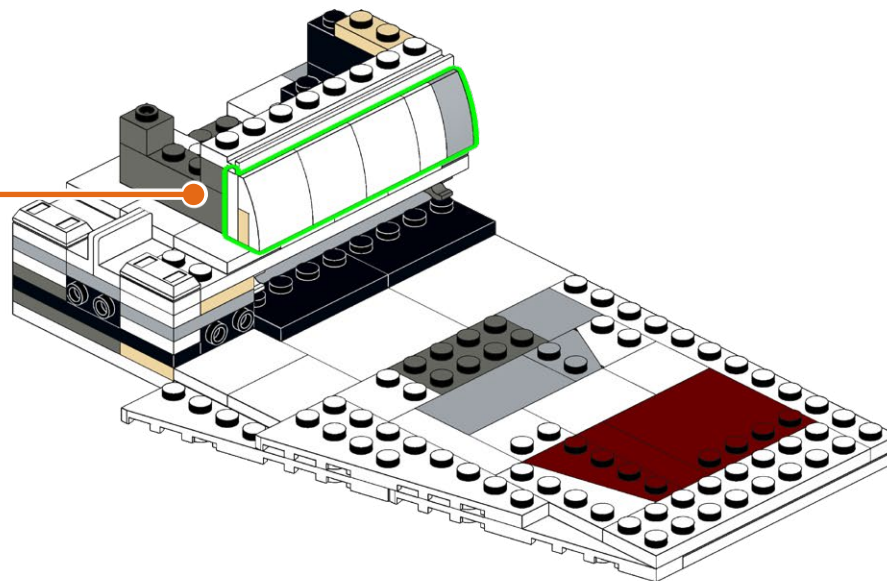
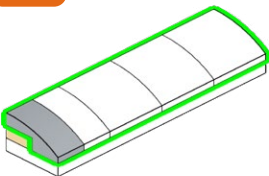

442

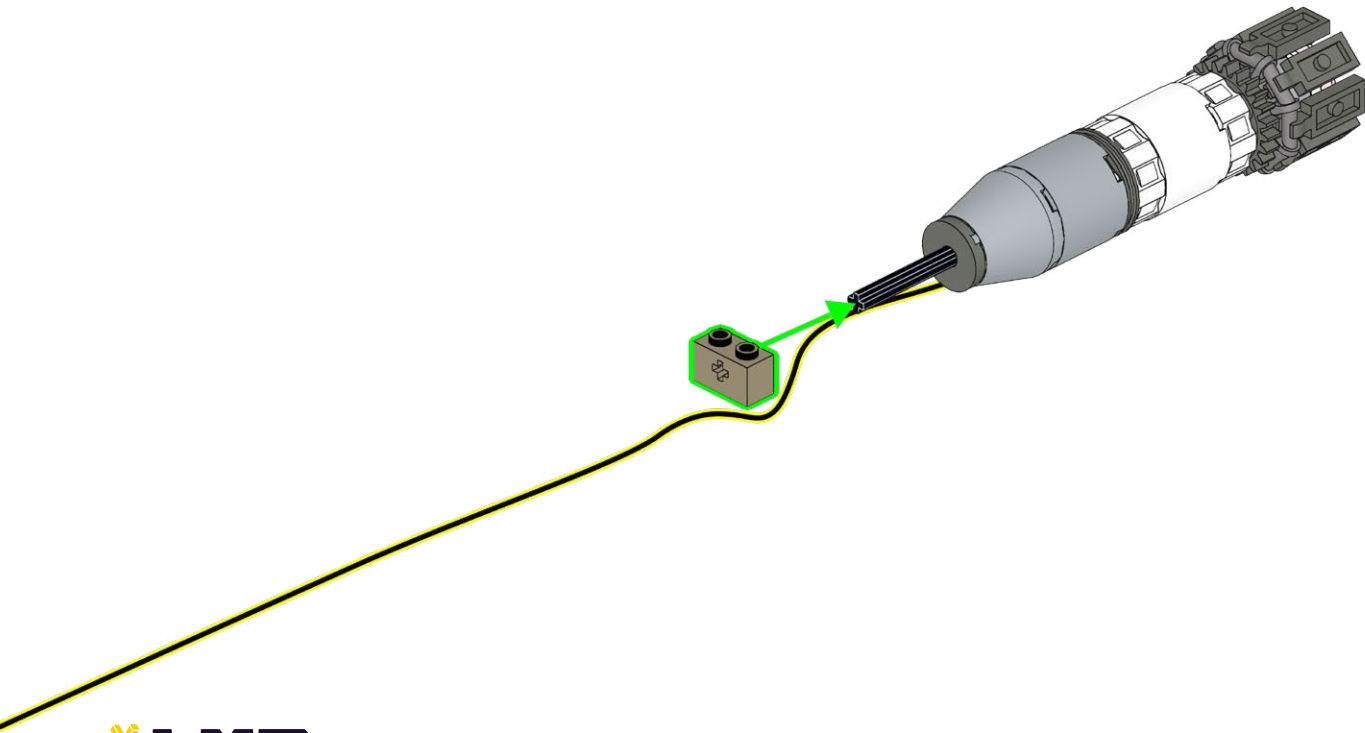
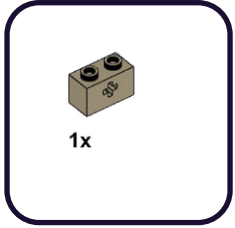

443

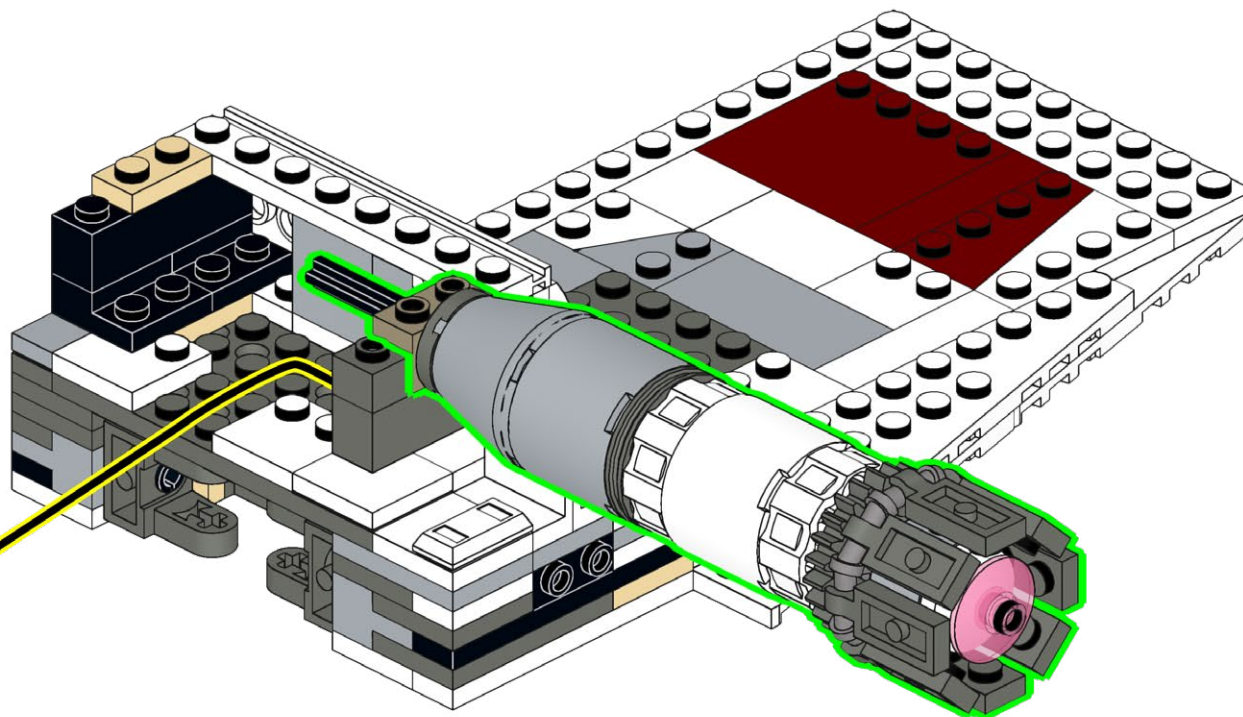

444

1x

1x

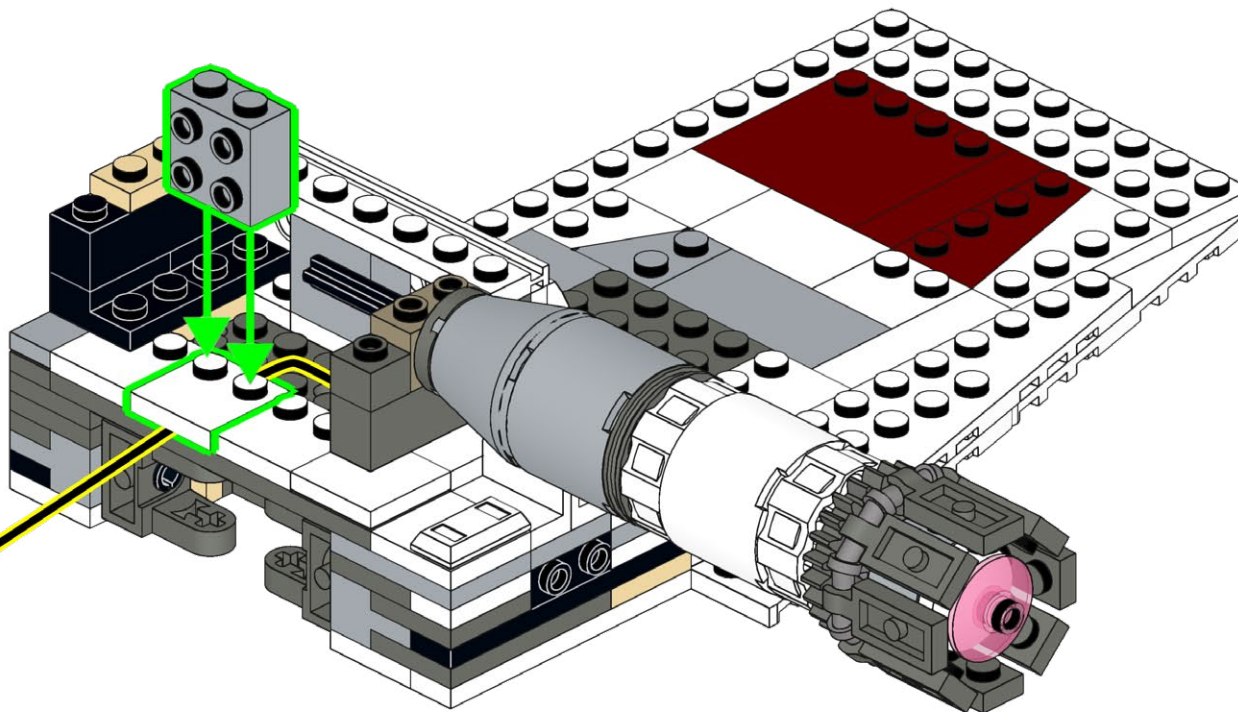
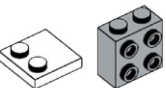

445

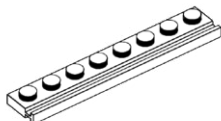

1x

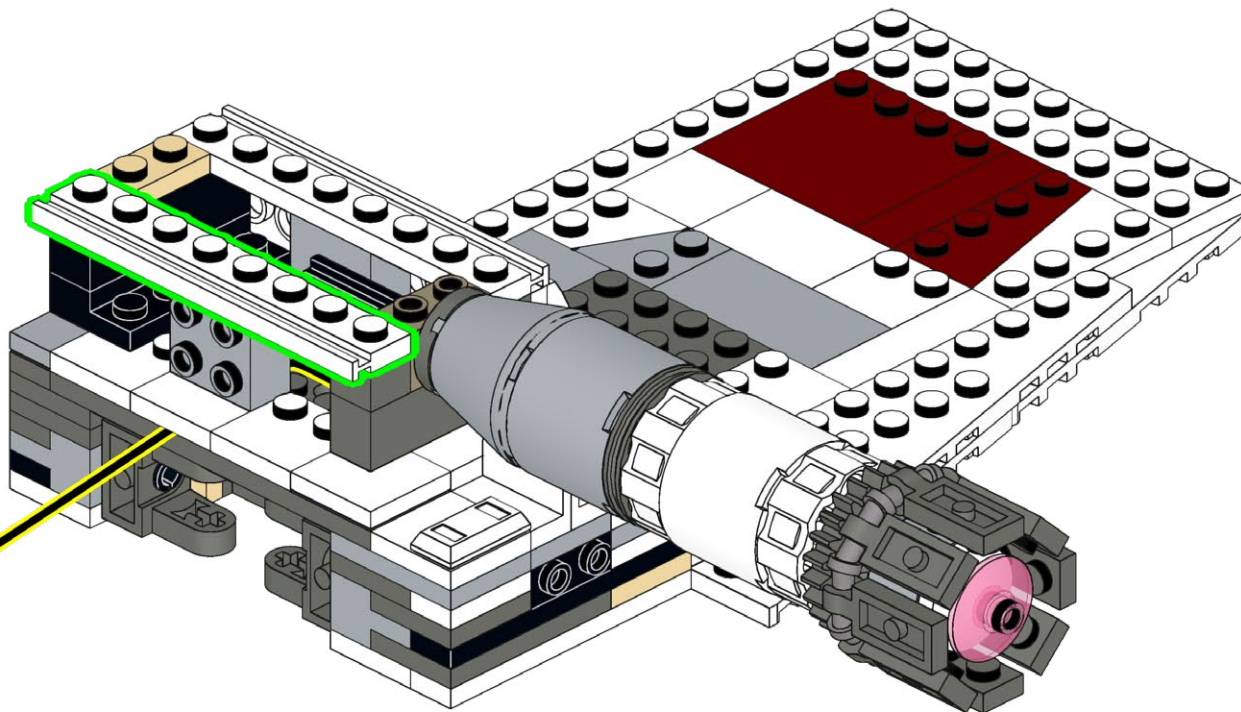

446

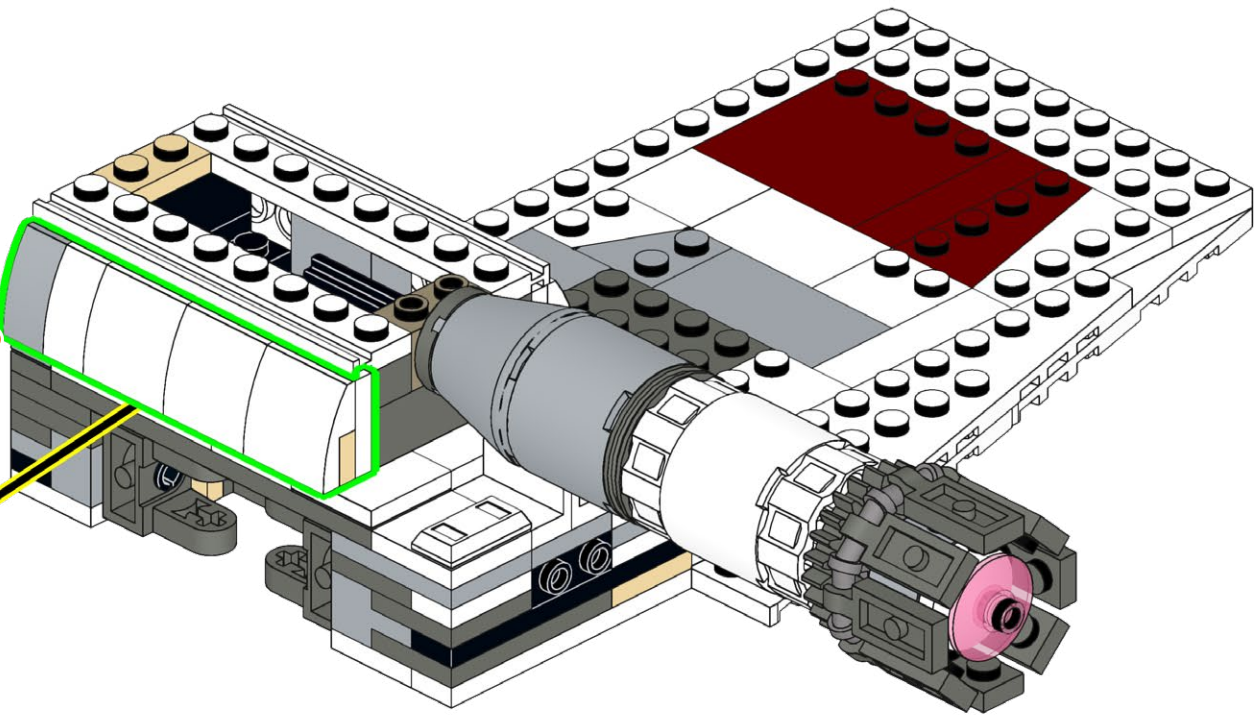
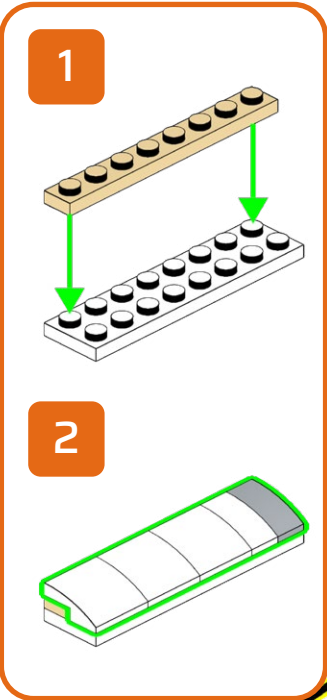
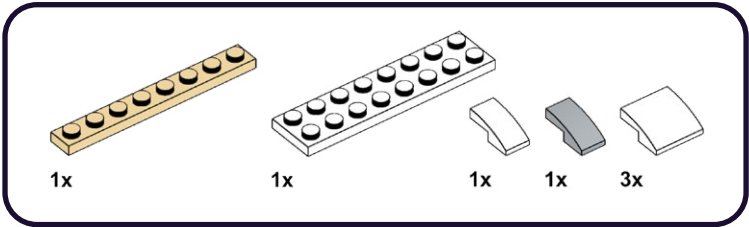

447

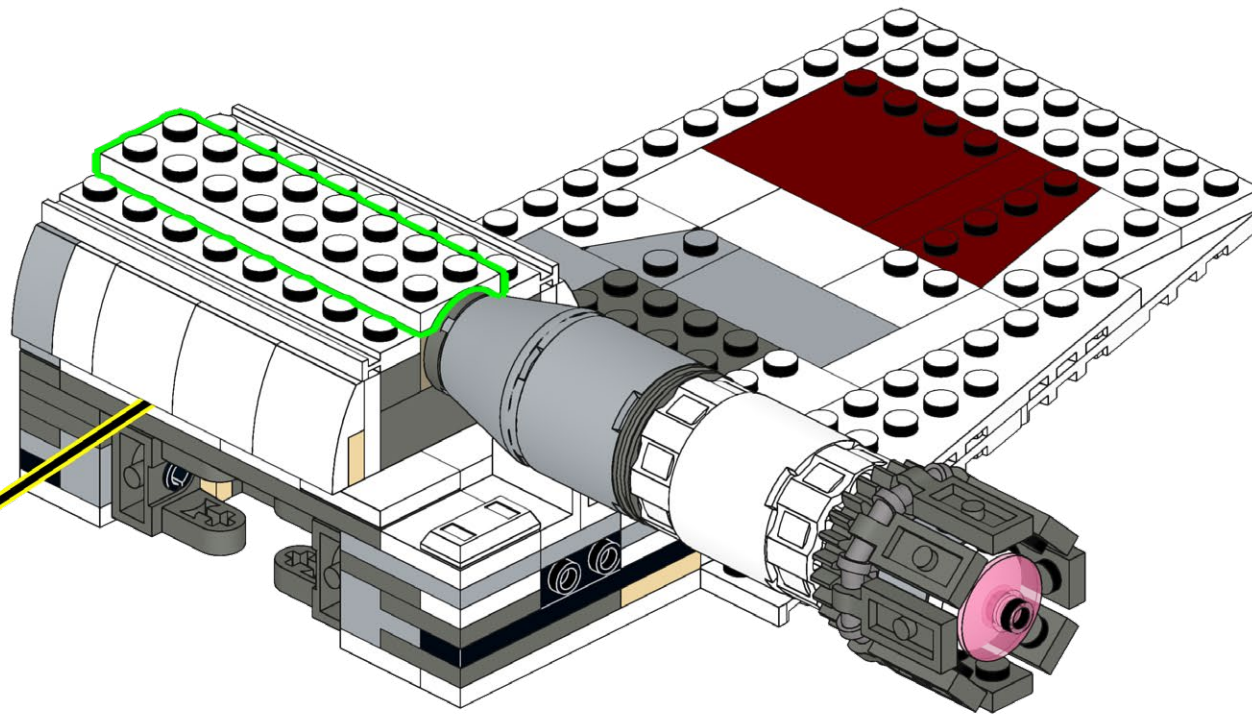
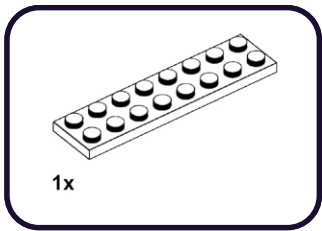

448

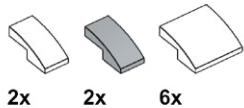

2x

2x

6x

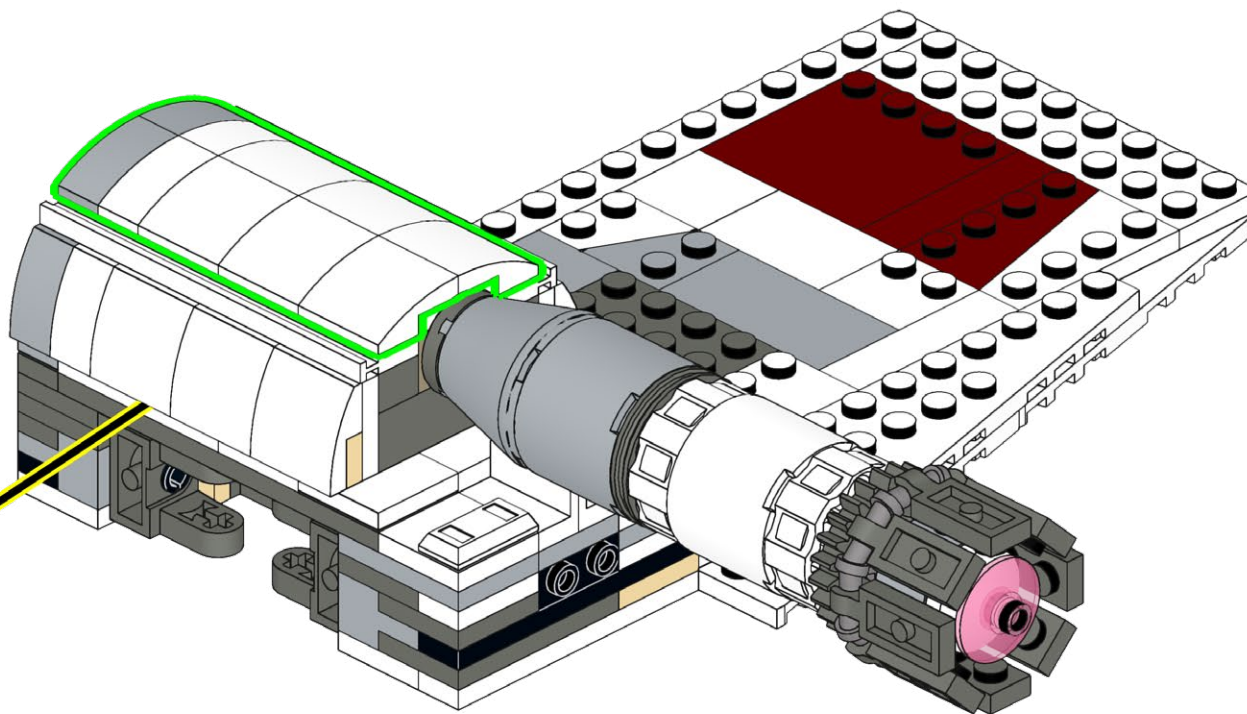

449

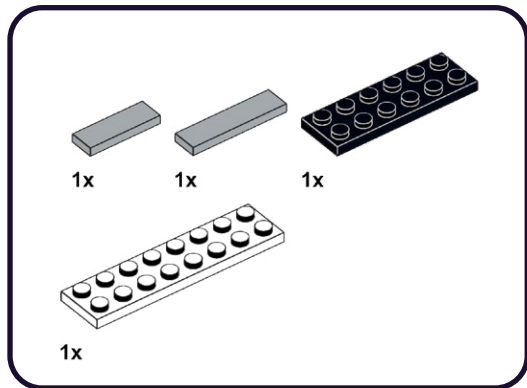

1

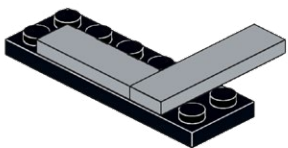

2

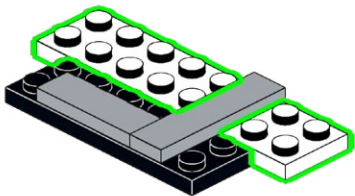

450

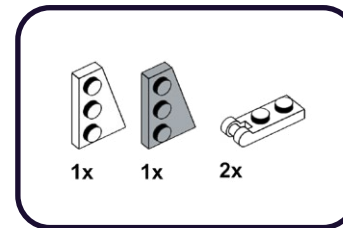

1

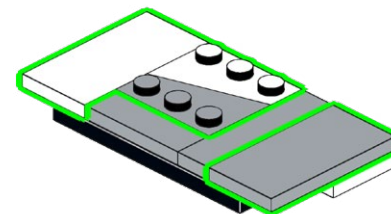

2

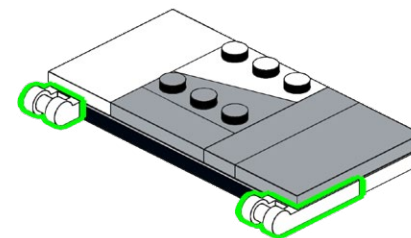

451

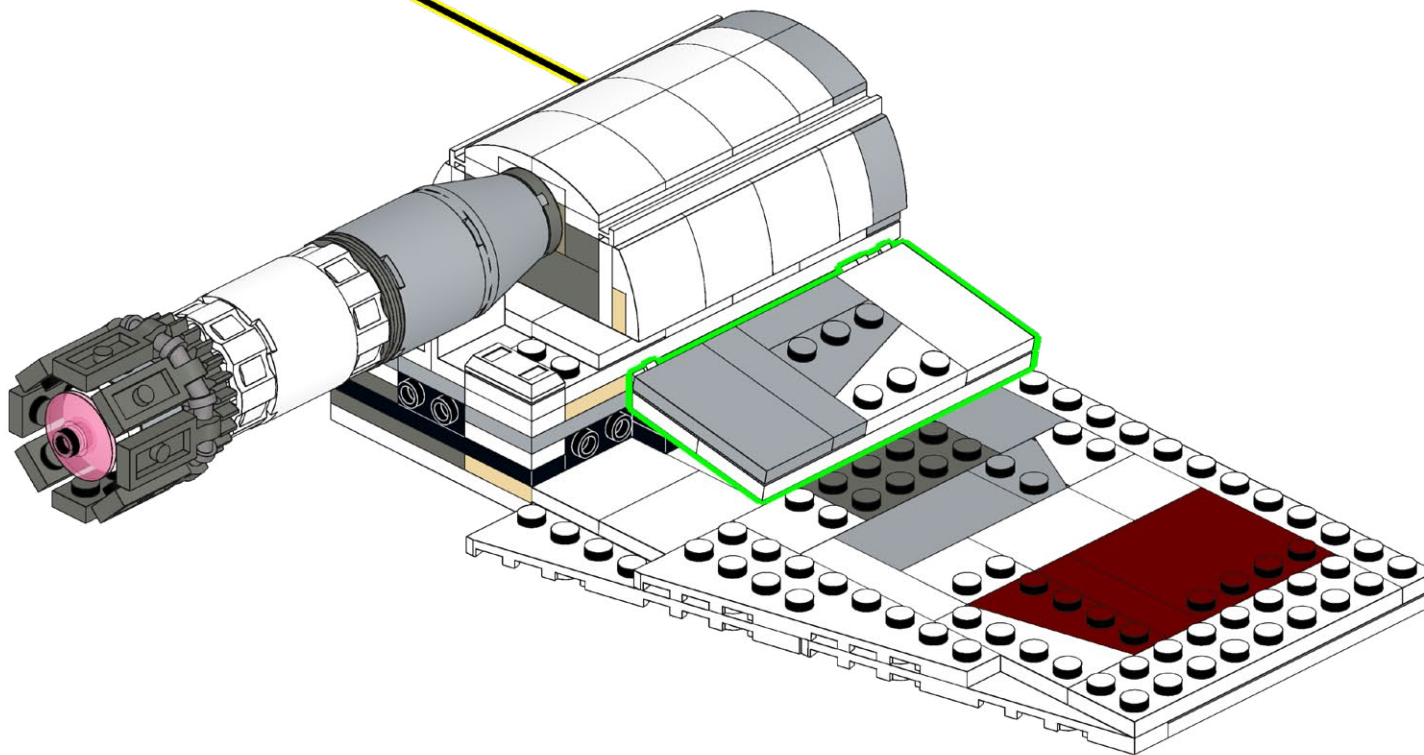

452

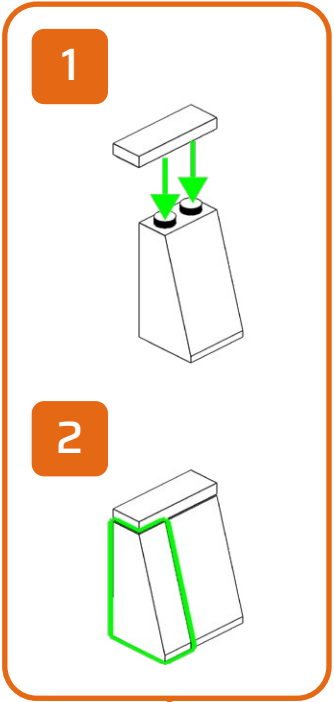
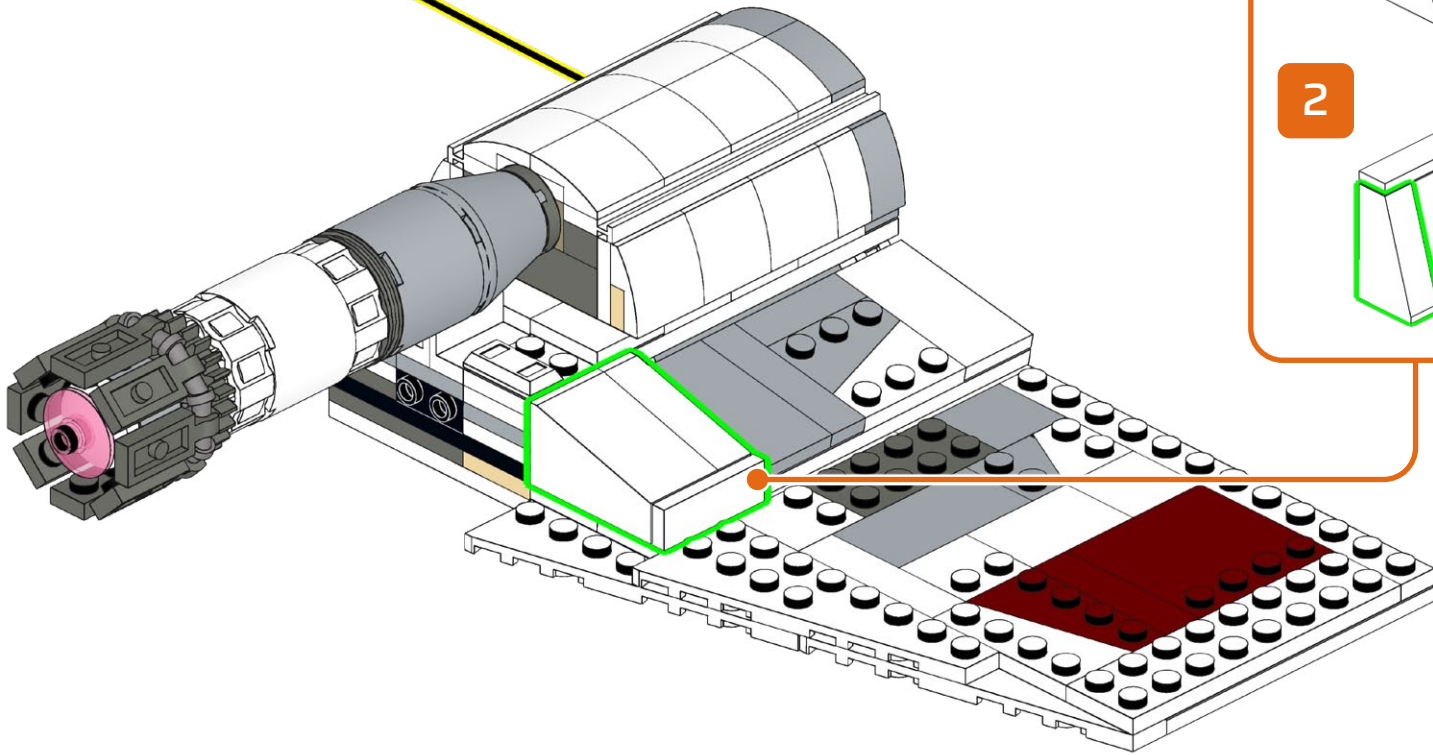
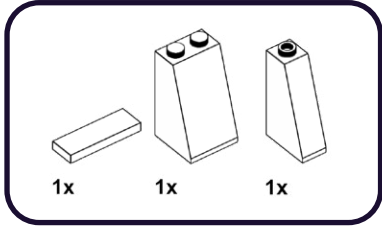

453



1x



1x

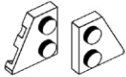

1x



1x

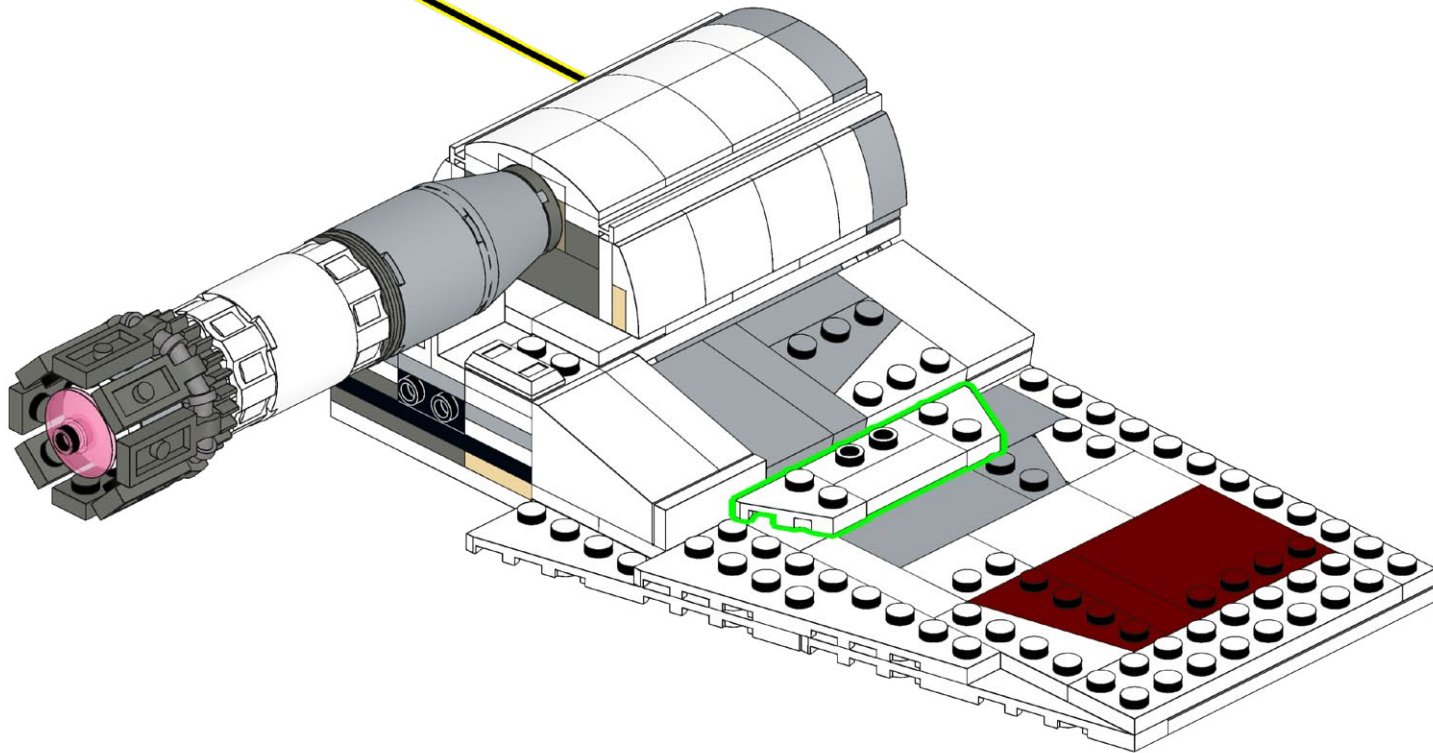

454

1x

5x

1x

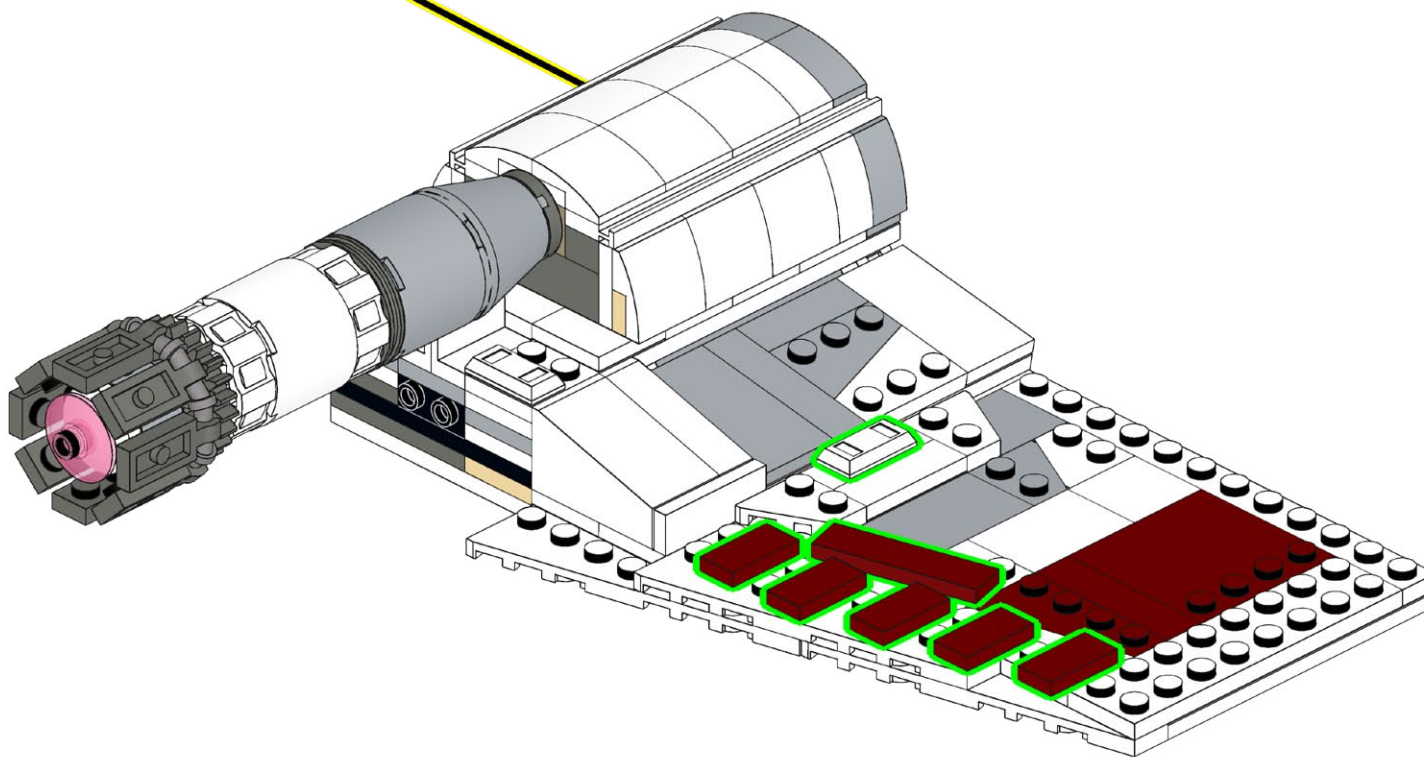

455

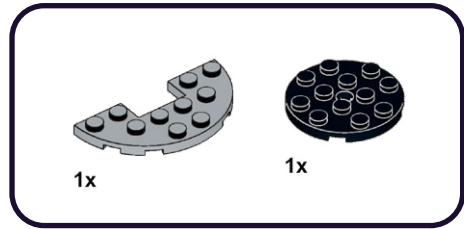

1

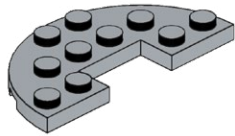

2

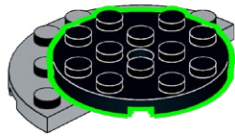

456

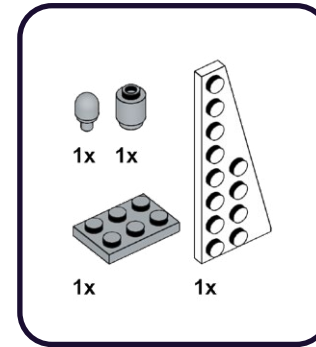

1

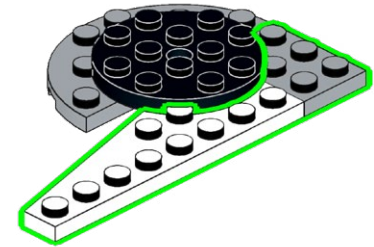

2

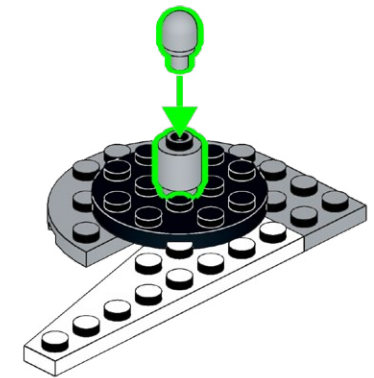

457

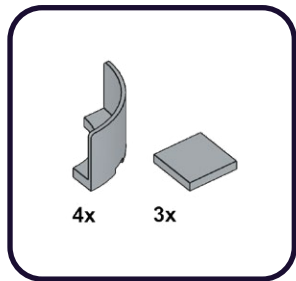

1

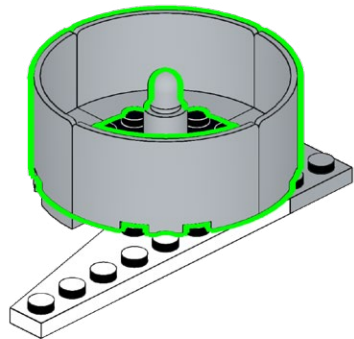

2

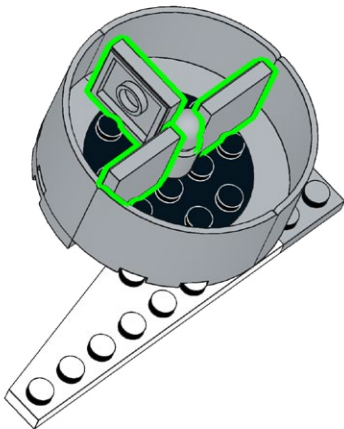

458

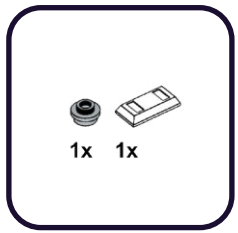

1

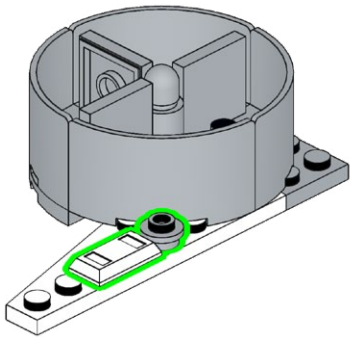

459

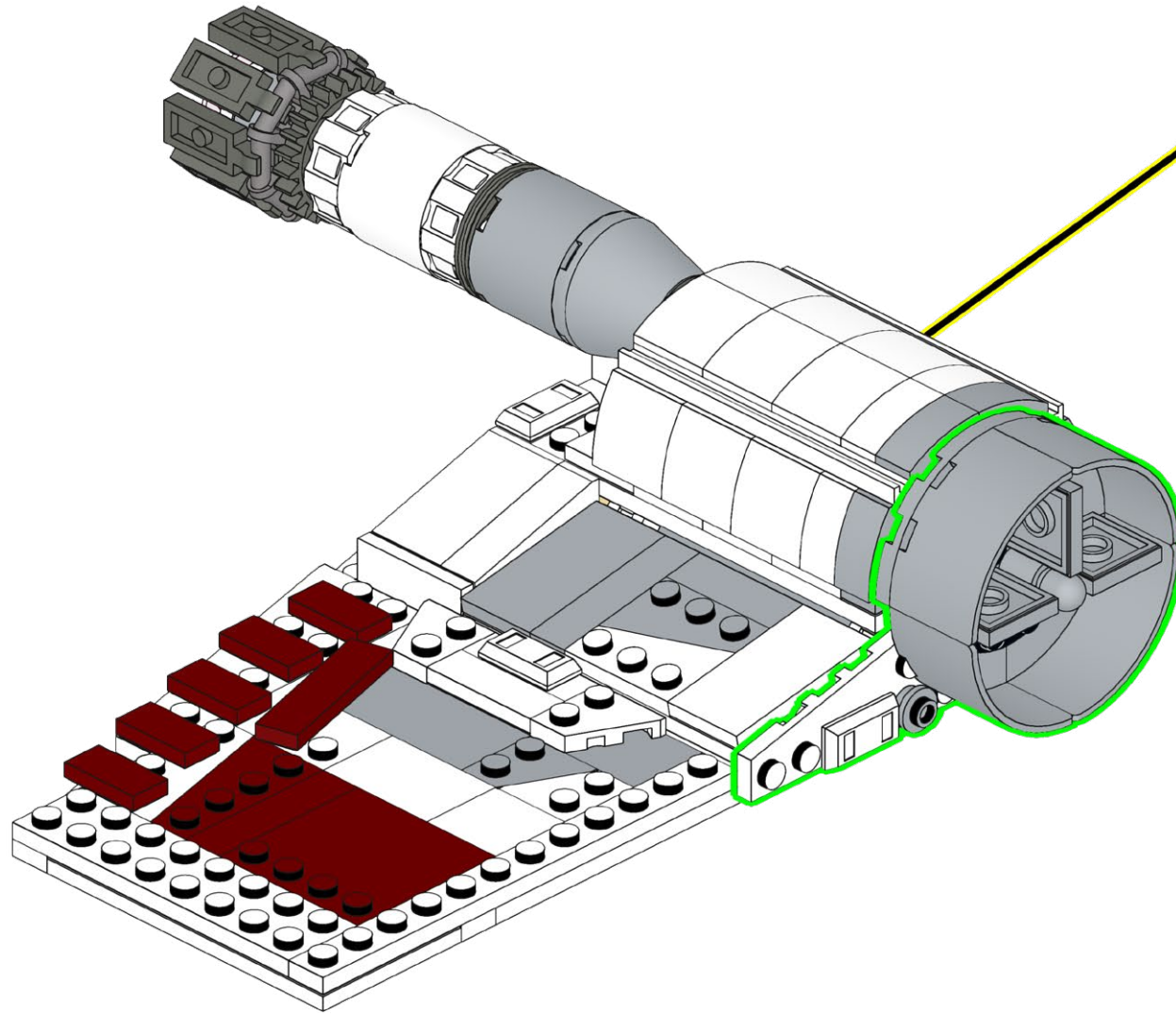

460

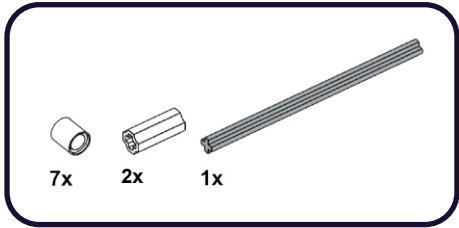

1

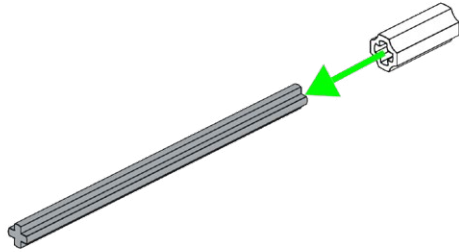

2

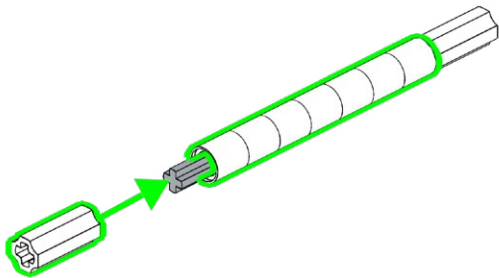

461

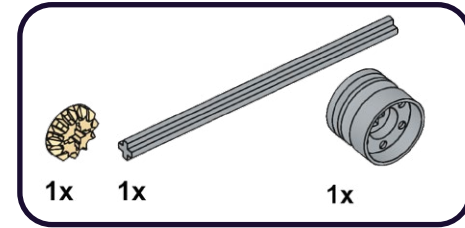

1

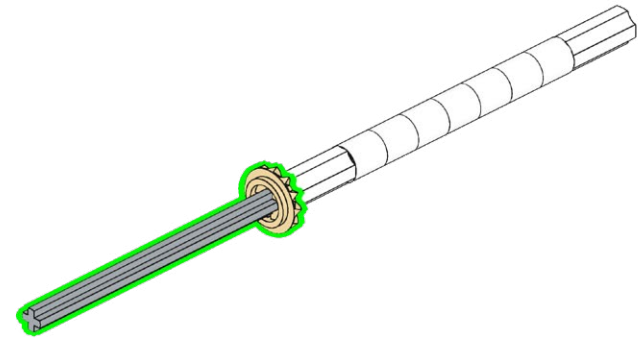

2

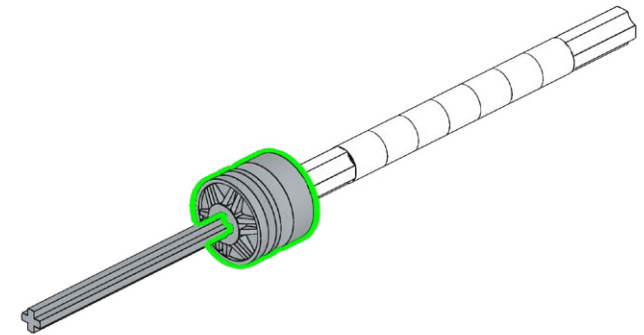

462

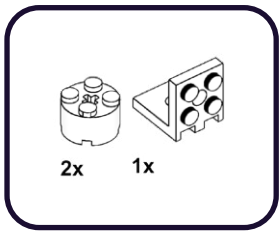

1

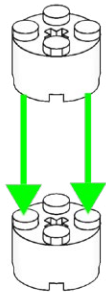

2

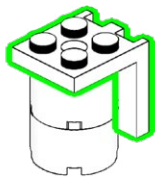

463

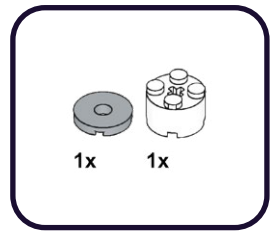

1

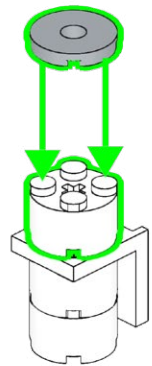

2

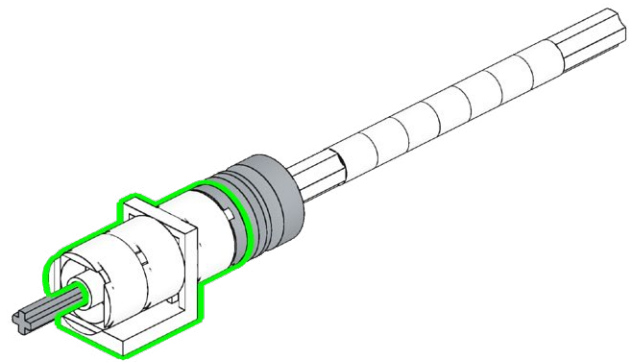

464

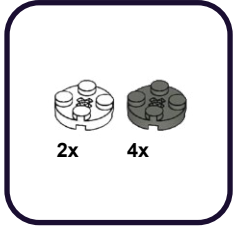

1

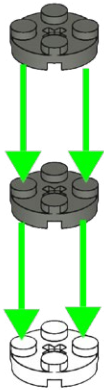

2

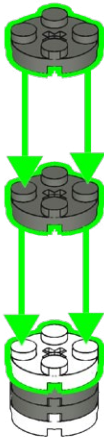

465

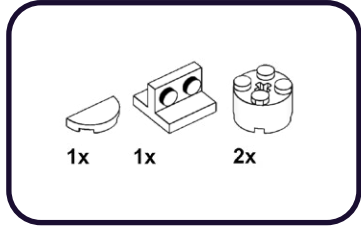

1

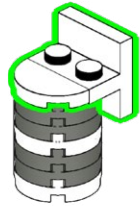

2

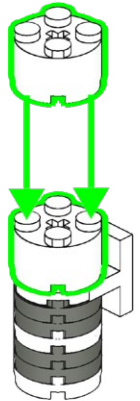

466

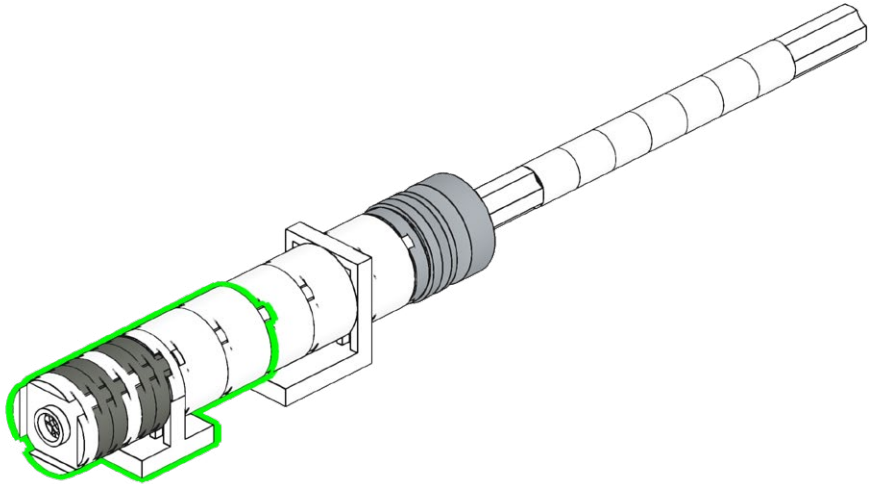

467

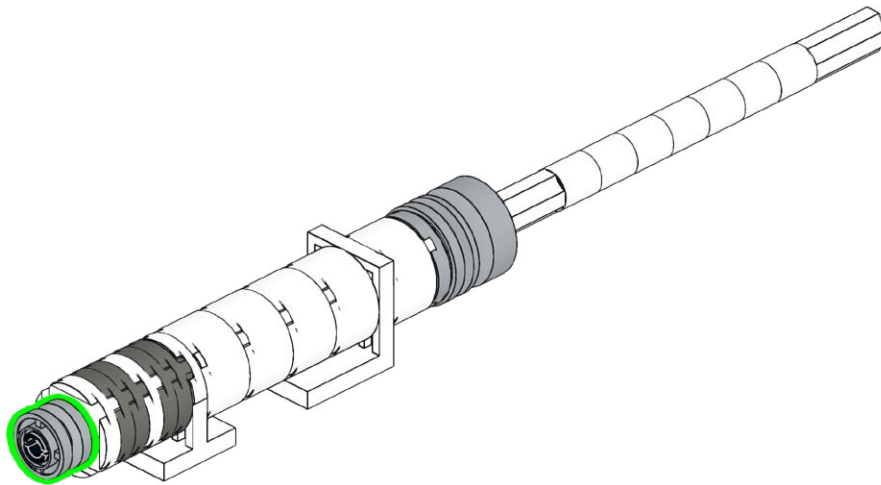
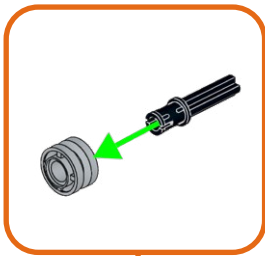
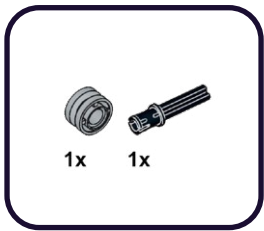

468

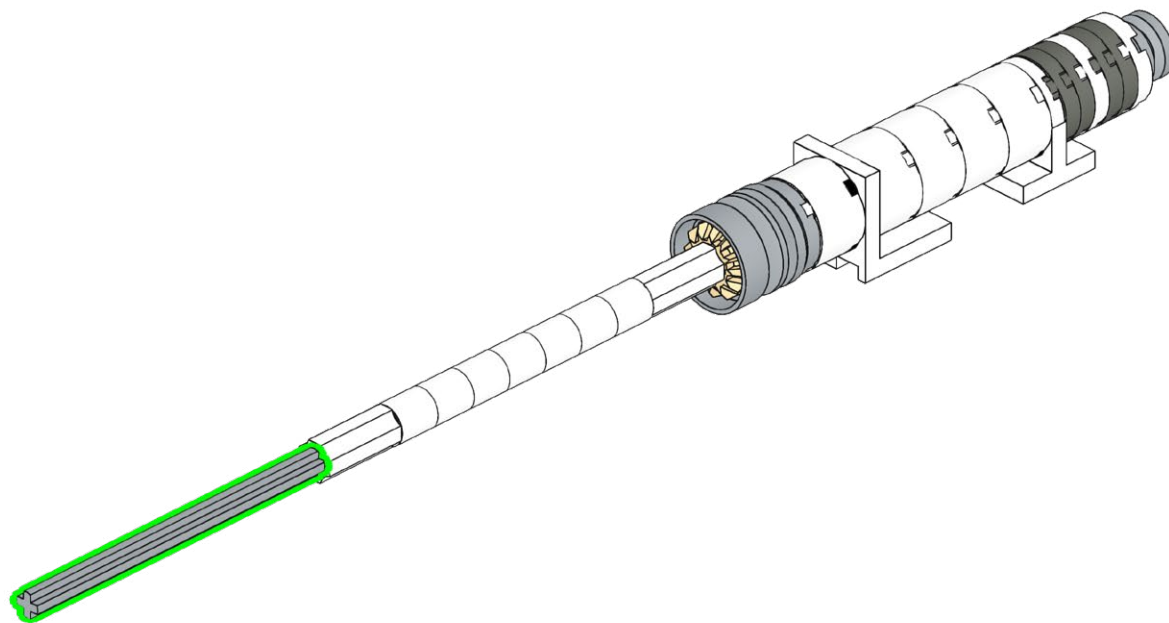
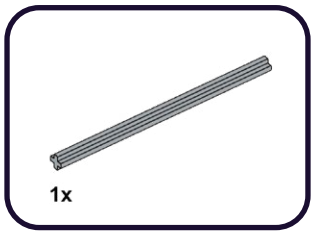
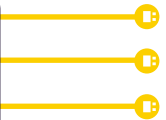

469

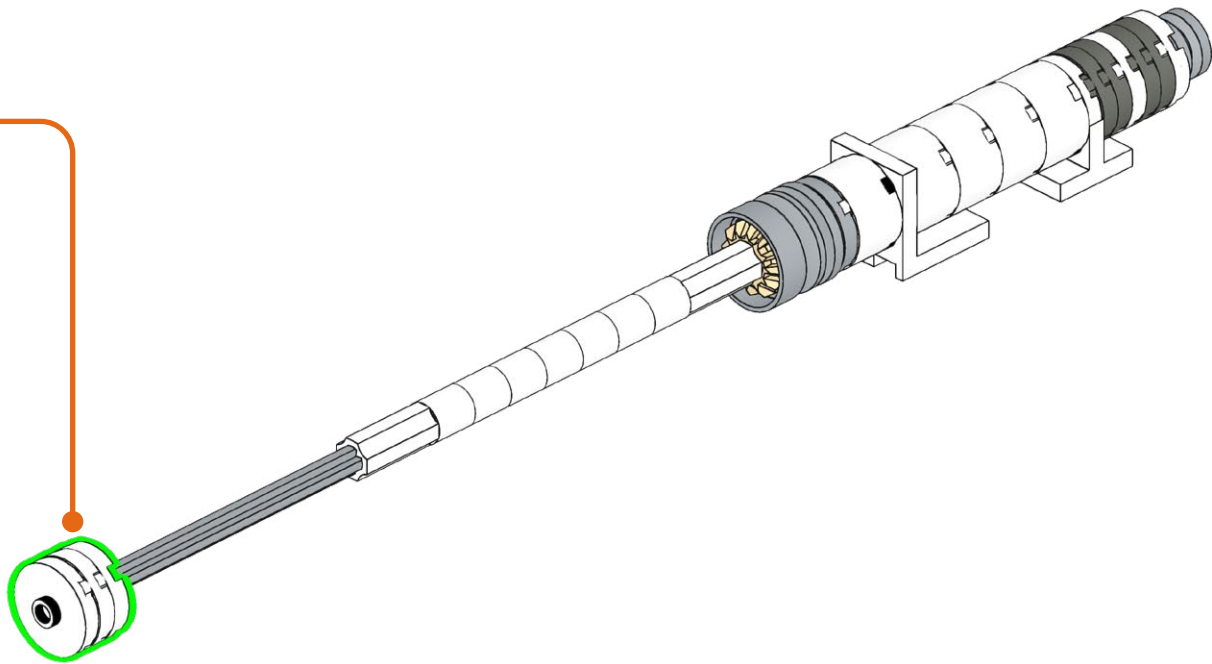
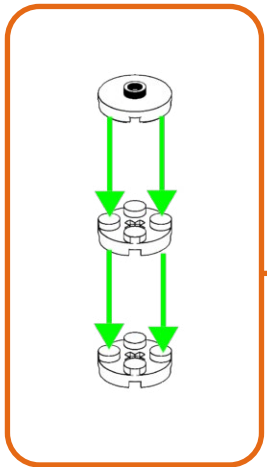
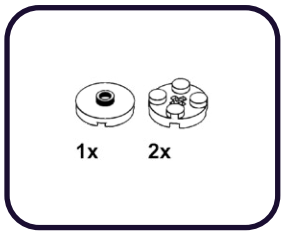

470

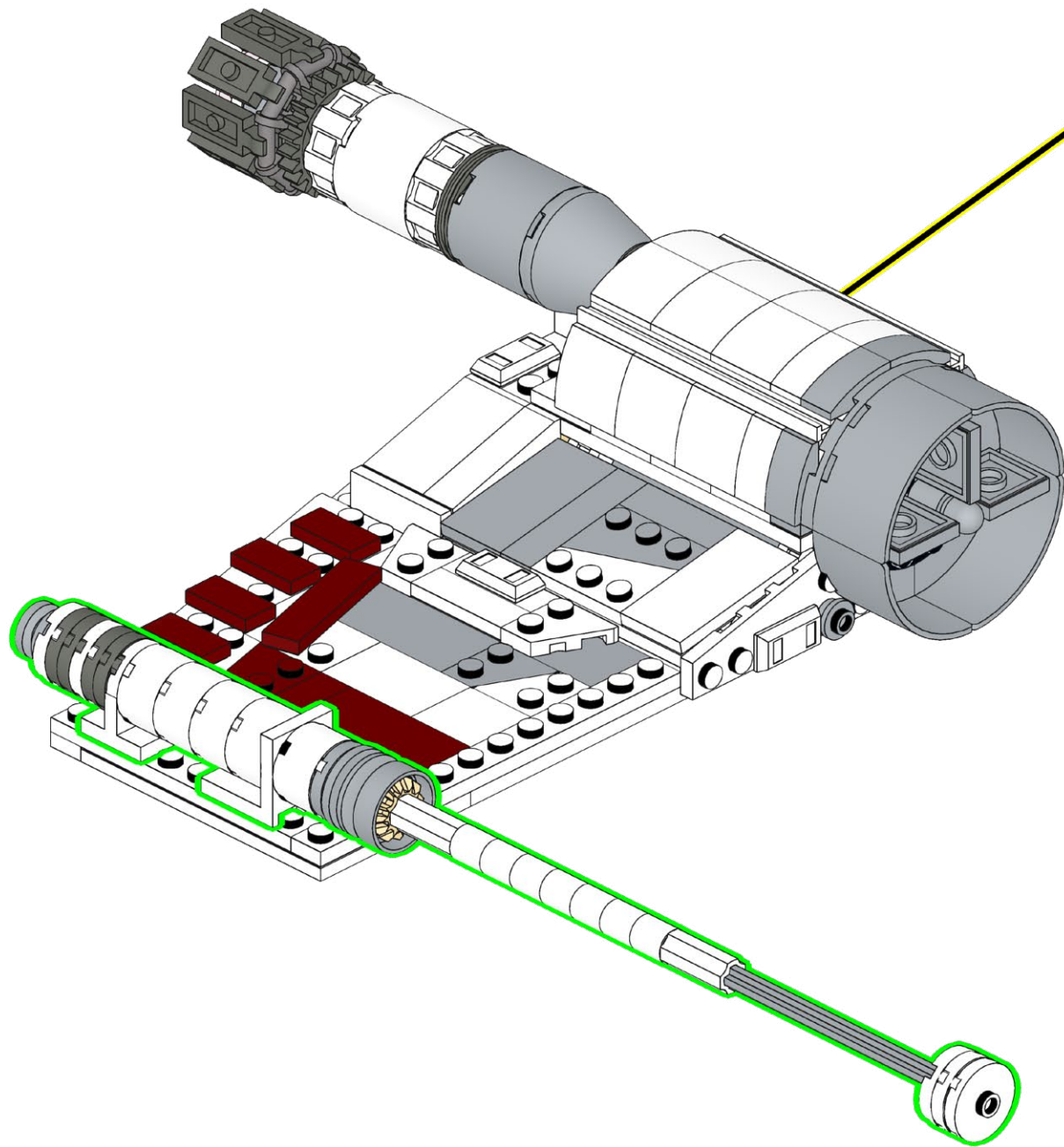

471

4x

3

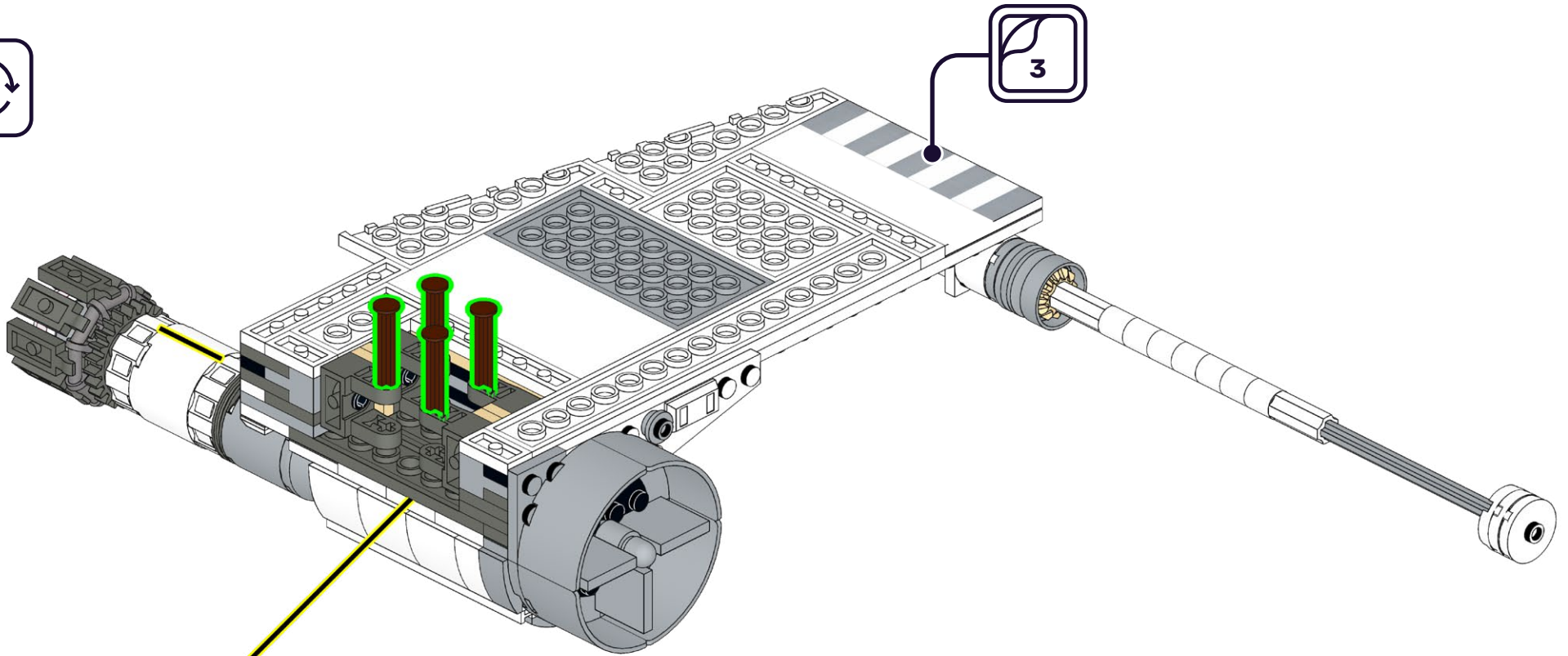

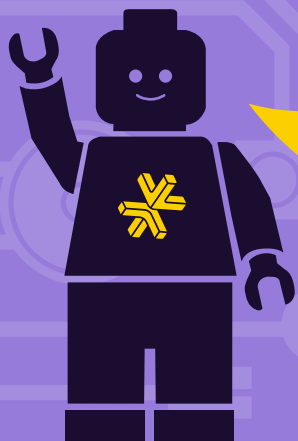
**HOLD UP!**

You might notice some bags aren't in order, as well as left over pieces, but that's ok! We're changing the way you build LEGO!

ATTENDEZ!

Vous remarquerez peut-être que certains sacs, ainsi que certaines pièces, ne sont pas dans le bon ordre. Mais pas de panique! Nous changeons simplement la façon avec laquelle vous construisez vos LEGO!

ASPETTA!

Potresti notare che alcuni sacchetti non sono in ordine, così come i pezzi avanzati, ma va bene così! Stiamo cambiando il modo in cui costruisci i LEGO!

HALT!

Sie werden möglicherweise bemerken, dass einige tüten durcheinander sind und teile übrig bleiben, aber das ist in Ordnung! Wir ändern die art und weise, wie Sie LEGO bauen!

¡ESPERA!

Es posible que notes que algunas bolsas están fuera de servicio, así como piezas sobrantes, ¡pero está bien! ¡Estamos cambiando la forma en que construyes LEGO!

暫停!

你可能会注意到一些袋子顺序错乱, 以及一些剩余的部件, 但没关系! 我们正在改变你搭建乐高的方式!

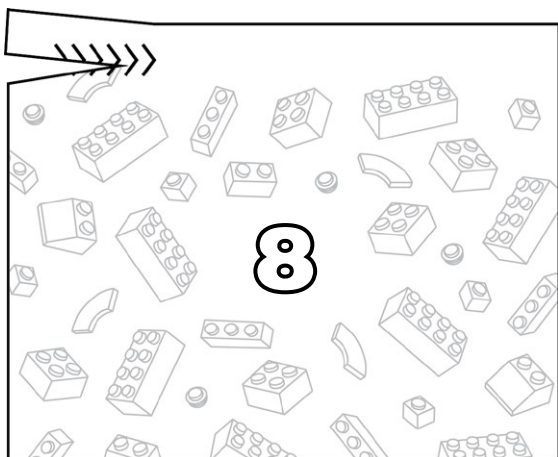
Open LEGO® Bag 8

472

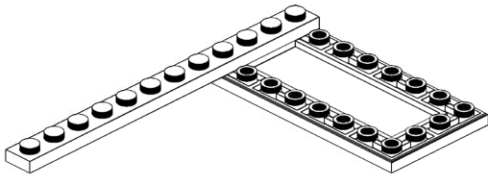
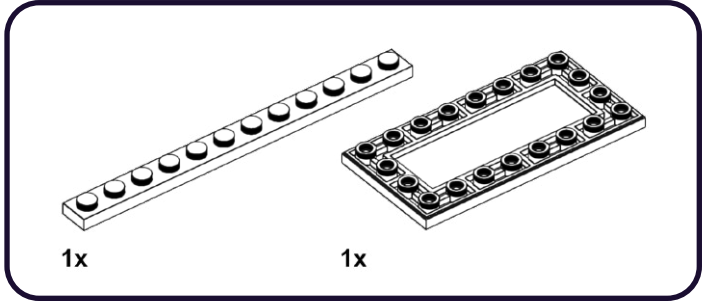

473

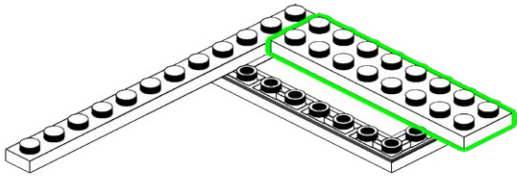
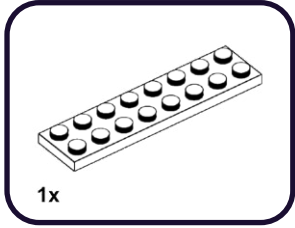

474

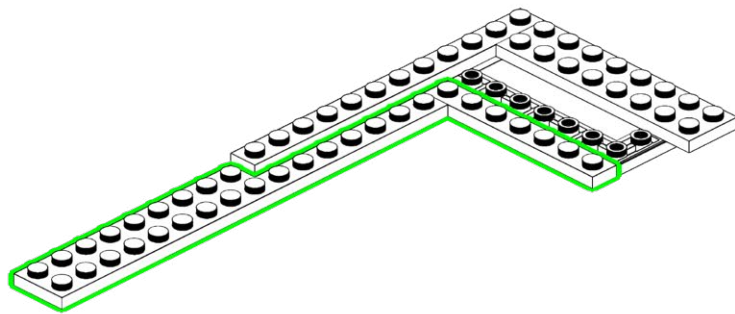
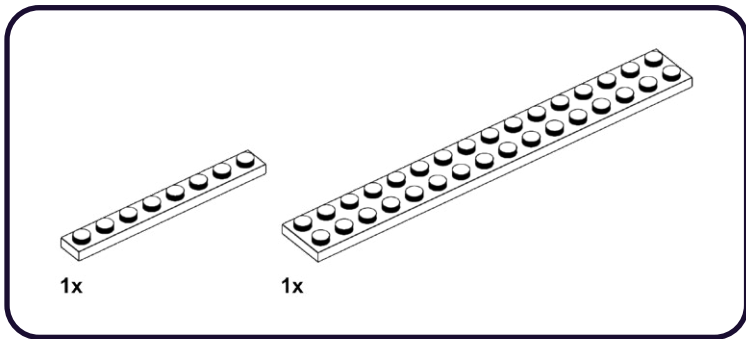

475

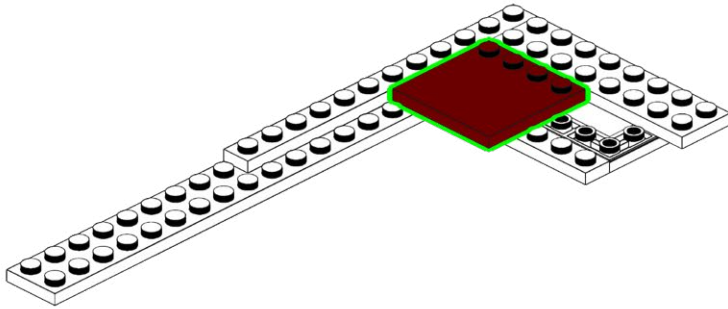
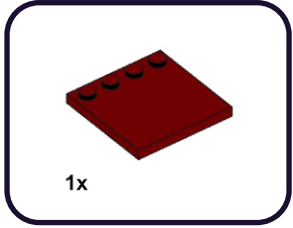

476

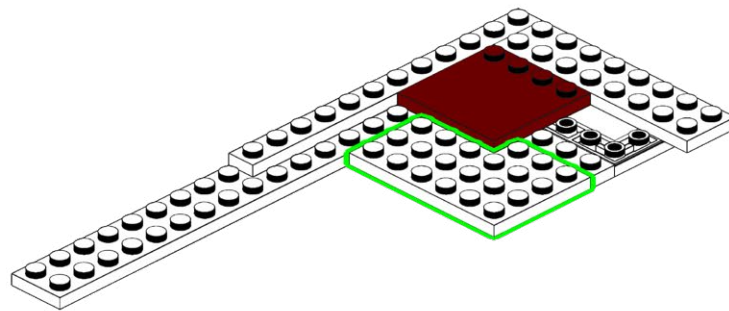
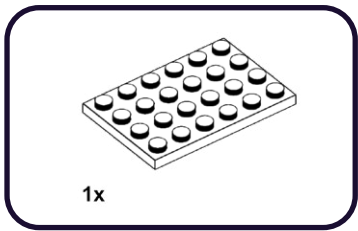

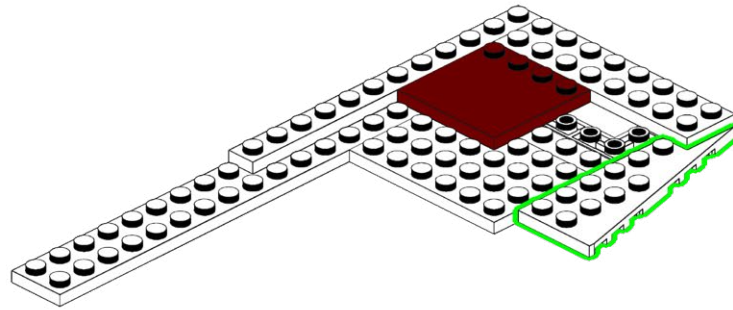
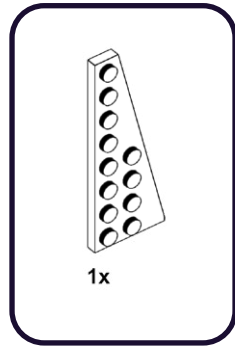
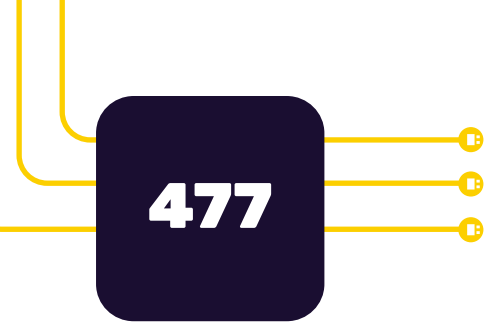

478

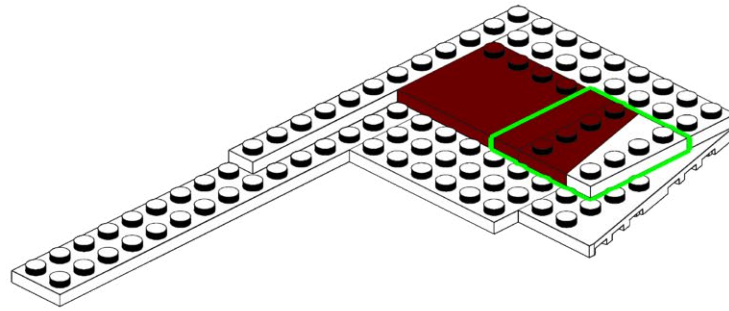
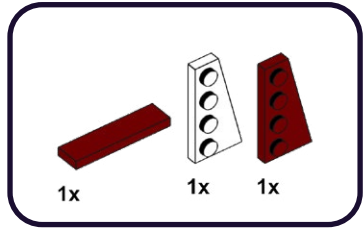

479

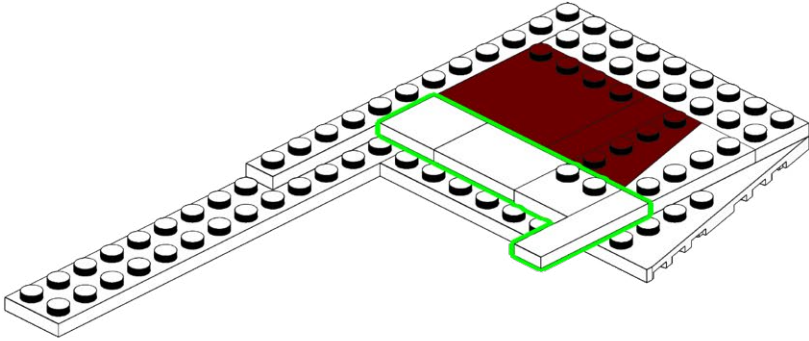
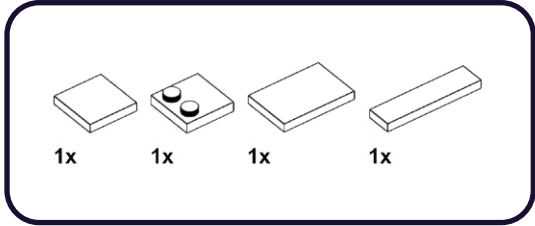

480

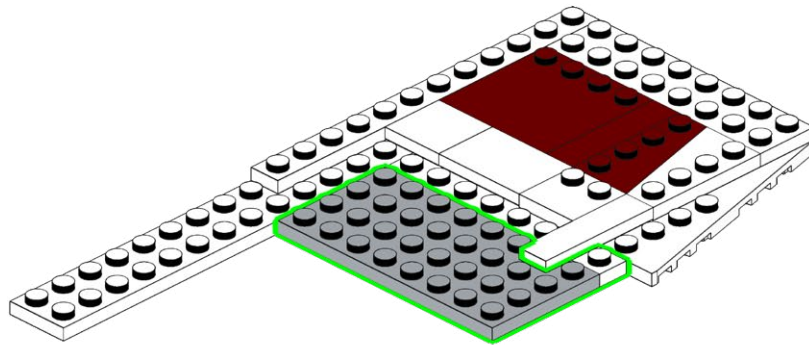
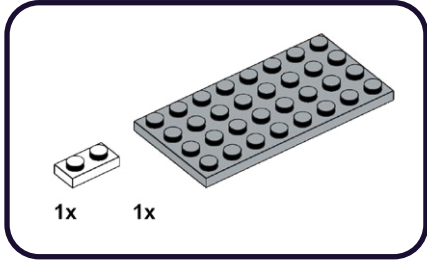

481

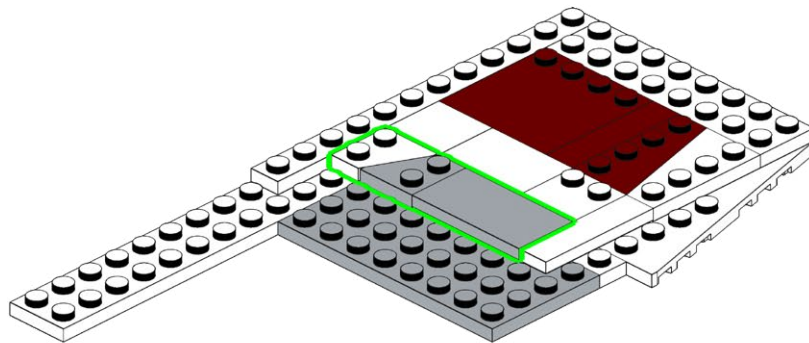
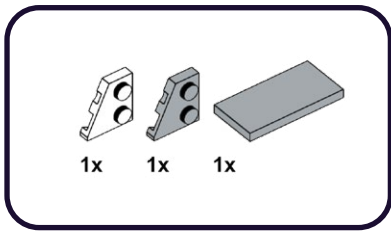

482

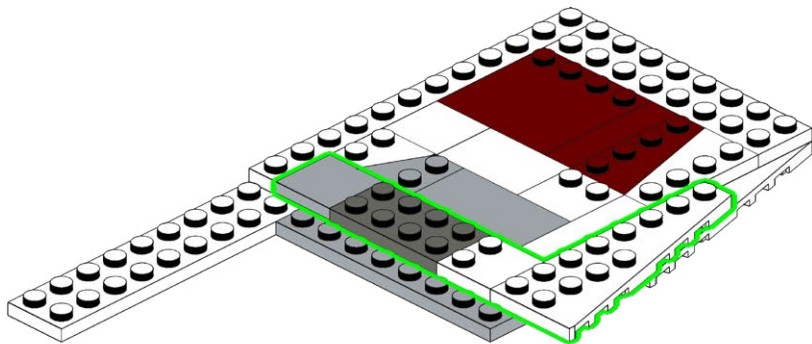
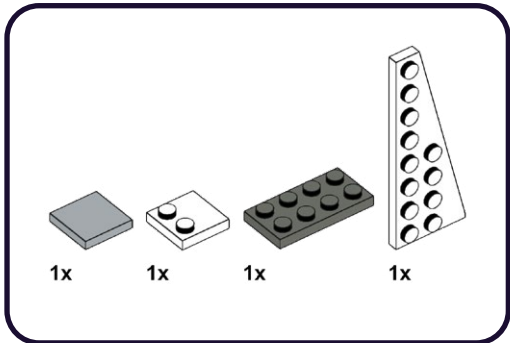

483

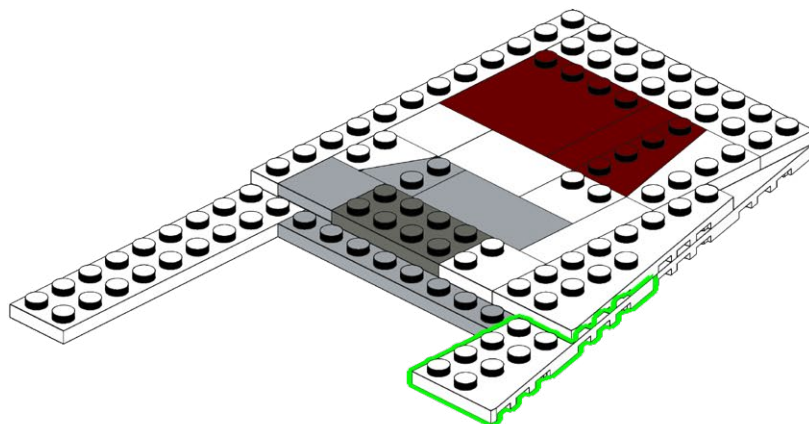
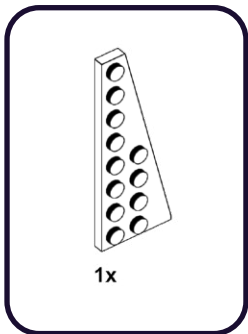

484

1x

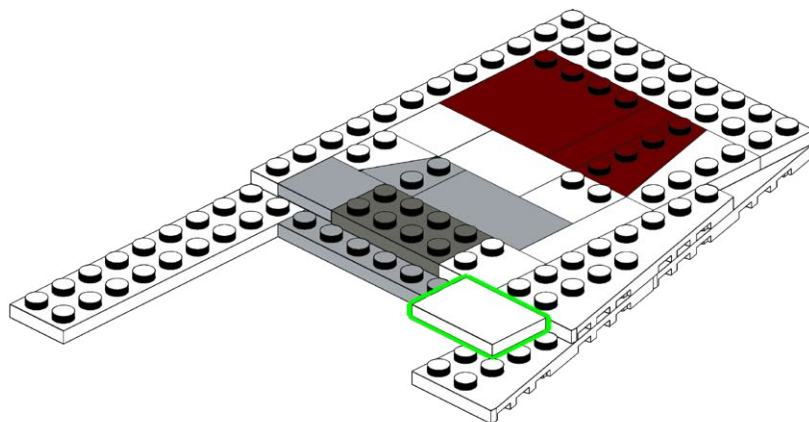

485

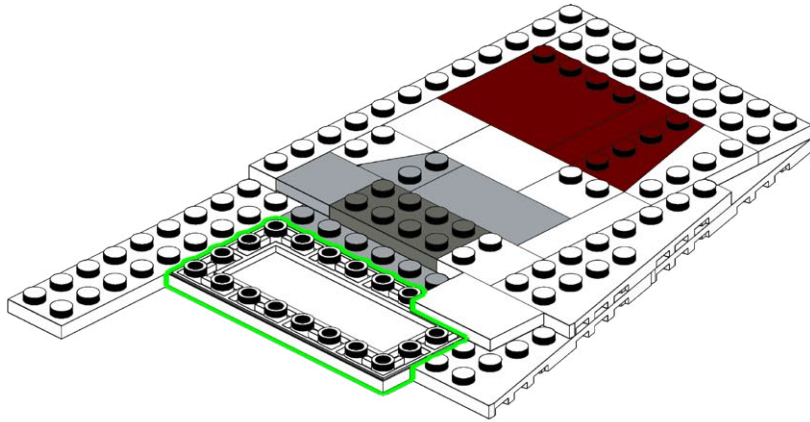
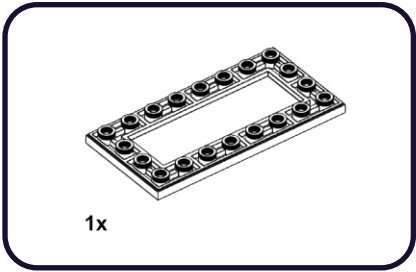

486

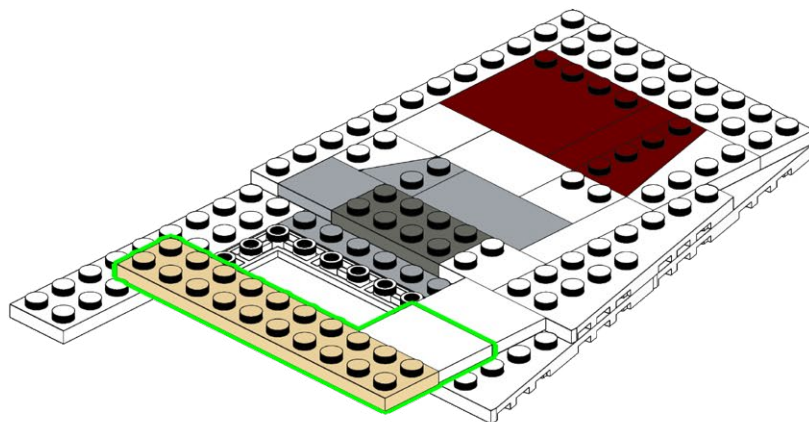
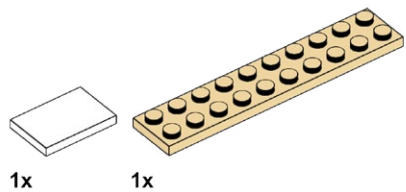

487

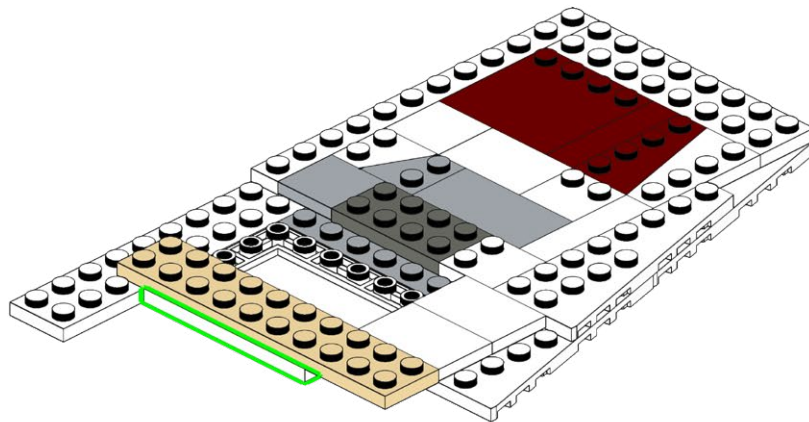
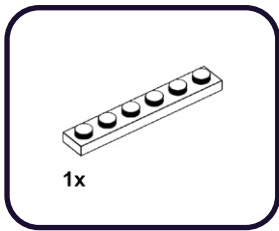

488

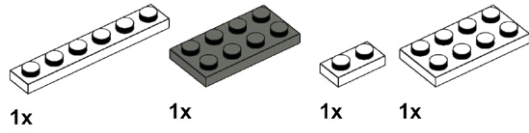

- 1
- 2
- 3

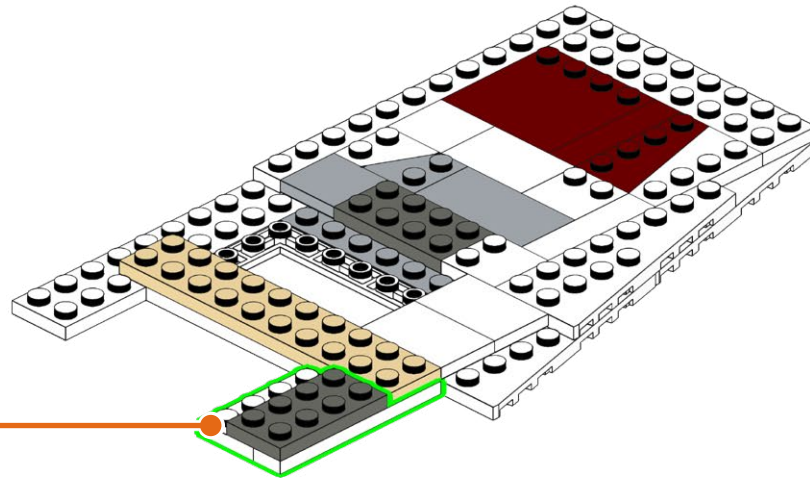

489

1x

1x

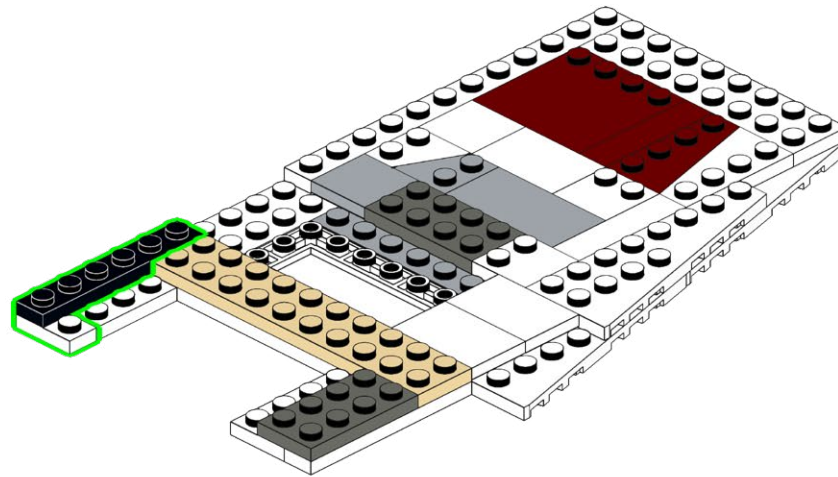

490

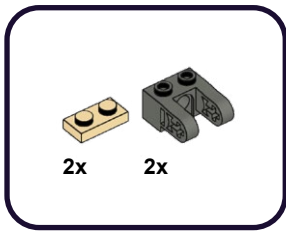

1

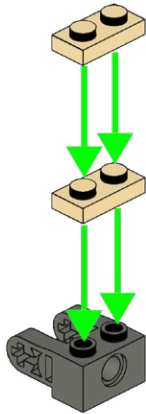

2

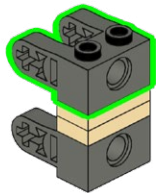

491

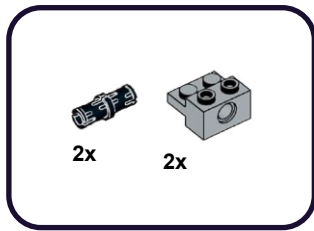

1

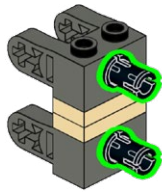

2

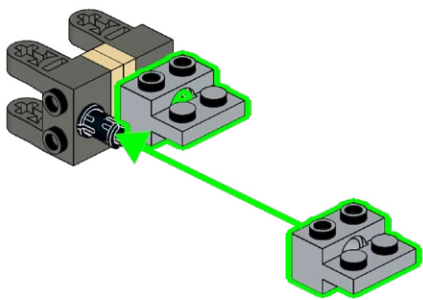

492

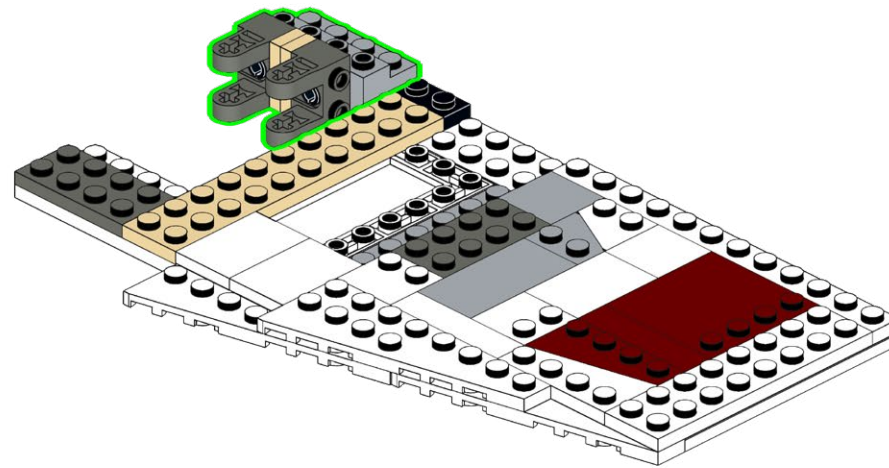

493

2x

2x

1

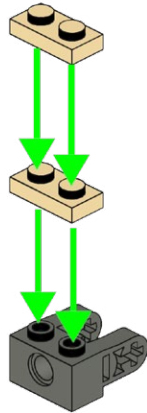

2

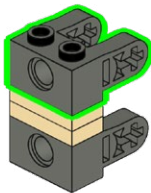

494

2x

2x

1

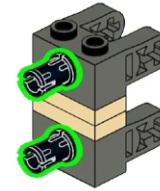

2

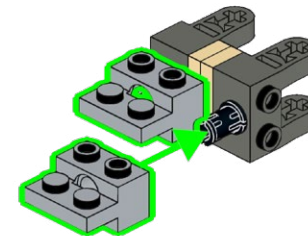

495

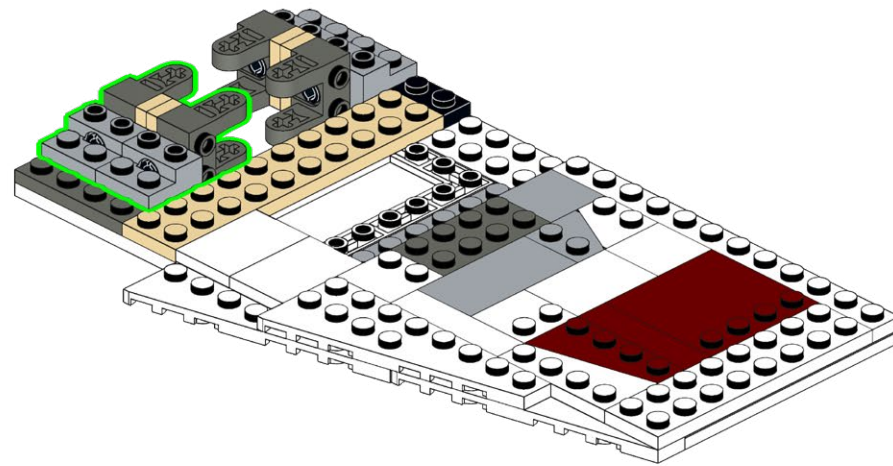

496

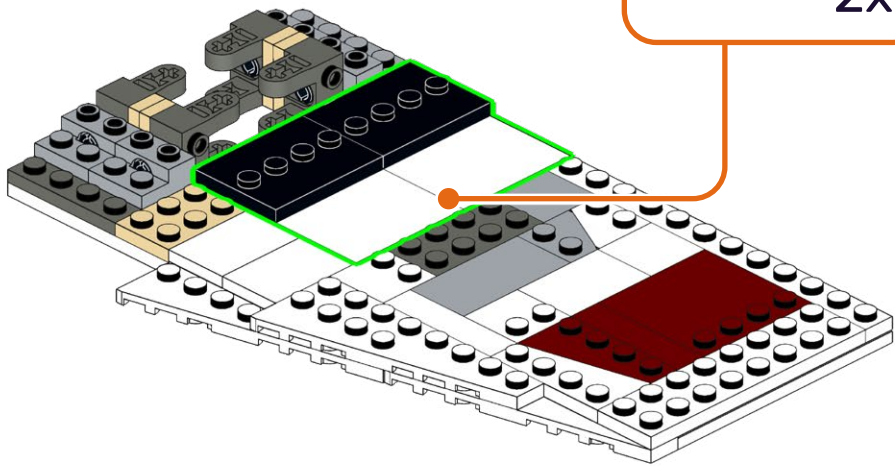
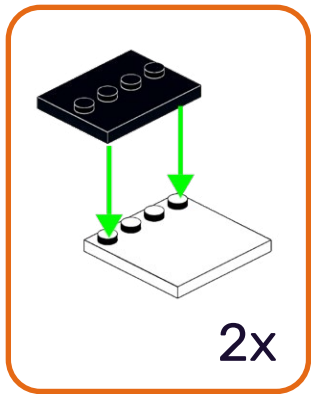
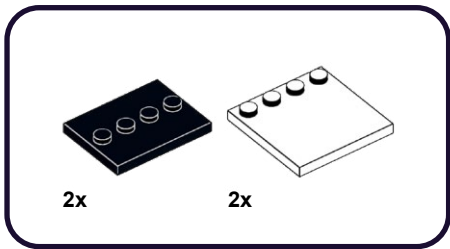

497

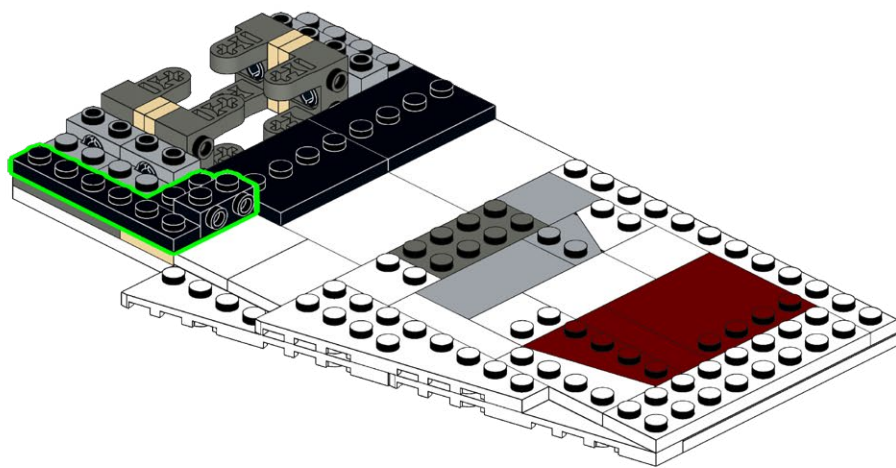
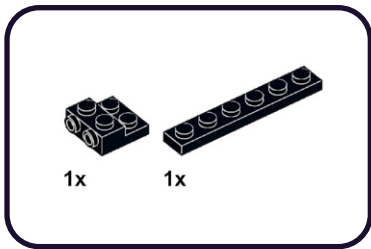

498

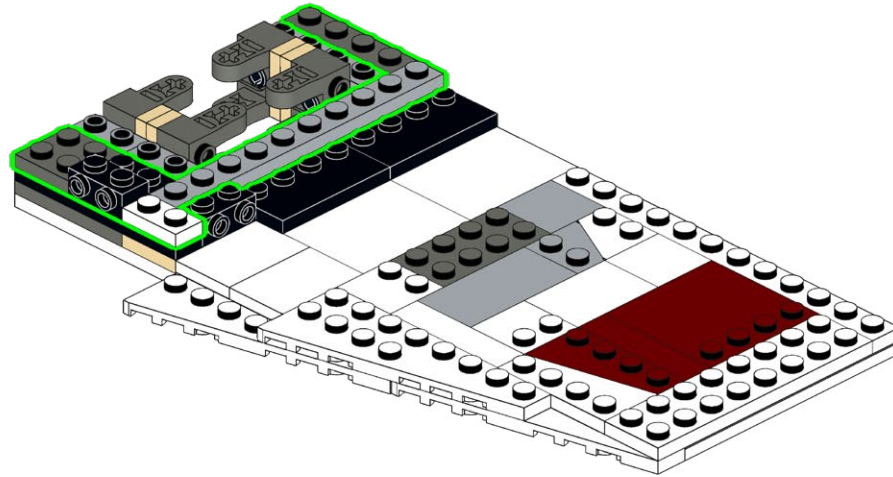
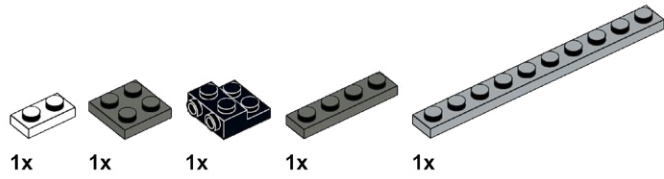

499

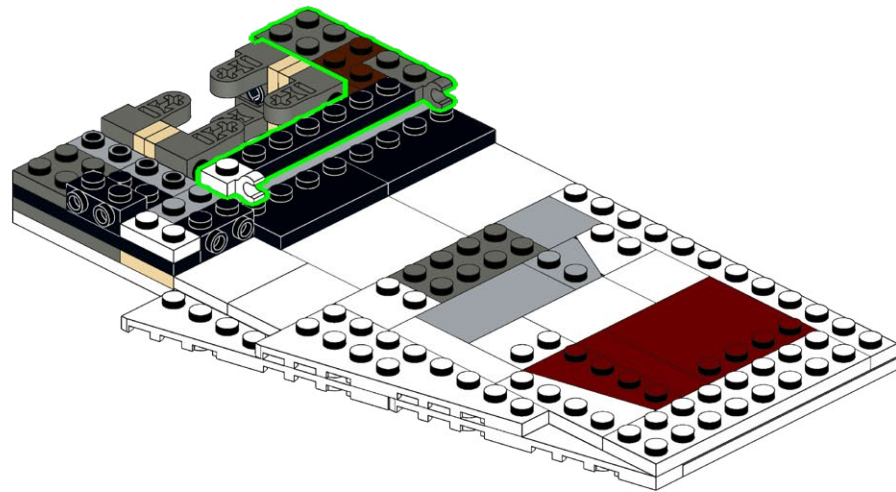
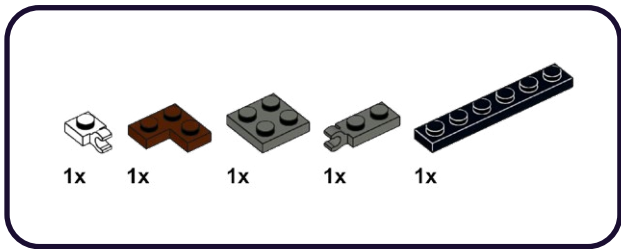

500

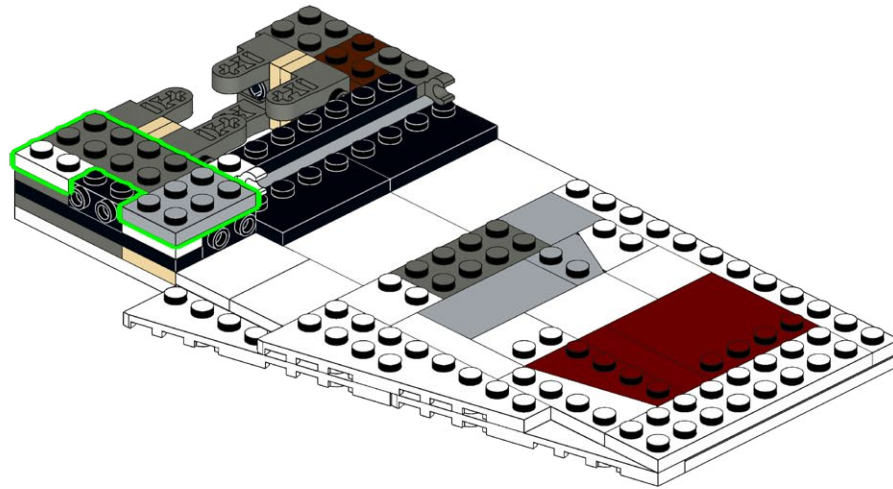
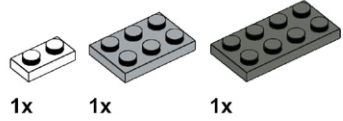

501

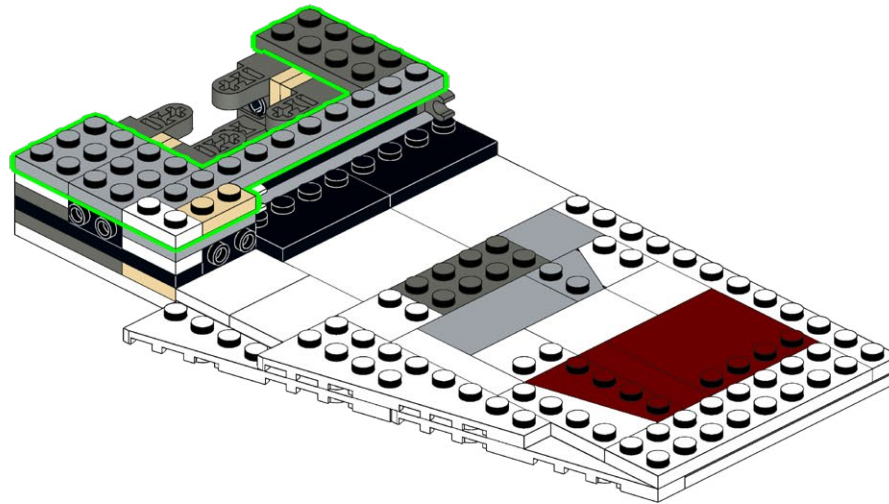
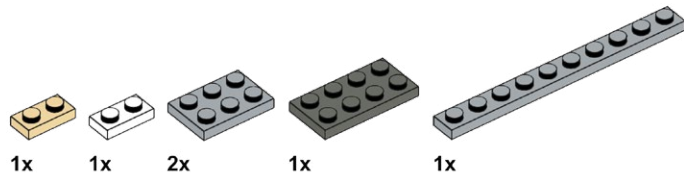

502

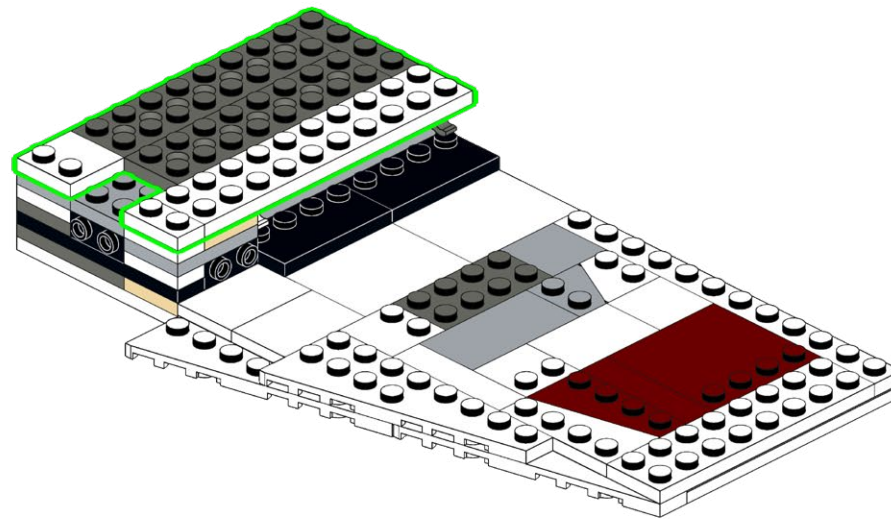
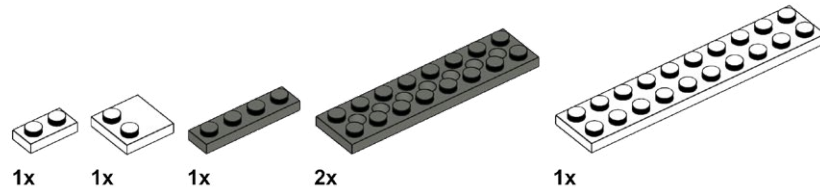

503

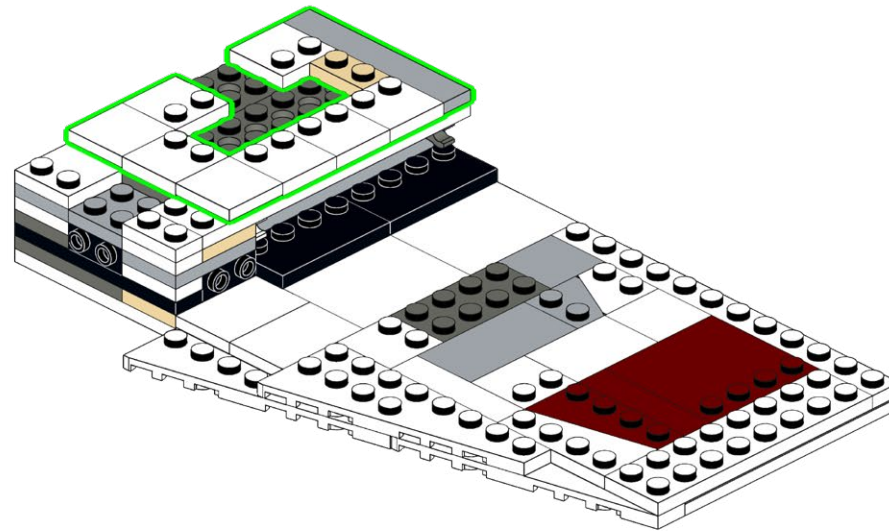
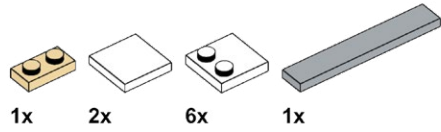

504

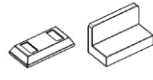

2x

2x

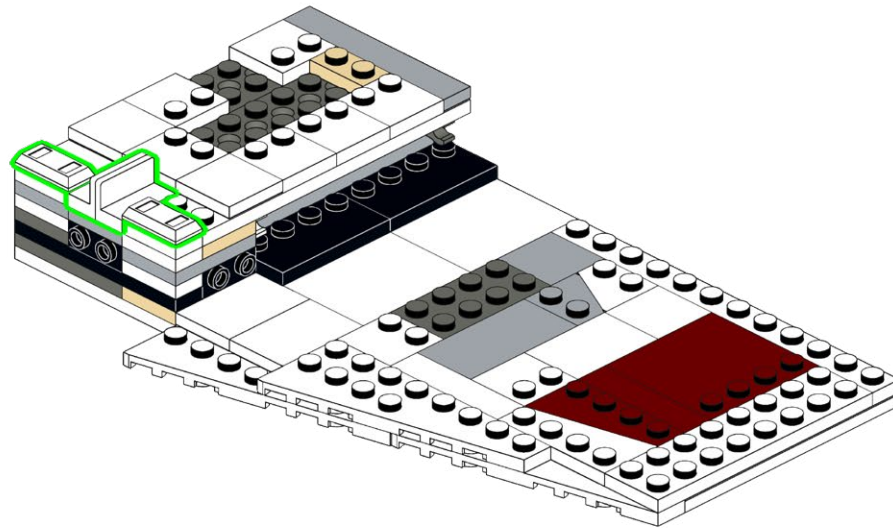

505

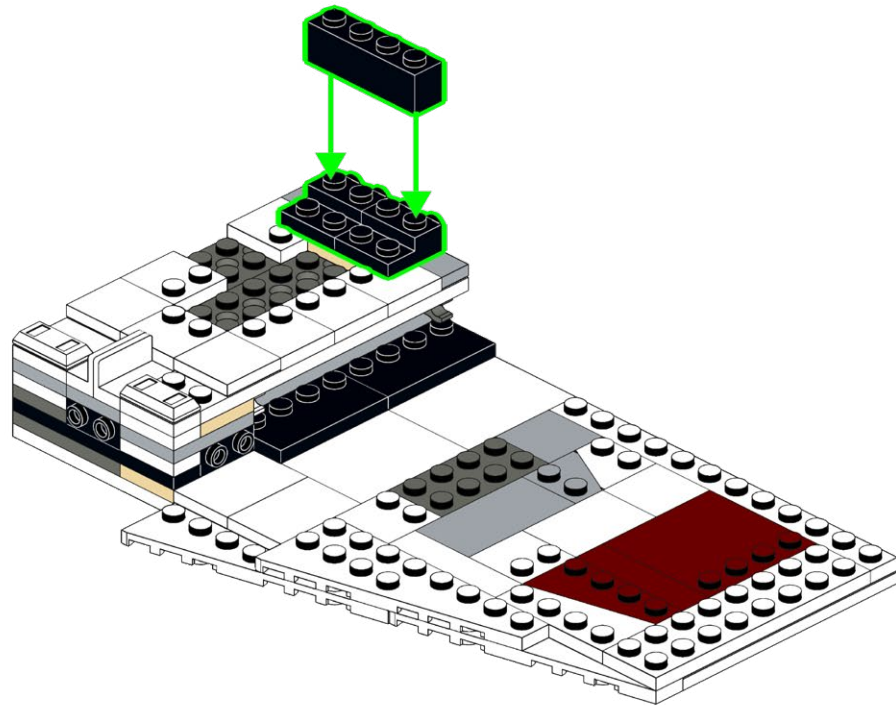
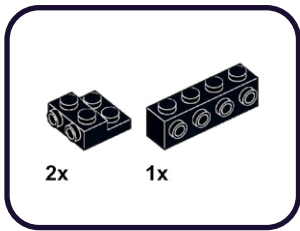

506



1x

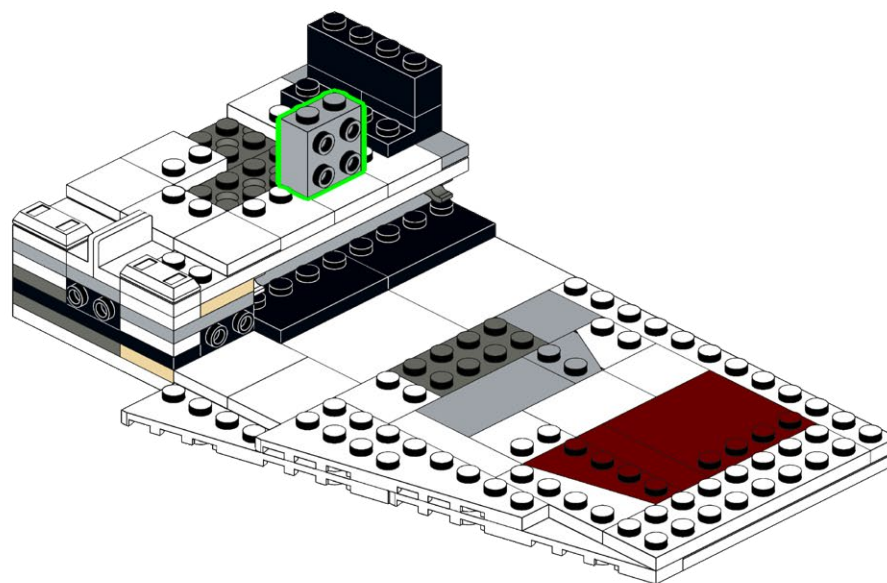

507

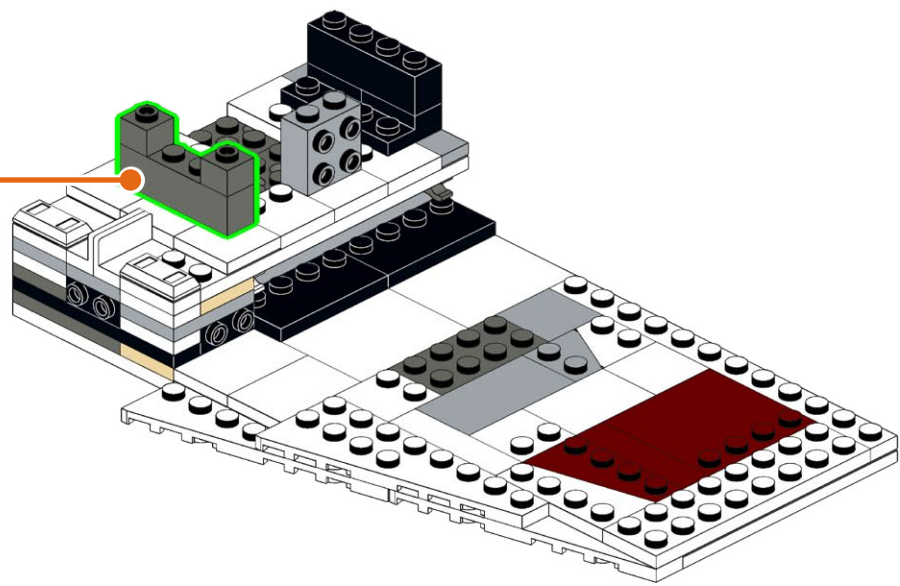
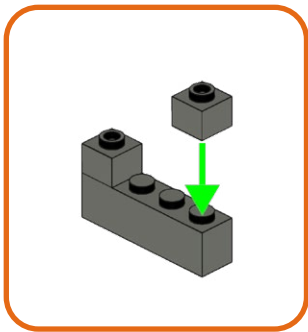
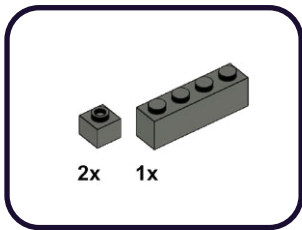

508

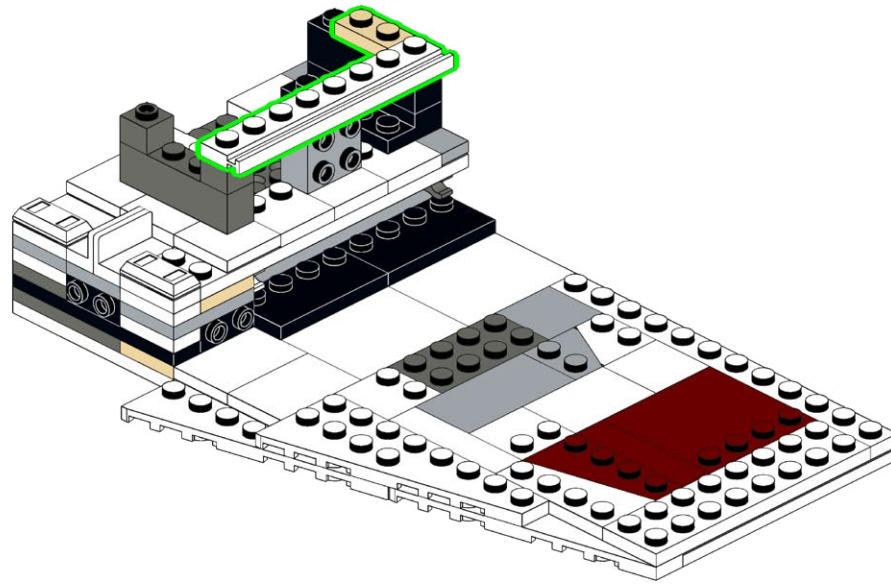
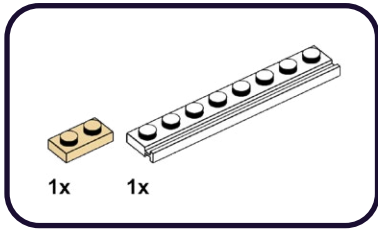

509

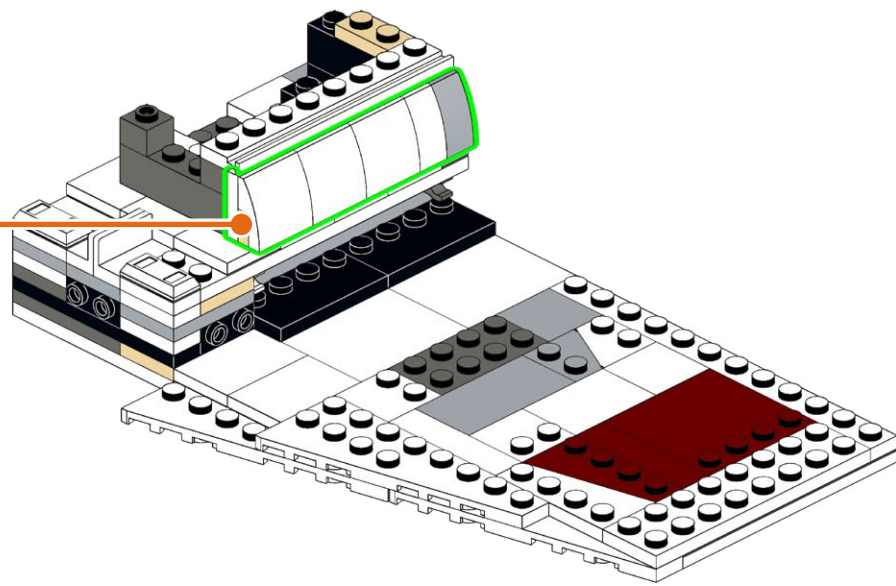
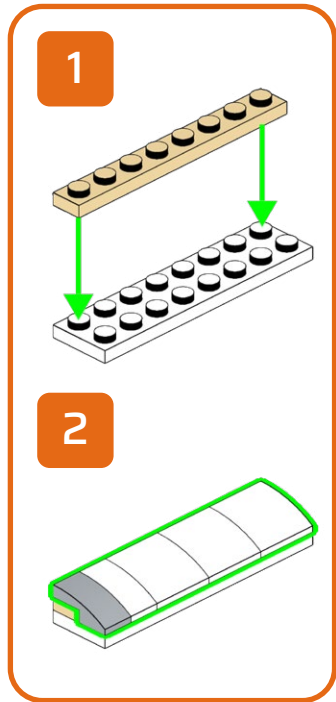
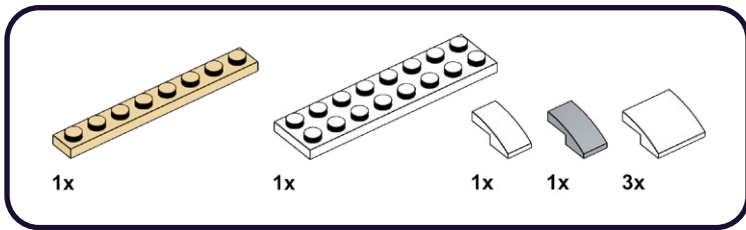

510

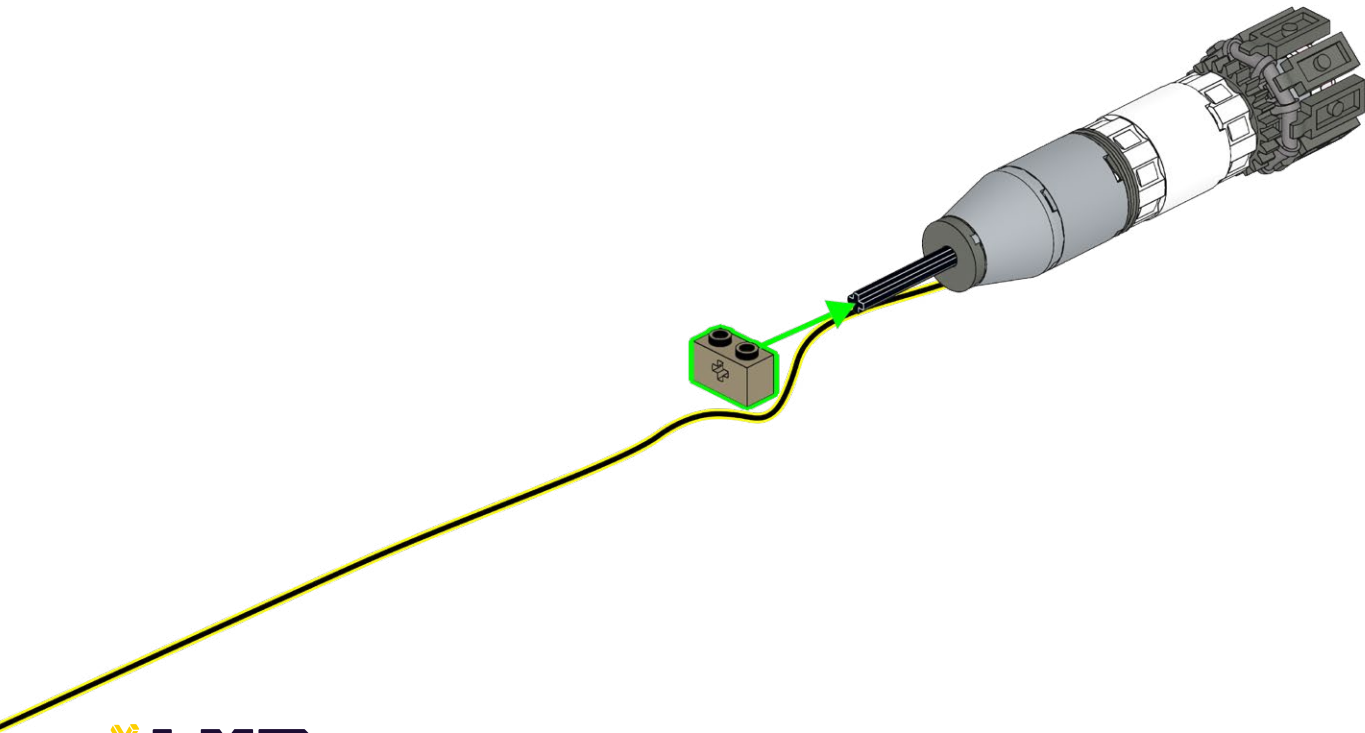
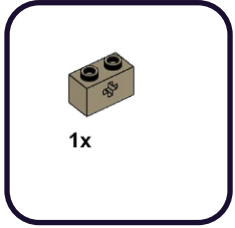

511

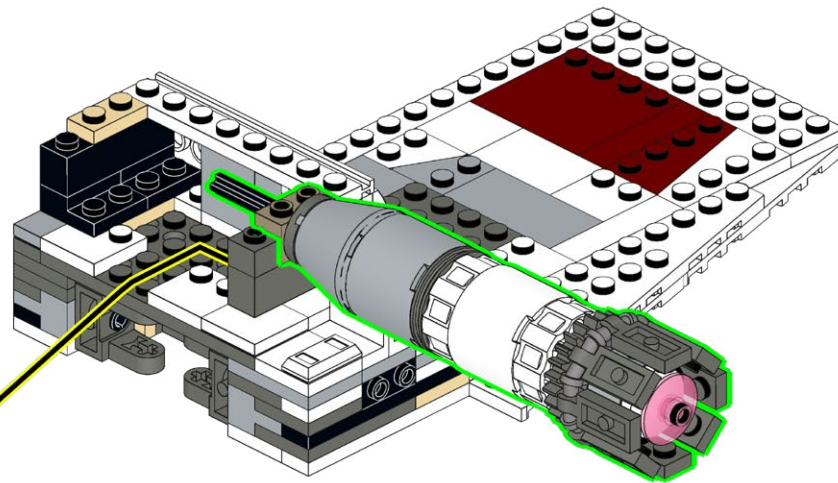

512

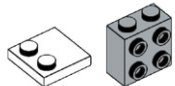

1x

1x

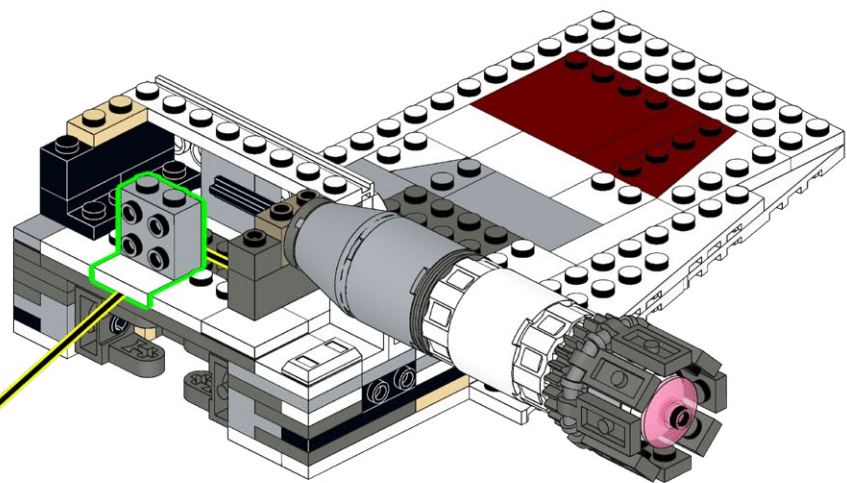

513

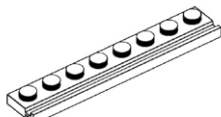

1x

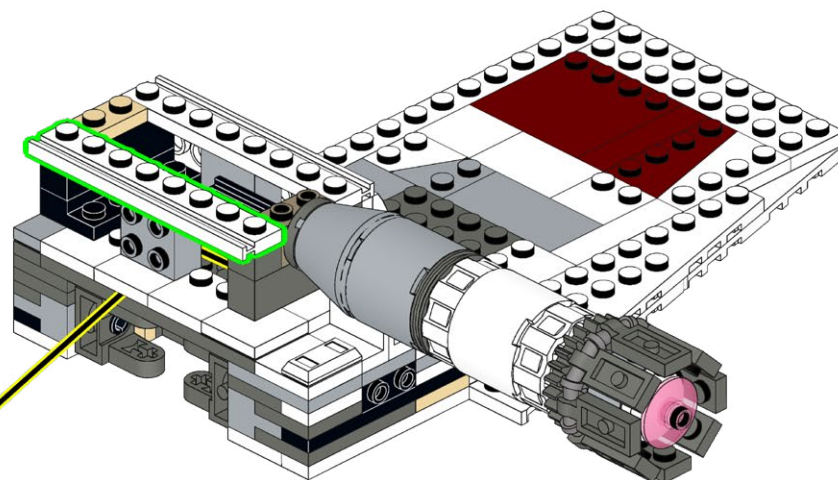

514

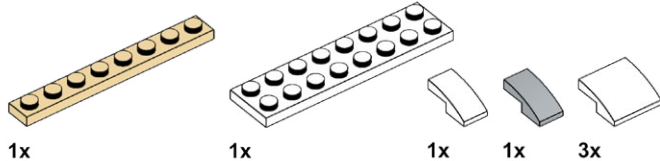

1

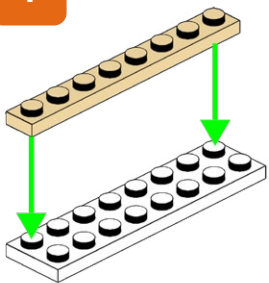

2

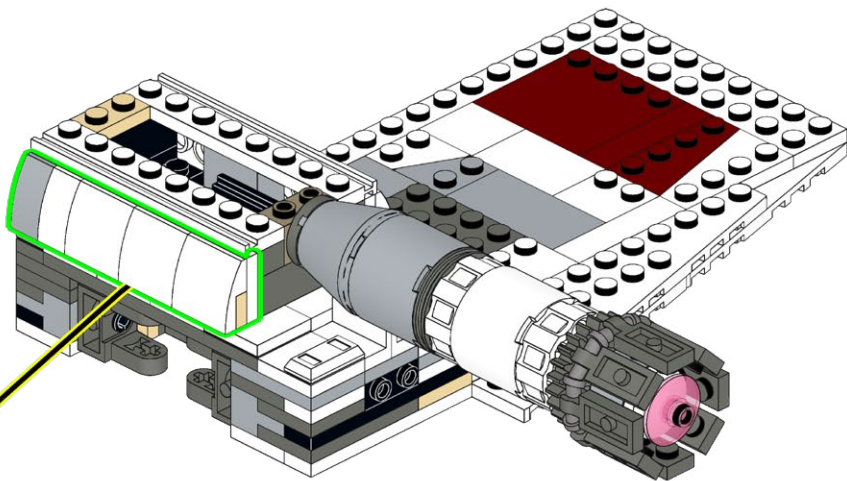
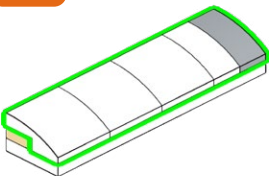

515

1x

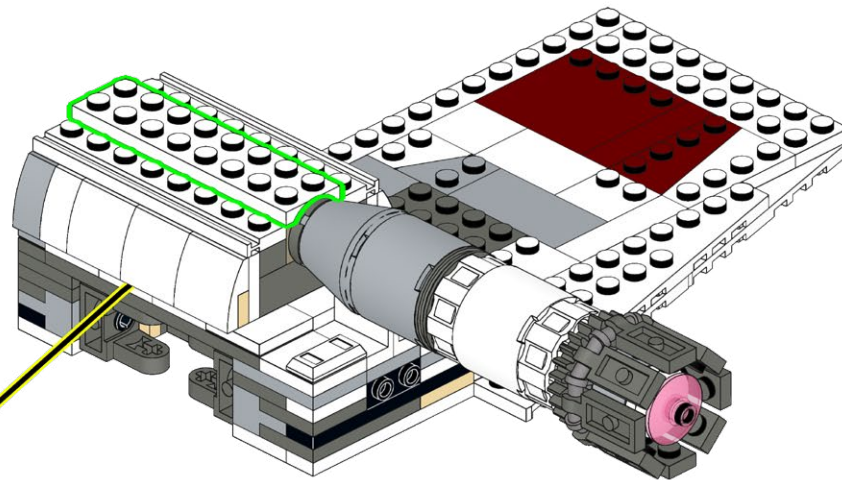

516

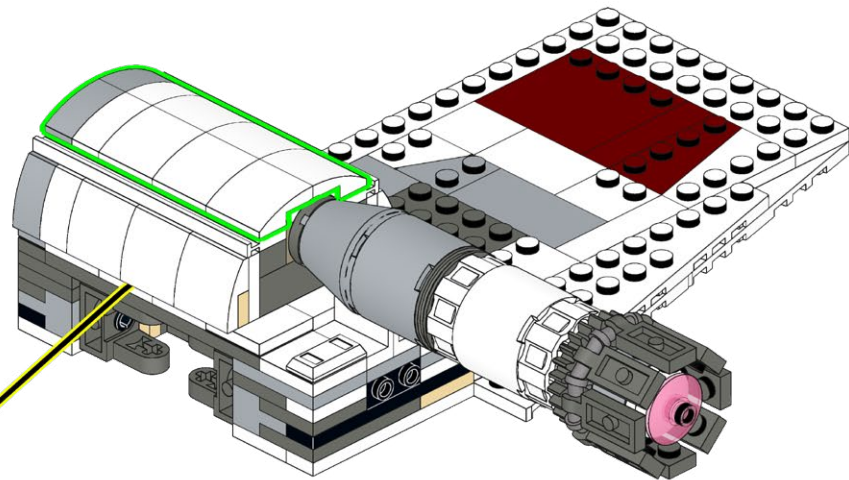
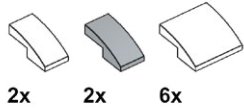

517

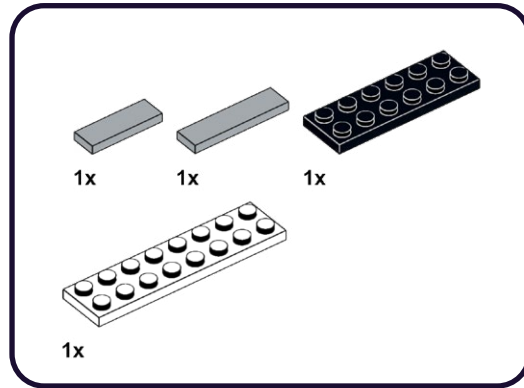

1

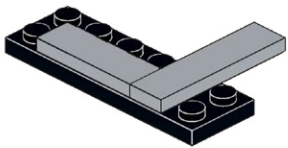

2

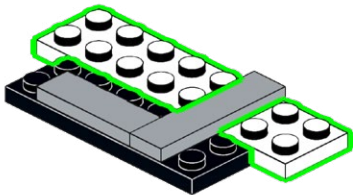

518

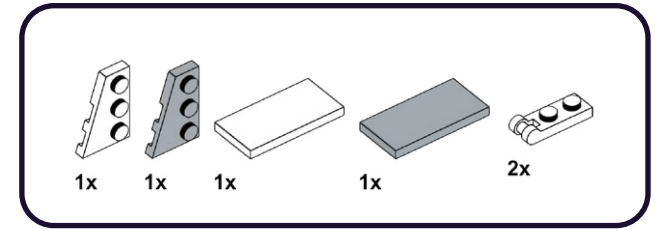

1

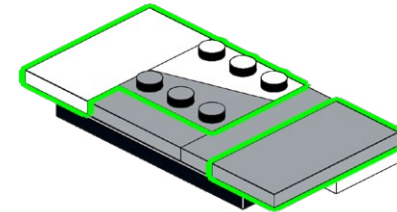

2

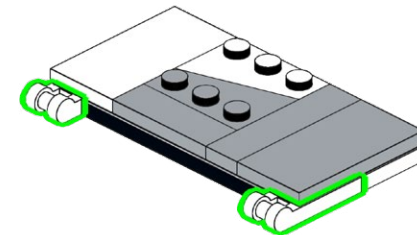

519

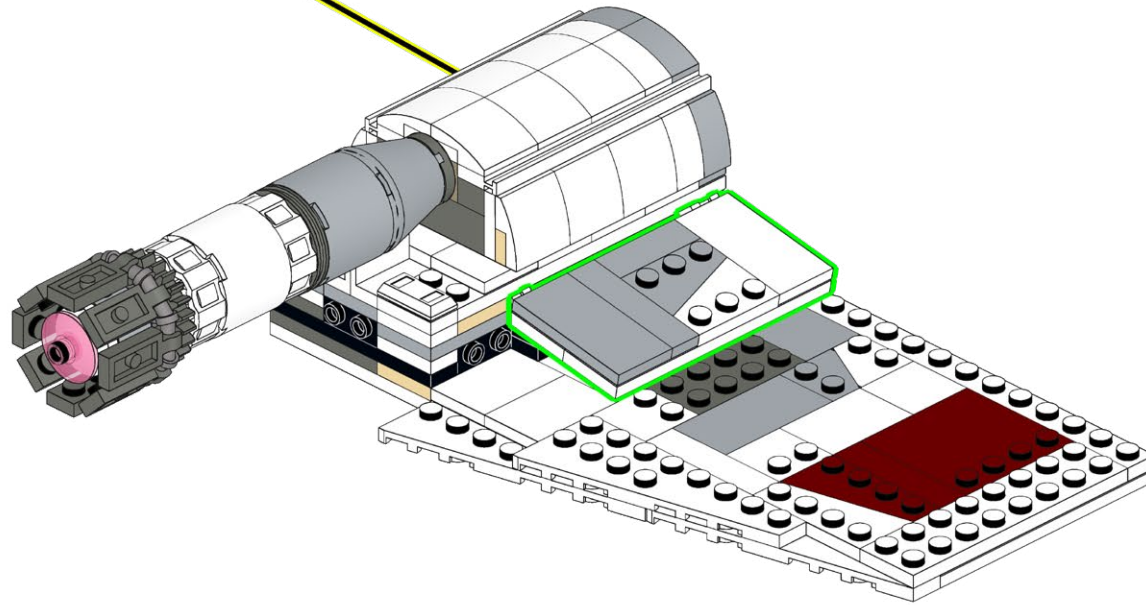

520

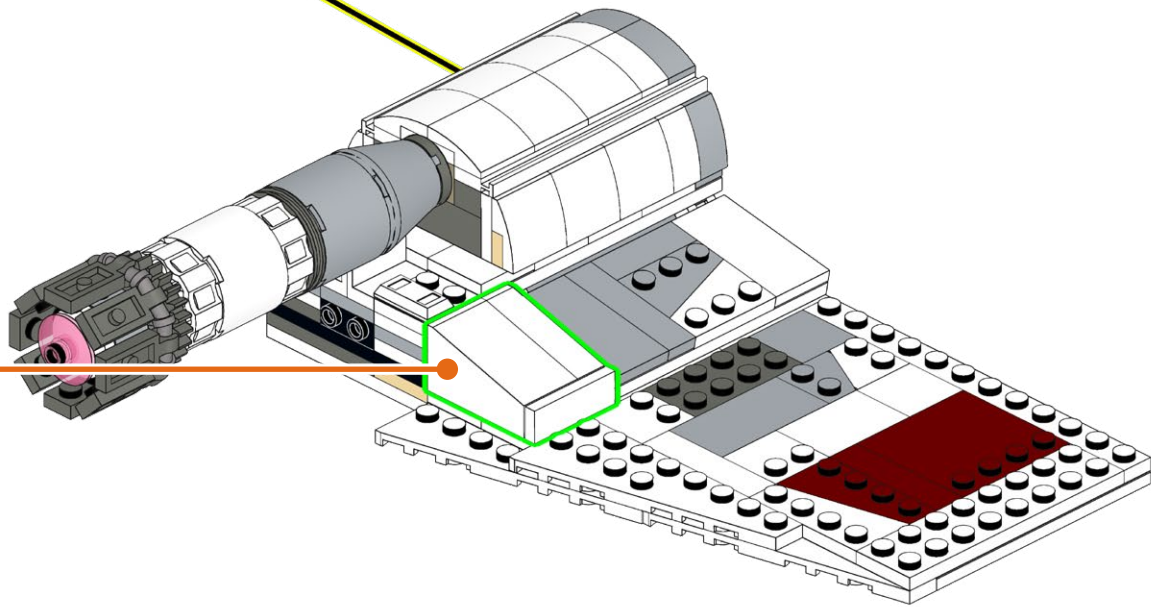
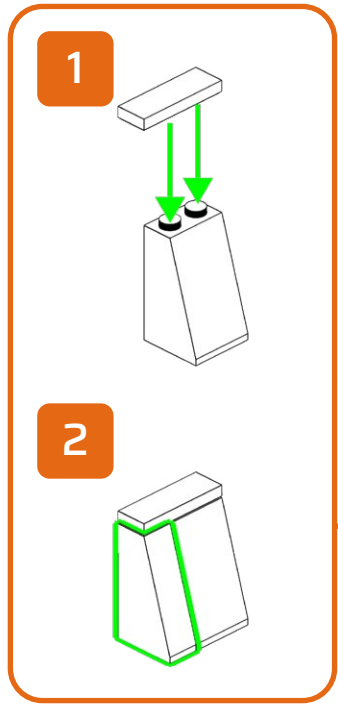
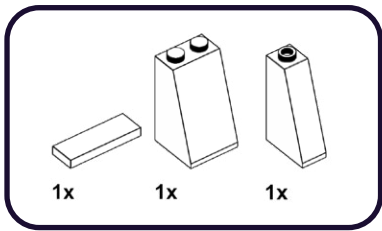

521

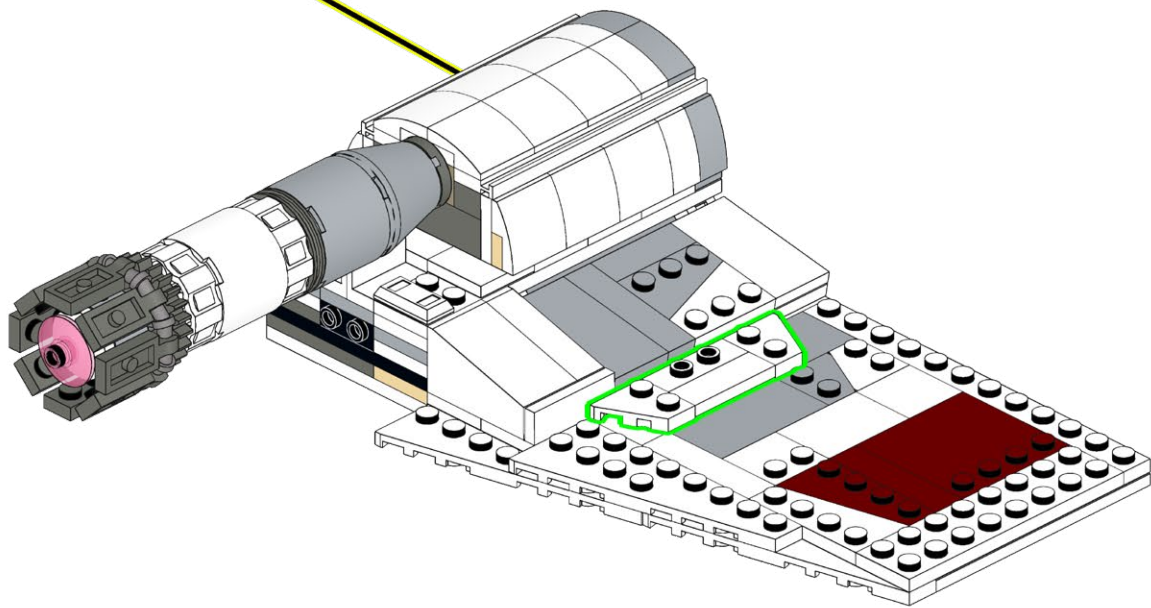
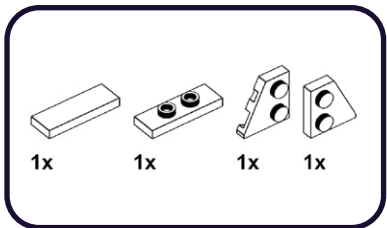

522

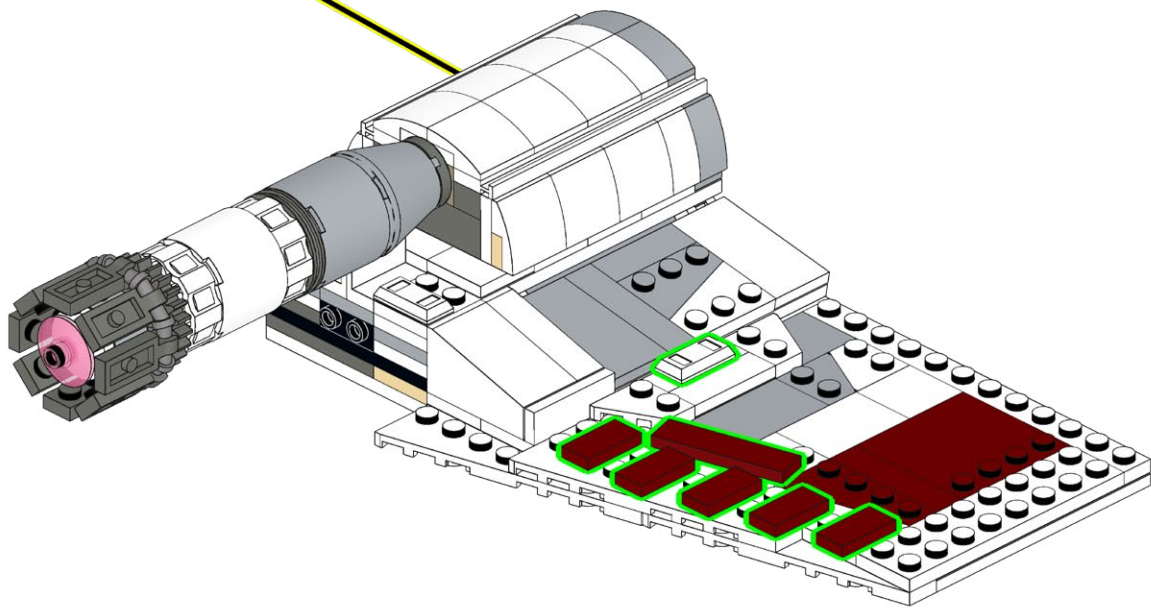
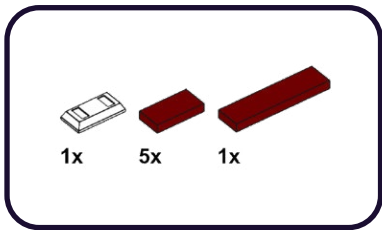

523

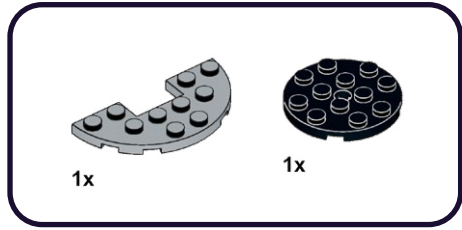

1

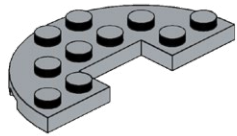

2

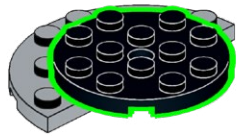

524

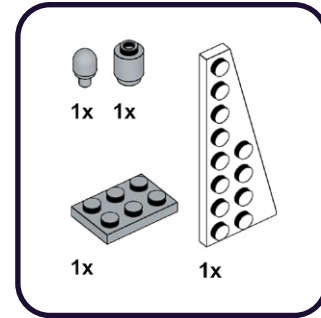

1

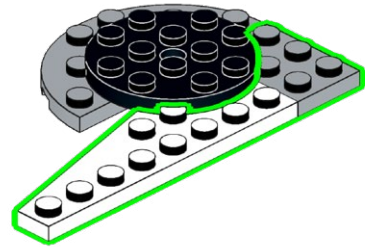

2

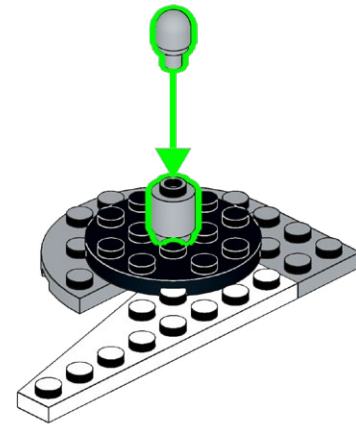

525

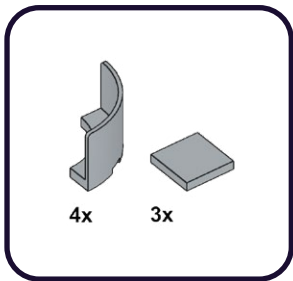

1

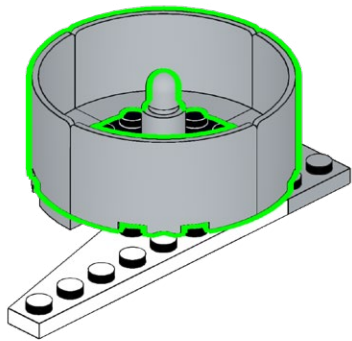

2

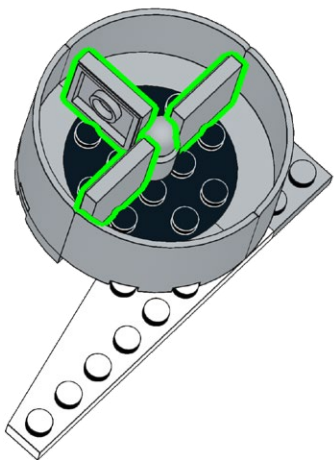

526

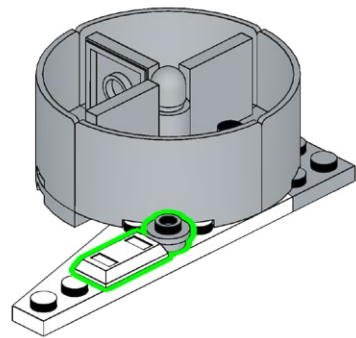
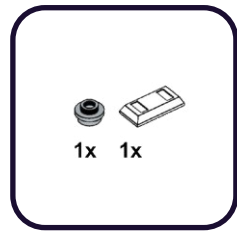

527

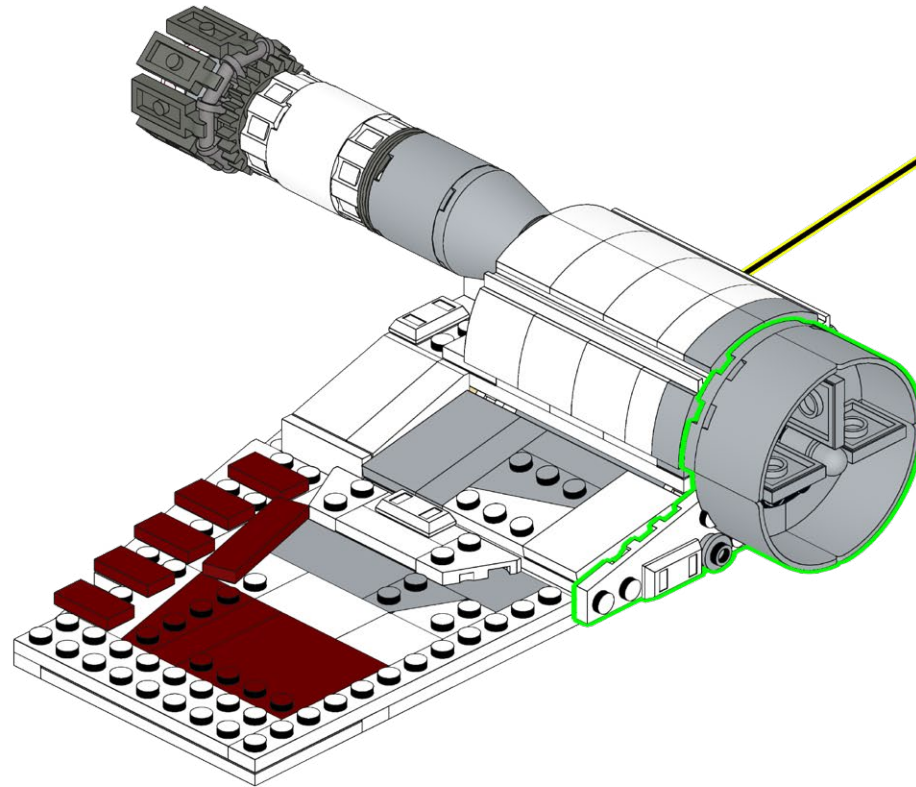

528

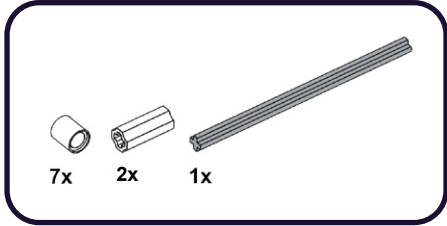

1

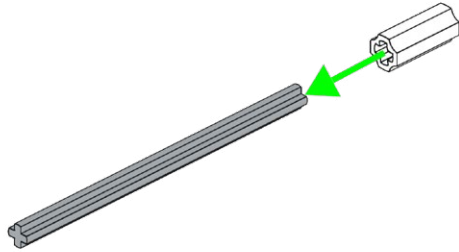

2

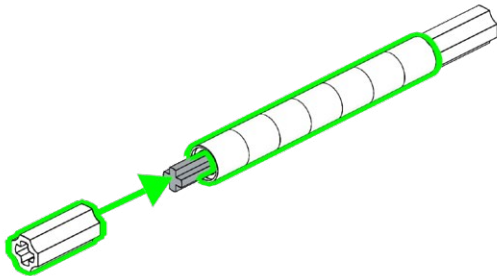

529

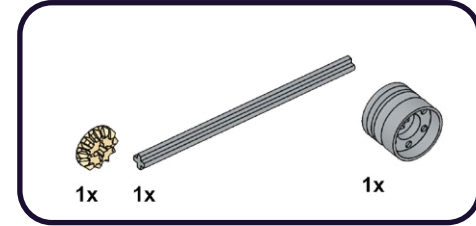

1

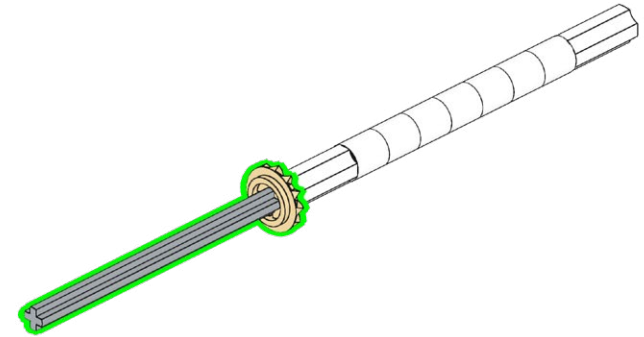

2

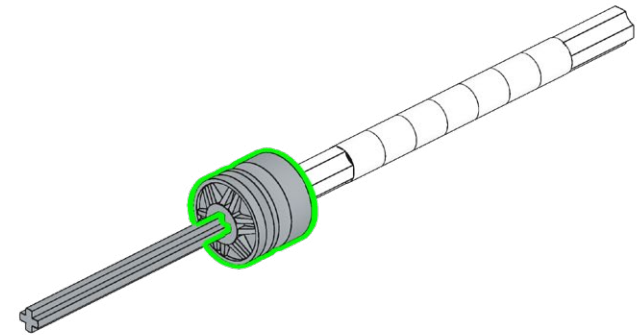

530

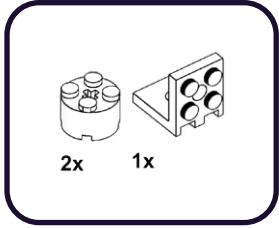

1

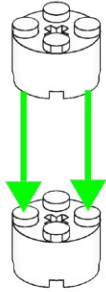

2

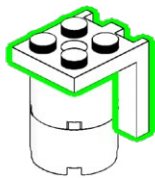

531

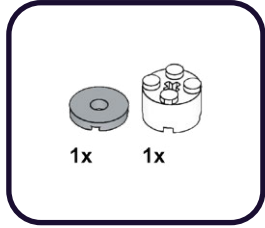

1

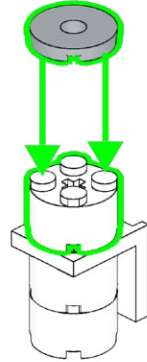

2

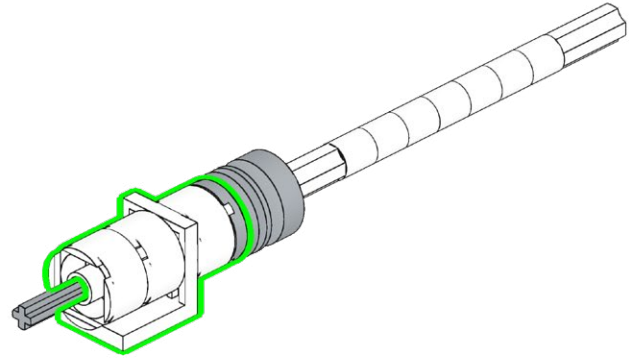

532

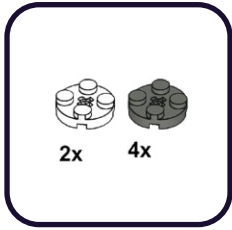

1

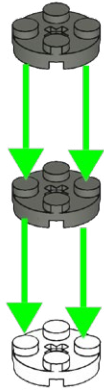

2

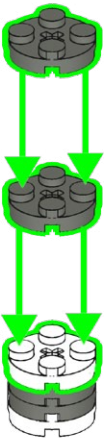

533

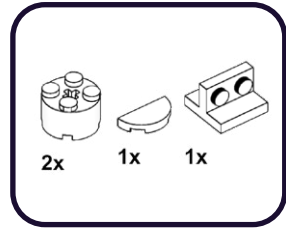

1

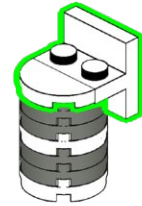

2

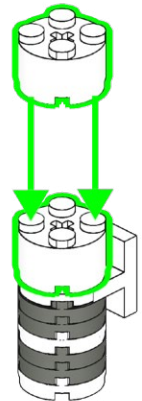

534

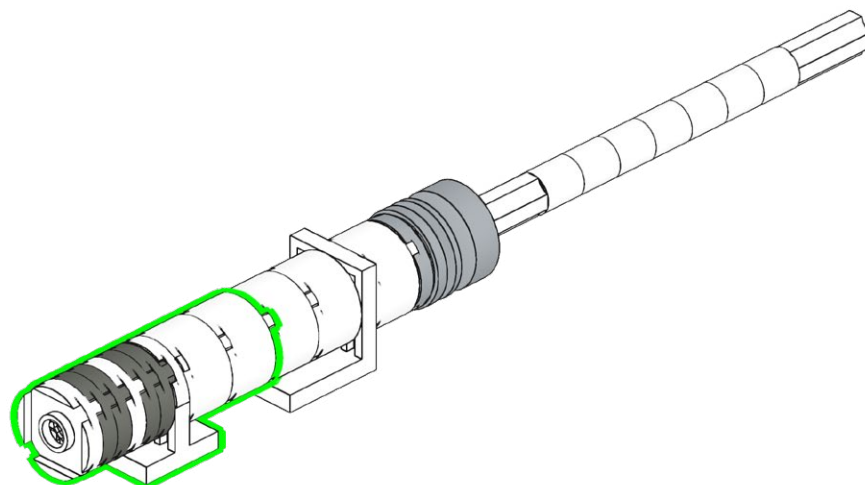

535

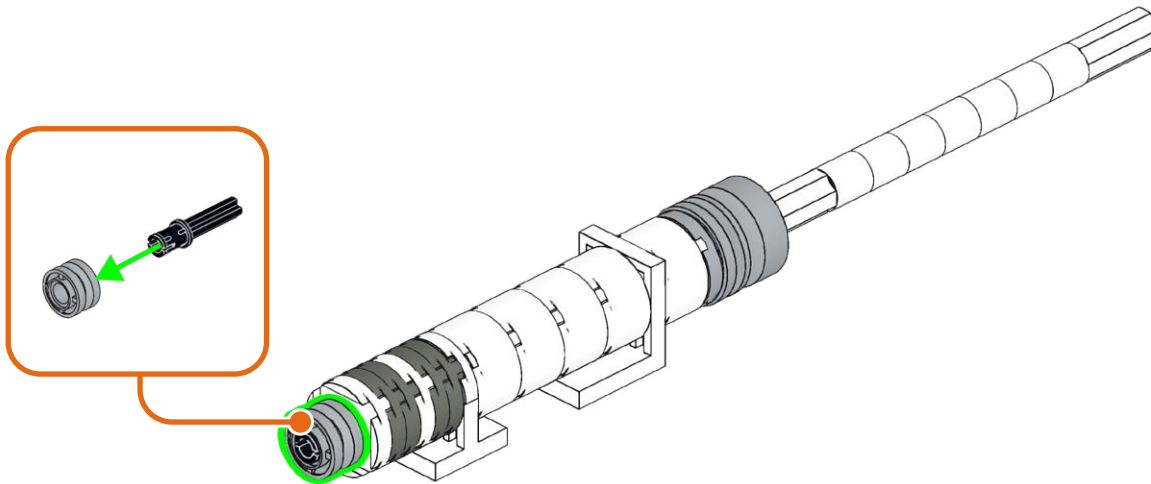
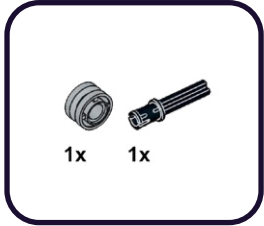

536

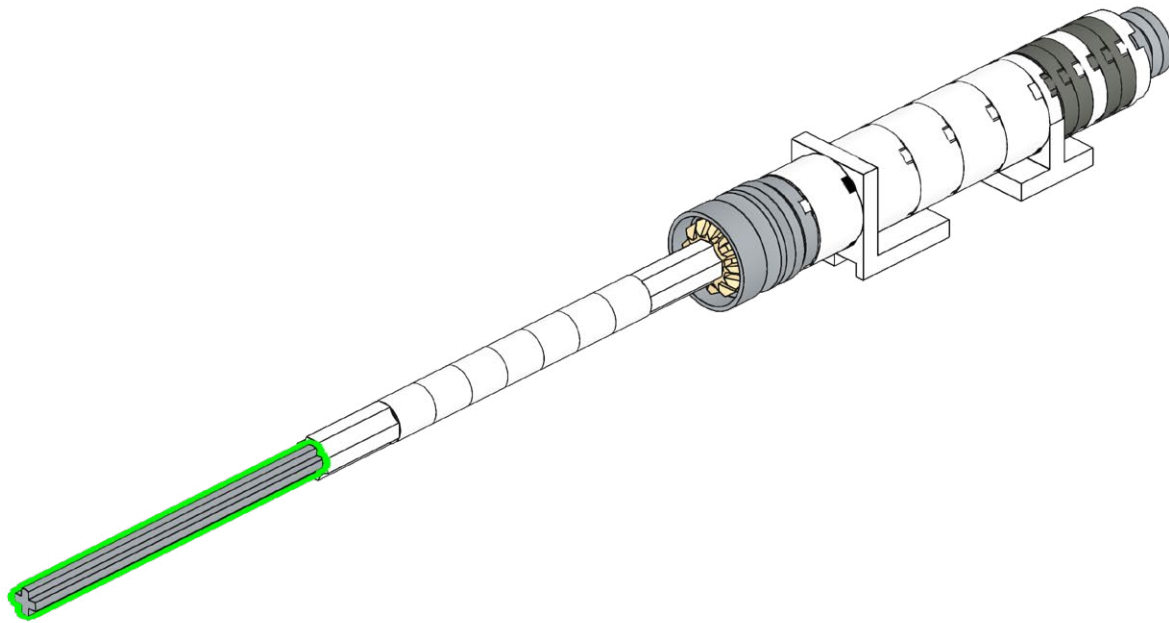
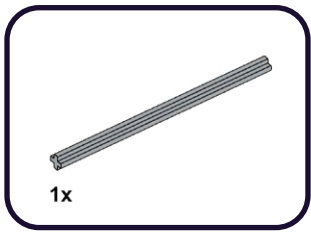

537

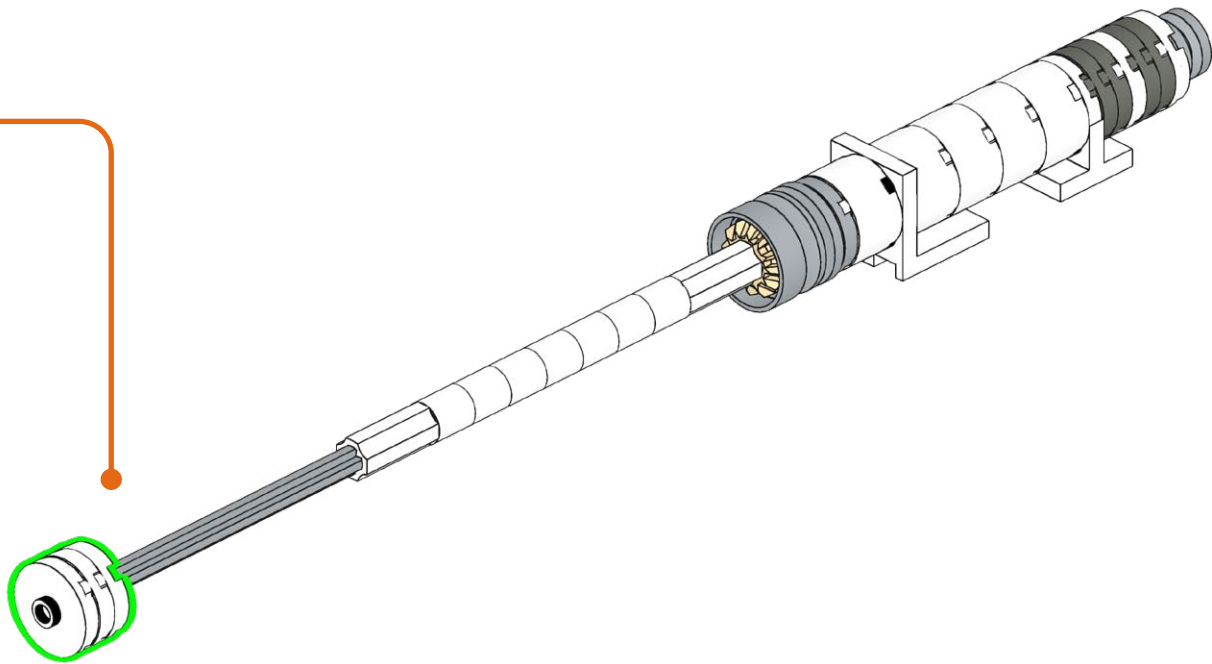
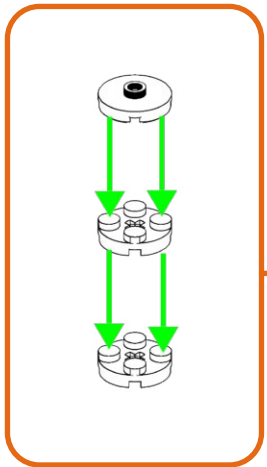
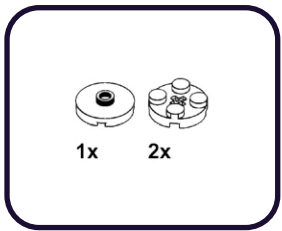

538

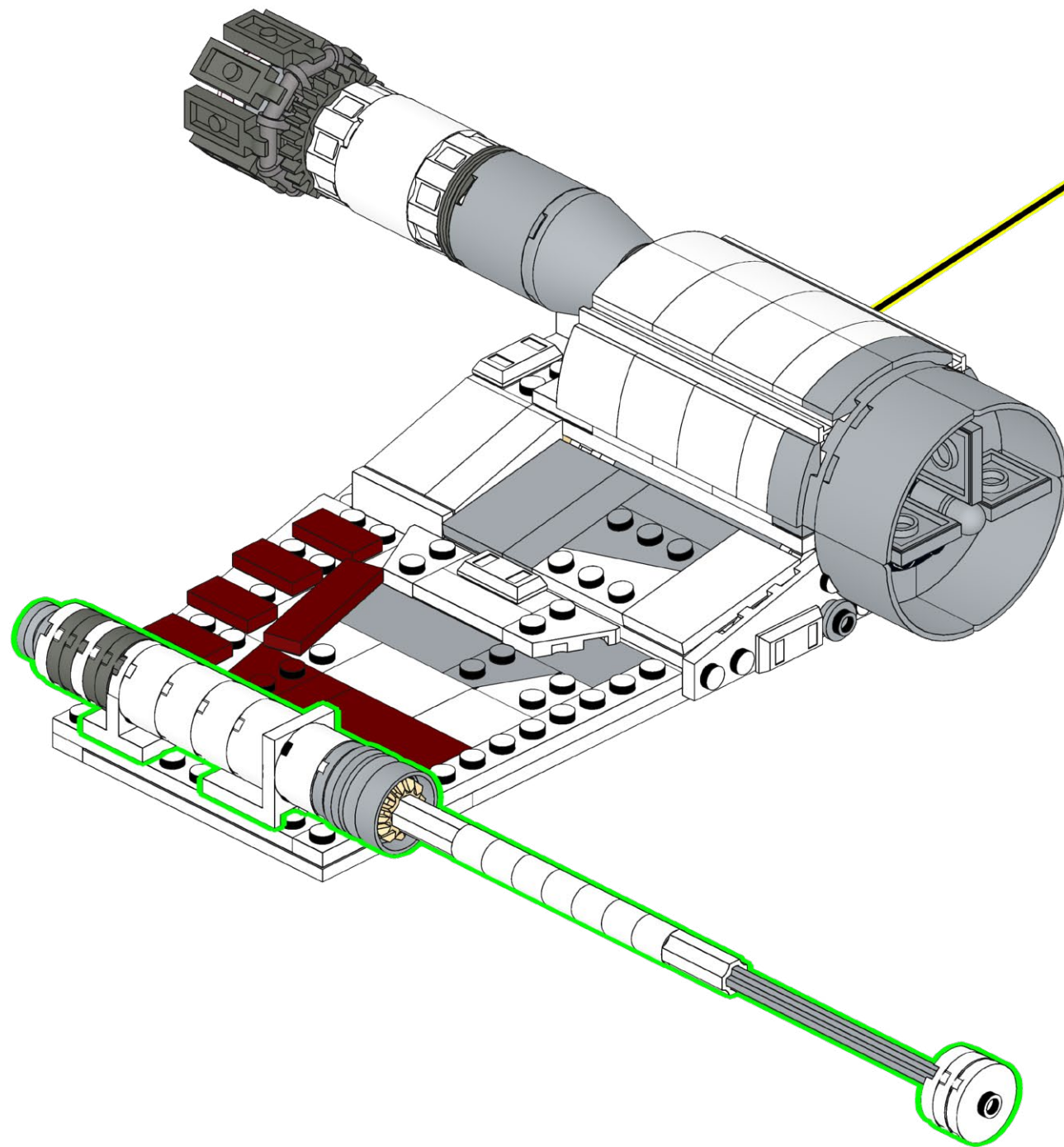

539

4x

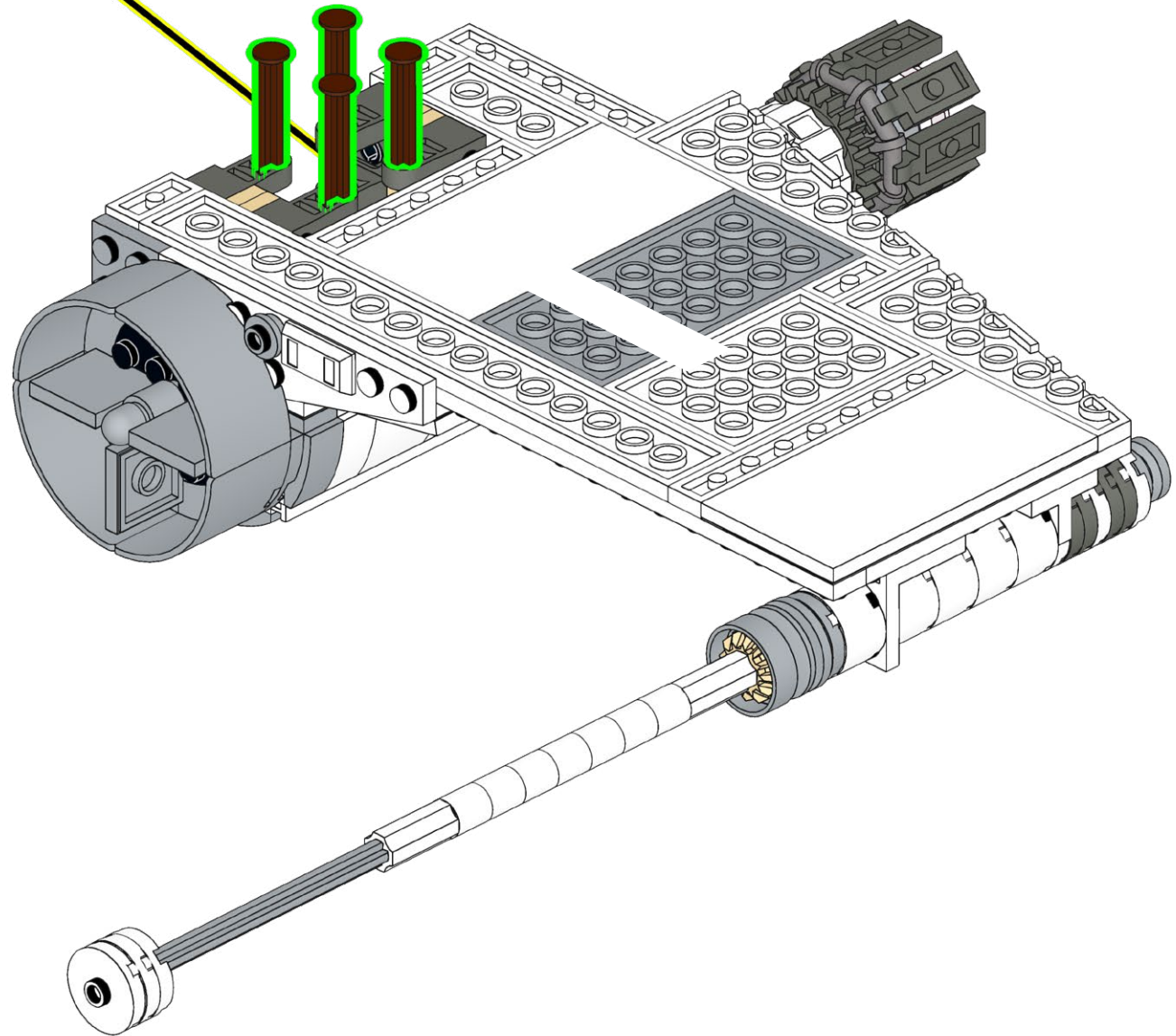

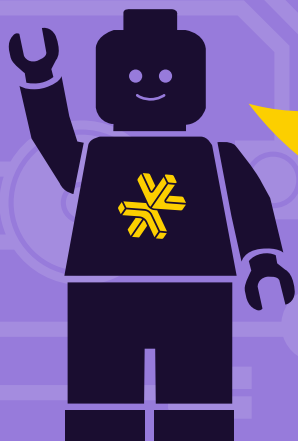
**HOLD UP!**

You might notice some bags aren't in order, as well as left over pieces, but that's ok! We're changing the way you build LEGO!

ATTENDEZ!

Vous remarquerez peut-être que certains sacs, ainsi que certaines pièces, ne sont pas dans le bon ordre. Mais pas de panique! Nous changeons simplement la façon avec laquelle vous construisez vos LEGO!

ASPETTA!

Potresti notare che alcuni sacchetti non sono in ordine, così come i pezzi avanzati, ma va bene così! Stiamo cambiando il modo in cui costruisci i LEGO!

HALT!

Sie werden möglicherweise bemerken, dass einige tüten durcheinander sind und teile übrig bleiben, aber das ist in Ordnung! Wir ändern die art und weise, wie Sie LEGO bauen!

¡ESPERA!

Es posible que notes que algunas bolsas están fuera de servicio, así como piezas sobrantes, ¡pero está bien! ¡Estamos cambiando la forma en que construyes LEGO!

暫停!

你可能会注意到一些袋子顺序错乱, 以及一些剩余的部件, 但没关系! 我们正在改变你搭建乐高的方式!

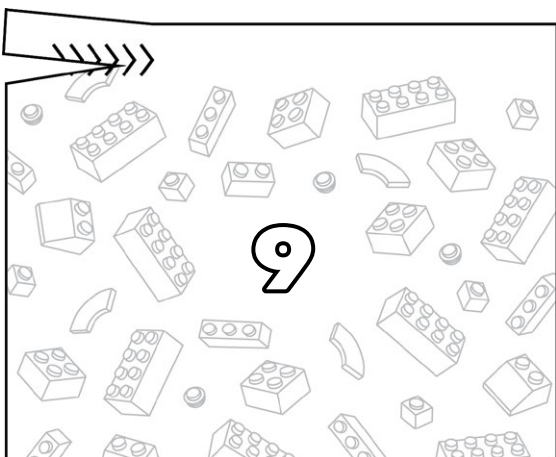
Open LEGO® Bag 9

540

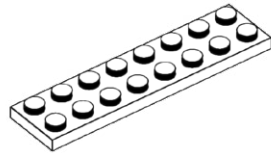

1x

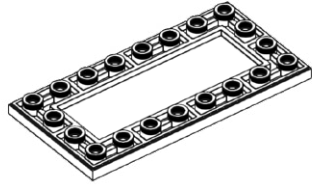

1x

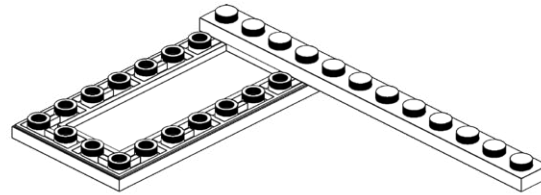

541

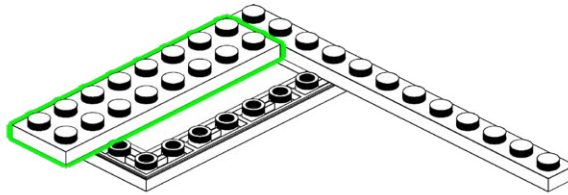
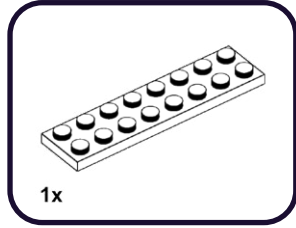

542

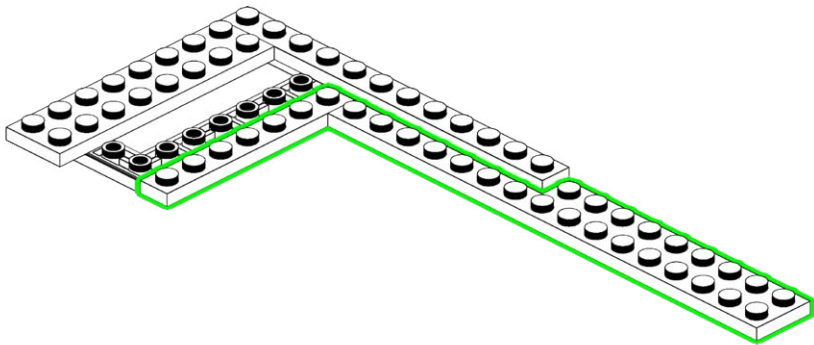
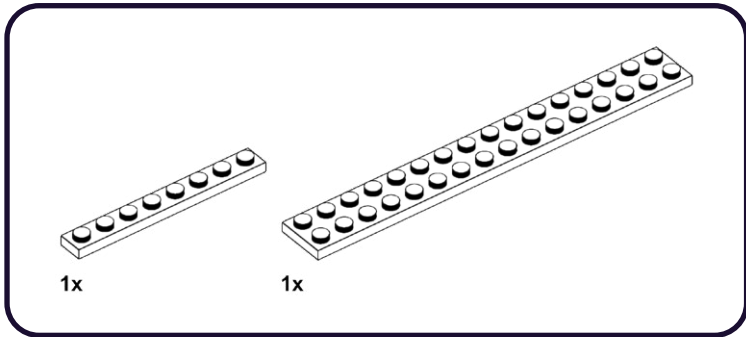

543

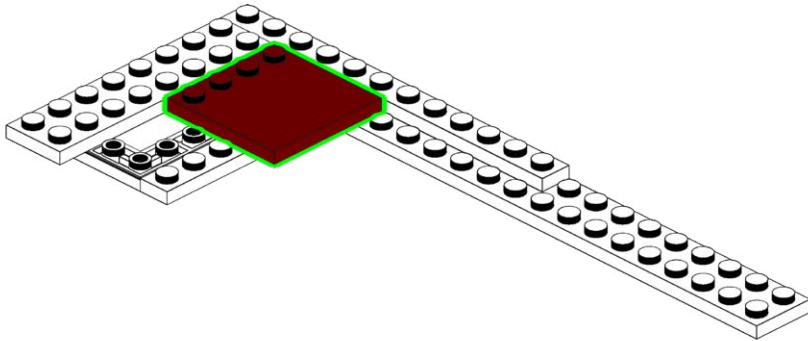
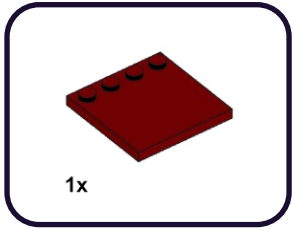

544

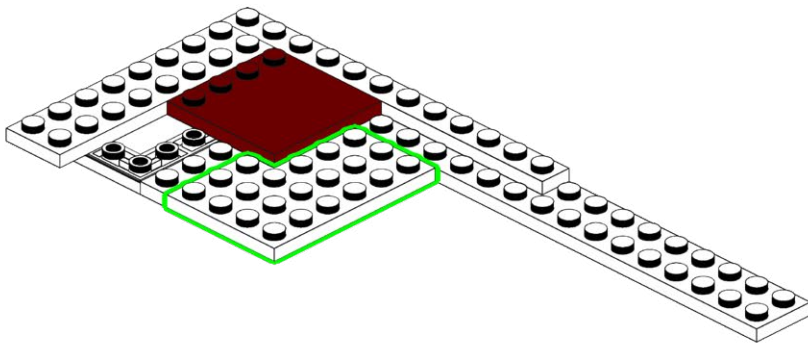
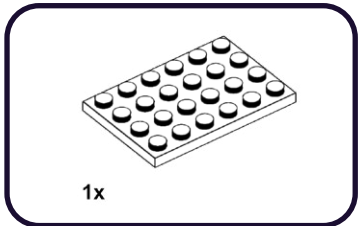

545

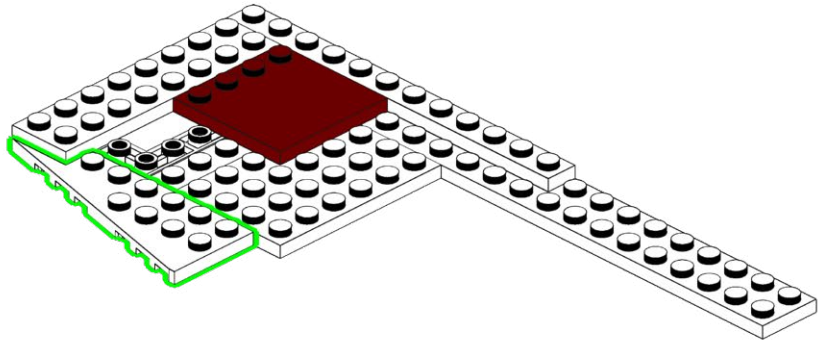
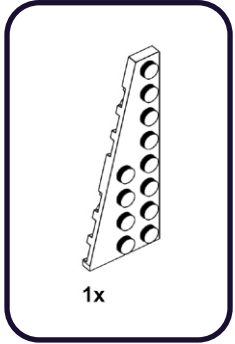

546

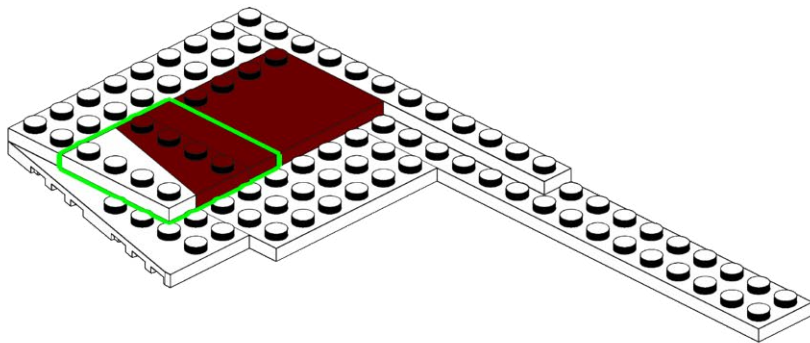
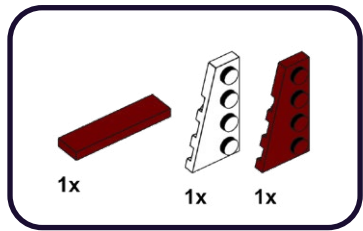

547

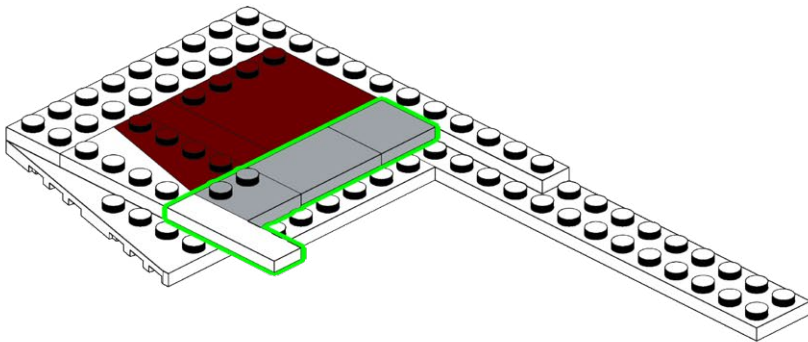
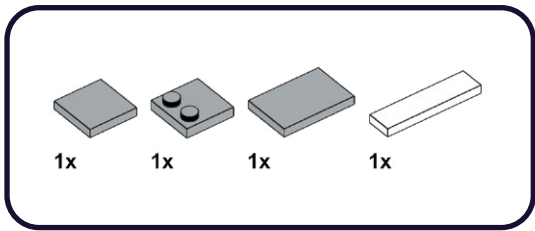

548

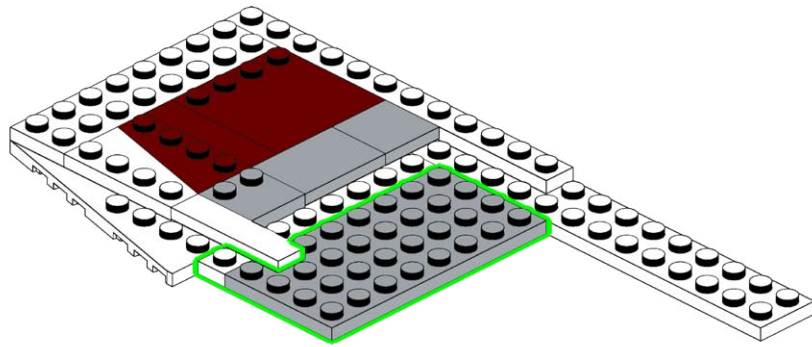
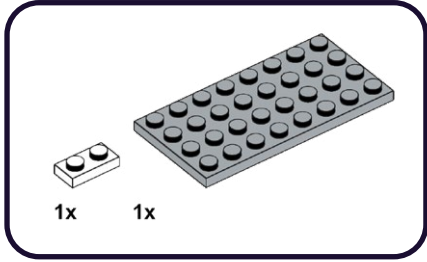

549

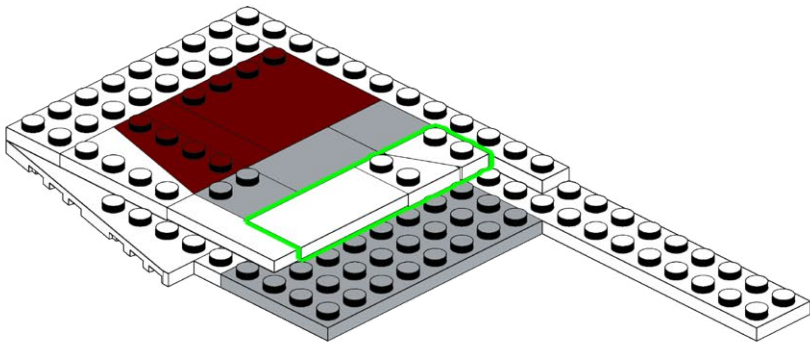
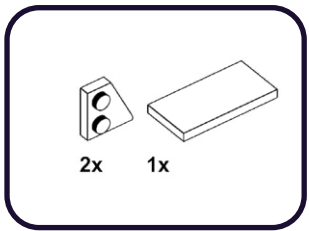

550

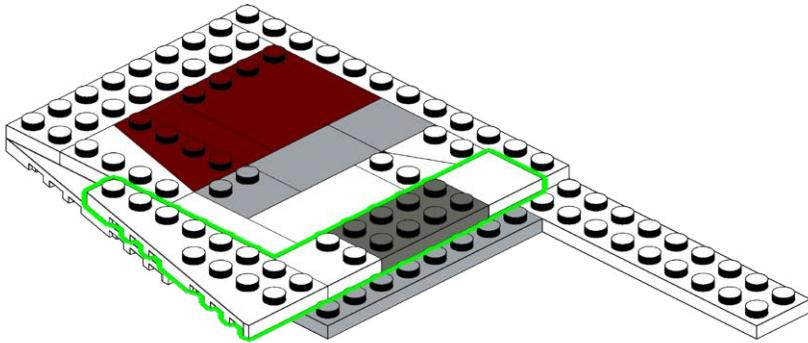
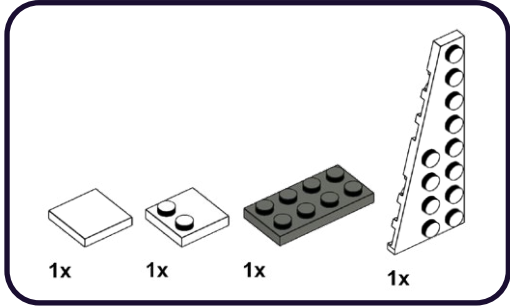

551

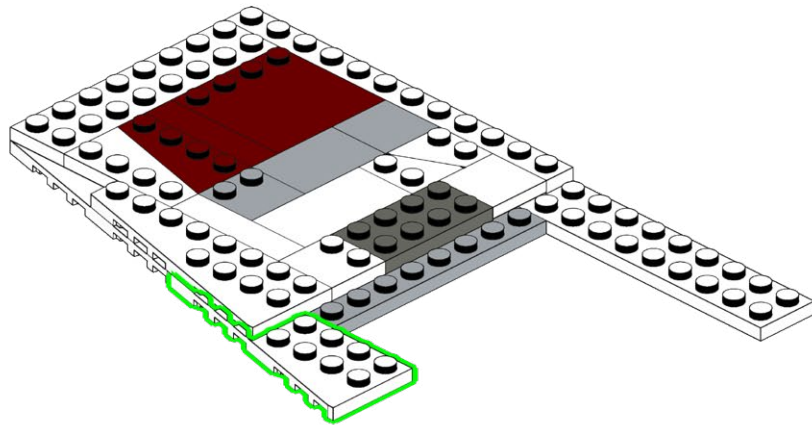
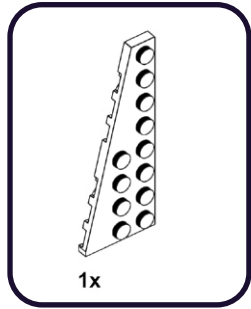

552

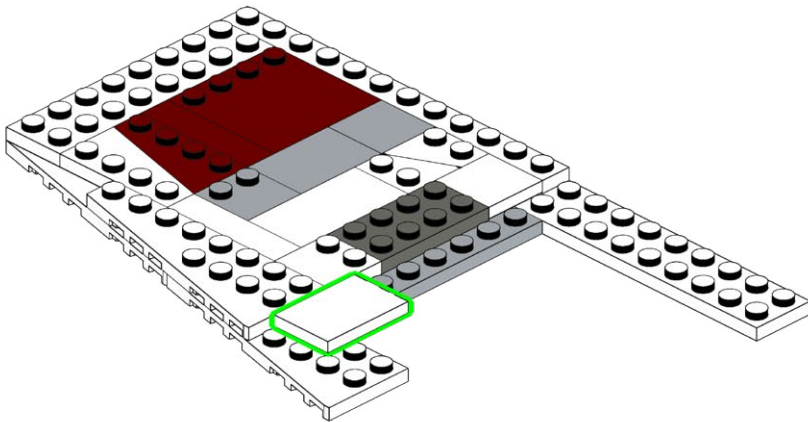
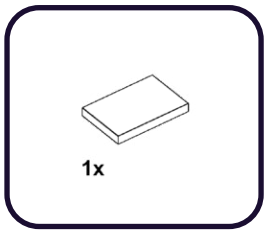

553

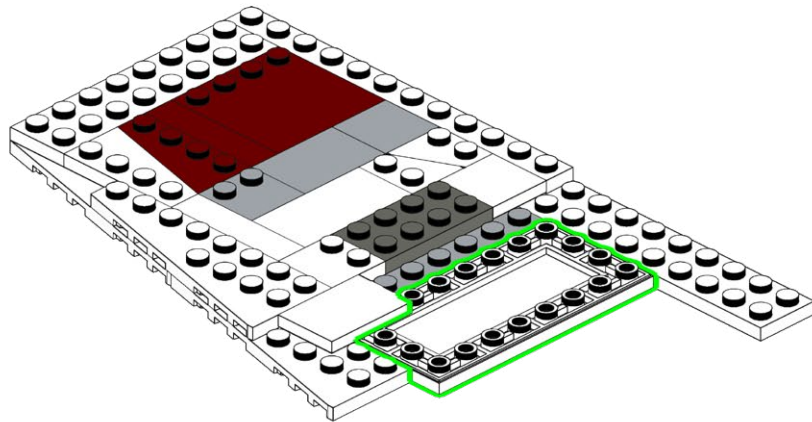
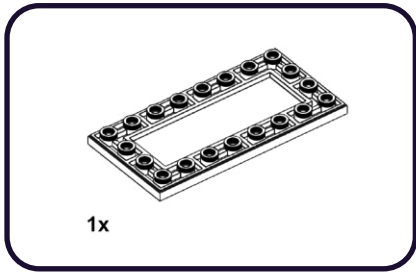

554

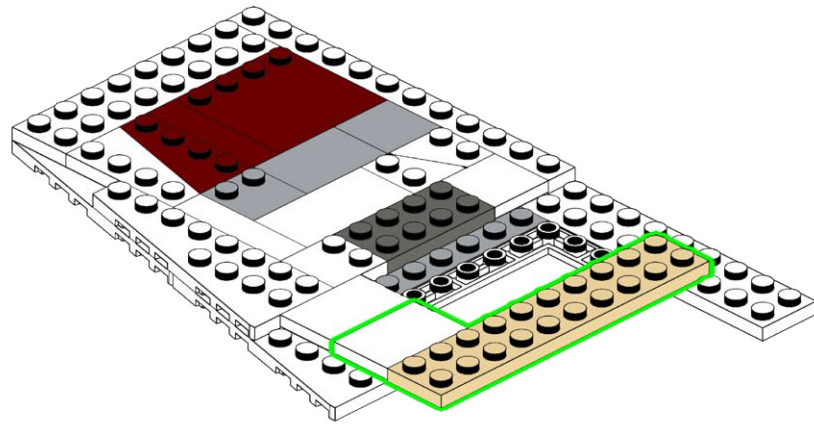
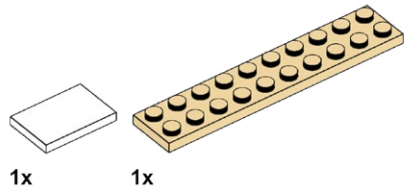

555

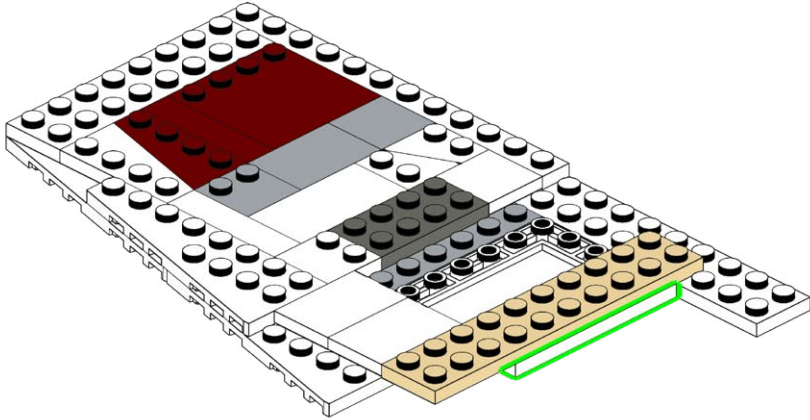
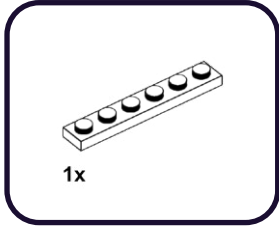

556

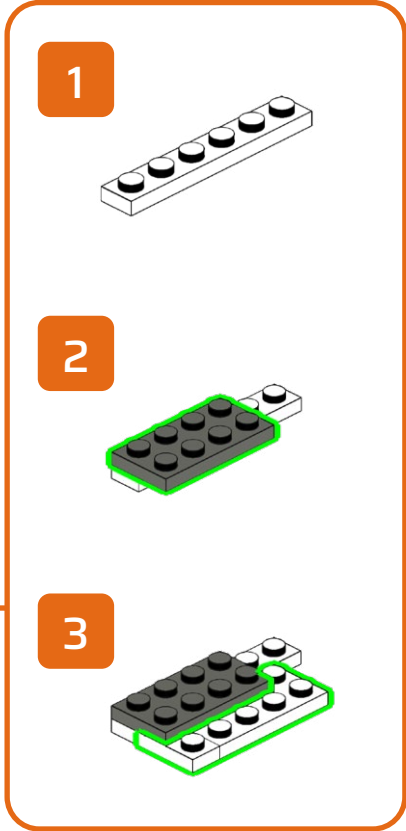
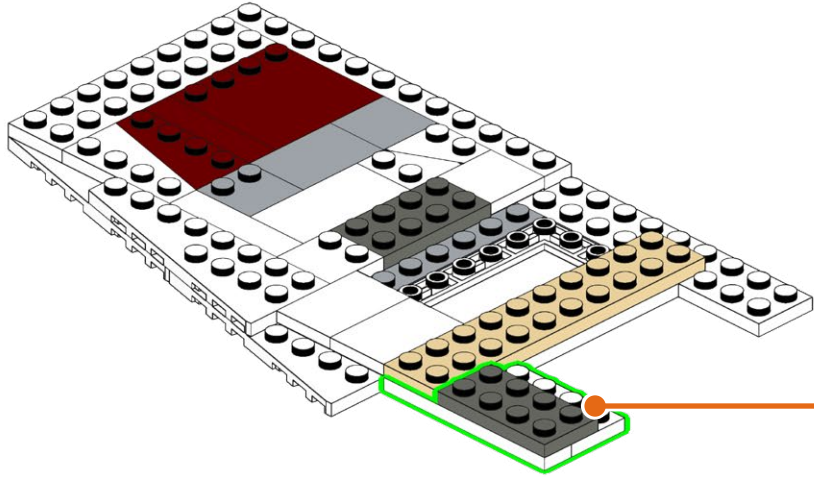
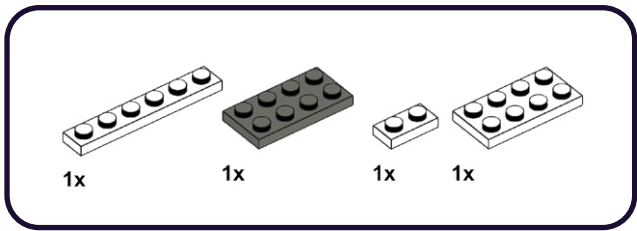

557

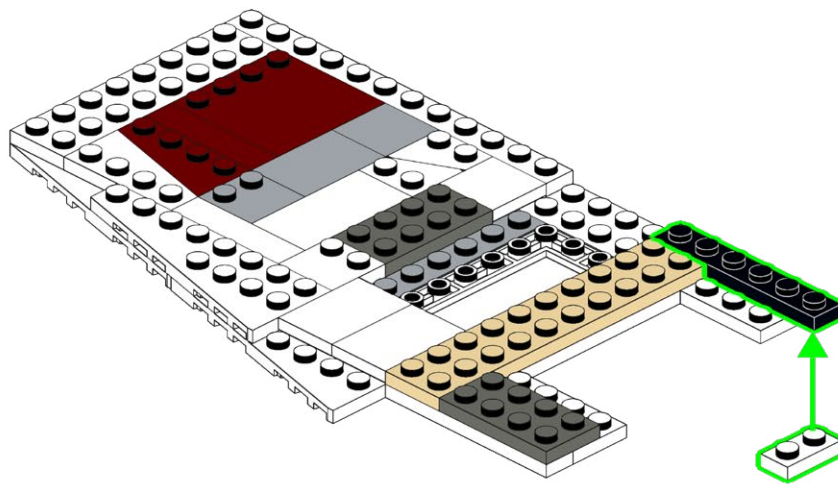
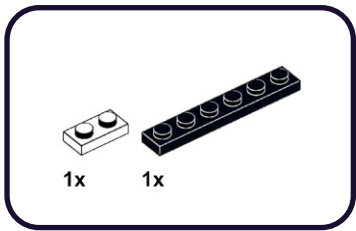

558

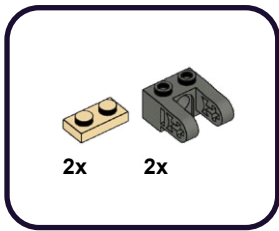

1

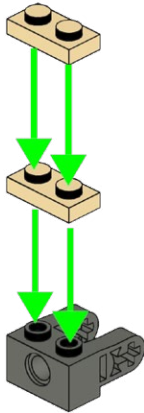

2

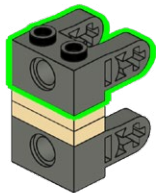

559

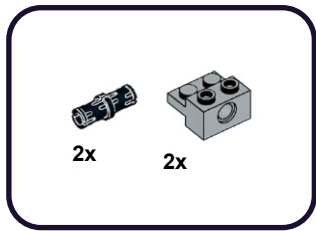

1

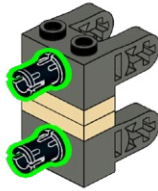

2

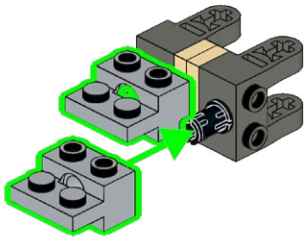

560

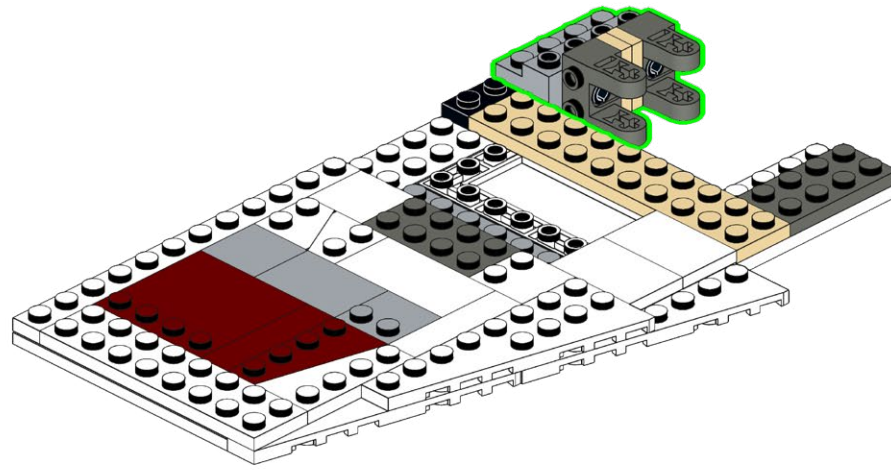

561

2x

2x

1

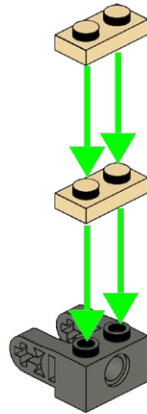

2

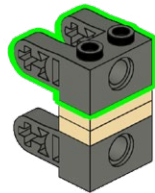

562

2x

2x

1

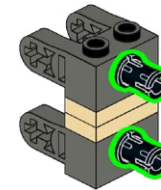

2

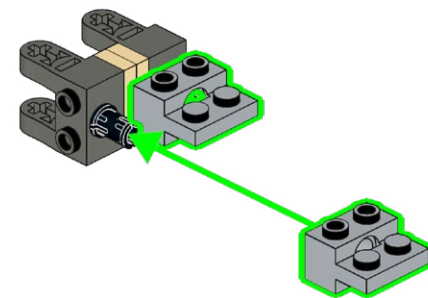

563

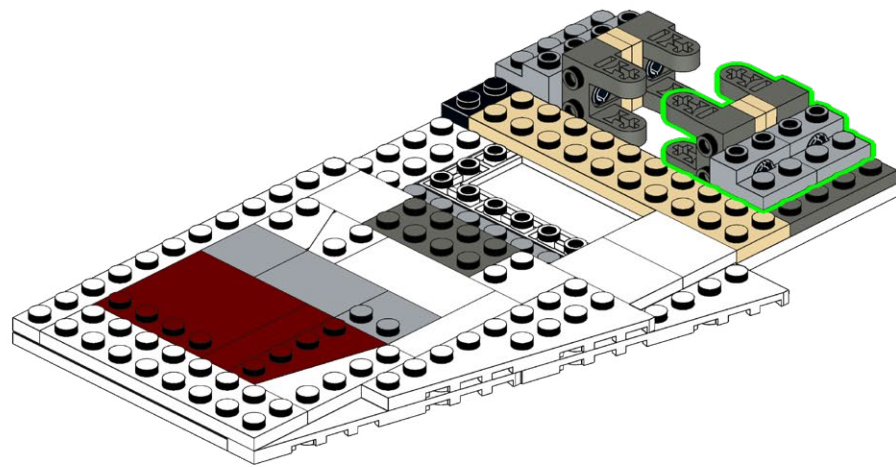

564

2x

2x

2x

565

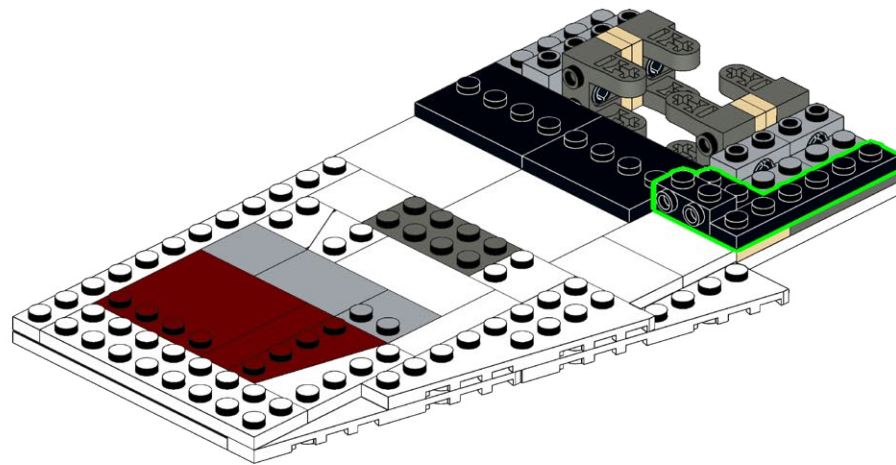
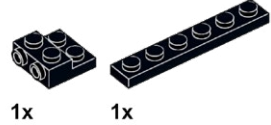

566

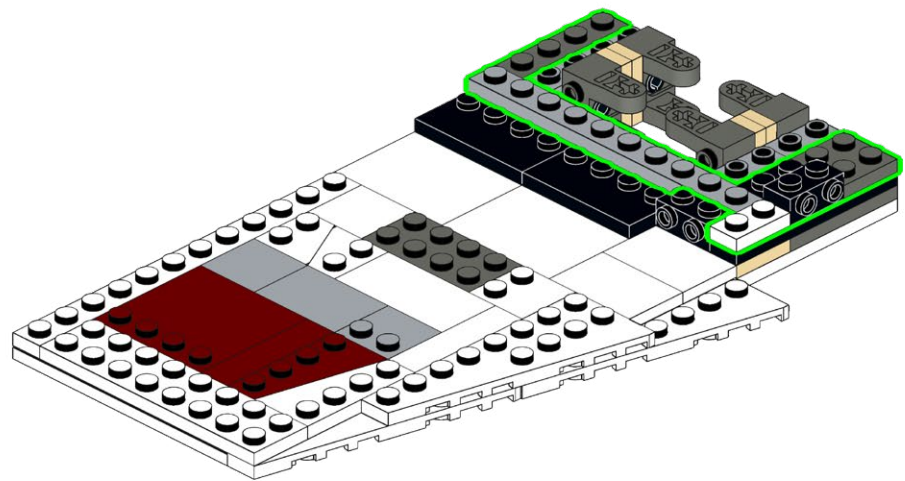
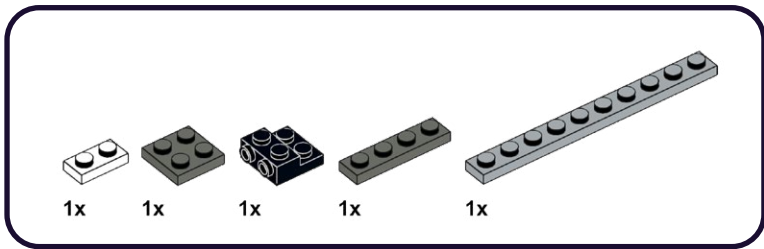

567

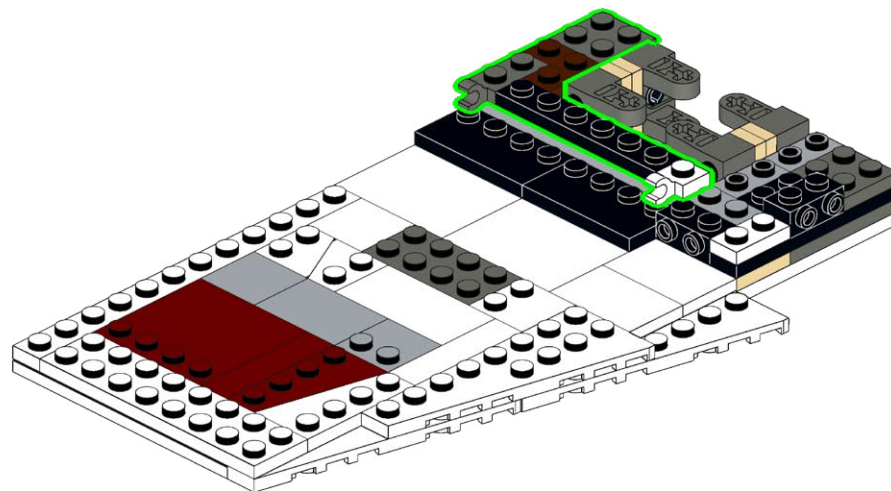
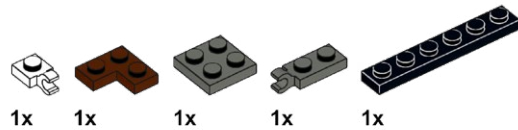

568

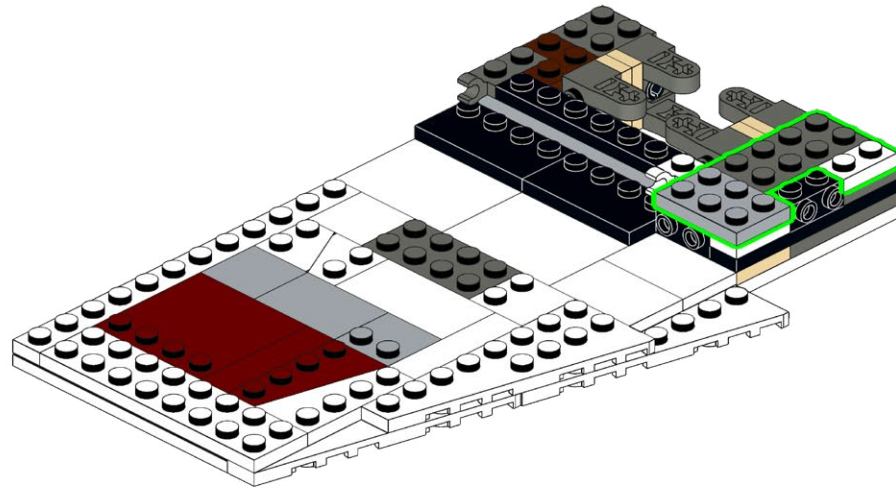
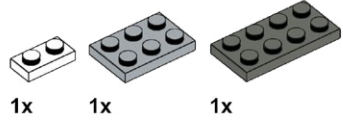

569

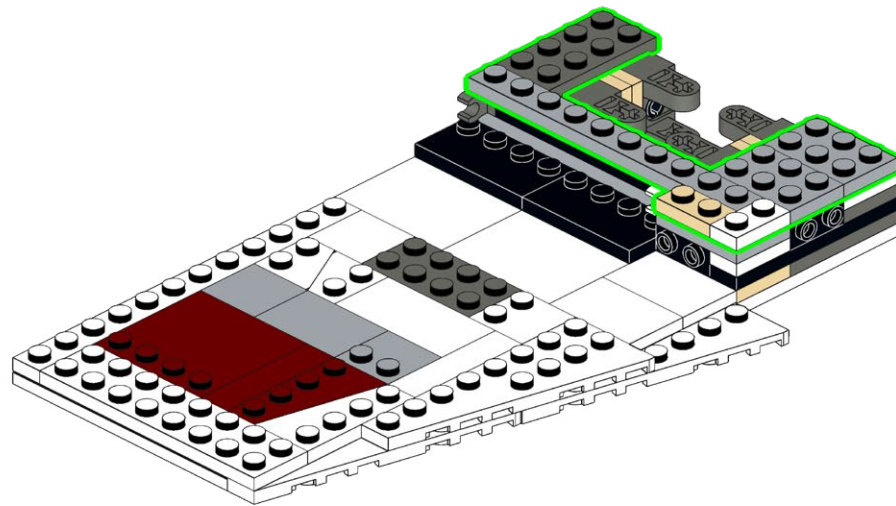
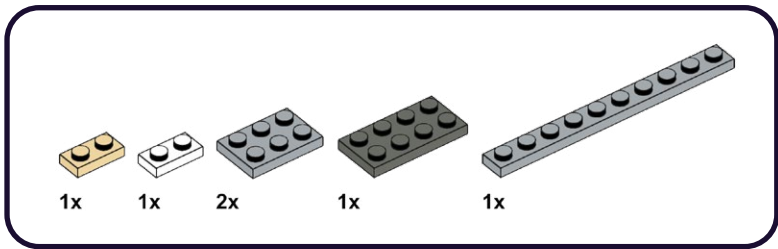

570

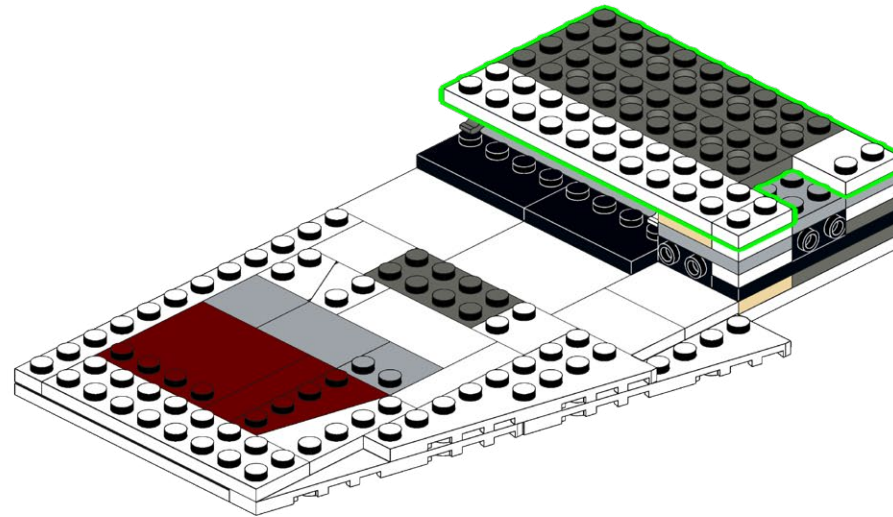
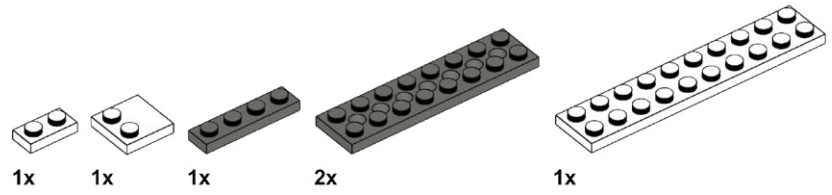

571

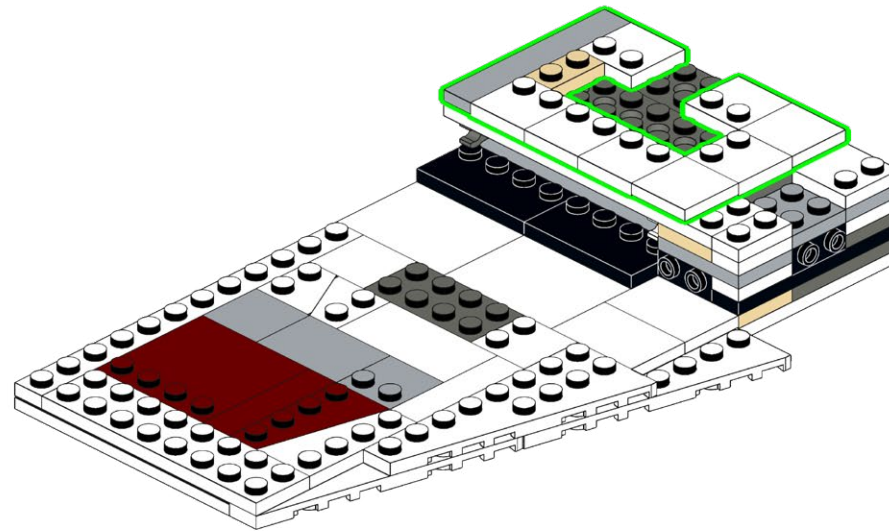
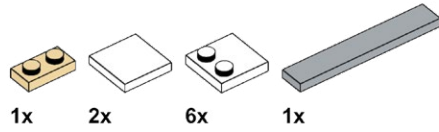

572

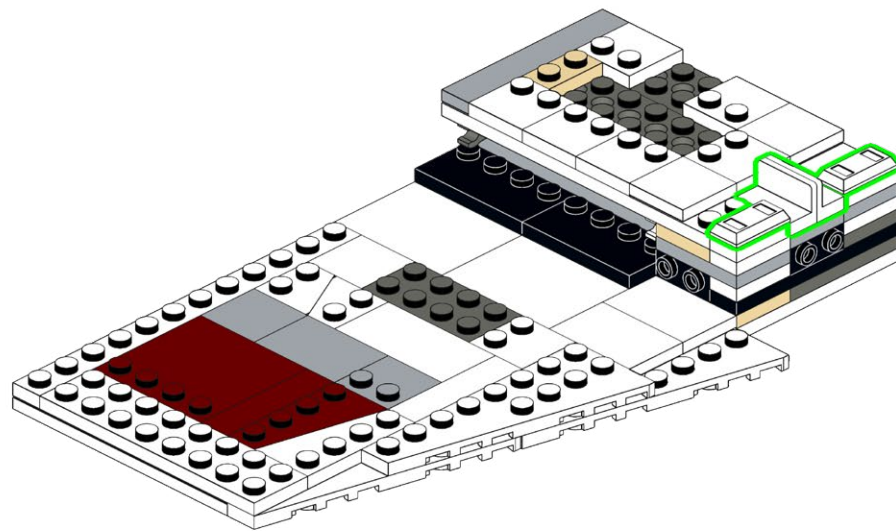
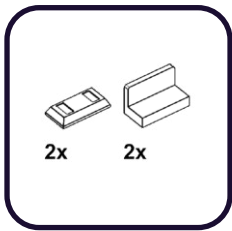

573

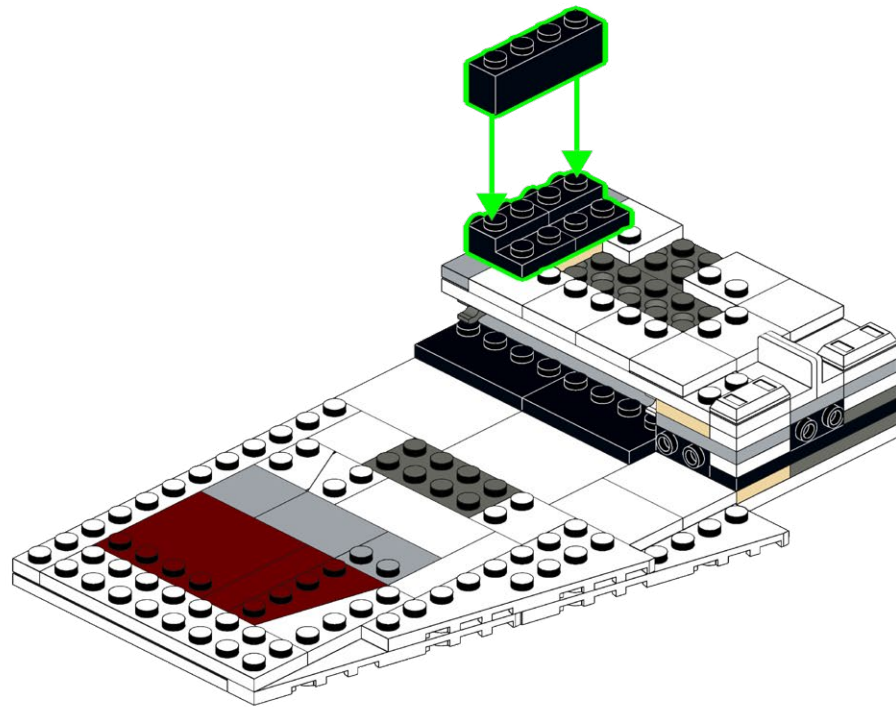
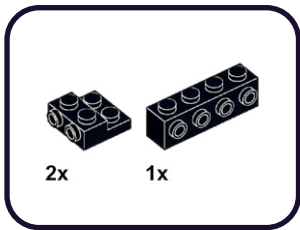

574

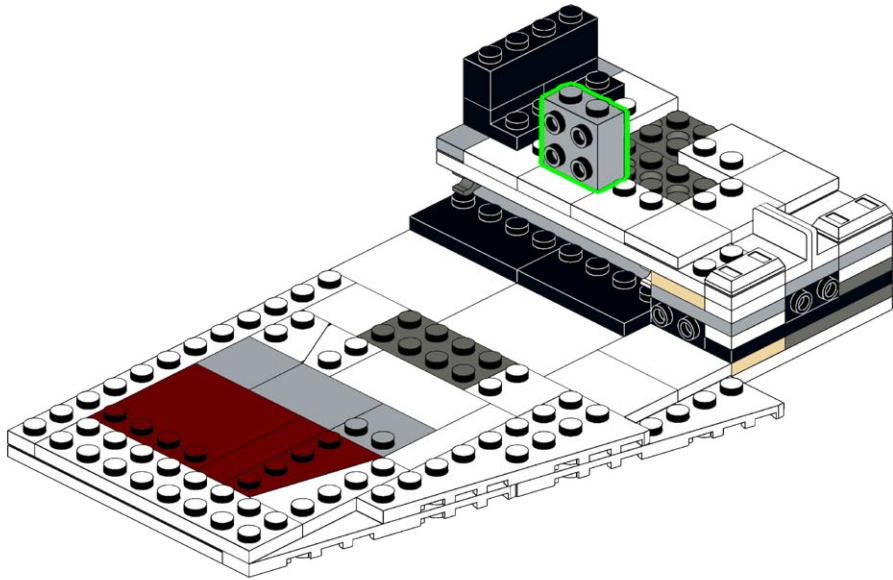
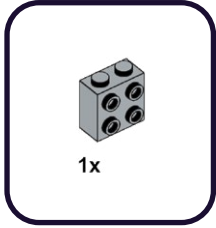

575

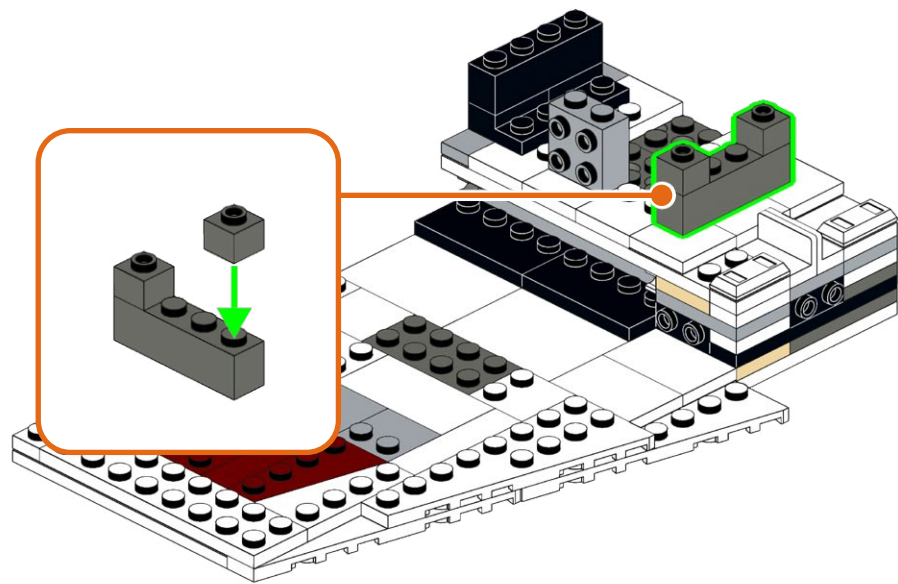
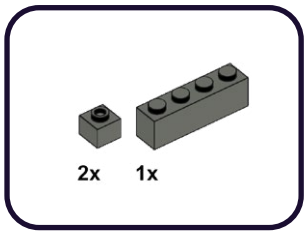

576

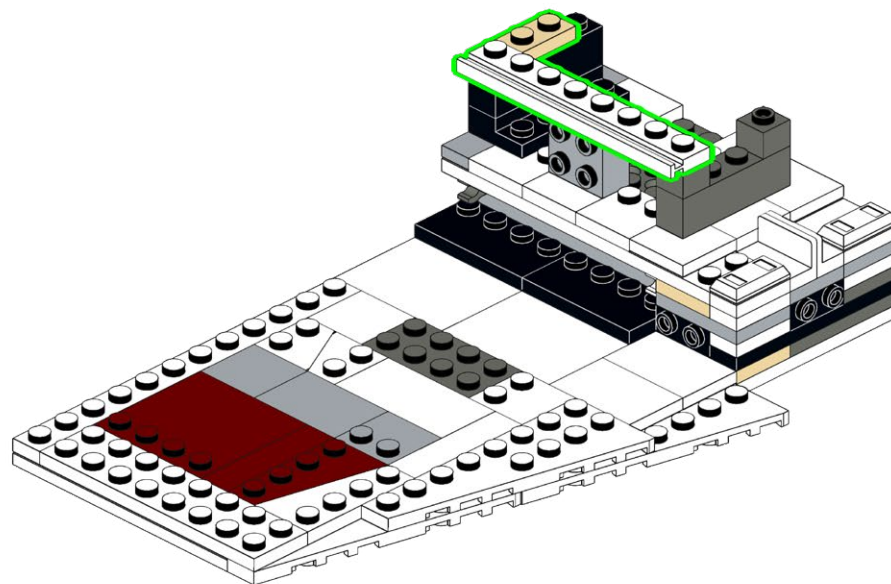
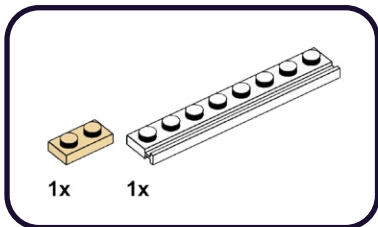

577

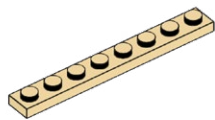

1x

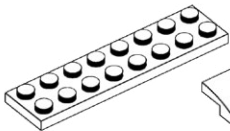

1x



3x



1x

1

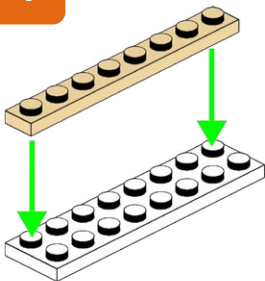

2

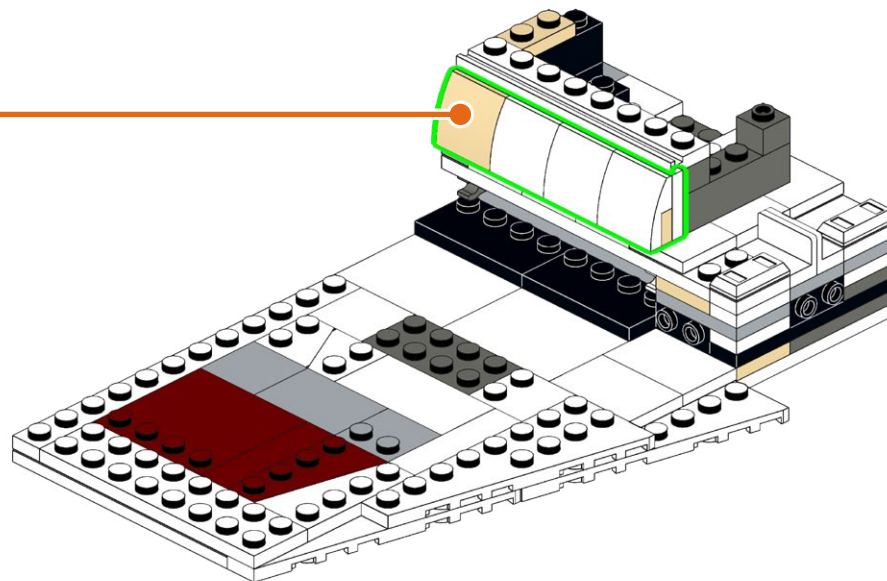
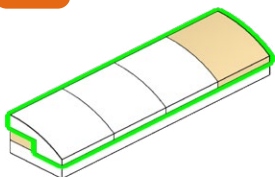

578

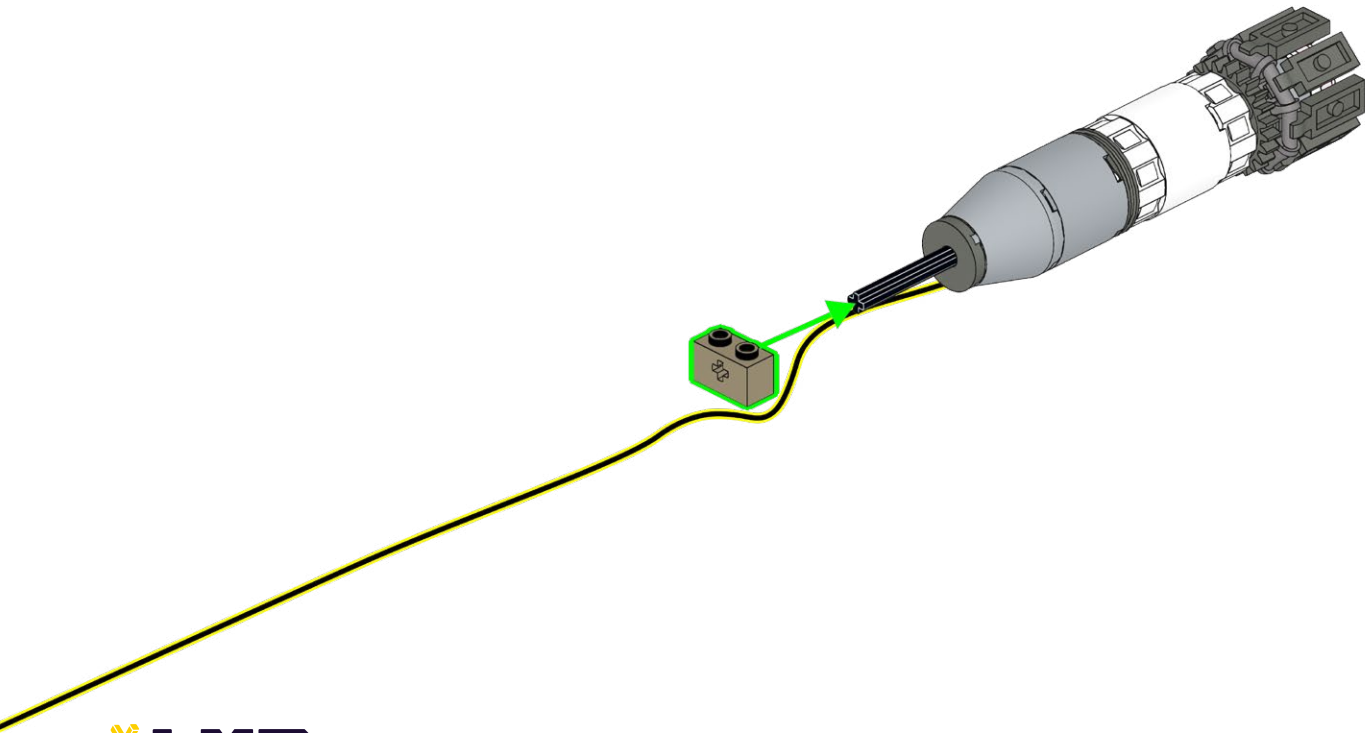
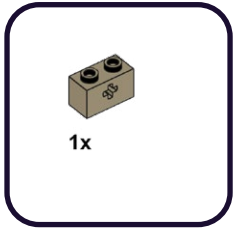

579

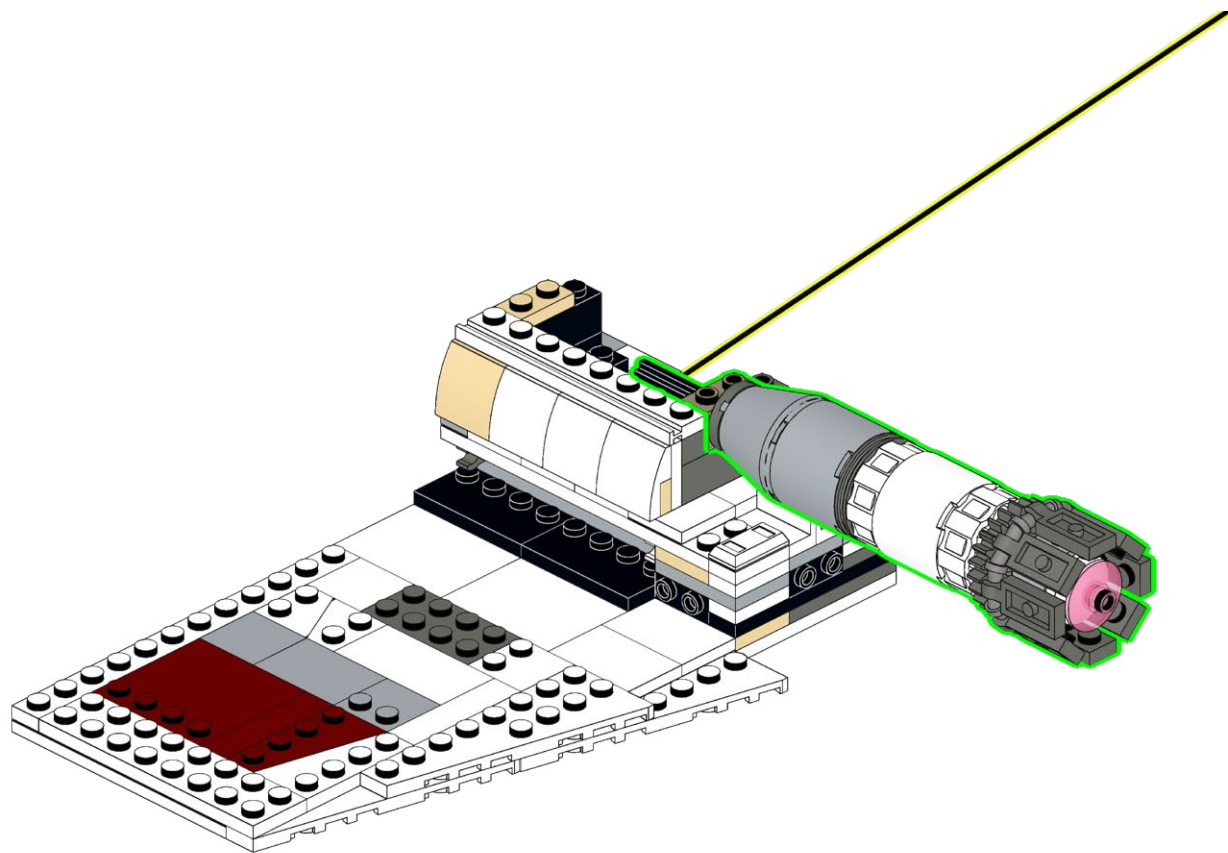

580

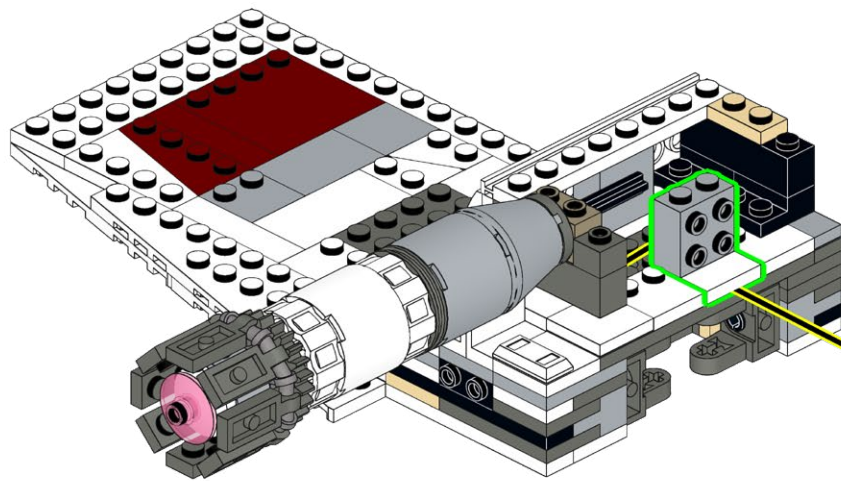
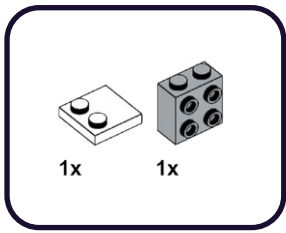

581

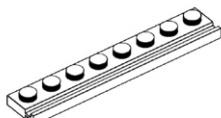

1x

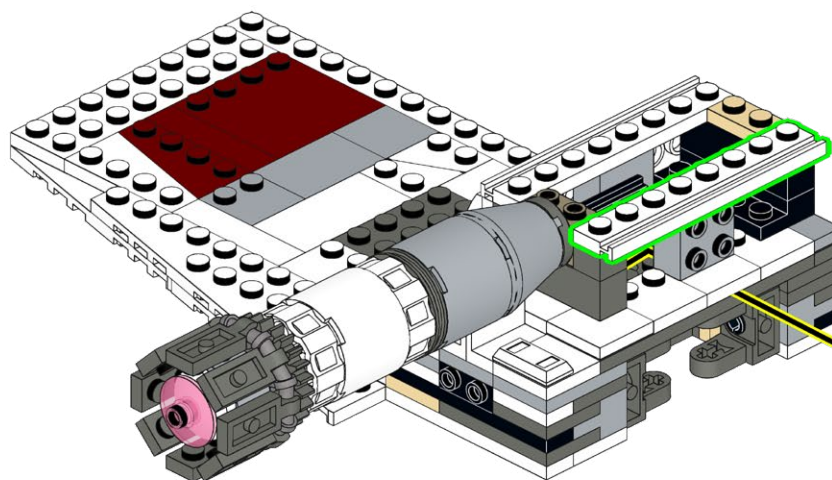

582

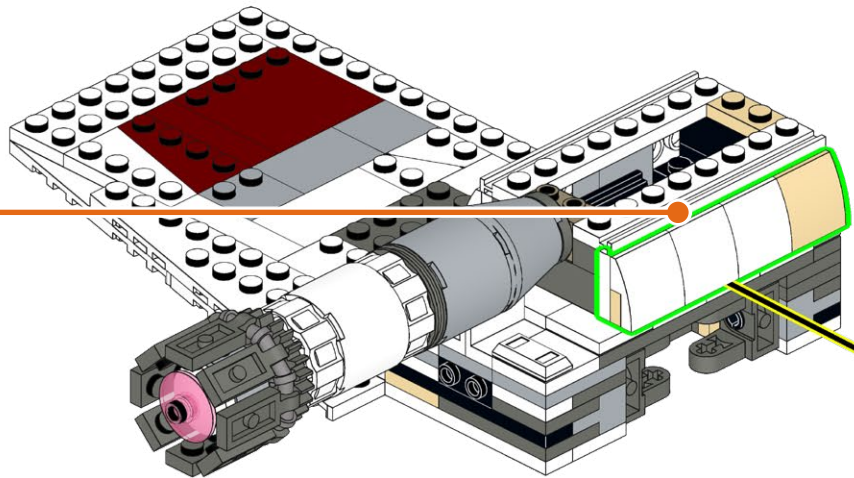
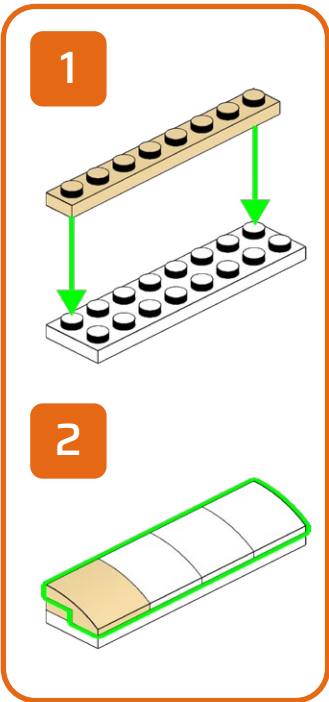
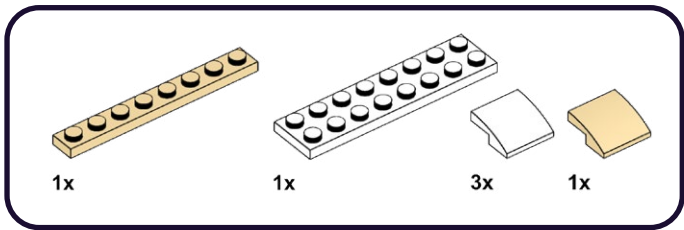

583

1x

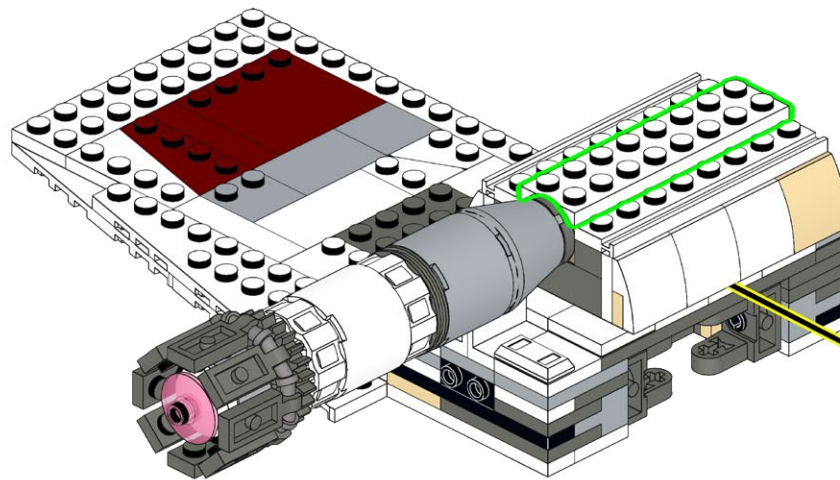

584

1x

1x

5x

2x

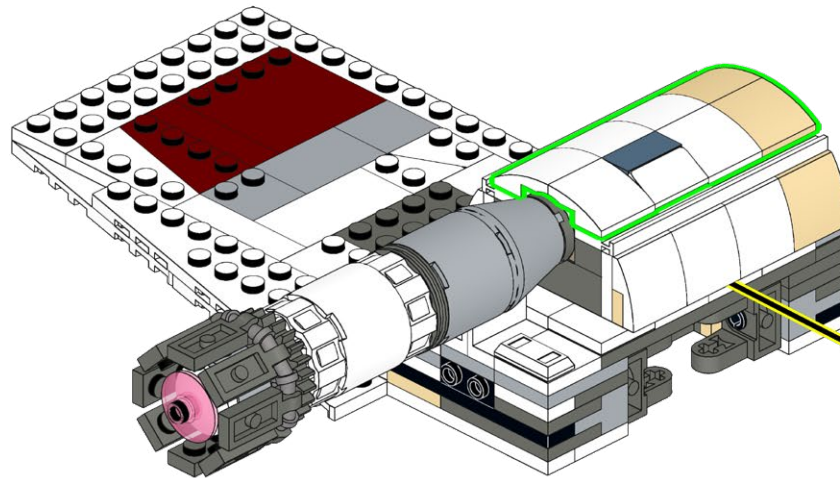

585

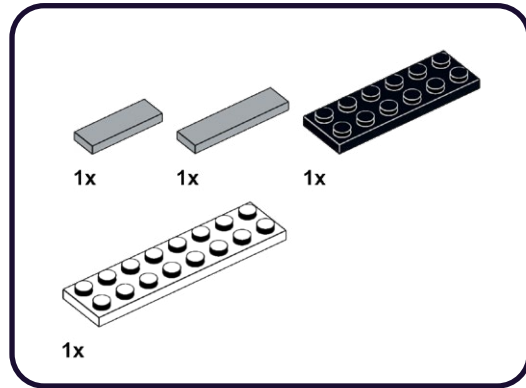

1

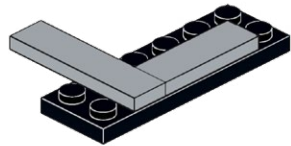

2

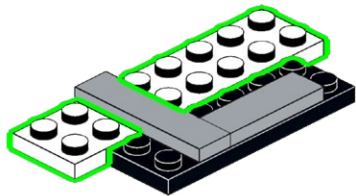

586

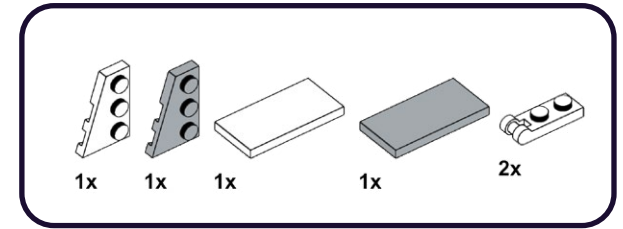

1

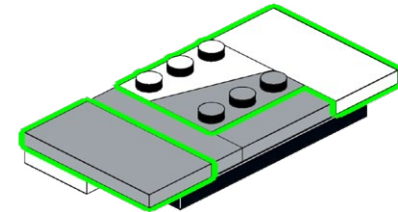

2

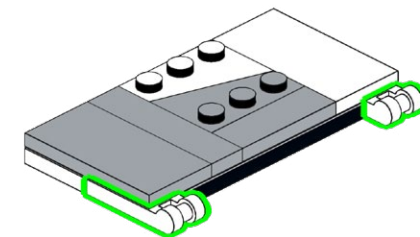

587

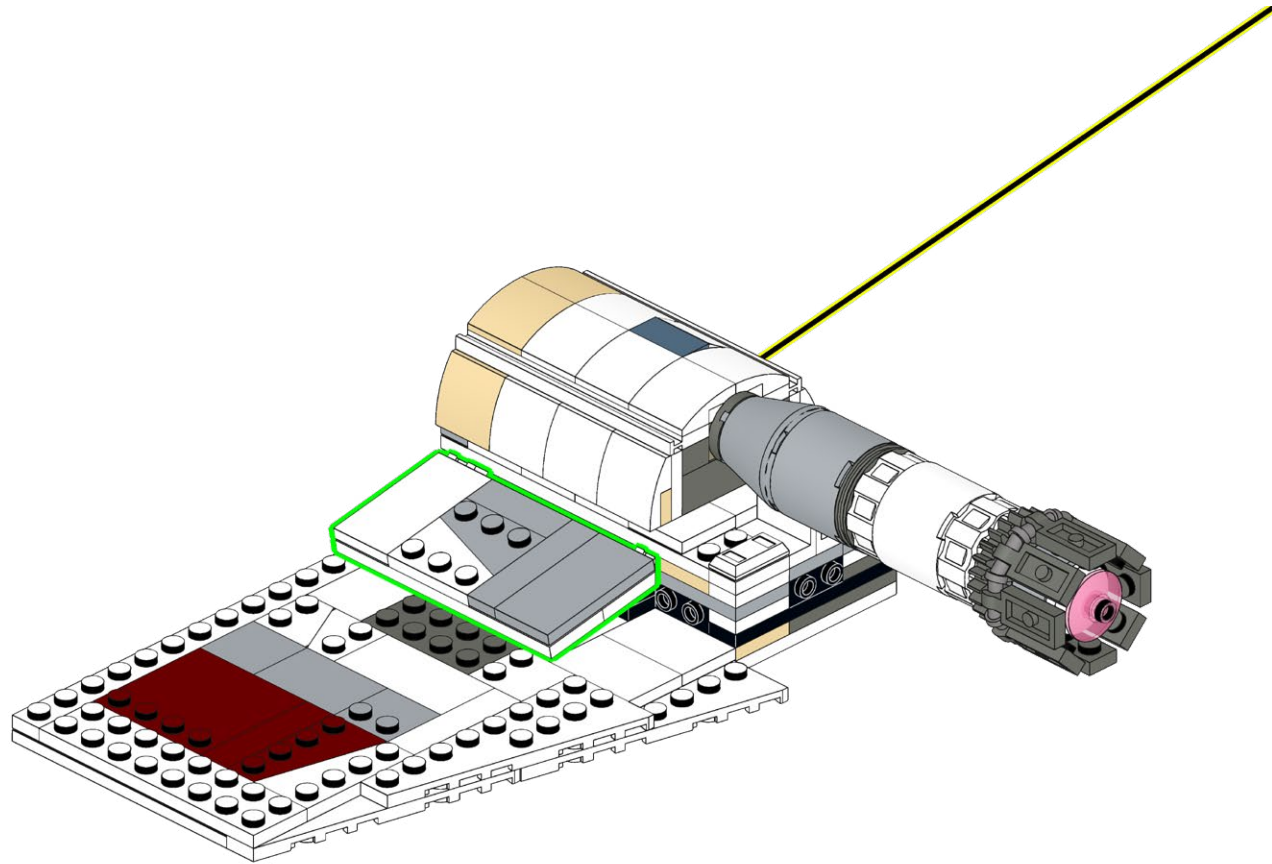

588

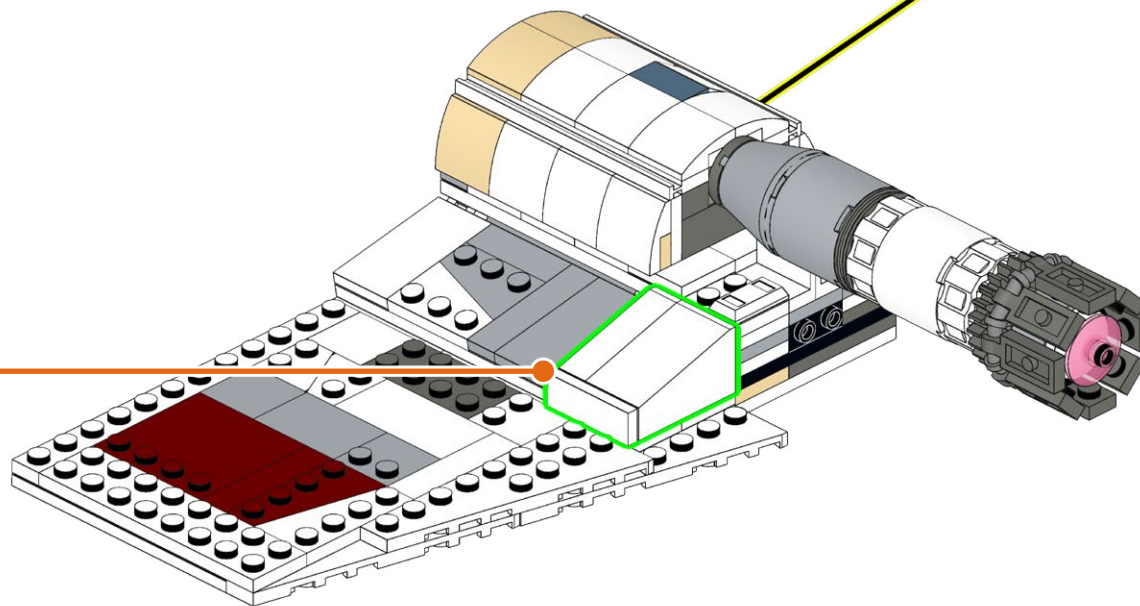
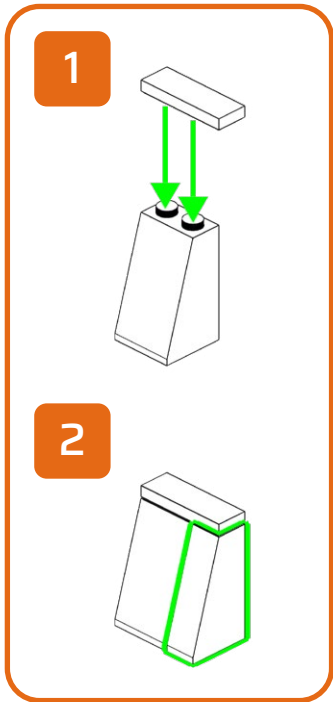
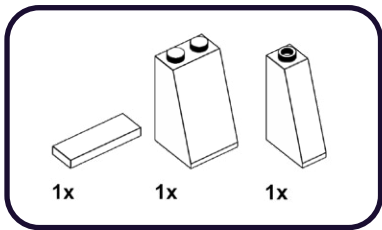

589

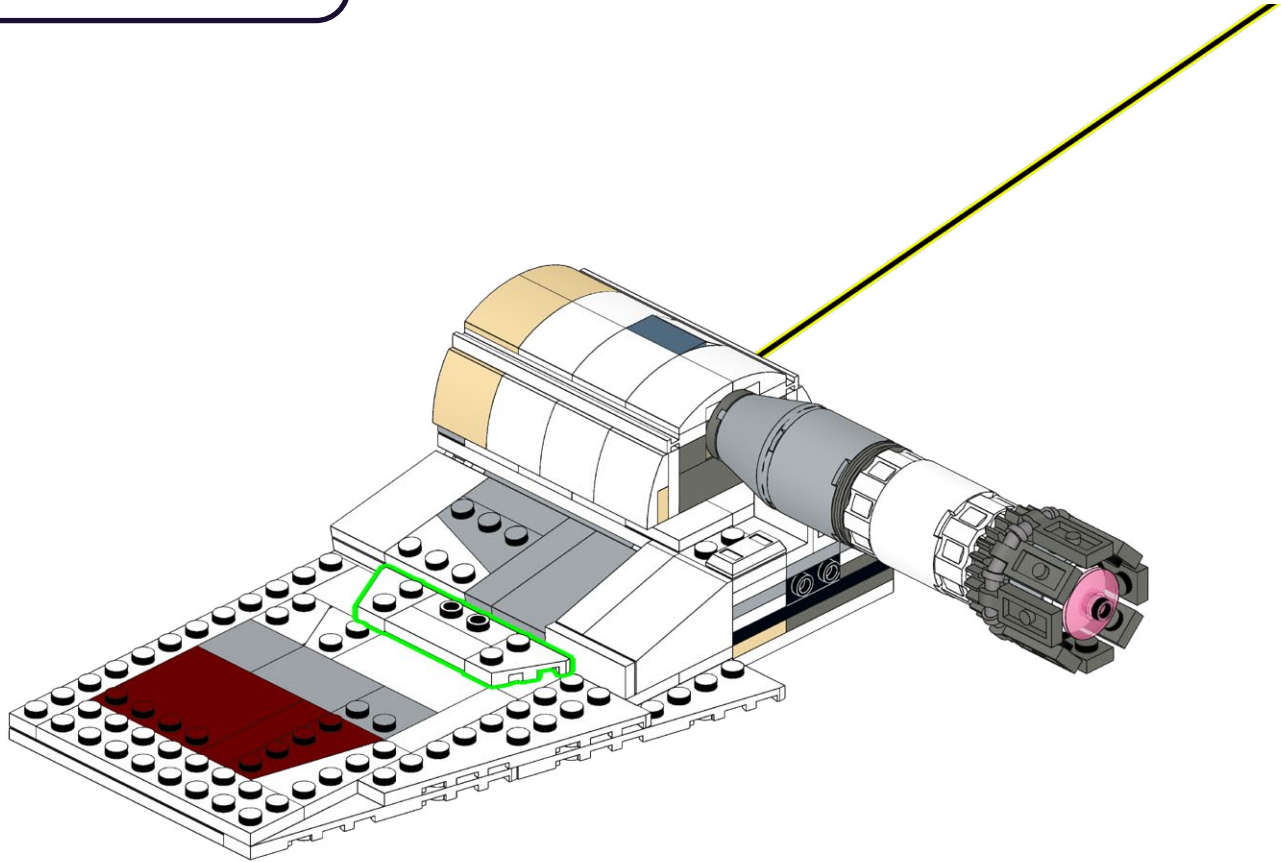
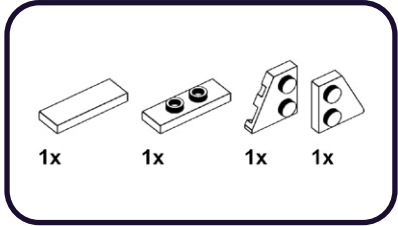

590

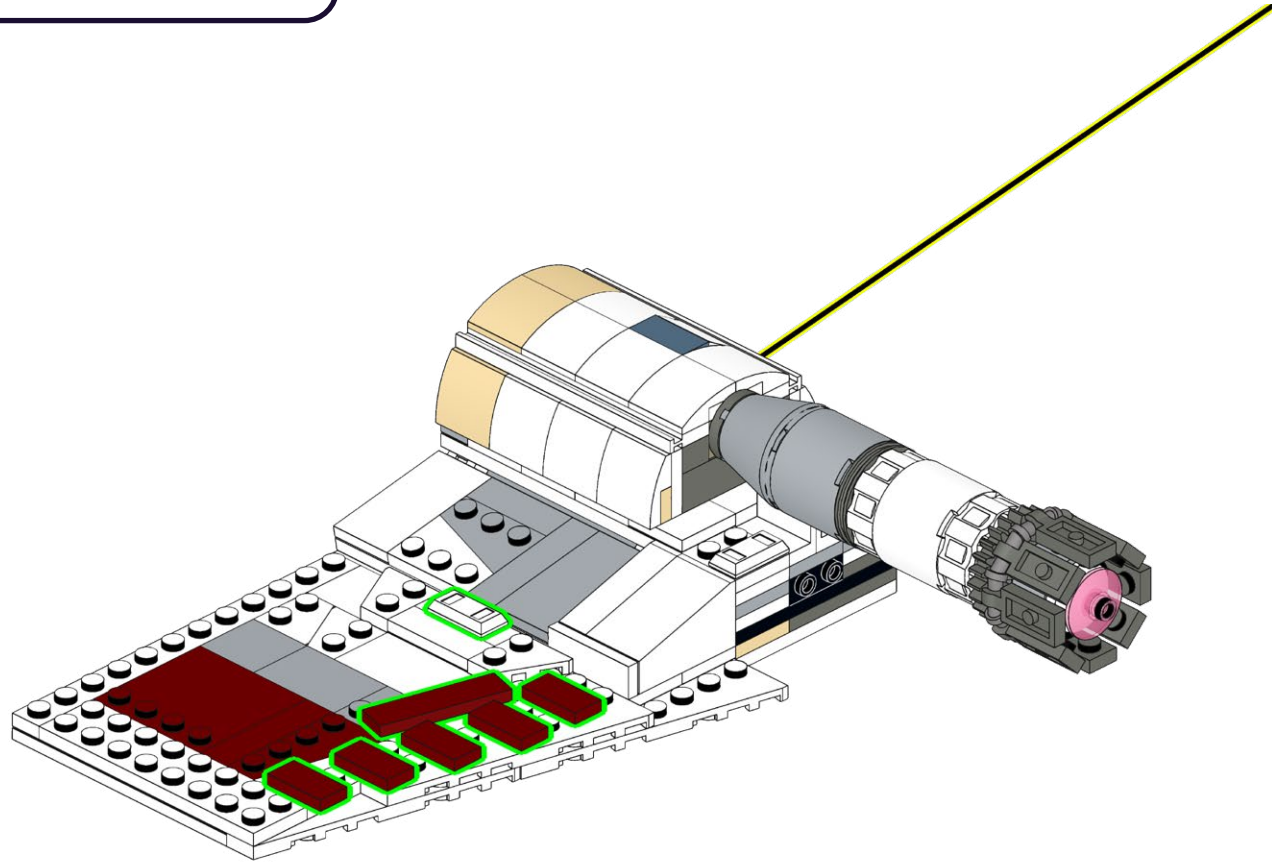
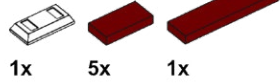

591

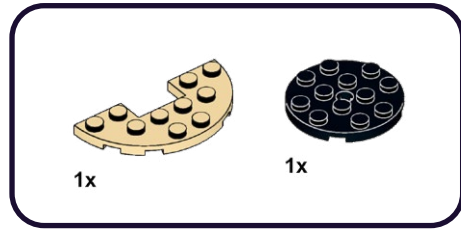

1

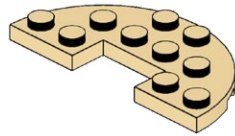

2

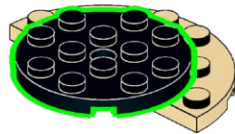

592

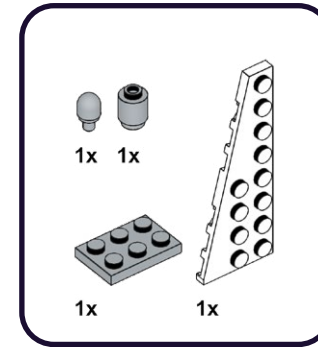

1

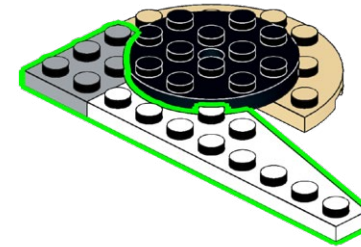

2

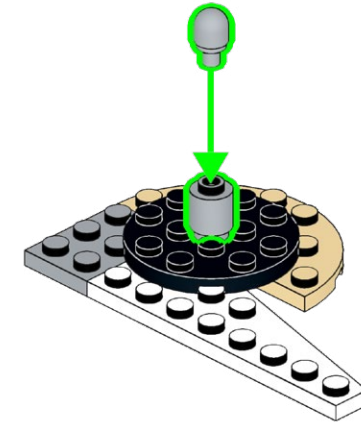

593

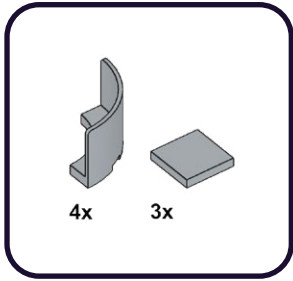

1

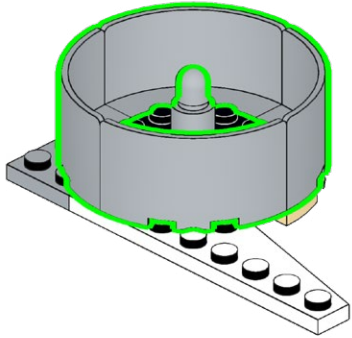

2

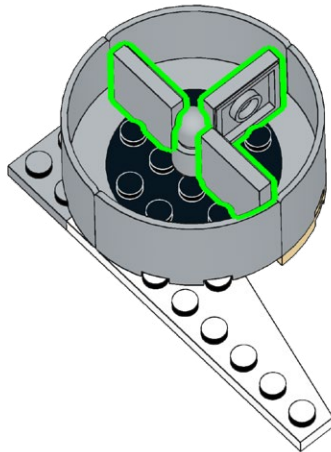

594

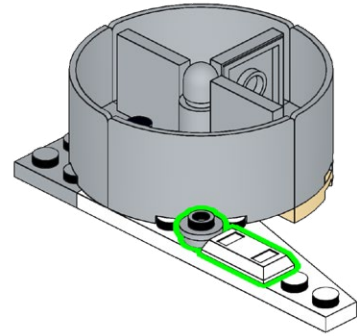
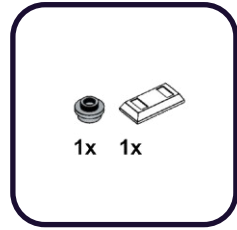

595

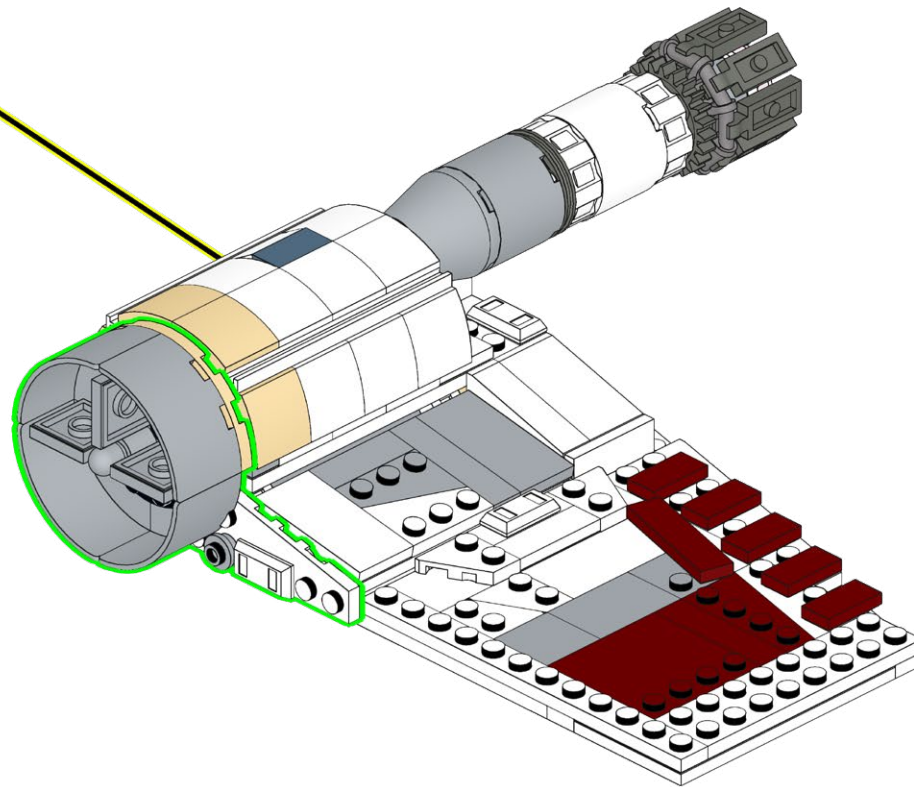

596

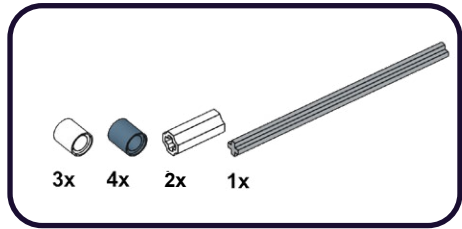

1

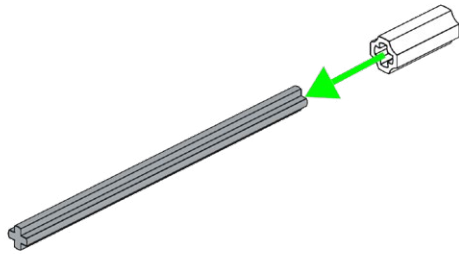

2

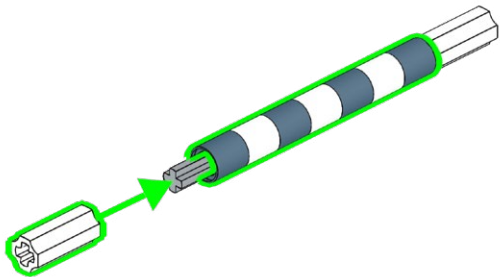

597

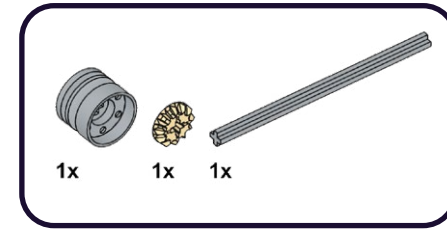

1

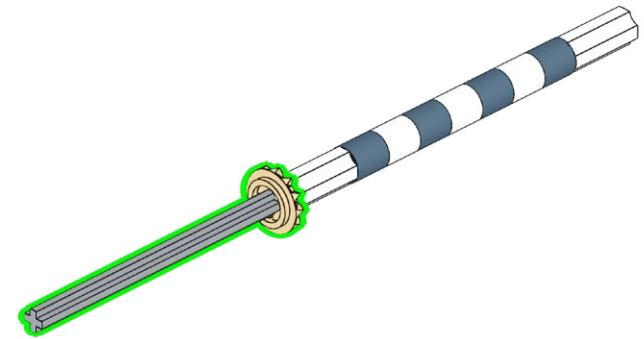

2

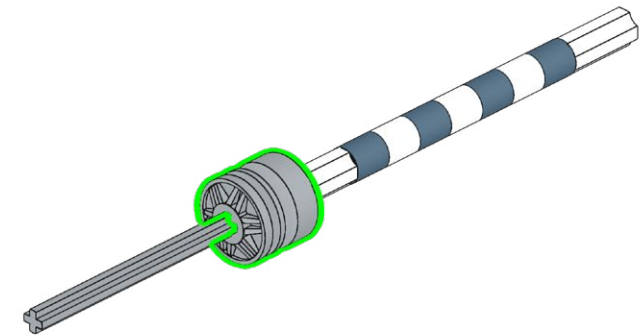

598

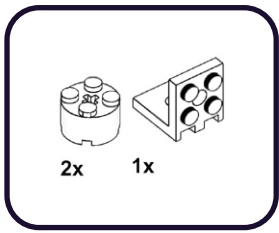

1

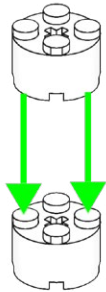

2

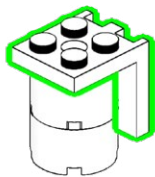

599

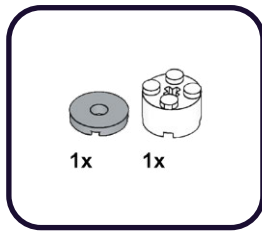

1

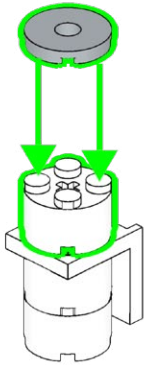

2

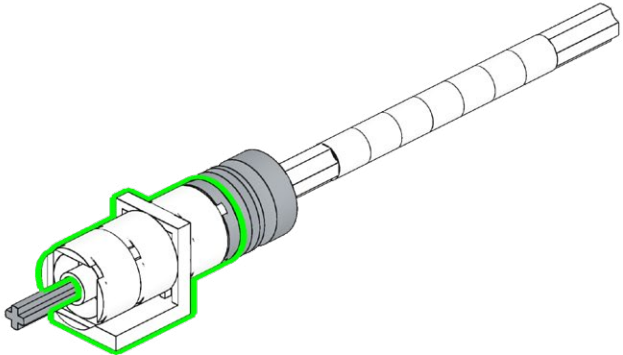

600

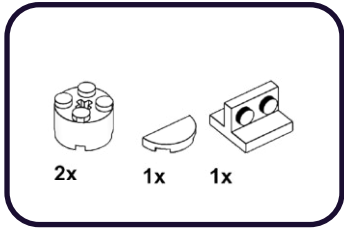

1

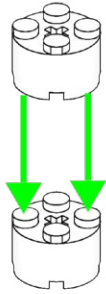

2

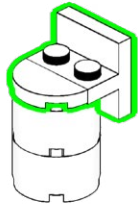

601

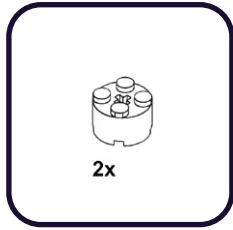

1

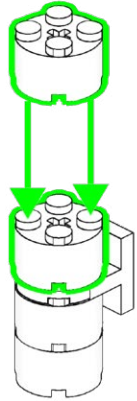

2

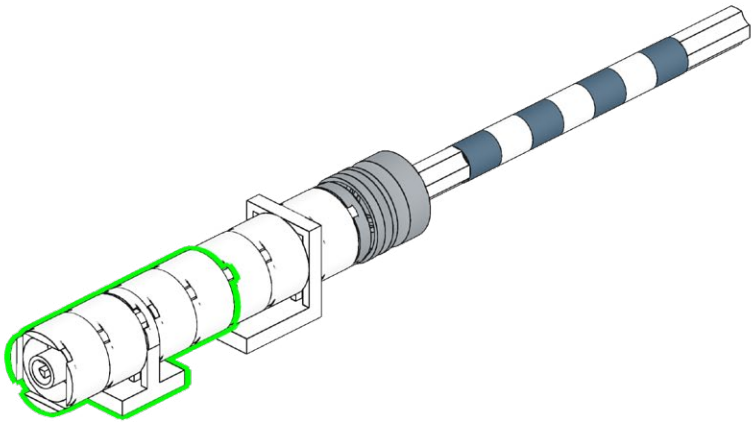

602

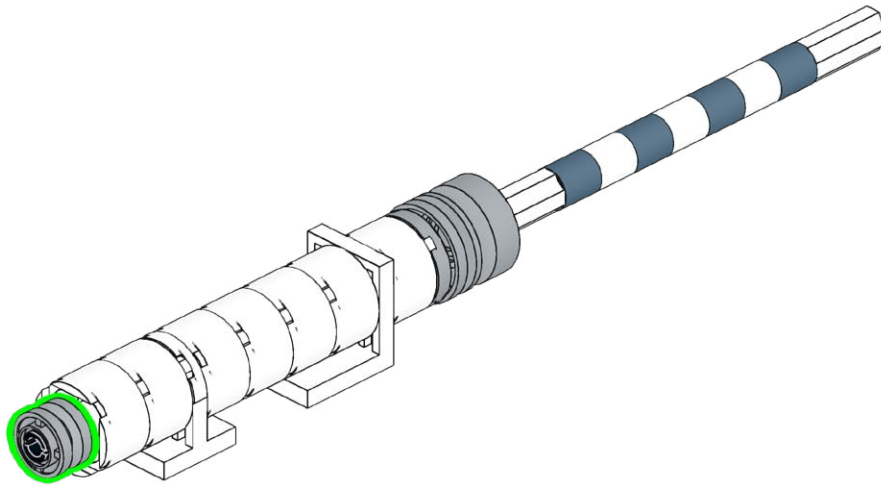
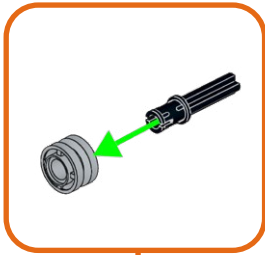

603

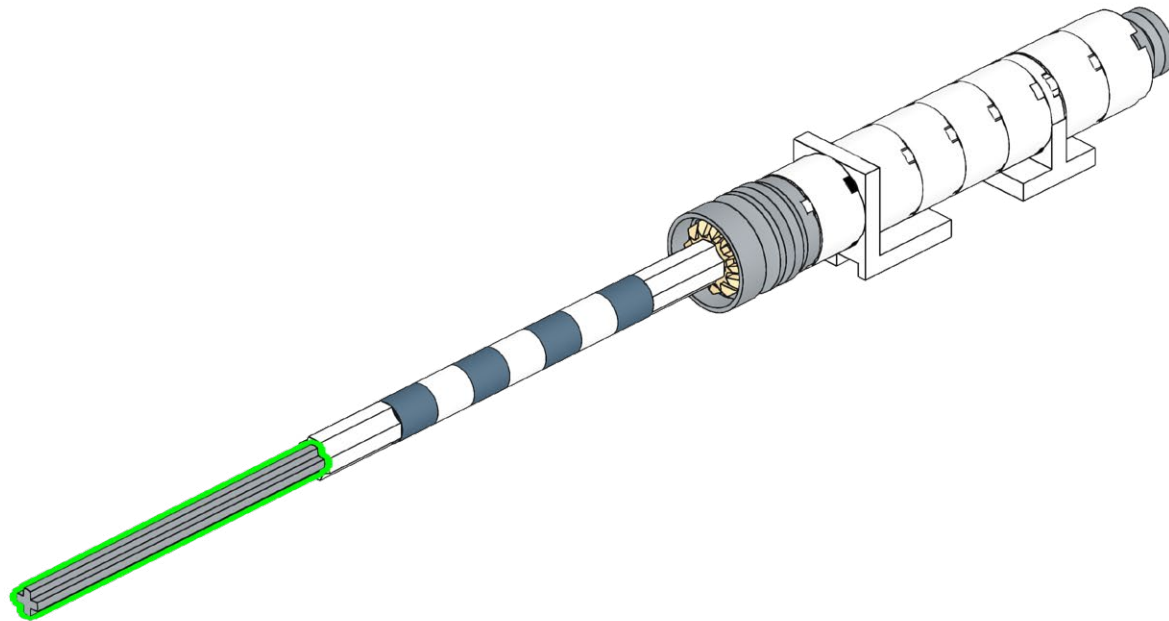
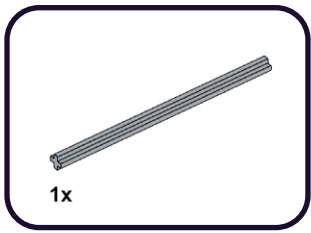

604

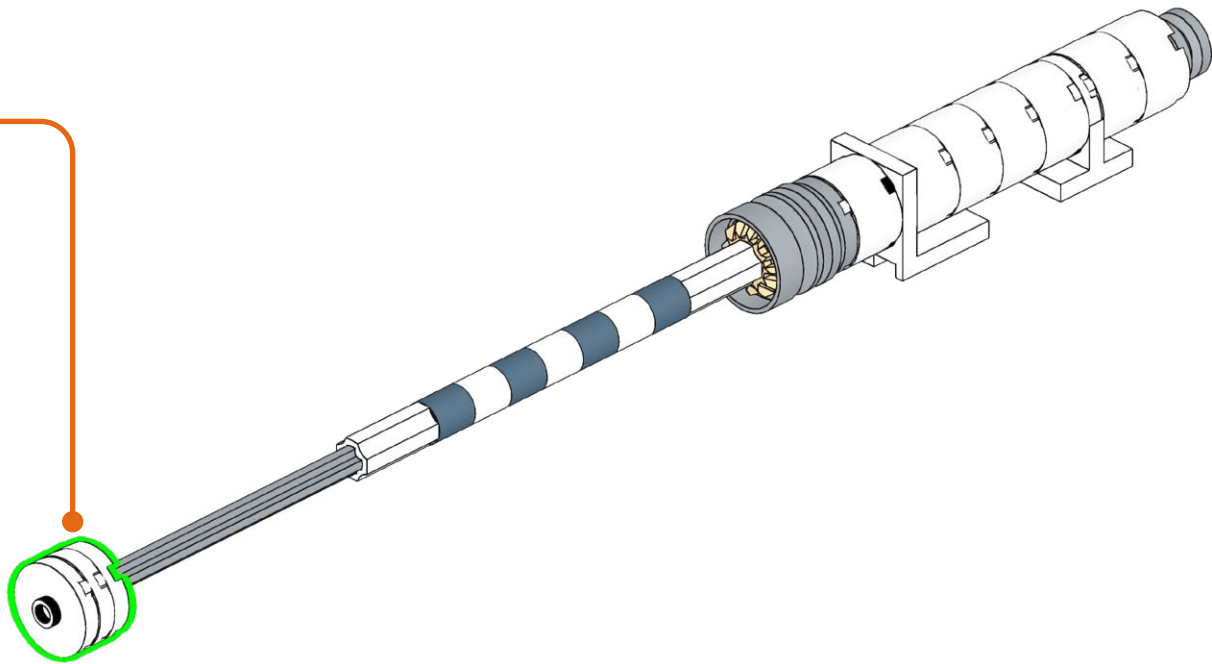
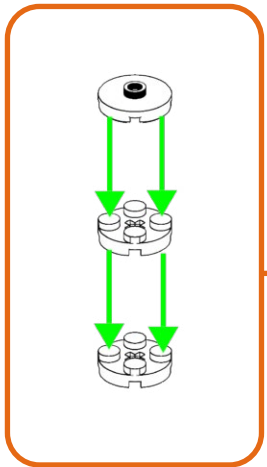
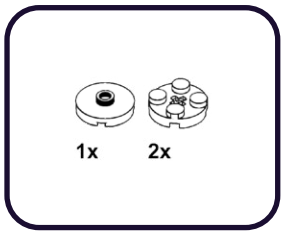

605

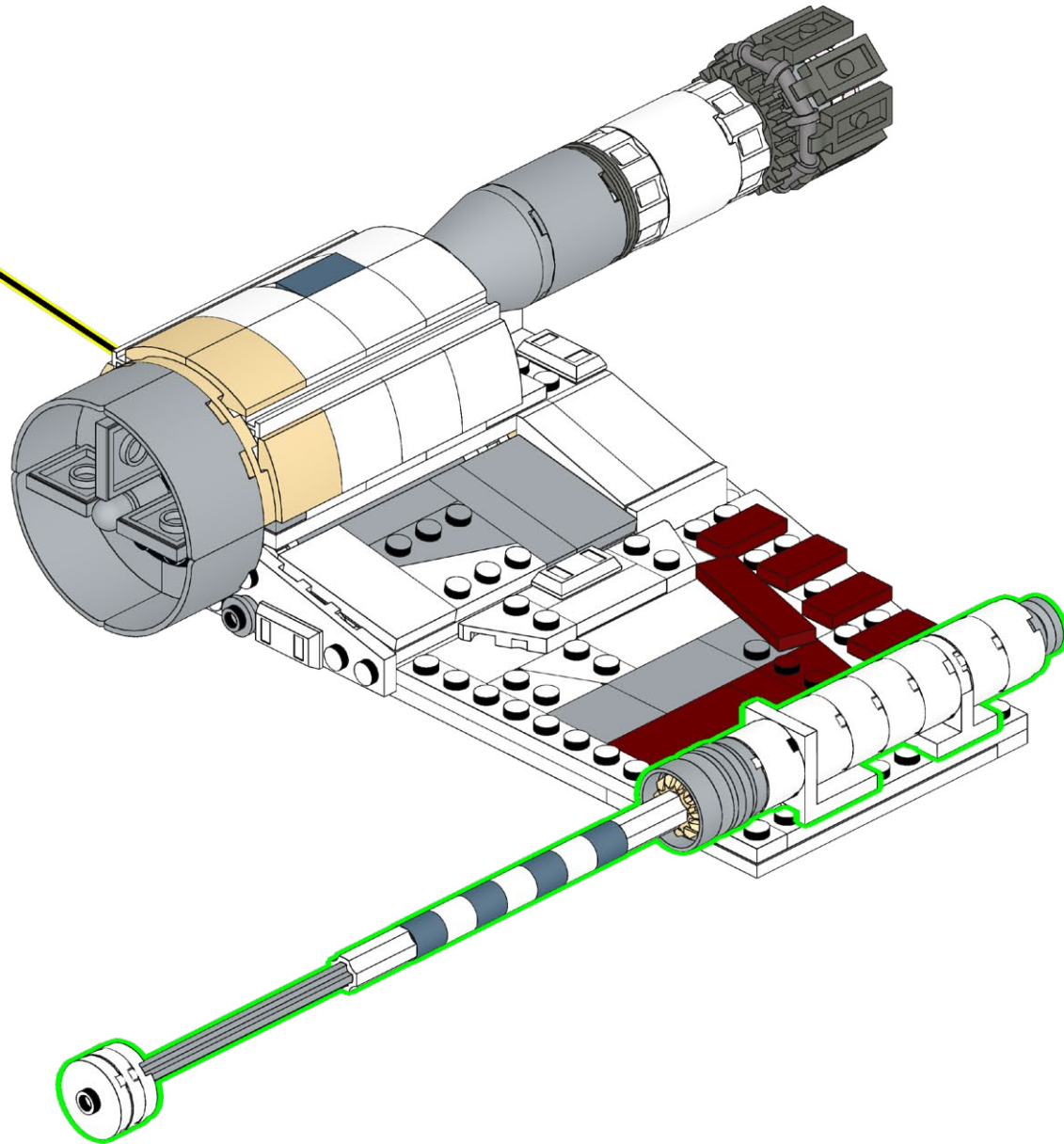

606

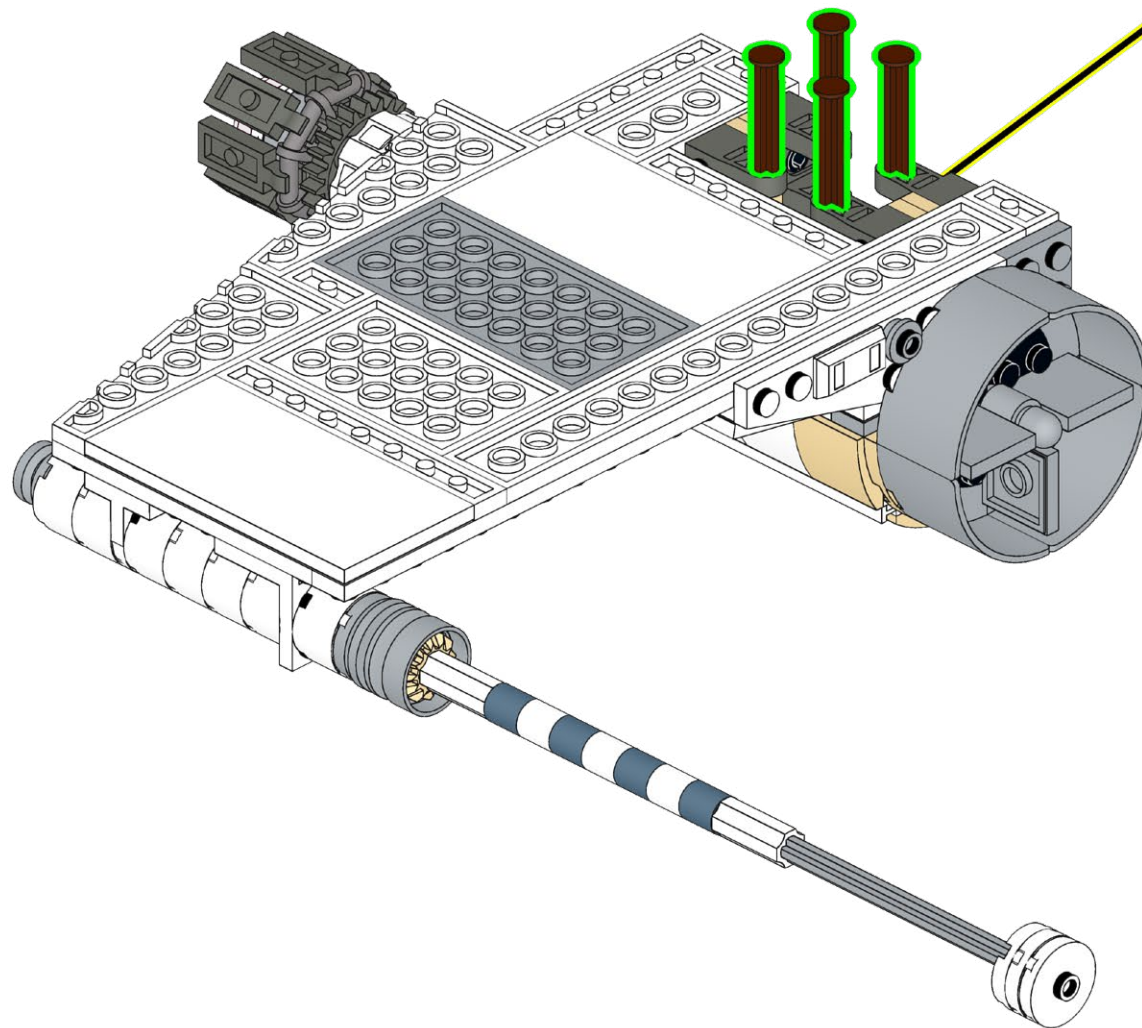

607

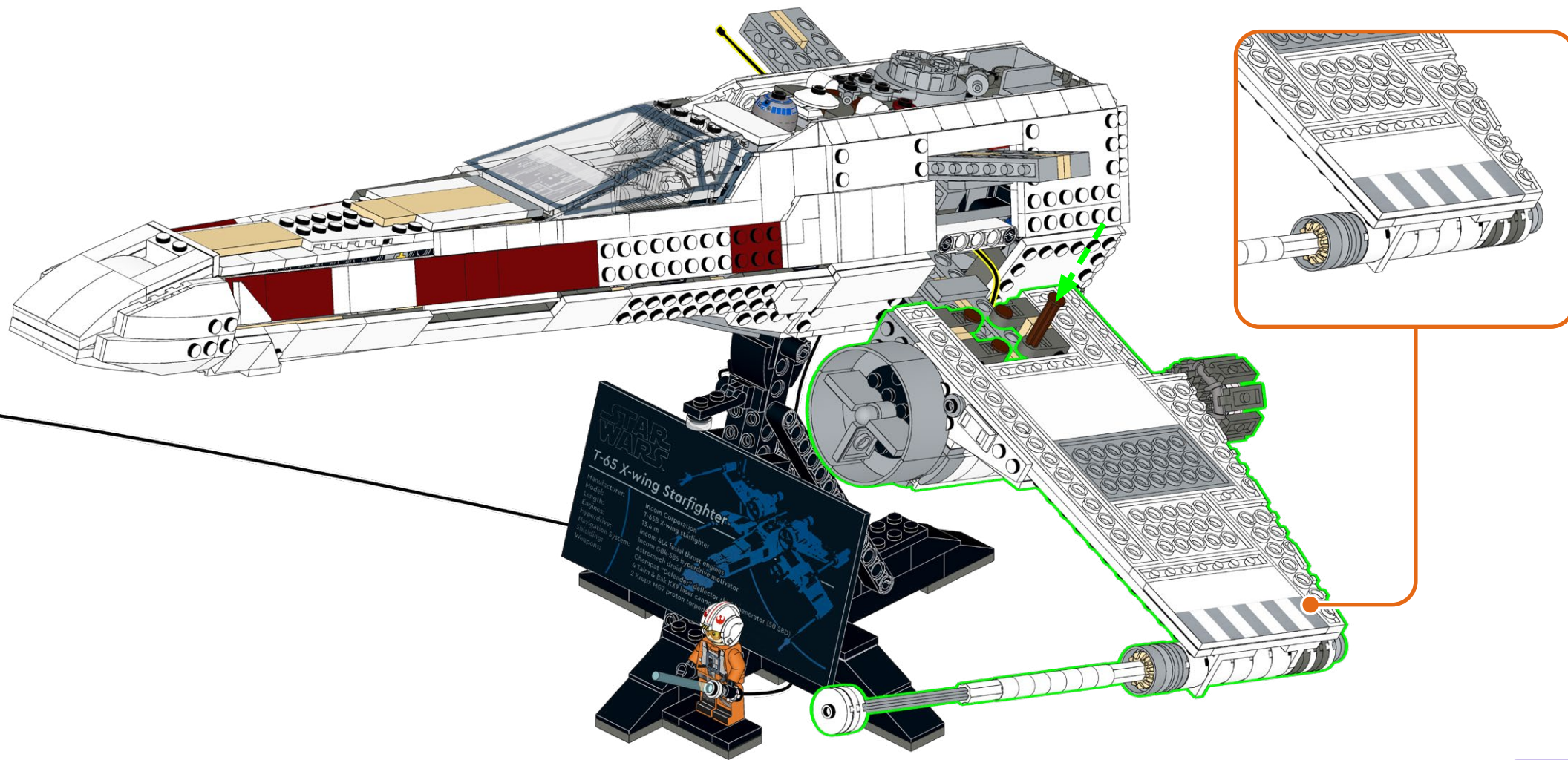

608

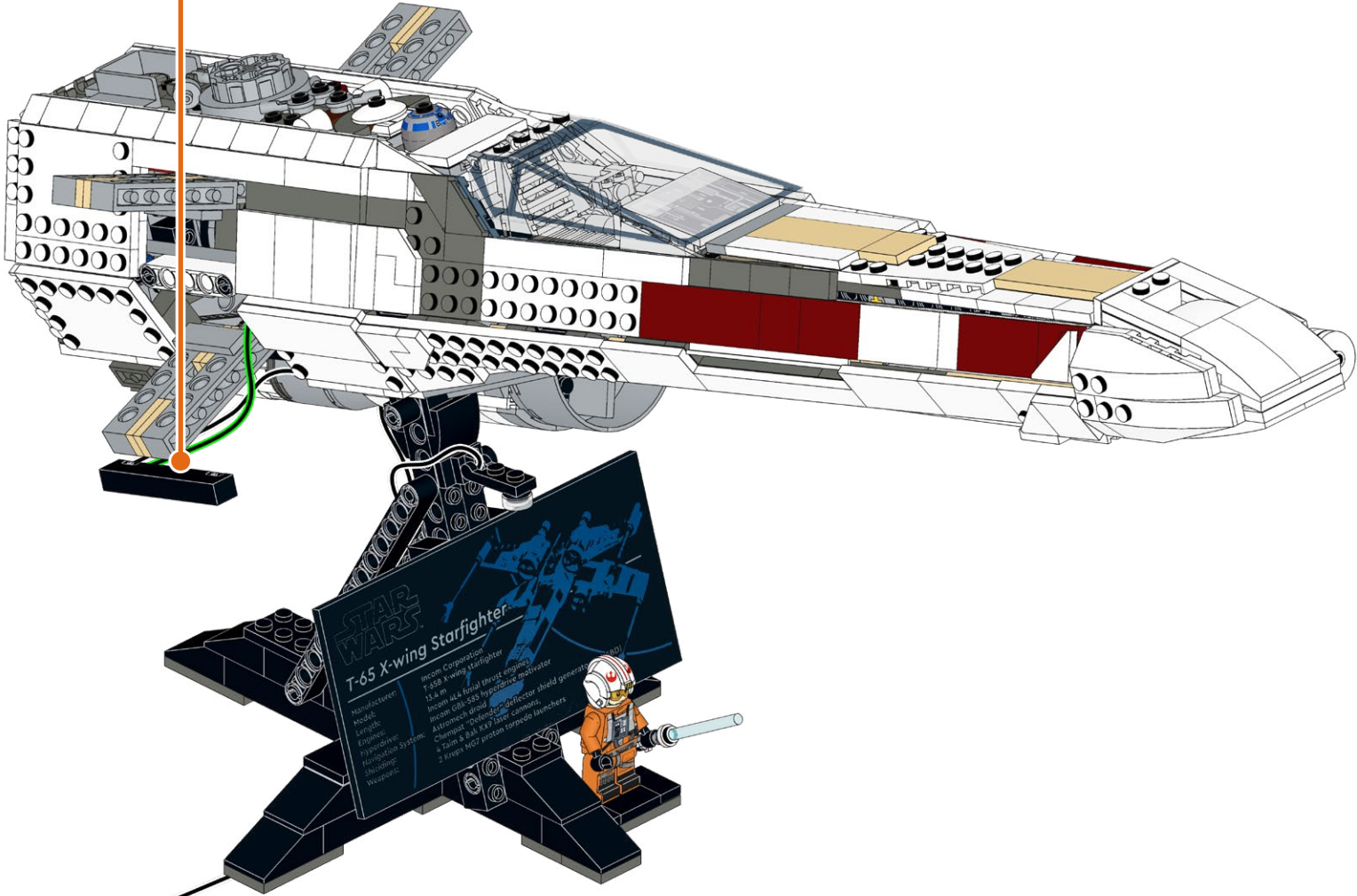
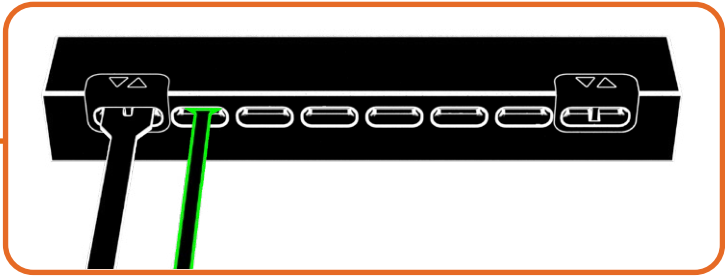

STAR WARS
T-65 X-wing Starfighter

Manufacturer: Incom Corporation
Model: T-65 X-wing Starfighter
Length: 13.8 m
Engines: Incom AT-4 turbo thruster engines
Propulsion System: Incom AT-4 turbo thruster engines
Armament: 4 twin 8.8m laser cannons, 2 triple M27 proton torpedo launchers

611

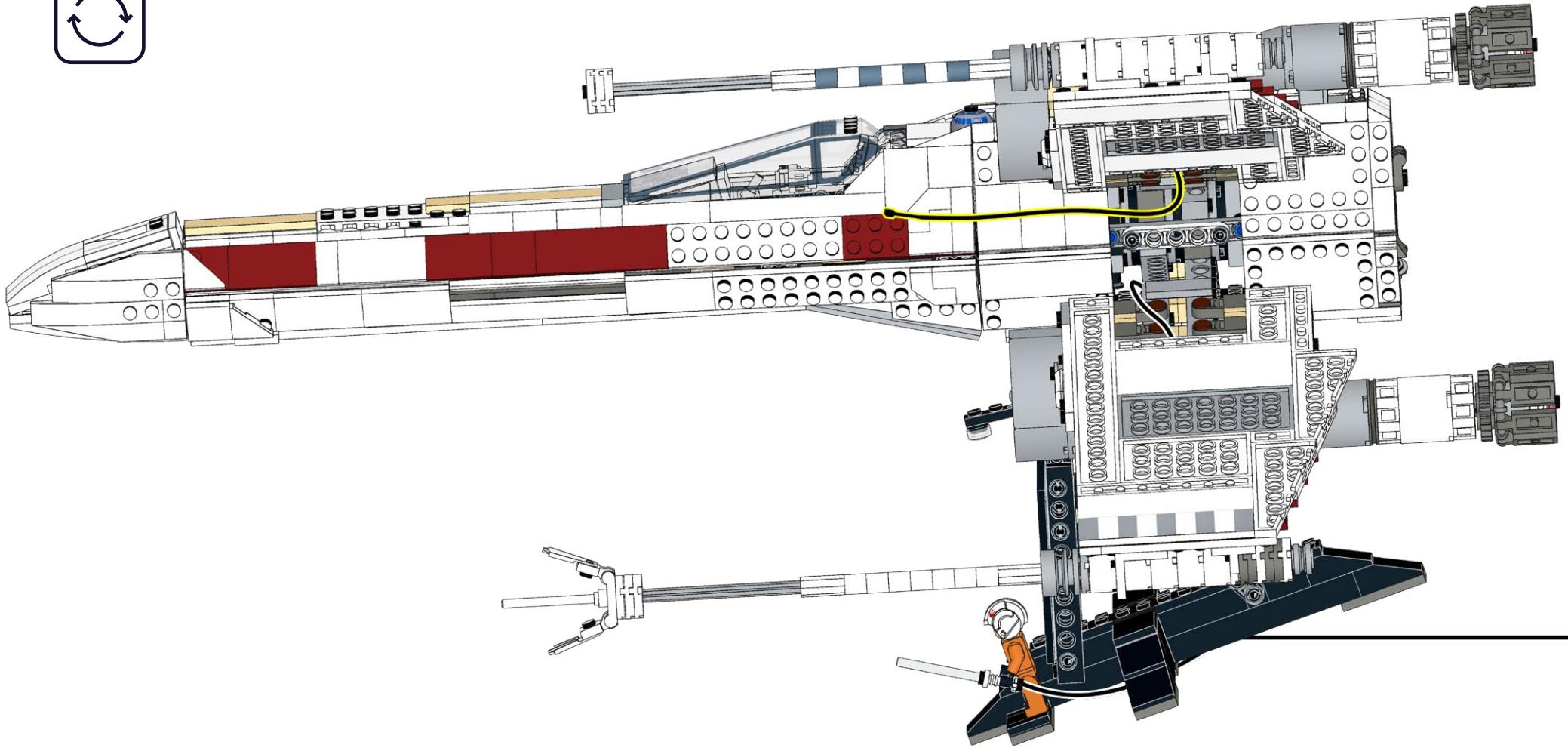

612

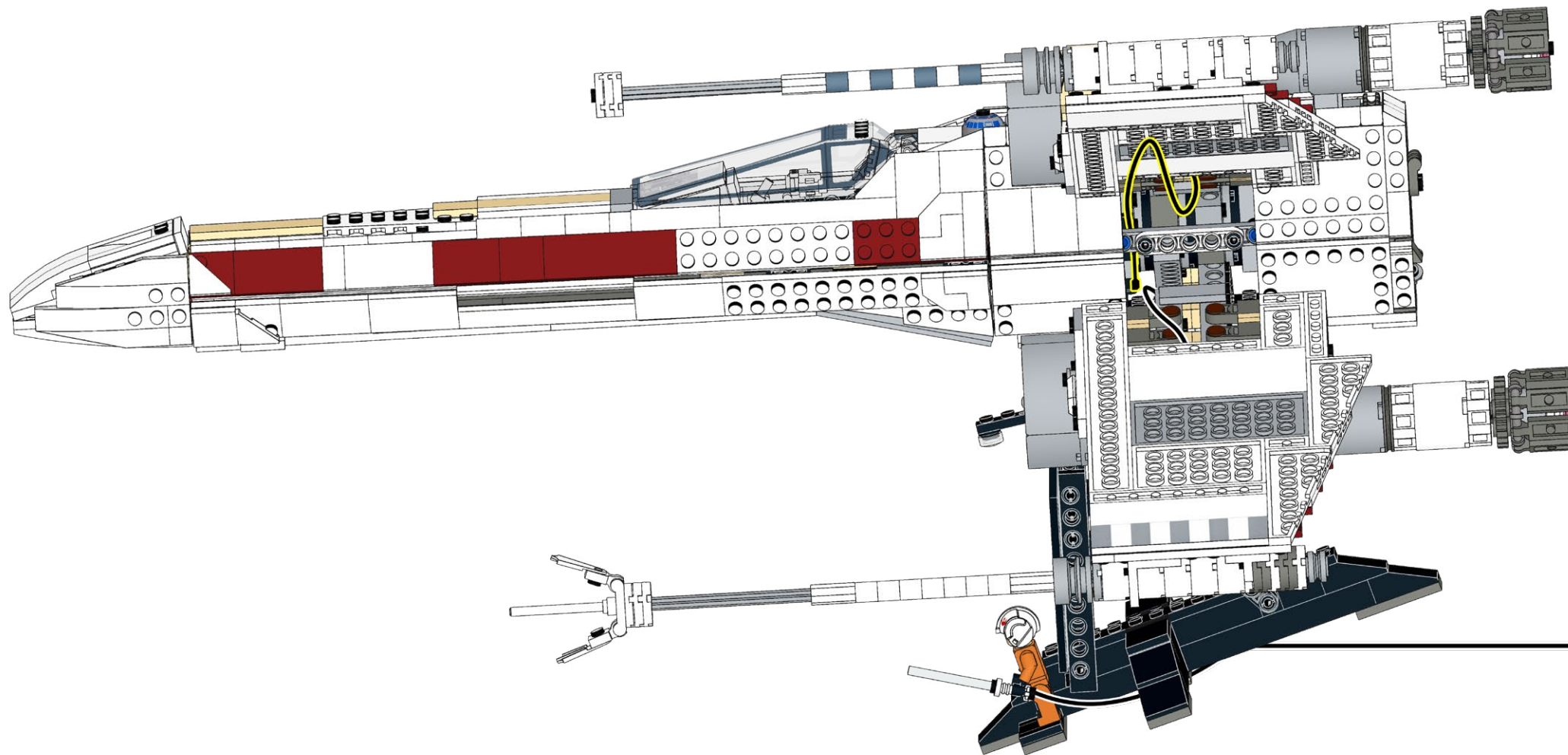



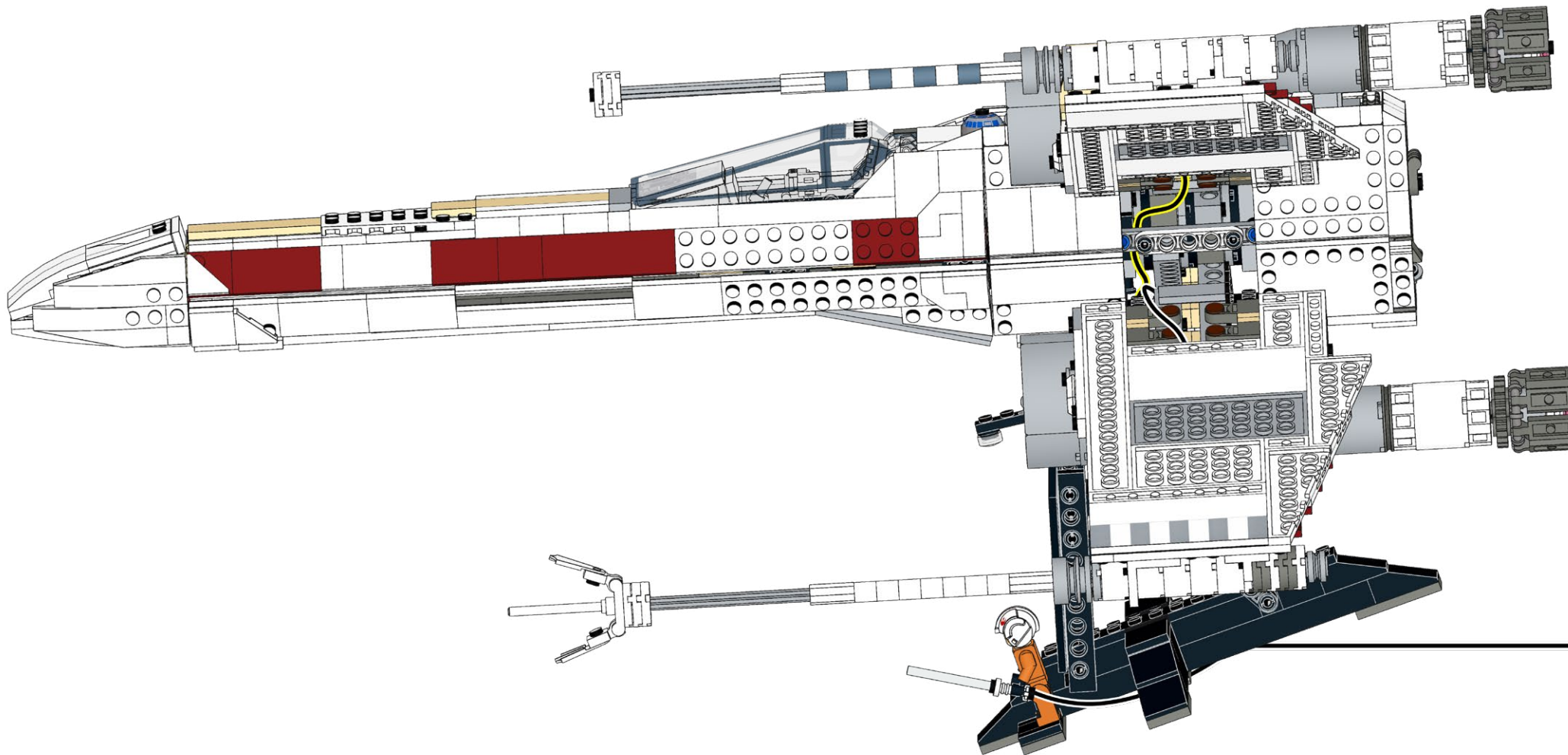

613

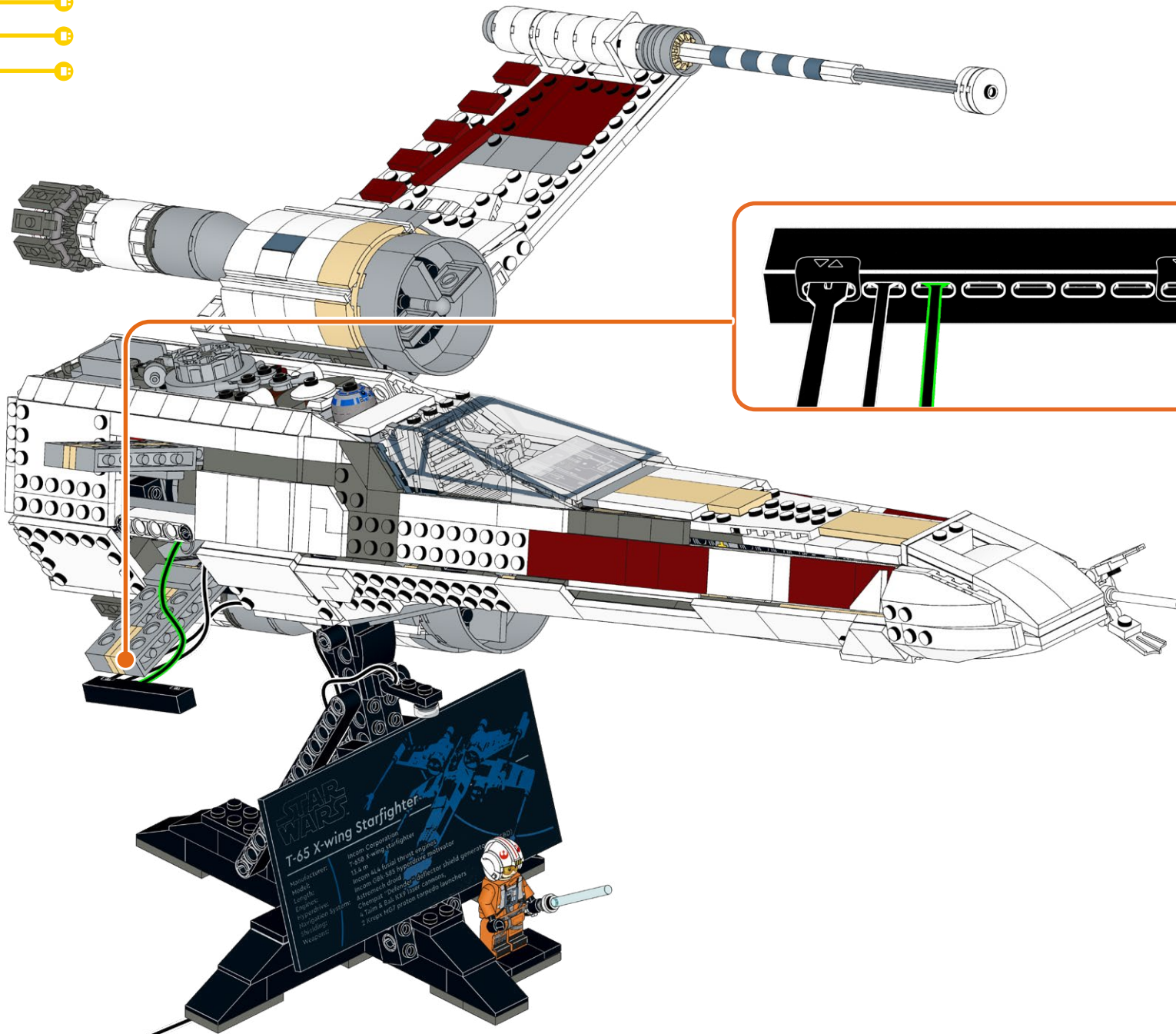

614



615

- 1x 
- 2x 
- 2x 
- 1x 

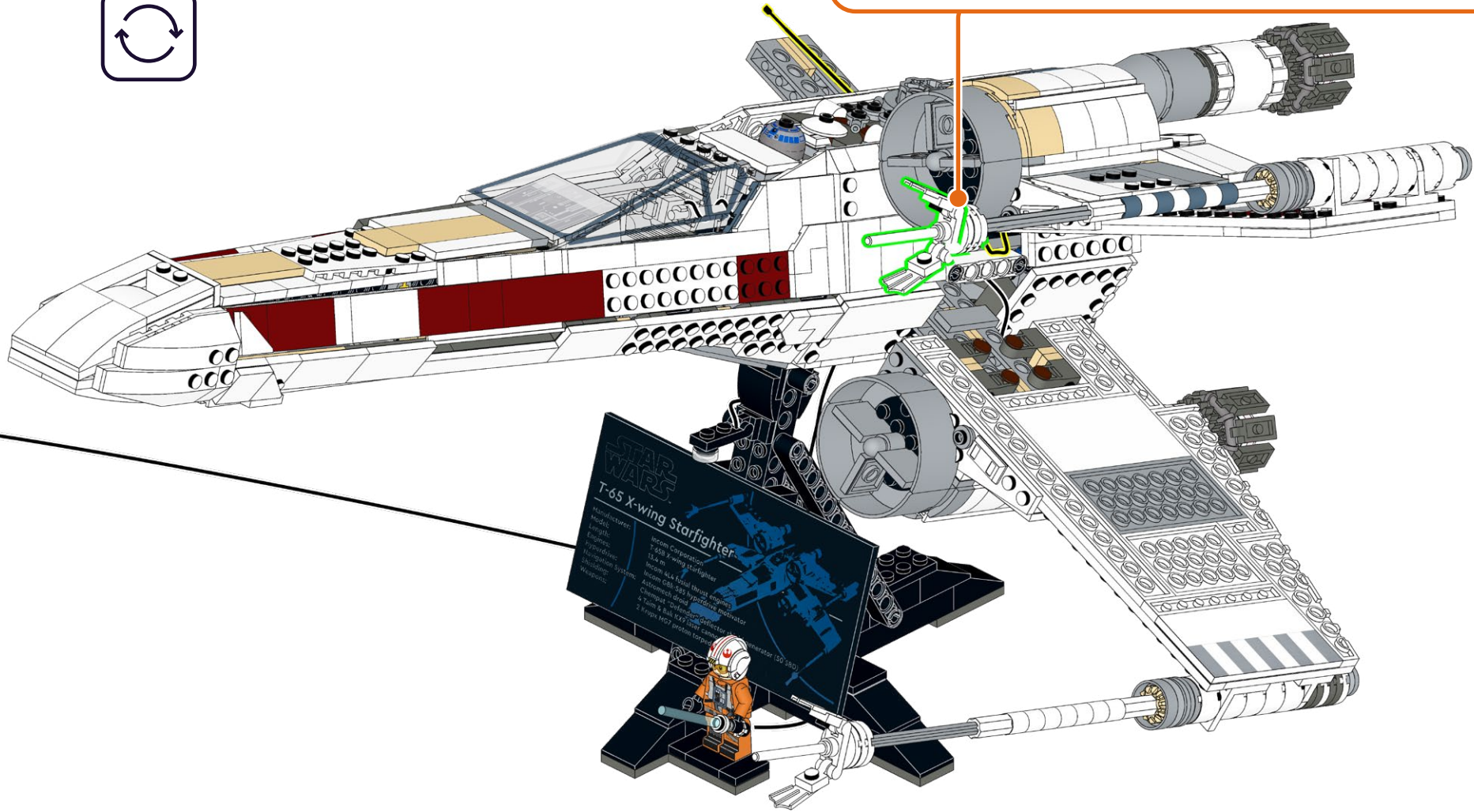
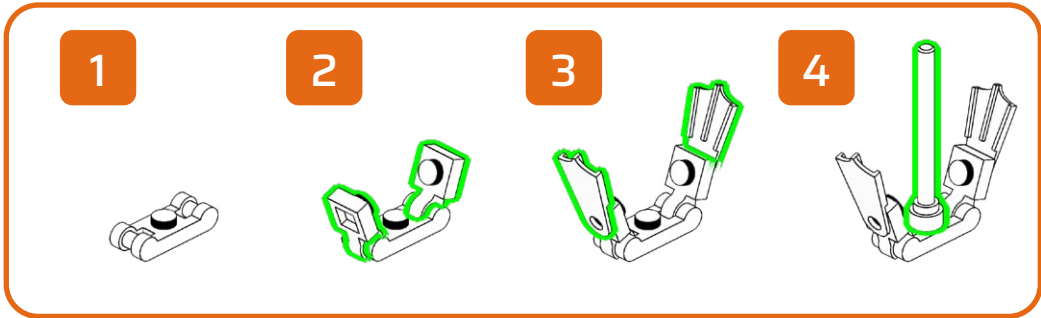
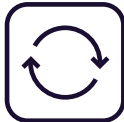

STAR WARS
T-65 X-wing Starfighter

Manufacturer: Lucasfilm
Model: T-65 X-wing Starfighter
Height: 13.4 m
Length: 13.4 m
Width: 13.4 m
Weight: 13.4 t
Engine: 4 x 1000 HP
Speed: 1000 km/h
Armament: 2 x 1000 HP
Crew: 1 x Pilot

616

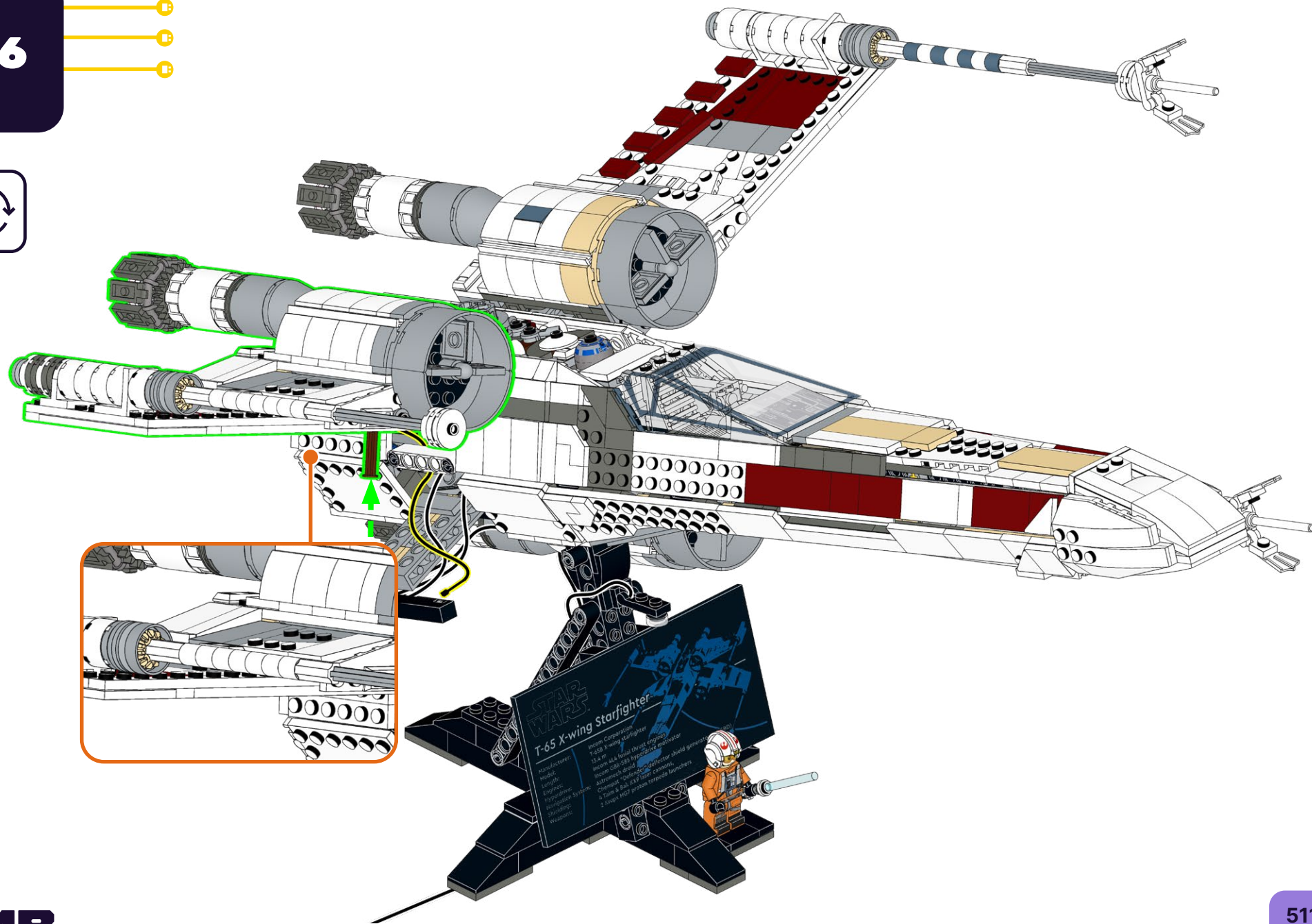

617

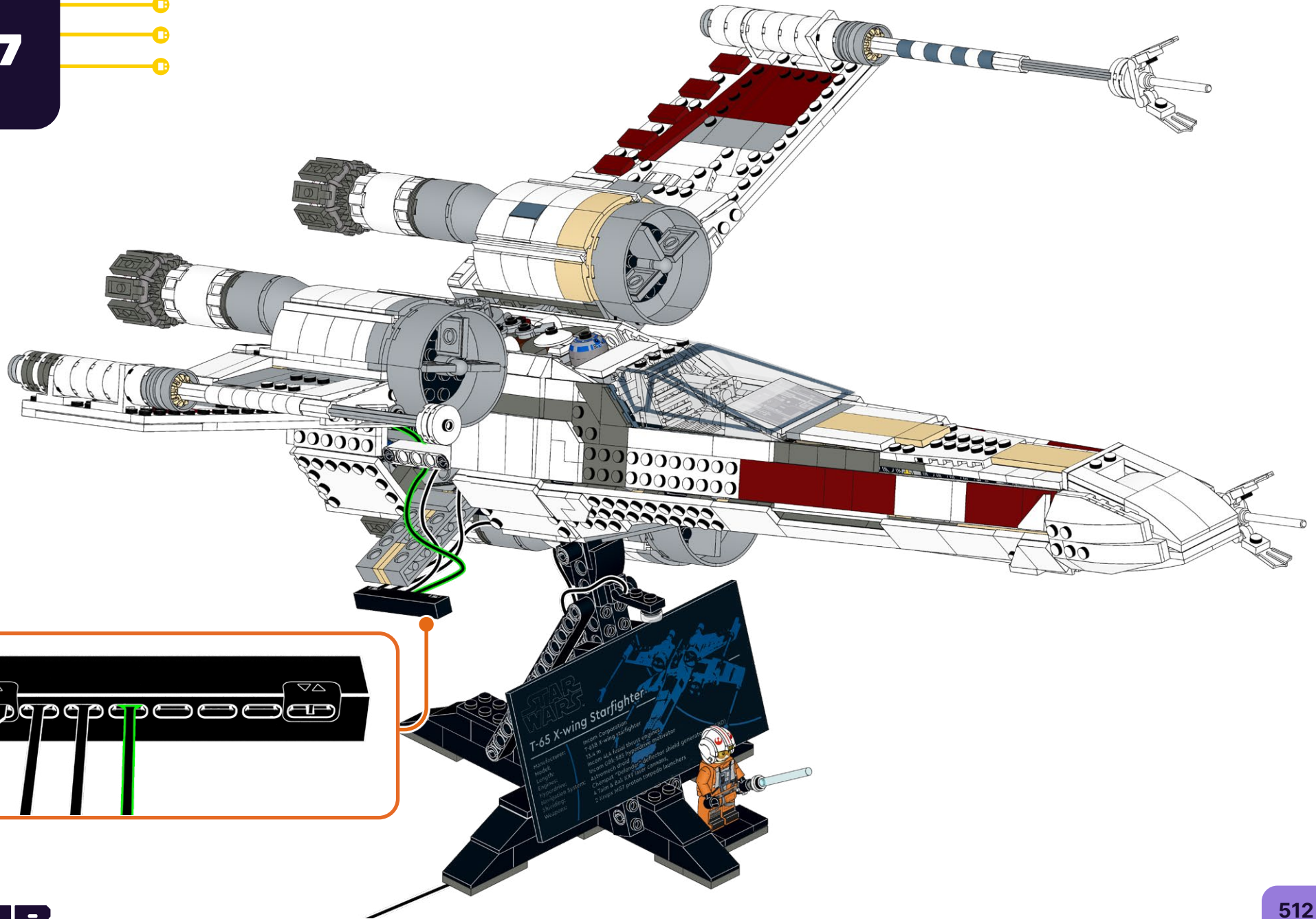

619

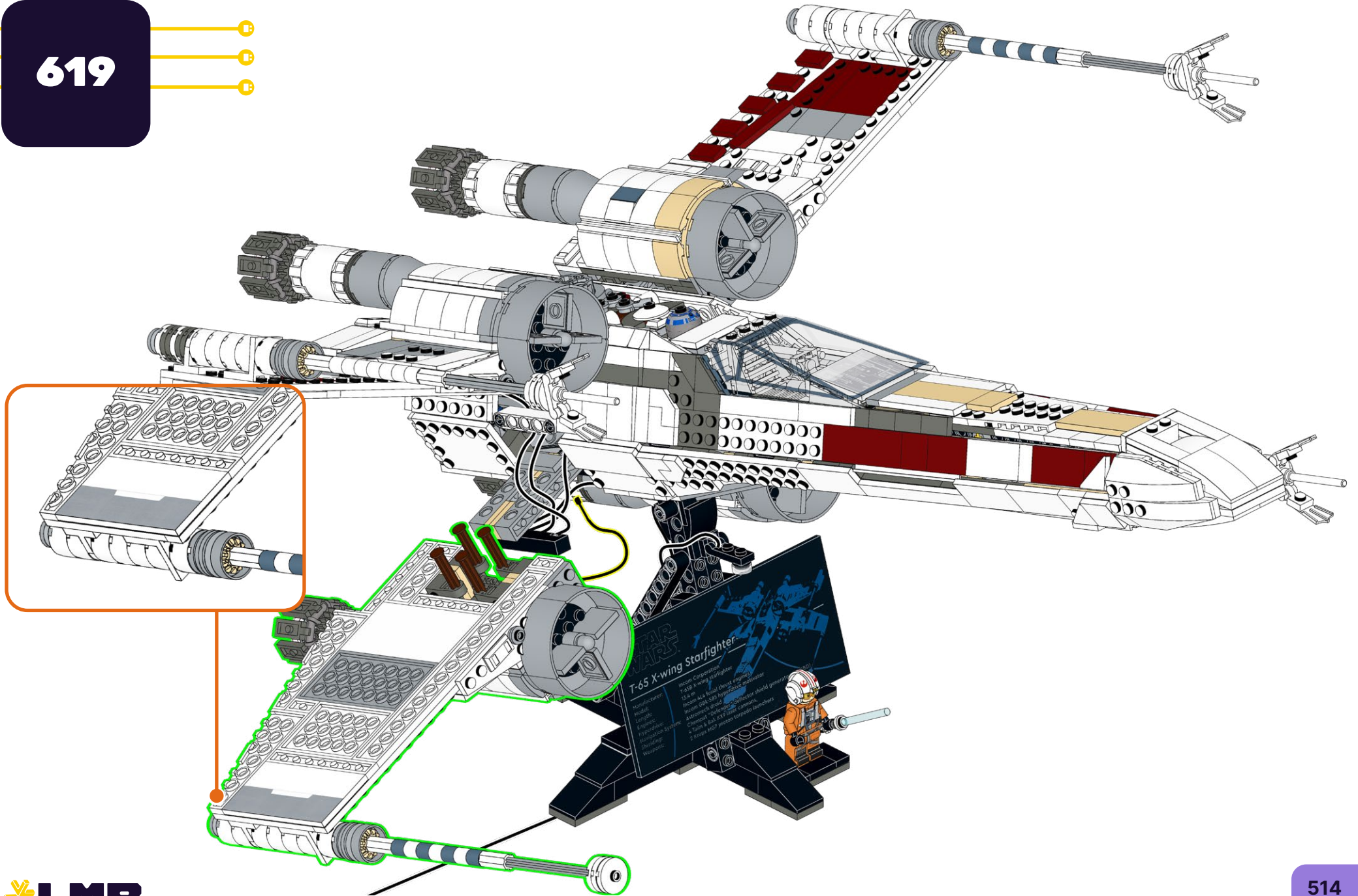

620

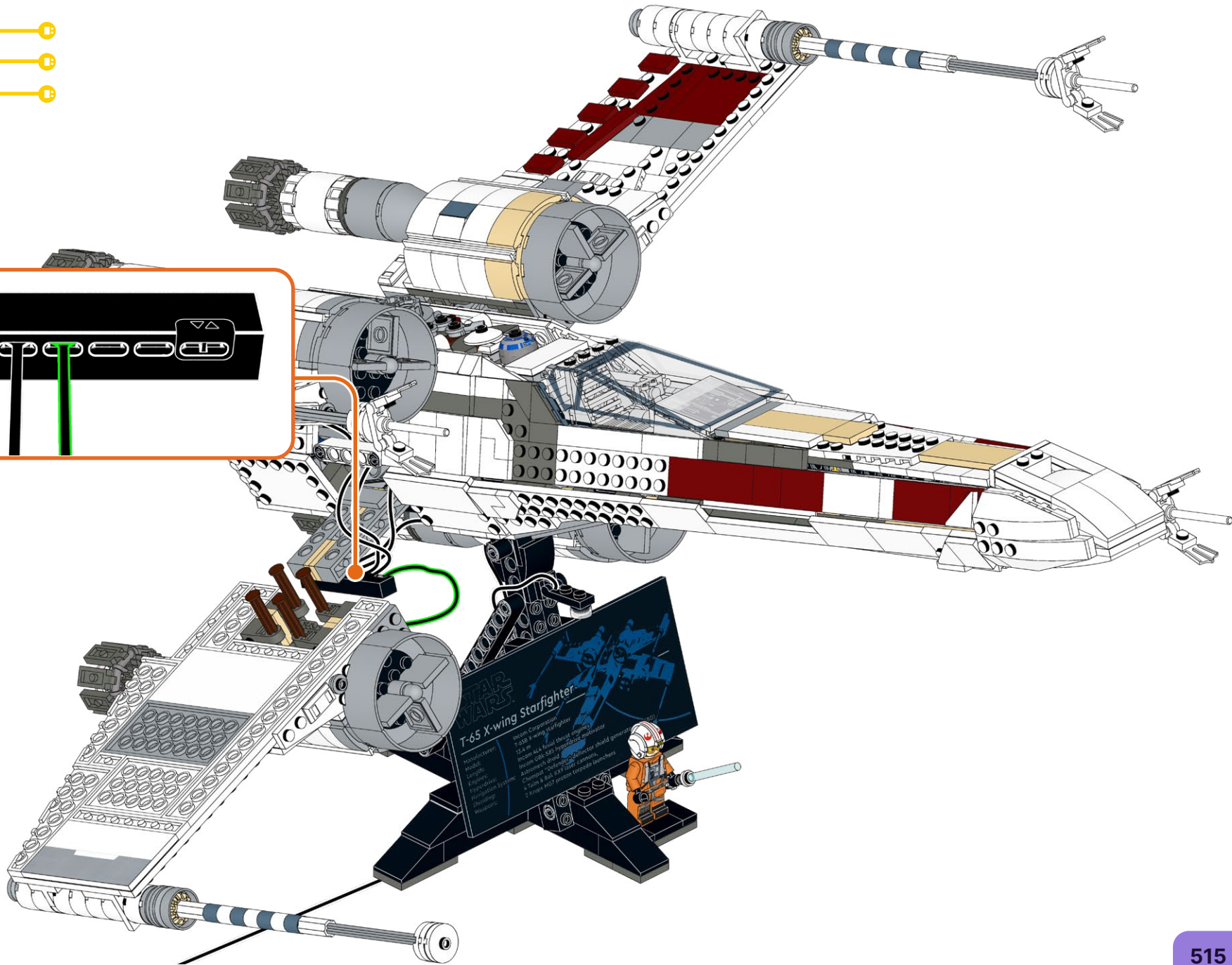
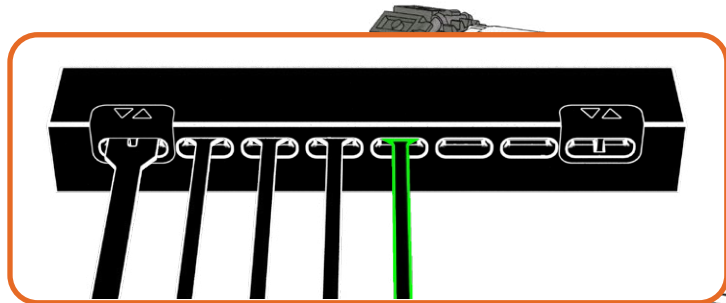

621

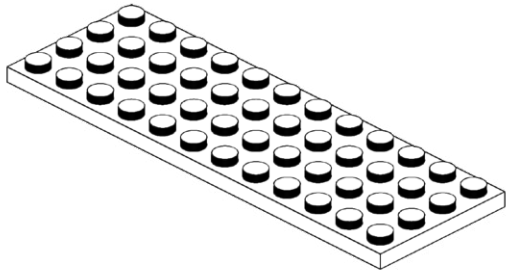
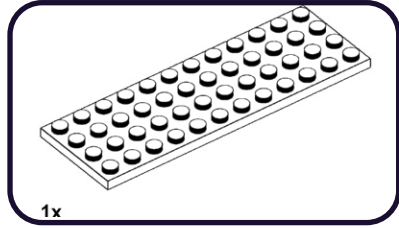

622

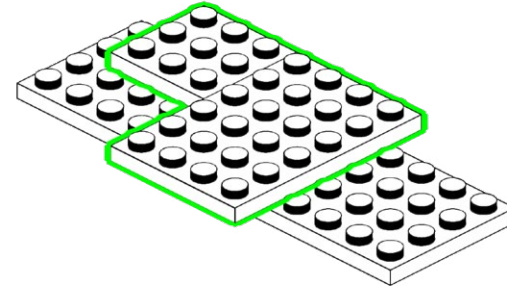
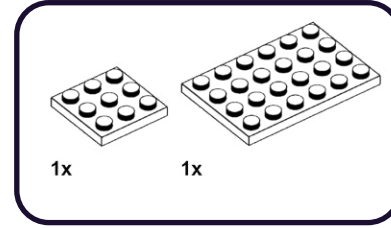

623

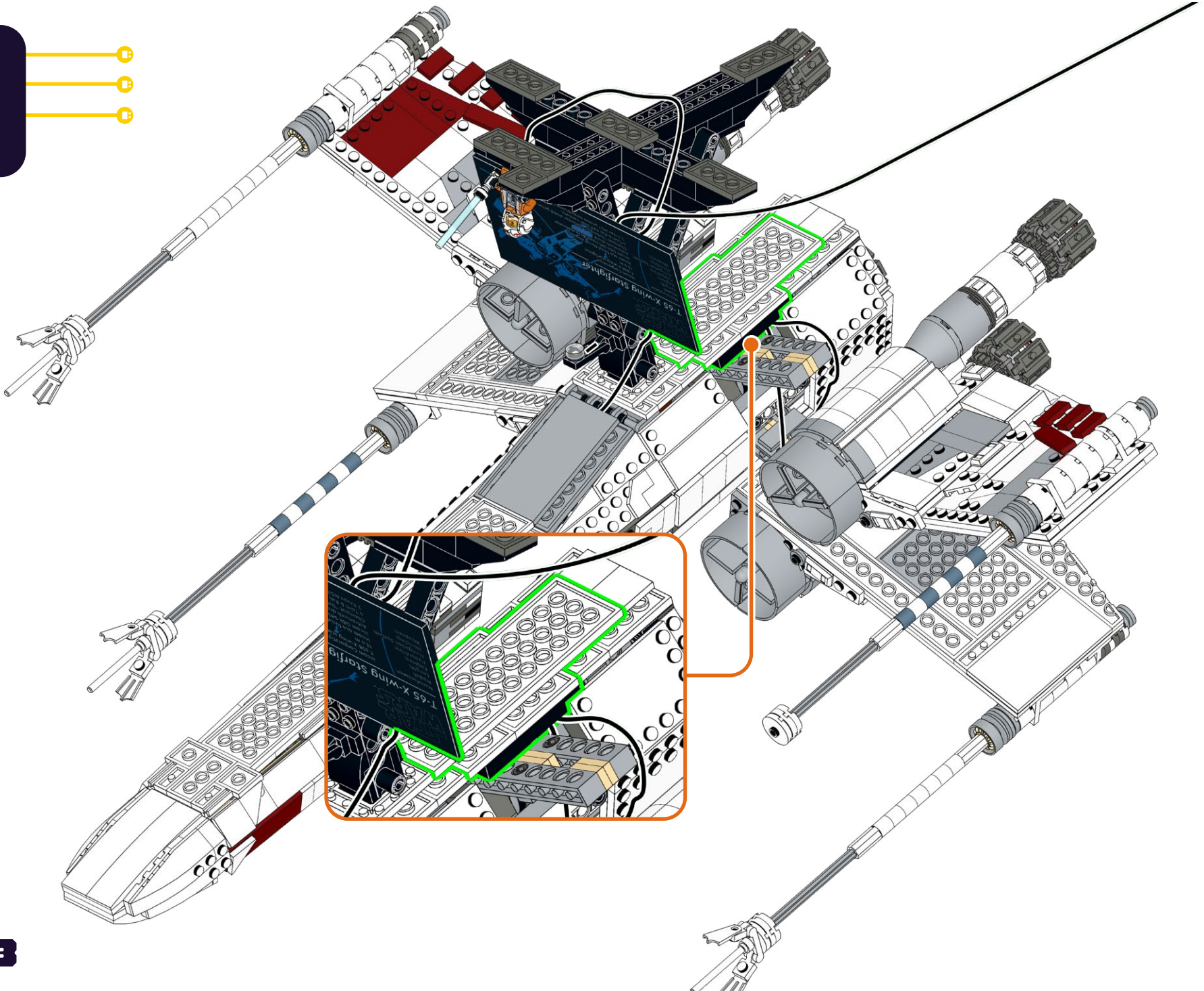

625

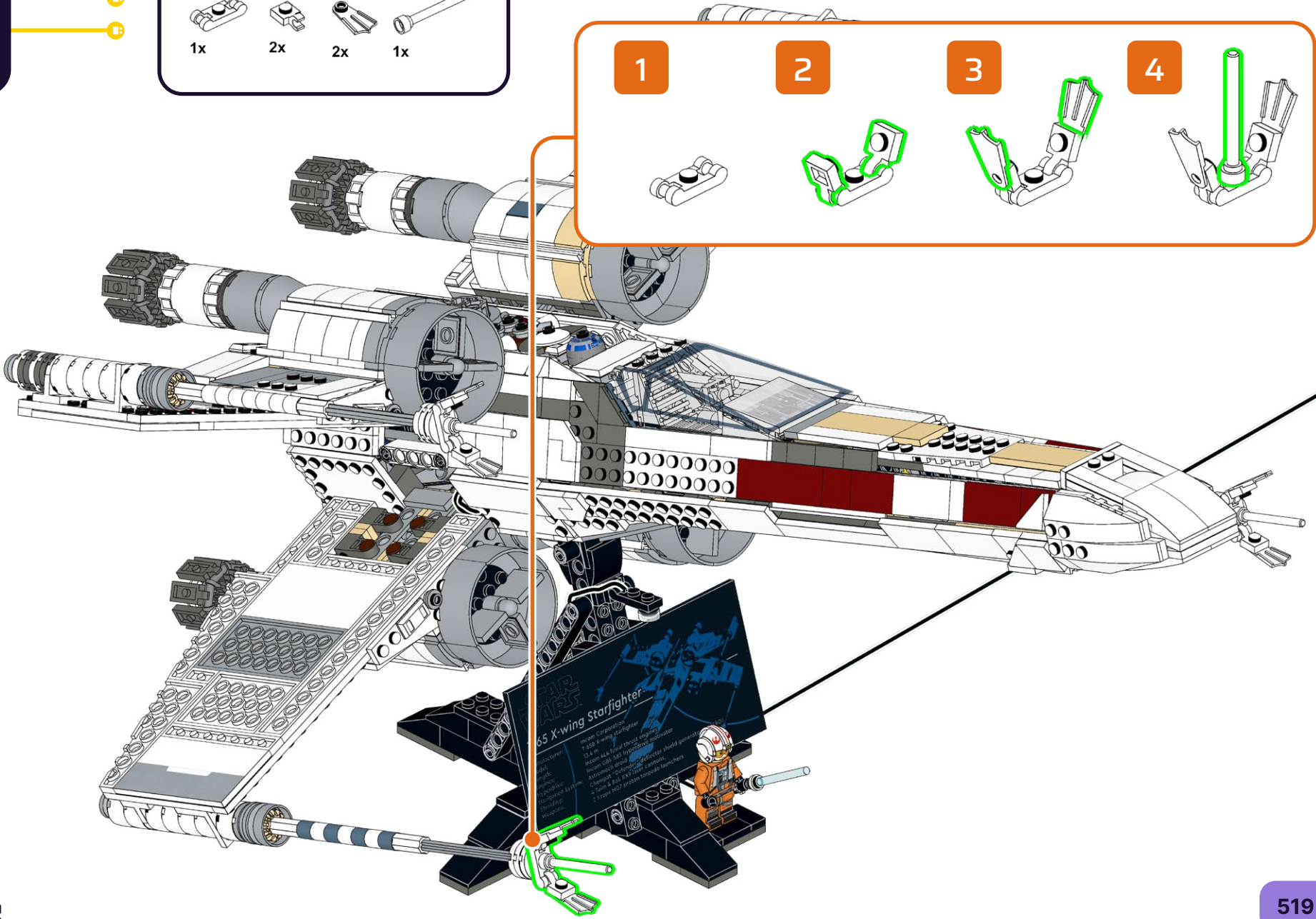
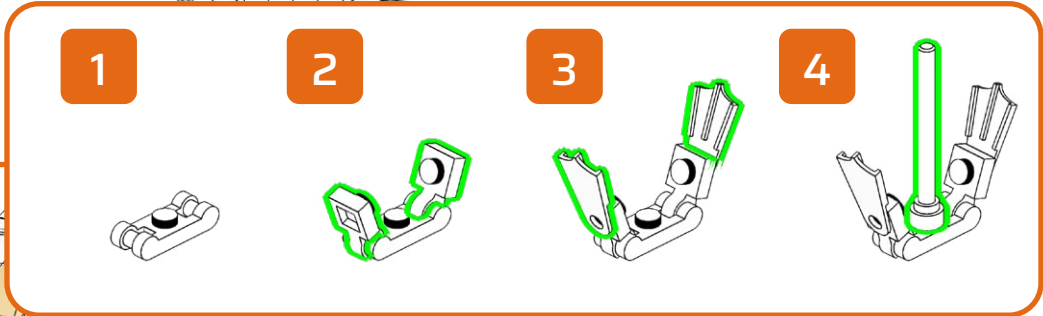
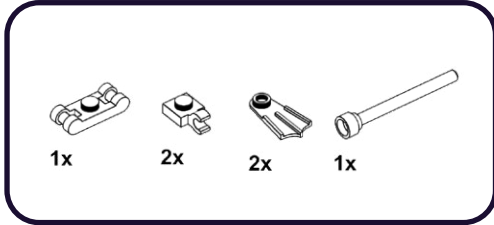

626

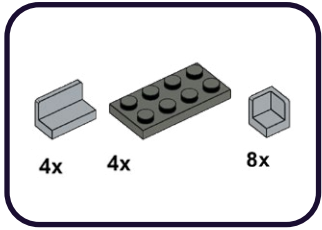

1

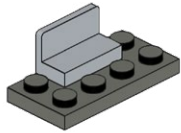

2

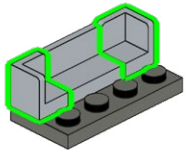

627

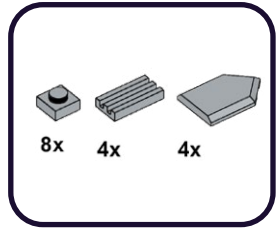

1

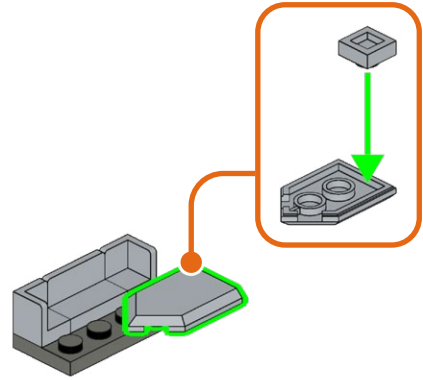

2

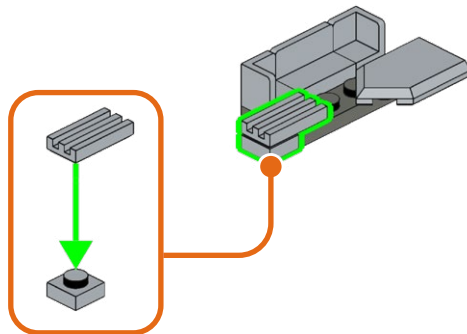

4x

628

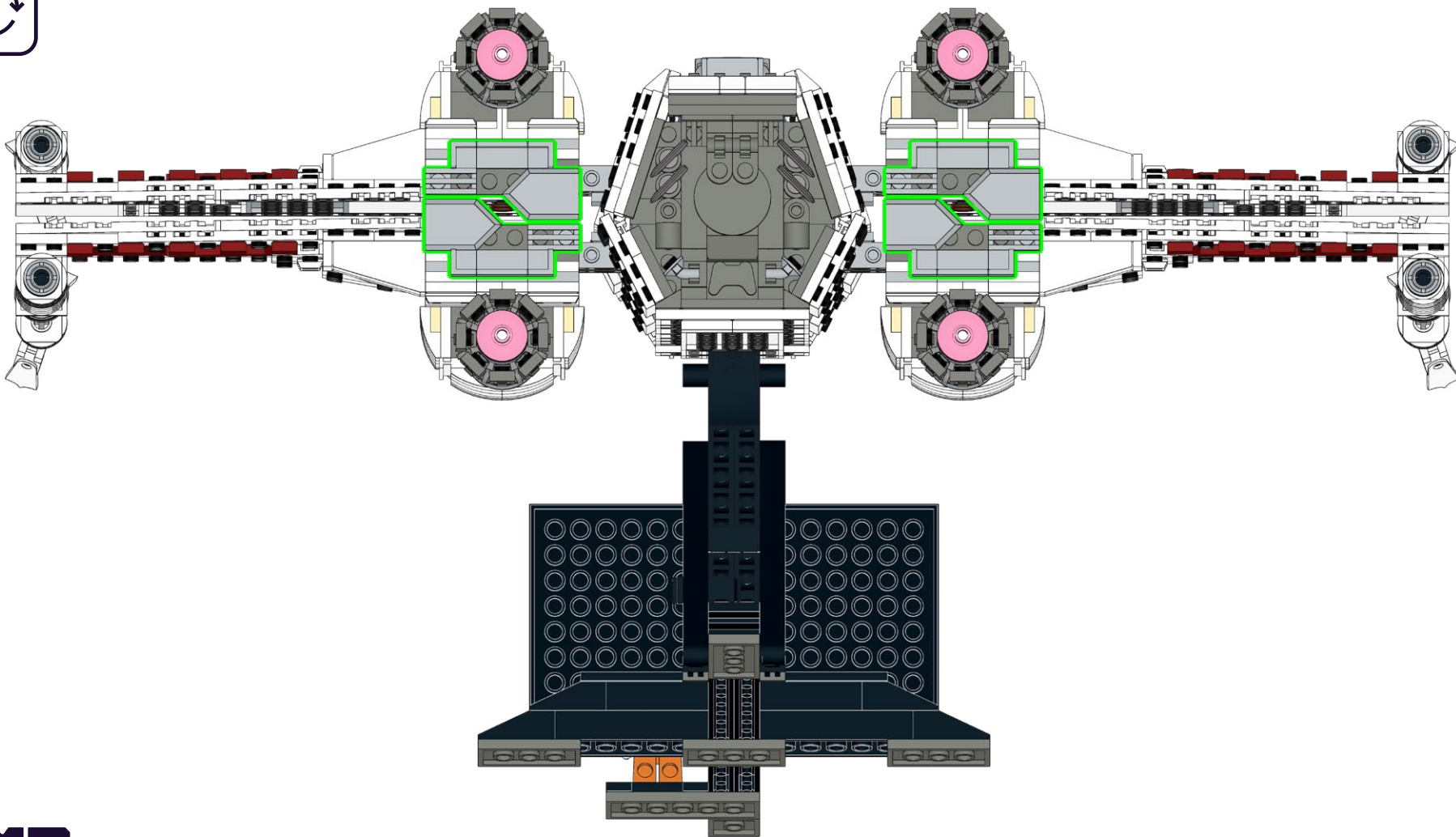

629

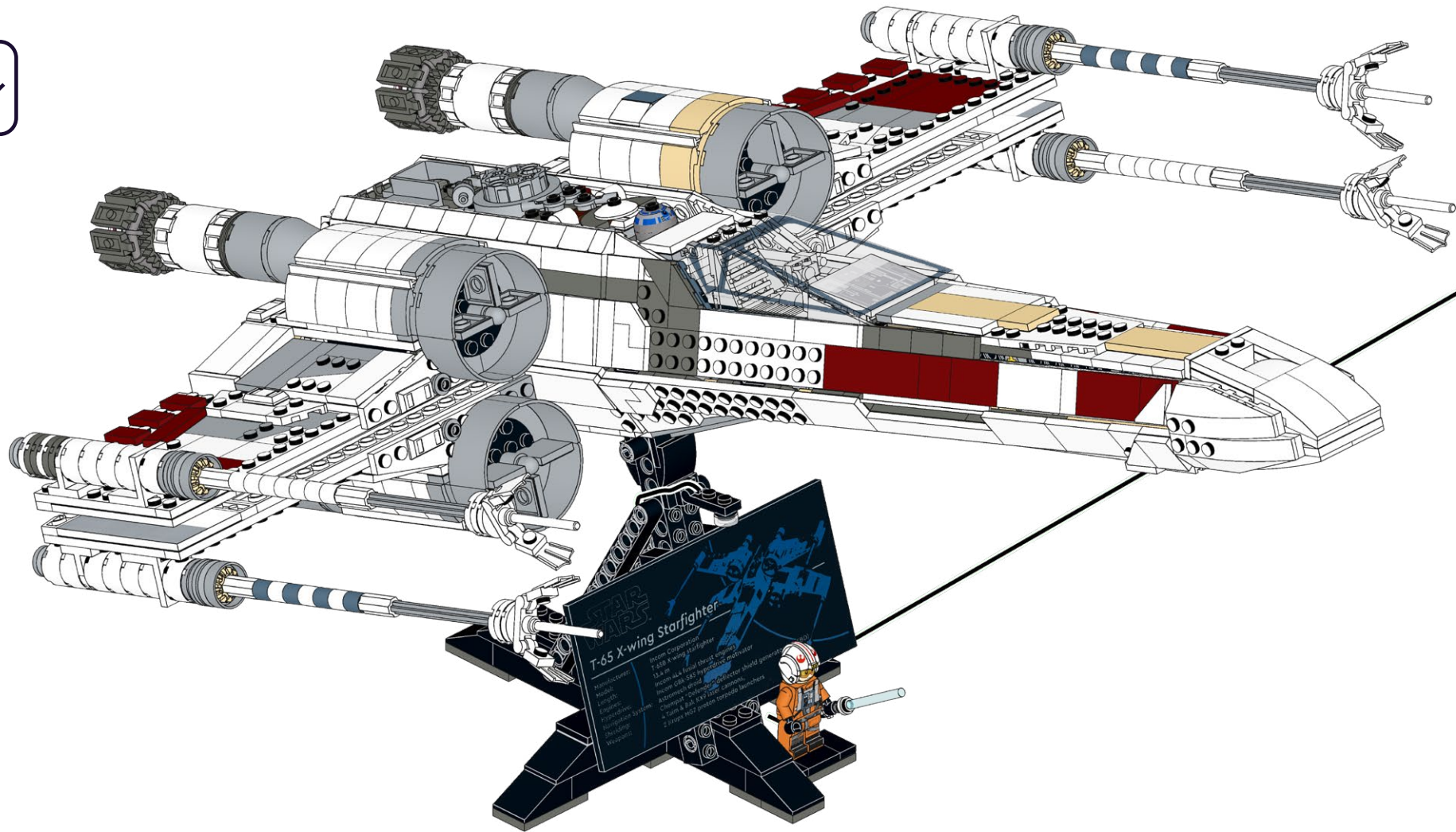

631



632



FINAL PRODUCT



STAR WARS
T-65 X-wing Starfighter

| | |
|--------------------|------------------------------|
| Manufacturer: | Incom Corporation |
| Height: | 12.4 m |
| Length: | 13.4 m |
| Hyperdrive: | Class 1 |
| Propulsion System: | 4 AEG-1000 ion engines |
| Weapons: | 2 Krupn 402 proton torpedoes |

PACKAGE CONTENTS



4x AL-P30
Astro Light Large
Pink 30cm



1x FLX-B
Flux Belt



1x T-1x4
Tether 1x4



2x AL-CW15
Astro Light Large
Cool White 15cm



2x D-3
Dock-3



2x A-CAP
Astro Cap



1x AR-FR15
Astro Light Regular
Flashing Red 15cm



1x D-6
Dock-6



1x LS-B30
Astro Lightsaber
Blue 30cm

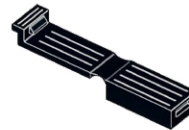

1x E-1x2
Eclipse 1x2



2x B-15
Belt 15cm

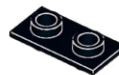

1x T-1x2
Tether 1x2

PACKAGE CONTENTS



4x Round Plate 1x1 - White



1x Tile, Modified 1x1 with Open O Clip - Black



3x Round Plate 1x1 w Open Stud - Black

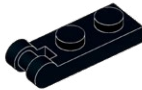

1x Plate, Modified 1x2 with Bar Handle on End - Black



1x Bracket, 1x1 - 1x1 Light Grey

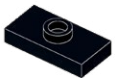

1x Plate, Modified 1x2 with 1 Stud with Groove and Bottom Stud Holder (Jumper) - Black

CONTACT US

Click below for customer support, or general inquiries.

Cliquez ci-dessous pour accéder au support client ou aux renseignements généraux.

Clicca qui sotto per l'assistenza clienti o per richieste generali.

Contact Us



Contactez-nous



Contattaci



Klicken sie unten für kundensupport oder allgemeine anfragen.

Haga clic a continuación para atención al cliente o consultas generales.

点击下方获取客户支持或一般咨询。

Kontaktieren sie uns



Contáctanos



联系我们



TROUBLESHOOTING

If you're stuck, scan the QR code for troubleshooting.

Se sei bloccato, scansiona il codice QR per la risoluzione dei problemi.

Wenn Sie nicht weiterkommen, scannen Sie den QR-Code zur Fehlerbehebung.

Si vous êtes bloqué, scannez le code QR pour le dépannage

Si está atascado, escanee el código QR para solucionar el problema.

如果遇到问题, 请扫描二维码进行故障排除

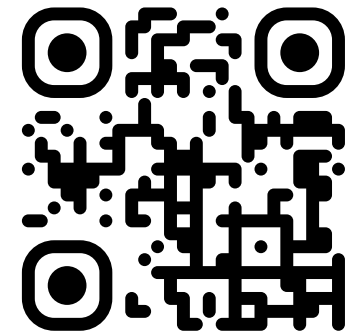



LIGHTMYBRICKS

lightmybricks.com



LEGO® is a trademark of the LEGO Group of companies, which does not sponsor, authorize or endorse this product. All LEGO® sets featured in images are sold separately. This is not a LEGO® product. The LEGO Group is not liable for any loss, injury or damage arising from the use or misuse of this product. ©2024 Light My Bricks Pty Ltd. All rights reserved. www.lightmybricks.com

Our components are designed and packaged in Australia by Light My Bricks Pty Ltd. Components are manufactured in China. 3fl bldg C, Shuanghuan Quanxin Technology Information Industry Park Baolong Street, Longgang District, Shenzhen, China. Imported in Australia by Light My Bricks Pty Ltd, 5/26 Rushdale St, Knoxfield, VIC, 3180, Australia.

WARNING: CHOKING HAZARD - Small parts. Not for children under 3 years.

AVERTISSEMENT : RISQUE D'ÉTOUFFEMENT - Petites pièces. Ne convient pas aux enfants de moins de 3 ans.

ATTENZIONE: PERICOLO DI SOFFOCAMENTO - Piccole parti. Non adatto a bambini di età inferiore a 3 anni.

WARNUNG: ERSTICKUNGSGEFAHR - Kleine Teile. Nicht für Kinder unter 3 Jahren geeignet.

ADVERTENCIA: PELIGRO DE ASFIXIA - Piezas pequeñas. No son apto para niños menores de 3 años.

警告：窒息危险 - 小零件。不适合3岁以下儿童。