

# LIGHT KIT INSTALLATION GUIDE

**DISNEY TIM BURTON'S THE  
NIGHTMARE BEFORE CHRISTMAS**

FOR LEGO  
SET  
#21351



# CONTENTS



## 03

### Getting Started

- 04 Legend
- 05 Component Handling
- 06 Blueprint

## 07

### Instructions

- 35 LMB Bag 01
- 119 LMB Bag 02
- 158 LMB Bag 03
- 189 LMB Bag 04

## 211

### Final Product

- 212 Package Contents
- 214 Contact & Troubleshooting

# GETTING STARTED



Bold, beautiful and bright, Light My Bricks elevates your favourite LEGO set from knick-knack to statement piece. Create a talking point at home or in the office that speaks to your passions with Light My Bricks. To learn more, click below.

[Learn More](#)



Audacieux, beau et lumineux, Light My Bricks élève votre ensemble LEGO préféré du statut de bibelot à celui de pièce maîtresse. Que ce soit à la maison ou au bureau, partagez votre passion des LEGO avec Light My Bricks. Cliquez ci-dessous pour en savoir plus.

[En savoir plus](#)



Audace, bello e luminoso, Light My Bricks eleva il tuo set LEGO preferito da soprammobile a pezzo di tendenza. Crea un punto di discussione a casa o in ufficio che parli alle tue passioni con Light My Bricks. Per saperne di più, clicca qui sotto.

[Ulteriori Informazioni](#)



Mutig, schön und hell – Light My Bricks verwandelt Ihr Lieblings-LEGO-Set von einem schnickschnack in ein statement-stück. Schaffen sie einen gesprächspunkt zu hause oder im büro, der Ihre leidenschaften widerspiegelt, mit Light My Bricks. Um mehr zu erfahren, klicken sie unten.

[Mehr erfahren](#)



Audaz, hermoso y brillante, Light My Bricks eleva tu set LEGO favorito de una chuchería a una pieza llamativa. Crea un tema de conversación en casa o en la oficina que hable de tus pasiones con Light My Bricks. Para obtener más información, haga clic a continuación.

[Más información](#)



大胆、美丽而明亮，Light My Bricks 将你喜爱的乐高套装从小摆件提升为引人注目的装饰品。在家或办公室打造一个能表达你激情的话题，了解更多，请点击下方。

[了解更多](#)



# LEGEND

## Rotate Set



Retournez L'ensemble  
Ruota Set  
Set Drehen  
Rotar Conjunto  
旋转套件

## Add Part



Ajoutez une Pièce  
Aggiungi Parte  
Teil Hinzufügen  
Agregar Pieza  
添加零件

## Click



Cliquez  
Clic  
Klicken  
Clic  
点击

## Pinch/Fold



Pincez/Pliez  
Pizzicare/Piegare  
Kneifen/Falten  
Pellizcar/Doblar  
折叠

## Pull Cable



Tirez le Cable  
Tirare il Cavo  
Kabel Ziehen  
Tirar del Cable  
拉动电缆

## Repeat Step



Répétez  
Ripetere  
Wiederholen  
Repetir  
重复

## Sticker



Autocollant  
Adesivo  
Aufkleber  
Pegatina  
贴纸

## Power On Test



Test de mise sous tension  
Test di Potenza  
Stromtest  
Prueba de Energía  
电源测试

## Disconnect Power

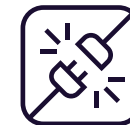

Débranchez L'alimentation  
Scollegare L'alimentazione  
Strom Trennen  
Desconectar la Energía  
断开电源

## Troubleshoot



Dépanner  
Risolvere  
Fehlerbehebung  
Solución de Problemas  
故障排除

# COMPONENT HANDLING

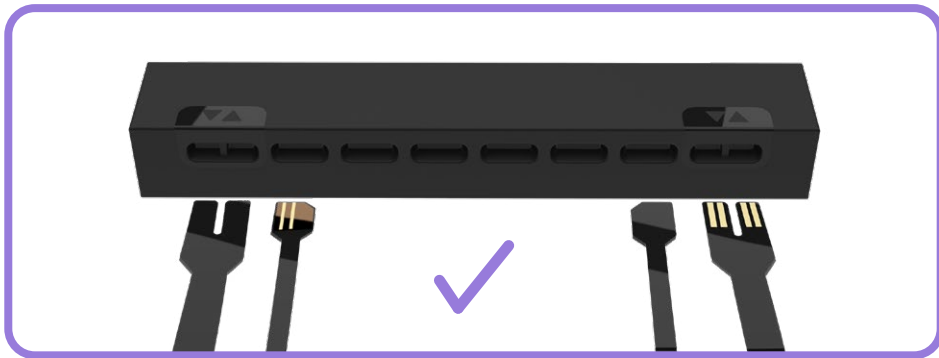
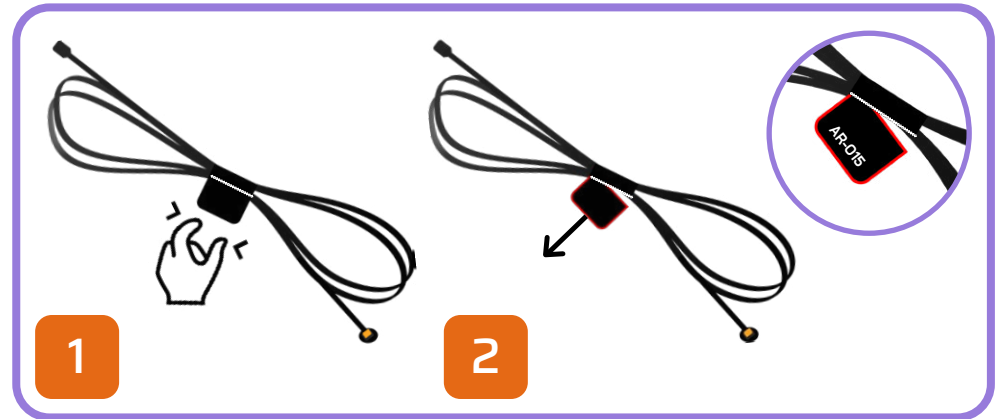
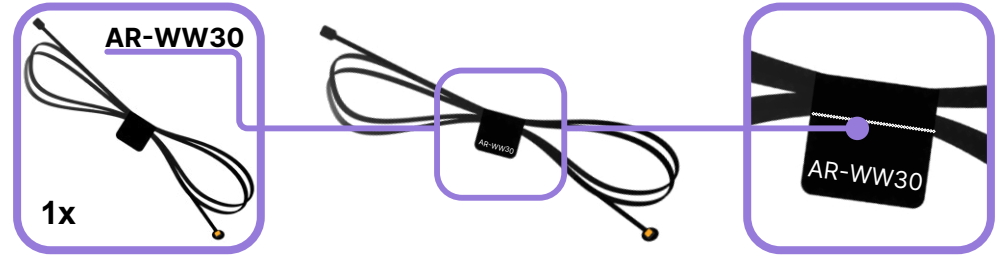
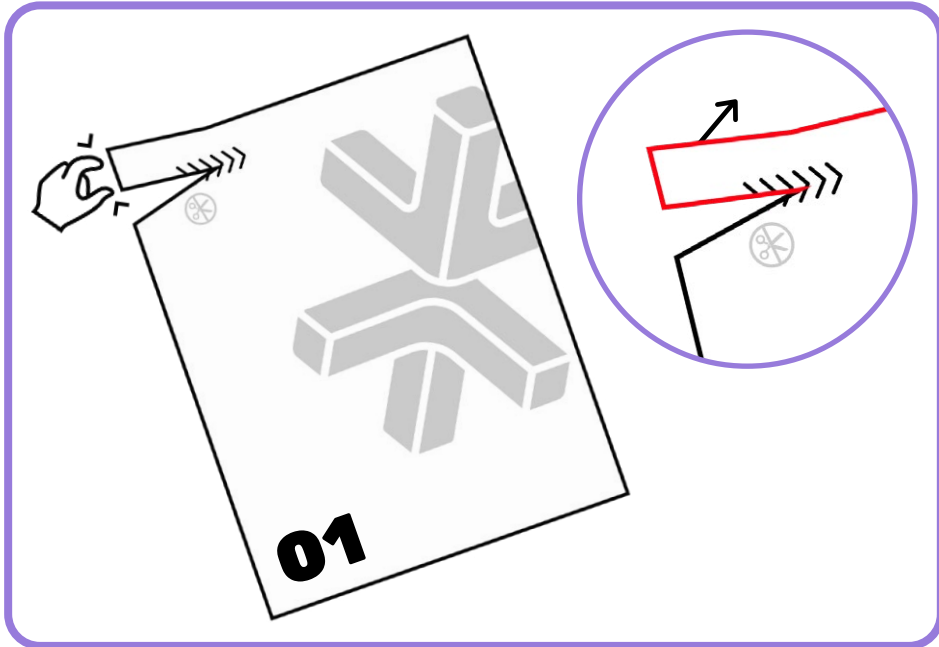

# BLUEPRINT

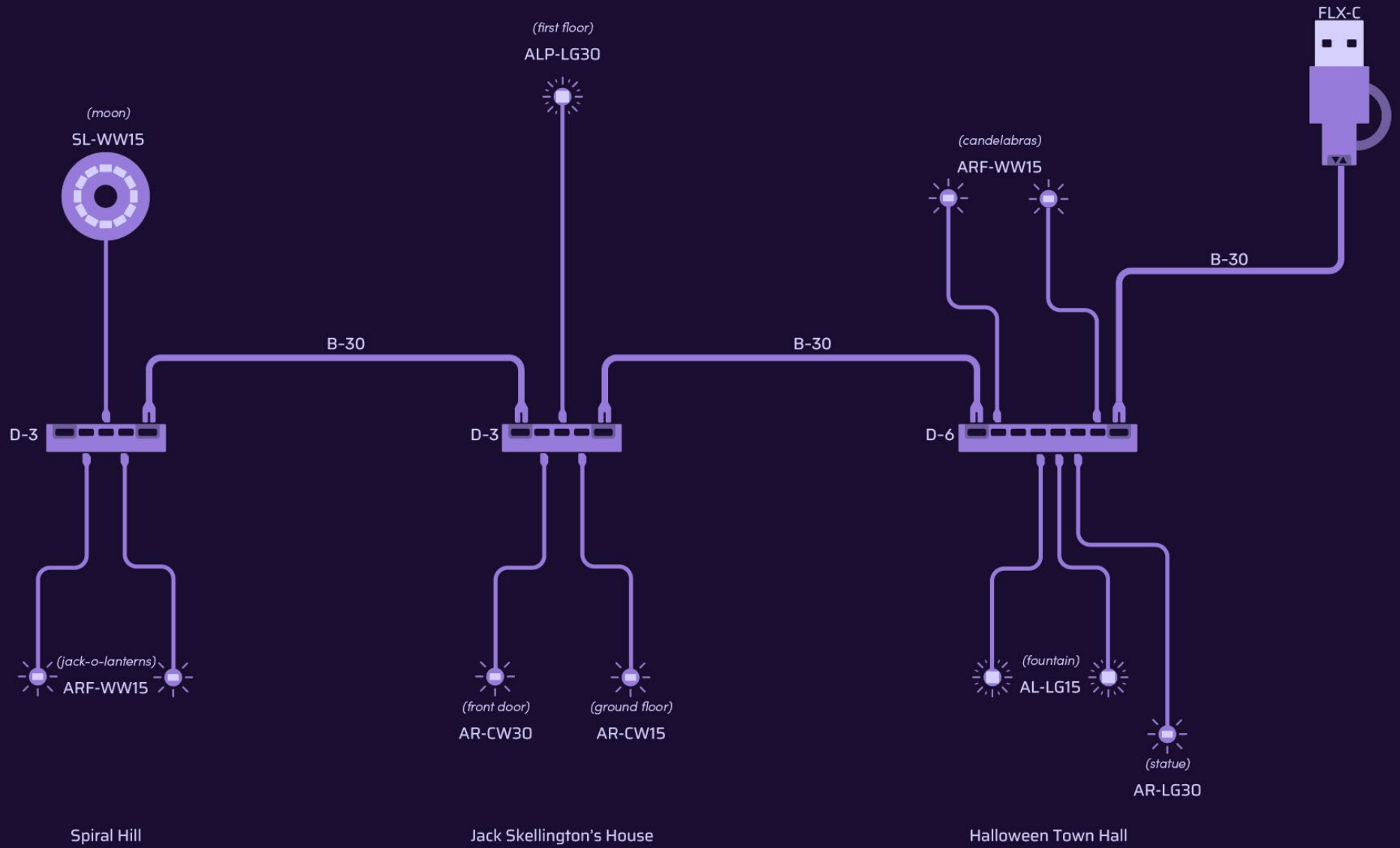

1



2





3



4



5



6



7



8



9

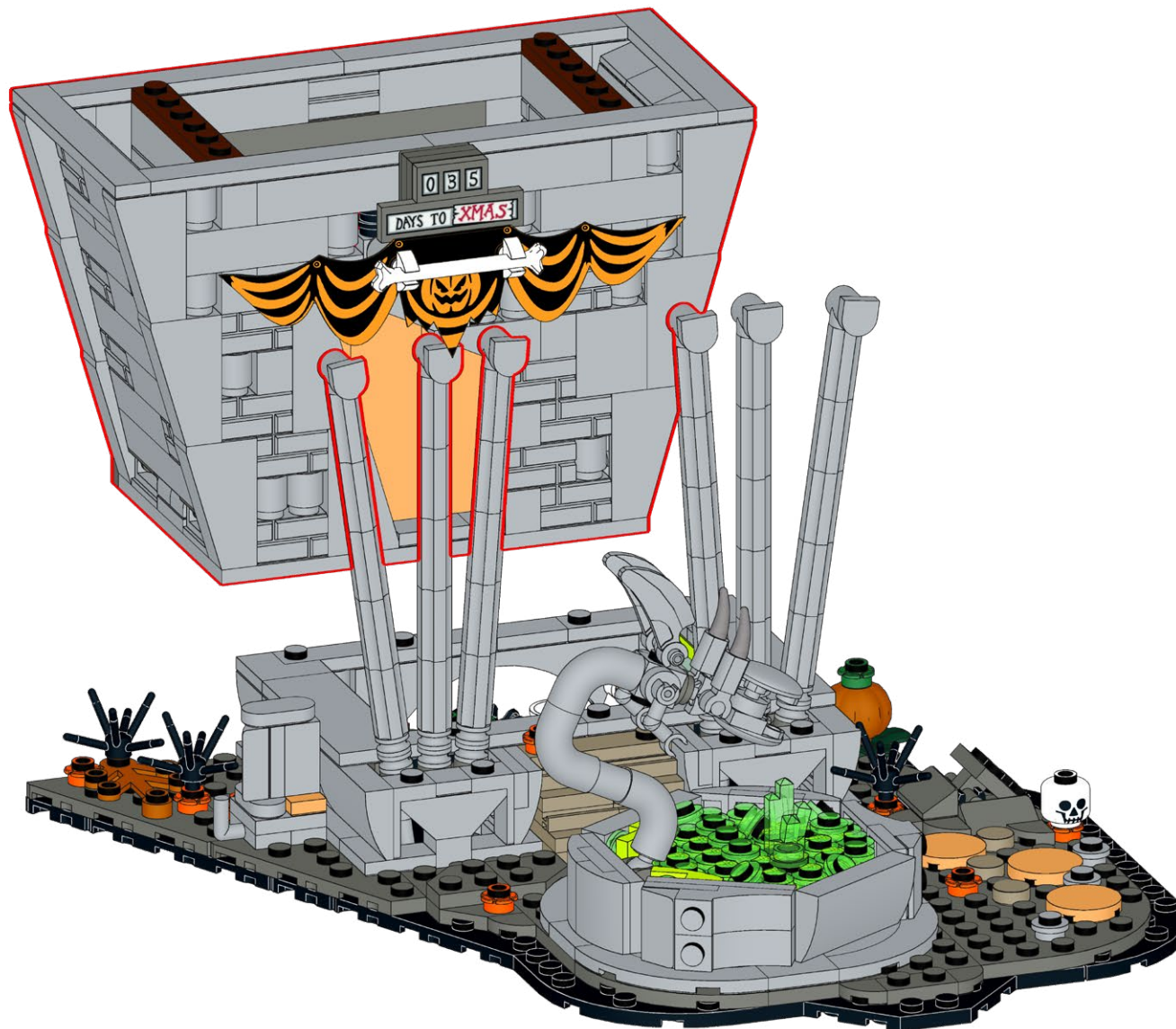

10





11

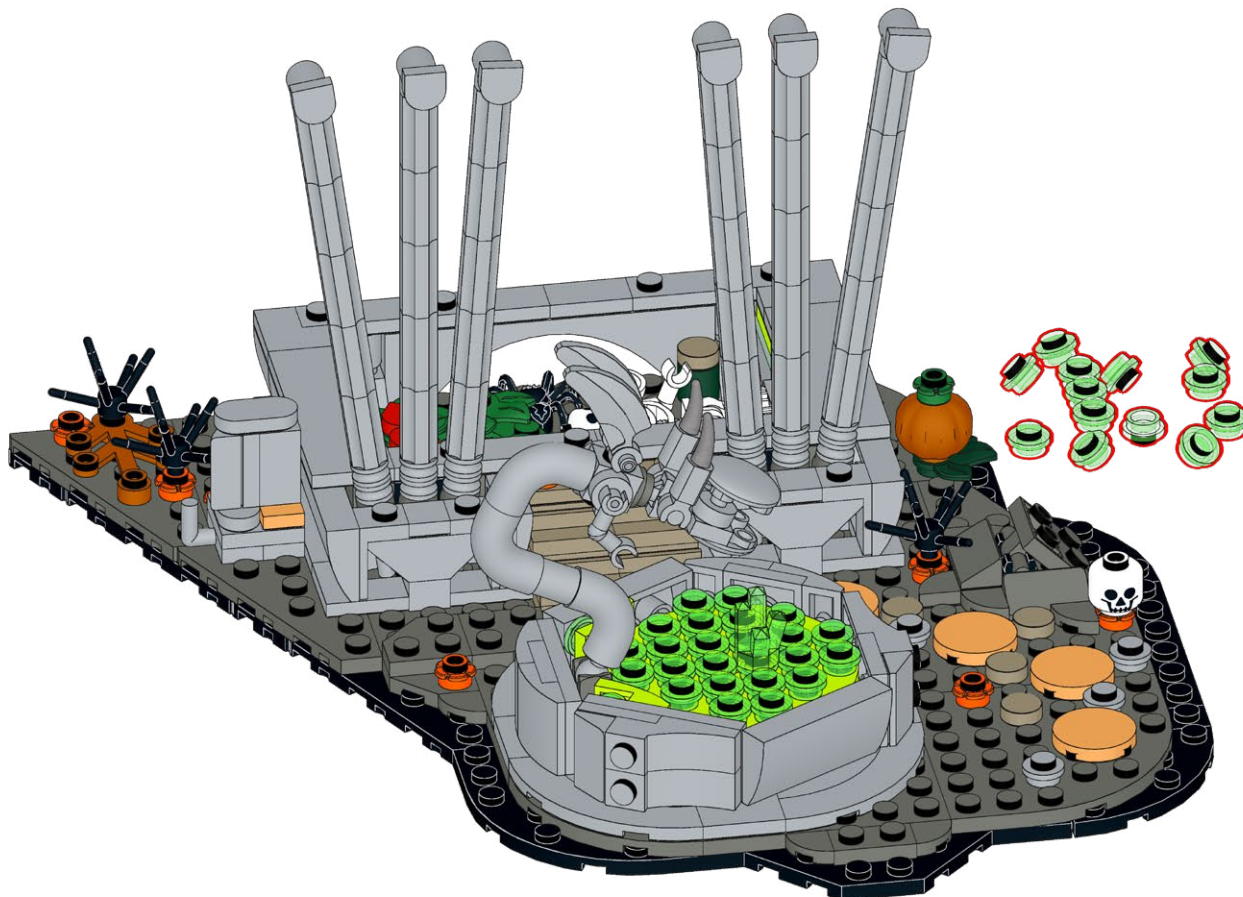

12

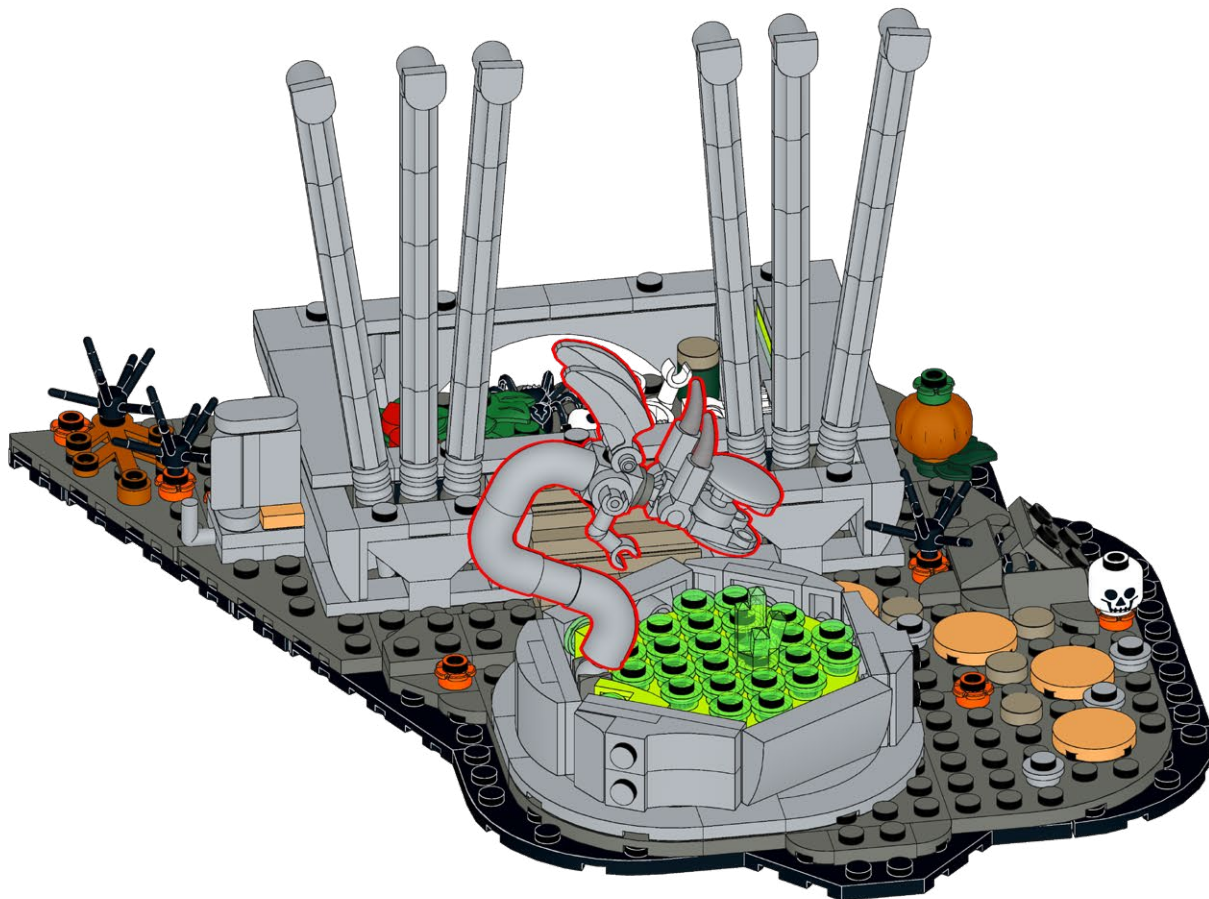

13

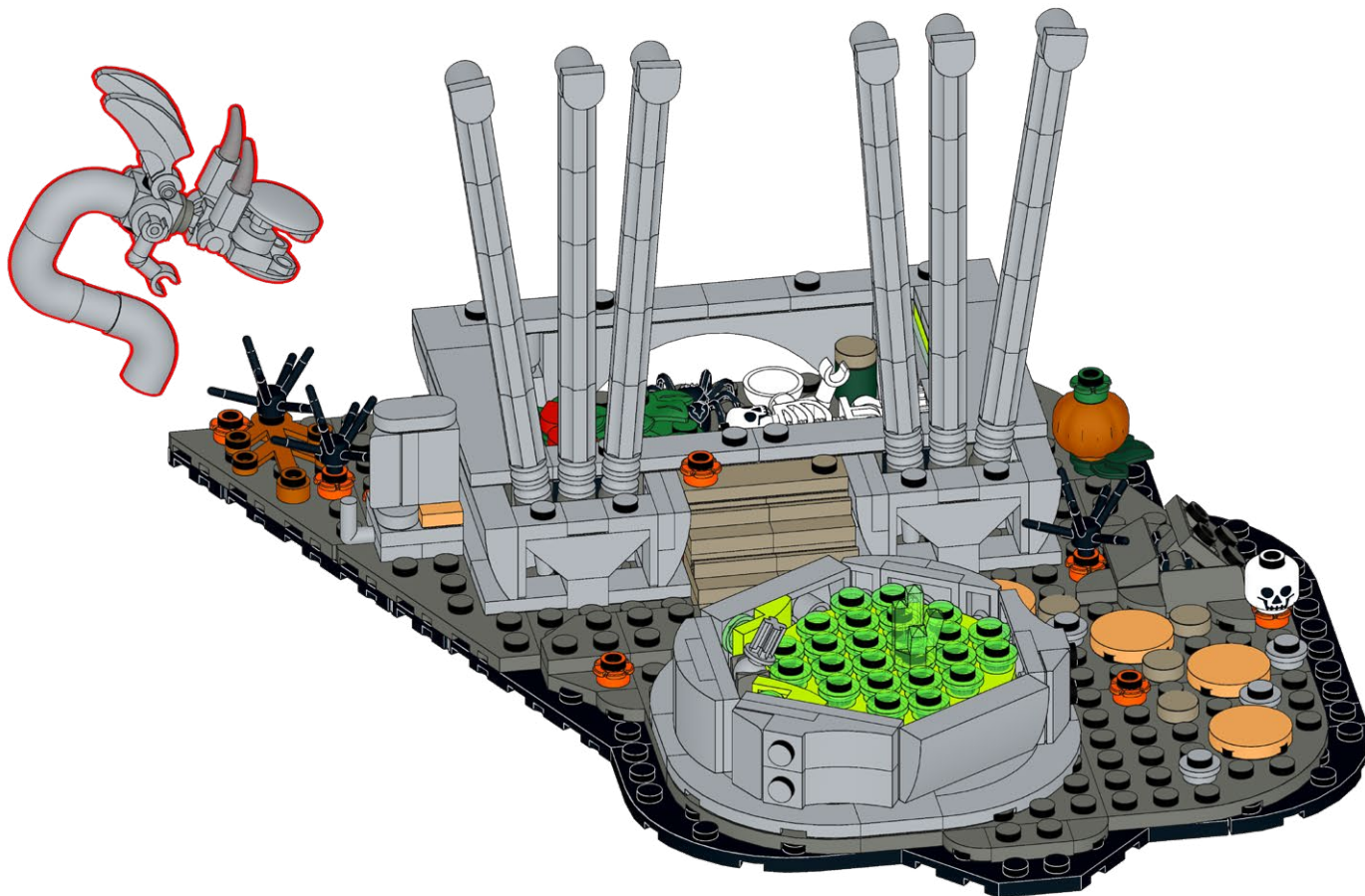

14

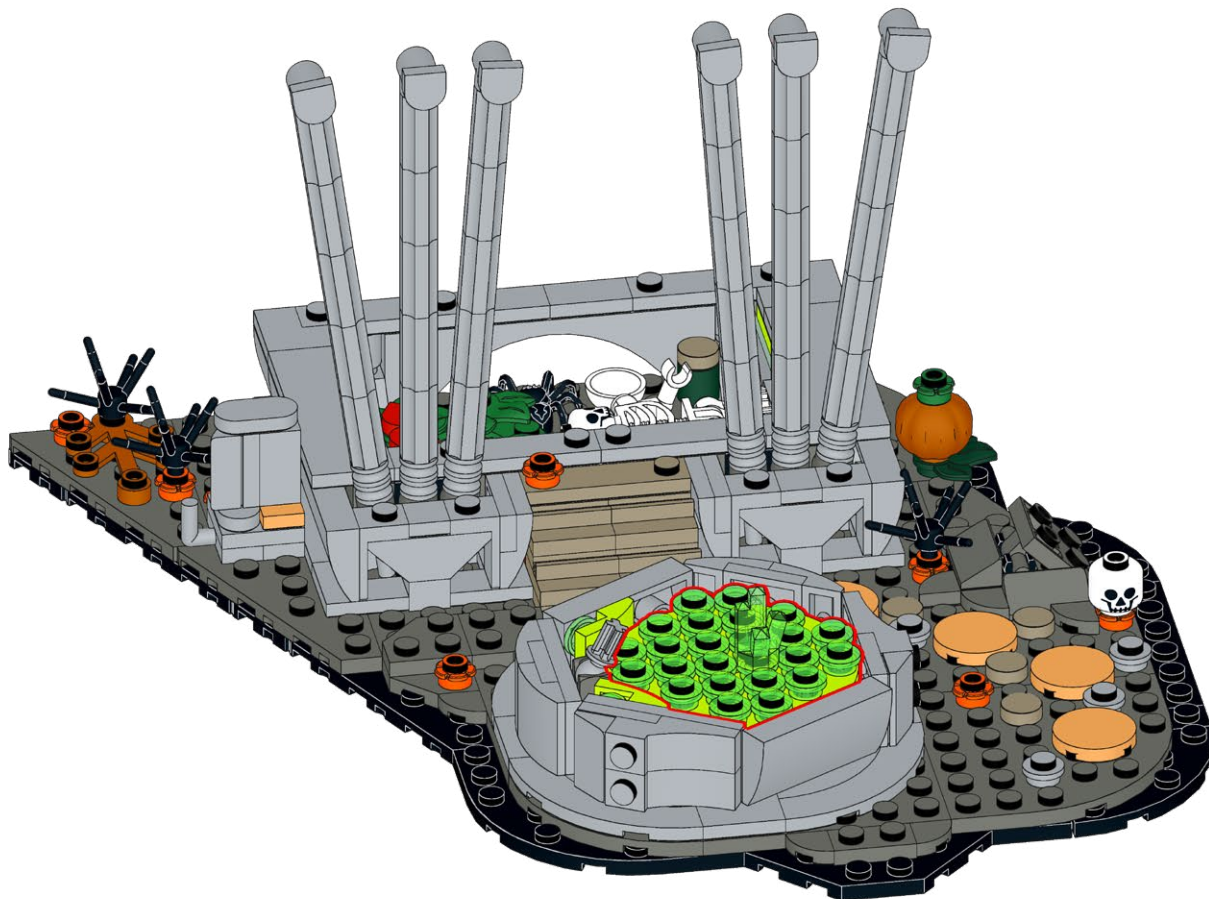

15

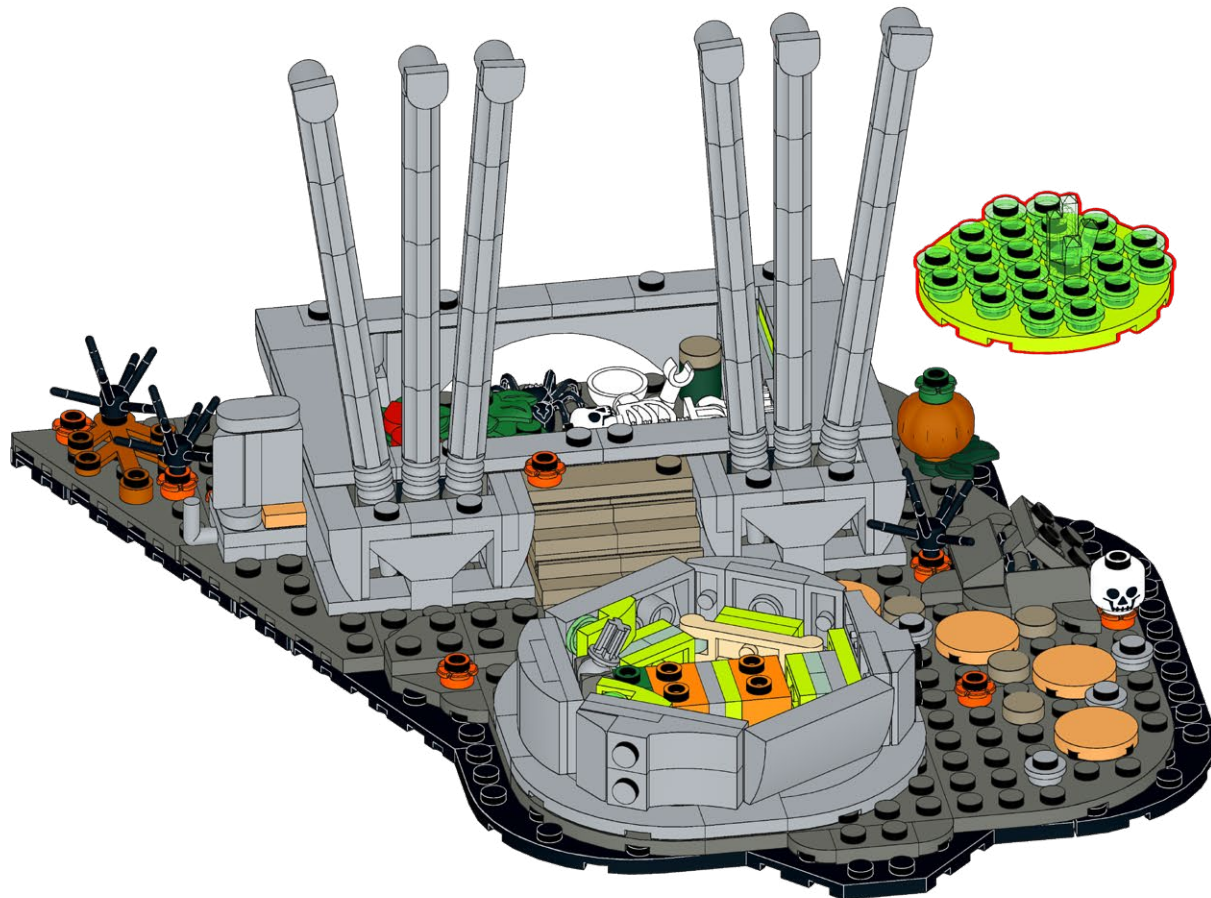

16

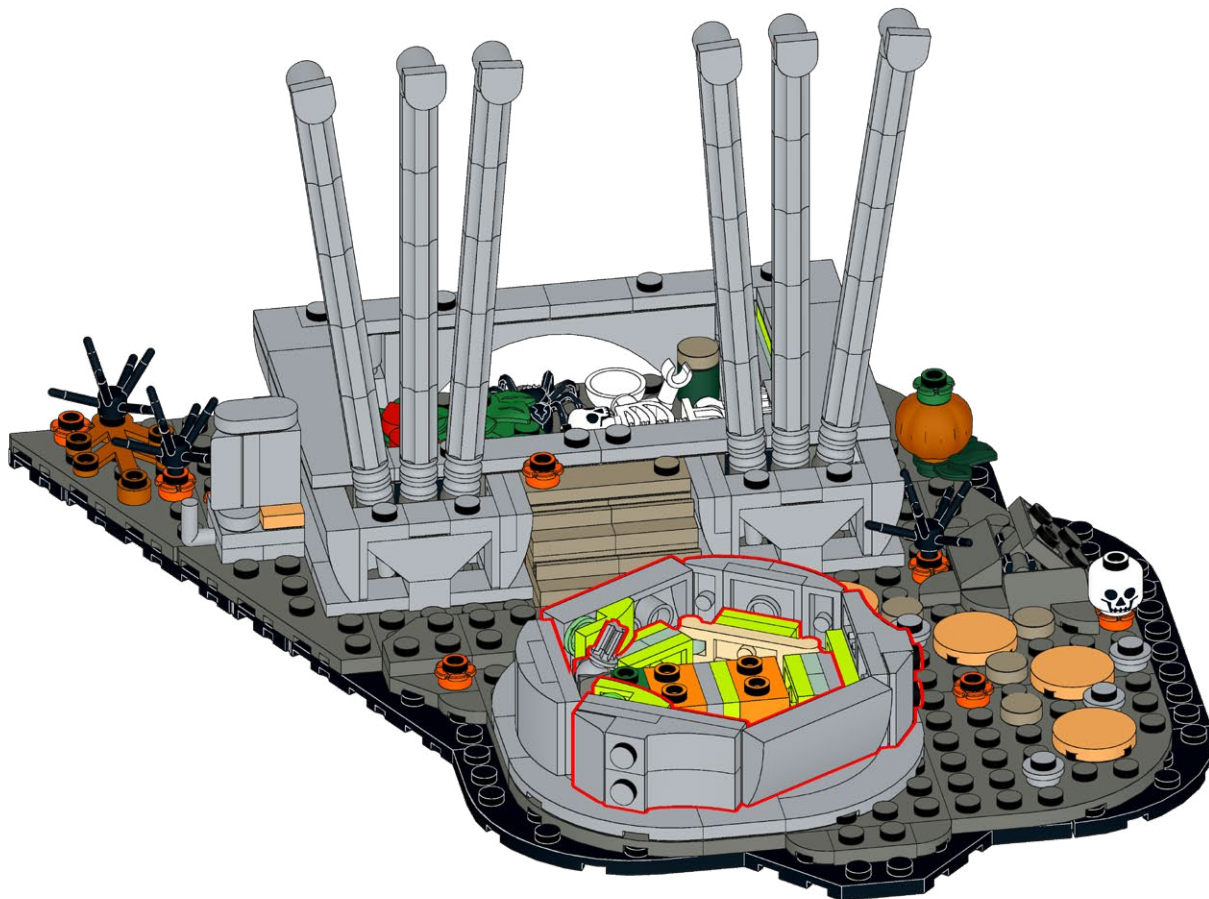

17

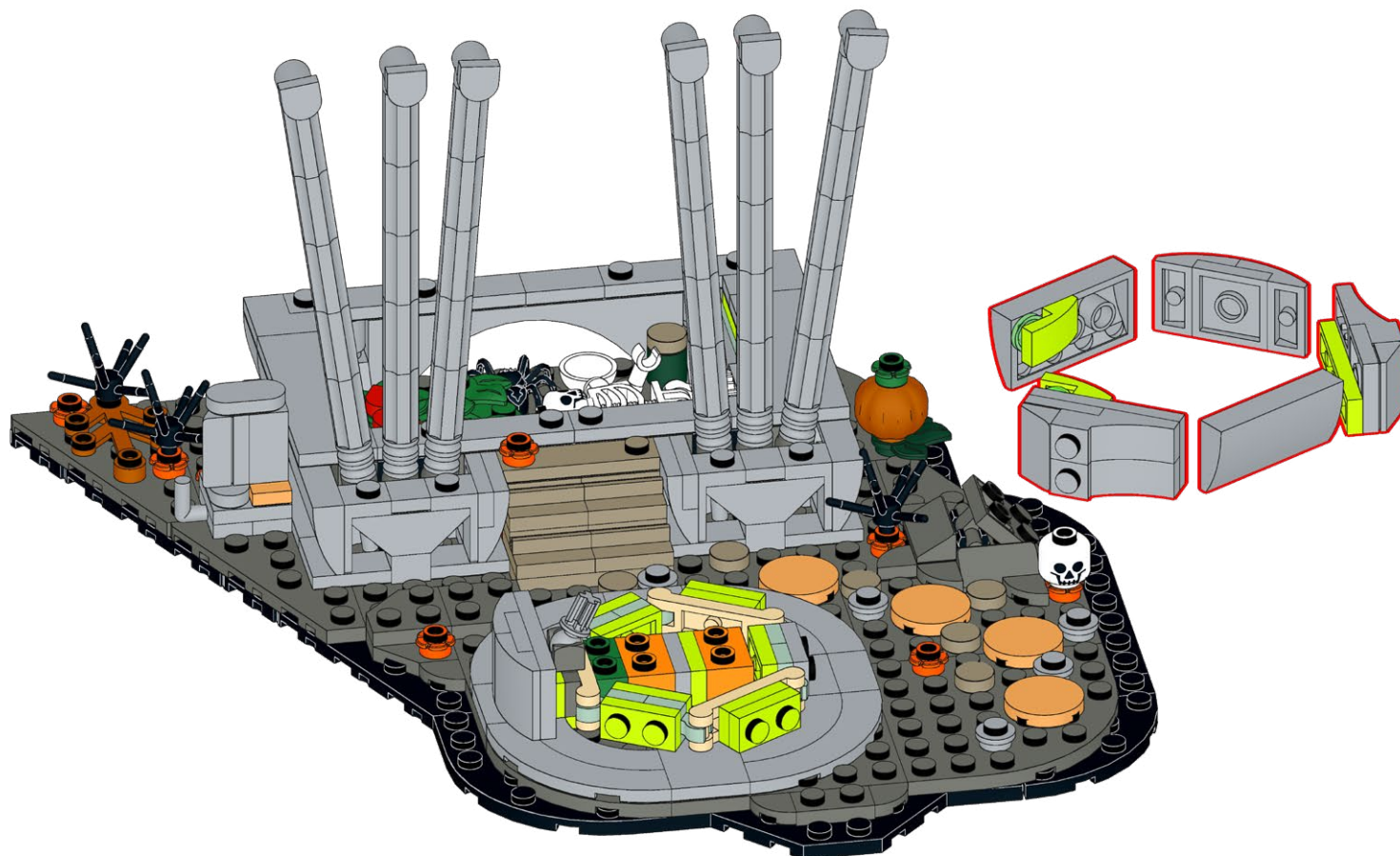

18





19

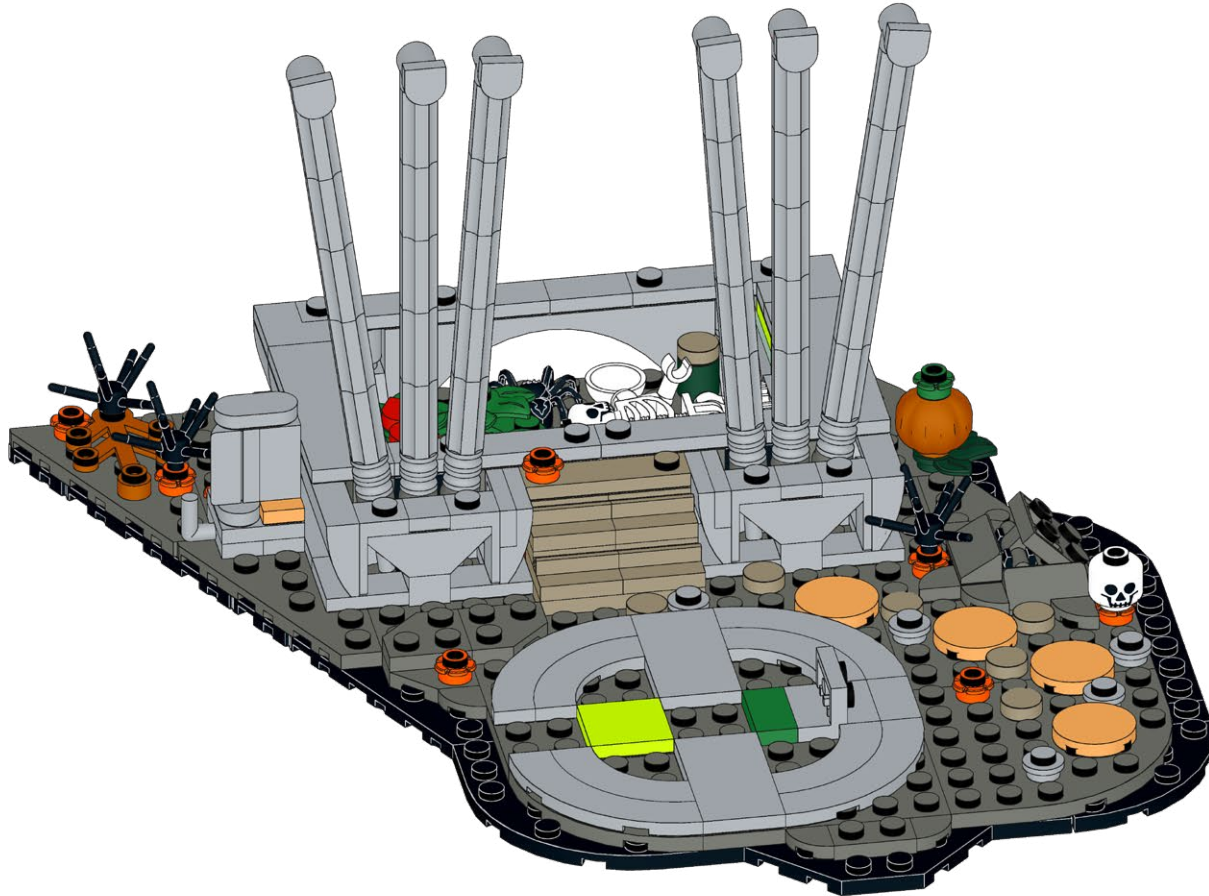
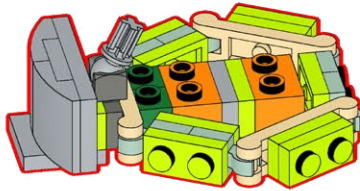

# 20

1

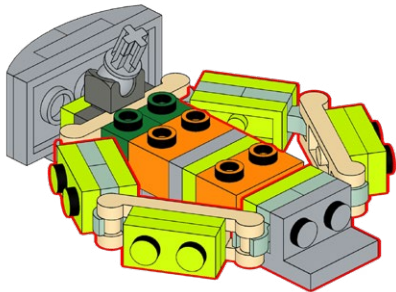

2

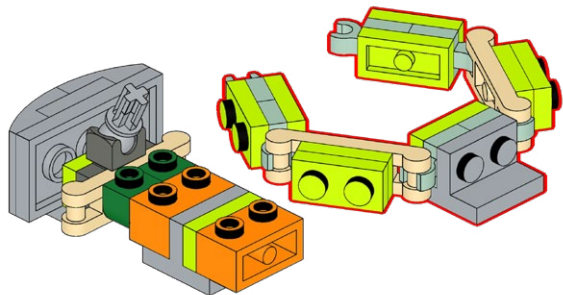

# 21

1

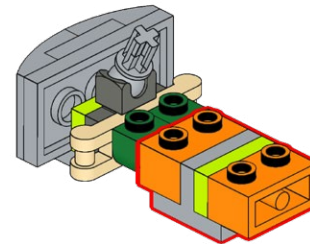

2

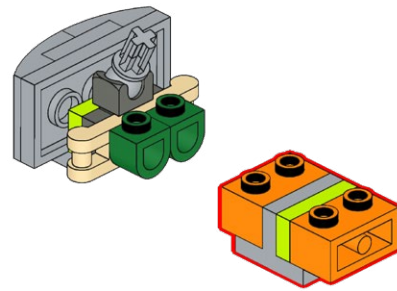

3

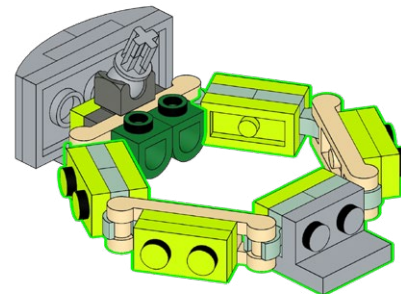

22

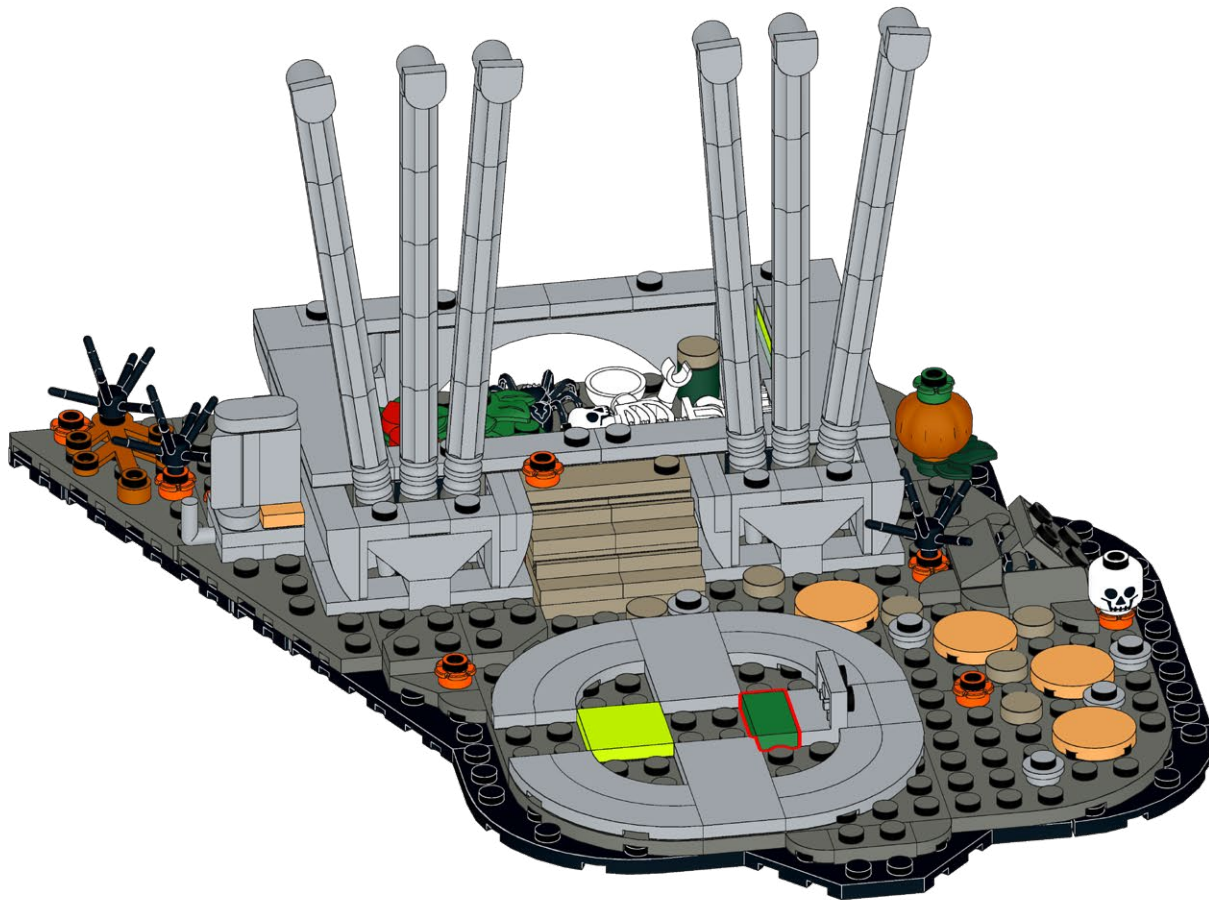

23

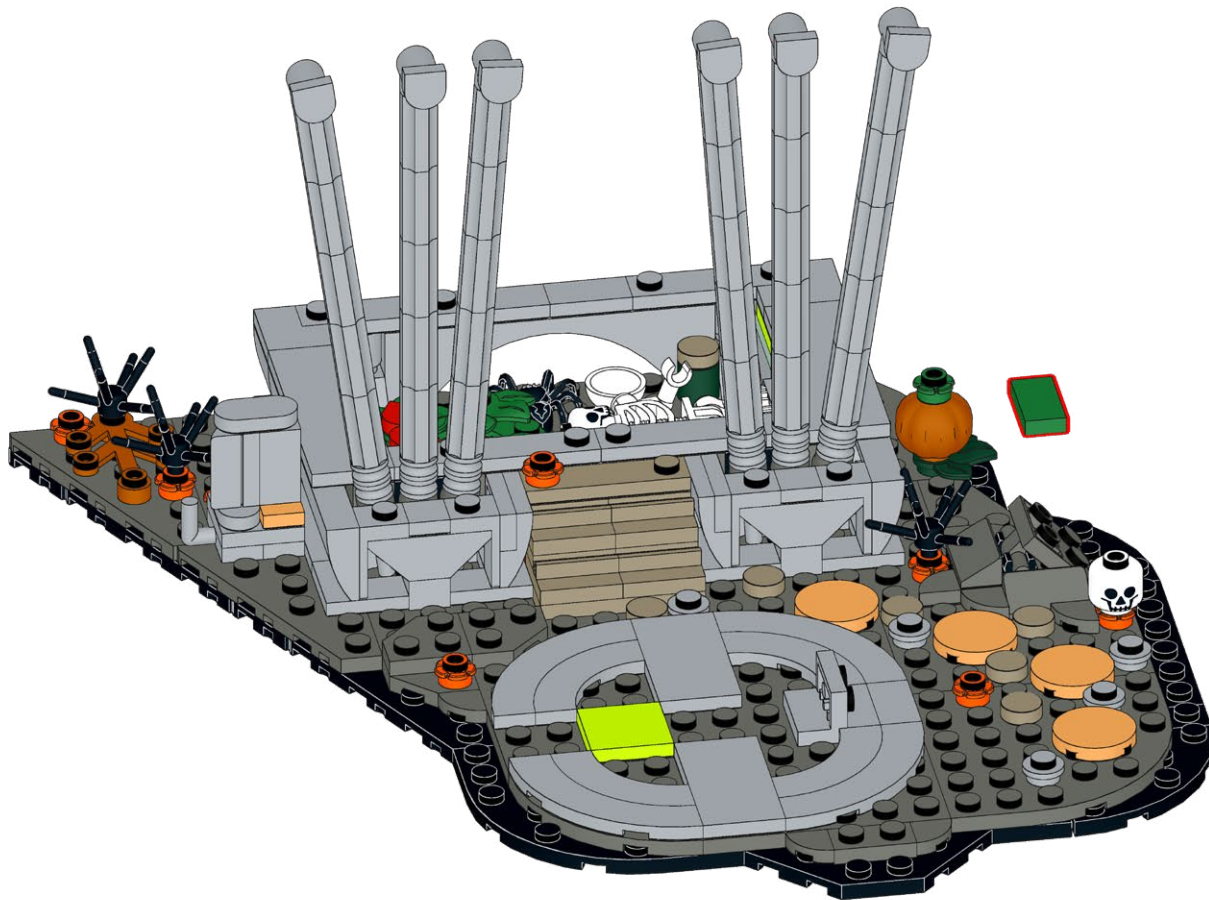

24

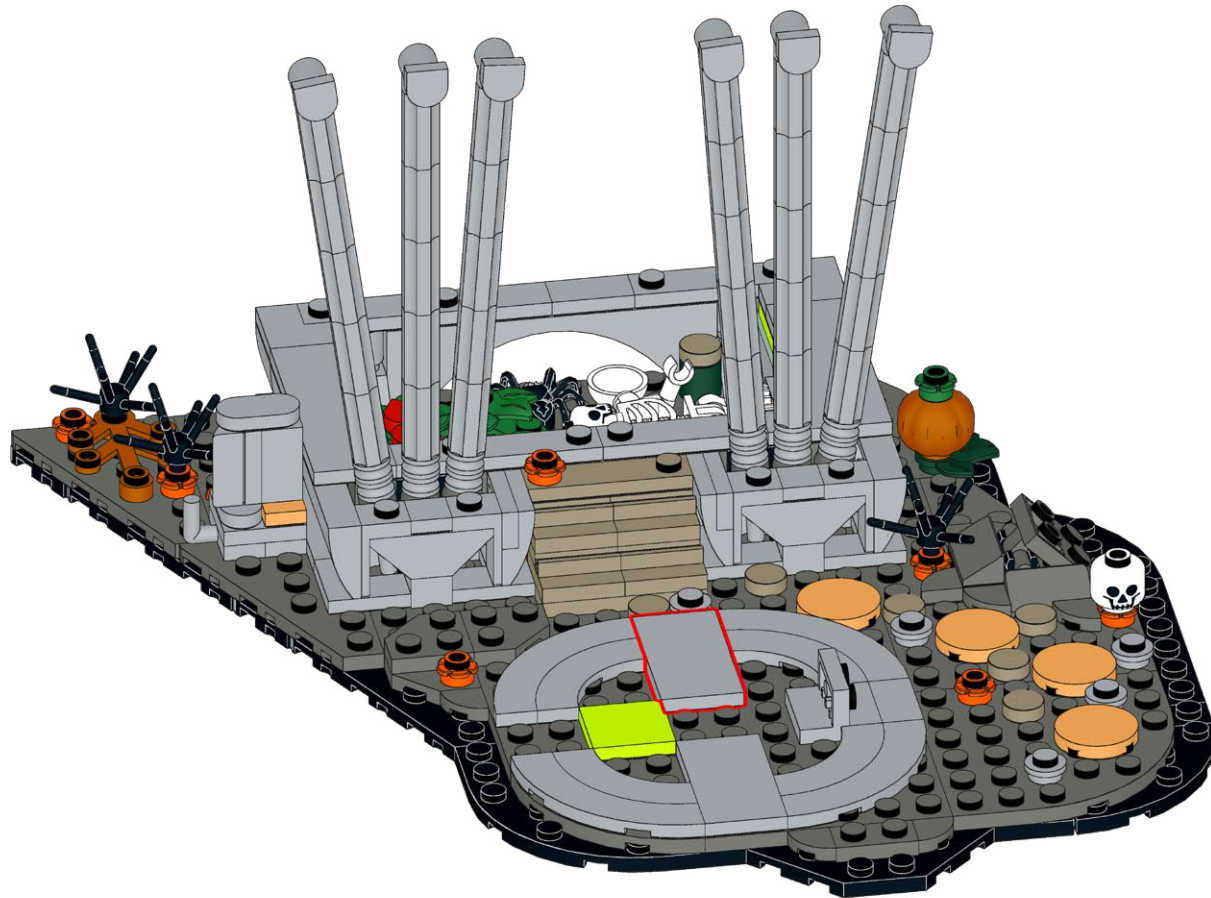

25

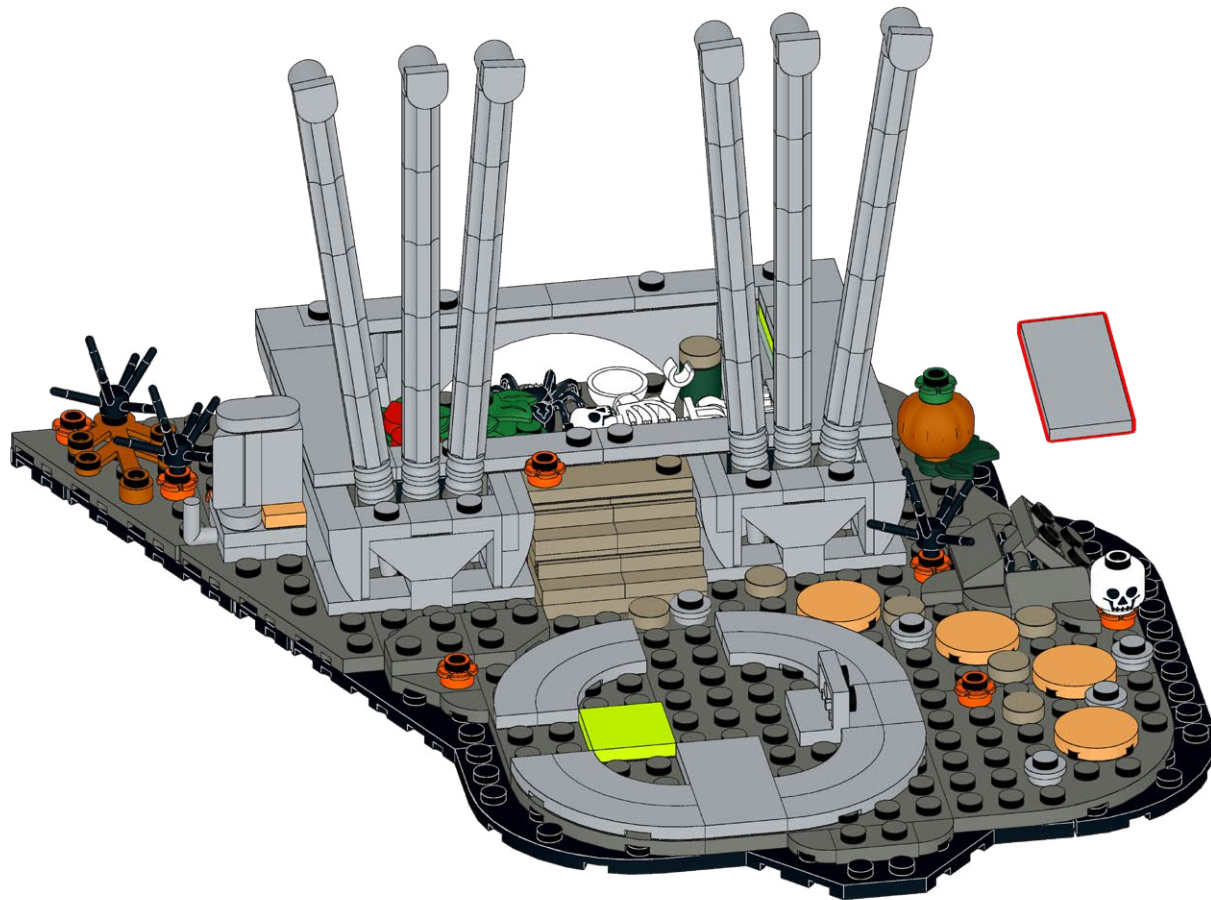

26

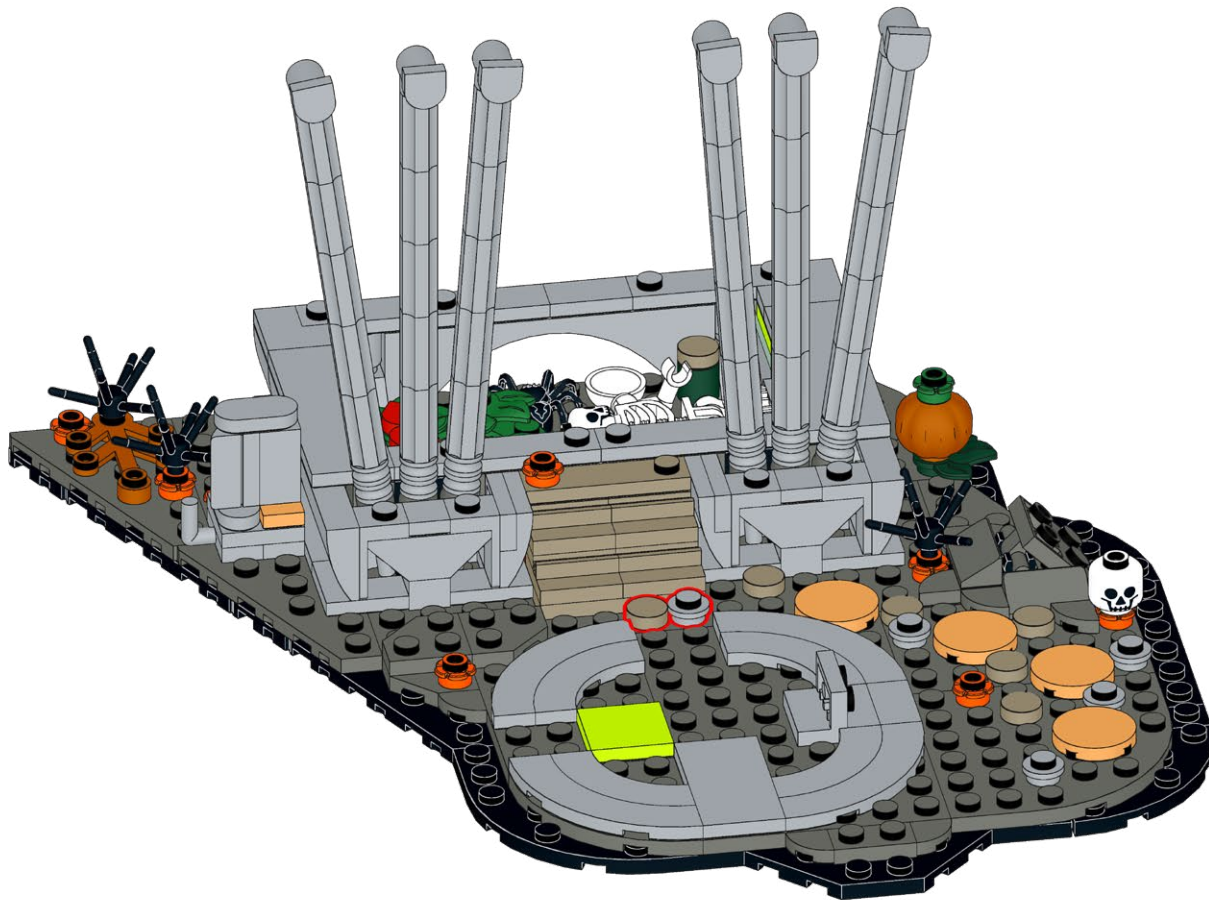

27

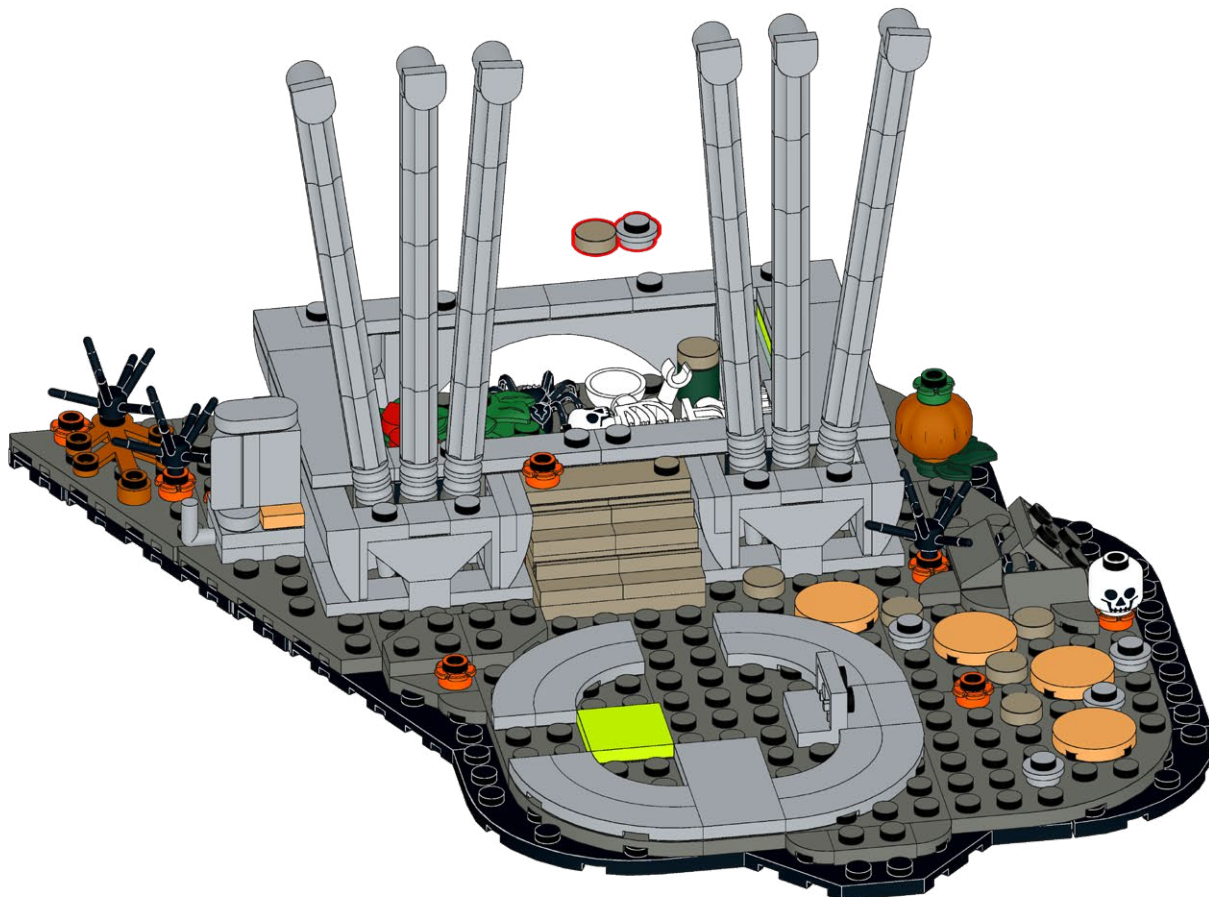



28

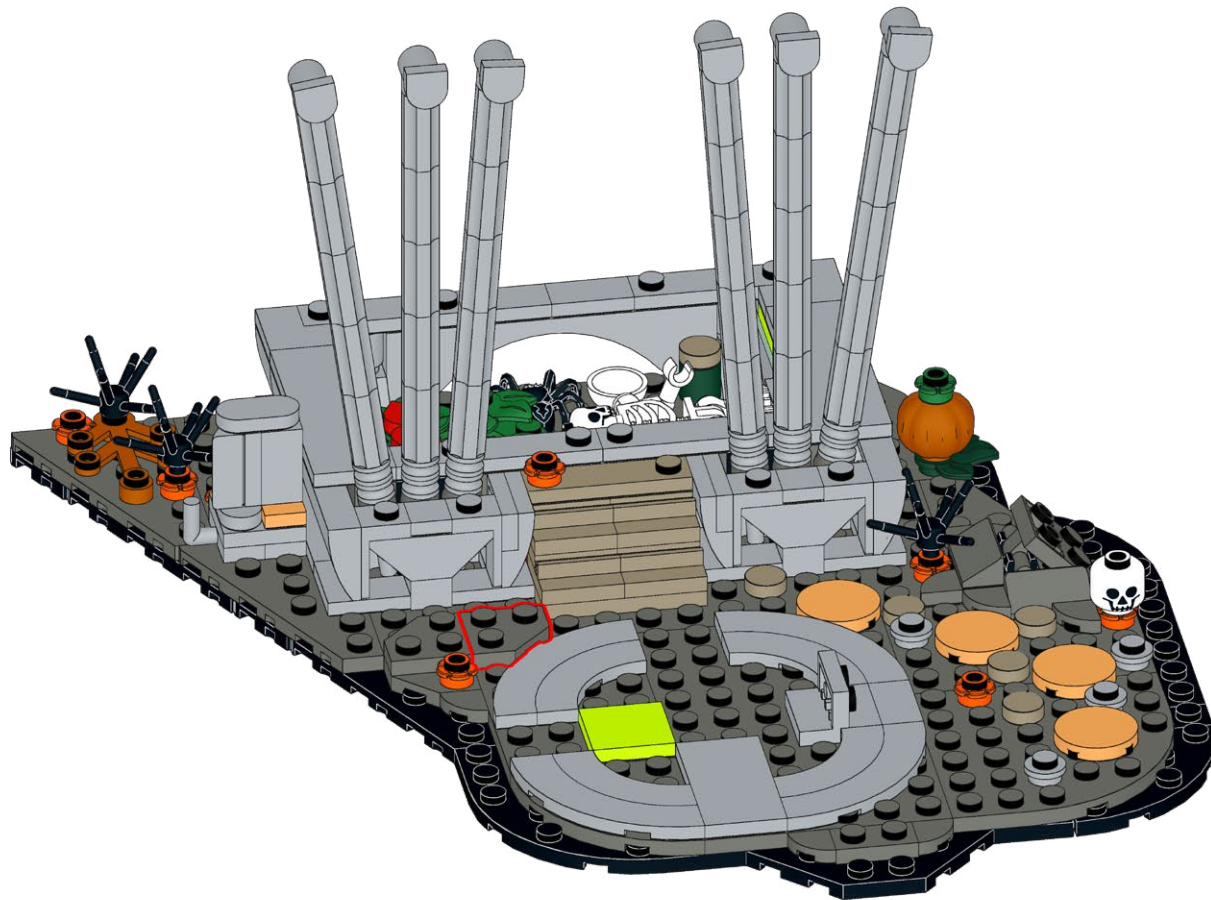

29

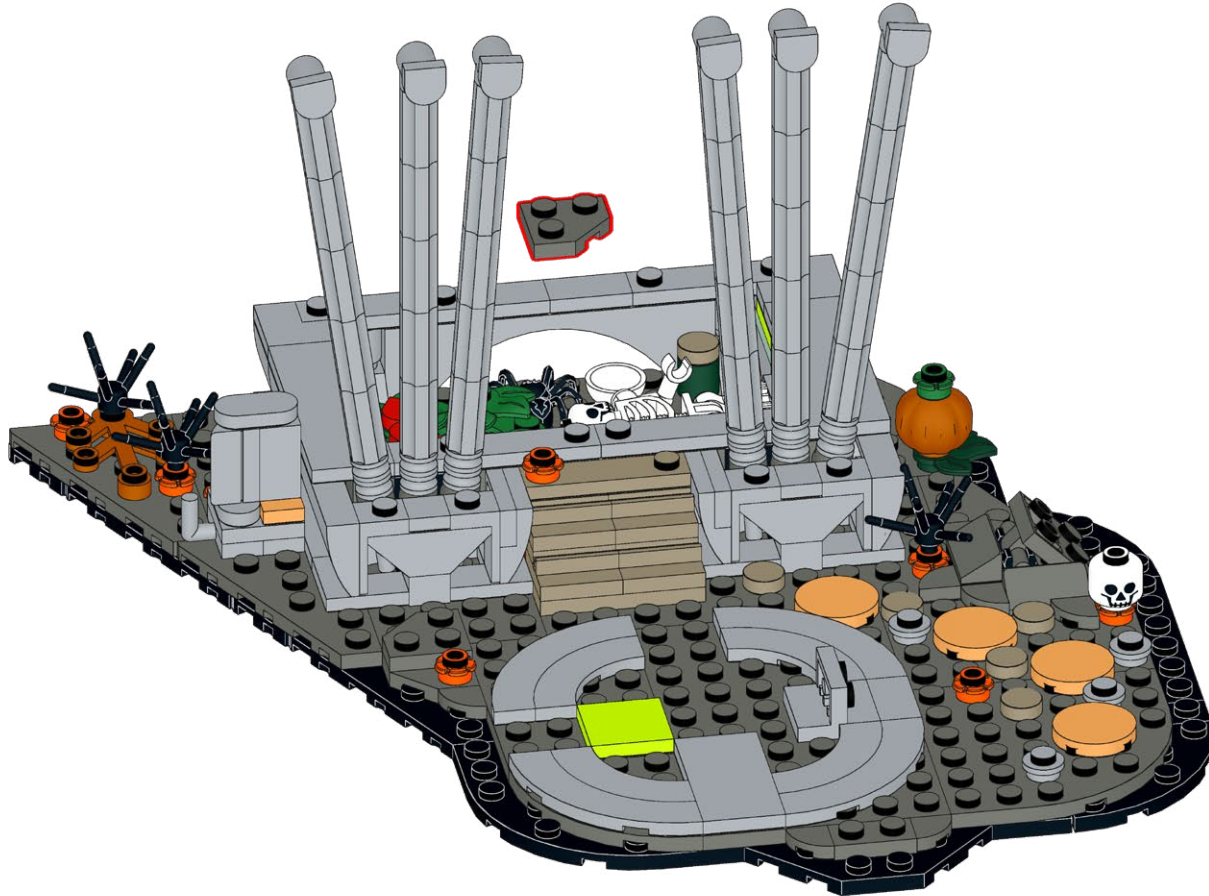



### **HOLD UP!**

You might notice some bags aren't in order, as well as left over pieces, but that's ok! We're changing the way you build LEGO!

### **ATTENDEZ!**

Vous remarquerez peut-être que certains sacs, ainsi que certaines pièces, ne sont pas dans le bon ordre. Mais pas de panique! Nous changeons simplement la façon avec laquelle vous construisez vos LEGO!

### **ASPETTA!**

Potresti notare che alcuni sacchetti non sono in ordine, così come i pezzi avanzati, ma va bene così! Stiamo cambiando il modo in cui costruisci i LEGO!

### **HALT!**

Sie werden möglicherweise bemerken, dass einige tüten durcheinander sind und teile übrig bleiben, aber das ist in Ordnung! Wir ändern die art und weise, wie Sie LEGO bauen!

### **¡ESPERA!**

Es posible que notes que algunas bolsas están fuera de servicio, así como piezas sobrantes, ¡pero está bien! ¡Estamos cambiando la forma en que construyes LEGO!

### **暫停!**

你可能会注意到一些袋子顺序错乱, 以及一些剩余的部件, 但没关系! 我们正在改变你搭建乐高的方式!

#### Open LMB Bag 01

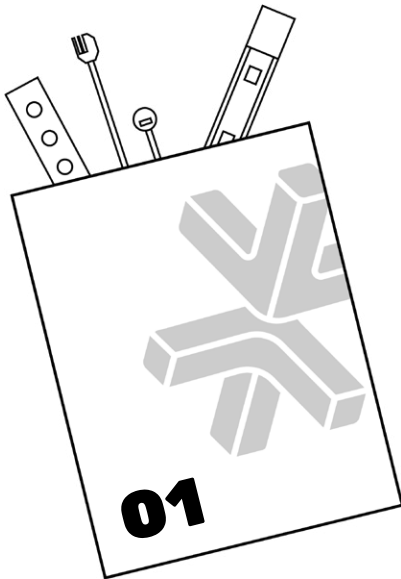

30

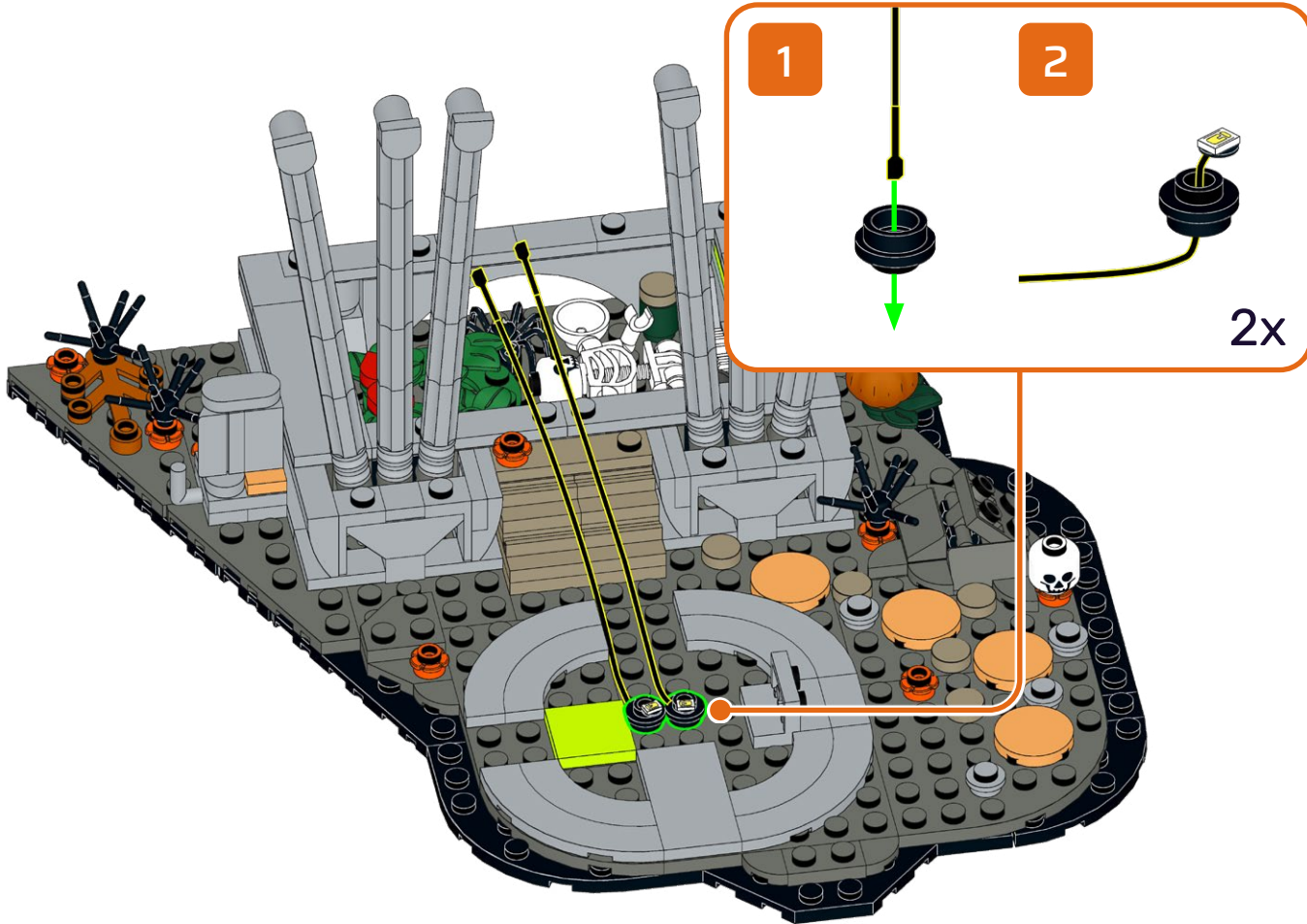
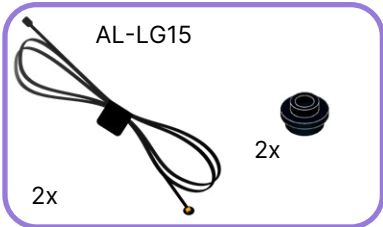

31

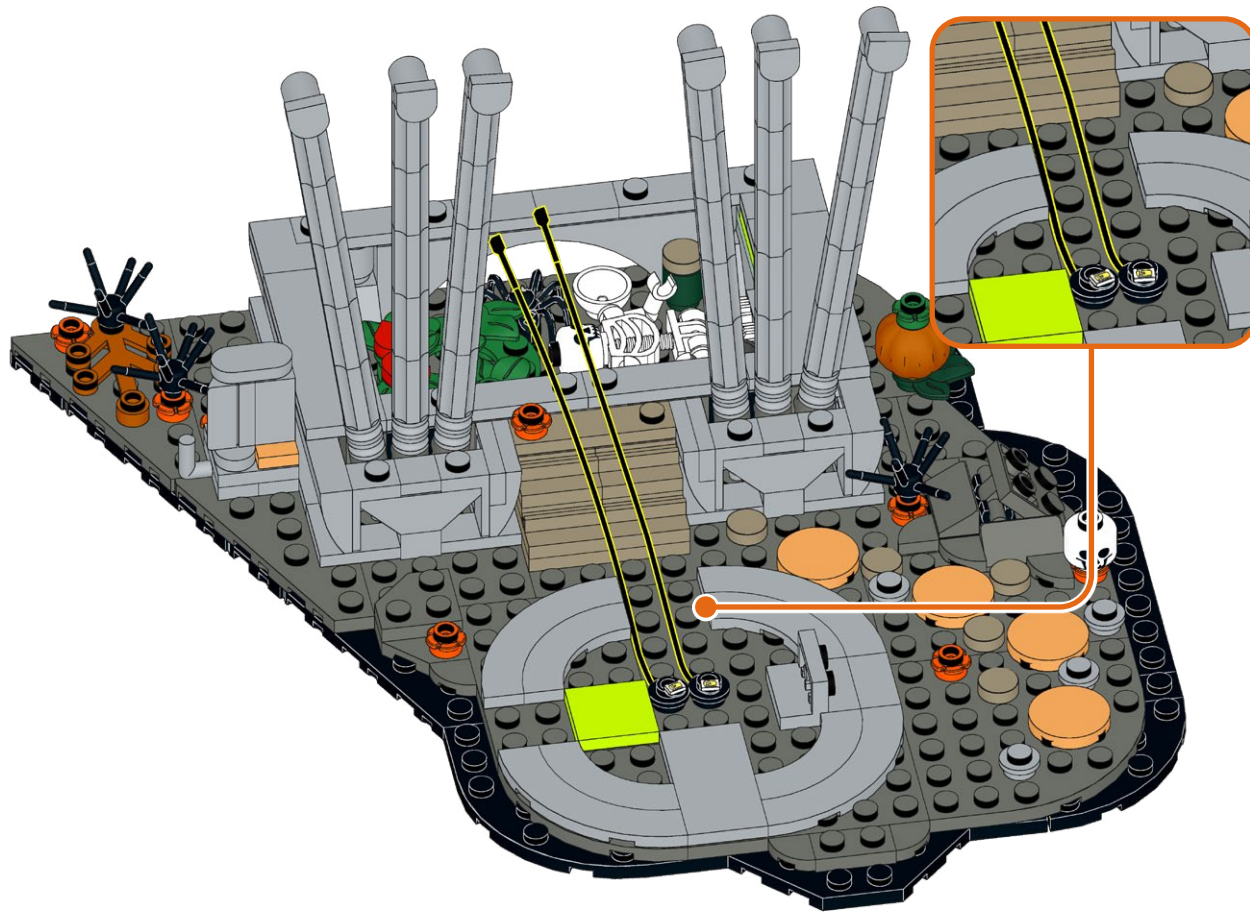

32

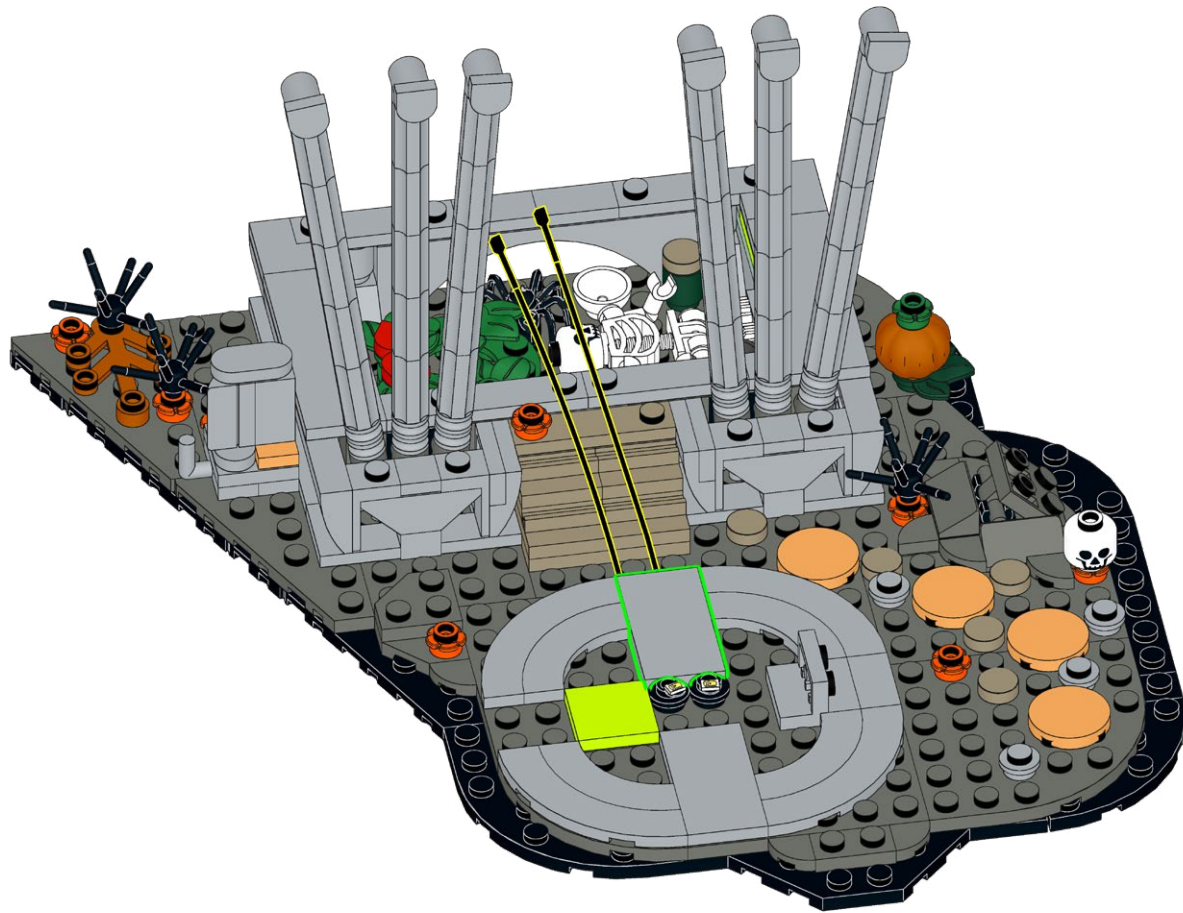

33

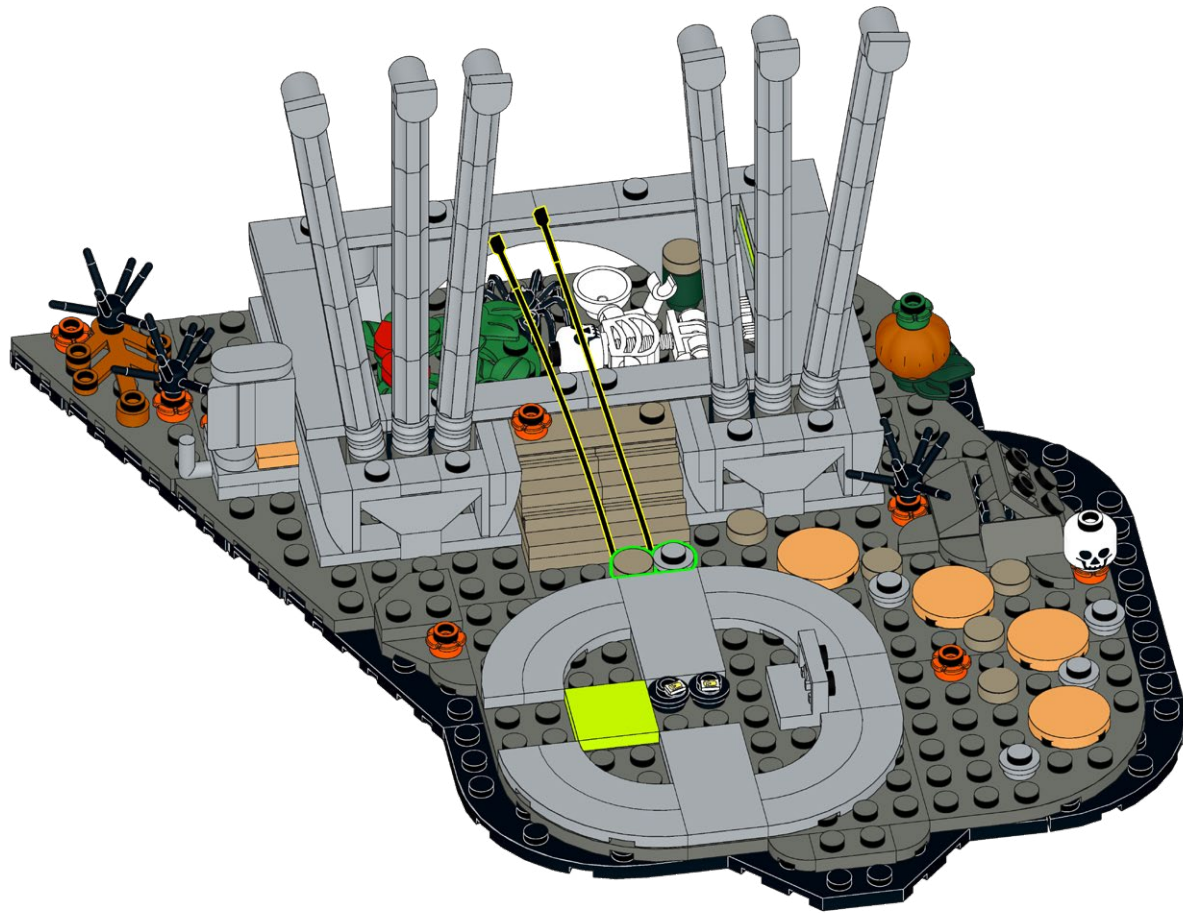

34

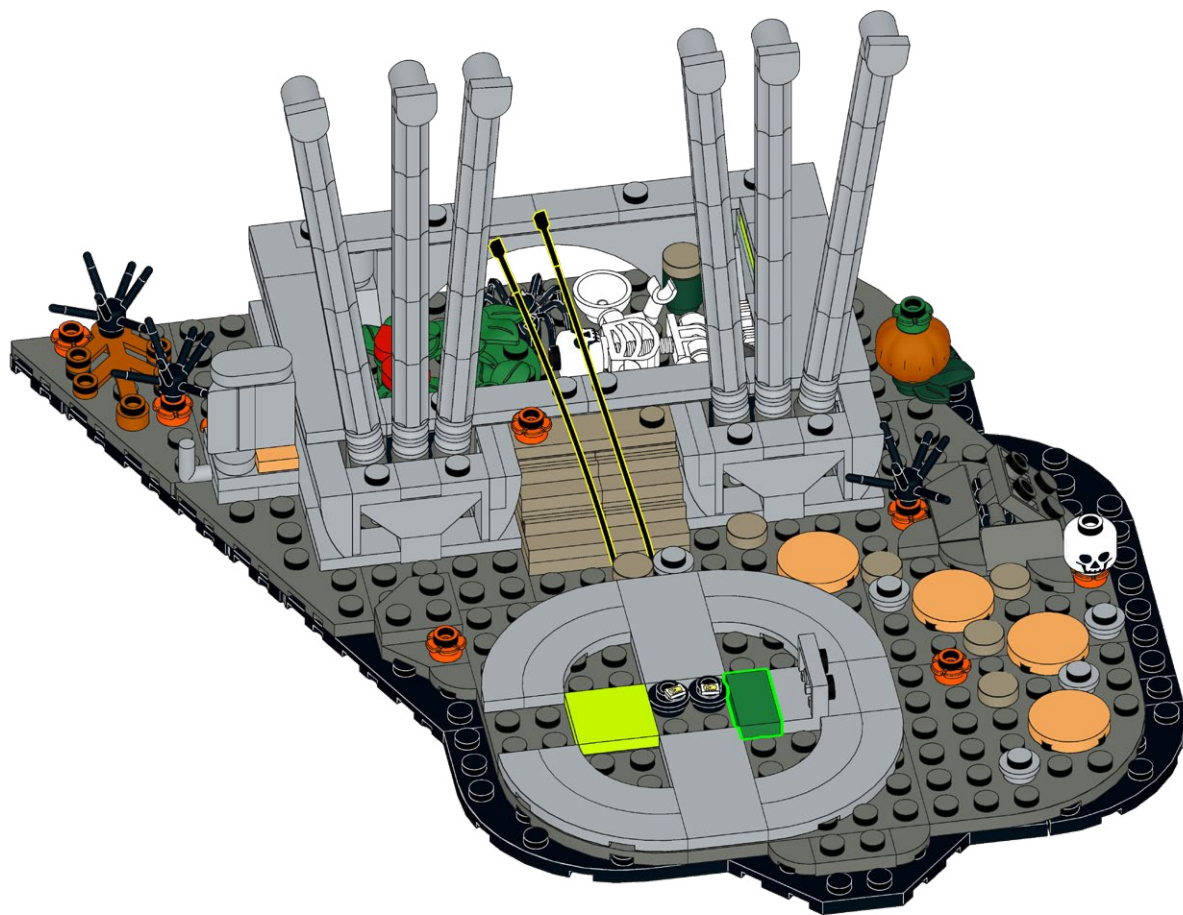



35

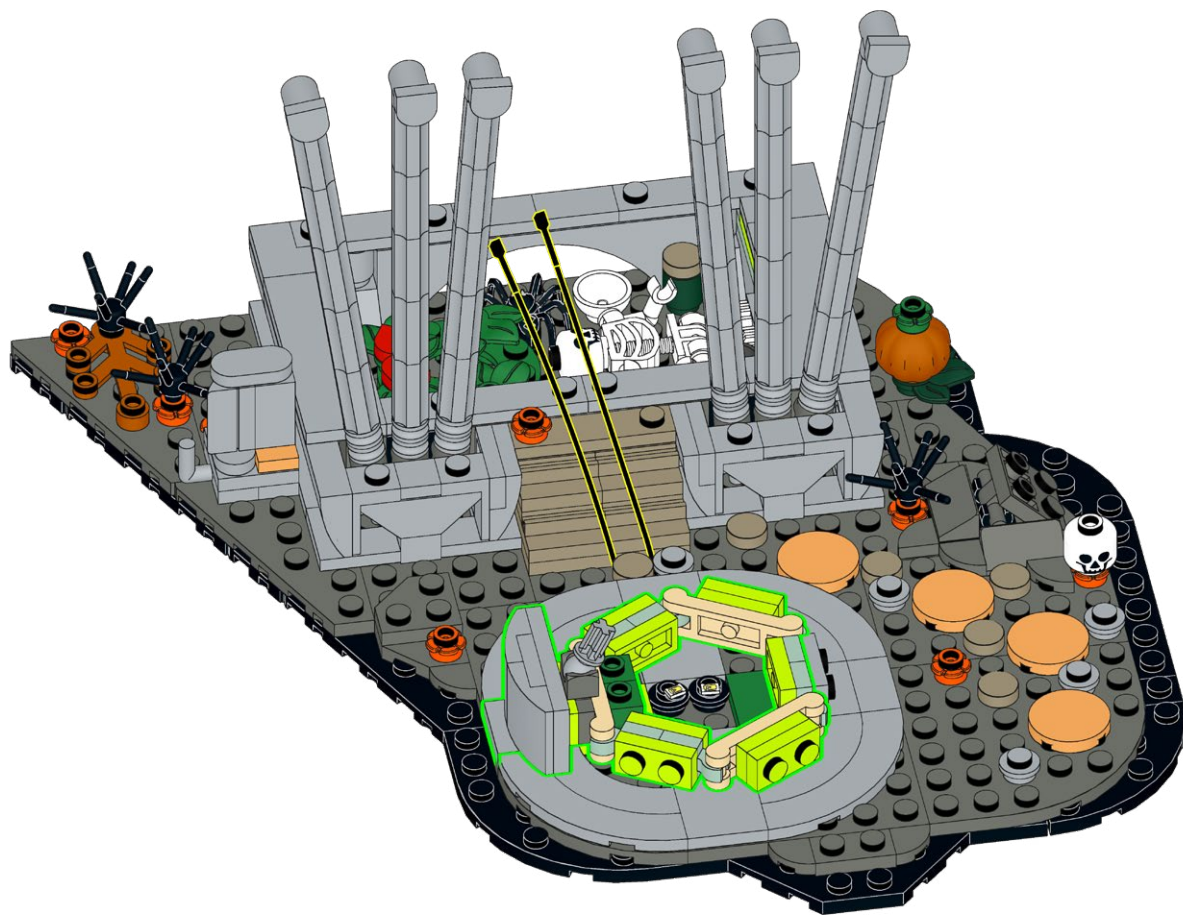

36

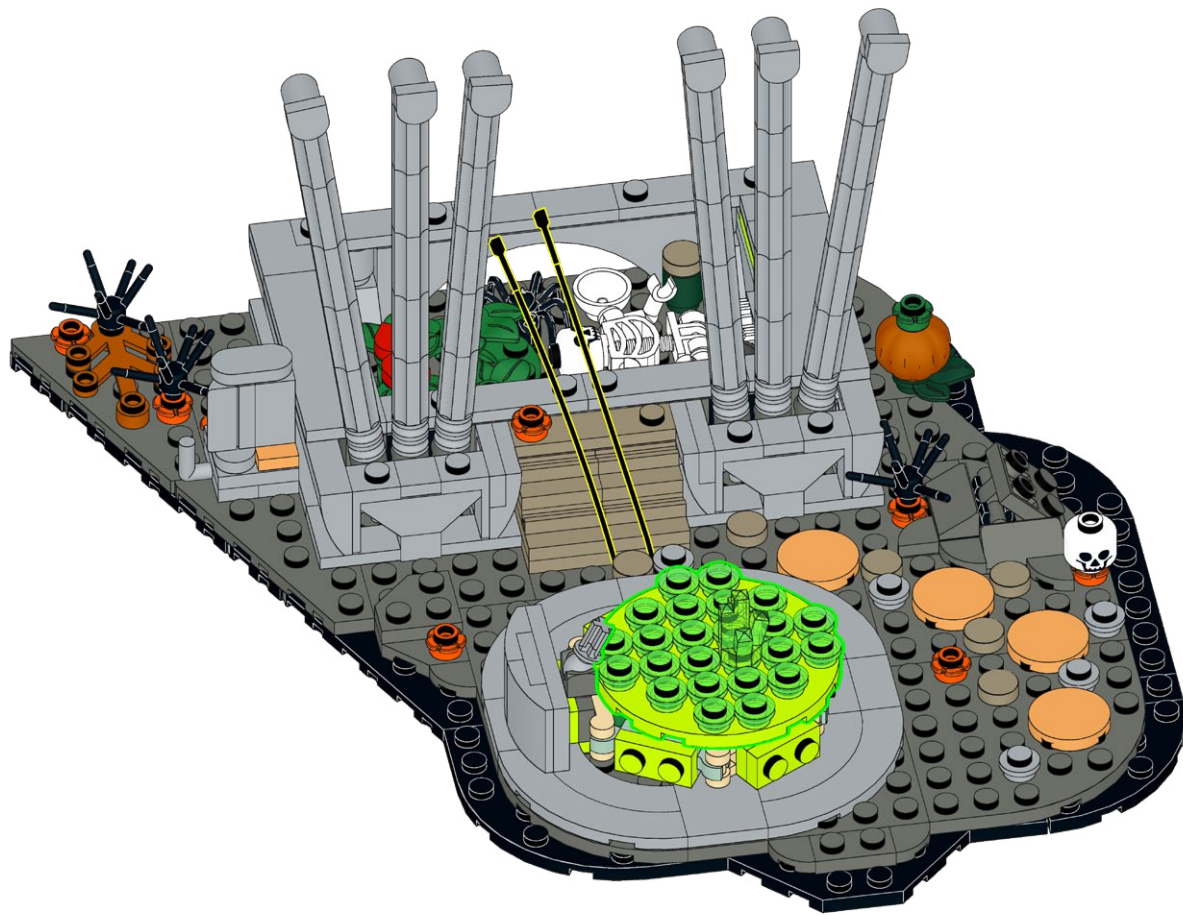

# 37

1

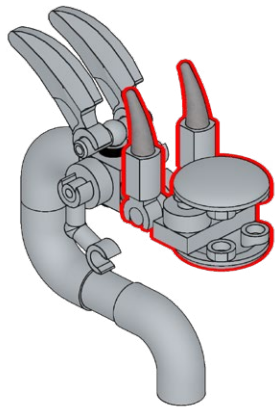

2

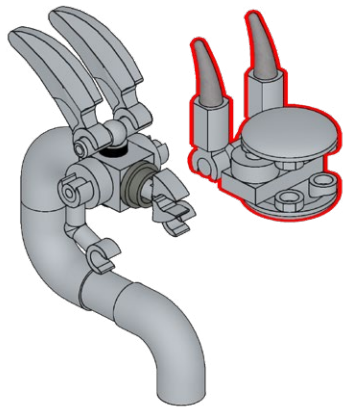

# 38

1

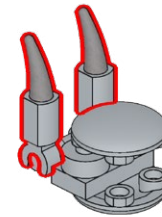

2

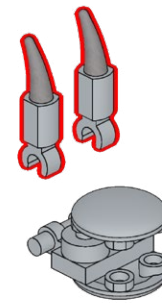



1

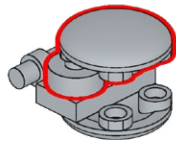

2

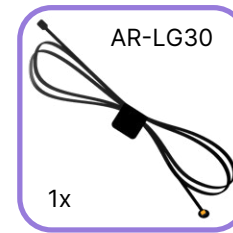
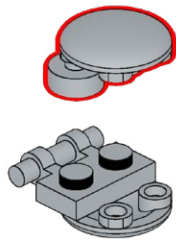

1

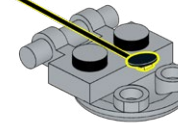

2

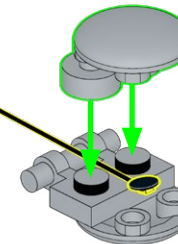

41



1

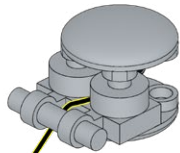

2

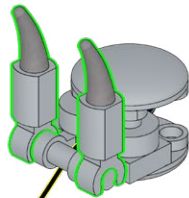

42

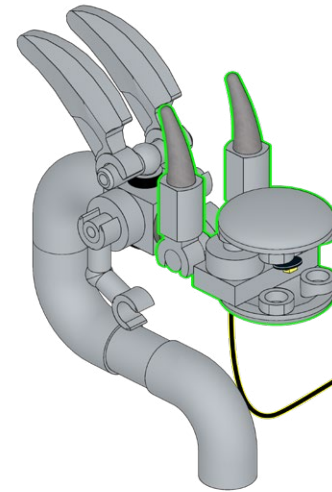

43

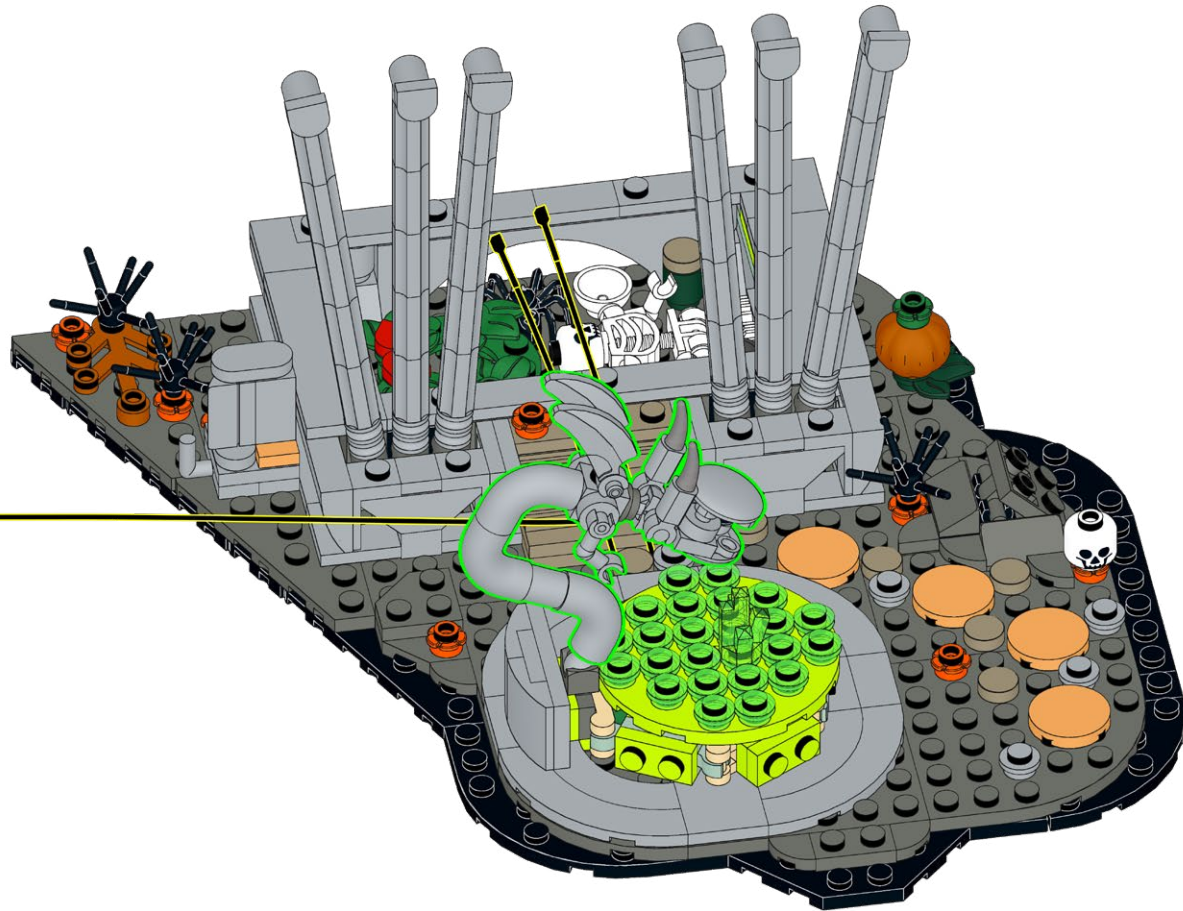

44

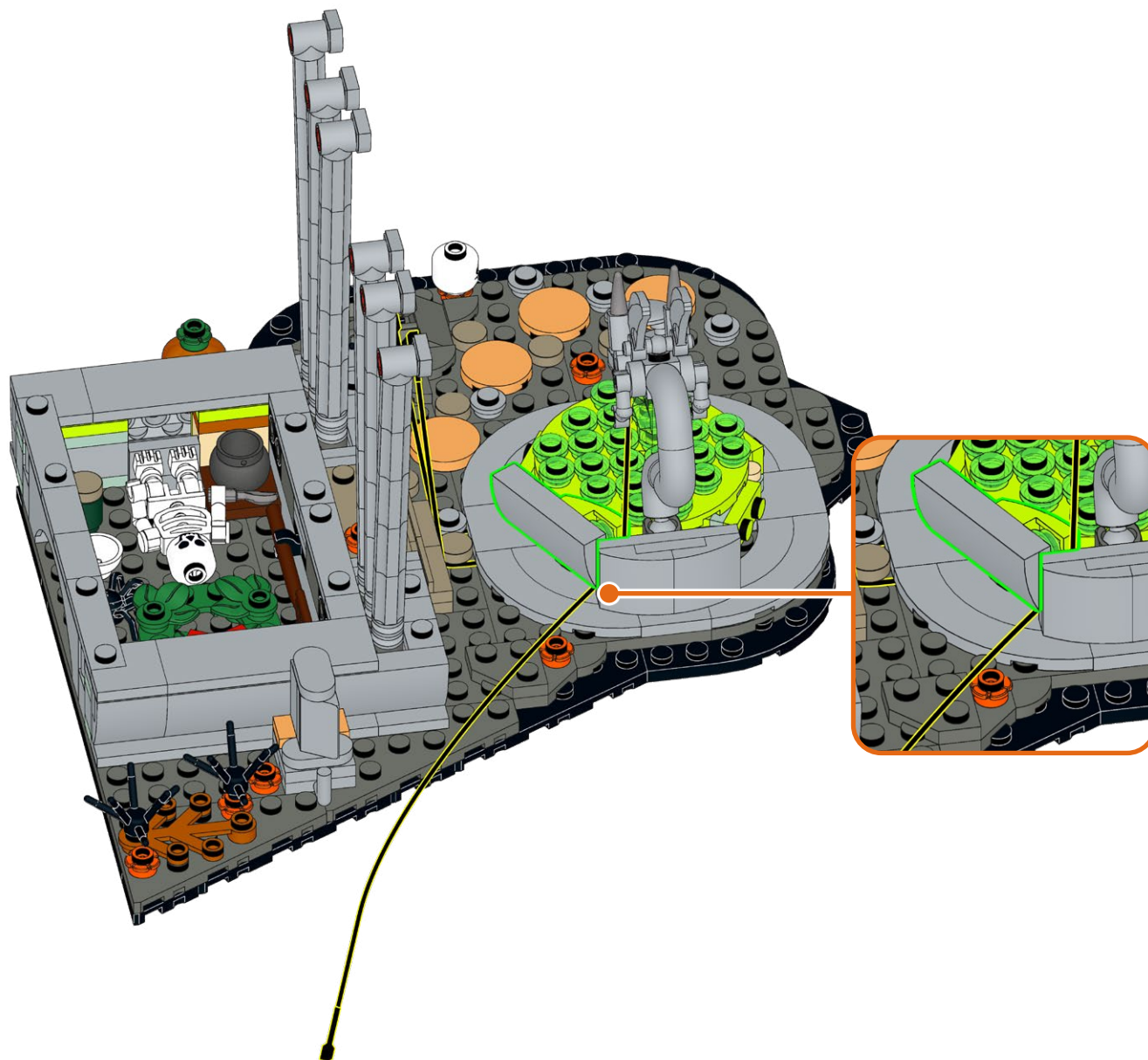

45

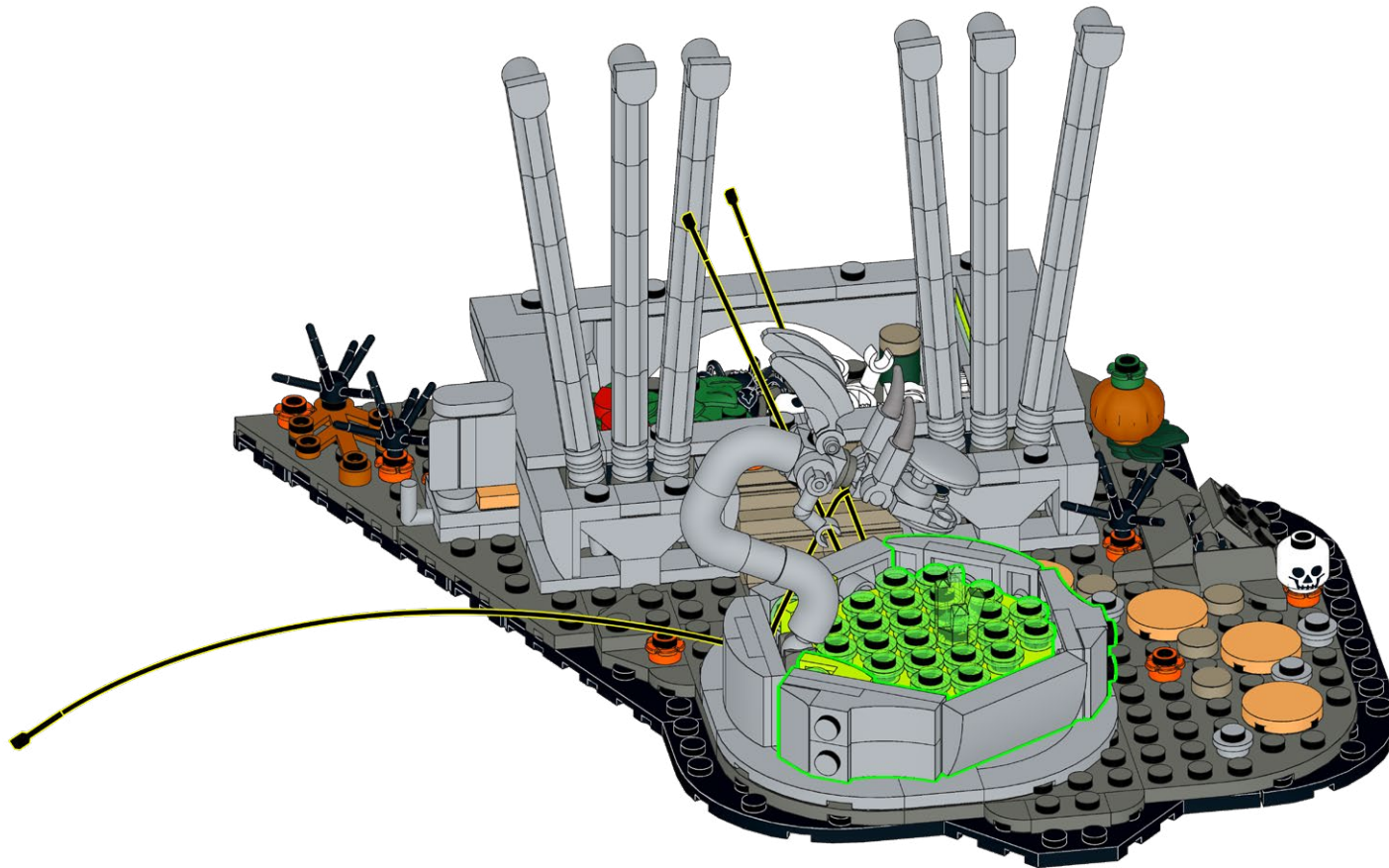



46

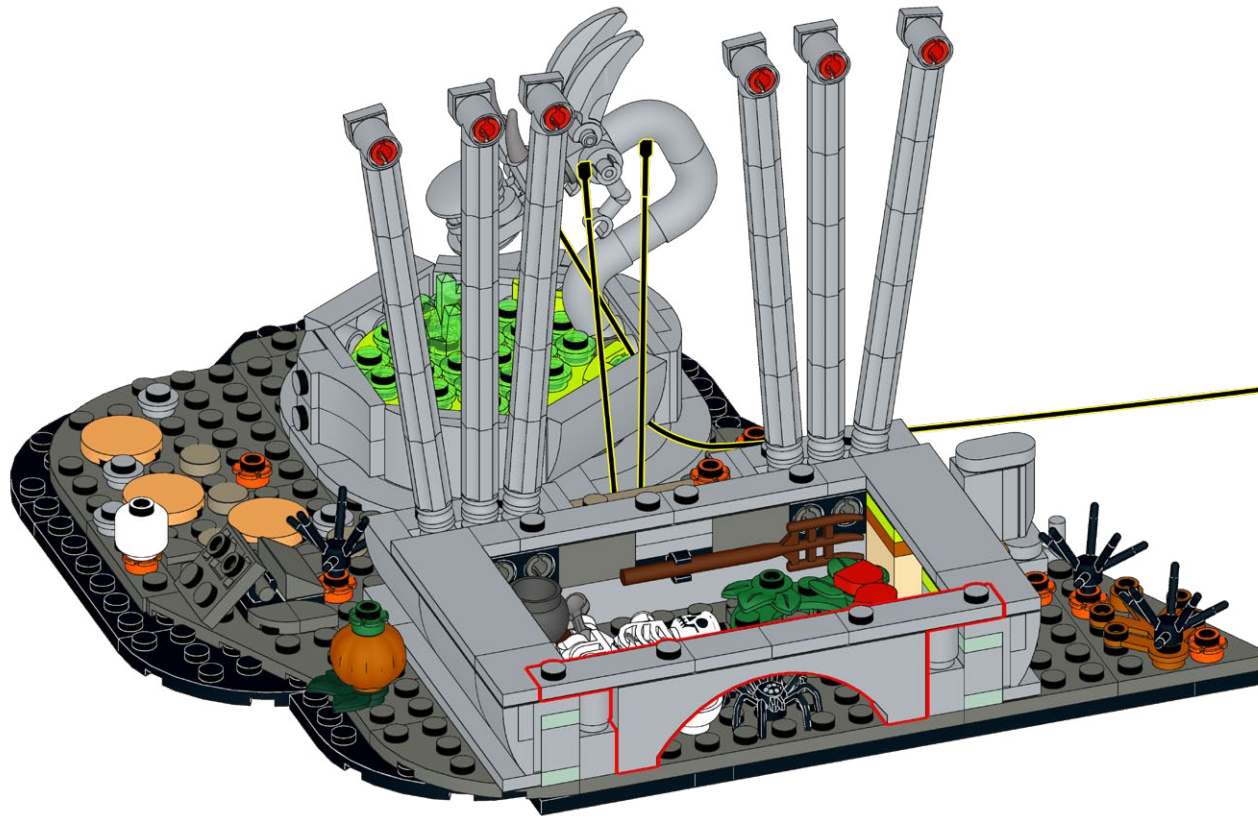

47

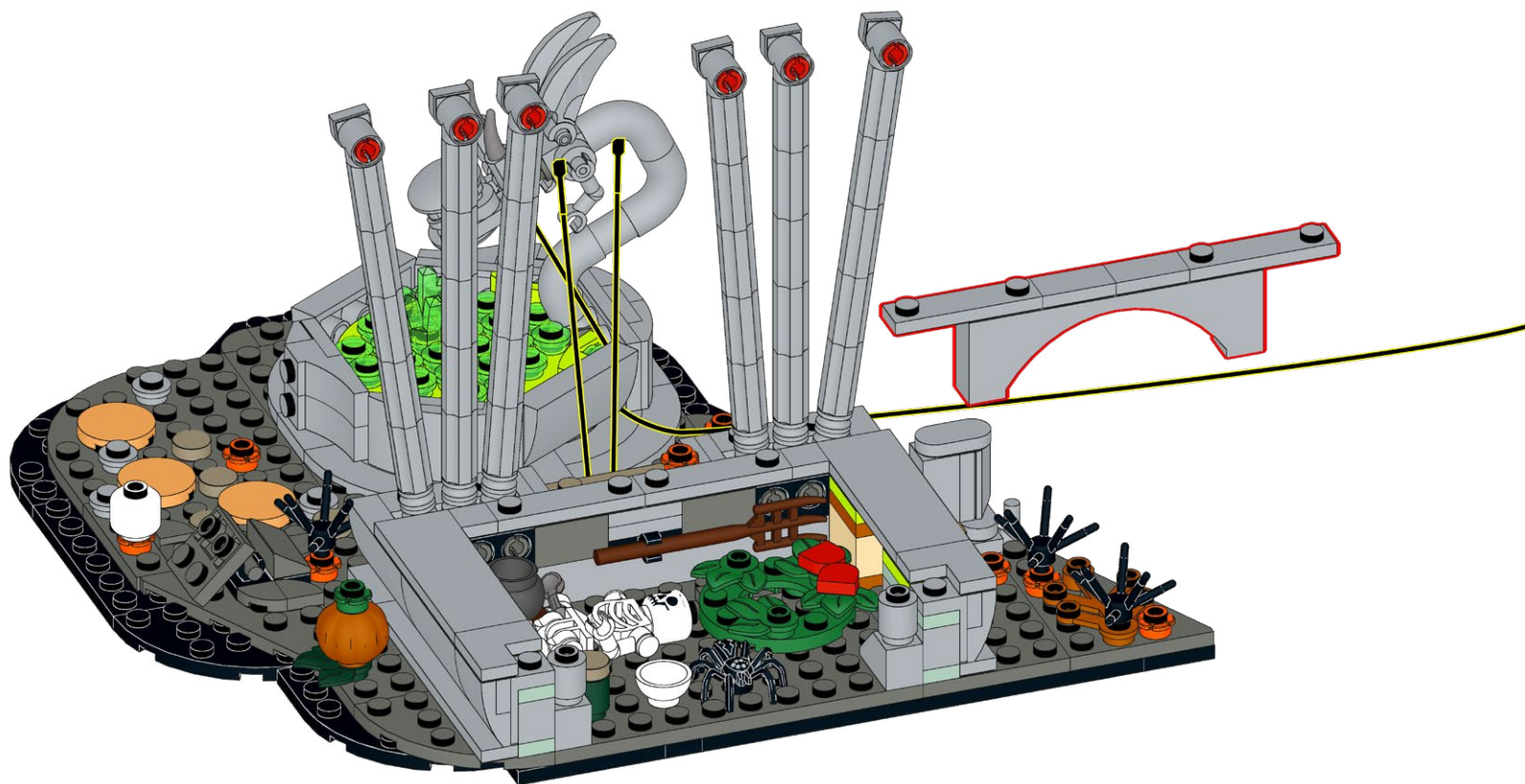

48

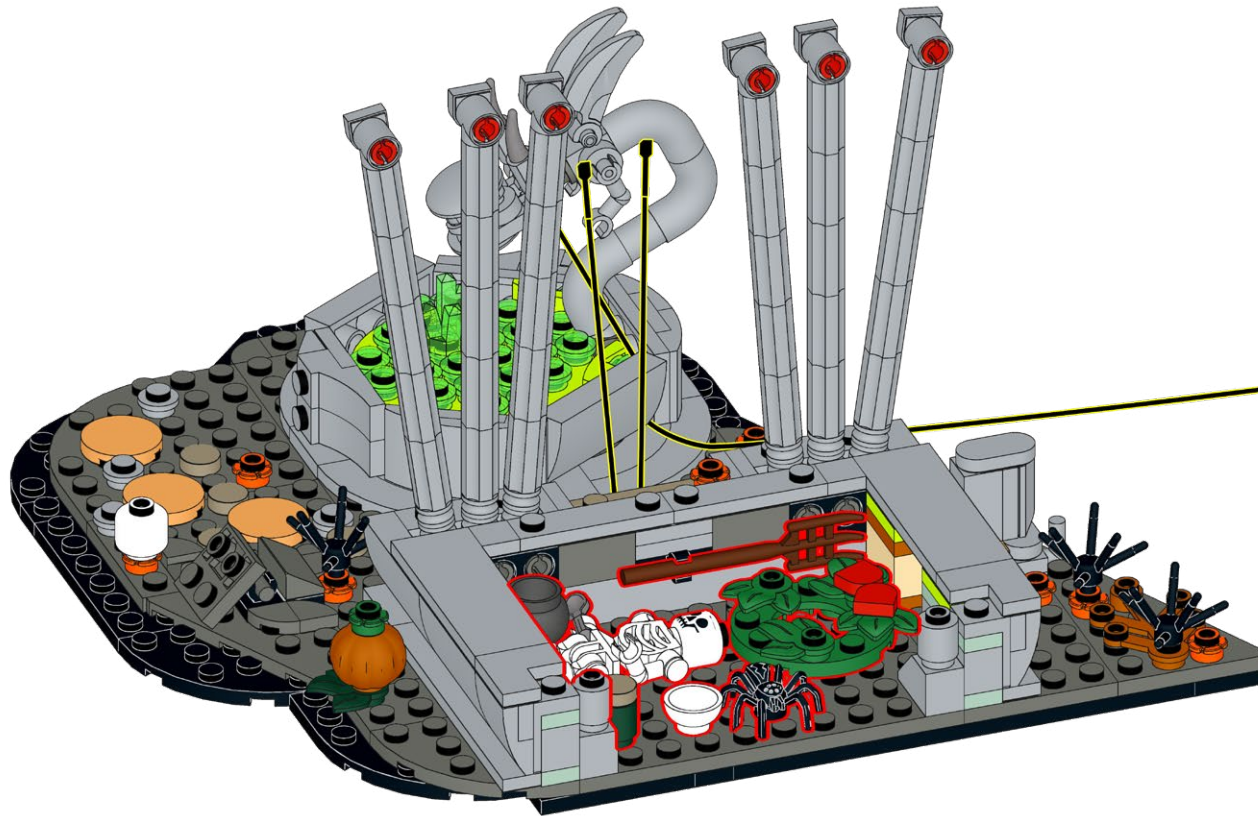

49

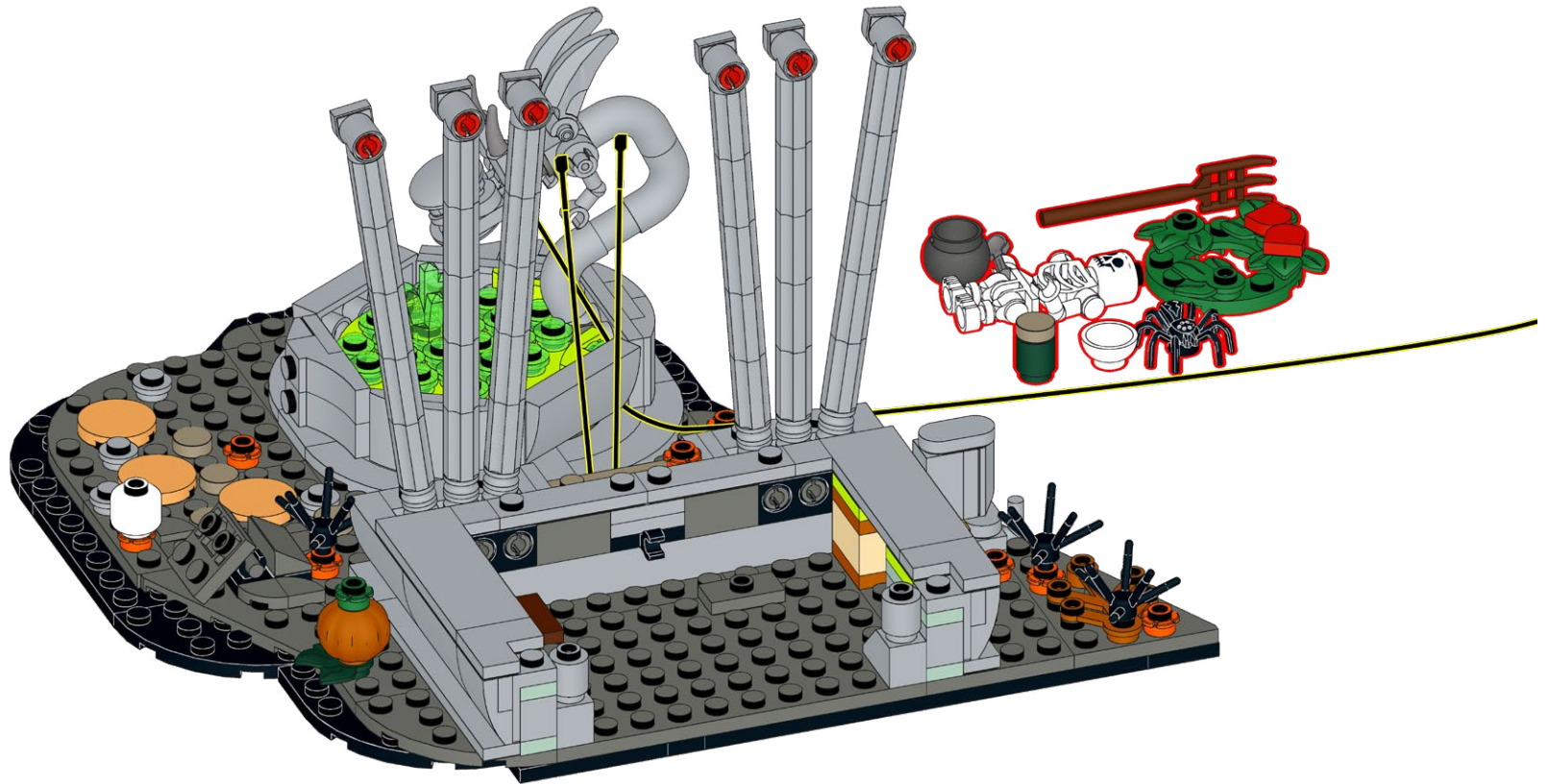

50

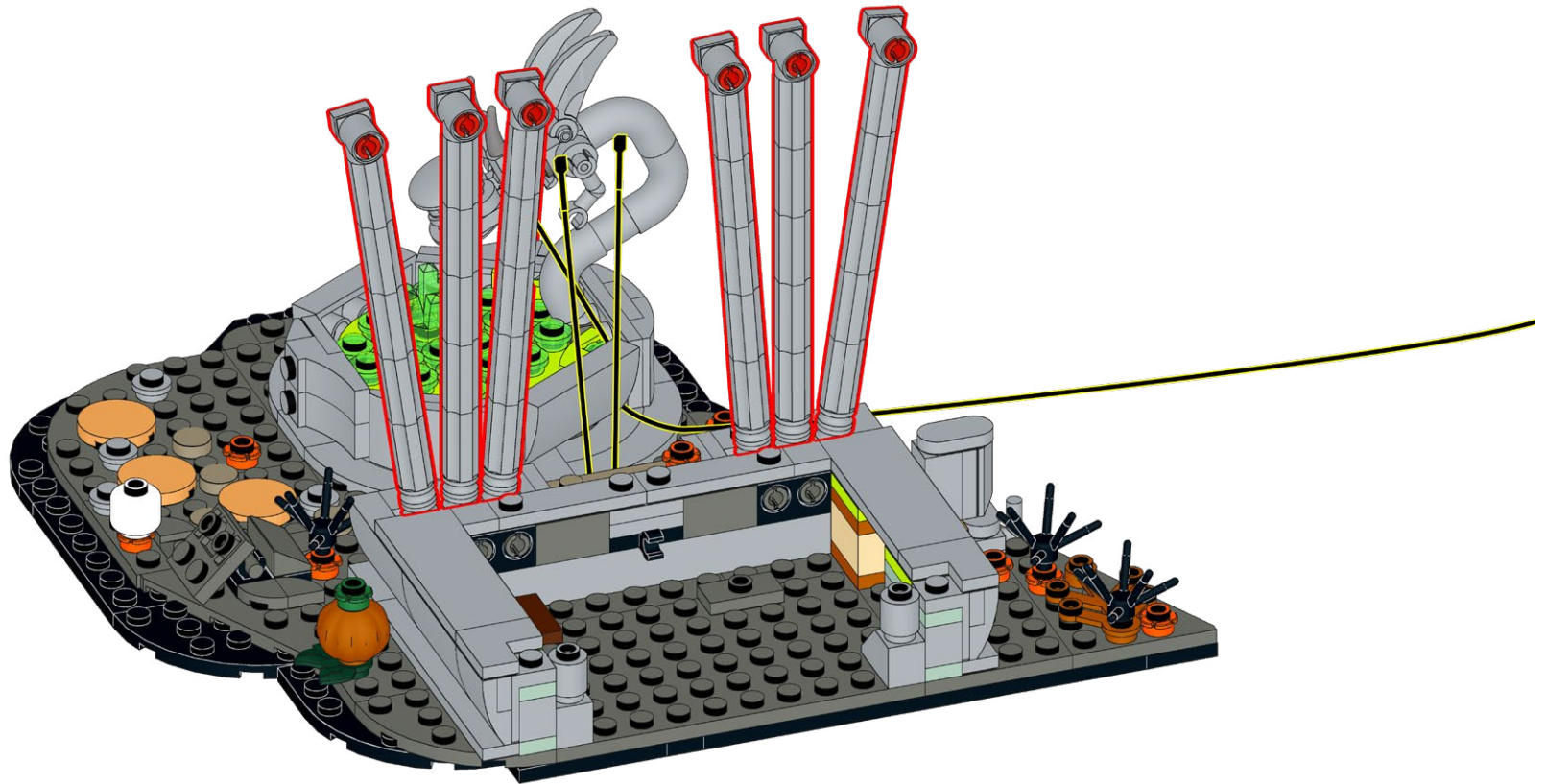

51

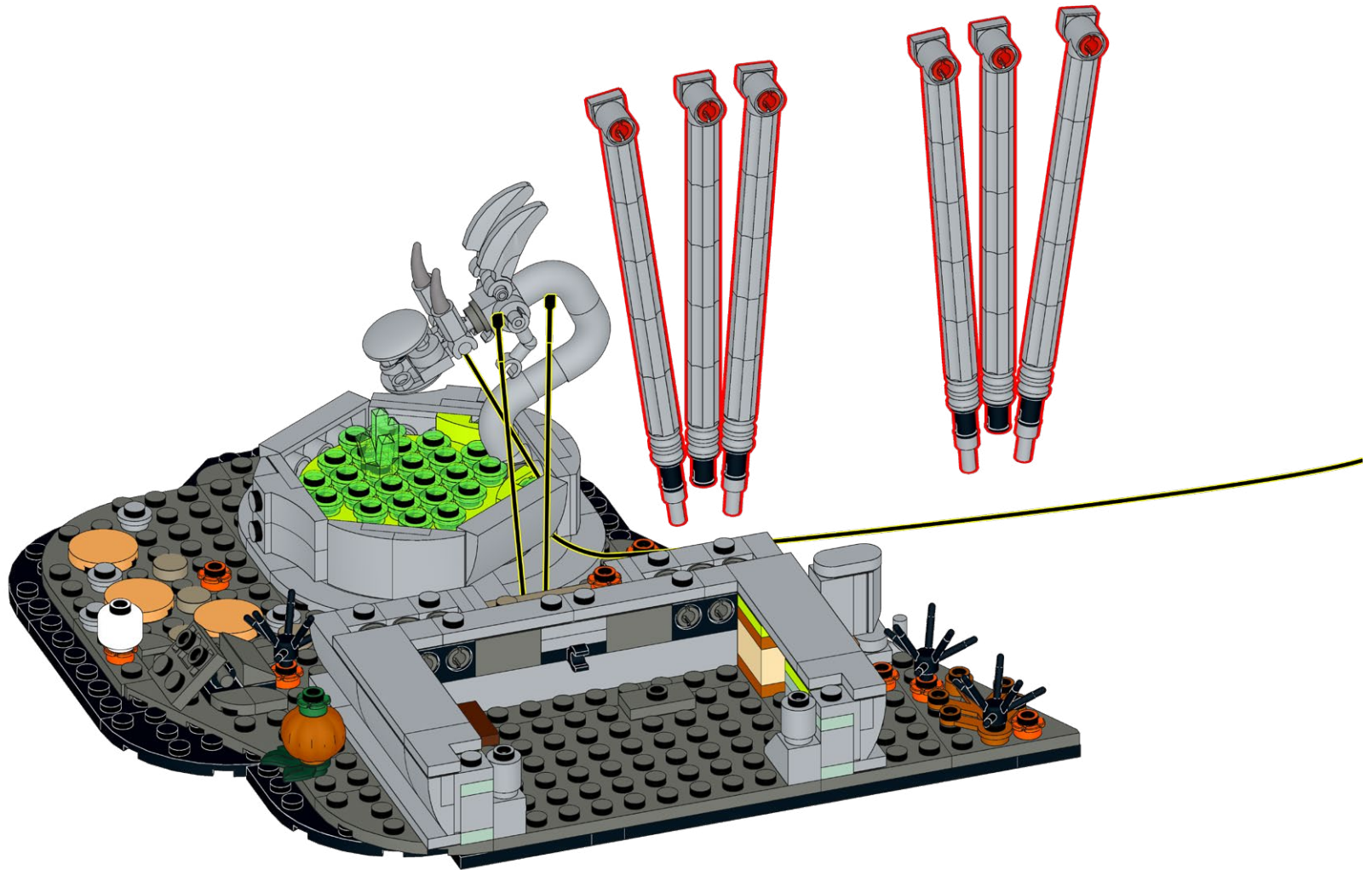

52

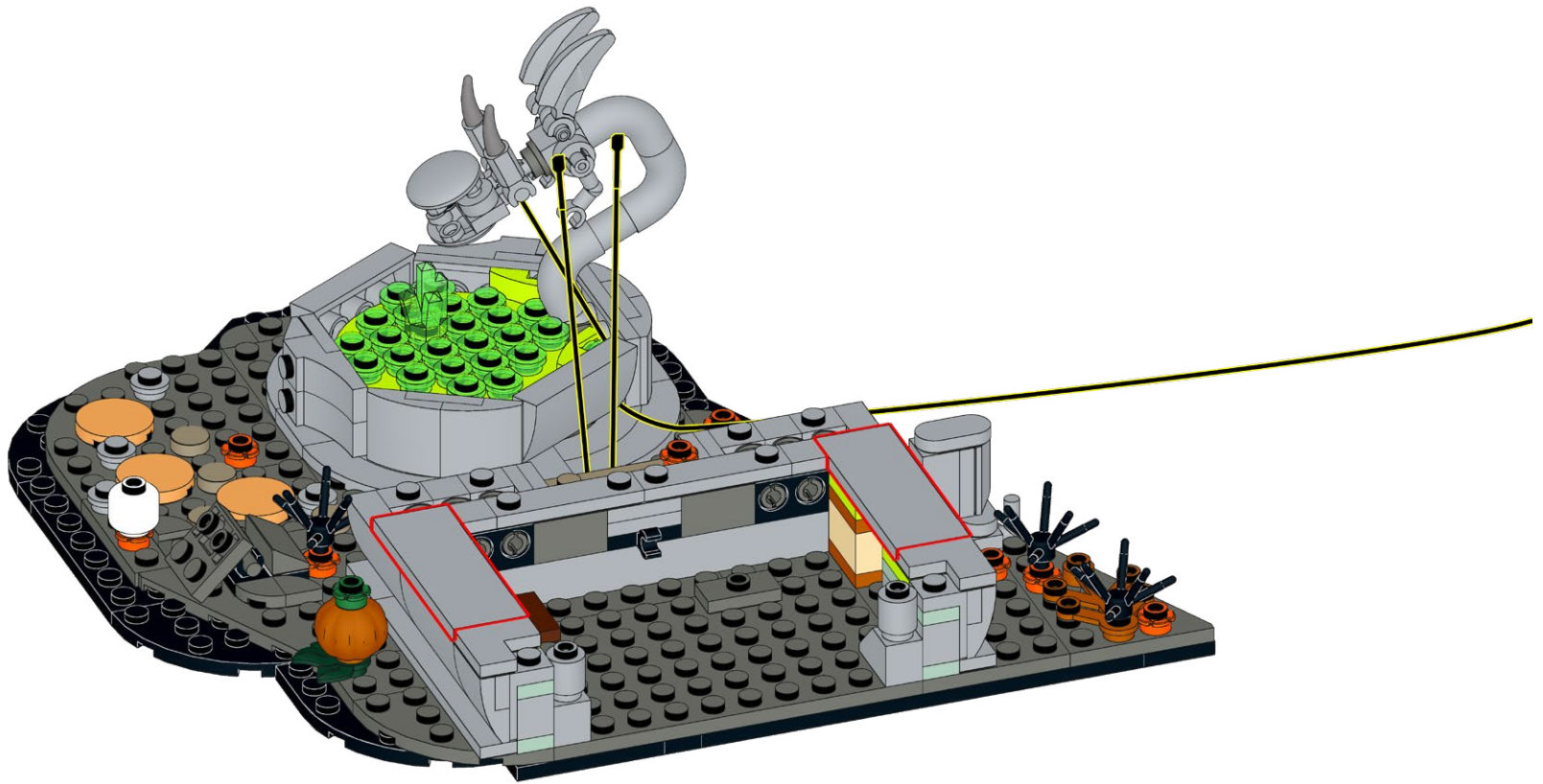

53

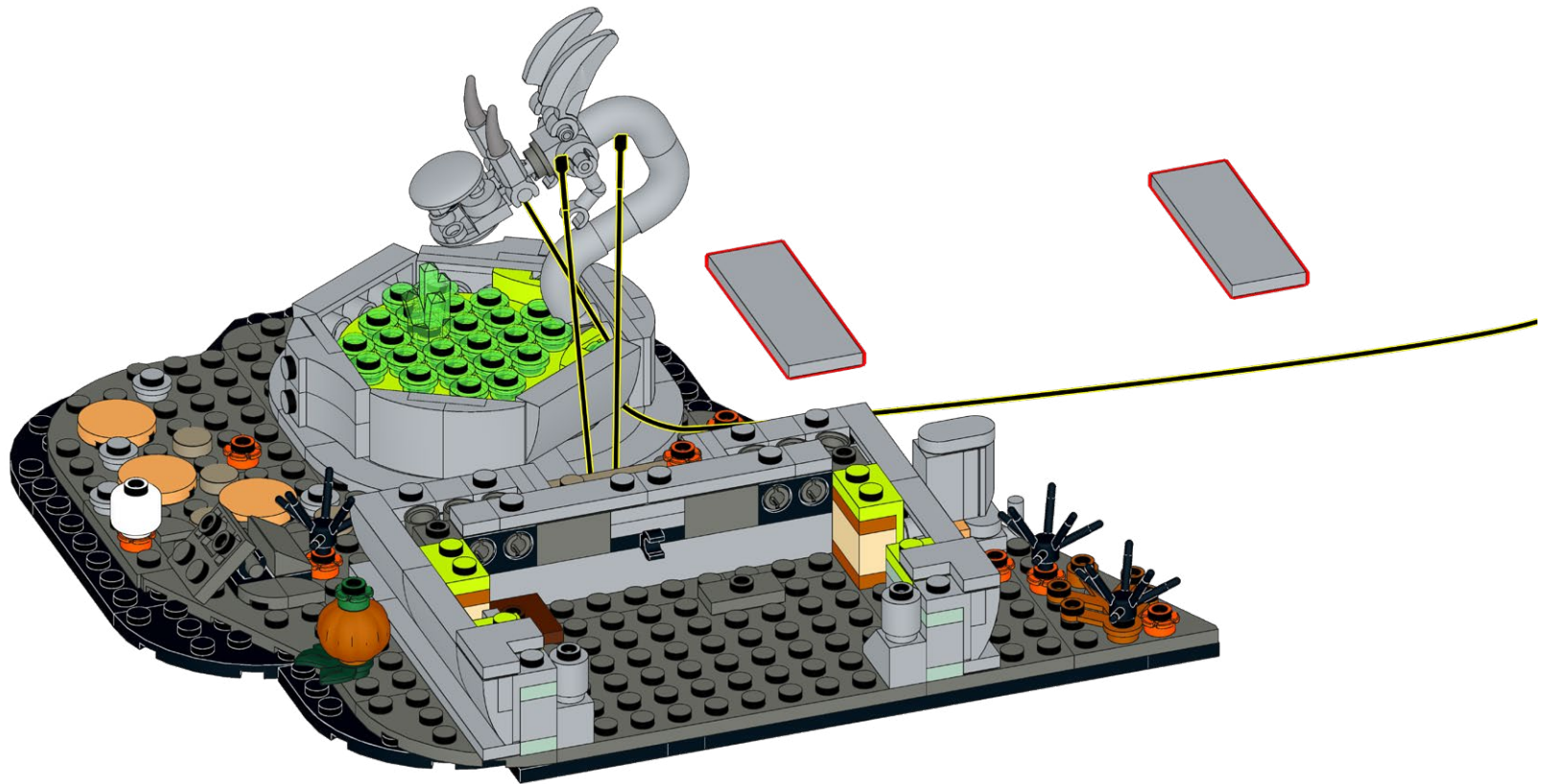



54

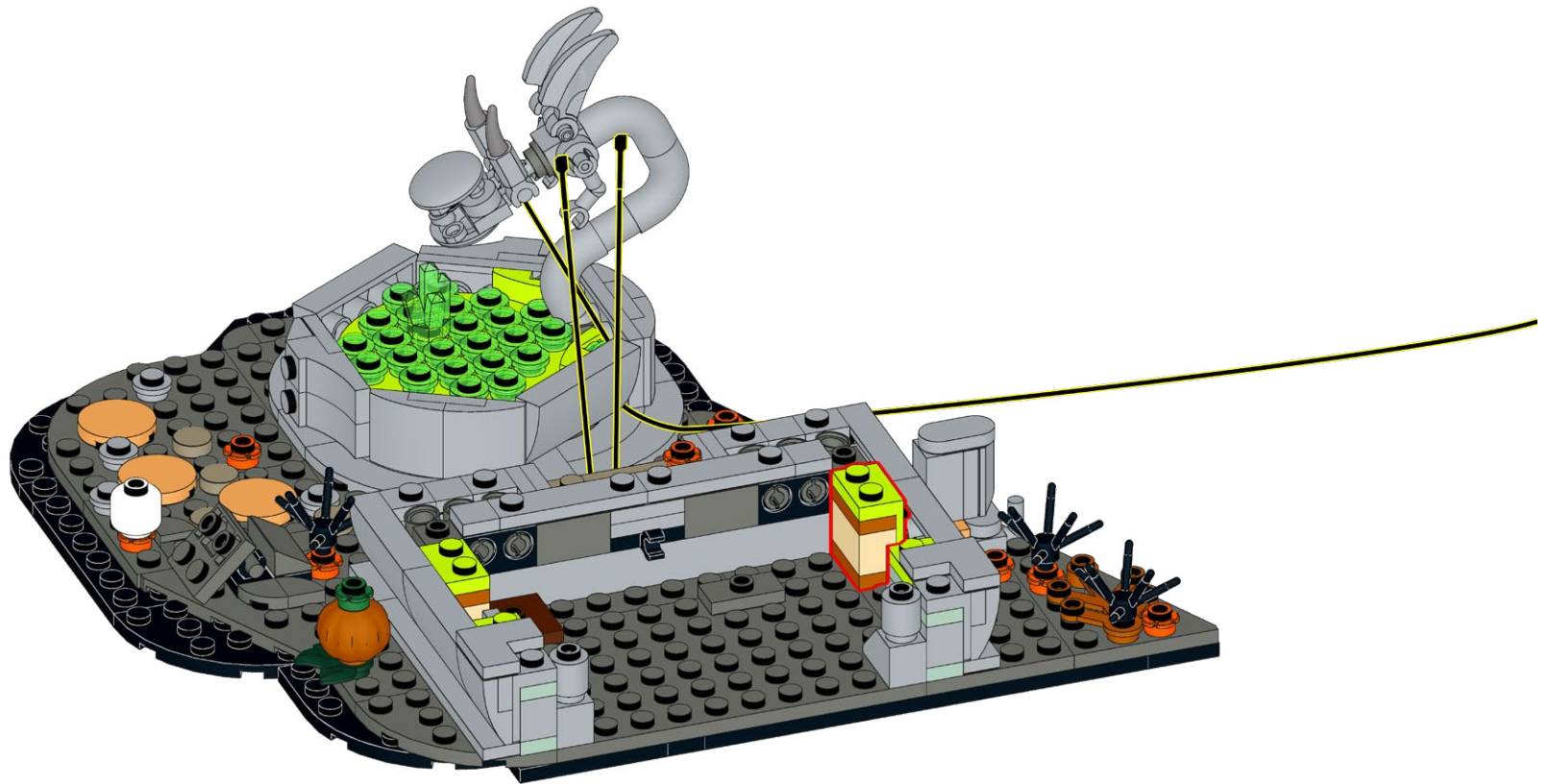

55

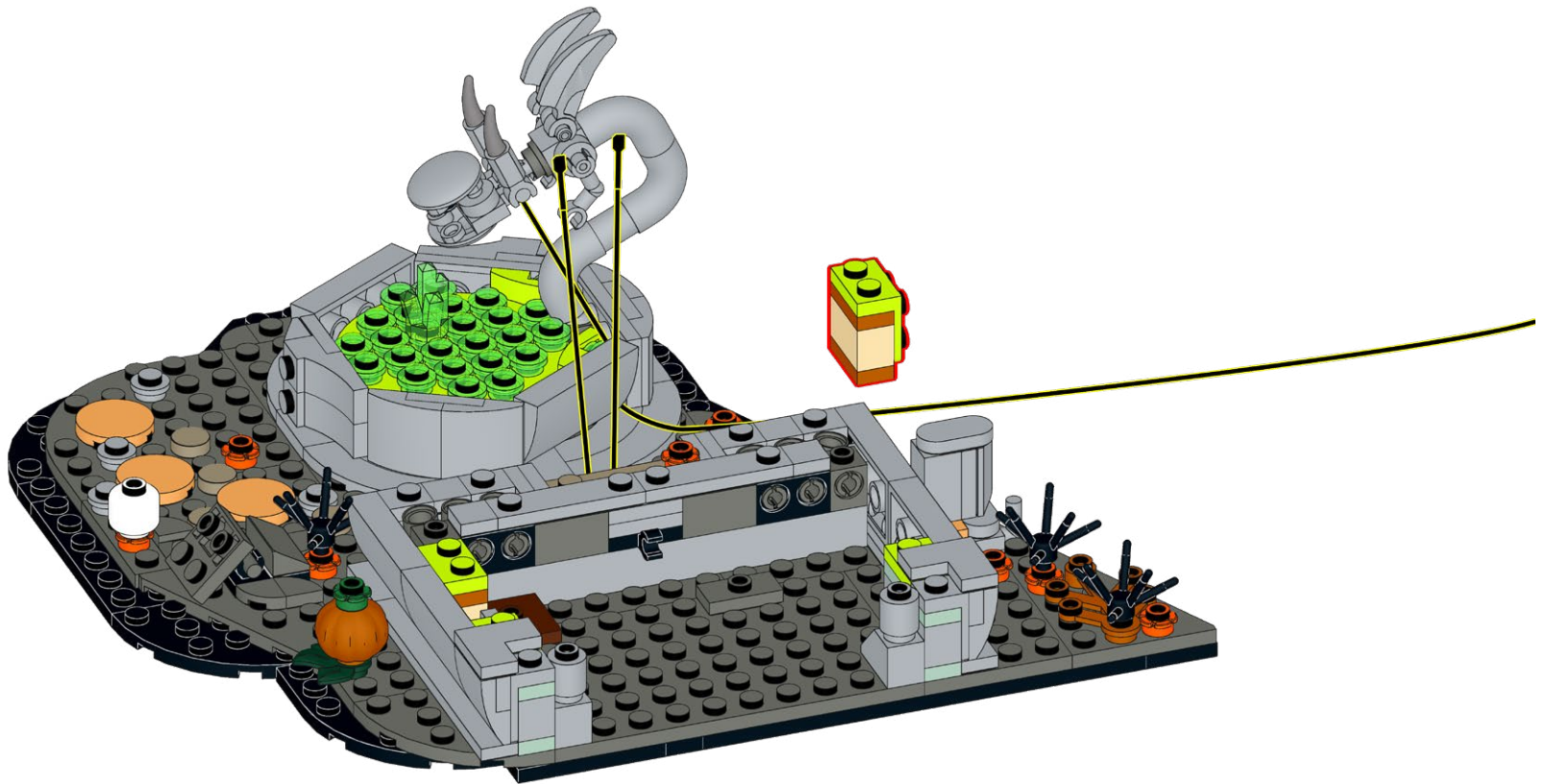

56

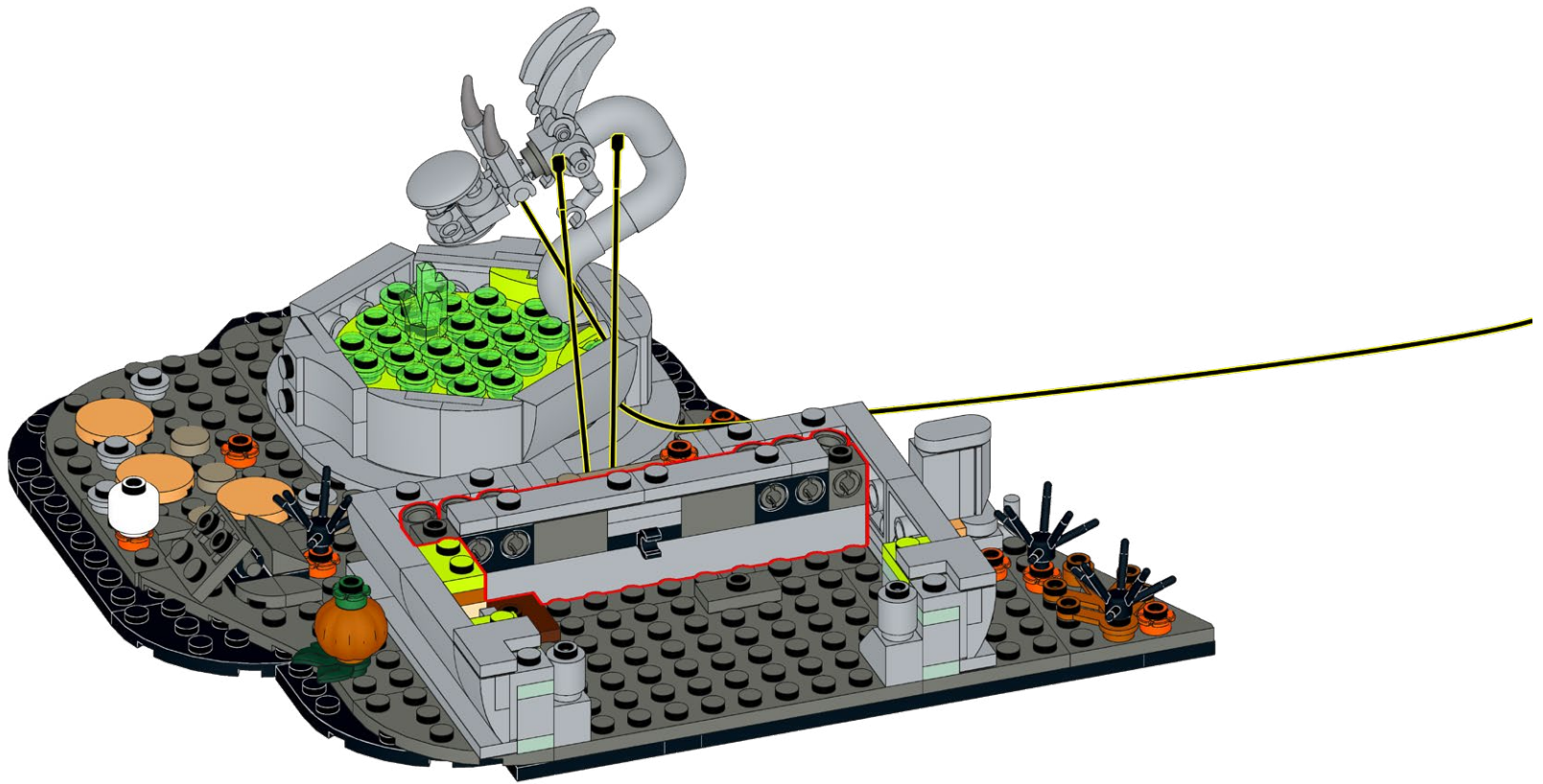

57

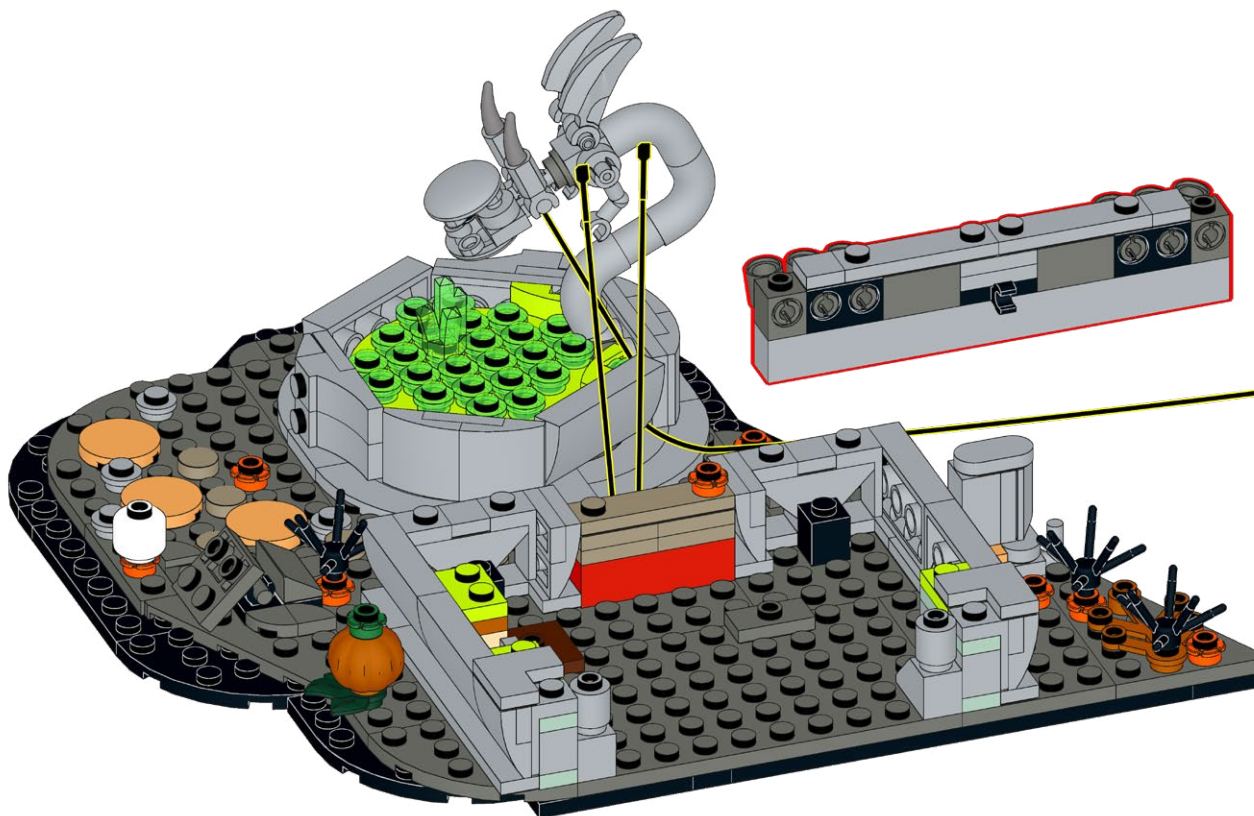

58

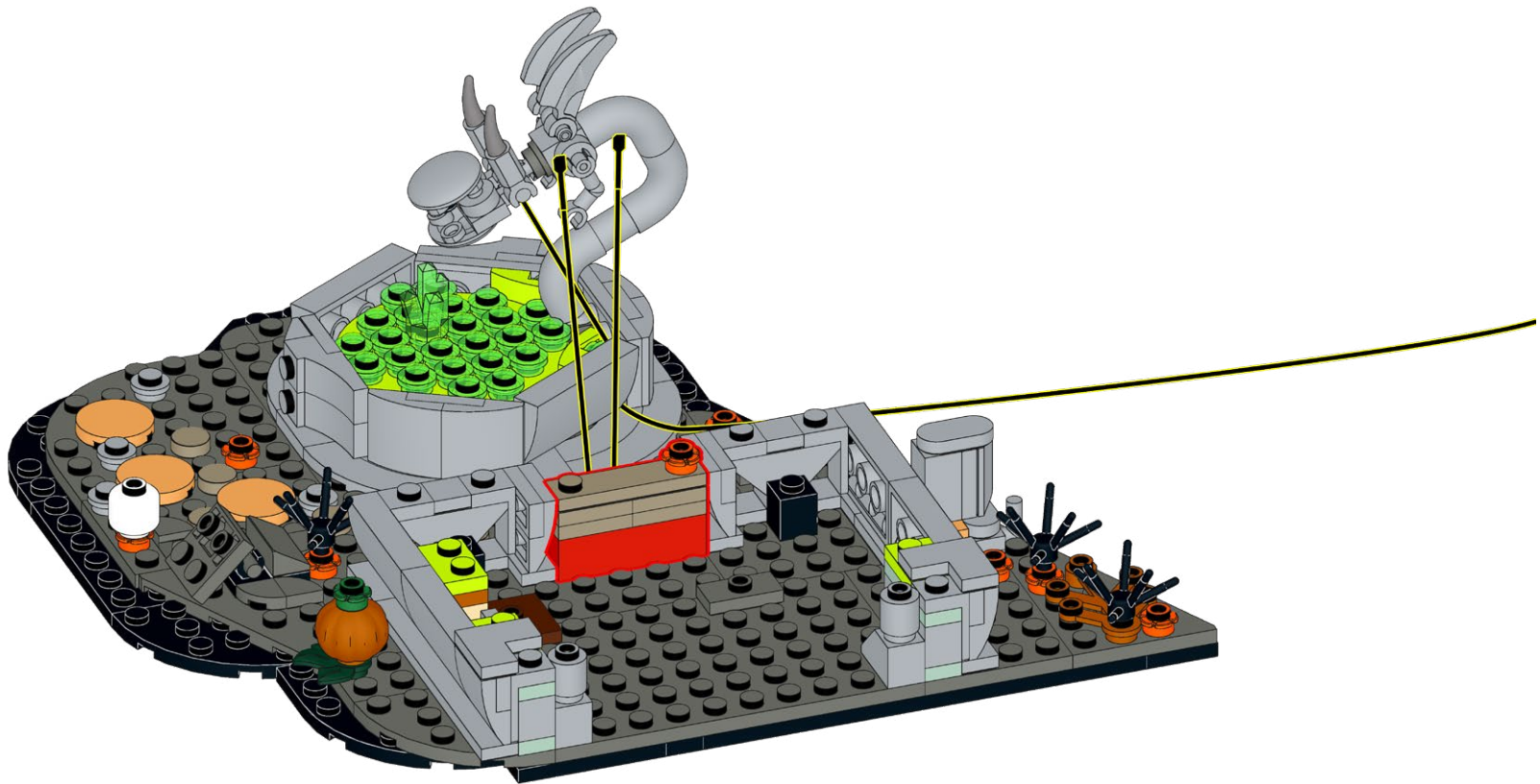

59

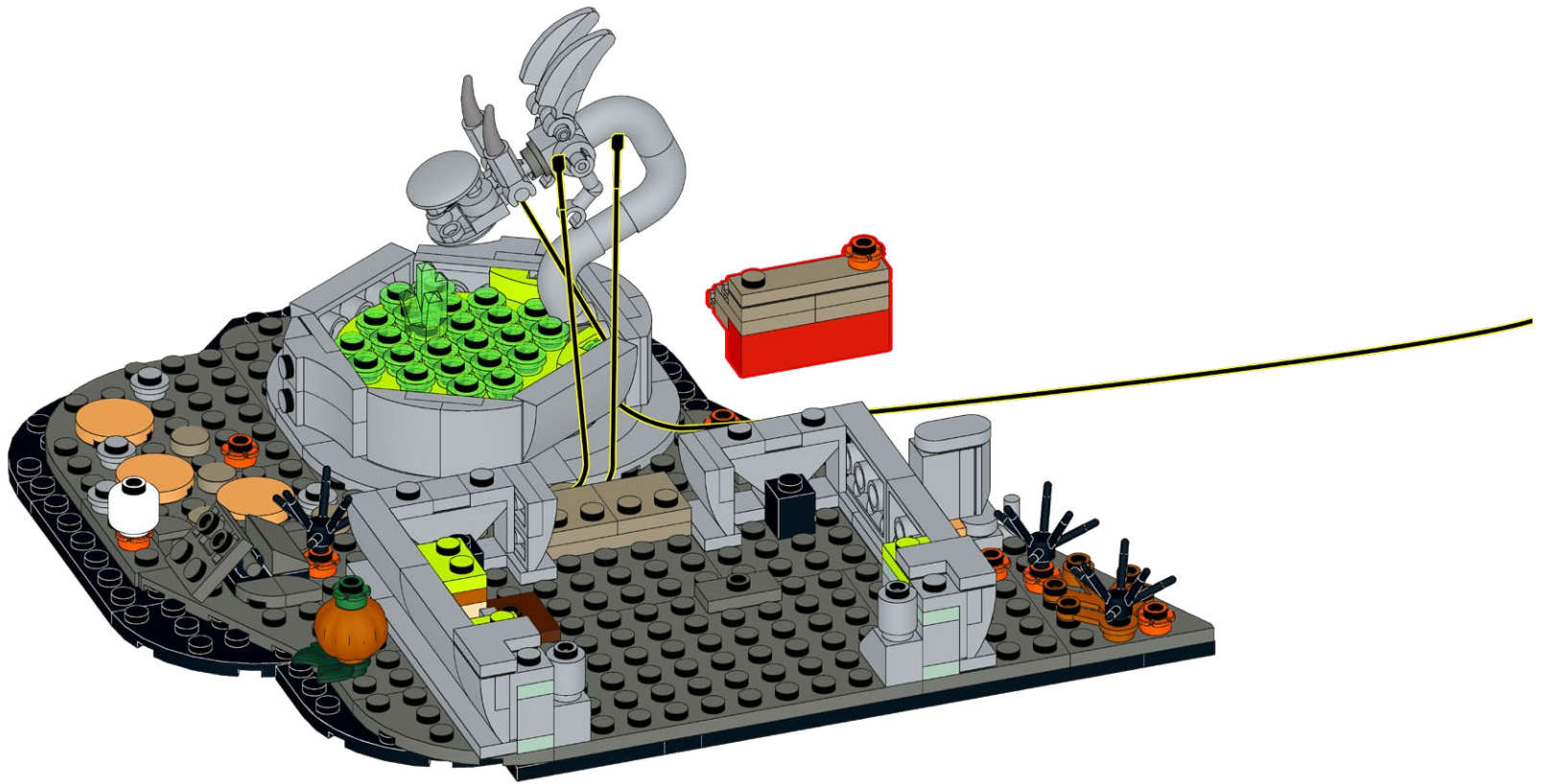

60

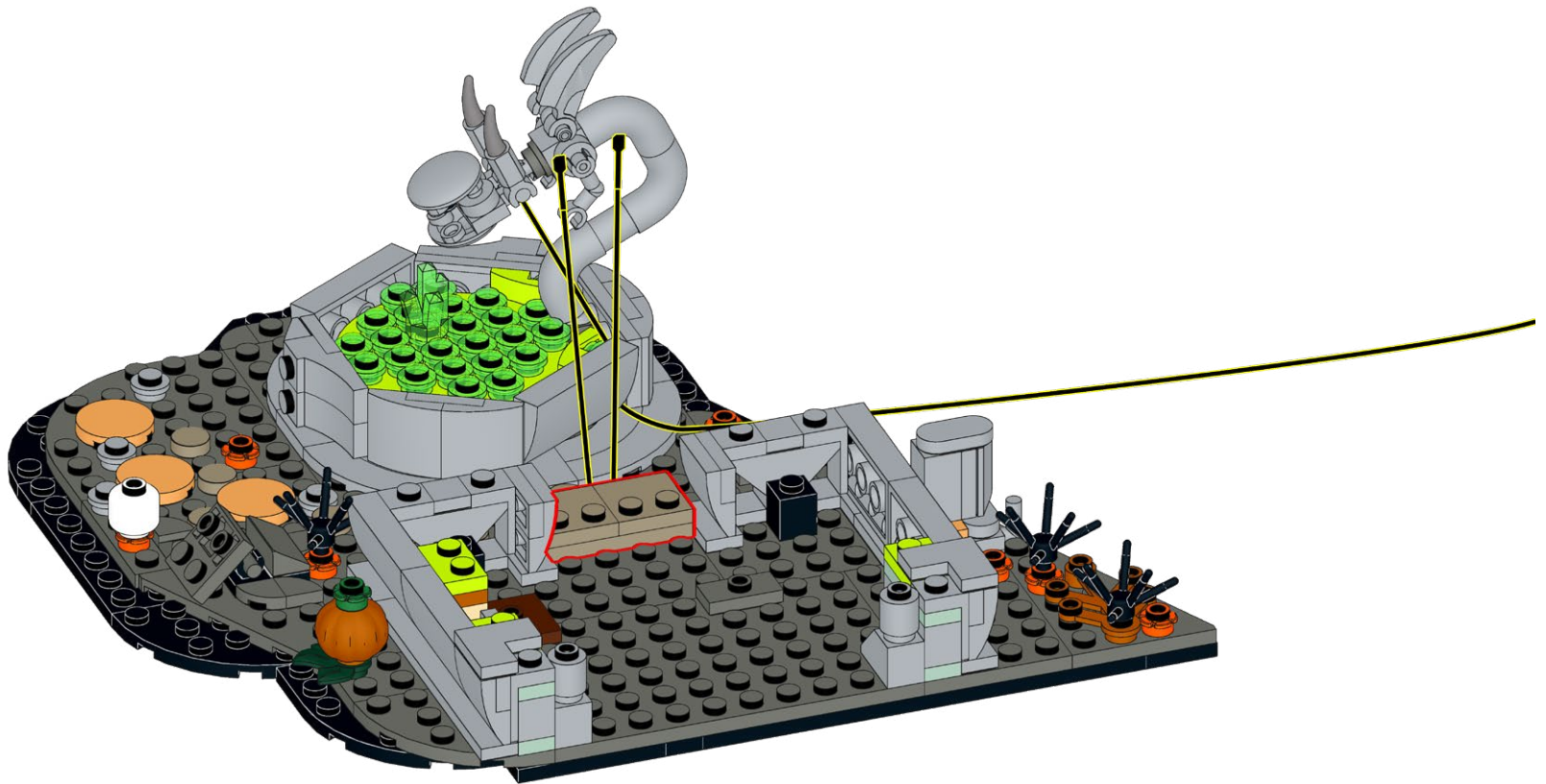

61

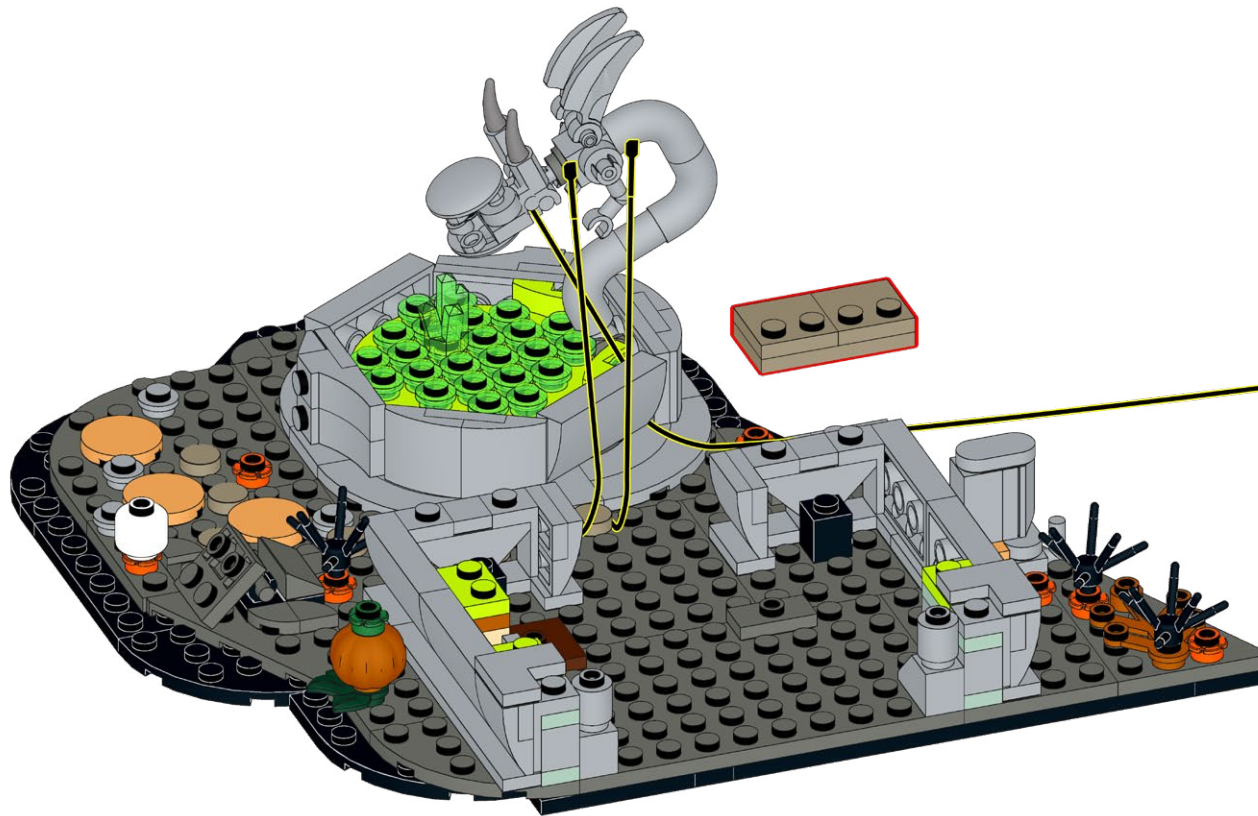



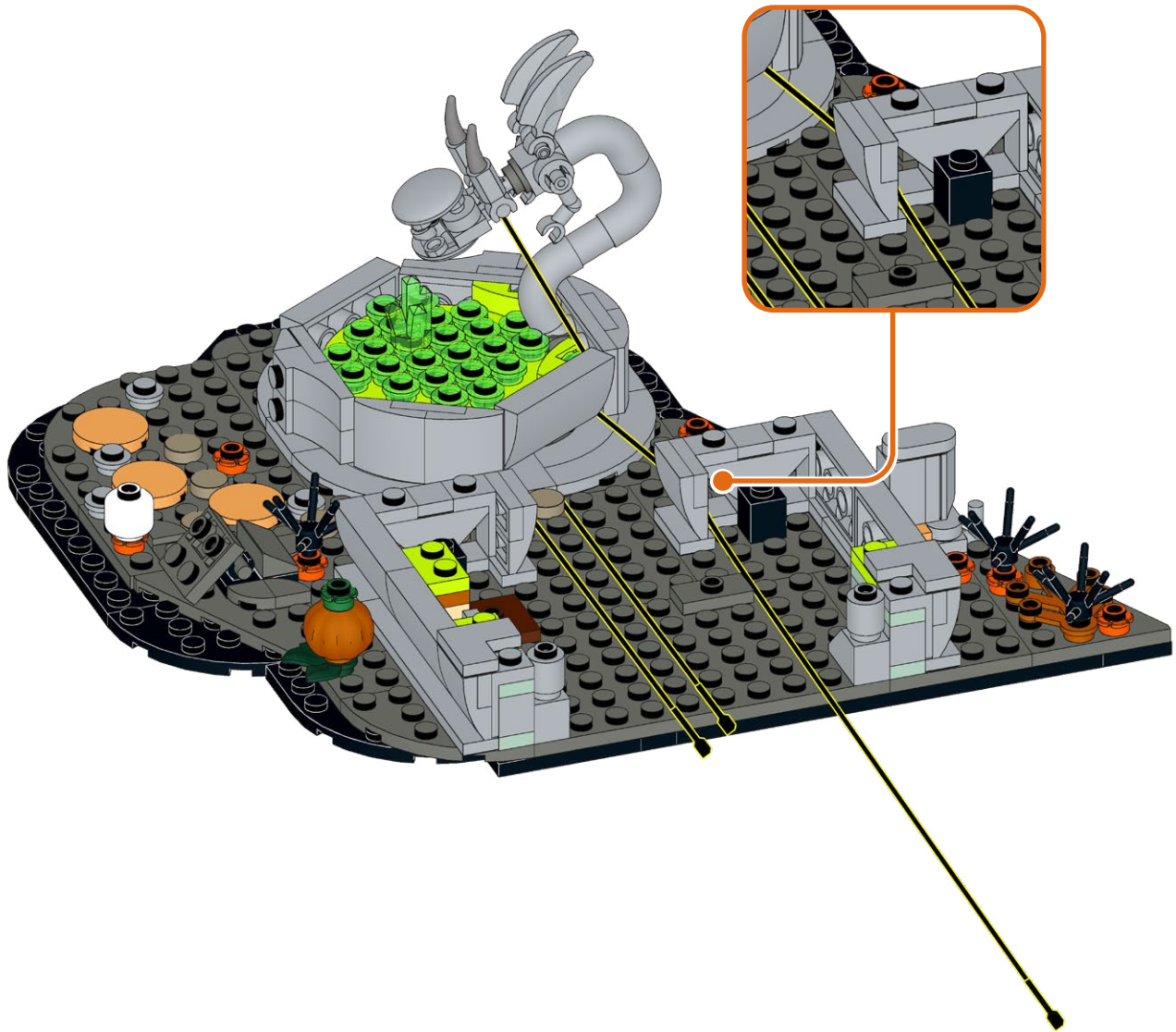

63

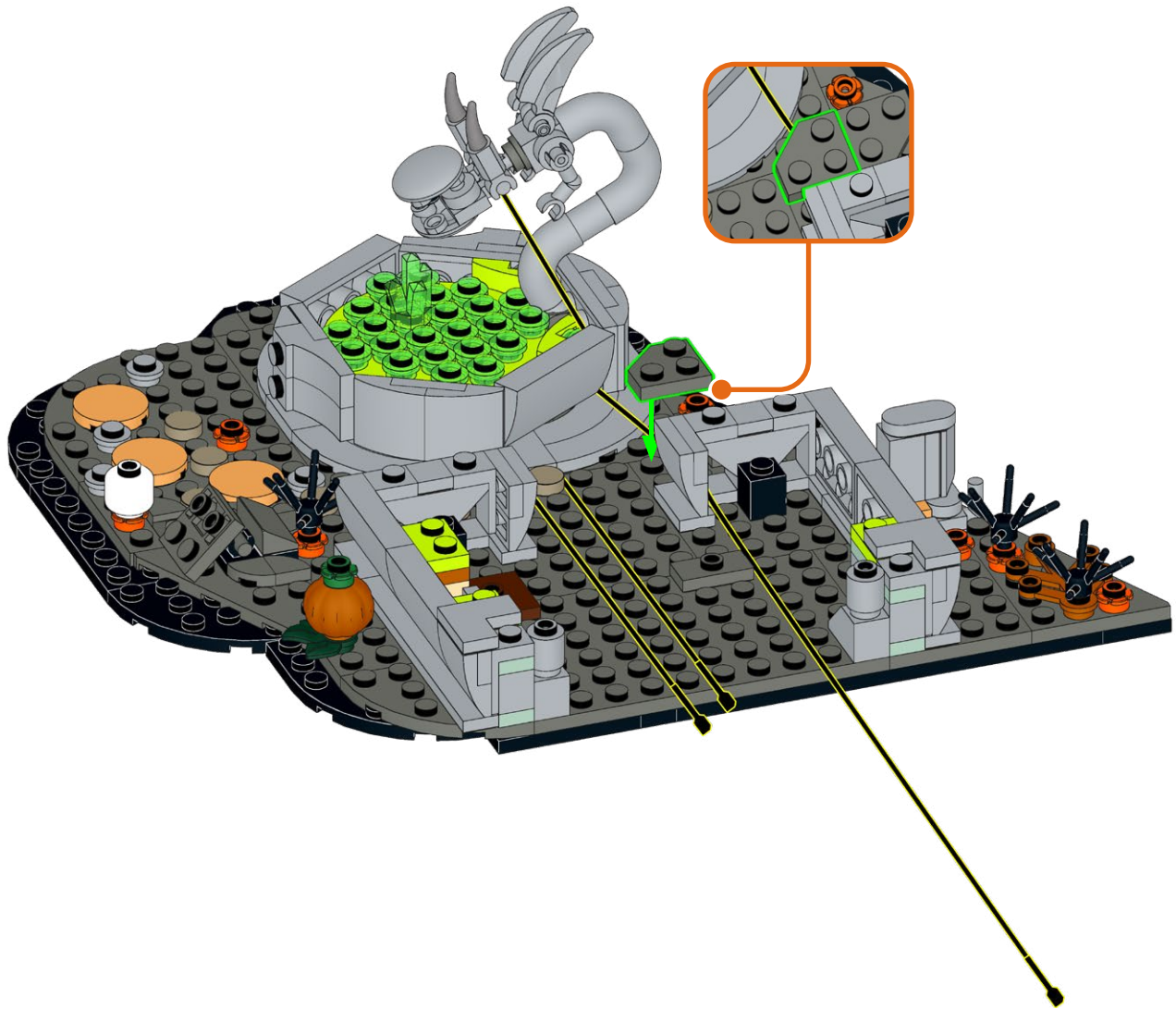

64

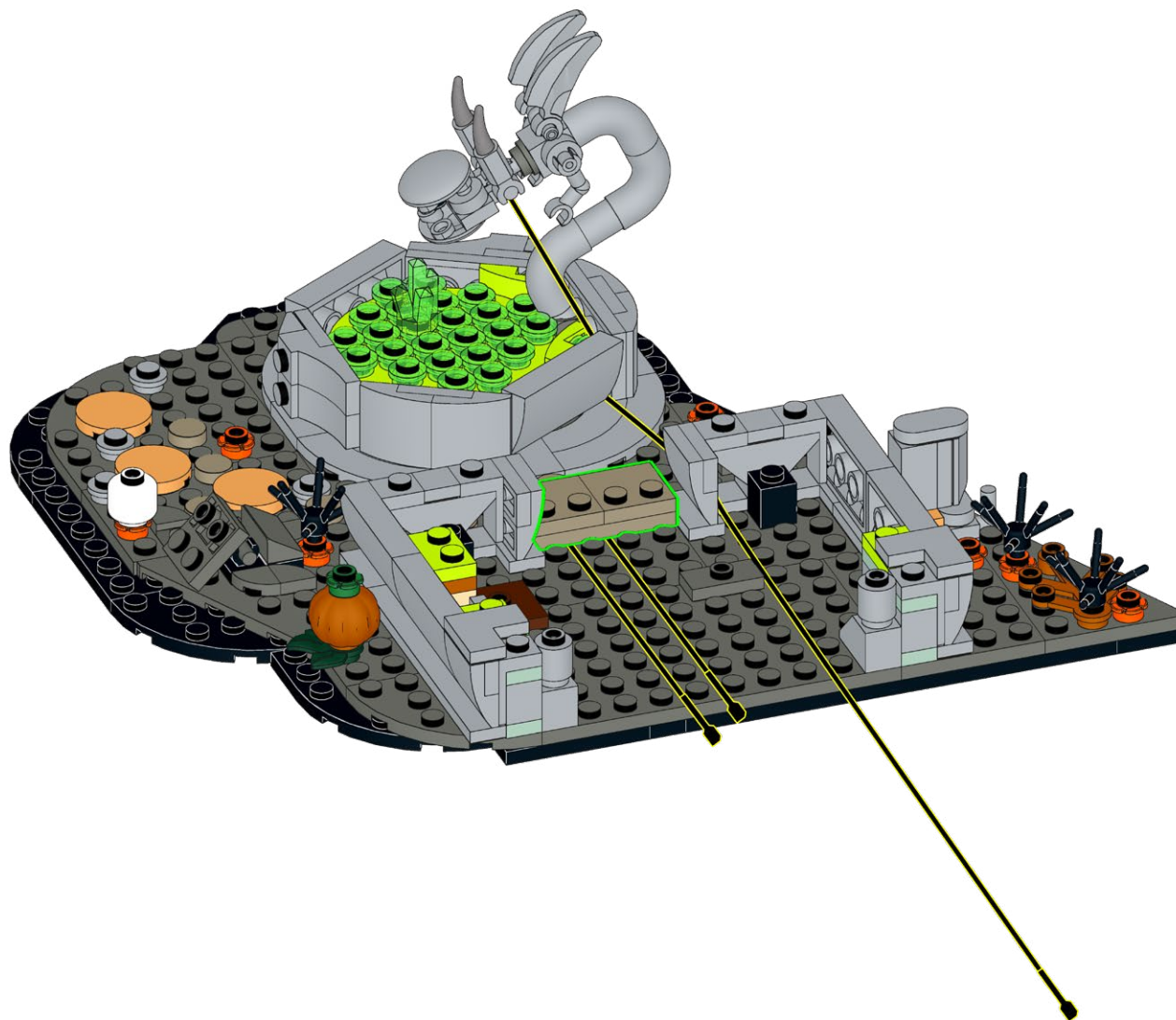

65

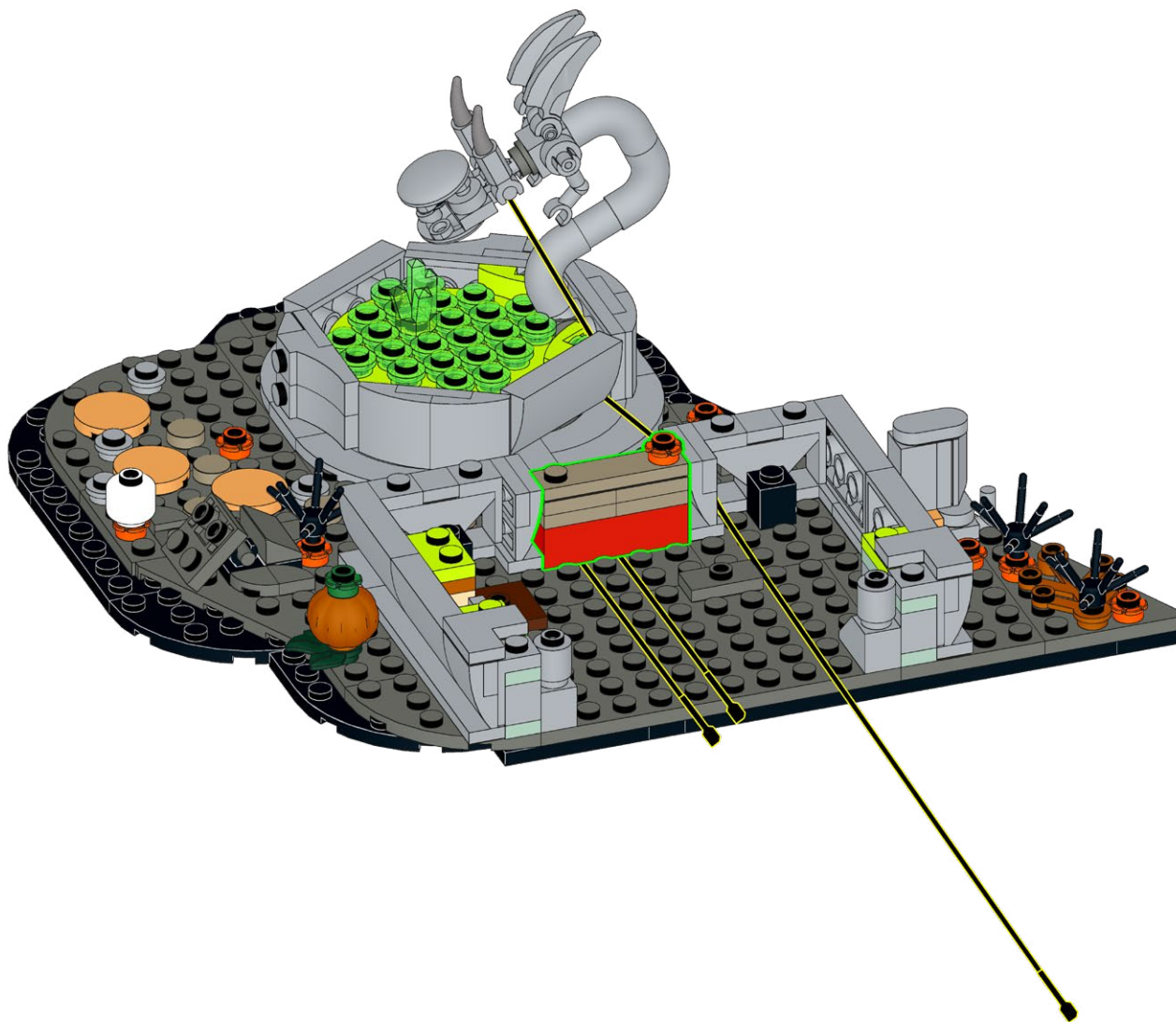

66

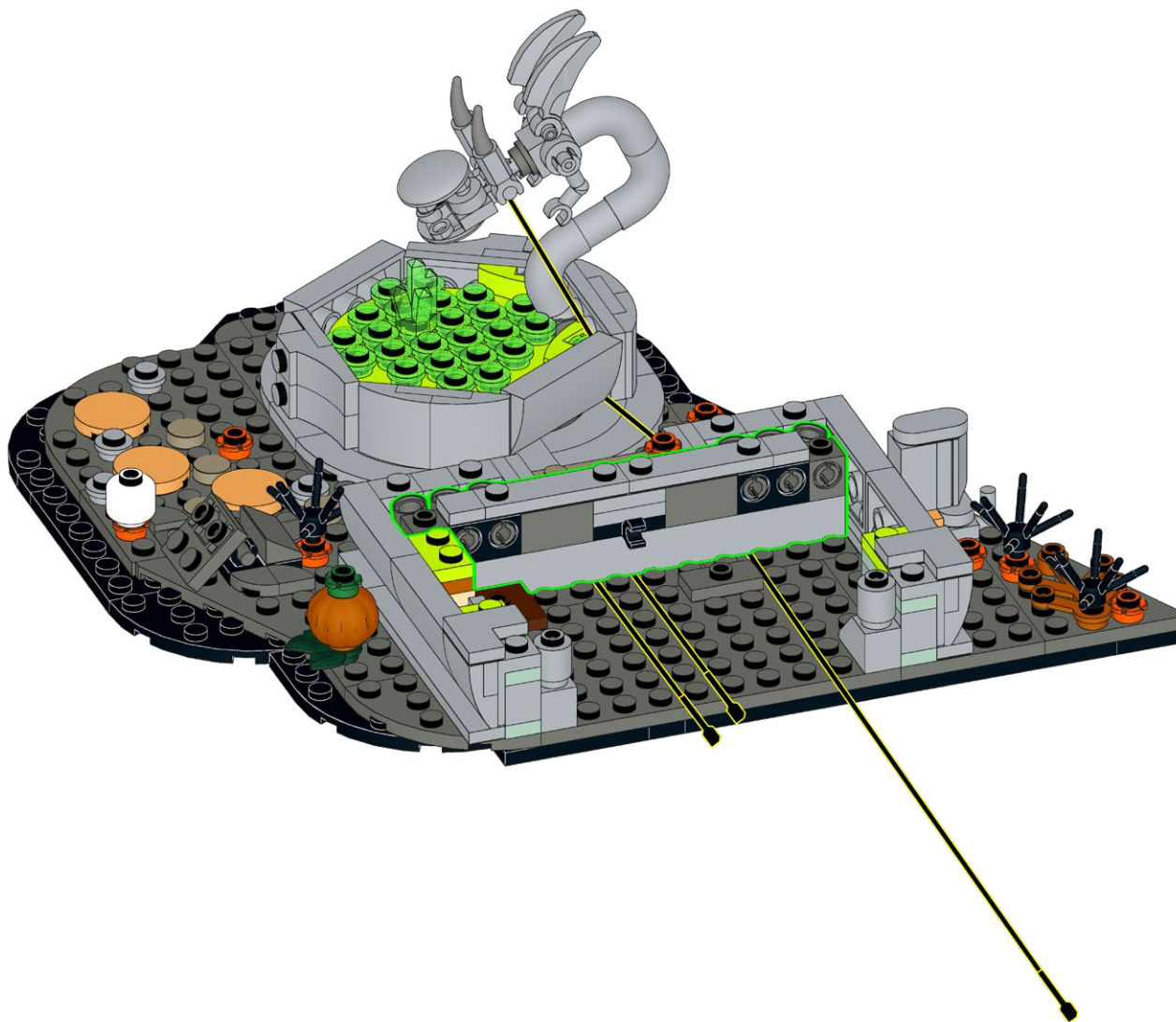

67

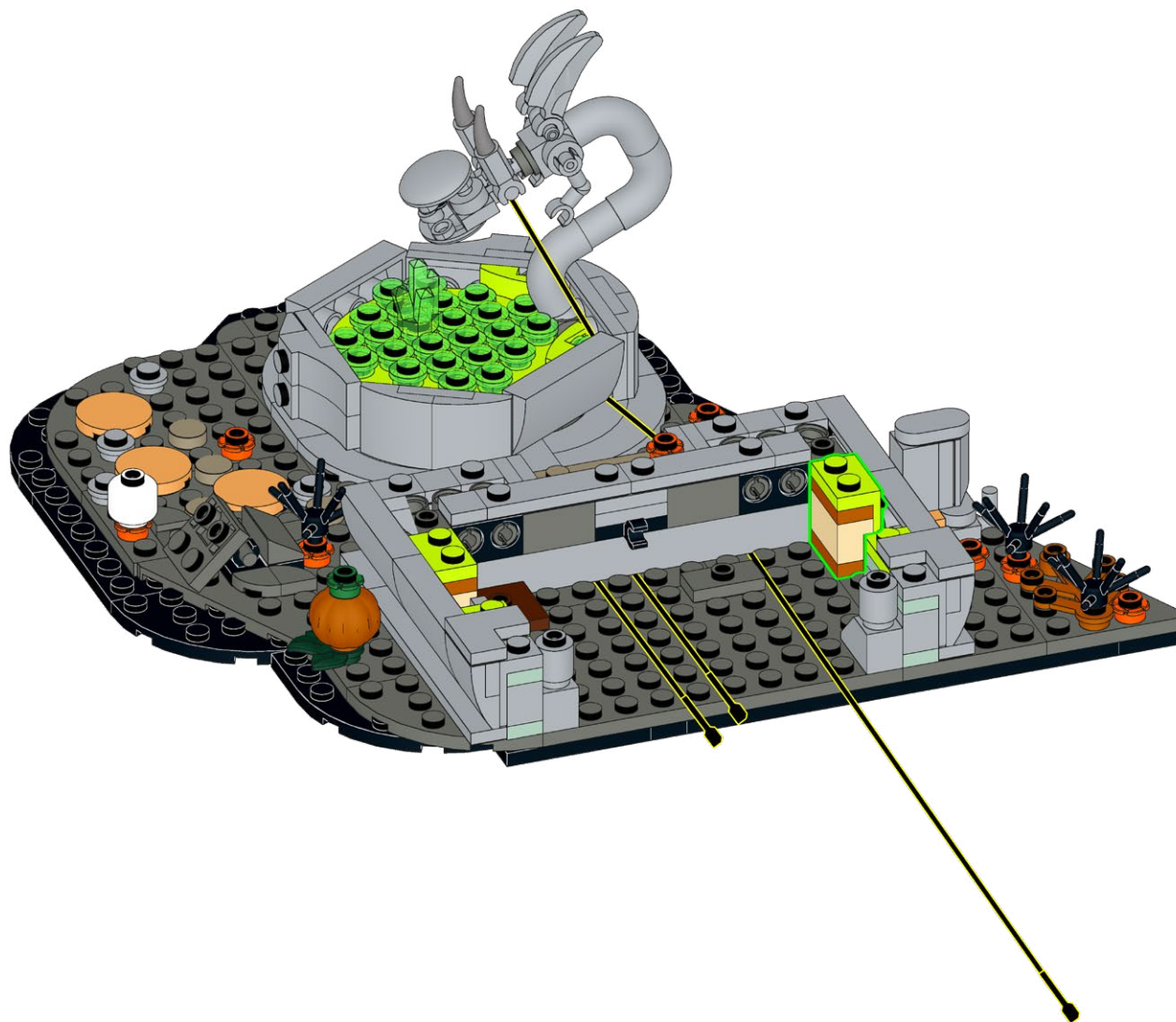

68

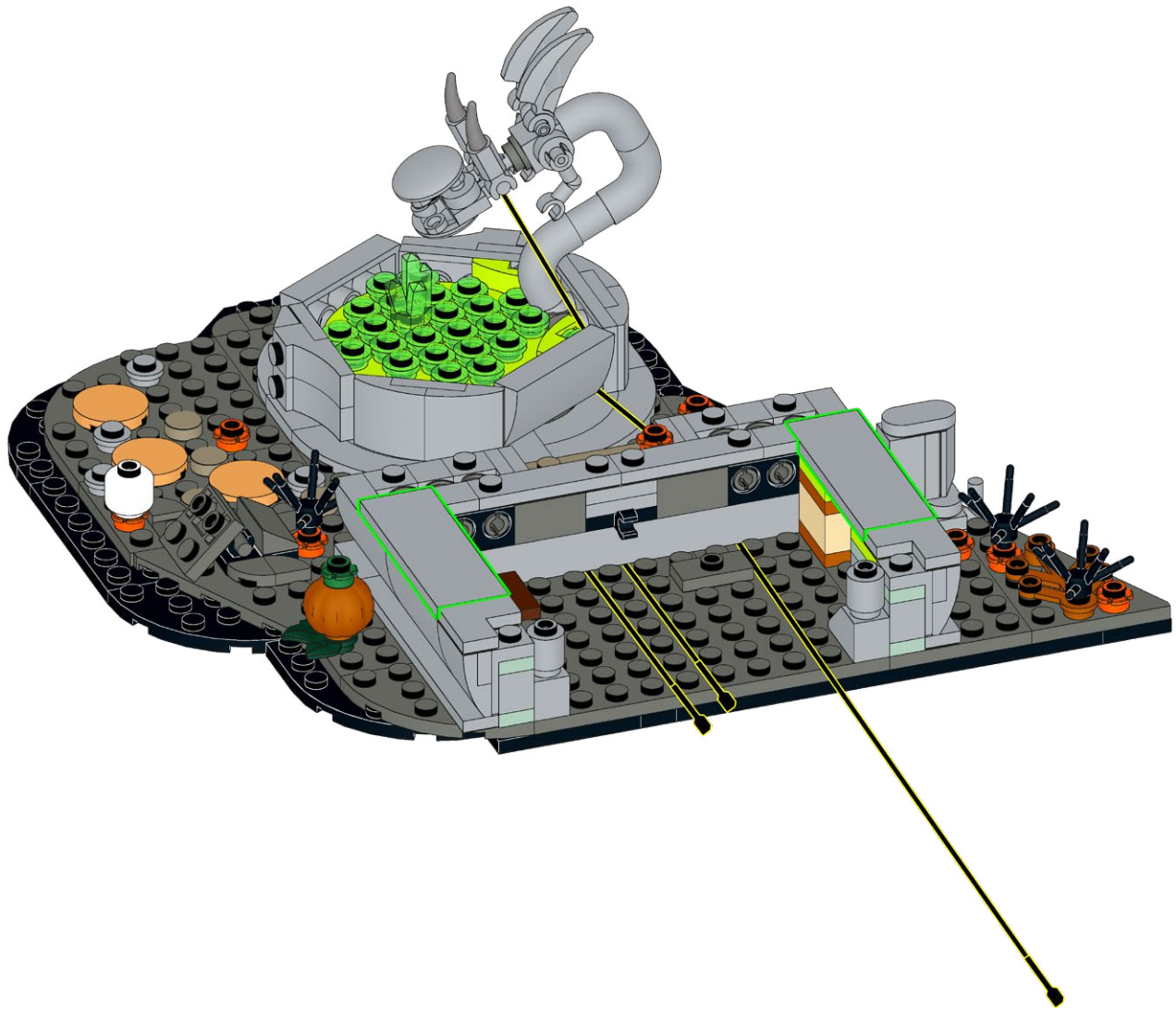

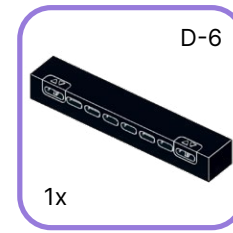
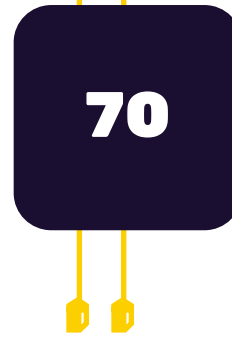

1

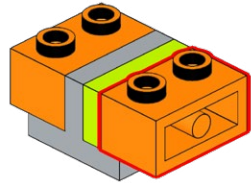

2

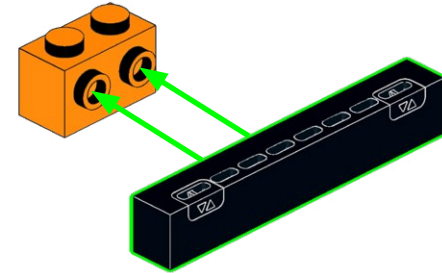
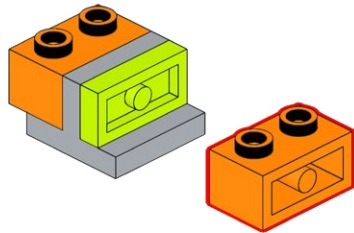



71

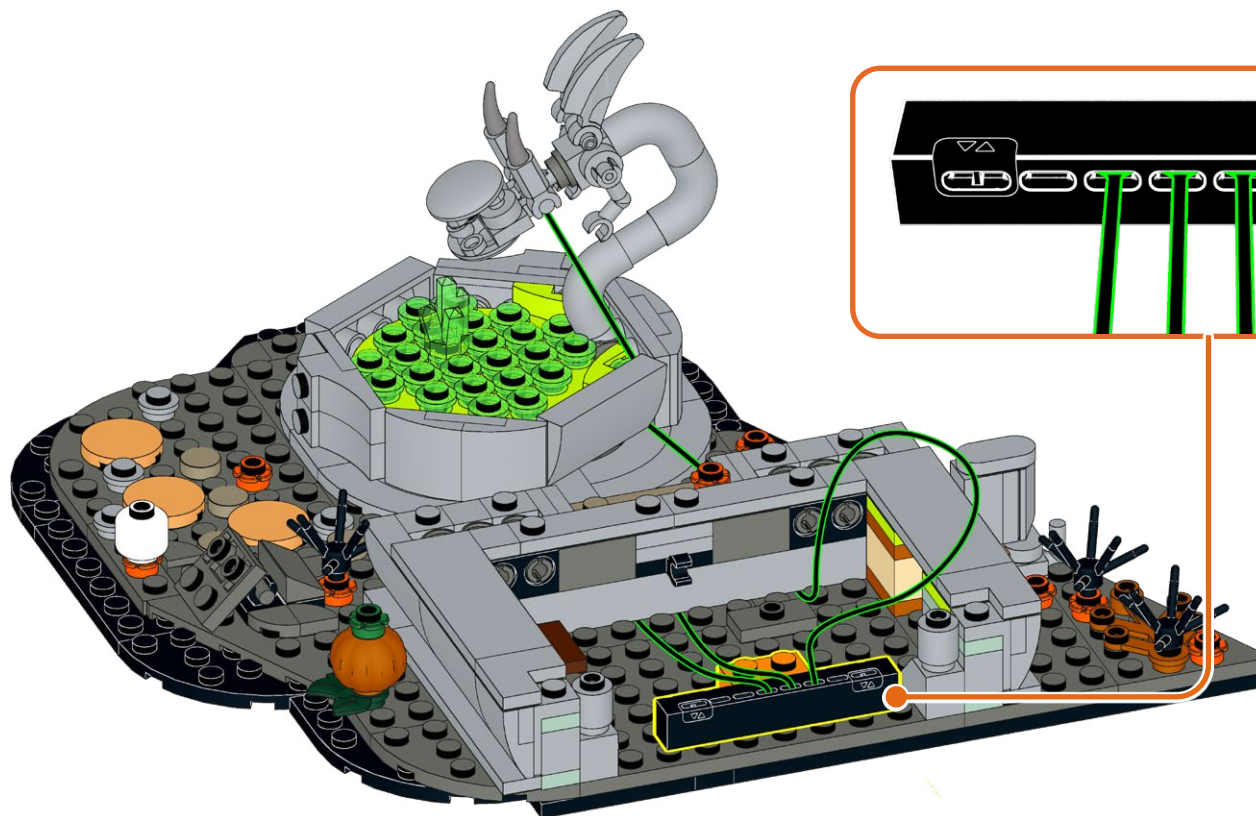

72

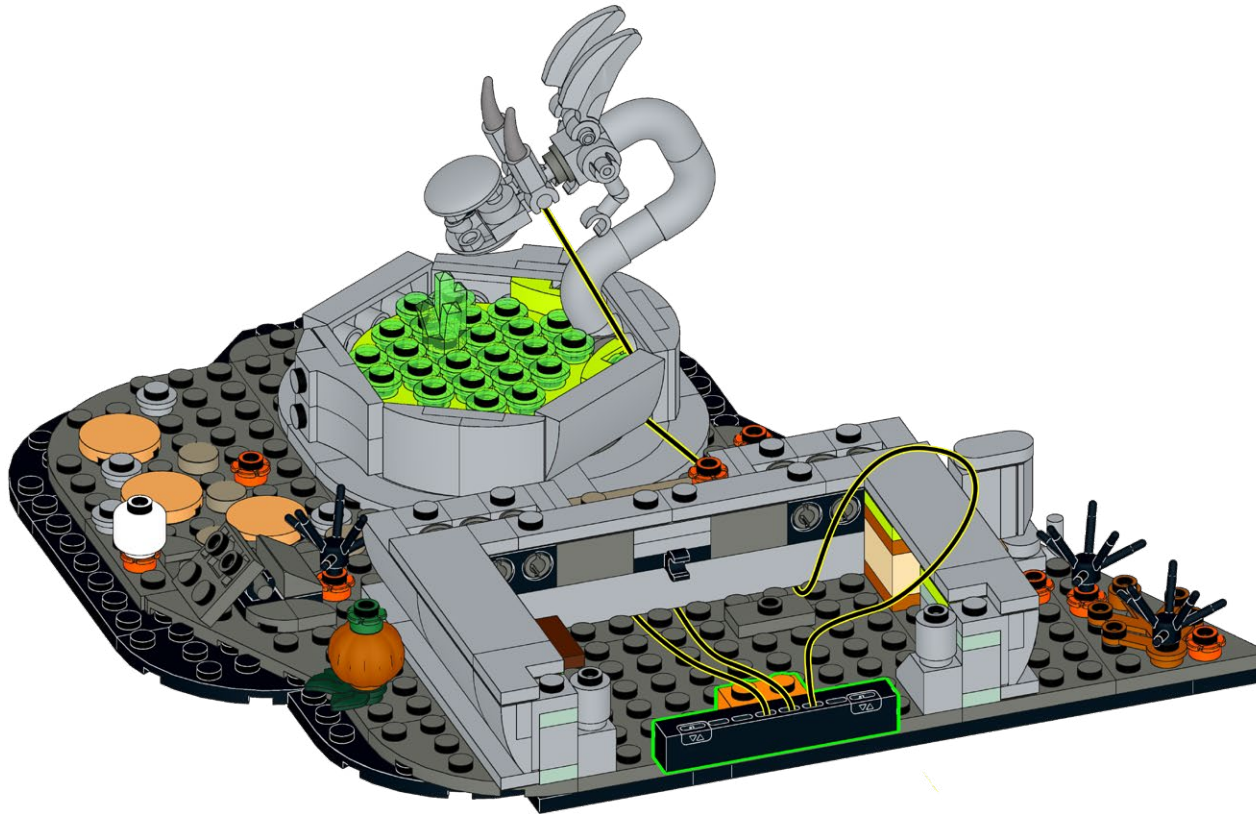

73

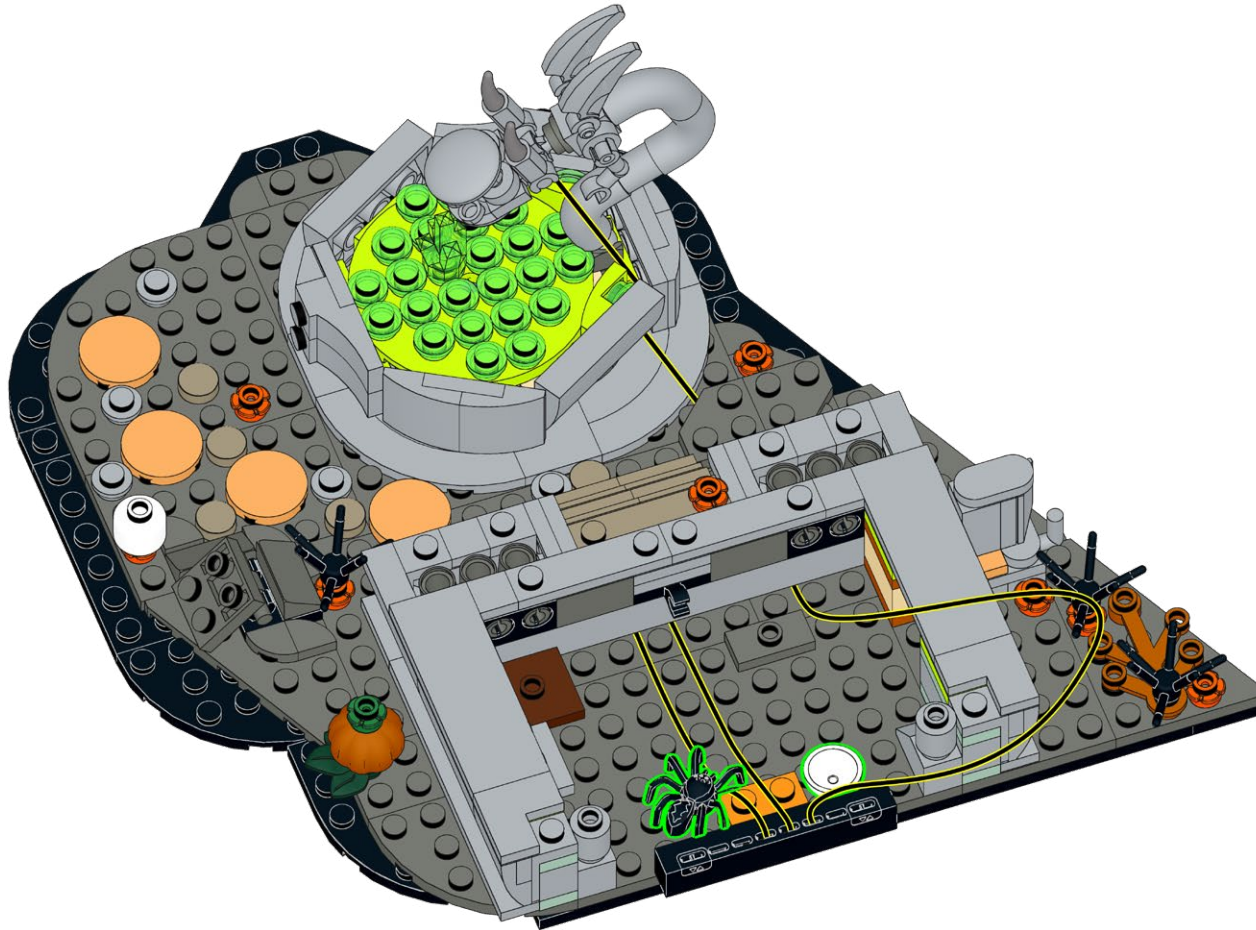

74

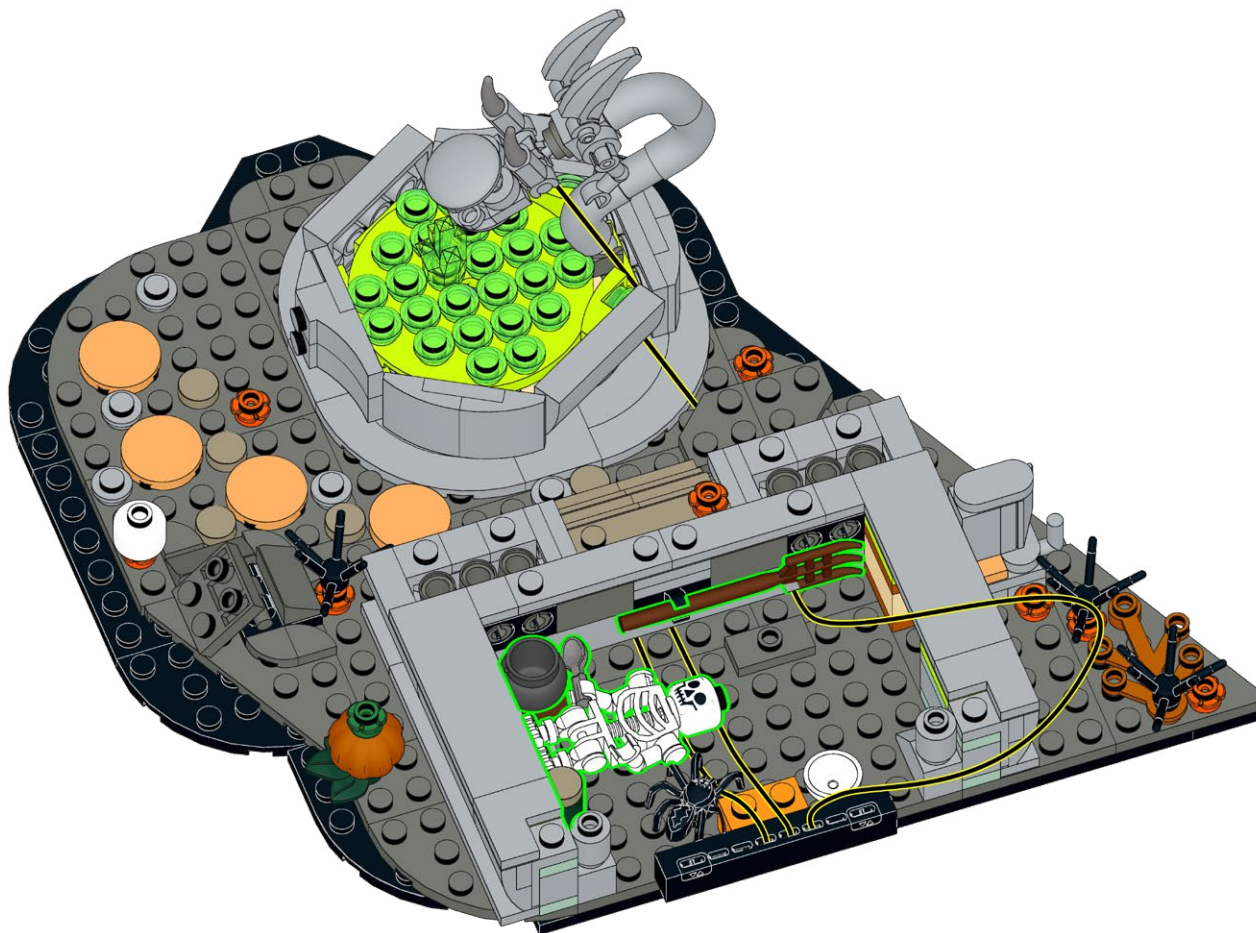

75

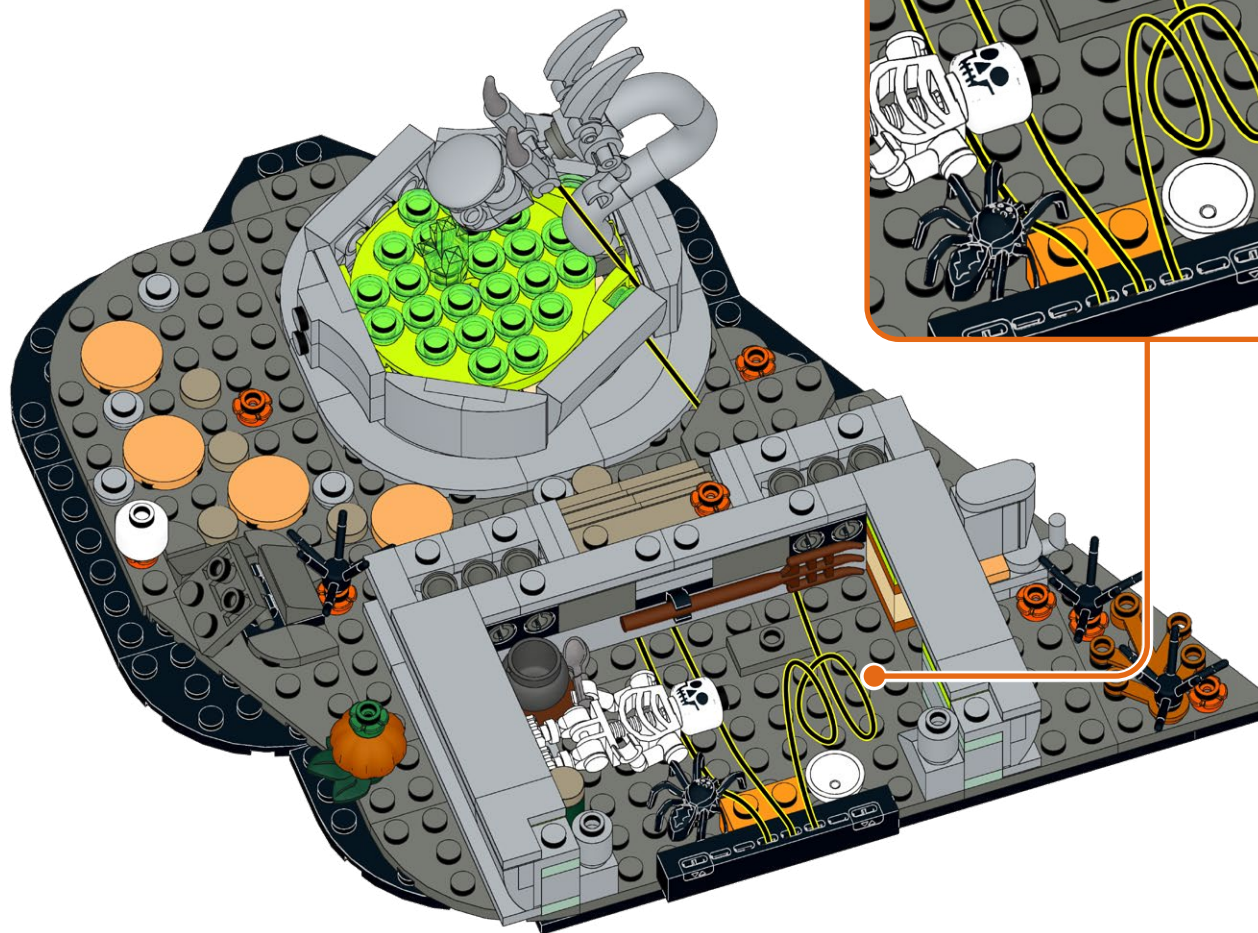

76

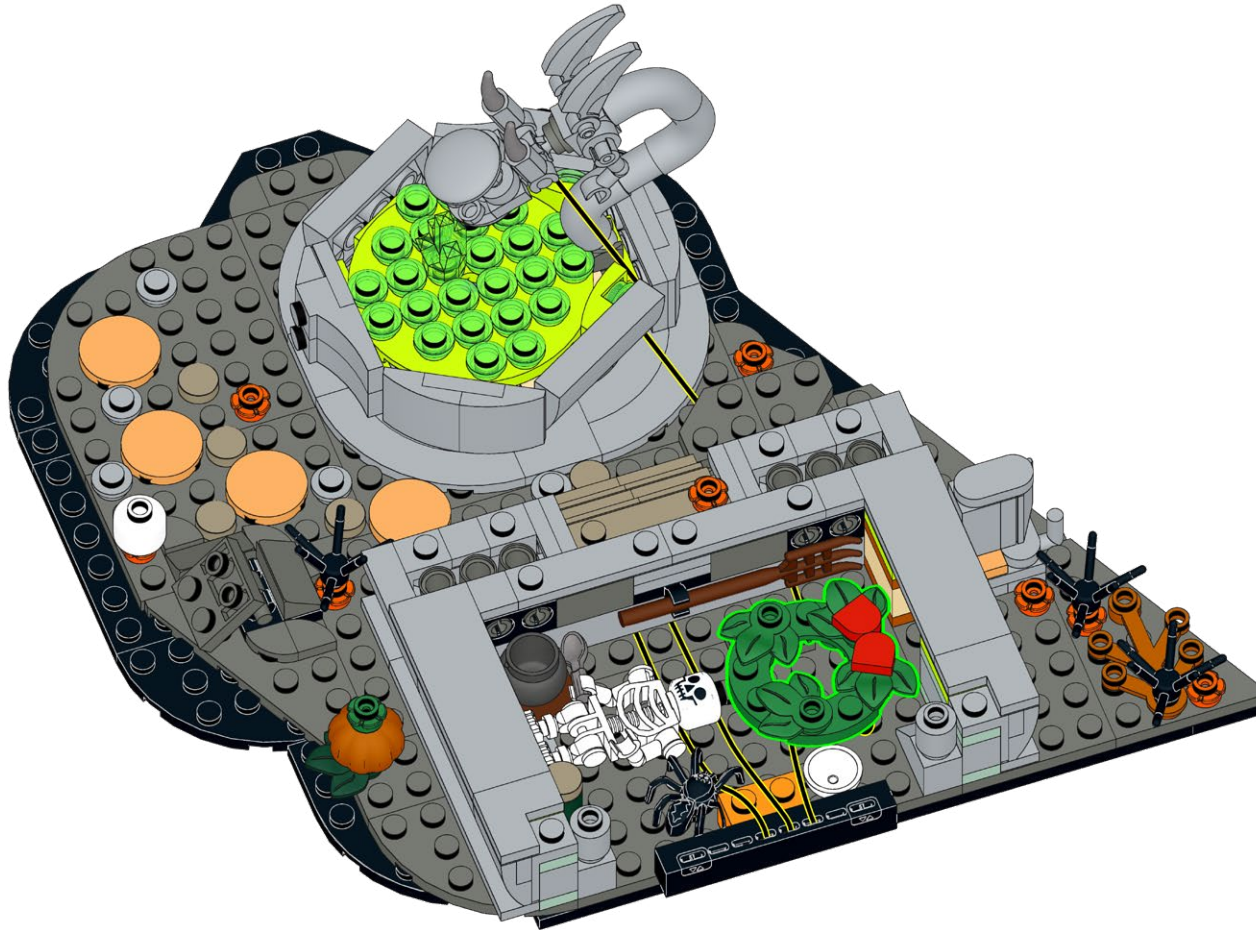

77

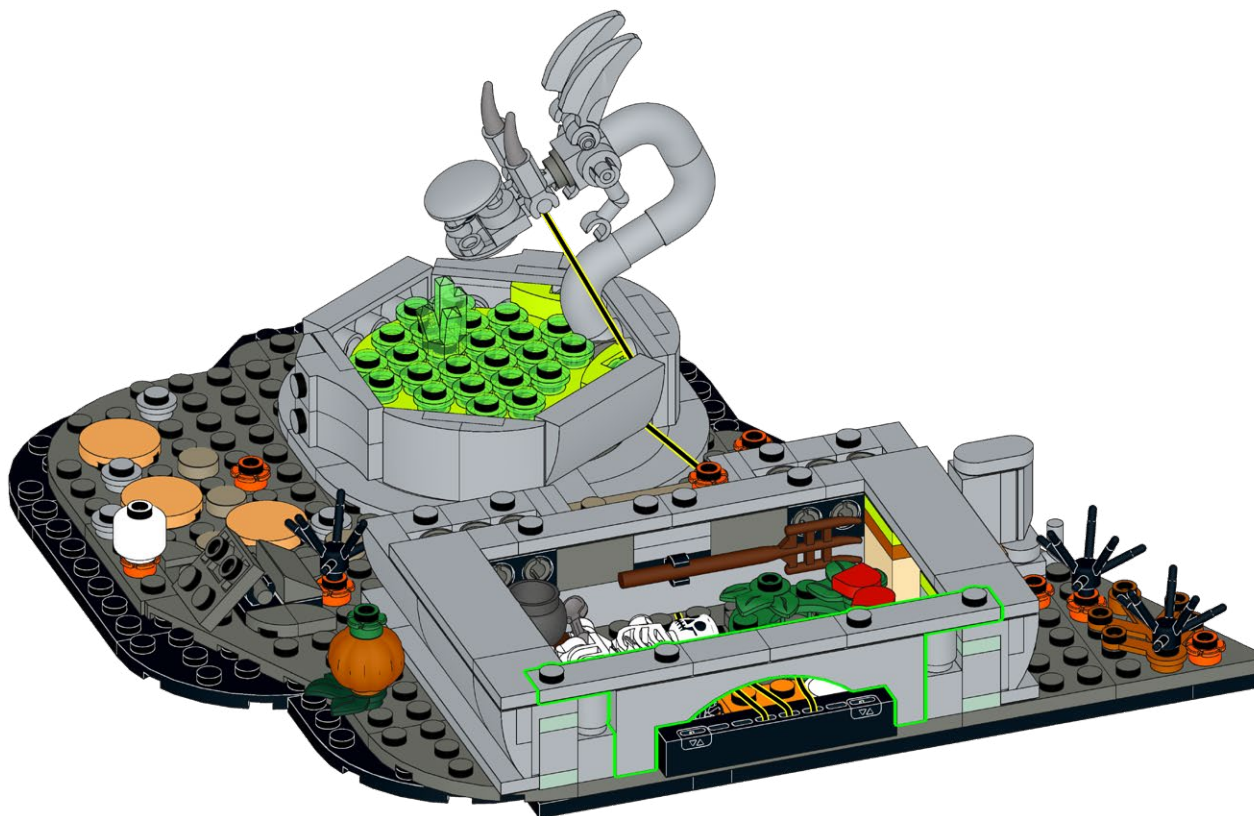

78

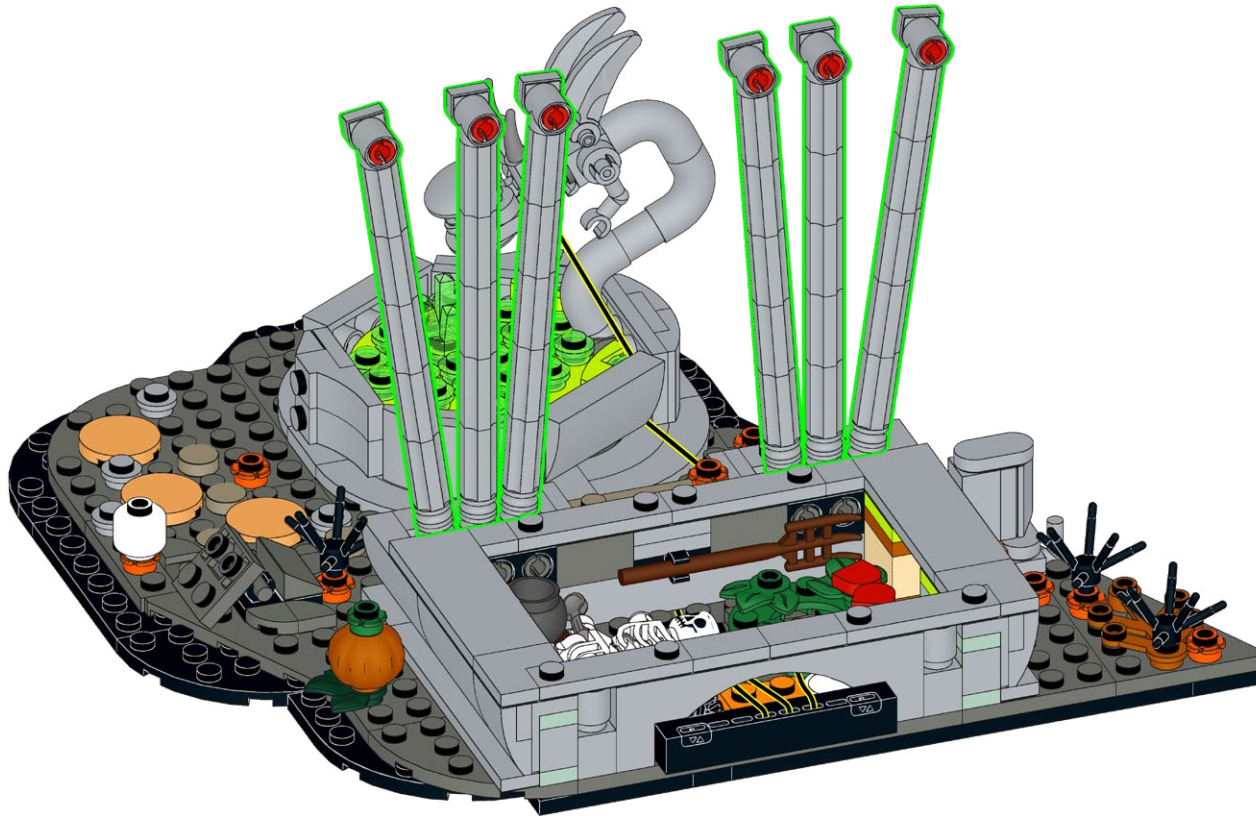



79

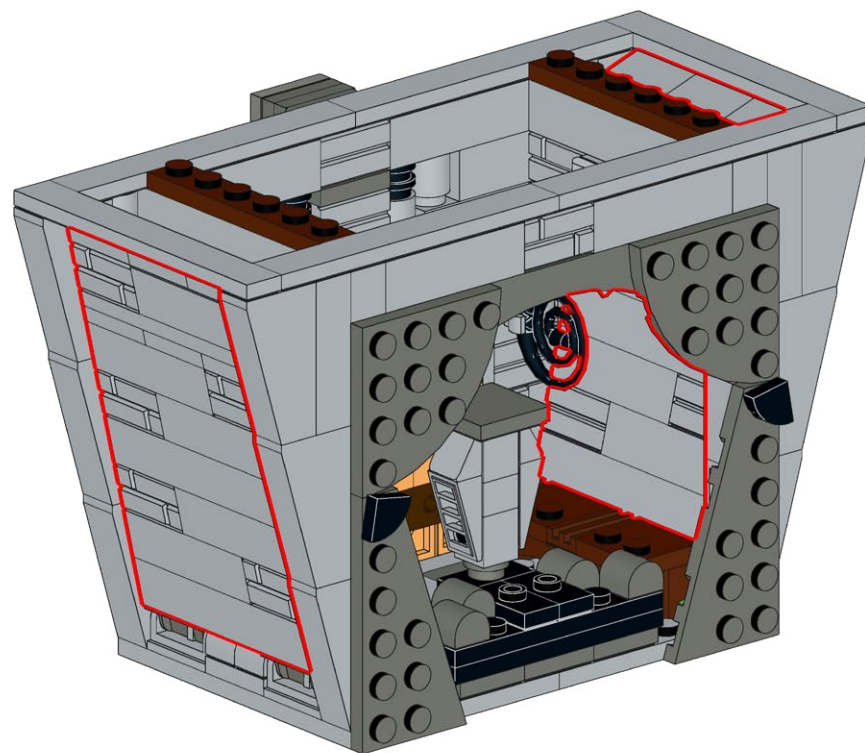

80

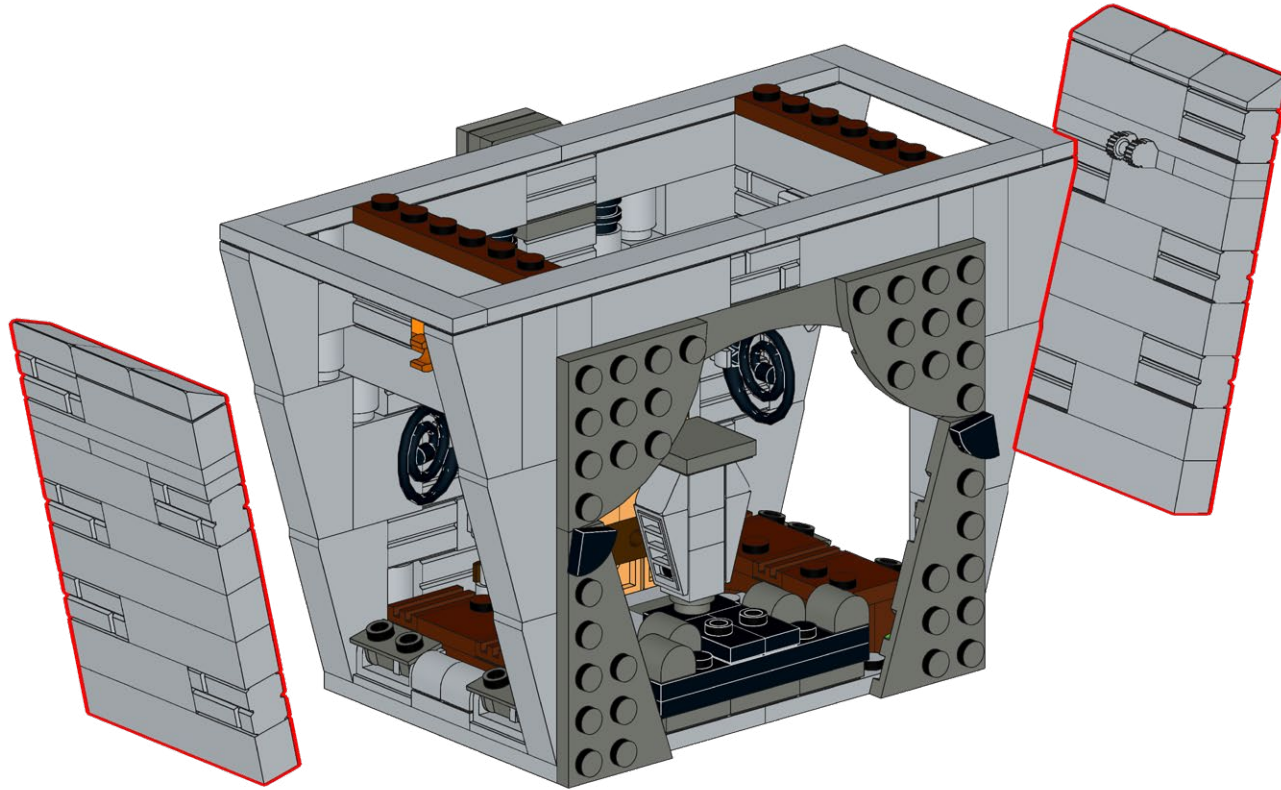

81

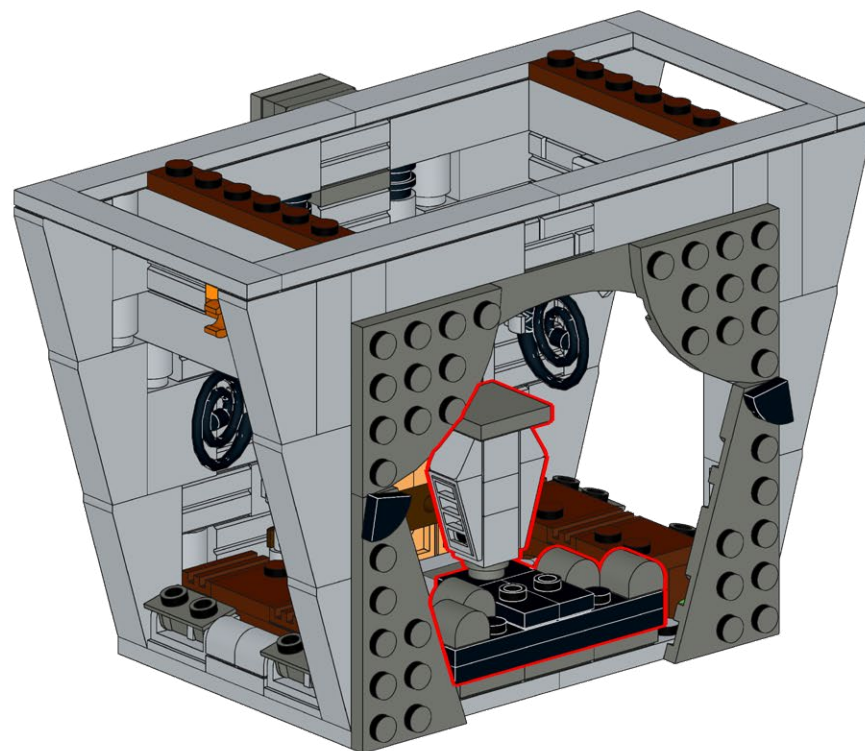

82

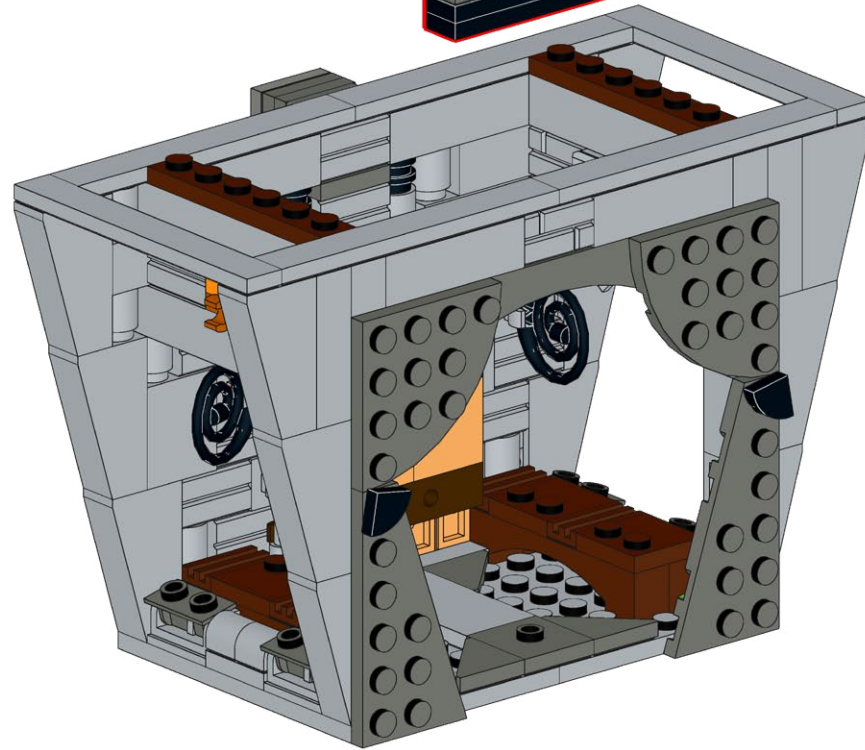
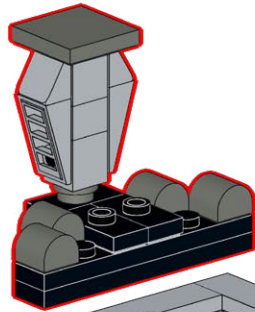

83

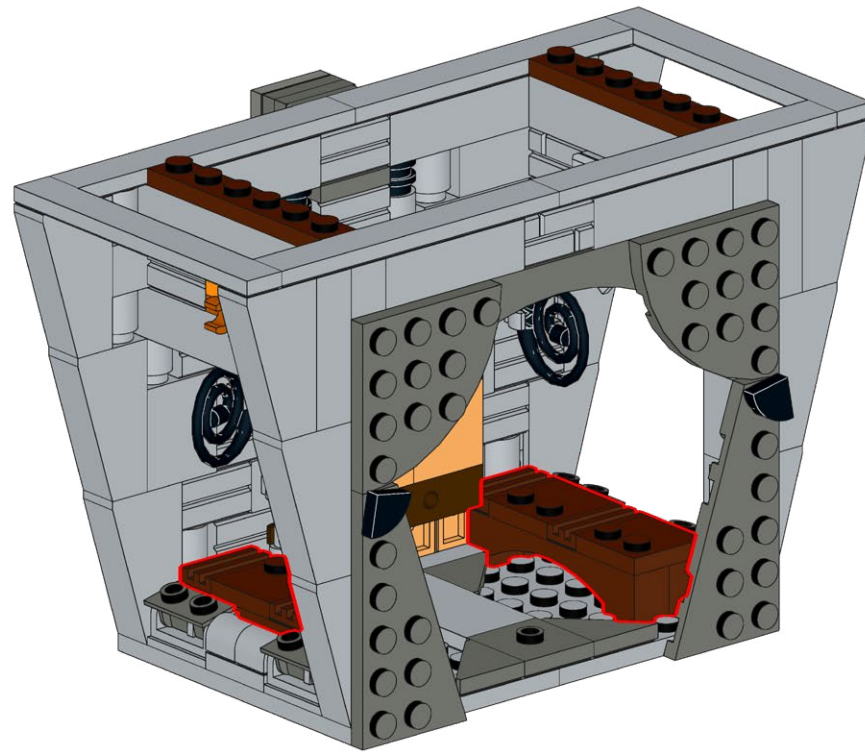

84

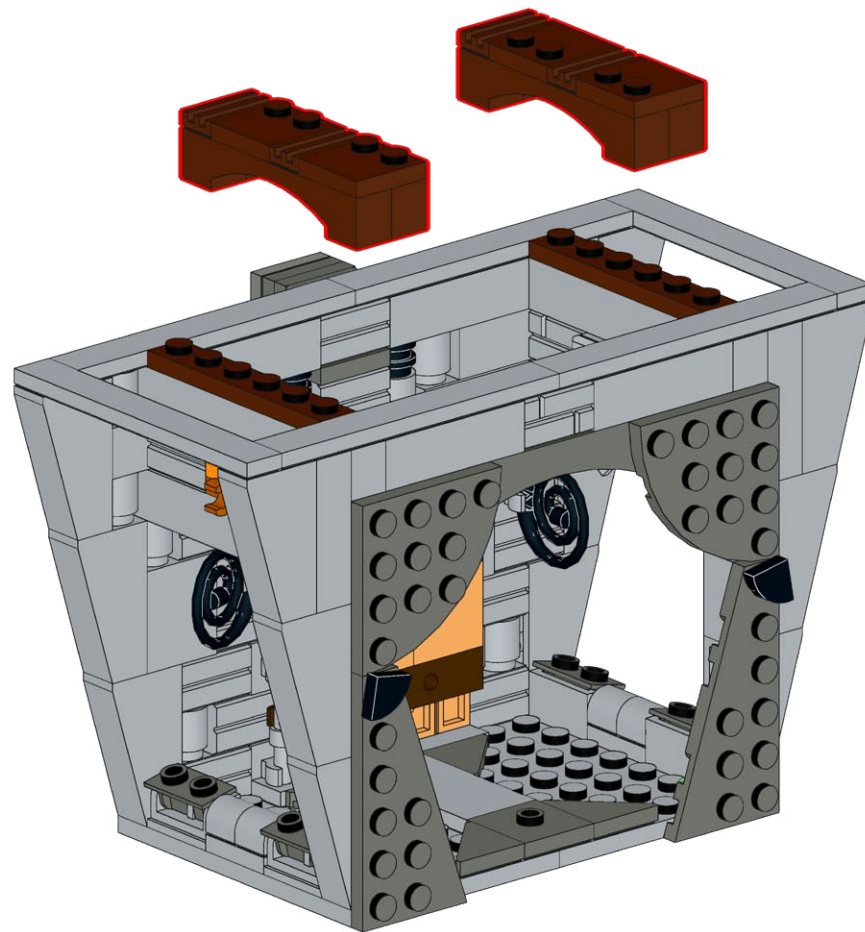

85

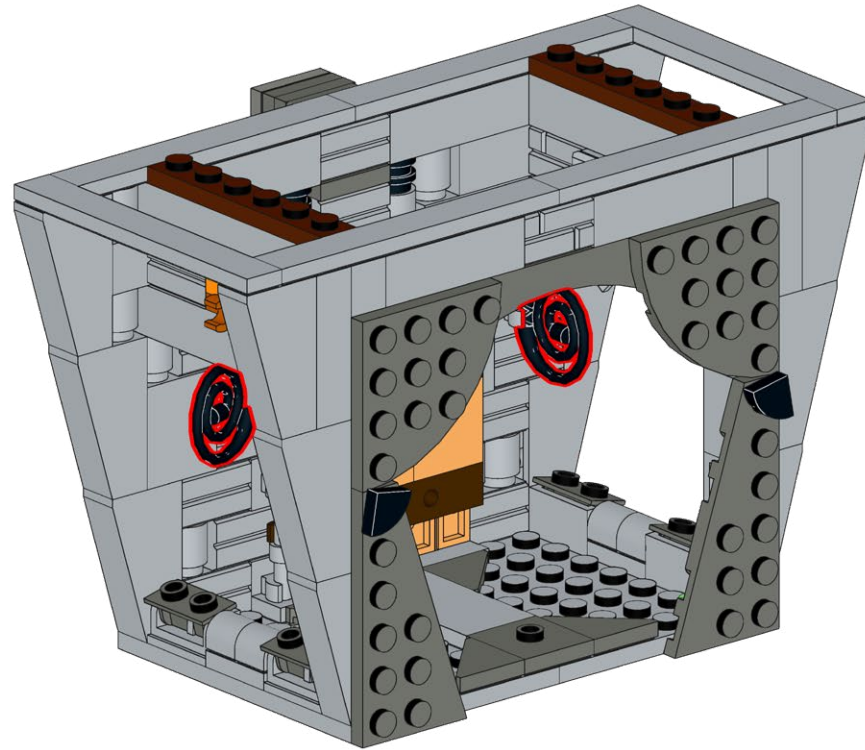

86

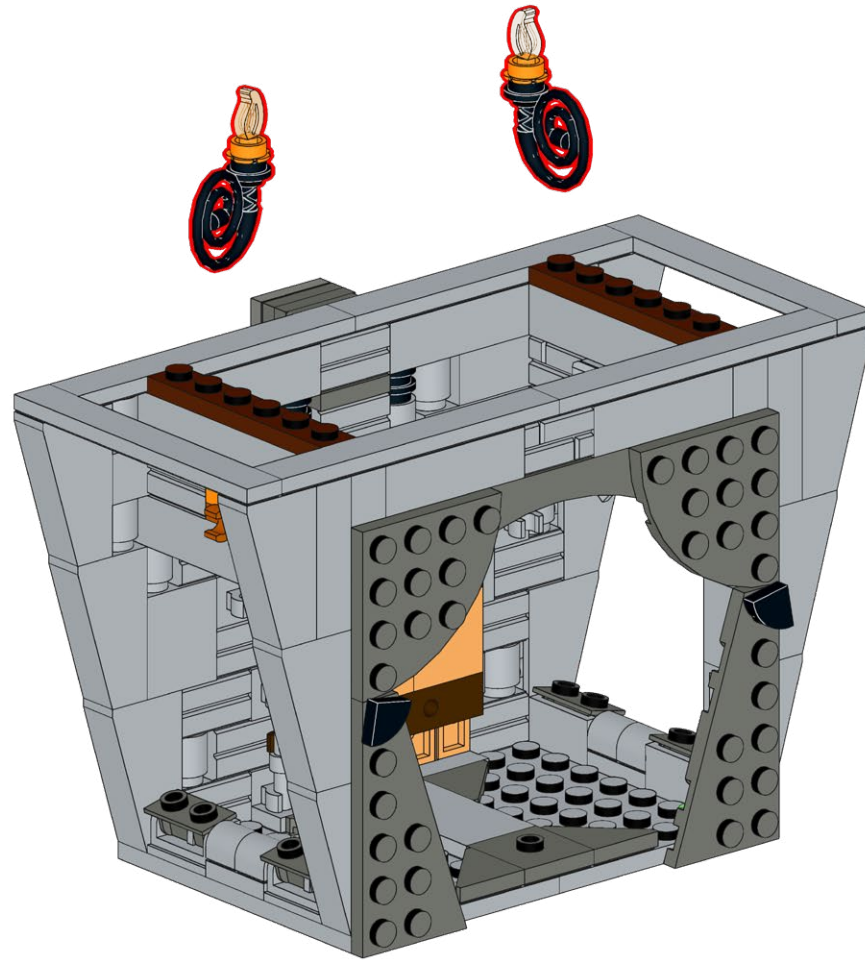



# 87

1



2

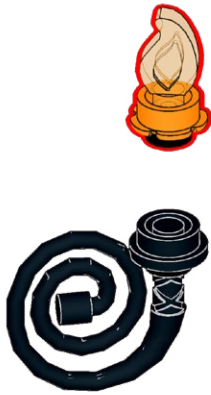

# 88

1



2

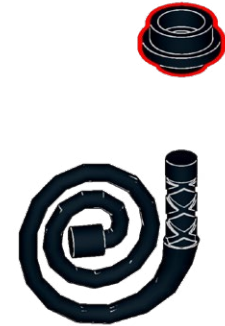

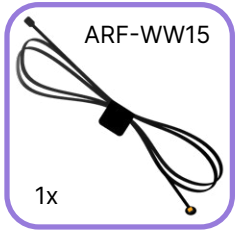

1

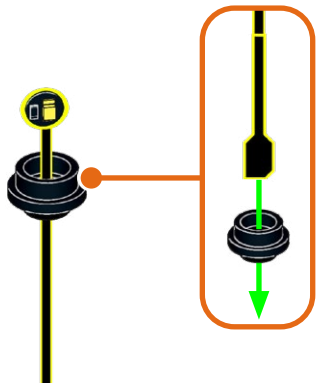

2



2x

91

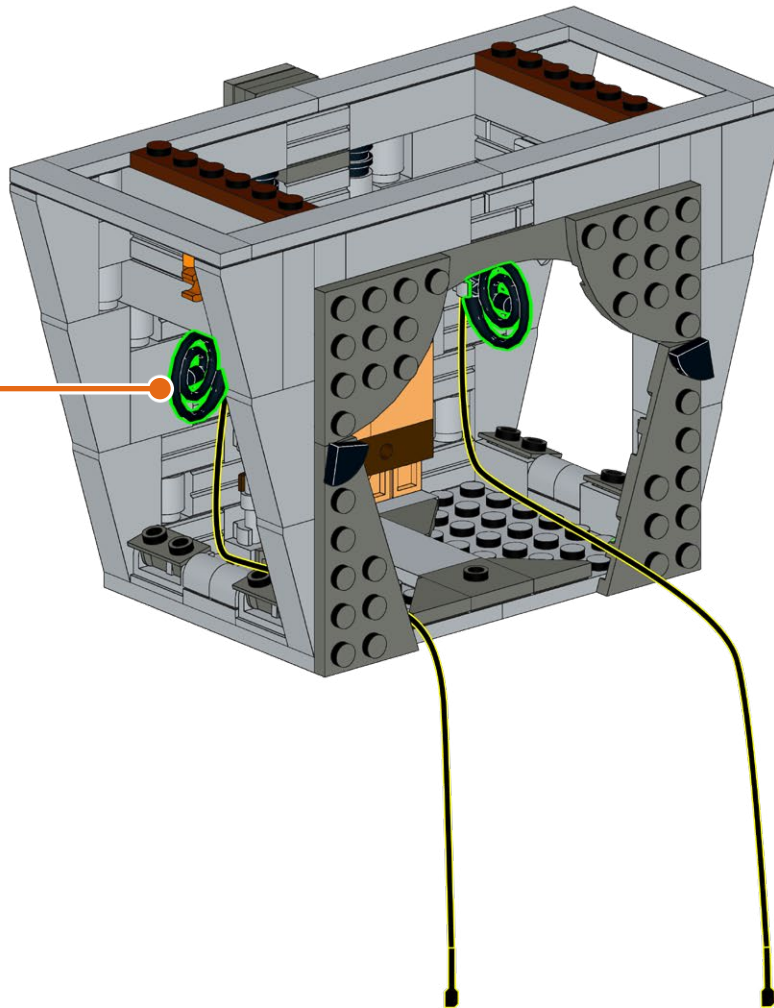
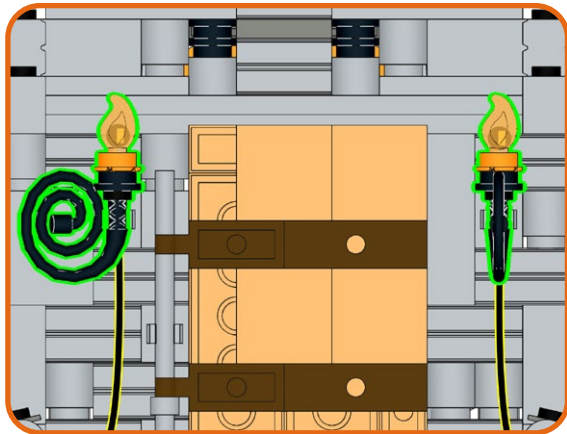

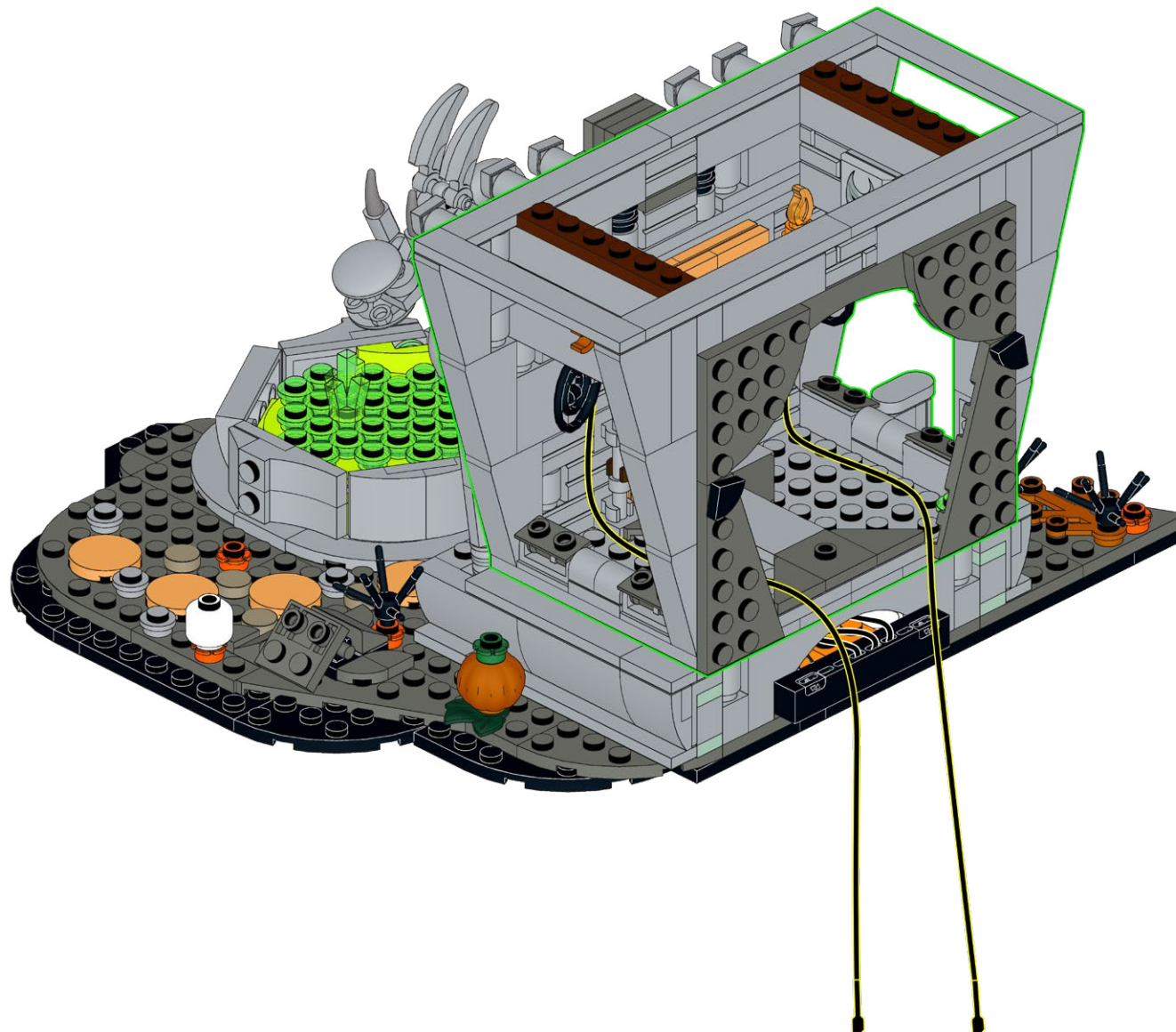

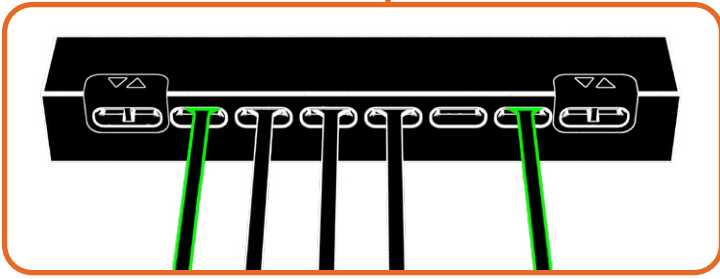
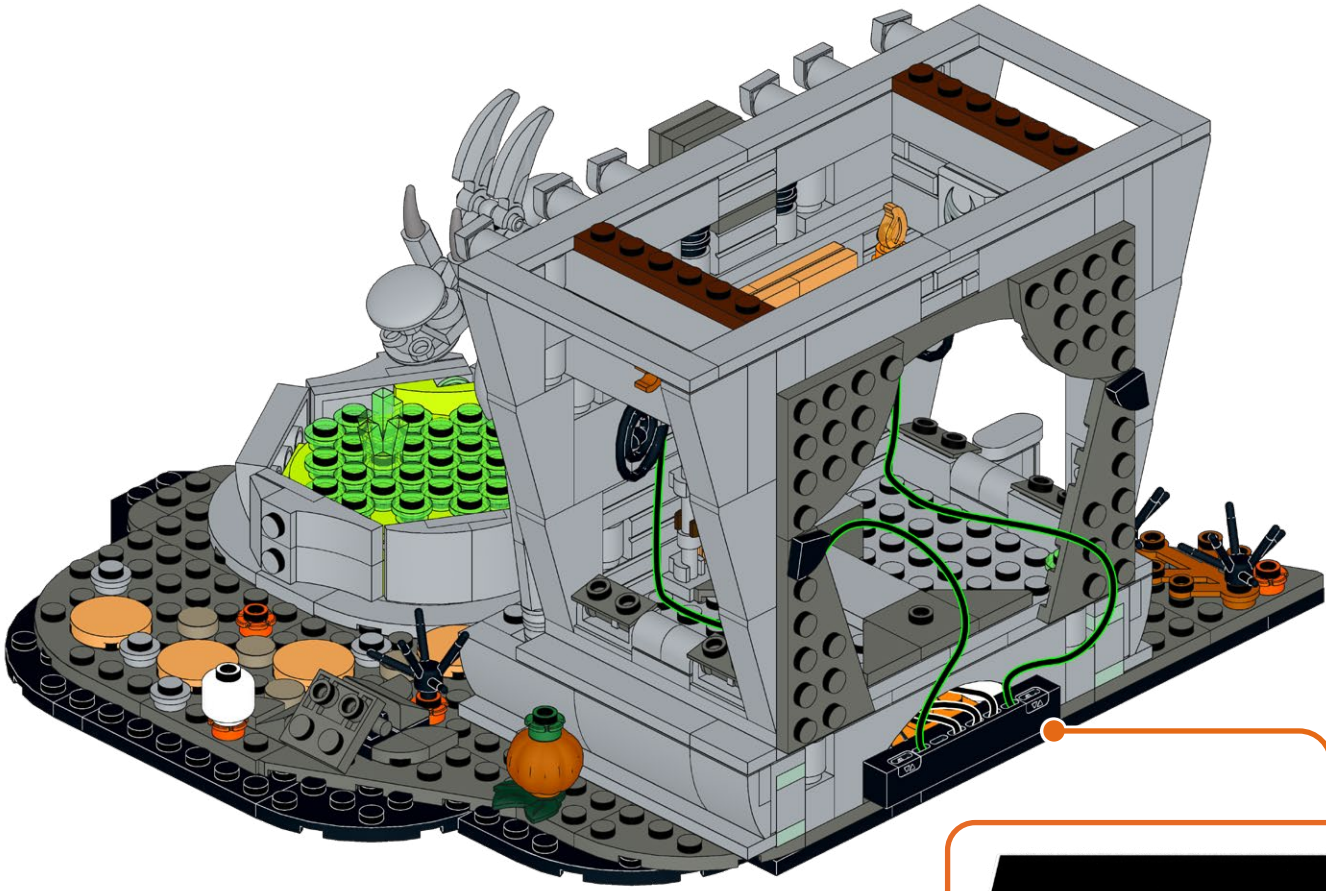

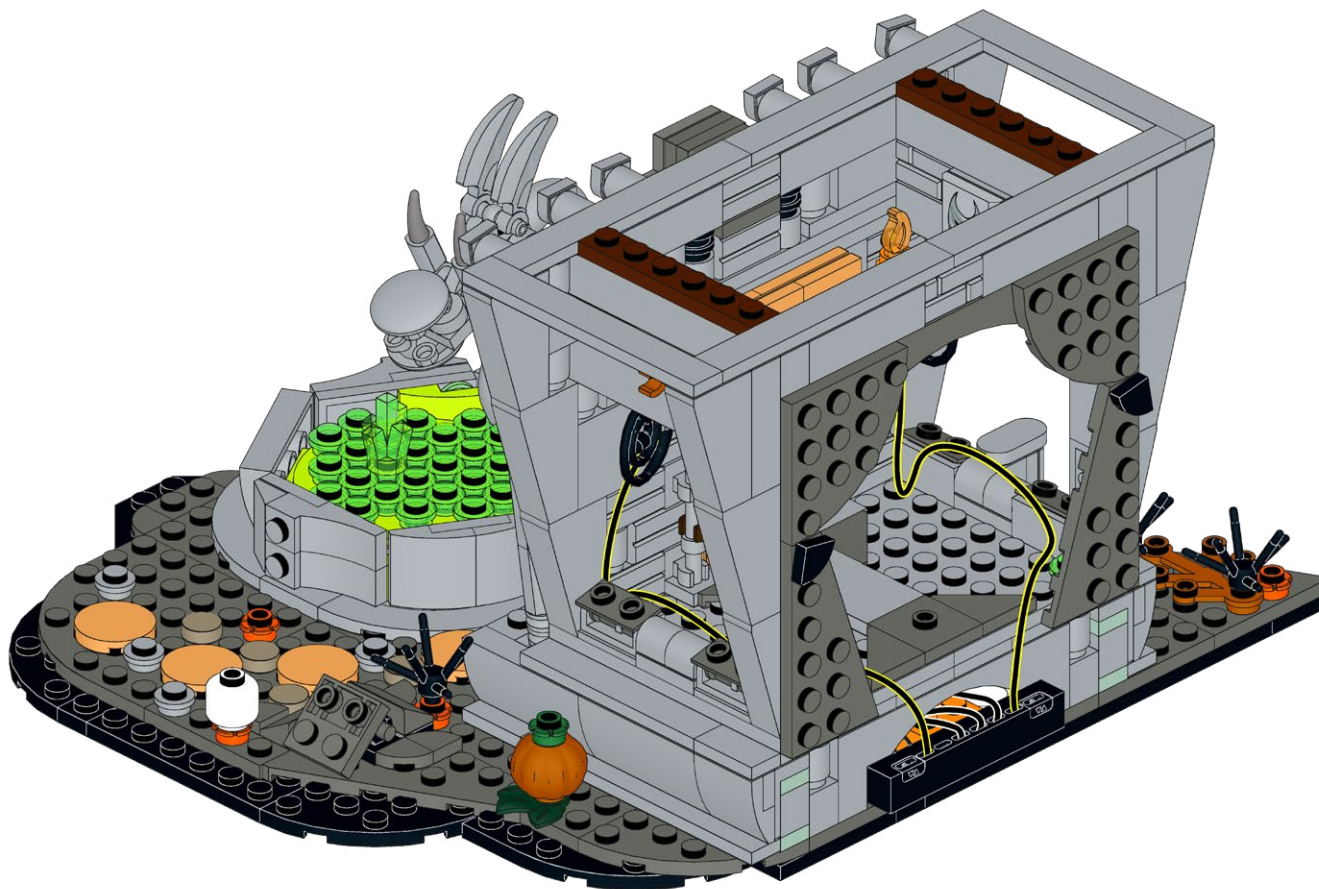

95

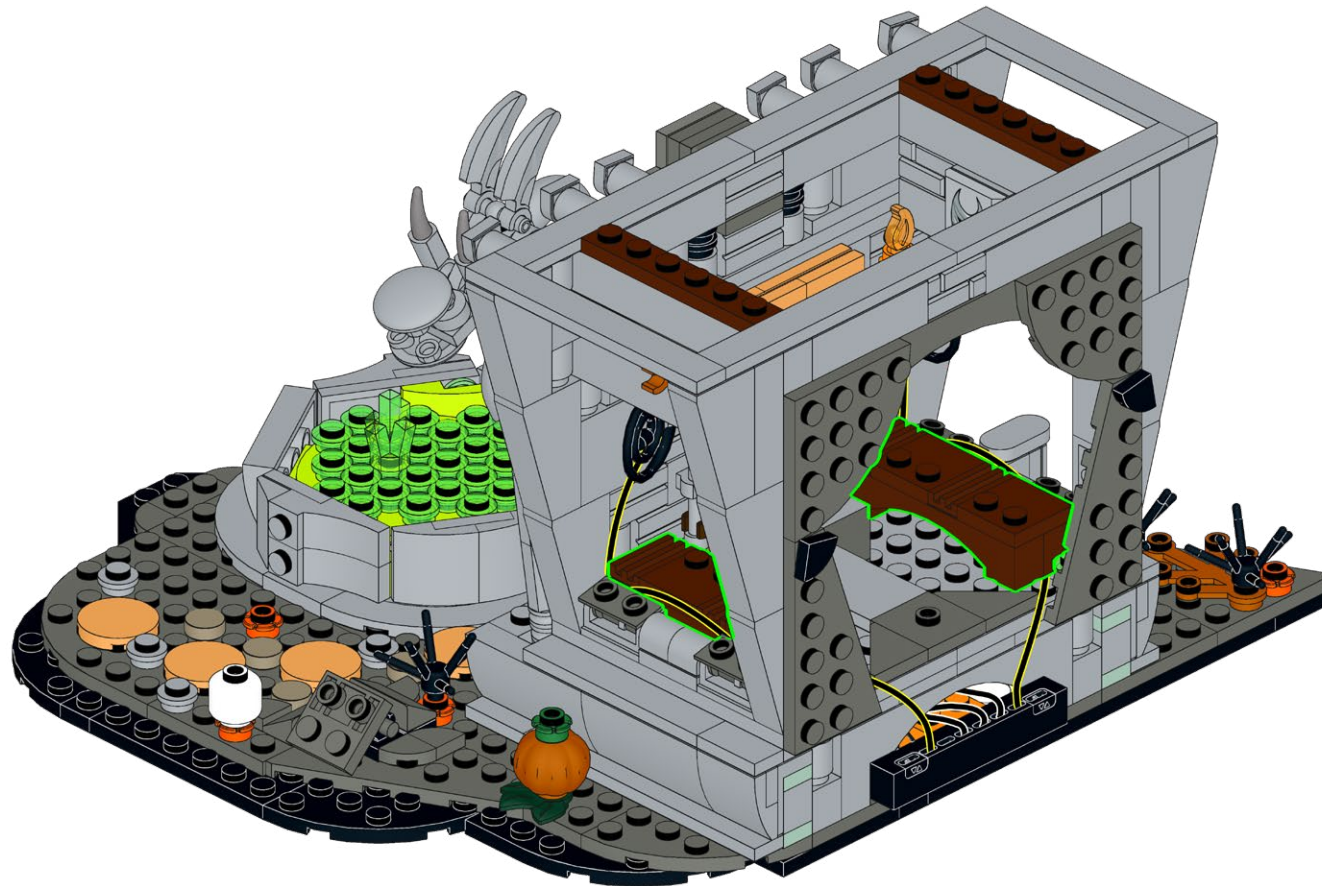





97

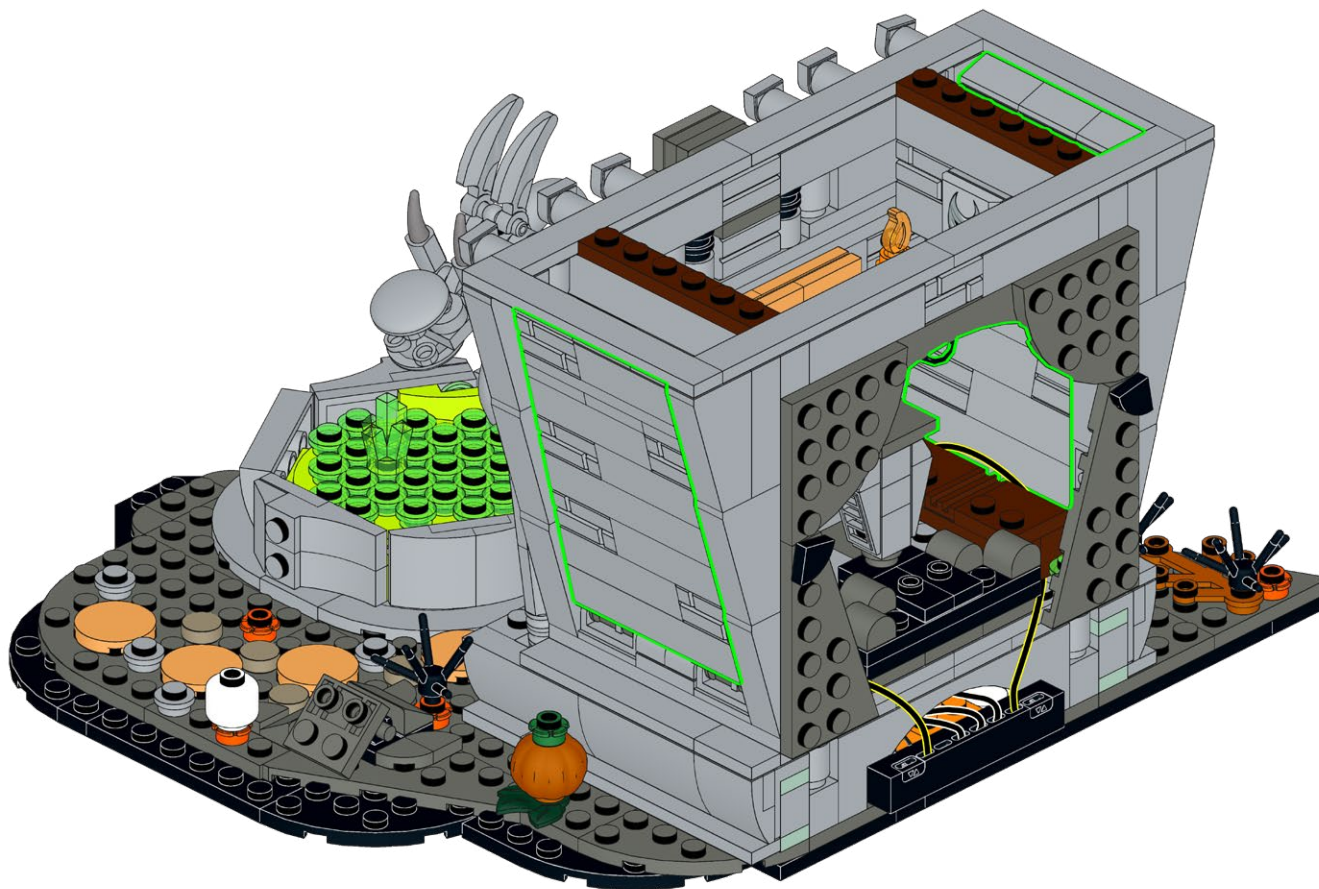



99



100





102

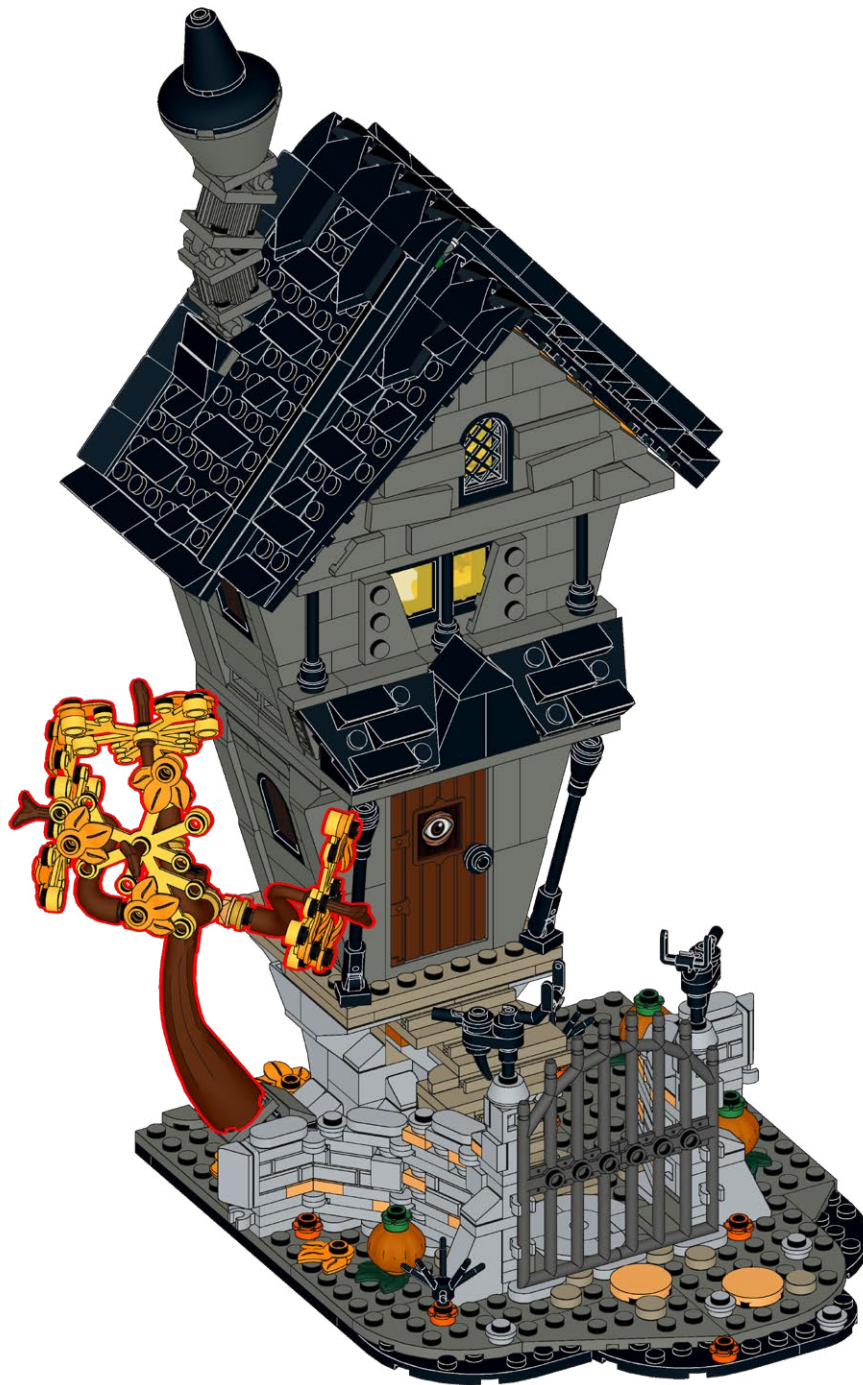

103

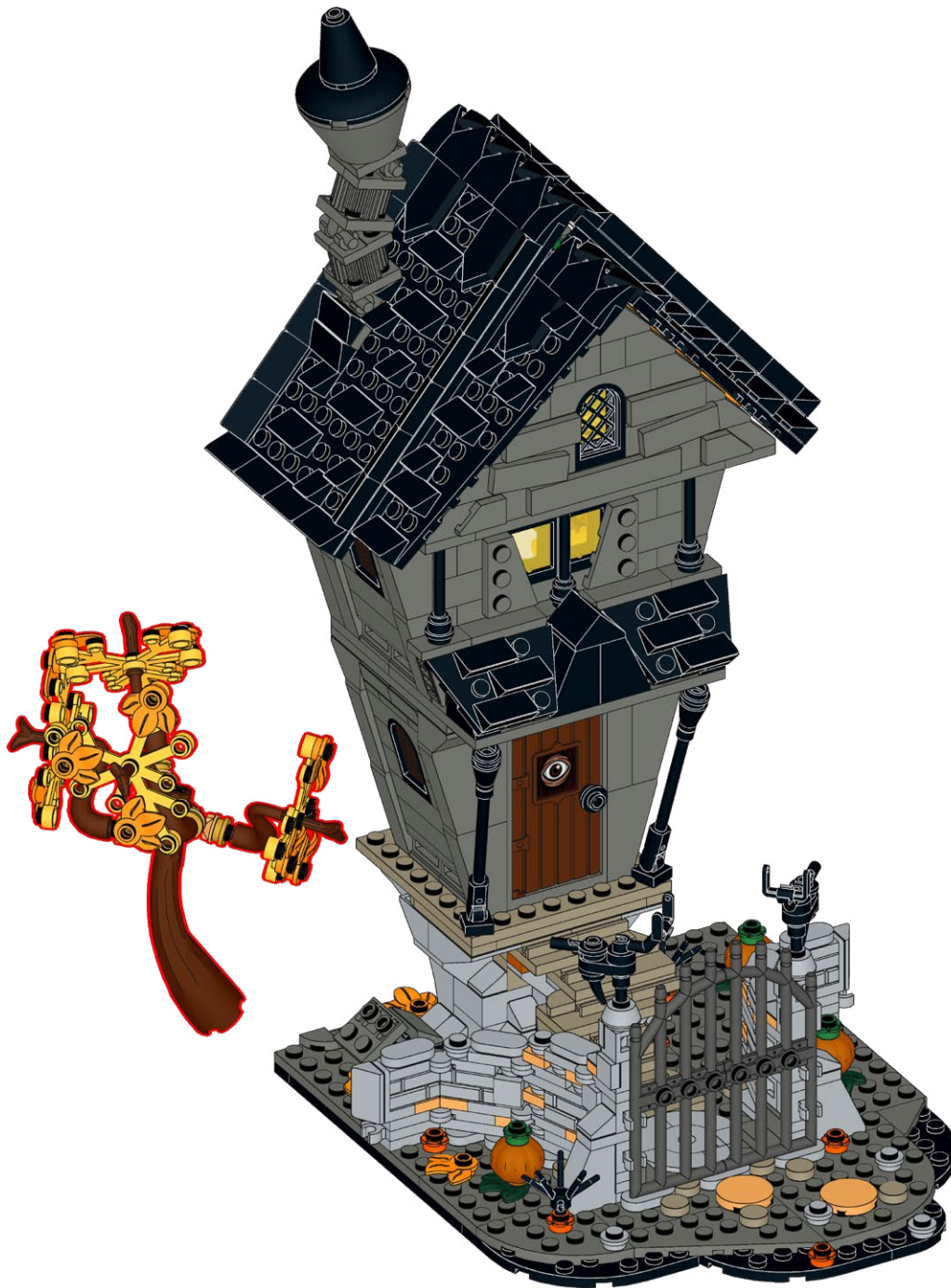

104





105

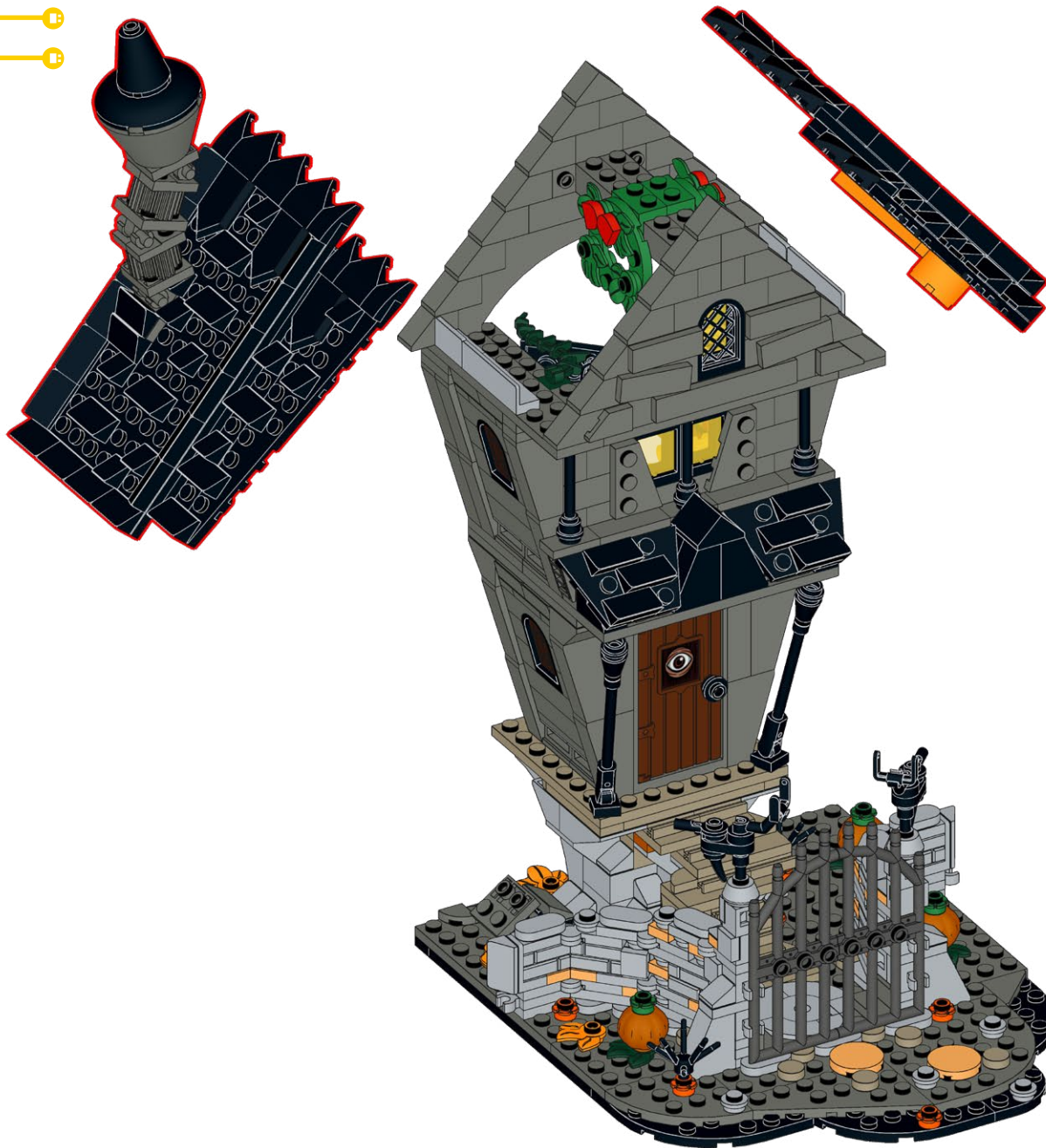

106



107

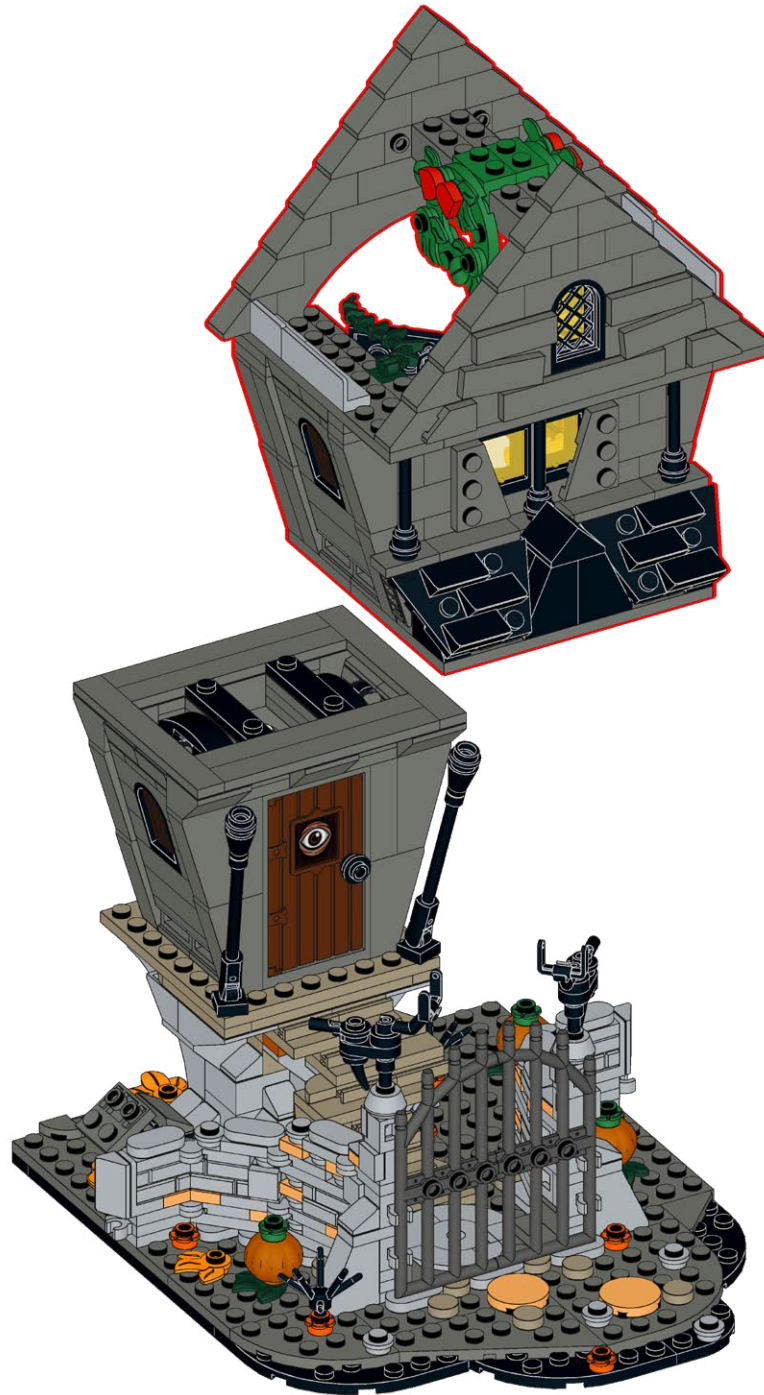

108



109

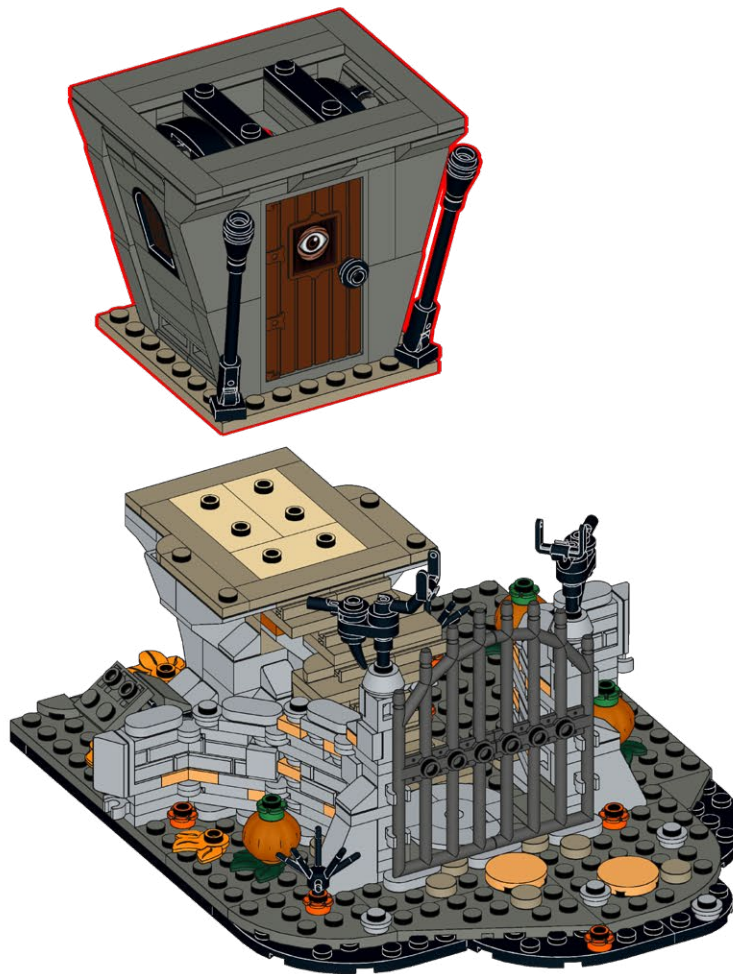

110



111



112





113



114

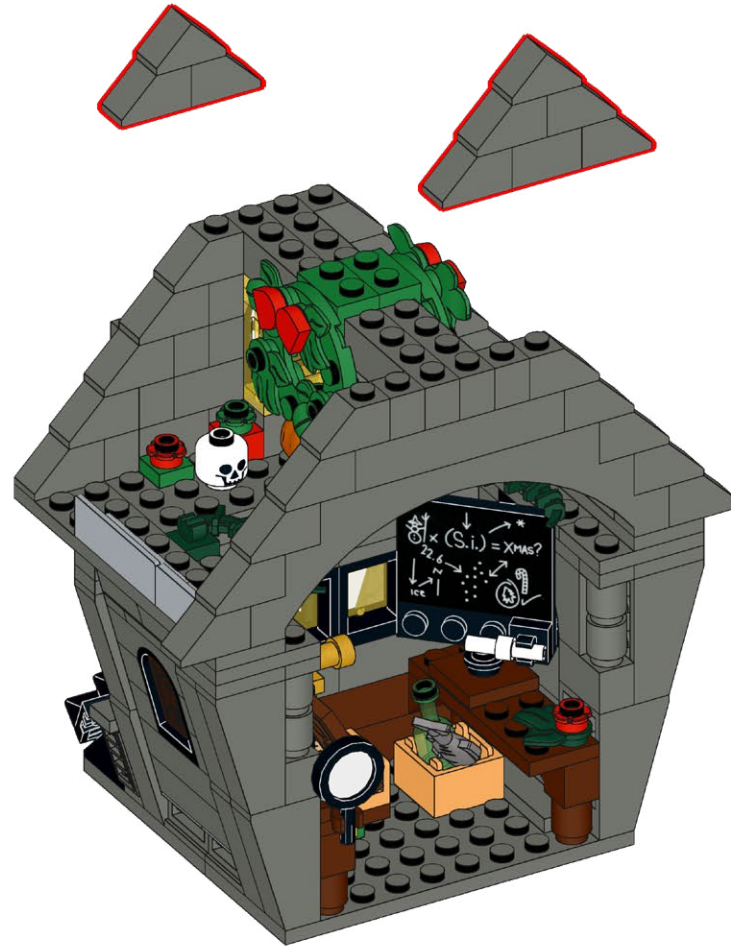

115



116



117



118

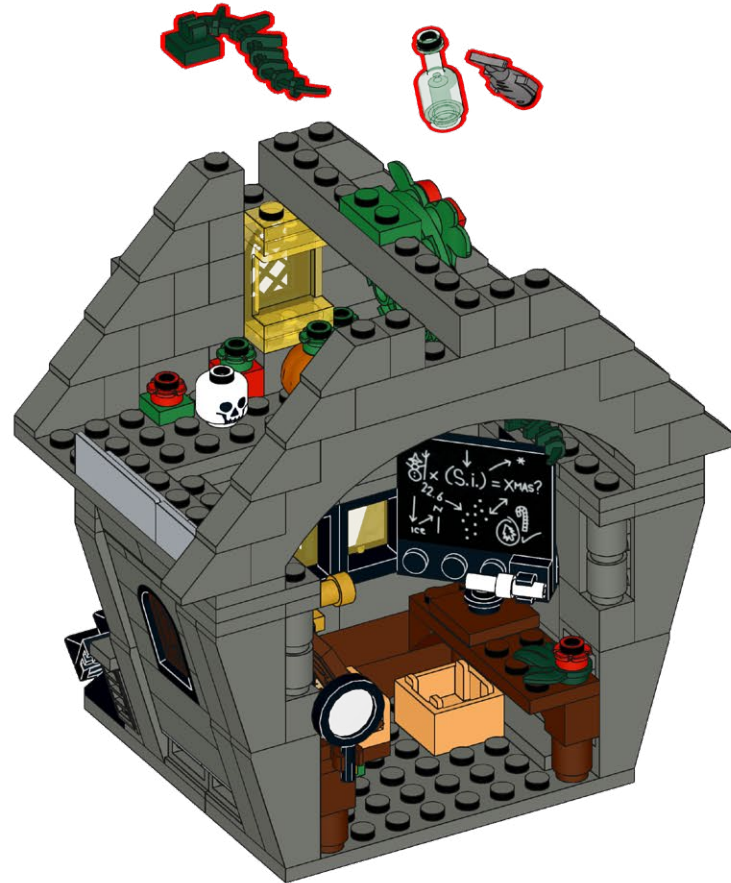



### **HOLD UP!**

You might notice some bags aren't in order, as well as left over pieces, but that's ok! We're changing the way you build LEGO!

### **ATTENDEZ!**

Vous remarquerez peut-être que certains sacs, ainsi que certaines pièces, ne sont pas dans le bon ordre. Mais pas de panique! Nous changeons simplement la façon avec laquelle vous construisez vos LEGO!

### **ASPETTA!**

Potresti notare che alcuni sacchetti non sono in ordine, così come i pezzi avanzati, ma va bene così! Stiamo cambiando il modo in cui costruisci i LEGO!

### **HALT!**

Sie werden möglicherweise bemerken, dass einige tüten durcheinander sind und teile übrig bleiben, aber das ist in Ordnung! Wir ändern die art und weise, wie Sie LEGO bauen!

### **¡ESPERA!**

Es posible que notes que algunas bolsas están fuera de servicio, así como piezas sobrantes, ¡pero está bien! ¡Estamos cambiando la forma en que construyes LEGO!

### **暫停!**

你可能会注意到一些袋子顺序错乱, 以及一些剩余的部件, 但没关系! 我们正在改变你搭建乐高的方式!

#### Open LMB Bag 02

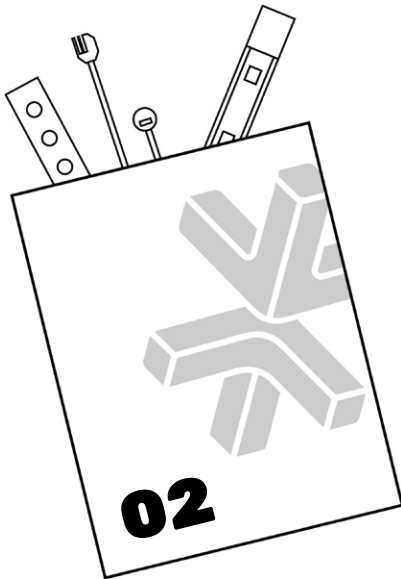

119

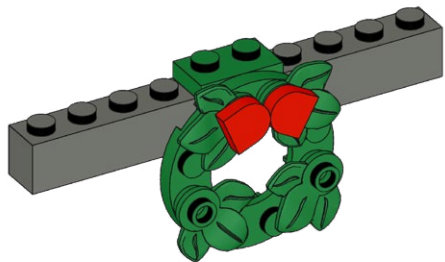

120

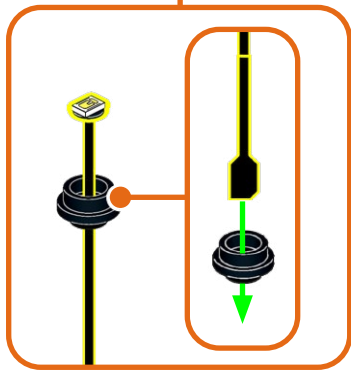
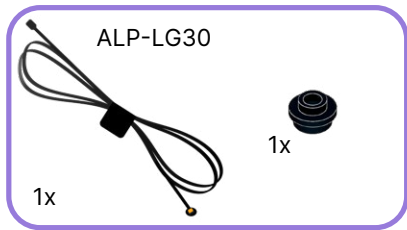
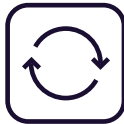



121

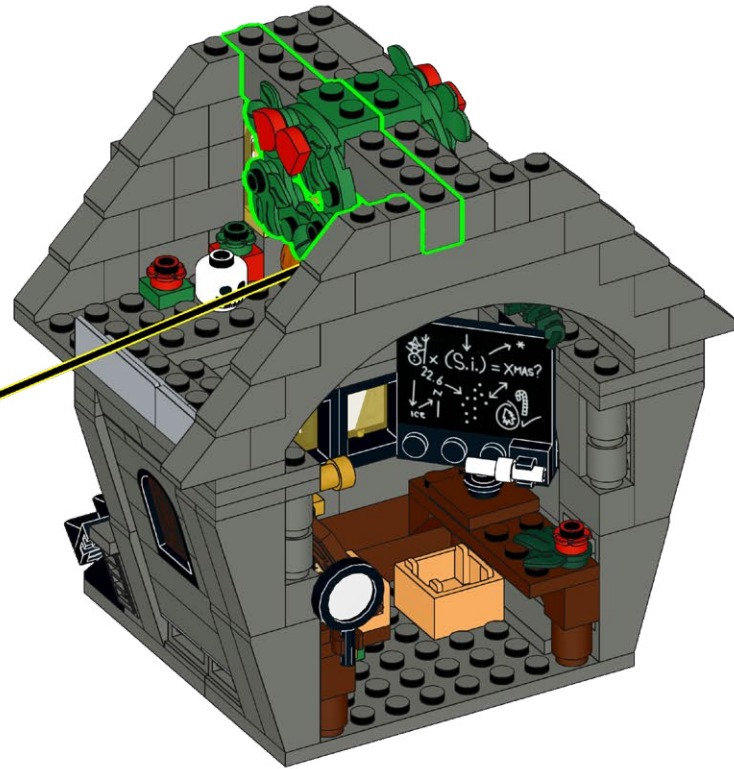

122

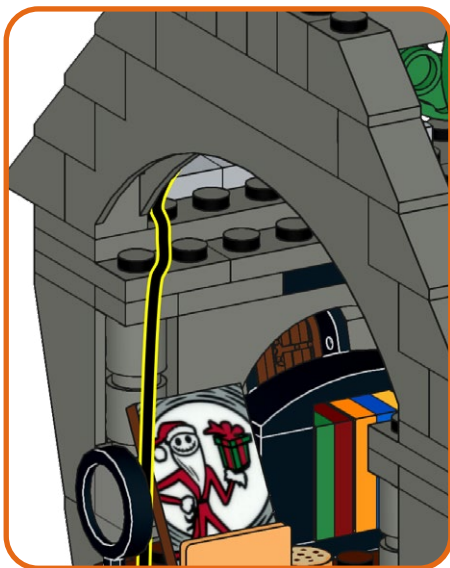

123

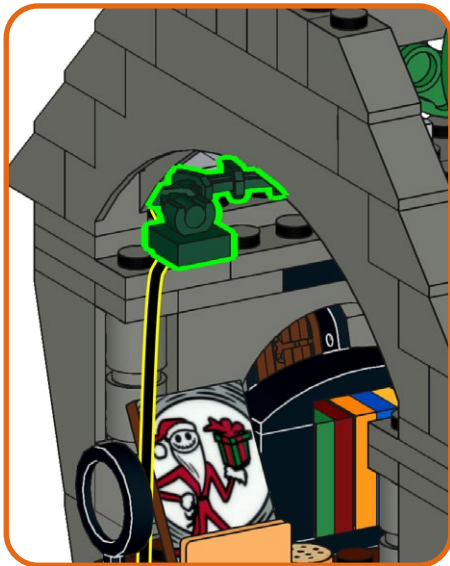

124



125



126

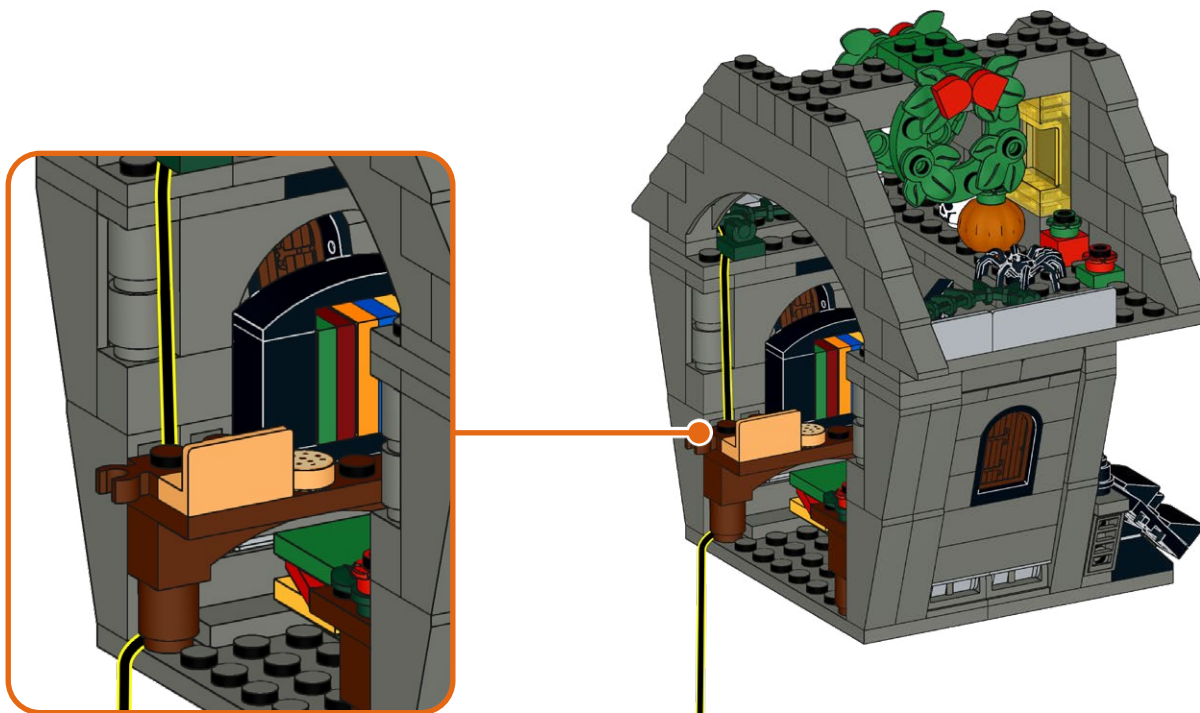

127



128





129

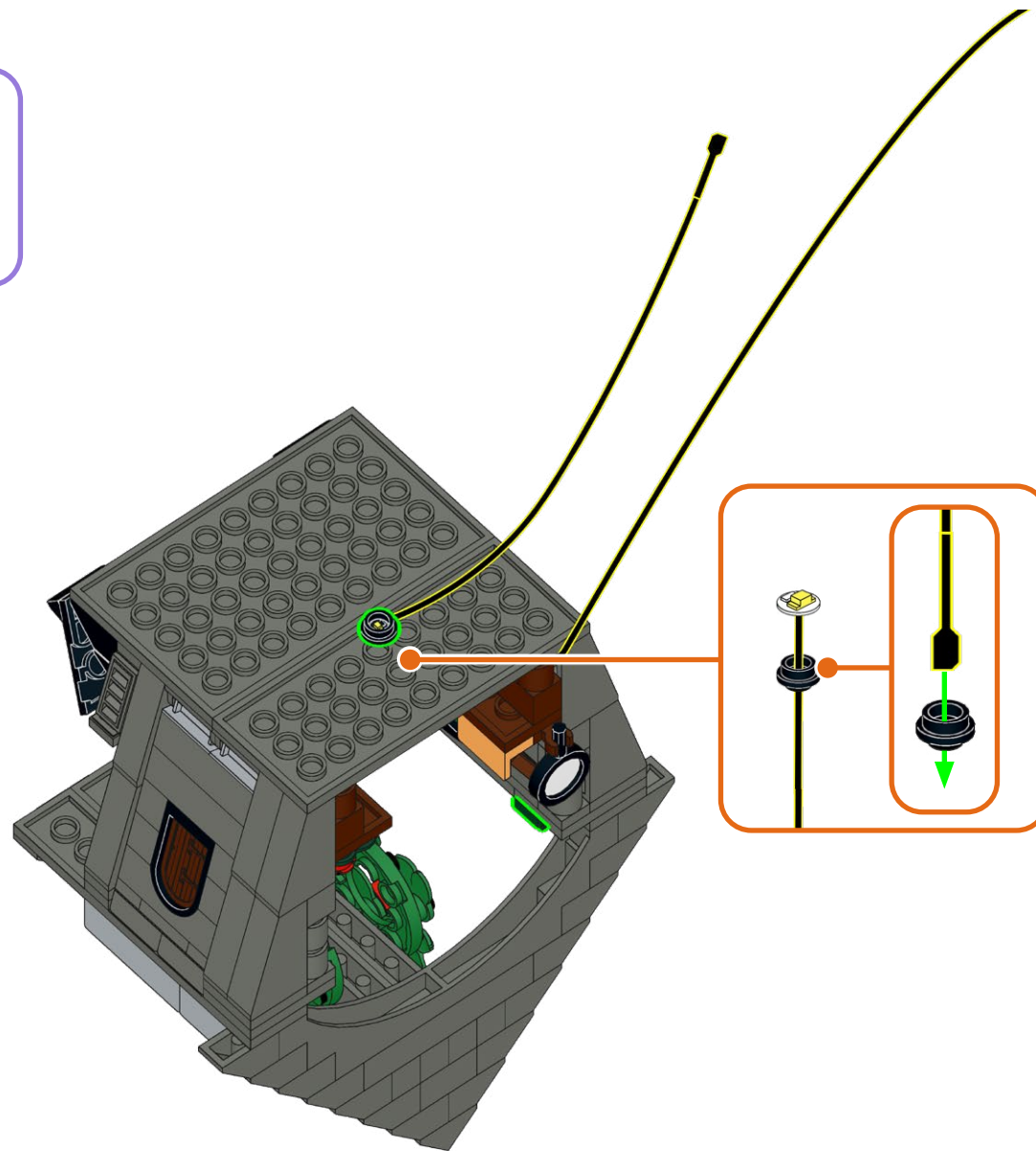
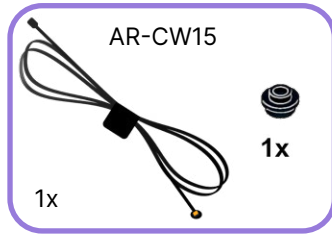

**130**

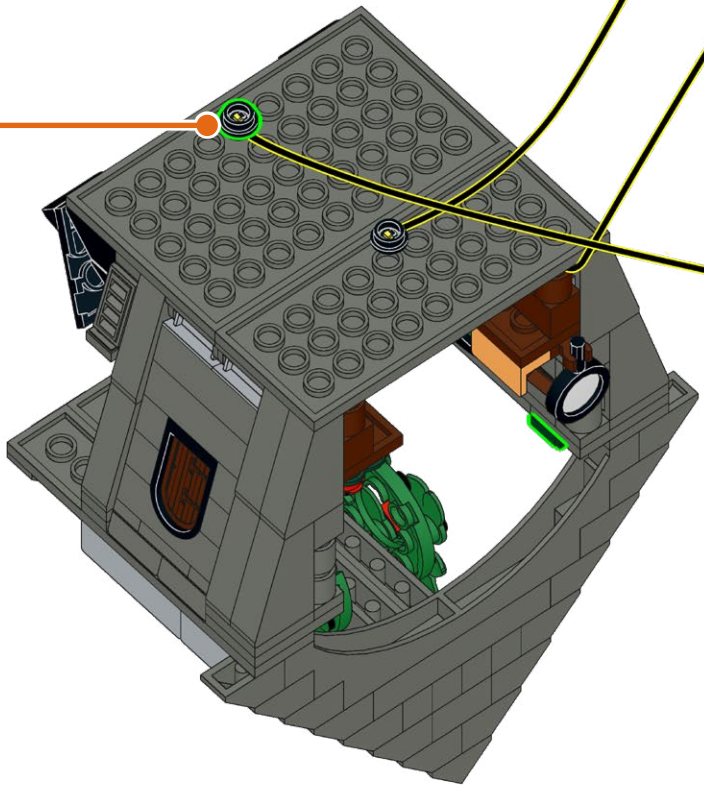
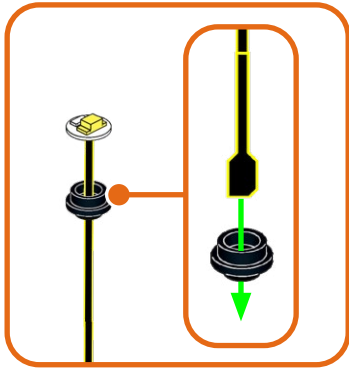
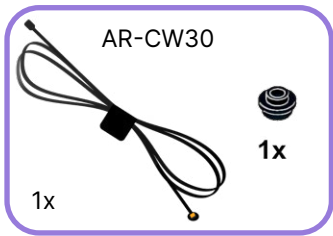

131



132

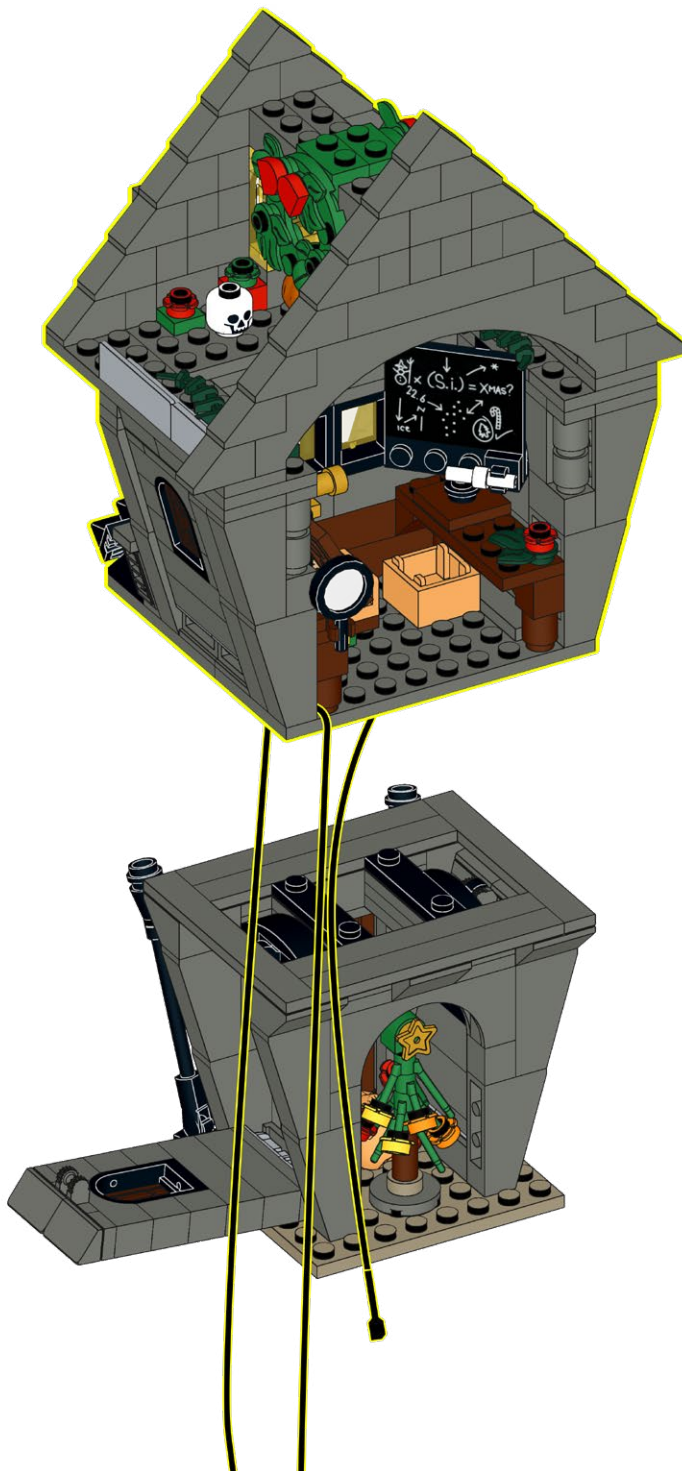

133

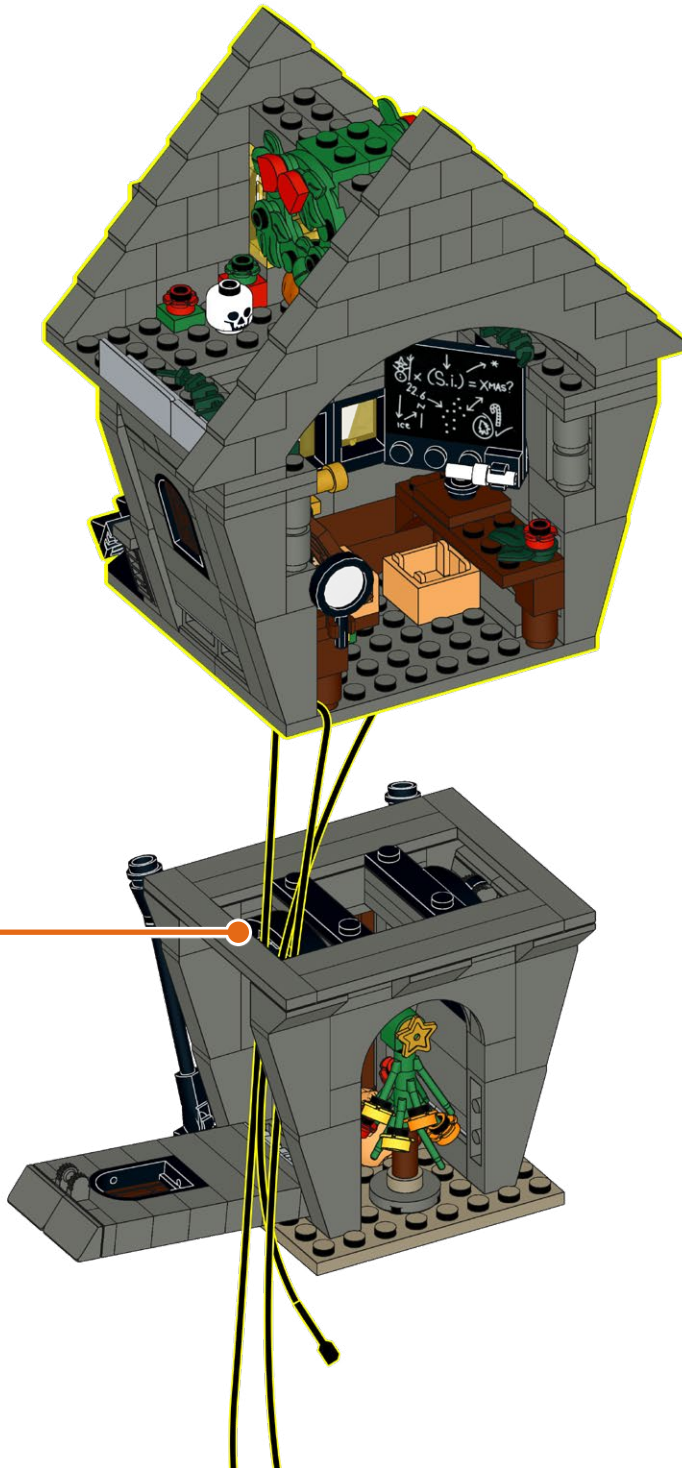

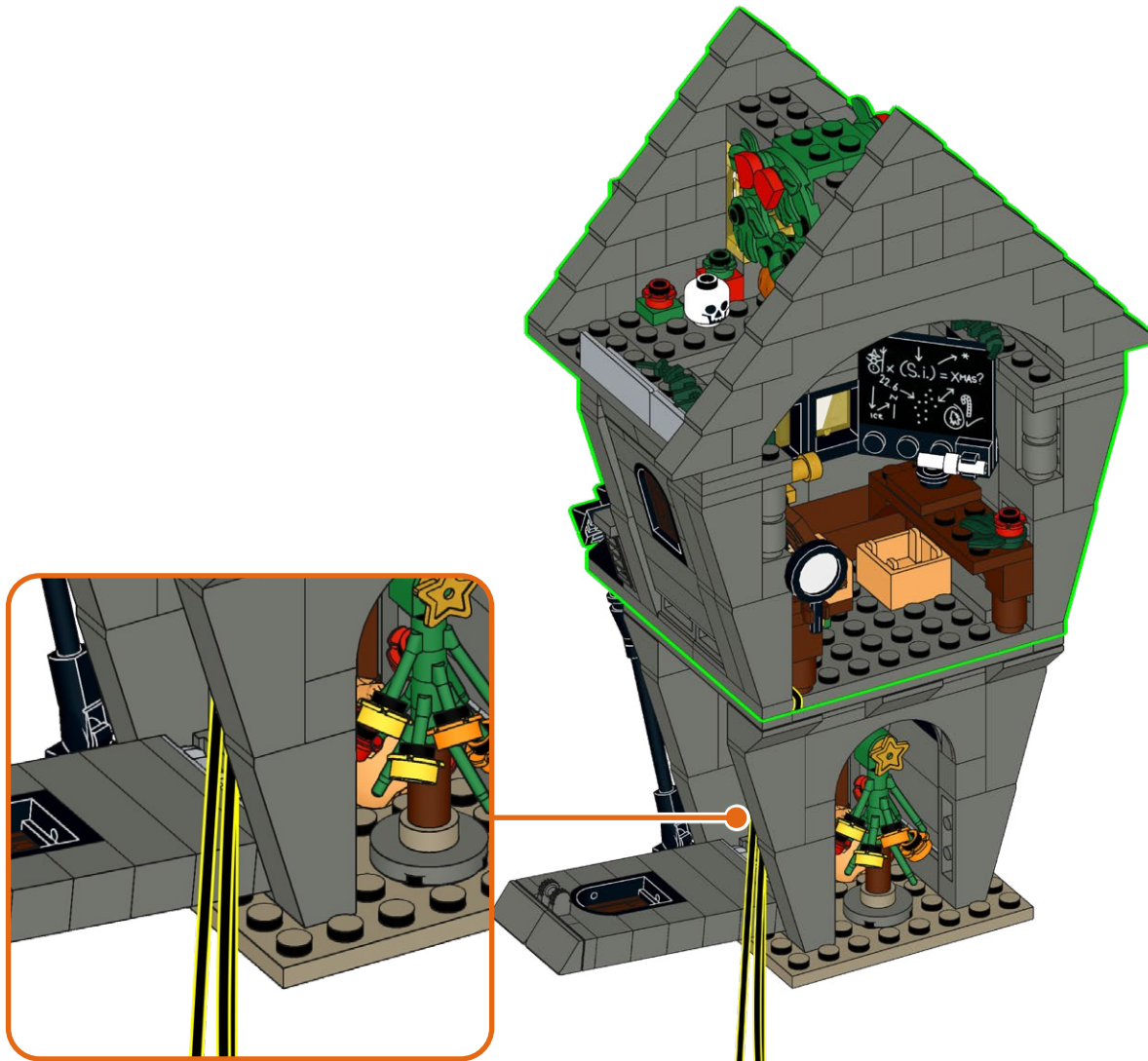

135

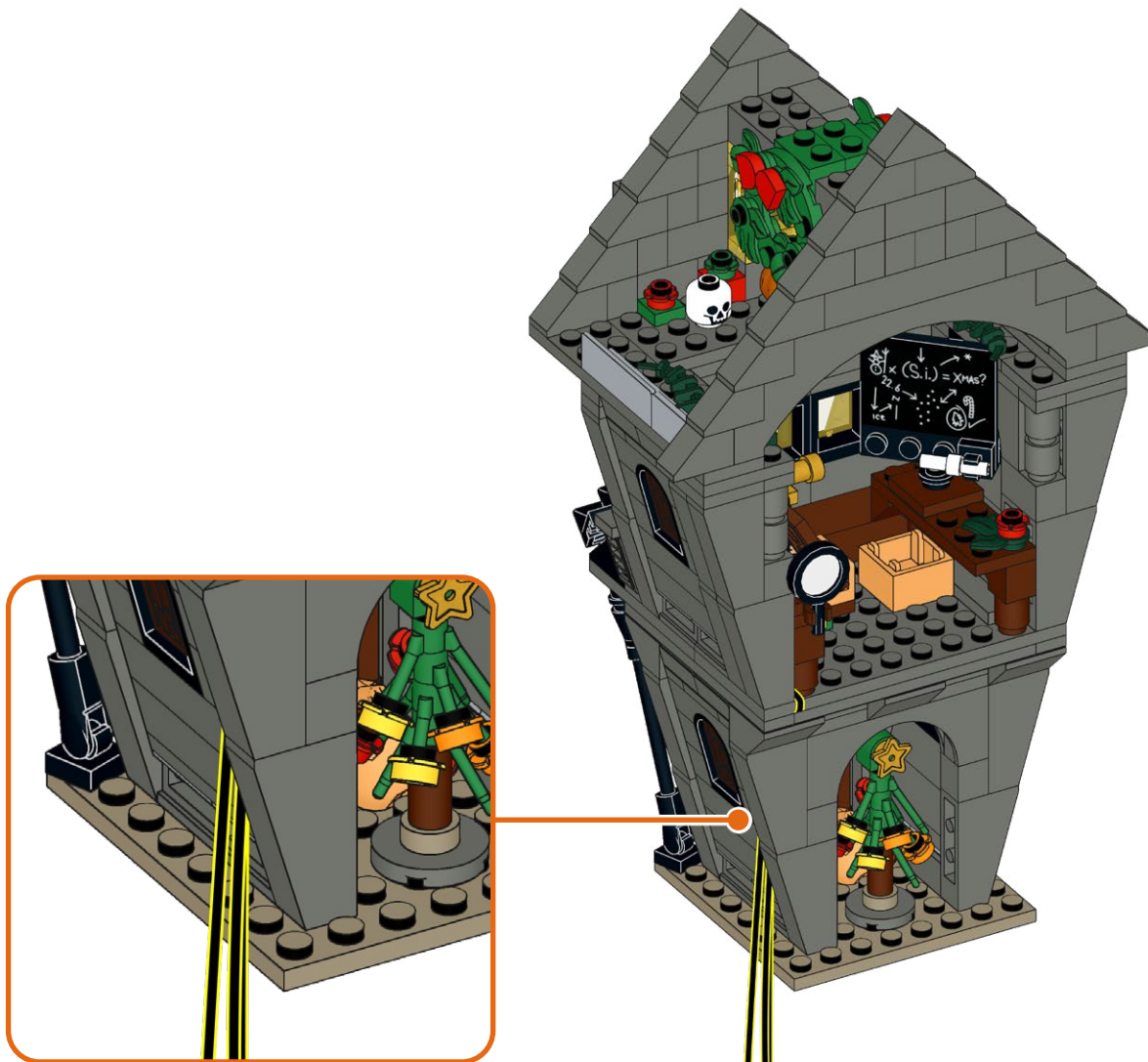

136





137



138



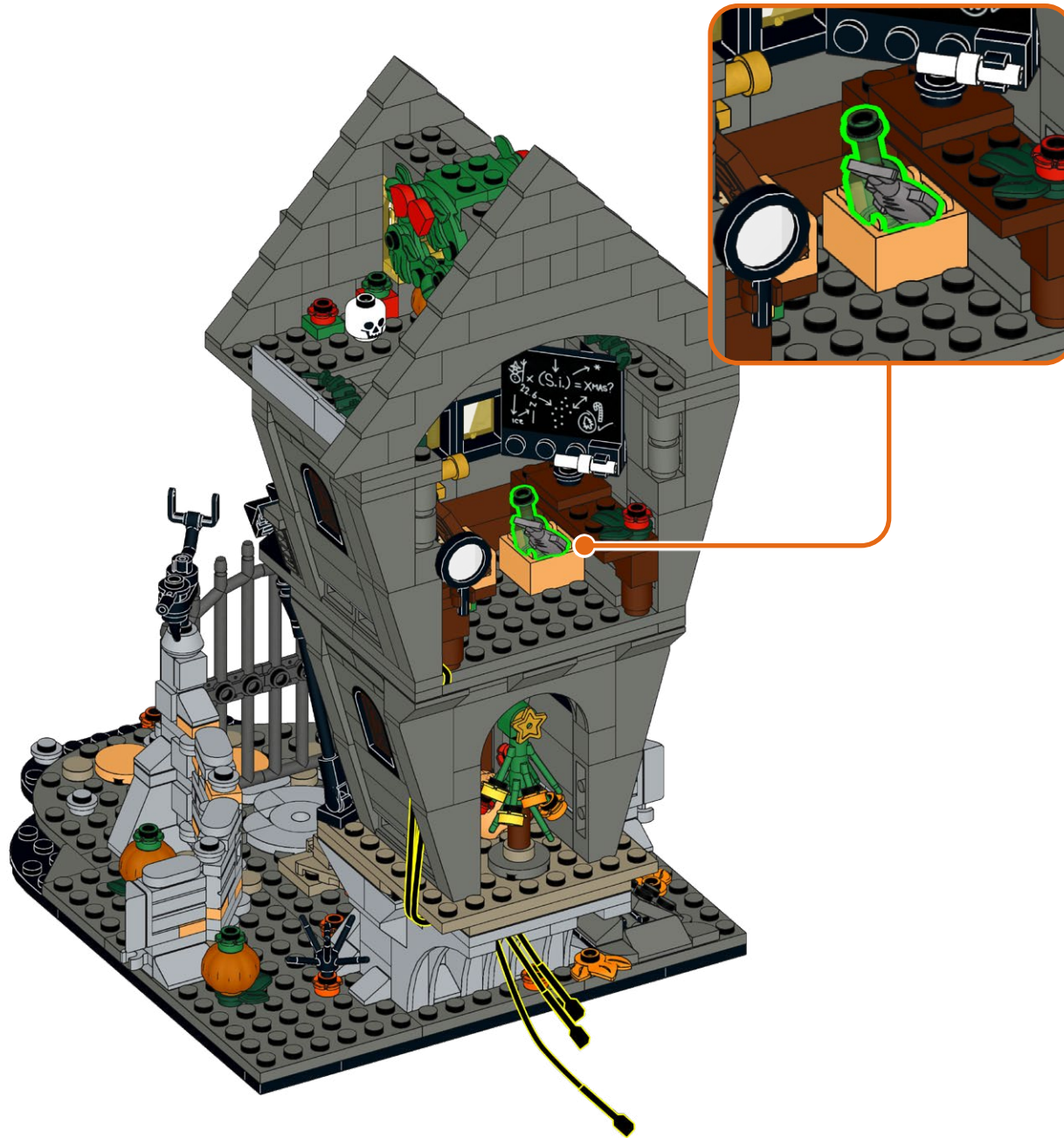

140

1x

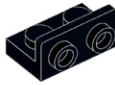

141

D-3



1x



142

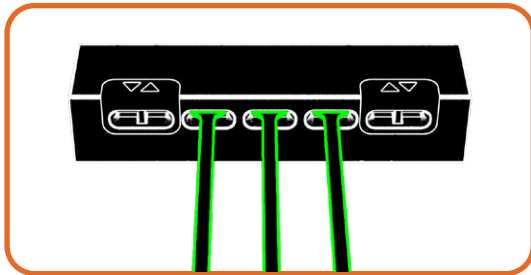

143



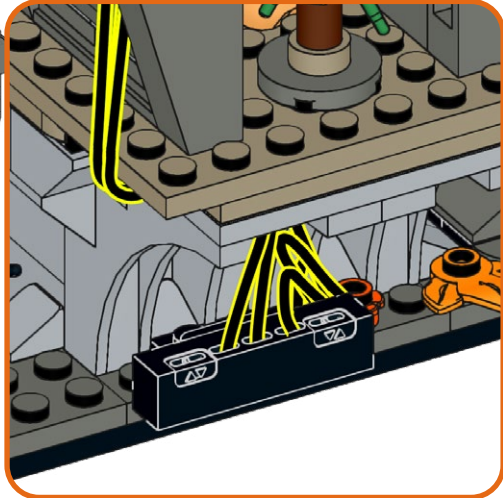



145

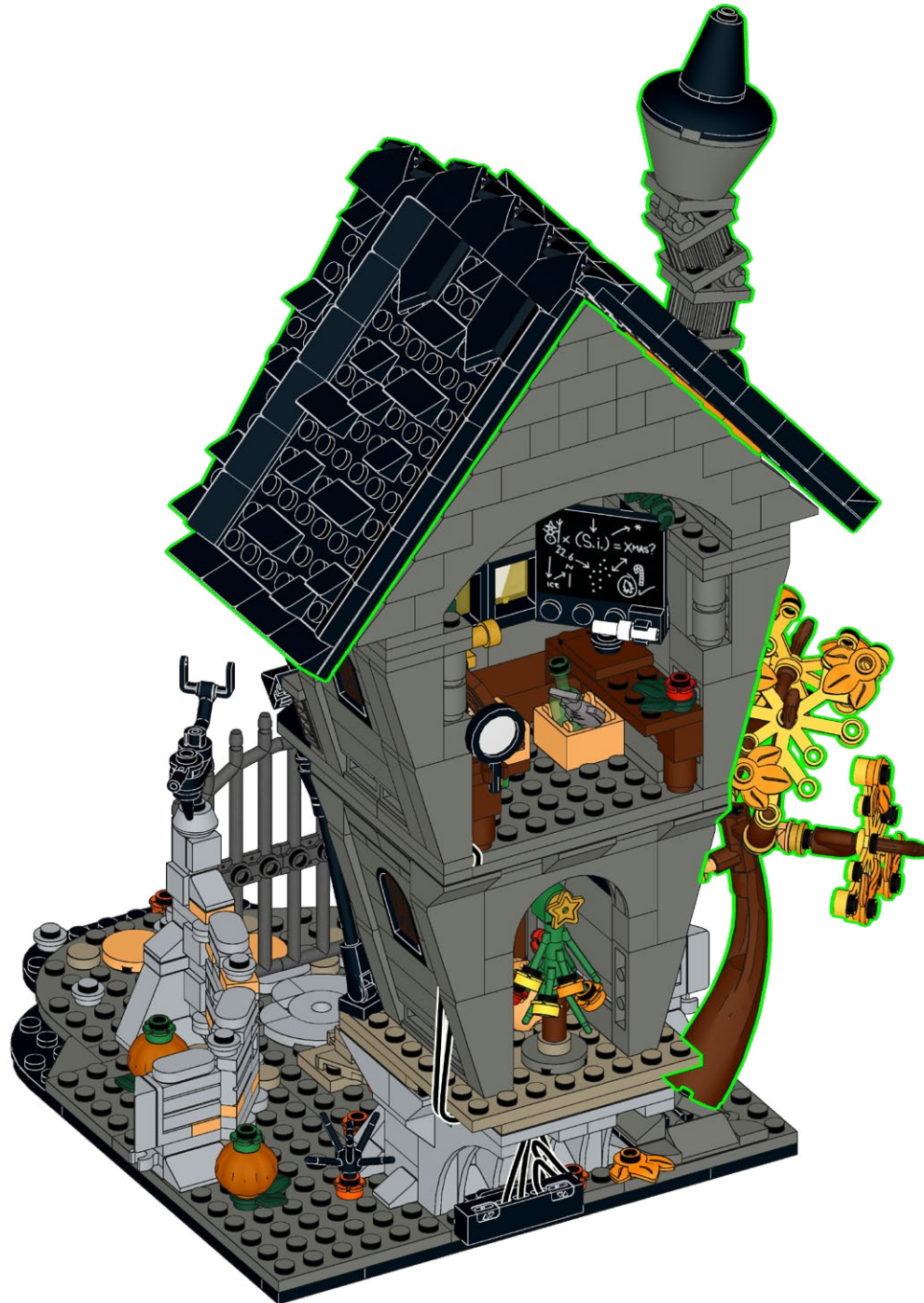



147



148





150



151



152

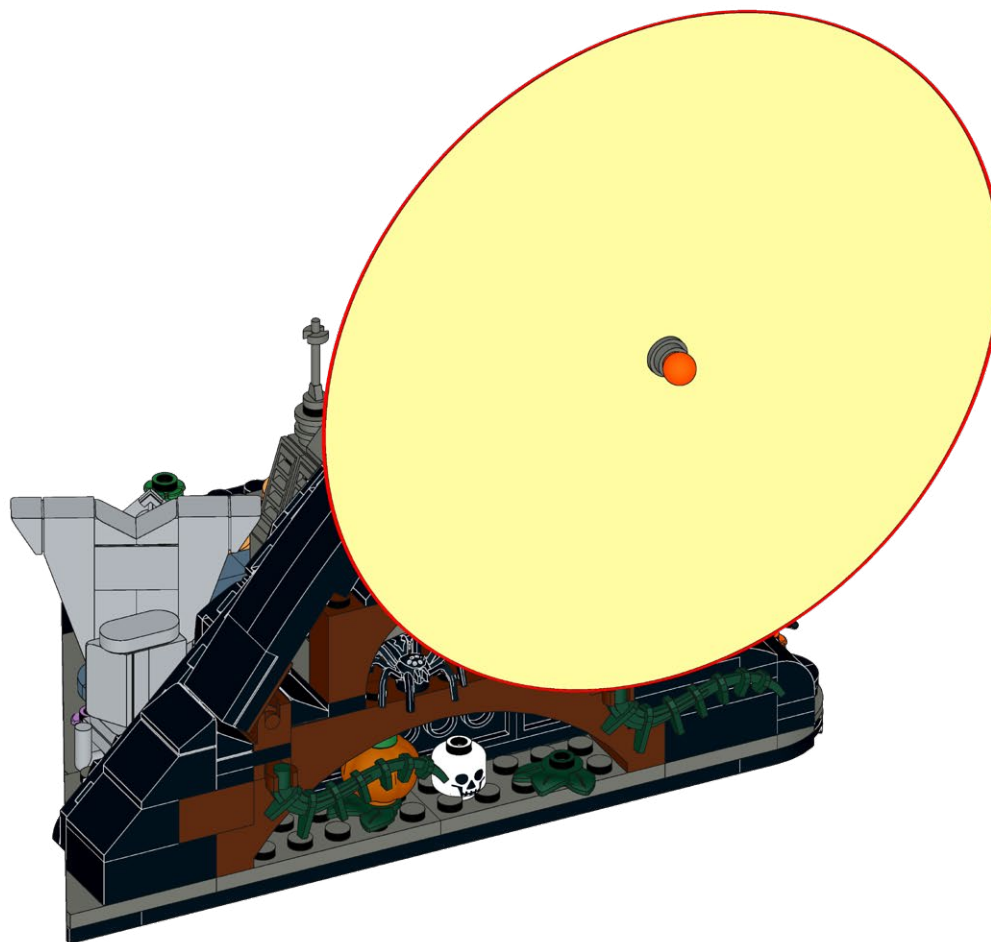



153

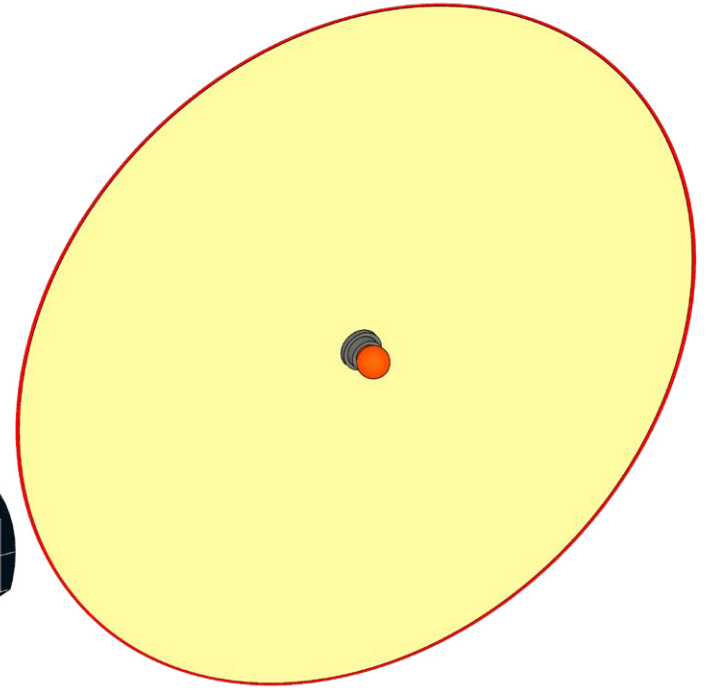

154

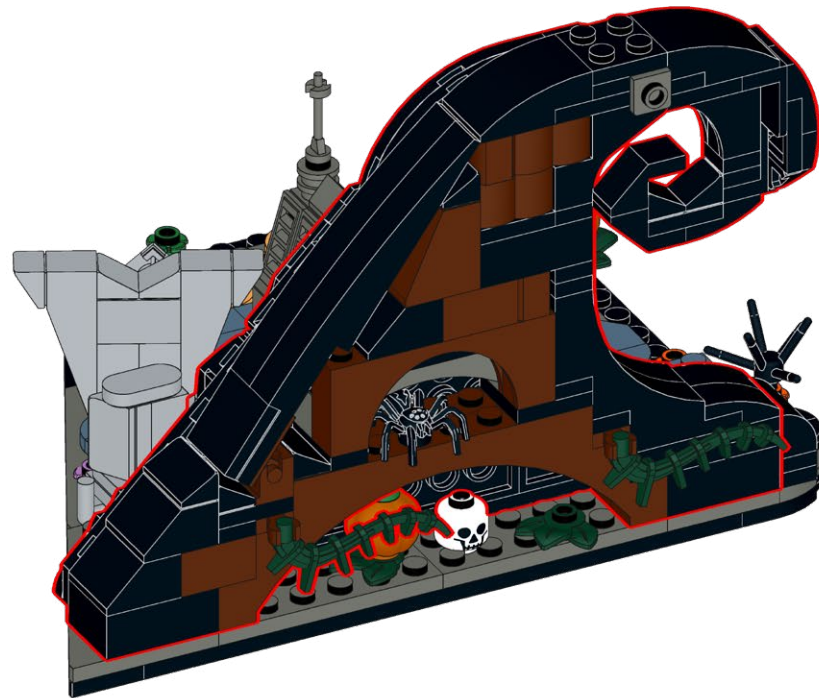

155



156

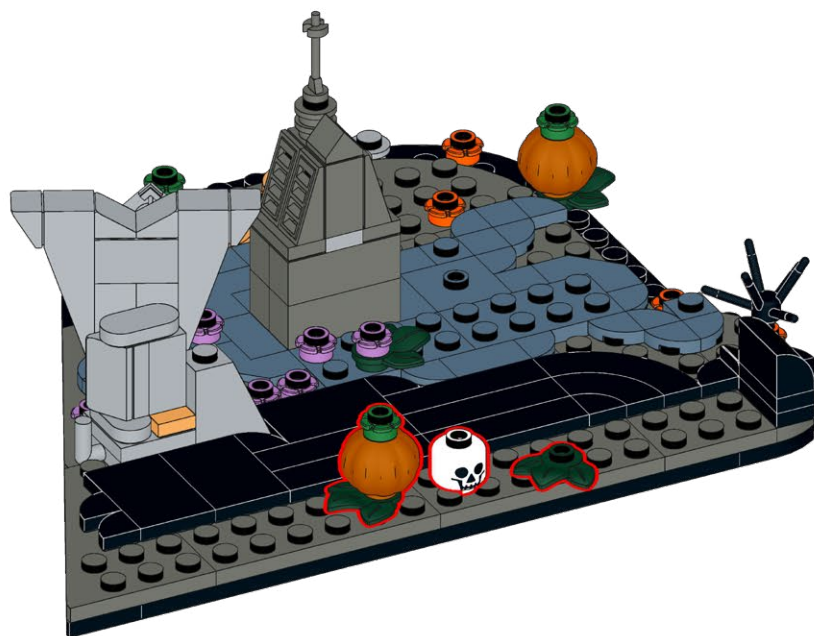

157

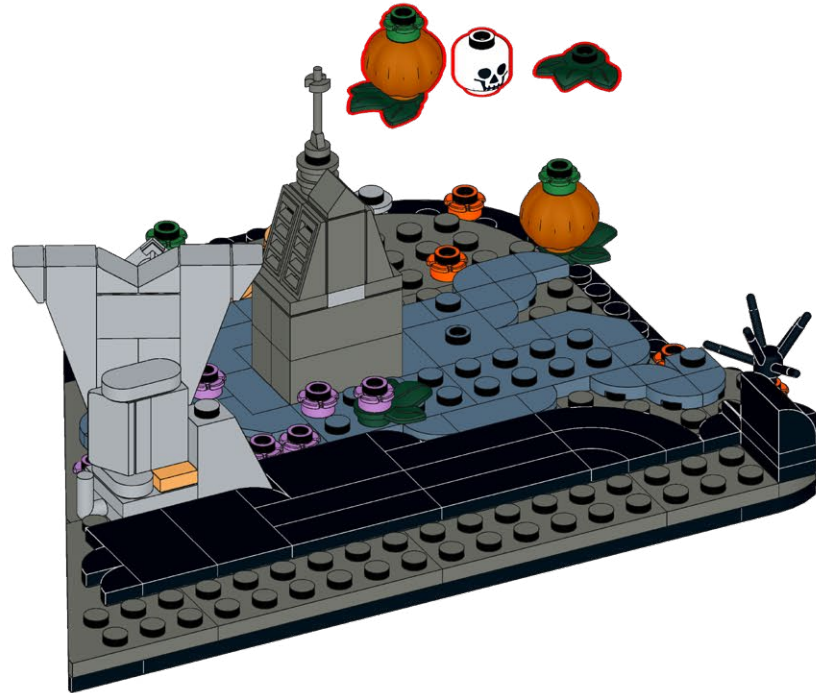



### **HOLD UP!**

You might notice some bags aren't in order, as well as left over pieces, but that's ok! We're changing the way you build LEGO!

### **ATTENDEZ!**

Vous remarquerez peut-être que certains sacs, ainsi que certaines pièces, ne sont pas dans le bon ordre. Mais pas de panique! Nous changeons simplement la façon avec laquelle vous construisez vos LEGO!

### **ASPETTA!**

Potresti notare che alcuni sacchetti non sono in ordine, così come i pezzi avanzati, ma va bene così! Stiamo cambiando il modo in cui costruisci i LEGO!

### **HALT!**

Sie werden möglicherweise bemerken, dass einige tüten durcheinander sind und teile übrig bleiben, aber das ist in Ordnung! Wir ändern die art und weise, wie Sie LEGO bauen!

### **¡ESPERA!**

Es posible que notes que algunas bolsas están fuera de servicio, así como piezas sobrantes, ¡pero está bien! ¡Estamos cambiando la forma en que construyes LEGO!

### **暫停!**

你可能会注意到一些袋子顺序错乱, 以及一些剩余的部件, 但没关系! 我们正在改变你搭建乐高的方式!

### Open LMB Bag 03

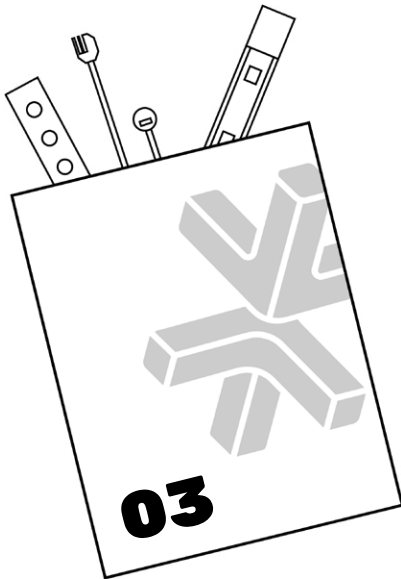

# 158

1



2

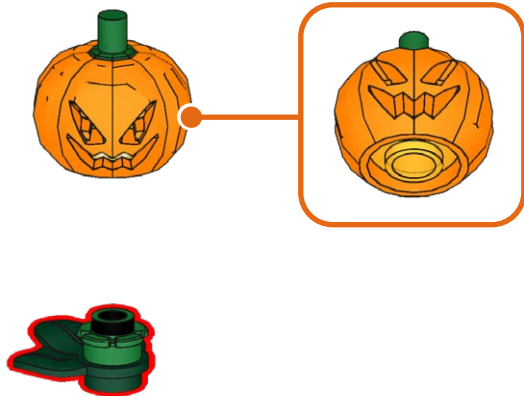

# 159

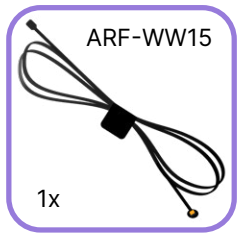

1



2

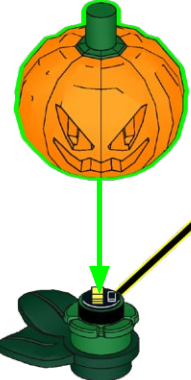

# 160

1



2

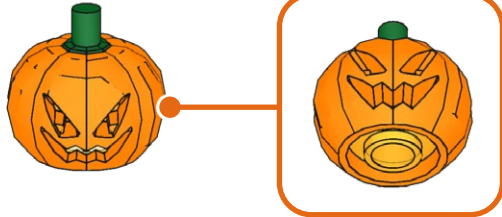

# 161

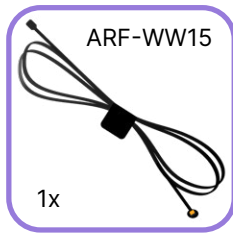

1



2





162



163

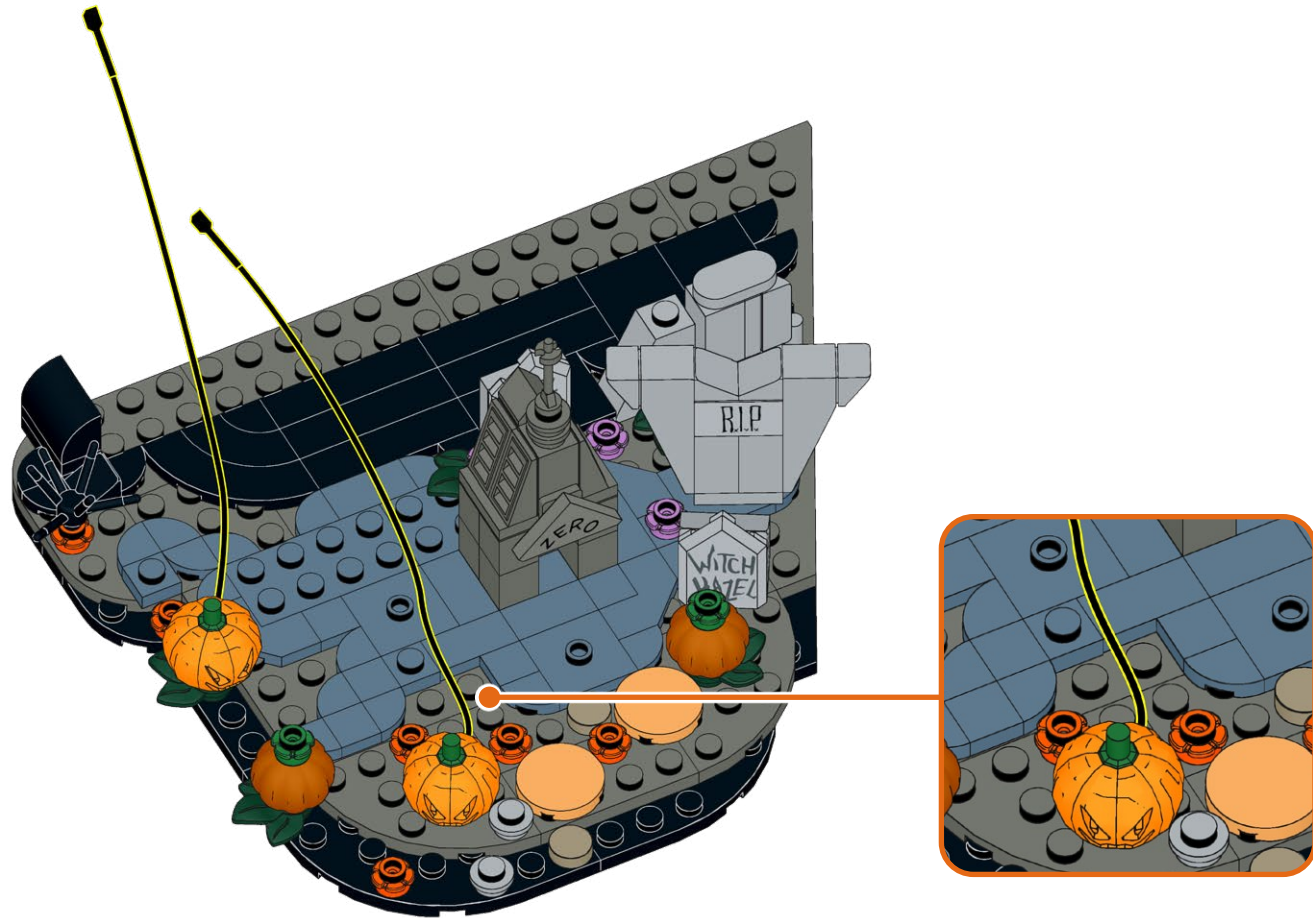

164

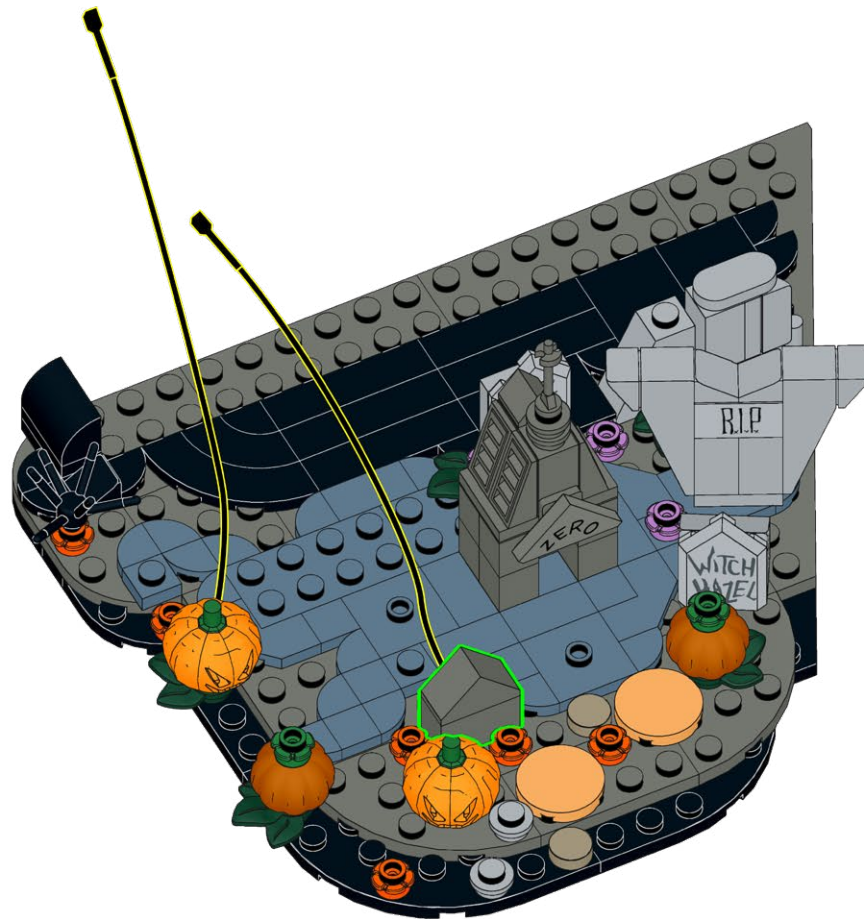

165

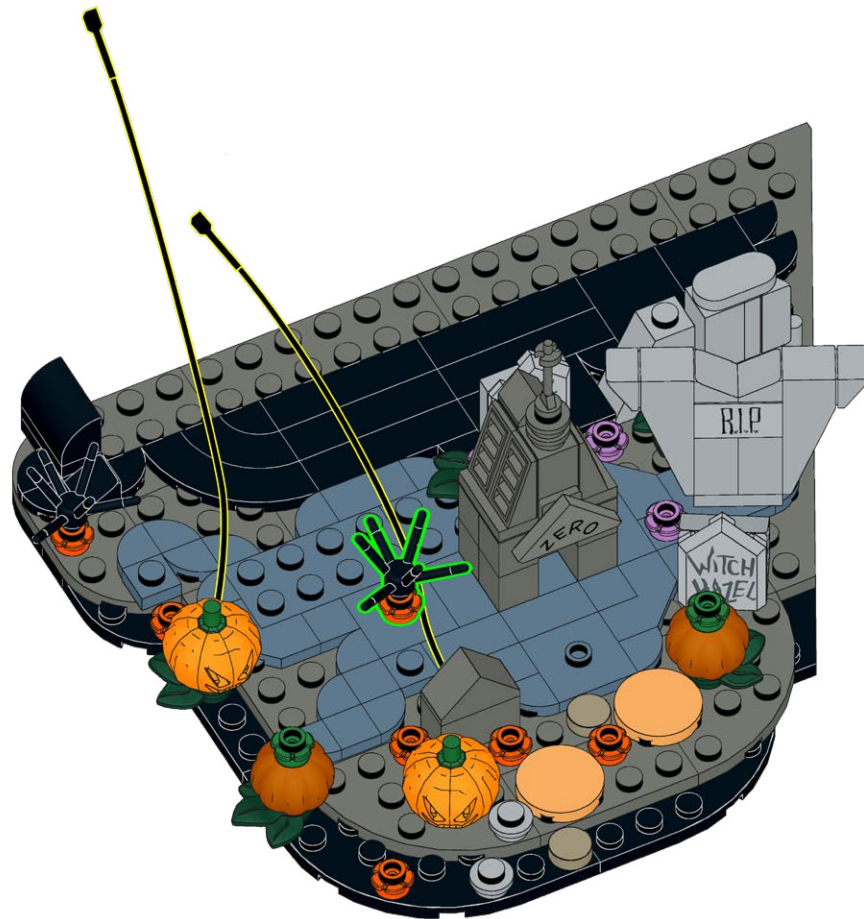

166

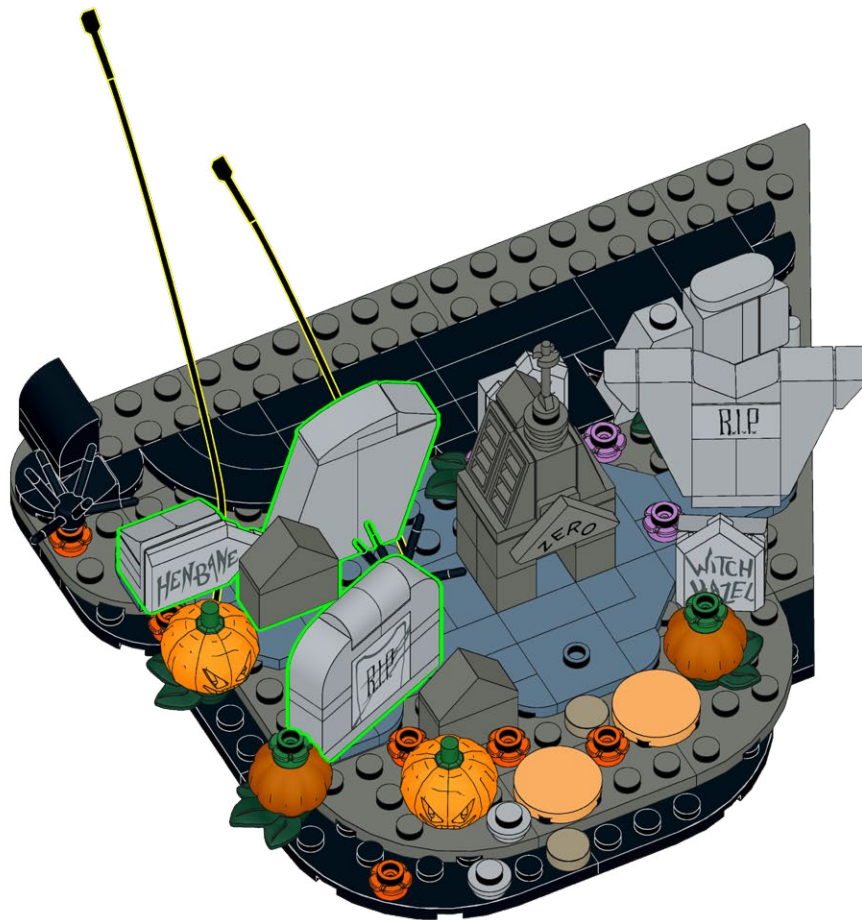

167

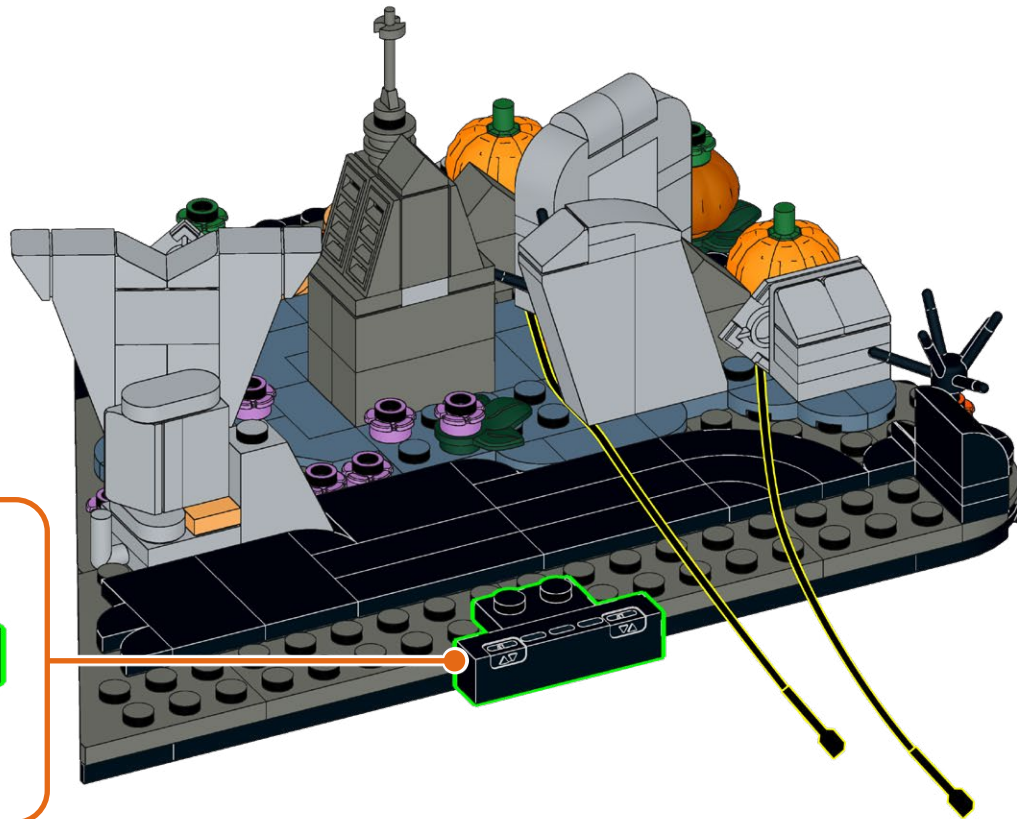
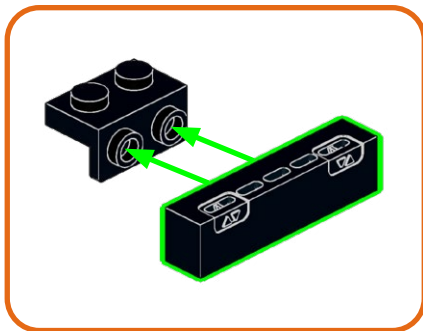
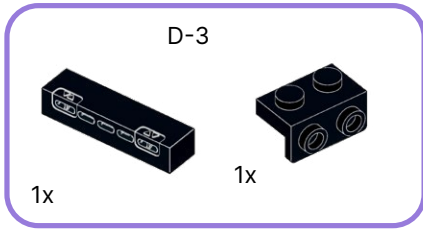

168

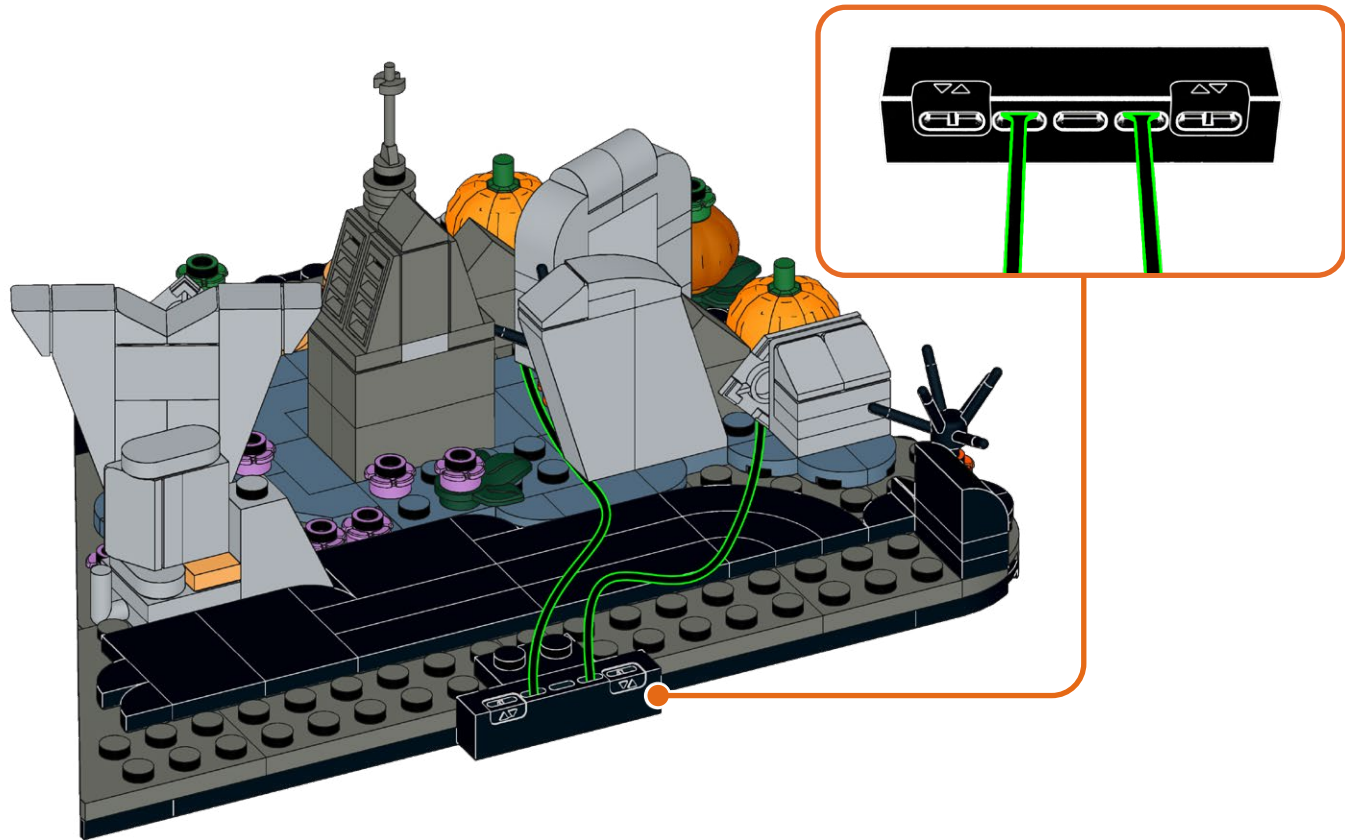

169

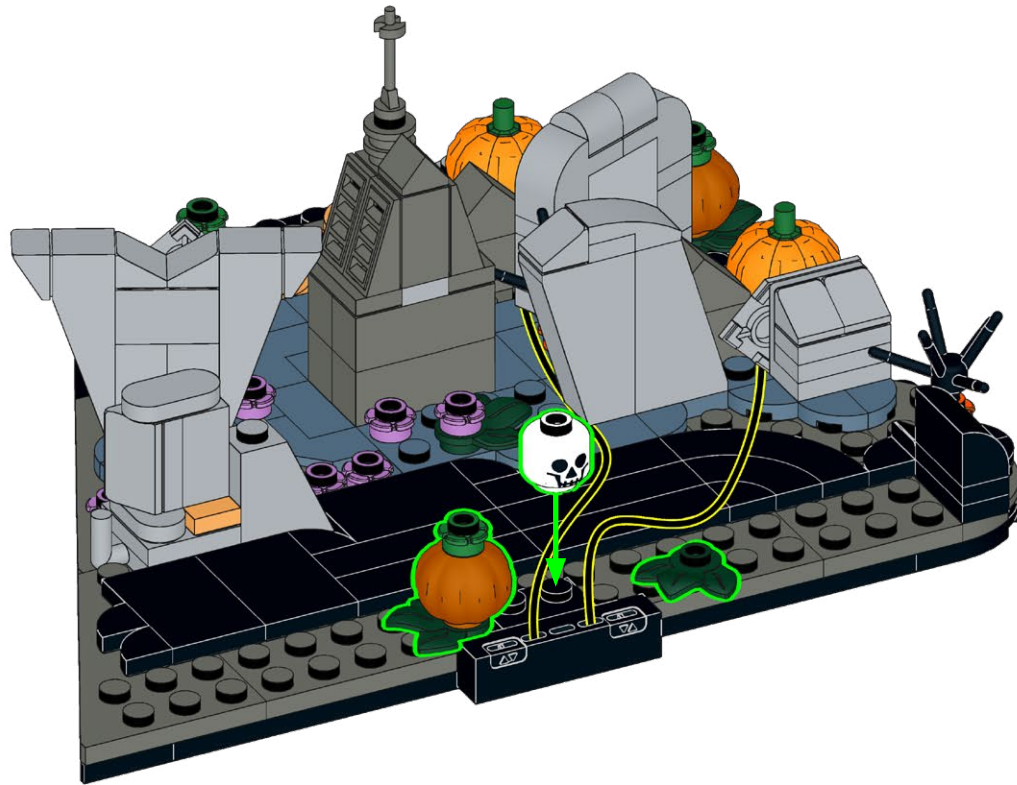



170

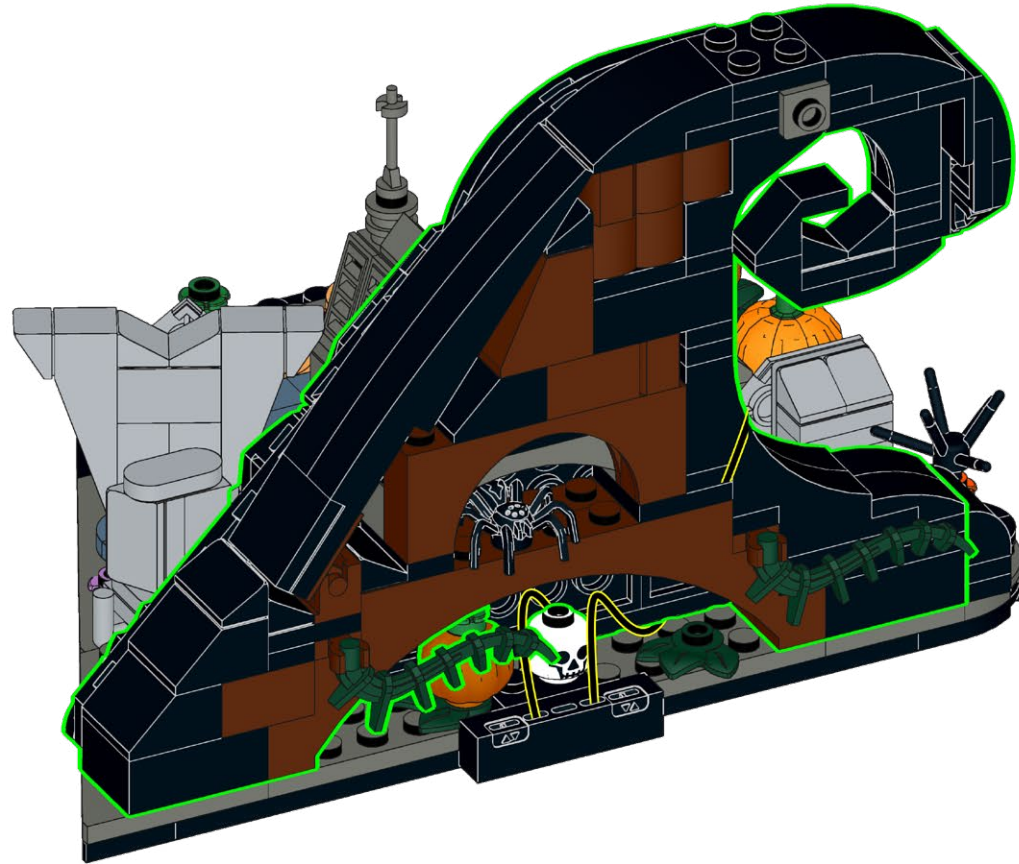

171

SL-WW15

1x

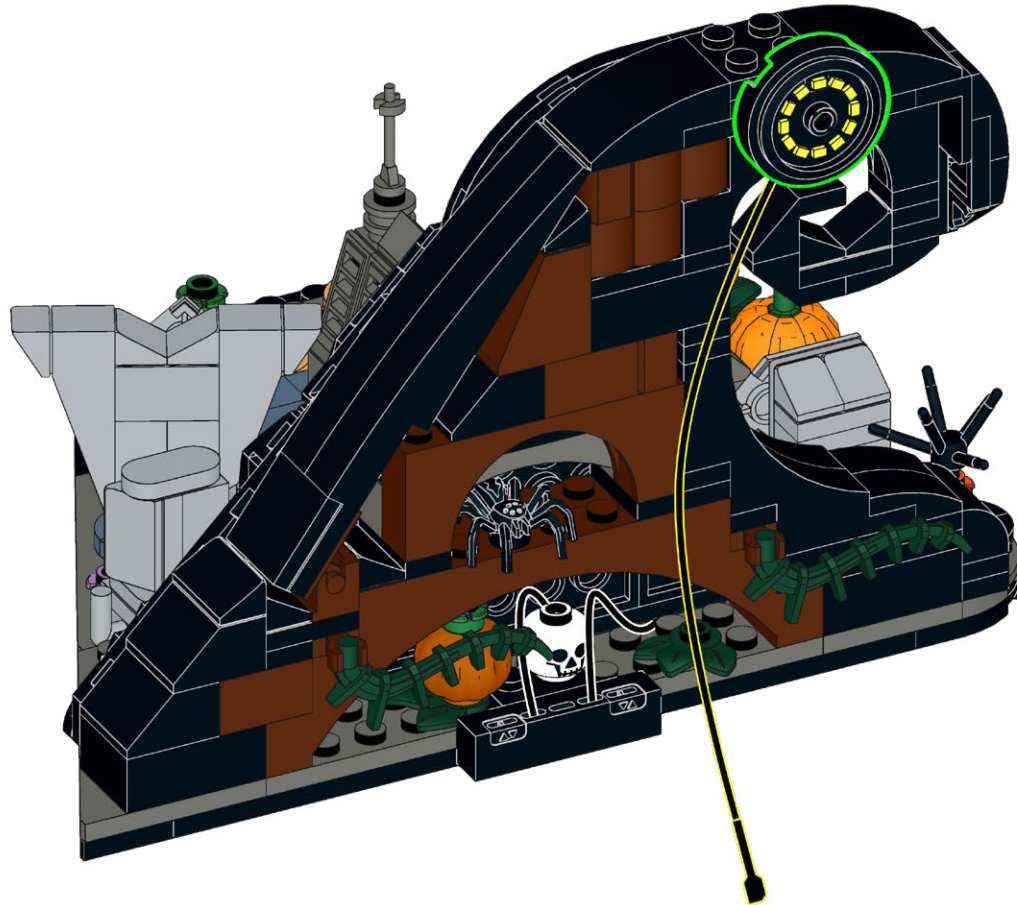

172

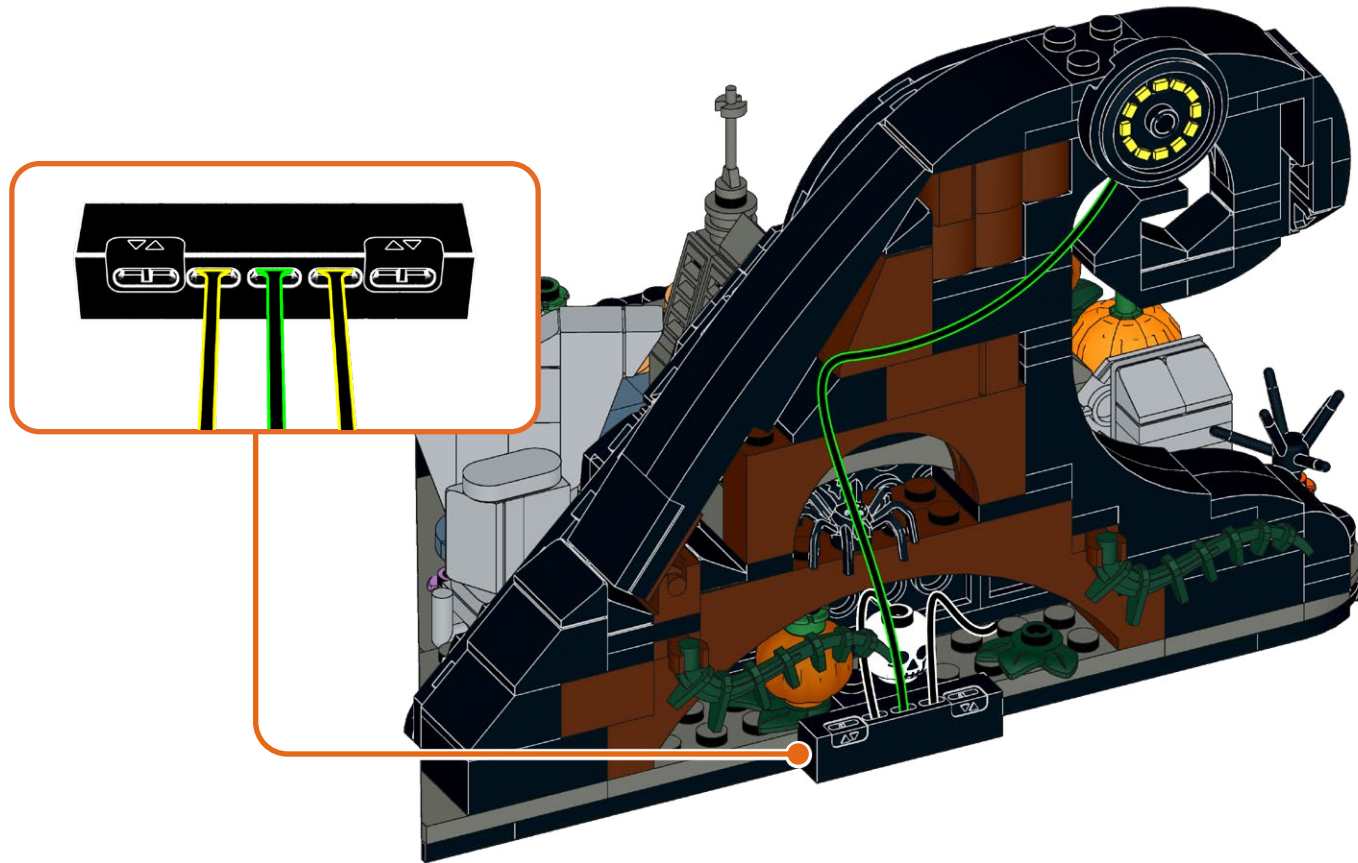

173

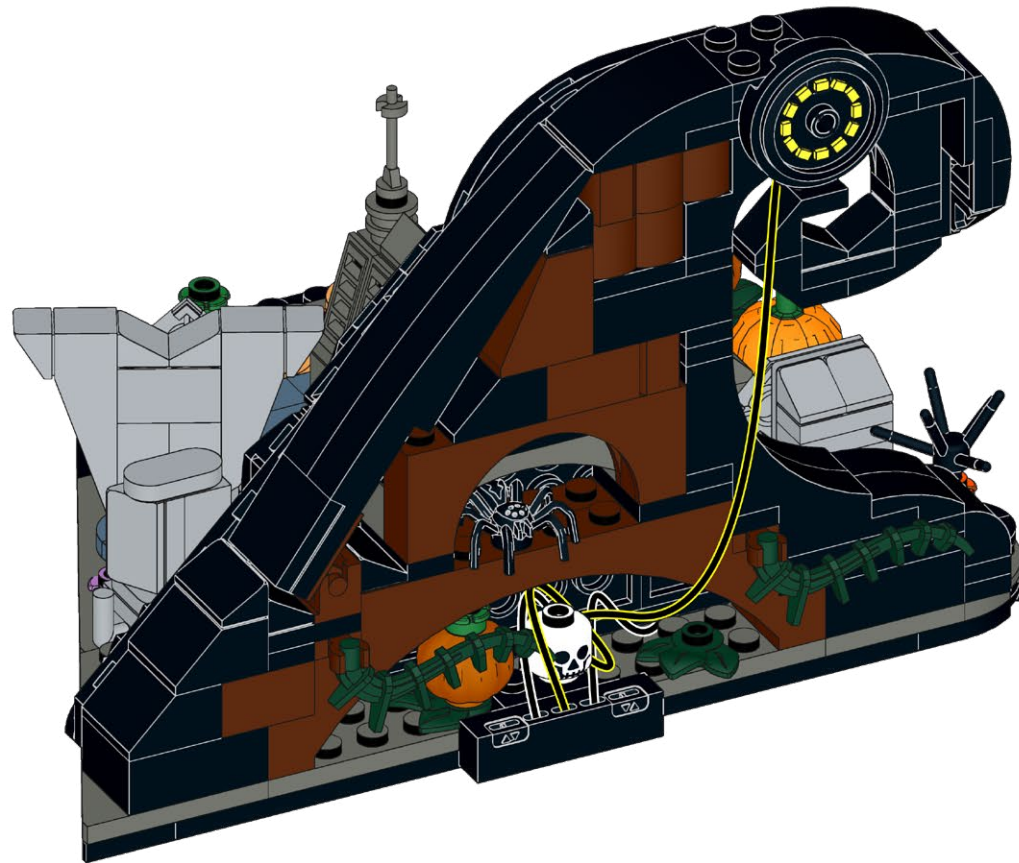

**174**

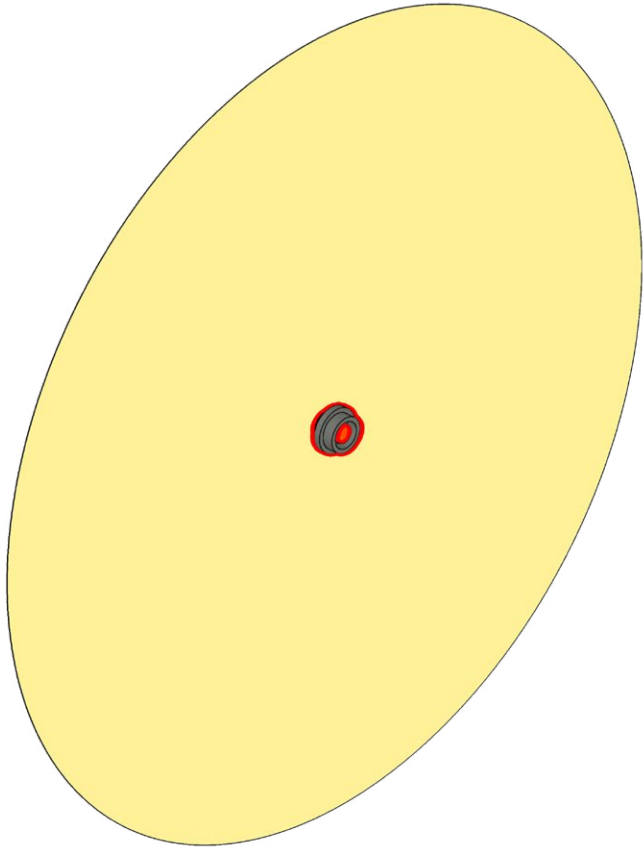

**175**

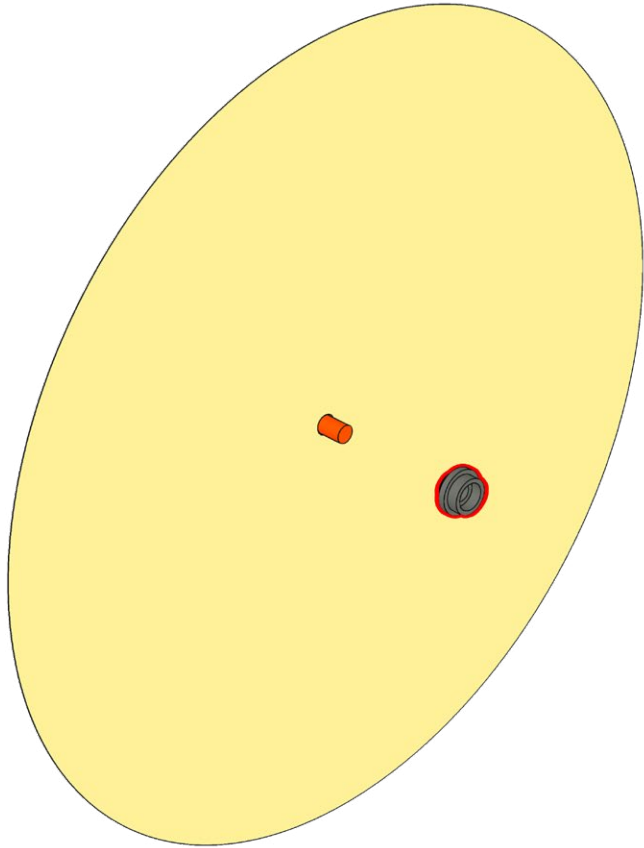

**176**

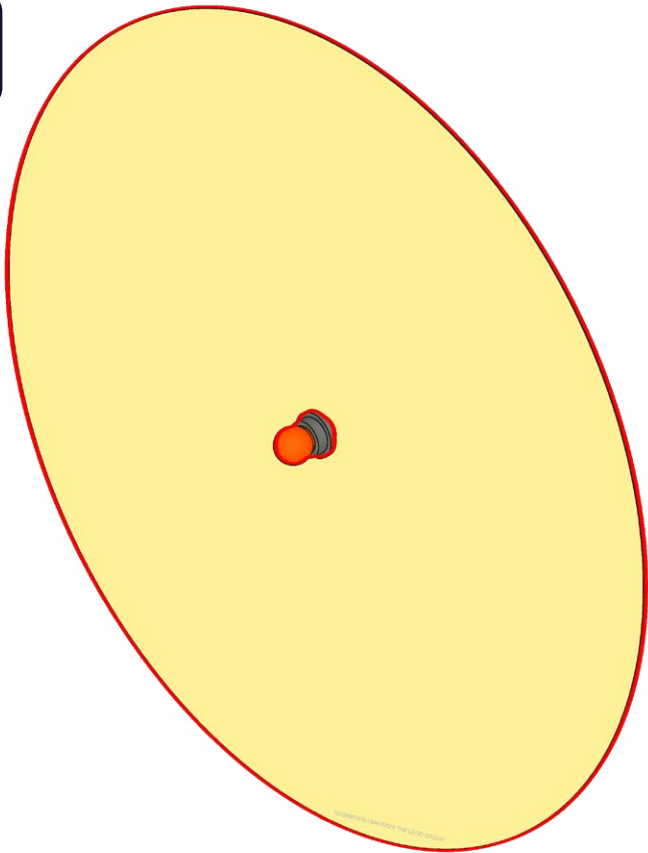

**177**

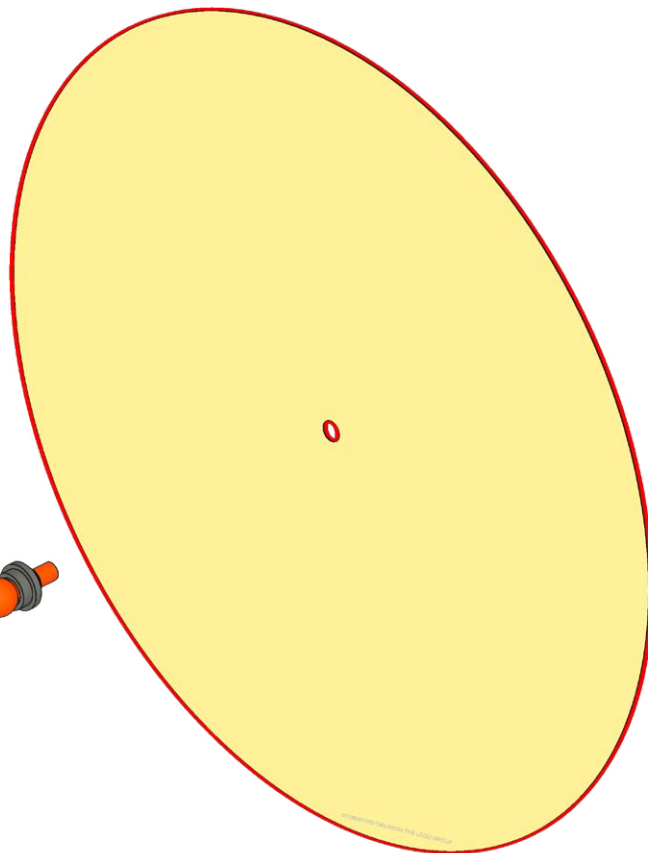

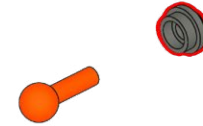
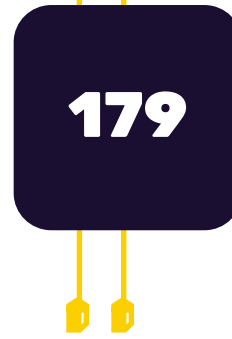

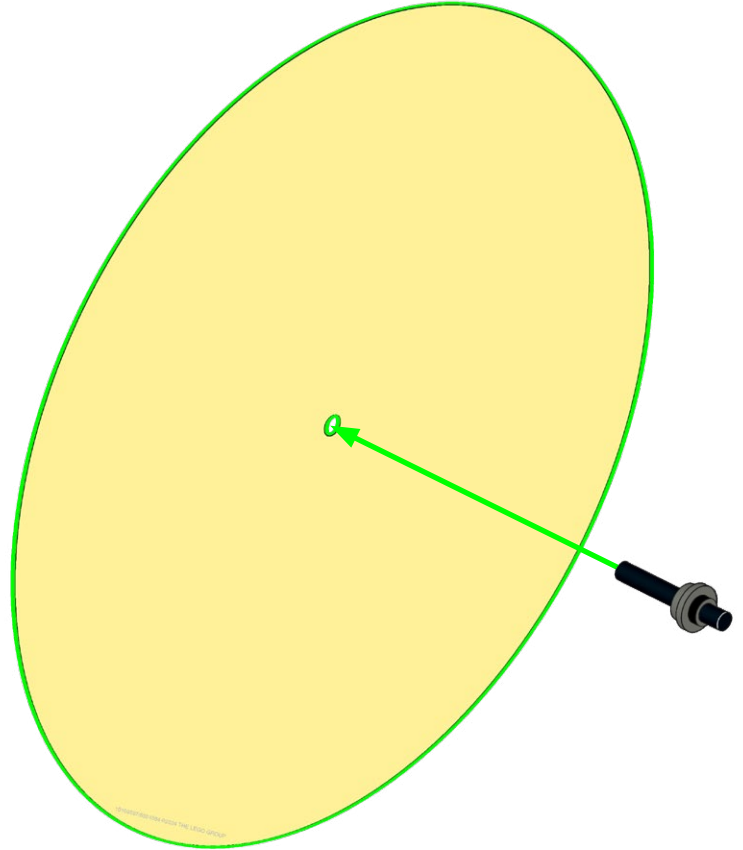
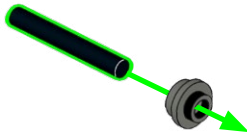



182

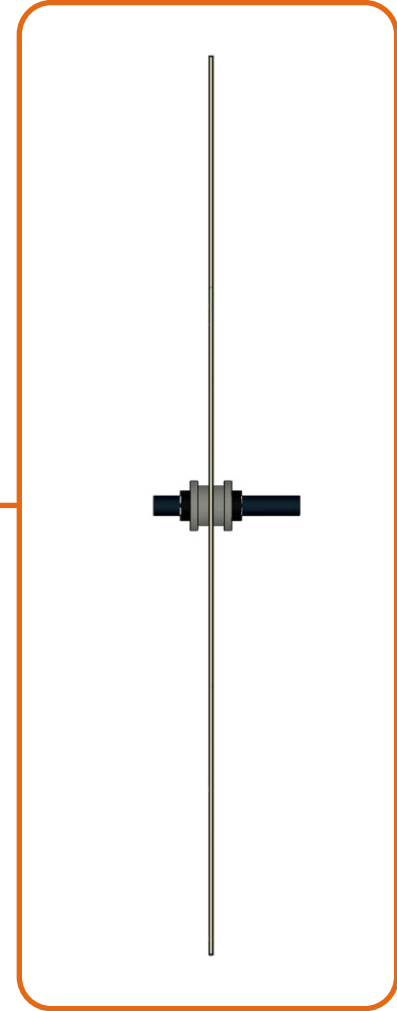
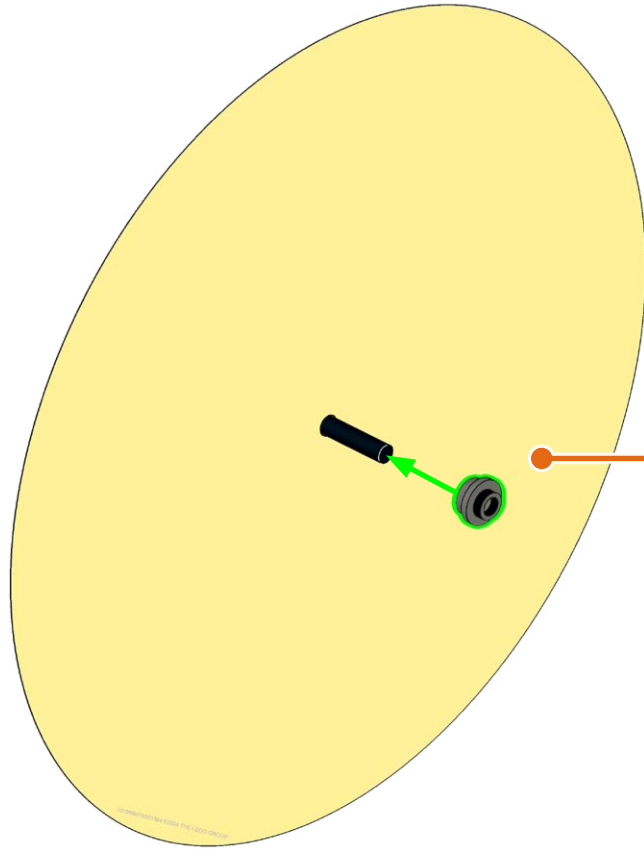

183

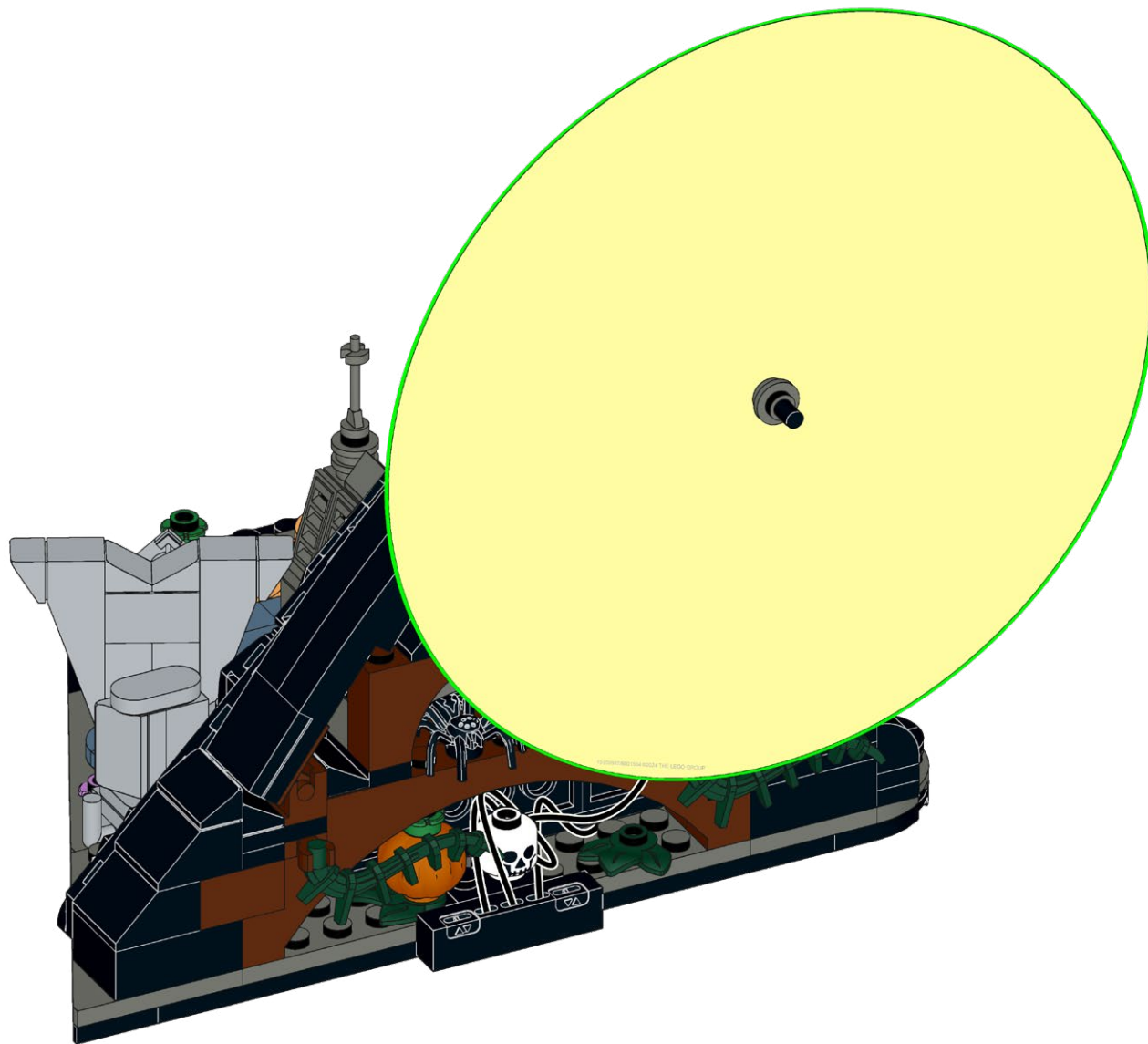

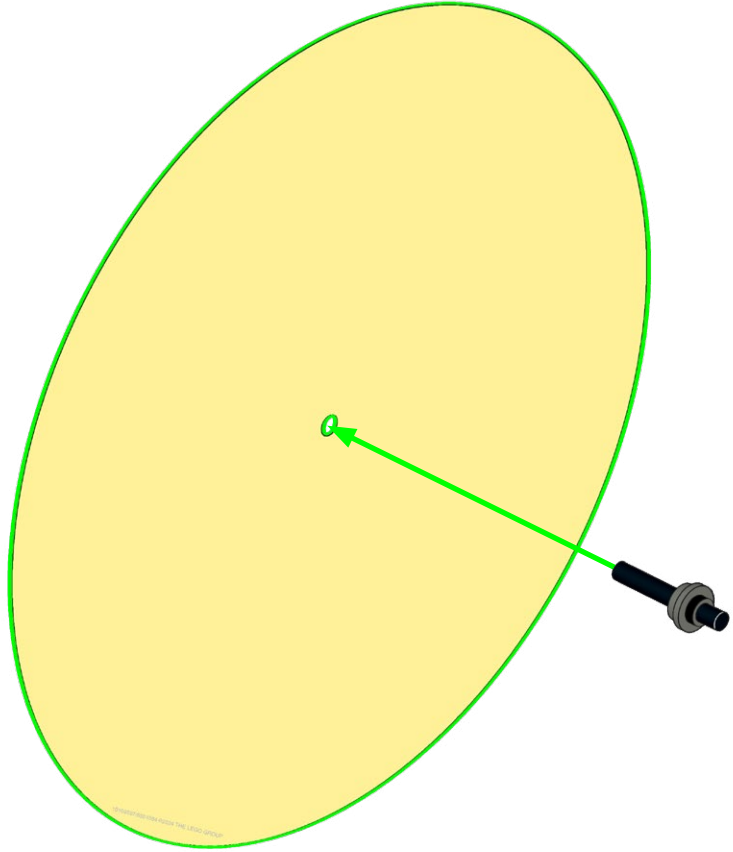
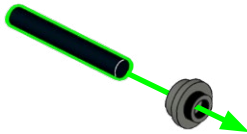

186

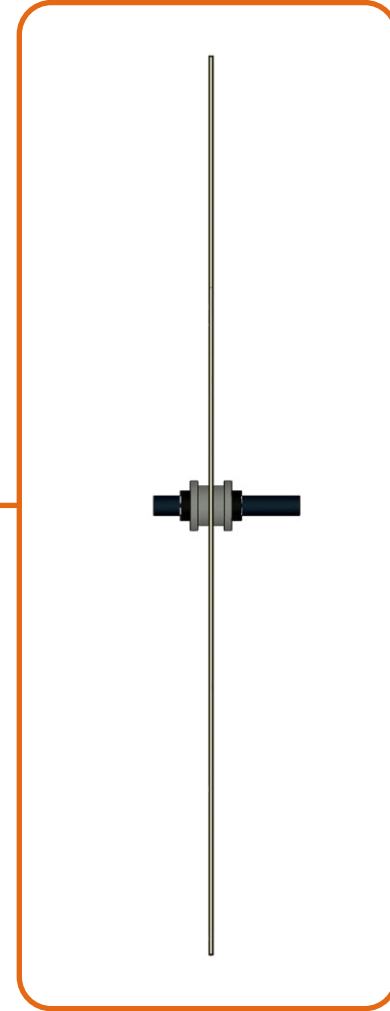
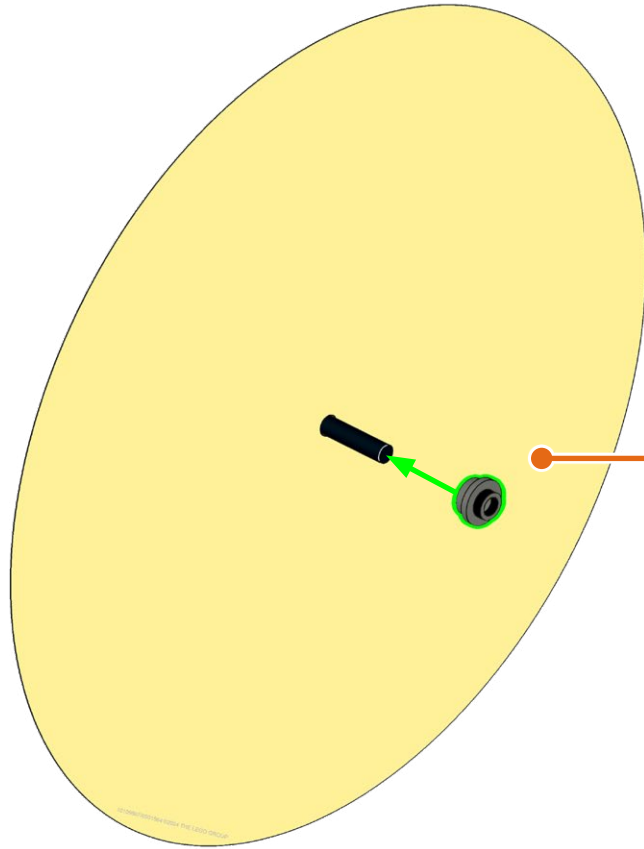

187

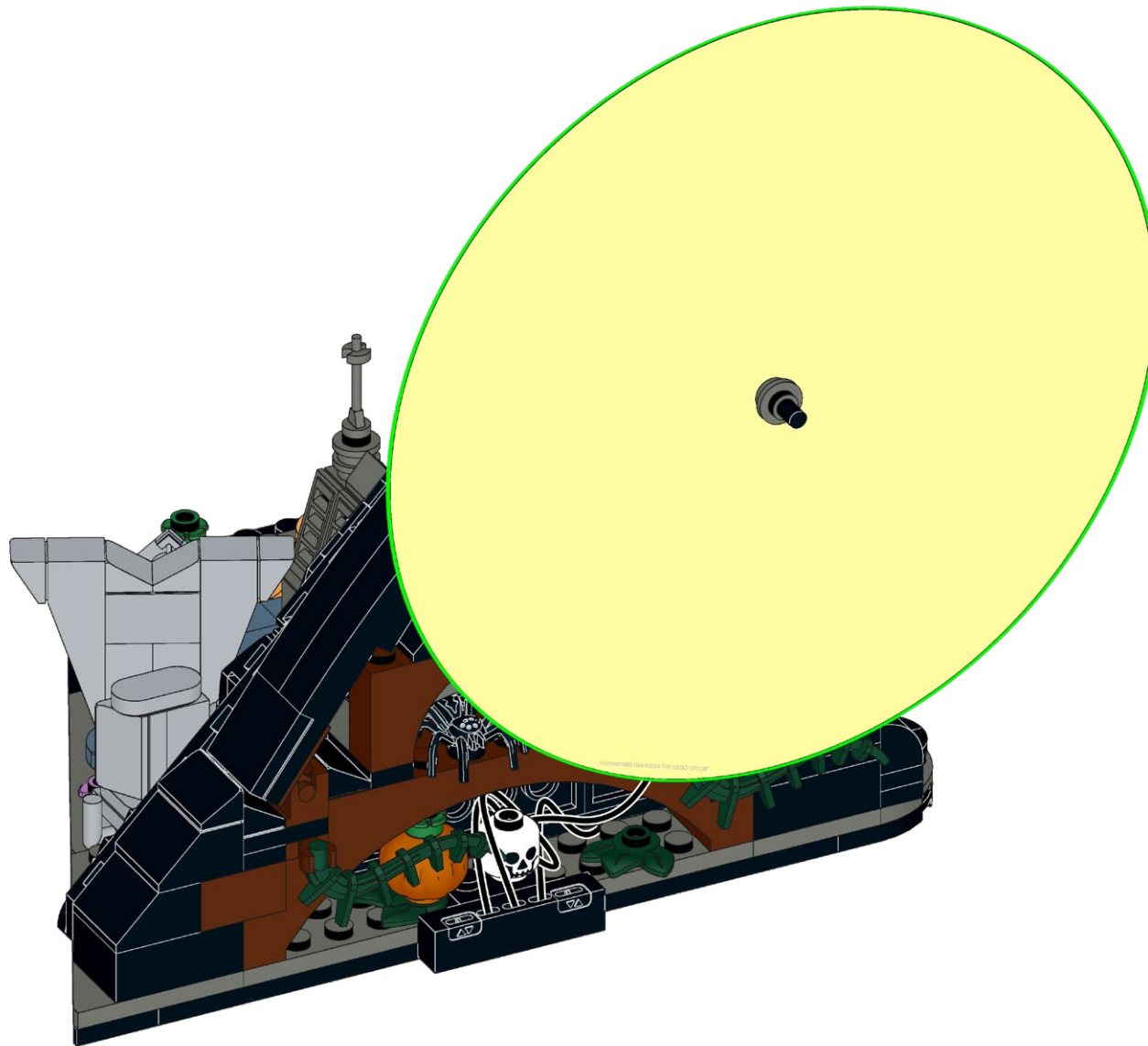

188



189



190





191



192



193



194





### **HOLD UP!**

You might notice some bags aren't in order, as well as left over pieces, but that's ok! We're changing the way you build LEGO!

### **ATTENDEZ!**

Vous remarquerez peut-être que certains sacs, ainsi que certaines pièces, ne sont pas dans le bon ordre. Mais pas de panique! Nous changeons simplement la façon avec laquelle vous construisez vos LEGO!

### **ASPETTA!**

Potresti notare che alcuni sacchetti non sono in ordine, così come i pezzi avanzati, ma va bene così! Stiamo cambiando il modo in cui costruisci i LEGO!

### **HALT!**

Sie werden möglicherweise bemerken, dass einige tüten durcheinander sind und teile übrig bleiben, aber das ist in Ordnung! Wir ändern die art und weise, wie Sie LEGO bauen!

### **¡ESPERA!**

Es posible que notes que algunas bolsas están fuera de servicio, así como piezas sobrantes, ¡pero está bien! ¡Estamos cambiando la forma en que construyes LEGO!

### **暫停!**

你可能会注意到一些袋子顺序错乱, 以及一些剩余的部件, 但没关系! 我们正在改变你搭建乐高的方式!

#### Open LMB Bag 04

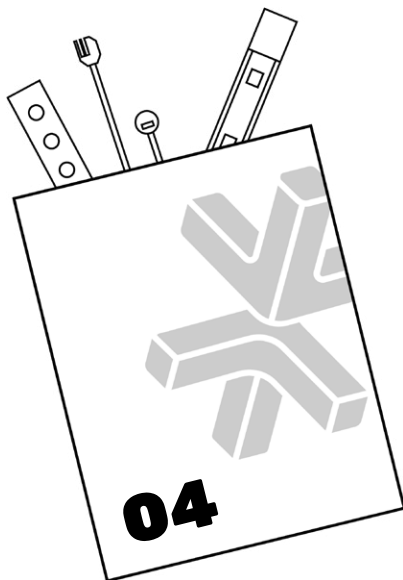

195

B-30

1x

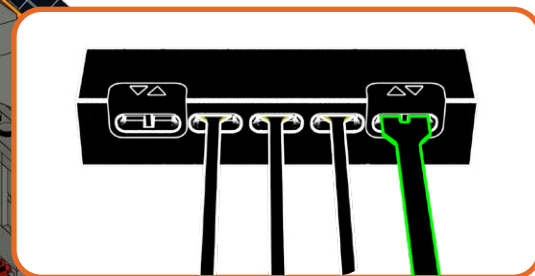
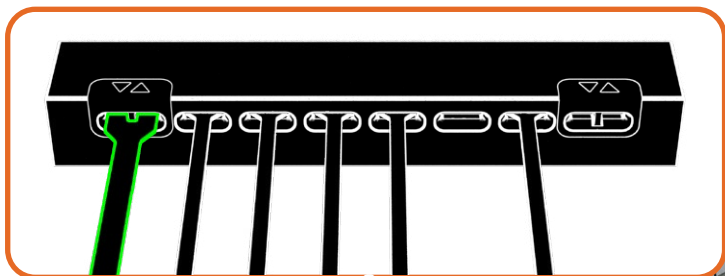
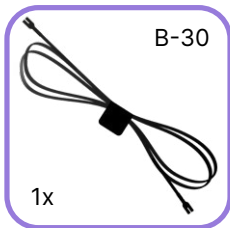

196

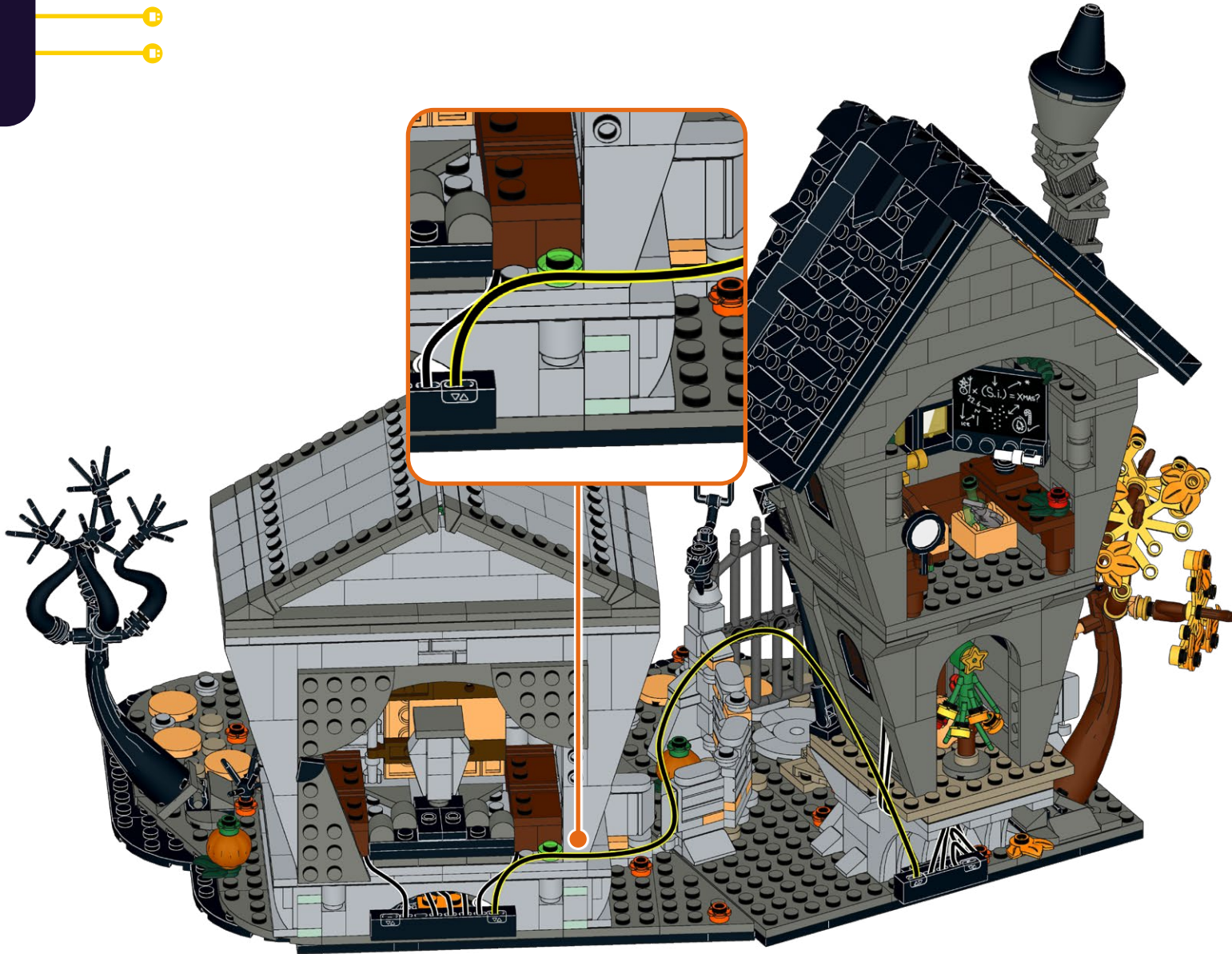

197





198

E-1x2

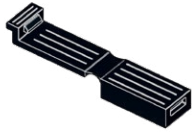

1x



199



200



201



202



203



204



205





206



207



208

E-1x2

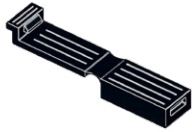

1x

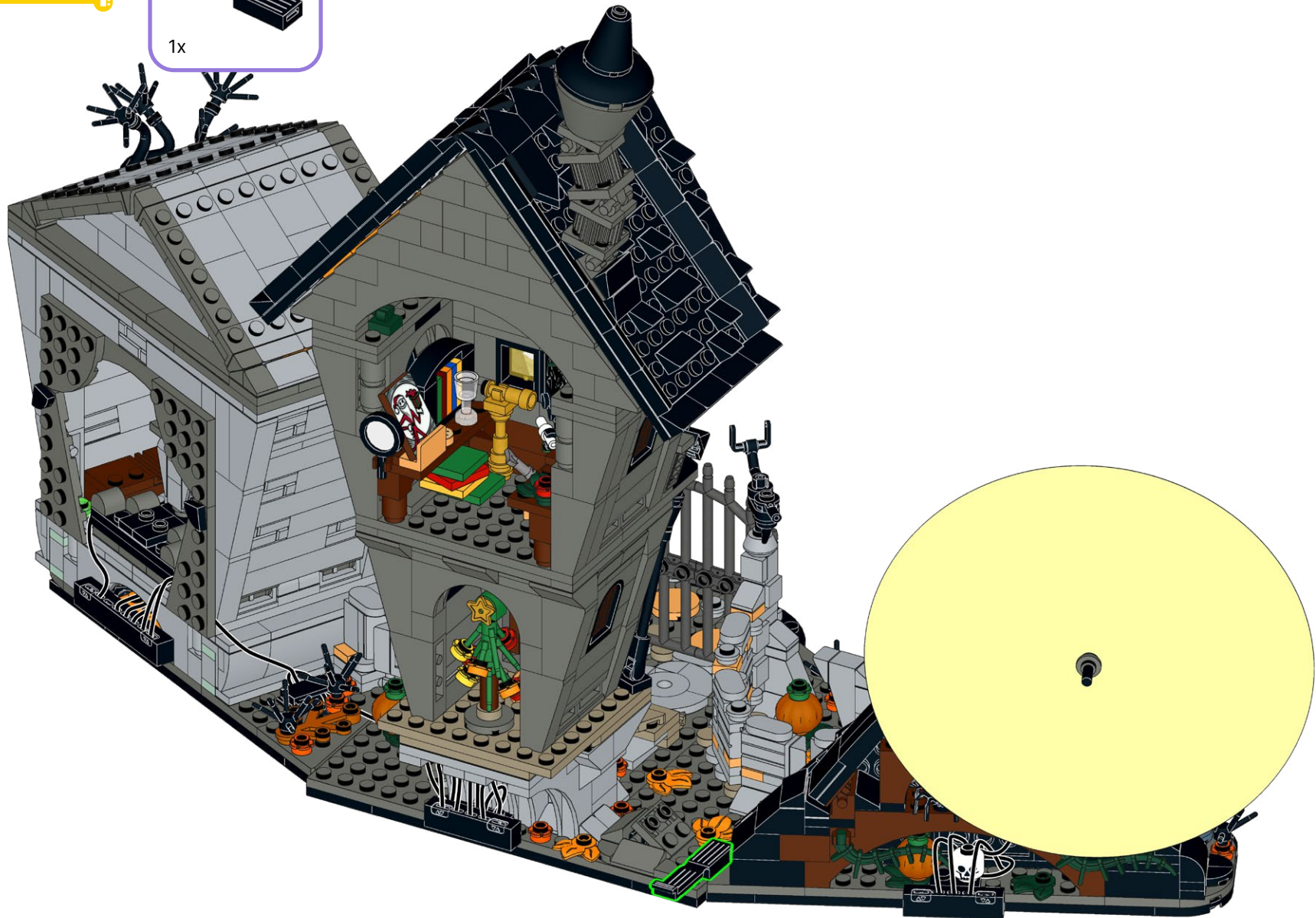

209

B-30

1x

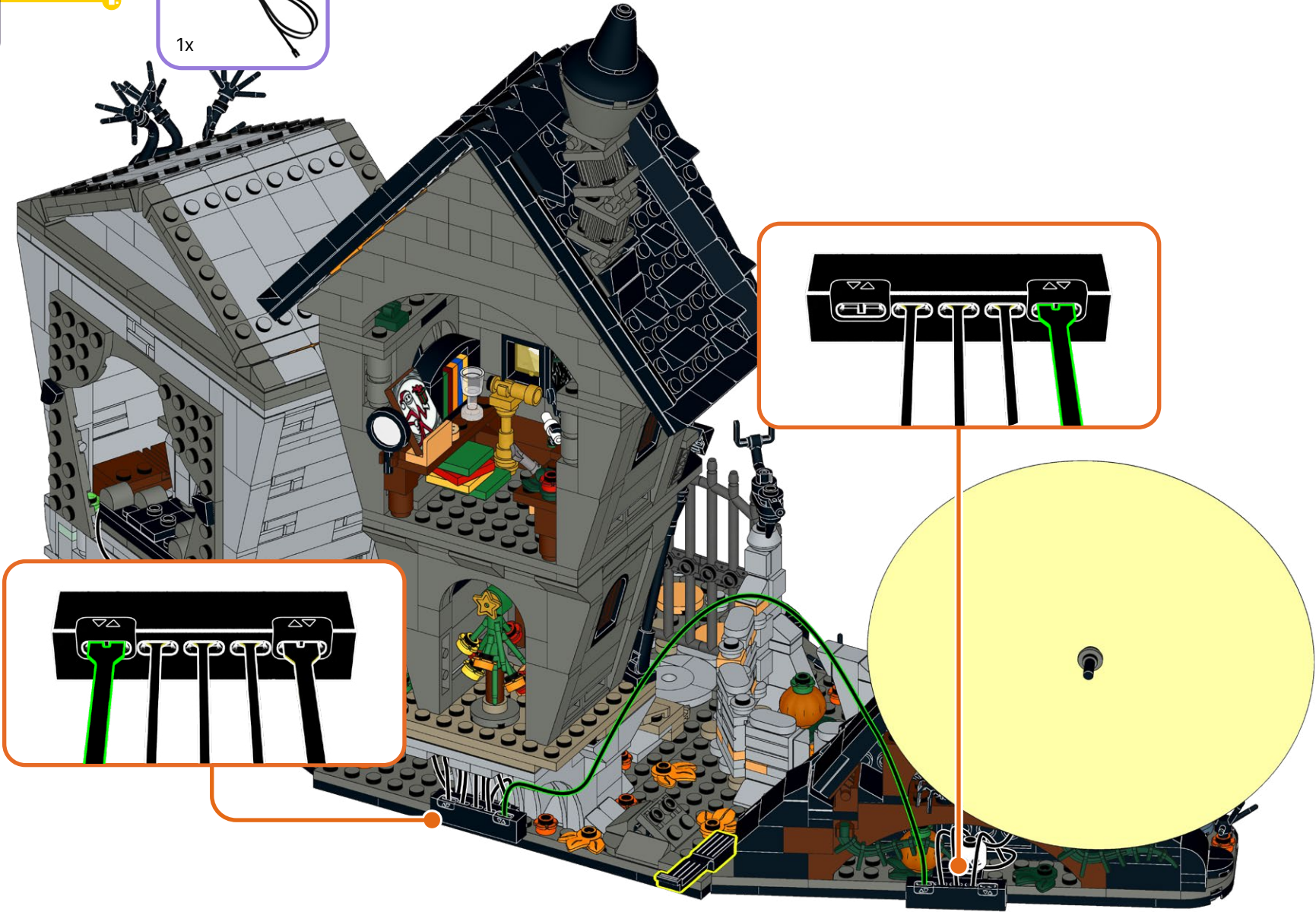

210

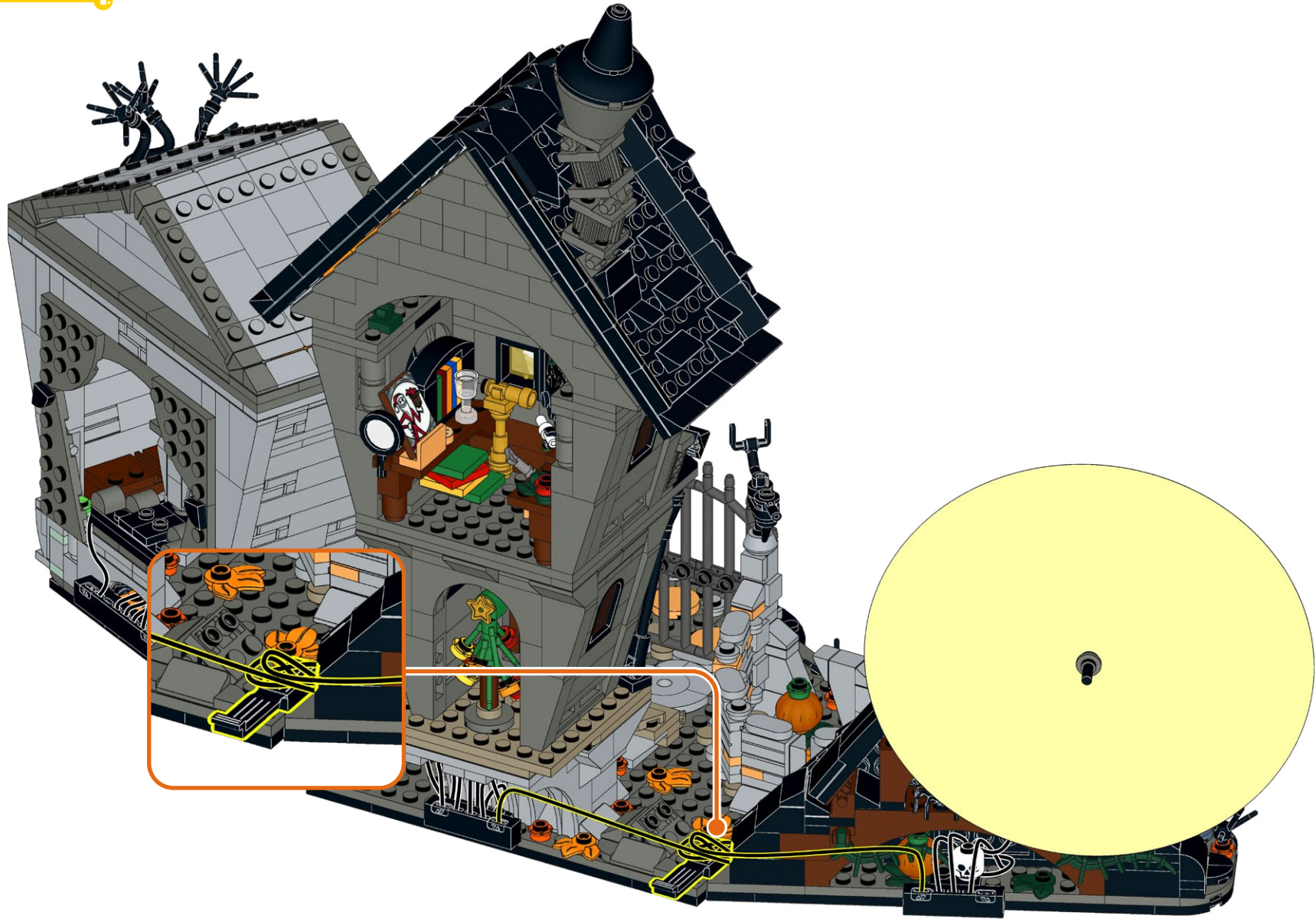

211



212



213

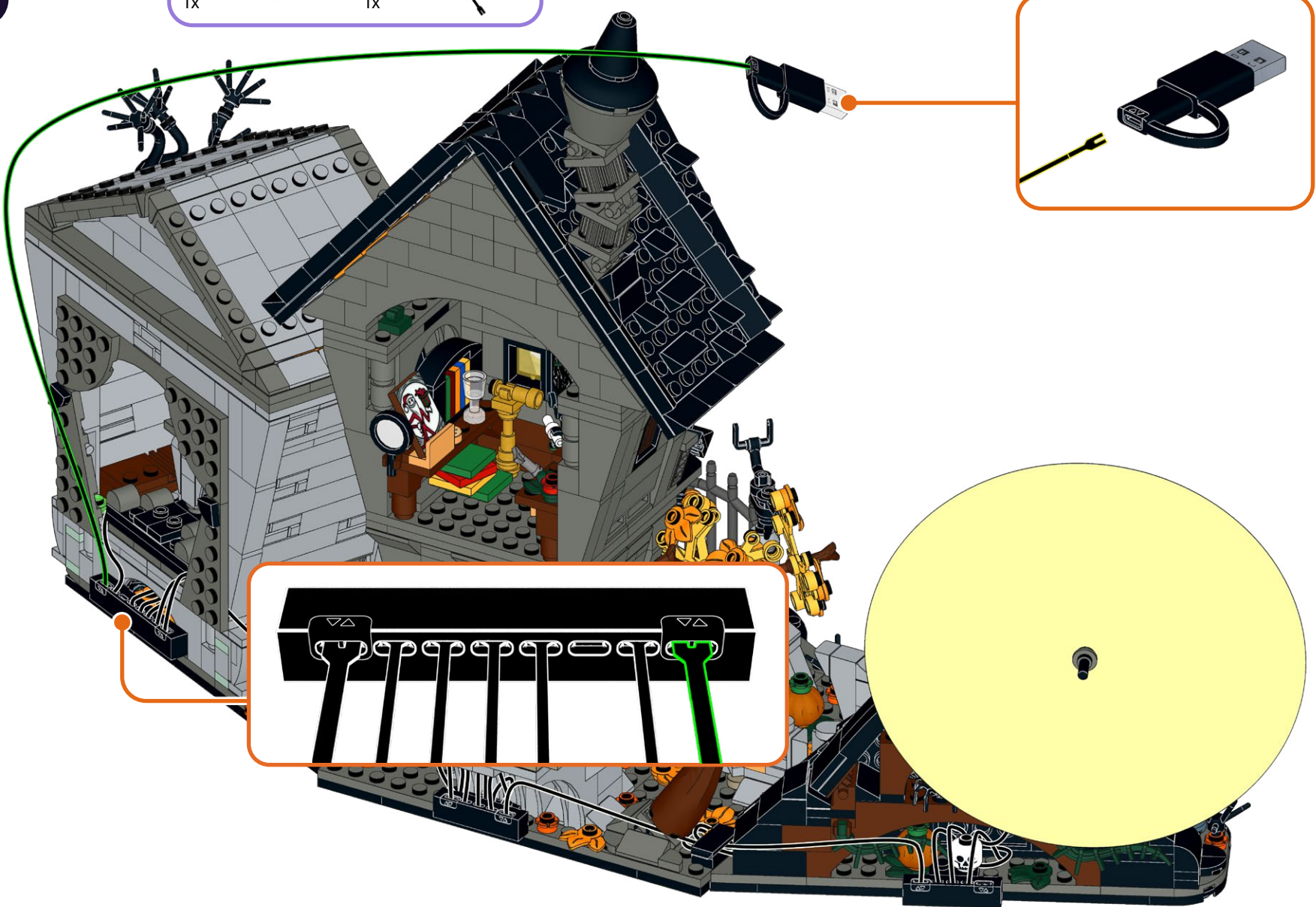
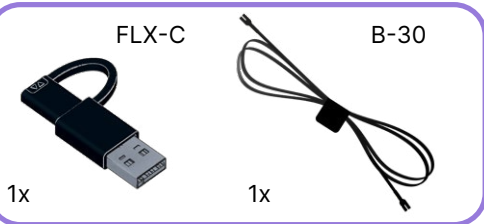



214



215



# FINAL PRODUCT



# PACKAGE CONTENTS



**4x** ARF-WW15  
Astro Light Regular  
Flickering Warm White 15cm



**1x** ALP-LG30  
Astro Light Large  
Pulse Light Green 30cm



**1x** FLX-C  
Flux Converter



**2x** AL-LG15  
Astro Light Large  
Light Green 15cm



**1x** SL-WW15  
Solar Light  
Warm White 15cm

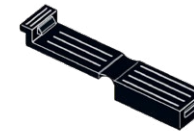

**2x** E-1x2  
Eclipse



**1x** AR-LG30  
Astro Light Regular  
Light Green 30cm



**3x** B-30  
Belt 30cm



**1x** AR-CW30  
Astro Light Regular  
Cool White 30cm



**1x** D-6  
6 Dock



**1x** AR-CW15  
Astro Light Regular  
Cool White 15cm



**2x** D-3  
3 Dock

# PACKAGE CONTENTS



**1x** Bracket 1 × 2 - 1 × 2  
Black

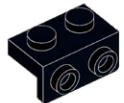

**1x** Bracket 1 × 2 - 1 × 2  
Inverted  
Black



**5x** Plate, Round 1×1 with  
Open Stud  
Black



**1x** 1 × 3L Bar  
Black

# CONTACT US

Click below for customer support, or general inquiries.

Cliquez ci-dessous pour accéder au support client ou aux renseignements généraux.

Clicca qui sotto per l'assistenza clienti o per richieste generali.

Contact Us



Contactez-nous



Contattaci



Klicken sie unten für kundensupport oder allgemeine anfragen.

Haga clic a continuación para atención al cliente o consultas generales.

点击下方获取客户支持或一般咨询。

Kontaktieren sie uns



Contáctanos



联系我们



## TROUBLESHOOTING

If you're stuck, scan the QR code for troubleshooting.

Se sei bloccato, scansiona il codice QR per la risoluzione dei problemi.

Wenn Sie nicht weiterkommen, scannen Sie den QR-Code zur Fehlerbehebung.

Si vous êtes bloqué, scannez le code QR pour le dépannage

Si está atascado, escanee el código QR para solucionar el problema.

如果遇到问题, 请扫描二维码进行故障排除

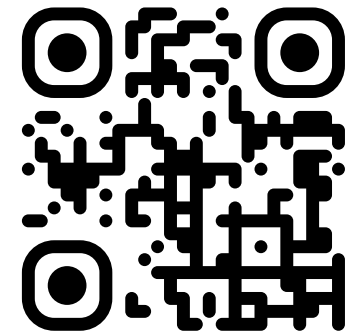



# LIGHT MY BRICKS

[lightmybricks.com](https://lightmybricks.com)



LEGO® is a trademark of the LEGO Group of companies, which does not sponsor, authorize or endorse this product. All LEGO® sets featured in images are sold separately. This is not a LEGO® product. The LEGO Group is not liable for any loss, injury or damage arising from the use or misuse of this product. ©2024 Light My Bricks Pty Ltd. All rights reserved. [www.lightmybricks.com](https://www.lightmybricks.com)

Our components are designed and packaged in Australia by Light My Bricks Pty Ltd. Components are manufactured in China. 3fl bldg C, Shuanghuan Quanxin Technology Information Industry Park Baolong Street, Longgang District, Shenzhen, China. Imported in Australia by Light My Bricks Pty Ltd, 5/26 Rushdale St, Knoxfield, VIC, 3180, Australia.

WARNING: CHOKING HAZARD - Small parts. Not for children under 3 years.

AVERTISSEMENT : RISQUE D'ÉTOUFFEMENT - Petites pièces. Ne convient pas aux enfants de moins de 3 ans.

ATTENZIONE: PERICOLO DI SOFFOCAMENTO - Piccole parti. Non adatto a bambini di età inferiore a 3 anni.

WARNUNG: ERSTICKUNGSGEFAHR - Kleine Teile. Nicht für Kinder unter 3 Jahren geeignet.

ADVERTENCIA: PELIGRO DE ASFIXIA - Piezas pequeñas. No son apto para niños menores de 3 años.

警告：窒息危險 - 小零件。不适合3岁以下儿童。