

# LIGHT KIT INSTALLATION GUIDE

**TALES OF THE  
SPACE AGE**

FOR LEGO  
SET  
#21340

# CONTENTS



## 03

### Getting Started

- 04 Legend
- 05 Component Handling
- 06 Blueprint

## 07

### Instructions

- 07 LEGO Bag 1 - LMB Bag 01
- 35 LEGO Bag 2
- 58 LEGO Bag 3 - LMB Bag 02
- 81 LEGO Bag 4
- 106 LEGO Bag 5 - LMB Bag 03
- 133 LEGO Bag 6
- 162 LEGO Bag 7 - LMB Bag 04
- 184 LEGO Bag 8

## 212

### Final Product

- 216 Package Contents
- 218 Contact & Troubleshooting

# GETTING STARTED

Bold, beautiful and bright, Light My Bricks elevates your favourite LEGO set from knick-knack to statement piece. Create a talking point at home or in the office that speaks to your passions with Light My Bricks. To learn more, click below.

[Learn More](#)



Audacieux, beau et lumineux, Light My Bricks élève votre ensemble LEGO préféré du statut de bibelot à celui de pièce maîtresse. Que ce soit à la maison ou au bureau, partagez votre passion des LEGO avec Light My Bricks. Cliquez ci-dessous pour en savoir plus.

[En savoir plus](#)



Audace, bello e luminoso, Light My Bricks eleva il tuo set LEGO preferito da soprammobile a pezzo di tendenza. Crea un punto di discussione a casa o in ufficio che parli alle tue passioni con Light My Bricks. Per saperne di più, clicca qui sotto.

[Ulteriori Informazioni](#)



Mutig, schön und hell – Light My Bricks verwandelt Ihr Lieblings-LEGO-Set von einem schnickschnack in ein statement-stück. Schaffen sie einen gesprächspunkt zu hause oder im büro, der Ihre leidenschaften widerspiegelt, mit Light My Bricks. Um mehr zu erfahren, klicken sie unten.

[Mehr erfahren](#)



Audaz, hermoso y brillante, Light My Bricks eleva tu set LEGO favorito de una chuchería a una pieza llamativa. Crea un tema de conversación en casa o en la oficina que hable de tus pasiones con Light My Bricks. Para obtener más información, haga clic a continuación.

[Más información](#)



大胆、美丽而明亮，Light My Bricks 将你喜爱的乐高套装从小摆件提升为引人注目的装饰品。在家或办公室打造一个能表达你激情的话题，了解更多，请点击下方。

[了解更多](#)



# LEGEND

## Rotate Set



Retournez L'ensemble  
Ruota Set  
Set Drehen  
Rotar Conjunto  
旋转套件

## Add Part



Ajoutez une Pièce  
Aggiungi Parte  
Teil Hinzufügen  
Agregar Pieza  
添加零件

## Click



Cliquez  
Clic  
Klicken  
Clic  
点击

## Pinch/Fold



Pincez/Pliez  
Pizzicare/Piegare  
Kneifen/Falten  
Pellizcar/Doblar  
折叠

## Pull Cable



Tirez le Cable  
Tirare il Cavo  
Kabel Ziehen  
Tirar del Cable  
拉动电缆

## Repeat Step



Répétez  
Ripetere  
Wiederholen  
Repetir  
重复

## Sticker



Autocollant  
Adesivo  
Aufkleber  
Pegatina  
贴纸

## Power On Test



Test de mise sous tension  
Test di Potenza  
Stromtest  
Prueba de Energía  
电源测试

## Disconnect Power

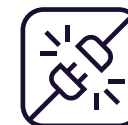

Débranchez L'alimentation  
Scollegare L'alimentazione  
Strom Trennen  
Desconectar la Energía  
断开电源

## Troubleshoot



Dépanner  
Risolvere  
Fehlerbehebung  
Solución de Problemas  
故障排除

# COMPONENT HANDLING

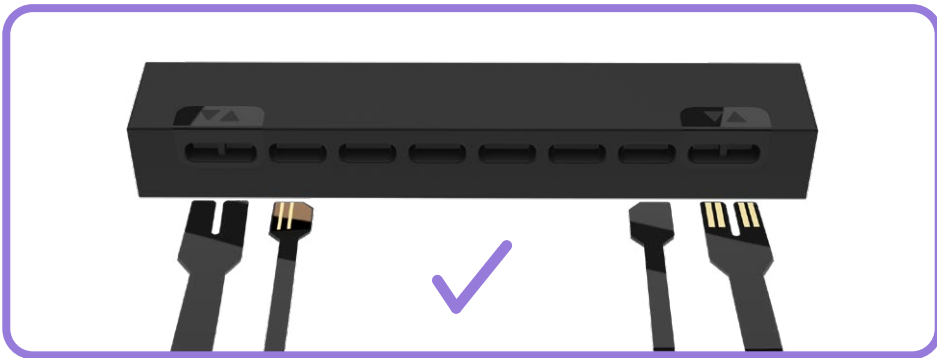
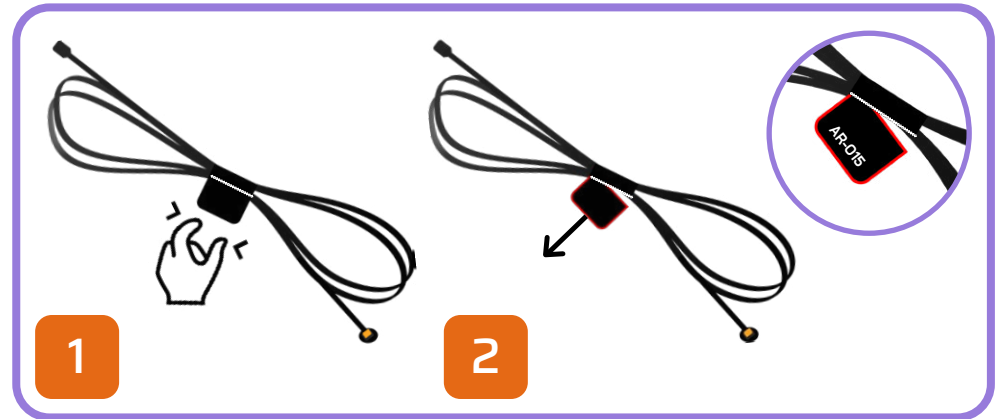
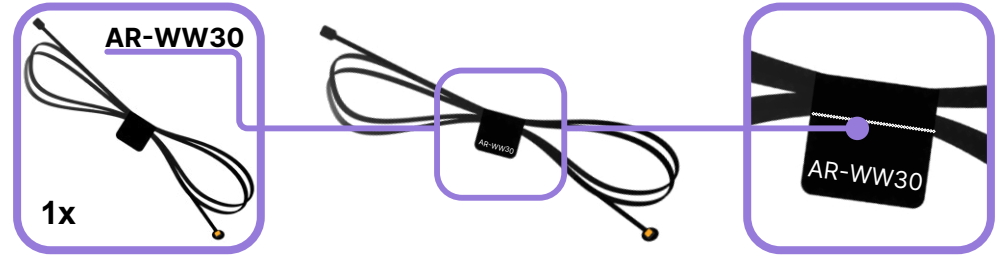
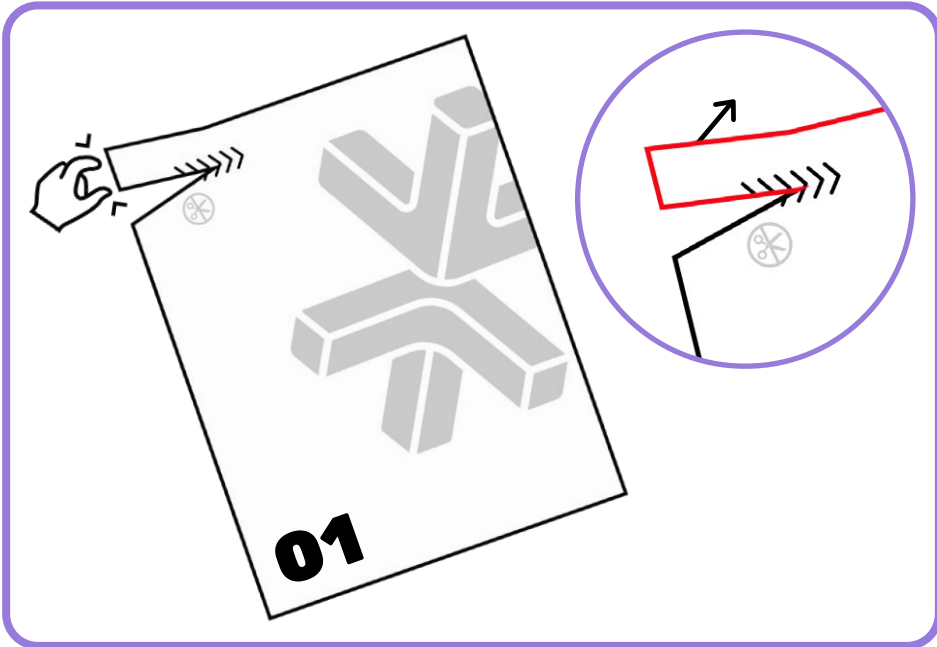

# BLUEPRINT

Comet

(banner spotlight)  
AL-B15

(banner spotlight)  
ALF-015



B-15

Eclipse

(banner spotlight)  
AL-015



(banner spotlight)  
2x AR-CW30



B-15

Rocket

(banner spotlight)  
AL-P15



(banner spotlight)  
AR-WW15



(banner spotlight)  
ARF-WW15



B-15

Black Hole

(banner spotlight)  
AL-G15



(banner spotlight)  
2x AR-CW15



FLX-B30

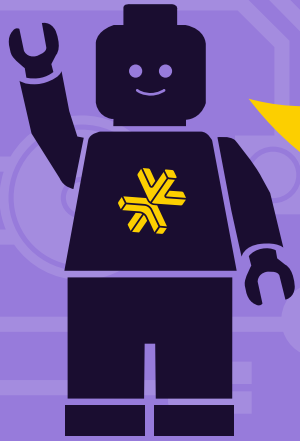

### **HOLD UP!**

You might notice some bags aren't in order, as well as left over pieces, but that's ok! We're changing the way you build LEGO!

### **ATTENDEZ!**

Vous remarquerez peut-être que certains sacs, ainsi que certaines pièces, ne sont pas dans le bon ordre. Mais pas de panique! Nous changeons simplement la façon avec laquelle vous construisez vos LEGO!

### **ASPETTA!**

Potresti notare che alcuni sacchetti non sono in ordine, così come i pezzi avanzati, ma va bene così! Stiamo cambiando il modo in cui costruisci i LEGO!

### **HALT!**

Sie werden möglicherweise bemerken, dass einige tüten durcheinander sind und teile übrig bleiben, aber das ist in Ordnung! Wir ändern die art und weise, wie Sie LEGO bauen!

### **¡ESPERA!**

Es posible que notes que algunas bolsas están fuera de servicio, así como piezas sobrantes, ¡pero está bien! ¡Estamos cambiando la forma en que construyes LEGO!

### **暫停!**

你可能会注意到一些袋子顺序错乱, 以及一些剩余的部件, 但没关系! 我们正在改变你搭建乐高的方式!

#### Open LEGO® Bag 1

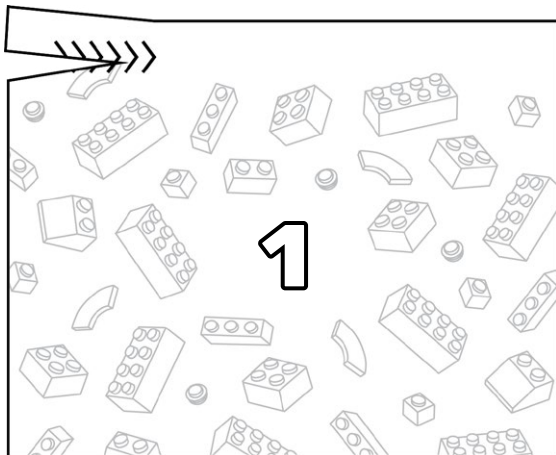

#### Open LMB Bags 01

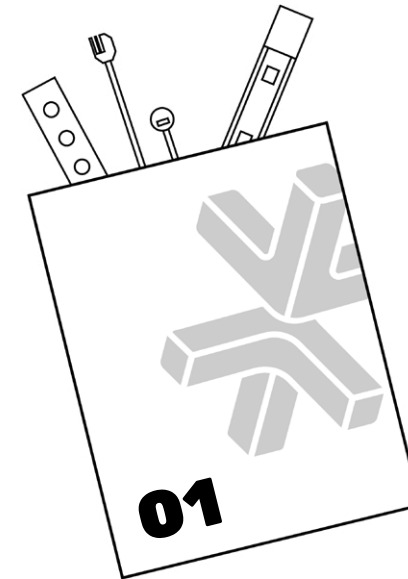

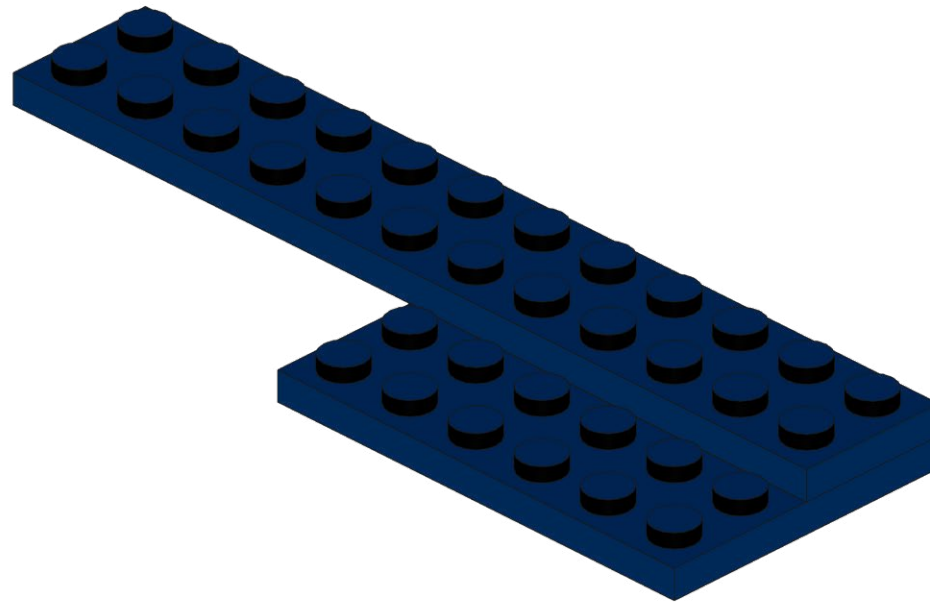
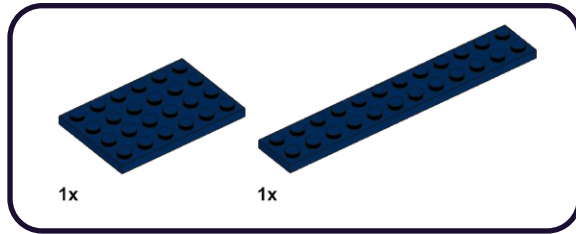



2

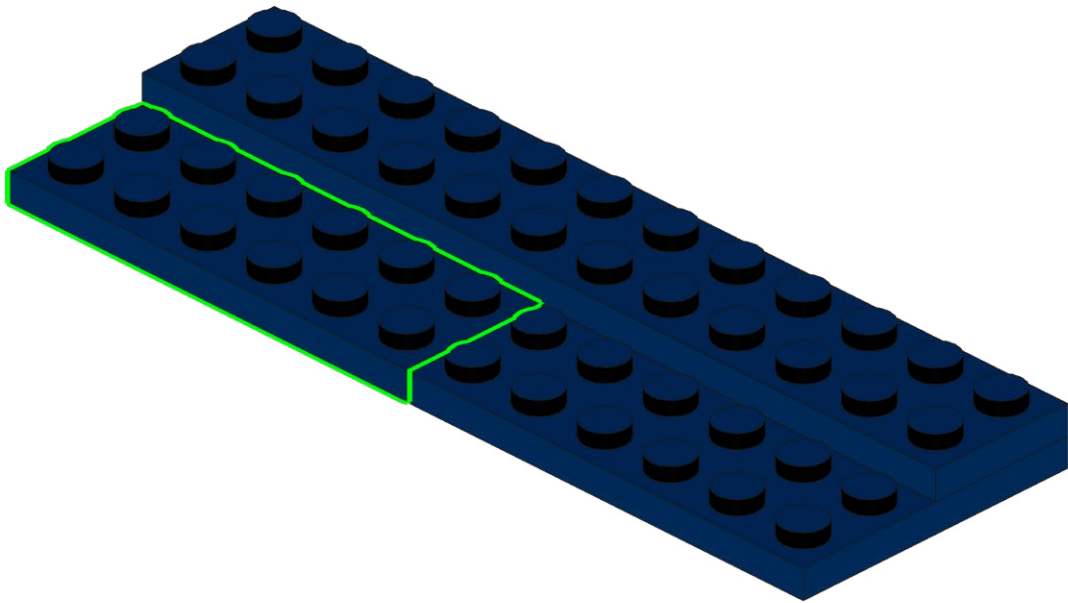
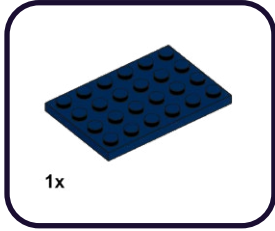

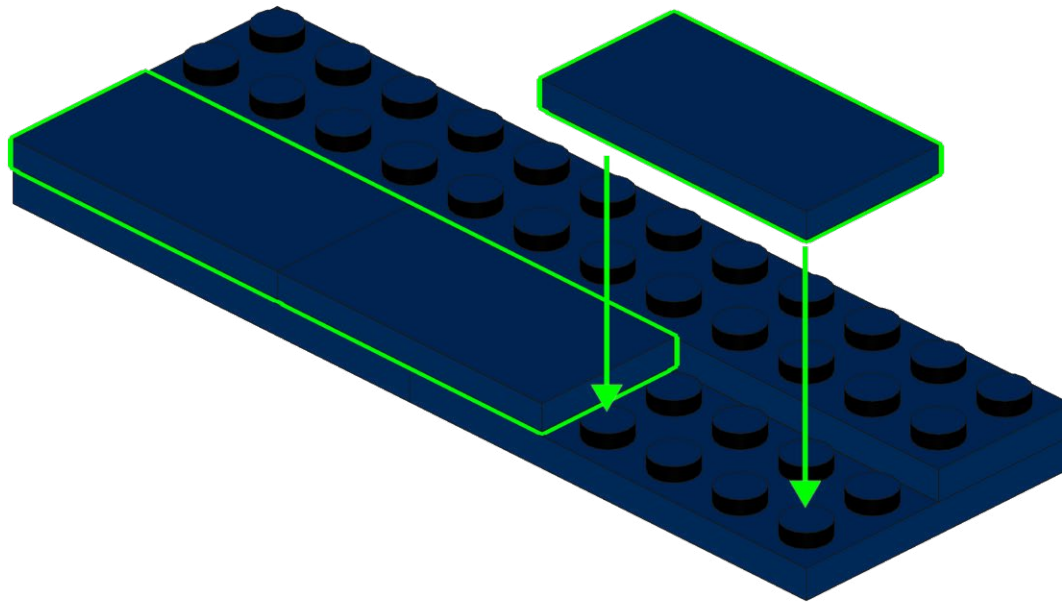
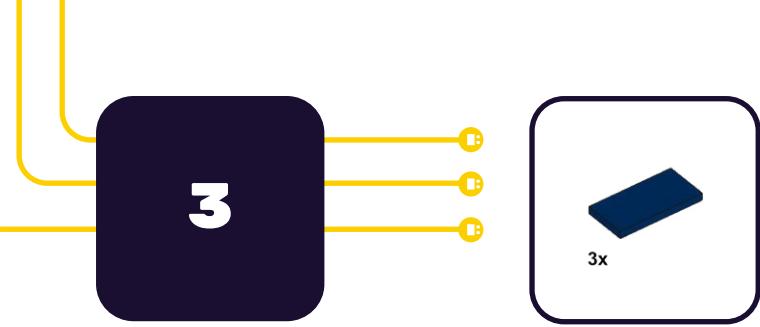

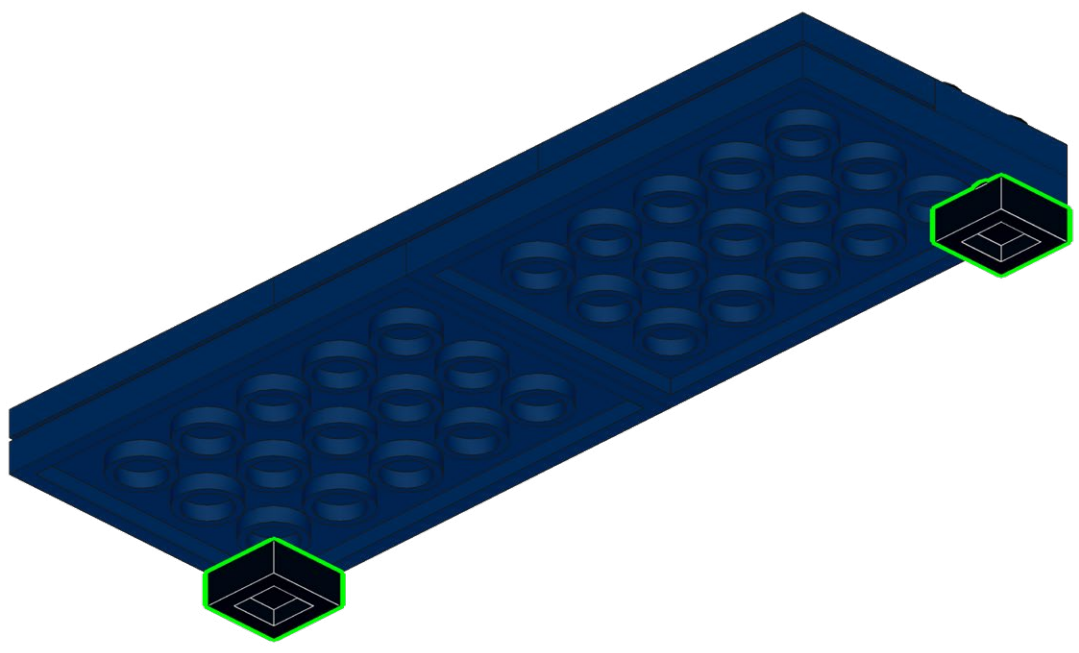
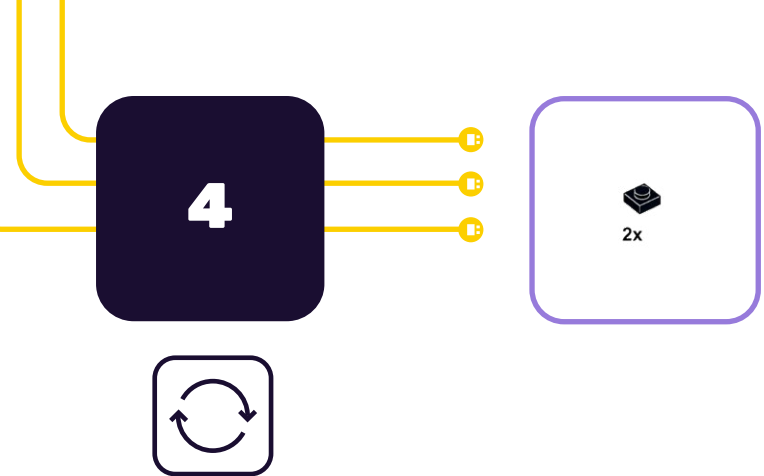

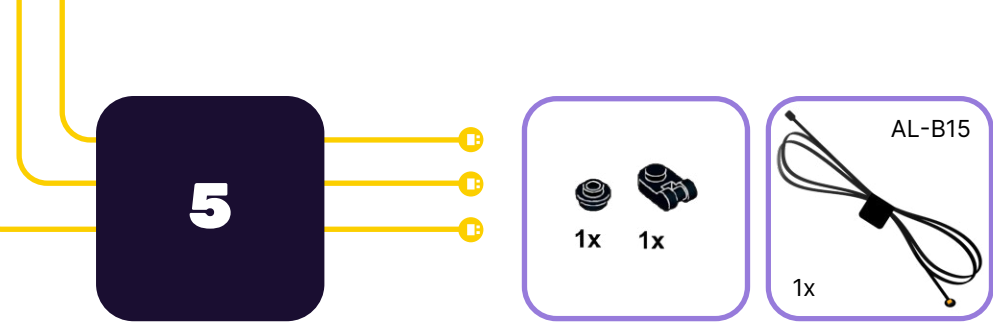

1



2



3

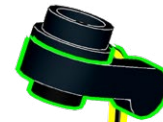

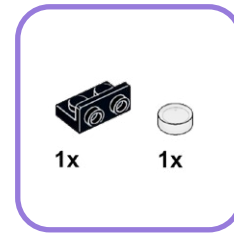
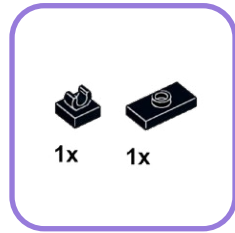
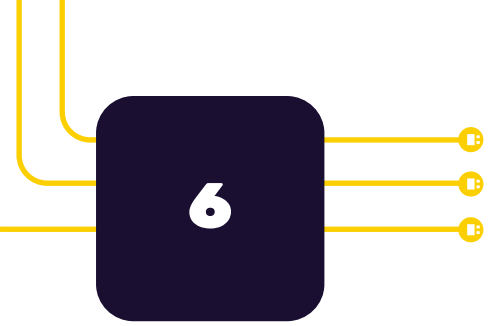

1

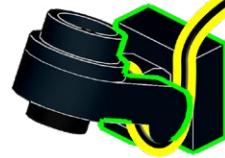

3

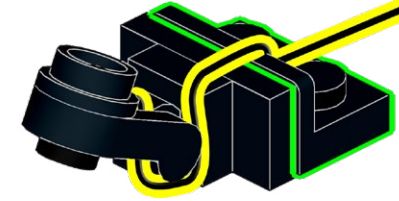

2

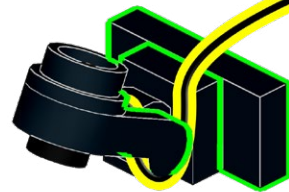

4

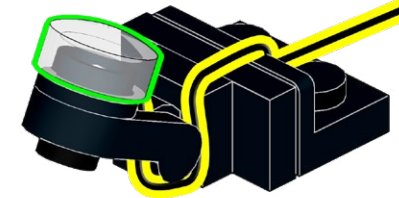

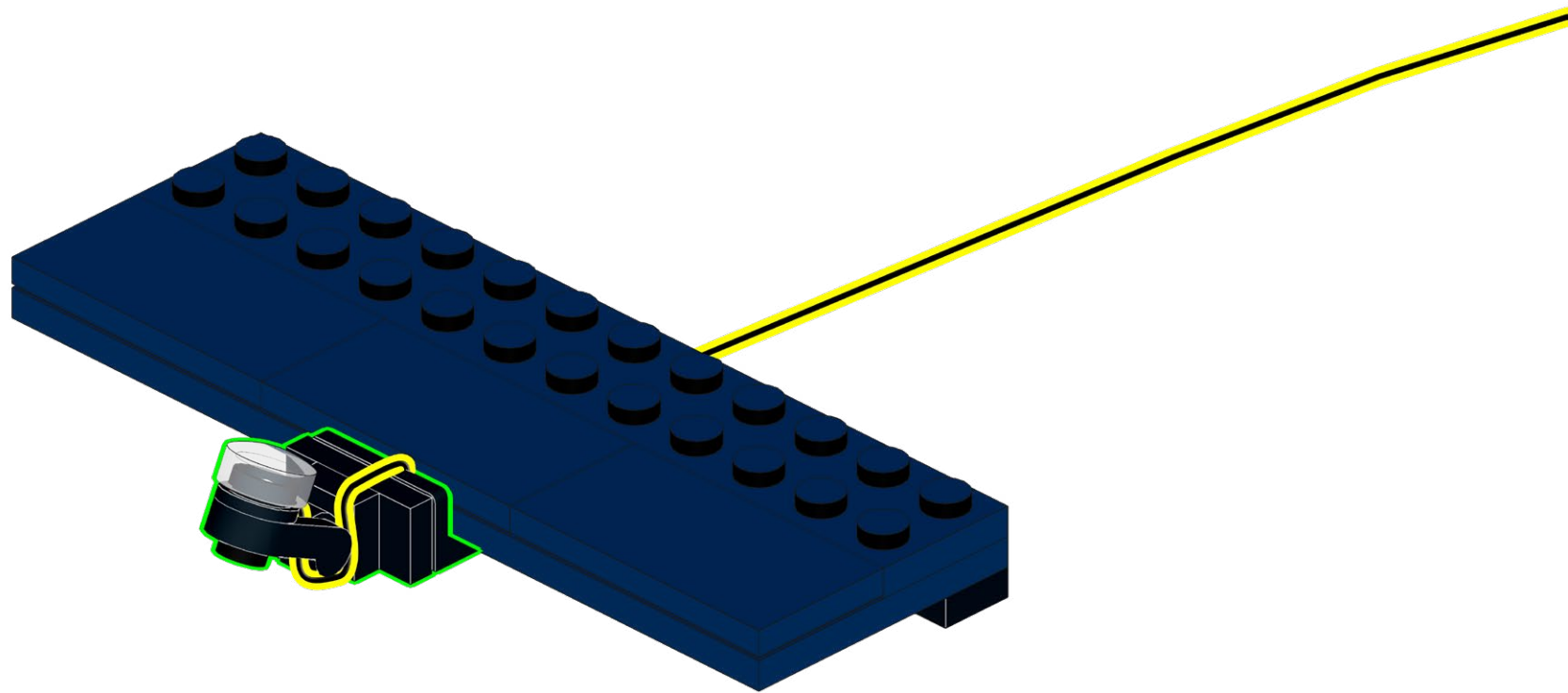

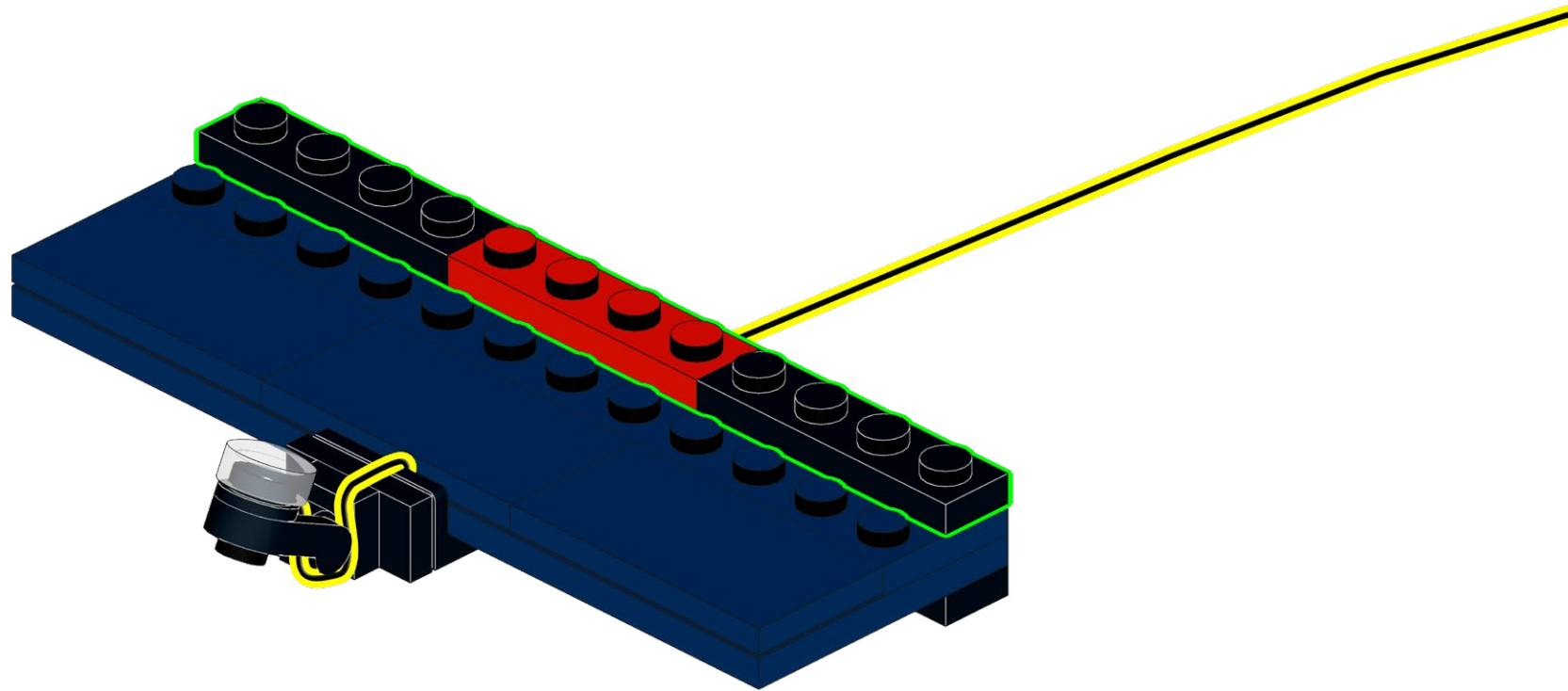
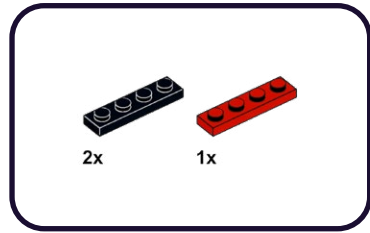
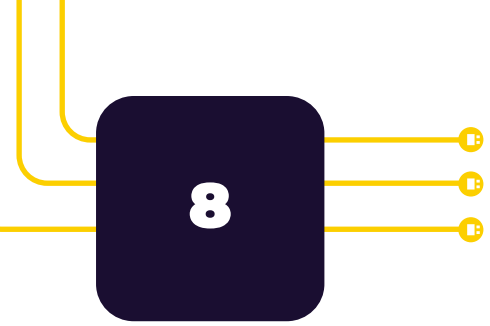

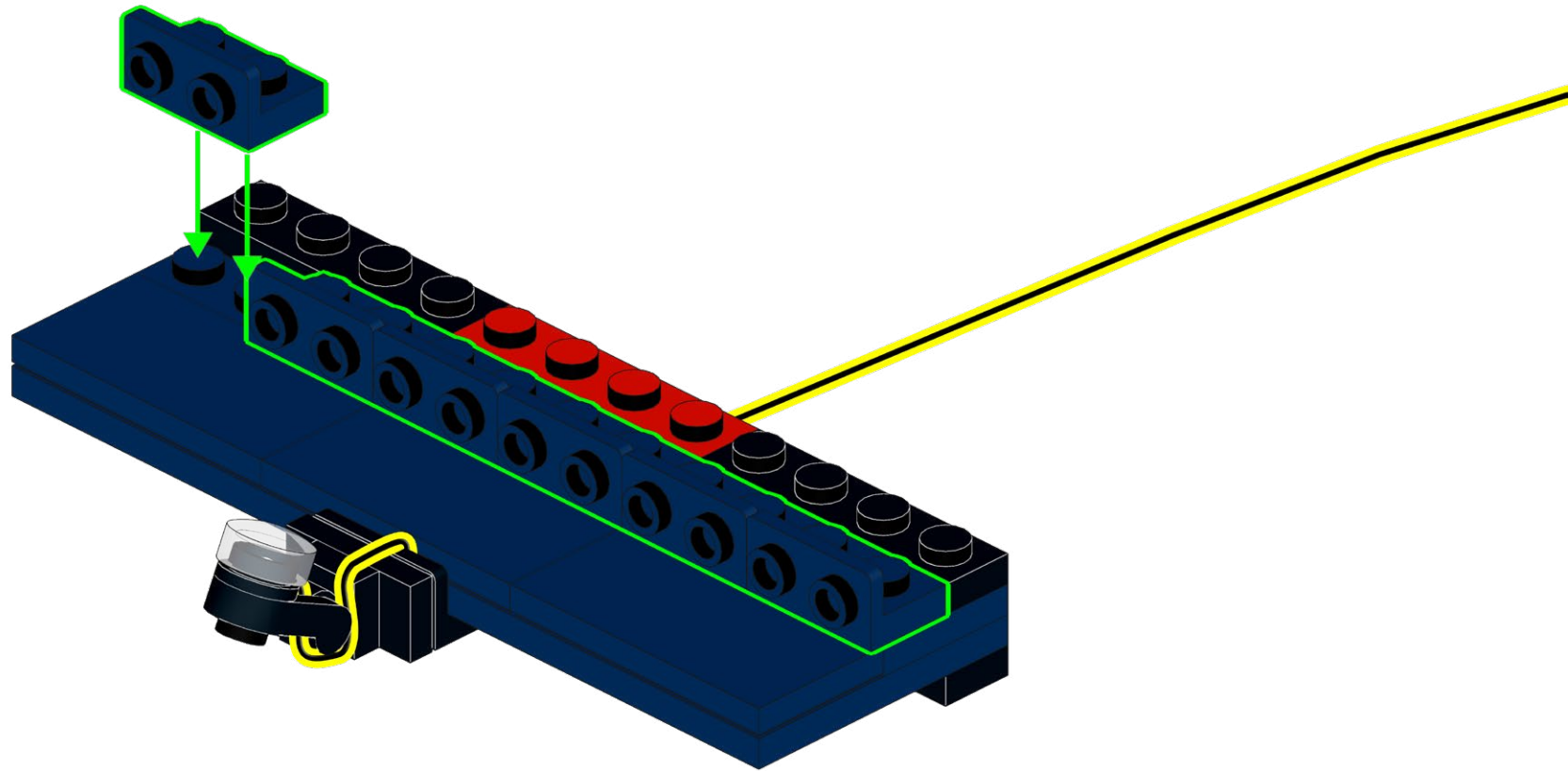
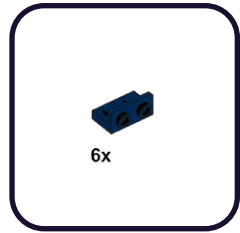
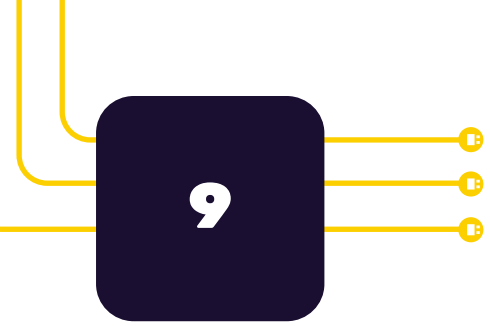



10



2x



1x

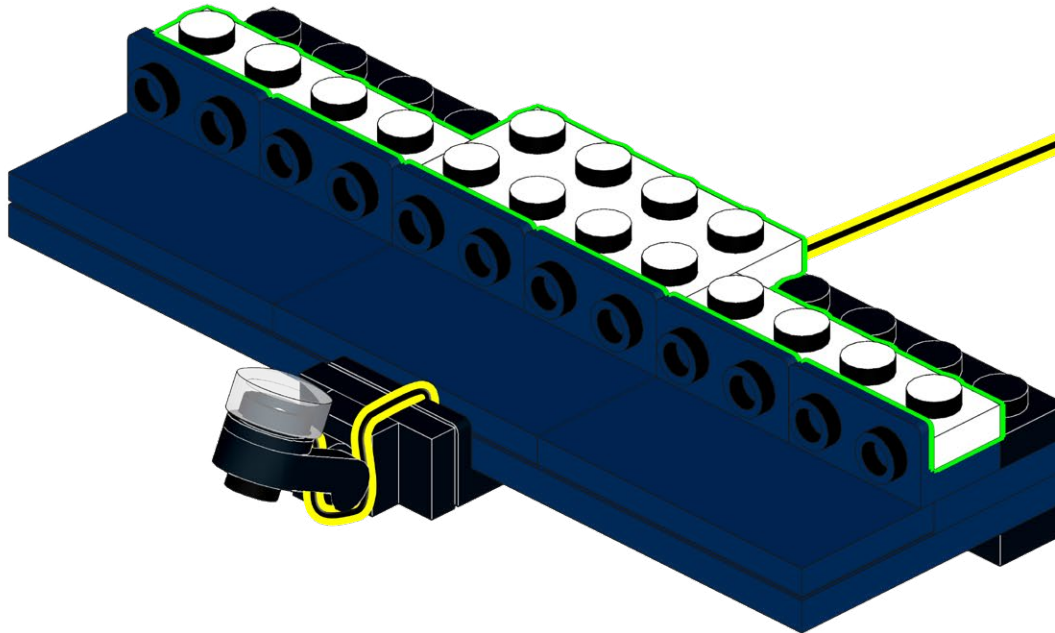

11

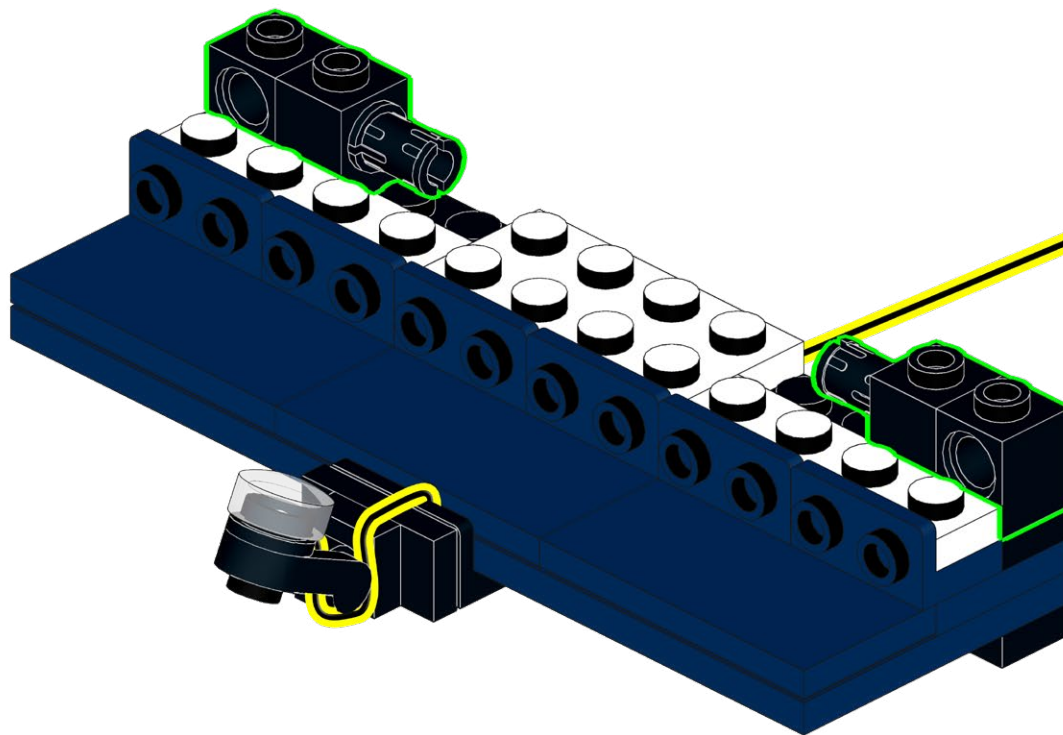
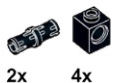

12

2x

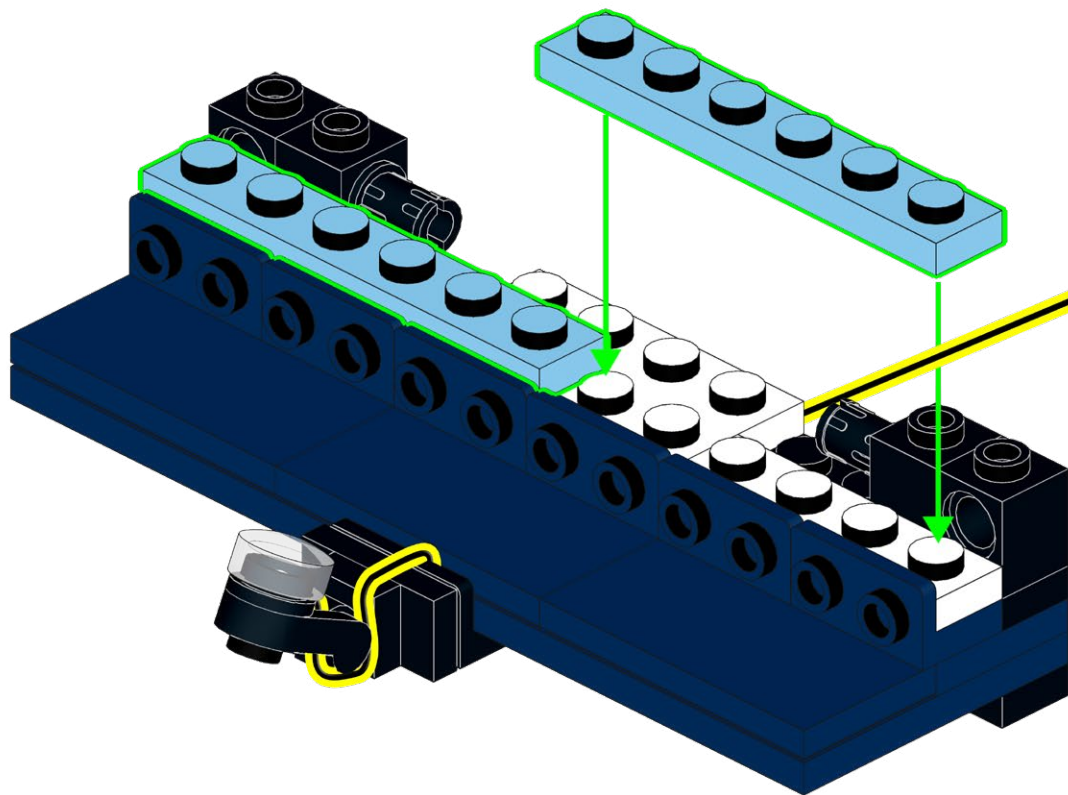
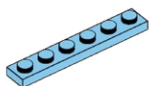

13

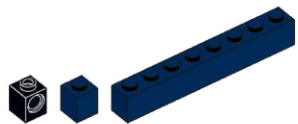

2x 2x 1x

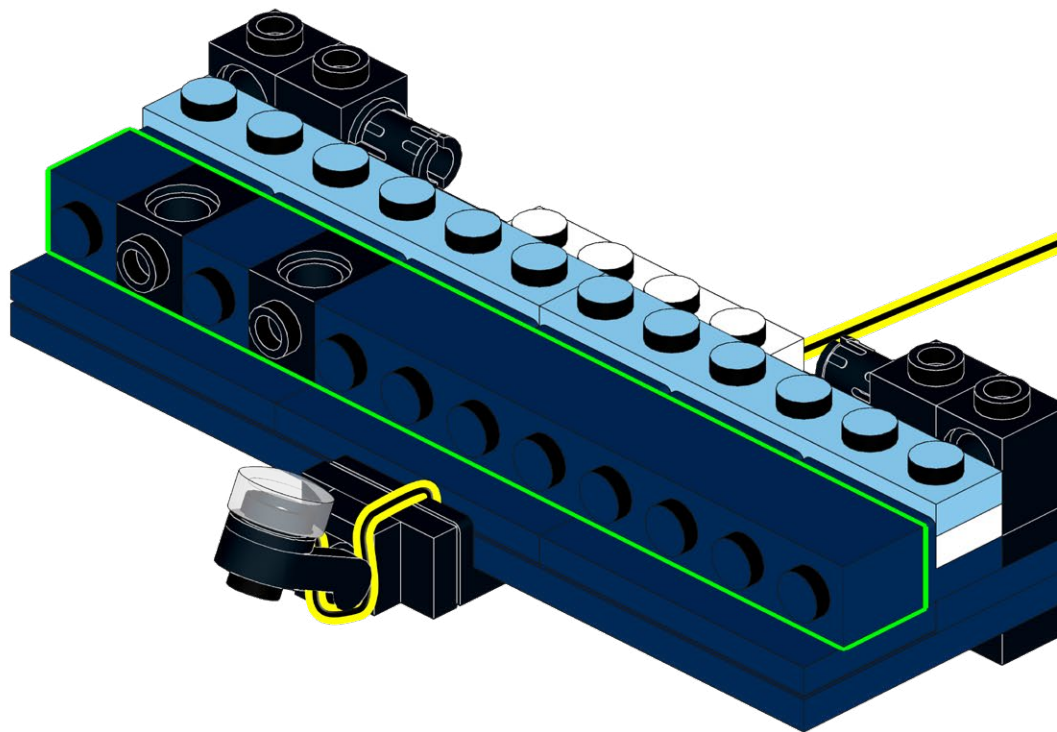

14

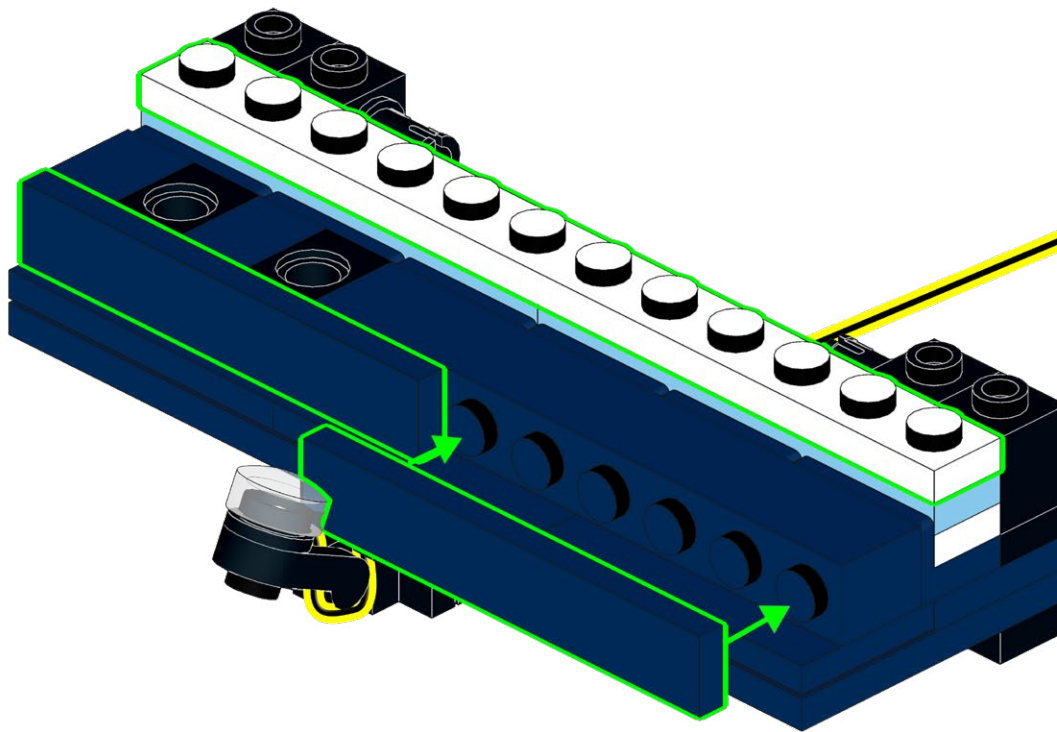
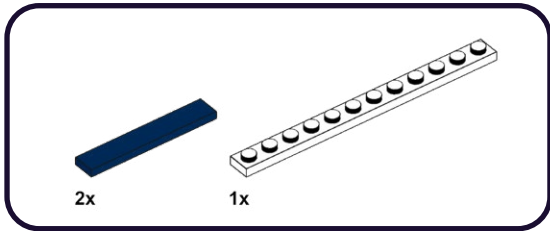

15

3x

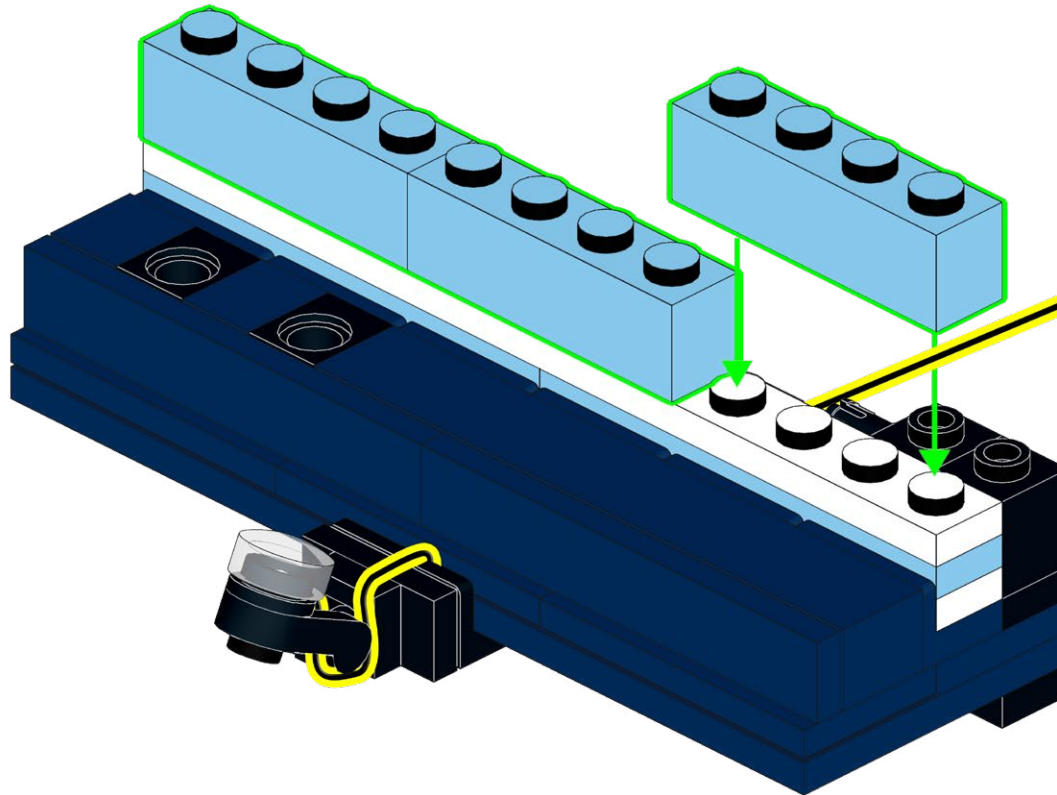

16

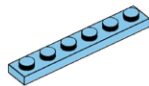

2x

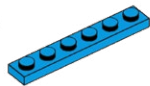

2x

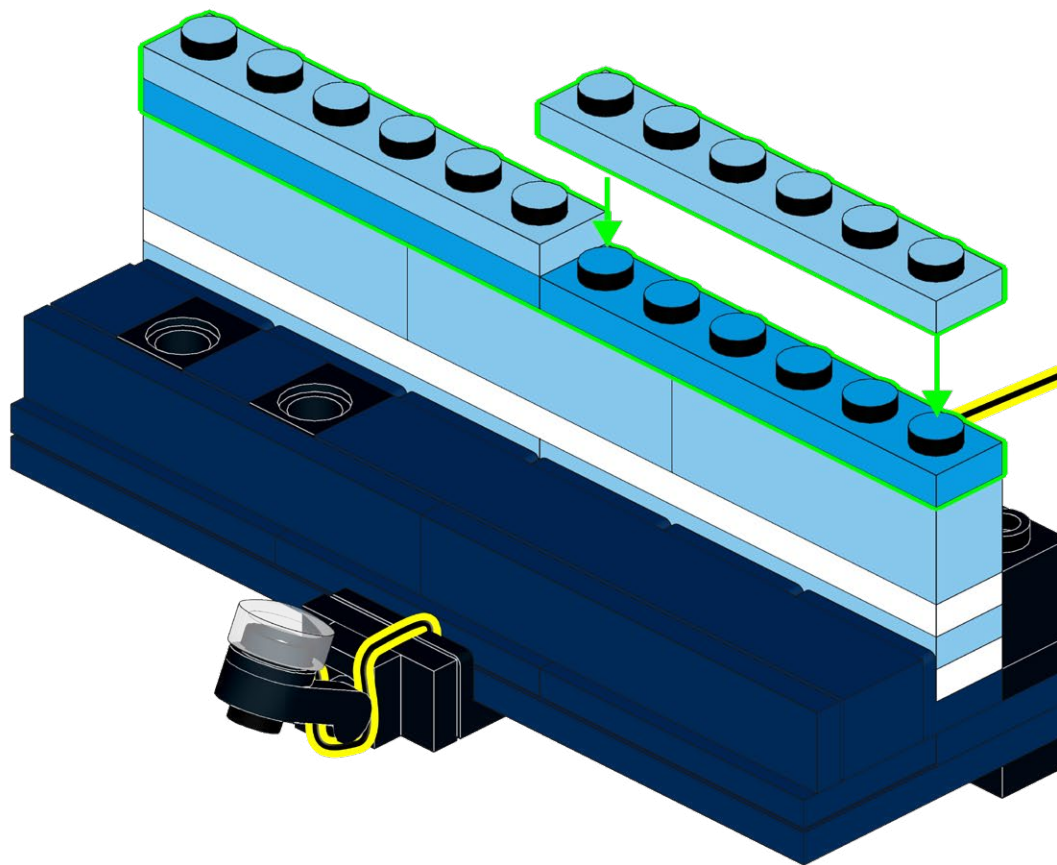

17

3x

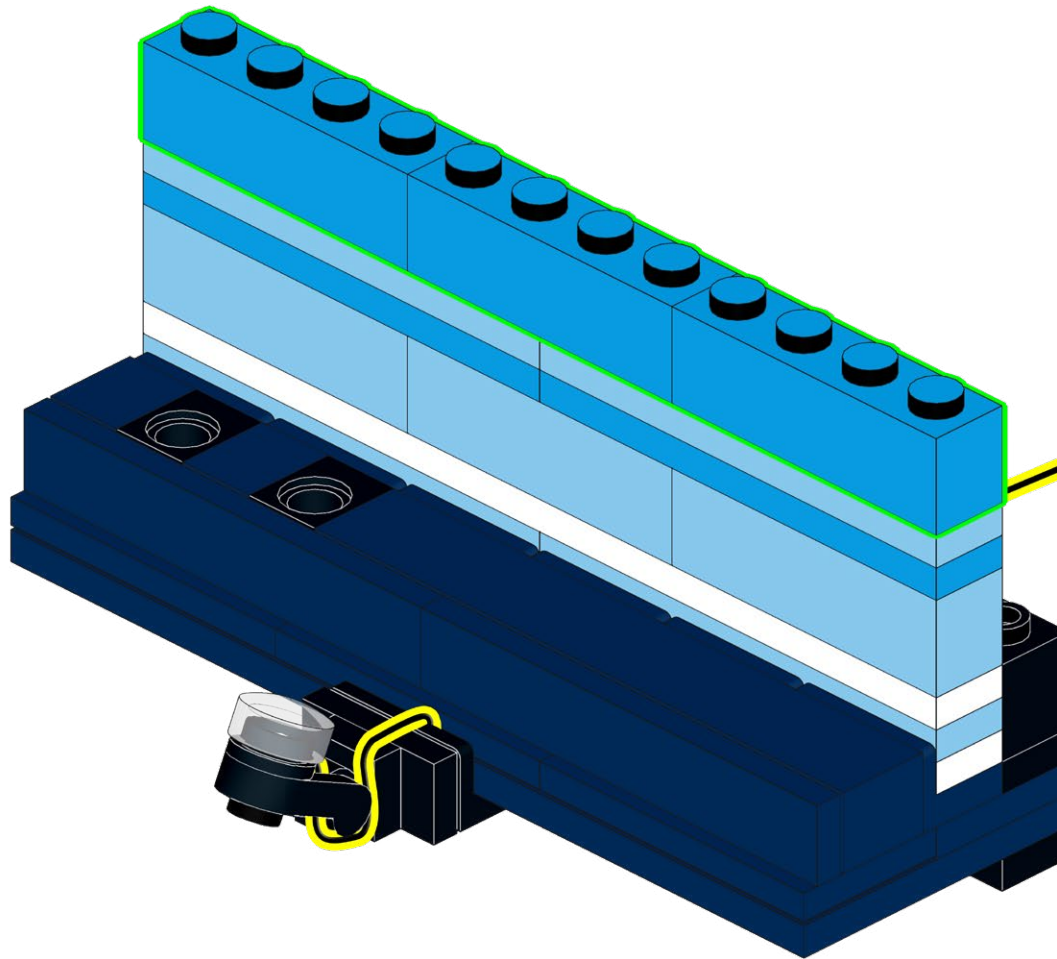



18



2x

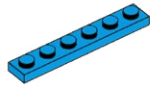

2x

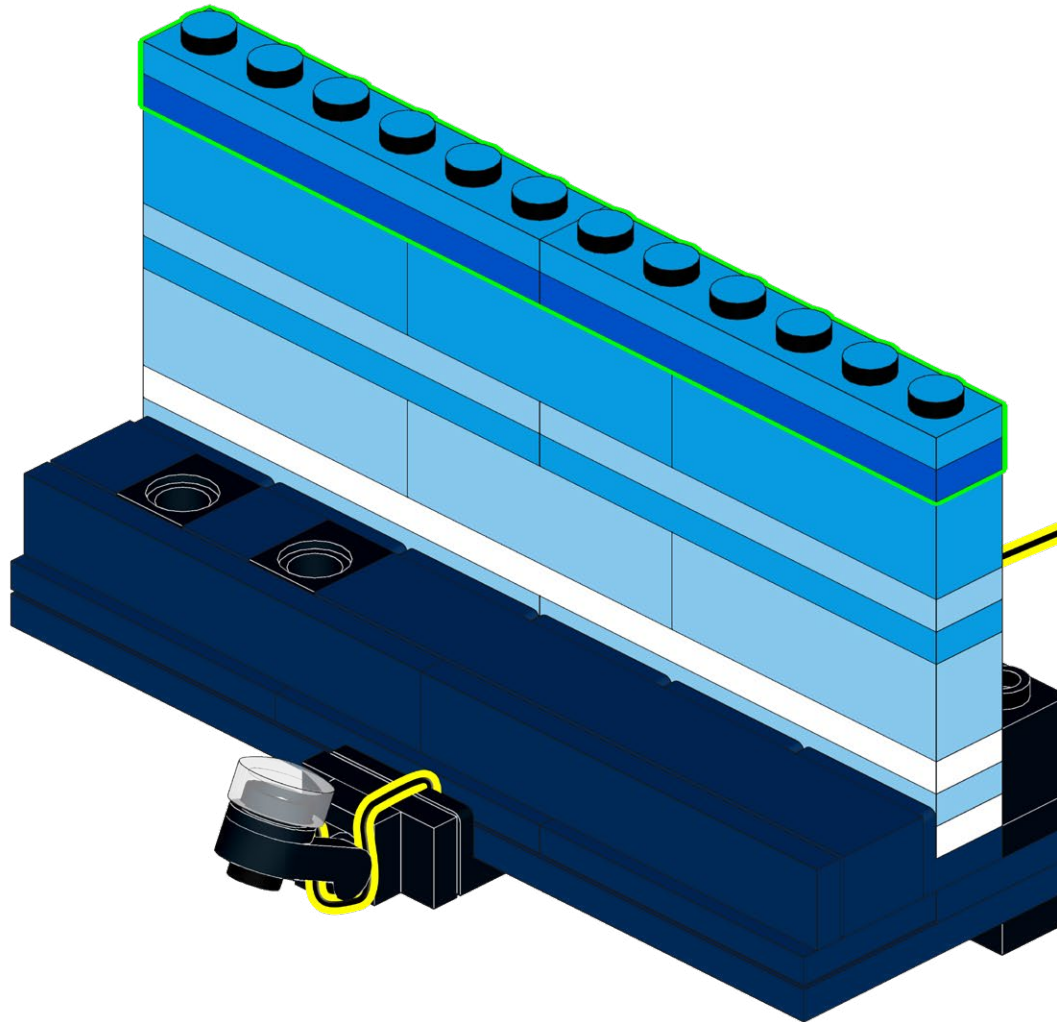

19

3x

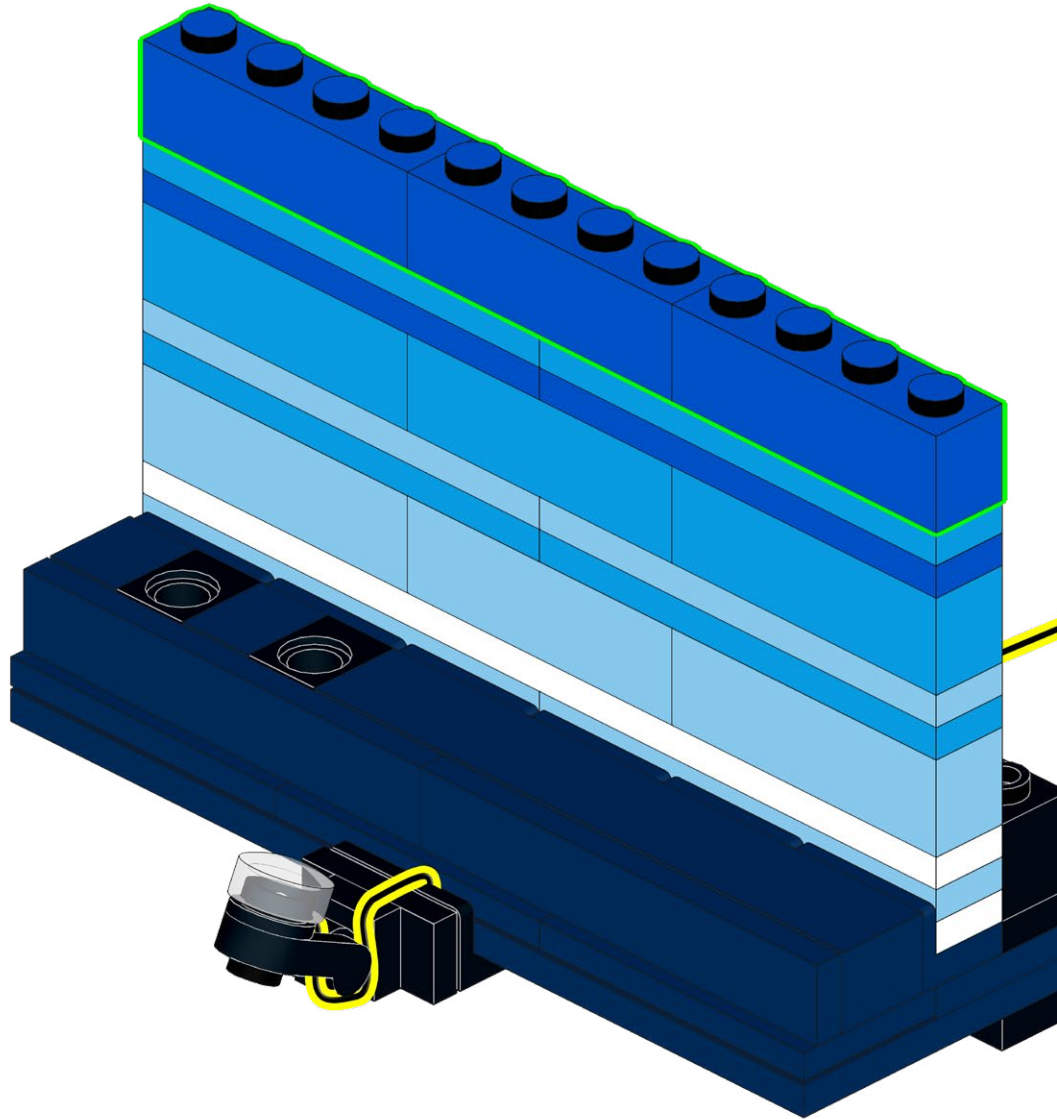

20

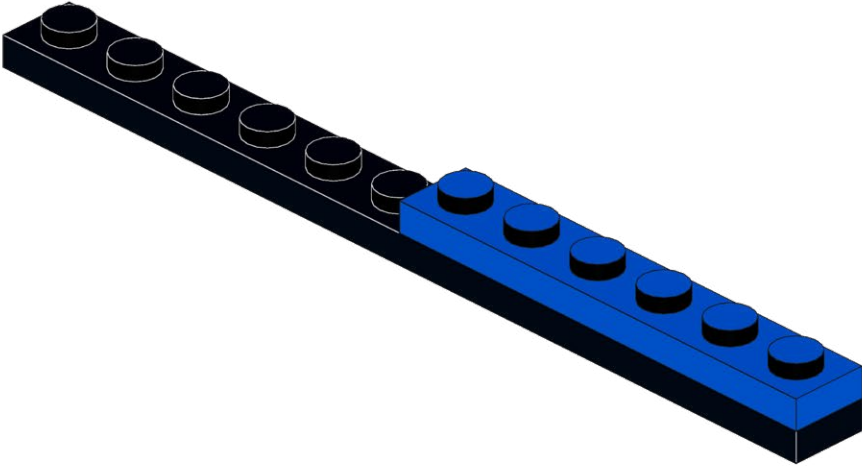
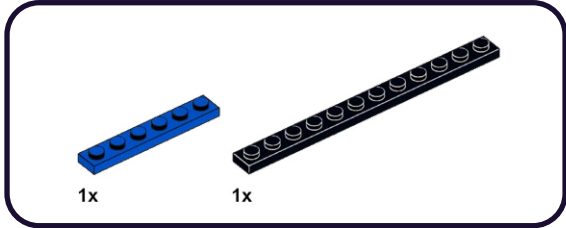

21

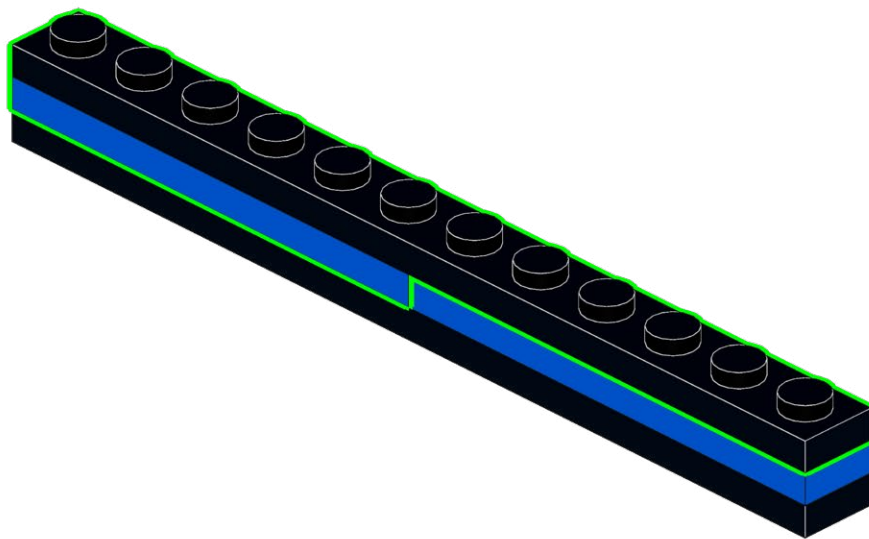
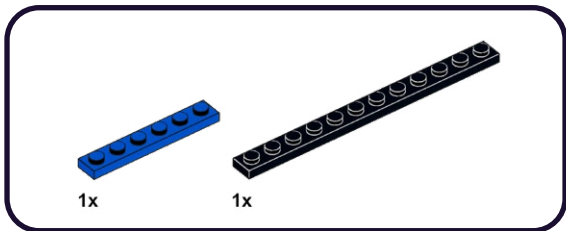

22

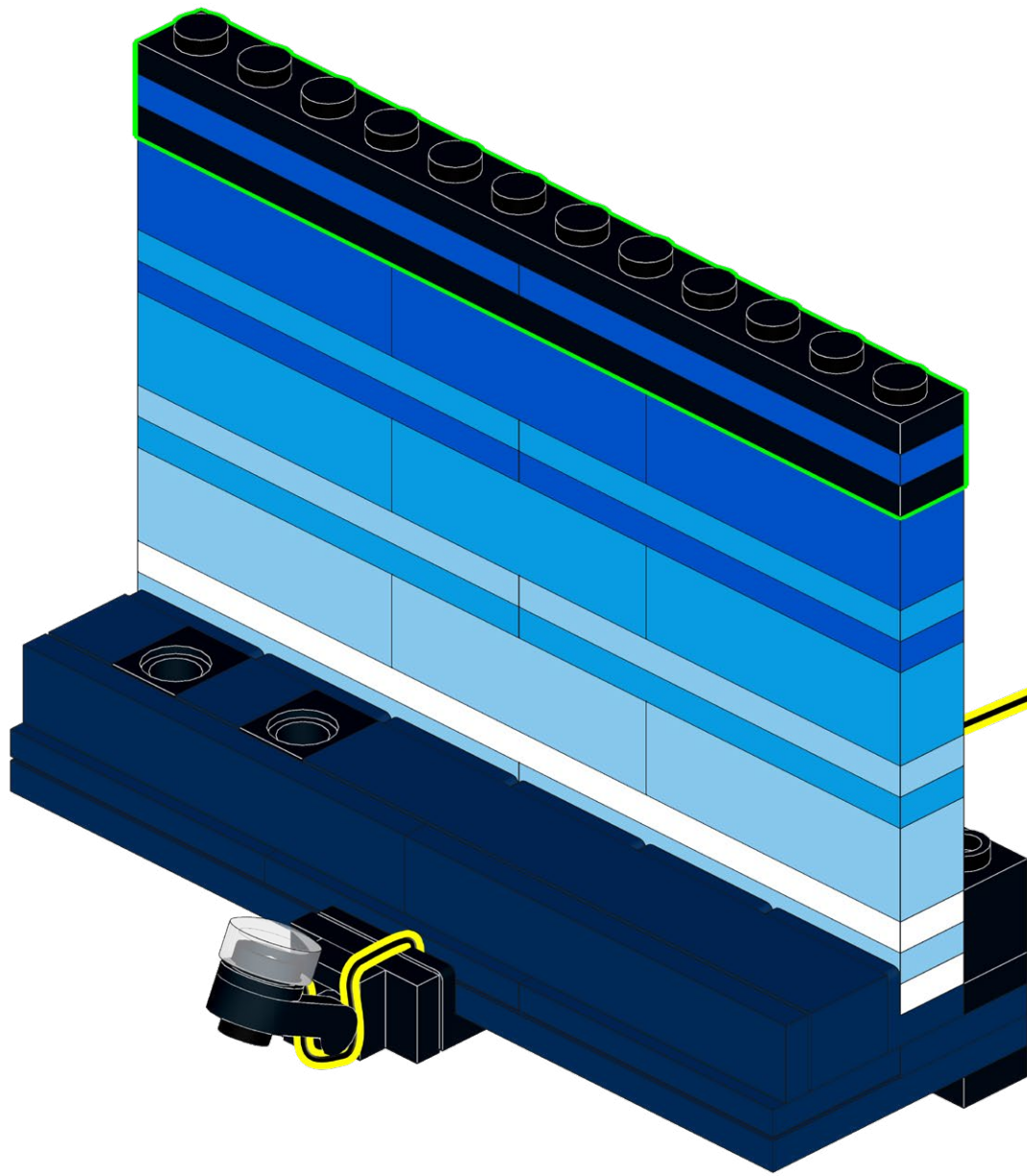

23



2x

1



2

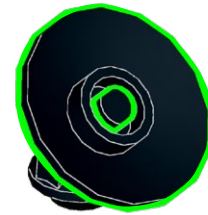

24

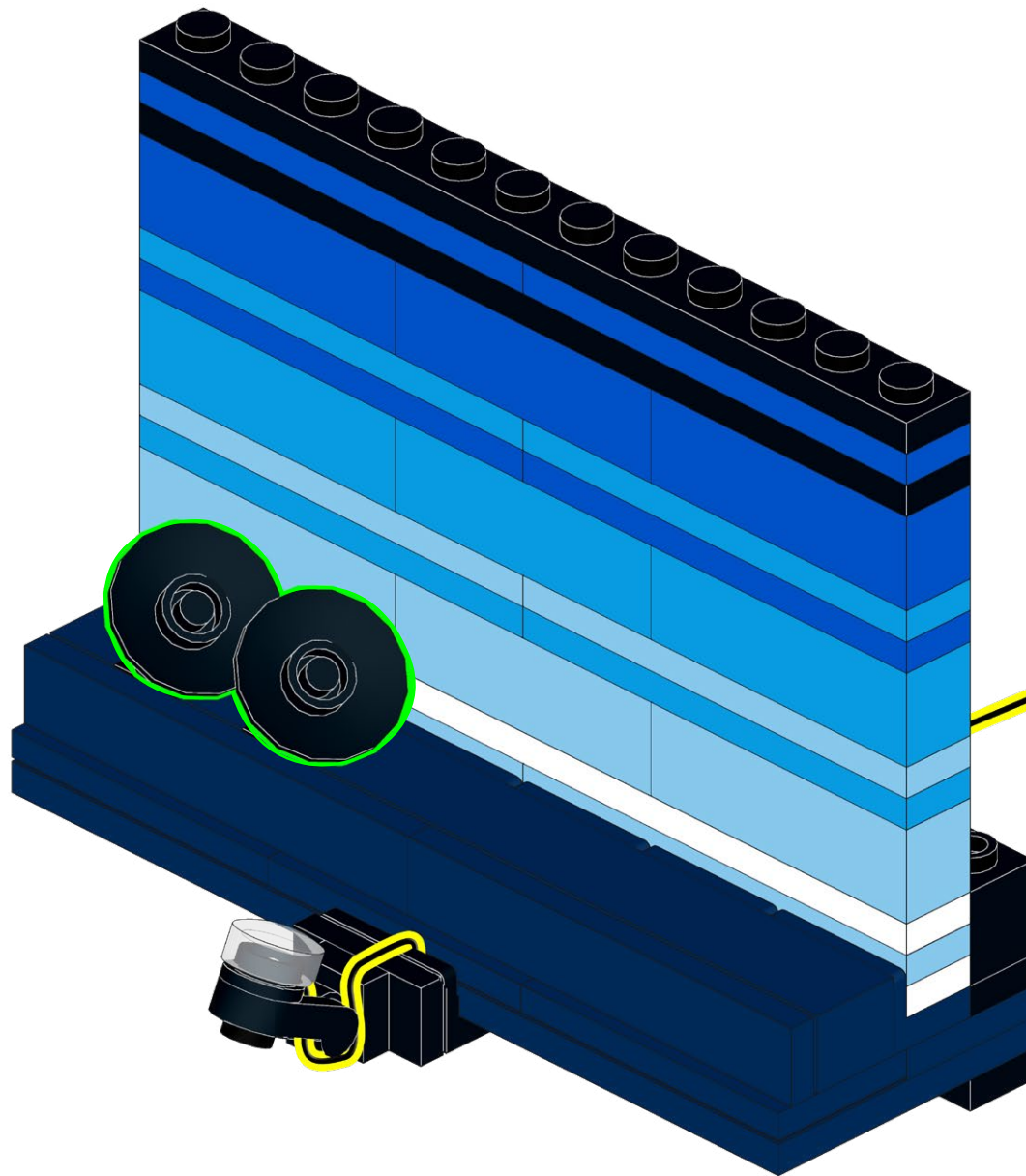

25

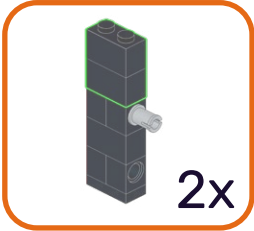
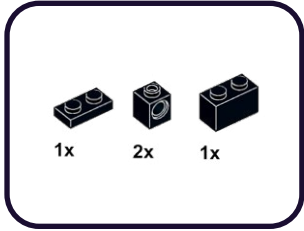

1

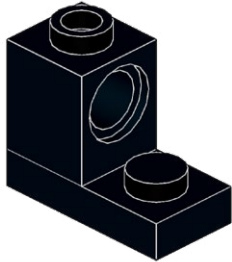

2

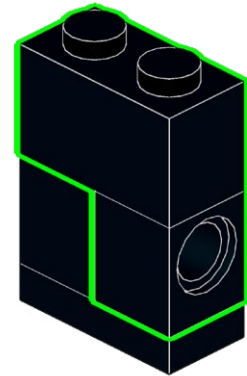



26

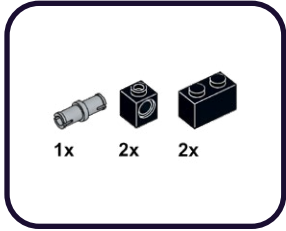

1

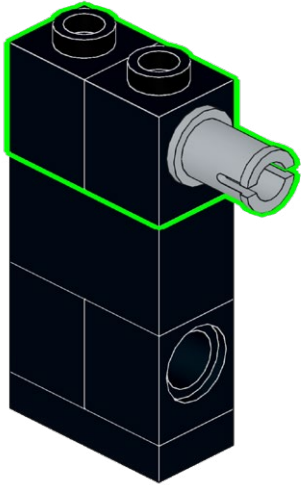

2

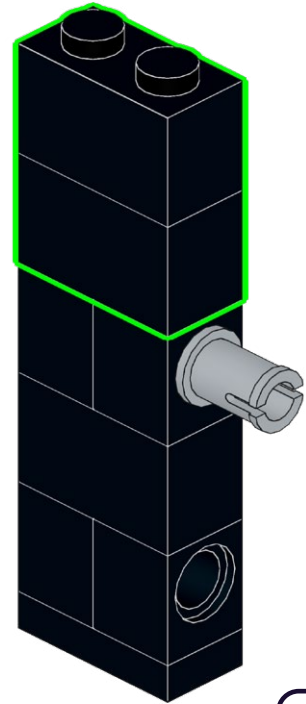

2x

27

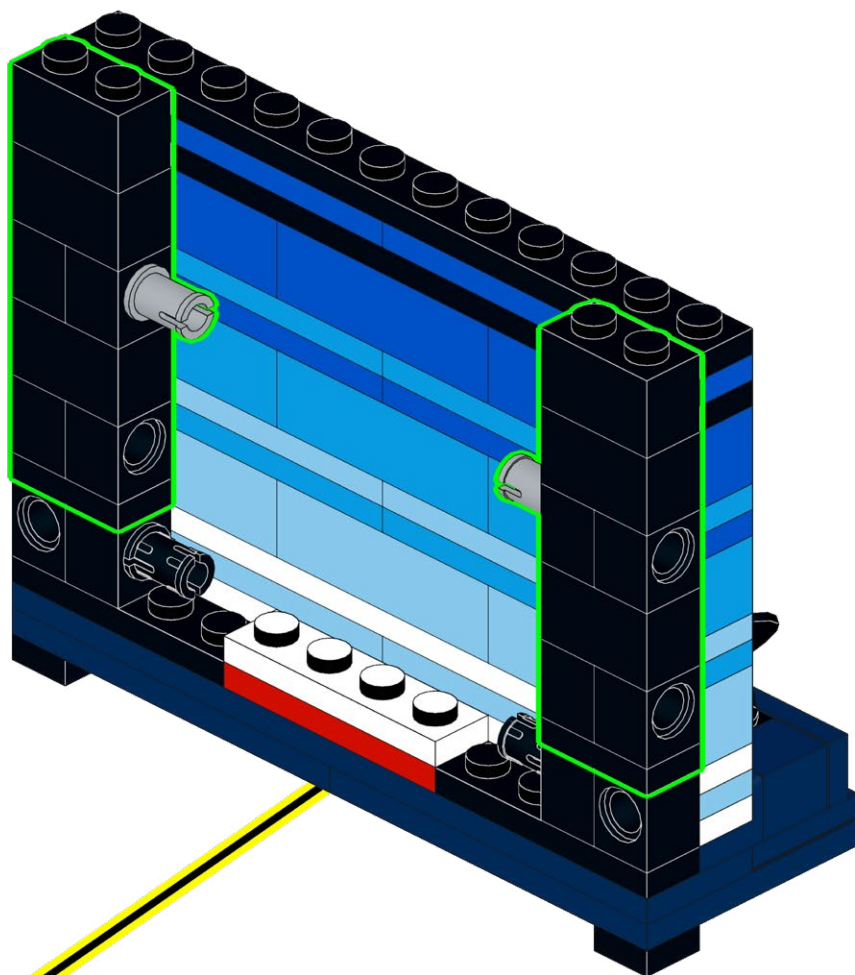
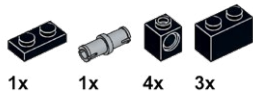

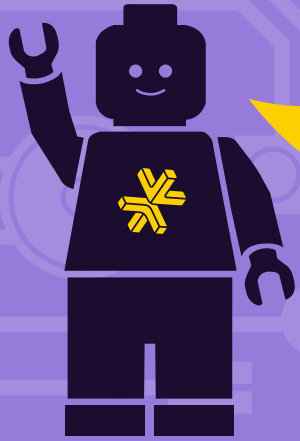
**HOLD UP!**

You might notice some bags aren't in order, as well as left over pieces, but that's ok! We're changing the way you build LEGO!

**ATTENDEZ!**

Vous remarquerez peut-être que certains sacs, ainsi que certaines pièces, ne sont pas dans le bon ordre. Mais pas de panique! Nous changeons simplement la façon avec laquelle vous construisez vos LEGO!

**ASPETTA!**

Potresti notare che alcuni sacchetti non sono in ordine, così come i pezzi avanzati, ma va bene così! Stiamo cambiando il modo in cui costruisci i LEGO!

**HALT!**

Sie werden möglicherweise bemerken, dass einige tüten durcheinander sind und teile übrig bleiben, aber das ist in Ordnung! Wir ändern die art und weise, wie Sie LEGO bauen!

**¡ESPERA!**

Es posible que notes que algunas bolsas están fuera de servicio, así como piezas sobrantes, ¡pero está bien! ¡Estamos cambiando la forma en que construyes LEGO!

**暫停!**

你可能会注意到一些袋子顺序错乱, 以及一些剩余的部件, 但没关系! 我们正在改变你搭建乐高的方式!

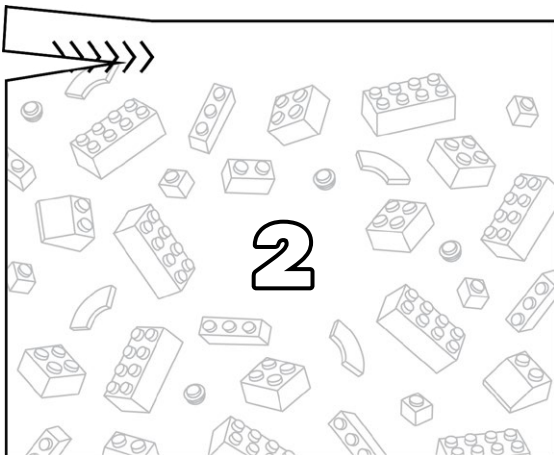
**Open LEGO® Bag 2**

28

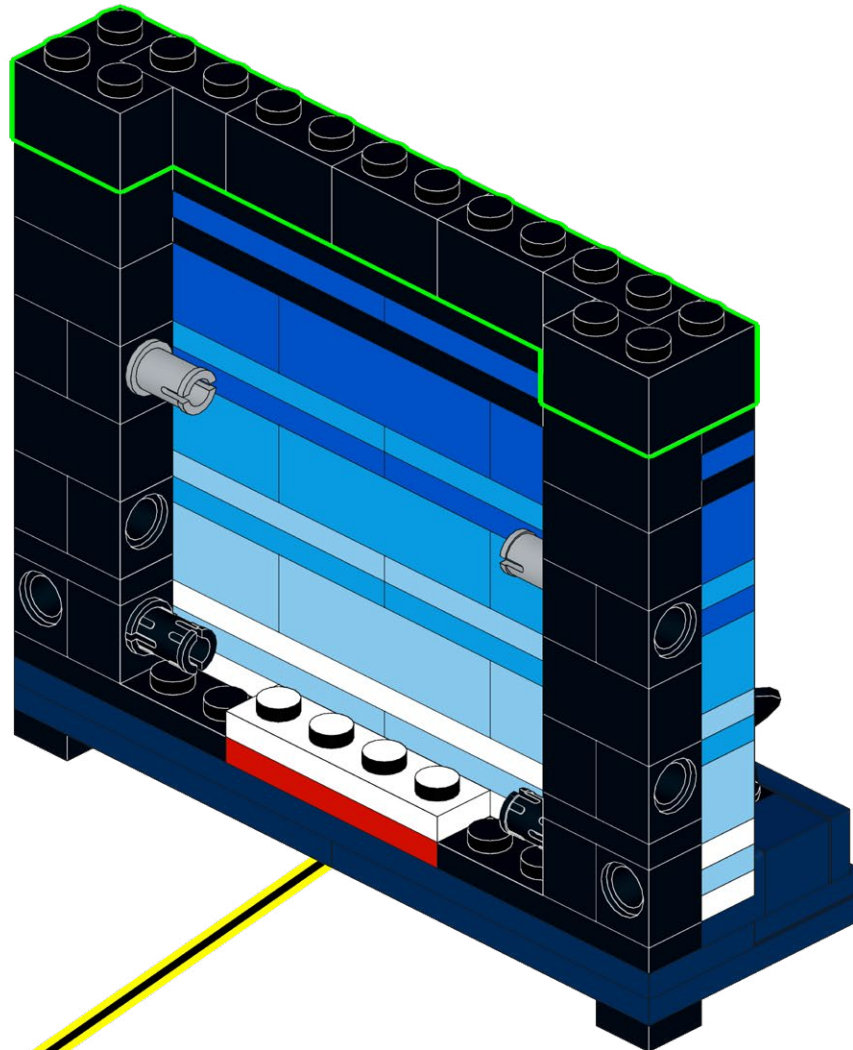
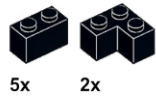

29

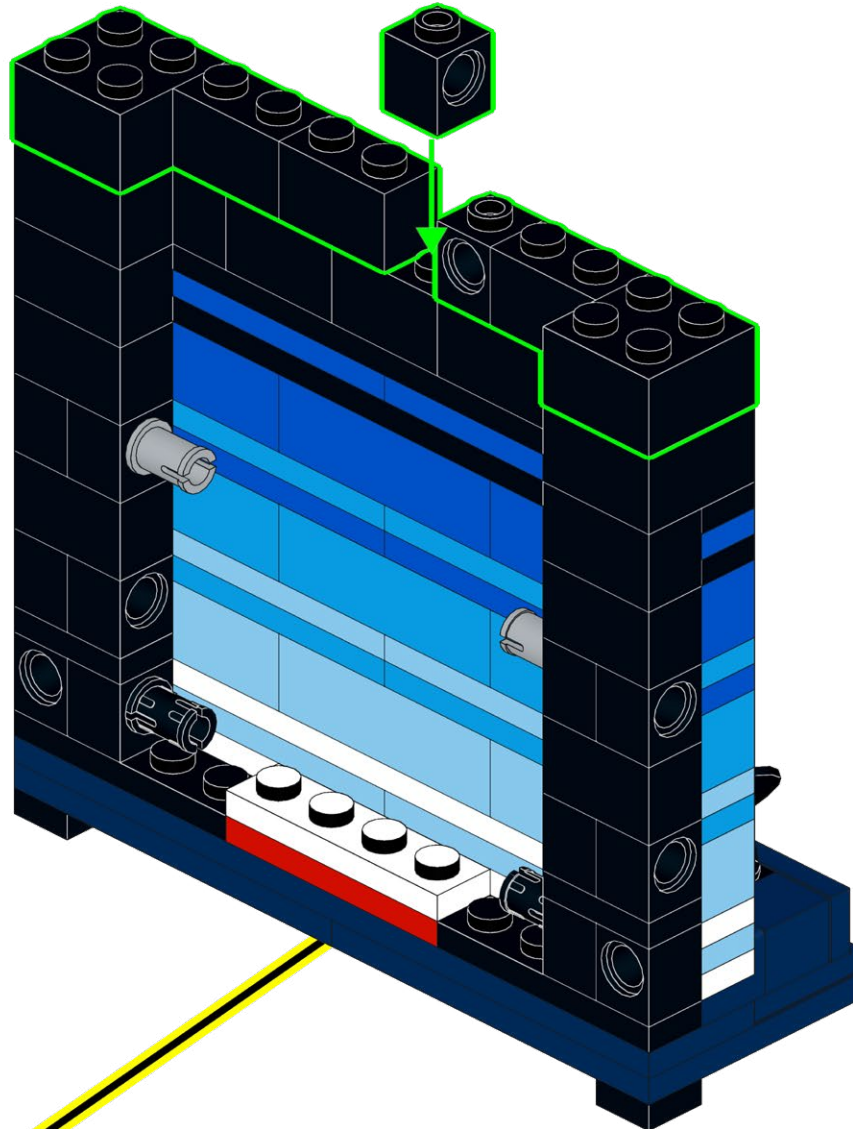
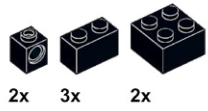

30

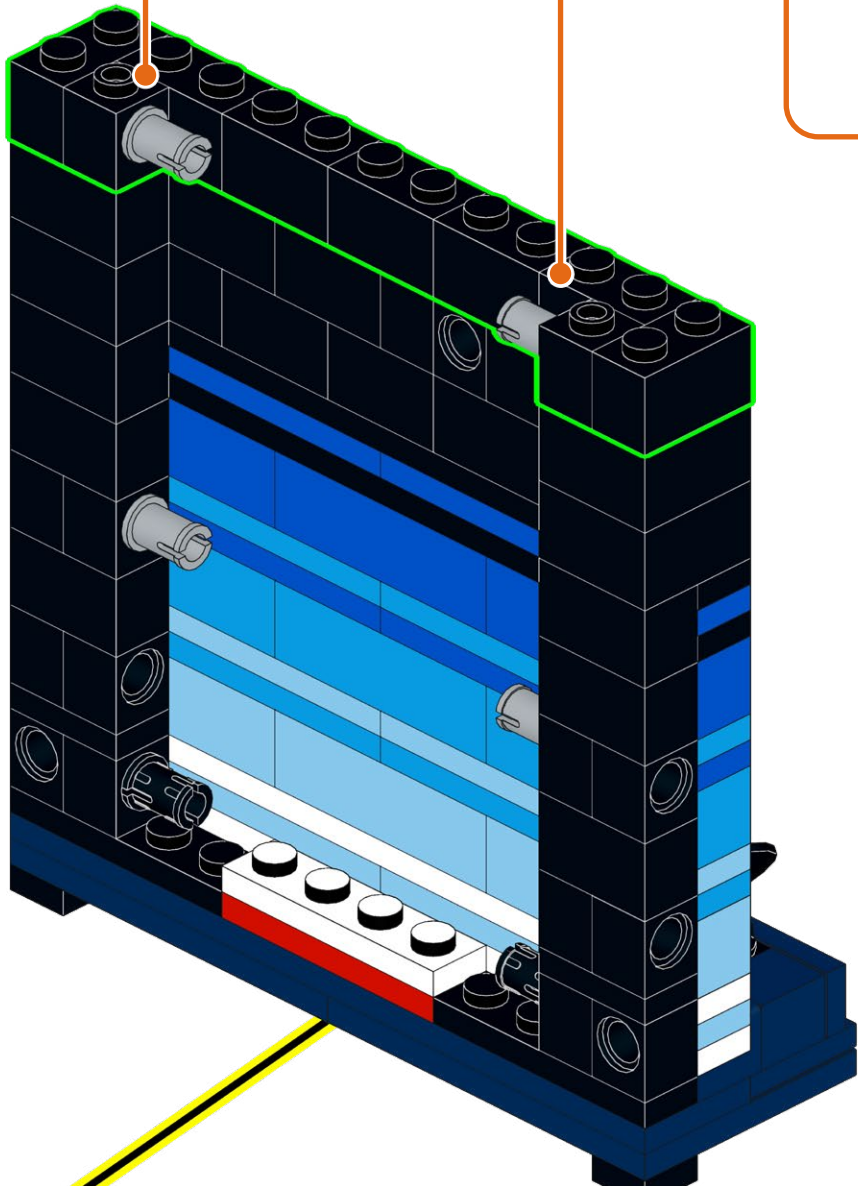
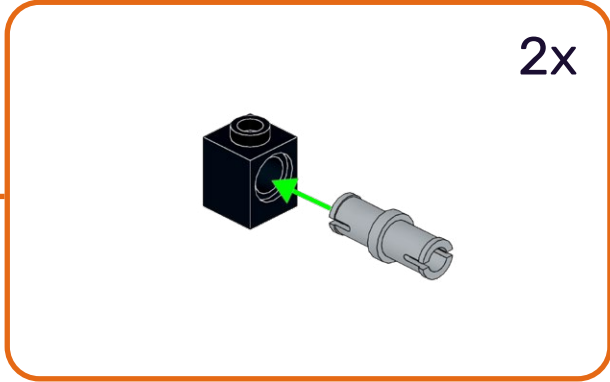
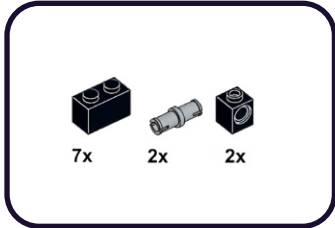

31

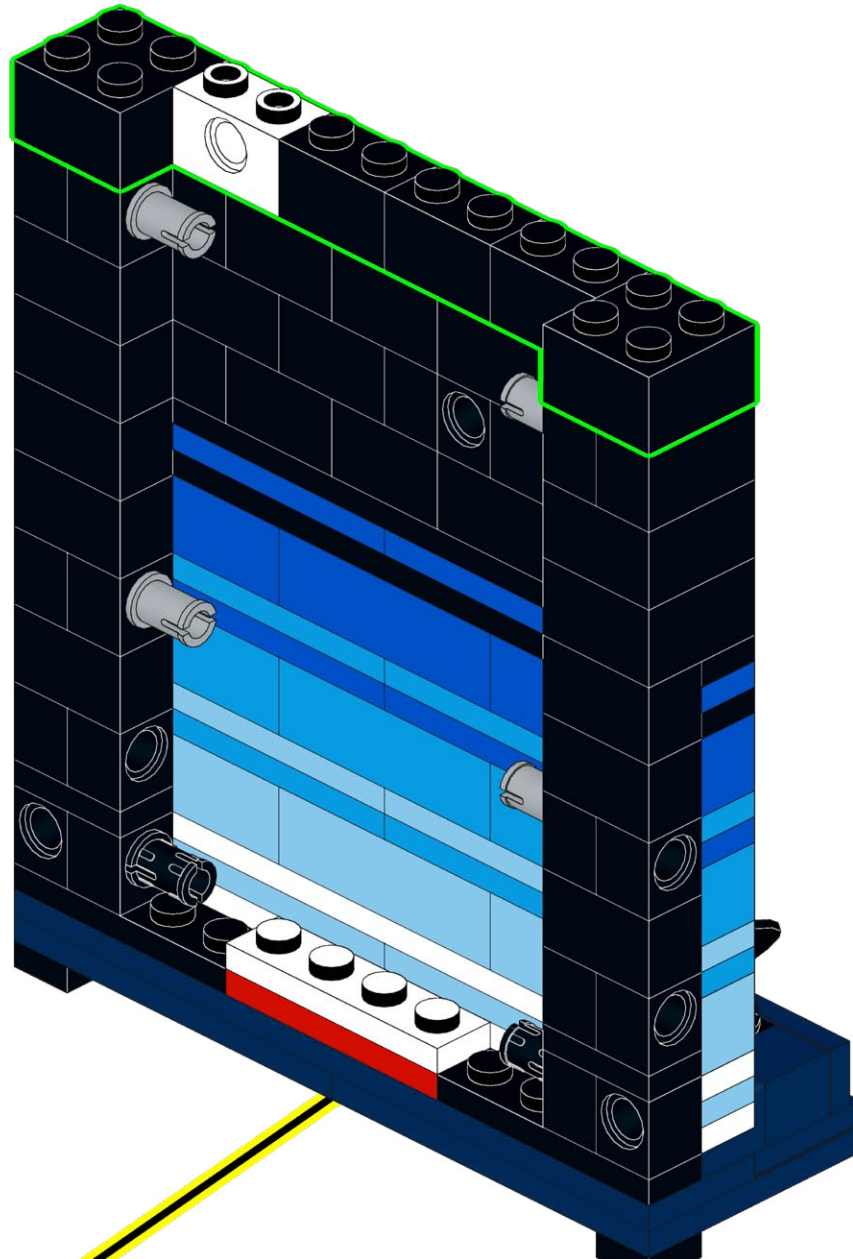
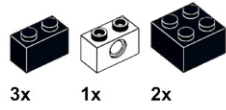

32

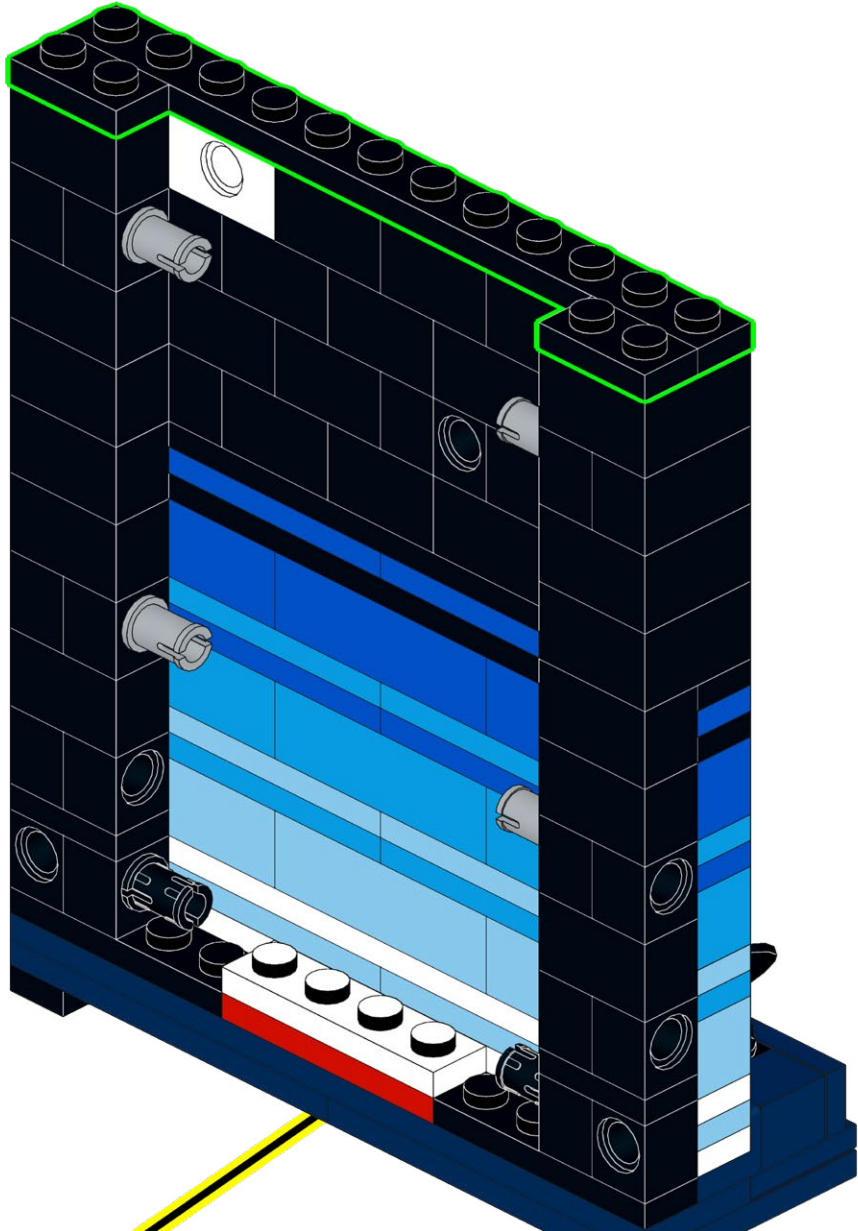
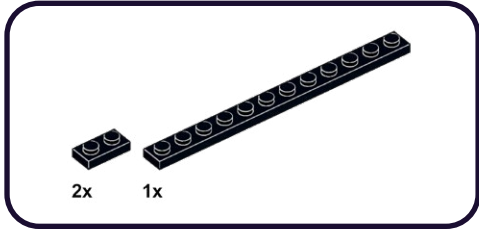



33

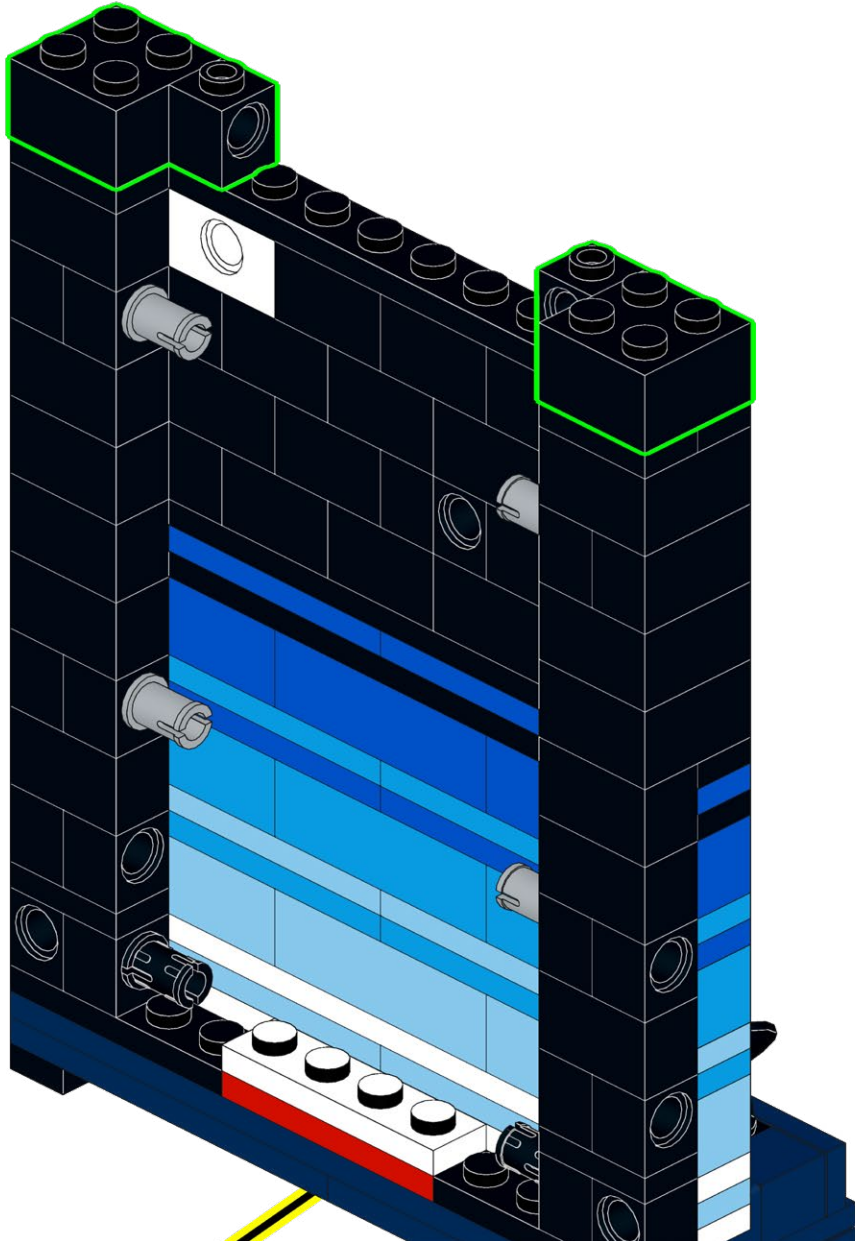
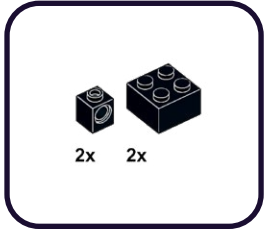

34

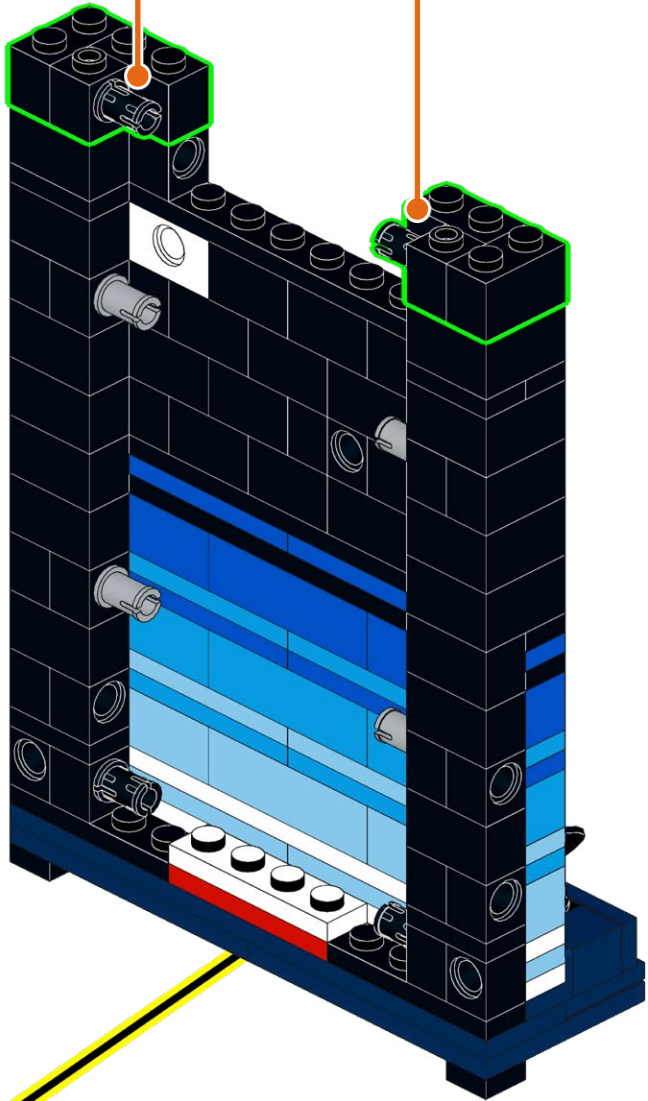
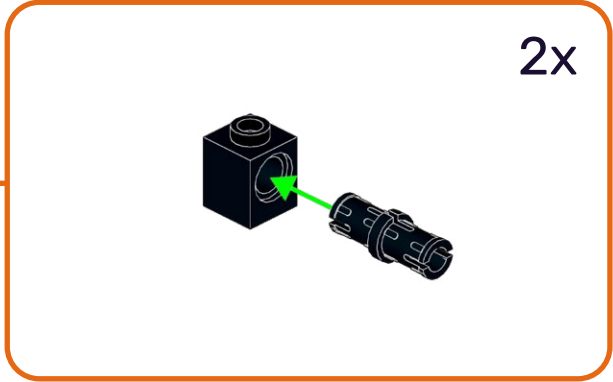
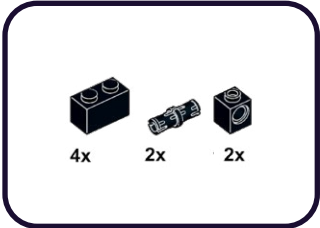

35

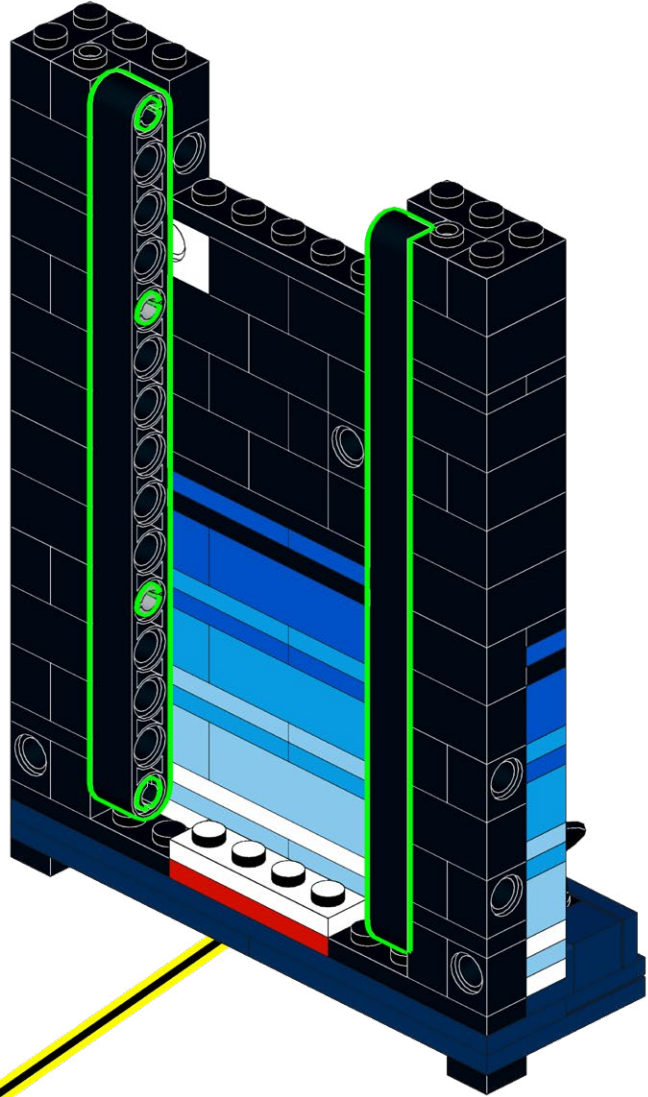

36

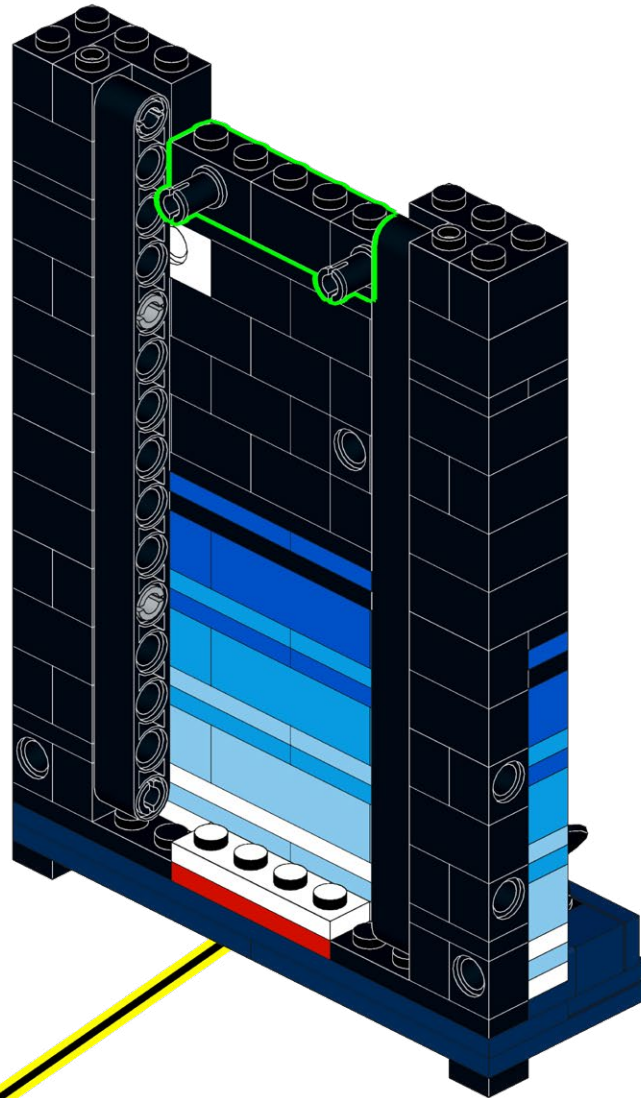
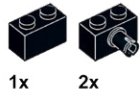

37

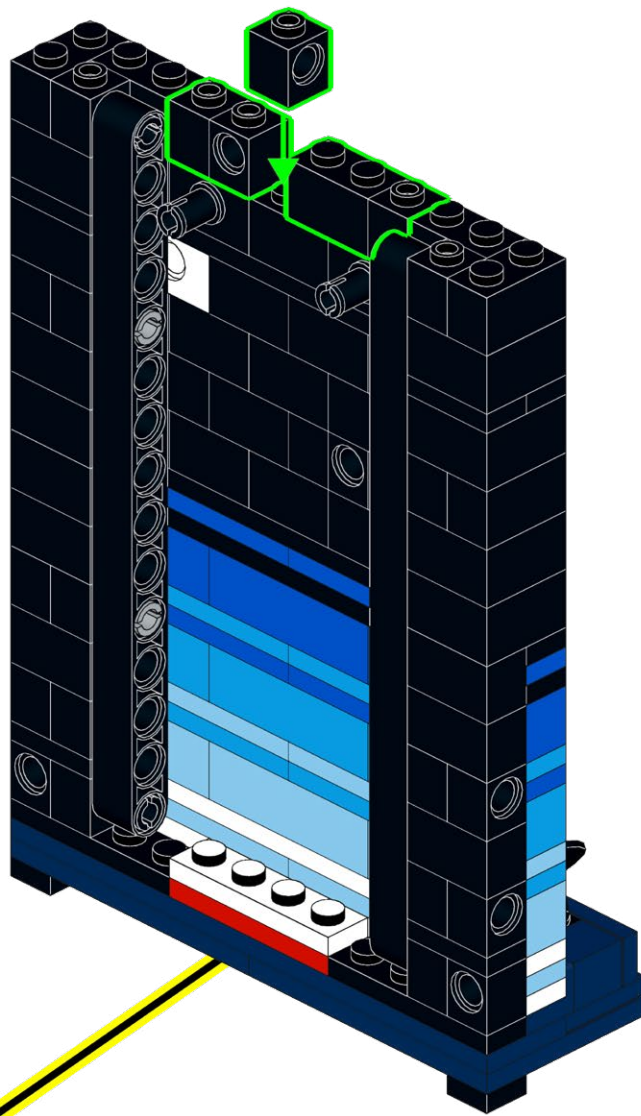
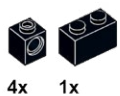

38

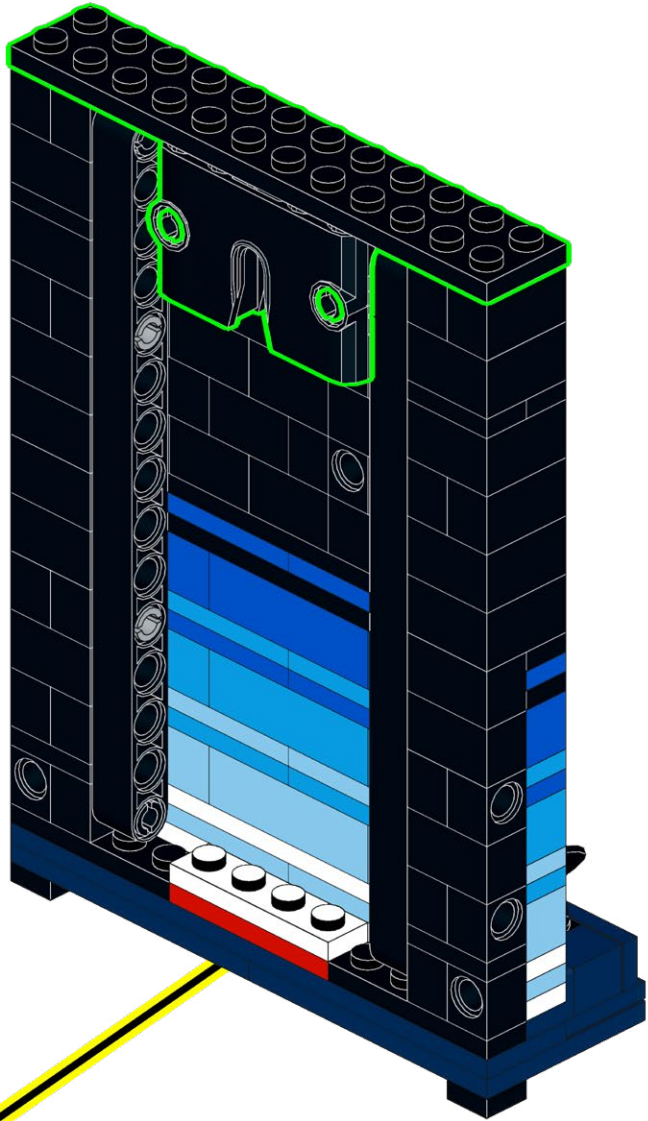
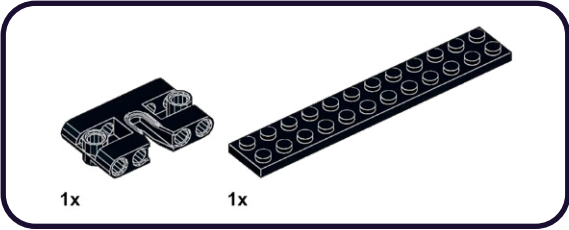

39

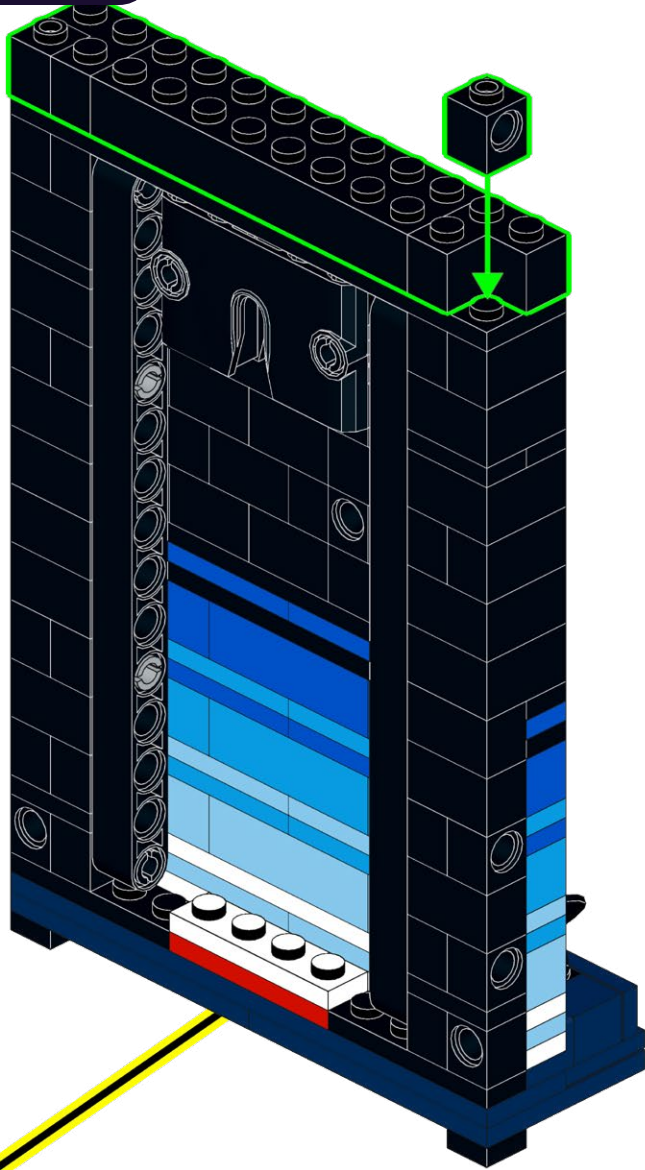
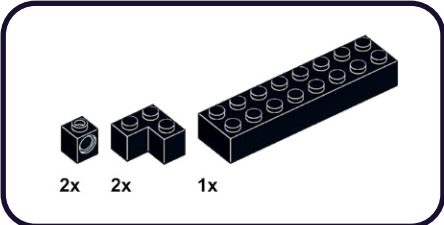

40

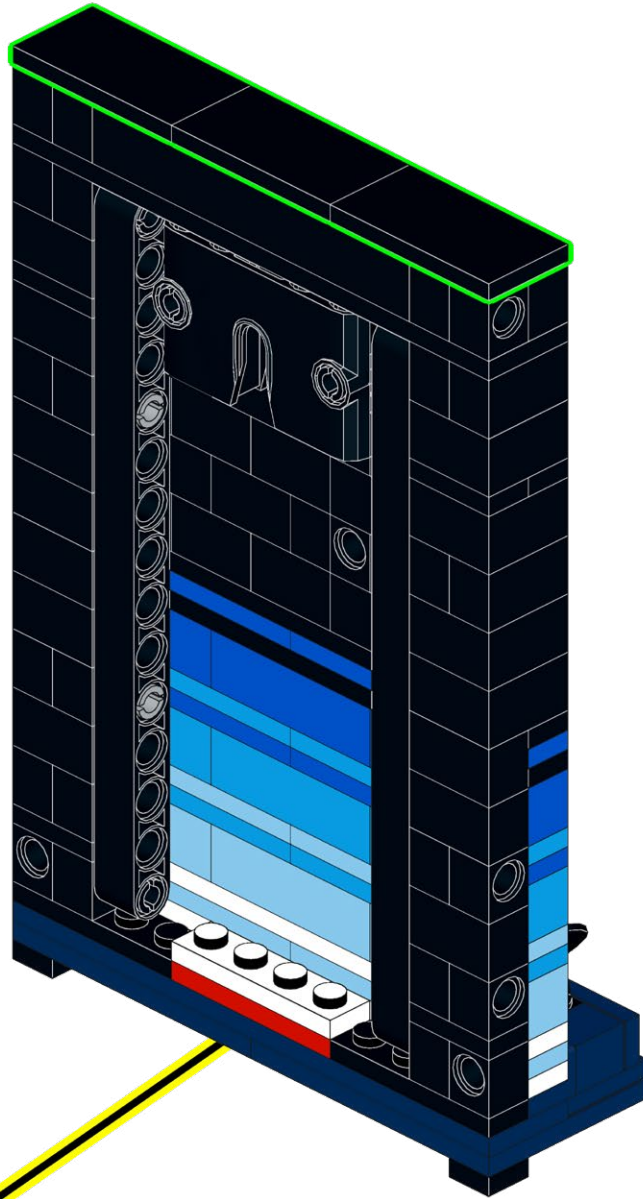
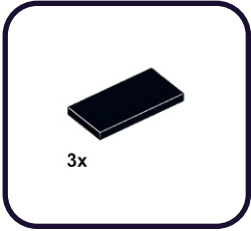



41

2x

D-3

1x

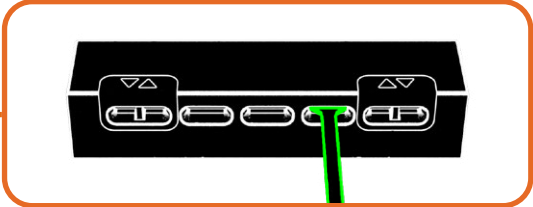
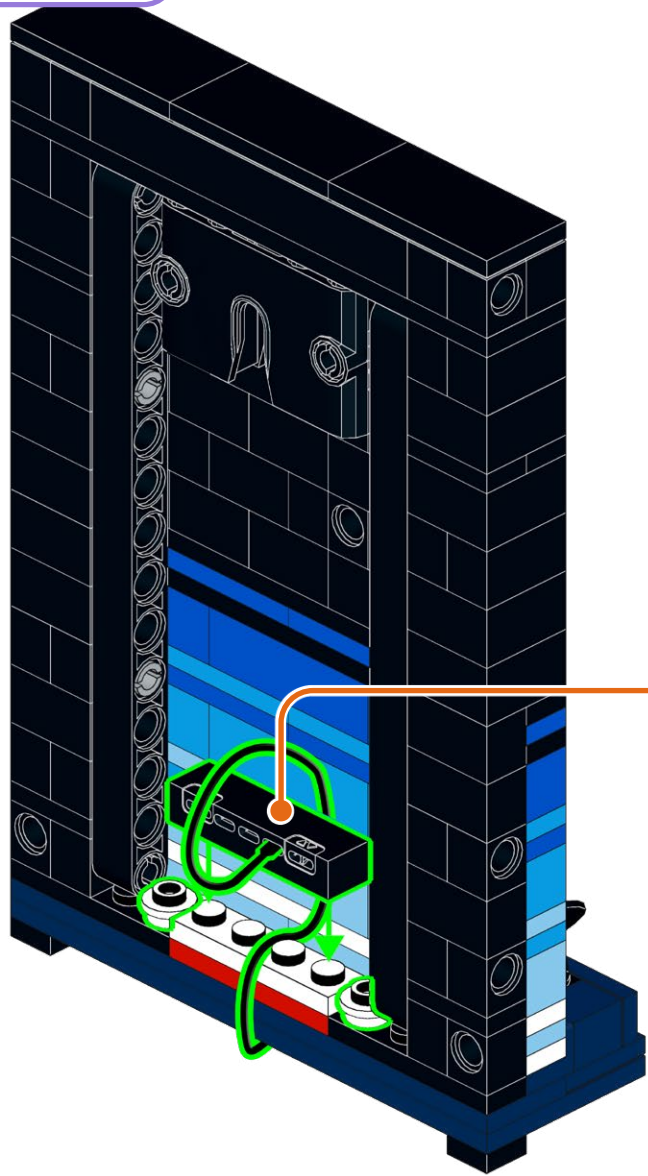

42

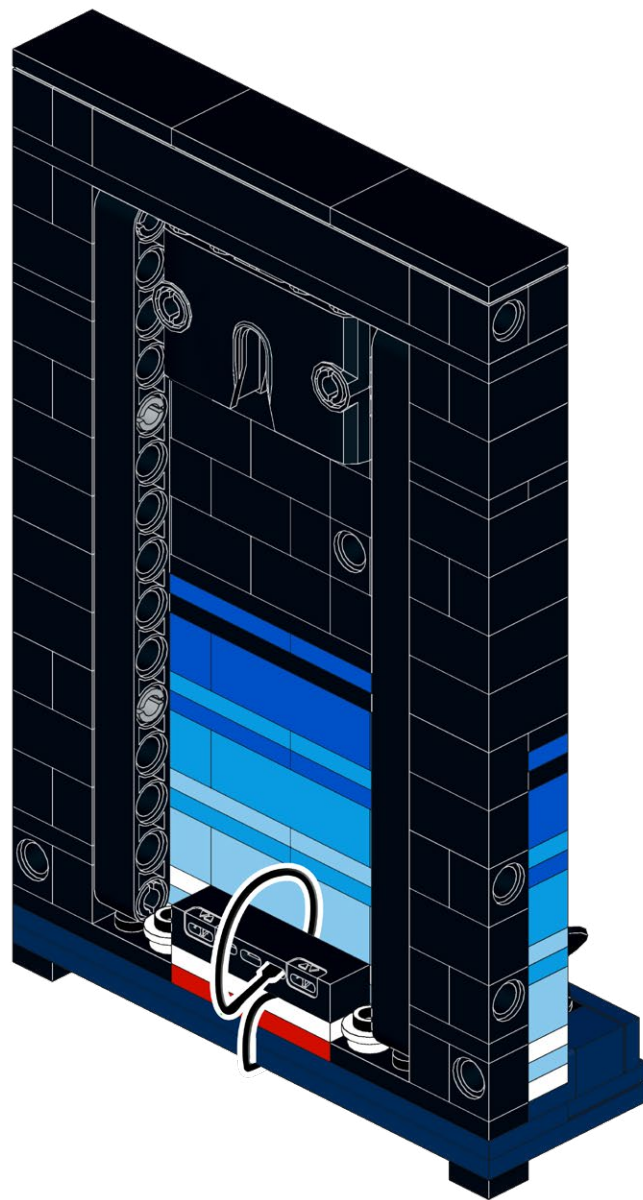

43

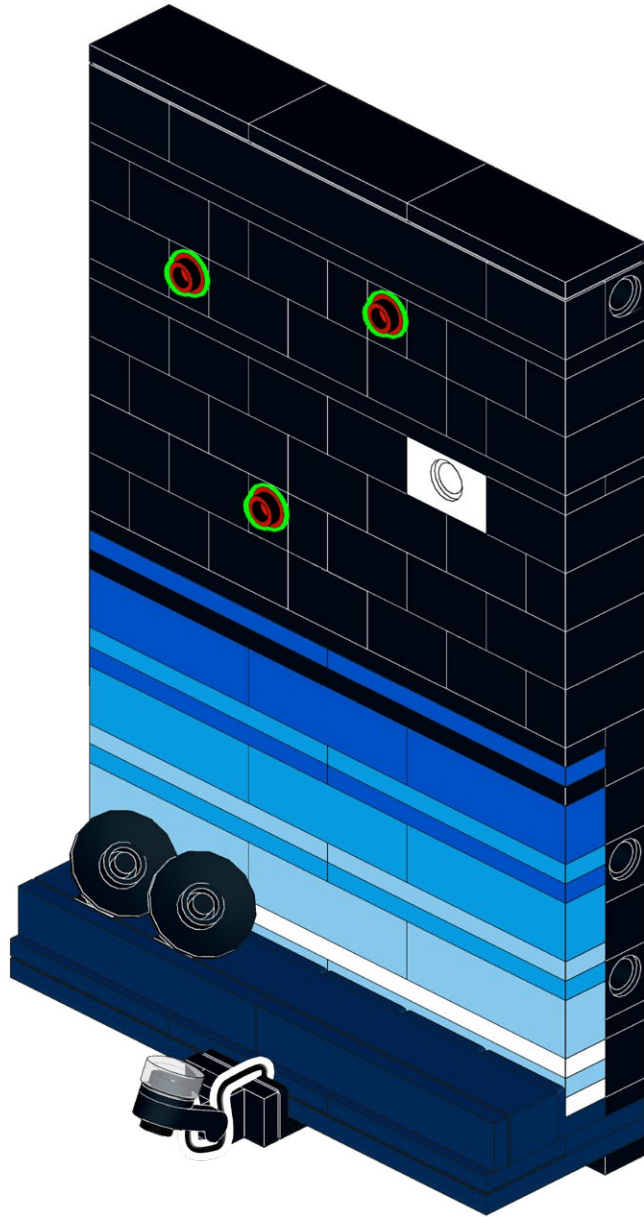
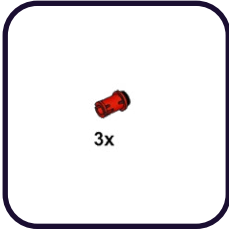

44

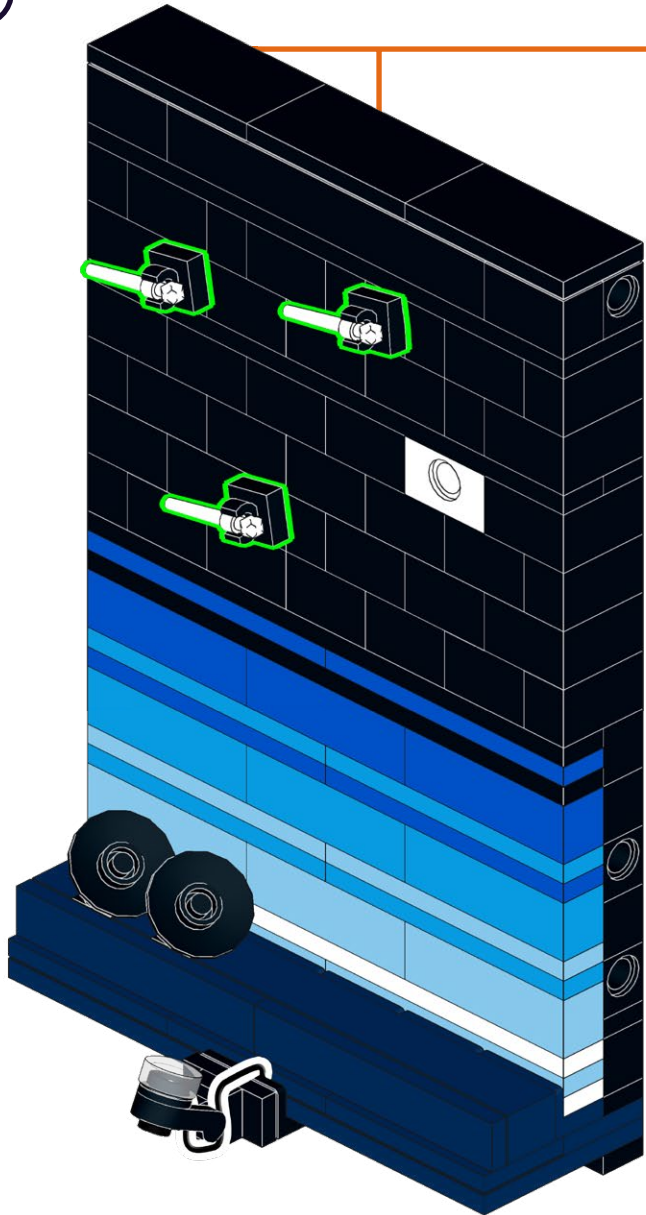
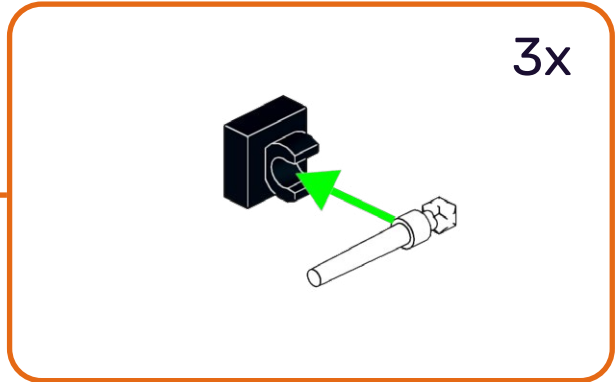

45



1x

3x

1



2



46

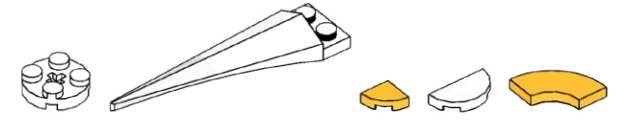

2x

1x

2x

1x

2x

1

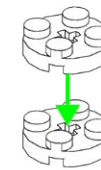

2

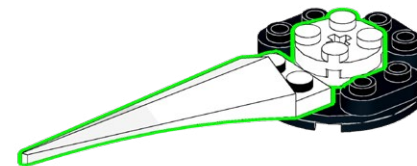

3

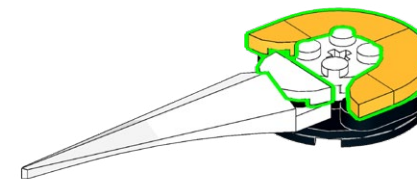

47

1x

1x

ALF-O15

1x

1

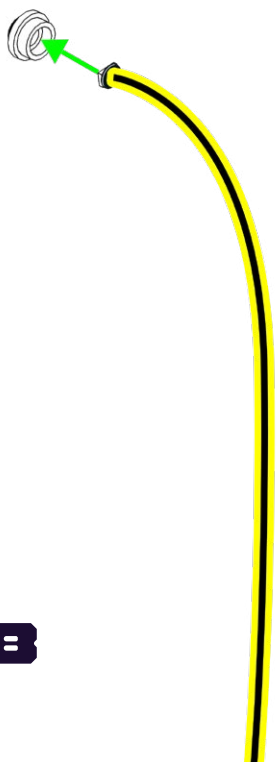

2

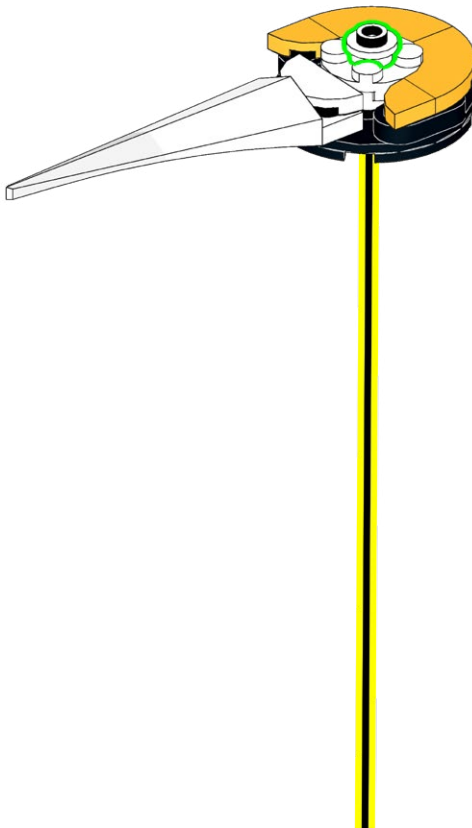

3

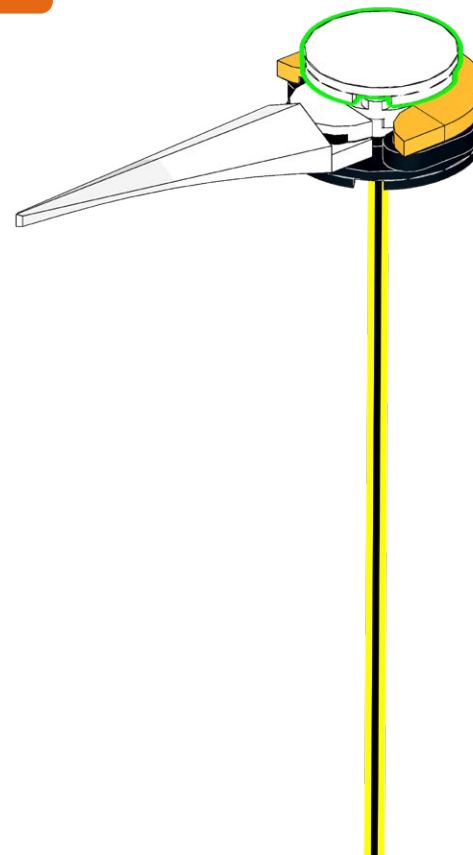

48

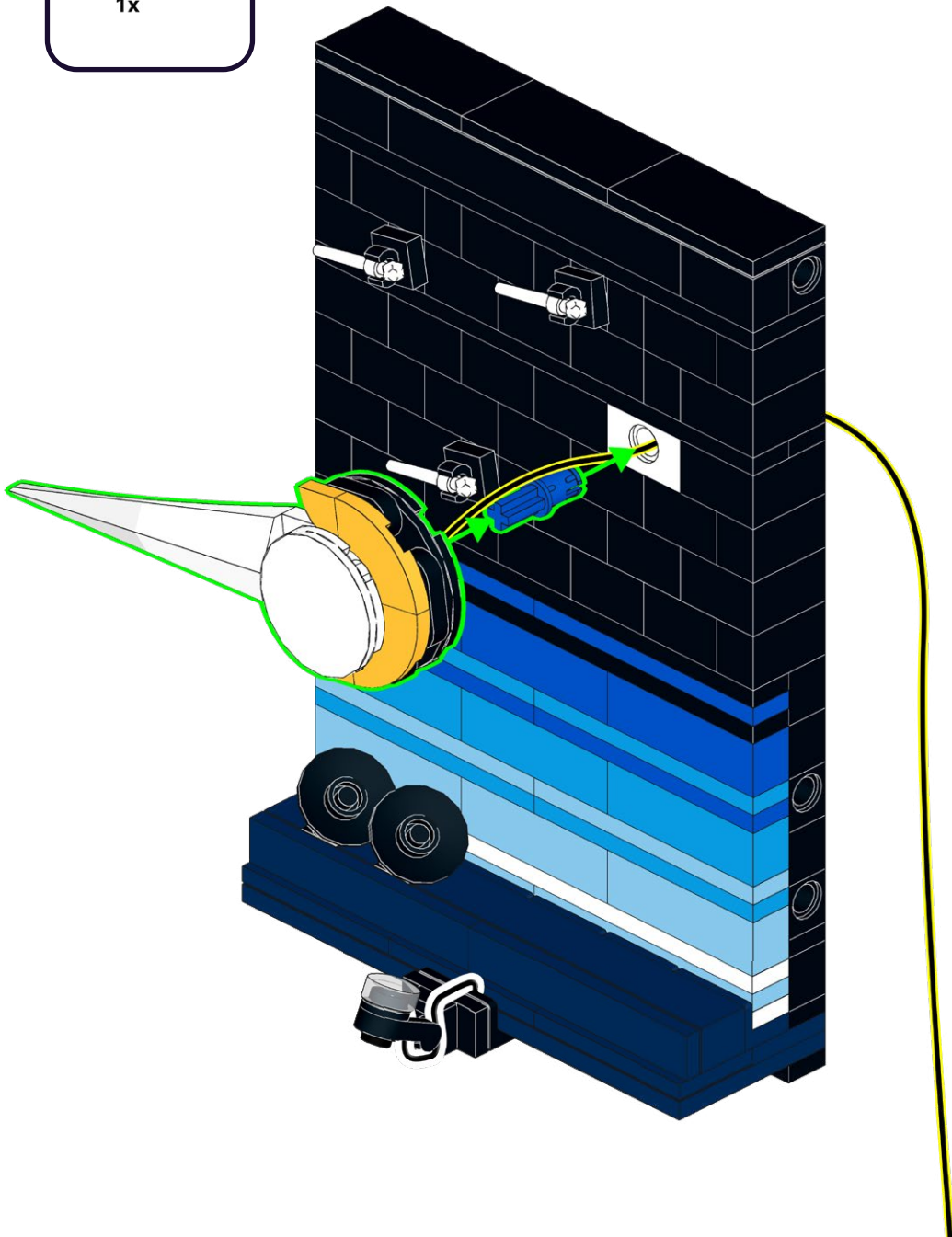
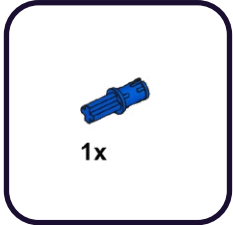

49

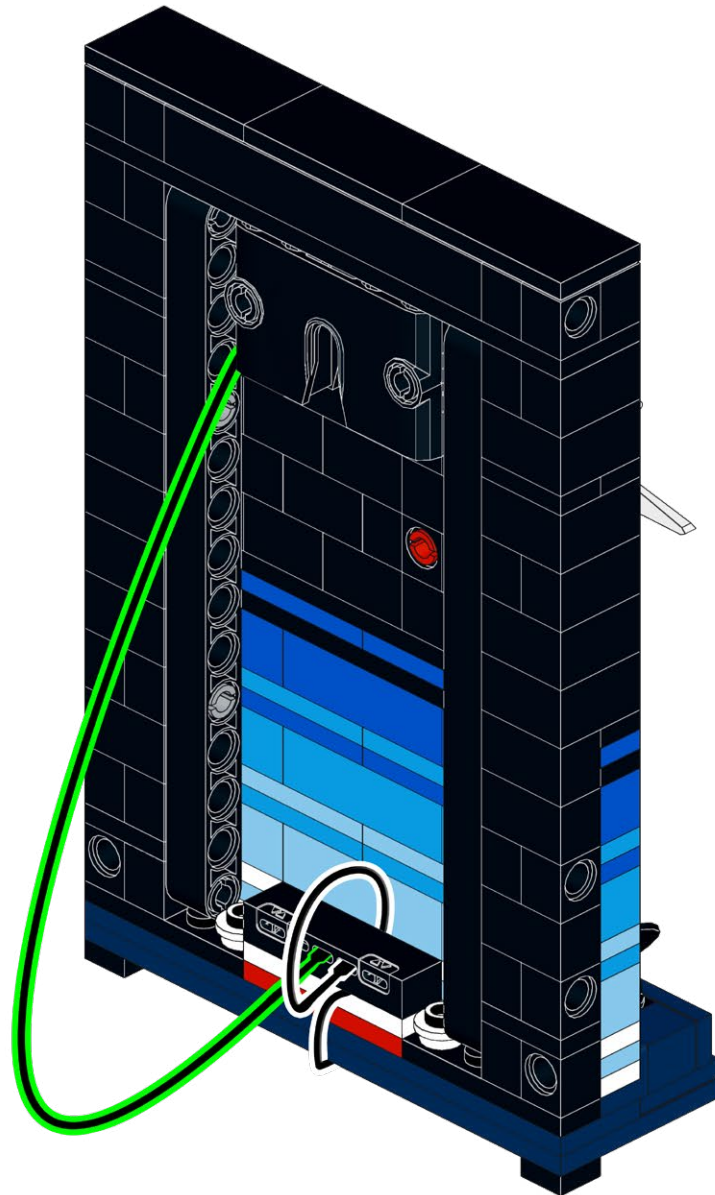



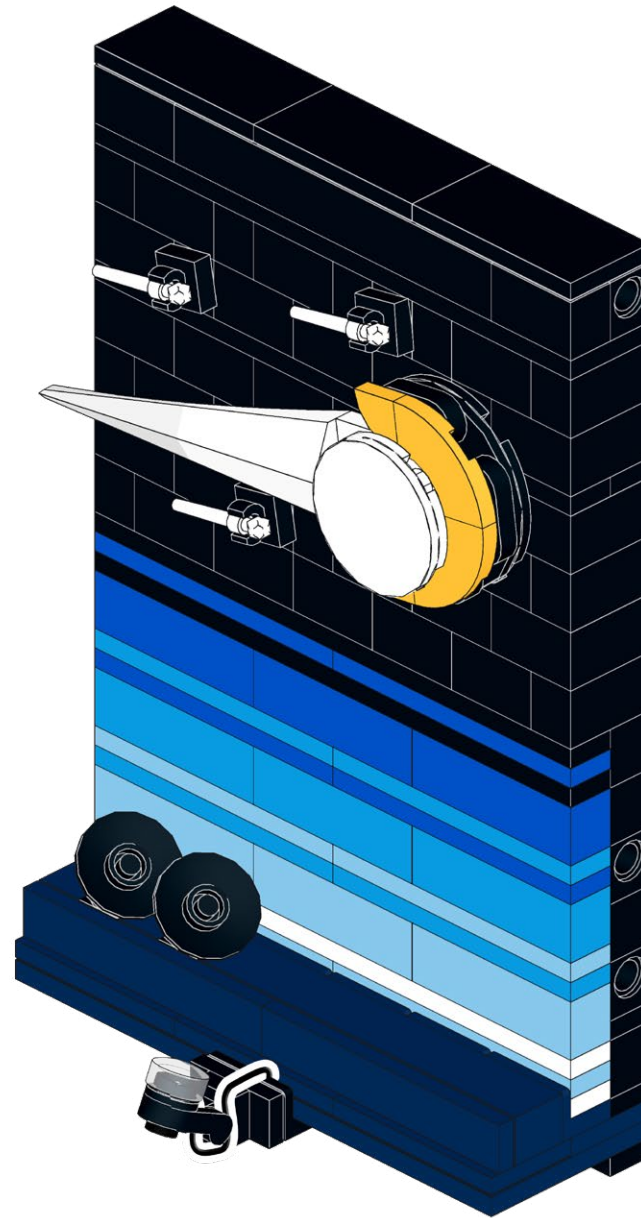
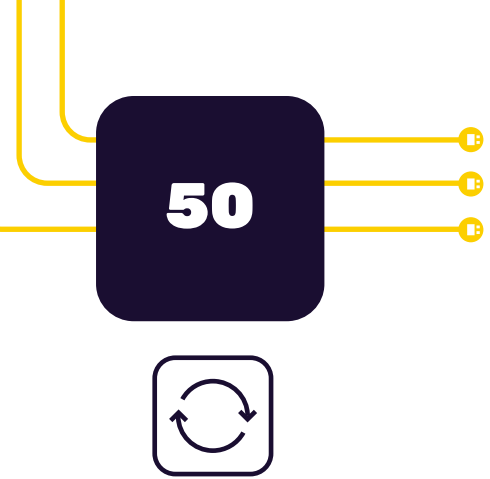



### **HOLD UP!**

You might notice some bags aren't in order, as well as left over pieces, but that's ok! We're changing the way you build LEGO!

### **ATTENDEZ!**

Vous remarquerez peut-être que certains sacs, ainsi que certaines pièces, ne sont pas dans le bon ordre. Mais pas de panique! Nous changeons simplement la façon avec laquelle vous construisez vos LEGO!

### **ASPETTA!**

Potresti notare che alcuni sacchetti non sono in ordine, così come i pezzi avanzati, ma va bene così! Stiamo cambiando il modo in cui costruisci i LEGO!

### **HALT!**

Sie werden möglicherweise bemerken, dass einige tüten durcheinander sind und teile übrig bleiben, aber das ist in Ordnung! Wir ändern die art und weise, wie Sie LEGO bauen!

### **¡ESPERA!**

Es posible que notes que algunas bolsas están fuera de servicio, así como piezas sobrantes, ¡pero está bien! ¡Estamos cambiando la forma en que construyes LEGO!

### **暫停!**

你可能会注意到一些袋子顺序错乱, 以及一些剩余的部件, 但没关系! 我们正在改变你搭建乐高的方式!

#### Open LEGO® Bag 3

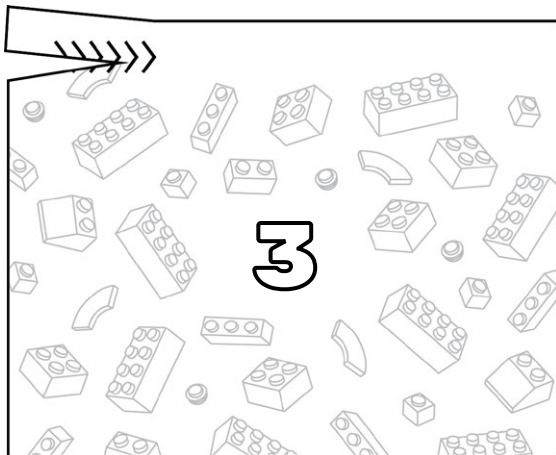

#### Open LMB Bags 02

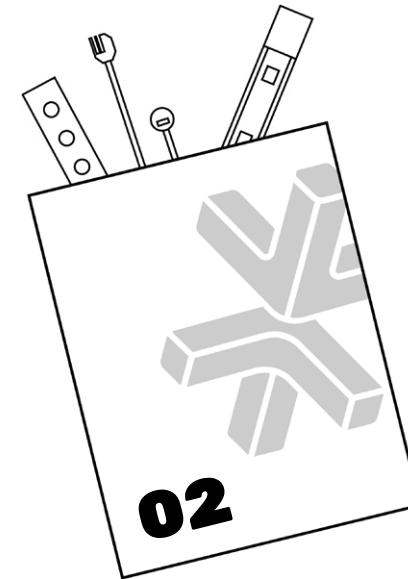

51

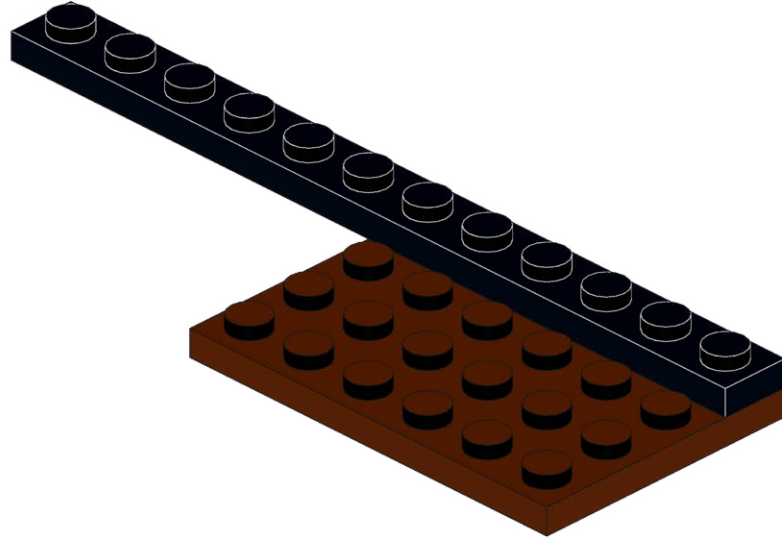
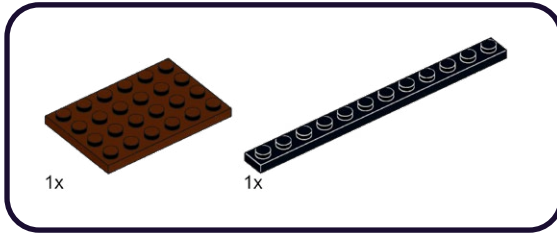

52

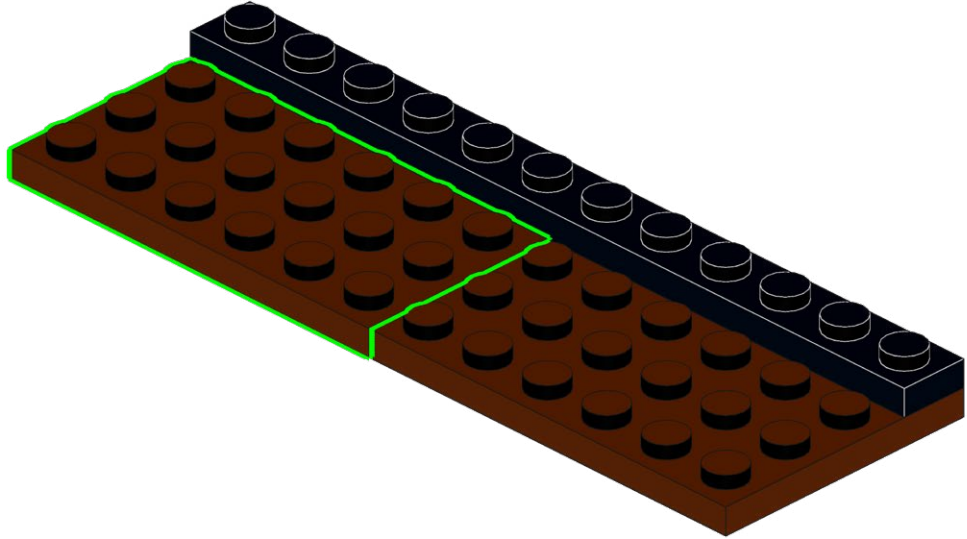
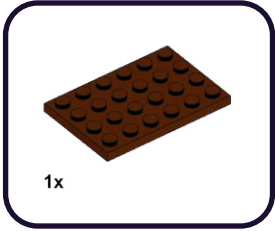

53

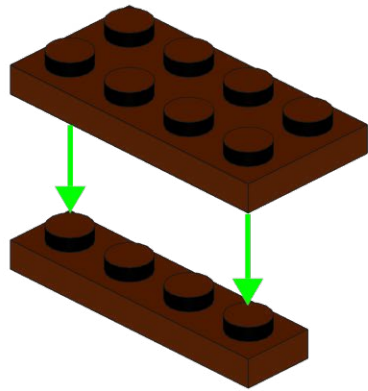
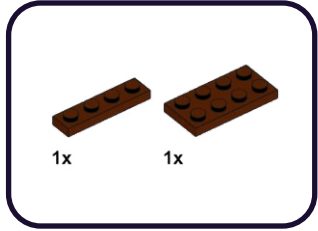

54

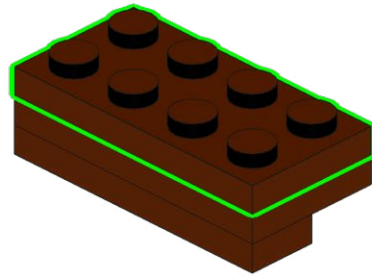
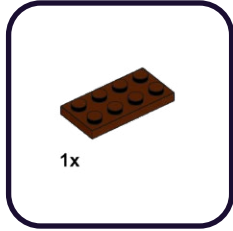

55

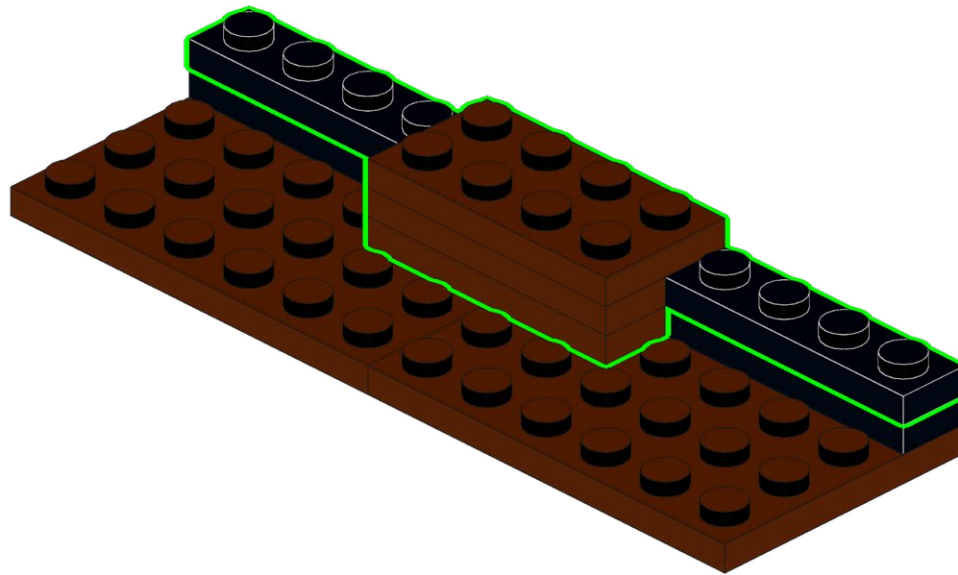
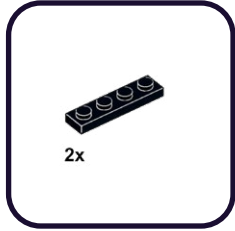

56

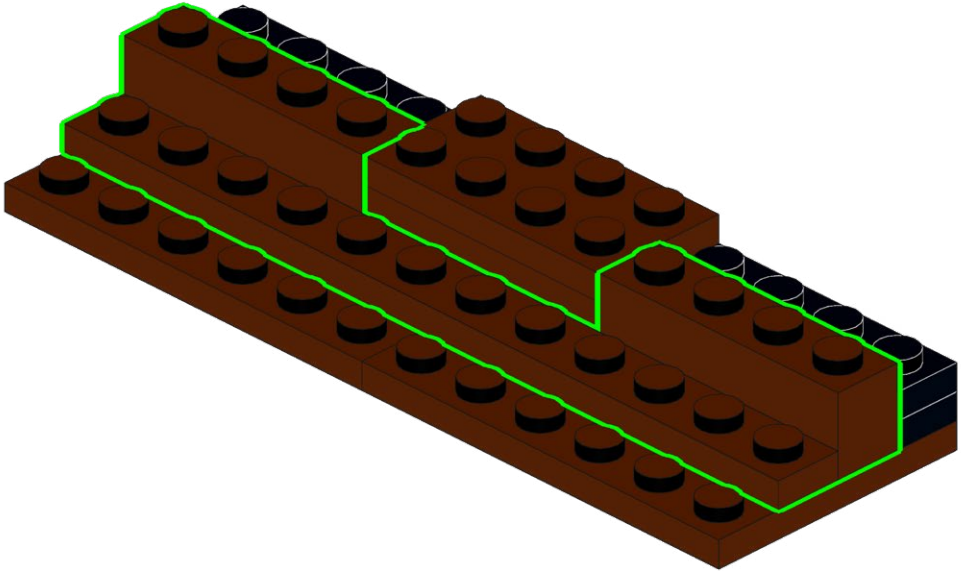
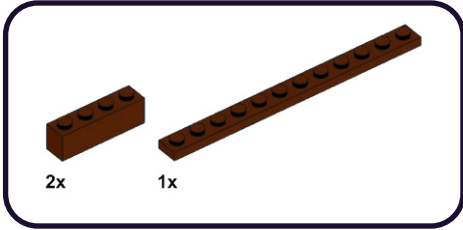



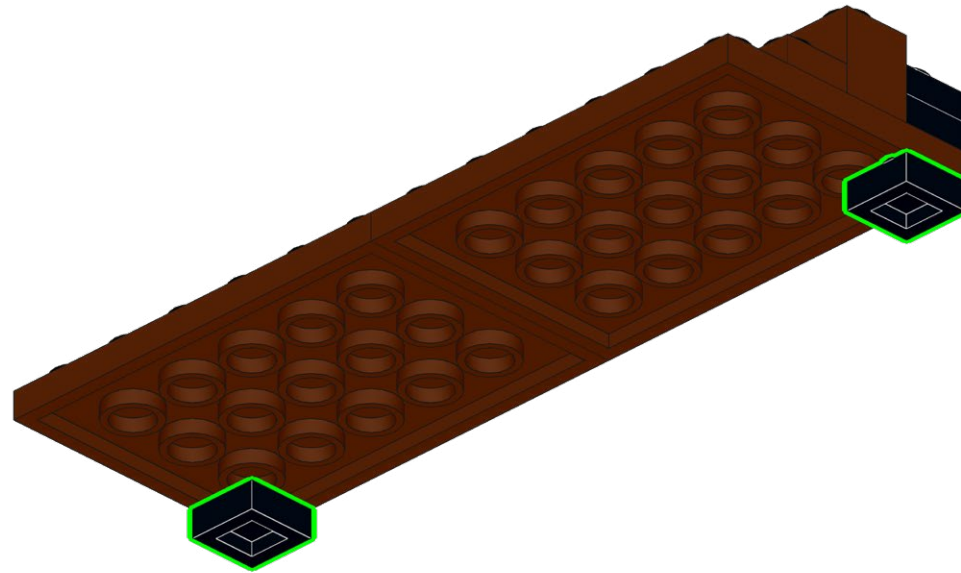
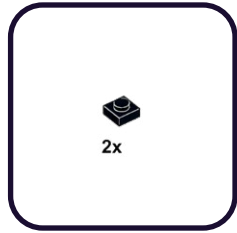

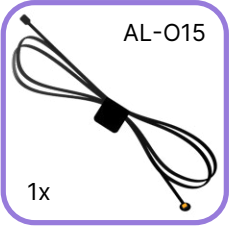

1



2



3

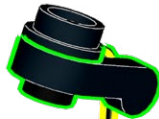

**59**

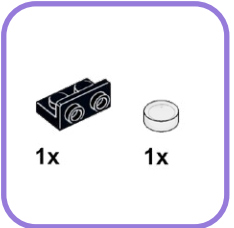
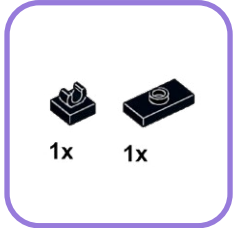

**1**



**3**

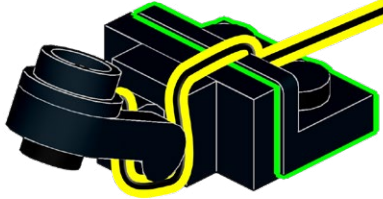

**2**

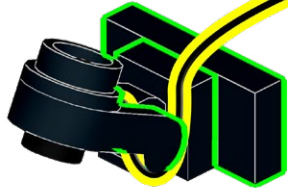

**4**

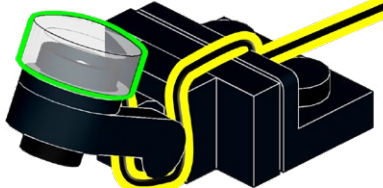

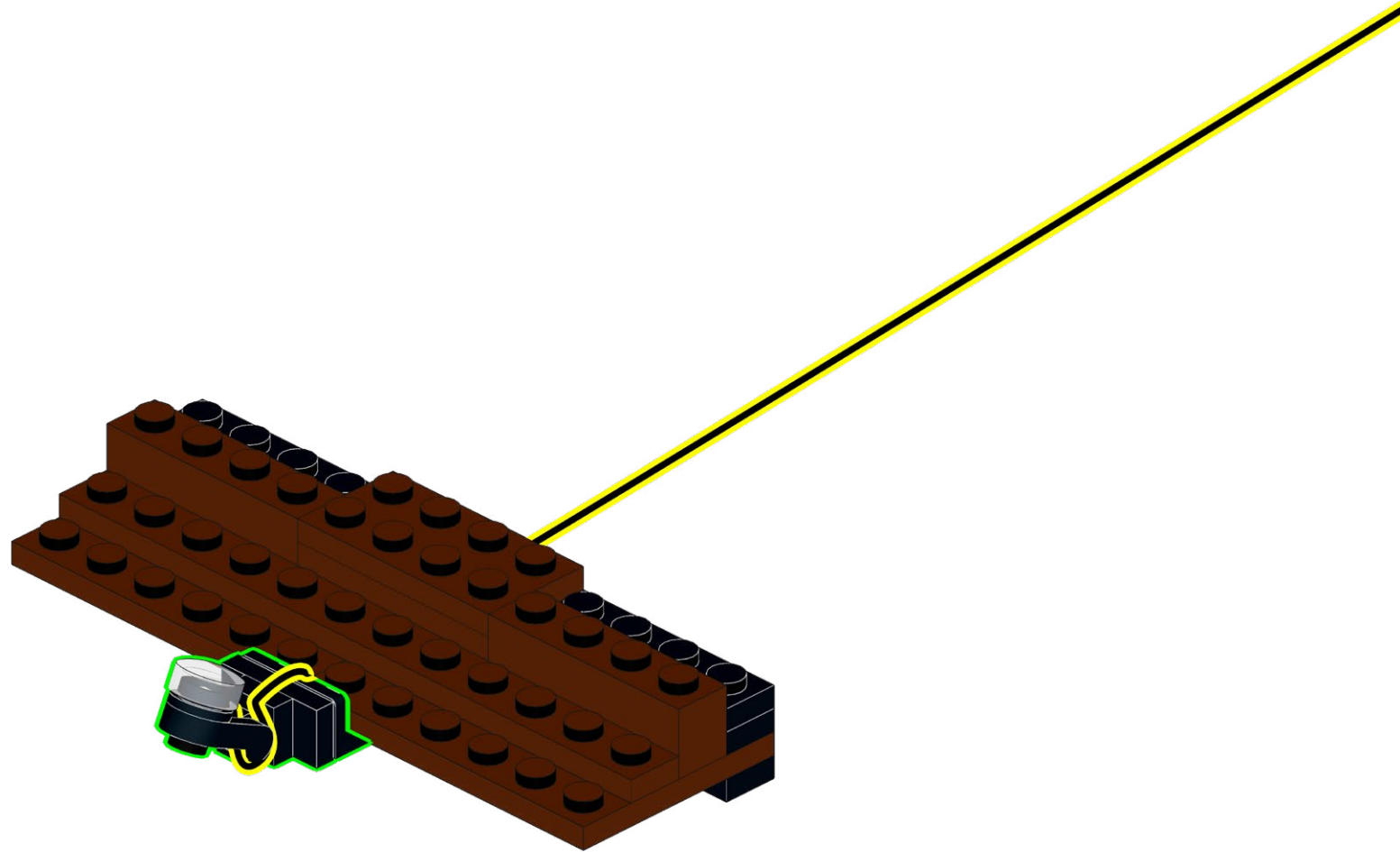
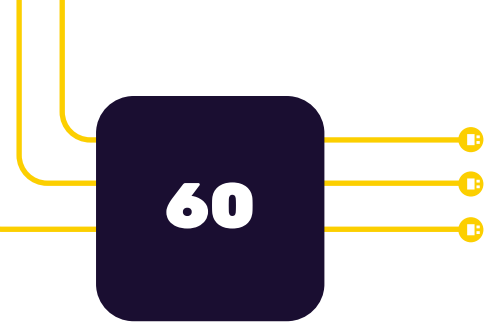

61

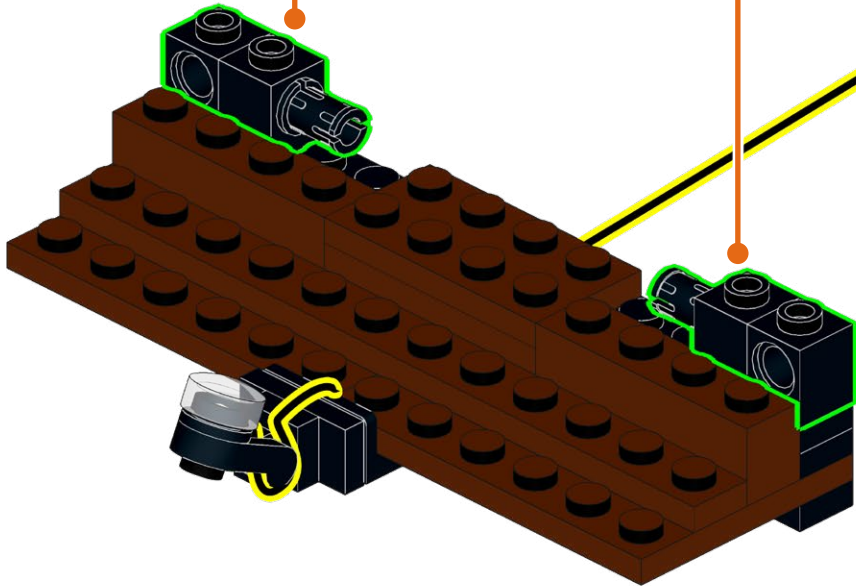
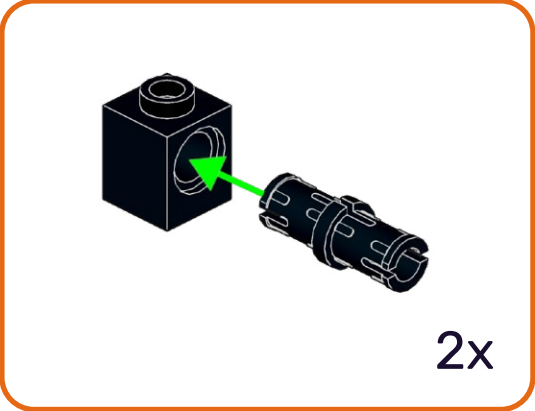
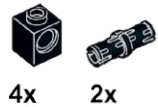

62

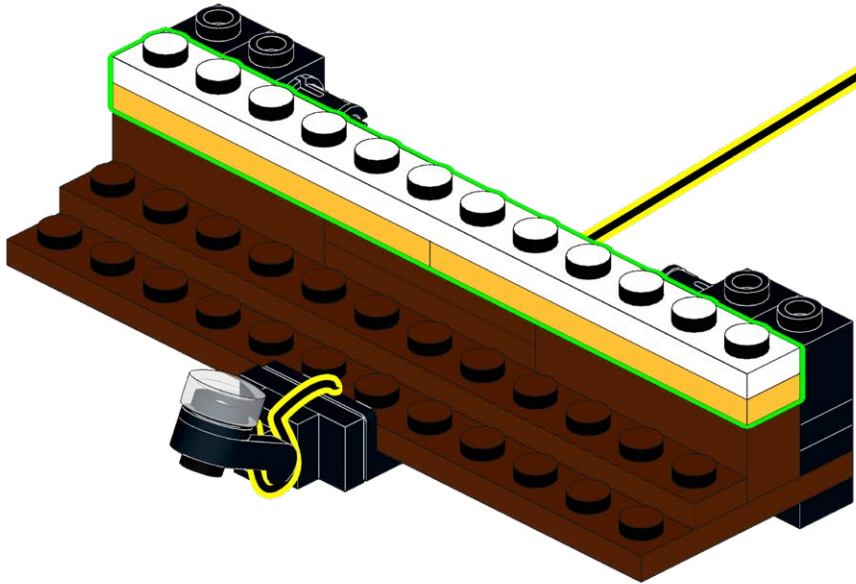
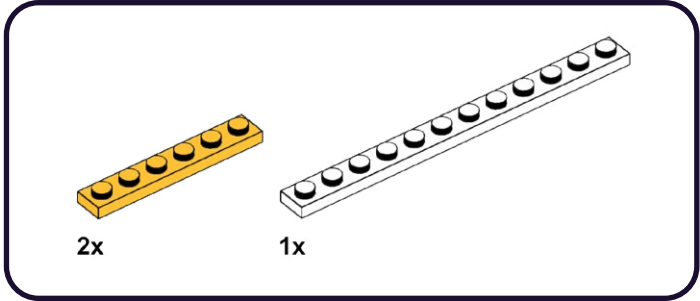

63

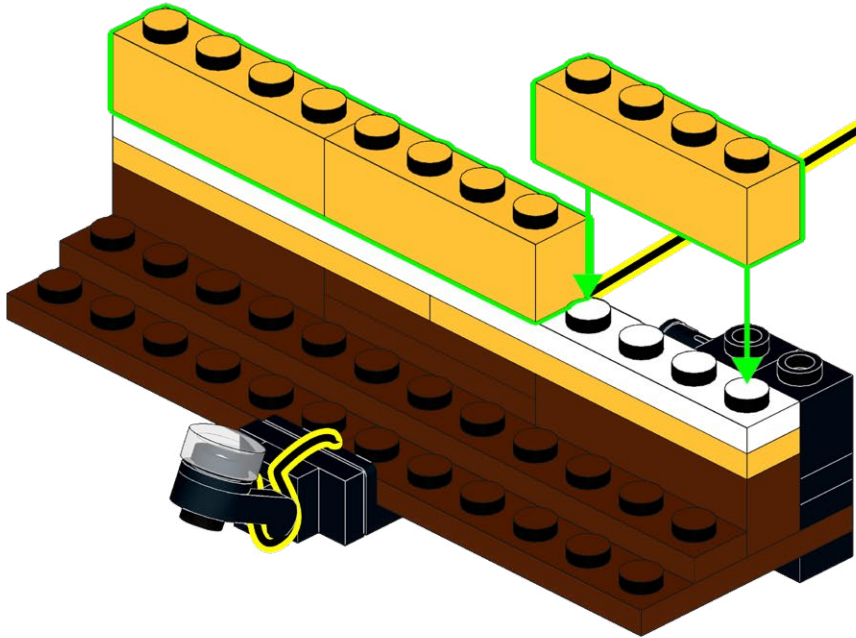
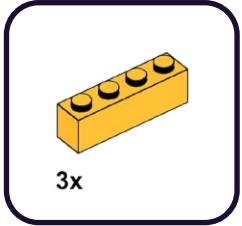

64

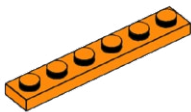

2x

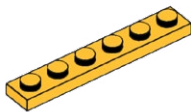

2x

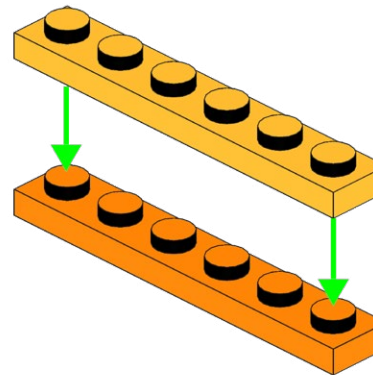

2x

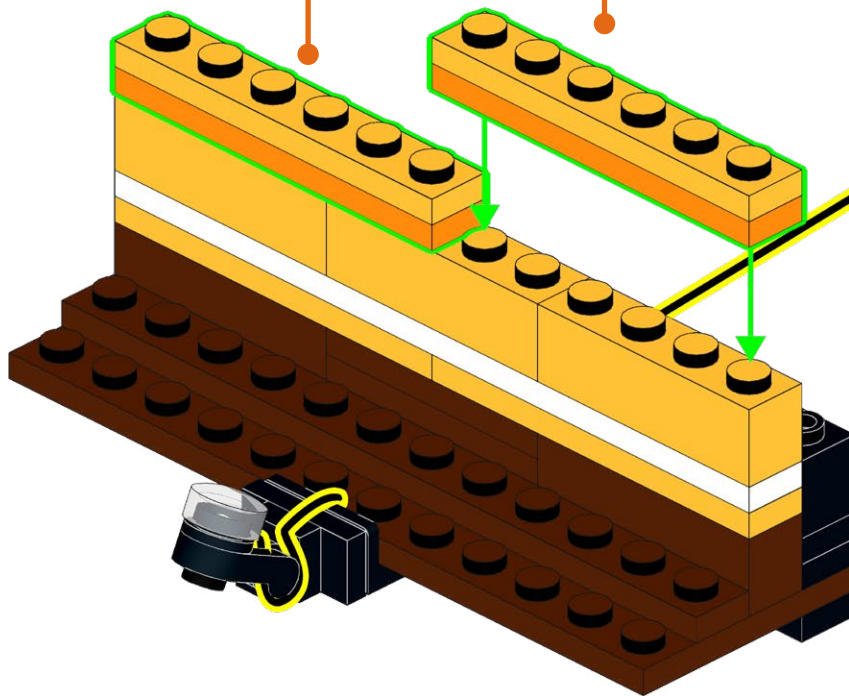



65

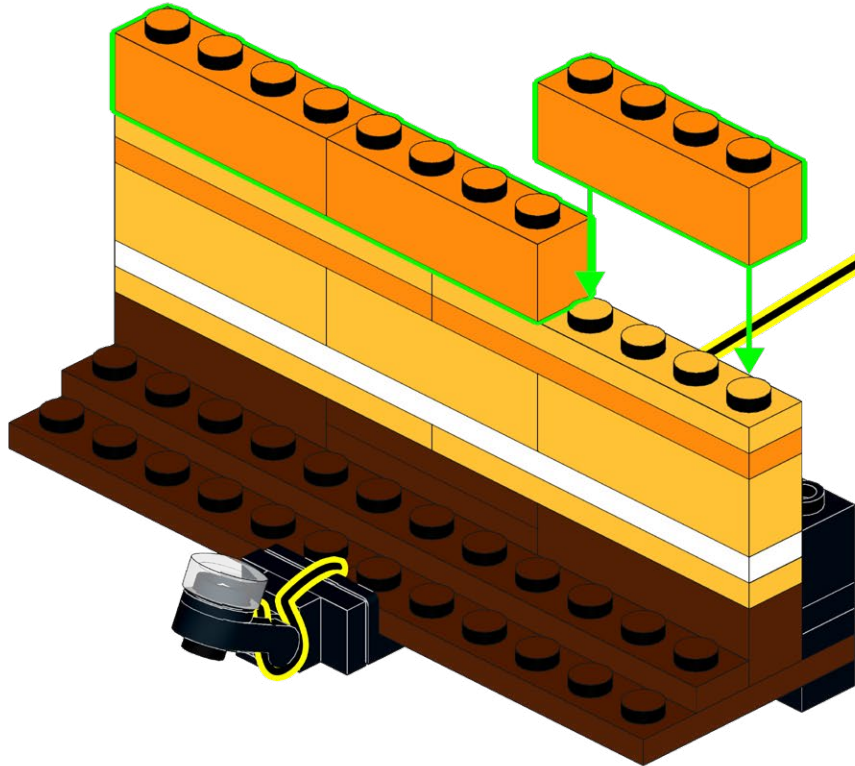
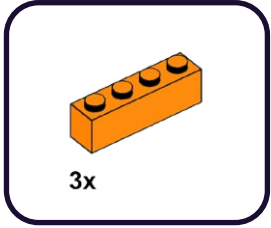

66

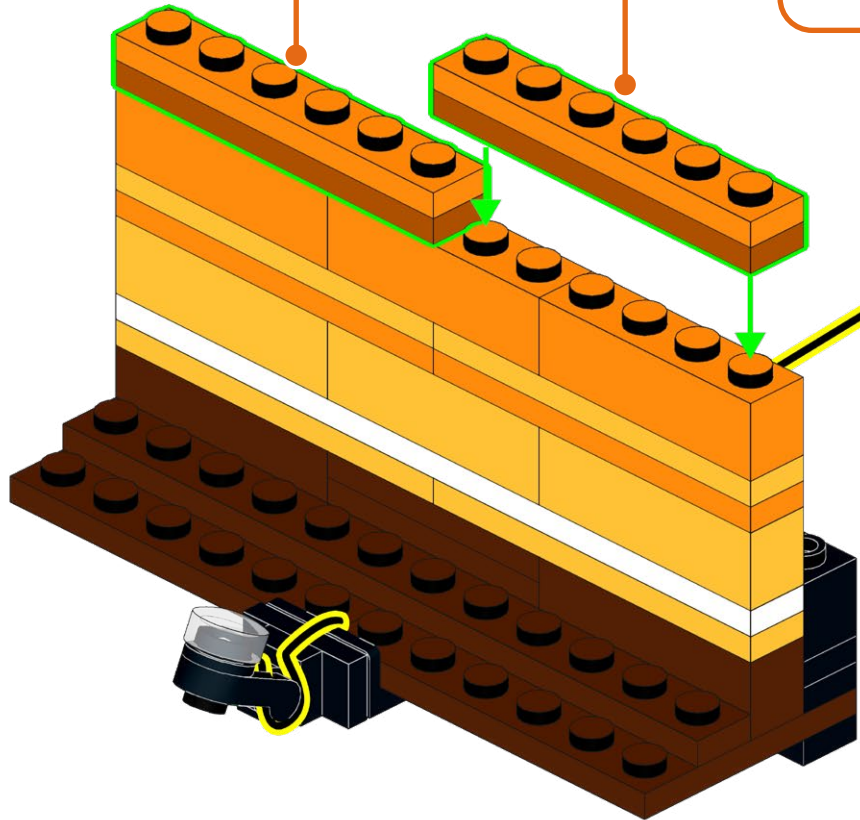
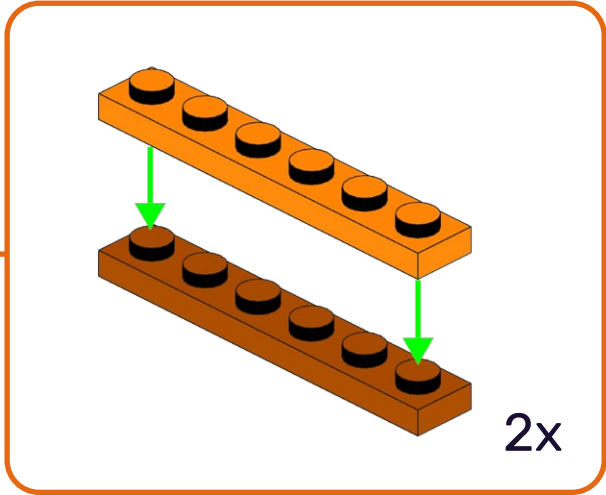
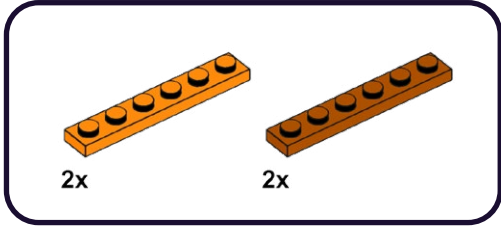

67

3x

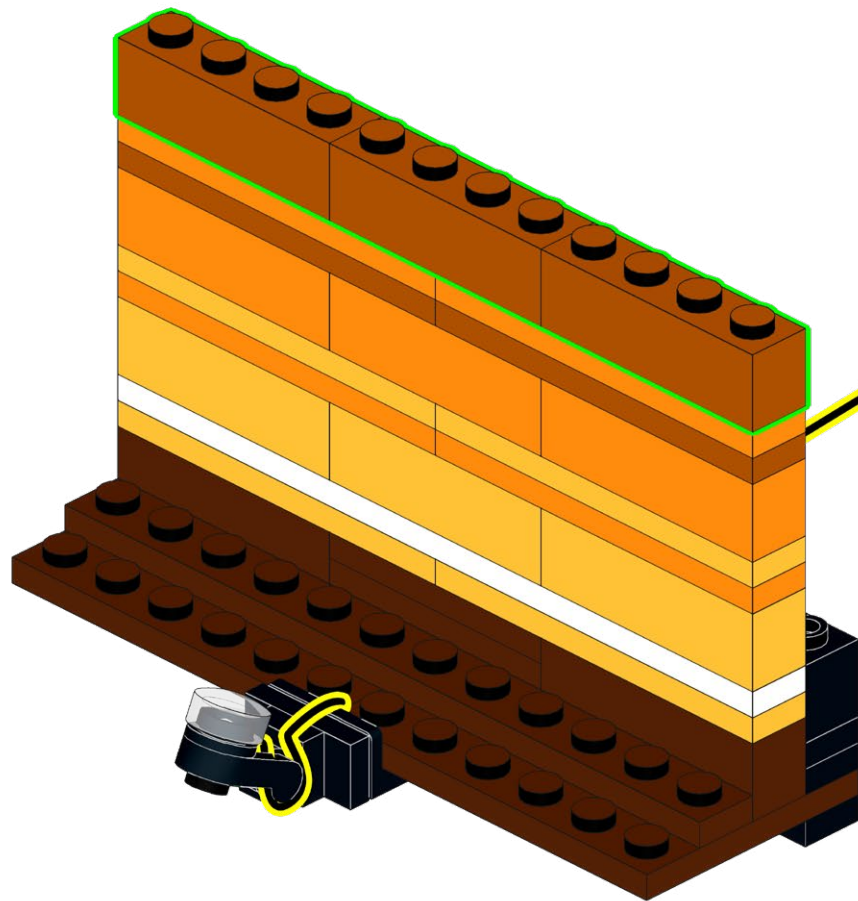

68

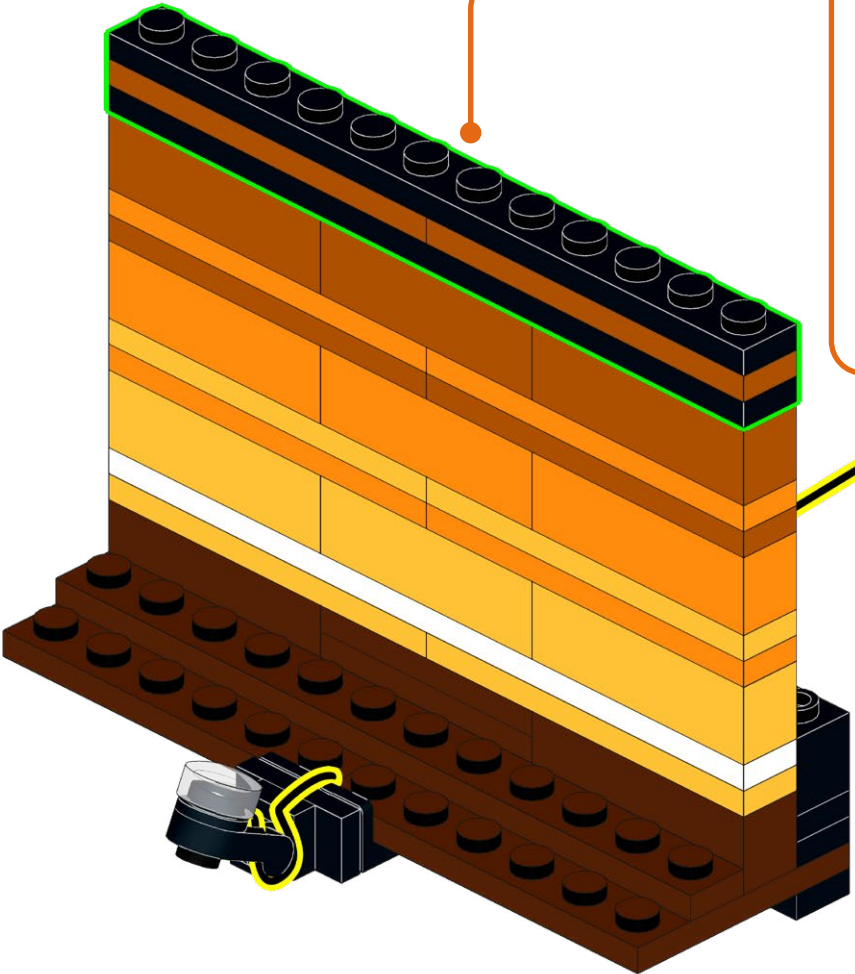
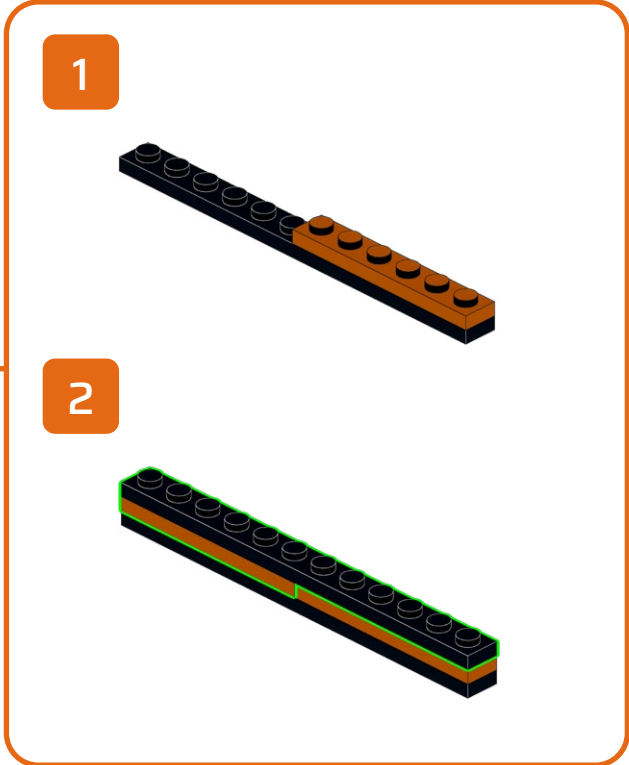
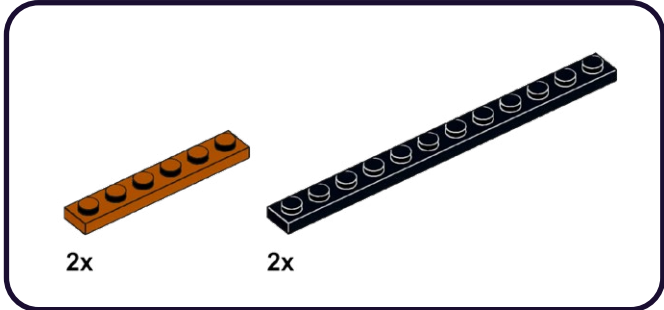



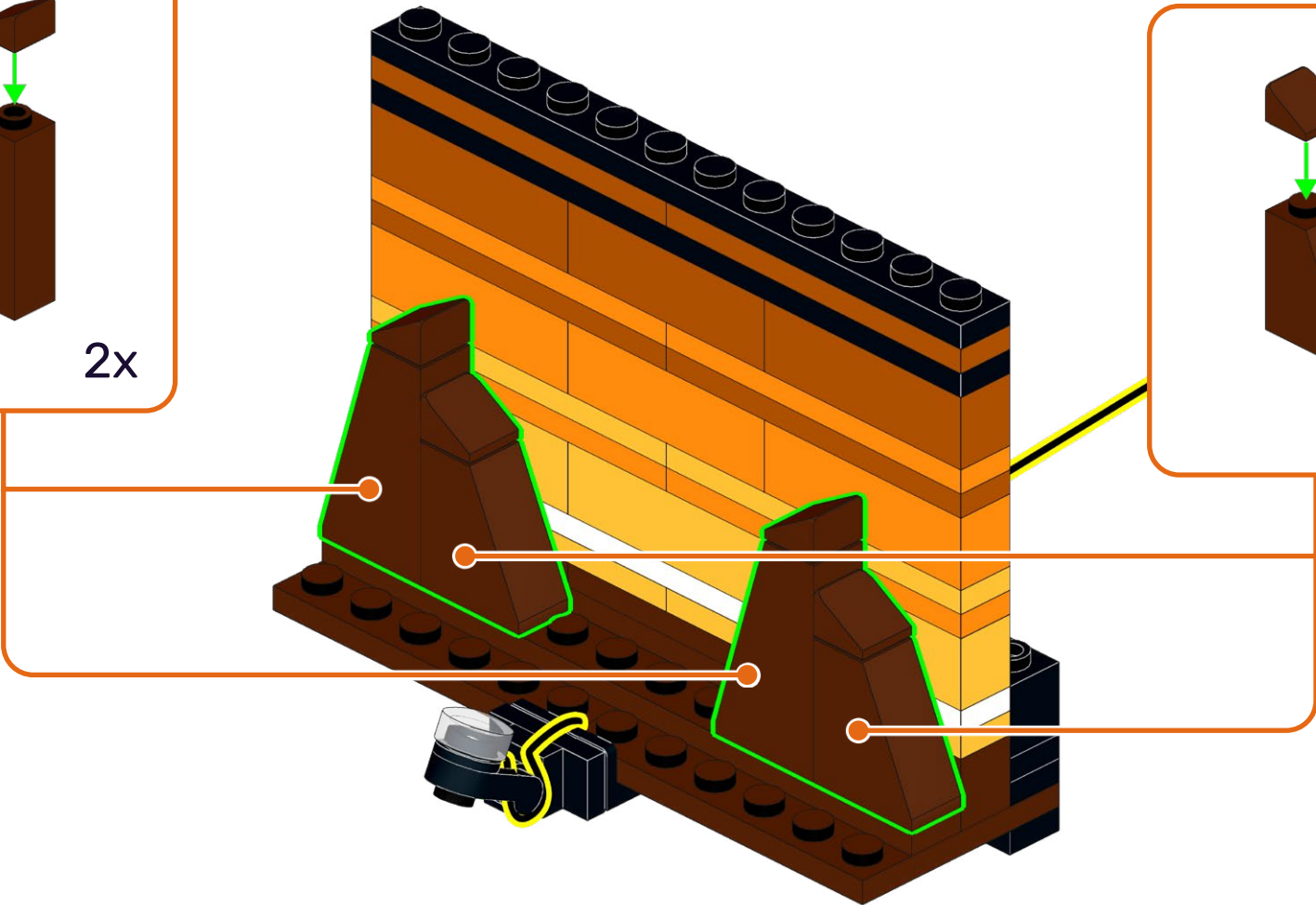
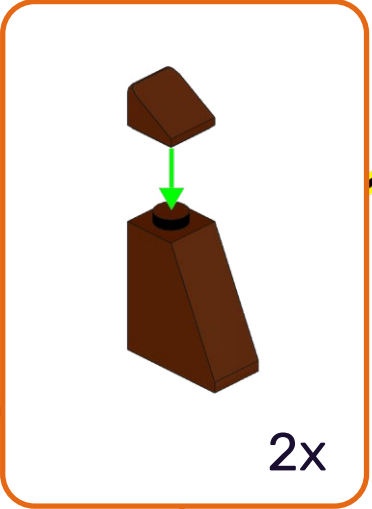
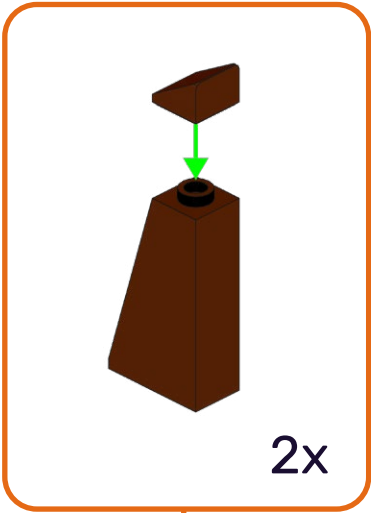
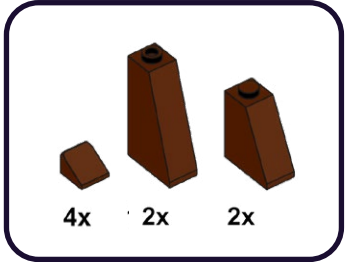

69

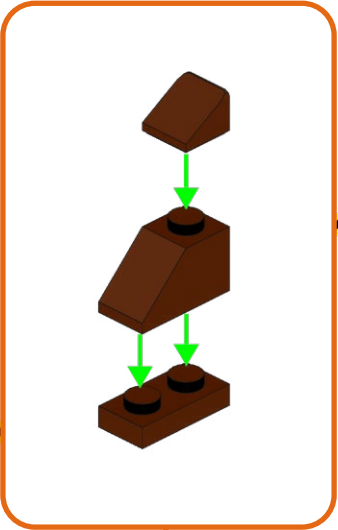
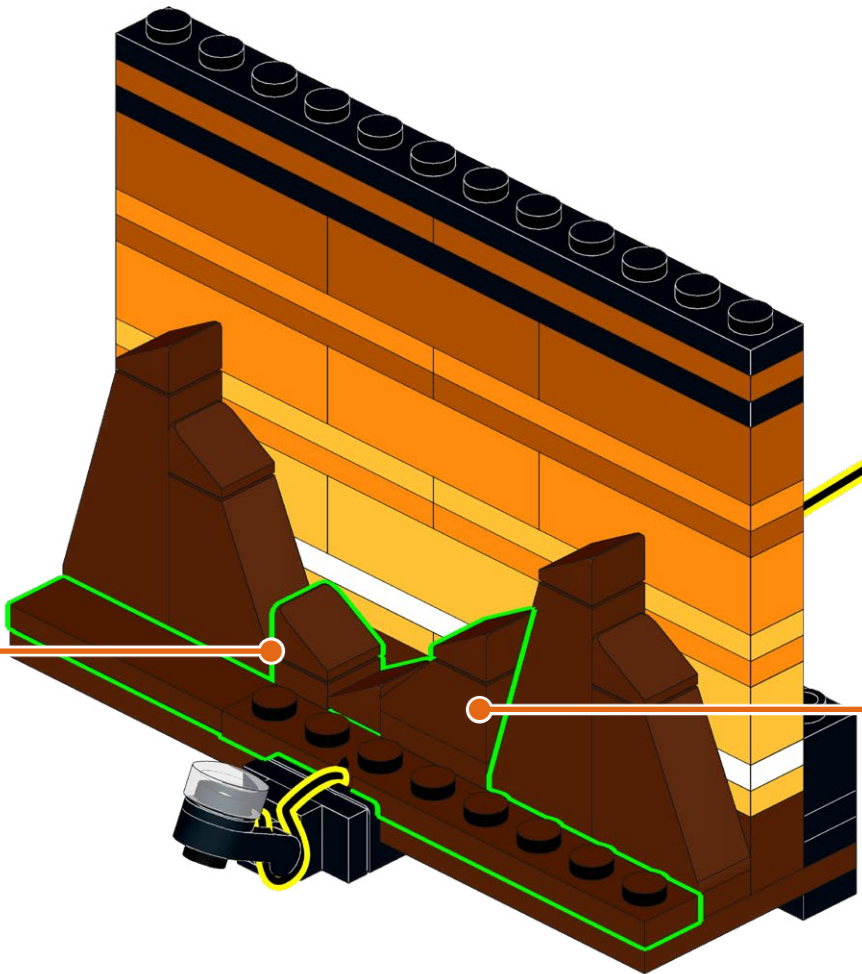
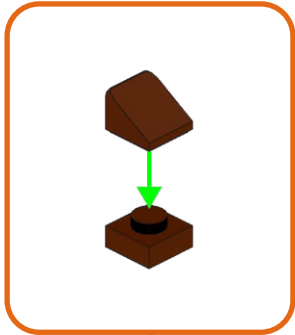
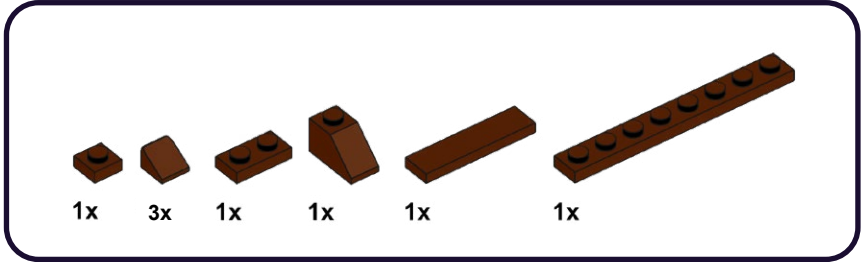

70



71

- 1x 
- 1x 
- 1x 
- 1x 
- 1x 

1

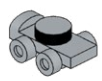

2

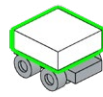

1



2



72

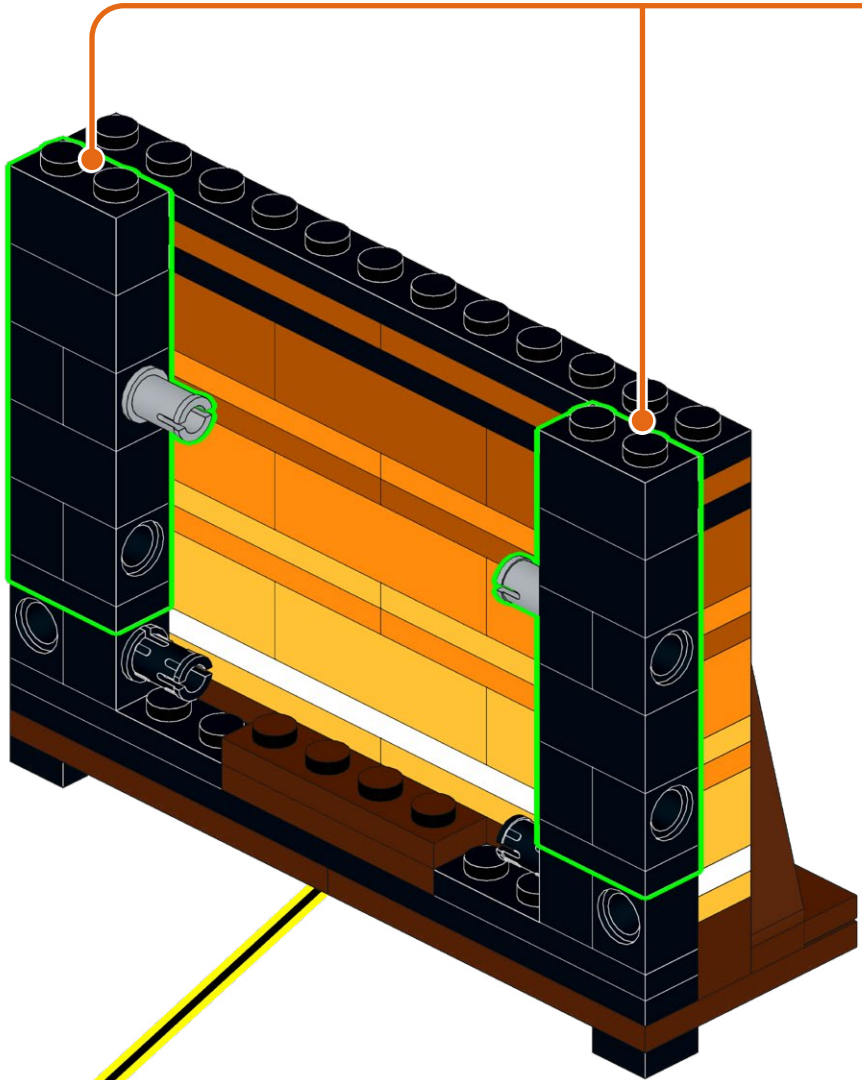
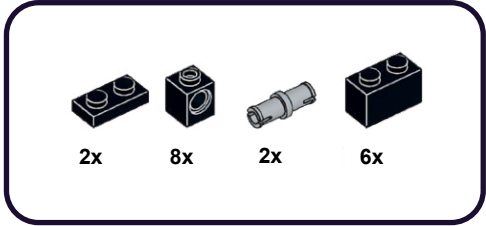

- 1
- 2
- 3
- 4
- 2x



**HOLD UP!**

You might notice some bags aren't in order, as well as left over pieces, but that's ok! We're changing the way you build LEGO!

**ATTENDEZ!**

Vous remarquerez peut-être que certains sacs, ainsi que certaines pièces, ne sont pas dans le bon ordre. Mais pas de panique! Nous changeons simplement la façon avec laquelle vous construisez vos LEGO!

**ASPETTA!**

Potresti notare che alcuni sacchetti non sono in ordine, così come i pezzi avanzati, ma va bene così! Stiamo cambiando il modo in cui costruisci i LEGO!

**HALT!**

Sie werden möglicherweise bemerken, dass einige tüten durcheinander sind und teile übrig bleiben, aber das ist in Ordnung! Wir ändern die art und weise, wie Sie LEGO bauen!

**¡ESPERA!**

Es posible que notes que algunas bolsas están fuera de servicio, así como piezas sobrantes, ¡pero está bien! ¡Estamos cambiando la forma en que construyes LEGO!

**暫停!**

你可能会注意到一些袋子顺序错乱, 以及一些剩余的部件, 但没关系! 我们正在改变你搭建乐高的方式!

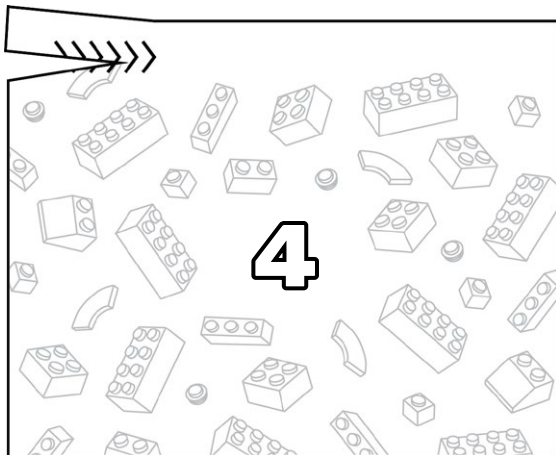
**Open LEGO® Bag 4**

73

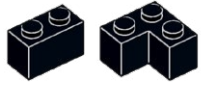

5x

2x

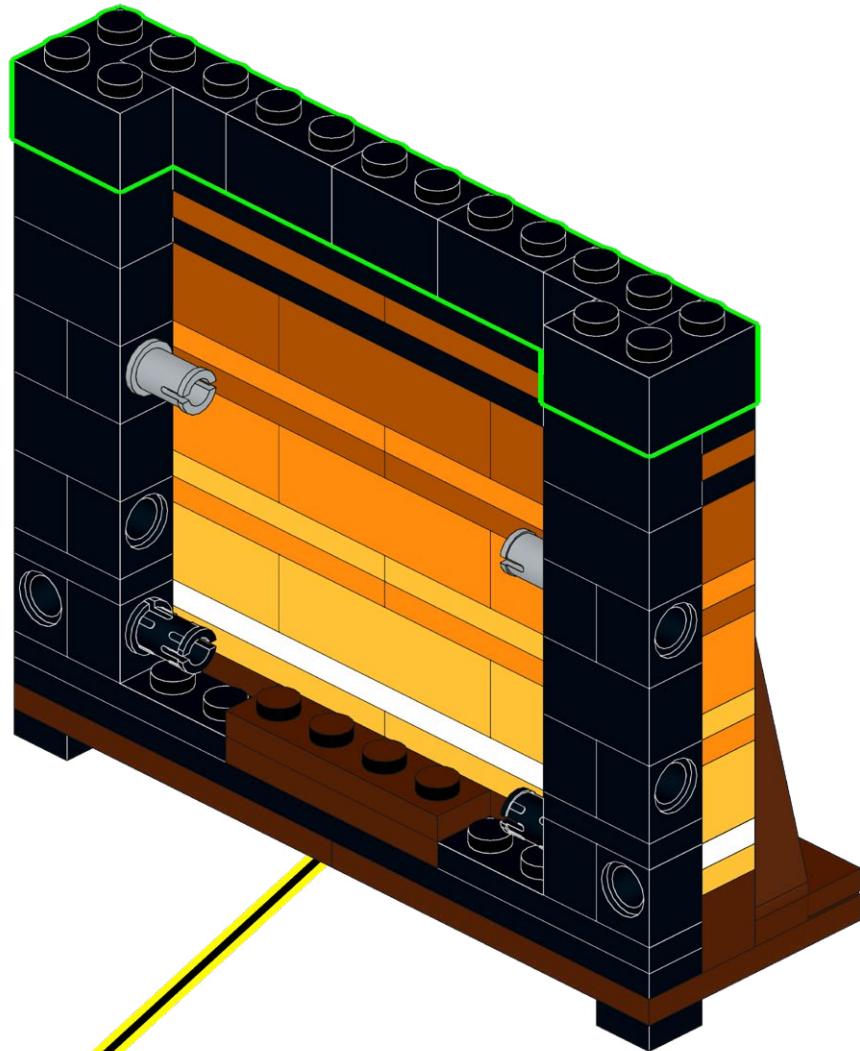

74

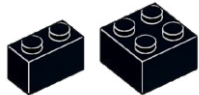

4x

2x

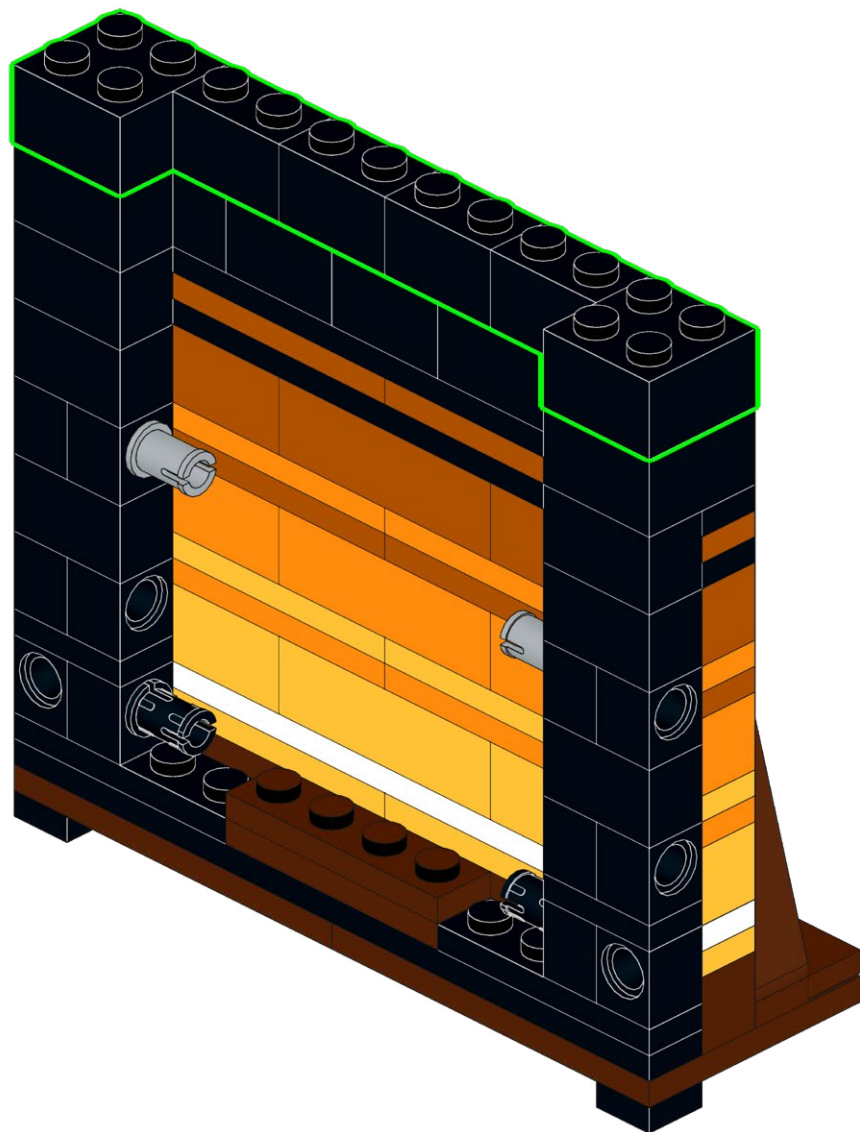

75

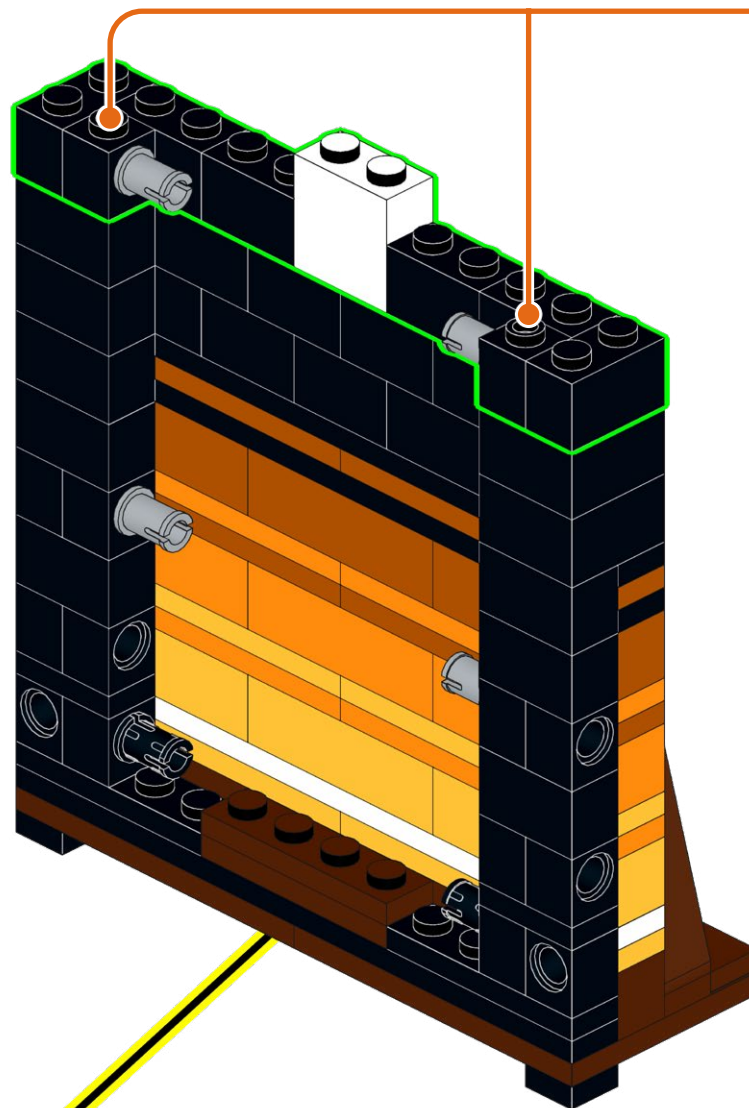
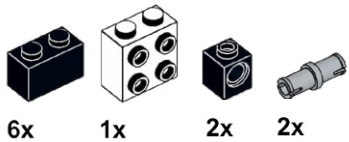

1



2

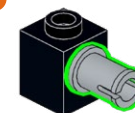

2x

76

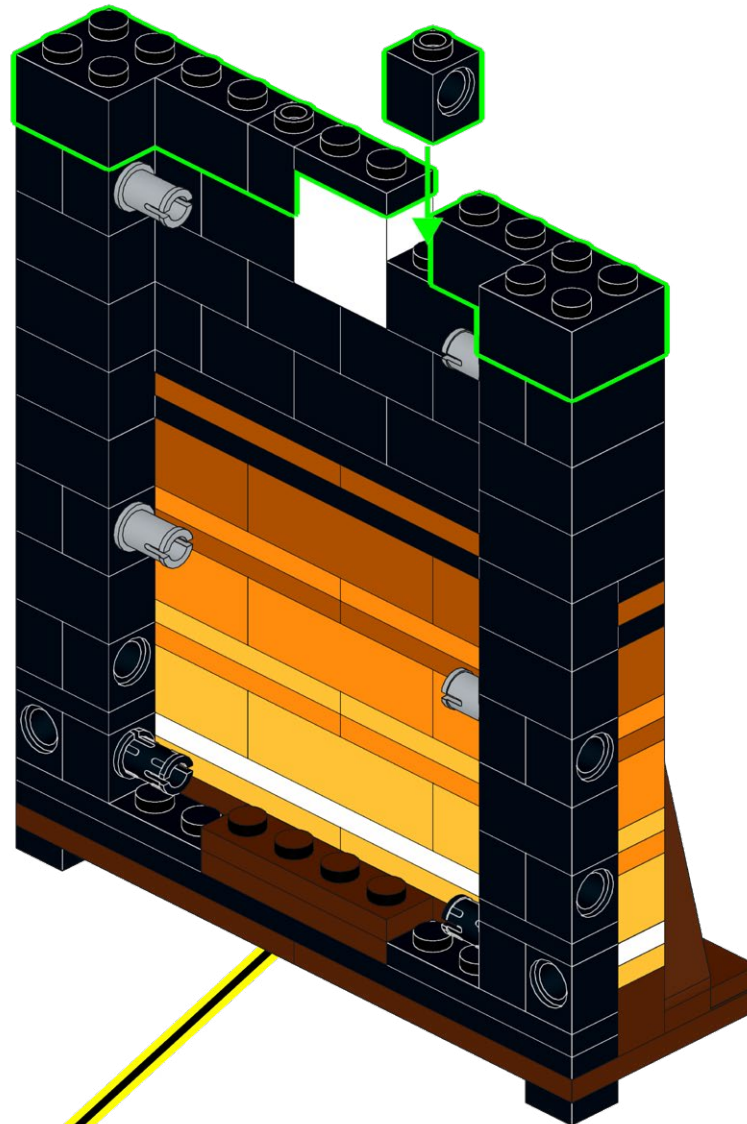
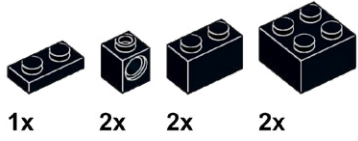

77



2x

1x

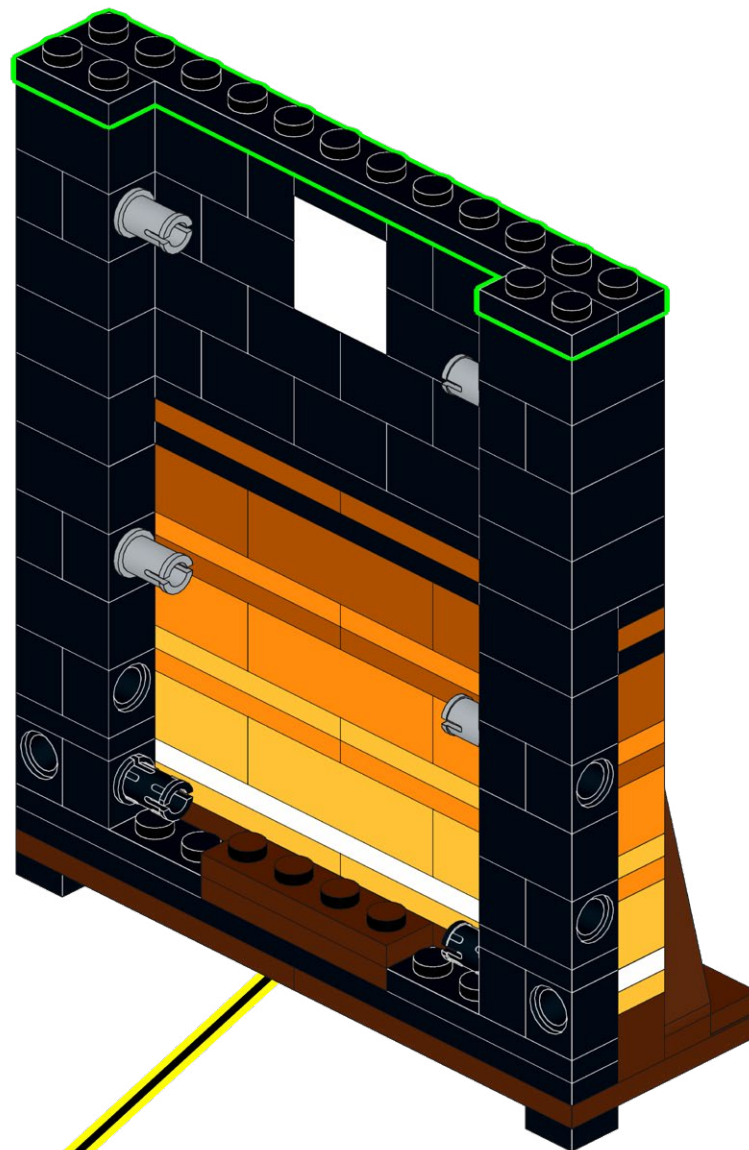

78

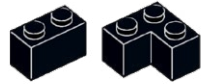

2x

2x

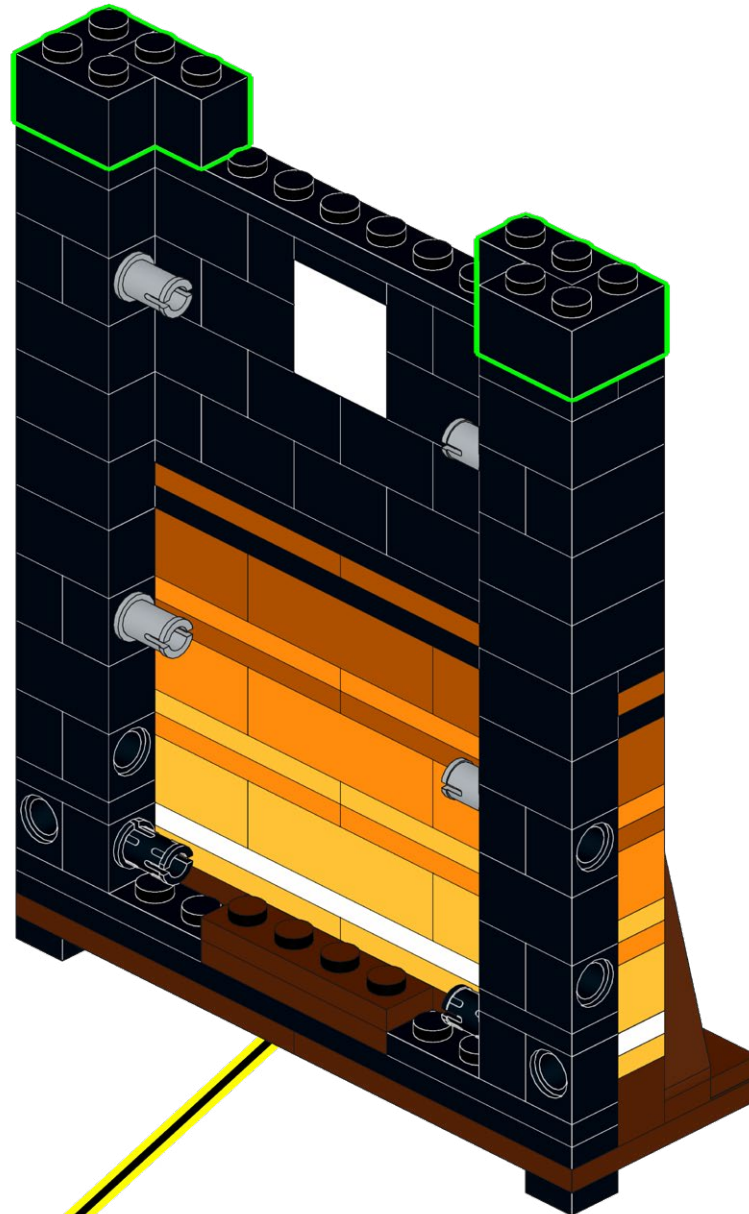

79

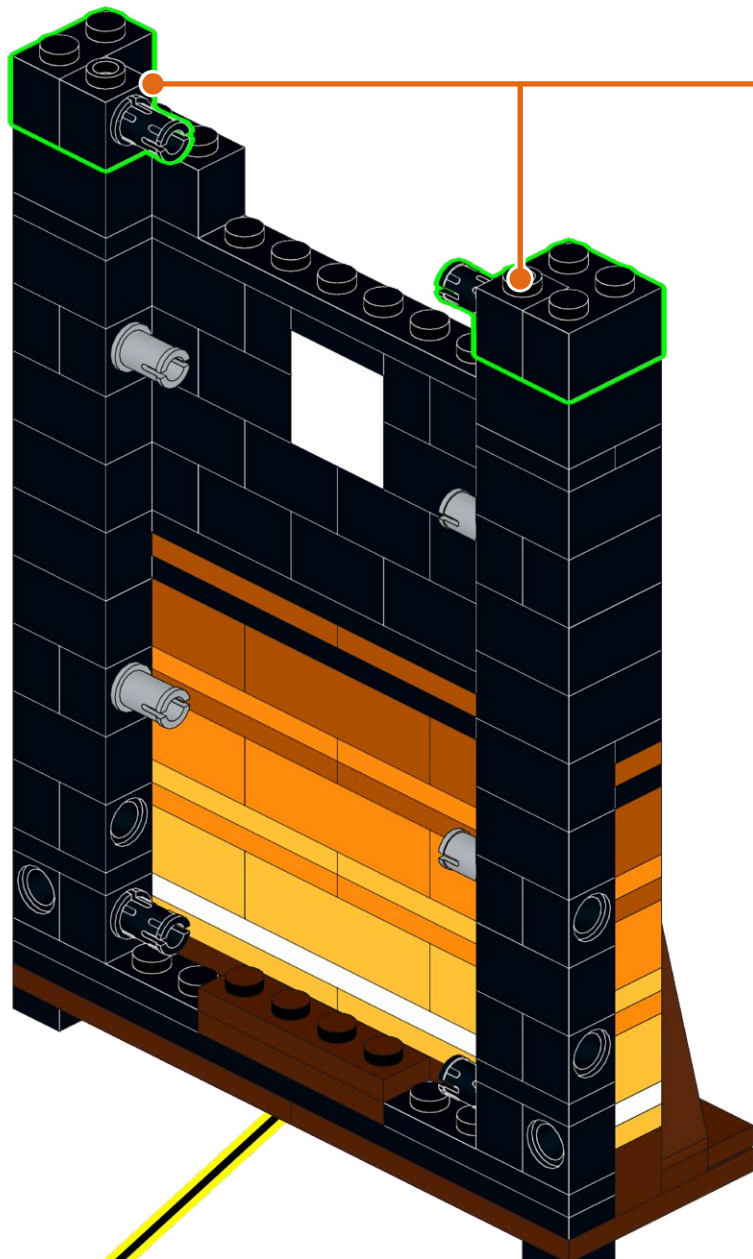
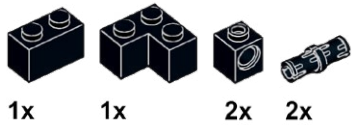

1



2

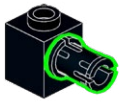

2x



80

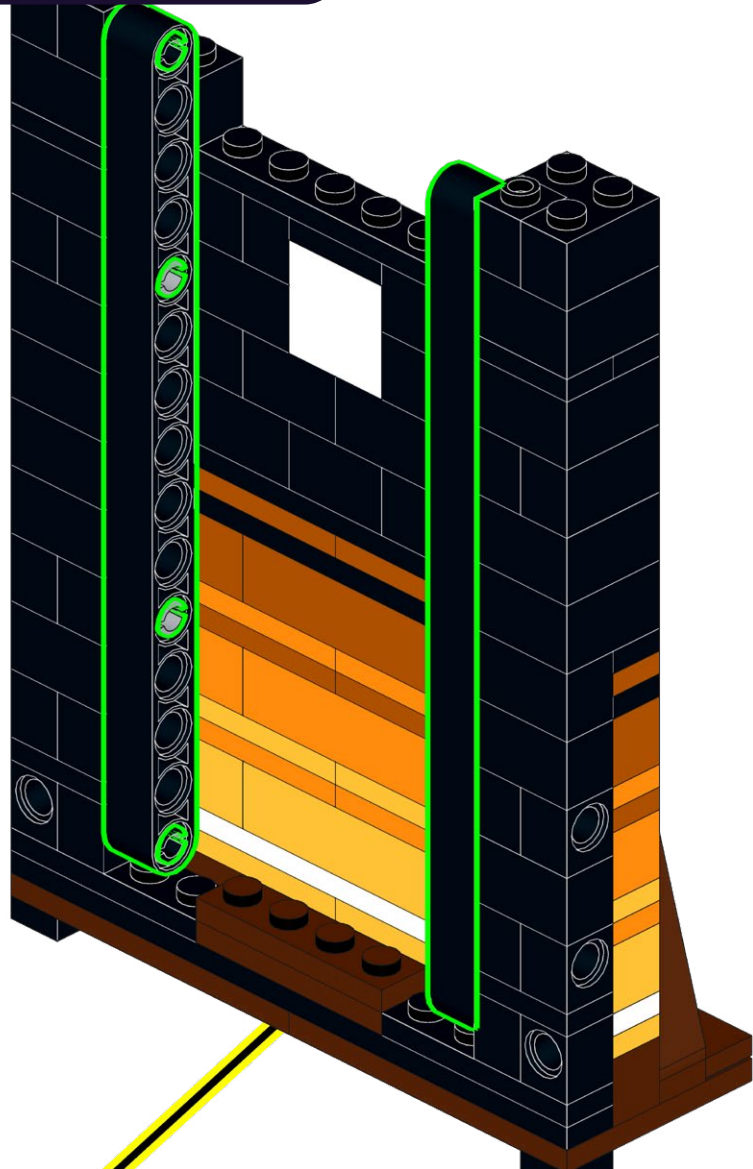

81

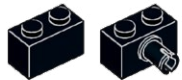

1x

2x

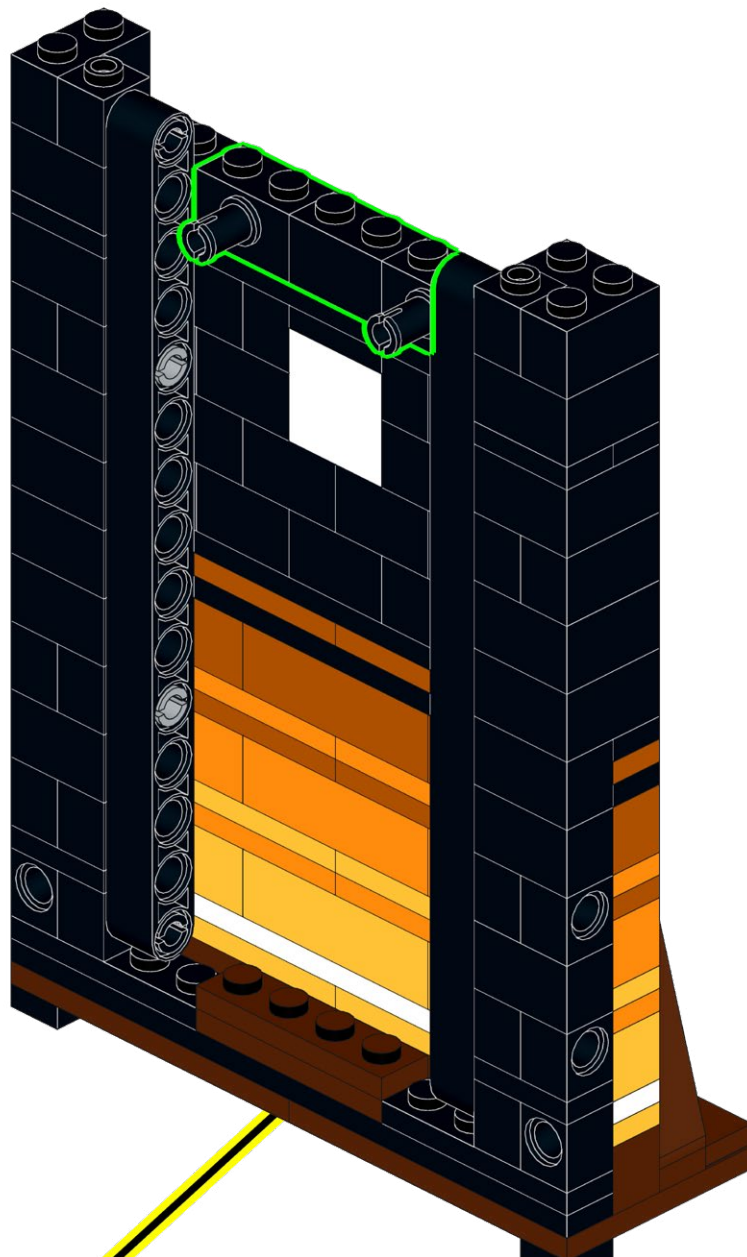

82

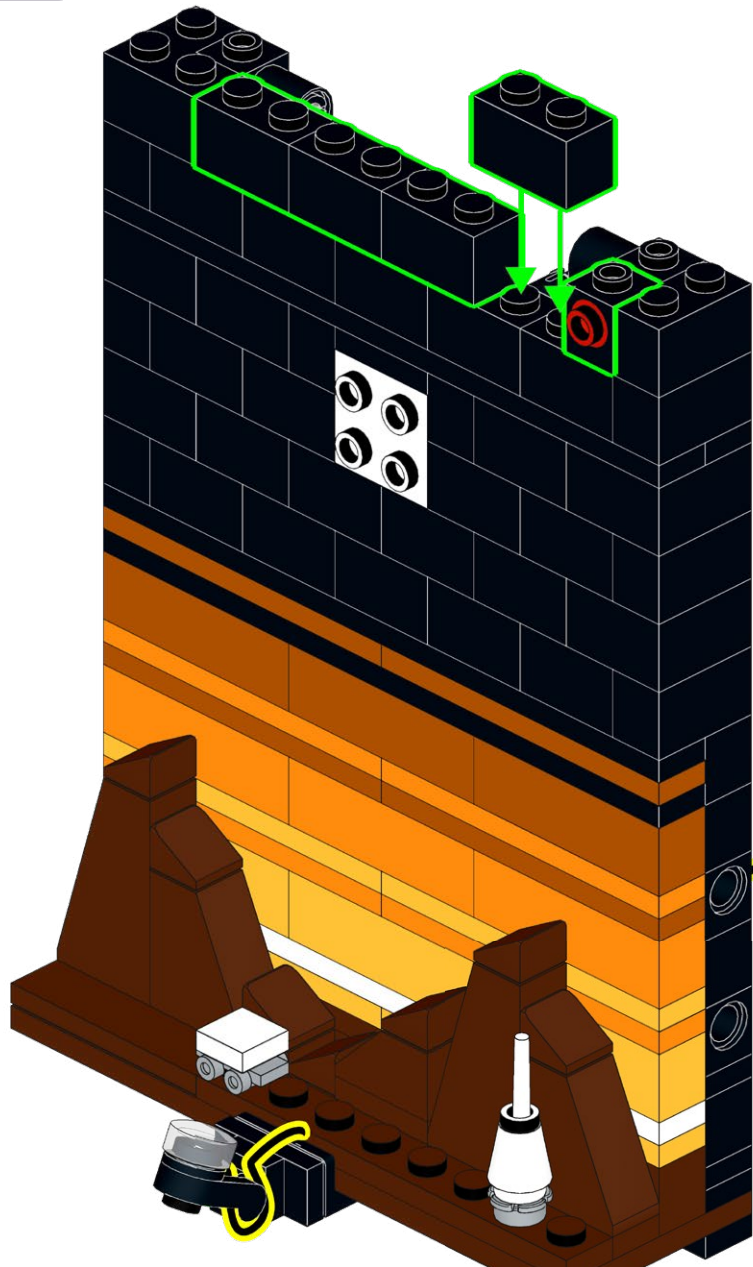
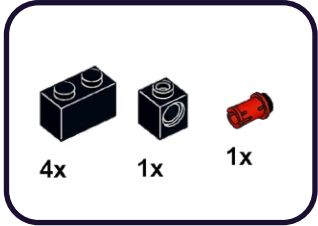

83

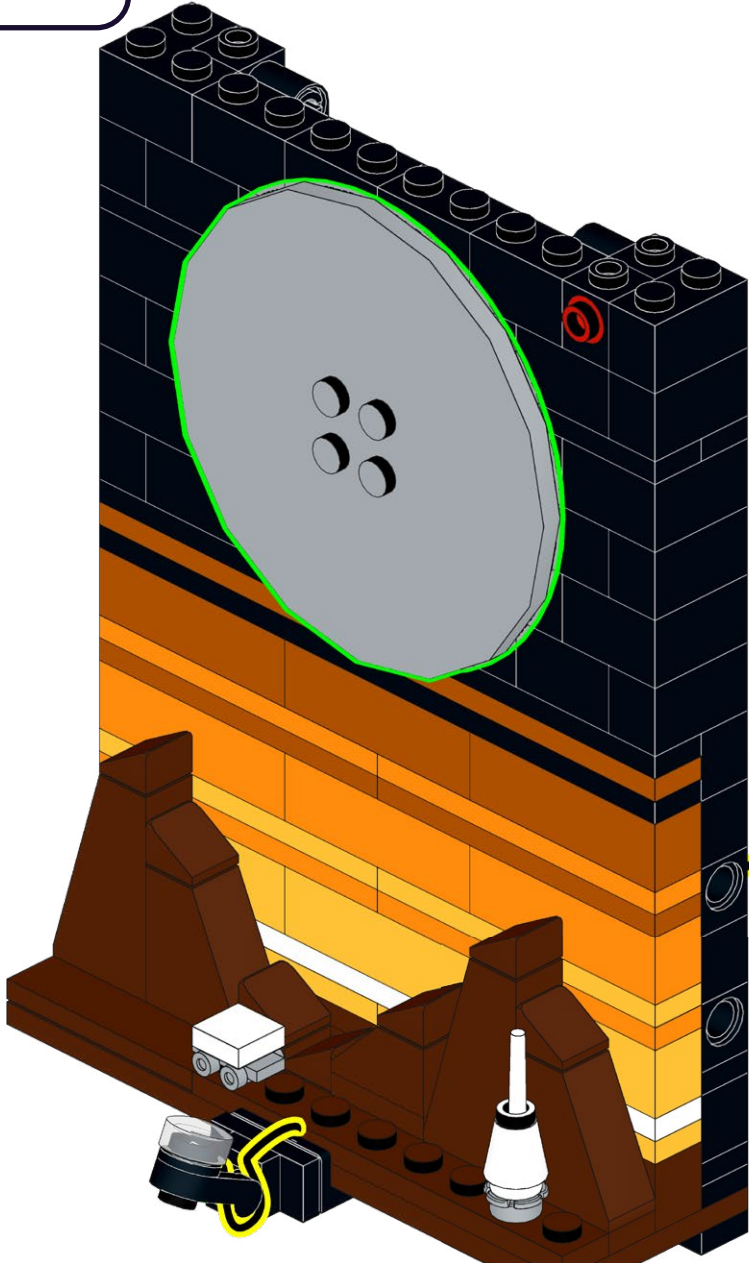
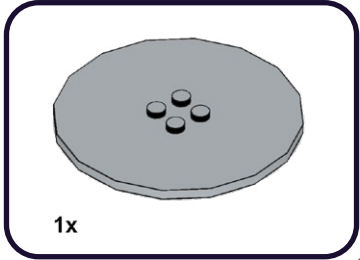

84

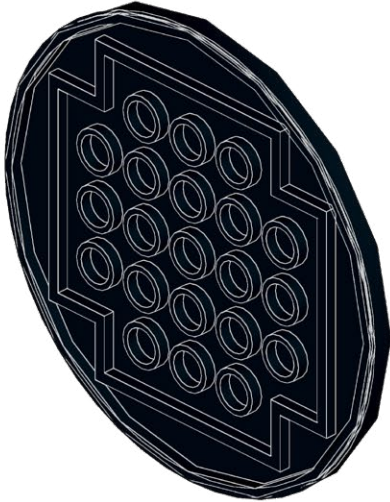

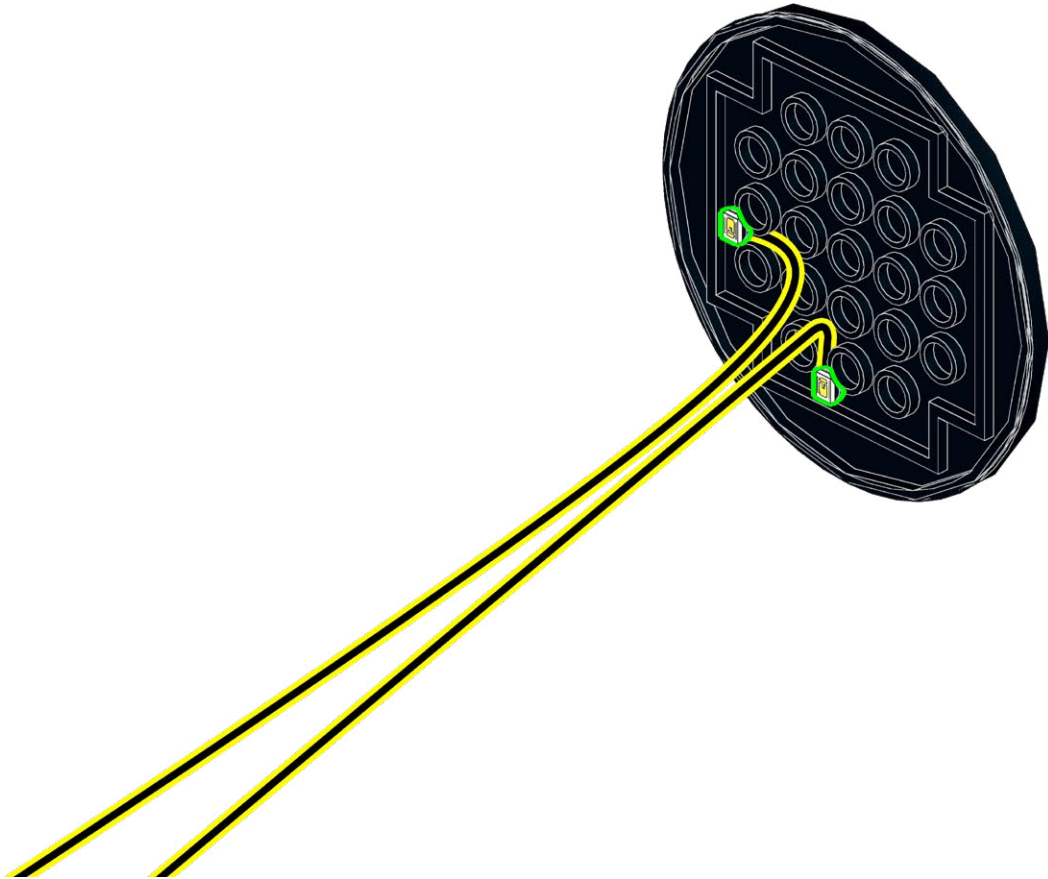
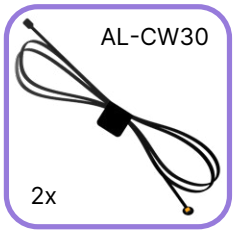
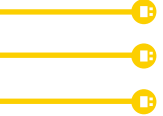

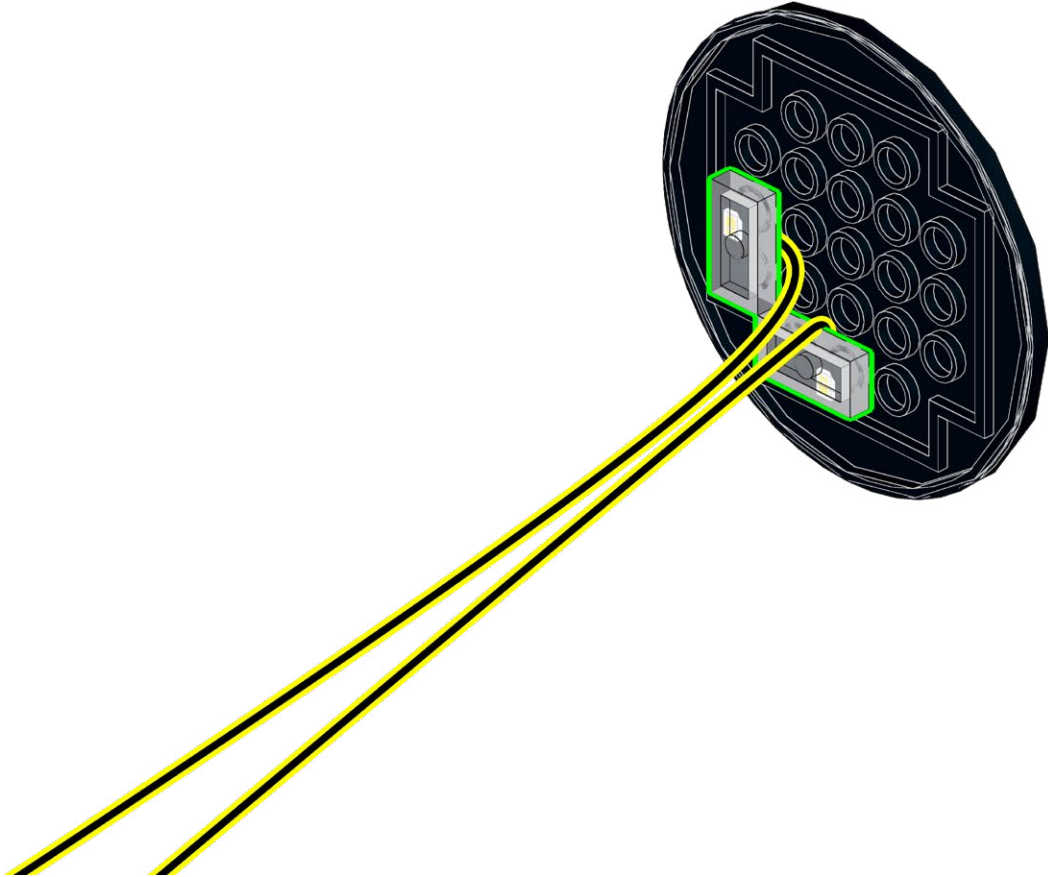
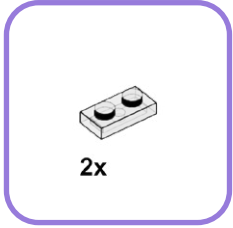

87



2x

1

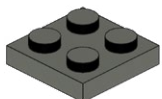

2

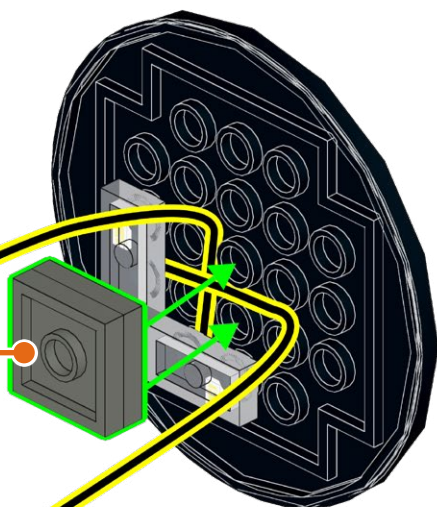
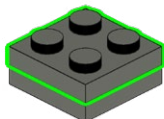

88

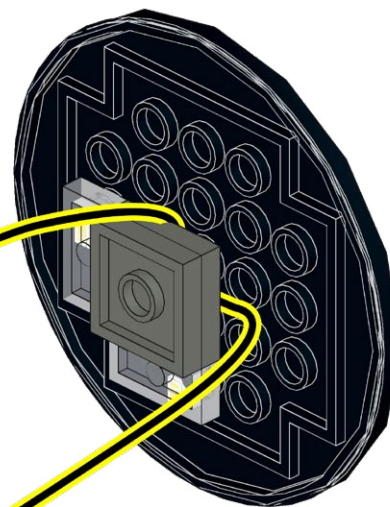



89

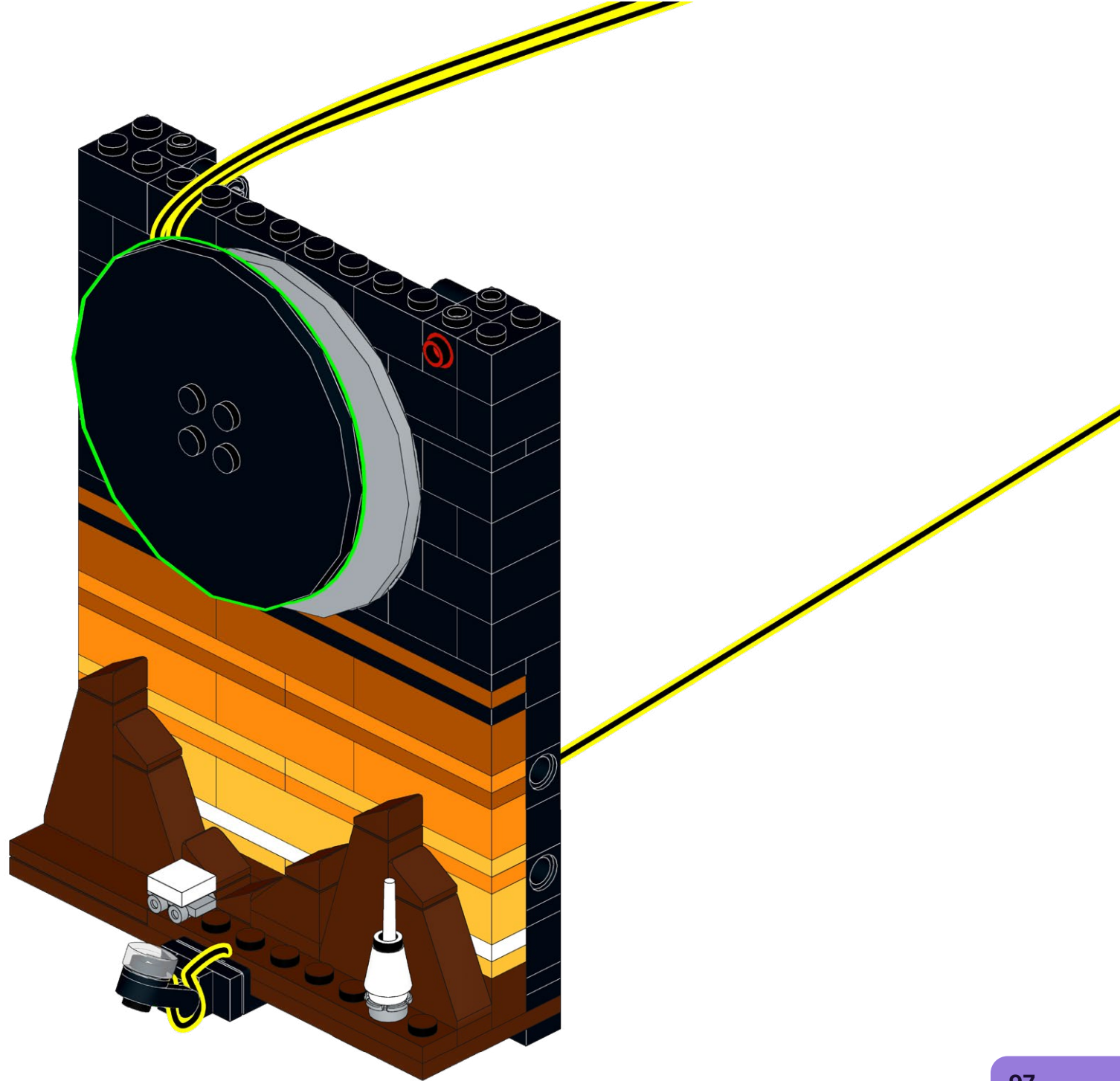

90

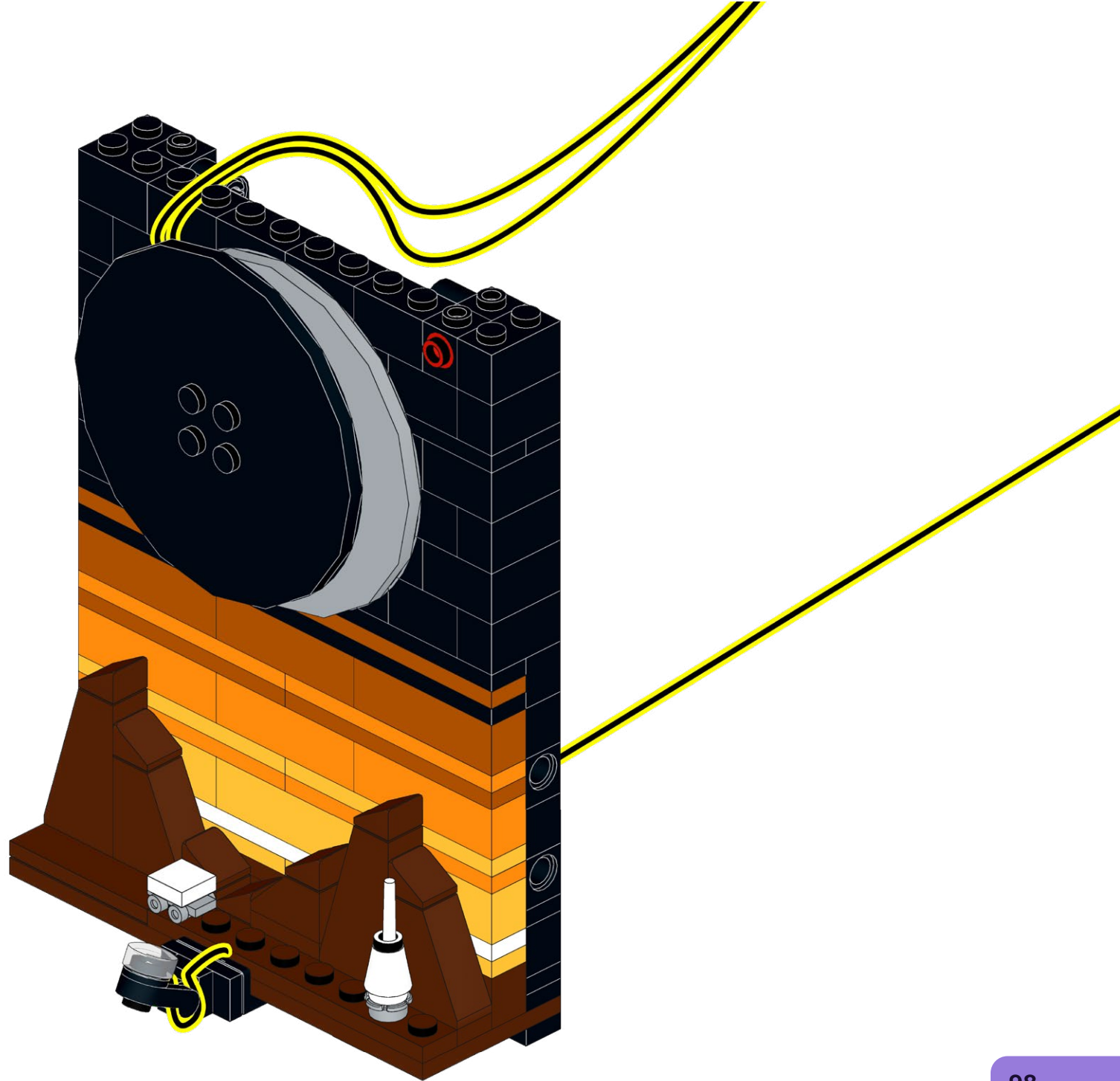

91



1x

1x

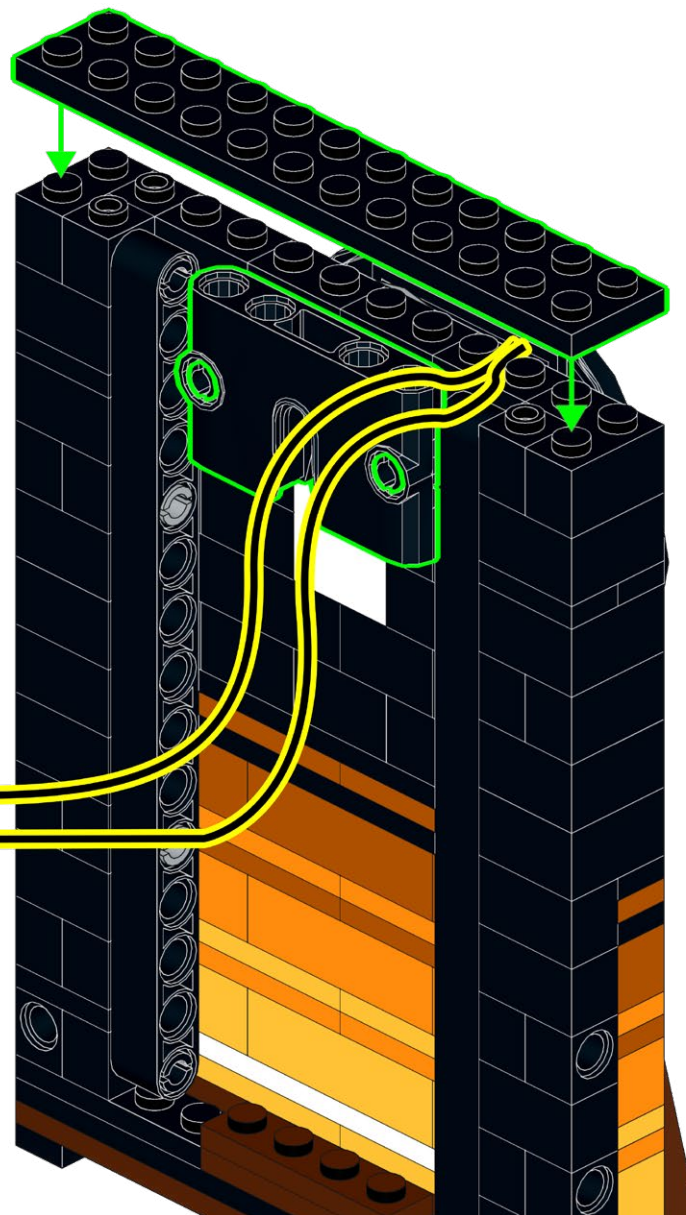

92

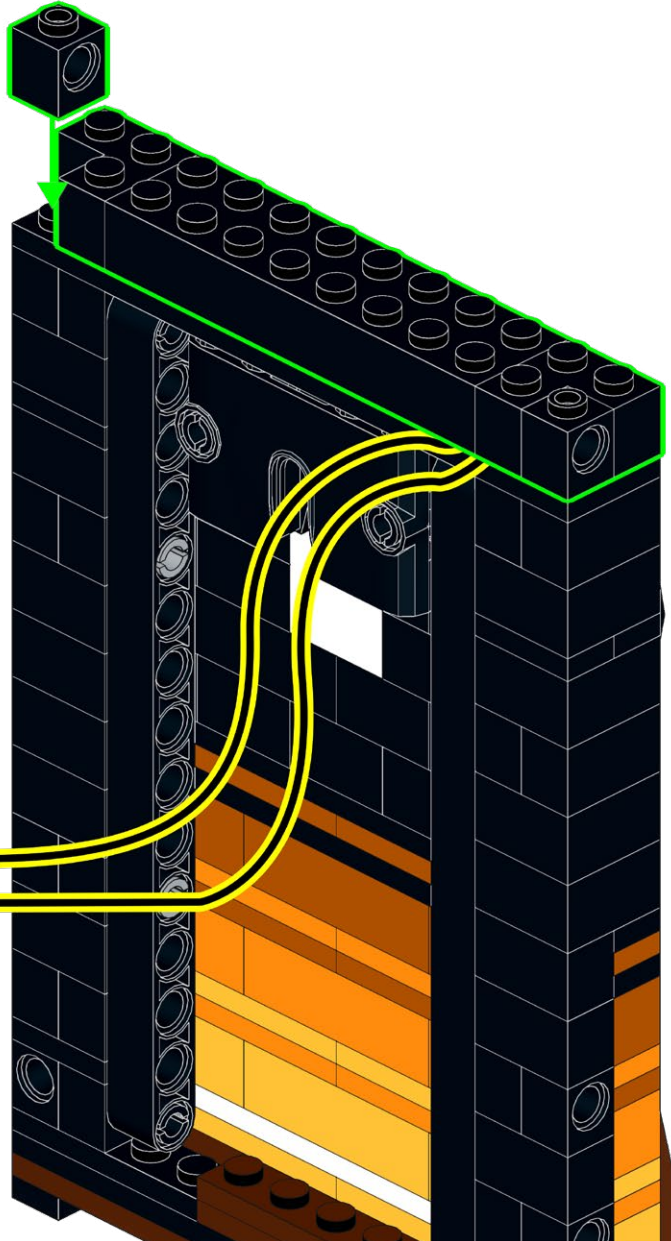
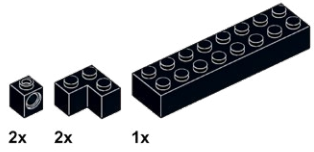

93

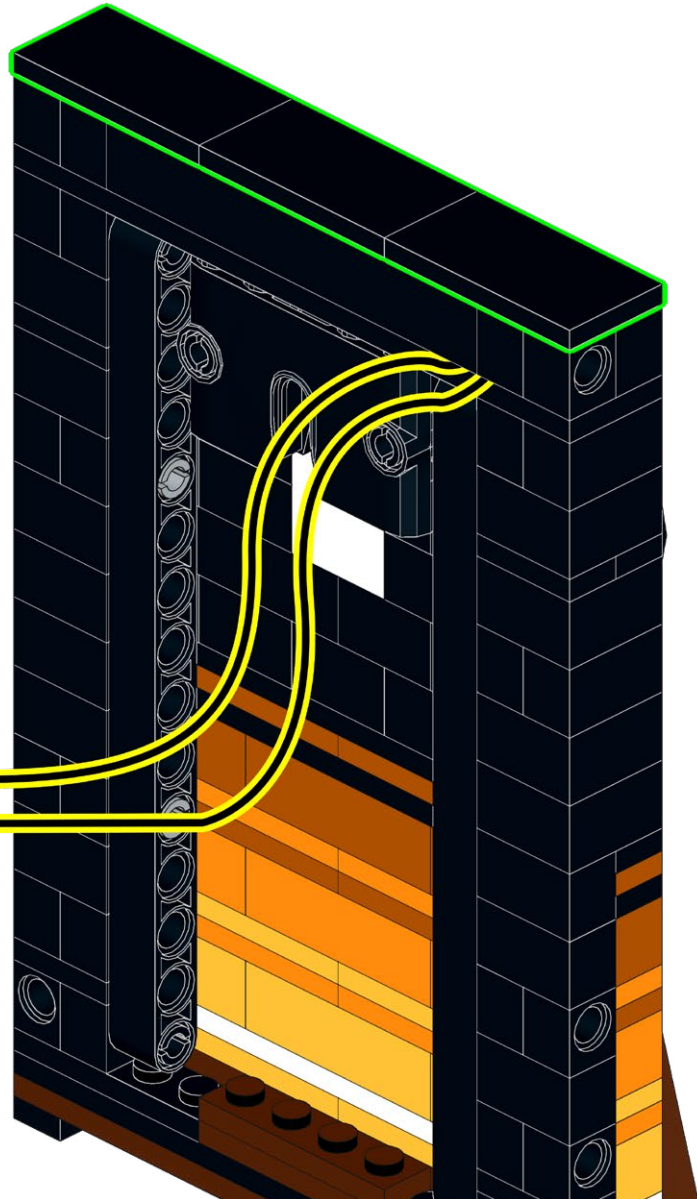

94

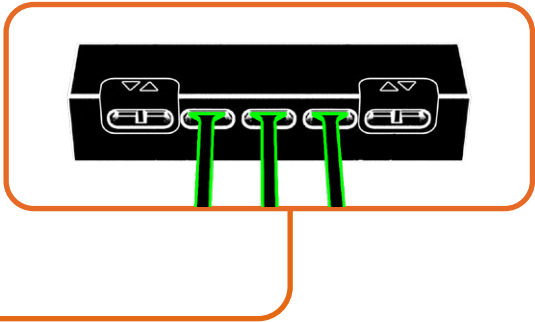
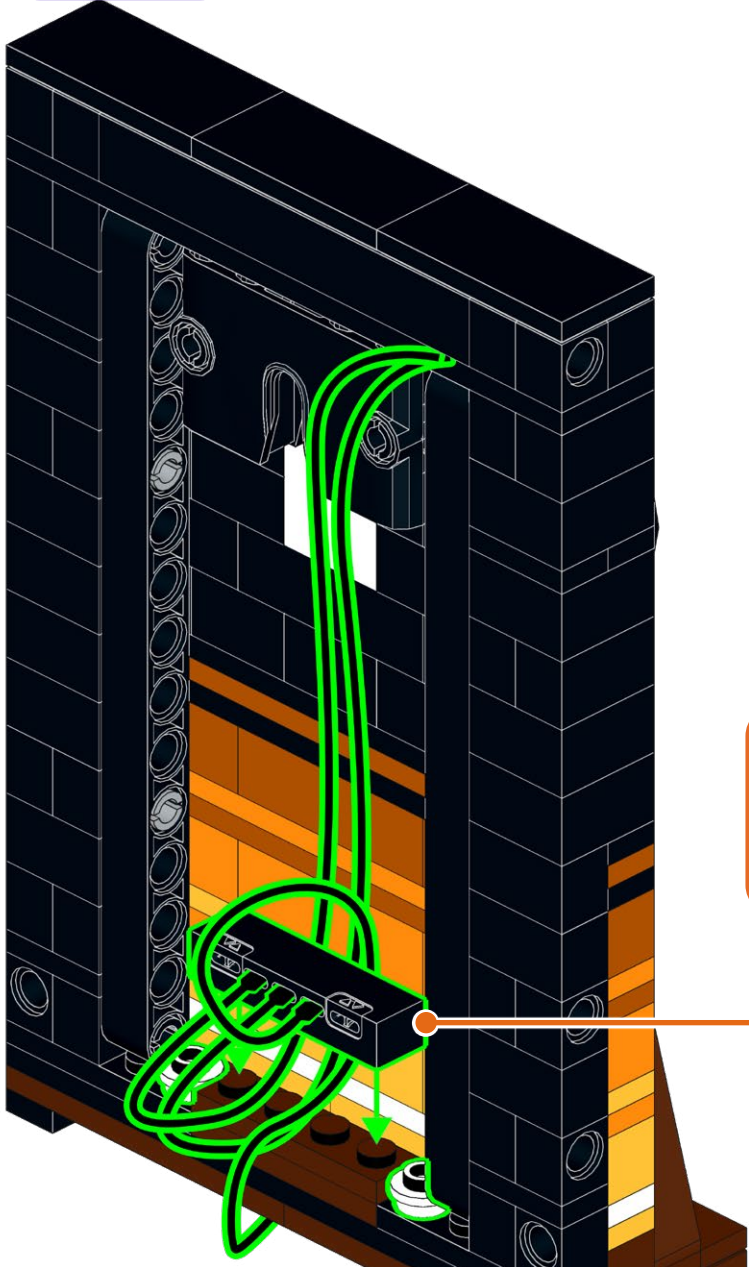
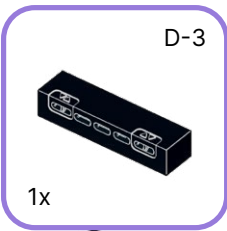
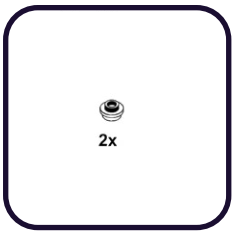



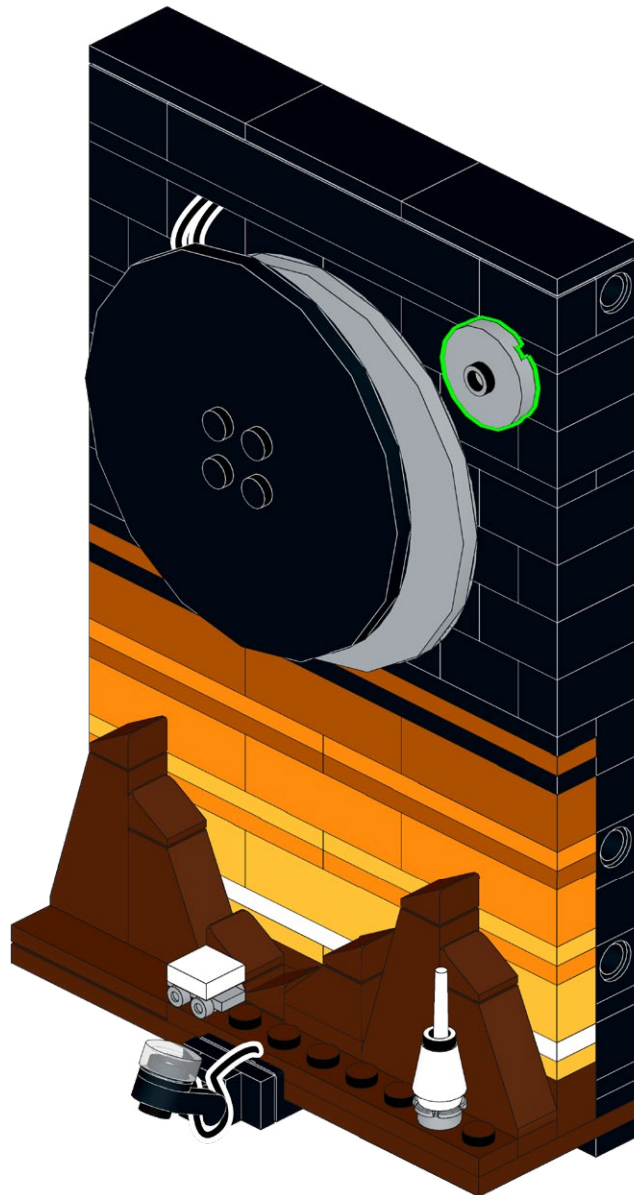
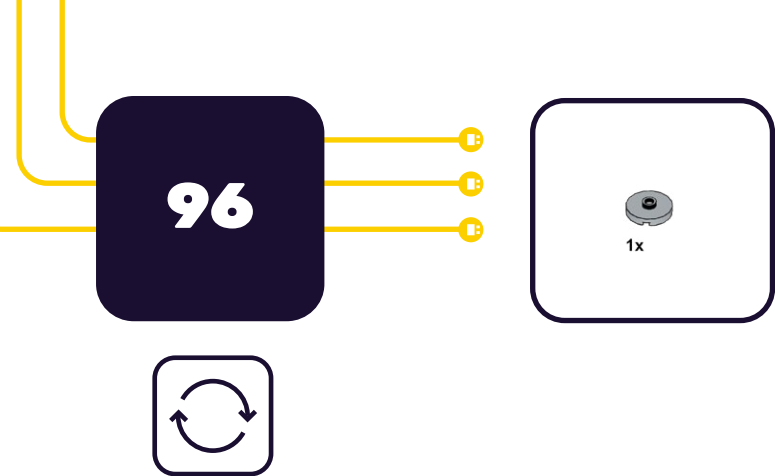



97

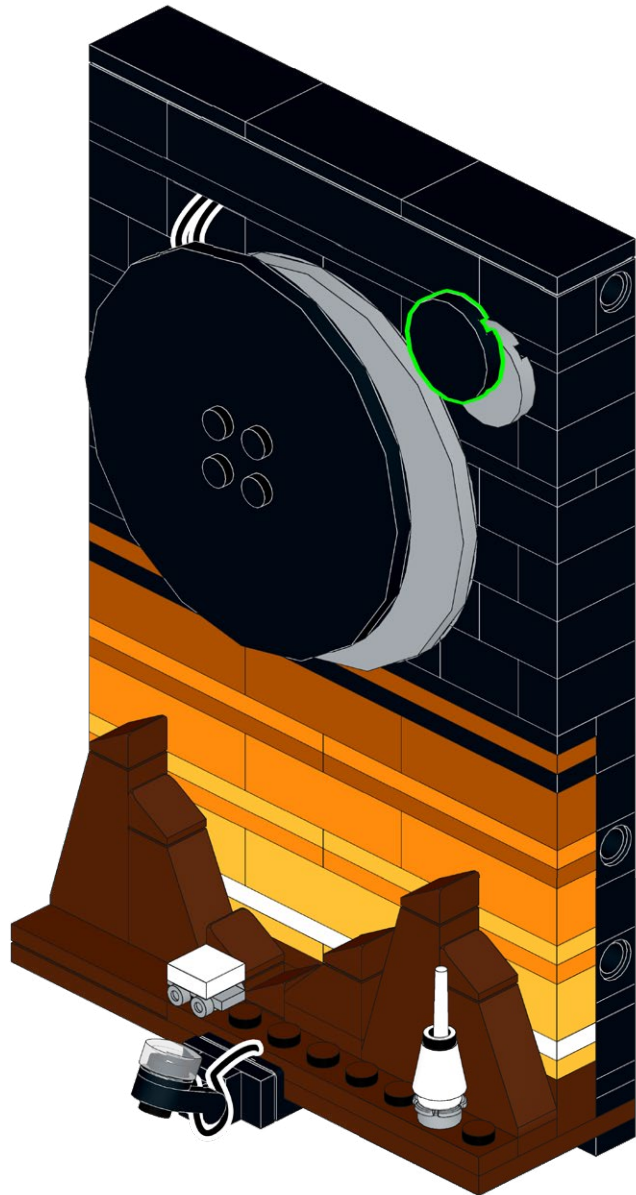
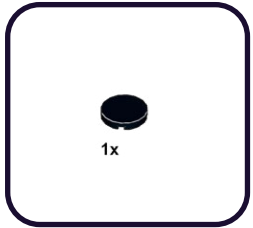



### **HOLD UP!**

You might notice some bags aren't in order, as well as left over pieces, but that's ok! We're changing the way you build LEGO!

### **ATTENDEZ!**

Vous remarquerez peut-être que certains sacs, ainsi que certaines pièces, ne sont pas dans le bon ordre. Mais pas de panique! Nous changeons simplement la façon avec laquelle vous construisez vos LEGO!

### **ASPETTA!**

Potresti notare che alcuni sacchetti non sono in ordine, così come i pezzi avanzati, ma va bene così! Stiamo cambiando il modo in cui costruisci i LEGO!

### **HALT!**

Sie werden möglicherweise bemerken, dass einige tüten durcheinander sind und teile übrig bleiben, aber das ist in Ordnung! Wir ändern die art und weise, wie Sie LEGO bauen!

### **¡ESPERA!**

Es posible que notes que algunas bolsas están fuera de servicio, así como piezas sobrantes, ¡pero está bien! ¡Estamos cambiando la forma en que construyes LEGO!

### **暫停!**

你可能会注意到一些袋子顺序错乱, 以及一些剩余的部件, 但没关系! 我们正在改变你搭建乐高的方式!

#### Open LEGO® Bag 5

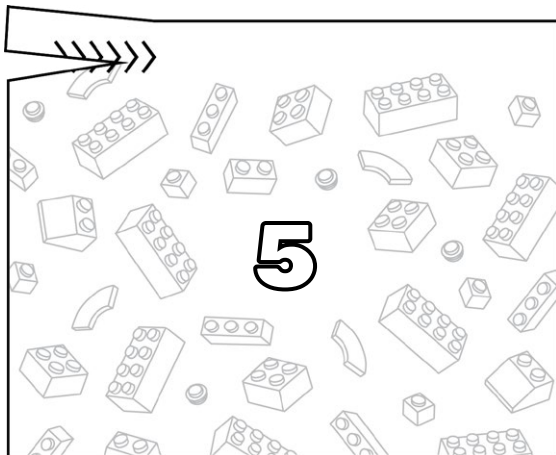

#### Open LMB Bag 03

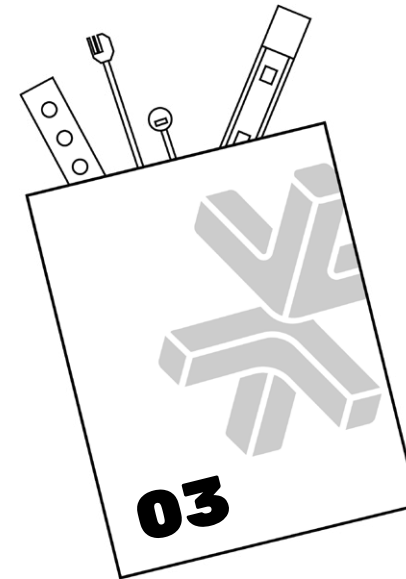

98

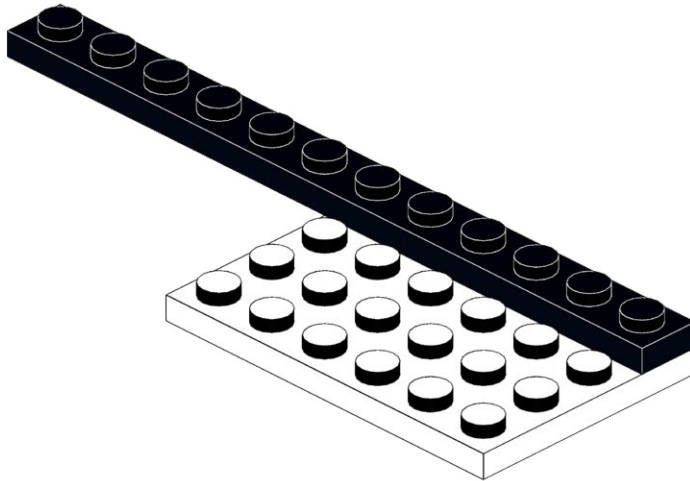
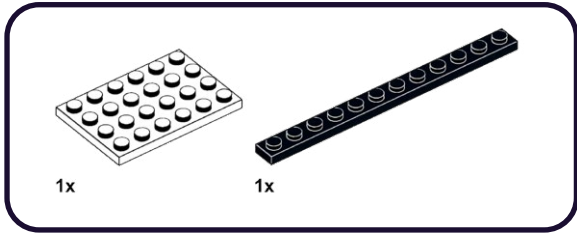

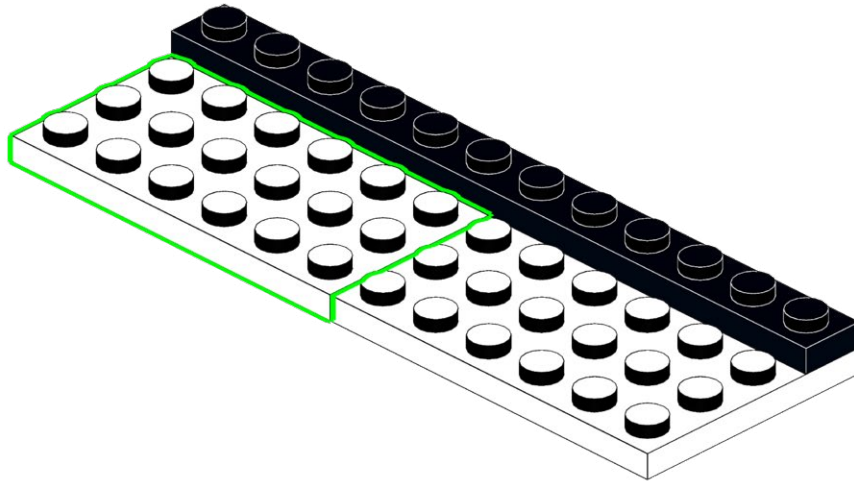
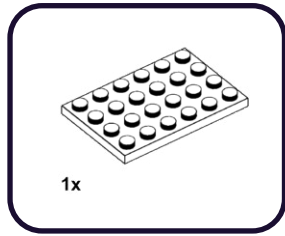

100

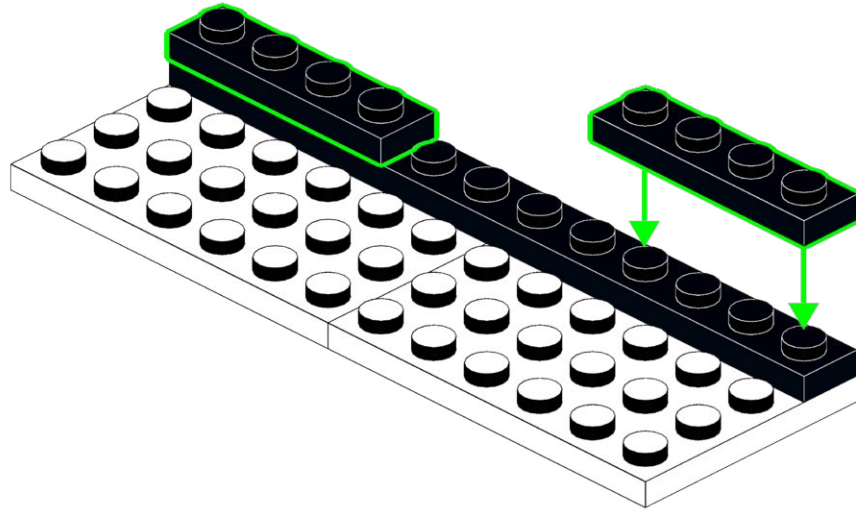
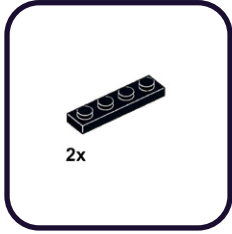

101

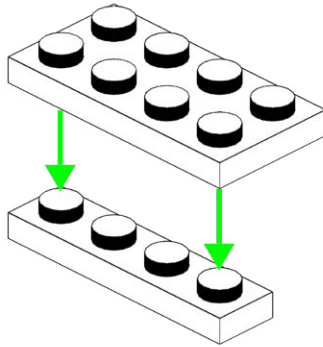
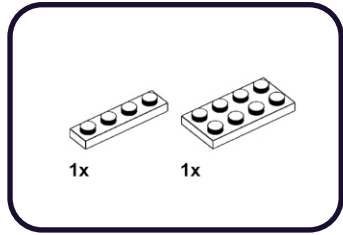

**102**

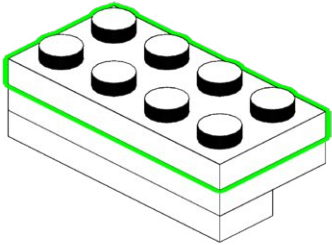
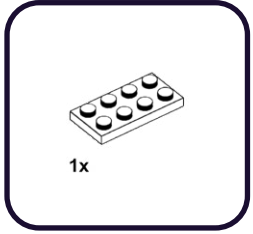

**103**

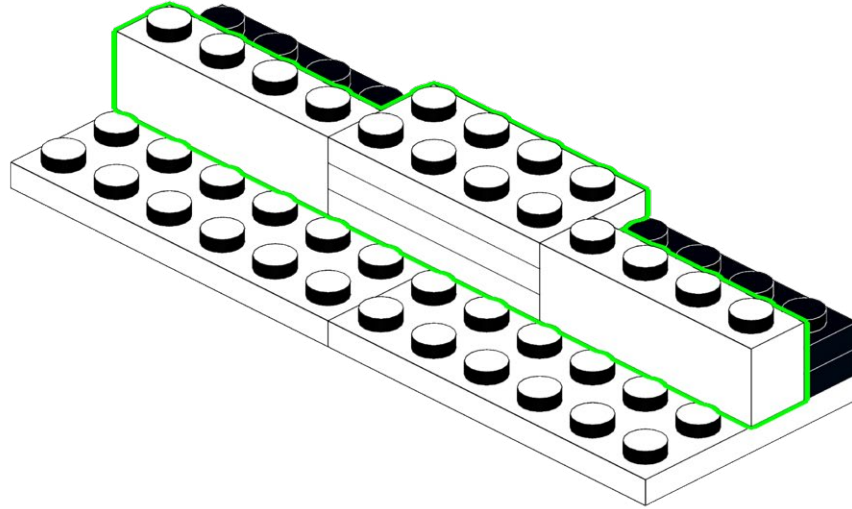
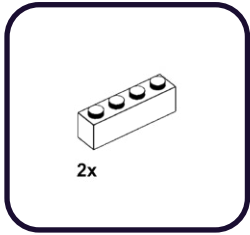



**104**

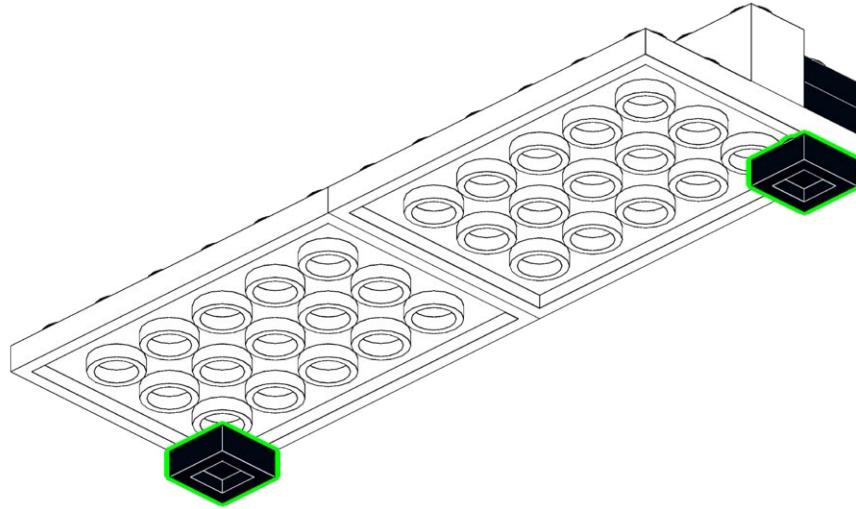

# 105

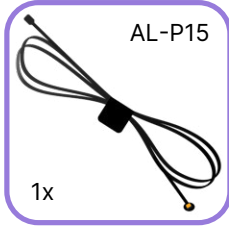

1



2



3

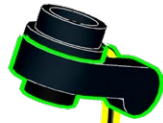

**106**

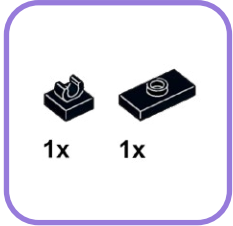

1



2

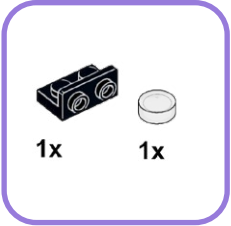
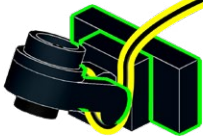

1



2

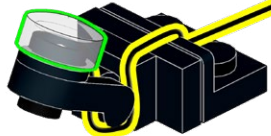

107

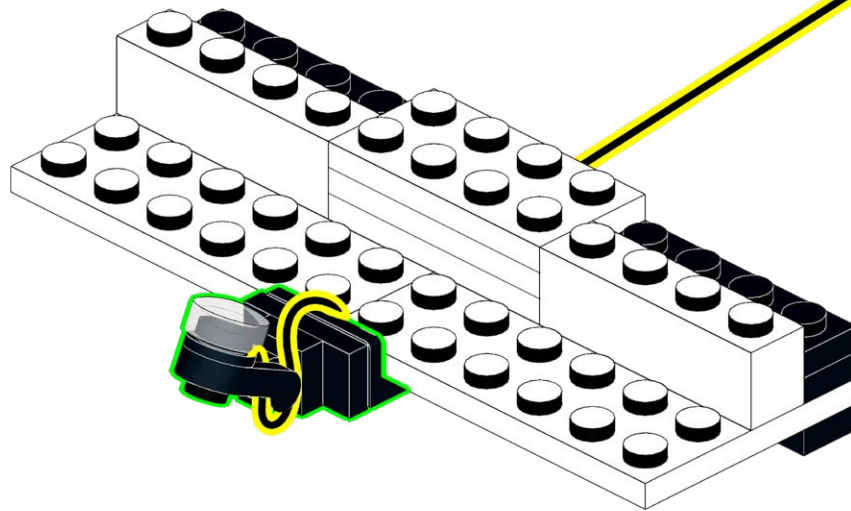

108

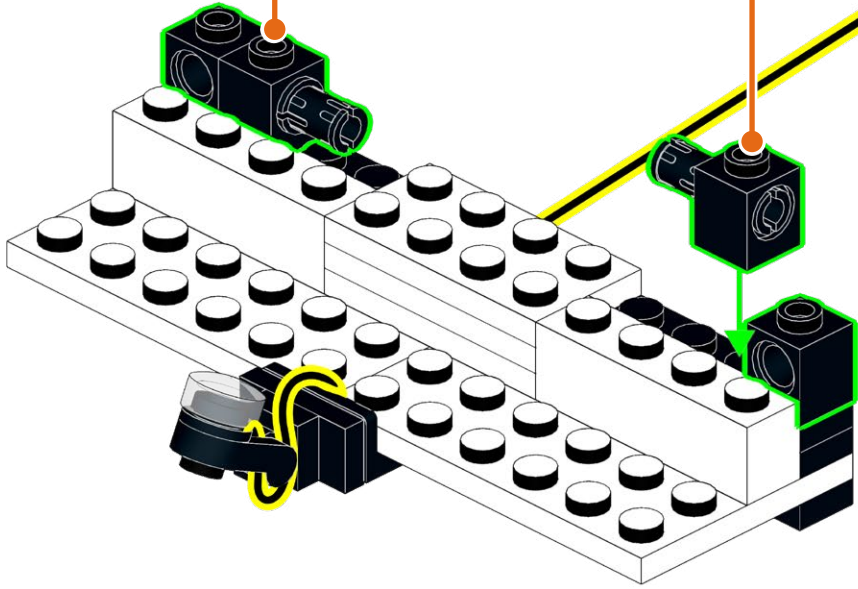
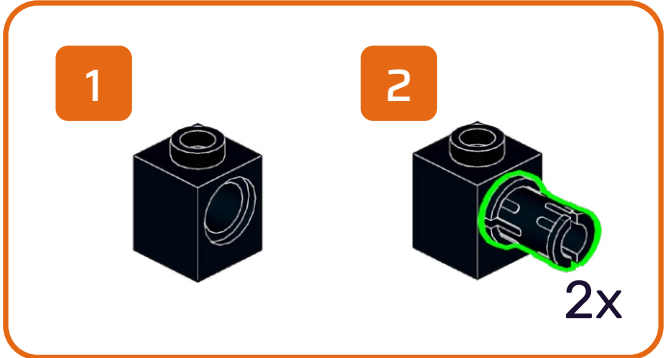
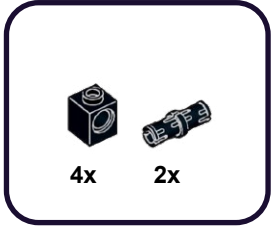

109

3x

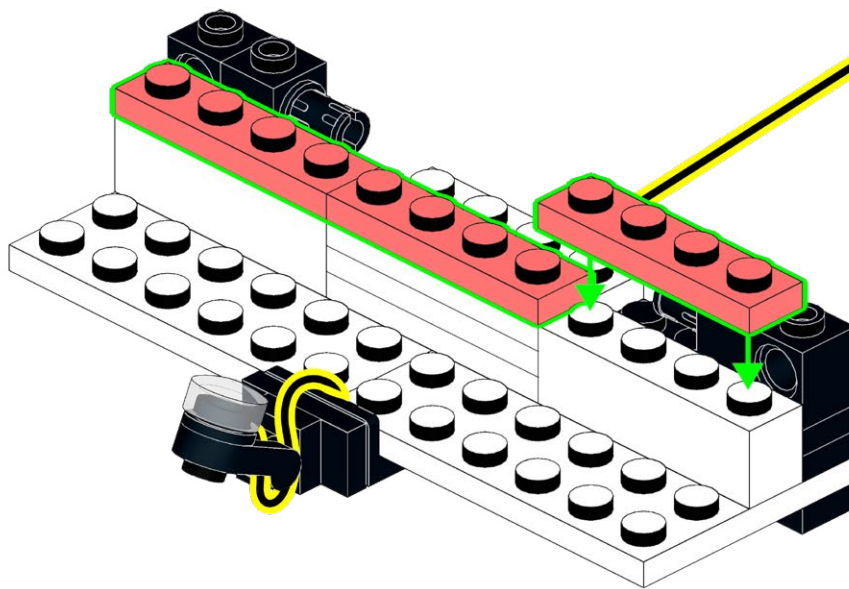

**110**

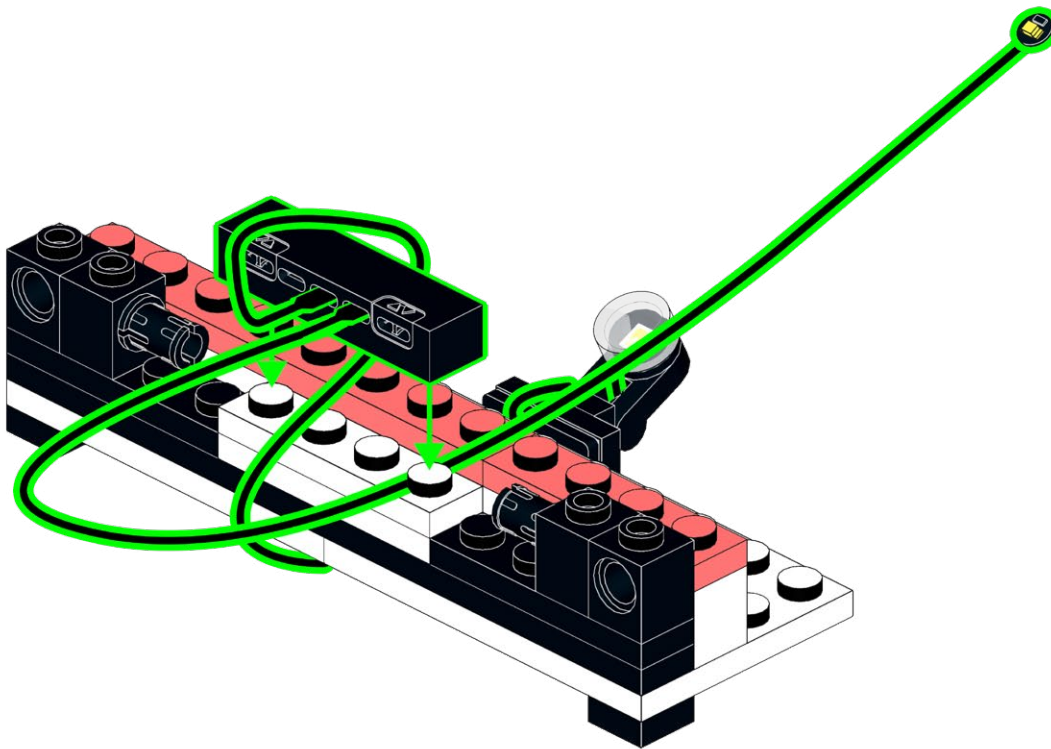
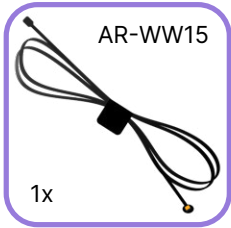
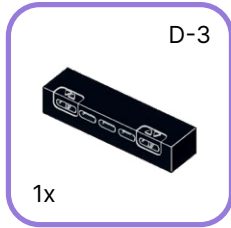

111

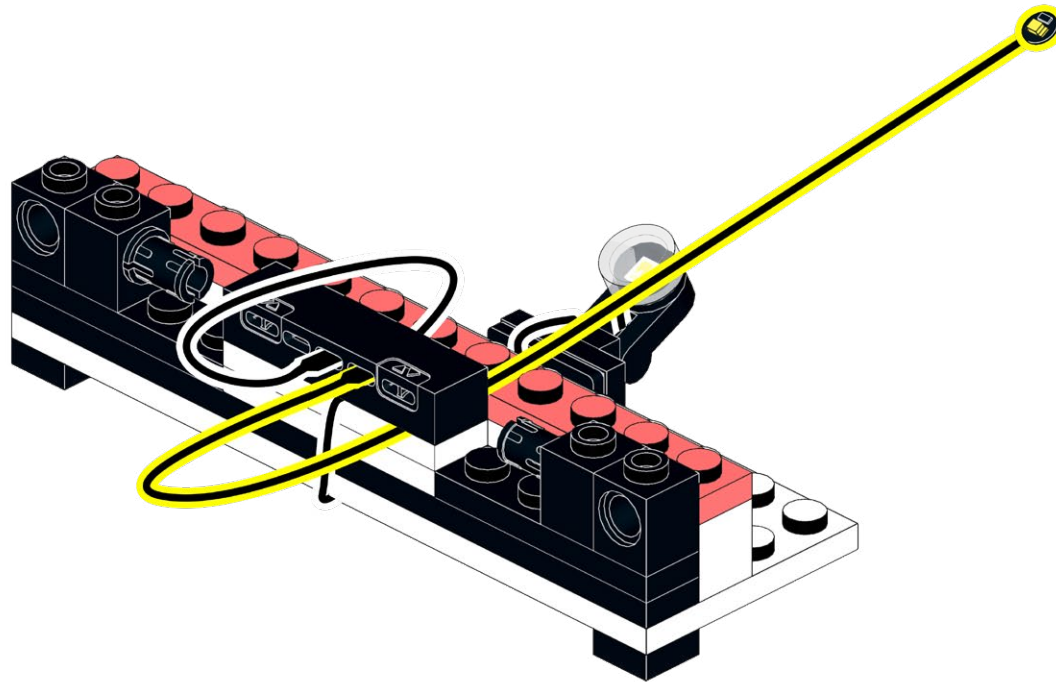



112

1x

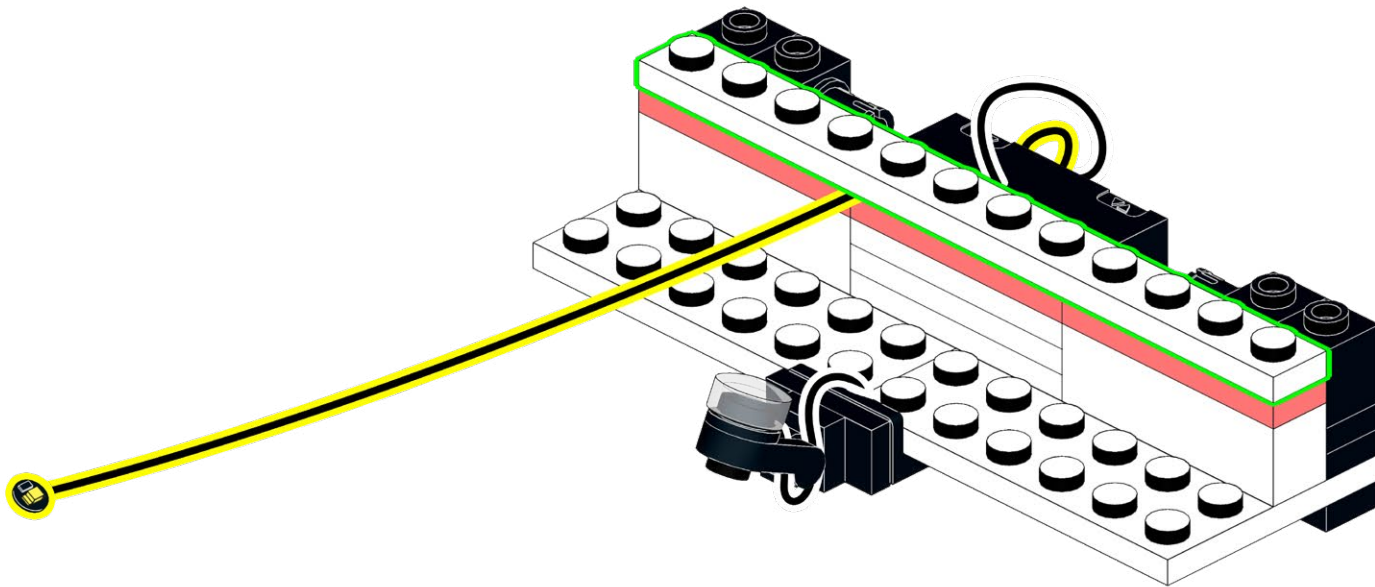

113

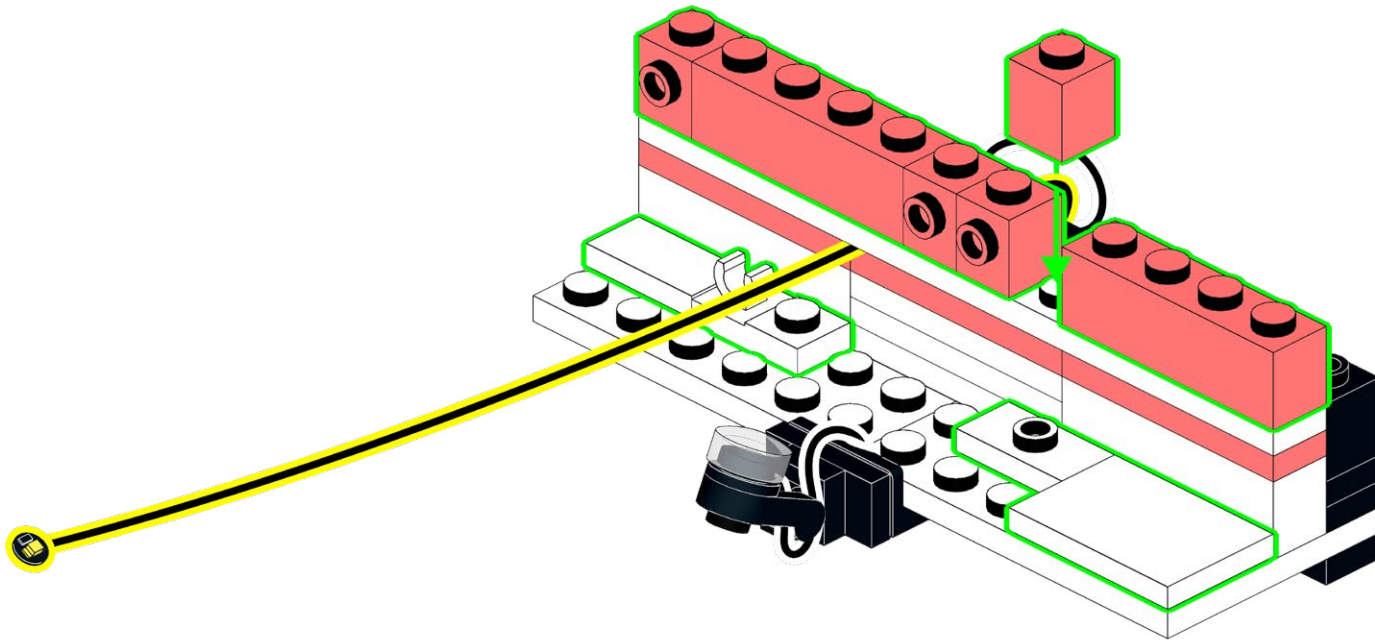
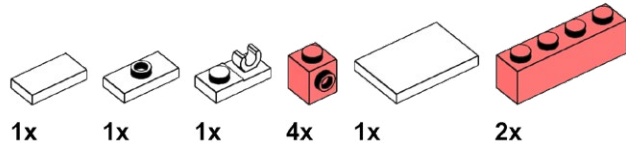

114

1x 1x

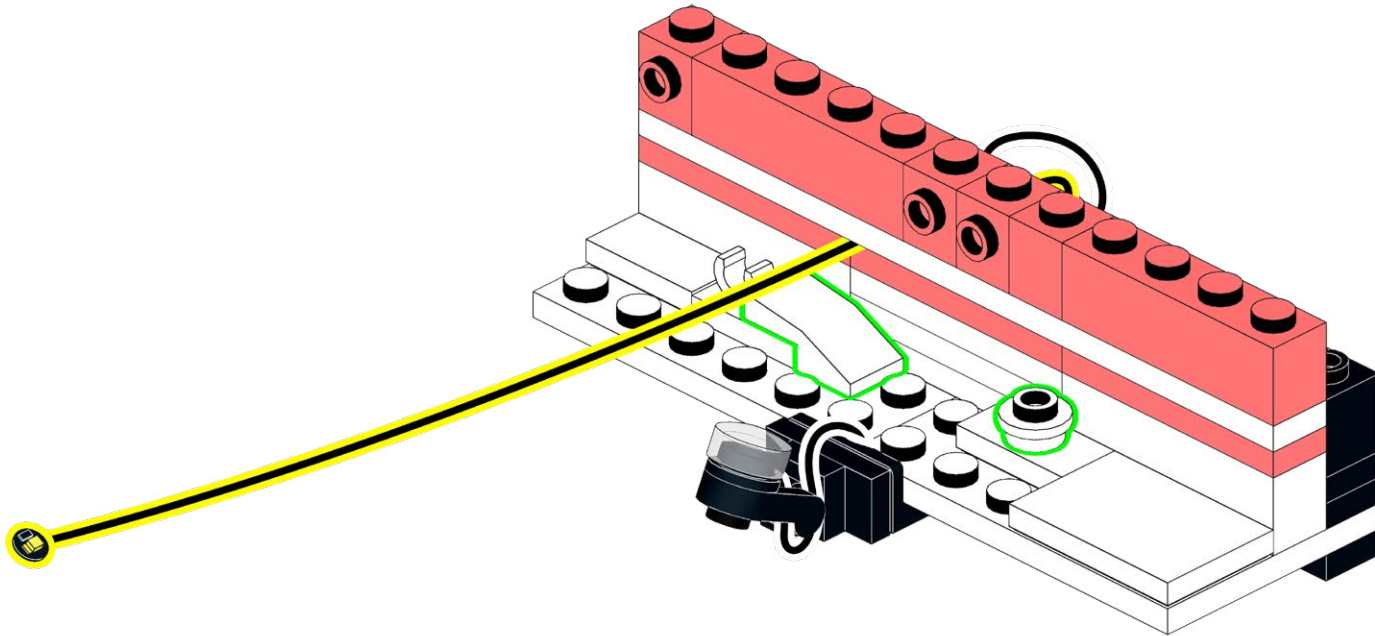

115

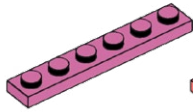

2x

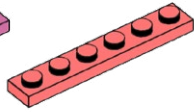

2x

1

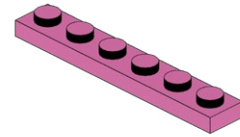

2

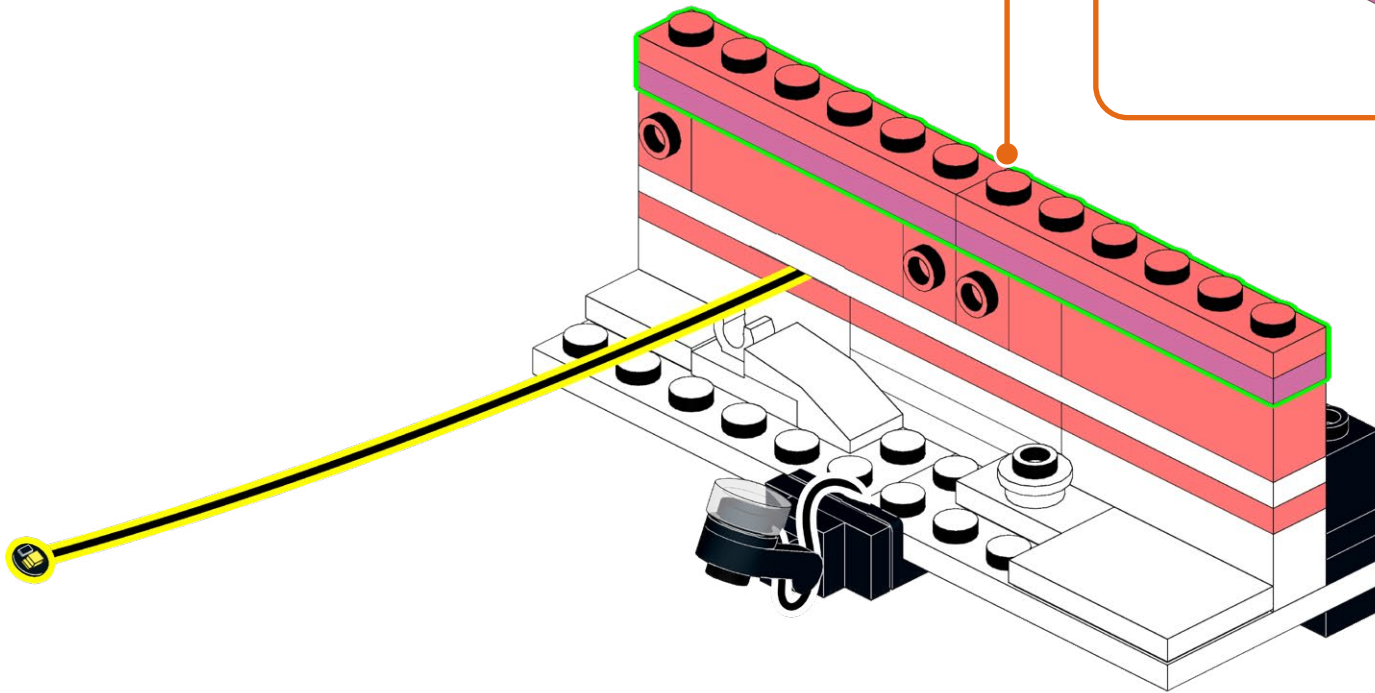
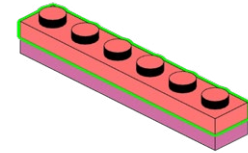

116



1x

1x

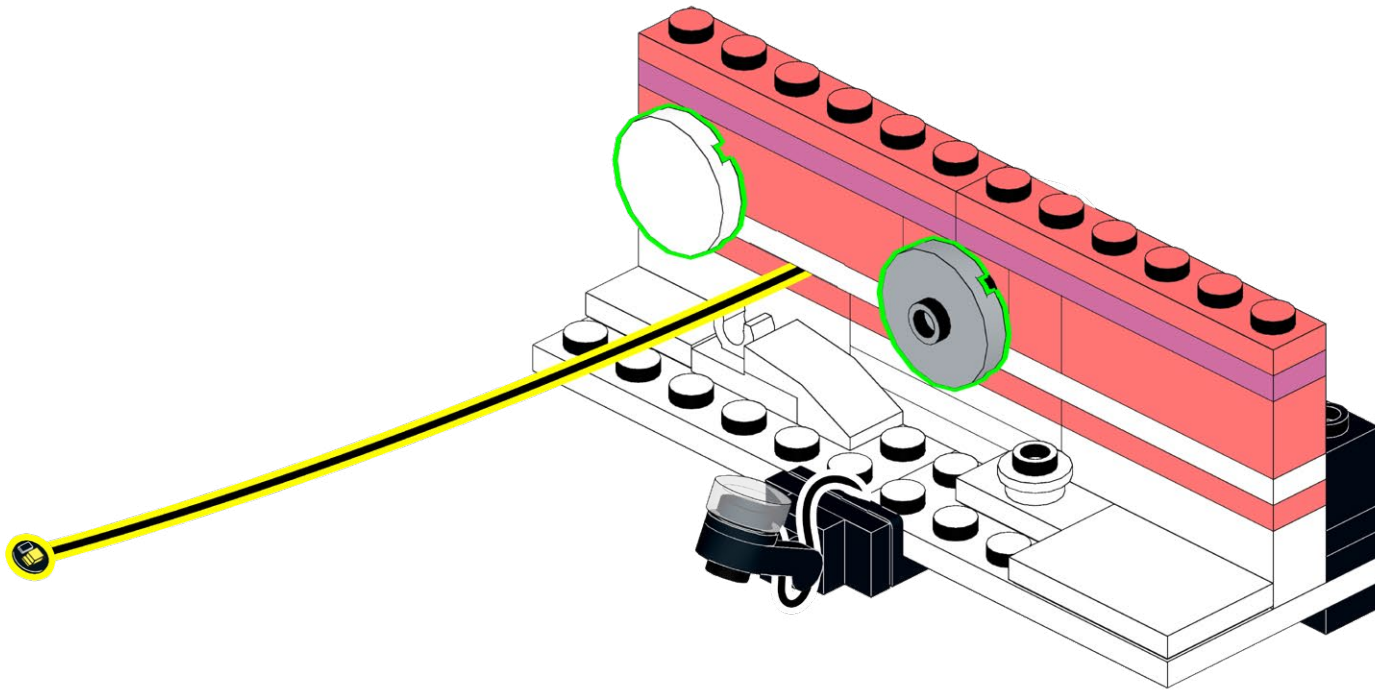

117

1x

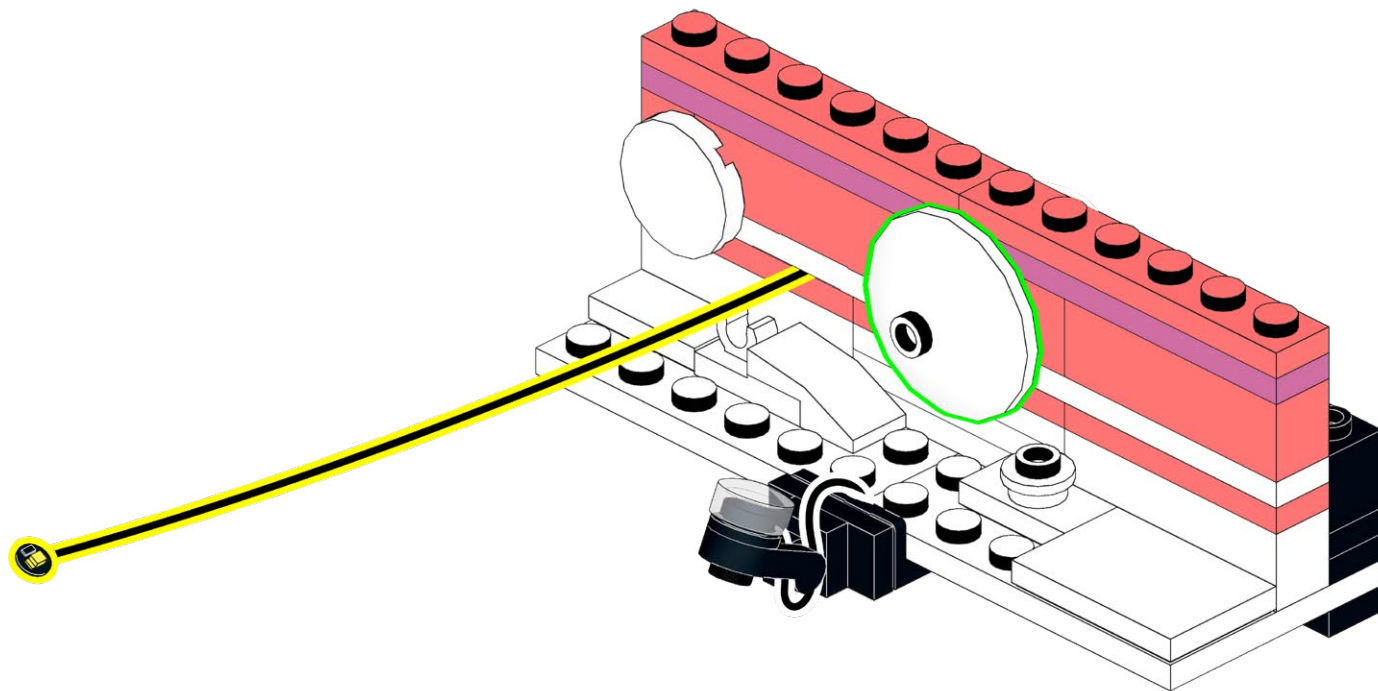

118

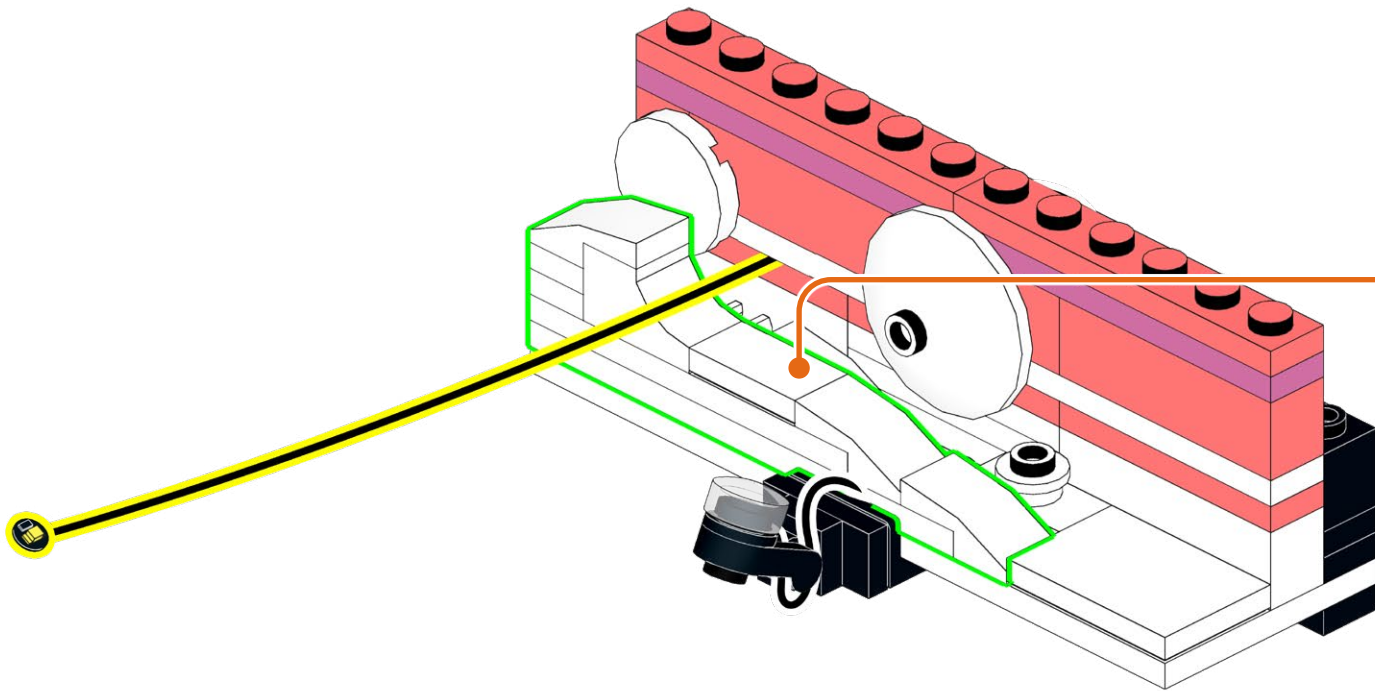
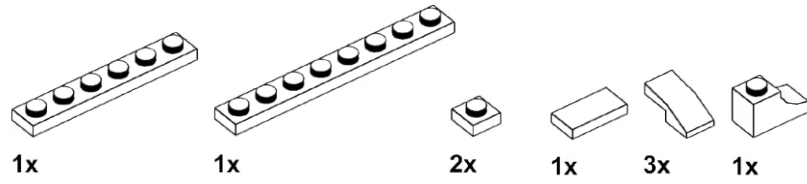

1. 1x6 Technic beam
2. 1x1 pin on 1x6 beam
3. 1x3 plate on 1x6 beam
4. 1x3 plate on 1x6 beam

119

1x

3x

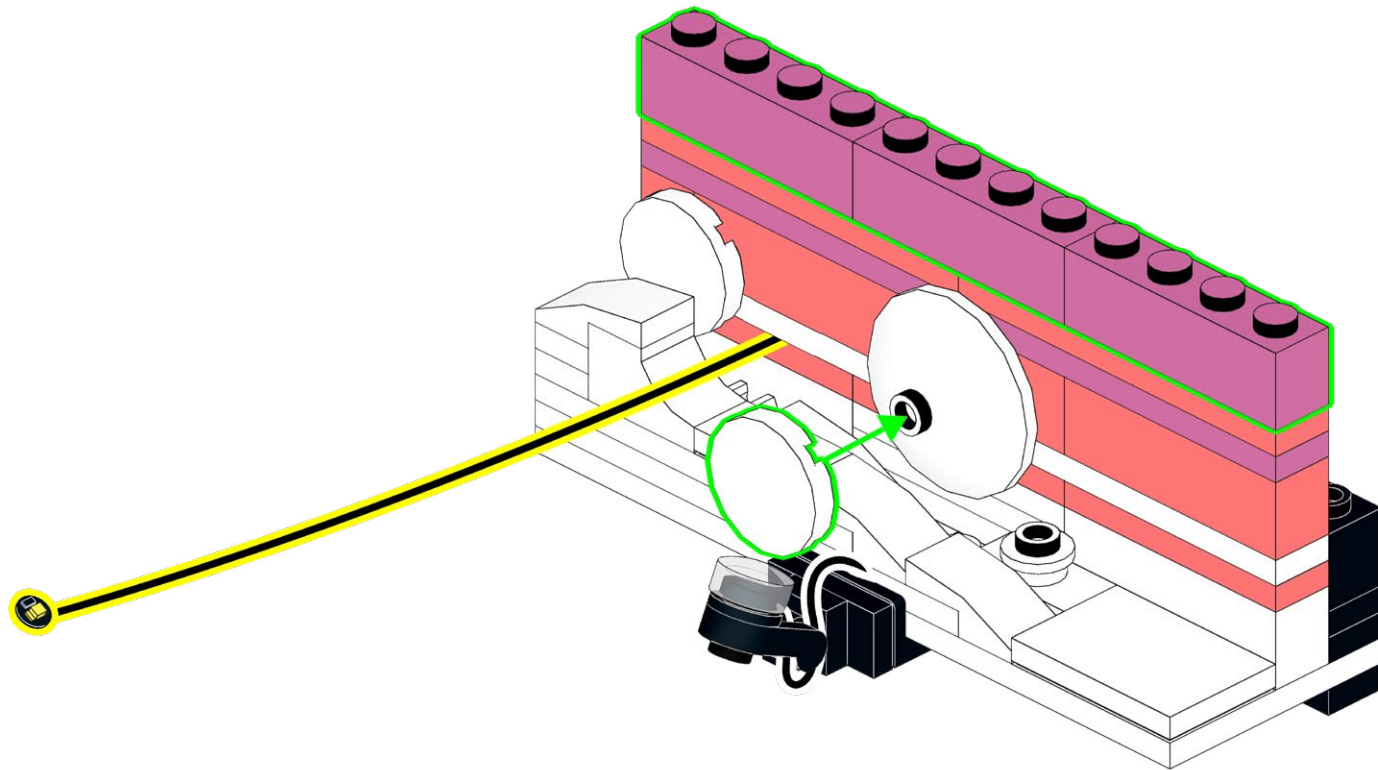



120

2x

2x

1

2

2x

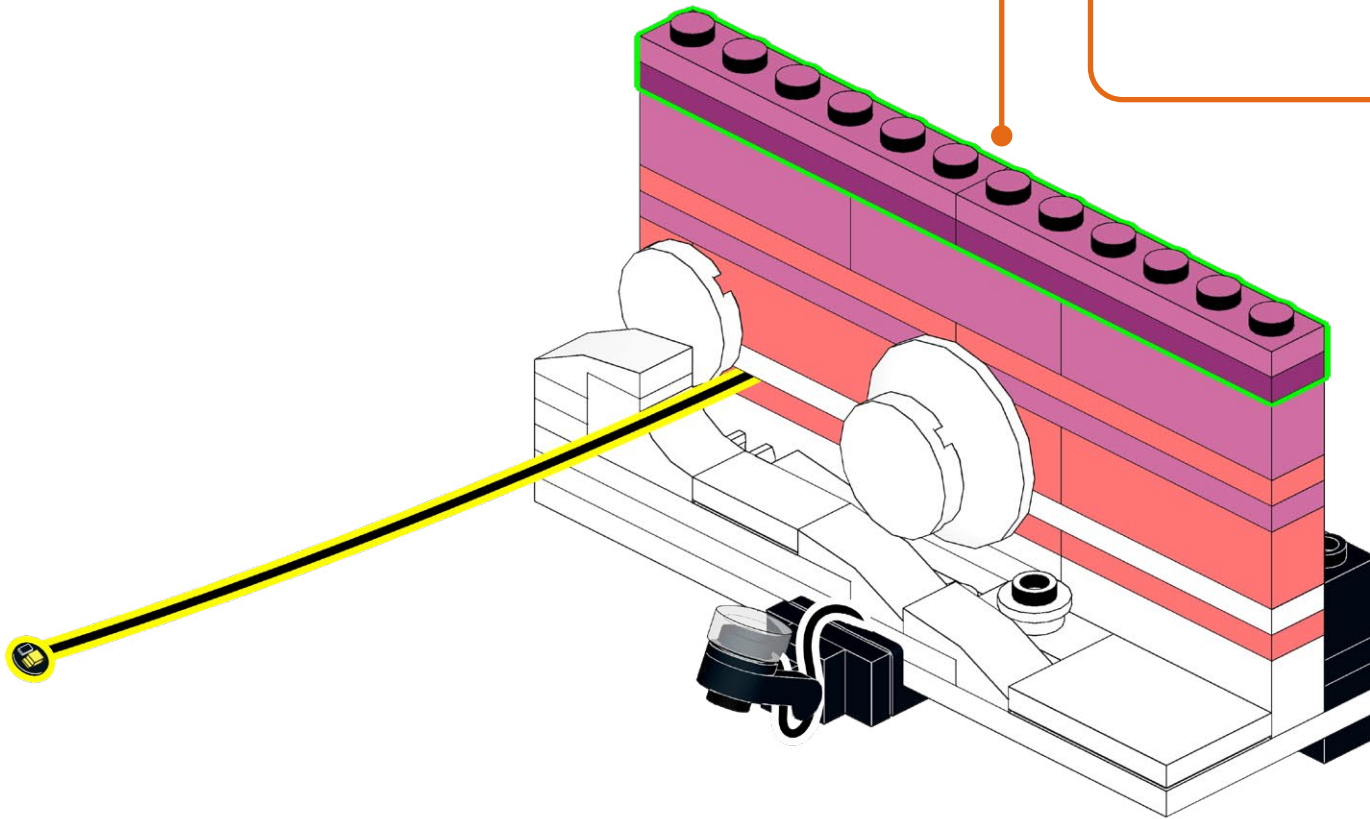

121

3x

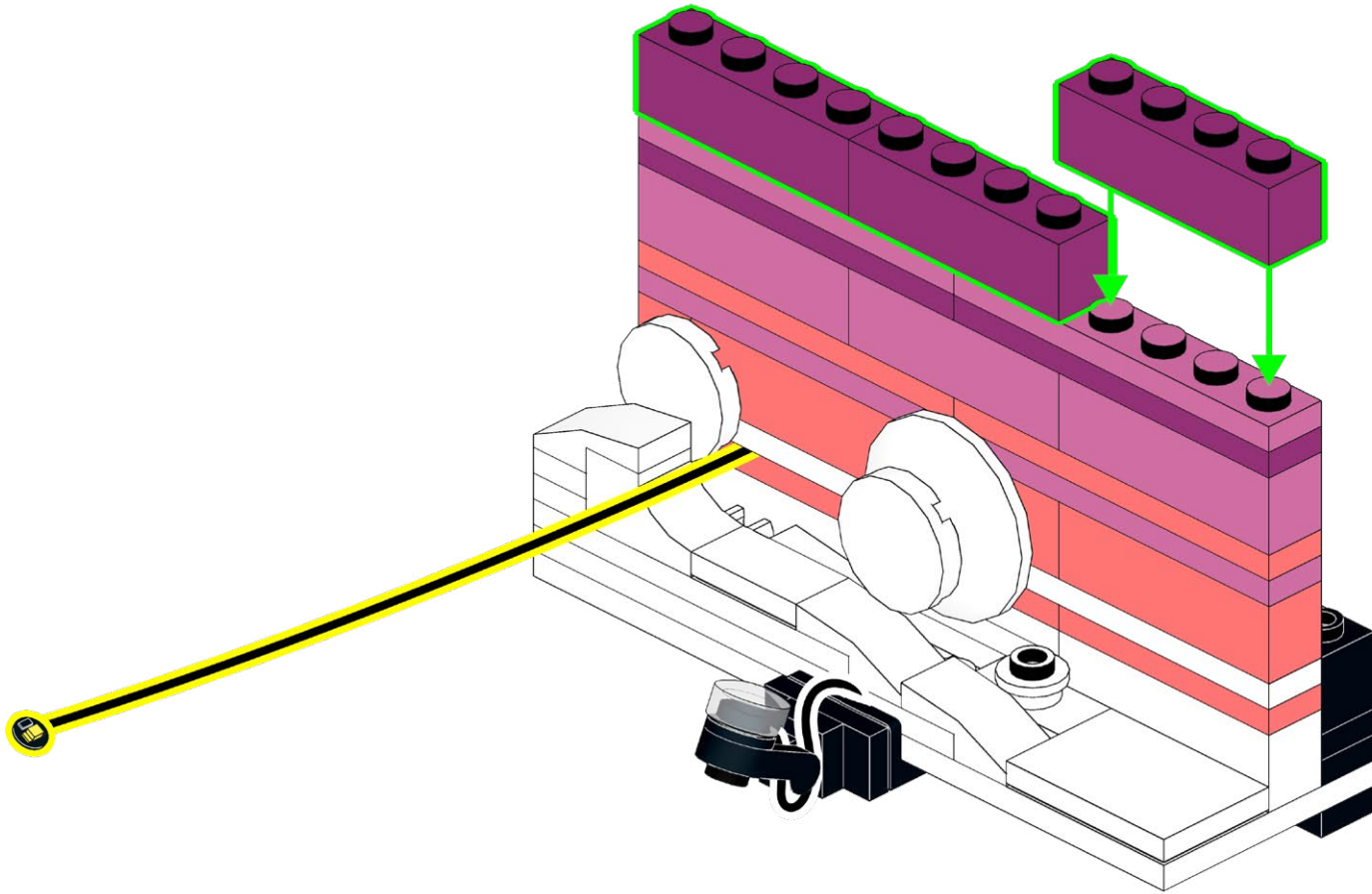

122



2x



2x

1



2

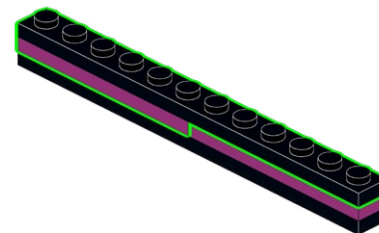

123



2x

8x

2x

6x

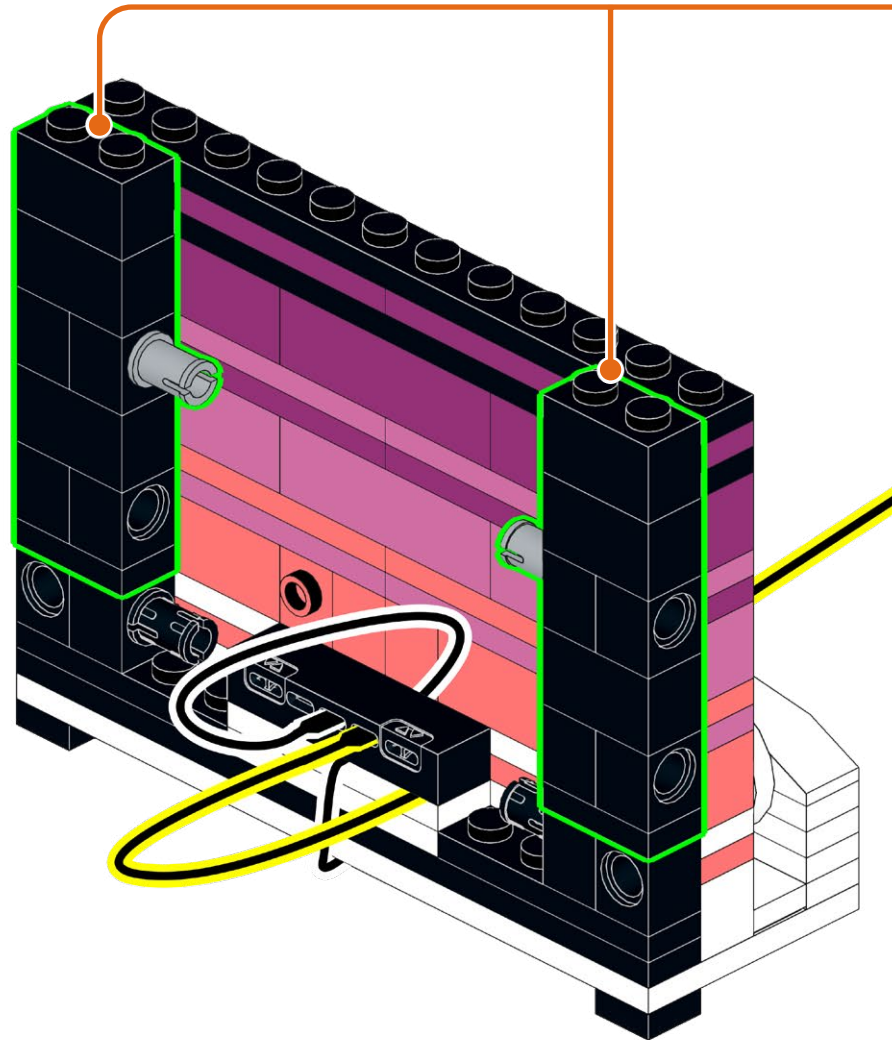

1

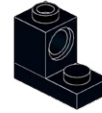

2

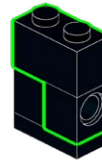

3

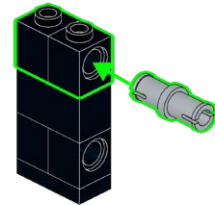

4

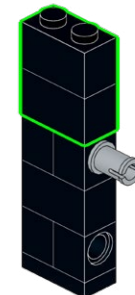

2x

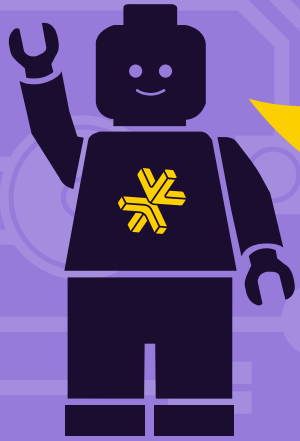
**HOLD UP!**

You might notice some bags aren't in order, as well as left over pieces, but that's ok! We're changing the way you build LEGO!

**ATTENDEZ!**

Vous remarquerez peut-être que certains sacs, ainsi que certaines pièces, ne sont pas dans le bon ordre. Mais pas de panique! Nous changeons simplement la façon avec laquelle vous construisez vos LEGO!

**ASPETTA!**

Potresti notare che alcuni sacchetti non sono in ordine, così come i pezzi avanzati, ma va bene così! Stiamo cambiando il modo in cui costruisci i LEGO!

**HALT!**

Sie werden möglicherweise bemerken, dass einige tüten durcheinander sind und teile übrig bleiben, aber das ist in Ordnung! Wir ändern die art und weise, wie Sie LEGO bauen!

**¡ESPERA!**

Es posible que notes que algunas bolsas están fuera de servicio, así como piezas sobrantes, ¡pero está bien! ¡Estamos cambiando la forma en que construyes LEGO!

**暫停!**

你可能会注意到一些袋子顺序错乱, 以及一些剩余的部件, 但没关系! 我们正在改变你搭建乐高的方式!

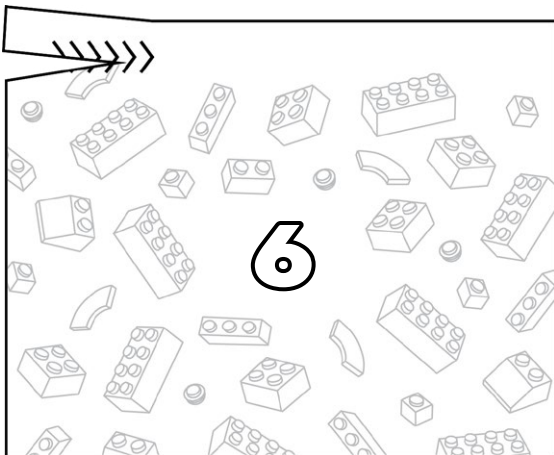
**Open LEGO® Bag 6**

124

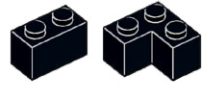

5x

2x

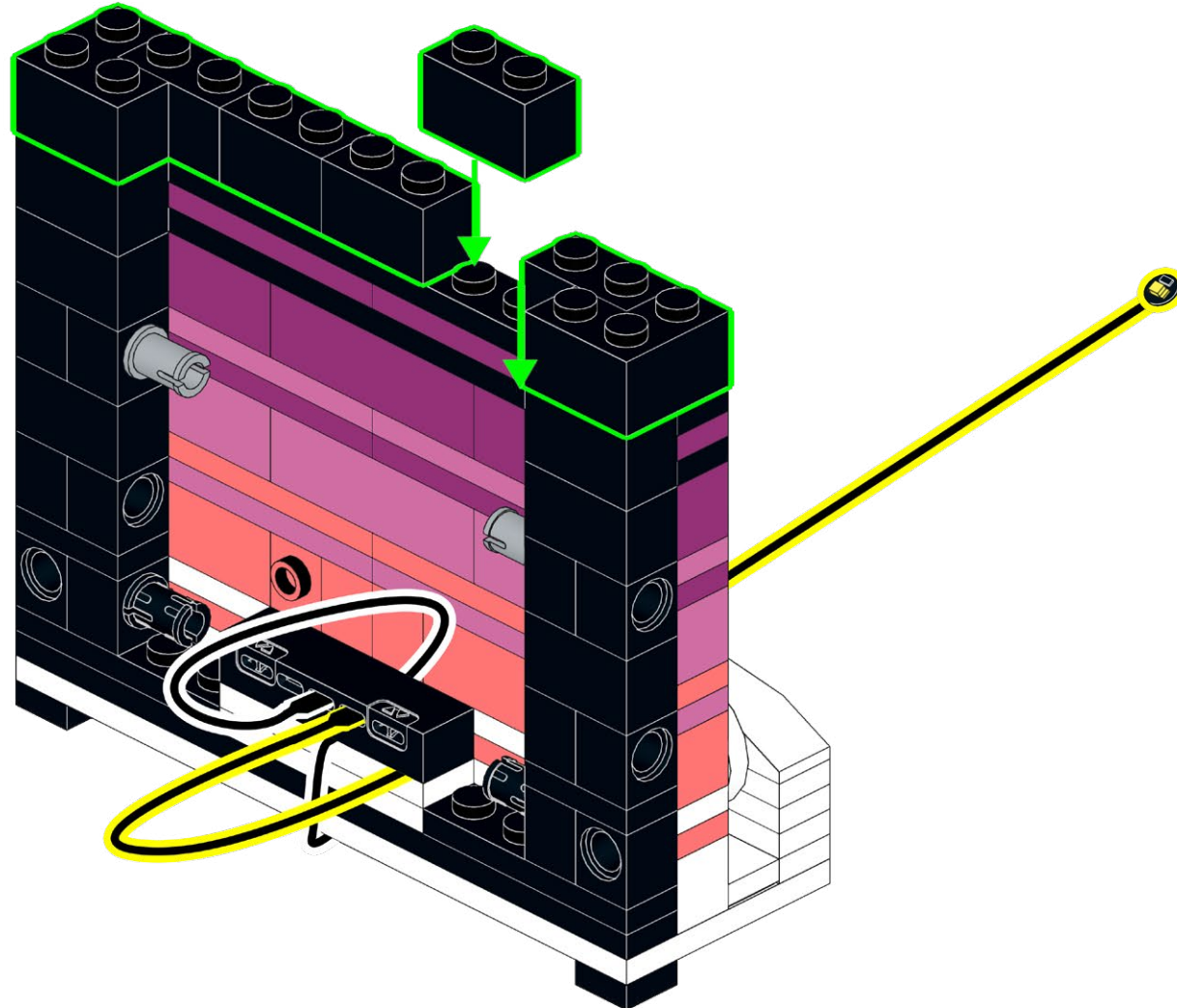

125

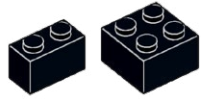

4x

2x

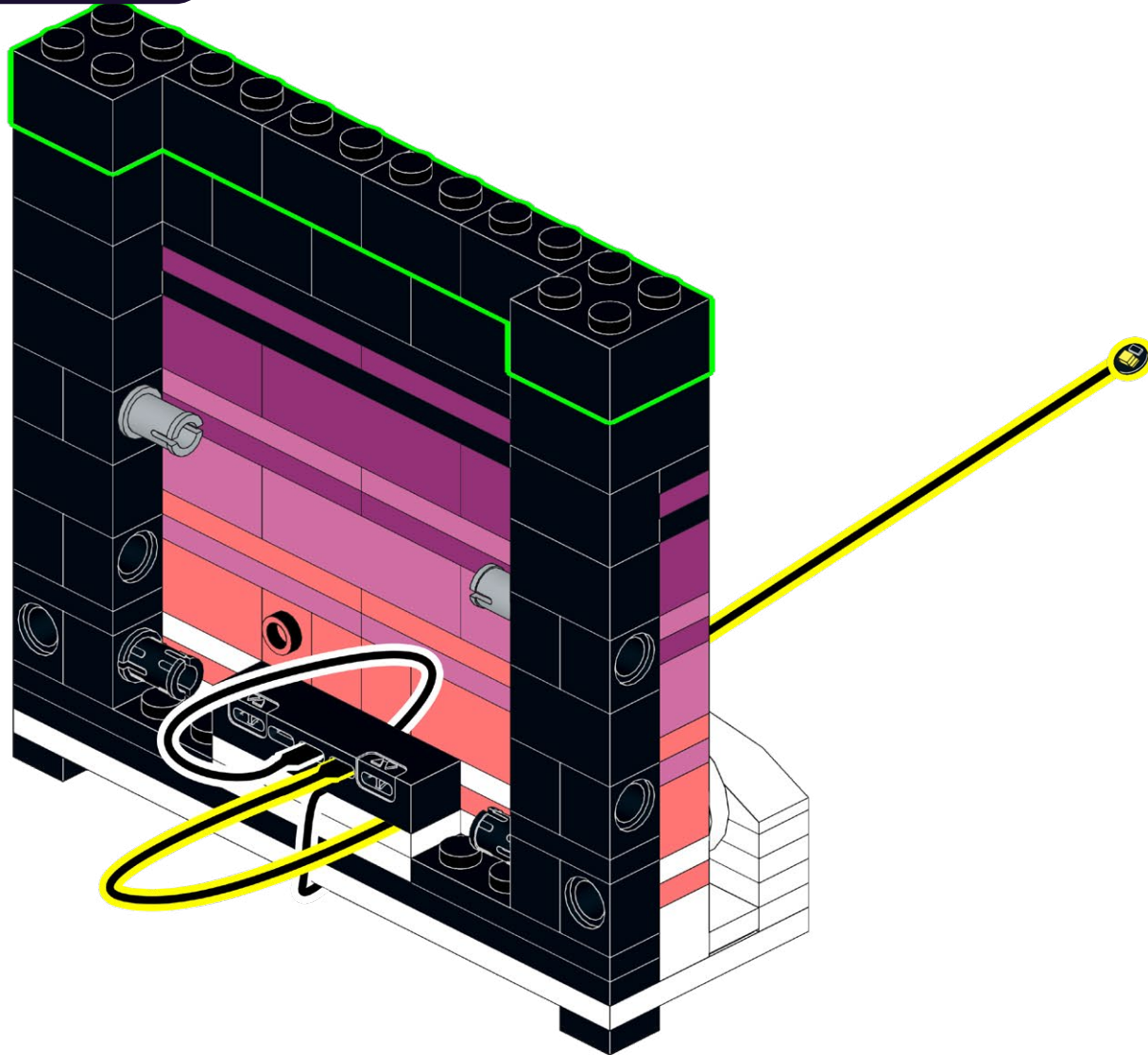

126

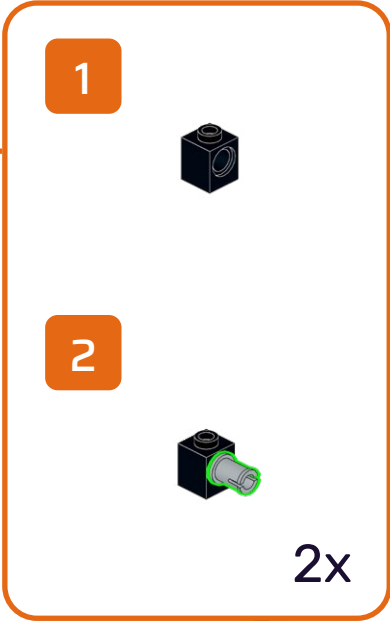
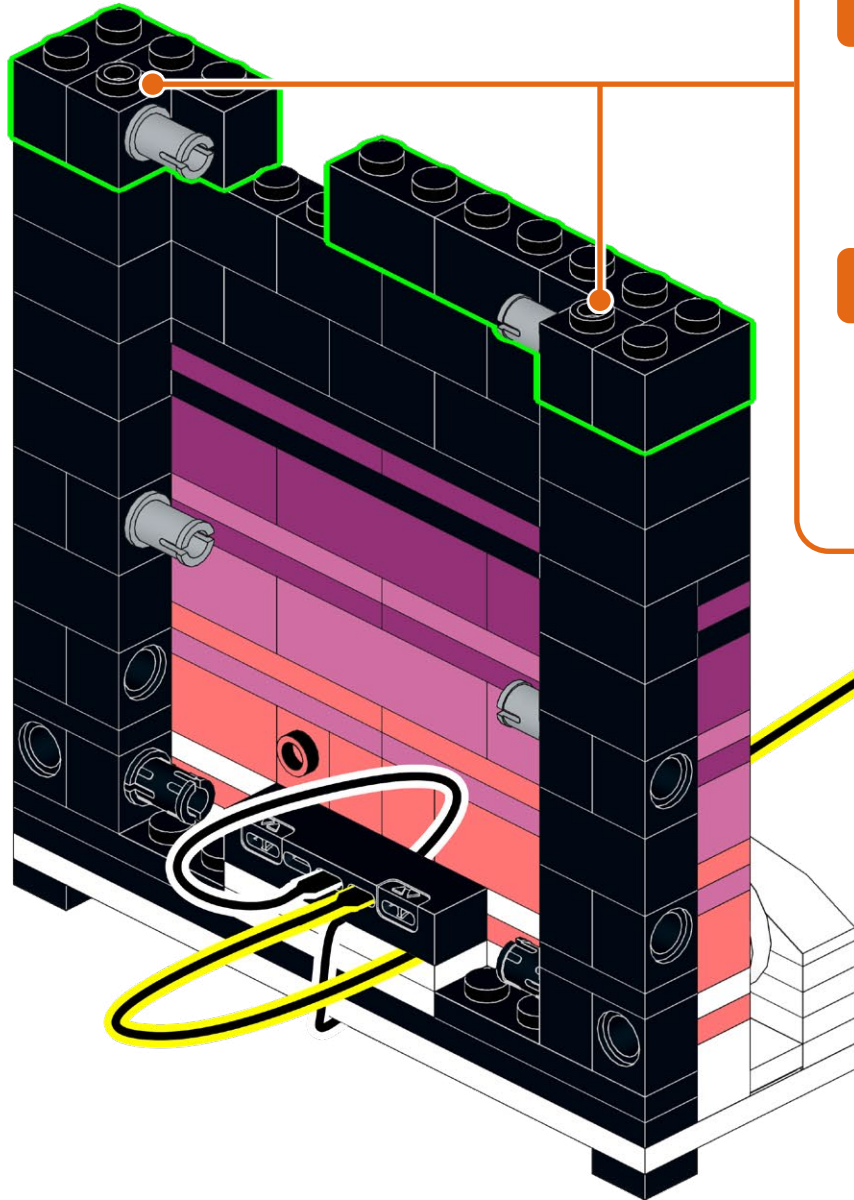
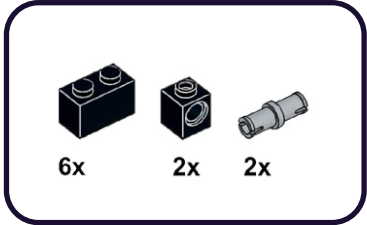



127

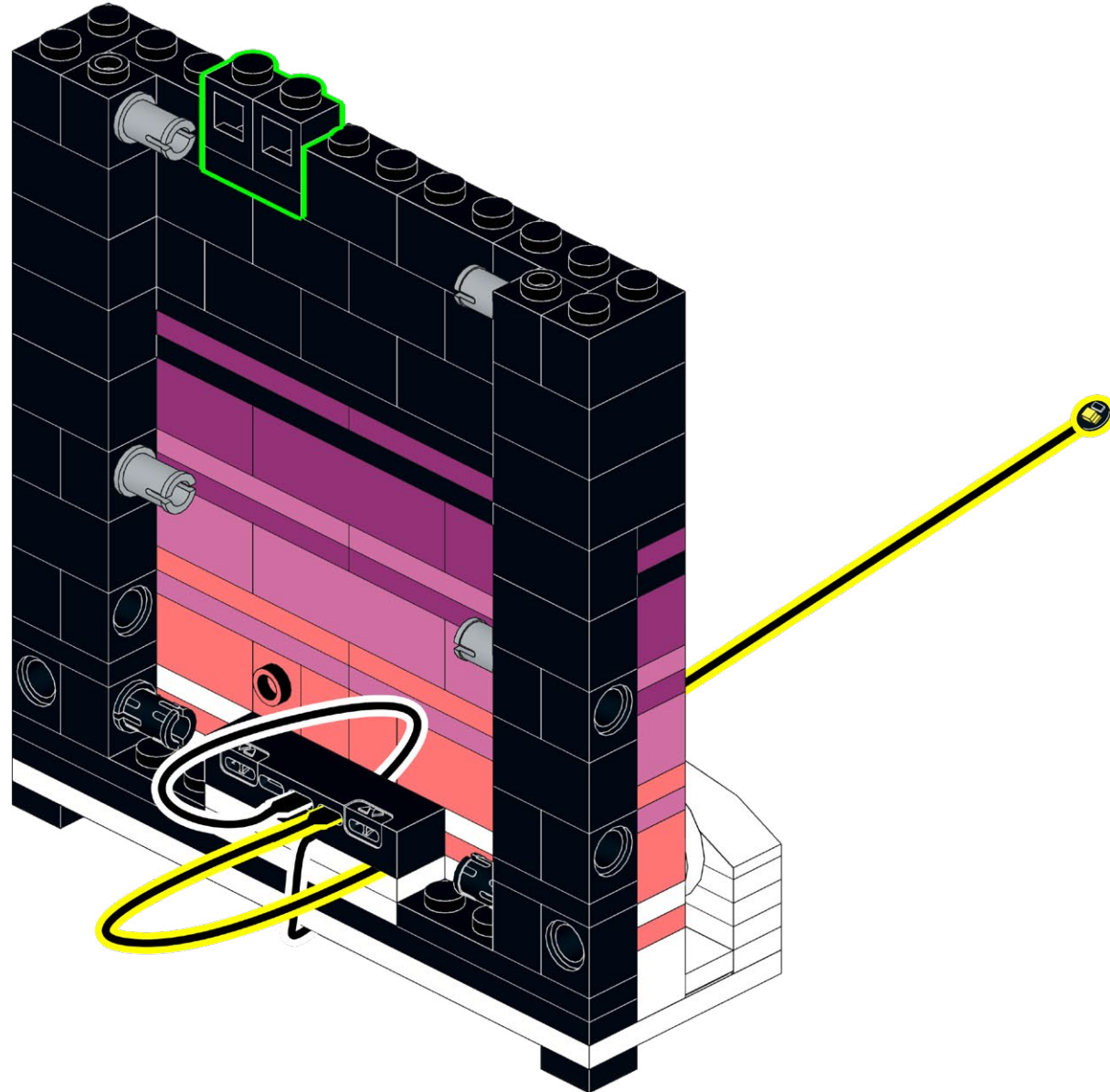
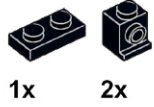

128

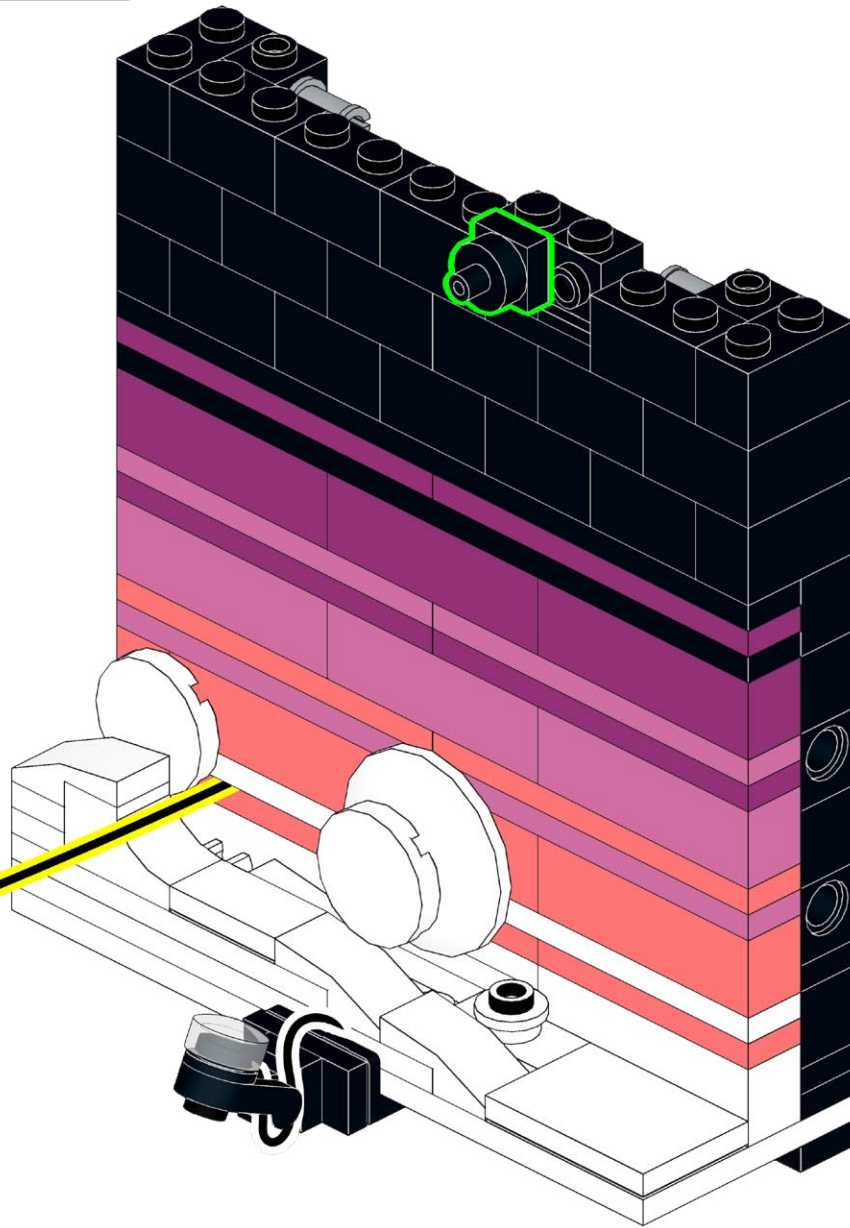
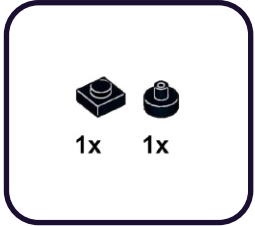

129

1x

1x

1x

1x

ARF-WW15

1

2

3

4

130

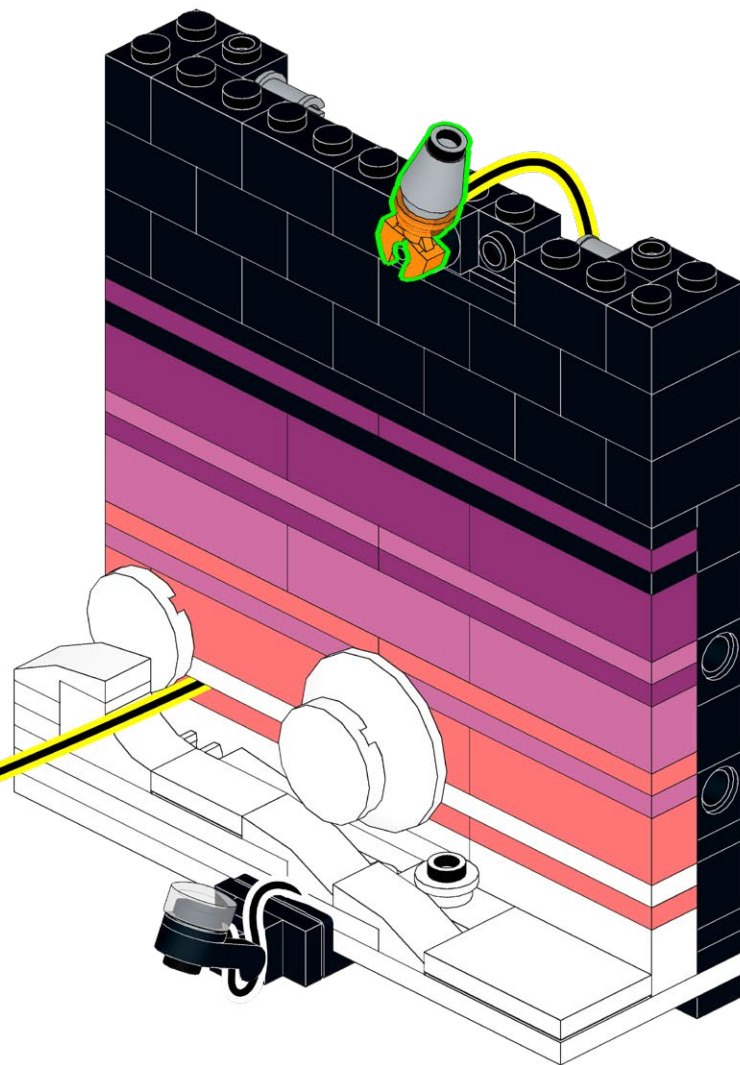

131

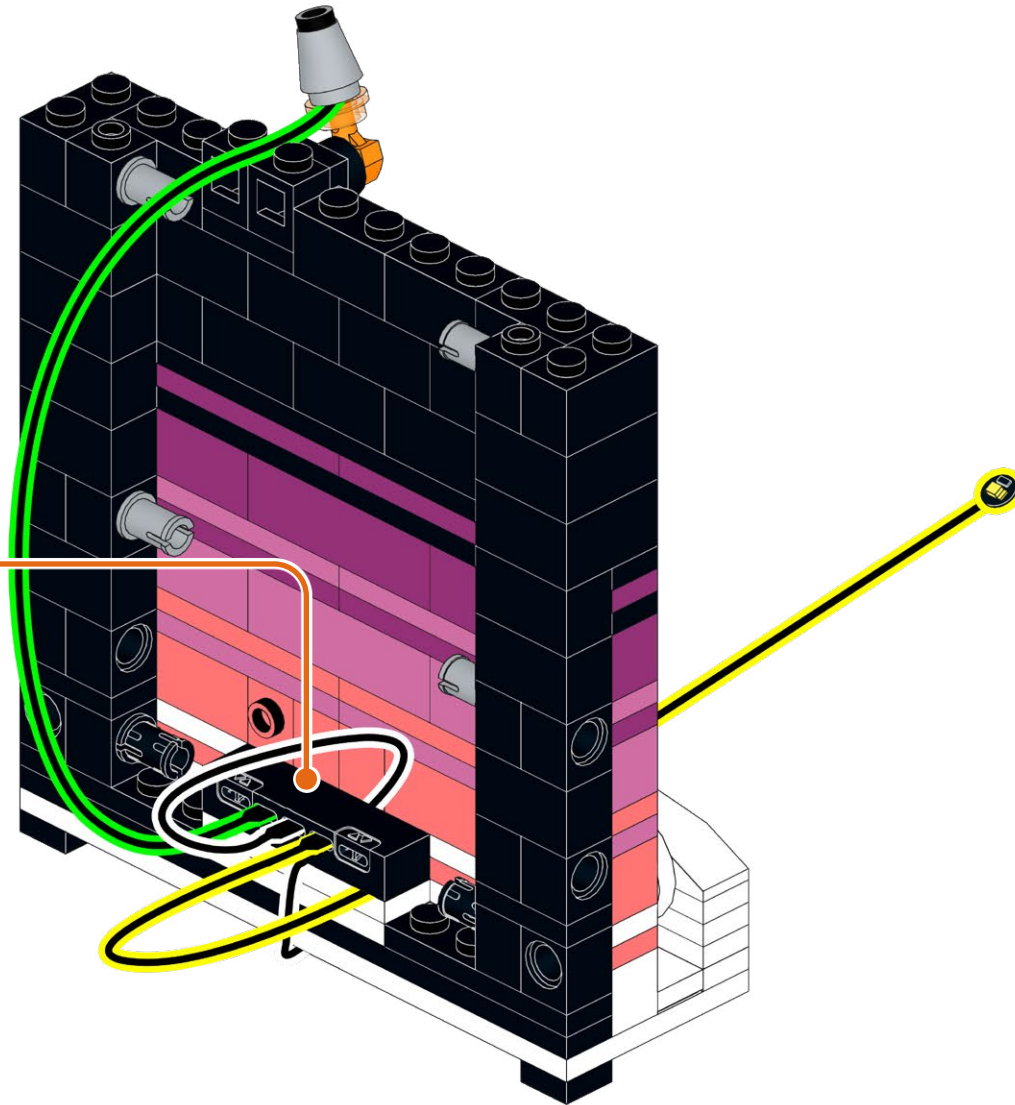
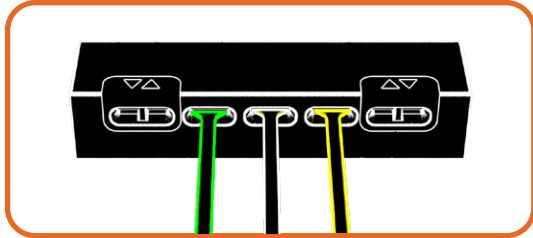

132

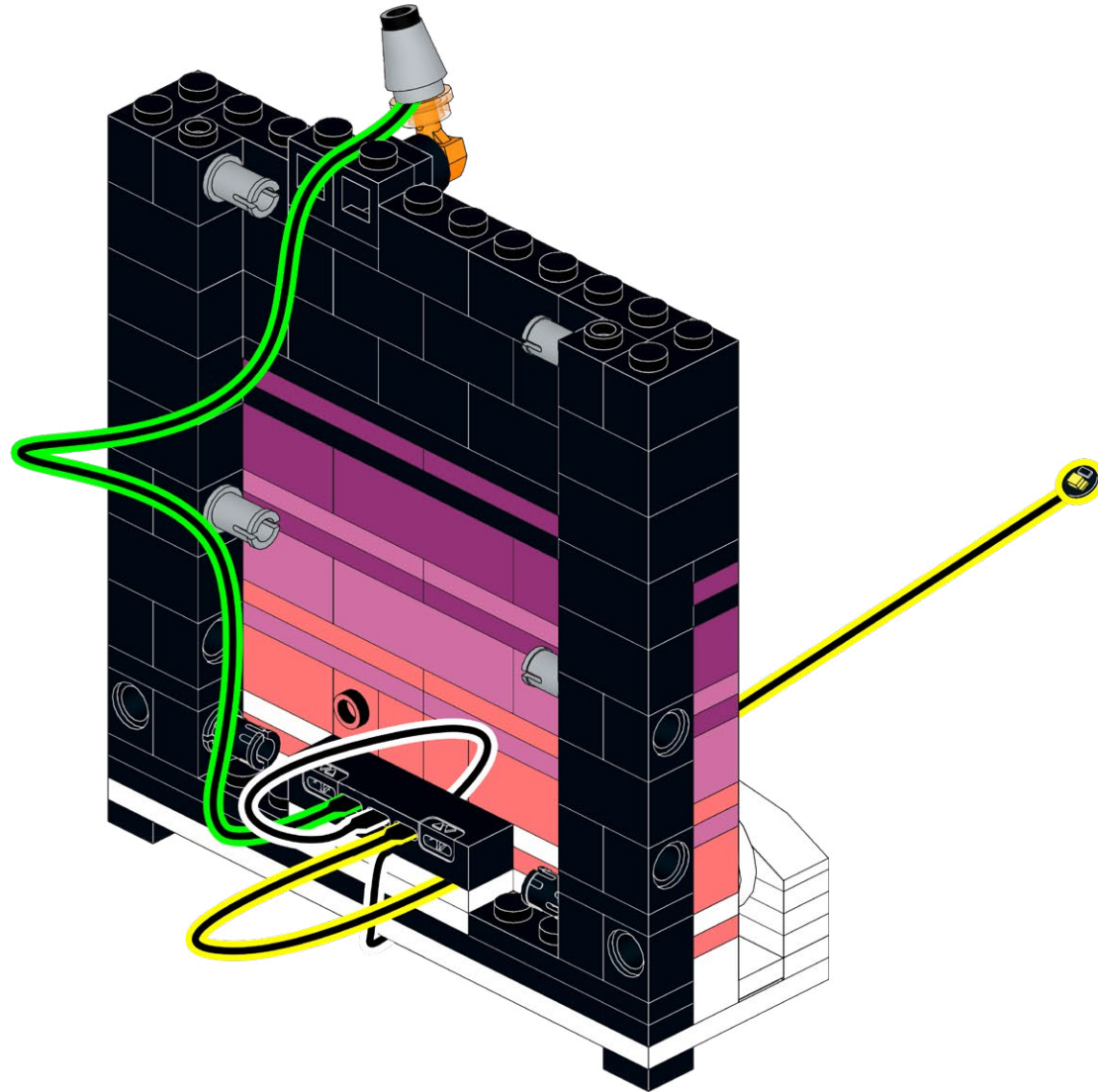

133

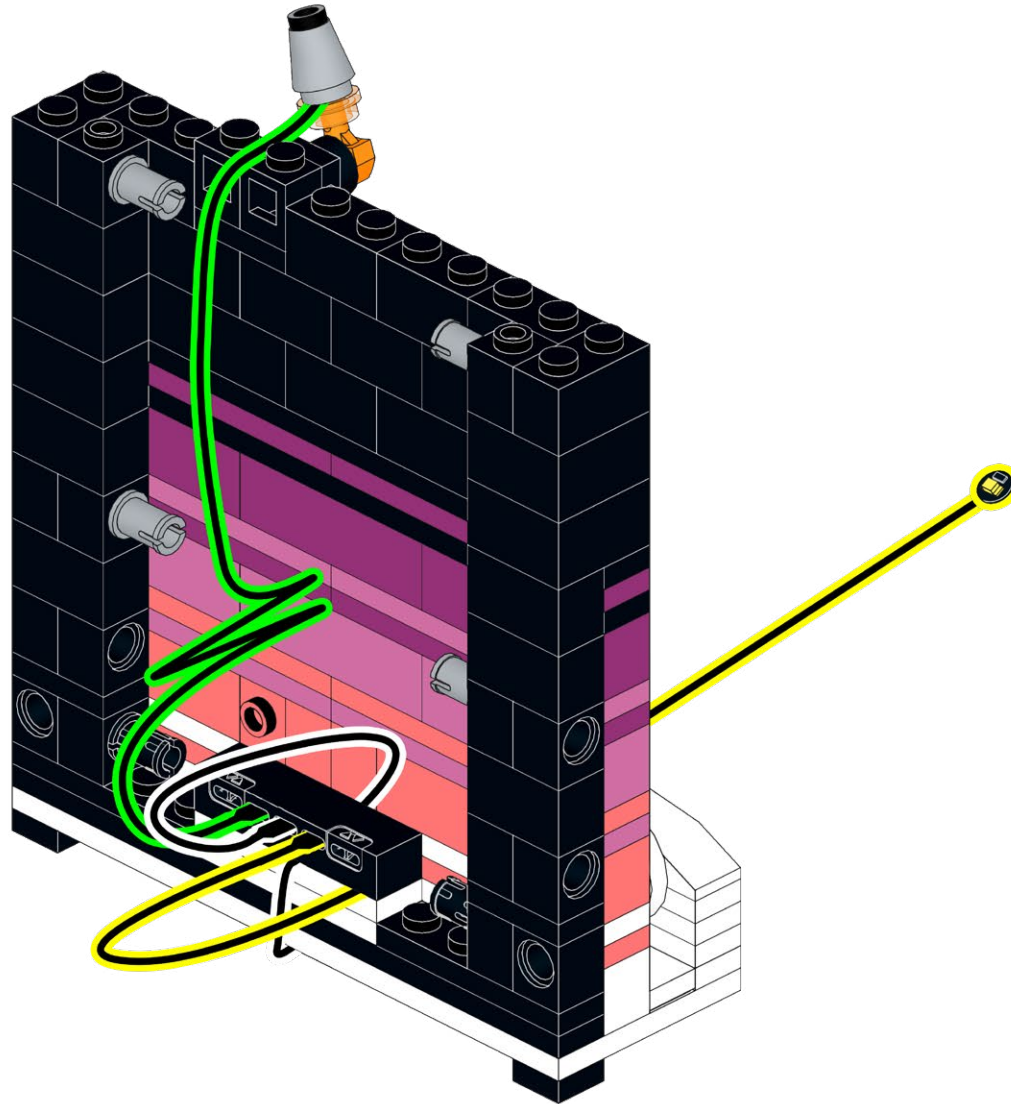

134

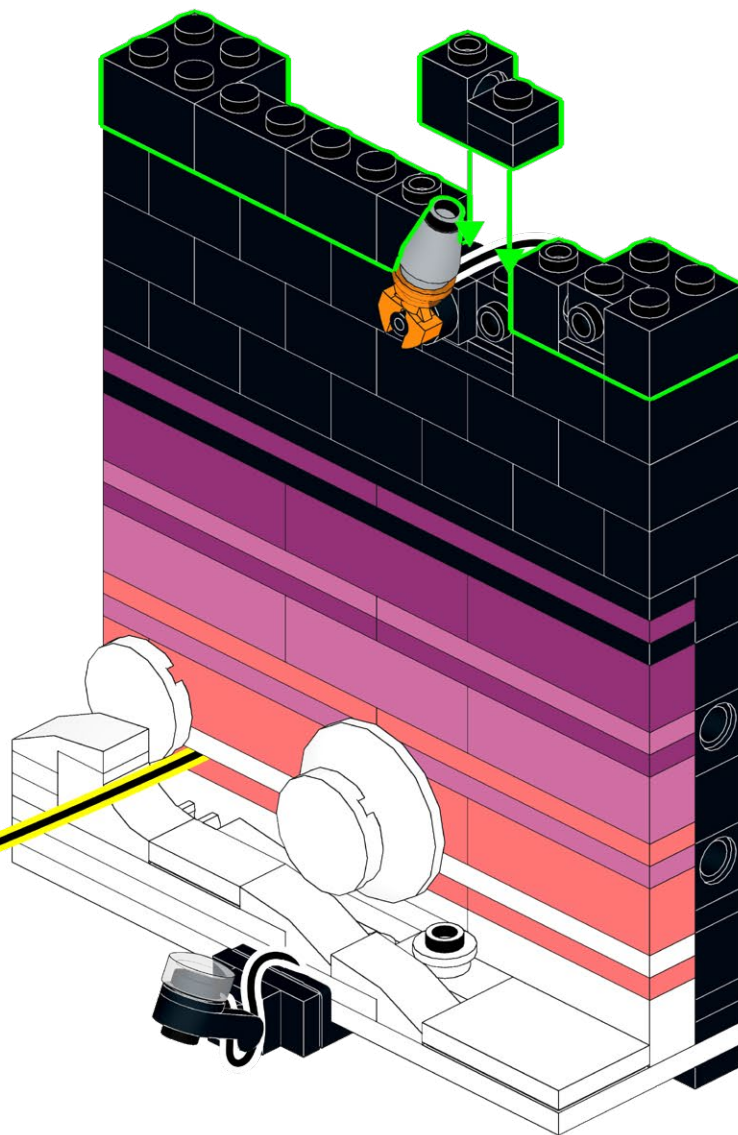
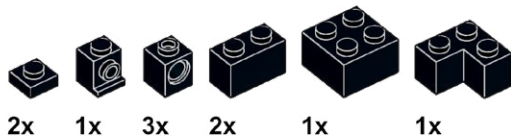



135

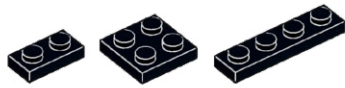

1x

2x

1x

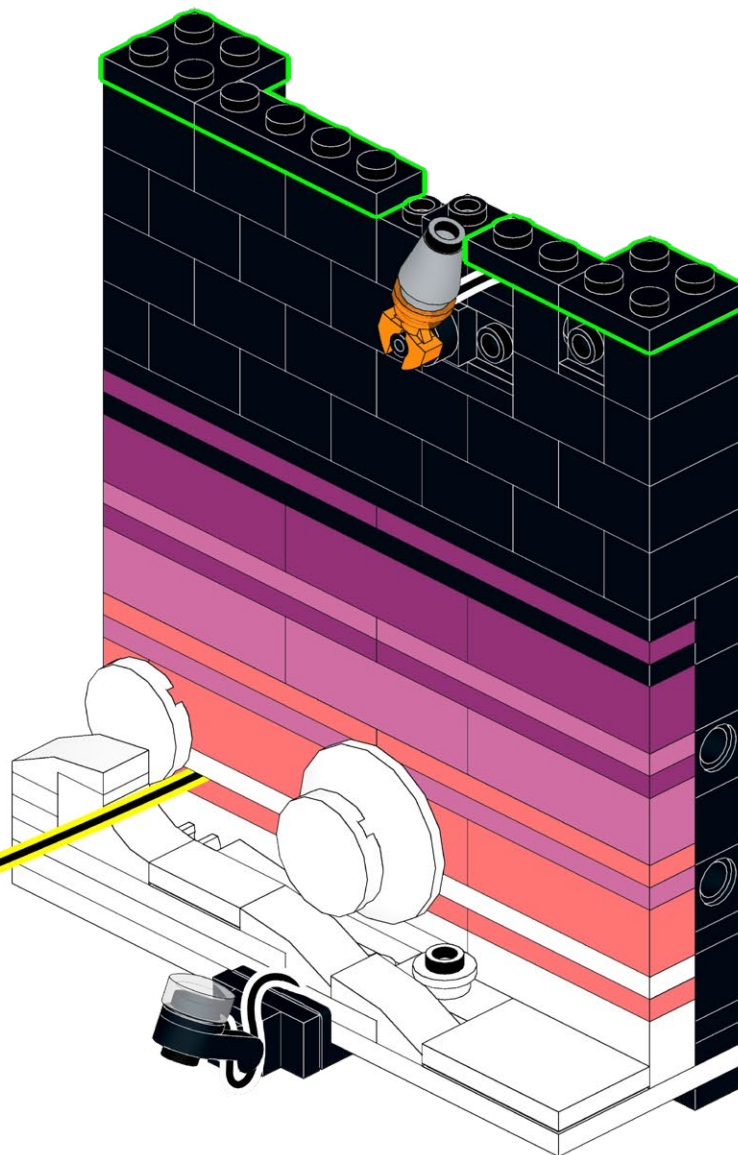

136

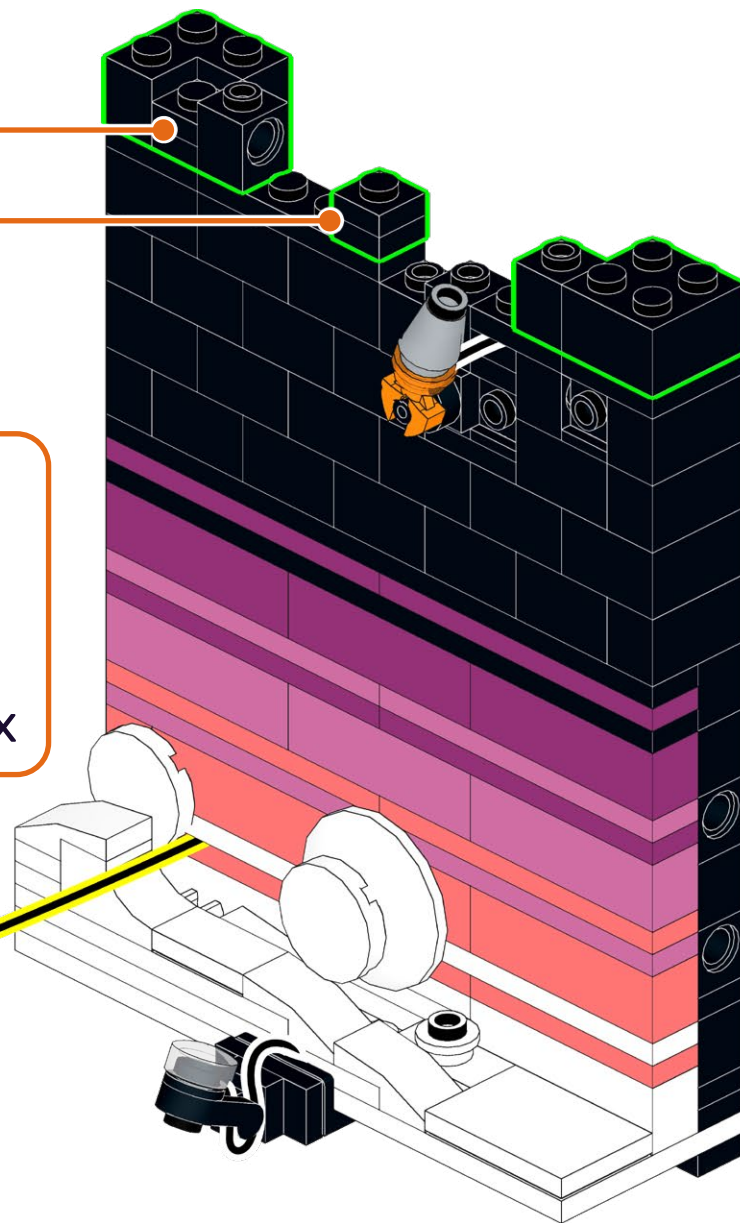
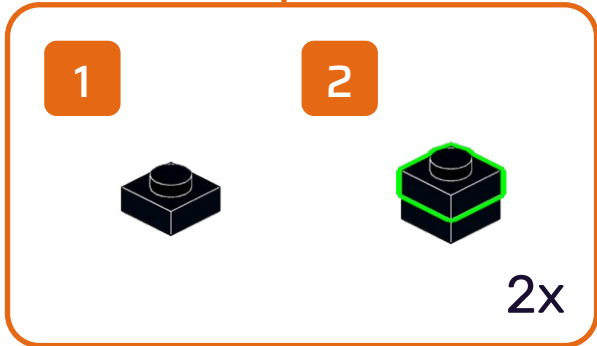
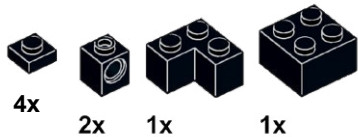

137

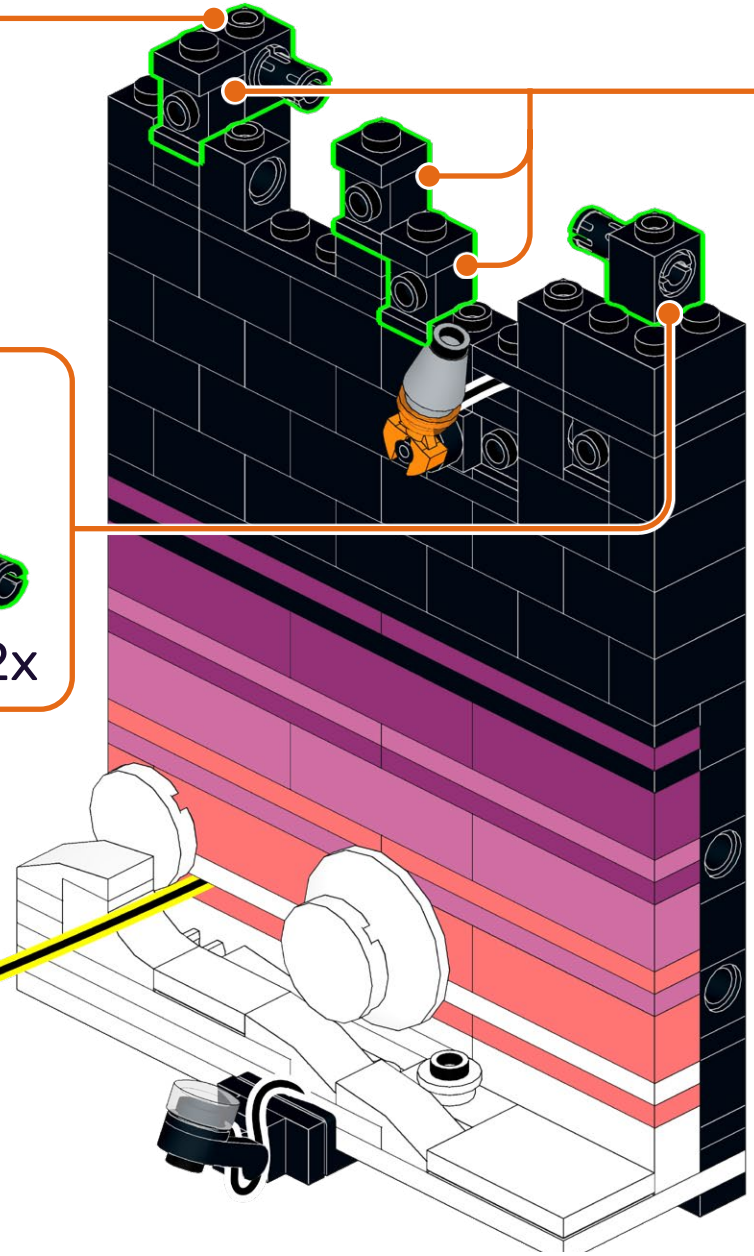
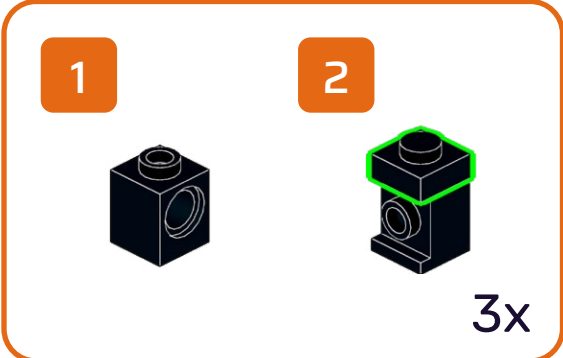
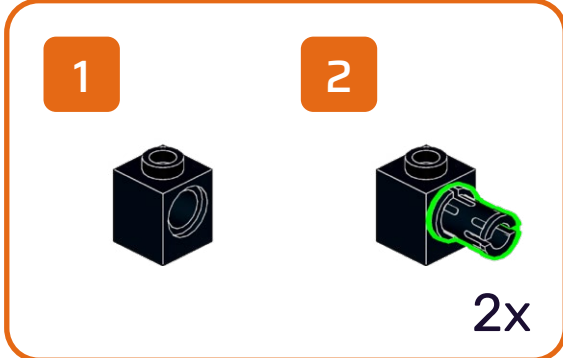
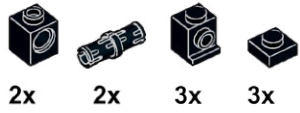

138

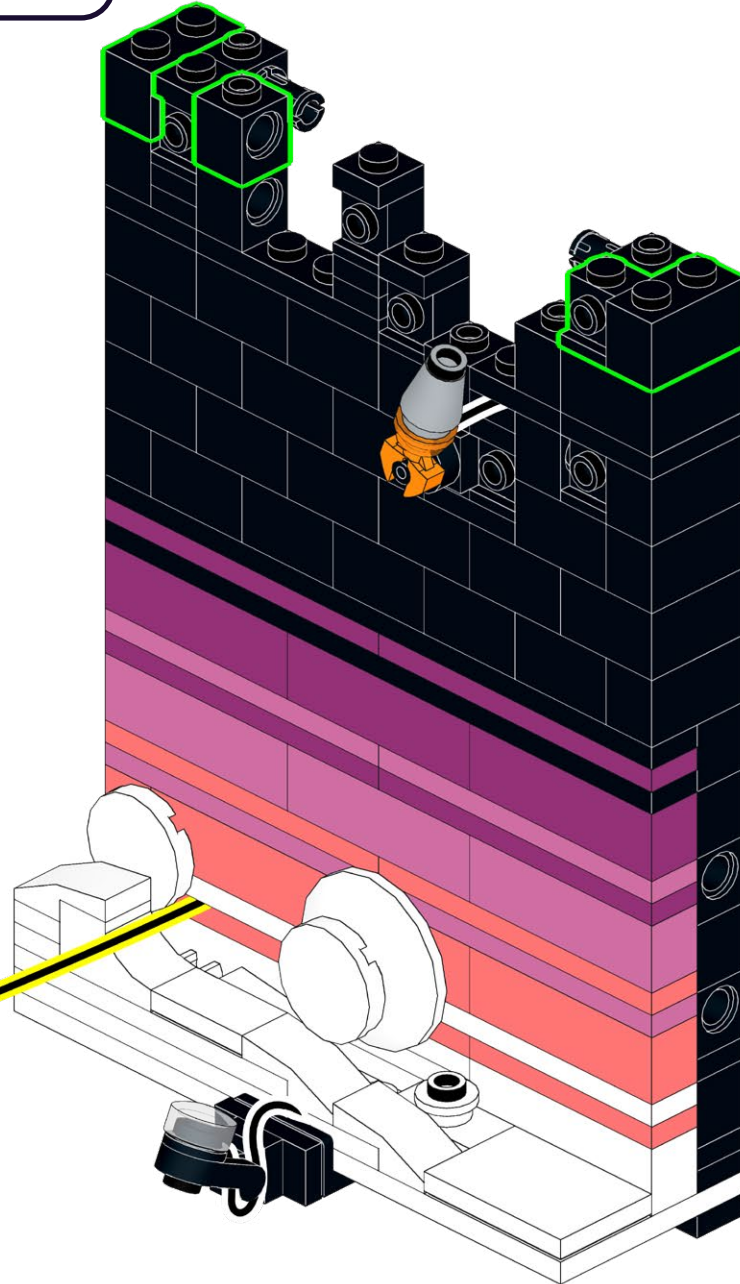
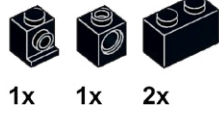

139

2x

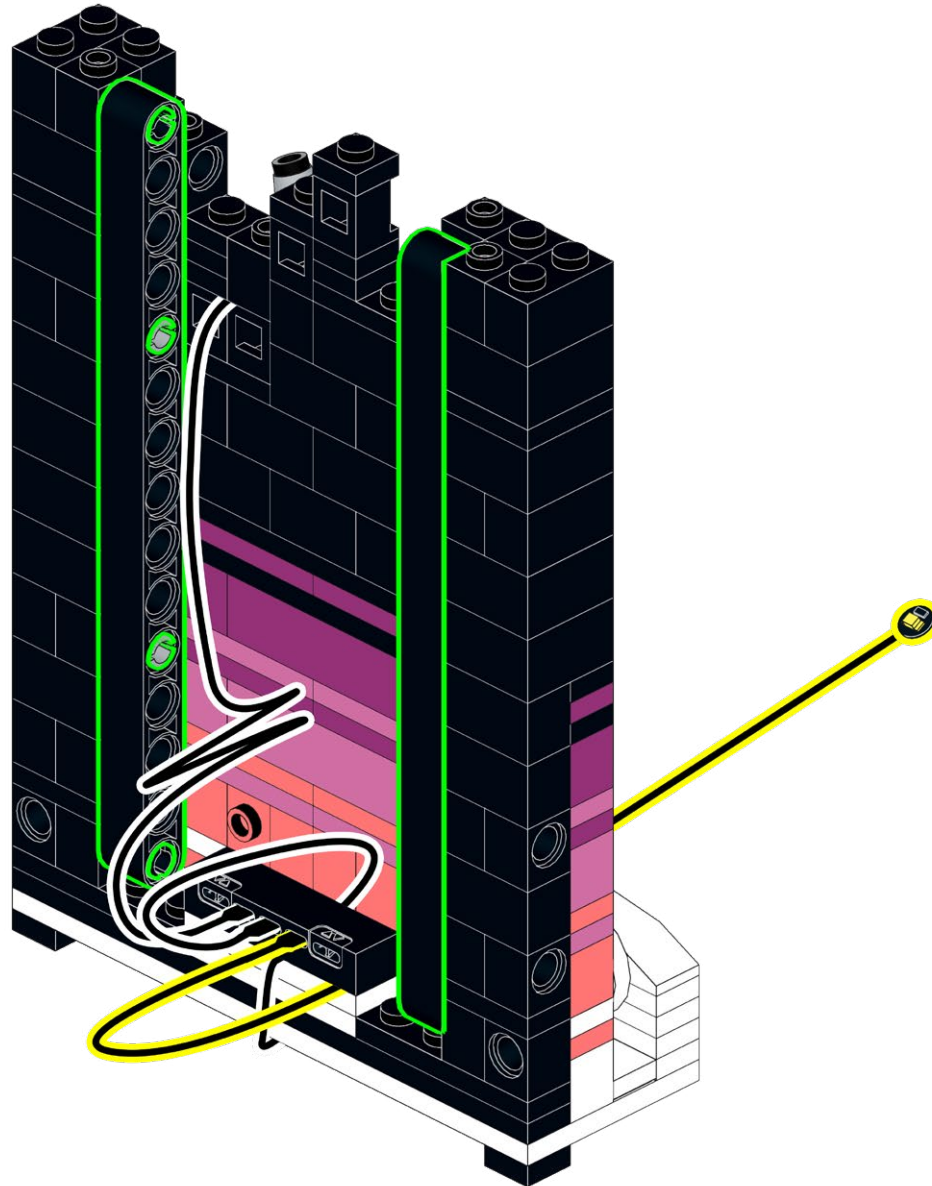

140

2x

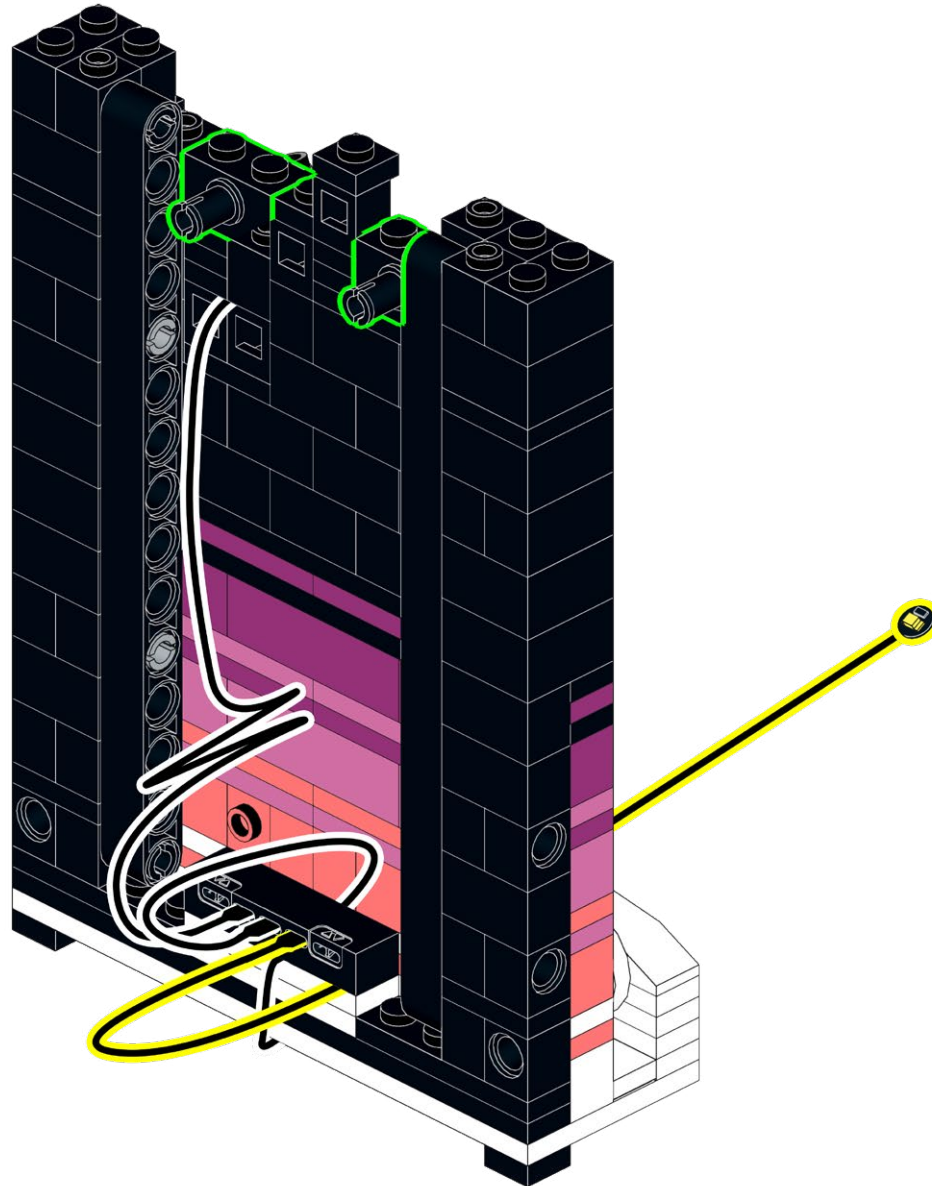

141

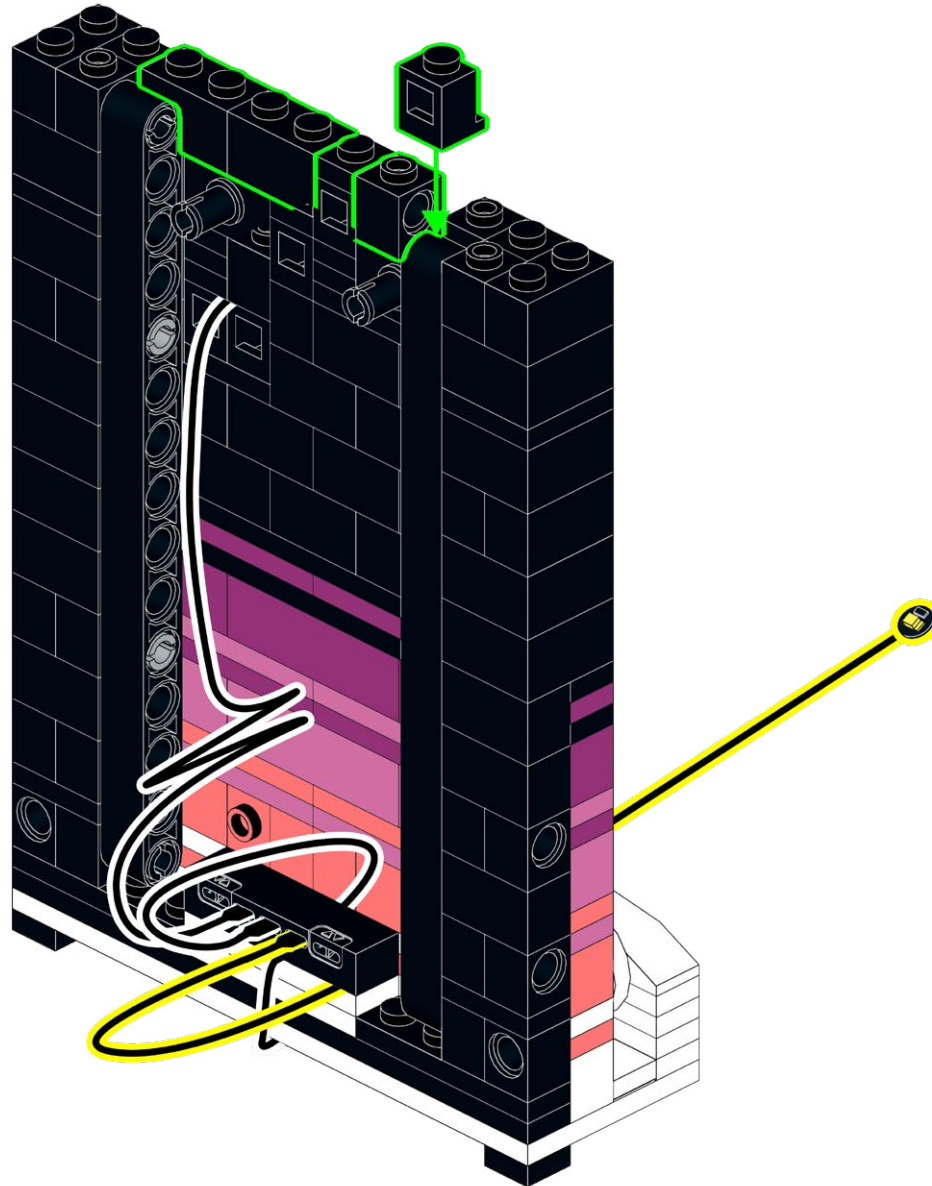
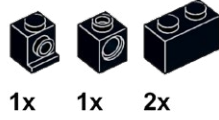

142

1x

1x

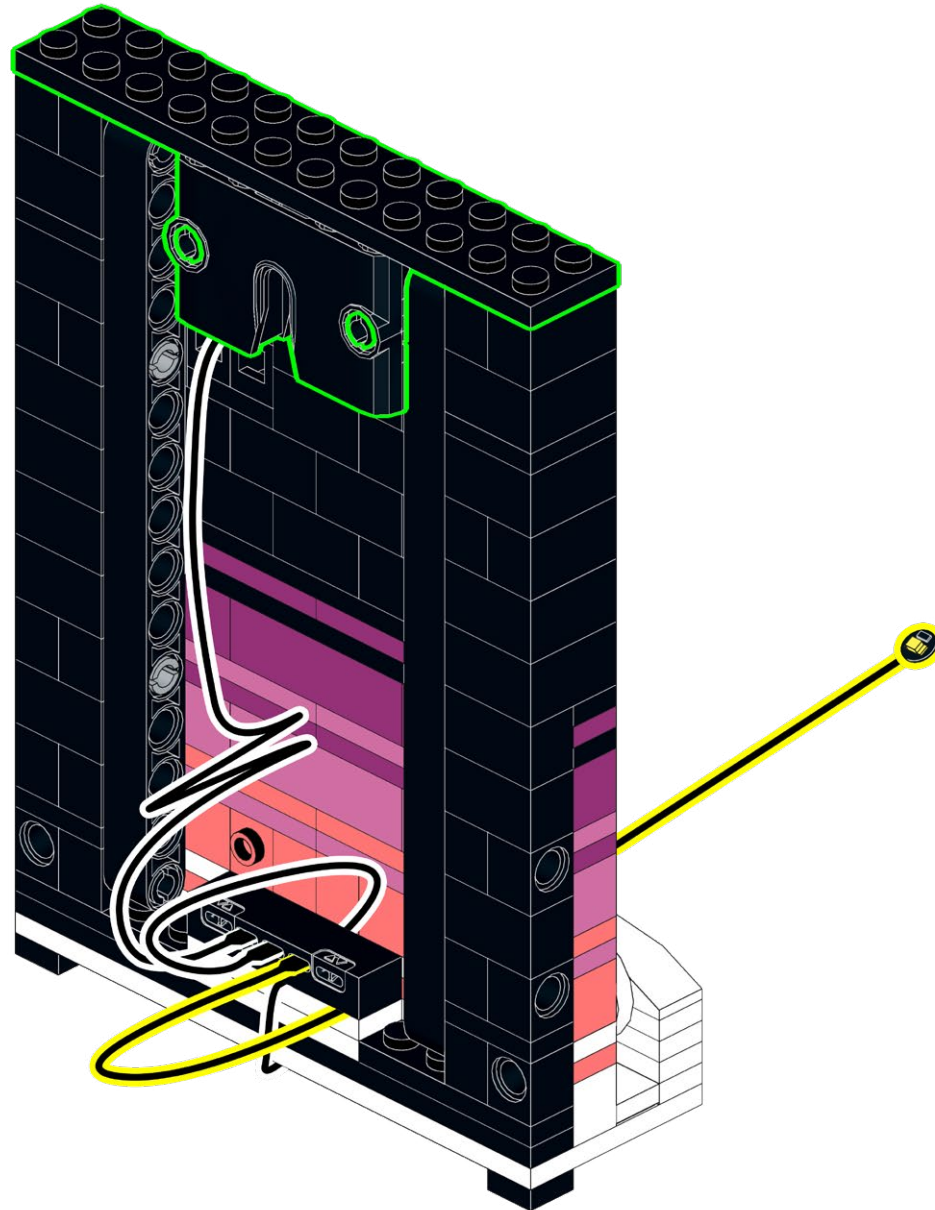



143

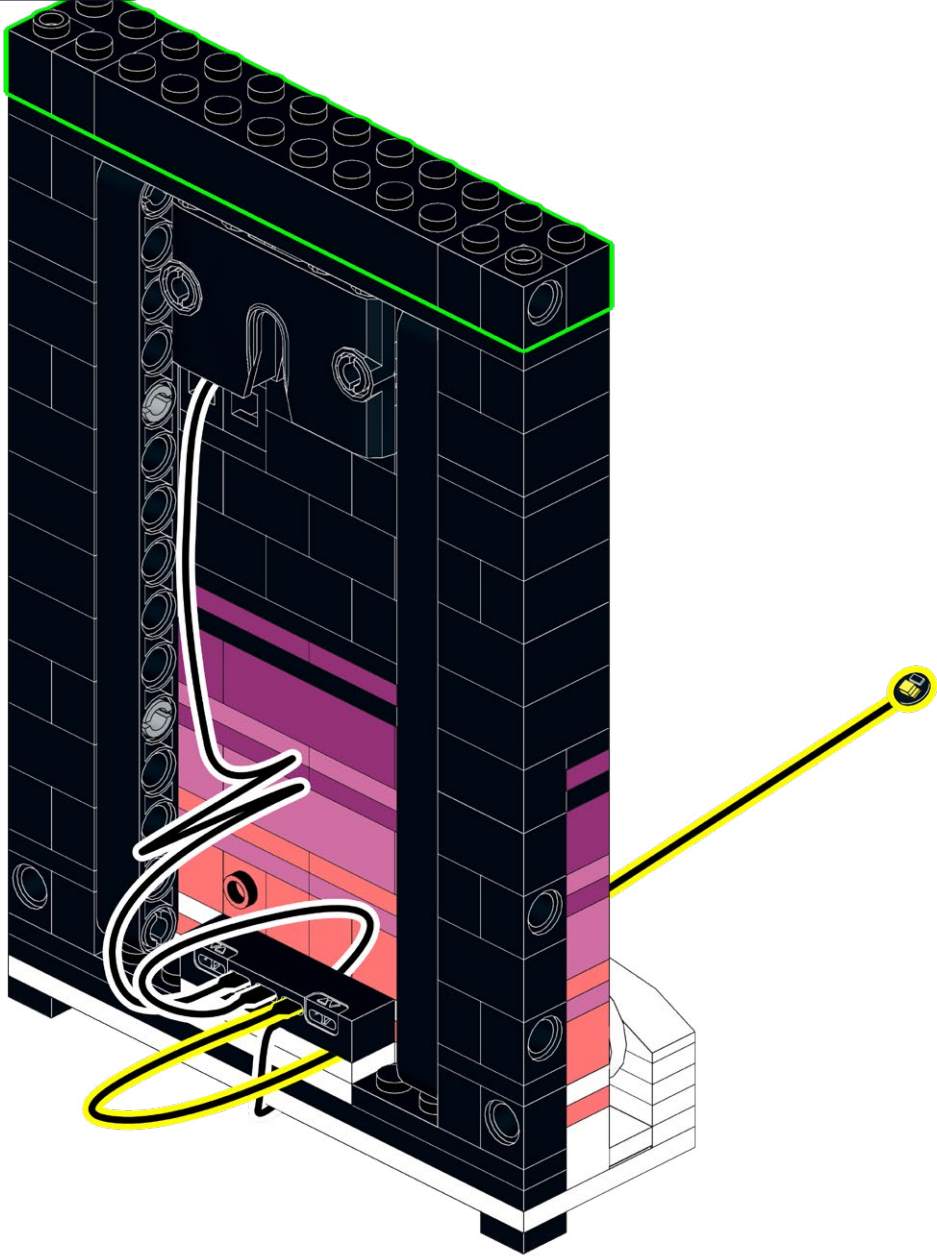
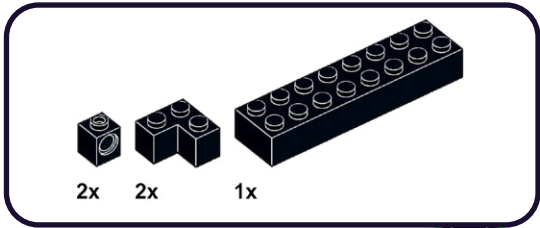

144

3x

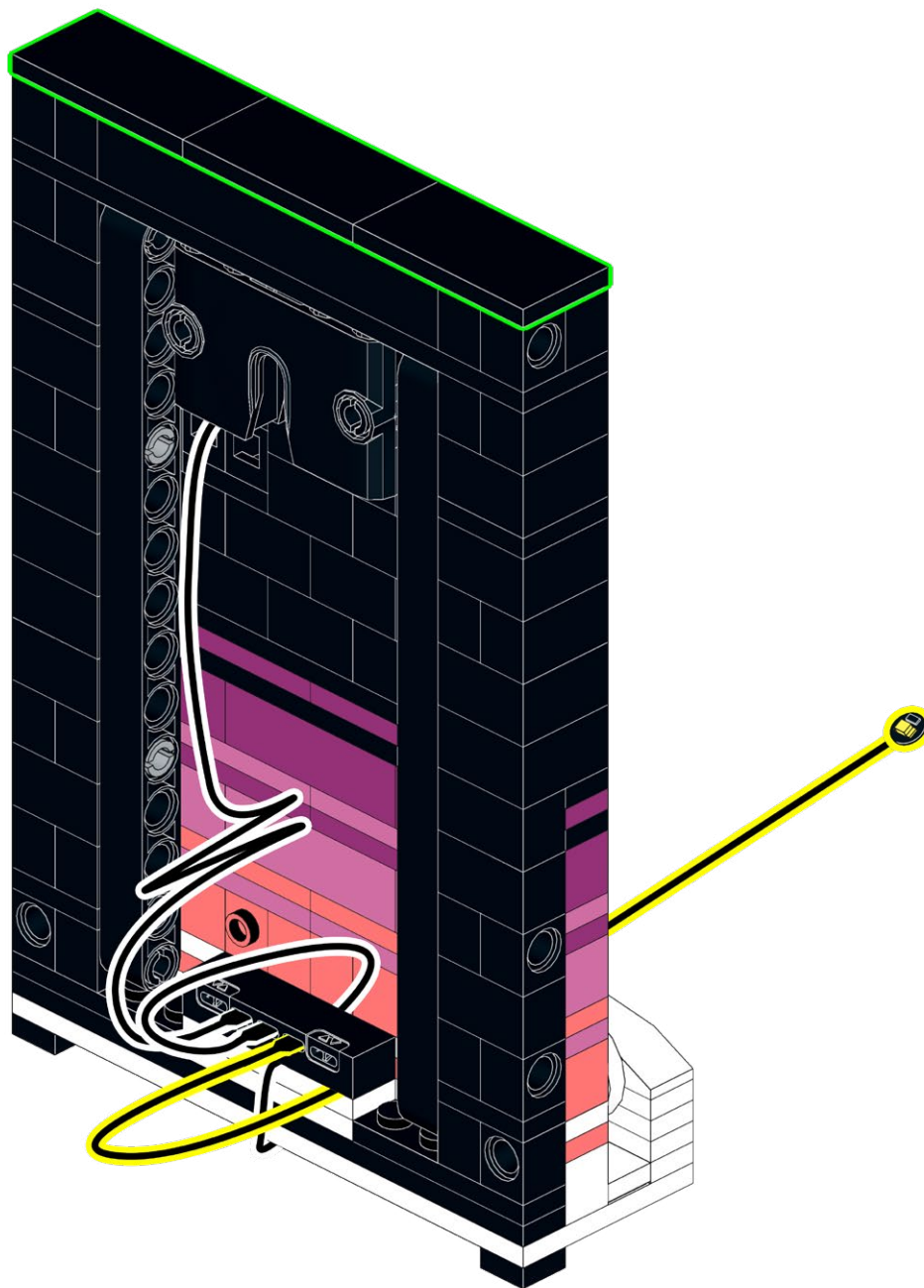

145

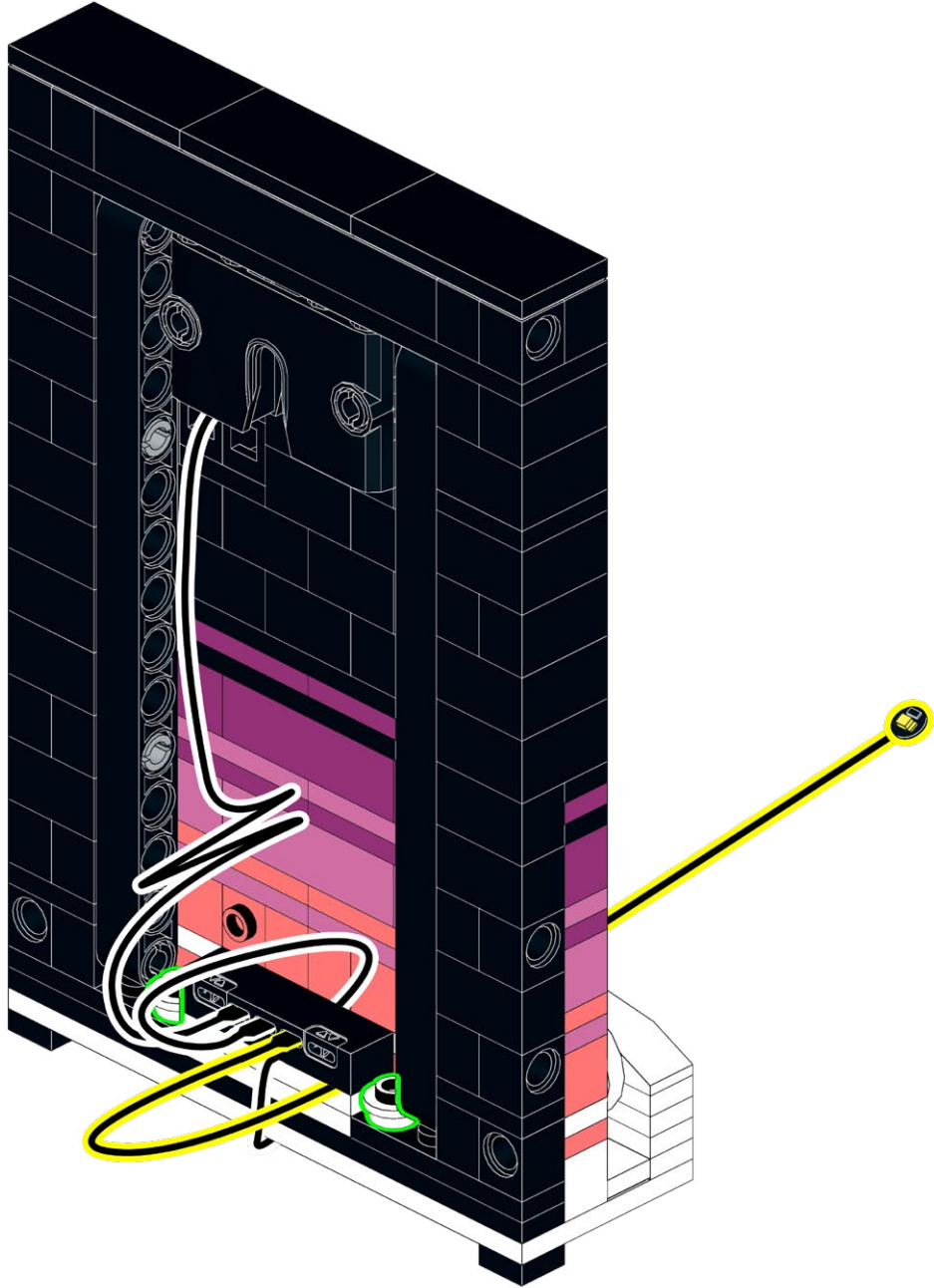

146

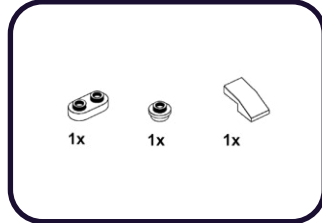
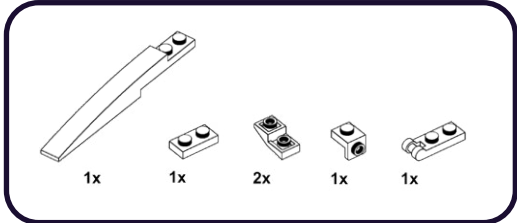

1

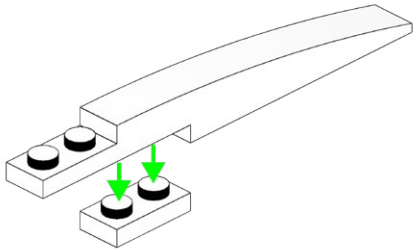

2

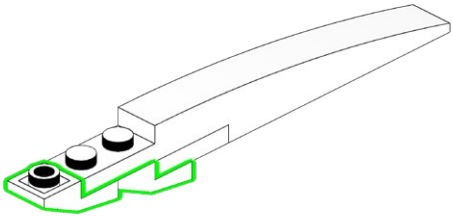

3

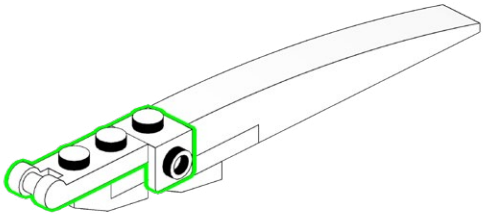

4

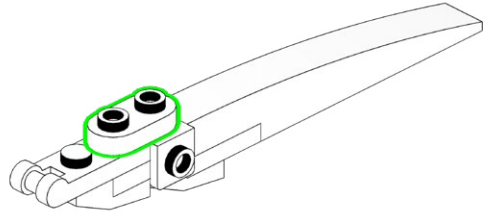

5

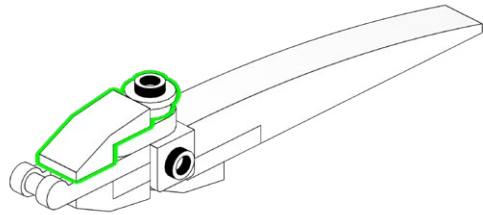

147

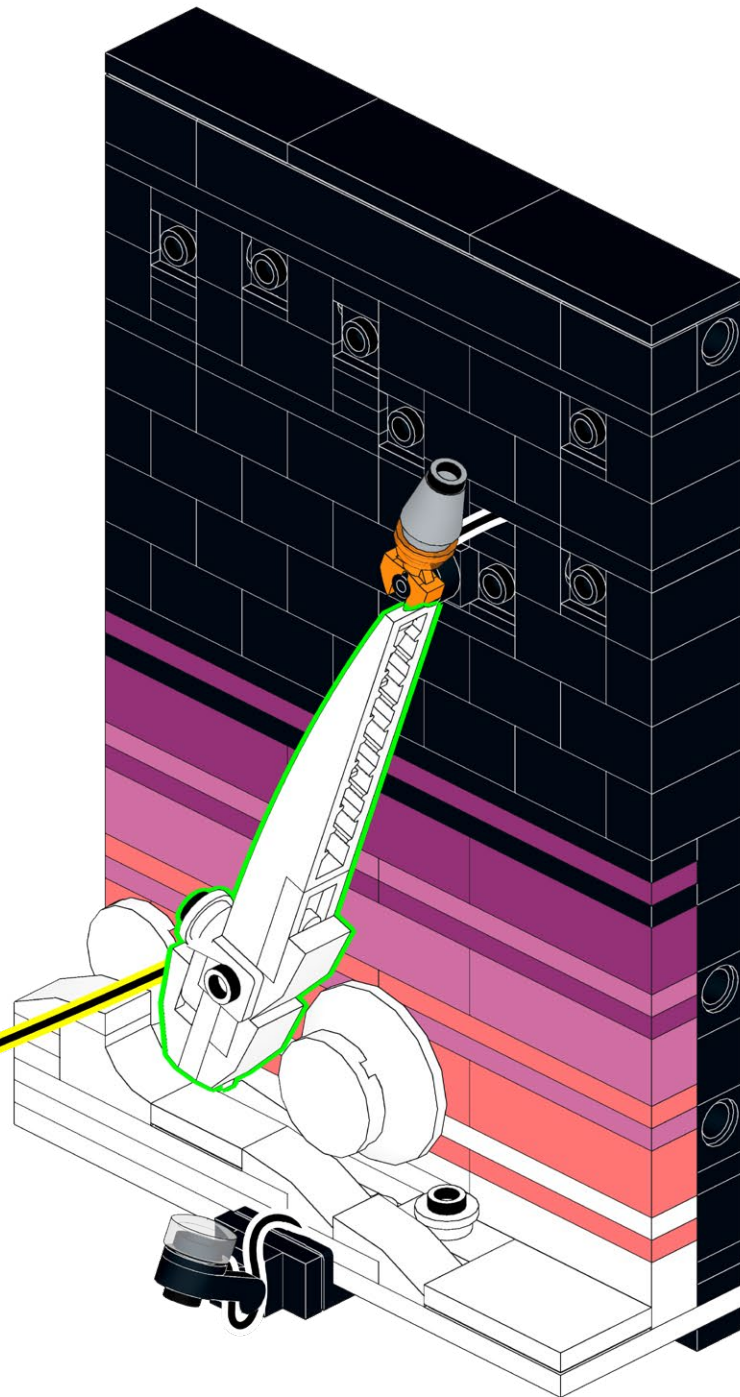

**148**

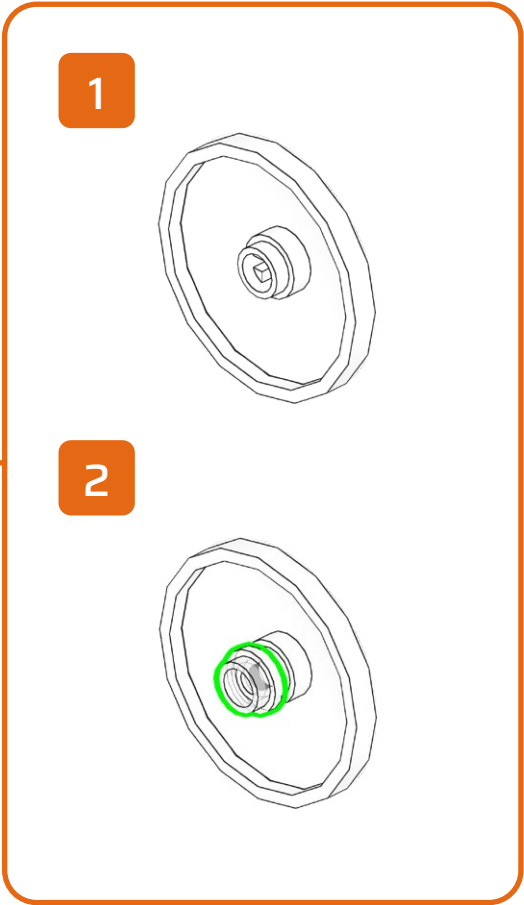
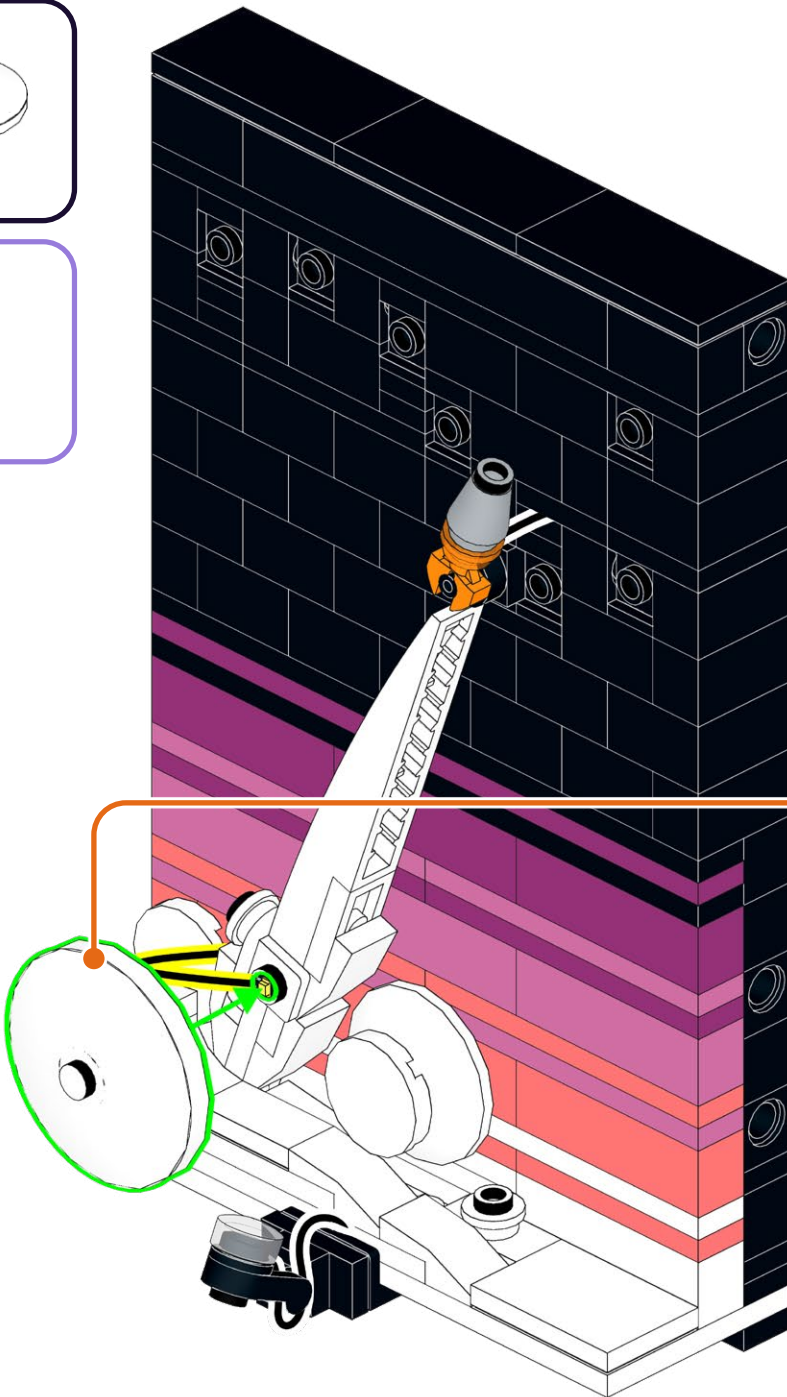
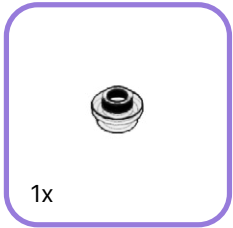
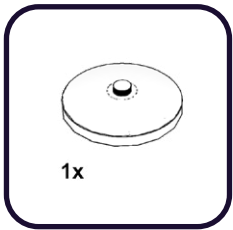

149



2x



2x

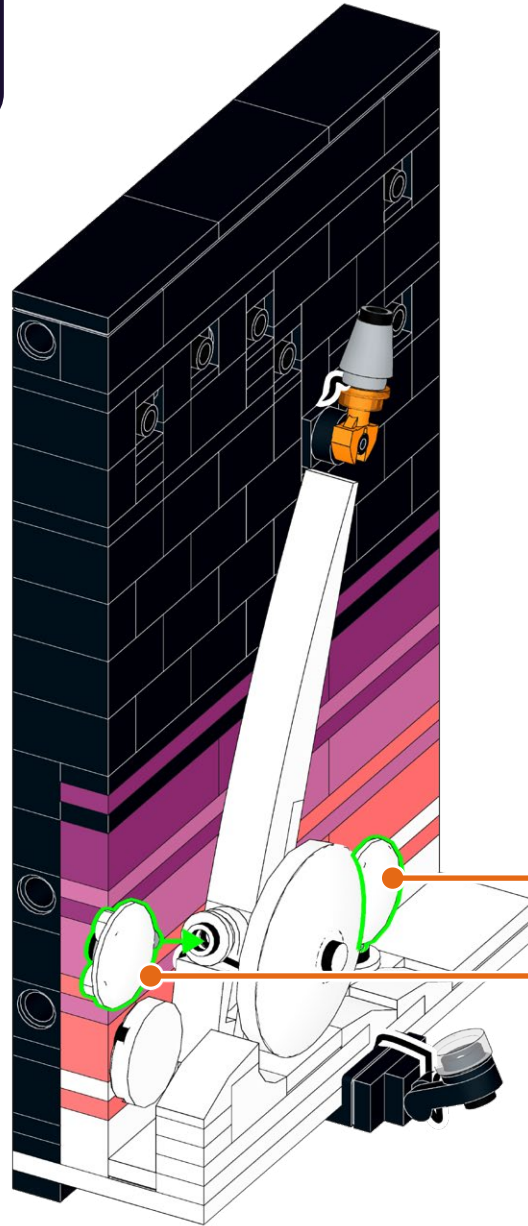

1

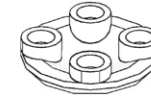

2

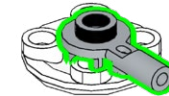

2x

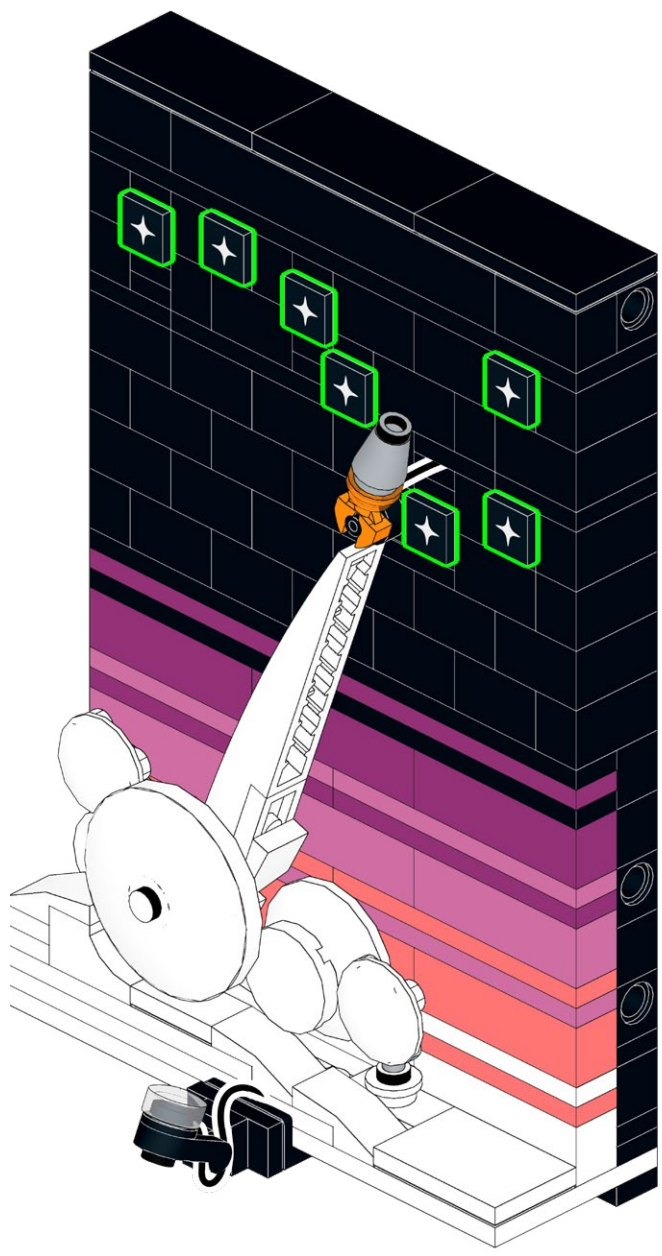
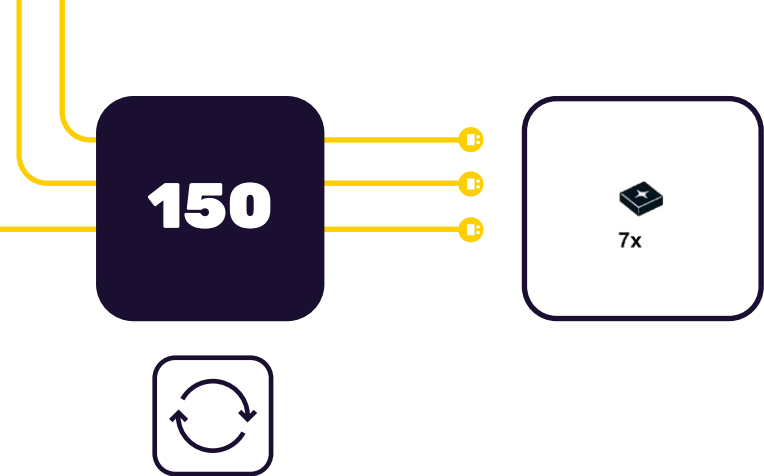



151

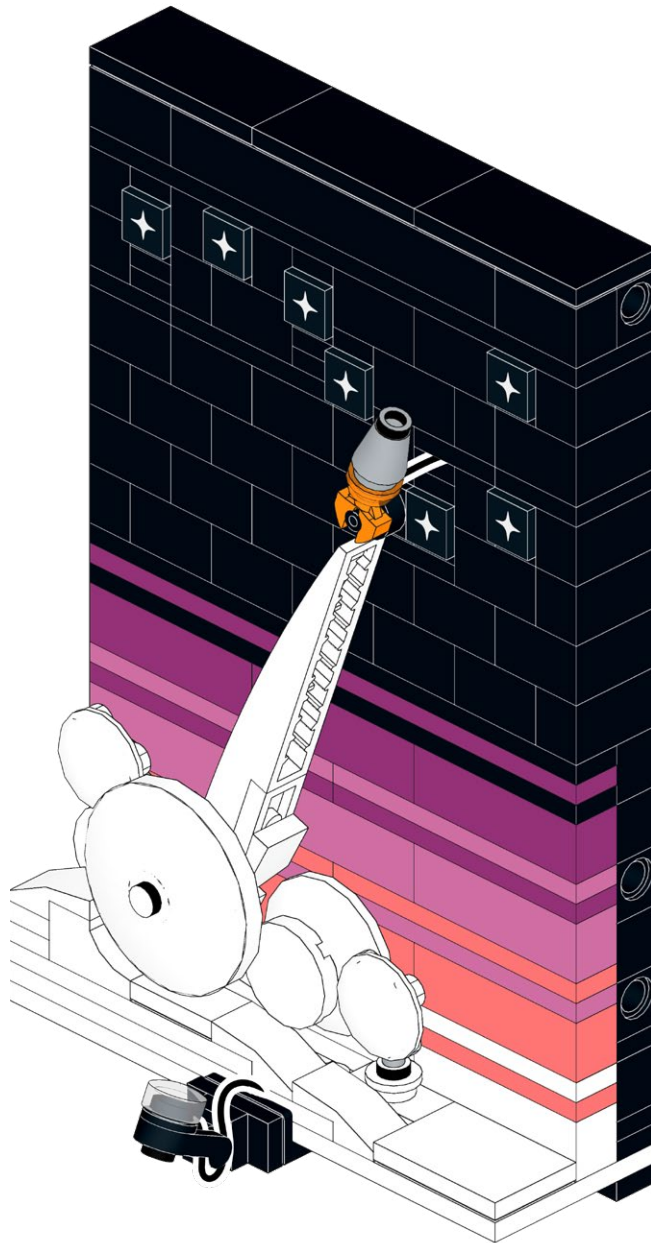



### **HOLD UP!**

You might notice some bags aren't in order, as well as left over pieces, but that's ok! We're changing the way you build LEGO!

### **ATTENDEZ!**

Vous remarquerez peut-être que certains sacs, ainsi que certaines pièces, ne sont pas dans le bon ordre. Mais pas de panique! Nous changeons simplement la façon avec laquelle vous construisez vos LEGO!

### **ASPETTA!**

Potresti notare che alcuni sacchetti non sono in ordine, così come i pezzi avanzati, ma va bene così! Stiamo cambiando il modo in cui costruisci i LEGO!

### **HALT!**

Sie werden möglicherweise bemerken, dass einige tüten durcheinander sind und teile übrig bleiben, aber das ist in Ordnung! Wir ändern die art und weise, wie Sie LEGO bauen!

### **¡ESPERA!**

Es posible que notes que algunas bolsas están fuera de servicio, así como piezas sobrantes, ¡pero está bien! ¡Estamos cambiando la forma en que construyes LEGO!

### **暫停!**

你可能会注意到一些袋子顺序错乱, 以及一些剩余的部件, 但没关系! 我们正在改变你搭建乐高的方式!

#### Open LEGO® Bag 7

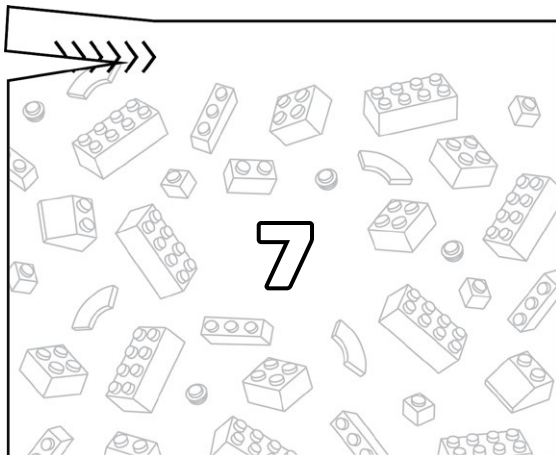

#### Open LMB Bags 04

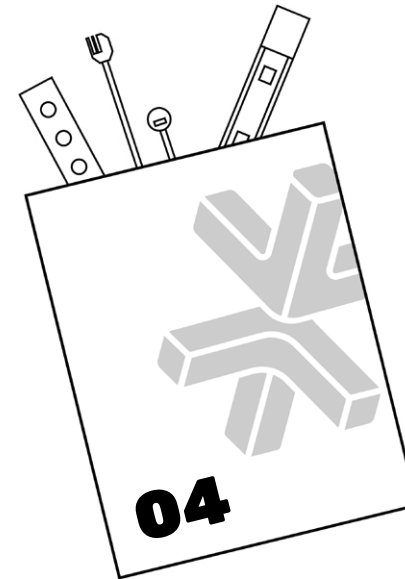

152



1x



1x

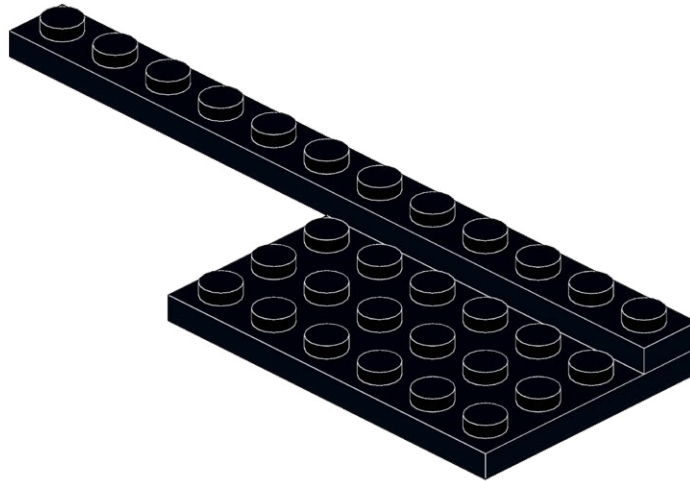

153

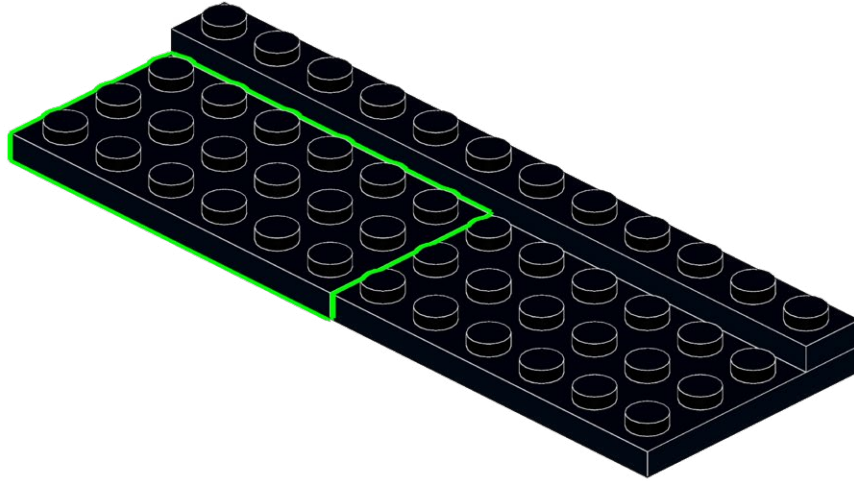
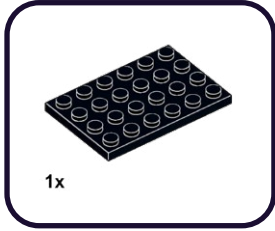

154

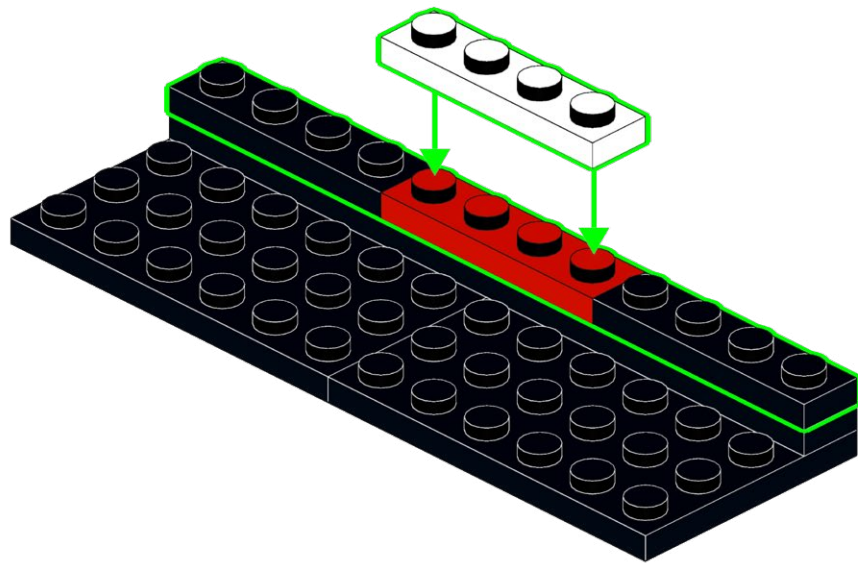
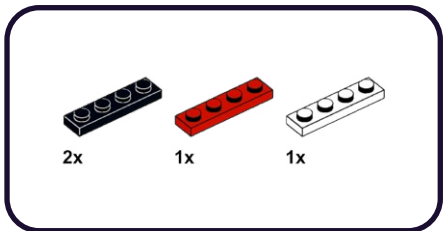

**155**

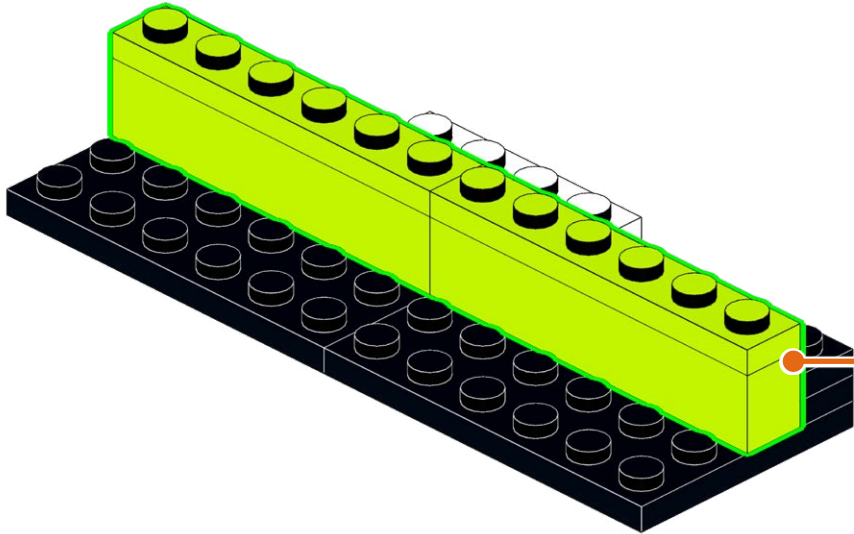
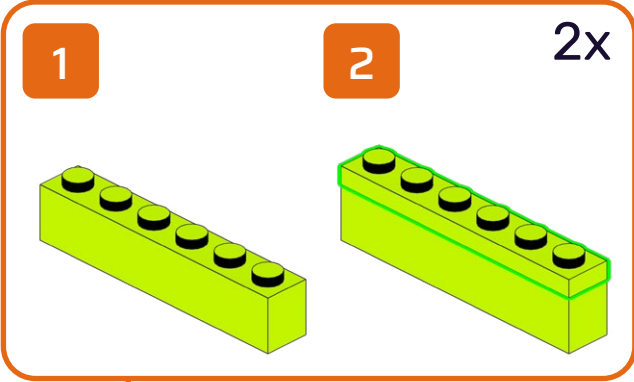
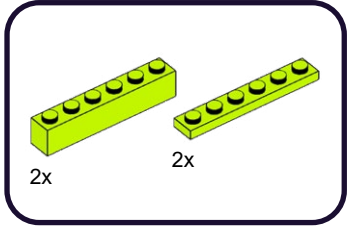

156

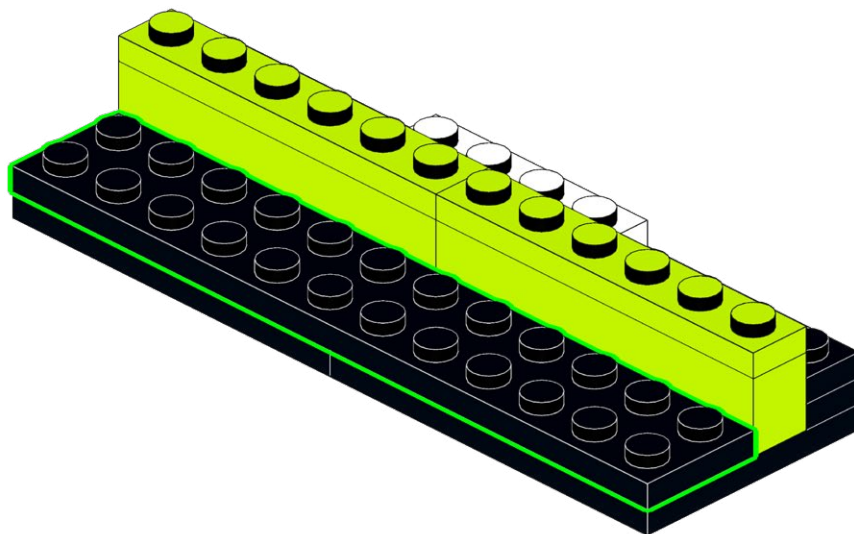
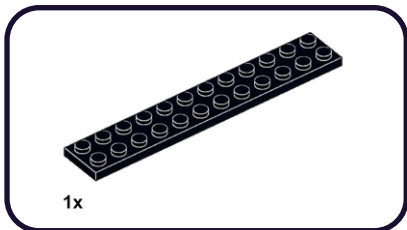

157

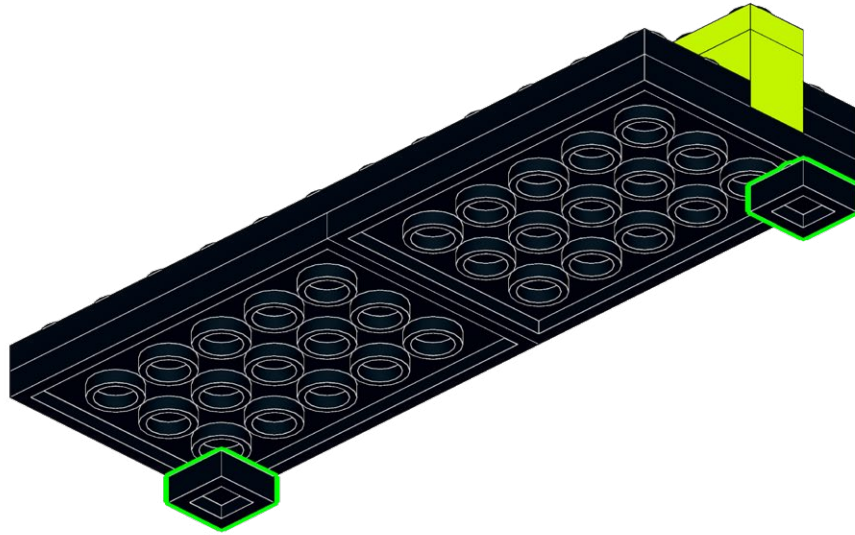



# 158

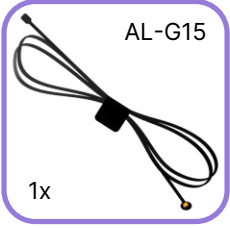

1



2



3

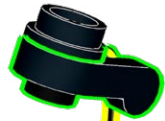

159

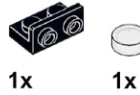
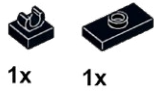

1



3

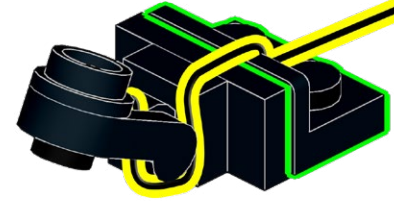

2

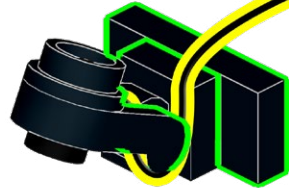

4

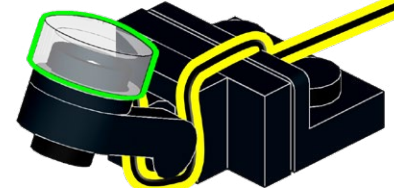

160

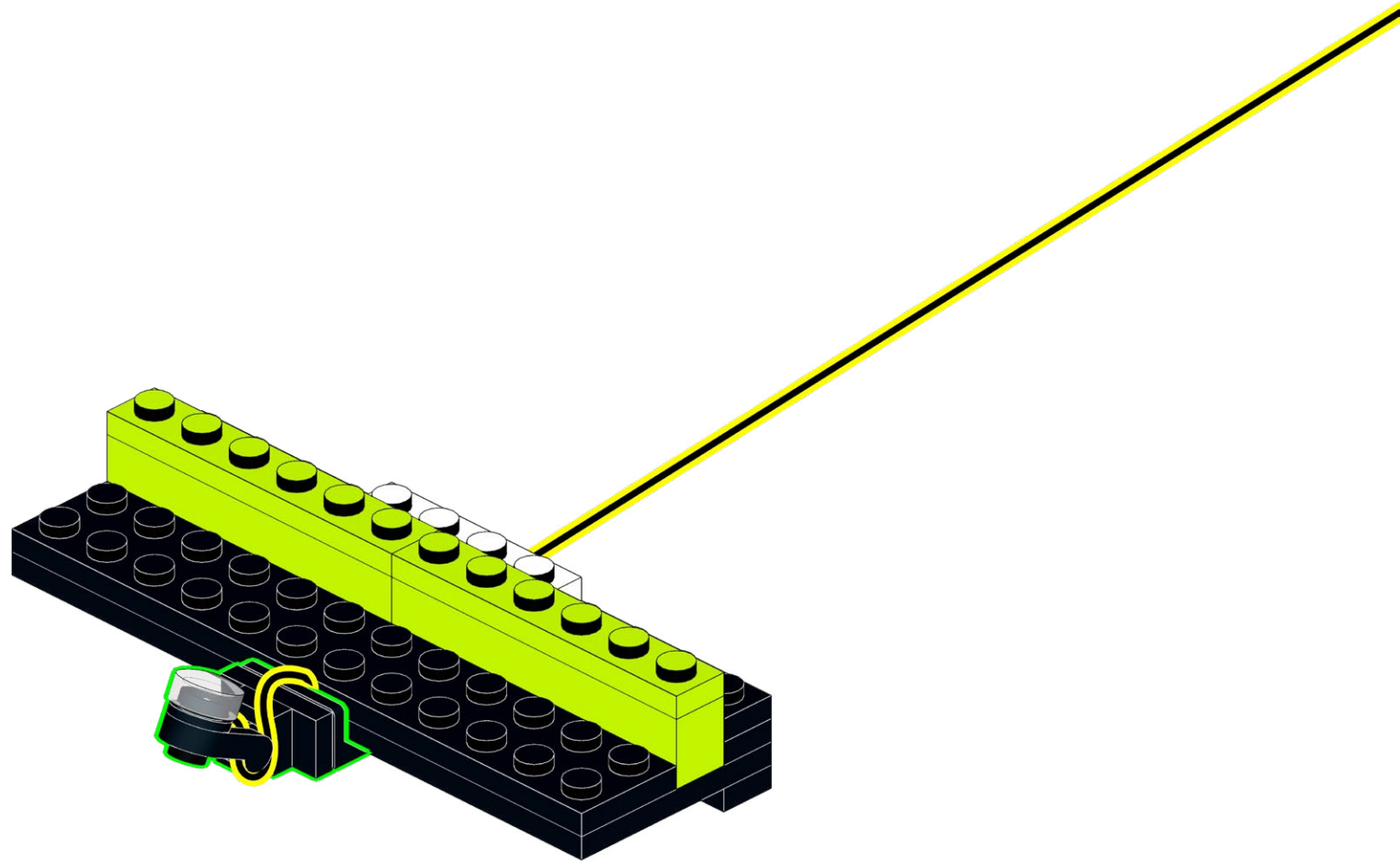

161

2x

4x

1



2

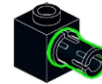

2x

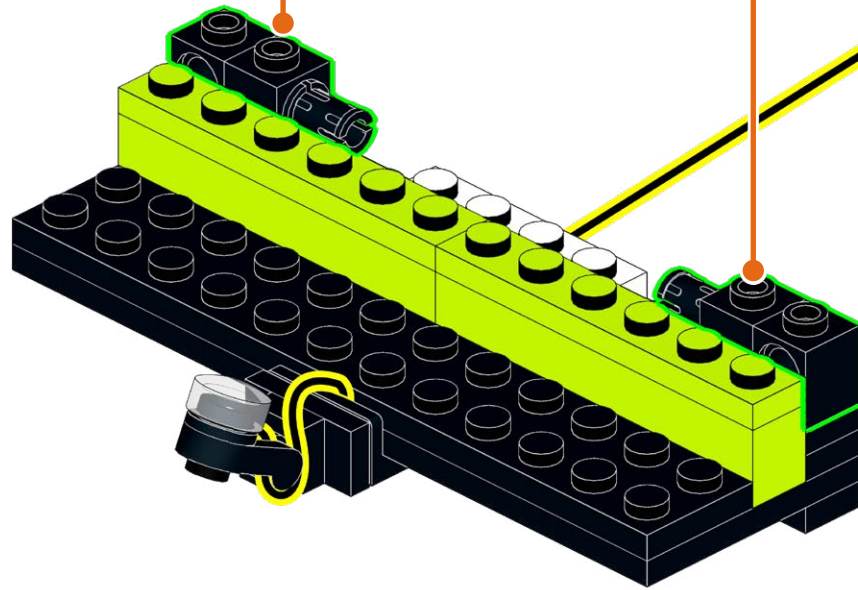

162

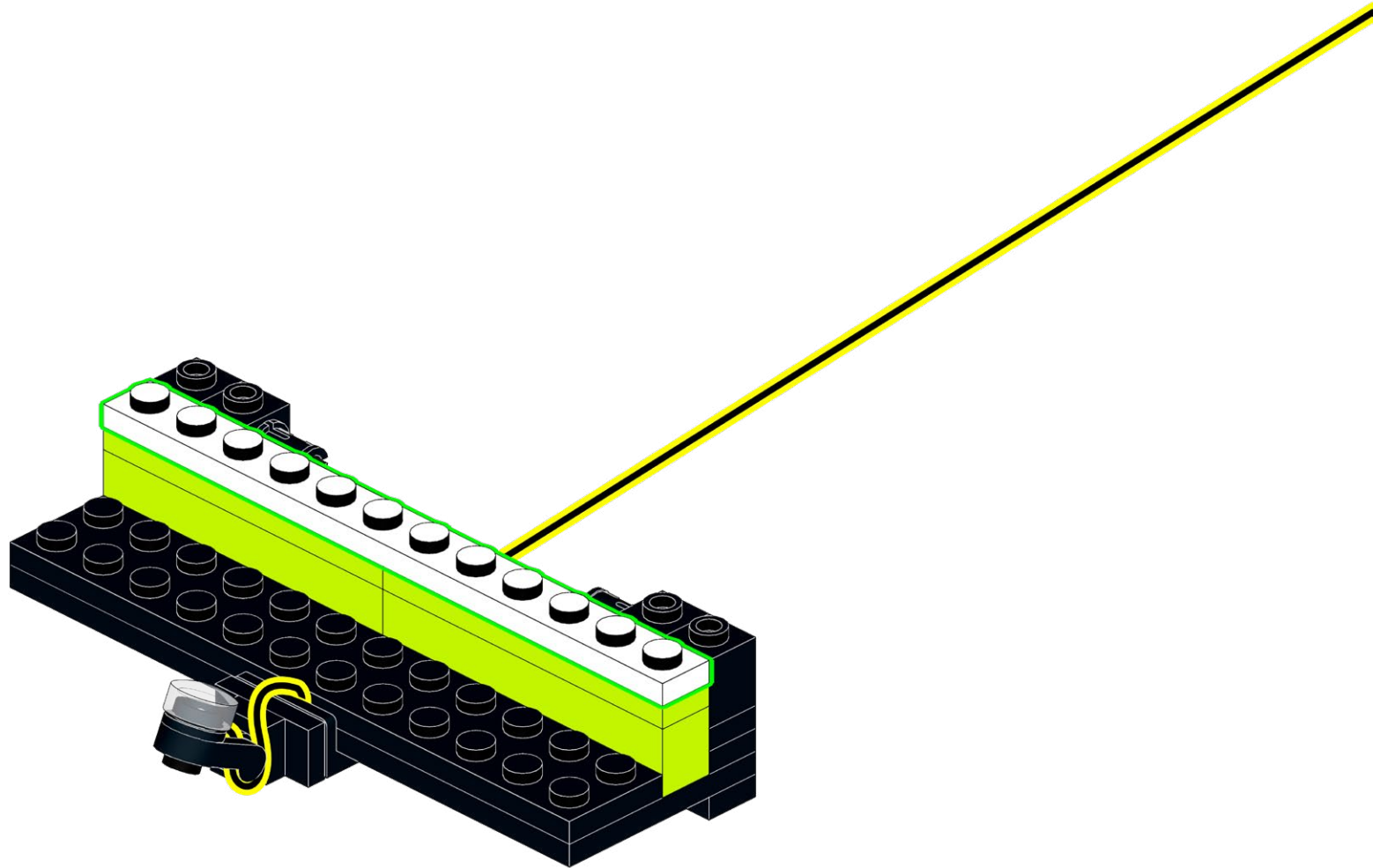
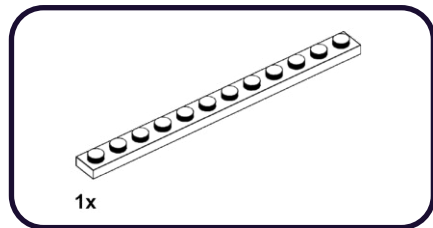

# 163

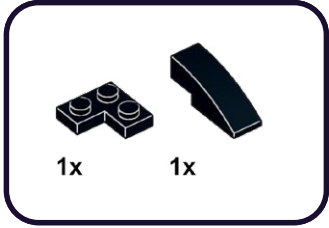

1

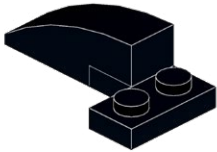

2

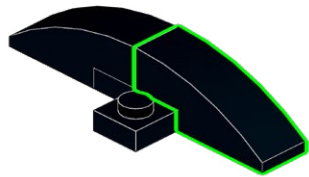

# 164



1

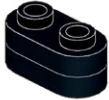

2

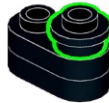

2



165

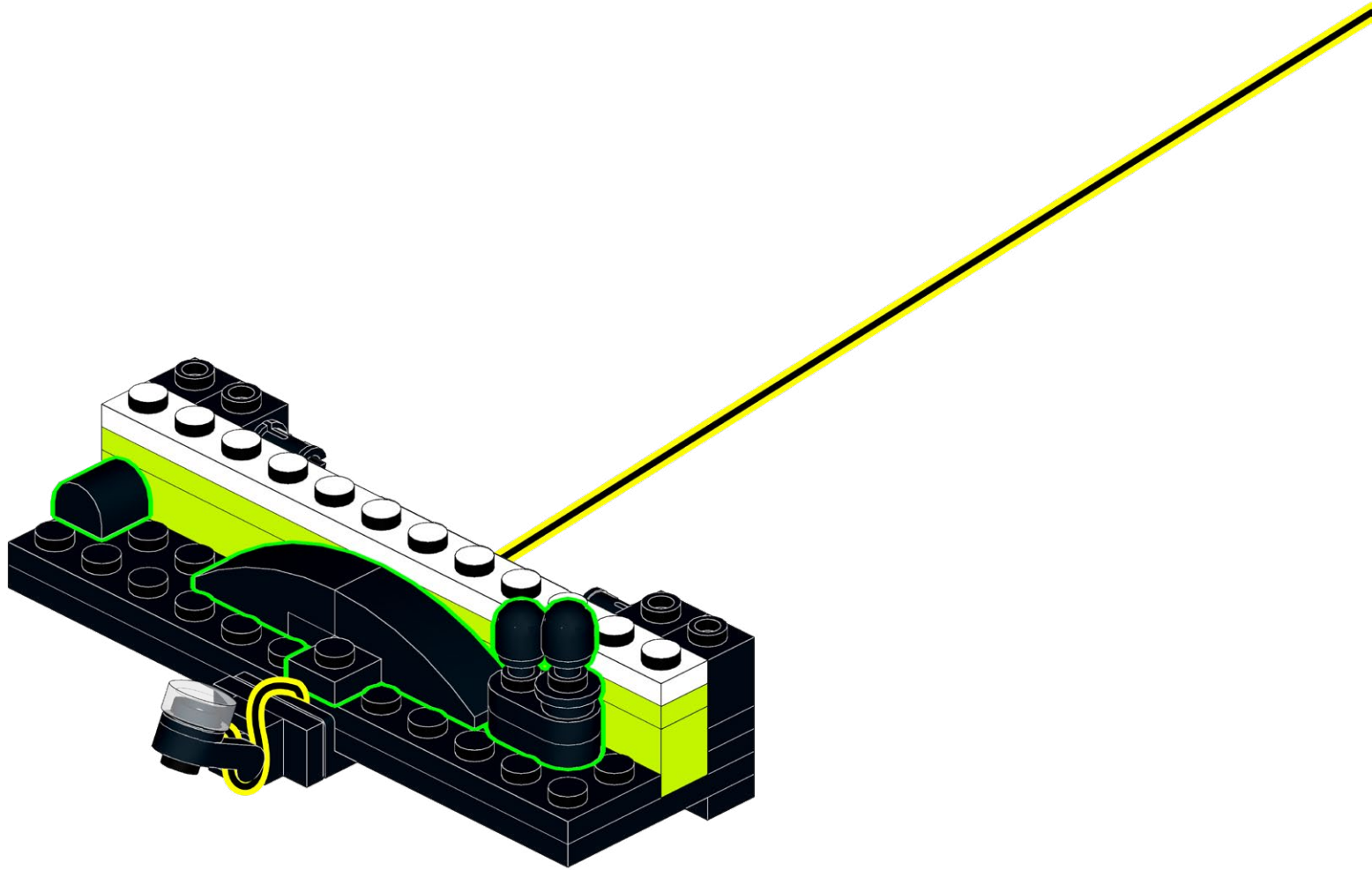
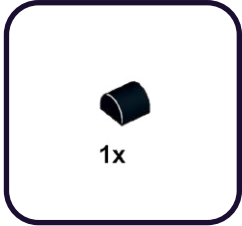

166

3x

2x

2x

2x

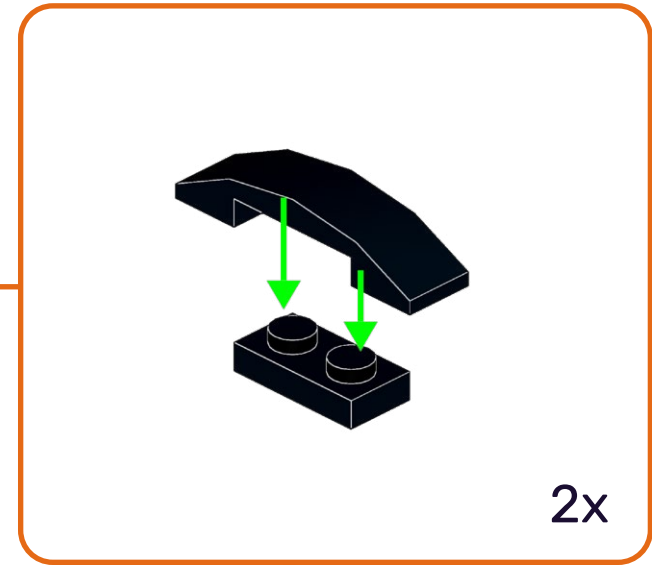
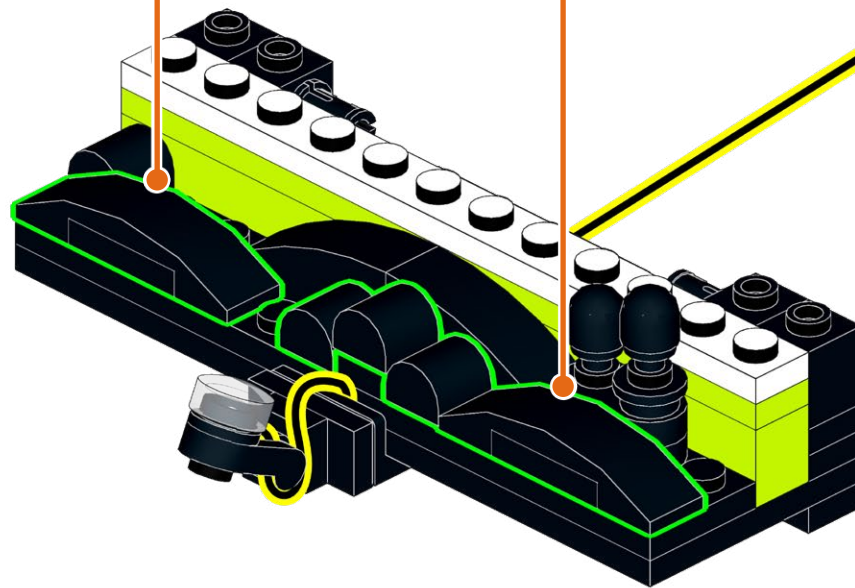



167

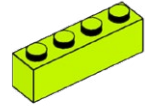

3x

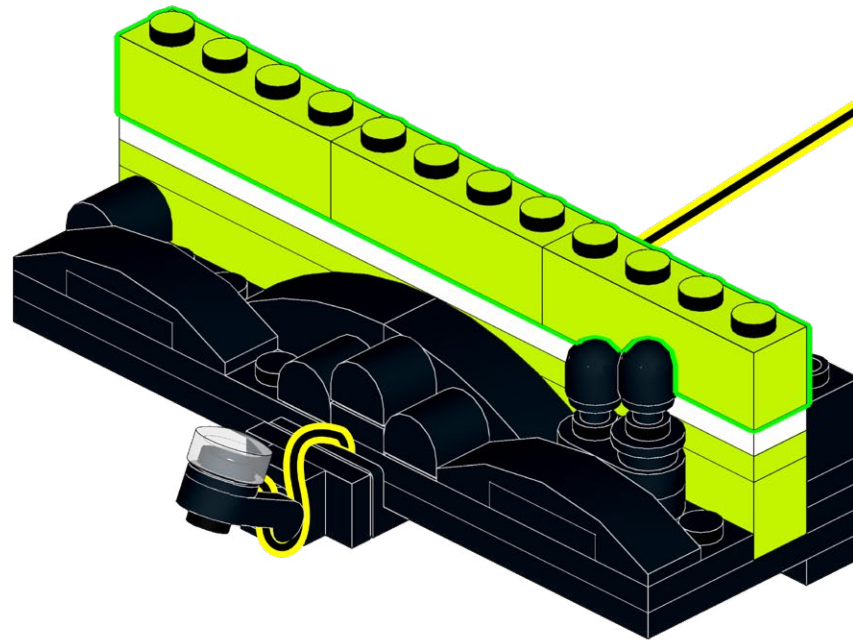

168

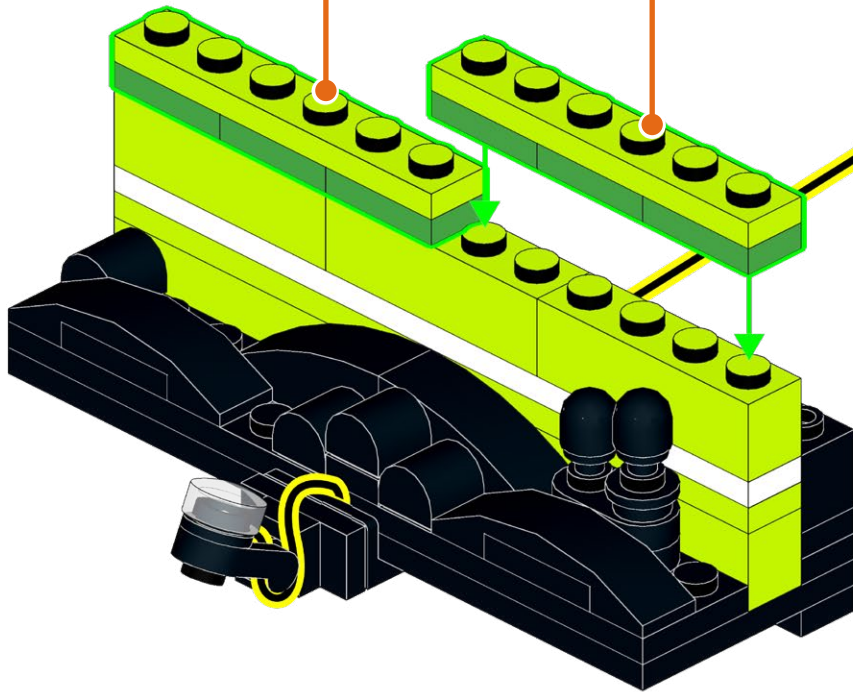
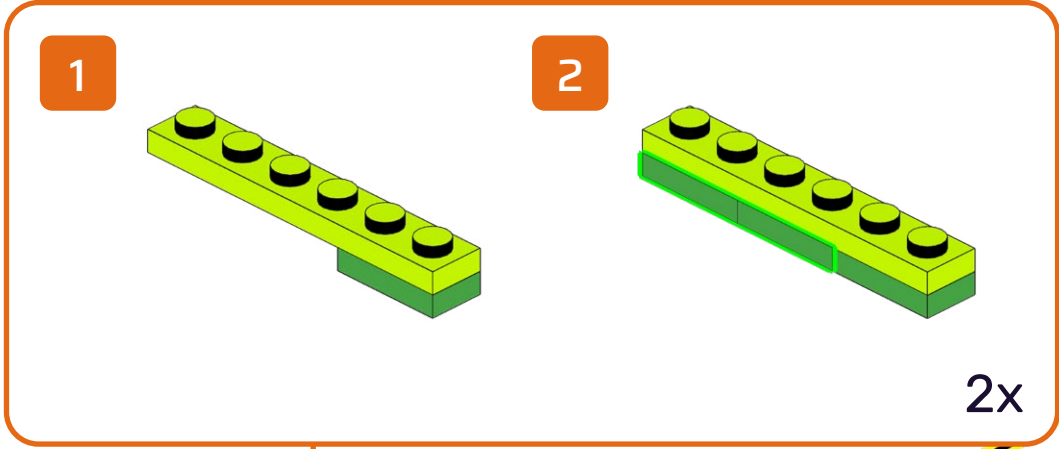
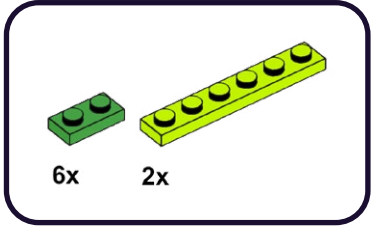

169

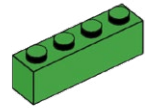

3x

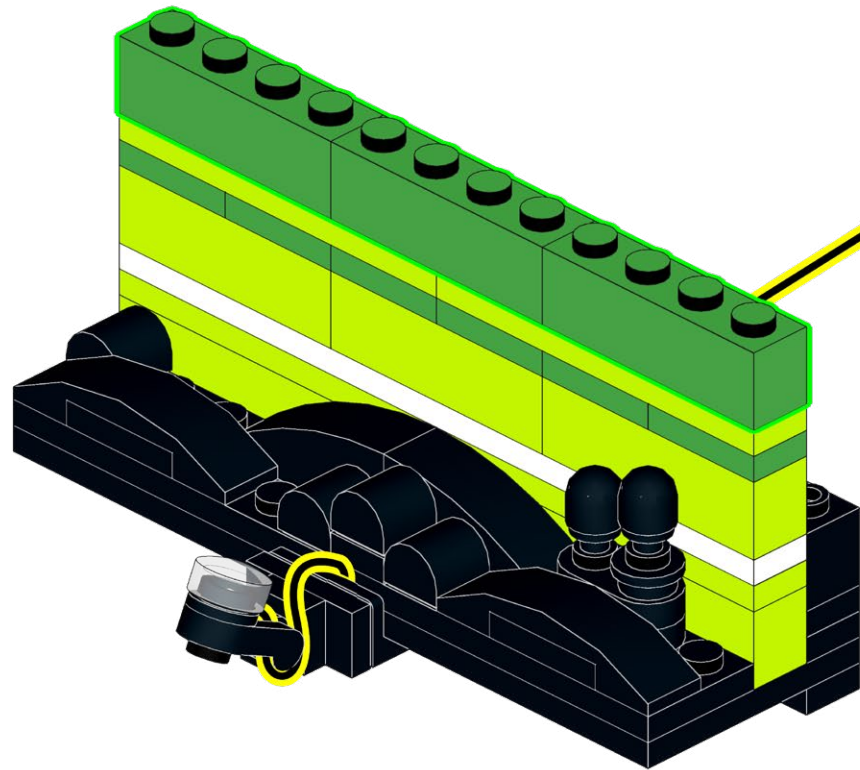

170

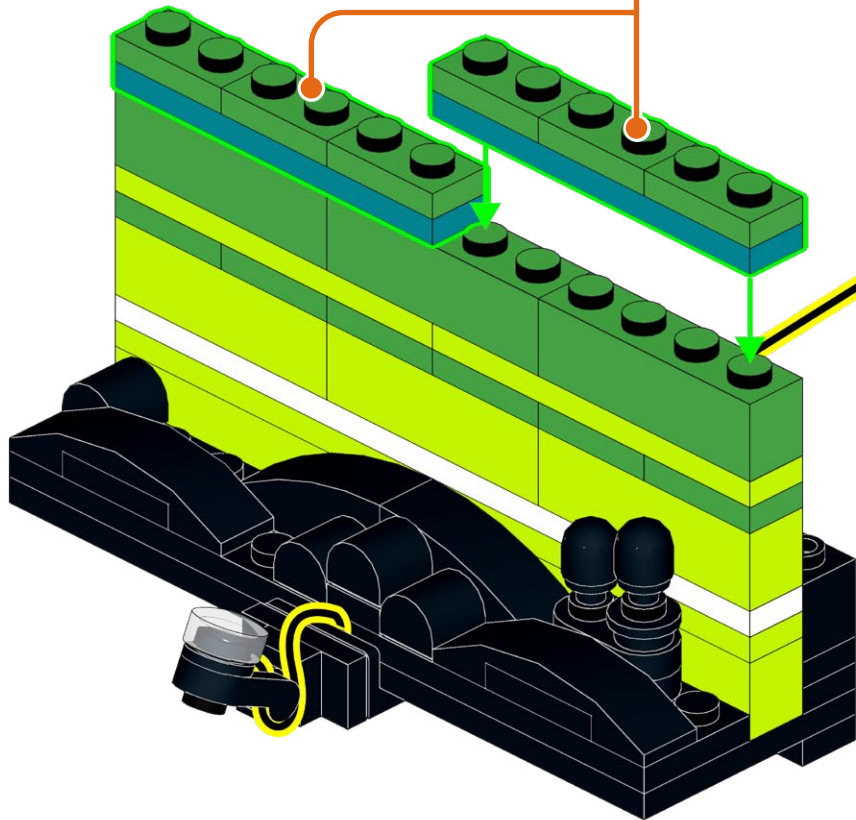
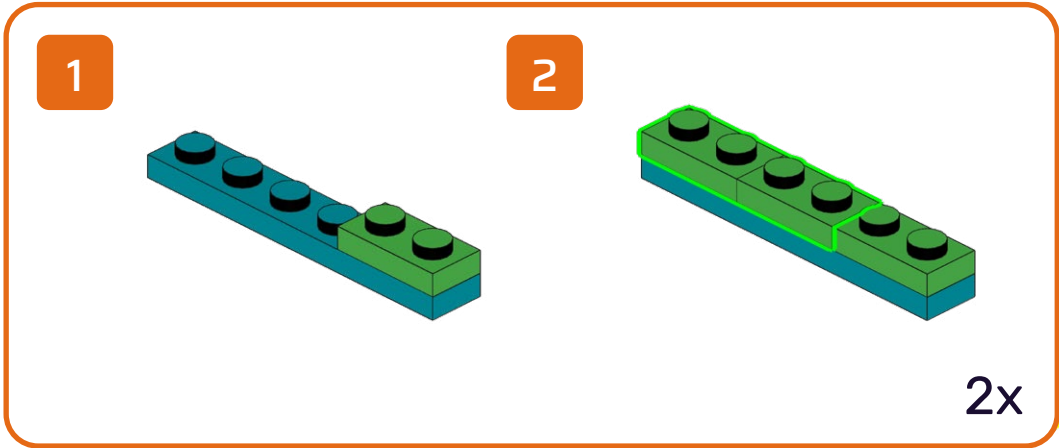
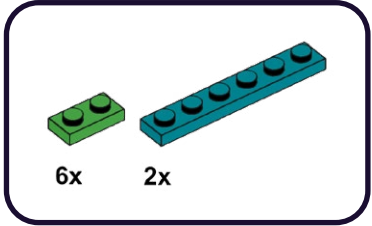

171

3x

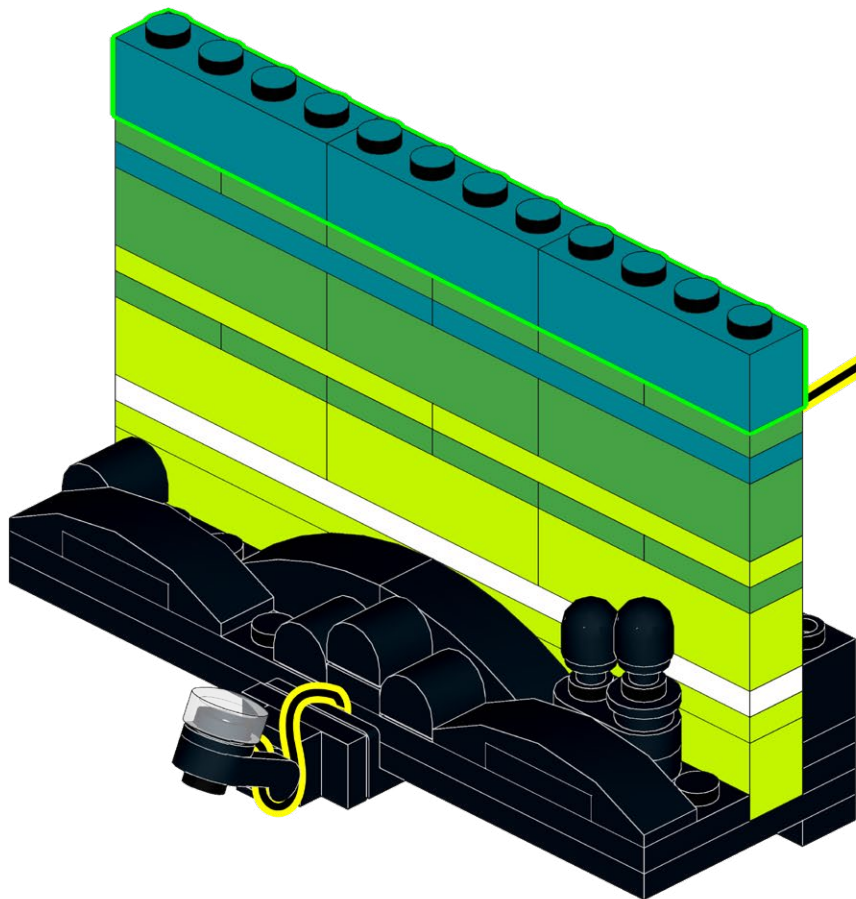

172

2x

2x

1

2

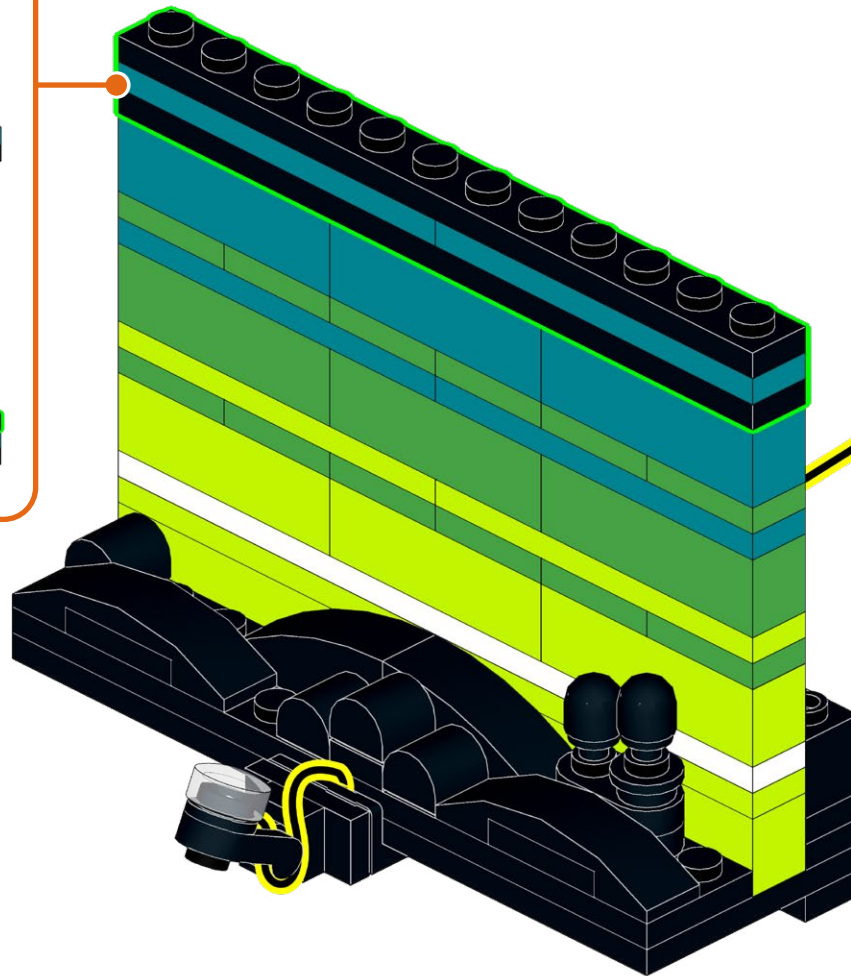

173

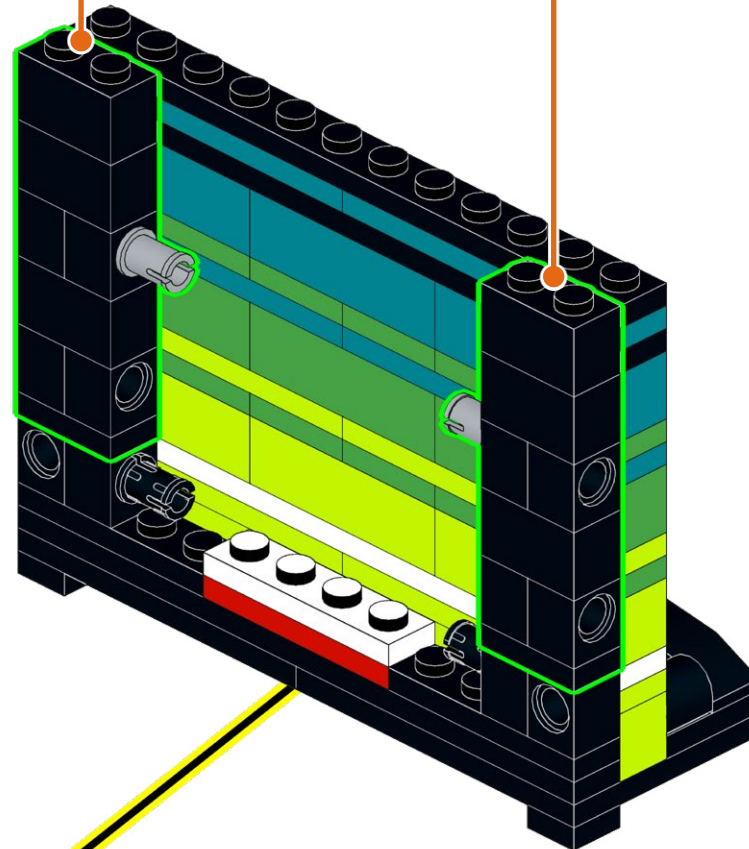
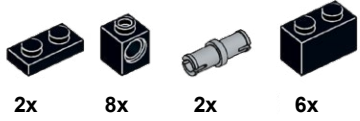

- 1
- 2
- 3
- 4
- 2x



### **HOLD UP!**

You might notice some bags aren't in order, as well as left over pieces, but that's ok! We're changing the way you build LEGO!

### **ATTENDEZ!**

Vous remarquerez peut-être que certains sacs, ainsi que certaines pièces, ne sont pas dans le bon ordre. Mais pas de panique! Nous changeons simplement la façon avec laquelle vous construisez vos LEGO!

### **ASPETTA!**

Potresti notare che alcuni sacchetti non sono in ordine, così come i pezzi avanzati, ma va bene così! Stiamo cambiando il modo in cui costruisci i LEGO!

### **HALT!**

Sie werden möglicherweise bemerken, dass einige tüten durcheinander sind und teile übrig bleiben, aber das ist in Ordnung! Wir ändern die art und weise, wie Sie LEGO bauen!

### **¡ESPERA!**

Es posible que notes que algunas bolsas están fuera de servicio, así como piezas sobrantes, ¡pero está bien! ¡Estamos cambiando la forma en que construyes LEGO!

### **暫停!**

你可能会注意到一些袋子顺序错乱, 以及一些剩余的部件, 但没关系! 我们正在改变你搭建乐高的方式!

### Open LEGO® Bag 8

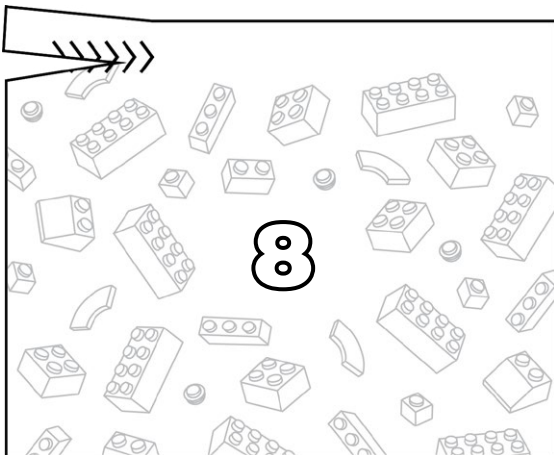



174

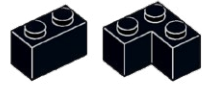

5x

2x

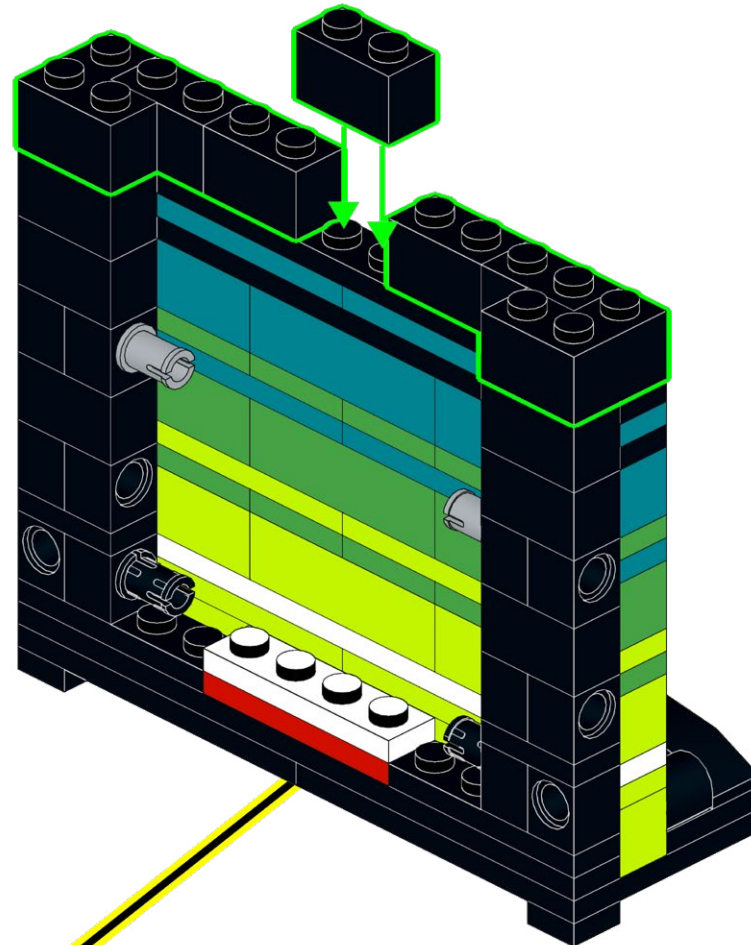

175

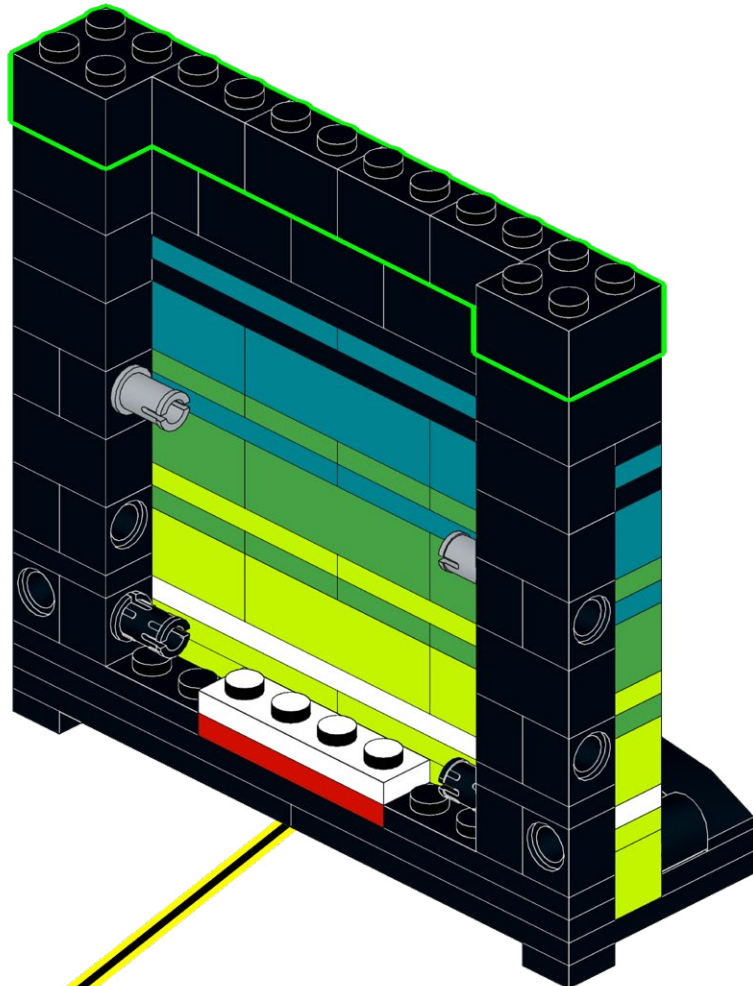
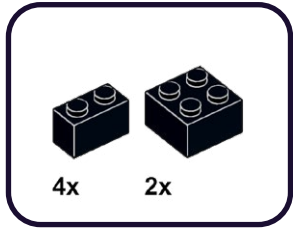

176

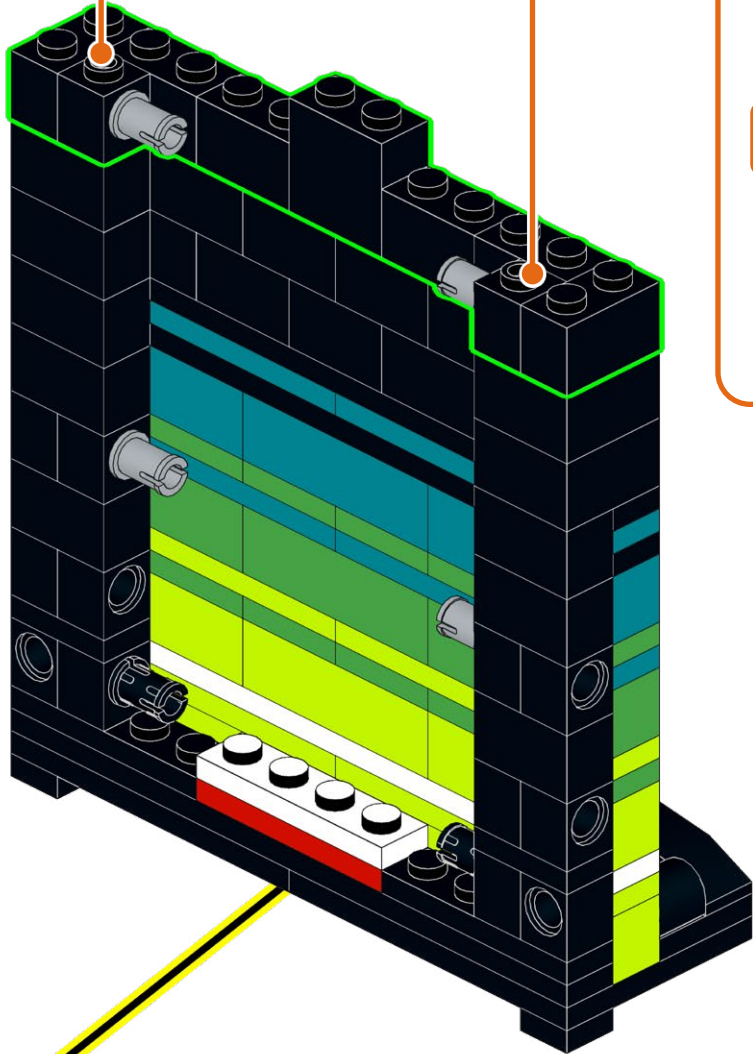
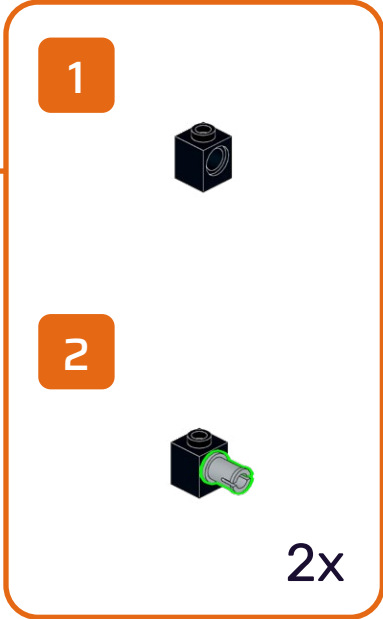
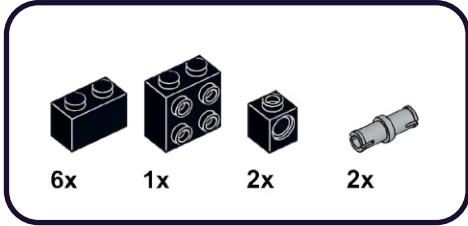

177

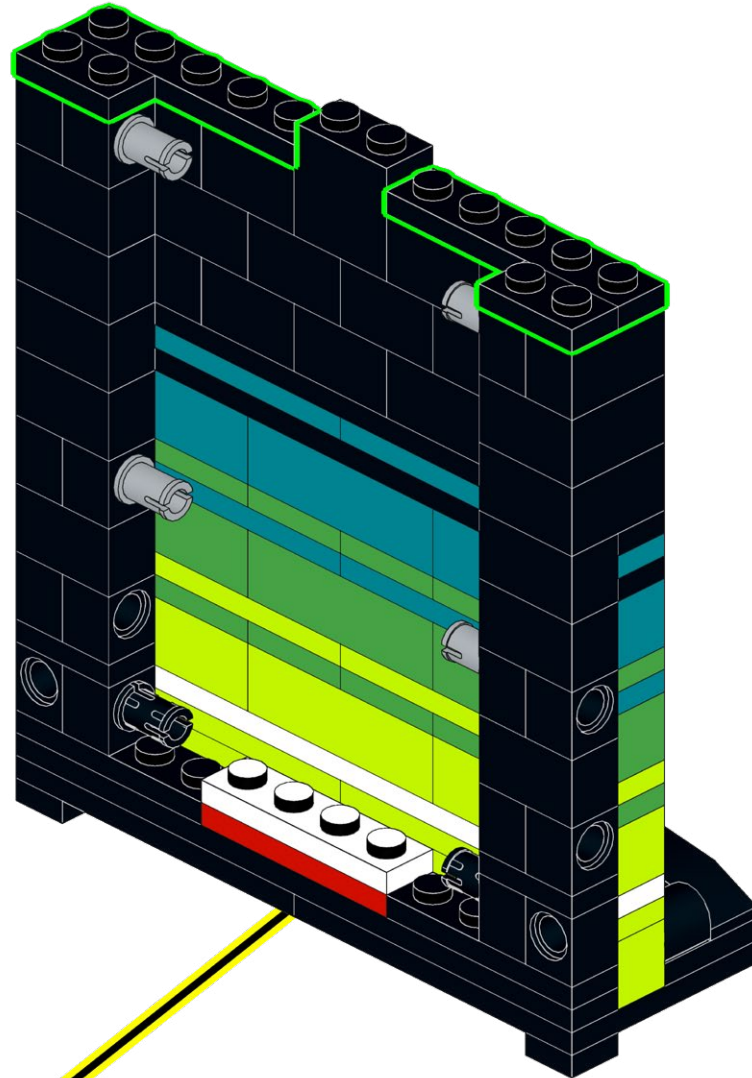
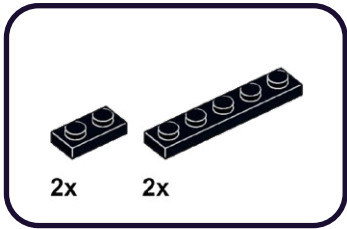

178

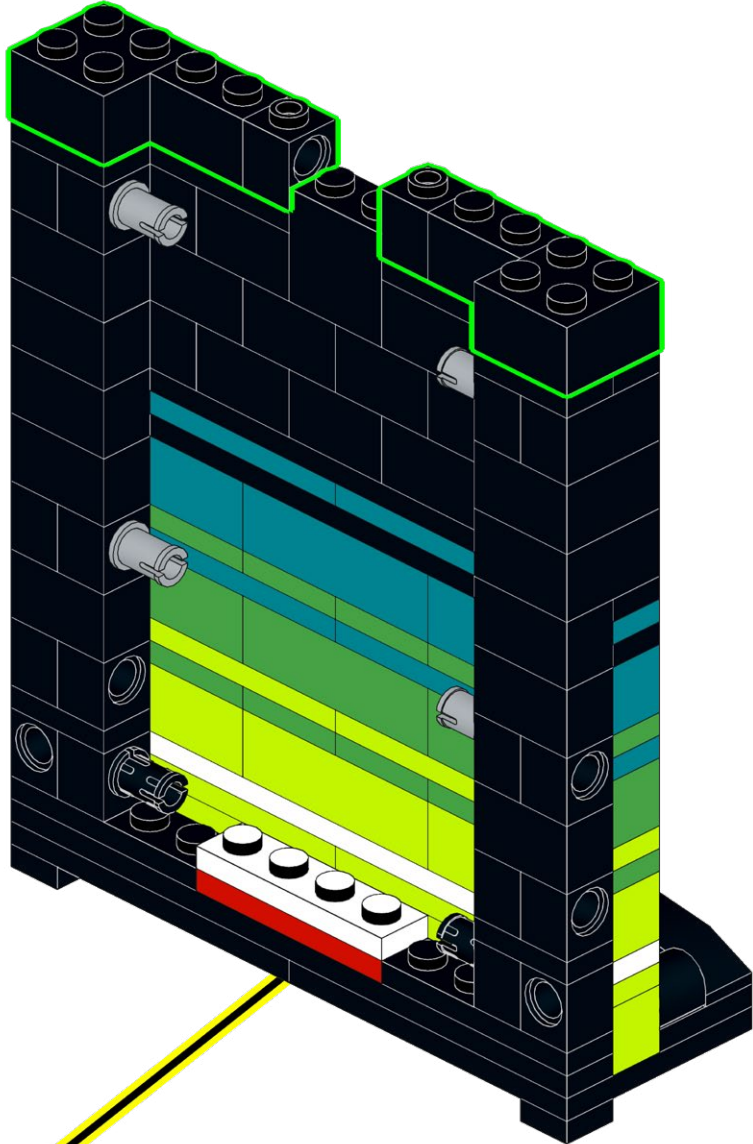
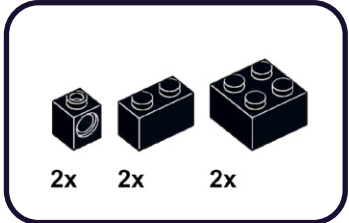

179

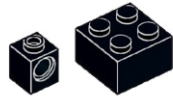

2x 2x

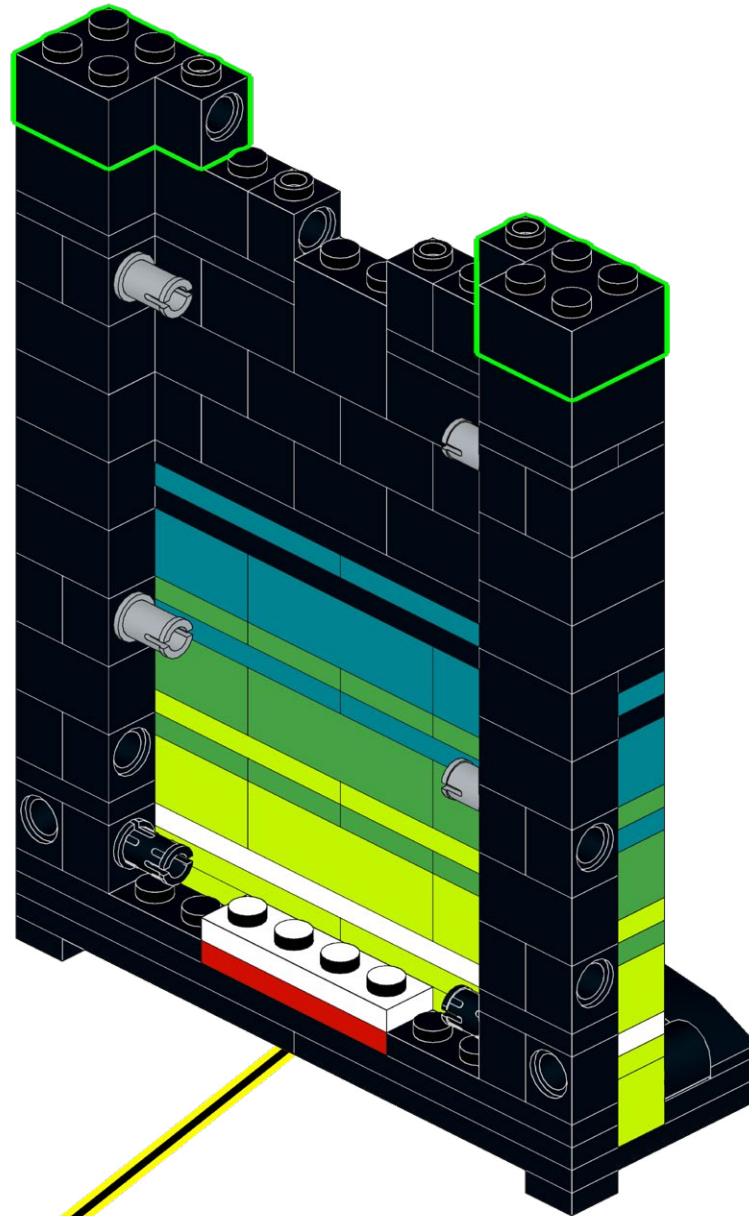

180

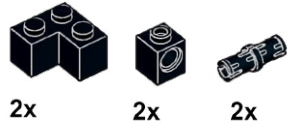

1



2



2x

181

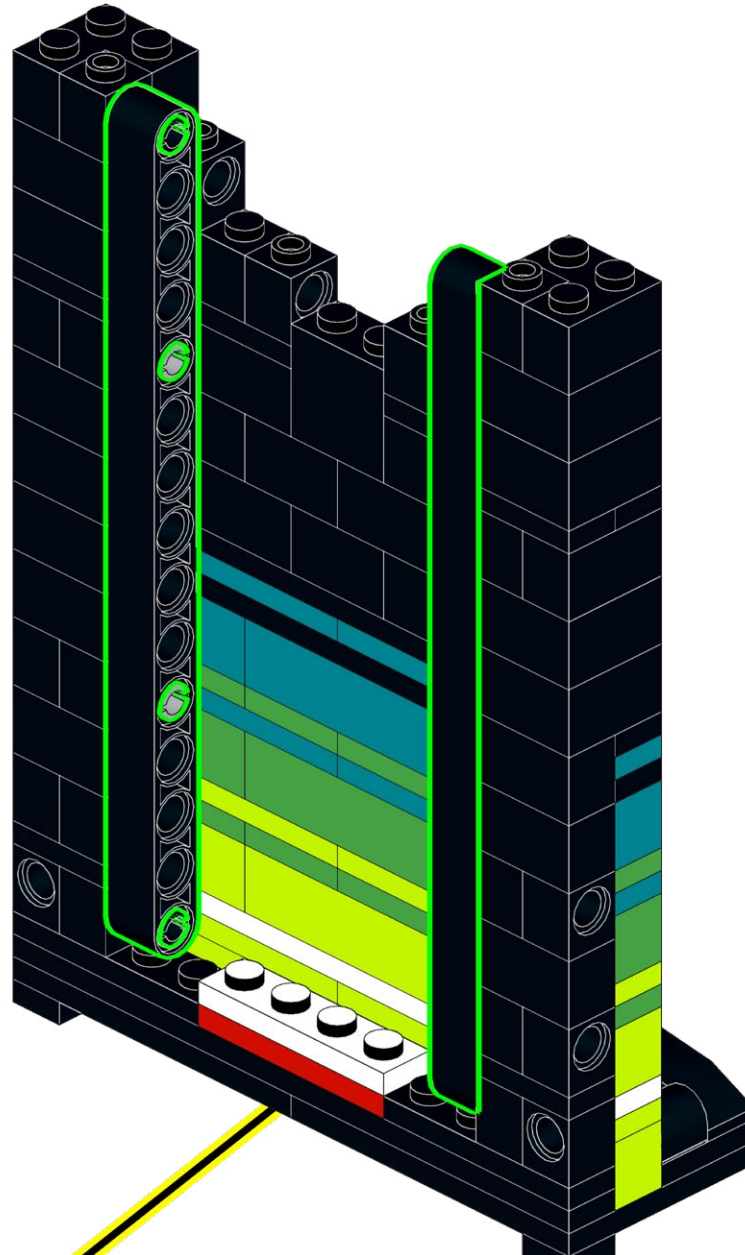



182

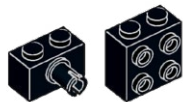

2x

1x

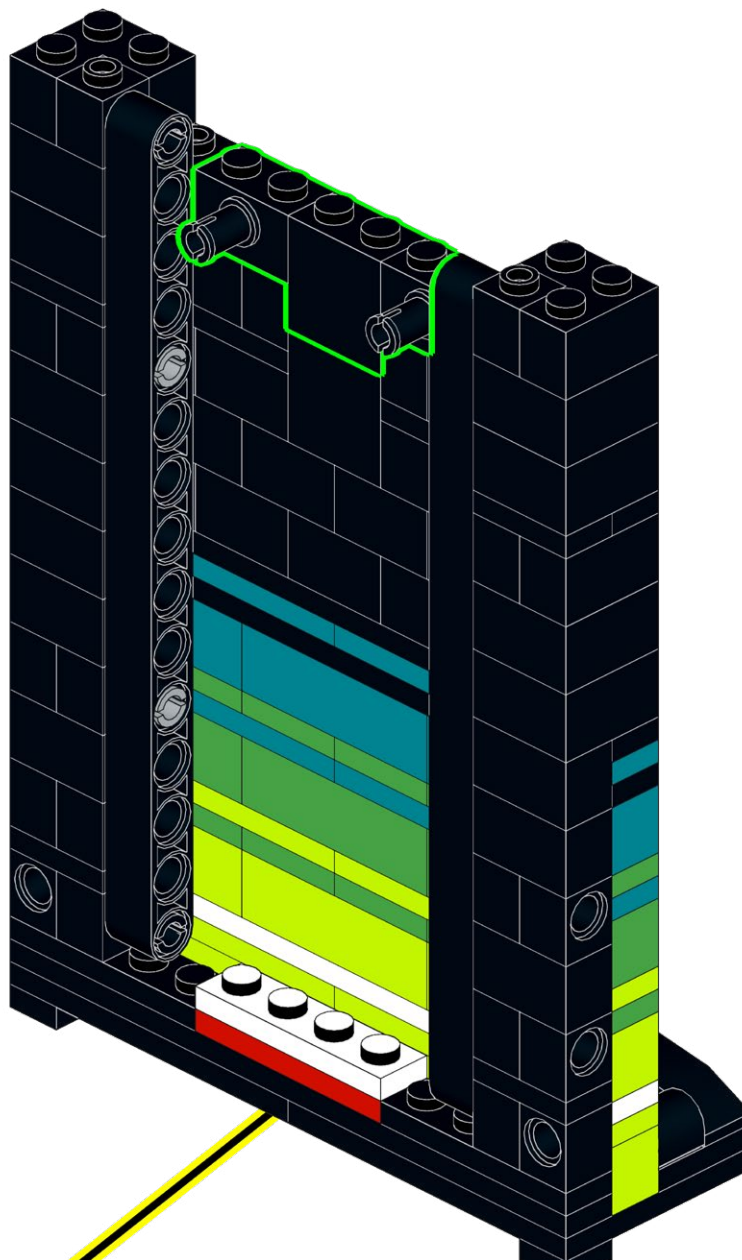

183

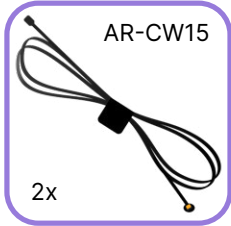

1

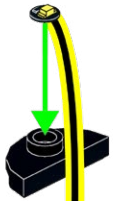

2

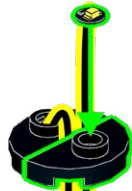

3

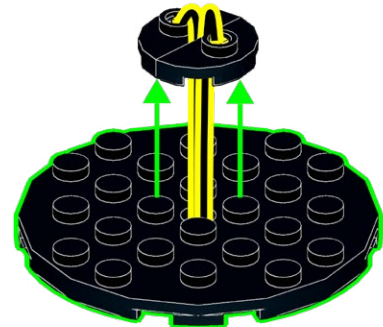

184

2x

2x

4x

1x

2x

1

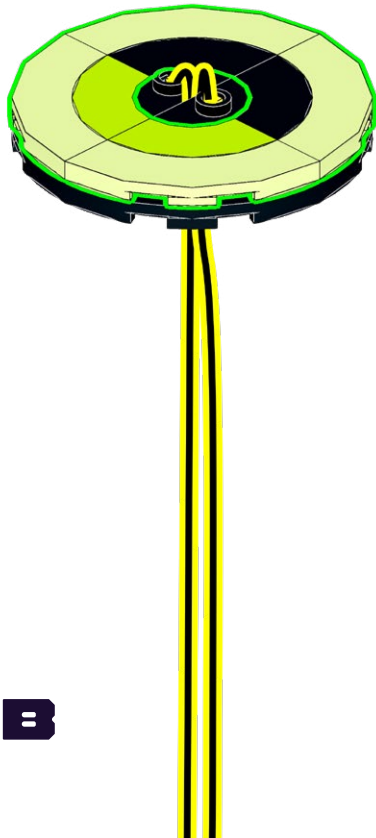

2



3

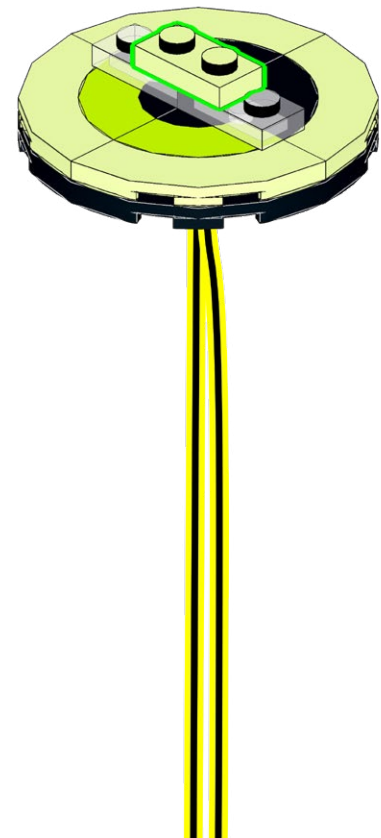

185



2x



2x

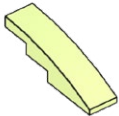

2x

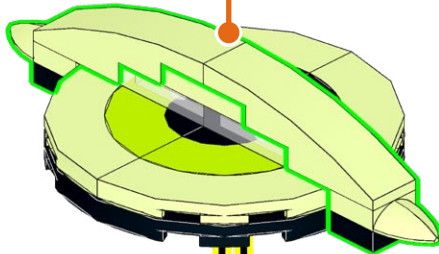

1



2



3

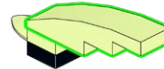

2x

186

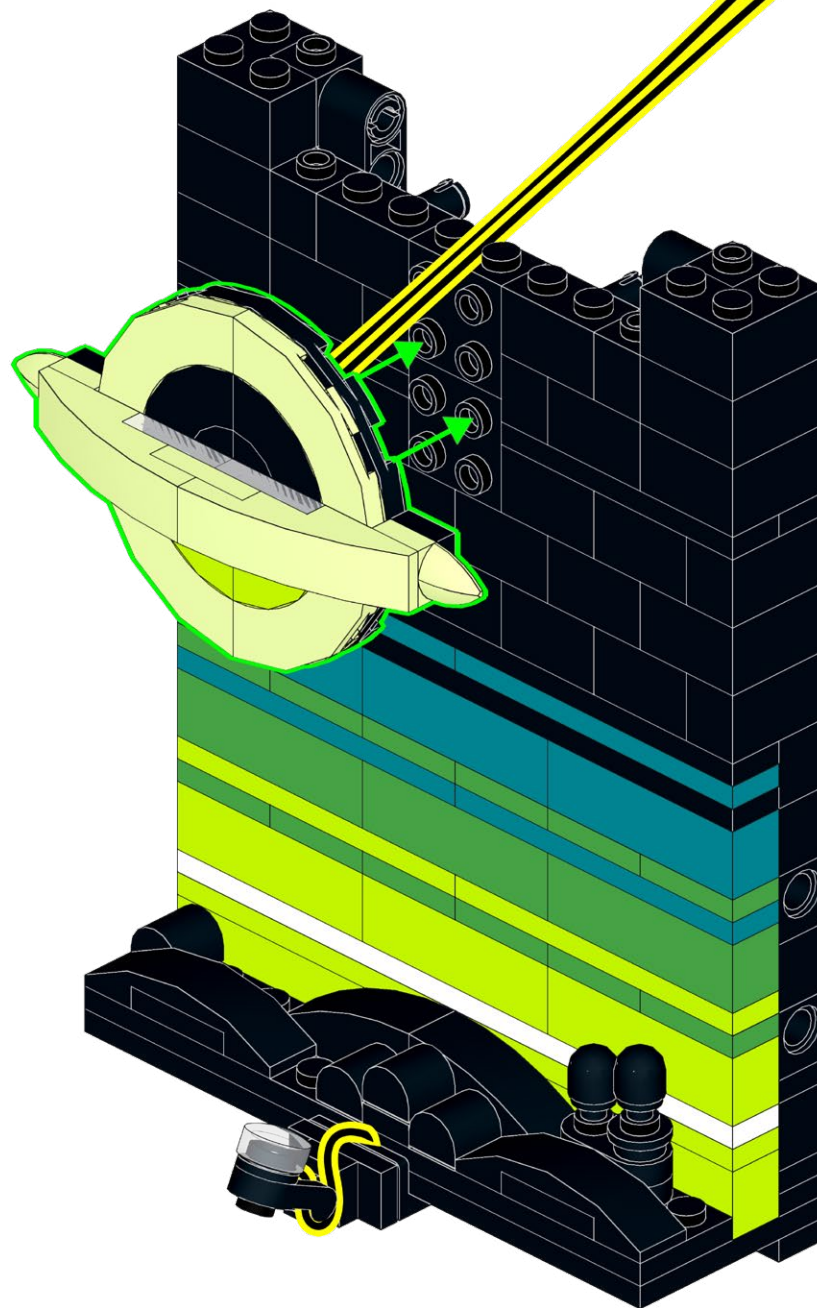

187

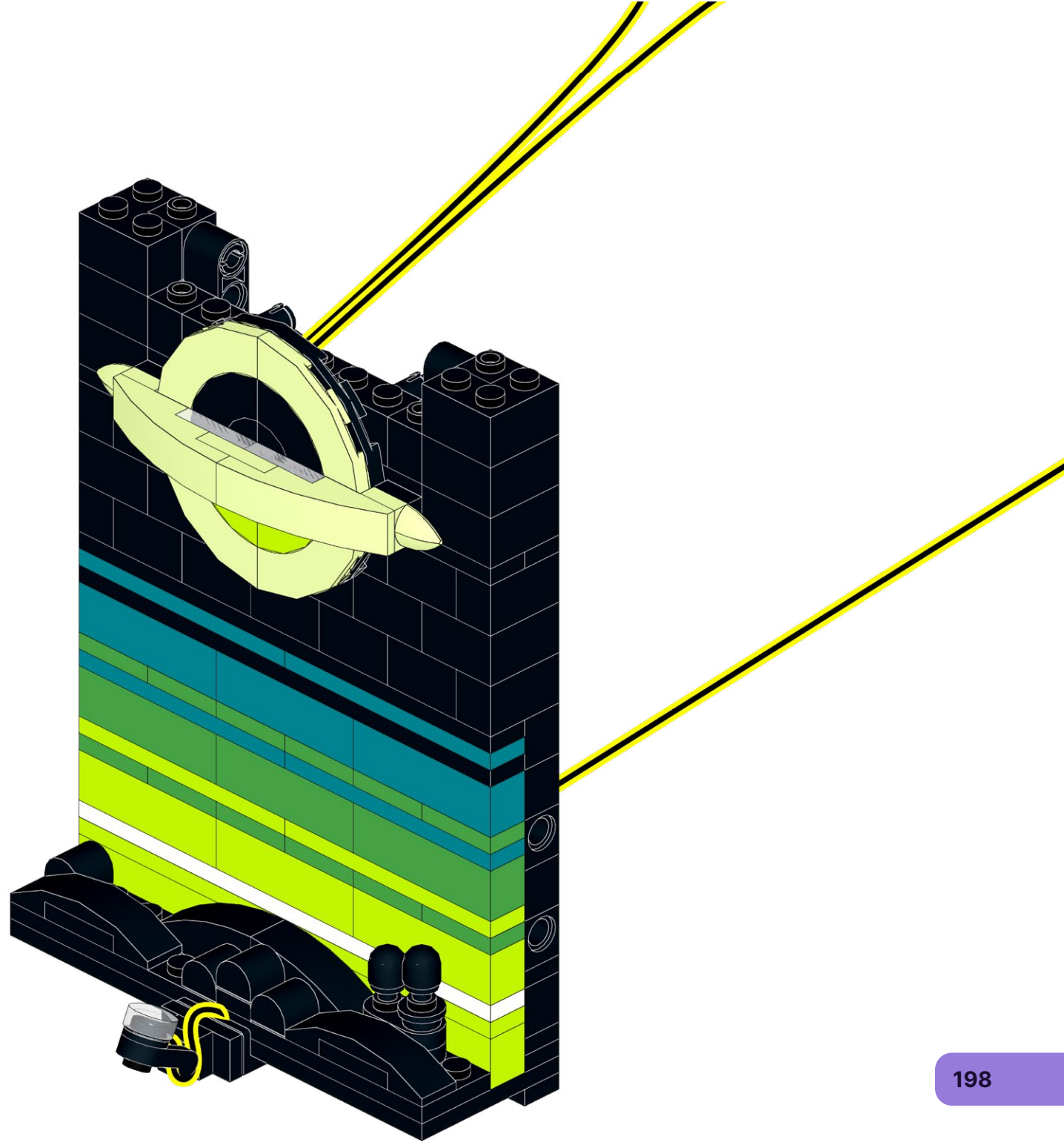

188



4x

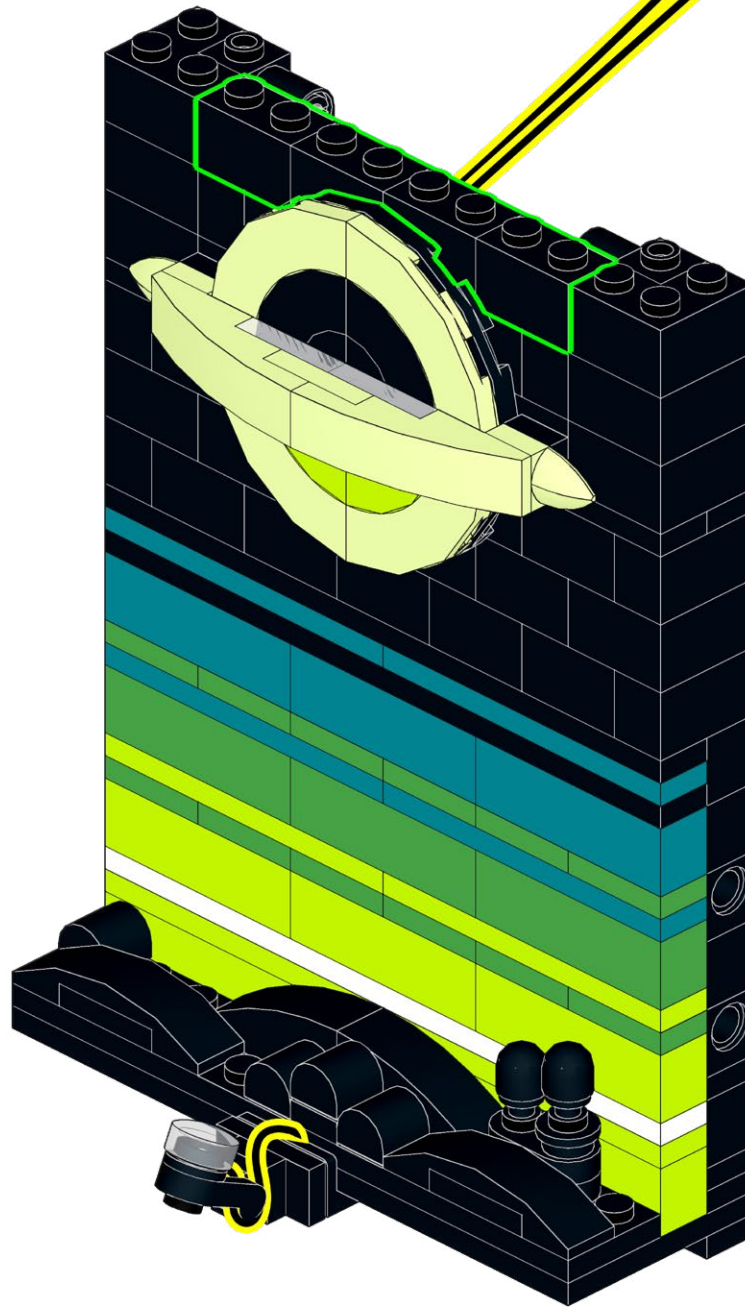

189



1x

1x

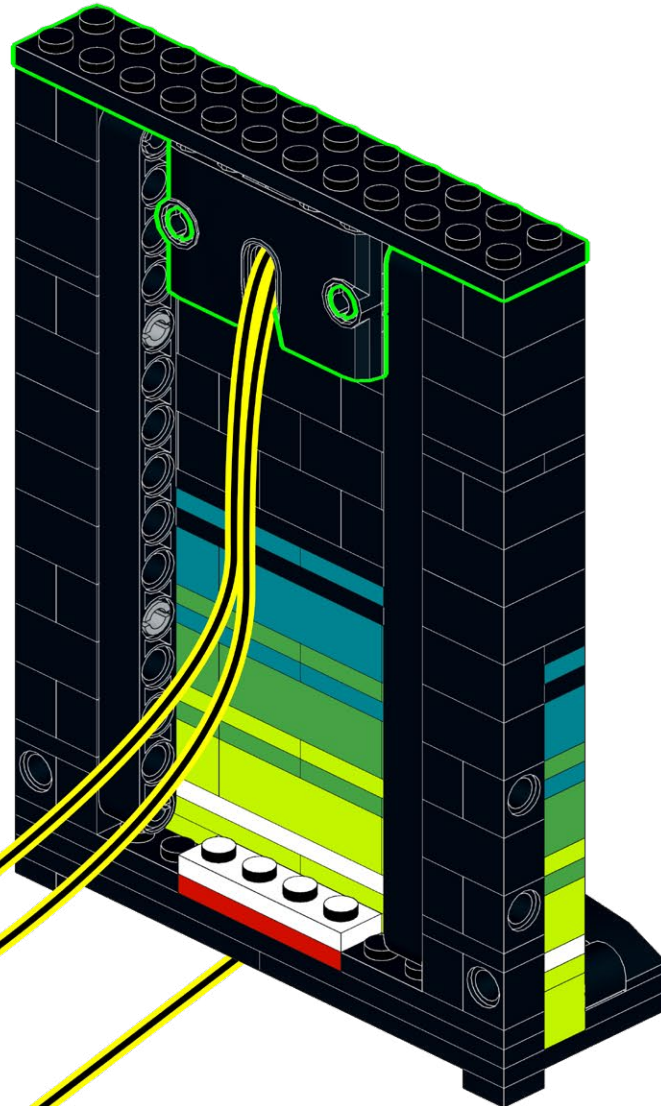



190

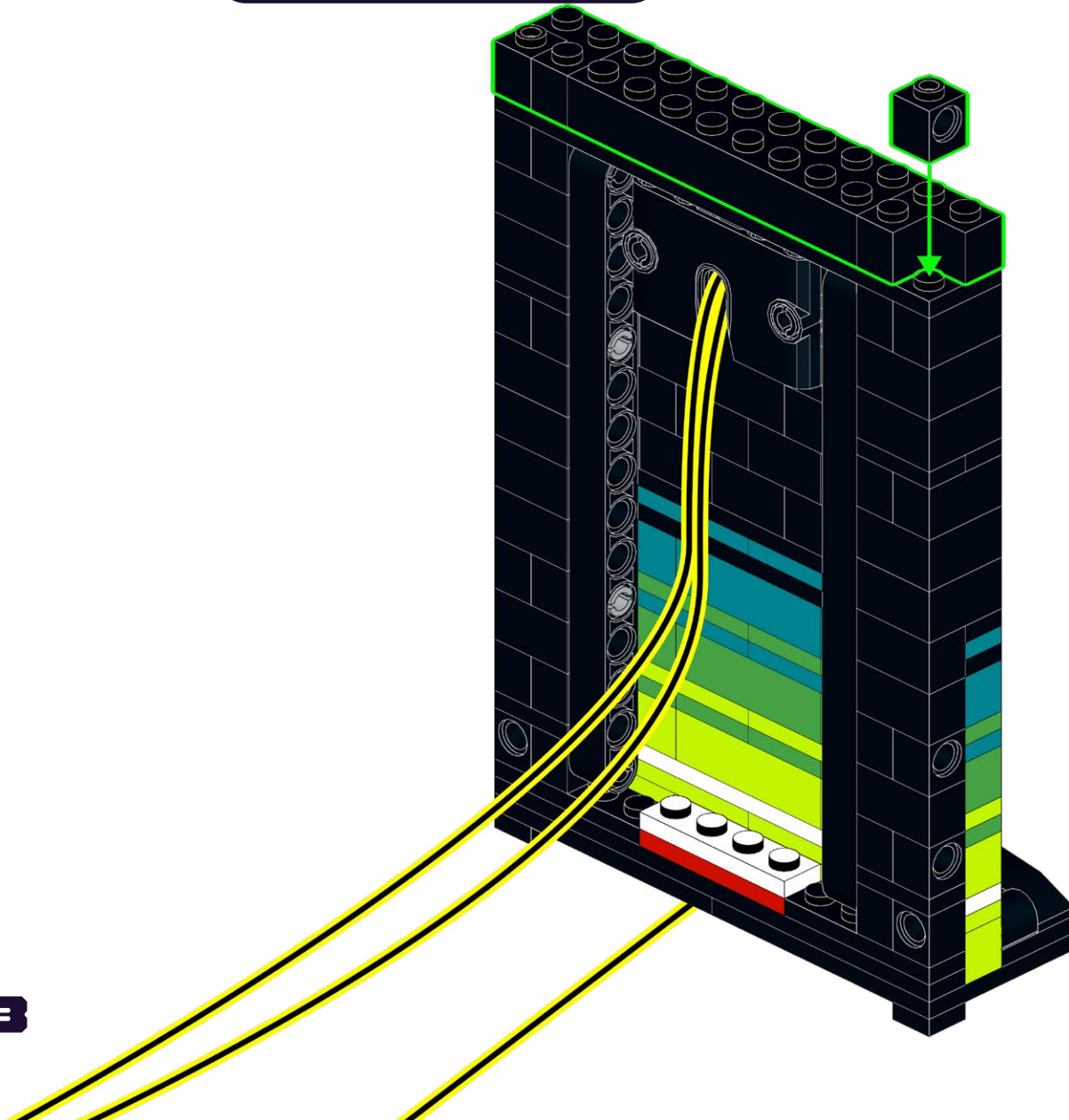
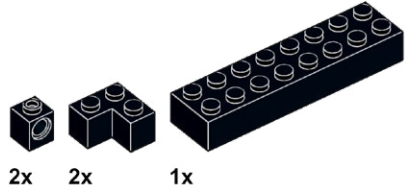

191

3x

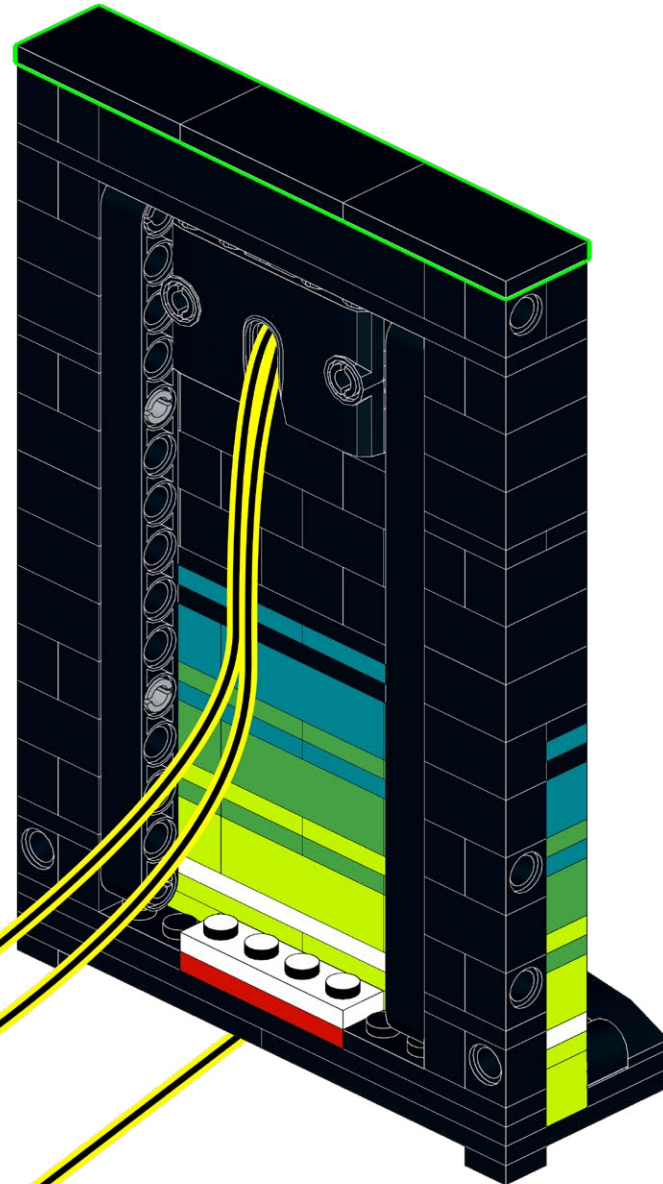

192

2x 1x

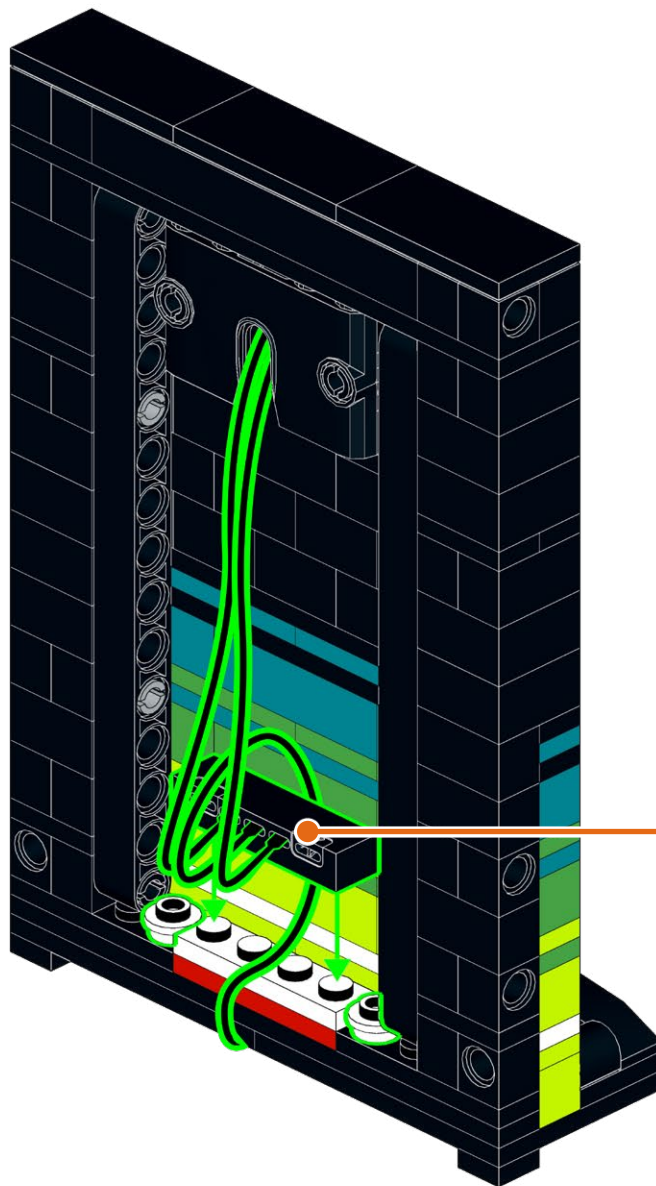

193

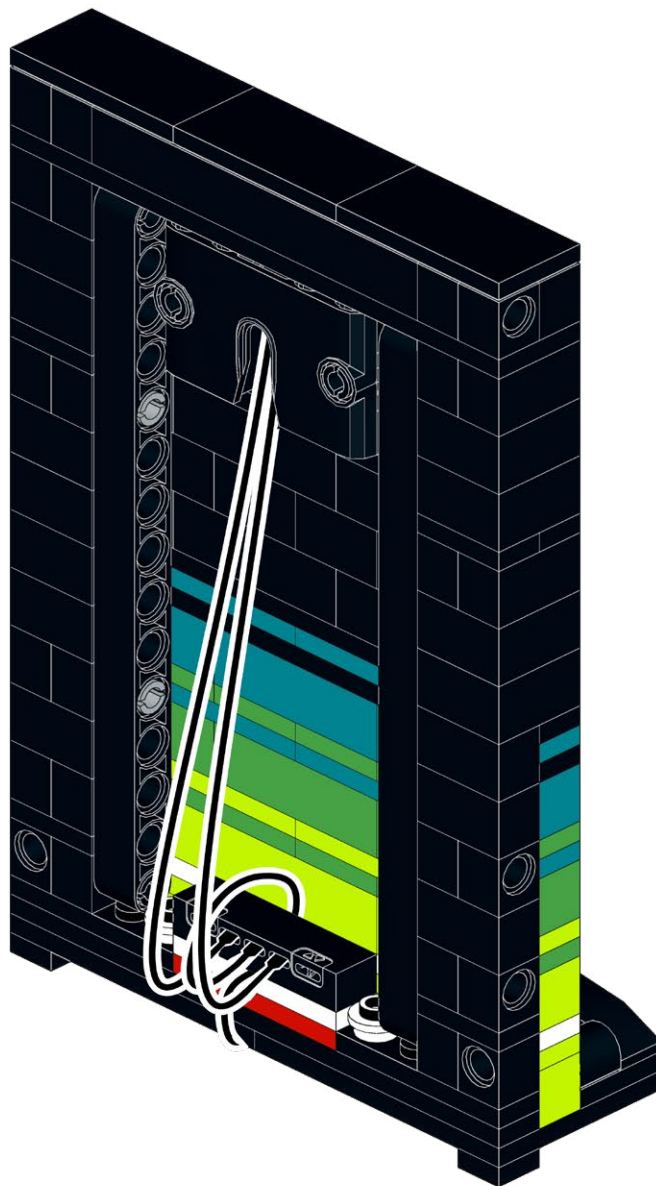

194

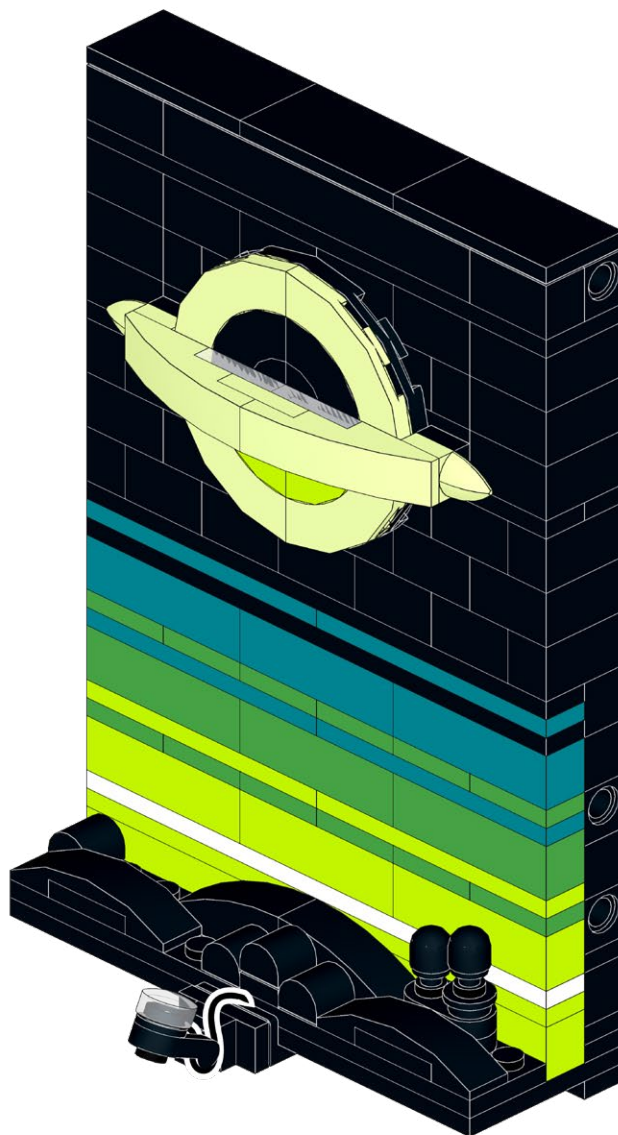

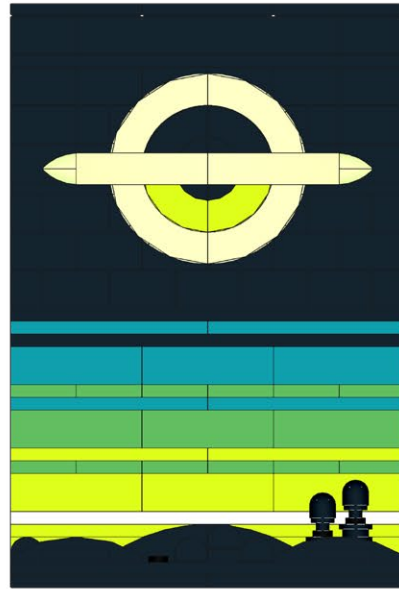
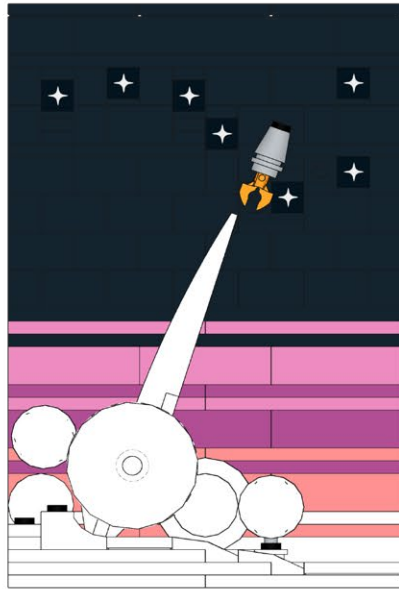
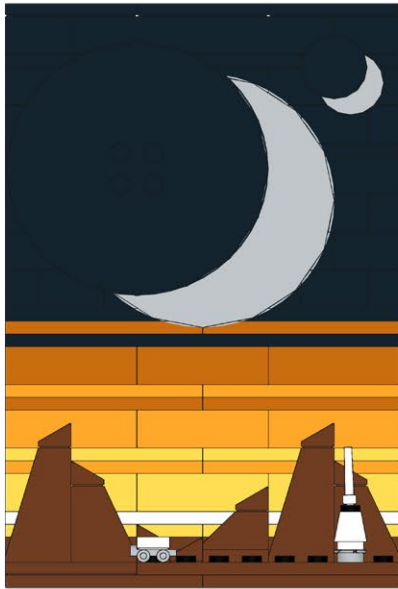
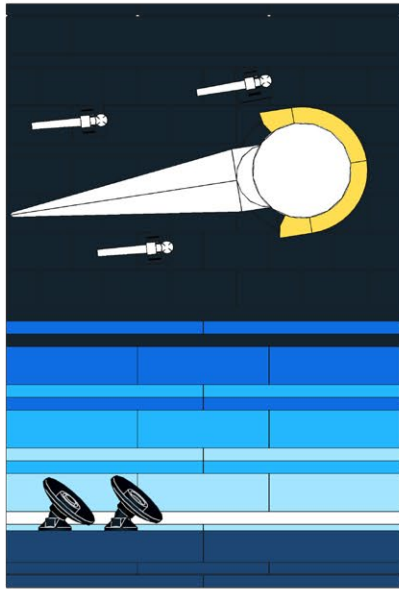

196

6x

3x

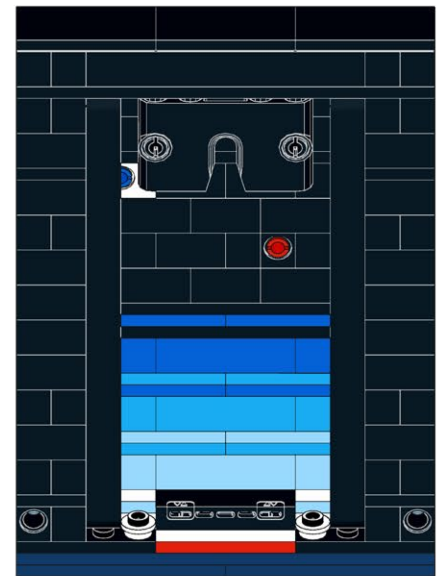
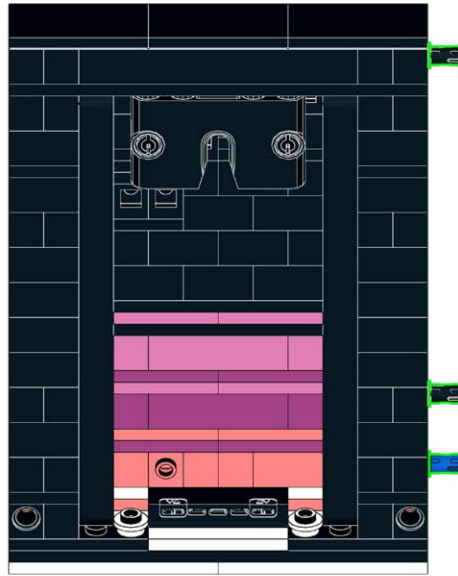

197

B-15

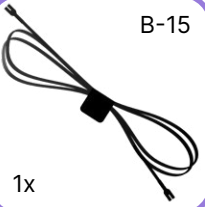

1x

FLX-B30



1x

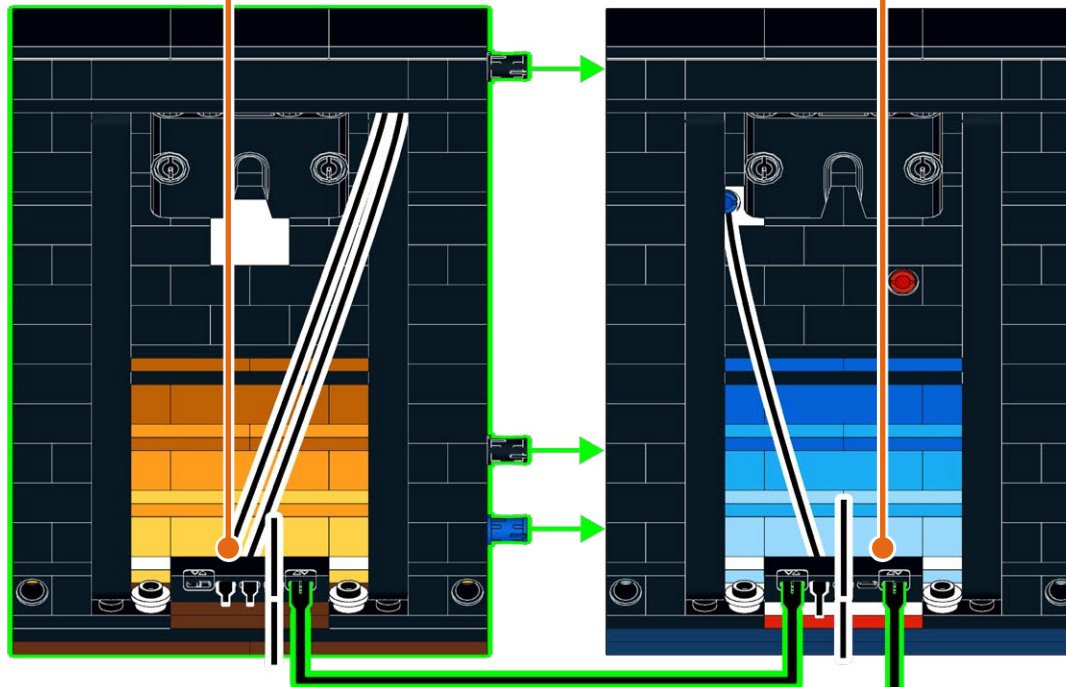
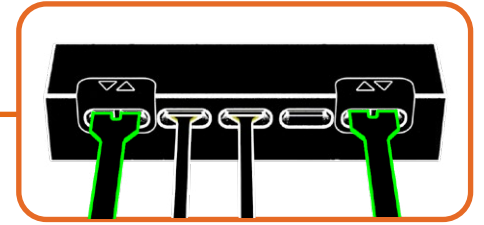
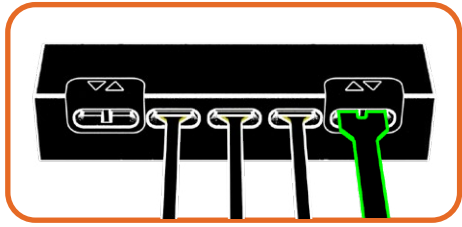



**198**

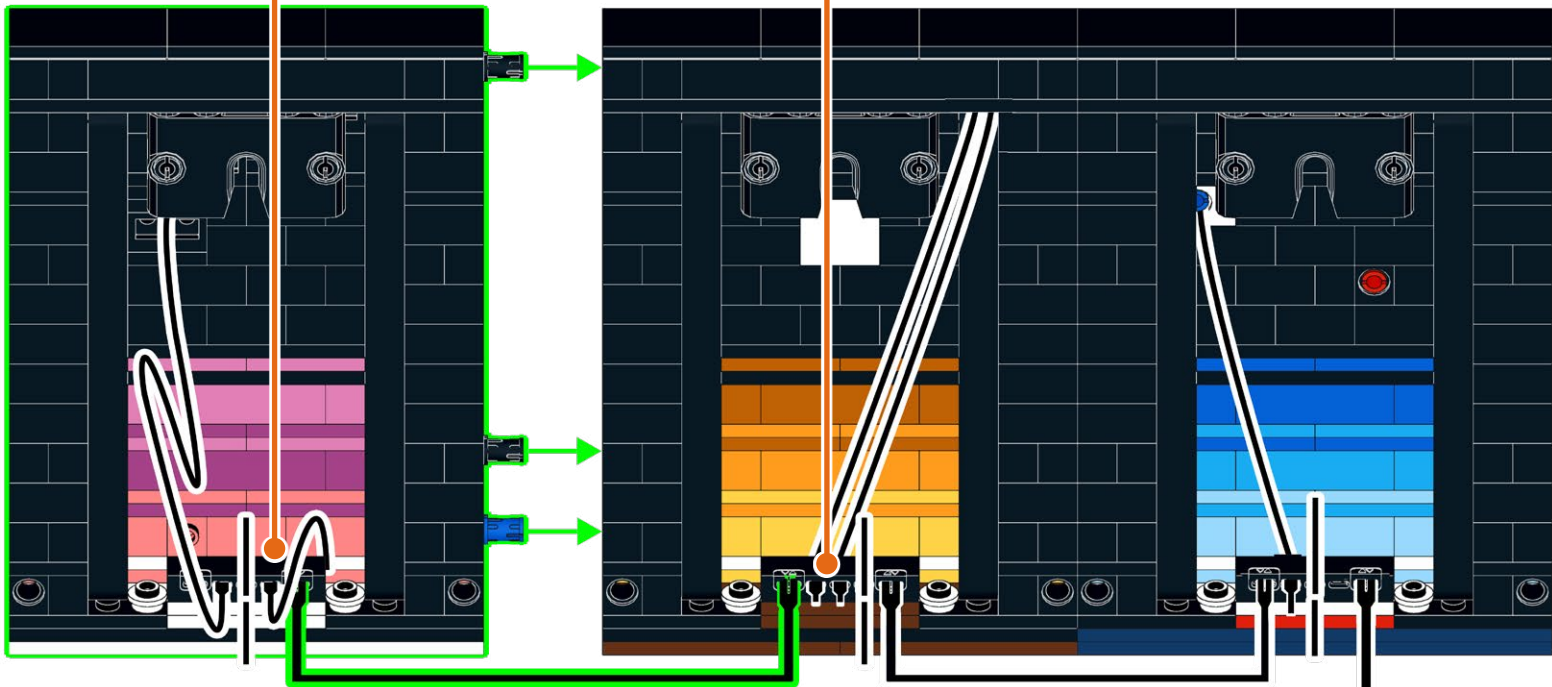
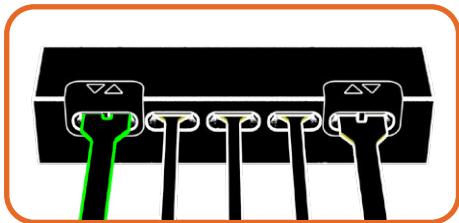
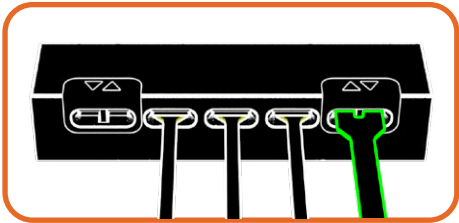
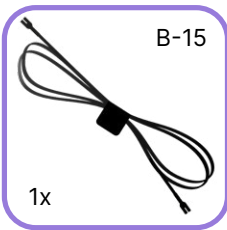



200

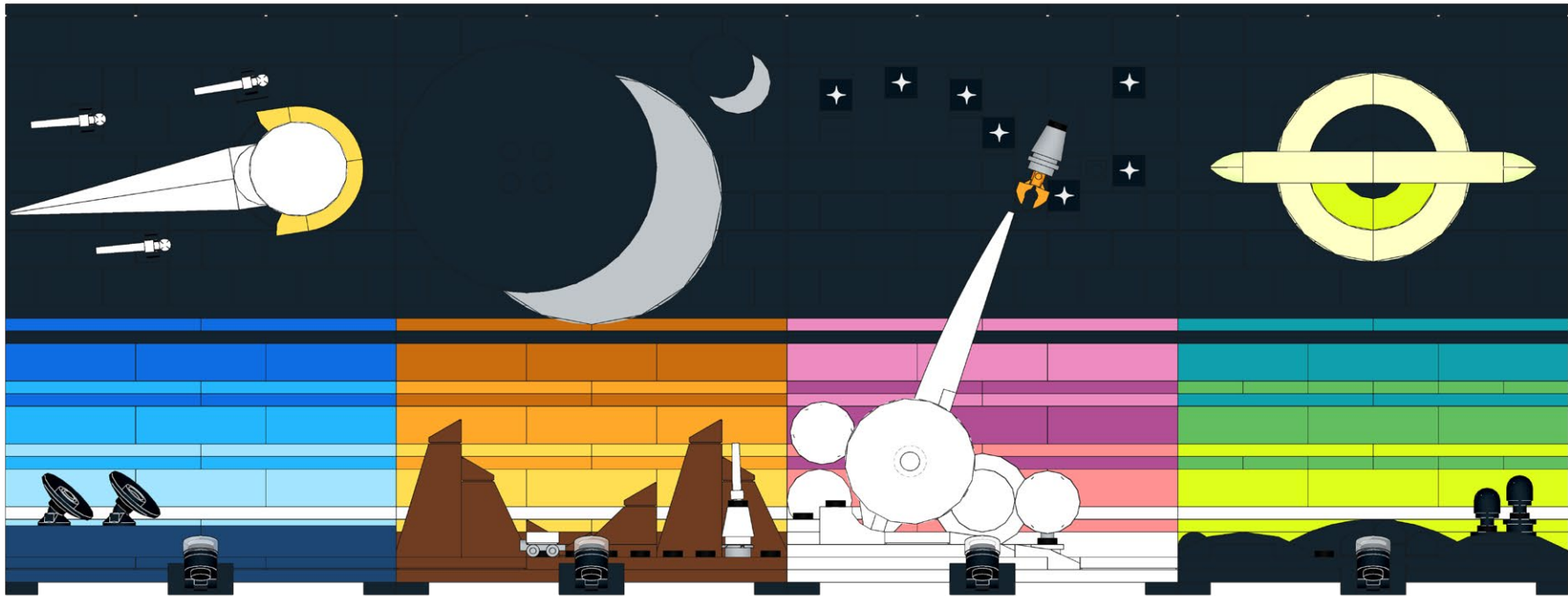

201

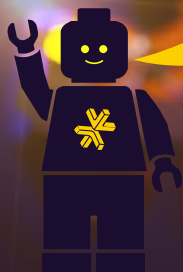

Power on Test  
Test de mise sous tension  
Test di Potenza  
Stromtest  
Prueba de Energía  
电源测试



202



203

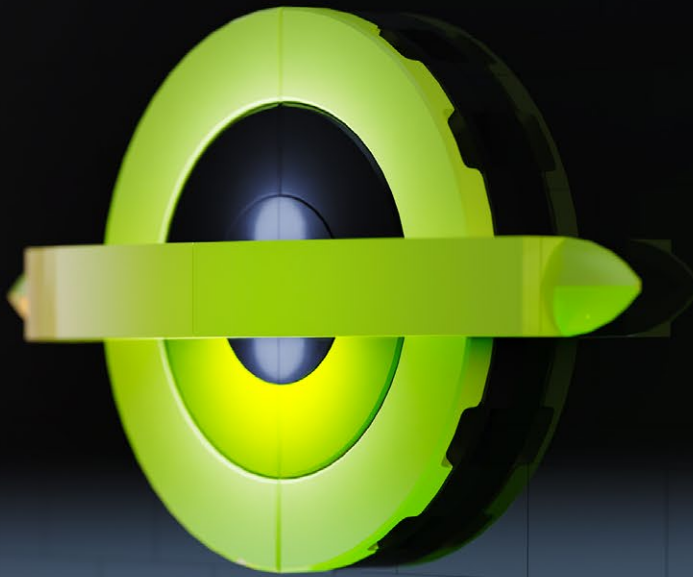

# FINAL PRODUCT



# PACKAGE CONTENTS



**1x** AL-B15  
Astro Light Large  
Blue 15cm



**1x** AL-O15  
Astro Light Large  
Orange 15cm



**1x** AL-P15  
Astro Light Large  
Pink 15cm



**1x** AL-G15  
Astro Light Large  
Green 15cm



**2x** AL-CW30  
Astro Light Large  
Cool White 30cm



**1x** AR-WW15  
Astro Light Regular  
Warm White 15cm



**2x** AR-CW15  
Astro Light Regular  
Cool White 15cm



**1x** ALF-O15  
Astro Light Flicker  
Large  
Orange 15cm



**1x** ARF-WW15  
Astro Light Flicker  
Regular  
Warm White 15cm



**3x** B-15  
Belt 15cm



**1x** FLX-B  
Flux Belt 30cm



**4x** D-3  
Dock-3



**4x** Astro Cap



# PACKAGE CONTENTS



**1x** Round Plate 1x1  
Trans Clear



**4x** Modified Tile 1x1  
with Open O Clip  
Black

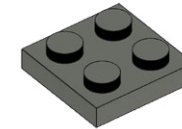

**2x** Plate 2x2  
Dark Bluish Grey



**1x** Round Plate 1x1  
with Open Stud  
White

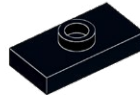

**4x** Modified Plate 1x2  
with 1 Stud with Groove  
and Bottom Stud Holder  
(Jumper)  
Black



**1x** Round Plate 1x1  
with Open Stud  
Orange

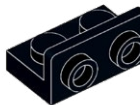

**4x** Bracket 1x2 - 1x2  
Inverted  
Black



**4x** Round Plate 1x1  
with Open Stud  
Black



**8x** Plate 1x1  
Black



**4x** Round Plate 1x1  
with Bar Handle  
Black

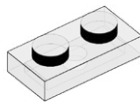

**4x** Plate 1x2  
Trans Clear

# CONTACT US

Click below for customer support, or general inquiries.

Cliquez ci-dessous pour accéder au support client ou aux renseignements généraux.

Clicca qui sotto per l'assistenza clienti o per richieste generali.

Contact Us



Contactez-nous



Contattaci



Klicken sie unten für kundensupport oder allgemeine anfragen.

Haga clic a continuación para atención al cliente o consultas generales.

点击下方获取客户支持或一般咨询。

Kontaktieren sie uns



Contáctanos



联系我们



## TROUBLESHOOTING

If you're stuck, scan the QR code for troubleshooting.

Se sei bloccato, scansiona il codice QR per la risoluzione dei problemi.

Wenn Sie nicht weiterkommen, scannen Sie den QR-Code zur Fehlerbehebung.

Si vous êtes bloqué, scannez le code QR pour le dépannage

Si está atascado, escanee el código QR para solucionar el problema.

如果遇到问题, 请扫描二维码进行故障排除

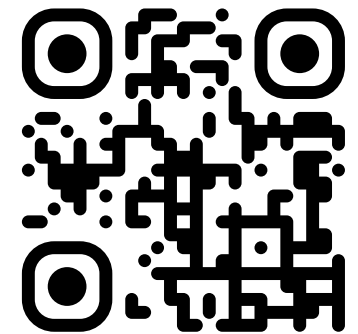



# LIGHT MY BRICKS

[lightmybricks.com](https://lightmybricks.com)



LEGO® is a trademark of the LEGO Group of companies, which does not sponsor, authorize or endorse this product. All LEGO® sets featured in images are sold separately. This is not a LEGO® product. The LEGO Group is not liable for any loss, injury or damage arising from the use or misuse of this product. ©2024 Light My Bricks Pty Ltd. All rights reserved. [www.lightmybricks.com](https://www.lightmybricks.com)

Our components are designed and packaged in Australia by Light My Bricks Pty Ltd. Components are manufactured in China. 3fl bldg C, Shuanghuan Quanxin Technology Information Industry Park Baolong Street, Longgang District, Shenzhen, China. Imported in Australia by Light My Bricks Pty Ltd, 5/26 Rushdale St, Knoxfield, VIC, 3180, Australia.

WARNING: CHOKING HAZARD - Small parts. Not for children under 3 years.

AVERTISSEMENT : RISQUE D'ÉTOUFFEMENT - Petites pièces. Ne convient pas aux enfants de moins de 3 ans.

ATTENZIONE: PERICOLO DI SOFFOCAMENTO - Piccole parti. Non adatto a bambini di età inferiore a 3 anni.

WARNUNG: ERSTICKUNGSGEFAHR - Kleine Teile. Nicht für Kinder unter 3 Jahren geeignet.

ADVERTENCIA: PELIGRO DE ASFIXIA - Piezas pequeñas. No son apto para niños menores de 3 años.

警告：窒息危险 - 小零件。不适合3岁以下儿童。