

LIGHT KIT INSTALLATION GUIDE

**STAR WARS VENATOR-CLASS REPUBLIC
ATTACK CRUISER (PART ONE)**

FOR LEGO
SET
#75367

CONTENTS



03

Getting Started

- 04 Legend
- 05 Component Handling
- 06 Blueprint

07

Instructions

- 07 LEGO Bag 13
- 33 LEGO Bag 14
- 58 LEGO Bag 15
- 61 LMB Bag 08
- 92 LMB Bag 05
- 105 LEGO Bag 17
- 110 LMB Bag 07
- 139 LEGO Bag 16
- 173 LEGO Bag 18
- 193 LEGO Bag 19
- 214 LEGO Bag 20 + 21
- 265 LEGO Bag 22 + 23

320

Final Product

- 320 Contact & Troubleshooting

GETTING STARTED



Bold, beautiful and bright, Light My Bricks elevates your favourite LEGO set from knick-knack to statement piece. Create a talking point at home or in the office that speaks to your passions with Light My Bricks. To learn more, click below.

[Learn More](#)



Audacieux, beau et lumineux, Light My Bricks élève votre ensemble LEGO préféré du statut de bibelot à celui de pièce maîtresse. Que ce soit à la maison ou au bureau, partagez votre passion des LEGO avec Light My Bricks. Cliquez ci-dessous pour en savoir plus.

[En savoir plus](#)



Audace, bello e luminoso, Light My Bricks eleva il tuo set LEGO preferito da soprammobile a pezzo di tendenza. Crea un punto di discussione a casa o in ufficio che parli alle tue passioni con Light My Bricks. Per saperne di più, clicca qui sotto.

[Ulteriori Informazioni](#)



Mutig, schön und hell – Light My Bricks verwandelt Ihr Lieblings-LEGO-Set von einem schnickschnack in ein statement-stück. Schaffen sie einen gesprächspunkt zu hause oder im büro, der Ihre leidenschaften widerspiegelt, mit Light My Bricks. Um mehr zu erfahren, klicken sie unten.

[Mehr erfahren](#)



Audaz, hermoso y brillante, Light My Bricks eleva tu set LEGO favorito de una chuchería a una pieza llamativa. Crea un tema de conversación en casa o en la oficina que hable de tus pasiones con Light My Bricks. Para obtener más información, haga clic a continuación.

[Más información](#)



大胆、美丽而明亮，Light My Bricks 将你喜爱的乐高套装从小摆件提升为引人注目的装饰品。在家或办公室打造一个能表达你激情的话题，了解更多，请点击下方。

[了解更多](#)



LEGEND

Rotate Set



Retournez L'ensemble
Ruota Set
Set Drehen
Rotar Conjunto
旋转套件

Add Part



Ajoutez une Pièce
Aggiungi Parte
Teil Hinzufügen
Agregar Pieza
添加零件

Click



Cliquez
Clic
Klicken
Clic
点击

Pinch/Fold



Pincez/Pliez
Pizzicare/Piegare
Kneifen/Falten
Pellizcar/Doblar
折叠

Pull Cable



Tirez le Cable
Tirare il Cavo
Kabel Ziehen
Tirar del Cable
拉动电缆

Repeat Step



Répétez
Ripetere
Wiederholen
Repetir
重复

Sticker



Autocollant
Adesivo
Aufkleber
Pegatina
贴纸

Power On Test



Test de mise sous tension
Test di Potenza
Stromtest
Prueba de Energía
电源测试

Disconnect Power

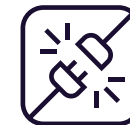

Débranchez L'alimentation
Scollegare L'alimentazione
Strom Trennen
Desconectar la Energía
断开电源

Troubleshoot



Dépanner
Risolvere
Fehlerbehebung
Solución de Problemas
故障排除

COMPONENT HANDLING

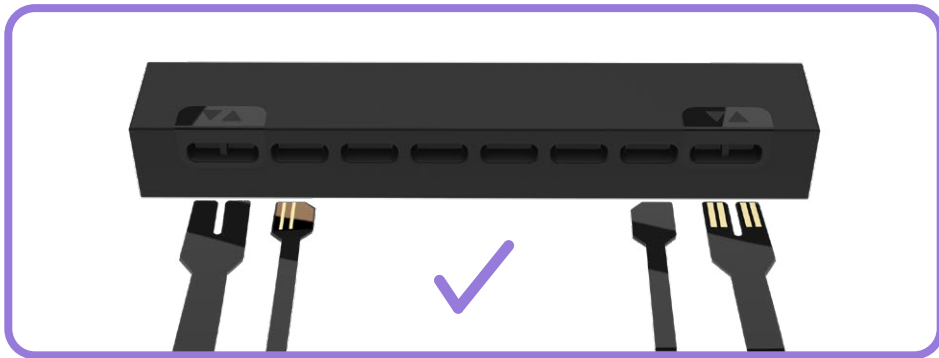
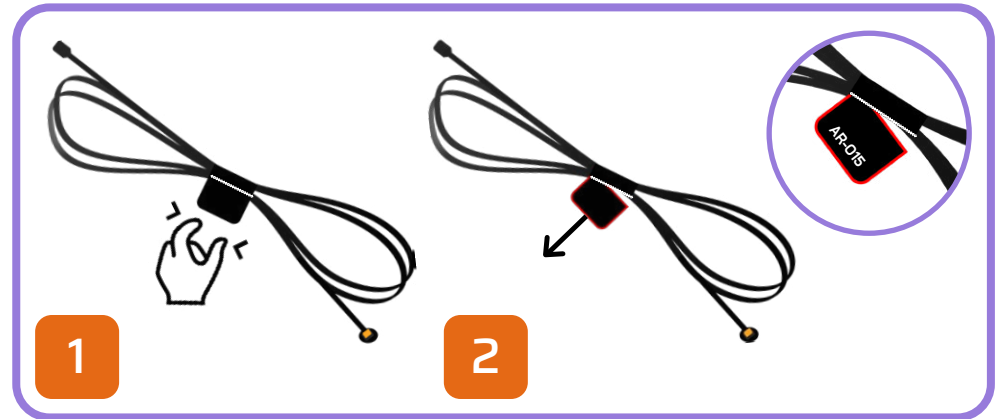
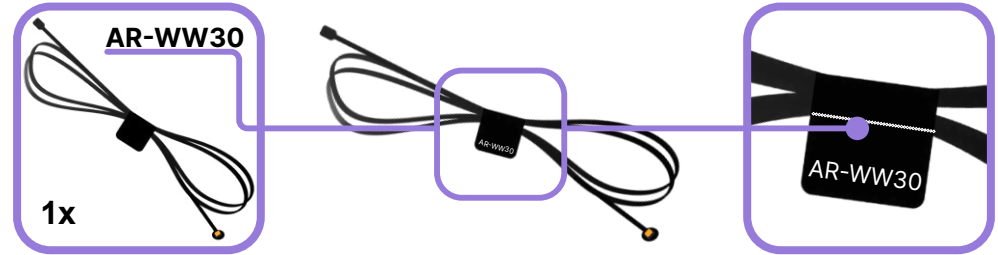
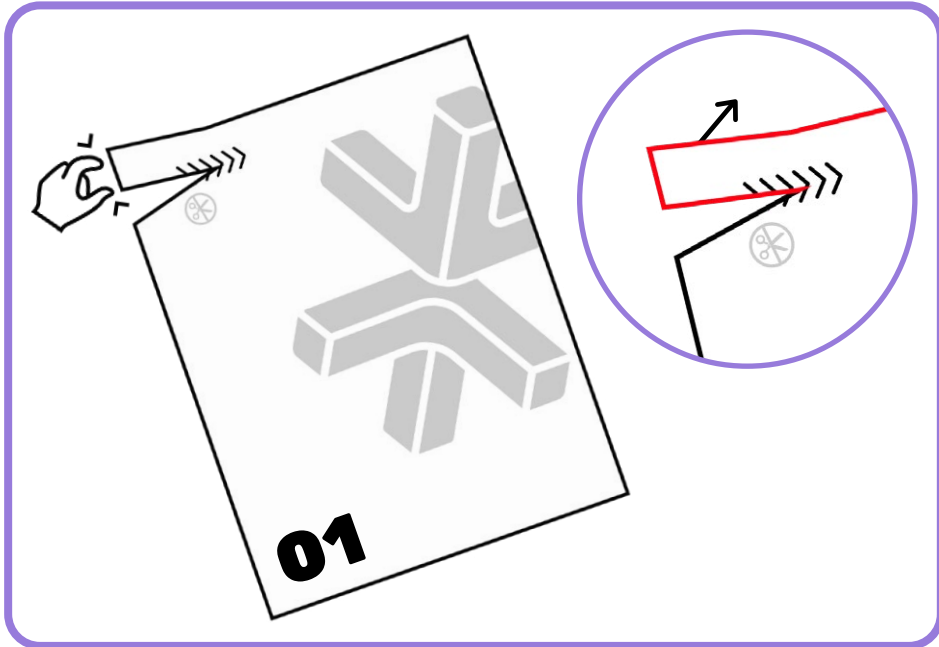

BLUEPRINT

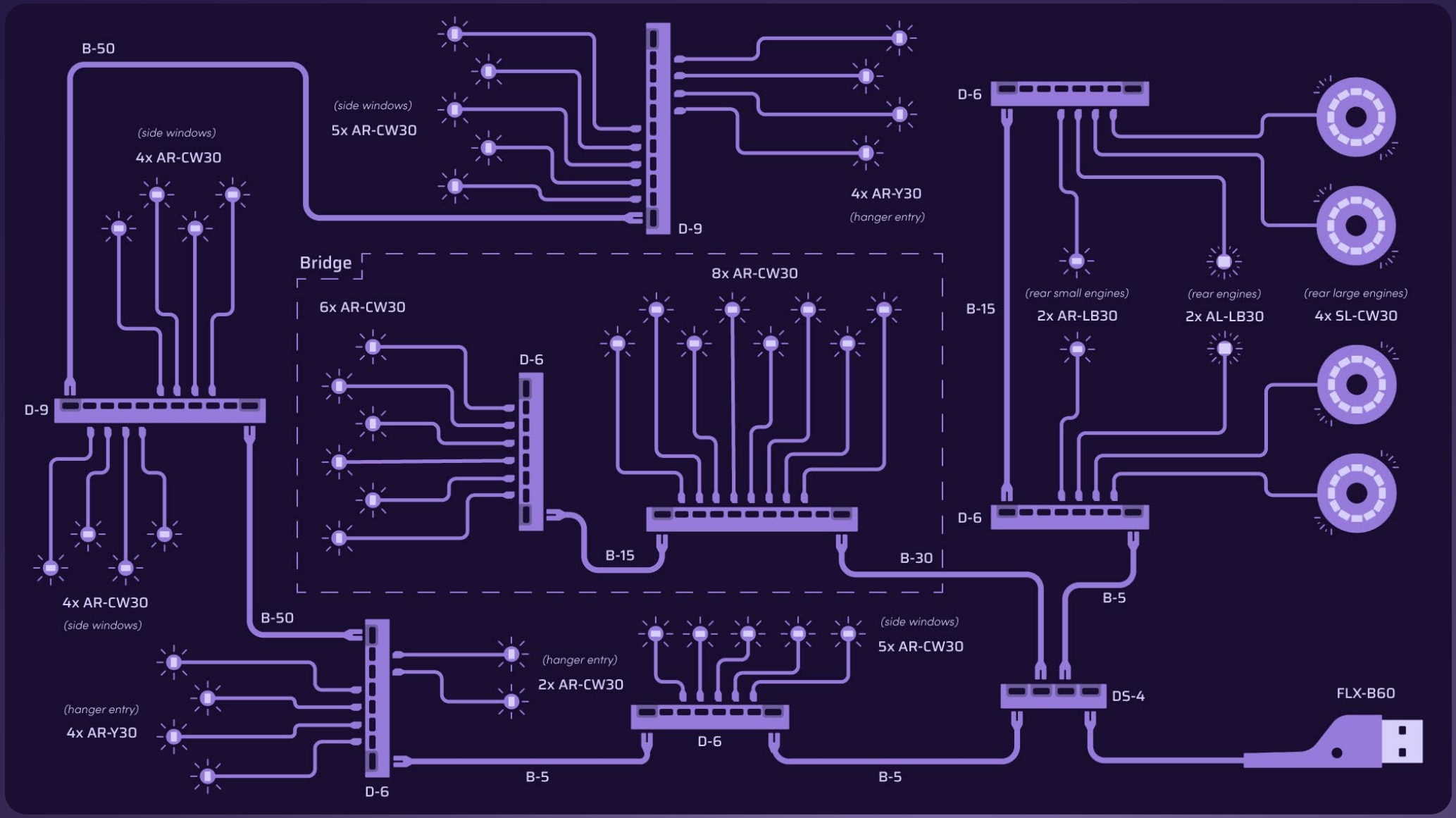

1

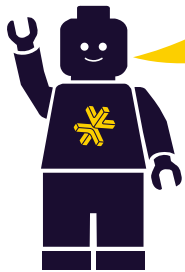
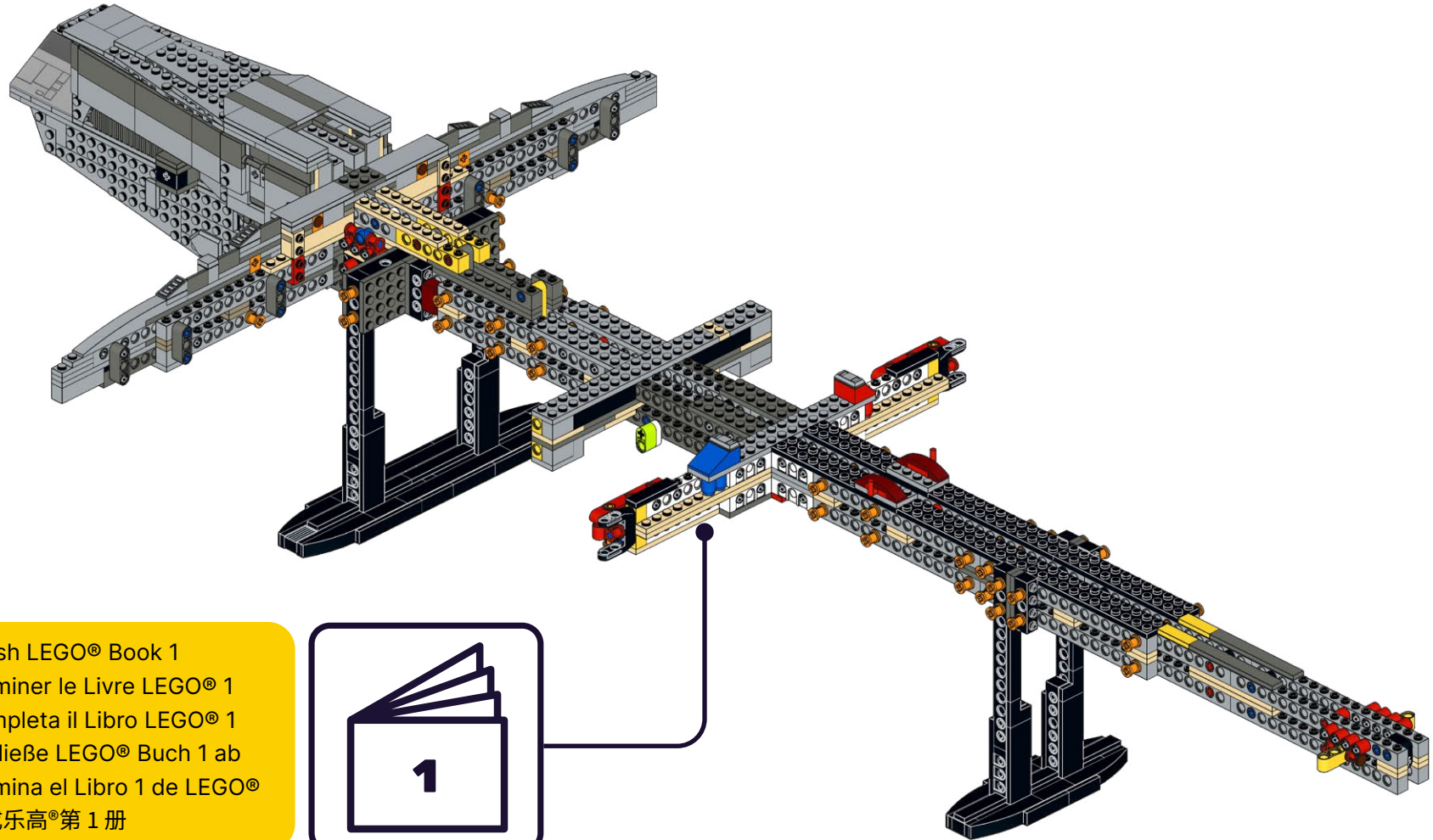

Finish LEGO® Book 1
Terminer le Livre LEGO® 1
Completa il Libro LEGO® 1
SchlieÙe LEGO® Buch 1 ab
Termina el Libro 1 de LEGO®
完成乐高®第 1 册





HOLD UP!

You might notice some bags aren't in order, as well as left over pieces, but that's ok! We're changing the way you build LEGO!

ATTENDEZ!

Vous remarquerez peut-être que certains sacs, ainsi que certaines pièces, ne sont pas dans le bon ordre. Mais pas de panique! Nous changeons simplement la façon avec laquelle vous construisez vos LEGO!

ASPETTA!

Potresti notare che alcuni sacchetti non sono in ordine, così come i pezzi avanzati, ma va bene così! Stiamo cambiando il modo in cui costruisci i LEGO!

HALT!

Sie werden möglicherweise bemerken, dass einige tüten durcheinander sind und teile übrig bleiben, aber das ist in Ordnung! Wir ändern die art und weise, wie Sie LEGO bauen!

¡ESPERA!

Es posible que notes que algunas bolsas están fuera de servicio, así como piezas sobrantes, ¡pero está bien! ¡Estamos cambiando la forma en que construyes LEGO!

暫停!

你可能会注意到一些袋子顺序错乱, 以及一些剩余的部件, 但没关系! 我们正在改变你搭建乐高的方式!

Open LEGO® Bag 13

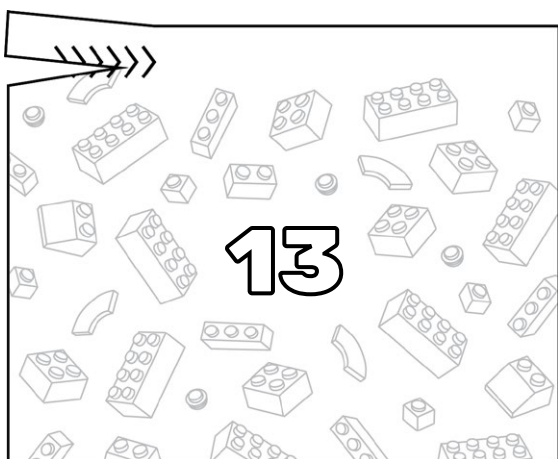

2

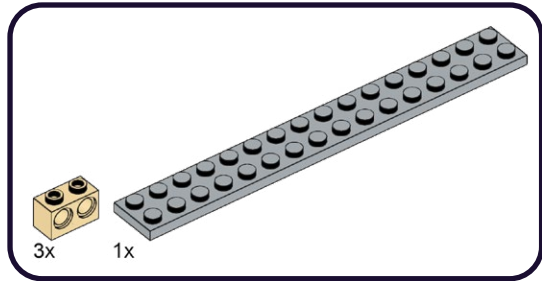

1

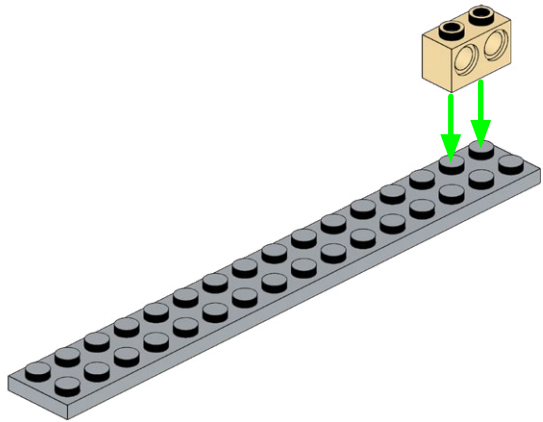

2

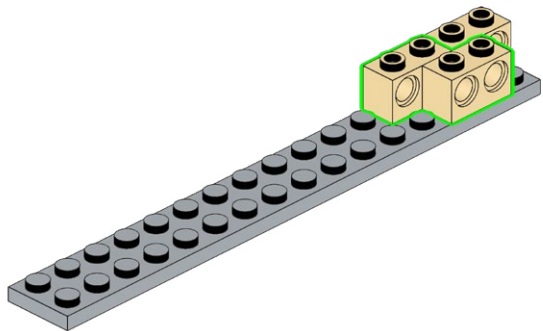

3

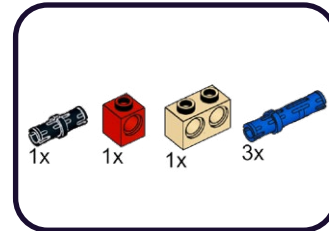

1

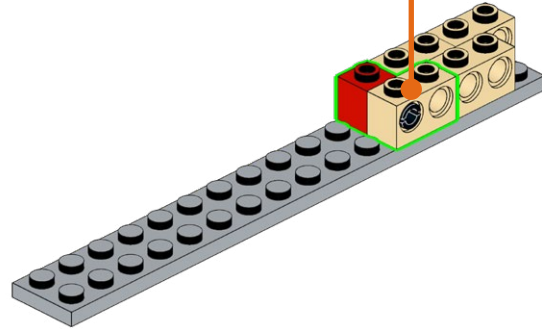
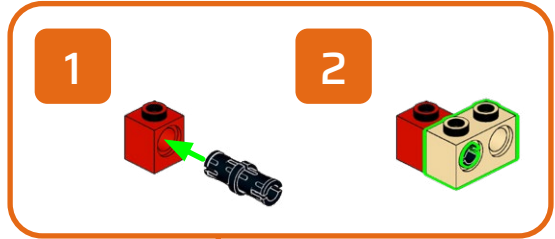

2

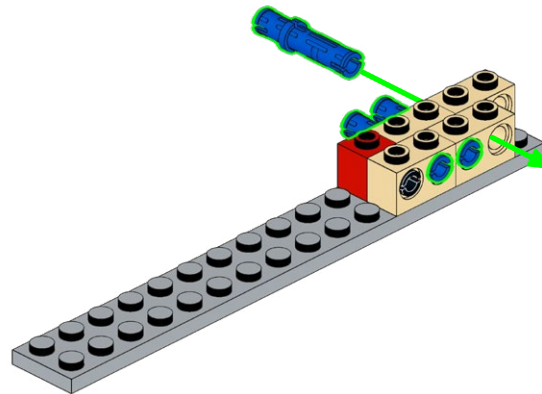

4

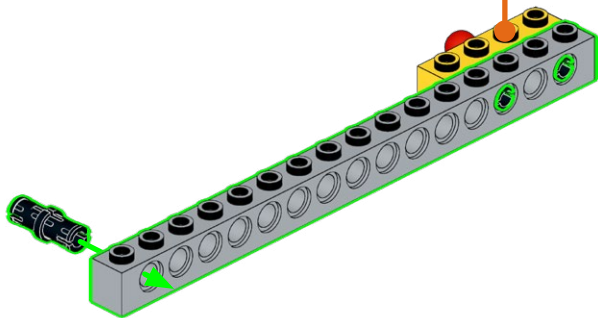
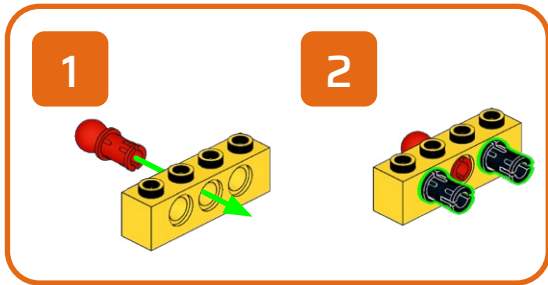
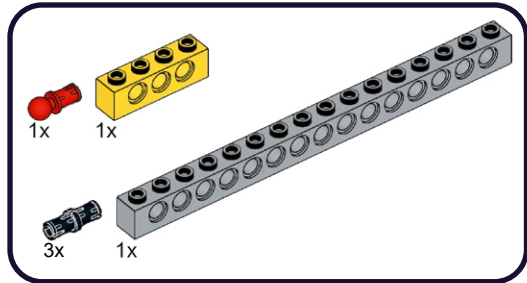

5

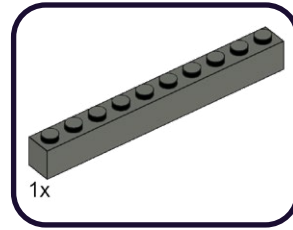

1

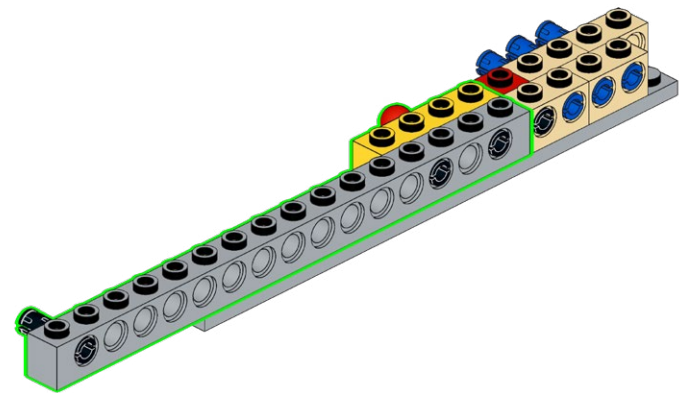

2

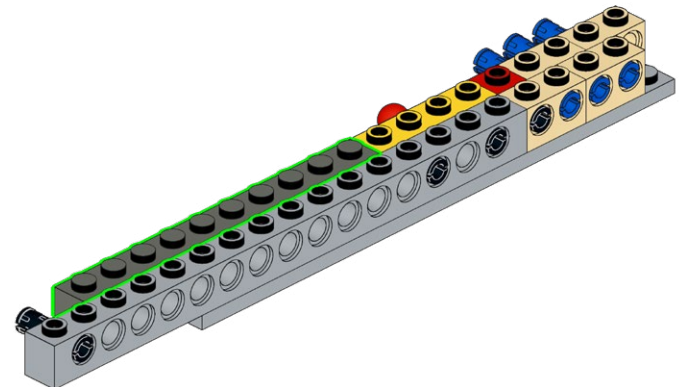

6

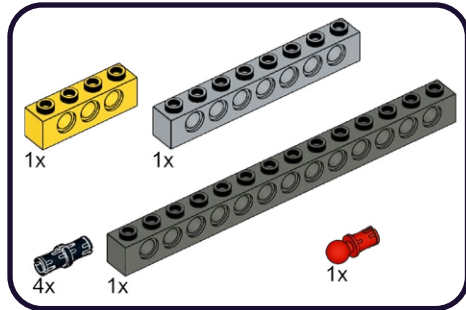

1

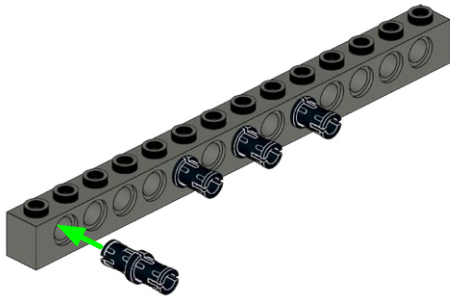

2

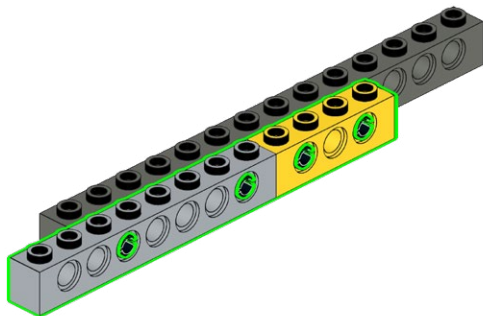

3

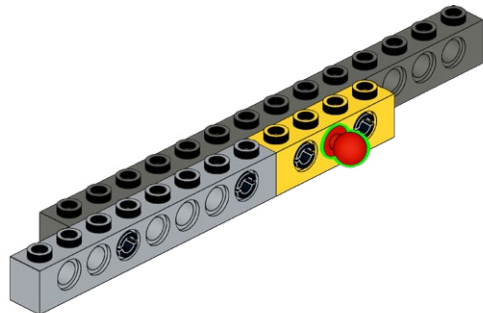

7

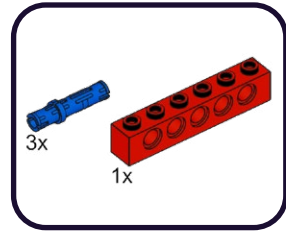

1

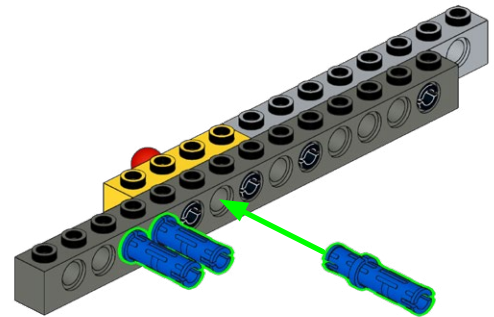
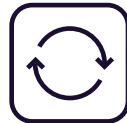

2

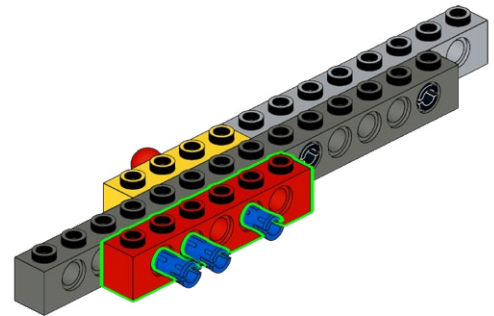

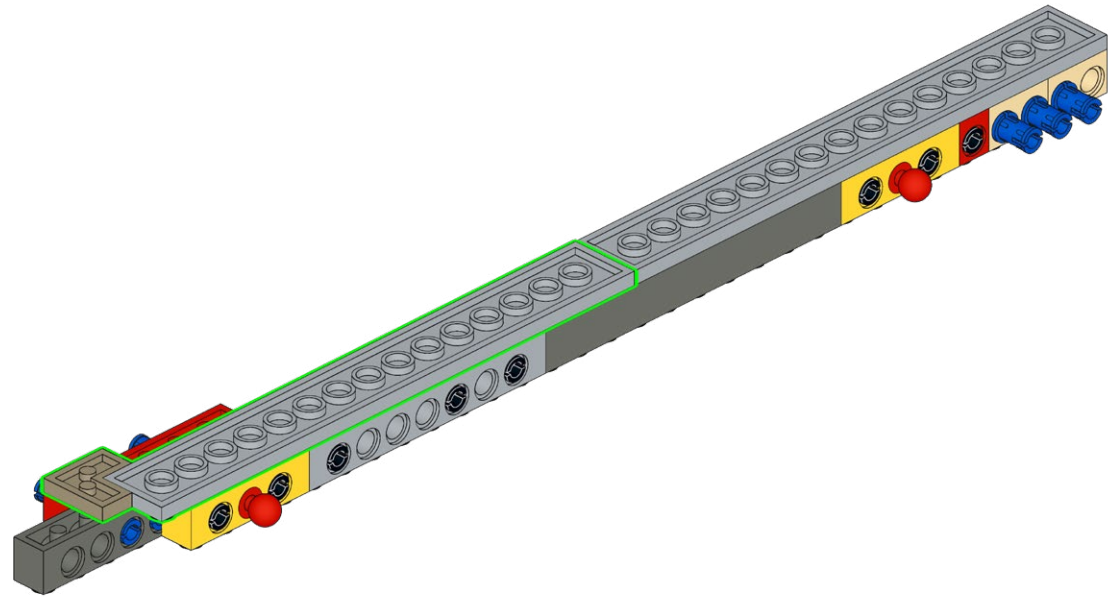
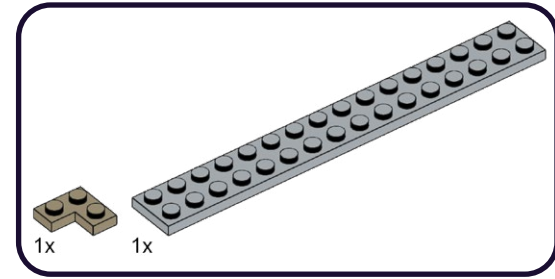
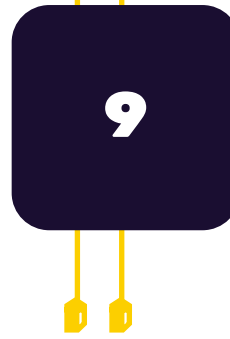
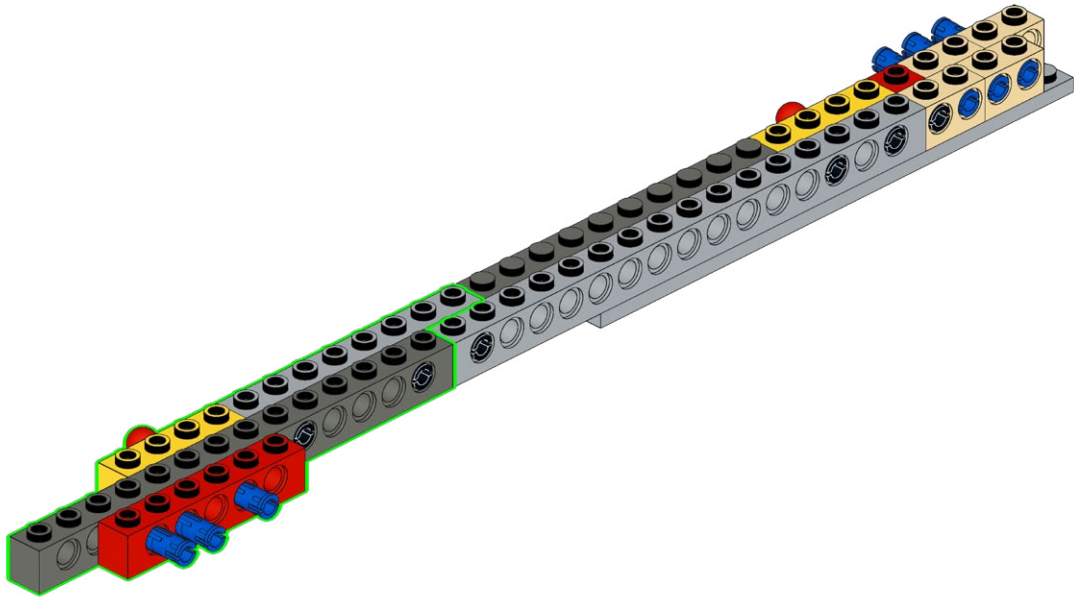
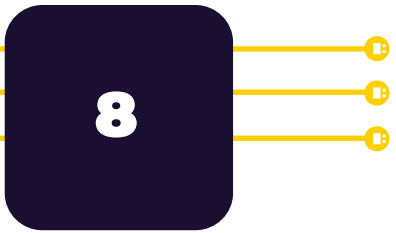

10

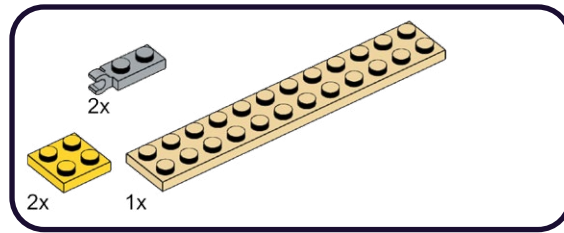

1

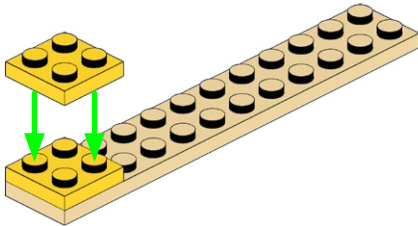

2

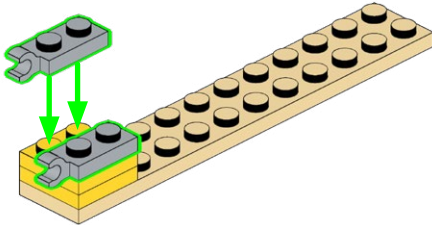

11

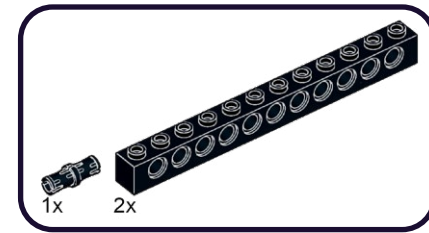

1



2

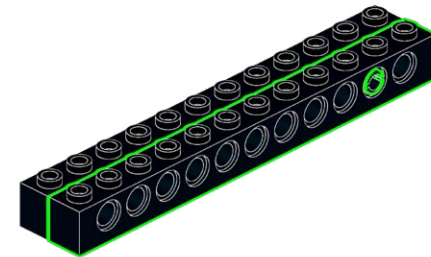

3

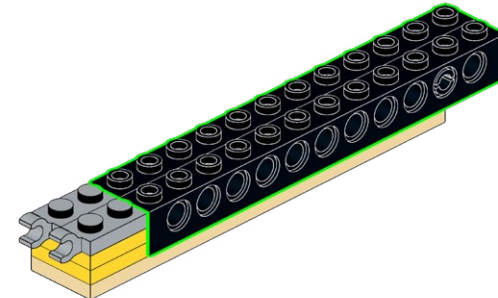

12

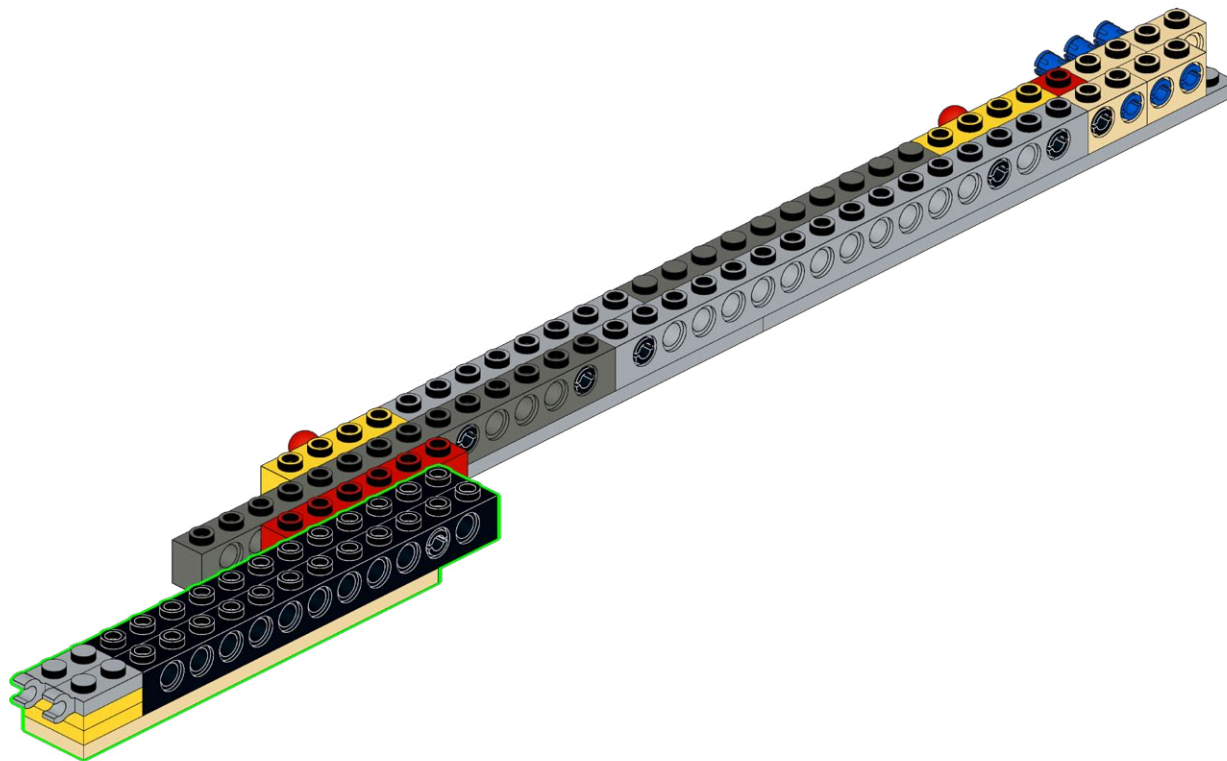

13

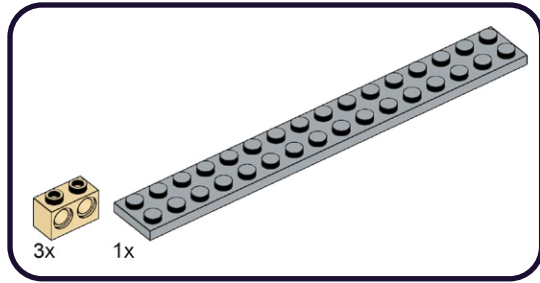

1

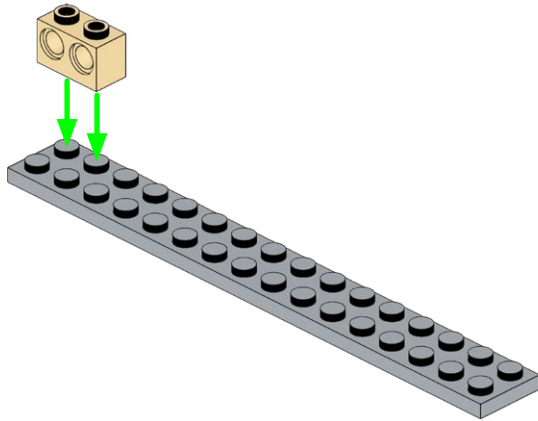

2

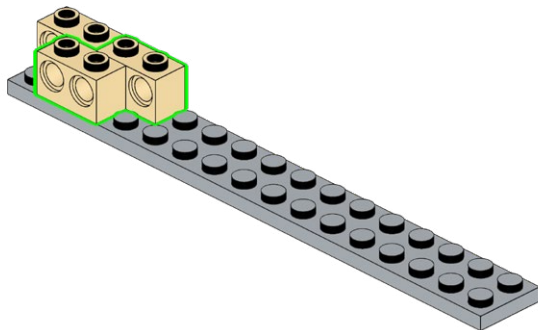

14

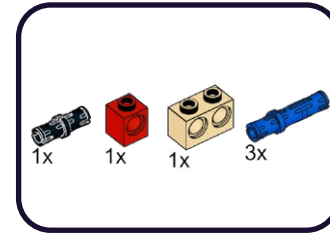

1

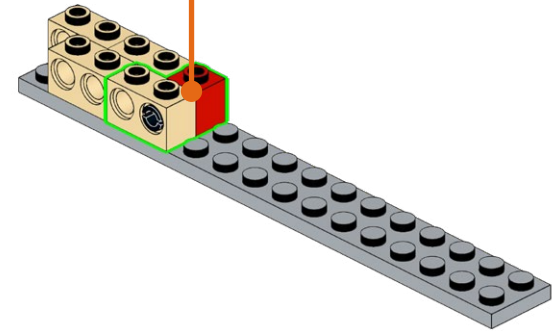
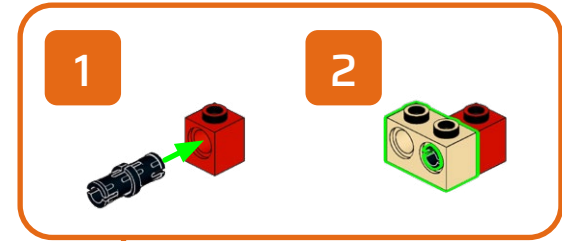

2

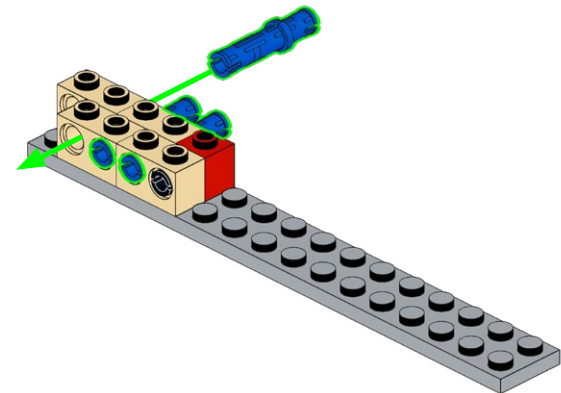

15

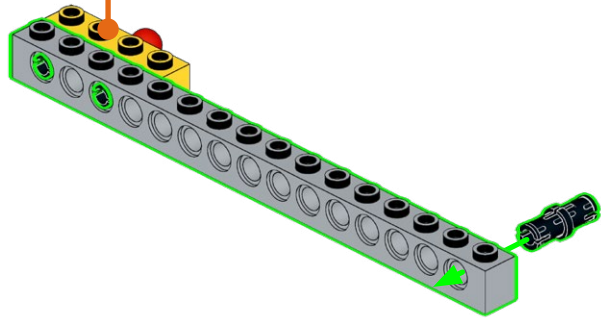
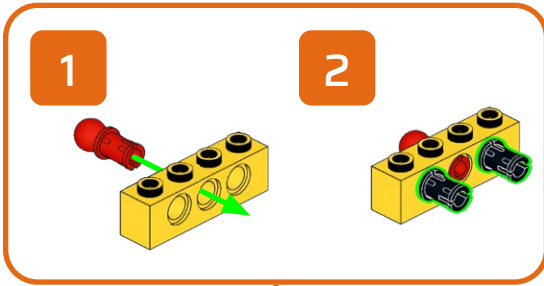
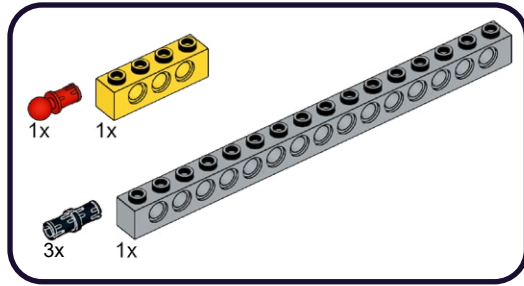

16

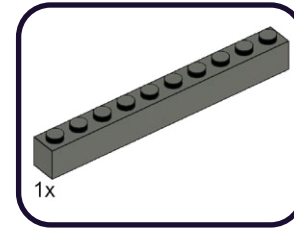

1

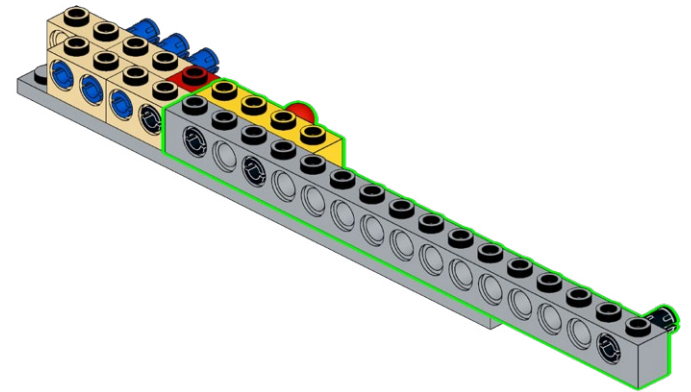

2

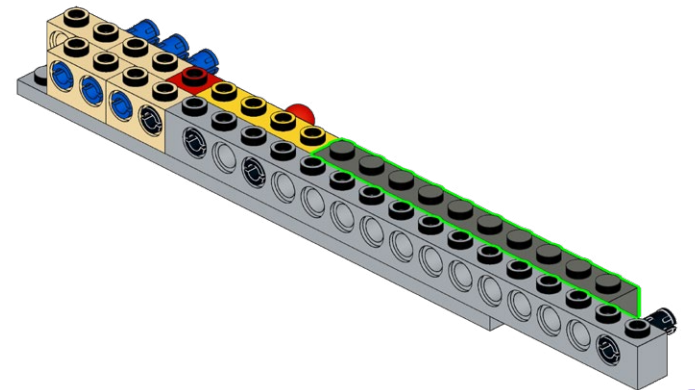

17

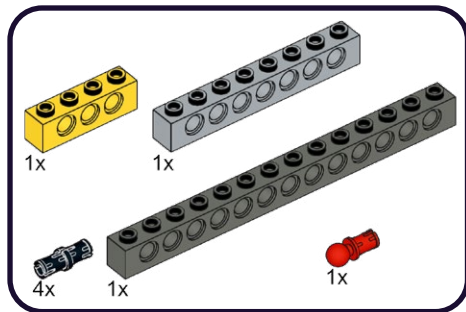

1

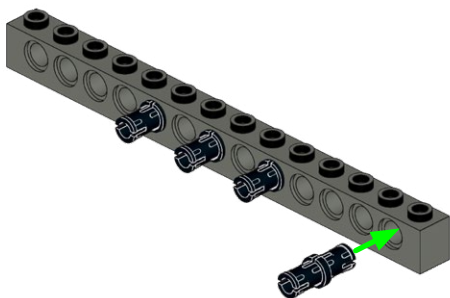

2

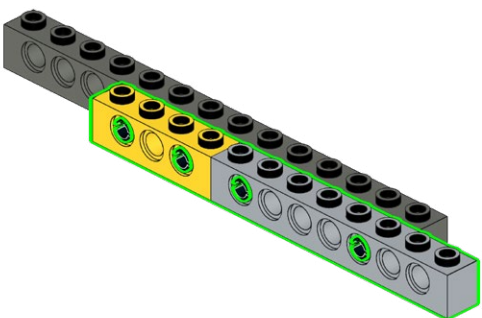

3

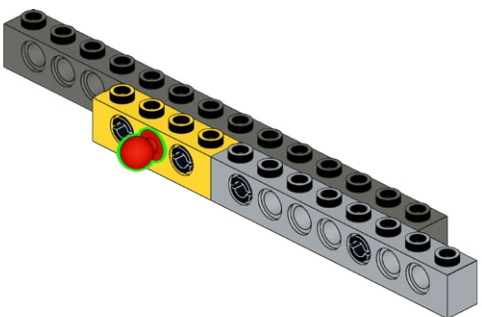

18

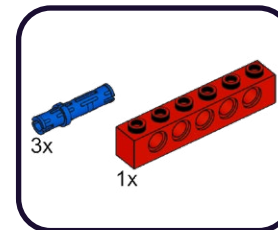

1

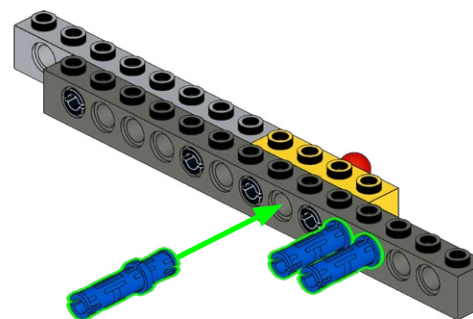
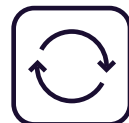

2

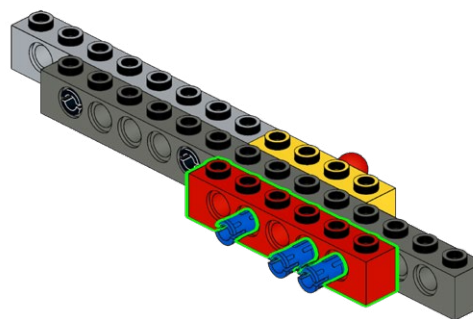

19

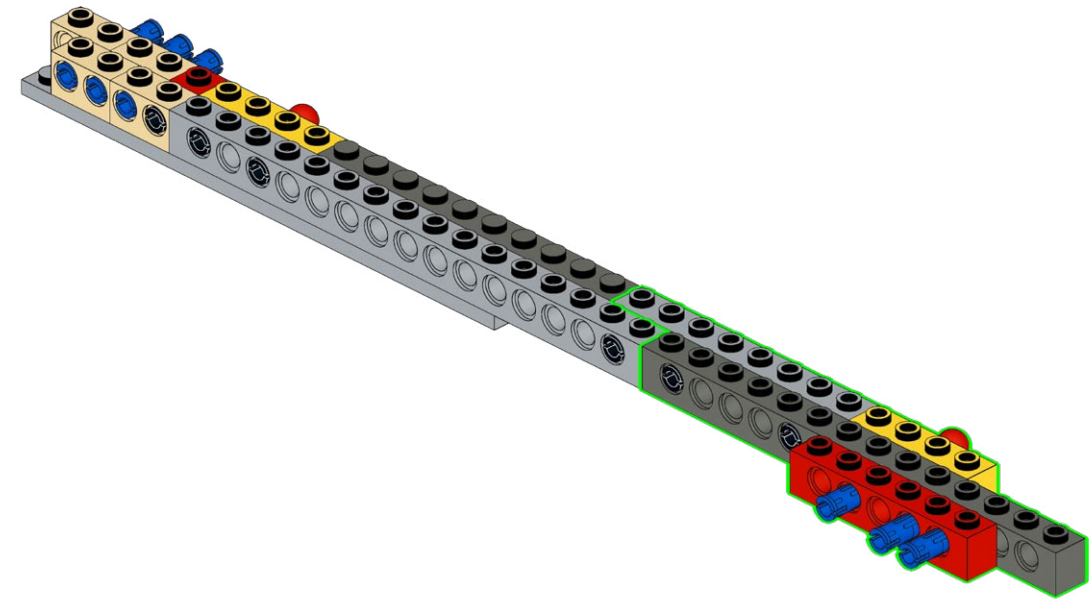

20

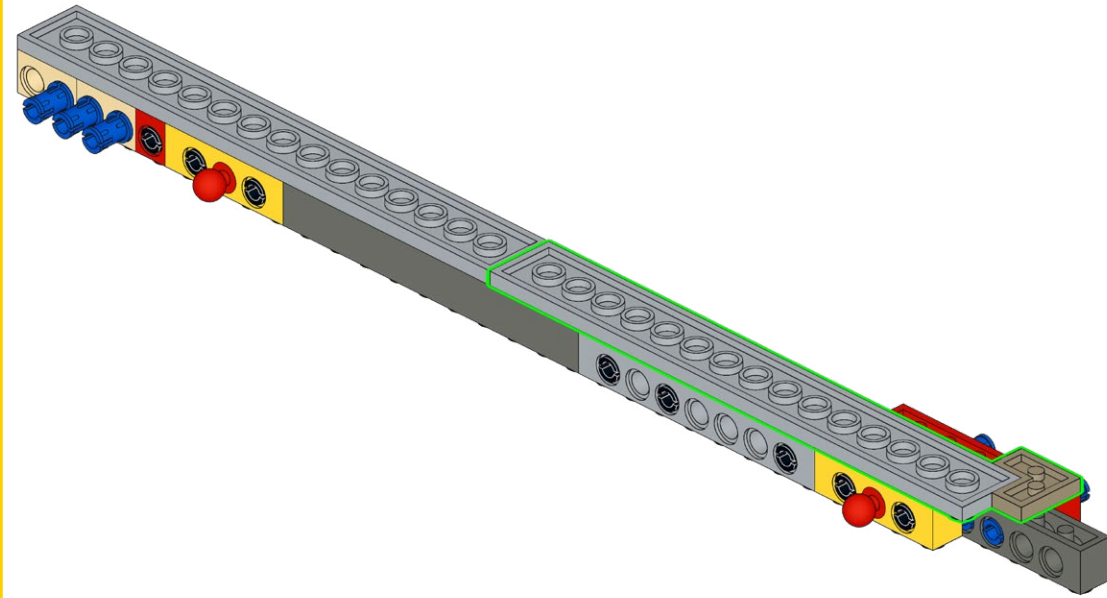
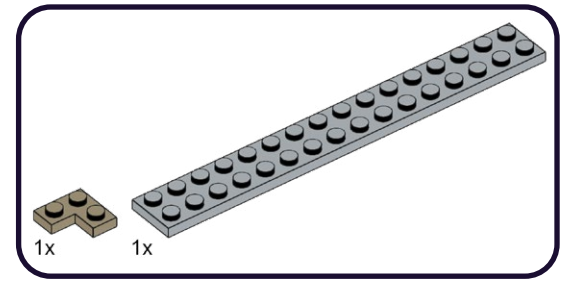

21

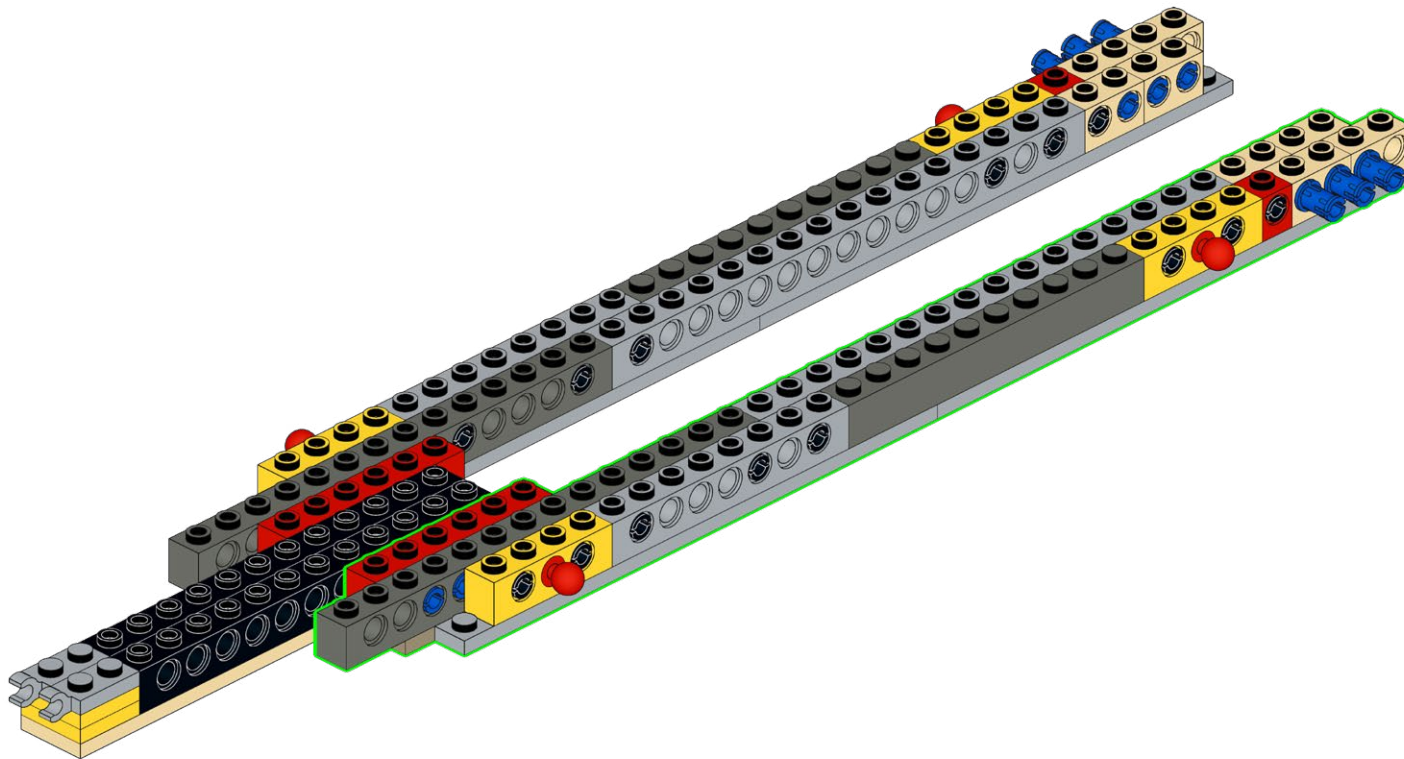

22

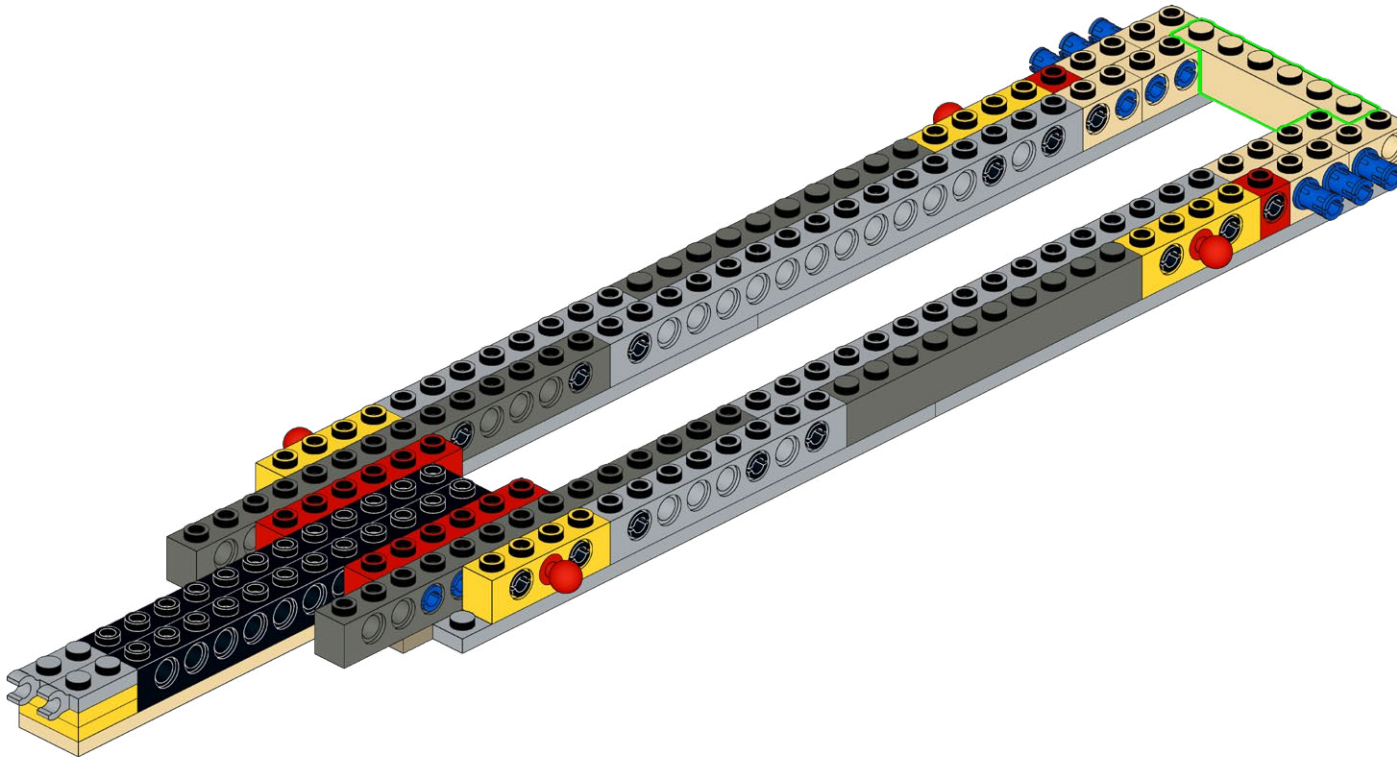
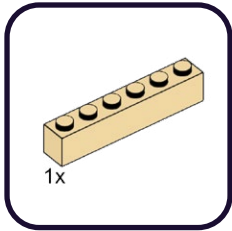

23

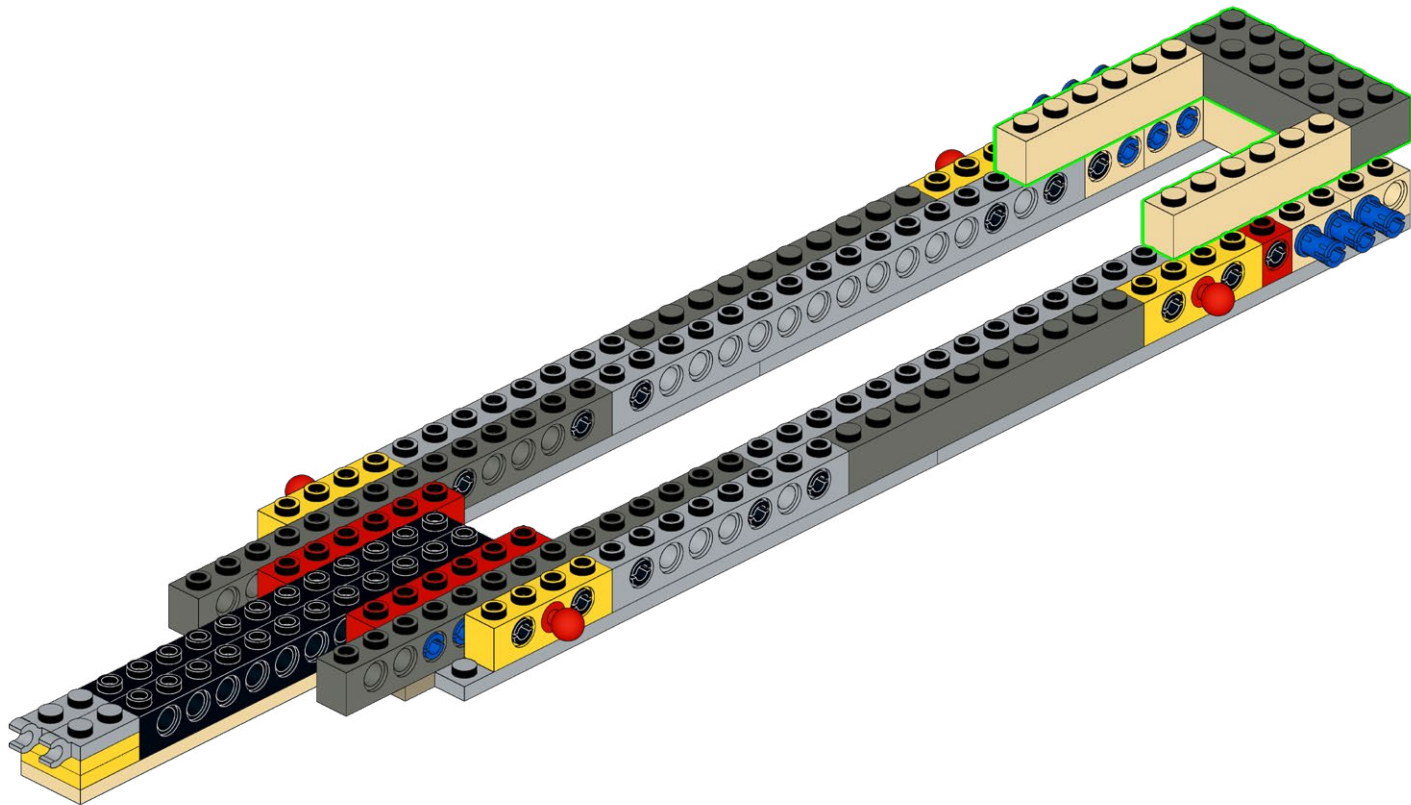
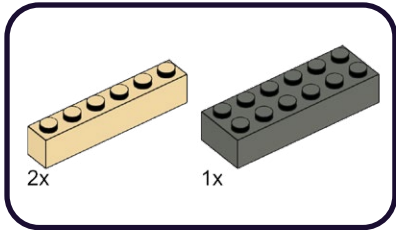

24

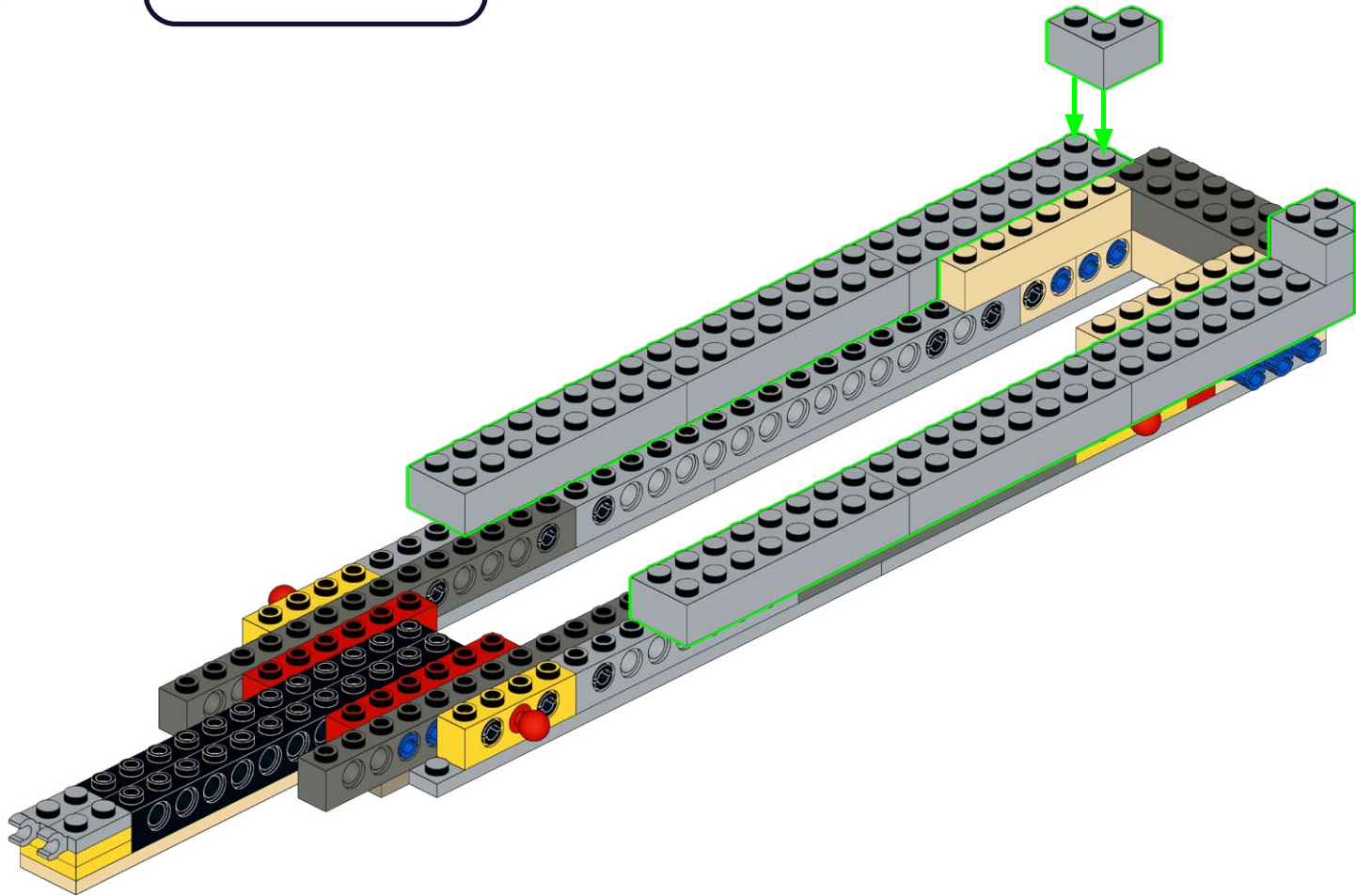
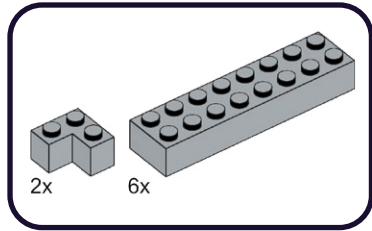

25

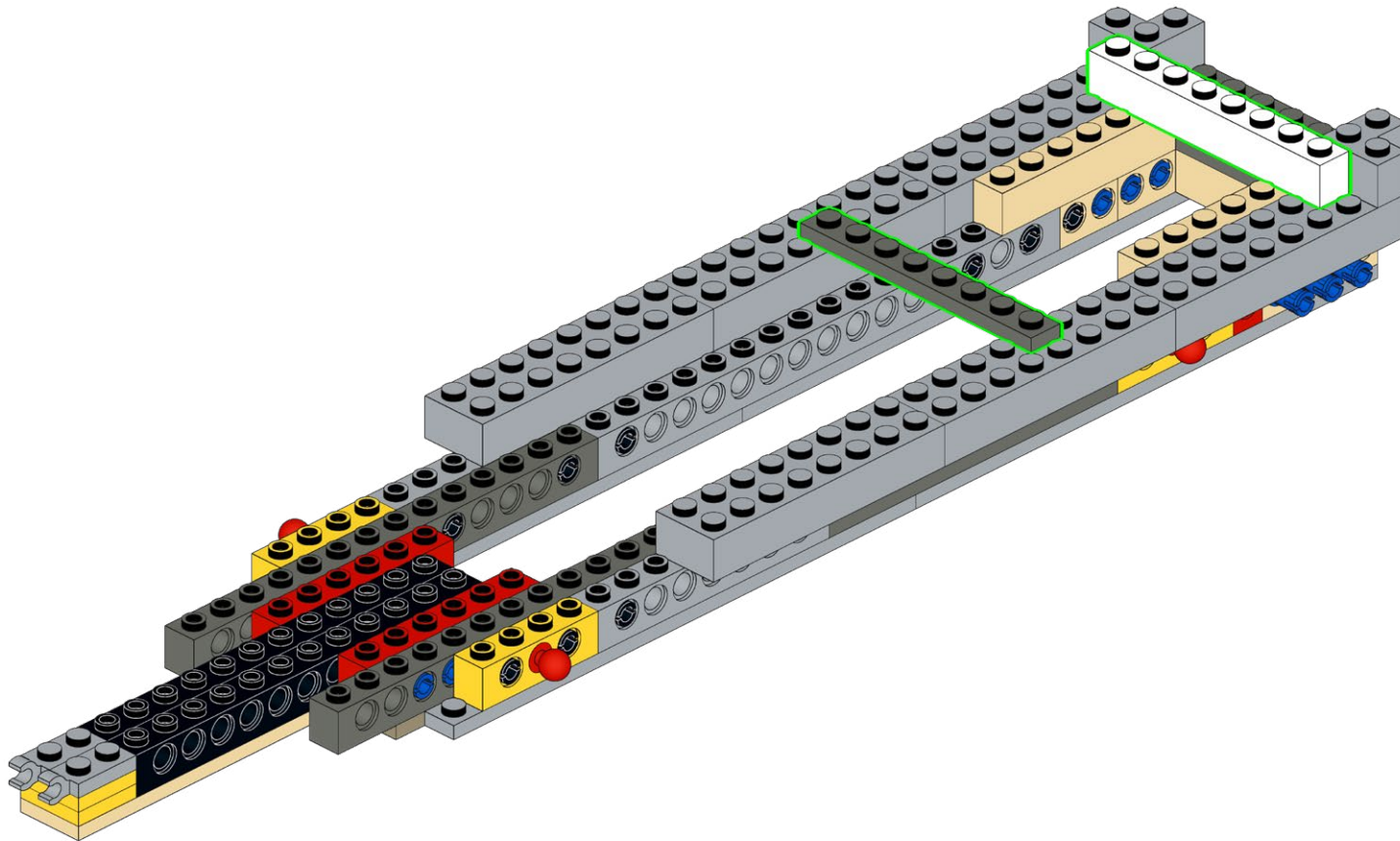
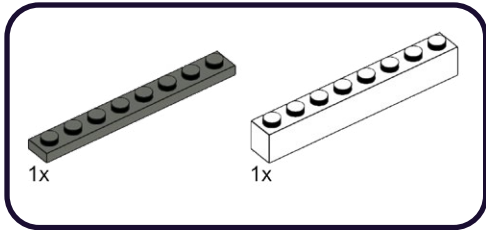

26

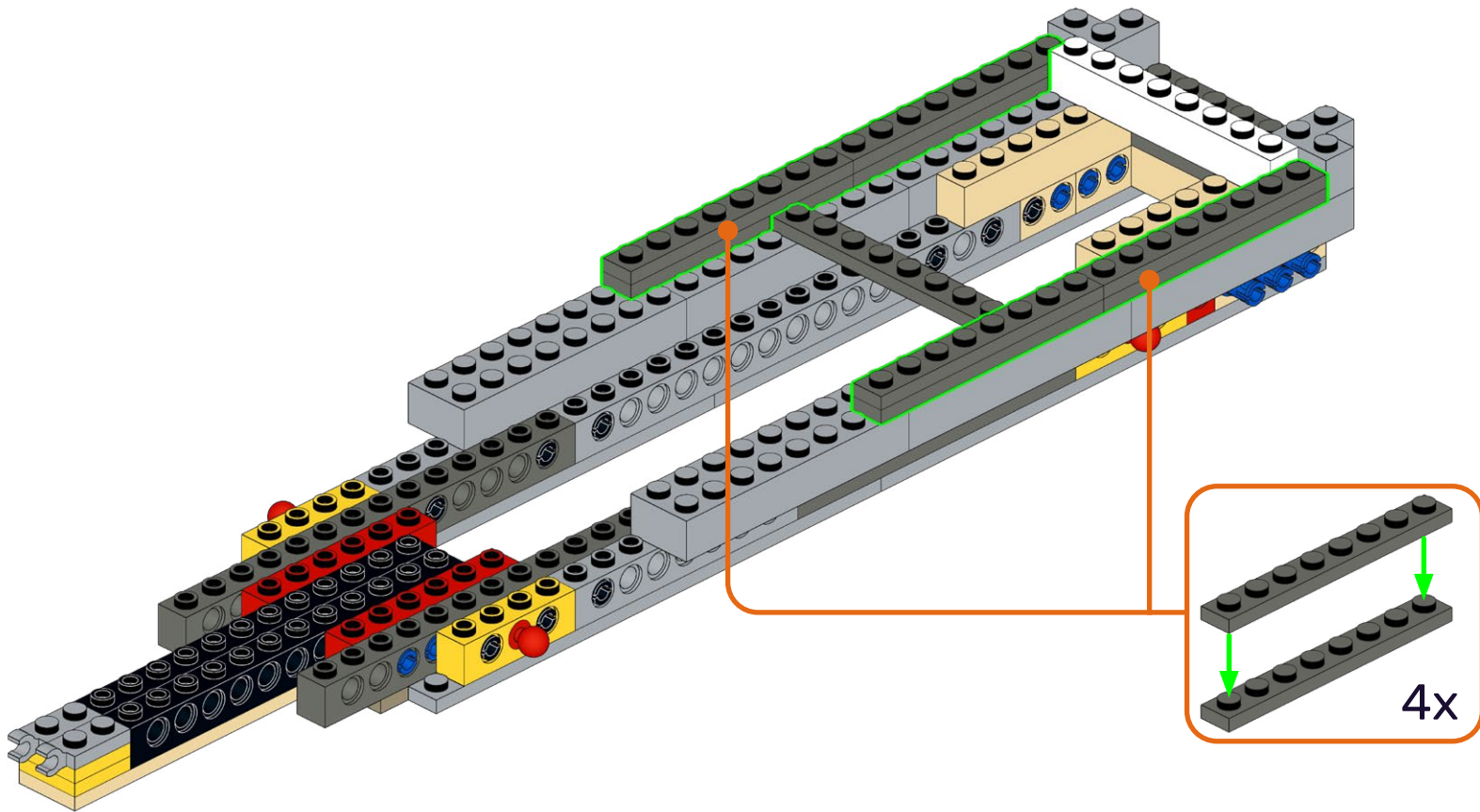
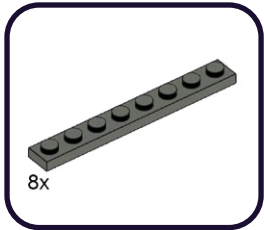

27

4x

2x

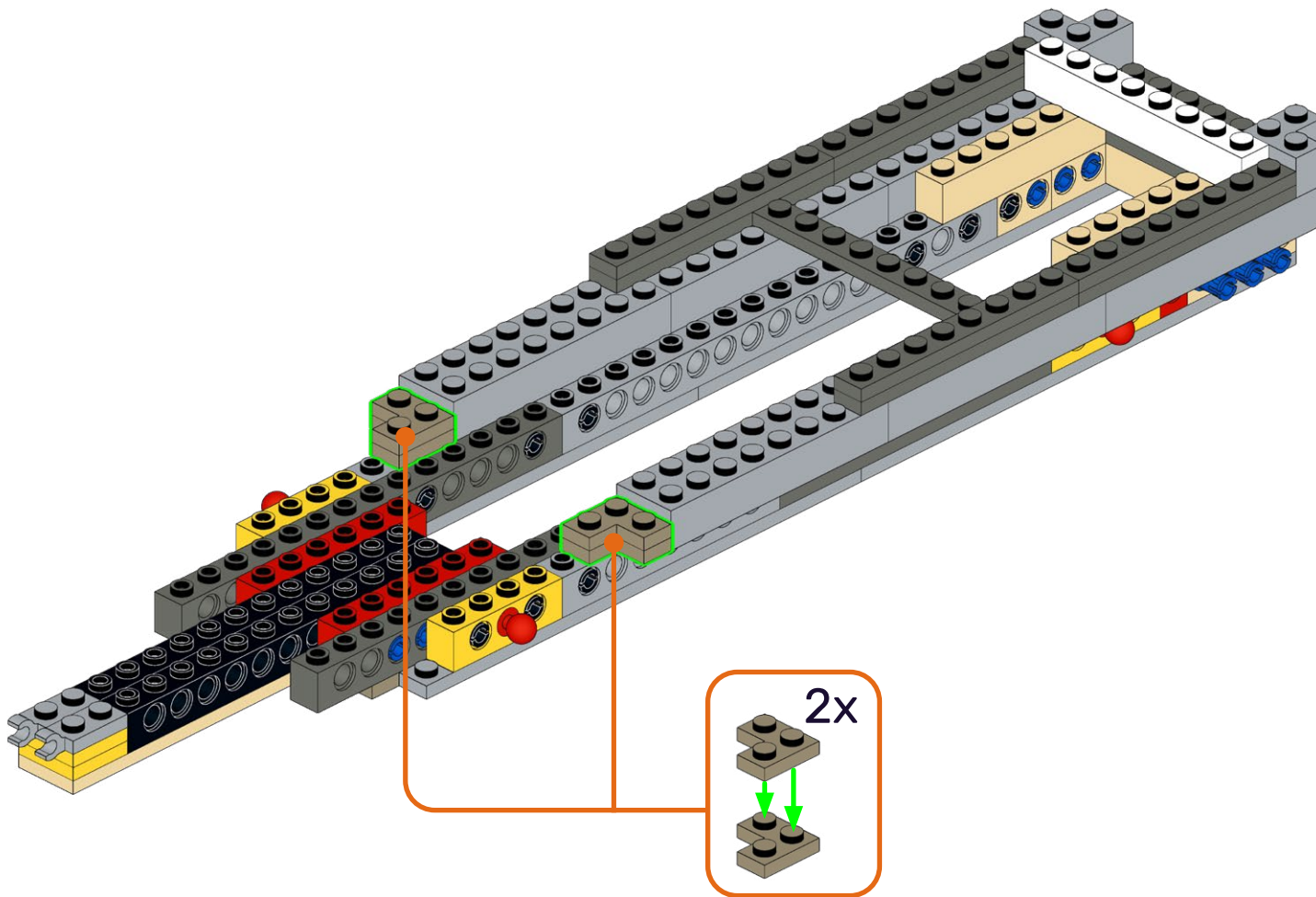

28

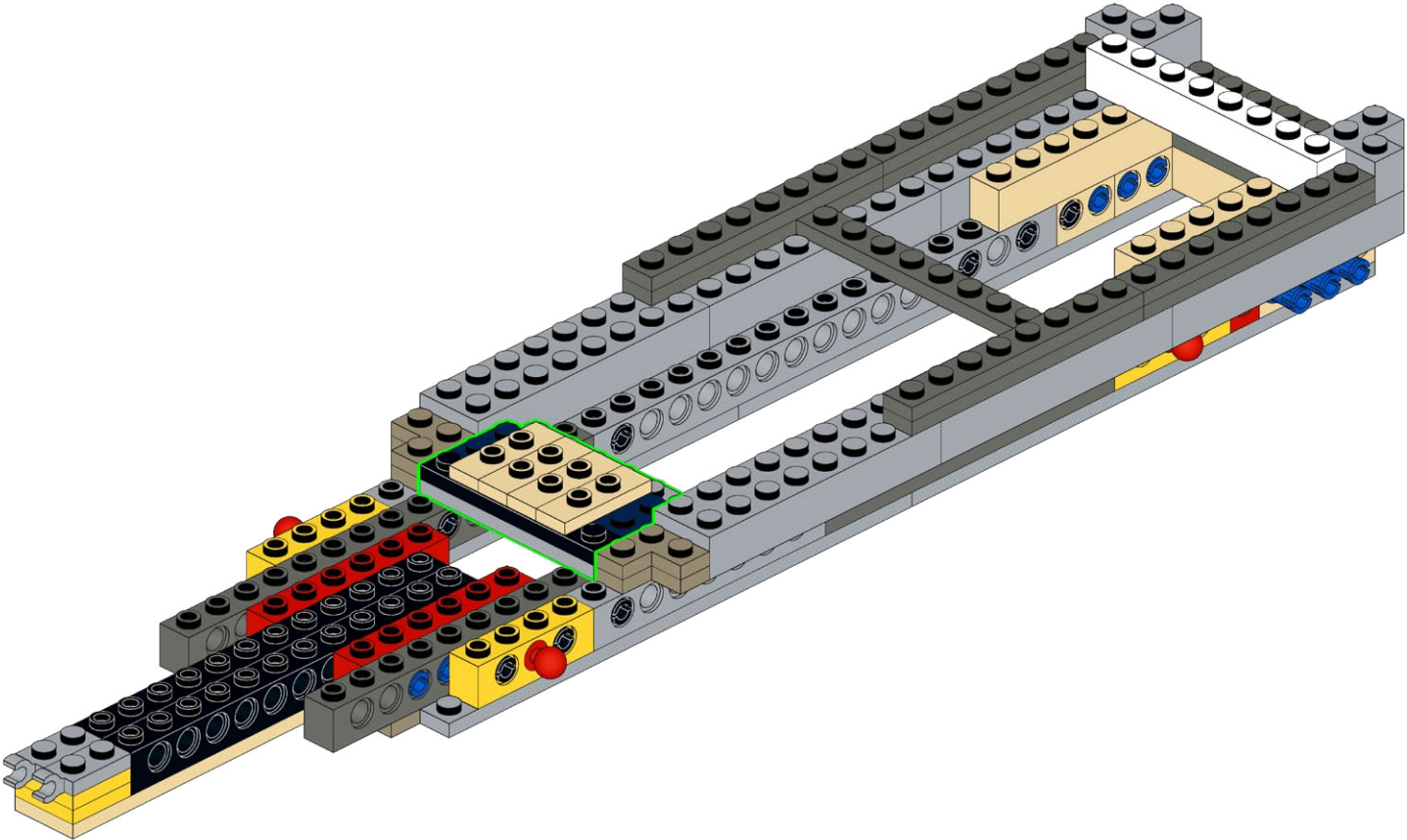
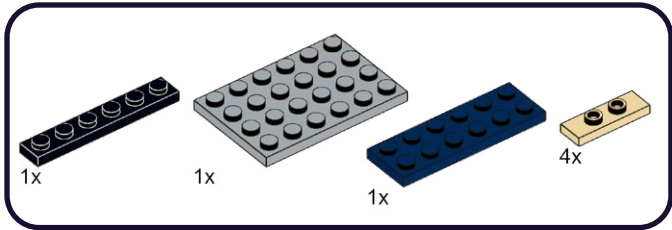

29

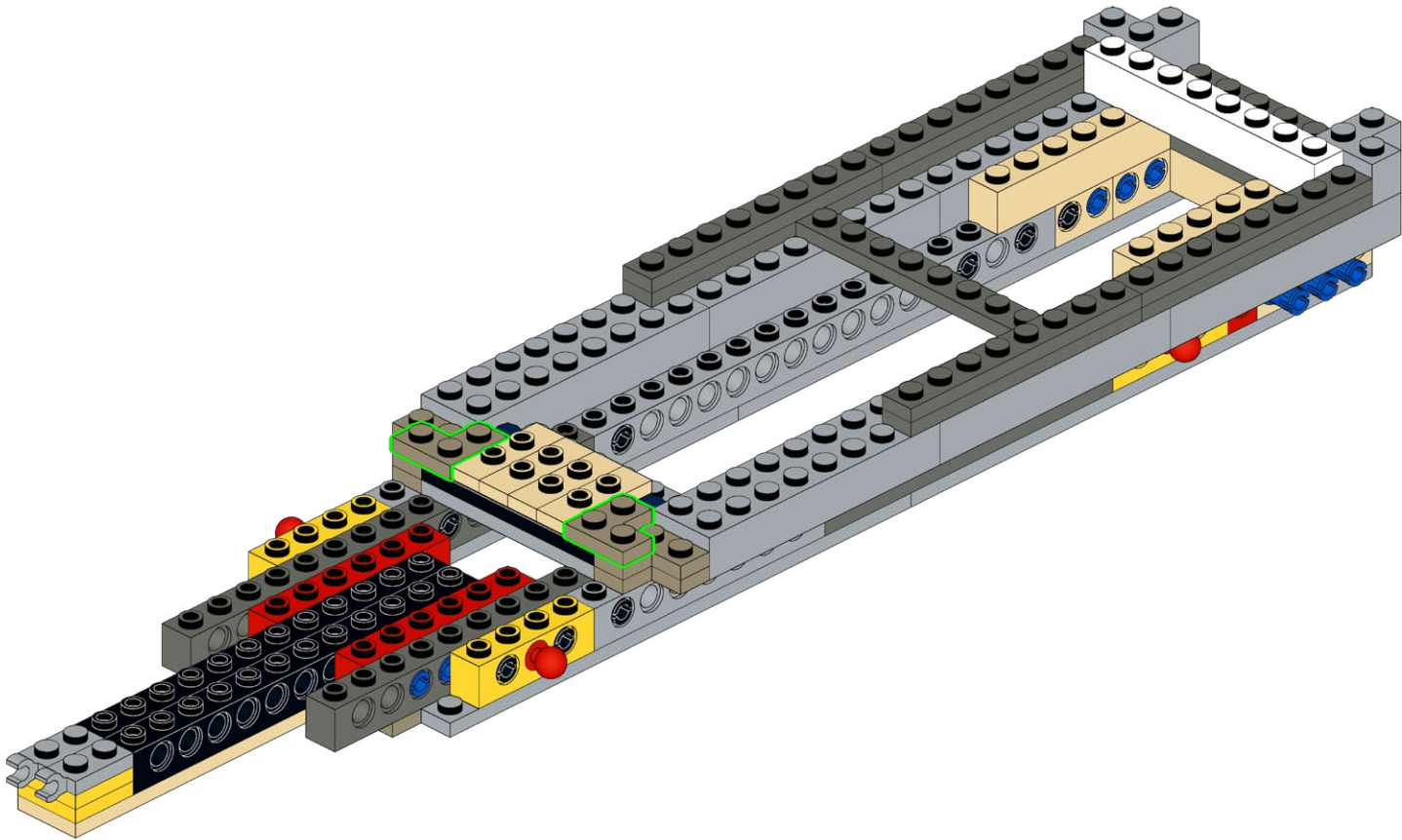
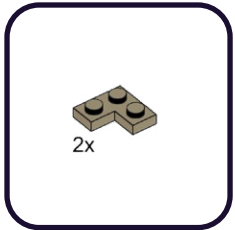

30

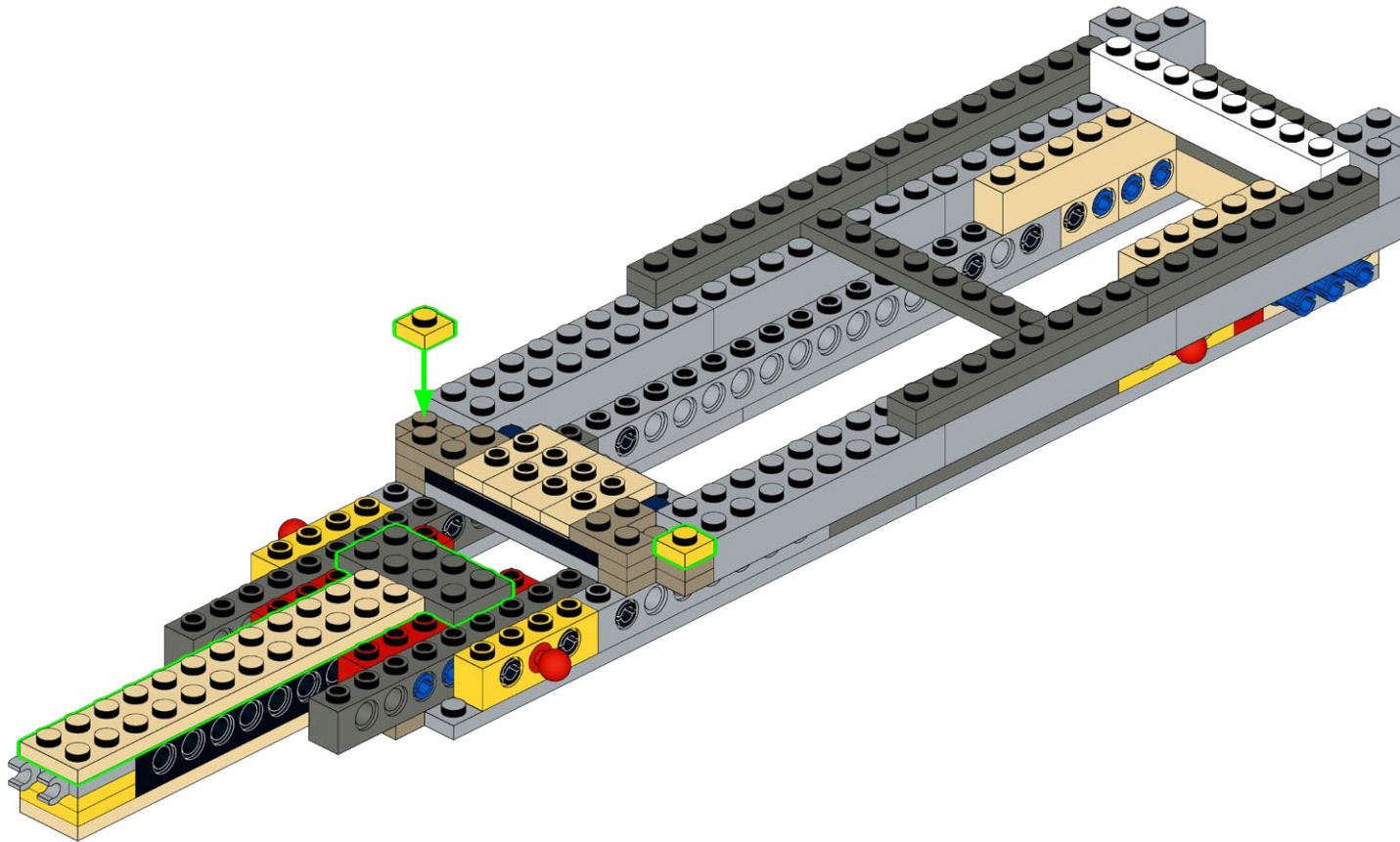
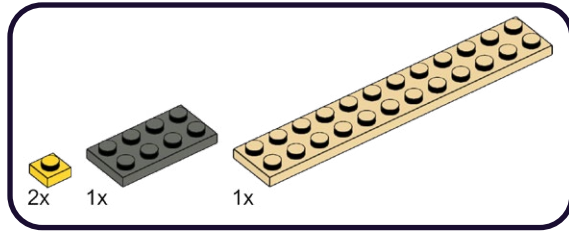

31

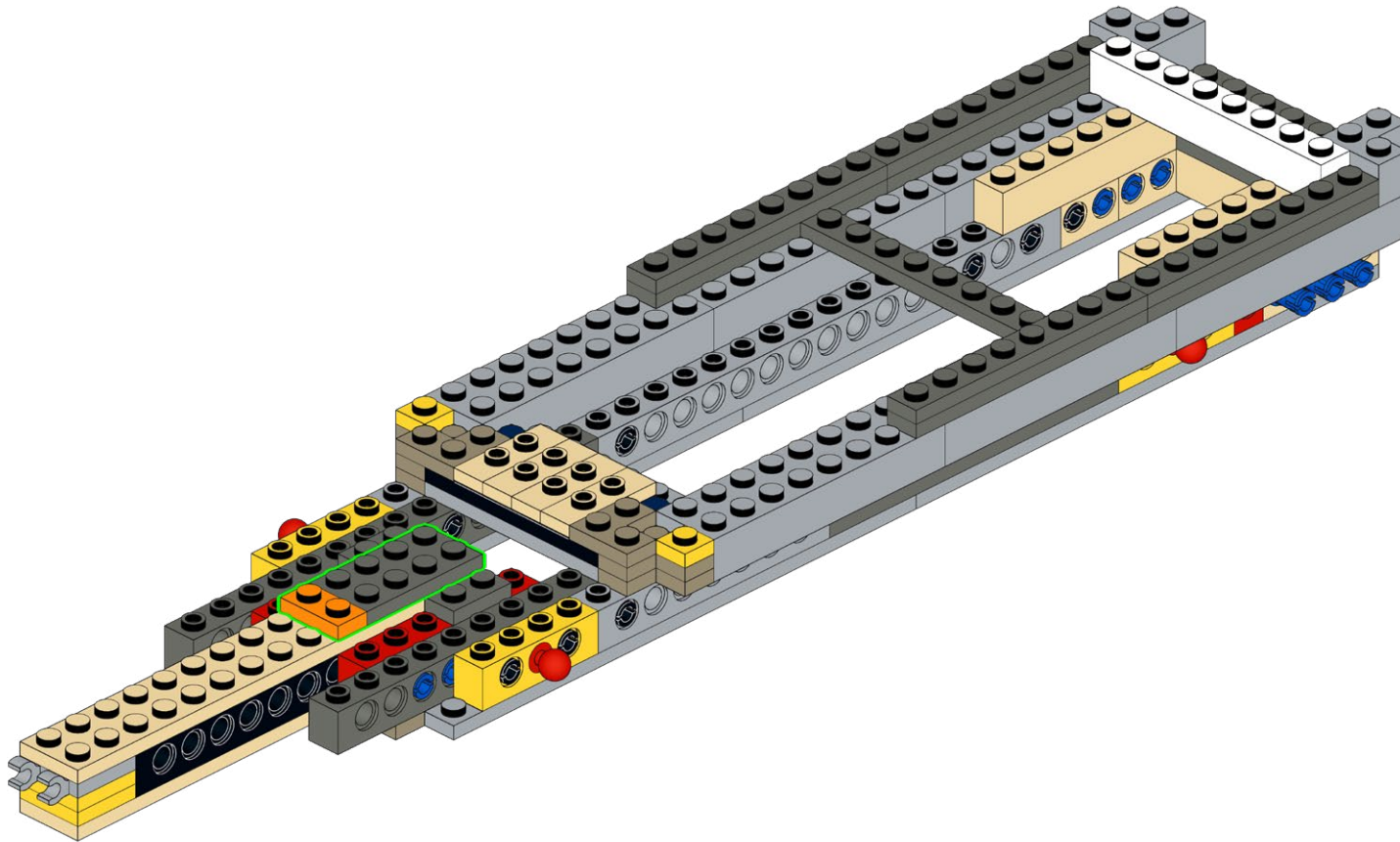
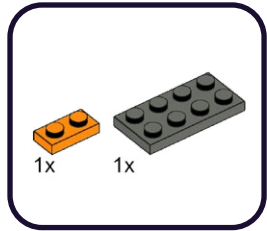

32

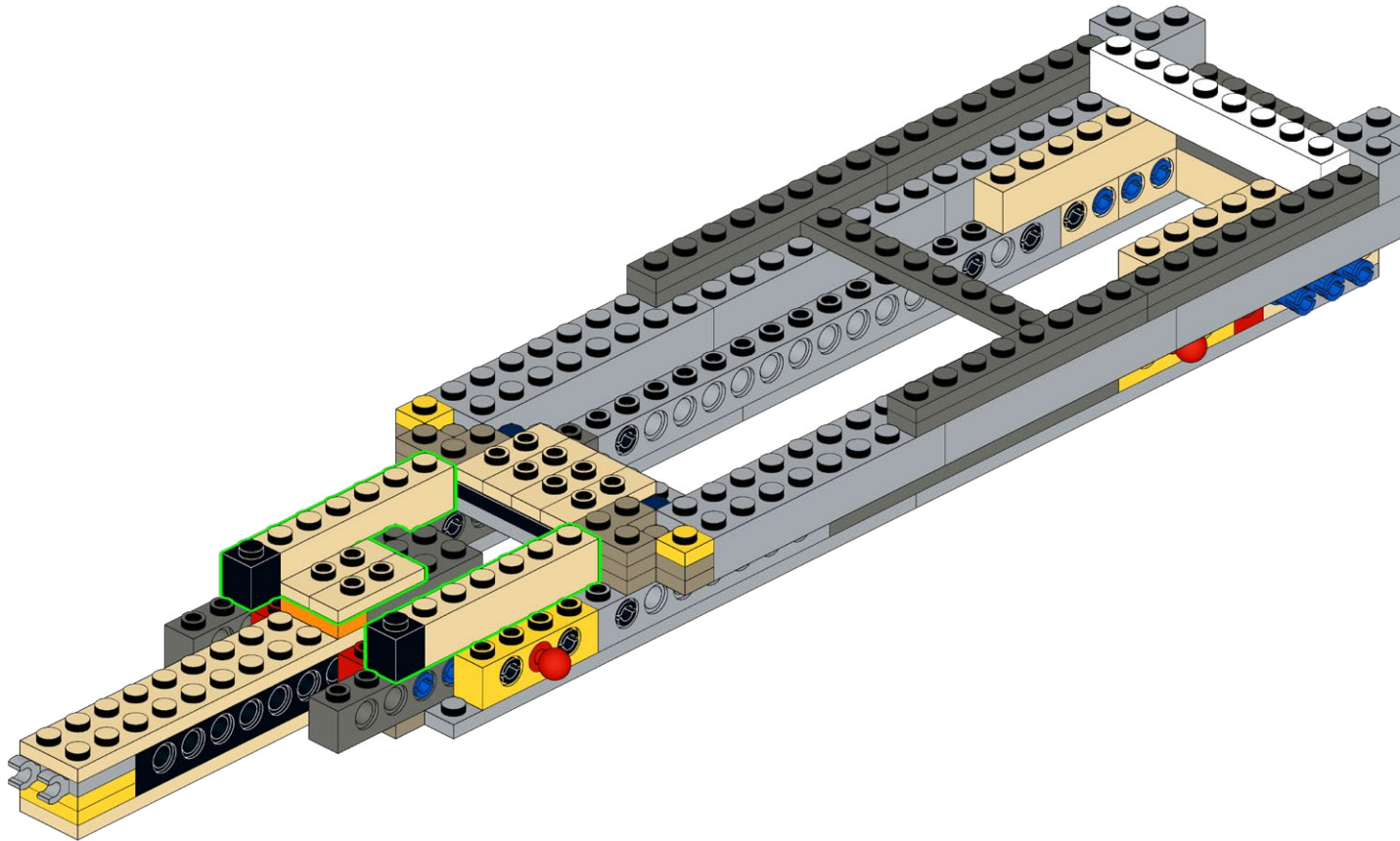
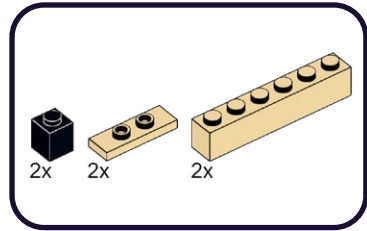

33

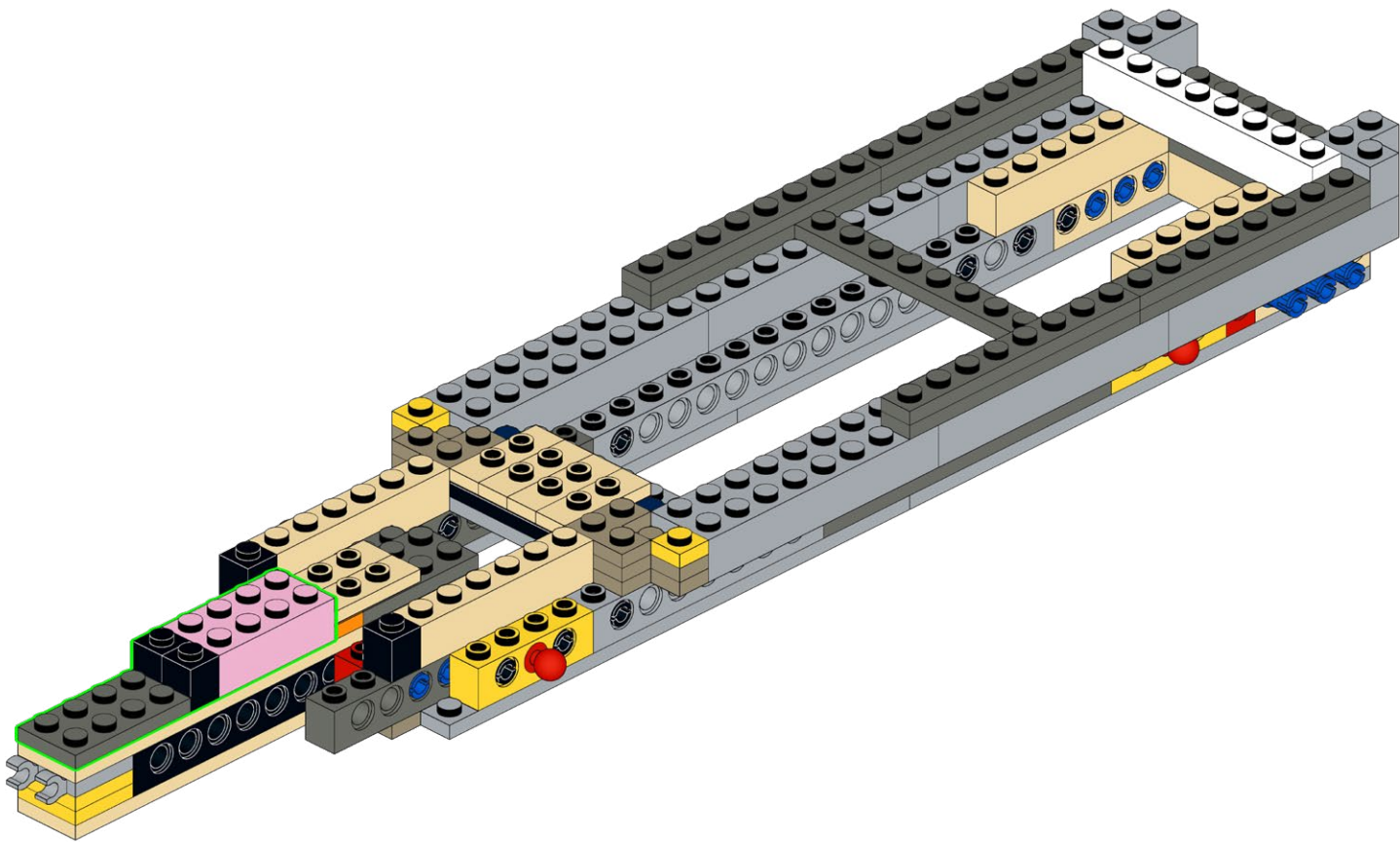
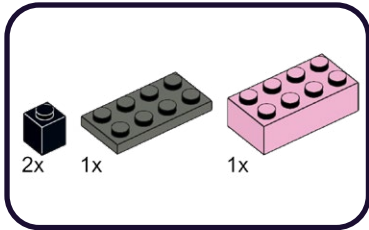

34

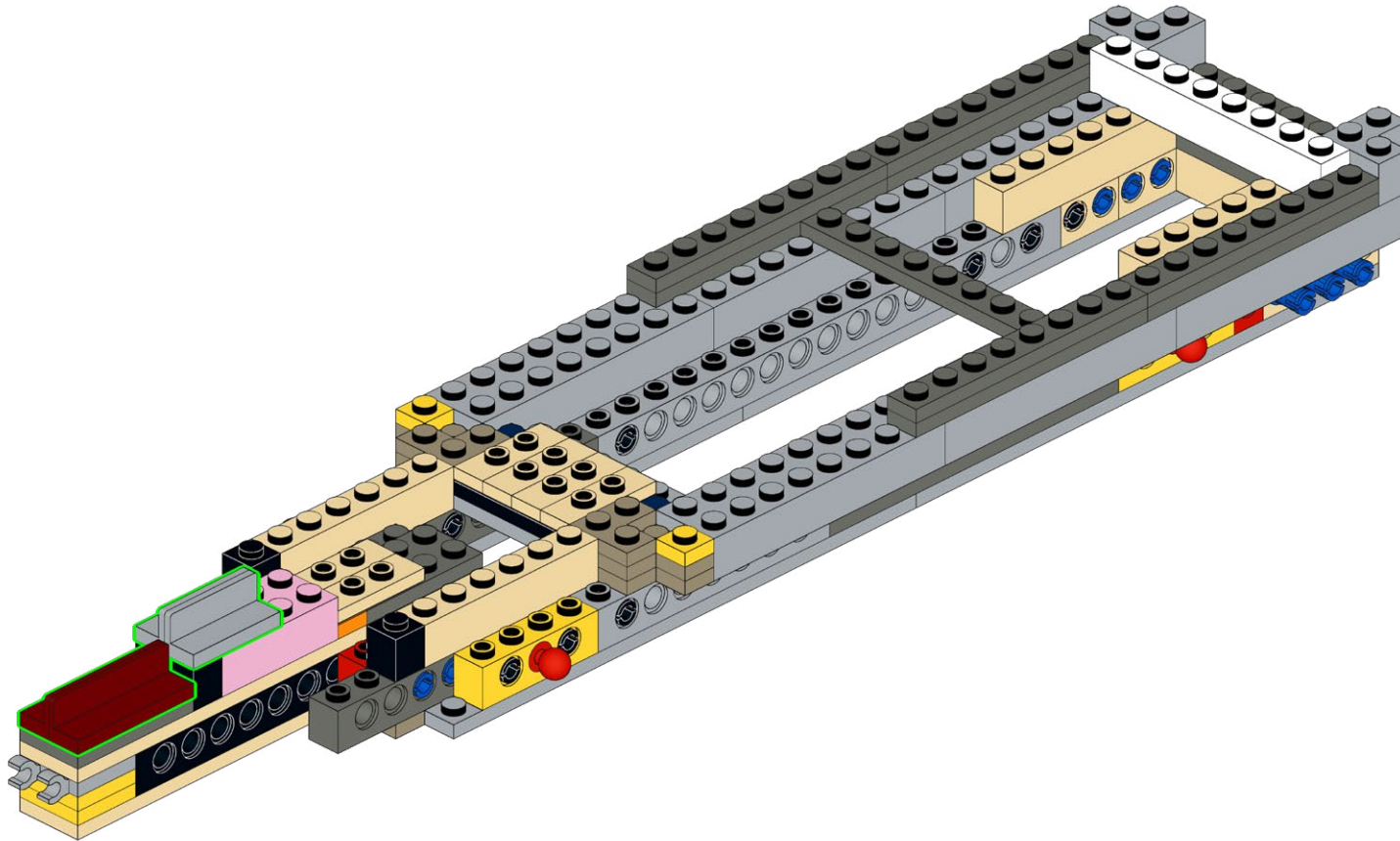
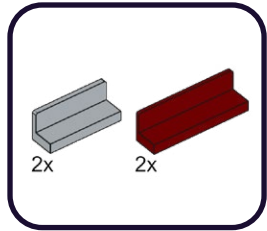

**HOLD UP!**

You might notice some bags aren't in order, as well as left over pieces, but that's ok! We're changing the way you build LEGO!

ATTENDEZ!

Vous remarquerez peut-être que certains sacs, ainsi que certaines pièces, ne sont pas dans le bon ordre. Mais pas de panique! Nous changeons simplement la façon avec laquelle vous construisez vos LEGO!

ASPETTA!

Potresti notare che alcuni sacchetti non sono in ordine, così come i pezzi avanzati, ma va bene così! Stiamo cambiando il modo in cui costruisci i LEGO!

HALT!

Sie werden möglicherweise bemerken, dass einige tüten durcheinander sind und teile übrig bleiben, aber das ist in Ordnung! Wir ändern die art und weise, wie Sie LEGO bauen!

¡ESPERA!

Es posible que notes que algunas bolsas están fuera de servicio, así como piezas sobrantes, ¡pero está bien! ¡Estamos cambiando la forma en que construyes LEGO!

暫停!

你可能会注意到一些袋子顺序错乱, 以及一些剩余的部件, 但没关系! 我们正在改变你搭建乐高的方式!

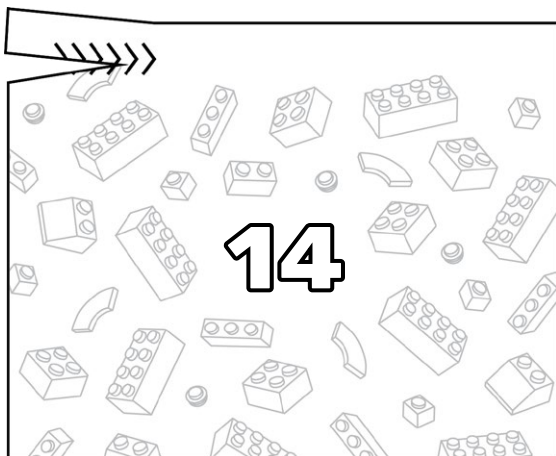
Open LEGO® Bag 14

35

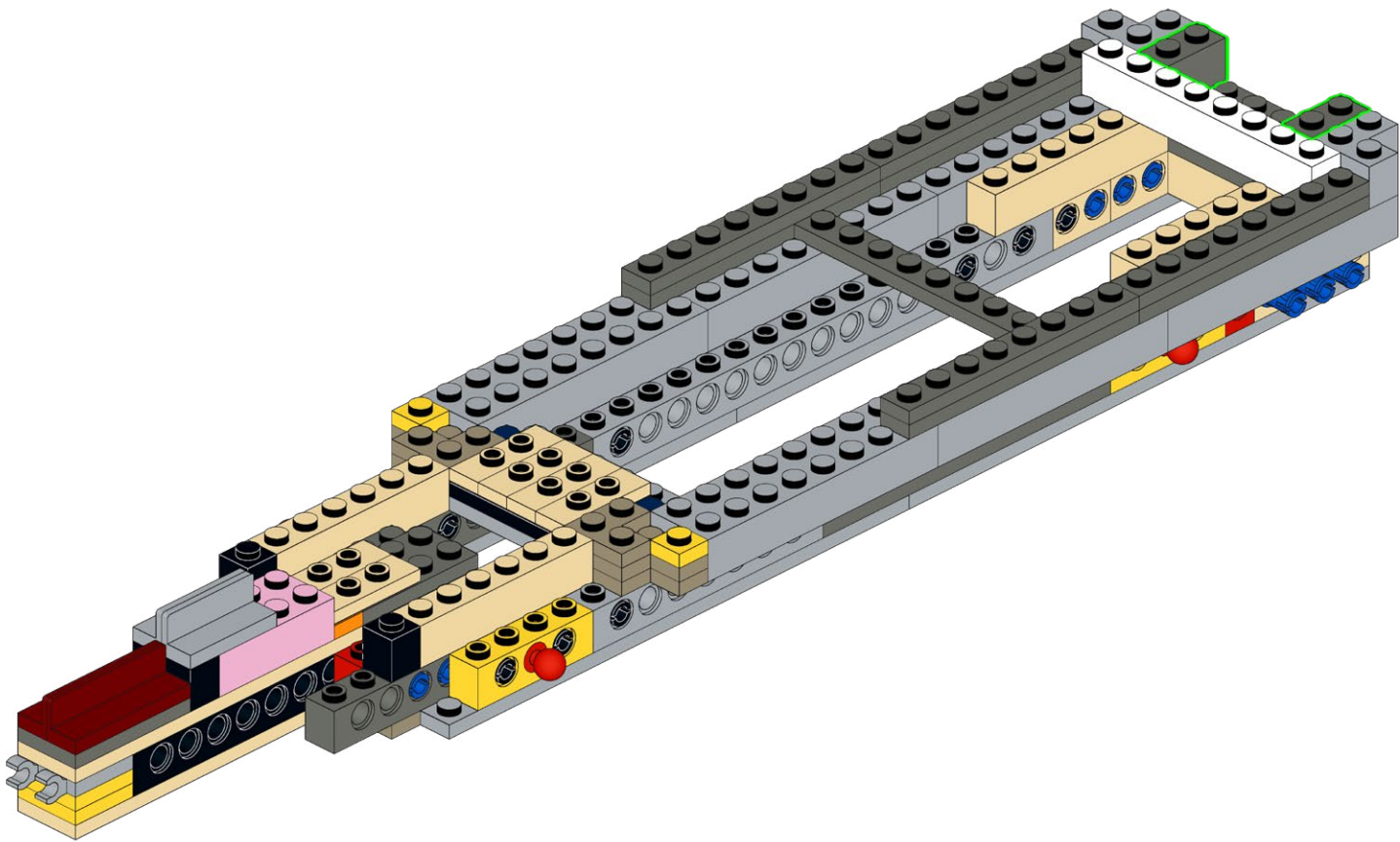
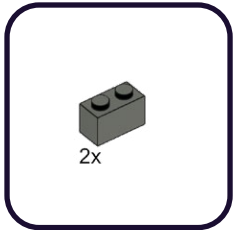

36

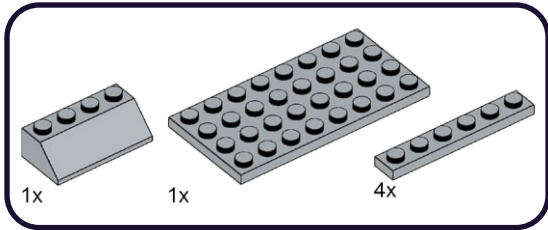

1

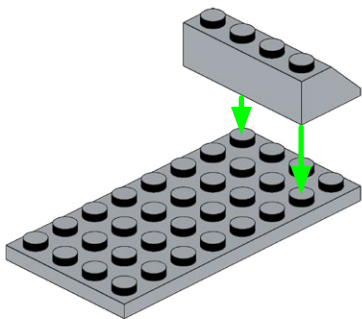

2

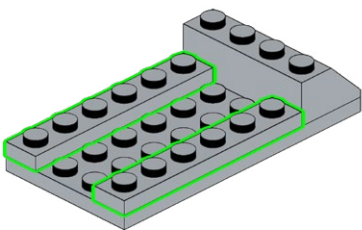

3

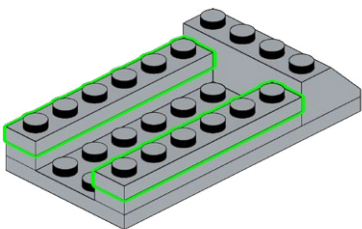

37

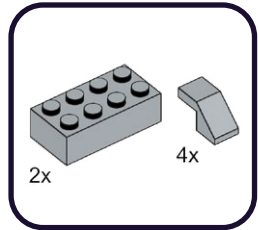

1

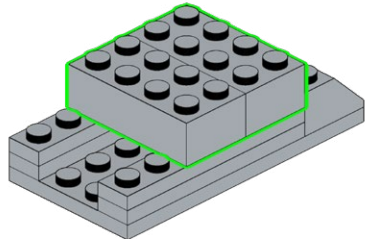

2

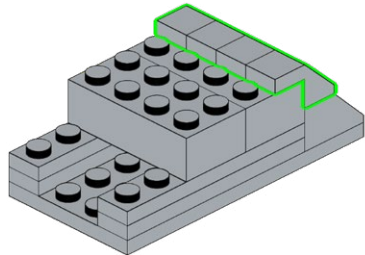

38

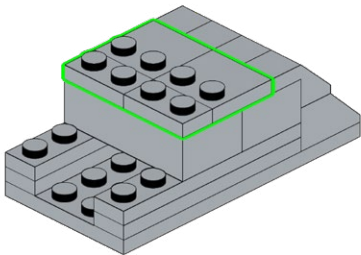
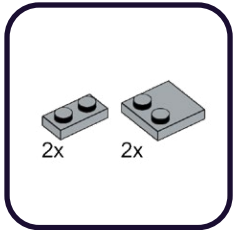

39

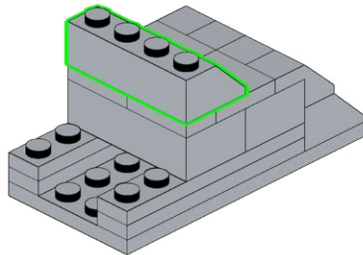
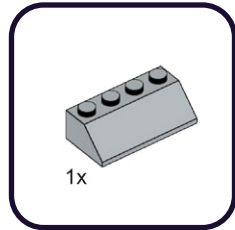

40

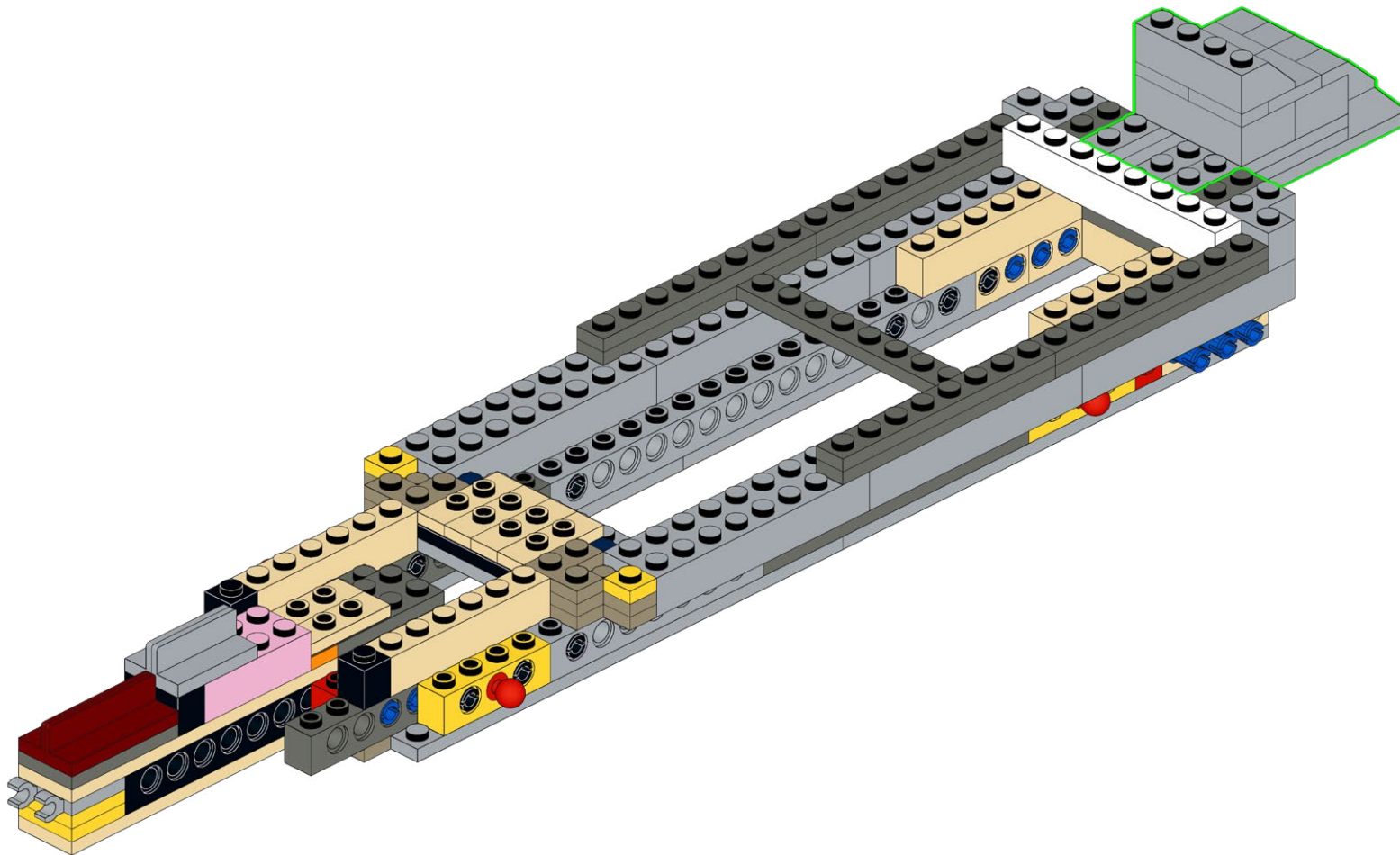

41

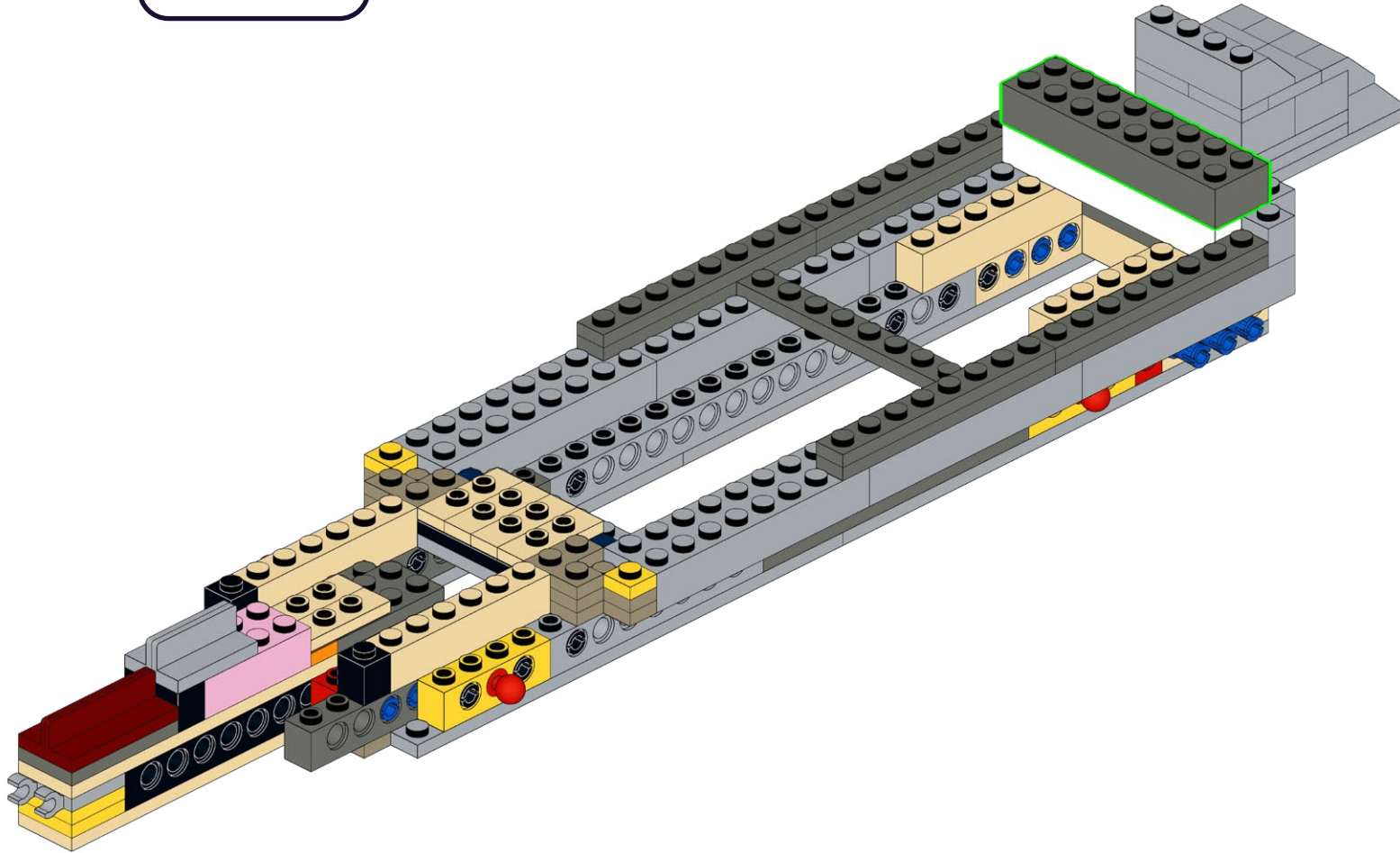
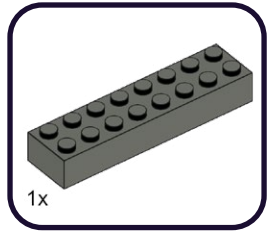

42

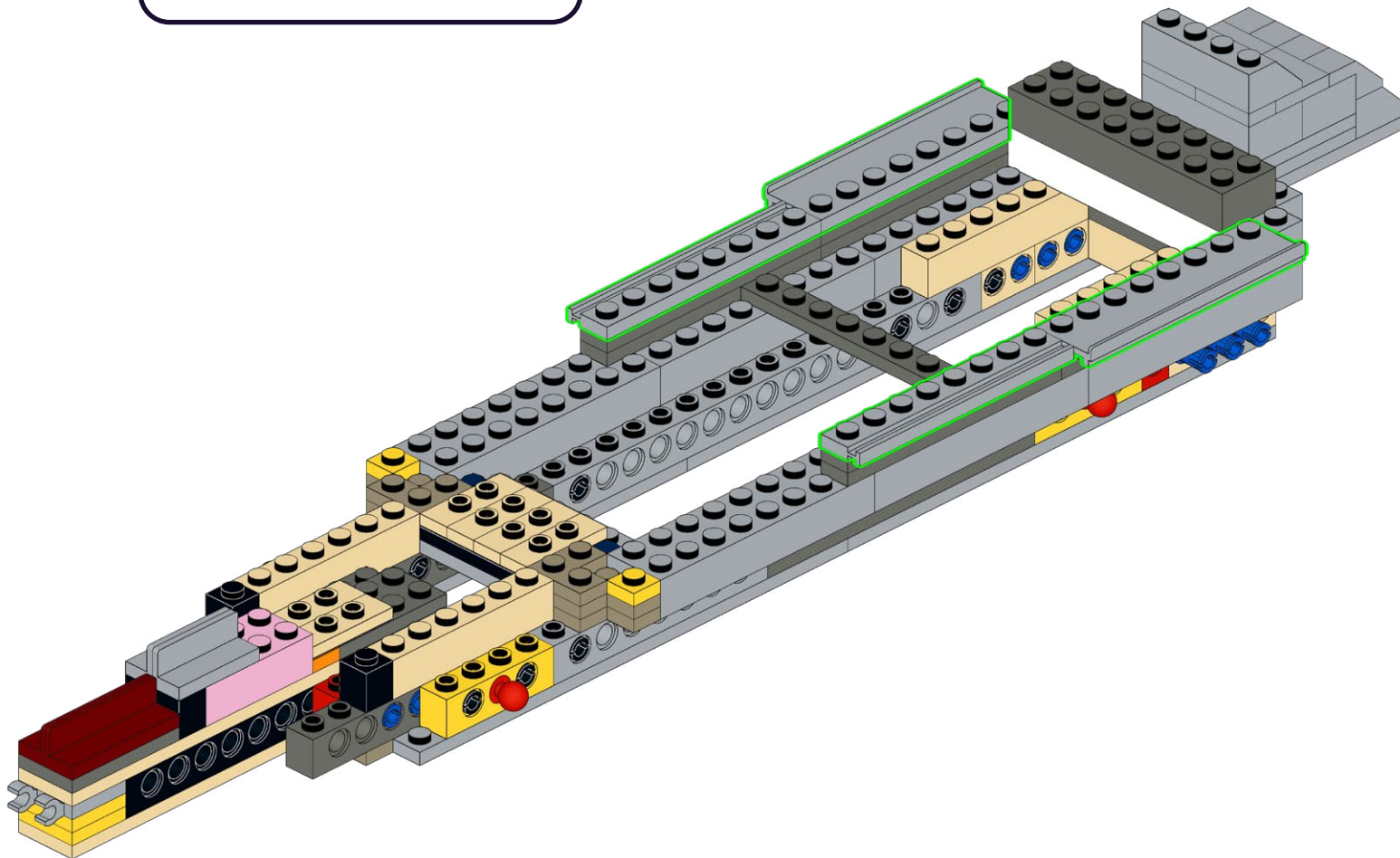
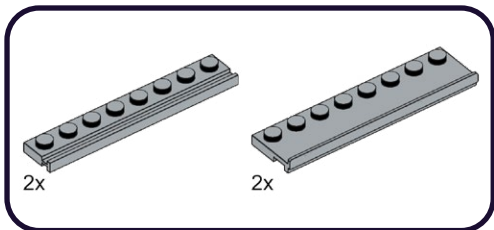

43

2x

2x

2x

2x

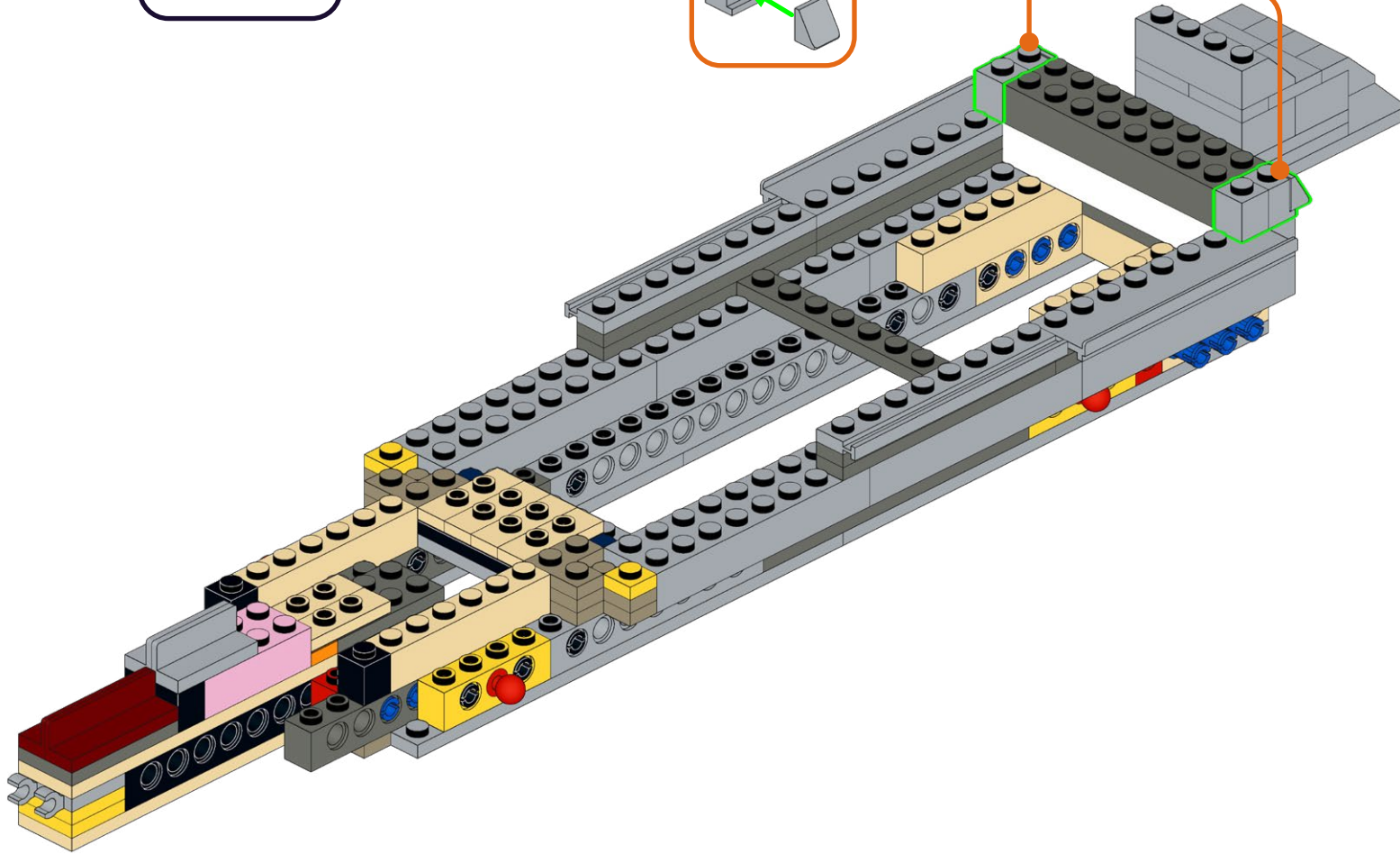

44

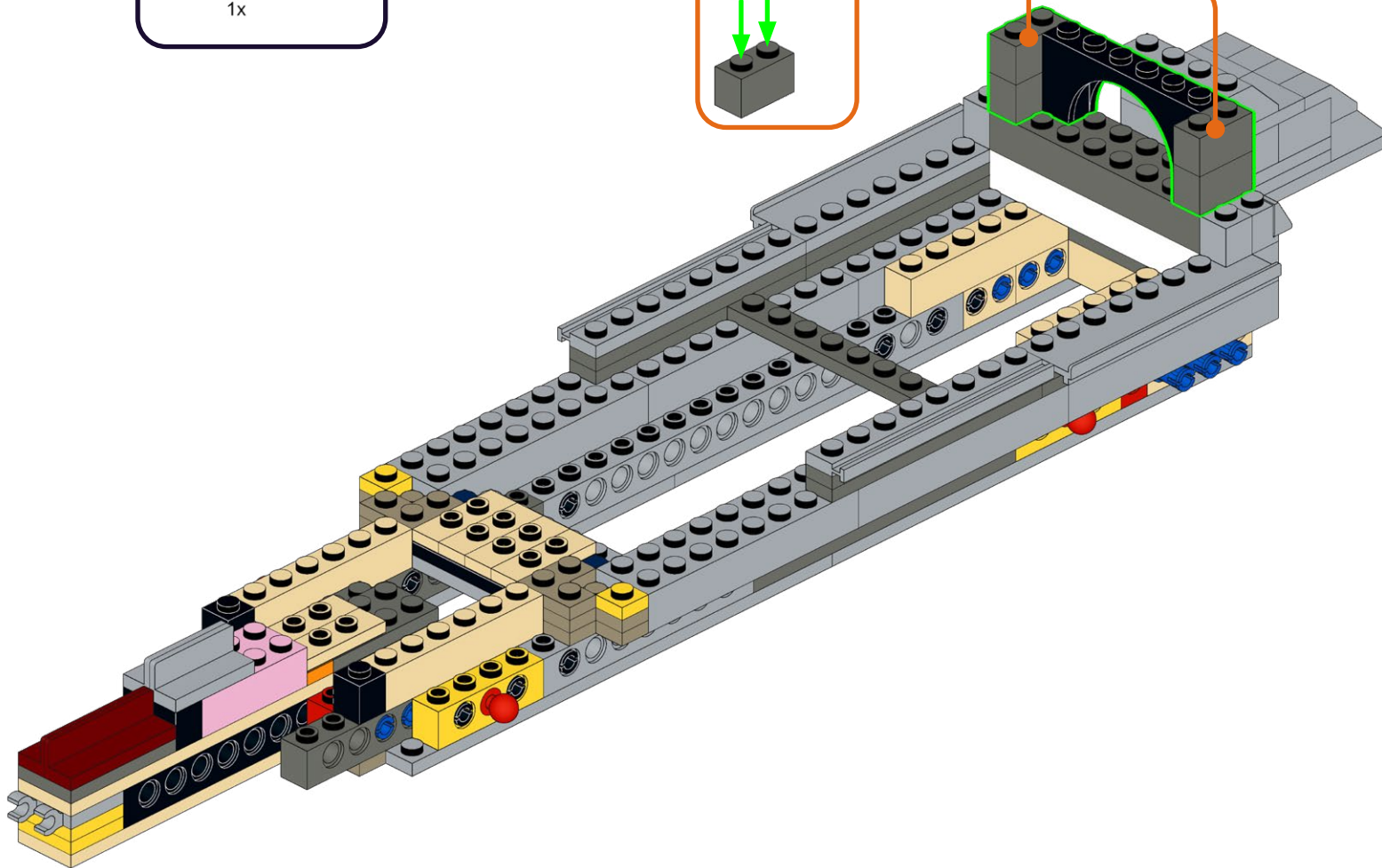
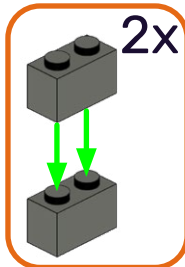
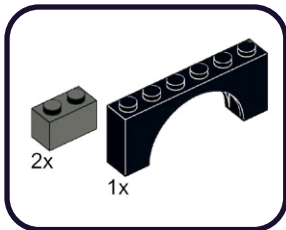

45

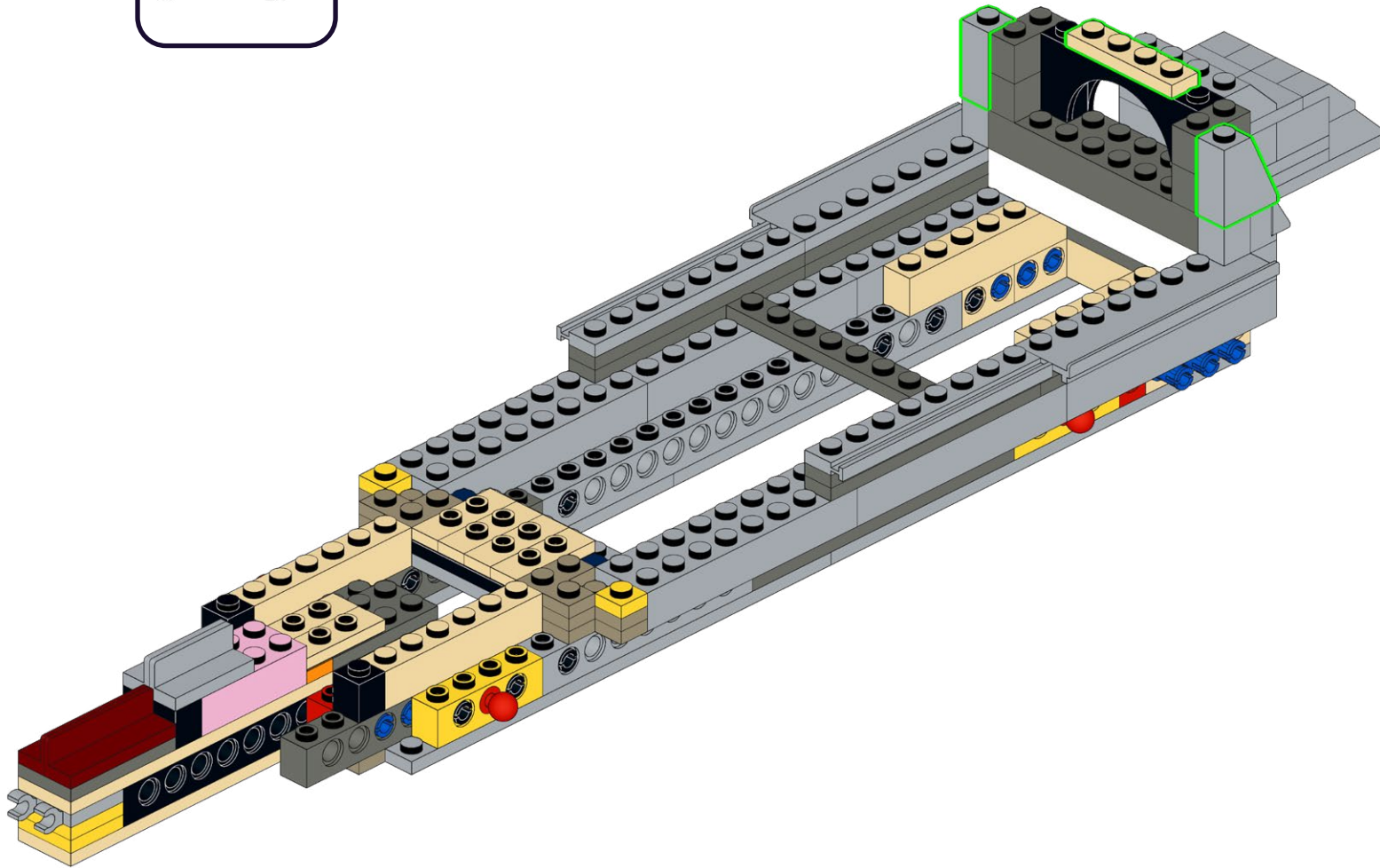
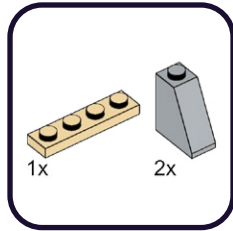

46

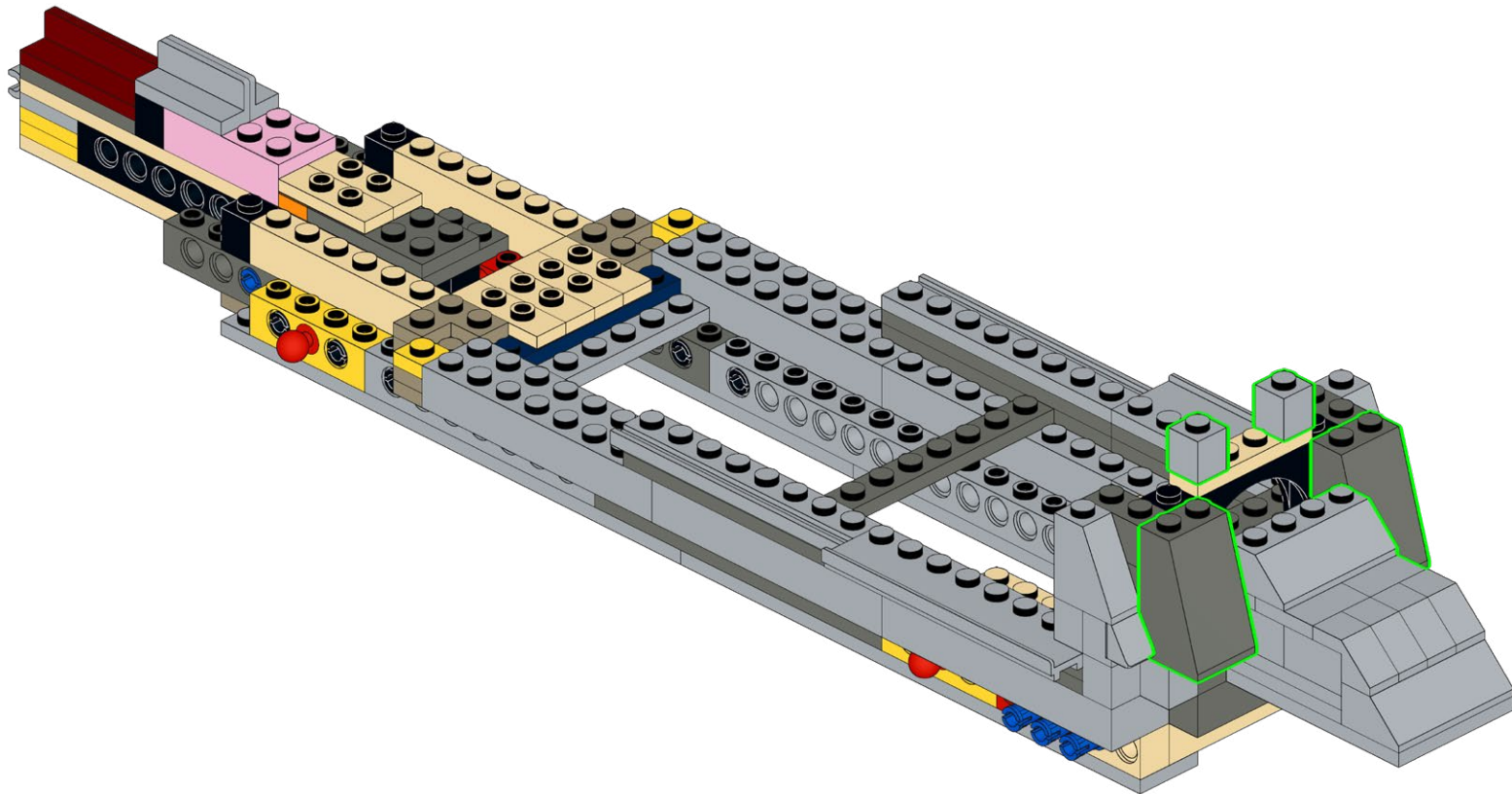
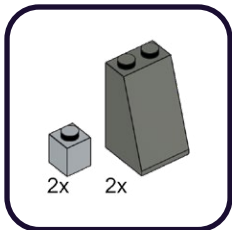

47



2x

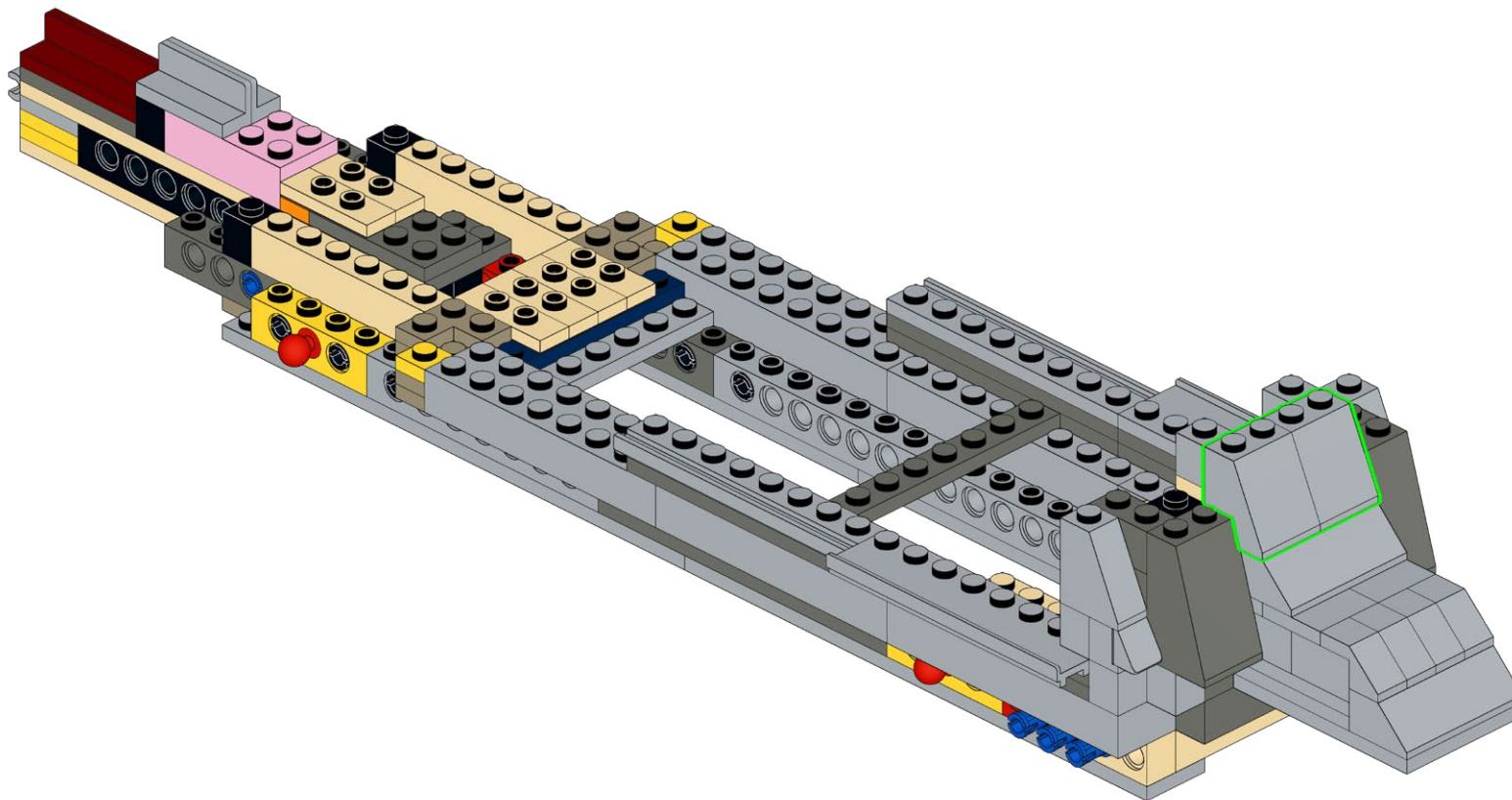

48

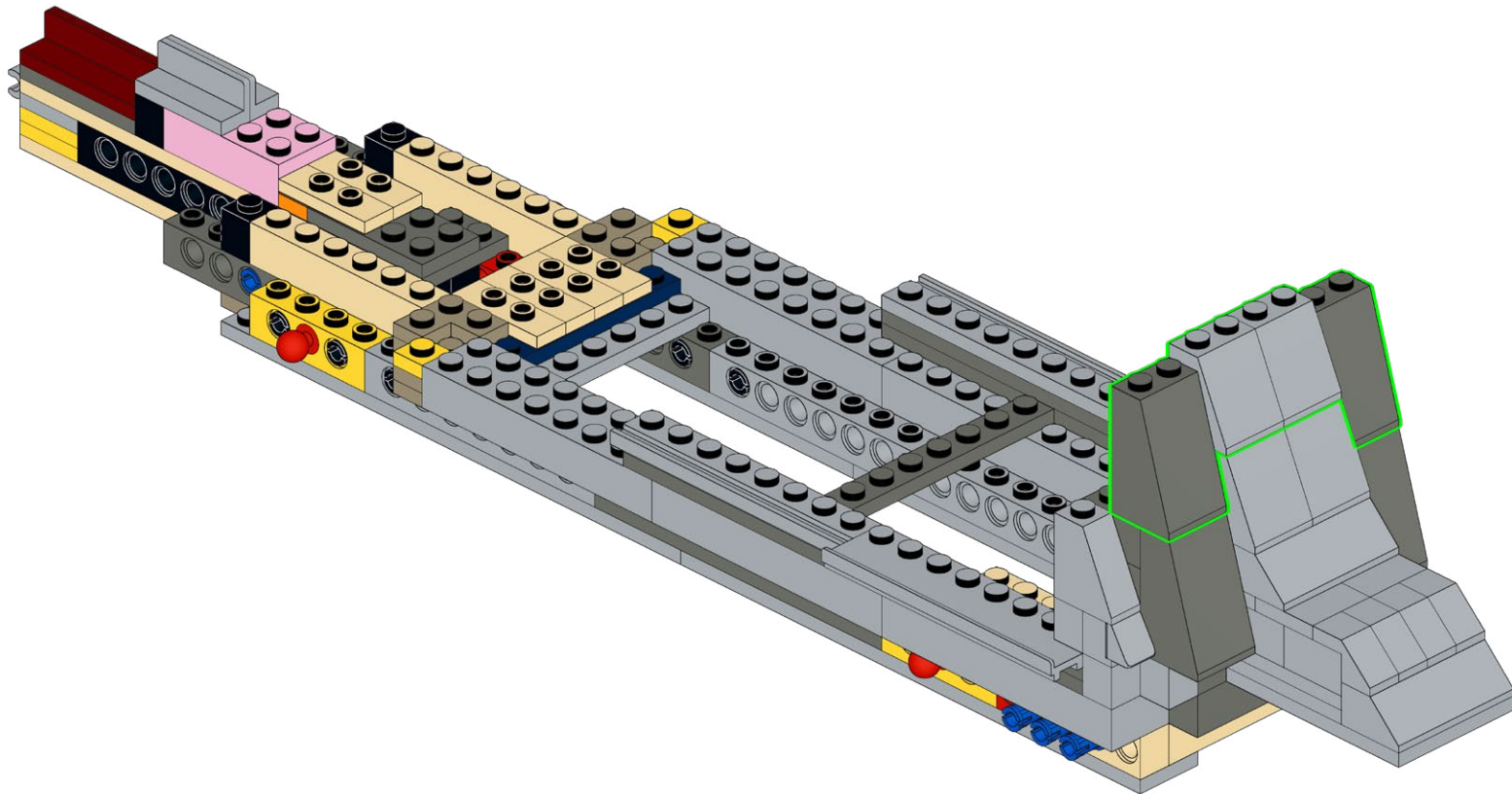
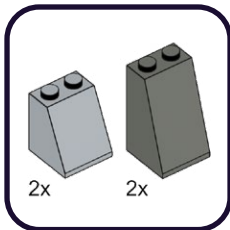

49

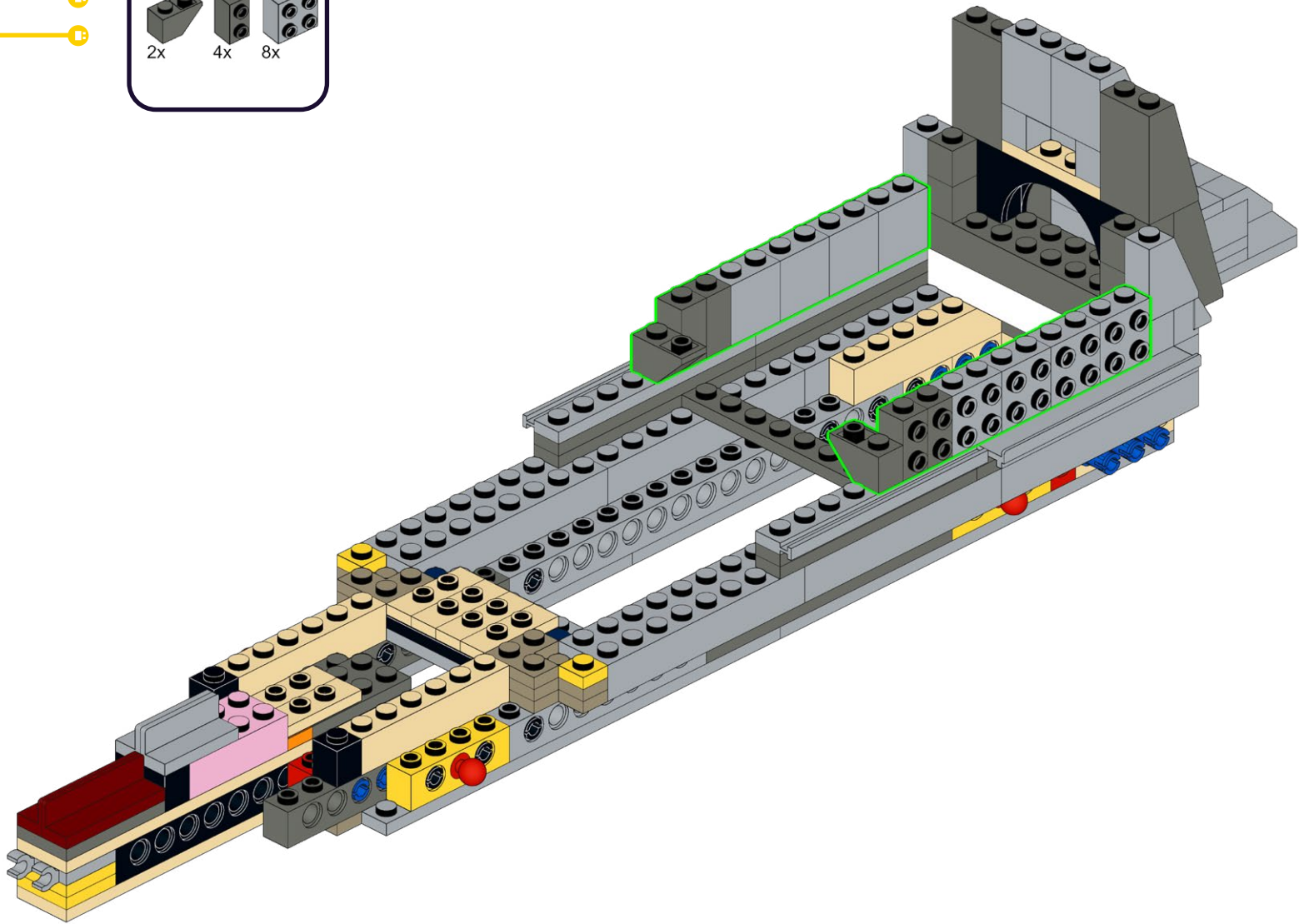
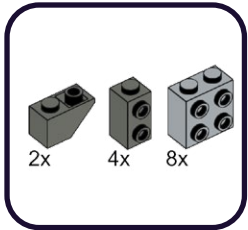

50

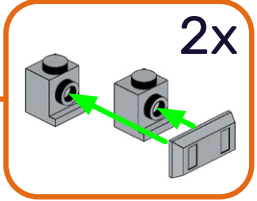
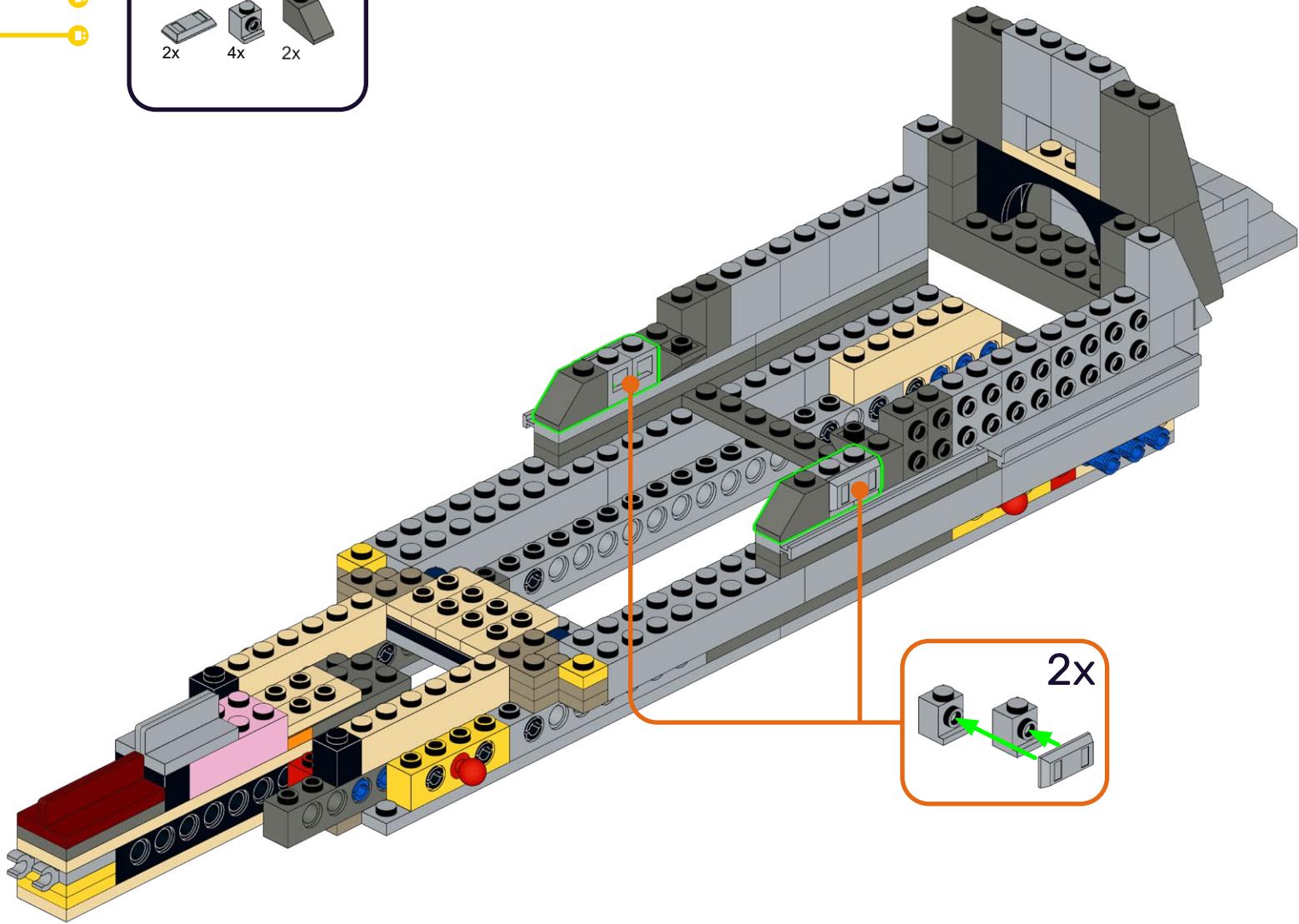
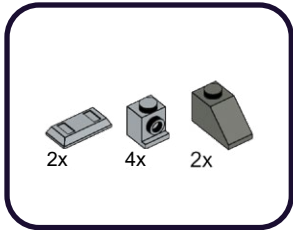

51

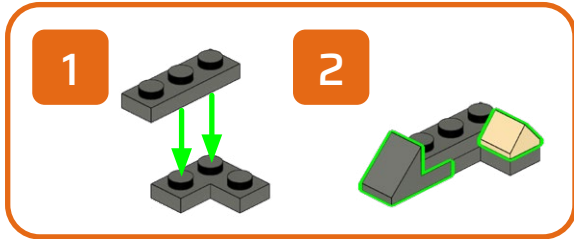
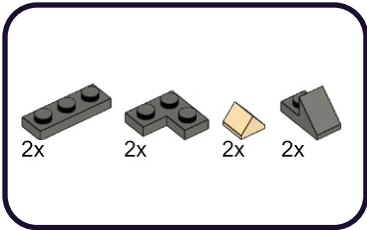

2

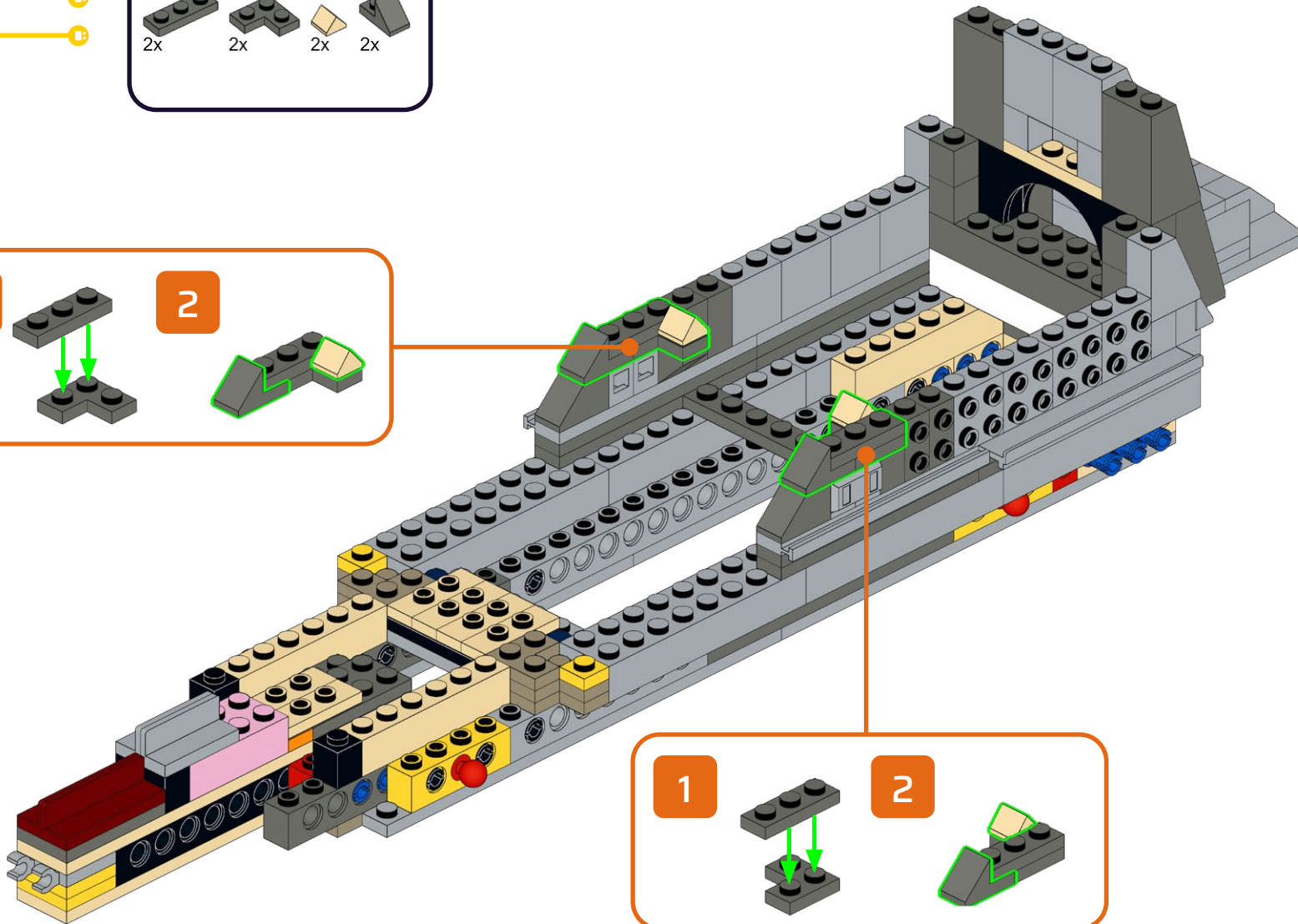
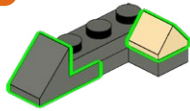

1

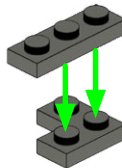

2

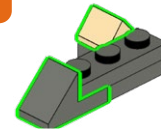

52

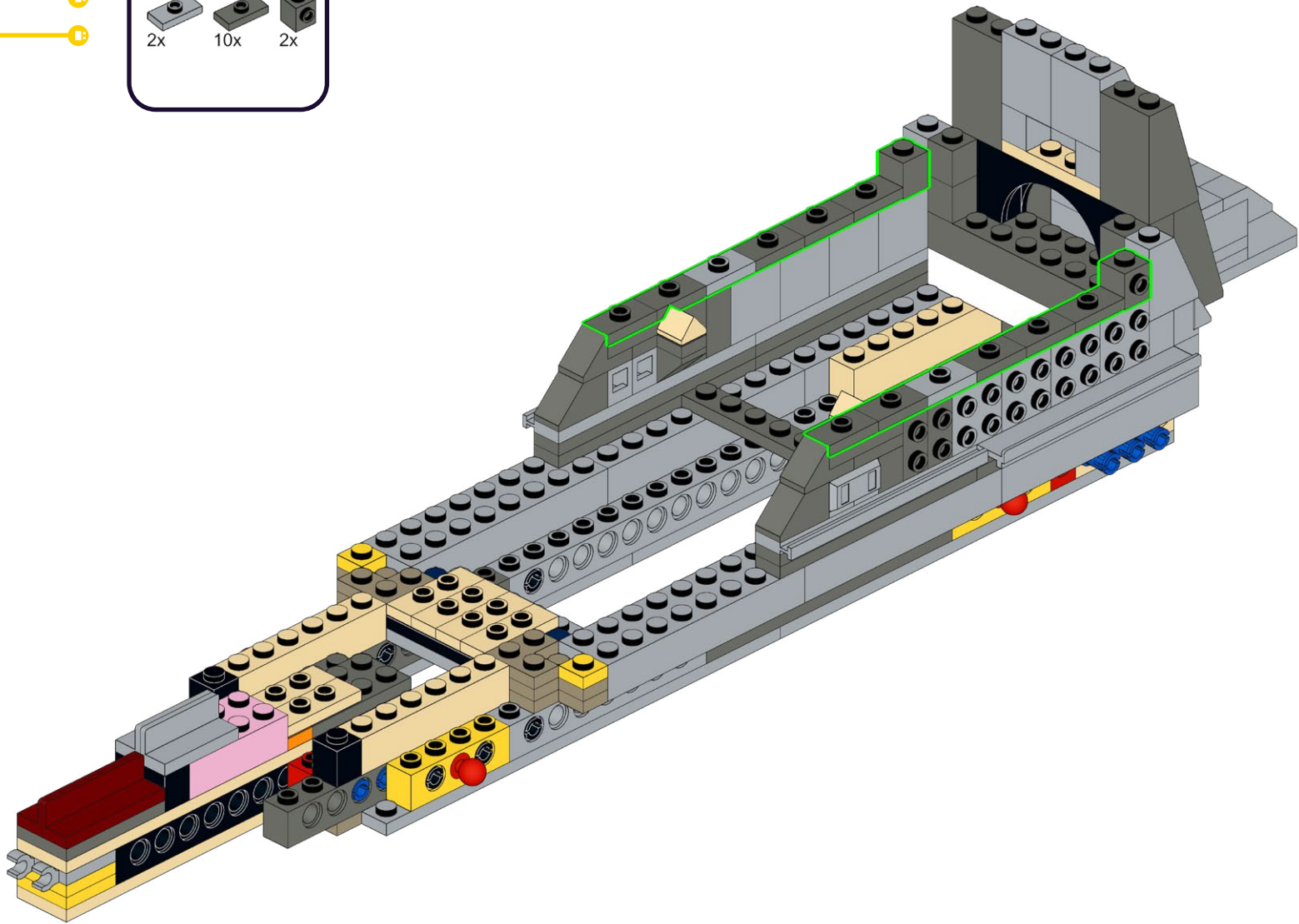
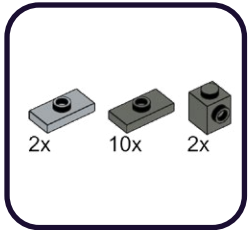

53

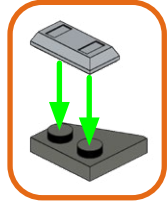
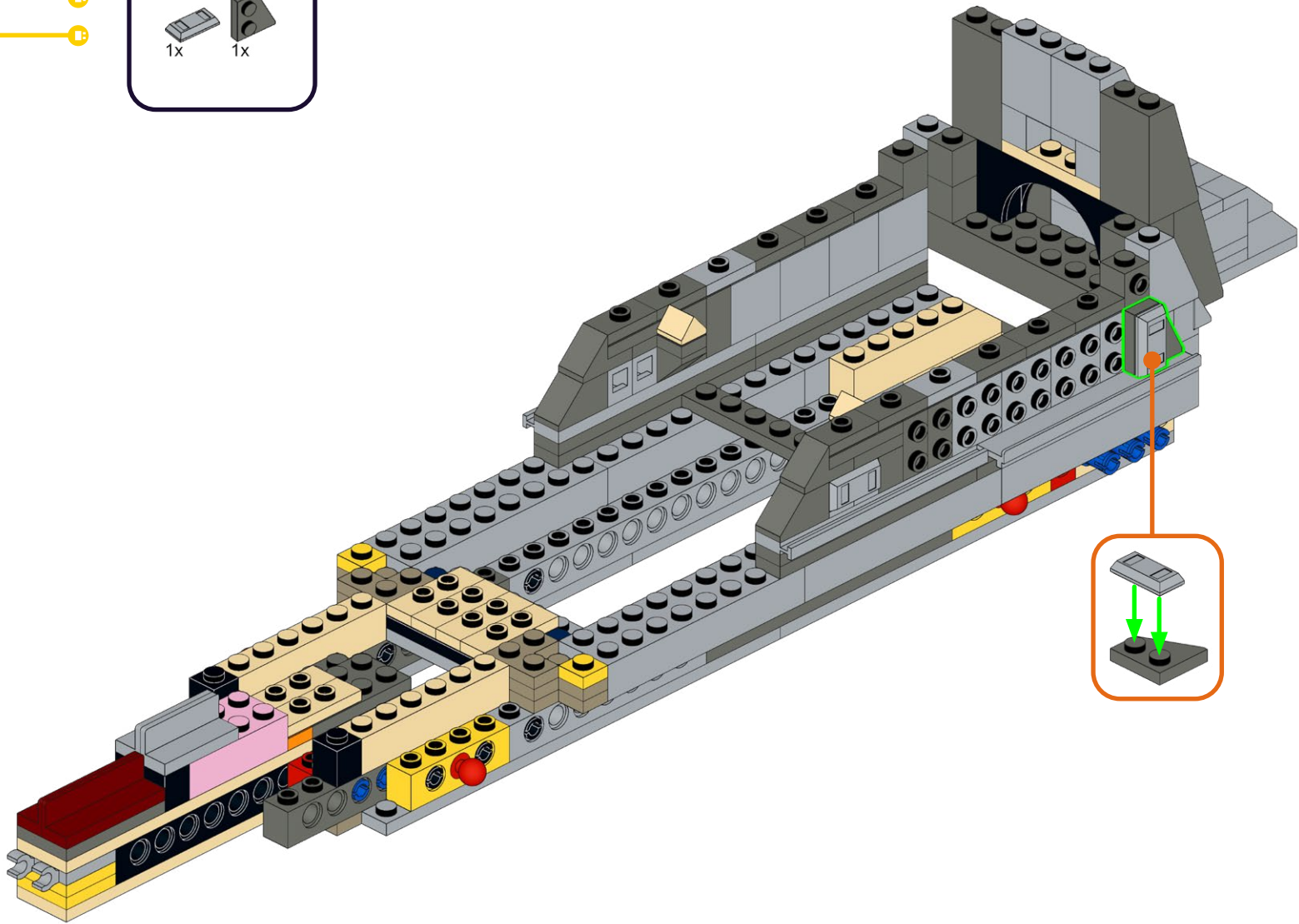
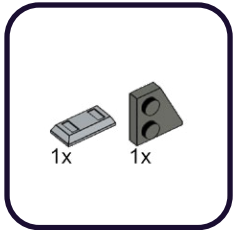

54

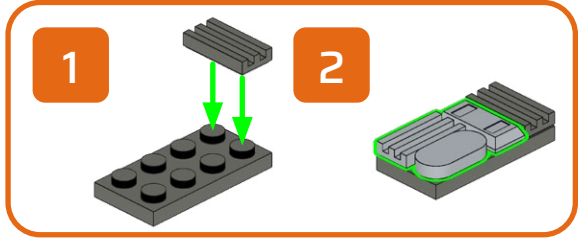
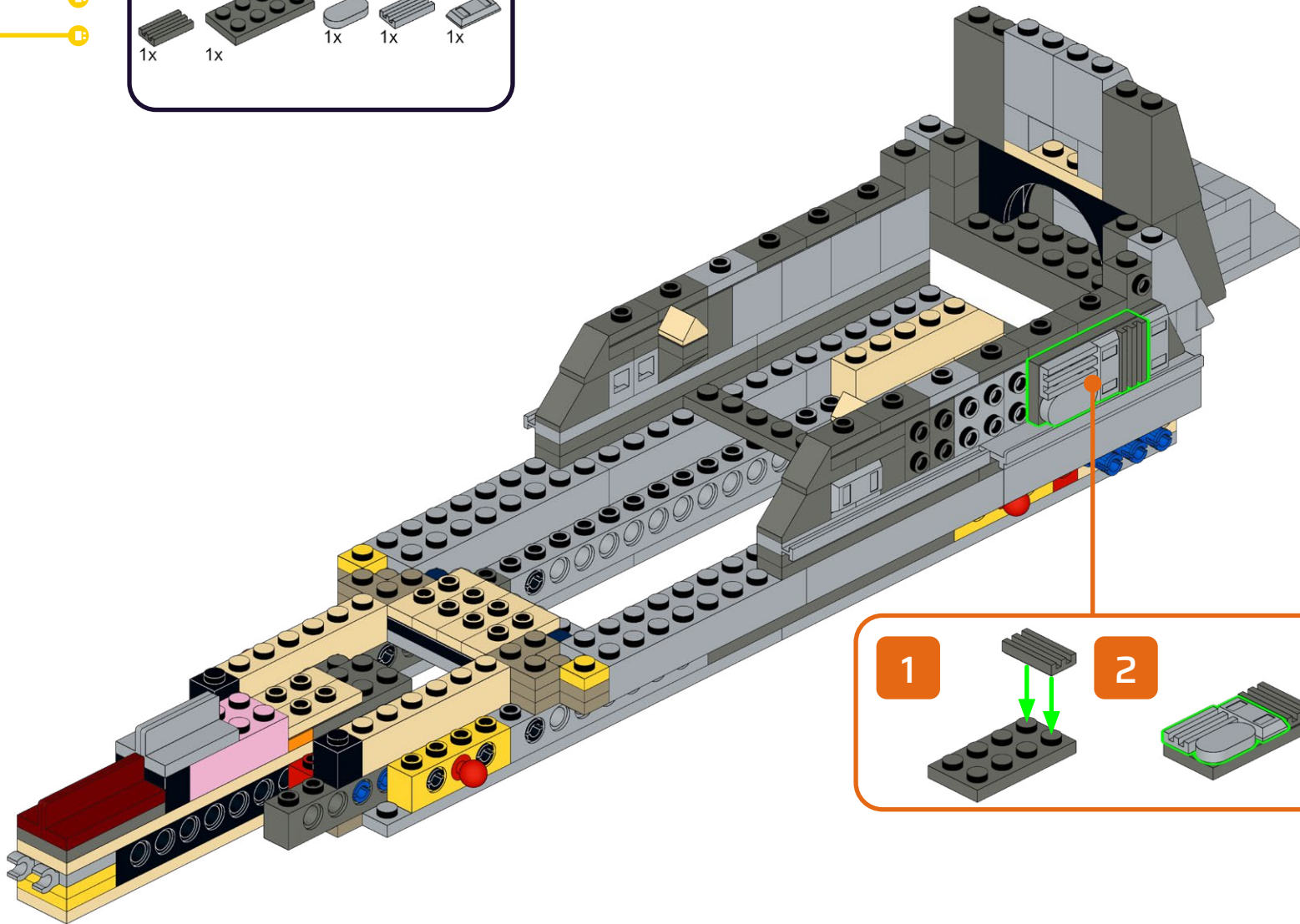
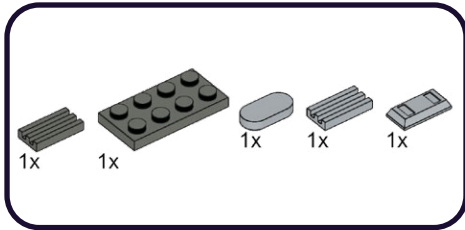

55

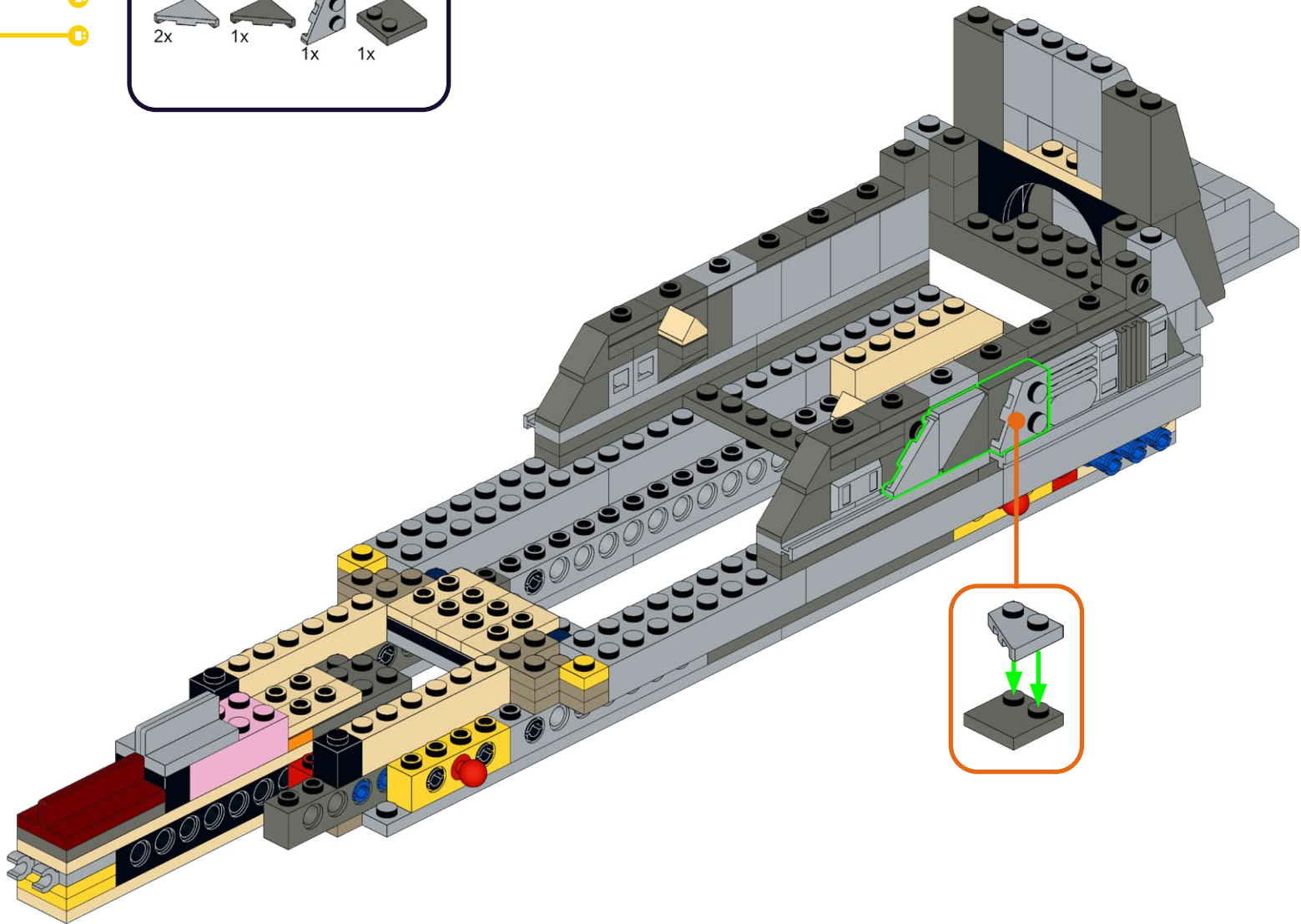
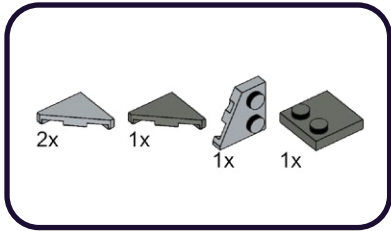

56

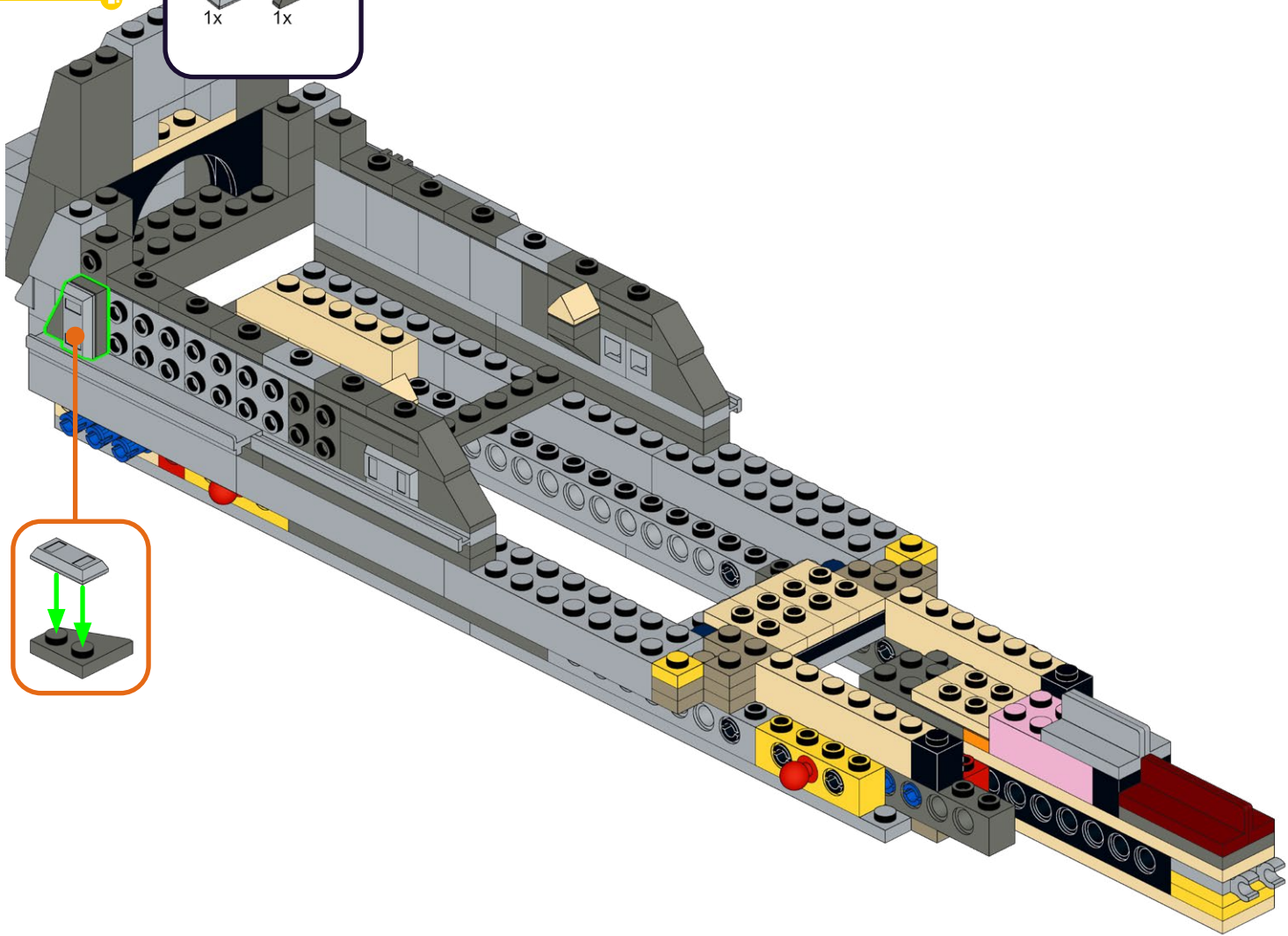
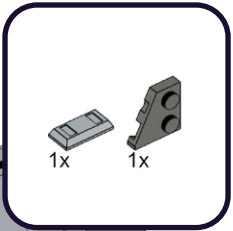

57

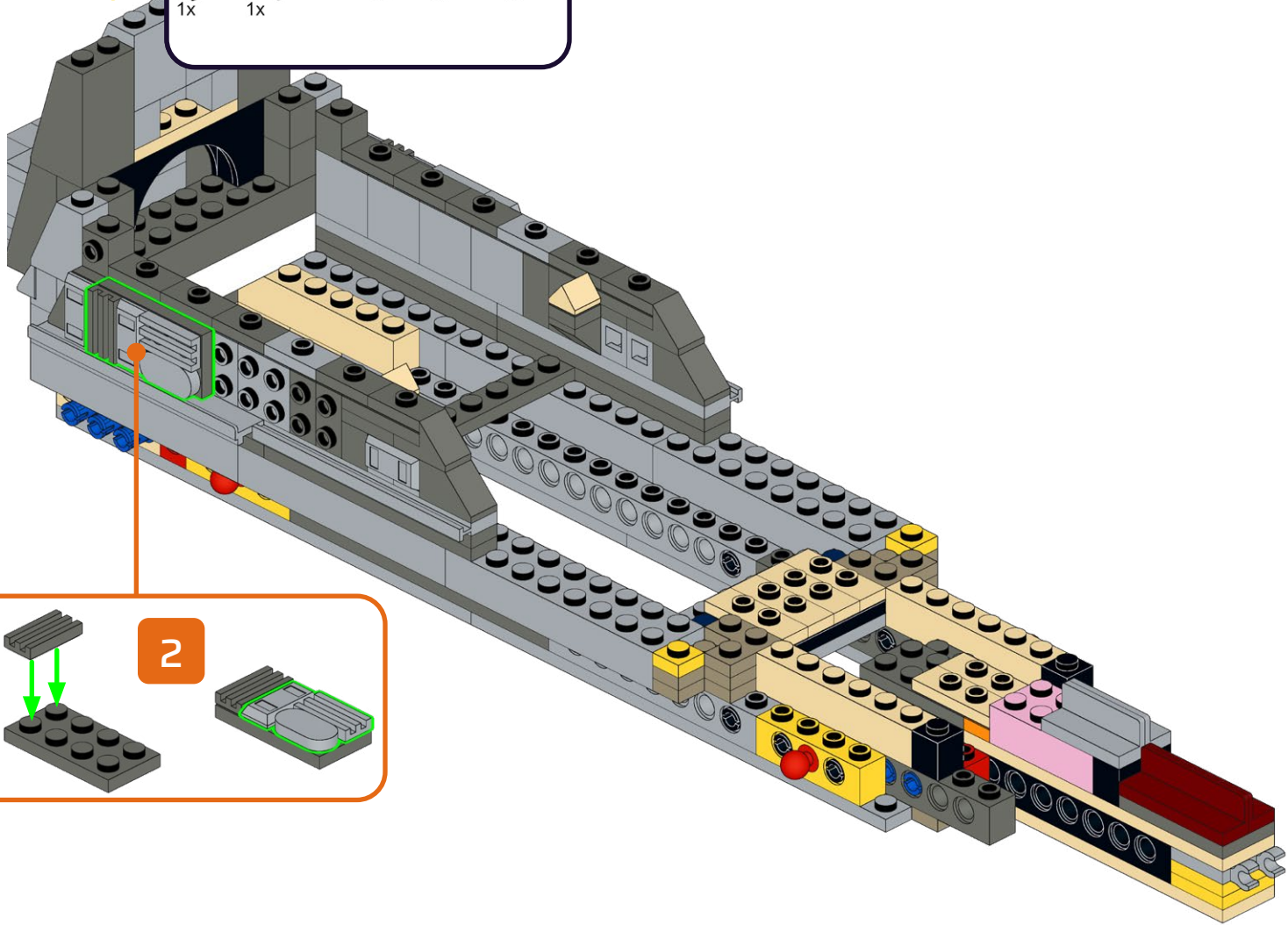
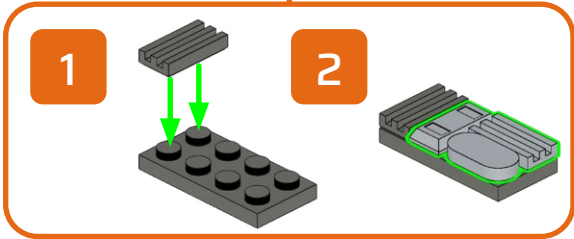
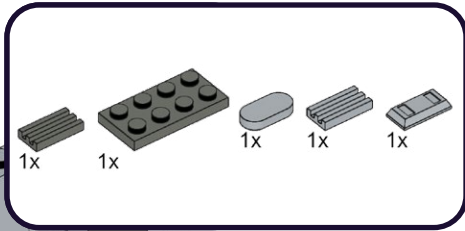

58

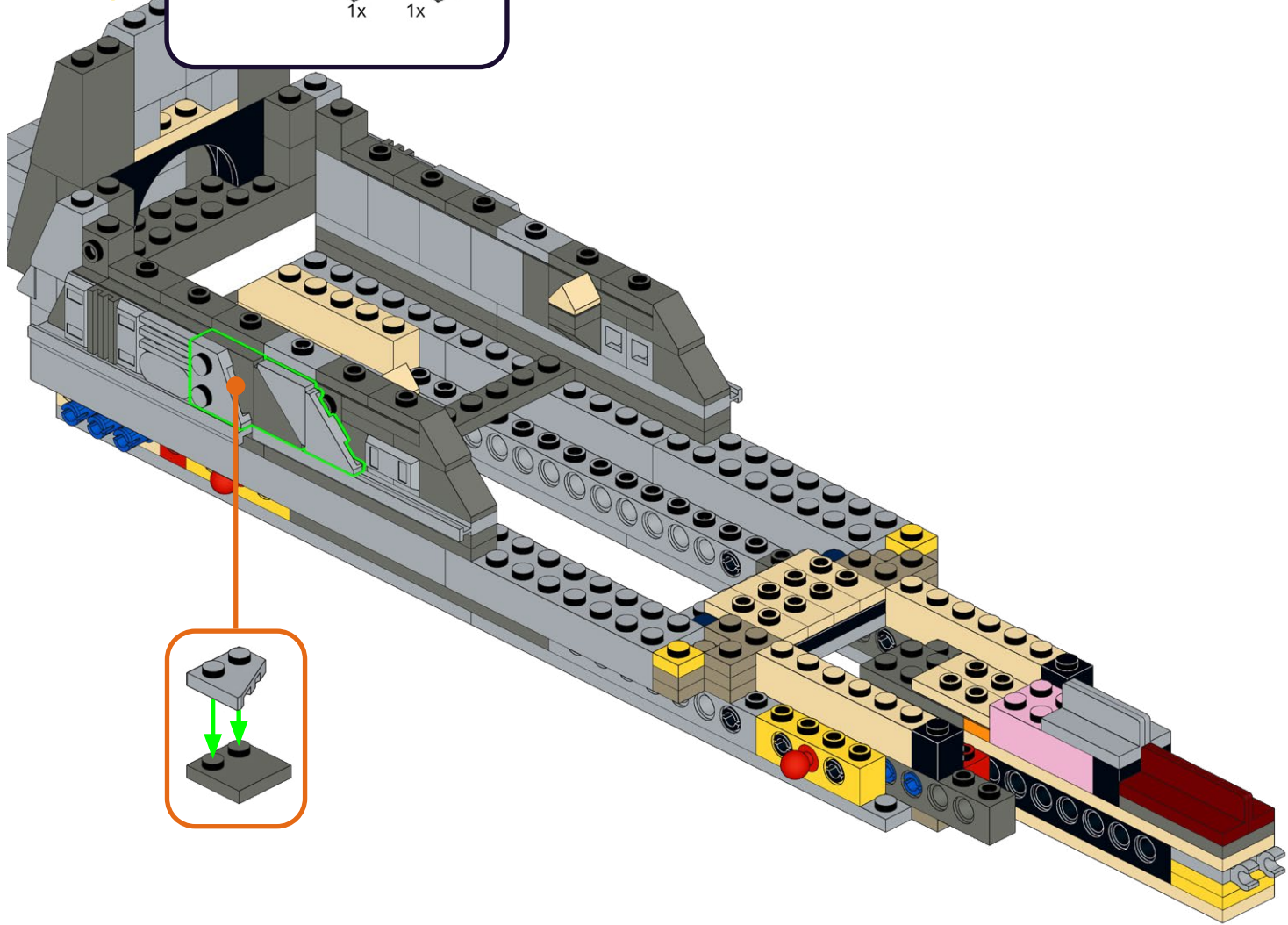
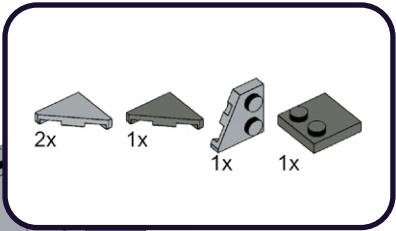

59

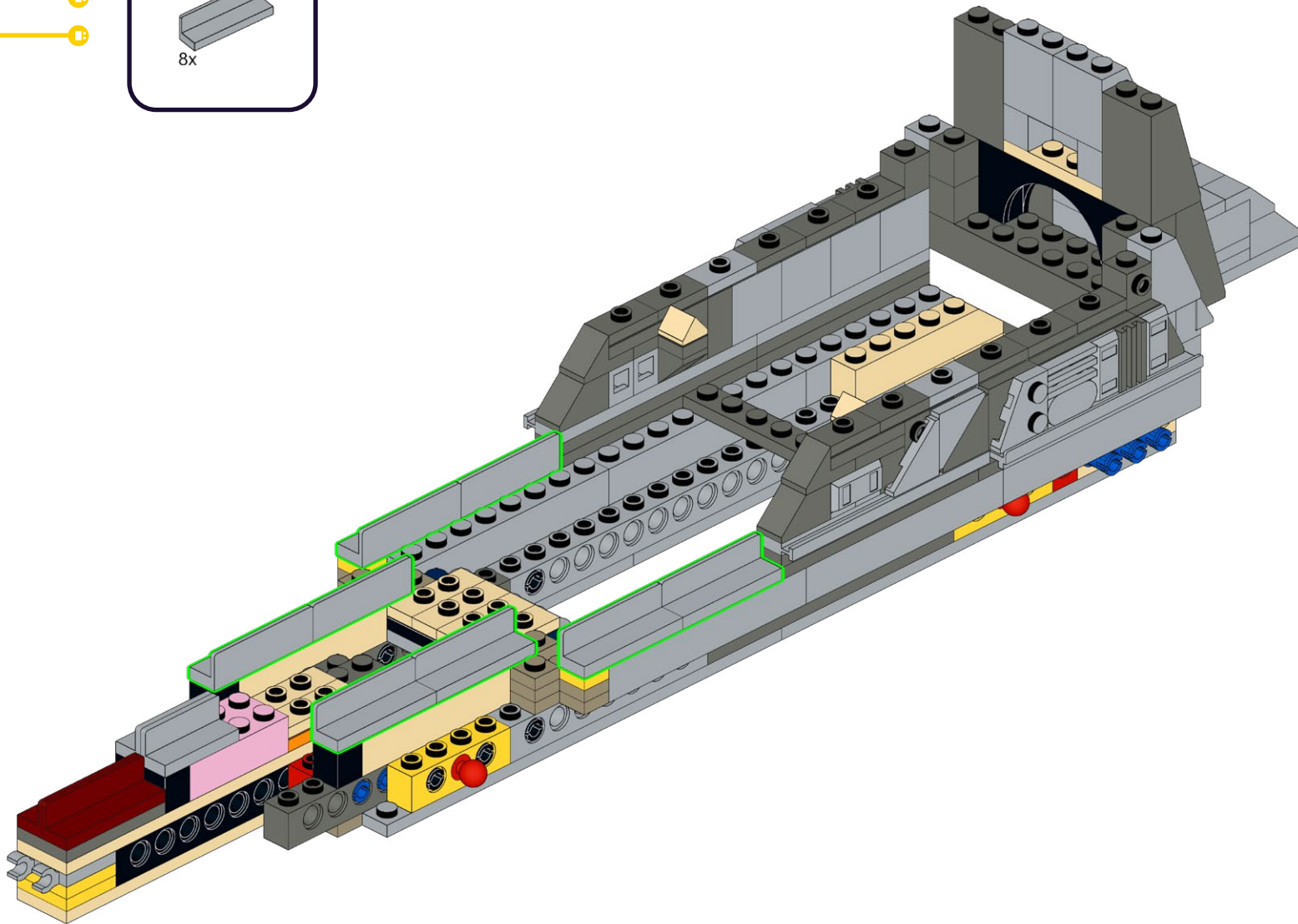
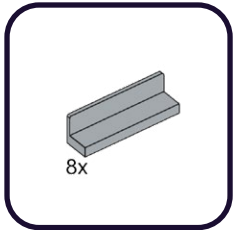

60

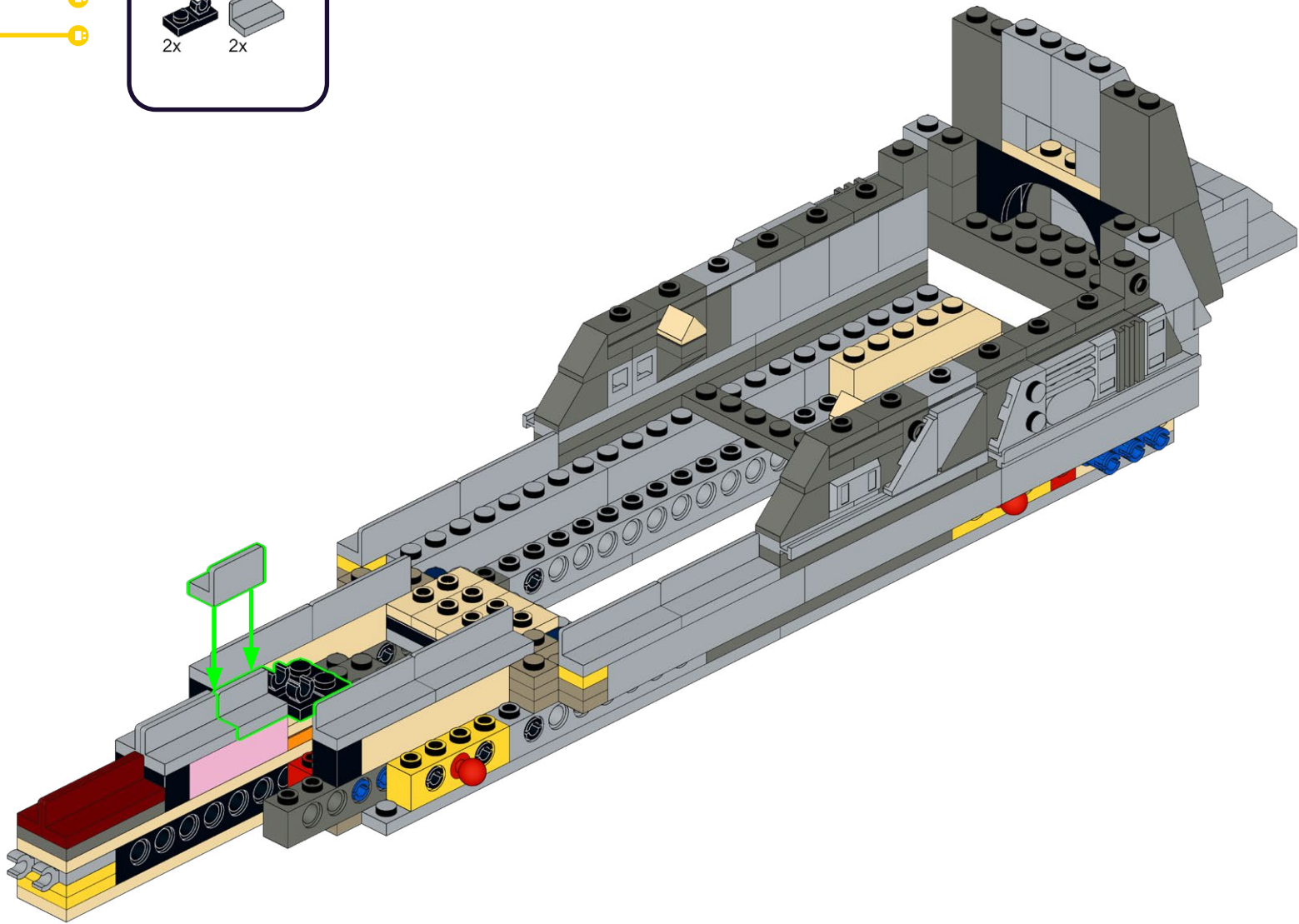
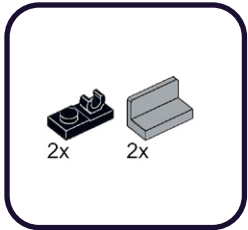

**HOLD UP!**

You might notice some bags aren't in order, as well as left over pieces, but that's ok! We're changing the way you build LEGO!

ATTENDEZ!

Vous remarquerez peut-être que certains sacs, ainsi que certaines pièces, ne sont pas dans le bon ordre. Mais pas de panique! Nous changeons simplement la façon avec laquelle vous construisez vos LEGO!

ASPETTA!

Potresti notare che alcuni sacchetti non sono in ordine, così come i pezzi avanzati, ma va bene così! Stiamo cambiando il modo in cui costruisci i LEGO!

HALT!

Sie werden möglicherweise bemerken, dass einige tüten durcheinander sind und teile übrig bleiben, aber das ist in Ordnung! Wir ändern die art und weise, wie Sie LEGO bauen!

¡ESPERA!

Es posible que notes que algunas bolsas están fuera de servicio, así como piezas sobrantes, ¡pero está bien! ¡Estamos cambiando la forma en que construyes LEGO!

暫停!

你可能会注意到一些袋子顺序错乱, 以及一些剩余的部件, 但没关系! 我们正在改变你搭建乐高的方式!

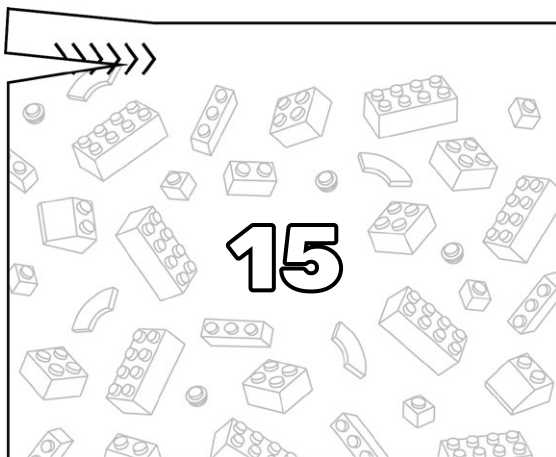
Open LEGO® Bag 15

61

2x

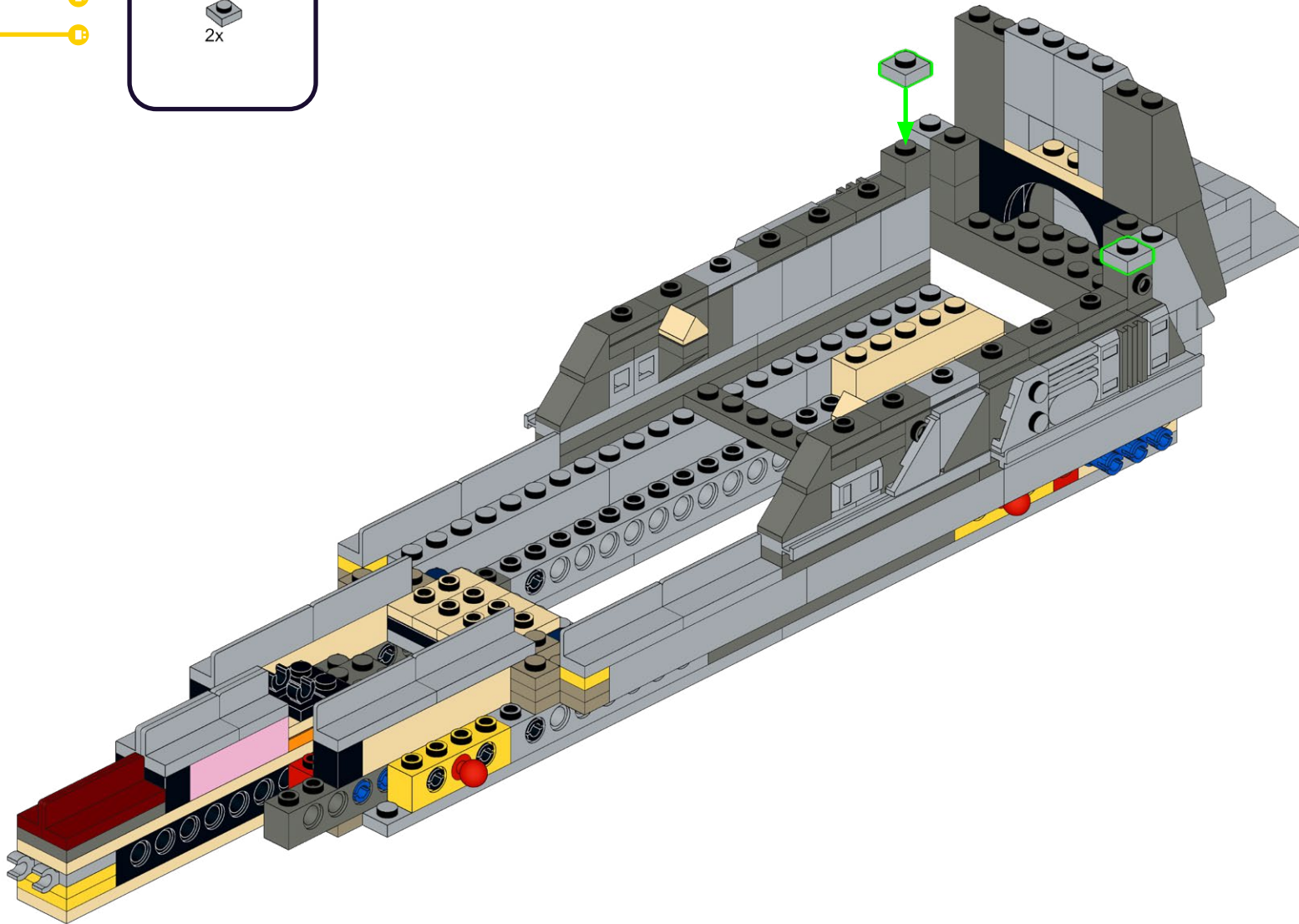

62

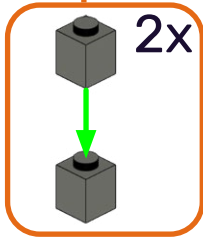
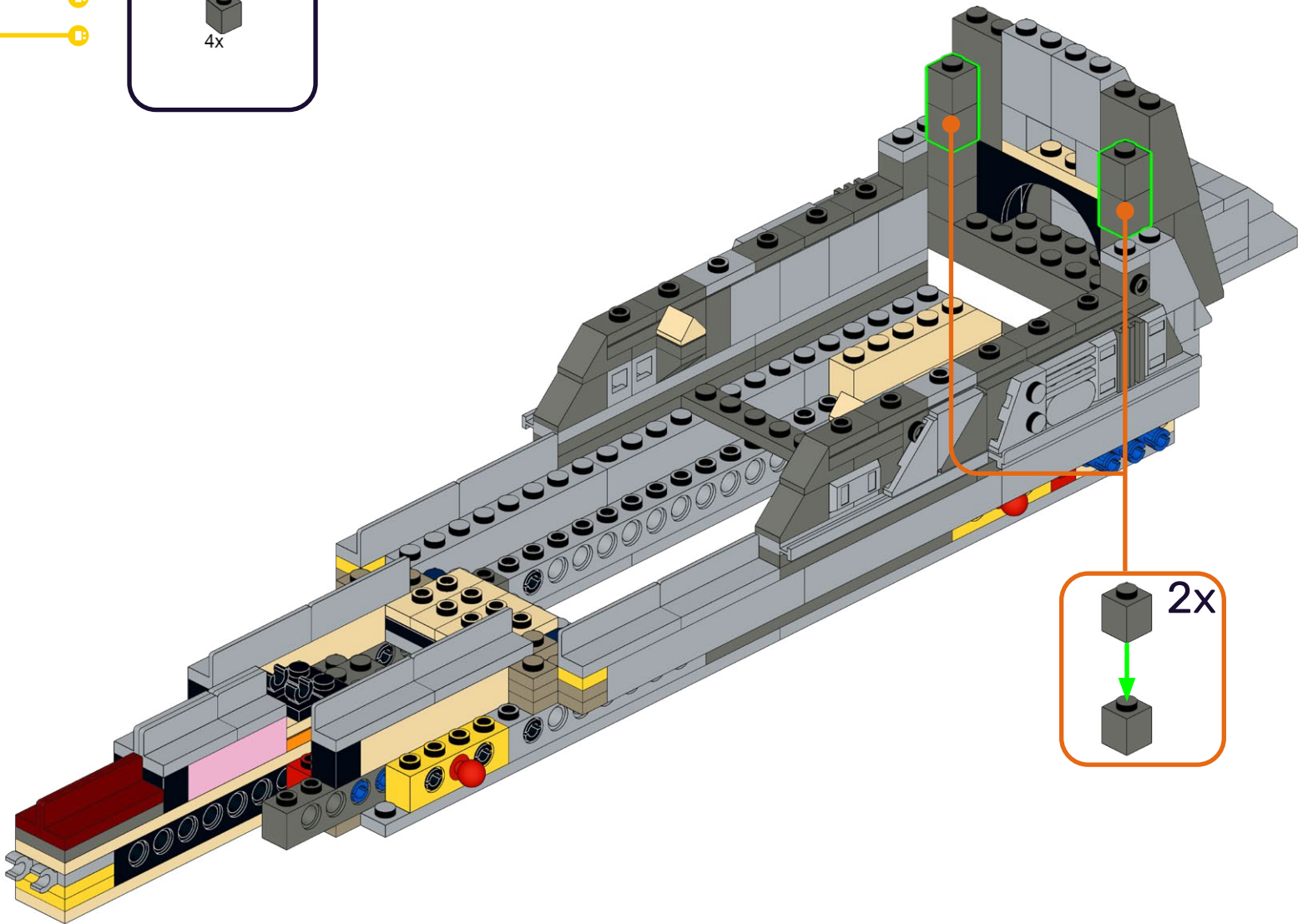
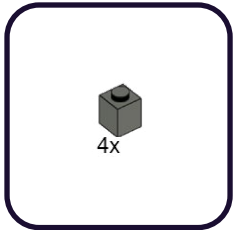

63

2x

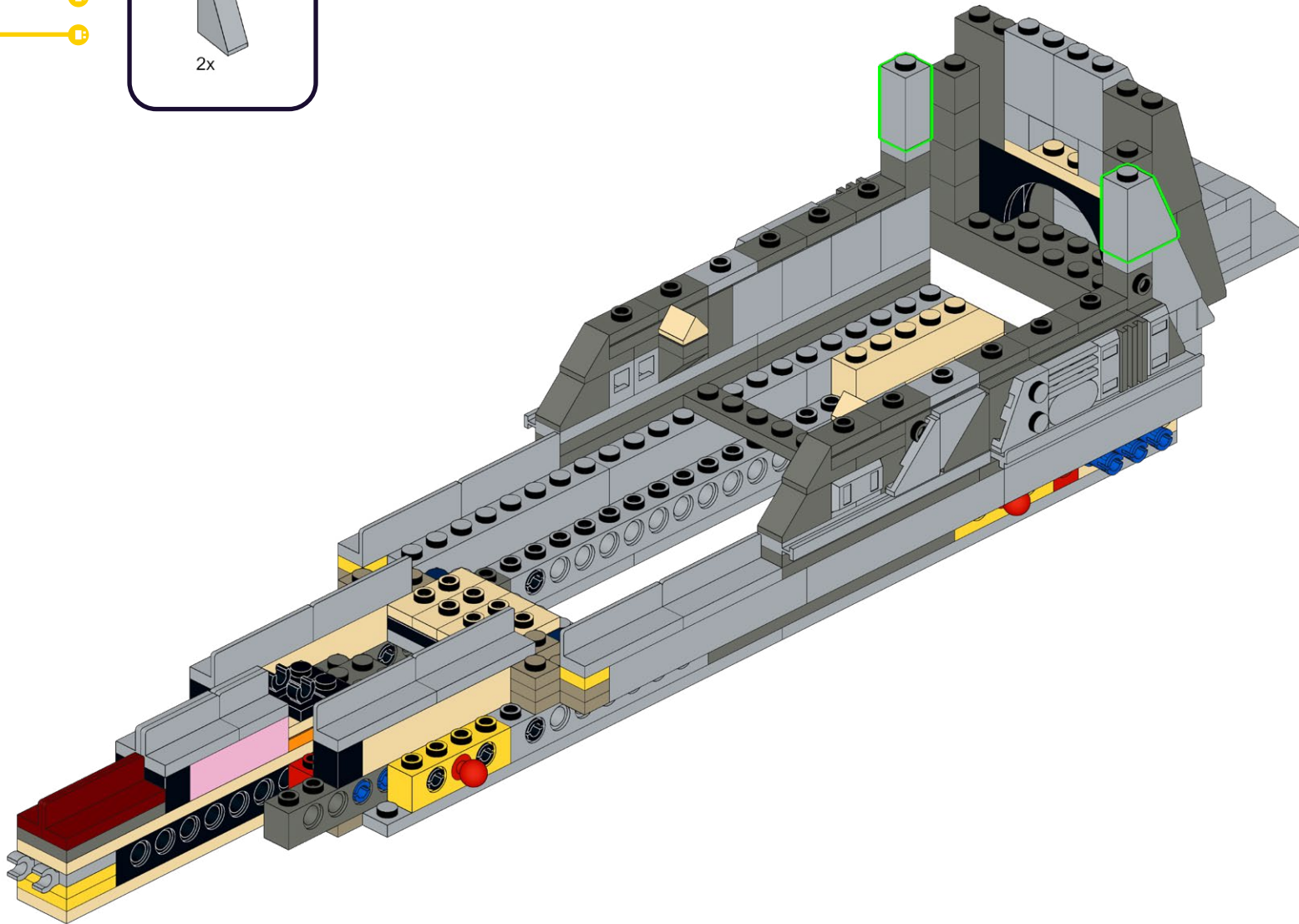

**HOLD UP!**

You might notice some bags aren't in order, as well as left over pieces, but that's ok! We're changing the way you build LEGO!

HALTEN!

Möglicherweise stellen Sie fest, dass einige Beutel nicht in Ordnung sind und auch Teile übrig bleiben, aber das ist in Ordnung! Wir verändern die Art und Weise, wie Sie LEGO bauen!

TENIR BON!

Vous remarquerez peut-être que certains sacs sont en panne, ainsi que des morceaux restants, mais ce n'est pas grave ! Nous changeons la façon dont vous construisez LEGO !

SOSTENERE!

Potresti notare che alcune borse sono fuori uso, così come alcuni pezzi avanzati, ma va bene! Stiamo cambiando il modo in cui costruisci i LEGO!

¡SOSTENER!

Puede que notes que algunas bolsas están fuera de orden, así como piezas sobrantes, ¡pero está bien! ¡Estamos cambiando la forma de construir LEGO!

耽误!

您可能会注意到有些袋子坏了, 还有剩余的碎片, 但这没关系! 我们正在改变您搭建乐高的方式!

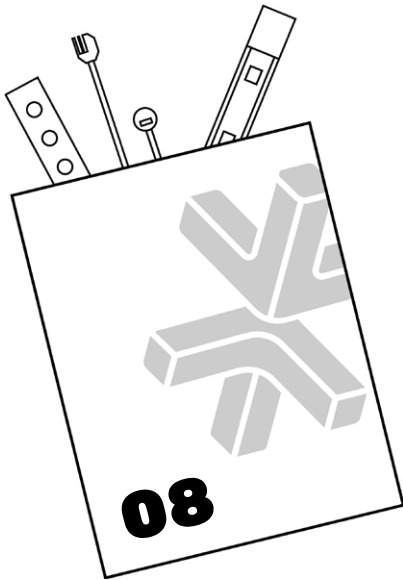
Open LMB Bag 08

64

AR-CW30

1x

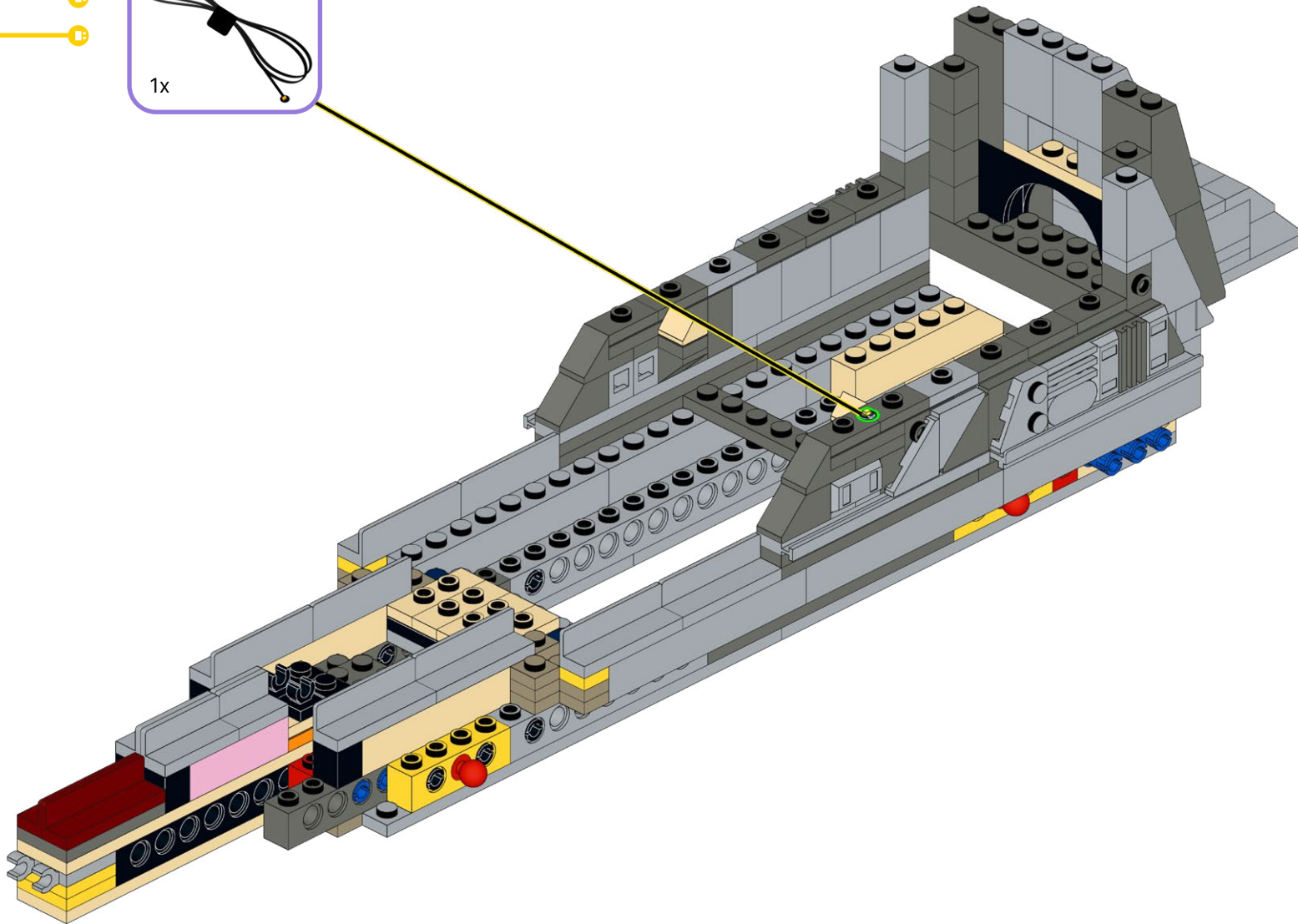

65

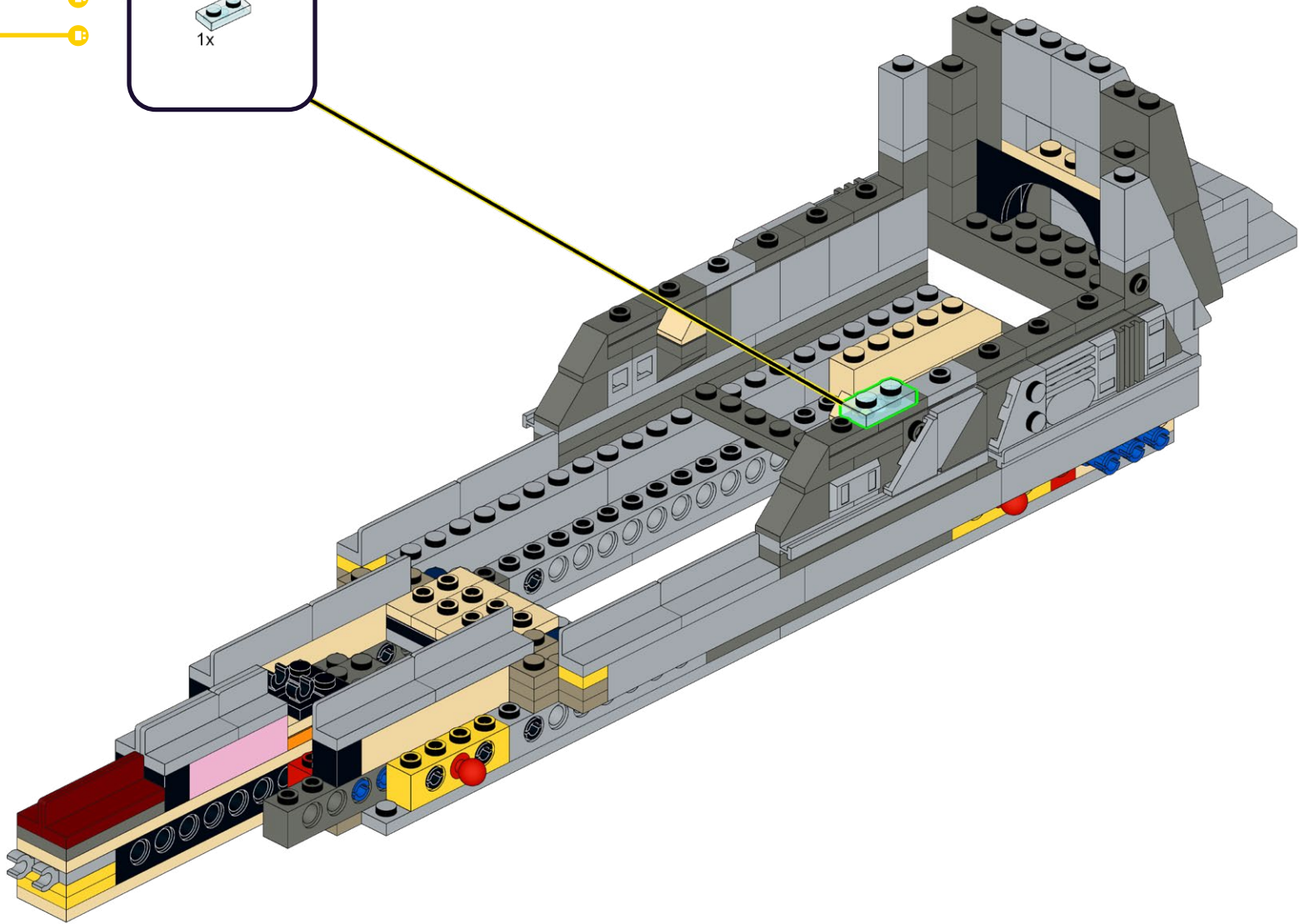
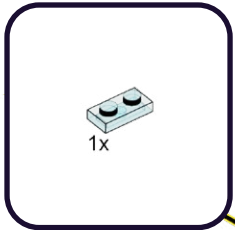

66

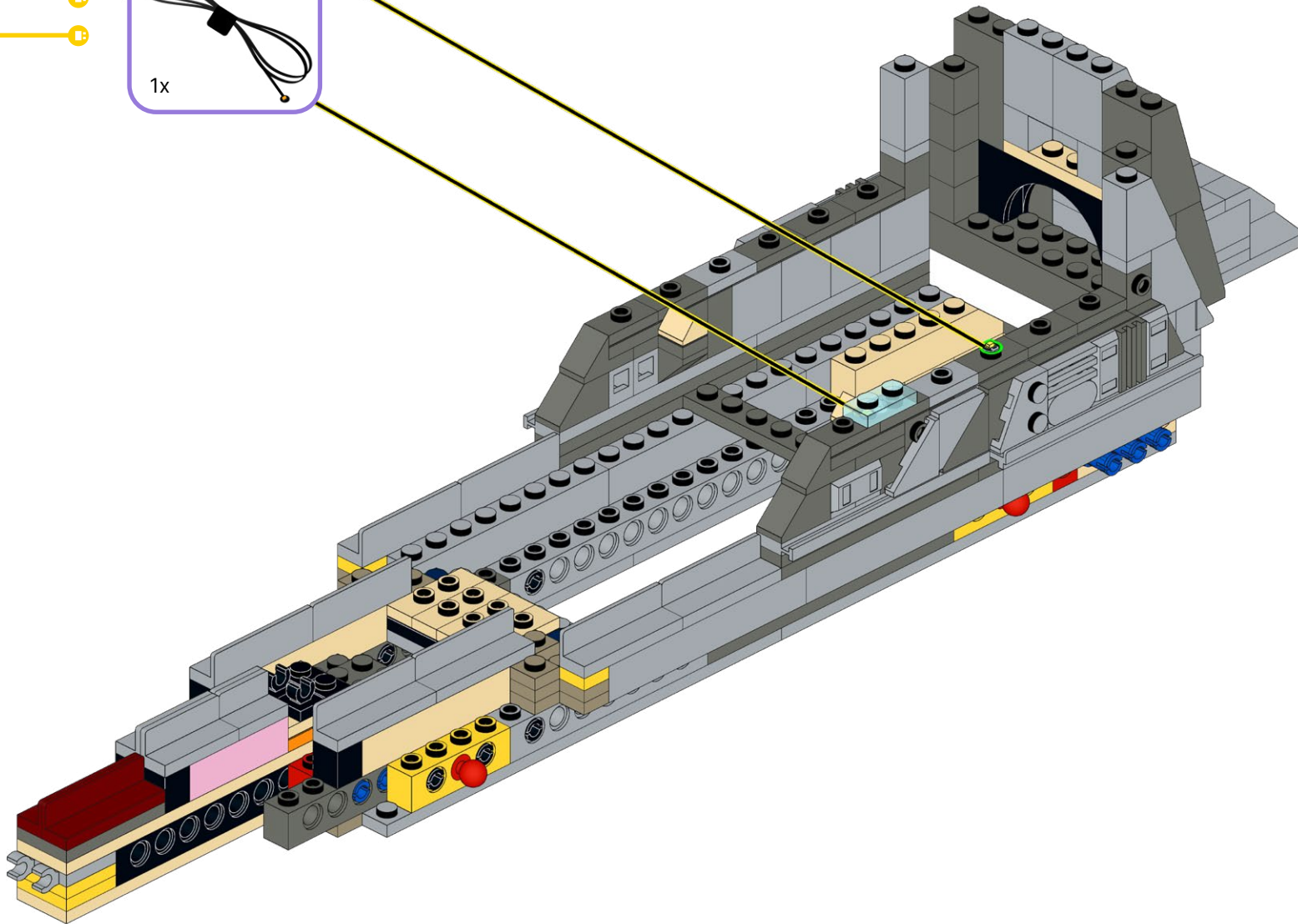
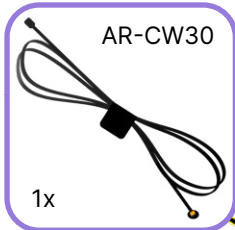

67

1x

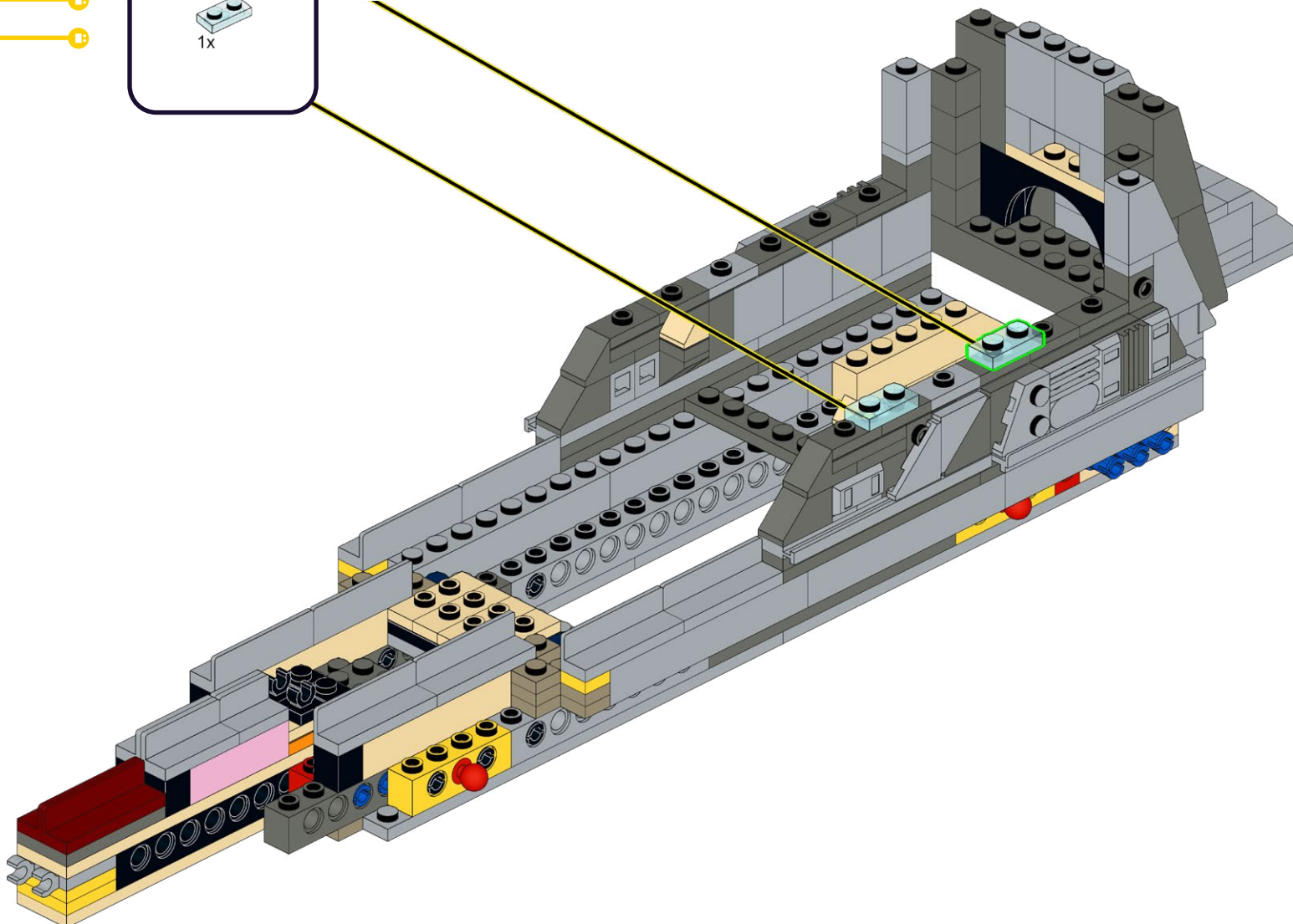

68

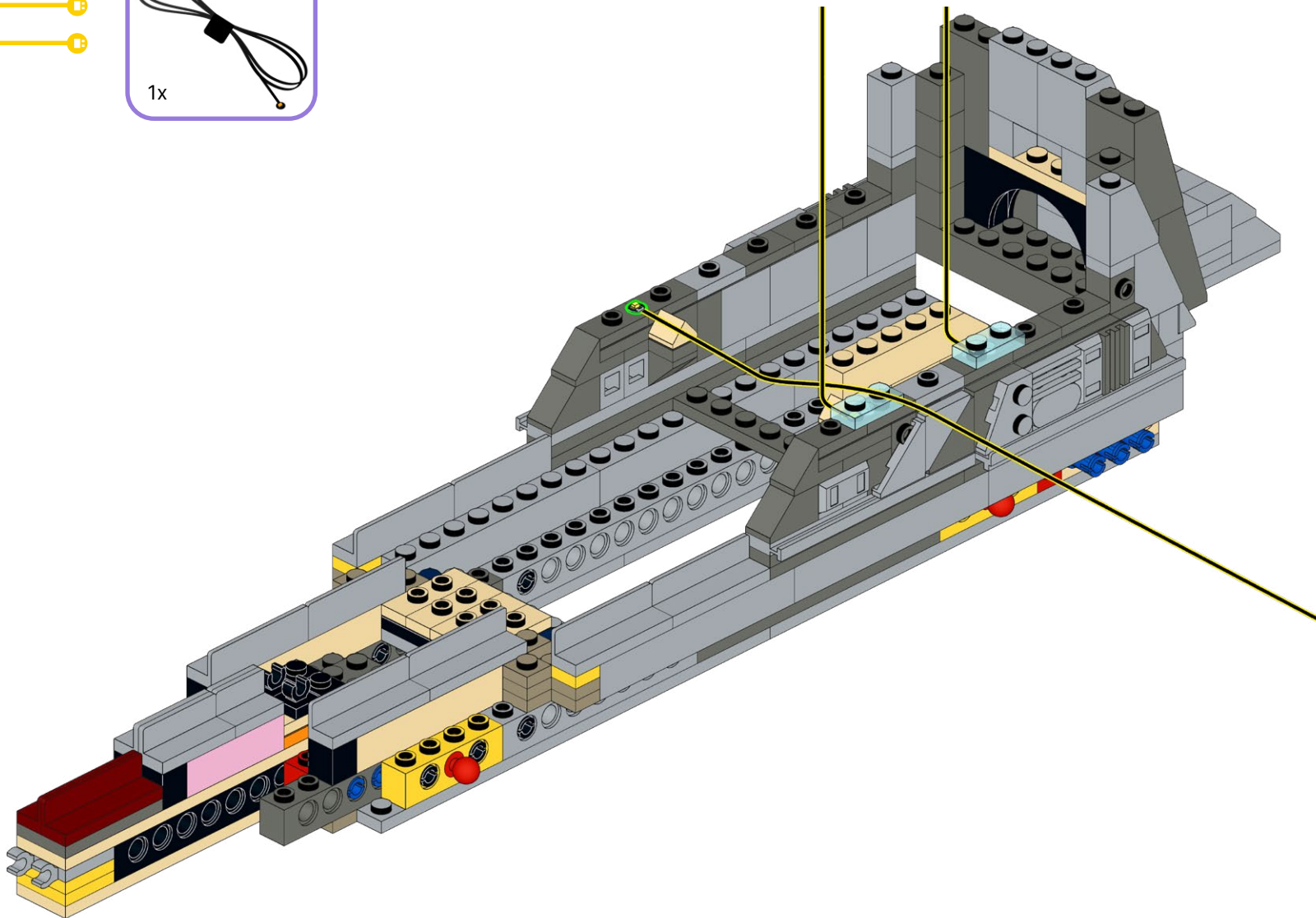
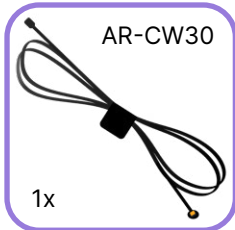

69

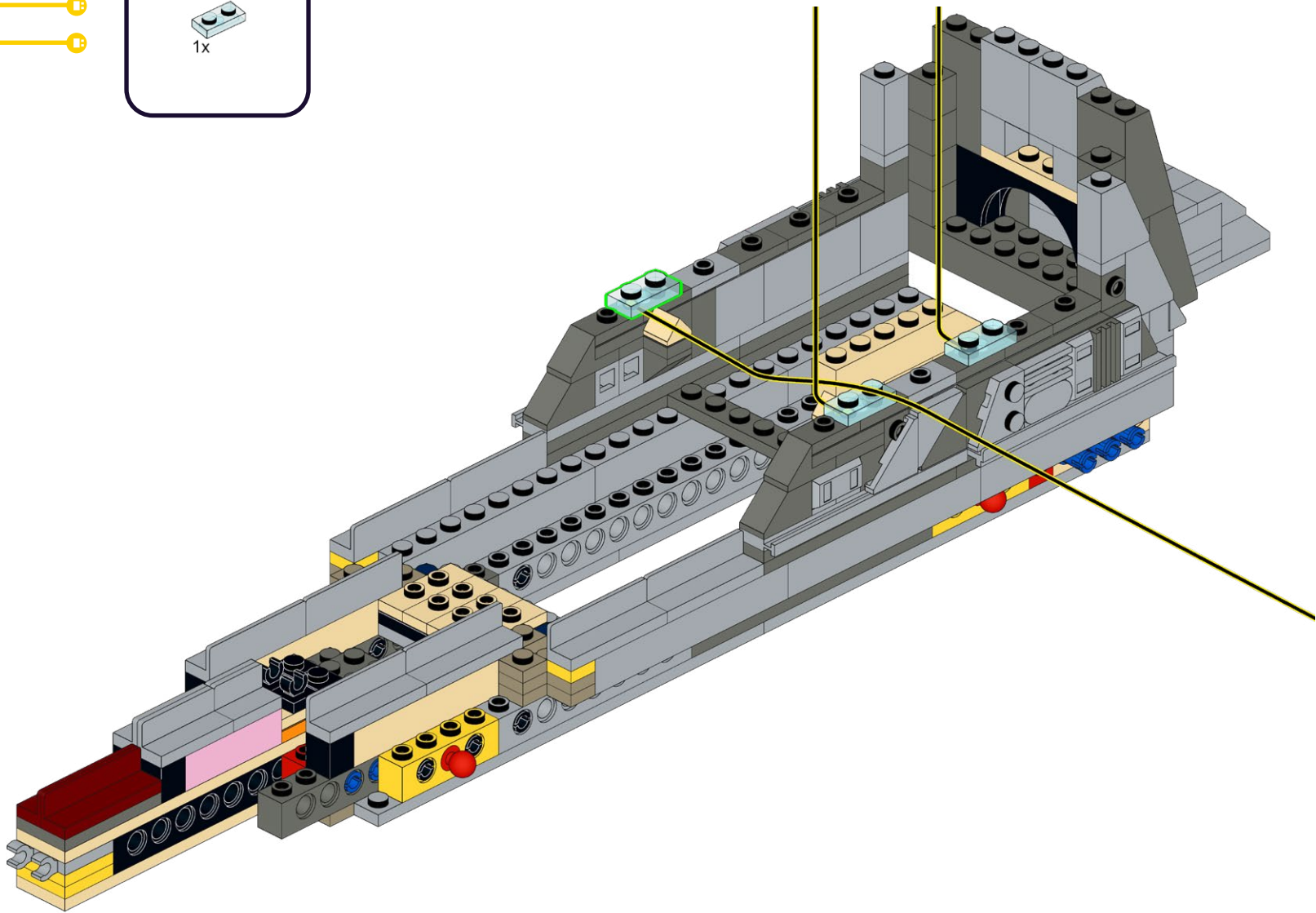
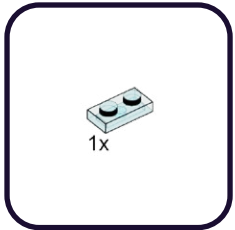

70

AR-CW30

1x

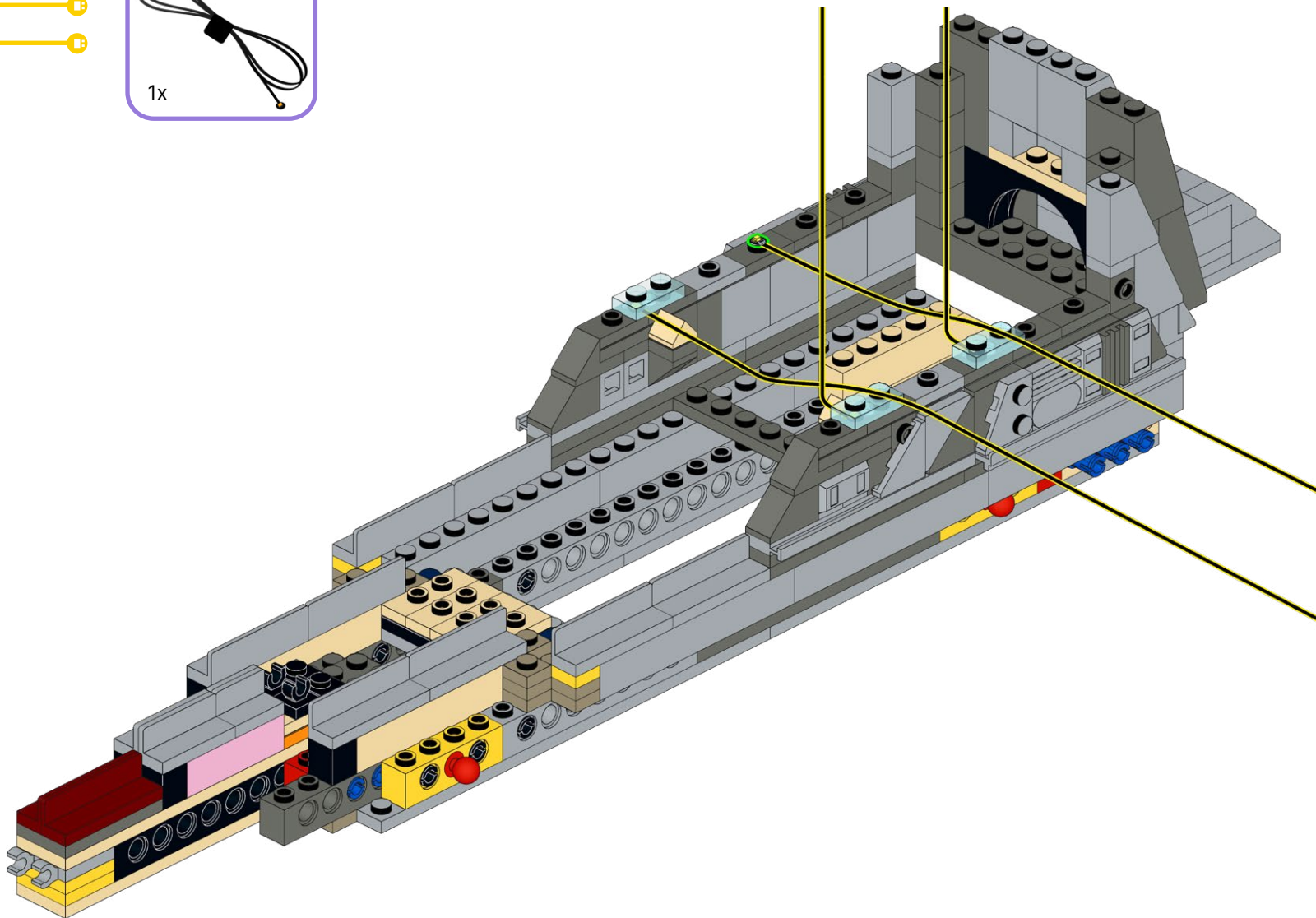

71

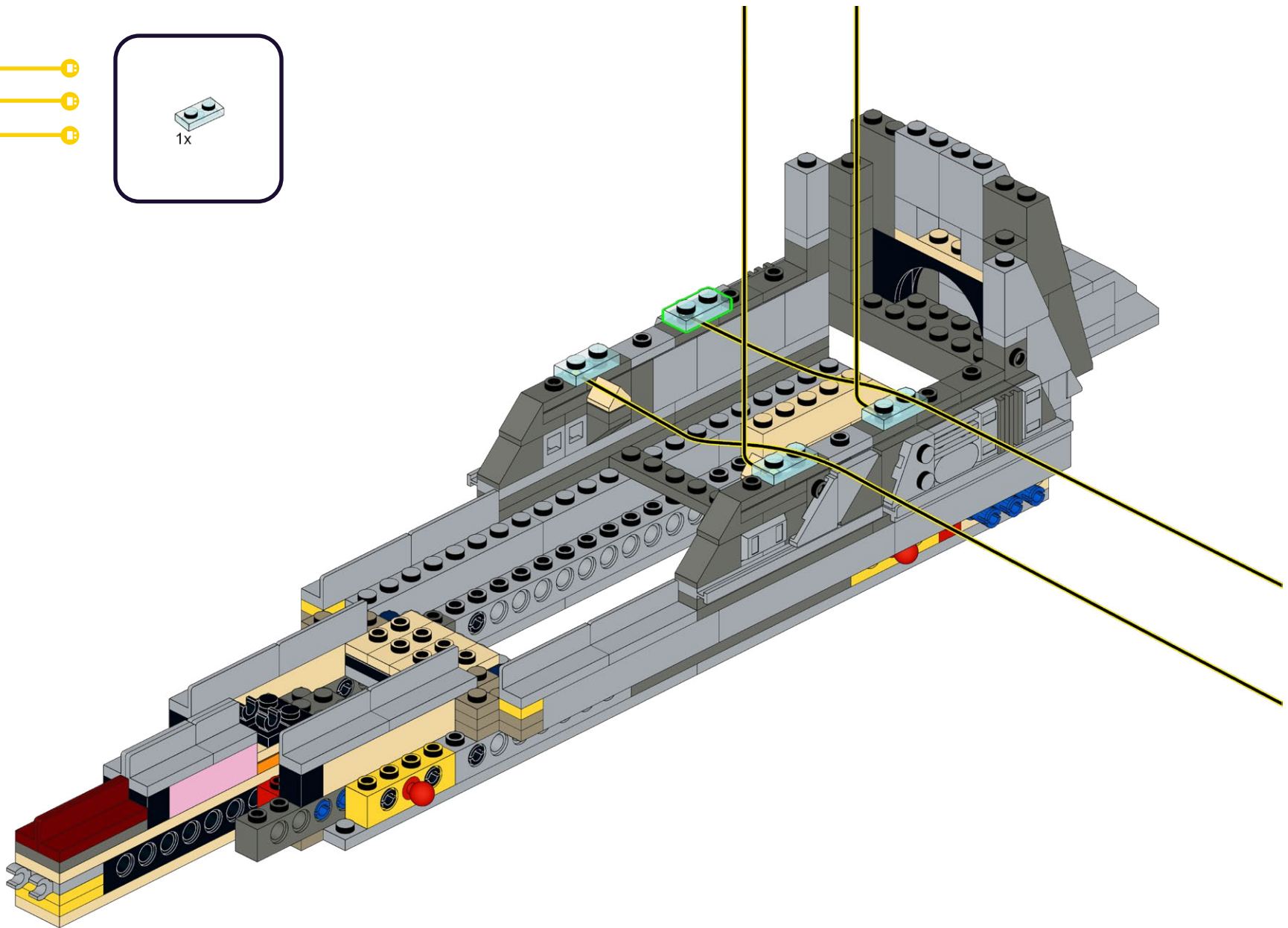
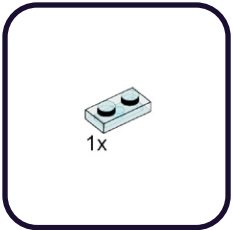

72

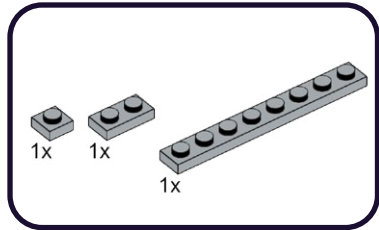

1

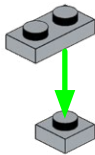

2

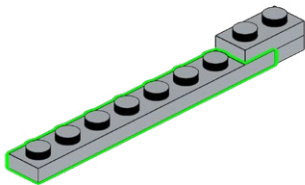

3

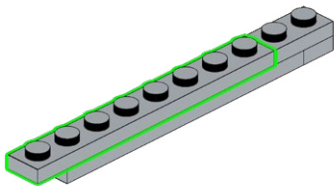

73

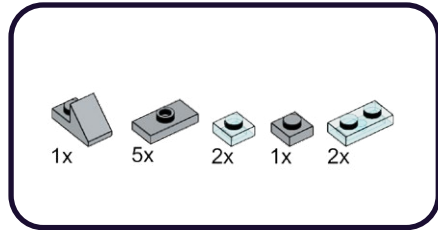

1

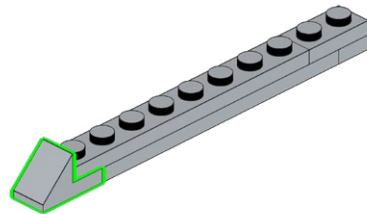

2

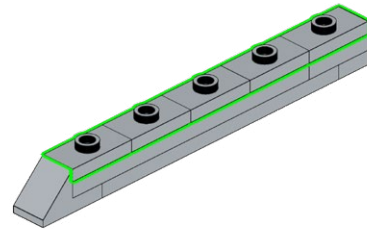

3

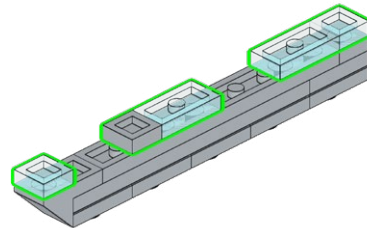

2x

74

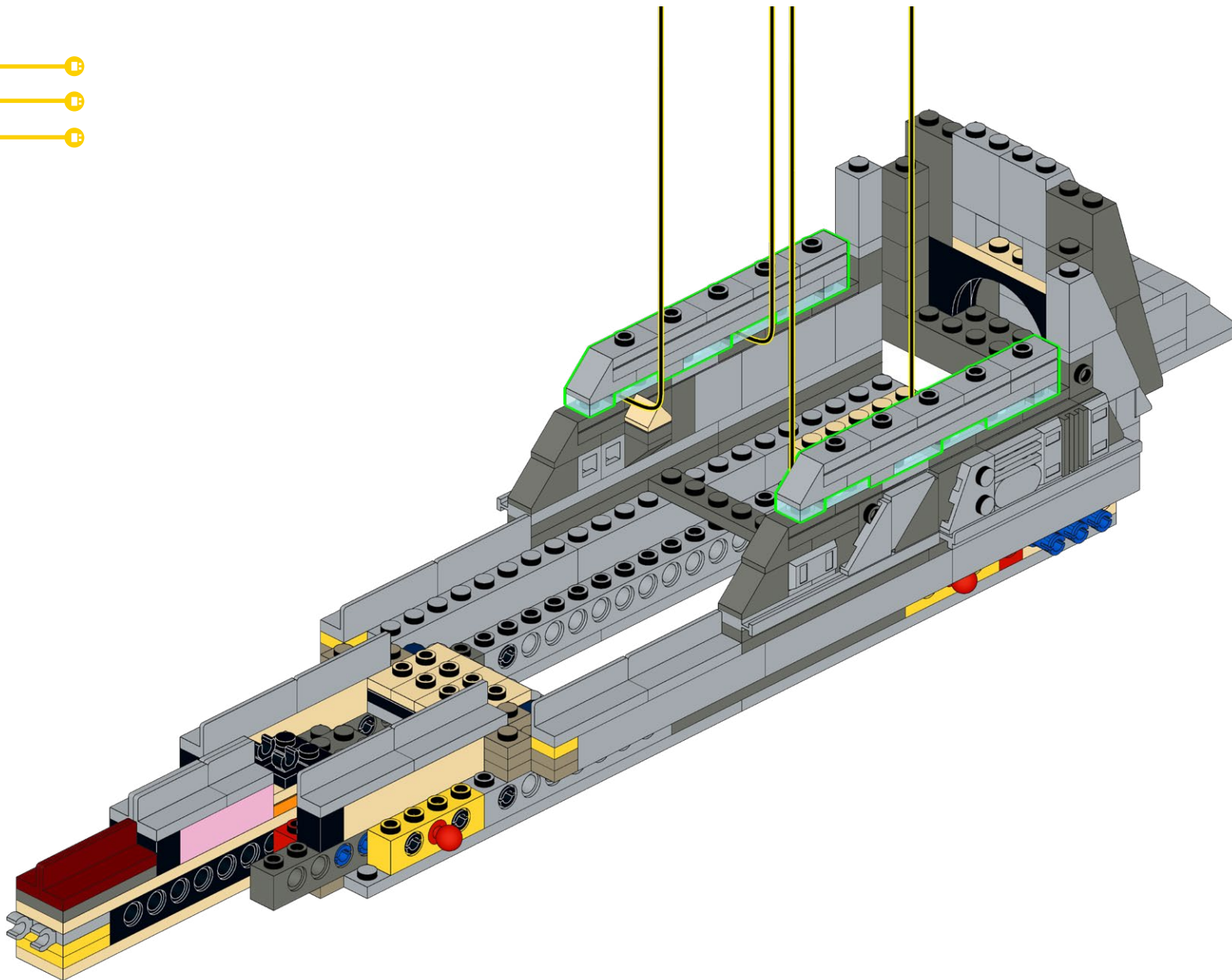

75

AR-CW30

1x

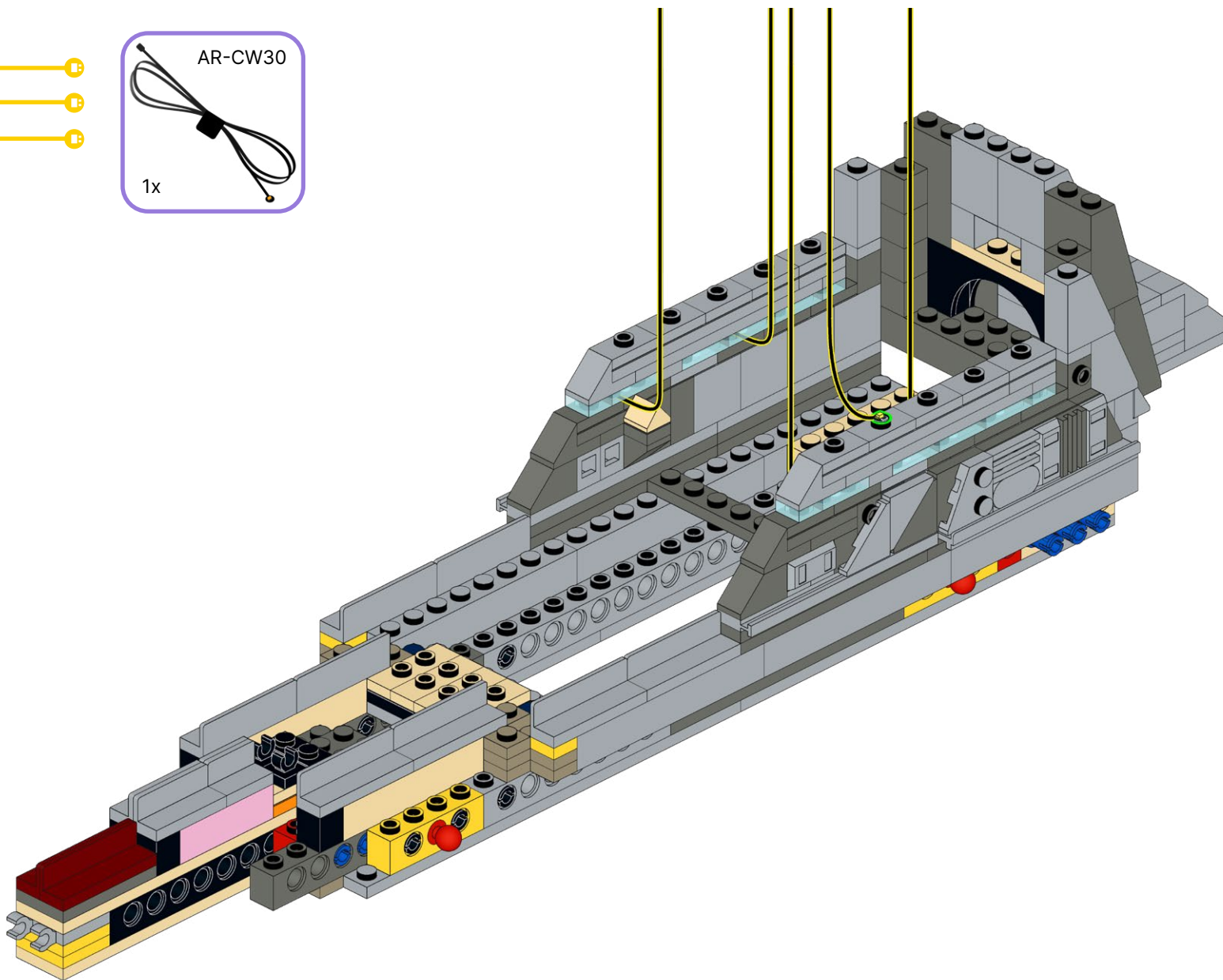

76

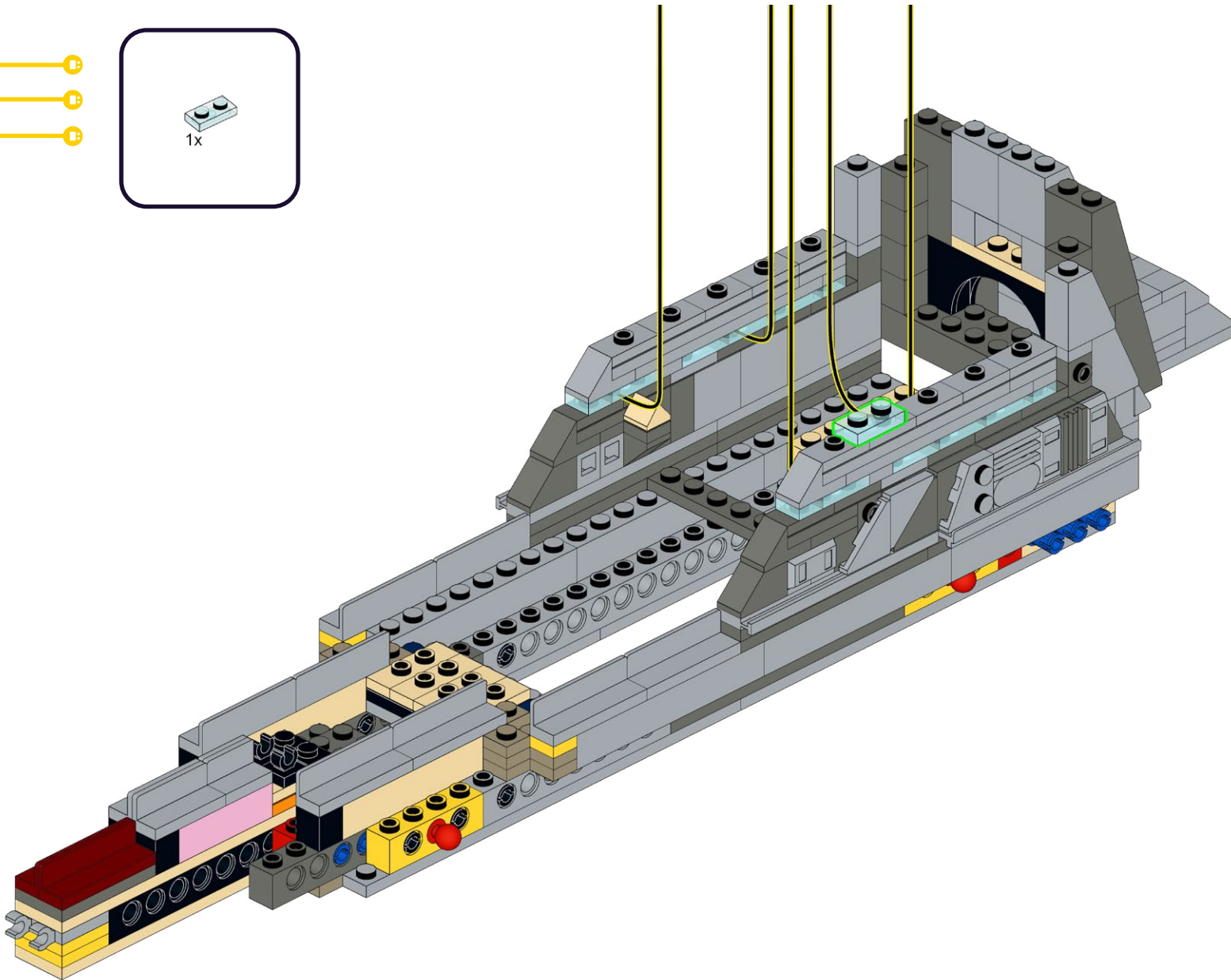
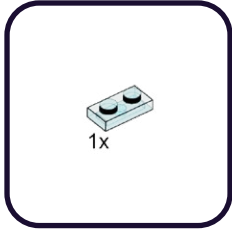

77

AR-CW30

1x

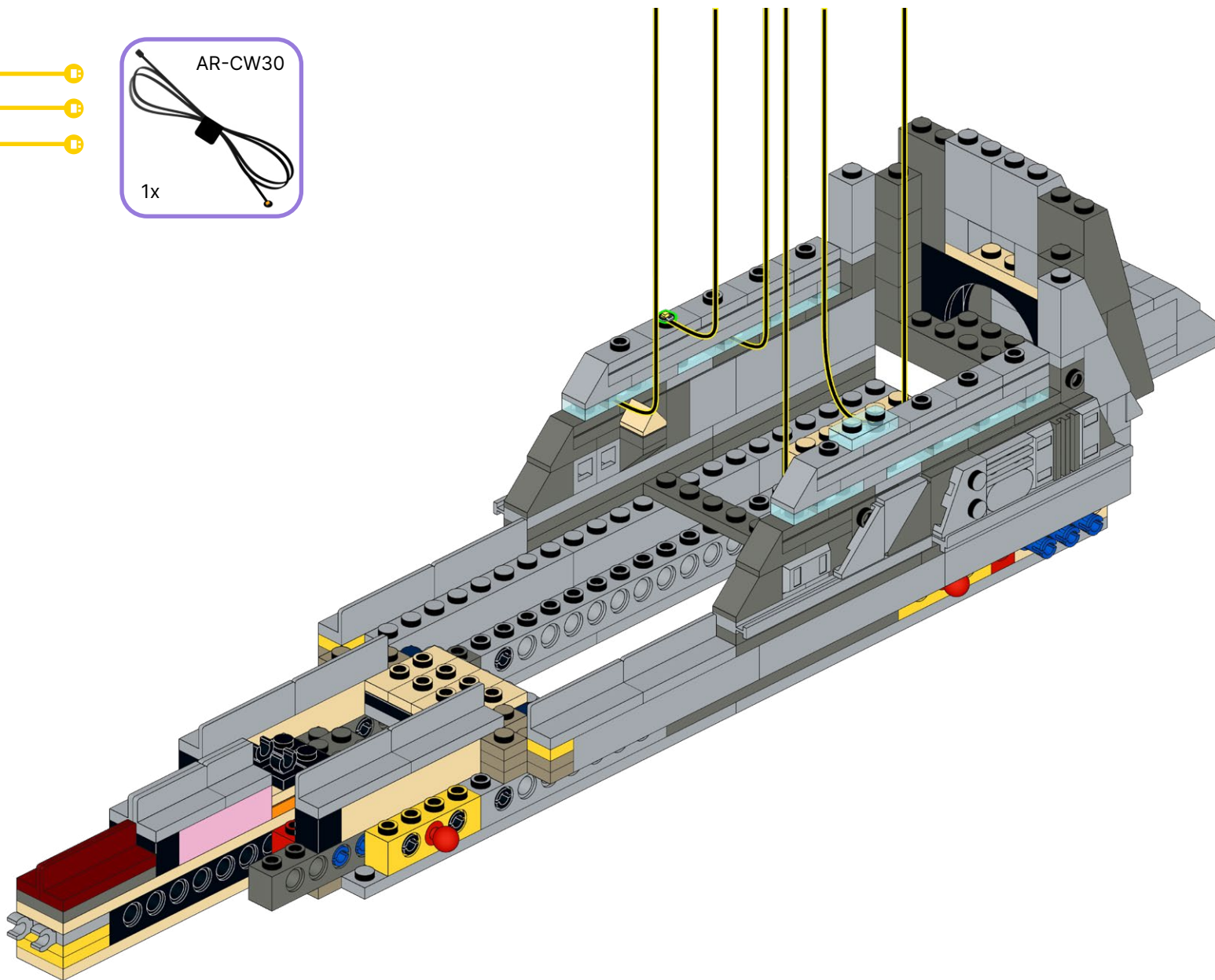

78

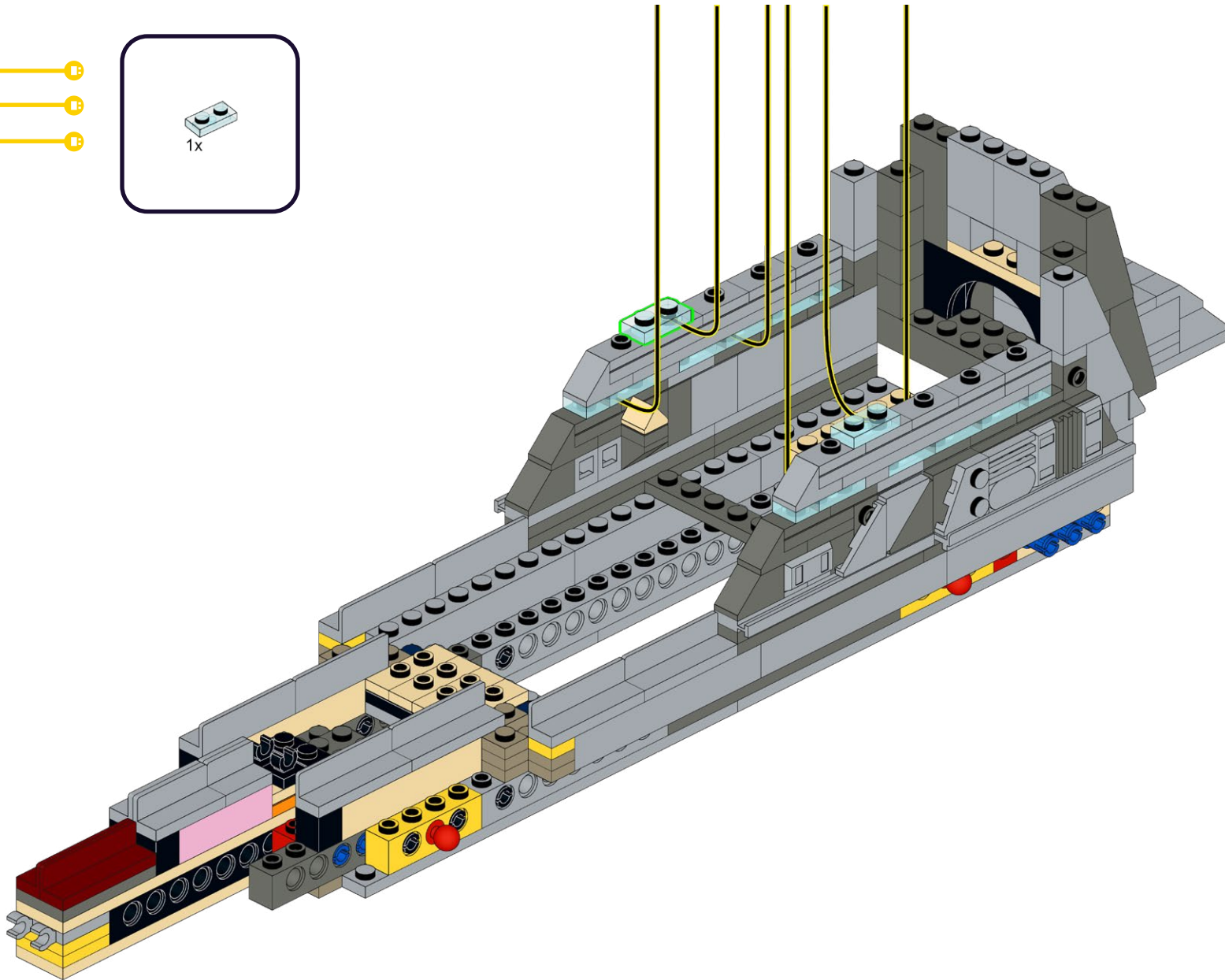
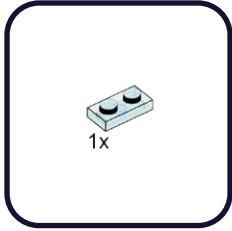

79

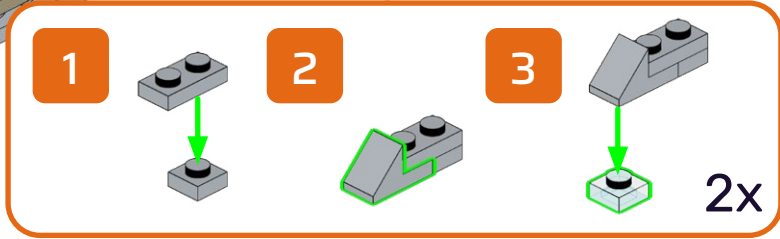
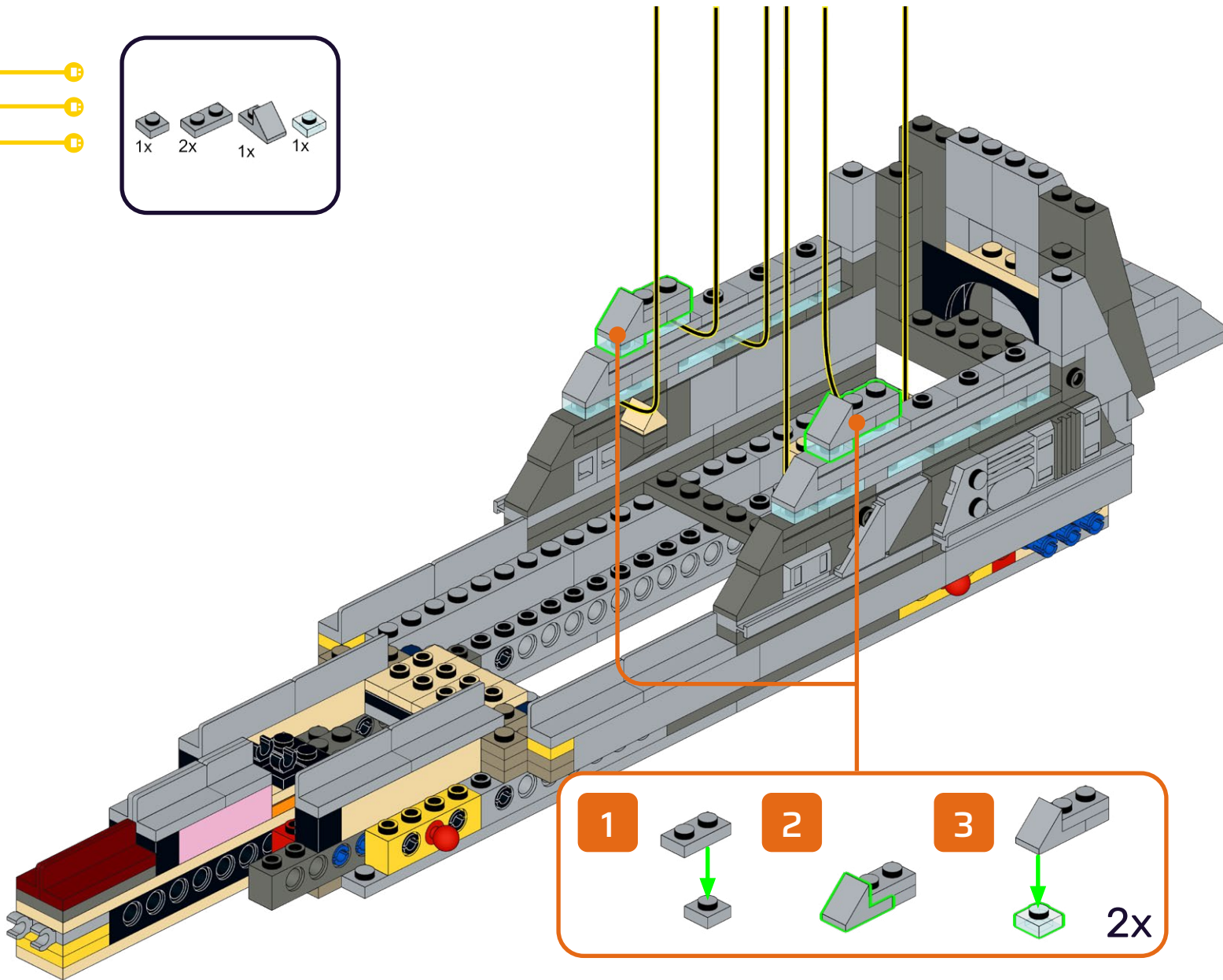
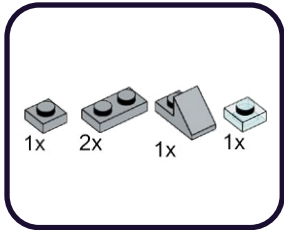

80

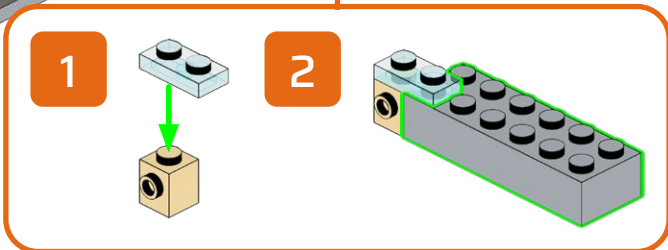
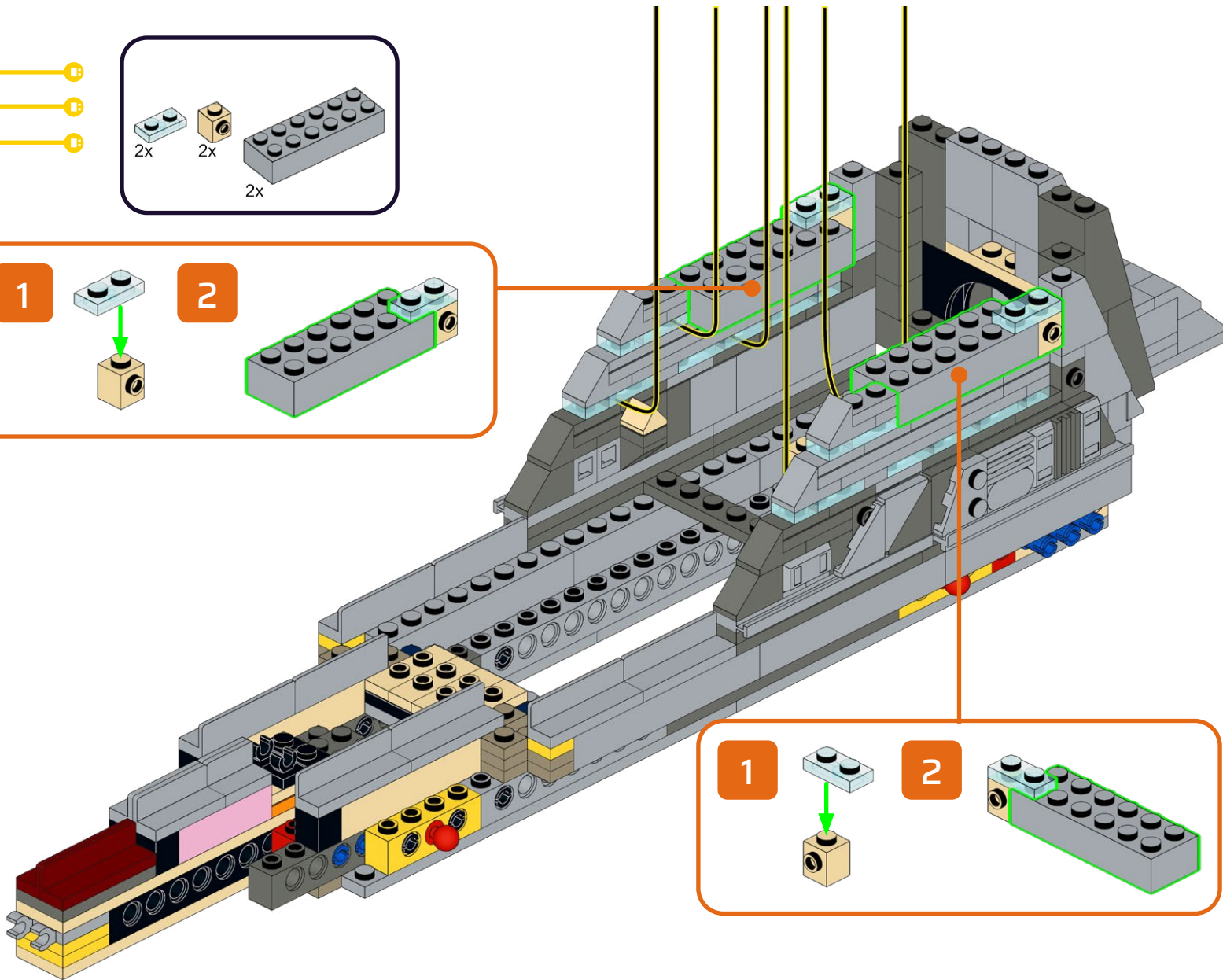
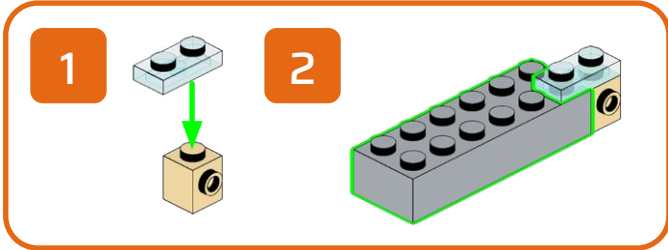
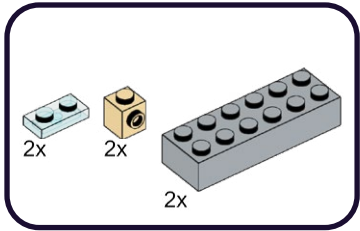

81

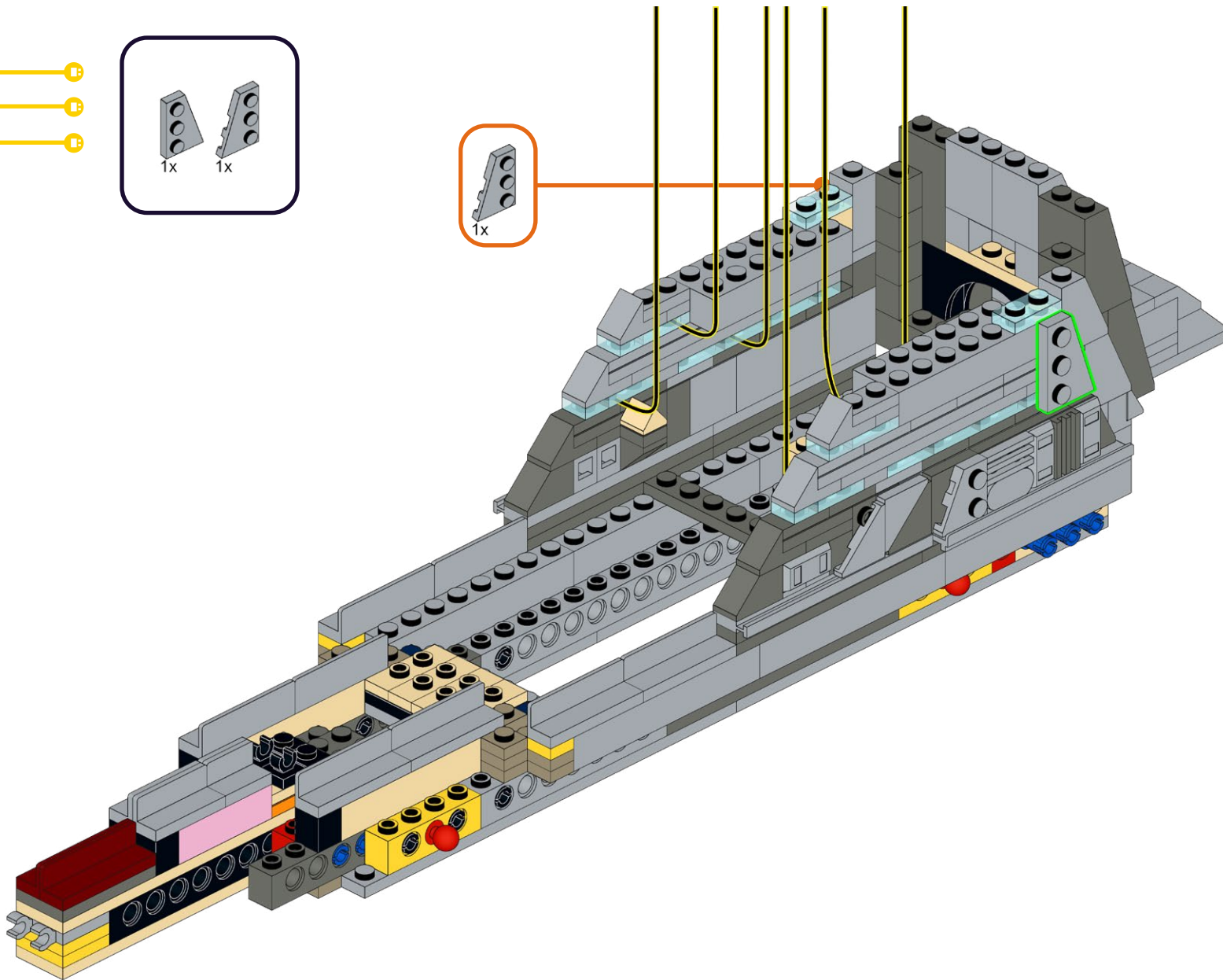
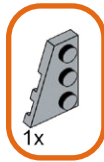
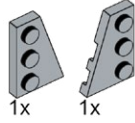

82

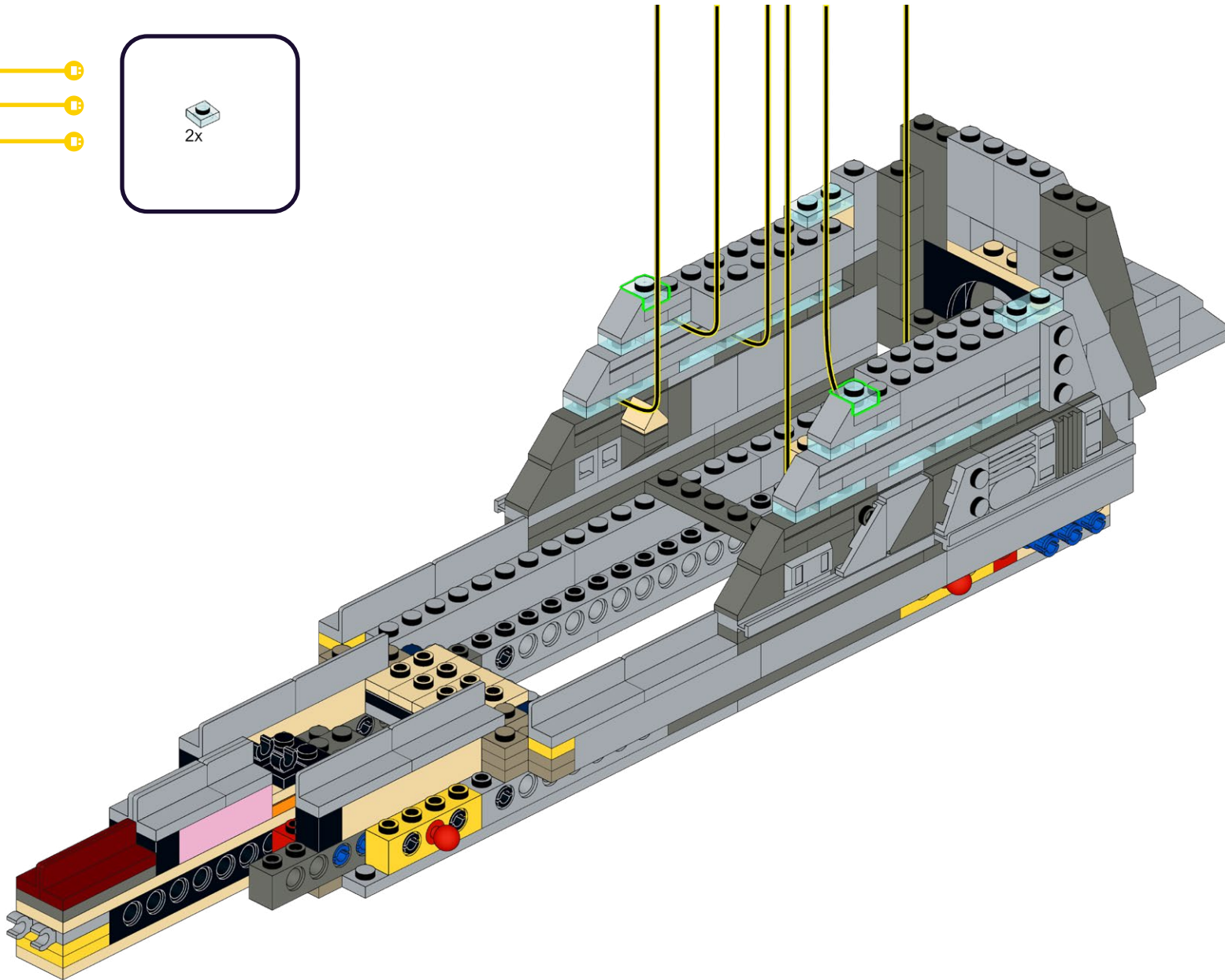
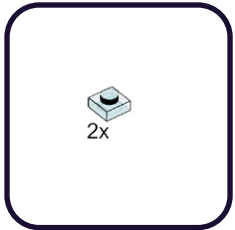

83

AR-CW30

1x

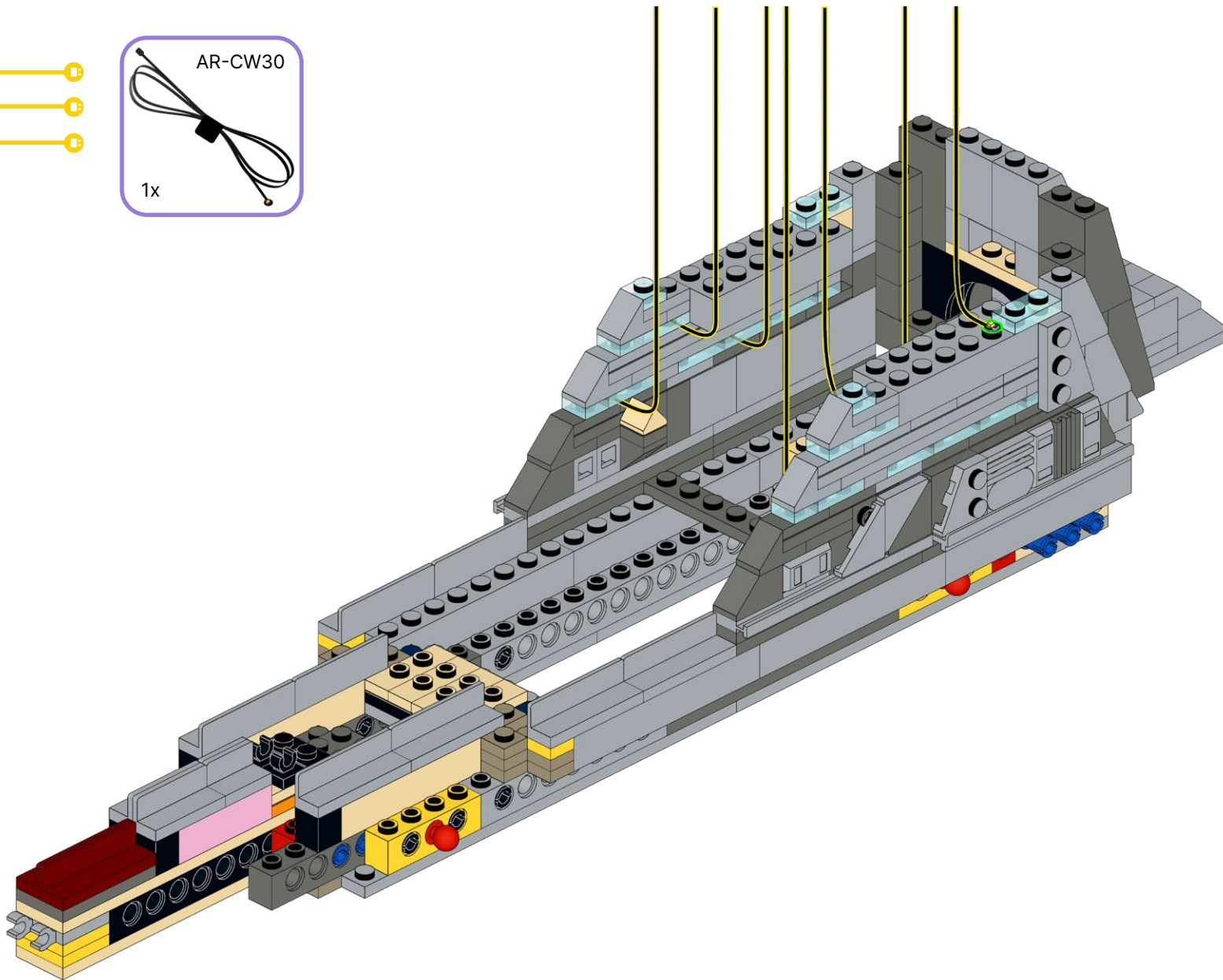

84

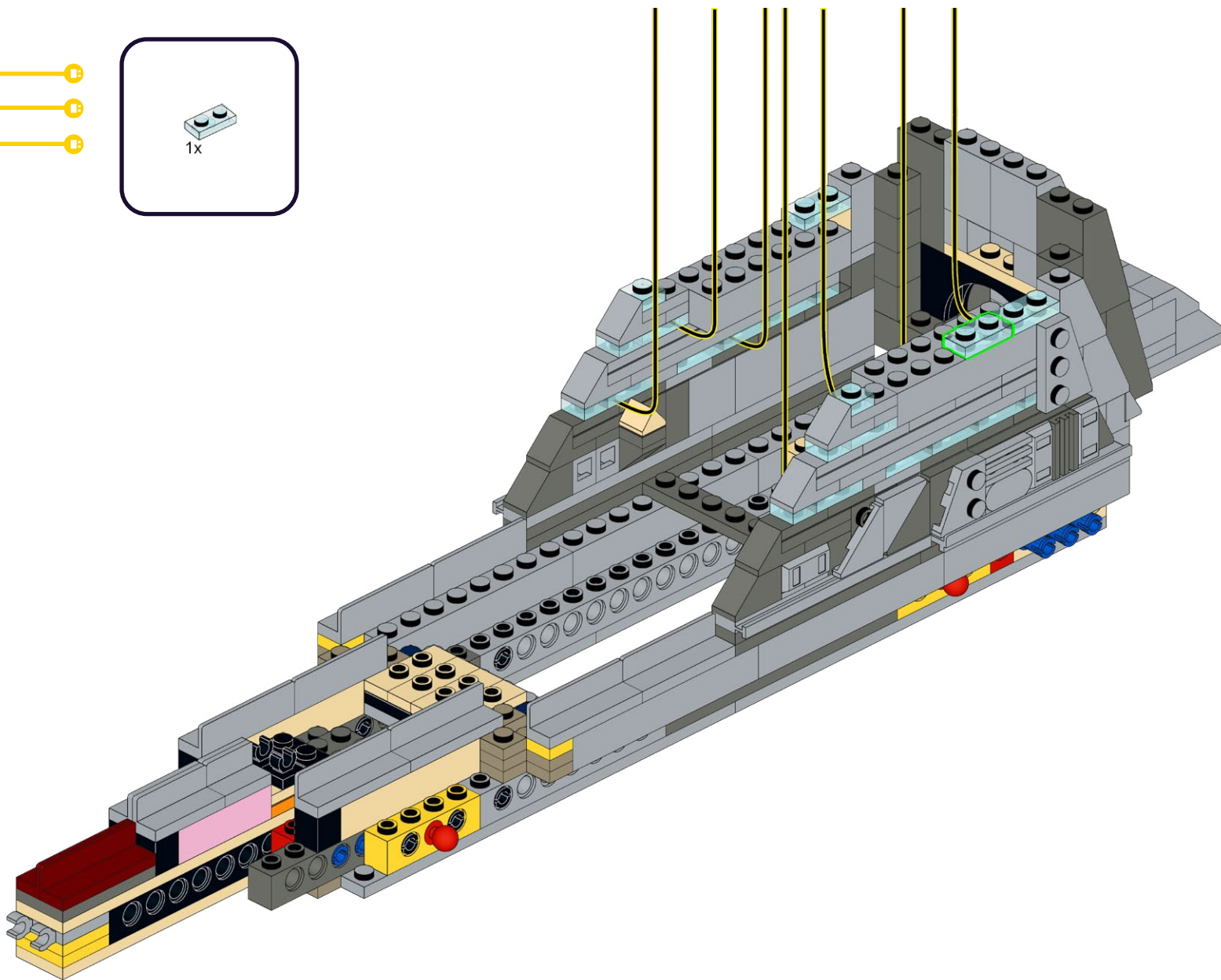
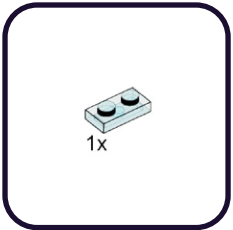

85

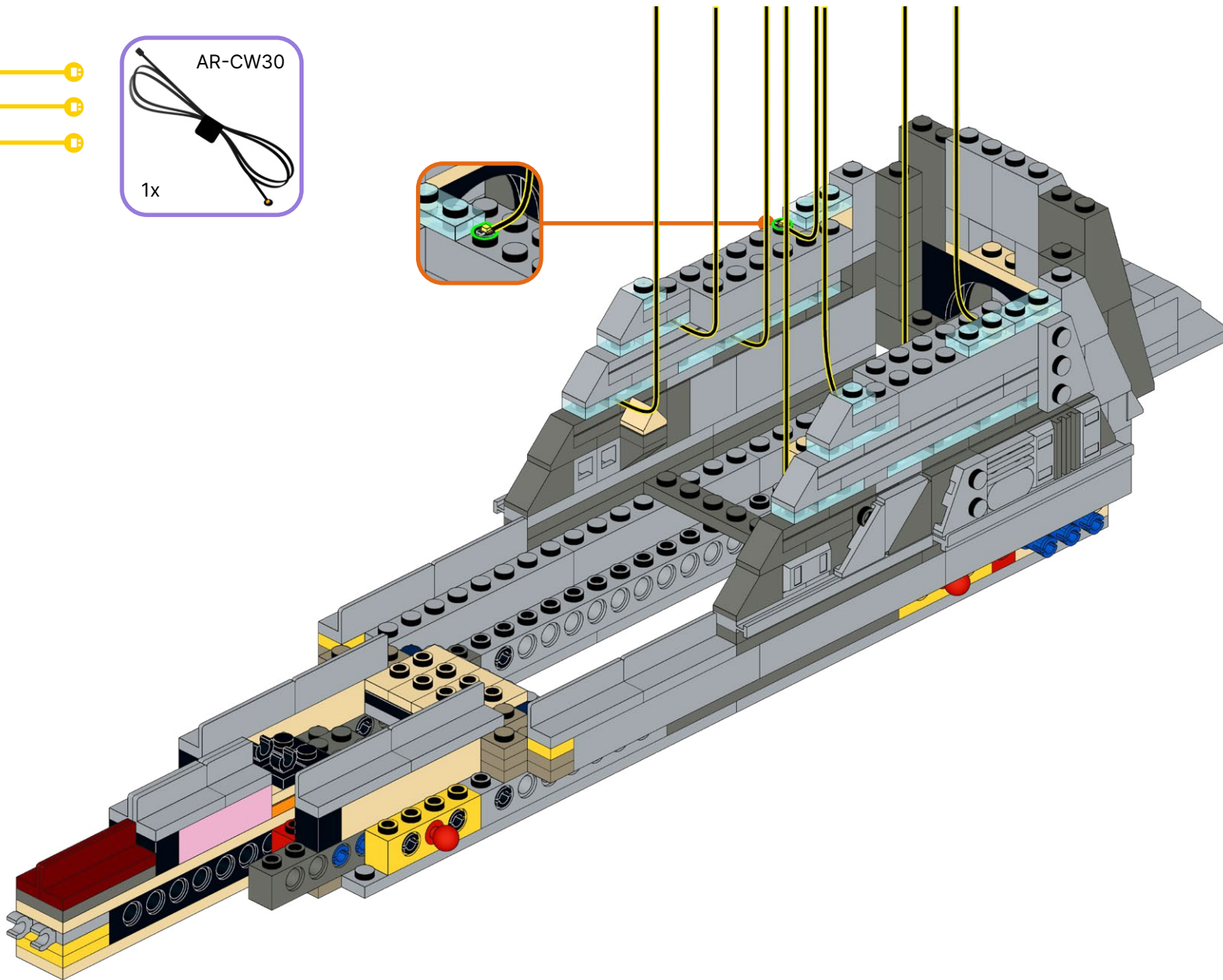
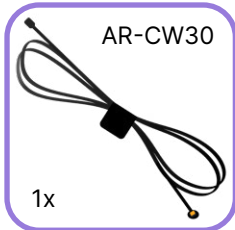

86

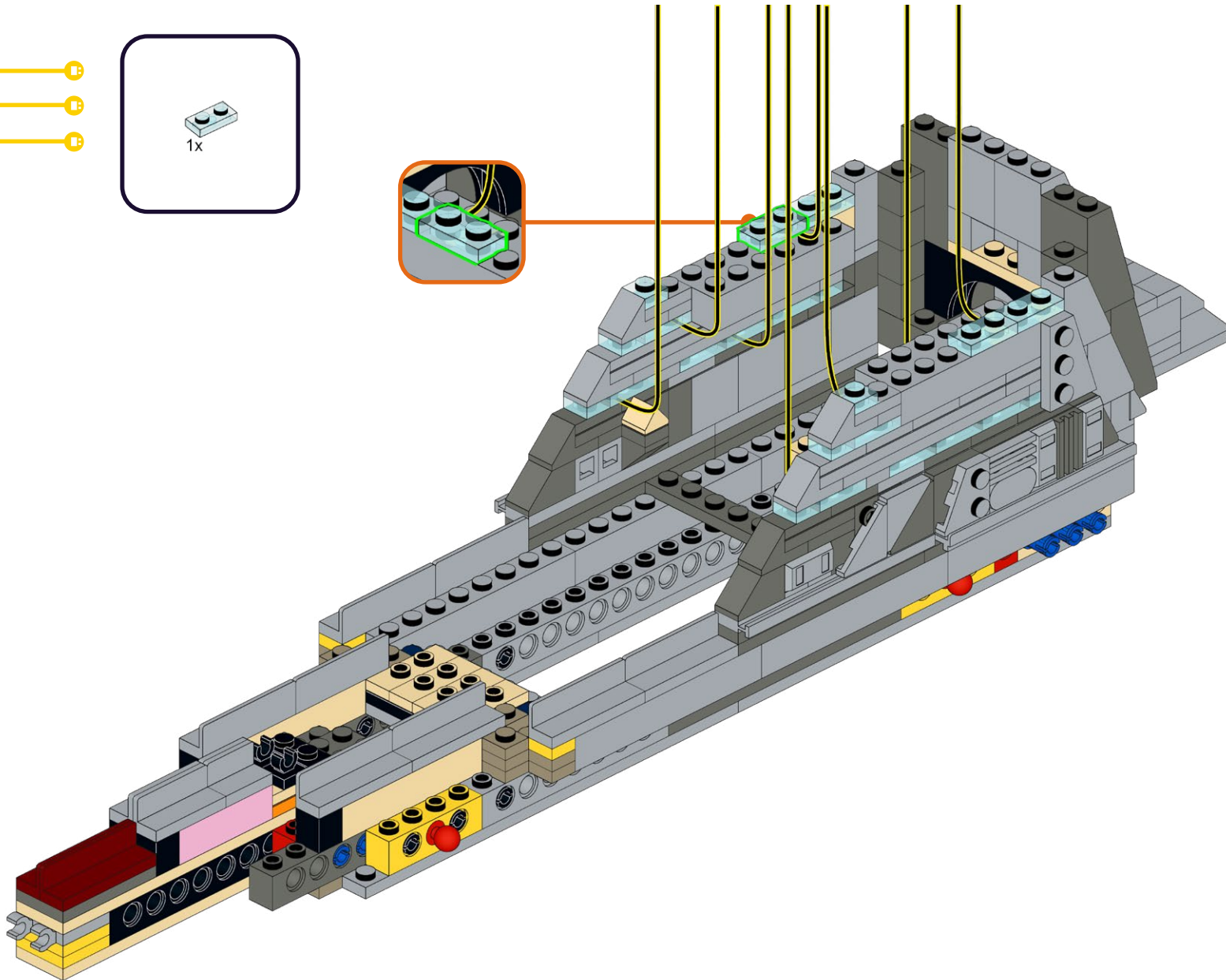
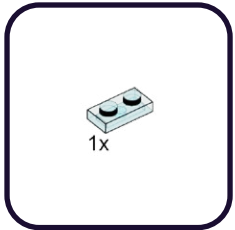

87

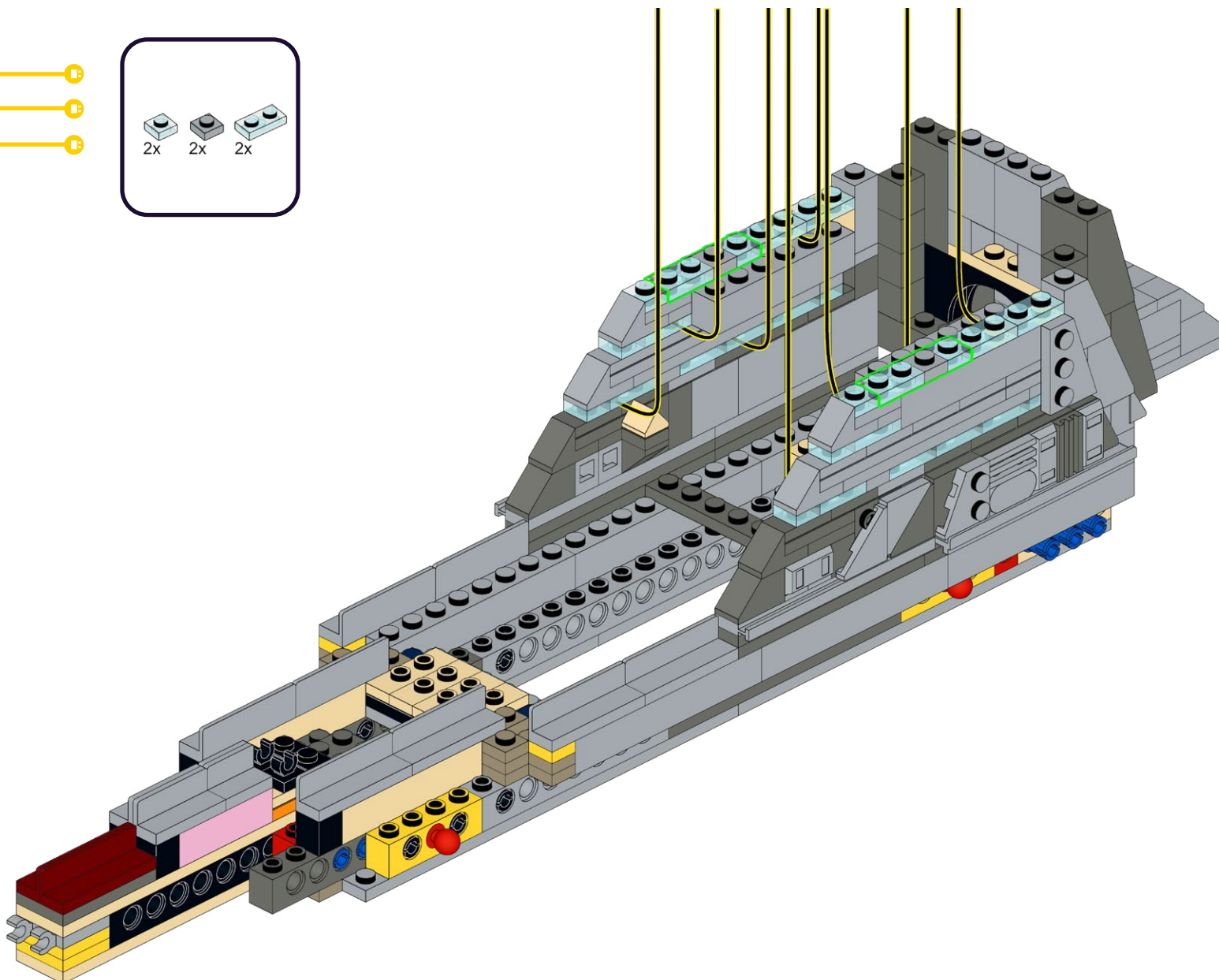
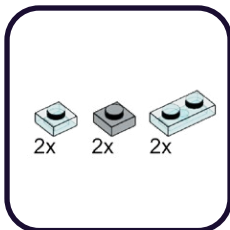

88

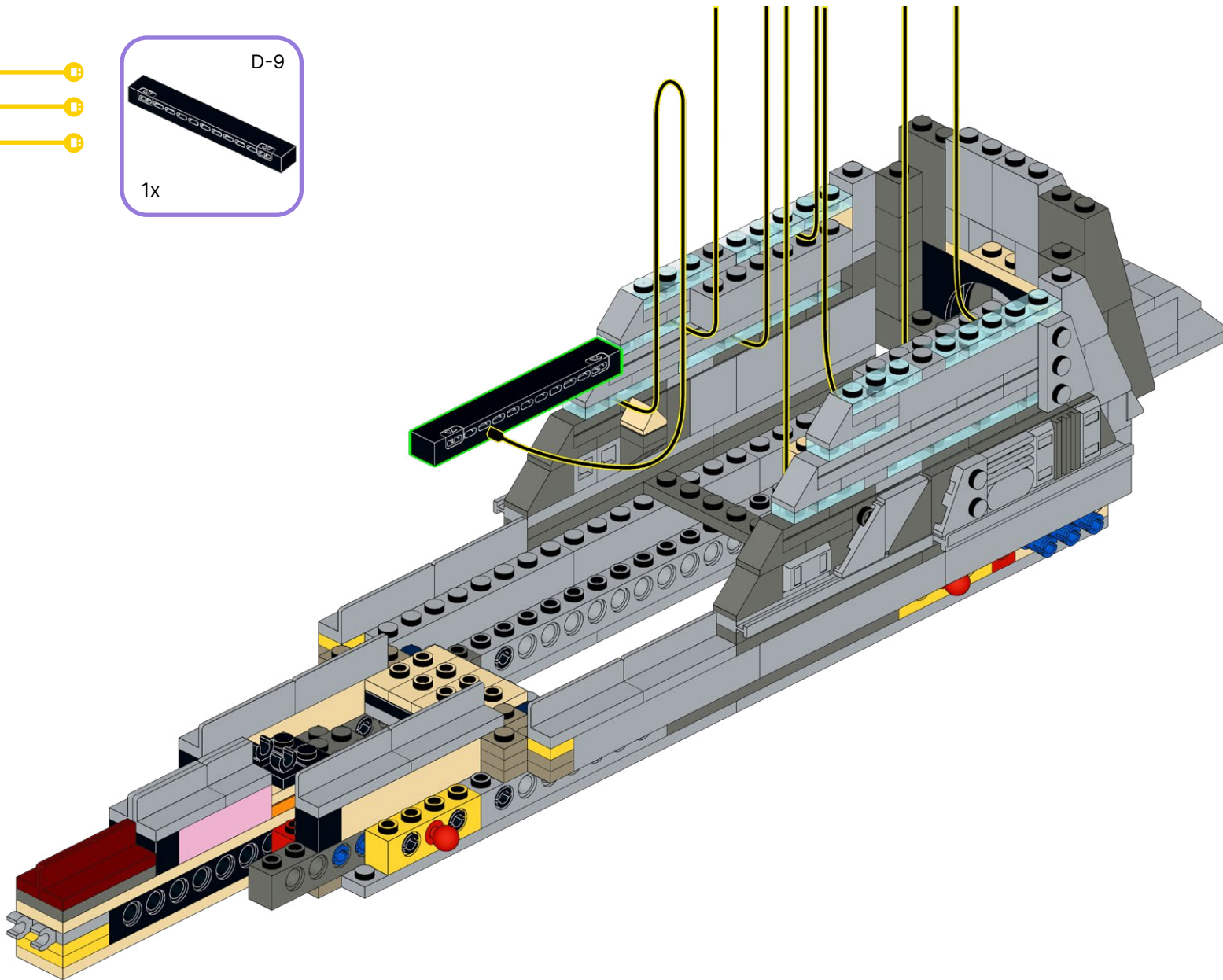
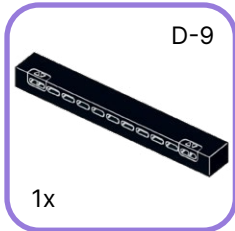

89

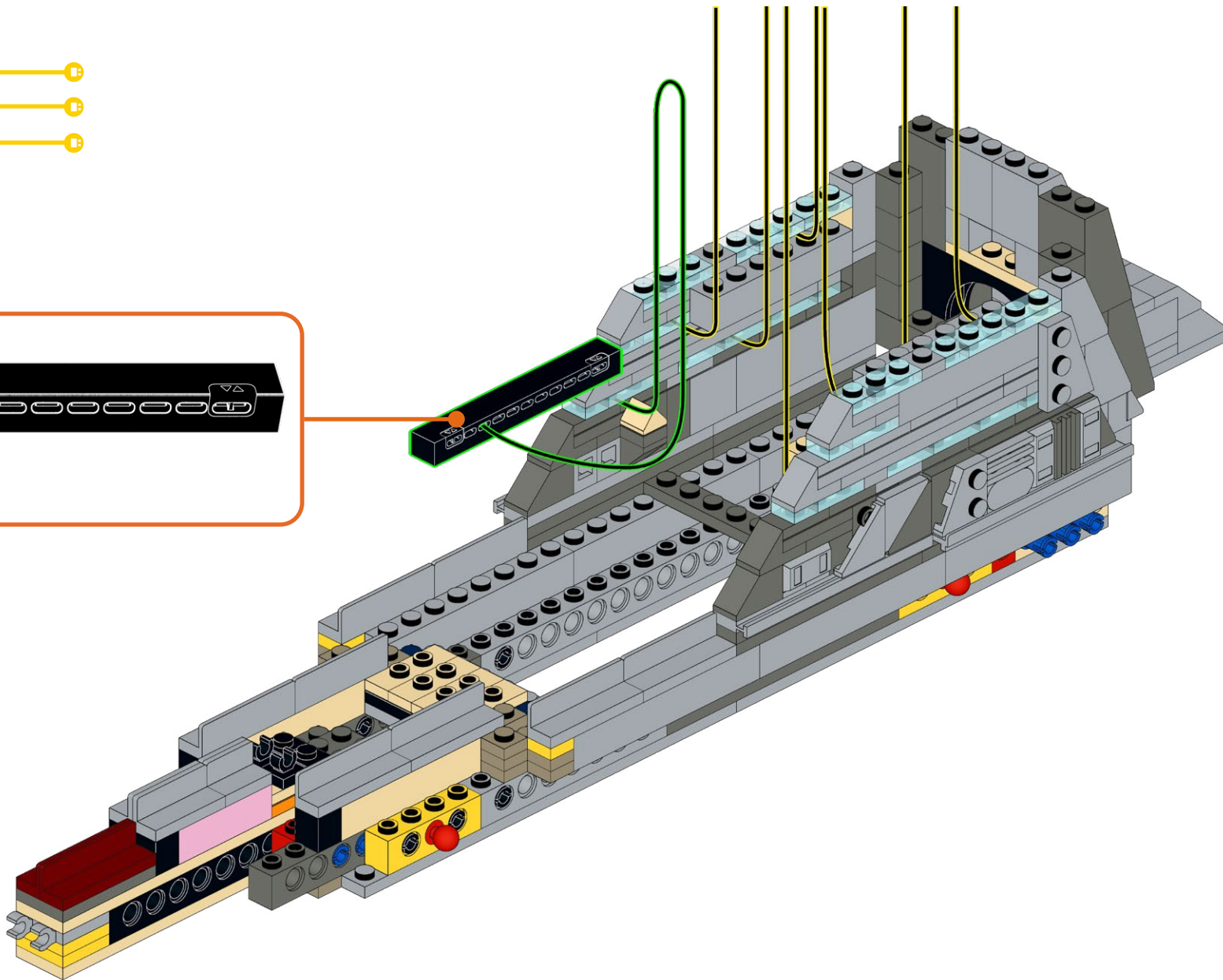
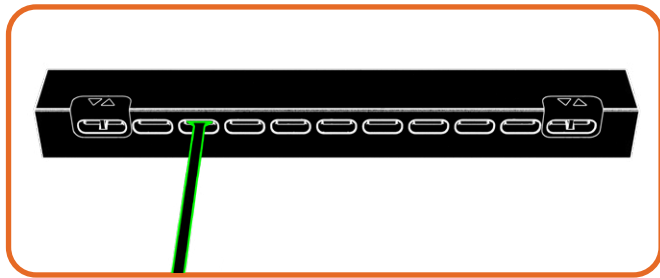

90

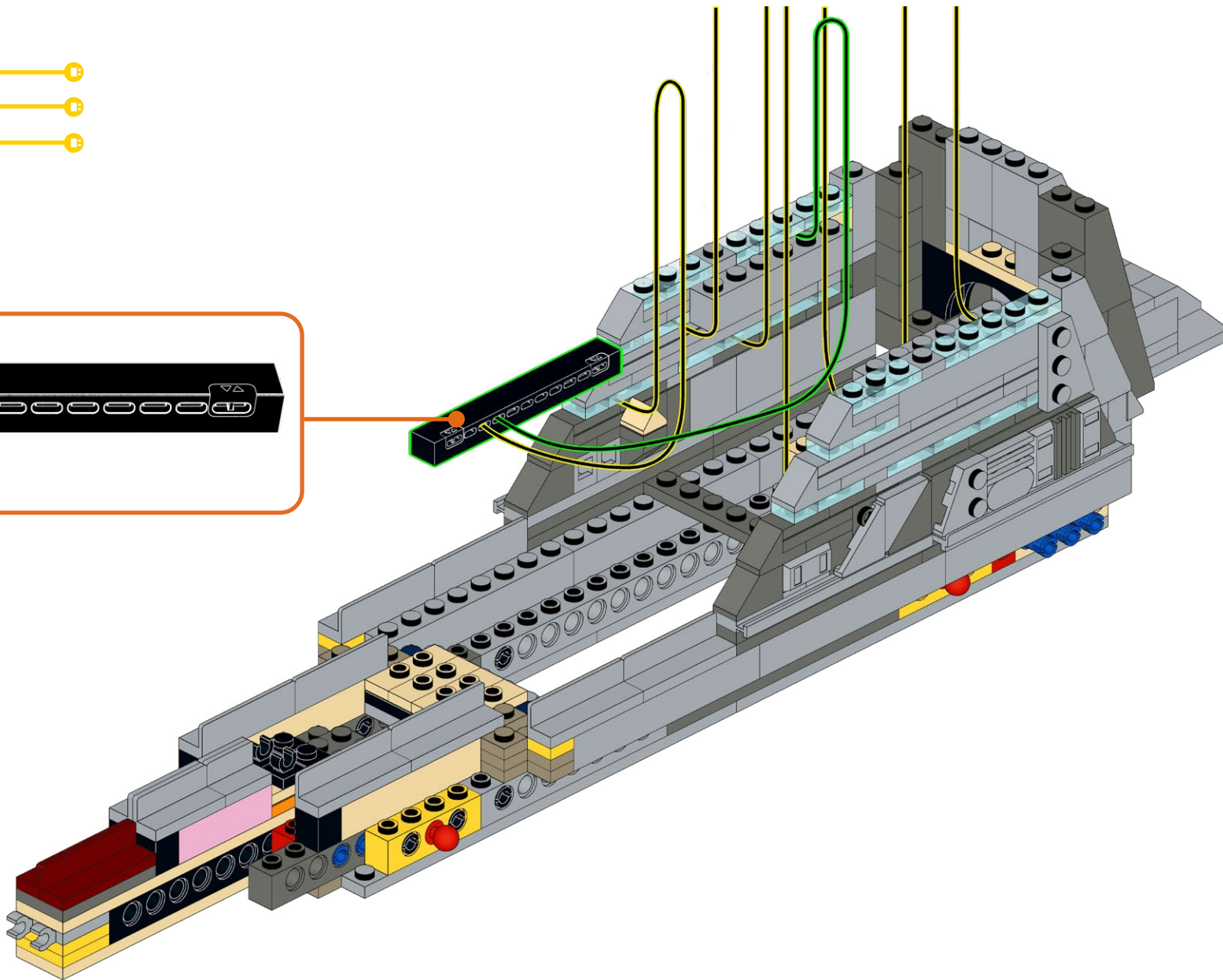
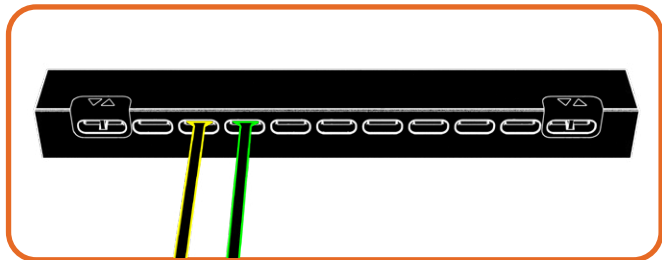

91

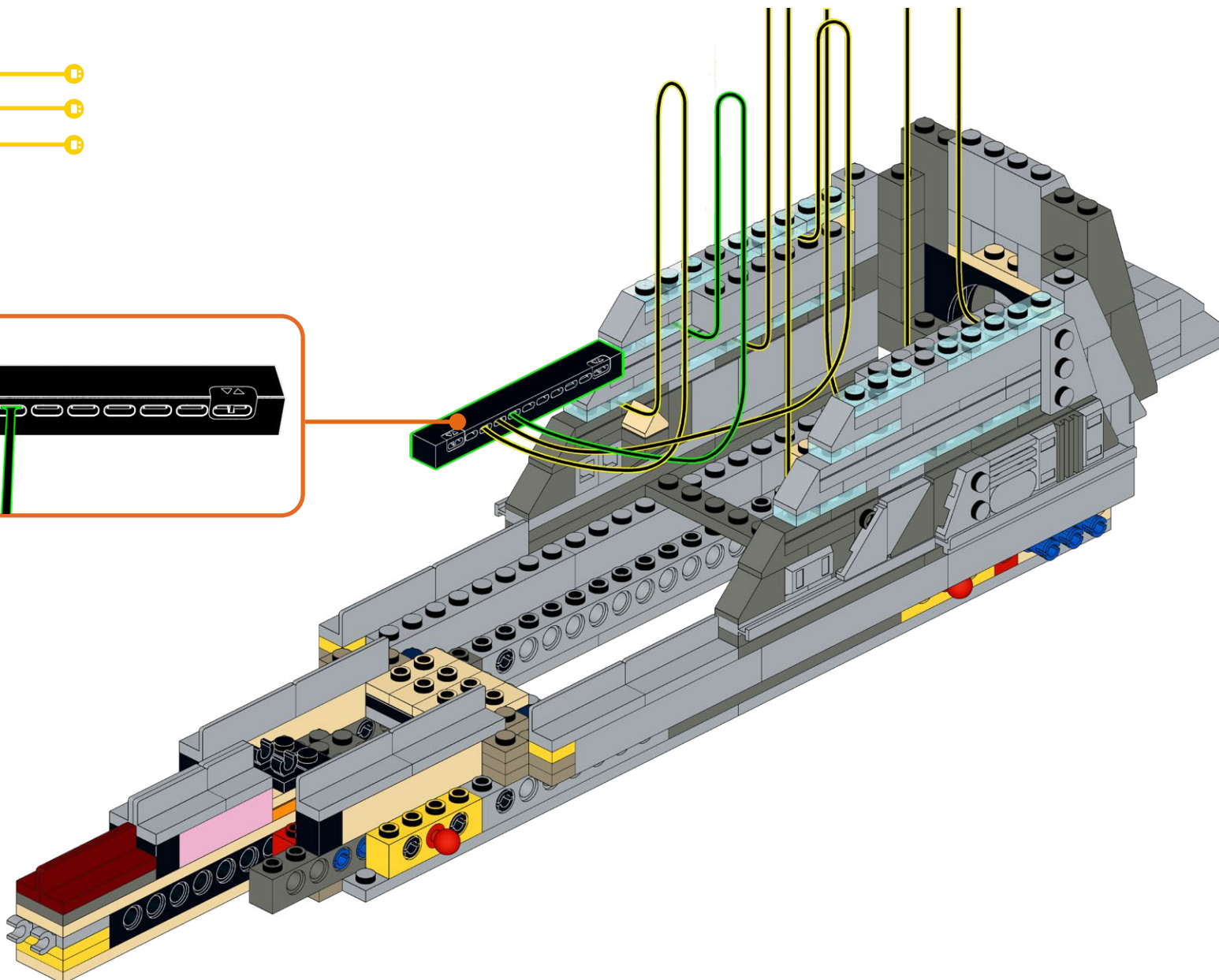
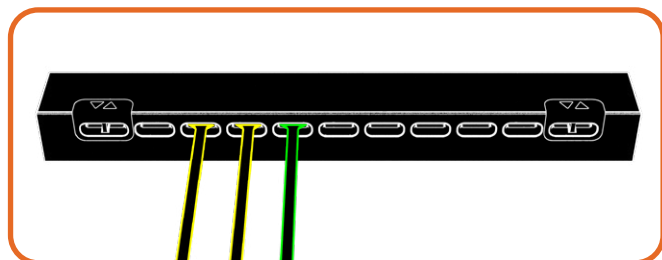

92

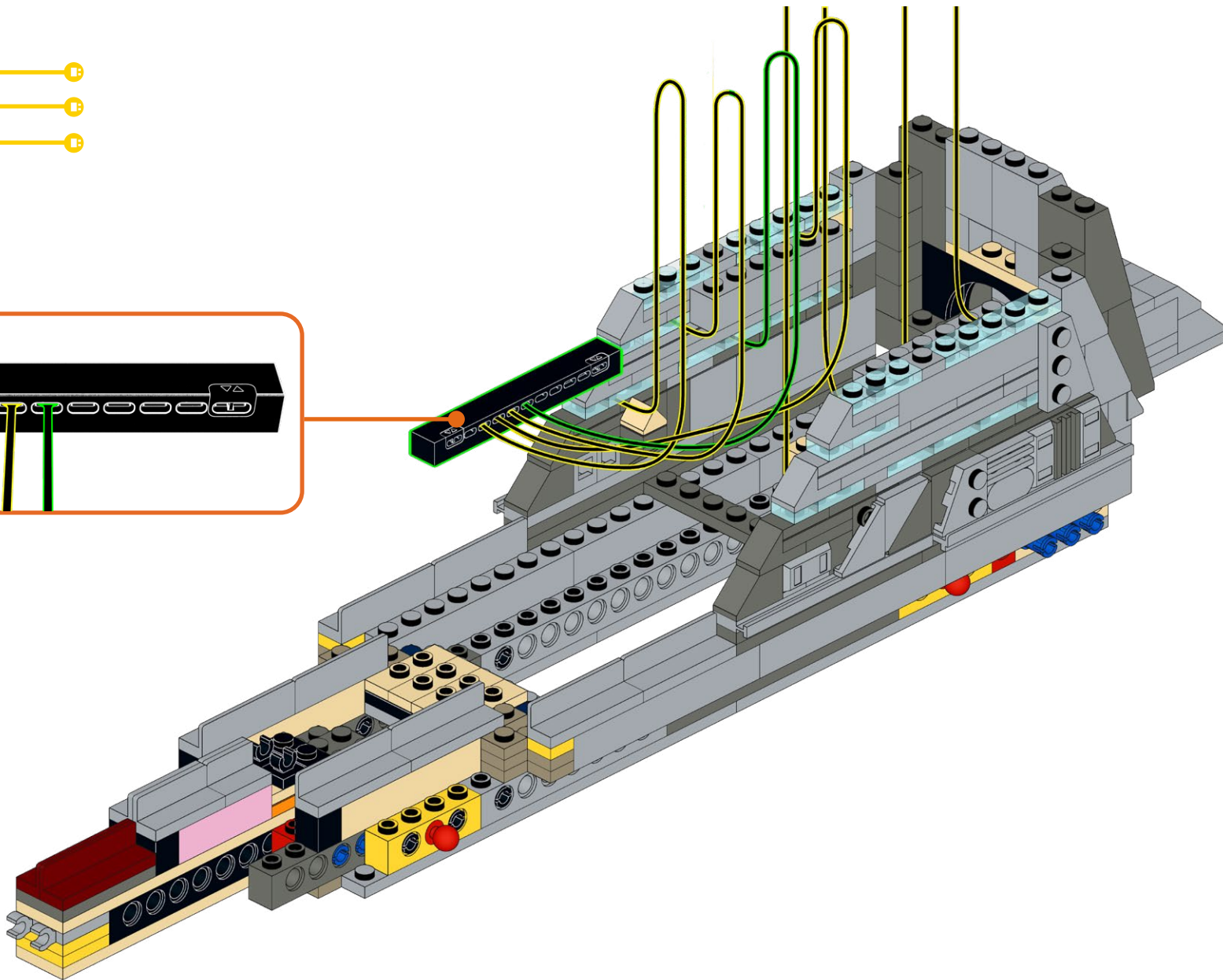

93

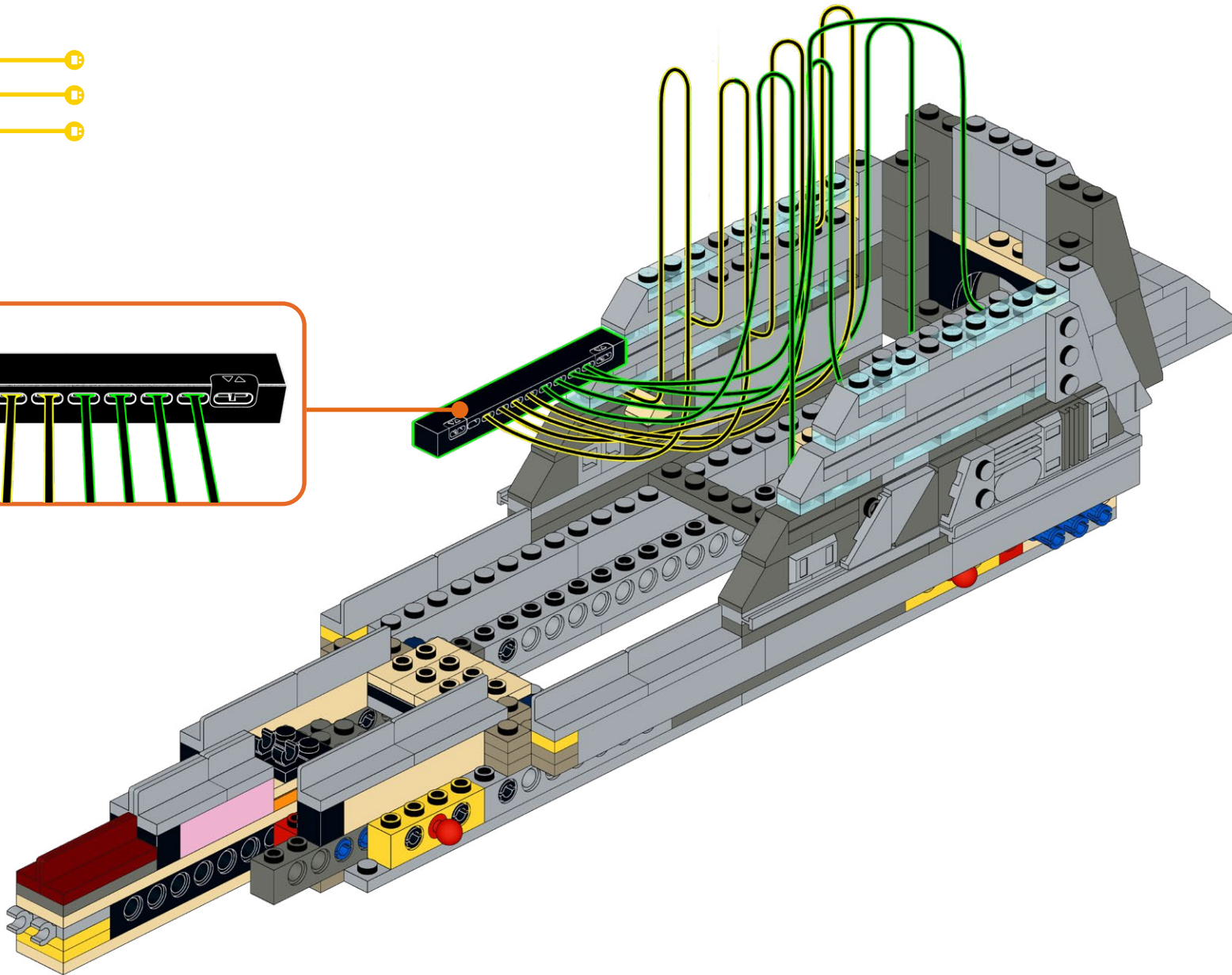
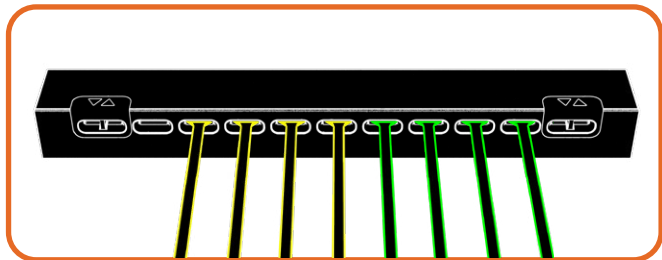

94

E-1x2

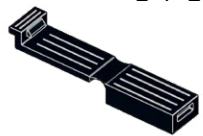

1x

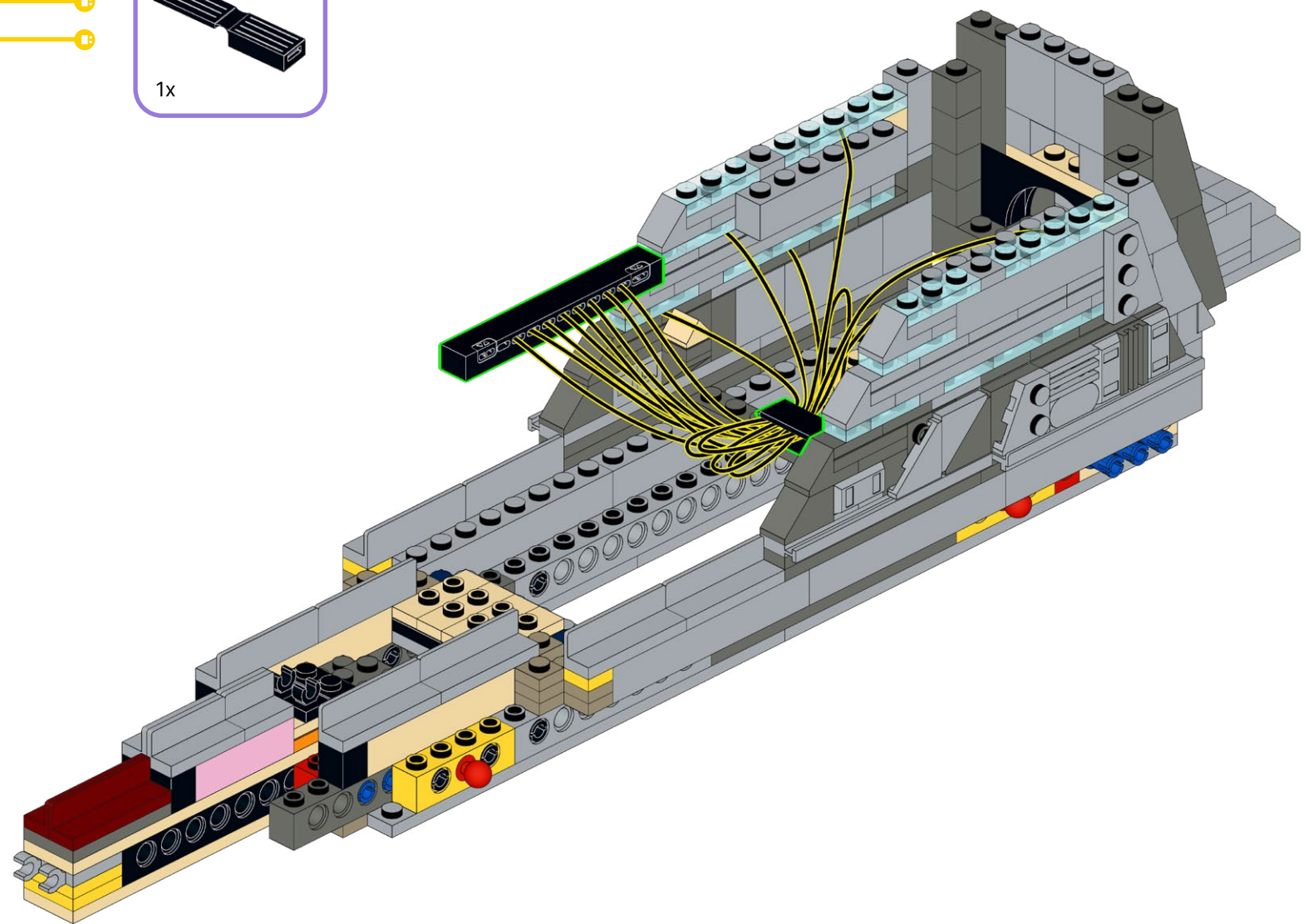

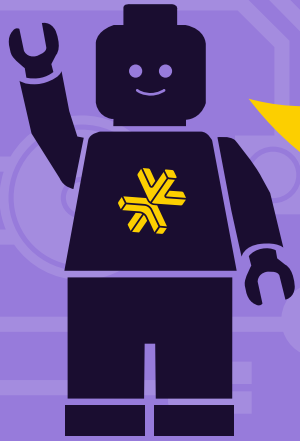
**HOLD UP!**

You might notice some bags aren't in order, as well as left over pieces, but that's ok! We're changing the way you build LEGO!

HALTEN!

Möglicherweise stellen Sie fest, dass einige Beutel nicht in Ordnung sind und auch Teile übrig bleiben, aber das ist in Ordnung! Wir verändern die Art und Weise, wie Sie LEGO bauen!

TENIR BON!

Vous remarquerez peut-être que certains sacs sont en panne, ainsi que des morceaux restants, mais ce n'est pas grave ! Nous changeons la façon dont vous construisez LEGO !

SOSTENERE!

Potresti notare che alcune borse sono fuori uso, così come alcuni pezzi avanzati, ma va bene! Stiamo cambiando il modo in cui costruisci i LEGO!

¡SOSTENER!

Puede que notes que algunas bolsas están fuera de orden, así como piezas sobrantes, ¡pero está bien! ¡Estamos cambiando la forma de construir LEGO!

耽误!

您可能会注意到有些袋子坏了, 还有剩余的碎片, 但这没关系! 我们正在改变您搭建乐高的方式!

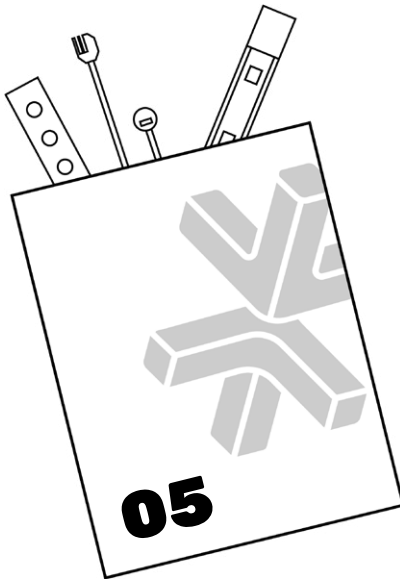
Open LMB Bag 05

95

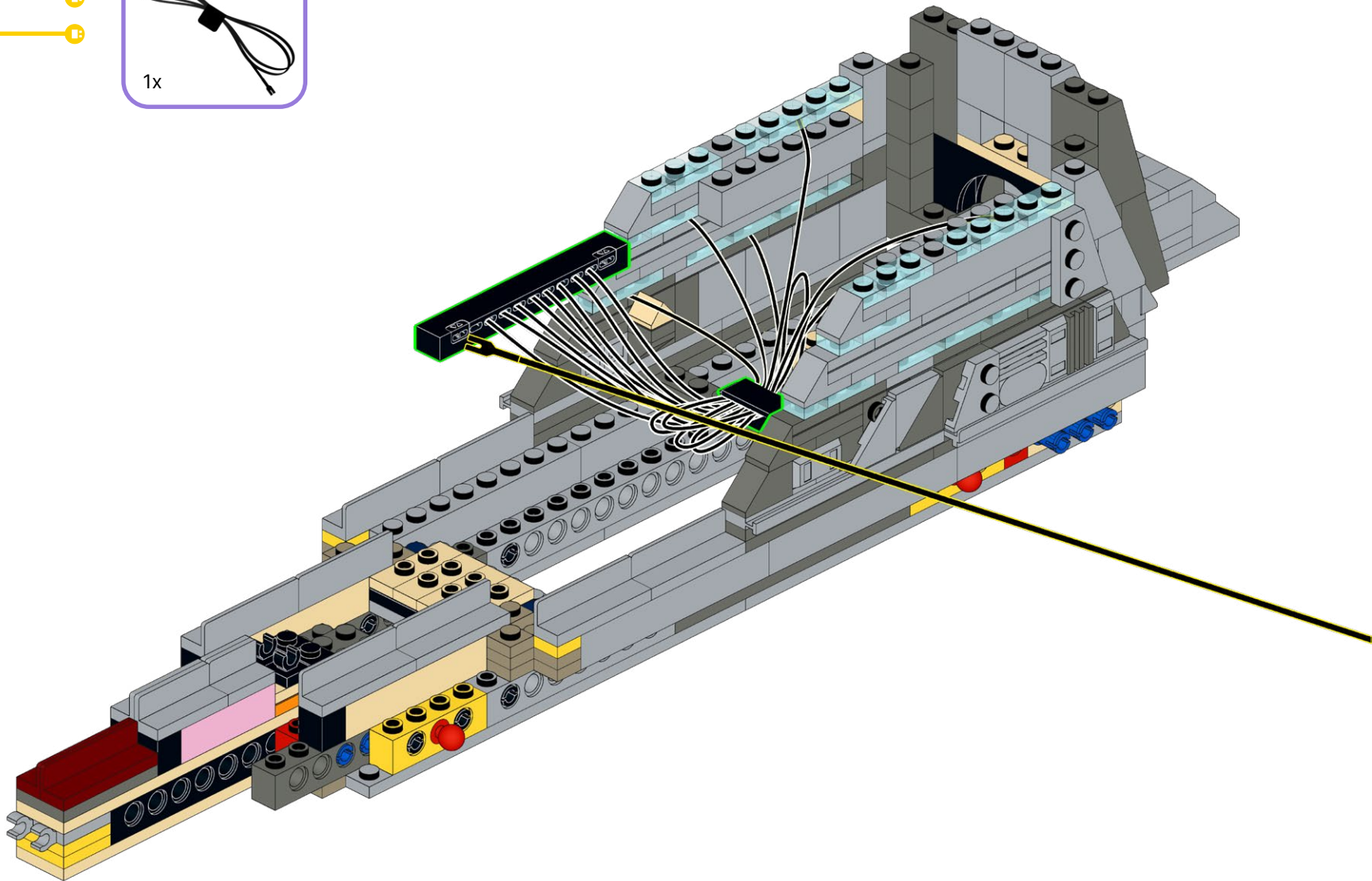
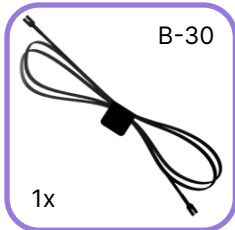

96

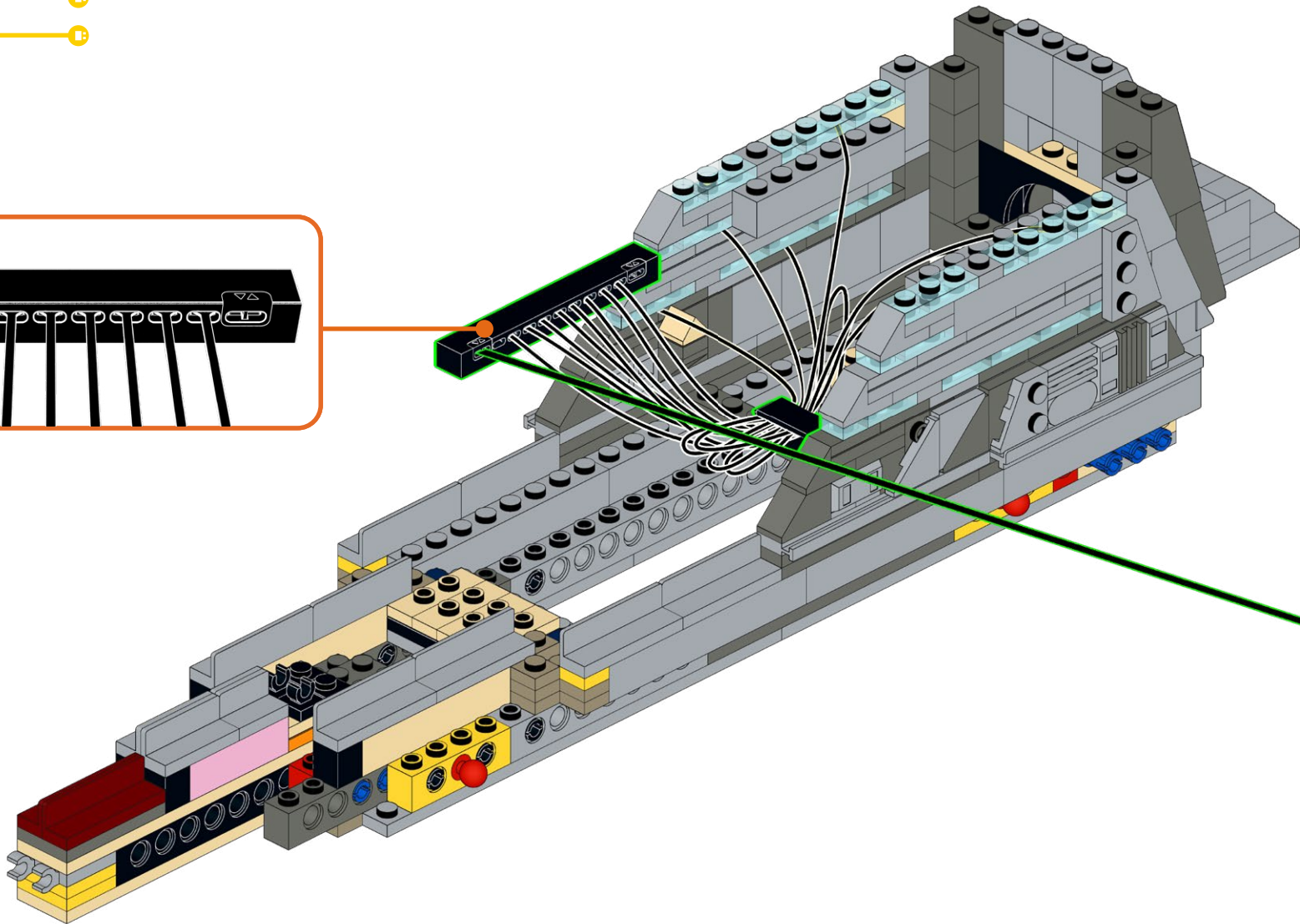
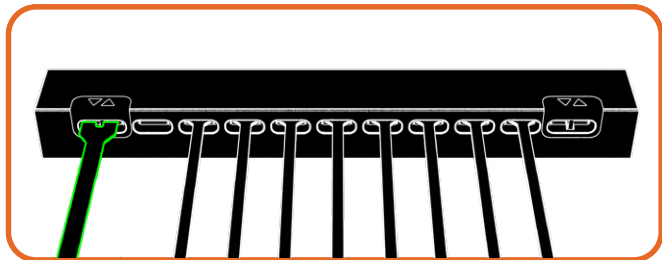

97

1x

B-15

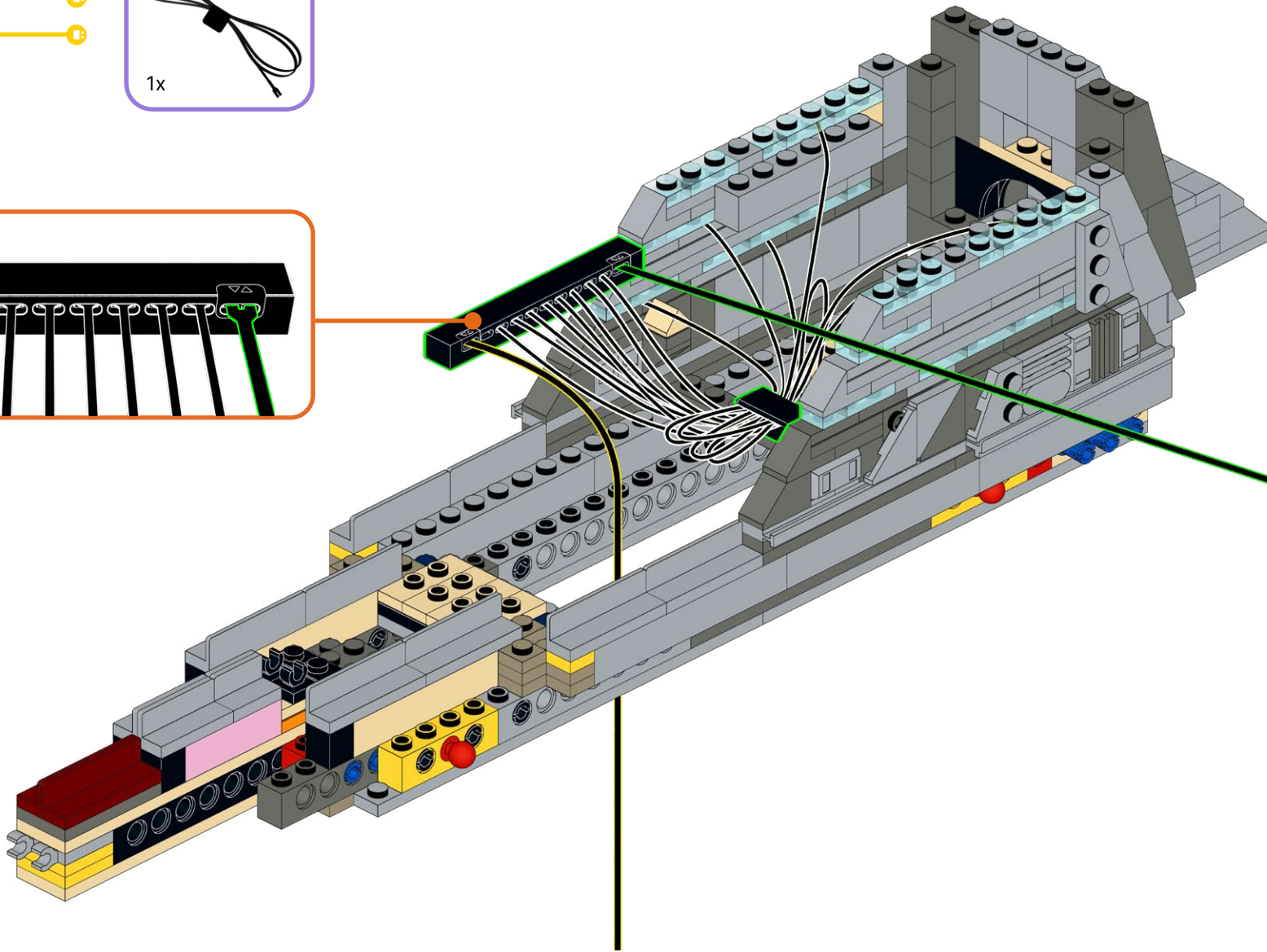
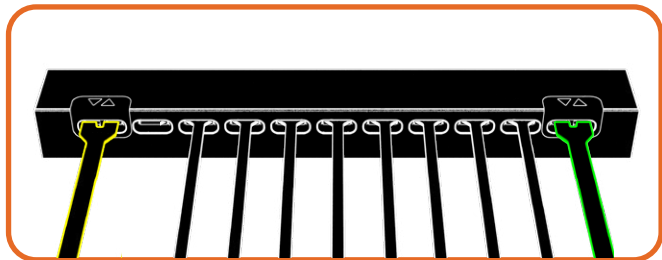

98

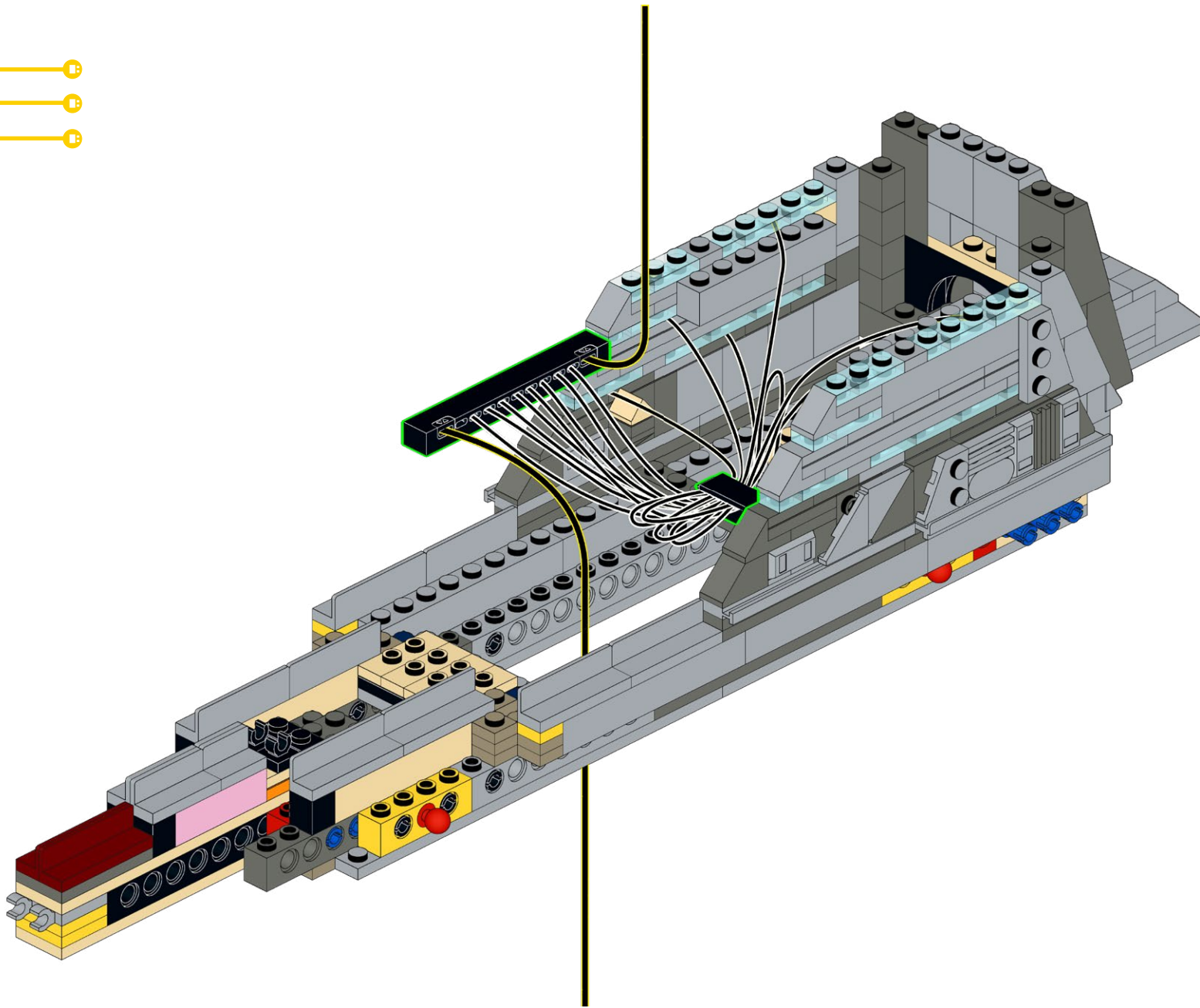

99

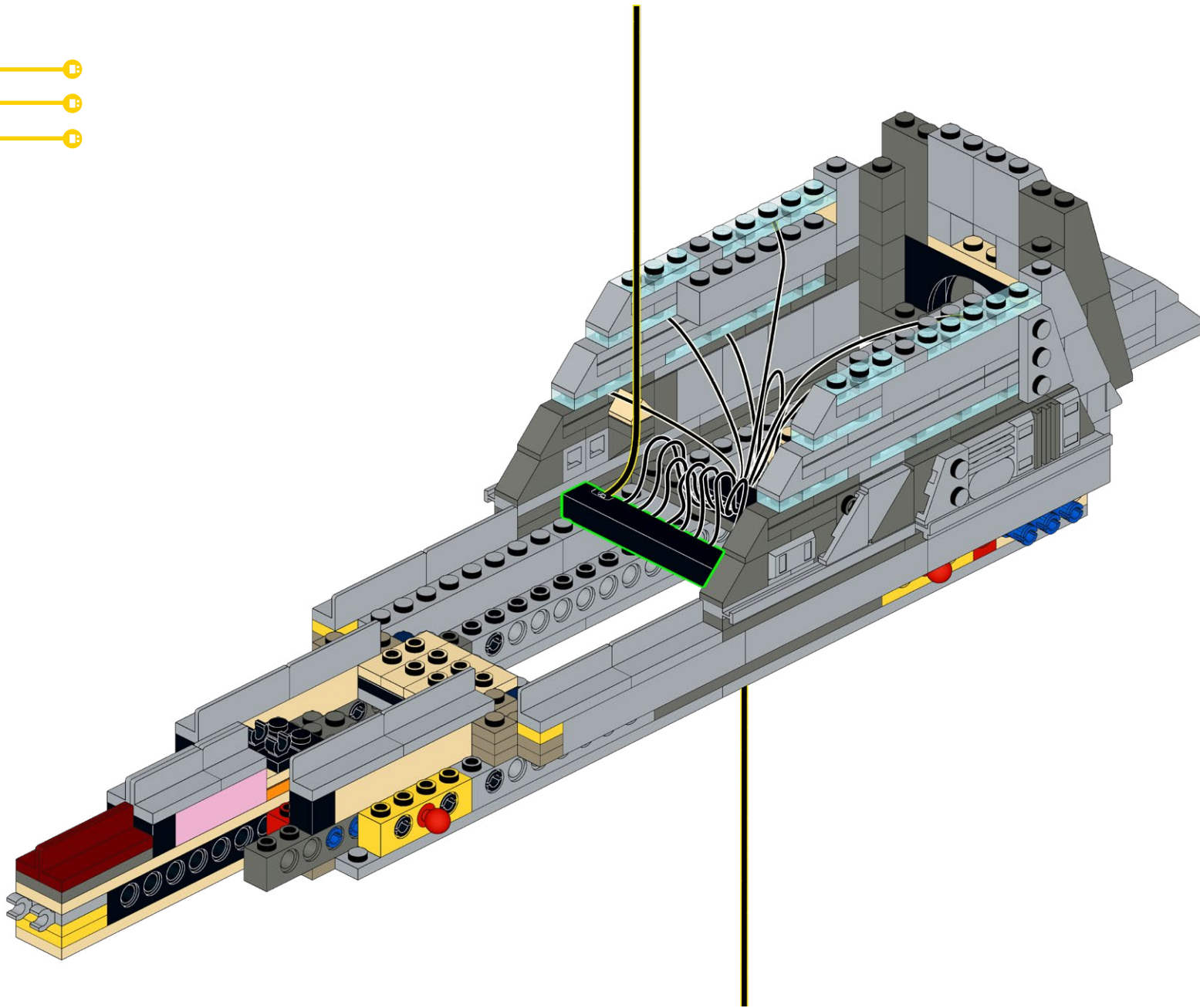

100

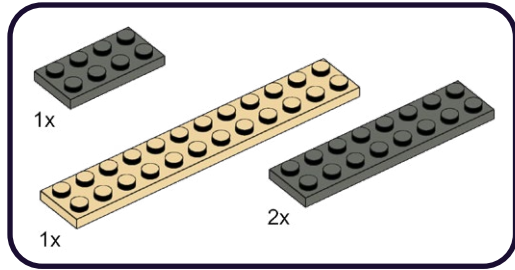

1

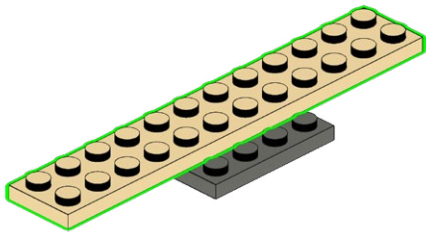

2

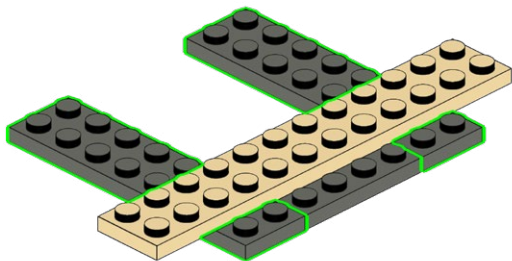

101

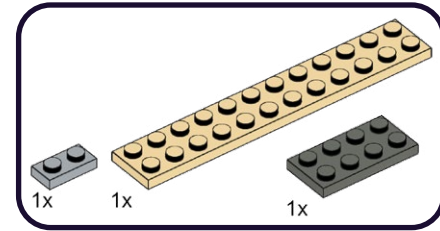

1

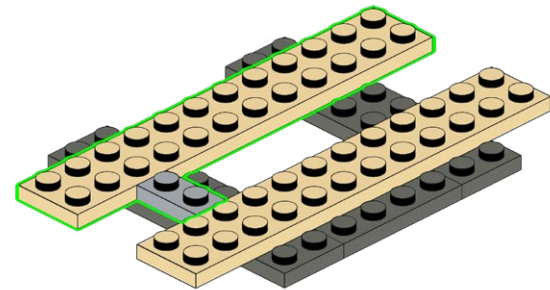

2

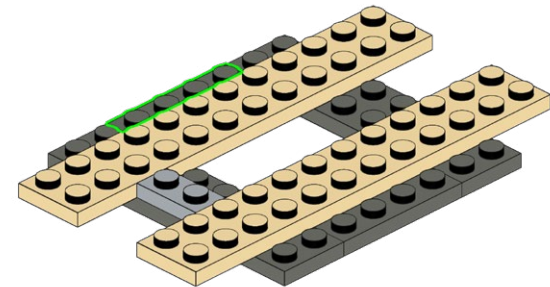

102

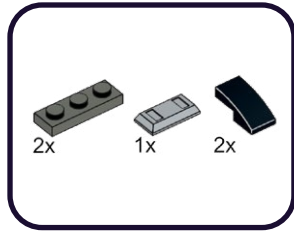

1

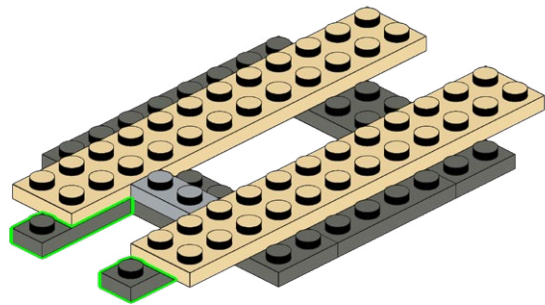

2

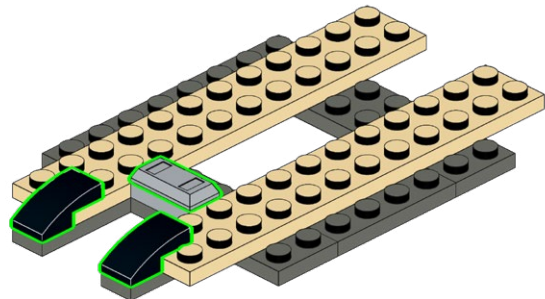

103

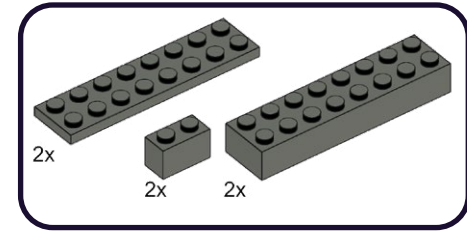

1

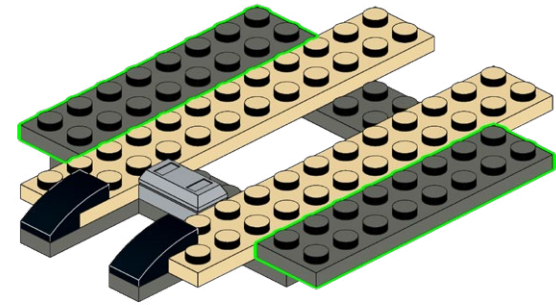

2

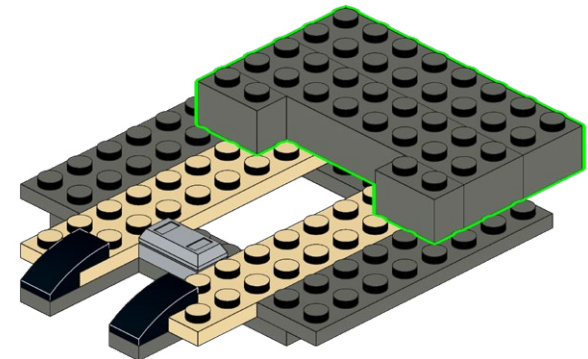

104

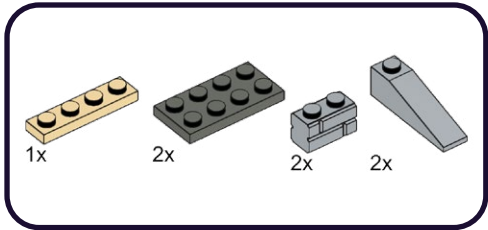

1

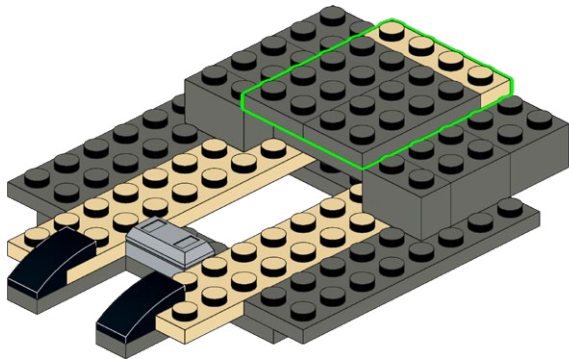

2

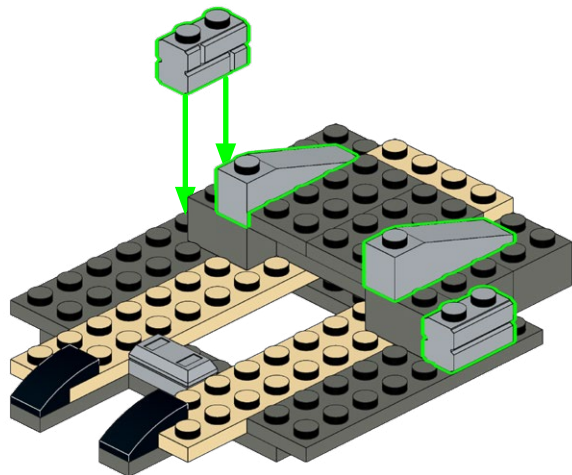

105

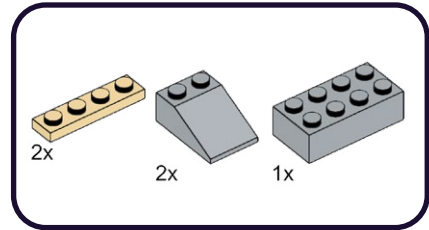

1

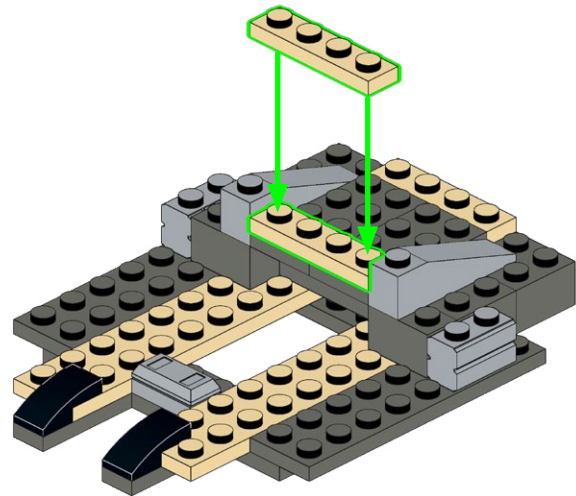

2

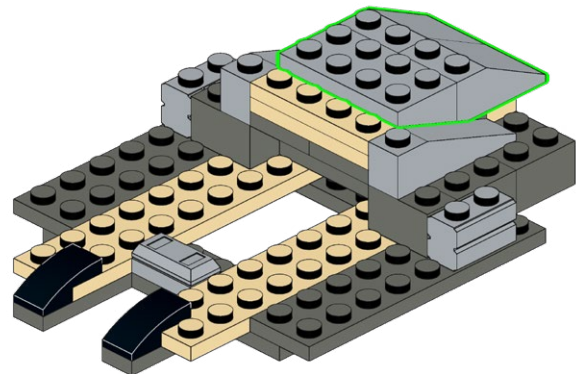

106

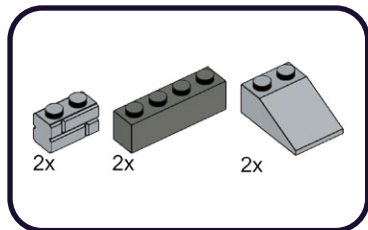

1

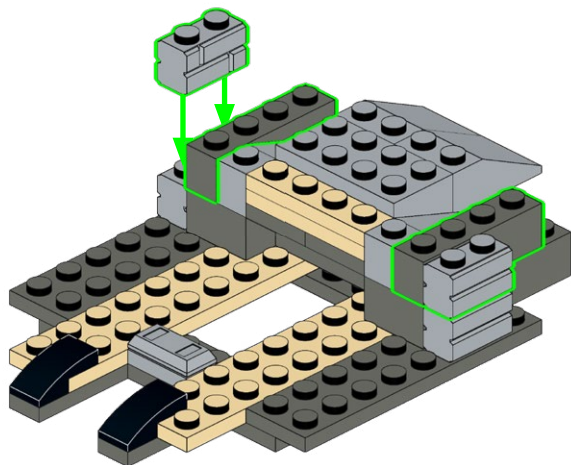

2

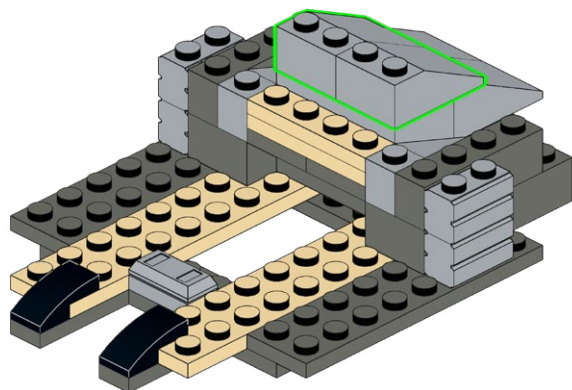

107

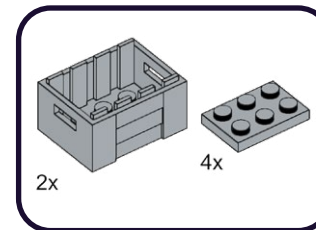

1

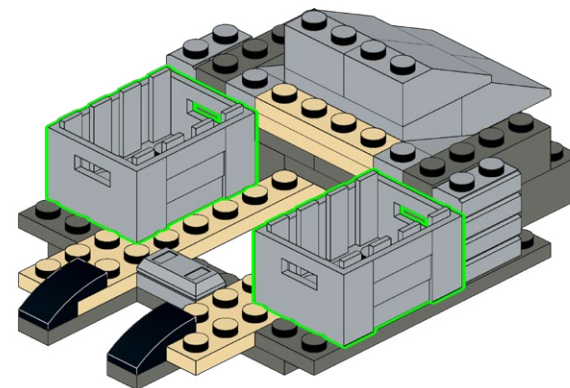

2

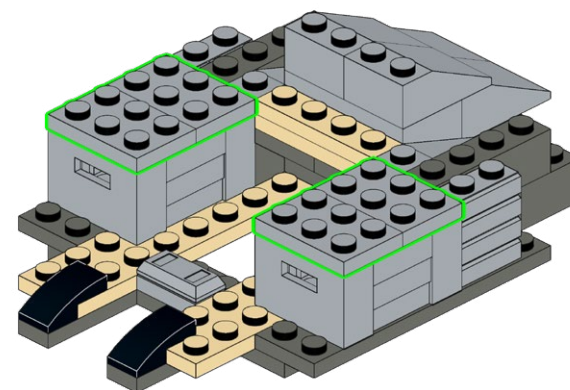

108

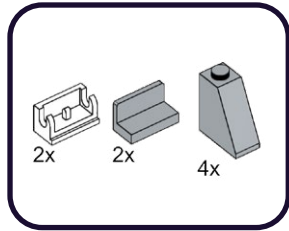

1

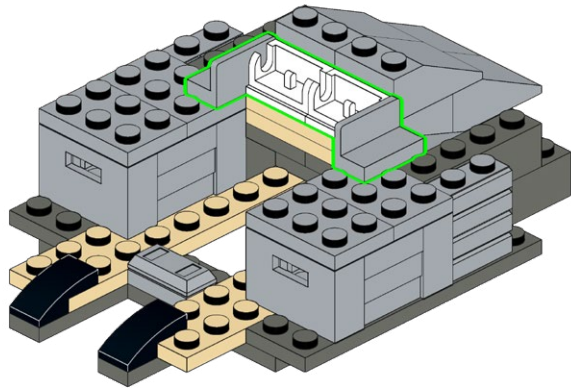

2

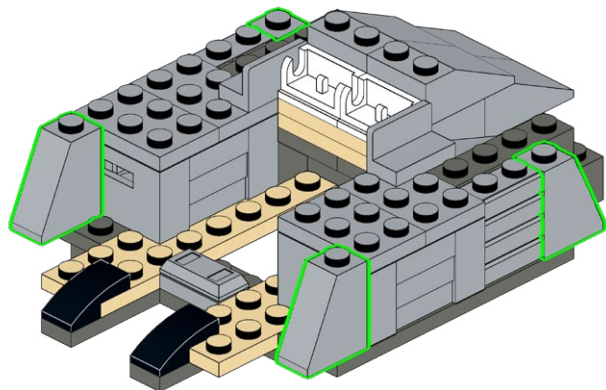

109

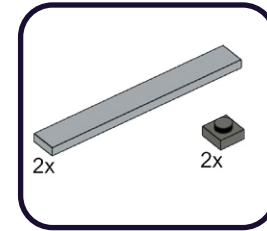

1

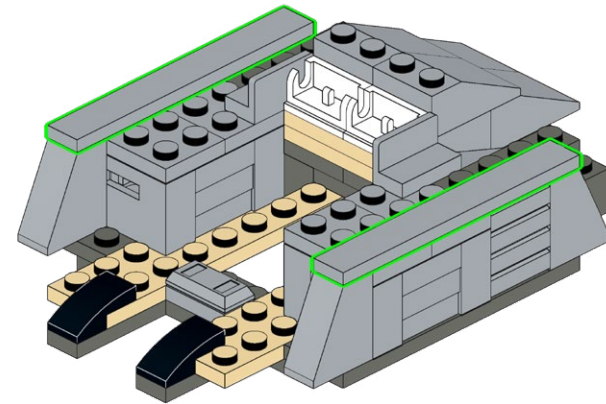

2

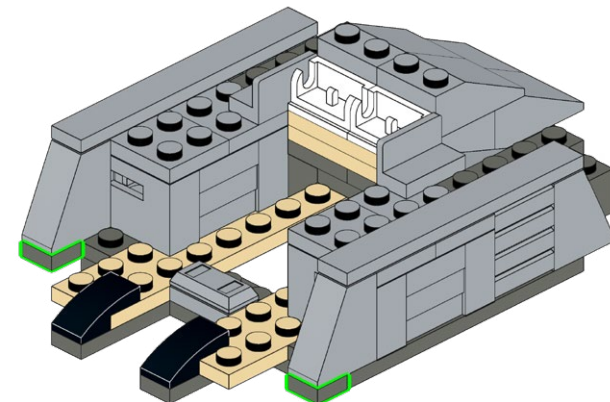

110

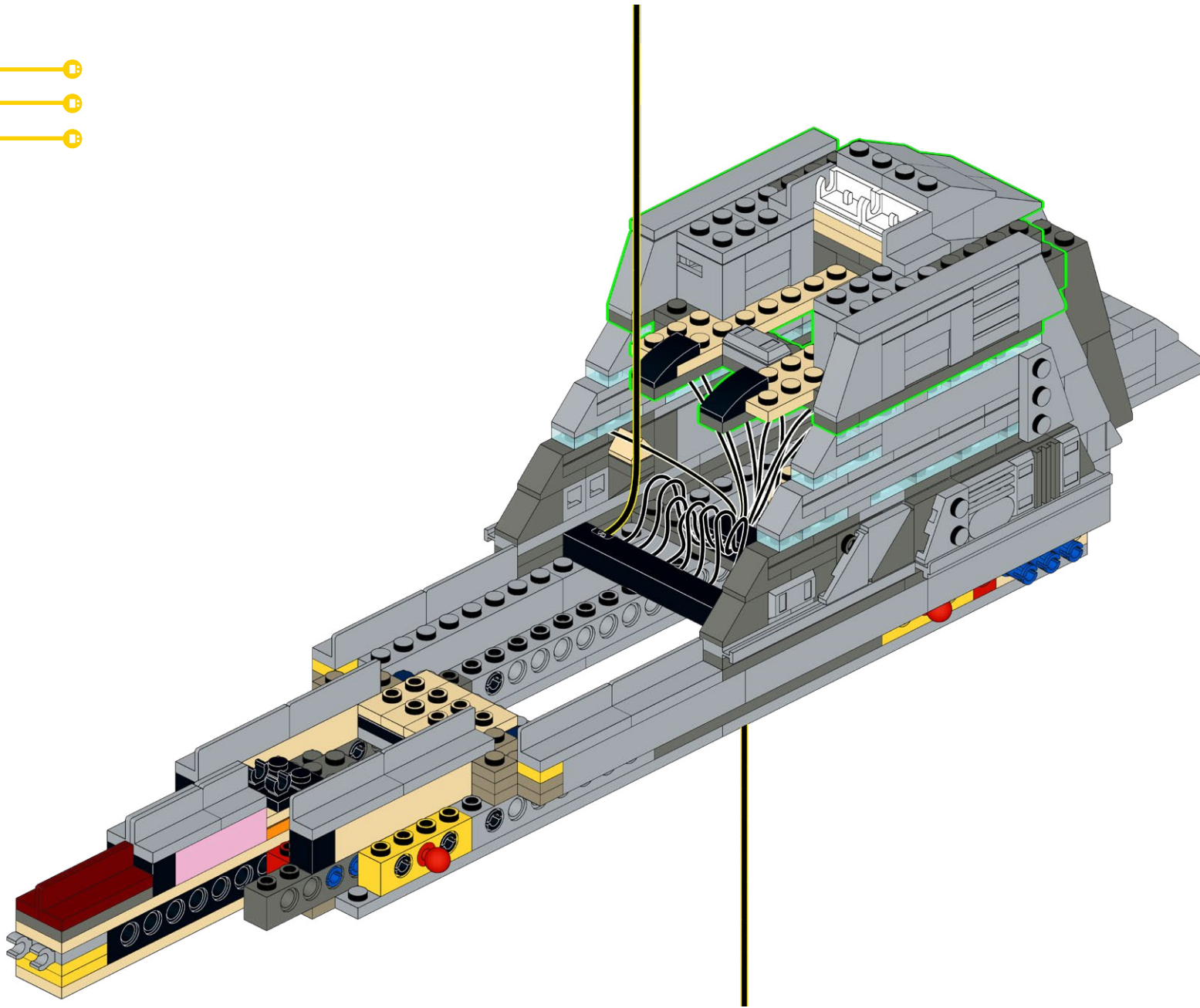

111

2x

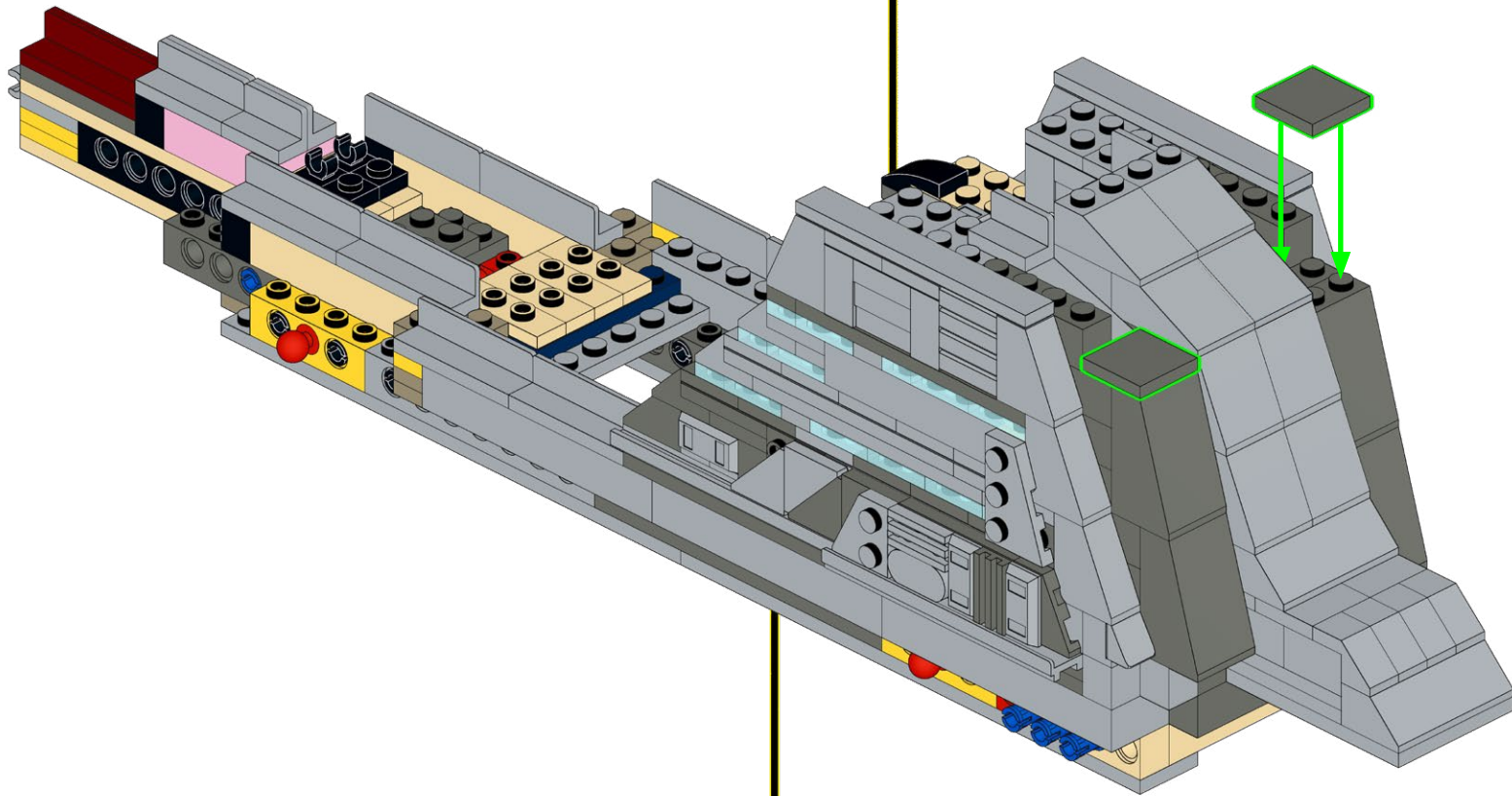

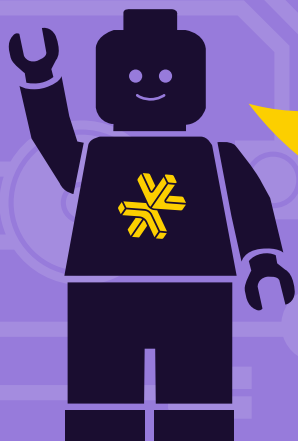
**HOLD UP!**

You might notice some bags aren't in order, as well as left over pieces, but that's ok! We're changing the way you build LEGO!

ATTENDEZ!

Vous remarquerez peut-être que certains sacs, ainsi que certaines pièces, ne sont pas dans le bon ordre. Mais pas de panique! Nous changeons simplement la façon avec laquelle vous construisez vos LEGO!

ASPETTA!

Potresti notare che alcuni sacchetti non sono in ordine, così come i pezzi avanzati, ma va bene così! Stiamo cambiando il modo in cui costruisci i LEGO!

HALT!

Sie werden möglicherweise bemerken, dass einige tüten durcheinander sind und teile übrig bleiben, aber das ist in Ordnung! Wir ändern die art und weise, wie Sie LEGO bauen!

¡ESPERA!

Es posible que notes que algunas bolsas están fuera de servicio, así como piezas sobrantes, ¡pero está bien! ¡Estamos cambiando la forma en que construyes LEGO!

暫停!

你可能会注意到一些袋子顺序错乱, 以及一些剩余的部件, 但没关系! 我们正在改变你搭建乐高的方式!

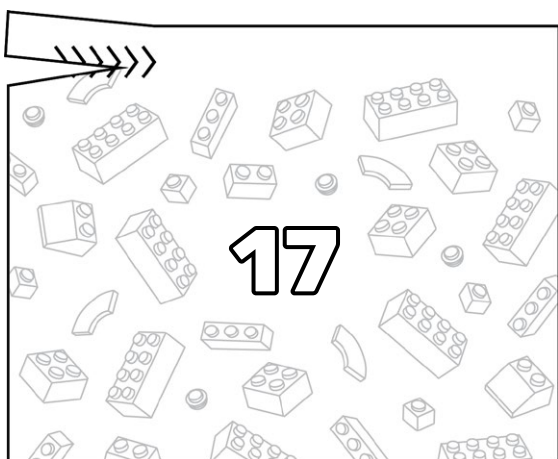
Open LEGO® Bag 17

112

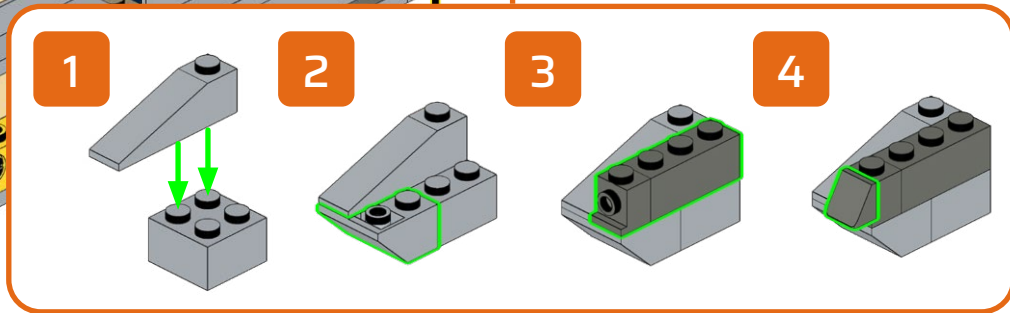
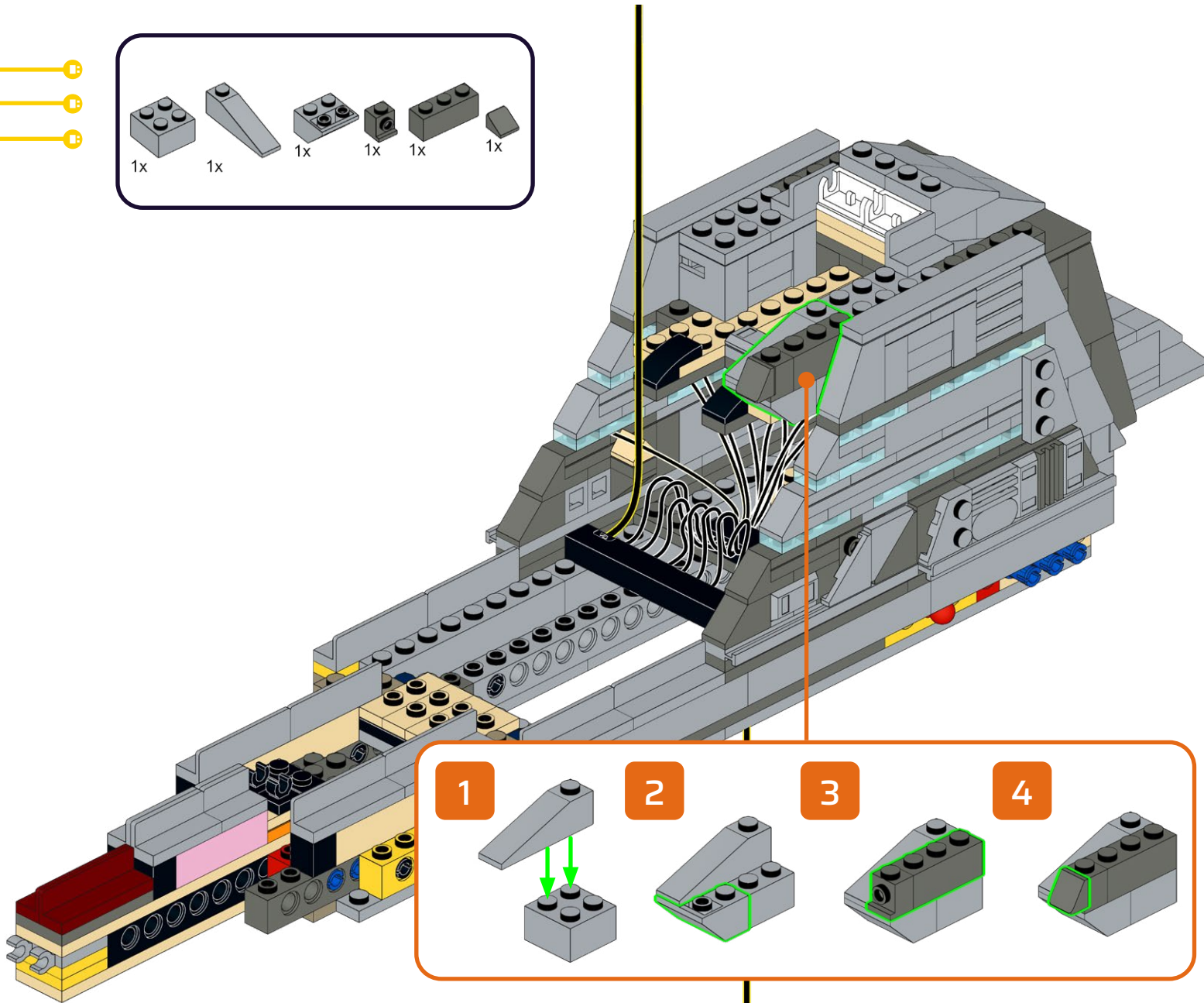
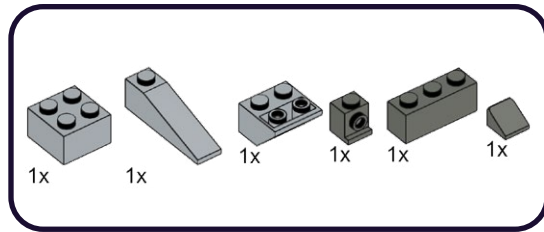

113

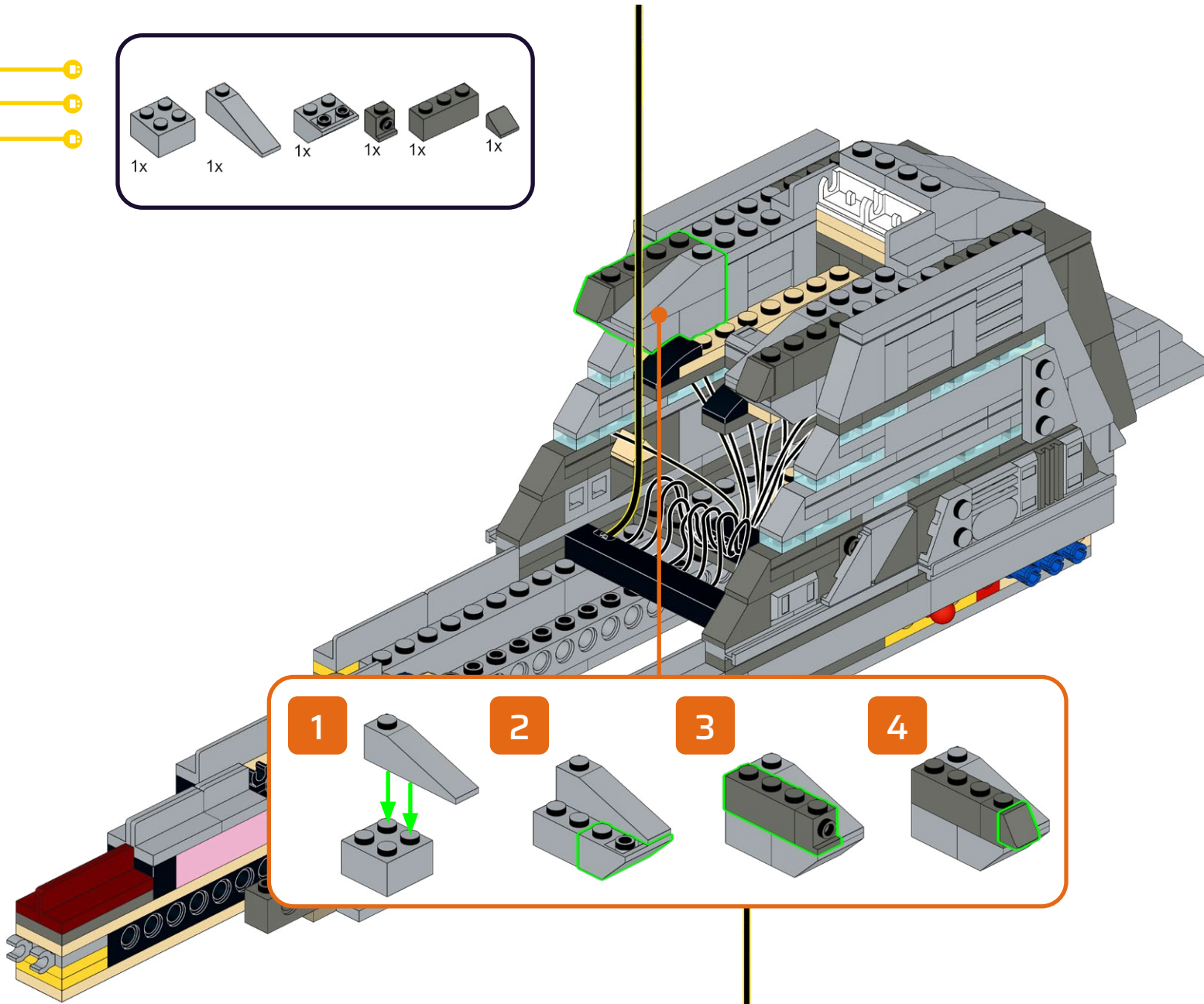
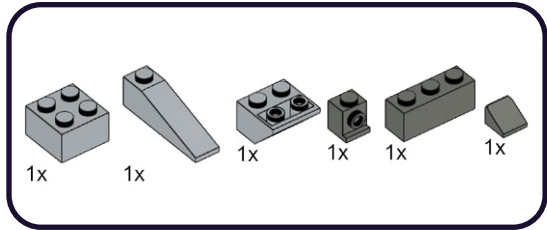

114

2x

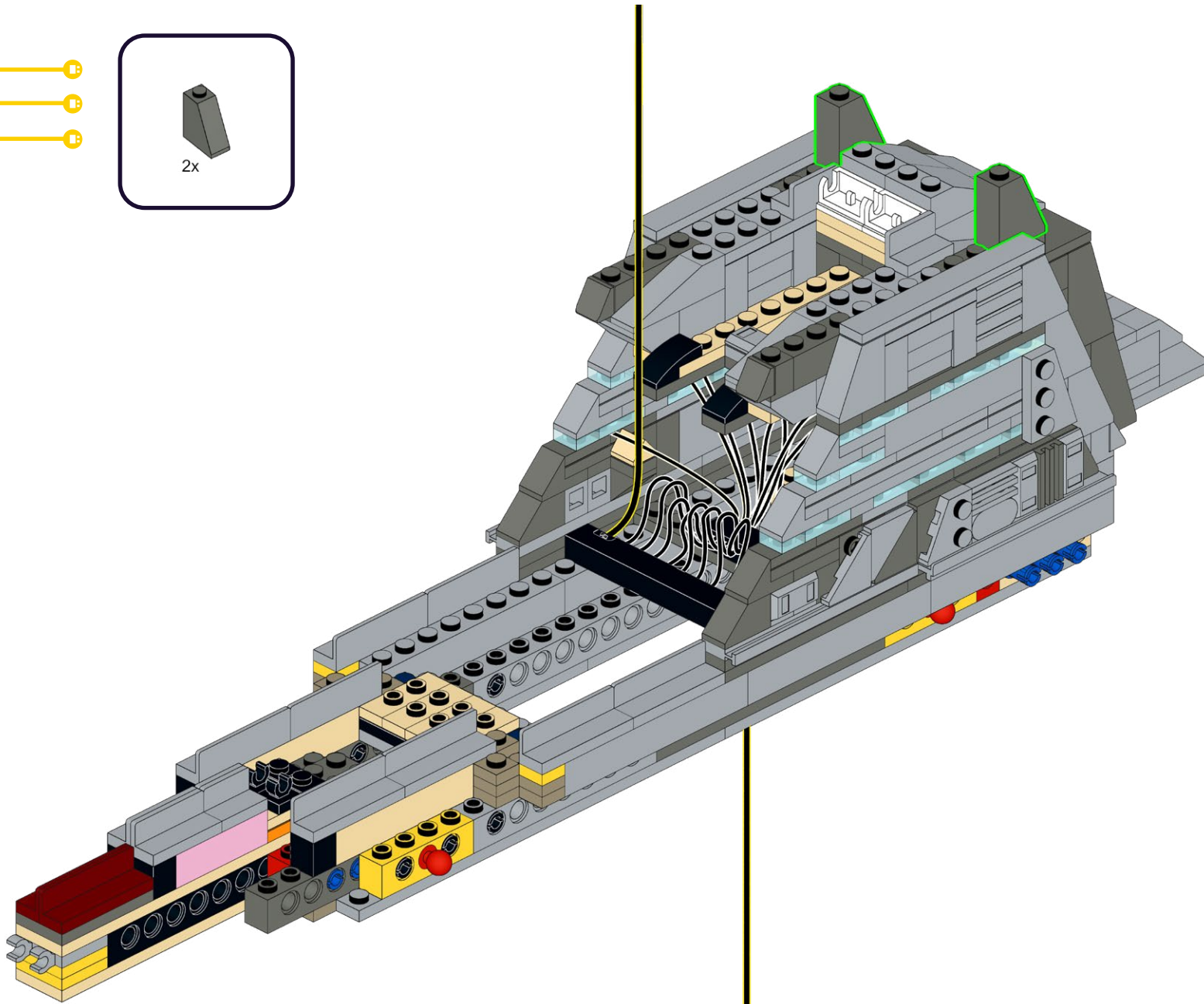

115

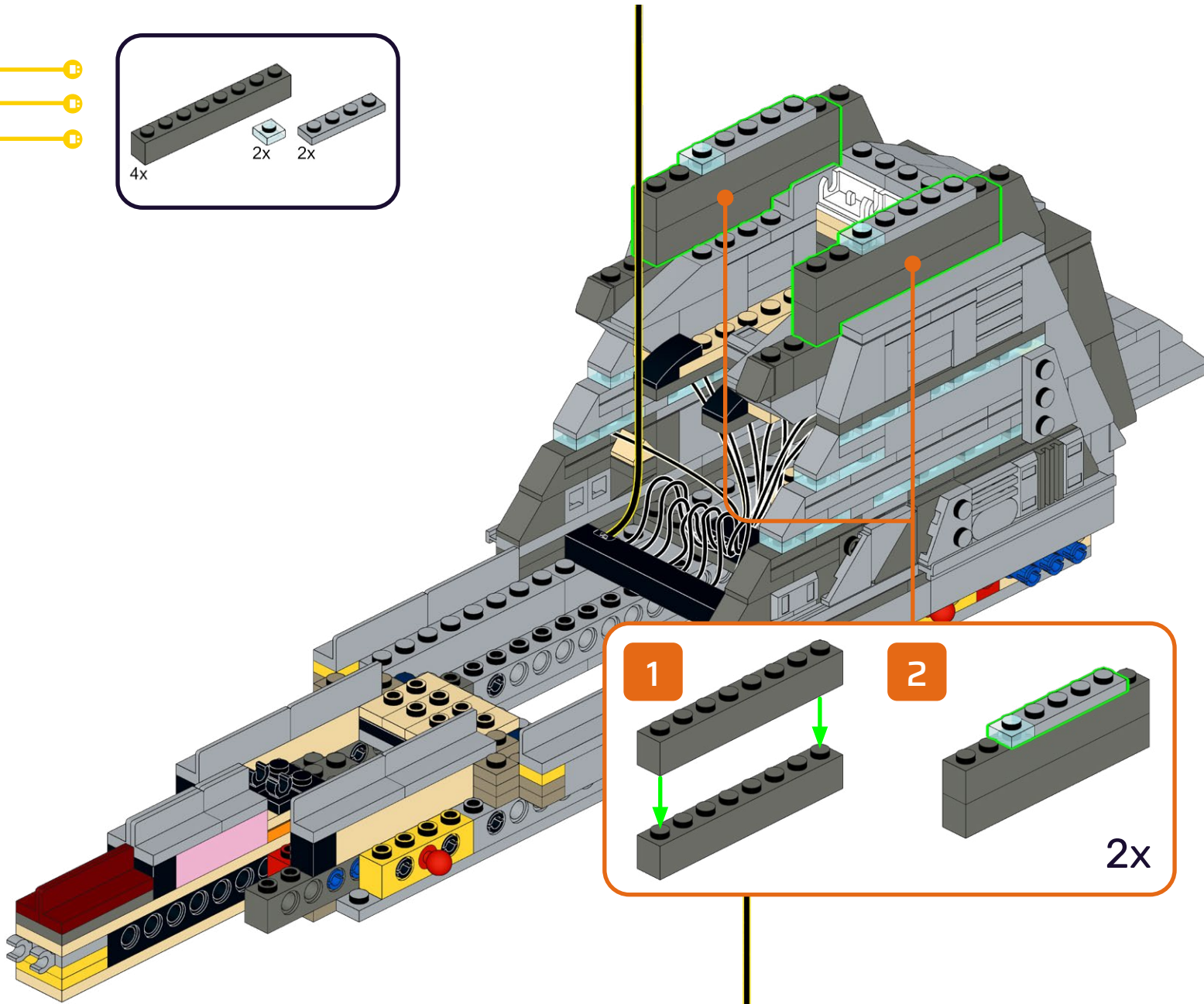
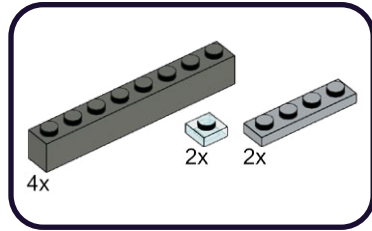

**HOLD UP!**

You might notice some bags aren't in order, as well as left over pieces, but that's ok! We're changing the way you build LEGO!

HALTEN!

Möglicherweise stellen Sie fest, dass einige Beutel nicht in Ordnung sind und auch Teile übrig bleiben, aber das ist in Ordnung! Wir verändern die Art und Weise, wie Sie LEGO bauen!

TENIR BON!

Vous remarquerez peut-être que certains sacs sont en panne, ainsi que des morceaux restants, mais ce n'est pas grave ! Nous changeons la façon dont vous construisez LEGO !

SOSTENERE!

Potresti notare che alcune borse sono fuori uso, così come alcuni pezzi avanzati, ma va bene! Stiamo cambiando il modo in cui costruisci i LEGO!

¡SOSTENER!

Puede que notes que algunas bolsas están fuera de orden, así como piezas sobrantes, ¡pero está bien! ¡Estamos cambiando la forma de construir LEGO!

耽误!

您可能会注意到有些袋子坏了, 还有剩余的碎片, 但这没关系! 我们正在改变您搭建乐高的方式!

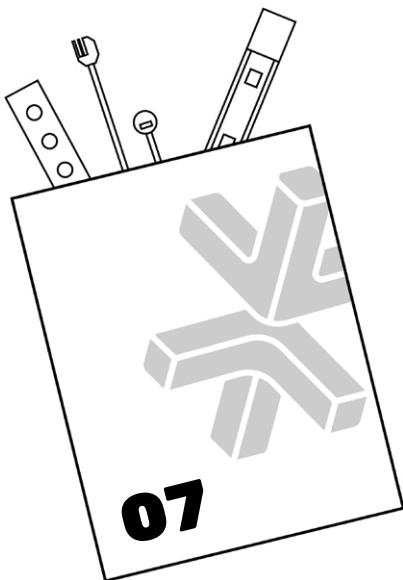
Open LMB Bag 07

116

AR-CW30

1x

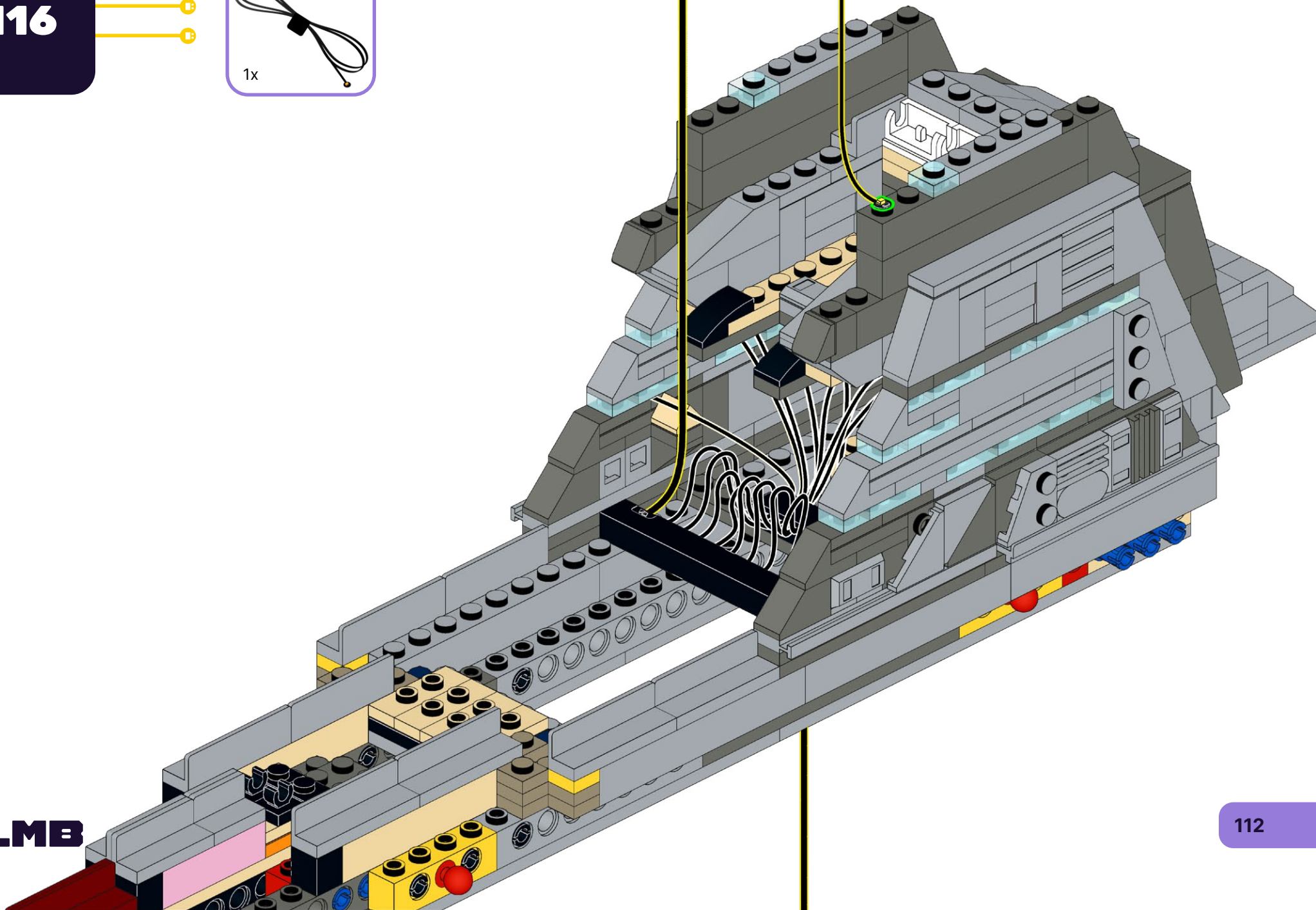
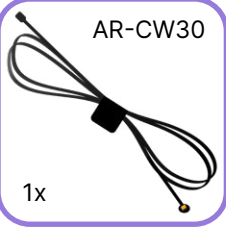

117

1x

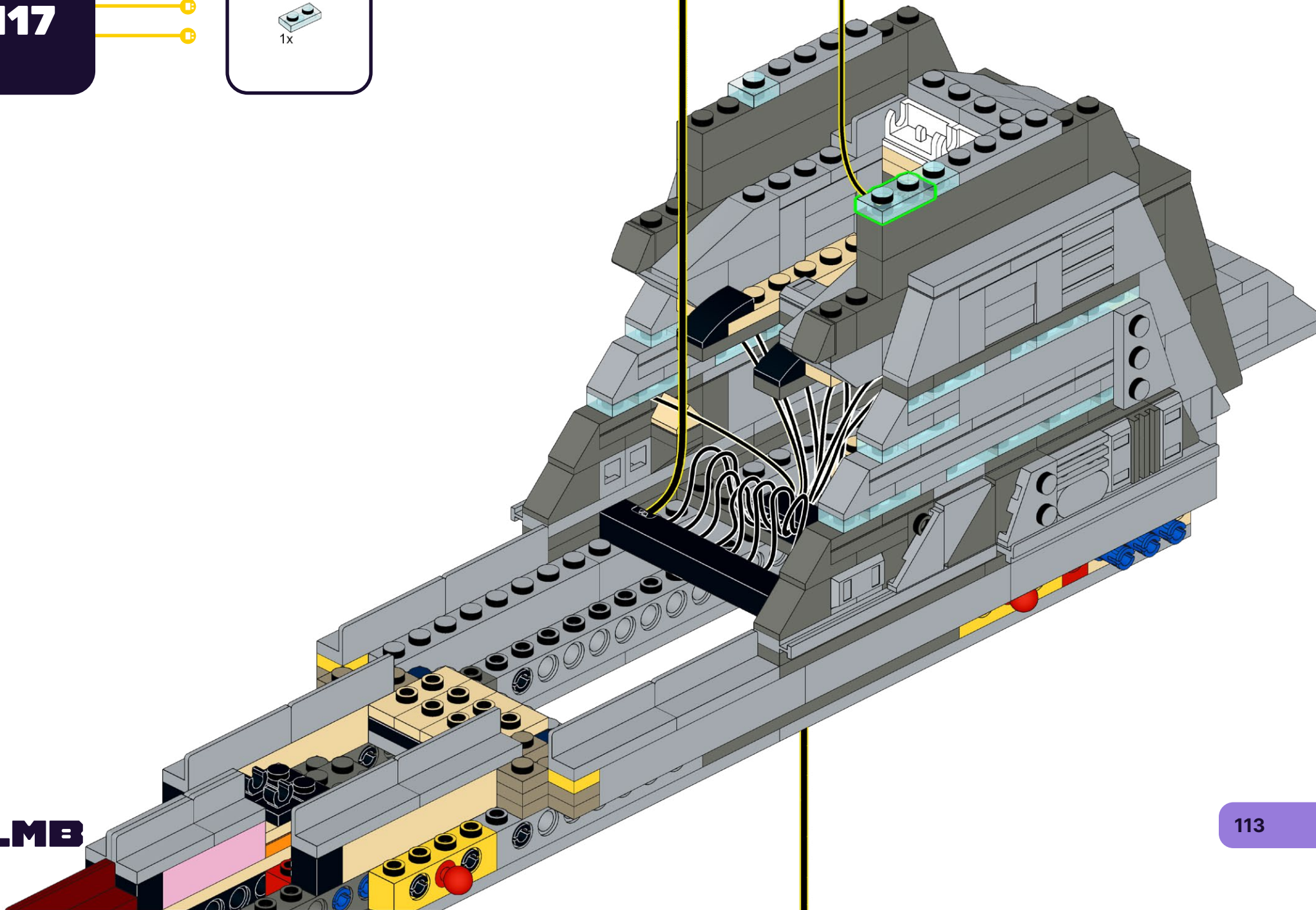
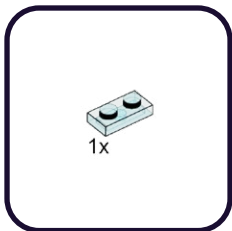

118

AR-CW30

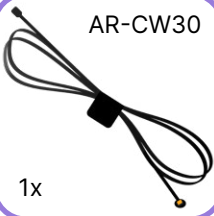

1x

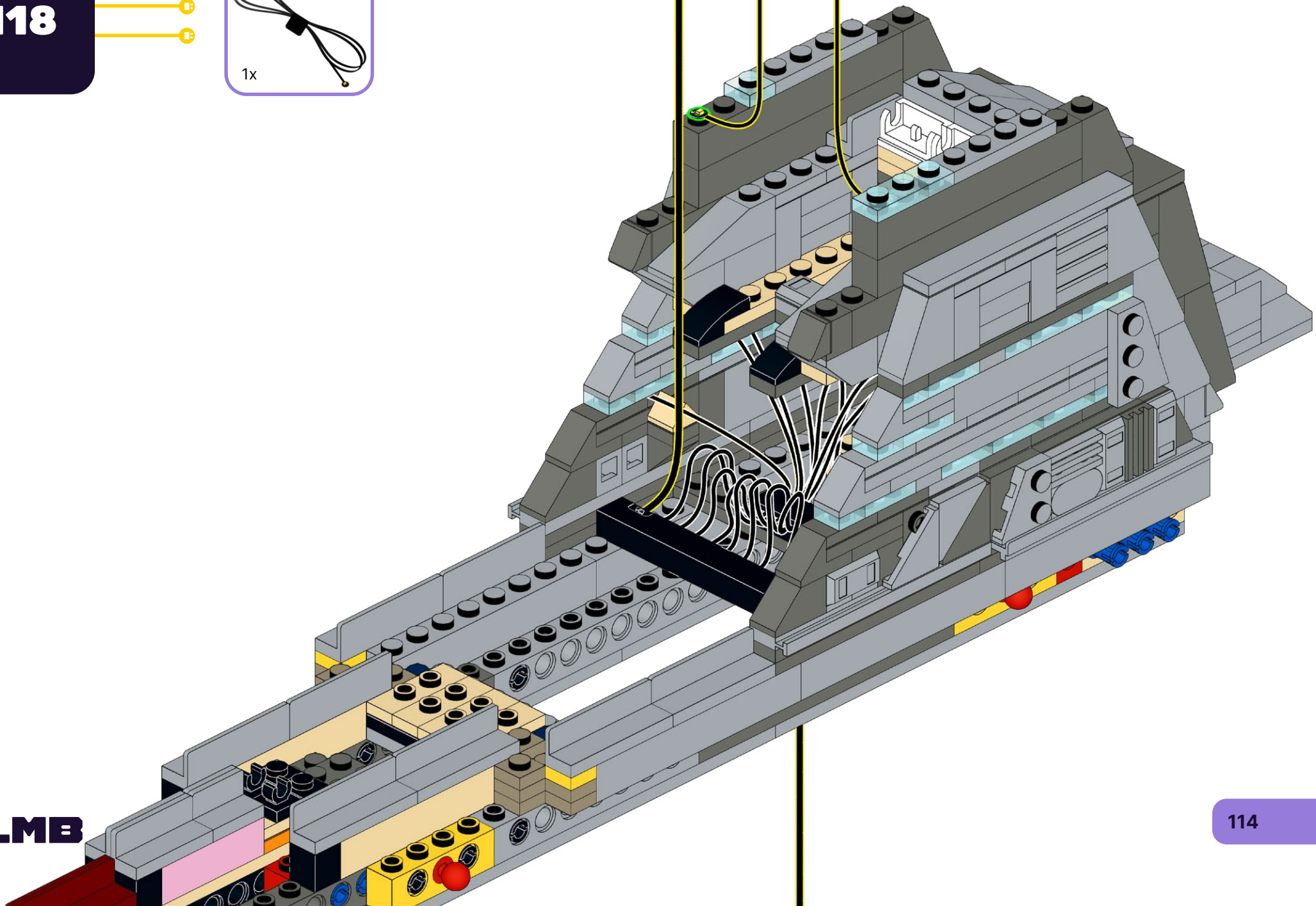

119

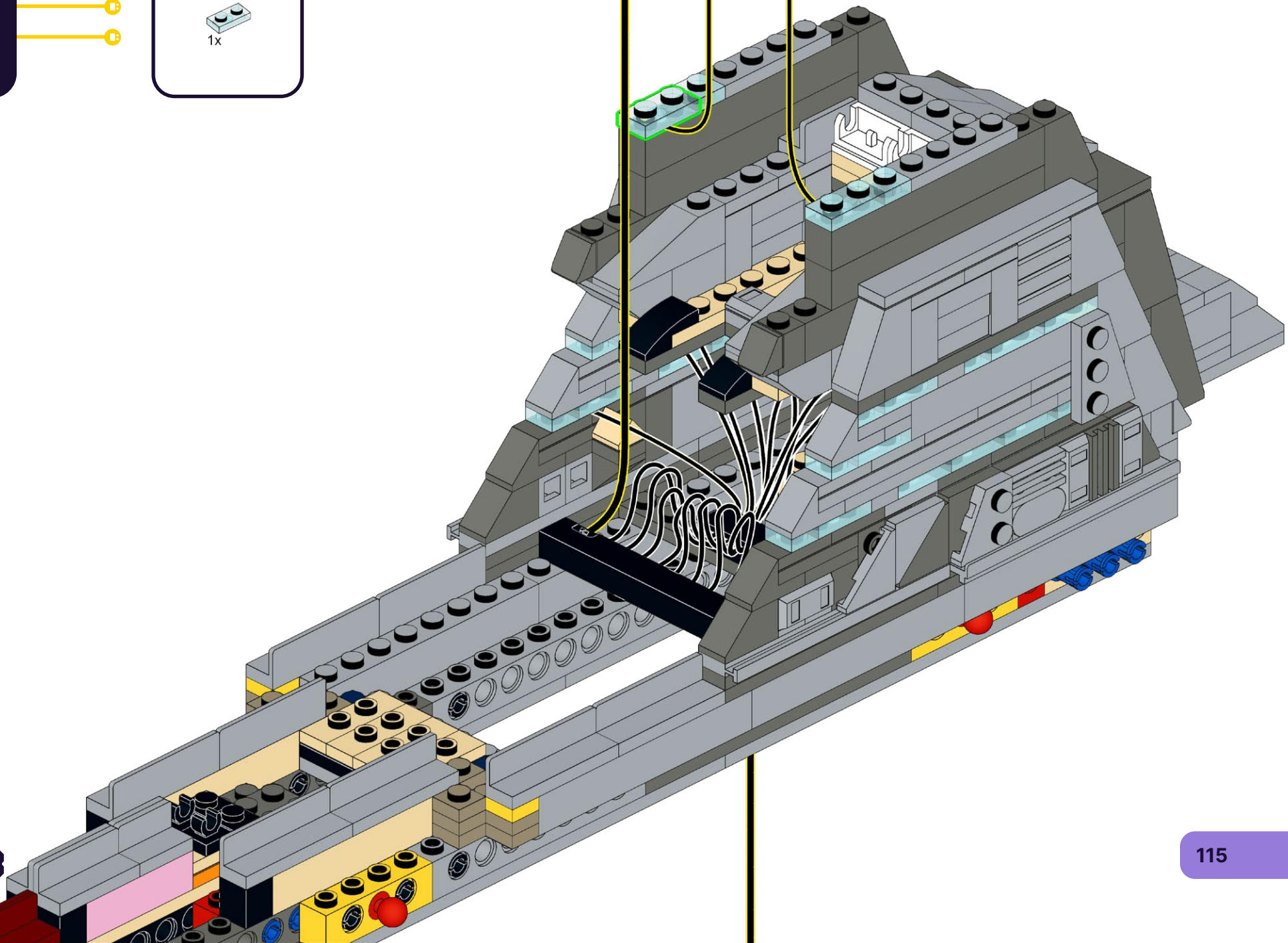
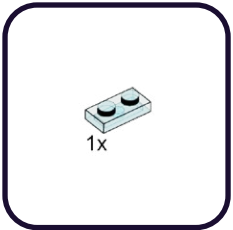

120

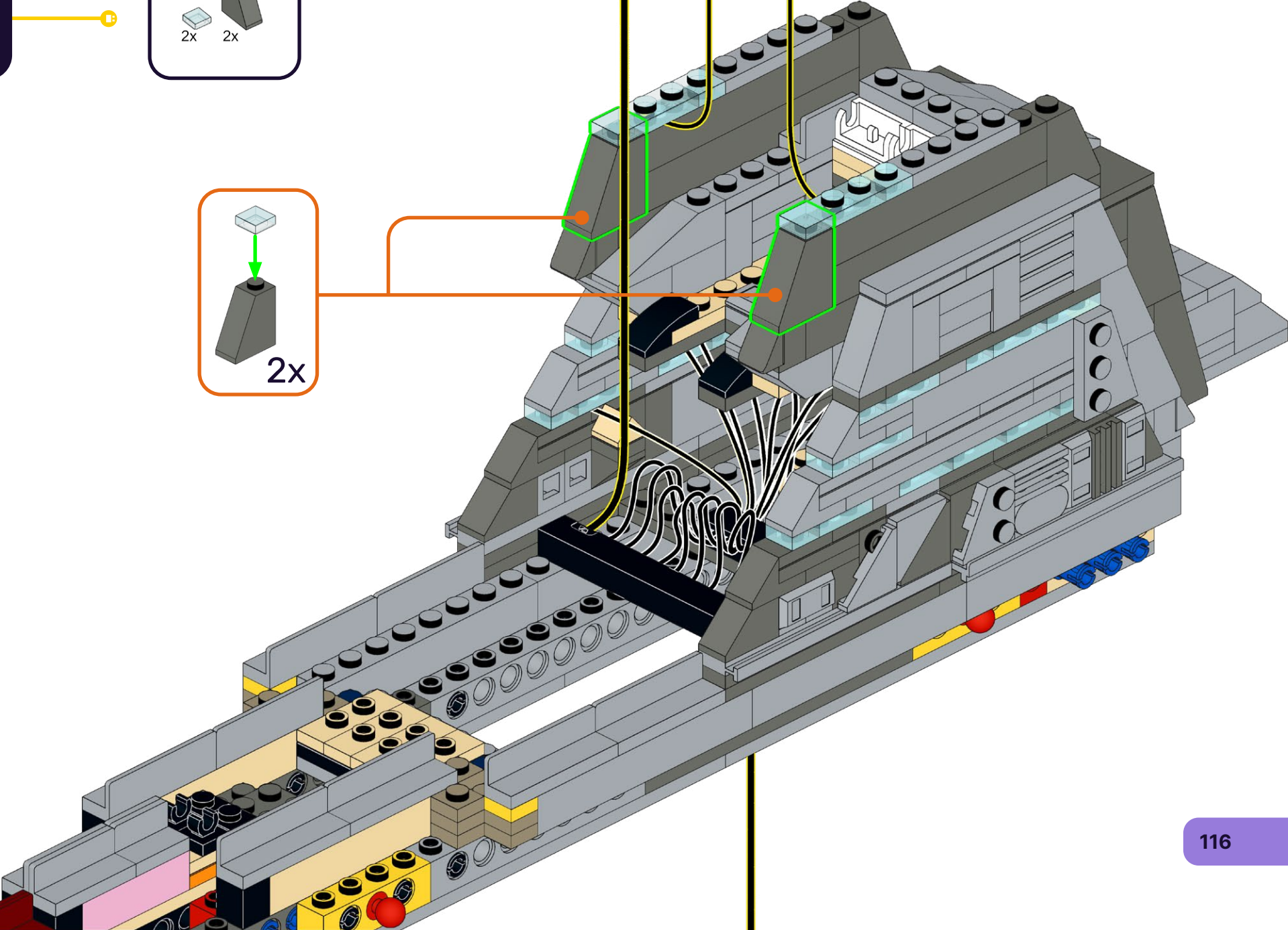
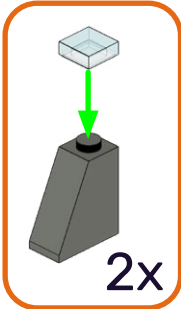
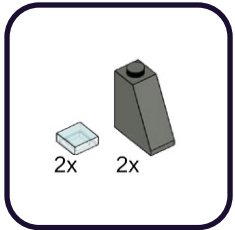

121

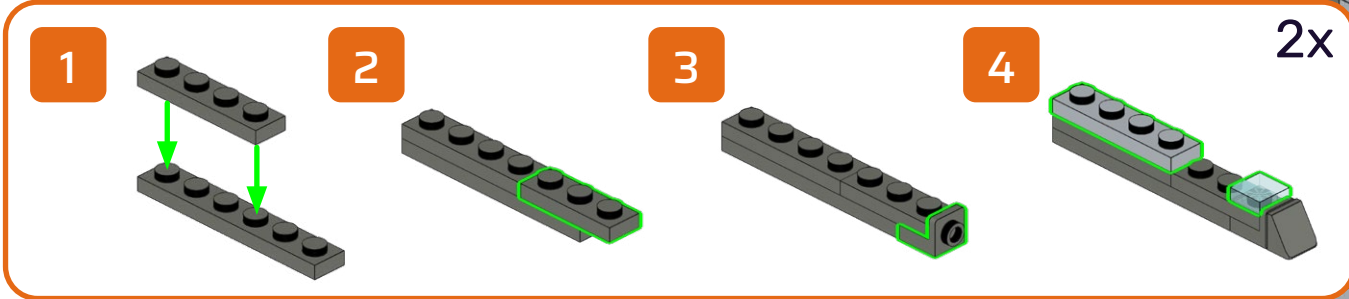
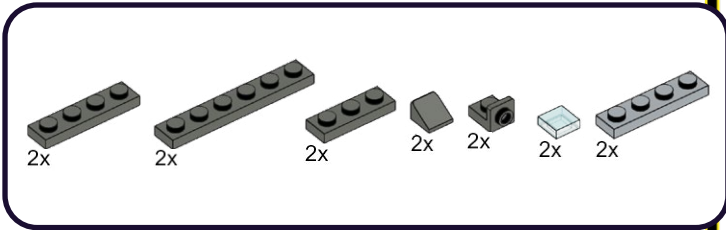

122

AR-CW30

1x

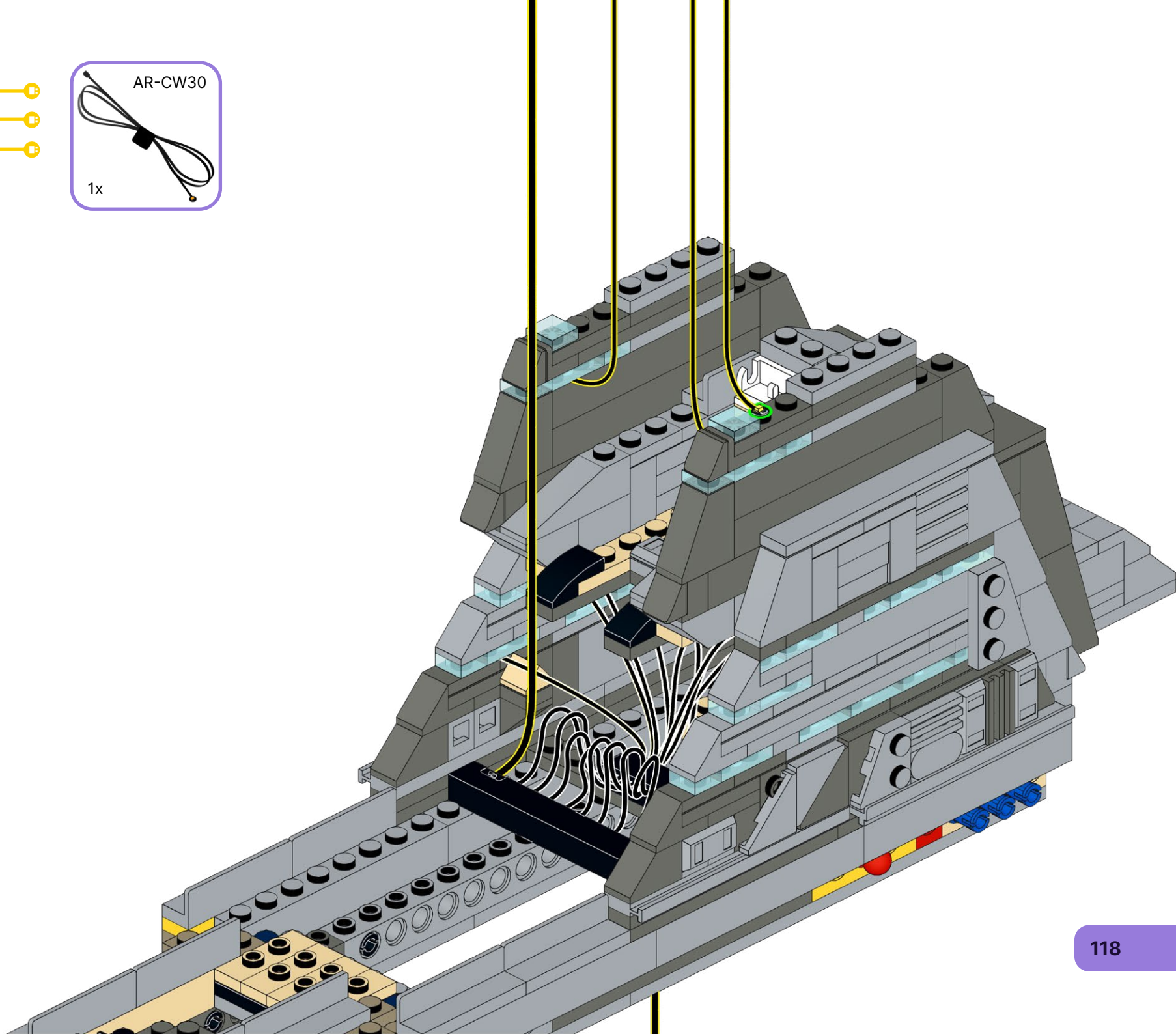
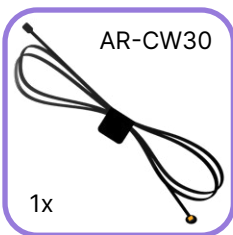

123

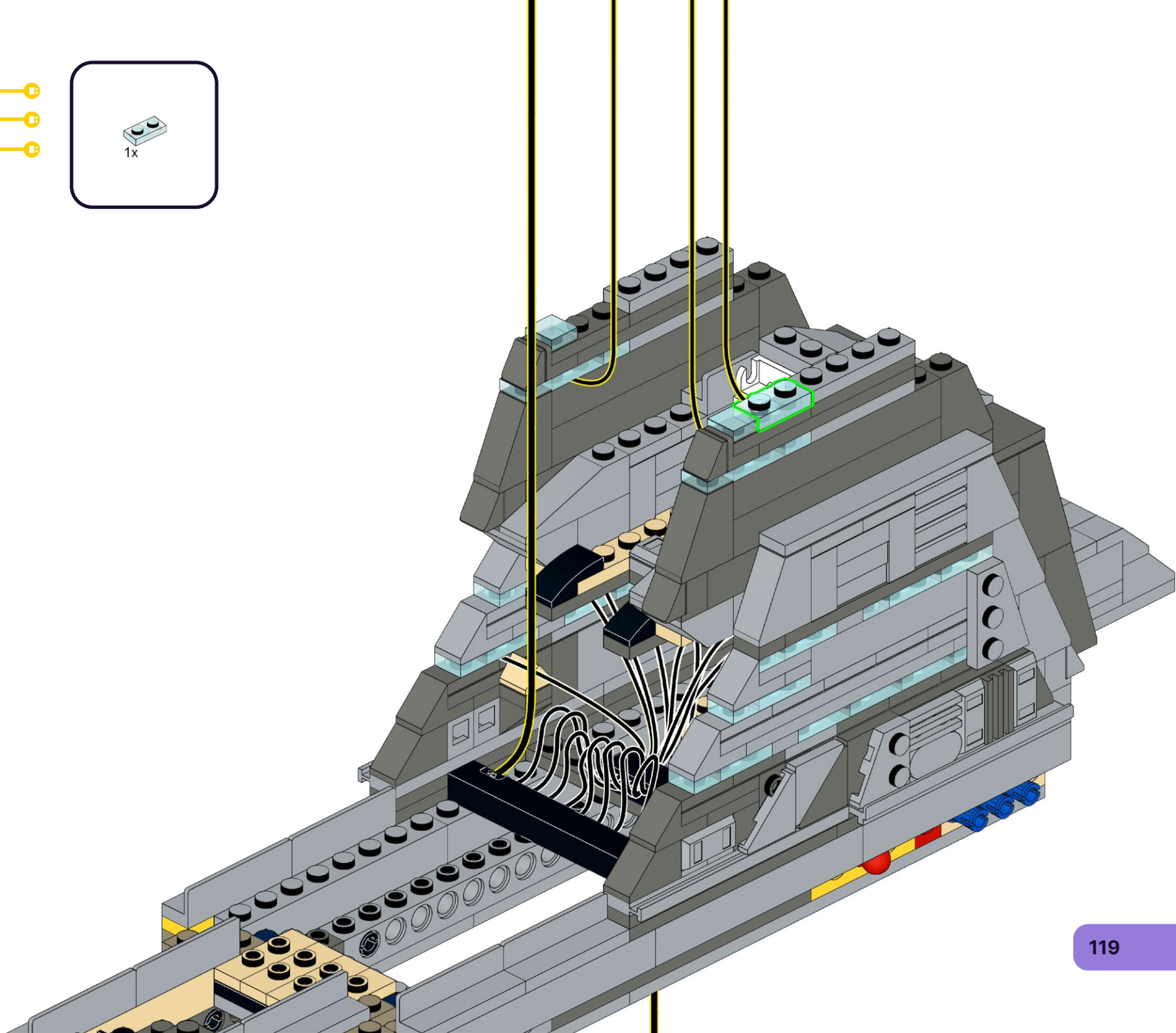
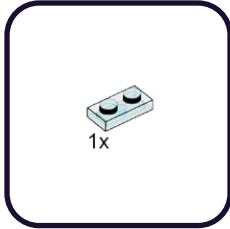

124

AR-CW30

1x

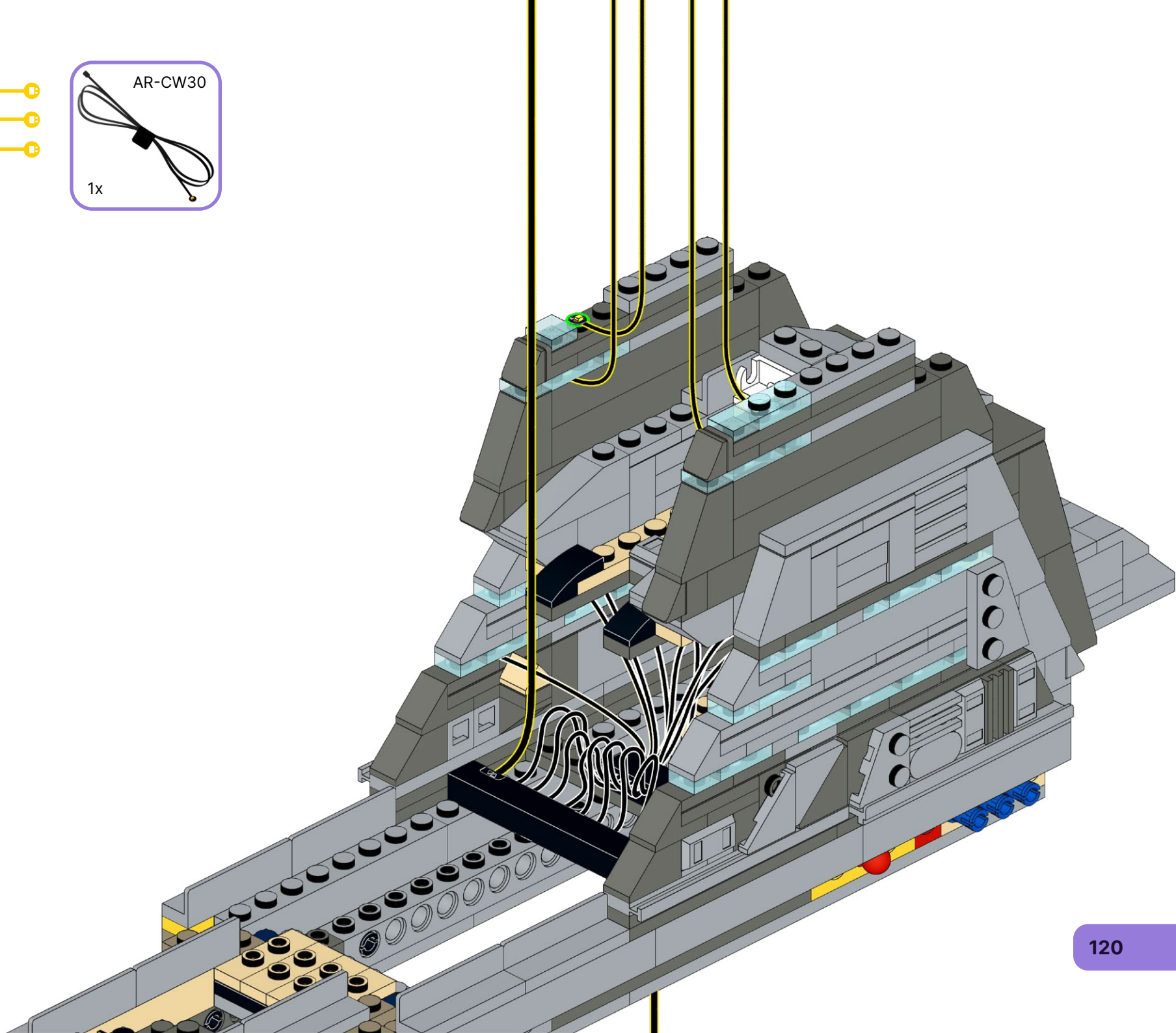
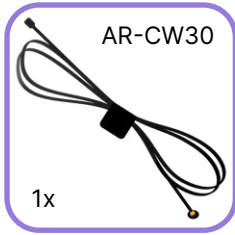

125

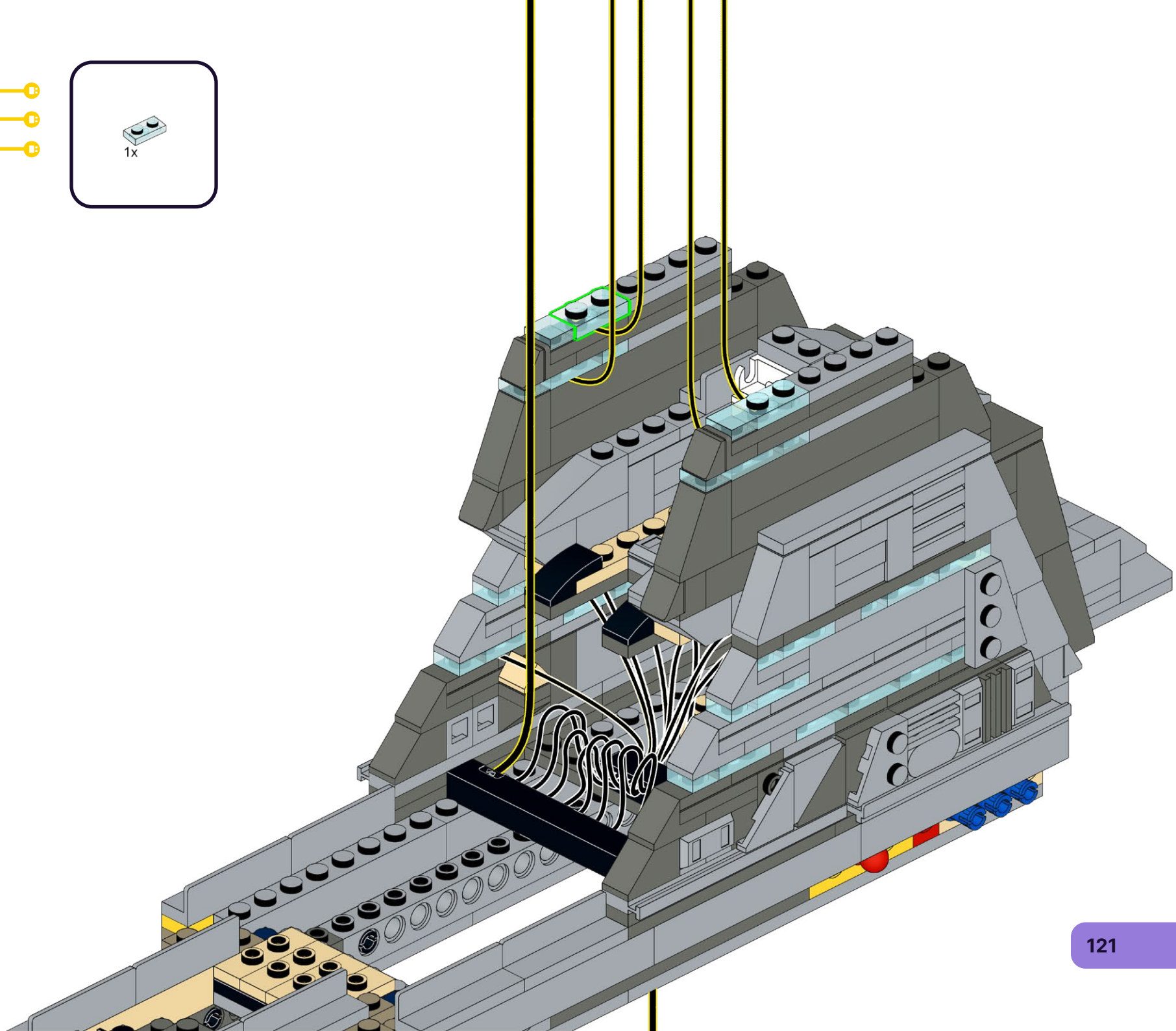
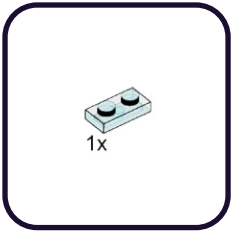

126

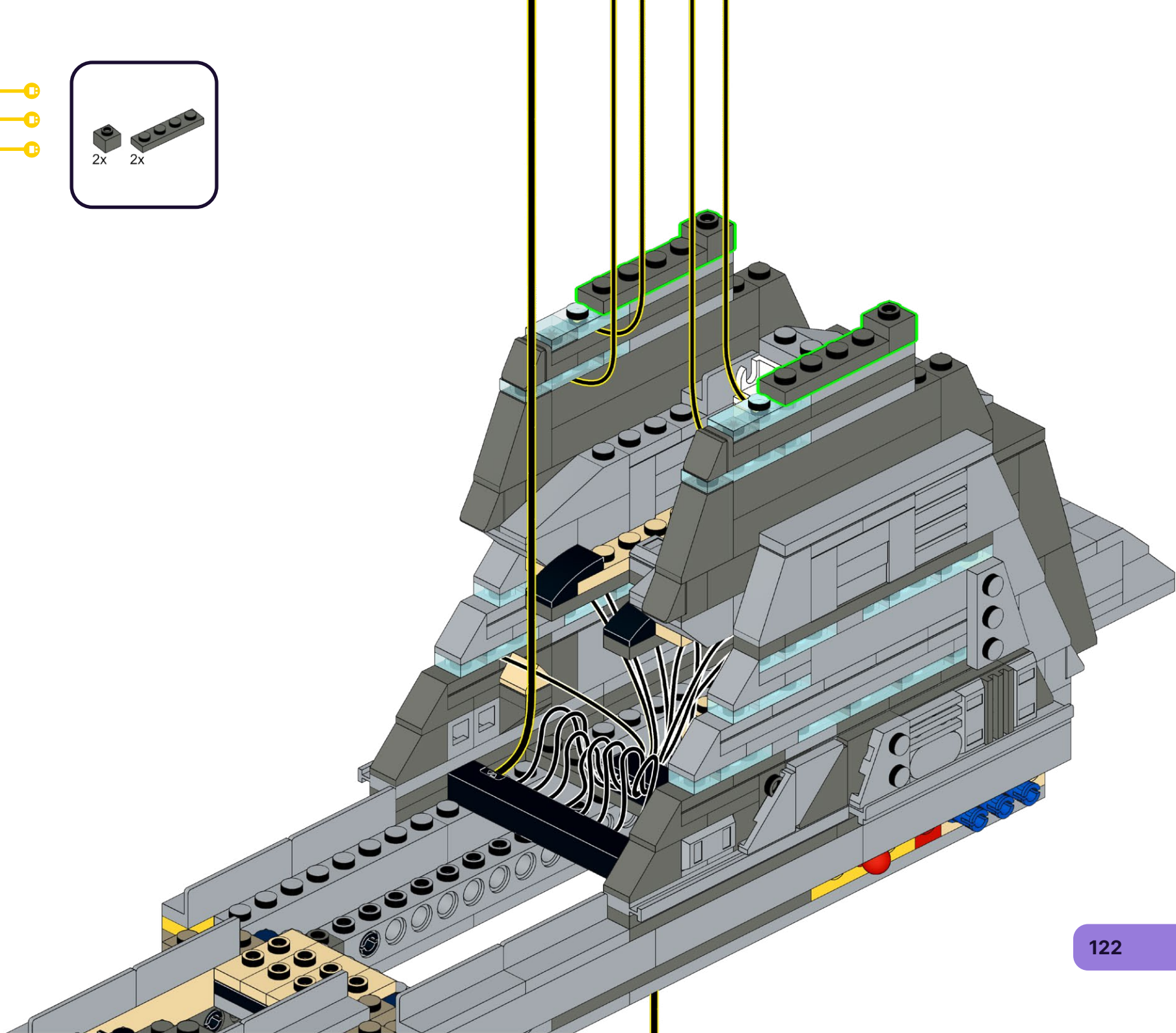
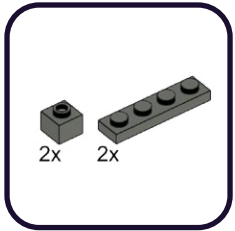

127

2x

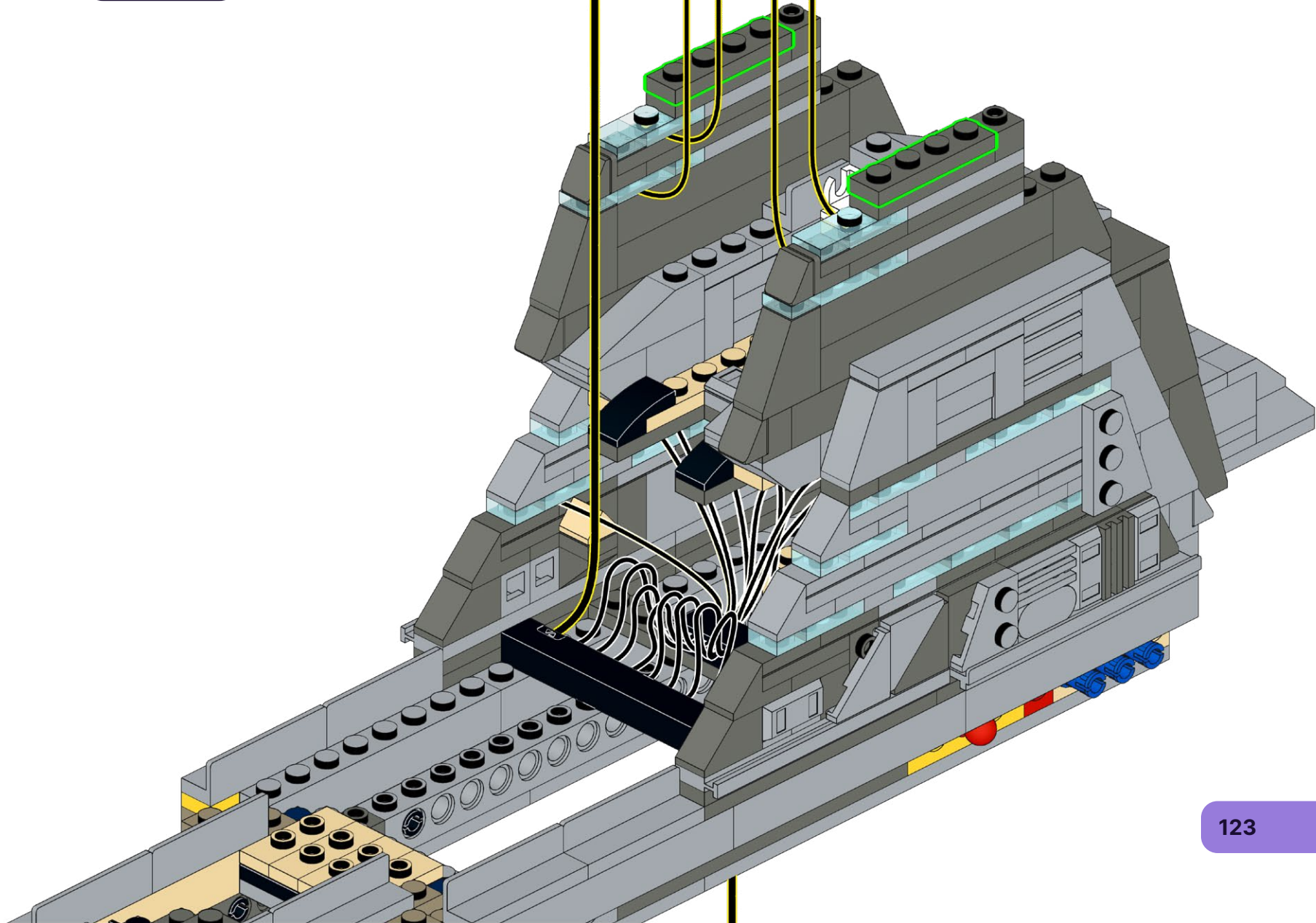

128

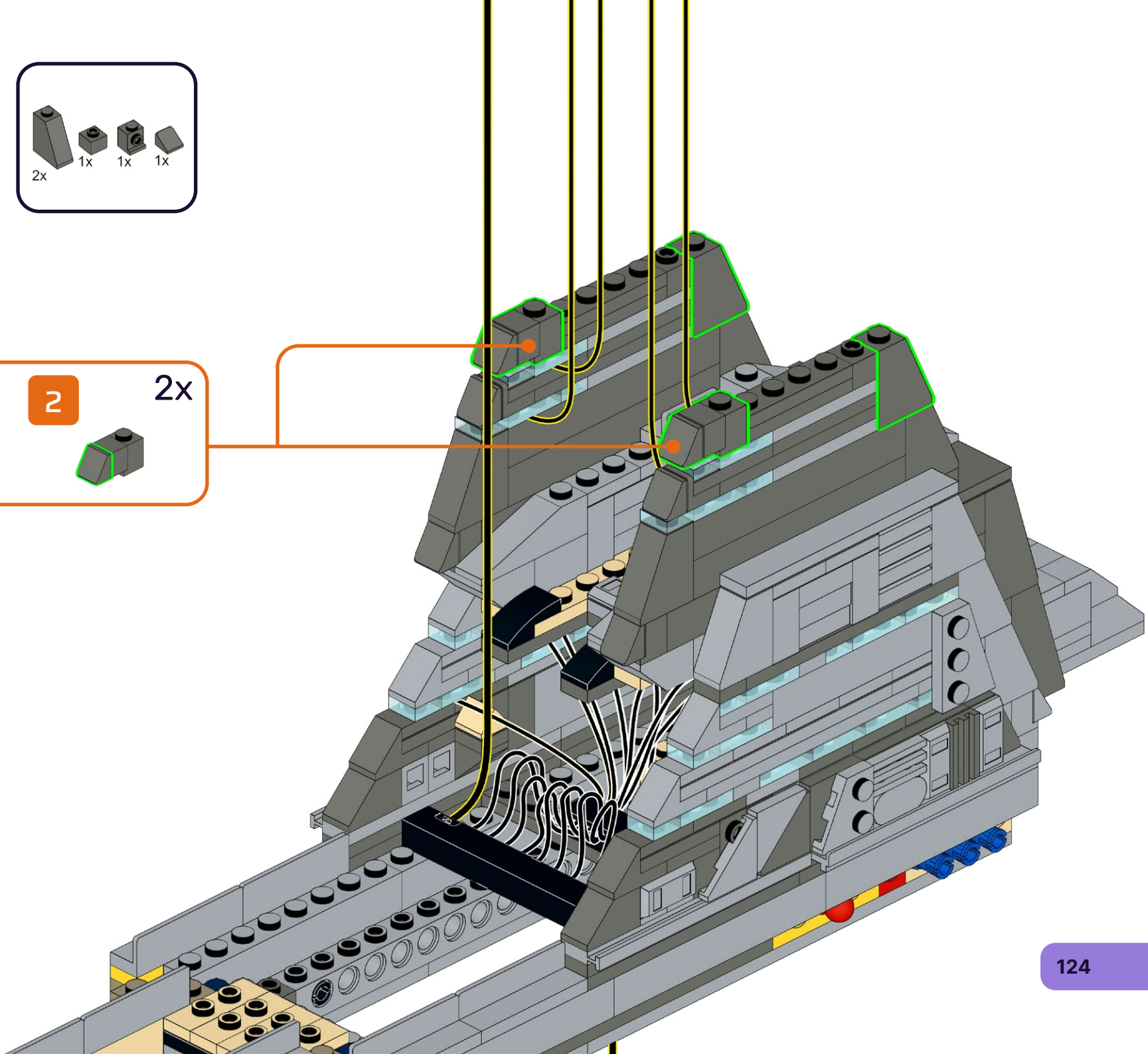
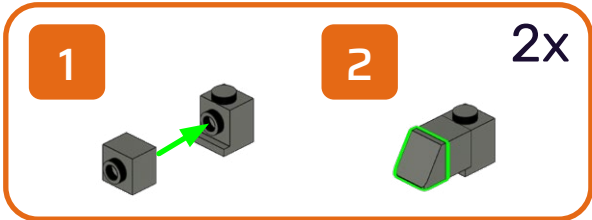
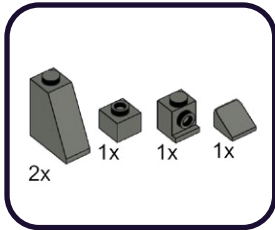

129

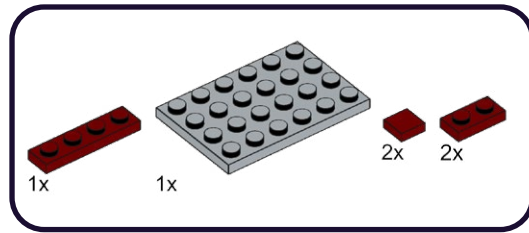

1

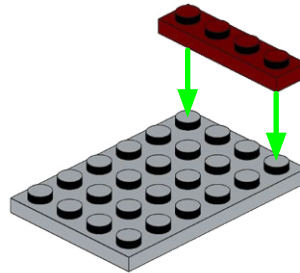

2

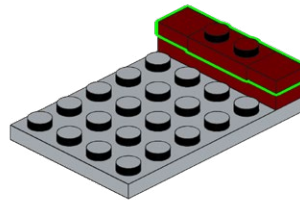

3

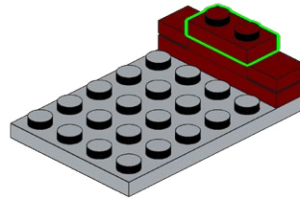

130

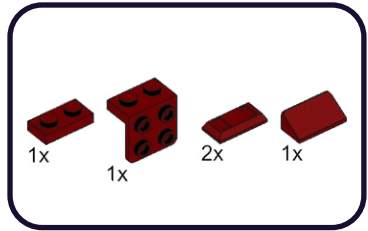

1

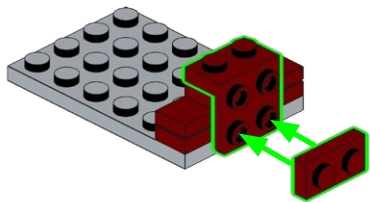

2

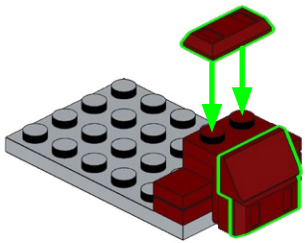

131

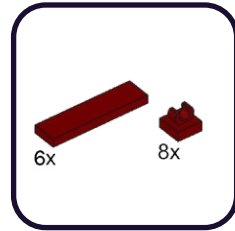

1

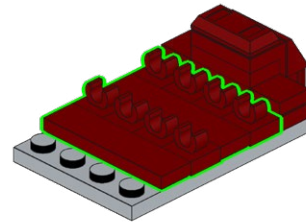
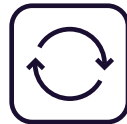

2

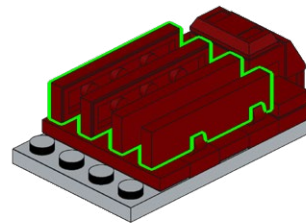

132

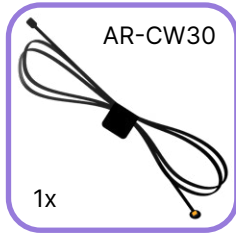
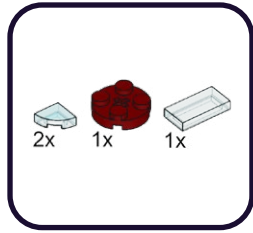

1

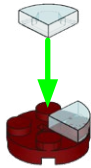

2



3

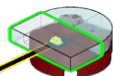

133

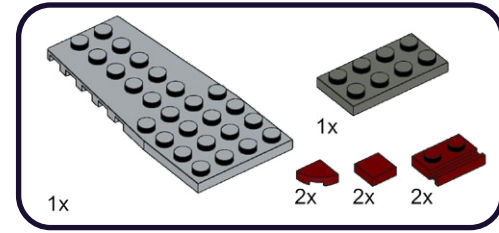

1

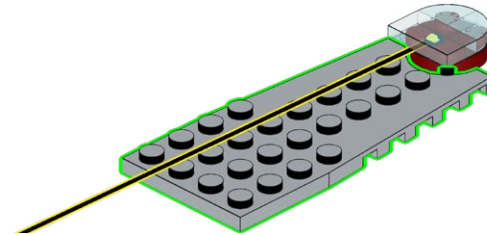

2

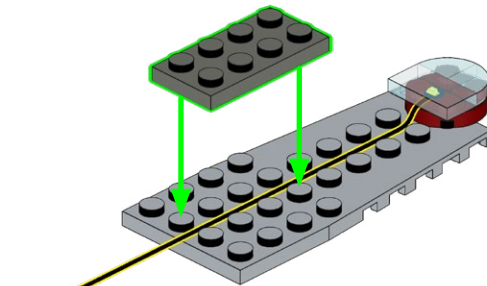

3

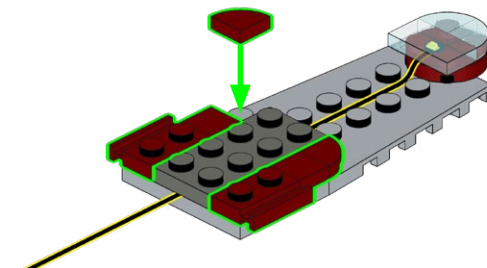

134

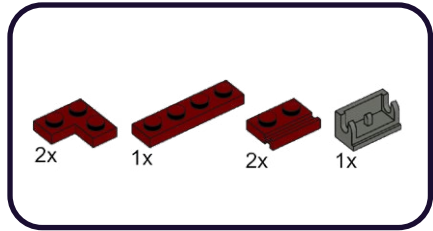

1

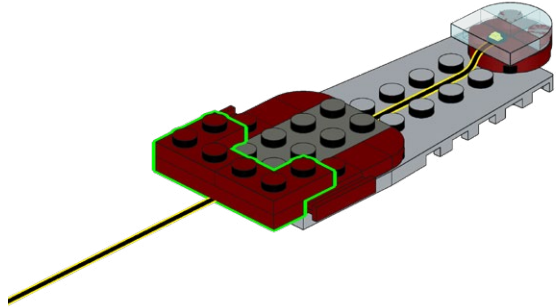

2

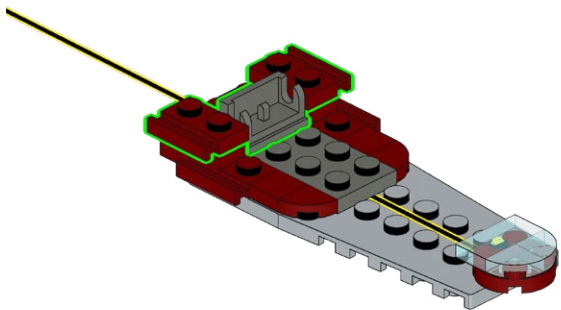

135

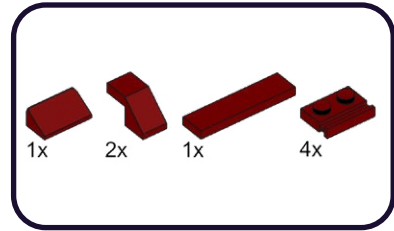

1

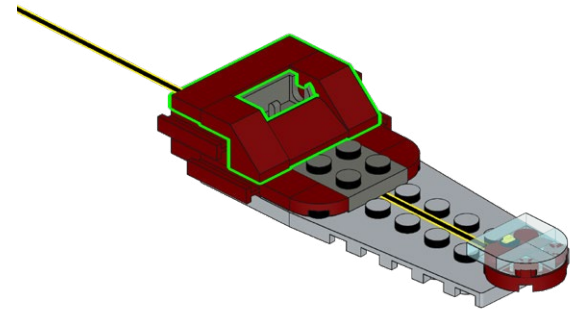

2

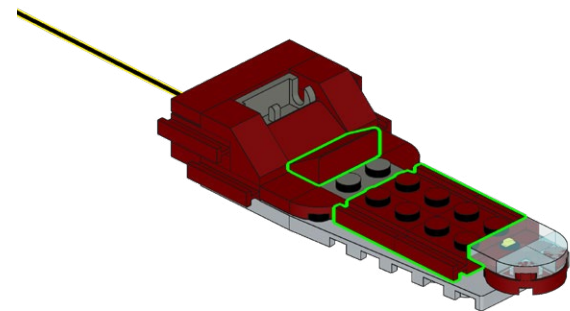

136

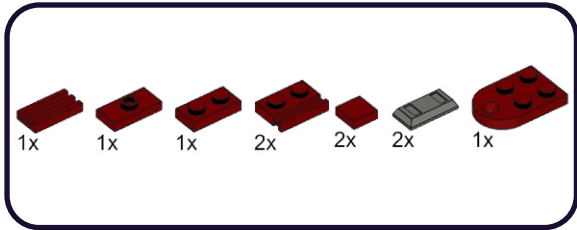

137

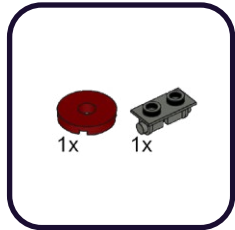

1

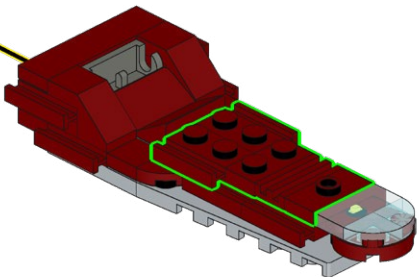

2

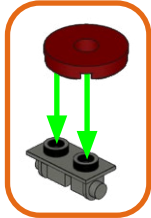
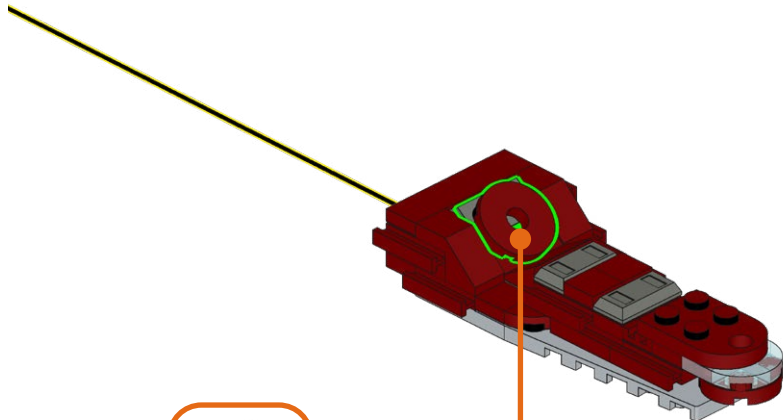
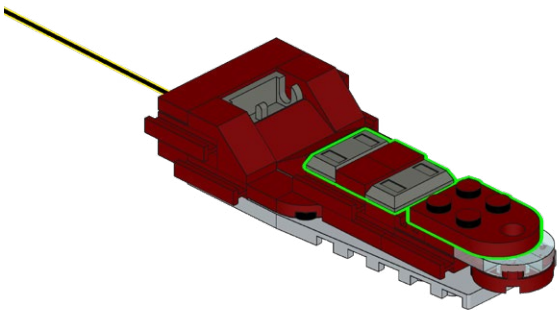

138

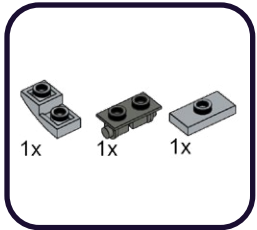

139



1

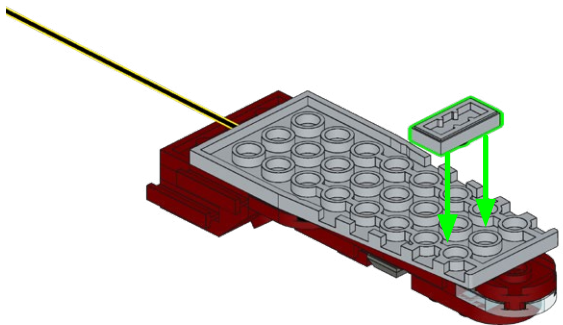

2

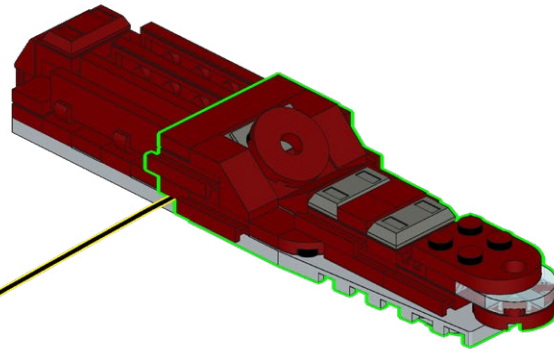
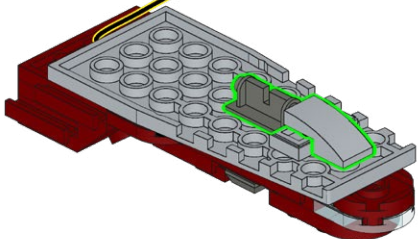

140

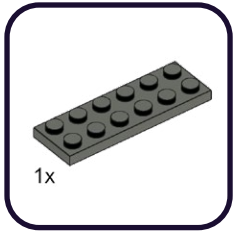

1

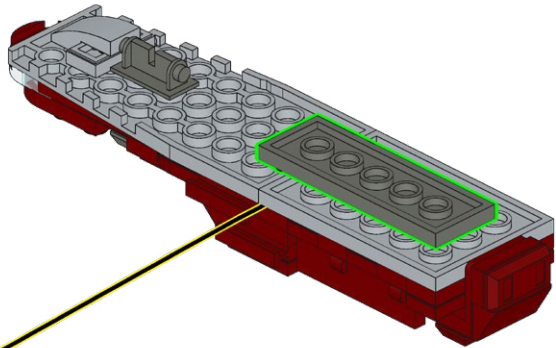

2

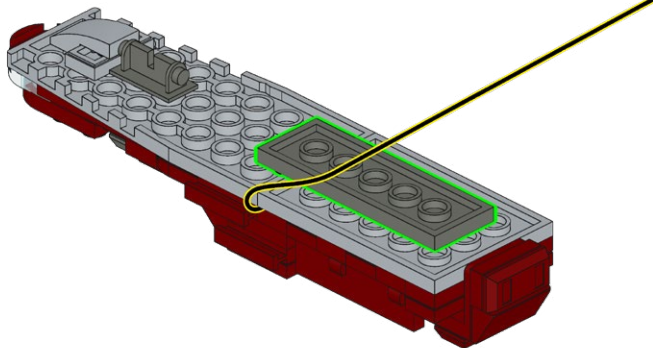

141

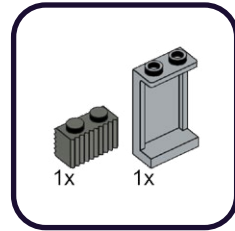

1

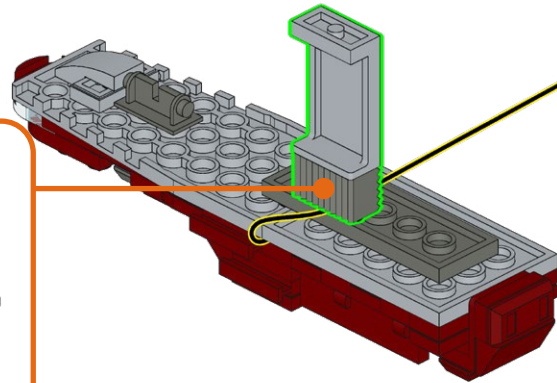
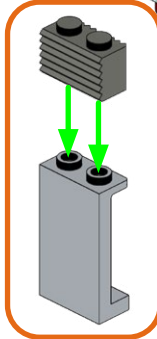

2

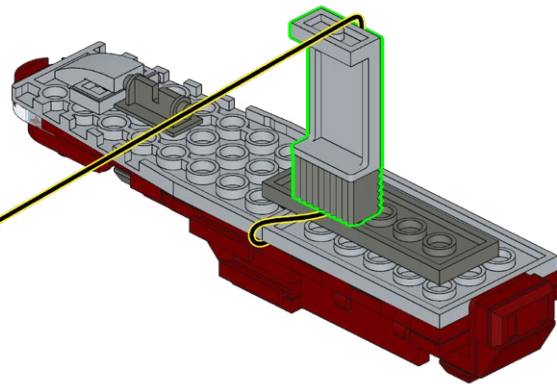

142

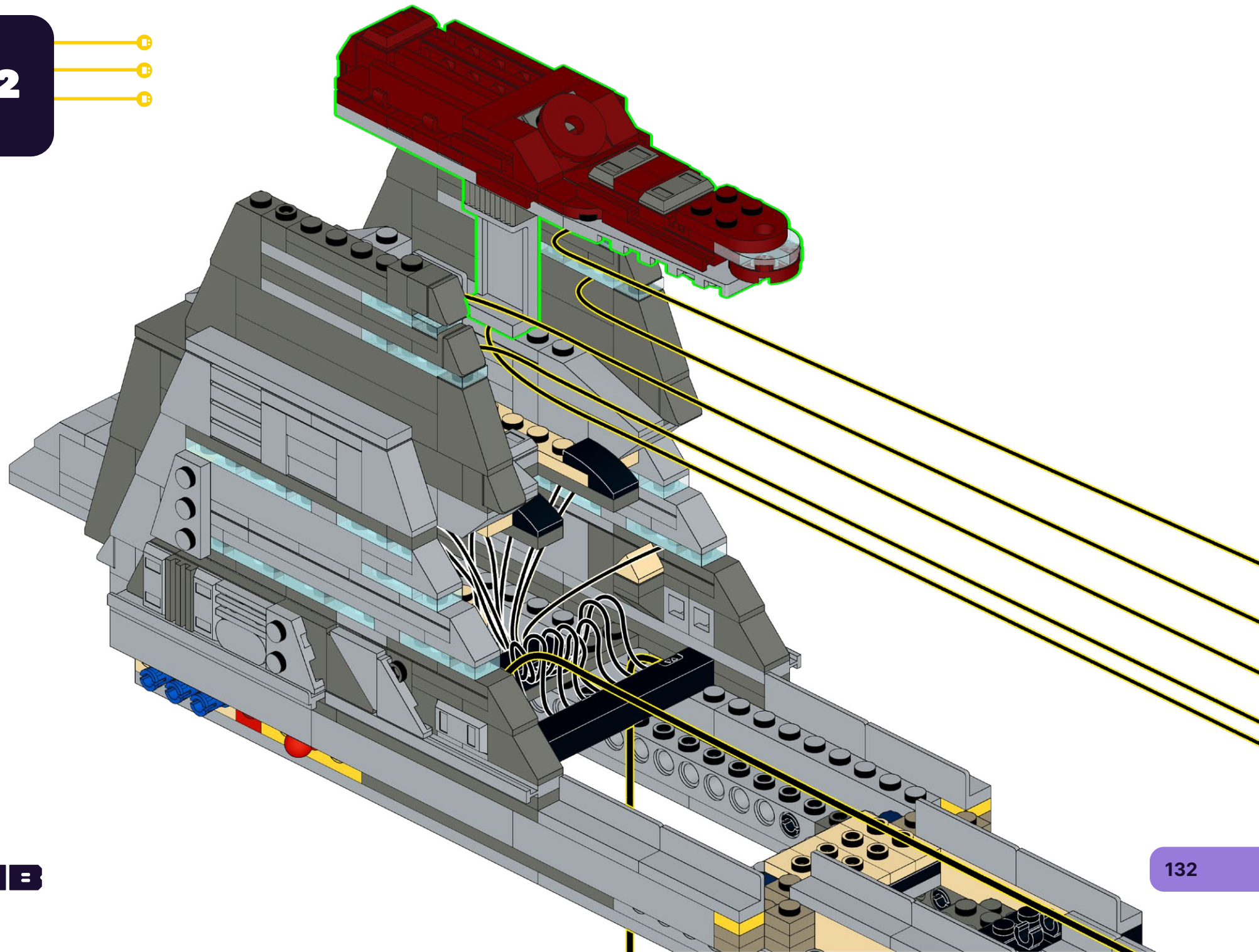

143

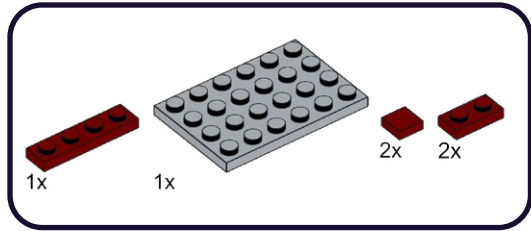

1

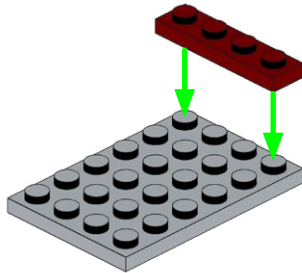

2

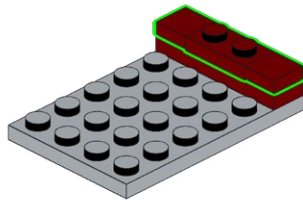

3

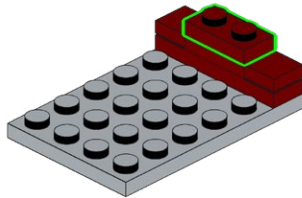

144

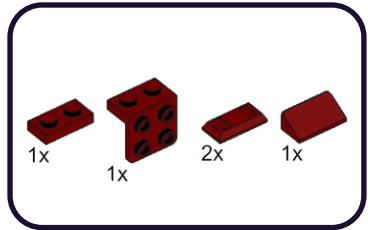

1

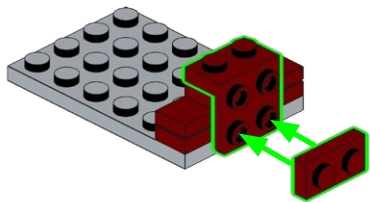

2

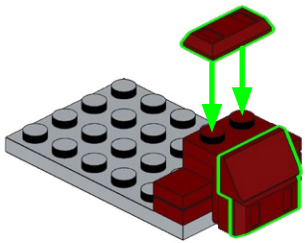

145

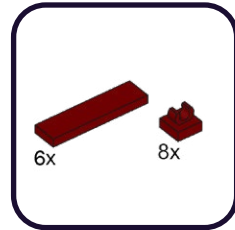

1

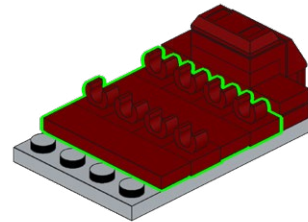
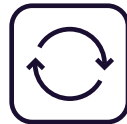

2

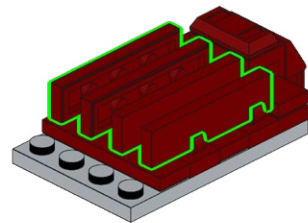

146

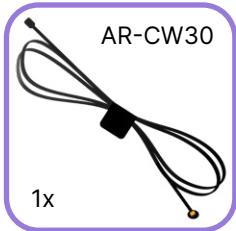
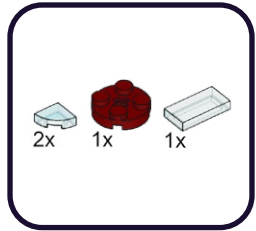

1

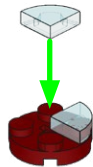

2



3

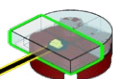

147

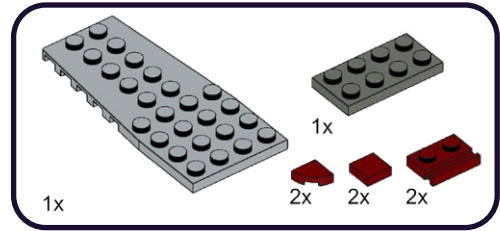

1

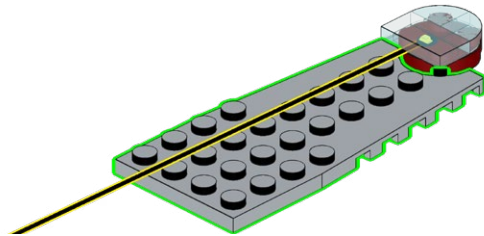

2

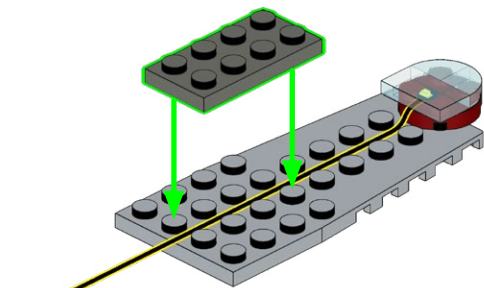

3

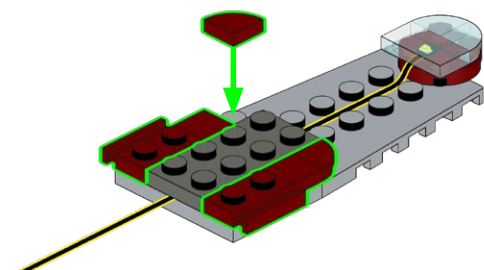

148

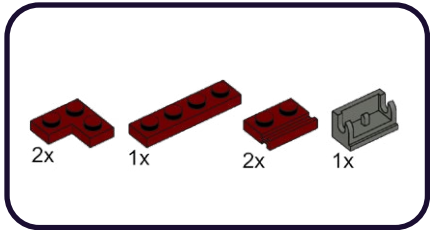

1

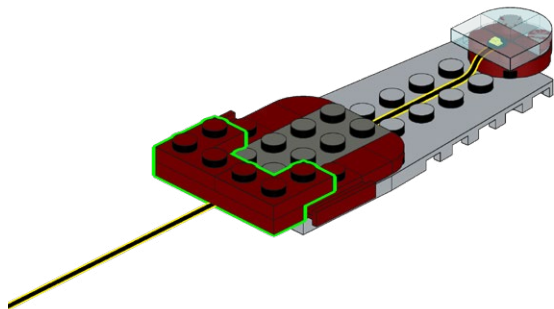

2

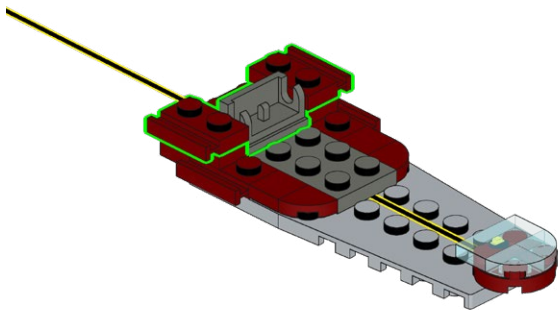

149

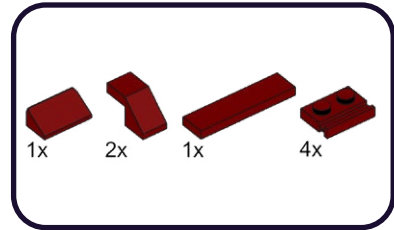

1

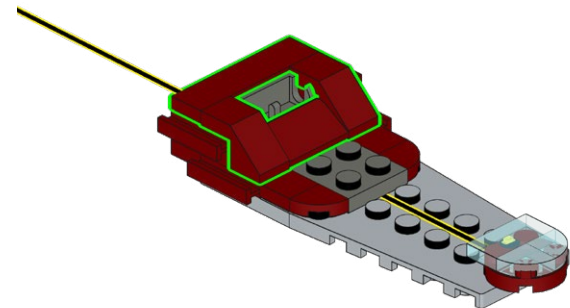

2

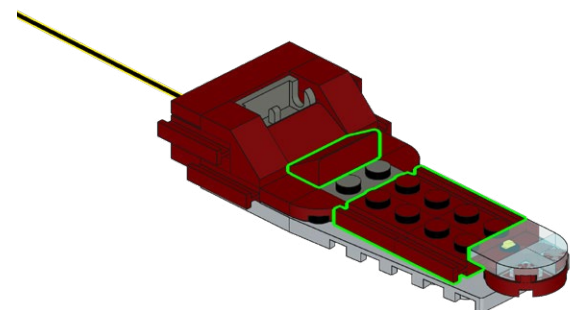

150

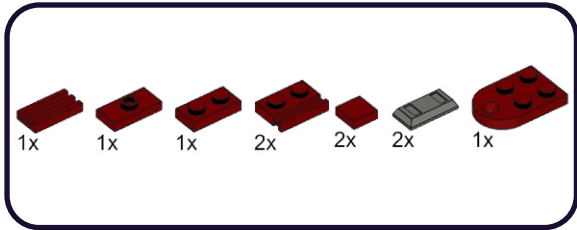

151

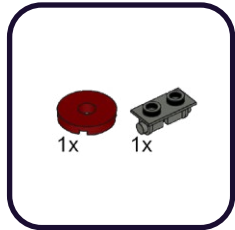

1

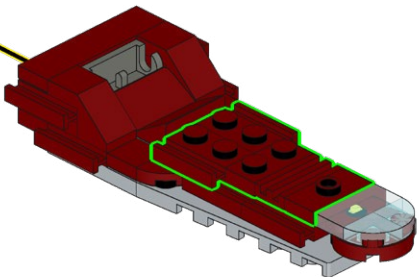

2

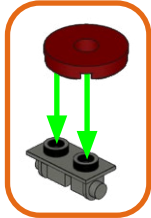
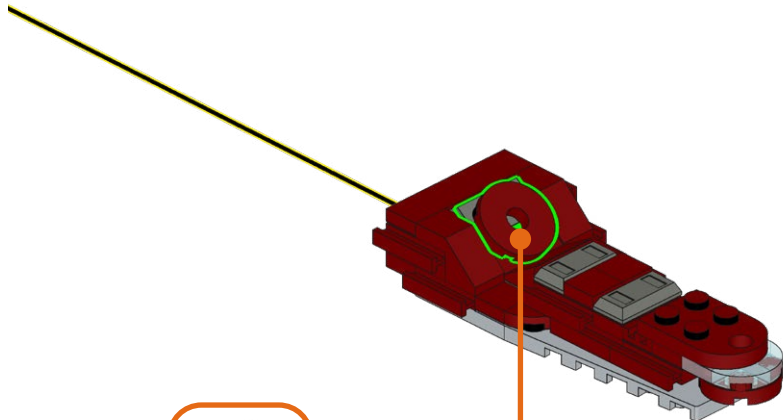
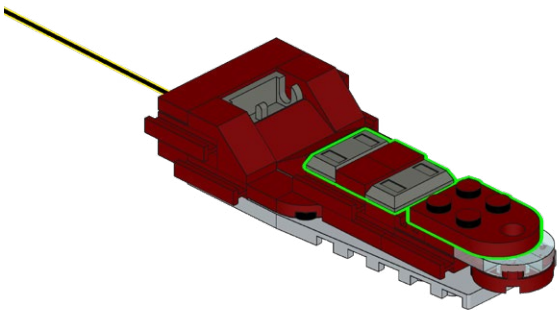

152

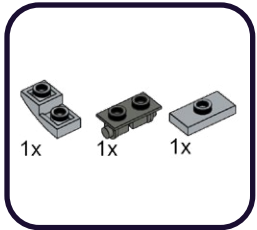

153



1

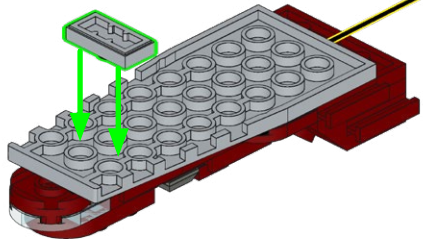

2

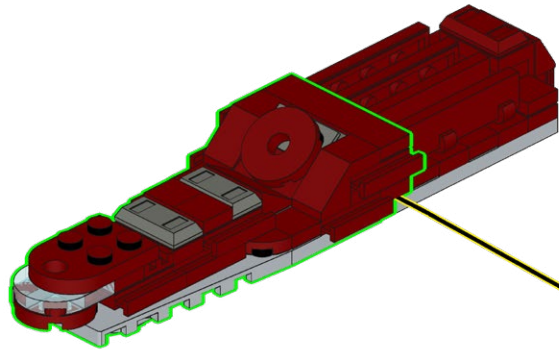
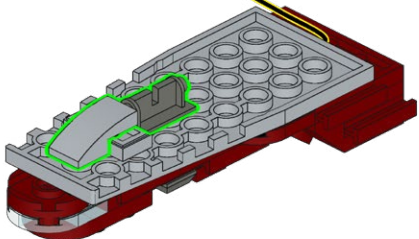

154

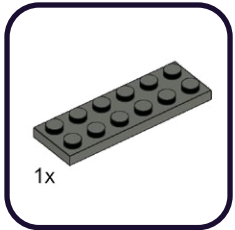

155

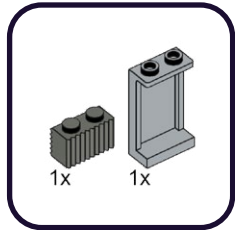

1

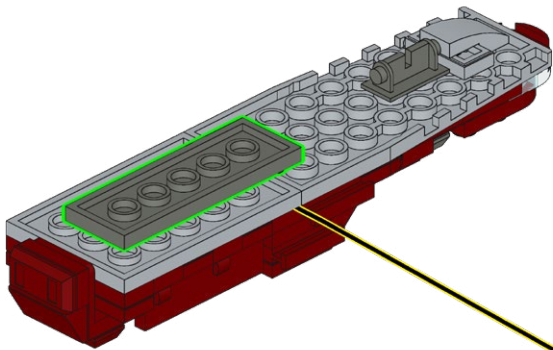

1

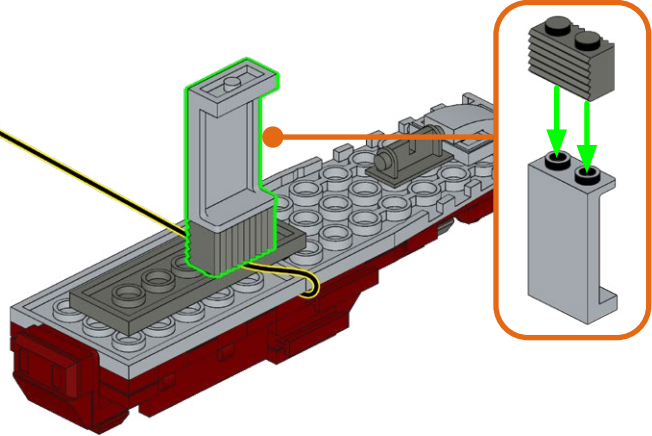

2

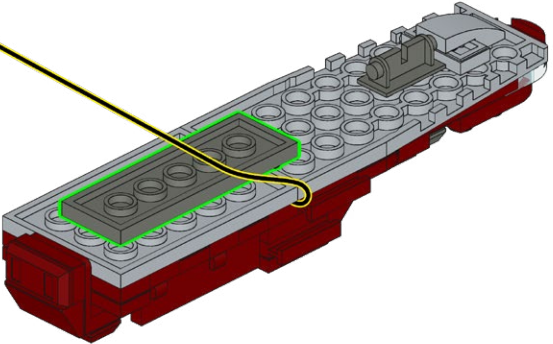

2

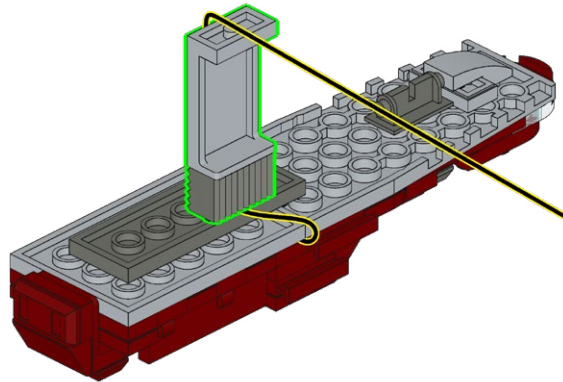

156

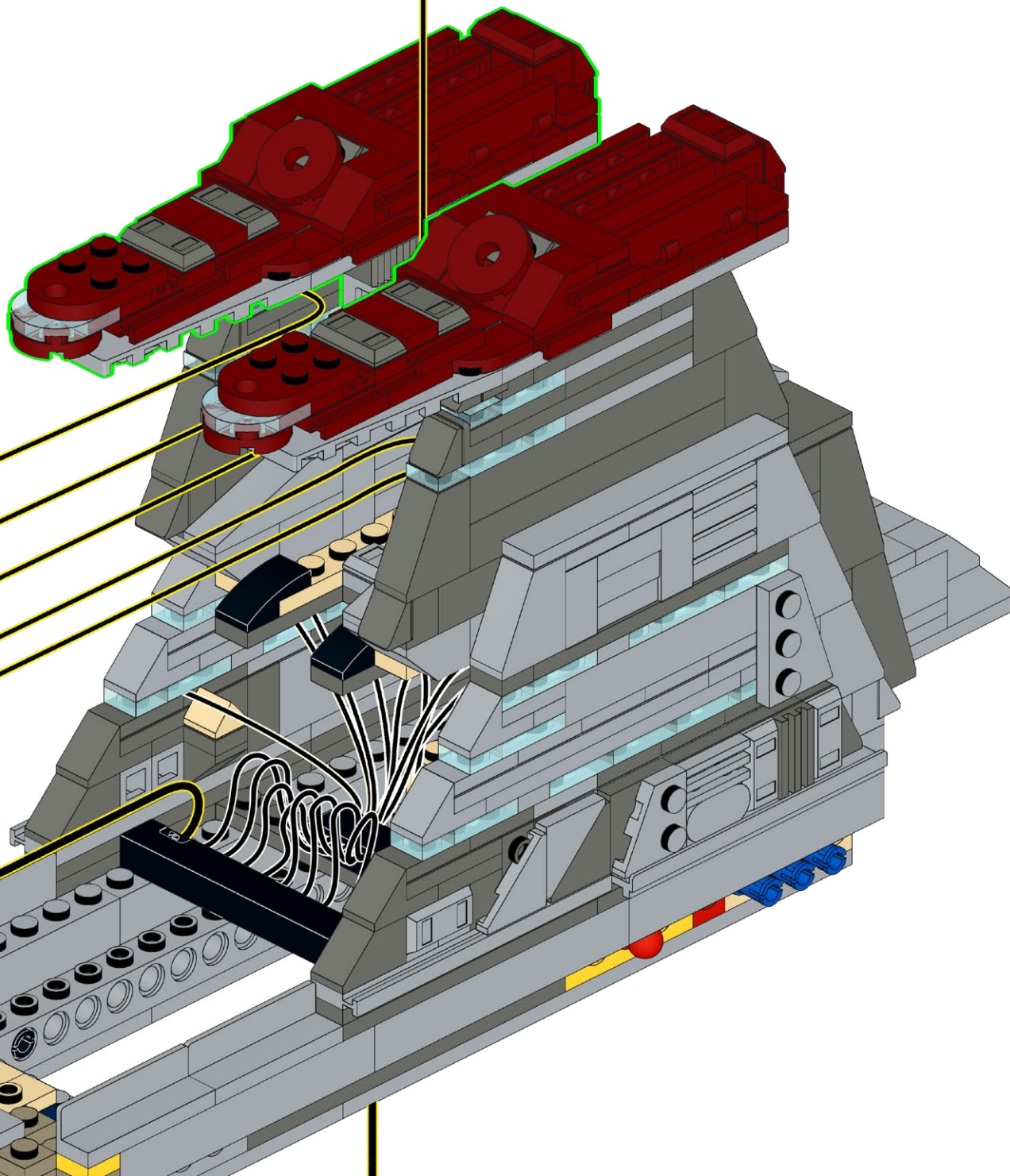

157

D-6



1x

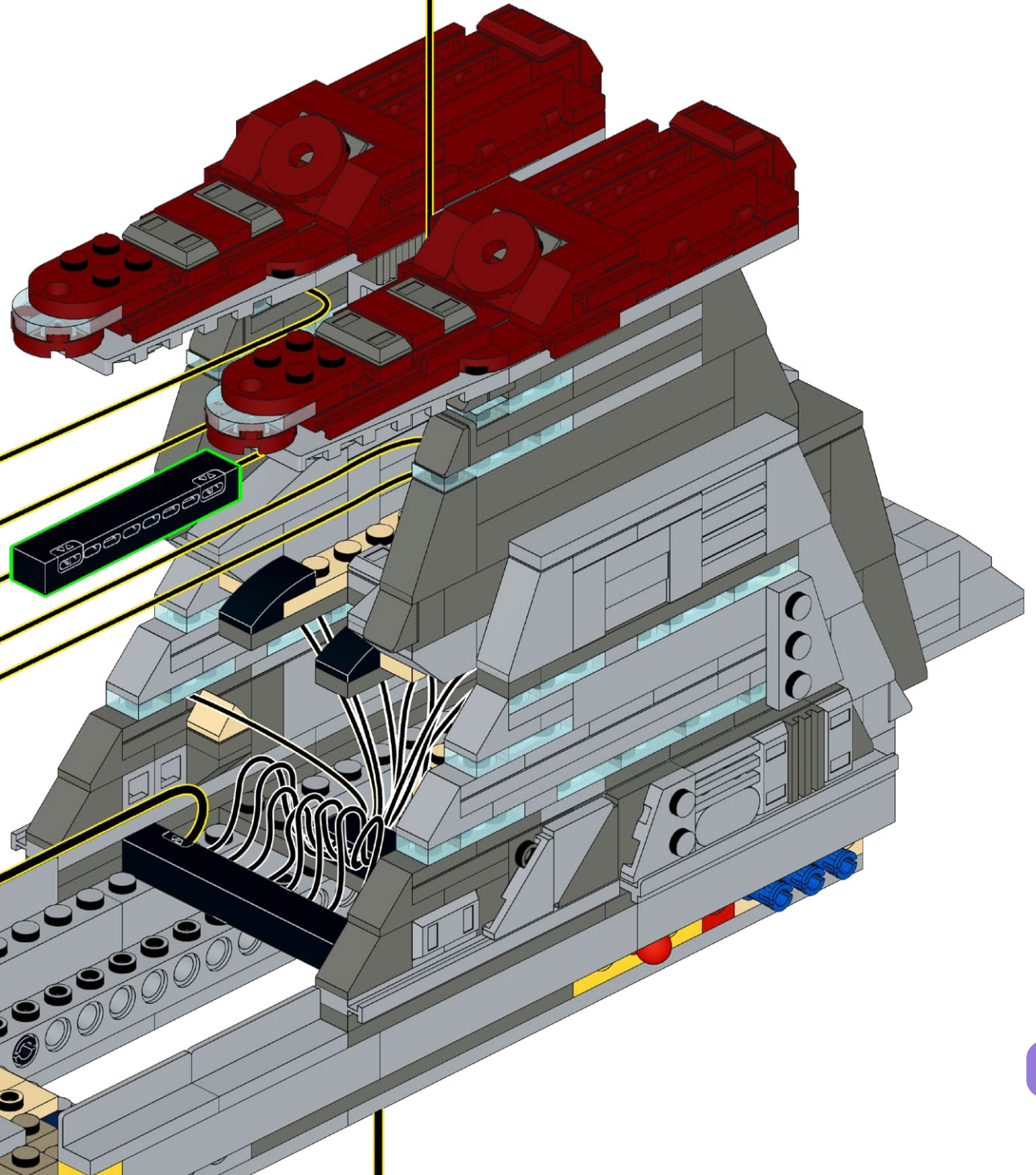

158

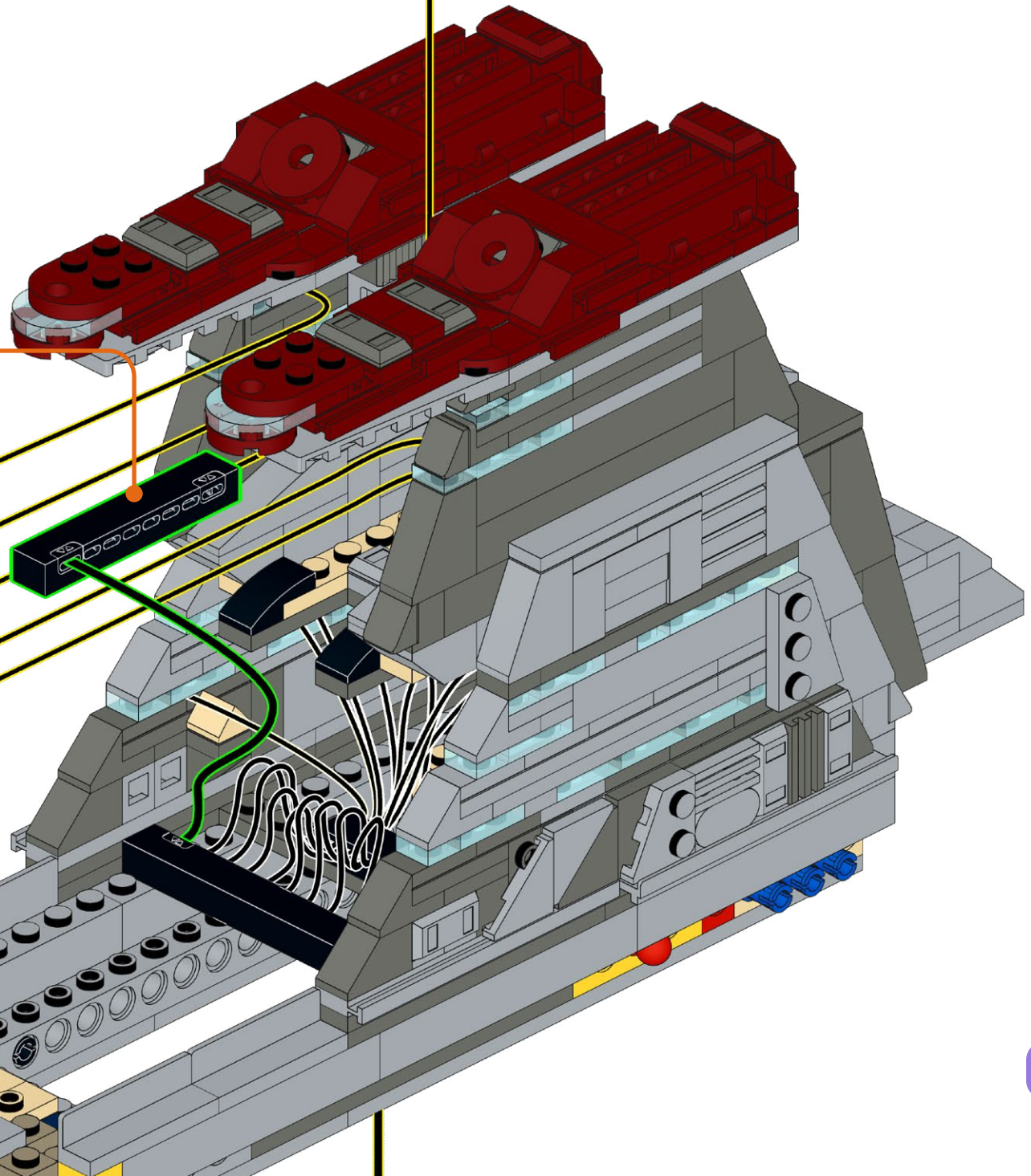
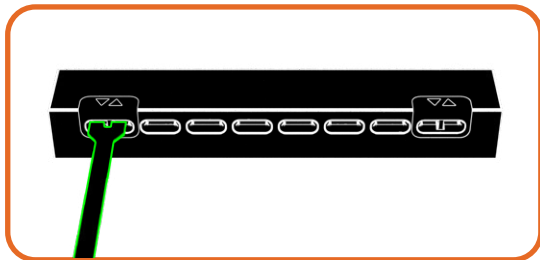

159

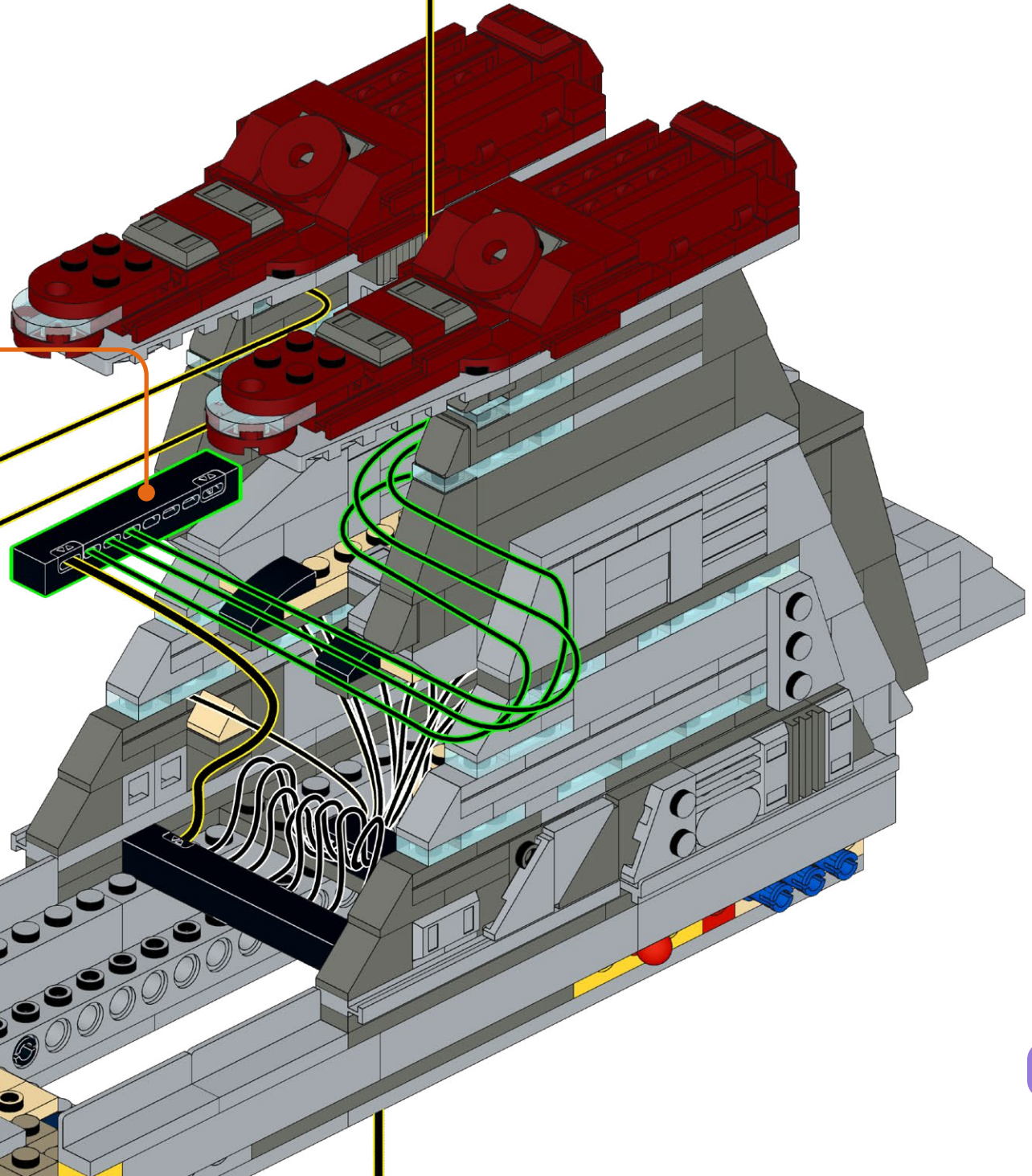
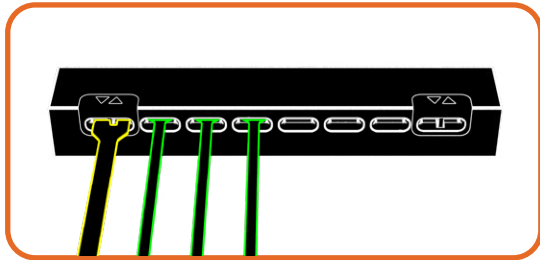

160

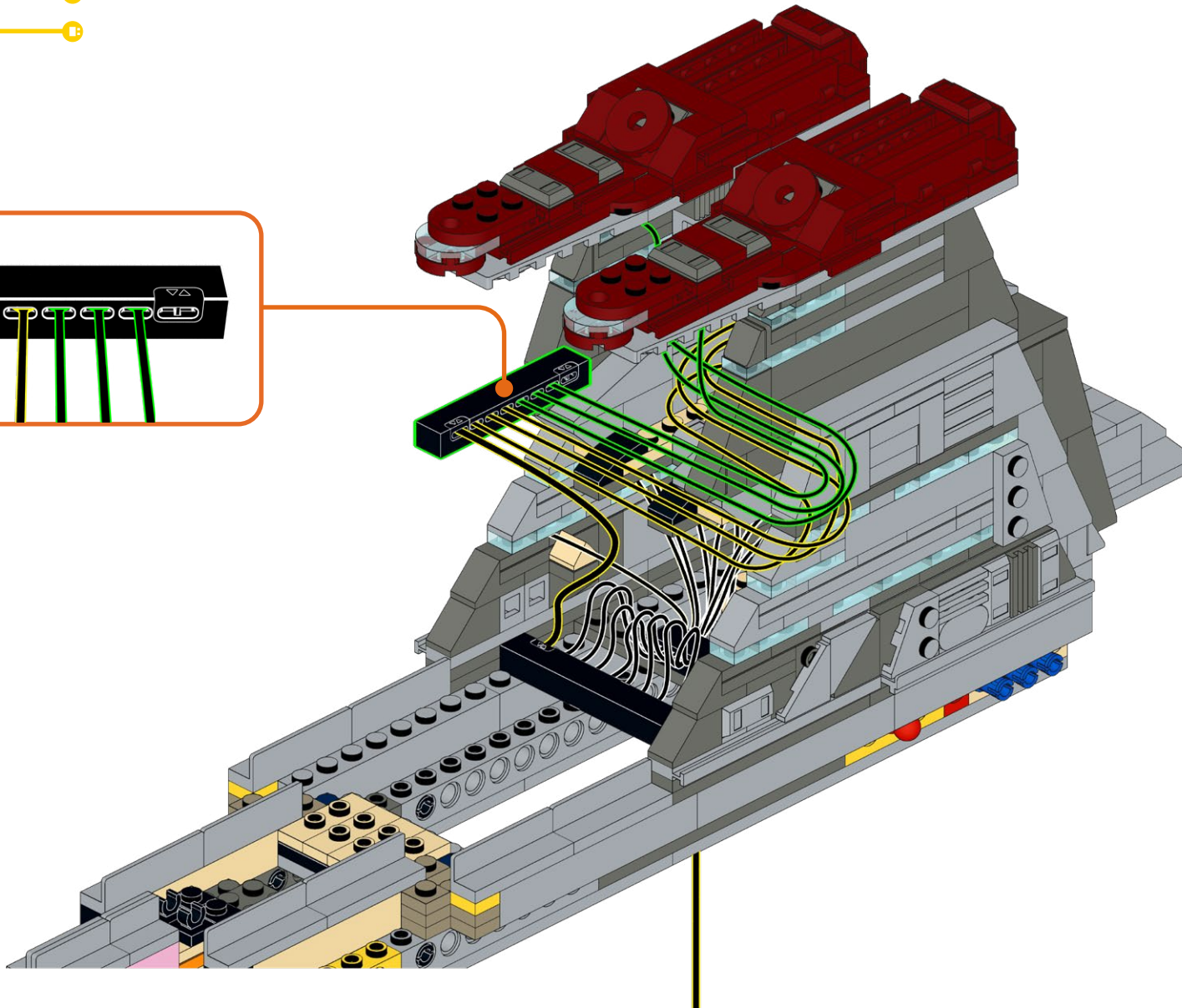

161

E-1x2

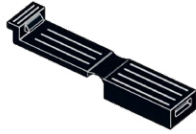

1x

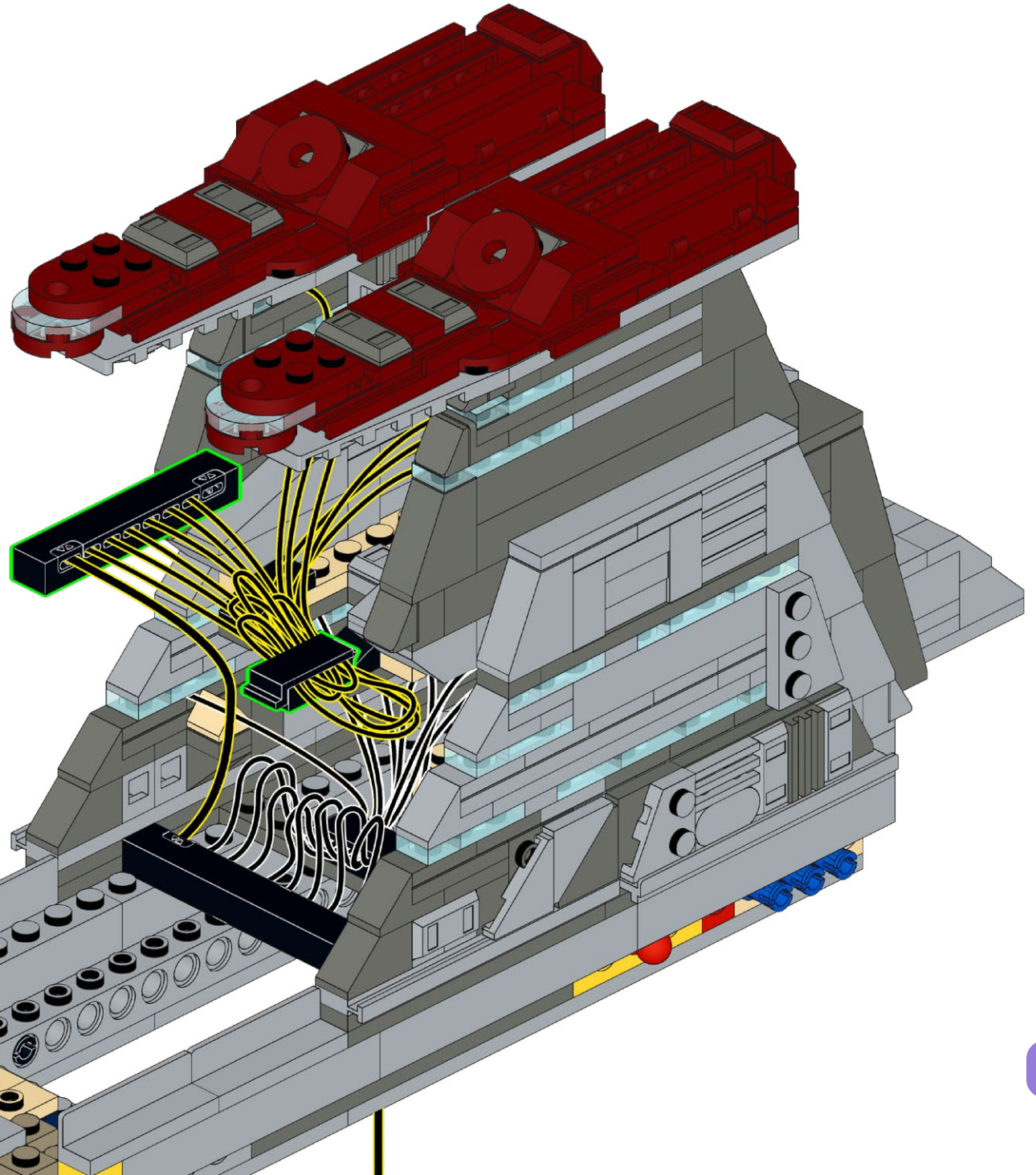

162

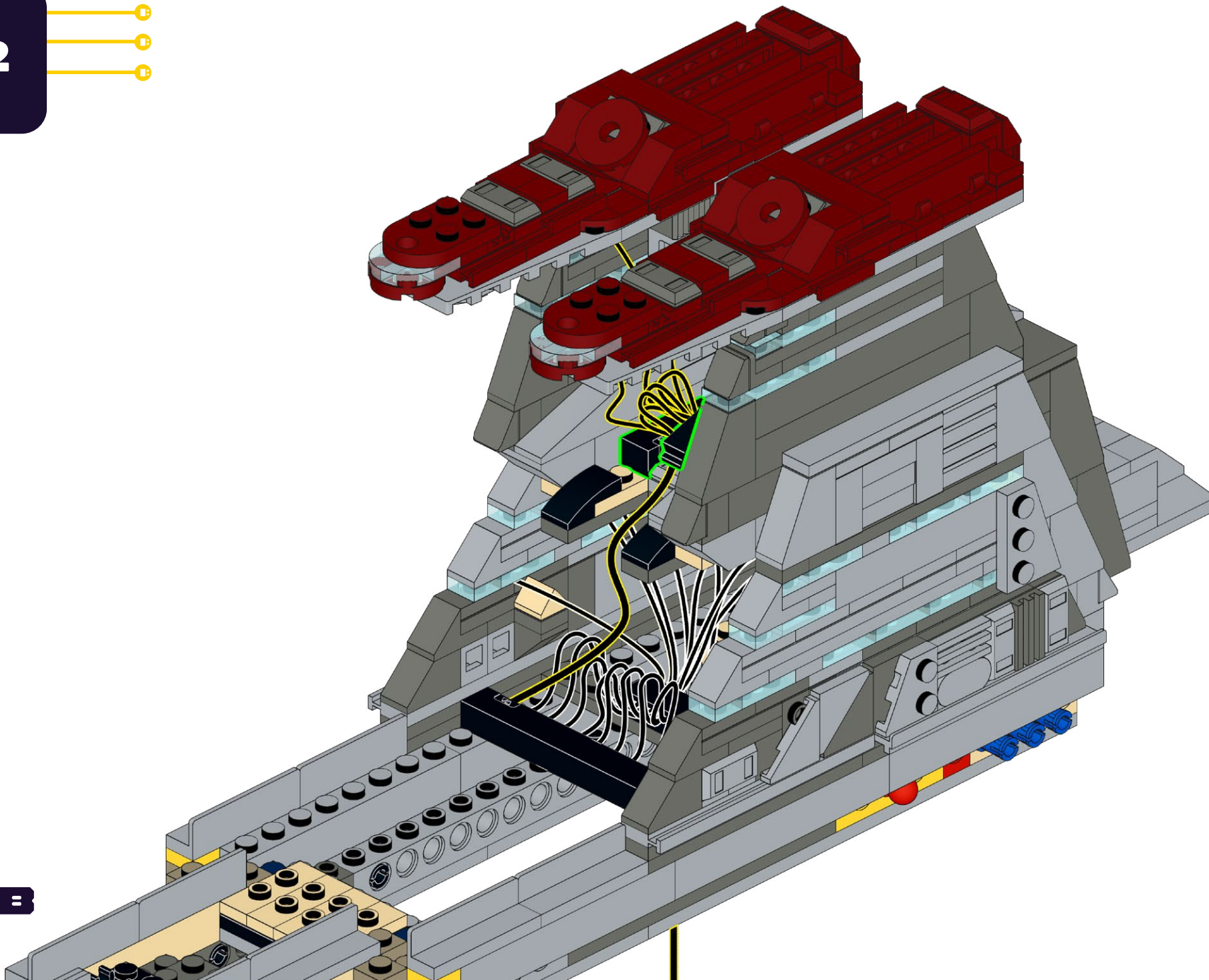

**HOLD UP!**

You might notice some bags aren't in order, as well as left over pieces, but that's ok! We're changing the way you build LEGO!

ATTENDEZ!

Vous remarquerez peut-être que certains sacs, ainsi que certaines pièces, ne sont pas dans le bon ordre. Mais pas de panique! Nous changeons simplement la façon avec laquelle vous construisez vos LEGO!

ASPETTA!

Potresti notare che alcuni sacchetti non sono in ordine, così come i pezzi avanzati, ma va bene così! Stiamo cambiando il modo in cui costruisci i LEGO!

HALT!

Sie werden möglicherweise bemerken, dass einige tüten durcheinander sind und teile übrig bleiben, aber das ist in Ordnung! Wir ändern die art und weise, wie Sie LEGO bauen!

¡ESPERA!

Es posible que notes que algunas bolsas están fuera de servicio, así como piezas sobrantes, ¡pero está bien! ¡Estamos cambiando la forma en que construyes LEGO!

暫停!

你可能会注意到一些袋子顺序错乱, 以及一些剩余的部件, 但没关系! 我们正在改变你搭建乐高的方式!

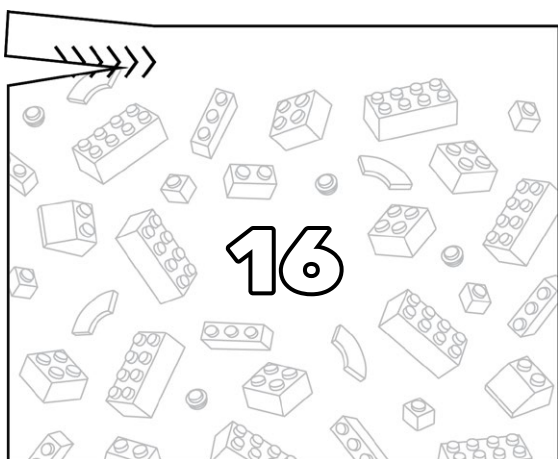
Open LEGO® Bag 16

163

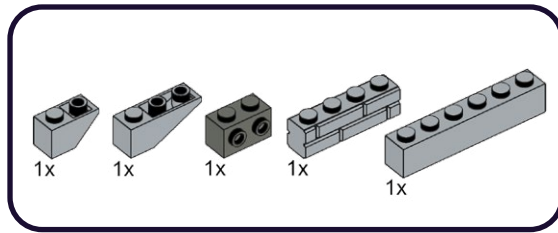

1

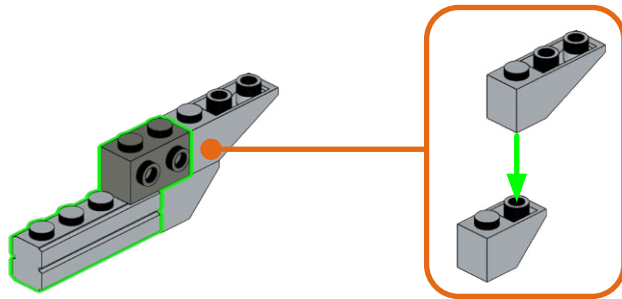

2

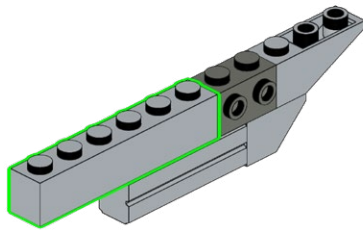

164

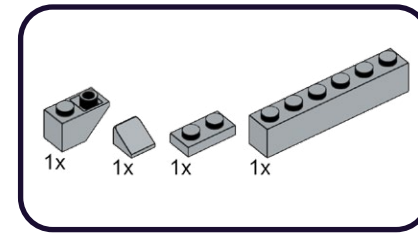

1

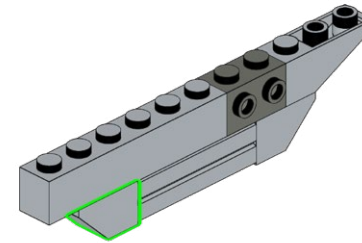

2

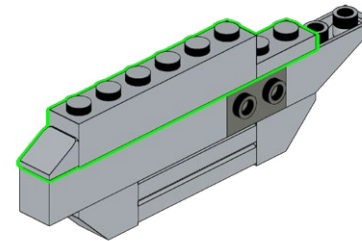

165

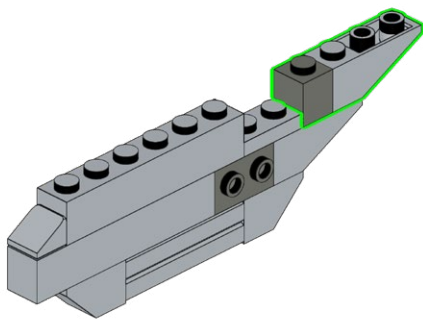
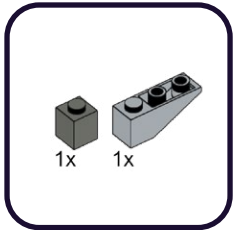

166

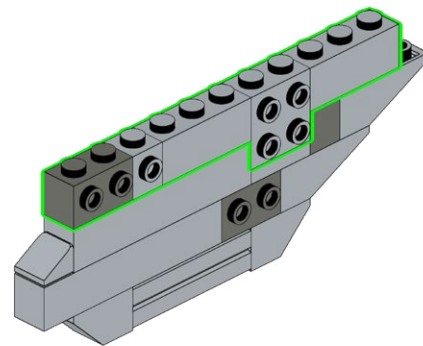
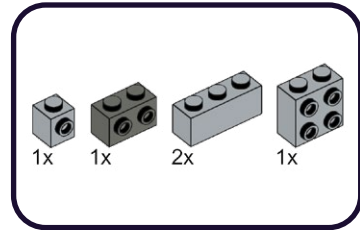

167

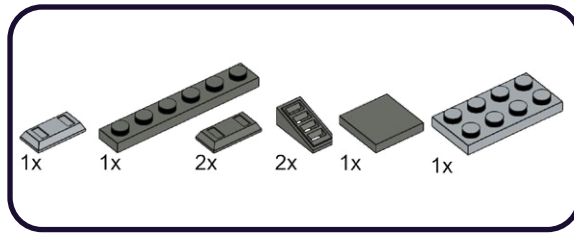

1

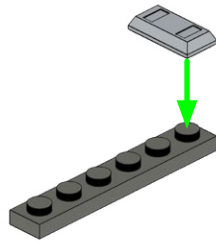

2

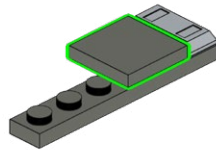

3

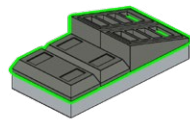

168

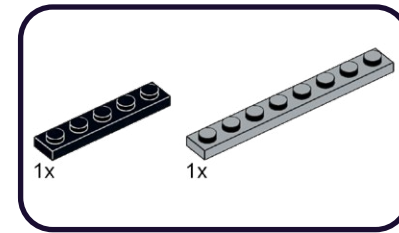

1

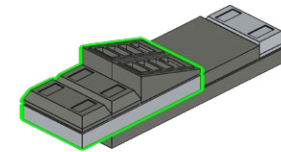

2

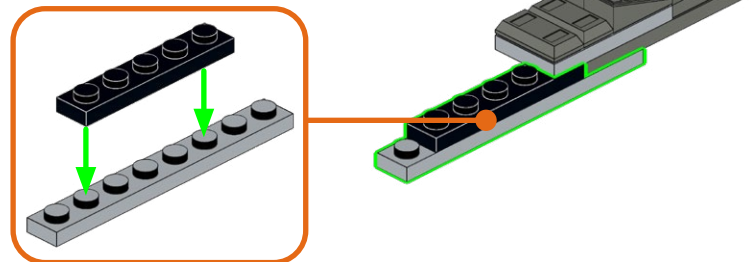

169

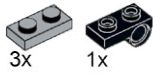

1

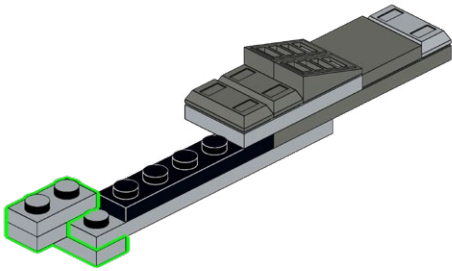

2

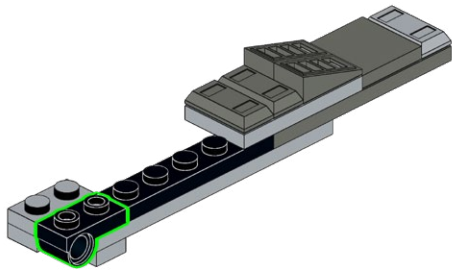

170

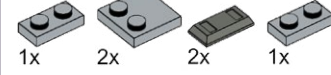

1

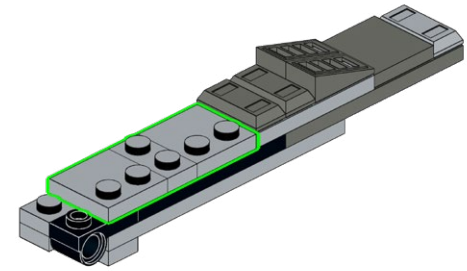

2

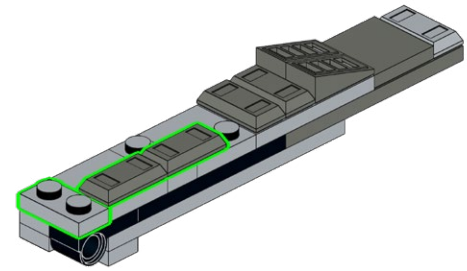

171



1x

1

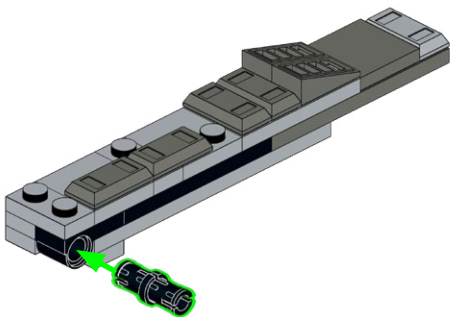

2

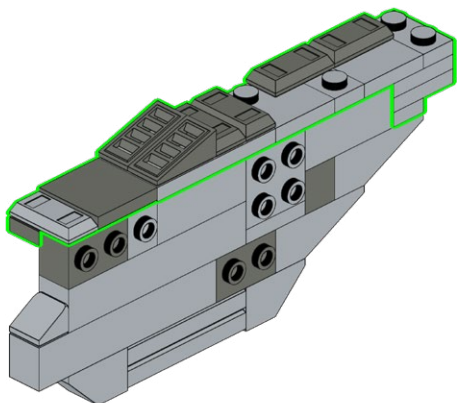

172

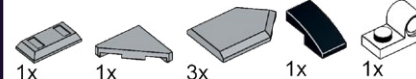

1x

1x

3x

1x

1x

1

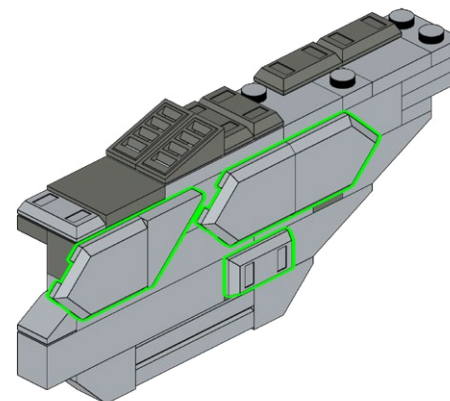

2

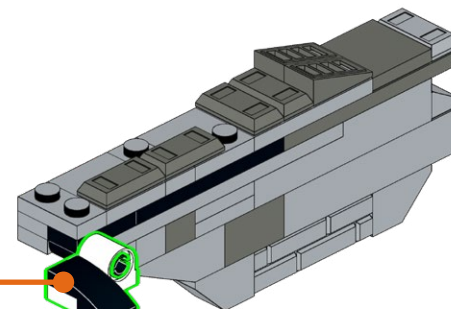
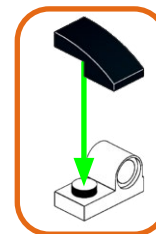

173

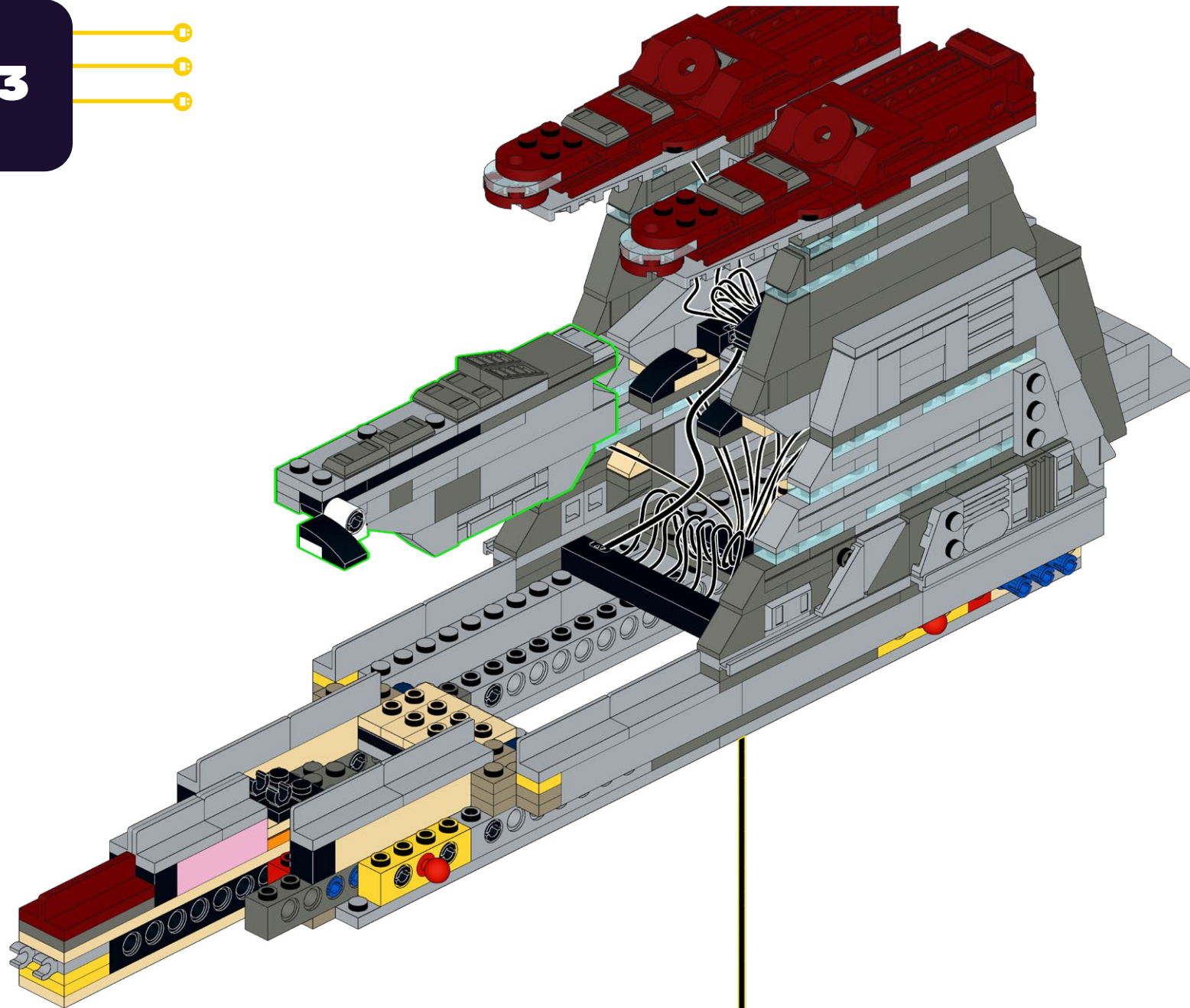

174

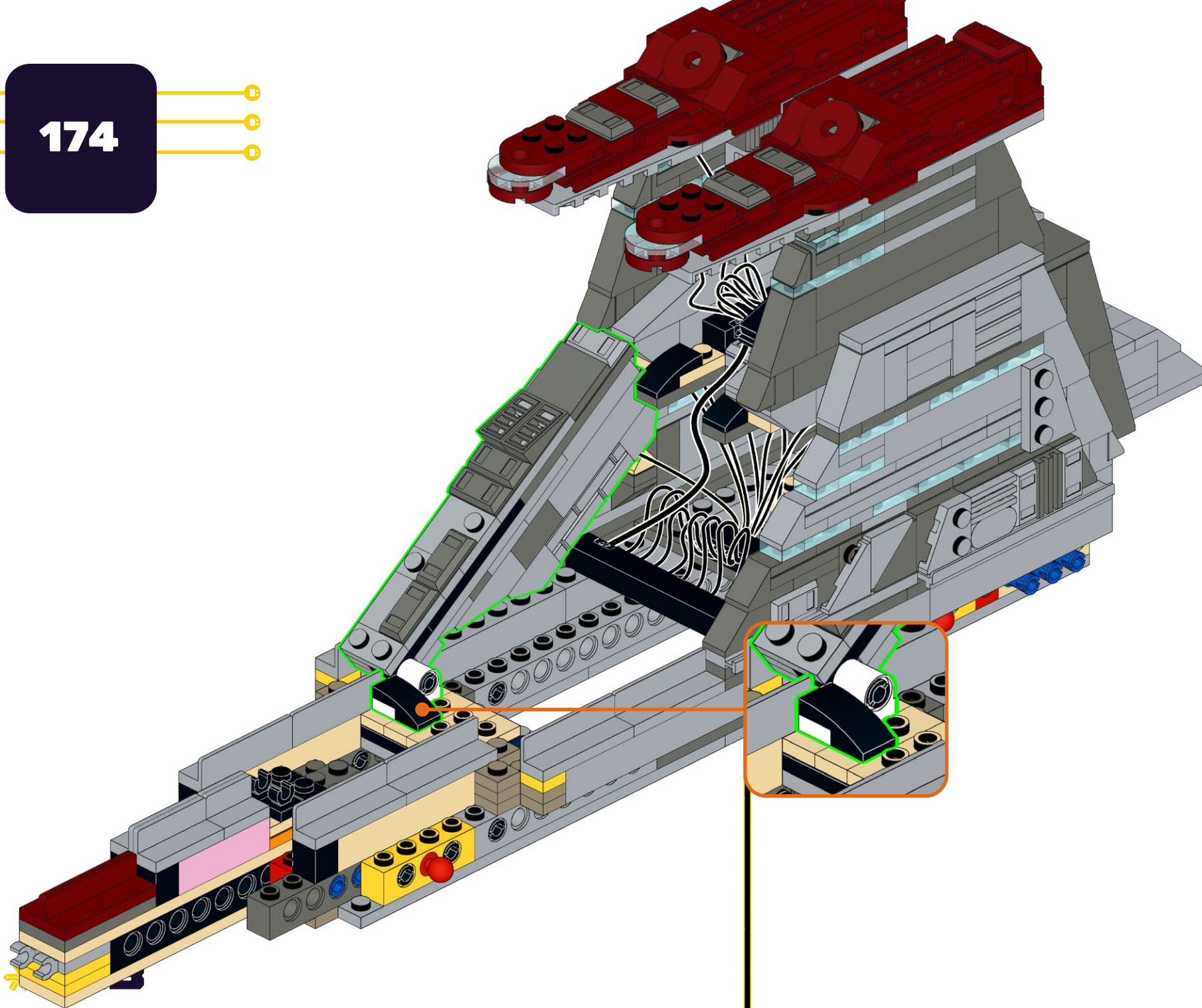

175

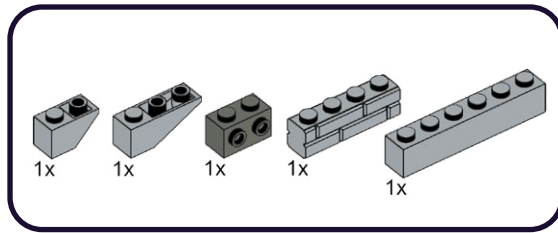

1

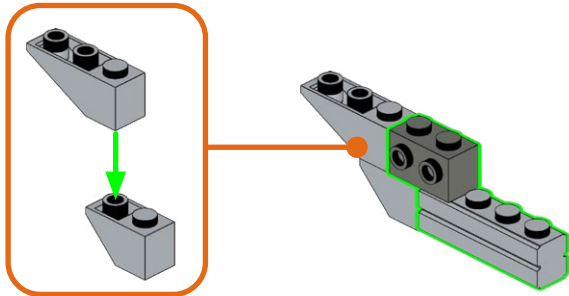

2

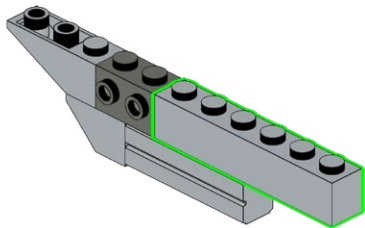

176

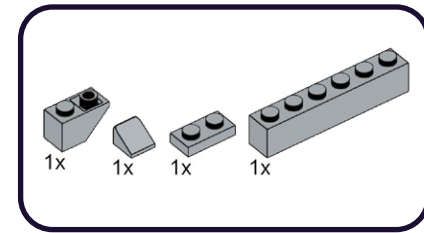

1

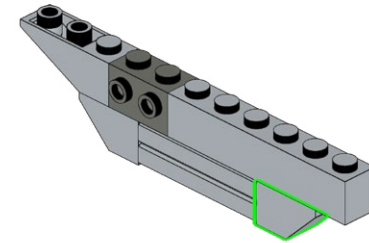

2

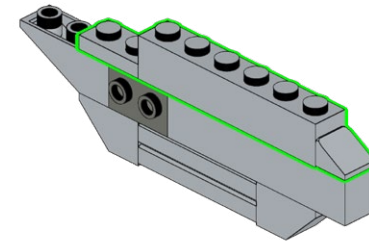

177

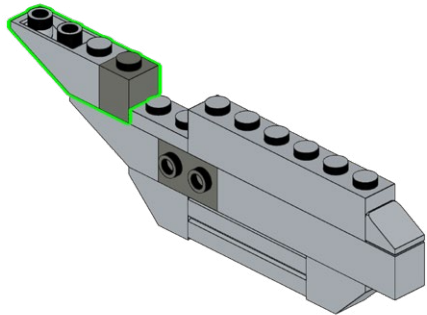
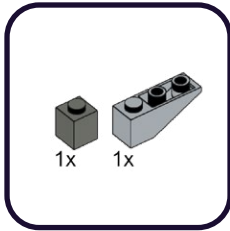

178

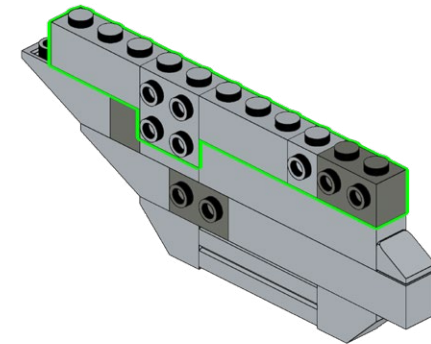
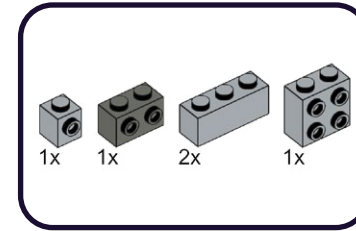

179

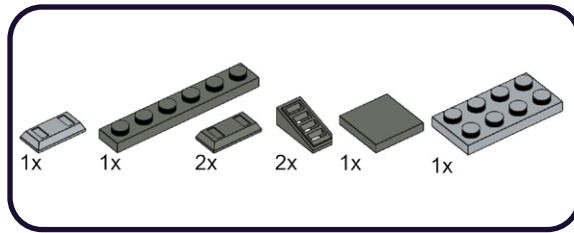

1

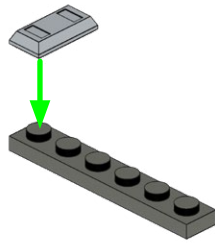

2

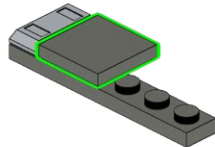

3

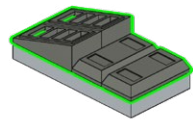

180

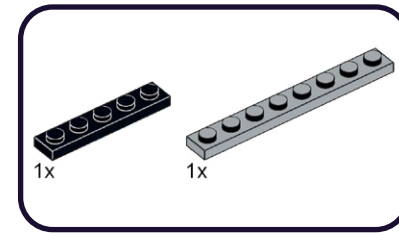

1

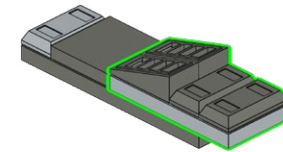

2

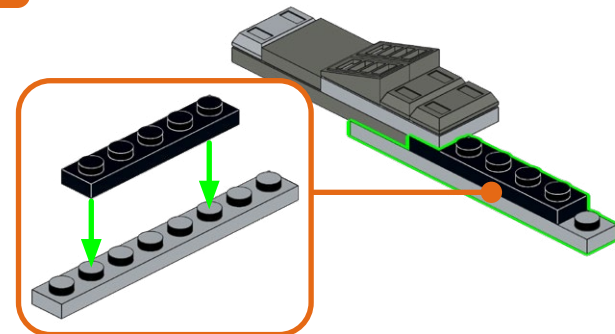

181

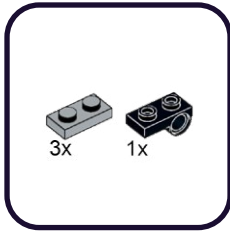

1

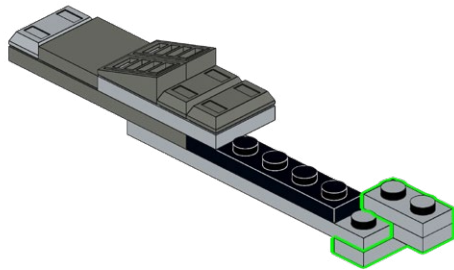

2

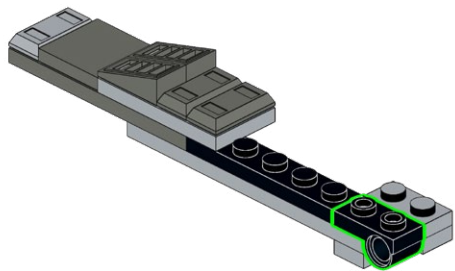

182

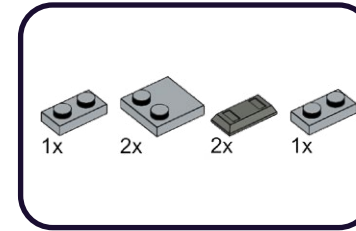

1

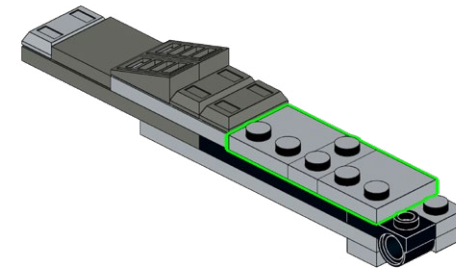

2

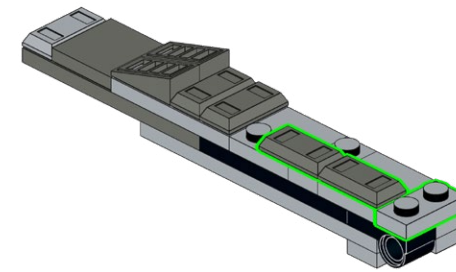

183

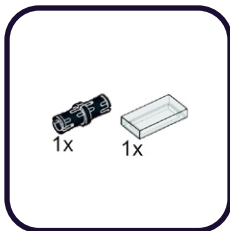

1

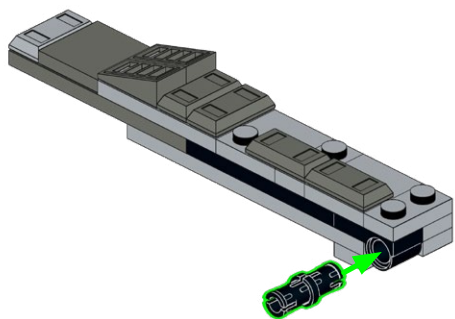

2

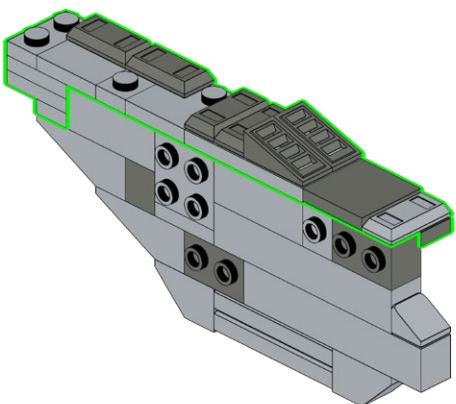

184

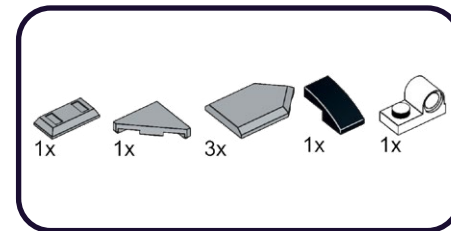

1

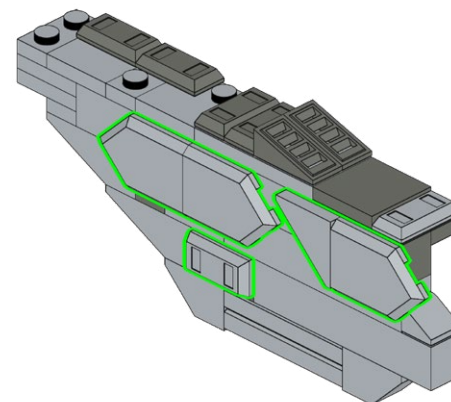

2

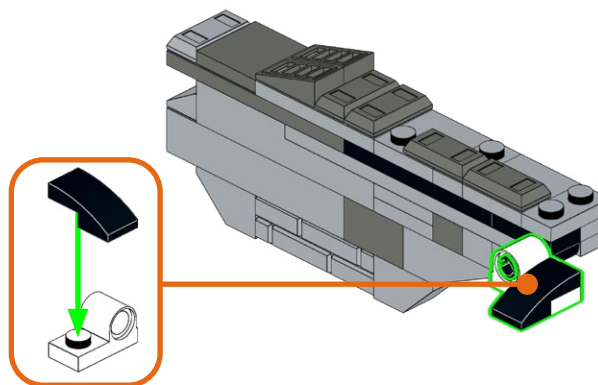

185

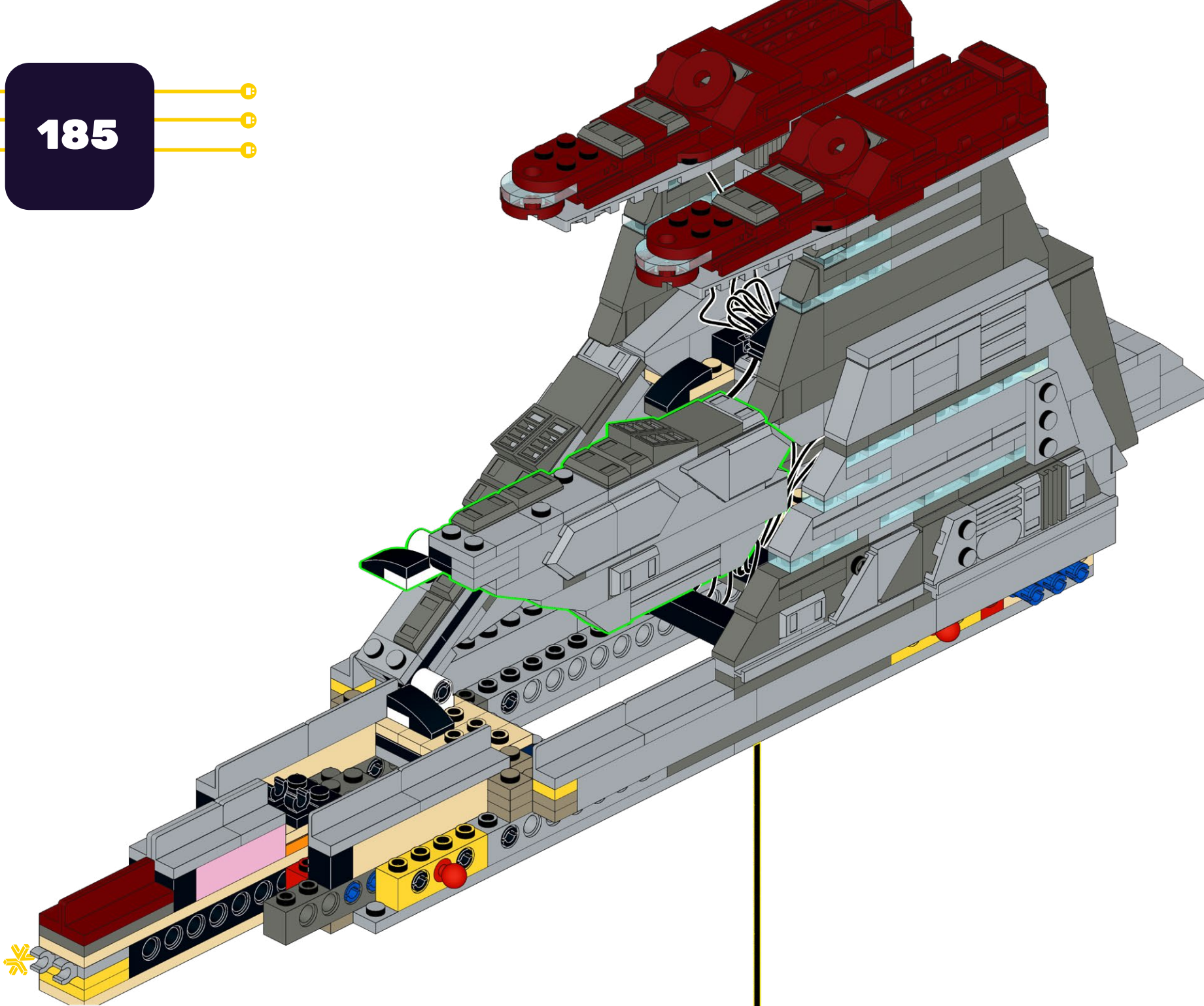

186

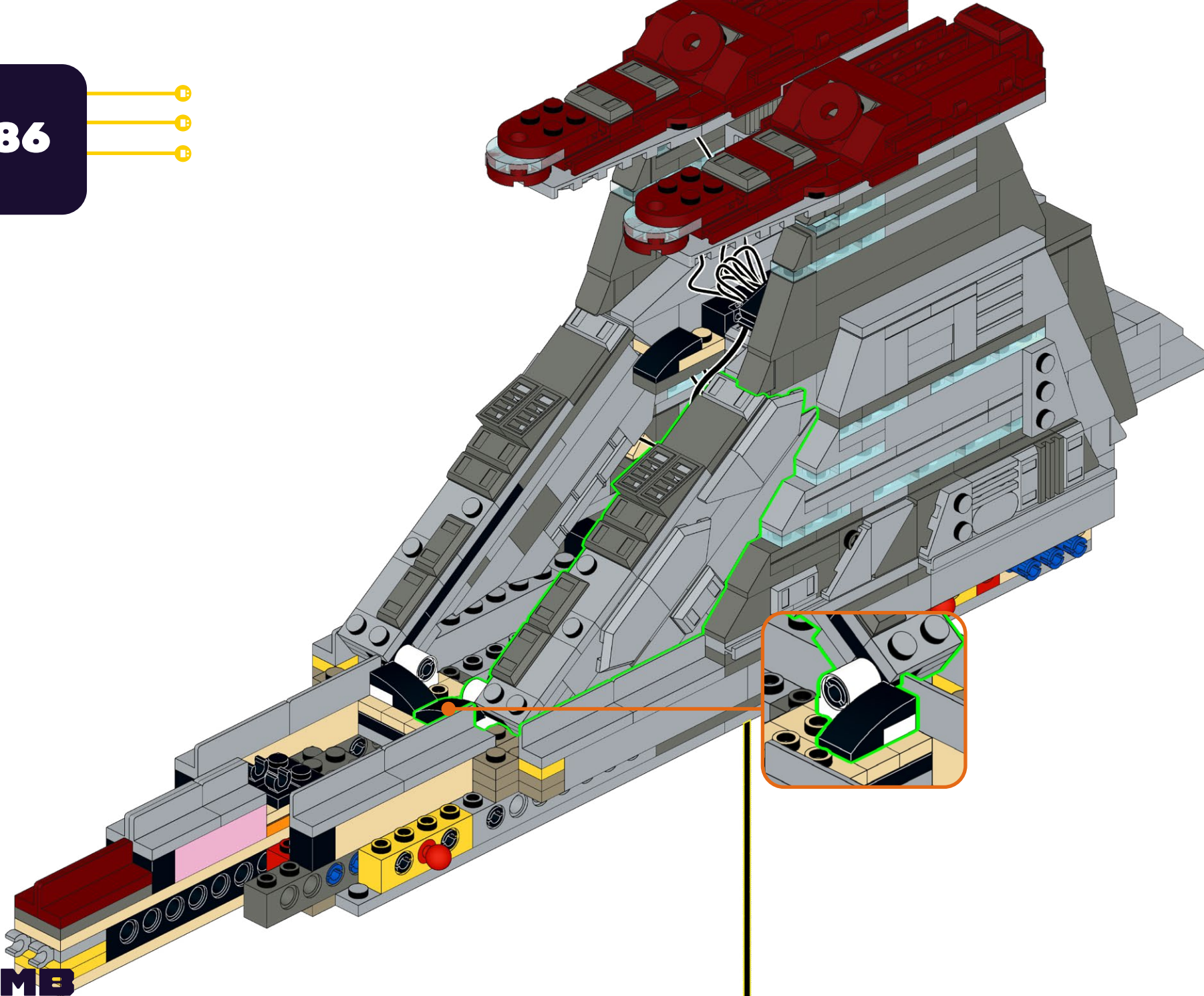

187

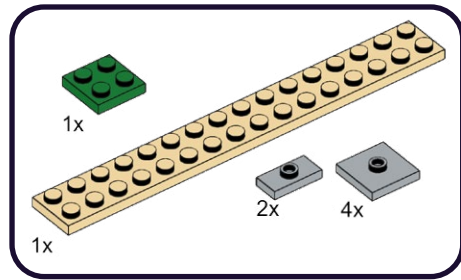

1

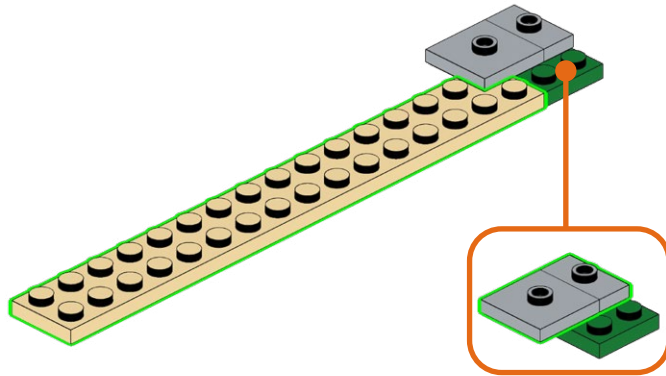

2

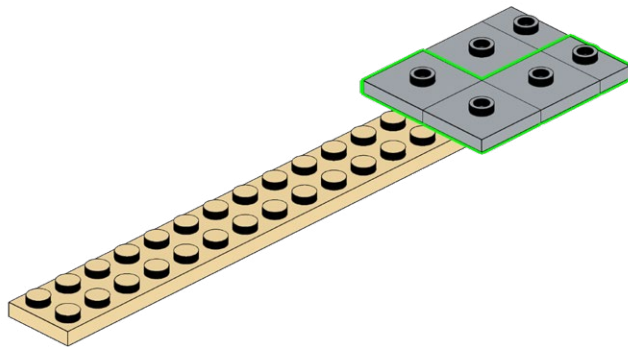

188

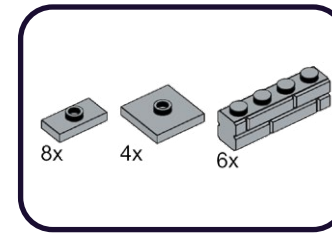

1

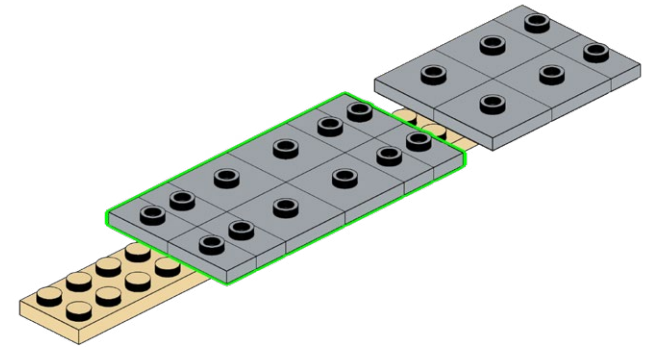

2

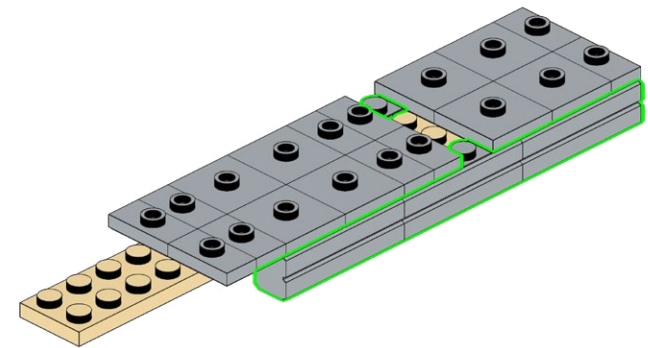

189

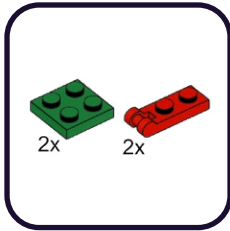

1

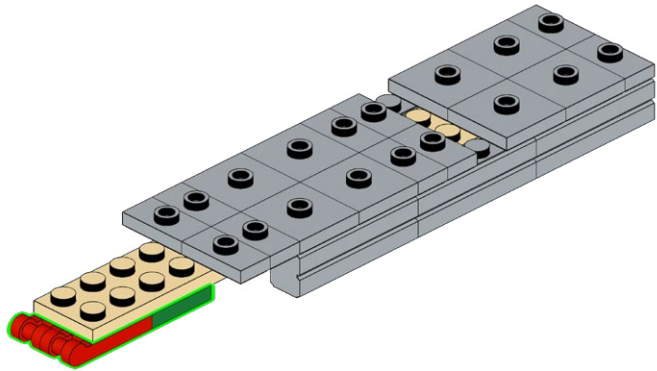

2

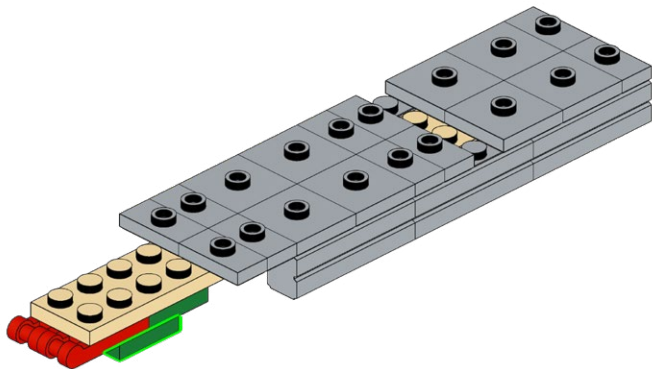

190

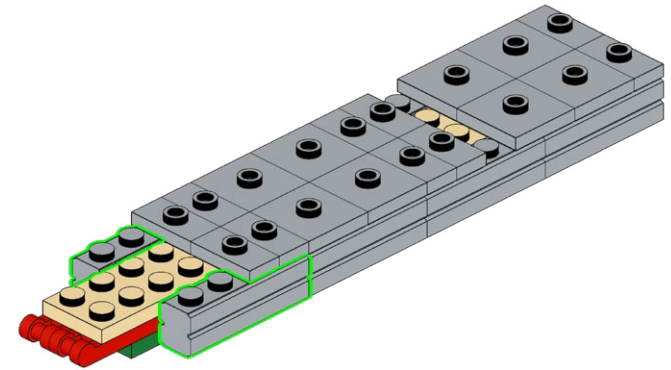
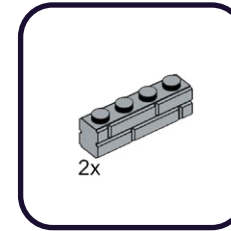

191

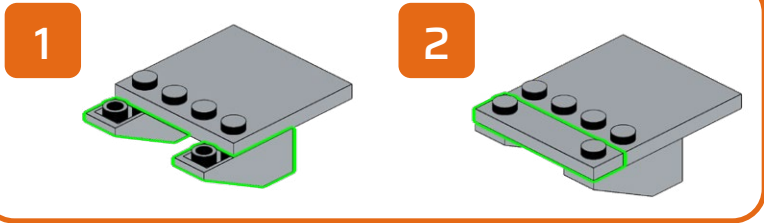
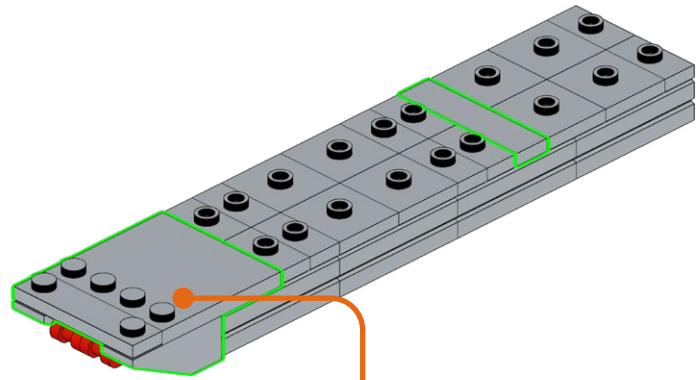
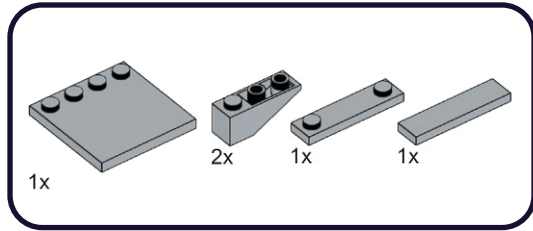

192

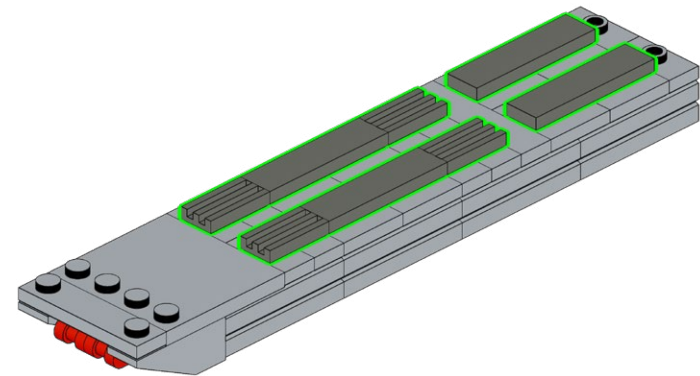
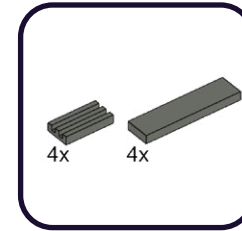

193

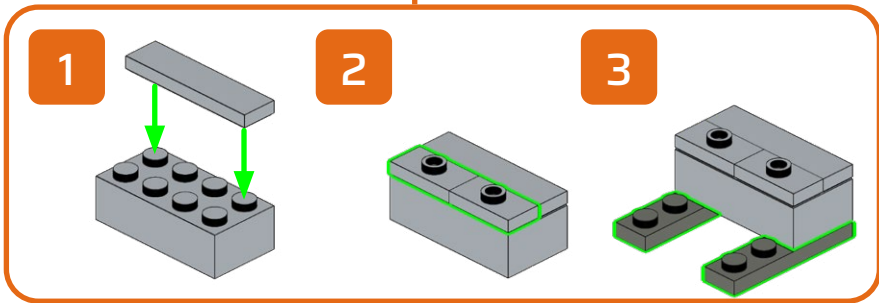
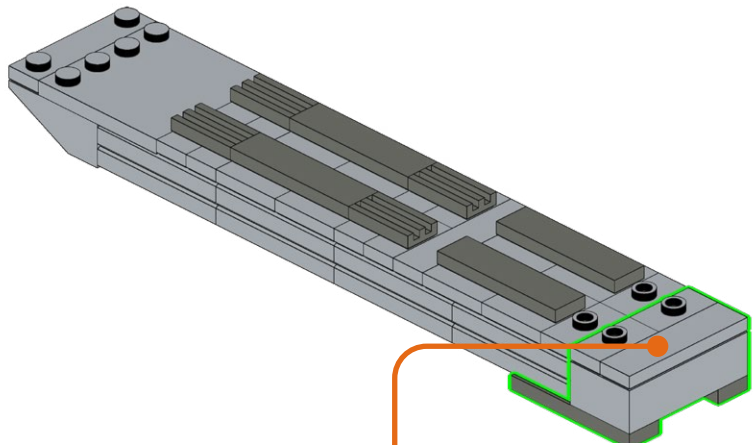
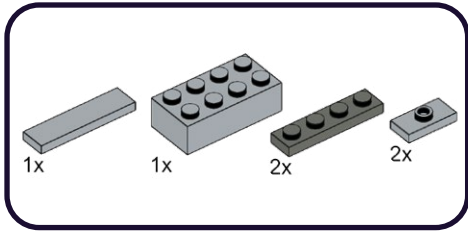

194

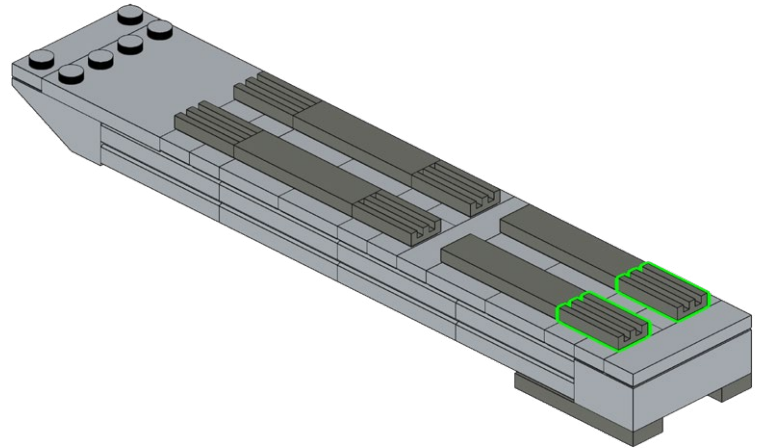
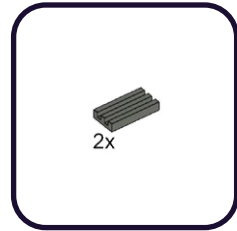

195

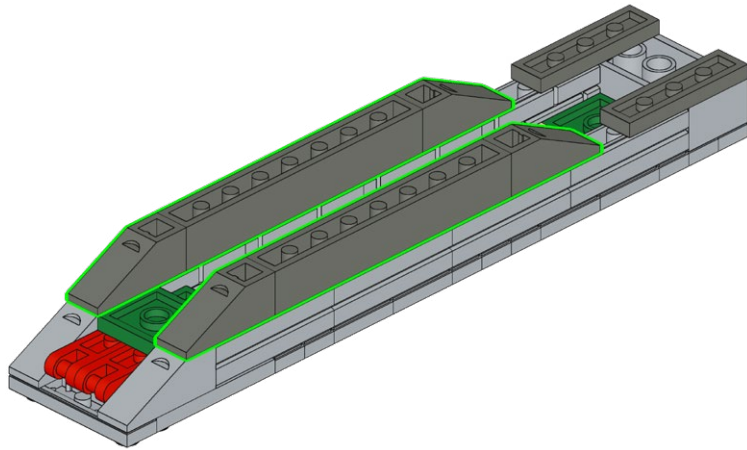
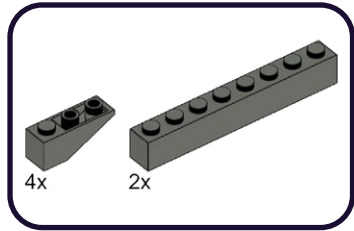

196

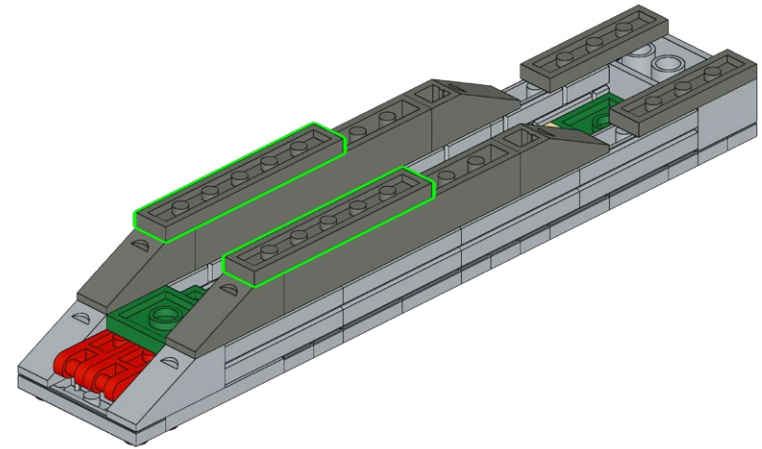
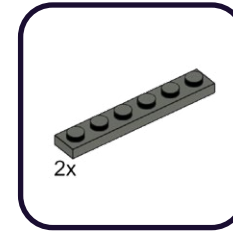

197

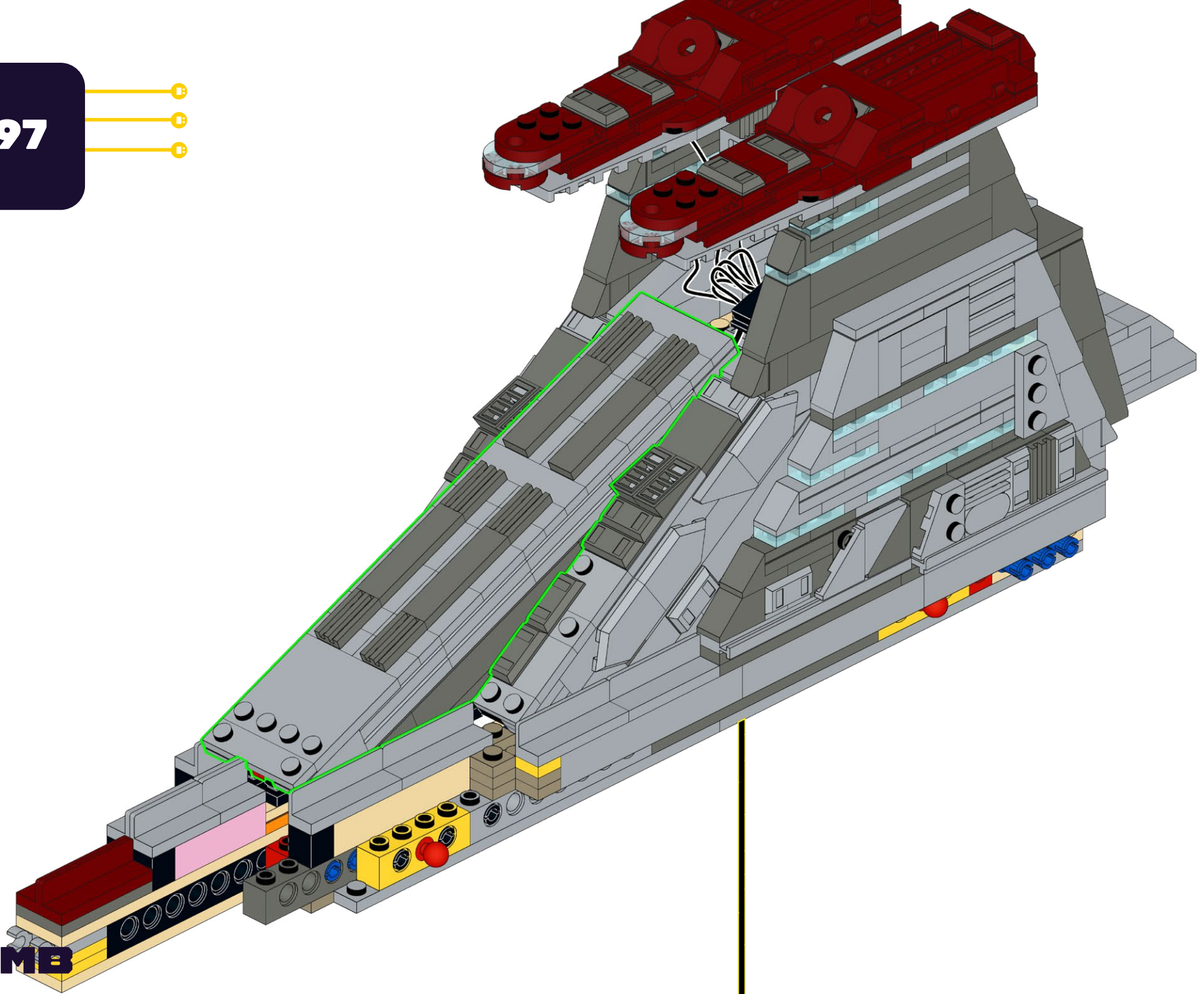

198

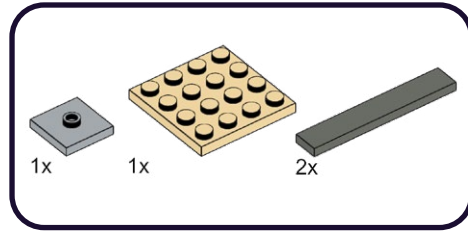

1

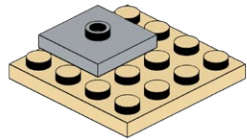

2

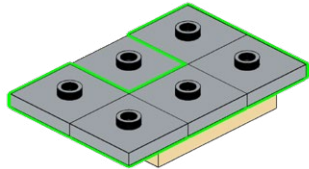

3

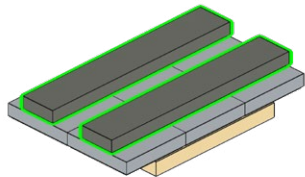

199

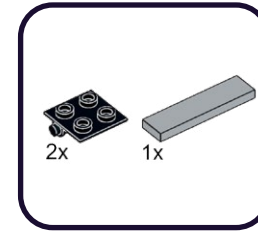

1

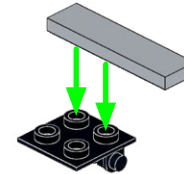

2

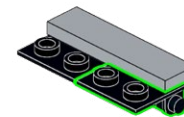

3

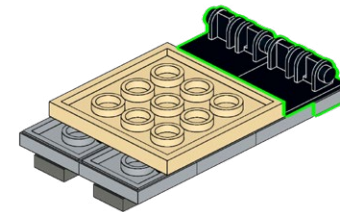

200

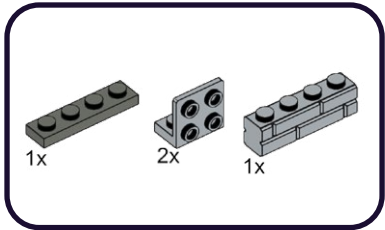

1

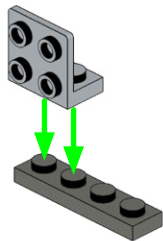

2

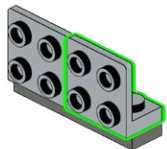

3

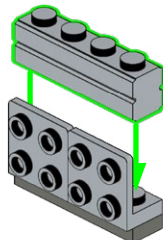

201

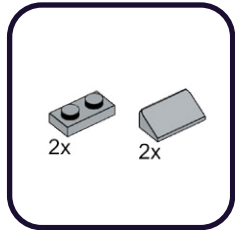

1

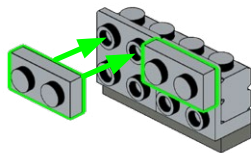

2

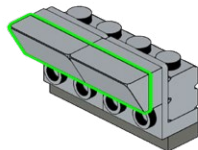

3

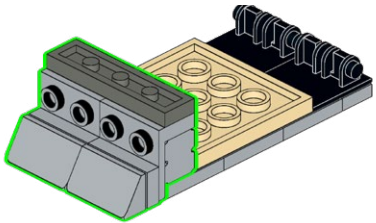

202

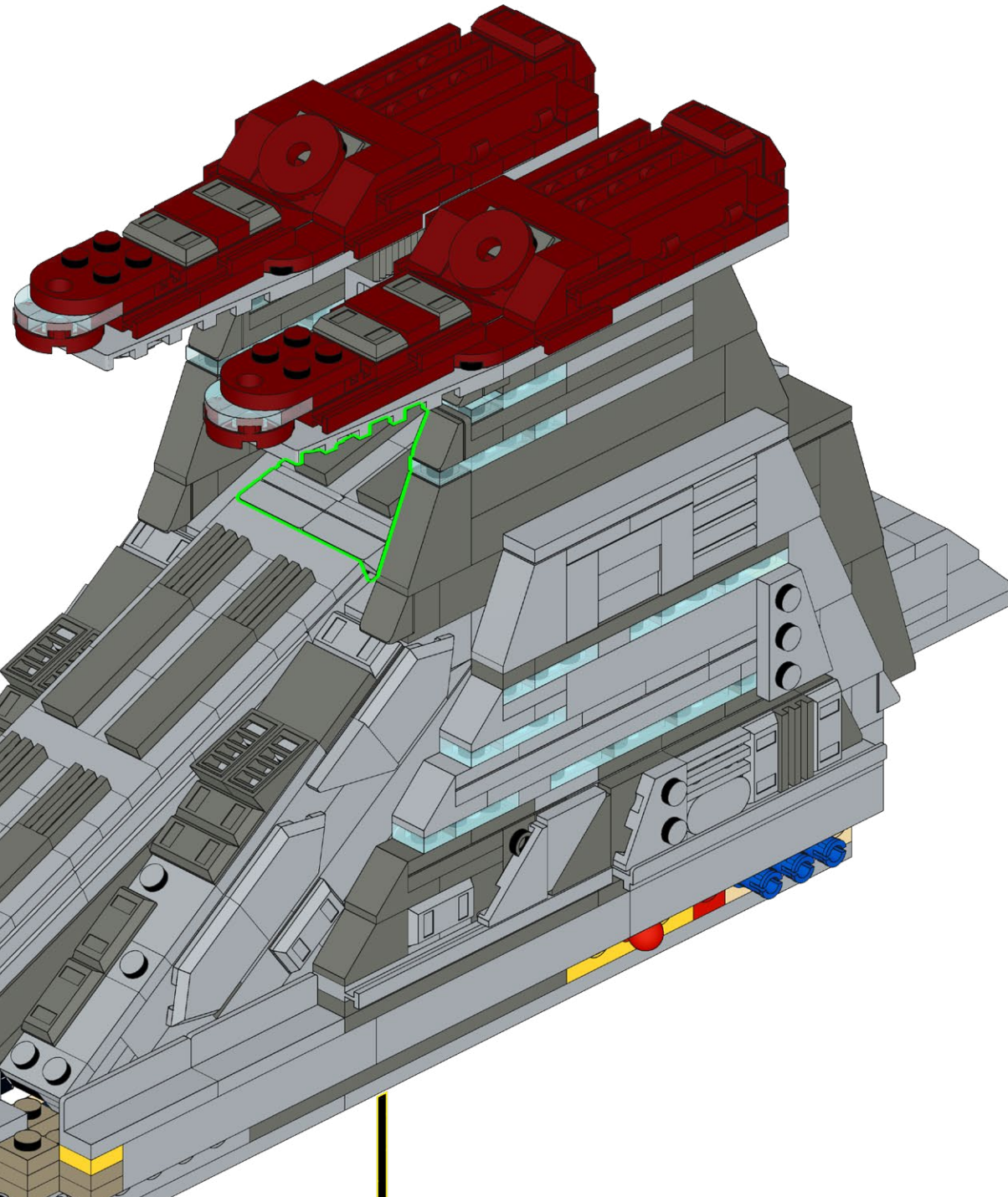

203

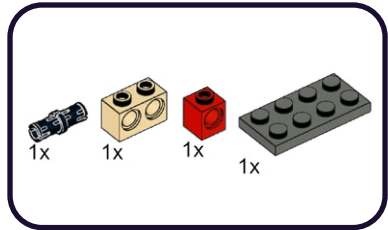

1

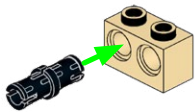

2

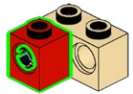

3

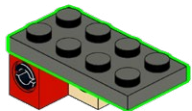

204

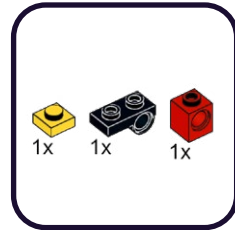

1

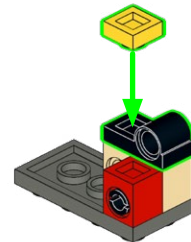

2

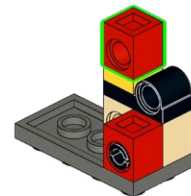

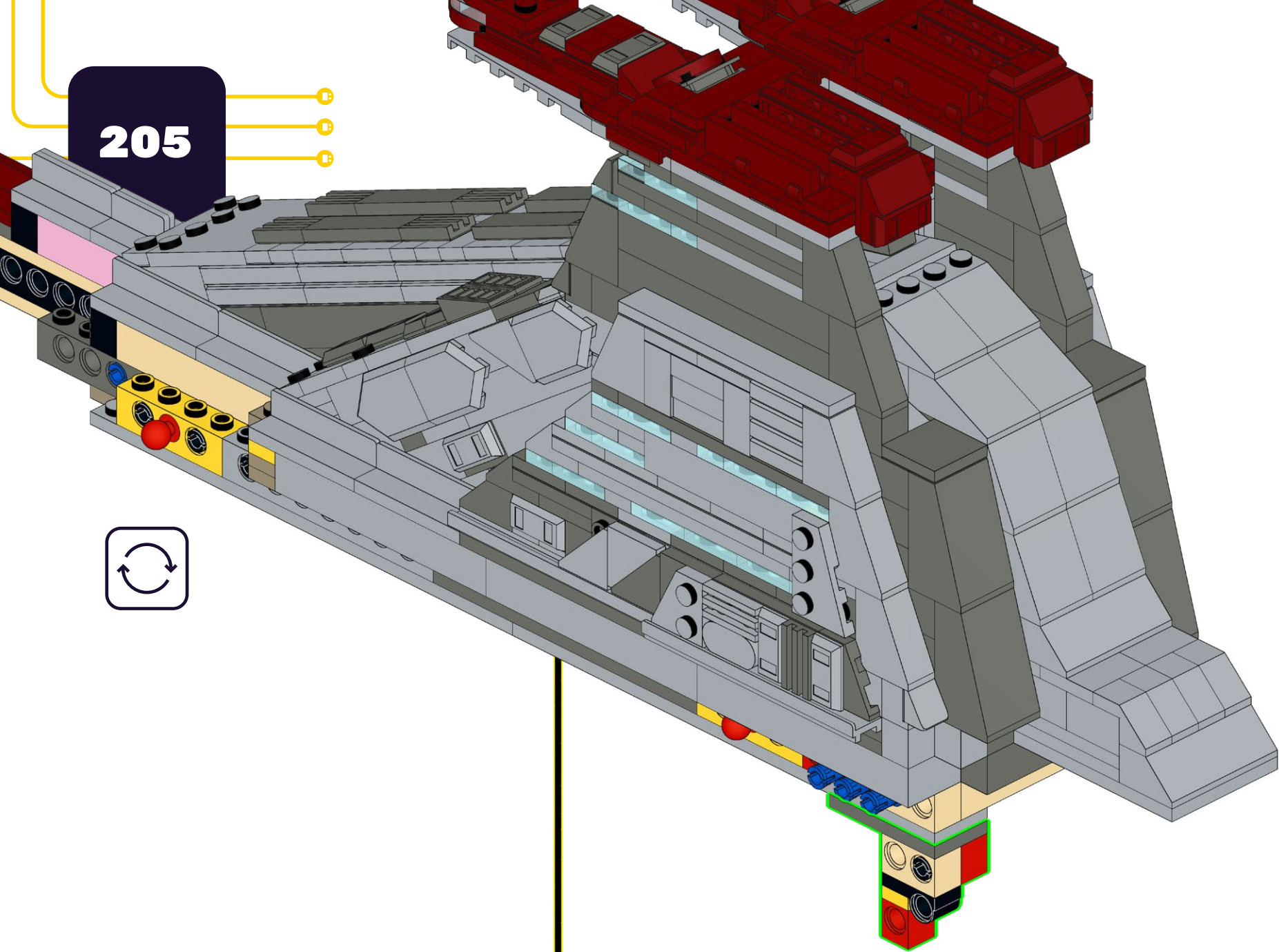

206

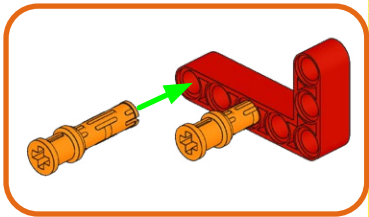
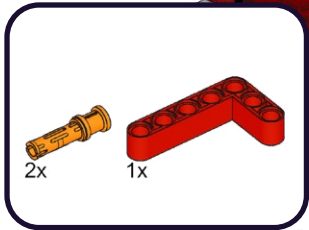

207

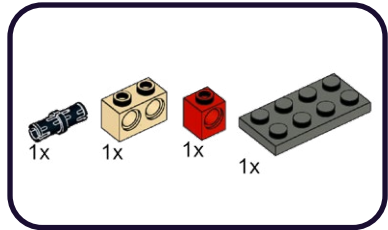

1

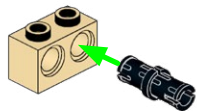

2

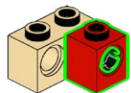

3

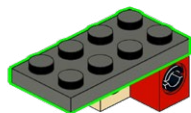

208

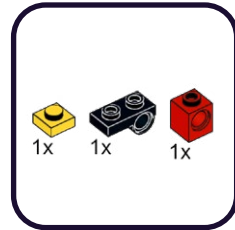

1

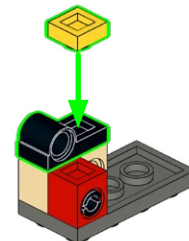

2

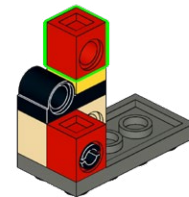

209

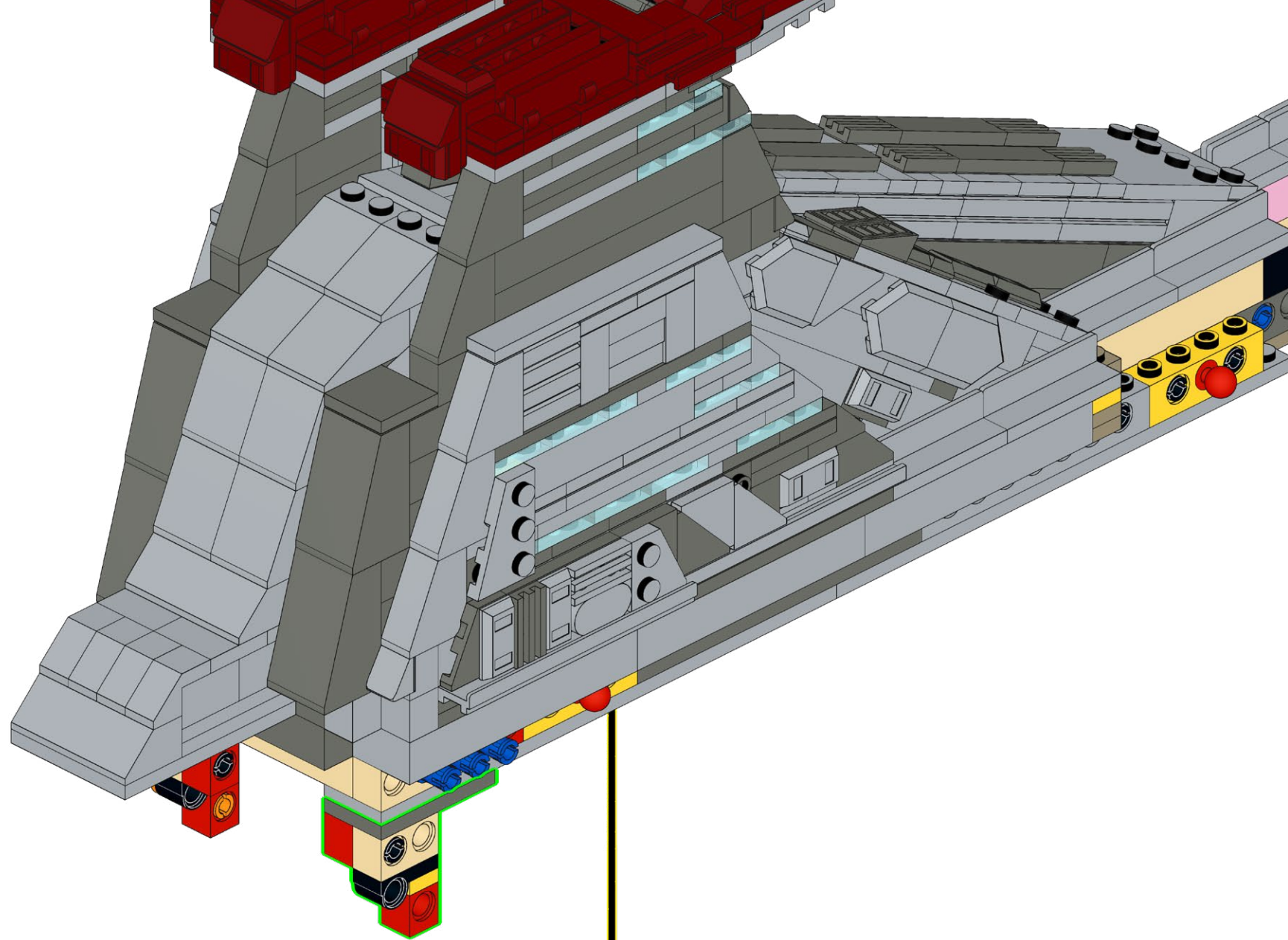

210

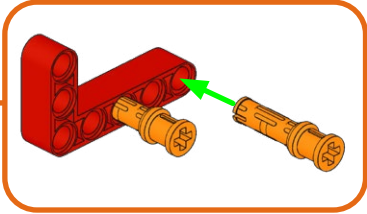
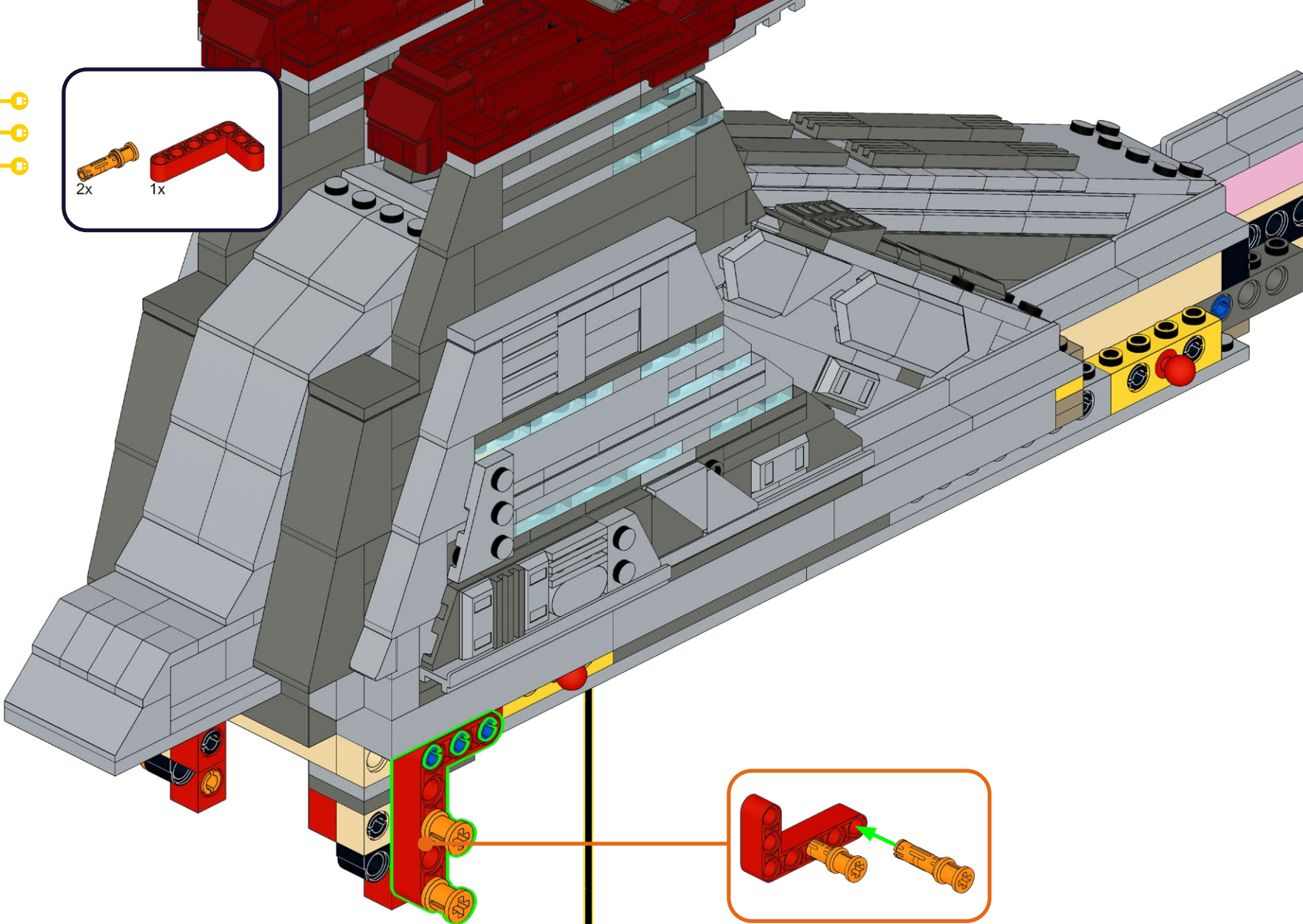
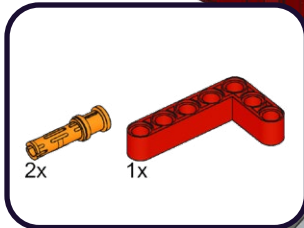

211

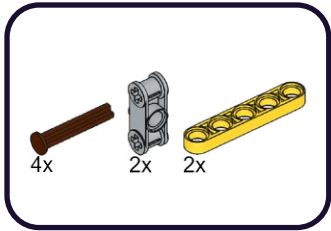

1

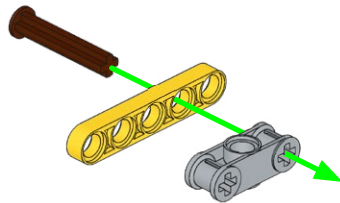

2

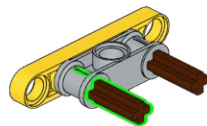

212

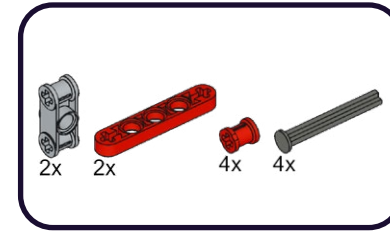

1

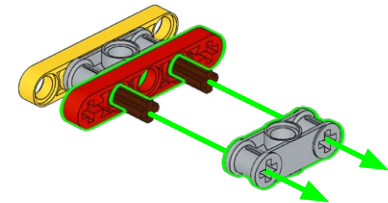

2

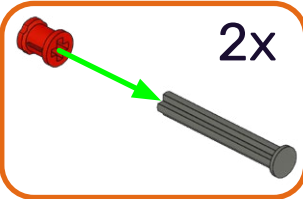
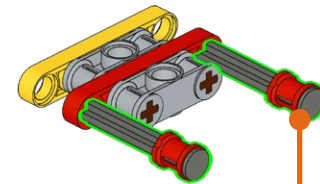

2x

213

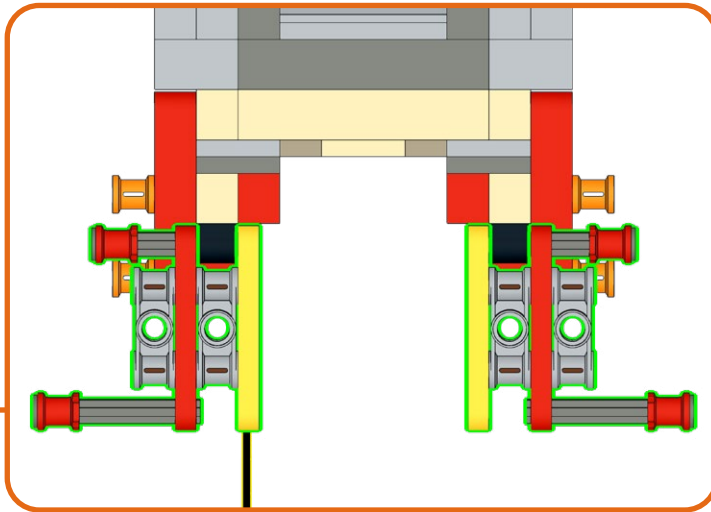
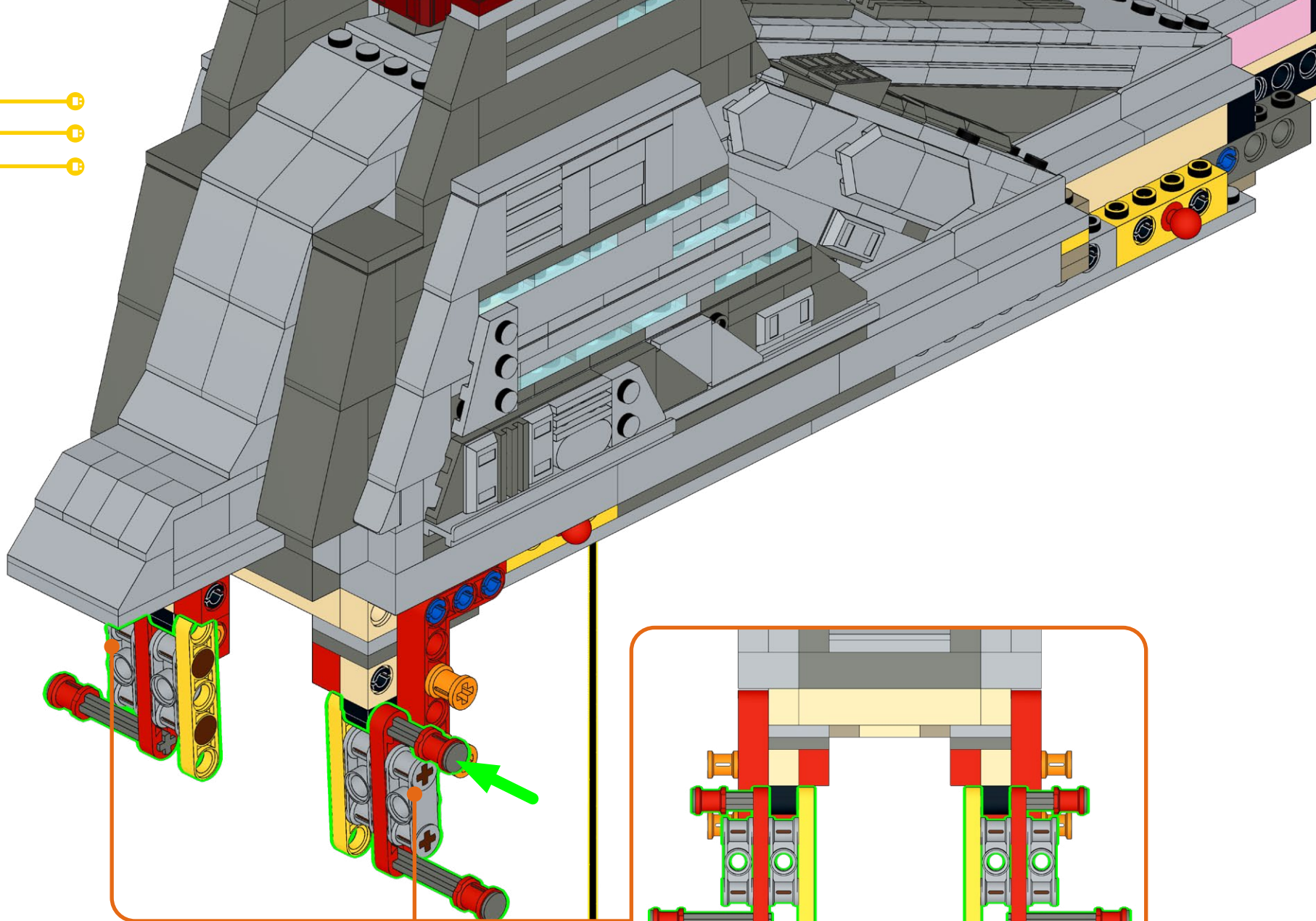

214

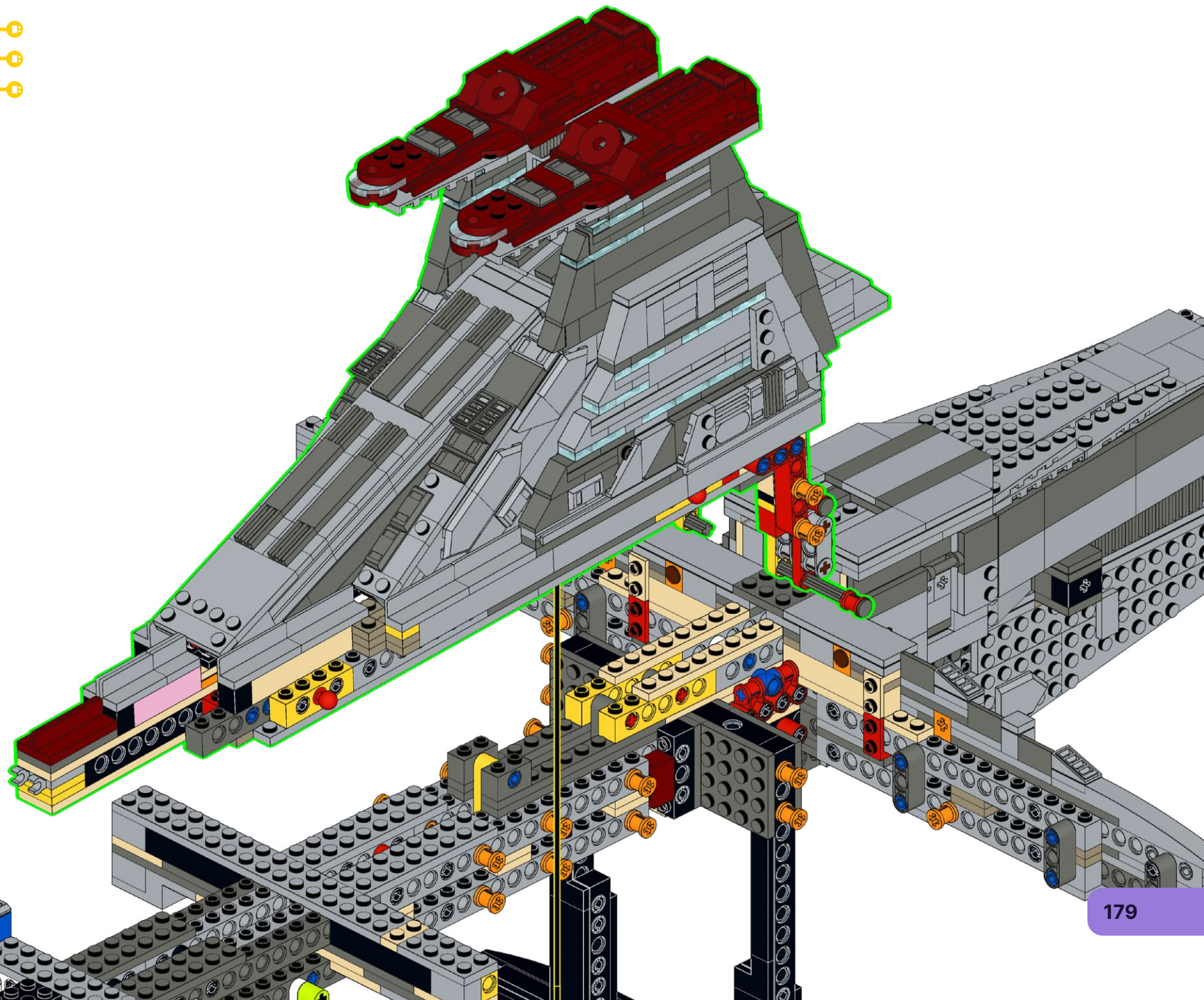

215

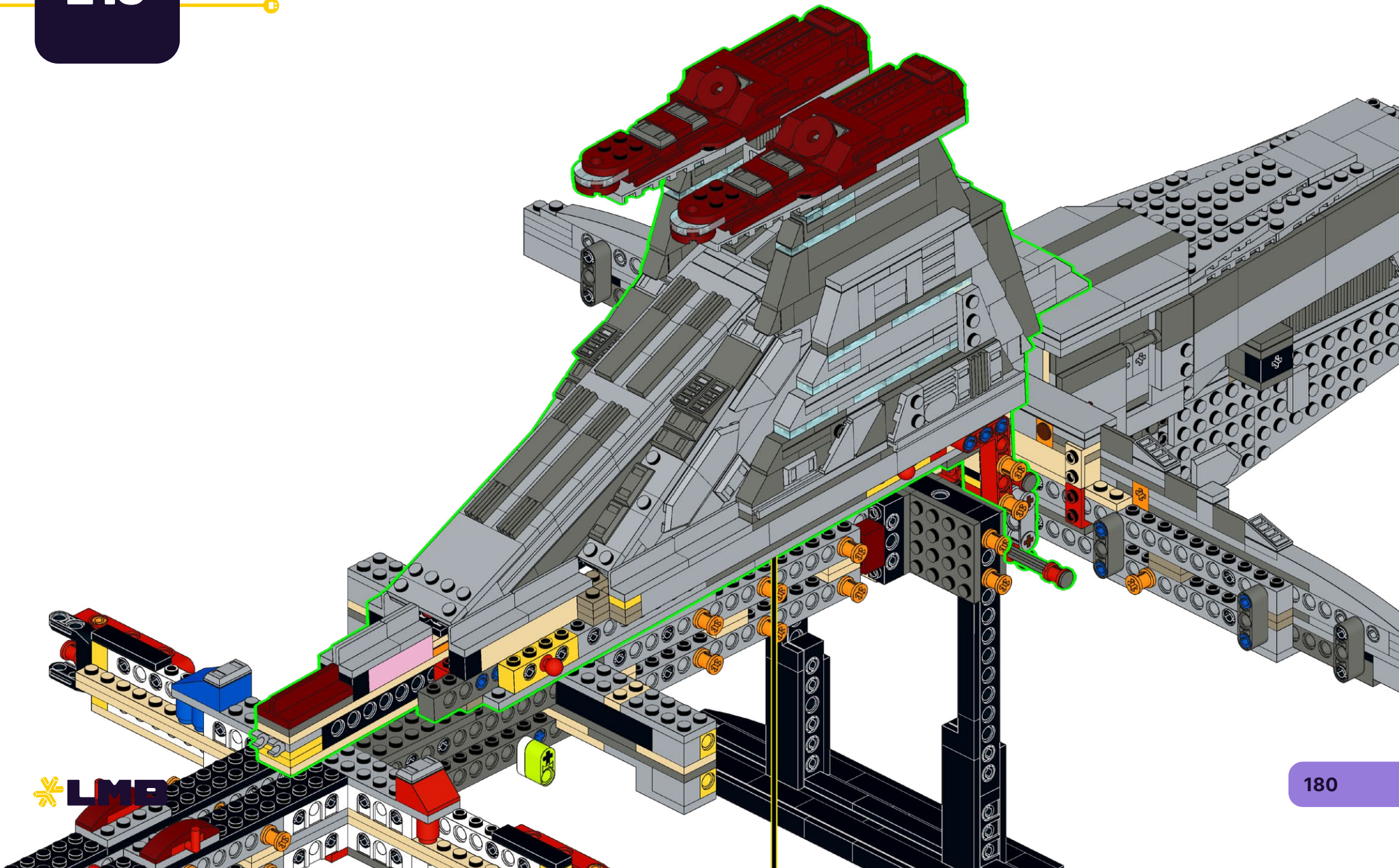

**HOLD UP!**

You might notice some bags aren't in order, as well as left over pieces, but that's ok! We're changing the way you build LEGO!

ATTENDEZ!

Vous remarquerez peut-être que certains sacs, ainsi que certaines pièces, ne sont pas dans le bon ordre. Mais pas de panique! Nous changeons simplement la façon avec laquelle vous construisez vos LEGO!

ASPETTA!

Potresti notare che alcuni sacchetti non sono in ordine, così come i pezzi avanzati, ma va bene così! Stiamo cambiando il modo in cui costruisci i LEGO!

HALT!

Sie werden möglicherweise bemerken, dass einige tüten durcheinander sind und teile übrig bleiben, aber das ist in Ordnung! Wir ändern die art und weise, wie Sie LEGO bauen!

¡ESPERA!

Es posible que notes que algunas bolsas están fuera de servicio, así como piezas sobrantes, ¡pero está bien! ¡Estamos cambiando la forma en que construyes LEGO!

暫停!

你可能会注意到一些袋子顺序错乱, 以及一些剩余的部件, 但没关系! 我们正在改变你搭建乐高的方式!

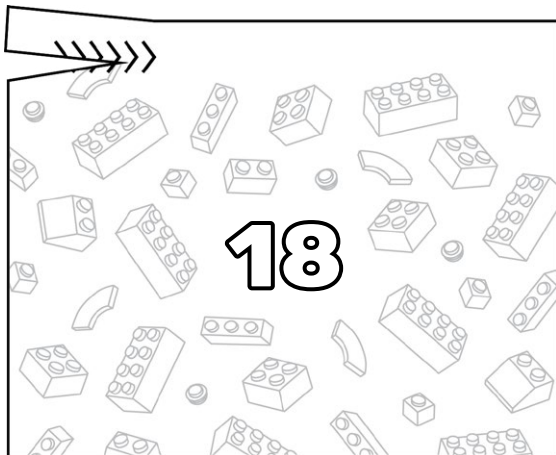
Open LEGO® Bag 18

216

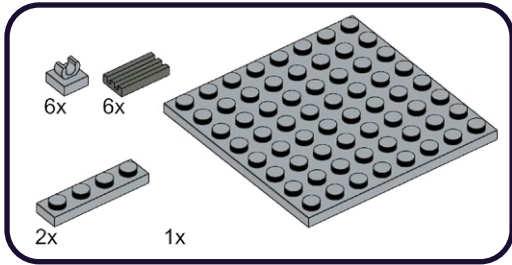

1

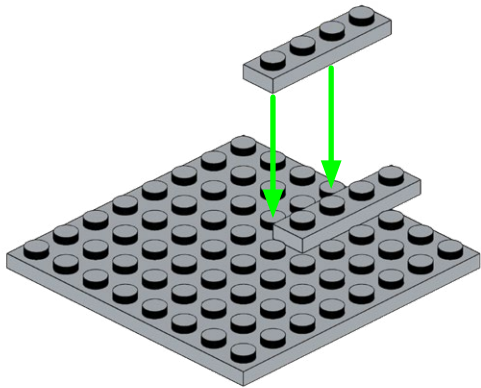

2

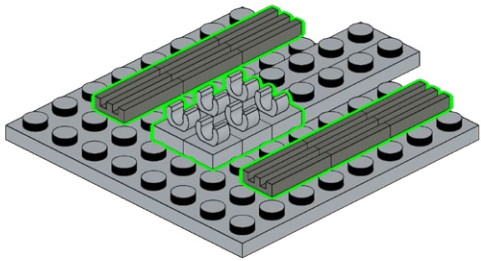

217

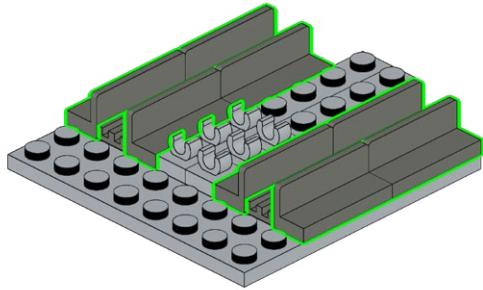
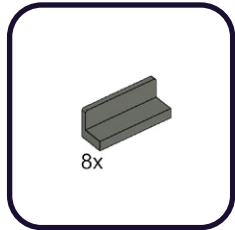

218

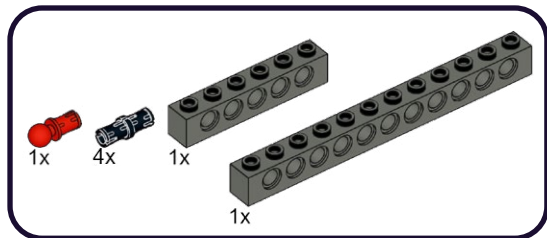

1

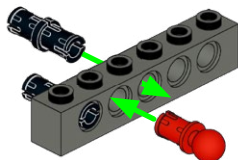

2

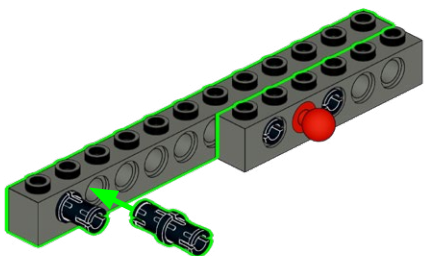

219

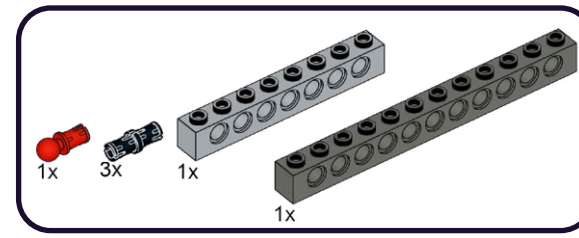

1

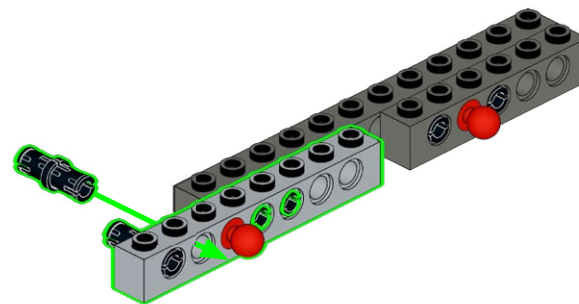

2

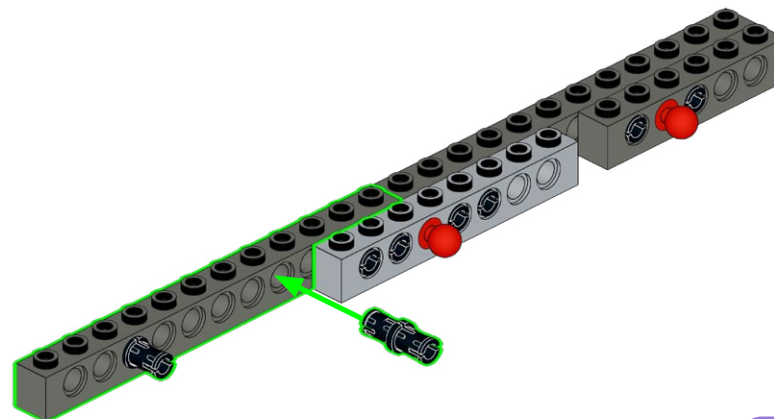

220

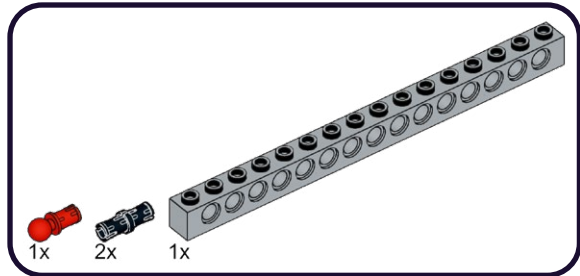

221

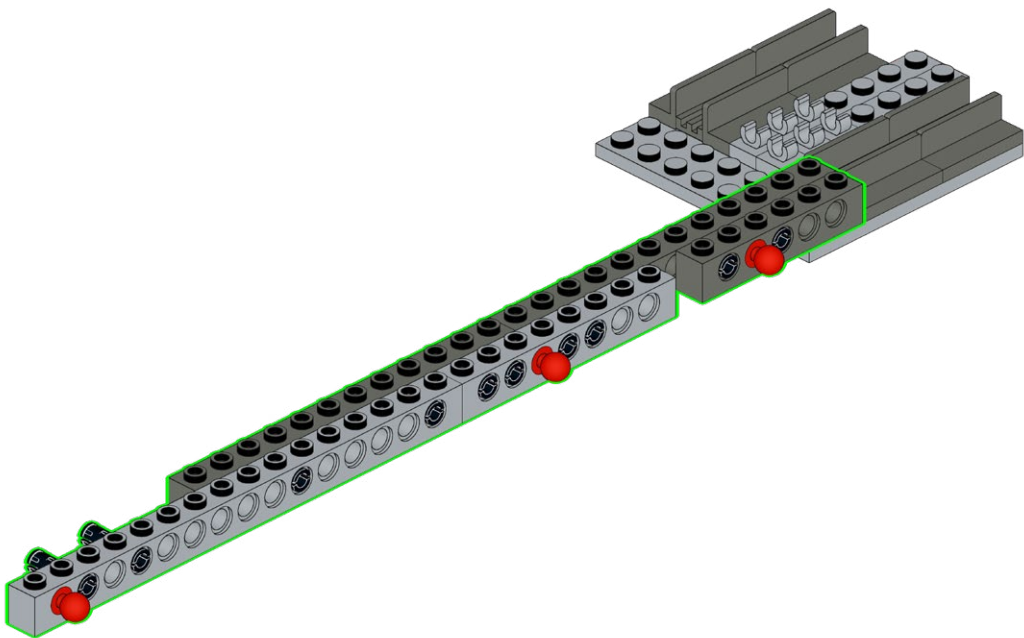
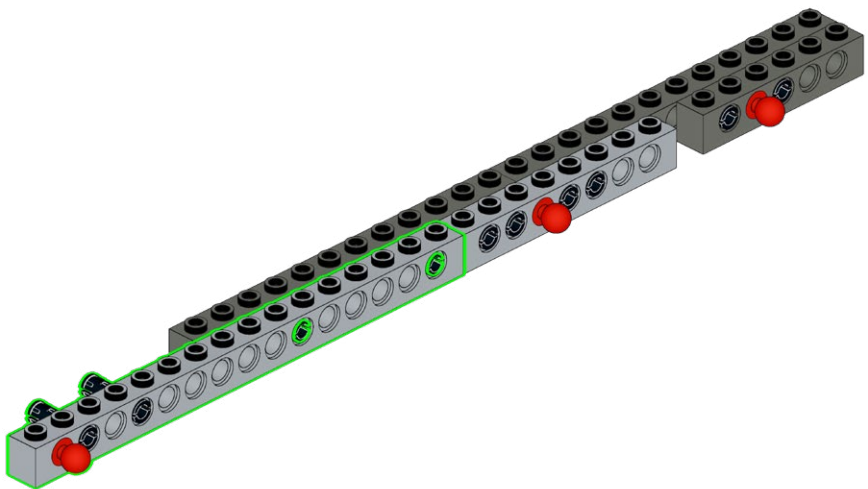

222

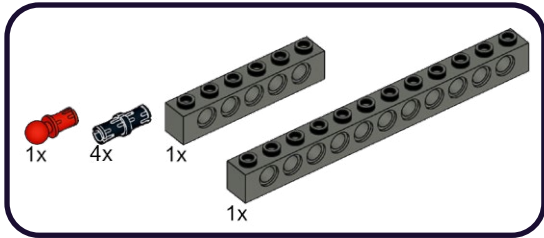

1

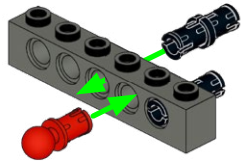

2

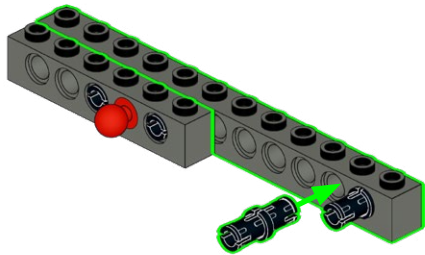

223

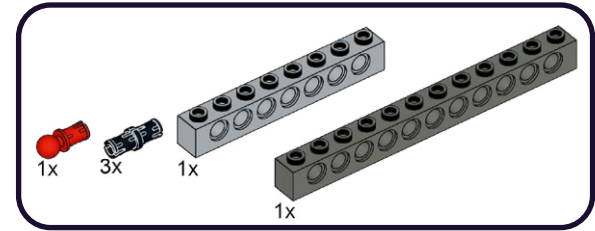

1

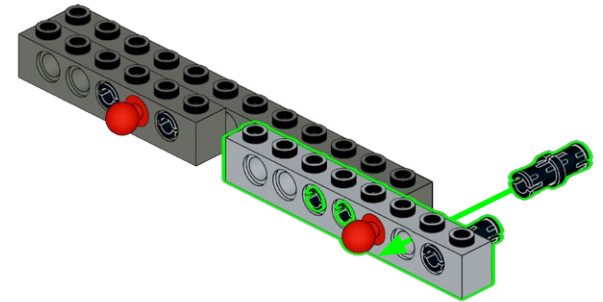

2

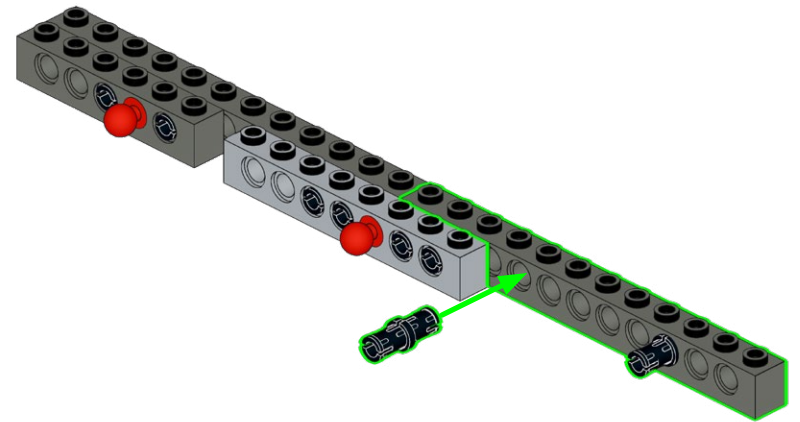

224

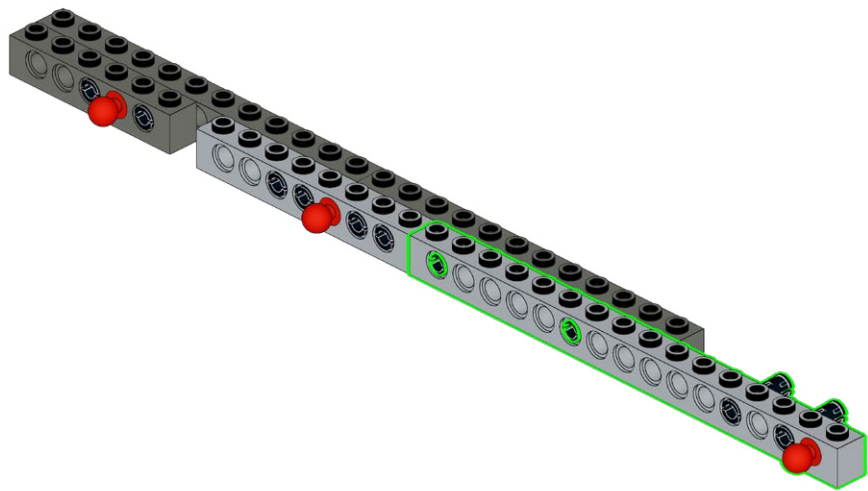
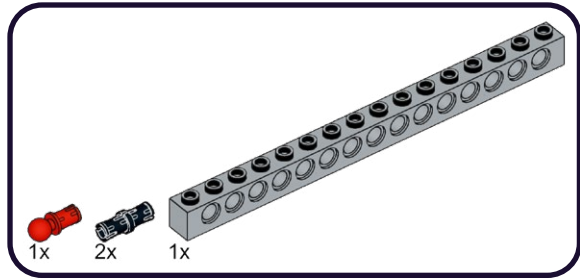

225

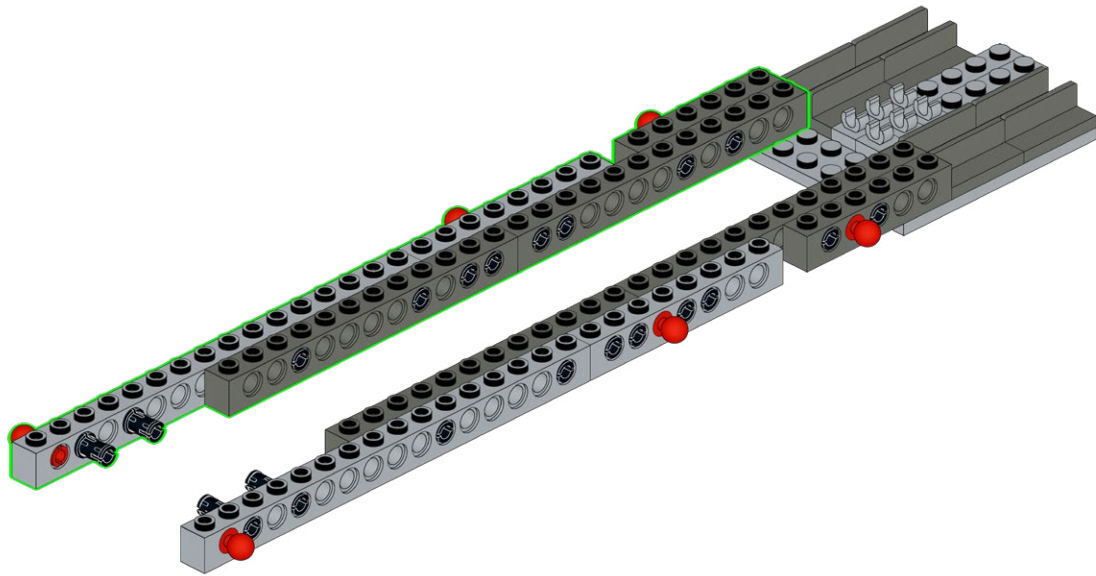

226

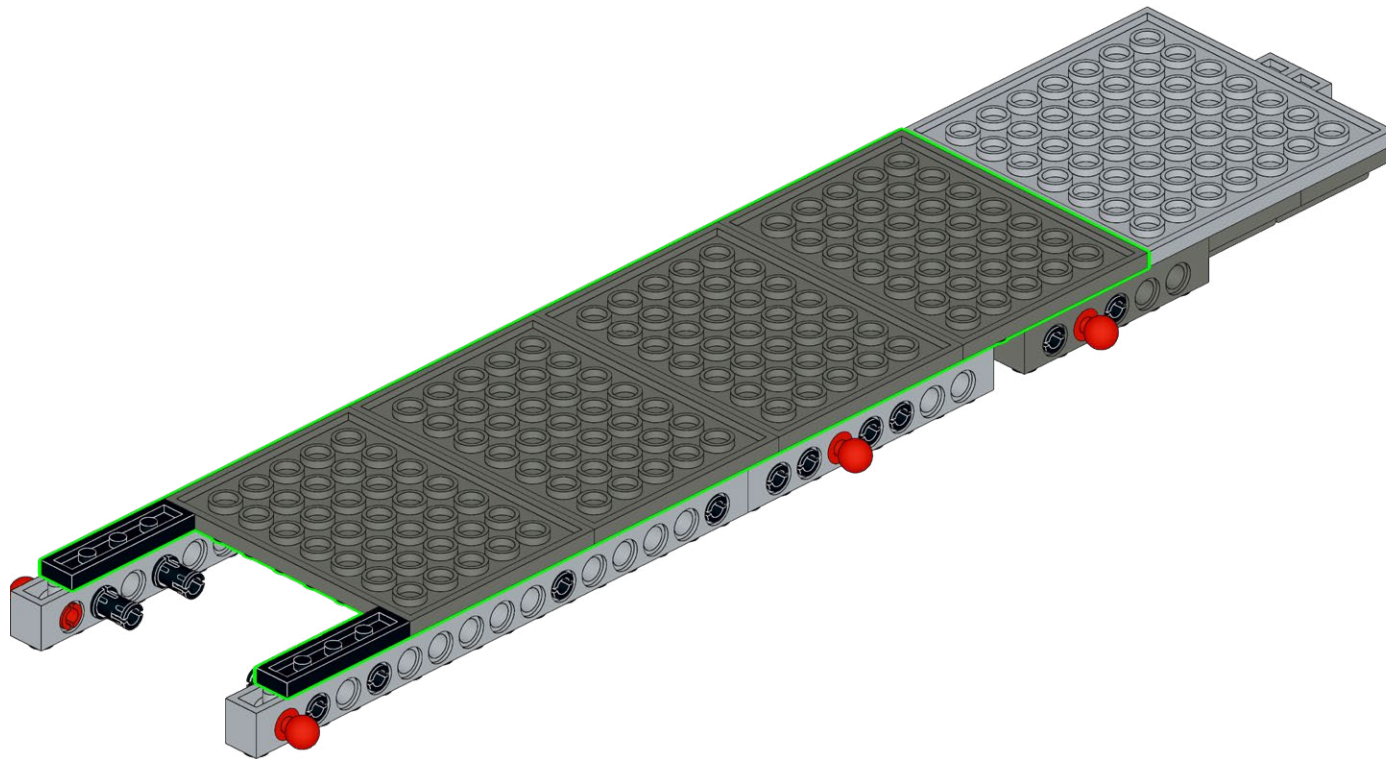
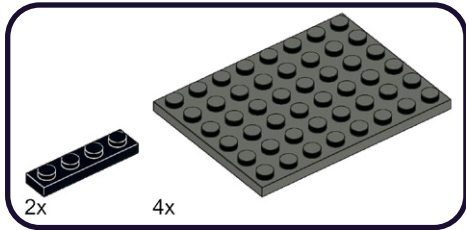

227

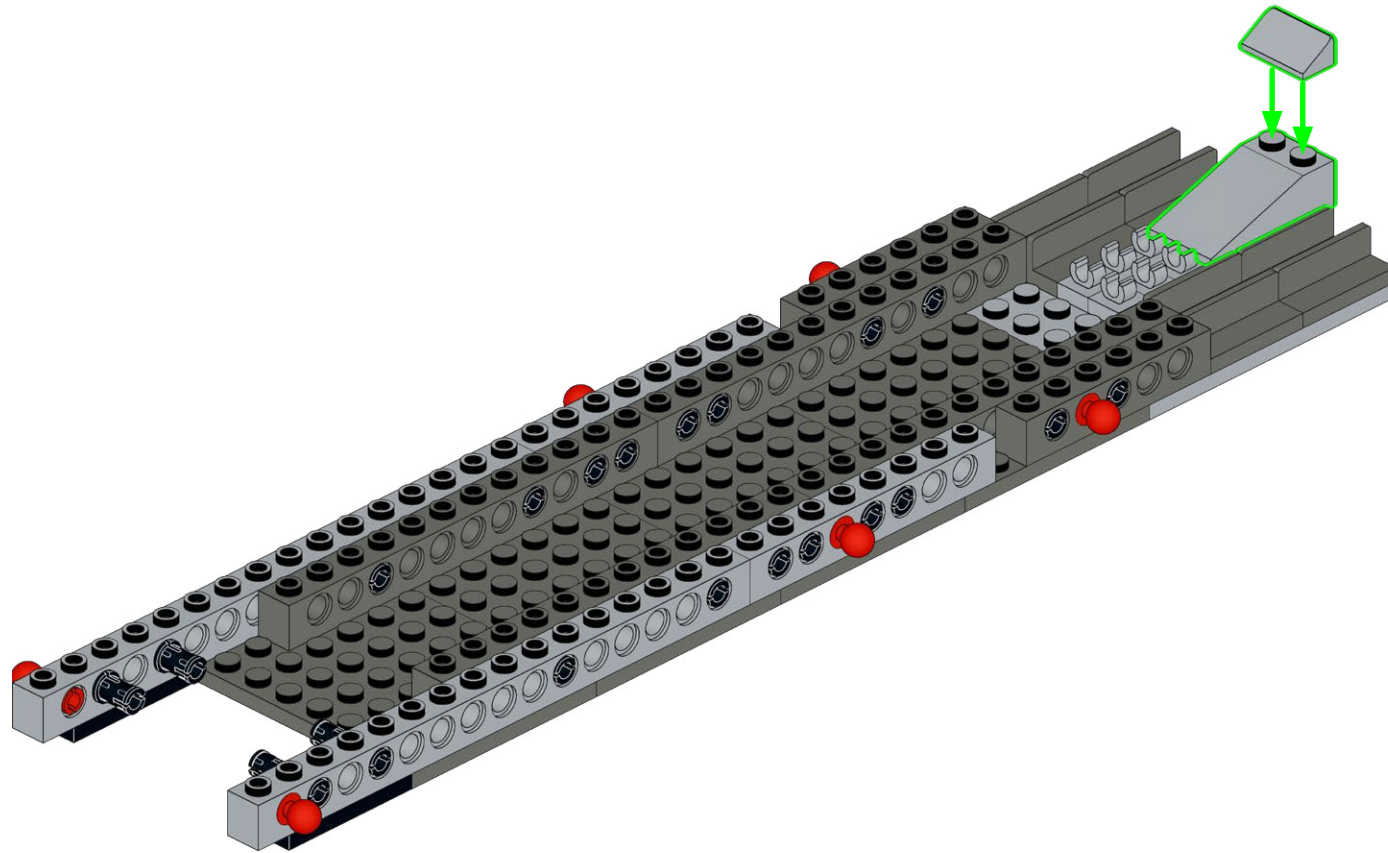
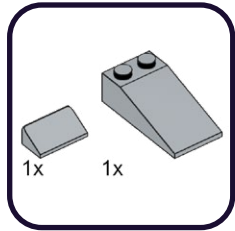

228

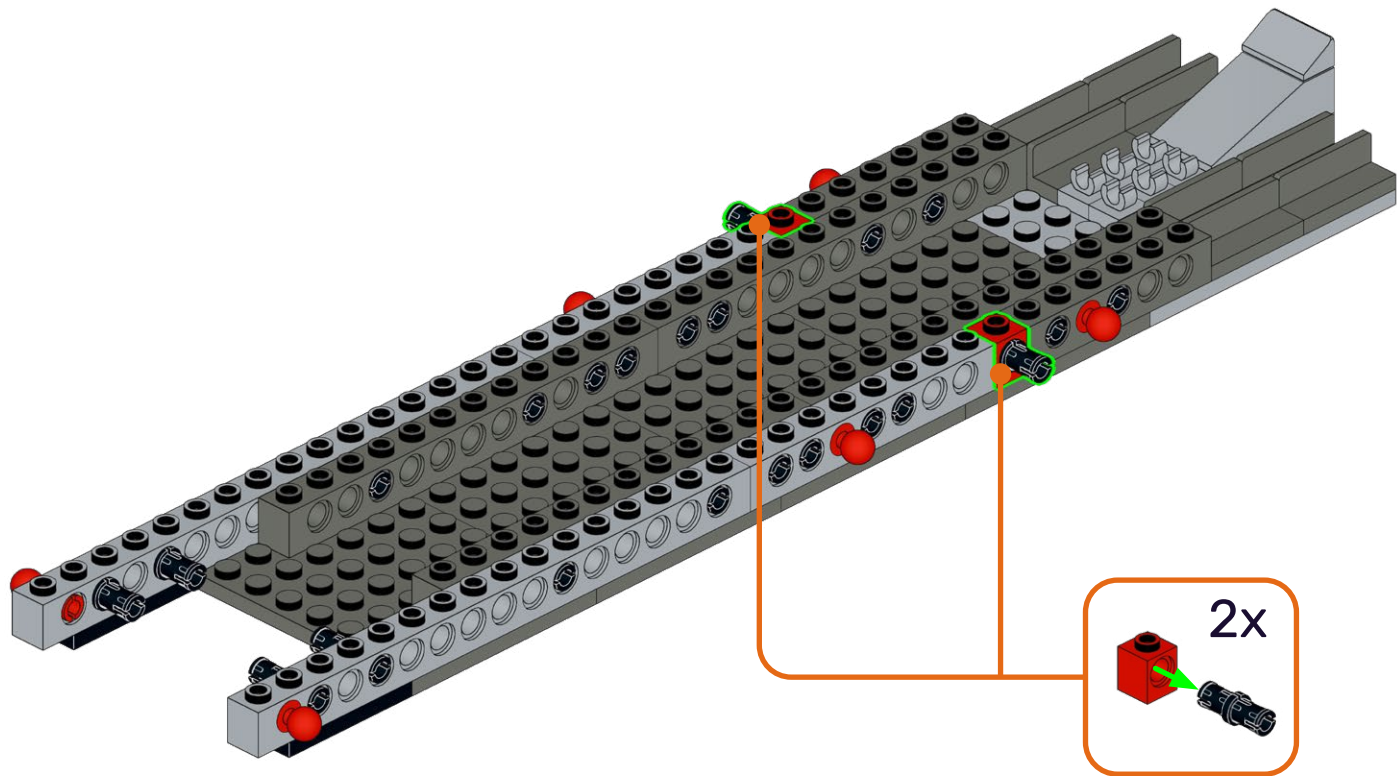
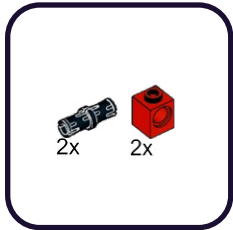

229

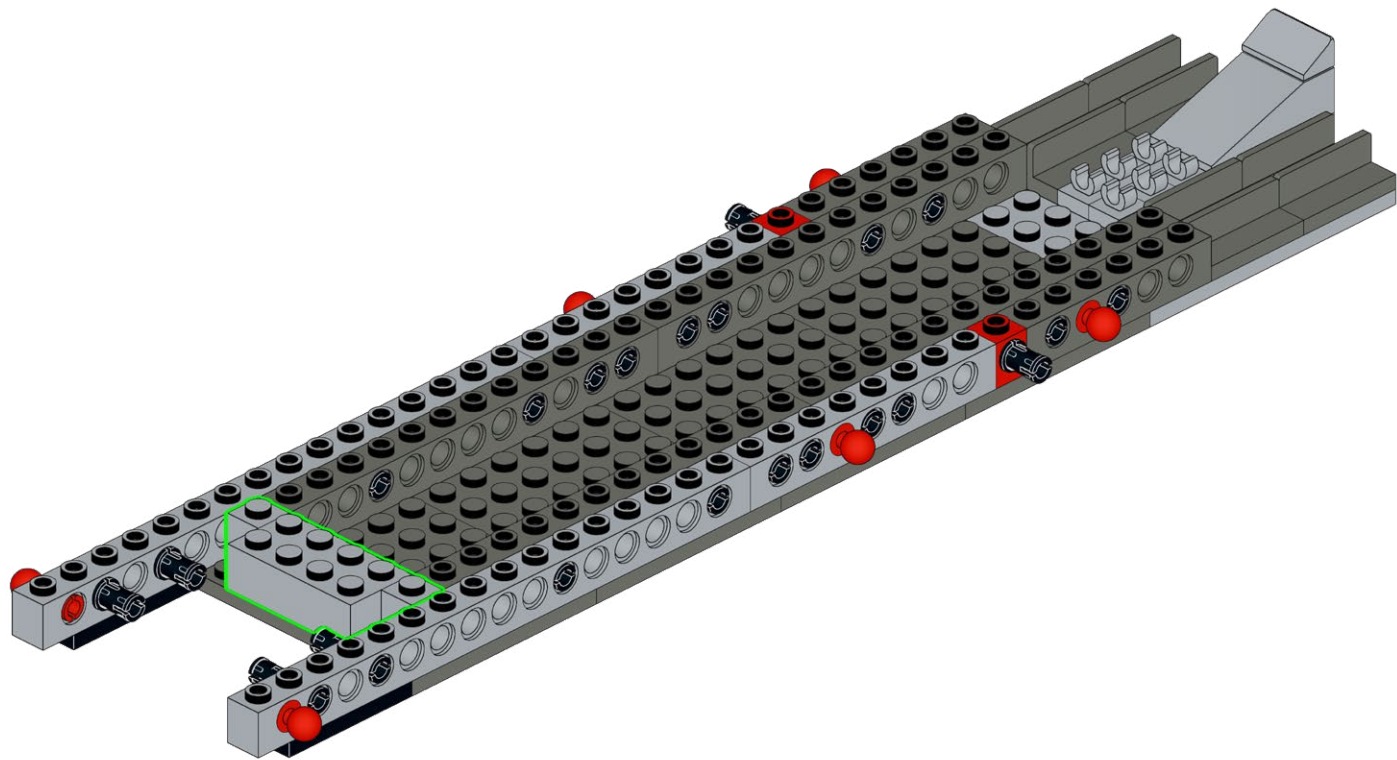
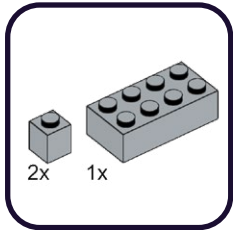

230

8x 4x

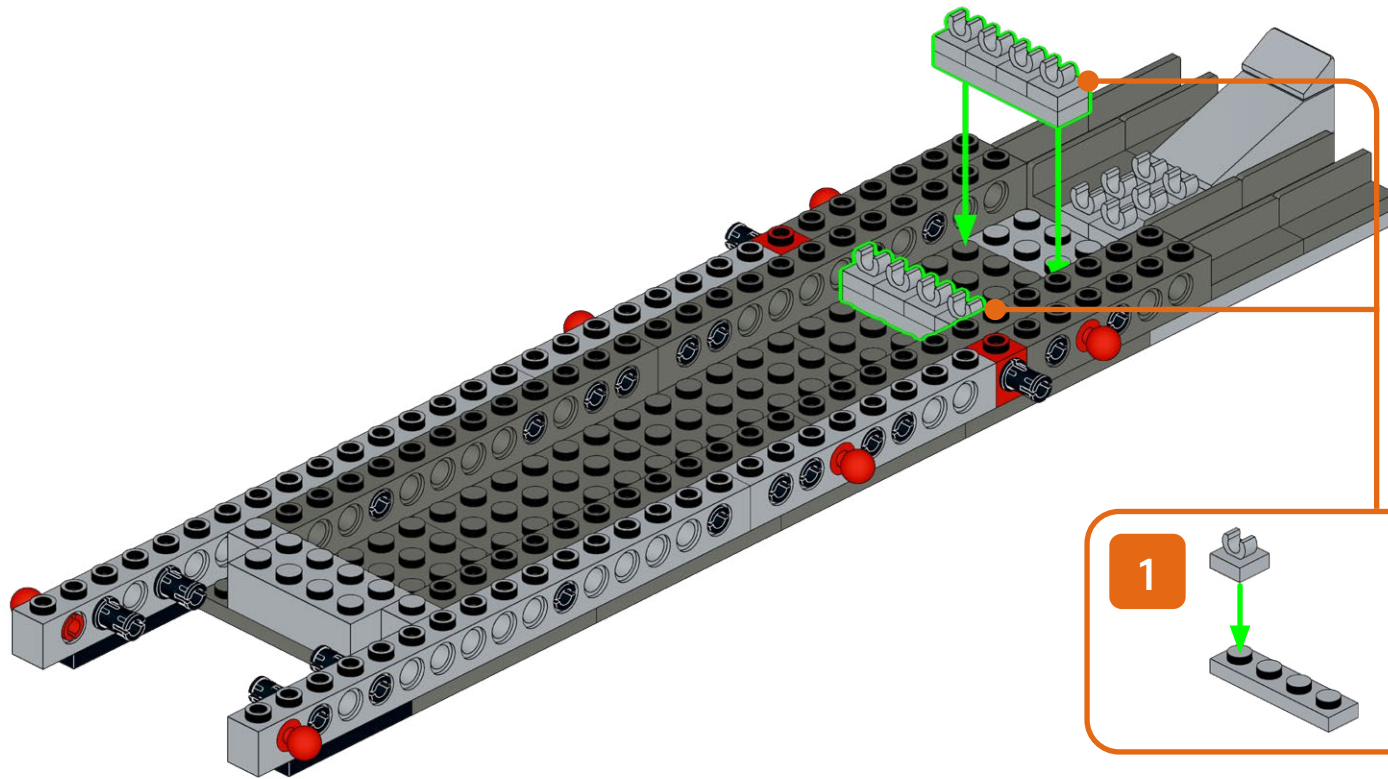

1



2

2x

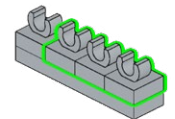

231

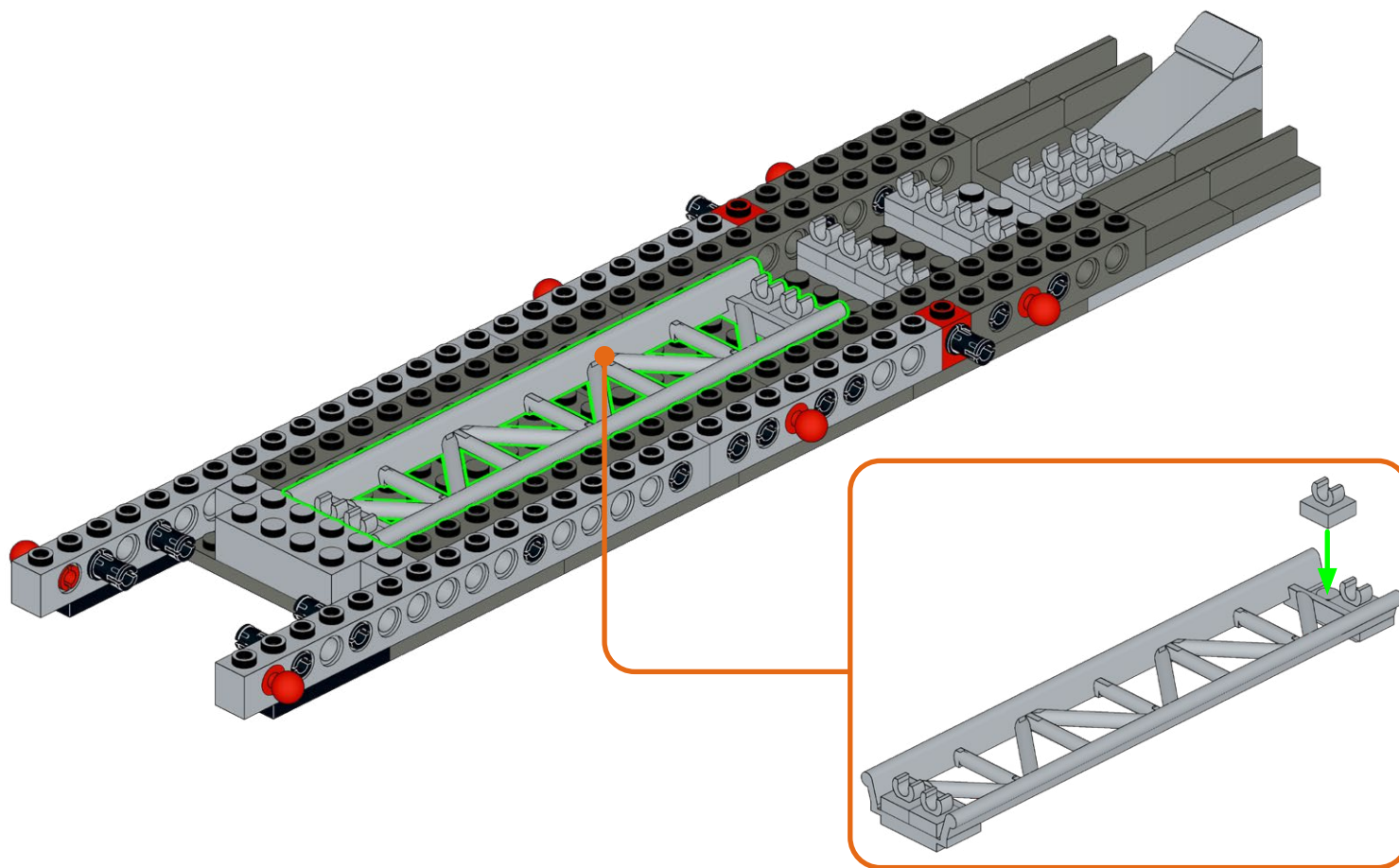
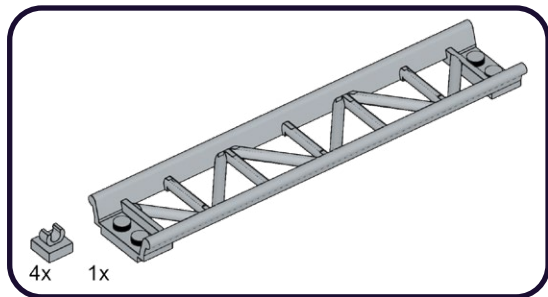

232

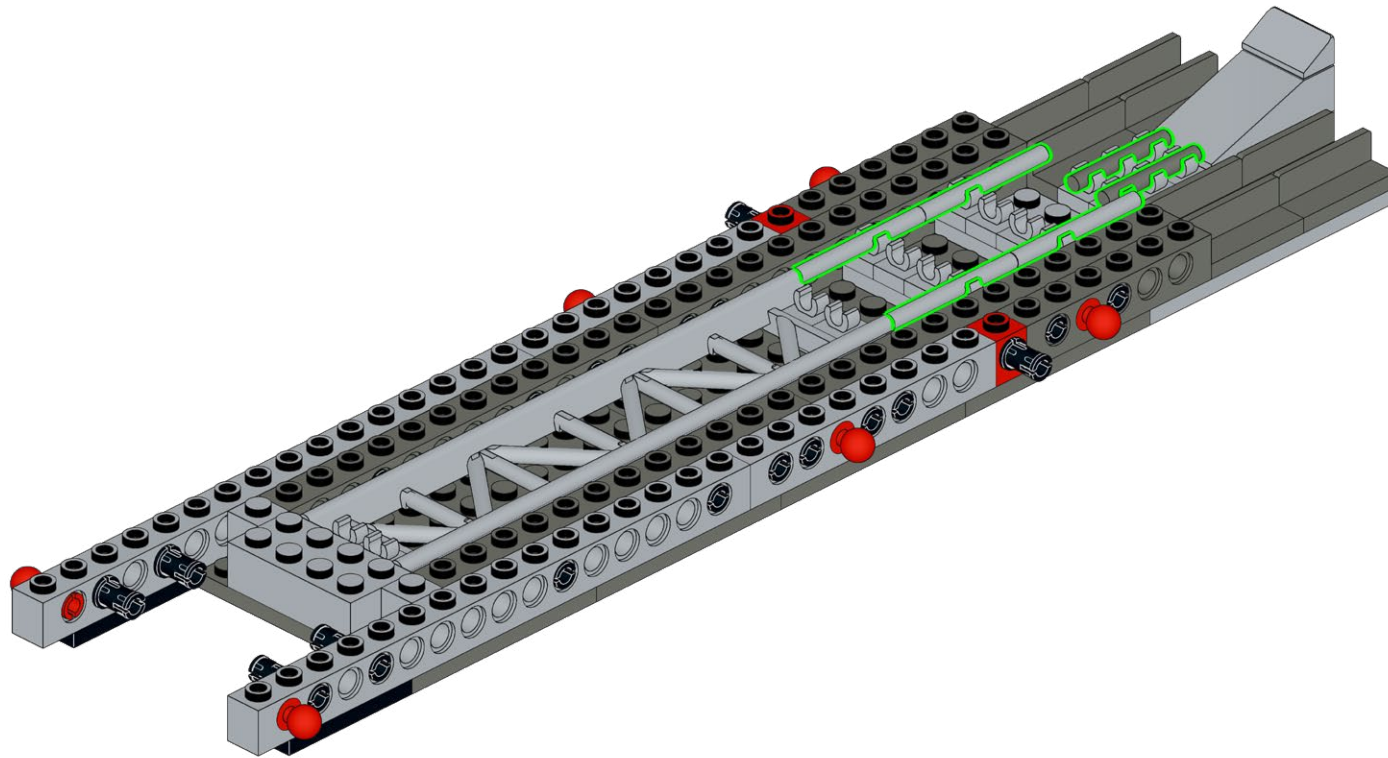
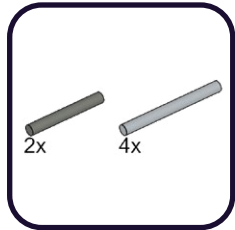

233

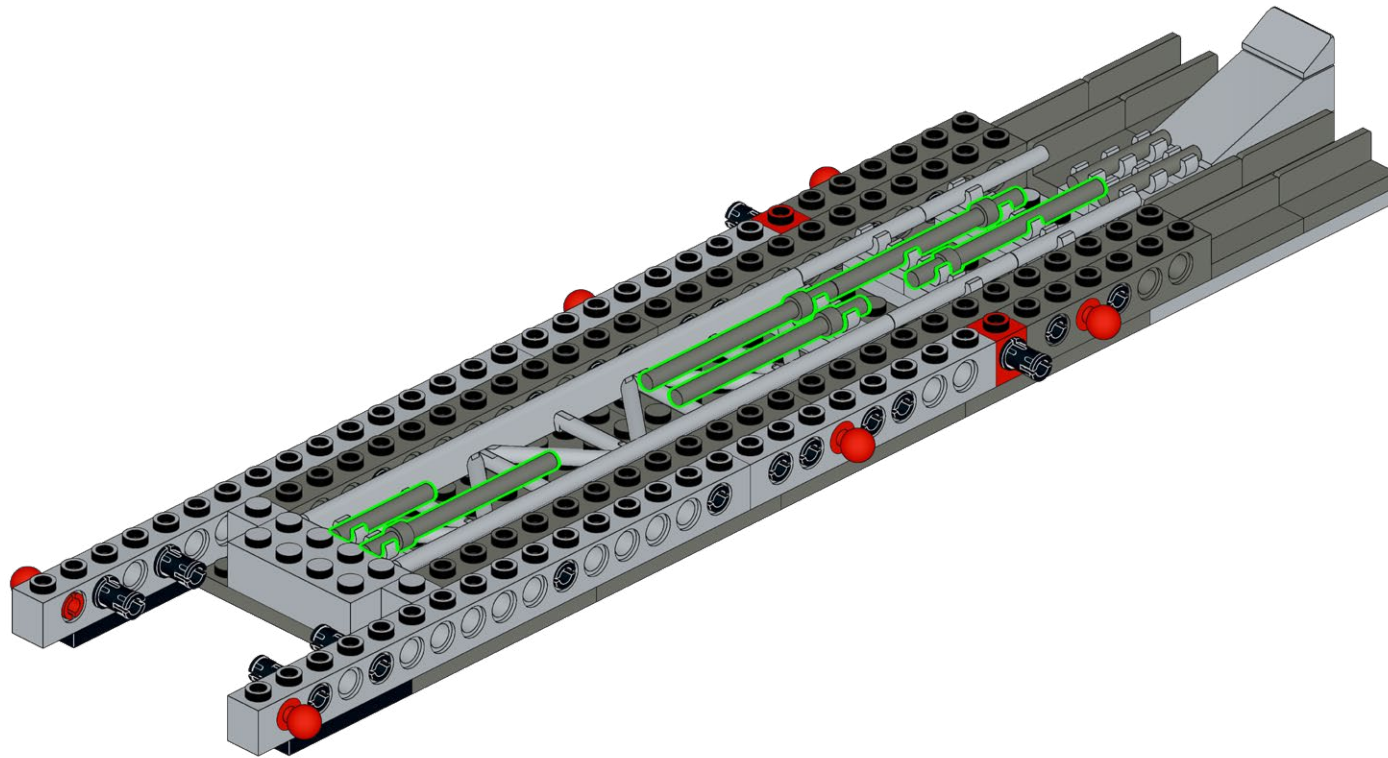
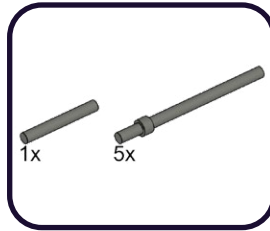

234

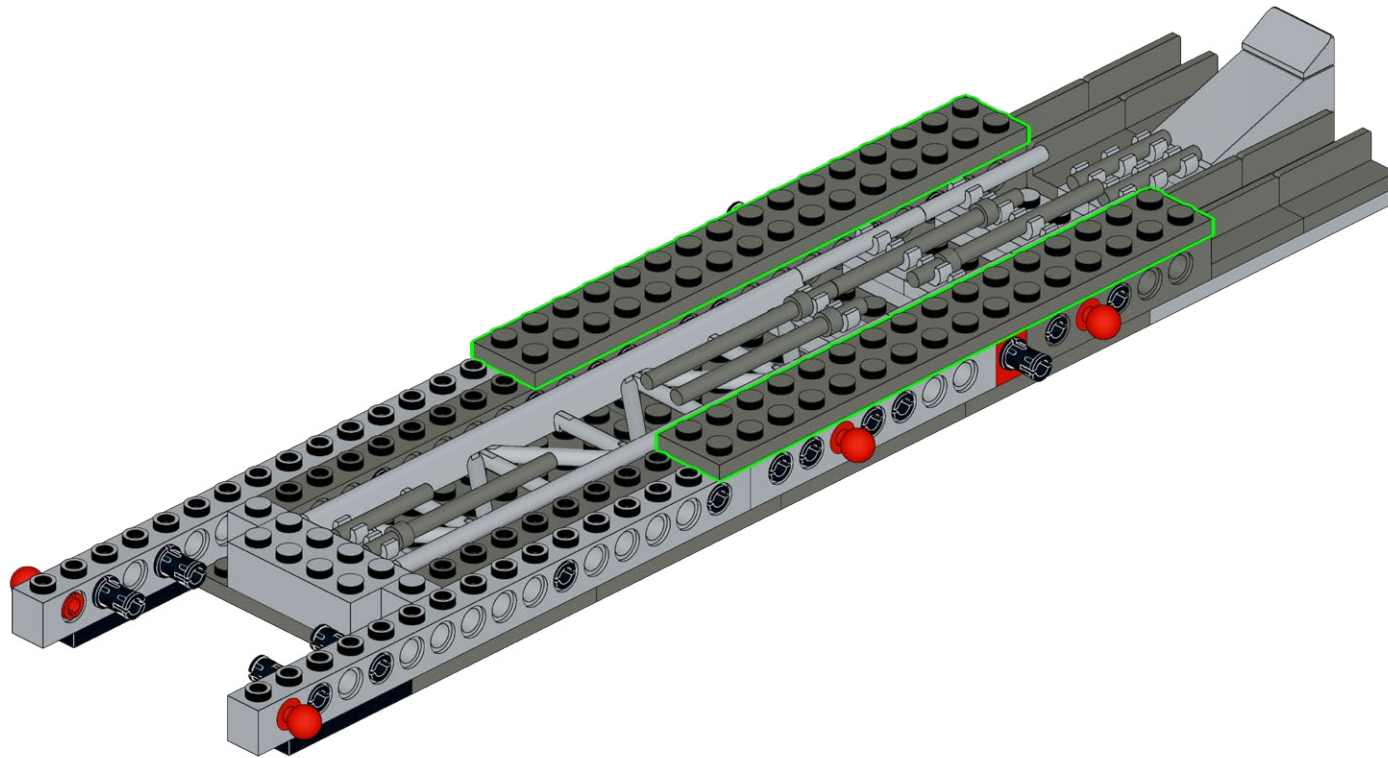
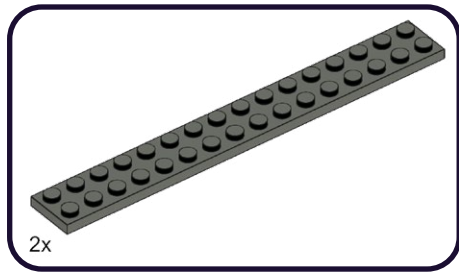

235

18x

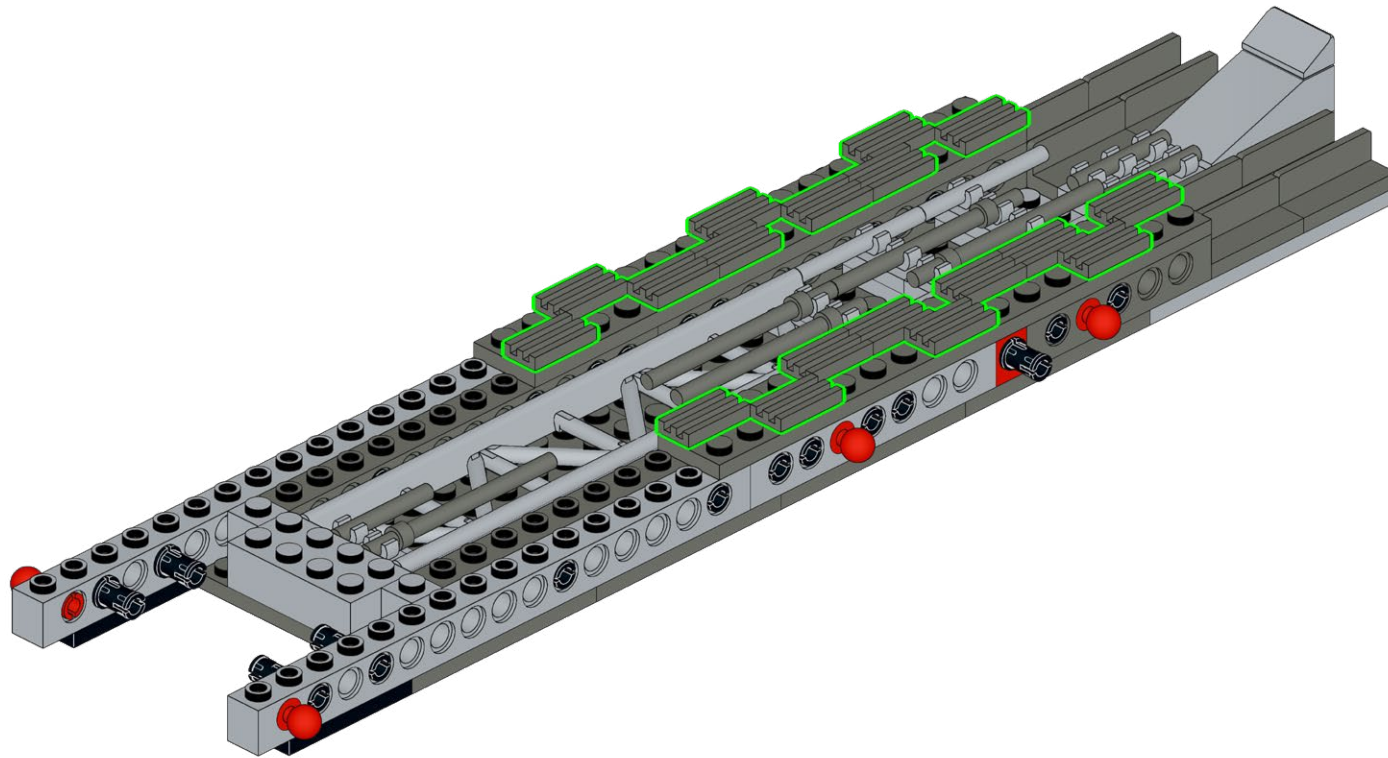

236

8x

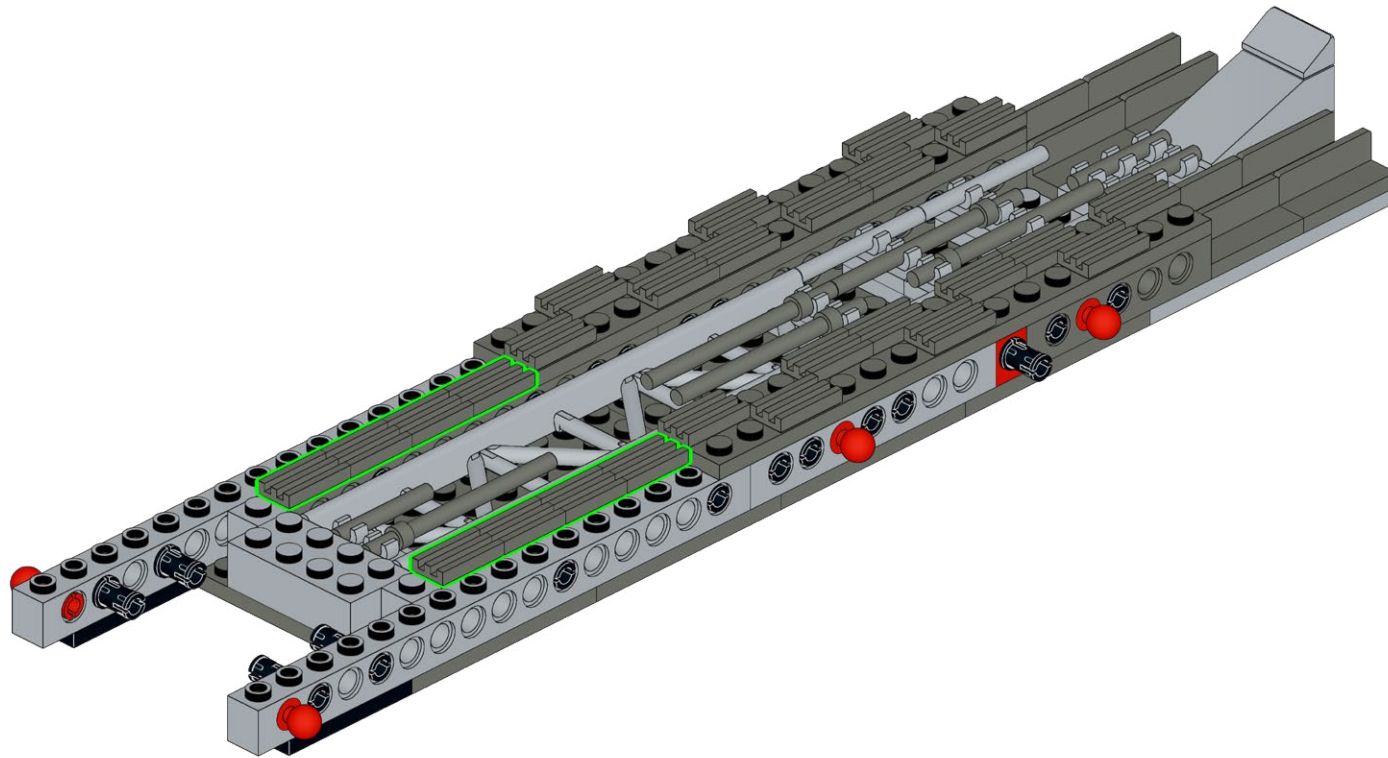

237

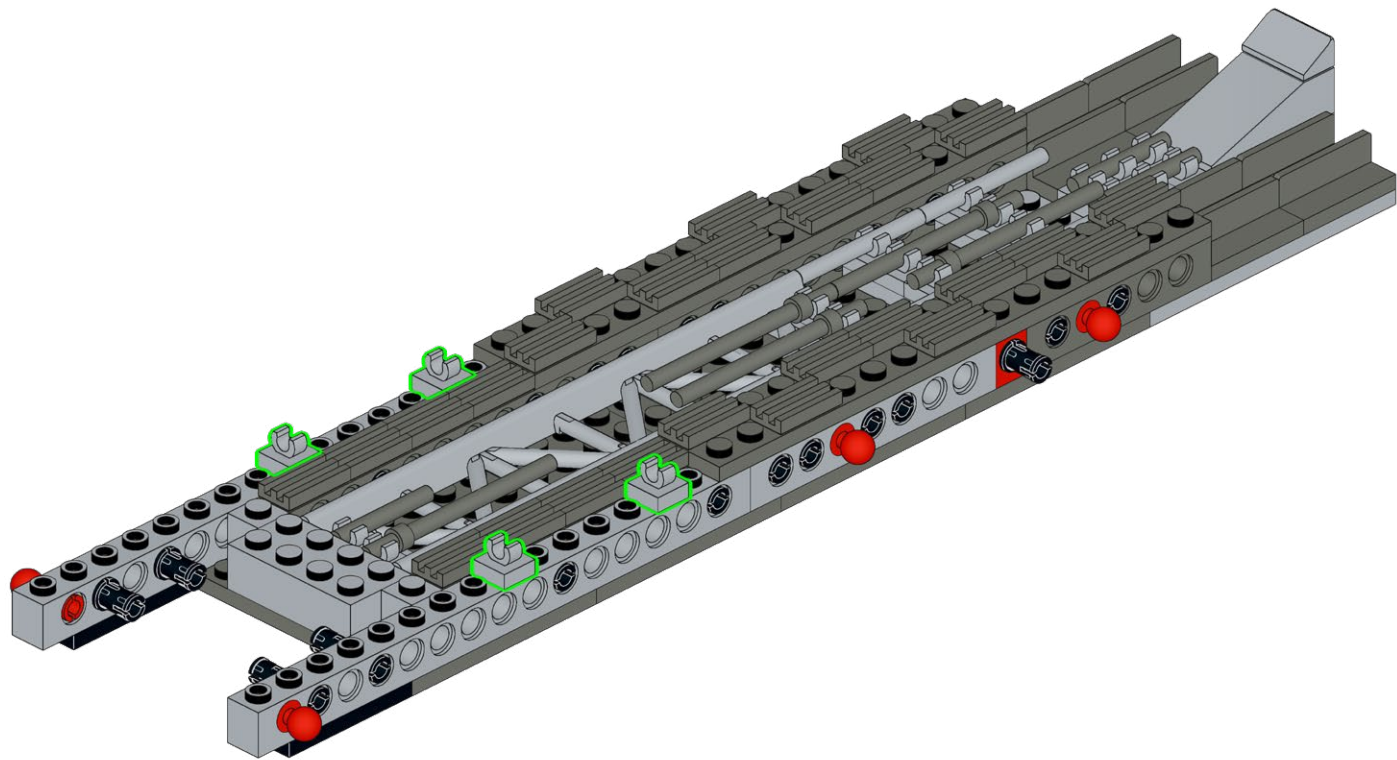
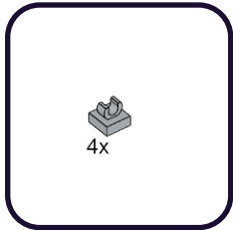

238

2x

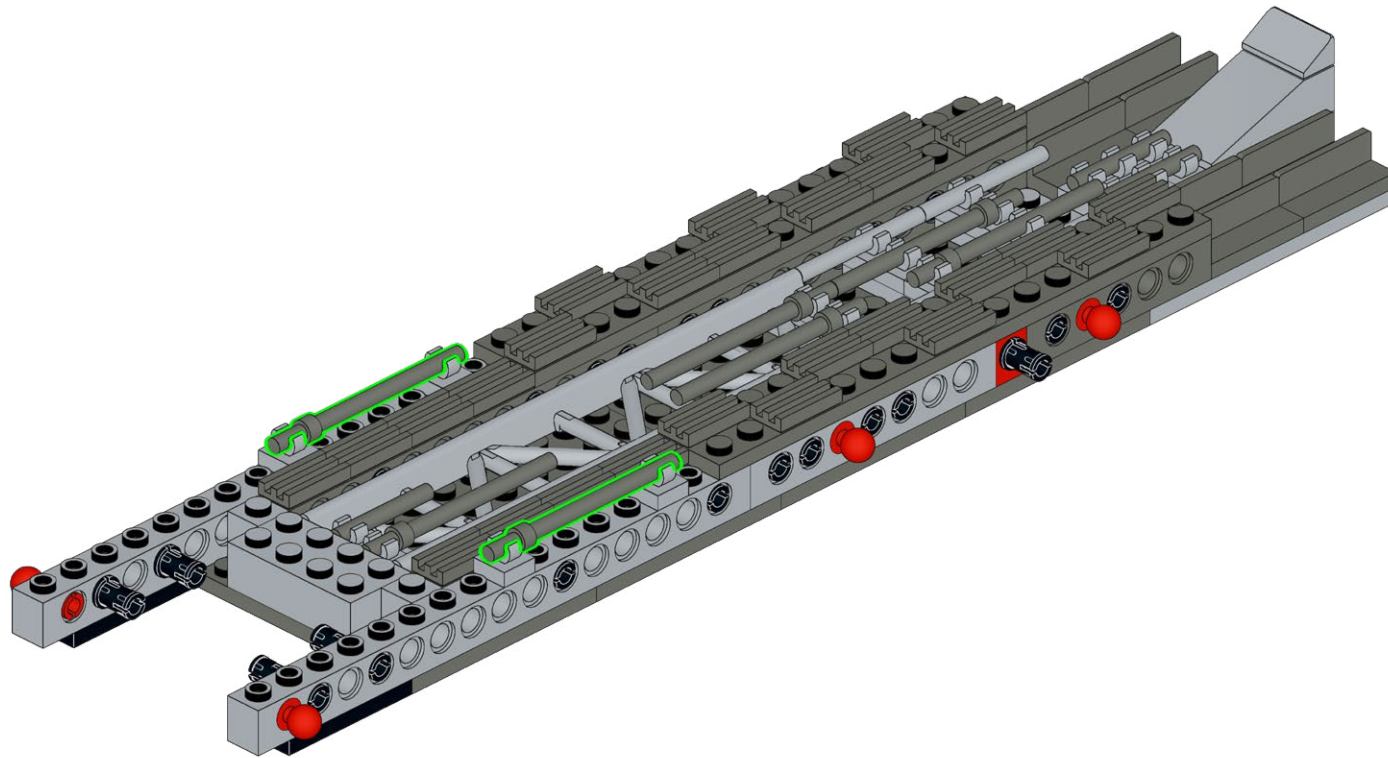

239

2x

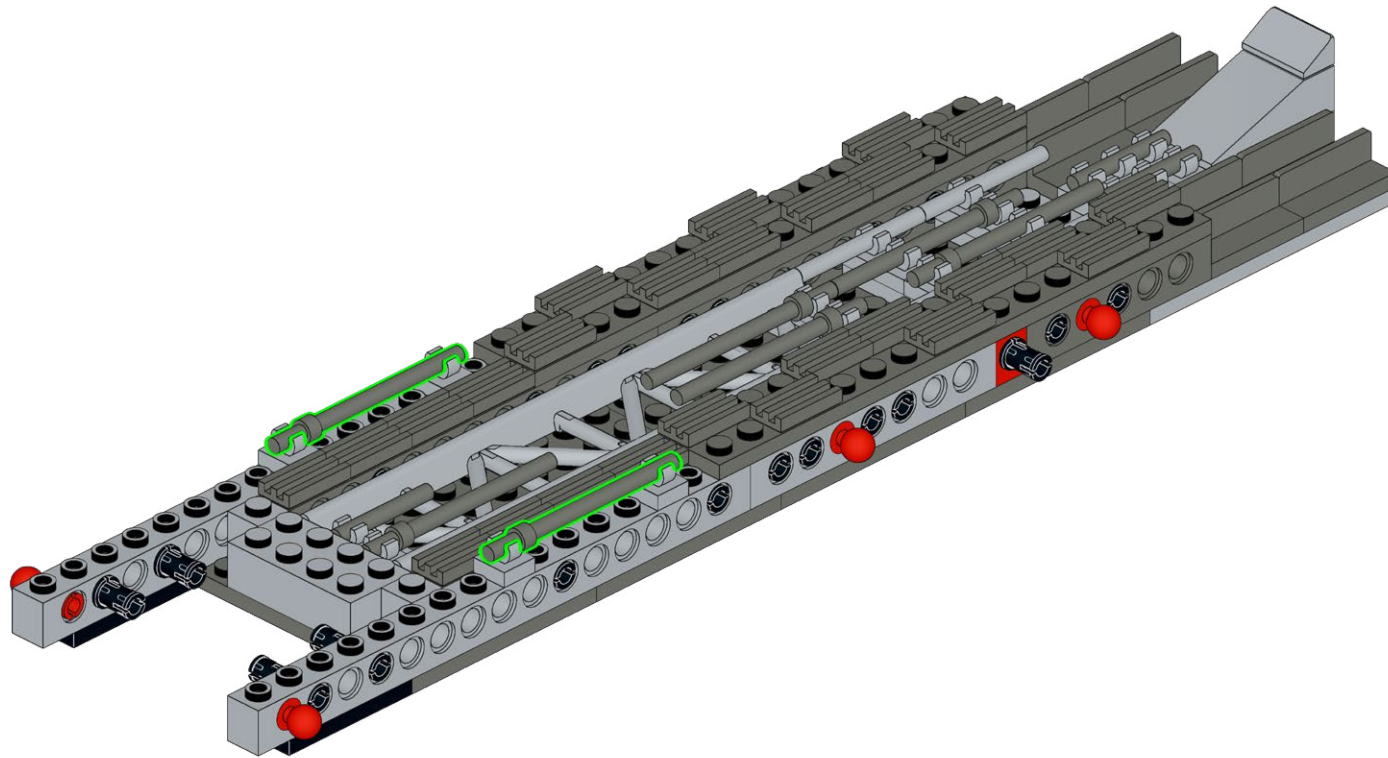

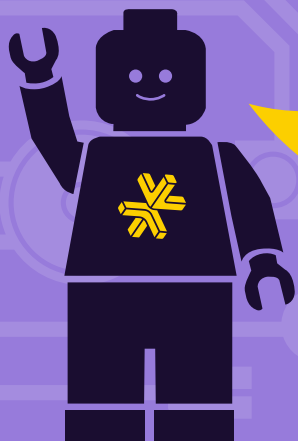
**HOLD UP!**

You might notice some bags aren't in order, as well as left over pieces, but that's ok! We're changing the way you build LEGO!

ATTENDEZ!

Vous remarquerez peut-être que certains sacs, ainsi que certaines pièces, ne sont pas dans le bon ordre. Mais pas de panique! Nous changeons simplement la façon avec laquelle vous construisez vos LEGO!

ASPETTA!

Potresti notare che alcuni sacchetti non sono in ordine, così come i pezzi avanzati, ma va bene così! Stiamo cambiando il modo in cui costruisci i LEGO!

HALT!

Sie werden möglicherweise bemerken, dass einige tüten durcheinander sind und teile übrig bleiben, aber das ist in Ordnung! Wir ändern die art und weise, wie Sie LEGO bauen!

¡ESPERA!

Es posible que notes que algunas bolsas están fuera de servicio, así como piezas sobrantes, ¡pero está bien! ¡Estamos cambiando la forma en que construyes LEGO!

暫停!

你可能会注意到一些袋子顺序错乱, 以及一些剩余的部件, 但没关系! 我们正在改变你搭建乐高的方式!

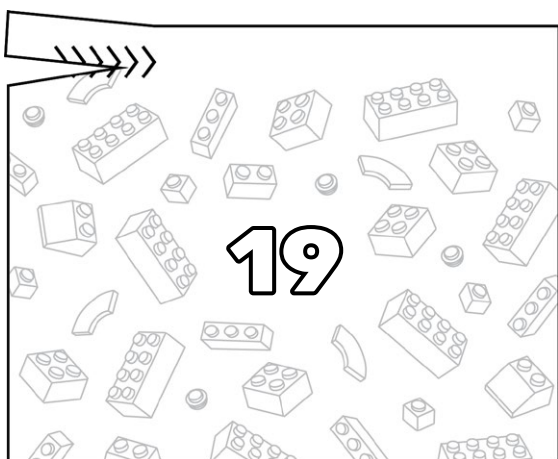
Open LEGO® Bag 19

240

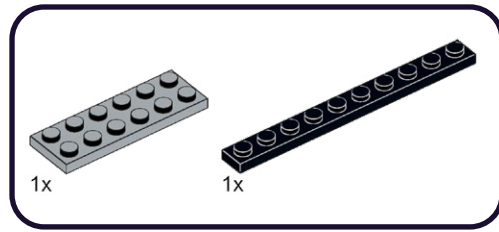

1

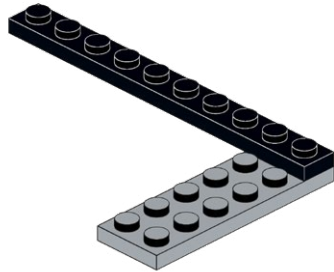

2

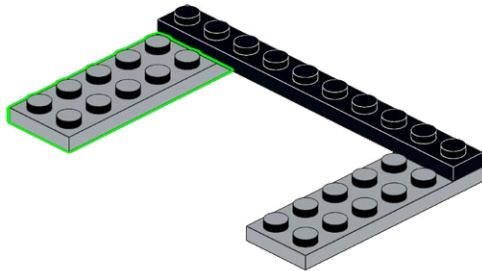

241

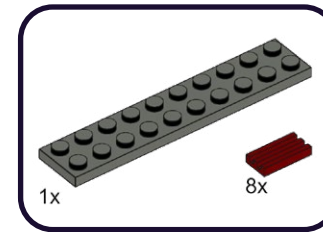

1

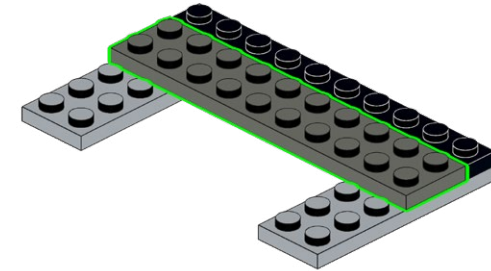

2

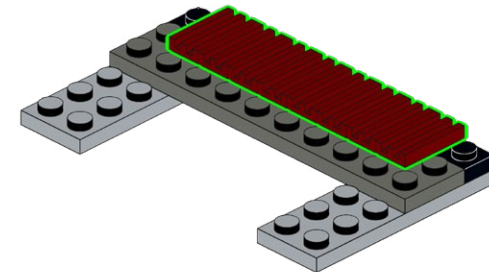

242

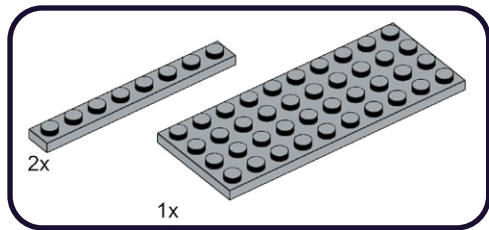

1

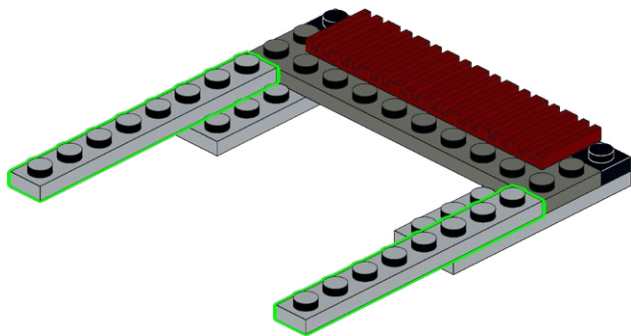

2

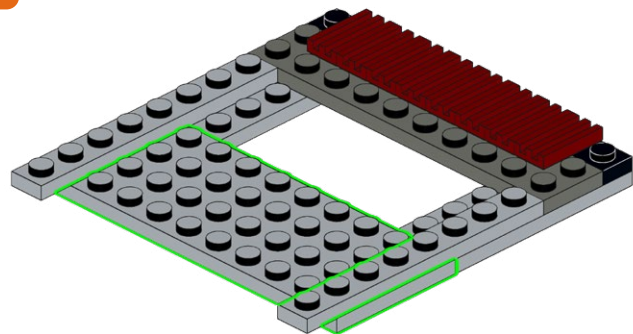

243

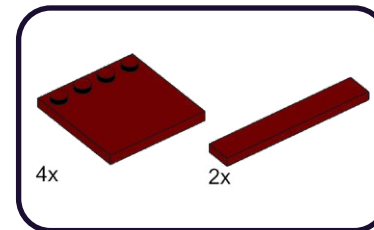

1

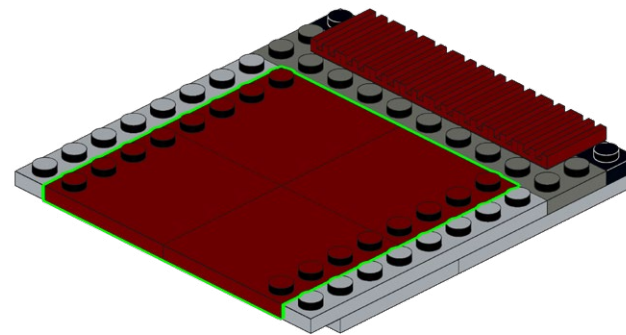

2

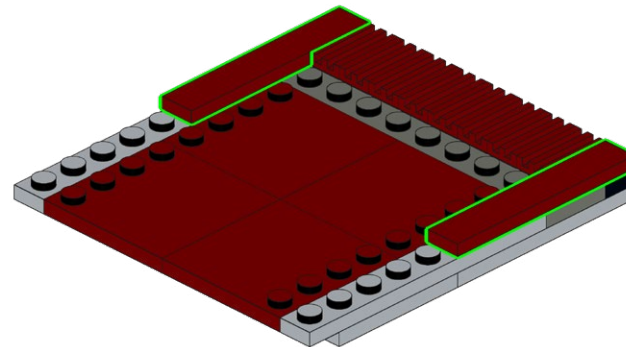

244

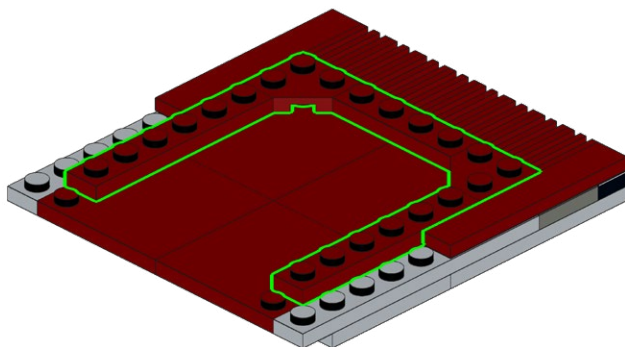
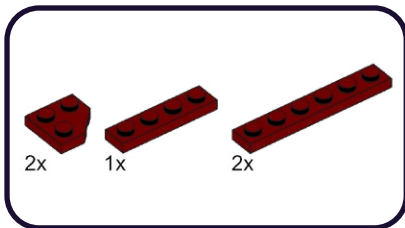

245

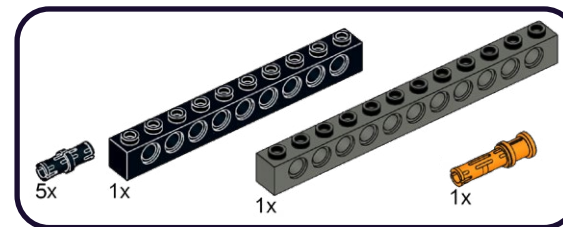

1

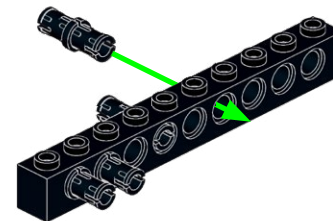

2

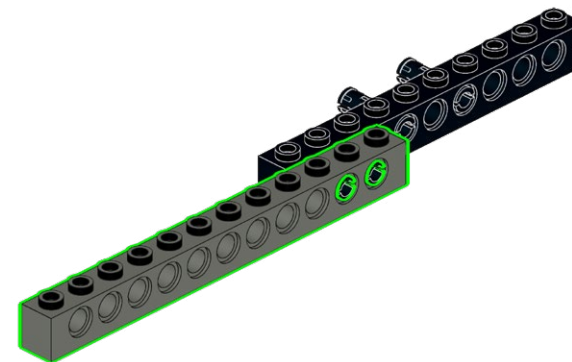

3

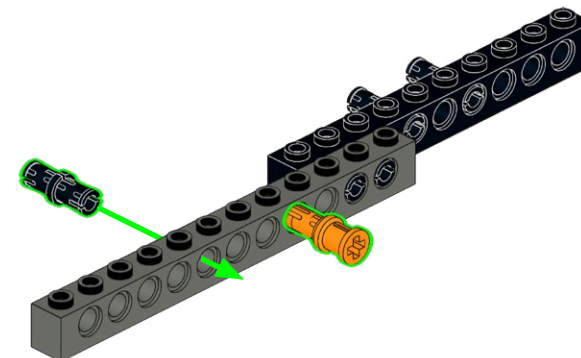

246

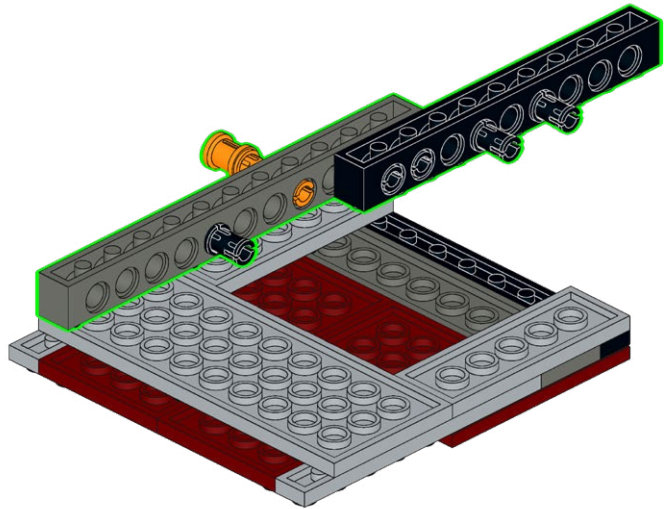

247

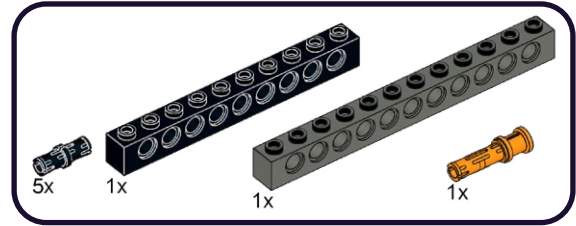

1

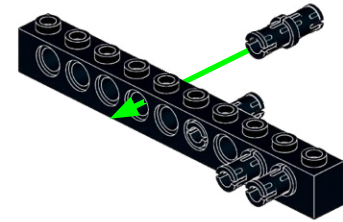

2

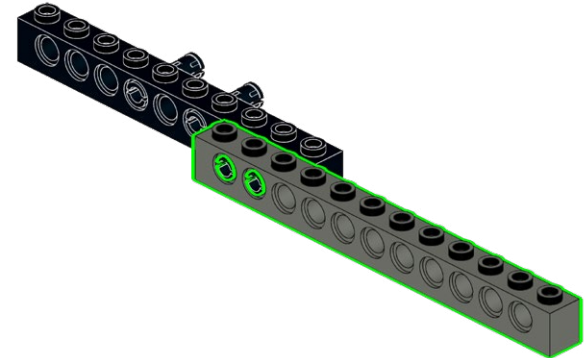

3

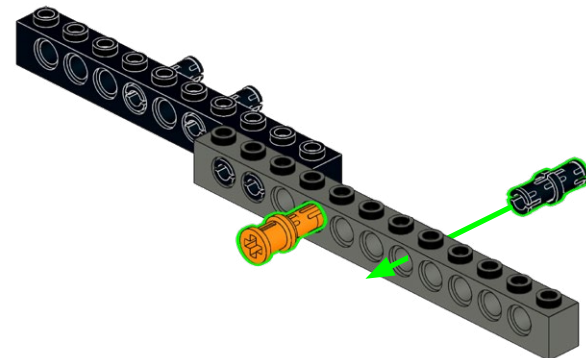

248

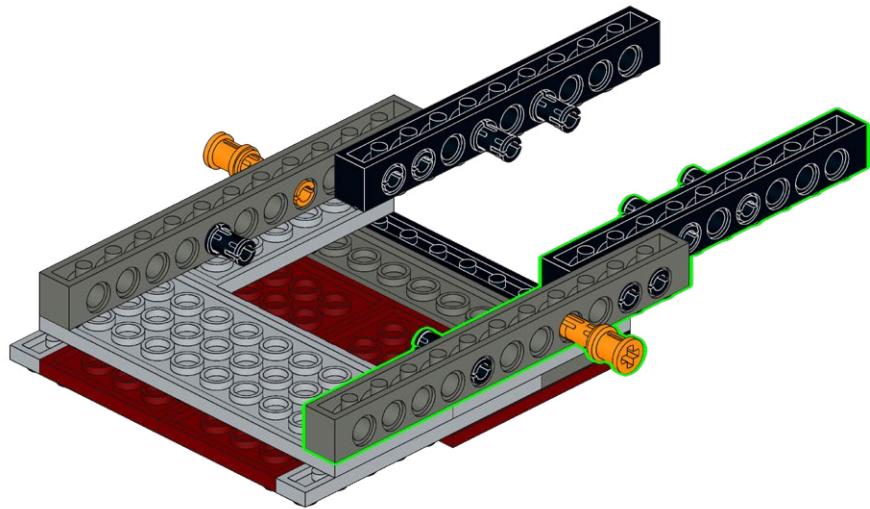

249

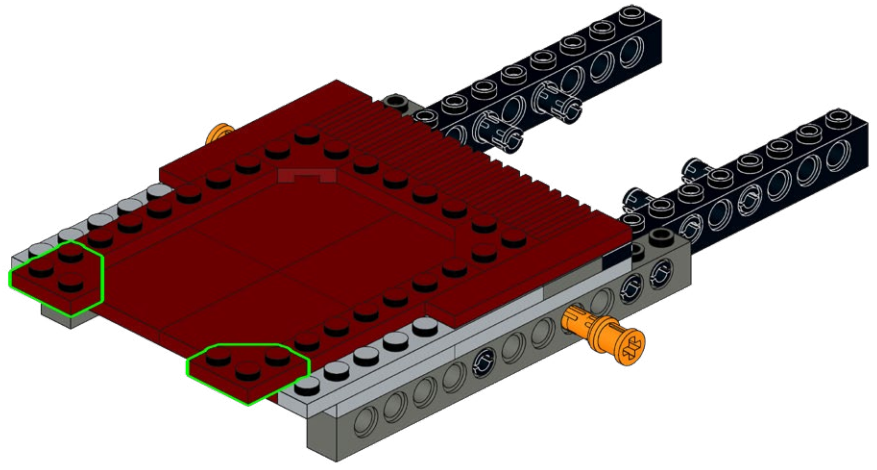
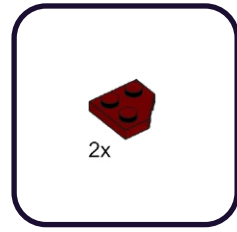

250

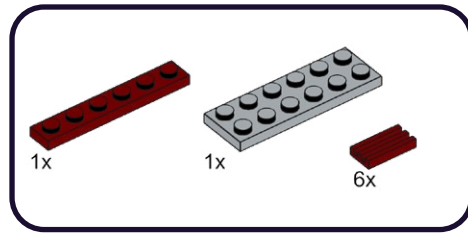

1

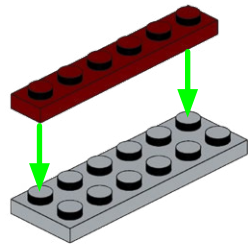

2

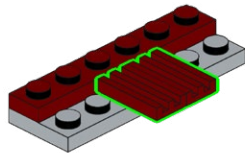

3

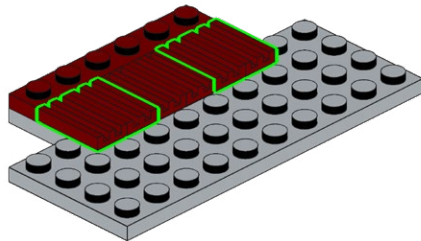

251

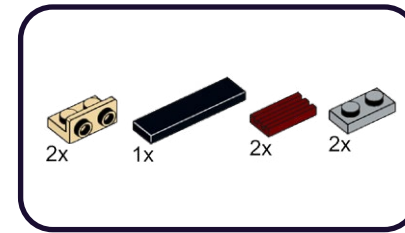

1

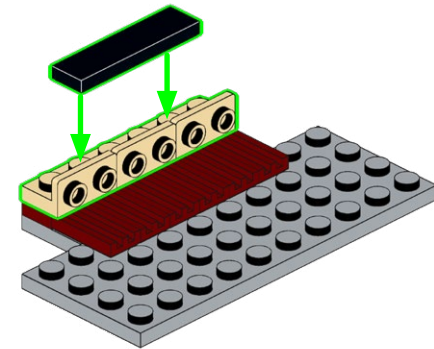

2

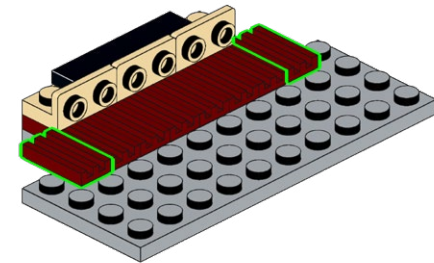

3

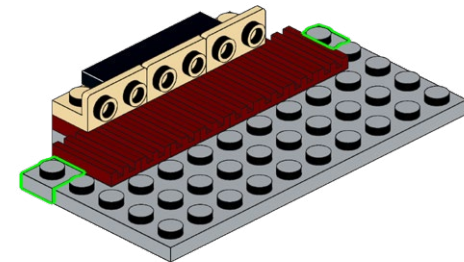

252

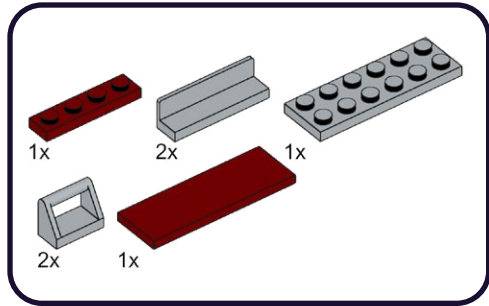

1

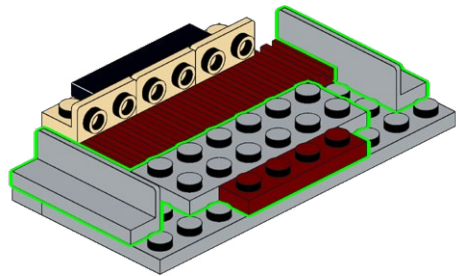

2

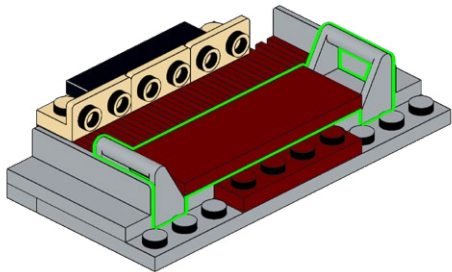

253

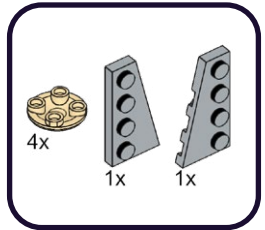

1

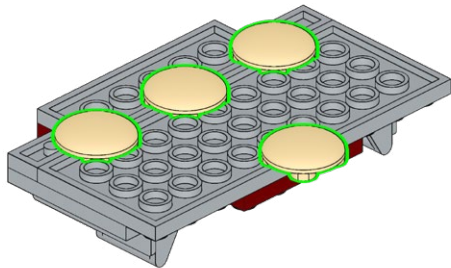

2

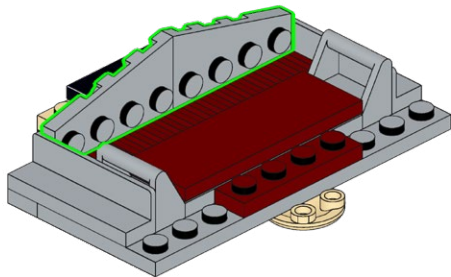

254

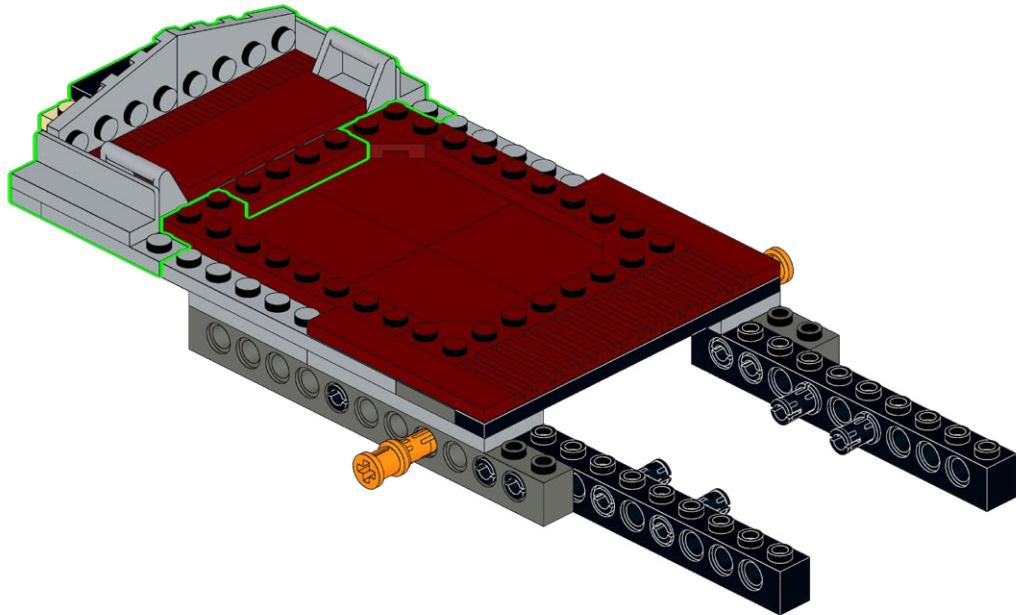

255

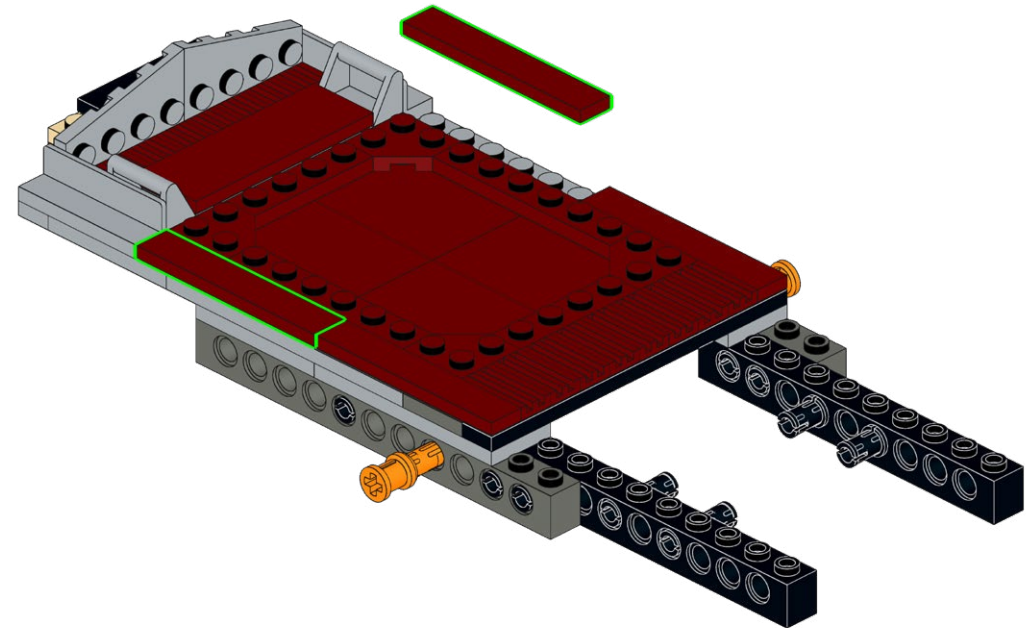
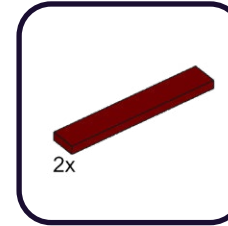

256



3x

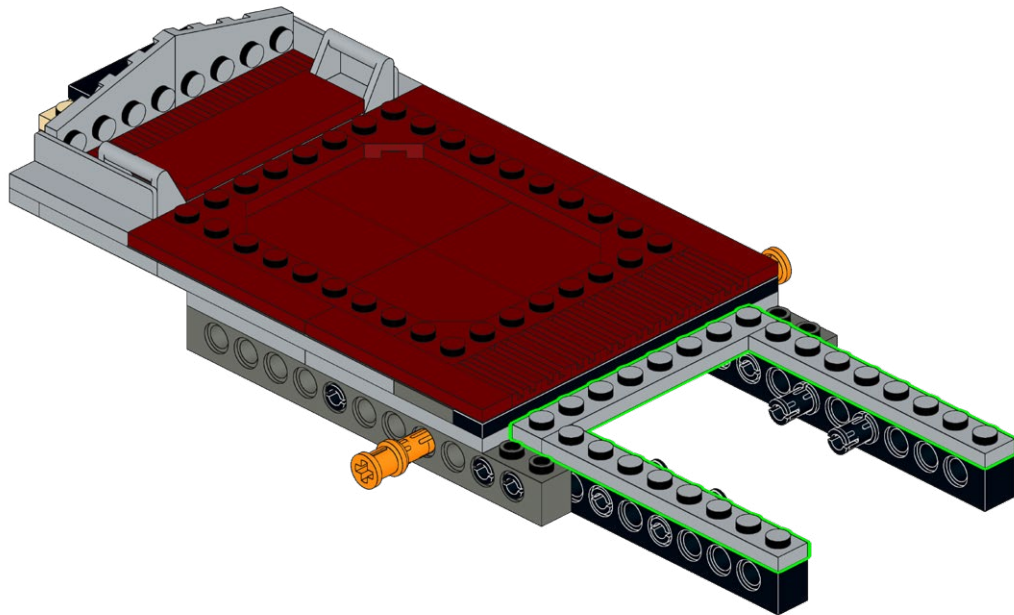

257

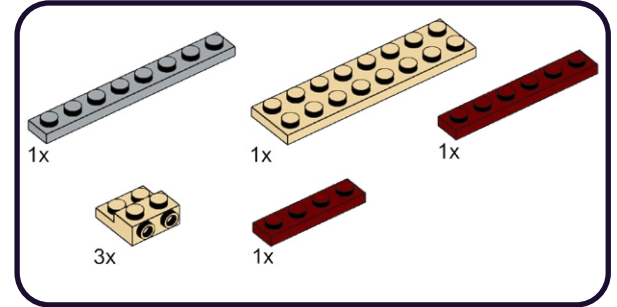

1

2

3

4

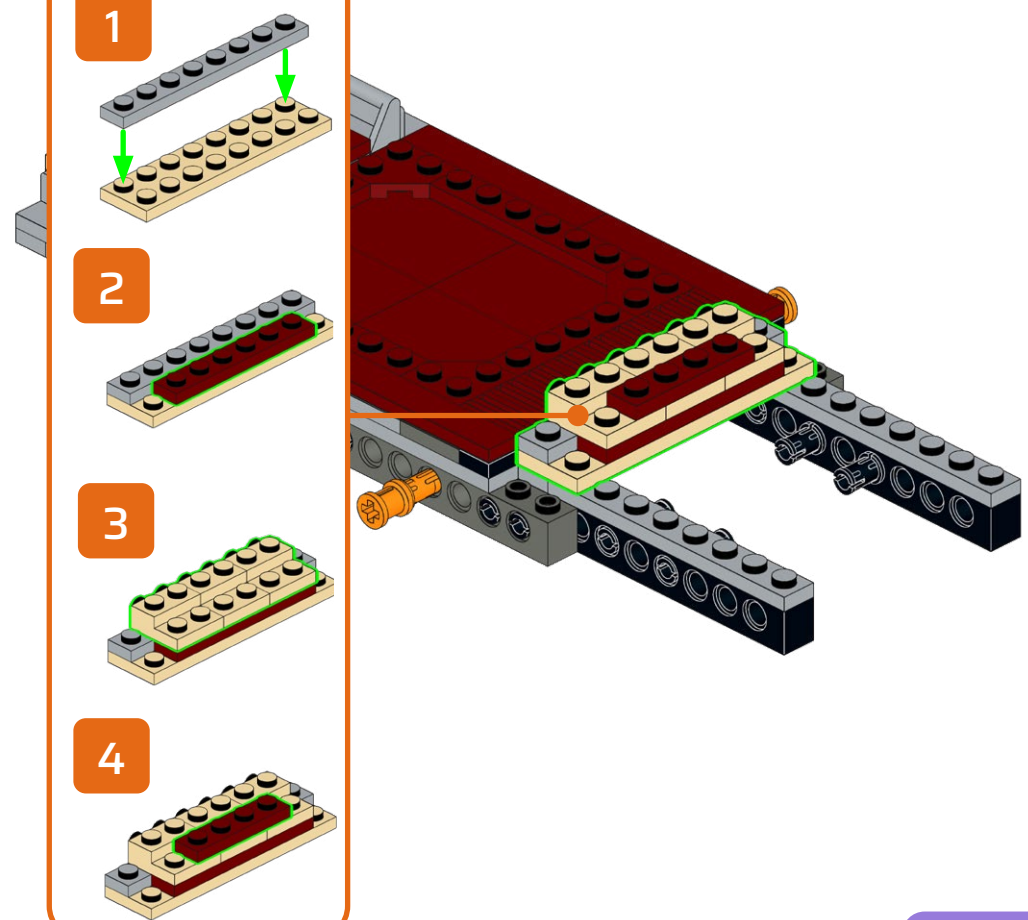

258

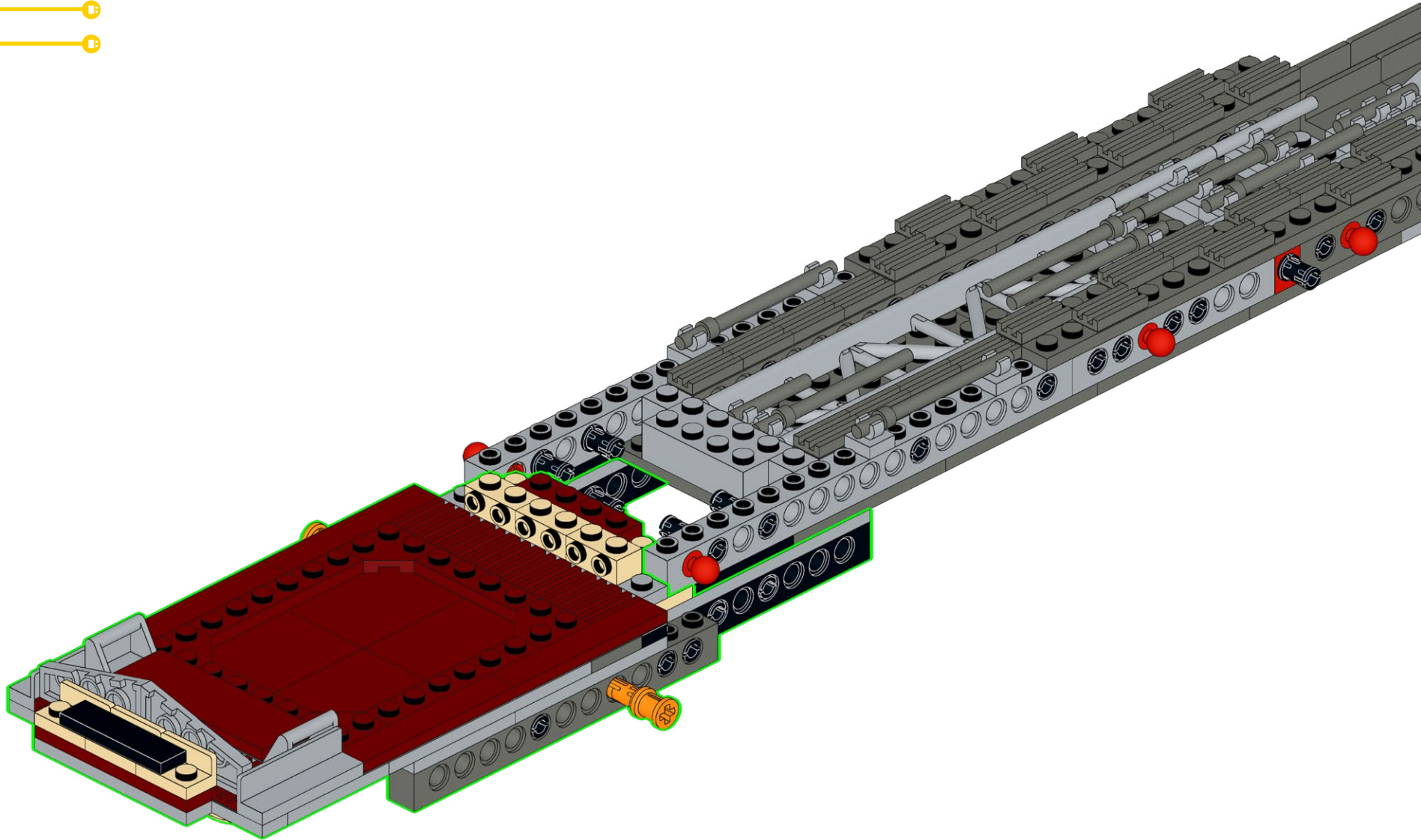

259

4x

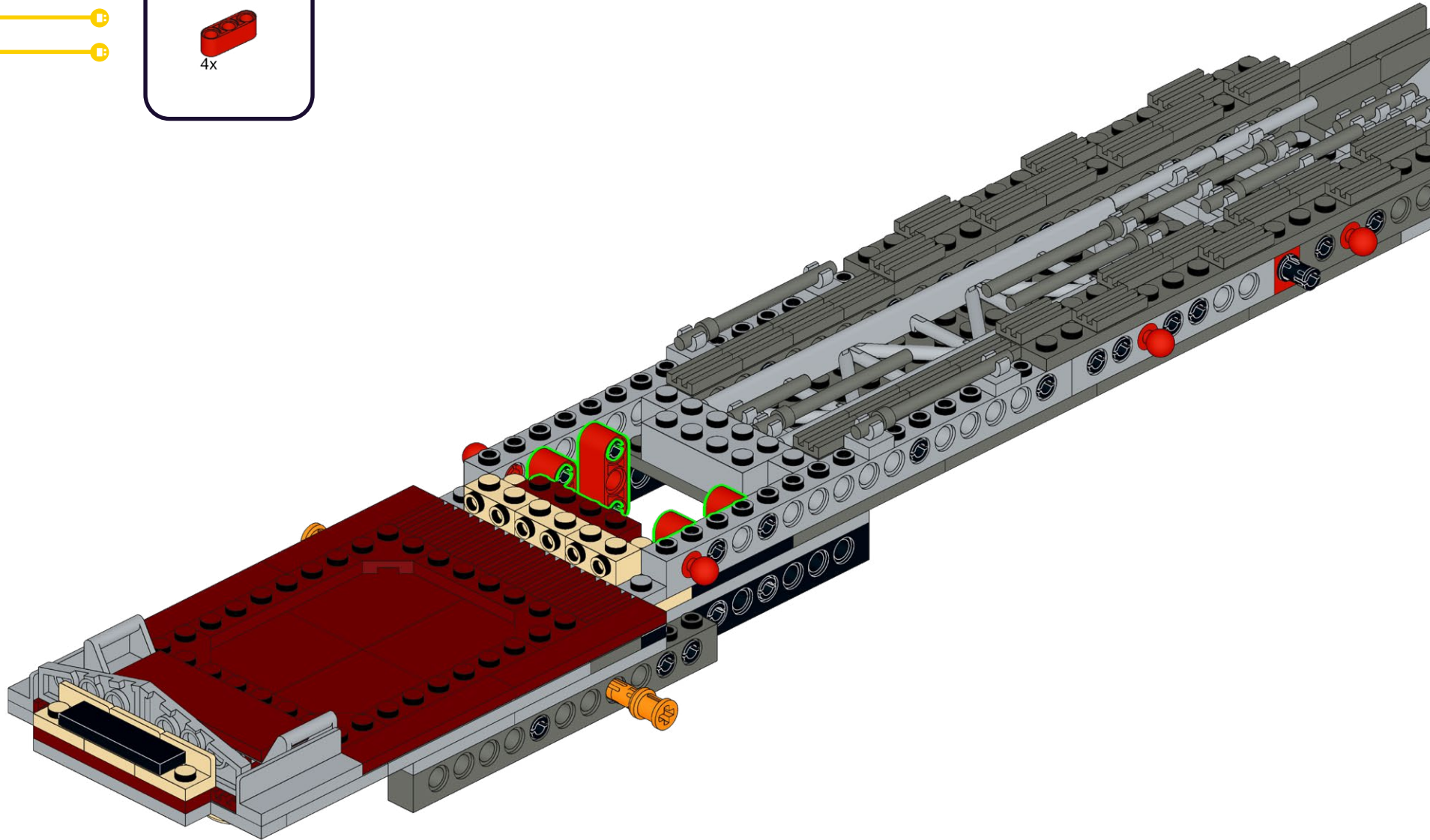

260

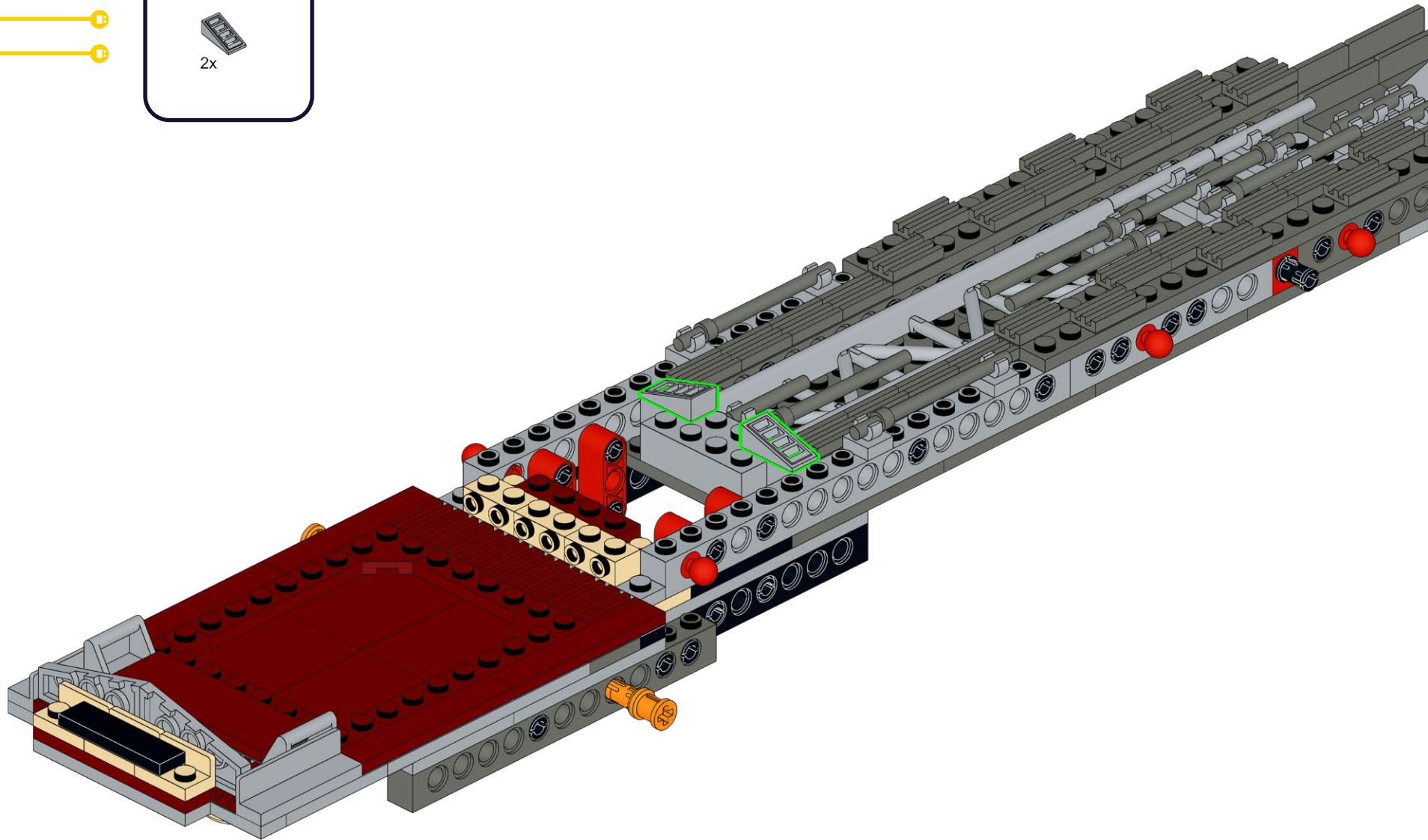
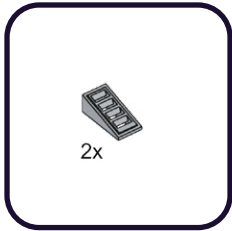

261

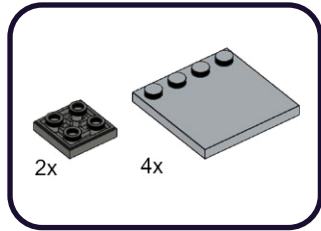

1

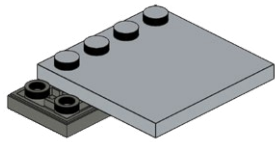

2

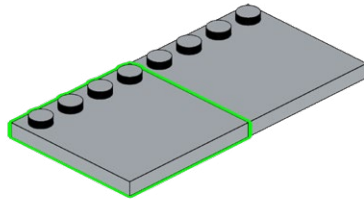

262

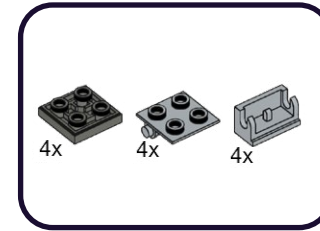

1

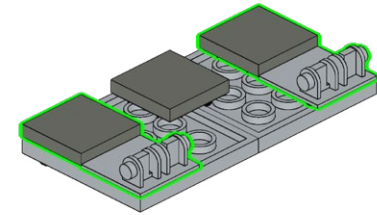

2

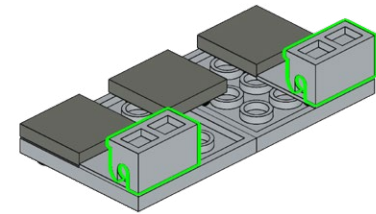

2x

263

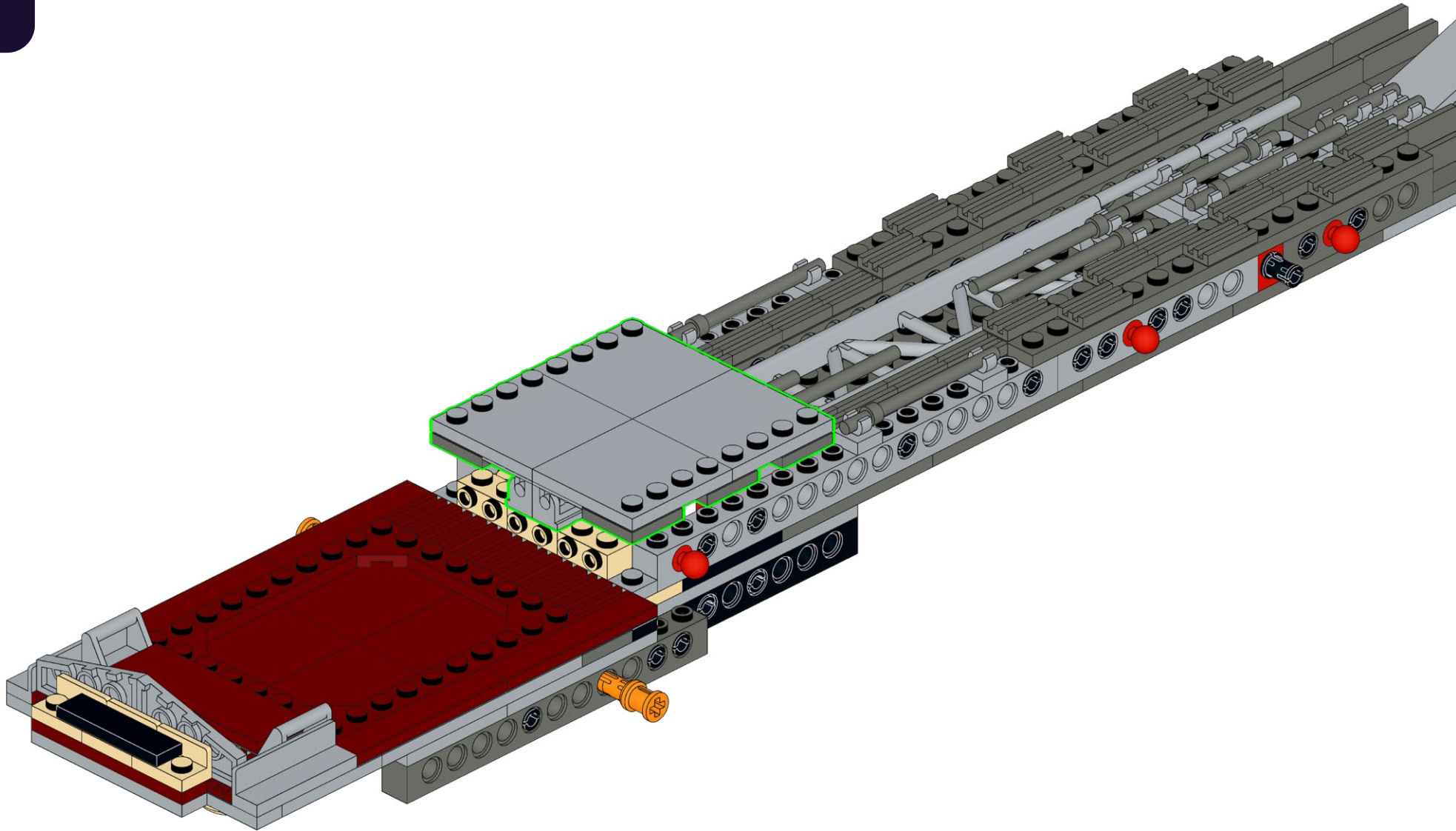

264

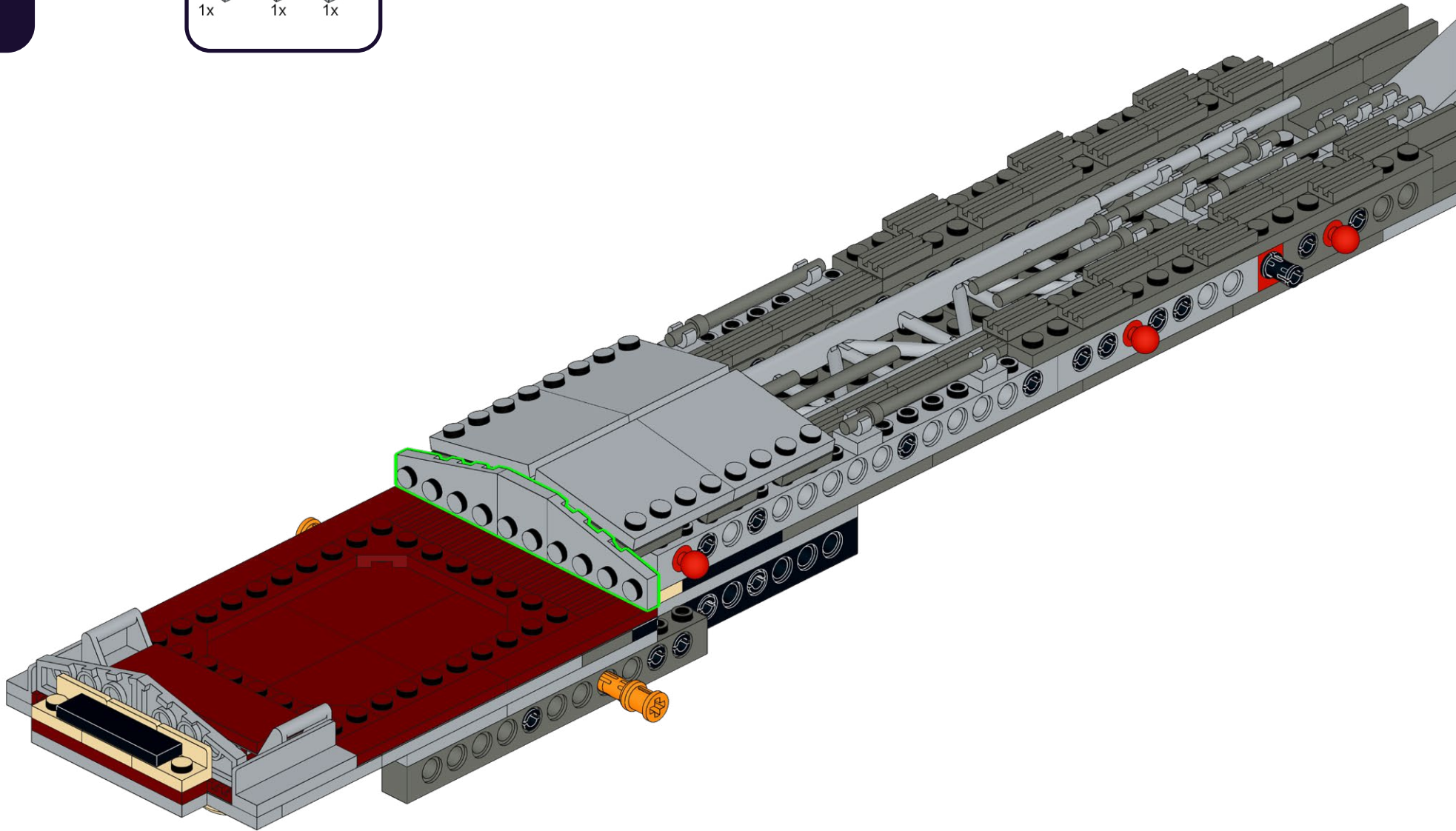
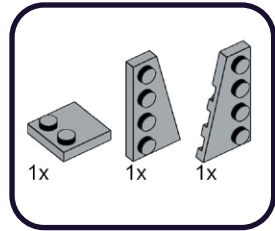

265

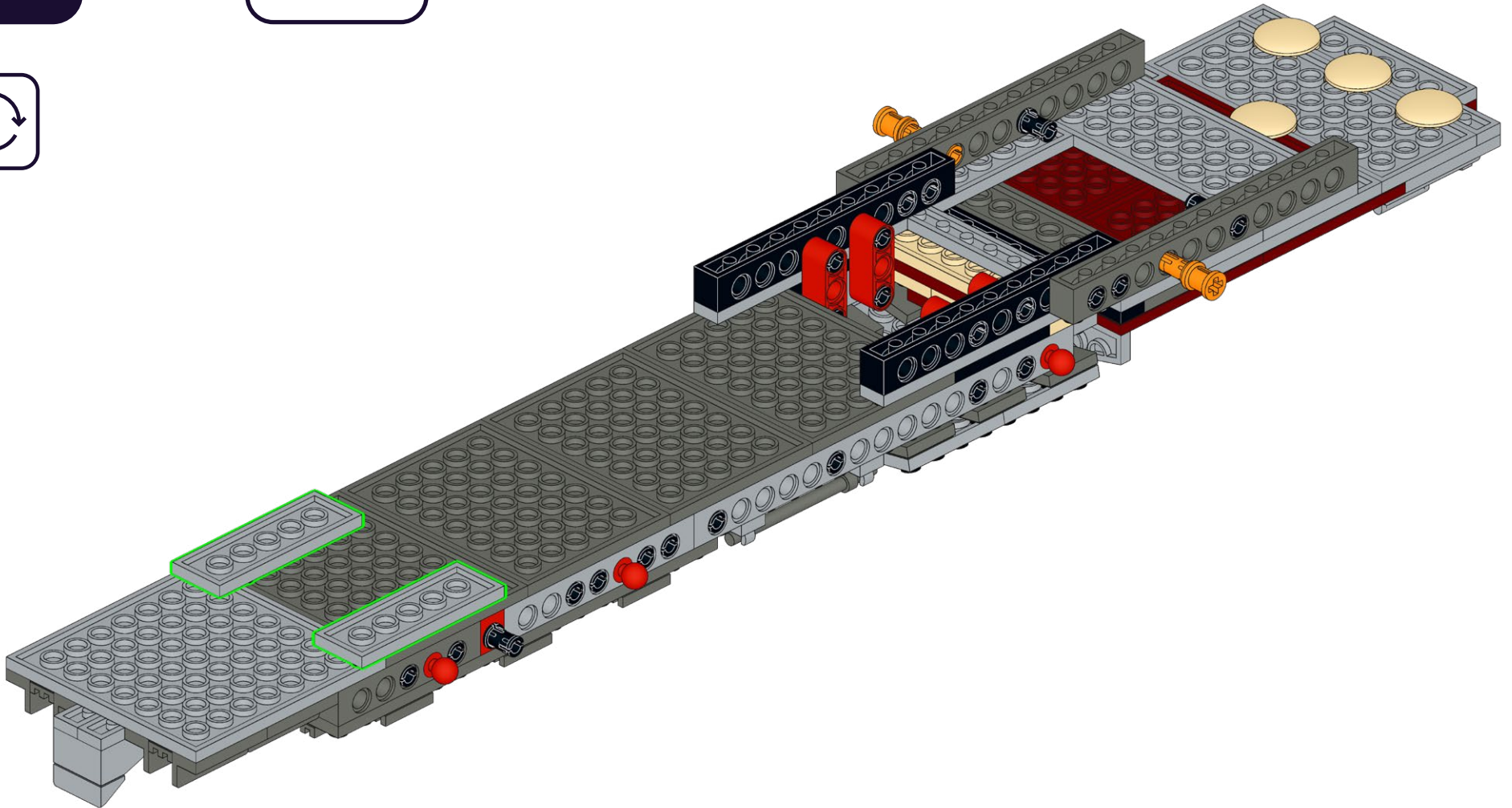
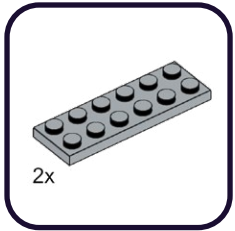

266

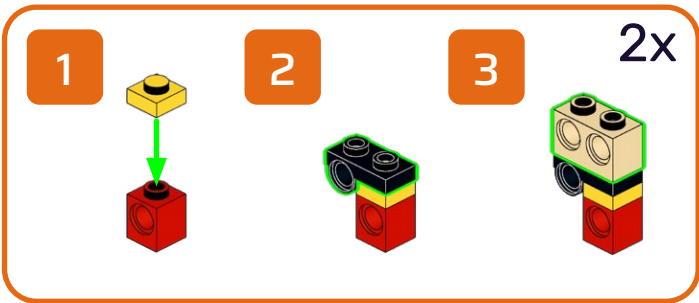
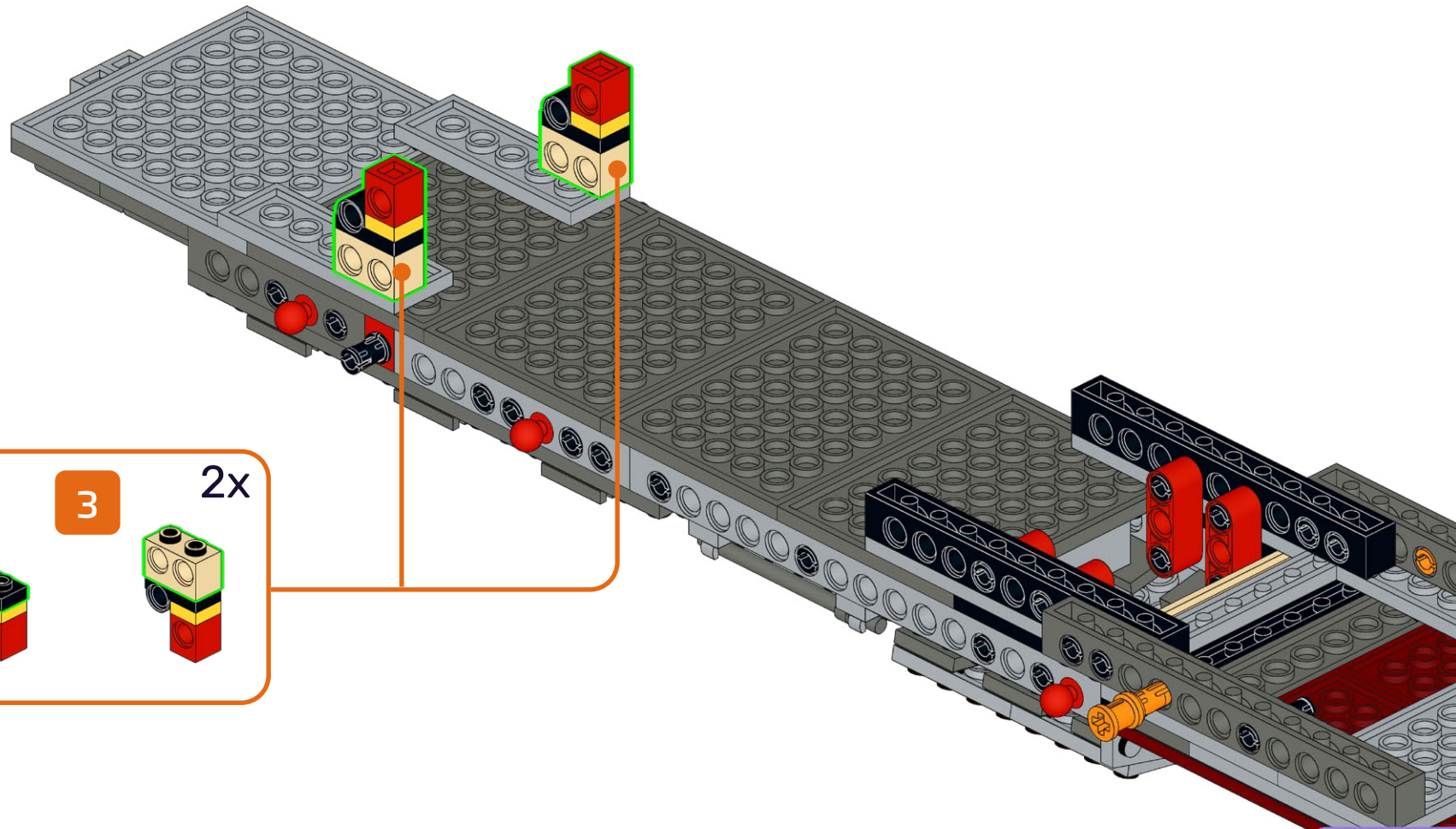
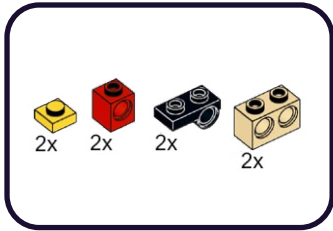

267

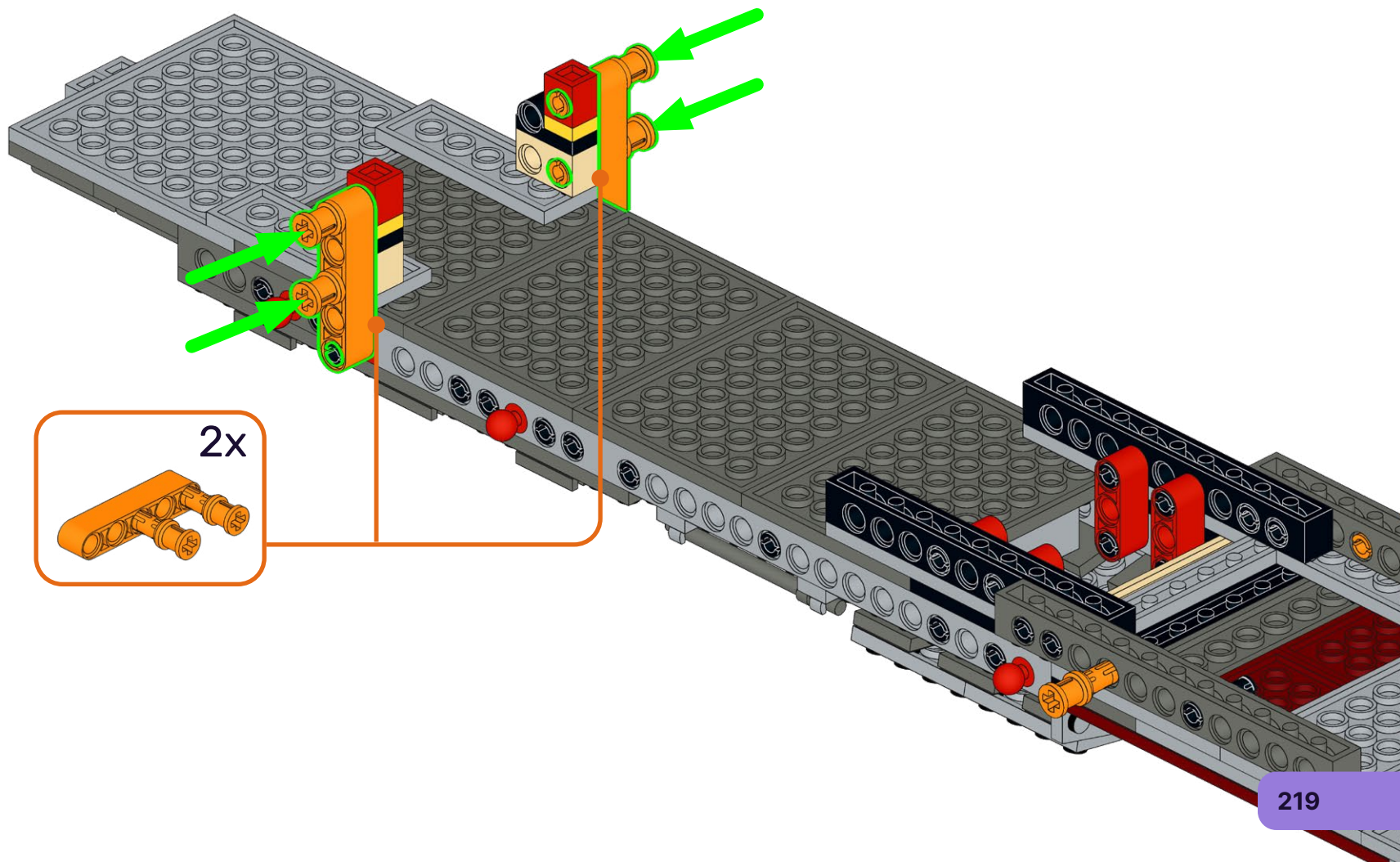
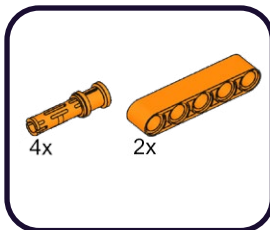

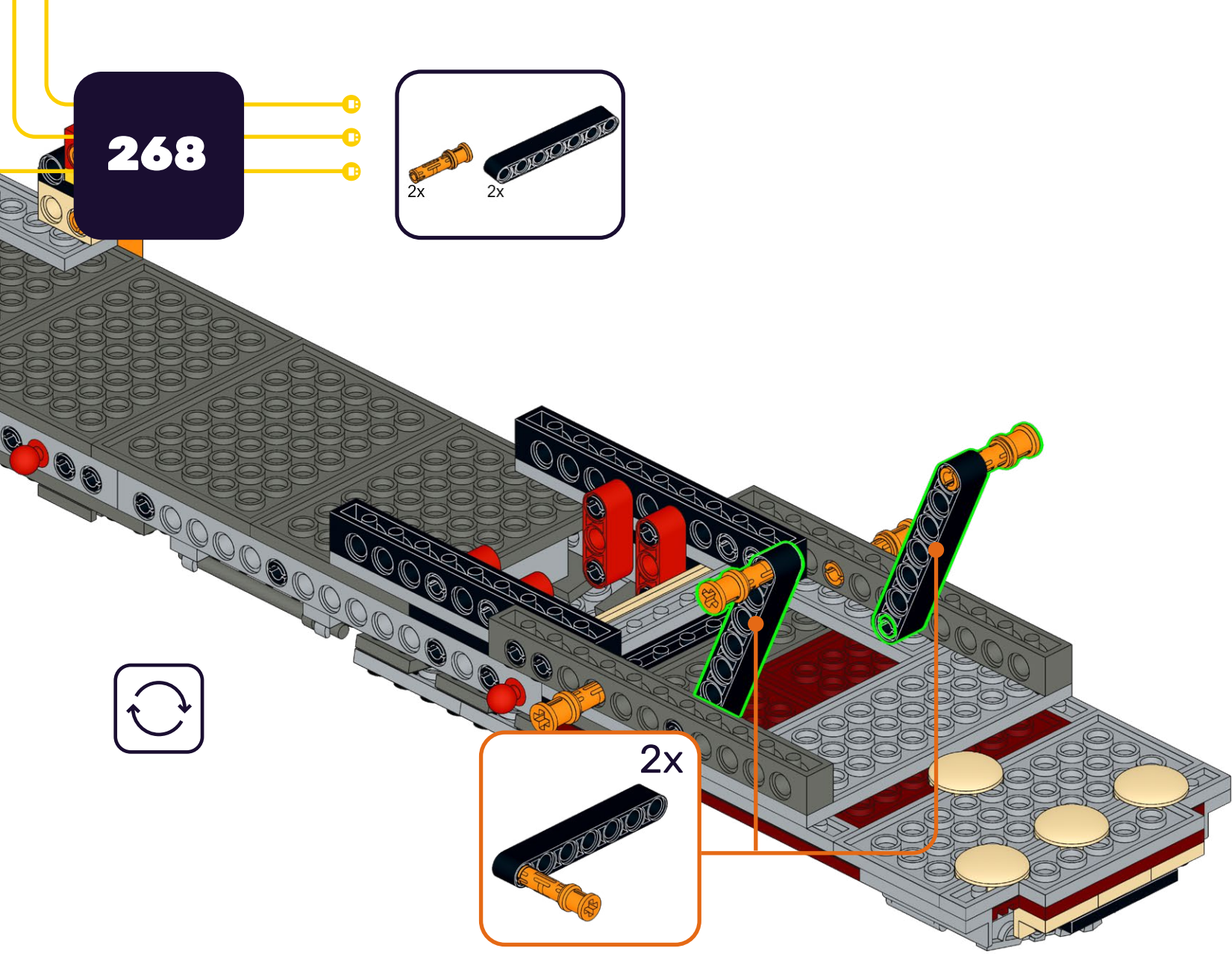

269

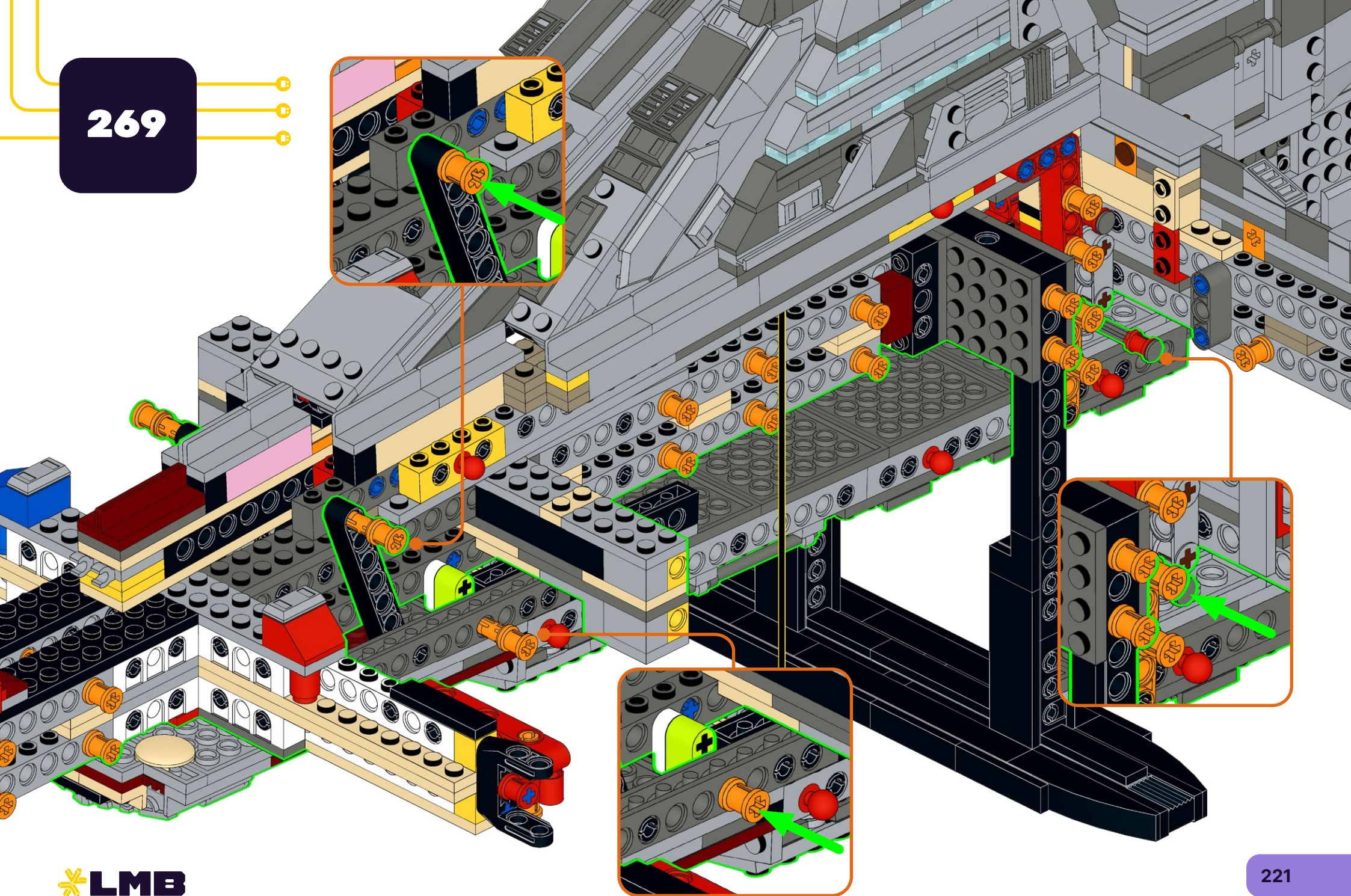

**HOLD UP!**

You might notice some bags aren't in order, as well as left over pieces, but that's ok! We're changing the way you build LEGO!

ATTENDEZ!

Vous remarquerez peut-être que certains sacs, ainsi que certaines pièces, ne sont pas dans le bon ordre. Mais pas de panique! Nous changeons simplement la façon avec laquelle vous construisez vos LEGO!

ASPETTA!

Potresti notare che alcuni sacchetti non sono in ordine, così come i pezzi avanzati, ma va bene così! Stiamo cambiando il modo in cui costruisci i LEGO!

HALT!

Sie werden möglicherweise bemerken, dass einige tüten durcheinander sind und teile übrig bleiben, aber das ist in Ordnung! Wir ändern die art und weise, wie Sie LEGO bauen!

¡ESPERA!

Es posible que notes que algunas bolsas están fuera de servicio, así como piezas sobrantes, ¡pero está bien! ¡Estamos cambiando la forma en que construyes LEGO!

暫停!

你可能会注意到一些袋子顺序错乱, 以及一些剩余的部件, 但没关系! 我们正在改变你搭建乐高的方式!

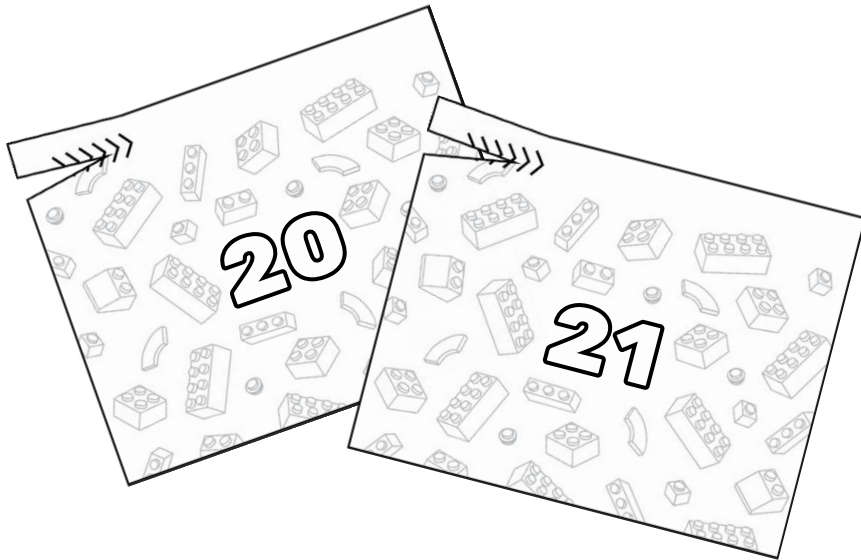
Open LEGO® Bags 20 & 21

270

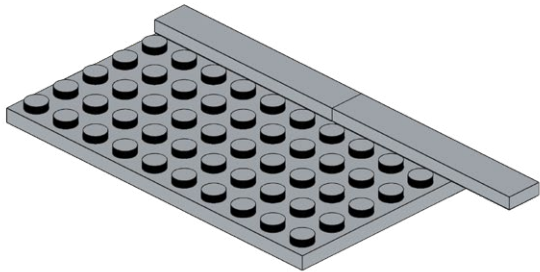
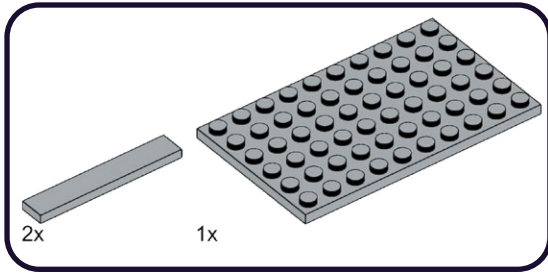

271

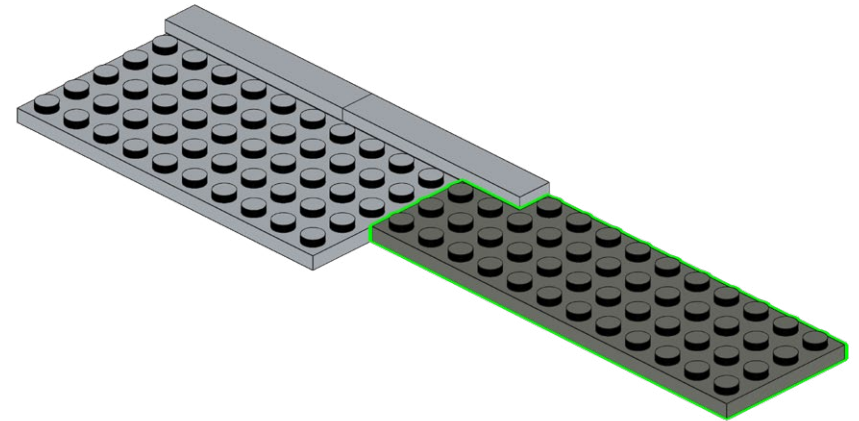
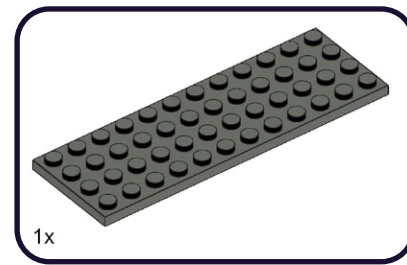

272

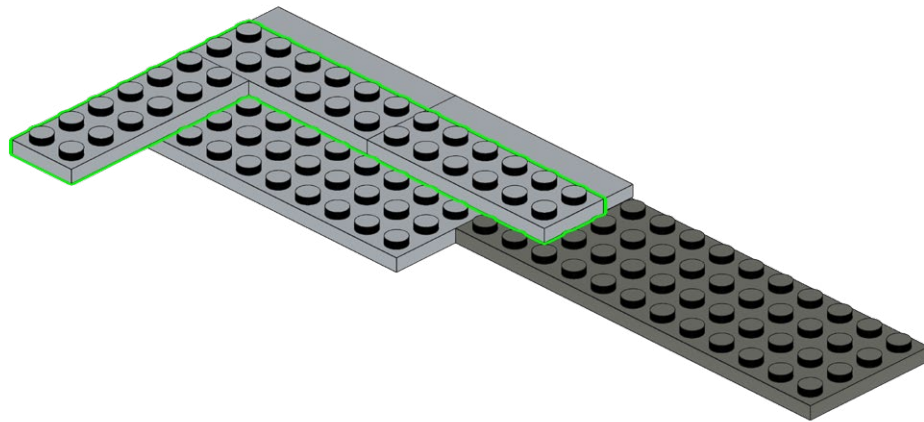
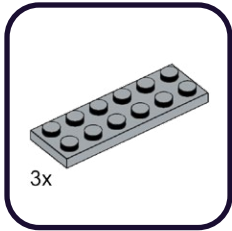

273

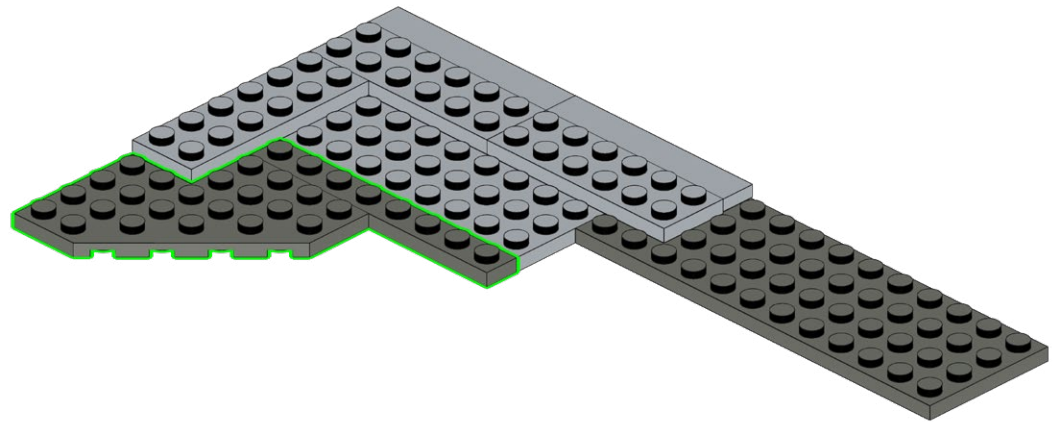
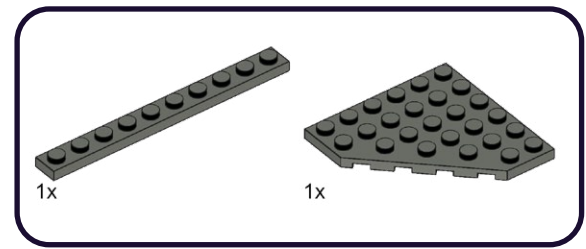

274

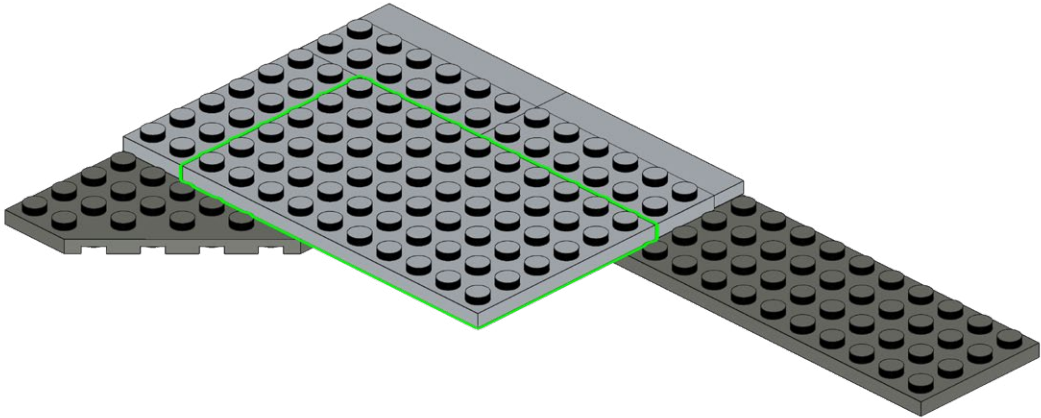
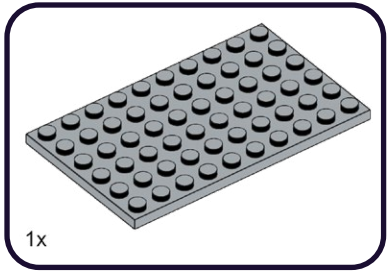

275

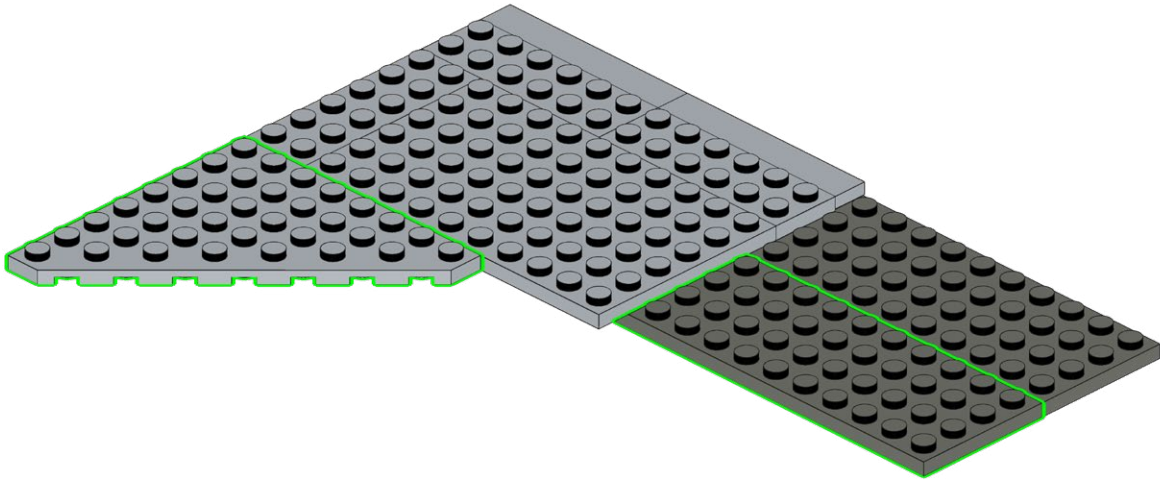
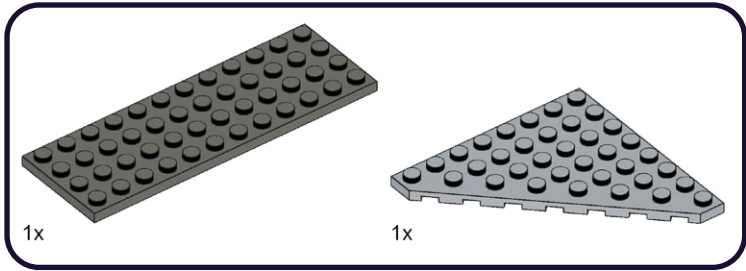

276

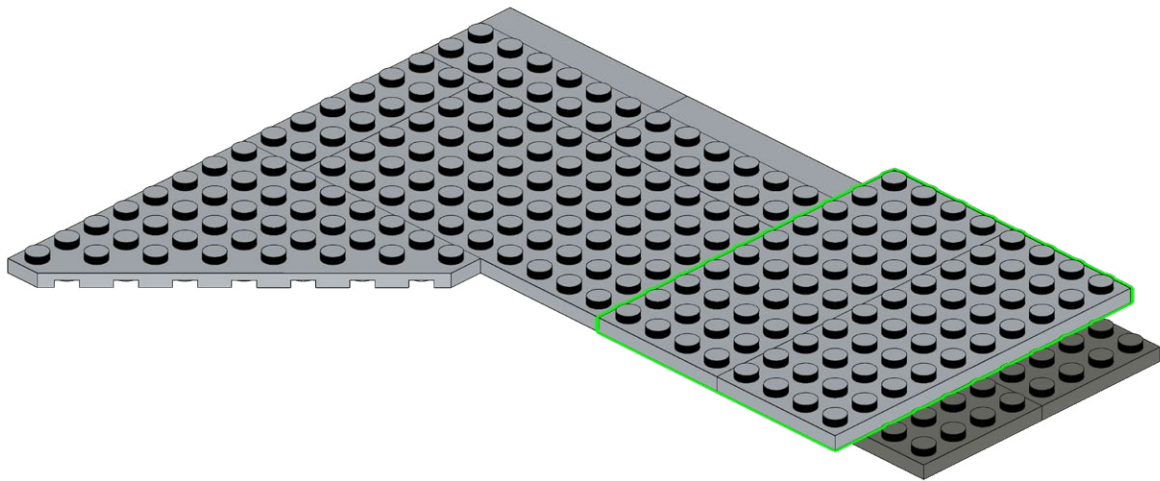
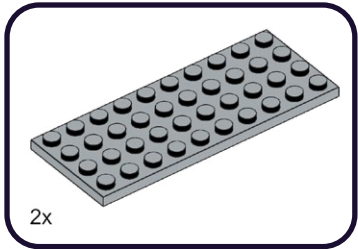

277

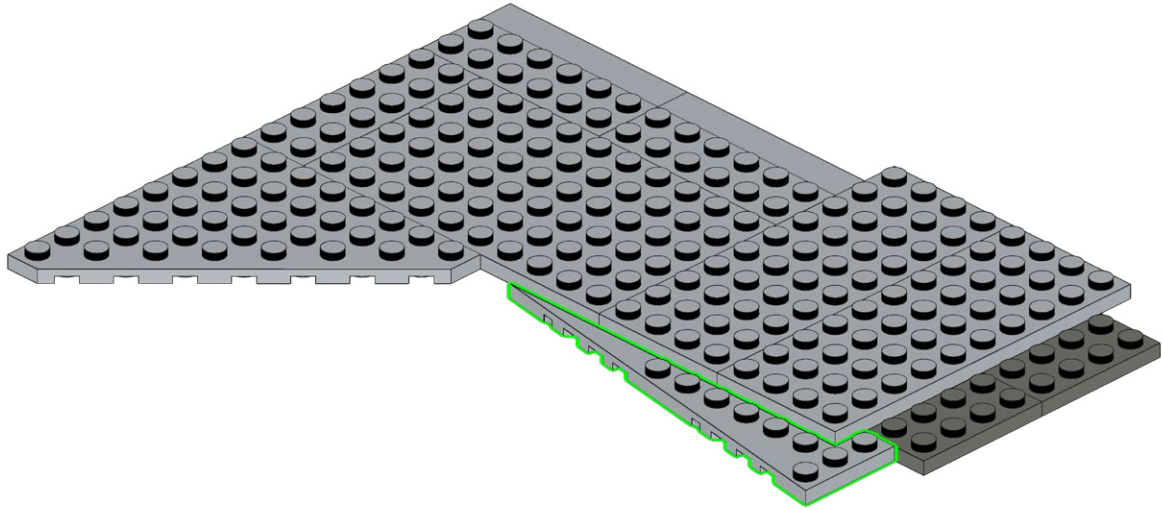
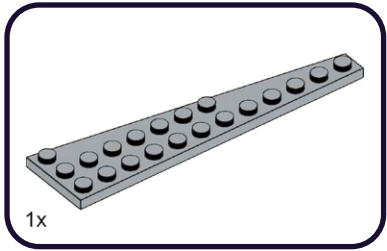

278

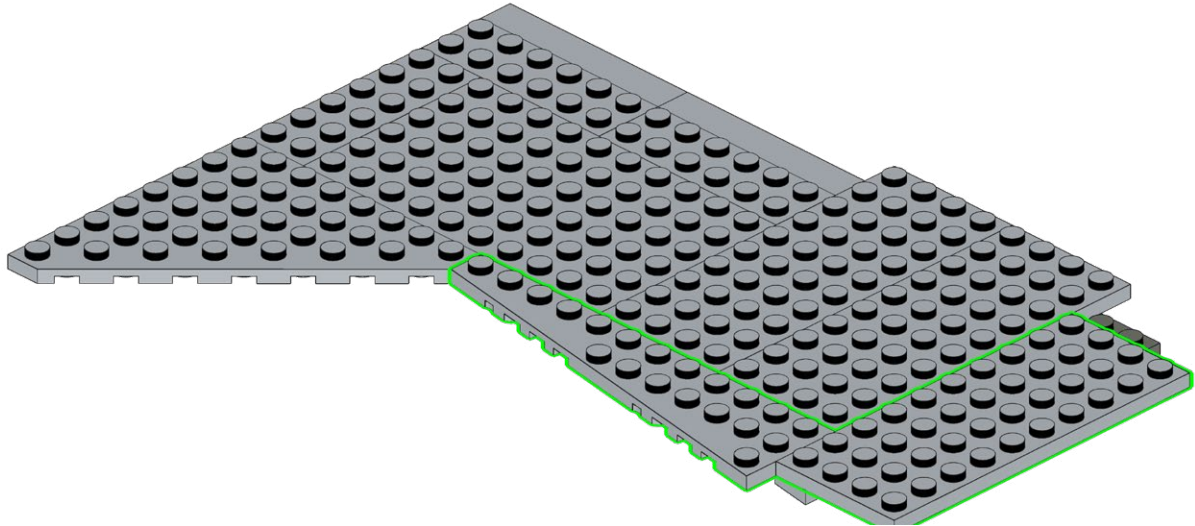
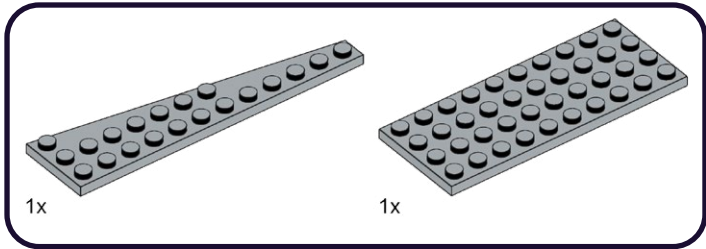

279

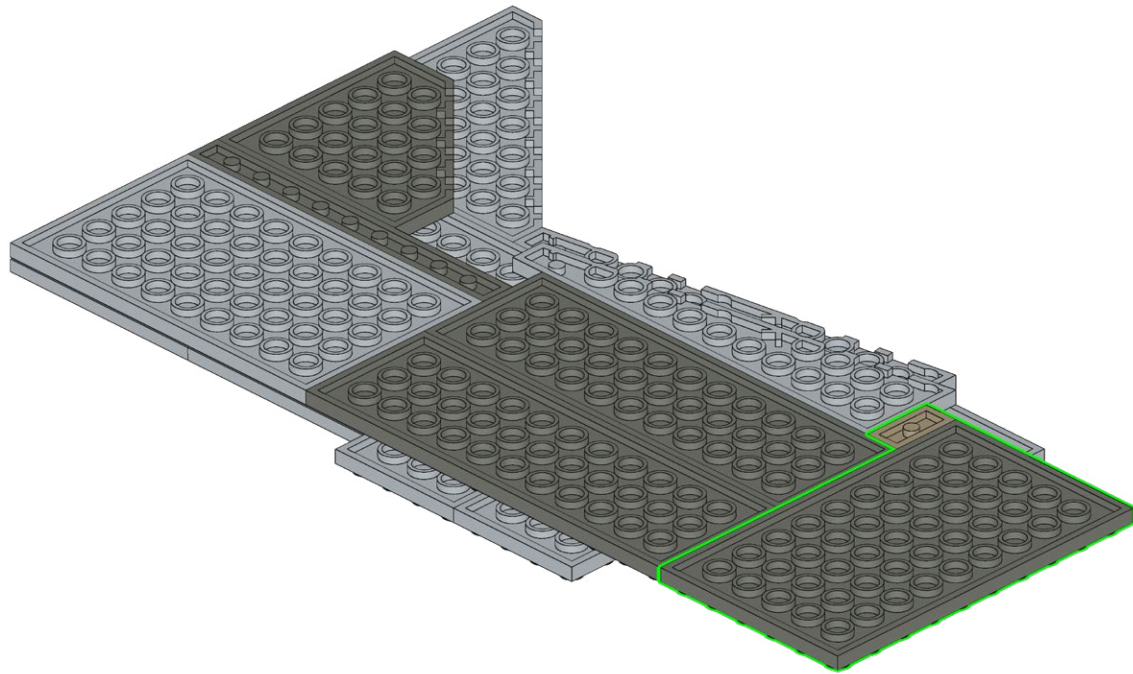
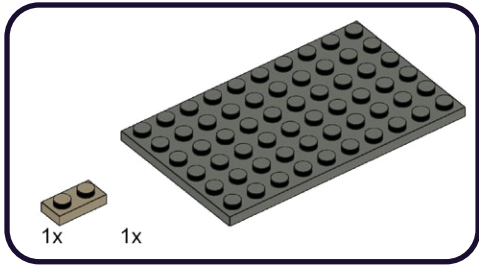

280

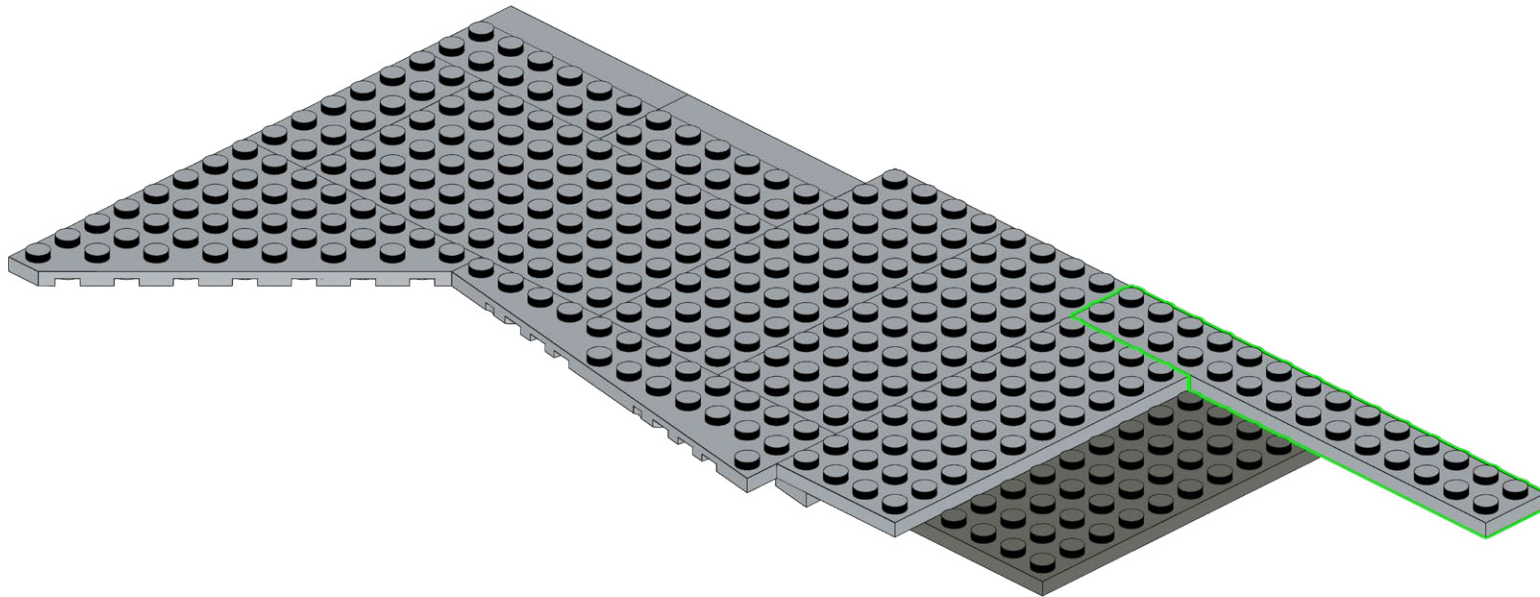
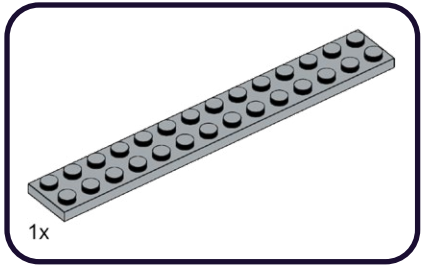

281

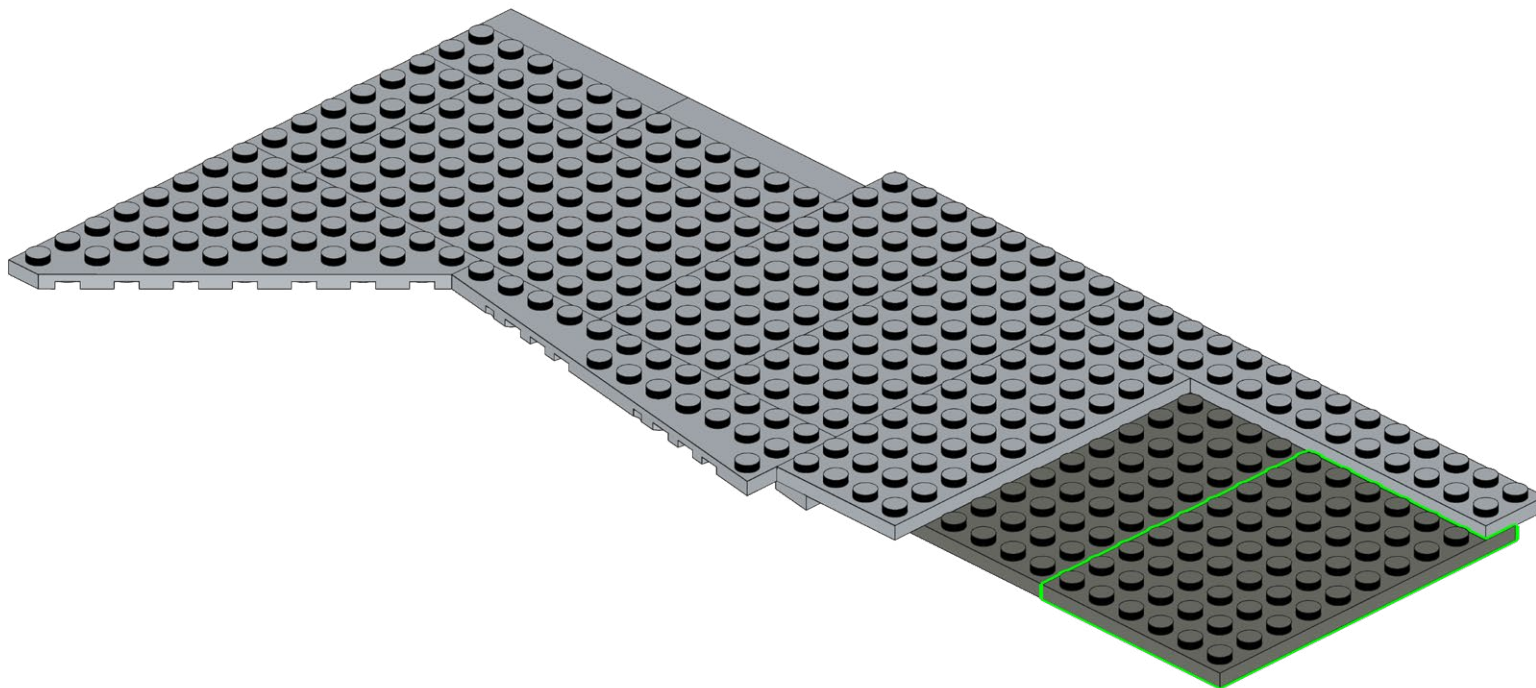
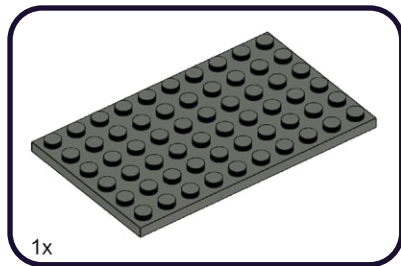

282

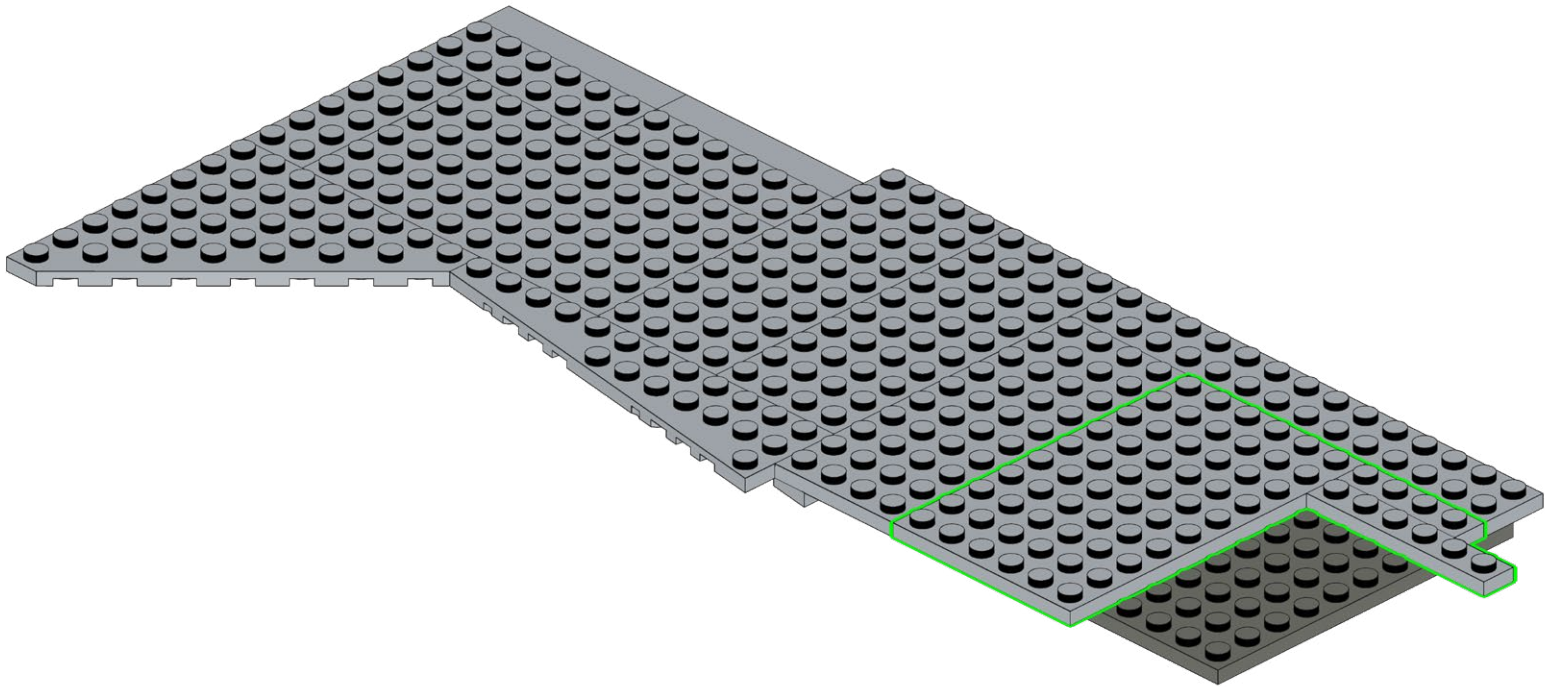
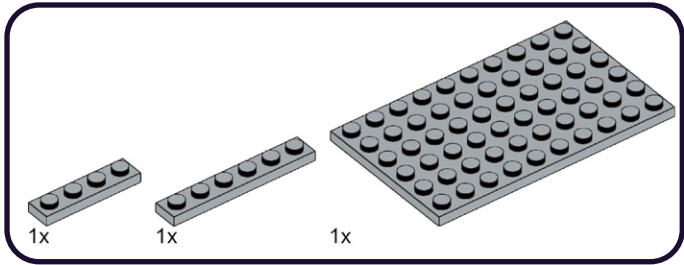

283

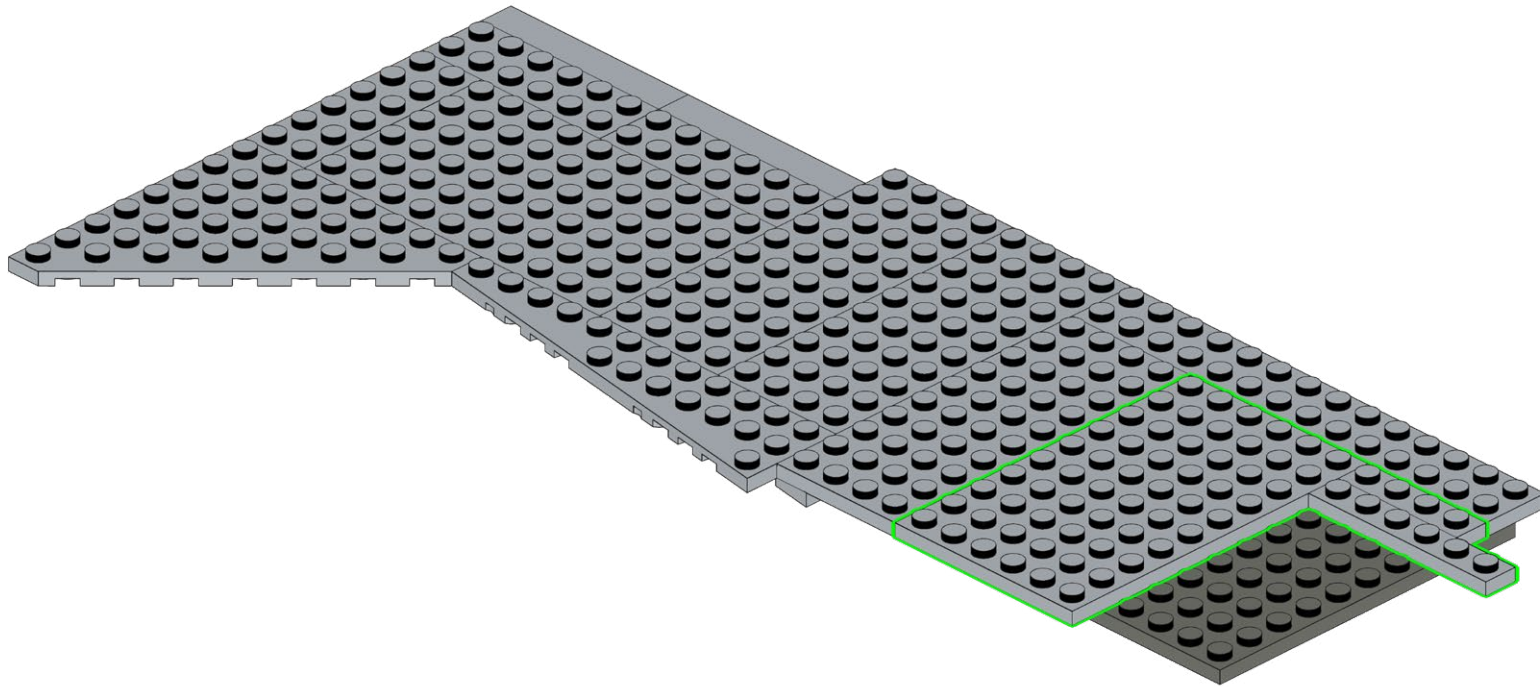
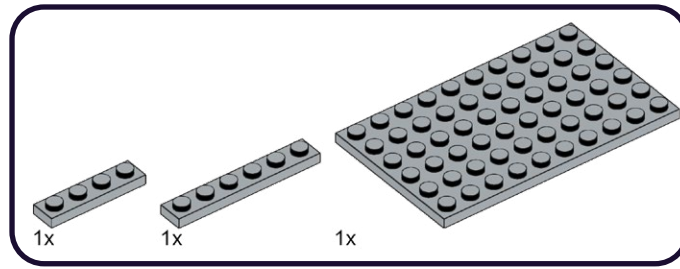

284

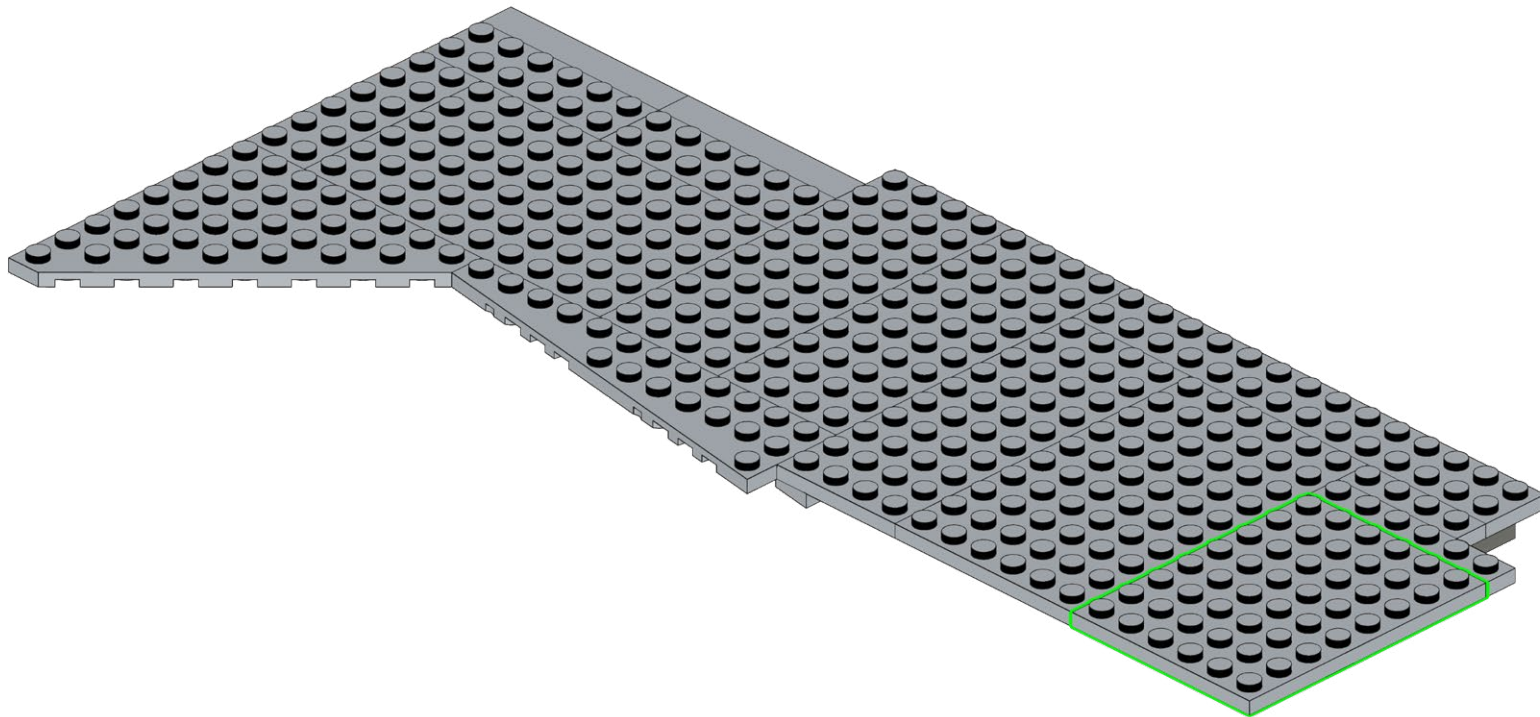
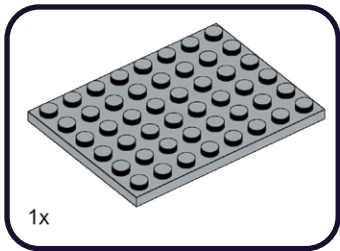

285

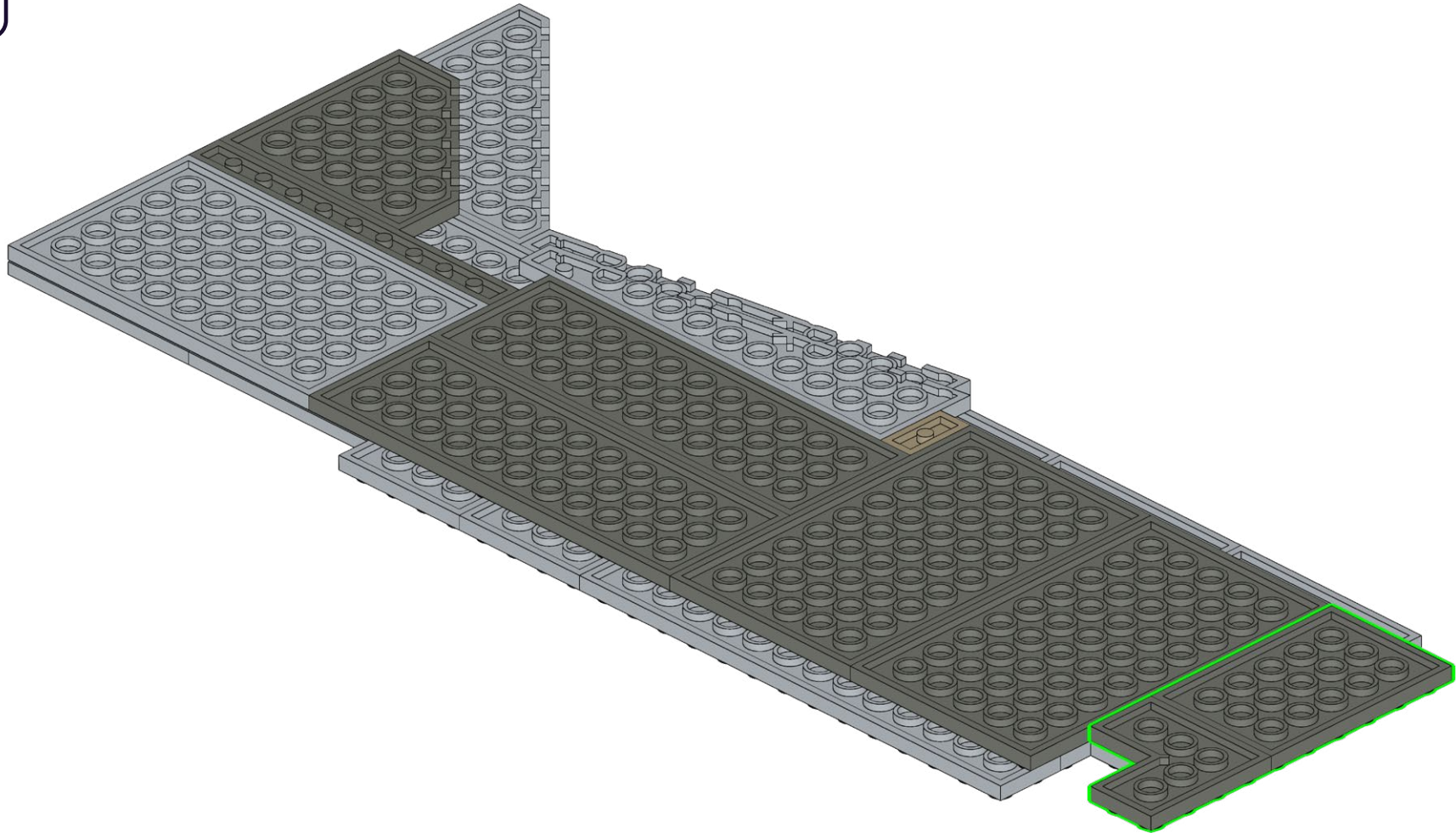
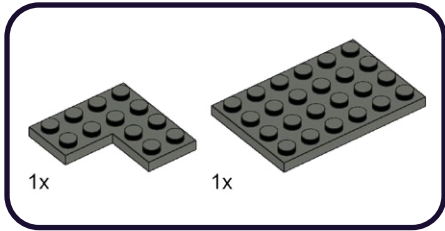

286

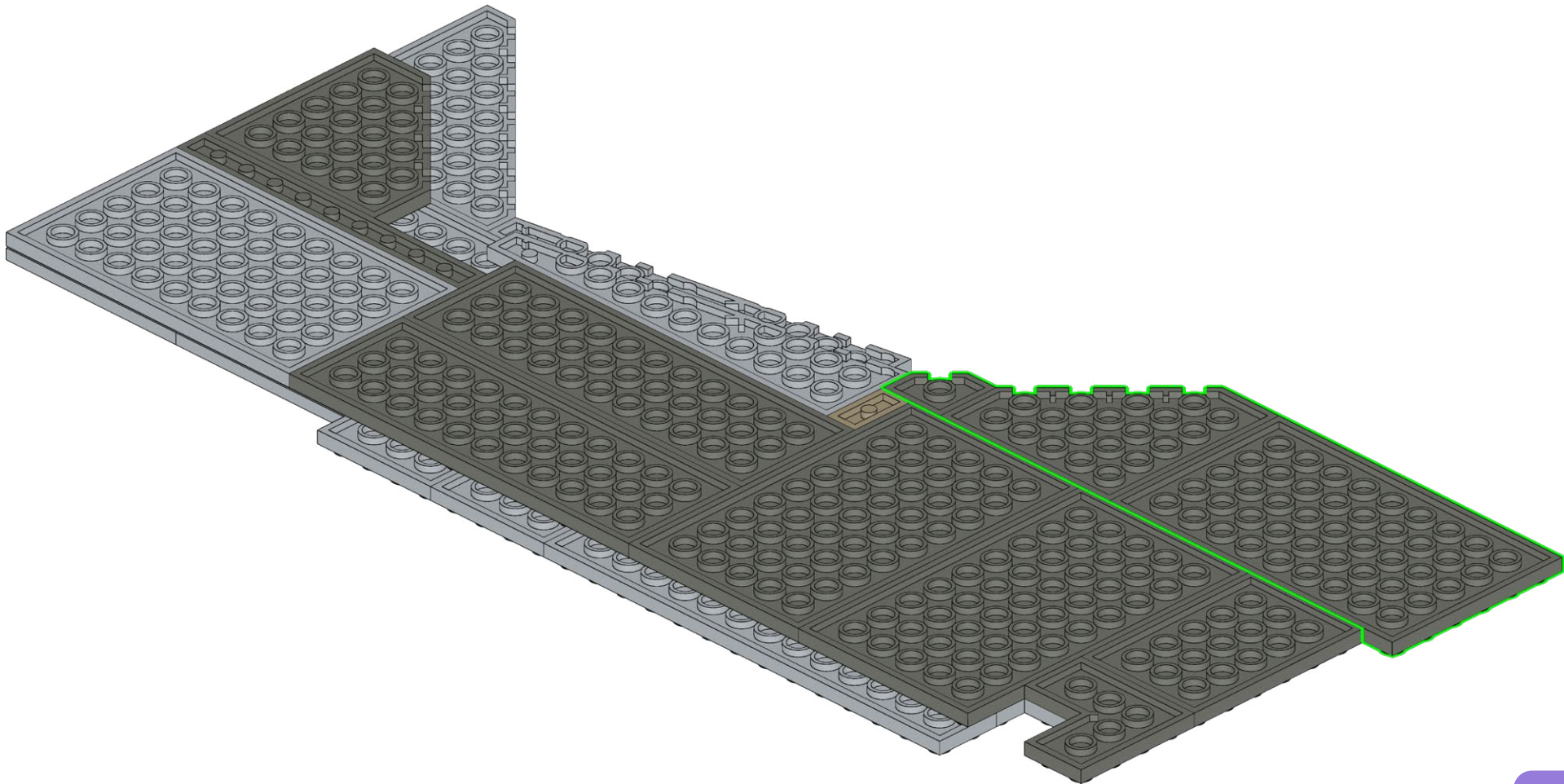
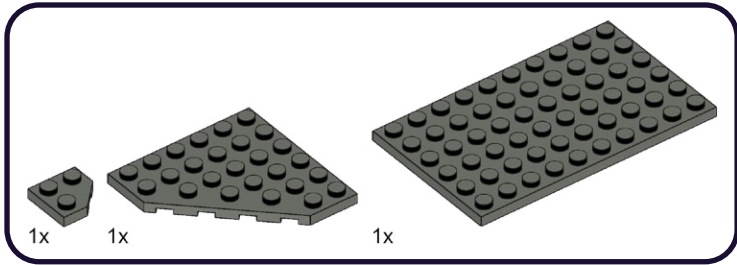

287

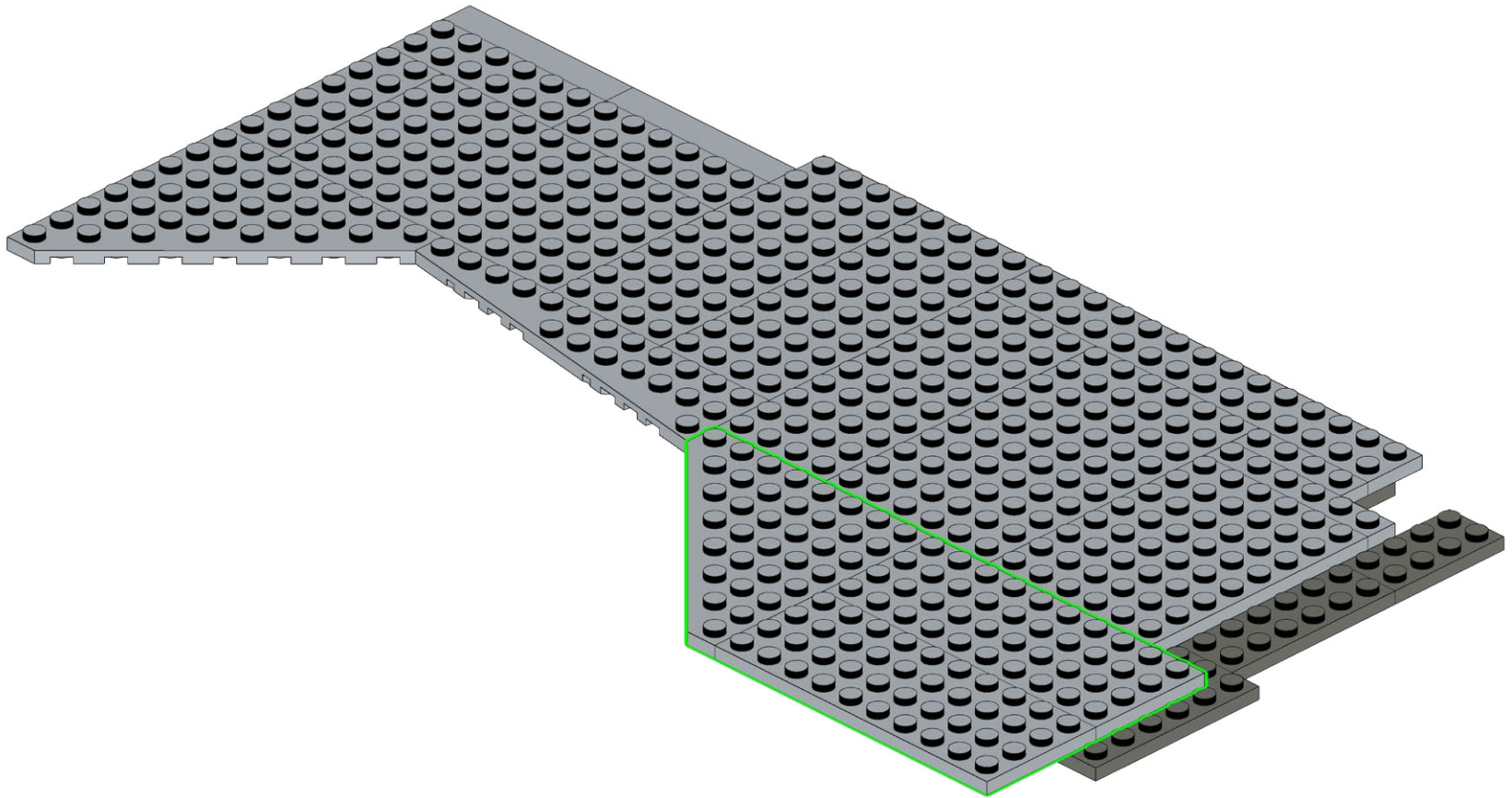
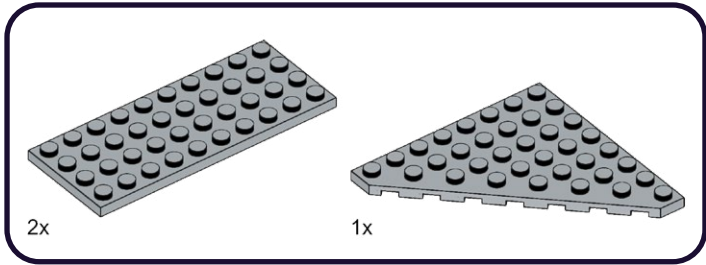

288

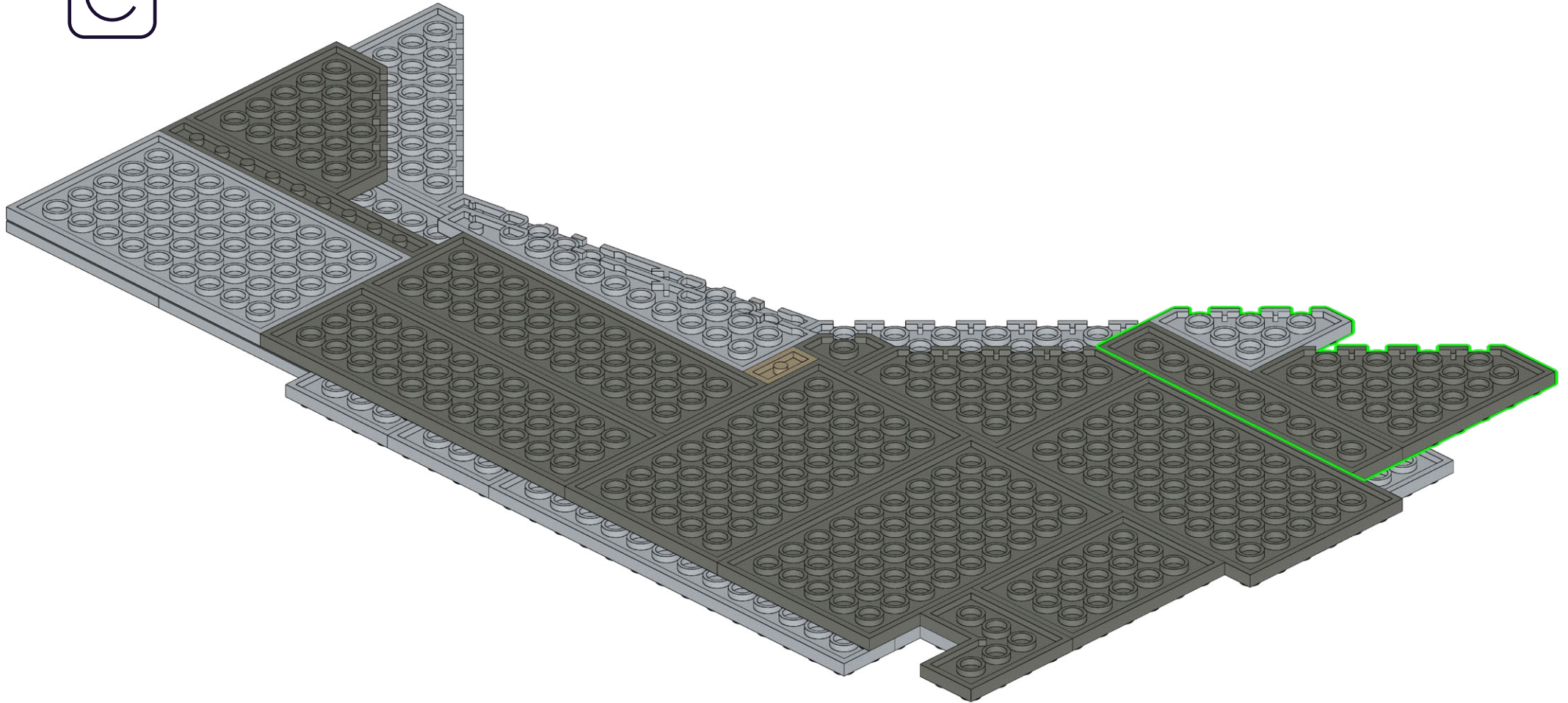
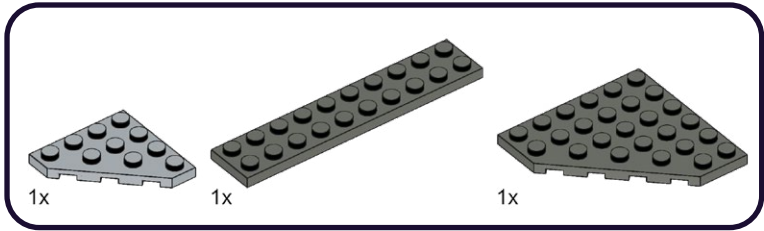

289

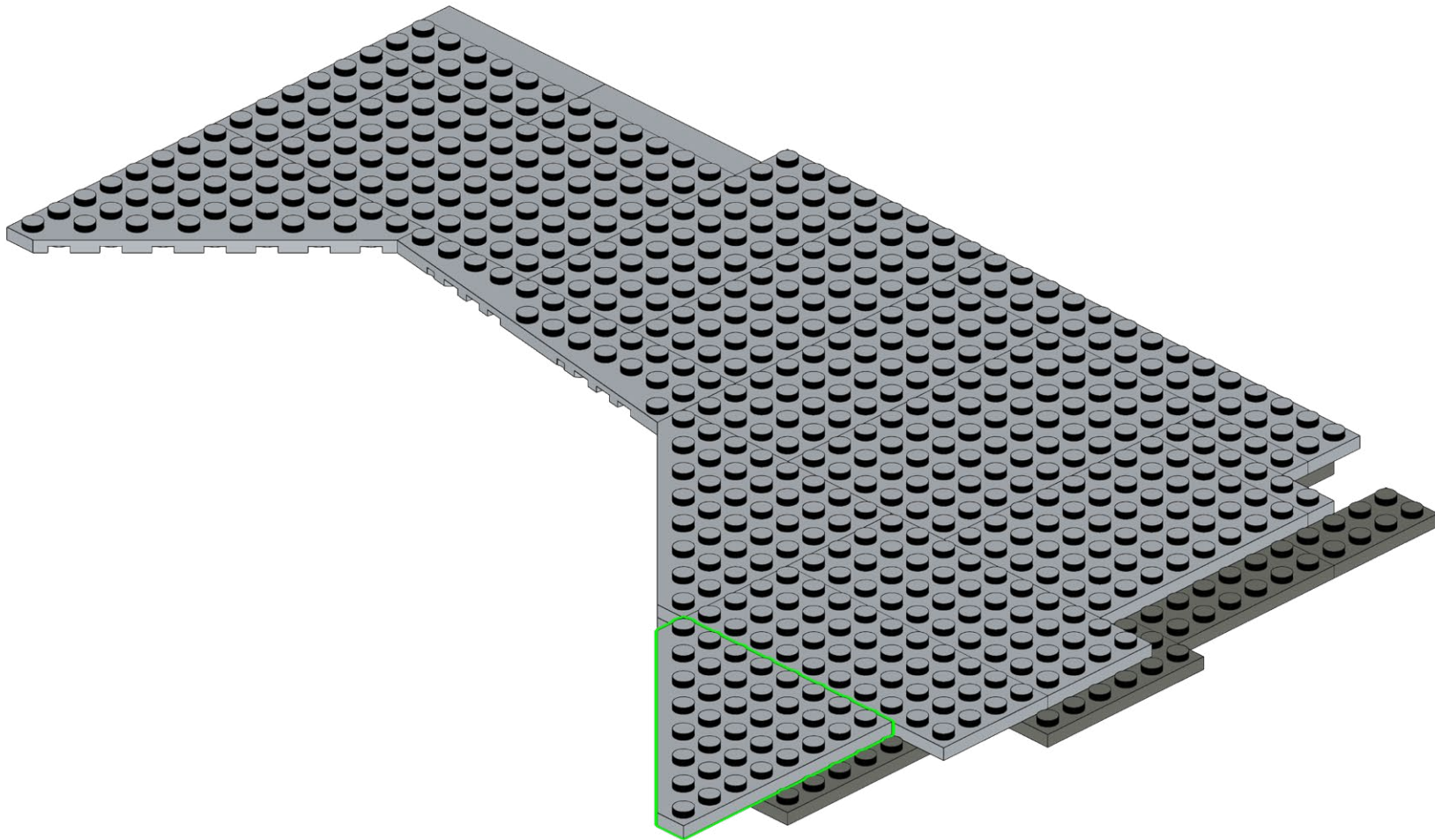
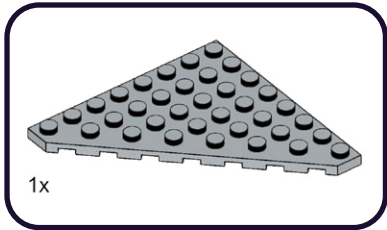

290

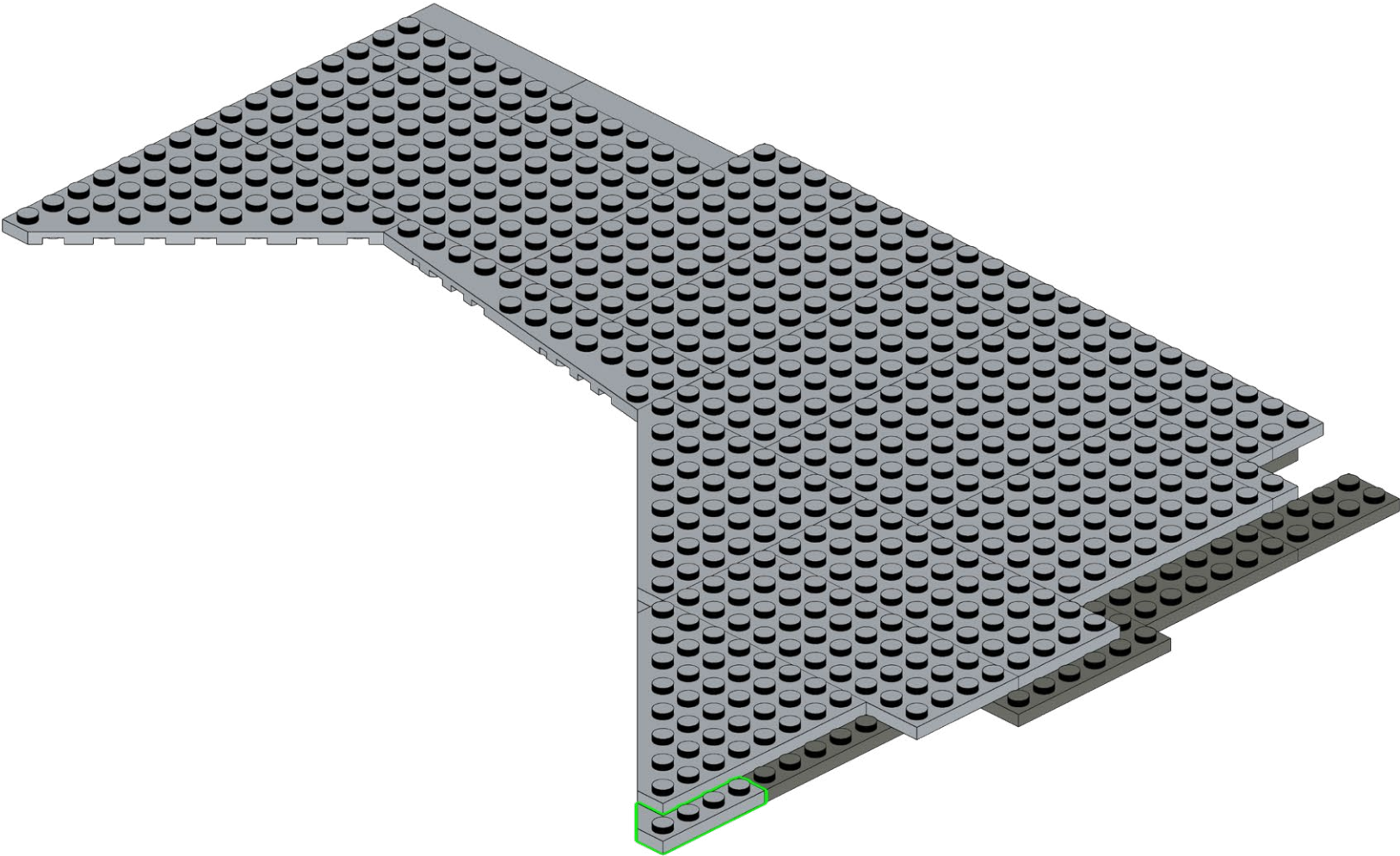
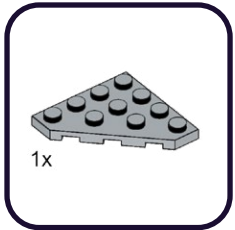

291

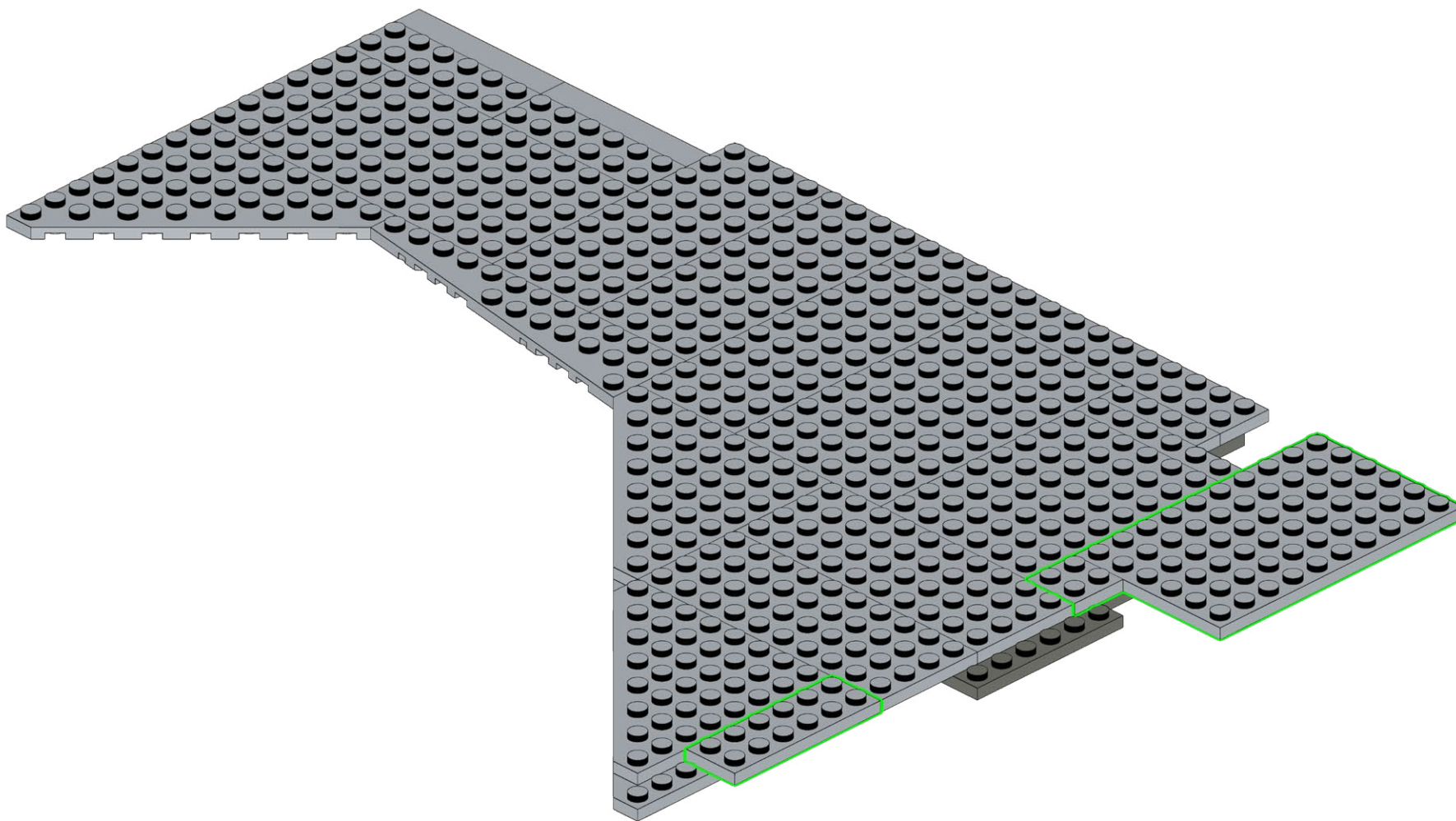
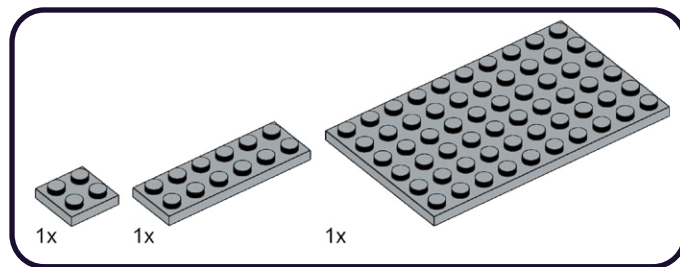

292

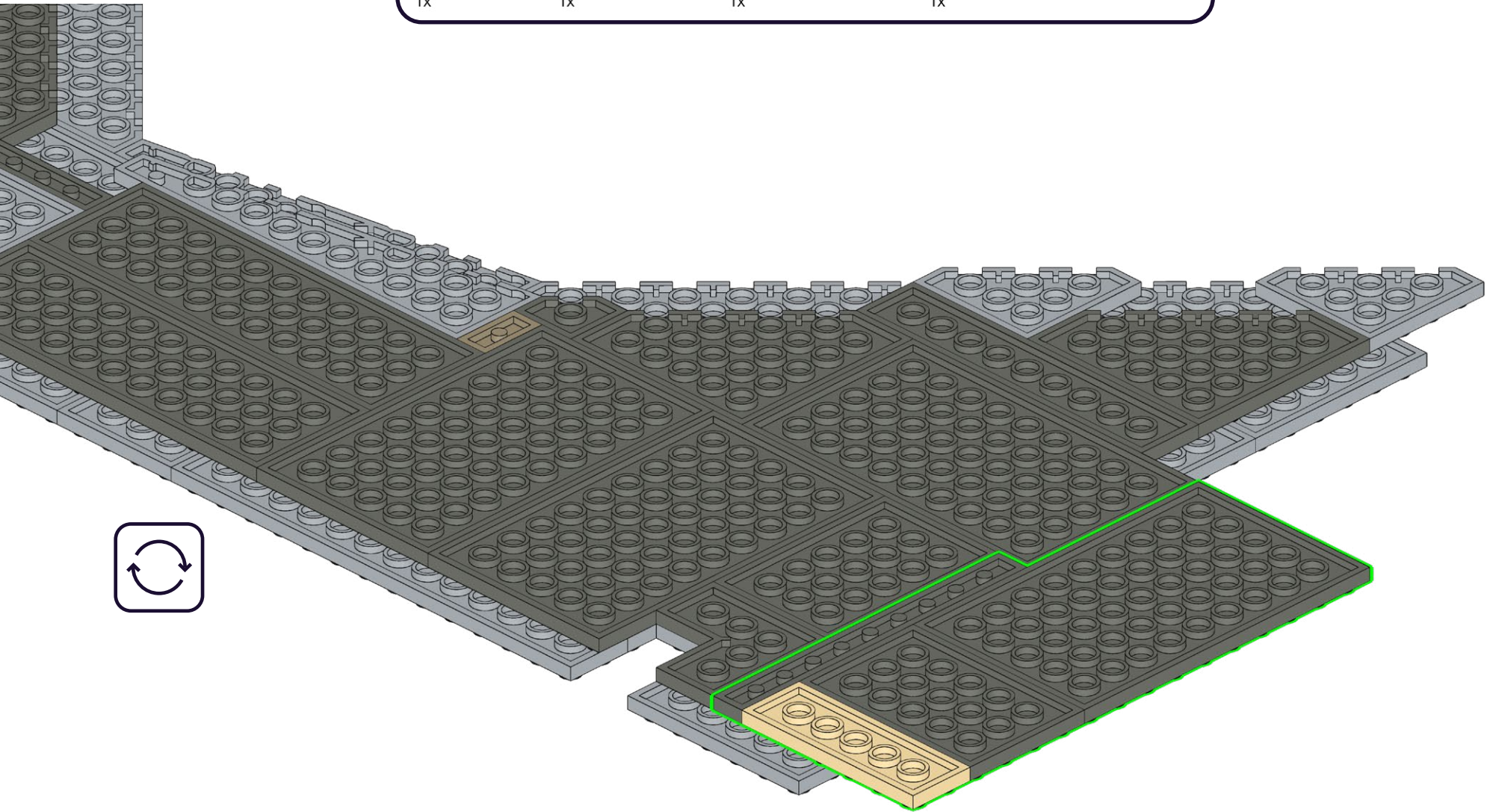
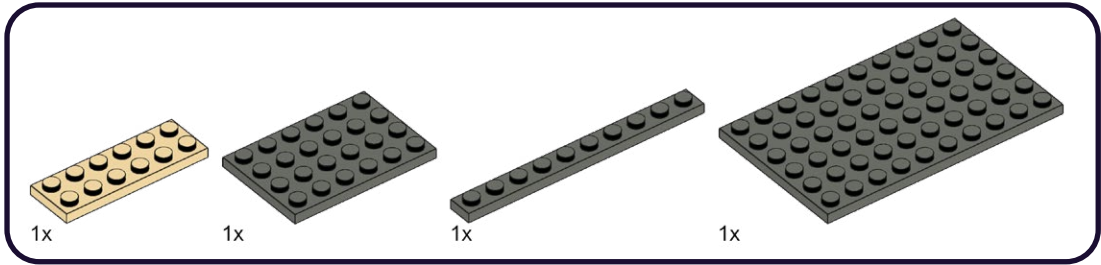

293

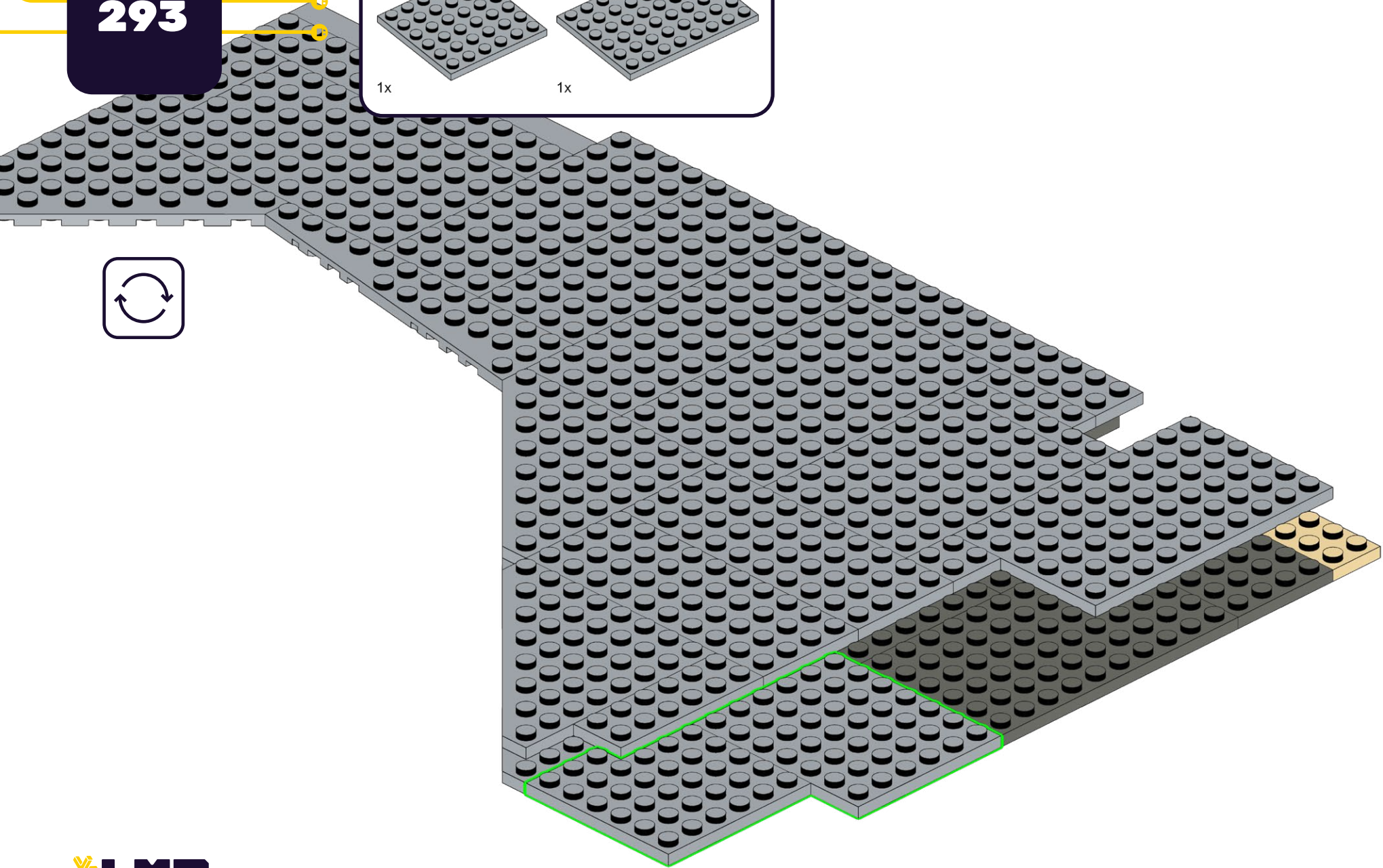
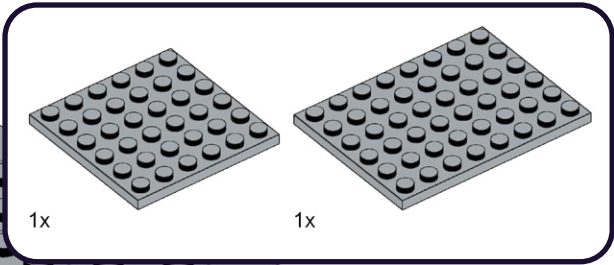

294

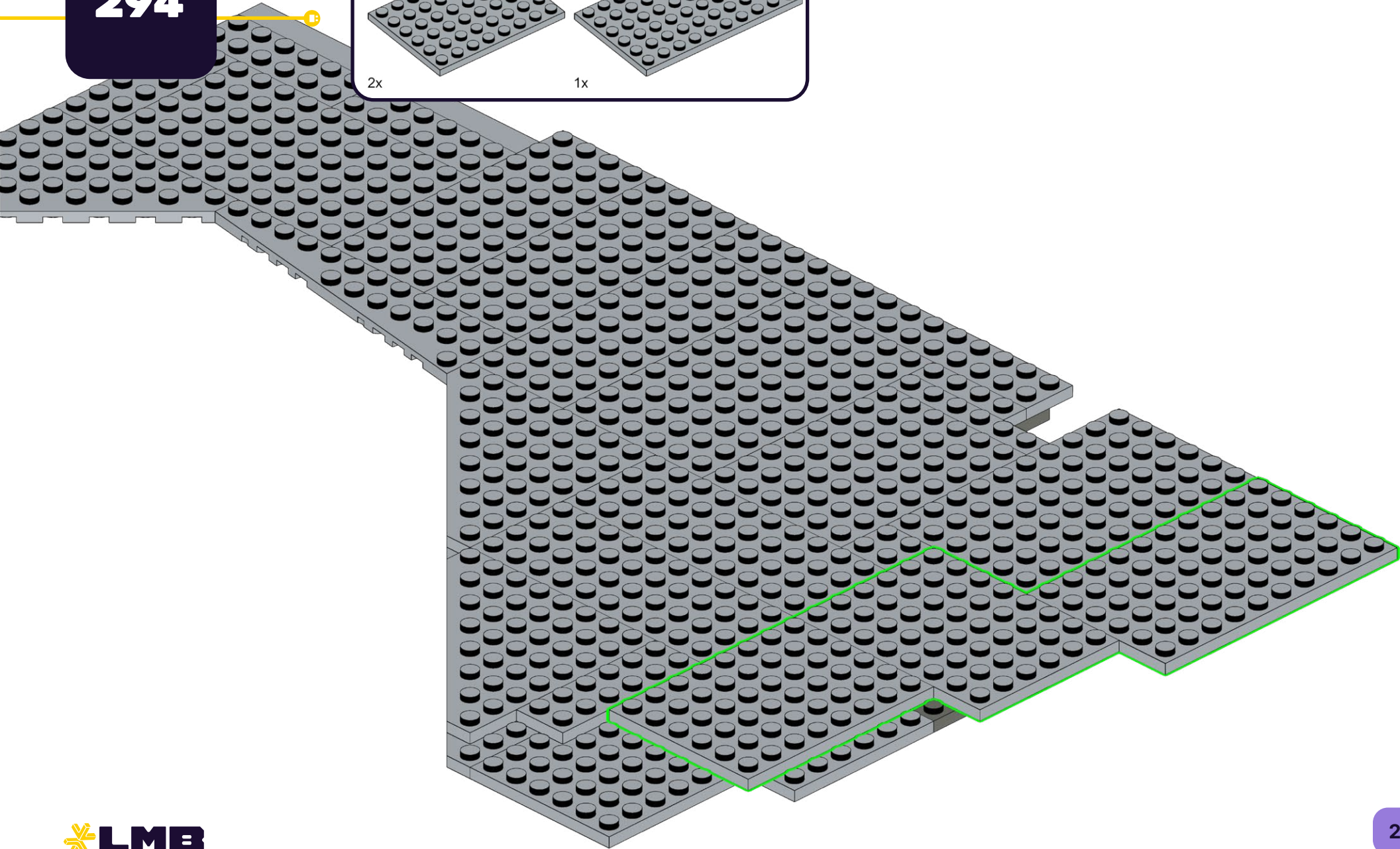
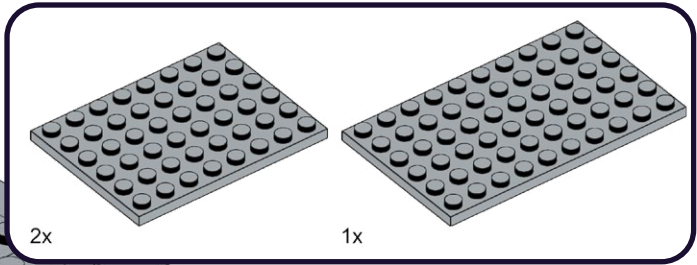

295

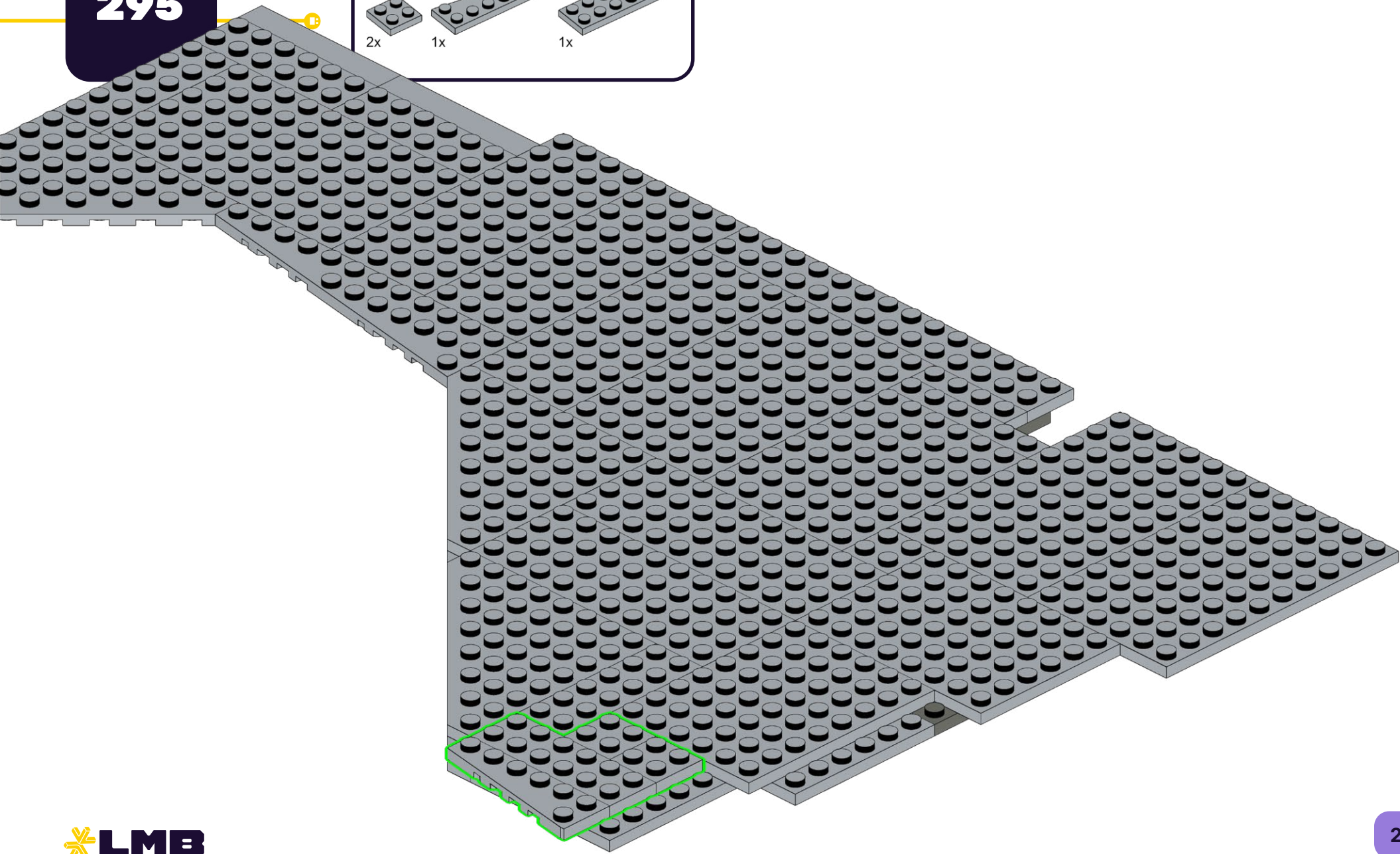
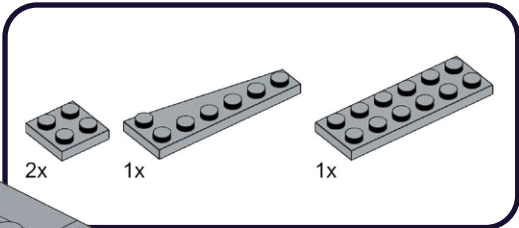

296

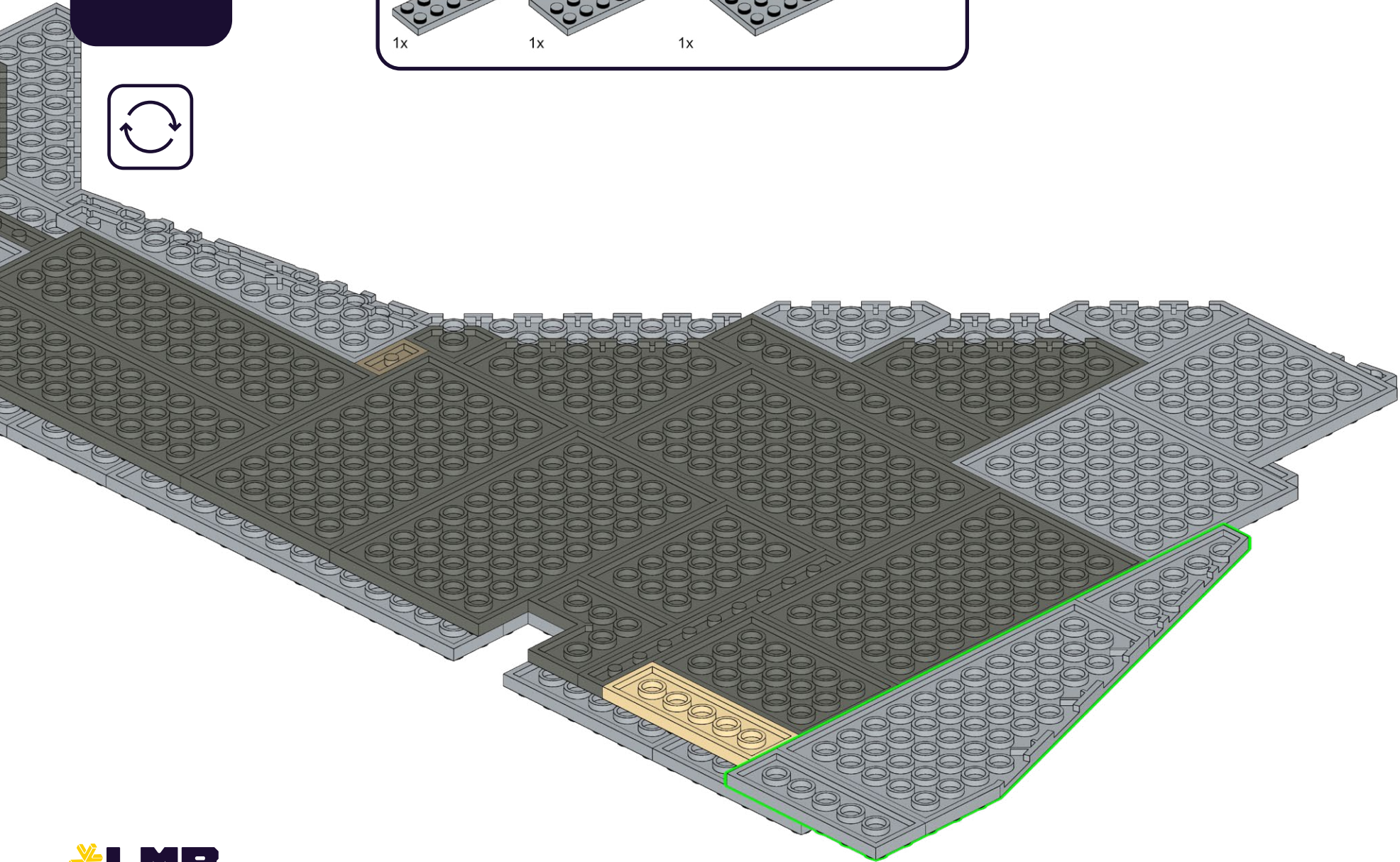
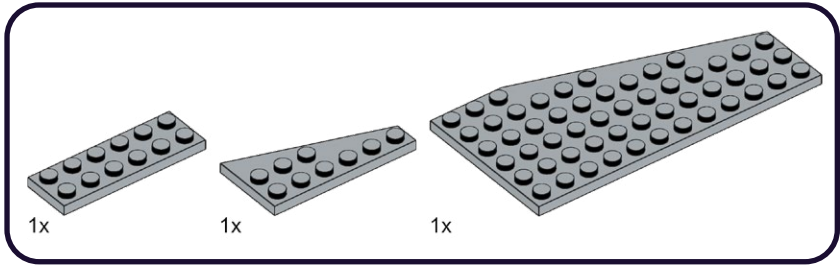

297

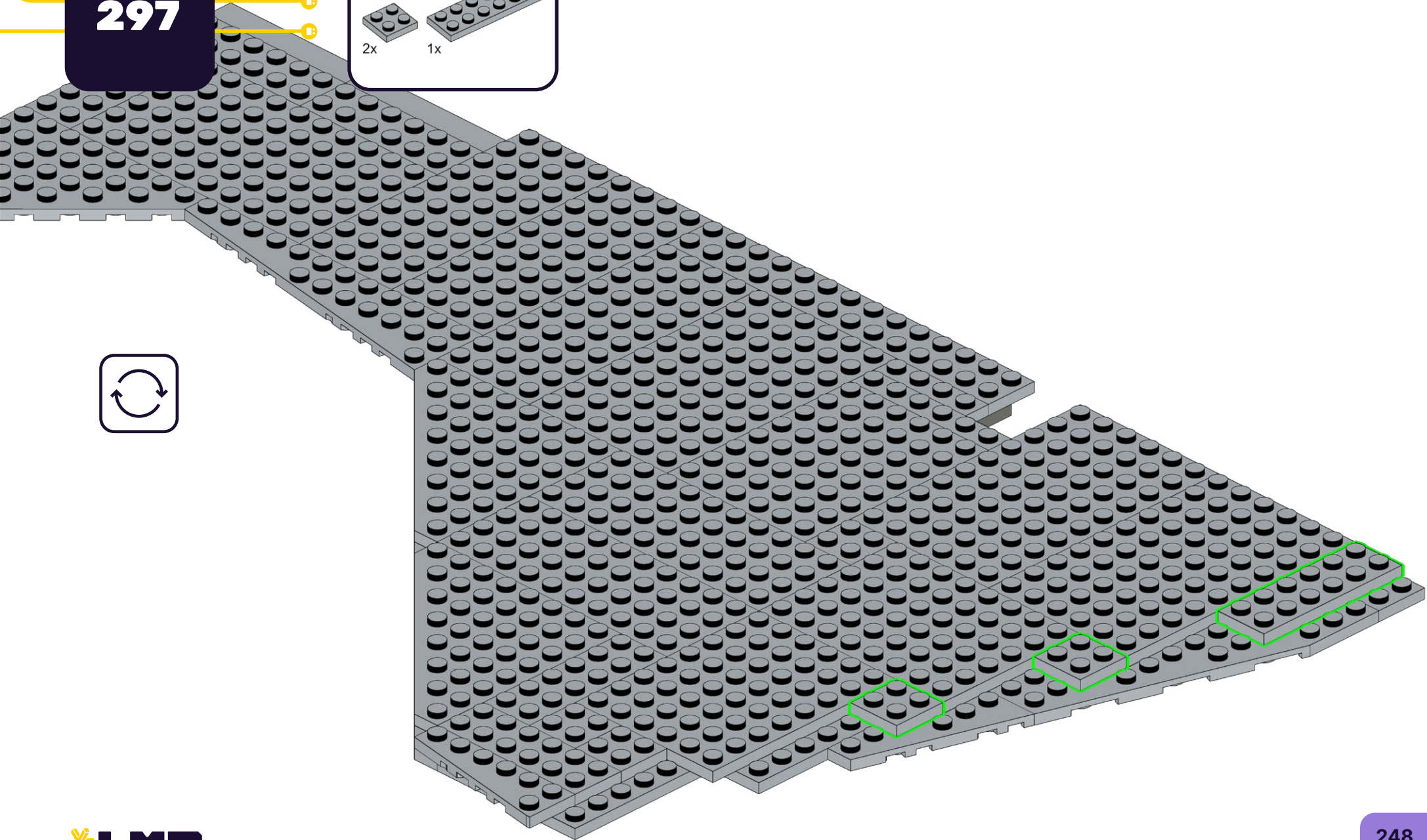
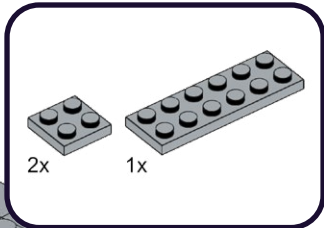

298

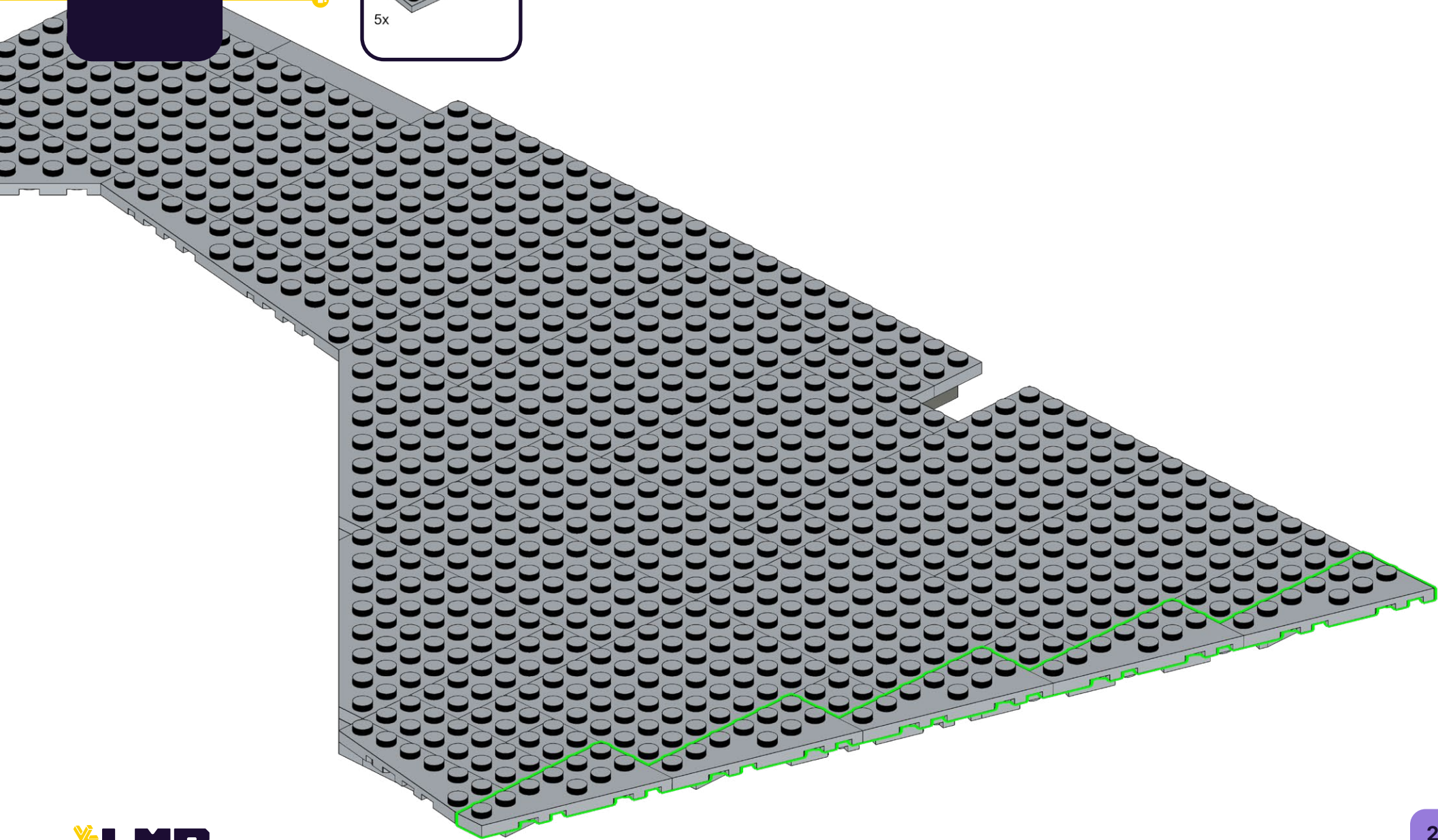
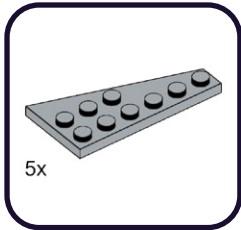

299

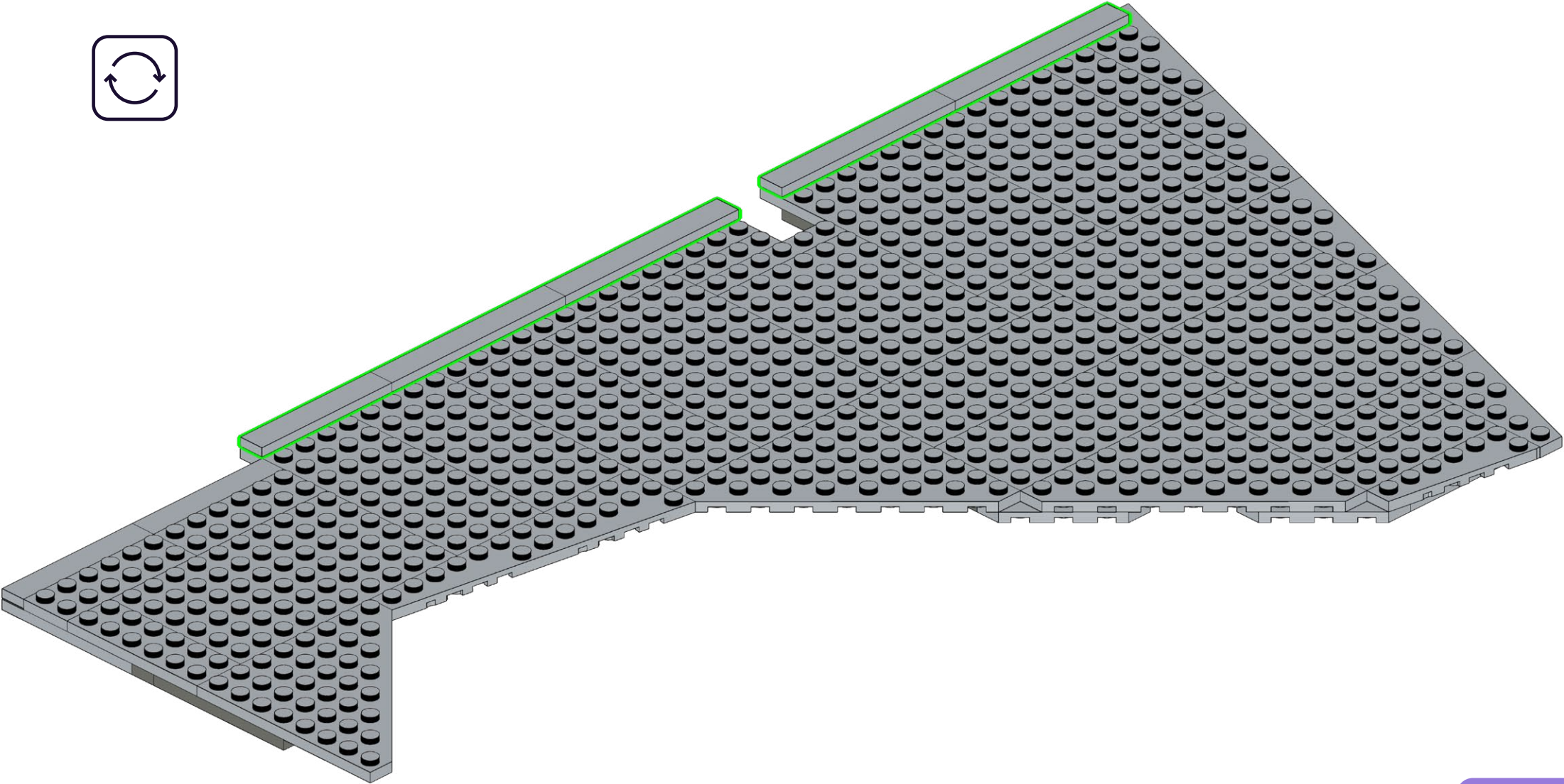
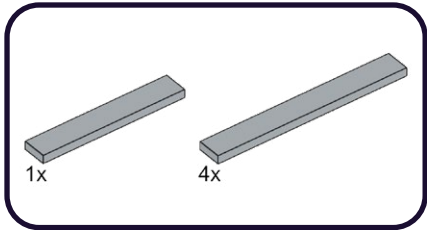

300

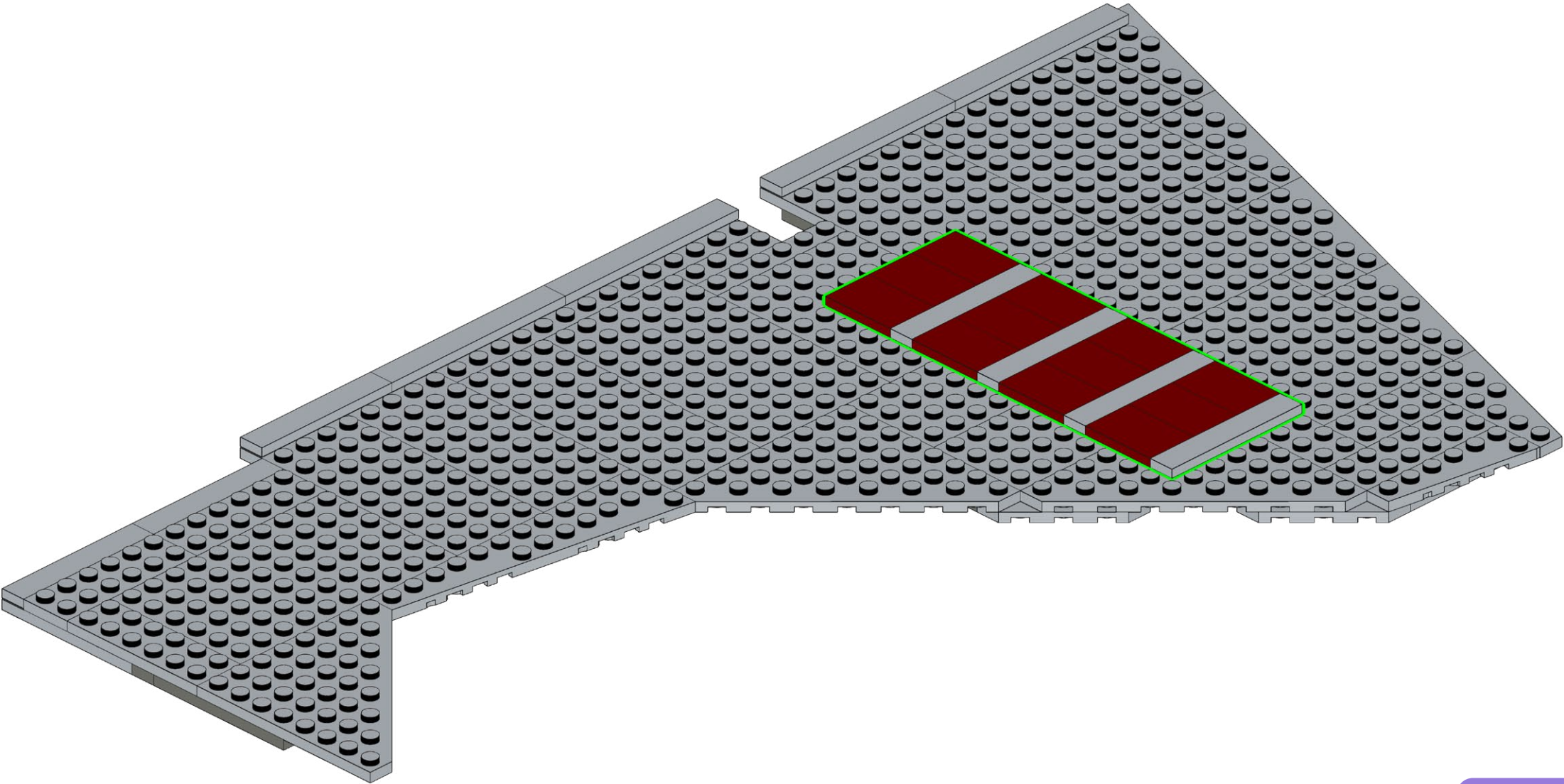
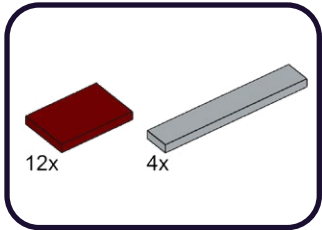

301

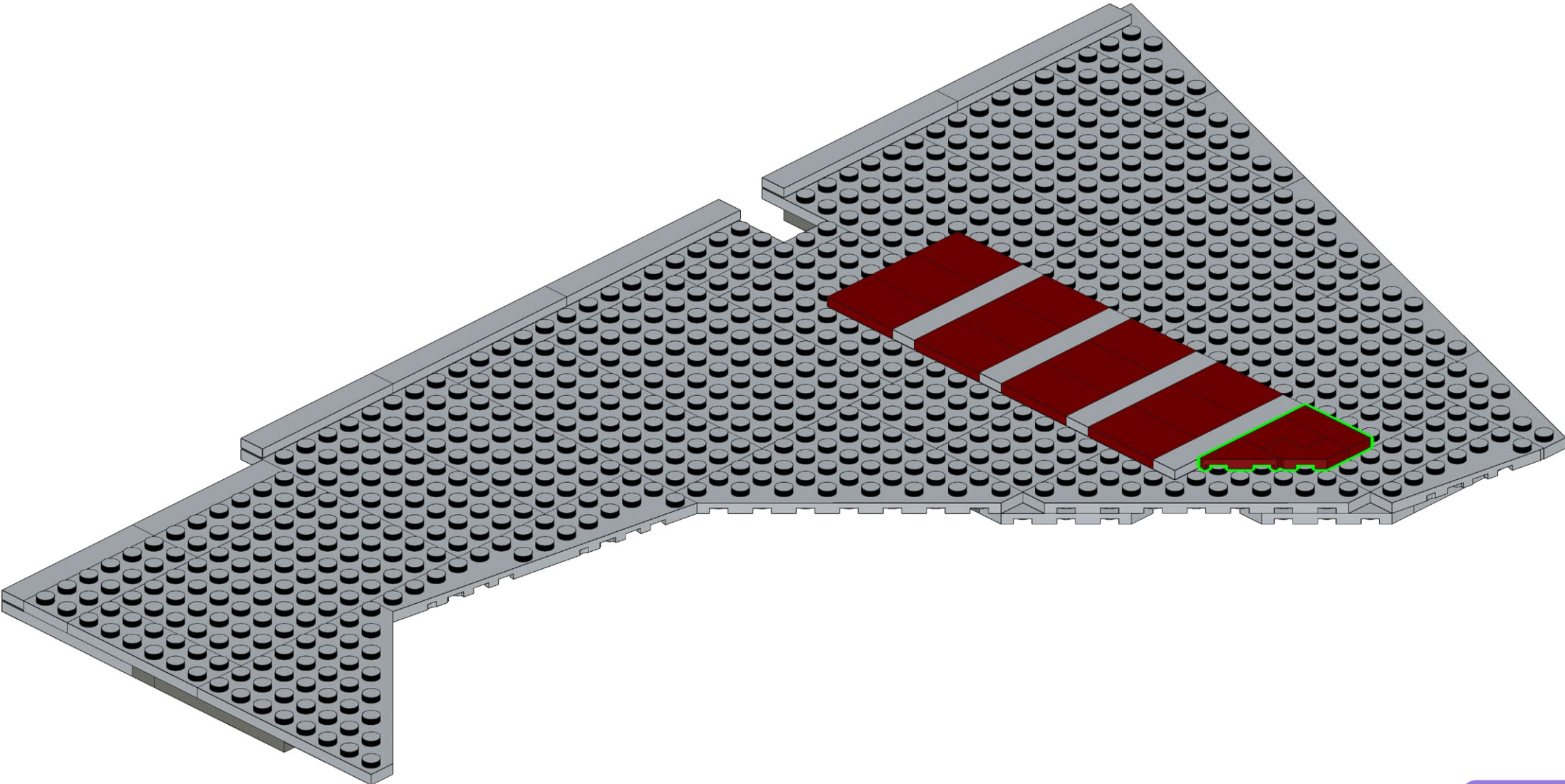
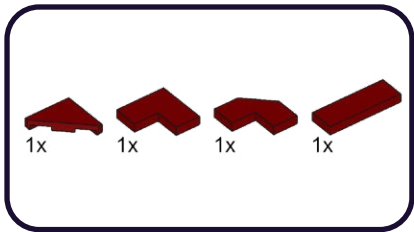

302

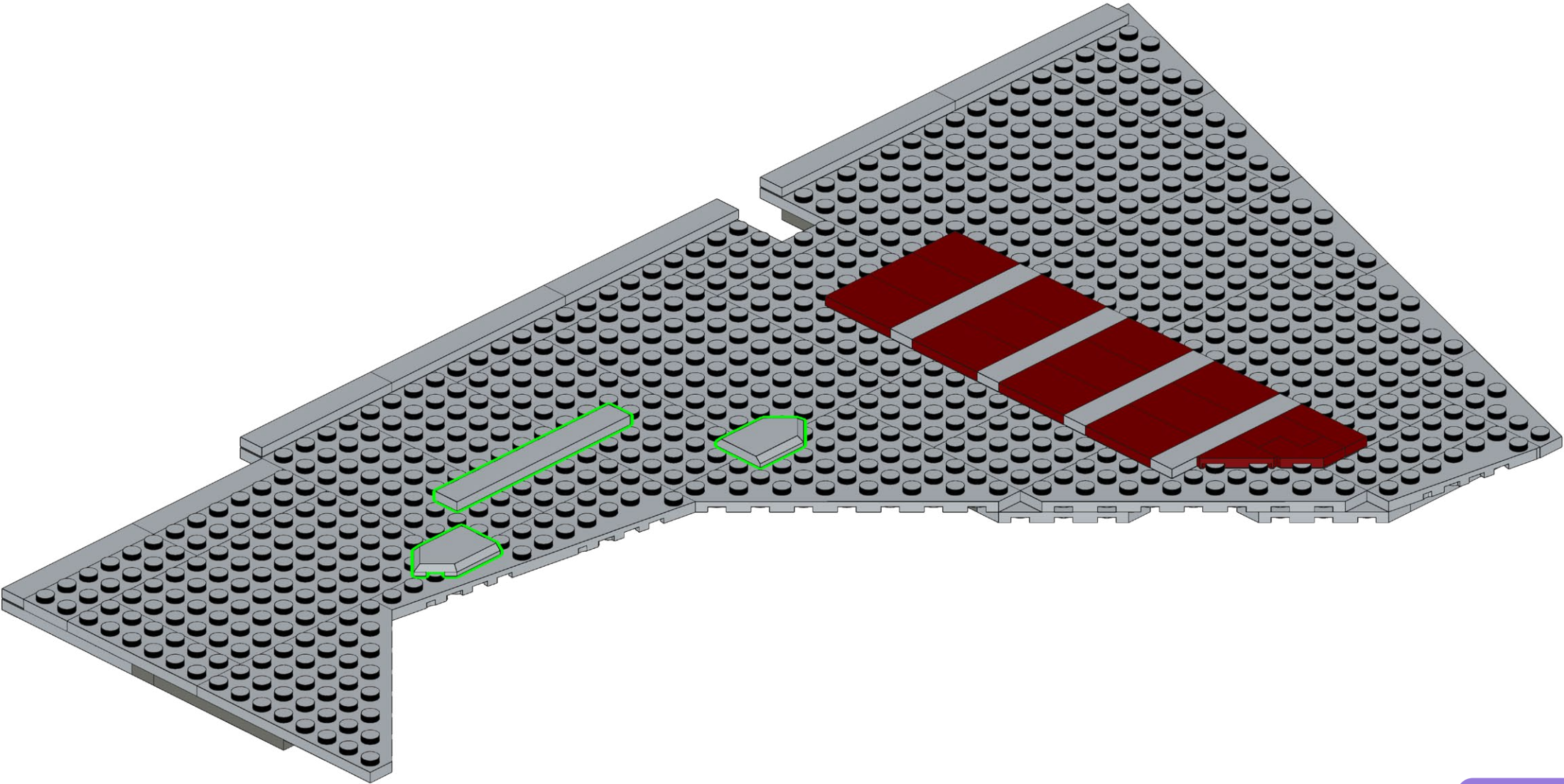
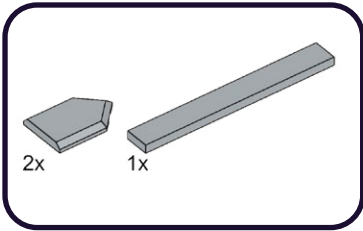

303

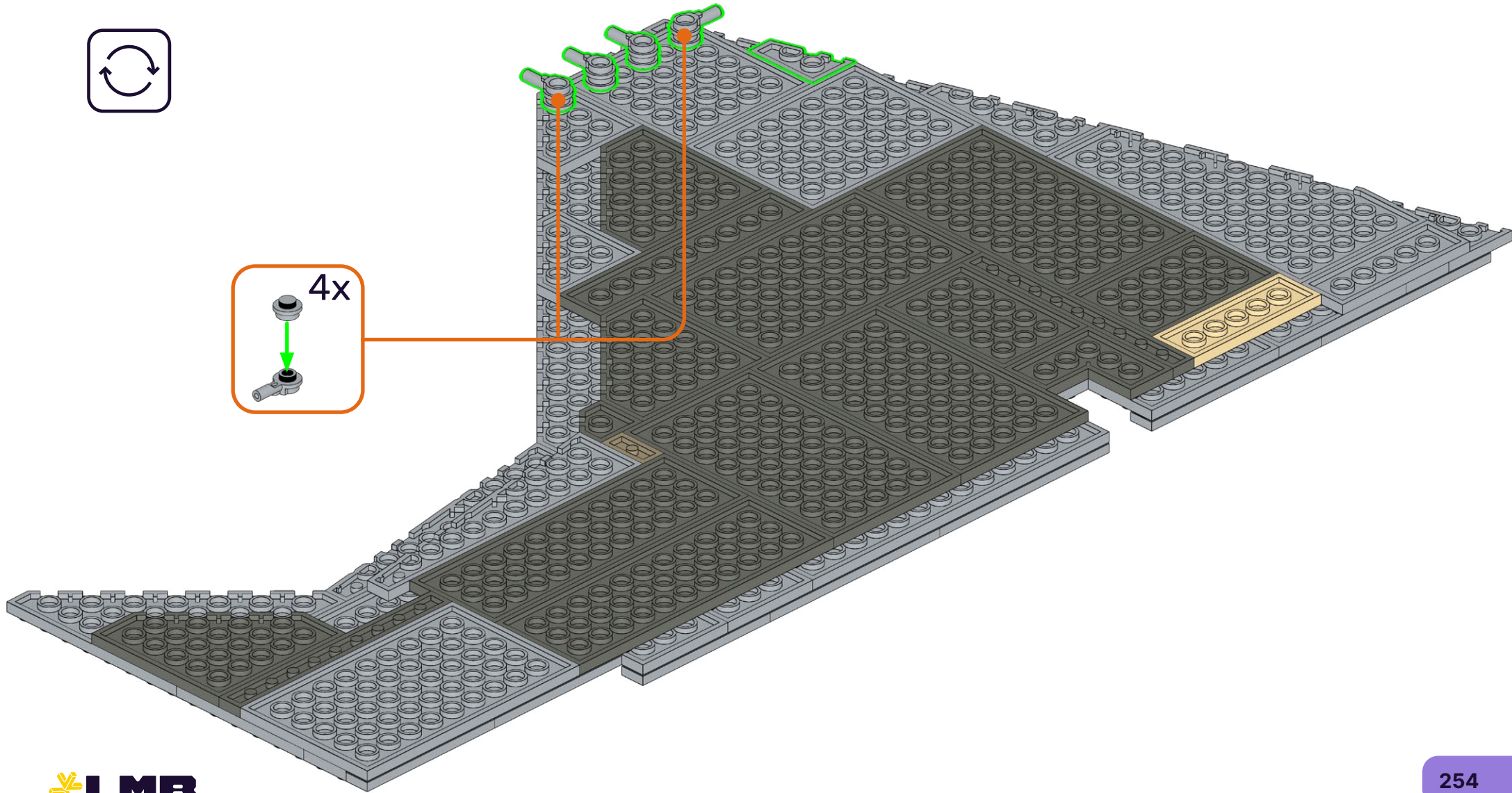
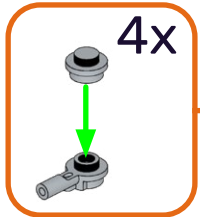
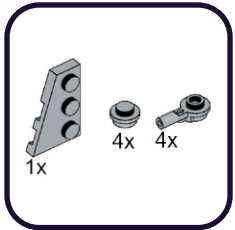

304

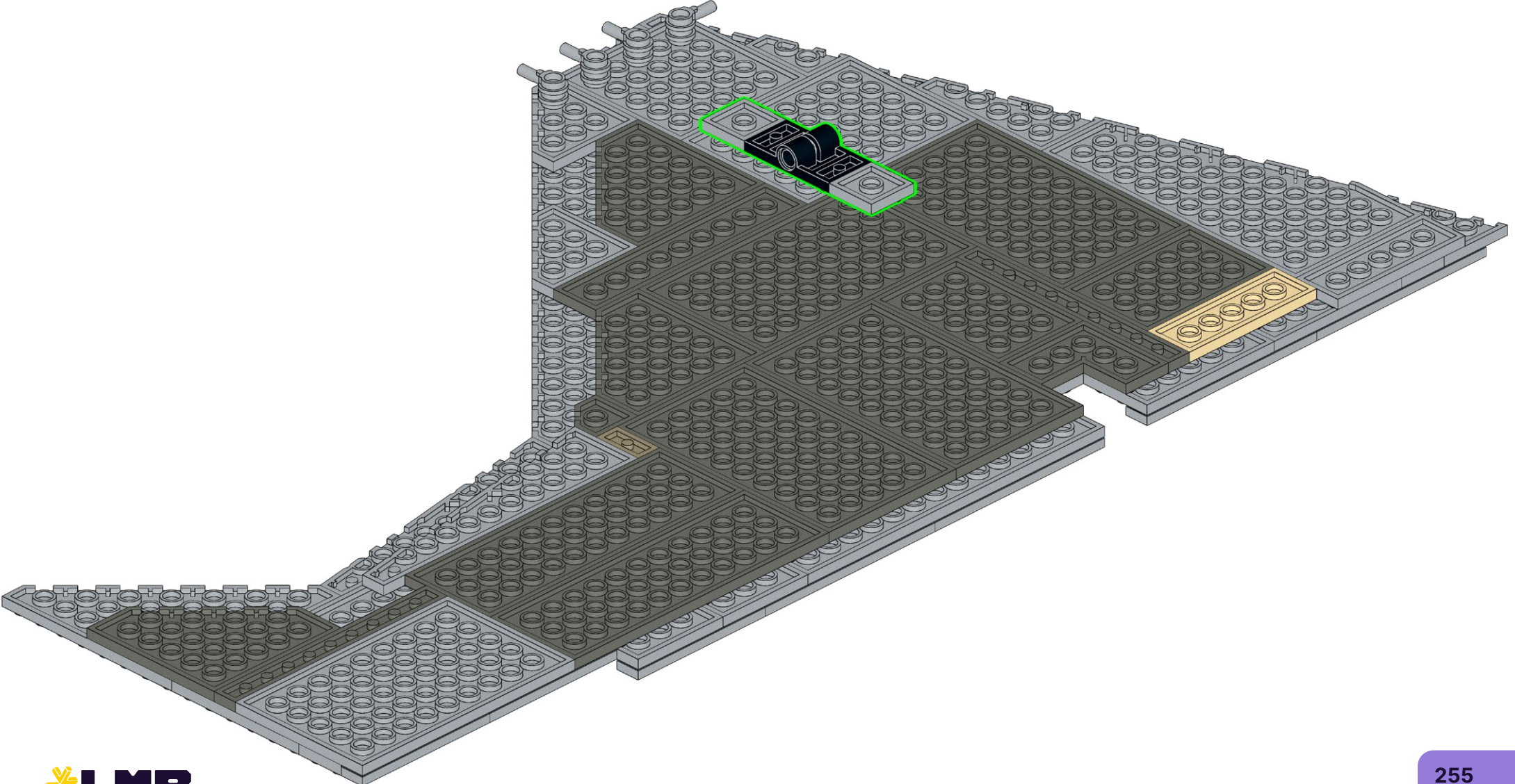
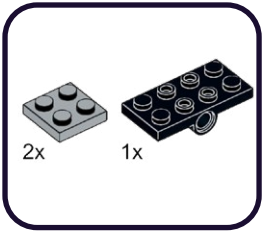

305

3x

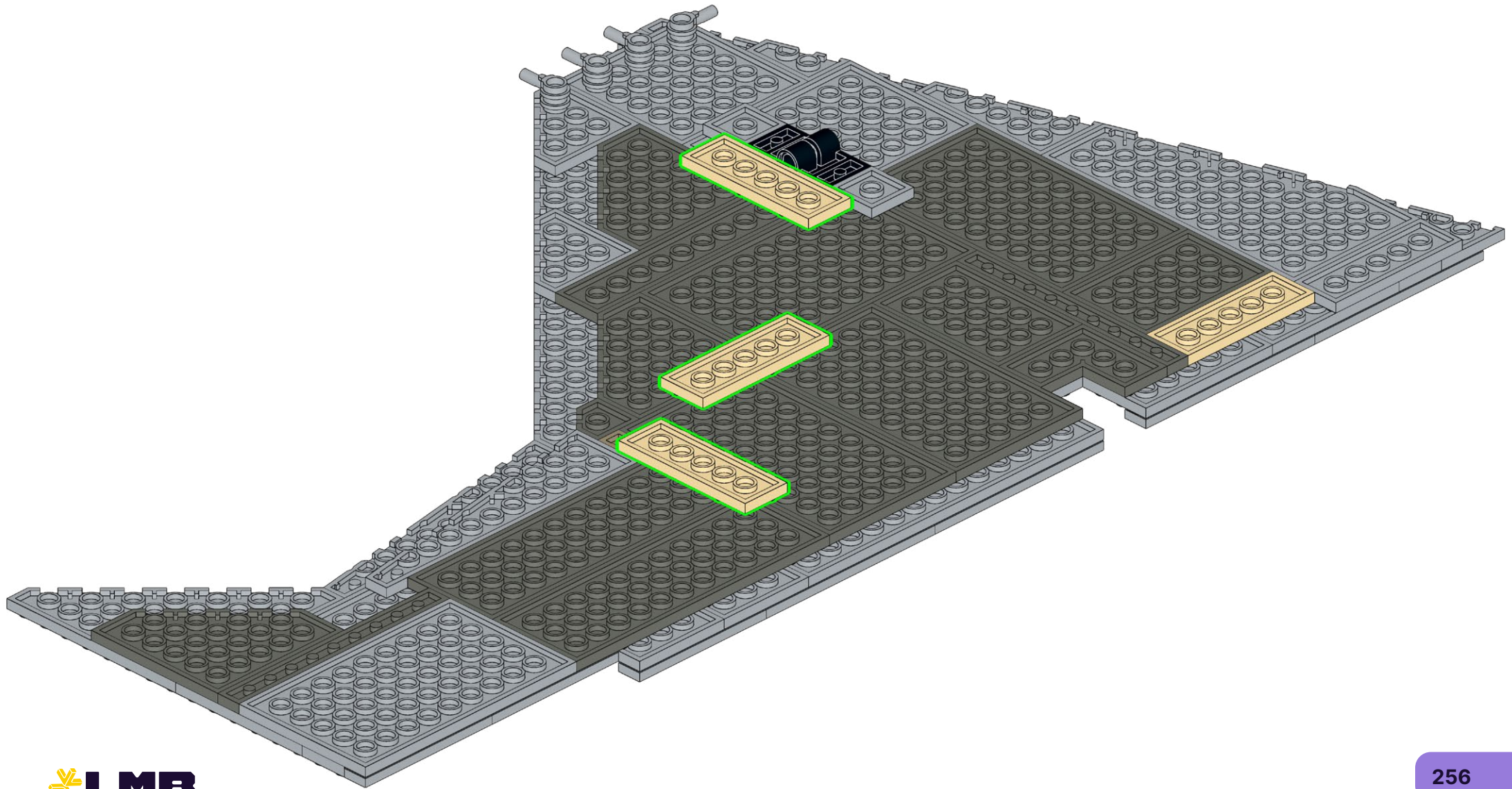
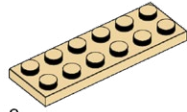

306

2x

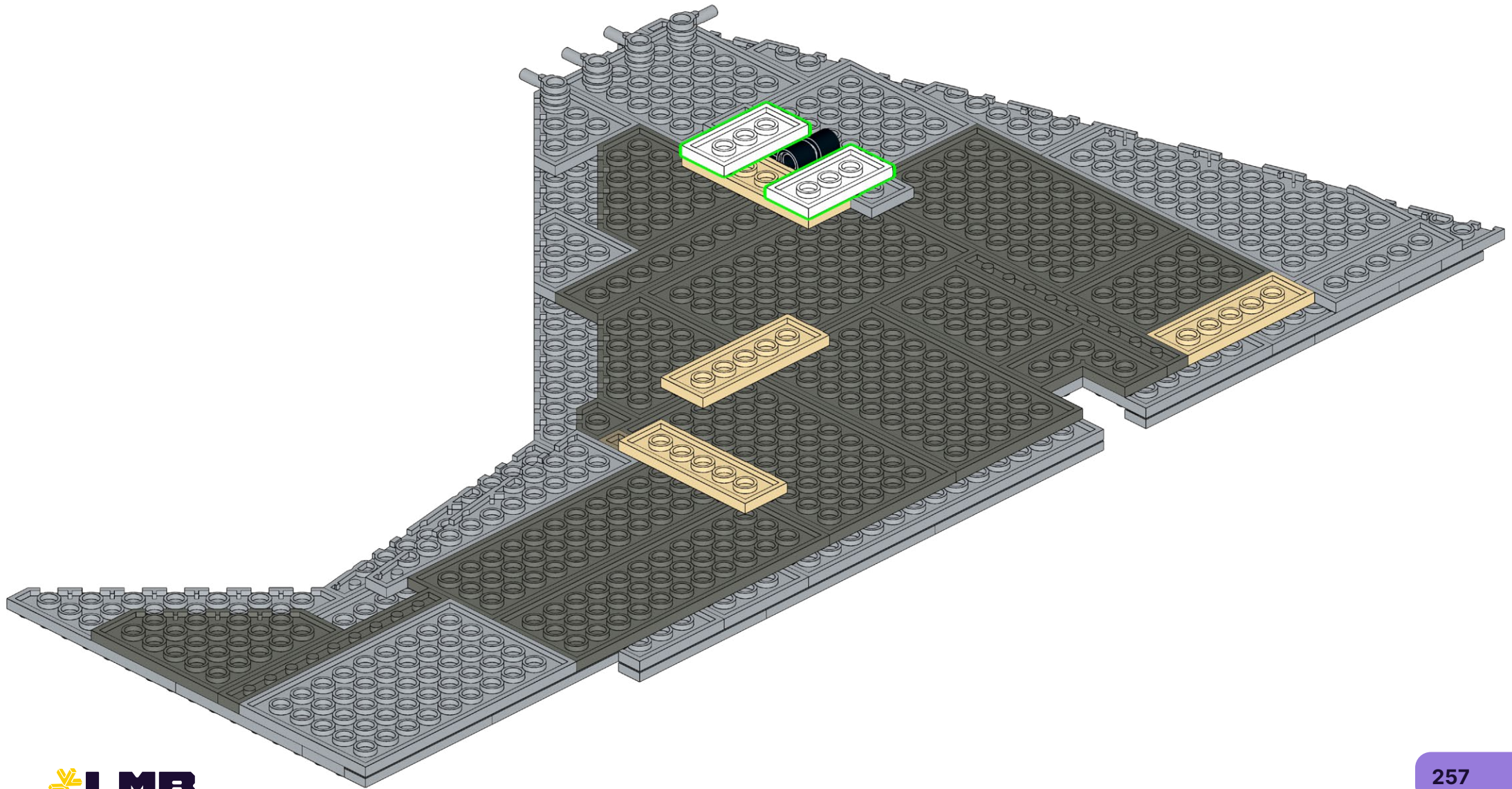
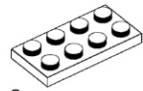

307

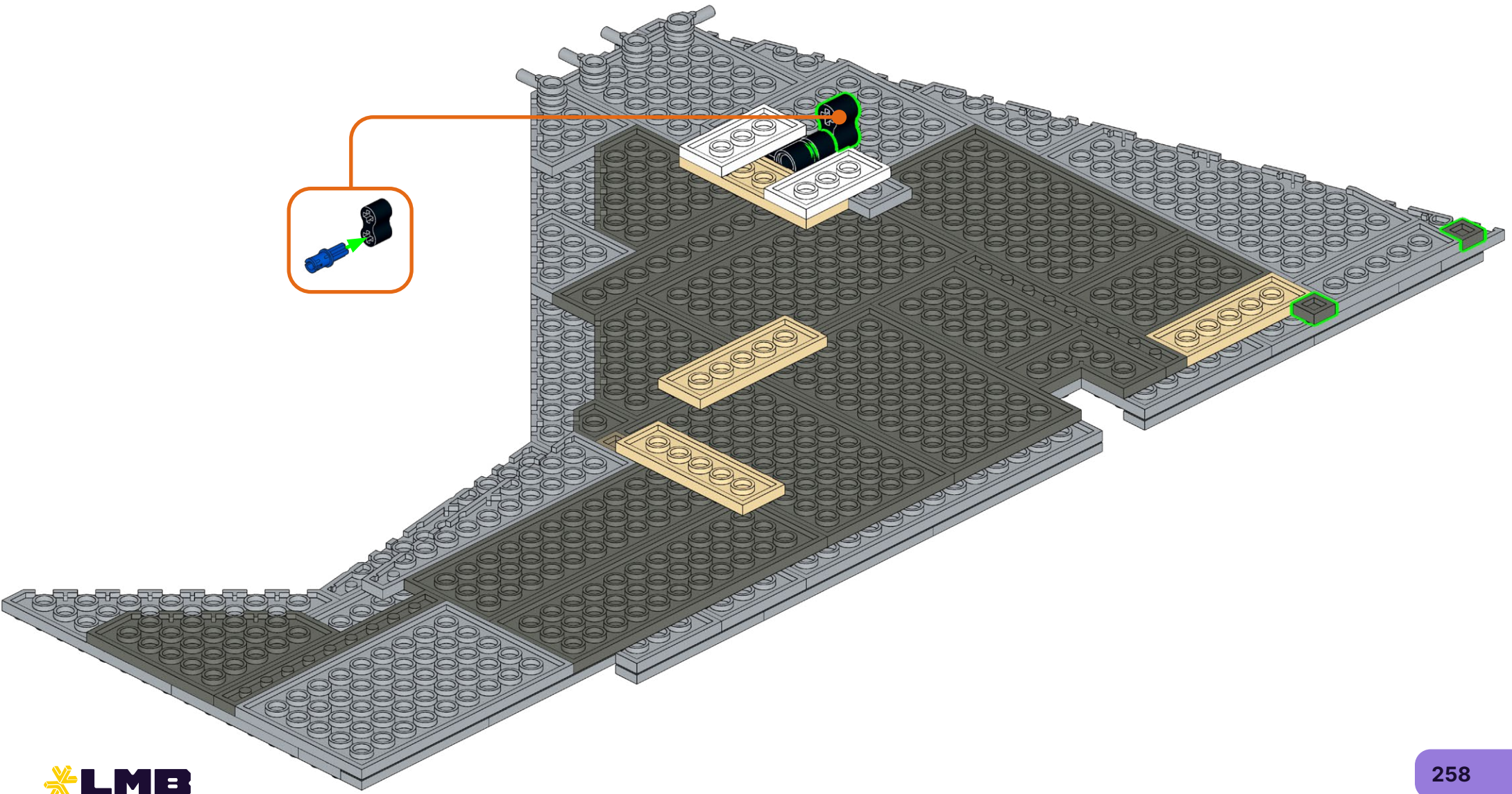

308

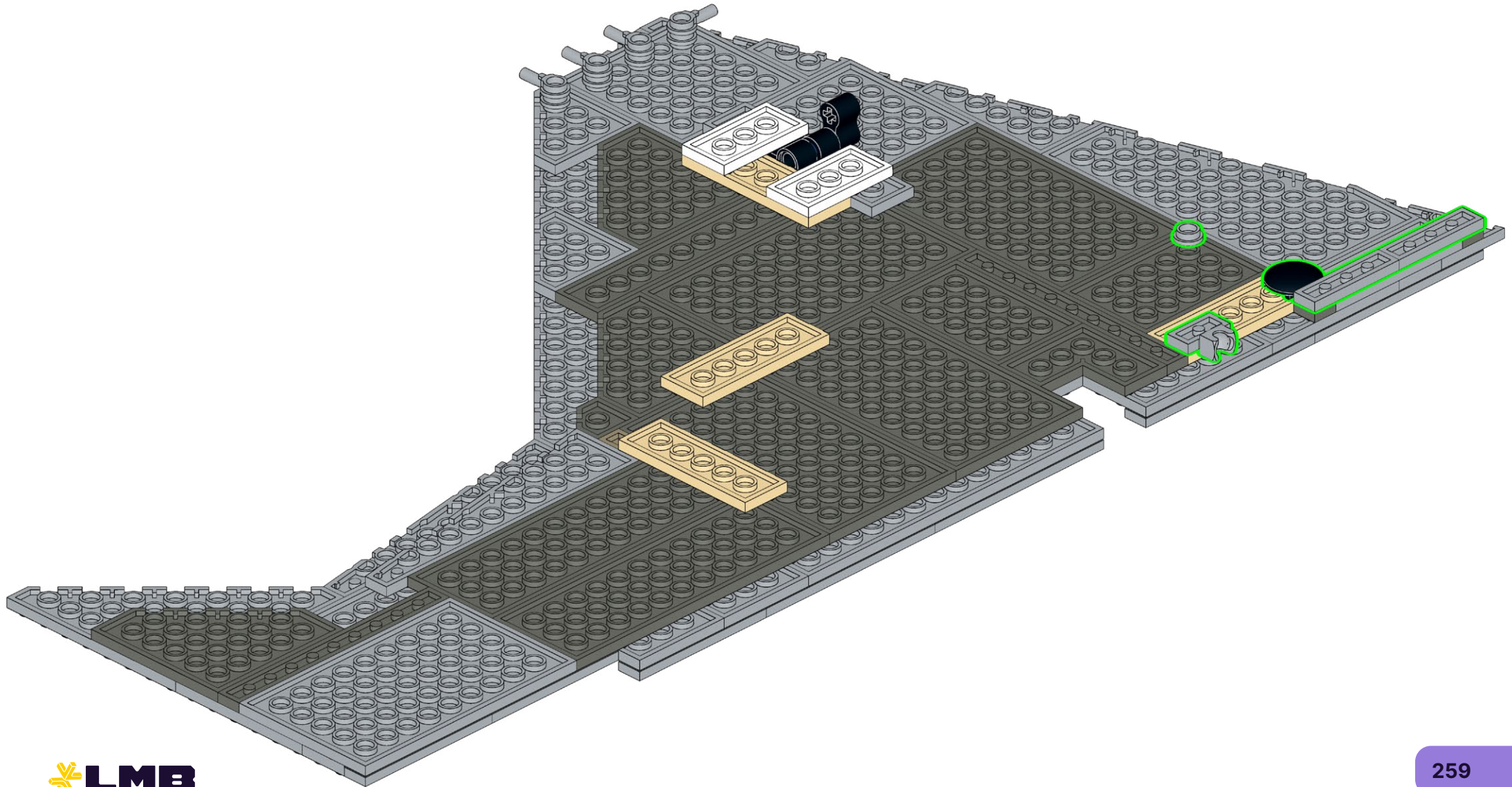
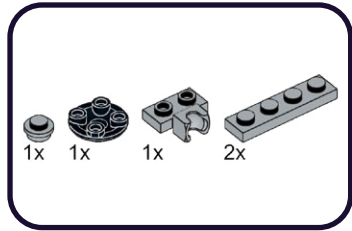

309

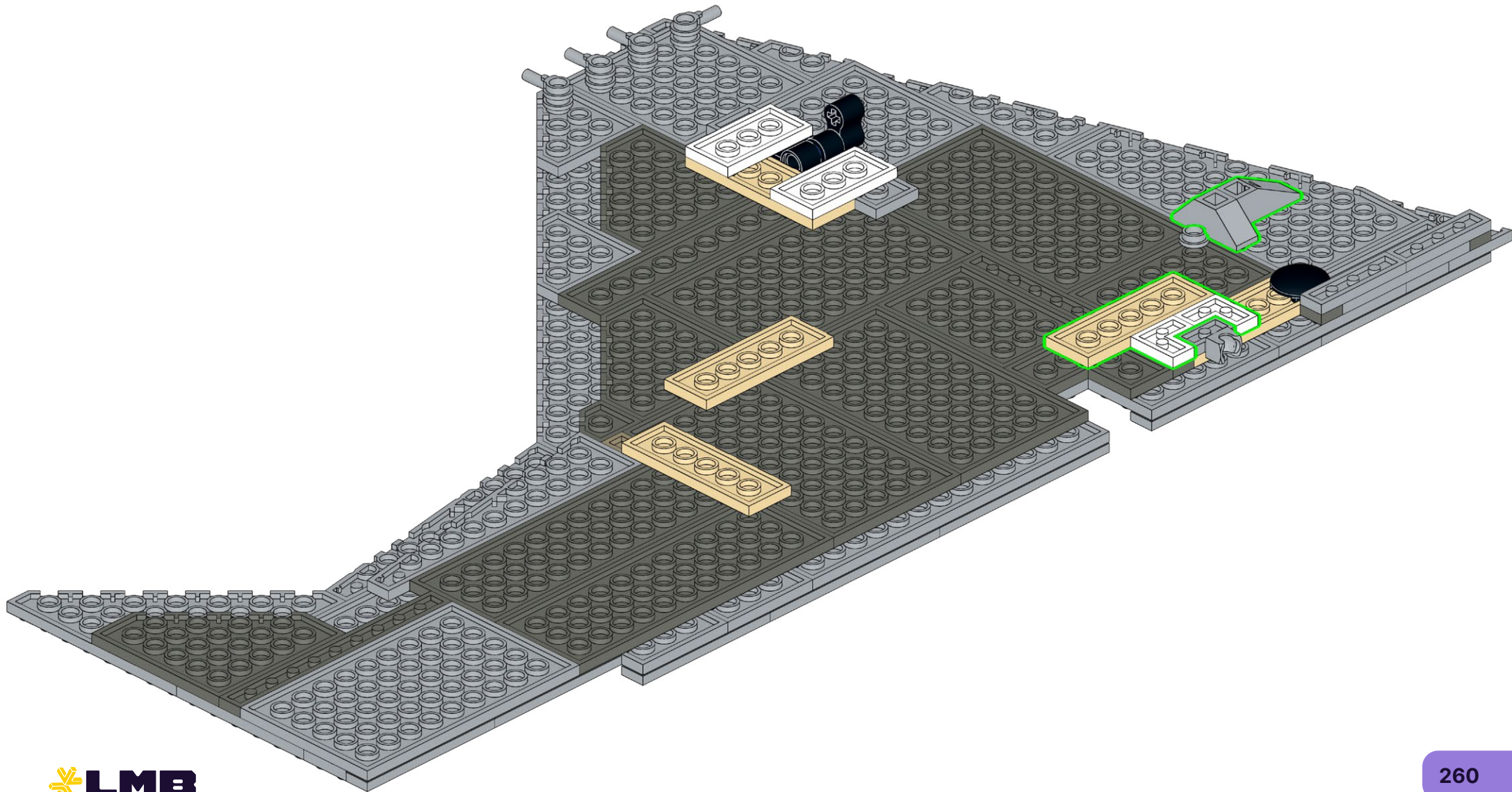
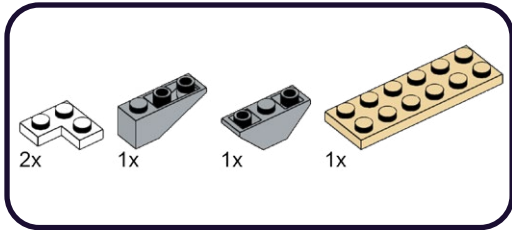

310

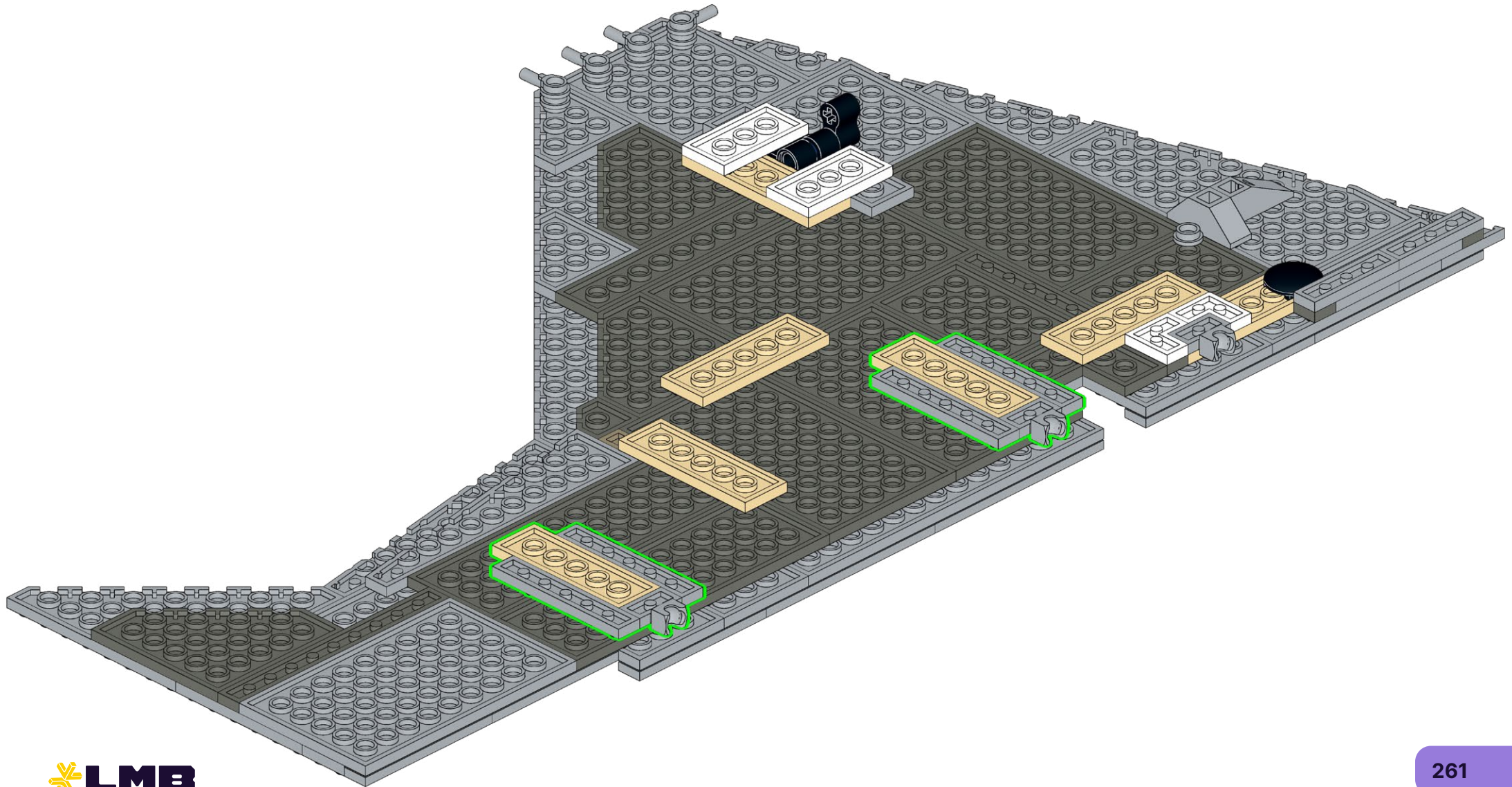
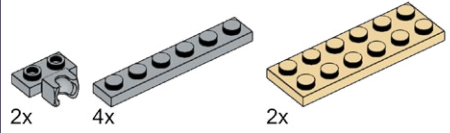

311

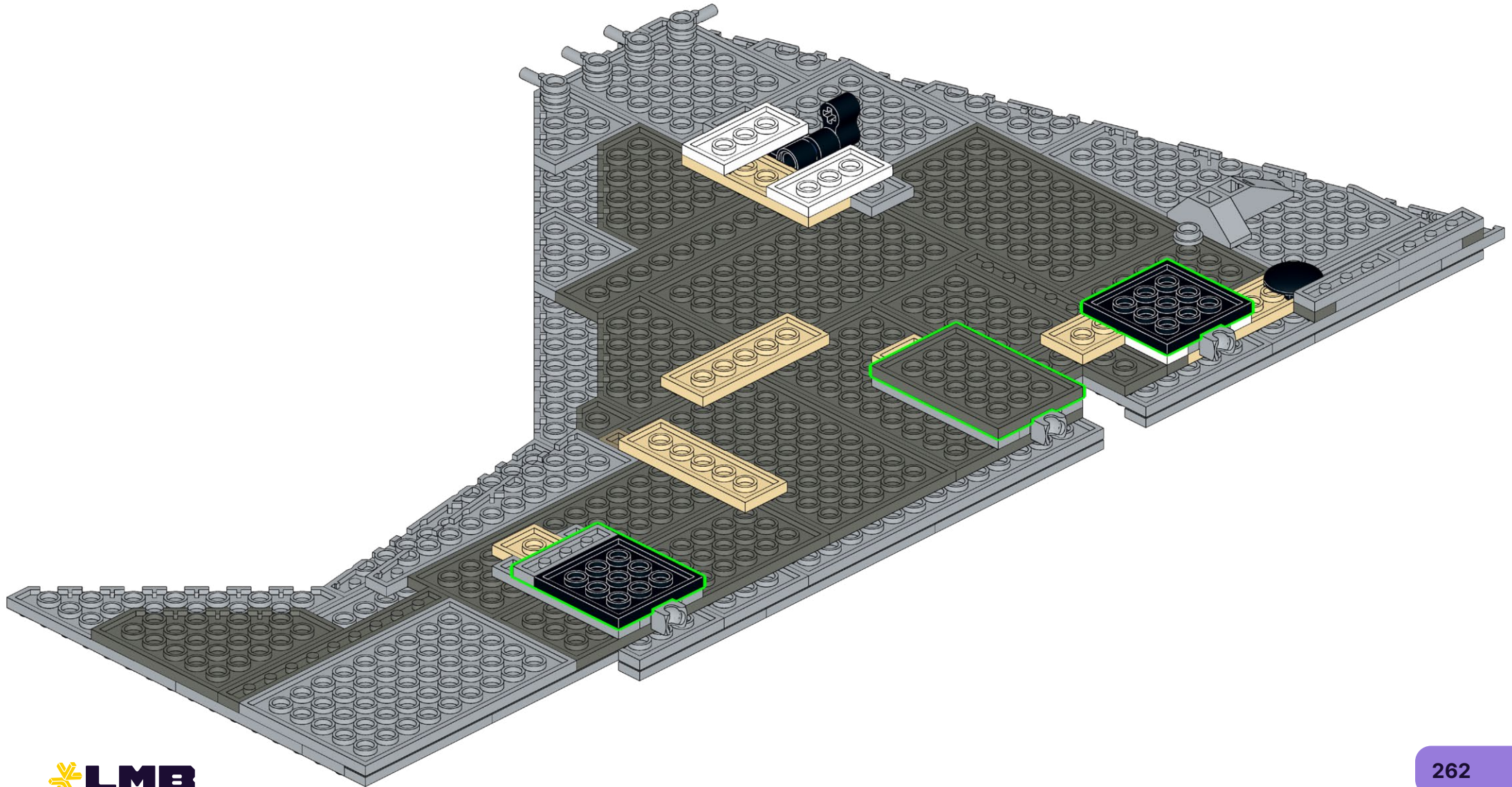
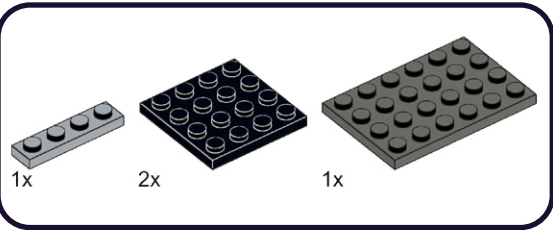

312

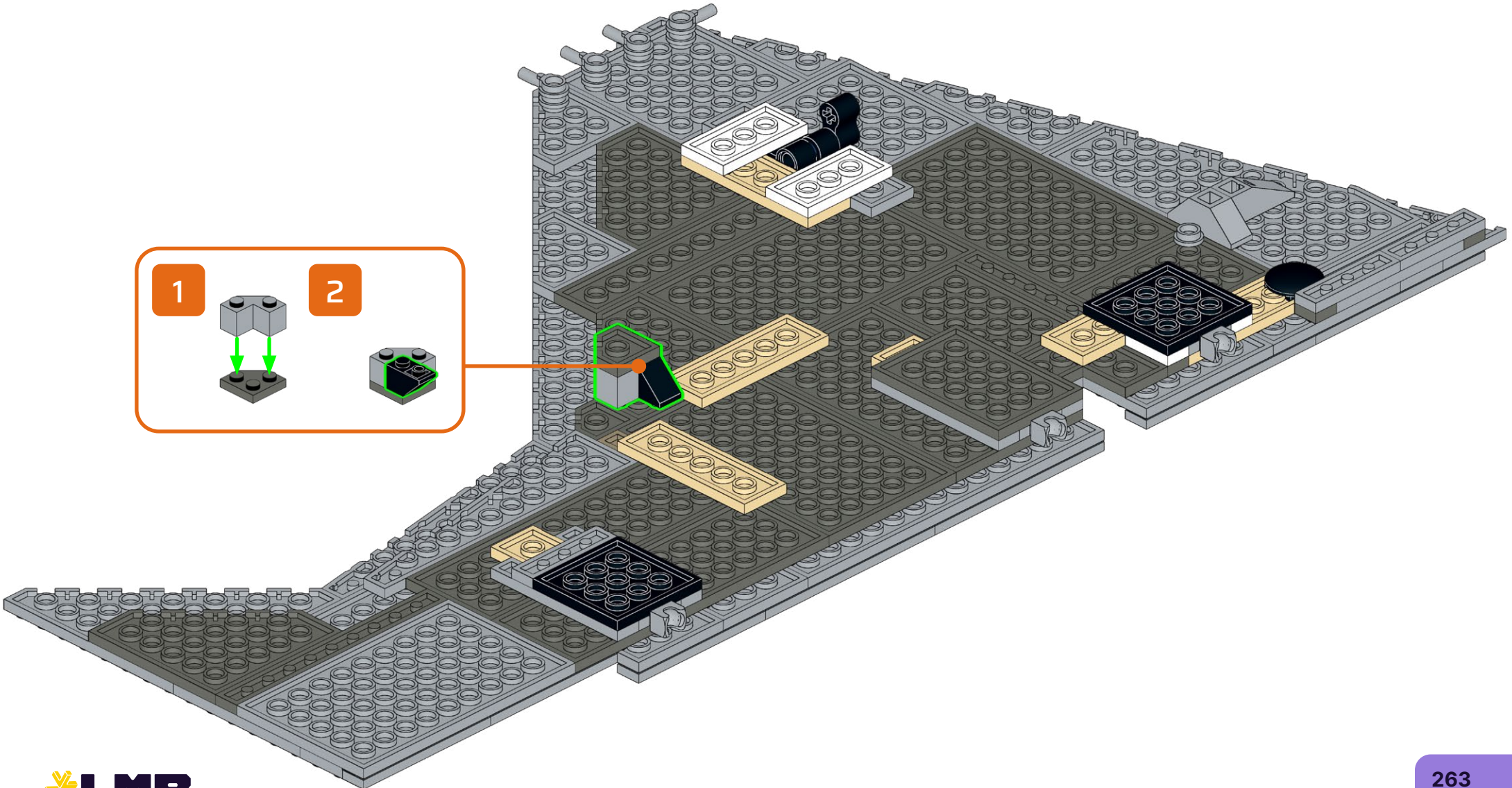
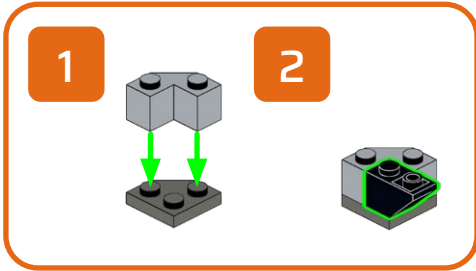
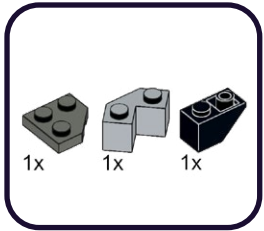

313

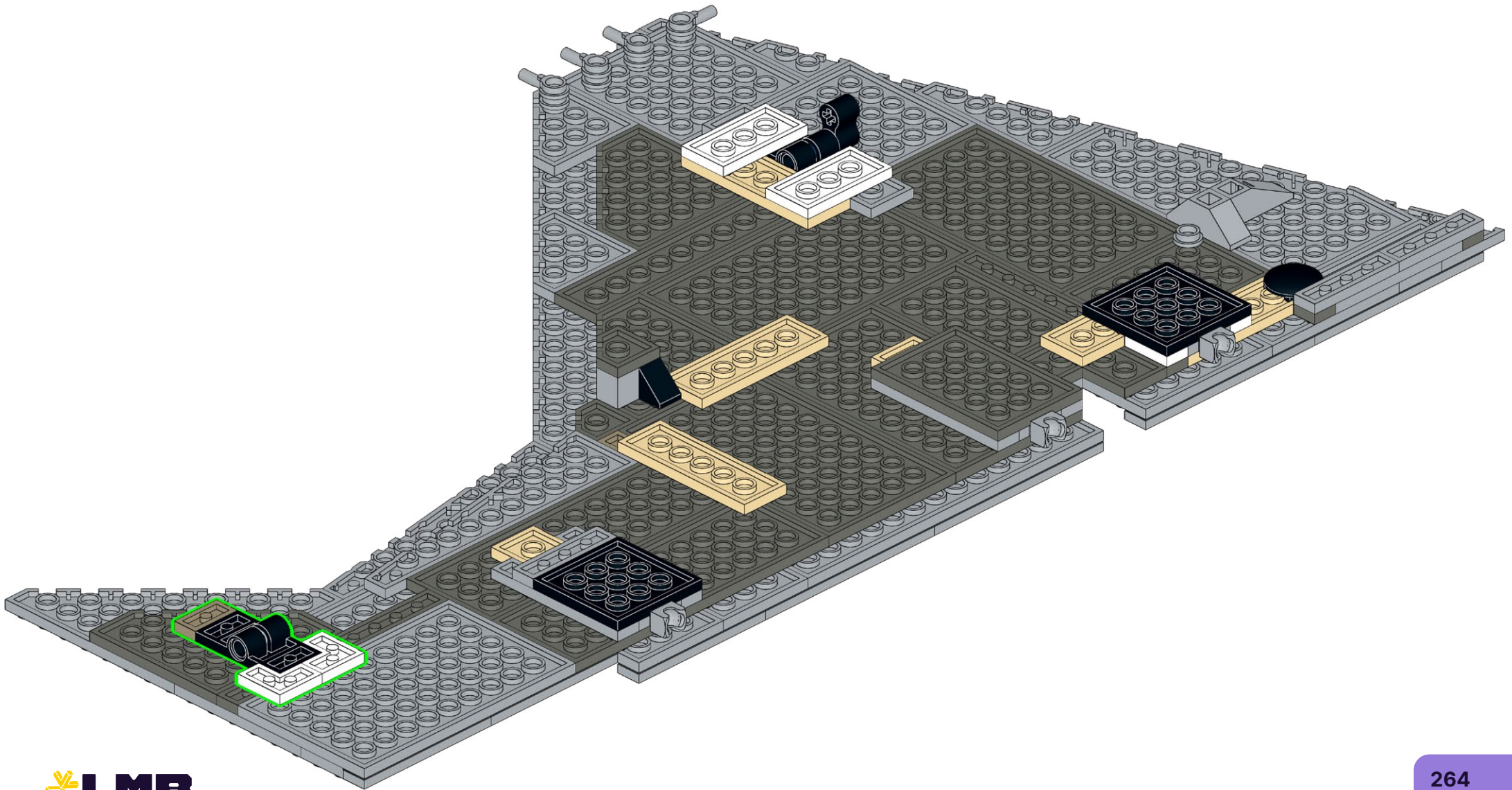
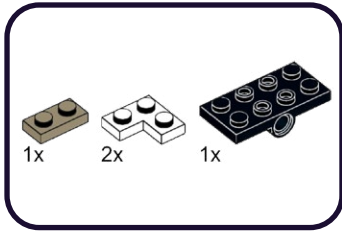

314

3x

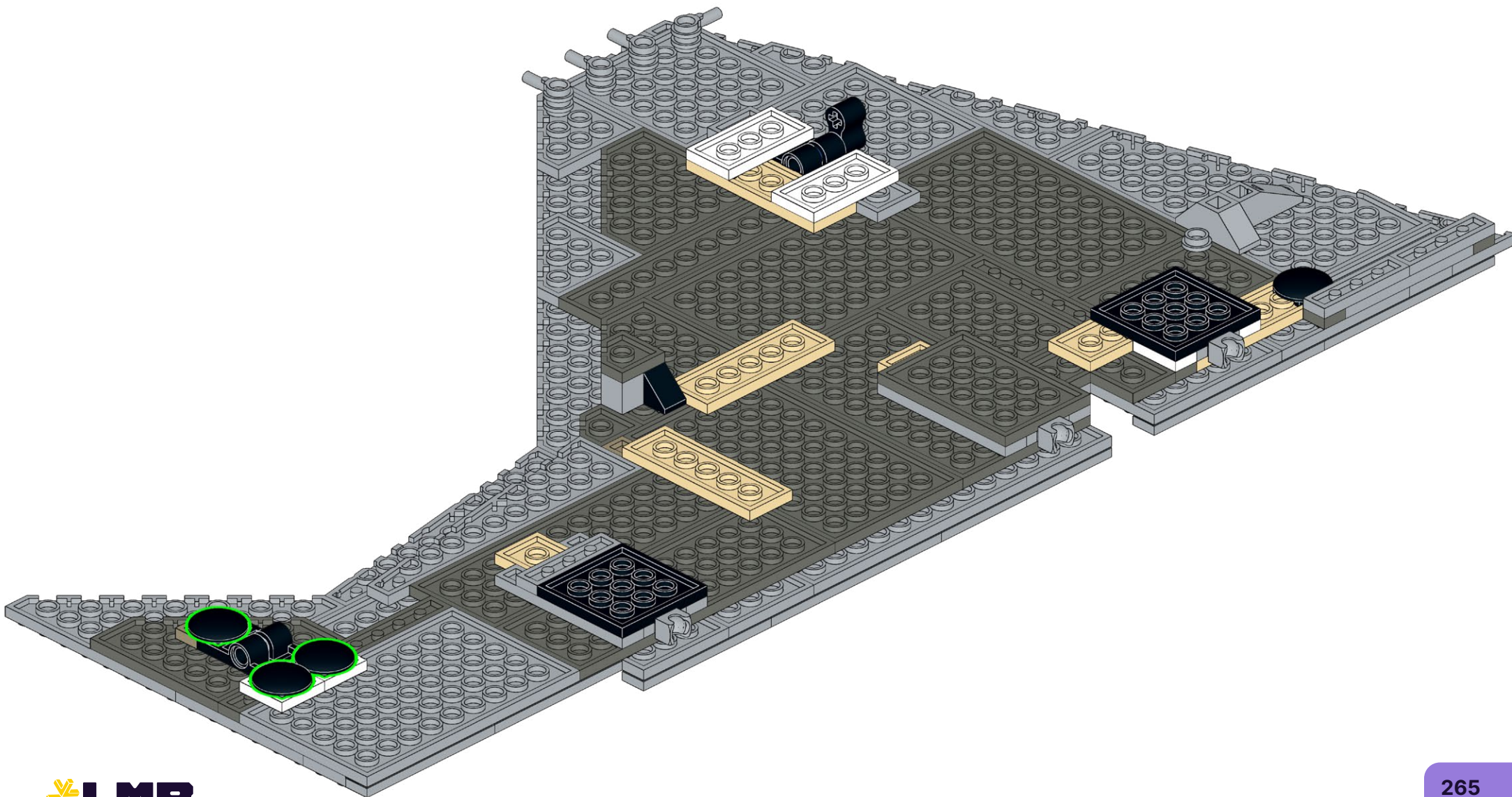

315

1x 1x

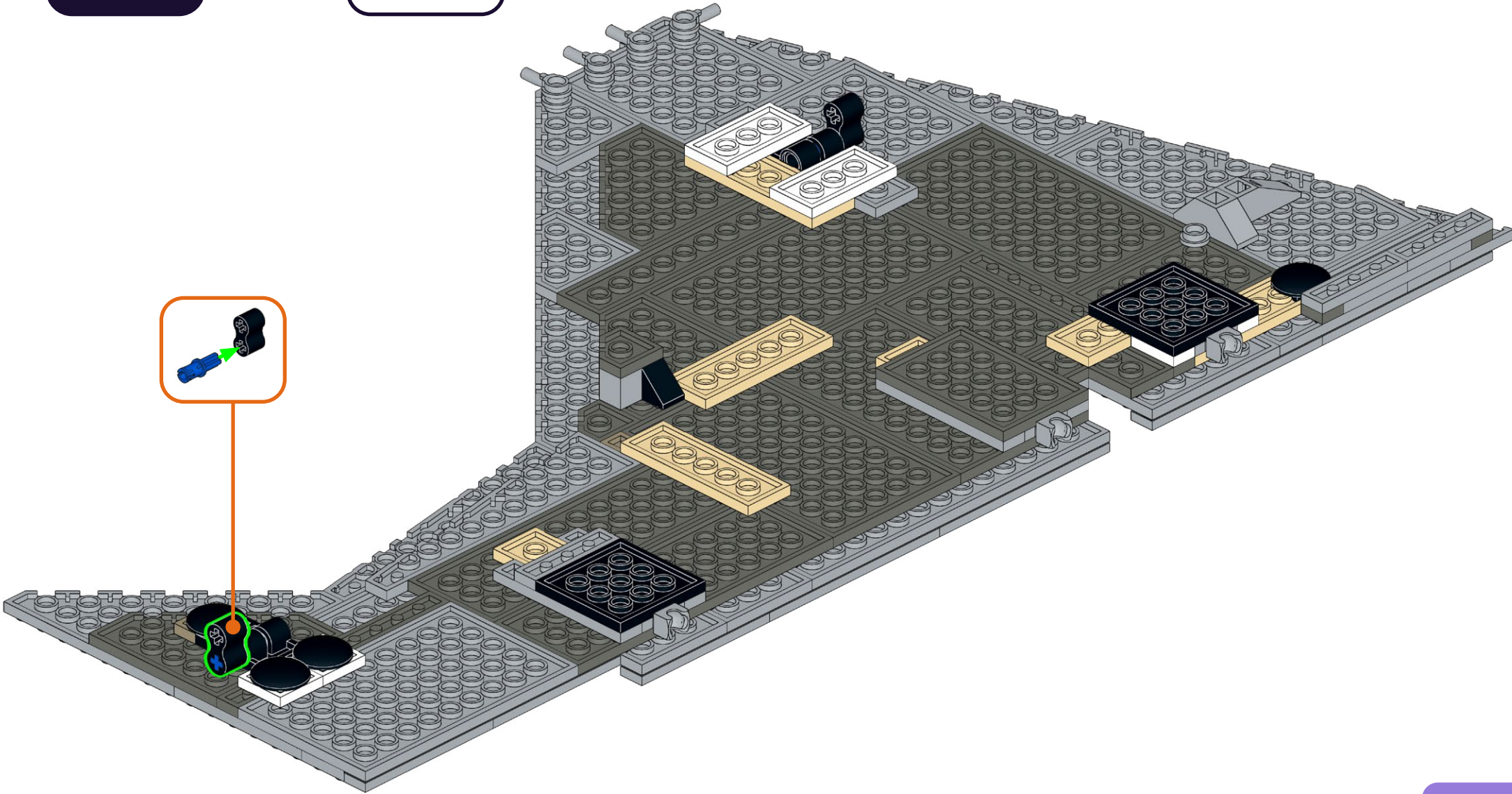
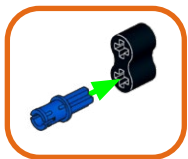

316

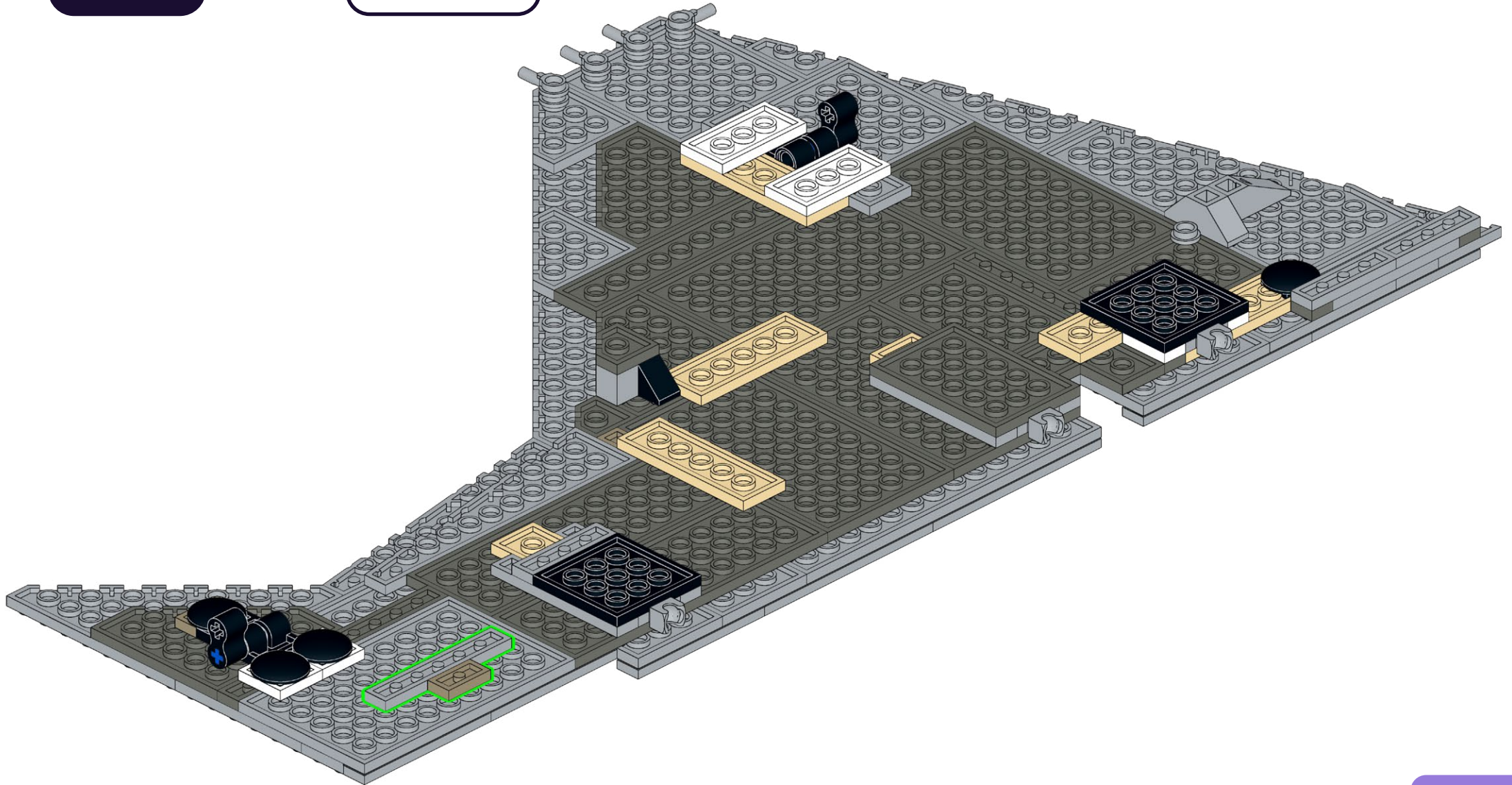
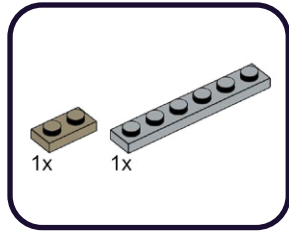

317



2x

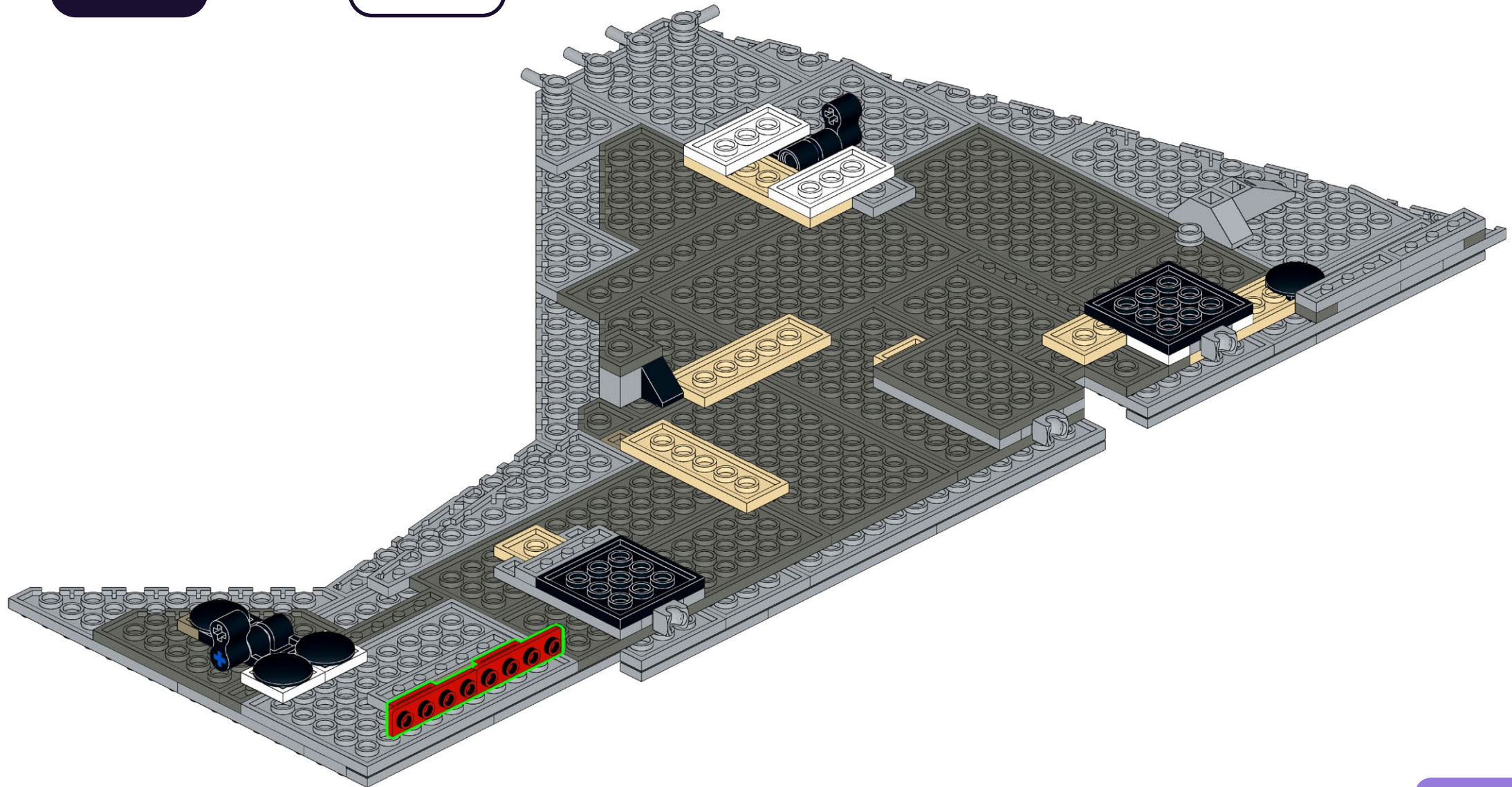

318

1x

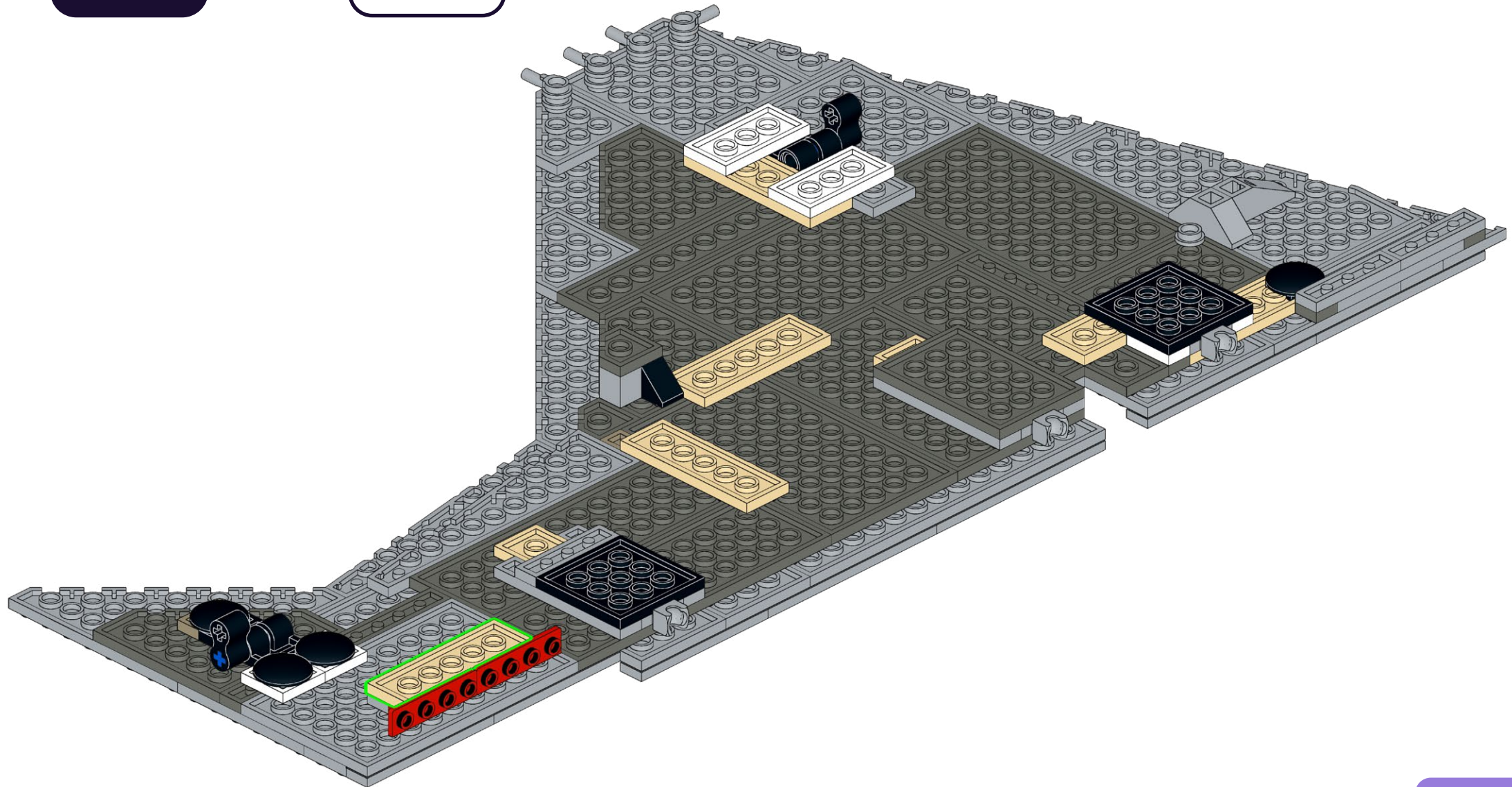

319

2x

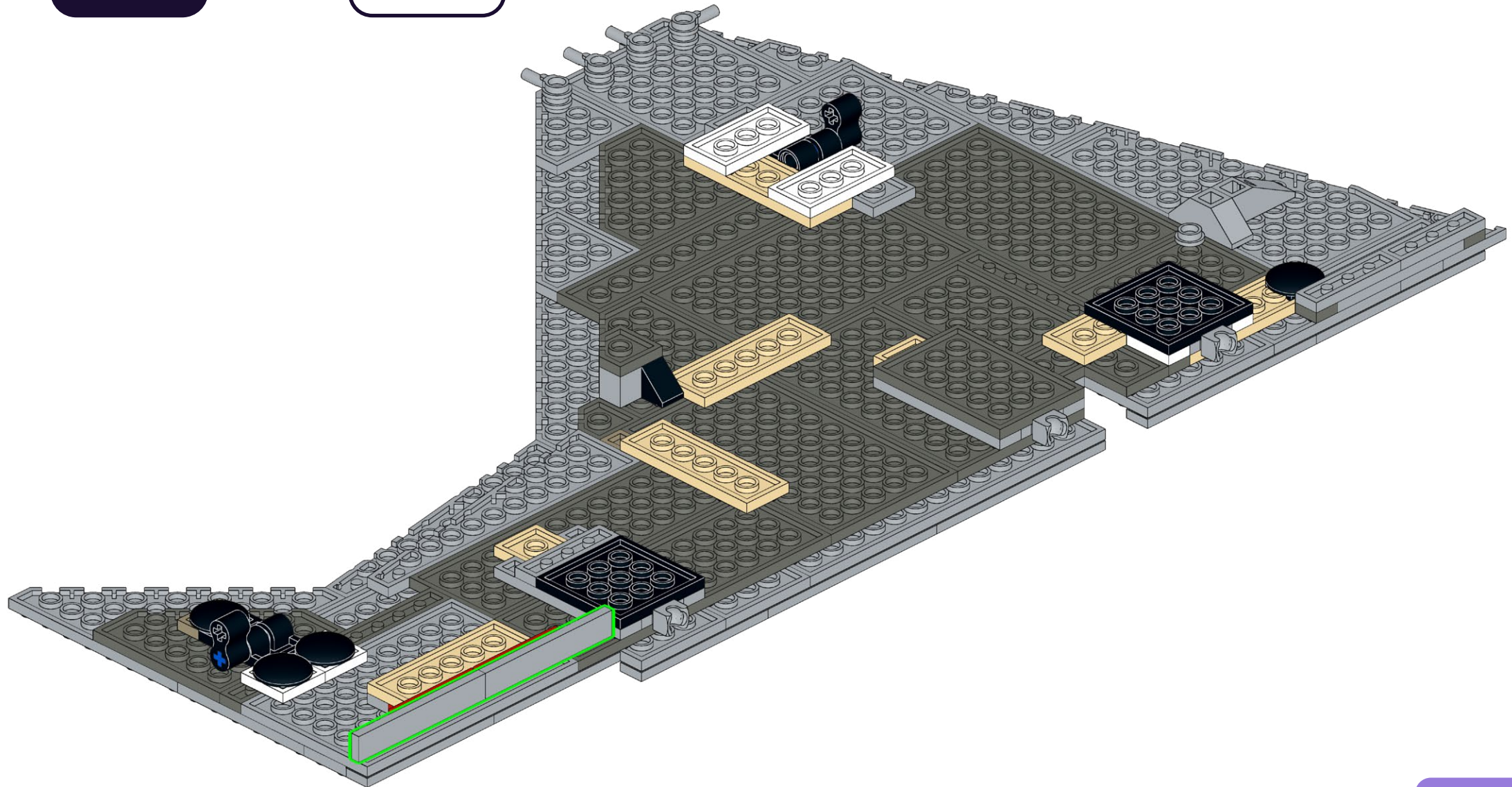

320

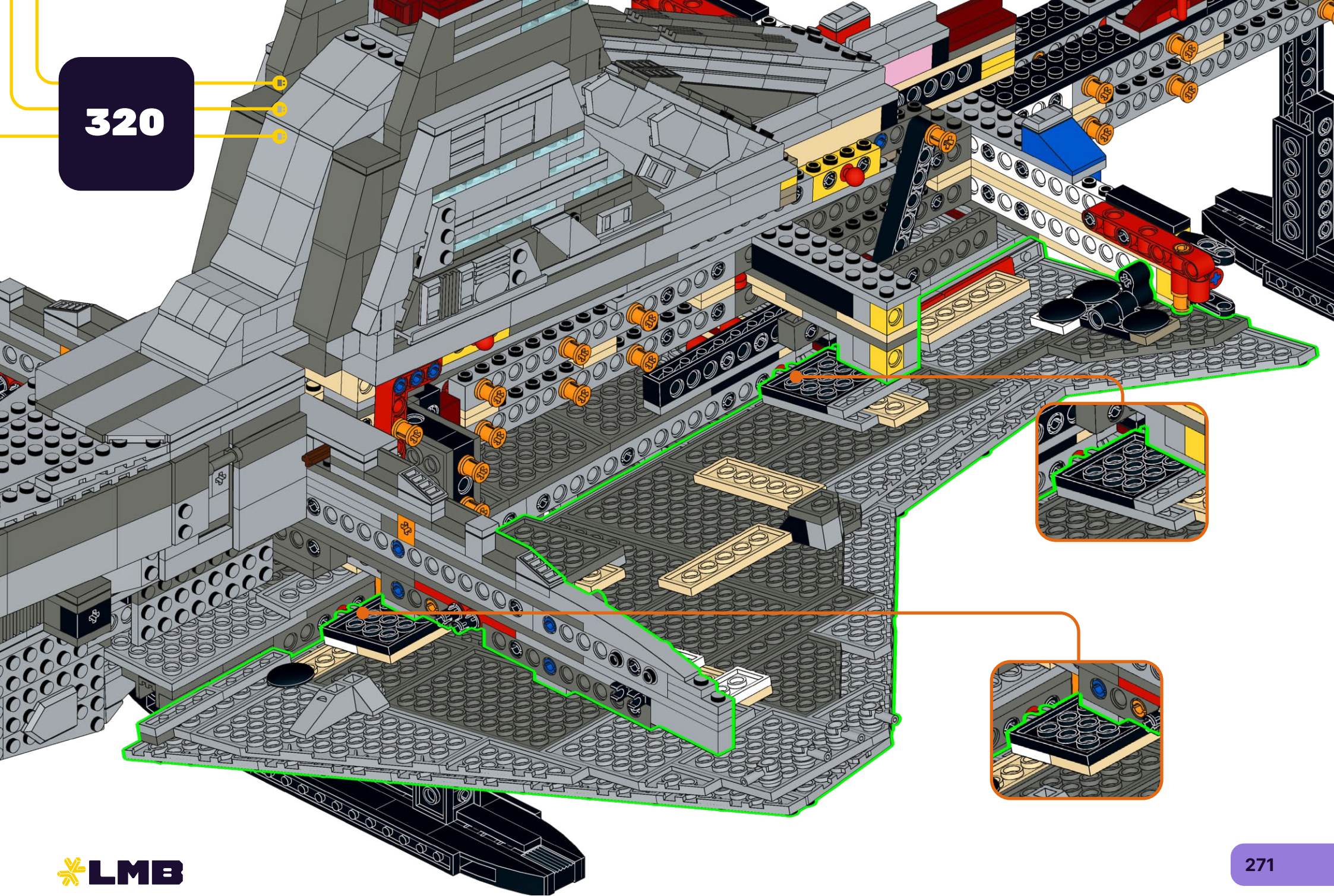

321

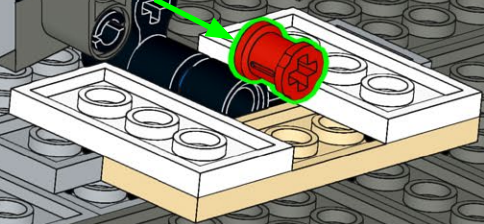
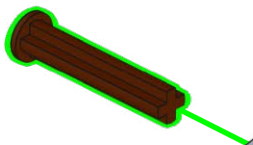
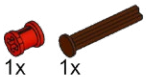

322

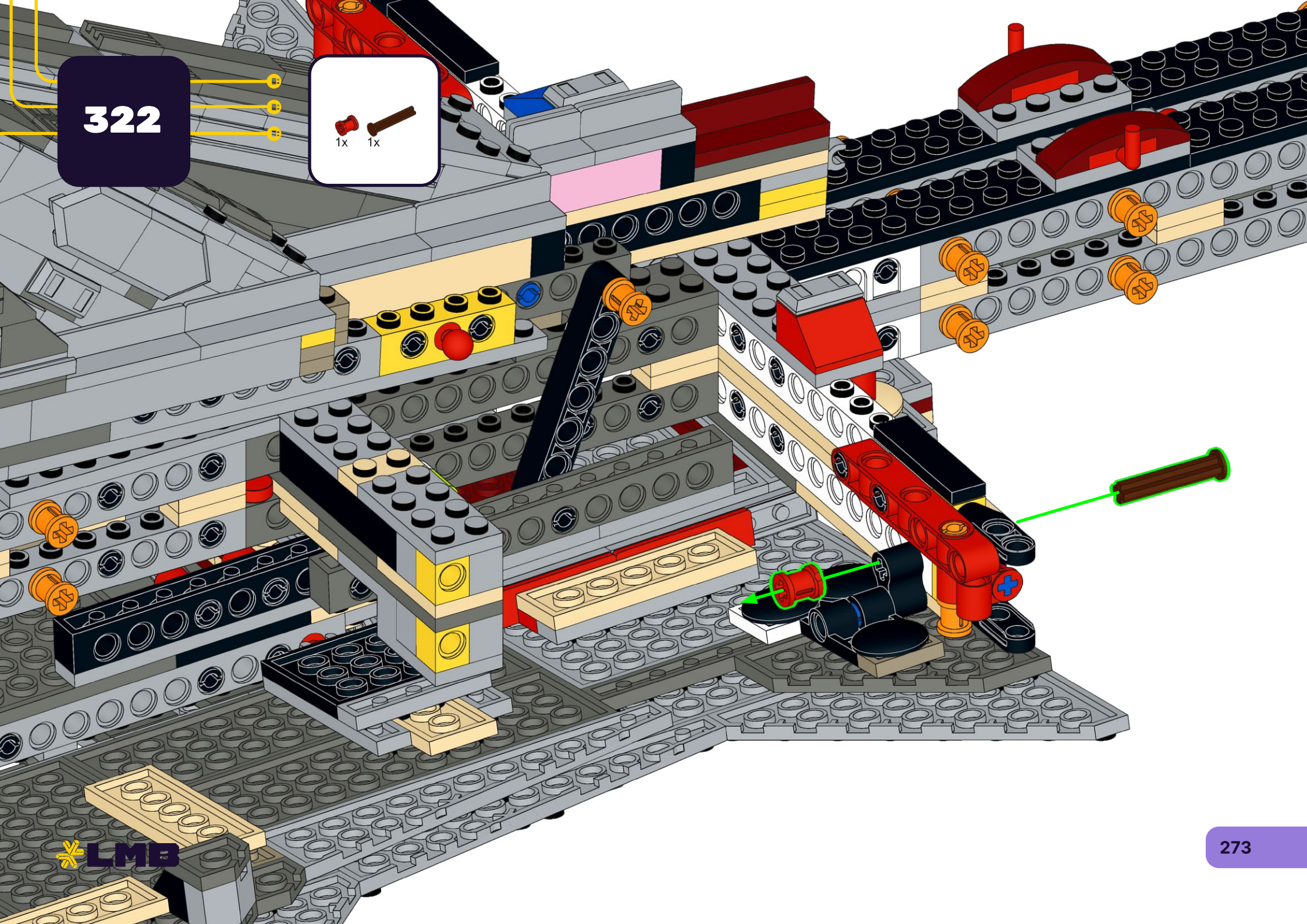
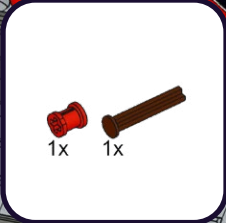

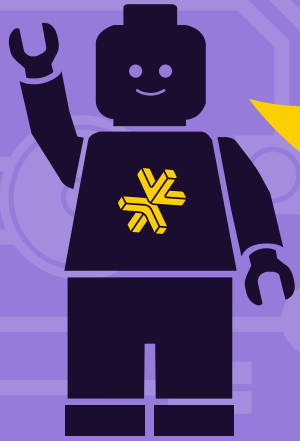
**HOLD UP!**

You might notice some bags aren't in order, as well as left over pieces, but that's ok! We're changing the way you build LEGO!

ATTENDEZ!

Vous remarquerez peut-être que certains sacs, ainsi que certaines pièces, ne sont pas dans le bon ordre. Mais pas de panique! Nous changeons simplement la façon avec laquelle vous construisez vos LEGO!

ASPETTA!

Potresti notare che alcuni sacchetti non sono in ordine, così come i pezzi avanzati, ma va bene così! Stiamo cambiando il modo in cui costruisci i LEGO!

HALT!

Sie werden möglicherweise bemerken, dass einige tüten durcheinander sind und teile übrig bleiben, aber das ist in Ordnung! Wir ändern die art und weise, wie Sie LEGO bauen!

¡ESPERA!

Es posible que notes que algunas bolsas están fuera de servicio, así como piezas sobrantes, ¡pero está bien! ¡Estamos cambiando la forma en que construyes LEGO!

暫停!

你可能会注意到一些袋子顺序错乱, 以及一些剩余的部件, 但没关系! 我们正在改变你搭建乐高的方式!

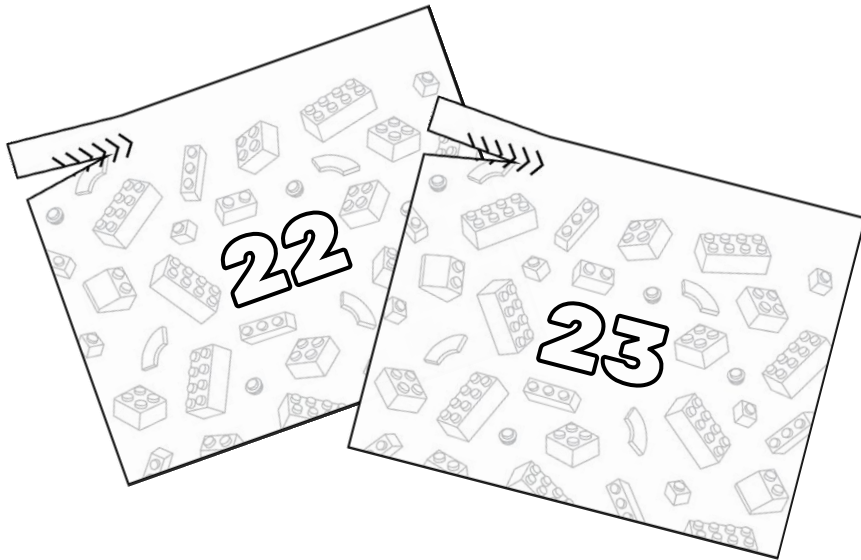
Open LEGO® Bags 22 & 23

325

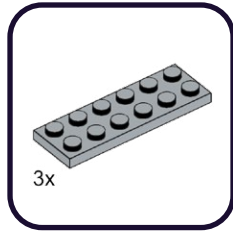

326

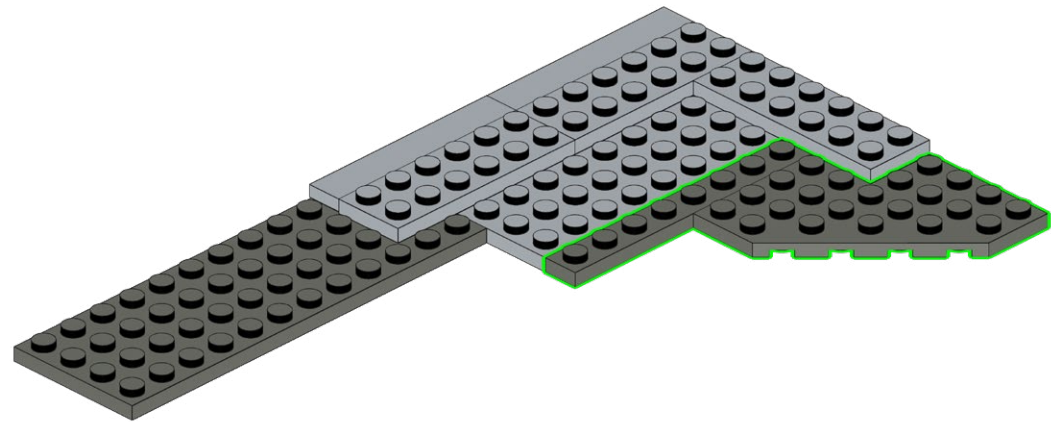
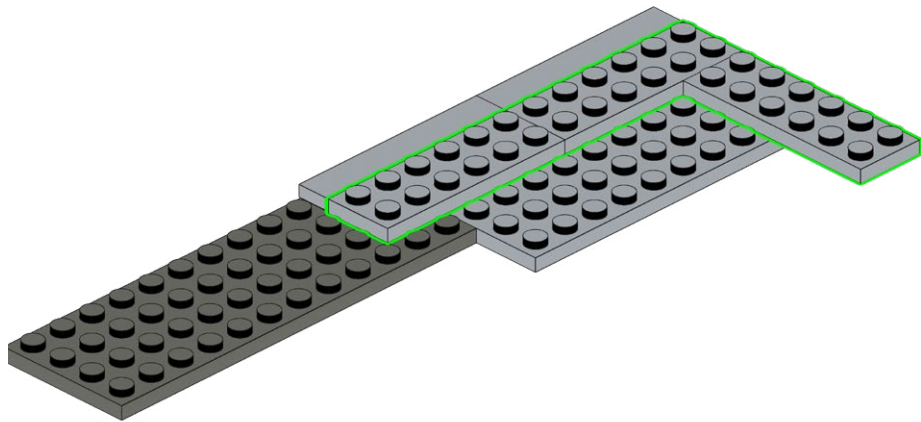
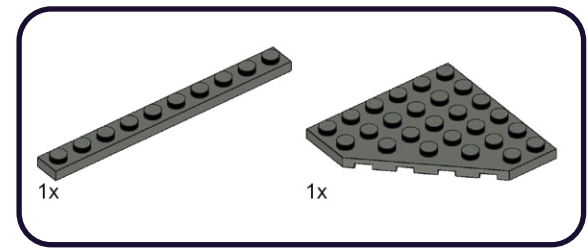

327

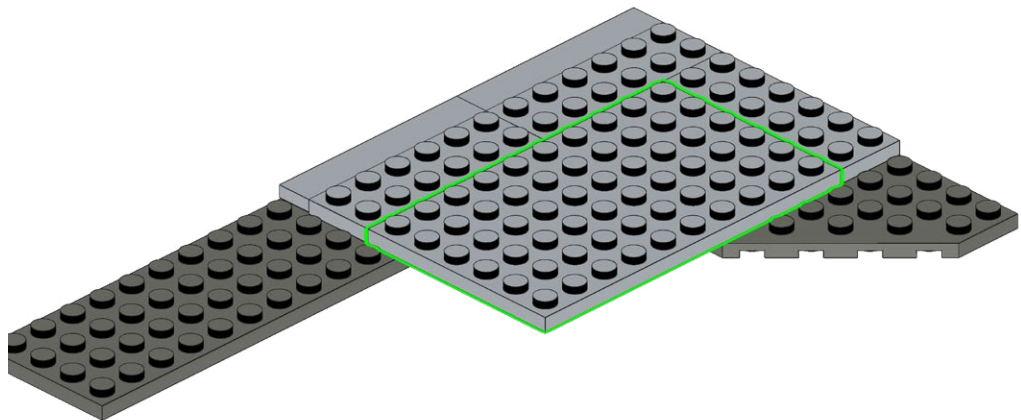
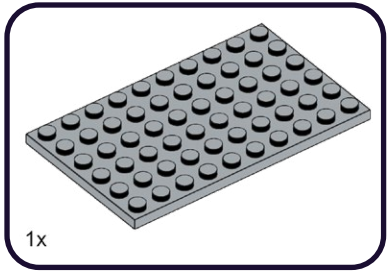

328

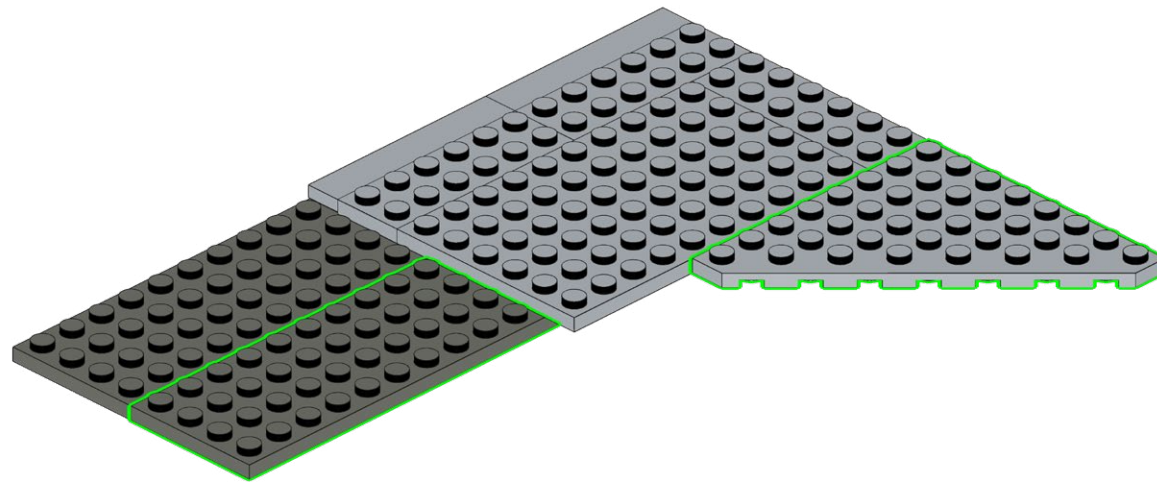
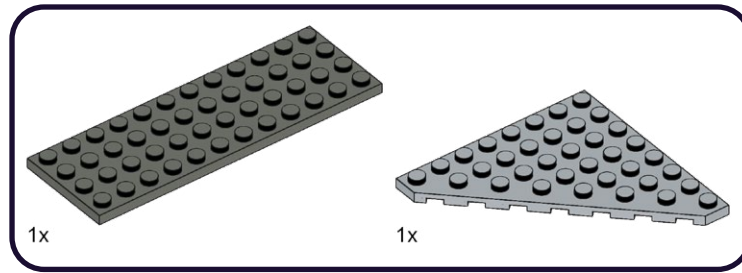

329

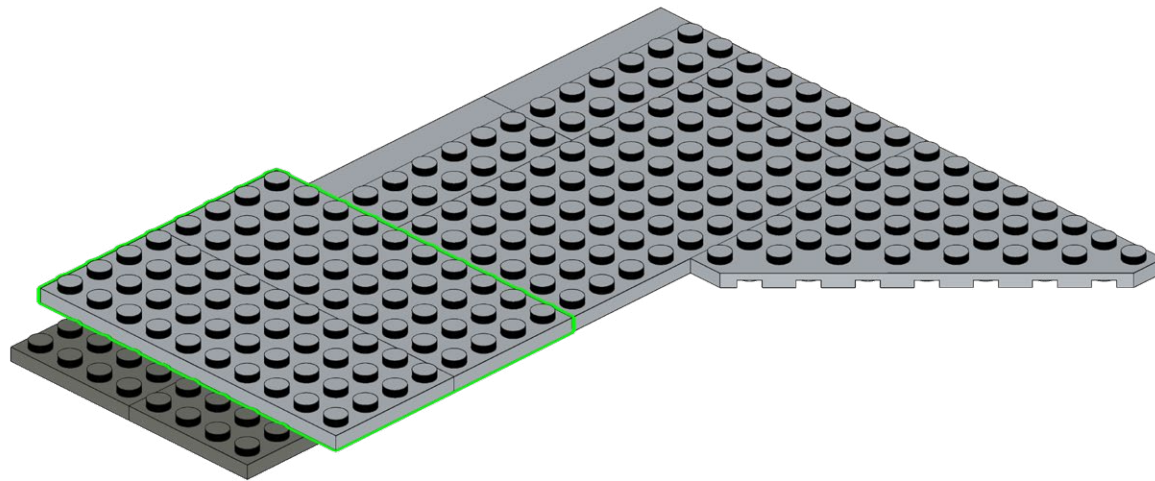
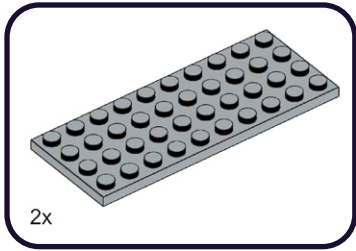

330

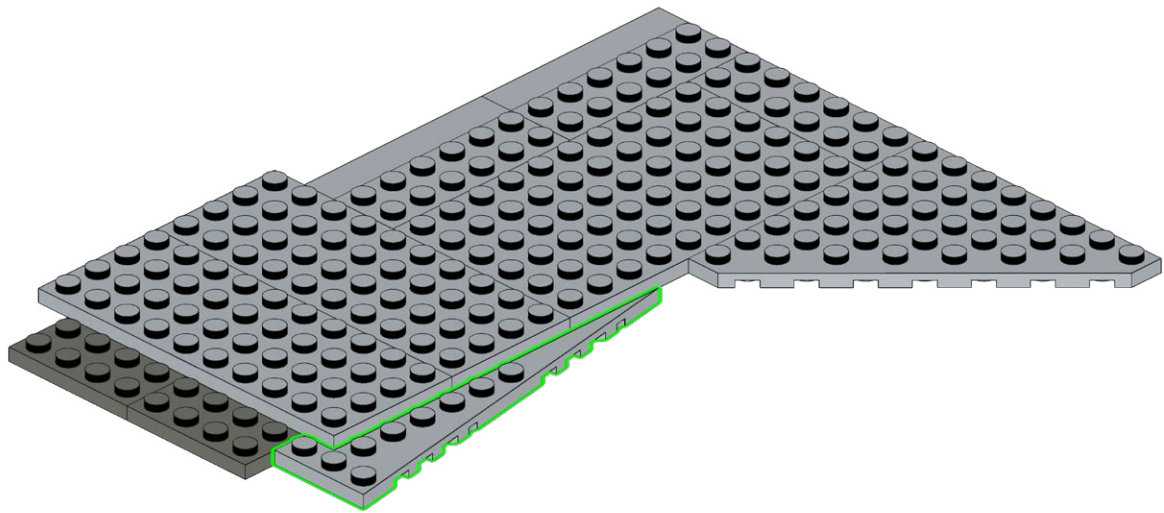
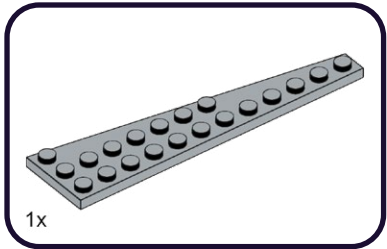

331

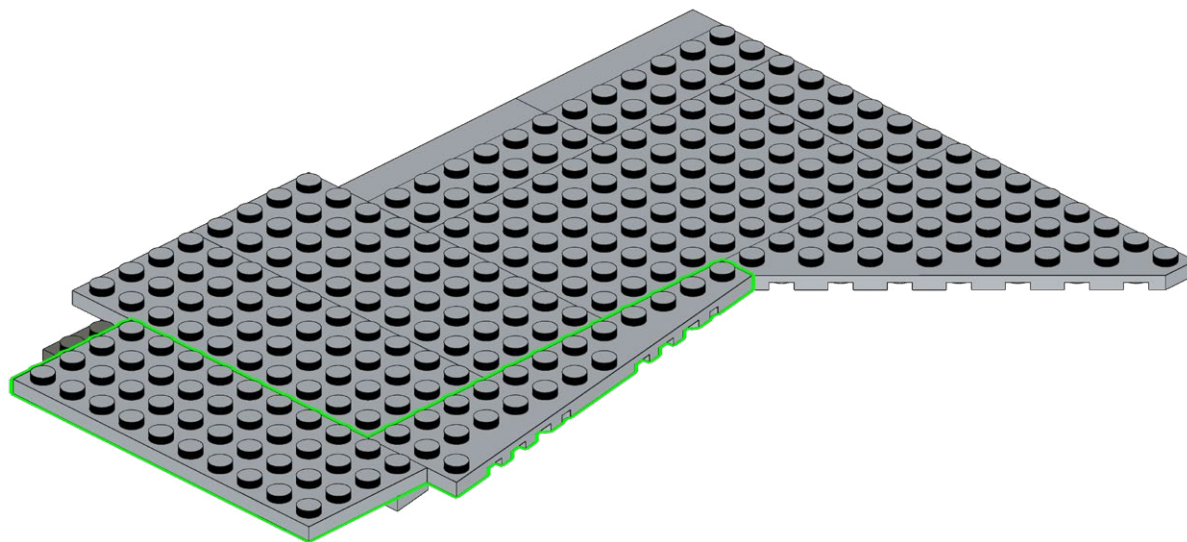
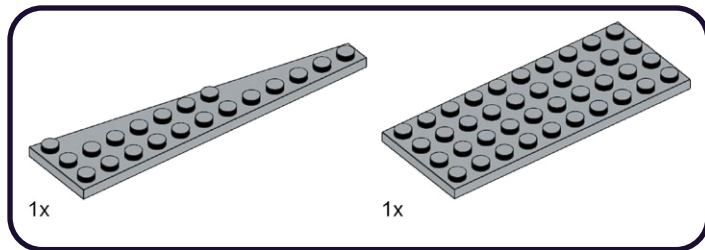

332

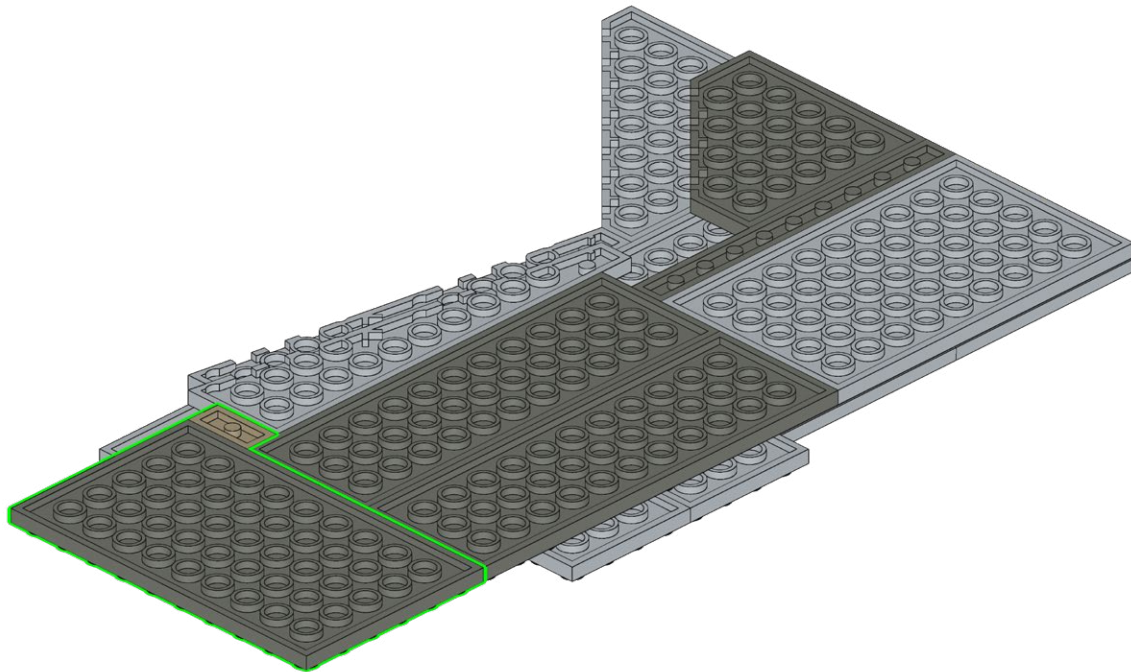
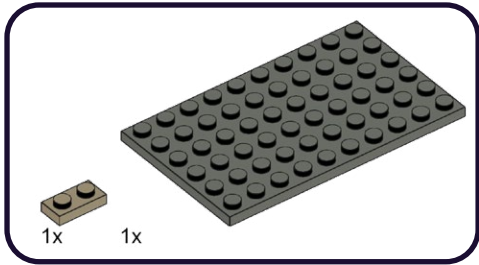

333

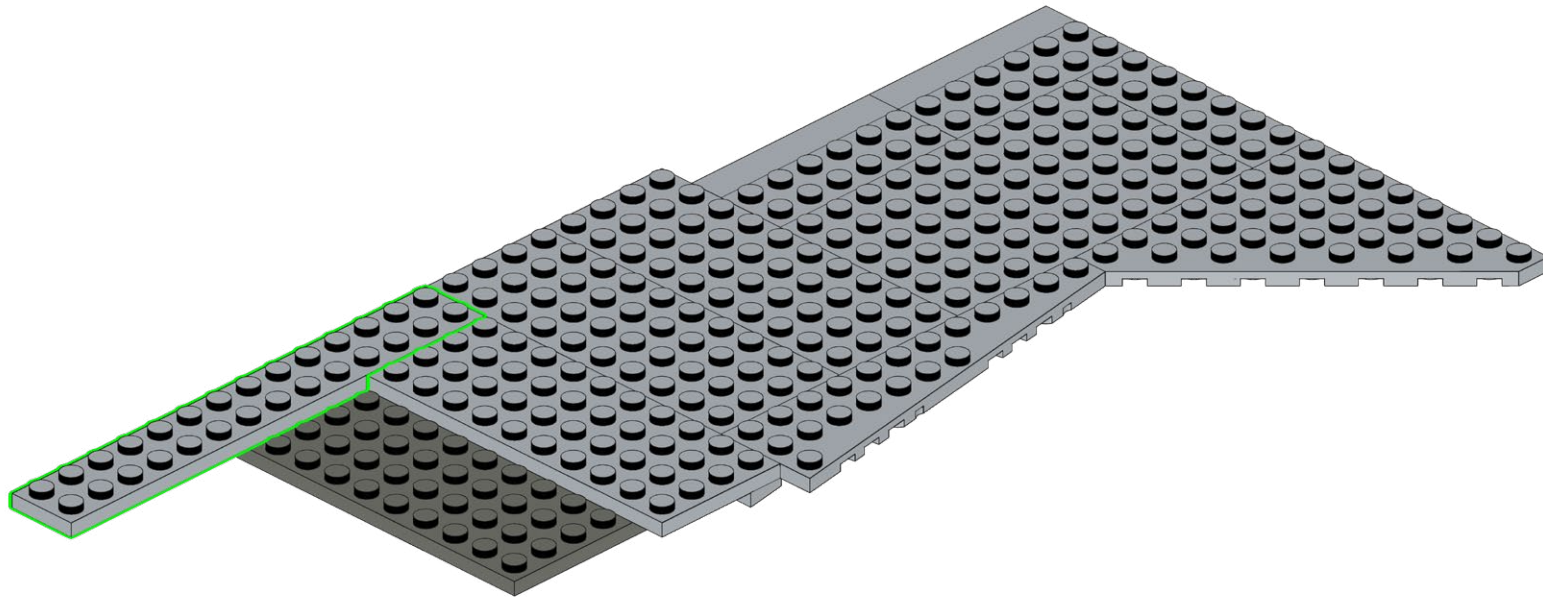
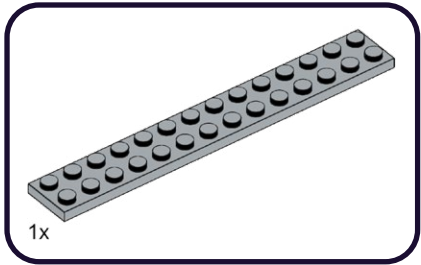

334

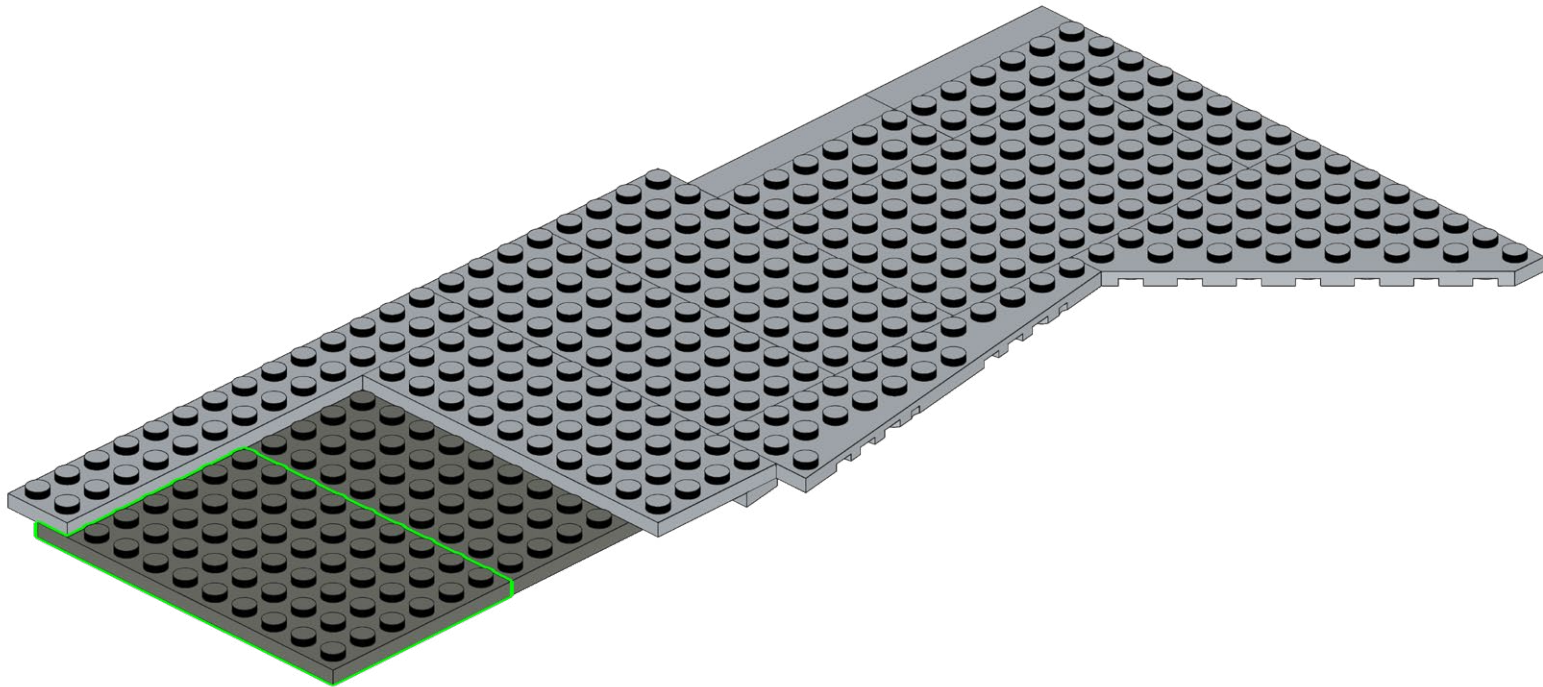
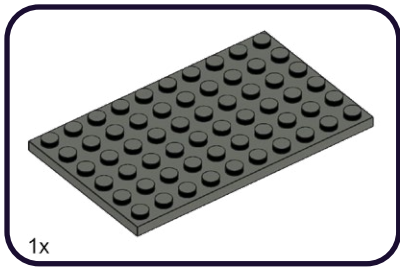

335

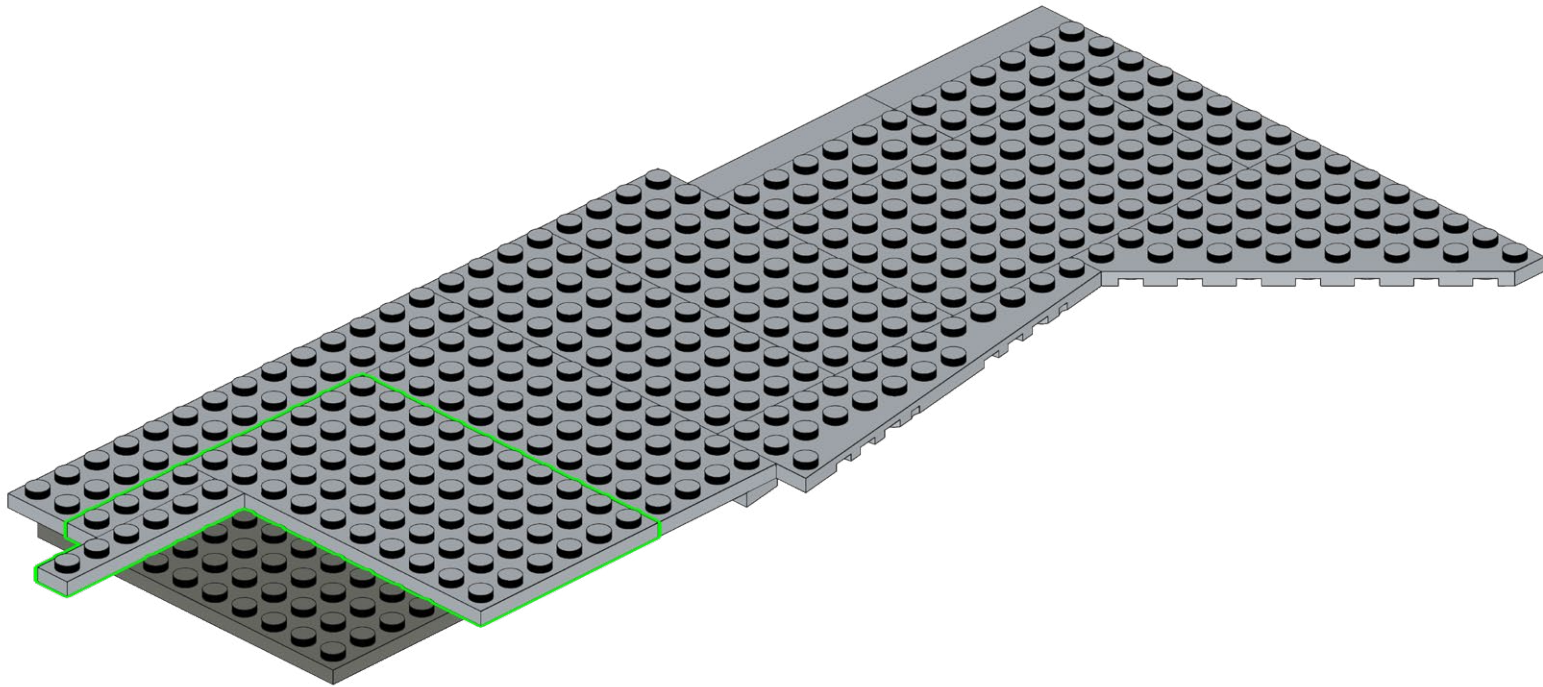
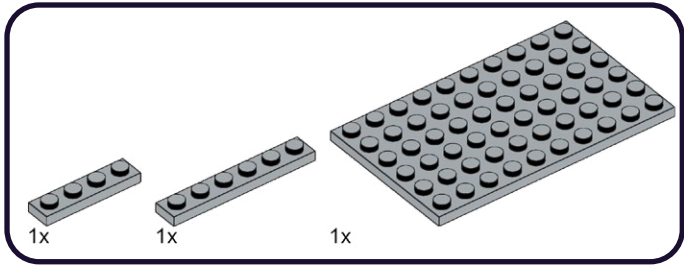

336

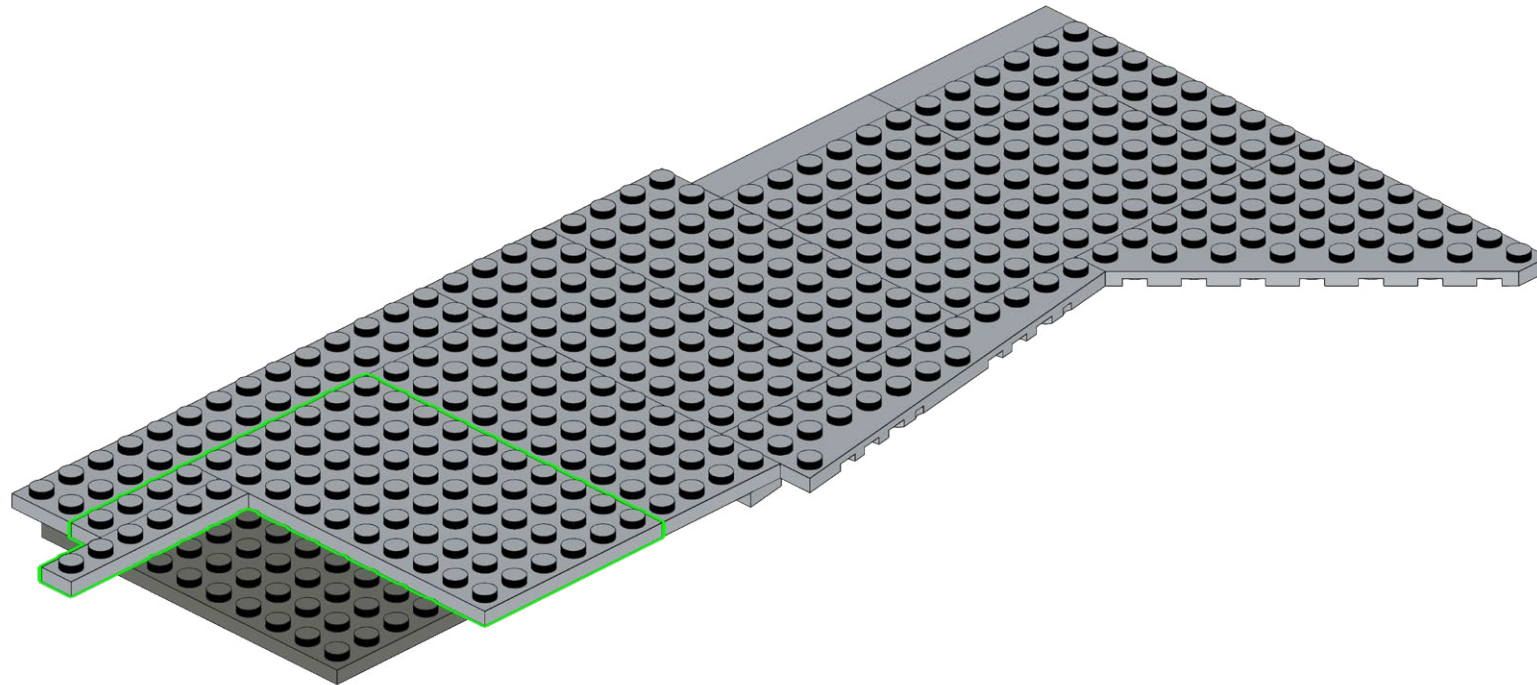
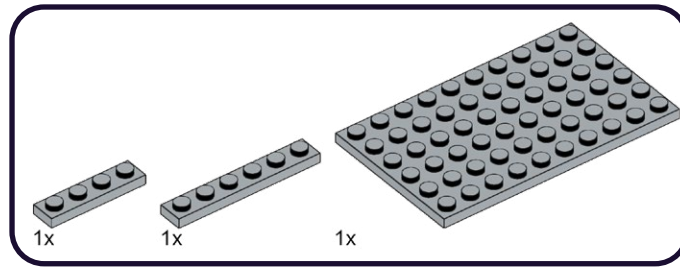

337

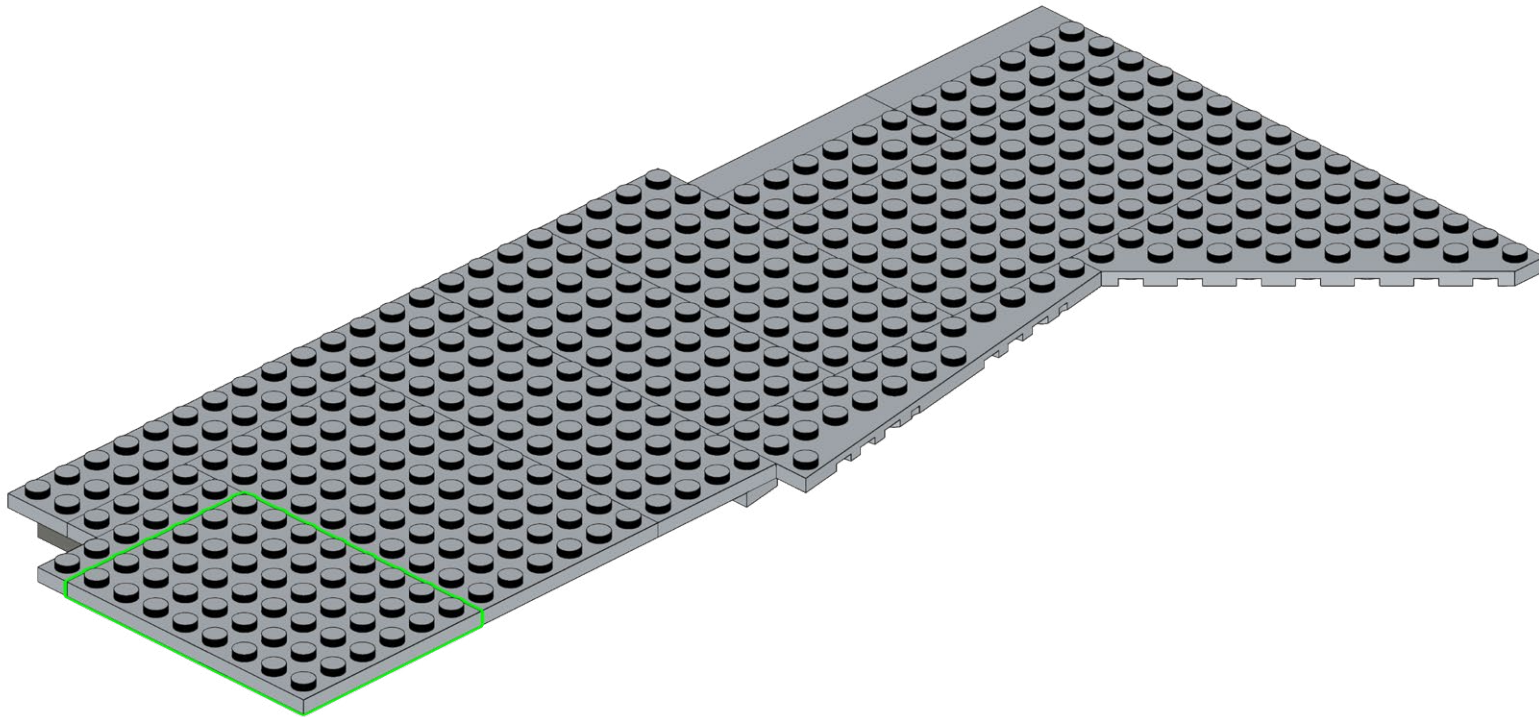
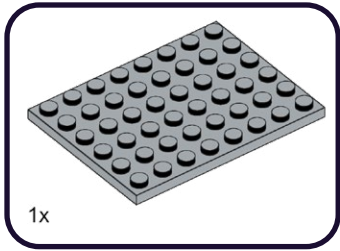

338

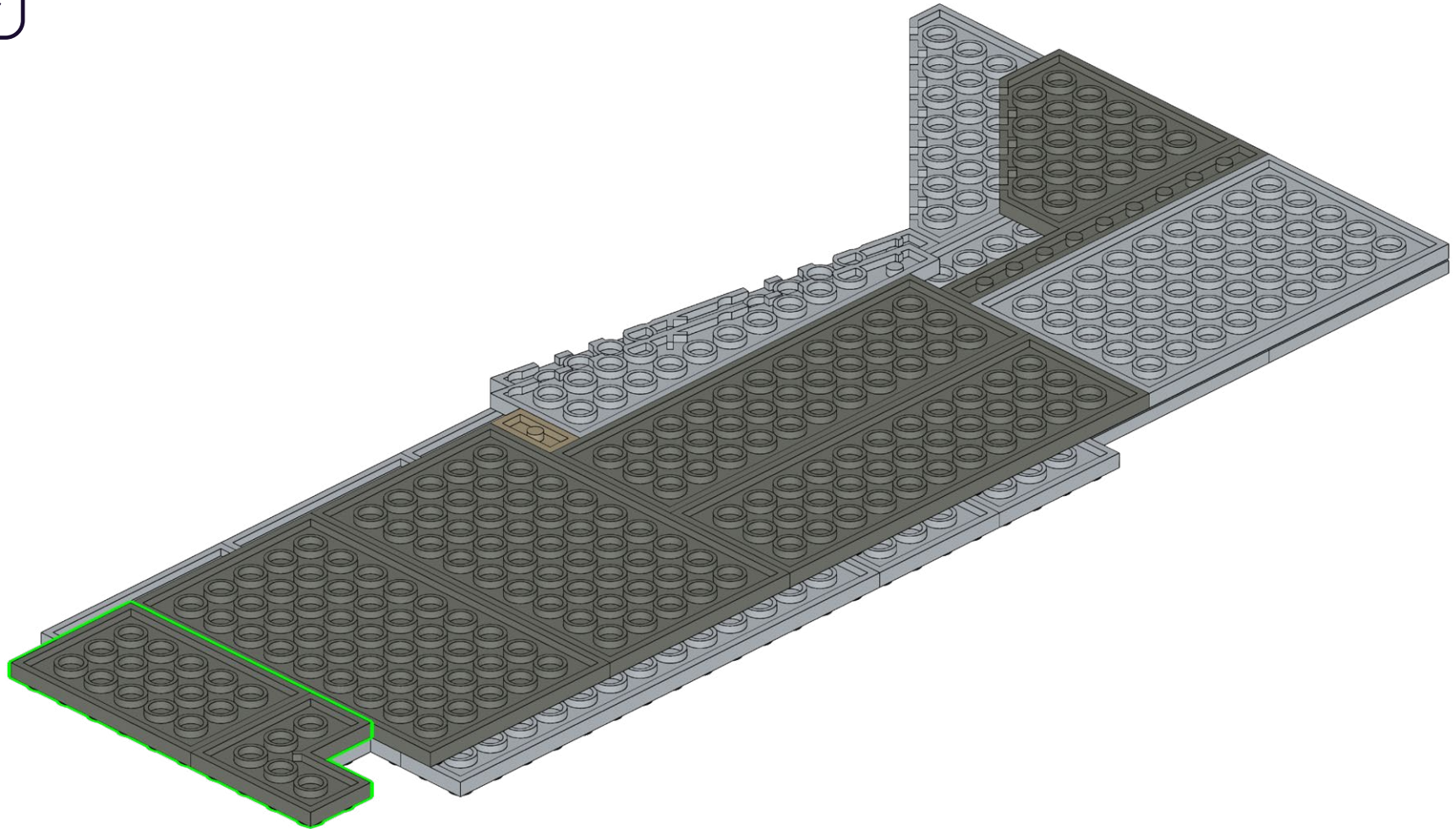
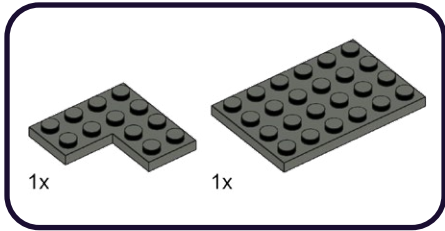

339

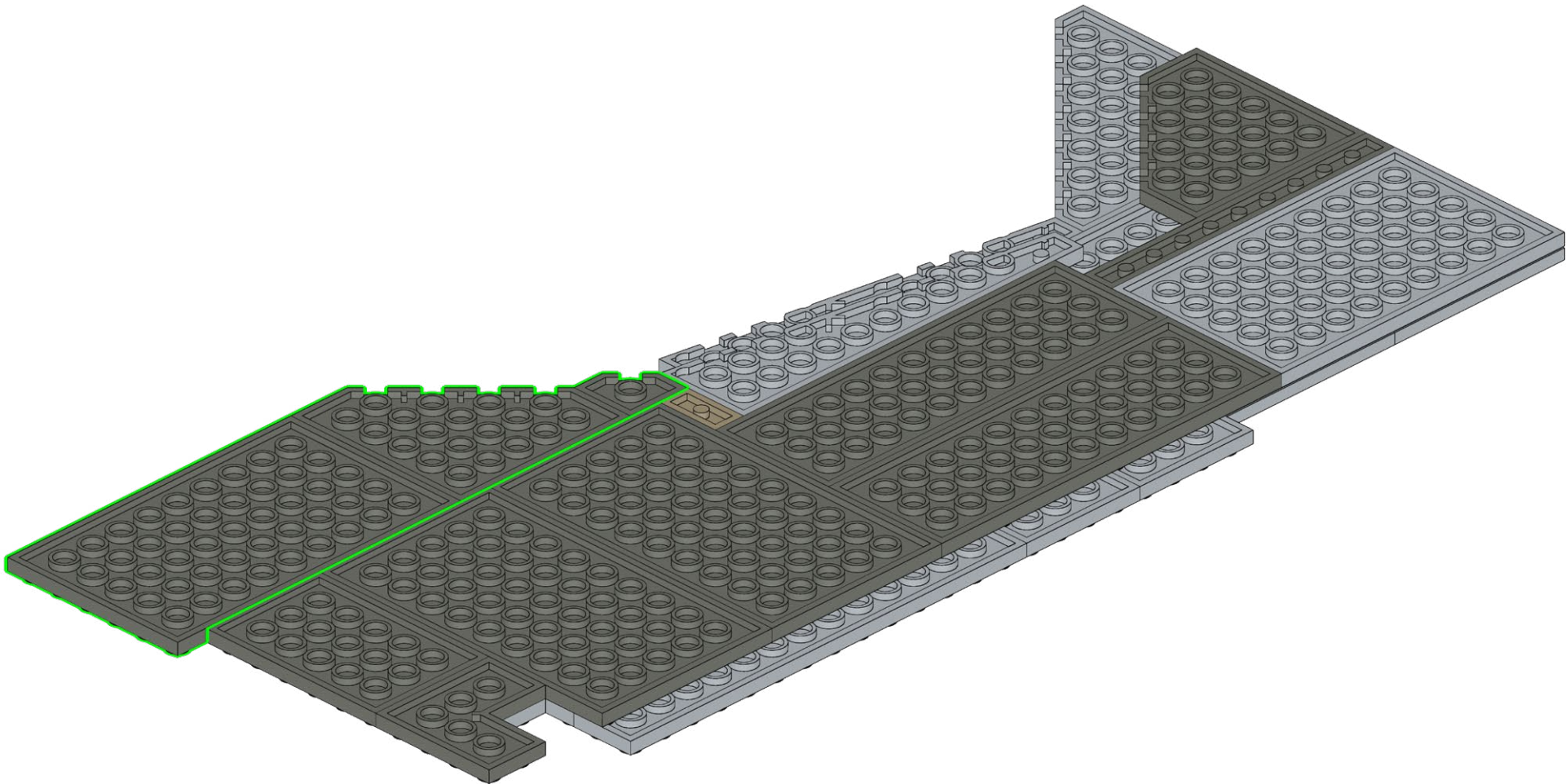
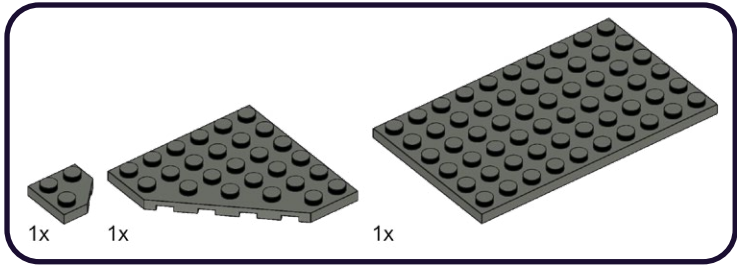

340

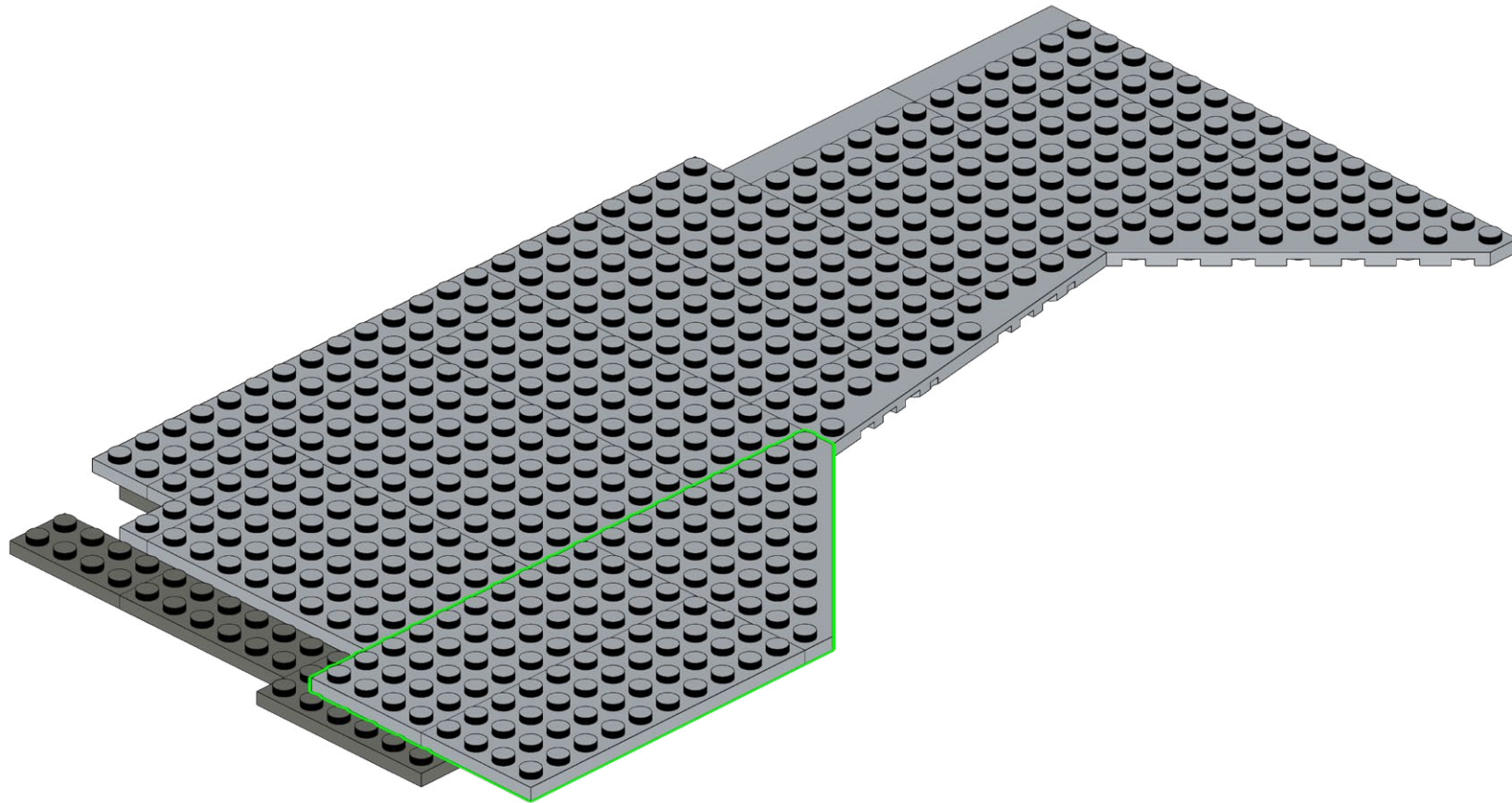
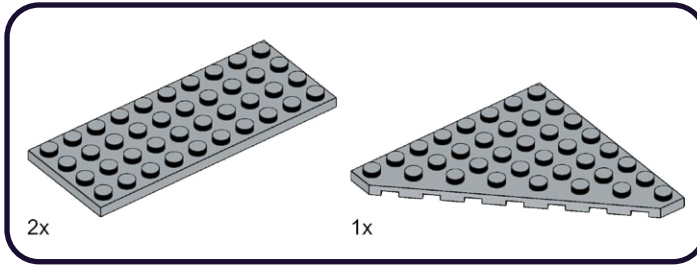

341

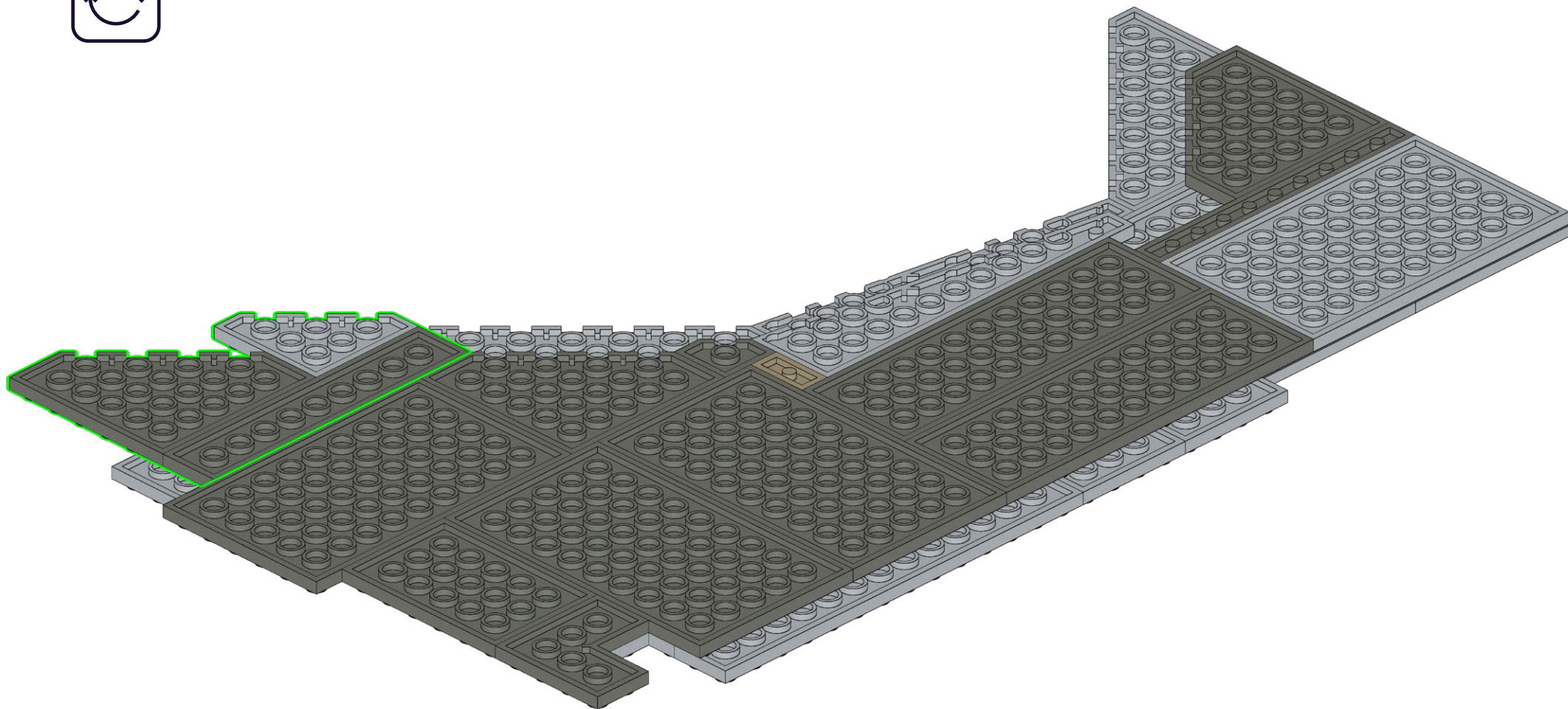
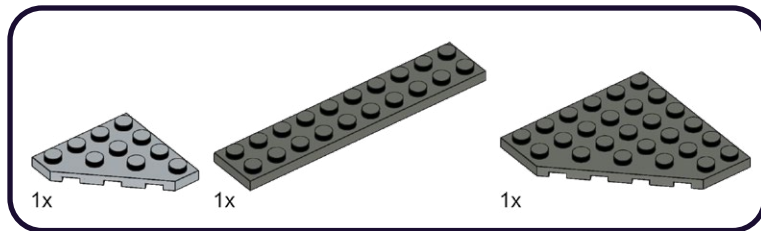

342

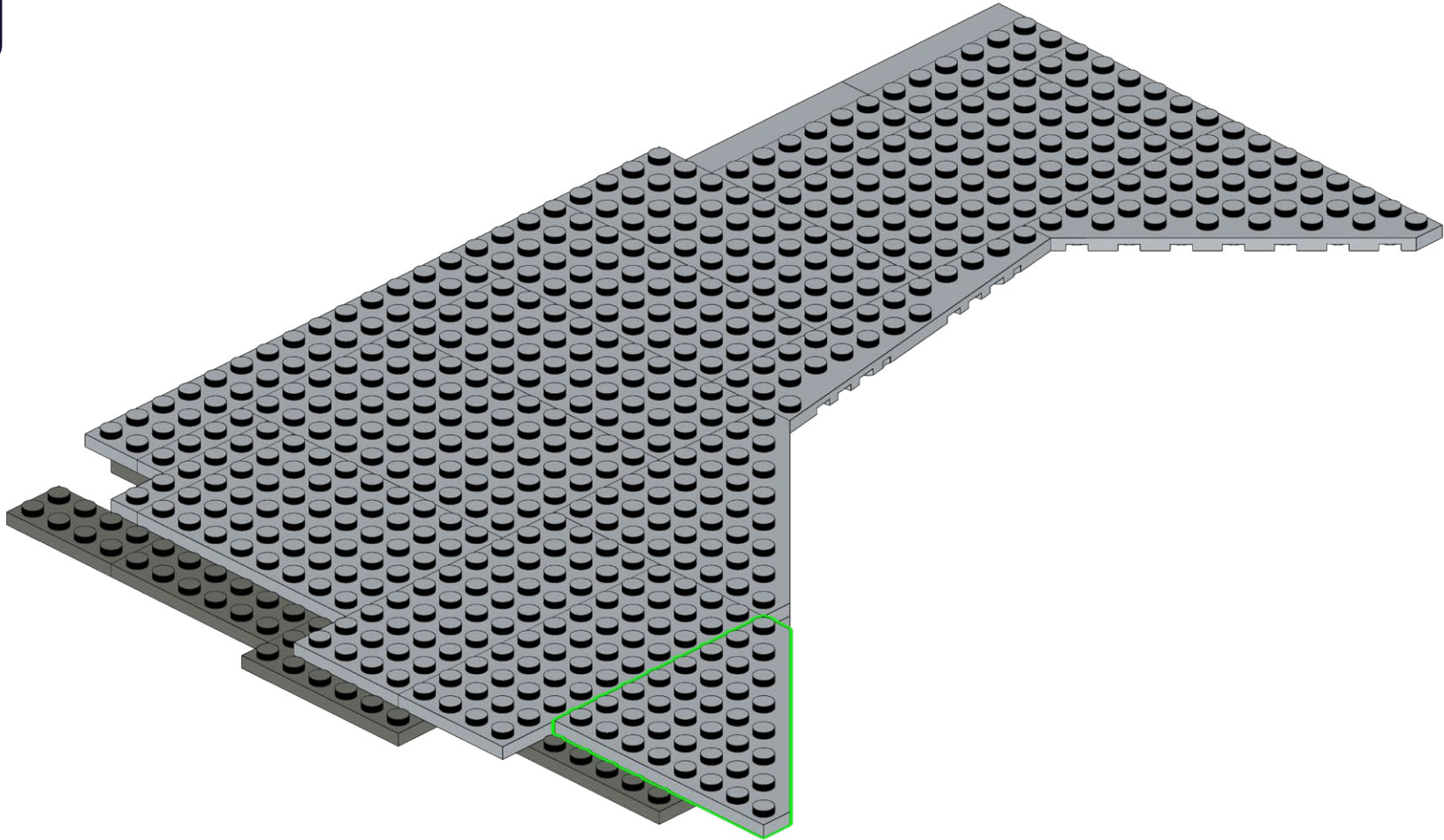
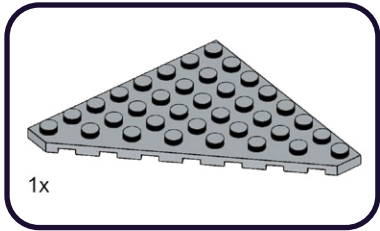

343

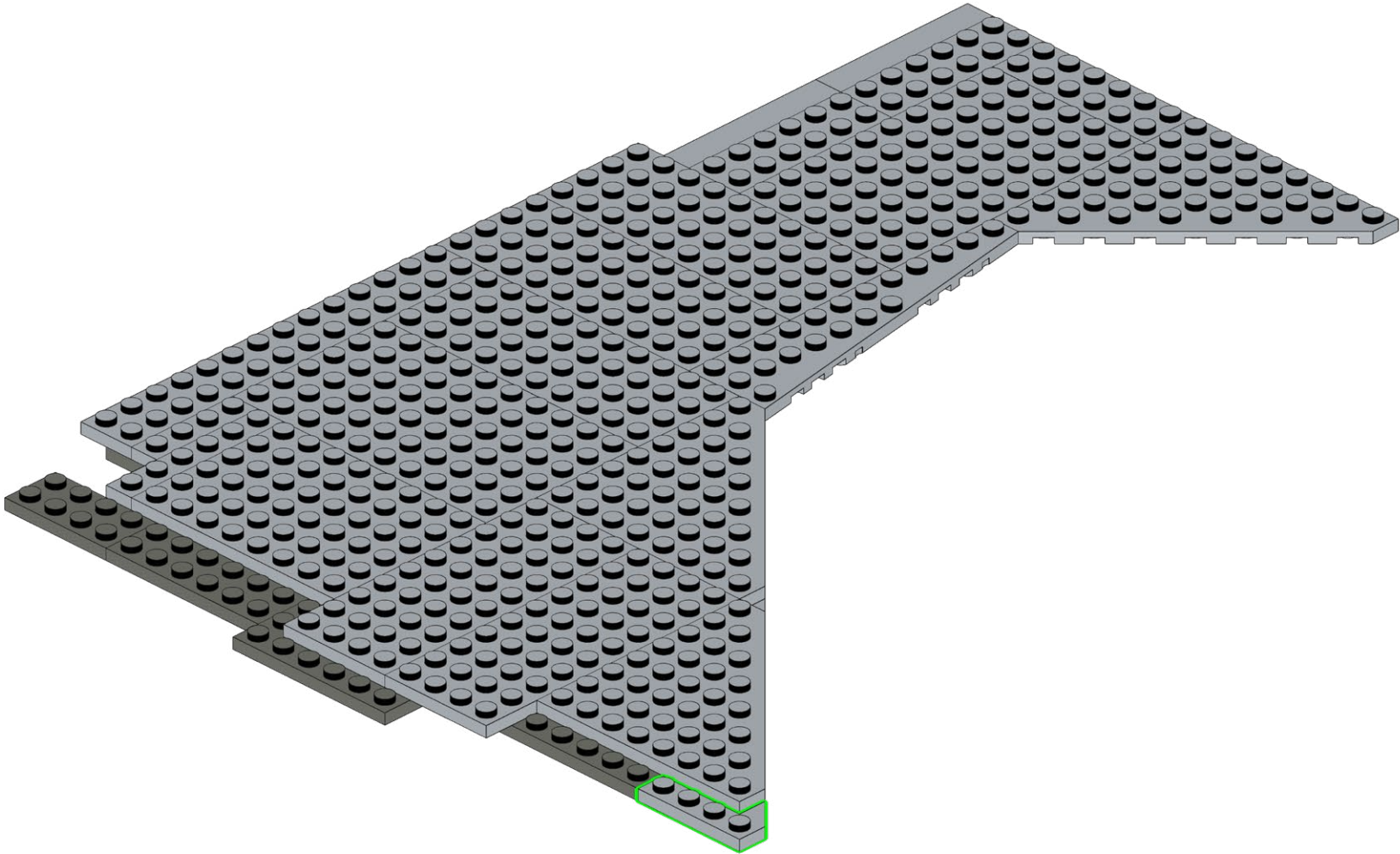
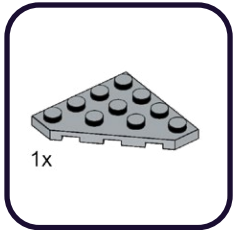

344

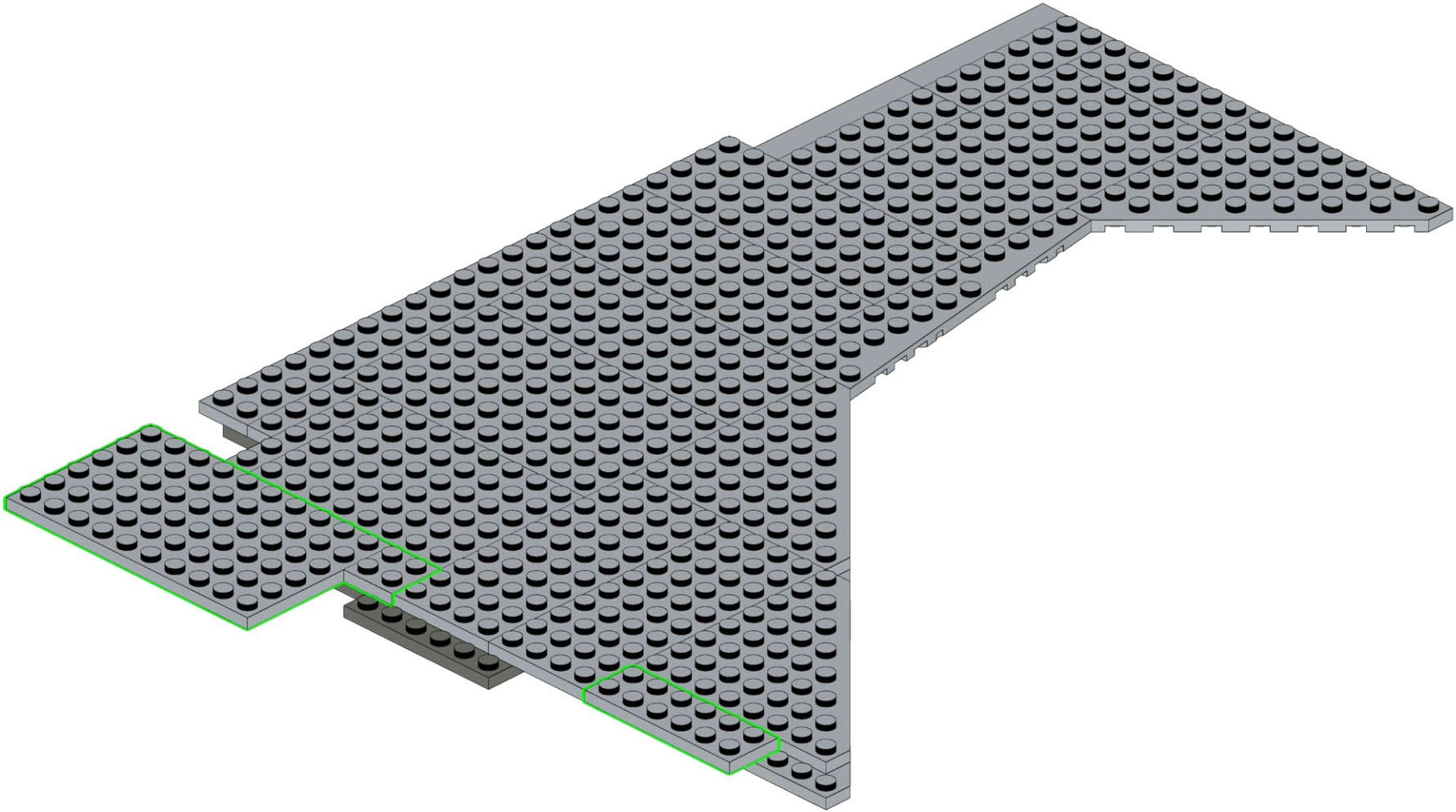
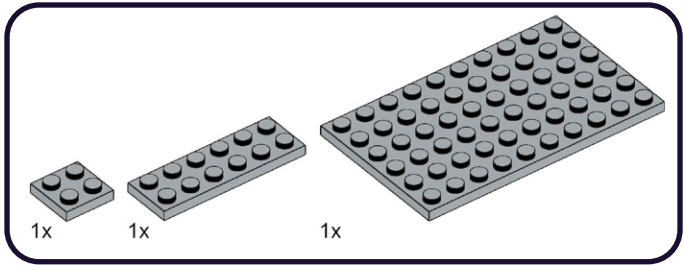

345

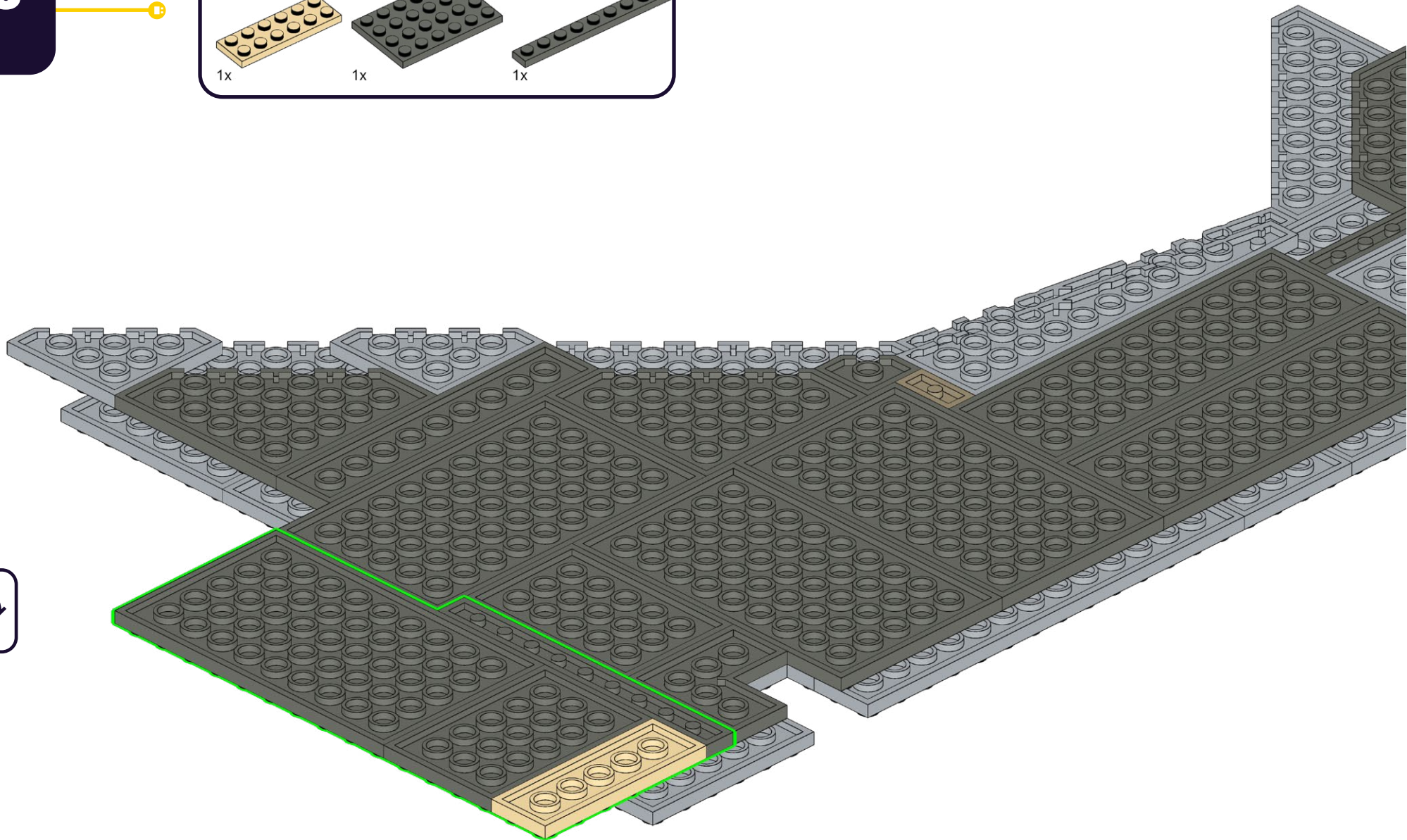
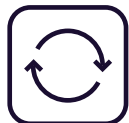
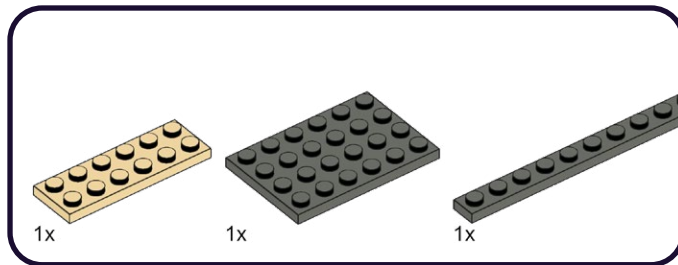

346

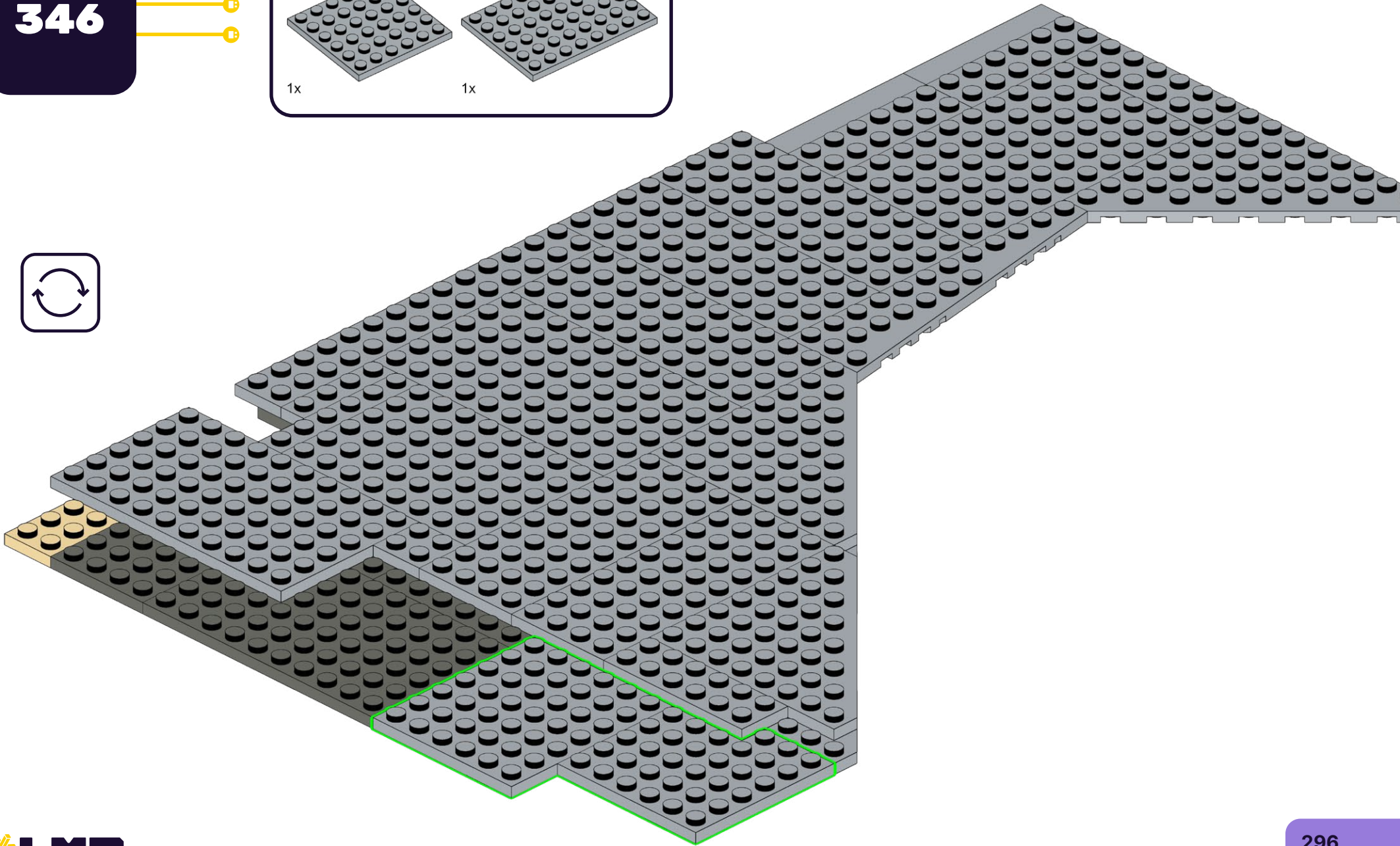
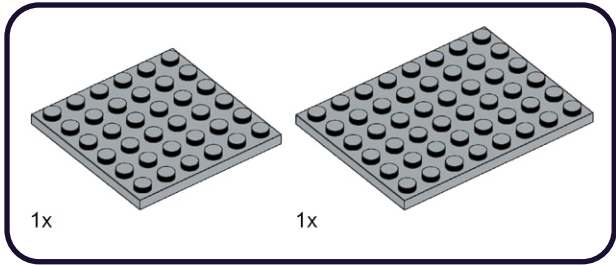

347

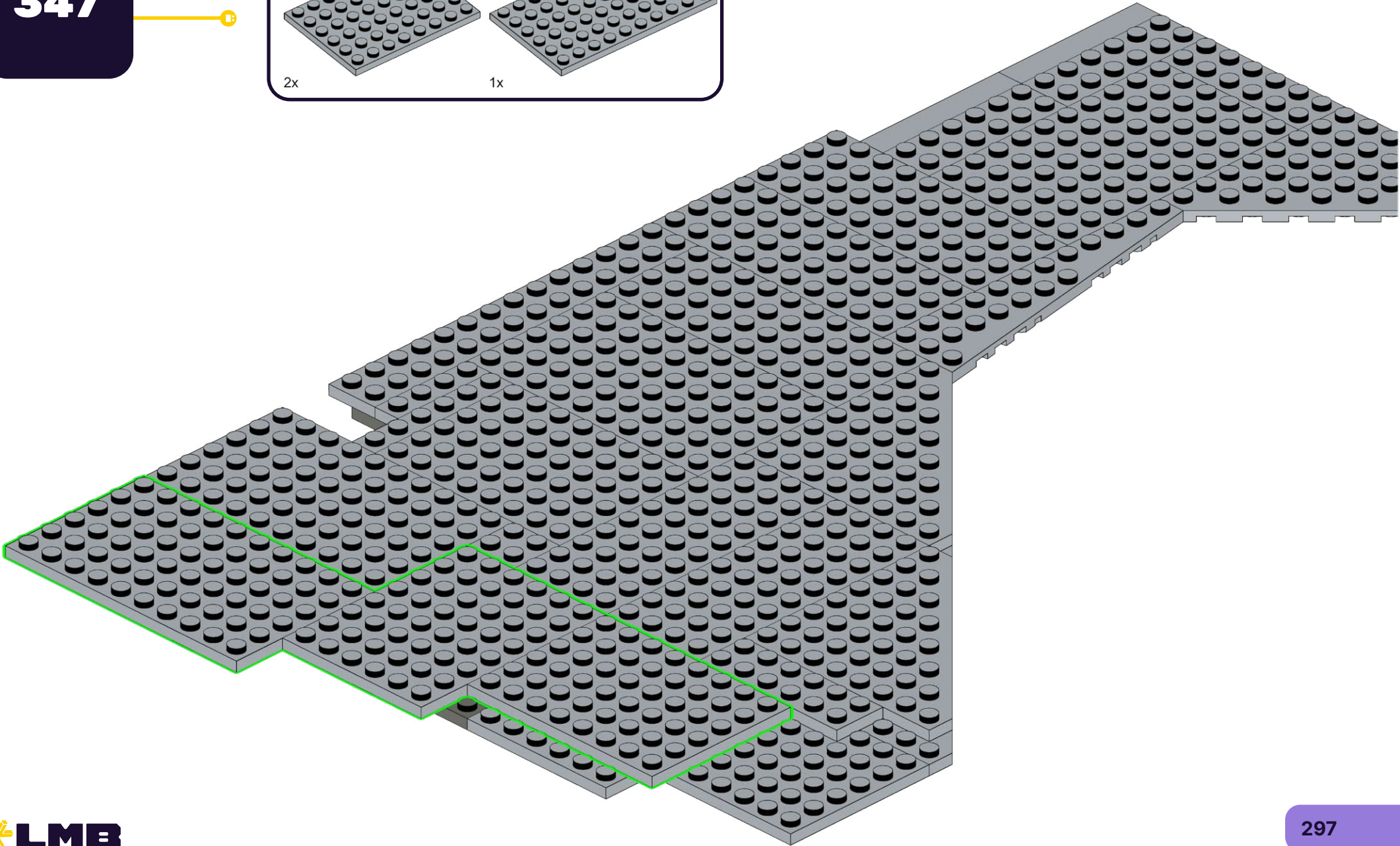
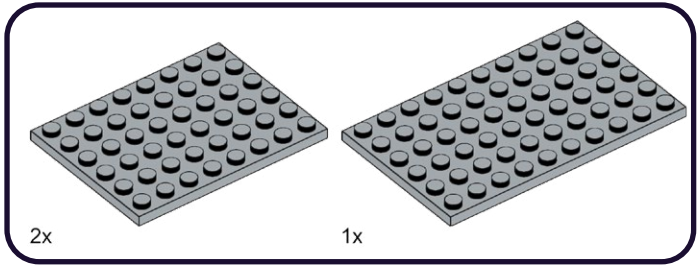

348

2x

1x

1x

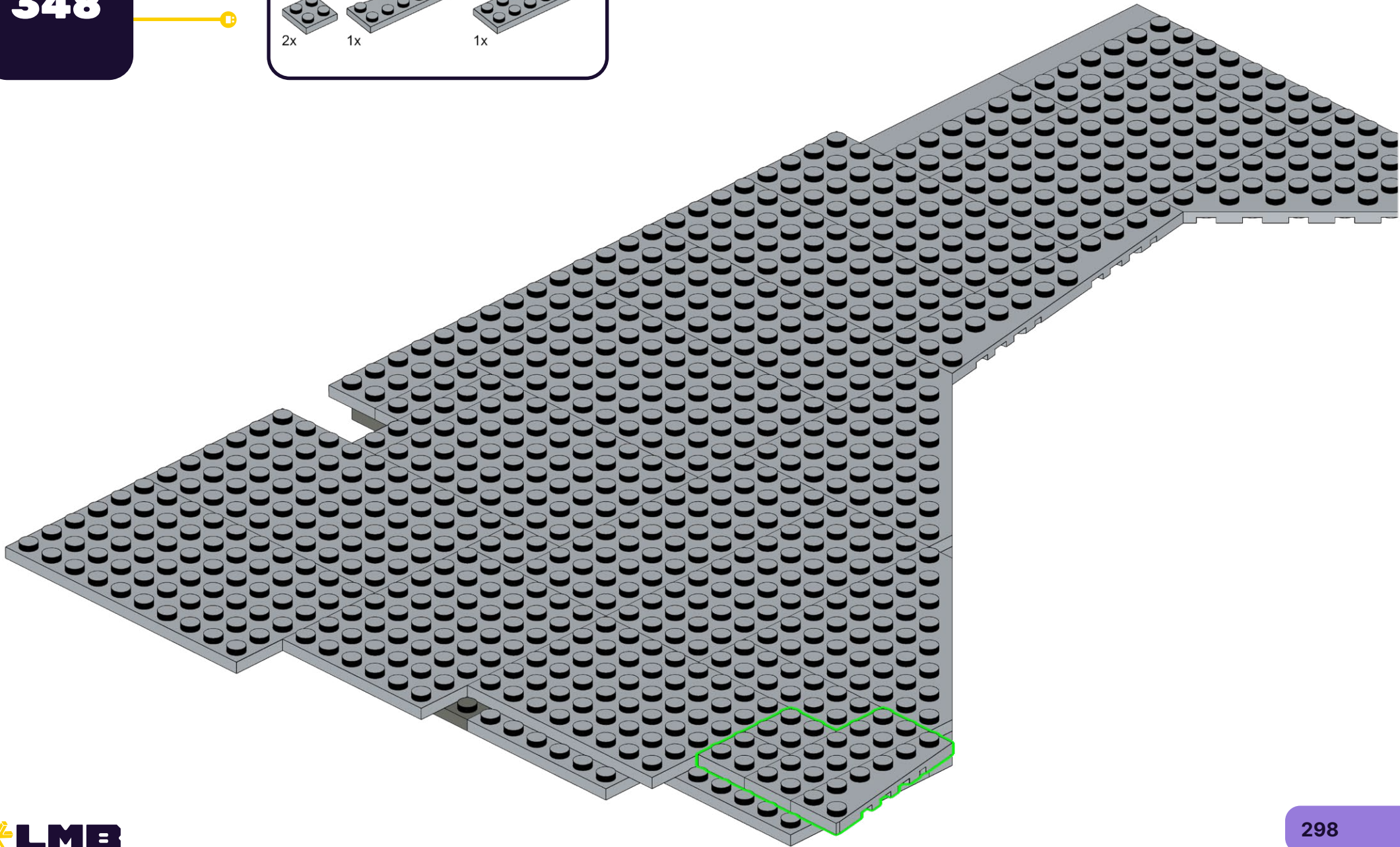

349

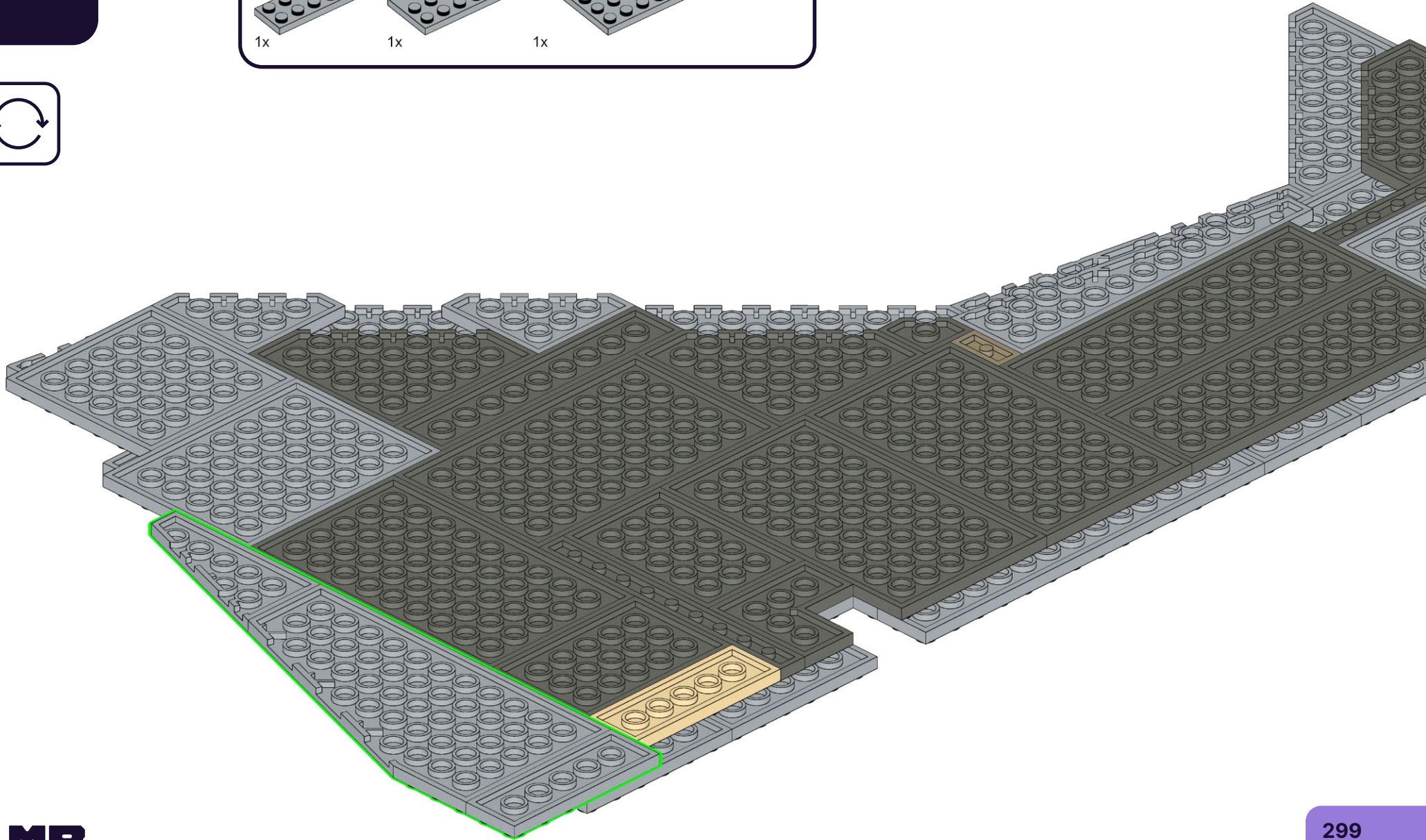
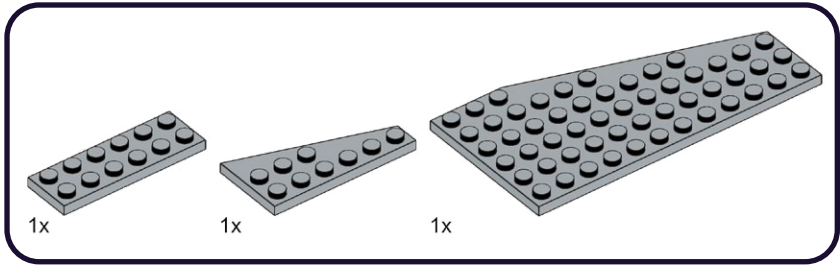

350

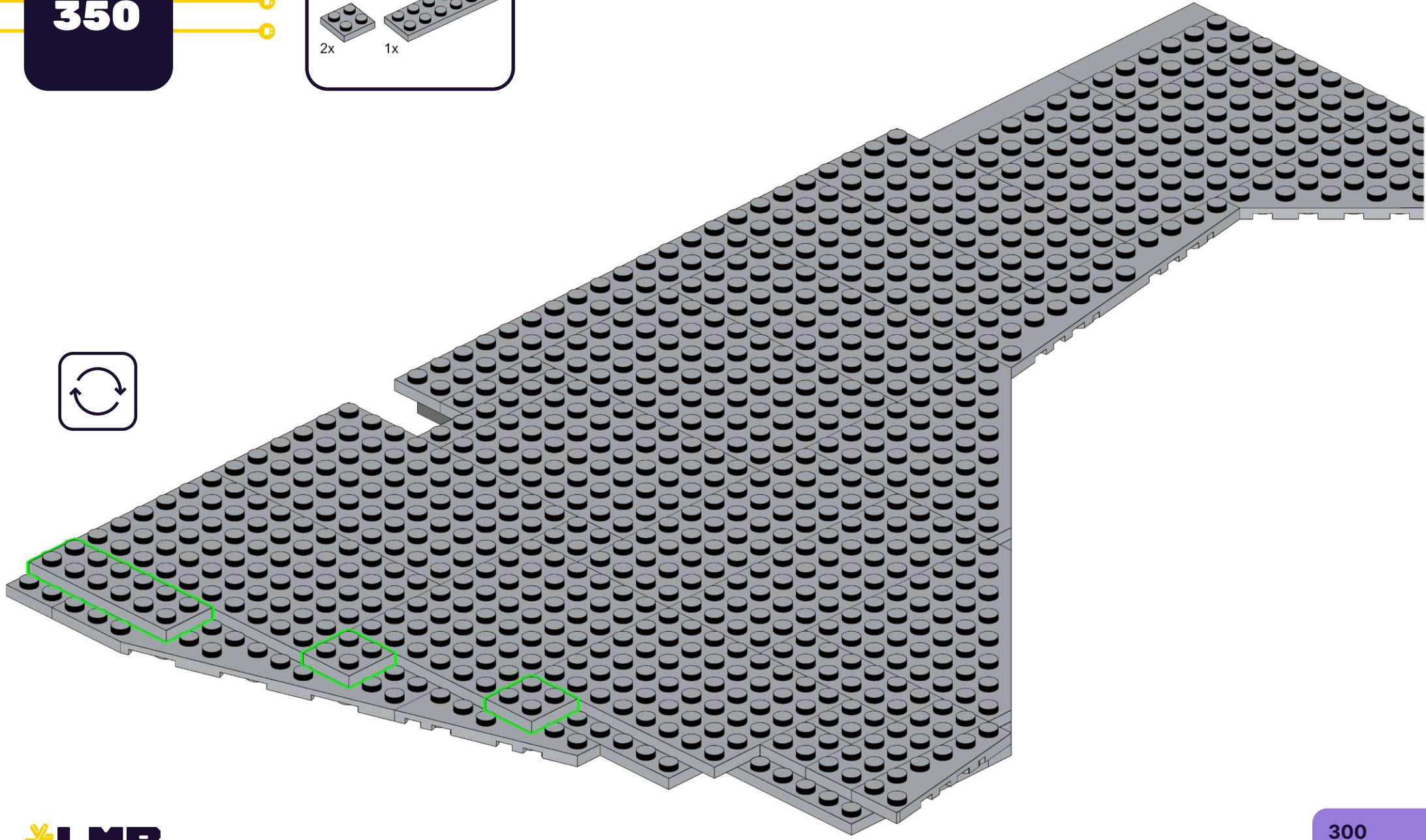
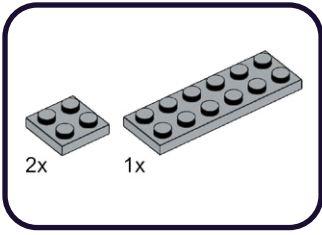

351

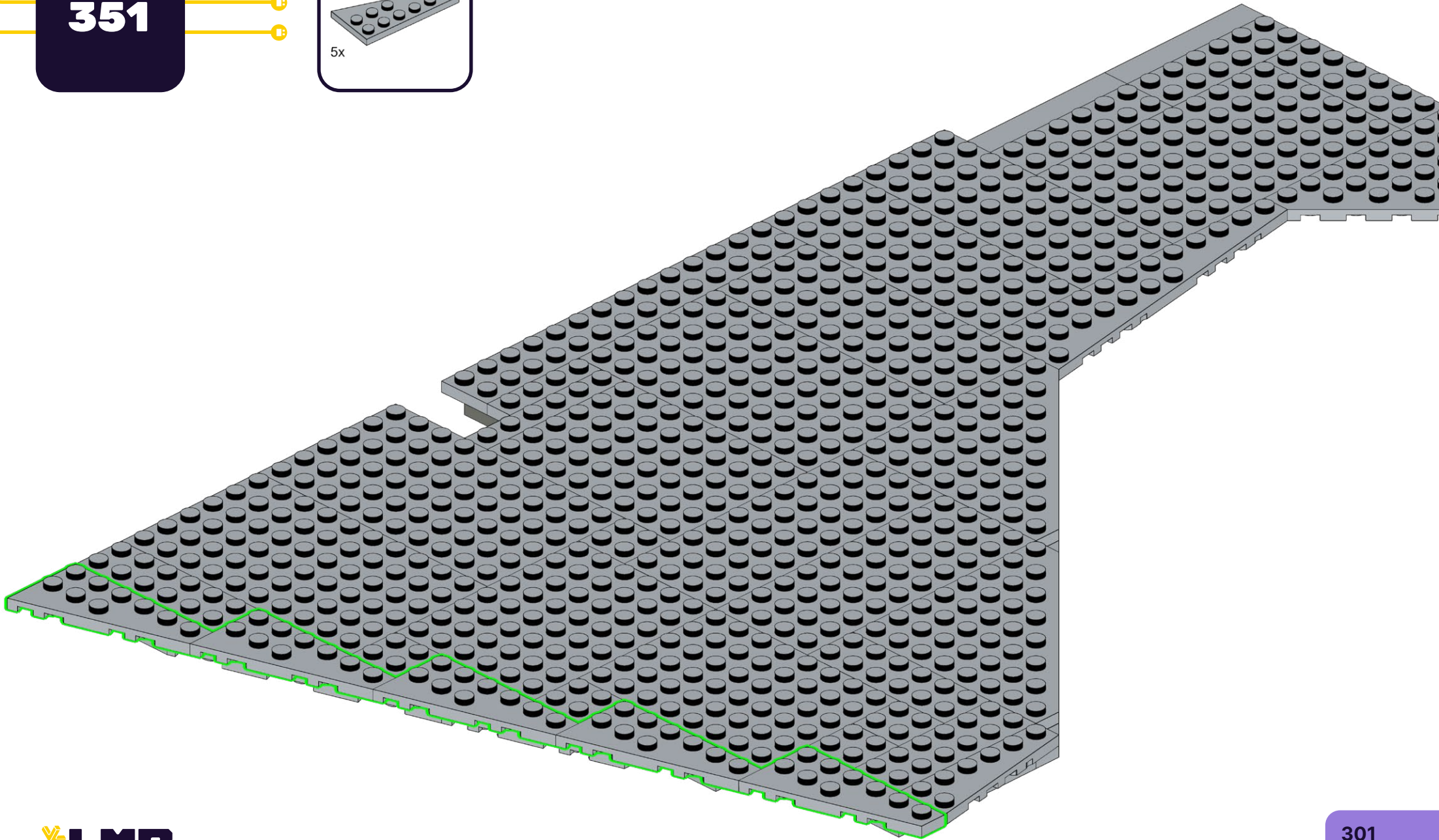
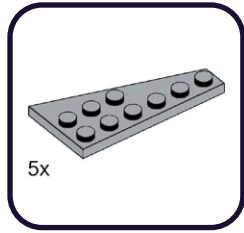

352

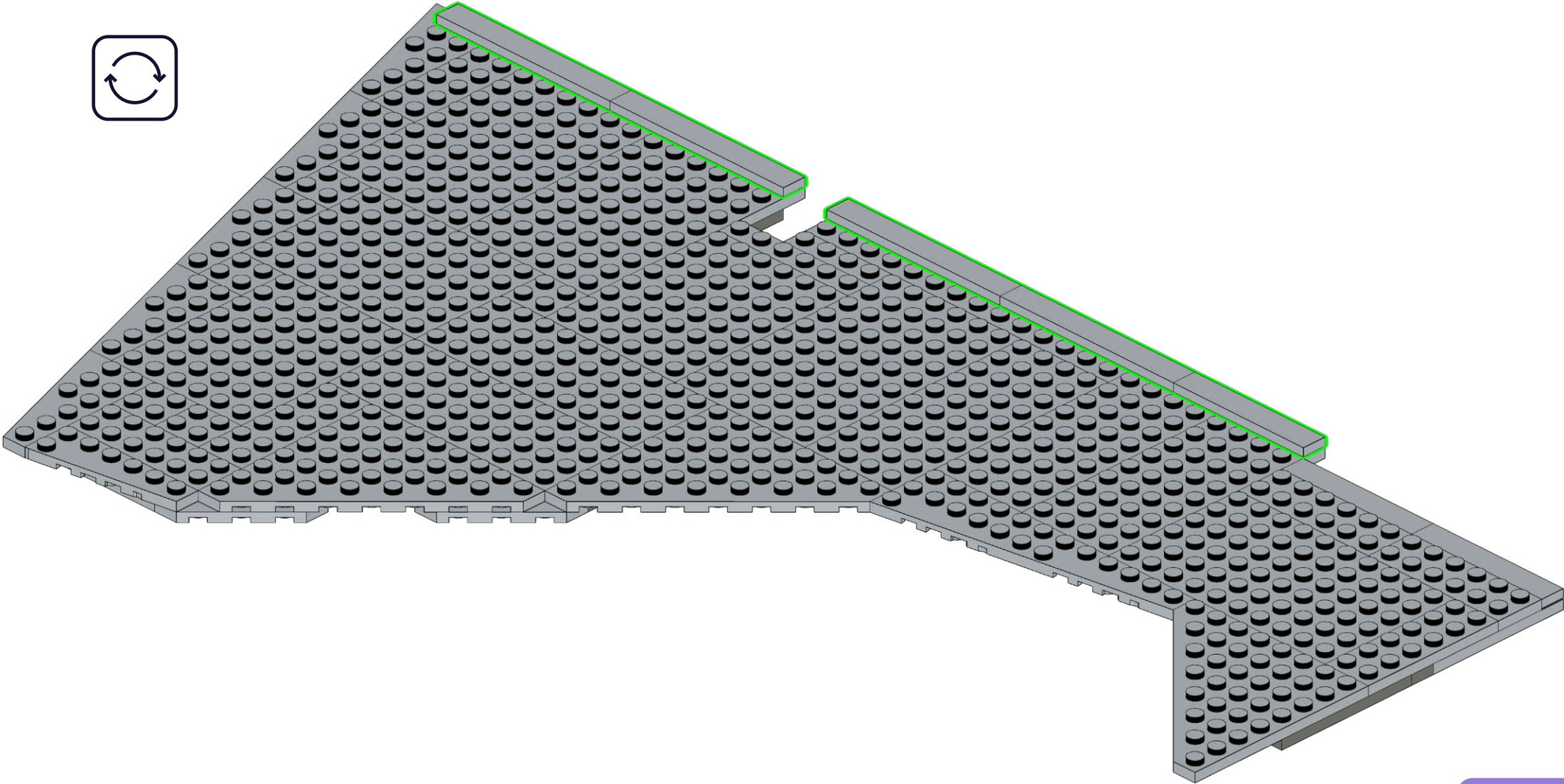
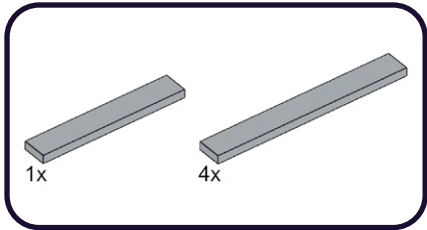

353

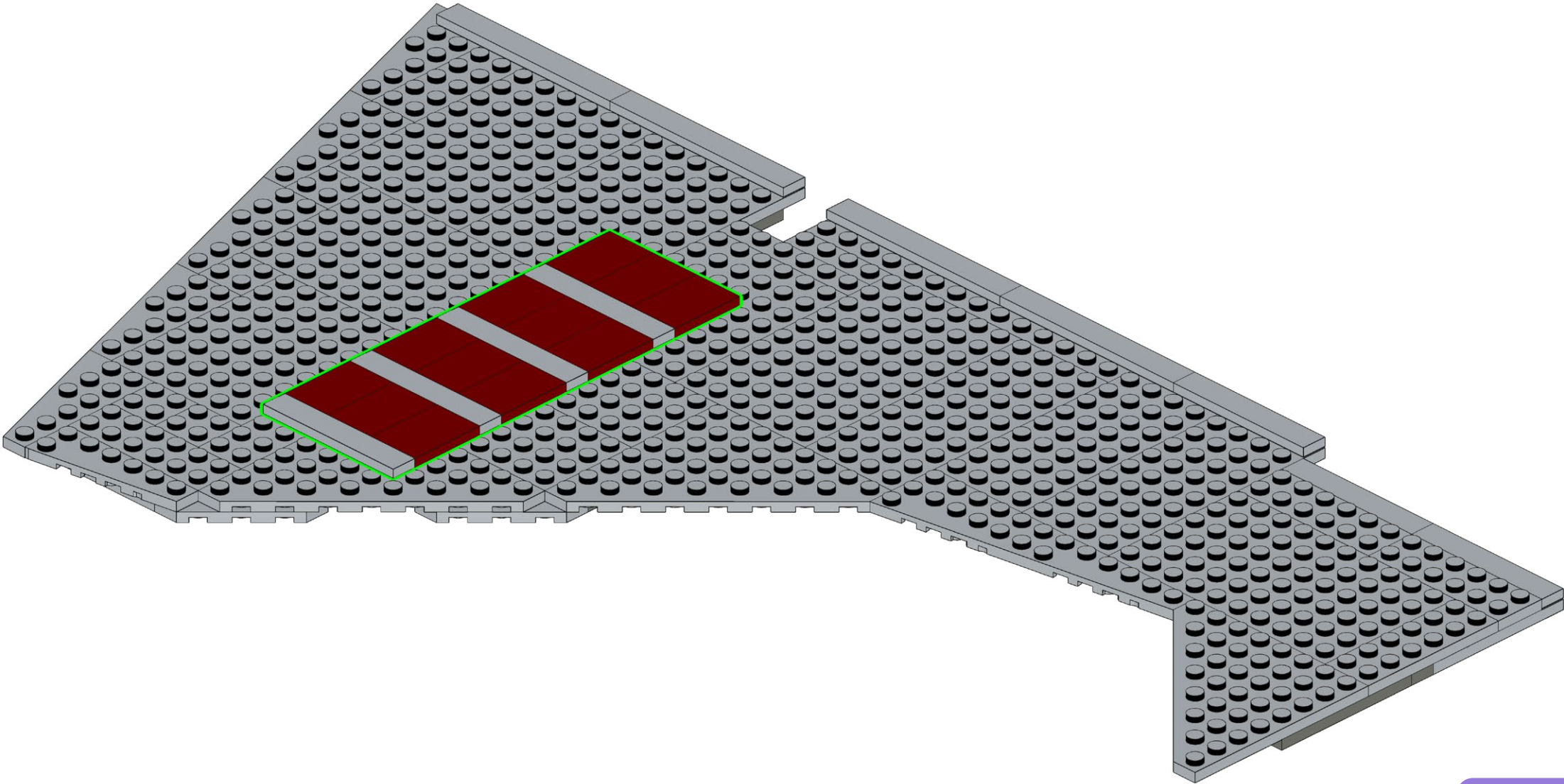
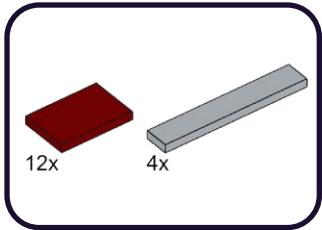

354

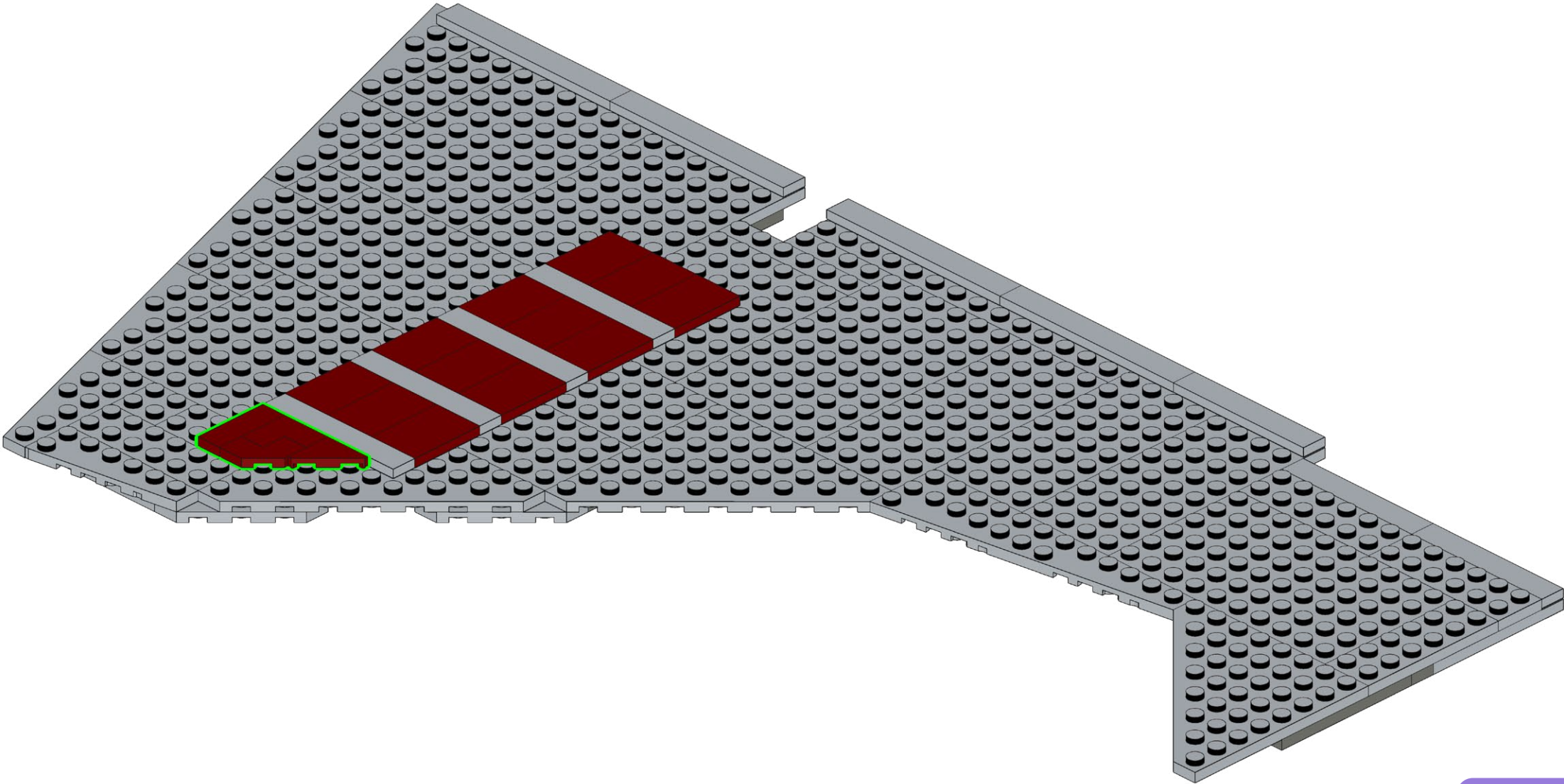
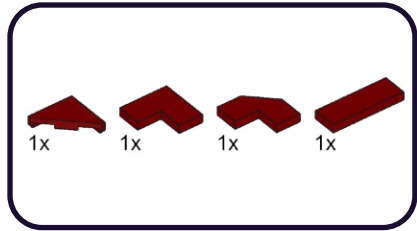

355

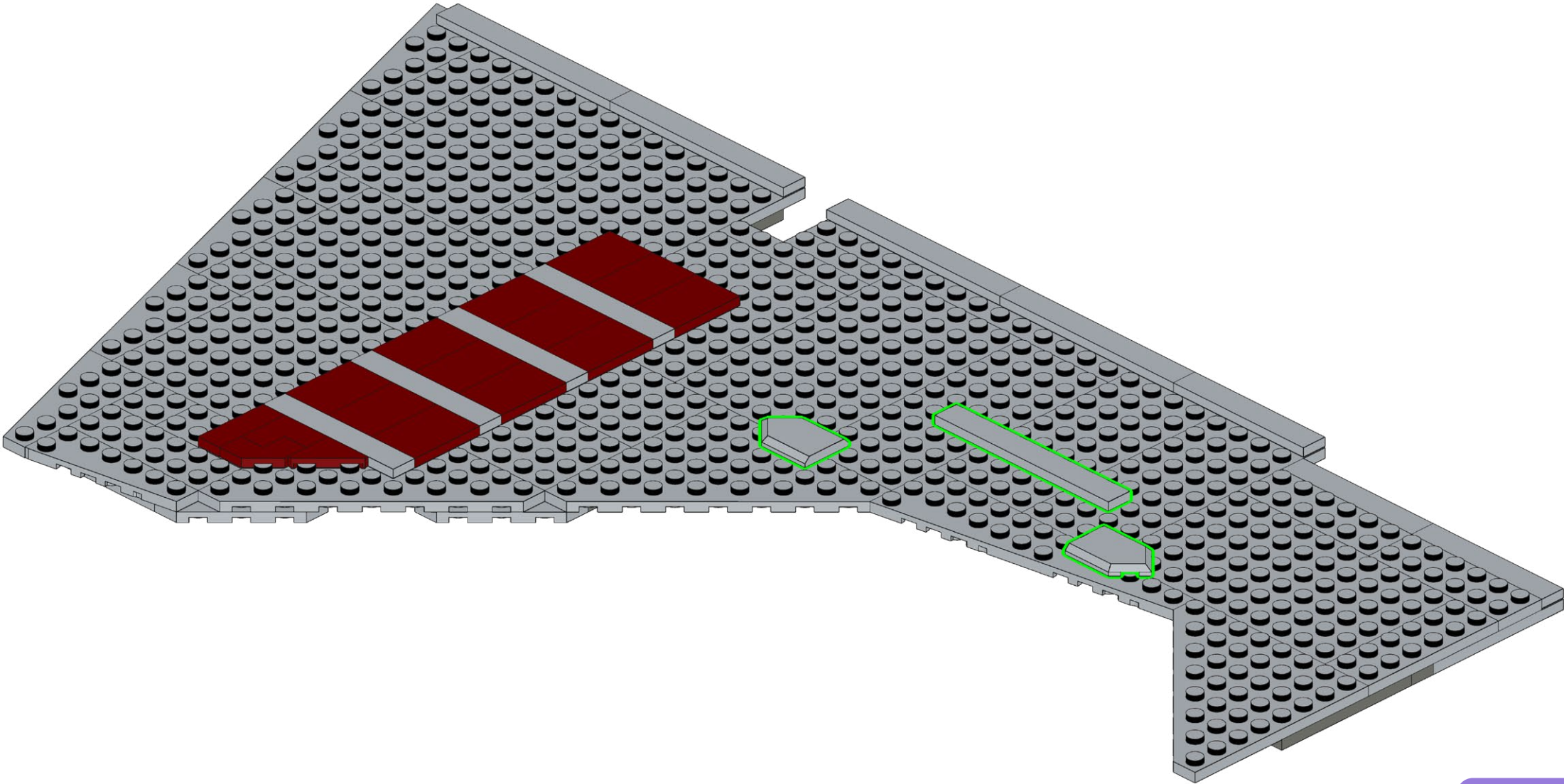
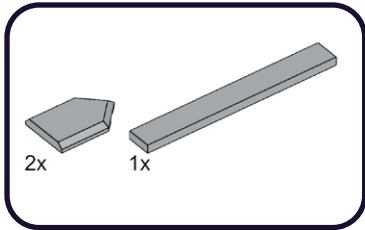

356

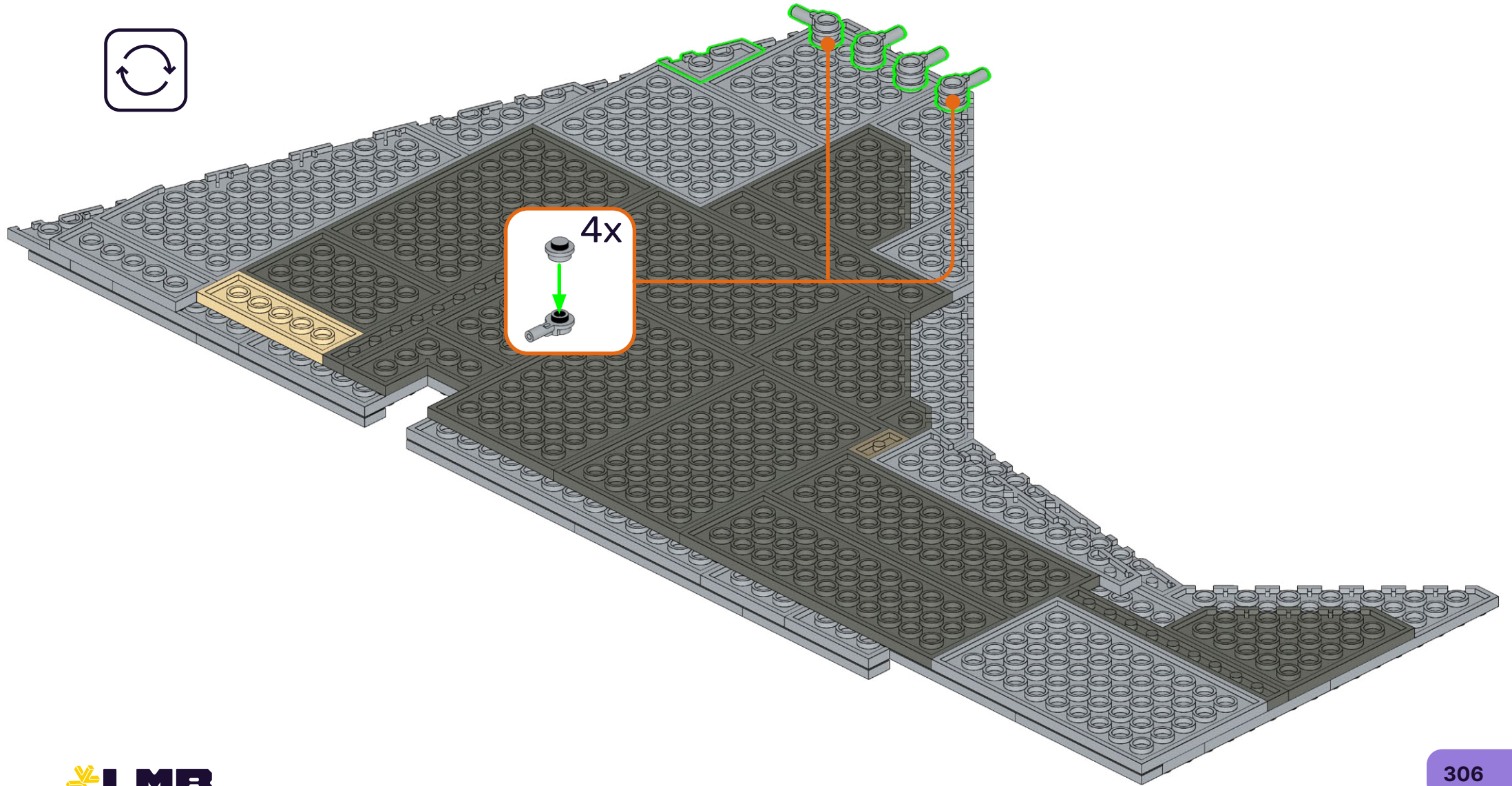
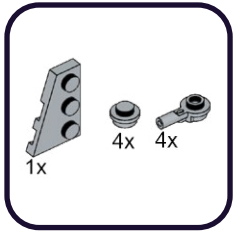

357

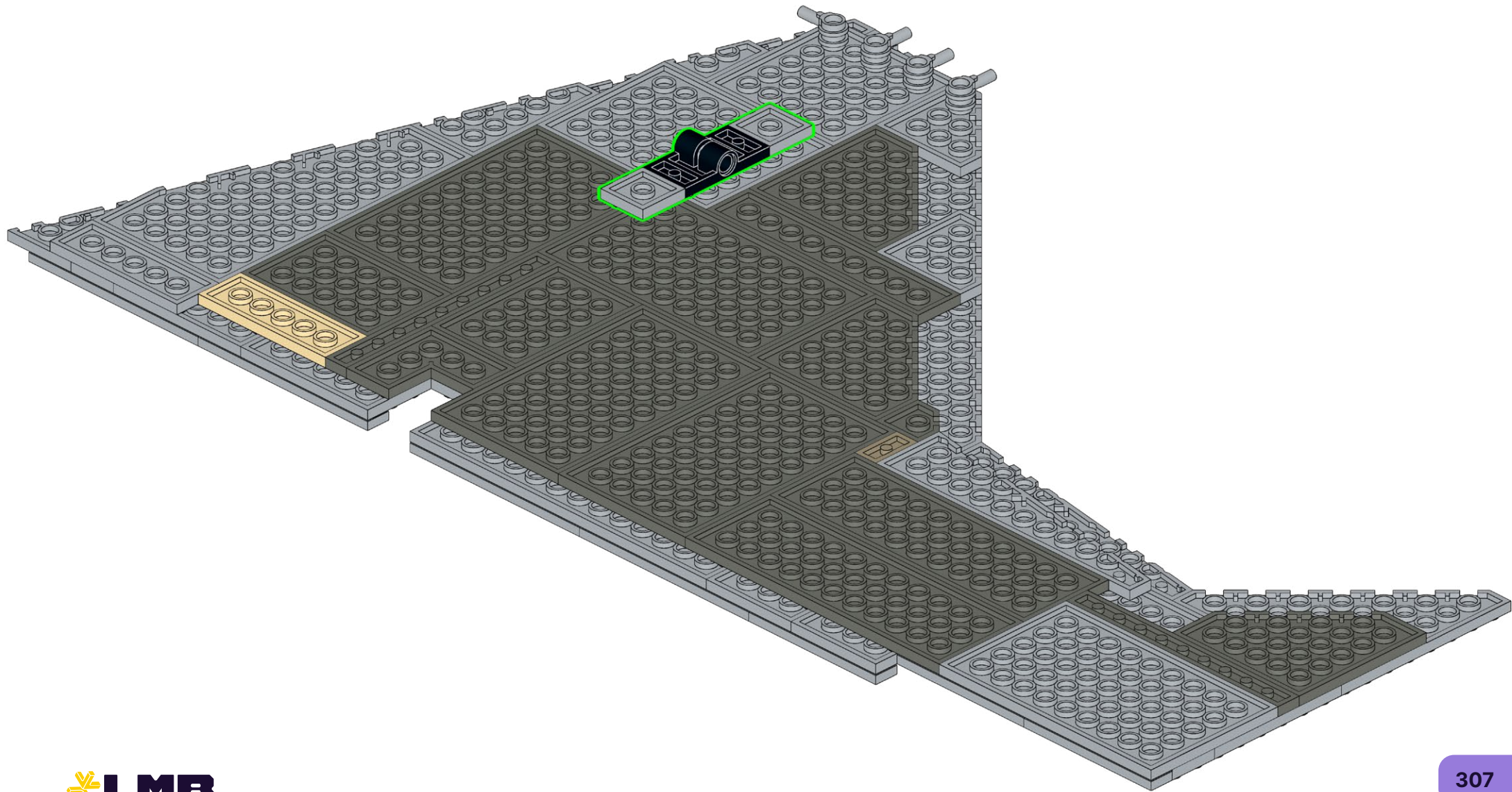
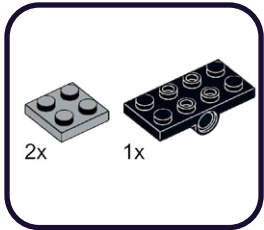

358

3x

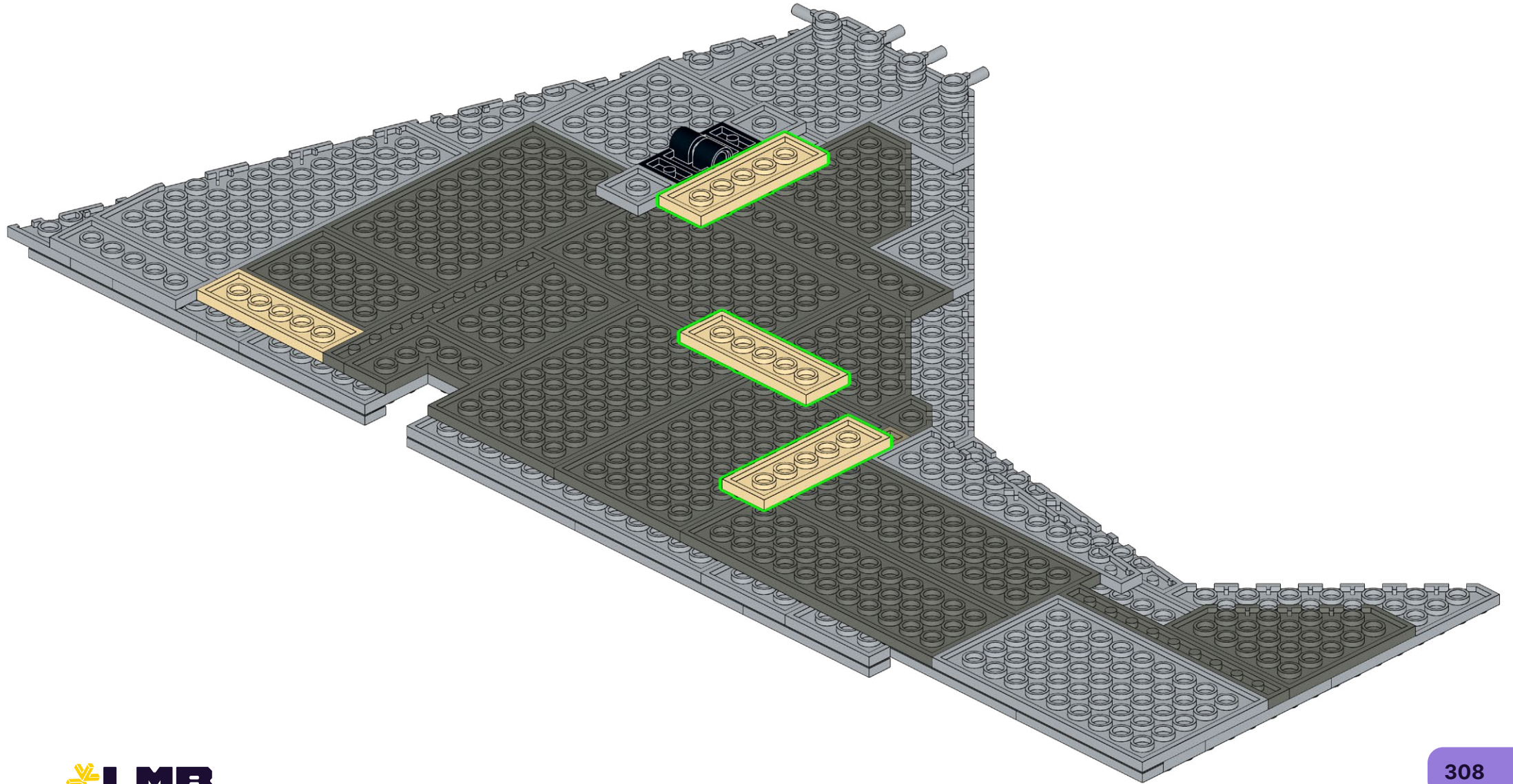
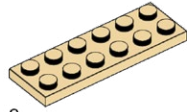

359

2x

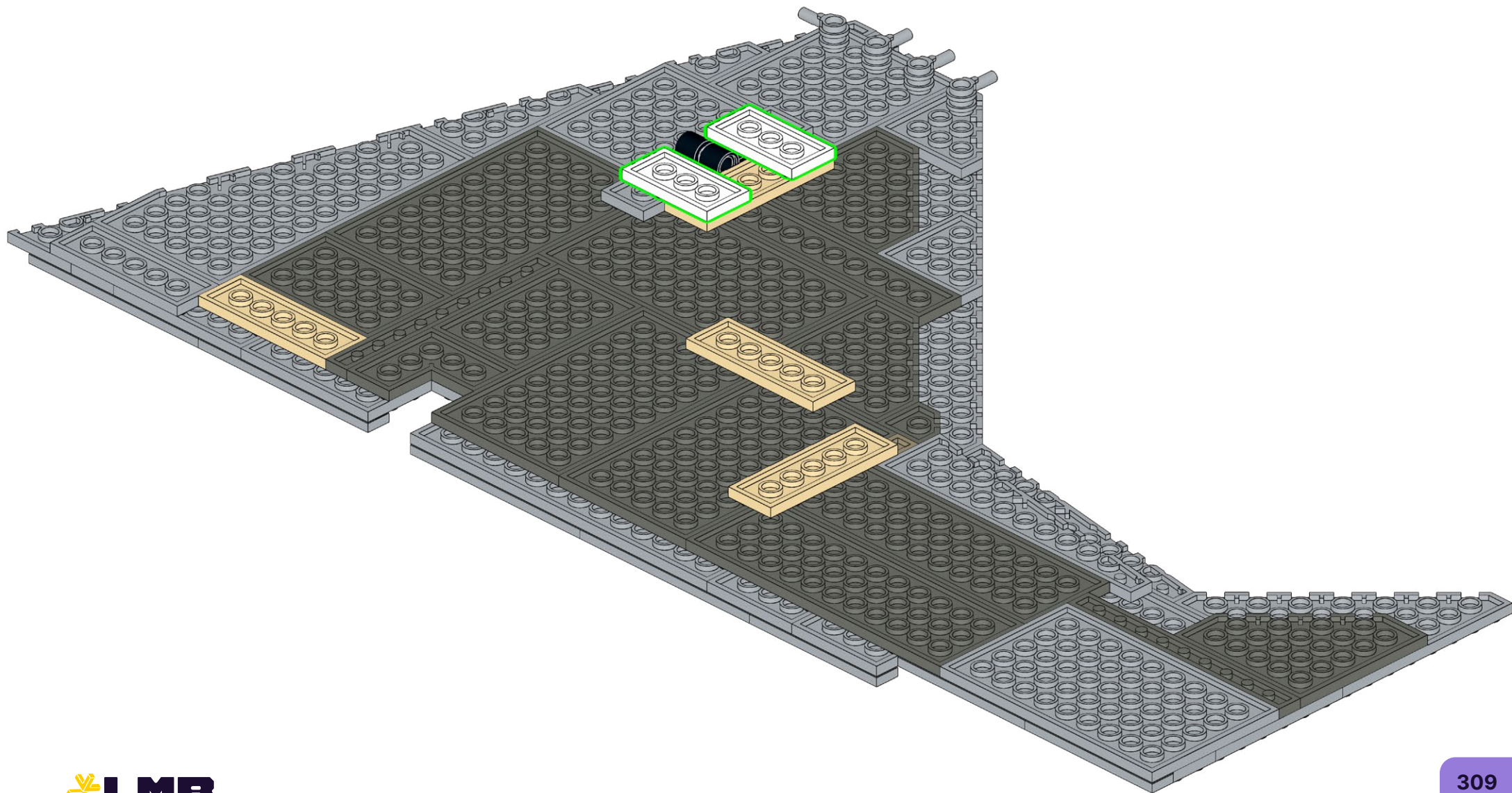
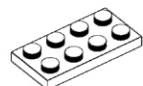

360

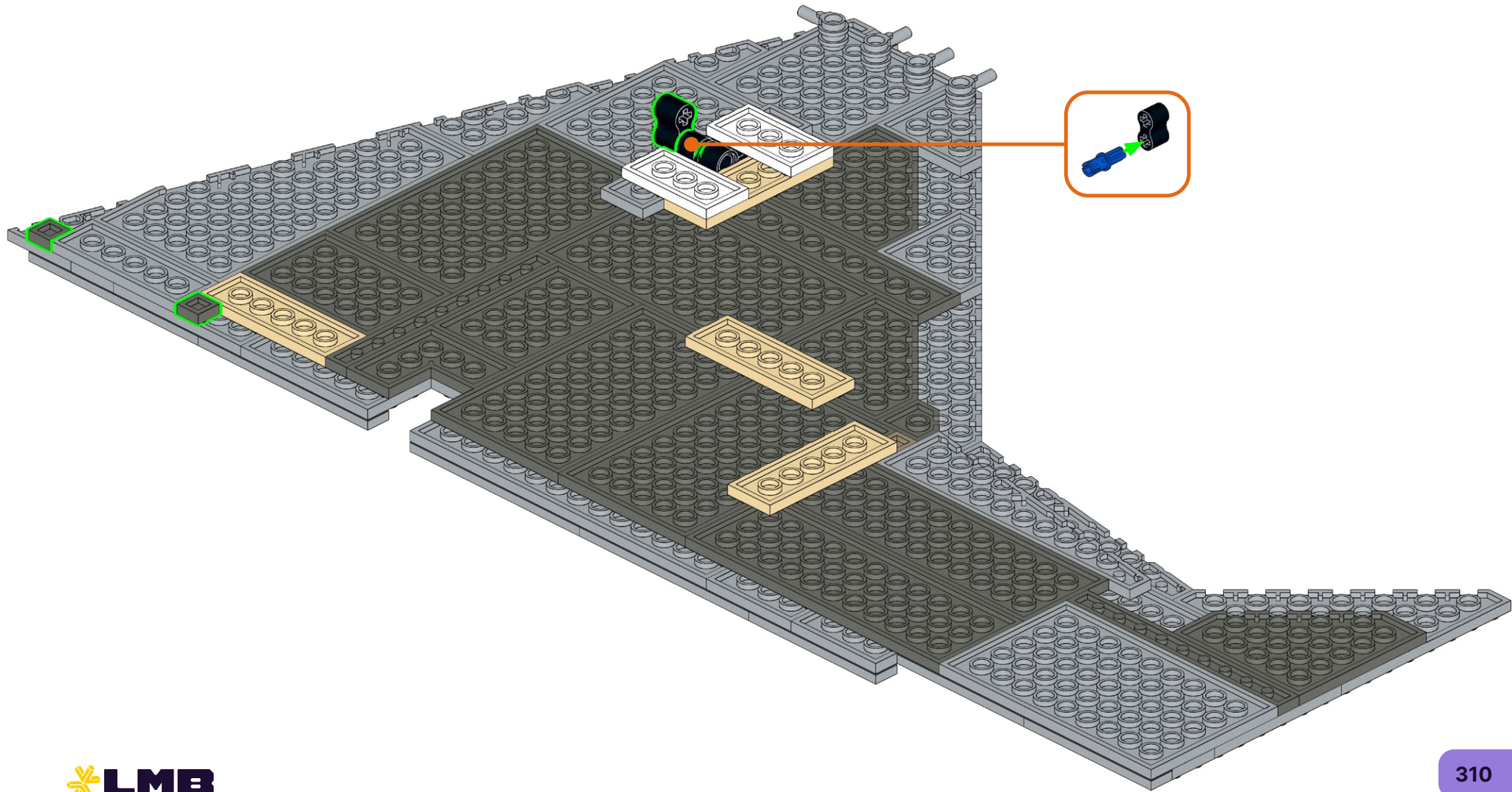
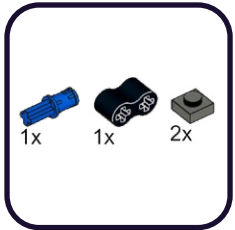

361

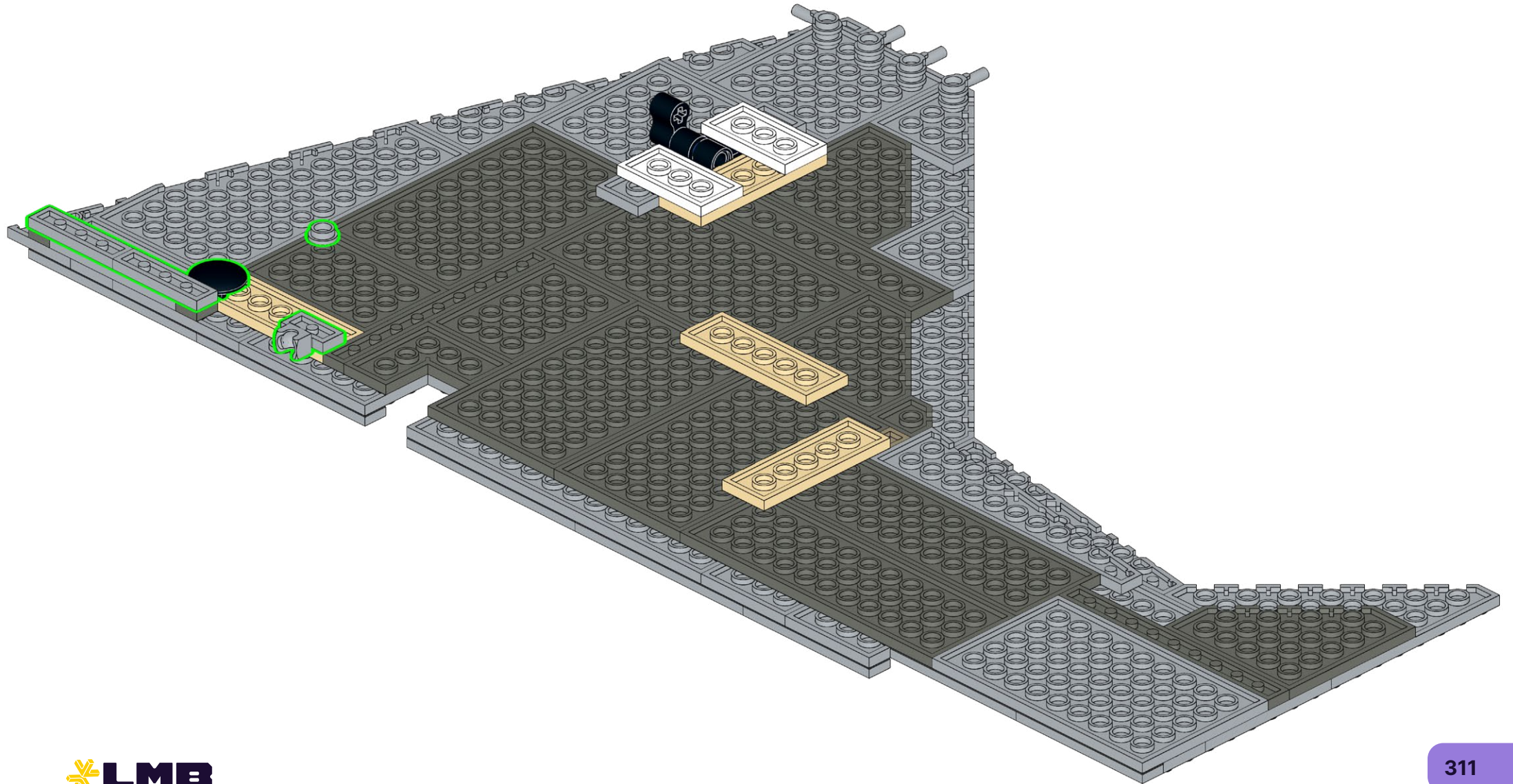
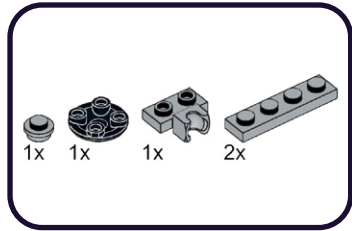

362

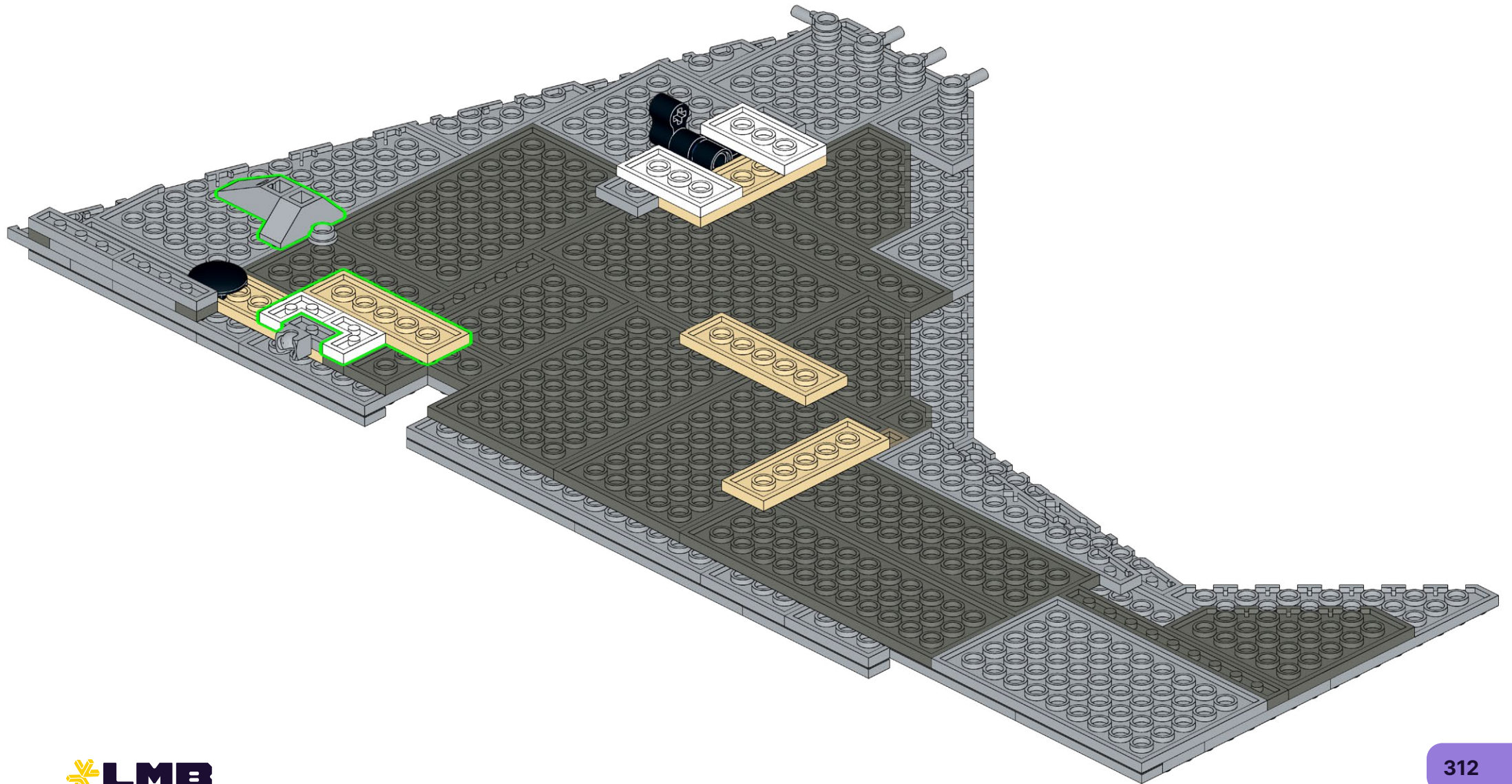
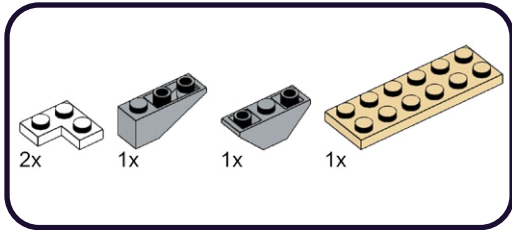

363

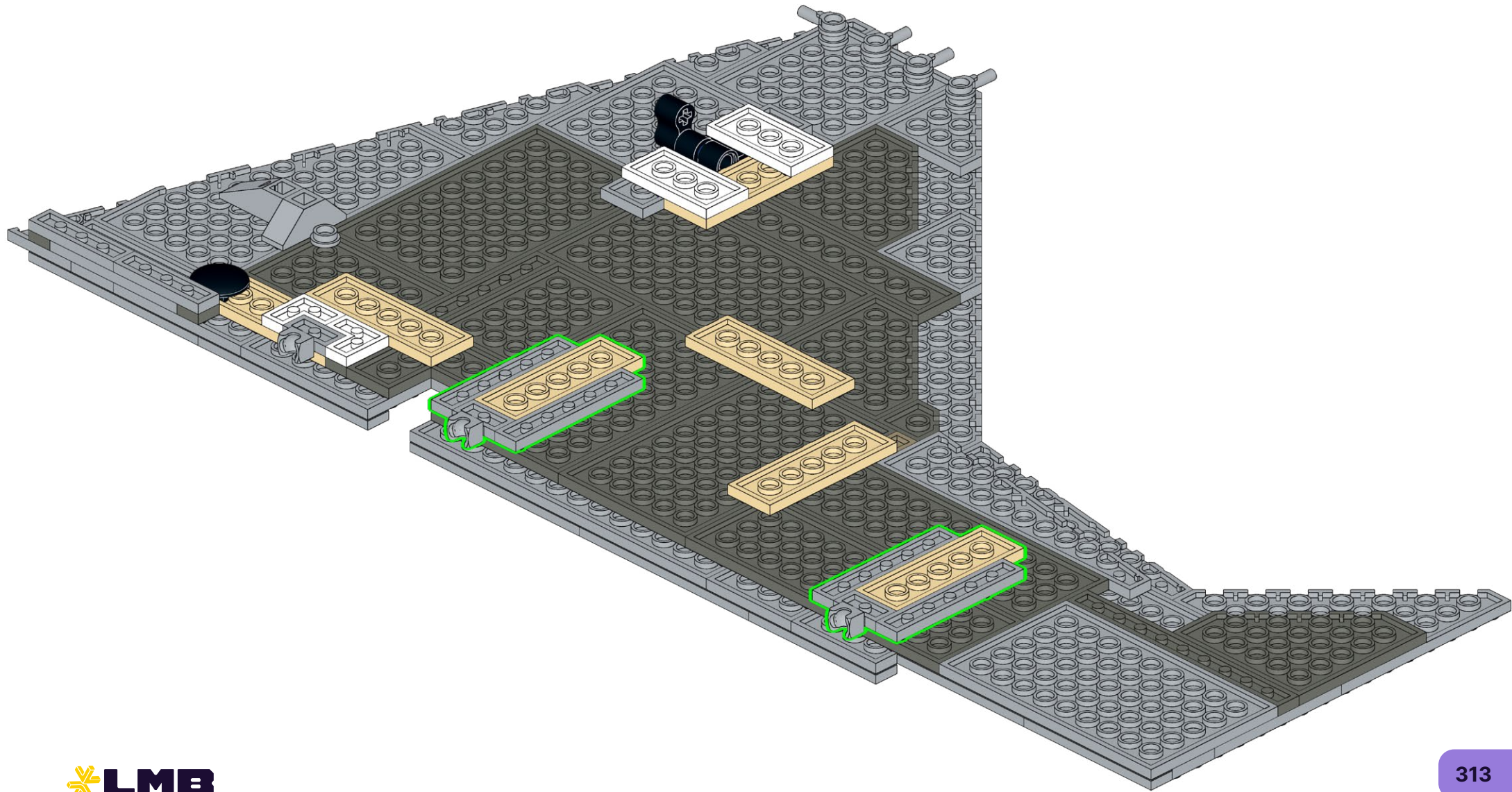
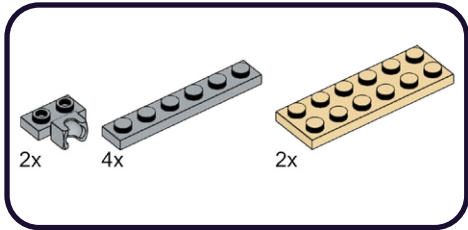

364

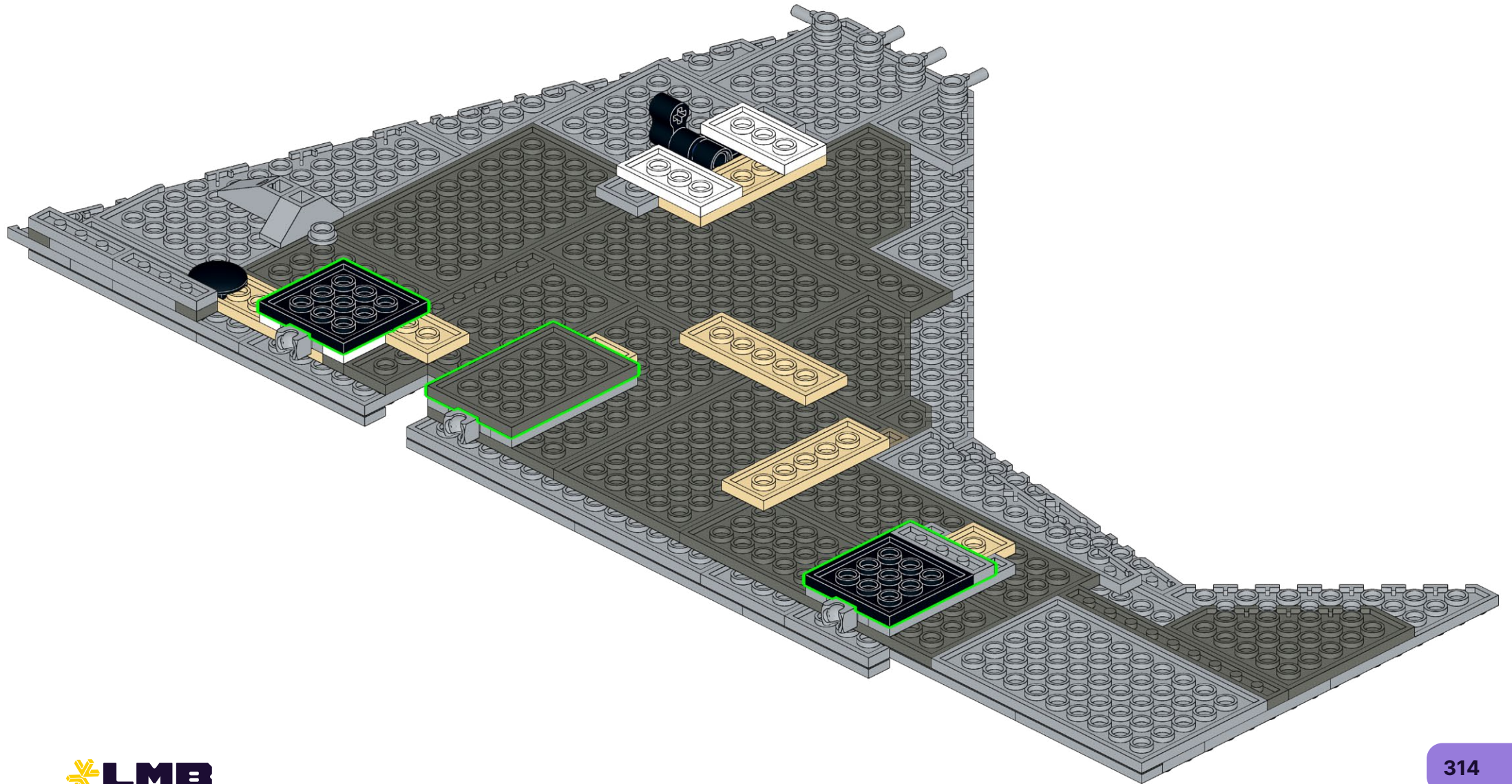
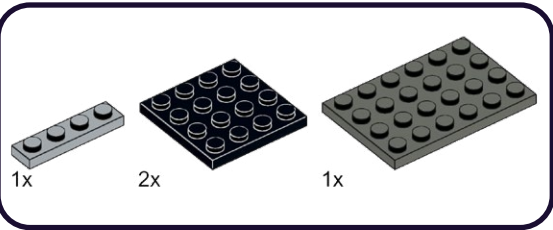

365

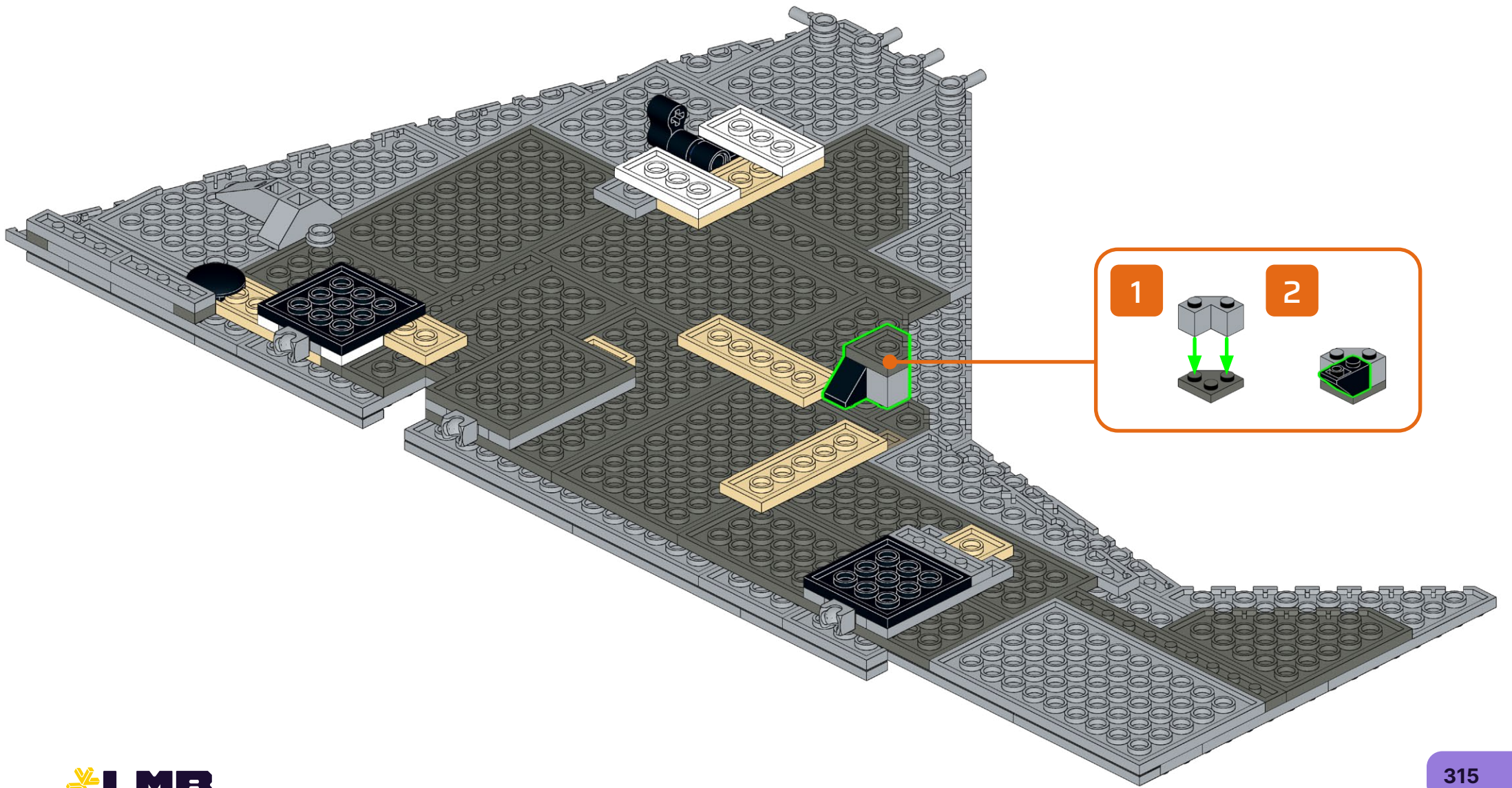
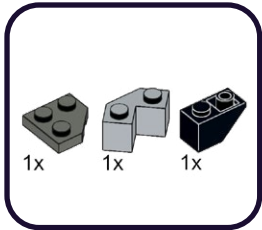

366

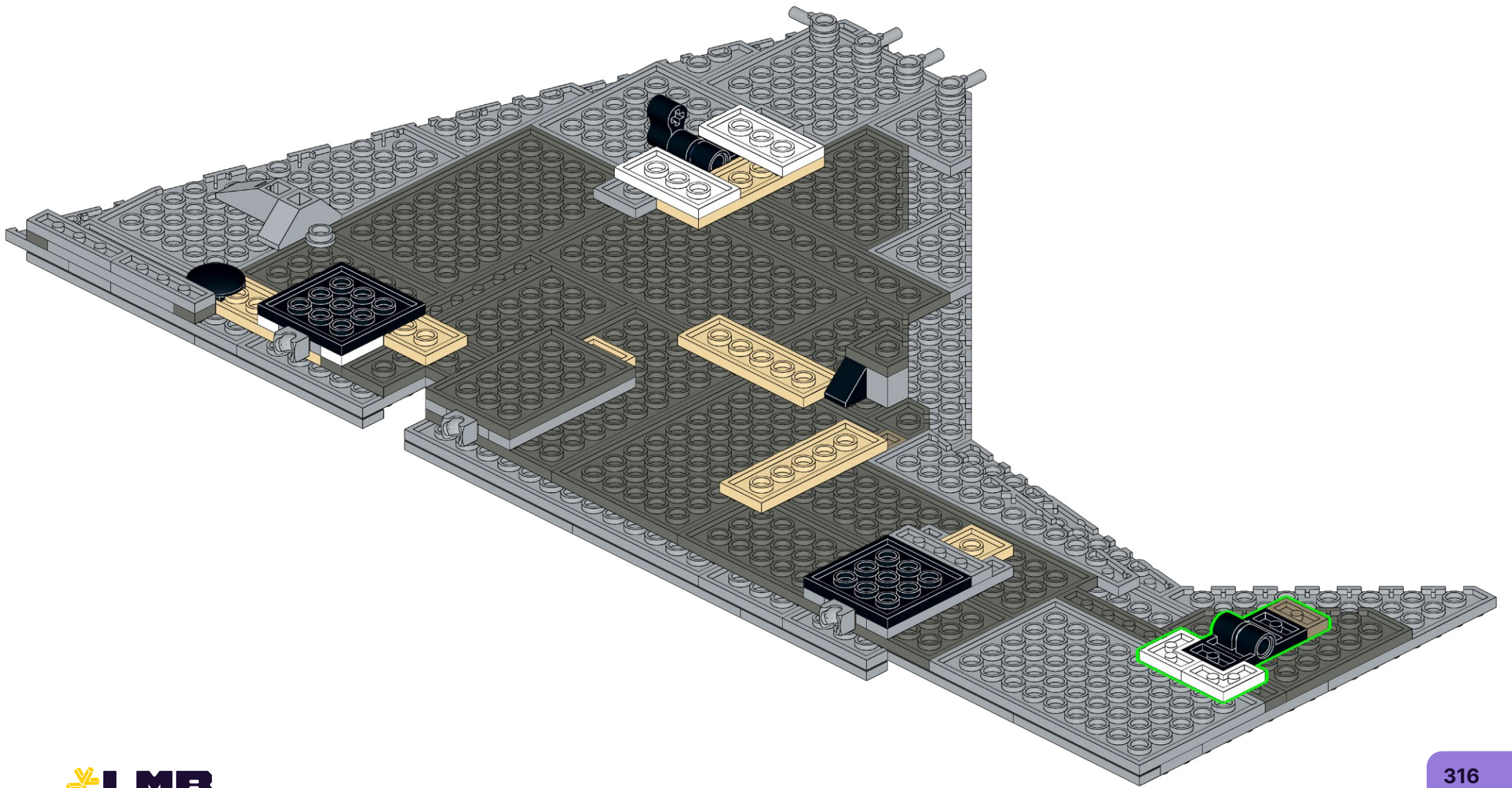
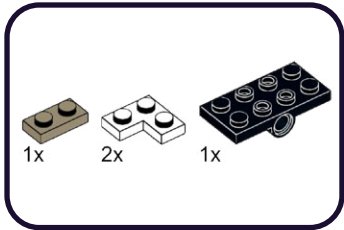

367

3x

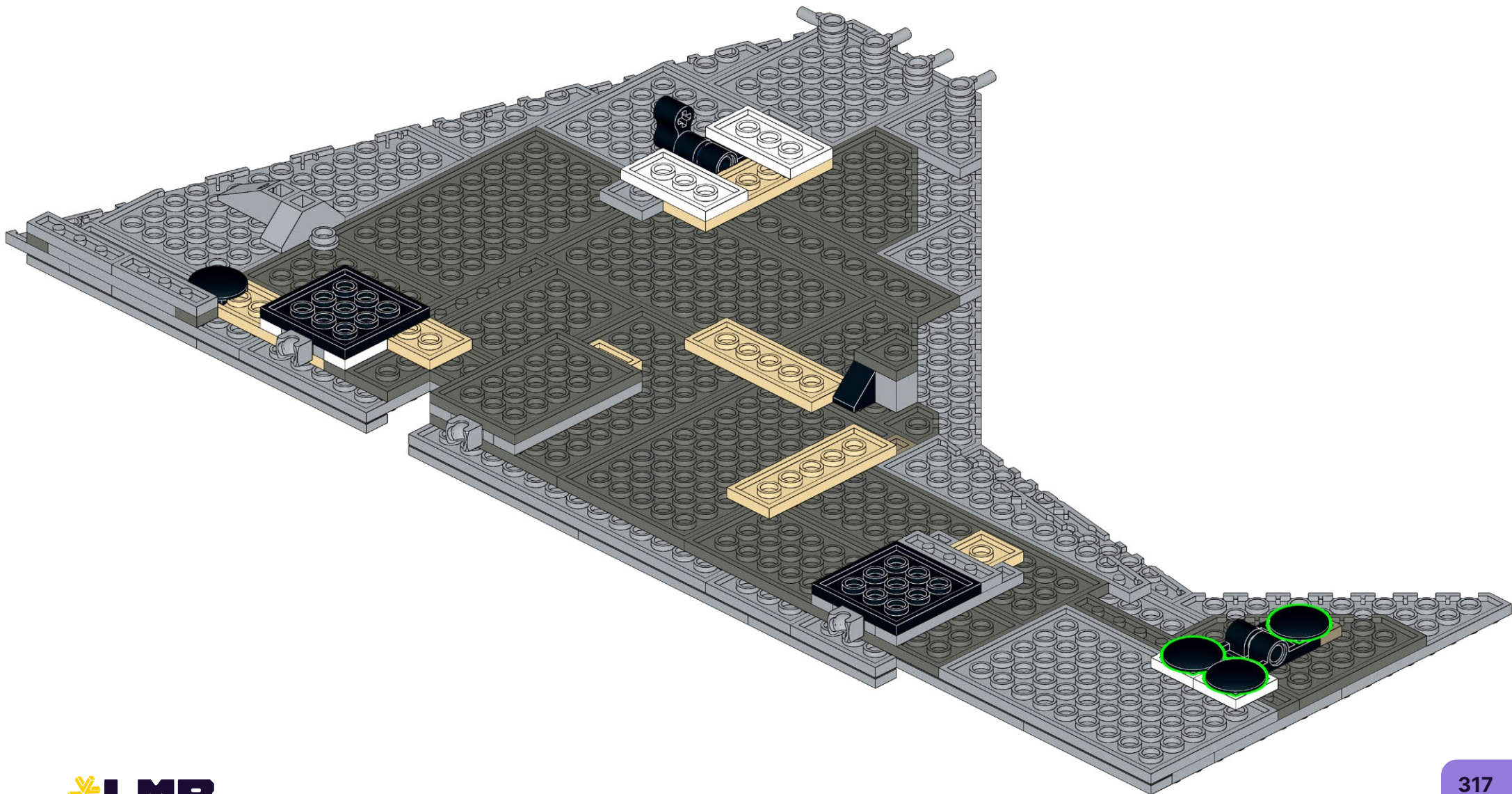

368

1x 1x

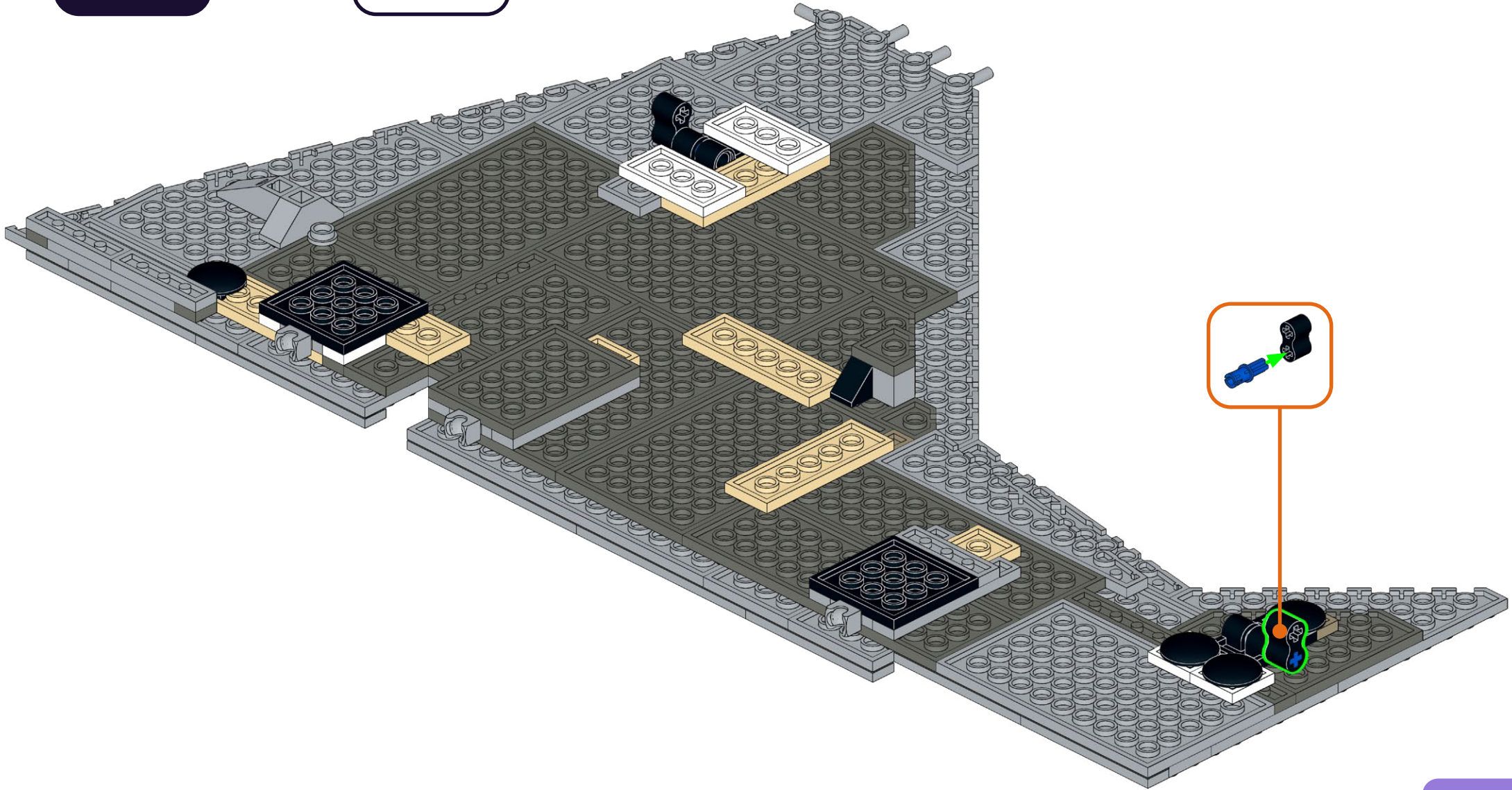

370

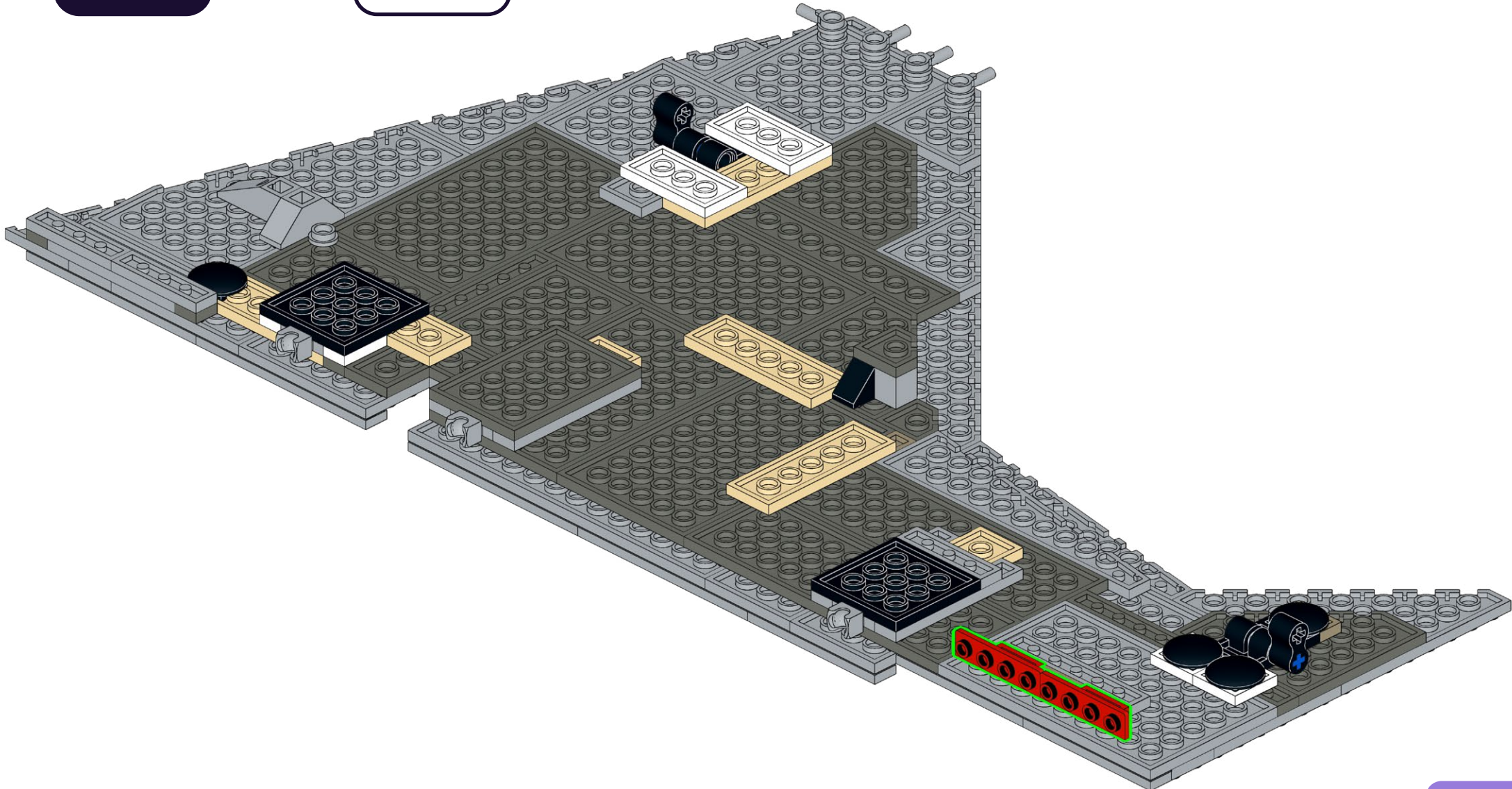
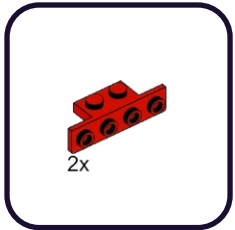

372

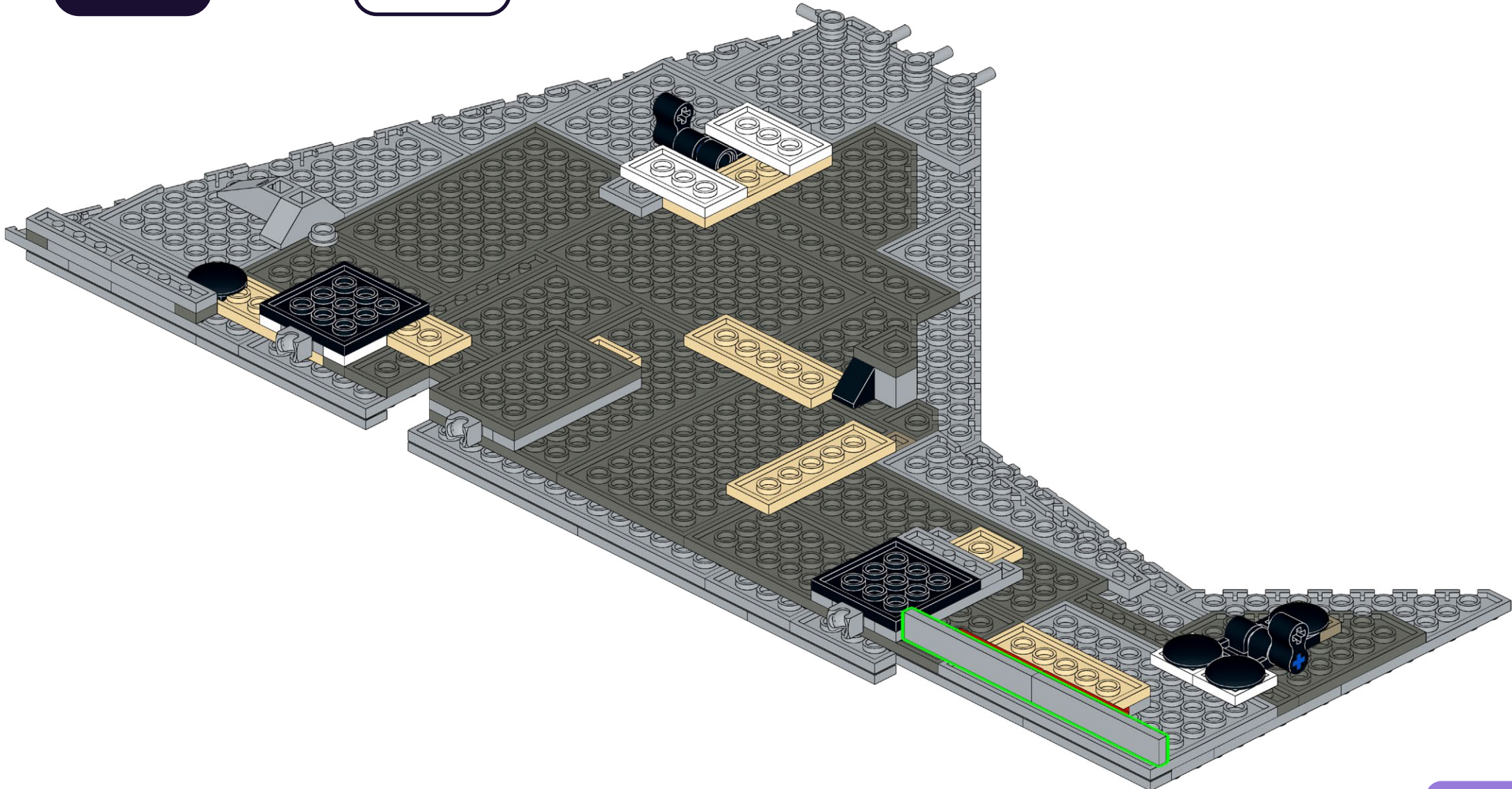
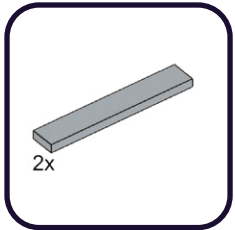

375

1x 1x

1x 1x



CONTACT US

Click below for customer support, or general inquiries.

Cliquez ci-dessous pour accéder au support client ou aux renseignements généraux.

Clicca qui sotto per l'assistenza clienti o per richieste generali.

Contact Us



Contactez-nous



Contattaci



Klicken sie unten für kundensupport oder allgemeine anfragen.

Haga clic a continuación para atención al cliente o consultas generales.

点击下方获取客户支持或一般咨询。

Kontaktieren sie uns



Contáctanos



联系我们



TROUBLESHOOTING

If you're stuck, scan the QR code for troubleshooting.

Se sei bloccato, scansiona il codice QR per la risoluzione dei problemi.

Wenn Sie nicht weiterkommen, scannen Sie den QR-Code zur Fehlerbehebung.

Si vous êtes bloqué, scannez le code QR pour le dépannage

Si está atascado, escanee el código QR para solucionar el problema.

如果遇到问题, 请扫描二维码进行故障排除

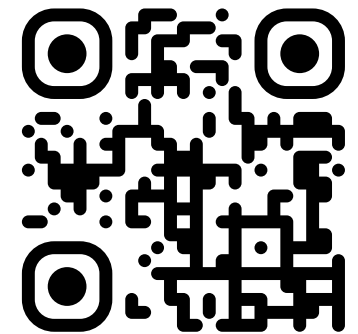



LIGHTMYBRICKS

lightmybricks.com



LEGO® is a trademark of the LEGO Group of companies, which does not sponsor, authorize or endorse this product. All LEGO® sets featured in images are sold separately. This is not a LEGO® product. The LEGO Group is not liable for any loss, injury or damage arising from the use or misuse of this product. ©2024 Light My Bricks Pty Ltd. All rights reserved. www.lightmybricks.com

Our components are designed and packaged in Australia by Light My Bricks Pty Ltd. Components are manufactured in China. 3fl bldg C, Shuanghuan Quanxin Technology Information Industry Park Baolong Street, Longgang District, Shenzhen, China. Imported in Australia by Light My Bricks Pty Ltd, 5/26 Rushdale St, Knoxfield, VIC, 3180, Australia.

WARNING: CHOKING HAZARD - Small parts. Not for children under 3 years.

AVERTISSEMENT : RISQUE D'ÉTOUFFEMENT - Petites pièces. Ne convient pas aux enfants de moins de 3 ans.

ATTENZIONE: PERICOLO DI SOFFOCAMENTO - Piccole parti. Non adatto a bambini di età inferiore a 3 anni.

WARNUNG: ERSTICKUNGSGEFAHR - Kleine Teile. Nicht für Kinder unter 3 Jahren geeignet.

ADVERTENCIA: PELIGRO DE ASFIXIA - Piezas pequeñas. No son apto para niños menores de 3 años.

警告：窒息危险 - 小零件。不适合3岁以下儿童。