

LIGHT KIT INSTALLATION GUIDE

**LORD OF THE RINGS
BARAD-DUR (PART 3)**

FOR LEGO
SET
#10333



CONTENTS



03

Getting Started

- 04 Legend
- 05 Component Handling
- 06 Blueprint

08

Instructions

- 08 LEGO Bag 28
- 20 LEGO Bag 29 & 31 - LMB Bag 04
- 86 LEGO Bag 30
- 129 LEGO Bag 32
- 147 LEGO Bag 33
- 182 LEGO Bag 34
- 212 LEGO Bag 35
- 246 LEGO Bag 36
- 278 LEGO Bag 37
- 311 LEGO Bag 38 - LMB Bag 05
- 355 LEGO Bag 39
- 383 LEGO Bag 40

479

Final Product

- 480 Package Contents
- 483 Contact & Troubleshooting

GETTING STARTED



Bold, beautiful and bright, Light My Bricks elevates your favourite LEGO set from knick-knack to statement piece. Create a talking point at home or in the office that speaks to your passions with Light My Bricks. To learn more, click below.

[Learn More](#)



Audacieux, beau et lumineux, Light My Bricks élève votre ensemble LEGO préféré du statut de bibelot à celui de pièce maîtresse. Que ce soit à la maison ou au bureau, partagez votre passion des LEGO avec Light My Bricks. Cliquez ci-dessous pour en savoir plus.

[En savoir plus](#)



Audace, bello e luminoso, Light My Bricks eleva il tuo set LEGO preferito da soprammobile a pezzo di tendenza. Crea un punto di discussione a casa o in ufficio che parli alle tue passioni con Light My Bricks. Per saperne di più, clicca qui sotto.

[Ulteriori Informazioni](#)



Mutig, schön und hell – Light My Bricks verwandelt Ihr Lieblings-LEGO-Set von einem schnickschnack in ein statement-stück. Schaffen sie einen gesprächspunkt zu hause oder im büro, der Ihre leidenschaften widerspiegelt, mit Light My Bricks. Um mehr zu erfahren, klicken sie unten.

[Mehr erfahren](#)



Audaz, hermoso y brillante, Light My Bricks eleva tu set LEGO favorito de una chuchería a una pieza llamativa. Crea un tema de conversación en casa o en la oficina que hable de tus pasiones con Light My Bricks. Para obtener más información, haga clic a continuación.

[Más información](#)



大胆、美丽而明亮，Light My Bricks 将你喜爱的乐高套装从小摆件提升为引人注目的装饰品。在家或办公室打造一个能表达你激情的话题，了解更多，请点击下方。

[了解更多](#)



LEGEND

Rotate Set



Retournez L'ensemble
Ruota Set
Set Drehen
Rotar Conjunto
旋转套件

Add Part



Ajoutez une Pièce
Aggiungi Parte
Teil Hinzufügen
Agregar Pieza
添加零件

Click



Cliquez
Clic
Klicken
Clic
点击

Pinch/Fold



Pincez/Pliez
Pizzicare/Piegare
Kneifen/Falten
Pellizcar/Doblar
折叠

Pull Cable



Tirez le Cable
Tirare il Cavo
Kabel Ziehen
Tirar del Cable
拉动电缆

Repeat Step



Répétez
Ripetere
Wiederholen
Repetir
重复

Sticker



Autocollant
Adesivo
Aufkleber
Pegatina
贴纸

Power On Test



Test de mise sous tension
Test di Potenza
Stromtest
Prueba de Energía
电源测试

Disconnect Power



Débranchez L'alimentation
Scollegare L'alimentazione
Strom Trennen
Desconectar la Energía
断开电源

Troubleshoot



Dépanner
Risolvere
Fehlerbehebung
Solución de Problemas
故障排除

COMPONENT HANDLING

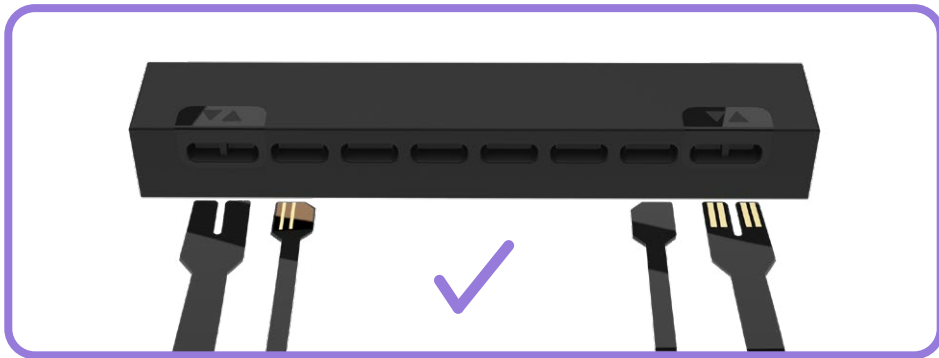
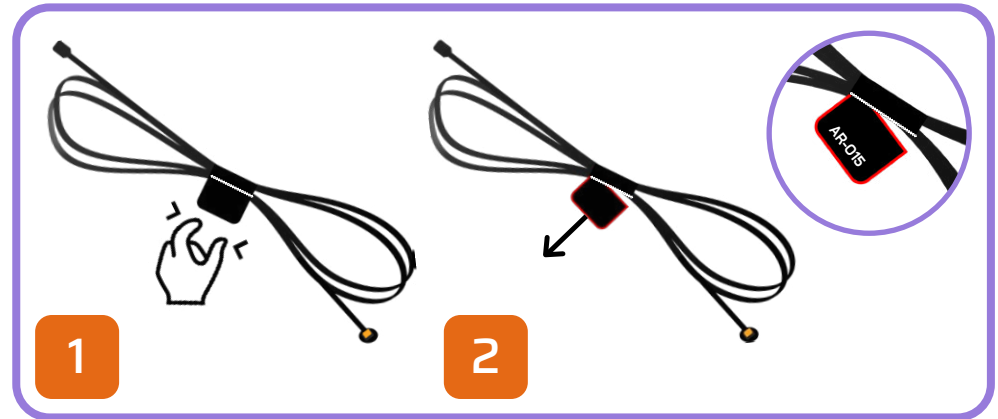
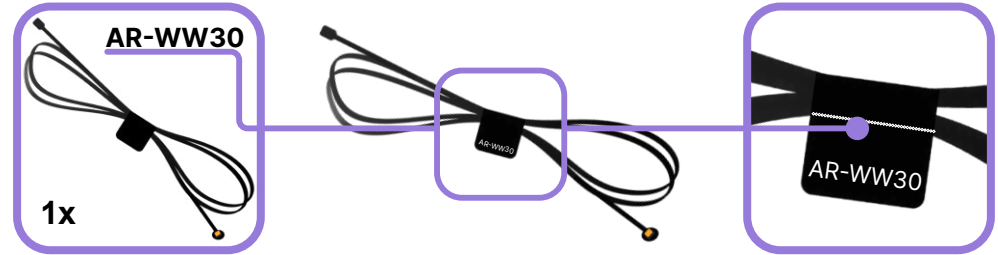
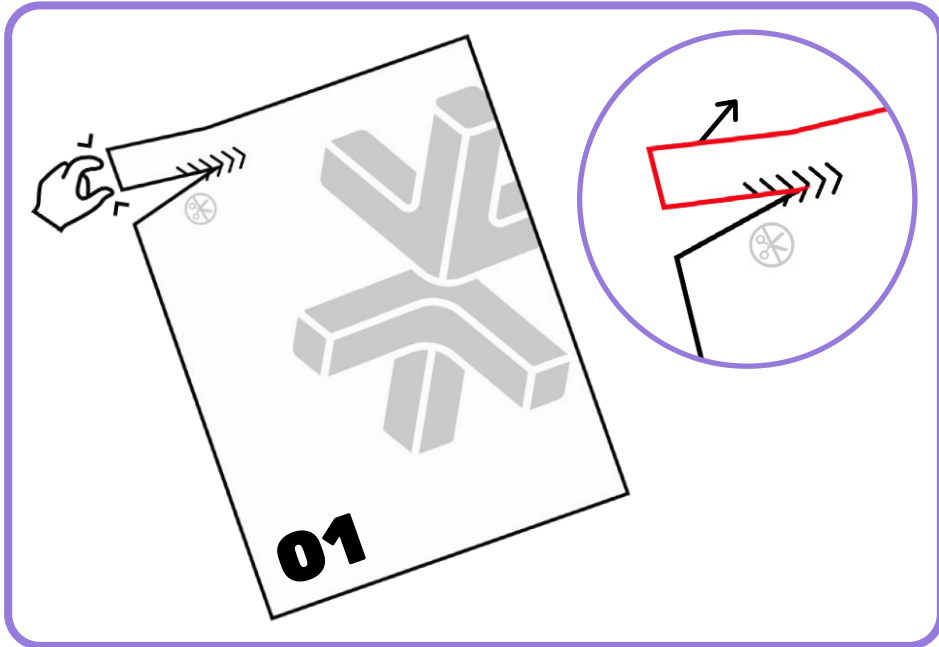

BLUEPRINT

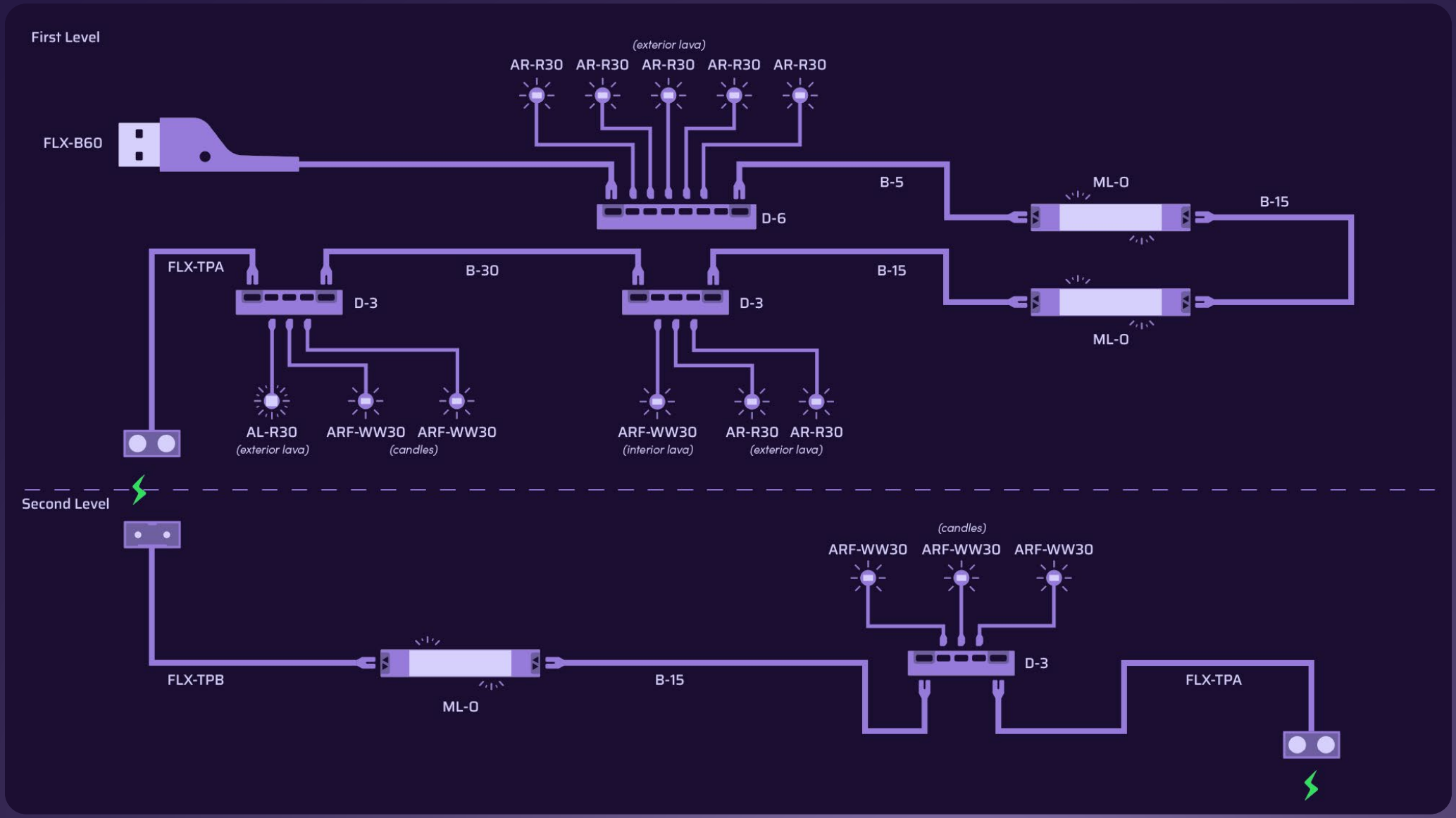

BLUEPRINT

Third Level

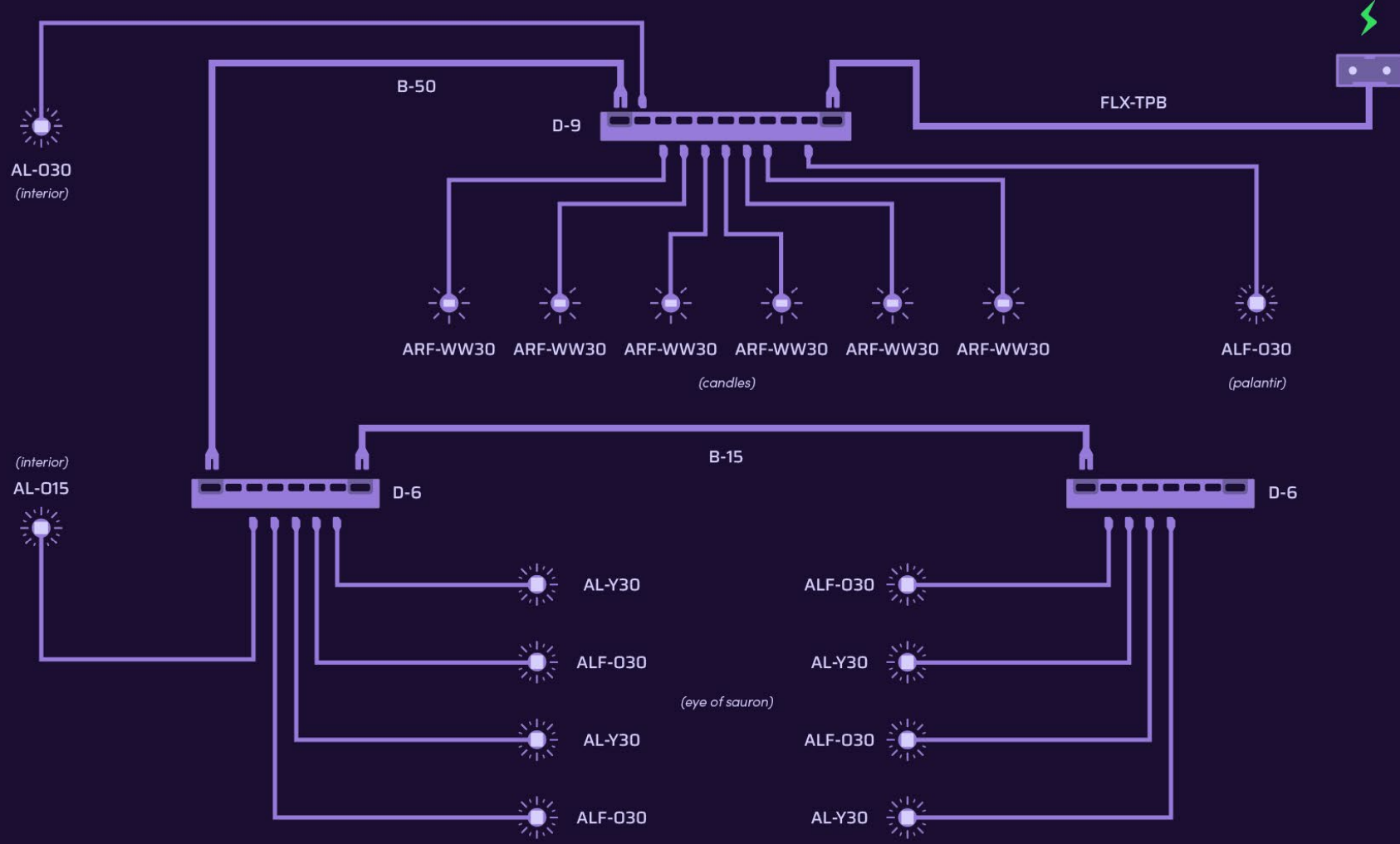

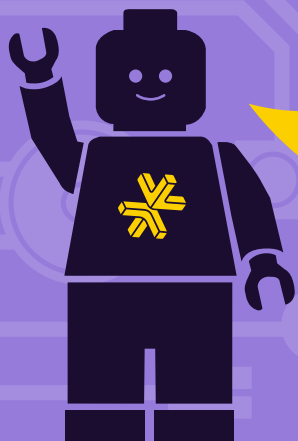
**HOLD UP!**

You might notice some bags aren't in order, as well as left over pieces, but that's ok! We're changing the way you build LEGO!

ATTENDEZ!

Vous remarquerez peut-être que certains sacs, ainsi que certaines pièces, ne sont pas dans le bon ordre. Mais pas de panique! Nous changeons simplement la façon avec laquelle vous construisez vos LEGO!

ASPETTA!

Potresti notare che alcuni sacchetti non sono in ordine, così come i pezzi avanzati, ma va bene così! Stiamo cambiando il modo in cui costruisci i LEGO!

HALT!

Sie werden möglicherweise bemerken, dass einige tüten durcheinander sind und teile übrig bleiben, aber das ist in Ordnung! Wir ändern die art und weise, wie Sie LEGO bauen!

¡ESPERA!

Es posible que notes que algunas bolsas están fuera de servicio, así como piezas sobrantes, ¡pero está bien! ¡Estamos cambiando la forma en que construyes LEGO!

暫停!

你可能会注意到一些袋子顺序错乱, 以及一些剩余的部件, 但没关系! 我们正在改变你搭建乐高的方式!

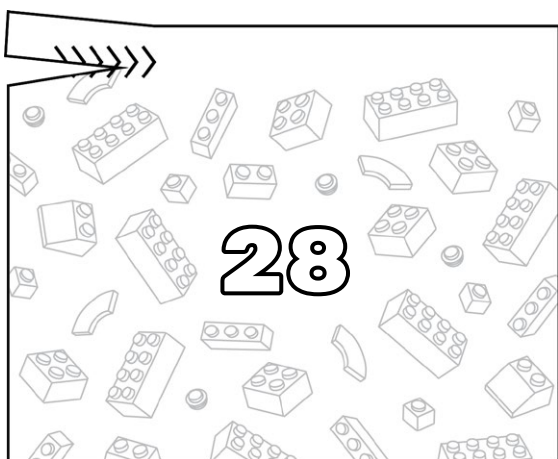
Open LEGO® Bag 28

1

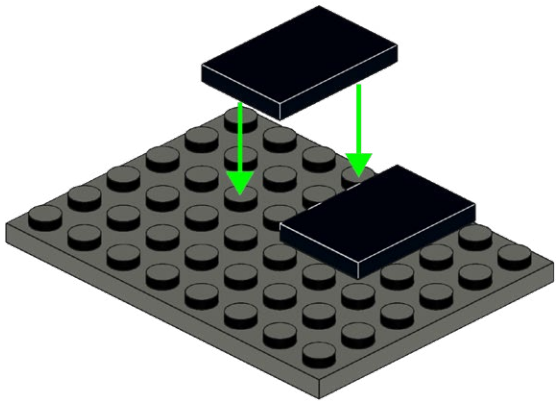
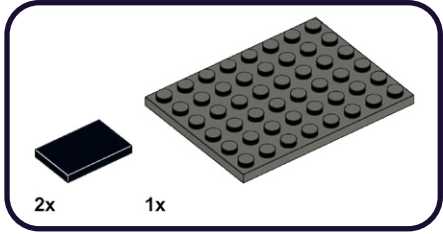

2

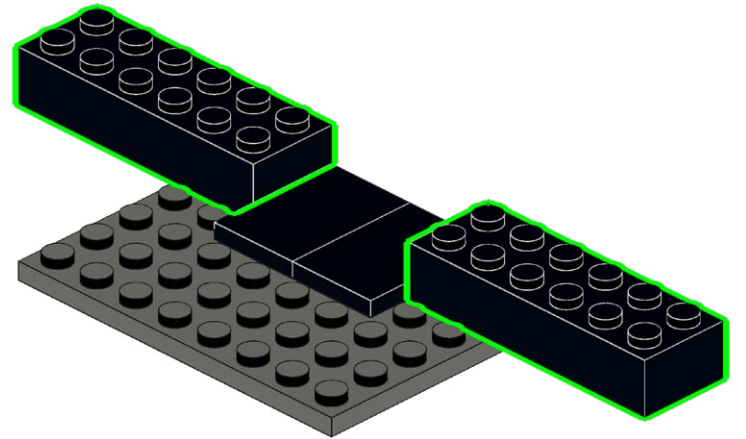
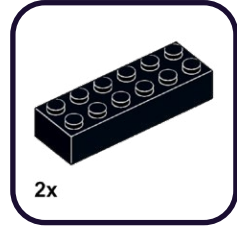

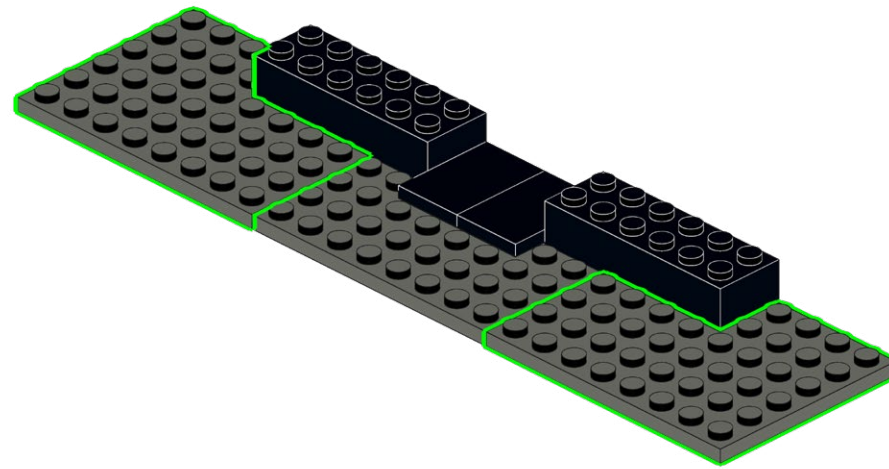

4

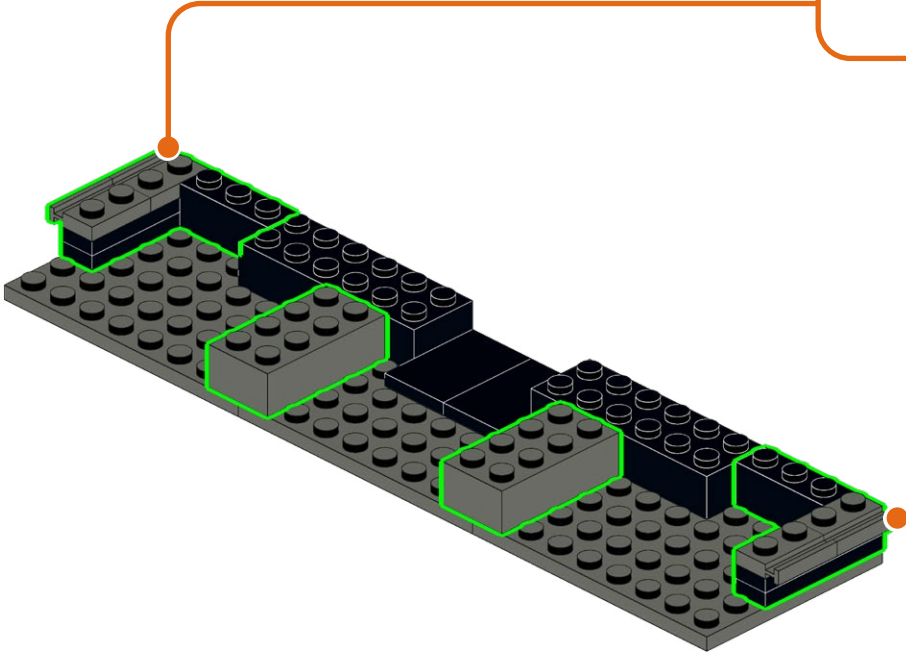
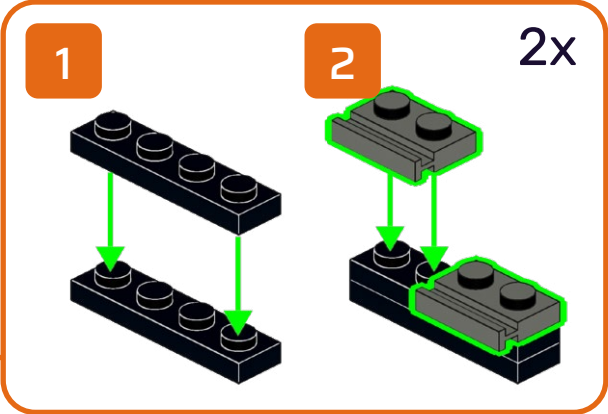
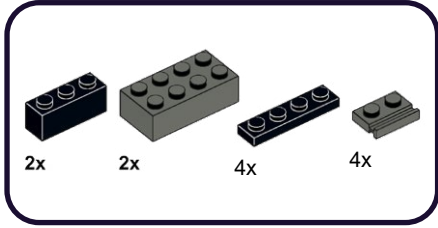

5

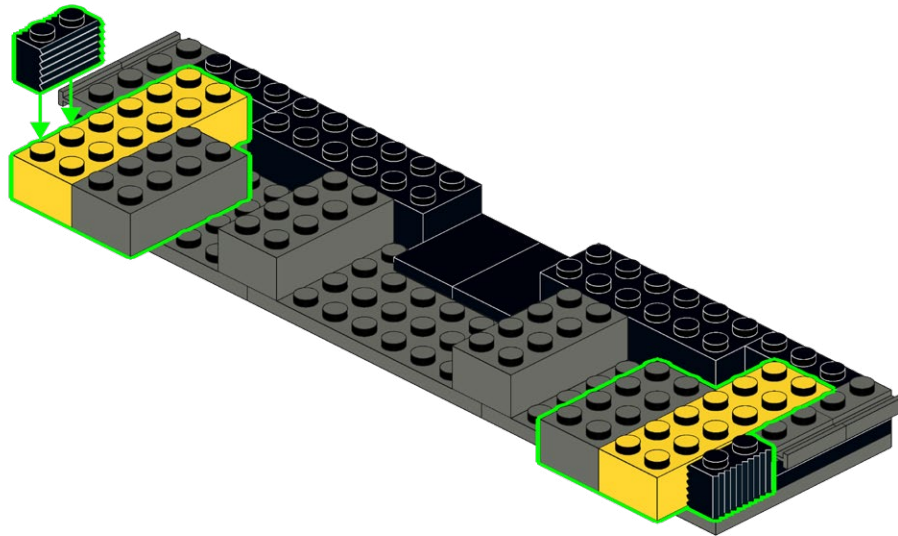
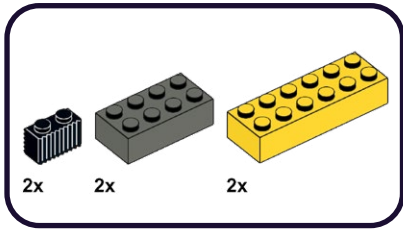

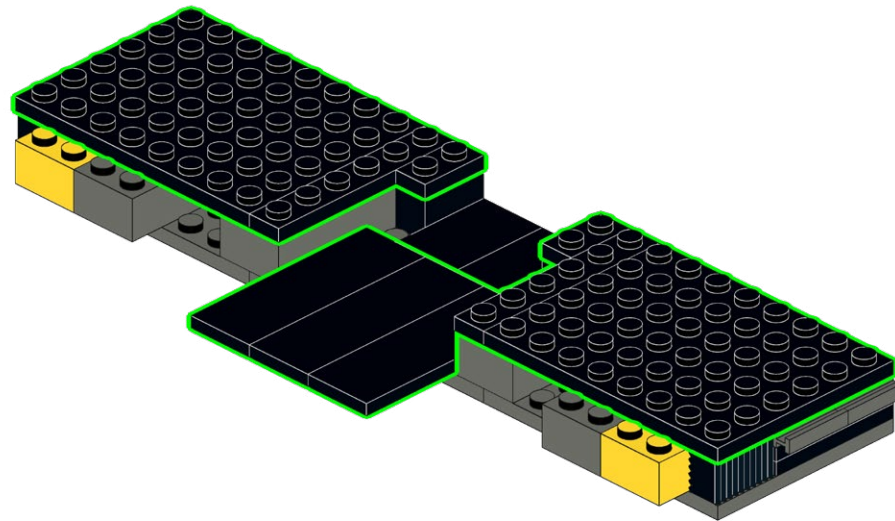
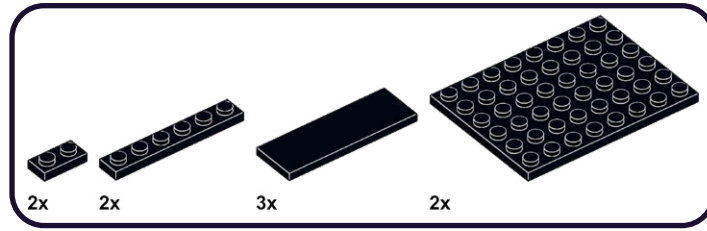

7

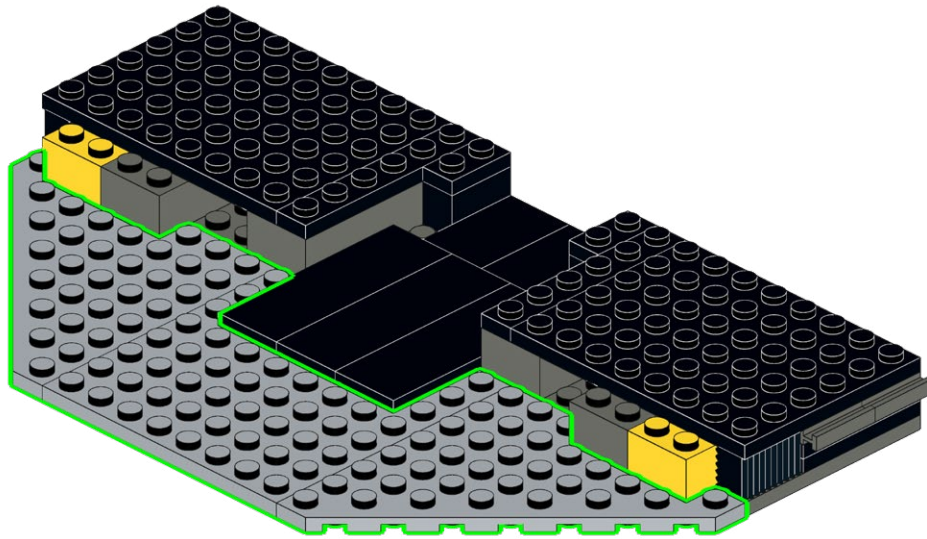
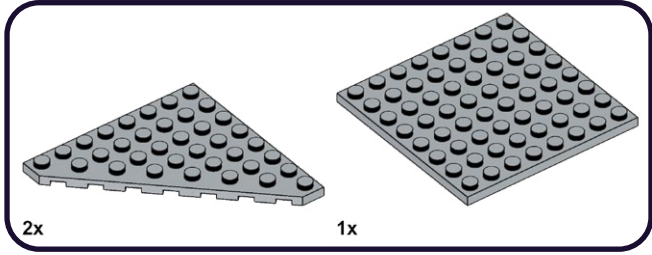

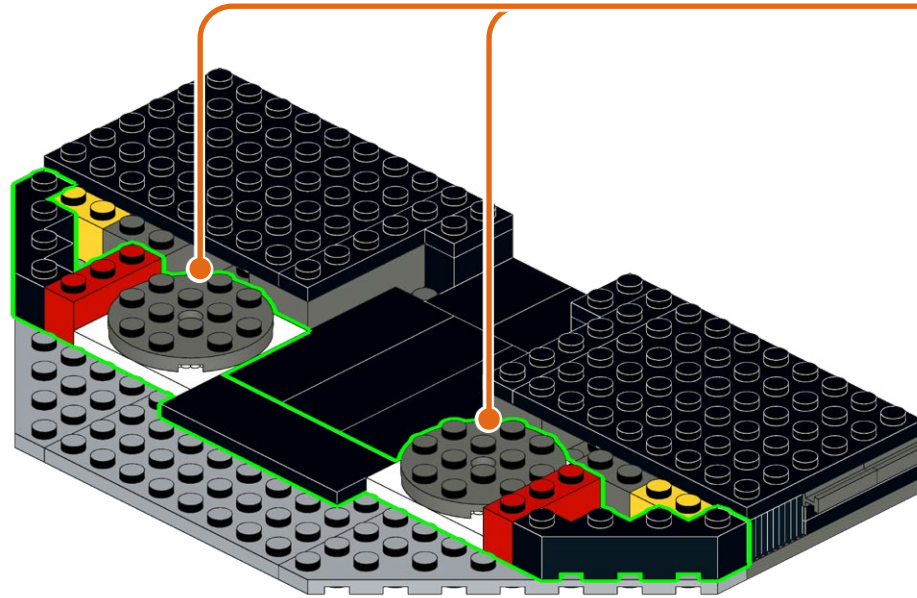
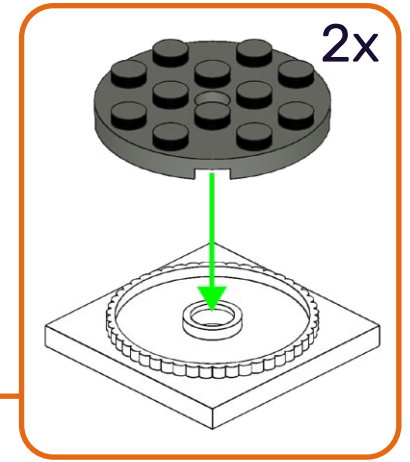
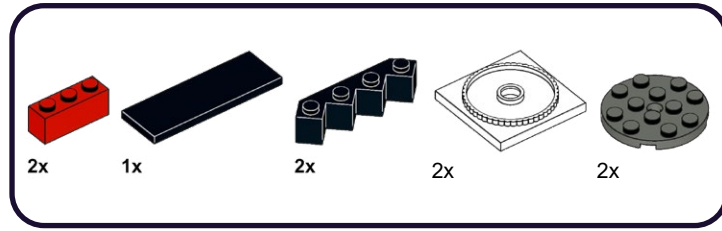
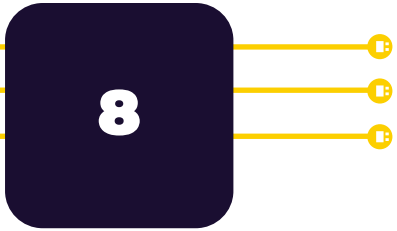

9

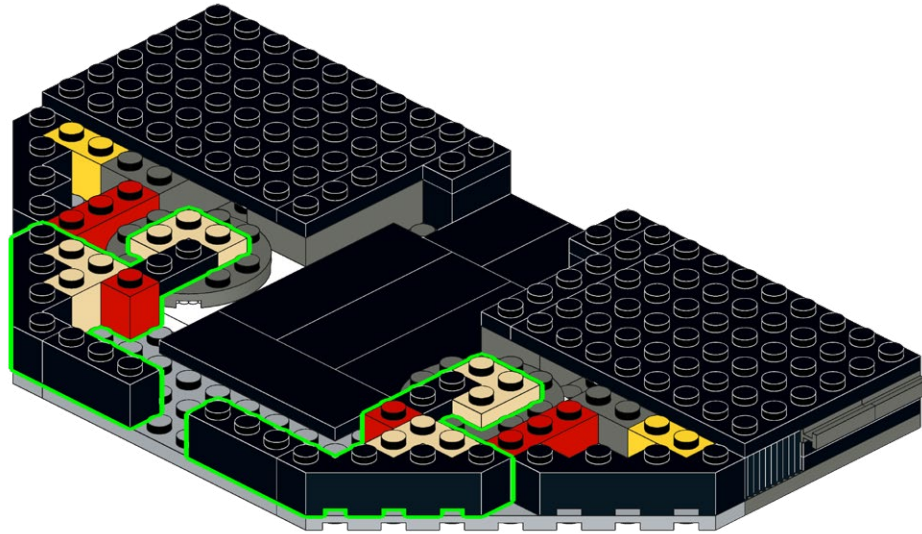
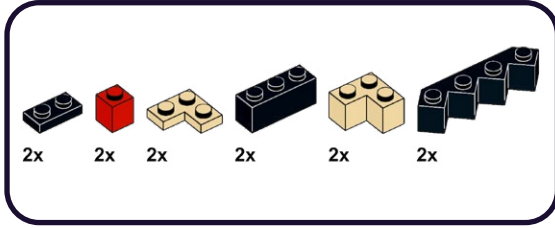

10

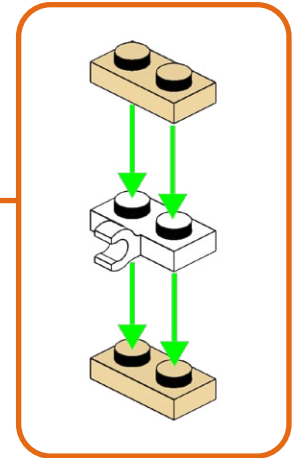
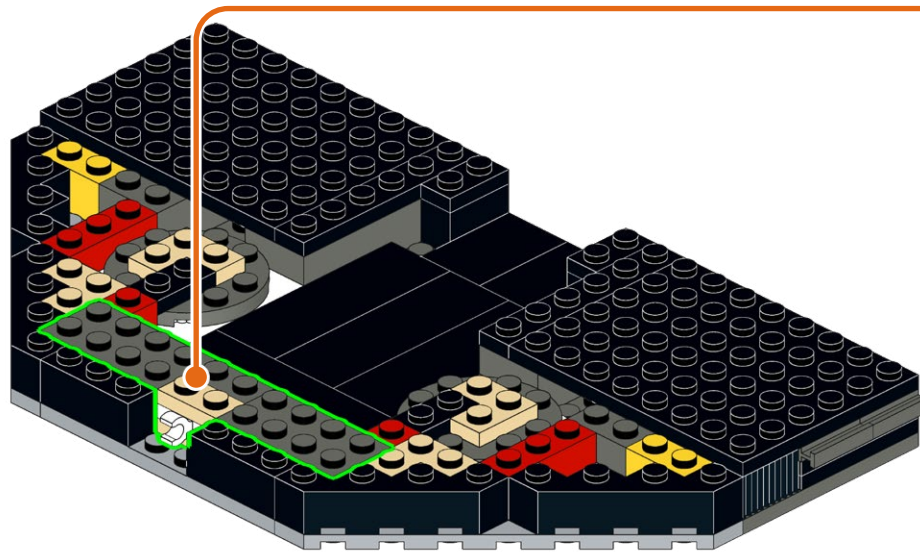
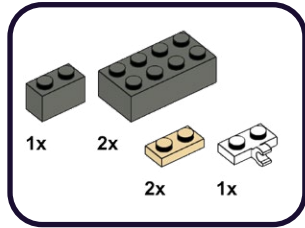

11

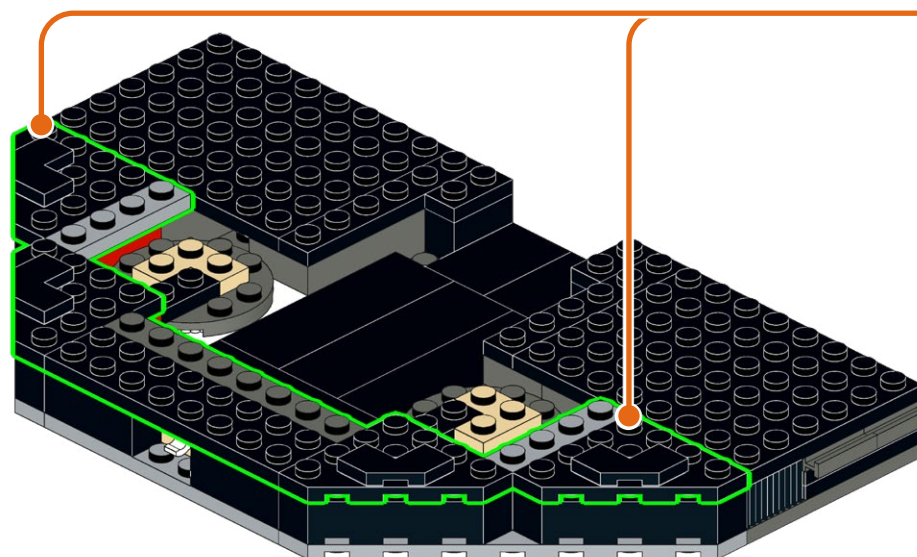
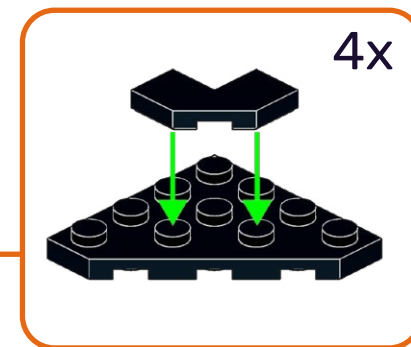
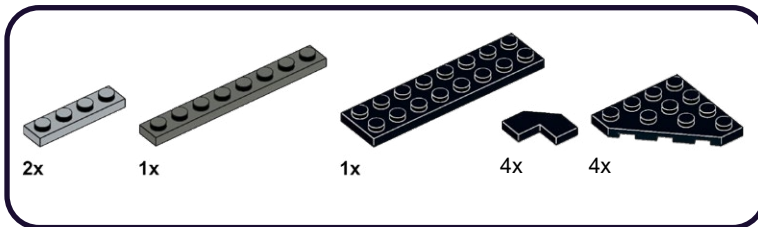

12

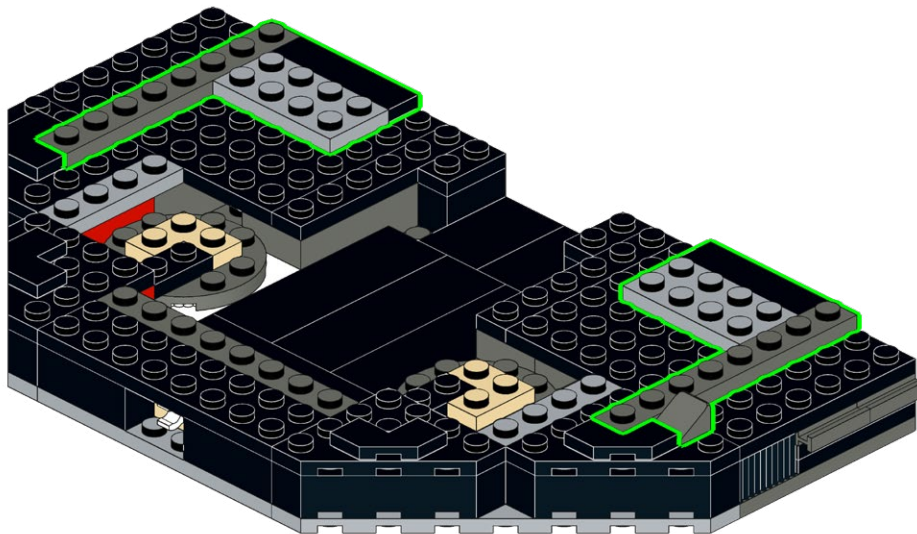
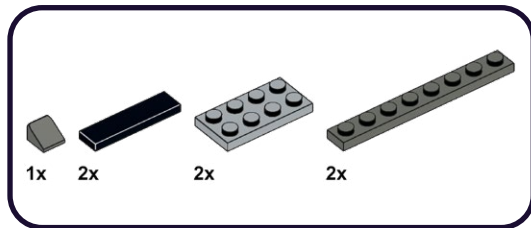

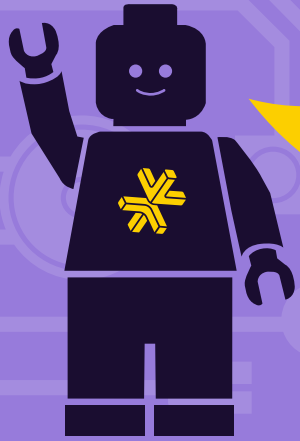

HOLD UP!

You might notice some bags aren't in order, as well as left over pieces, but that's ok! We're changing the way you build LEGO!

ATTENDEZ!

Vous remarquerez peut-être que certains sacs, ainsi que certaines pièces, ne sont pas dans le bon ordre. Mais pas de panique! Nous changeons simplement la façon avec laquelle vous construisez vos LEGO!

ASPETTA!

Potresti notare che alcuni sacchetti non sono in ordine, così come i pezzi avanzati, ma va bene così! Stiamo cambiando il modo in cui costruisci i LEGO!

HALT!

Sie werden möglicherweise bemerken, dass einige tüten durcheinander sind und teile übrig bleiben, aber das ist in Ordnung! Wir ändern die art und weise, wie Sie LEGO bauen!

¡ESPERA!

Es posible que notes que algunas bolsas están fuera de servicio, así como piezas sobrantes, ¡pero está bien! ¡Estamos cambiando la forma en que construyes LEGO!

暫停!

你可能会注意到一些袋子顺序错乱, 以及一些剩余的部件, 但没关系! 我们正在改变你搭建乐高的方式!

Open LEGO® Bags 29 & 31

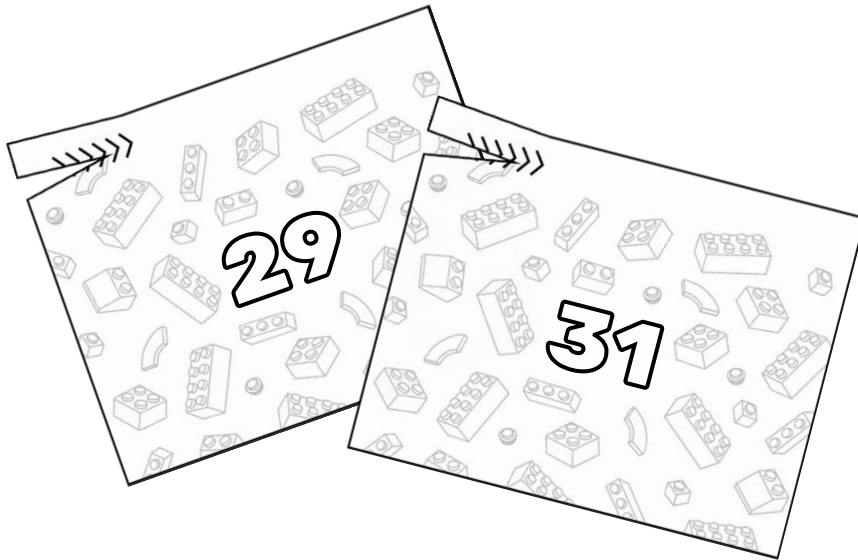

Open LMB Bag 04

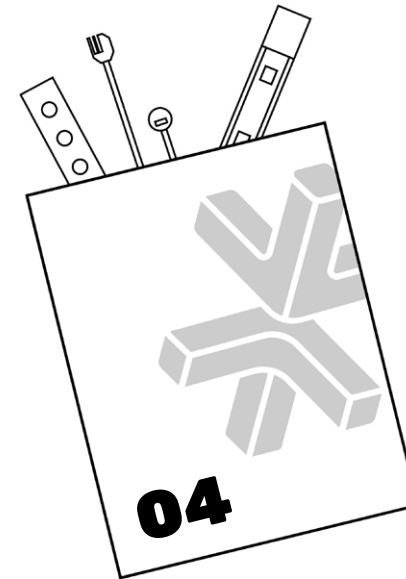

13

1

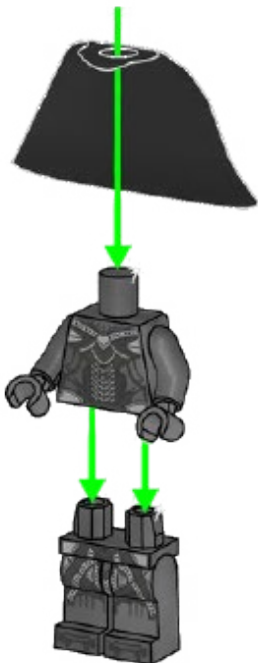

1



1

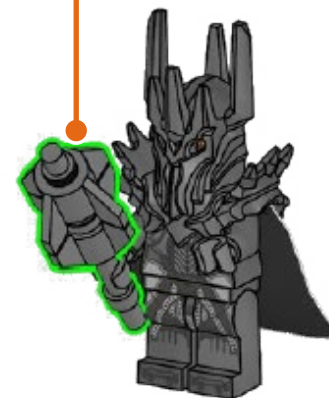

1

2

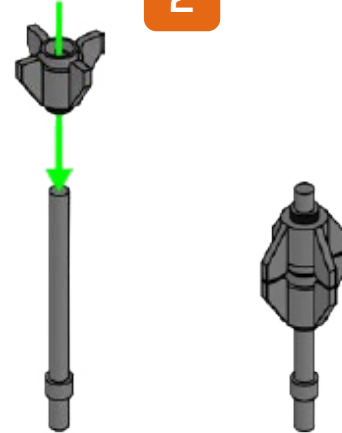

14

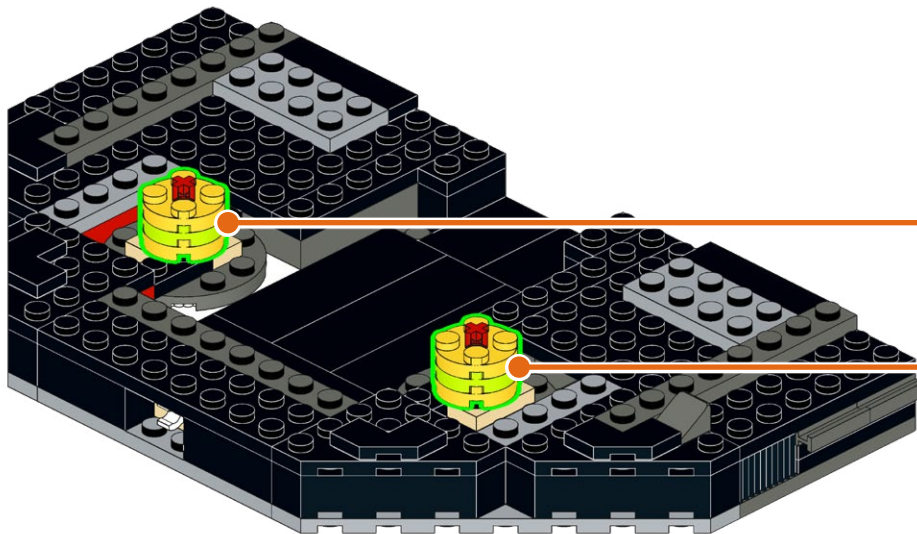
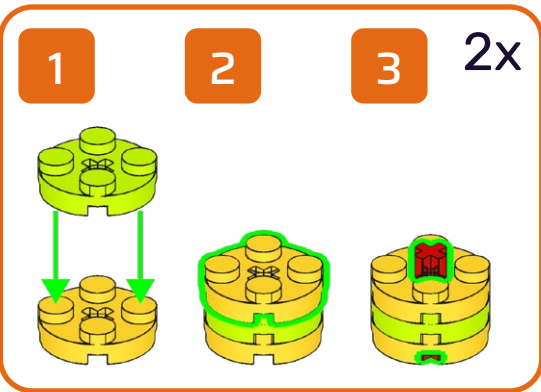
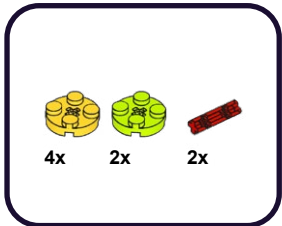

15

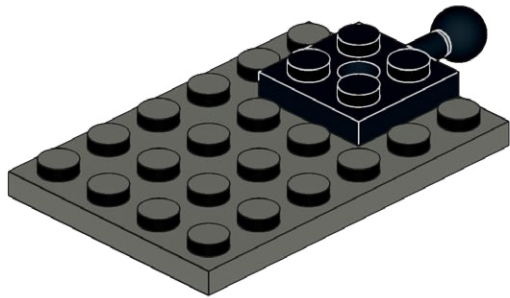
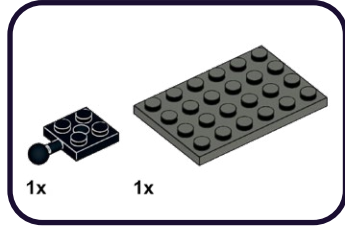

16

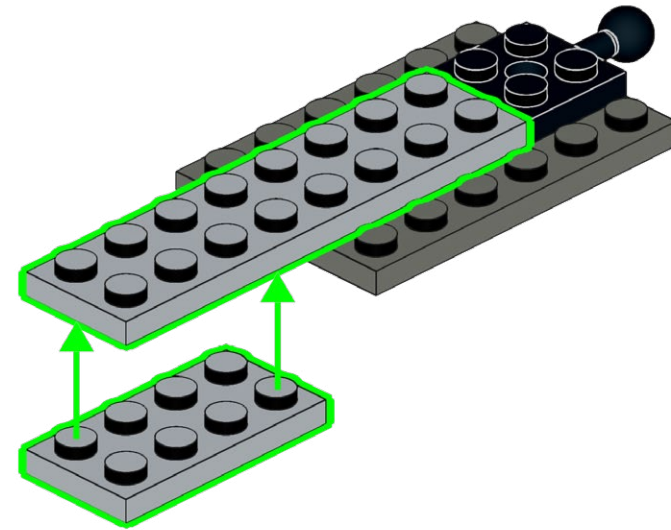
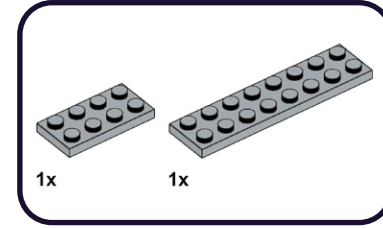

17

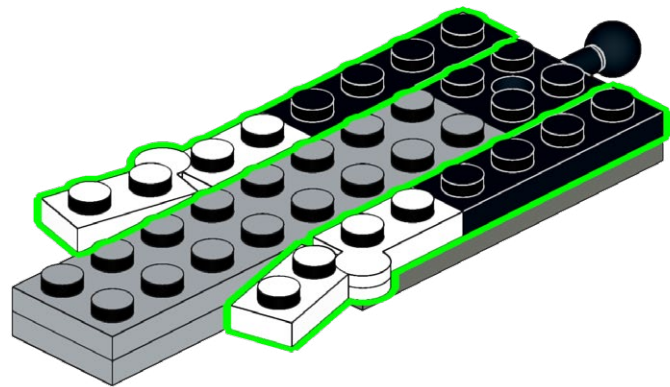
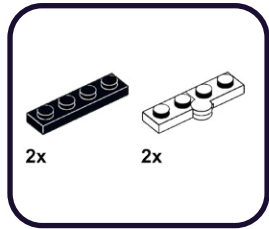

18

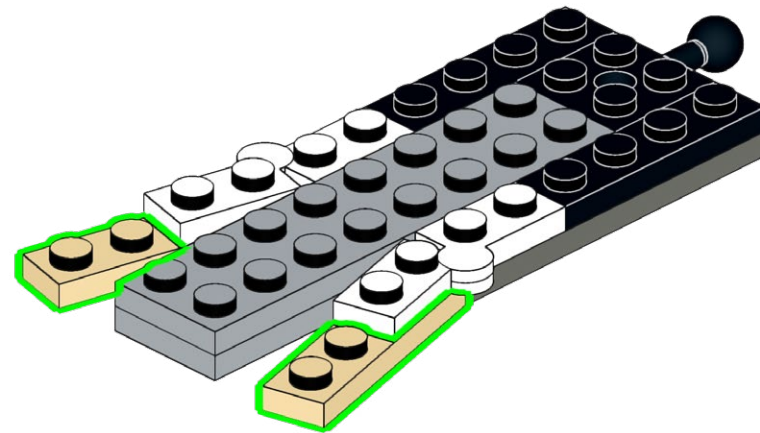
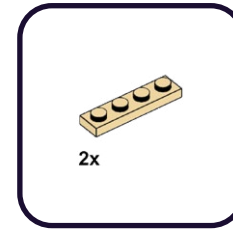

19

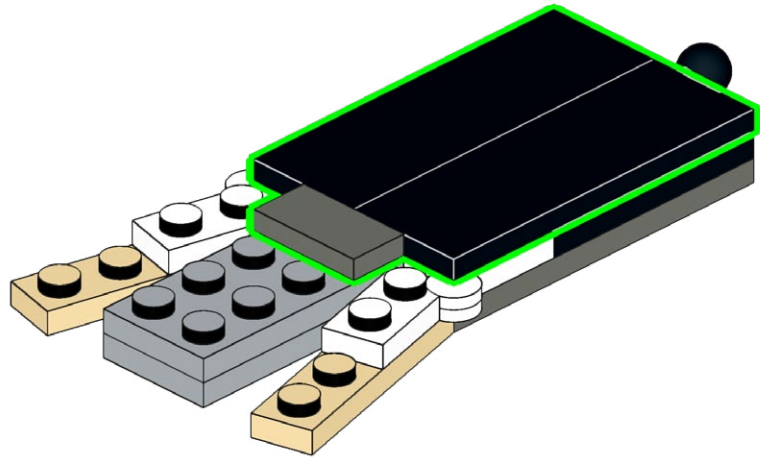
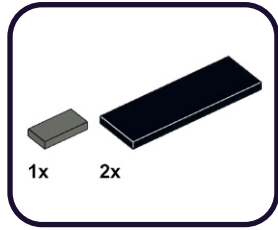

20

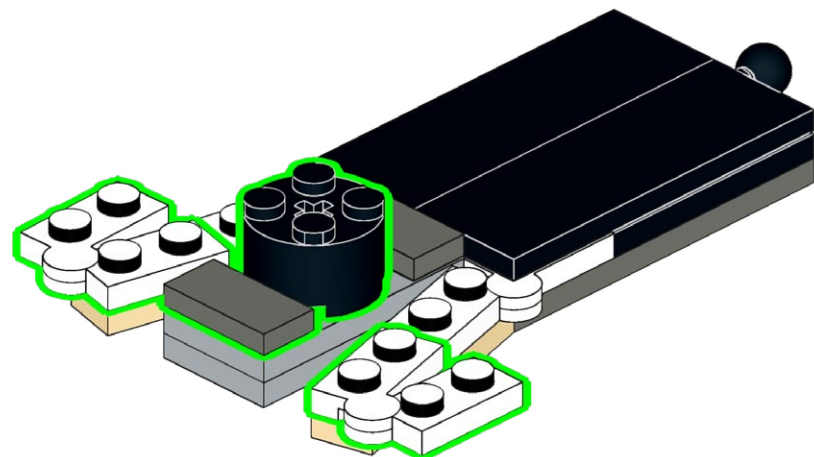
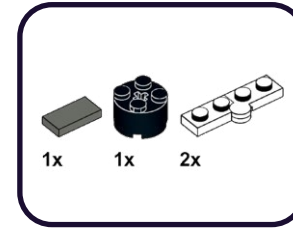

21



2x

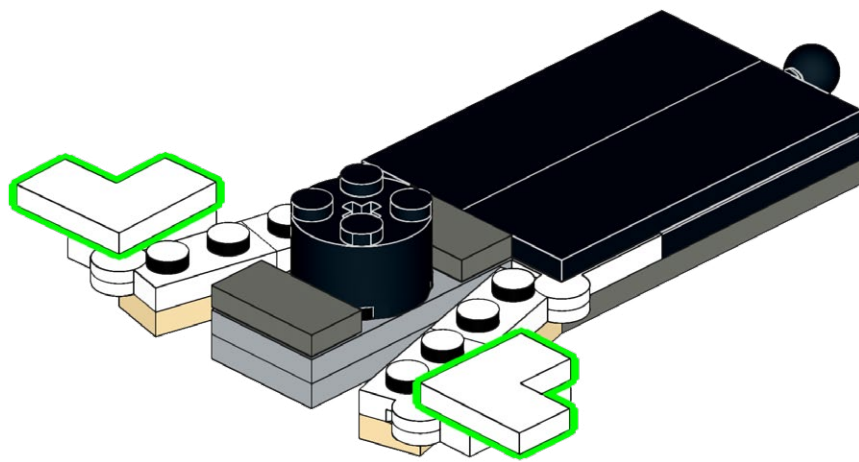

22

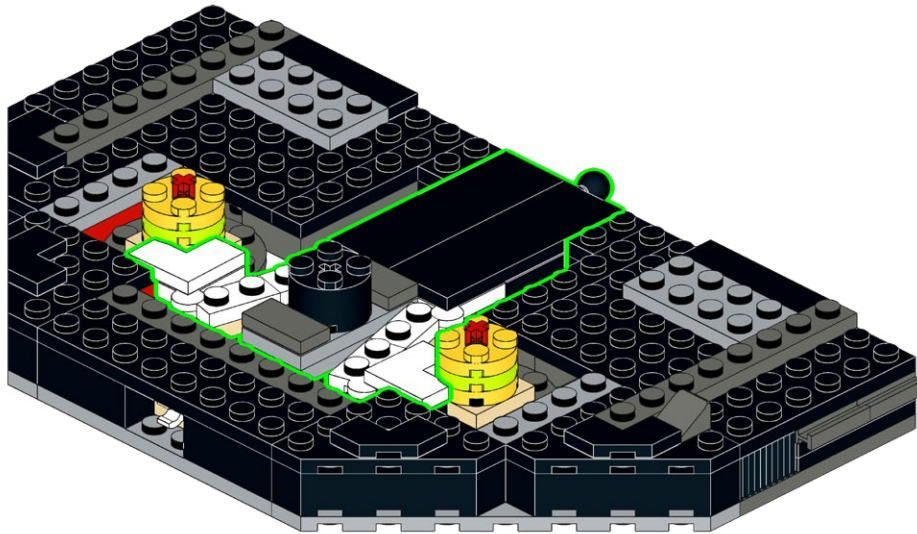

23

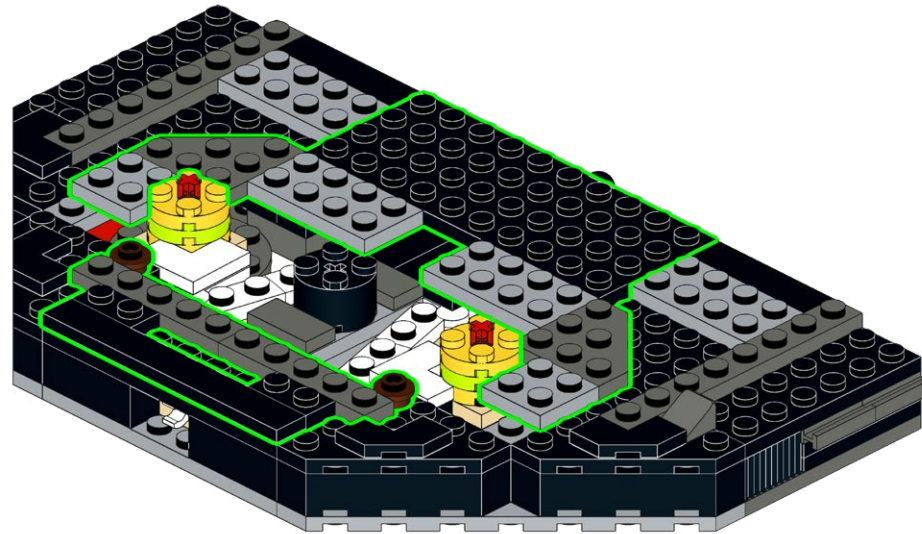
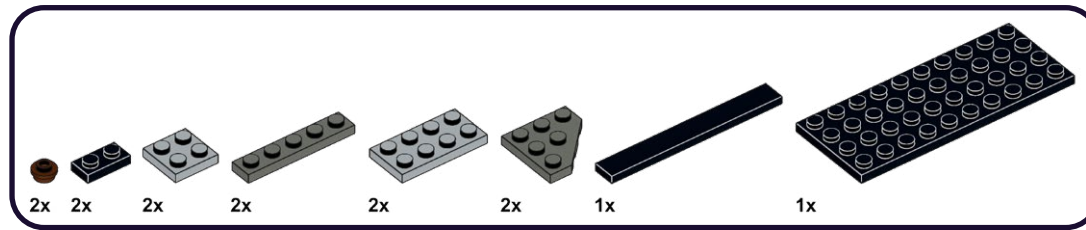

24

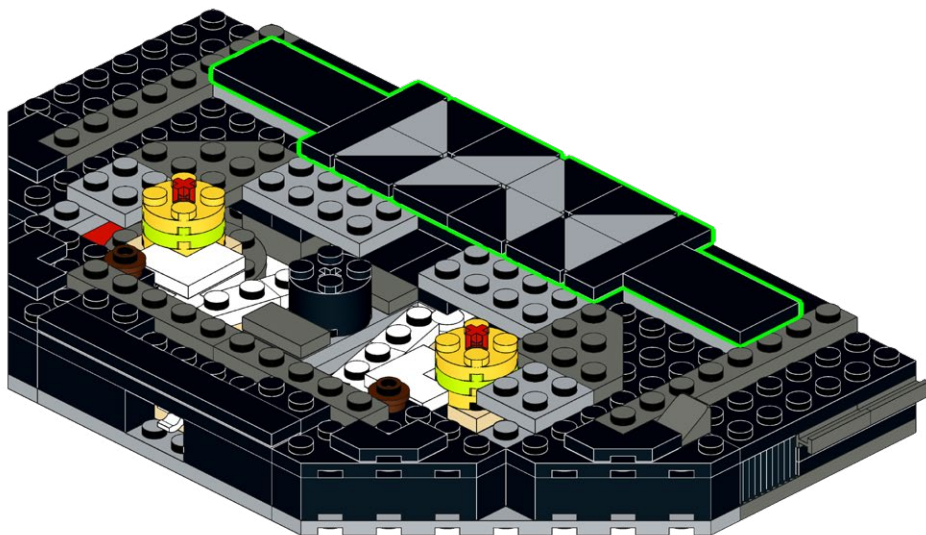
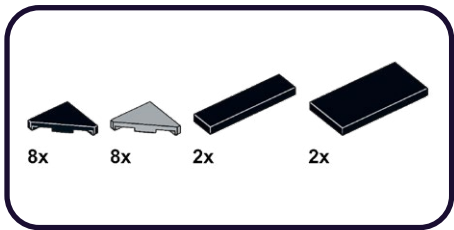

25

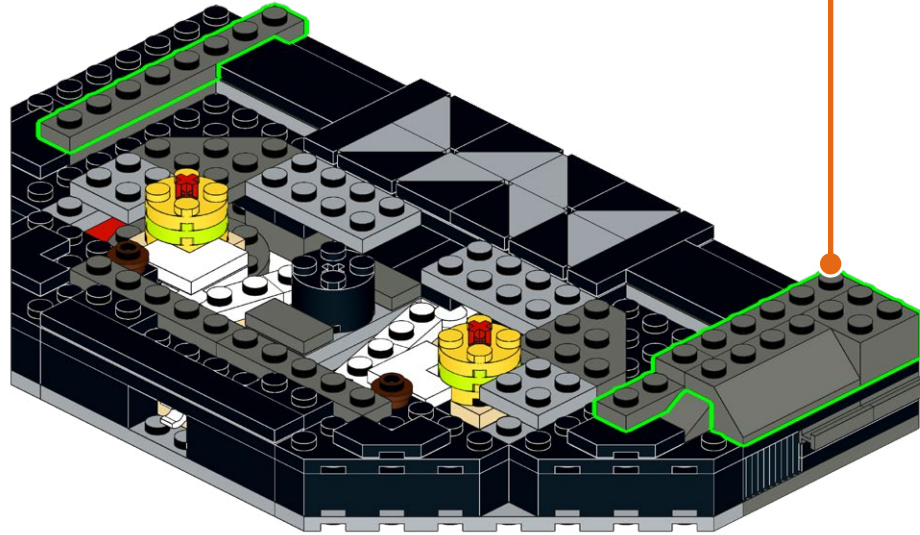
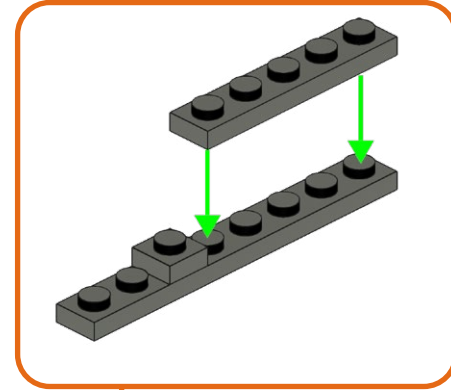
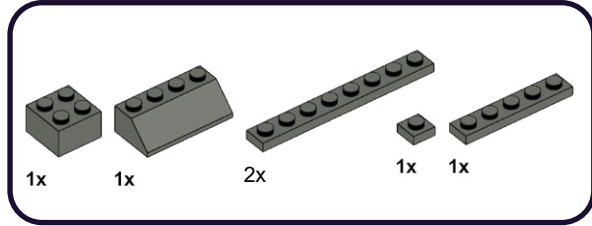

26

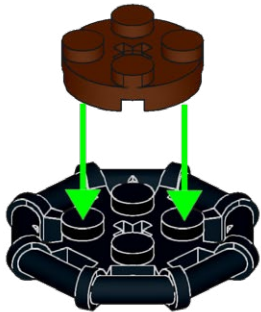
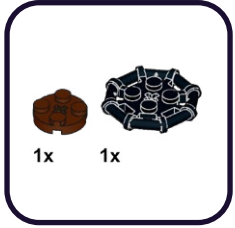

27

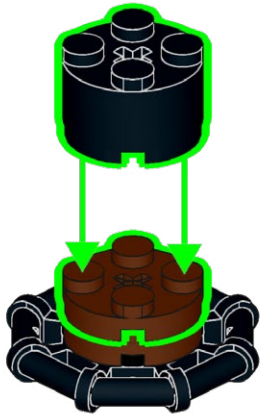
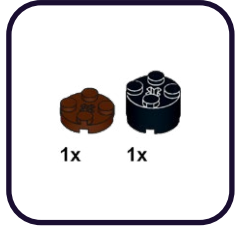

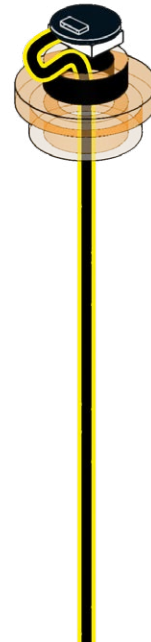
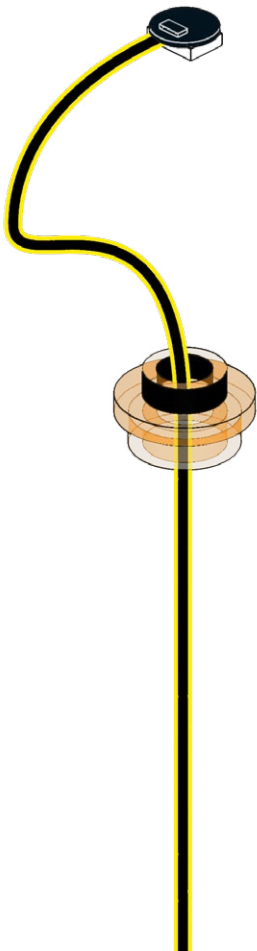
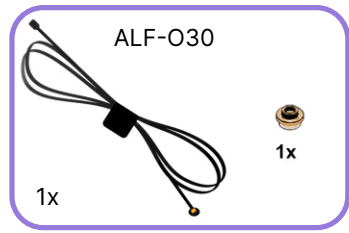

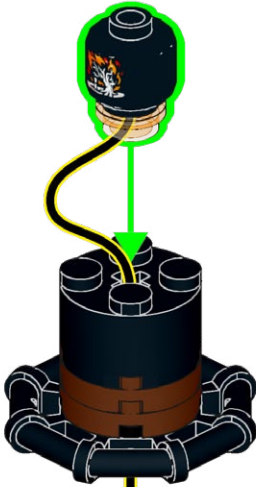

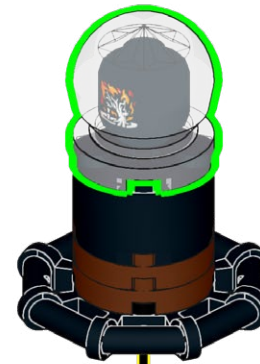
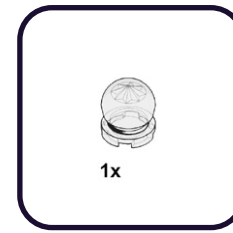
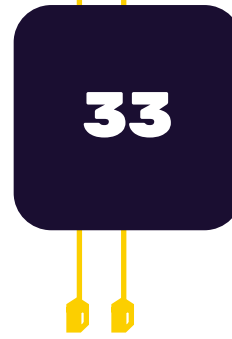

34

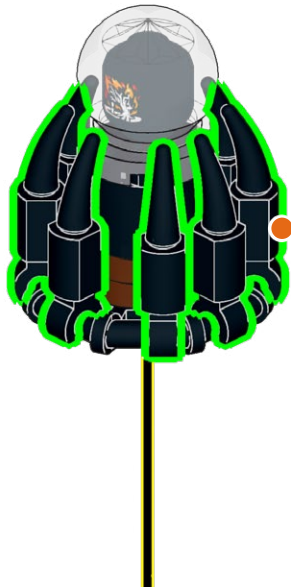
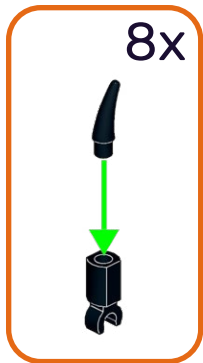

35

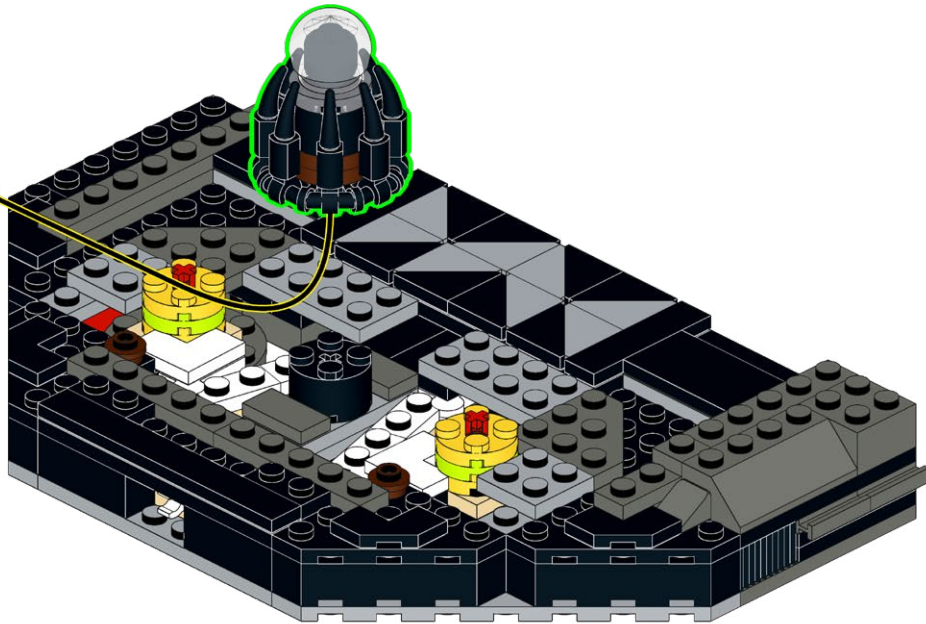

36

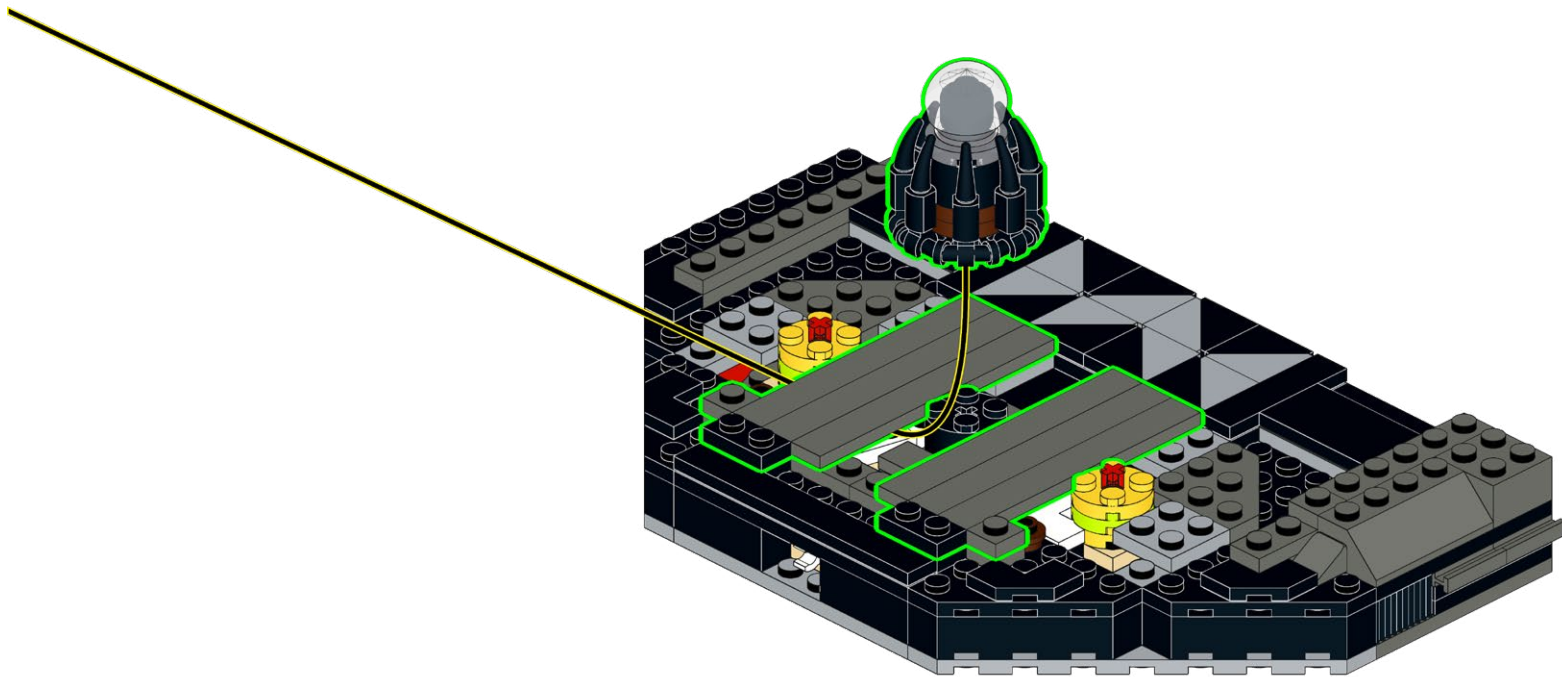
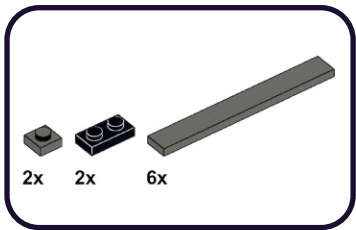

37

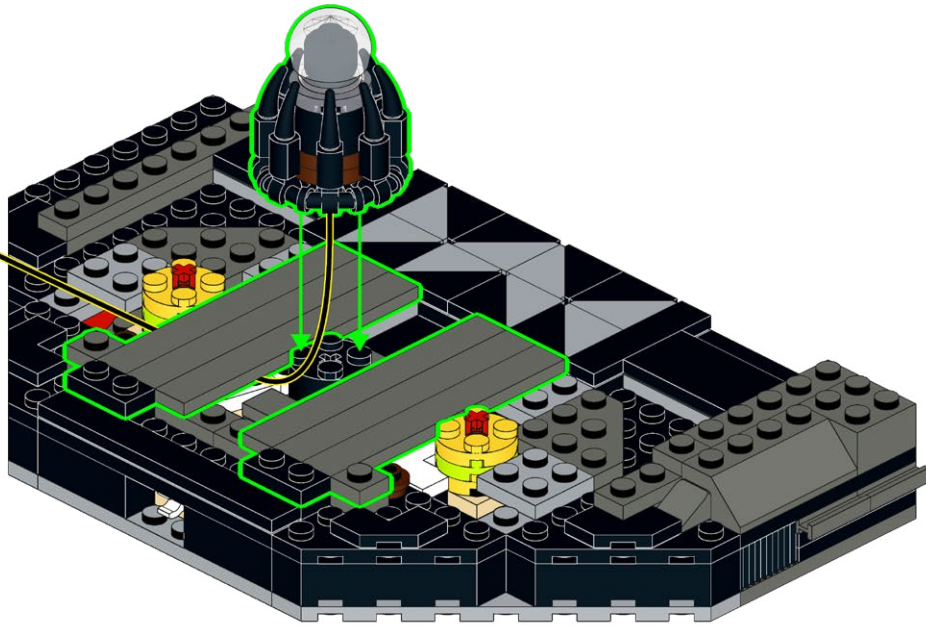

38

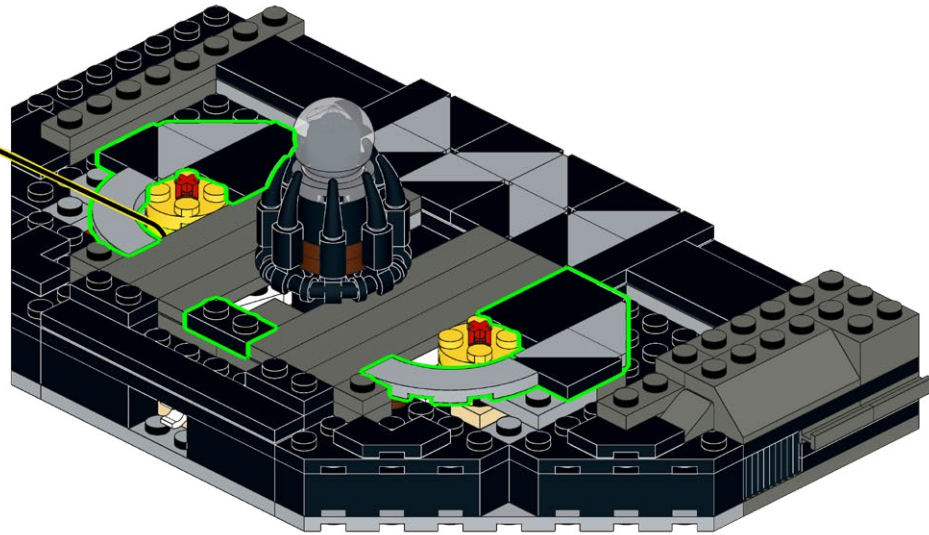
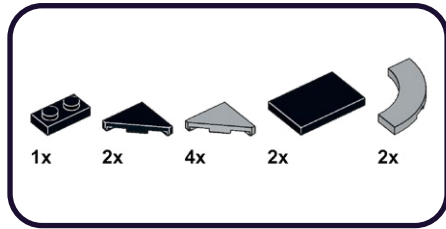

39

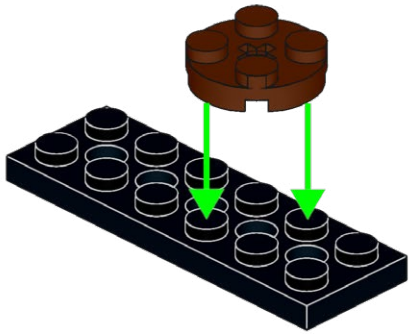
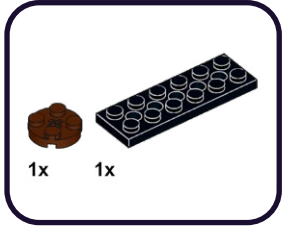

40

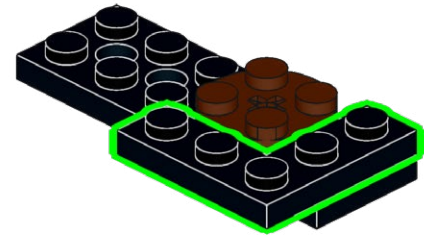
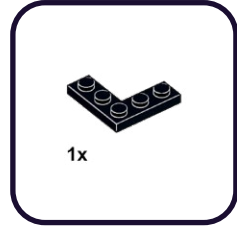

41

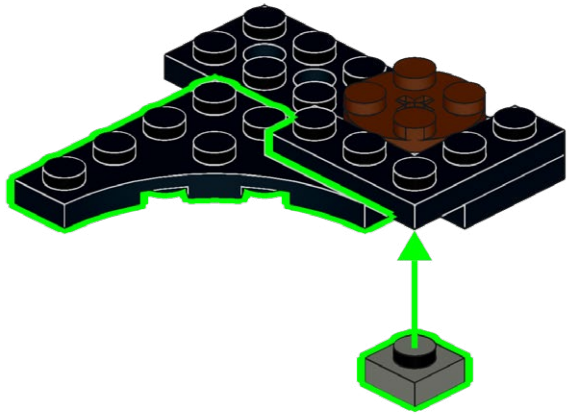
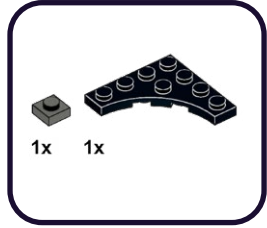

42

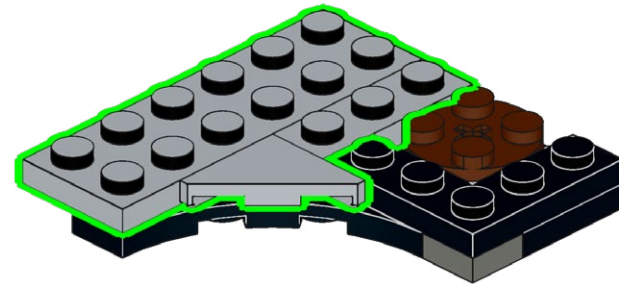
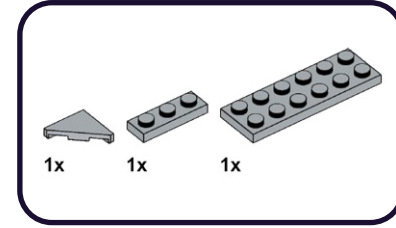

43

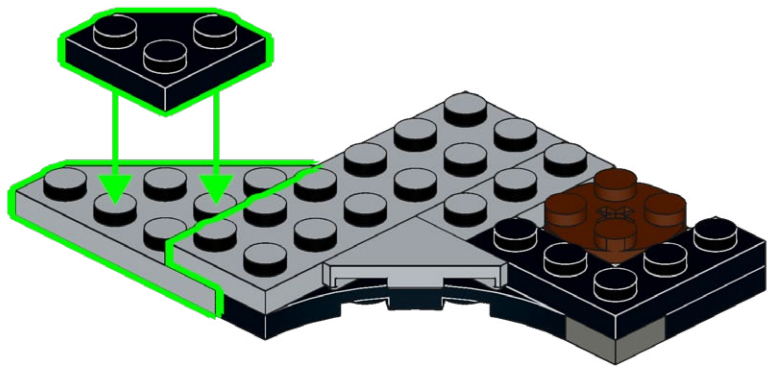
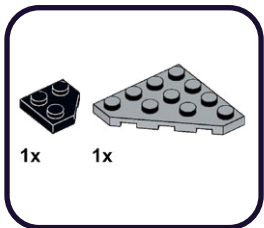

44

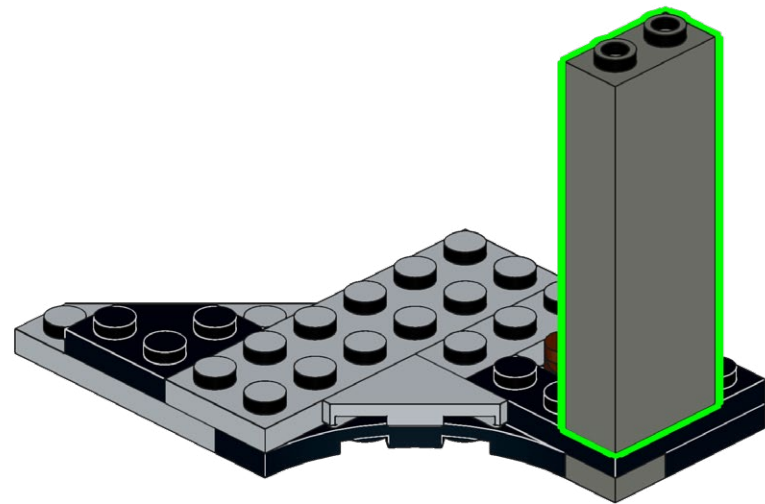
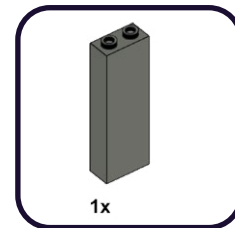

45

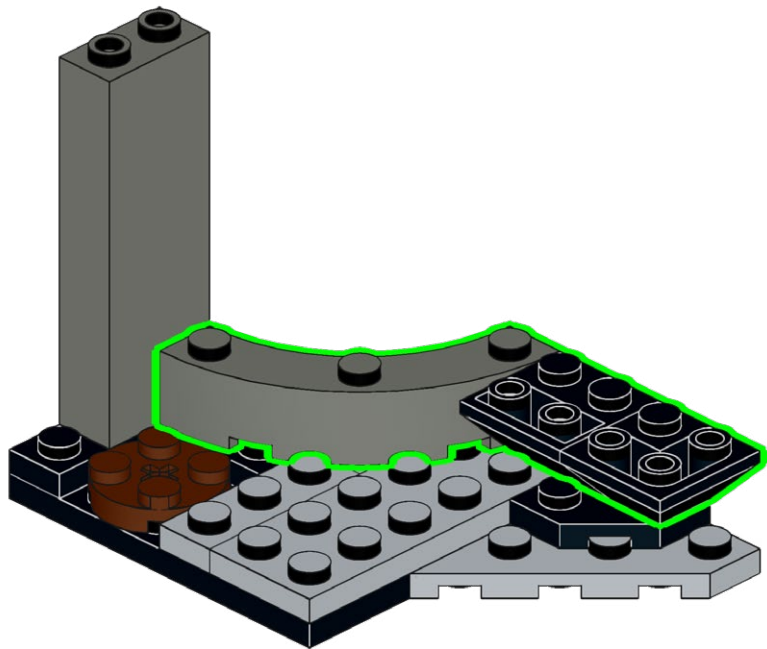
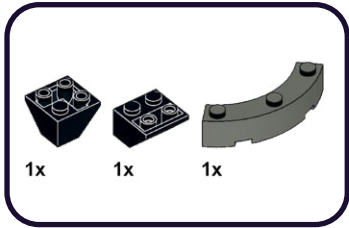

46

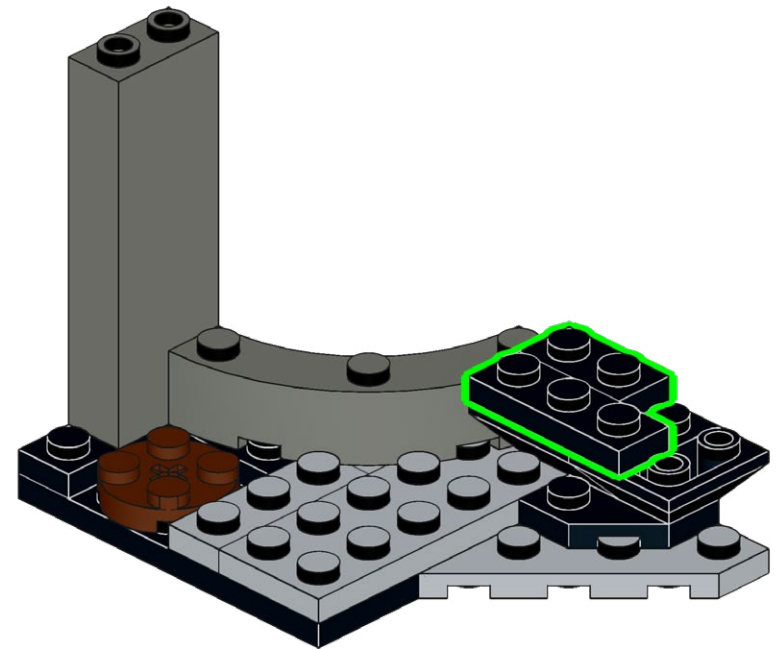
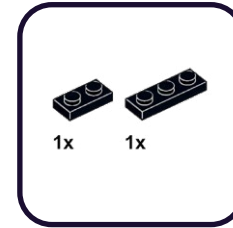

47

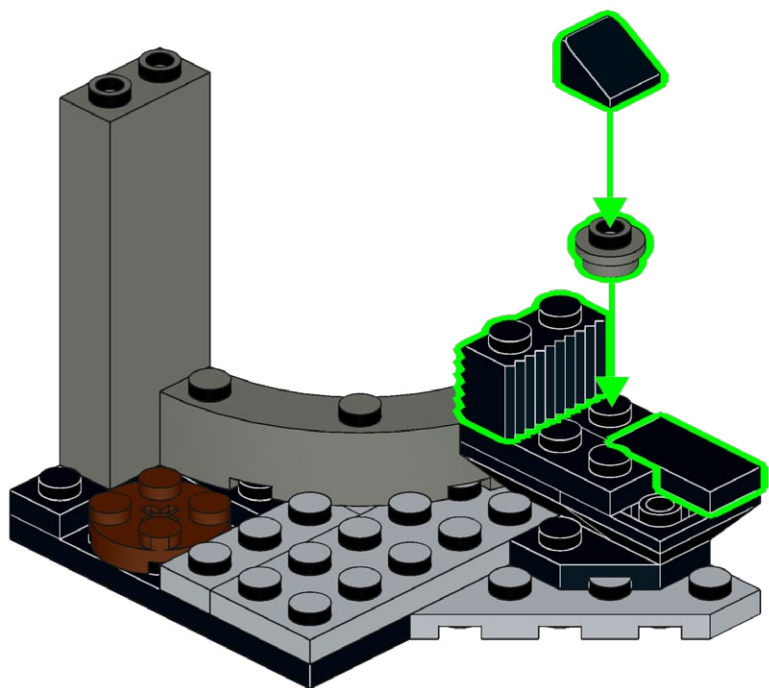
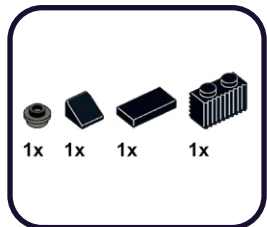

48

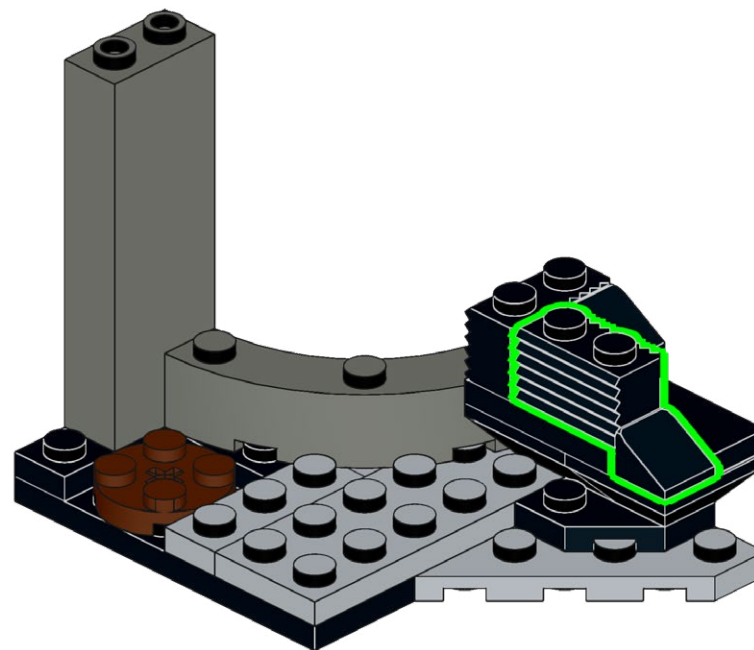
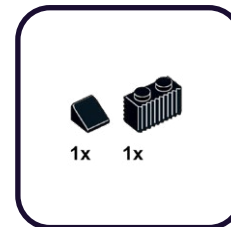

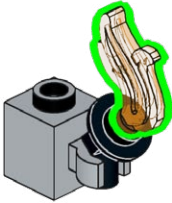
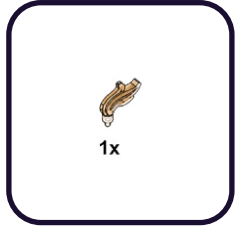
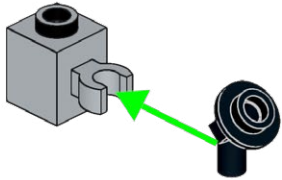
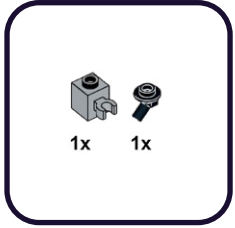

51

1x 1x 1x

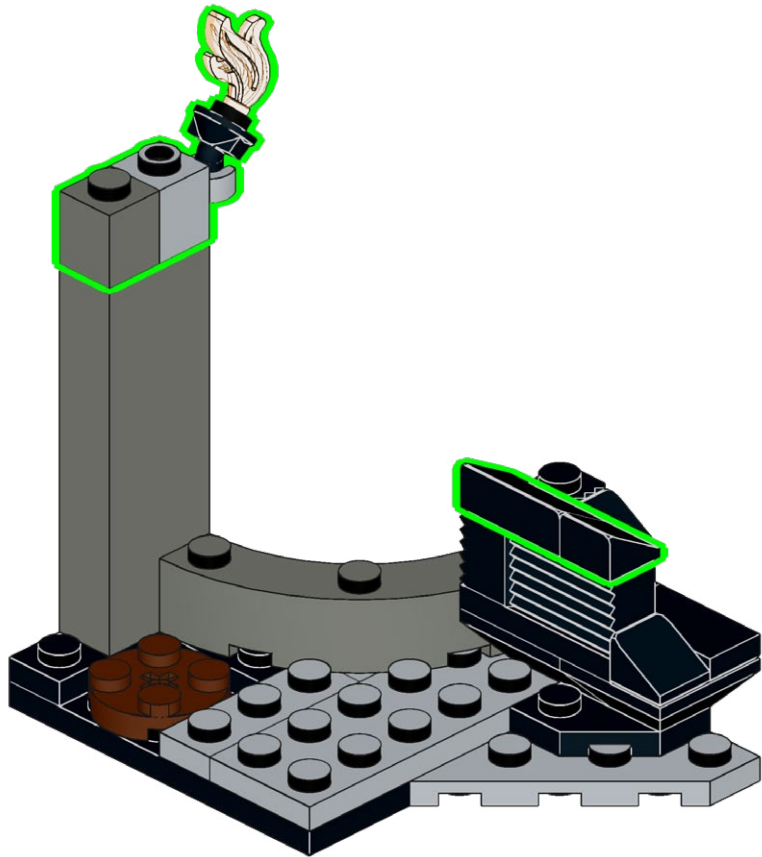

52

1x 1x

8

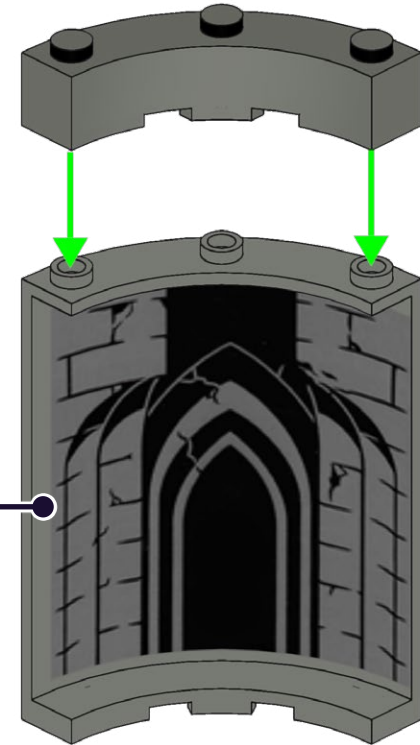

53

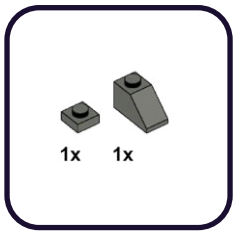

54

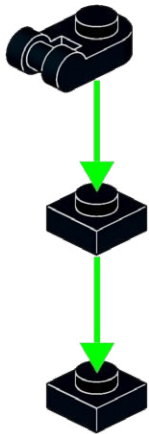
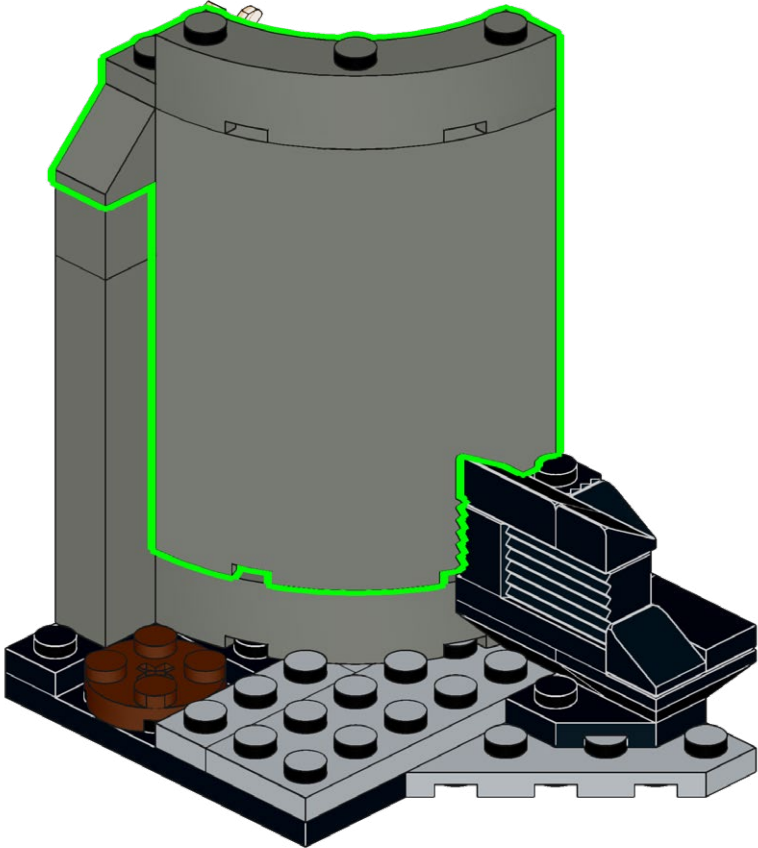
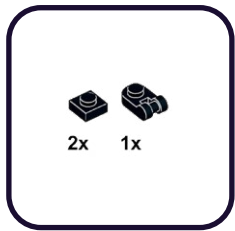

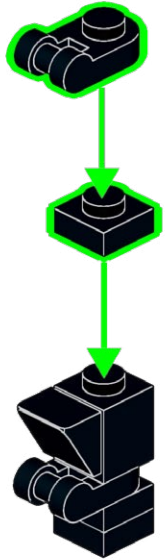
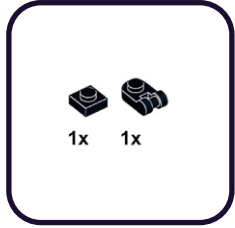
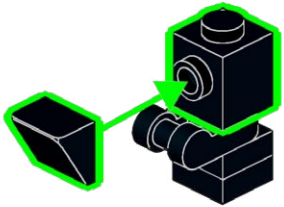
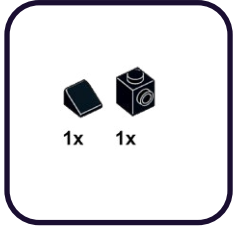

57

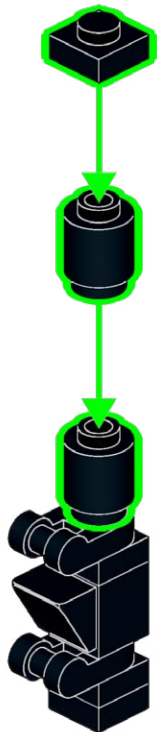

58

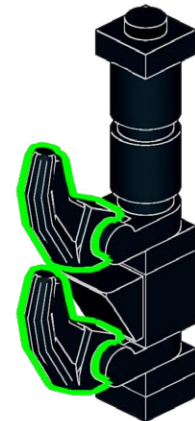

59

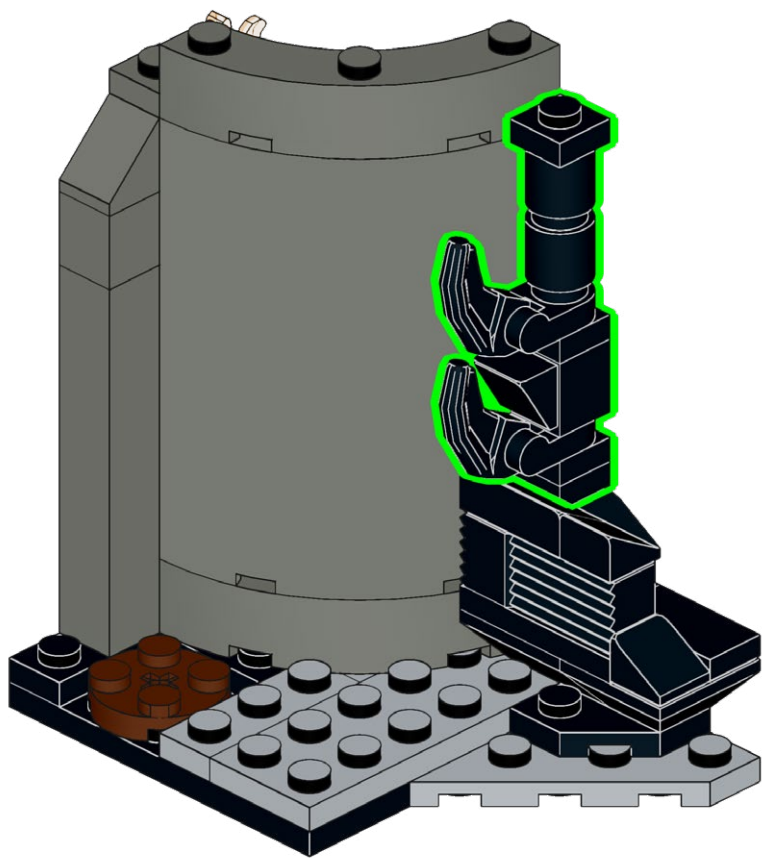

60

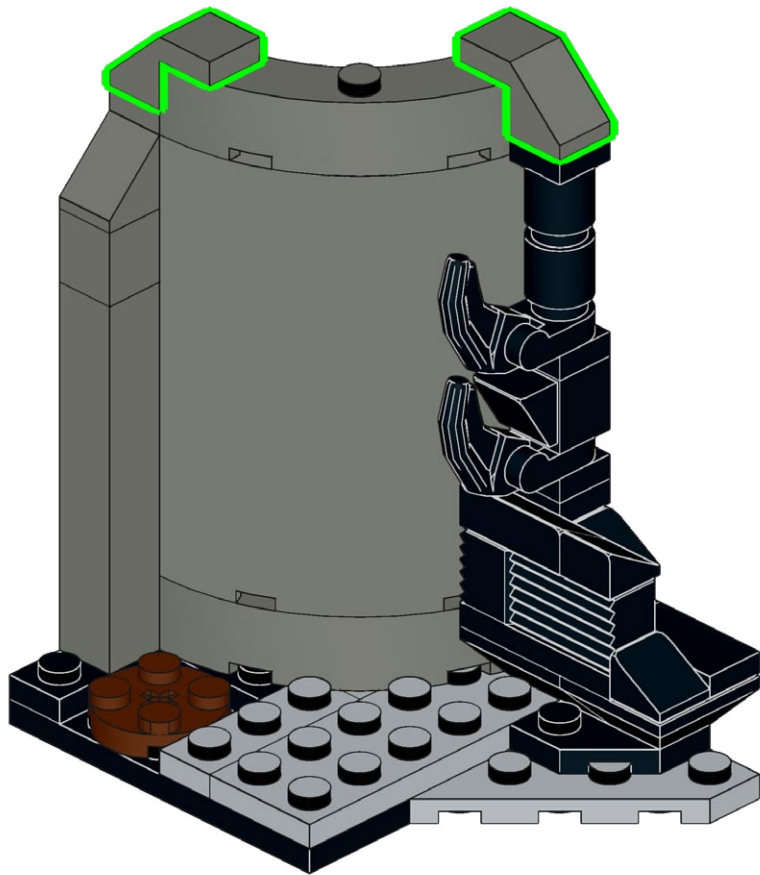
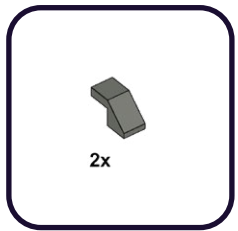

61

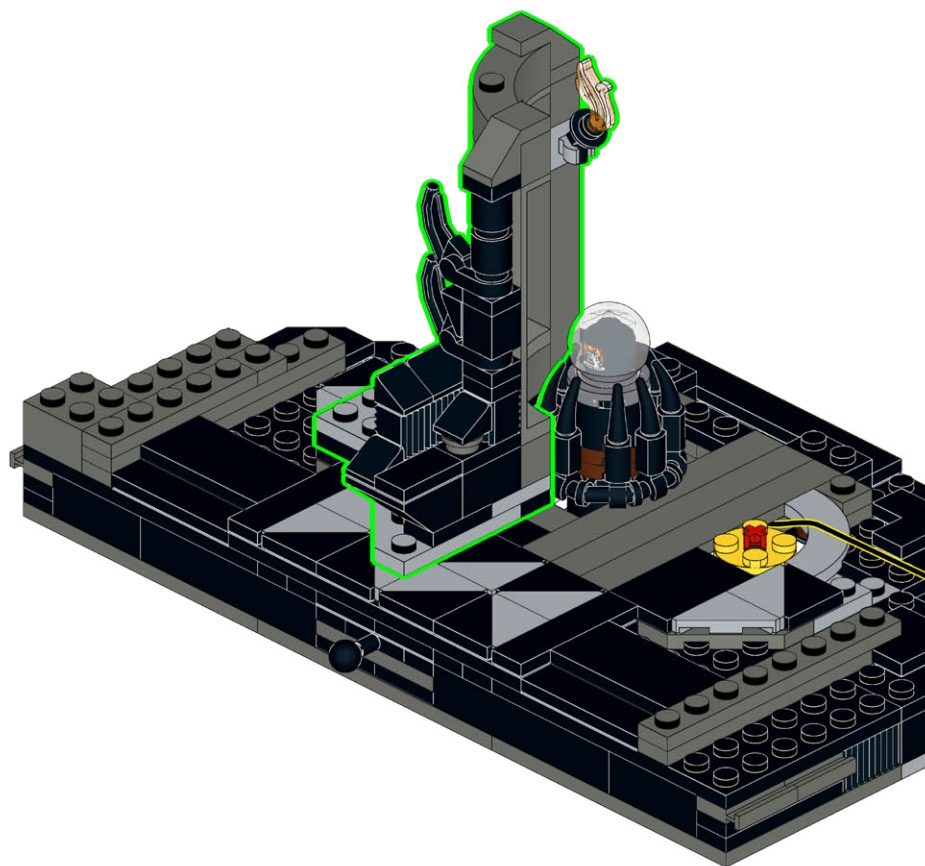

62

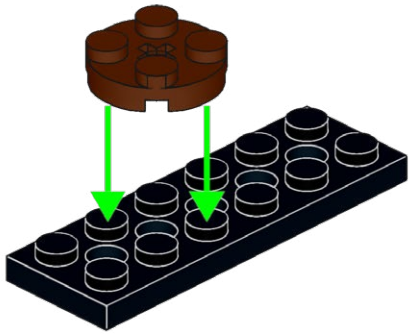
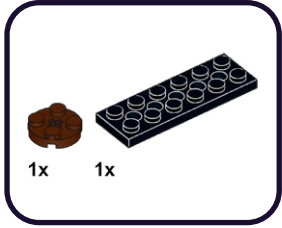

63

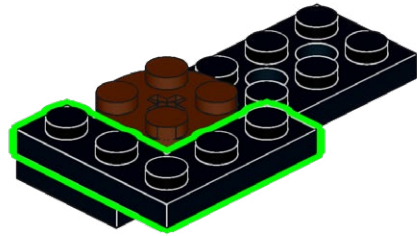
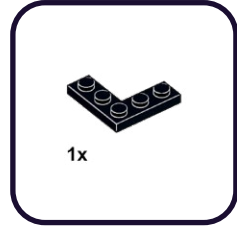

64

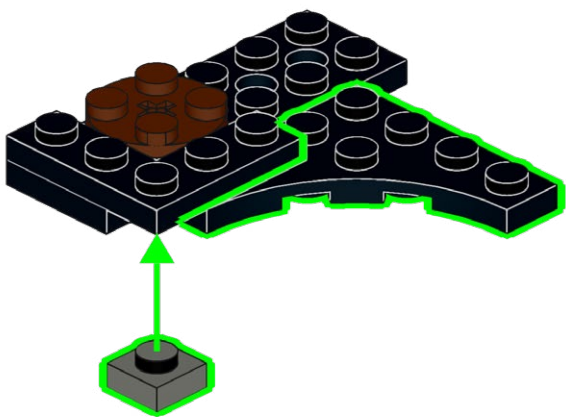
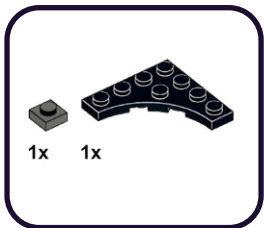

65

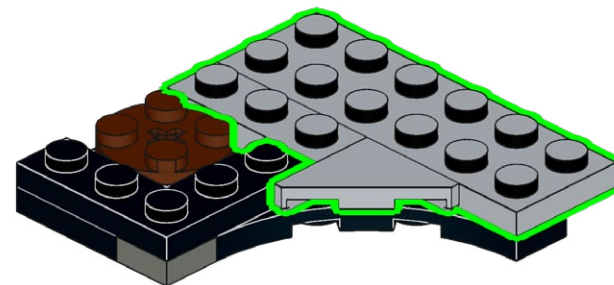
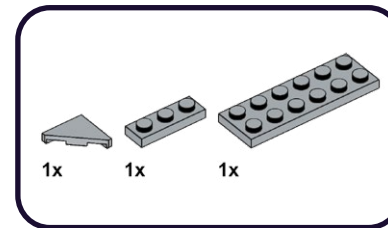

66

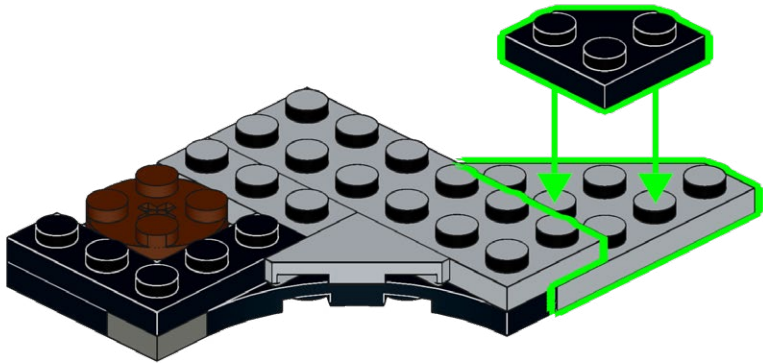
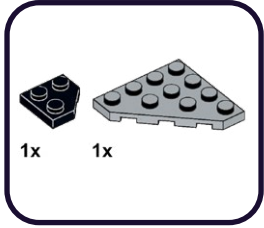

67

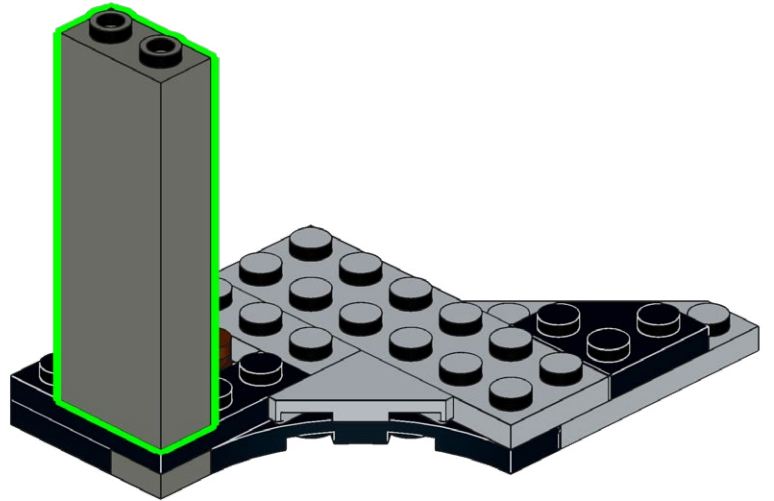
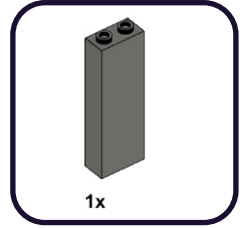

68

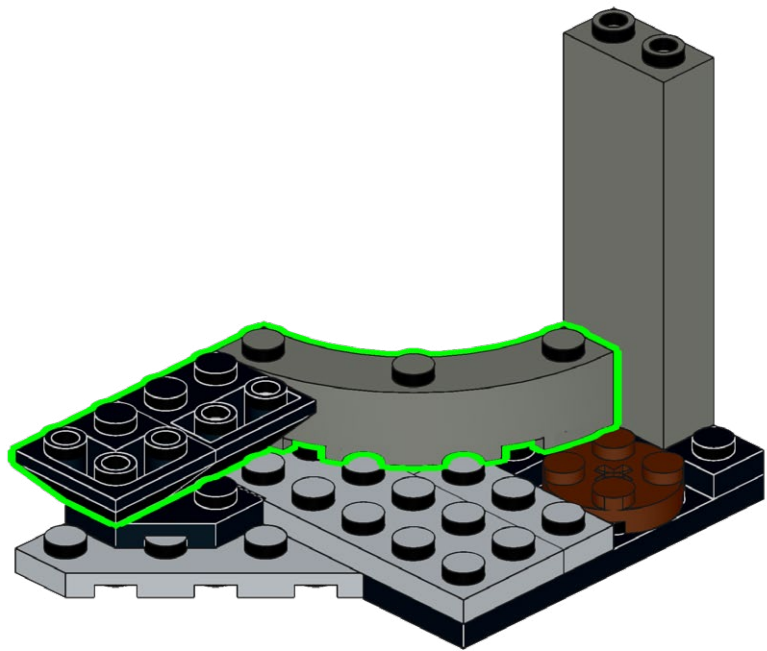
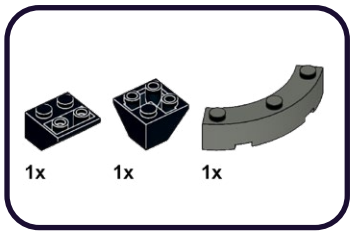

69

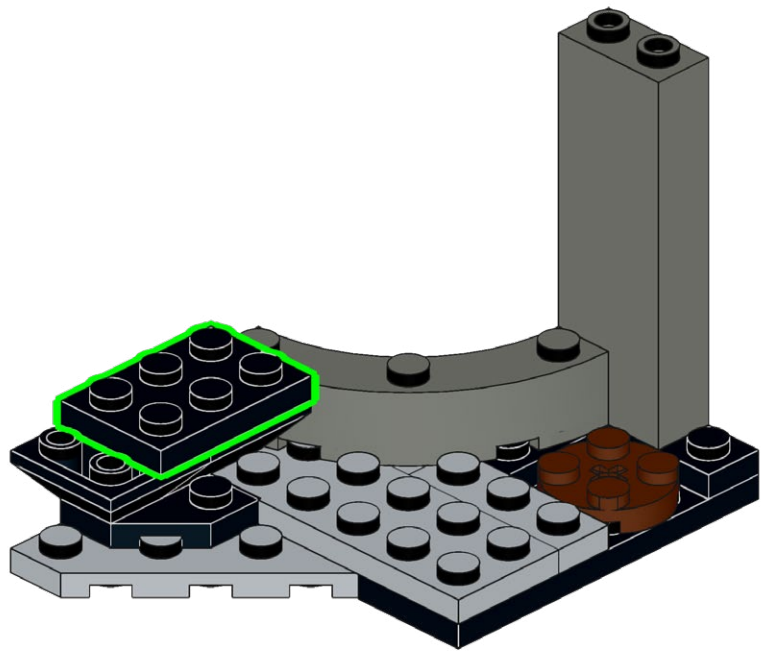
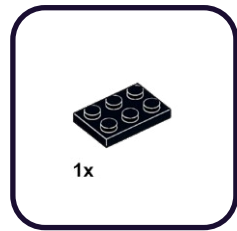

70

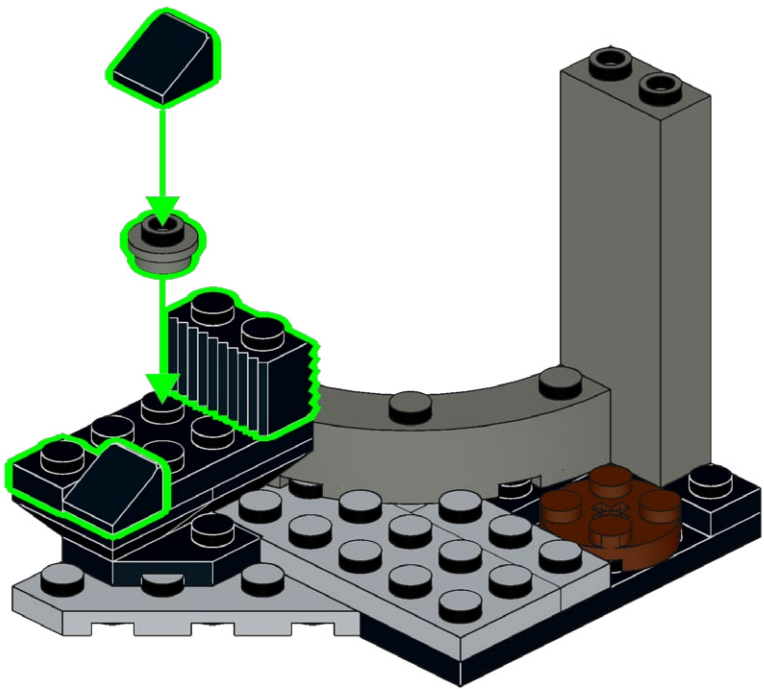
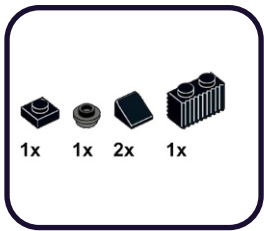

71

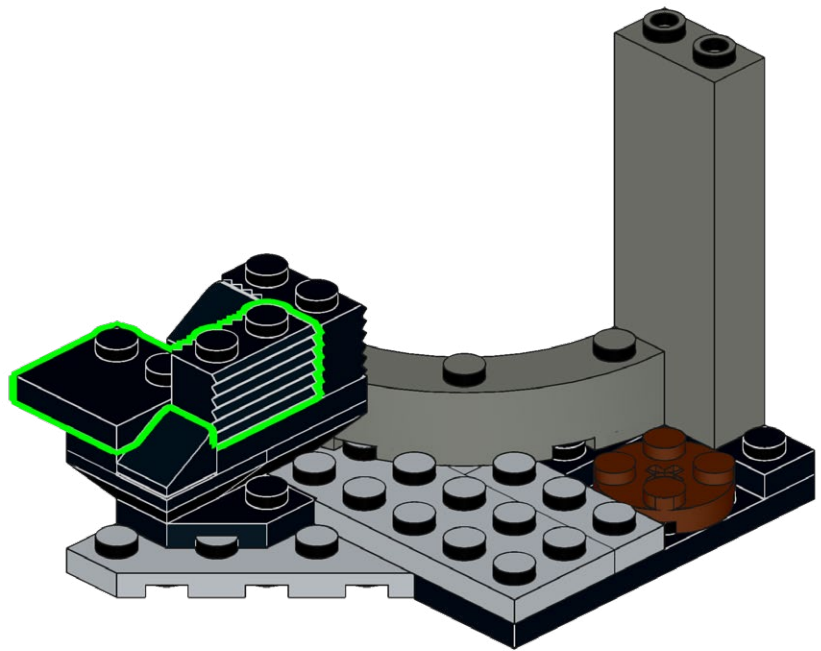
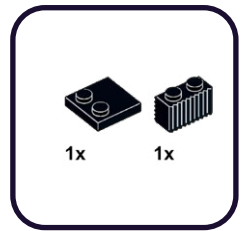

72

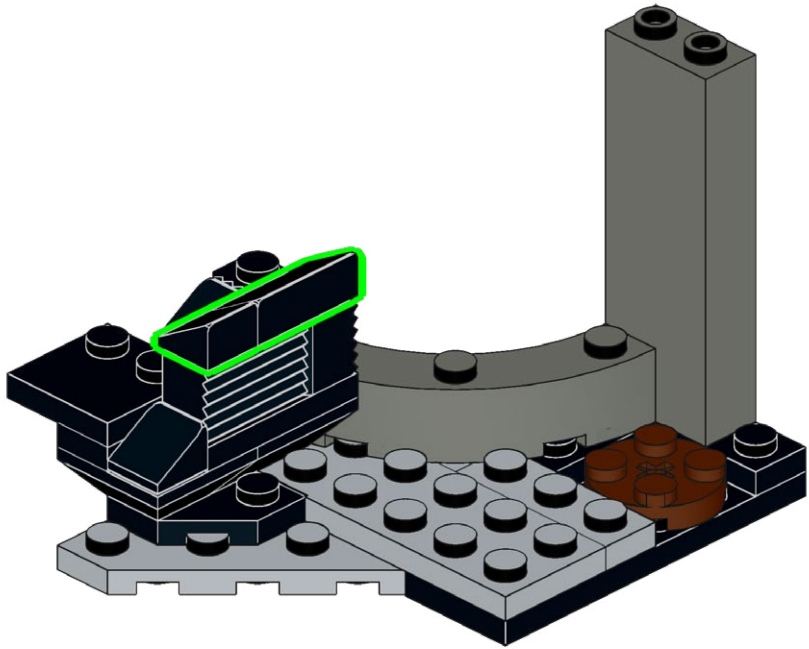

73

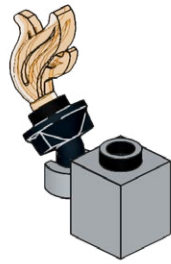
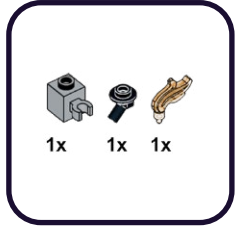

74

1x



75

1x

1x

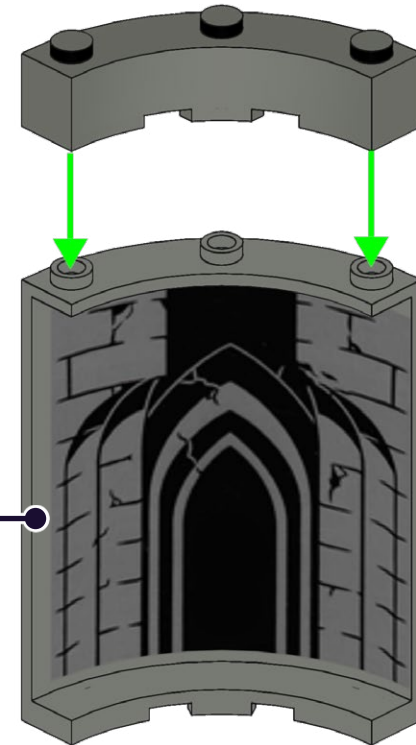
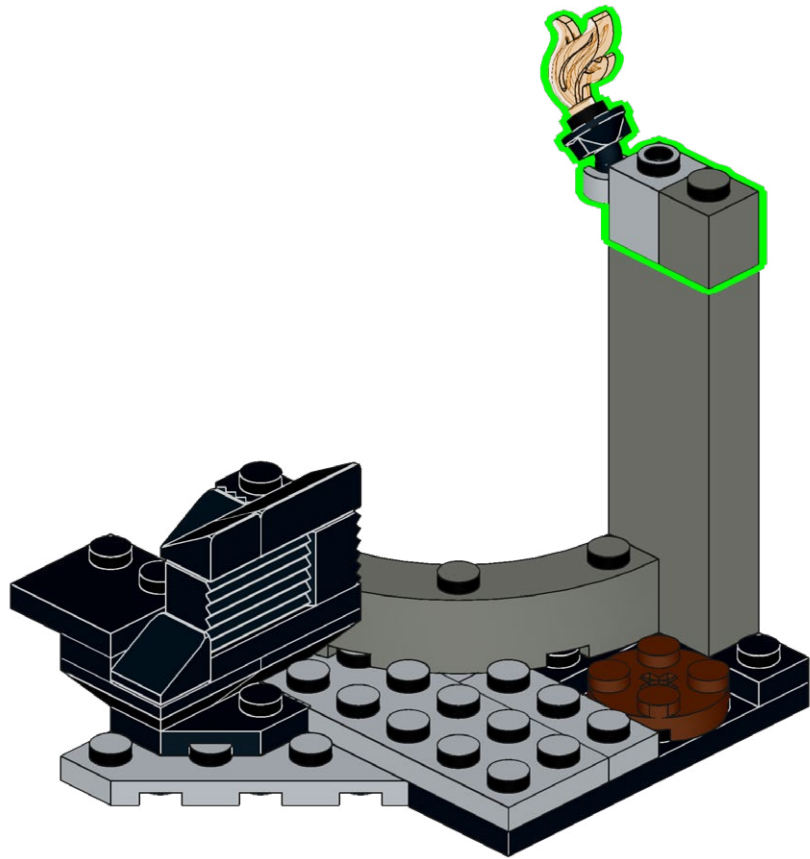
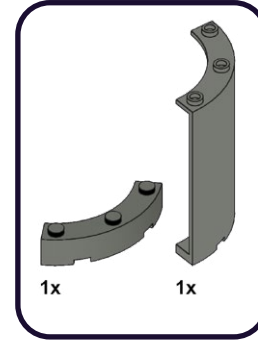

76

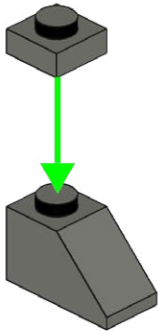
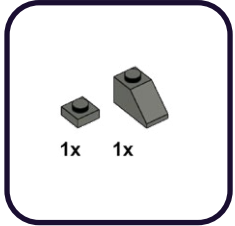

77

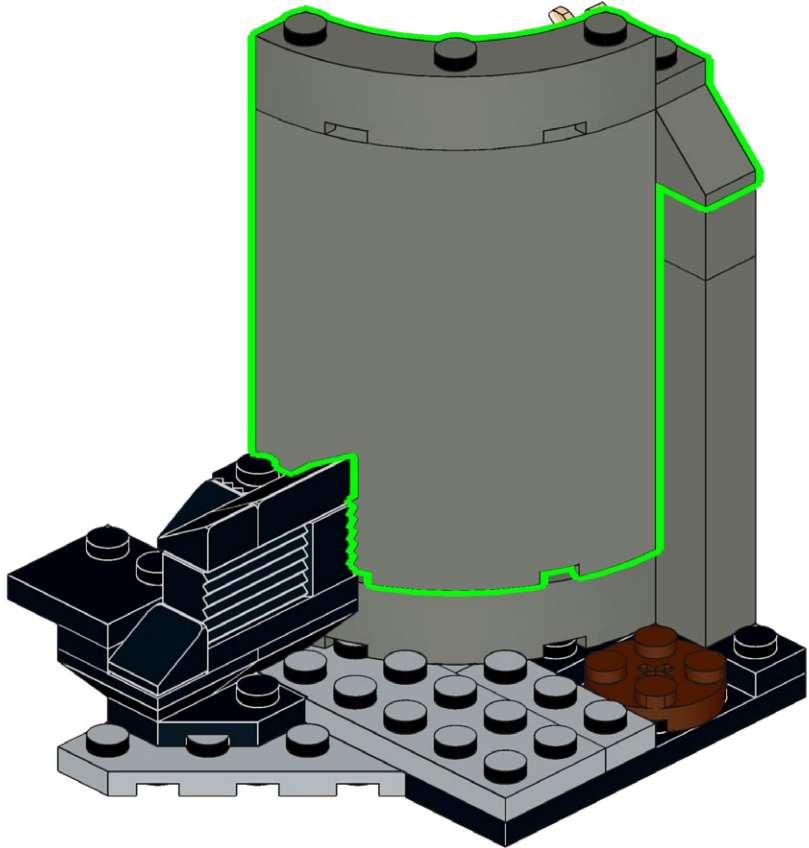

78

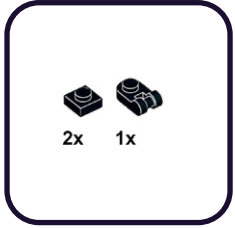

79

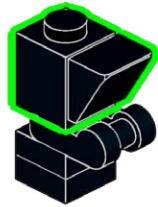
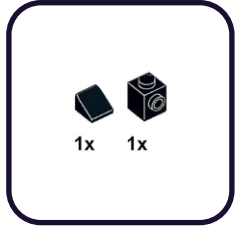

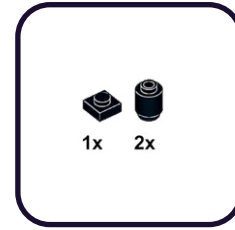
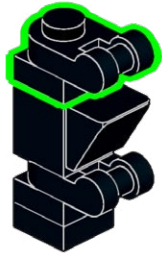
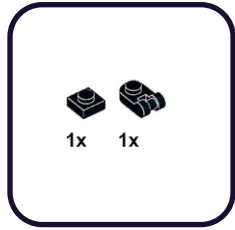

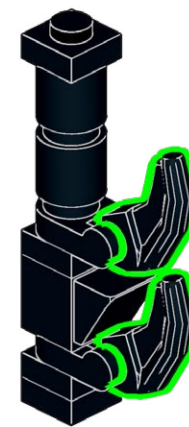
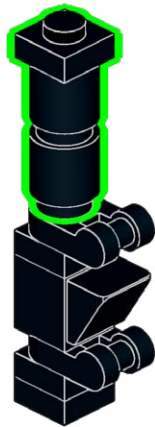
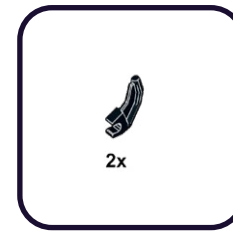
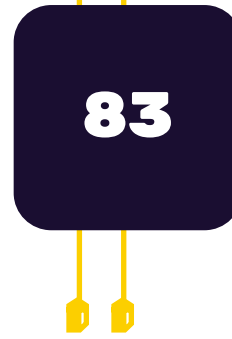

84

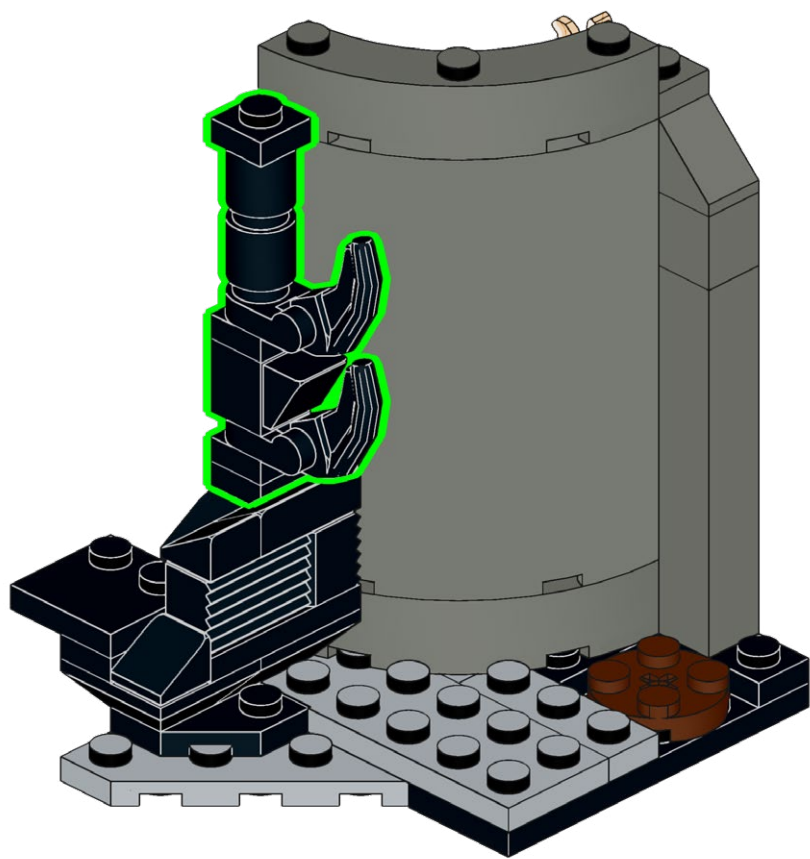

85

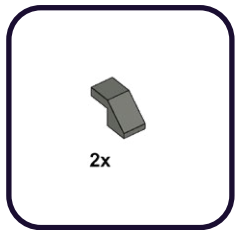

2x

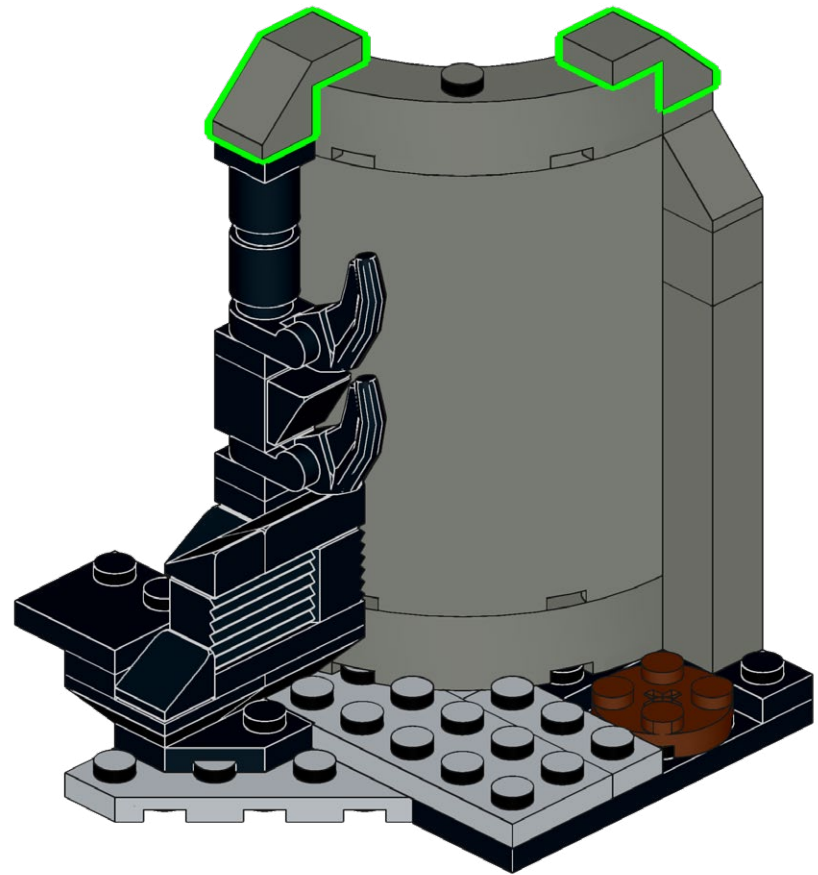

86

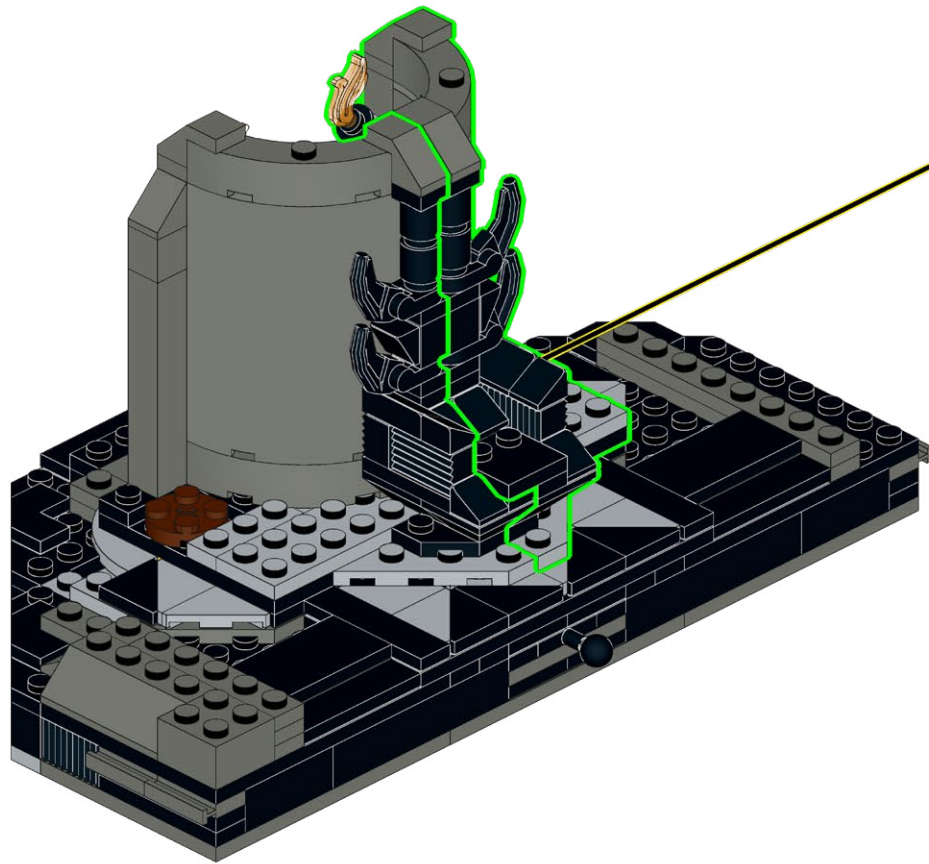

87

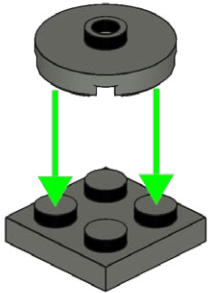
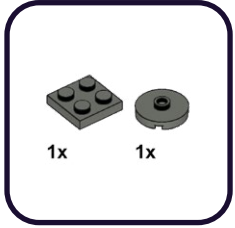

88

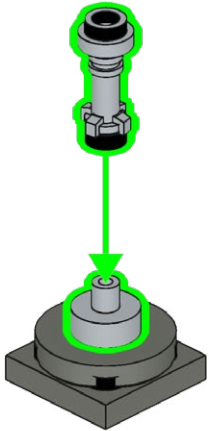
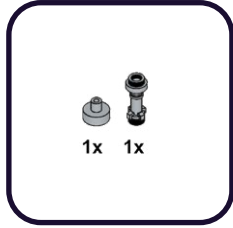

89

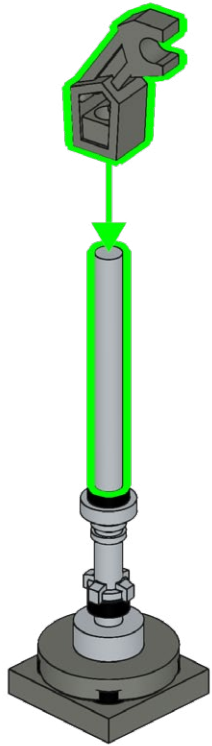
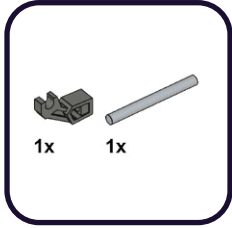

90

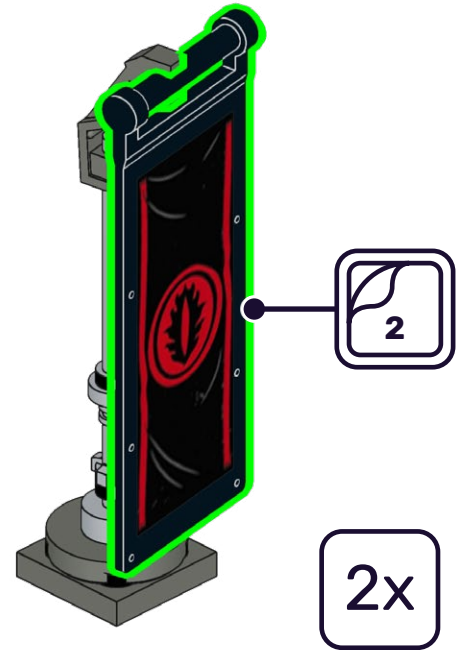

91

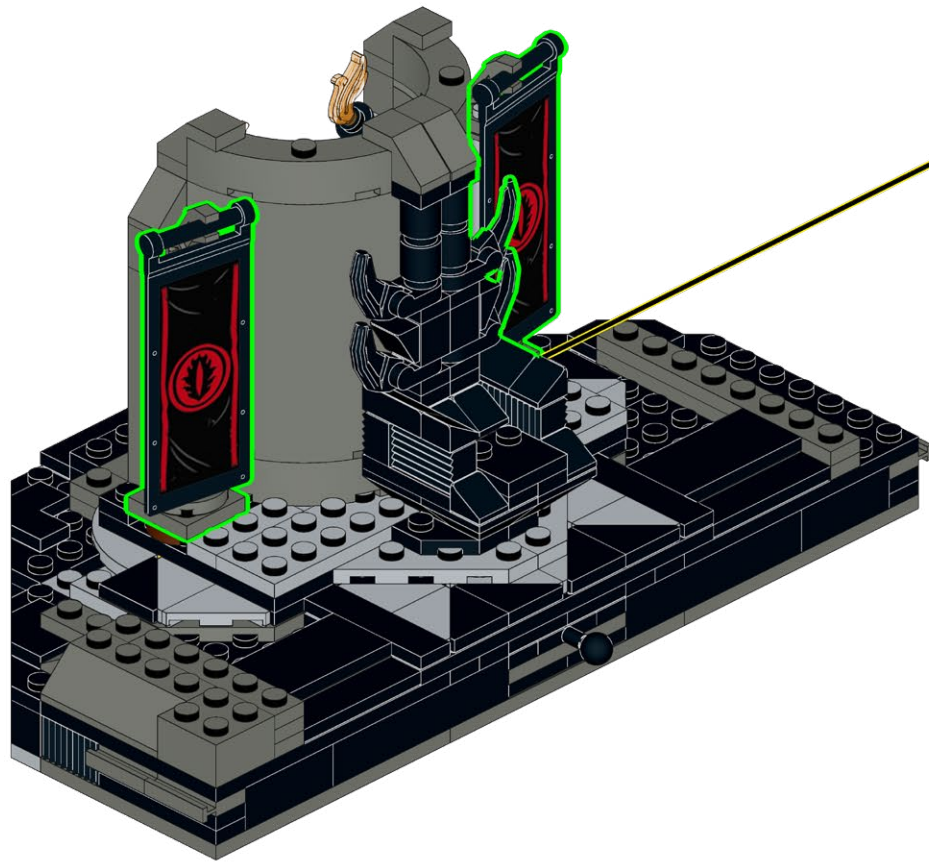

92

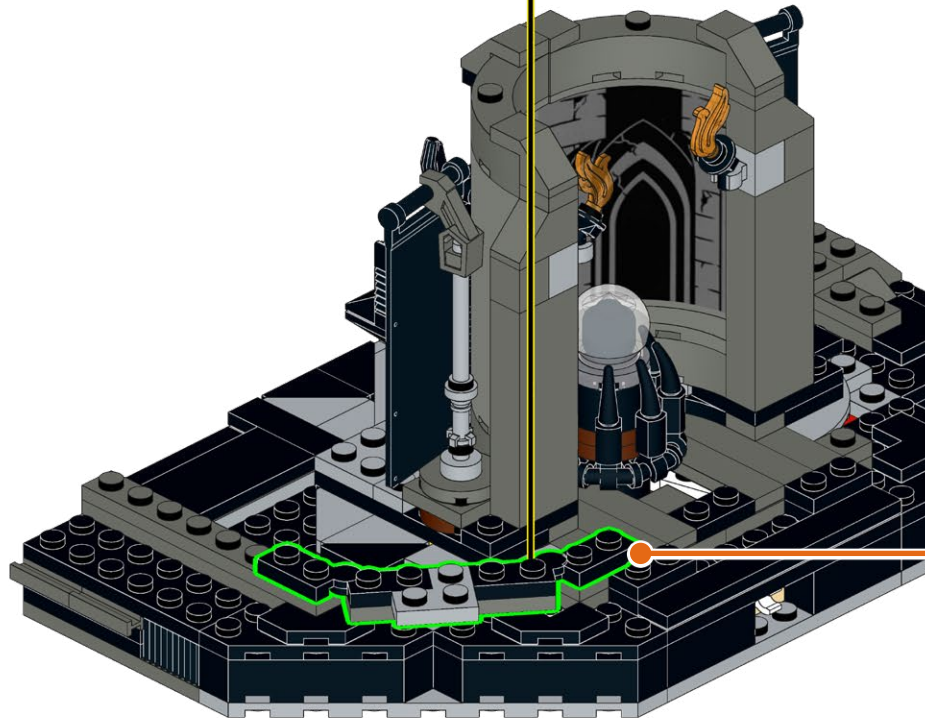
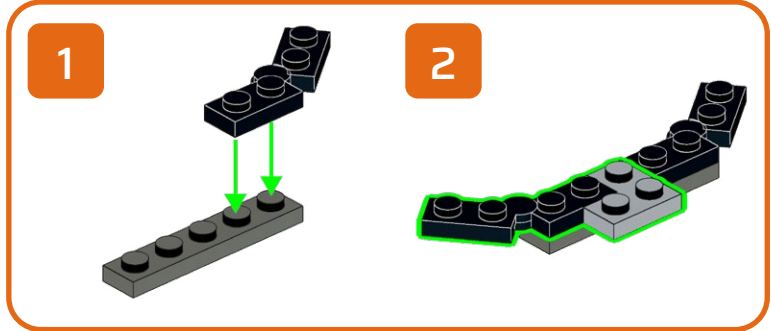
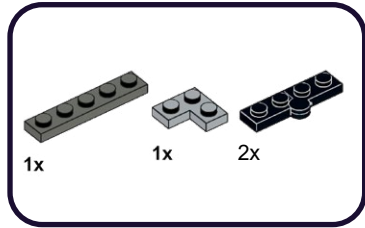

93

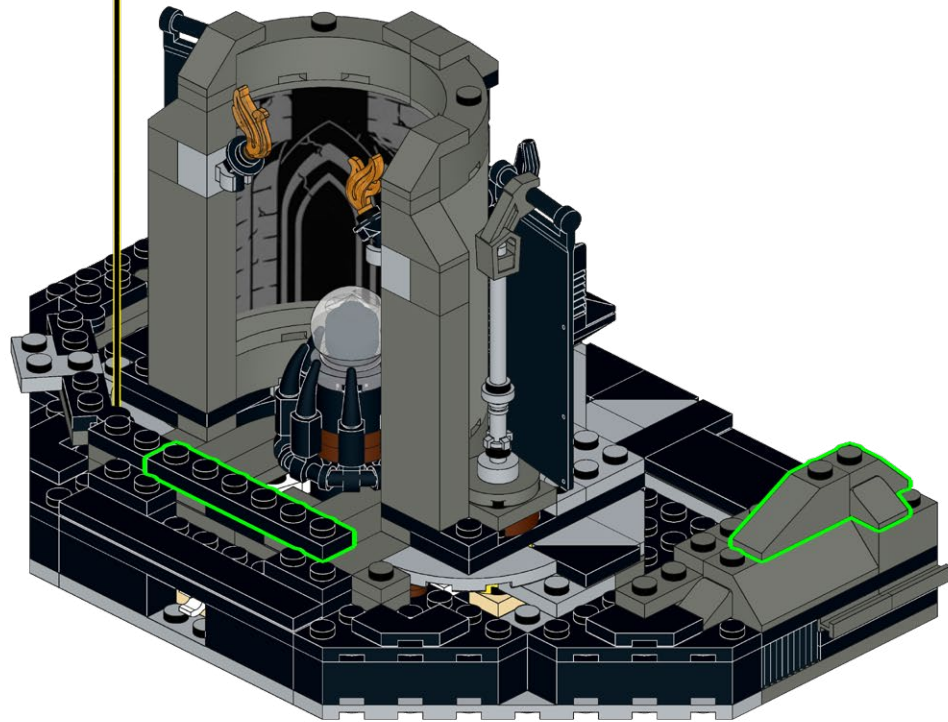
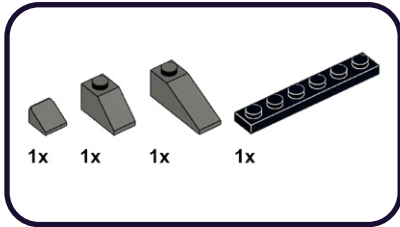

94

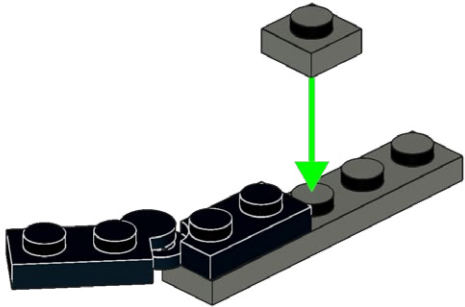
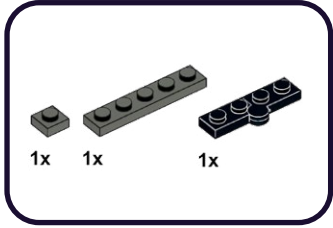

95

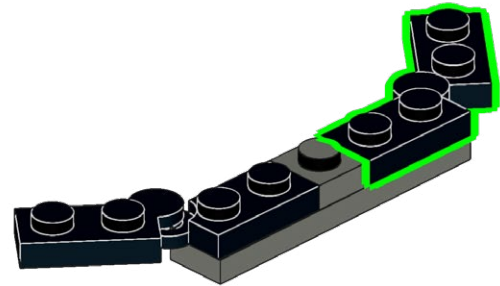
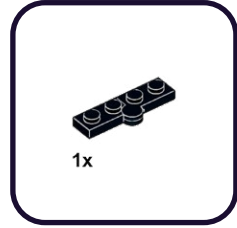

96

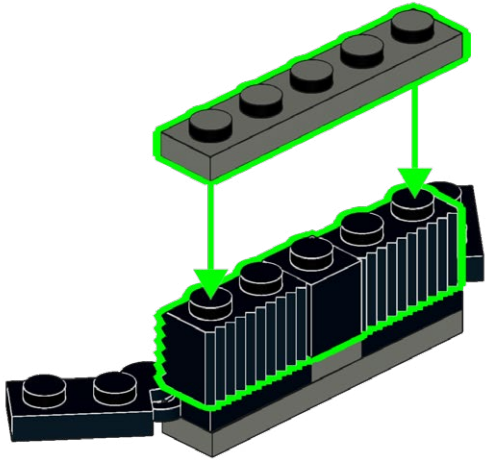
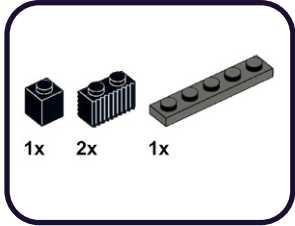

97

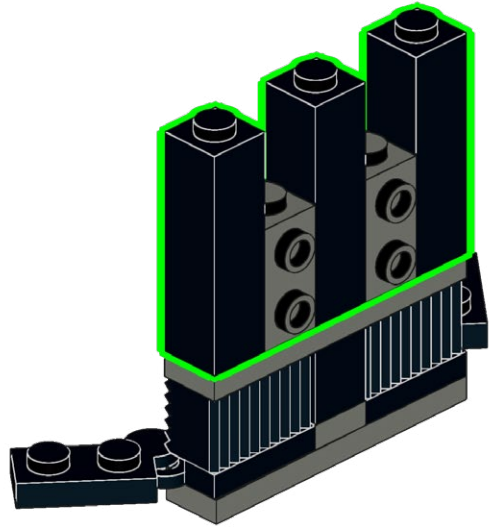
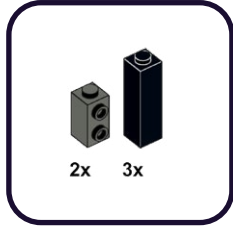

98

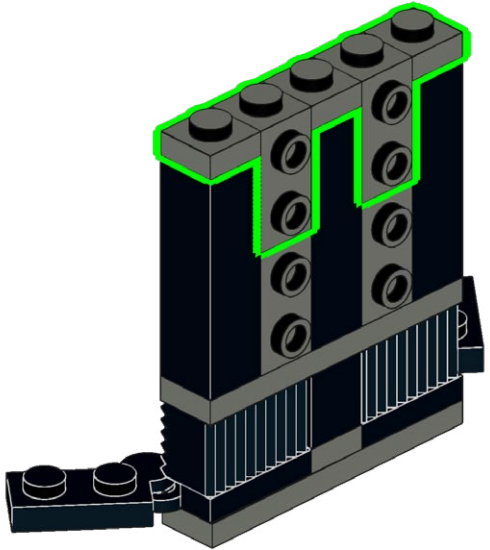
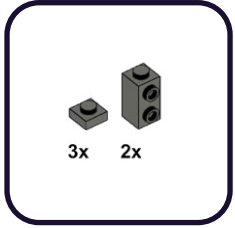

99

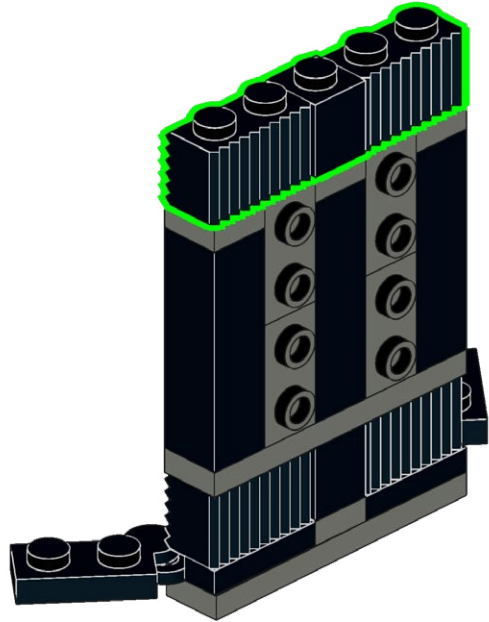
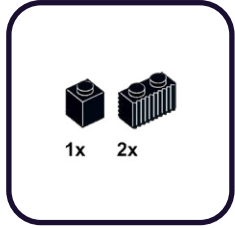

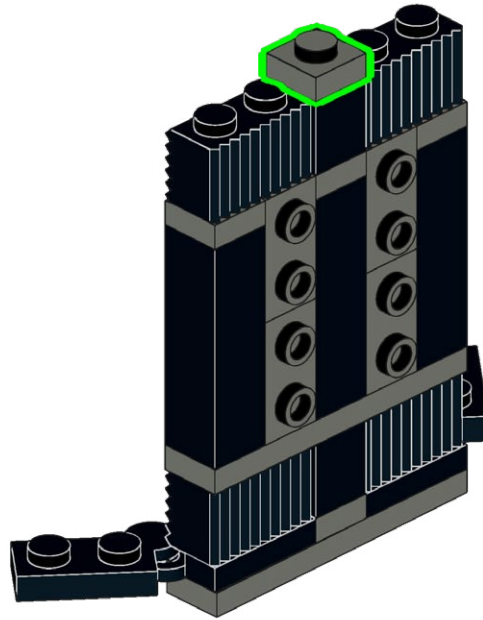

101

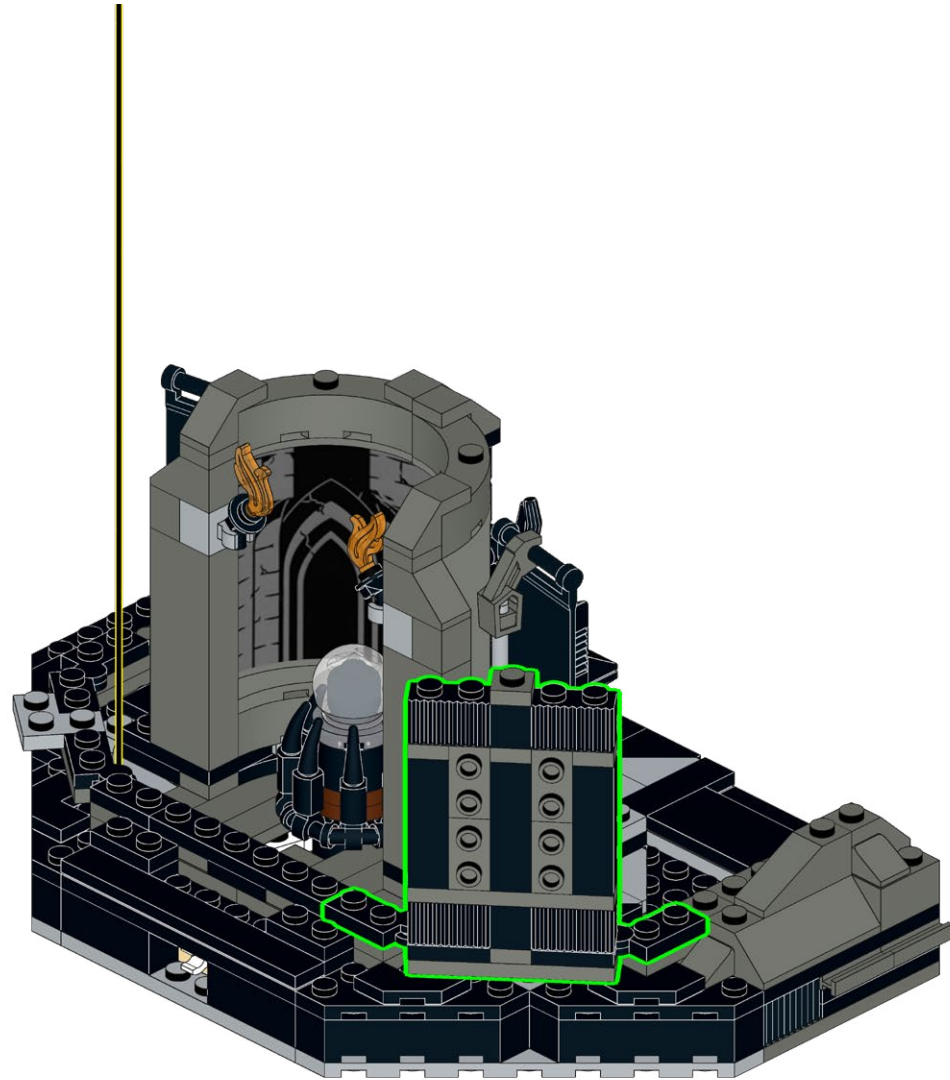

102

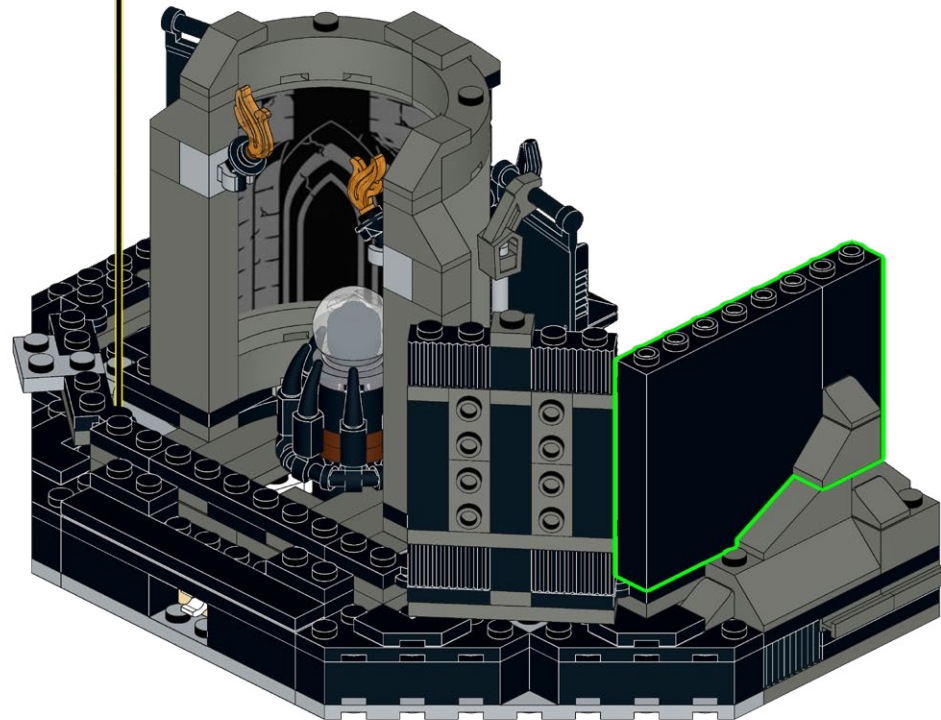
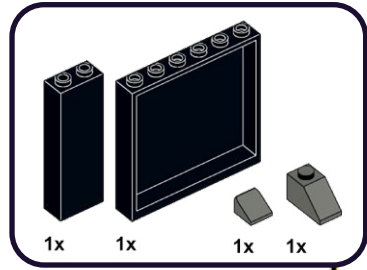

103

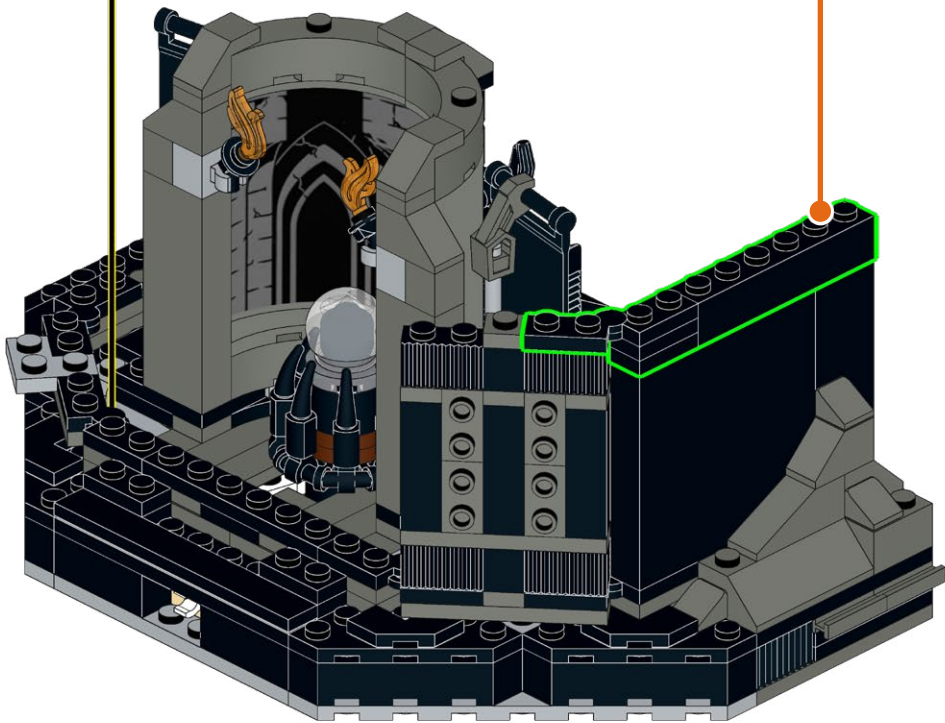
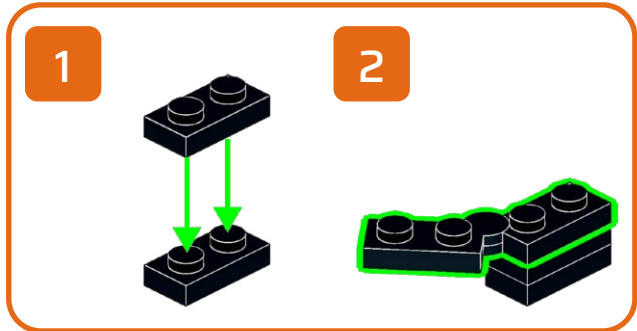
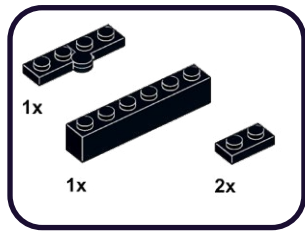

104

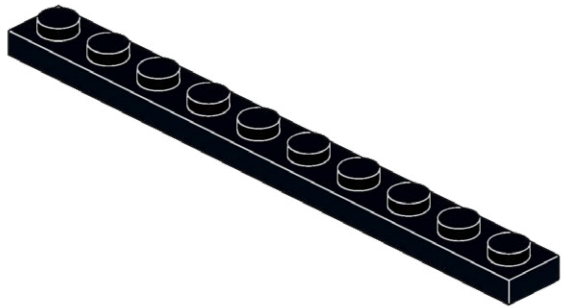
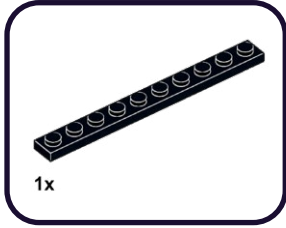

105

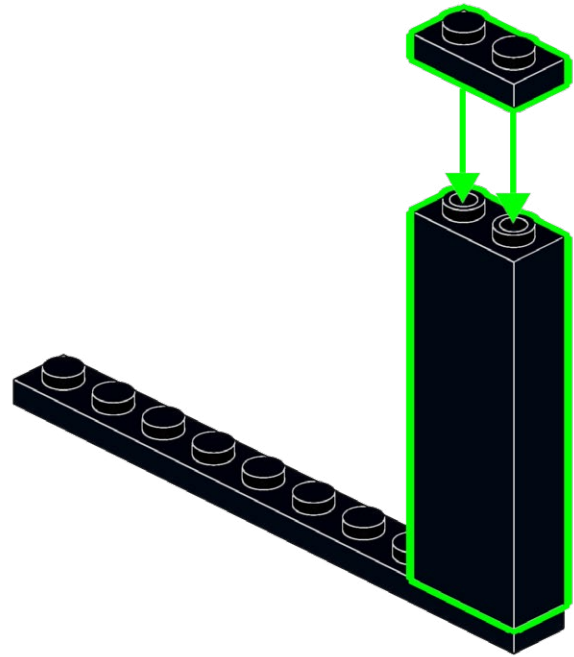
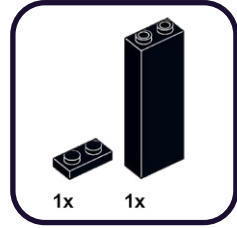

106

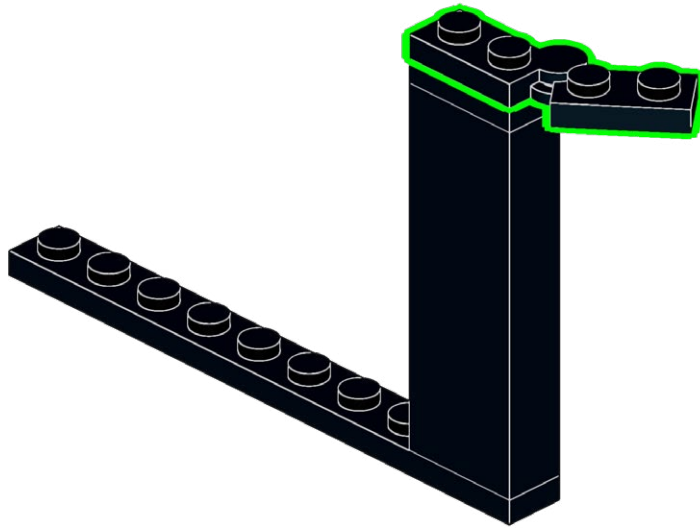
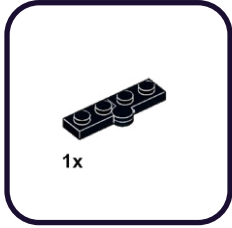

107

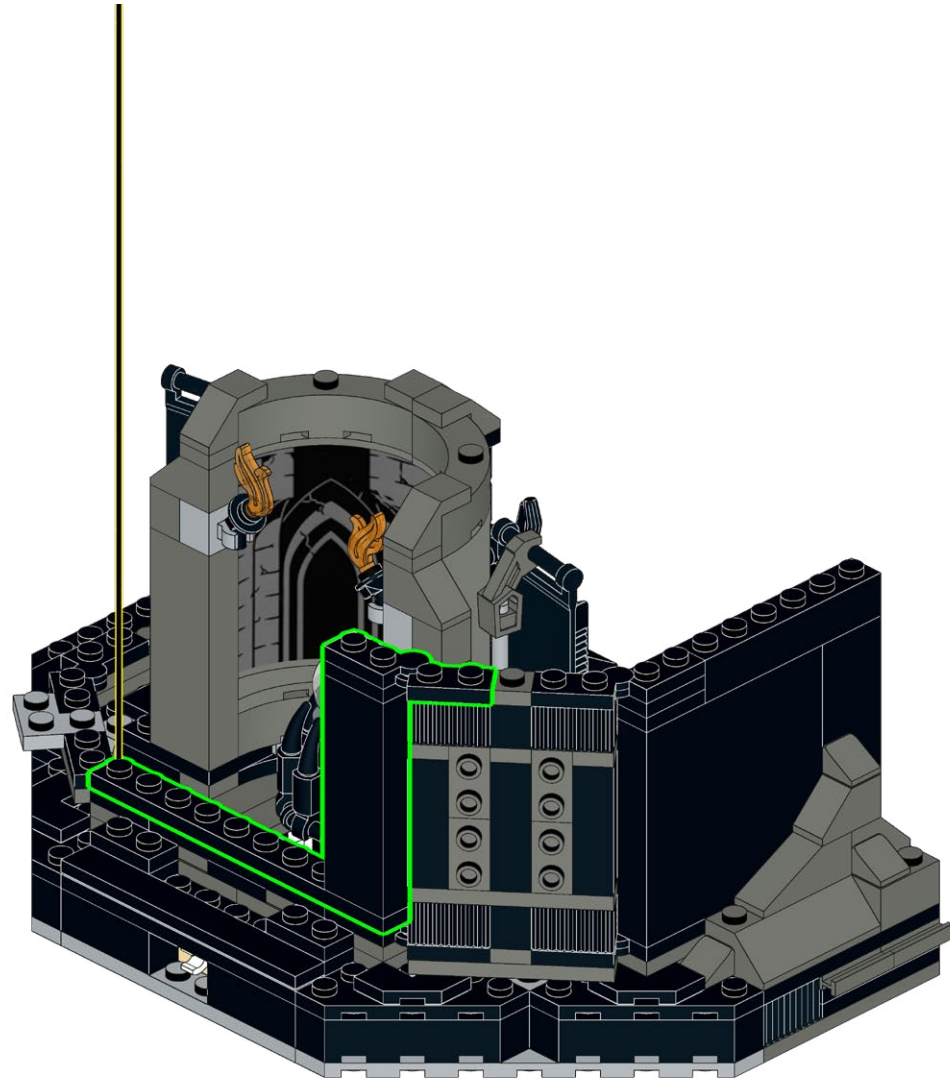

108

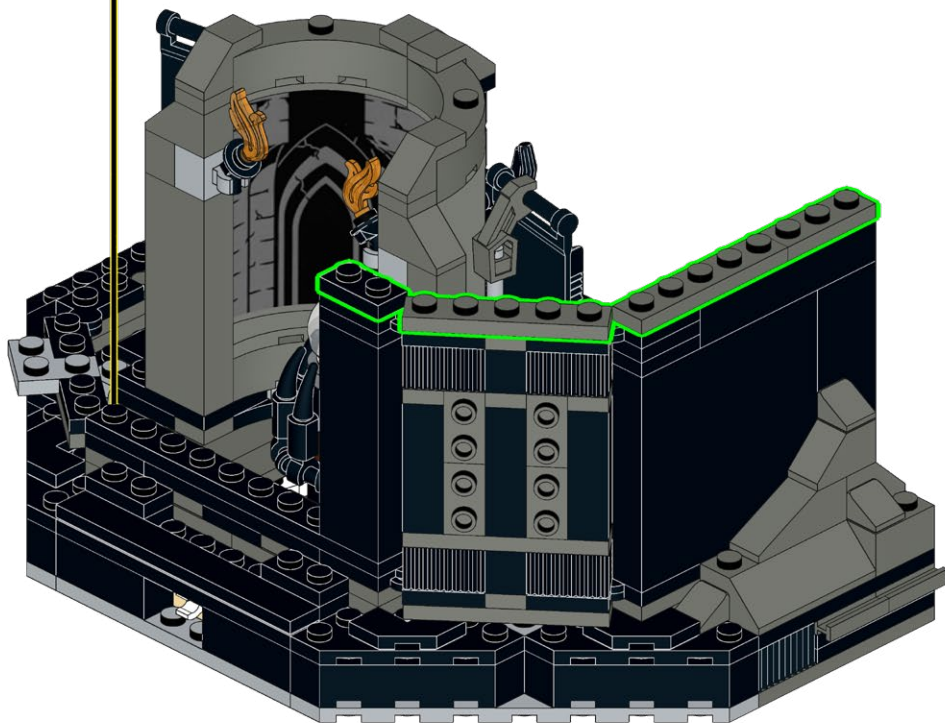
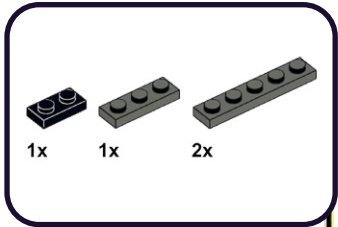

109

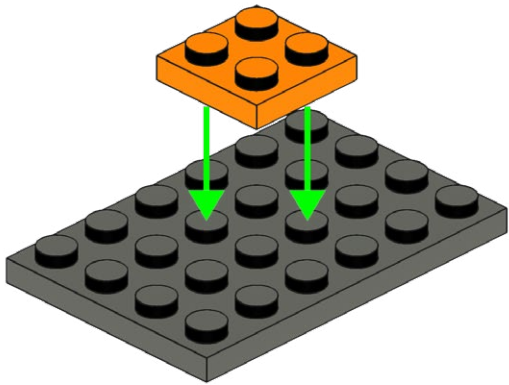
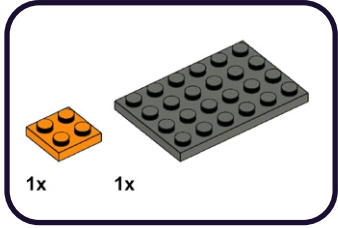

110

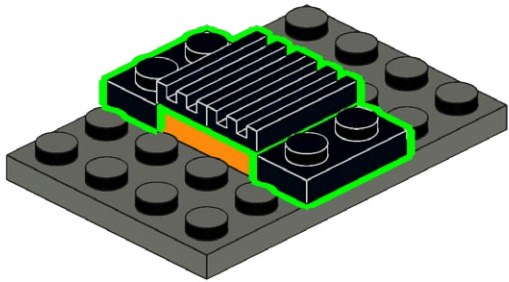
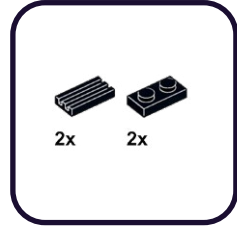

111

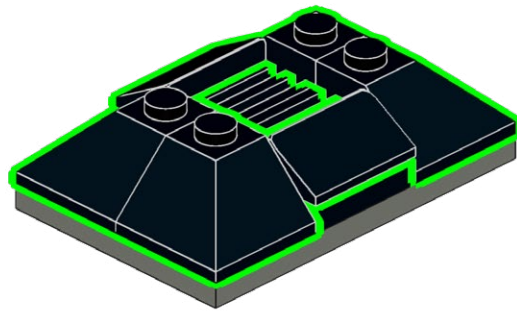

112

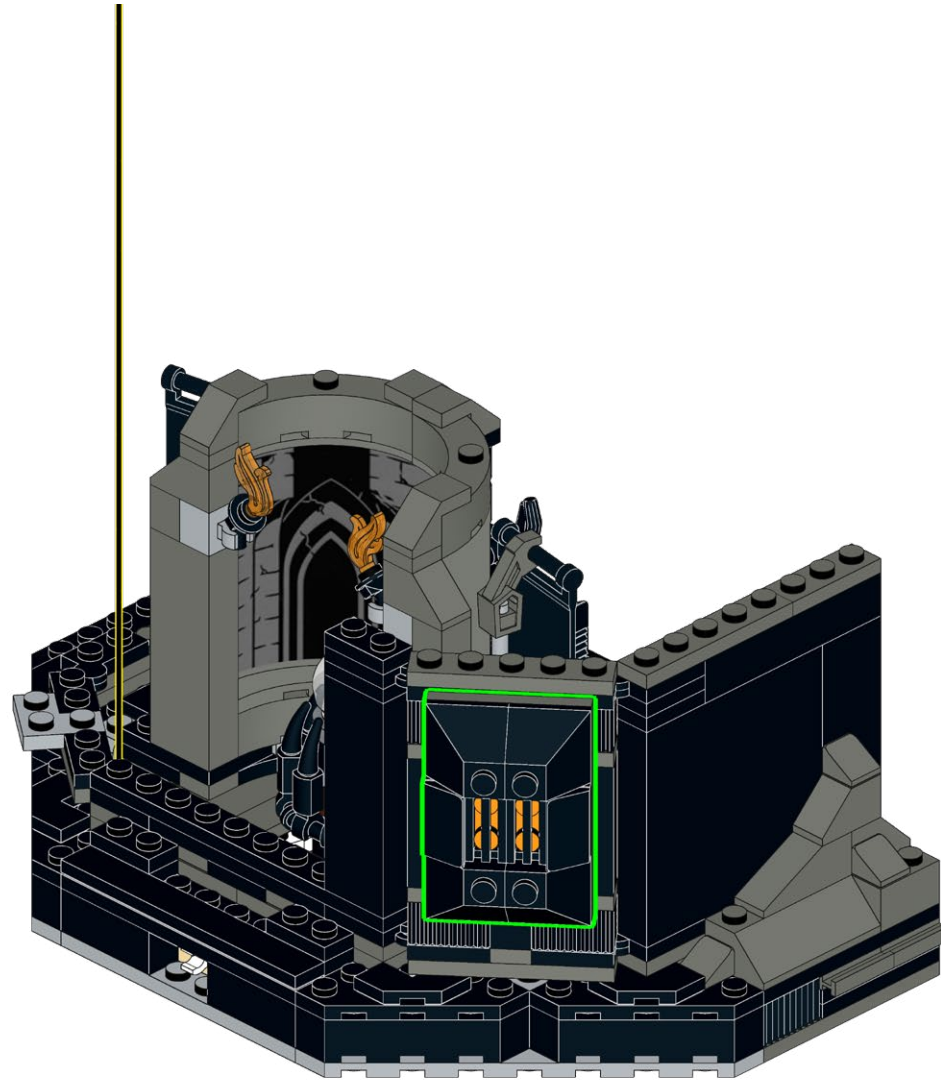



HOLD UP!

You might notice some bags aren't in order, as well as left over pieces, but that's ok! We're changing the way you build LEGO!

ATTENDEZ!

Vous remarquerez peut-être que certains sacs, ainsi que certaines pièces, ne sont pas dans le bon ordre. Mais pas de panique! Nous changeons simplement la façon avec laquelle vous construisez vos LEGO!

ASPETTA!

Potresti notare che alcuni sacchetti non sono in ordine, così come i pezzi avanzati, ma va bene così! Stiamo cambiando il modo in cui costruisci i LEGO!

HALT!

Sie werden möglicherweise bemerken, dass einige tüten durcheinander sind und teile übrig bleiben, aber das ist in Ordnung! Wir ändern die art und weise, wie Sie LEGO bauen!

¡ESPERA!

Es posible que notes que algunas bolsas están fuera de servicio, así como piezas sobrantes, ¡pero está bien! ¡Estamos cambiando la forma en que construyes LEGO!

暫停!

你可能会注意到一些袋子顺序错乱, 以及一些剩余的部件, 但没关系! 我们正在改变你搭建乐高的方式!

Open LEGO® Bag 30

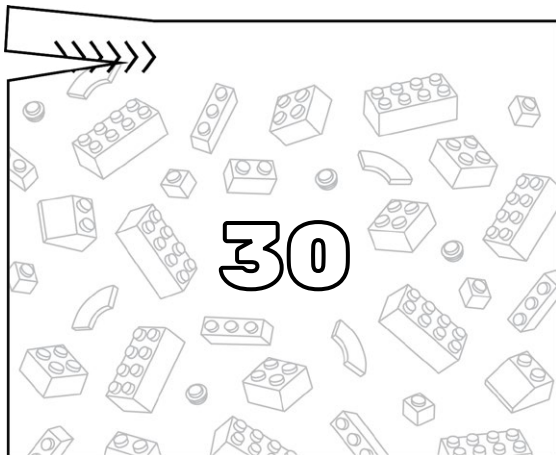

113

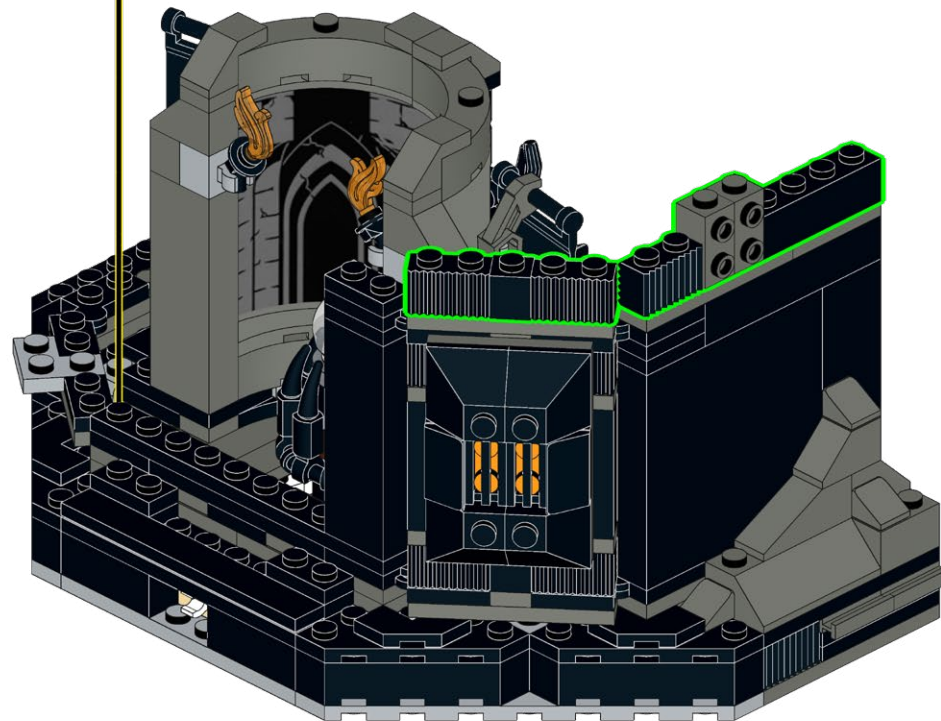
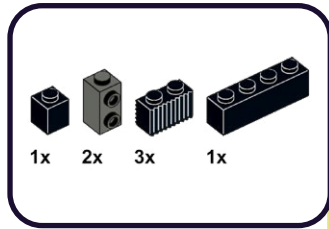

114

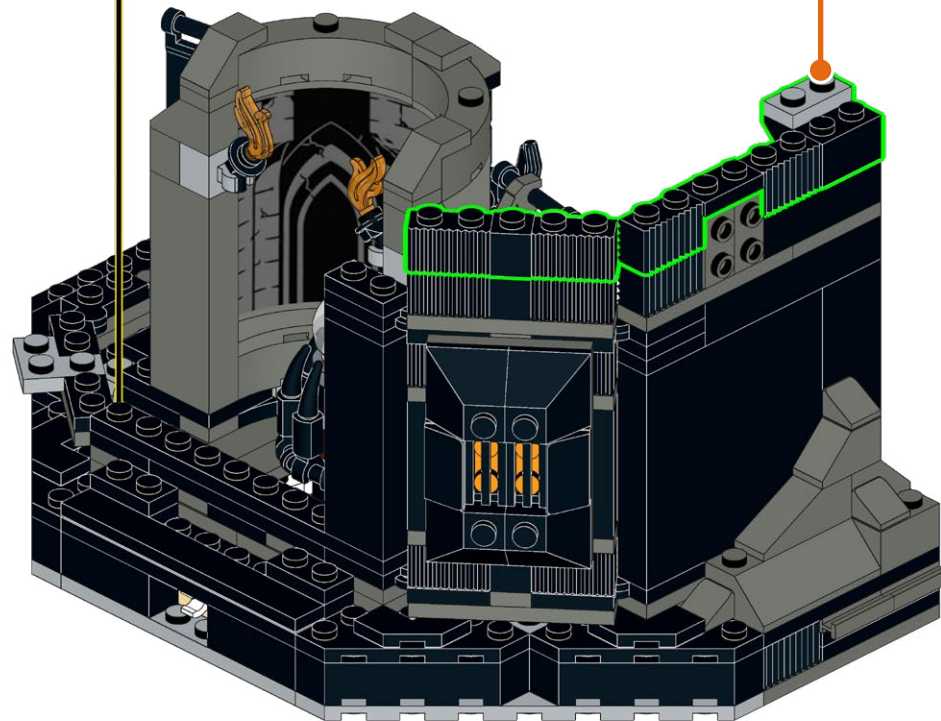
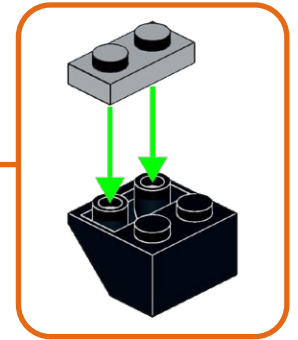
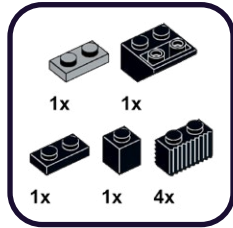

115

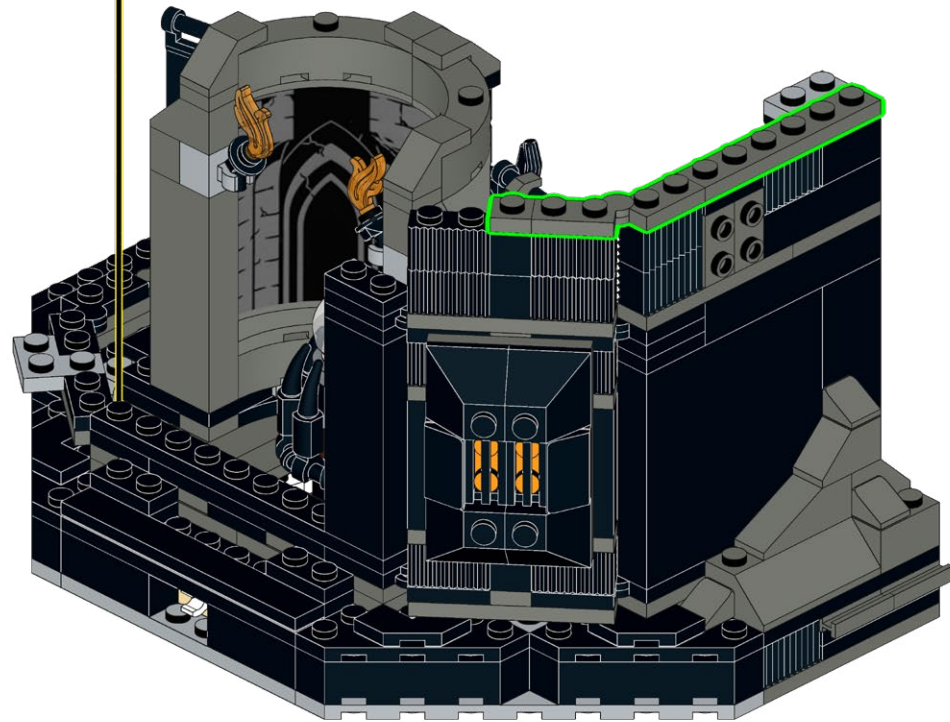
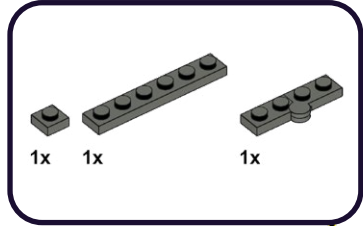

116

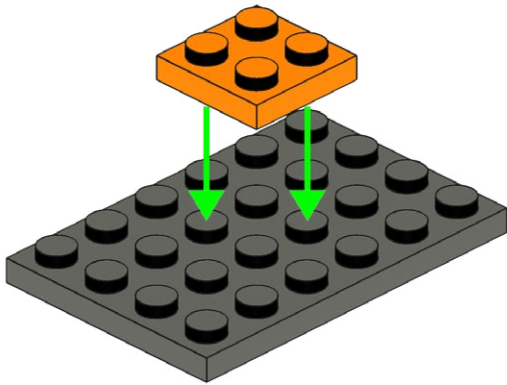
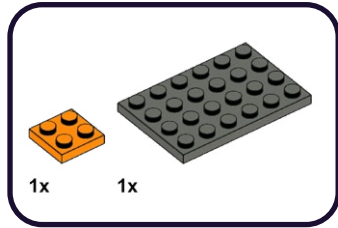

117

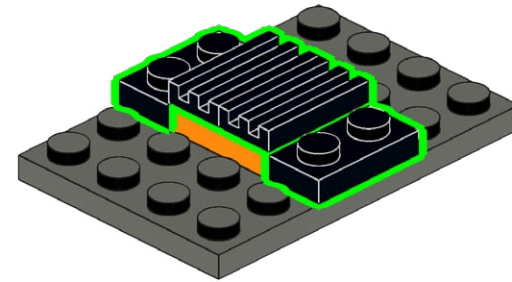
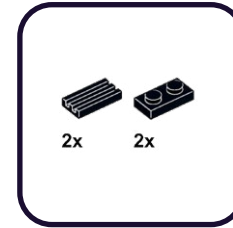

118

2x

4x

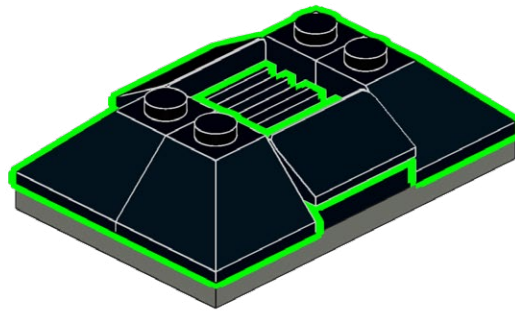

119

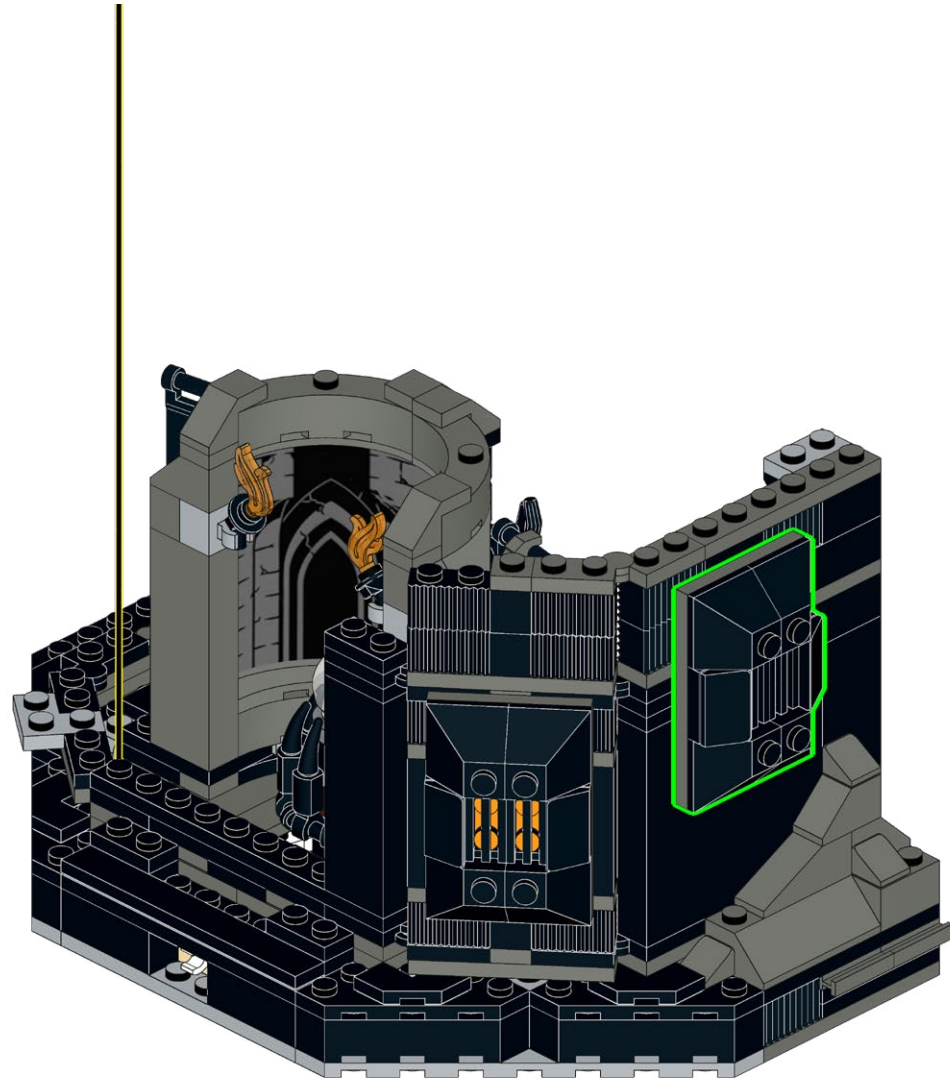

120

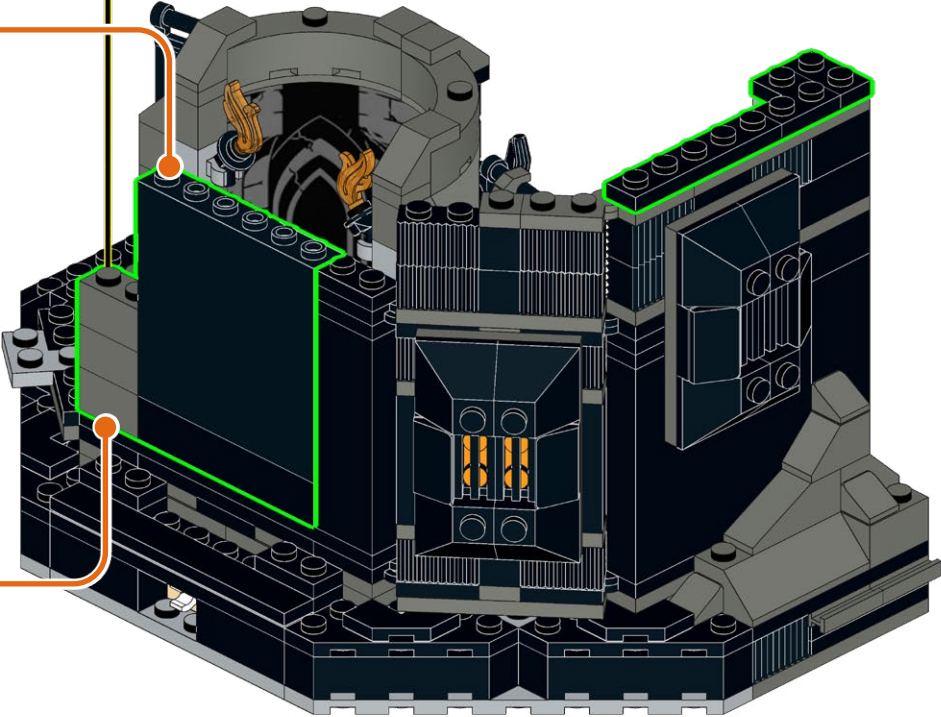
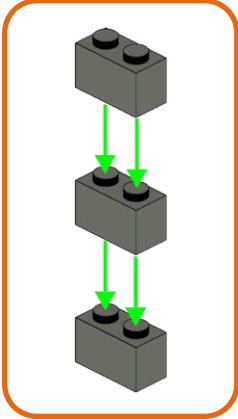
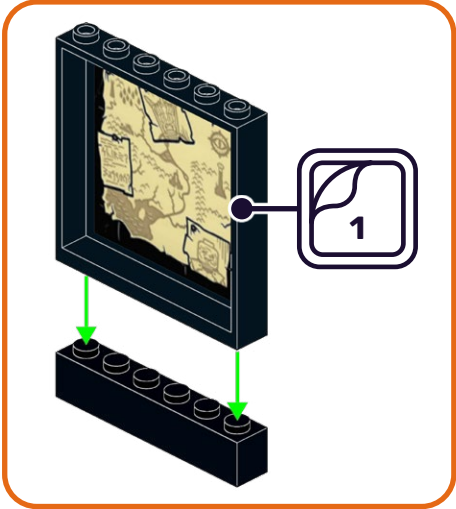
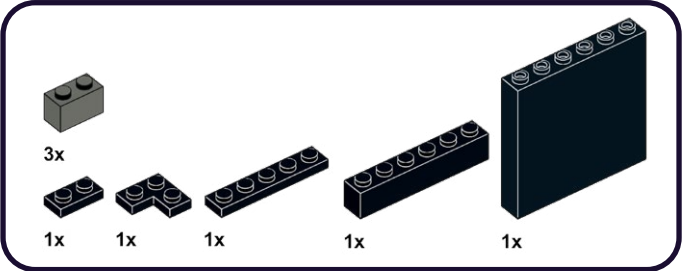

121

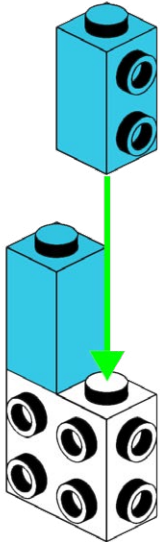
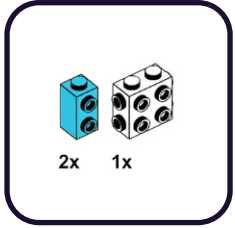

122

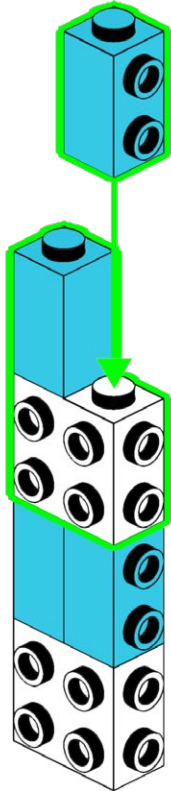
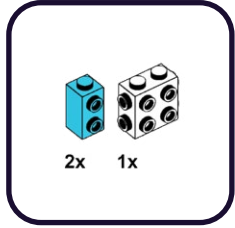

123

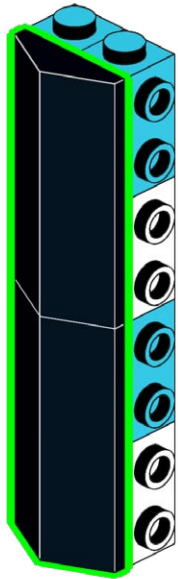
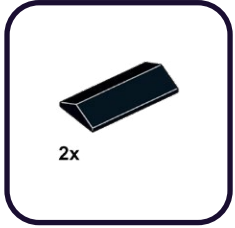

124

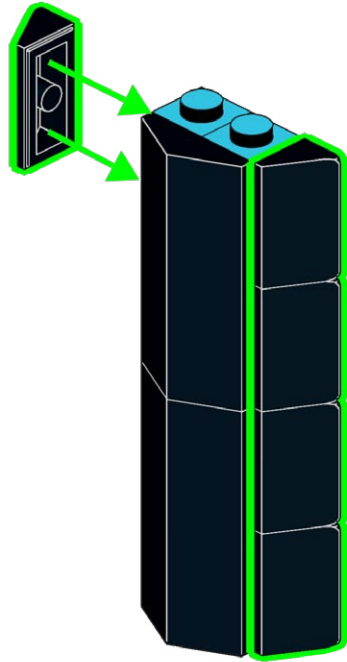
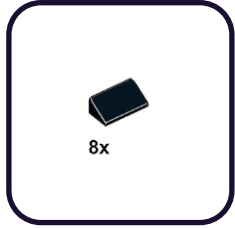

125

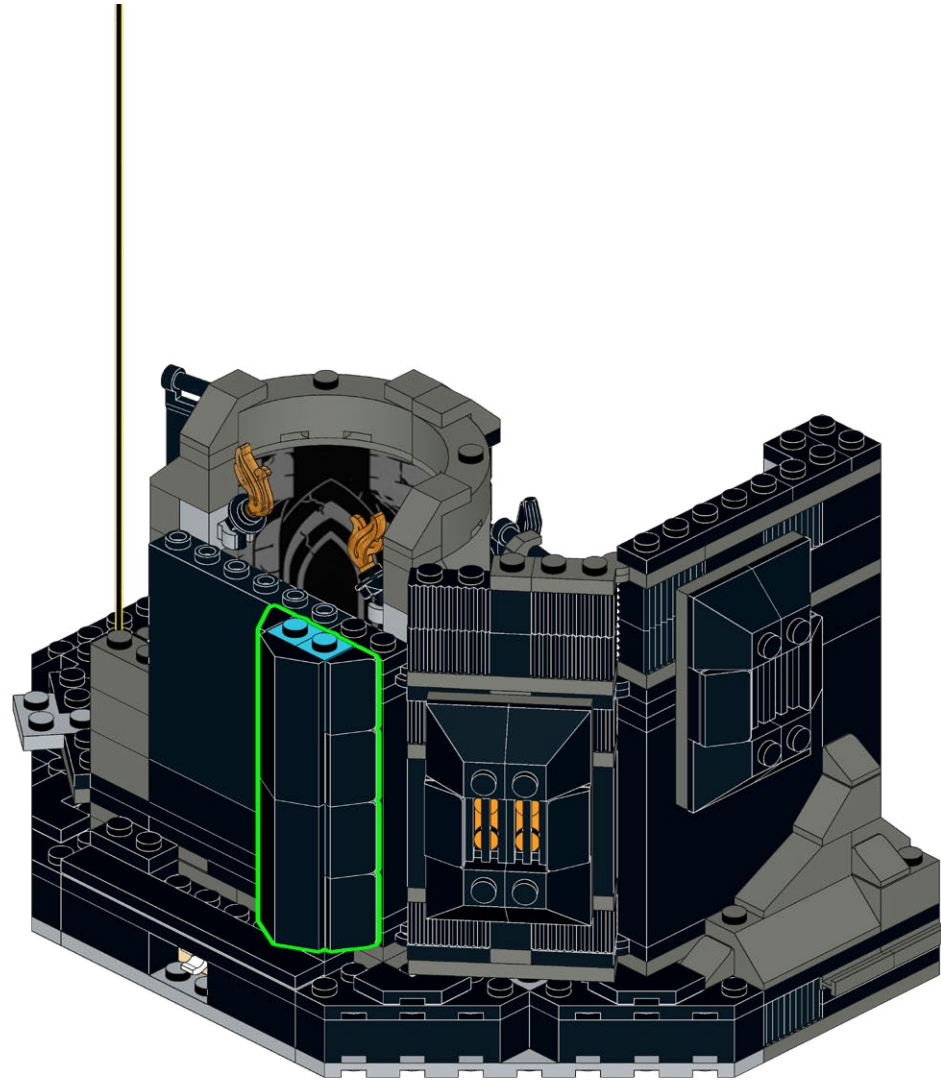

126

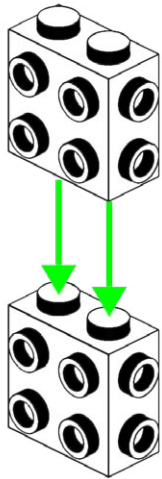
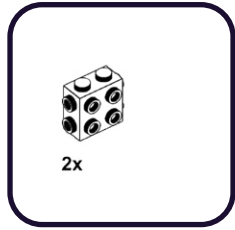

127

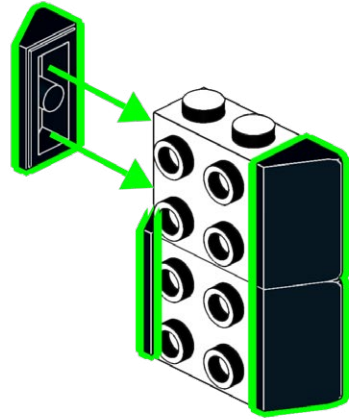
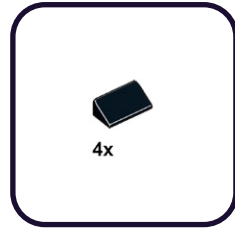

128

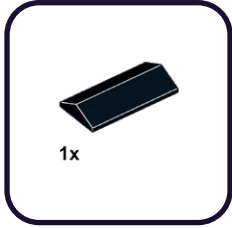

129

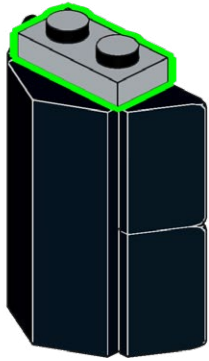
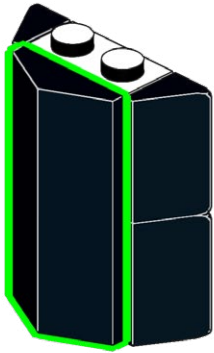
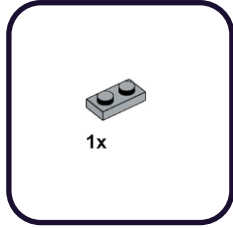

130

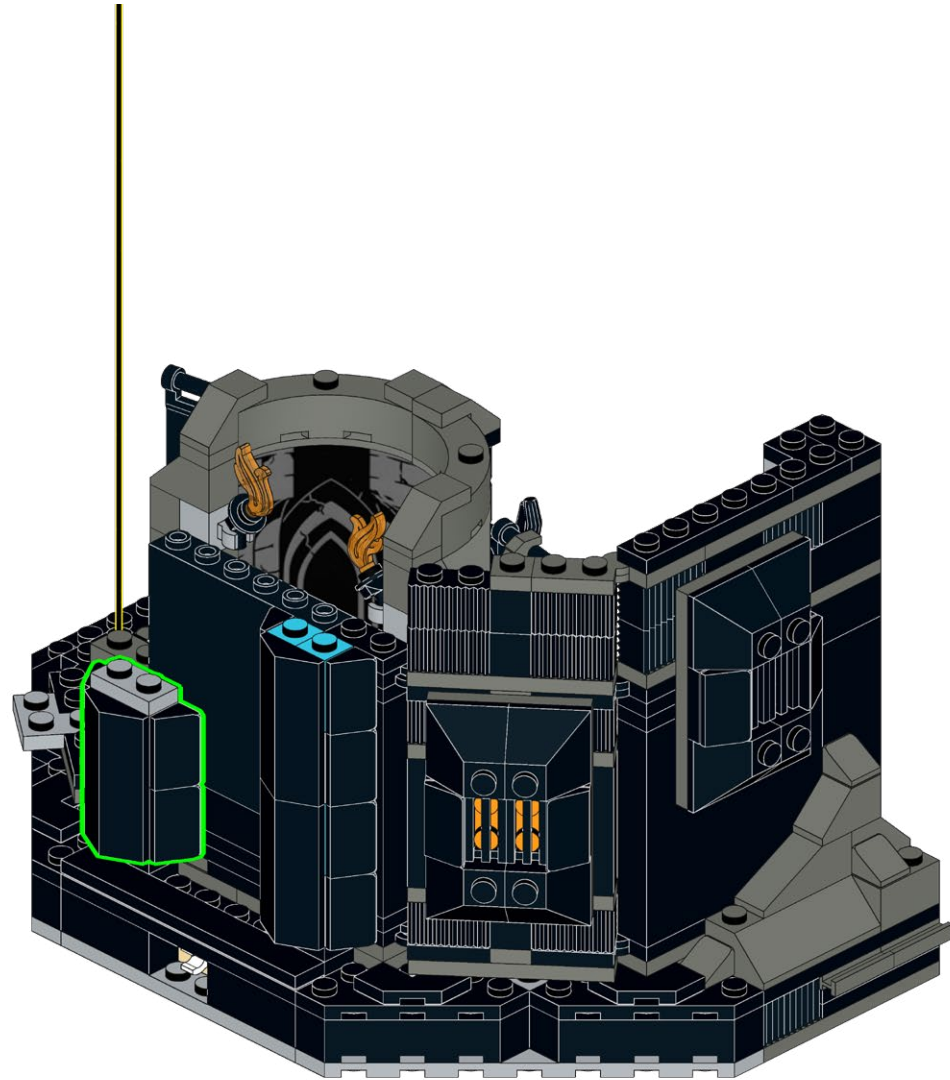

131

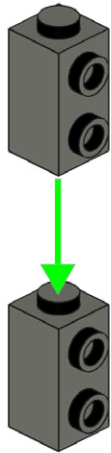
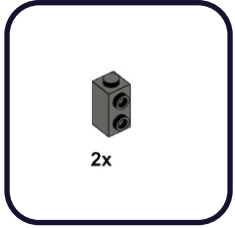

132

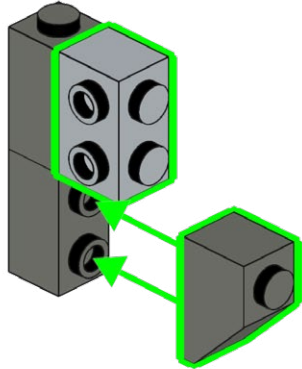
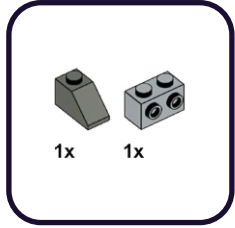

133

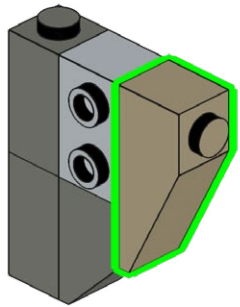
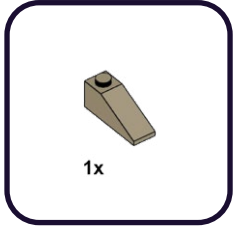

134

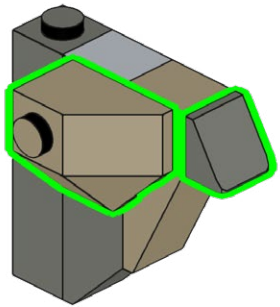
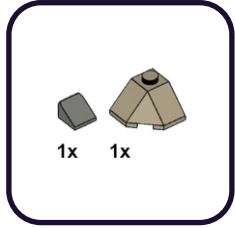

135

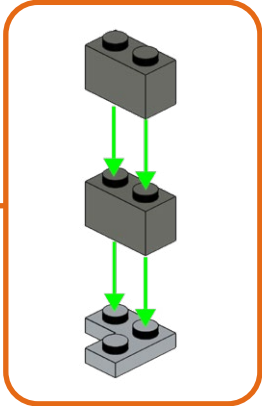
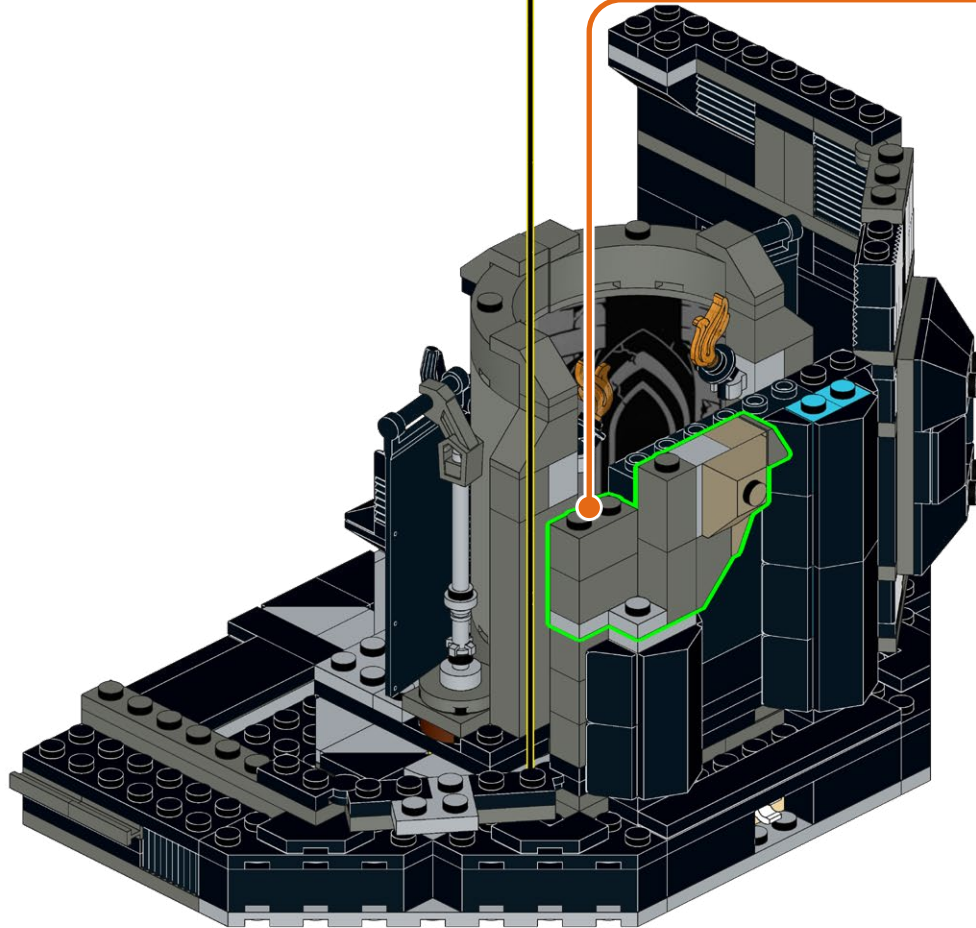
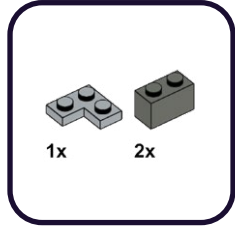

136

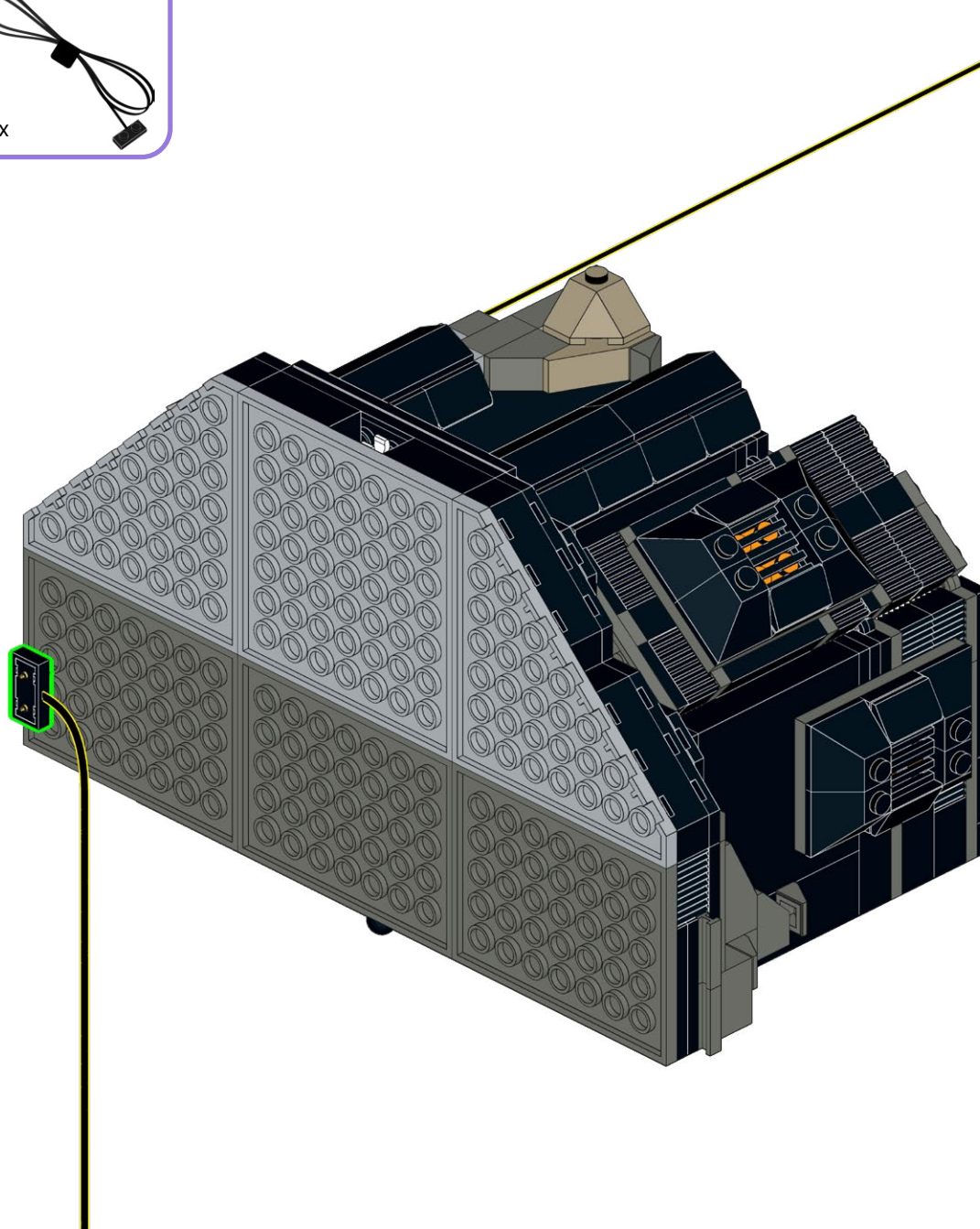

137

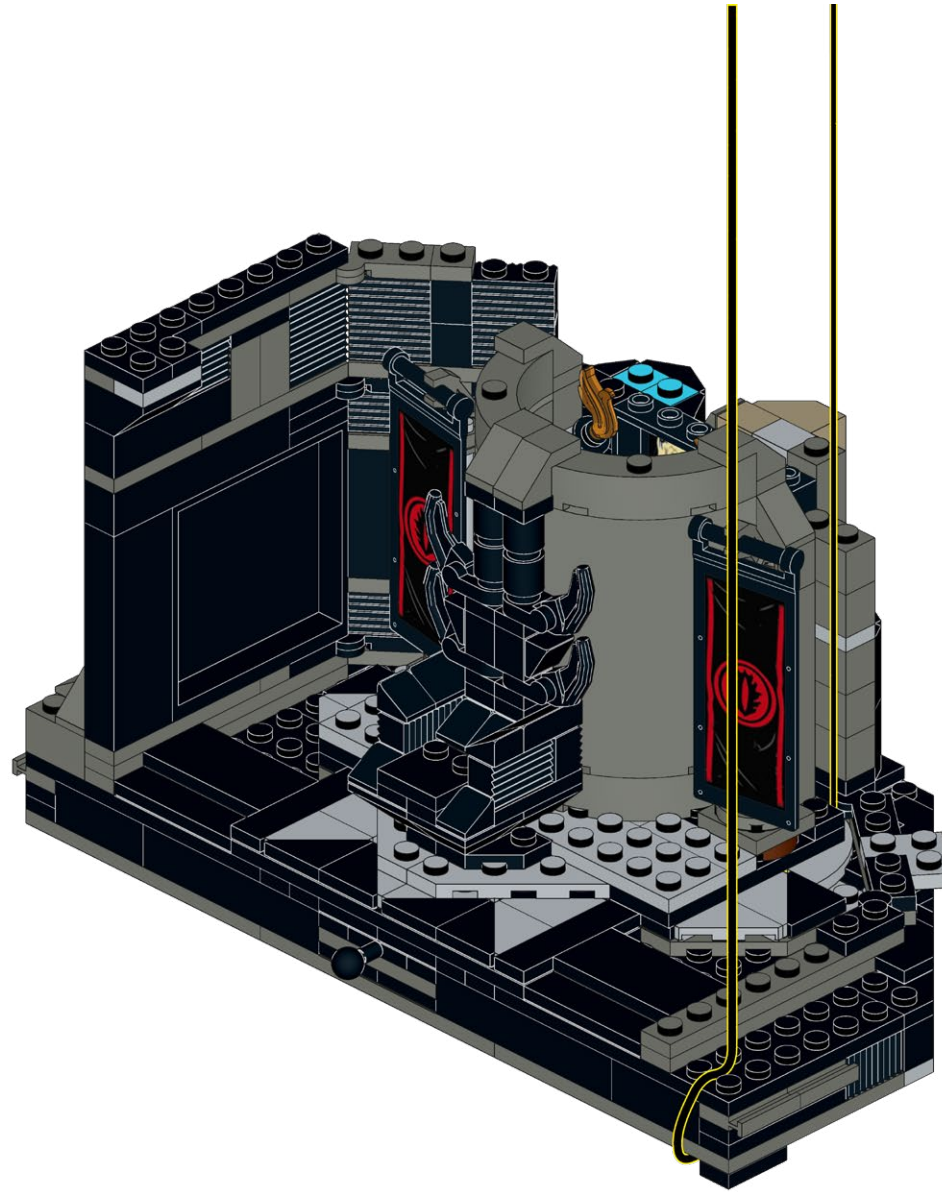

138

1x

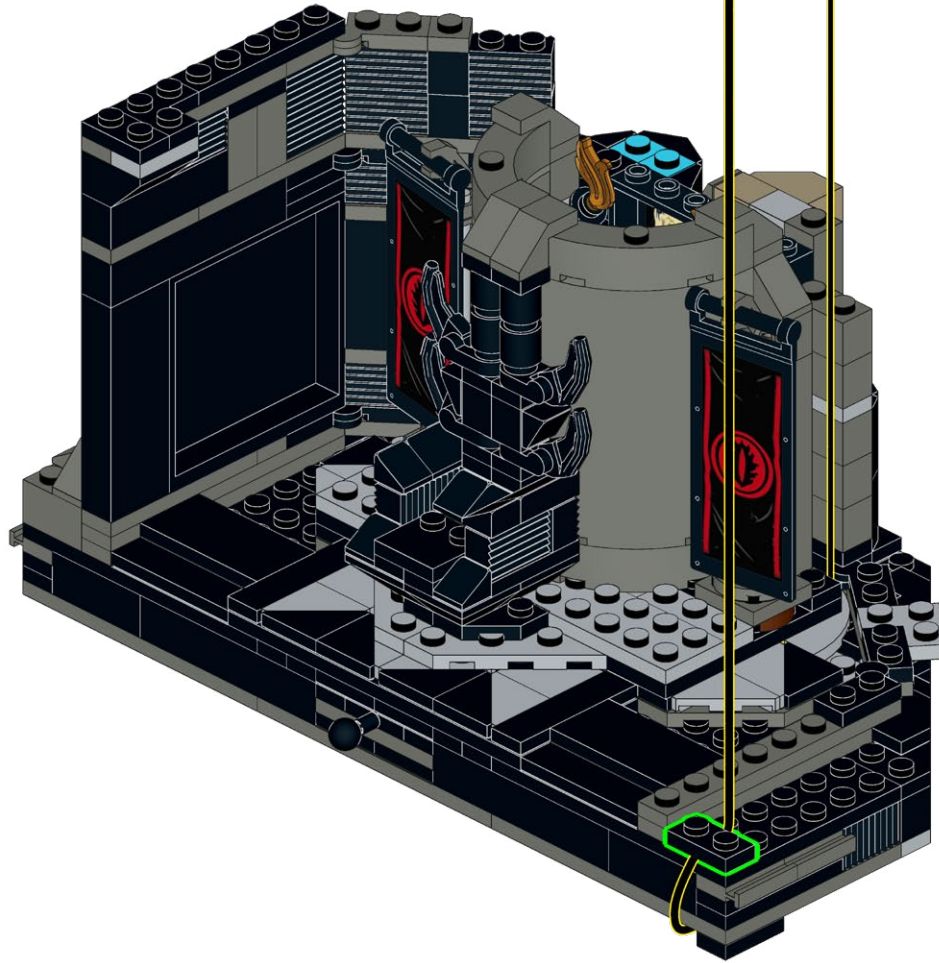

139

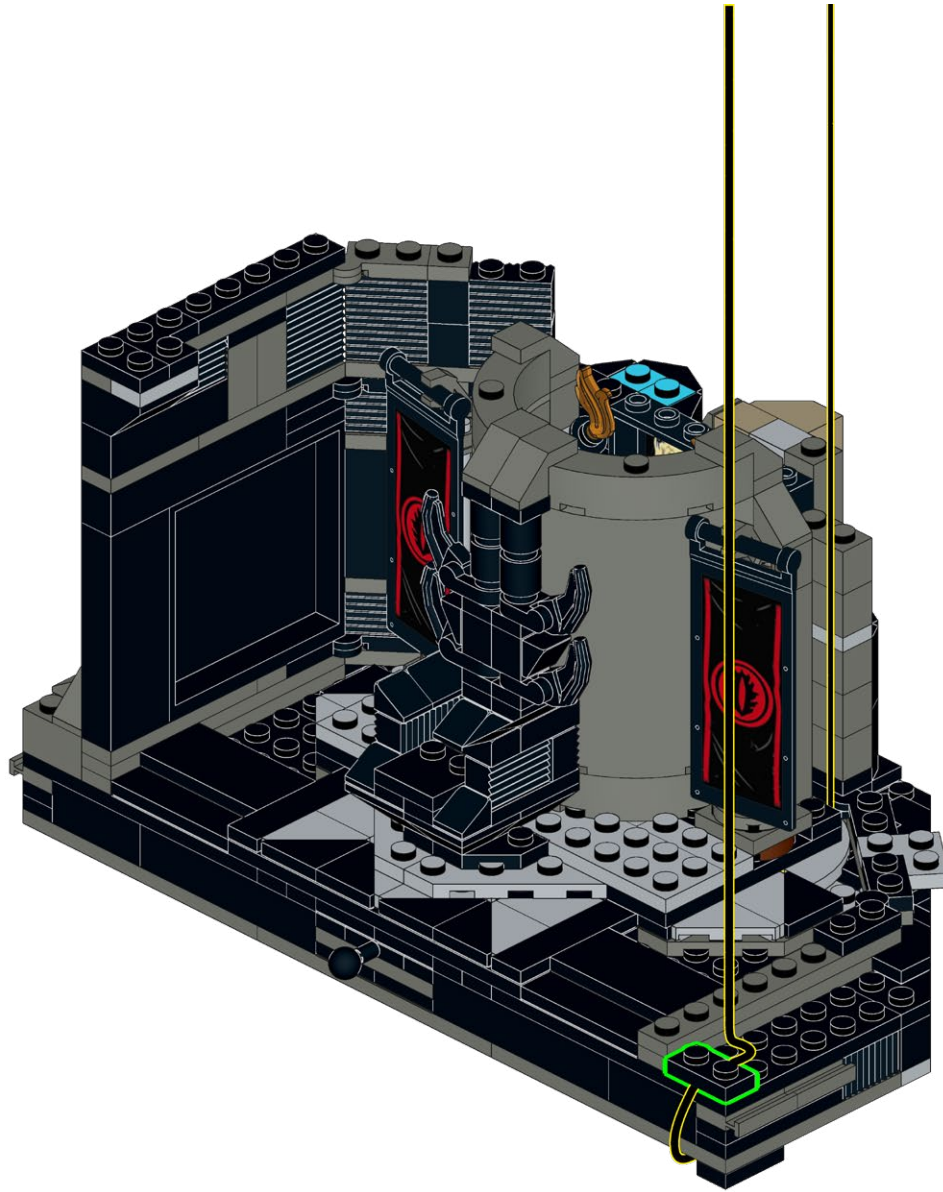

140

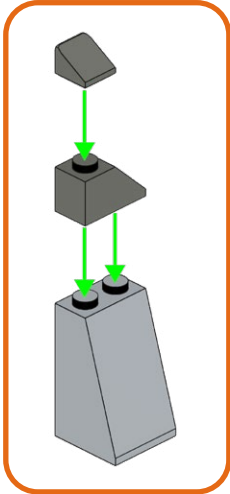
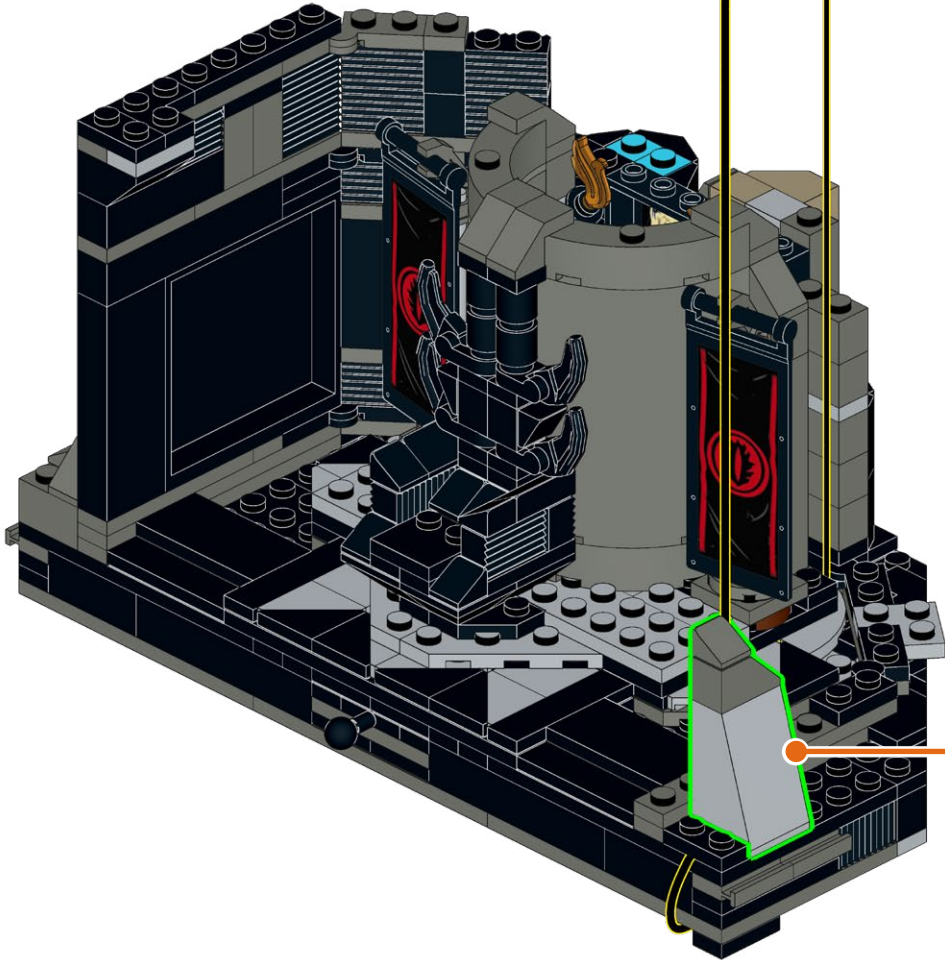
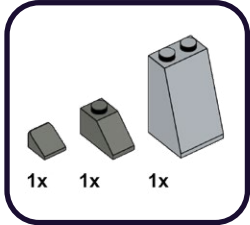

141

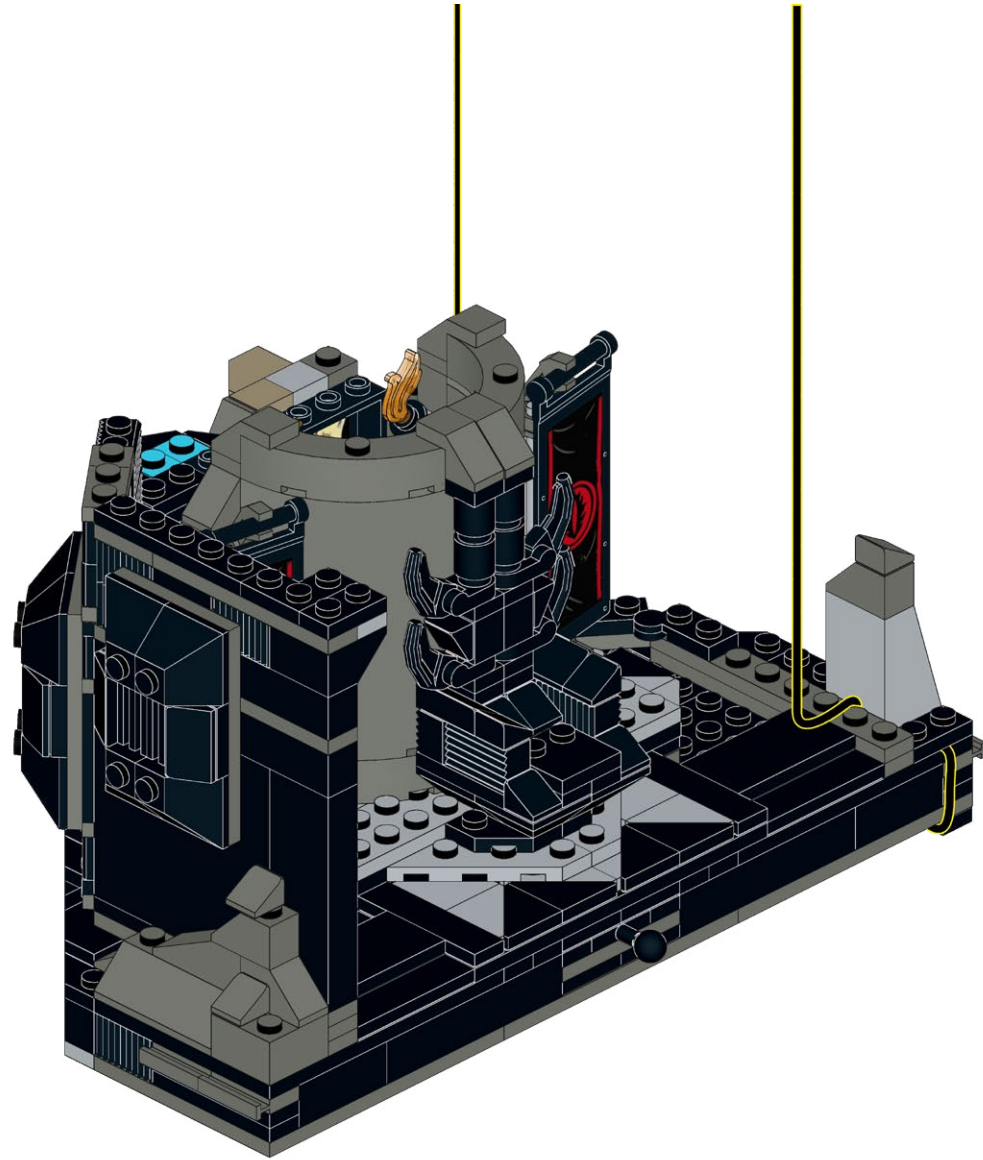

142

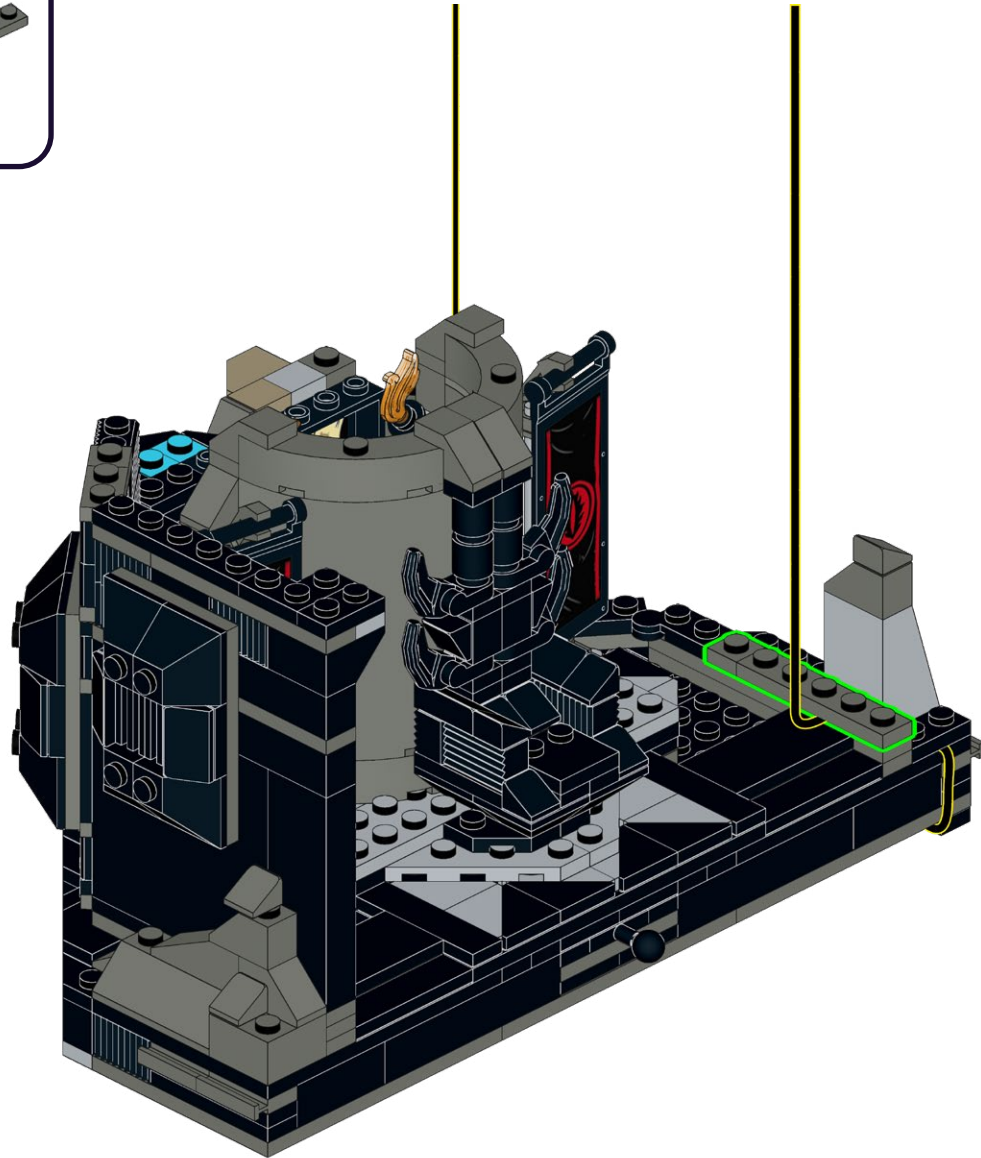
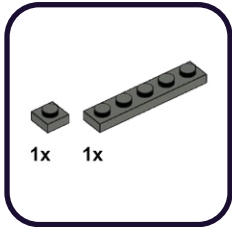

143

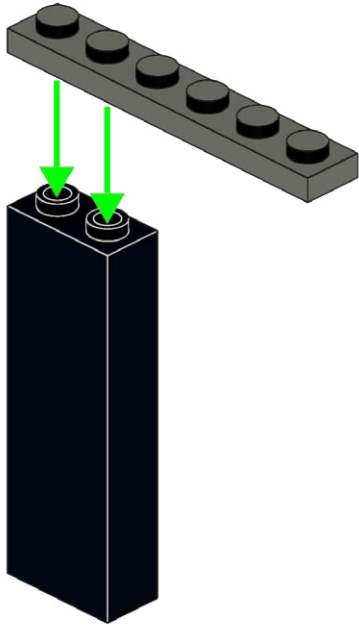
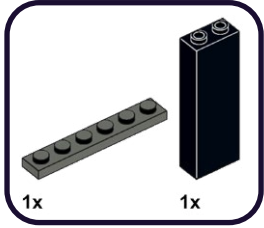

144

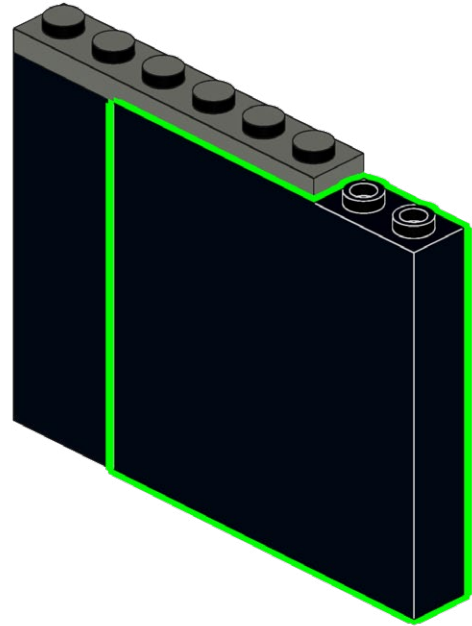
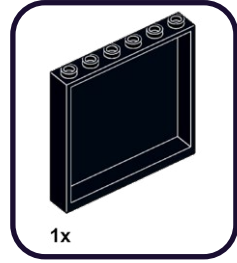

145

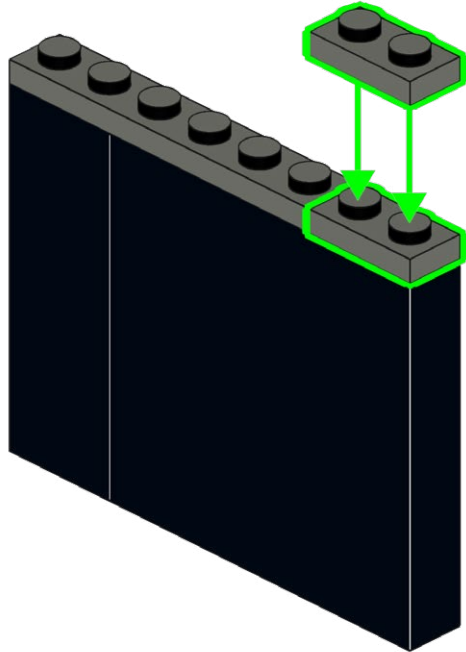
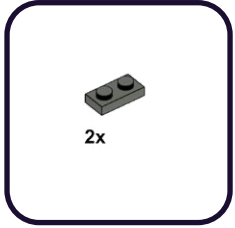

146

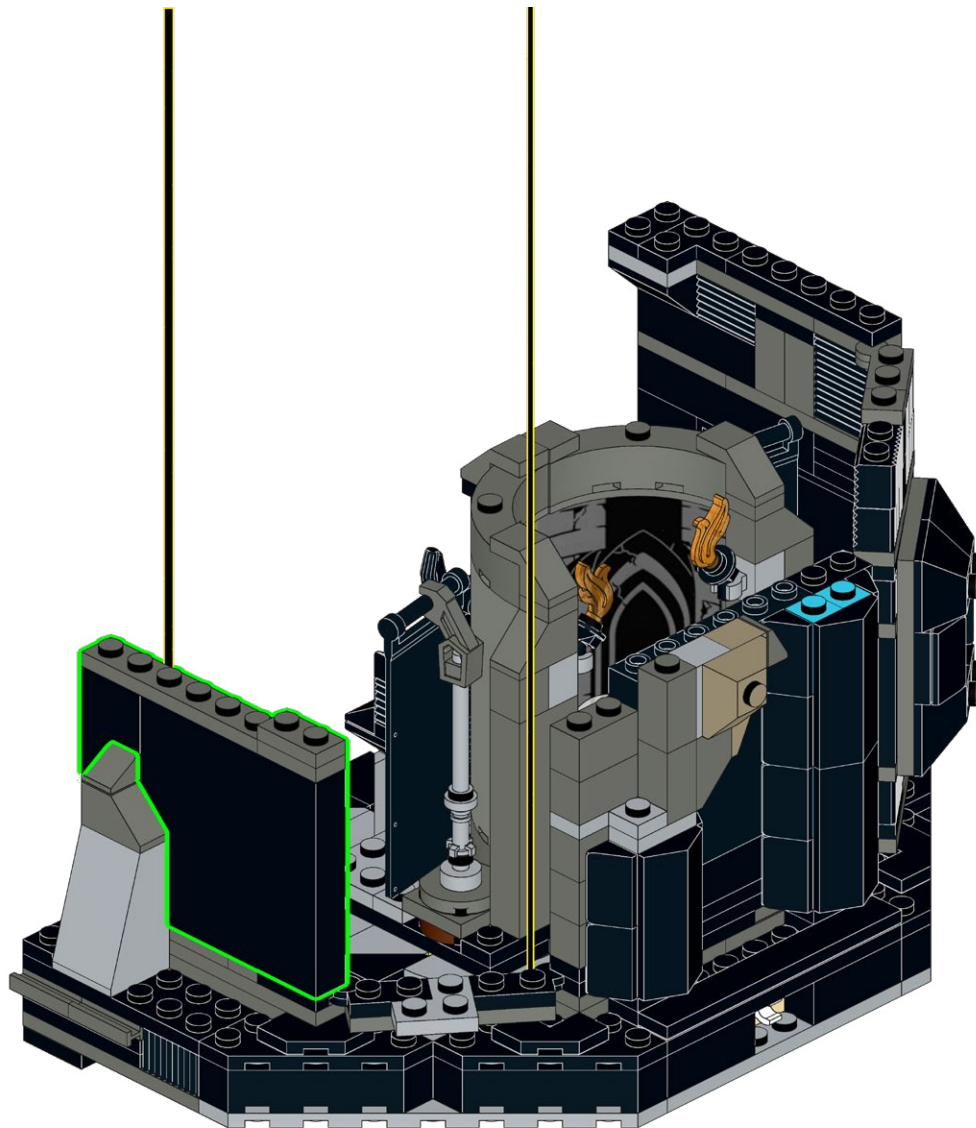

147

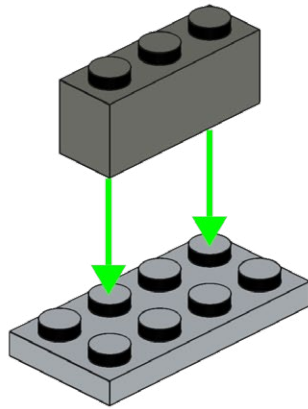
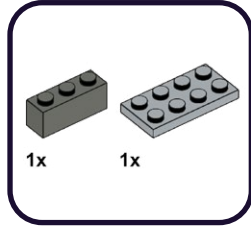

148

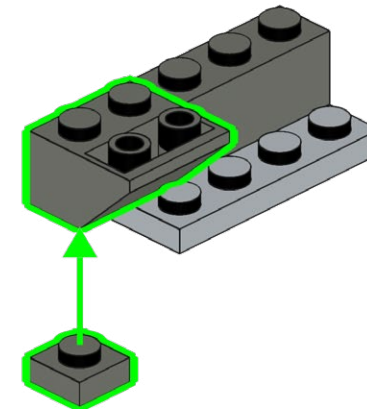
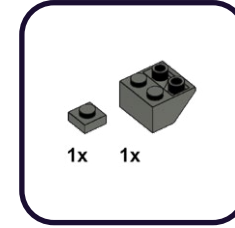

149

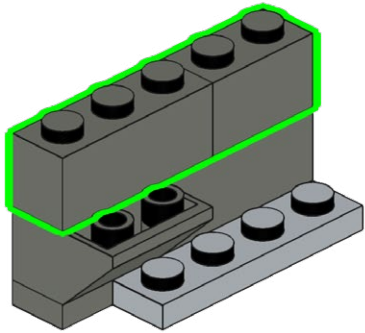
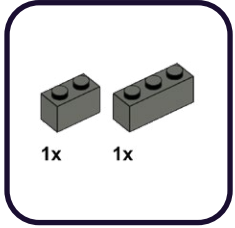

150

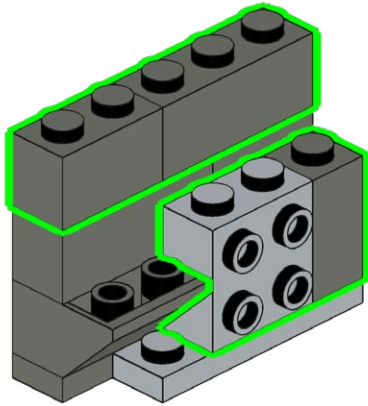
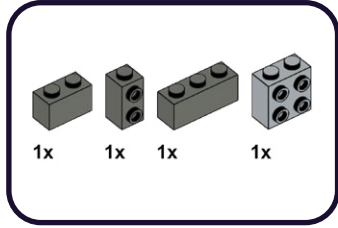

151

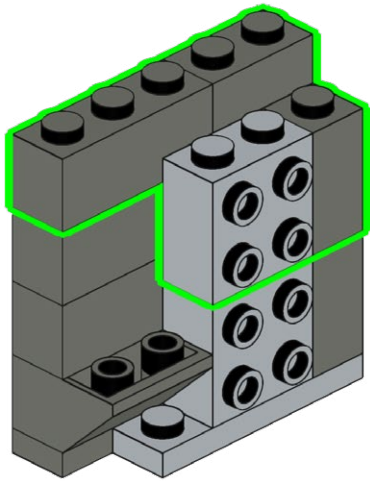
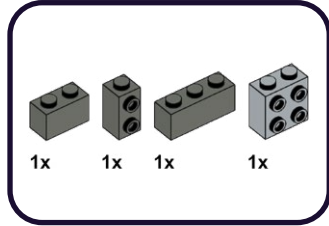

152

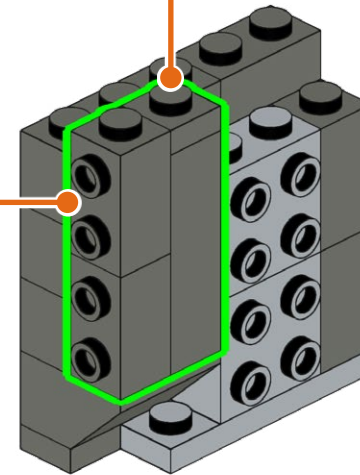
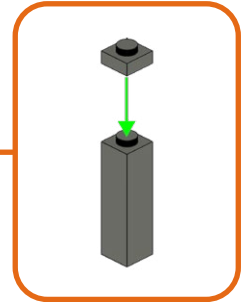
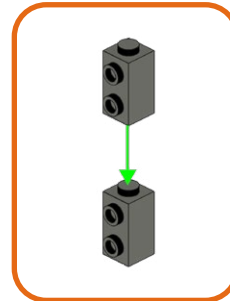
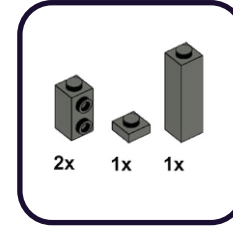

153

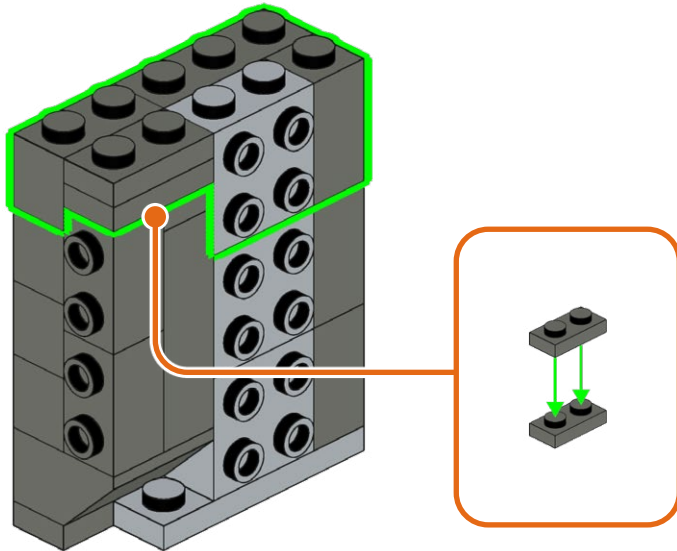
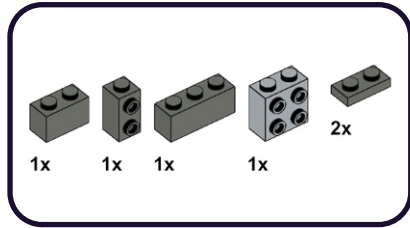

154

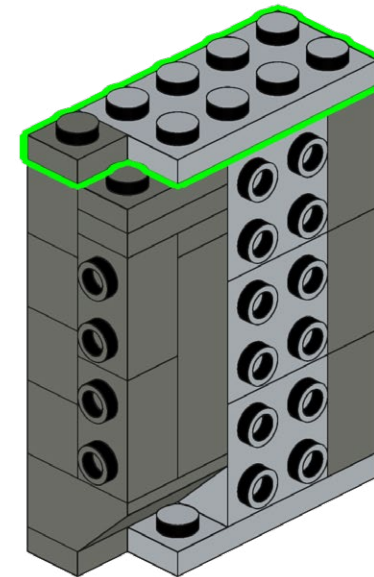
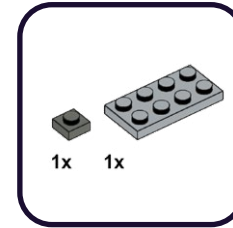

155

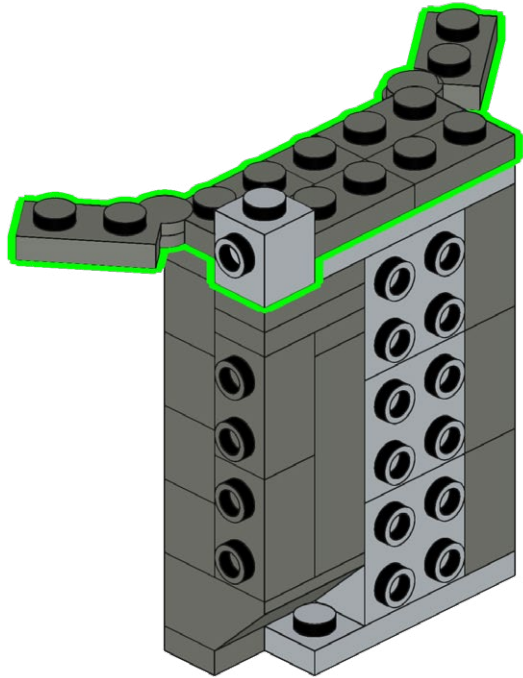
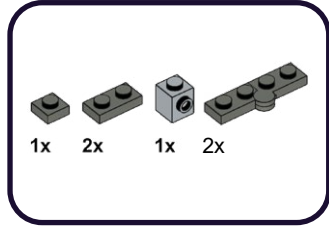

156

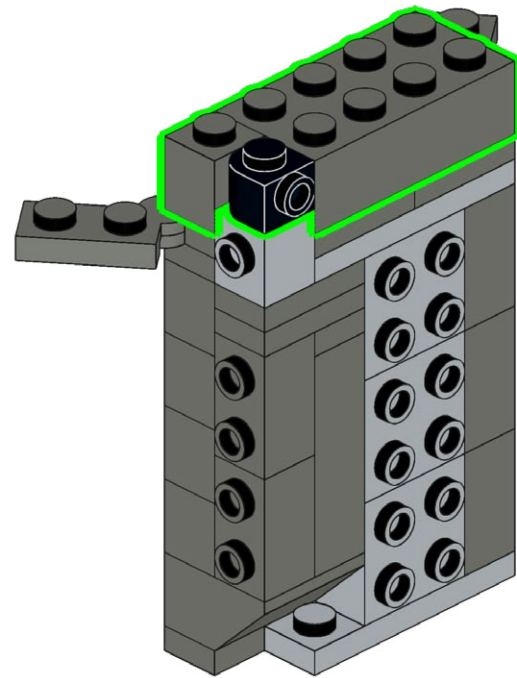
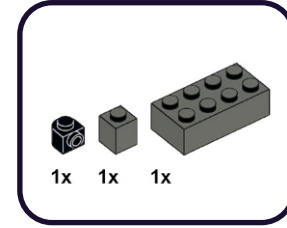

157

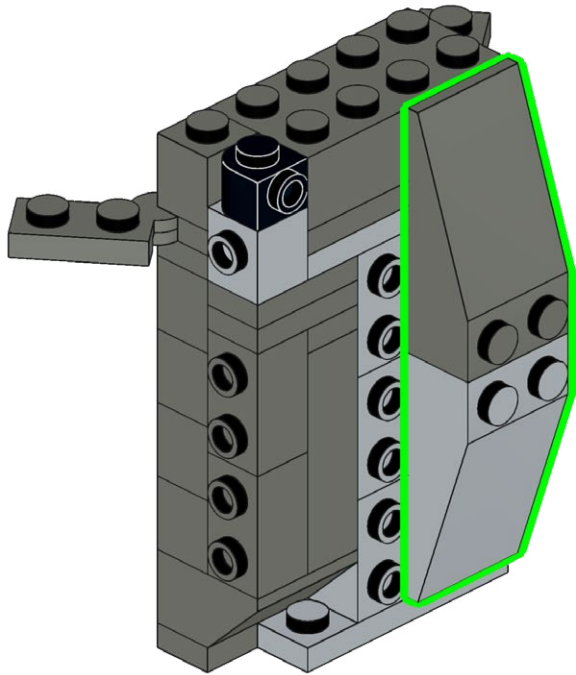
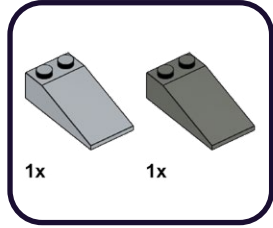

158

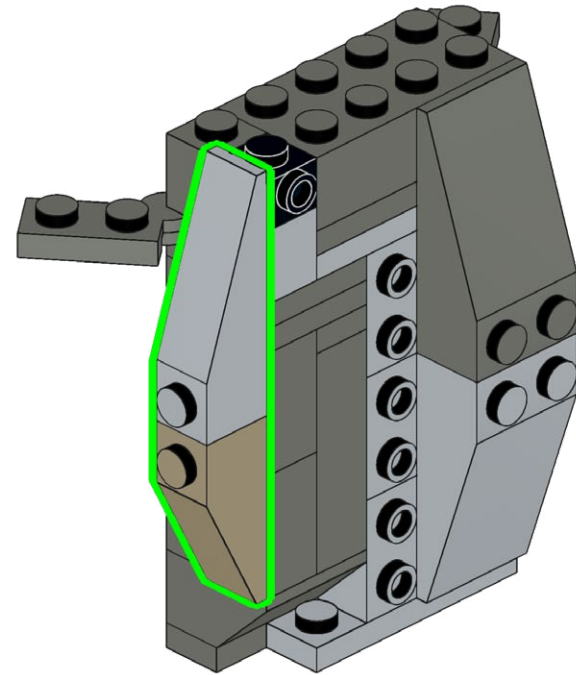
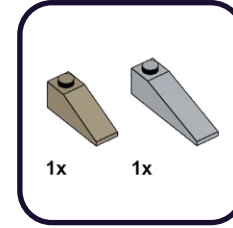

159

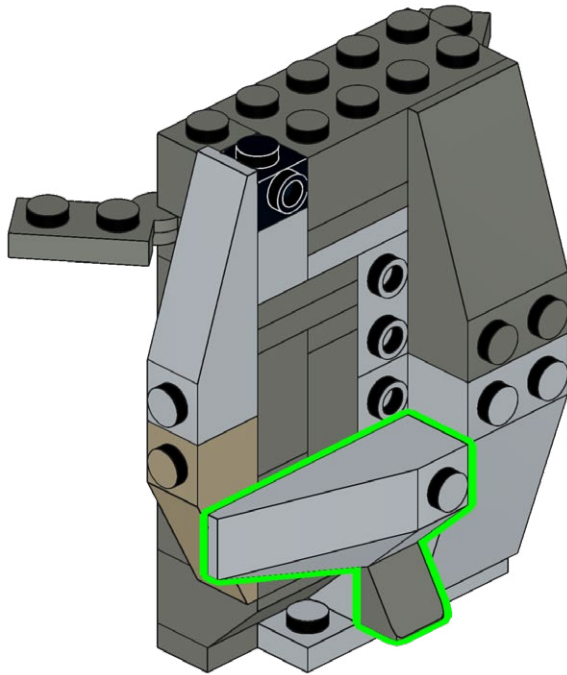
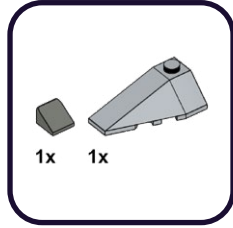

160

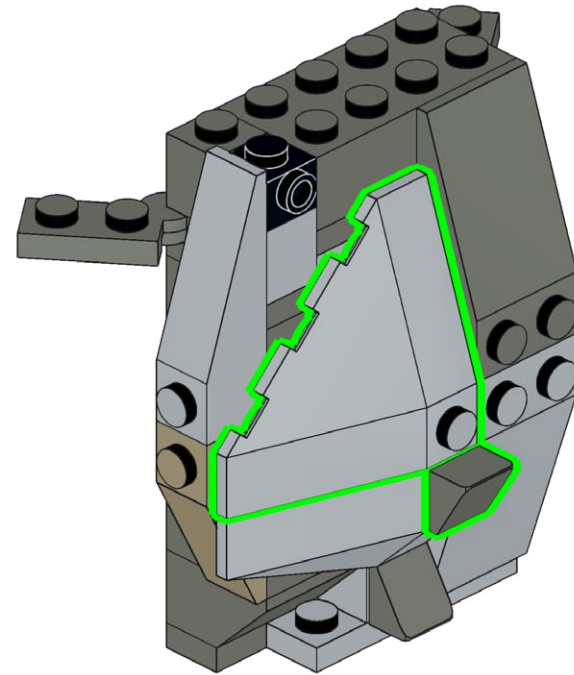
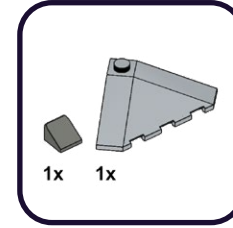

161

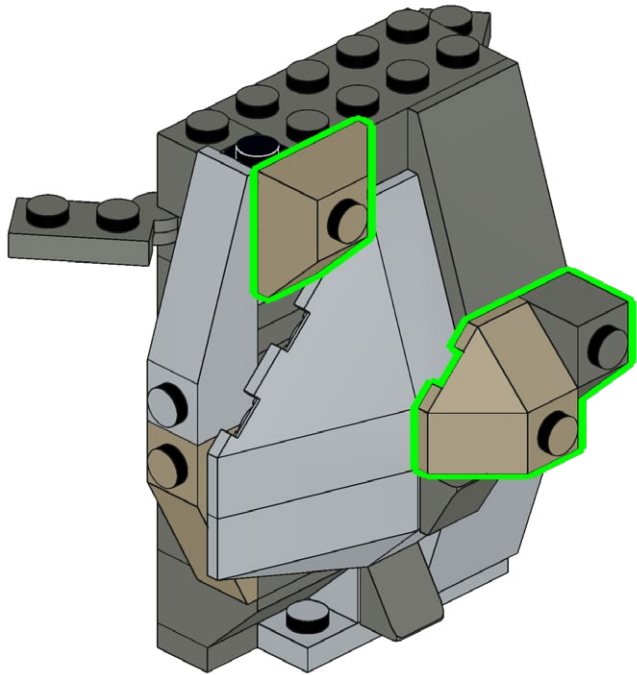
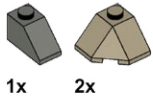

162

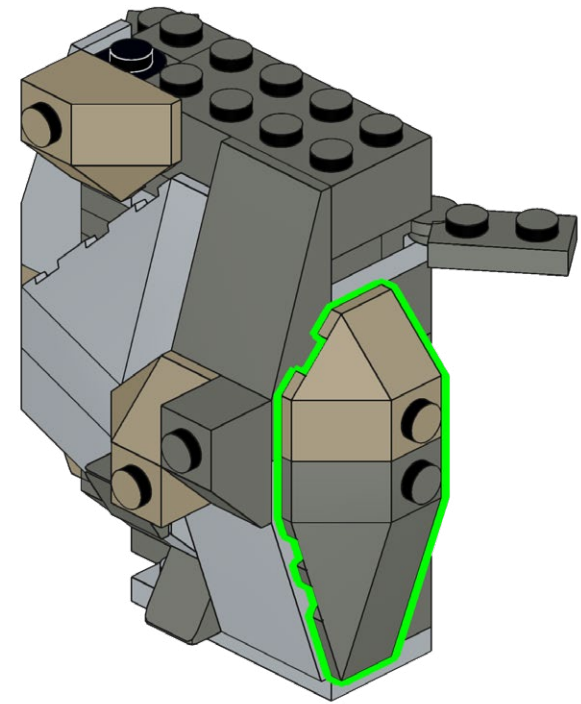
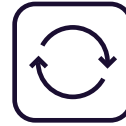
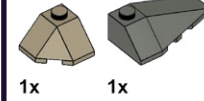

163

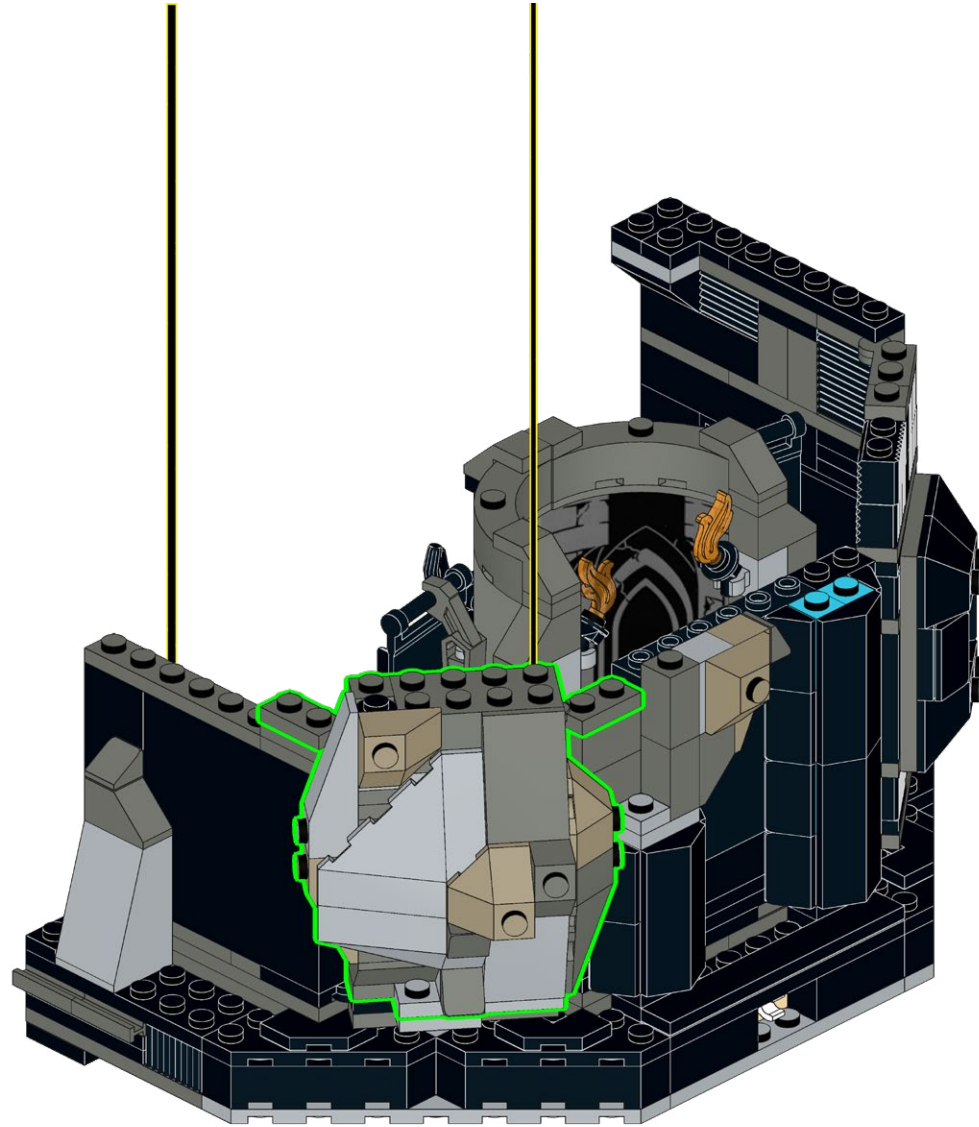

164

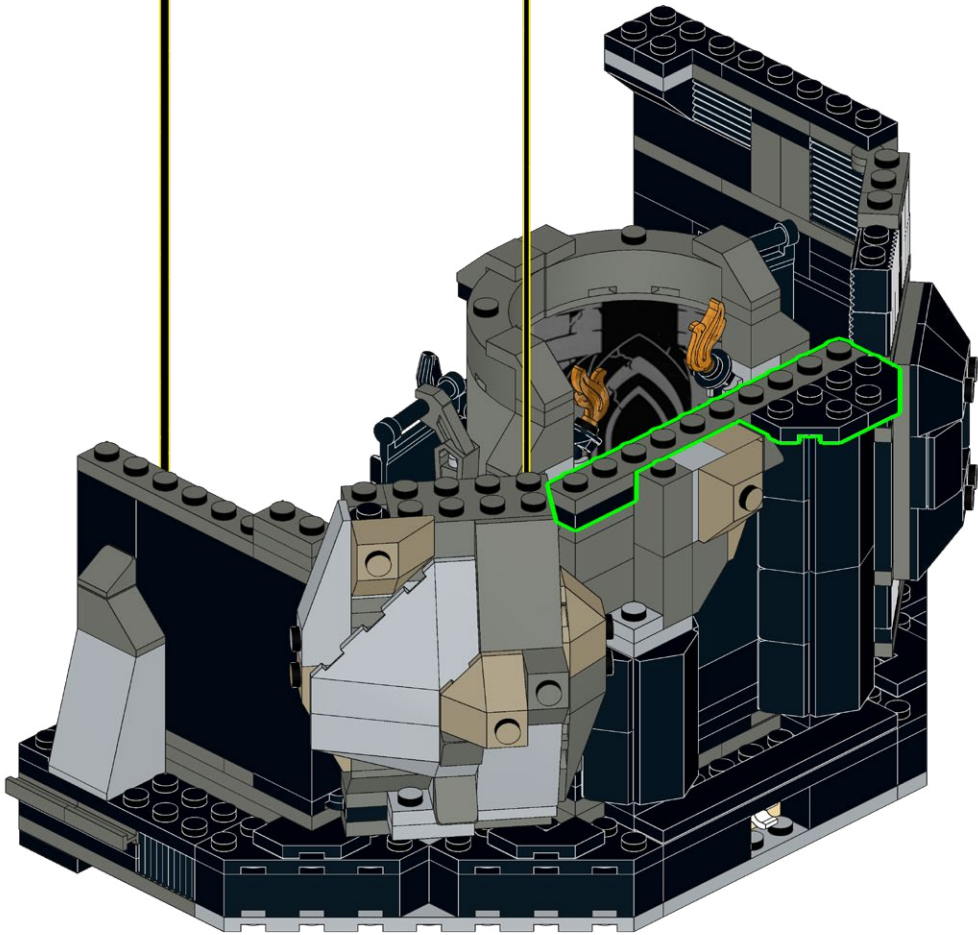
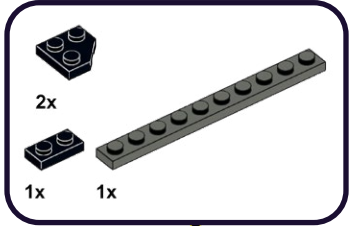

165

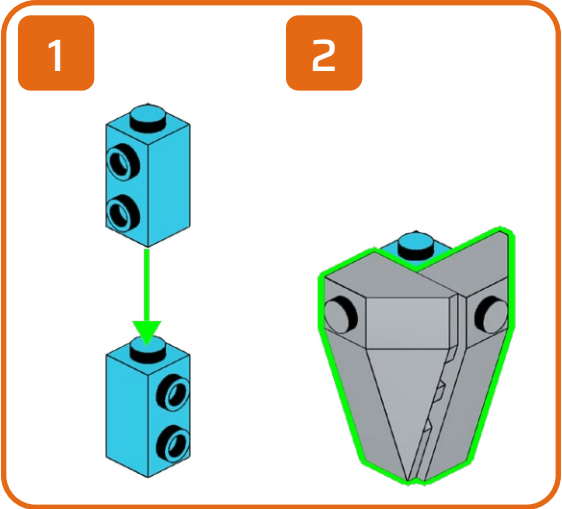
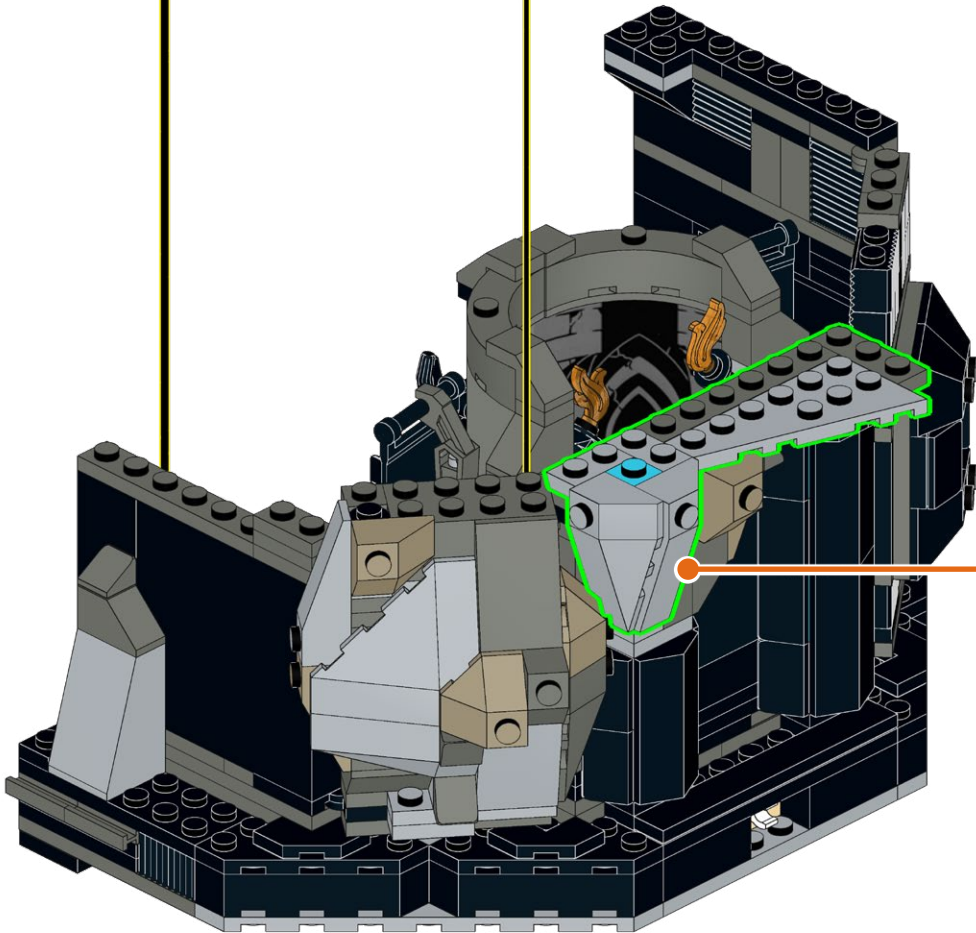
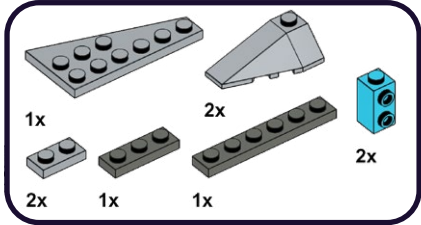

166

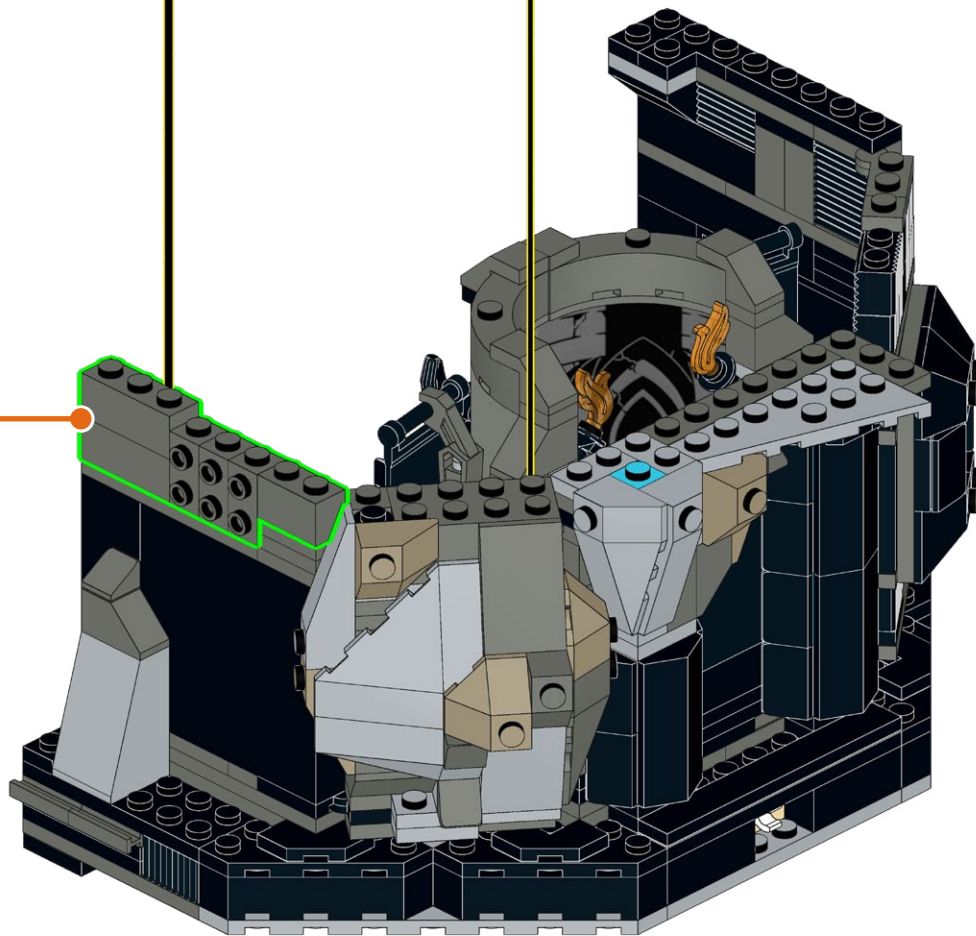
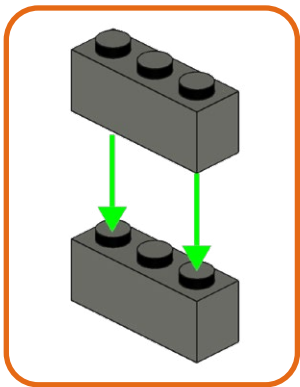
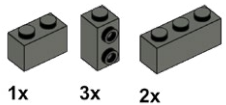

167

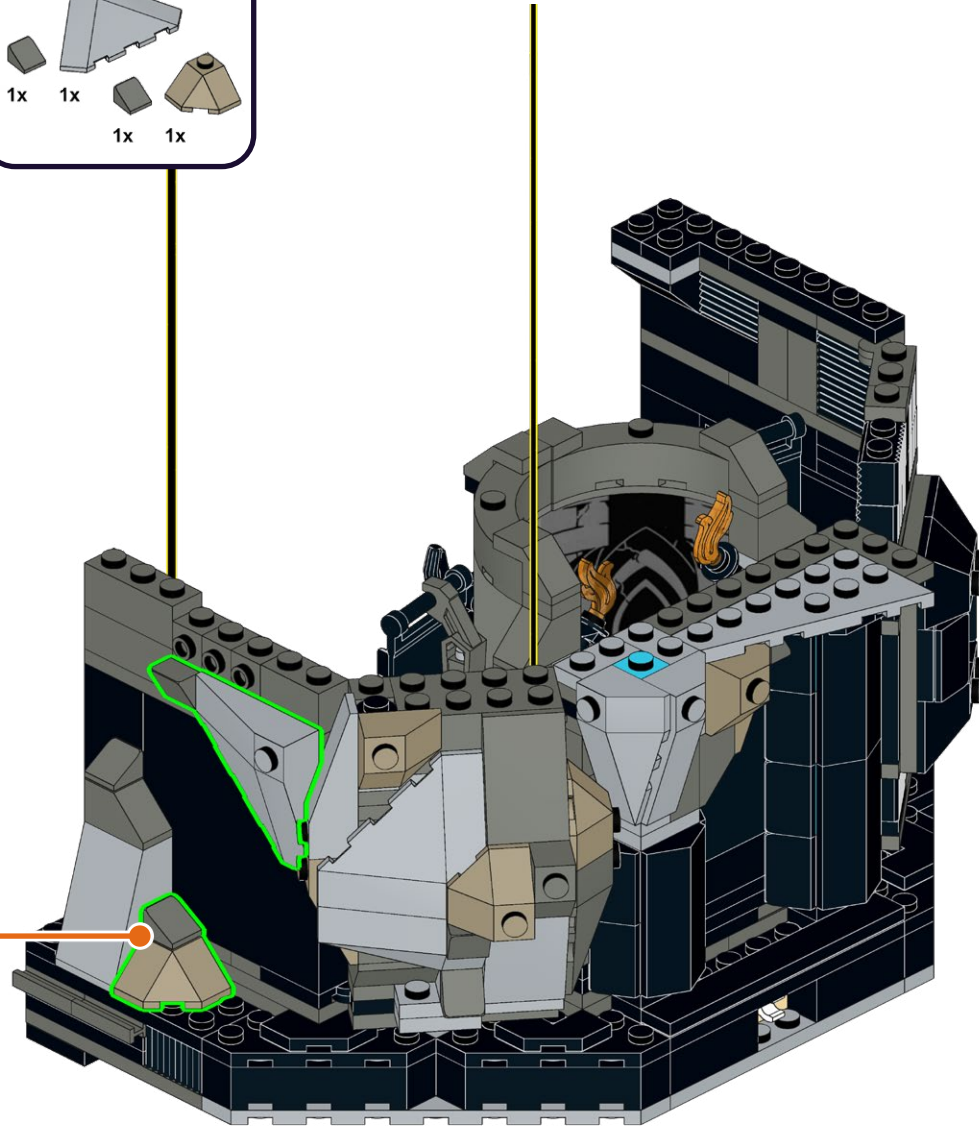
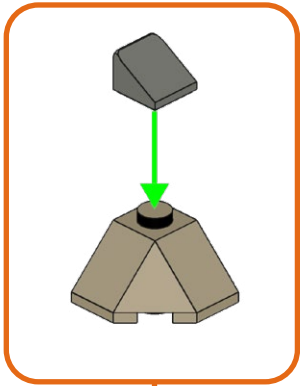
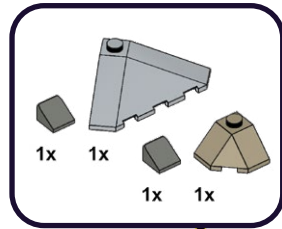

168

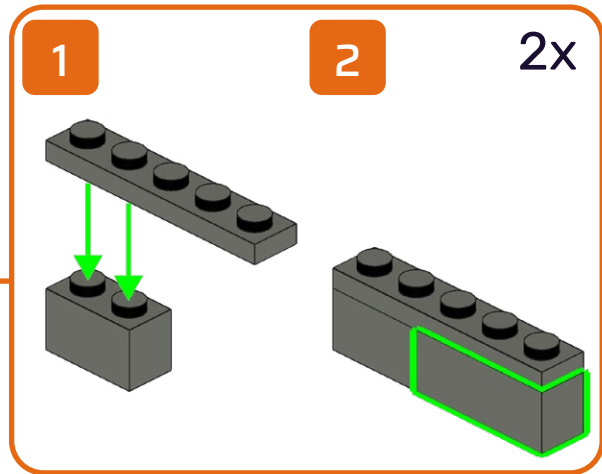
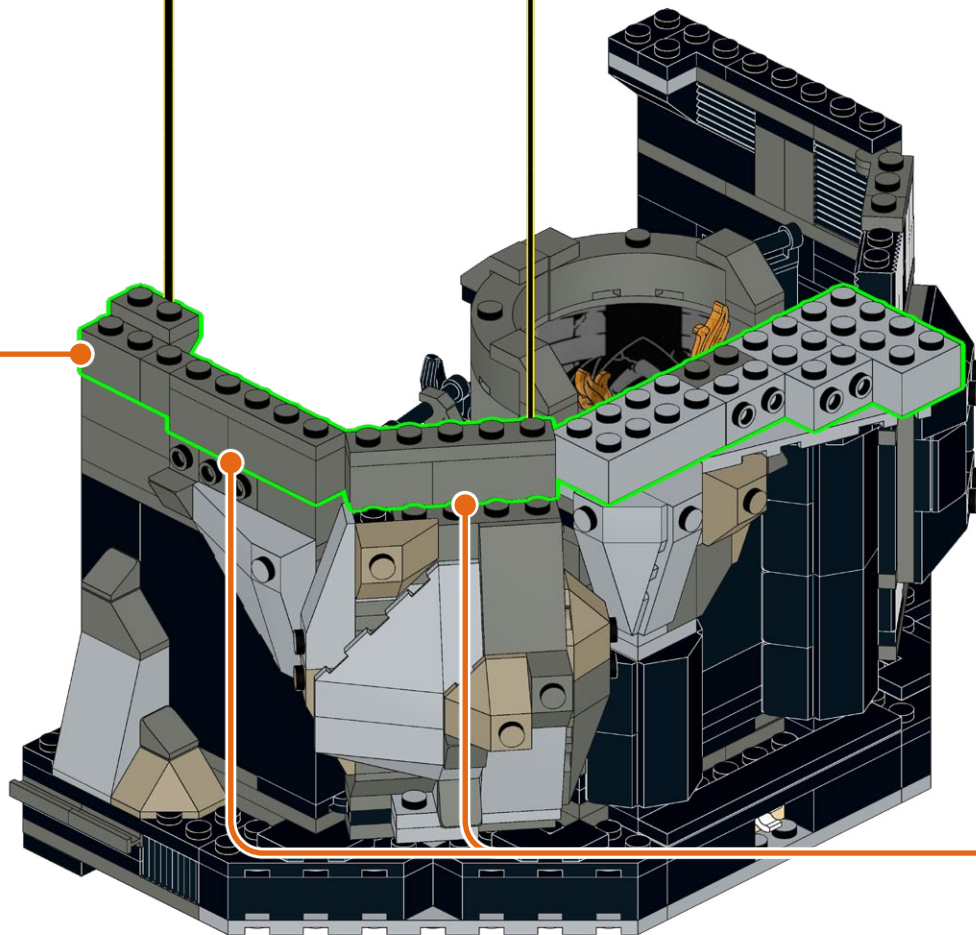
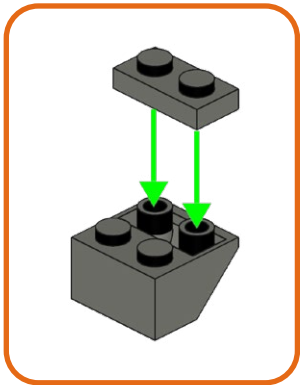
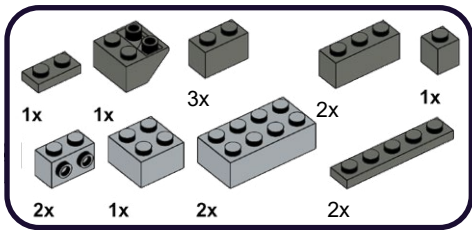

169

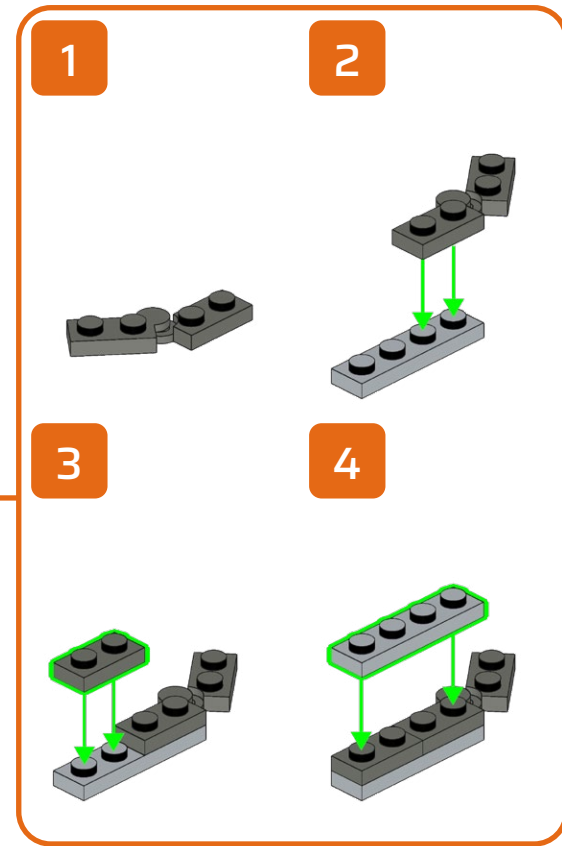
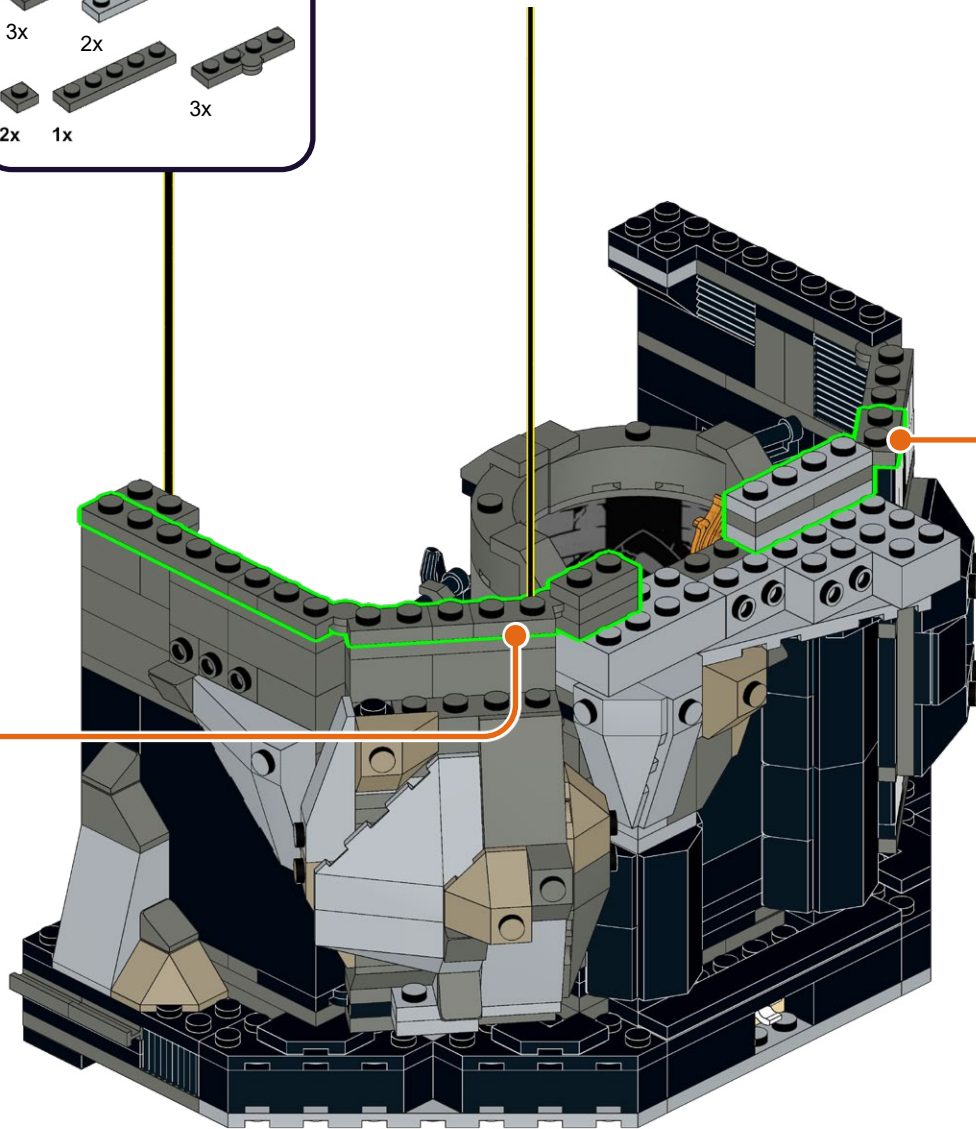
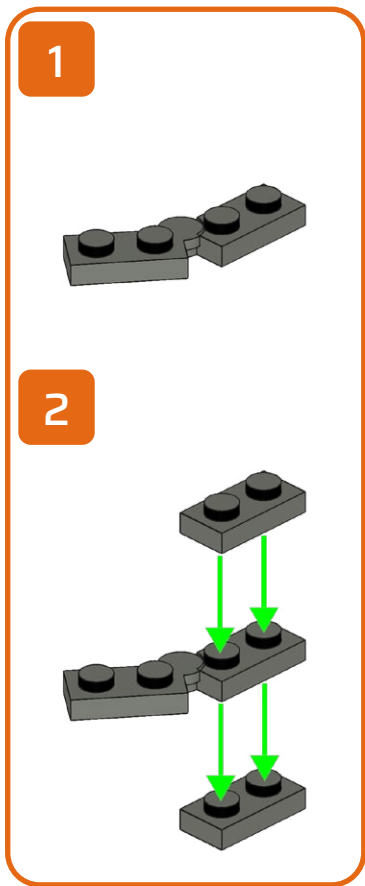
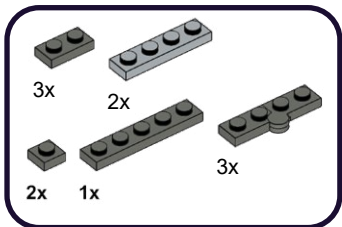

170

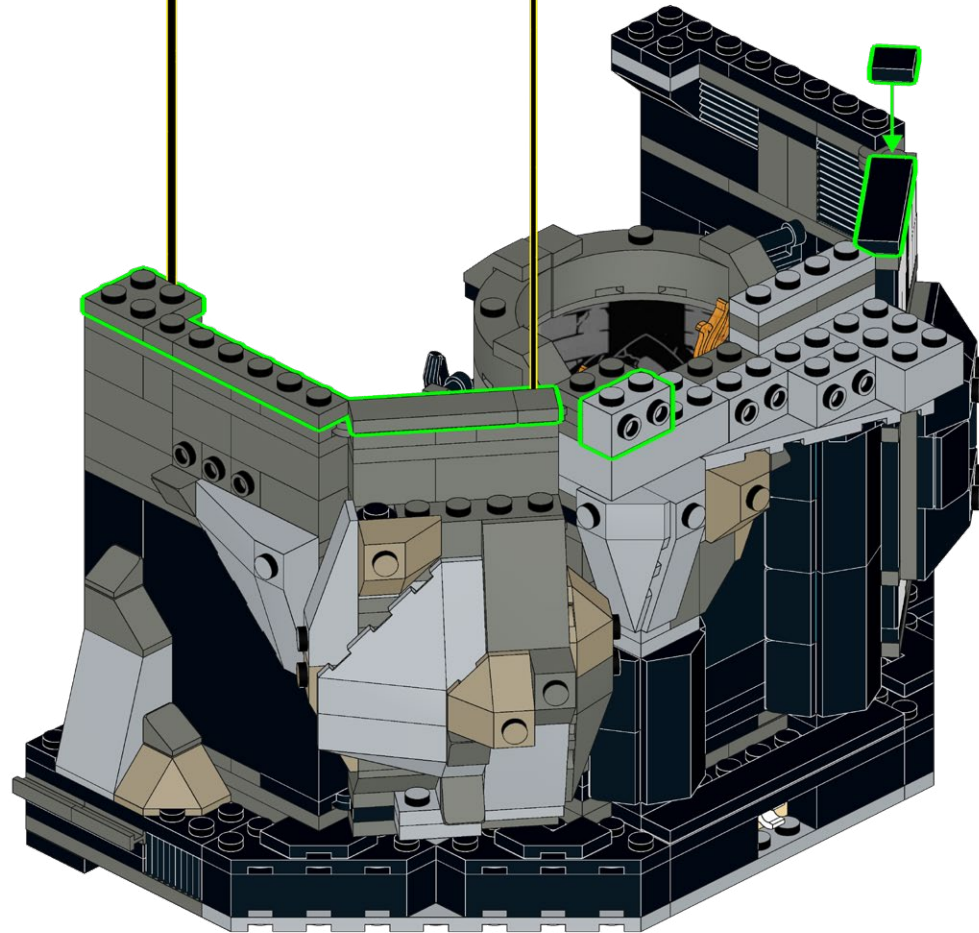
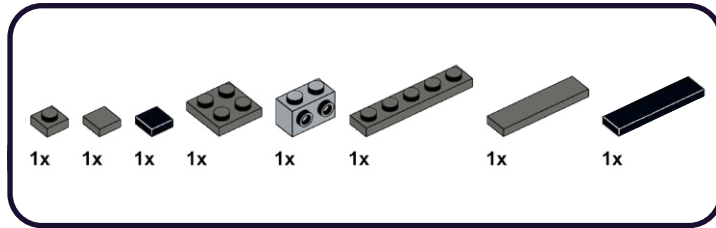

171

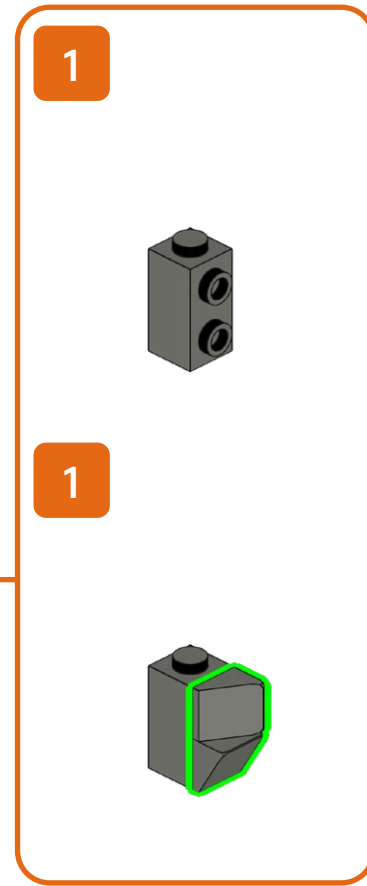
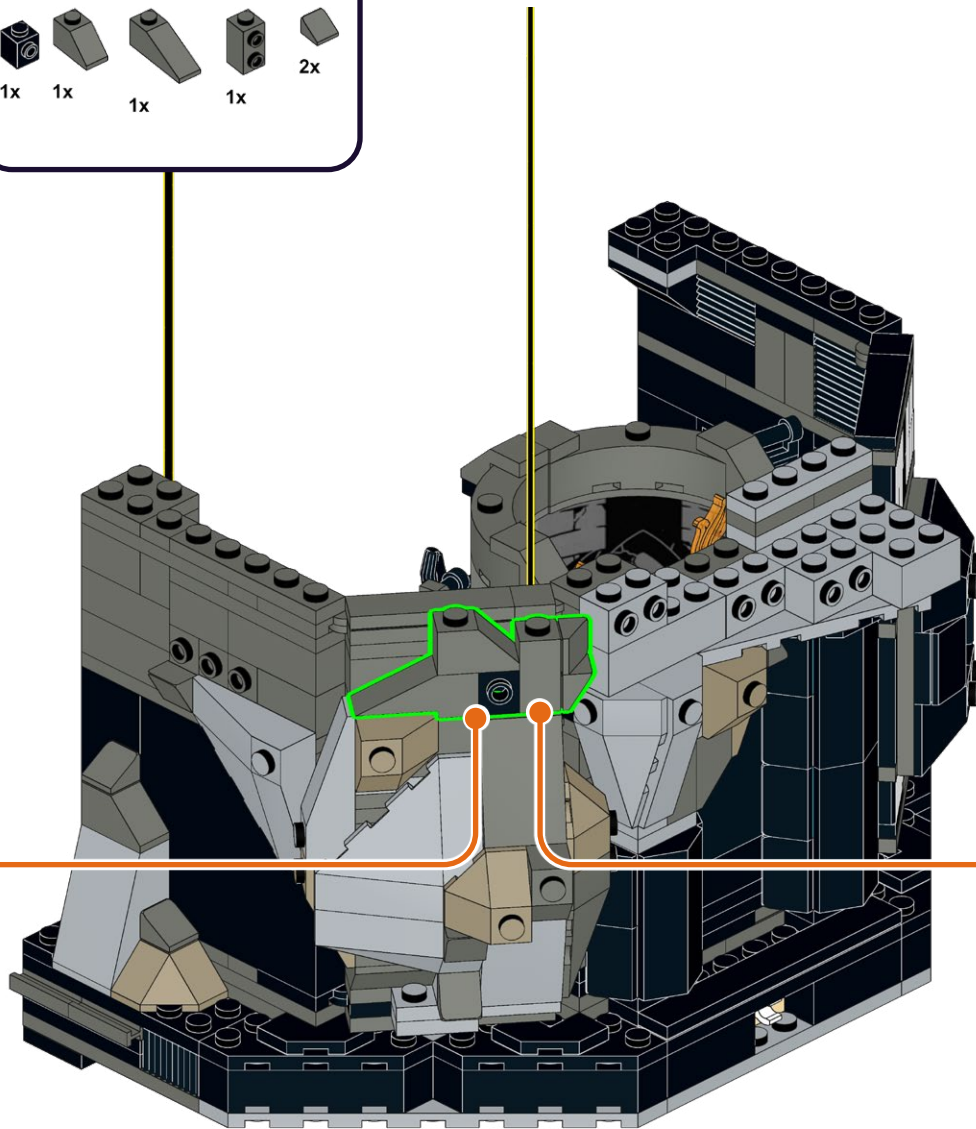
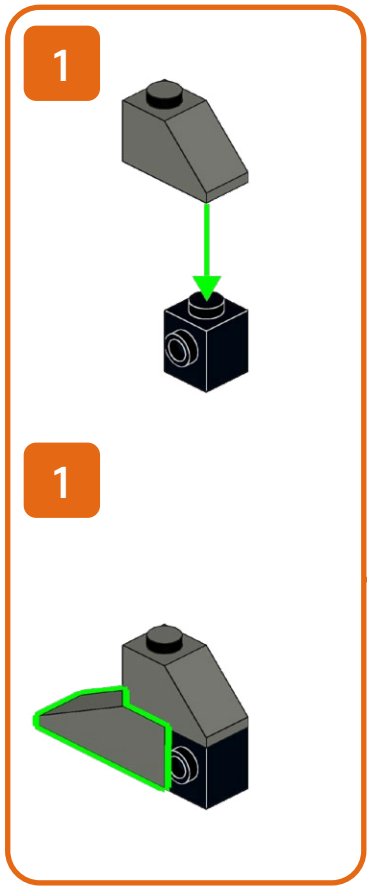
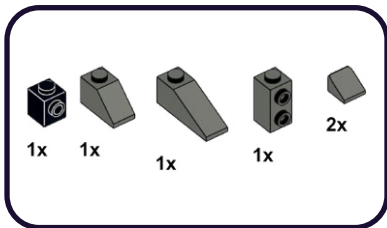

172

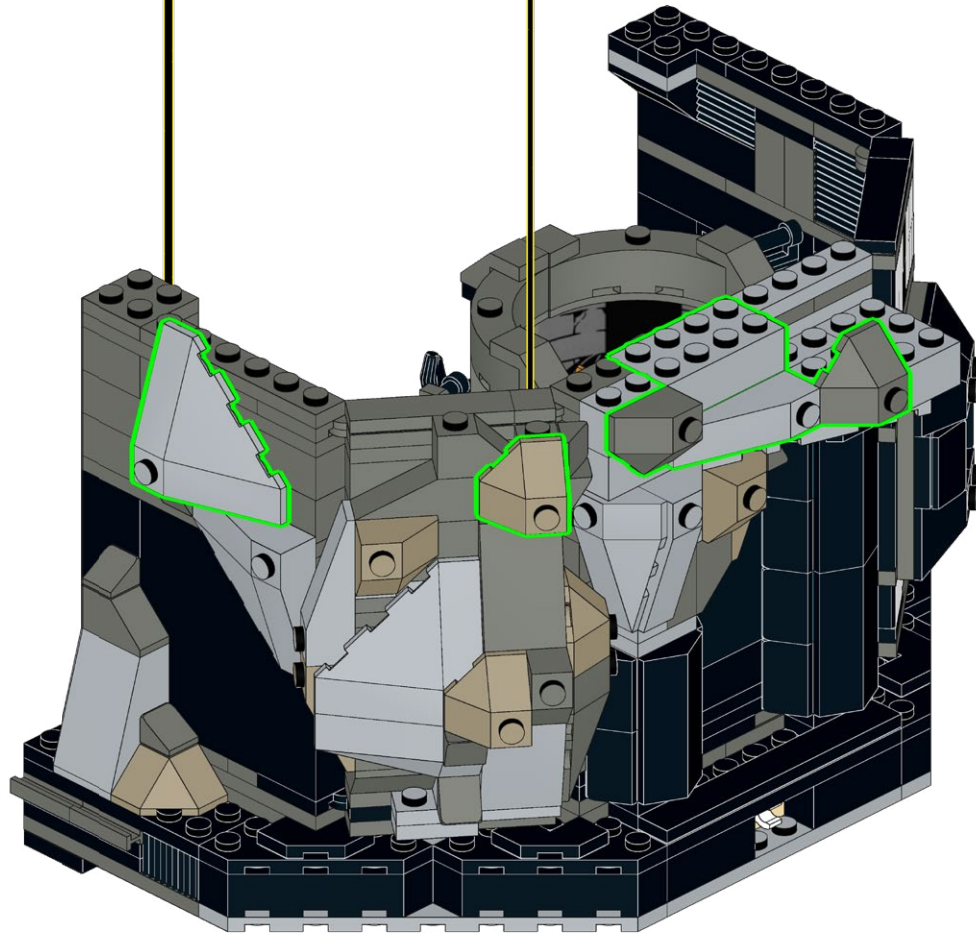
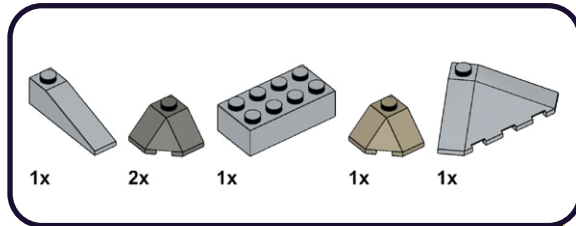

**HOLD UP!**

You might notice some bags aren't in order, as well as left over pieces, but that's ok! We're changing the way you build LEGO!

ATTENDEZ!

Vous remarquerez peut-être que certains sacs, ainsi que certaines pièces, ne sont pas dans le bon ordre. Mais pas de panique! Nous changeons simplement la façon avec laquelle vous construisez vos LEGO!

ASPETTA!

Potresti notare che alcuni sacchetti non sono in ordine, così come i pezzi avanzati, ma va bene così! Stiamo cambiando il modo in cui costruisci i LEGO!

HALT!

Sie werden möglicherweise bemerken, dass einige tüten durcheinander sind und teile übrig bleiben, aber das ist in Ordnung! Wir ändern die art und weise, wie Sie LEGO bauen!

¡ESPERA!

Es posible que notes que algunas bolsas están fuera de servicio, así como piezas sobrantes, ¡pero está bien! ¡Estamos cambiando la forma en que construyes LEGO!

暫停!

你可能会注意到一些袋子顺序错乱, 以及一些剩余的部件, 但没关系! 我们正在改变你搭建乐高的方式!

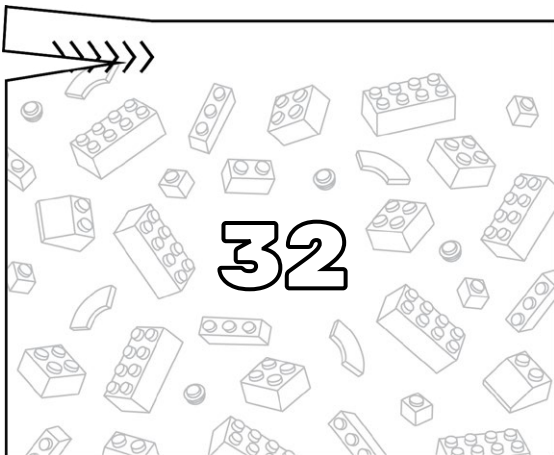
Open LEGO® Bag 32

173

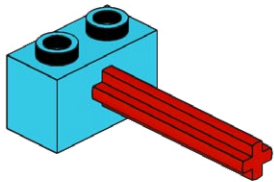
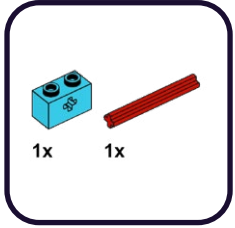

174

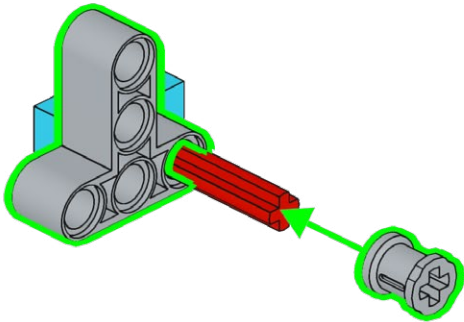
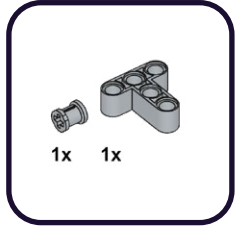

175

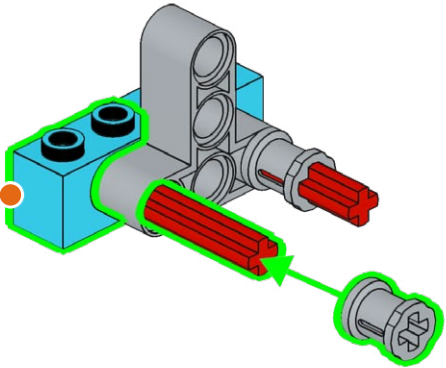
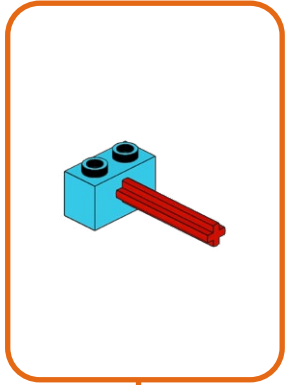
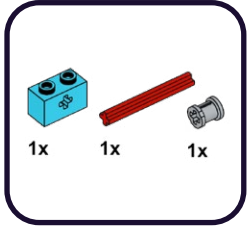

176

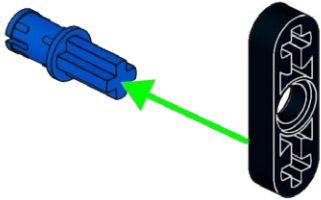

177



178

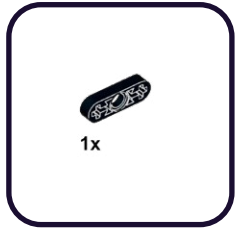

179

180

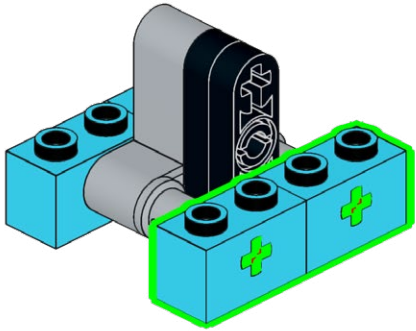
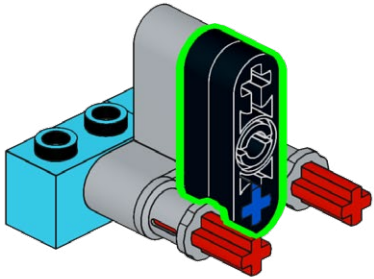
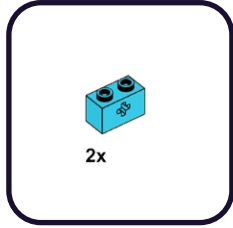

181

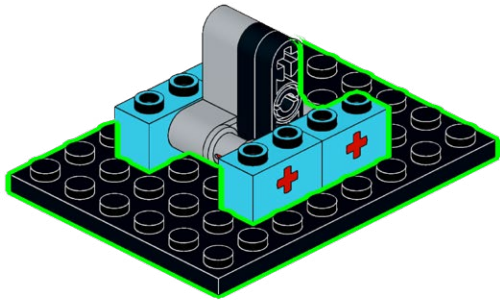
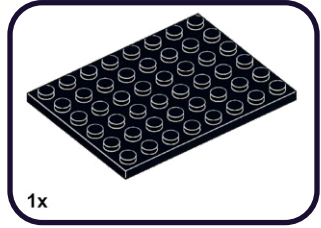

182

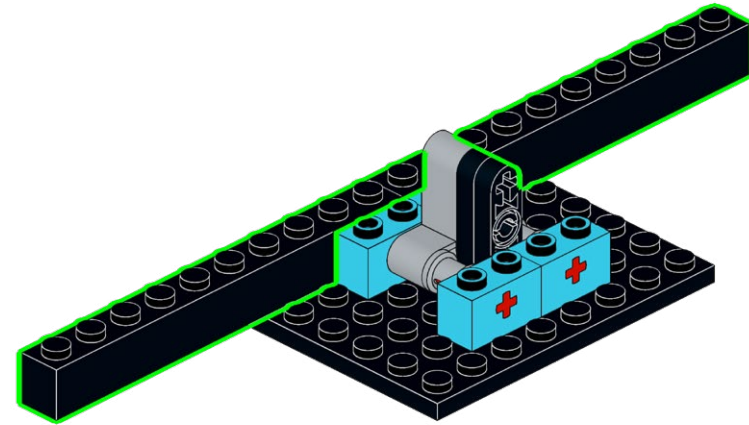
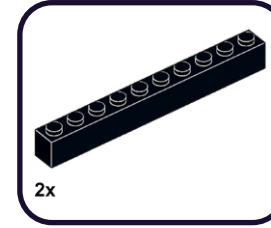

183

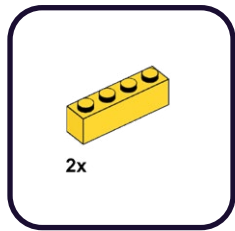

184

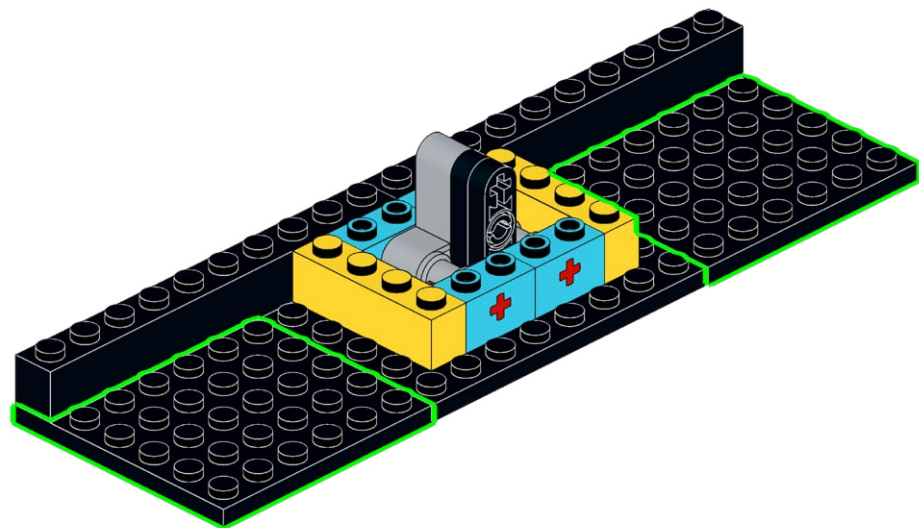
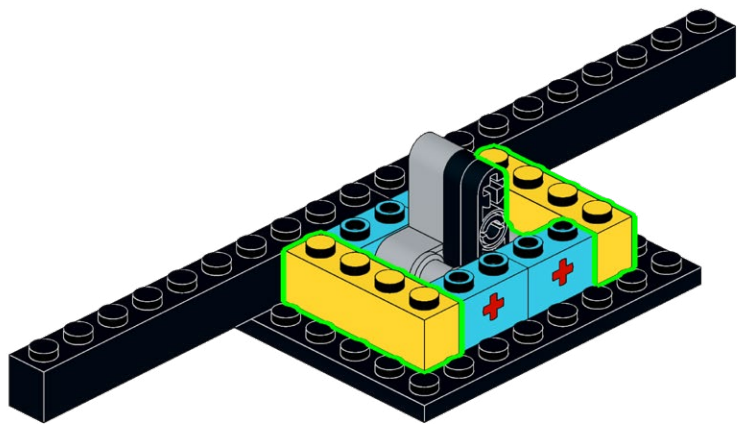
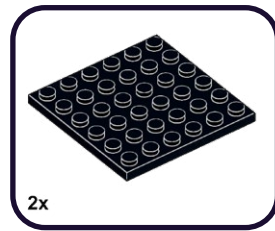

185

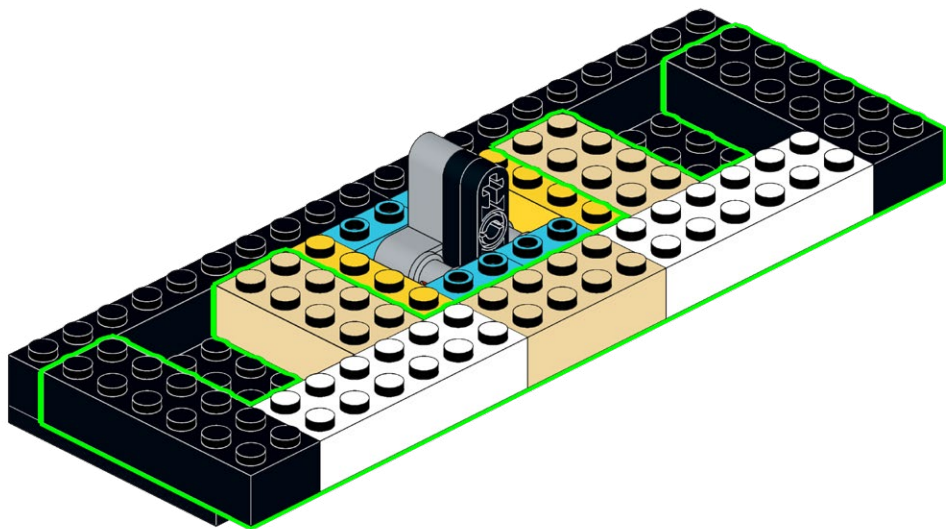
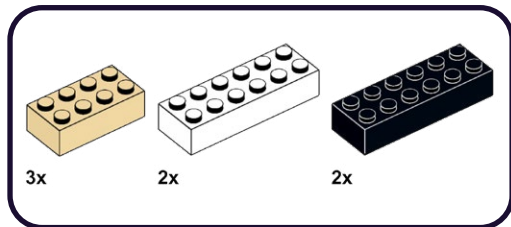

186

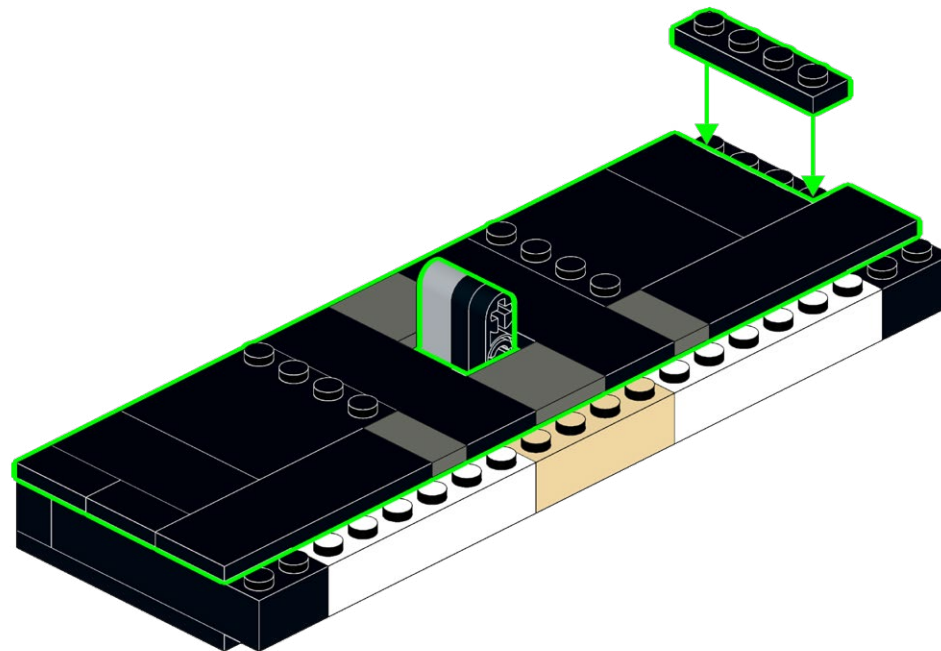
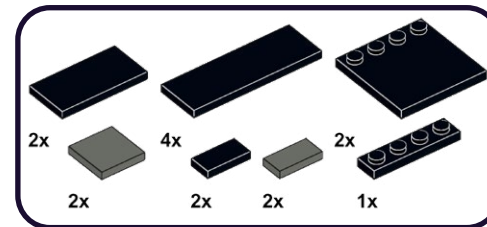

187

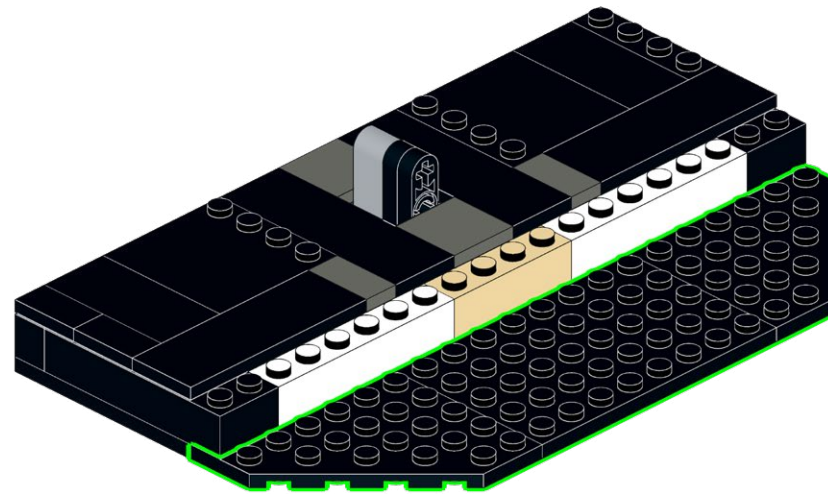
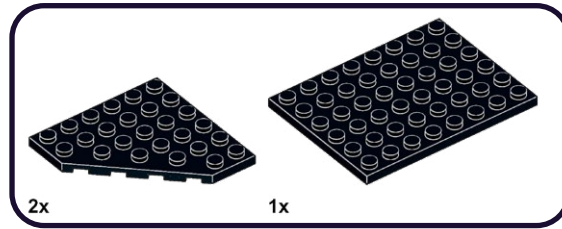

188

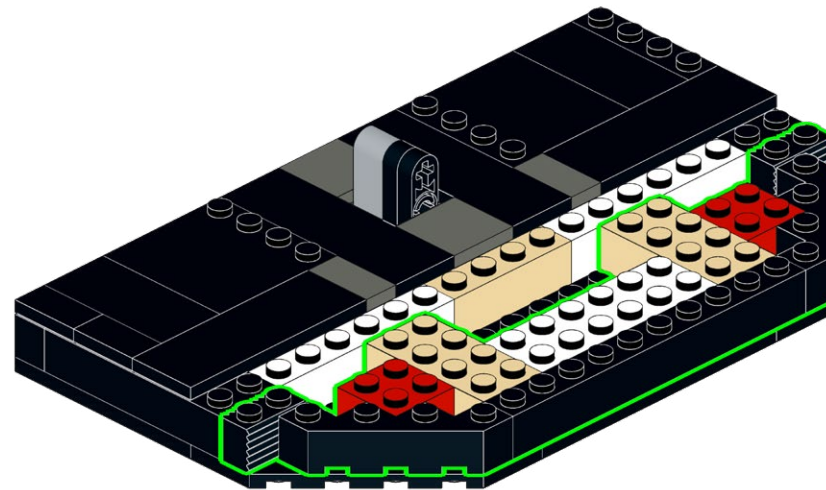
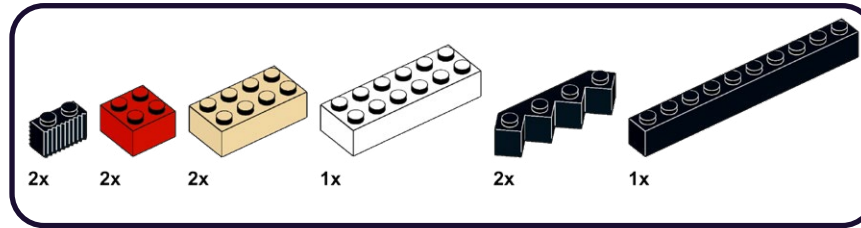

189

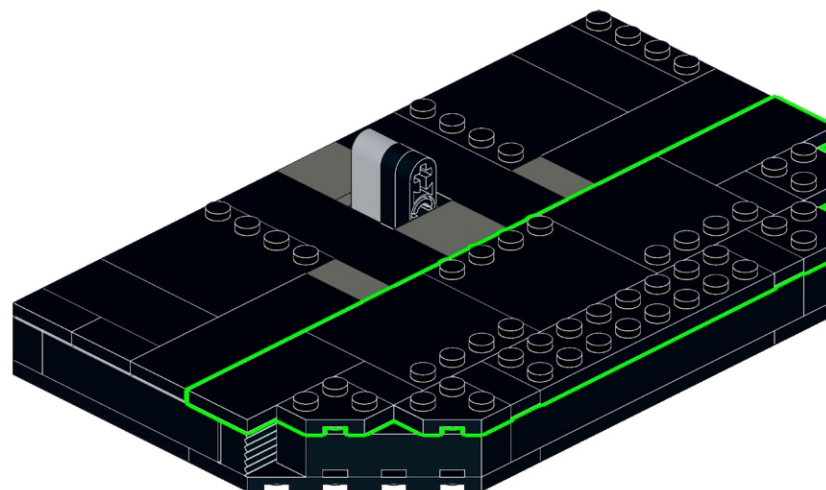
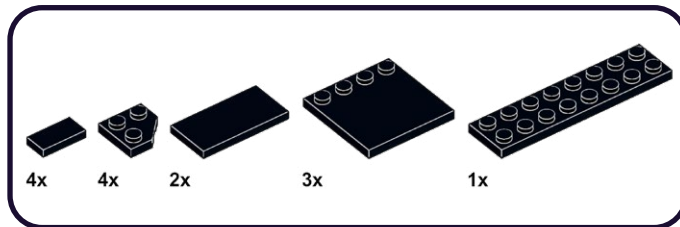

190

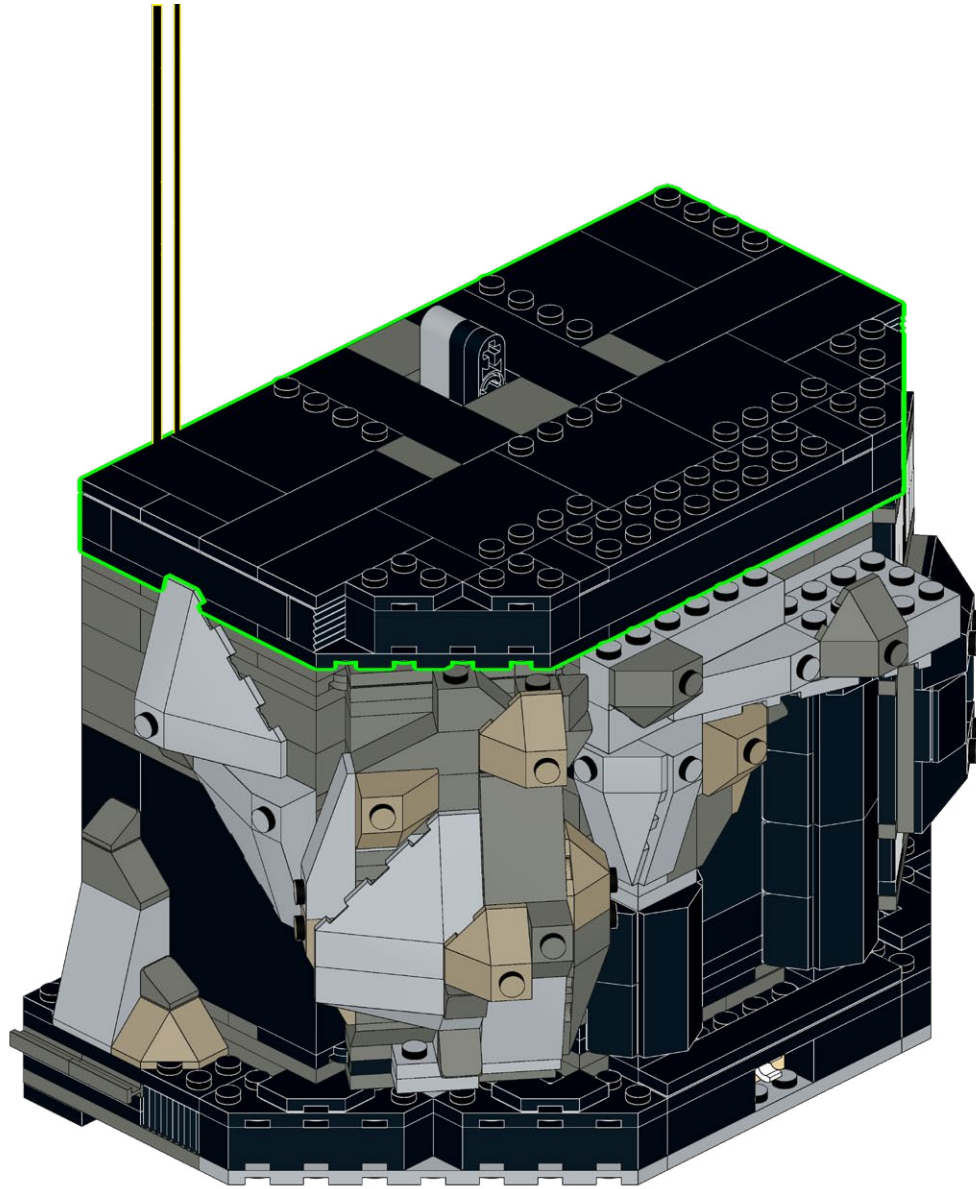

191

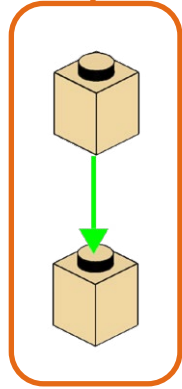
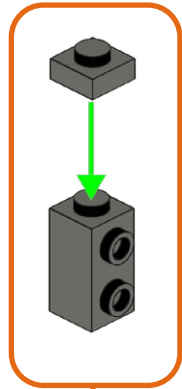
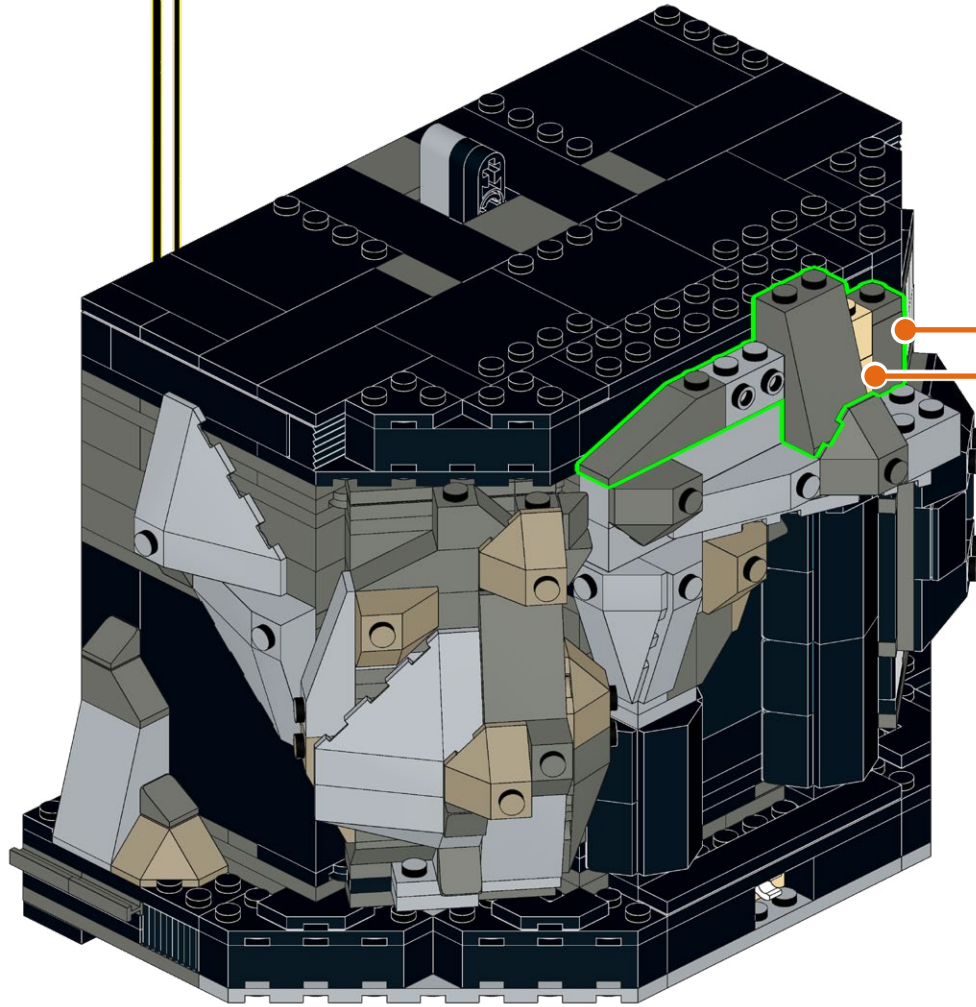
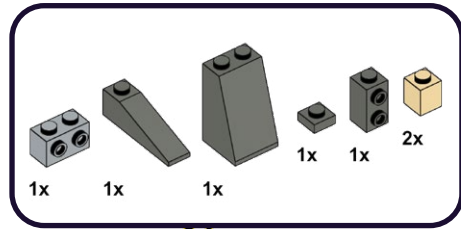

192

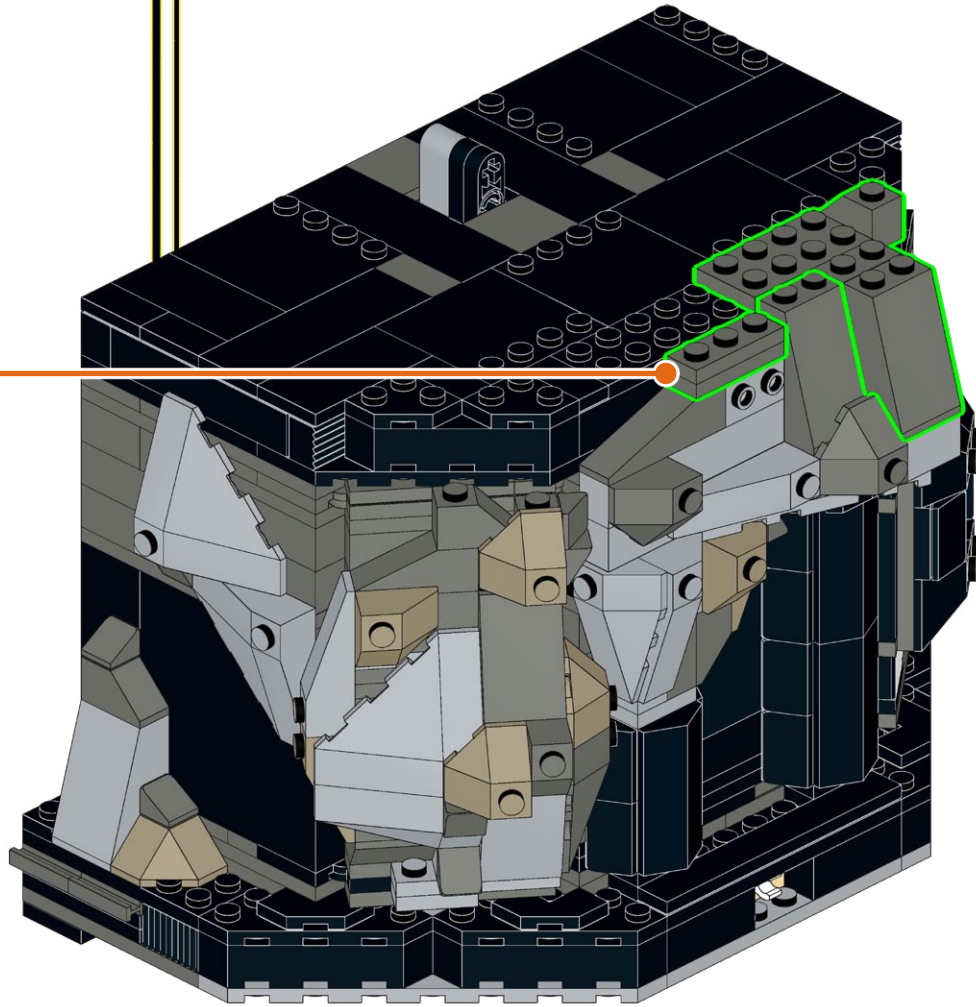
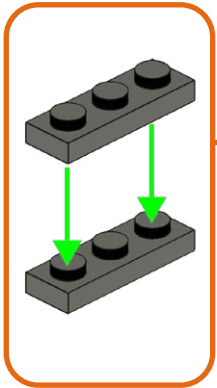
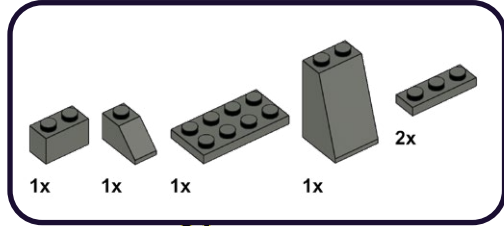

193

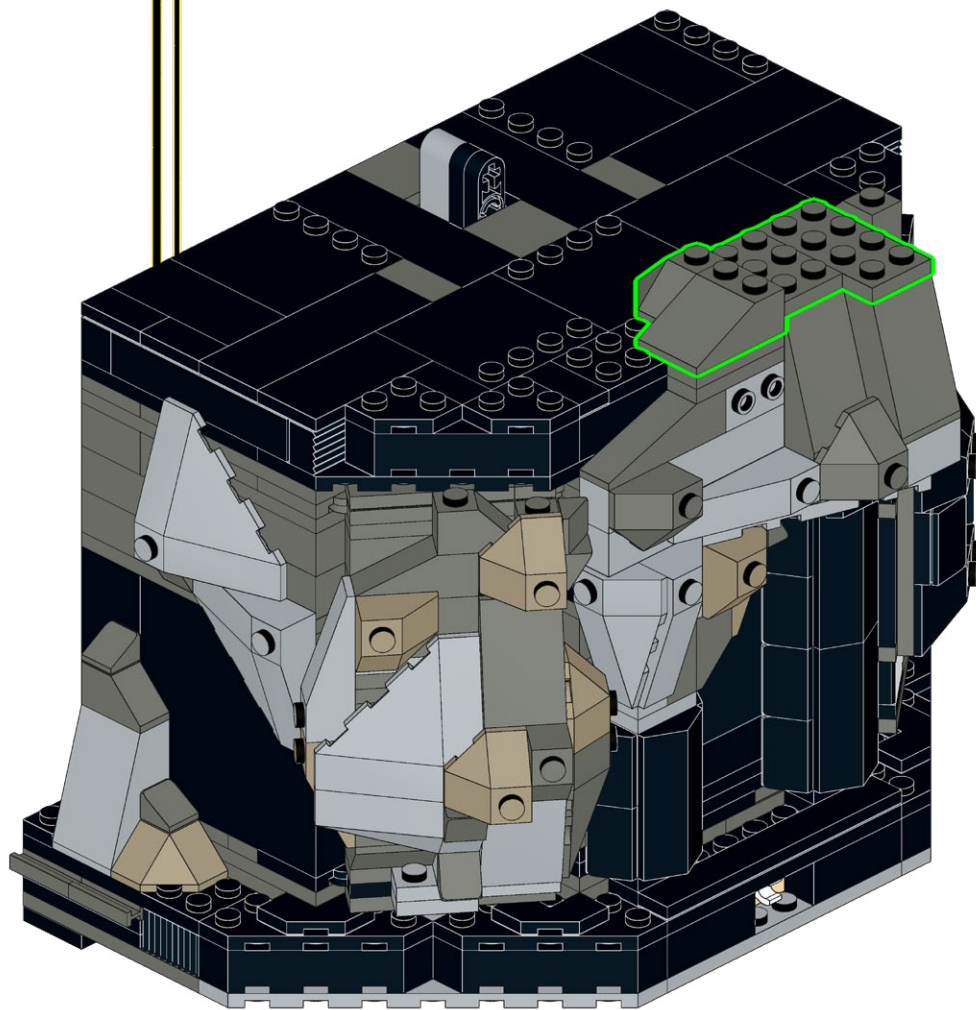
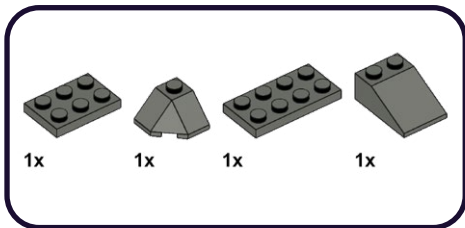

194

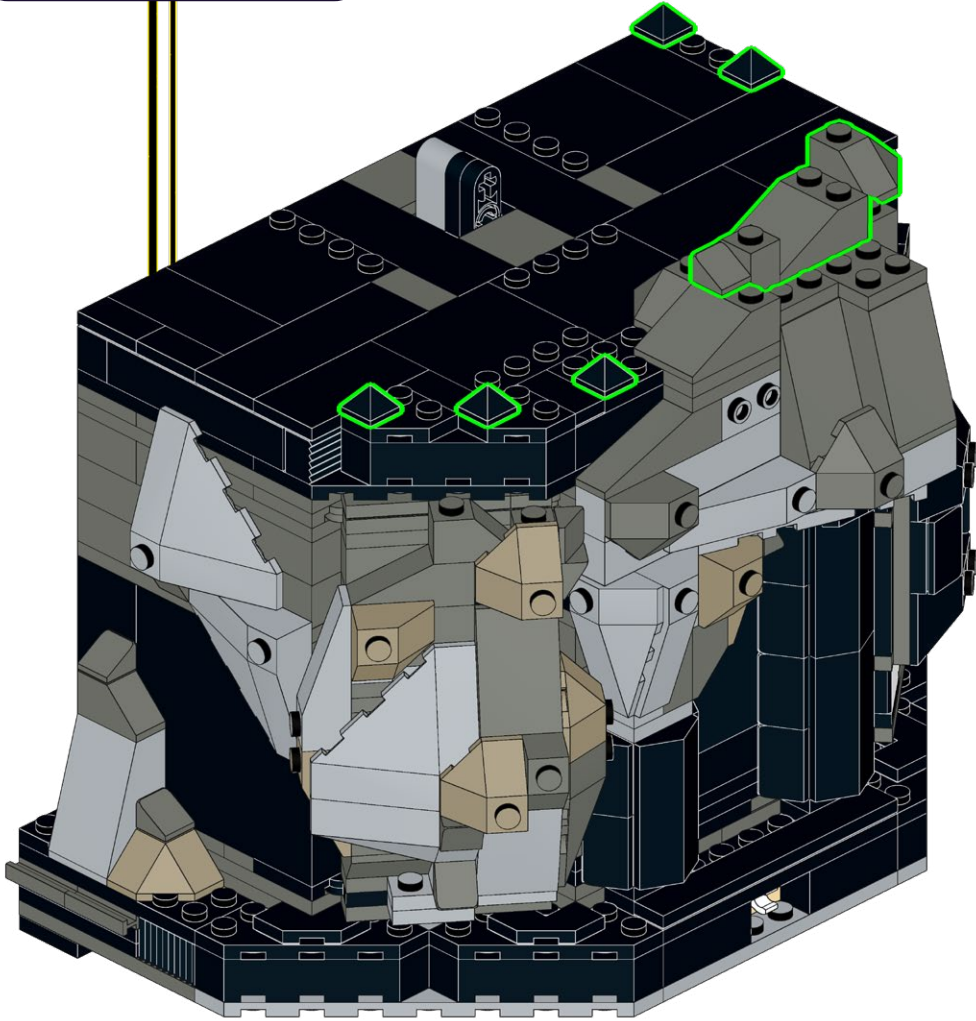
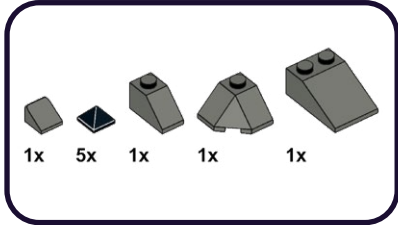

195

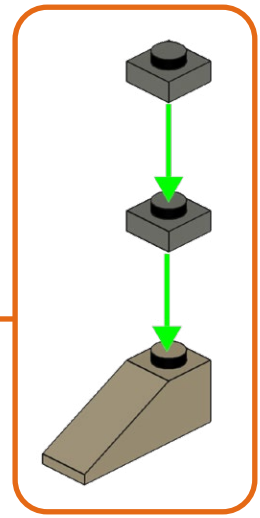
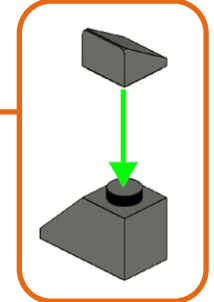
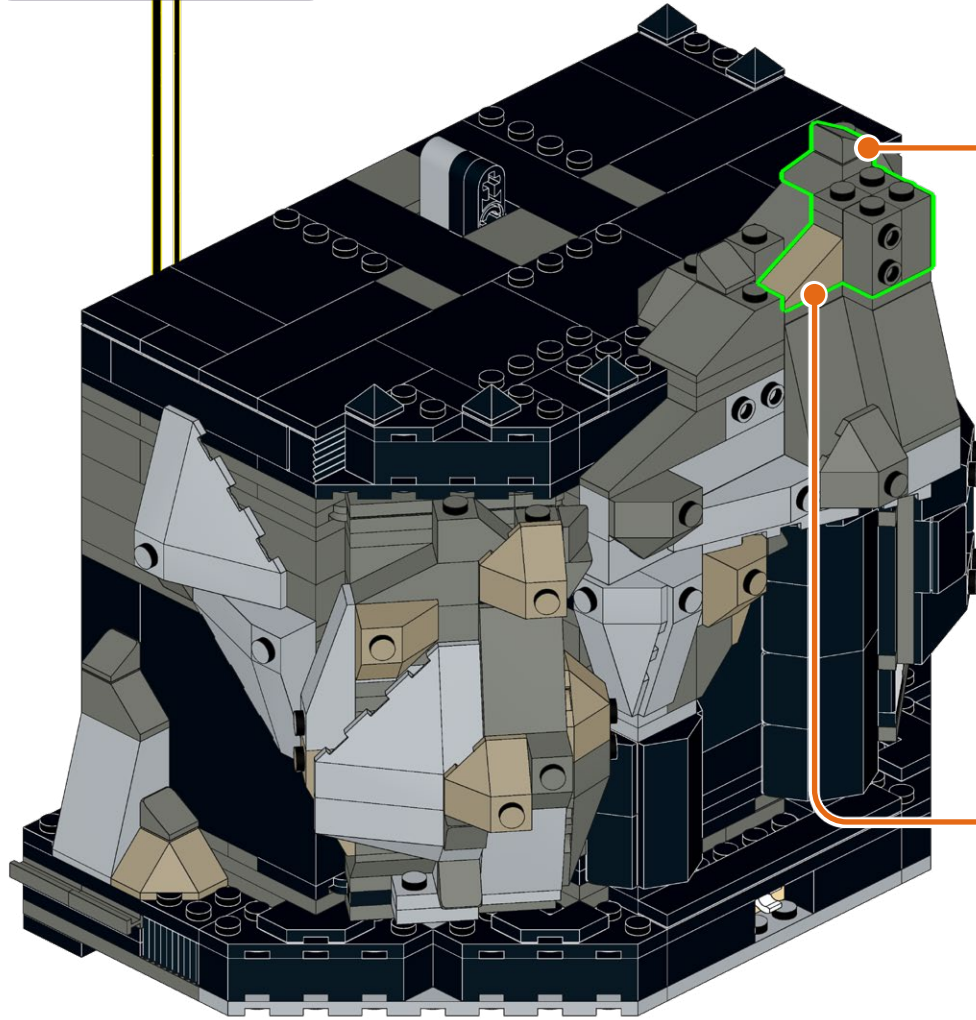
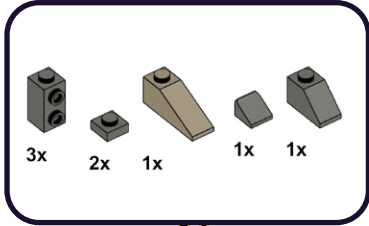

**HOLD UP!**

You might notice some bags aren't in order, as well as left over pieces, but that's ok! We're changing the way you build LEGO!

ATTENDEZ!

Vous remarquerez peut-être que certains sacs, ainsi que certaines pièces, ne sont pas dans le bon ordre. Mais pas de panique! Nous changeons simplement la façon avec laquelle vous construisez vos LEGO!

ASPETTA!

Potresti notare che alcuni sacchetti non sono in ordine, così come i pezzi avanzati, ma va bene così! Stiamo cambiando il modo in cui costruisci i LEGO!

HALT!

Sie werden möglicherweise bemerken, dass einige tüten durcheinander sind und teile übrig bleiben, aber das ist in Ordnung! Wir ändern die art und weise, wie Sie LEGO bauen!

¡ESPERA!

Es posible que notes que algunas bolsas están fuera de servicio, así como piezas sobrantes, ¡pero está bien! ¡Estamos cambiando la forma en que construyes LEGO!

暫停!

你可能会注意到一些袋子顺序错乱, 以及一些剩余的部件, 但没关系! 我们正在改变你搭建乐高的方式!

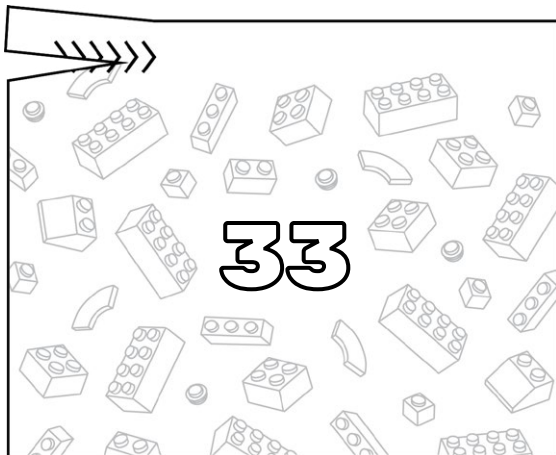
Open LEGO® Bag 33

196

1

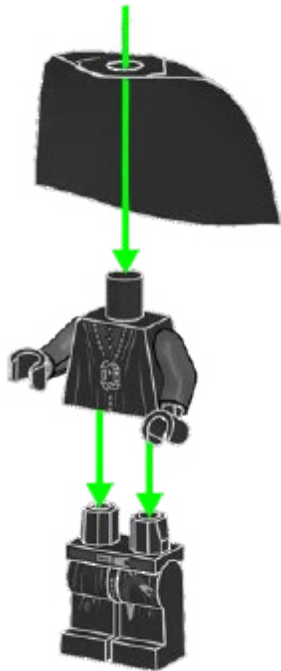

1

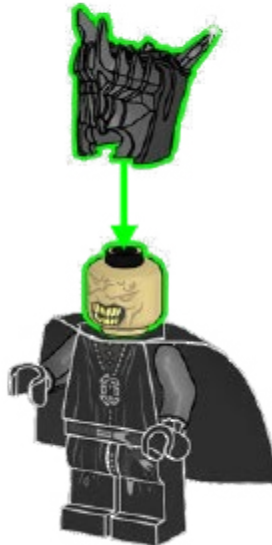

1



197

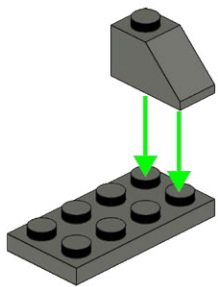
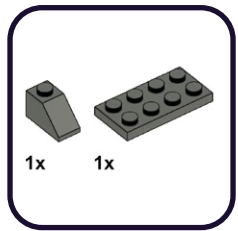

198

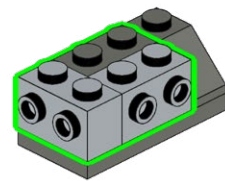
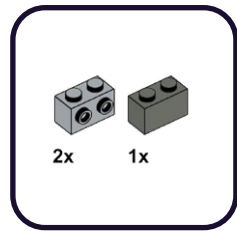

199

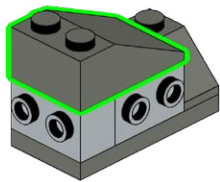
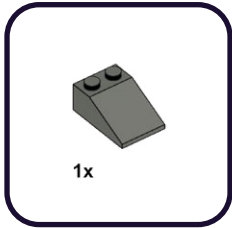

200

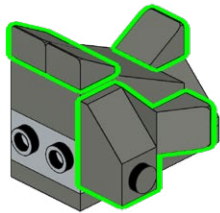
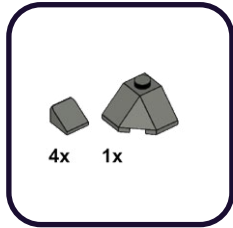

201

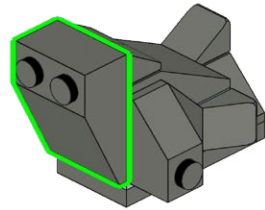
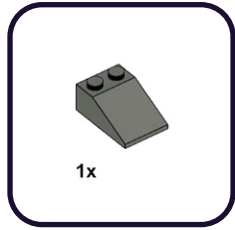

202

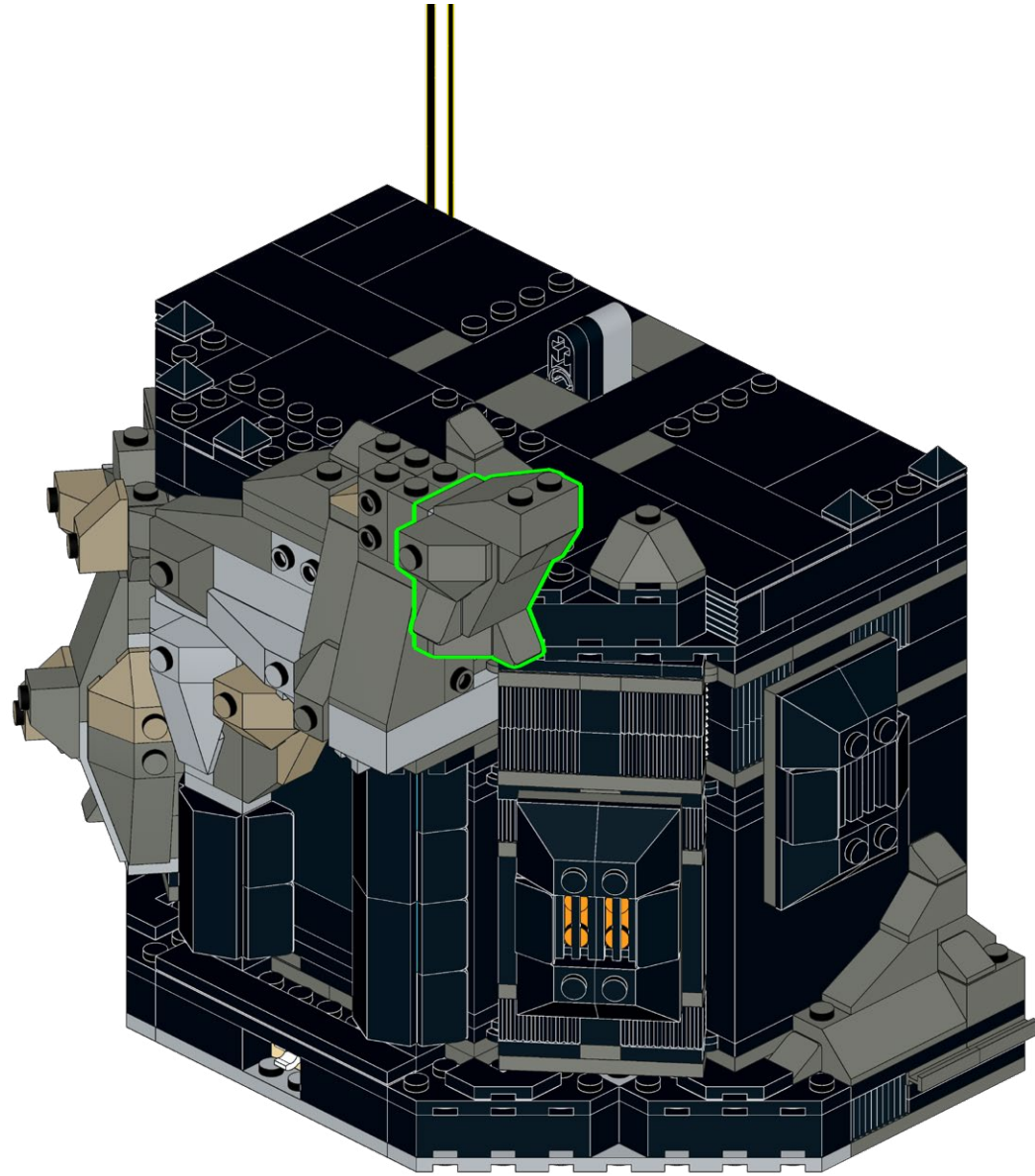

203

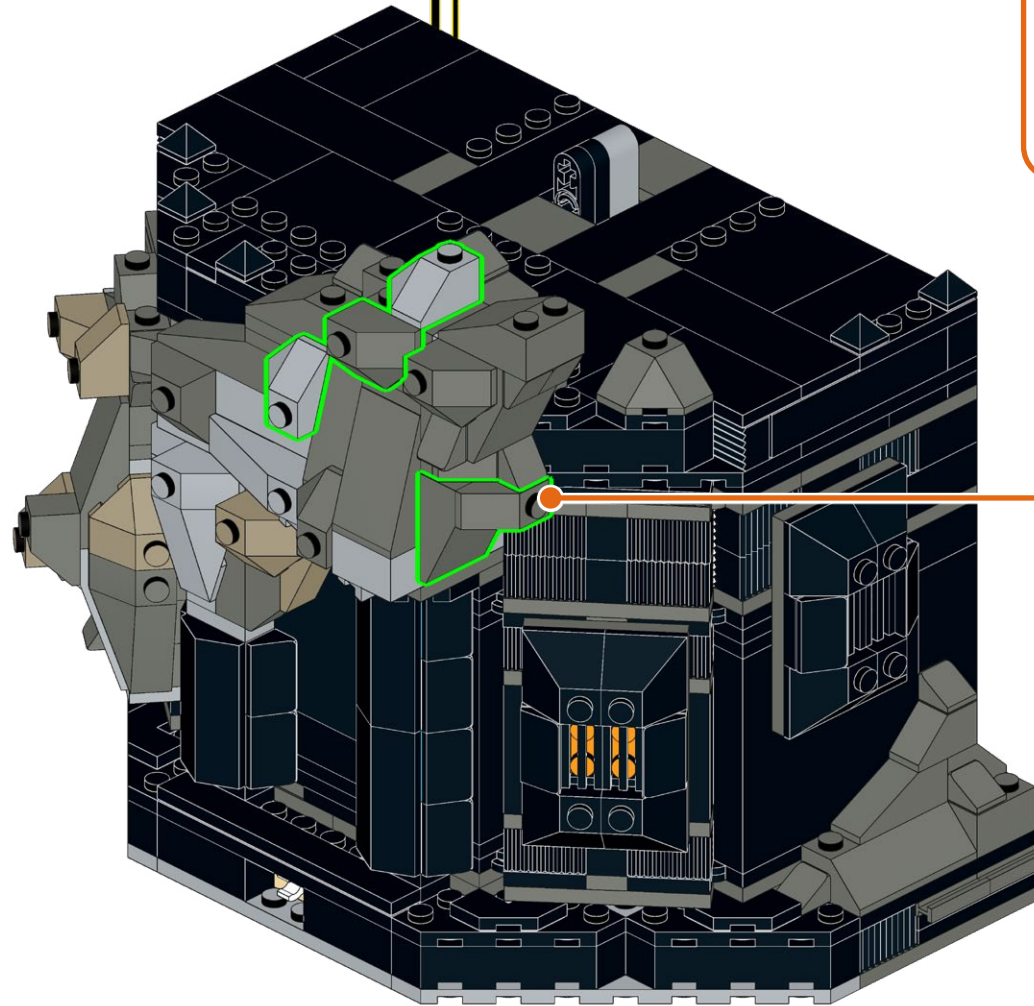
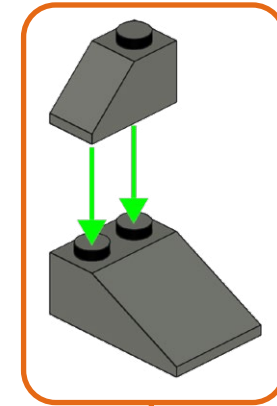
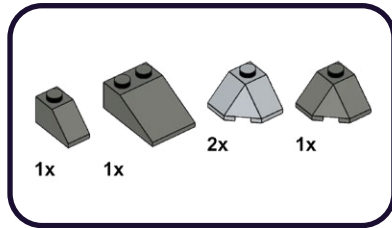

204

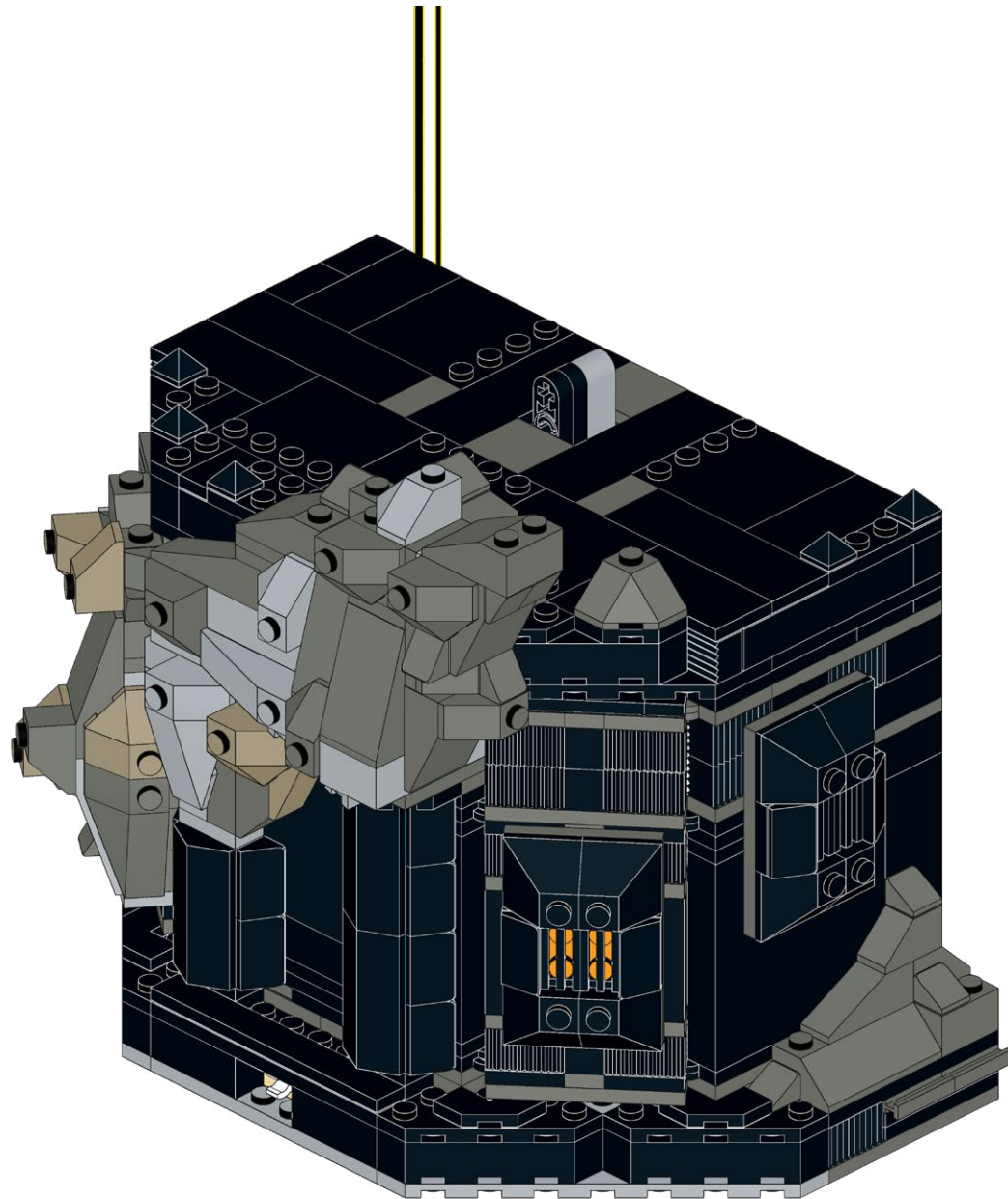

205

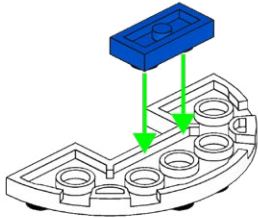
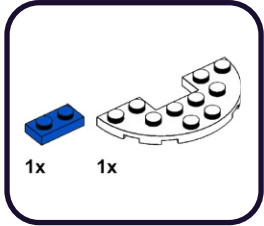

206

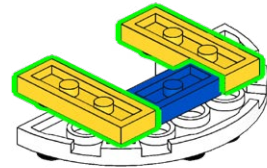
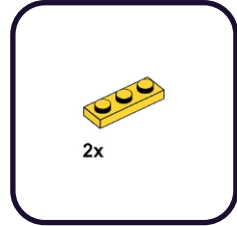

207

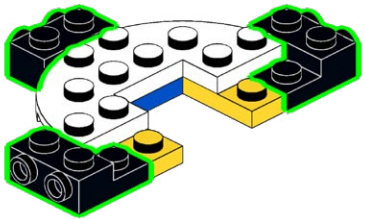
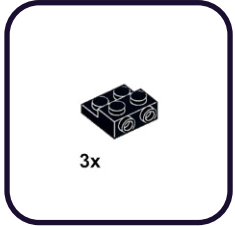

208

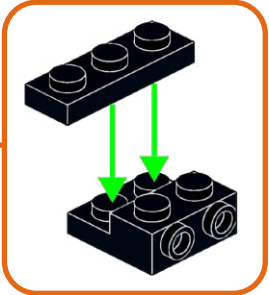
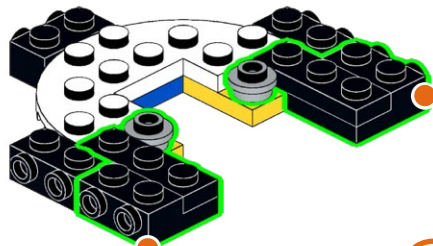
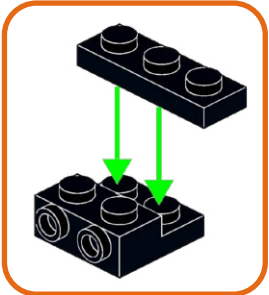
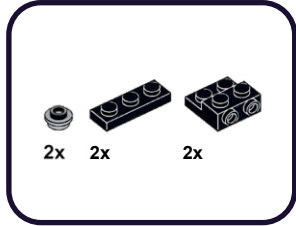

209

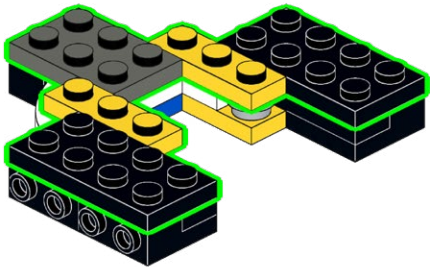
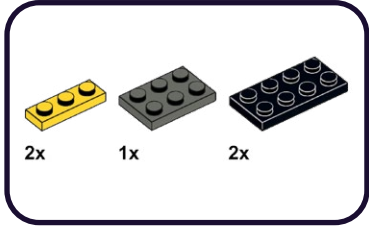

210

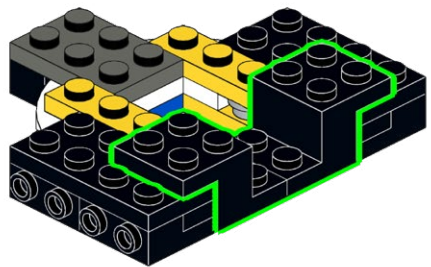
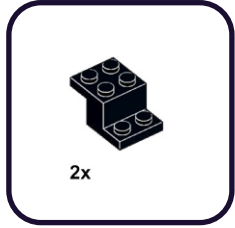

211

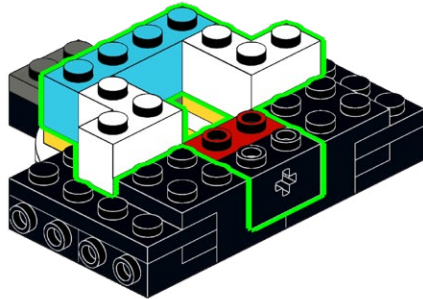
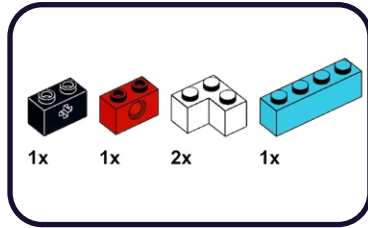

212

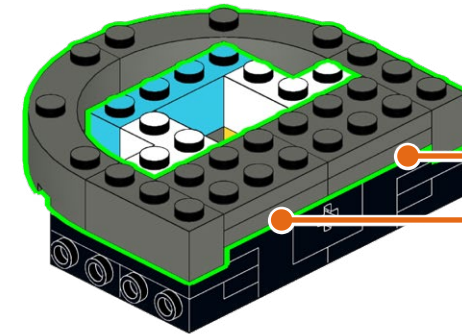
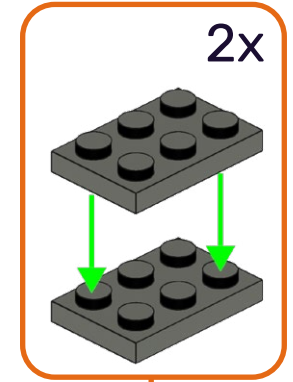
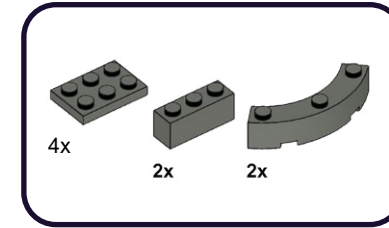

213

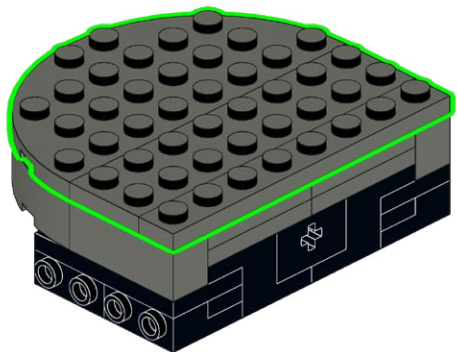
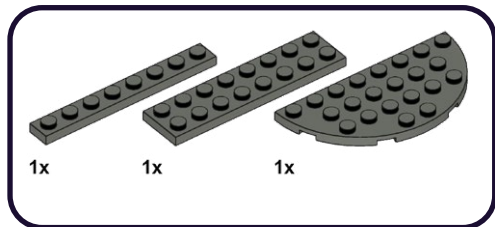

214

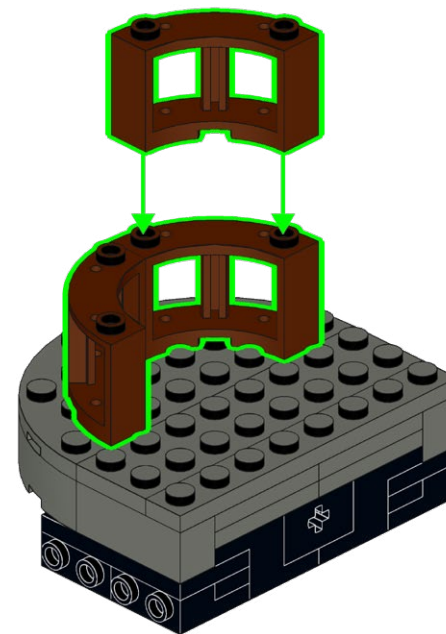
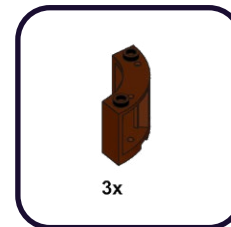

215

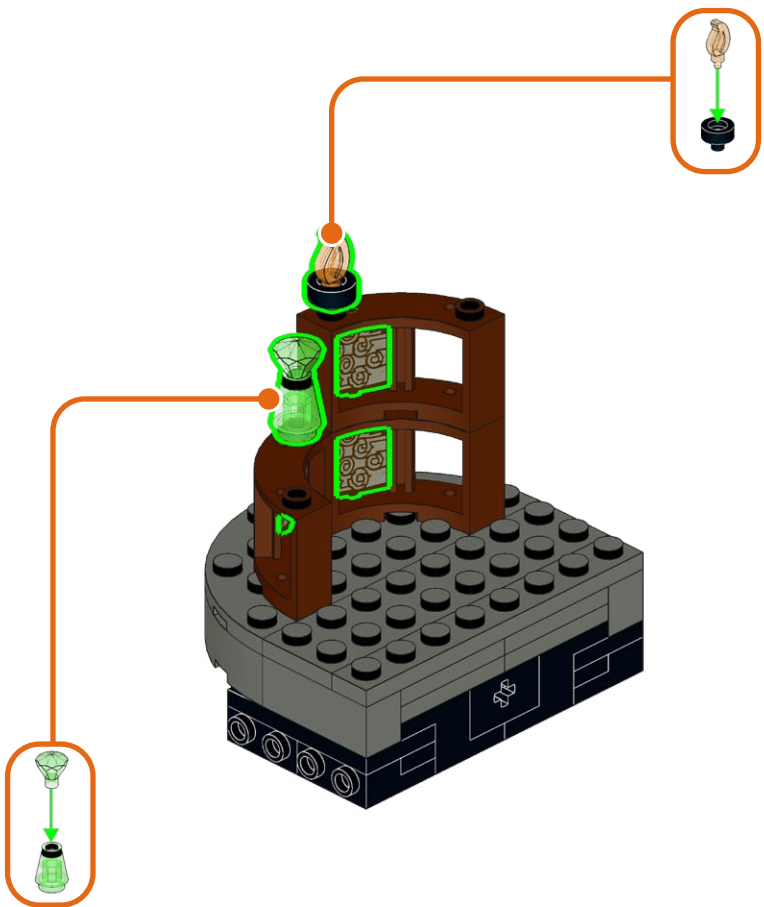
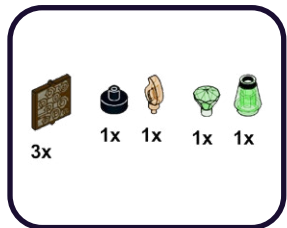

216

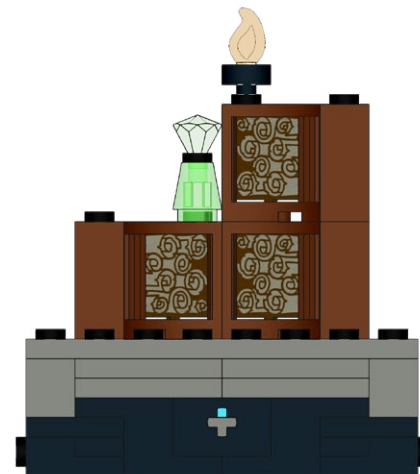
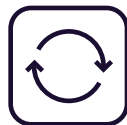

217

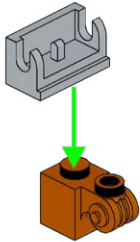
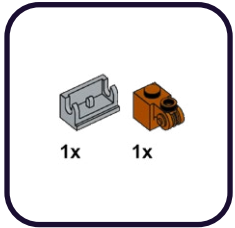

218

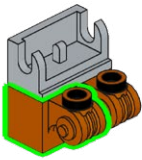
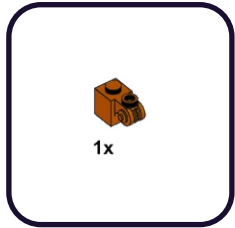

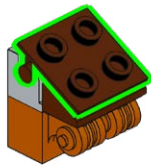
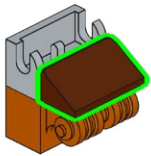
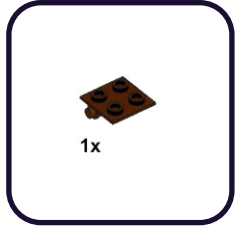
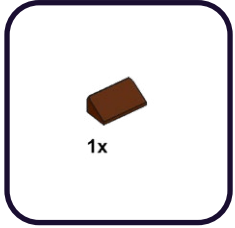

221

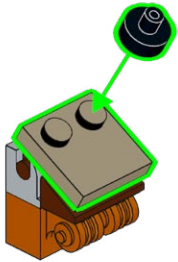
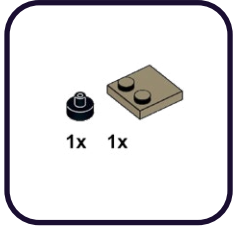

222

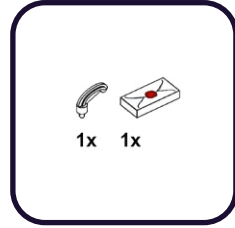

223

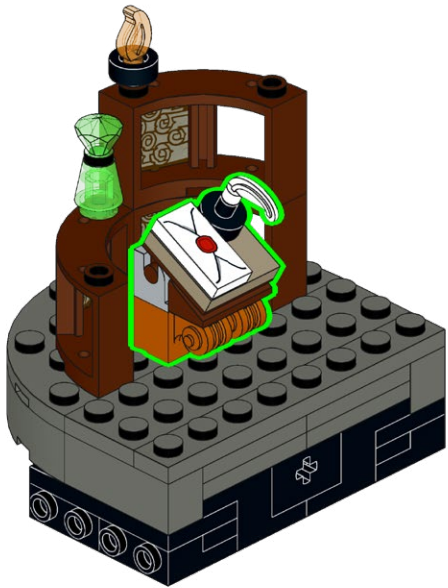

224

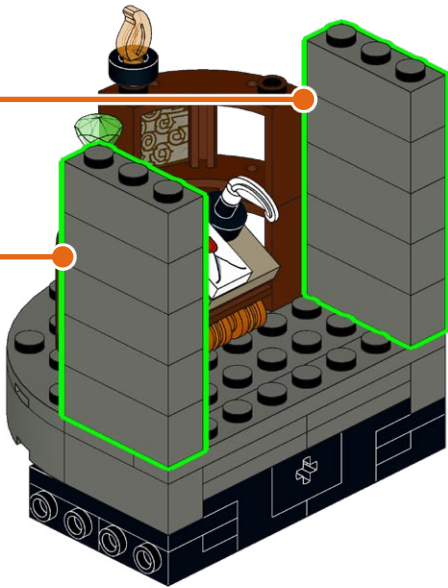
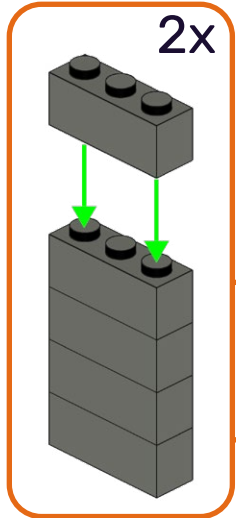
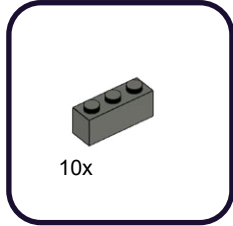

225

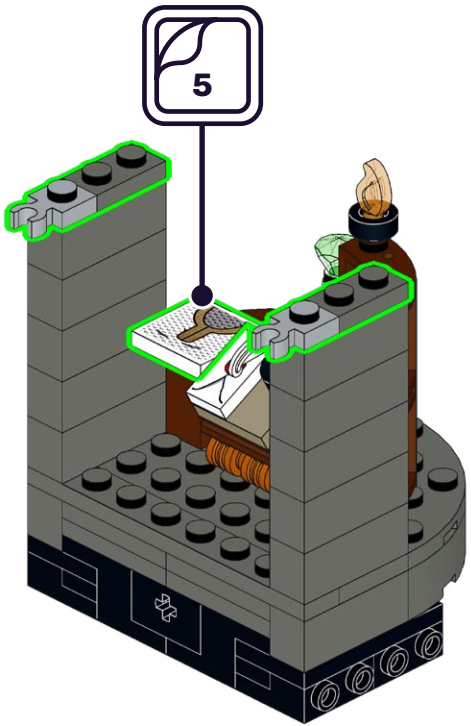
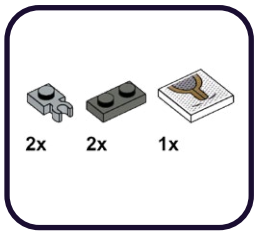

226

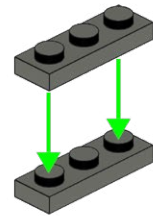
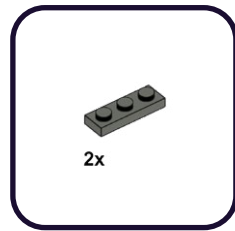

227

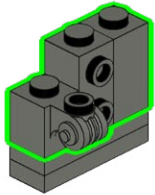
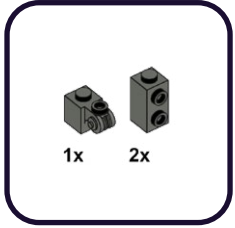

228

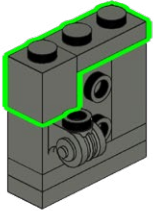
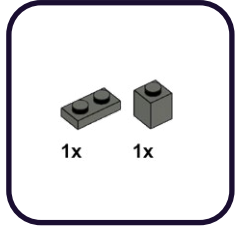

229

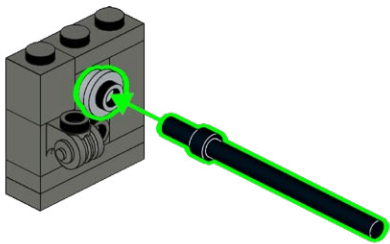

230

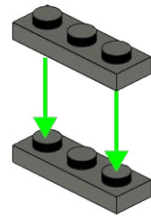
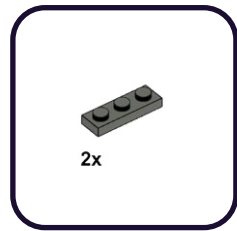

231

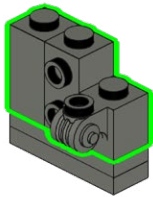
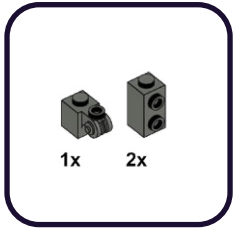

232

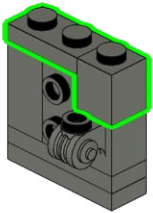
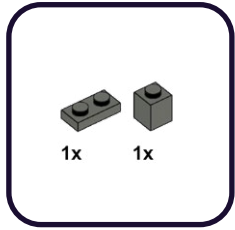

233

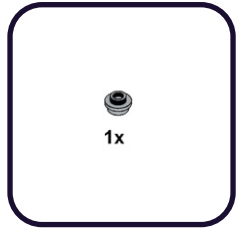

234

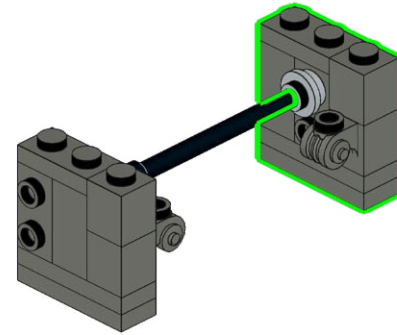
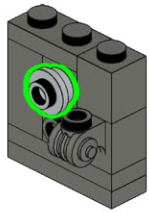

235

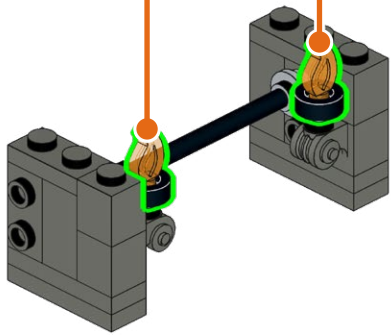
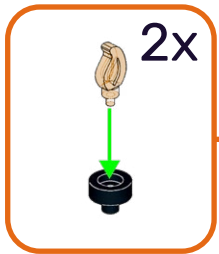
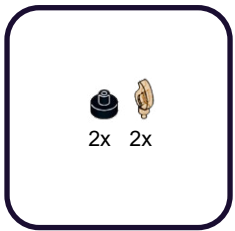

236

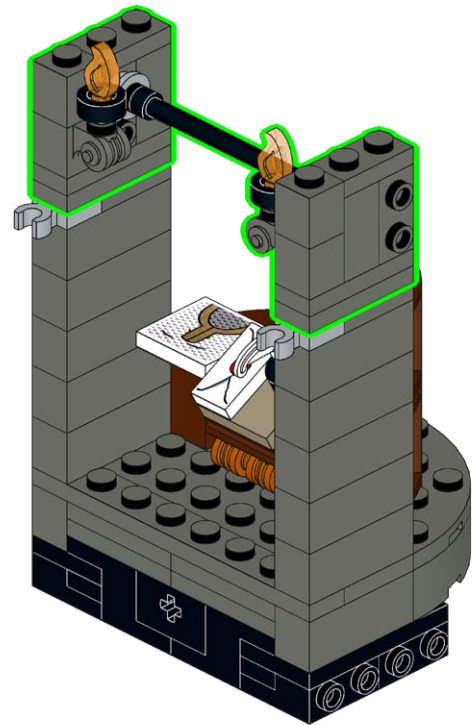

237

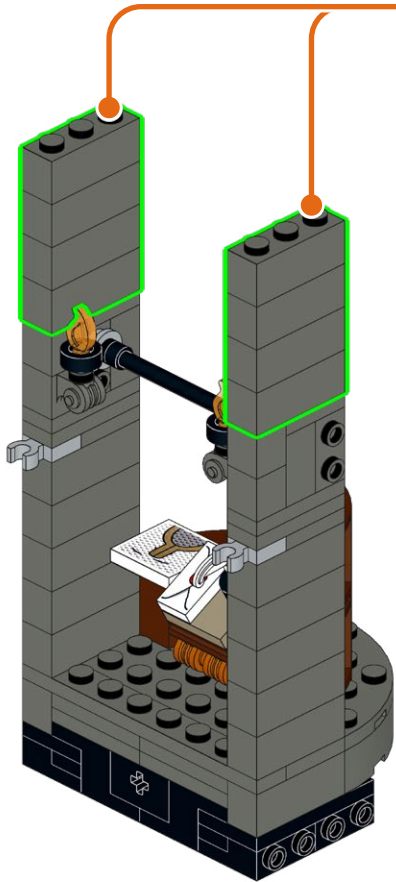
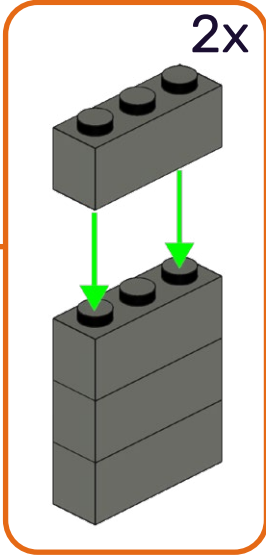
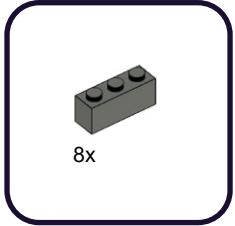

238

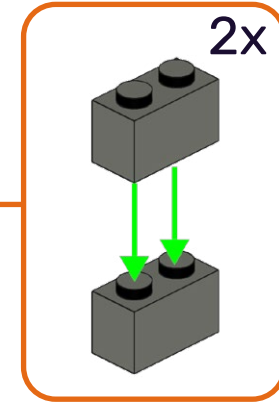
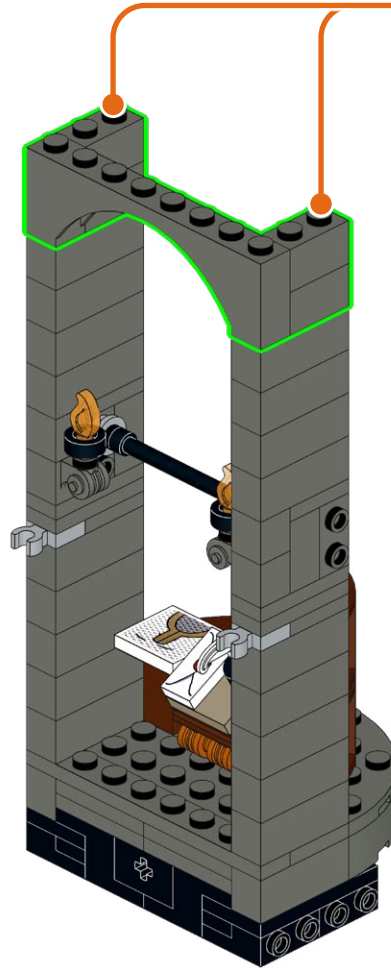
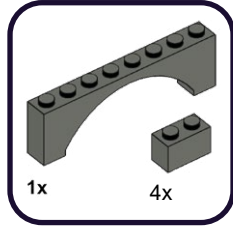

239

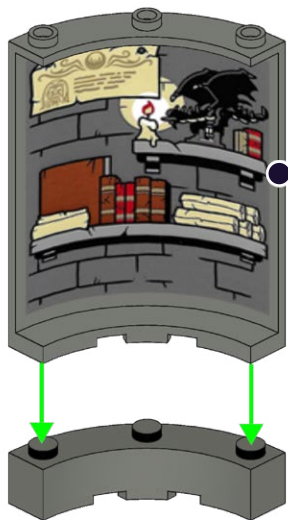
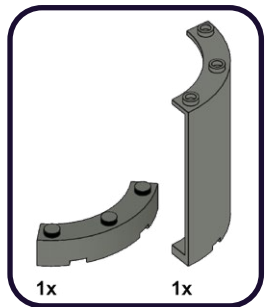

3

240

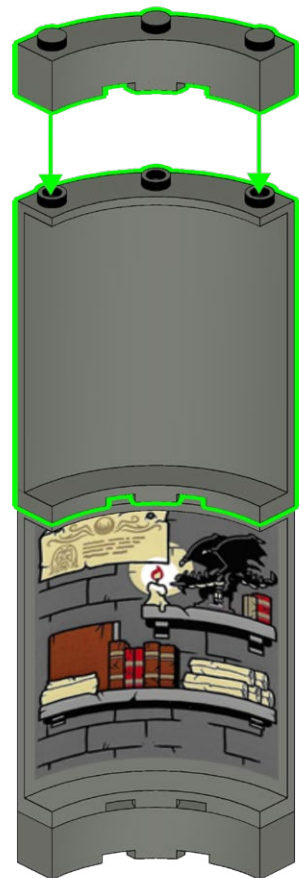
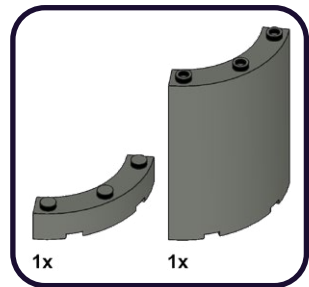

241

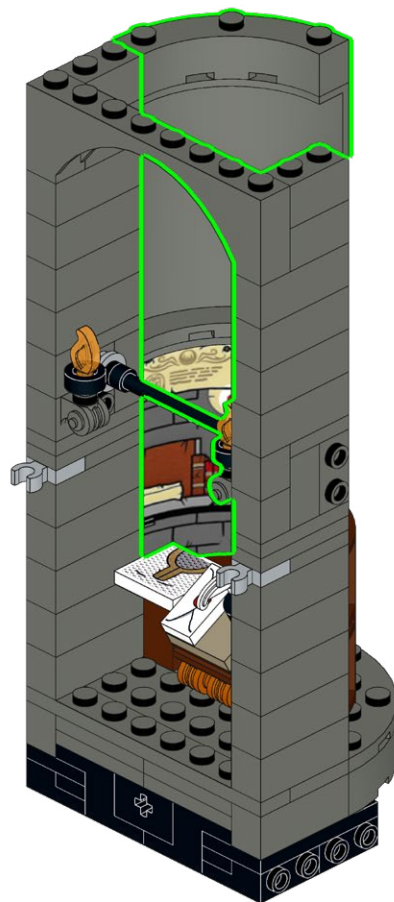

242

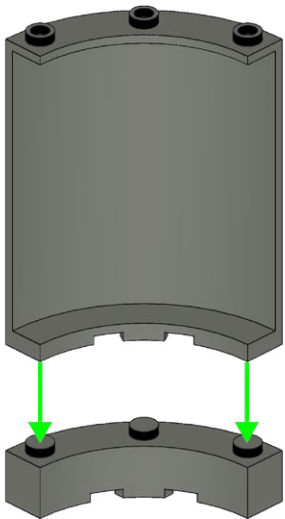
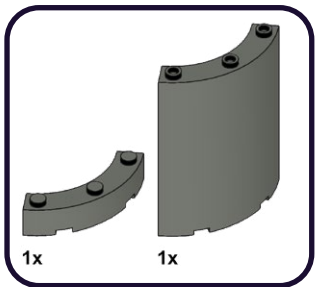

243

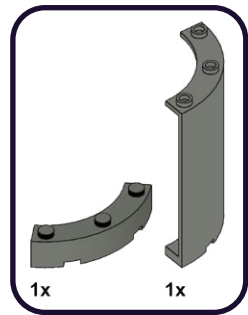

244

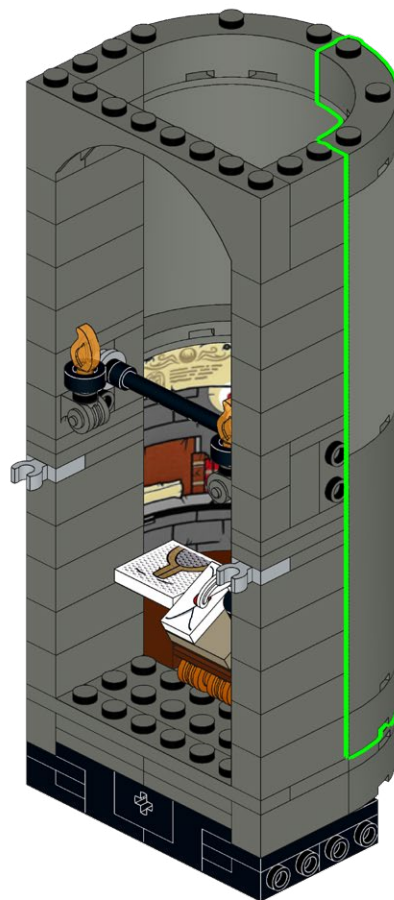

245

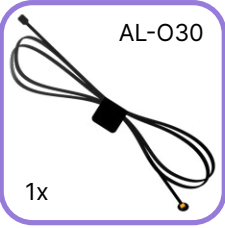

246

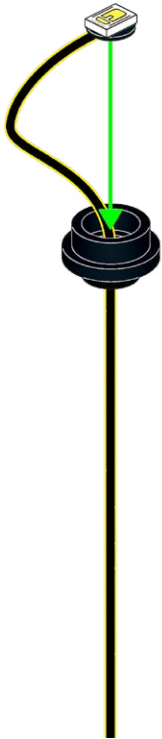

247

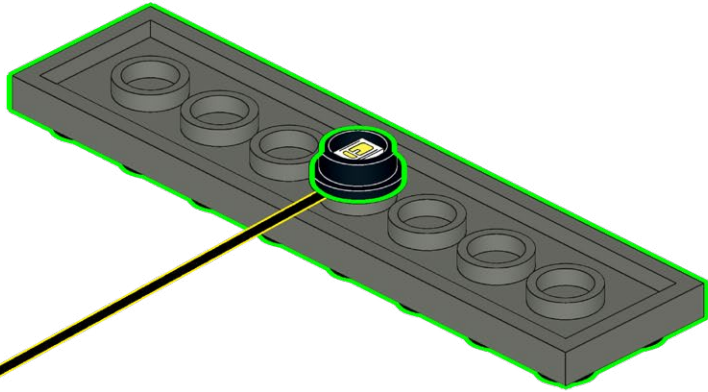
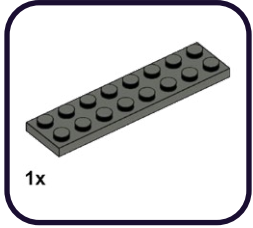

248

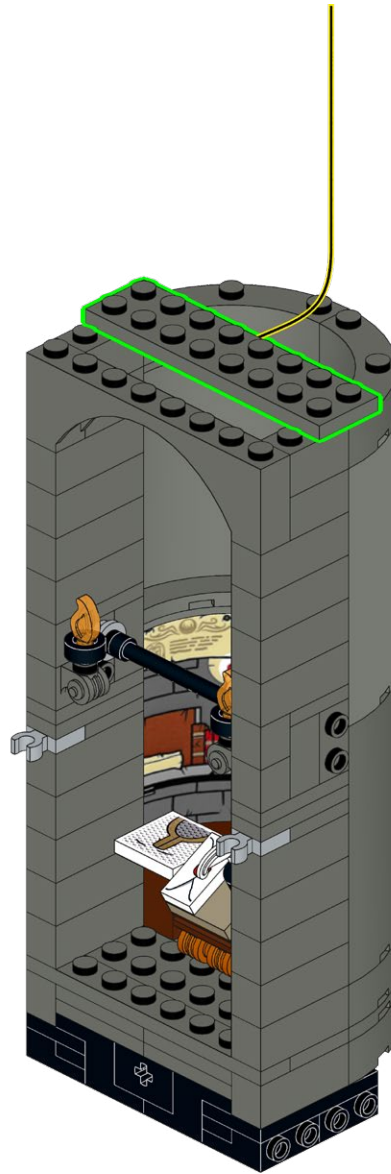

249



250

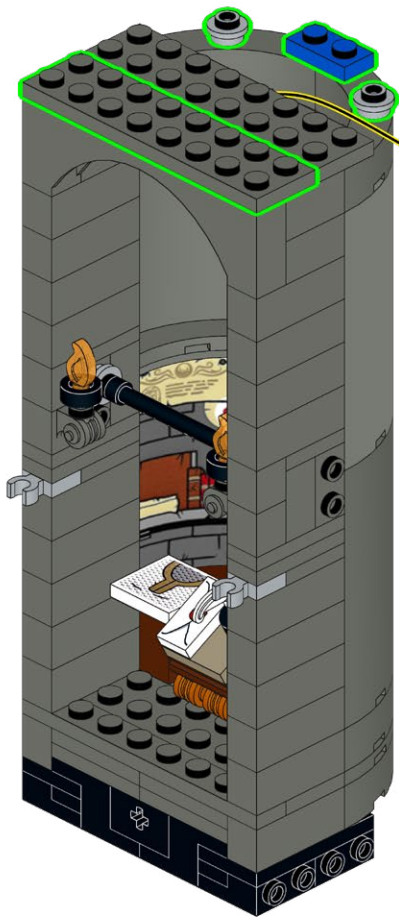
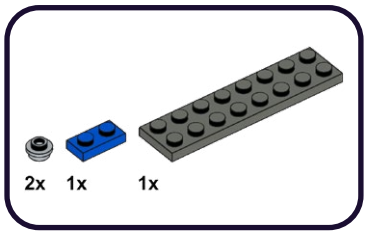

**HOLD UP!**

You might notice some bags aren't in order, as well as left over pieces, but that's ok! We're changing the way you build LEGO!

ATTENDEZ!

Vous remarquerez peut-être que certains sacs, ainsi que certaines pièces, ne sont pas dans le bon ordre. Mais pas de panique! Nous changeons simplement la façon avec laquelle vous construisez vos LEGO!

ASPETTA!

Potresti notare che alcuni sacchetti non sono in ordine, così come i pezzi avanzati, ma va bene così! Stiamo cambiando il modo in cui costruisci i LEGO!

HALT!

Sie werden möglicherweise bemerken, dass einige tüten durcheinander sind und teile übrig bleiben, aber das ist in Ordnung! Wir ändern die art und weise, wie Sie LEGO bauen!

¡ESPERA!

Es posible que notes que algunas bolsas están fuera de servicio, así como piezas sobrantes, ¡pero está bien! ¡Estamos cambiando la forma en que construyes LEGO!

暫停!

你可能会注意到一些袋子顺序错乱, 以及一些剩余的部件, 但没关系! 我们正在改变你搭建乐高的方式!

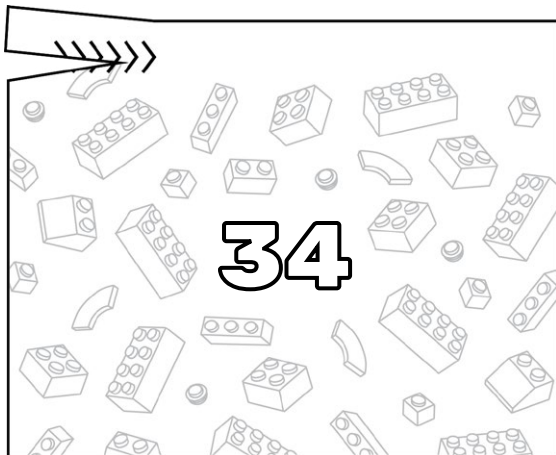
Open LEGO® Bag 34

251

4x

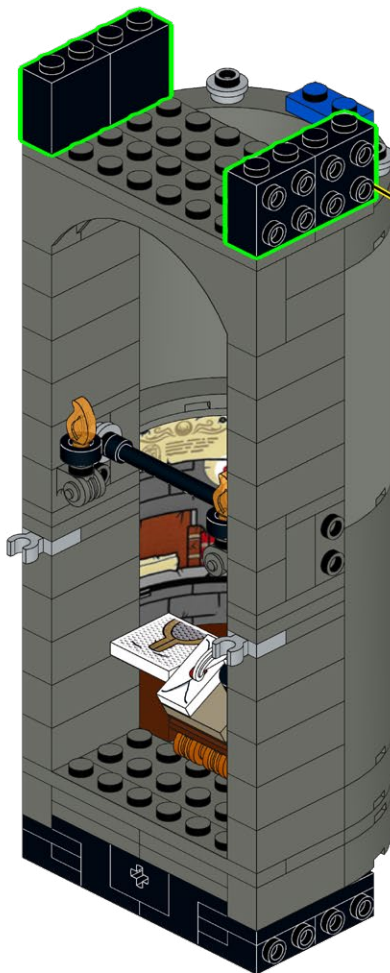

252

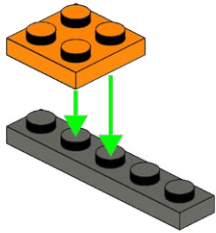
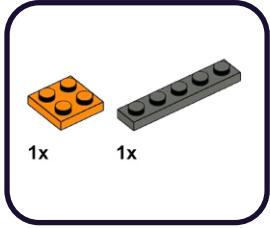

253

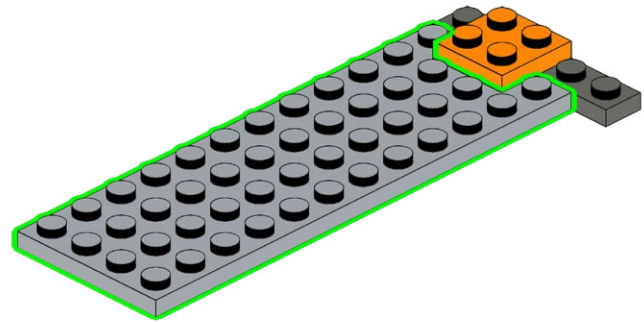
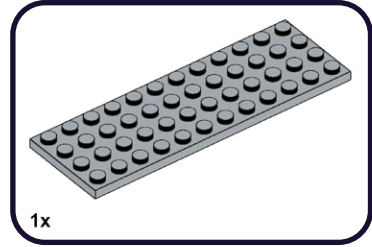

254

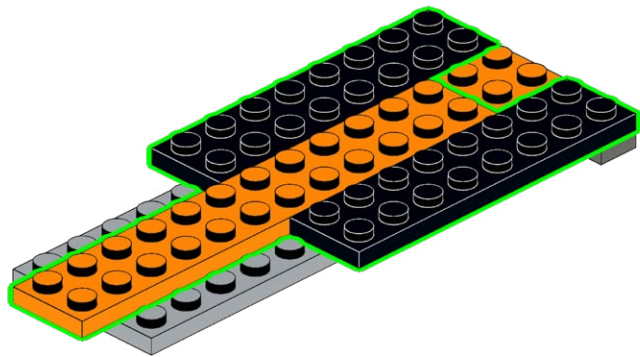
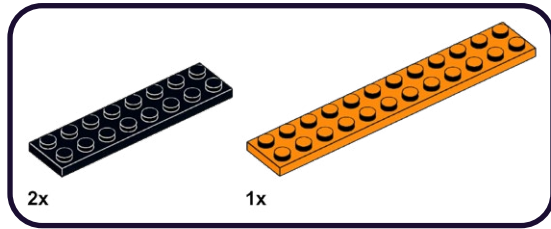

255

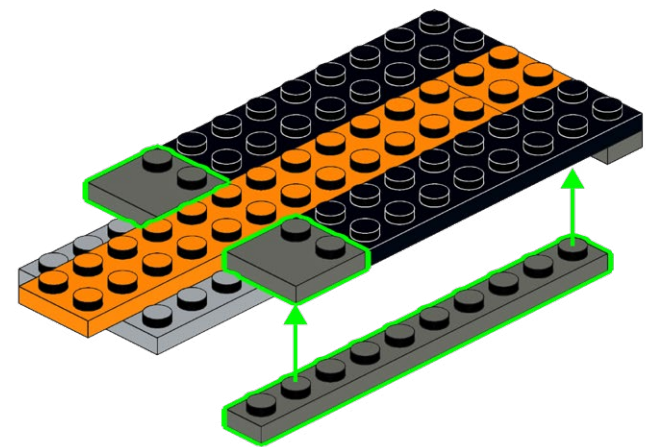
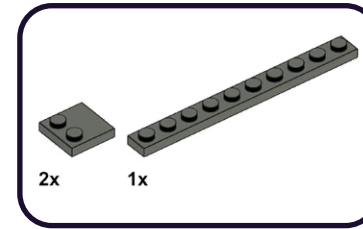

256

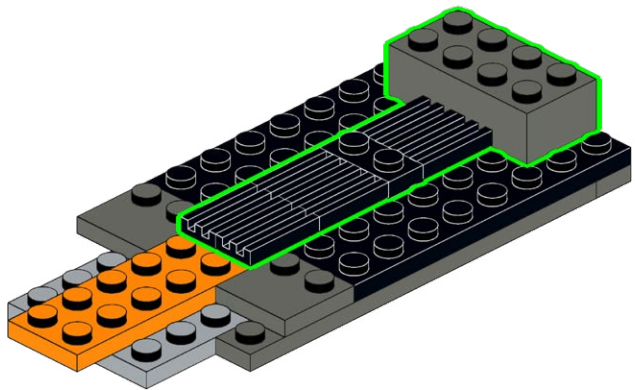
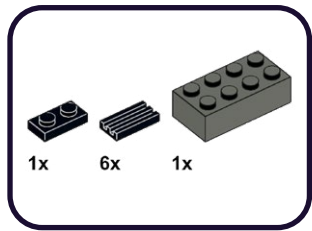

257

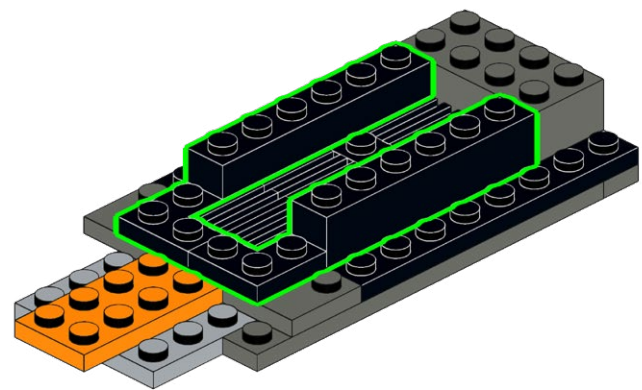
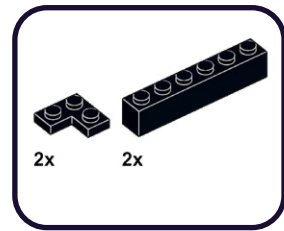

258

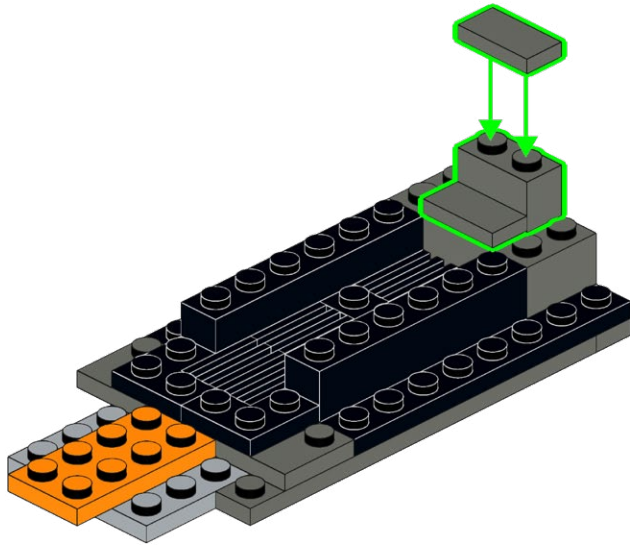
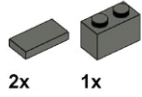

259

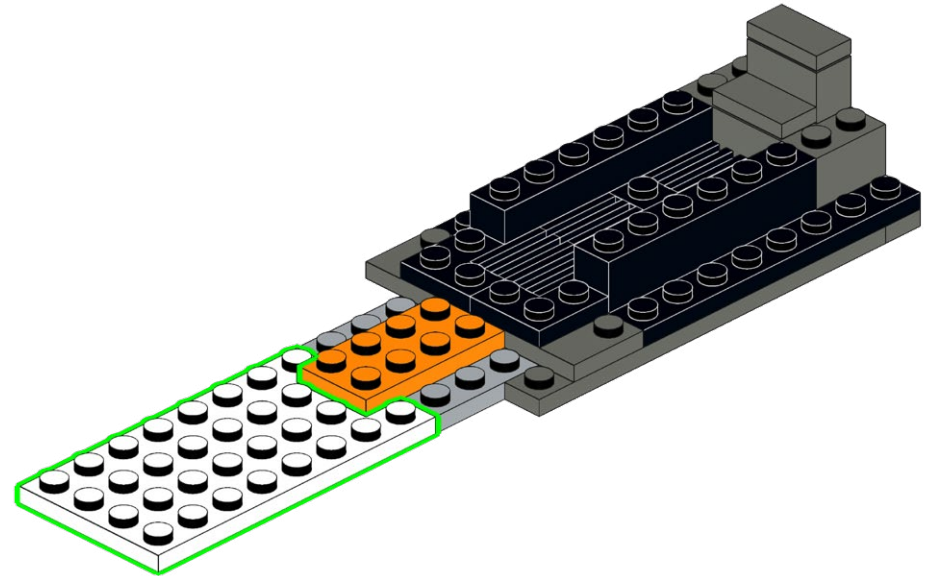
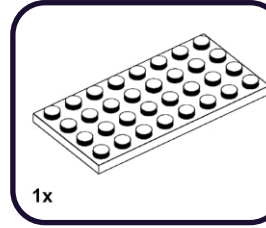

260

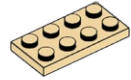

2x

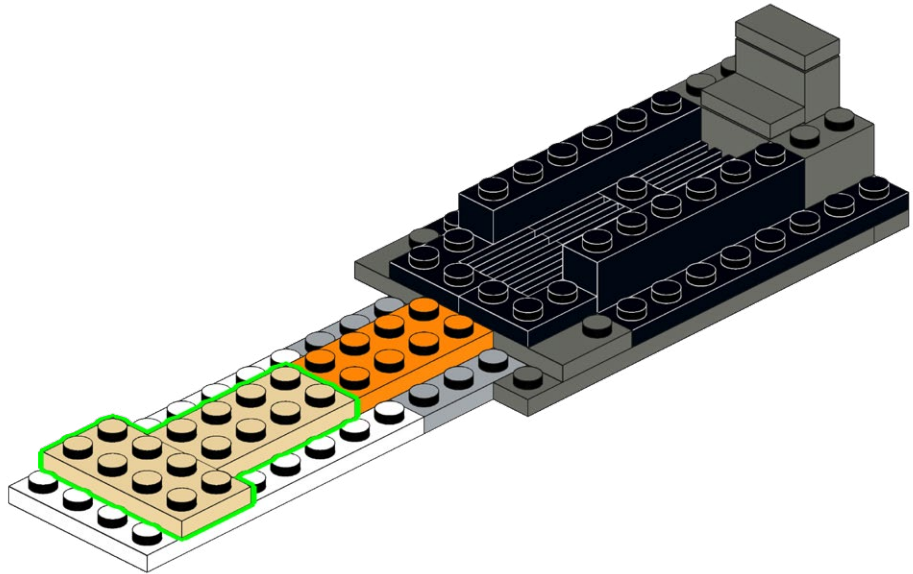

261



1x

1x

2x

4x

1x

2x

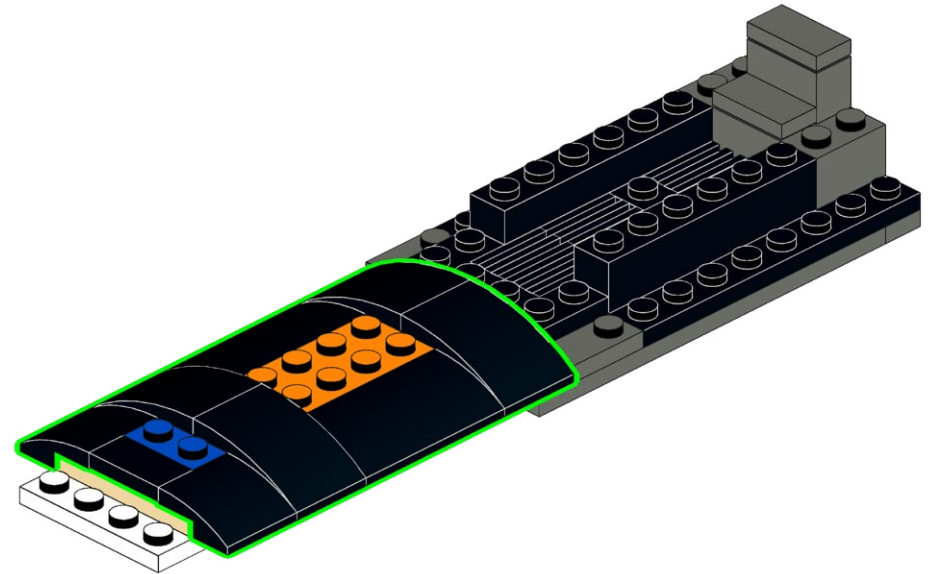

262

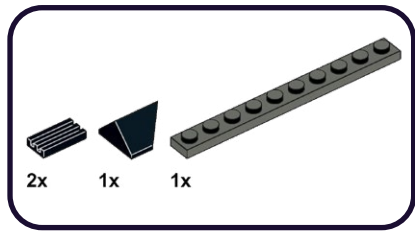

263

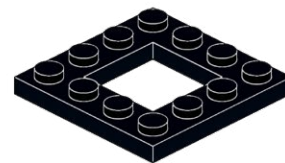
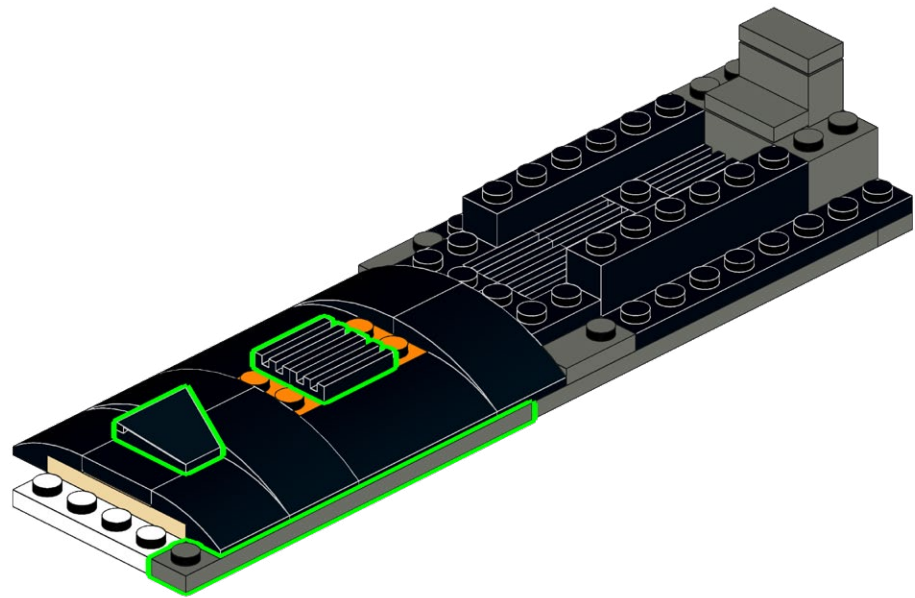
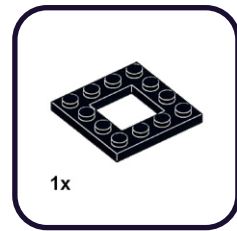

264

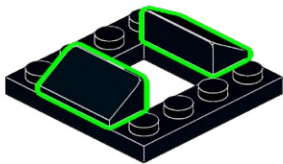

265

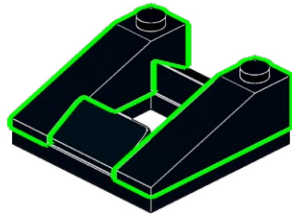
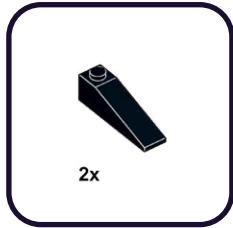

266

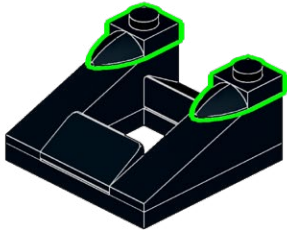

267

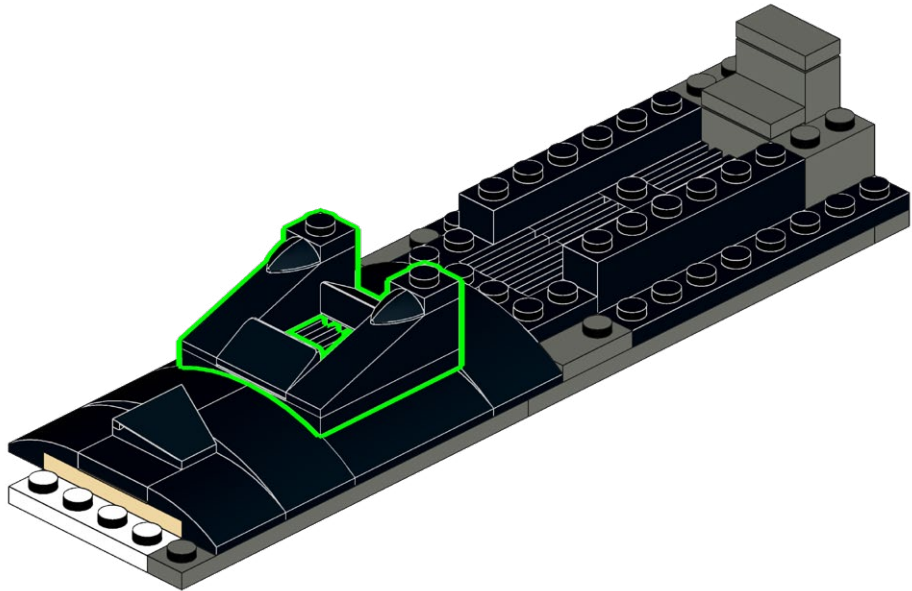

268

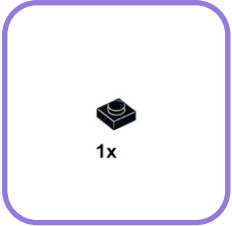
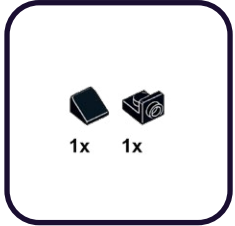

269

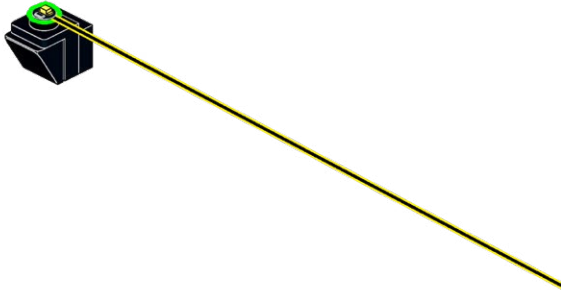
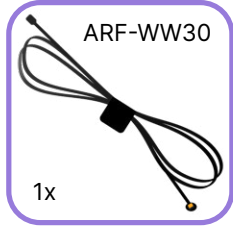

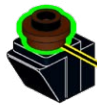
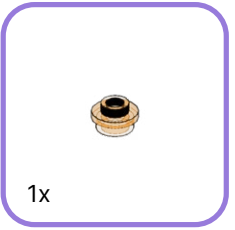
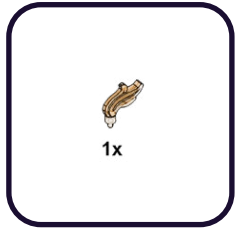
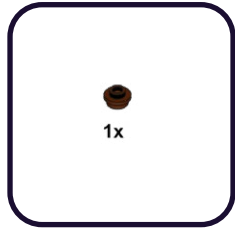

2x

272

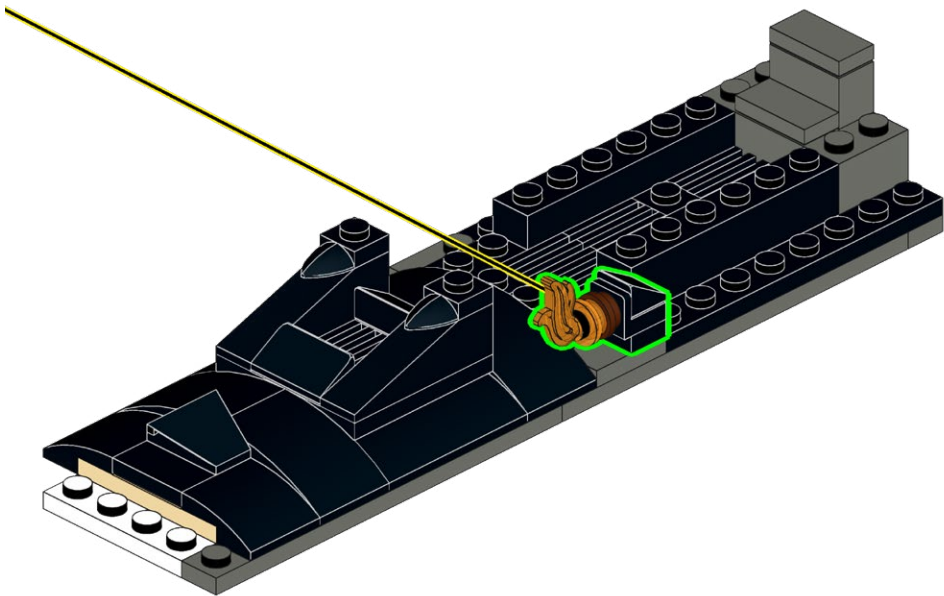

273

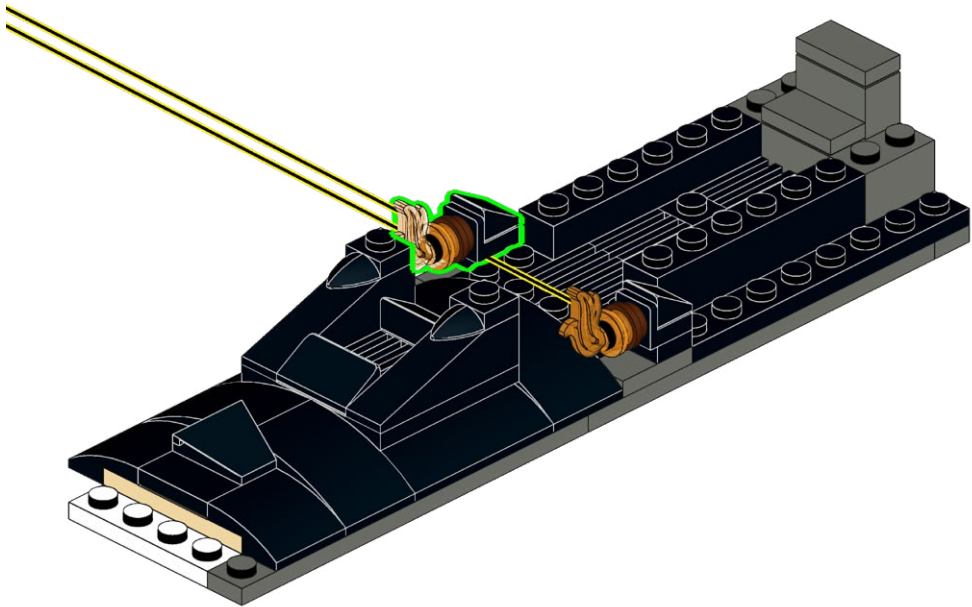

274

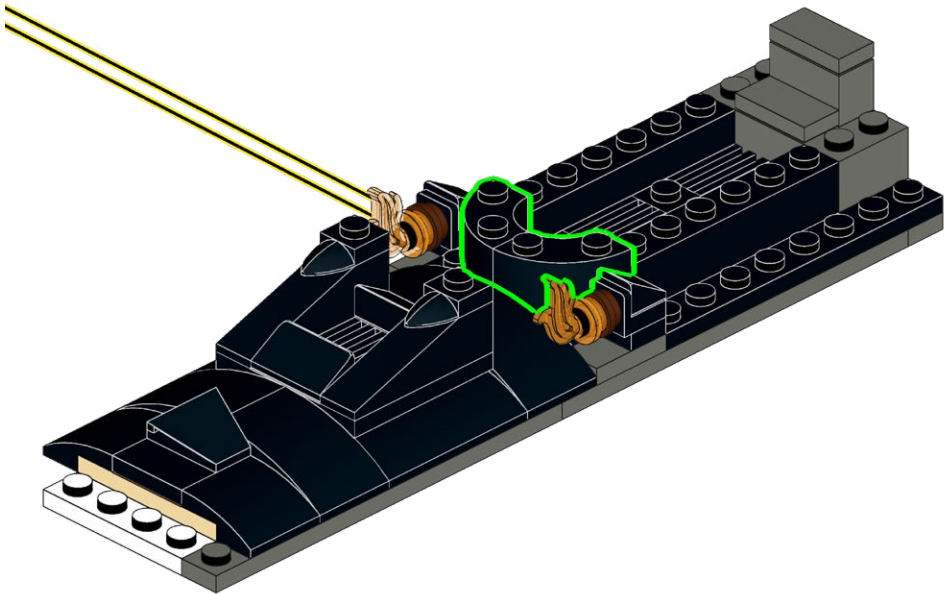

275

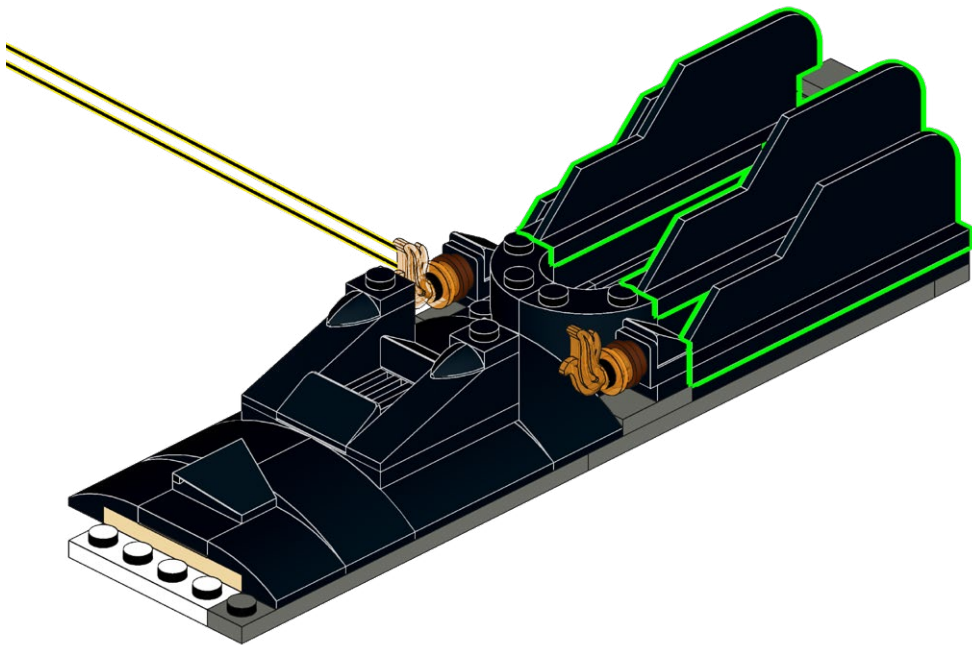

276



277

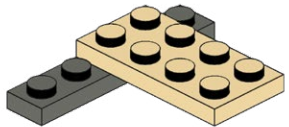
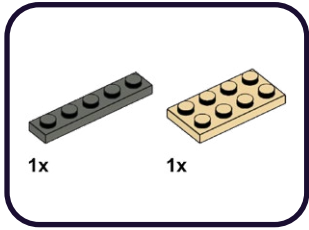

278

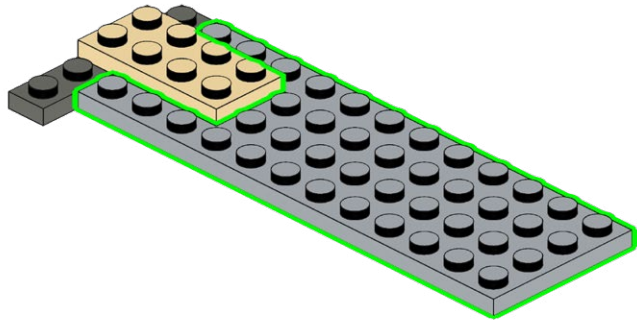
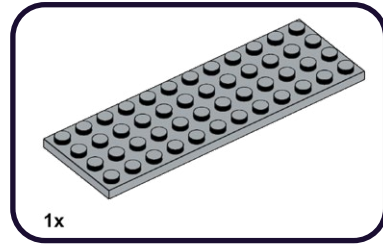

279

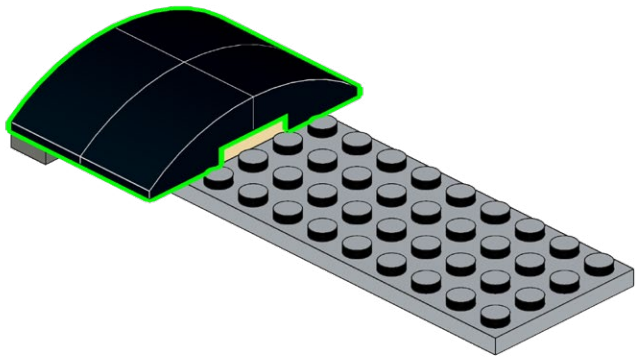

280

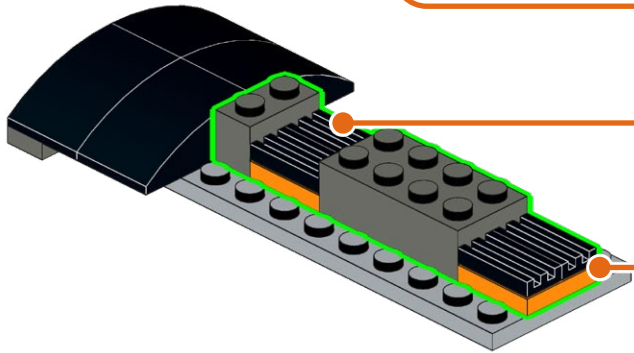
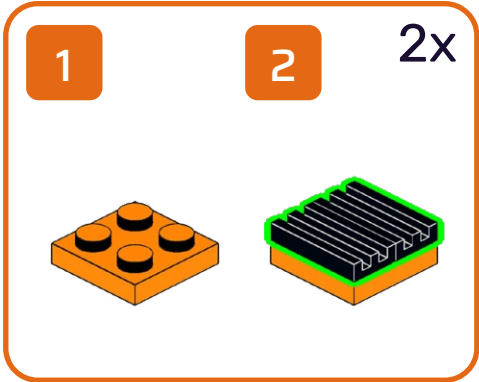
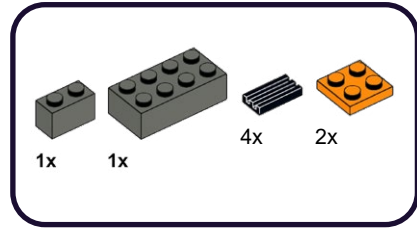

283

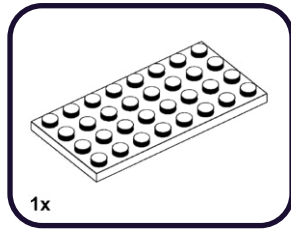

284

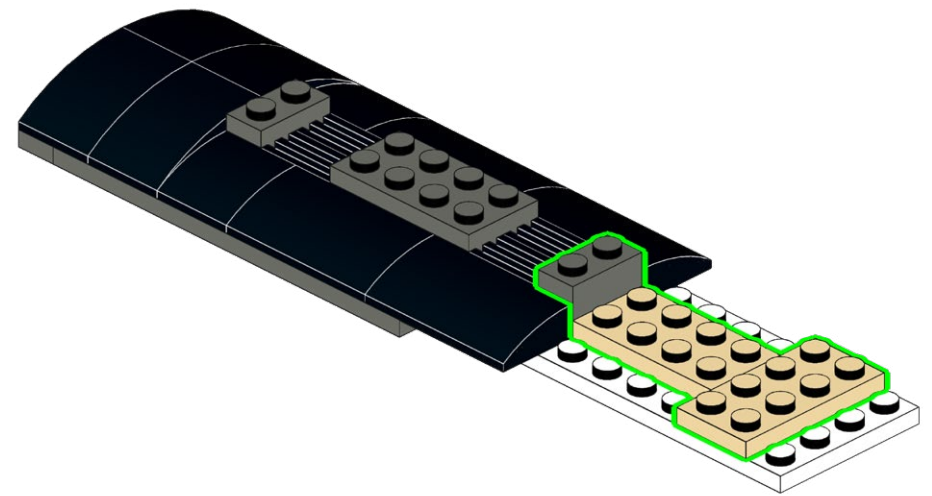
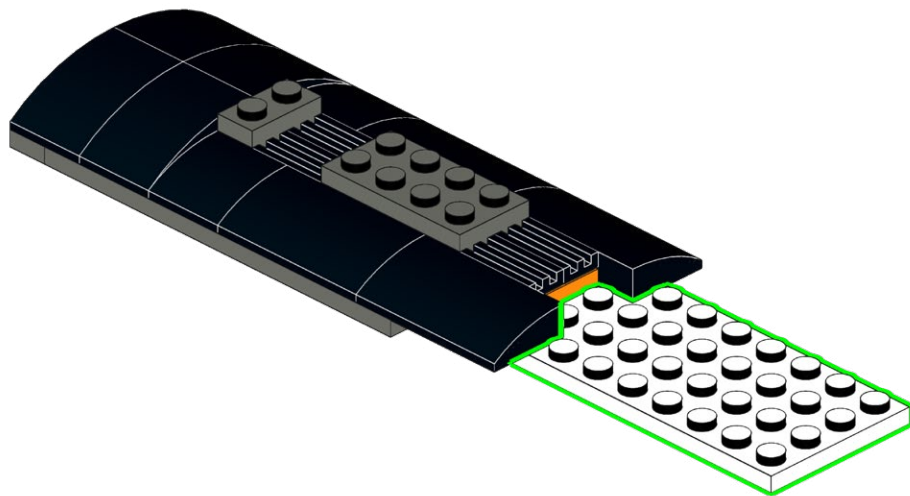
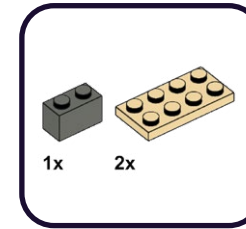

285

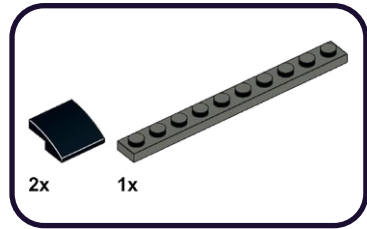

286

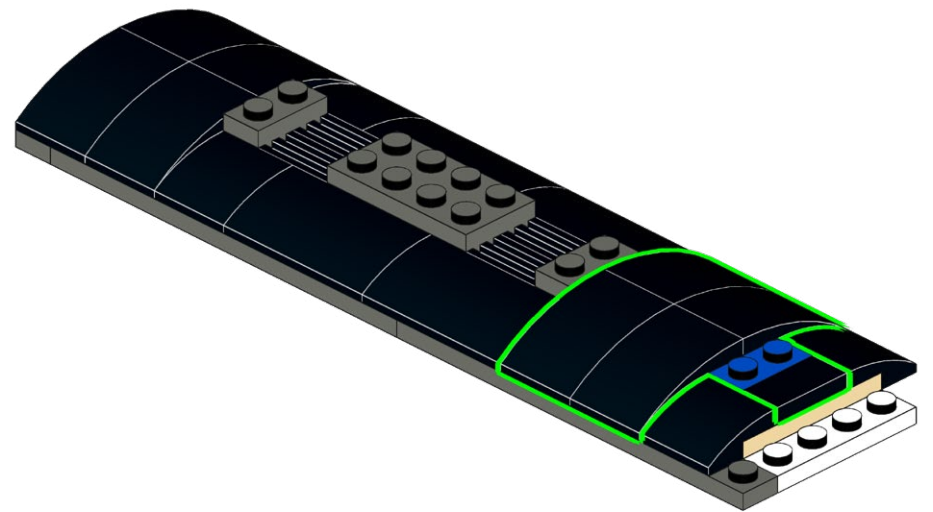
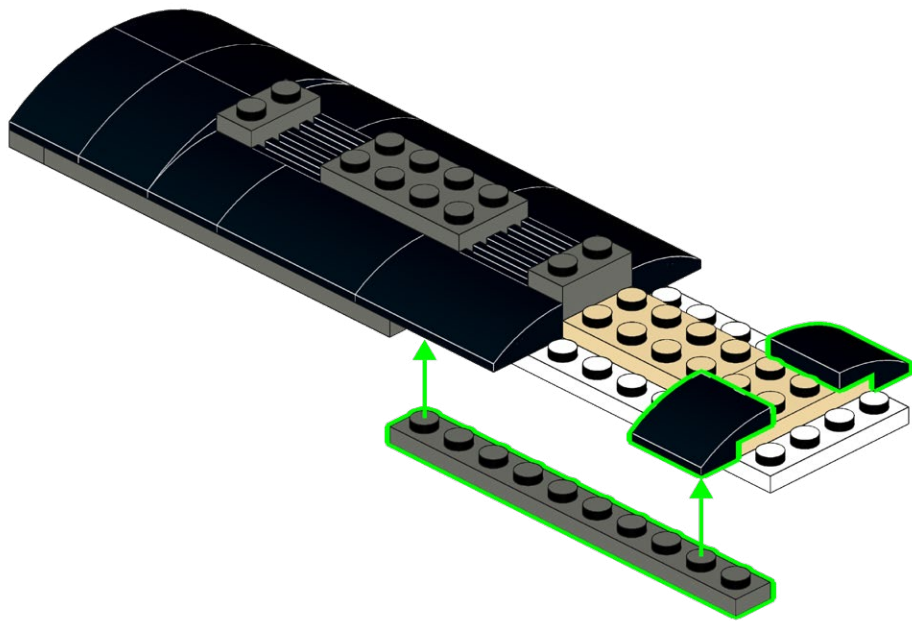
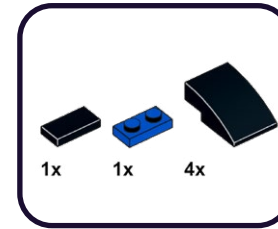

287

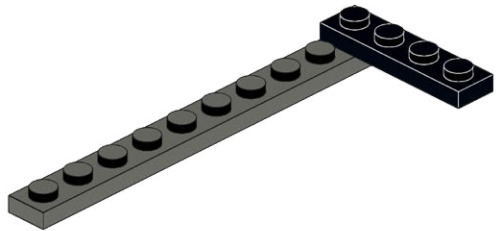
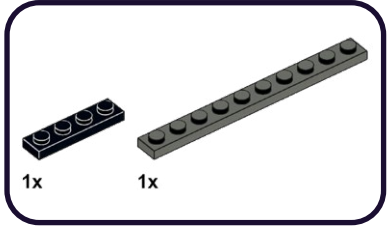

288

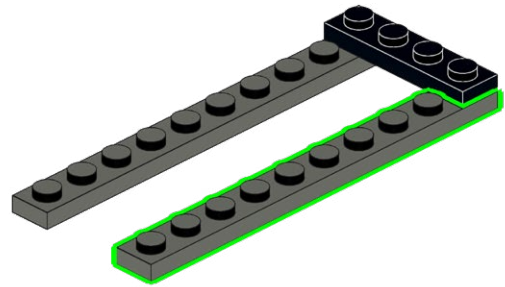
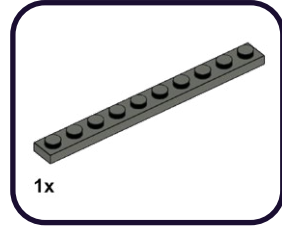

289

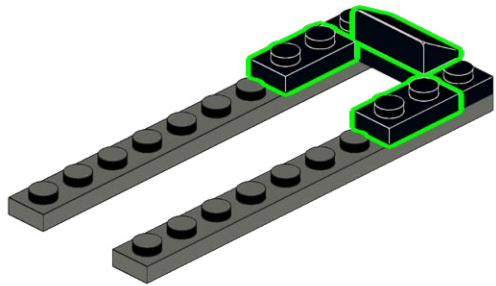
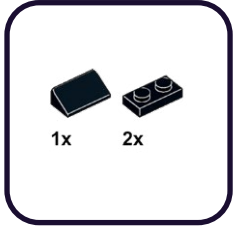

290

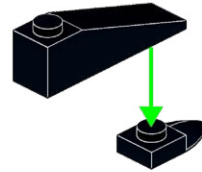
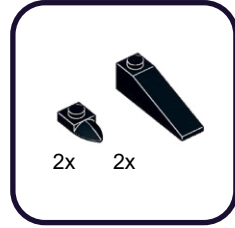

2x

291

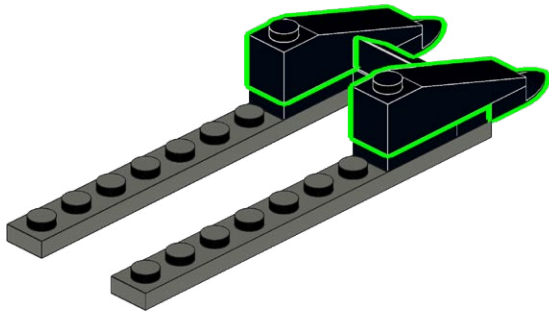

292

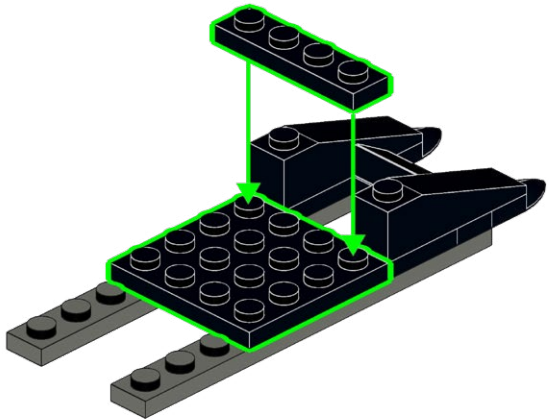
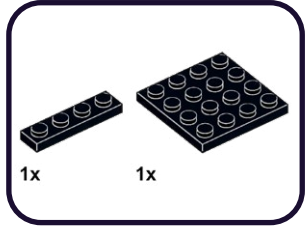

293

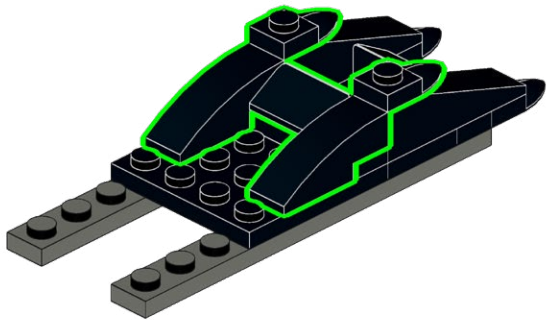
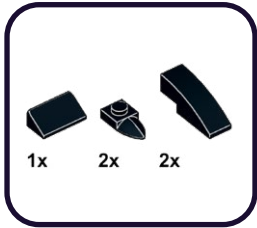

294

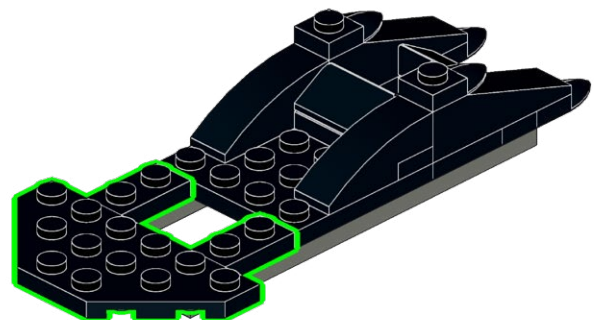
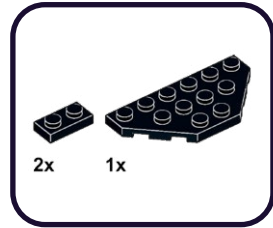

295

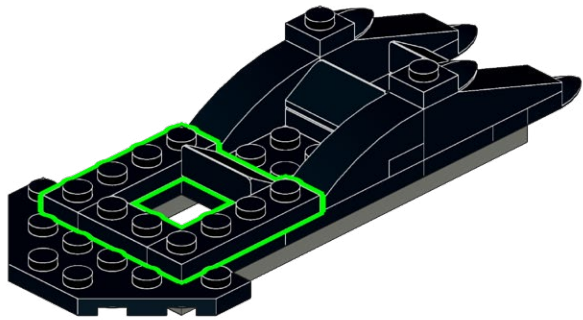
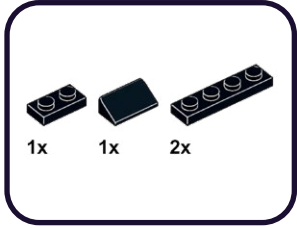

296

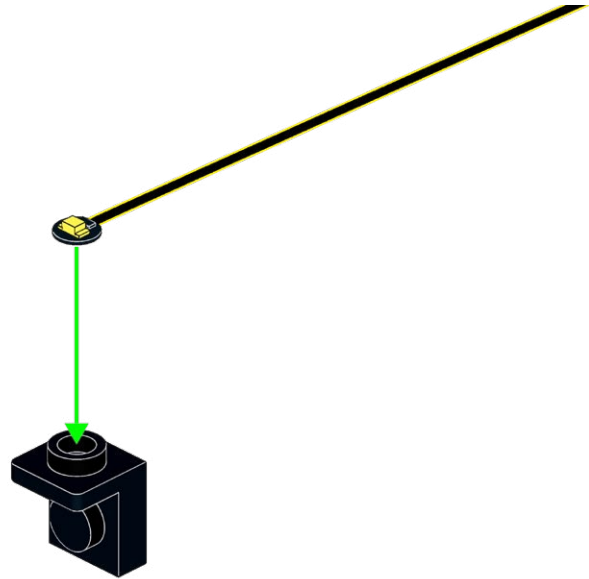
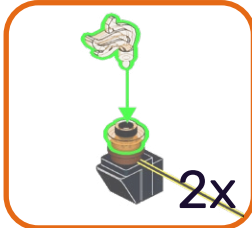
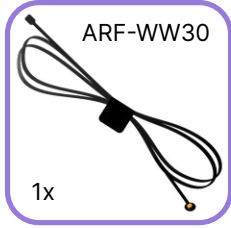
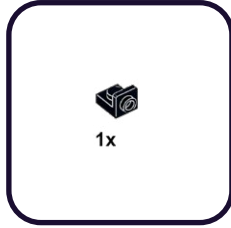

297

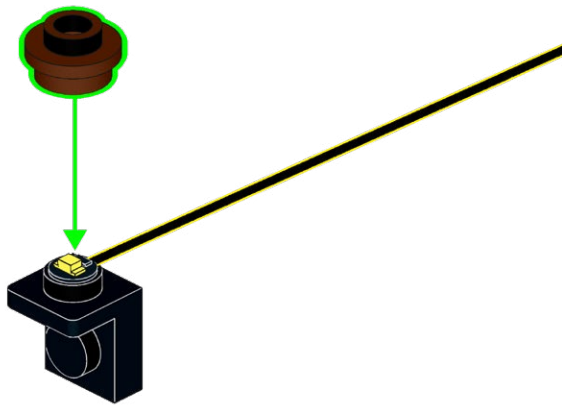

298

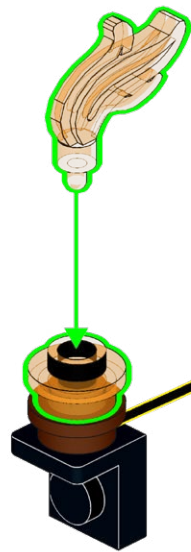
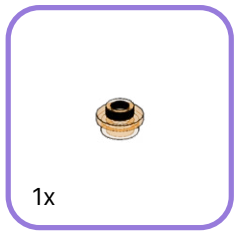
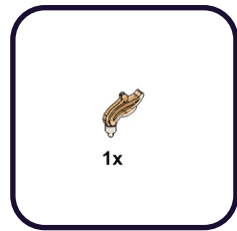

2x

299

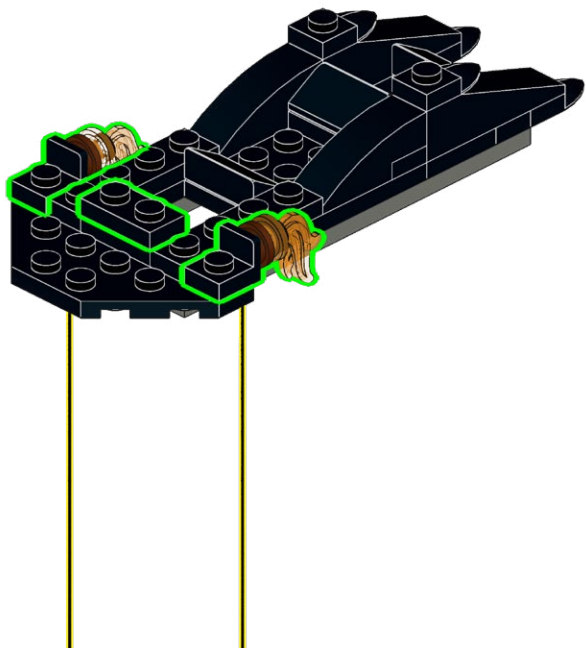
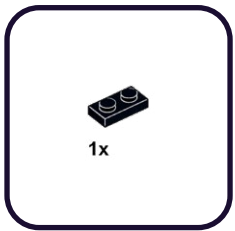

300

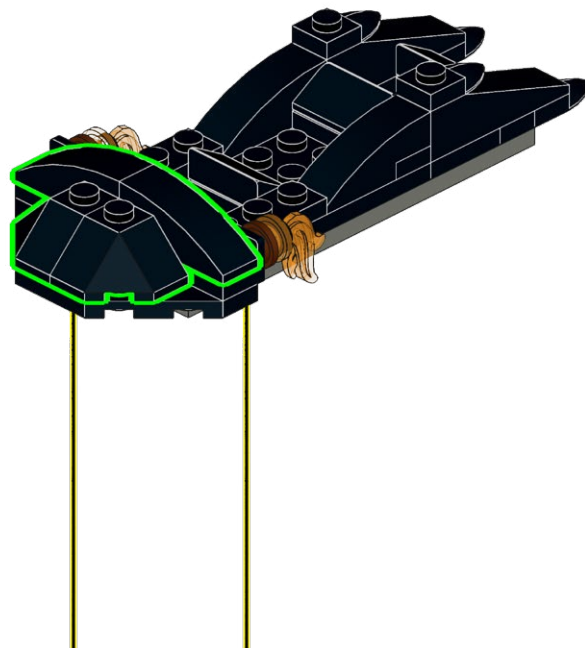
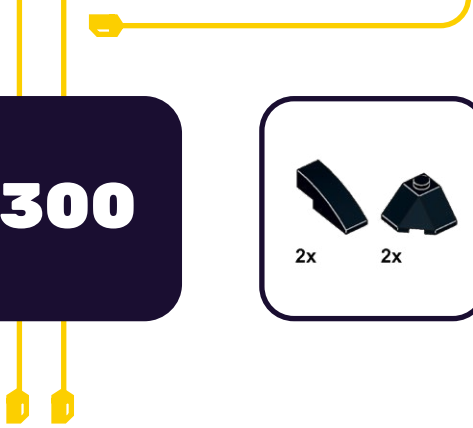

301

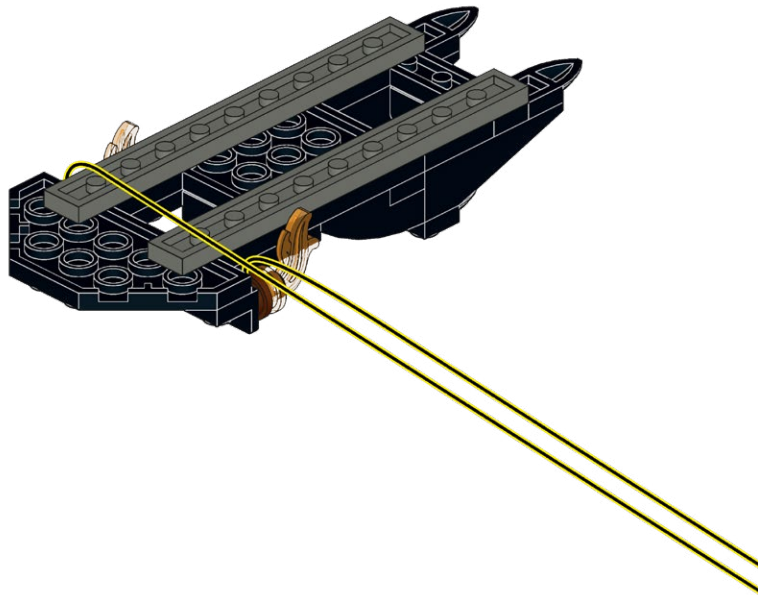

302

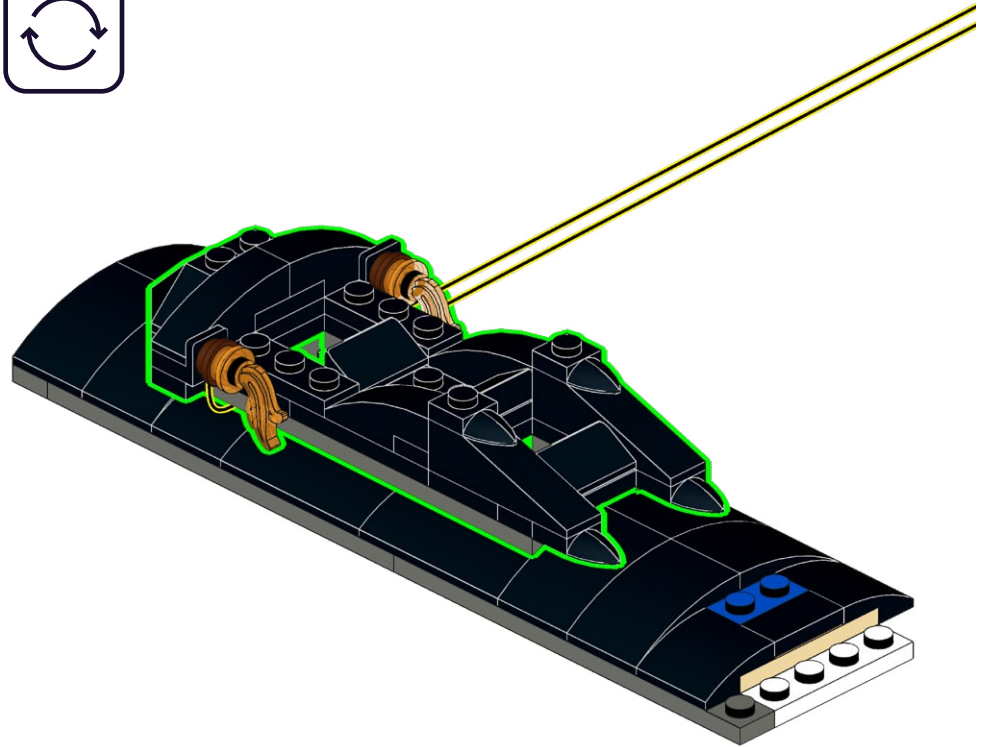
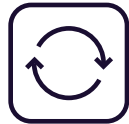

303

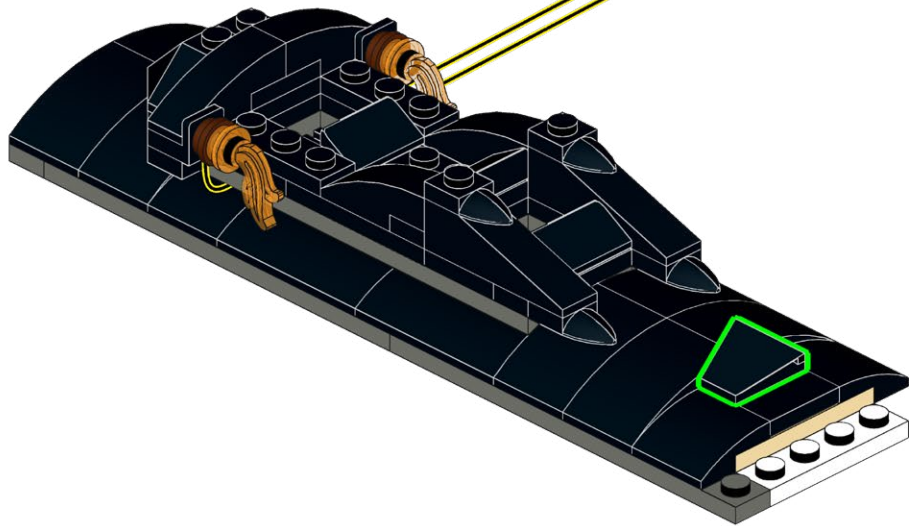
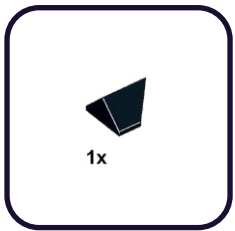

304

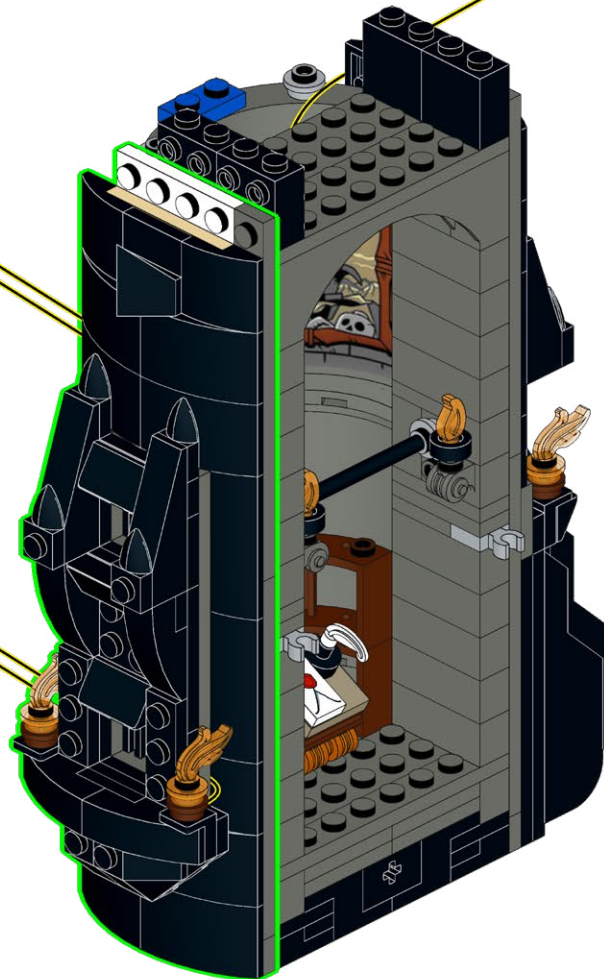

**HOLD UP!**

You might notice some bags aren't in order, as well as left over pieces, but that's ok! We're changing the way you build LEGO!

ATTENDEZ!

Vous remarquerez peut-être que certains sacs, ainsi que certaines pièces, ne sont pas dans le bon ordre. Mais pas de panique! Nous changeons simplement la façon avec laquelle vous construisez vos LEGO!

ASPETTA!

Potresti notare che alcuni sacchetti non sono in ordine, così come i pezzi avanzati, ma va bene così! Stiamo cambiando il modo in cui costruisci i LEGO!

HALT!

Sie werden möglicherweise bemerken, dass einige tüten durcheinander sind und teile übrig bleiben, aber das ist in Ordnung! Wir ändern die art und weise, wie Sie LEGO bauen!

¡ESPERA!

Es posible que notes que algunas bolsas están fuera de servicio, así como piezas sobrantes, ¡pero está bien! ¡Estamos cambiando la forma en que construyes LEGO!

暫停!

你可能会注意到一些袋子顺序错乱, 以及一些剩余的部件, 但没关系! 我们正在改变你搭建乐高的方式!

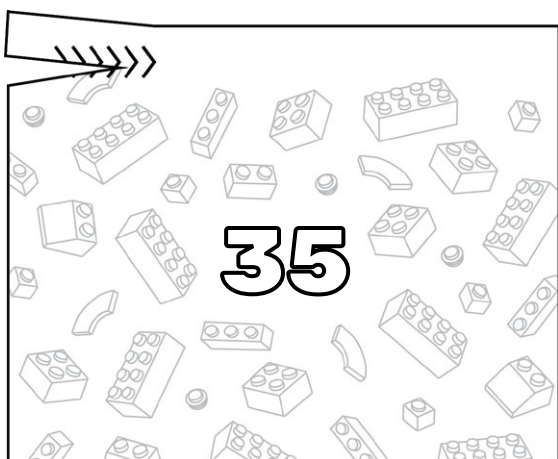
Open LEGO® Bag 35

305

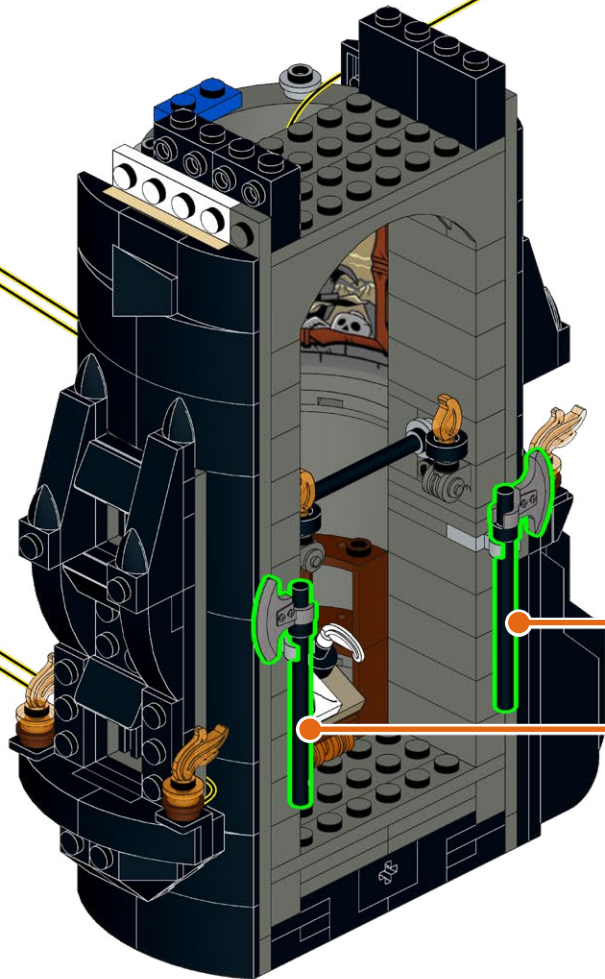
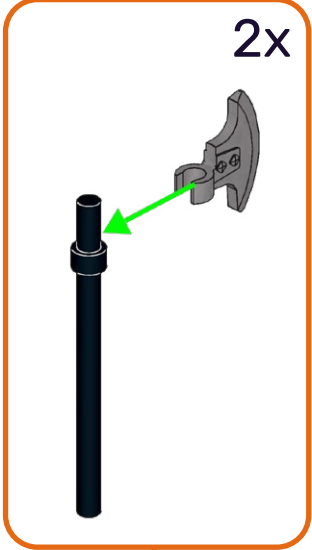

306

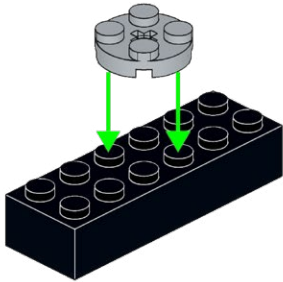
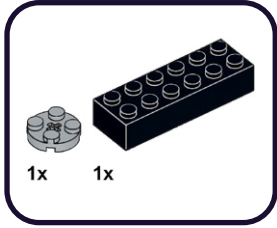

307

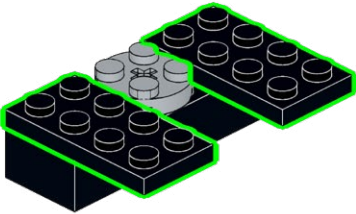

308

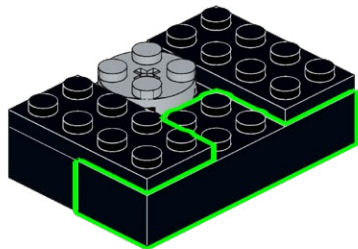
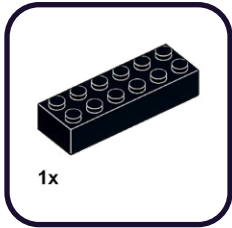

309

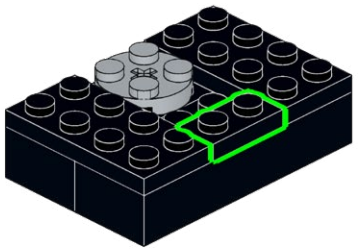
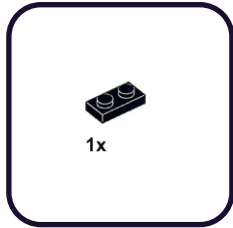

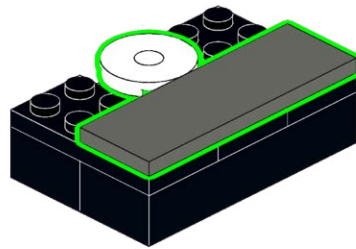
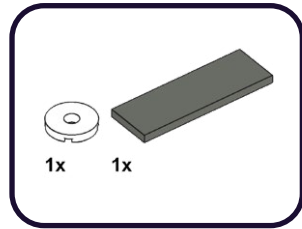
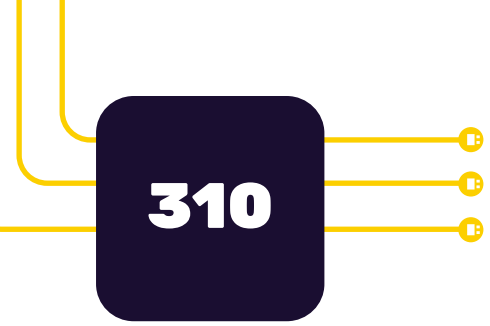

311



312

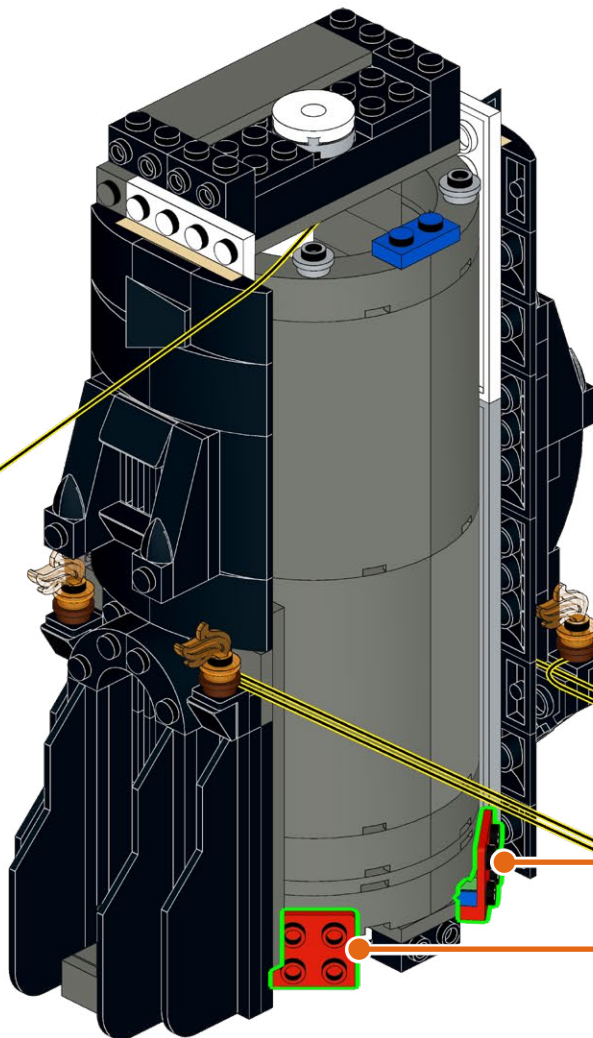
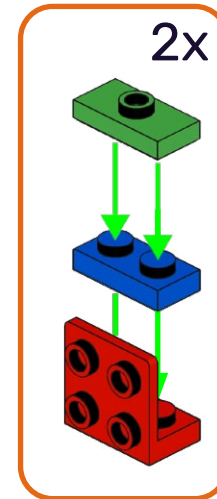
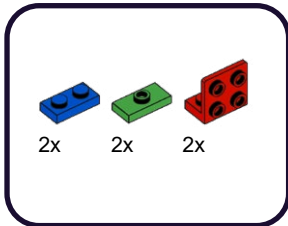

313

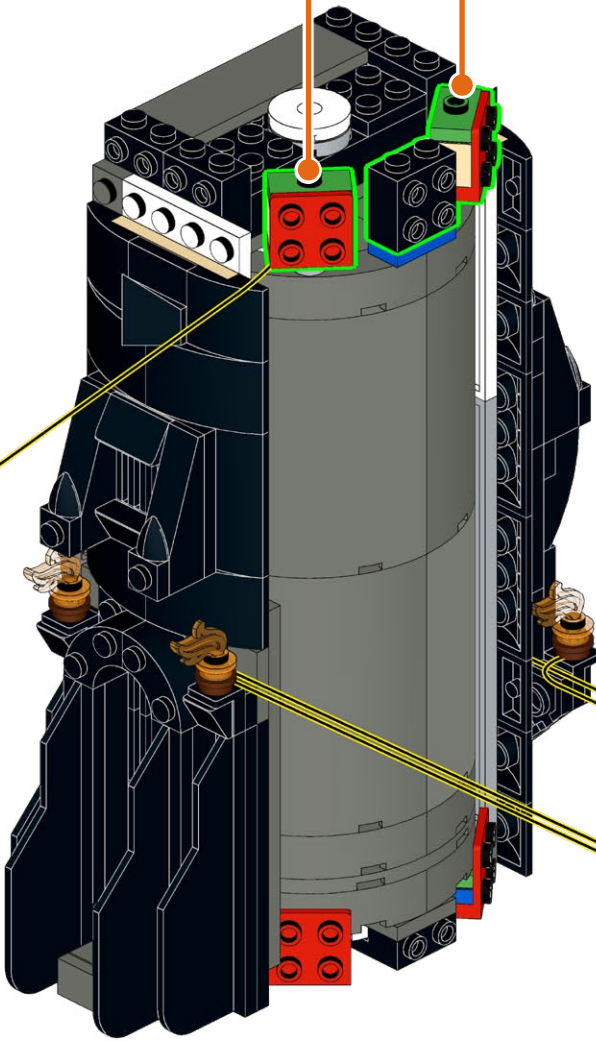
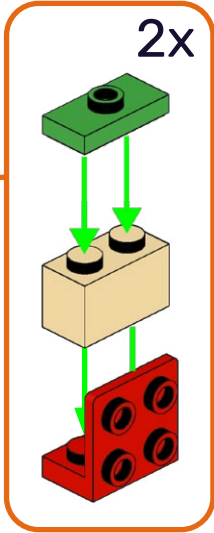
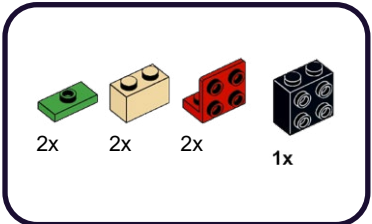

314

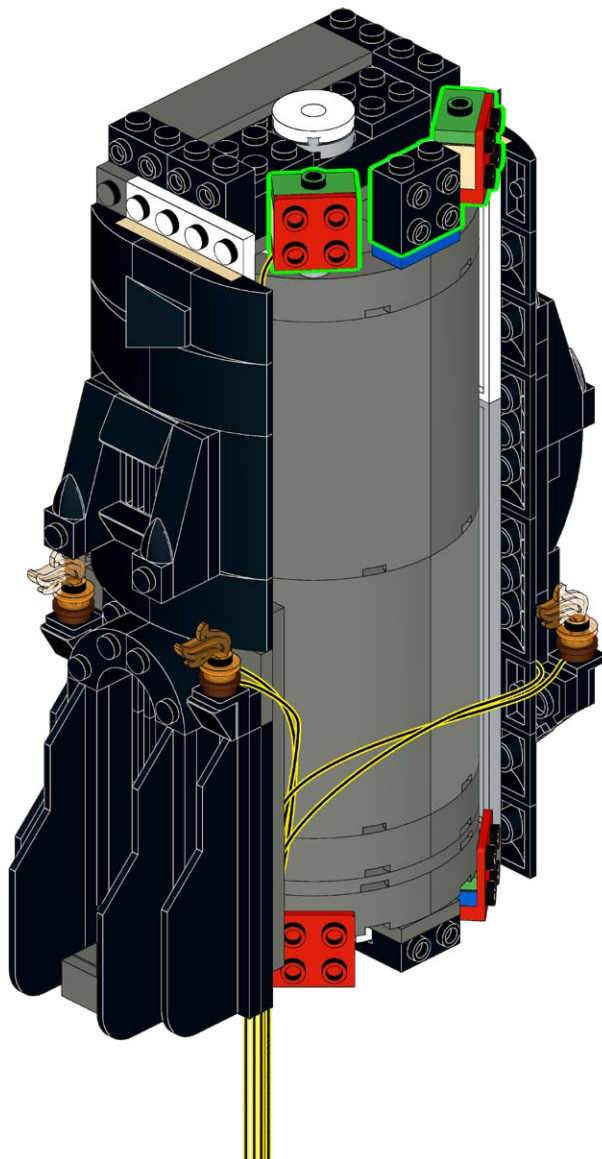

315

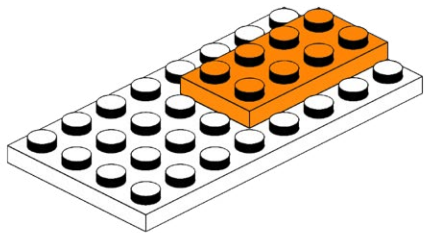
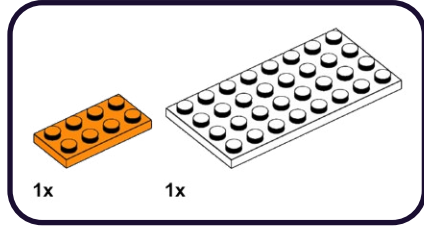

316

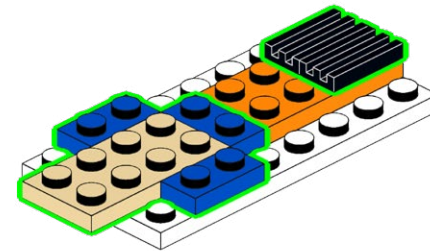
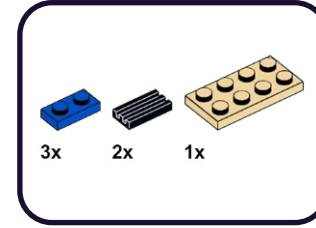

317

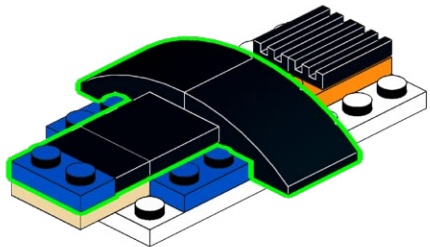
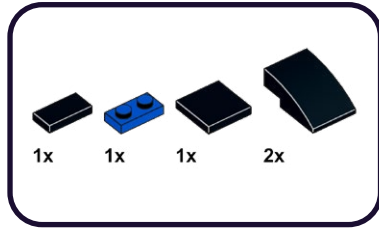

318

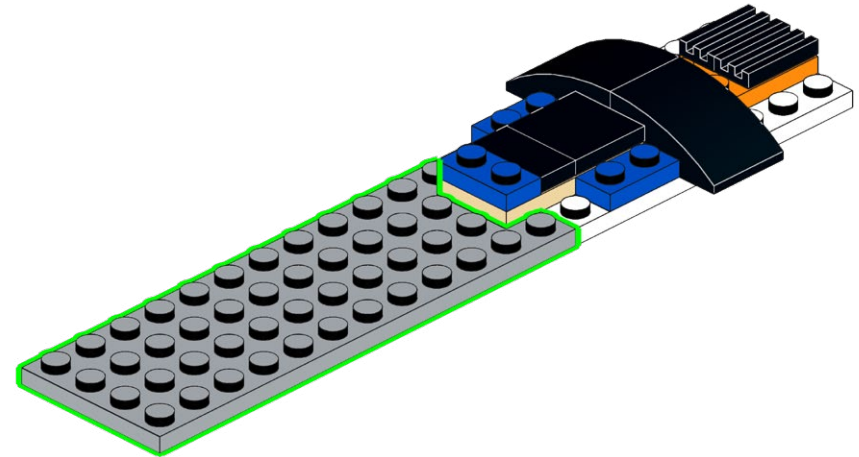
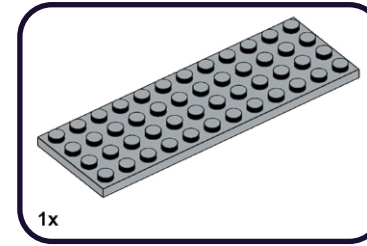

319

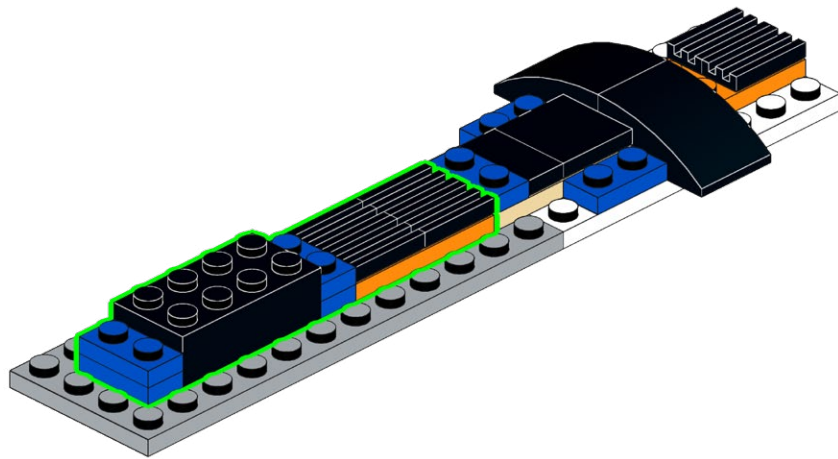
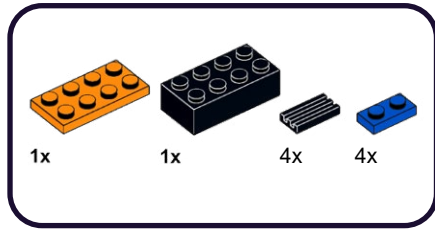

320

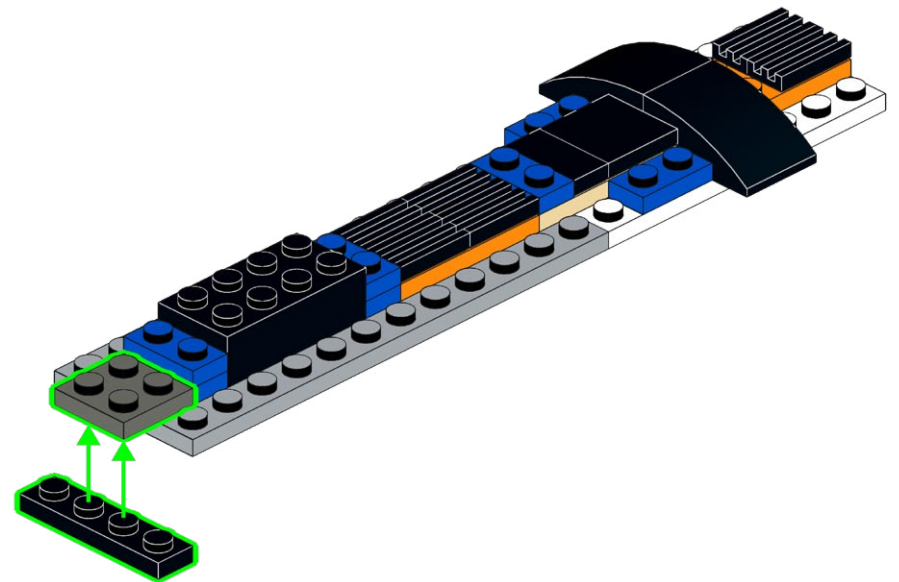
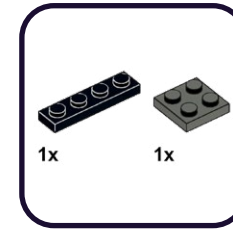

321

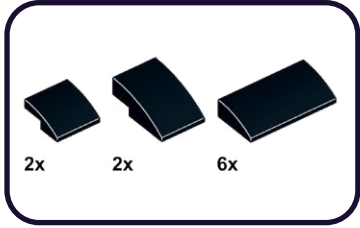

322

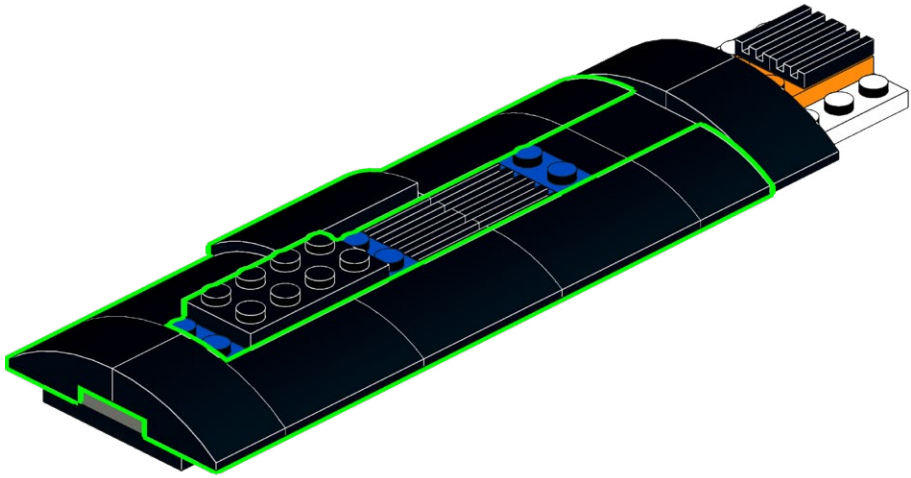
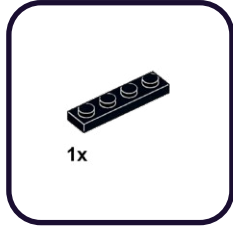

323

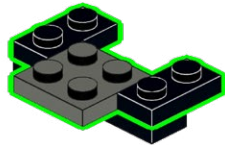
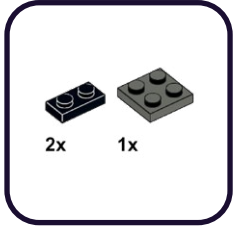

324

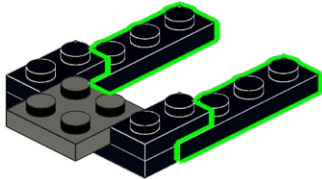
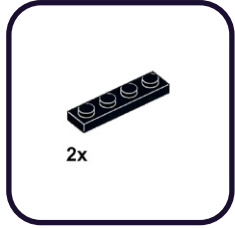

325

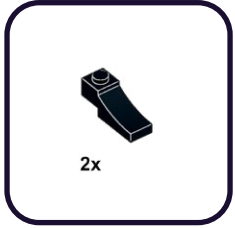

326

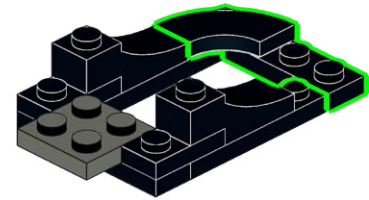
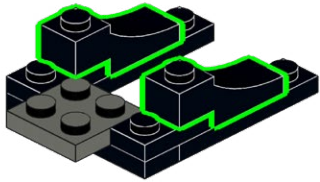
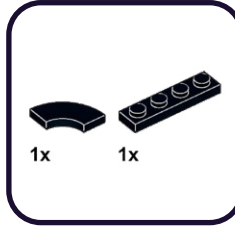

327

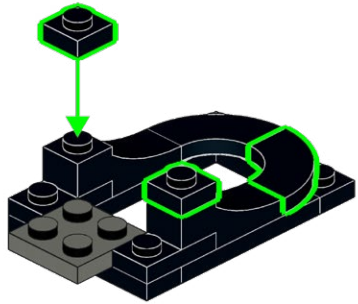
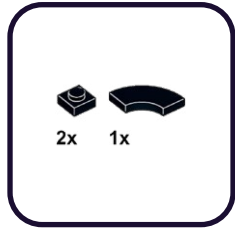

328

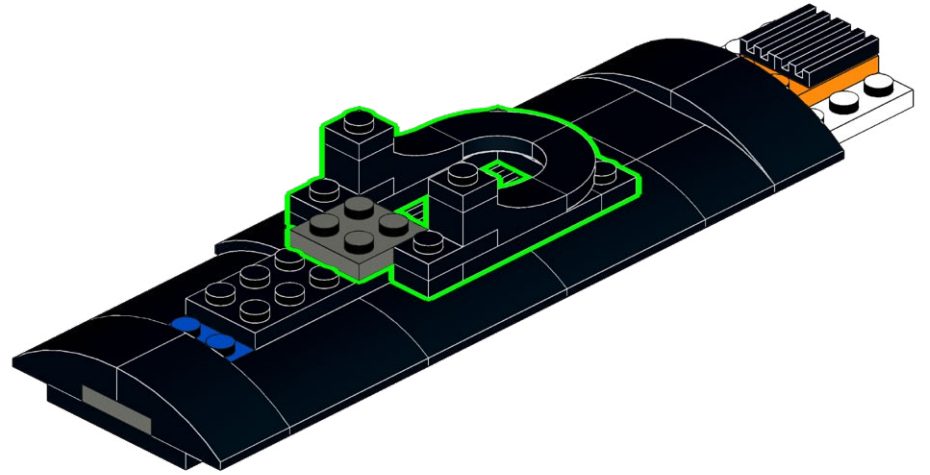

329

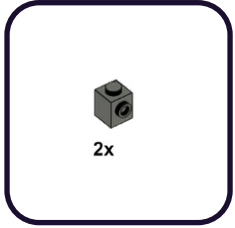

330

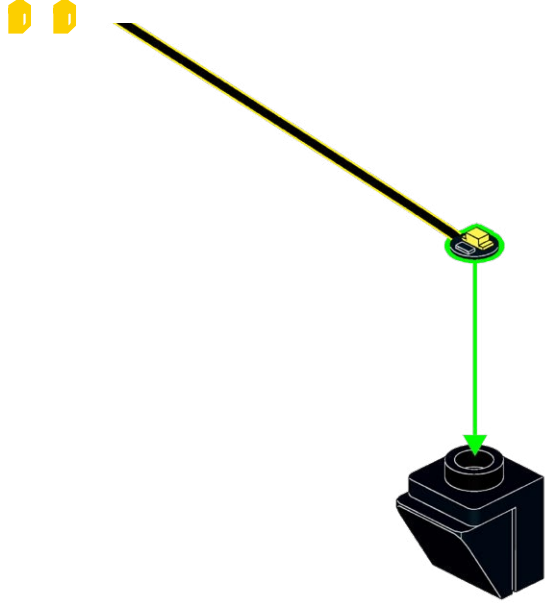
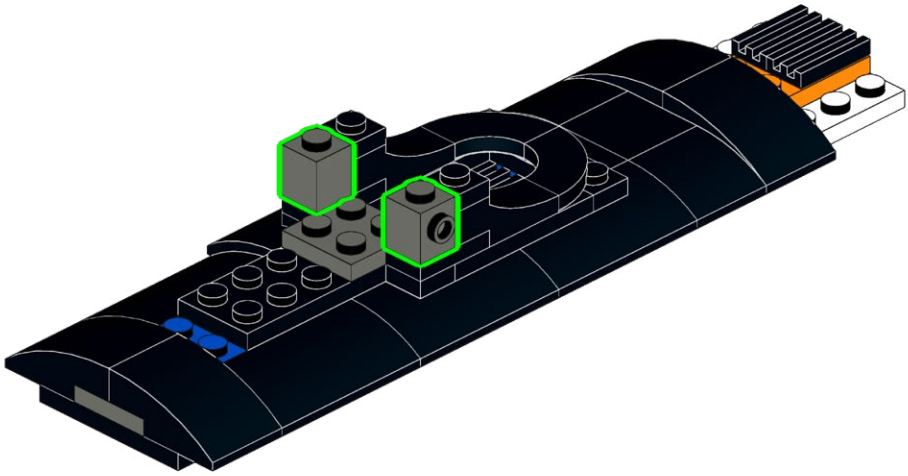
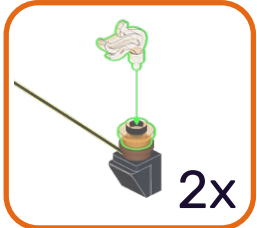
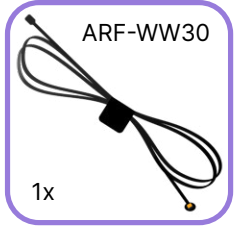
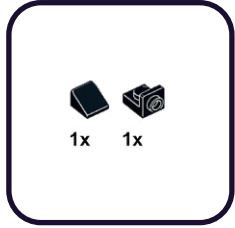

331

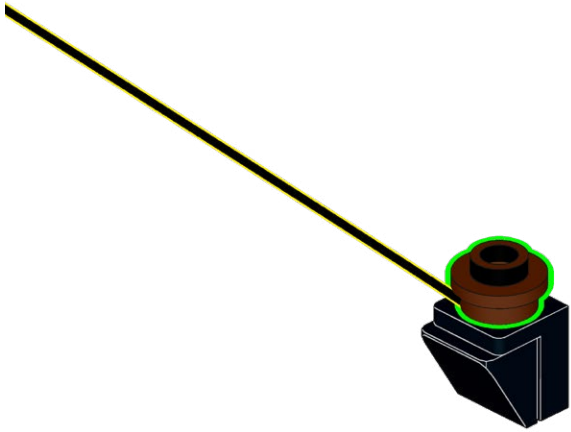
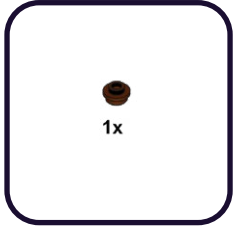

332

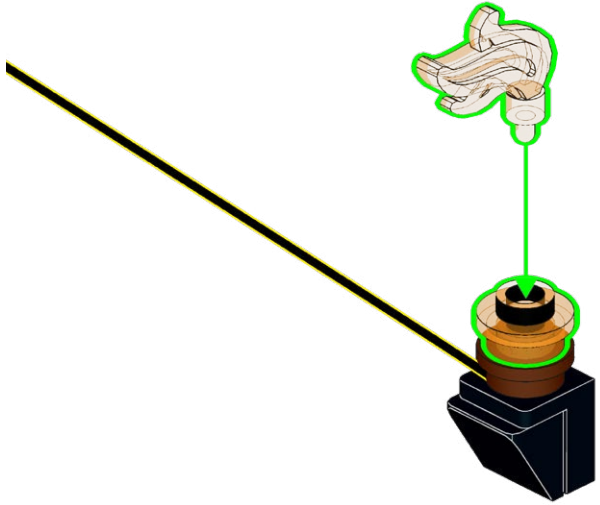
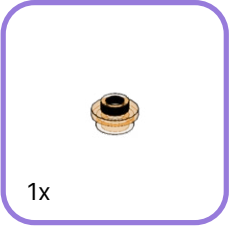
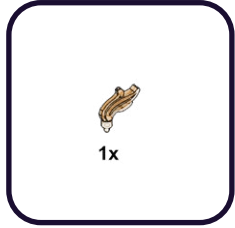

2x

333

334

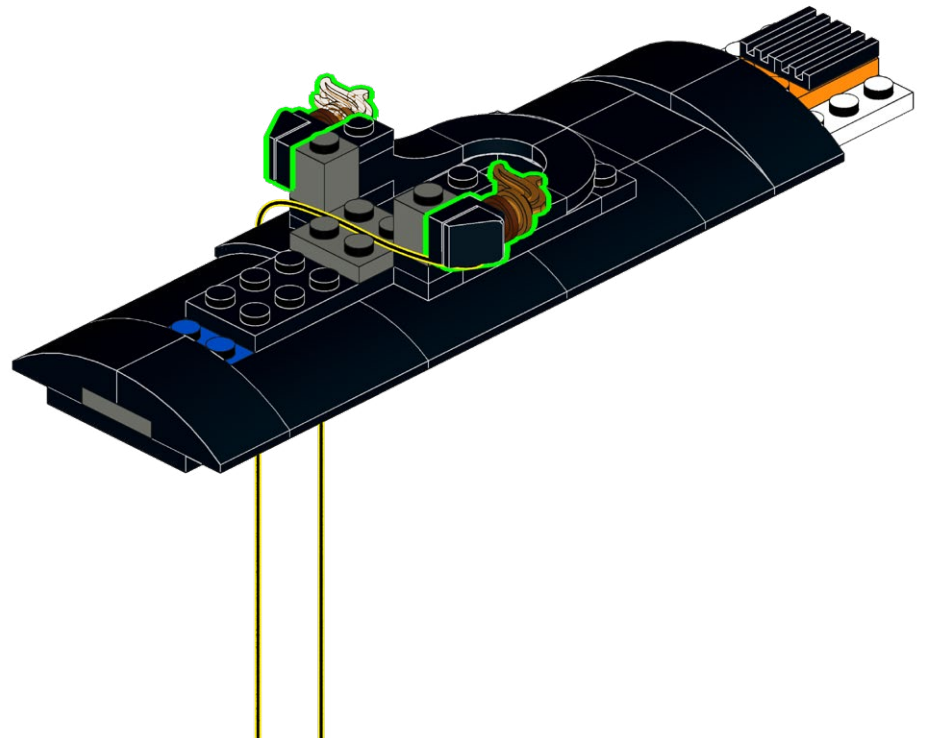
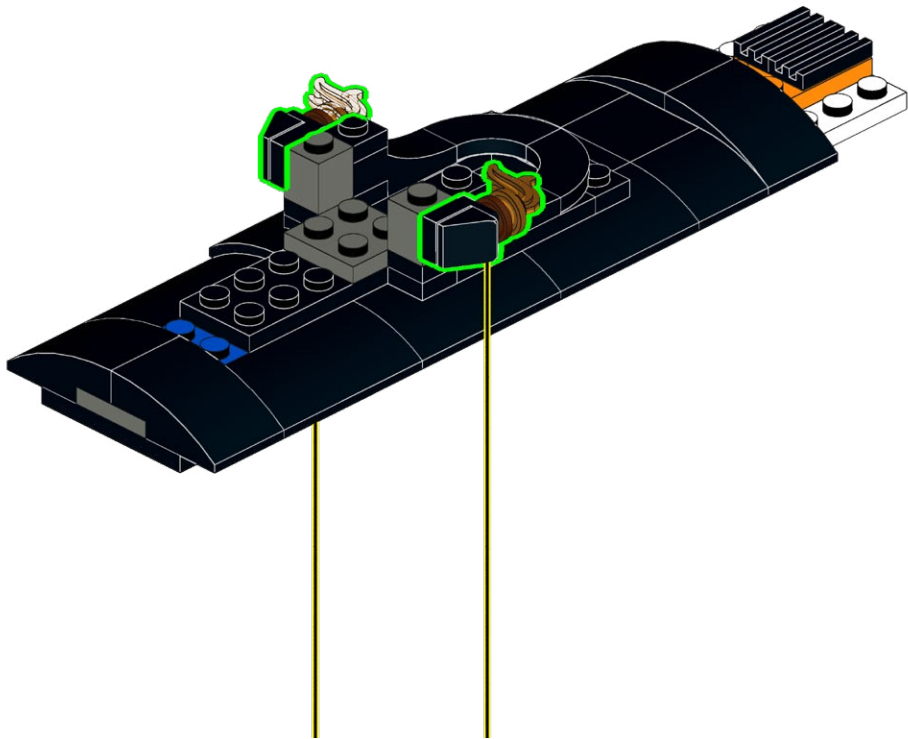

335

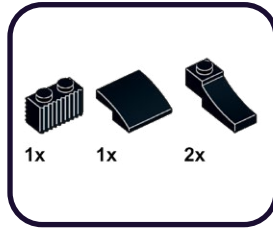

336

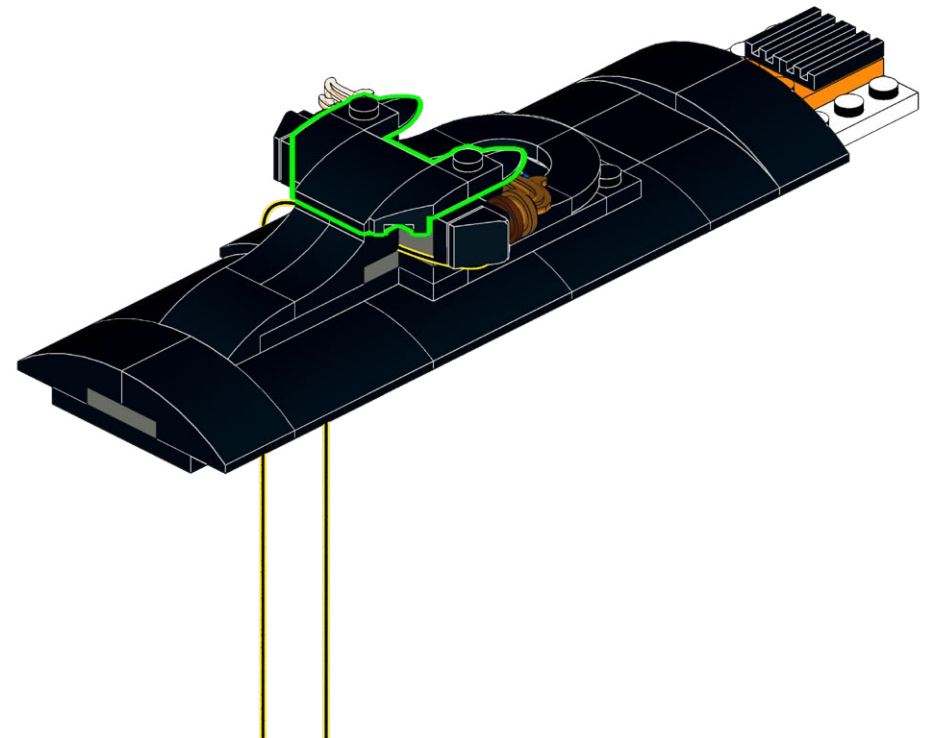
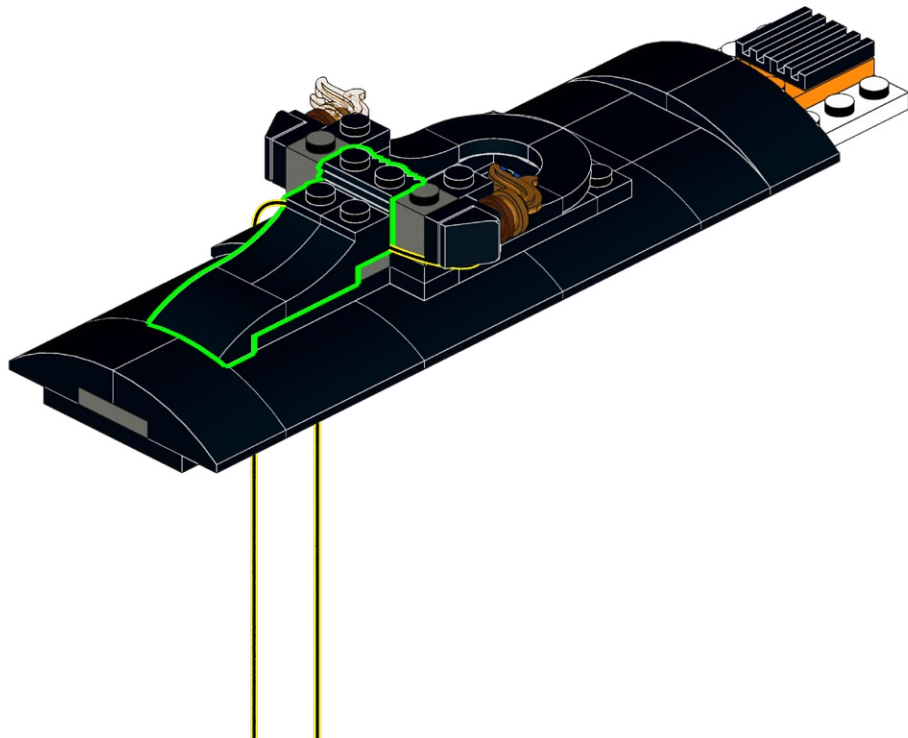
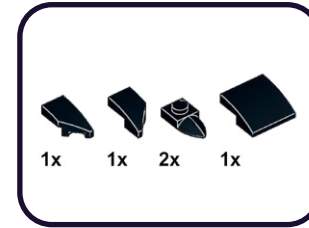

337

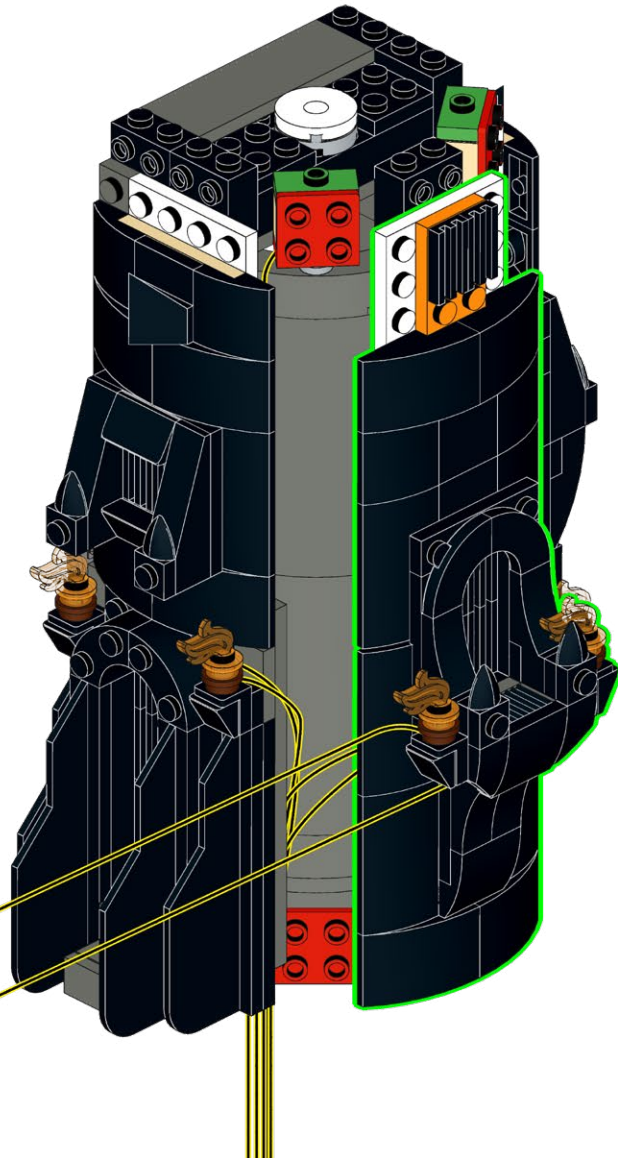

338

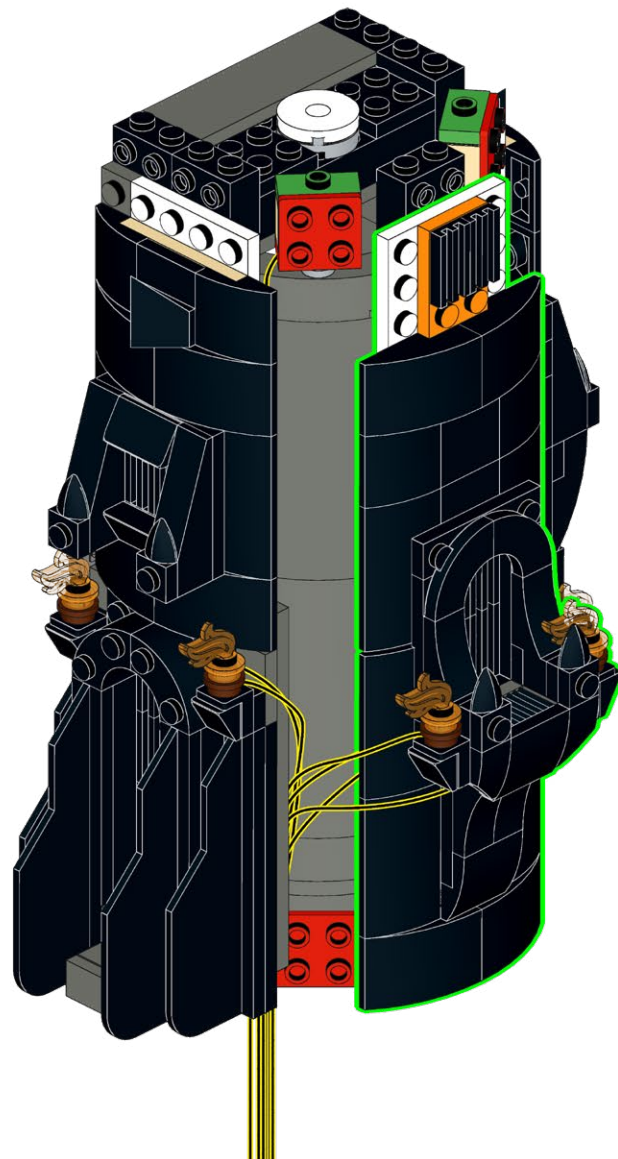

339

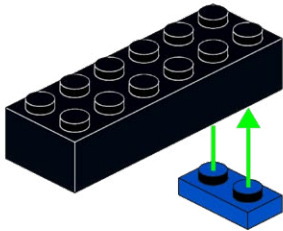
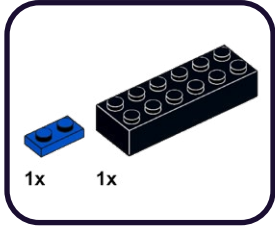

340

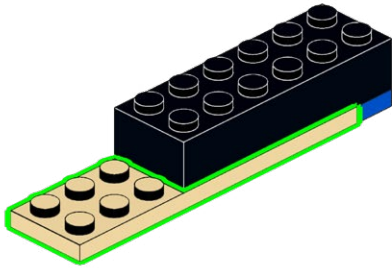
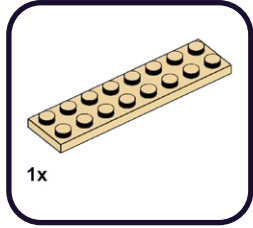

341

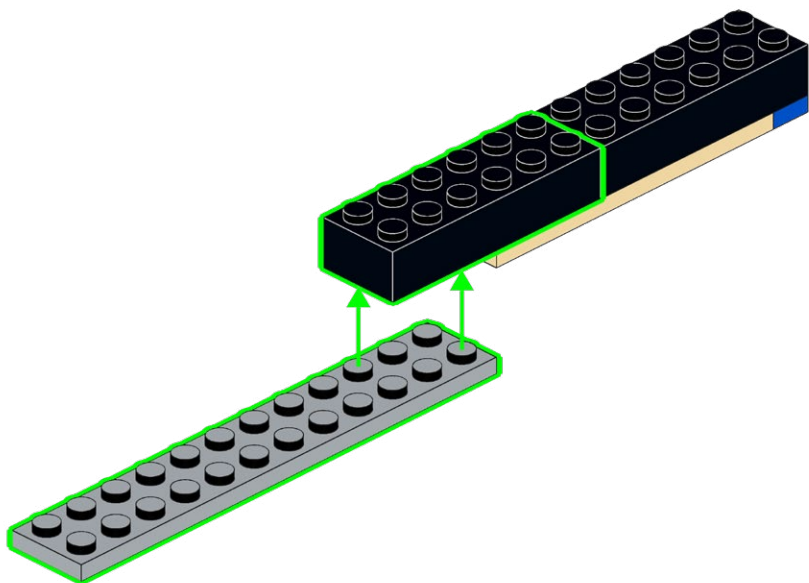
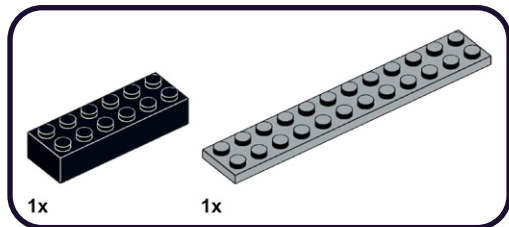

342

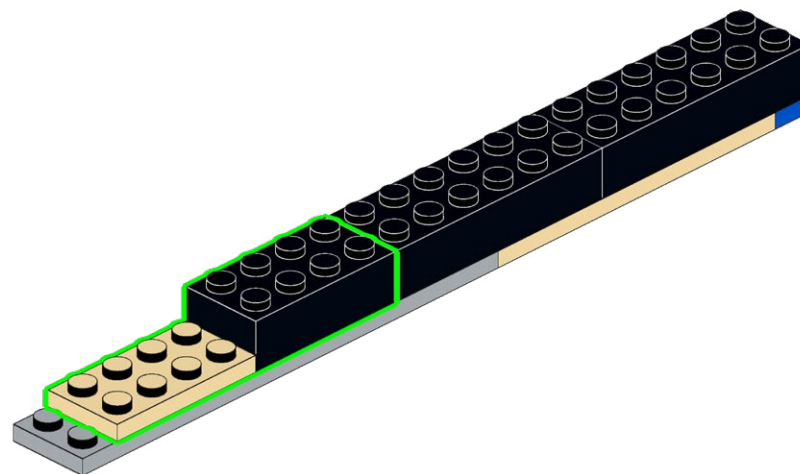
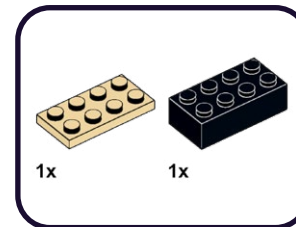

343

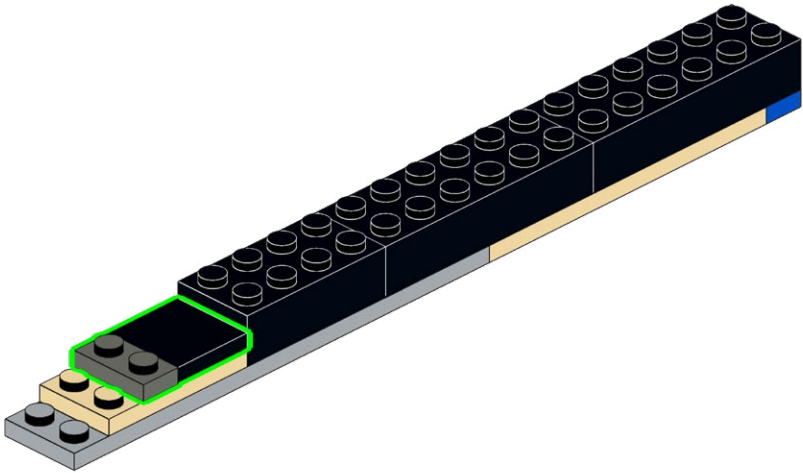
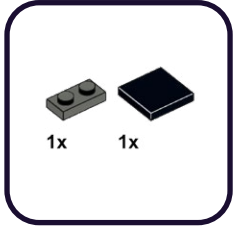

344

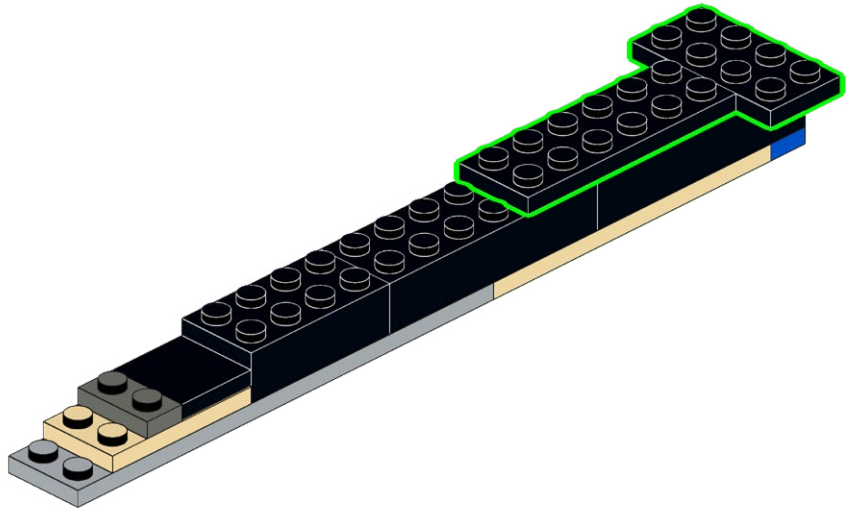
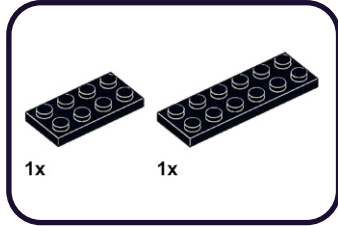

345

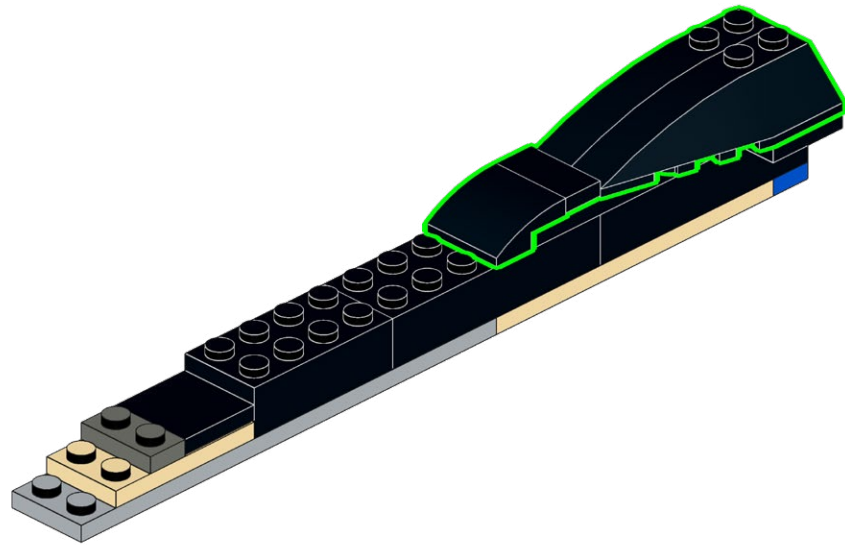
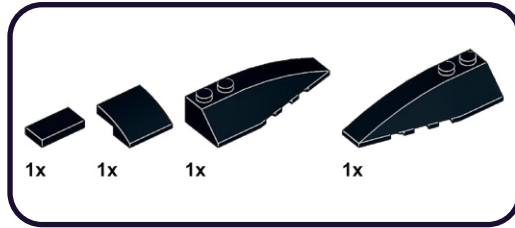

346

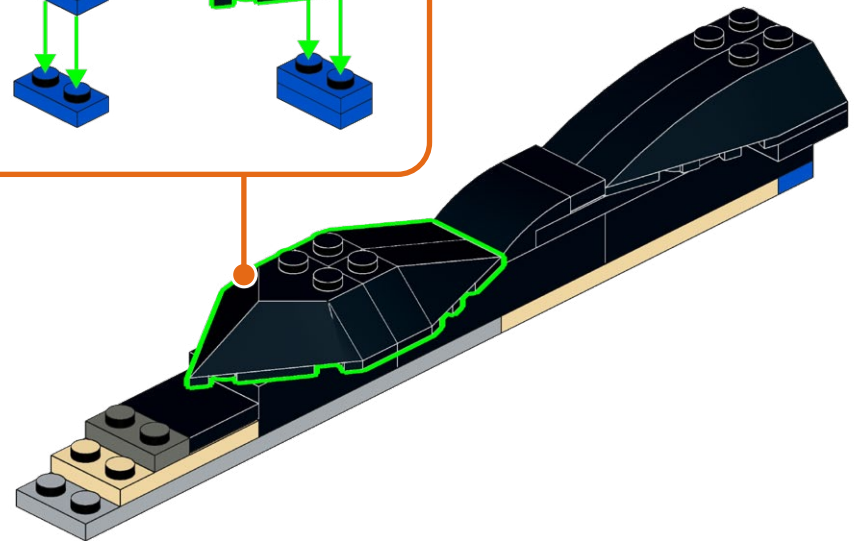
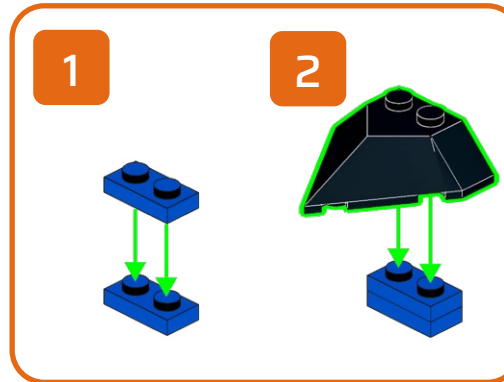
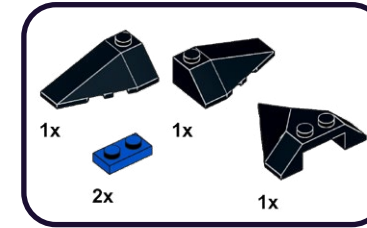

347

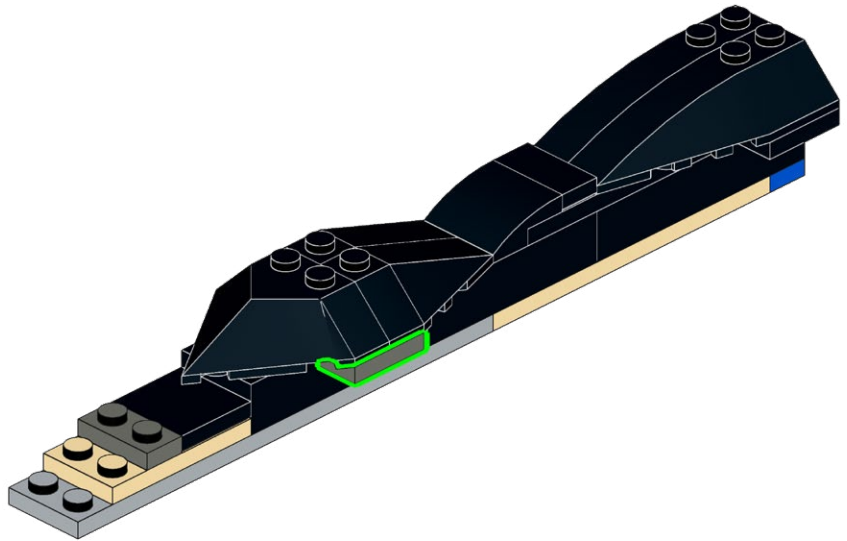
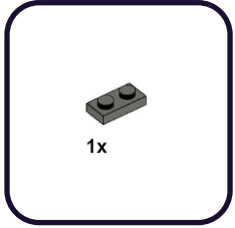

348

1x

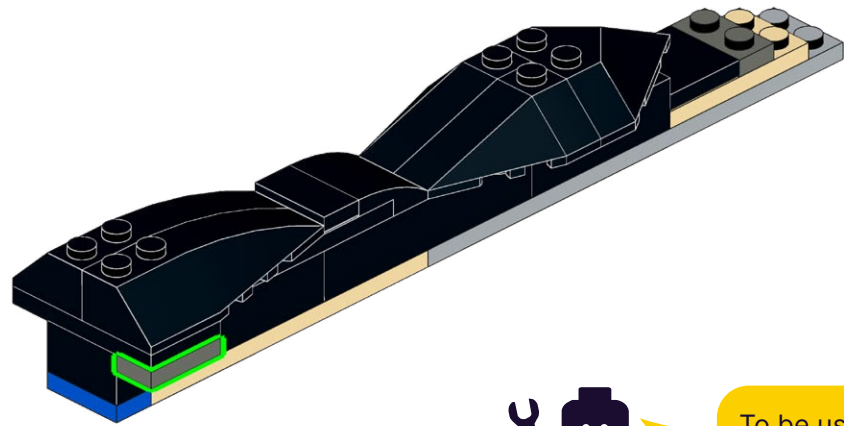

To be used later
A utiliser plus tard
Da utilizzare dopo
Zur späteren Verwendung
Para ser utilizado más tarde
稍后使用

349

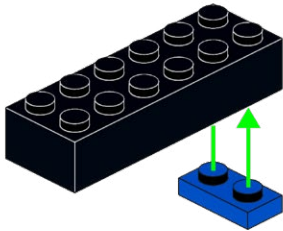
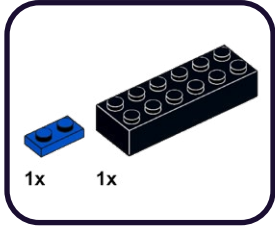

350

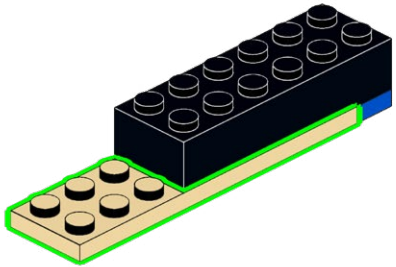
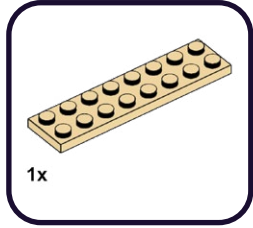

351

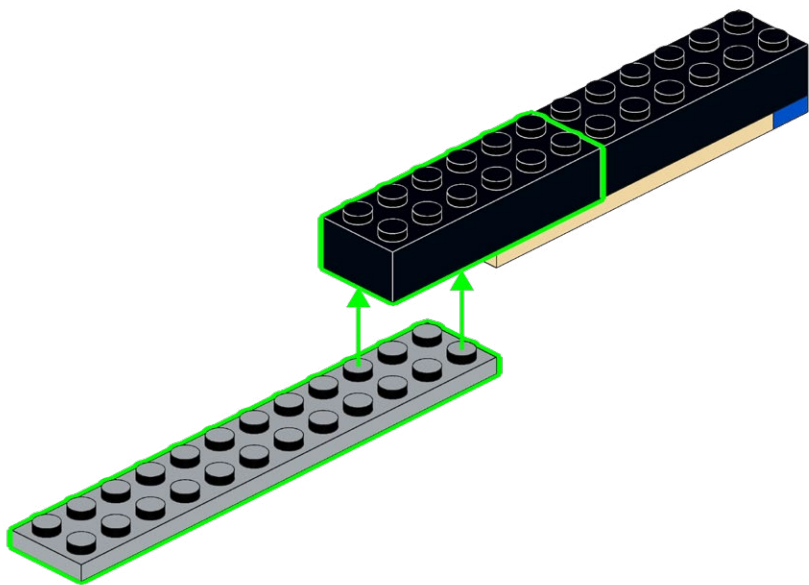
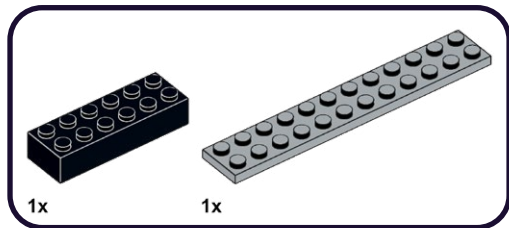

352

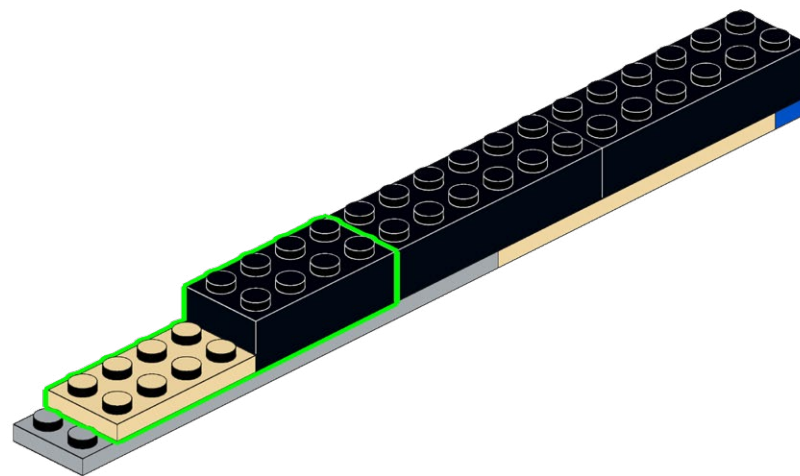
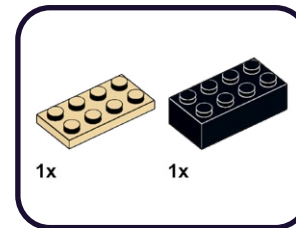

353

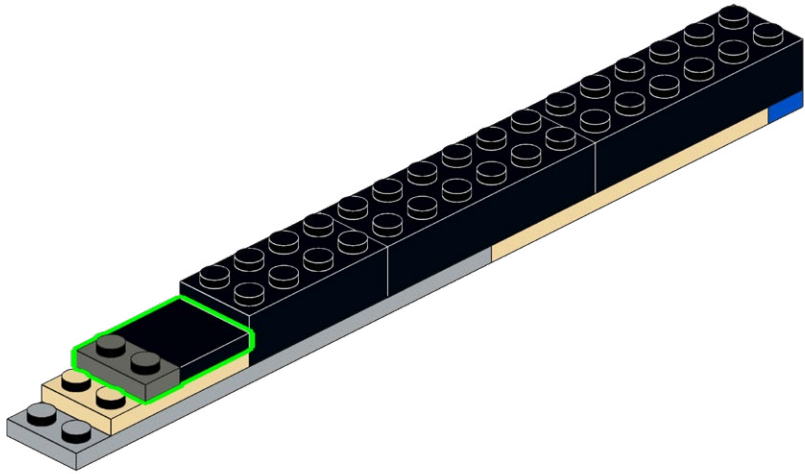
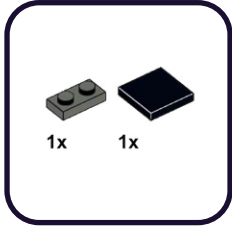

354

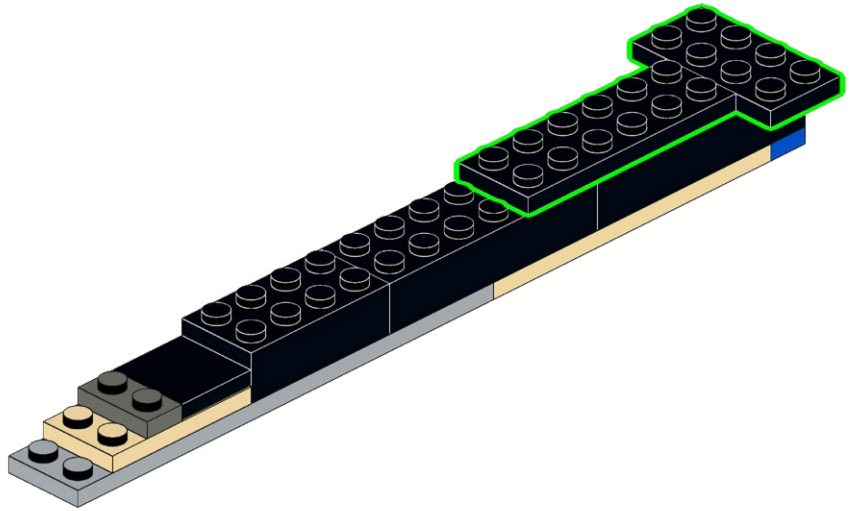
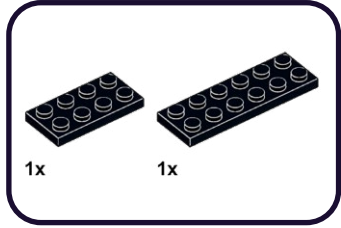

355

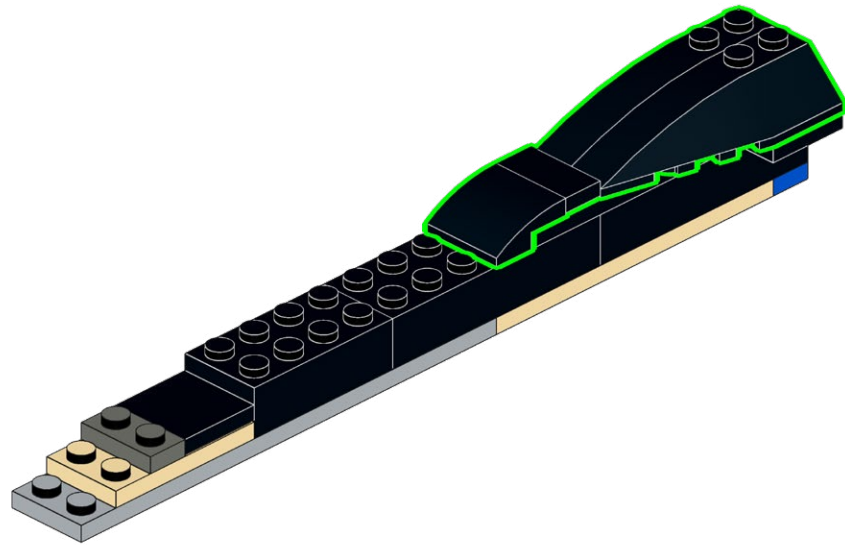
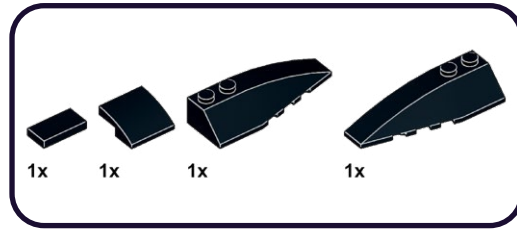

356

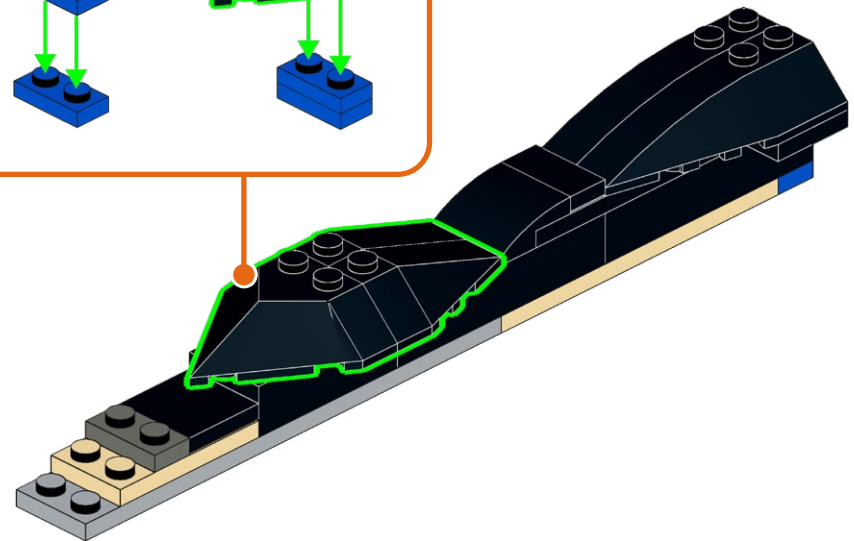
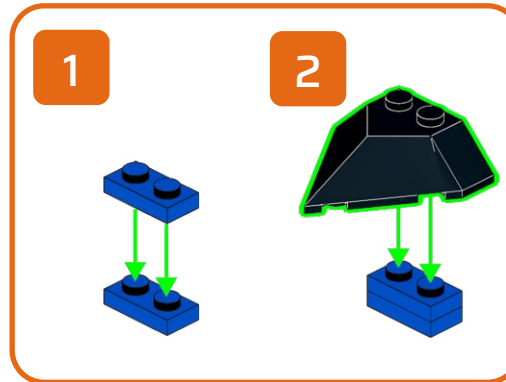
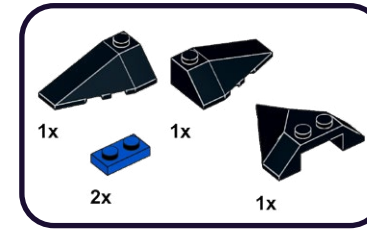

357

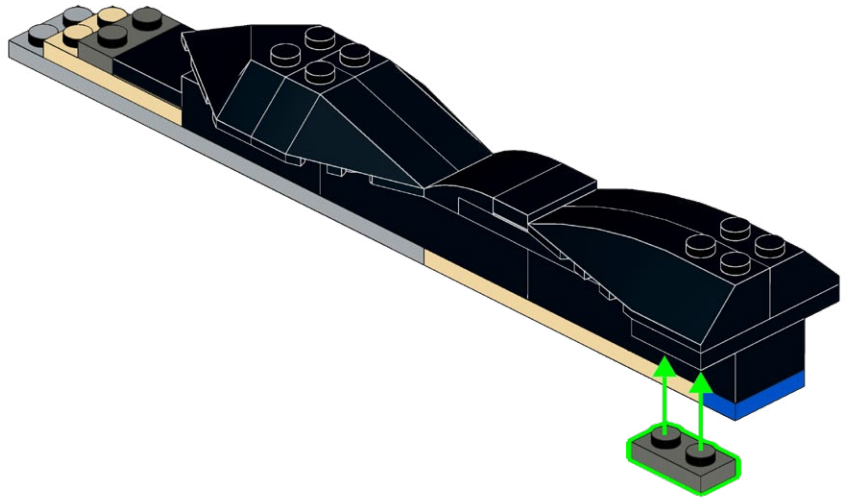
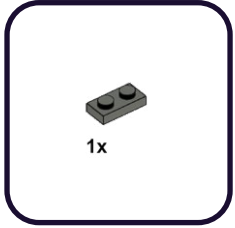

358

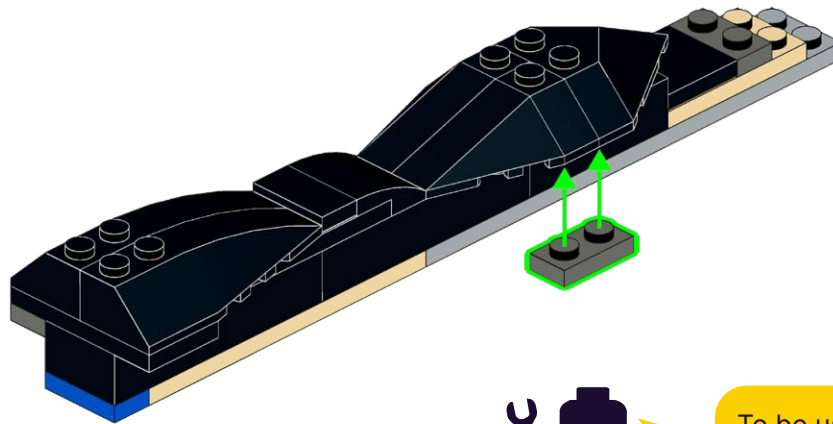
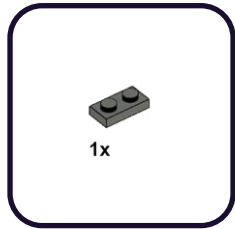

To be used later
A utiliser plus tard
Da utilizzare dopo
Zur späteren Verwendung
Para ser utilizado más tarde
稍后使用

**HOLD UP!**

You might notice some bags aren't in order, as well as left over pieces, but that's ok! We're changing the way you build LEGO!

ATTENDEZ!

Vous remarquerez peut-être que certains sacs, ainsi que certaines pièces, ne sont pas dans le bon ordre. Mais pas de panique! Nous changeons simplement la façon avec laquelle vous construisez vos LEGO!

ASPETTA!

Potresti notare che alcuni sacchetti non sono in ordine, così come i pezzi avanzati, ma va bene così! Stiamo cambiando il modo in cui costruisci i LEGO!

HALT!

Sie werden möglicherweise bemerken, dass einige tüten durcheinander sind und teile übrig bleiben, aber das ist in Ordnung! Wir ändern die art und weise, wie Sie LEGO bauen!

¡ESPERA!

Es posible que notes que algunas bolsas están fuera de servicio, así como piezas sobrantes, ¡pero está bien! ¡Estamos cambiando la forma en que construyes LEGO!

暫停!

你可能会注意到一些袋子顺序错乱, 以及一些剩余的部件, 但没关系! 我们正在改变你搭建乐高的方式!

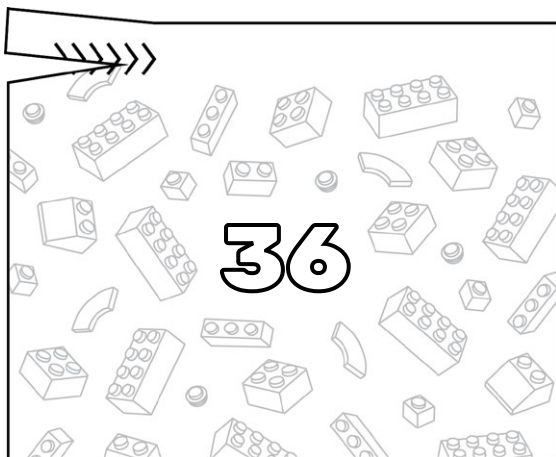
Open LEGO® Bag 36

359

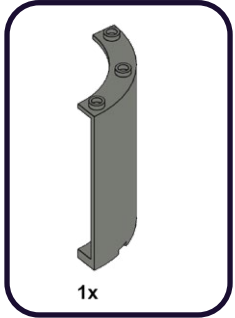

360

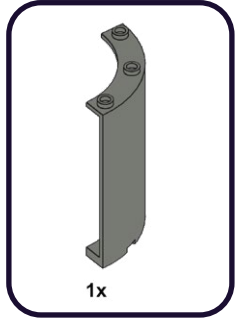

12

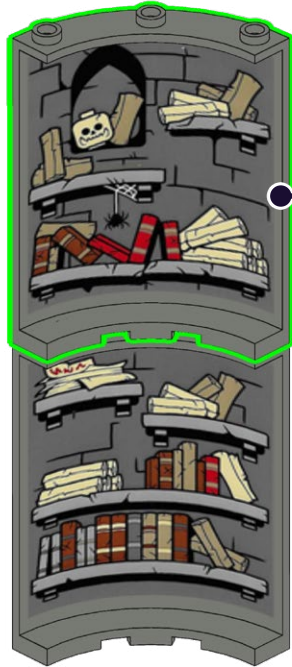

10

361

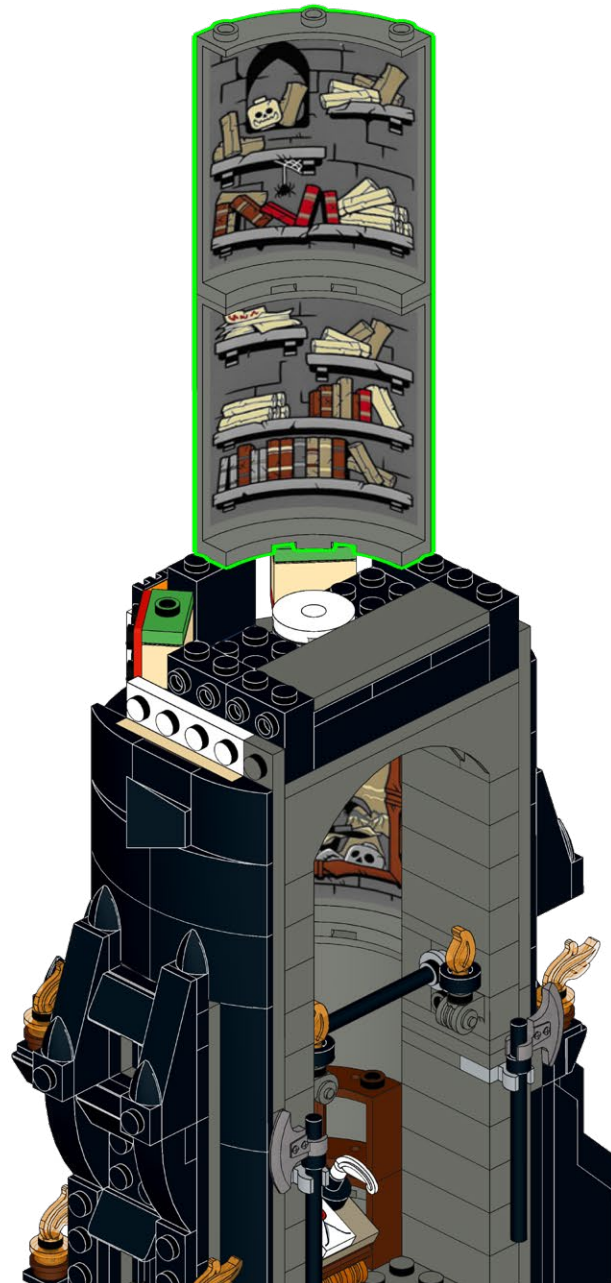

362

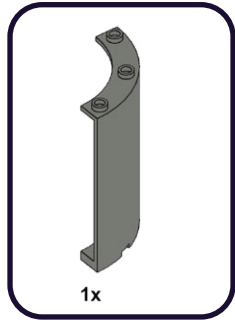

363

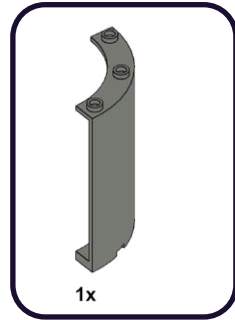

11

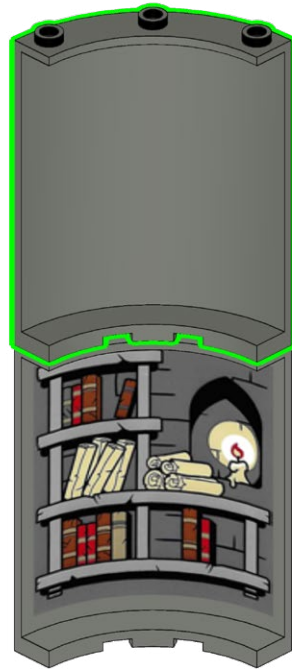

364

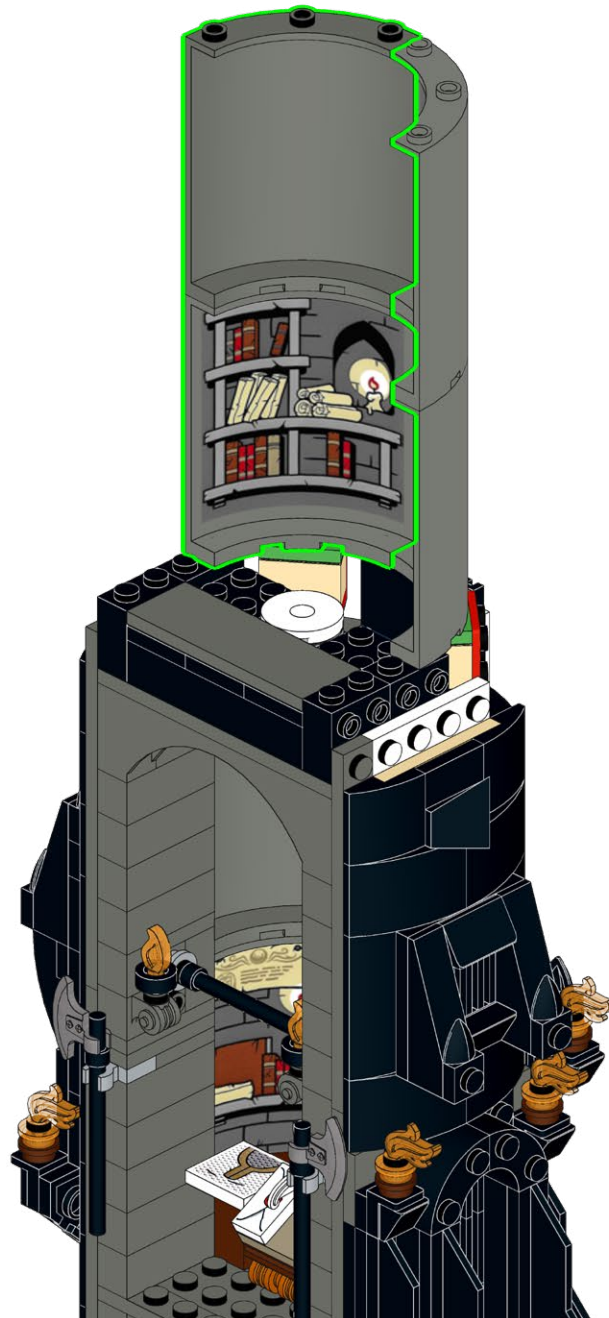

365

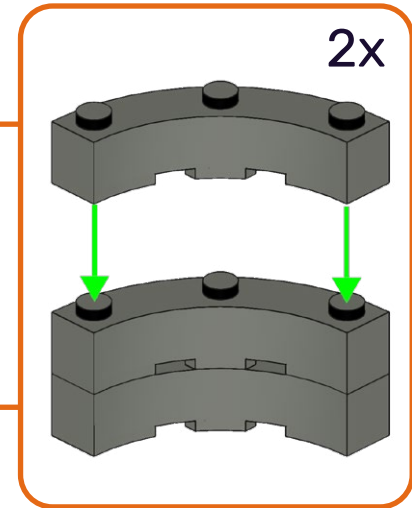
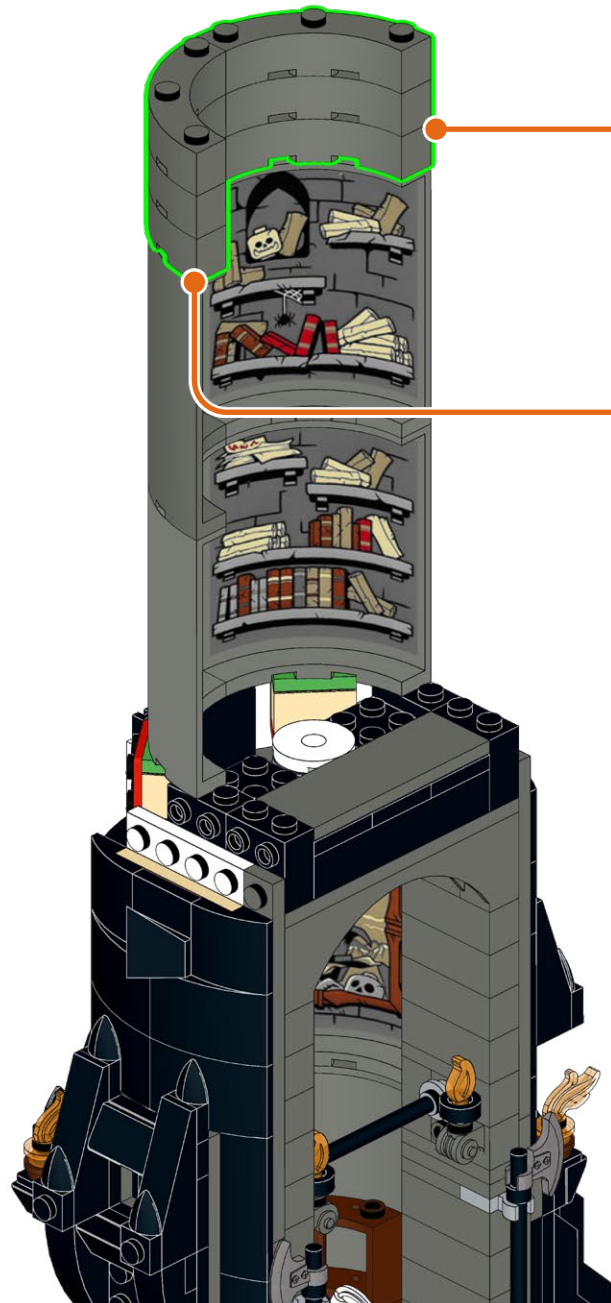
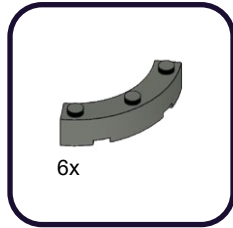

366

4x

1x

2x

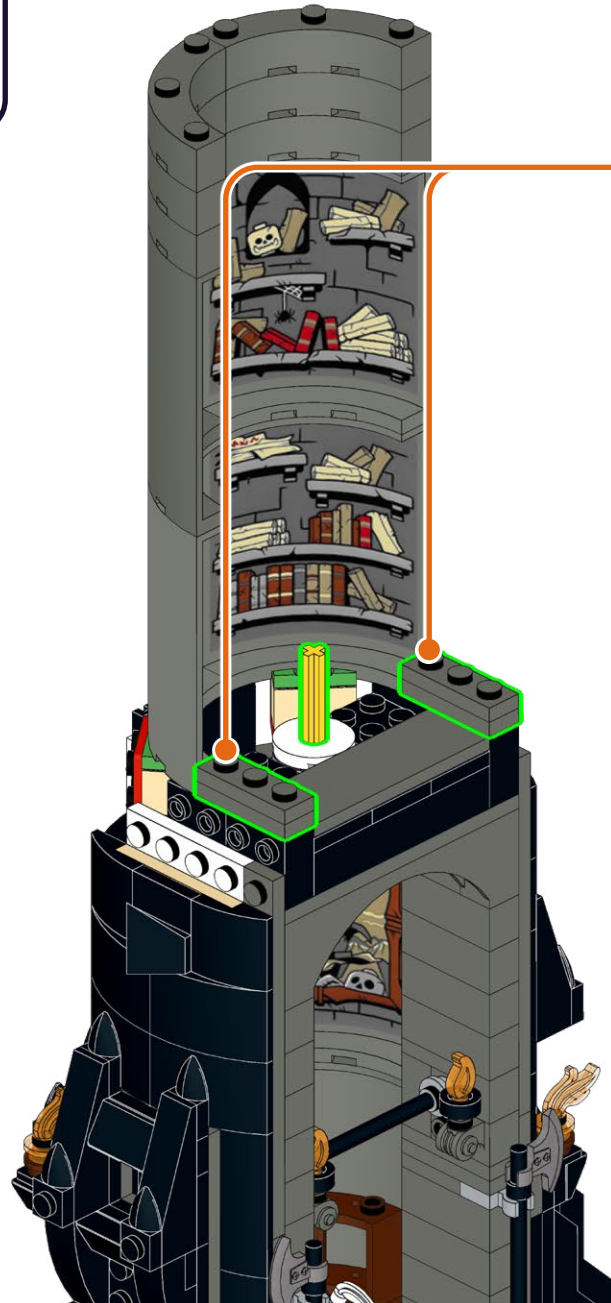

367

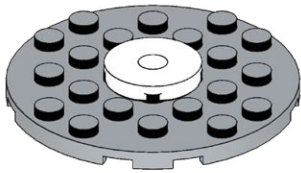
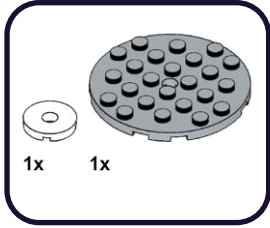

368

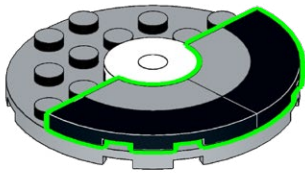
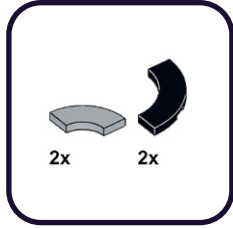

369



370

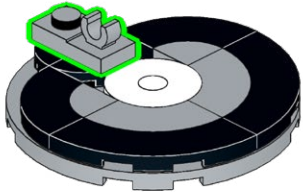
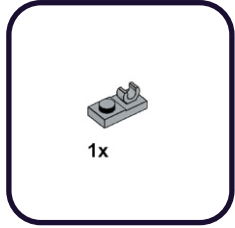

371

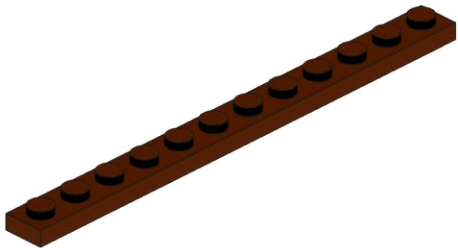
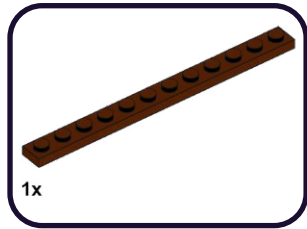

372

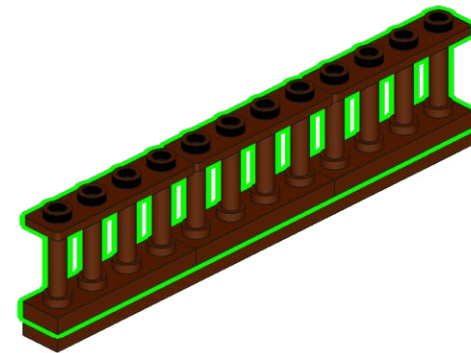
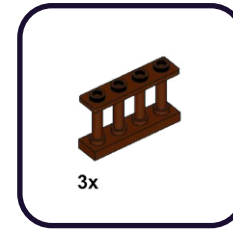

373

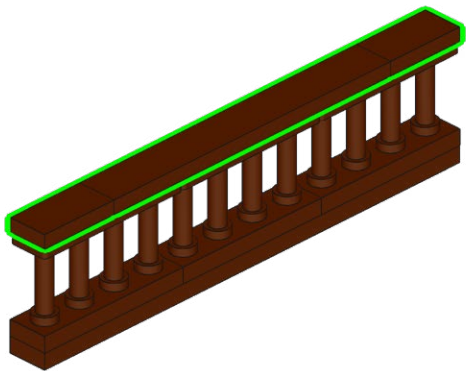
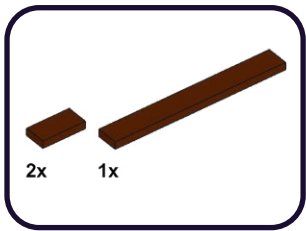

374

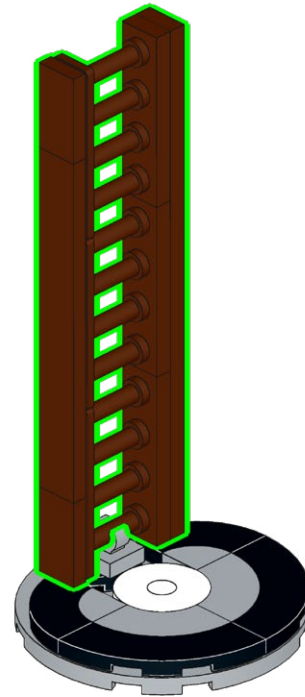

375

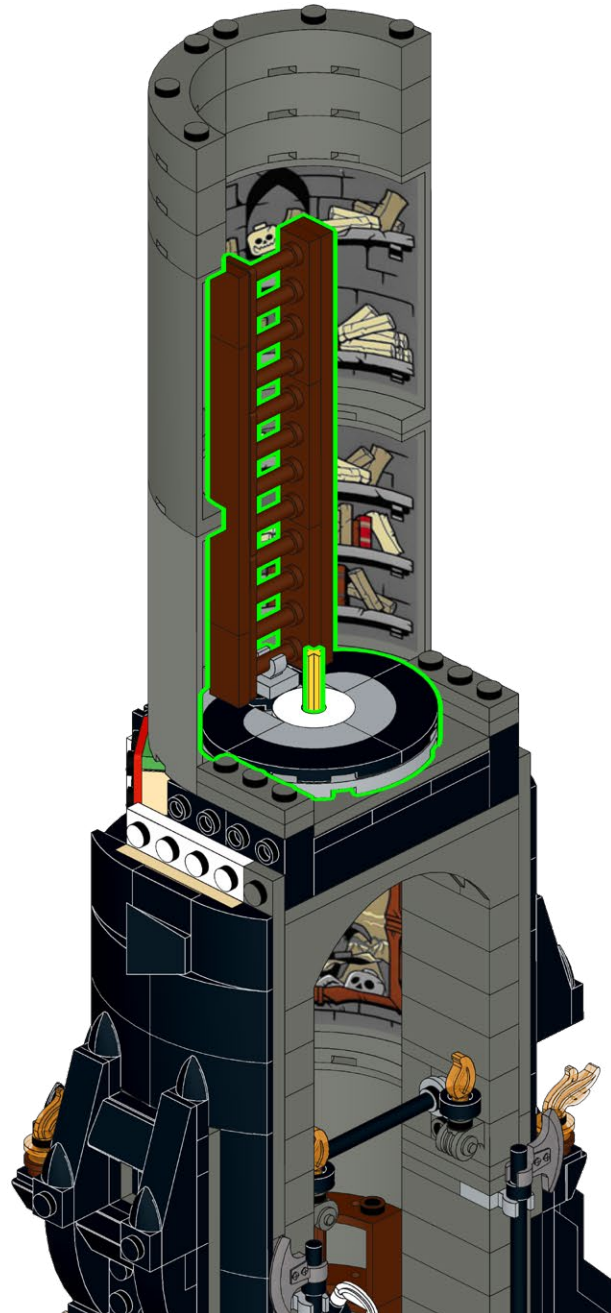

376

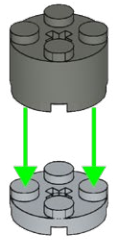
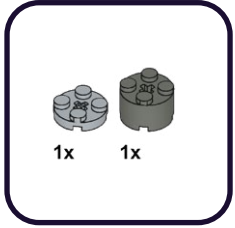

377

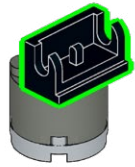
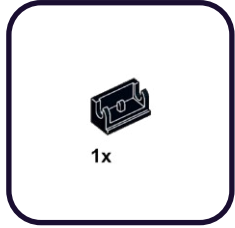

378

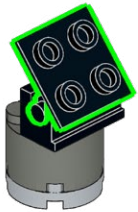
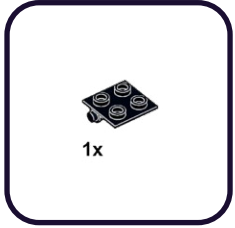

379

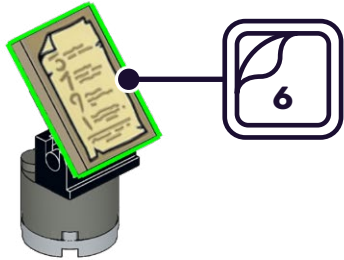
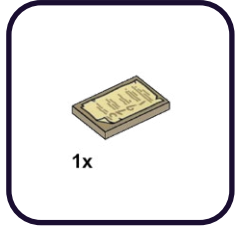

380

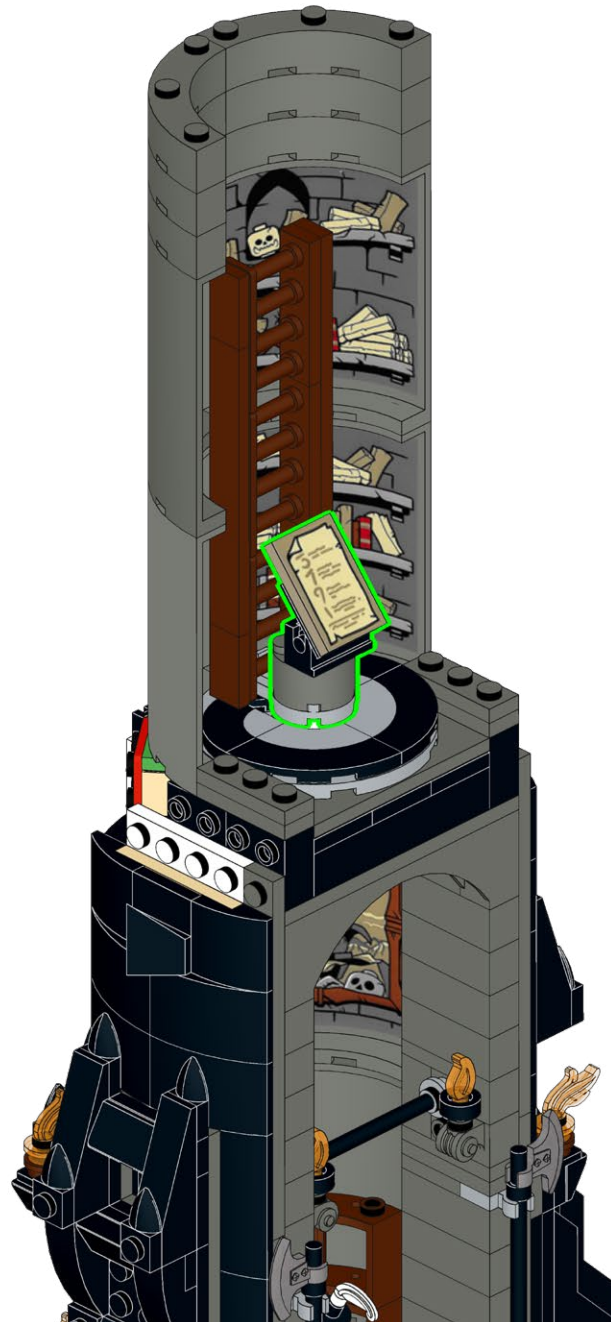

381

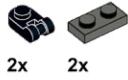

382

10x

2x

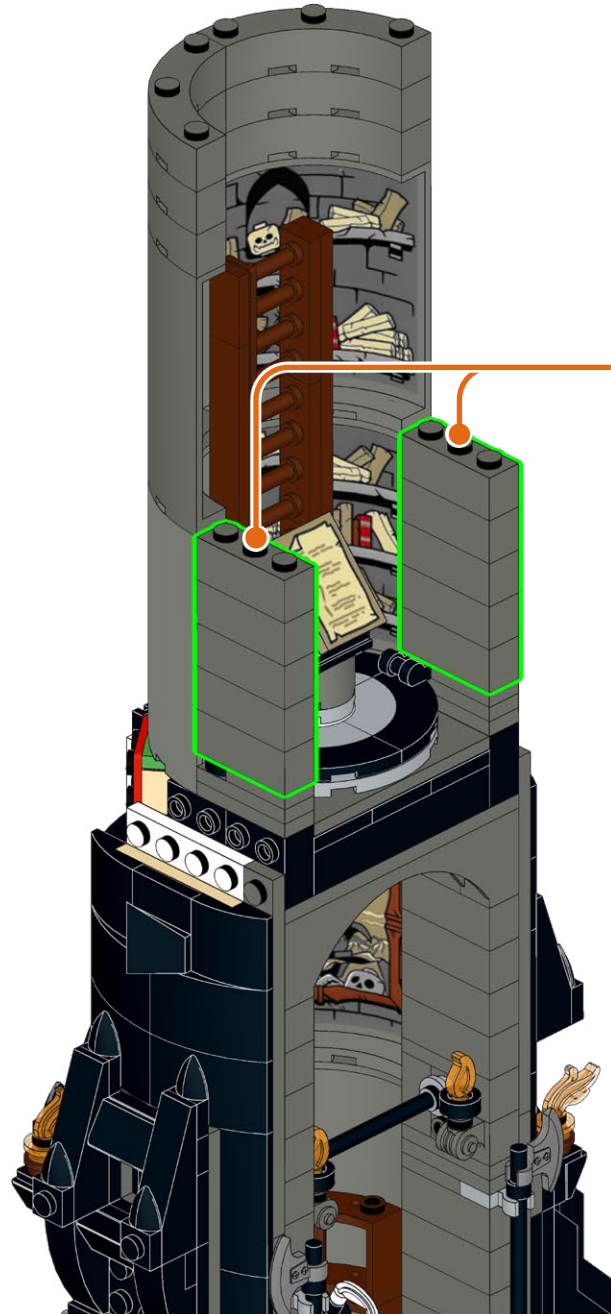

383

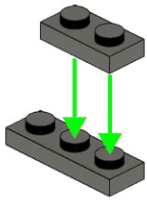
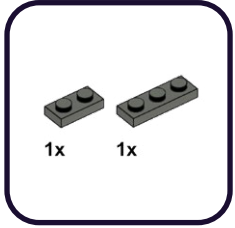

384

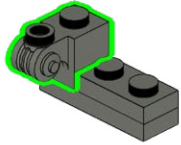
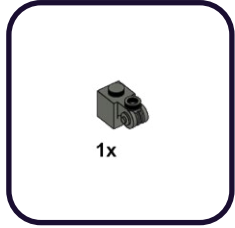

385

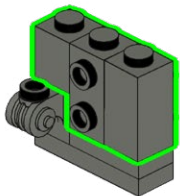
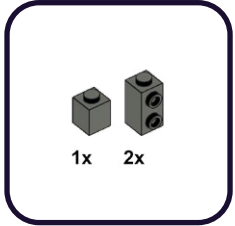

386

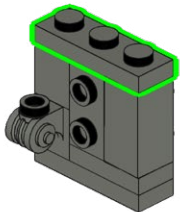
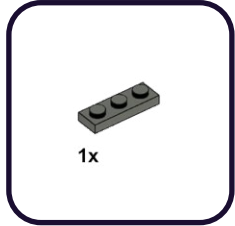

387

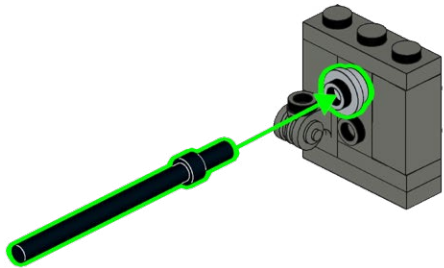

388

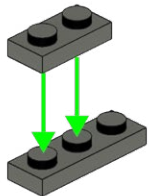
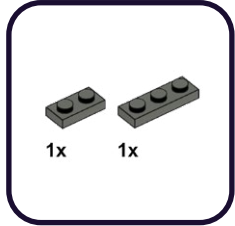

389

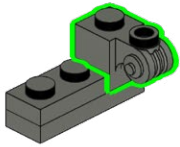
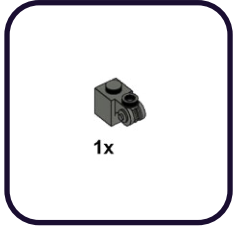

390

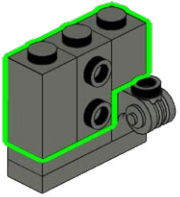
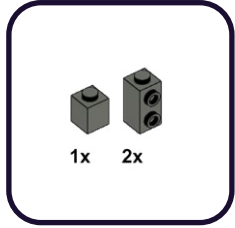

391

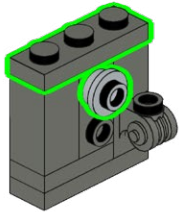
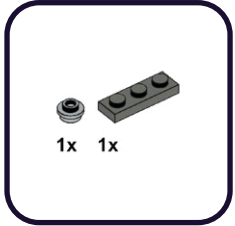

392

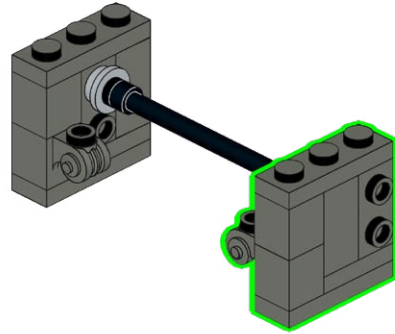

393

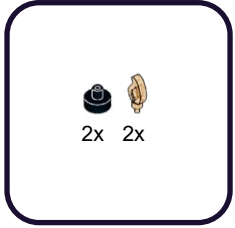

2x

394

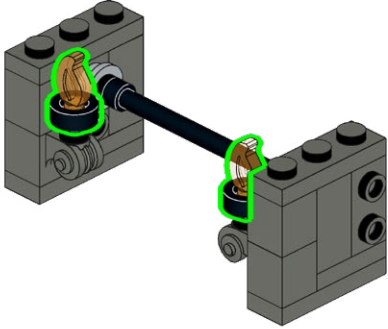

395

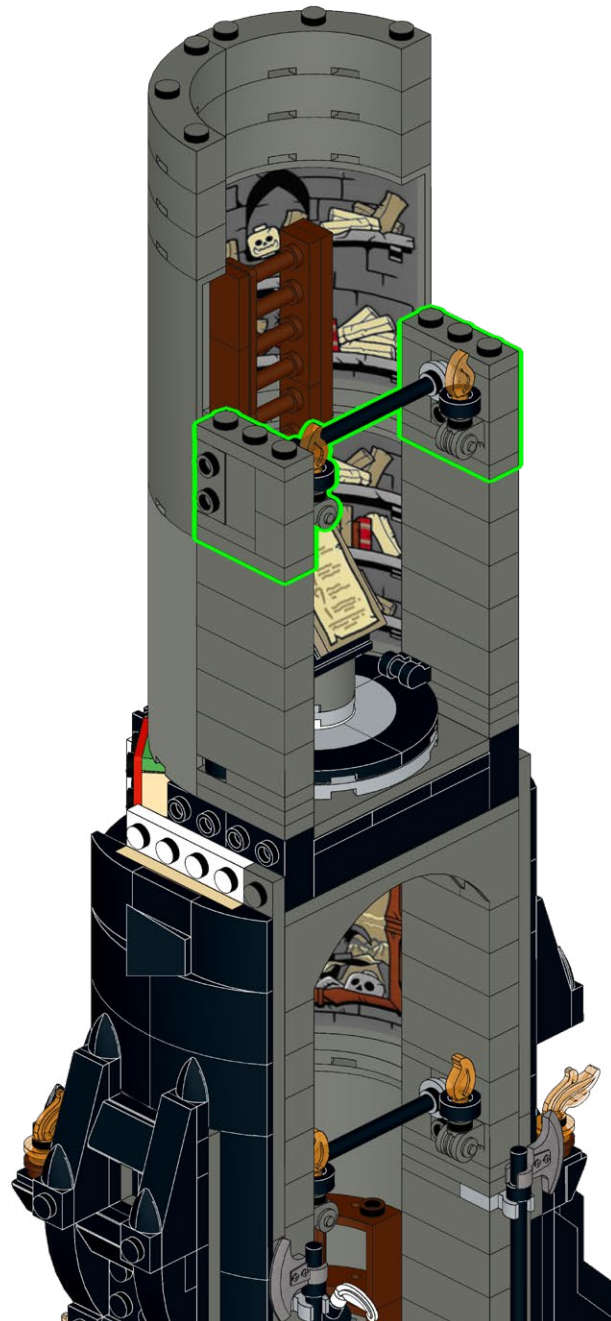

396

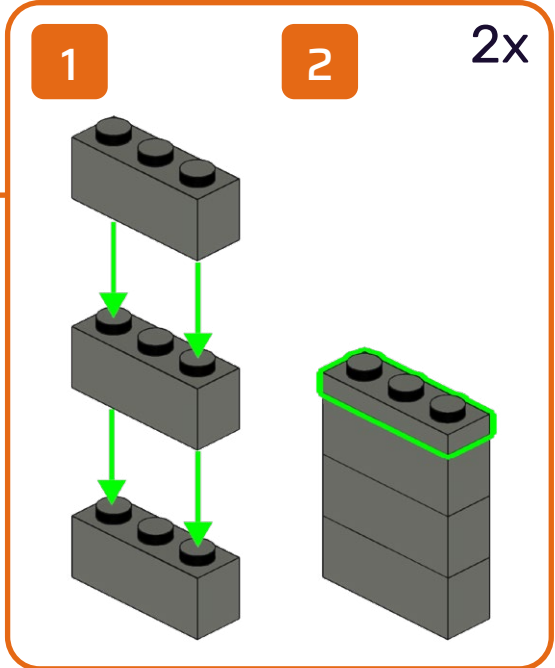
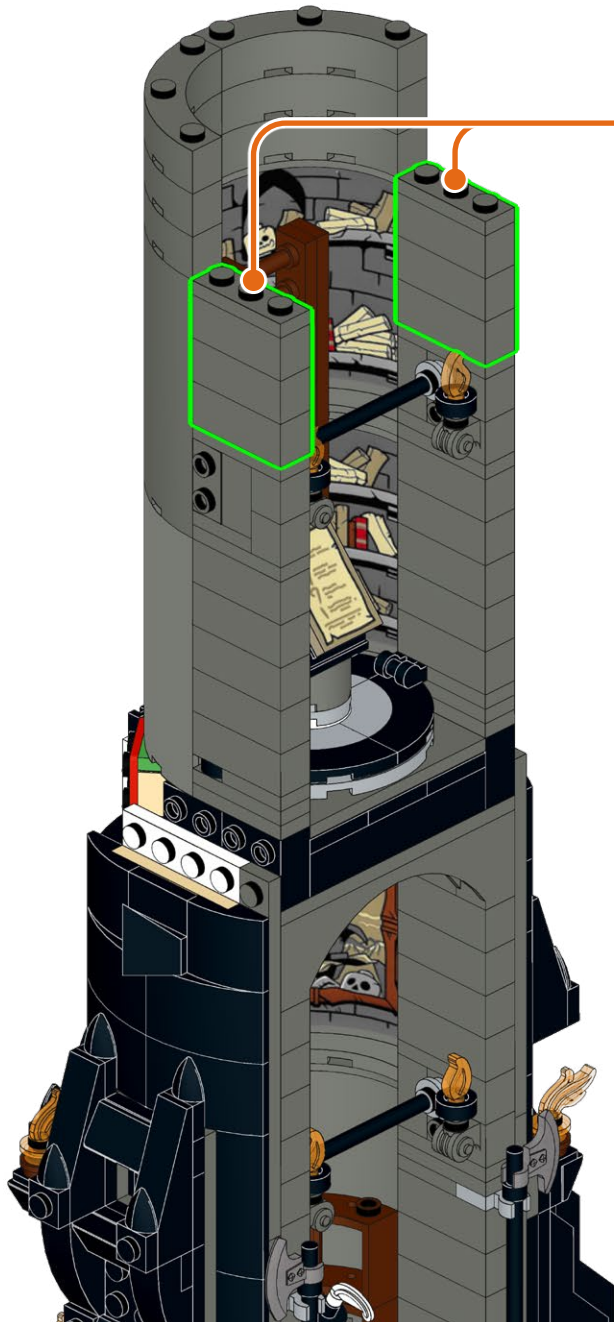
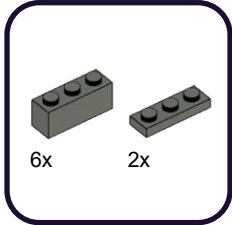

397

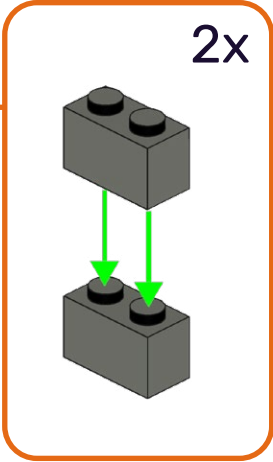
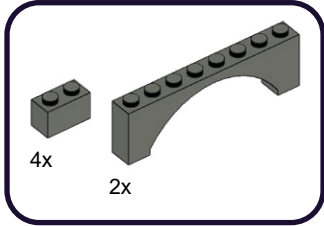

398

4x



399

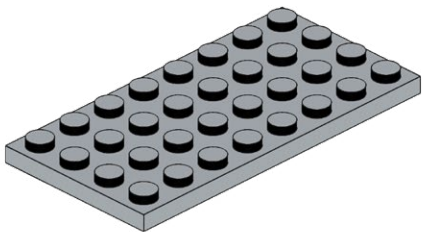
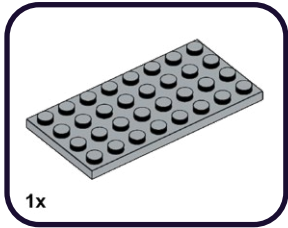

400

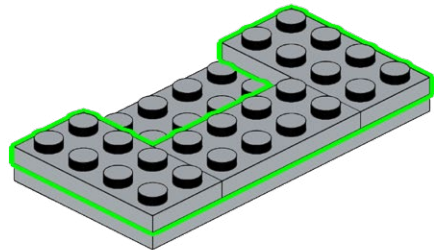
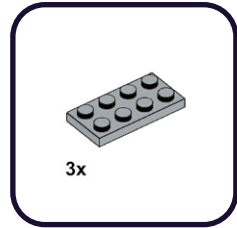

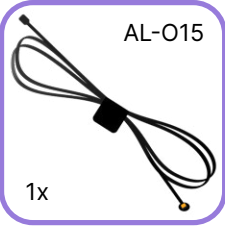
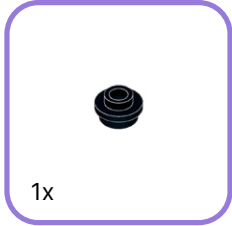

403

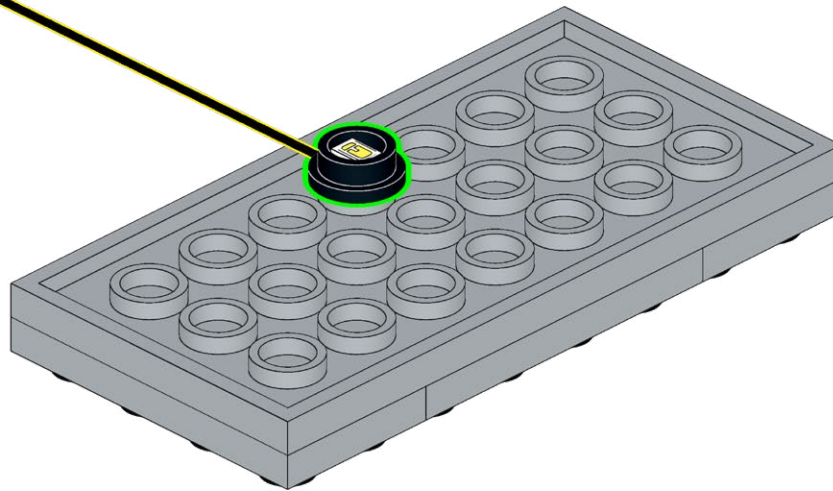

404



405



**HOLD UP!**

You might notice some bags aren't in order, as well as left over pieces, but that's ok! We're changing the way you build LEGO!

ATTENDEZ!

Vous remarquerez peut-être que certains sacs, ainsi que certaines pièces, ne sont pas dans le bon ordre. Mais pas de panique! Nous changeons simplement la façon avec laquelle vous construisez vos LEGO!

ASPETTA!

Potresti notare che alcuni sacchetti non sono in ordine, così come i pezzi avanzati, ma va bene così! Stiamo cambiando il modo in cui costruisci i LEGO!

HALT!

Sie werden möglicherweise bemerken, dass einige tüten durcheinander sind und teile übrig bleiben, aber das ist in Ordnung! Wir ändern die art und weise, wie Sie LEGO bauen!

¡ESPERA!

Es posible que notes que algunas bolsas están fuera de servicio, así como piezas sobrantes, ¡pero está bien! ¡Estamos cambiando la forma en que construyes LEGO!

暫停!

你可能会注意到一些袋子顺序错乱, 以及一些剩余的部件, 但没关系! 我们正在改变你搭建乐高的方式!

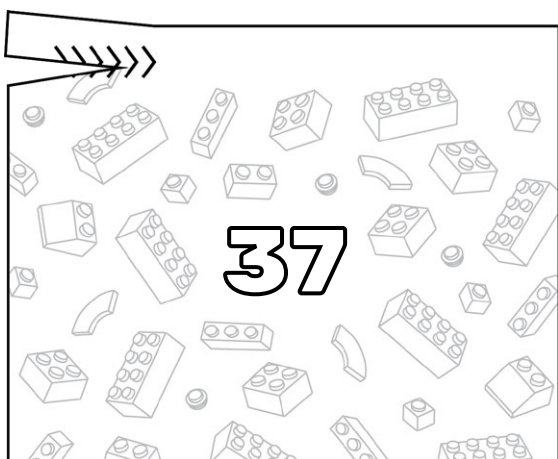
Open LEGO® Bag 37

406

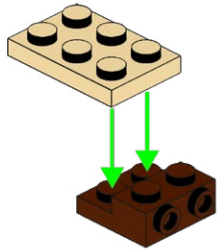
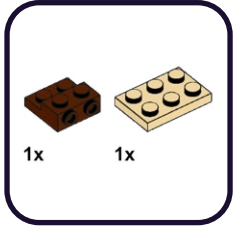

407

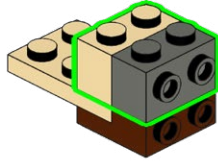
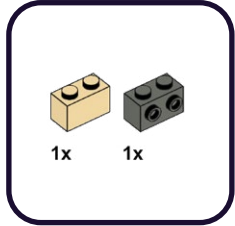

408

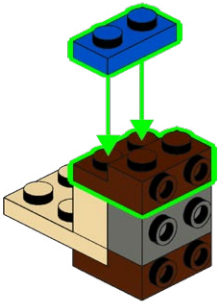
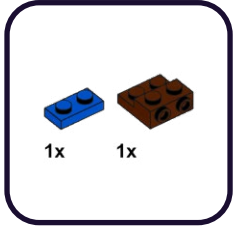

409

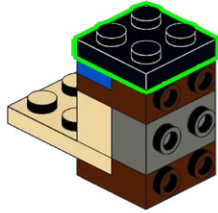
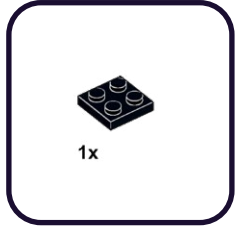

410

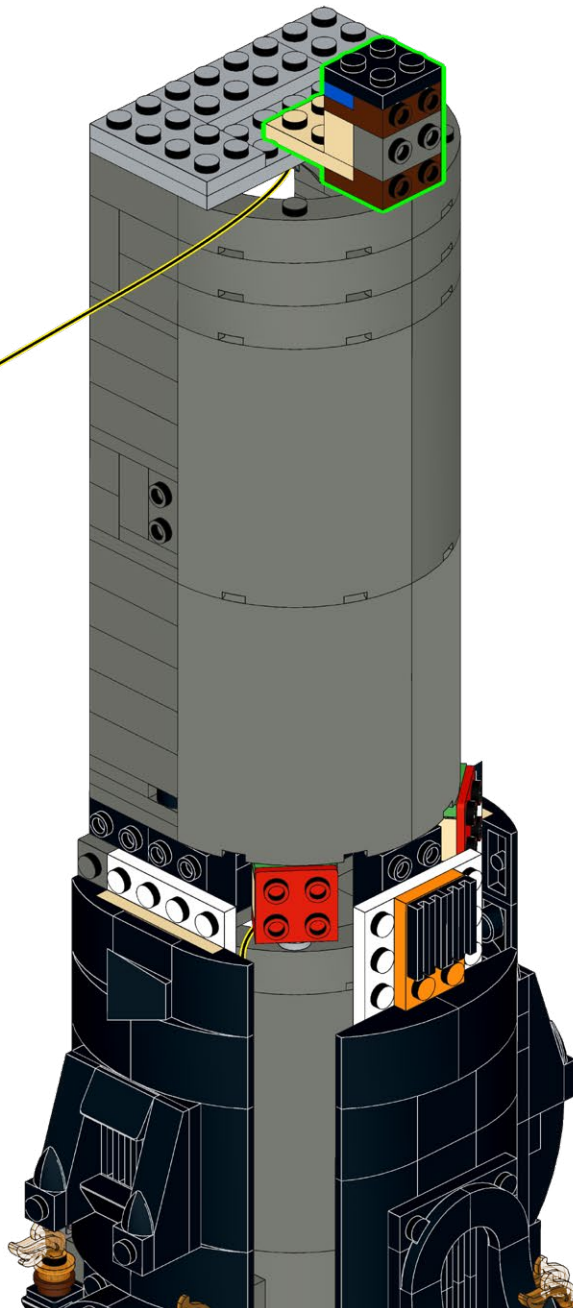

411

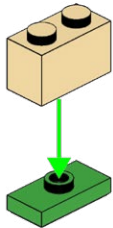
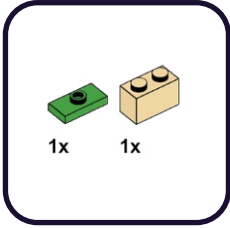
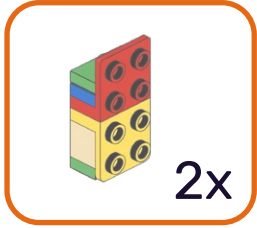

412

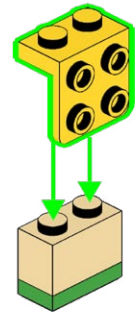
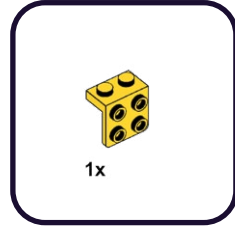

413

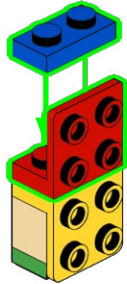
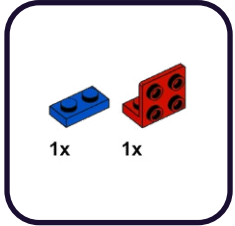

414

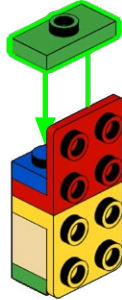
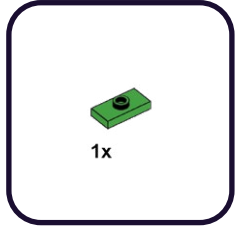

2x

415

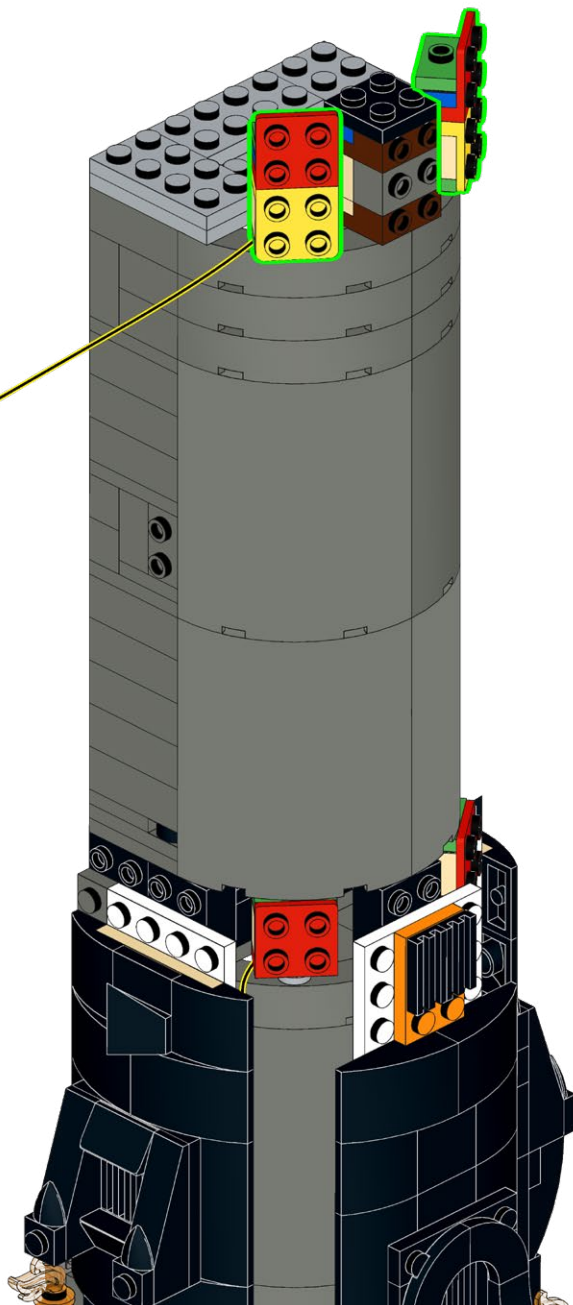

416

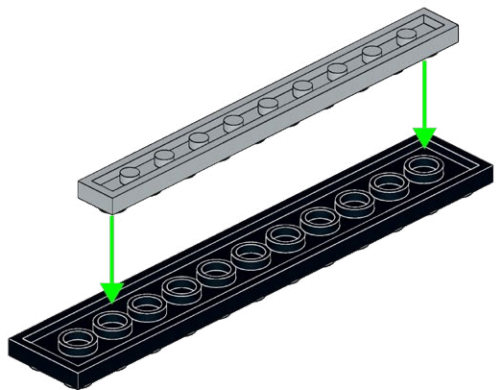
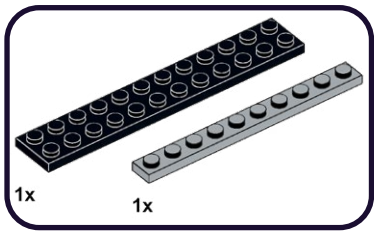

417

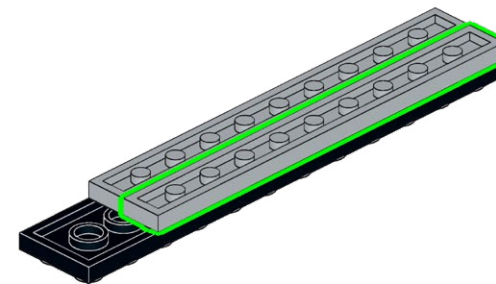
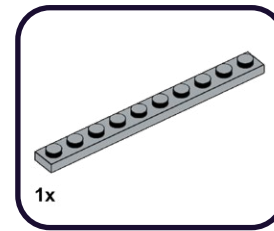

418

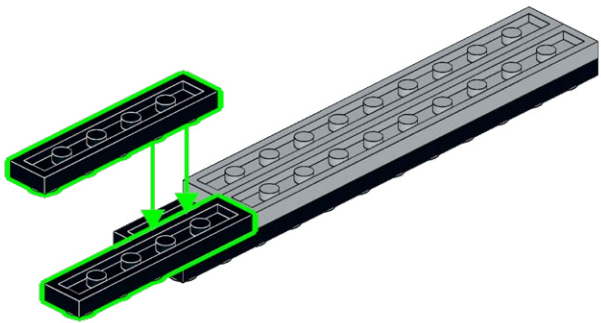
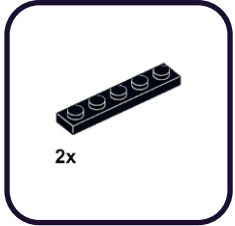

419

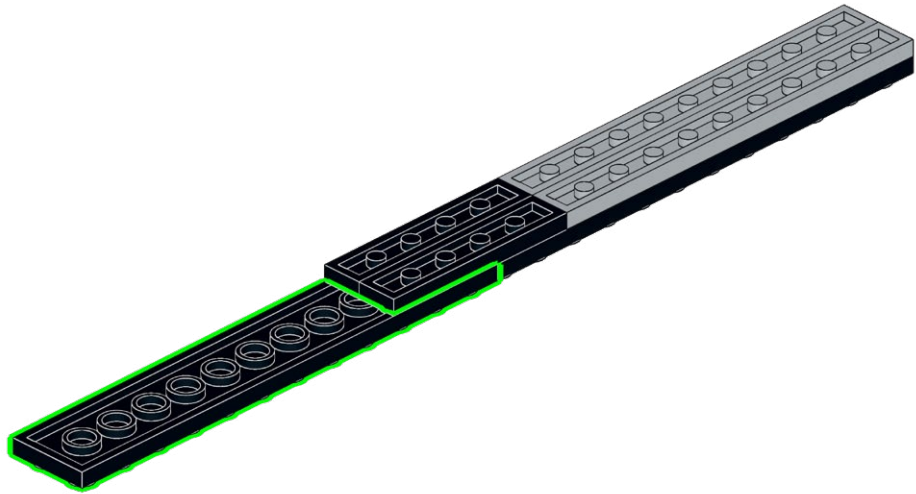
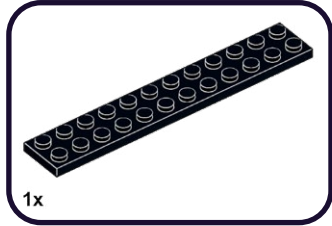

420

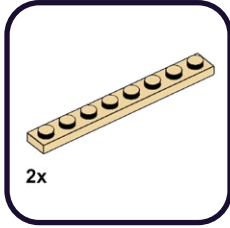

2x

421

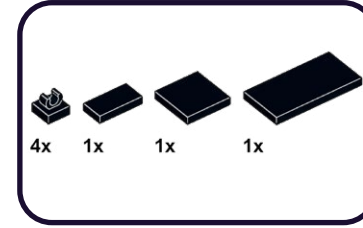

4x

1x

1x

1x

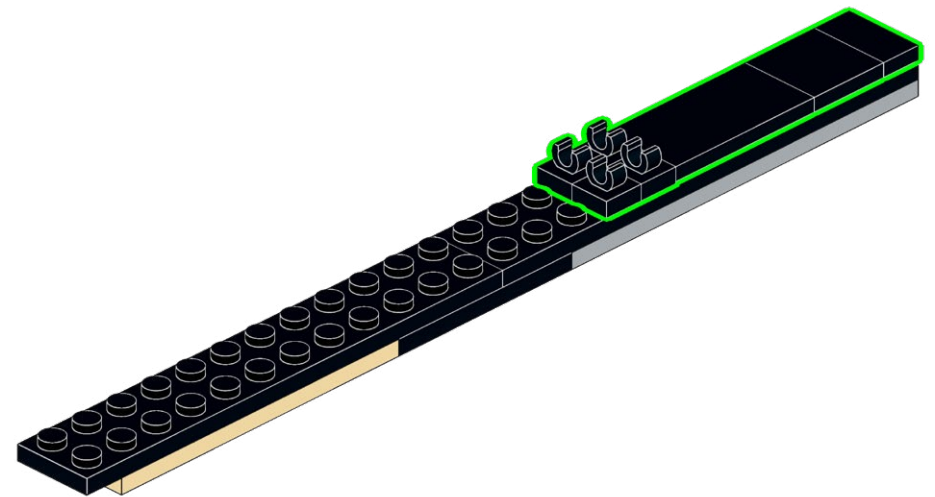
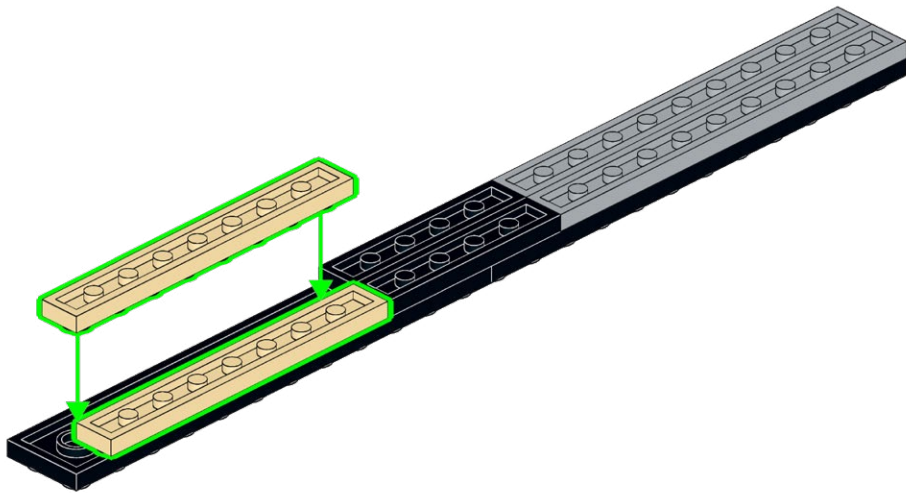
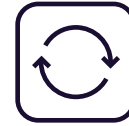

422

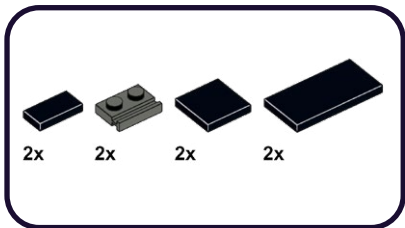

423

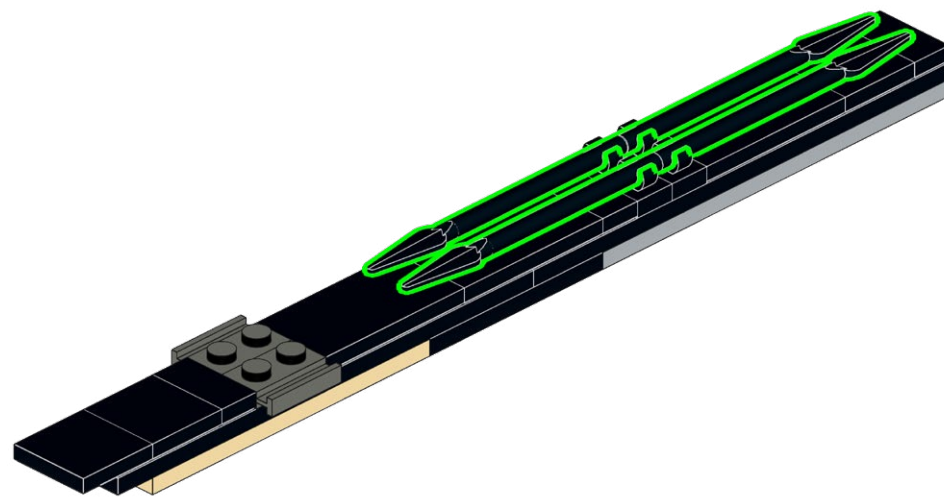
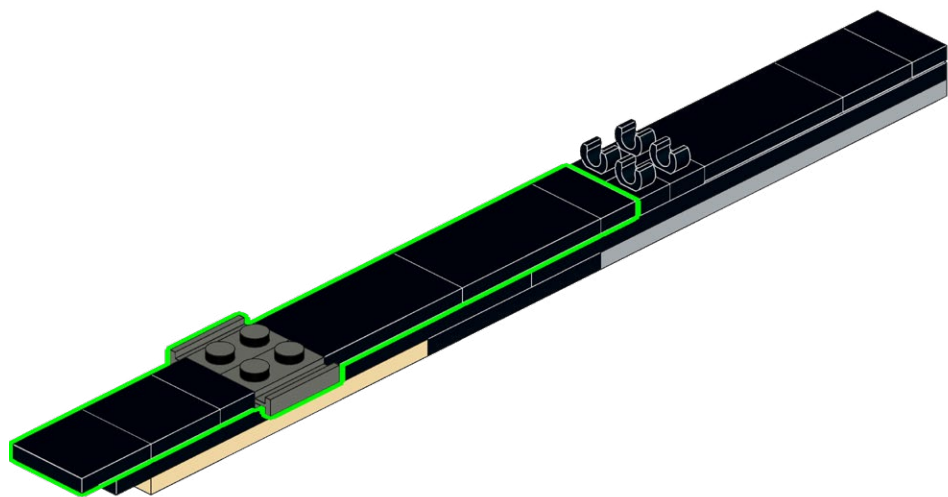
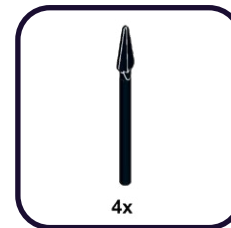

424

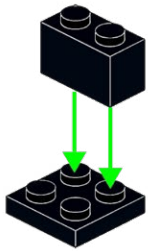
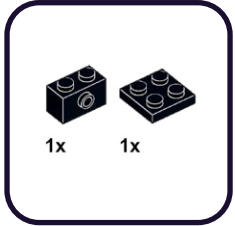

425

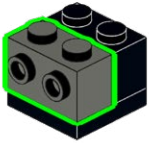
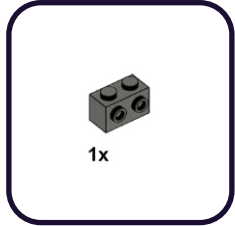

426

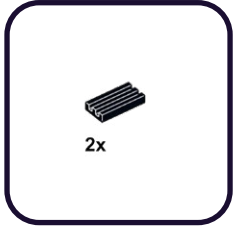

427

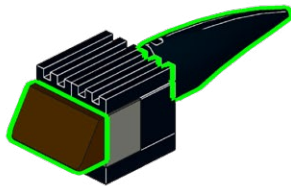
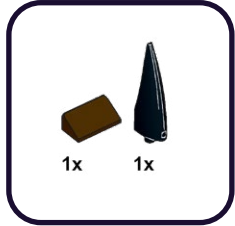

428

429

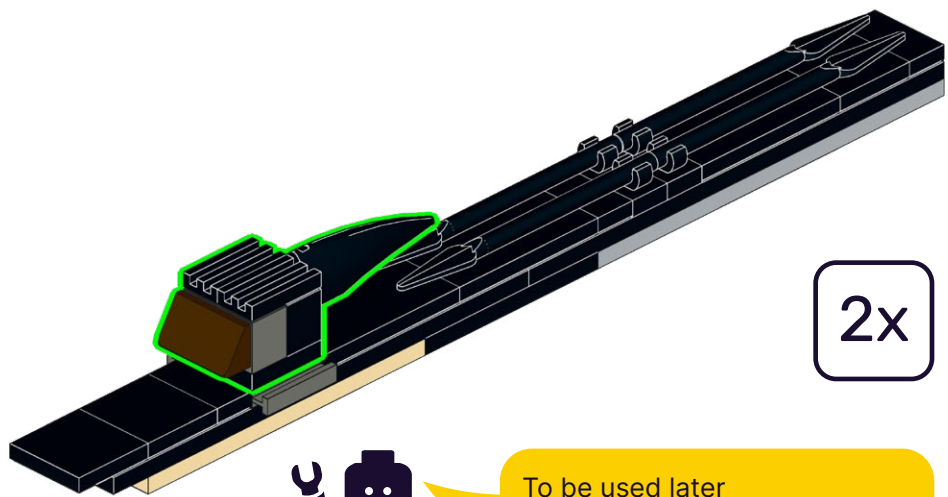
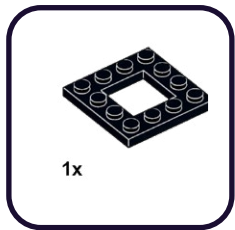

2x



To be used later
 A utiliser plus tard
 Da utilizzare dopo
 Zur späteren Verwendung
 Para ser utilizado más tarde
 稍后使用

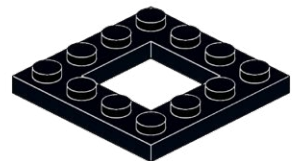

430



431

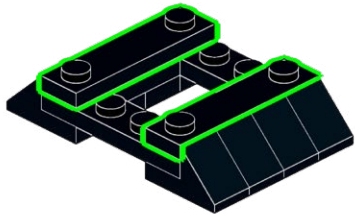
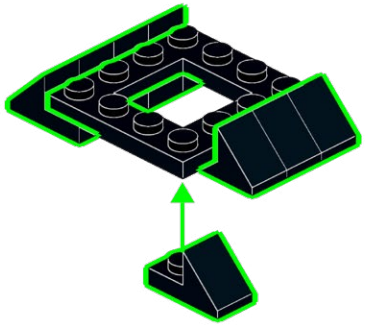
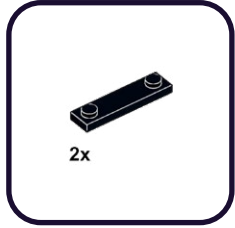

432

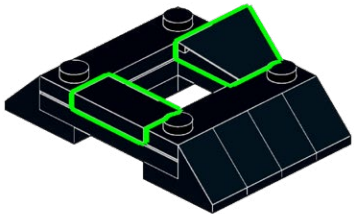
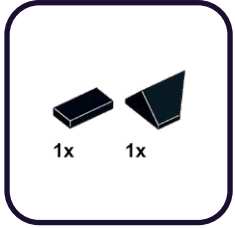

433

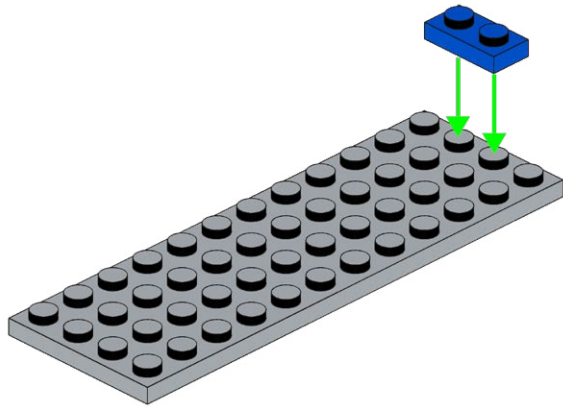
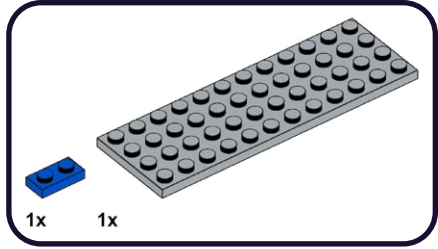

434

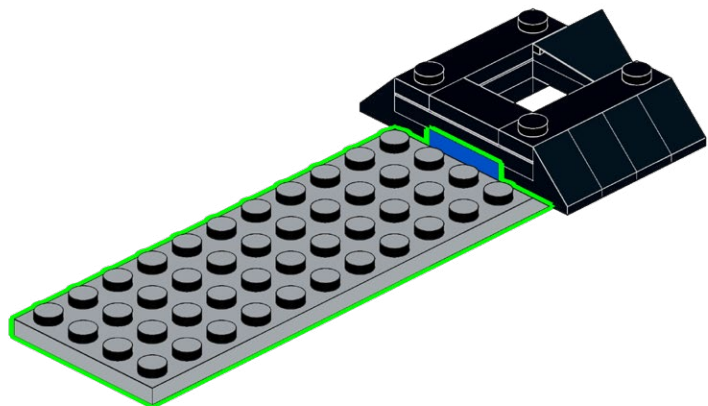

435

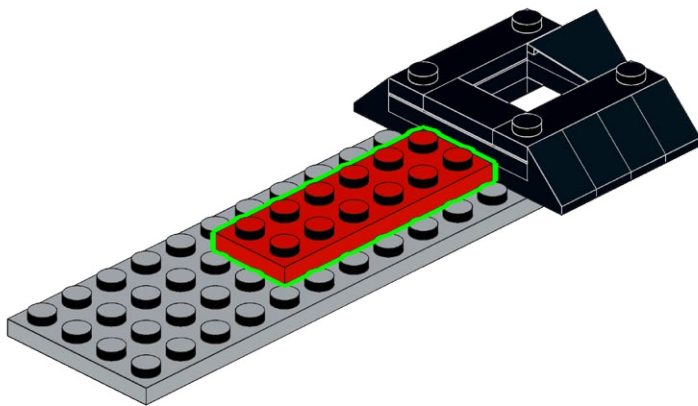
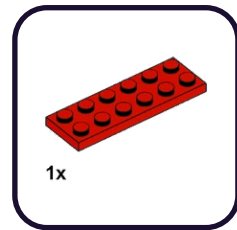

436

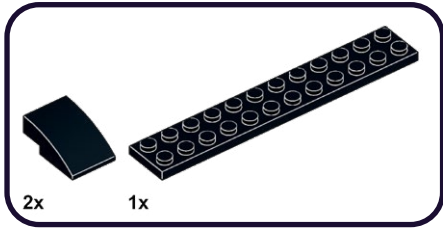

437

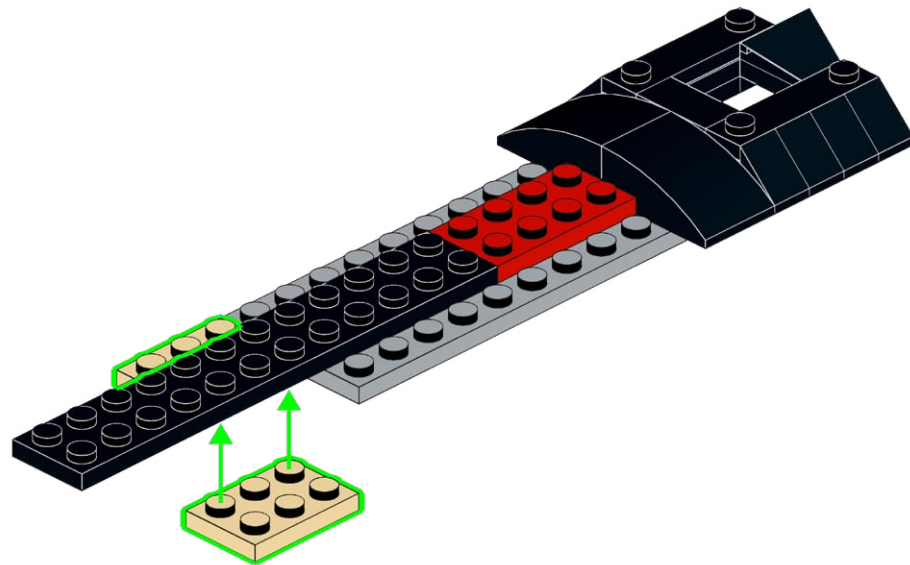
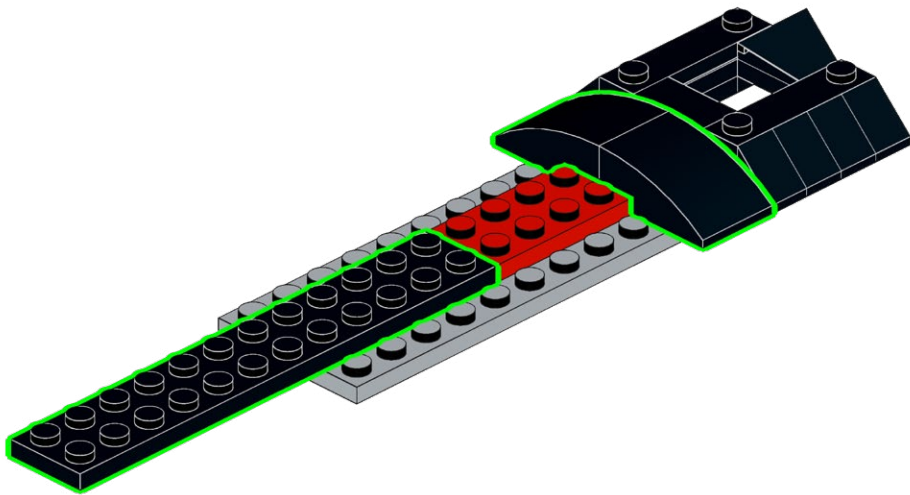
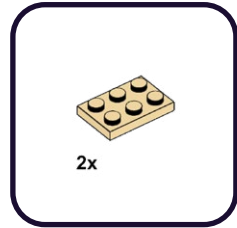

438

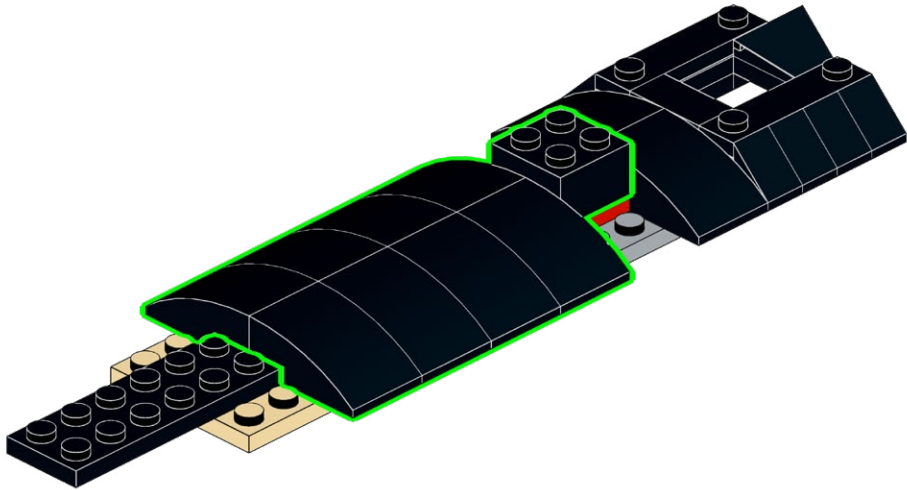
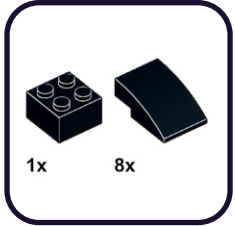

439

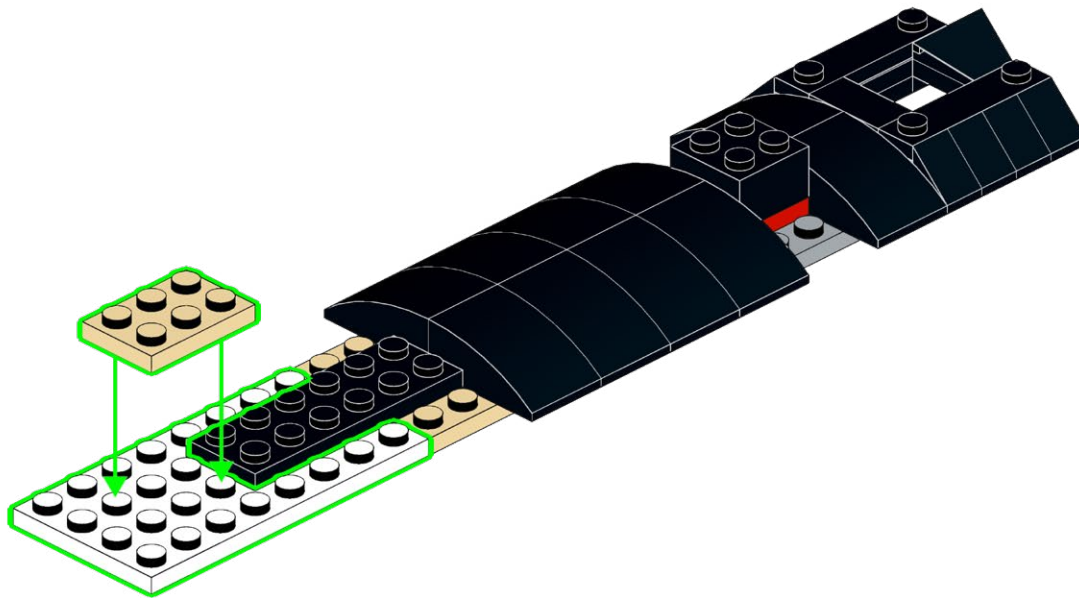
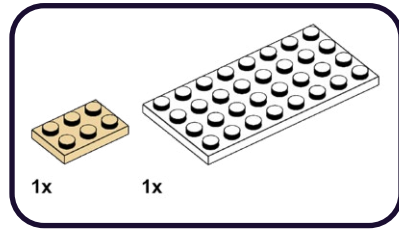

440

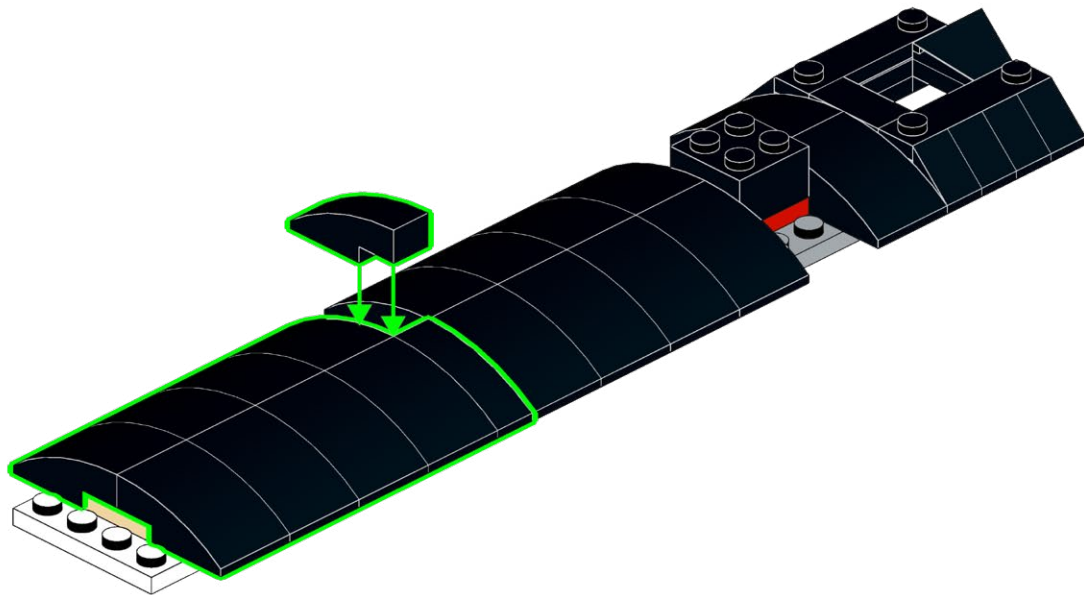

441

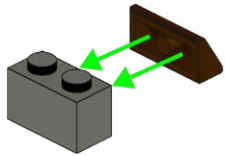
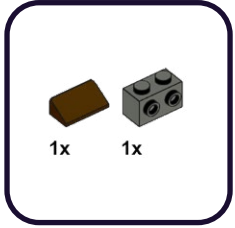

442

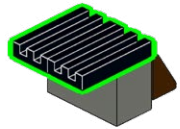
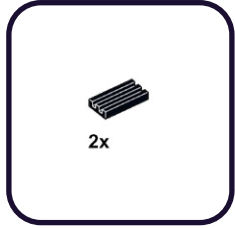

443

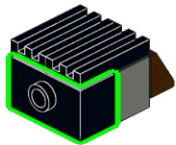
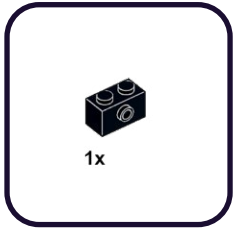

444

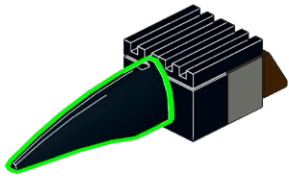

445

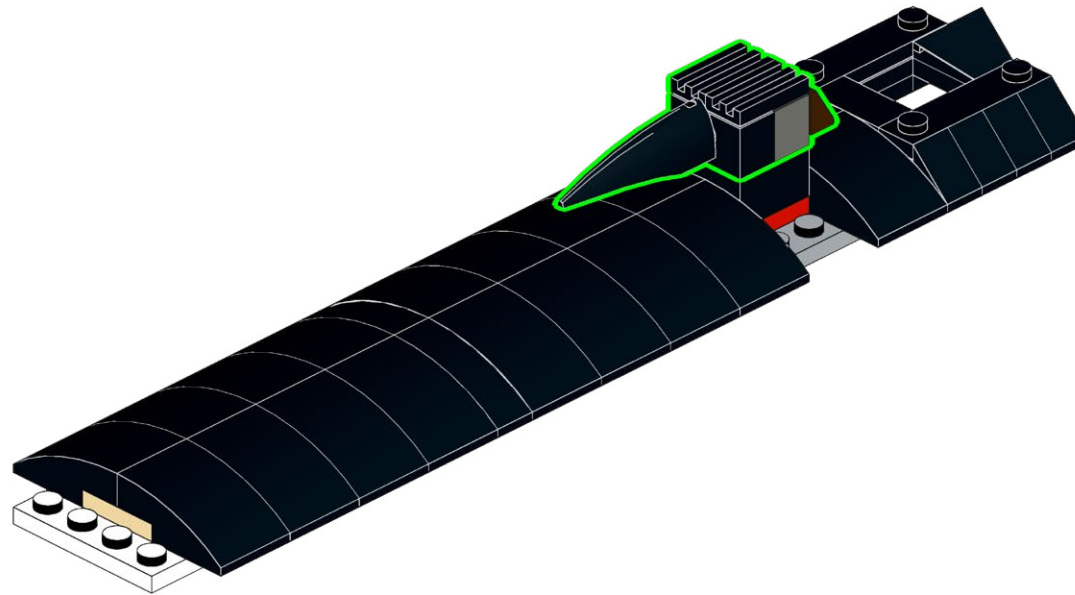

446

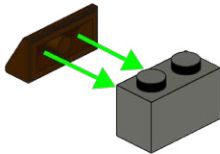
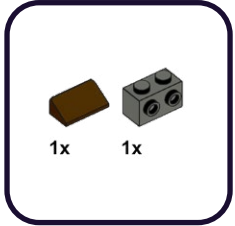

447

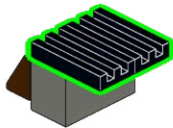
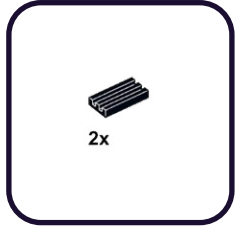

448

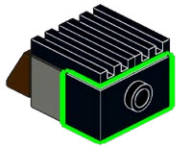
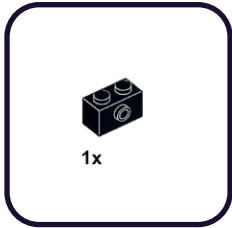

449

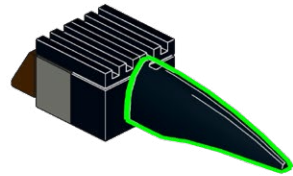

450

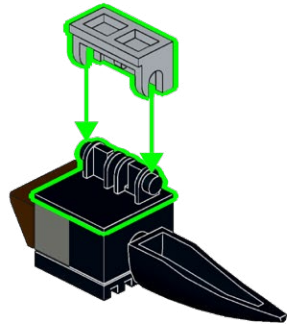
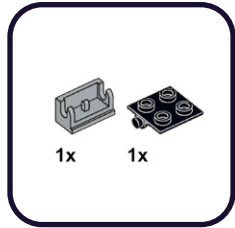

451

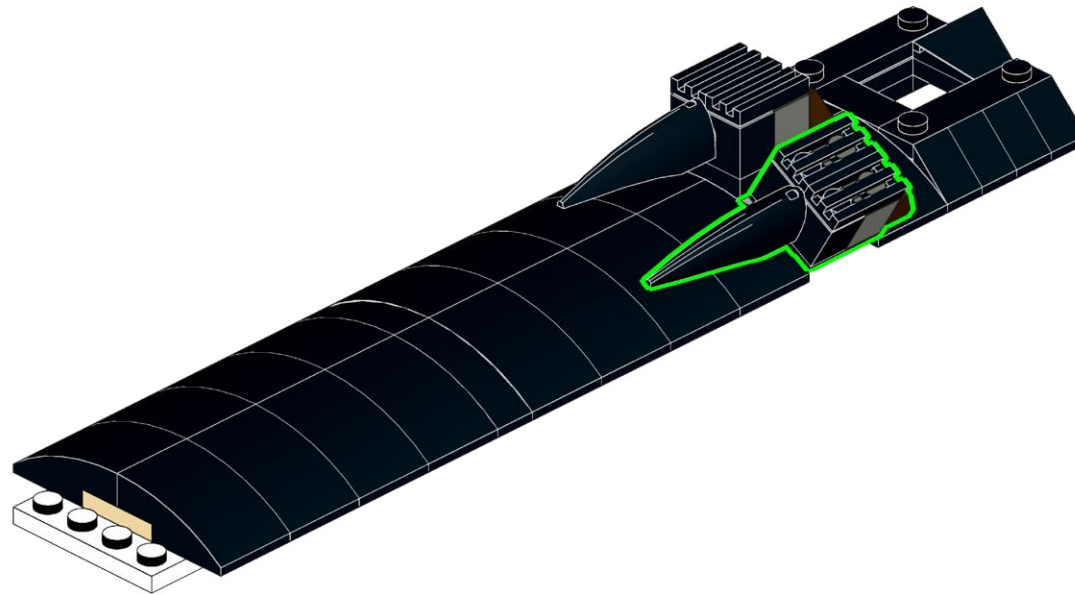

452

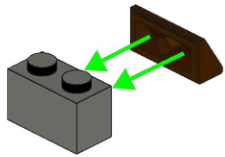
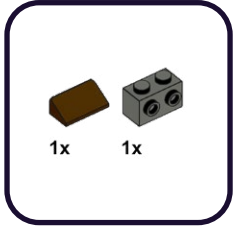

453

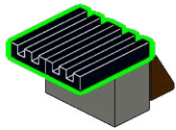
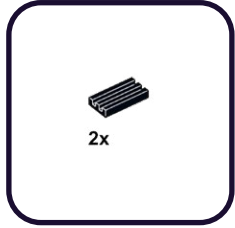

454

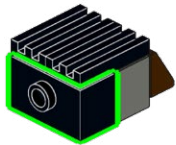
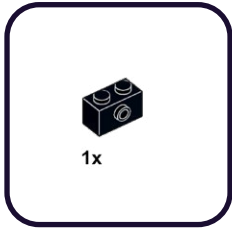

455

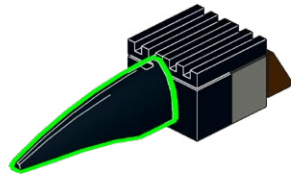

456

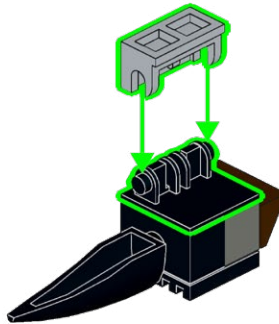
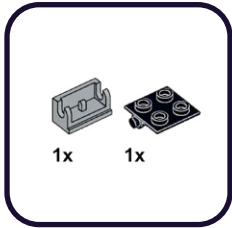

457

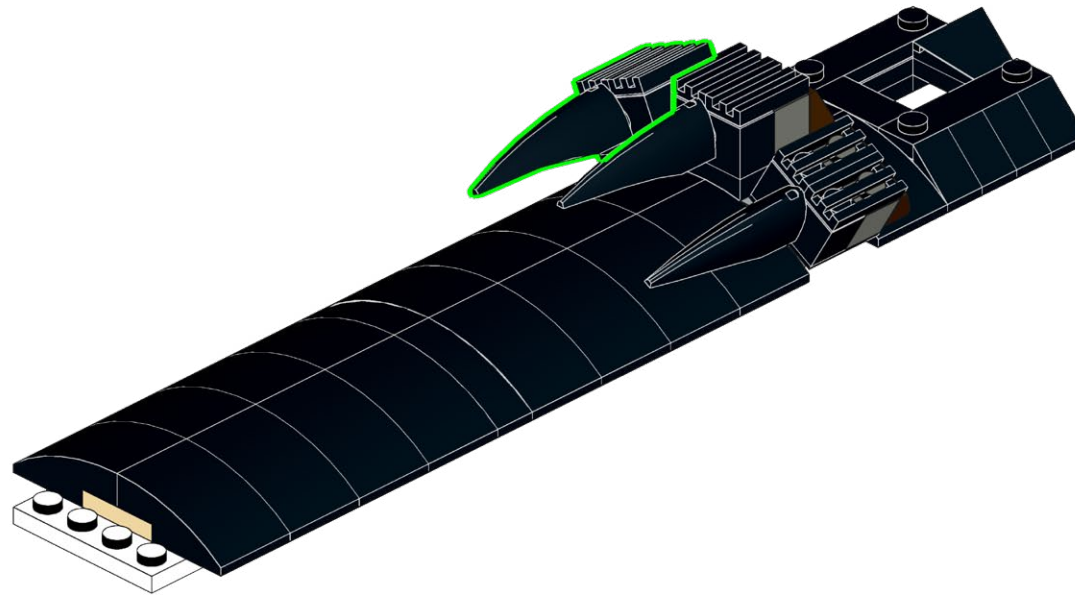

458

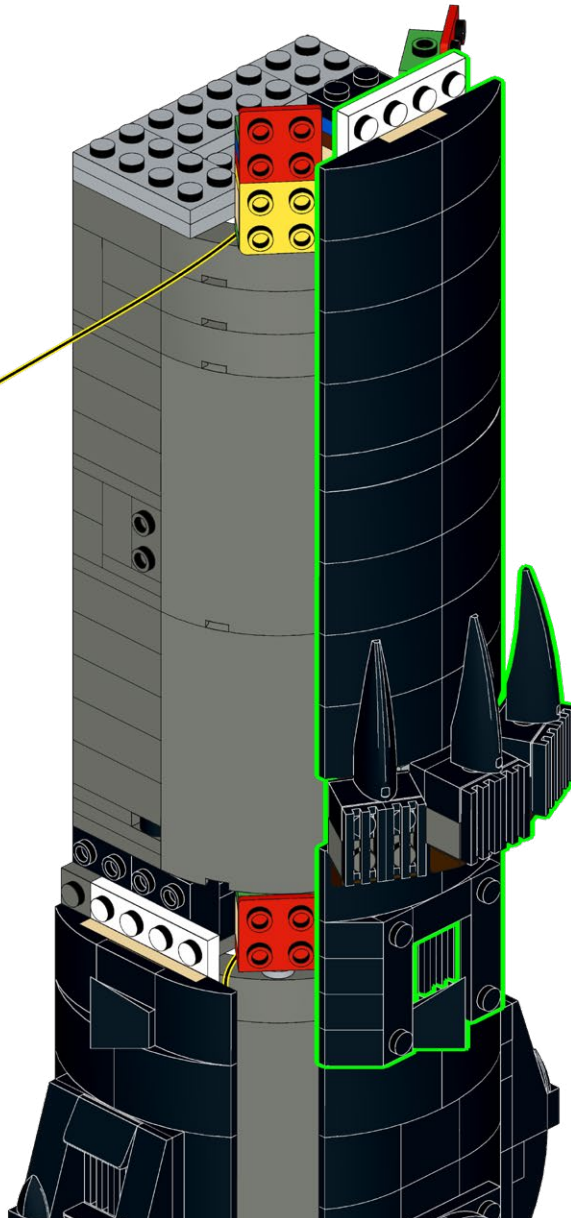

**HOLD UP!**

You might notice some bags aren't in order, as well as left over pieces, but that's ok! We're changing the way you build LEGO!

ATTENDEZ!

Vous remarquerez peut-être que certains sacs, ainsi que certaines pièces, ne sont pas dans le bon ordre. Mais pas de panique! Nous changeons simplement la façon avec laquelle vous construisez vos LEGO!

ASPETTA!

Potresti notare che alcuni sacchetti non sono in ordine, così come i pezzi avanzati, ma va bene così! Stiamo cambiando il modo in cui costruisci i LEGO!

HALT!

Sie werden möglicherweise bemerken, dass einige tüten durcheinander sind und teile übrig bleiben, aber das ist in Ordnung! Wir ändern die art und weise, wie Sie LEGO bauen!

¡ESPERA!

Es posible que notes que algunas bolsas están fuera de servicio, así como piezas sobrantes, ¡pero está bien! ¡Estamos cambiando la forma en que construyes LEGO!

暫停!

你可能会注意到一些袋子顺序错乱, 以及一些剩余的部件, 但没关系! 我们正在改变你搭建乐高的方式!

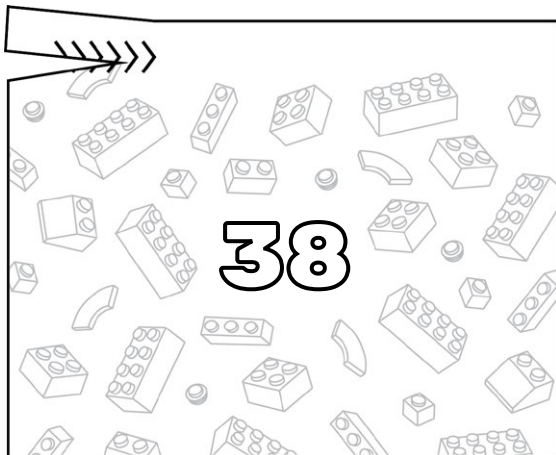
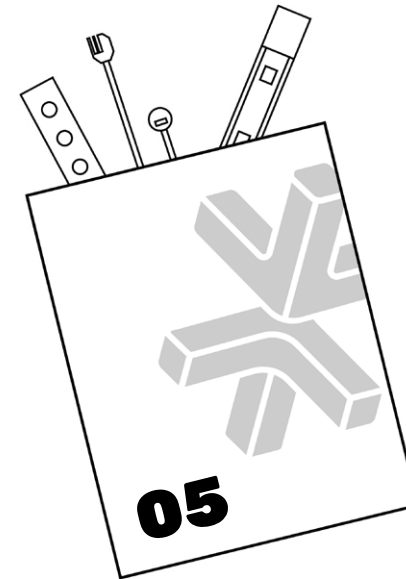
Open LEGO® Bag 38**Open LMB Bag 05**

459

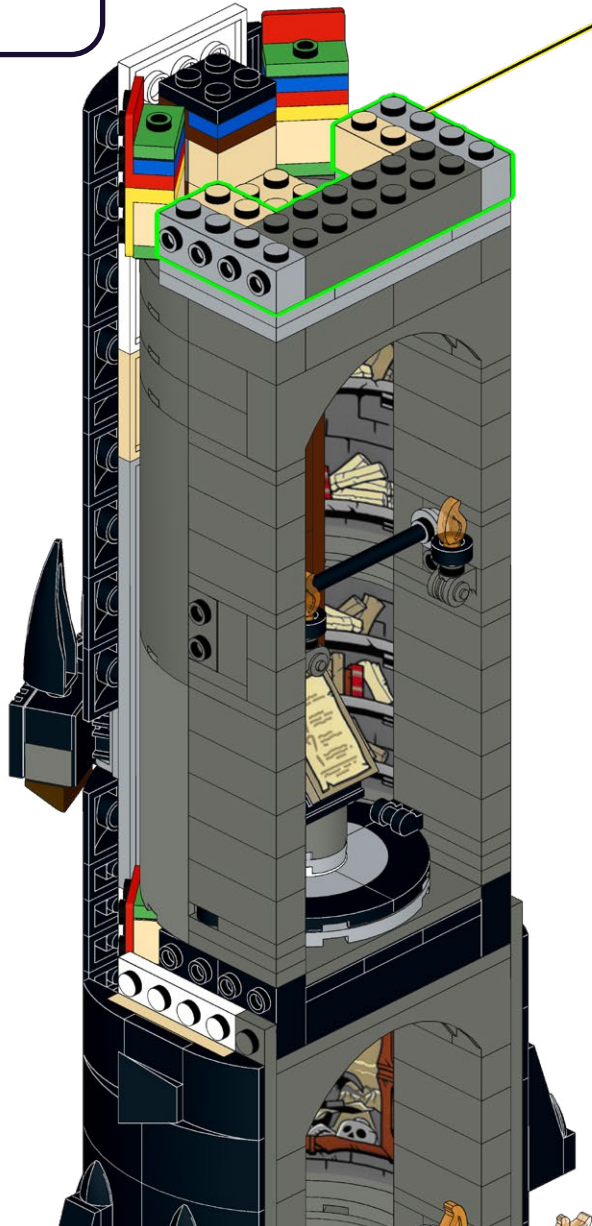
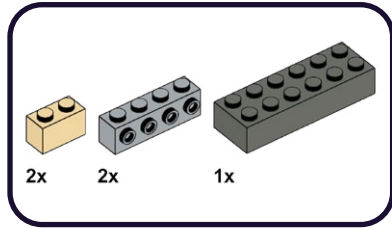

460

4x

2x

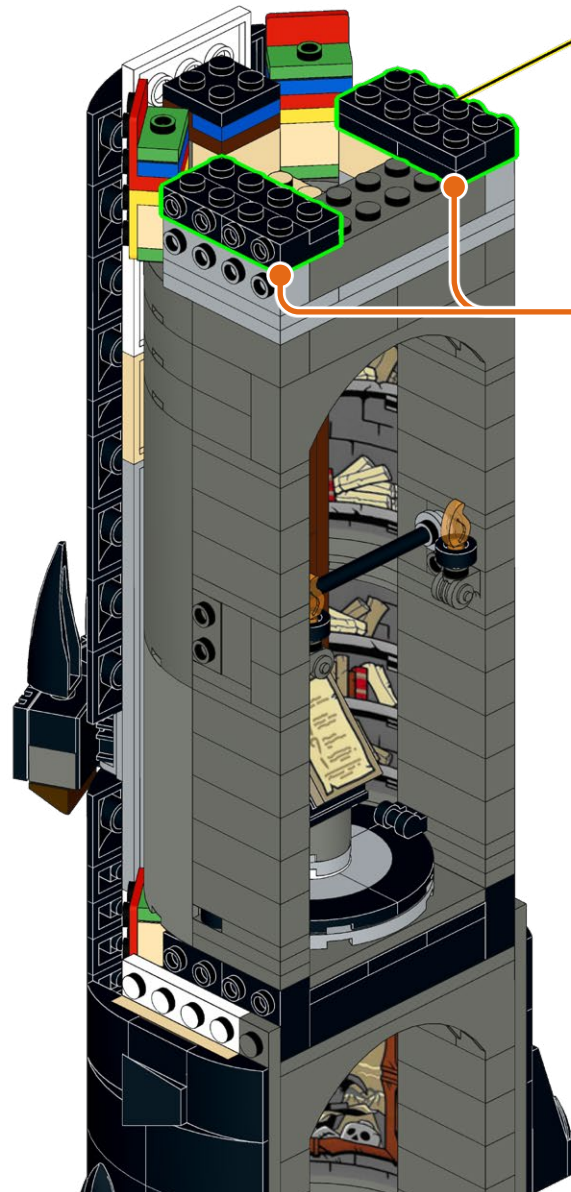

1

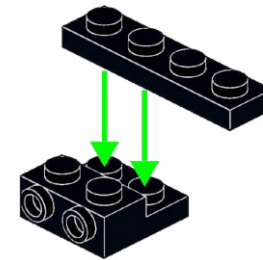

2

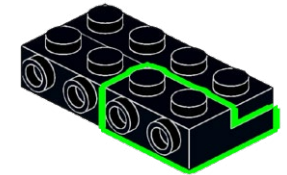

2x

461

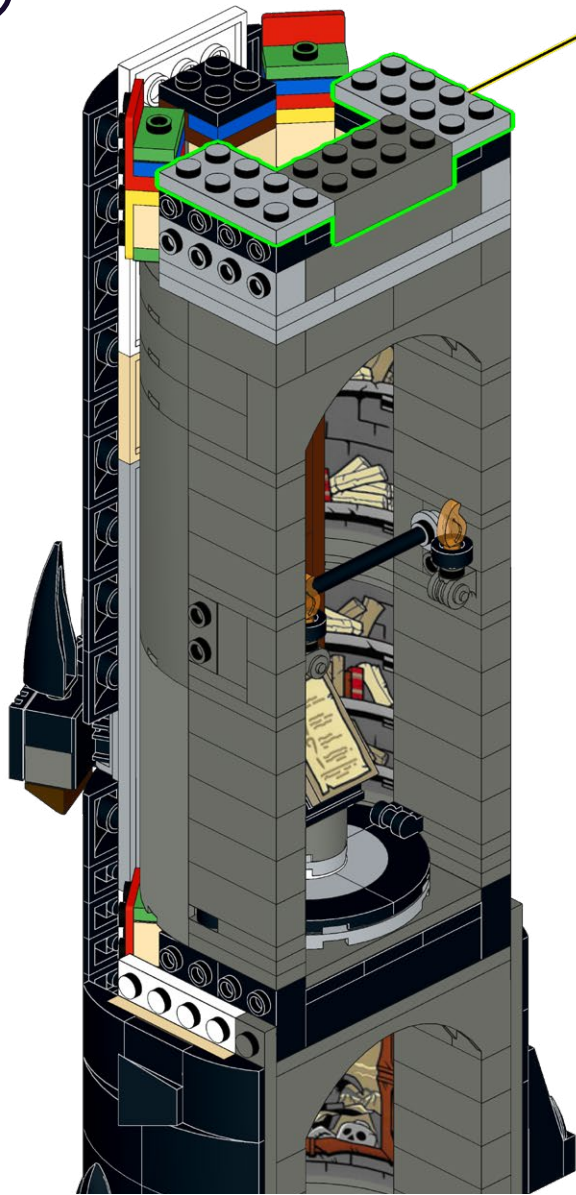
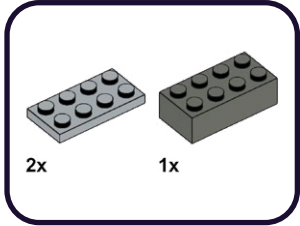

462

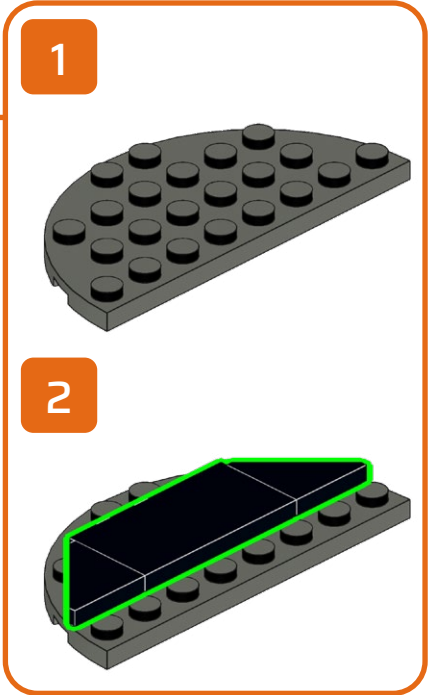
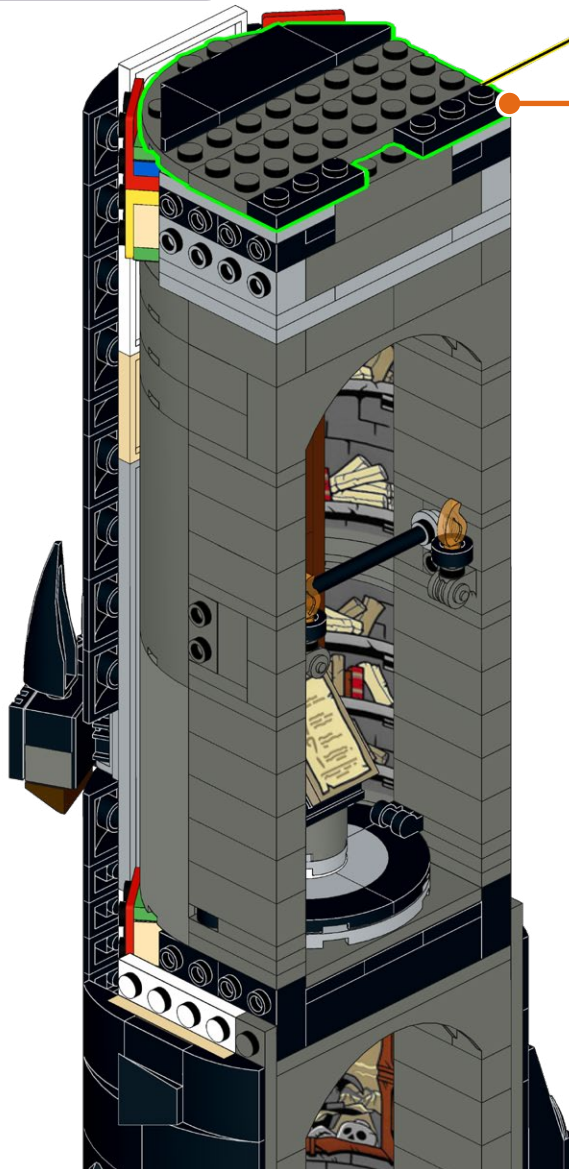
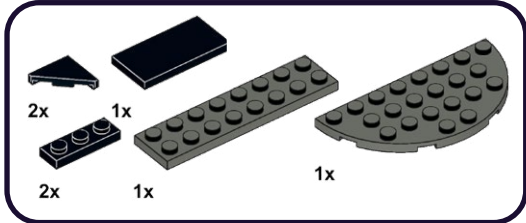

463

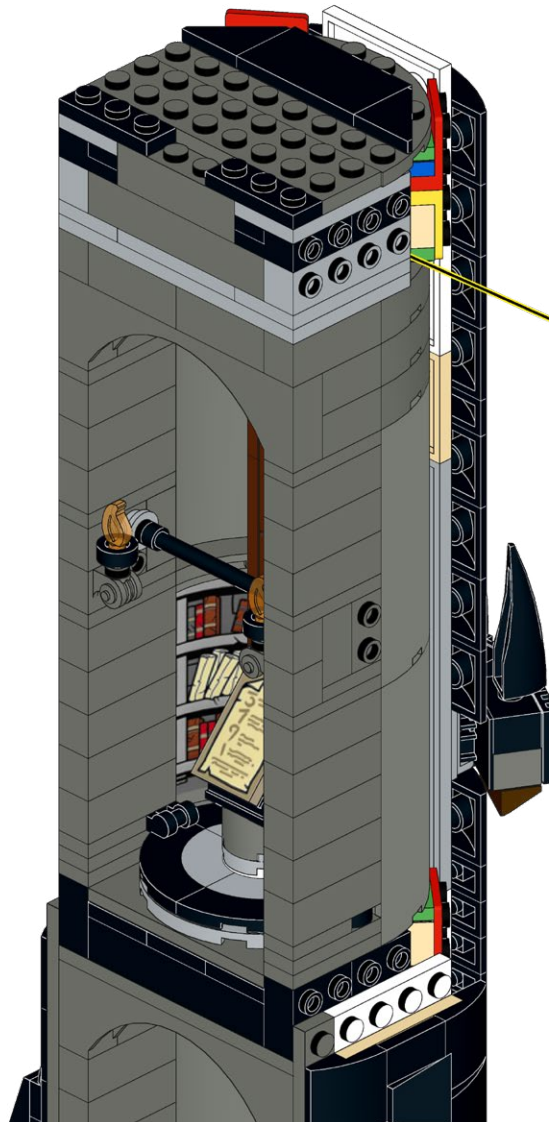

464

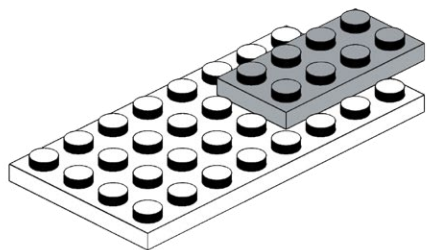
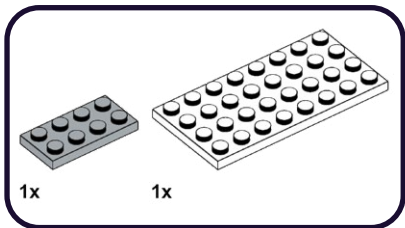

465

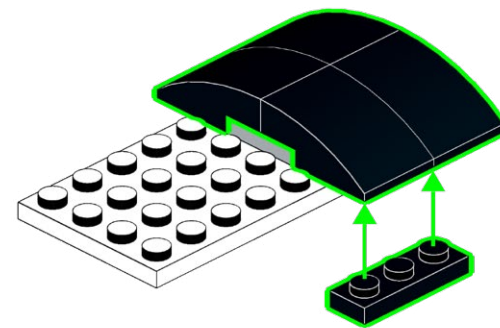
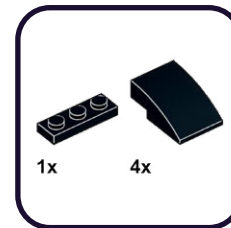

466

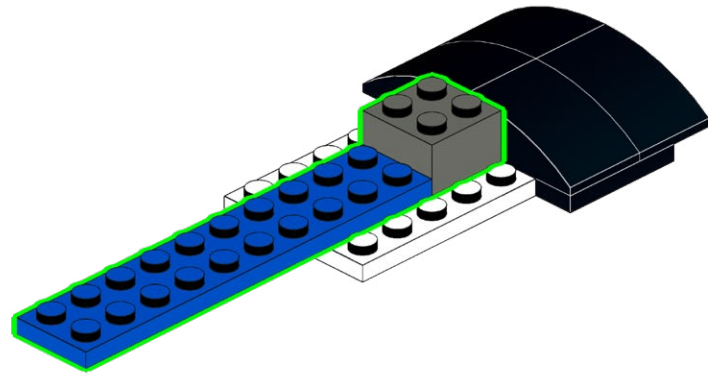
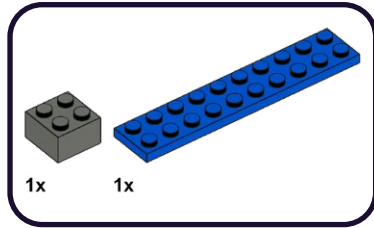

467

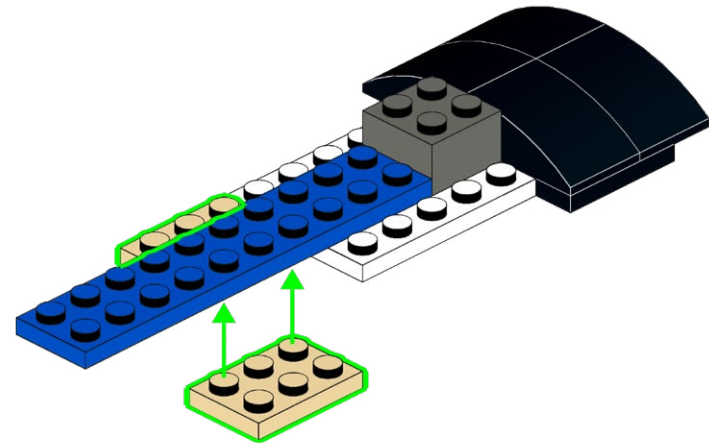
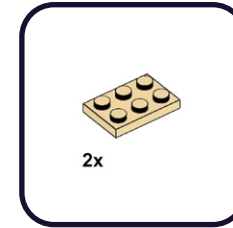

468

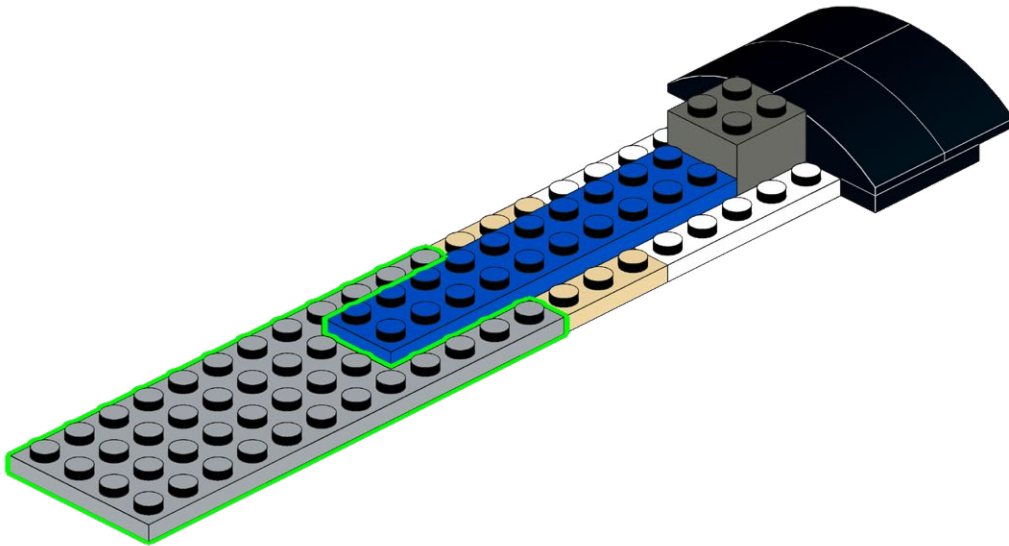
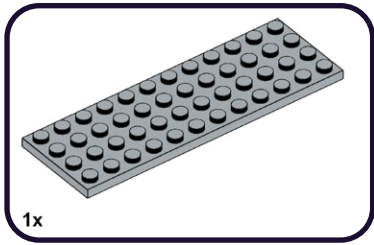

469

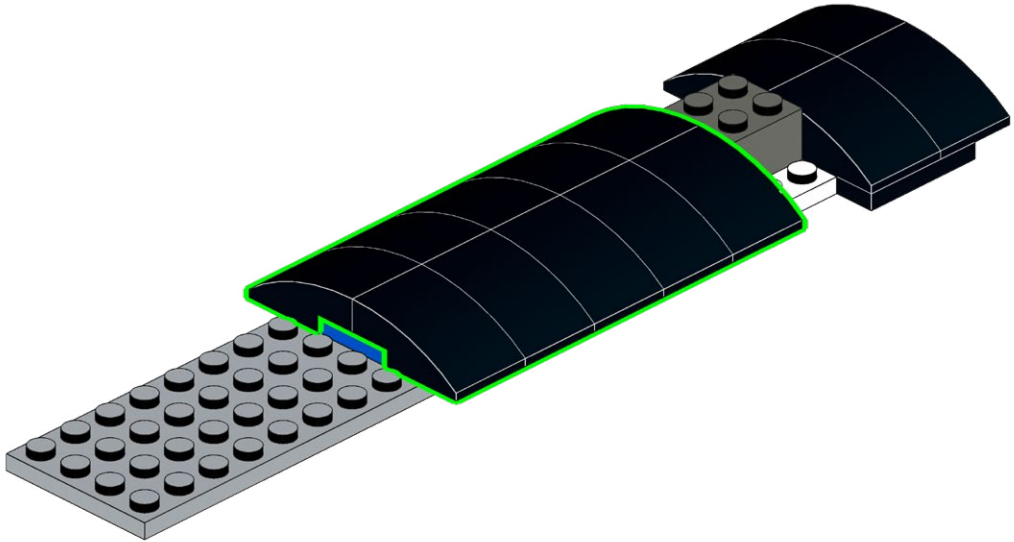

470

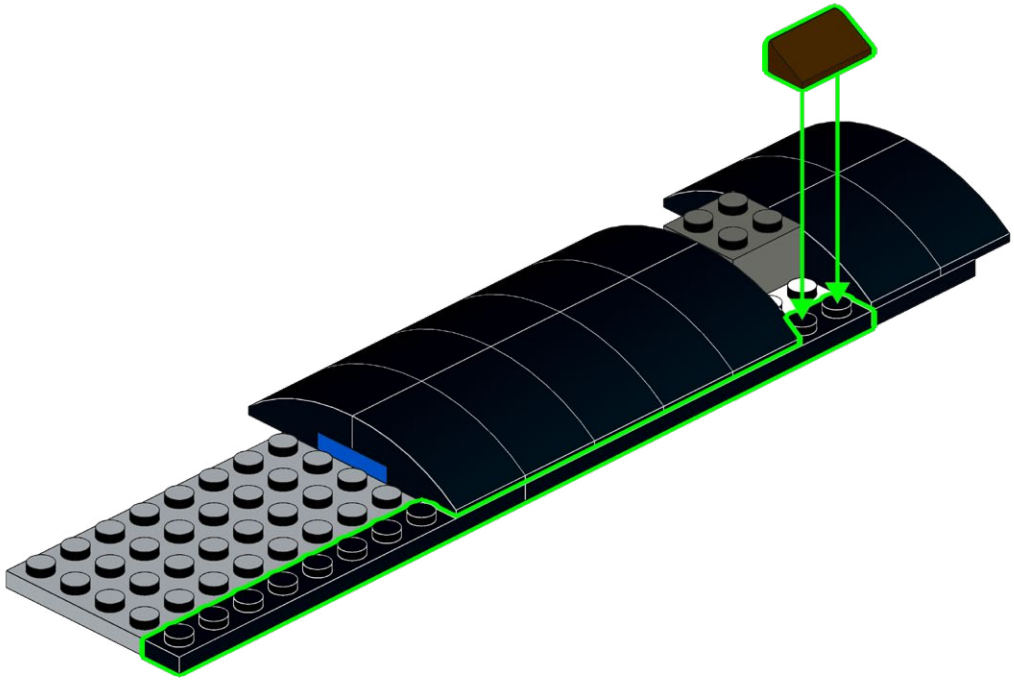
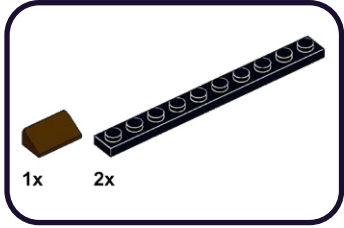

471

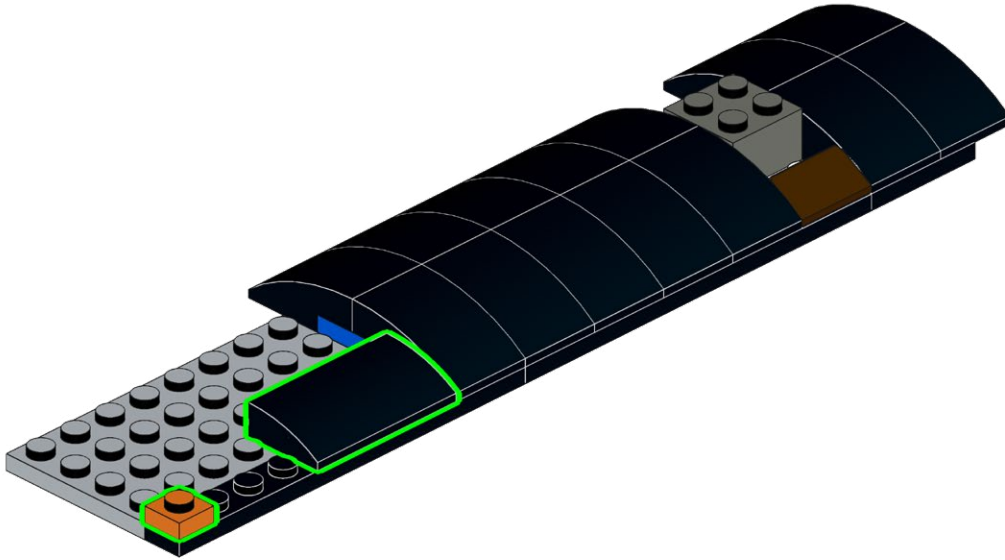
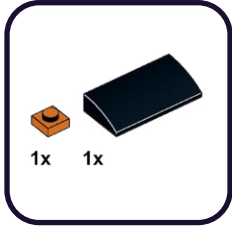

472

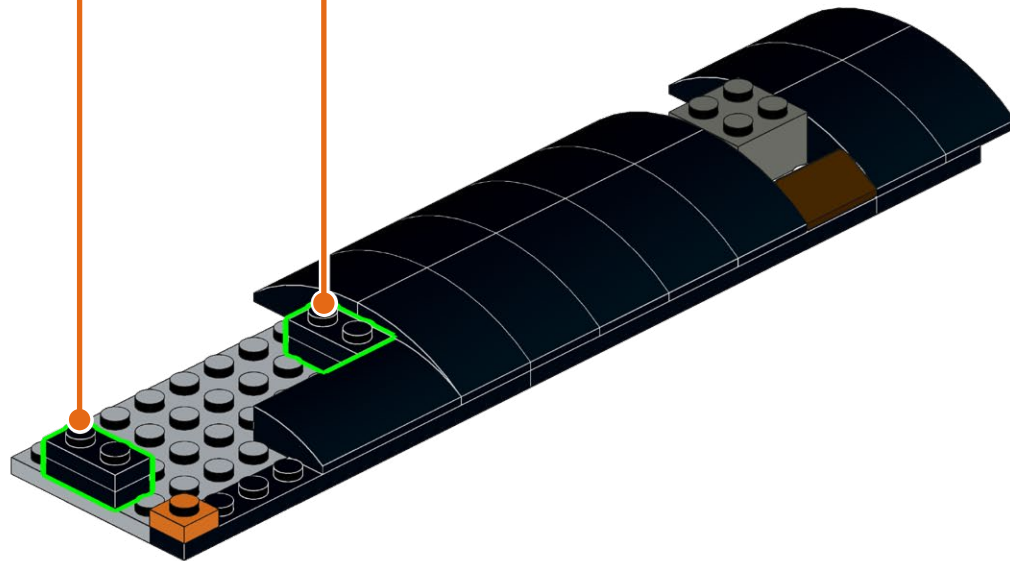
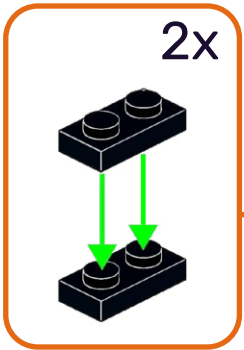

473

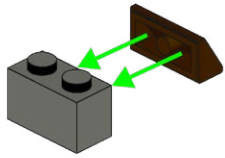
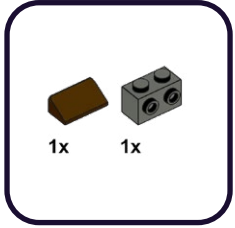

474

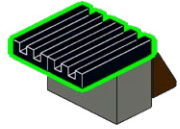
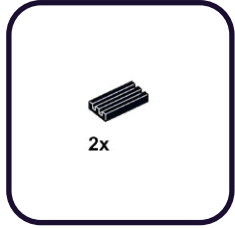

475

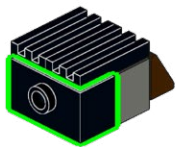
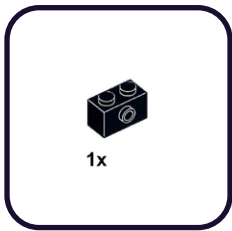

476

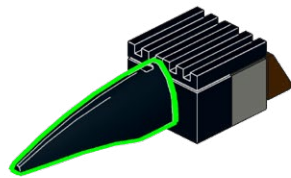

477

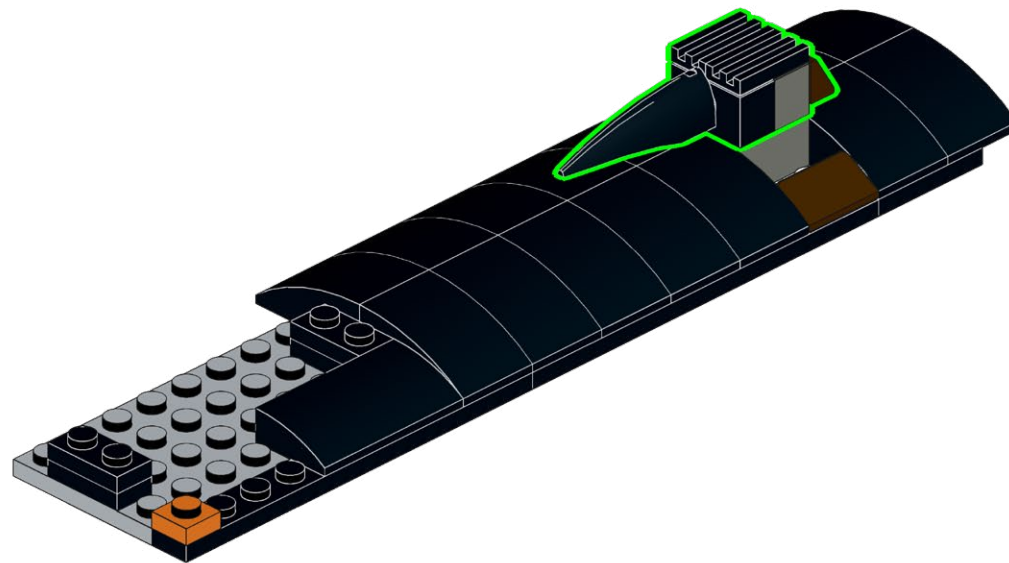

478

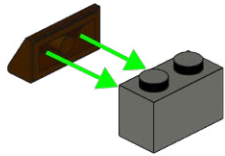
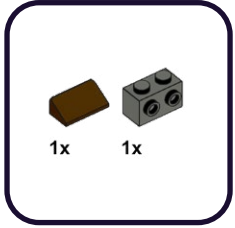

479

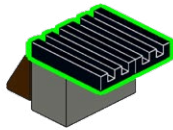
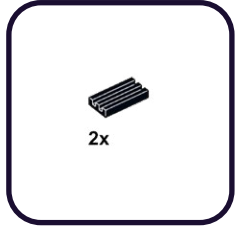

480

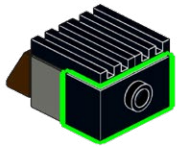
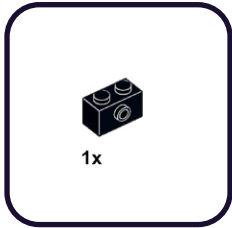

481

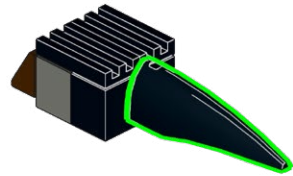

482

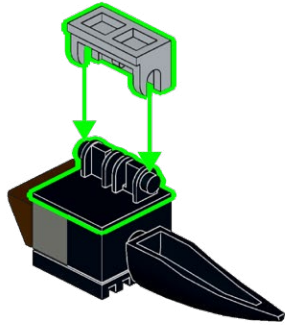
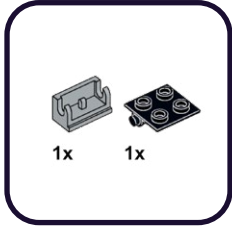

483

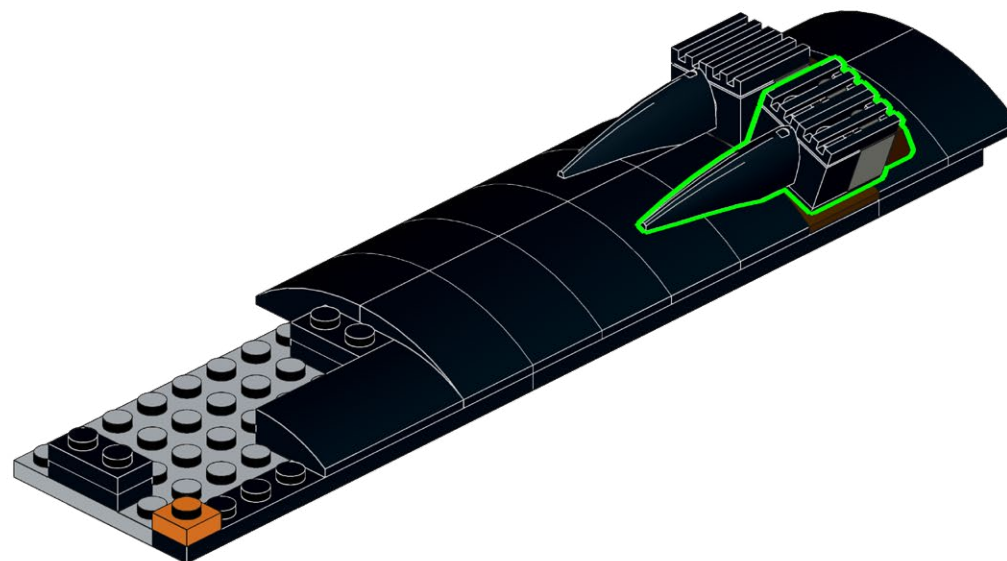

484

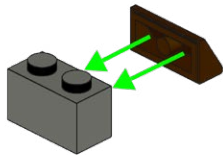
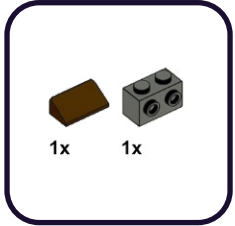

485

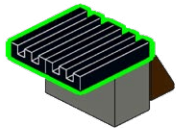
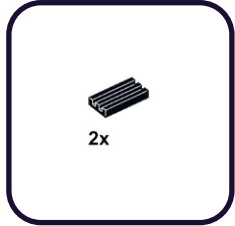

486

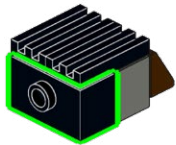
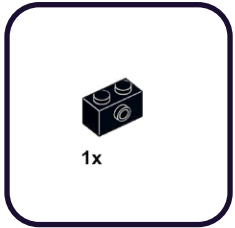

487

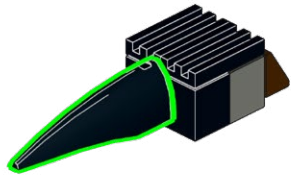

488

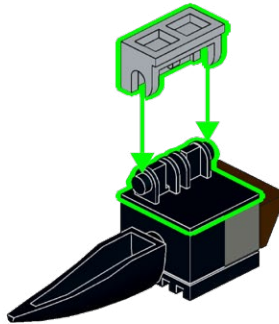
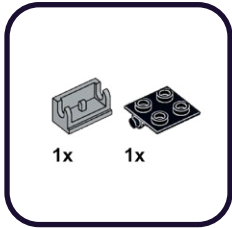

489

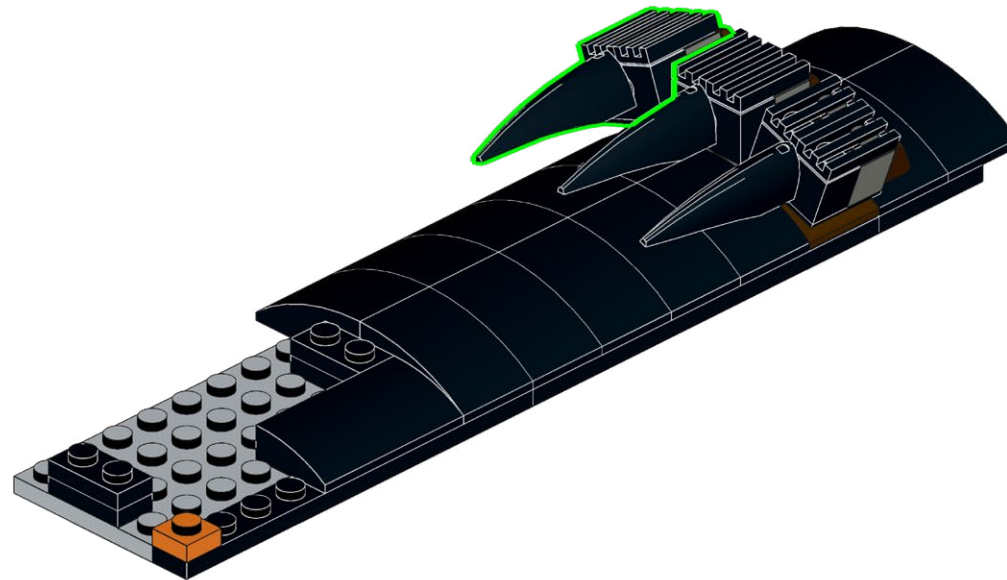

490

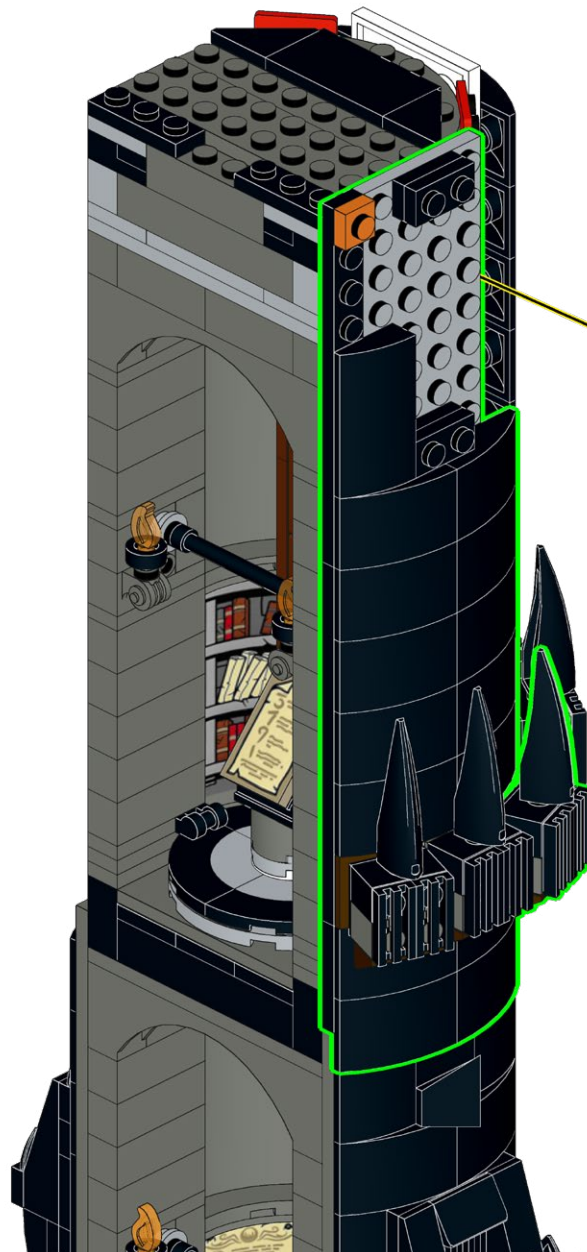

491

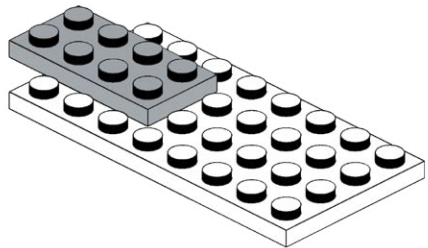
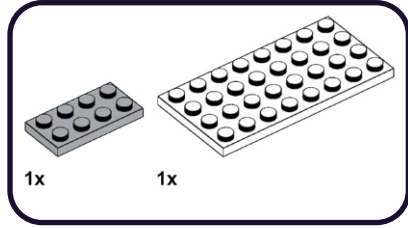

492

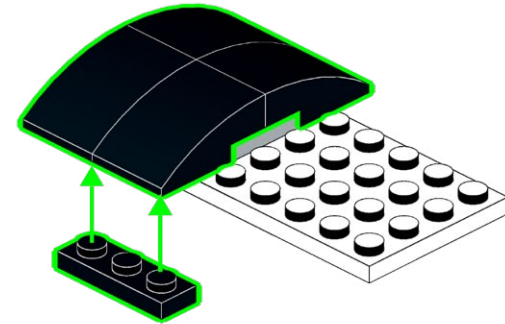
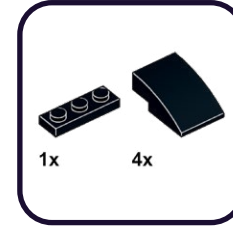

493

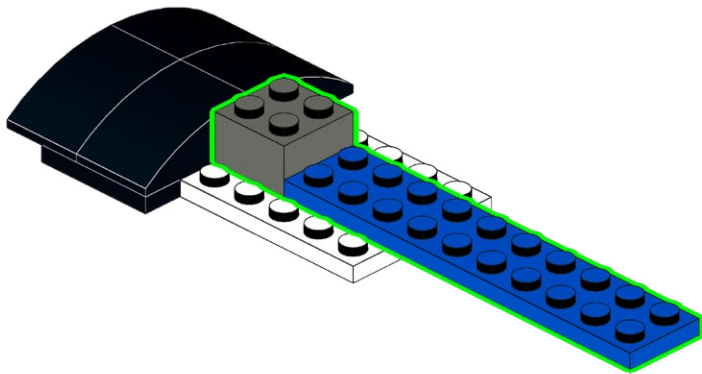
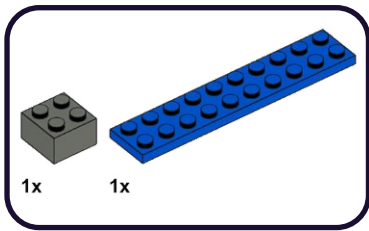

494

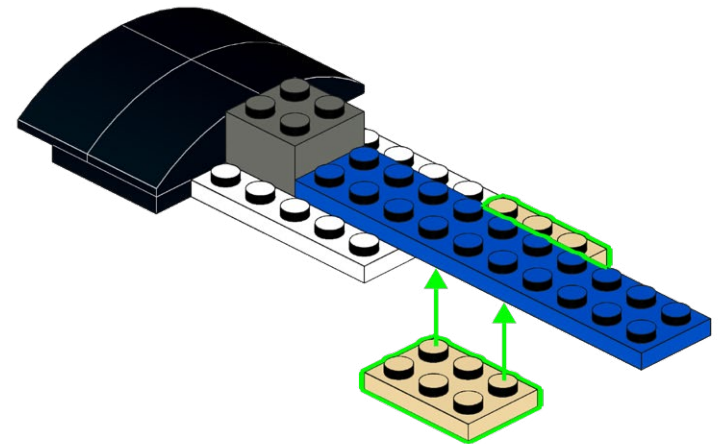
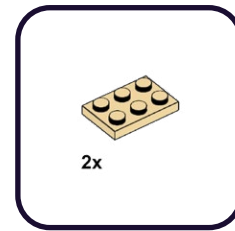

495

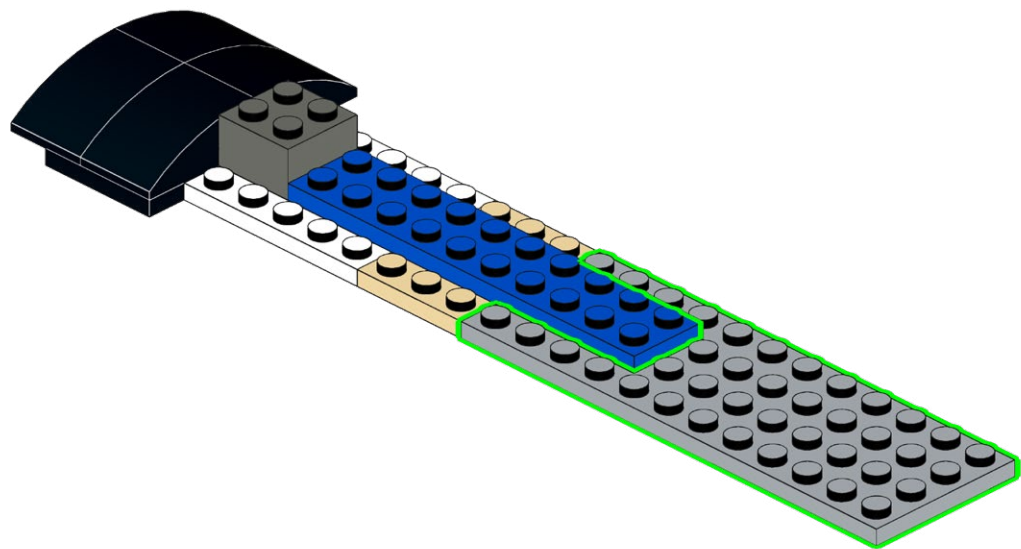
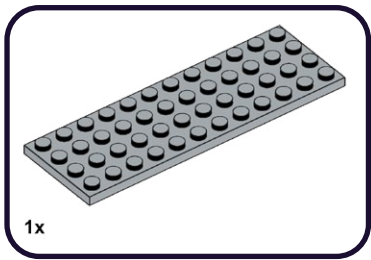

496

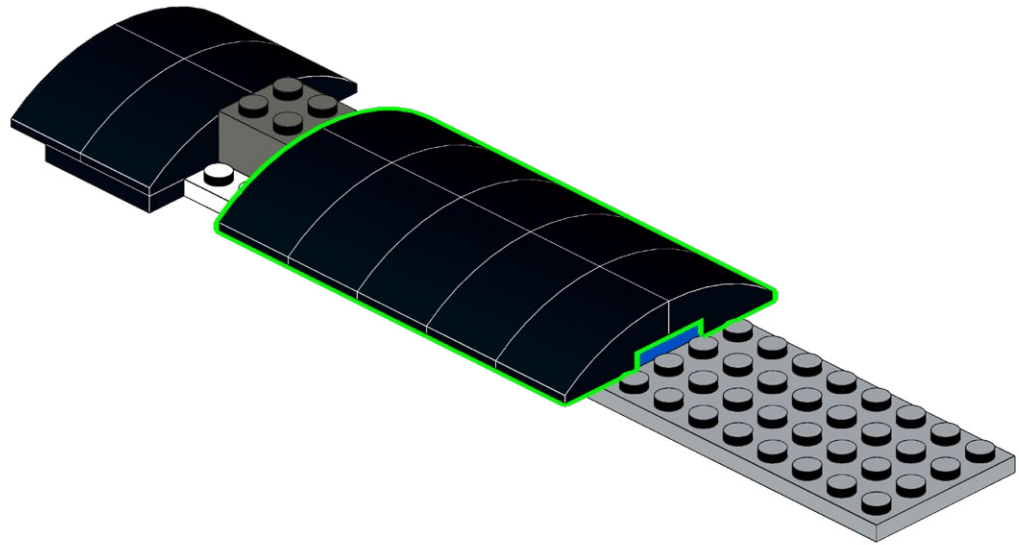

497

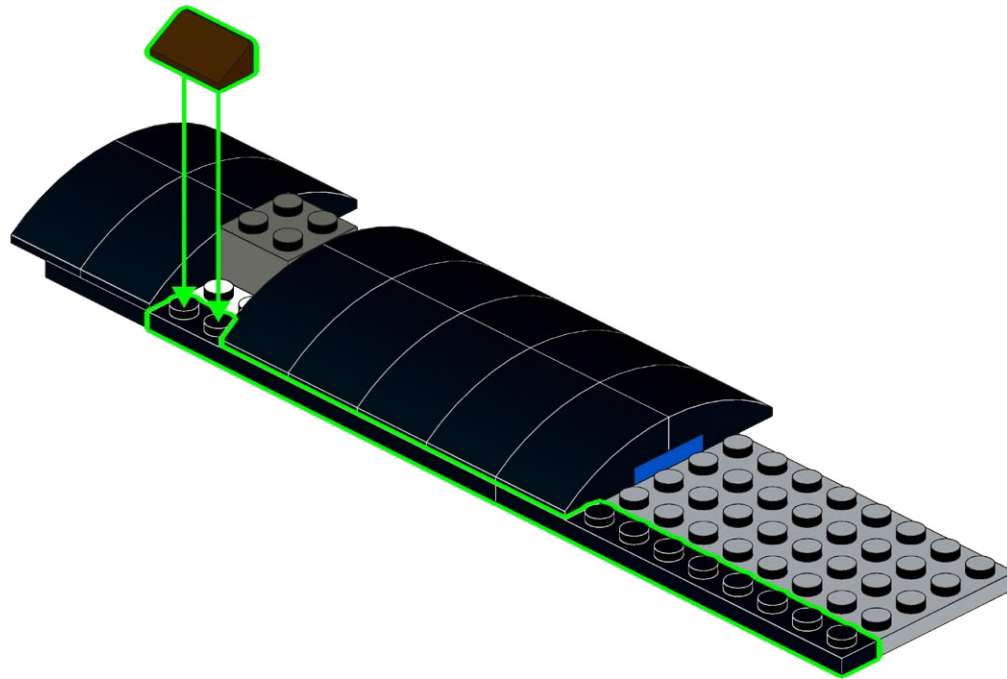
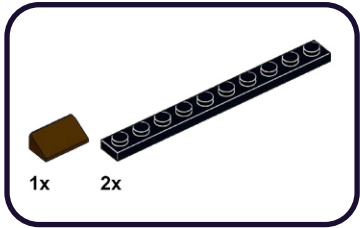

498

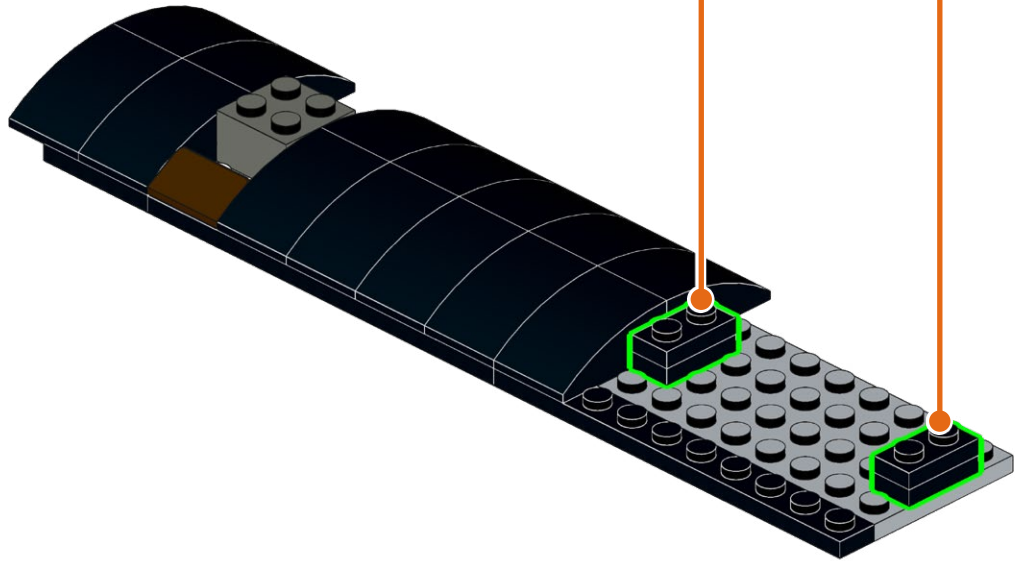
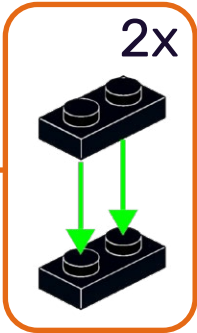
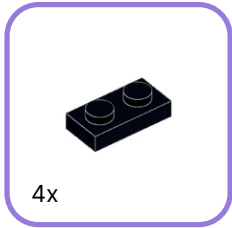

499

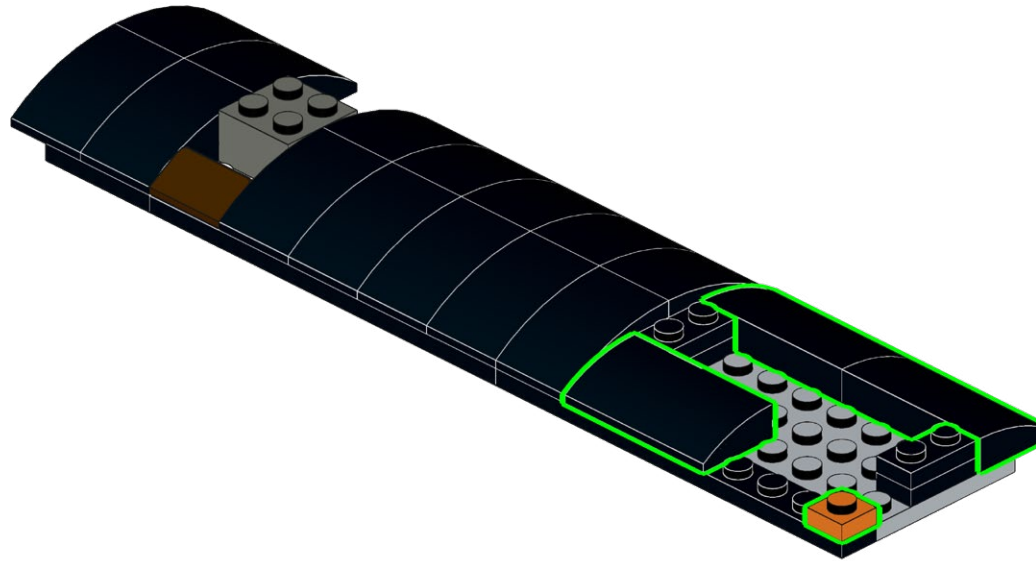
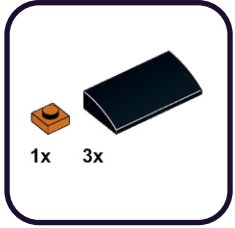

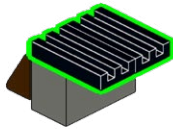
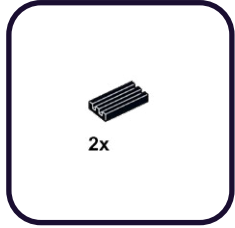
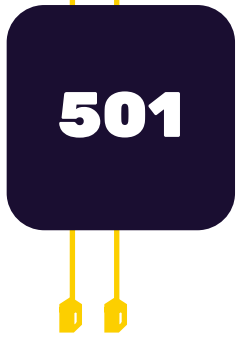
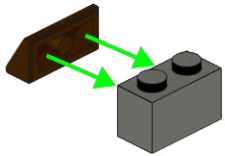
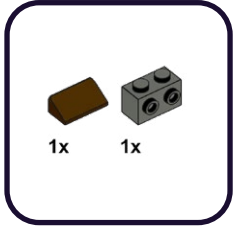

502

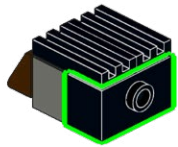
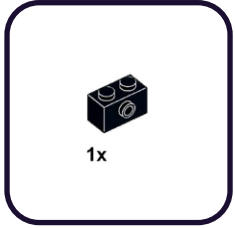

503

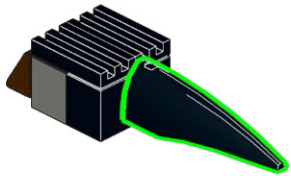

504

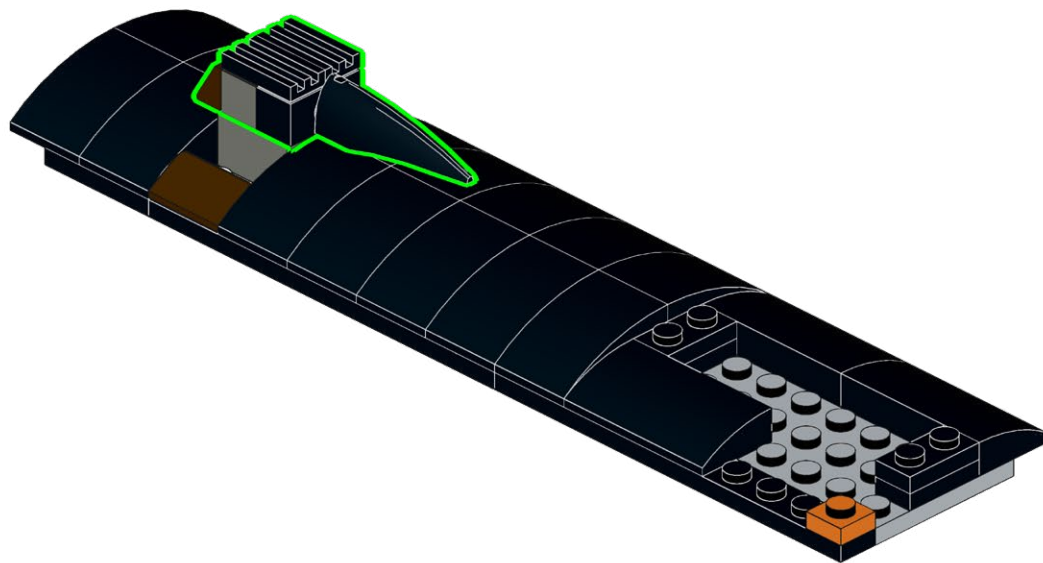

505

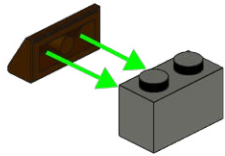
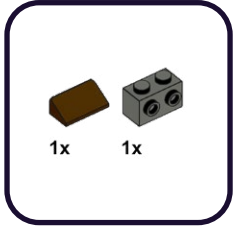

506

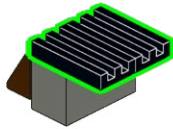
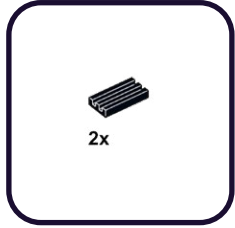

507

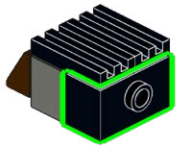
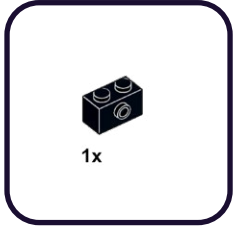

508

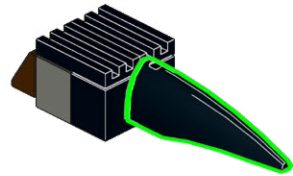

509

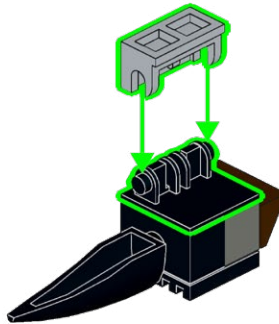
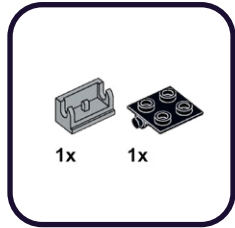

510

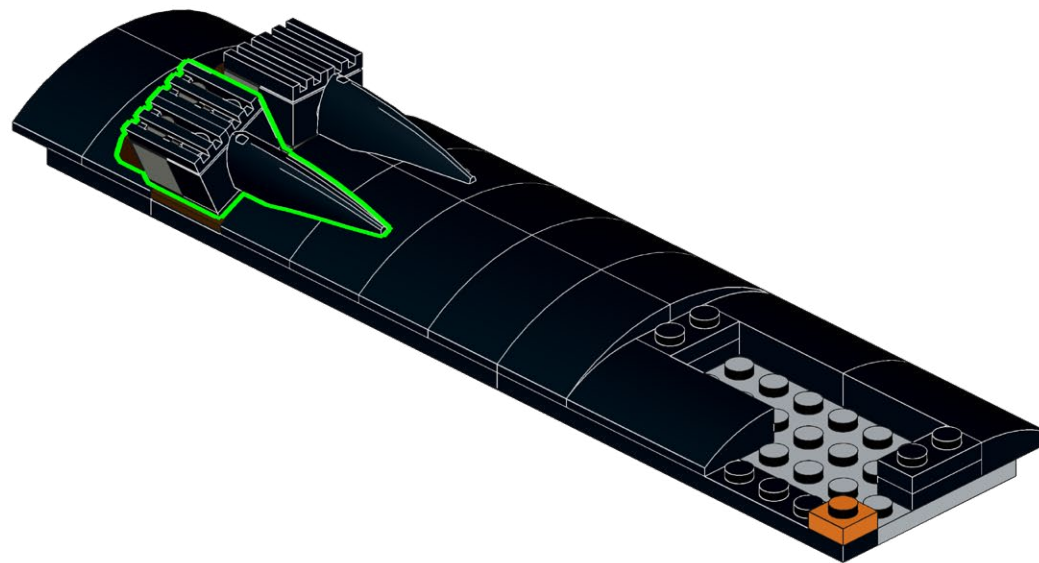

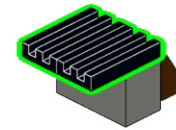
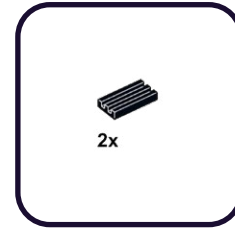
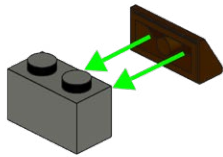
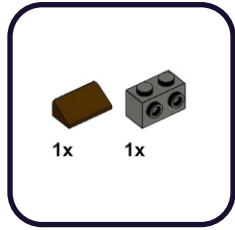

513

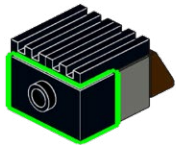
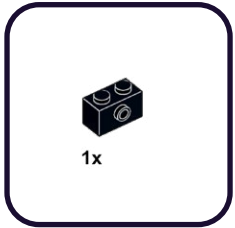

514

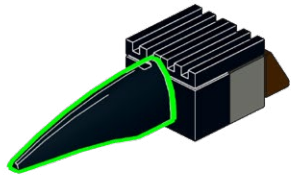

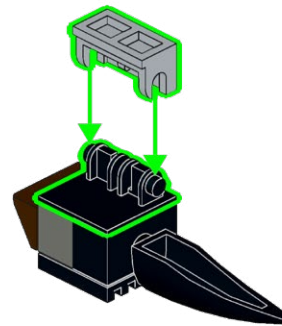
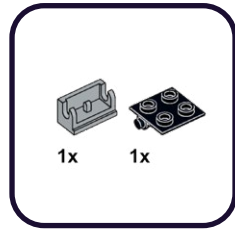

516

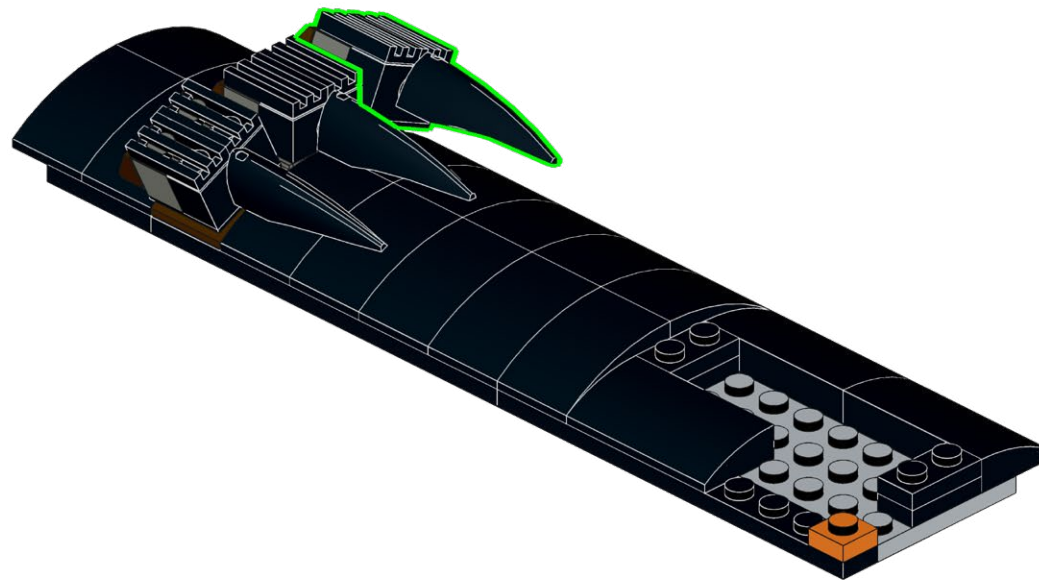

517

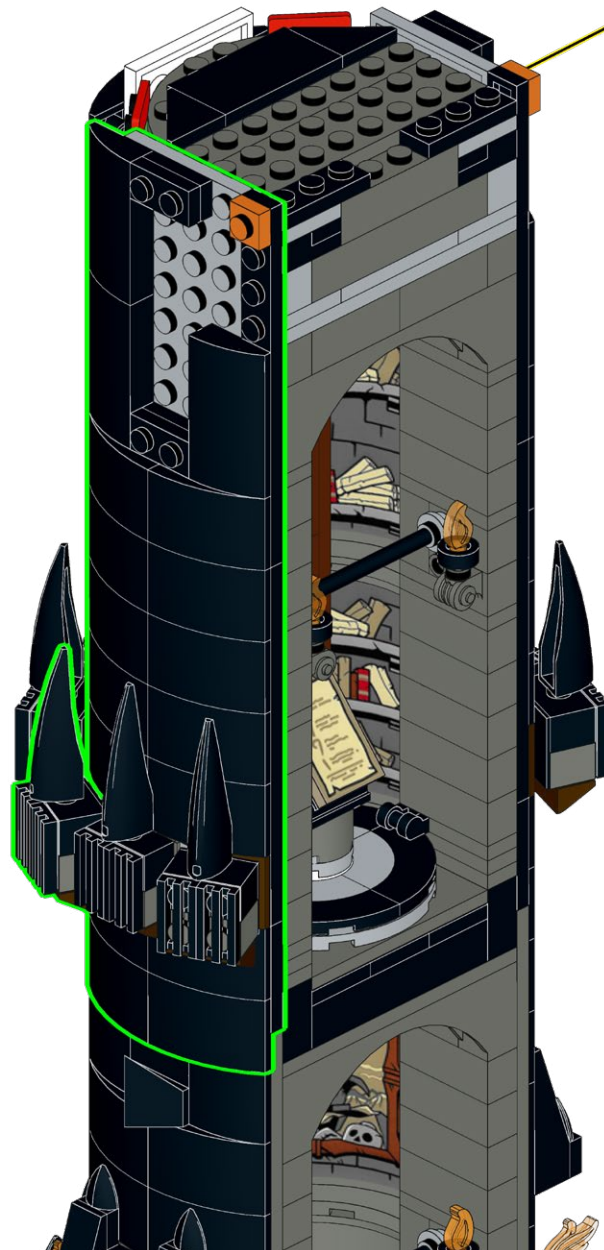

**HOLD UP!**

You might notice some bags aren't in order, as well as left over pieces, but that's ok! We're changing the way you build LEGO!

ATTENDEZ!

Vous remarquerez peut-être que certains sacs, ainsi que certaines pièces, ne sont pas dans le bon ordre. Mais pas de panique! Nous changeons simplement la façon avec laquelle vous construisez vos LEGO!

ASPETTA!

Potresti notare che alcuni sacchetti non sono in ordine, così come i pezzi avanzati, ma va bene così! Stiamo cambiando il modo in cui costruisci i LEGO!

HALT!

Sie werden möglicherweise bemerken, dass einige tüten durcheinander sind und teile übrig bleiben, aber das ist in Ordnung! Wir ändern die art und weise, wie Sie LEGO bauen!

¡ESPERA!

Es posible que notes que algunas bolsas están fuera de servicio, así como piezas sobrantes, ¡pero está bien! ¡Estamos cambiando la forma en que construyes LEGO!

暫停!

你可能会注意到一些袋子顺序错乱, 以及一些剩余的部件, 但没关系! 我们正在改变你搭建乐高的方式!

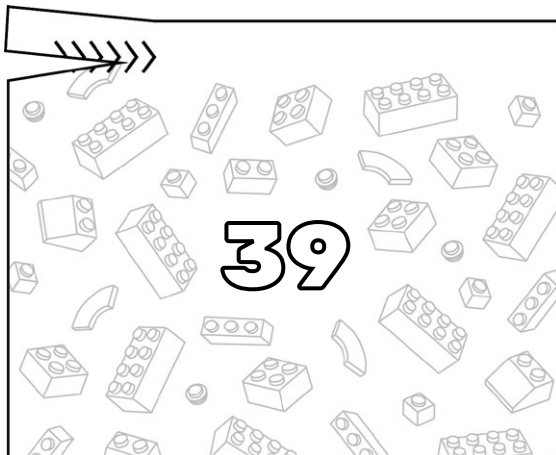
Open LEGO® Bag 39

518

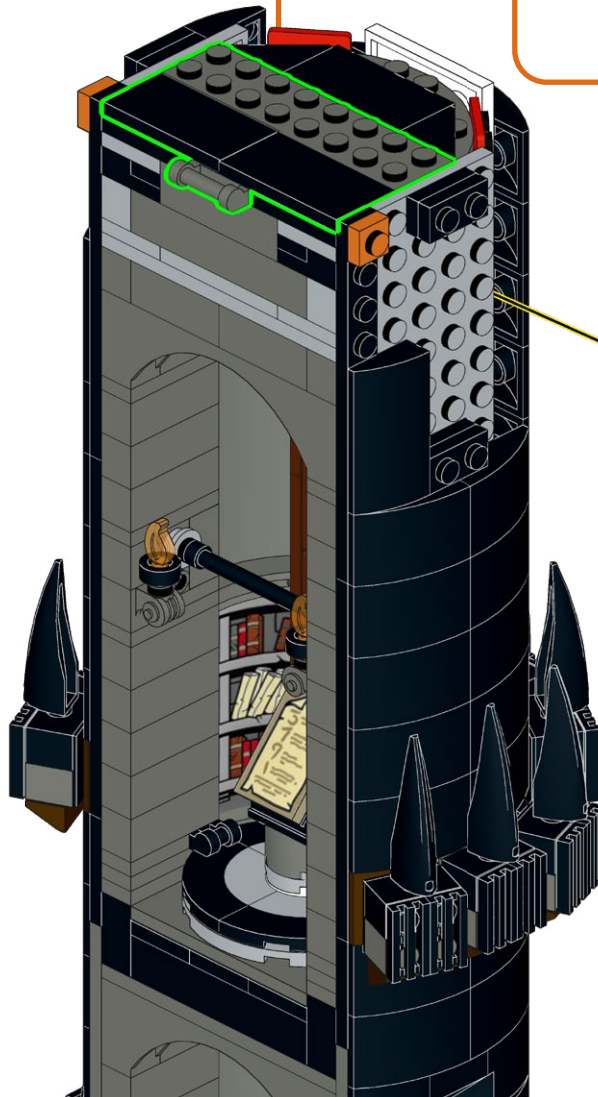
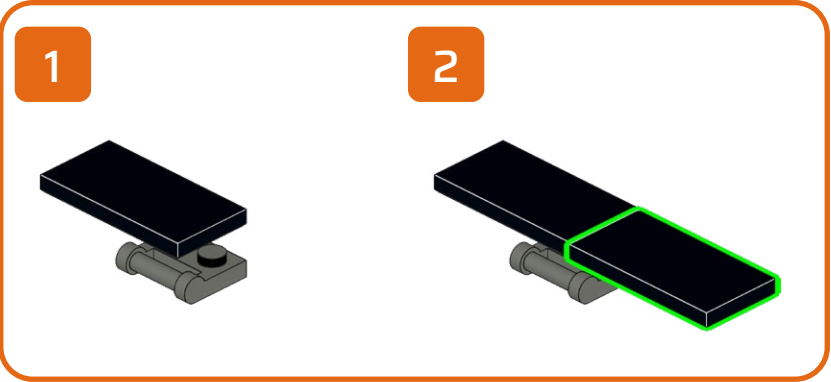
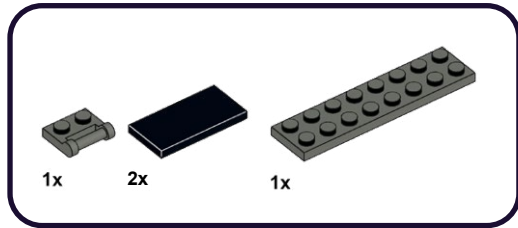

519

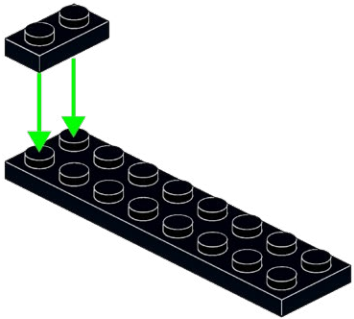
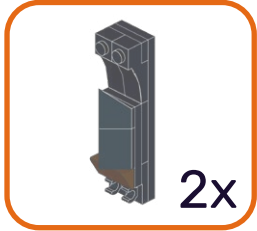
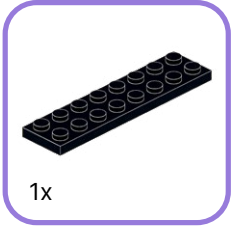
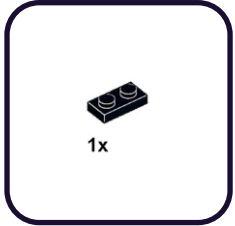

520

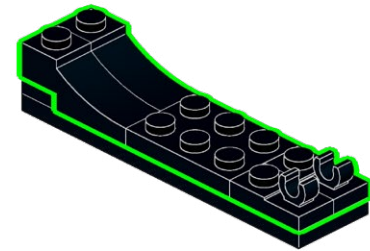
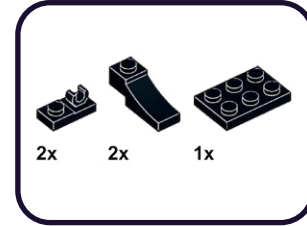

521

1x

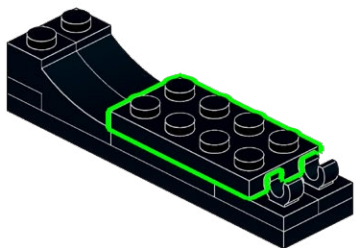
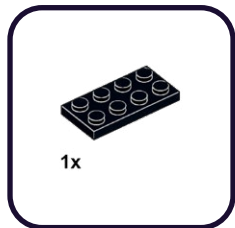

522

1x 1x 1x

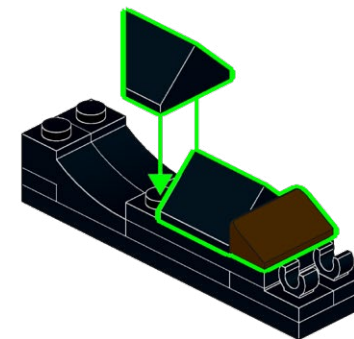
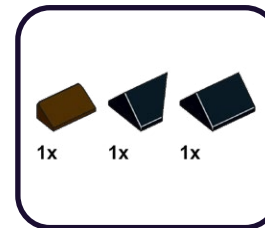

2x



To be used later
A utiliser plus tard
Da utilizzare dopo
Zur späteren Verwendung
Para ser utilizado más tarde
稍后使用

523

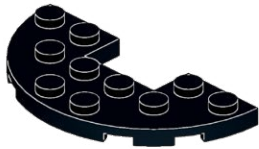

524

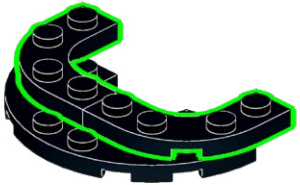
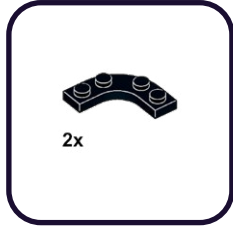

525

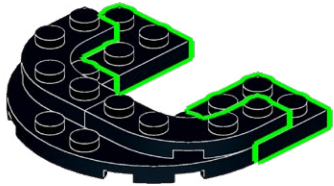
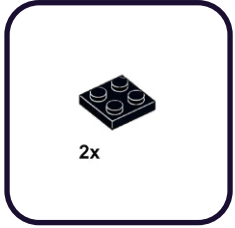

526

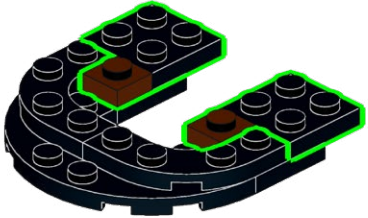
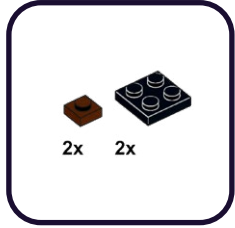

527

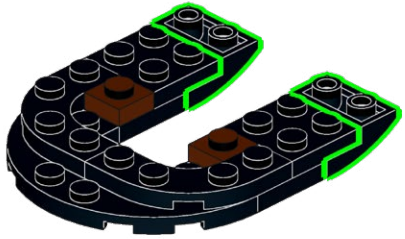
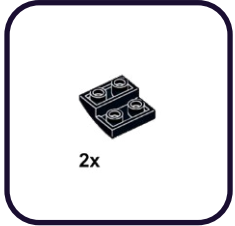

528

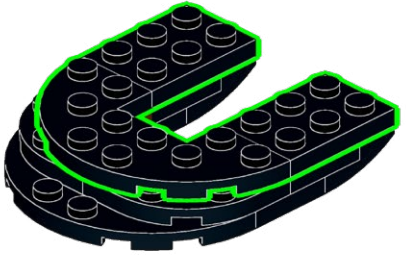
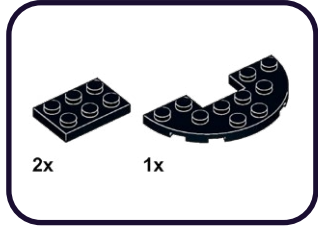

529

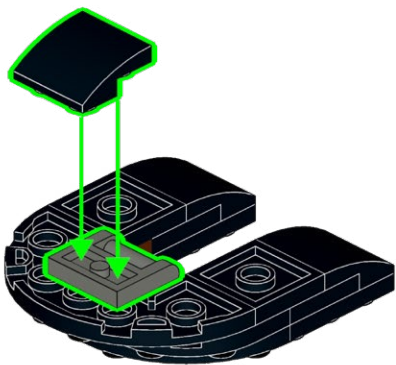
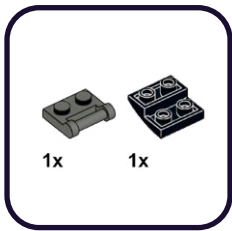

2x



To be used later
A utiliser plus tard
Da utilizzare dopo
Zur späteren Verwendung
Para ser utilizado más tarde
稍后使用

530

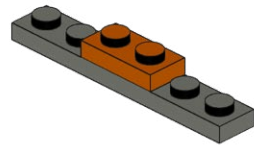
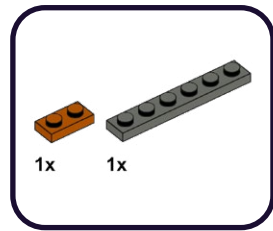

531

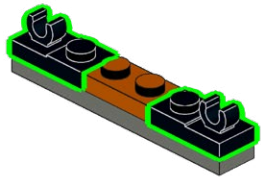
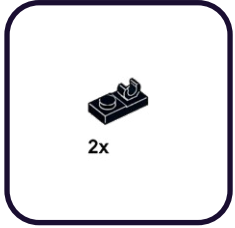

532

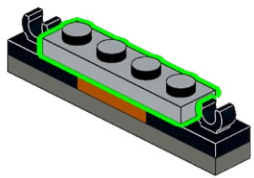
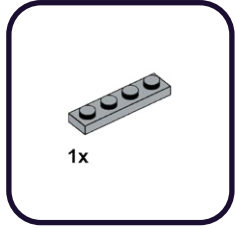

533

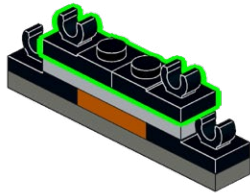
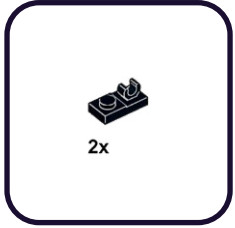

534

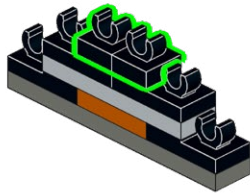

535

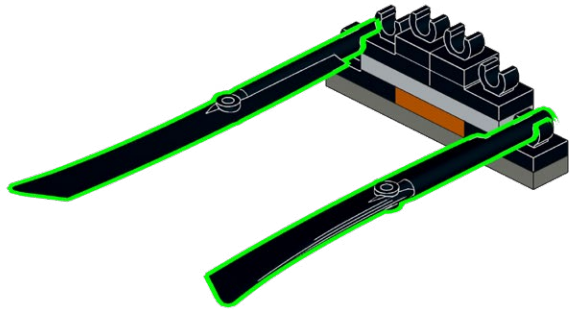

536

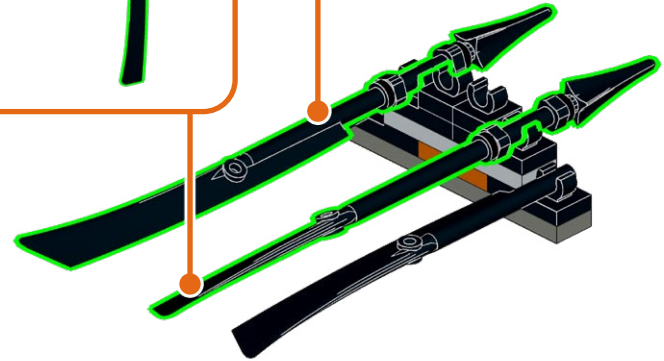

537

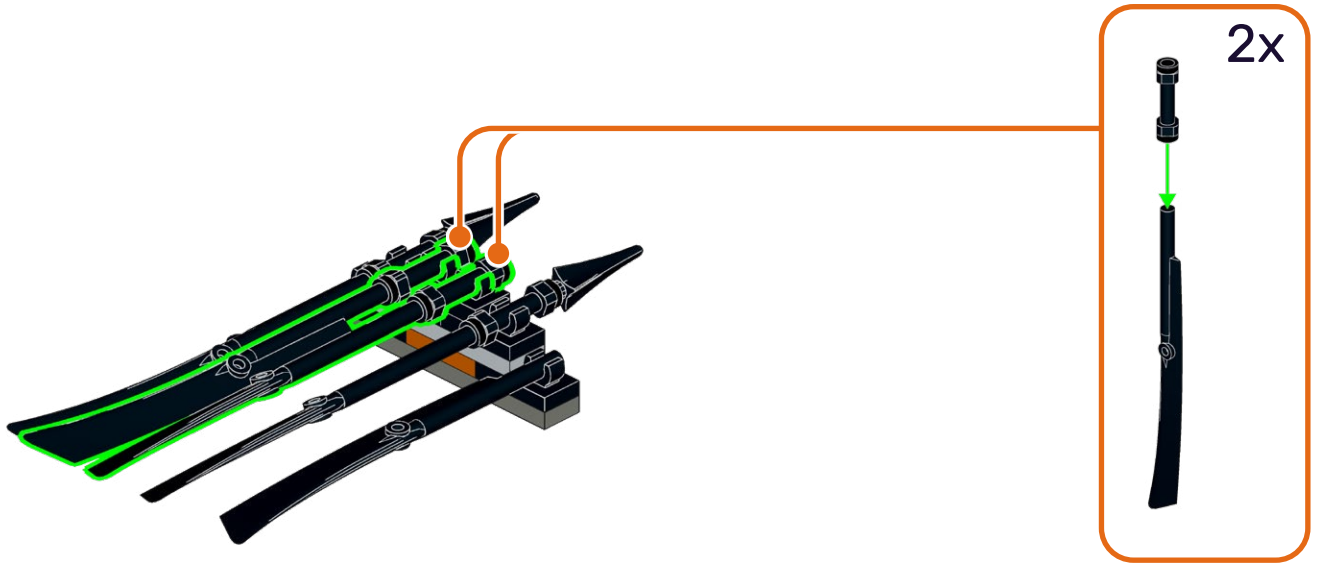

538

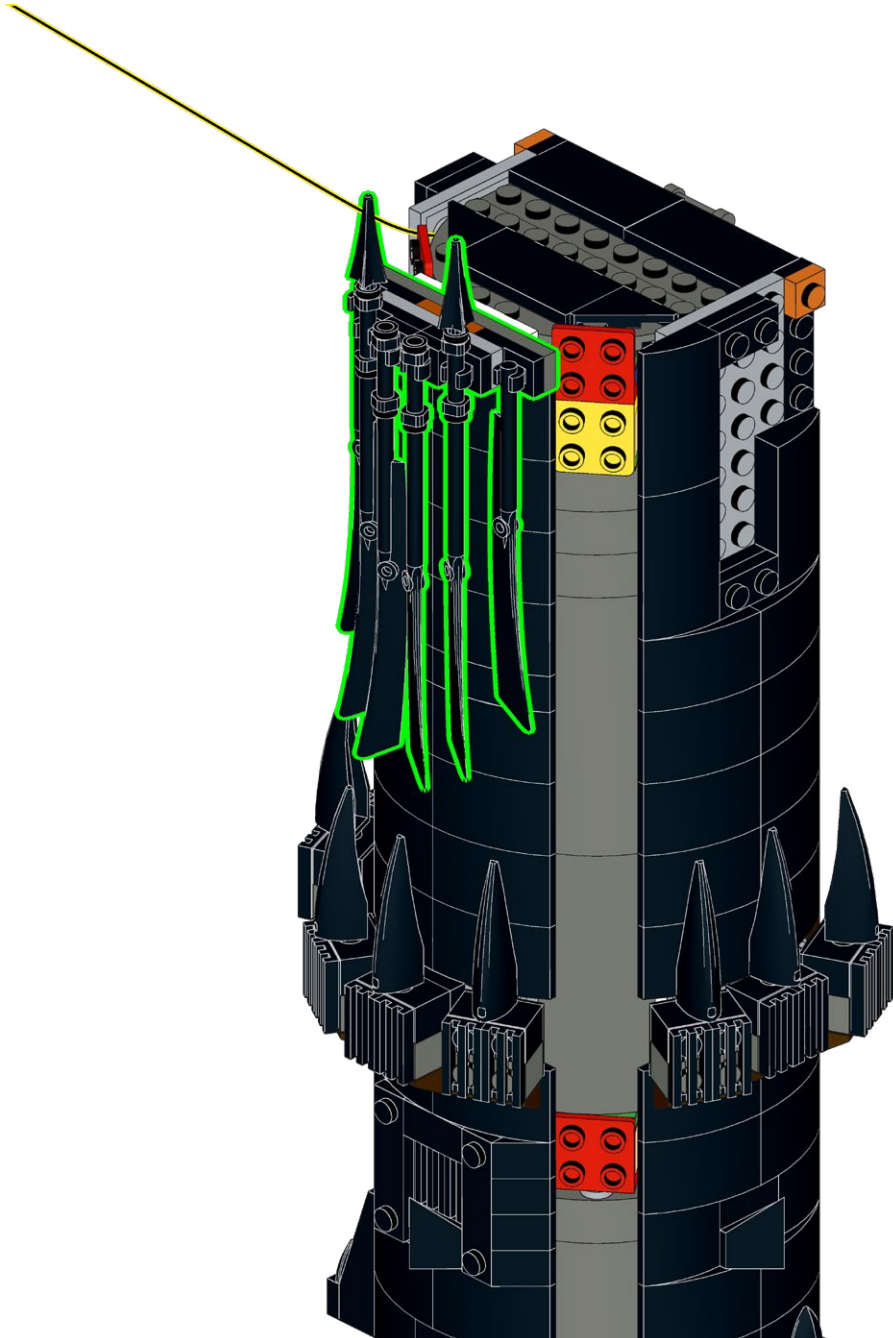

539

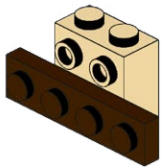
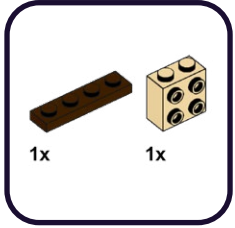

540

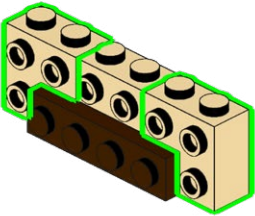
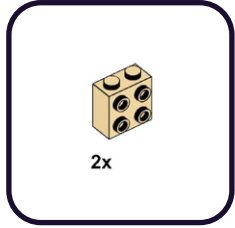

541

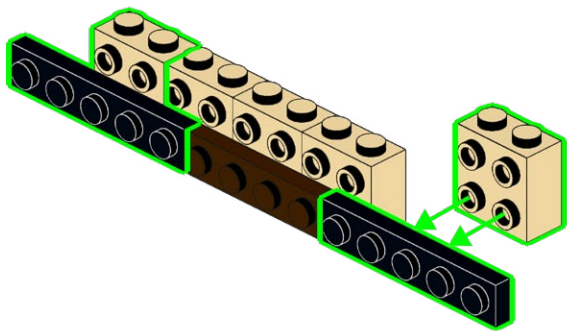
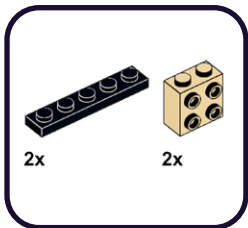

542

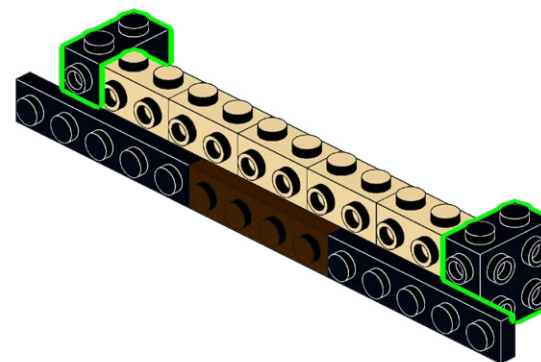
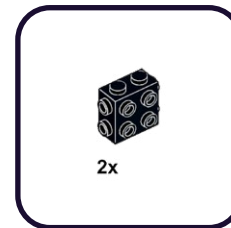

543

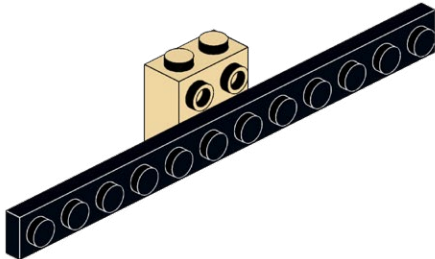
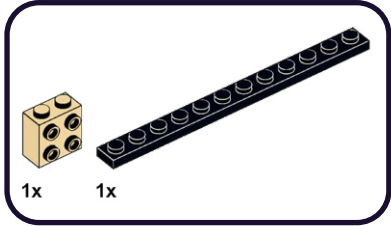

544

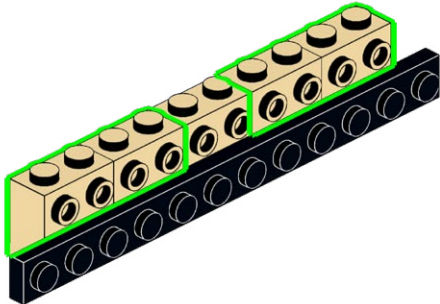
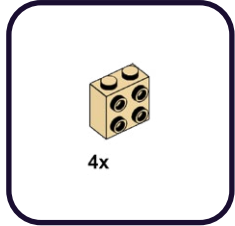

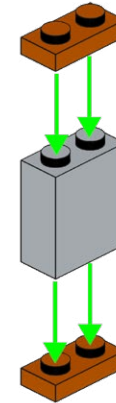
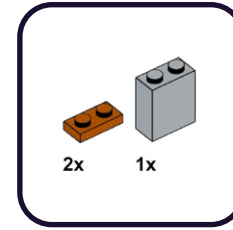
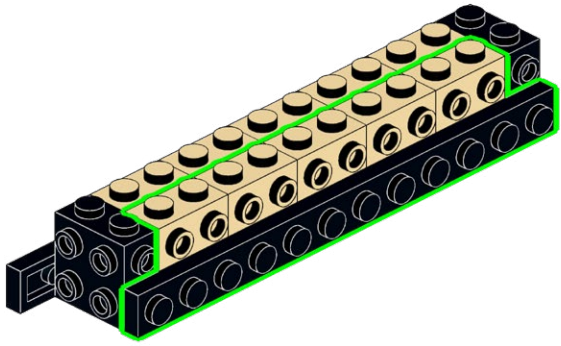

547

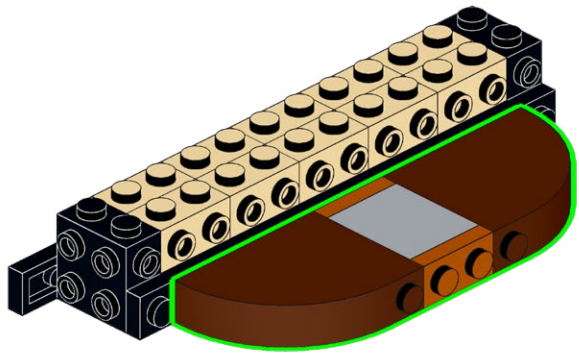
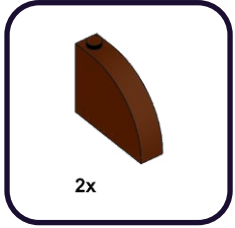

548

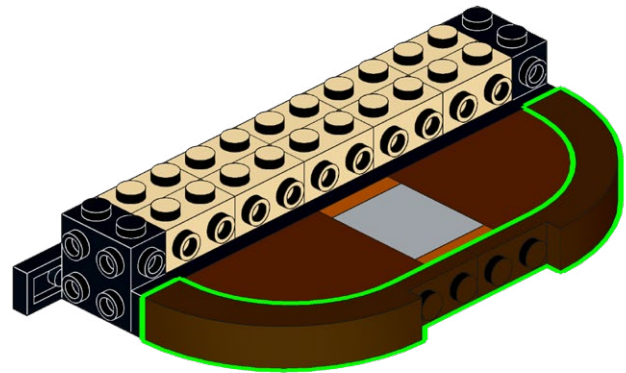

549

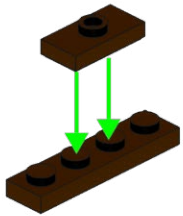
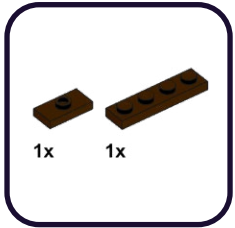

550

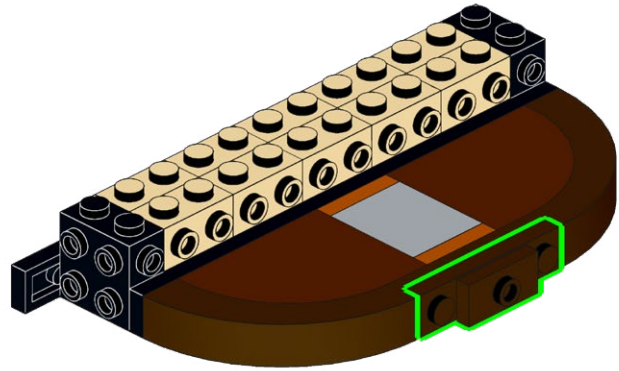

551

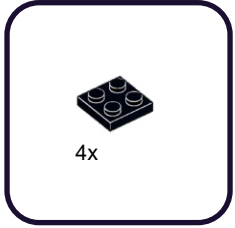

552

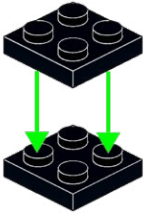

2x

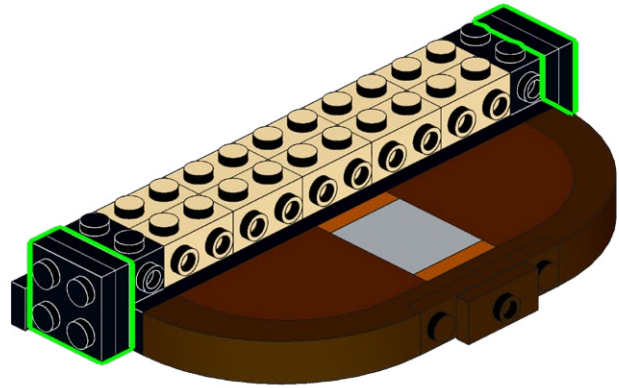

553

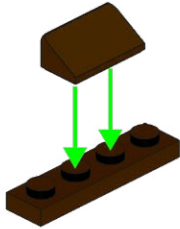
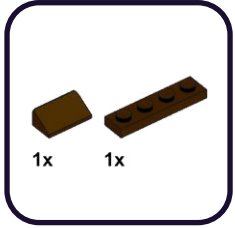

554

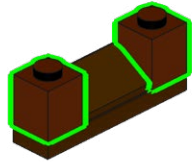
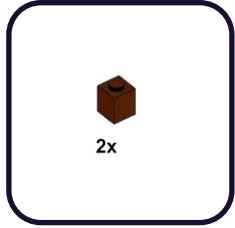

555

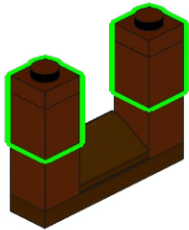
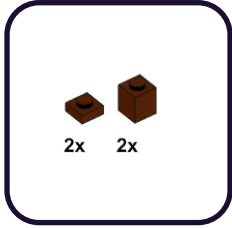

556

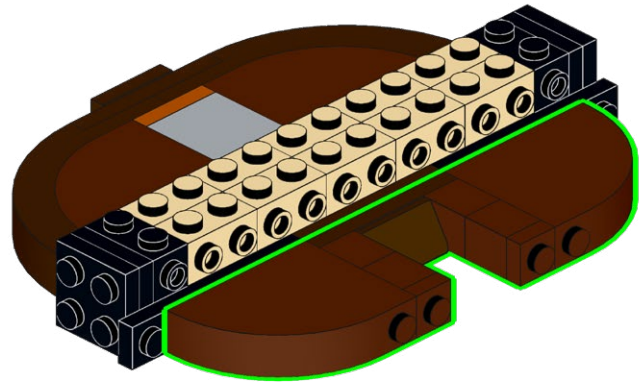
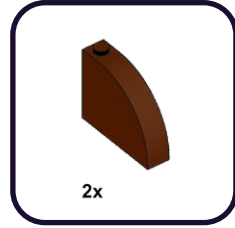

557

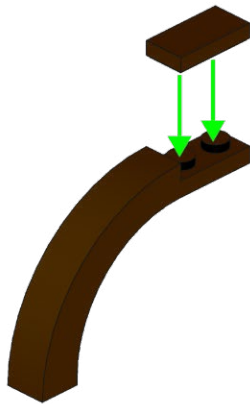
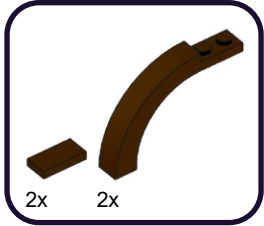

2x

558

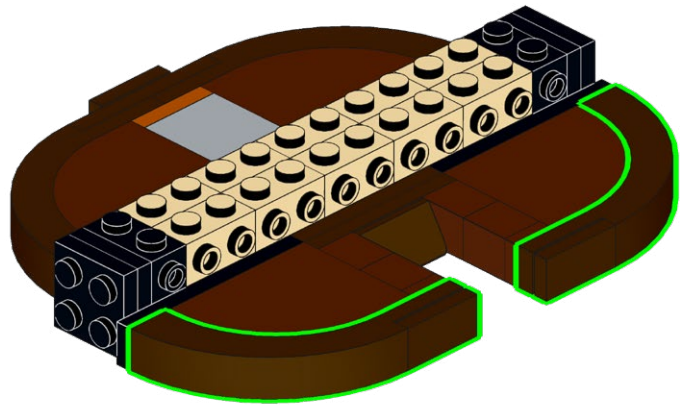

559

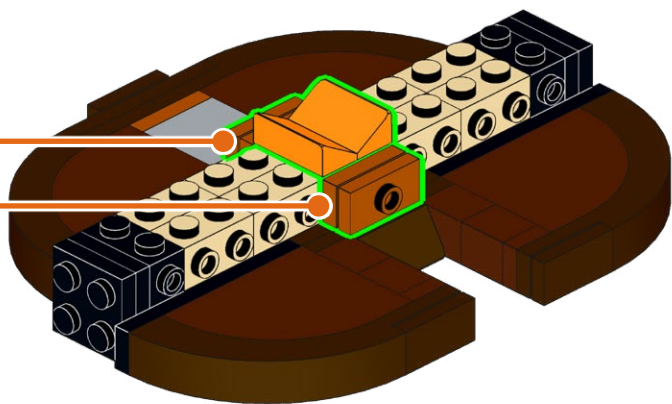
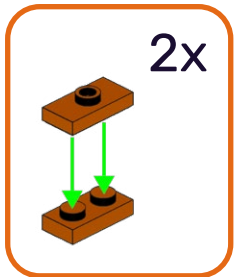
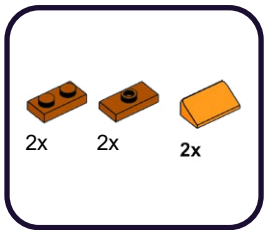

560

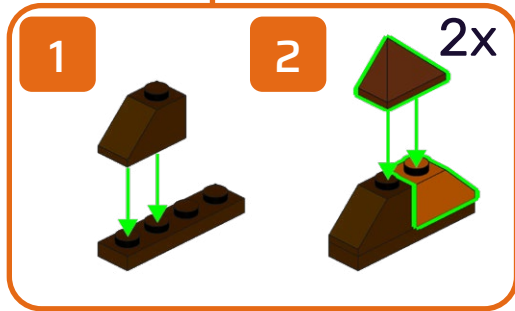
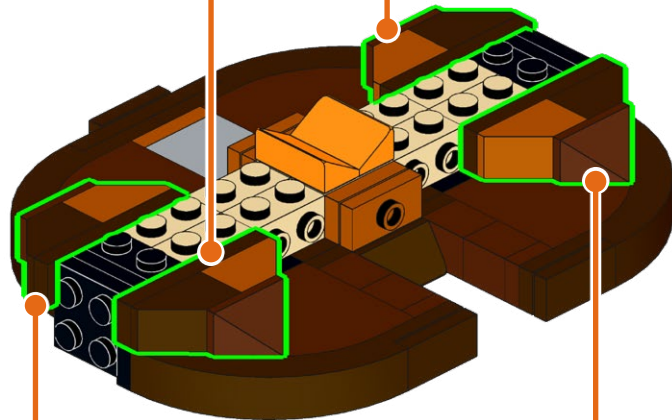
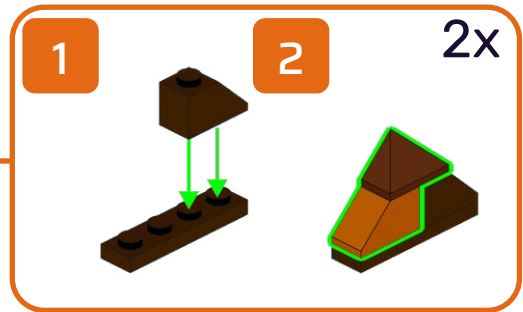
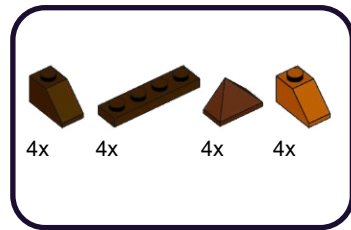

561

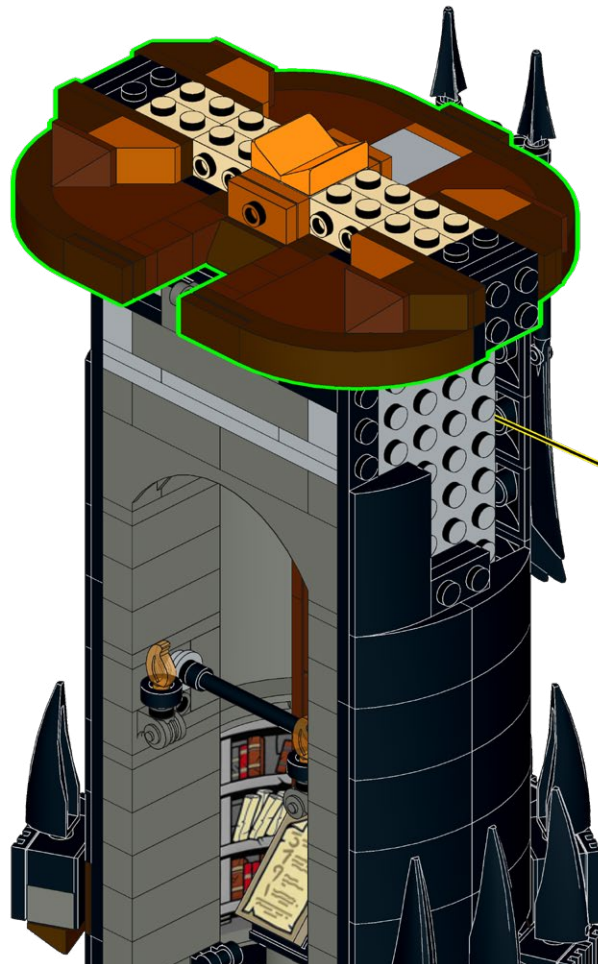

562

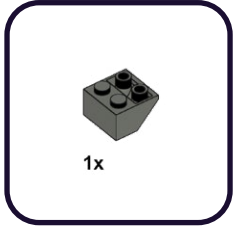

563

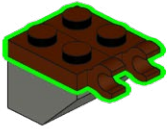
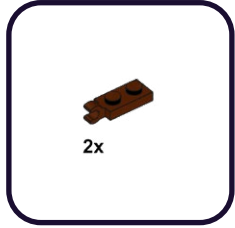

564

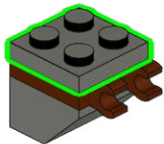
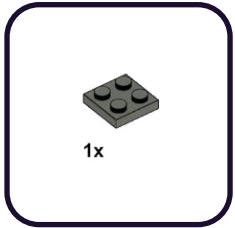

565

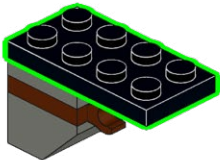
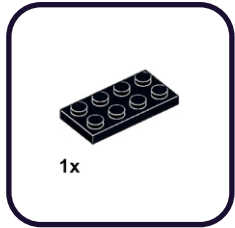

566

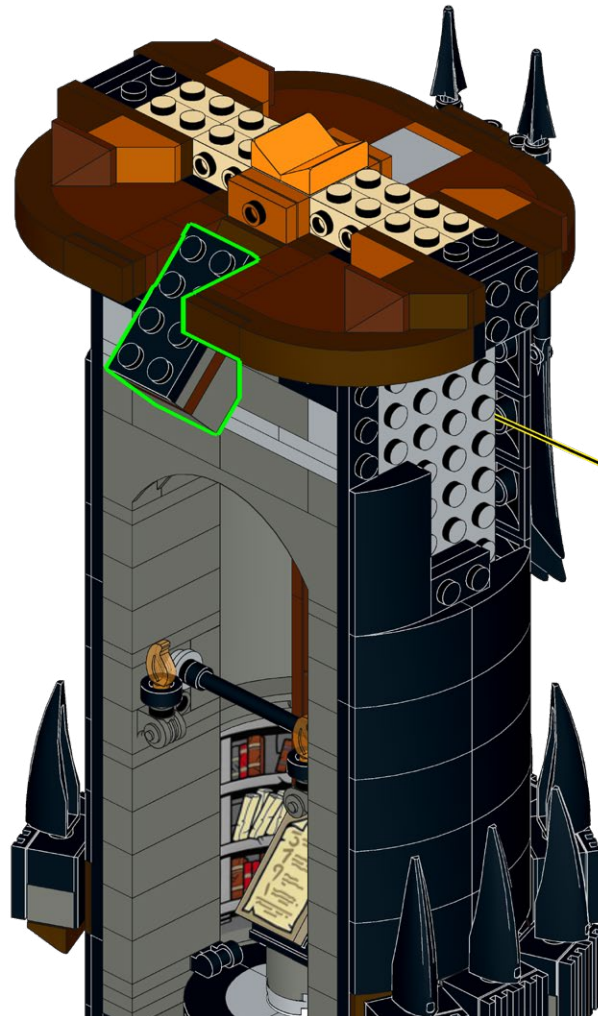

**HOLD UP!**

You might notice some bags aren't in order, as well as left over pieces, but that's ok! We're changing the way you build LEGO!

ATTENDEZ!

Vous remarquerez peut-être que certains sacs, ainsi que certaines pièces, ne sont pas dans le bon ordre. Mais pas de panique! Nous changeons simplement la façon avec laquelle vous construisez vos LEGO!

ASPETTA!

Potresti notare che alcuni sacchetti non sono in ordine, così come i pezzi avanzati, ma va bene così! Stiamo cambiando il modo in cui costruisci i LEGO!

HALT!

Sie werden möglicherweise bemerken, dass einige tüten durcheinander sind und teile übrig bleiben, aber das ist in Ordnung! Wir ändern die art und weise, wie Sie LEGO bauen!

¡ESPERA!

Es posible que notes que algunas bolsas están fuera de servicio, así como piezas sobrantes, ¡pero está bien! ¡Estamos cambiando la forma en que construyes LEGO!

暫停!

你可能会注意到一些袋子顺序错乱, 以及一些剩余的部件, 但没关系! 我们正在改变你搭建乐高的方式!

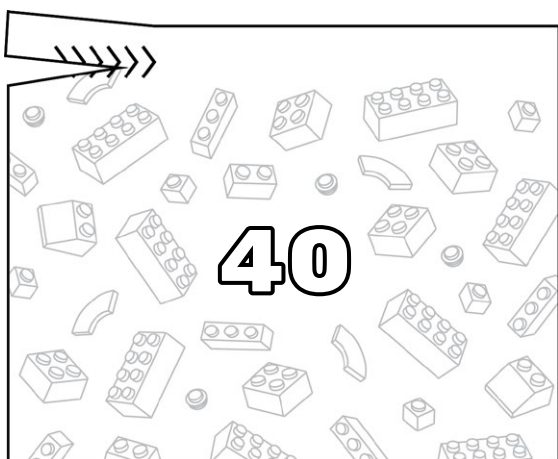
Open LEGO® Bag 40

567

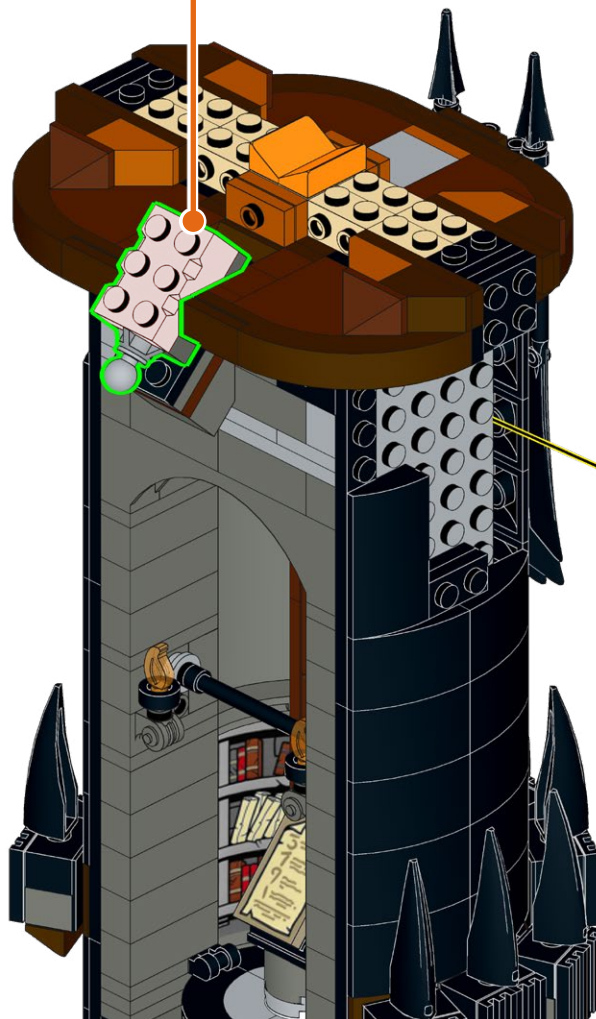
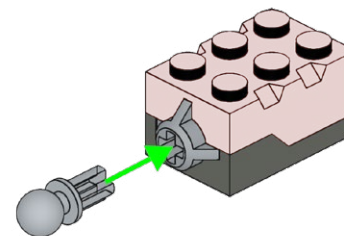
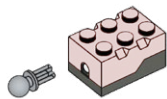

568

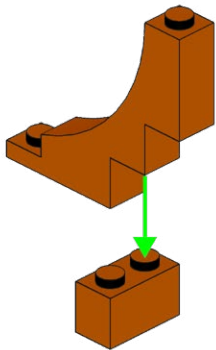
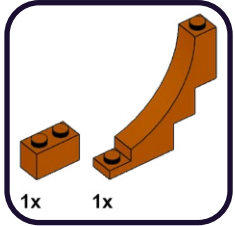

569

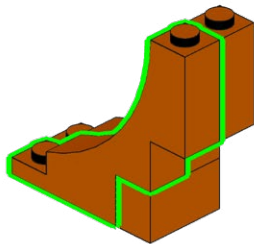
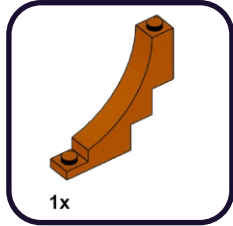

570

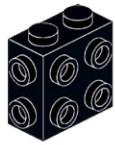
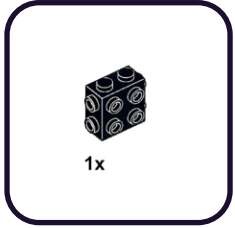

571

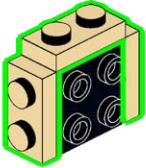
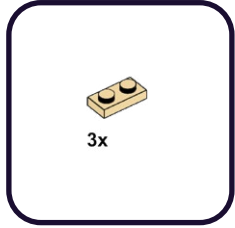

572

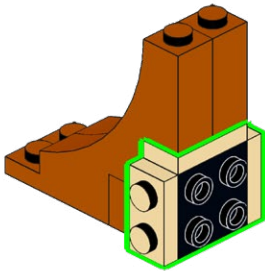

573

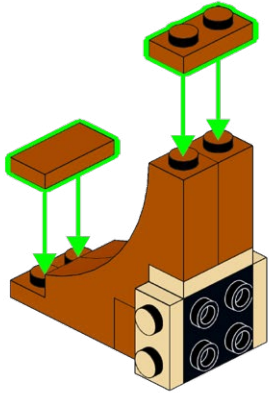
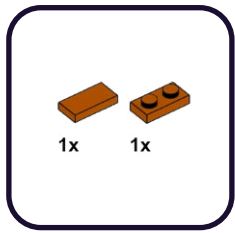

574

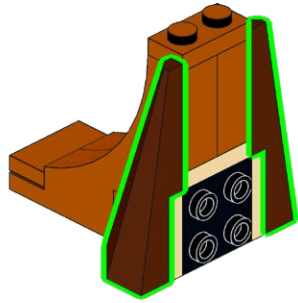
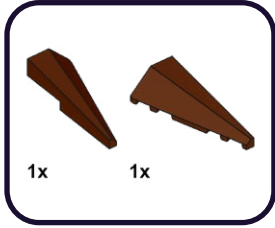

2x

575

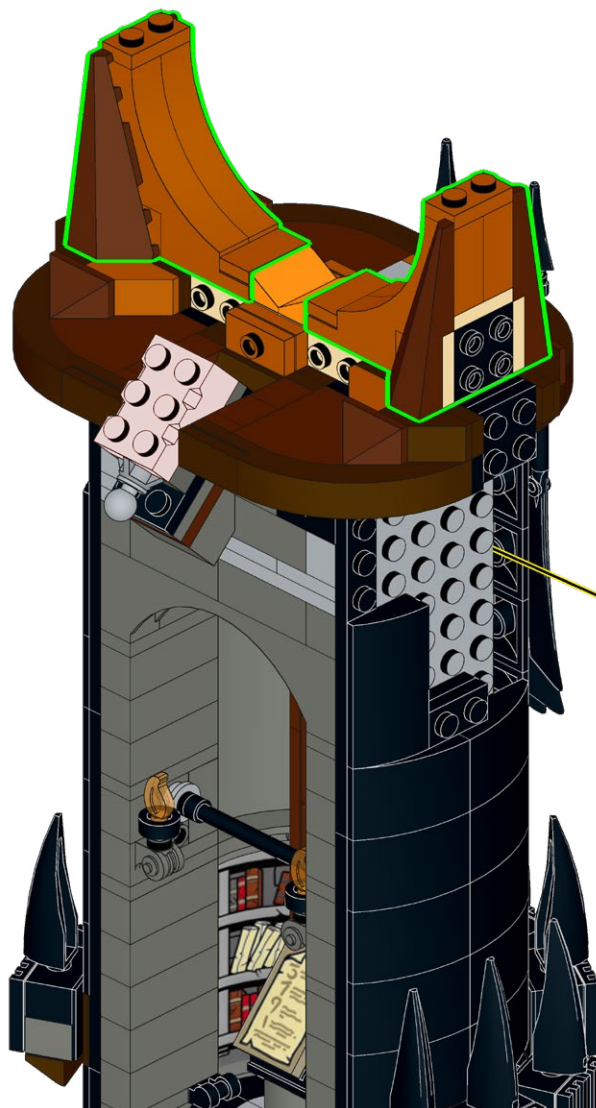

576

4x 4x

2x

2x

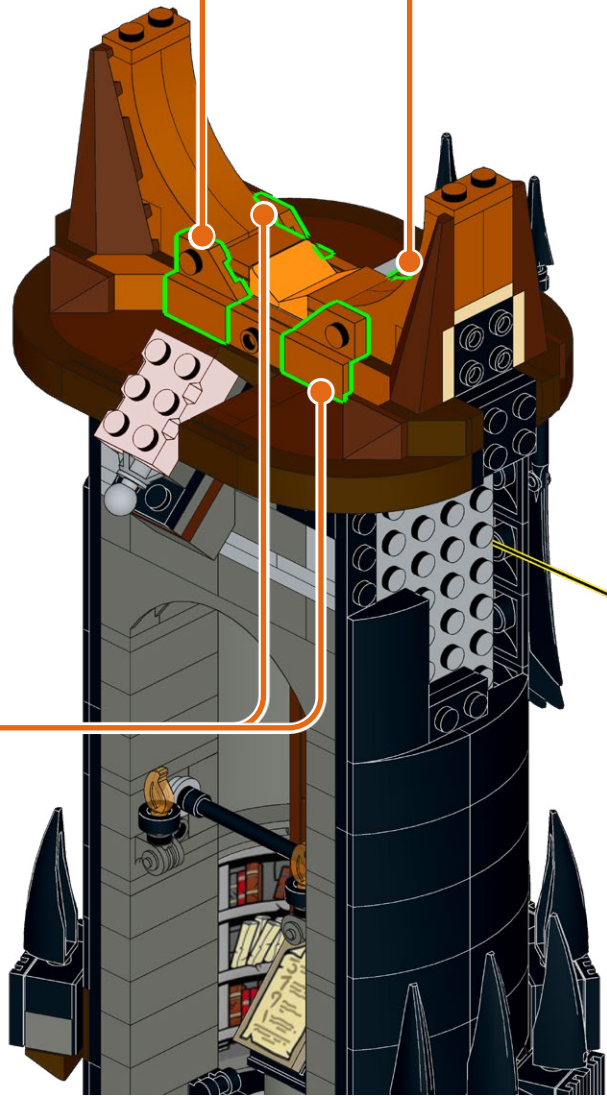

577

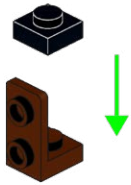
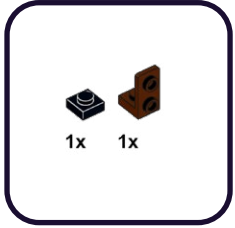

578

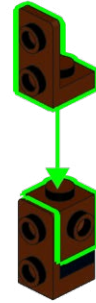
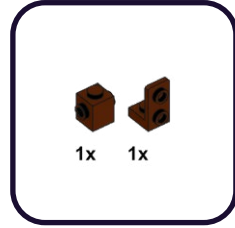

579

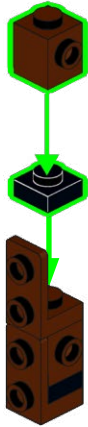
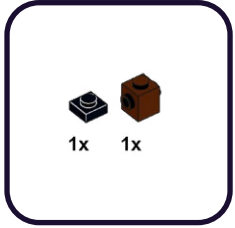

580

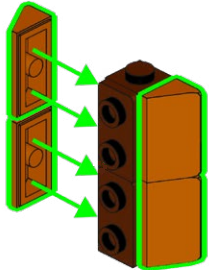
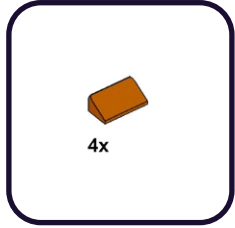

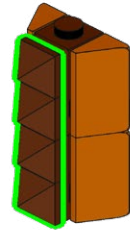

582

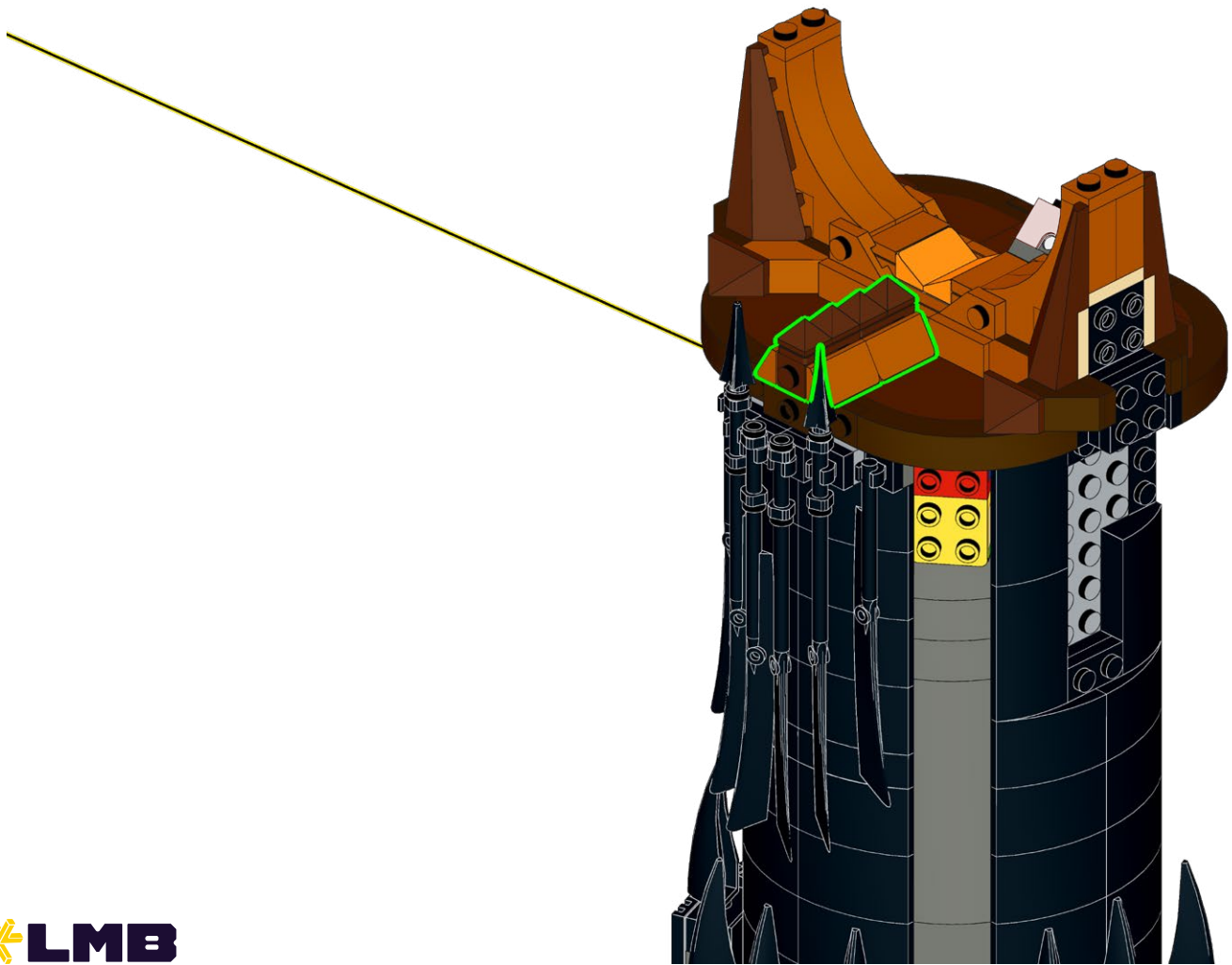

583

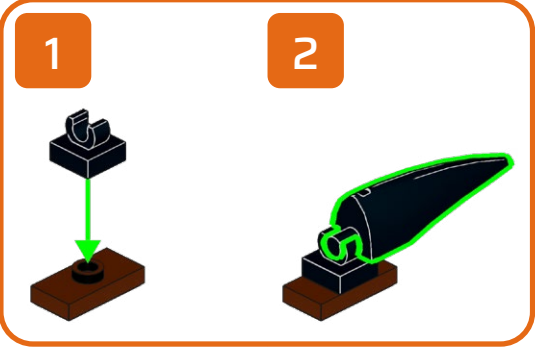
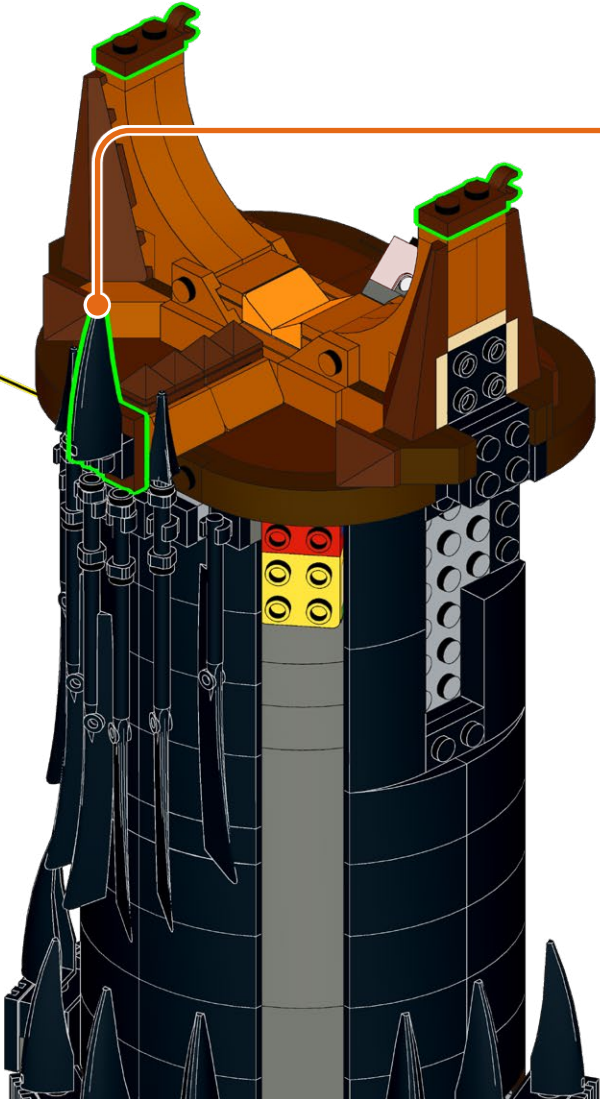

584

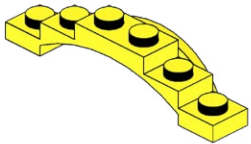
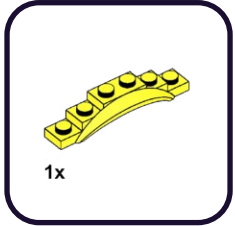

585

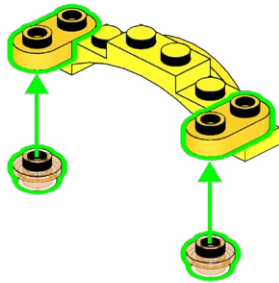

586

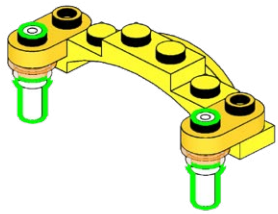
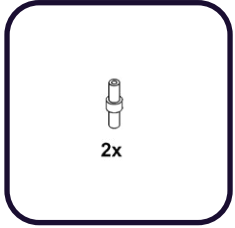

587

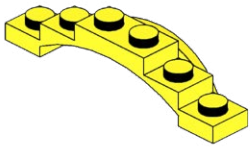
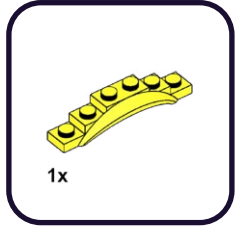

588

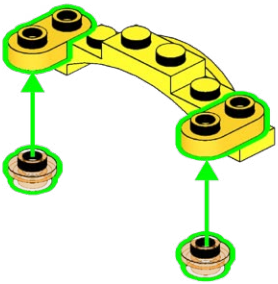

589

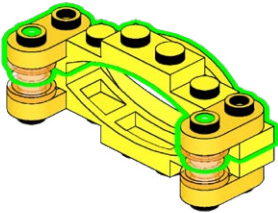

590

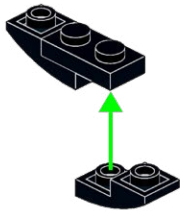
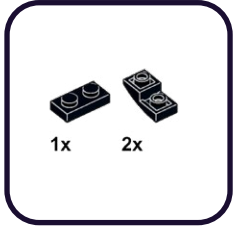

591

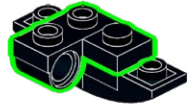
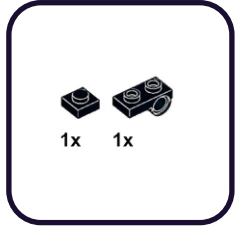

592

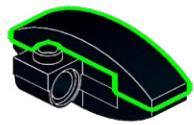

593

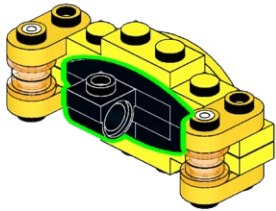

594

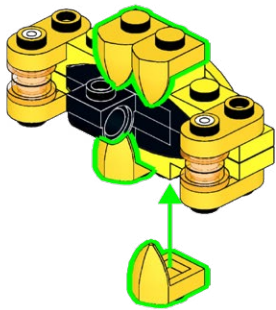
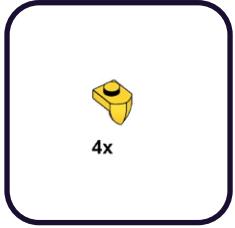

595

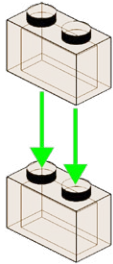
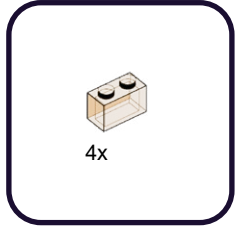

2x

596

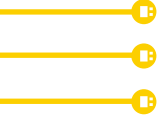

597

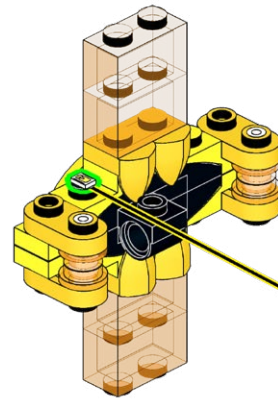
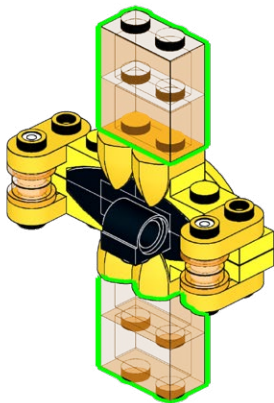
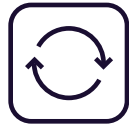
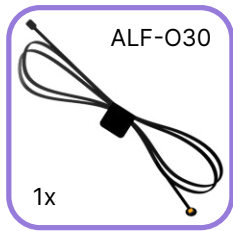

598

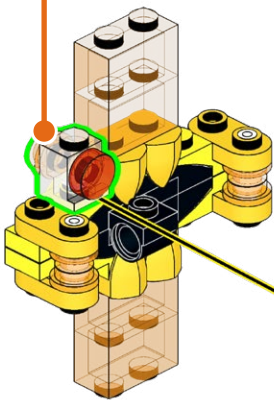
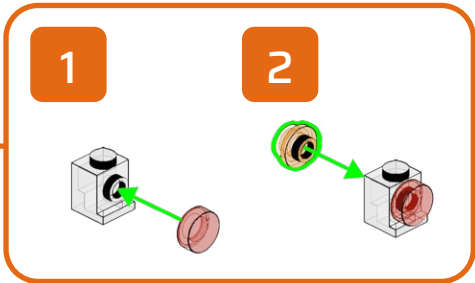
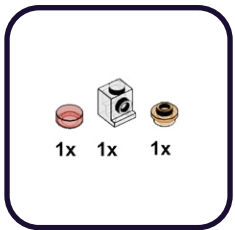

599

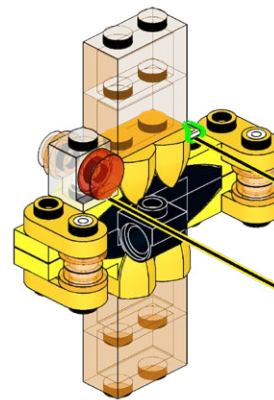
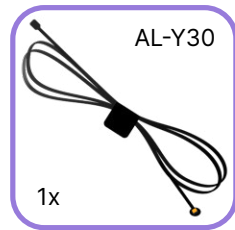

600

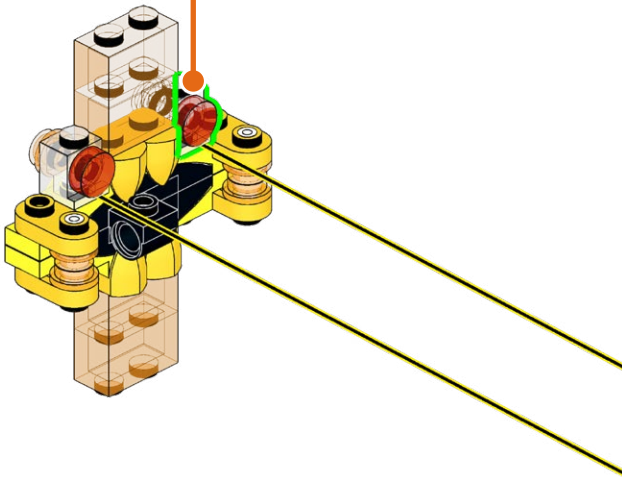
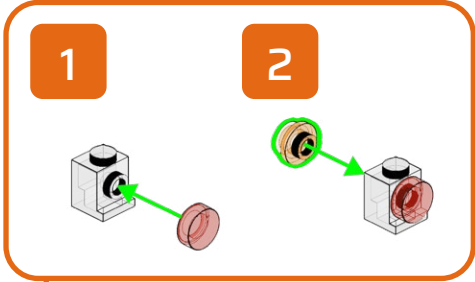
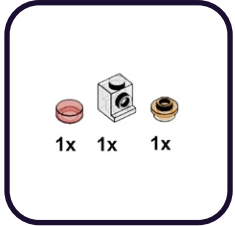

601

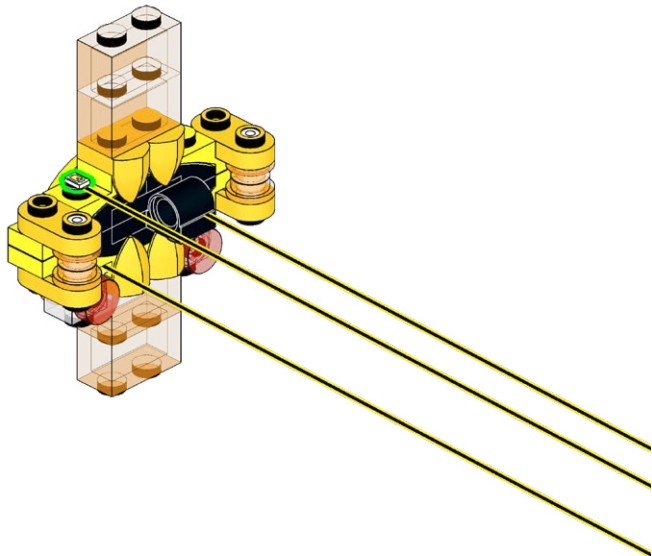
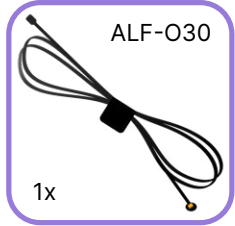

602

1x 1x 1x



1

2

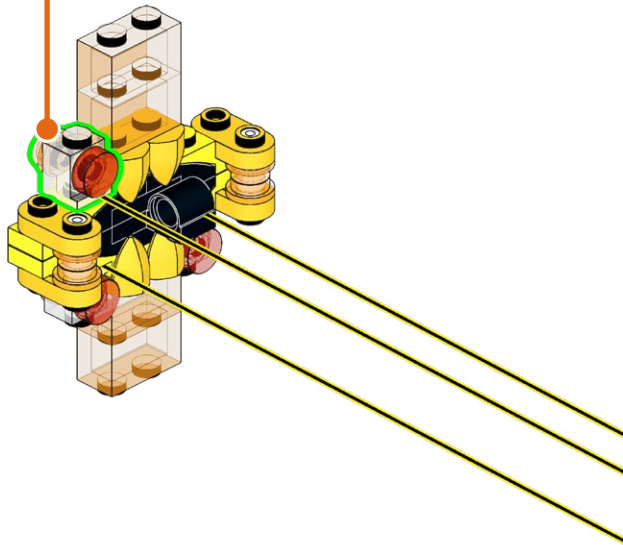

603

AL-Y30

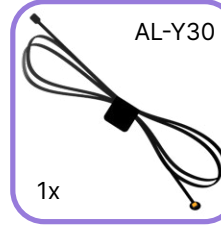

1x

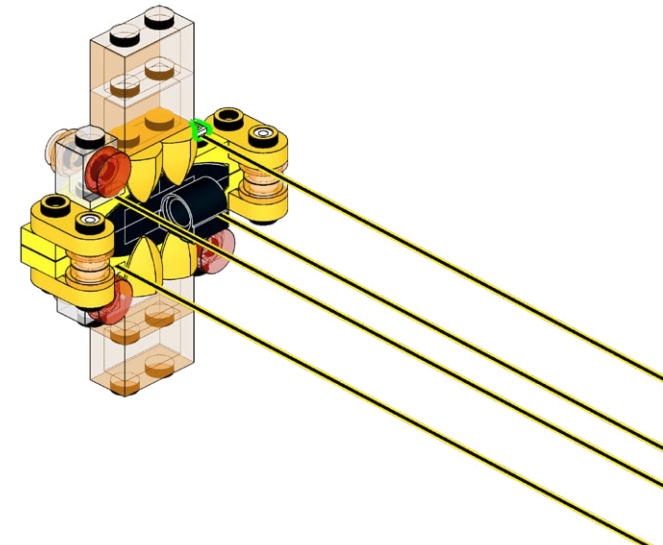

604

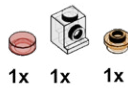

1

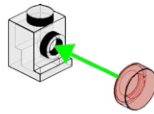

2

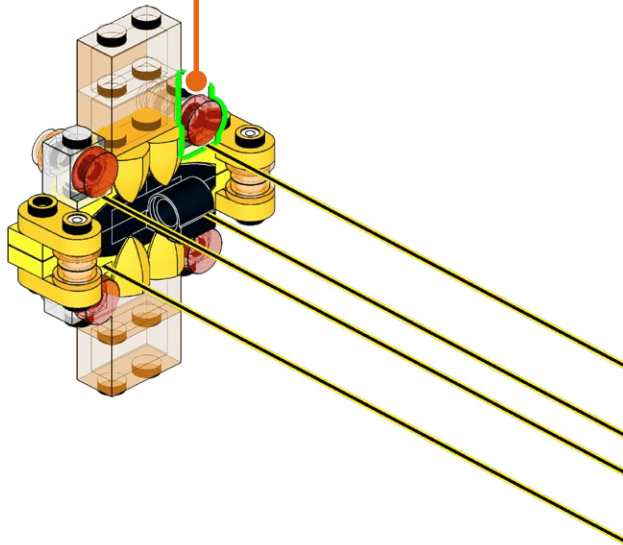
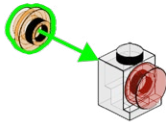

605

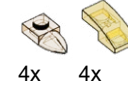

4x

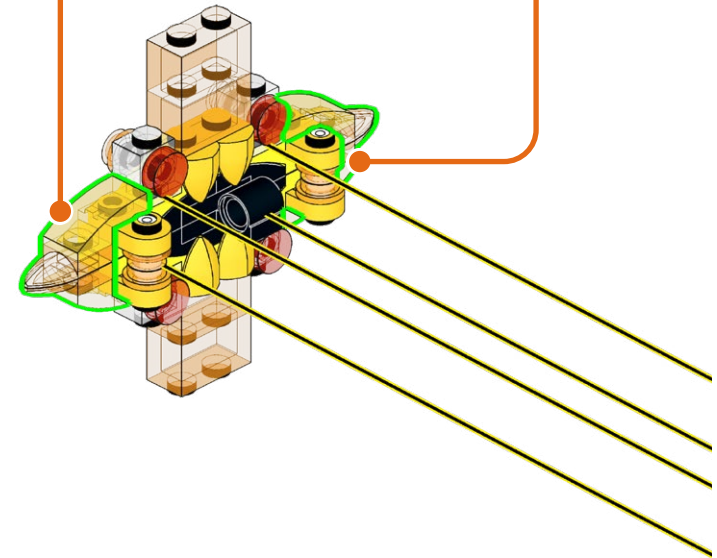
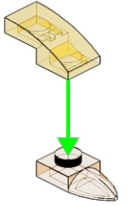

606

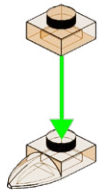
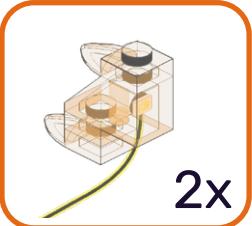
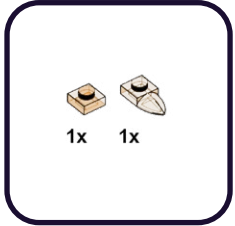

607

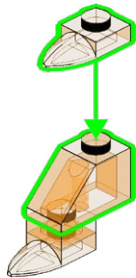
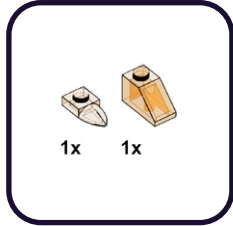

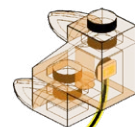
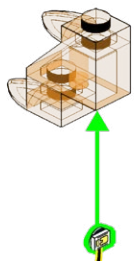
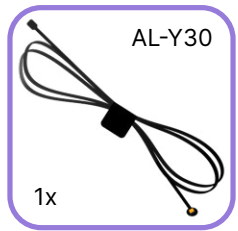

2x

610

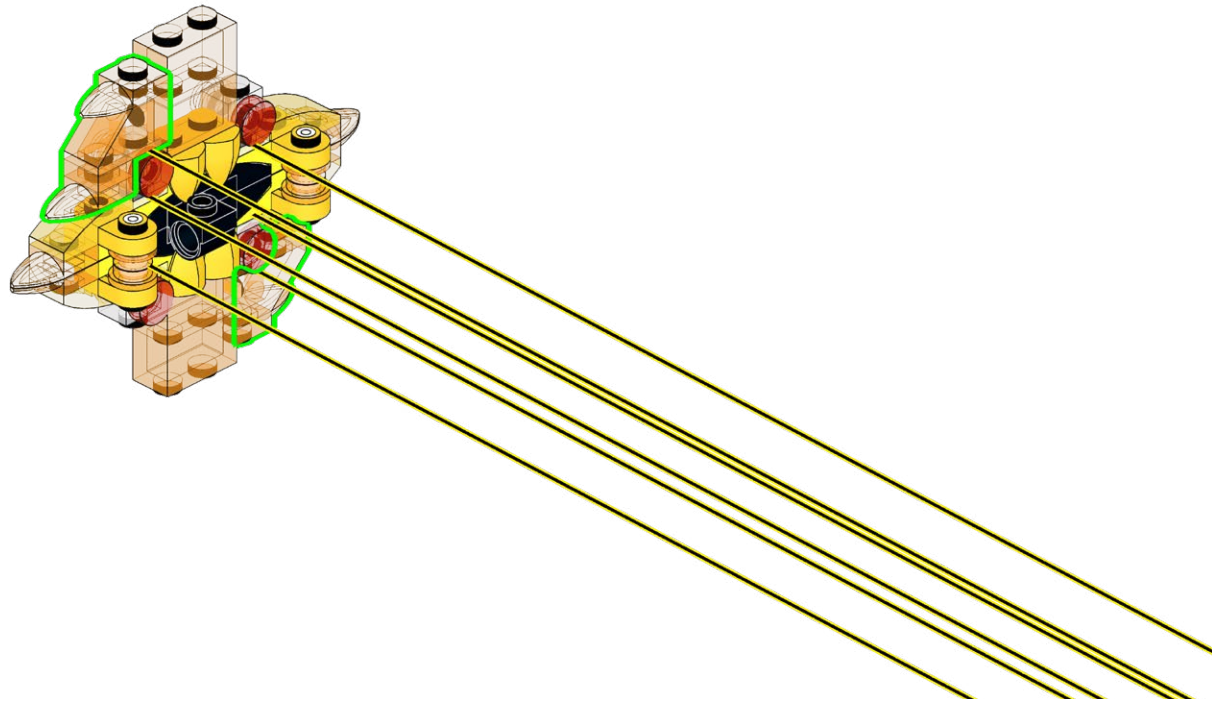

611

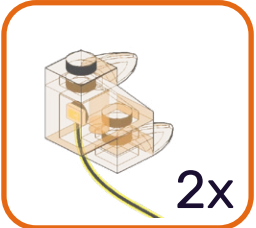
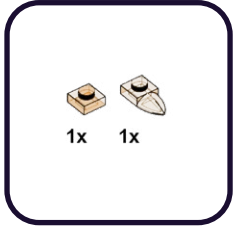

612

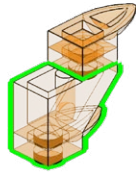
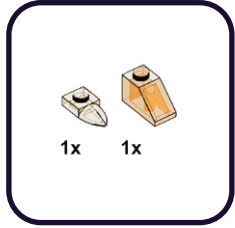

613

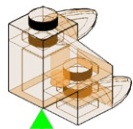
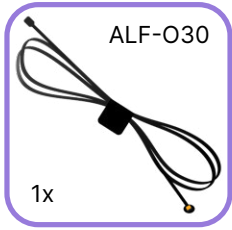

614

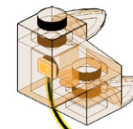

2x

615

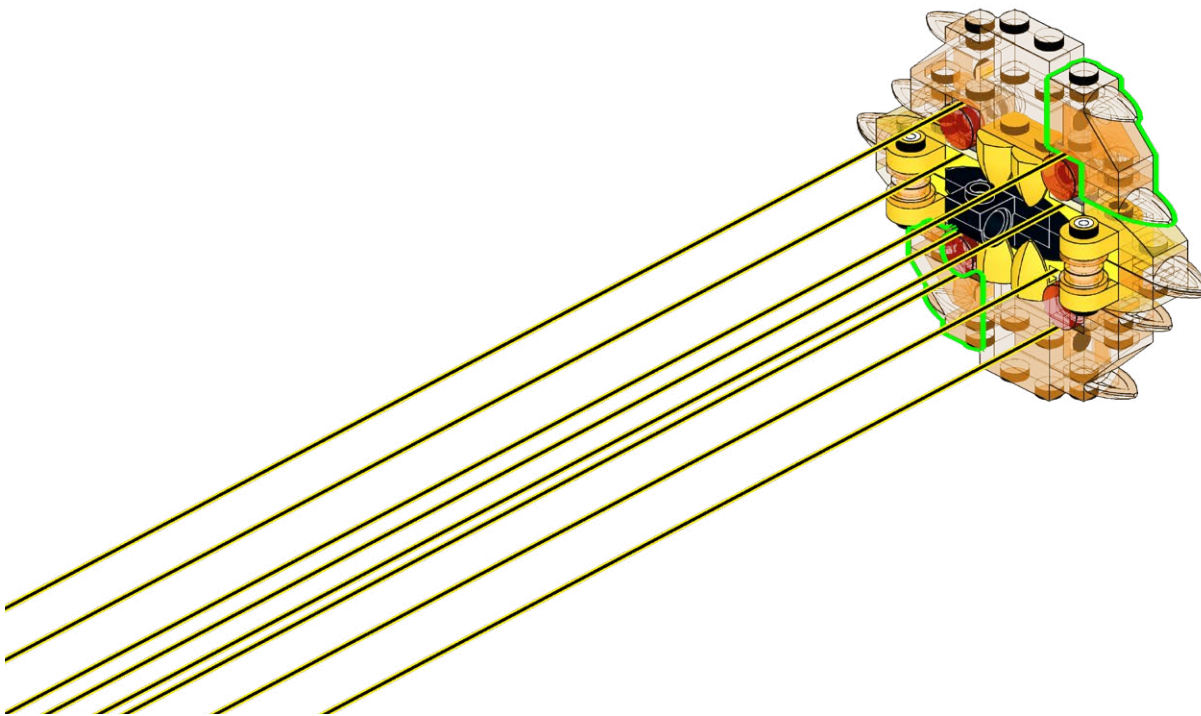

616

4x

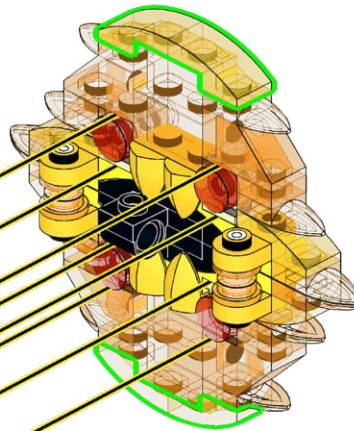

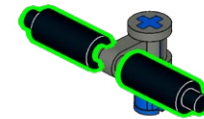
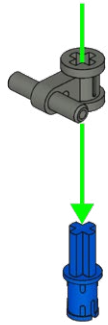
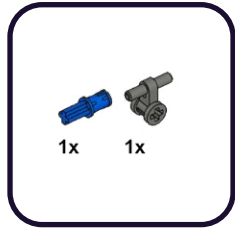

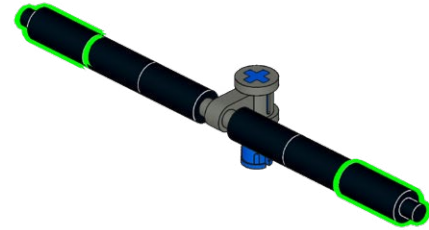
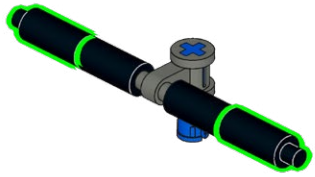
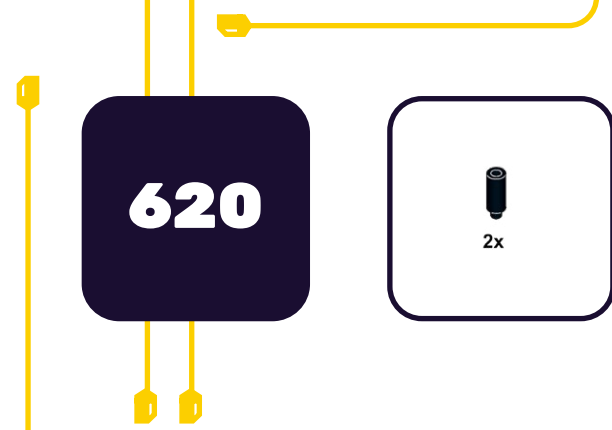

621

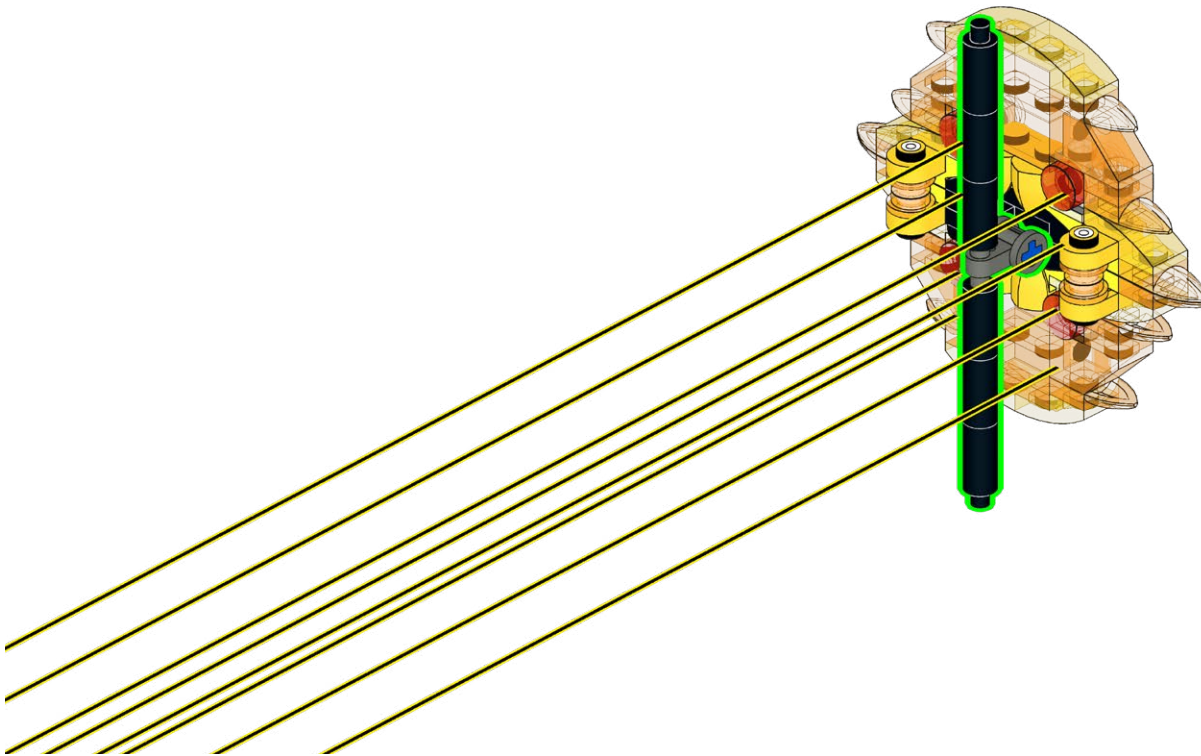

622

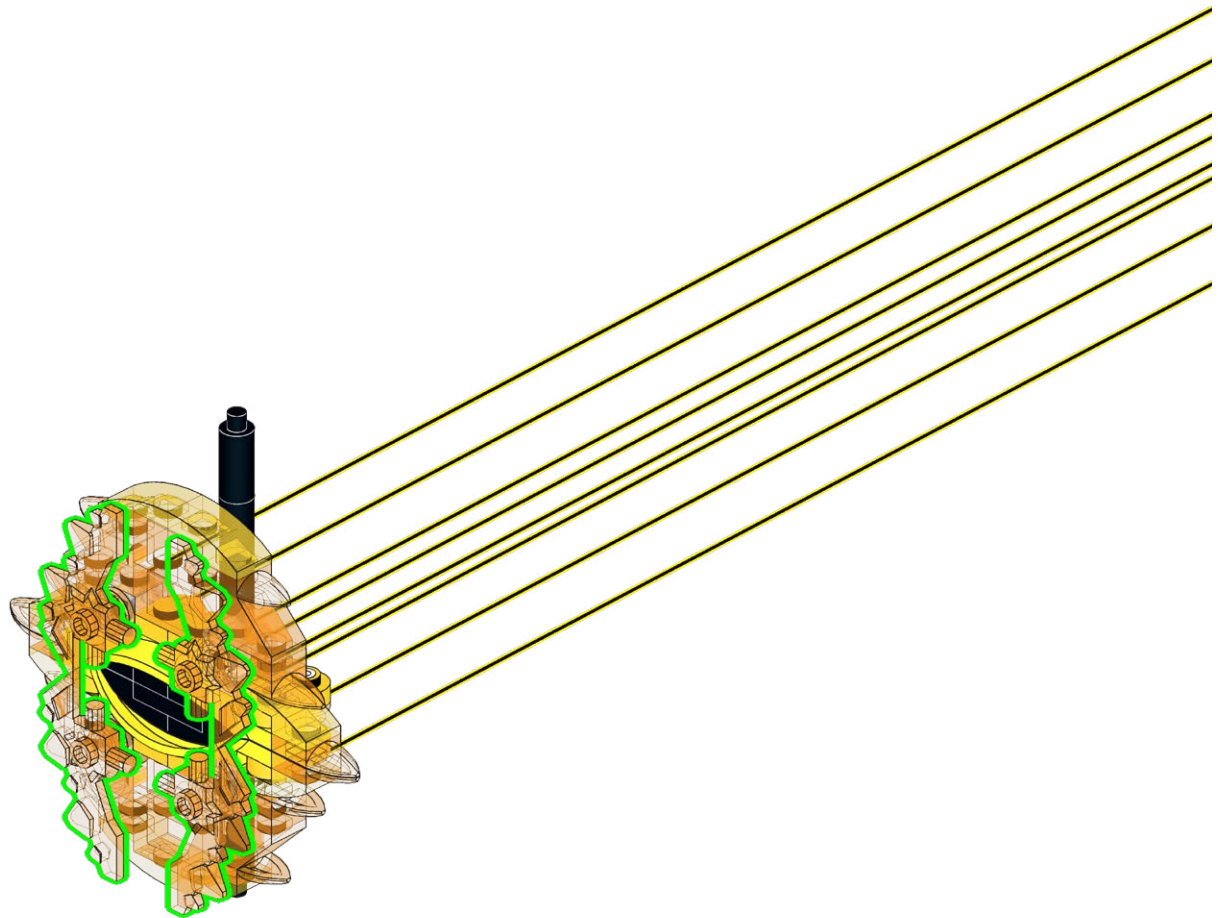
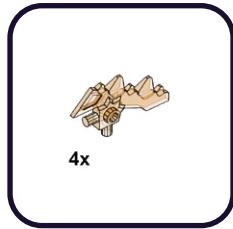

623



624

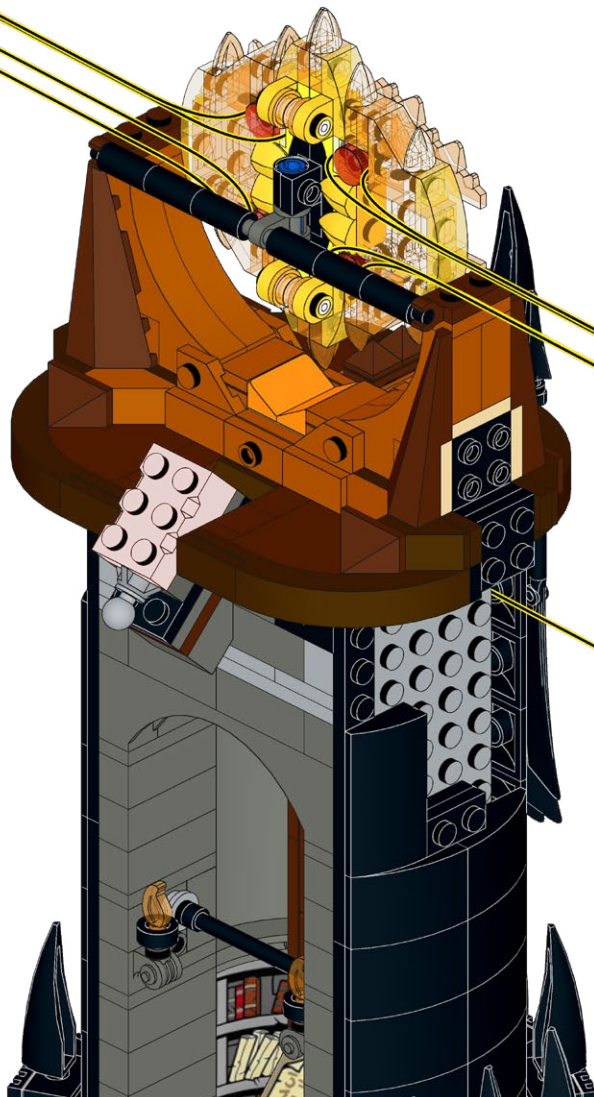

625

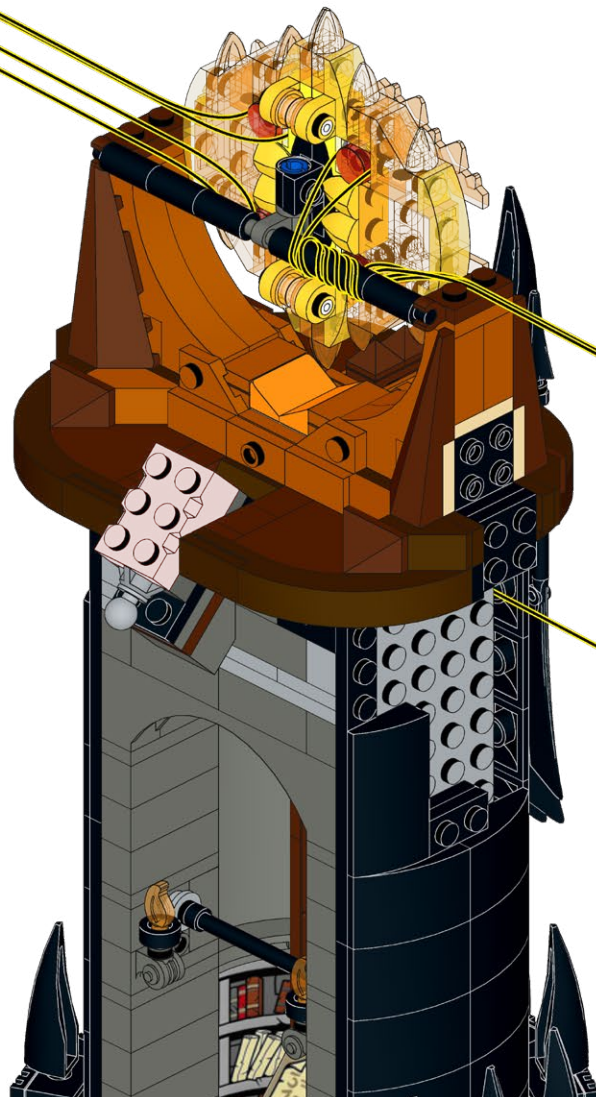

626

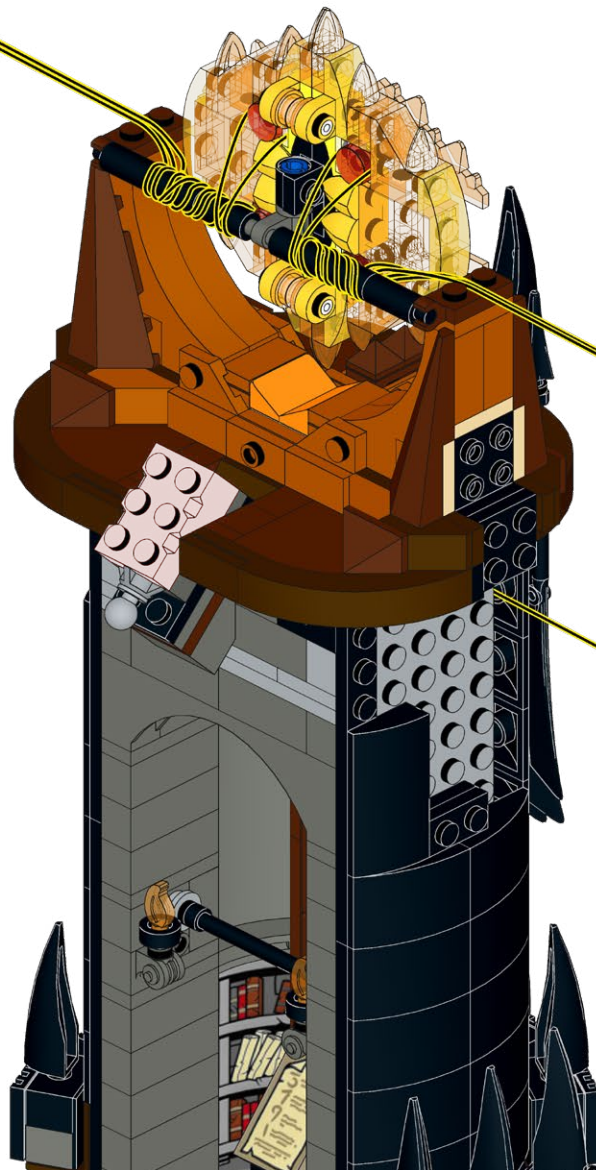

420

627

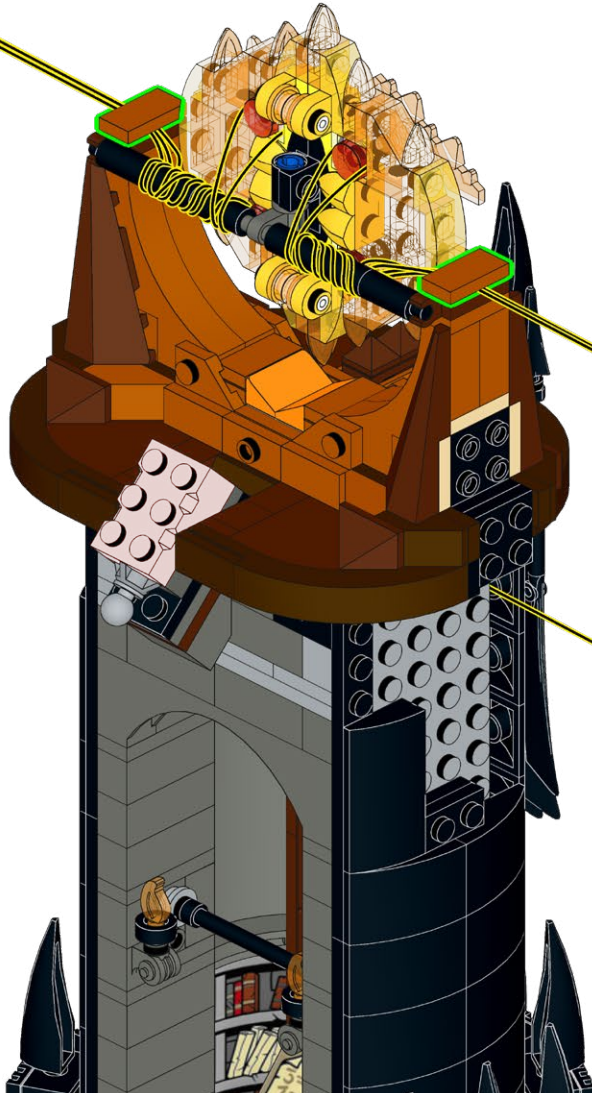
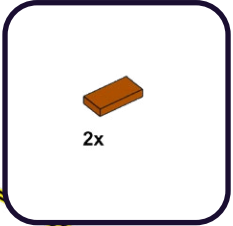

628

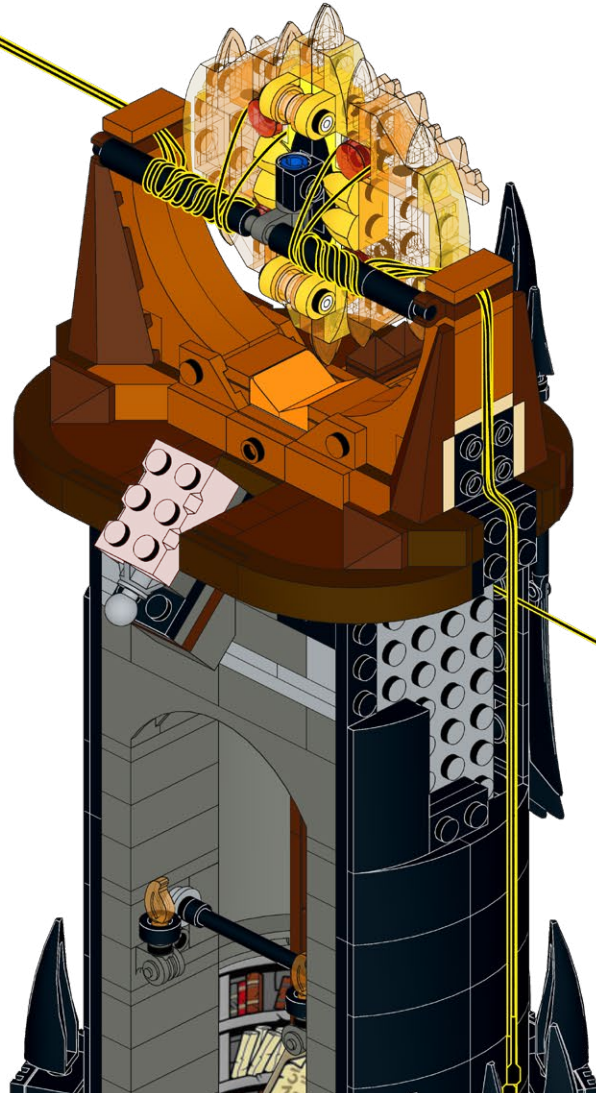

629

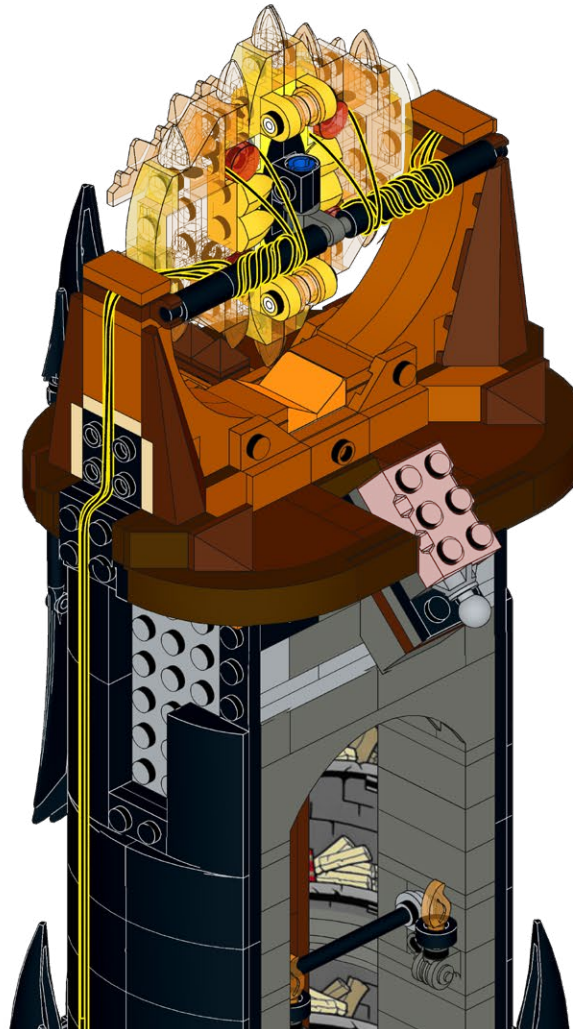

630

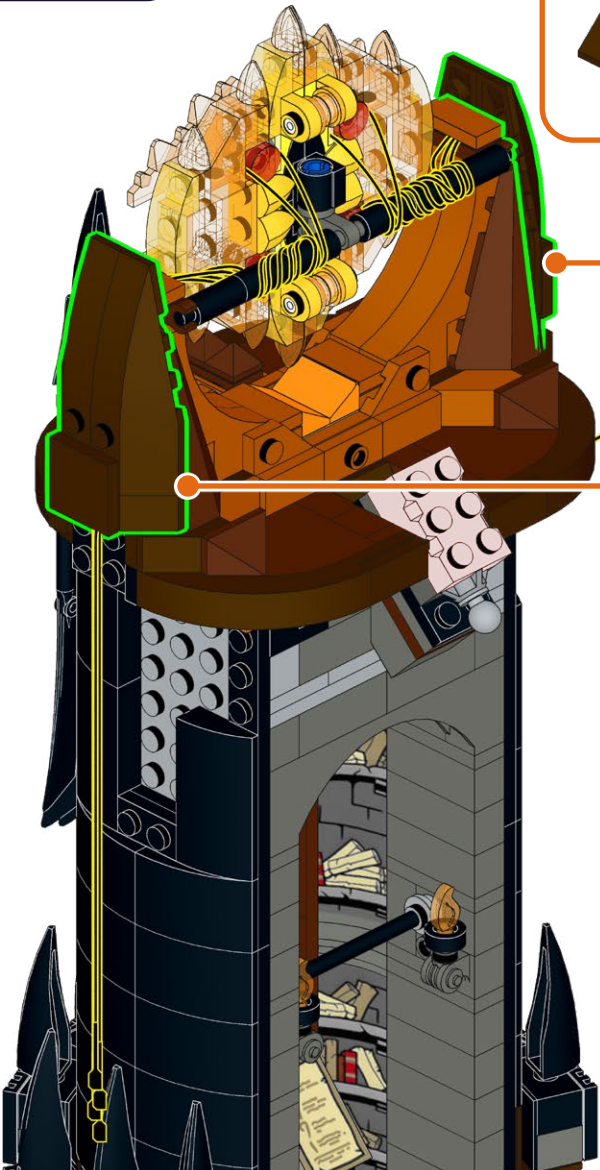
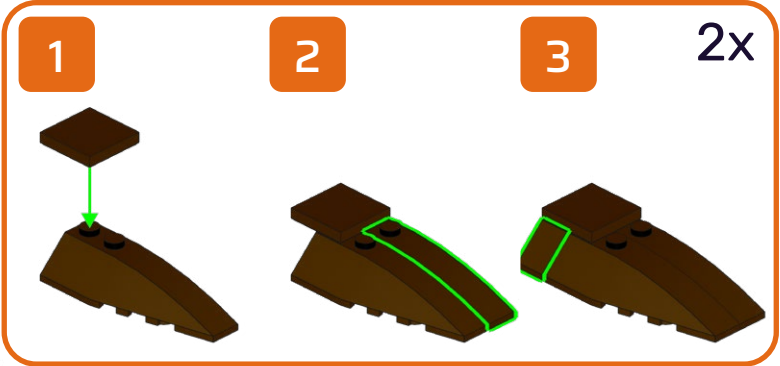
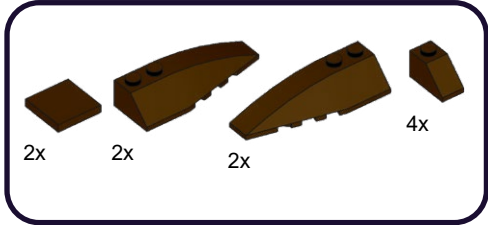

631

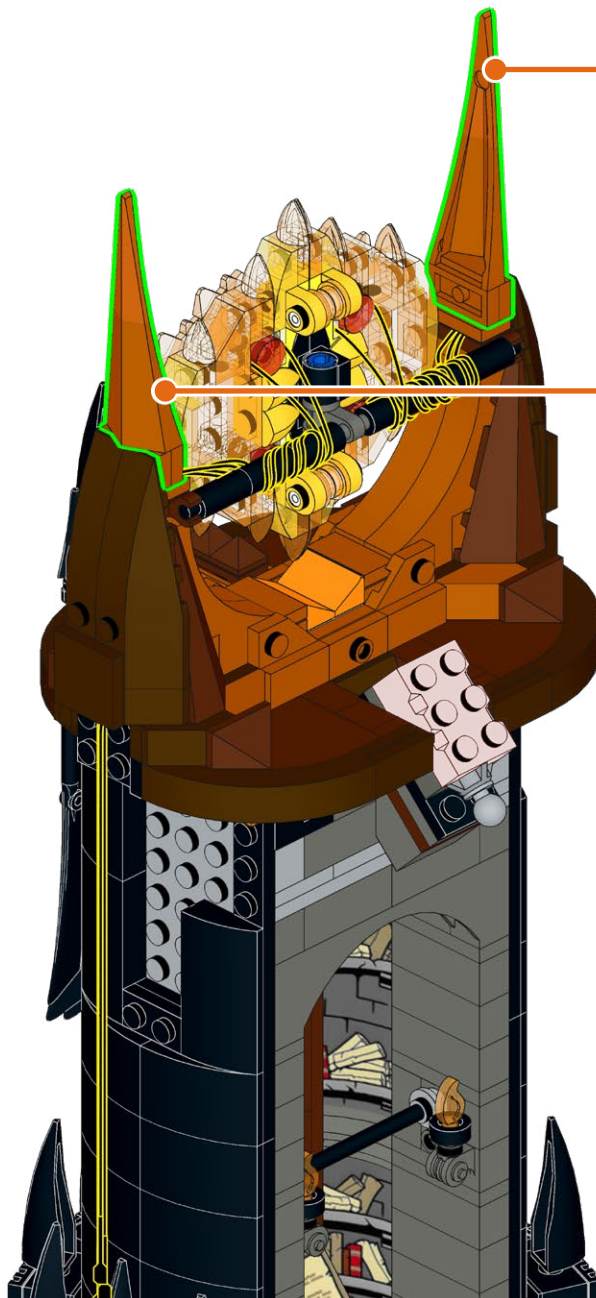
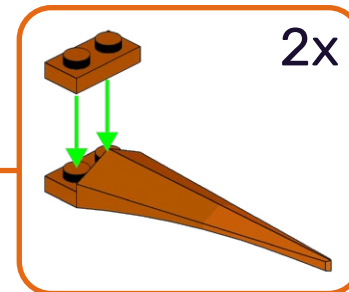
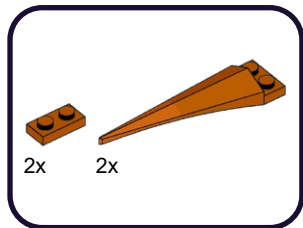

632

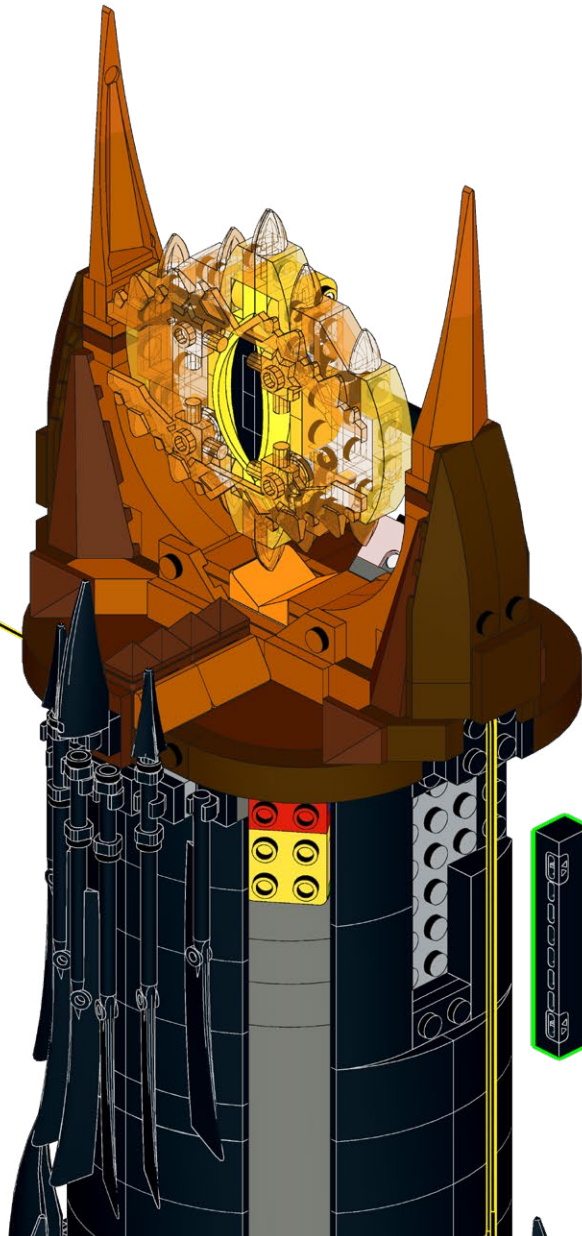
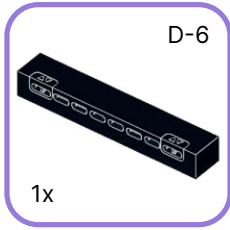
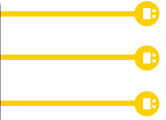

633



634

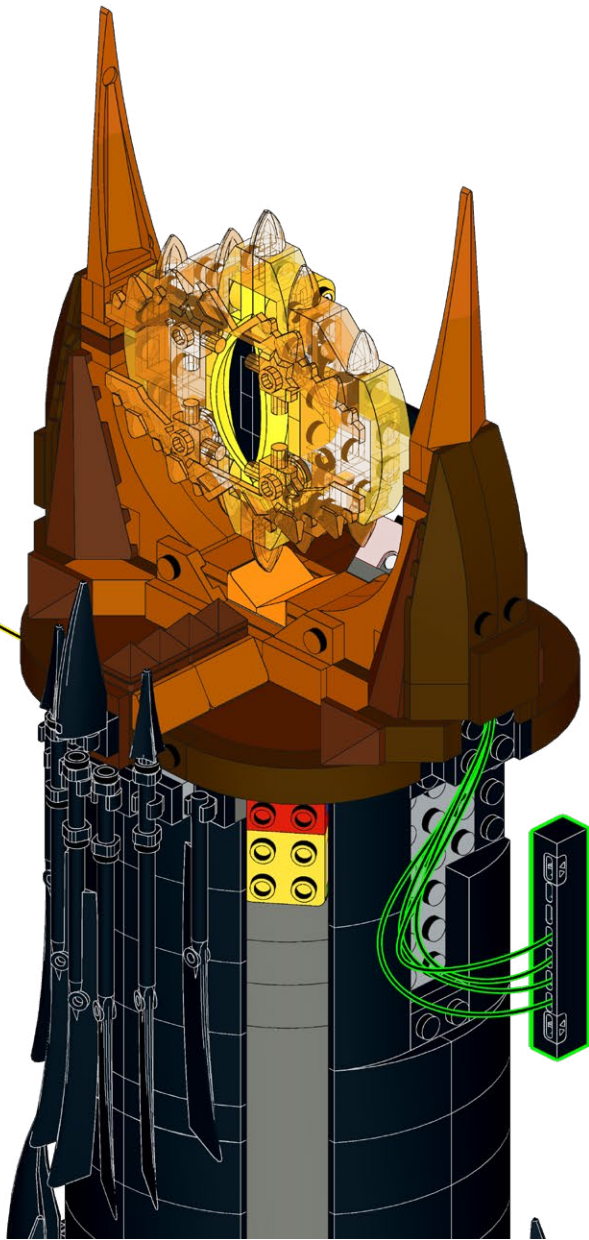
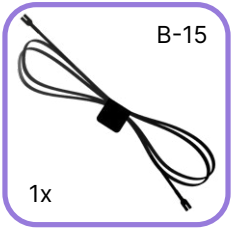

635



636

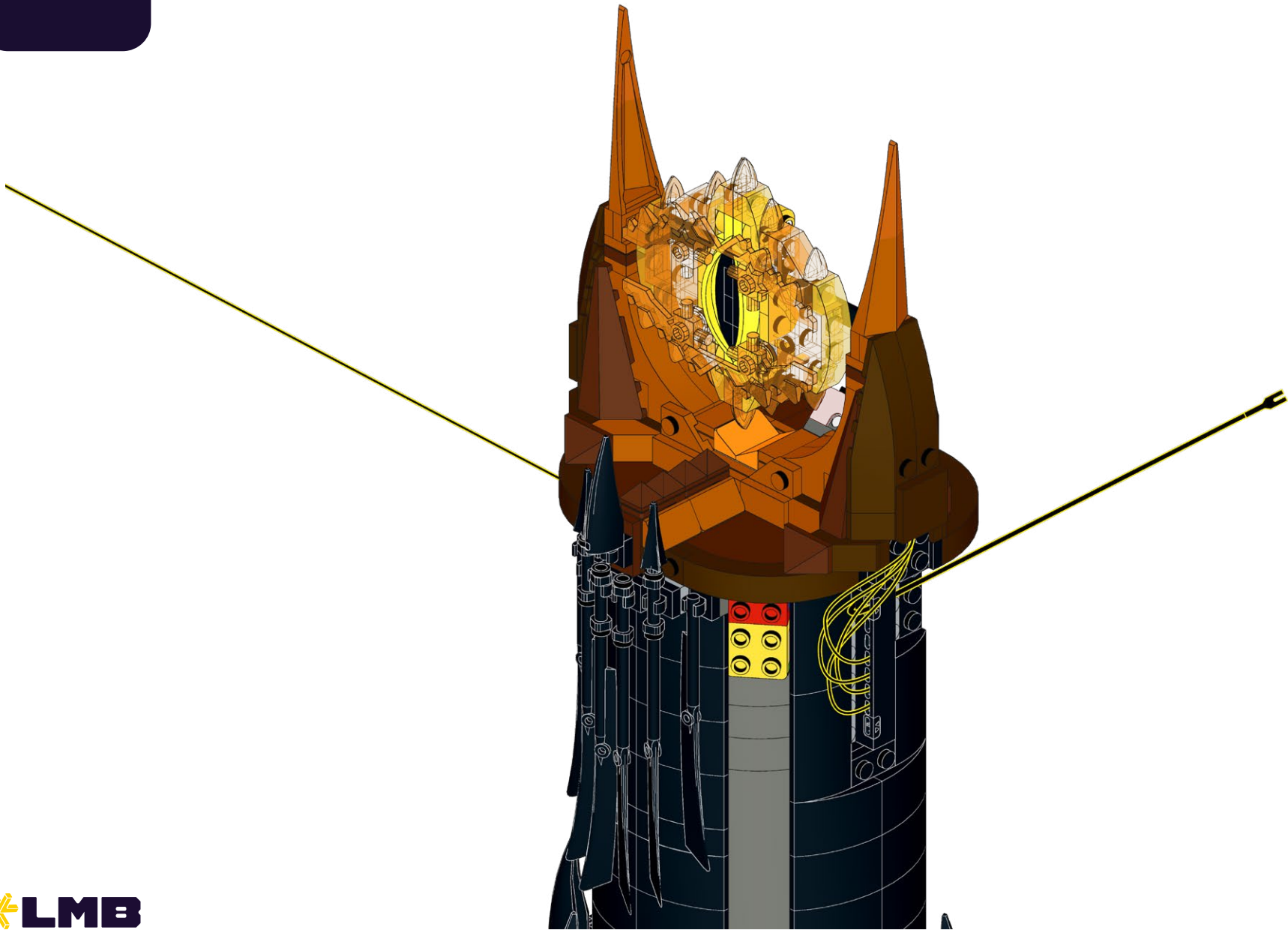

637

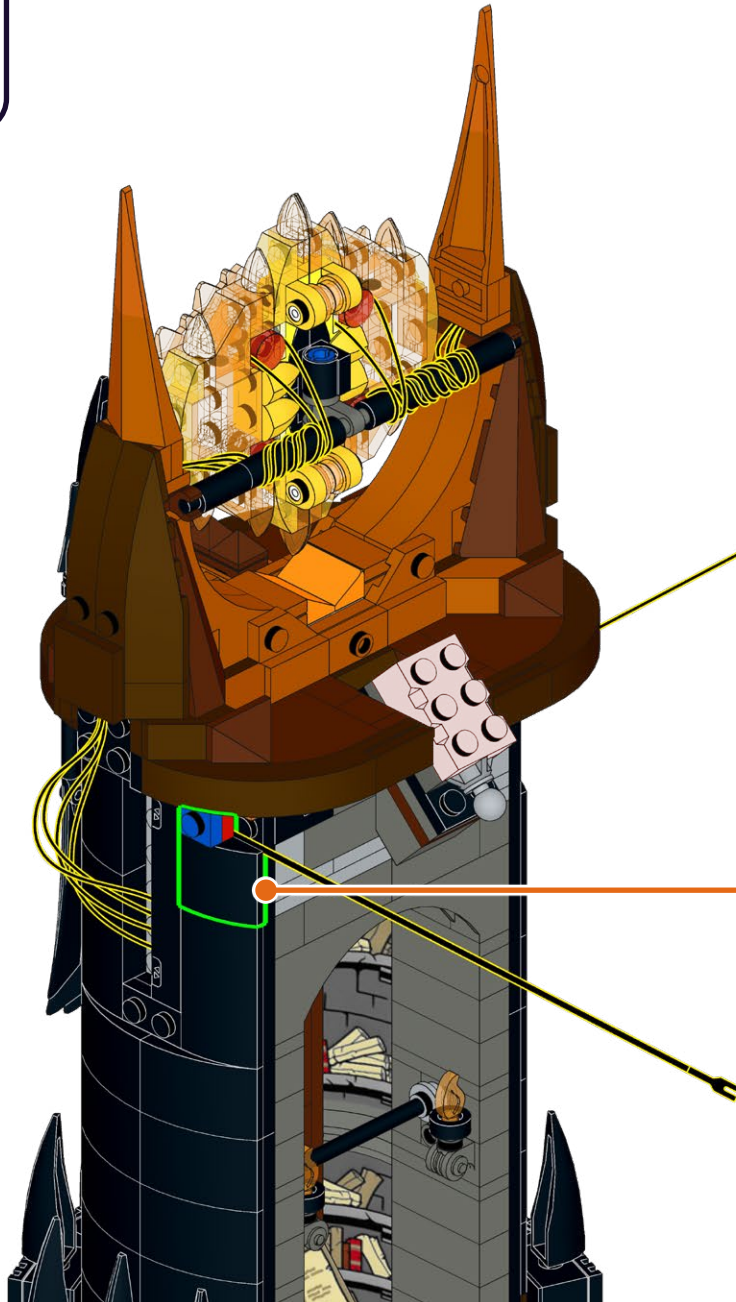
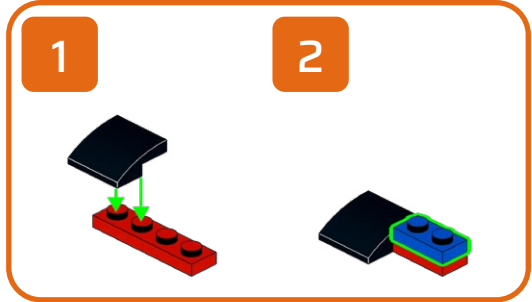
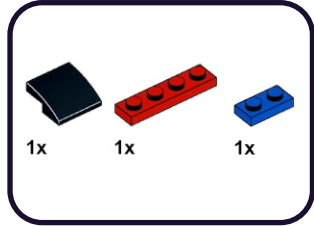

638

1x

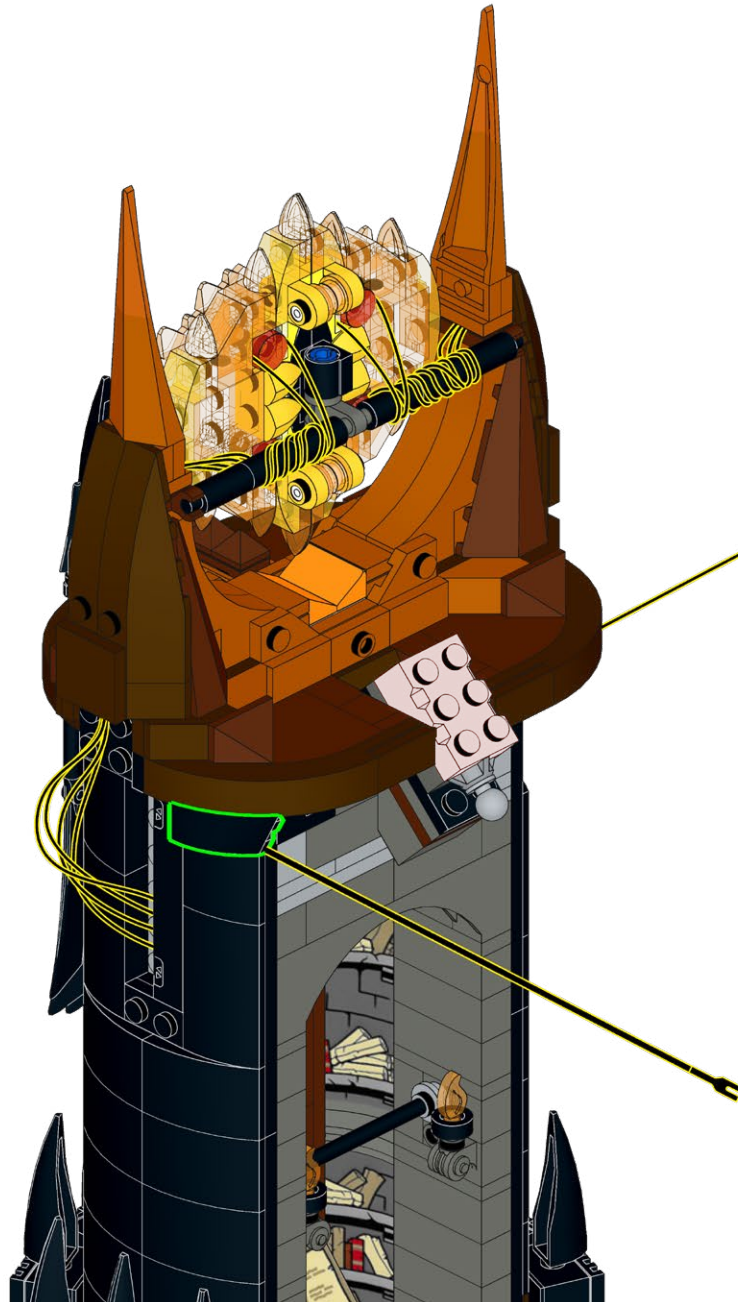

639

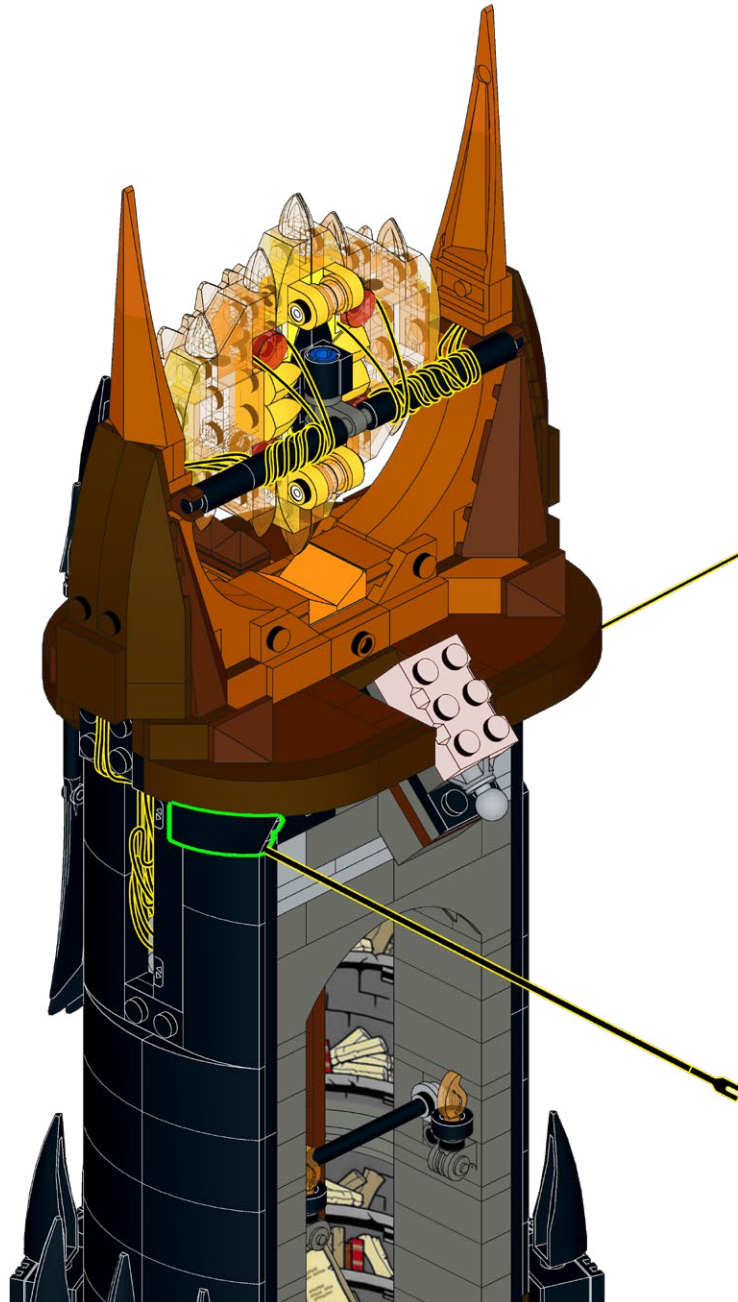

640

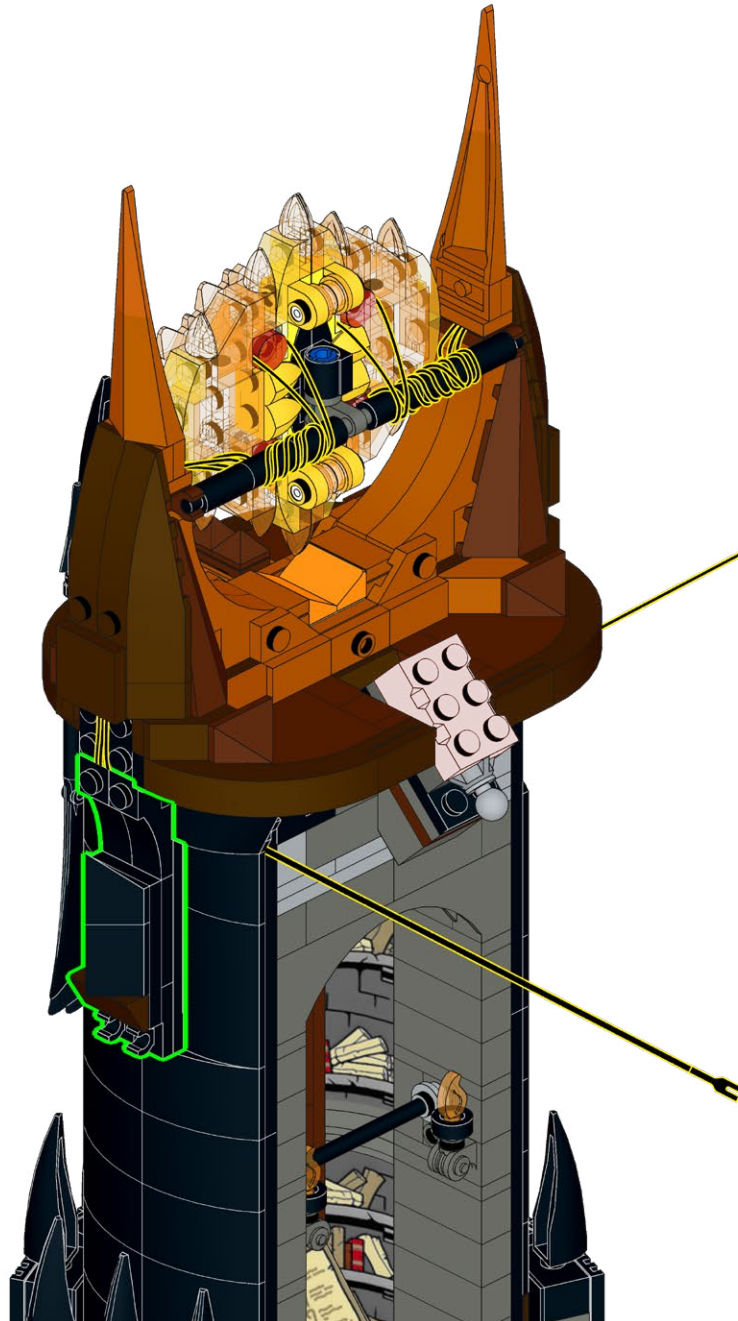

641



642

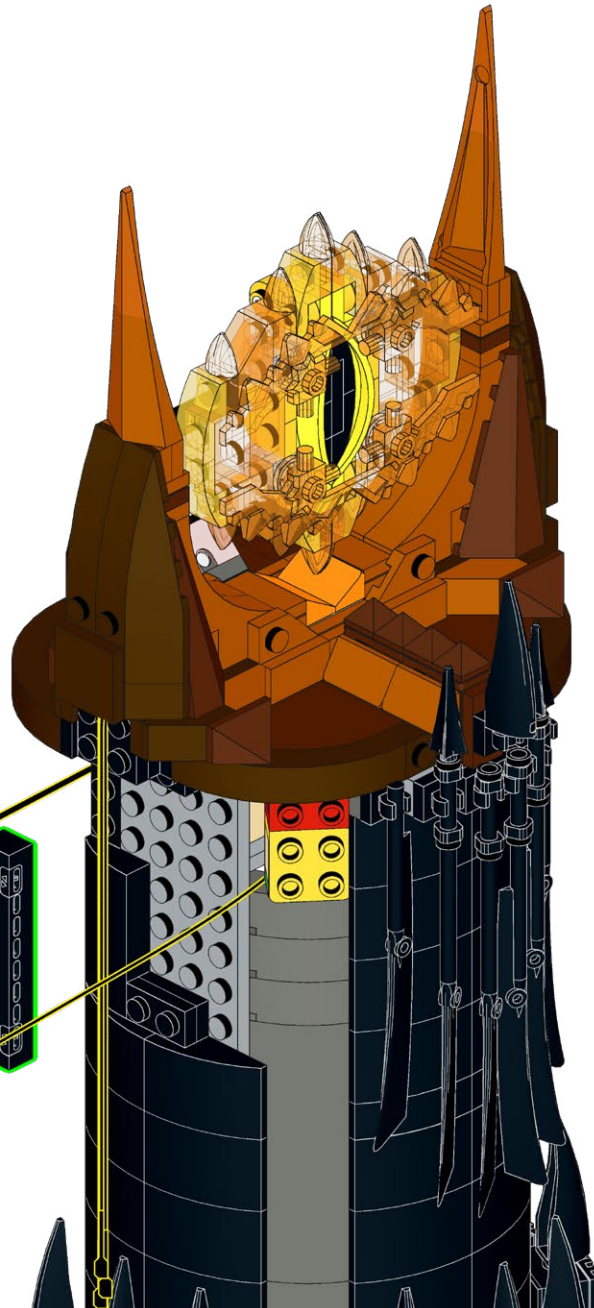
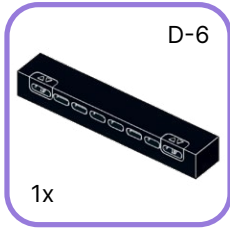

643

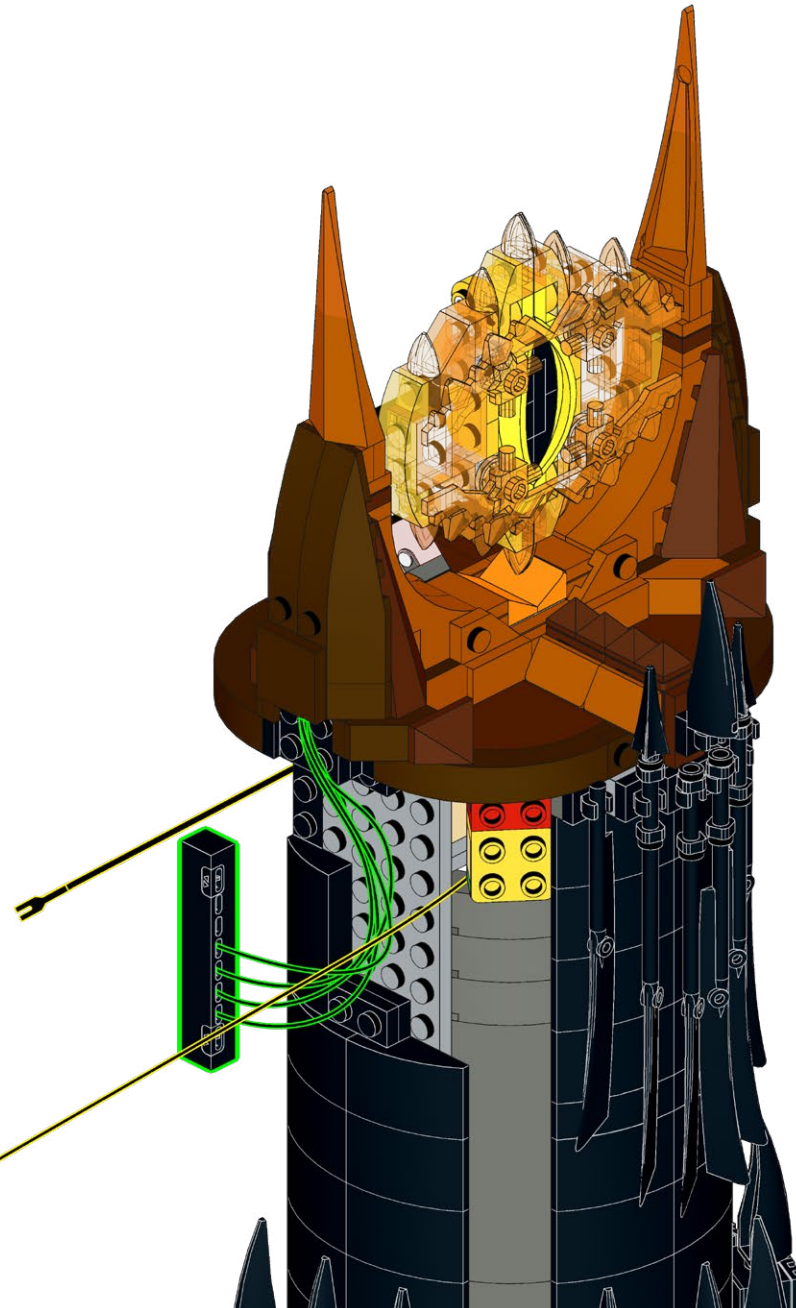

644

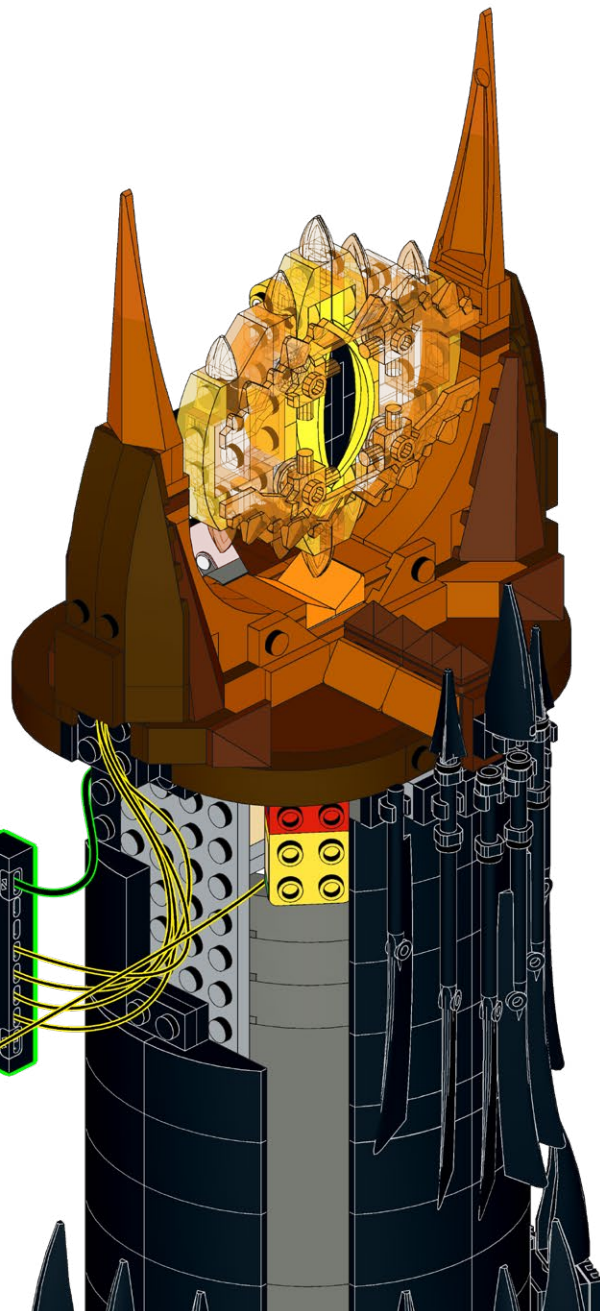

645

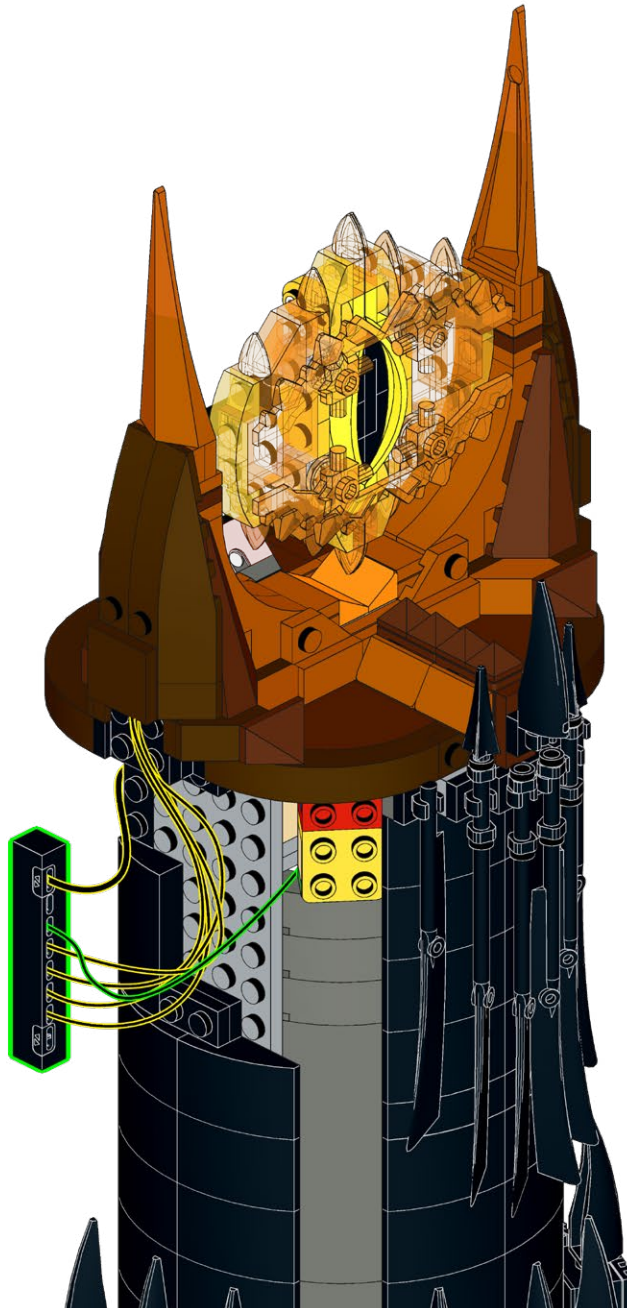

646

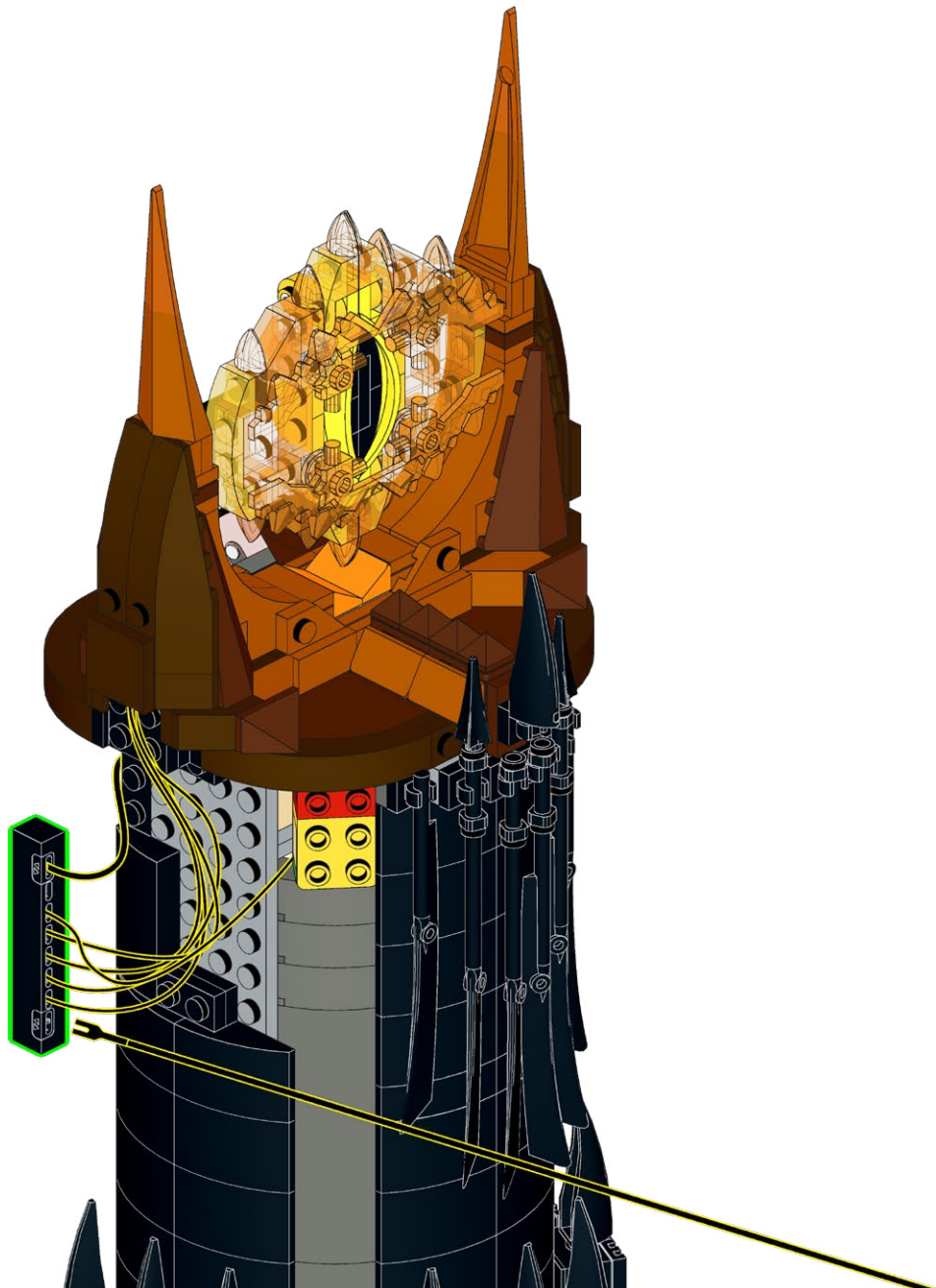
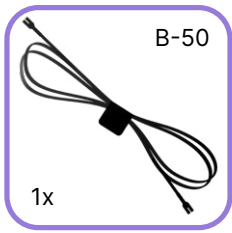

647

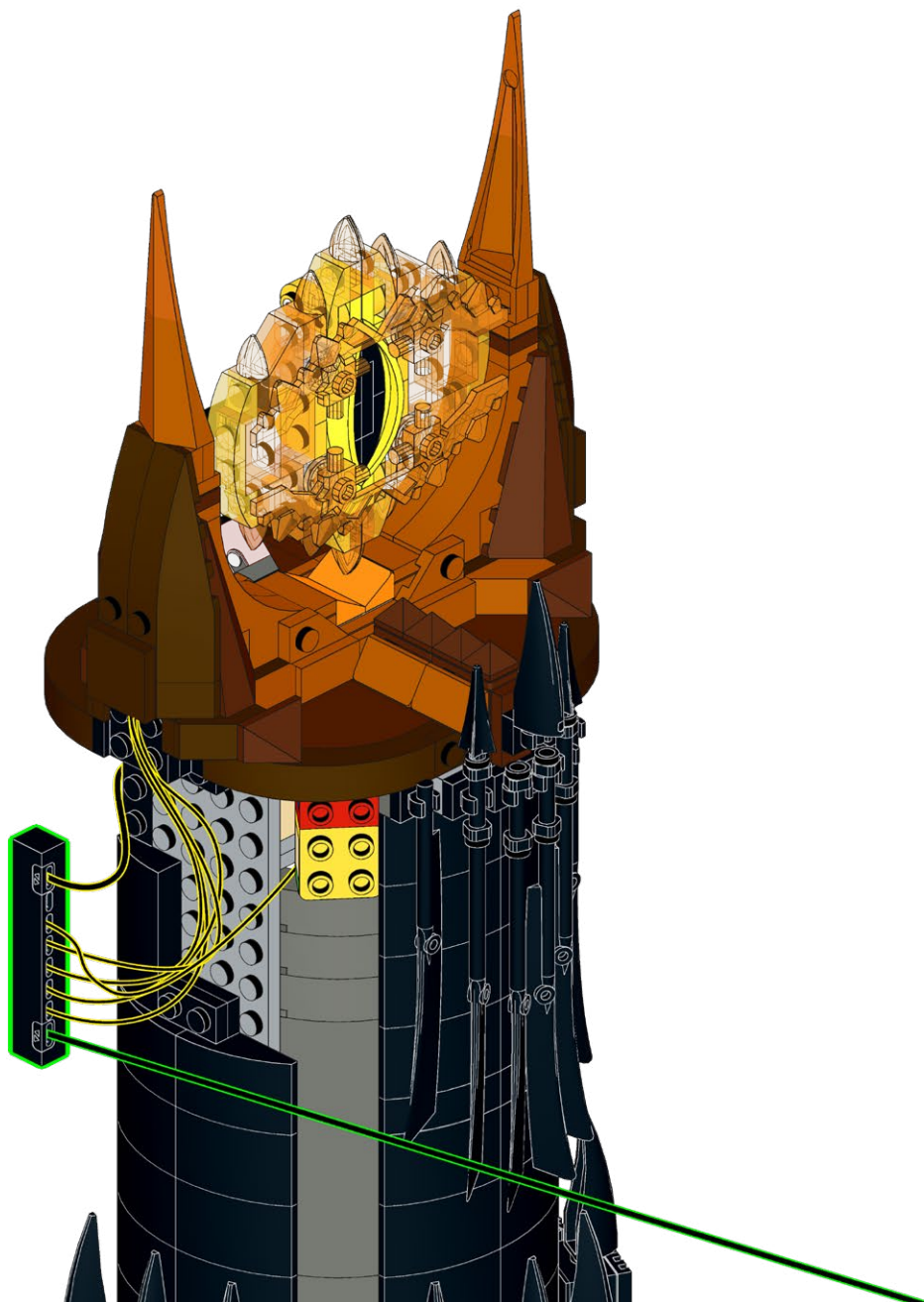

648

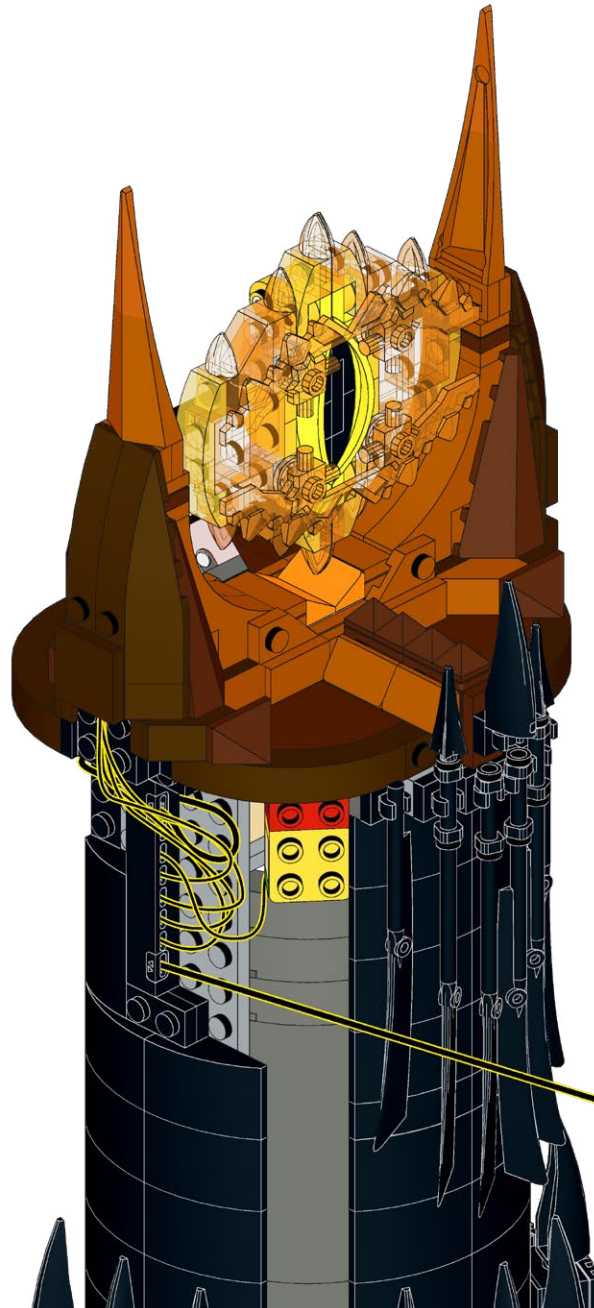

649

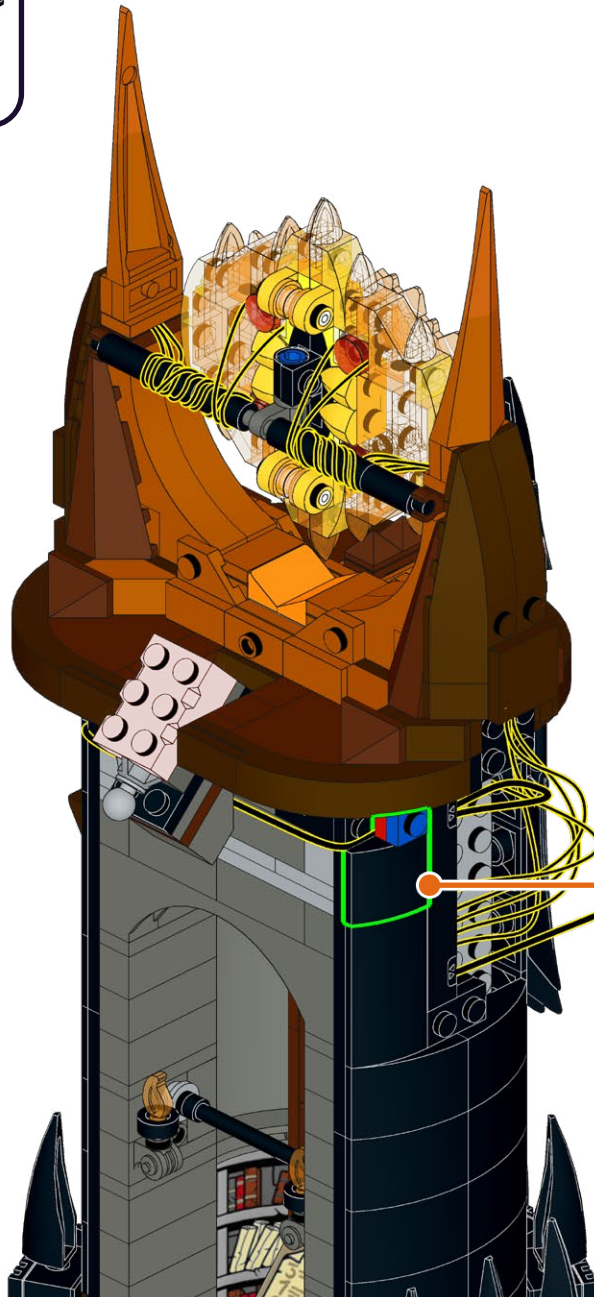
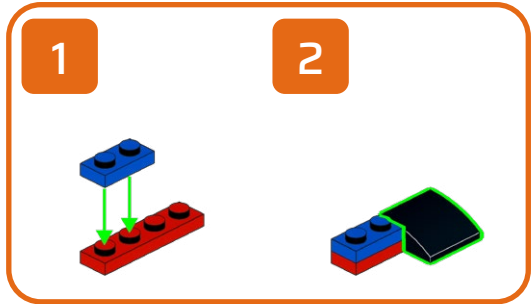
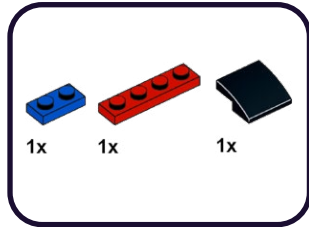

650

1x

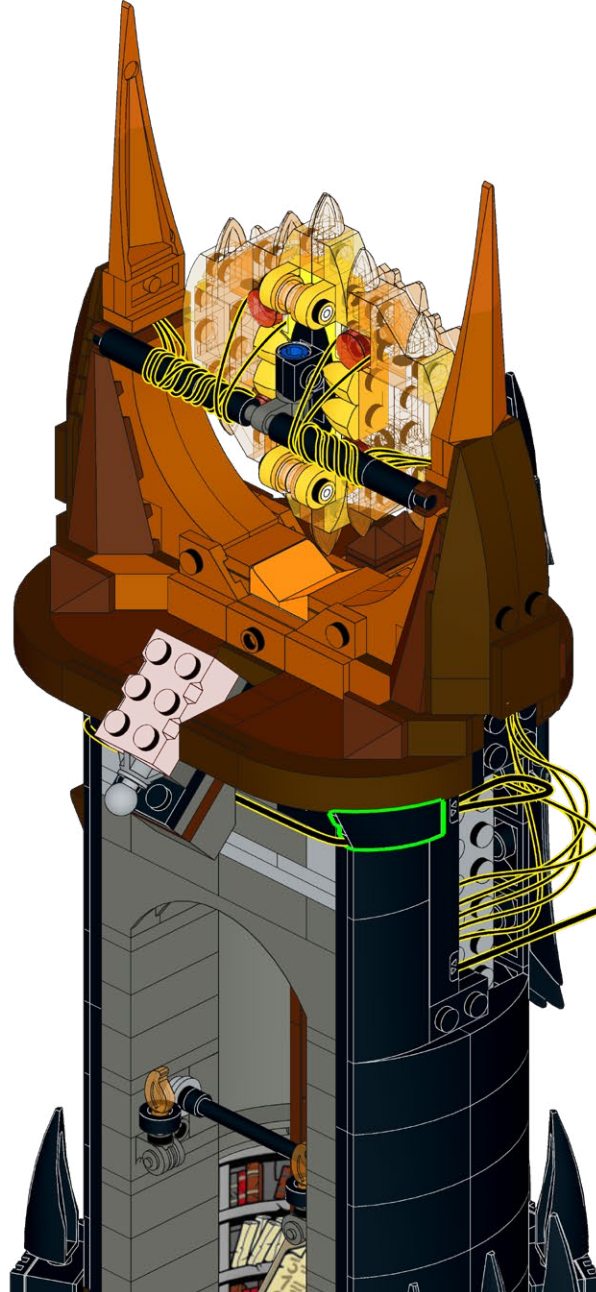

651

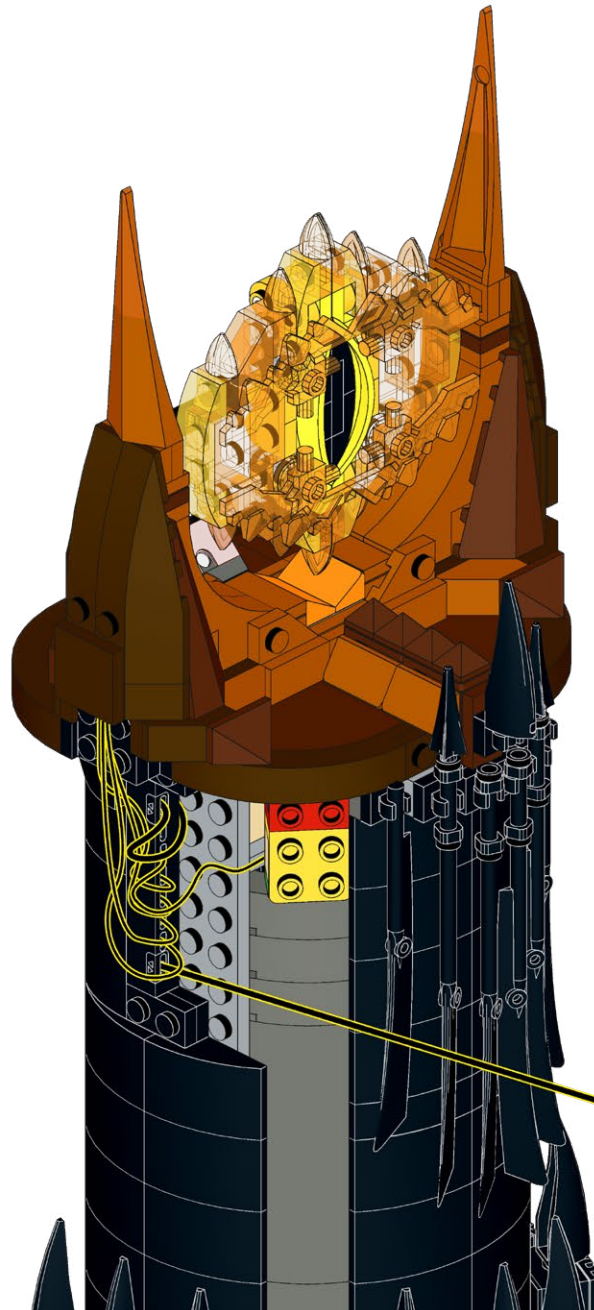

652

1x



653

1x

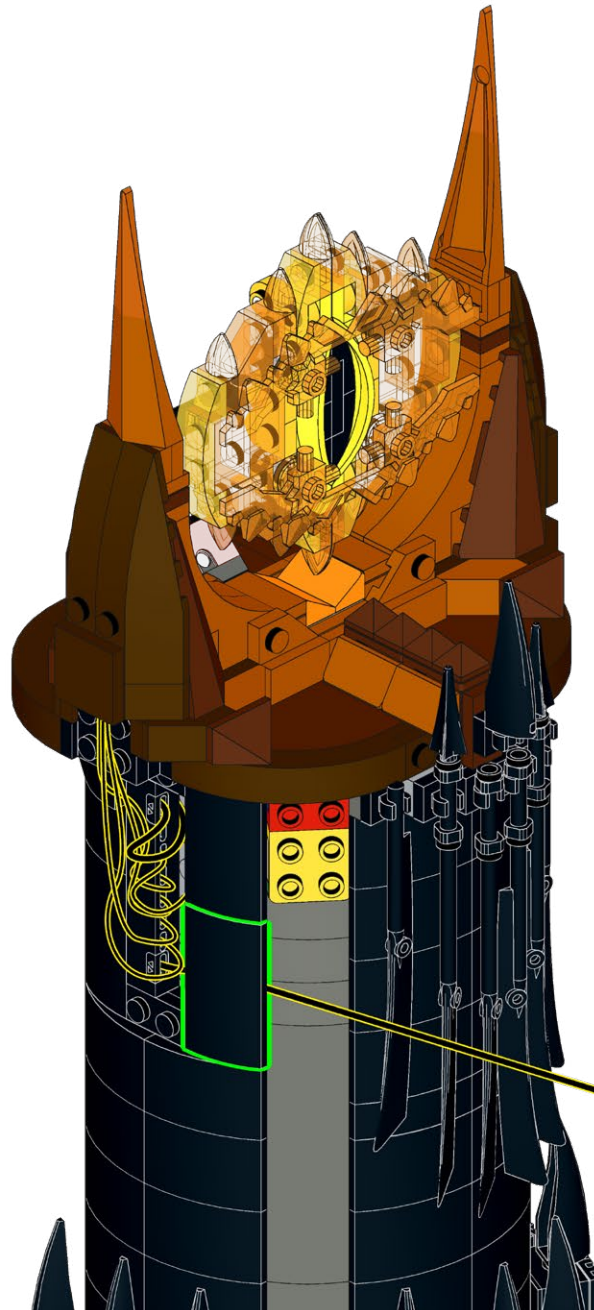

654

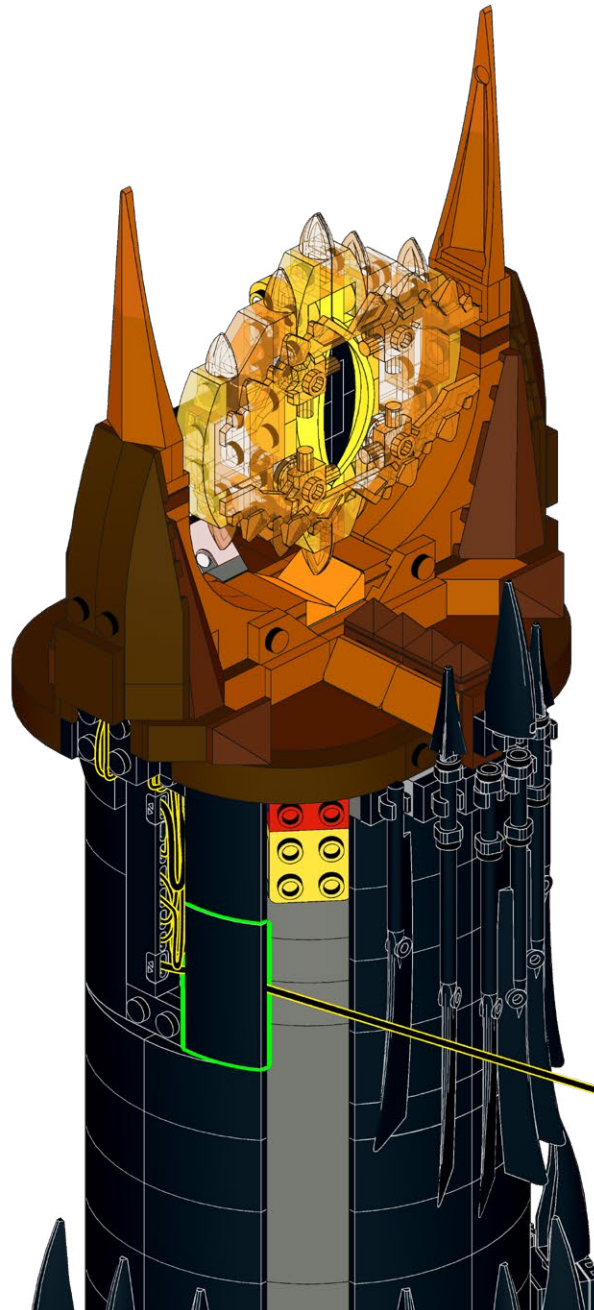

655

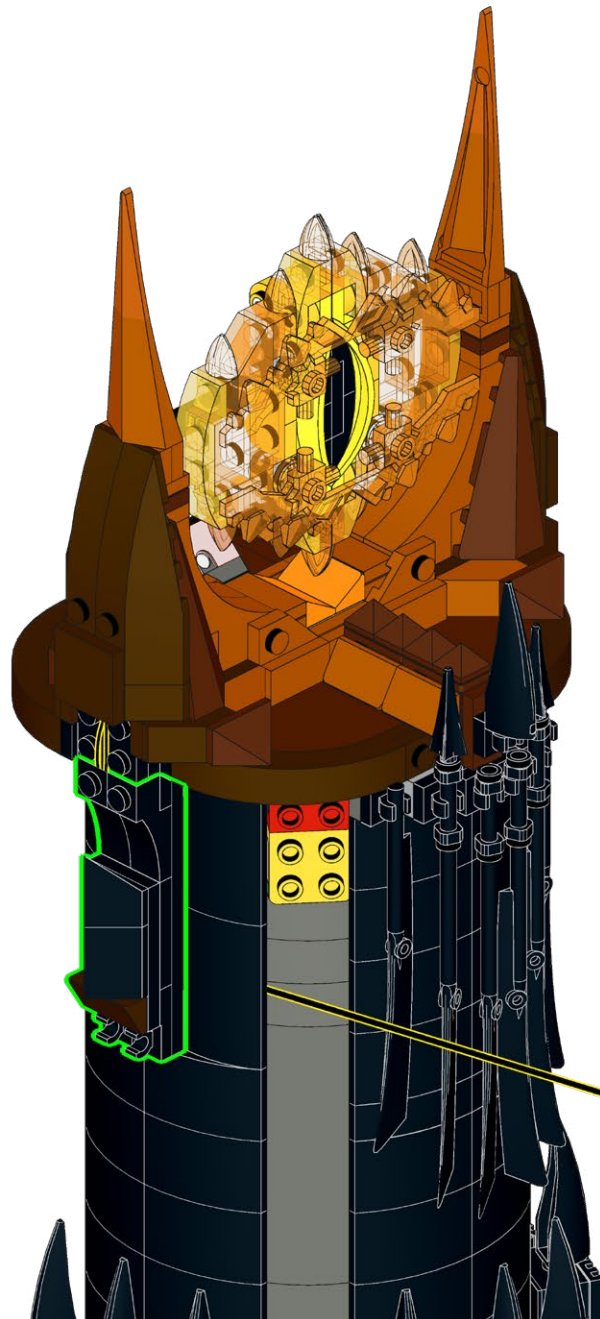

656

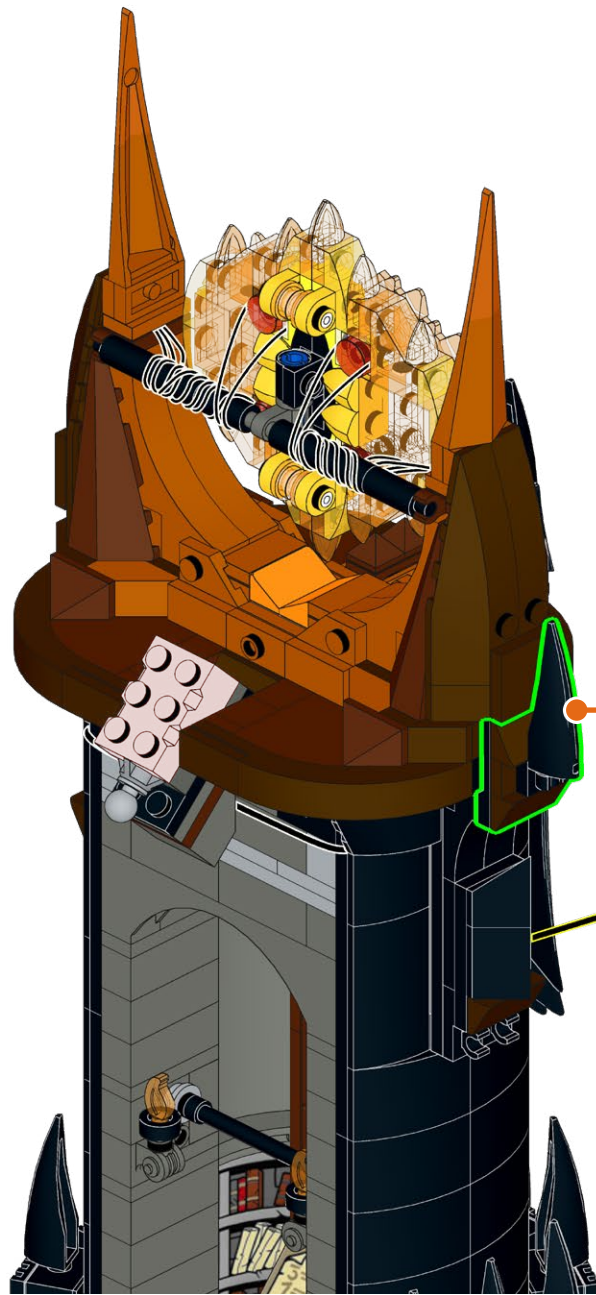
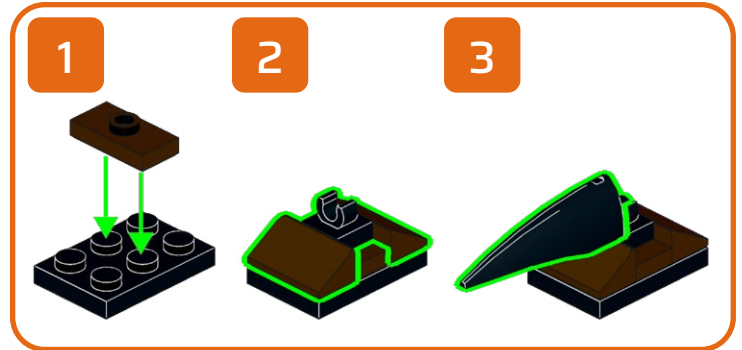

658

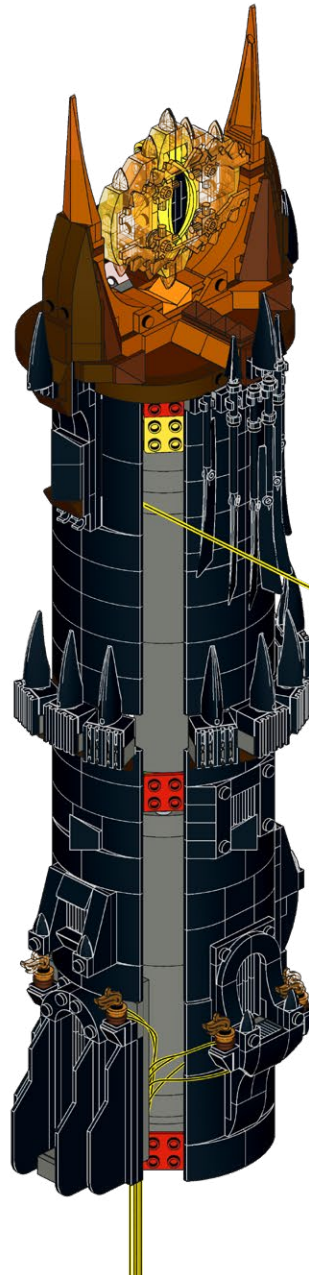

659

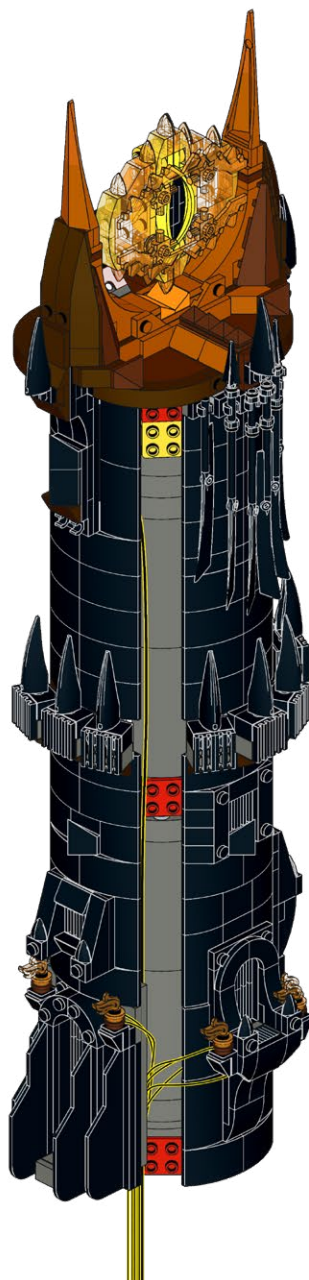

660

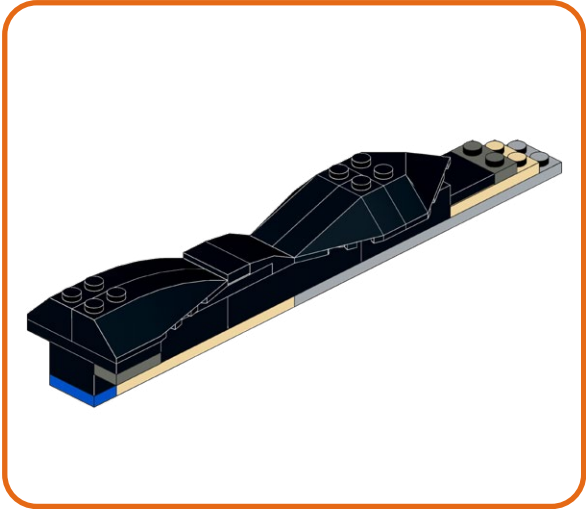
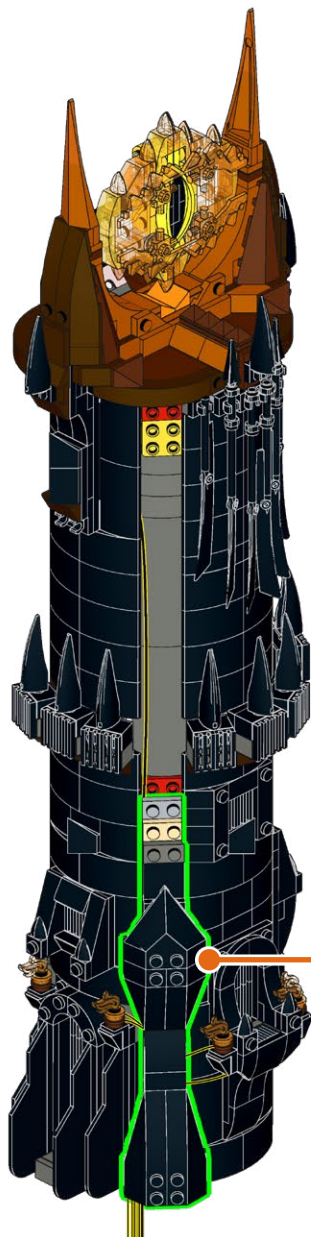

661

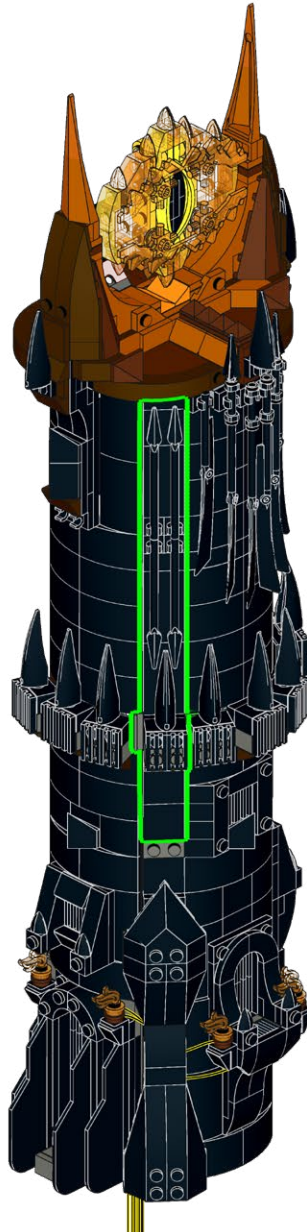

662

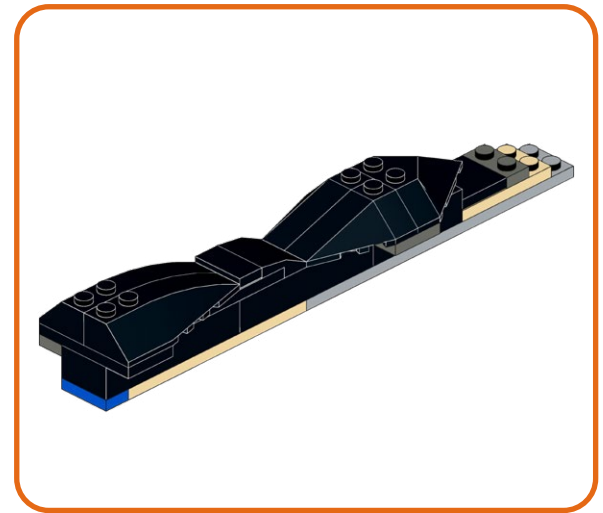
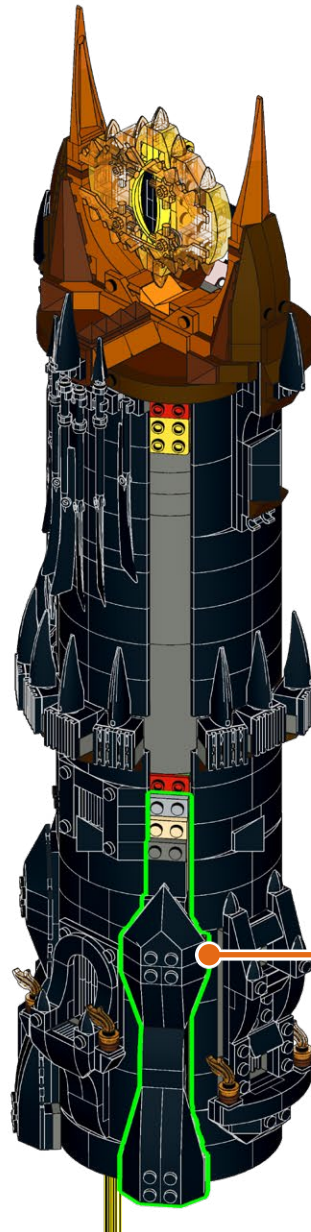

663

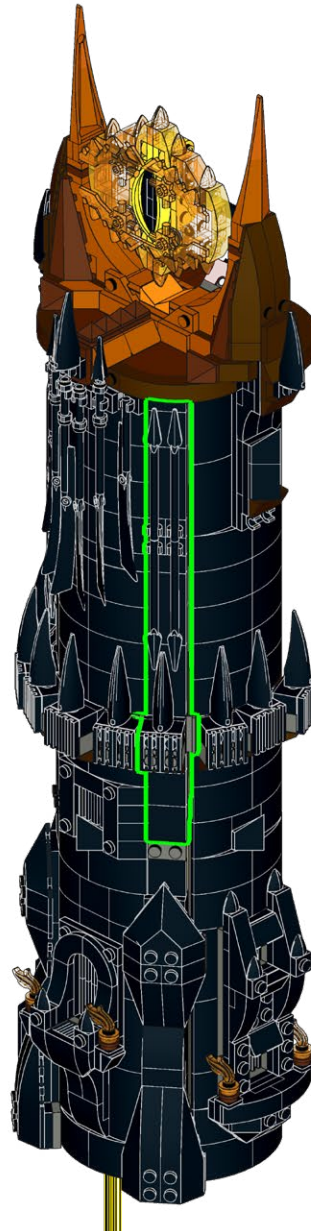

664

2x

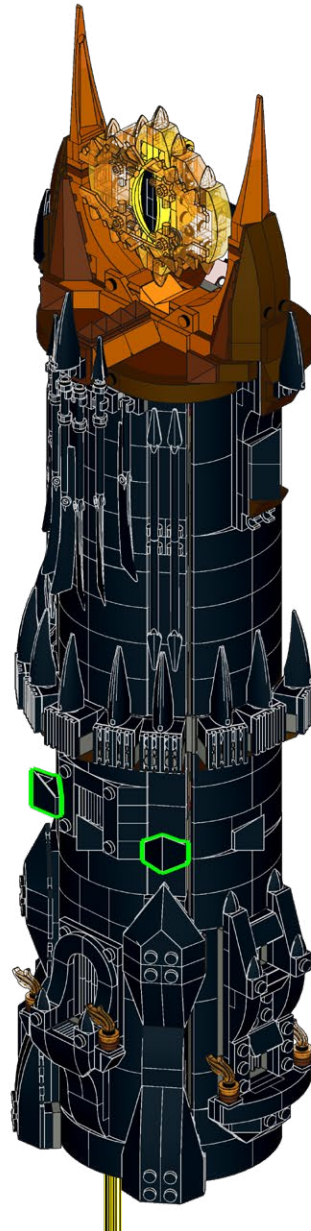

665

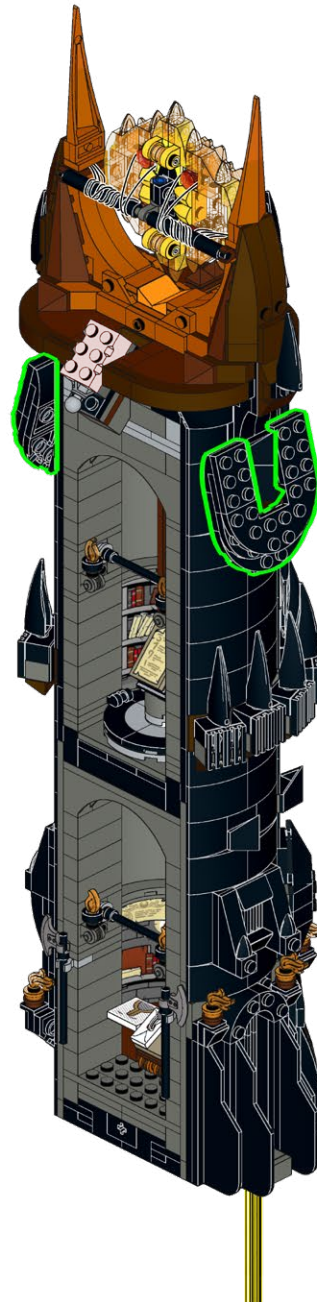

666

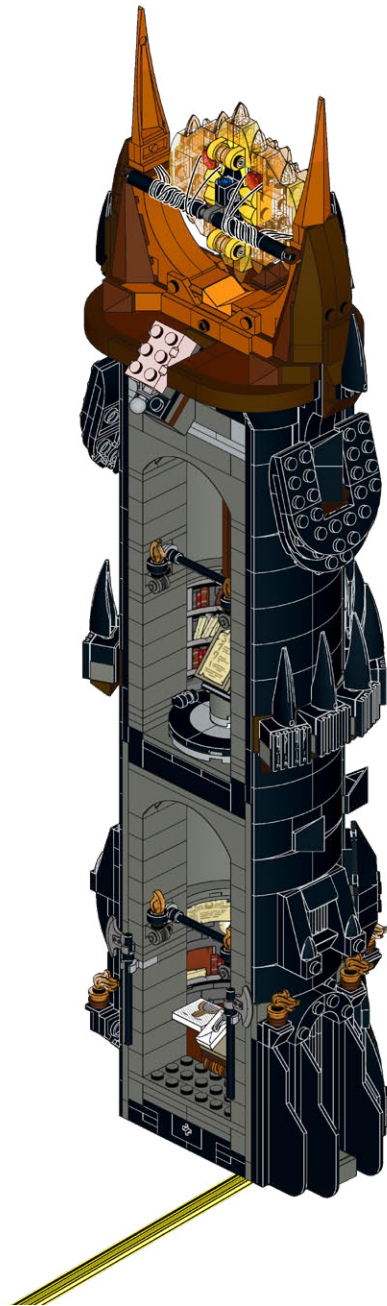

667

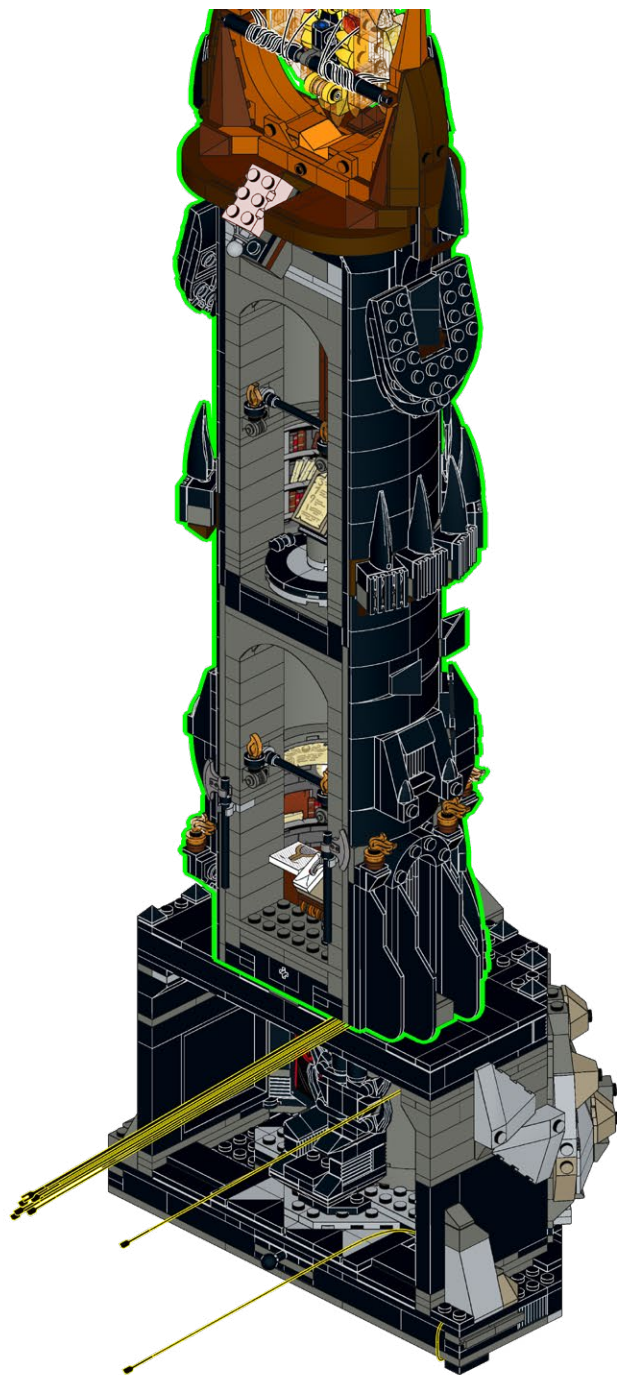

668

1x 1x

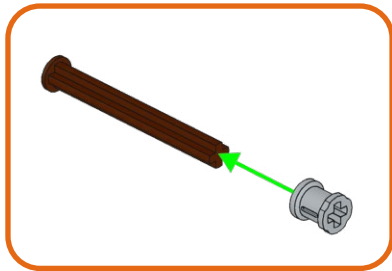

669

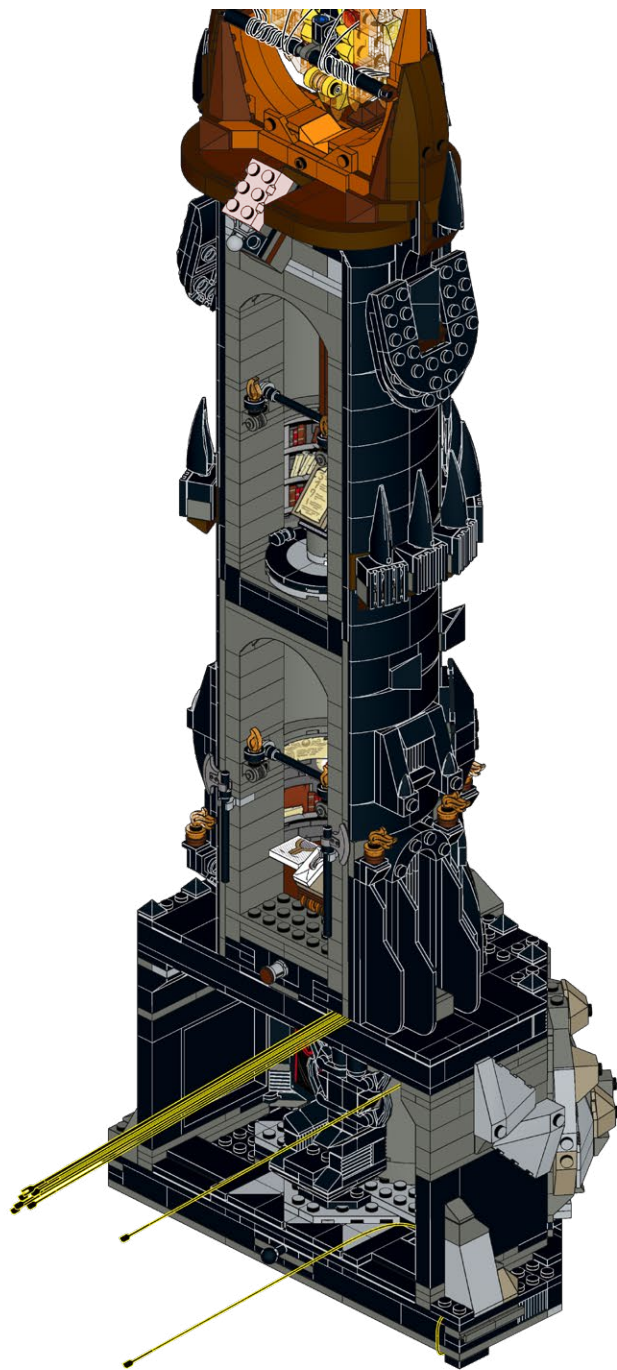

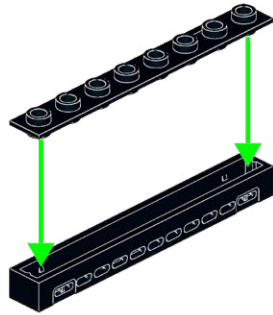
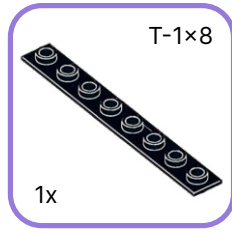
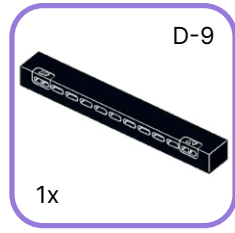
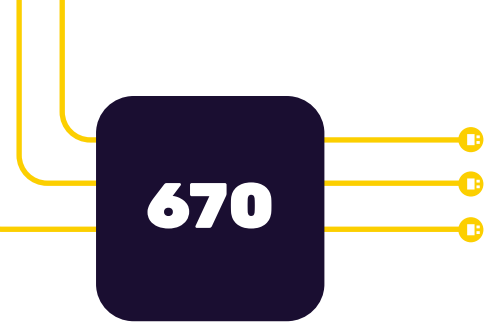

671

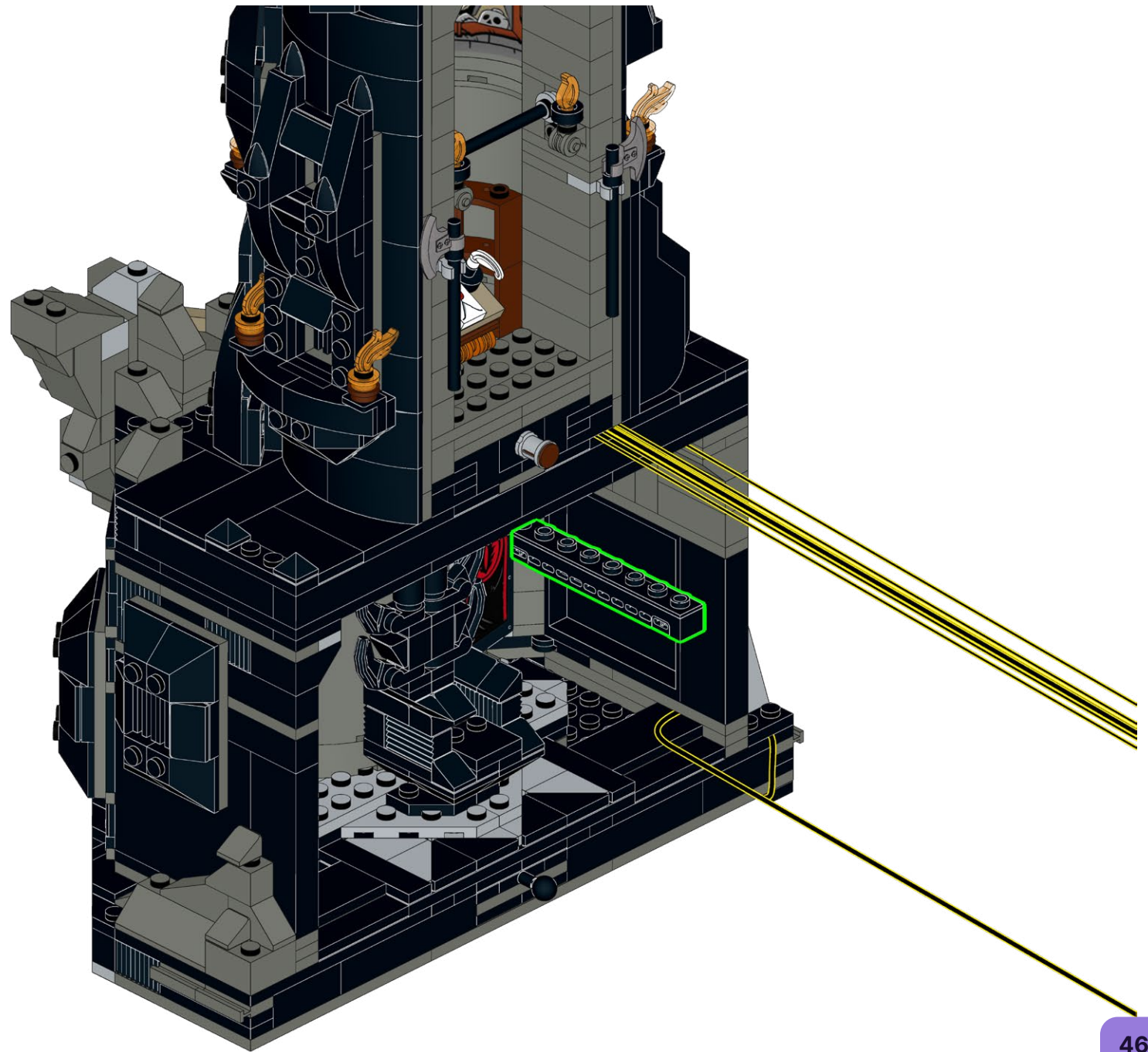

672

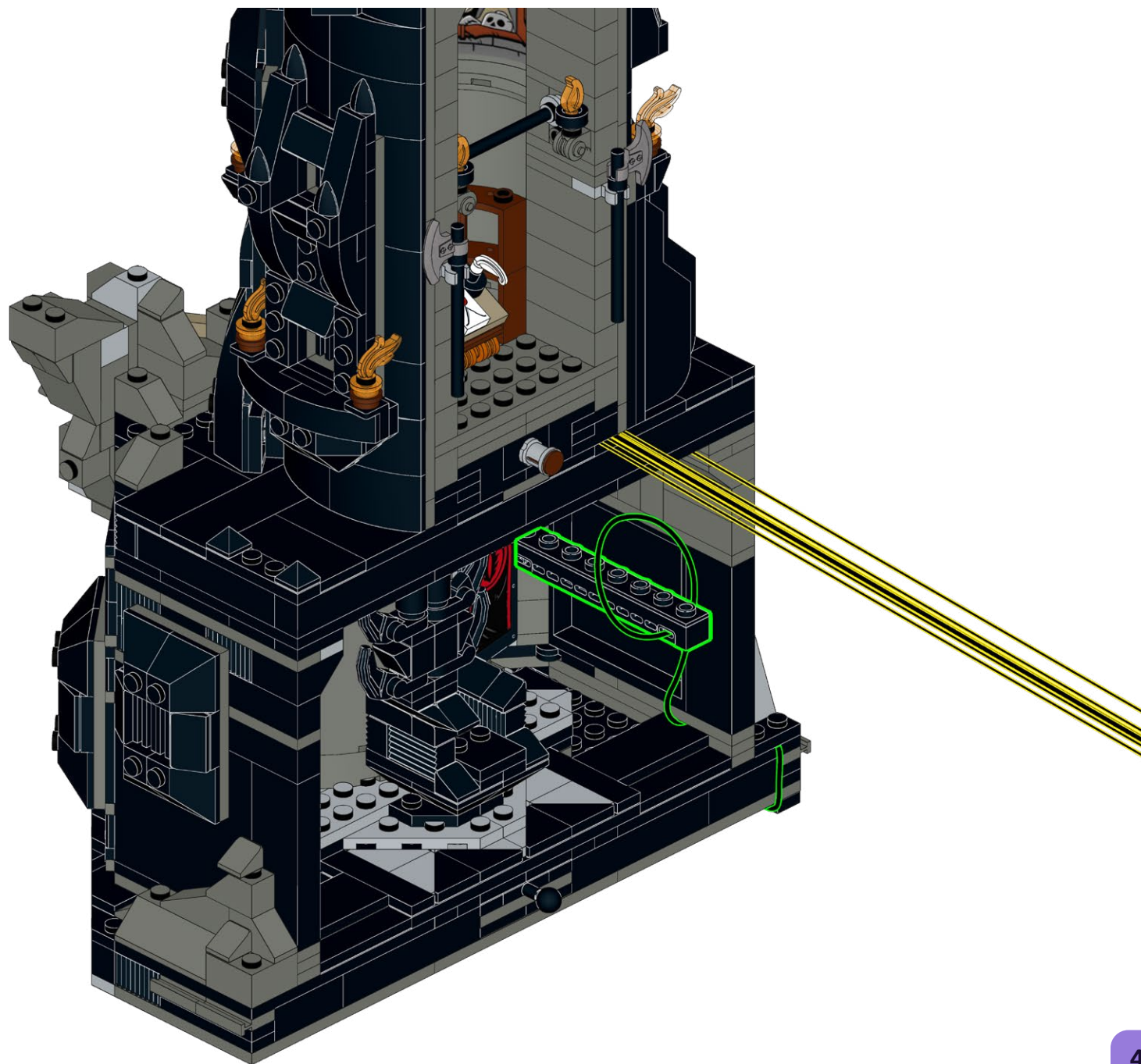

673

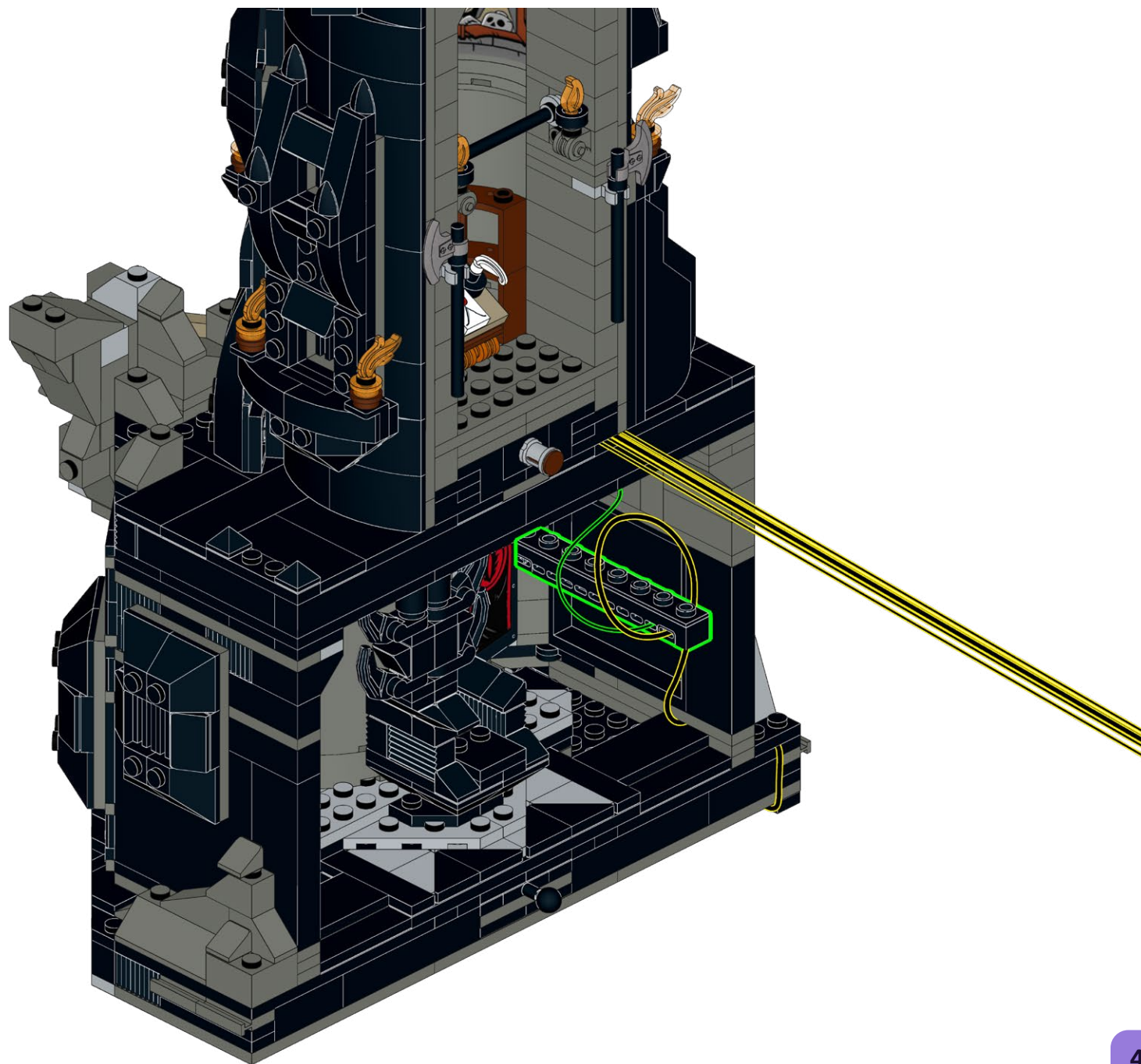

674

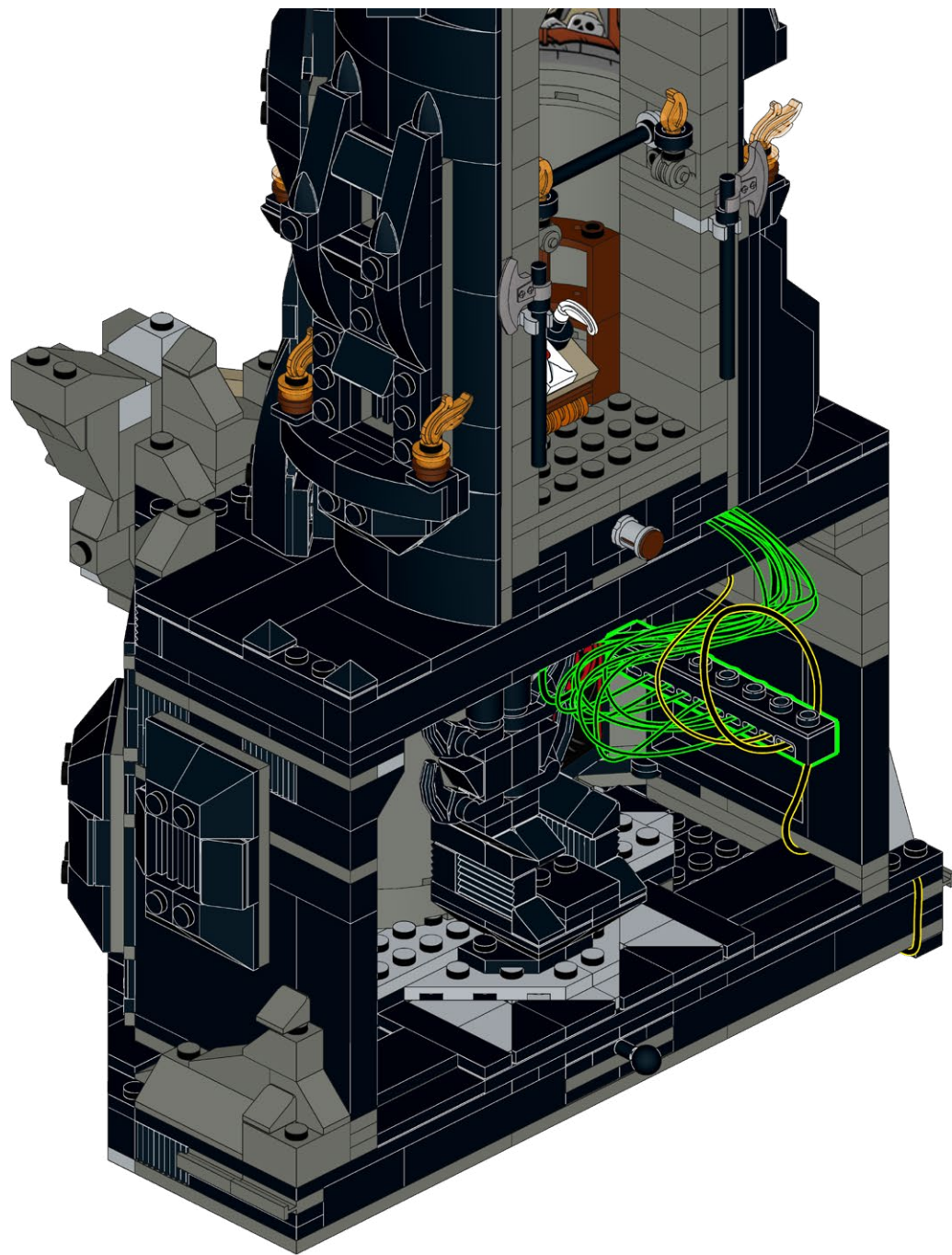

675

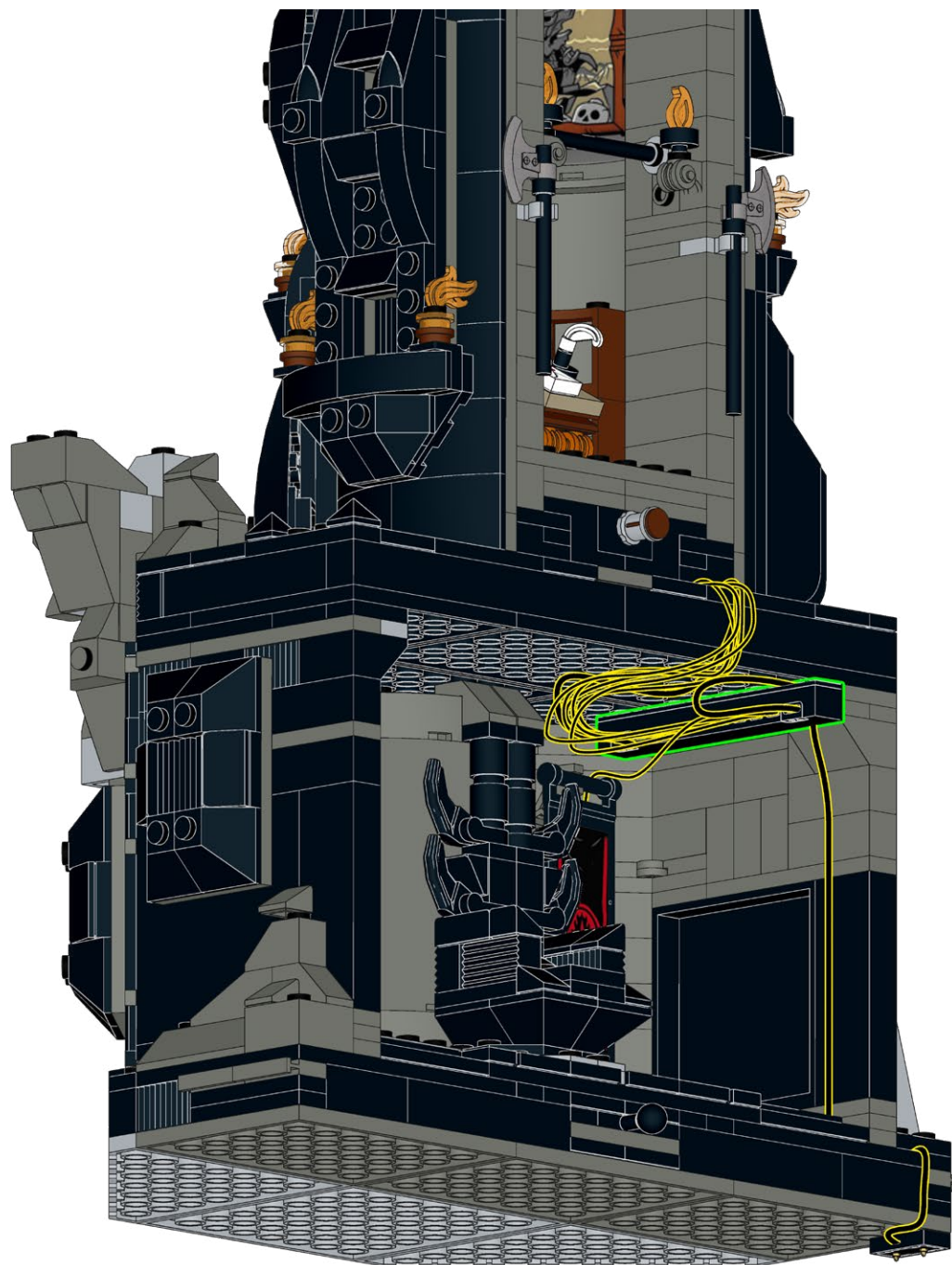

676

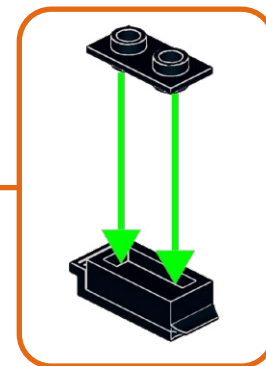
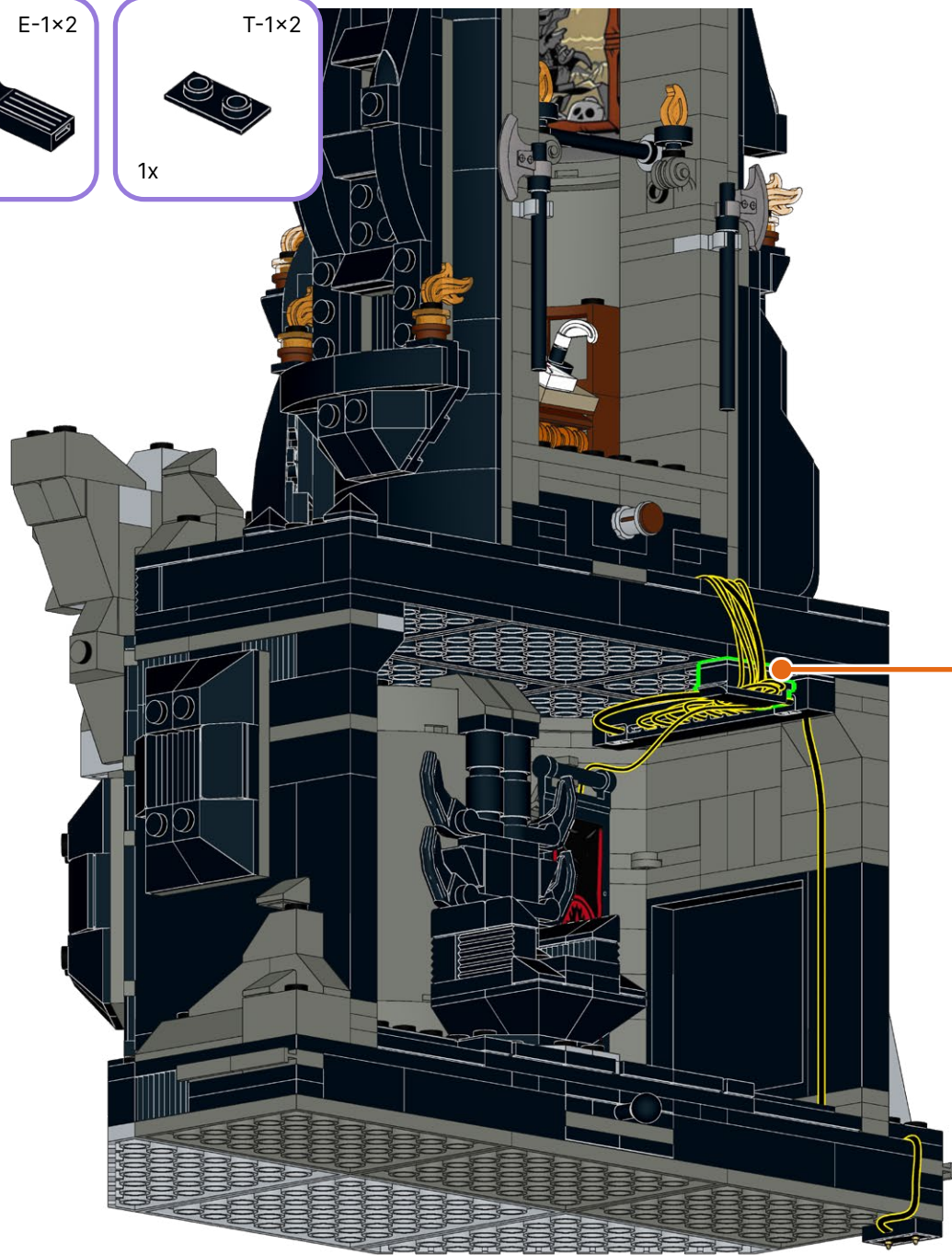
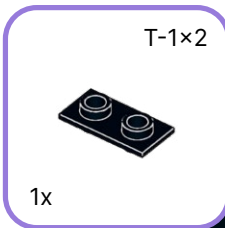
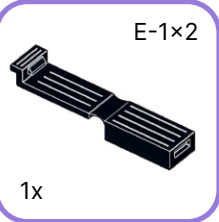

677

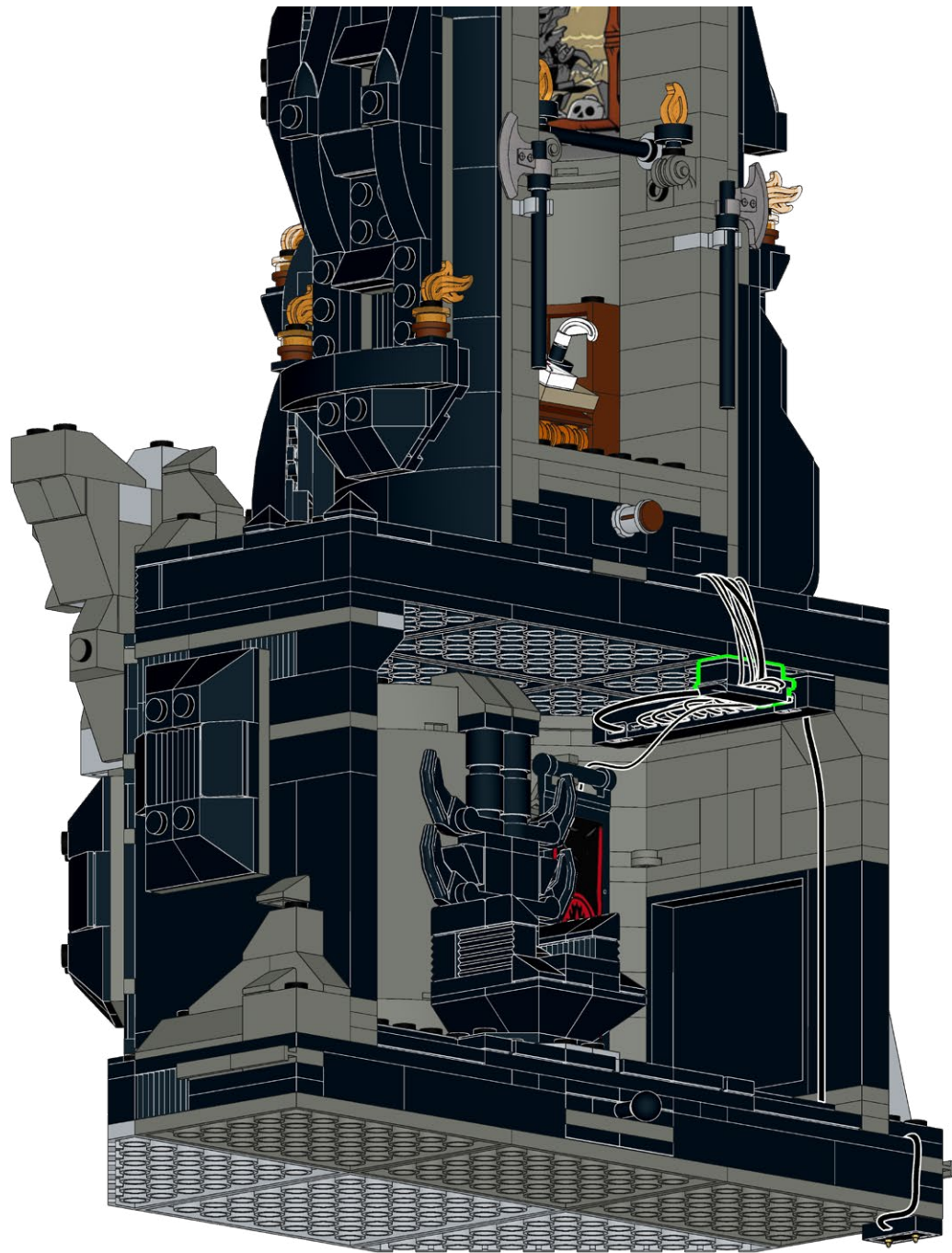

678



679

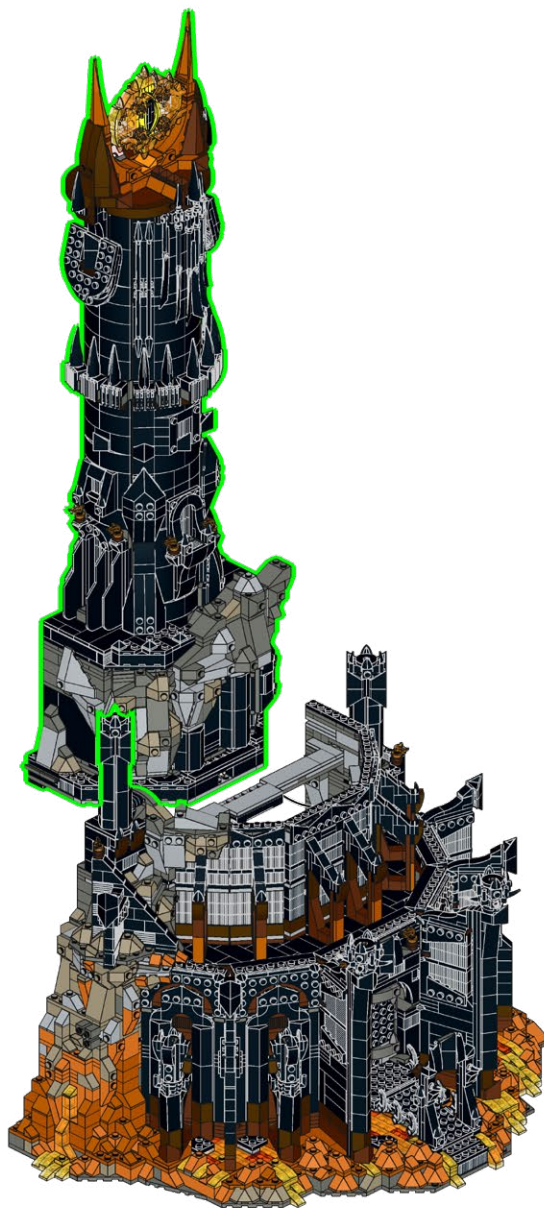

680

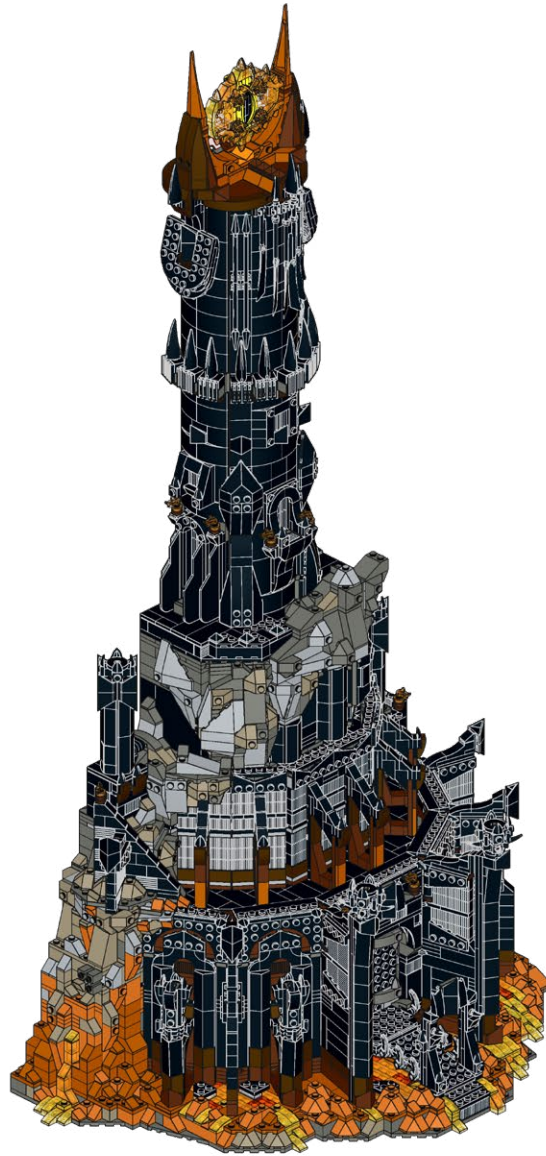

681



682



FINAL PRODUCT



PACKAGE CONTENTS



12x ARF-WW30
Astro Light Regular
Flickering Warm White
30cm



7x AR-R30
Astro Light Regular
Red 30cm



4x AL-Y30
Astro Light Large
Yellow 30cm



1x AL-O30
Astro Light Large
Orange 30cm



1x AL-O15
Astro Light Large
Orange 15cm



1x AL-R30
Astro Light Large
Red 30cm



5x ALF-O30
Astro Light Large
Flickering Orange 30cm

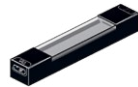

3x ML-O
Meteor Light Orange



1x FLX-TPA
Flux Touch Plate (A)
15cm



1x FLX-TPA
Flux Touch Plate (A)
30cm



2x FLX-TPB
Flux Touch Plate (B)
15cm



1x B-5
Belt 5cm



4x B-15
Belt 15cm



1x B-30
Belt 30cm



2x B-50
Belt 50cm

PACKAGE CONTENTS



3x D-3
Dock-3



1x T-1x8
Tether 1x8

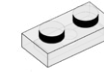

6x Plate 1x2 - Trans Clear



3x D-6
Dock-6

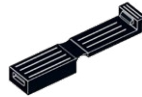

3x E-1x2
Eclipse 1x2



1x Plate 1x4 - Dark Bluish
Gray



1x D-9
Dock-9



3x Plate 1x1 - Black



2x Plate 2x8 - Black



1x T-1x2
Tether 1x2



1x Plate 1x1 - Trans Clear



12x Plate, Round 1x1 w Open
Stud - Trans-Orange



4x T-1x6
Tether 1x6



9x Plate 1x2 - Black



2x Plate, Round 1x1 w Open
Stud - Black

PACKAGE CONTENTS



2x Brick, Modified 1×1 with
Stud on Side - Light
Bluish Gray



2x Technic, Brick 1×1 with
Hole - Black



1x Brick 1×2 - Black

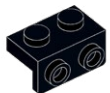

2x Bracket 1×2 - 1×2 -
Black



1x FLX-C
Flux Converter

CONTACT US

Click below for customer support, or general inquiries.

Cliquez ci-dessous pour accéder au support client ou aux renseignements généraux.

Clicca qui sotto per l'assistenza clienti o per richieste generali.

Contact Us



Contactez-nous



Contattaci



Klicken sie unten für kundensupport oder allgemeine anfragen.

Haga clic a continuación para atención al cliente o consultas generales.

点击下方获取客户支持或一般咨询。

Kontaktieren sie uns



Contáctanos



联系我们



TROUBLESHOOTING

If you're stuck, scan the QR code for troubleshooting.

Se sei bloccato, scansiona il codice QR per la risoluzione dei problemi.

Wenn Sie nicht weiterkommen, scannen Sie den QR-Code zur Fehlerbehebung.

Si vous êtes bloqué, scannez le code QR pour le dépannage

Si está atascado, escanee el código QR para solucionar el problema.

如果遇到问题, 请扫描二维码进行故障排除

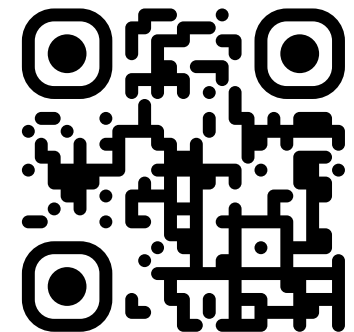



LIGHTMYBRICKS

lightmybricks.com



LEGO® is a trademark of the LEGO Group of companies, which does not sponsor, authorize or endorse this product. All LEGO® sets featured in images are sold separately. This is not a LEGO® product. The LEGO Group is not liable for any loss, injury or damage arising from the use or misuse of this product. ©2024 Light My Bricks Pty Ltd. All rights reserved. www.lightmybricks.com

Our components are designed and packaged in Australia by Light My Bricks Pty Ltd. Components are manufactured in China. 3fl bldg C, Shuanghuan Quanxin Technology Information Industry Park Baolong Street, Longgang District, Shenzhen, China. Imported in Australia by Light My Bricks Pty Ltd, 5/26 Rushdale St, Knoxfield, VIC, 3180, Australia.

WARNING: CHOKING HAZARD - Small parts. Not for children under 3 years.

AVERTISSEMENT : RISQUE D'ÉTOUFFEMENT - Petites pièces. Ne convient pas aux enfants de moins de 3 ans.

ATTENZIONE: PERICOLO DI SOFFOCAMENTO - Piccole parti. Non adatto a bambini di età inferiore a 3 anni.

WARNUNG: ERSTICKUNGSGEFAHR - Kleine Teile. Nicht für Kinder unter 3 Jahren geeignet.

ADVERTENCIA: PELIGRO DE ASFIXIA - Piezas pequeñas. No son apto para niños menores de 3 años.

警告：窒息危险 - 小零件。不适合3岁以下儿童。