

LIGHT KIT INSTALLATION GUIDE

TANTIVE IV™

FOR LEGO
SET
#75376



CONTENTS



03

Getting Started

- 04 Legend
- 05 Component Handling
- 06 Blueprint

07

Instructions

- 07 LEGO Bag 1
- 26 LEGO Bag 2
- 32 LMB Bag 02 & 04
- 46 LEGO Bag 3
- 58 LMB Bag 01
- 69 LEGO Bag 4
- 107 LEGO Bag 5
- 135 LEGO Bag 6
- 142 LEGO Bag 7
- 160 LMB Bag 03

199

Final Product

- 200 Package Contents
- 201 Package Contents
- 202 Contact & Troubleshooting

GETTING STARTED



Bold, beautiful and bright, Light My Bricks elevates your favourite LEGO set from knick-knack to statement piece. Create a talking point at home or in the office that speaks to your passions with Light My Bricks. To learn more, click below.

[Learn More](#)



Audacieux, beau et lumineux, Light My Bricks élève votre ensemble LEGO préféré du statut de bibelot à celui de pièce maîtresse. Que ce soit à la maison ou au bureau, partagez votre passion des LEGO avec Light My Bricks. Cliquez ci-dessous pour en savoir plus.

[En savoir plus](#)



Audace, bello e luminoso, Light My Bricks eleva il tuo set LEGO preferito da soprammobile a pezzo di tendenza. Crea un punto di discussione a casa o in ufficio che parli alle tue passioni con Light My Bricks. Per saperne di più, clicca qui sotto.

[Ulteriori Informazioni](#)



Mutig, schön und hell – Light My Bricks verwandelt Ihr Lieblings-LEGO-Set von einem schnickschnack in ein statement-stück. Schaffen sie einen gesprächspunkt zu hause oder im büro, der Ihre leidenschaften widerspiegelt, mit Light My Bricks. Um mehr zu erfahren, klicken sie unten.

[Mehr erfahren](#)



Audaz, hermoso y brillante, Light My Bricks eleva tu set LEGO favorito de una chuchería a una pieza llamativa. Crea un tema de conversación en casa o en la oficina que hable de tus pasiones con Light My Bricks. Para obtener más información, haga clic a continuación.

[Más información](#)



大胆、美丽而明亮，Light My Bricks 将你喜爱的乐高套装从小摆件提升为引人注目的装饰品。在家或办公室打造一个能表达你激情的话题，了解更多，请点击下方。

[了解更多](#)



LEGEND

Rotate Set



Retournez L'ensemble
Ruota Set
Set Drehen
Rotar Conjunto
旋转套件

Add Part



Ajoutez une Pièce
Aggiungi Parte
Teil Hinzufügen
Agregar Pieza
添加零件

Click



Cliquez
Clic
Klicken
Clic
点击

Pinch/Fold



Pincez/Pliez
Pizzicare/Piegare
Kneifen/Falten
Pellizcar/Doblar
折叠

Pull Cable



Tirez le Cable
Tirare il Cavo
Kabel Ziehen
Tirar del Cable
拉动电缆

Repeat Step



Répétez
Ripetere
Wiederholen
Repetir
重复

Sticker



Autocollant
Adesivo
Aufkleber
Pegatina
贴纸

Power On Test



Test de mise sous tension
Test di Potenza
Stromtest
Prueba de Energía
电源测试

Disconnect Power

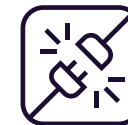

Débranchez L'alimentation
Scollegare L'alimentazione
Strom Trennen
Desconectar la Energía
断开电源

Troubleshoot



Dépanner
Risolvere
Fehlerbehebung
Solución de Problemas
故障排除

COMPONENT HANDLING

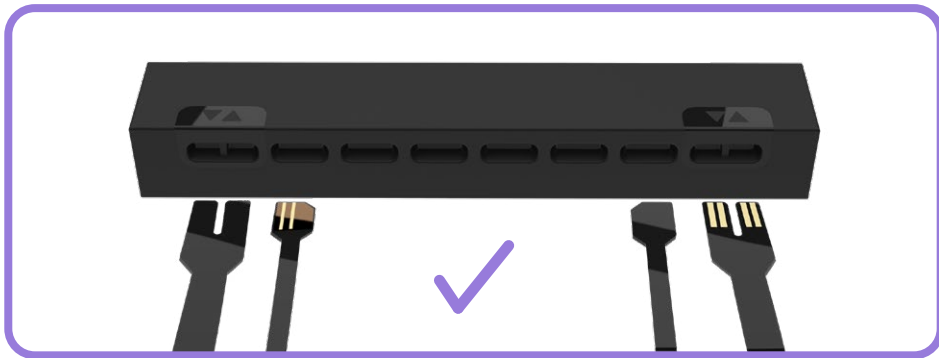
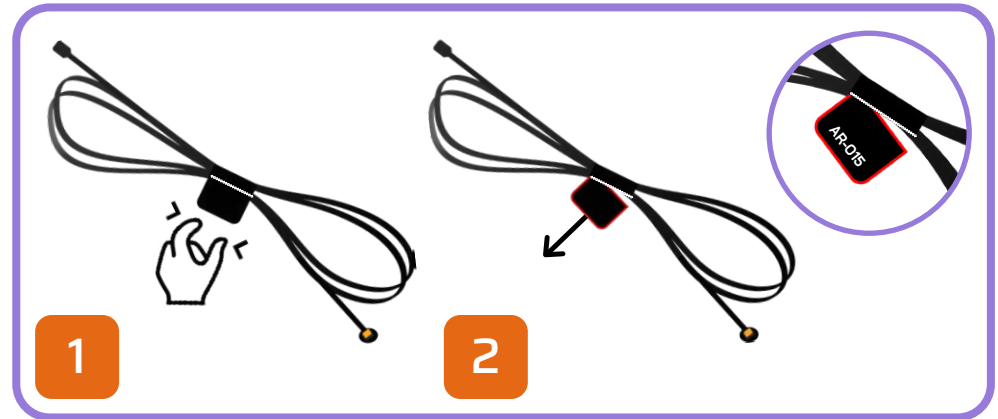
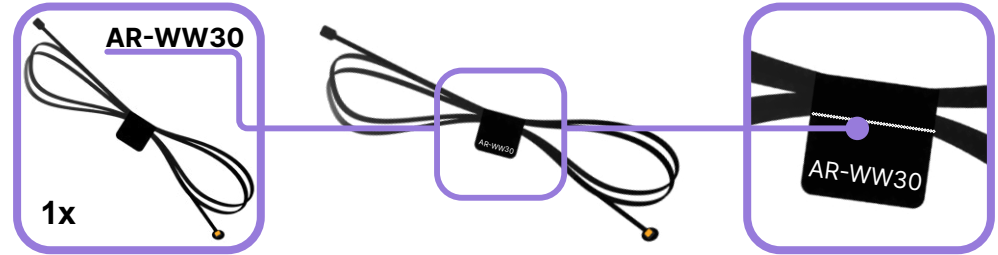
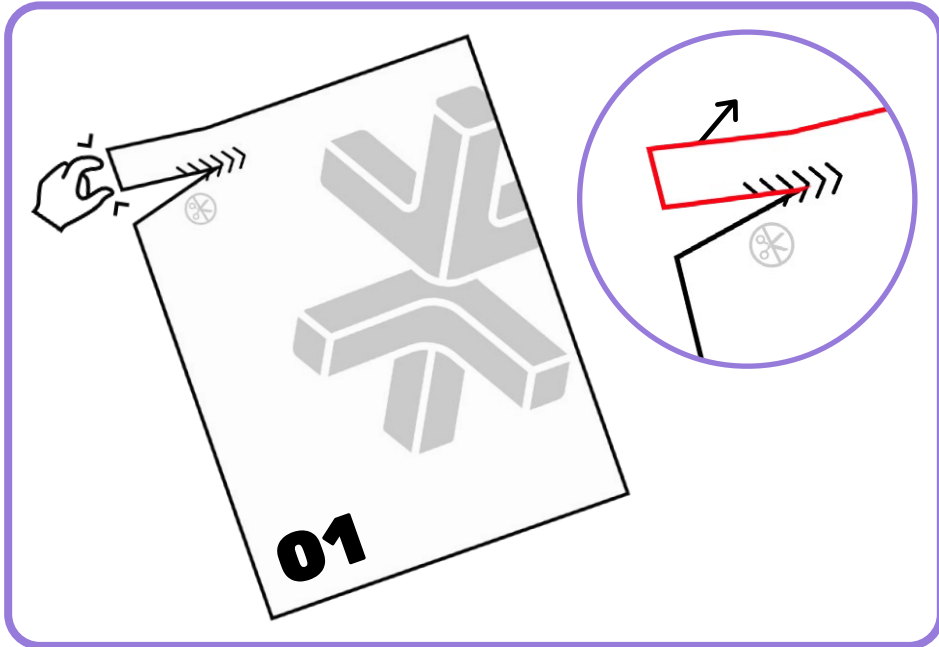

BLUEPRINT

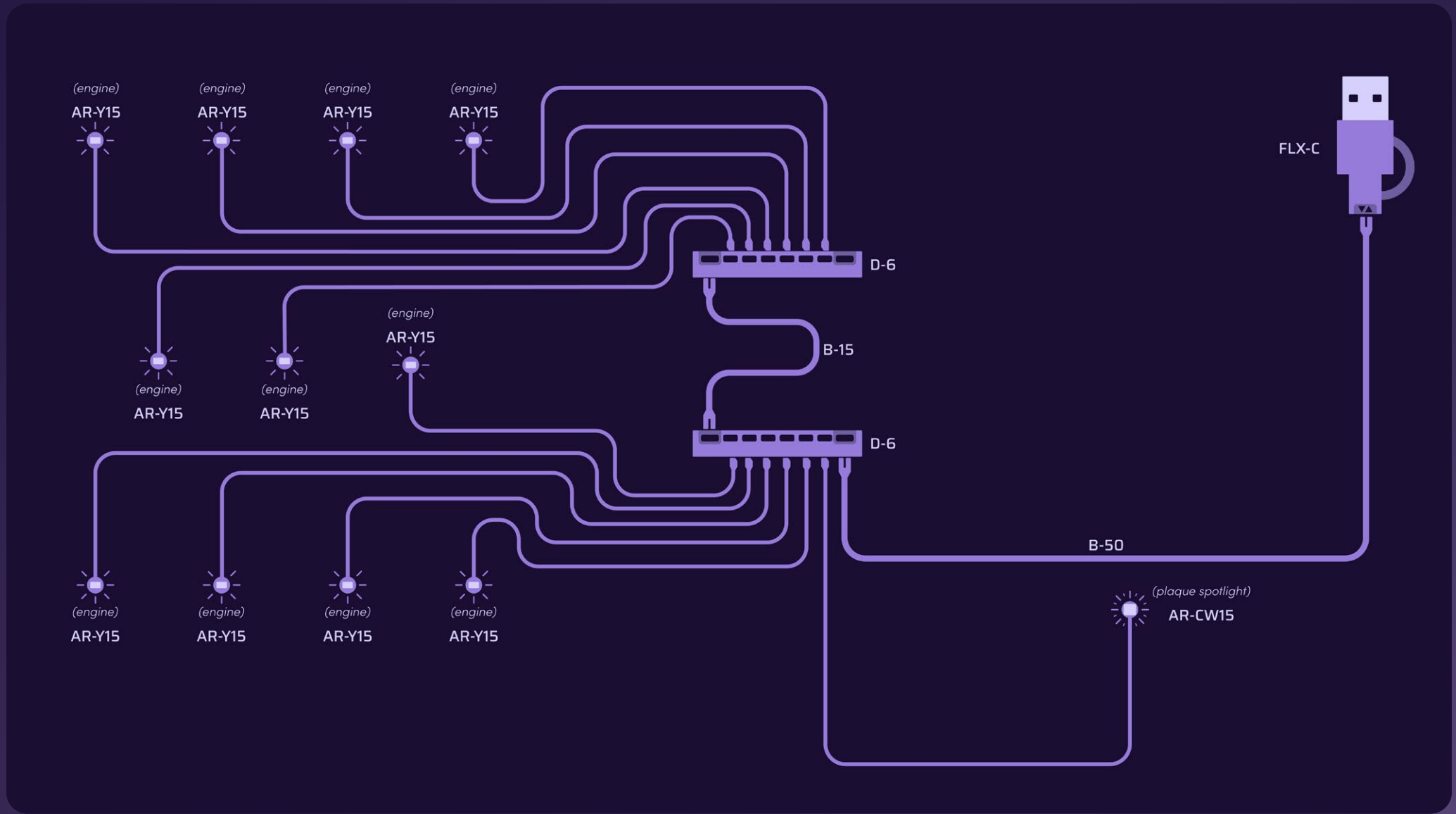

**HOLD UP!**

You might notice some bags aren't in order, as well as left over pieces, but that's ok! We're changing the way you build LEGO!

ATTENDEZ!

Vous remarquerez peut-être que certains sacs, ainsi que certaines pièces, ne sont pas dans le bon ordre. Mais pas de panique! Nous changeons simplement la façon avec laquelle vous construisez vos LEGO!

ASPETTA!

Potresti notare che alcuni sacchetti non sono in ordine, così come i pezzi avanzati, ma va bene così! Stiamo cambiando il modo in cui costruisci i LEGO!

HALT!

Sie werden möglicherweise bemerken, dass einige tüten durcheinander sind und teile übrig bleiben, aber das ist in Ordnung! Wir ändern die art und weise, wie Sie LEGO bauen!

¡ESPERA!

Es posible que notes que algunas bolsas están fuera de servicio, así como piezas sobrantes, ¡pero está bien! ¡Estamos cambiando la forma en que construyes LEGO!

暫停!

你可能会注意到一些袋子顺序错乱, 以及一些剩余的部件, 但没关系! 我们正在改变你搭建乐高的方式!

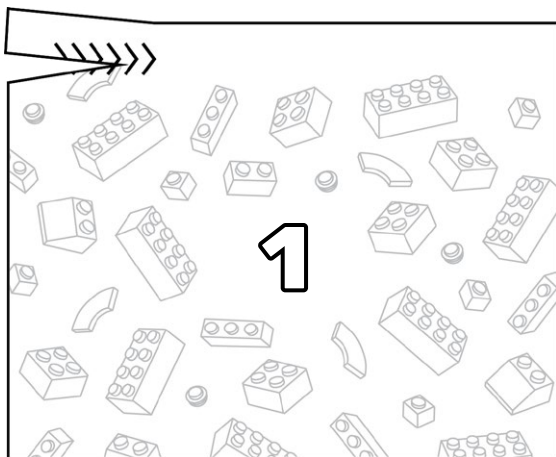
Open LEGO® Bag 1

1

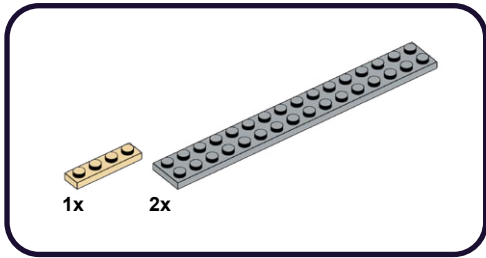

1

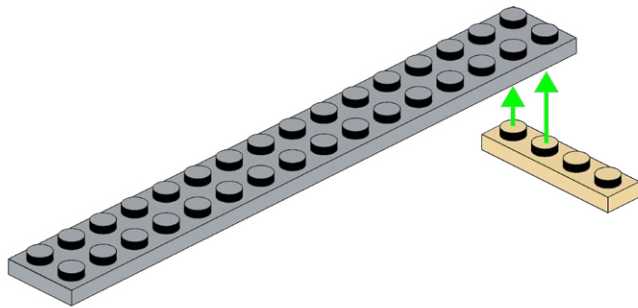

2

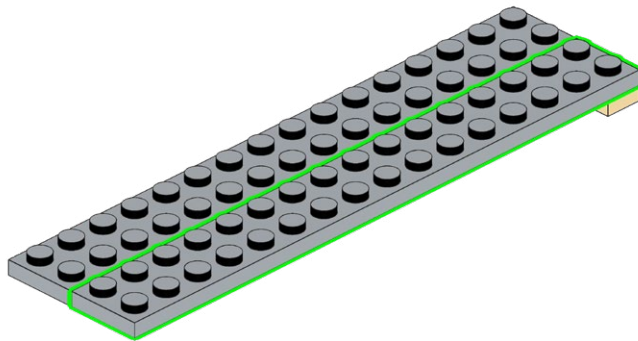

2

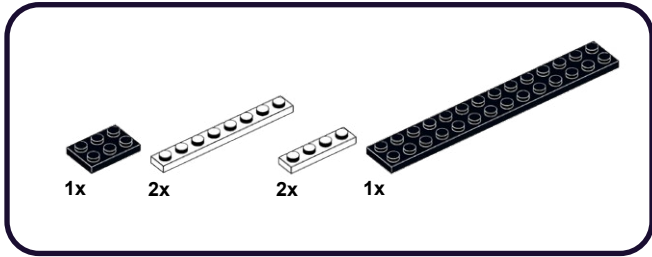
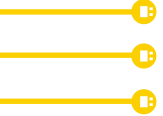

1

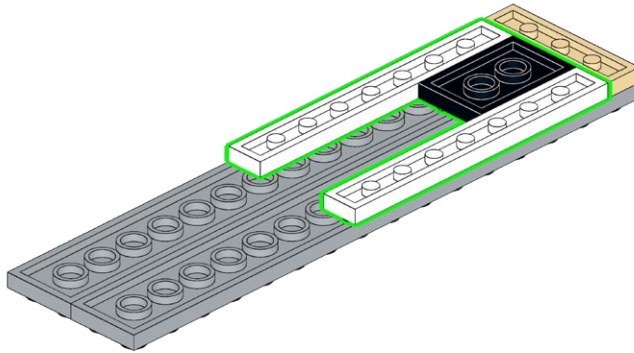

2

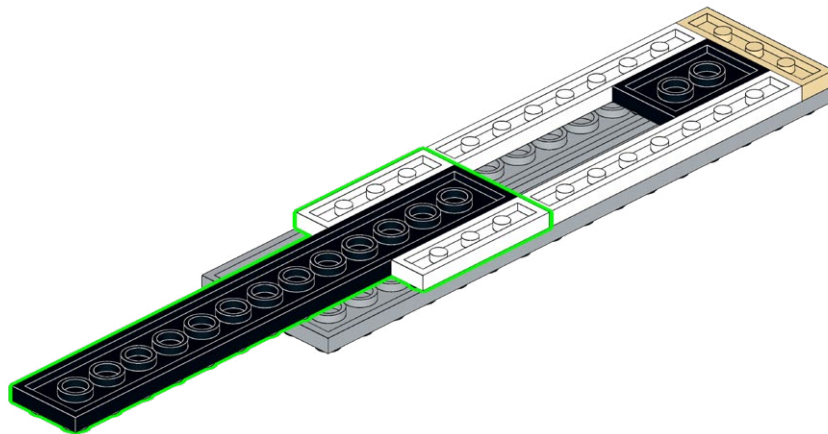

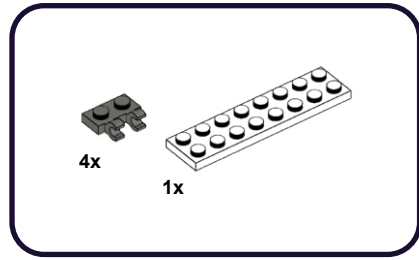

1

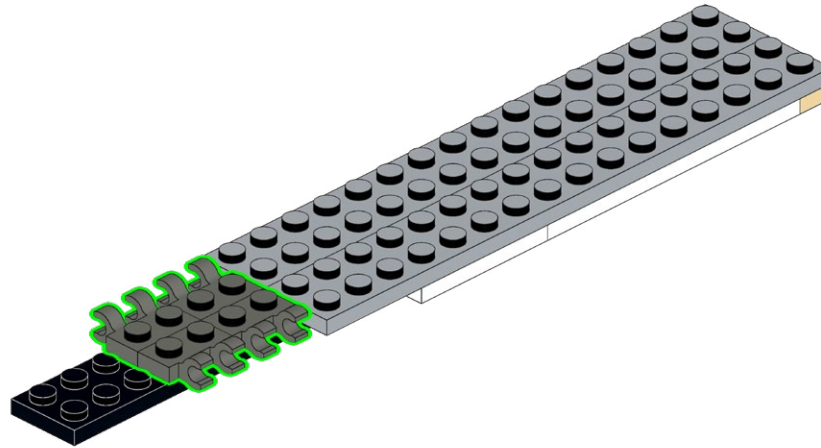

2

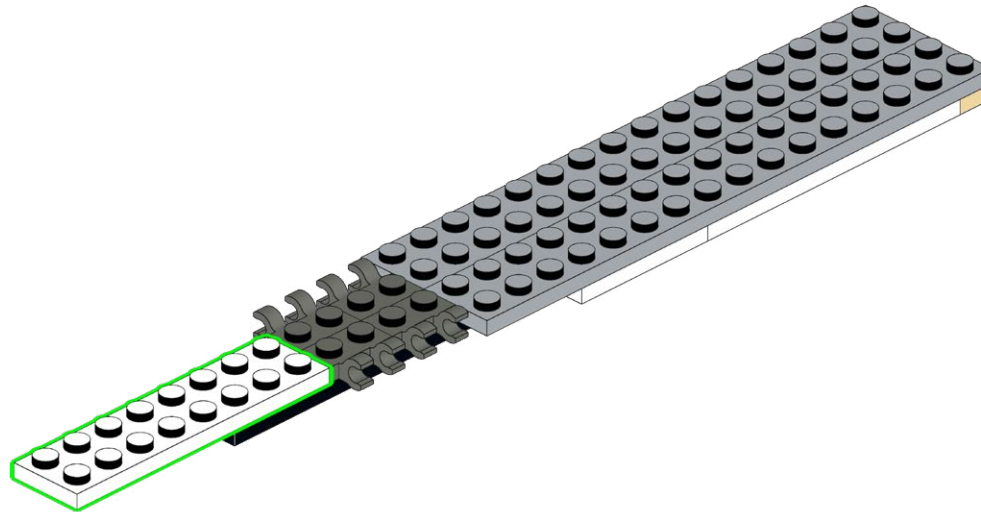

4

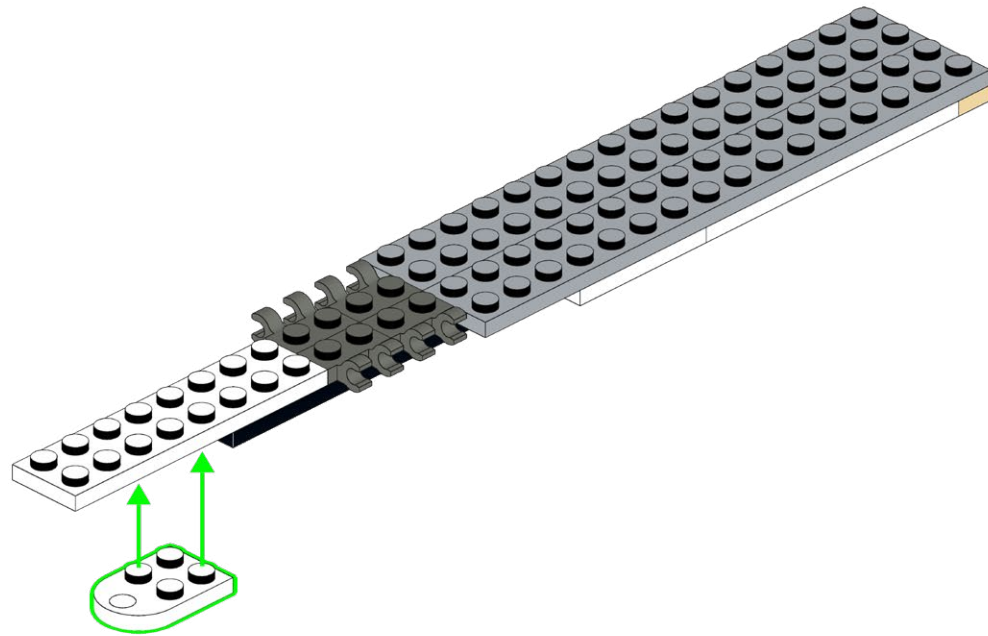
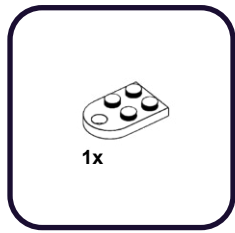

5

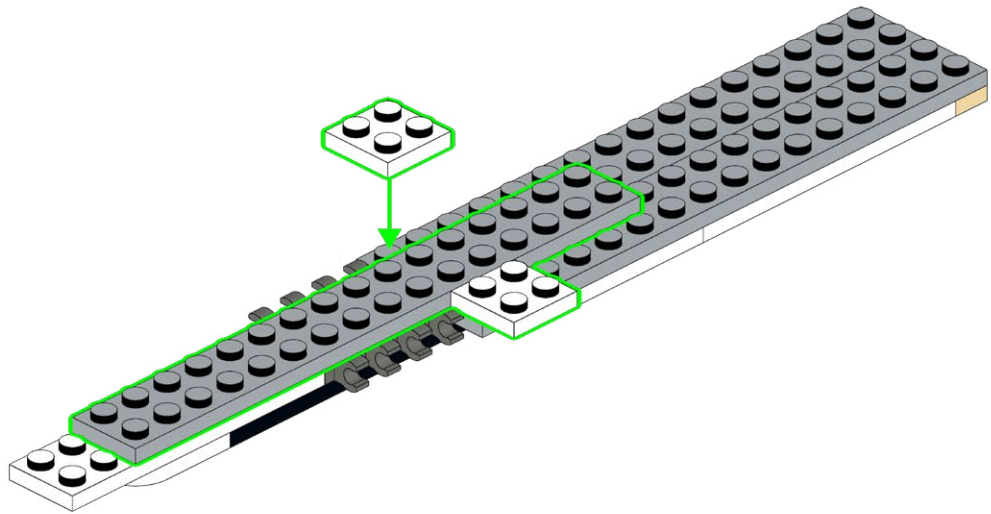
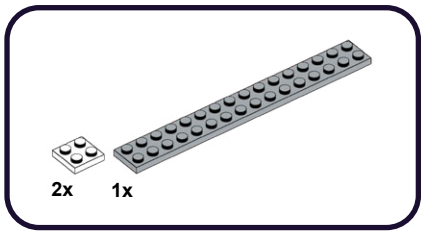

6

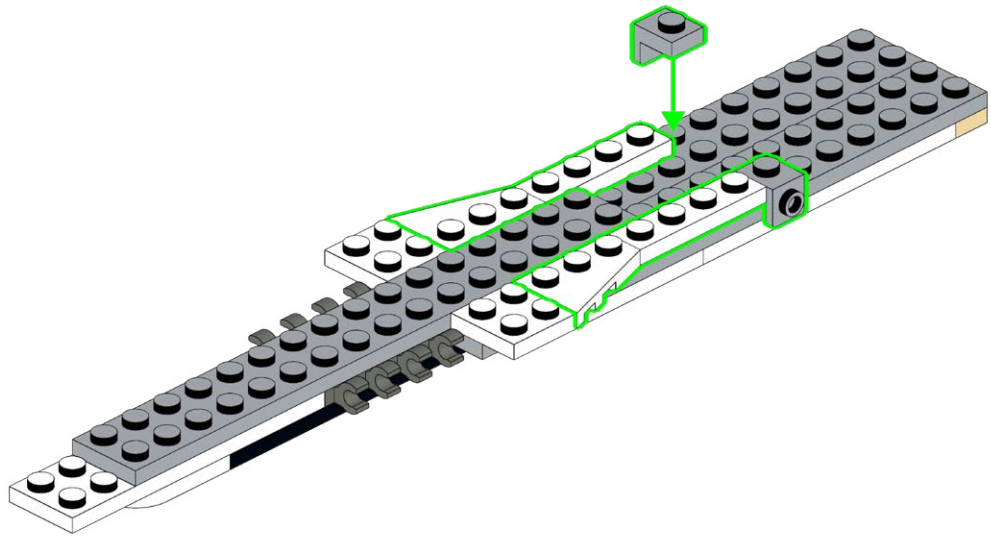
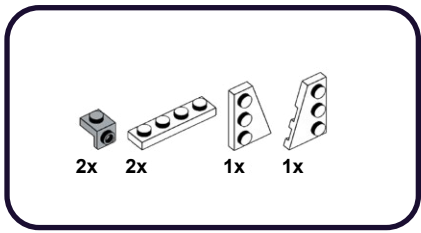

7

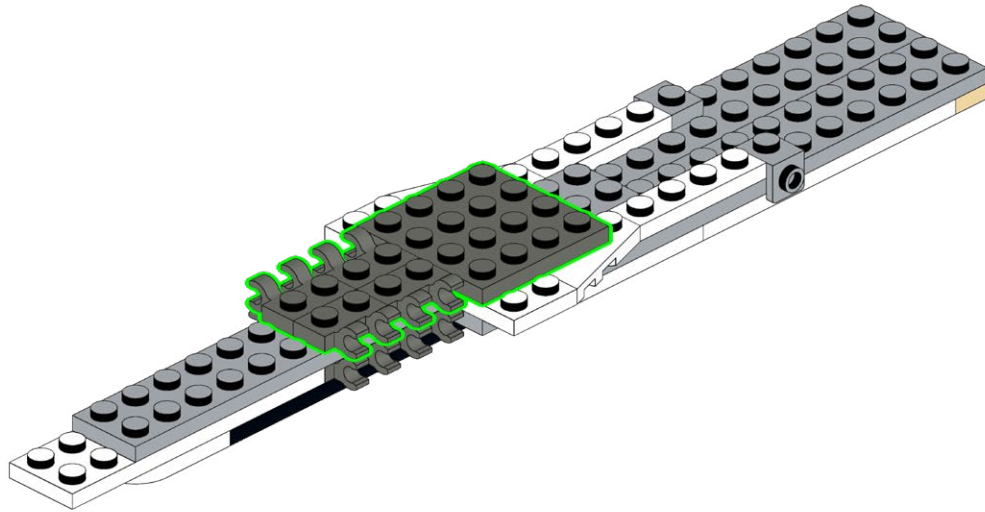
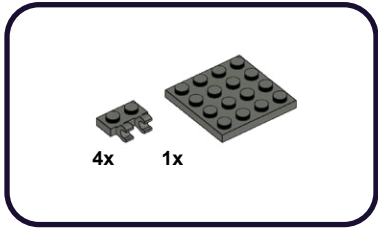

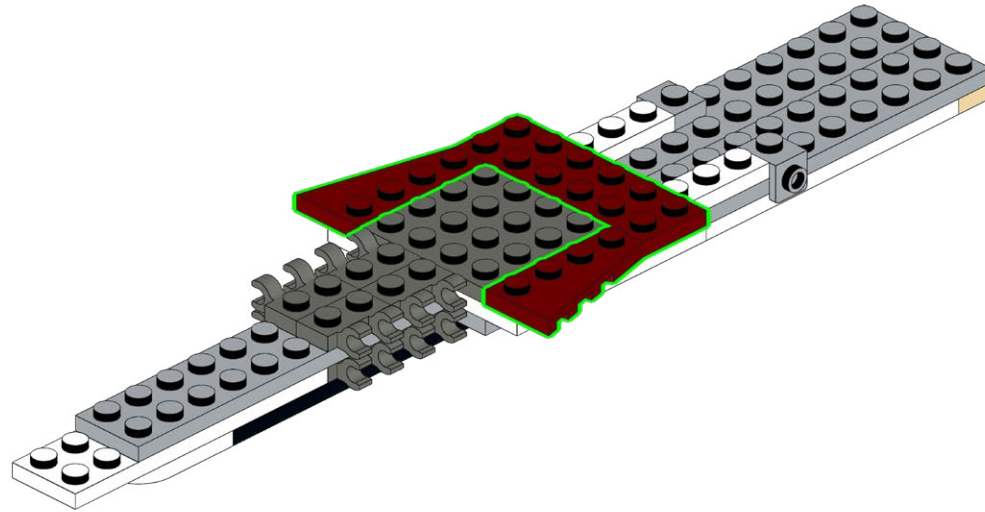
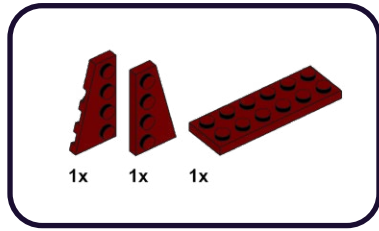

9

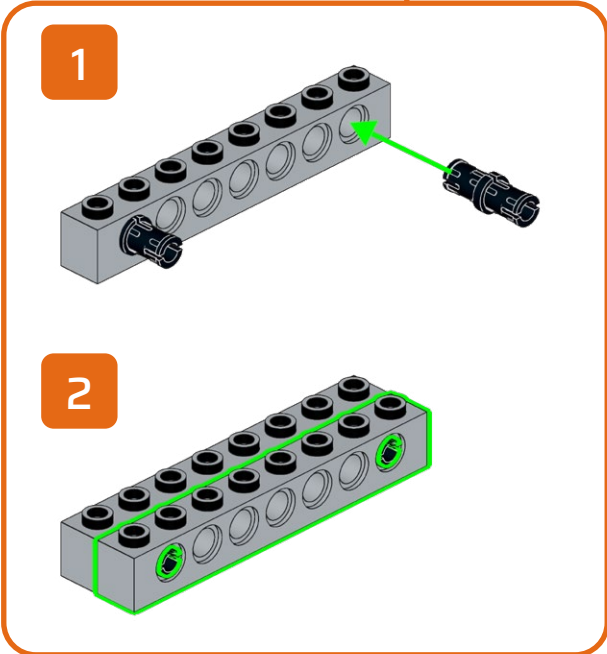
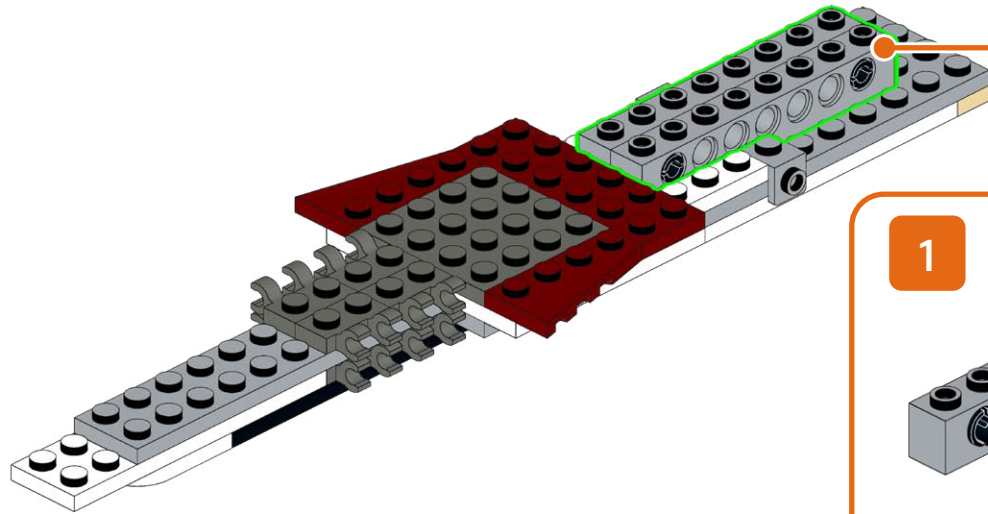
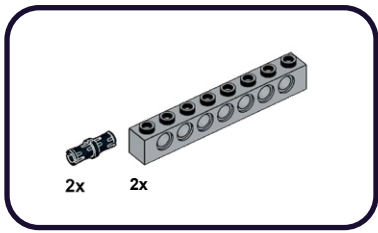

10

2x

1x

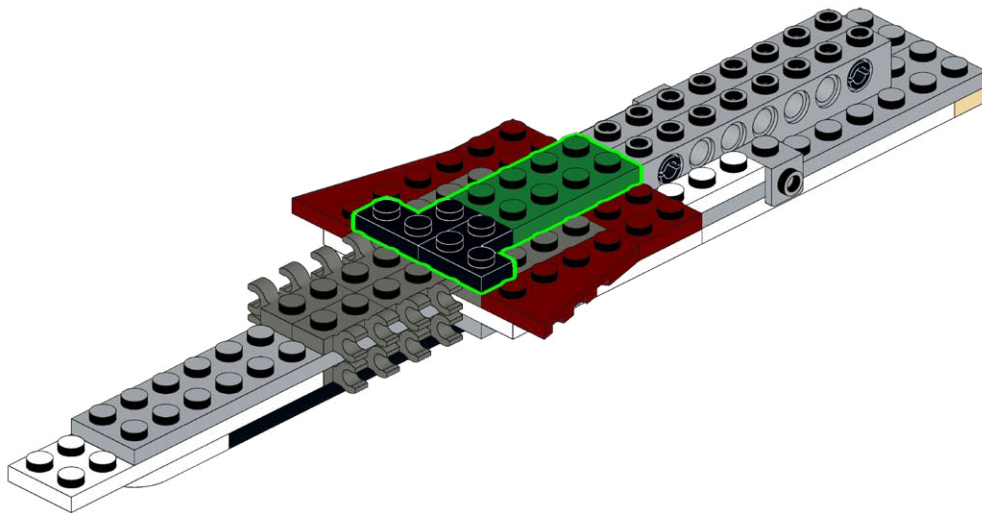

11

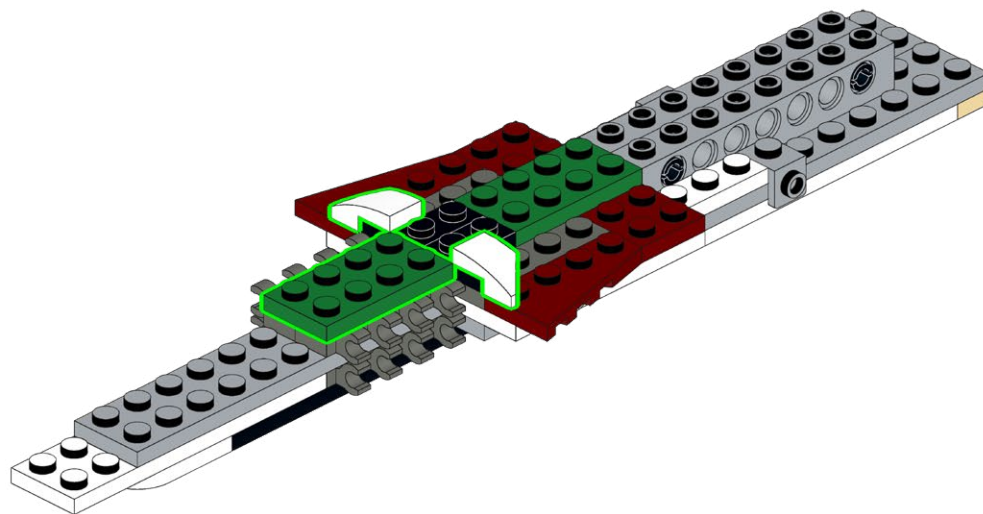
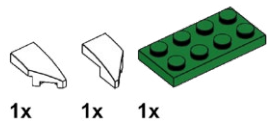

12

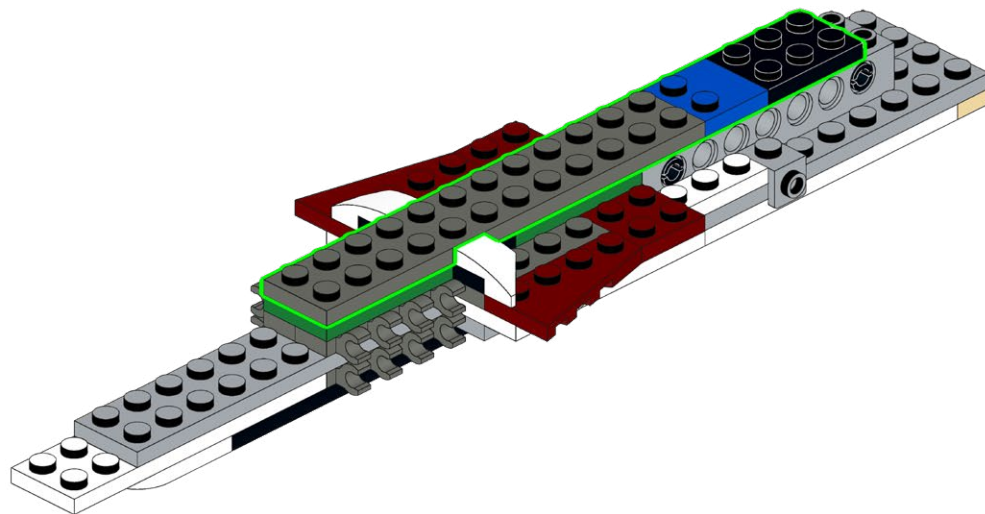
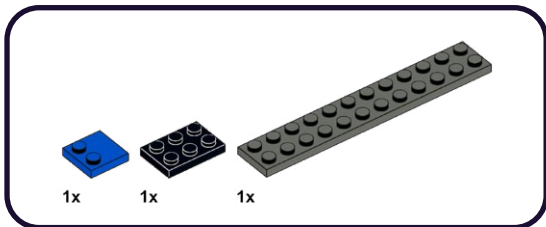

13

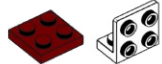

2x

2x

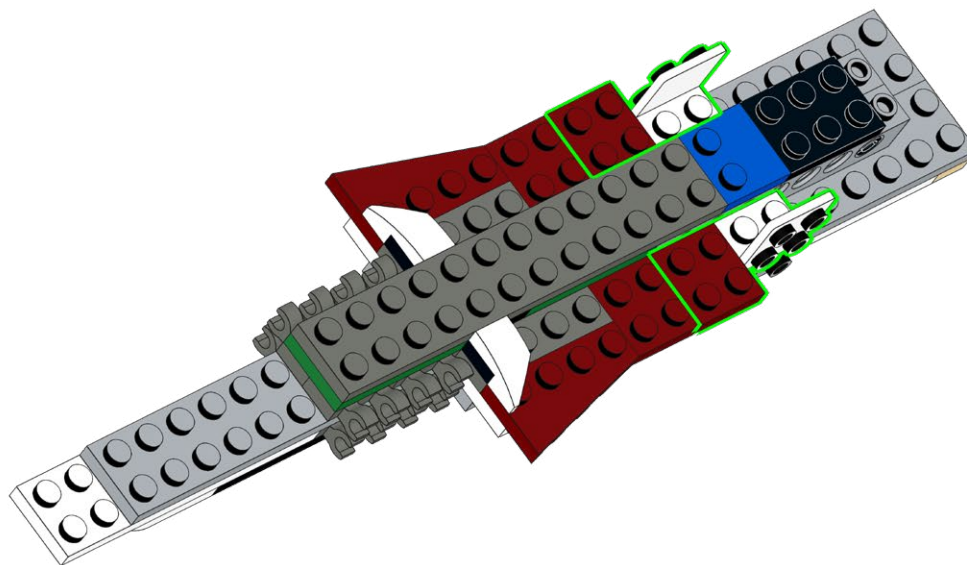

14

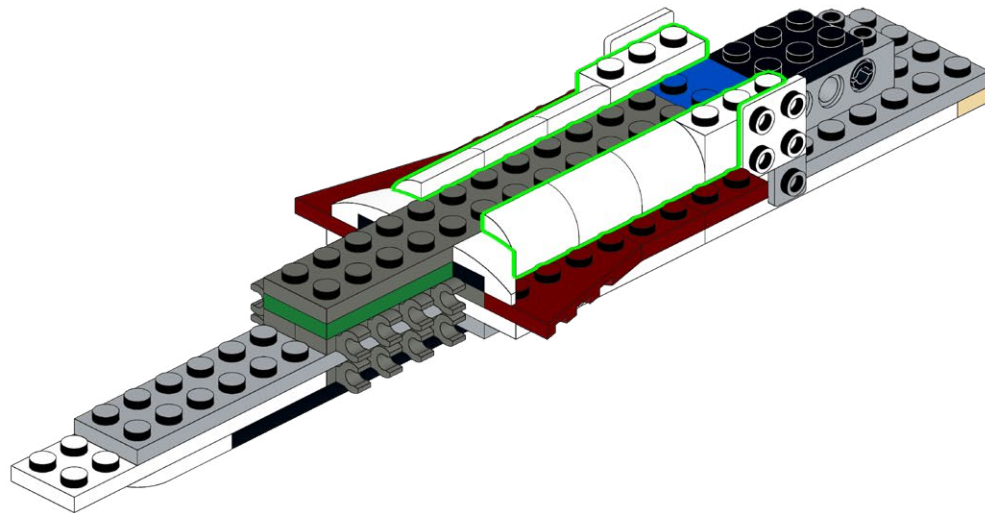
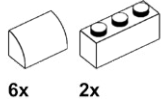

15

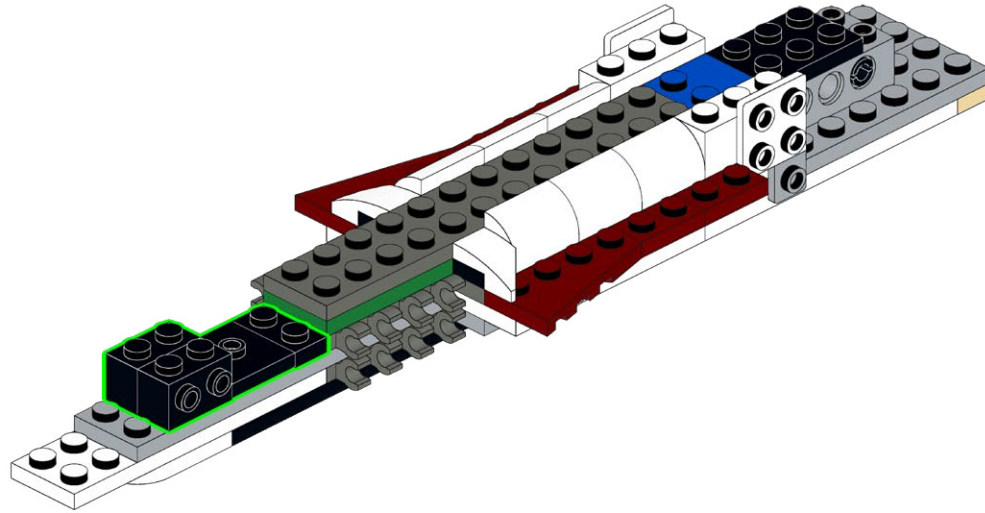
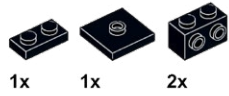

16

- 1x 
- 2x 
- 1x 
- 2x 

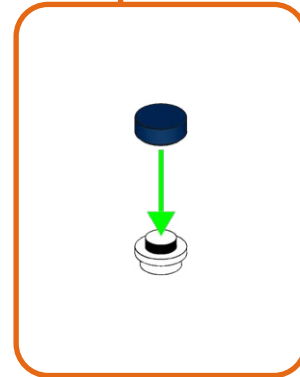
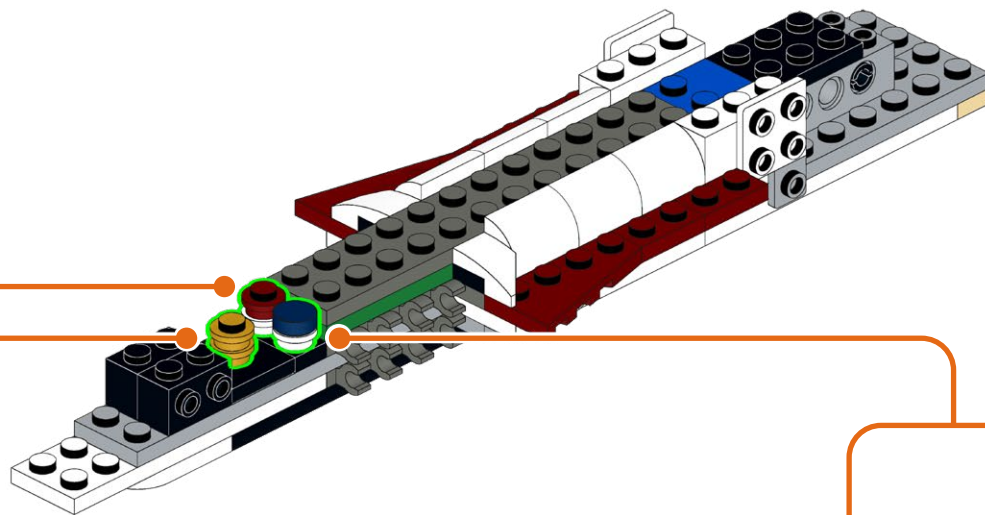
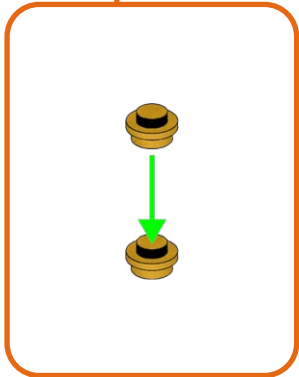
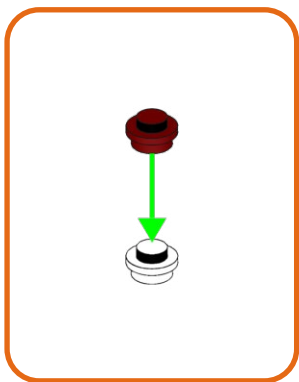

17

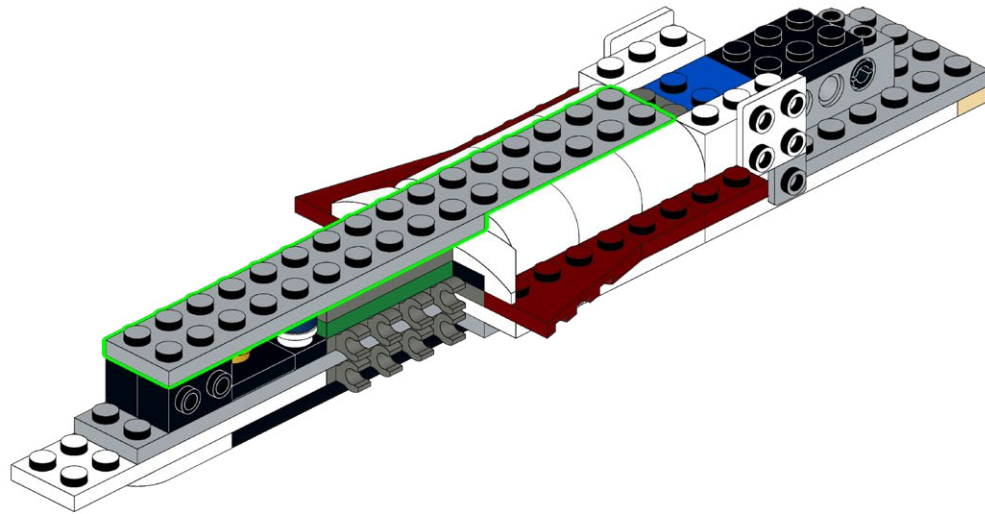
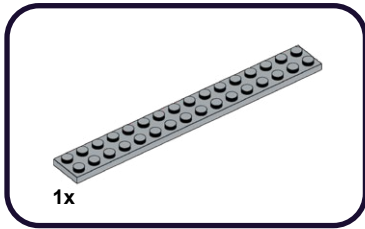

18

2x

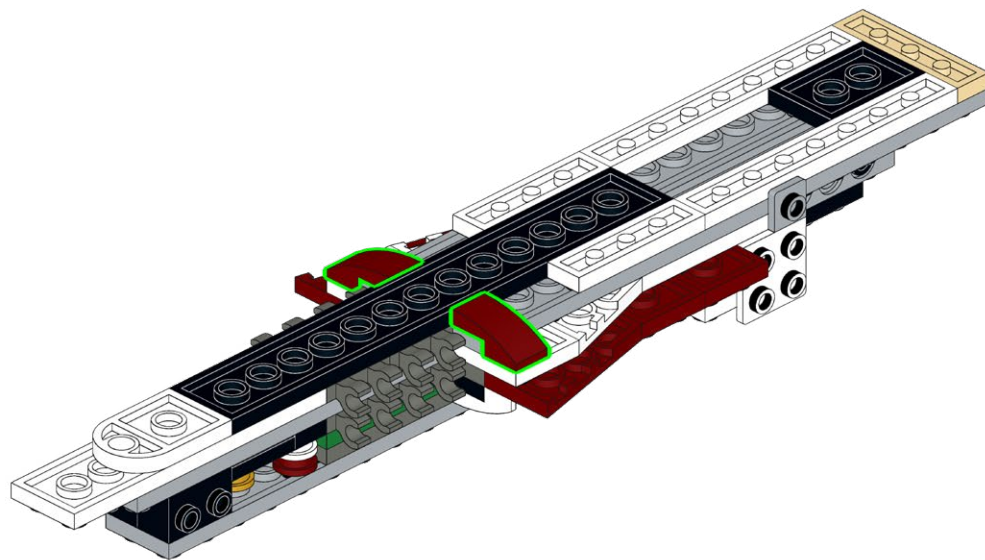

**HOLD UP!**

You might notice some bags aren't in order, as well as left over pieces, but that's ok! We're changing the way you build LEGO!

ATTENDEZ!

Vous remarquerez peut-être que certains sacs, ainsi que certaines pièces, ne sont pas dans le bon ordre. Mais pas de panique! Nous changeons simplement la façon avec laquelle vous construisez vos LEGO!

ASPETTA!

Potresti notare che alcuni sacchetti non sono in ordine, così come i pezzi avanzati, ma va bene così! Stiamo cambiando il modo in cui costruisci i LEGO!

HALT!

Sie werden möglicherweise bemerken, dass einige tüten durcheinander sind und teile übrig bleiben, aber das ist in Ordnung! Wir ändern die art und weise, wie Sie LEGO bauen!

¡ESPERA!

Es posible que notes que algunas bolsas están fuera de servicio, así como piezas sobrantes, ¡pero está bien! ¡Estamos cambiando la forma en que construyes LEGO!

暫停!

你可能会注意到一些袋子顺序错乱, 以及一些剩余的部件, 但没关系! 我们正在改变你搭建乐高的方式!

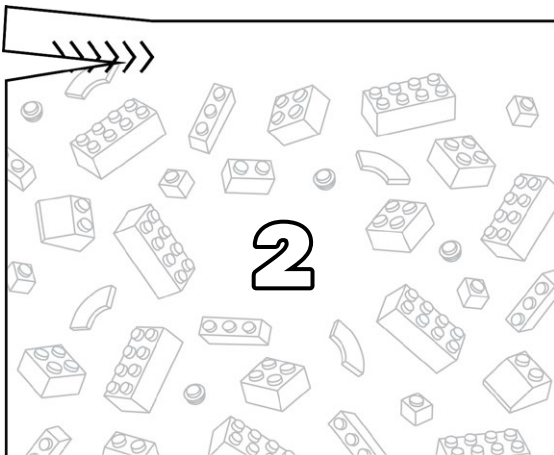
Open LEGO® Bag 2

19

1x

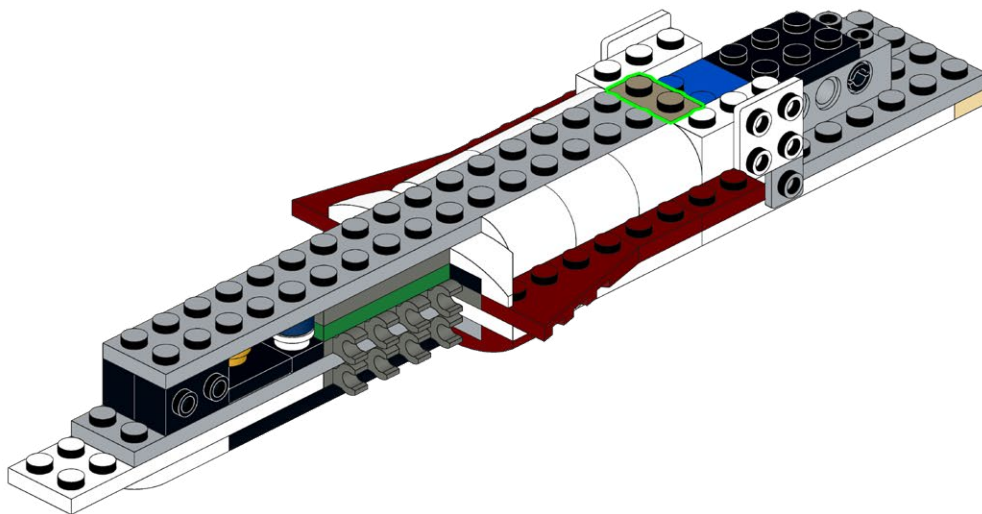

20

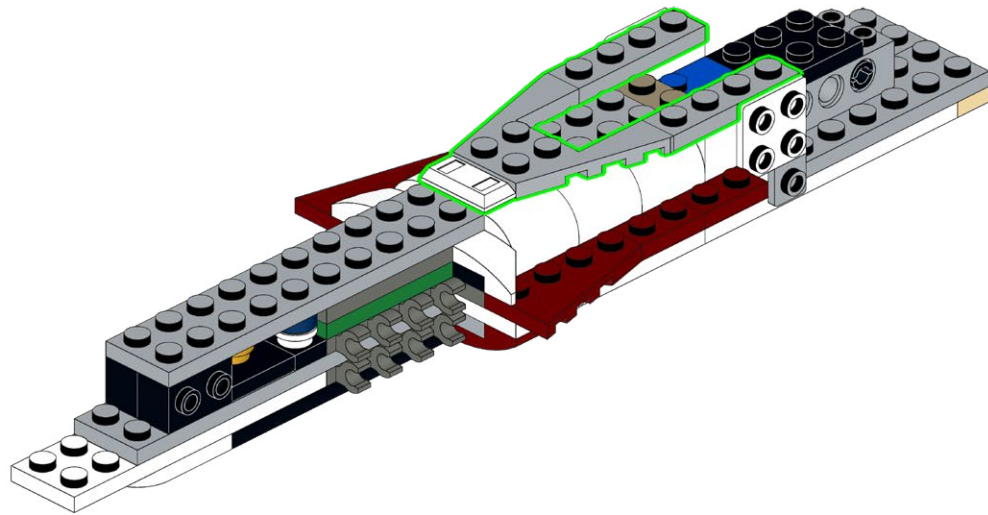
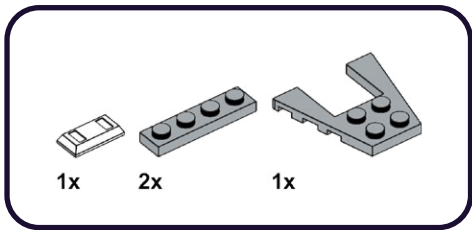

21

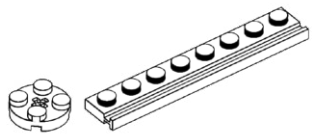

1x 2x

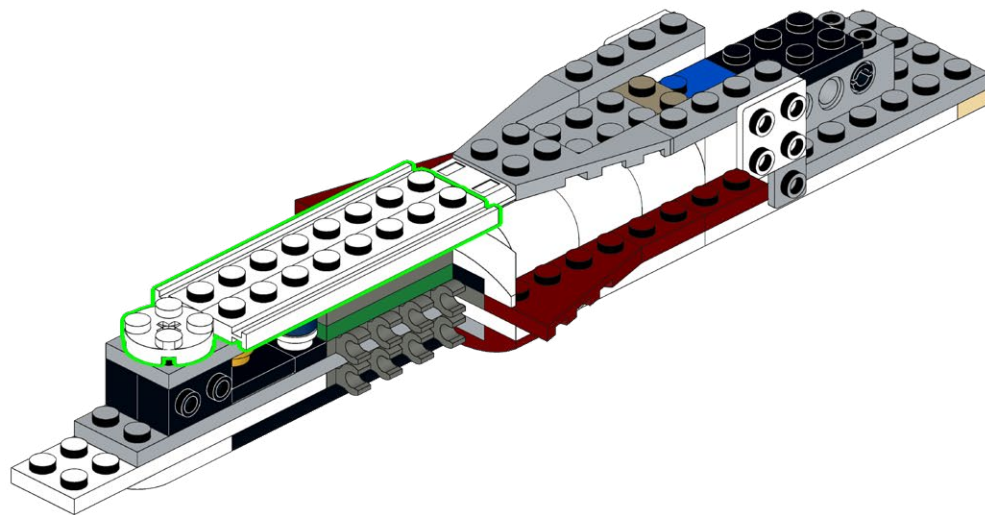

22

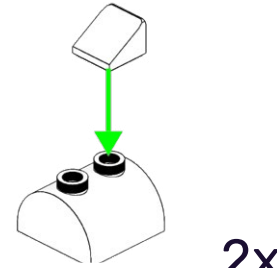
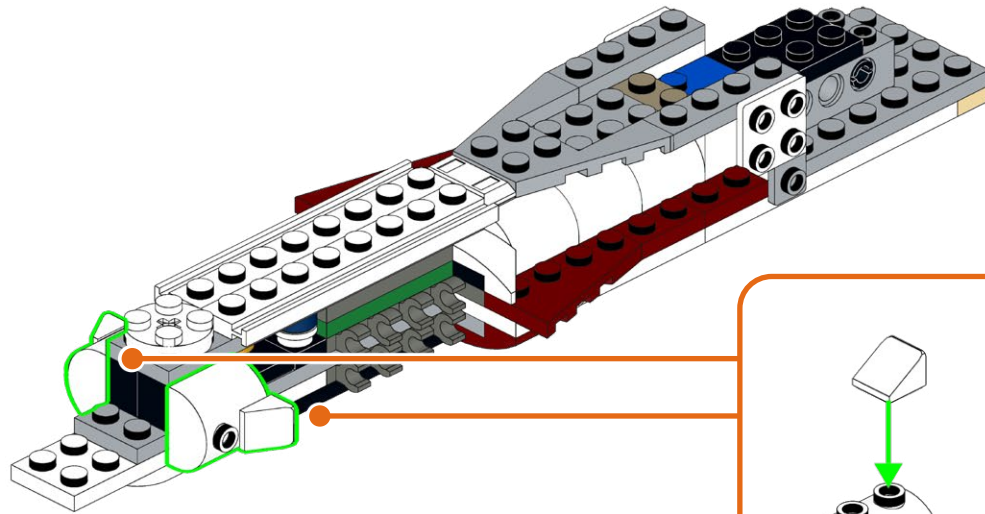
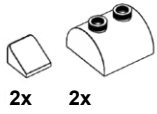

23

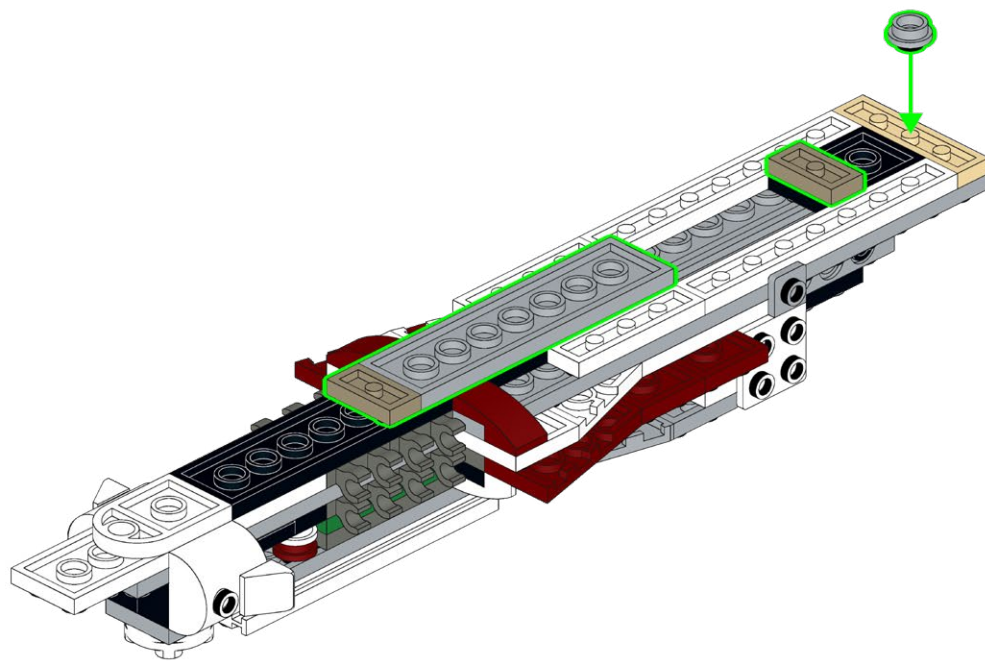
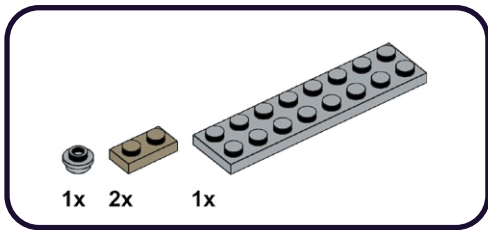



HOLD UP!

You might notice some bags aren't in order, as well as left over pieces, but that's ok! We're changing the way you build LEGO!

ATTENDEZ!

Vous remarquerez peut-être que certains sacs, ainsi que certaines pièces, ne sont pas dans le bon ordre. Mais pas de panique! Nous changeons simplement la façon avec laquelle vous construisez vos LEGO!

ASPETTA!

Potresti notare che alcuni sacchetti non sono in ordine, così come i pezzi avanzati, ma va bene così! Stiamo cambiando il modo in cui costruisci i LEGO!

HALT!

Sie werden möglicherweise bemerken, dass einige tüten durcheinander sind und teile übrig bleiben, aber das ist in Ordnung! Wir ändern die art und weise, wie Sie LEGO bauen!

¡ESPERA!

Es posible que notes que algunas bolsas están fuera de servicio, así como piezas sobrantes, ¡pero está bien! ¡Estamos cambiando la forma en que construyes LEGO!

暫停!

你可能会注意到一些袋子顺序错乱, 以及一些剩余的部件, 但没关系! 我们正在改变你搭建乐高的方式!

Open LMB Bag 02 and 04

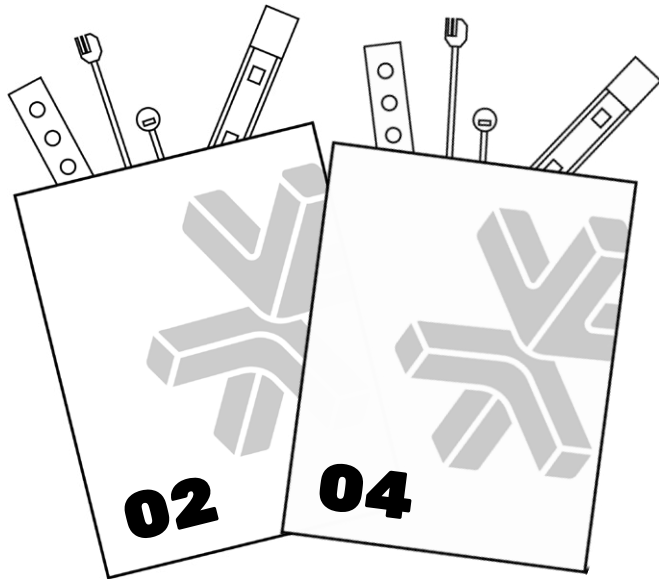

24

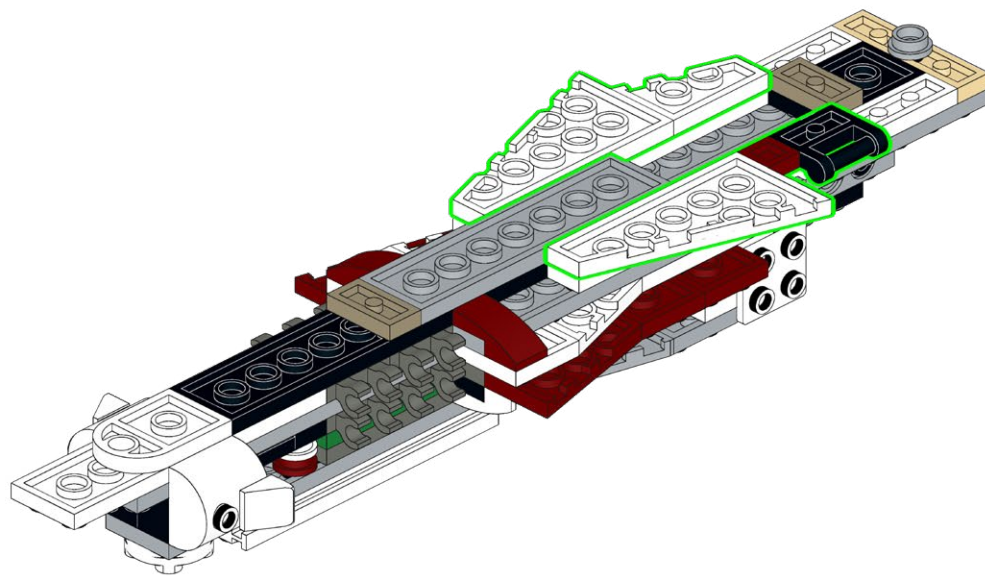
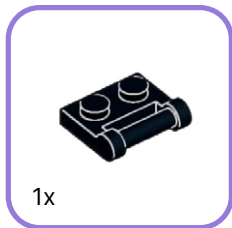
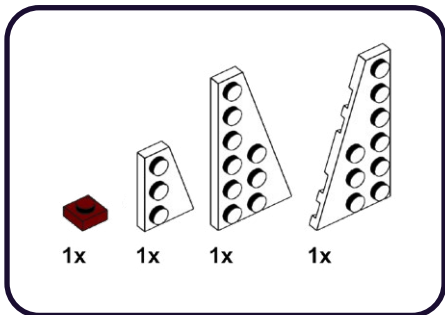

25

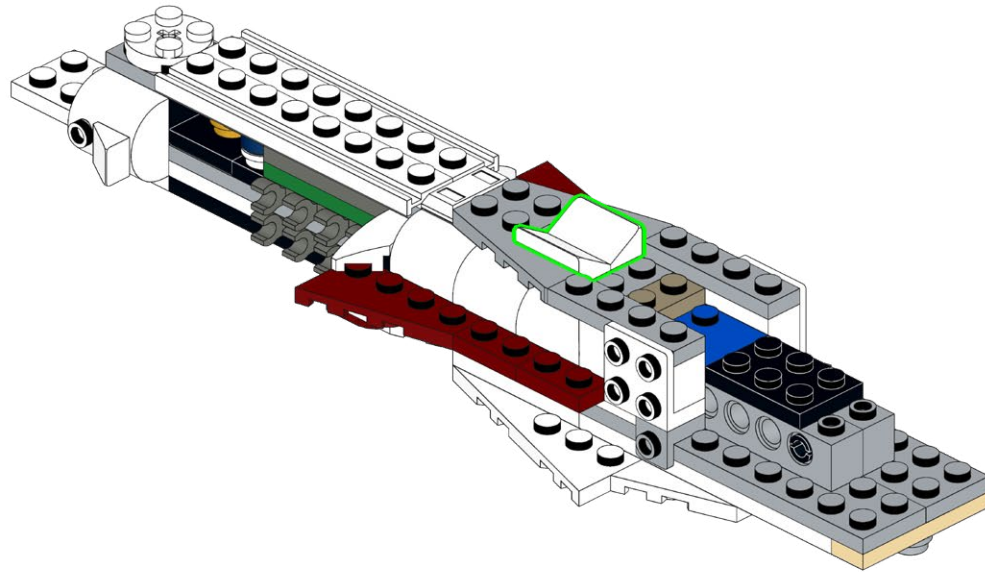
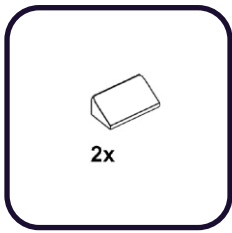

26

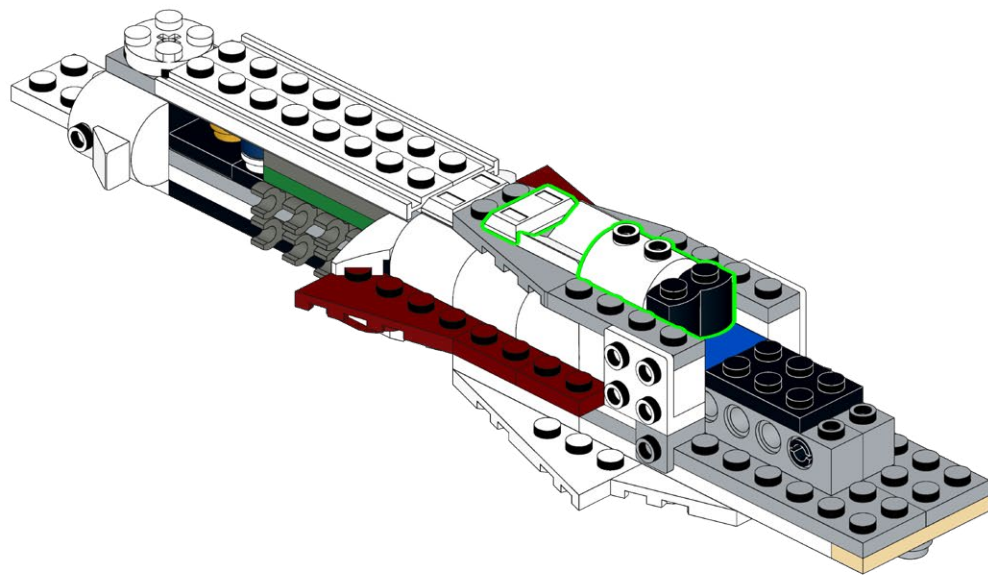
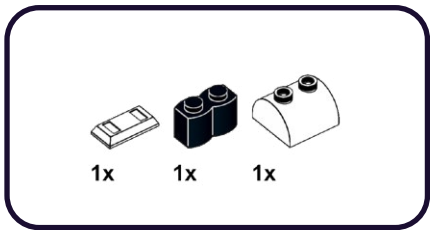

27

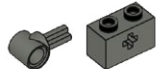

1x

1x

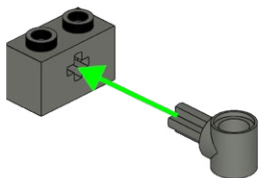
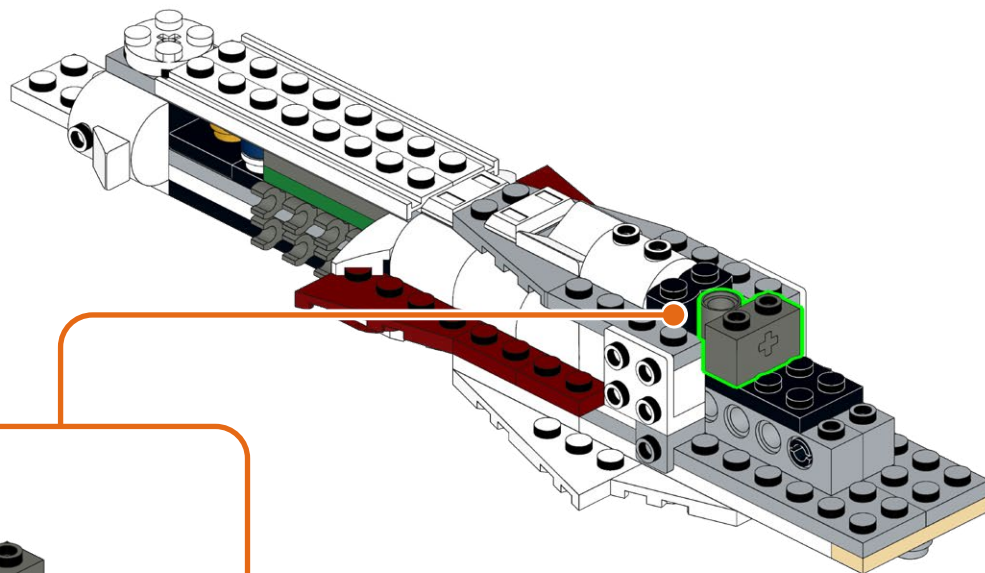

28

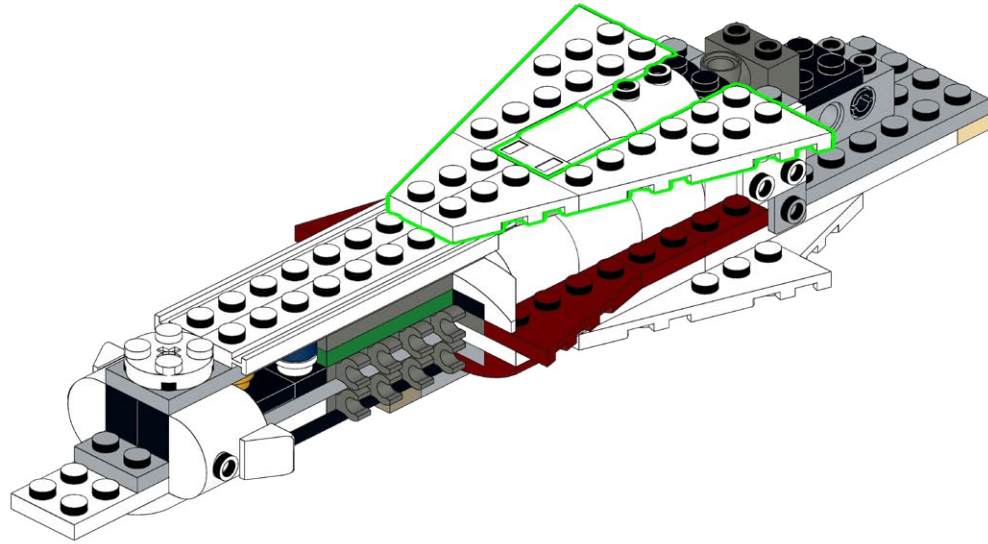
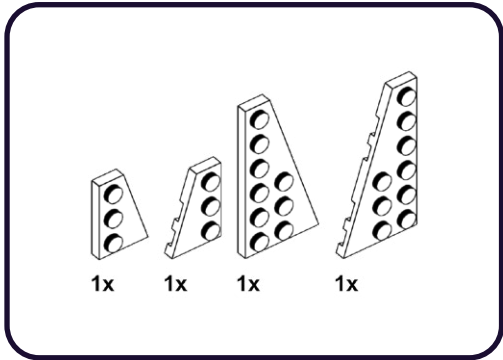

29

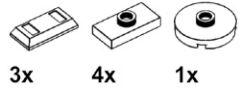

3x

4x

1x

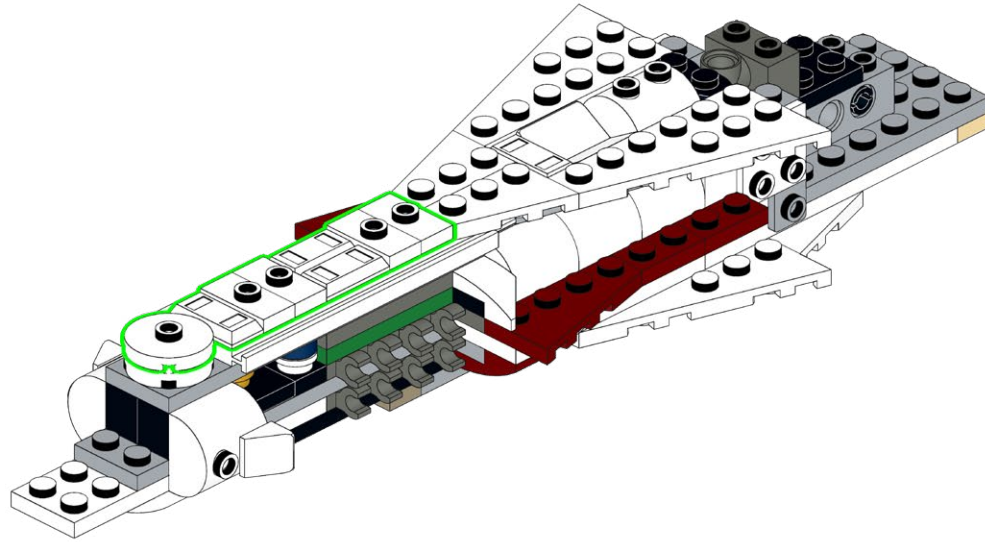

30

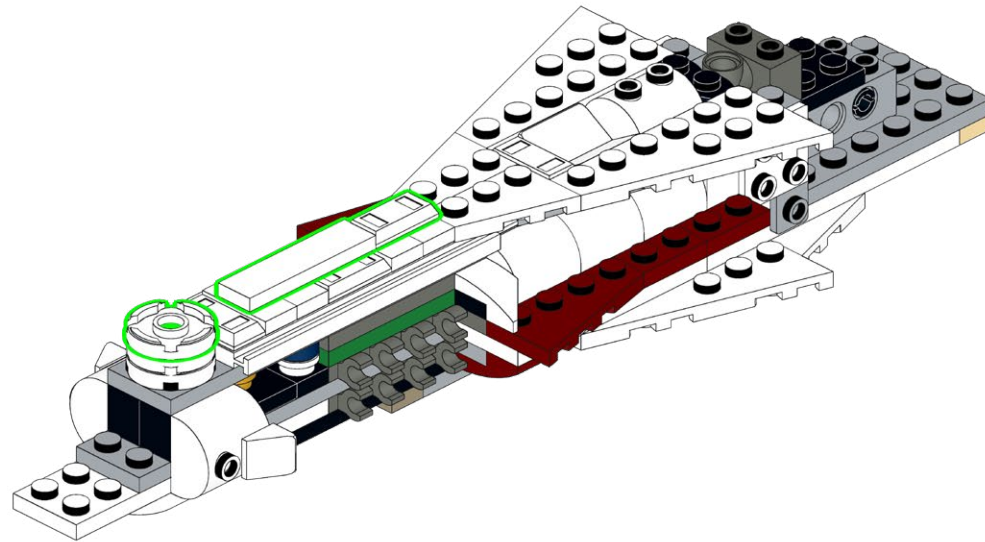
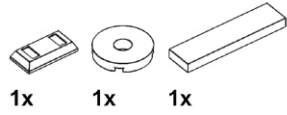

31

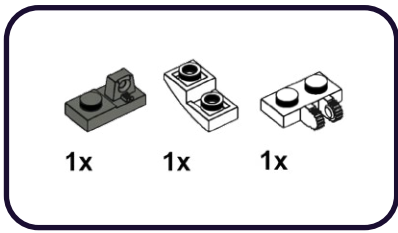

1

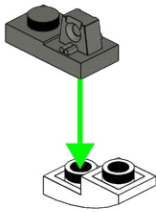

2

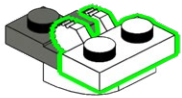

32

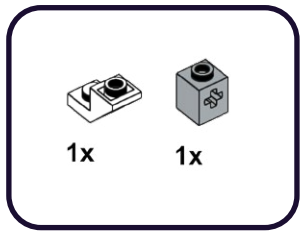

1

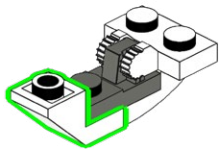

2

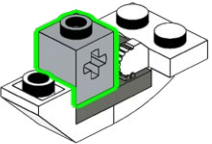

33

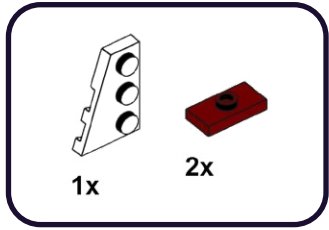

1

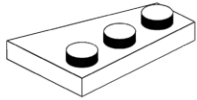

2

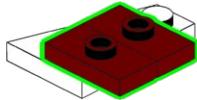

34

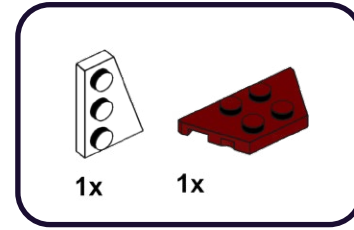

1

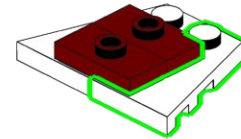

2

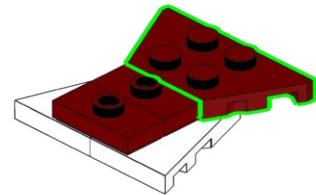

35



2x

1

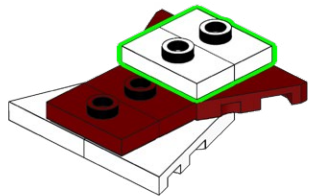

2

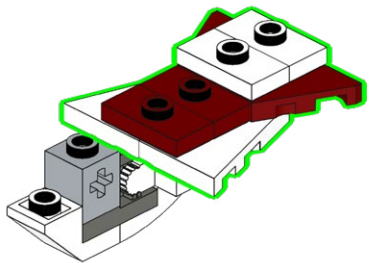

36

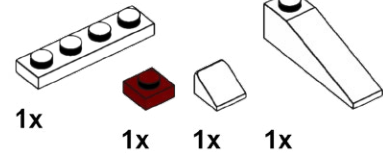

1x

1x

1x

1x

1

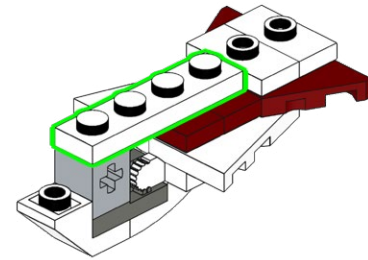

2

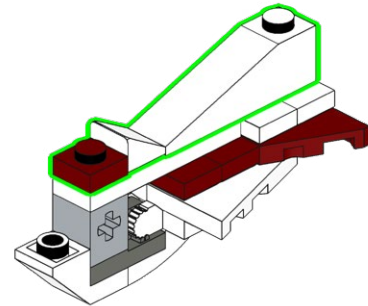

37

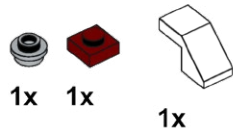

1

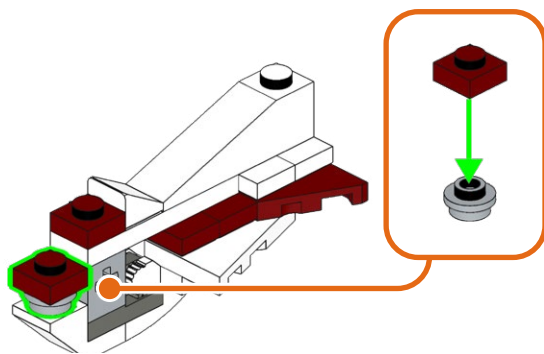

2

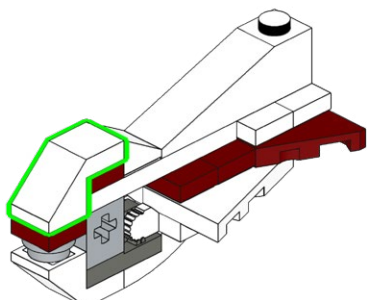

38

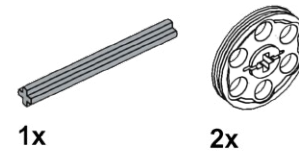

1

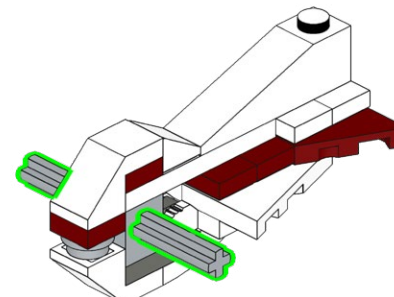

2

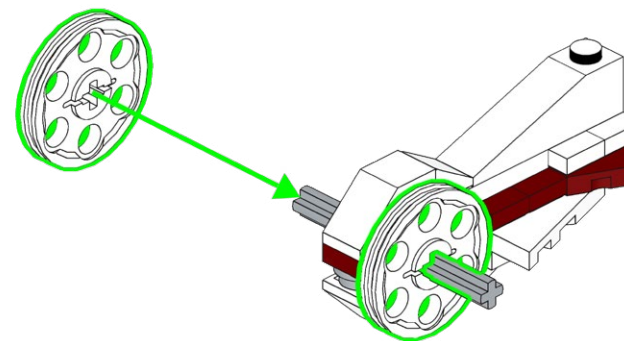

39

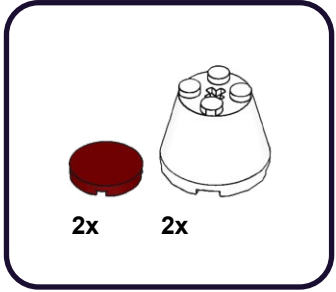

1

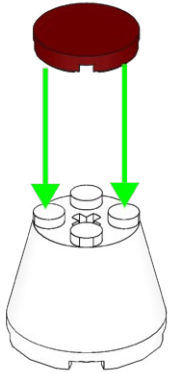

2

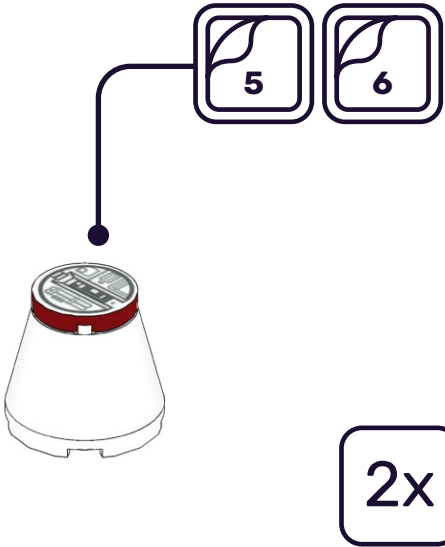

40

1

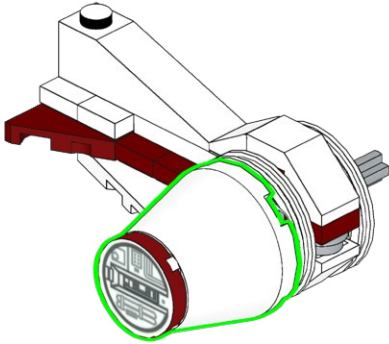

2

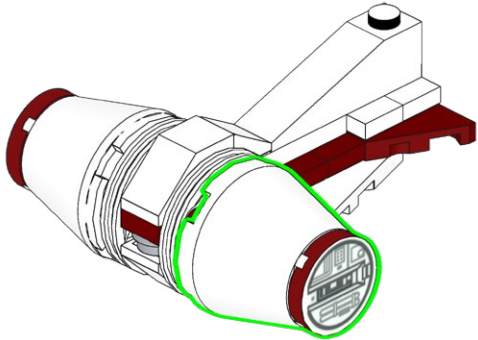

41

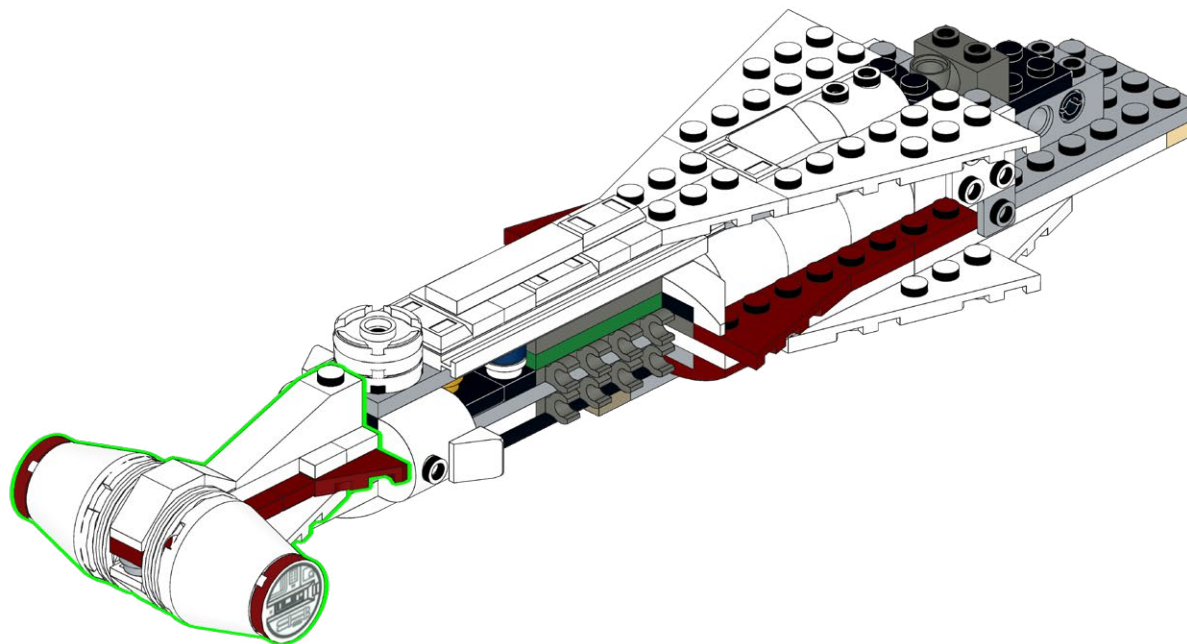

**HOLD UP!**

You might notice some bags aren't in order, as well as left over pieces, but that's ok! We're changing the way you build LEGO!

ATTENDEZ!

Vous remarquerez peut-être que certains sacs, ainsi que certaines pièces, ne sont pas dans le bon ordre. Mais pas de panique! Nous changeons simplement la façon avec laquelle vous construisez vos LEGO!

ASPETTA!

Potresti notare che alcuni sacchetti non sono in ordine, così come i pezzi avanzati, ma va bene così! Stiamo cambiando il modo in cui costruisci i LEGO!

HALT!

Sie werden möglicherweise bemerken, dass einige tüten durcheinander sind und teile übrig bleiben, aber das ist in Ordnung! Wir ändern die art und weise, wie Sie LEGO bauen!

¡ESPERA!

Es posible que notes que algunas bolsas están fuera de servicio, así como piezas sobrantes, ¡pero está bien! ¡Estamos cambiando la forma en que construyes LEGO!

暫停!

你可能会注意到一些袋子顺序错乱, 以及一些剩余的部件, 但没关系! 我们正在改变你搭建乐高的方式!

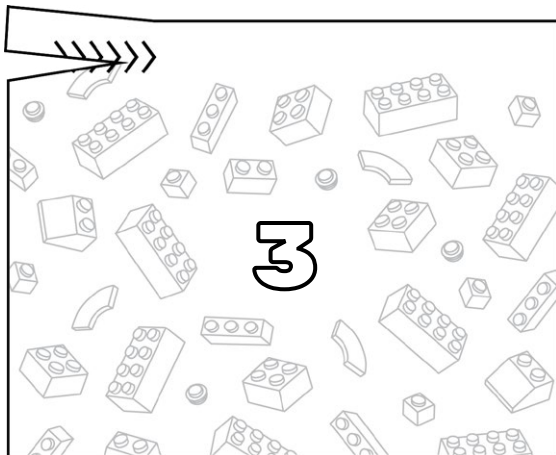
Open LEGO® Bag 3

42

1x

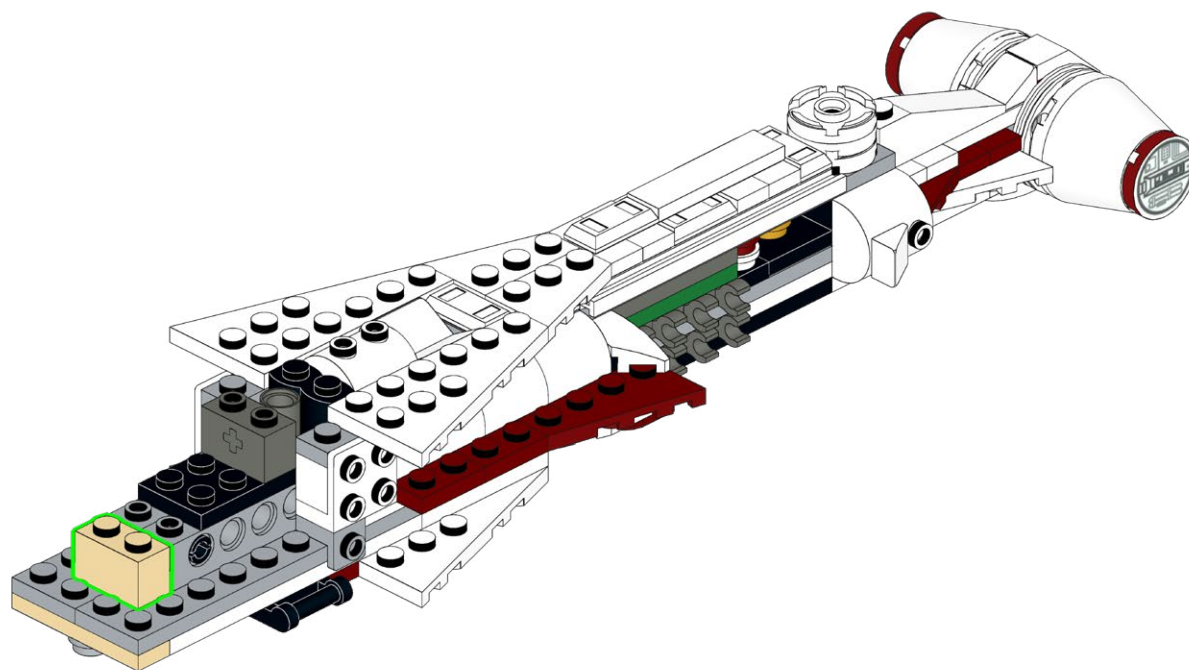

43



2x

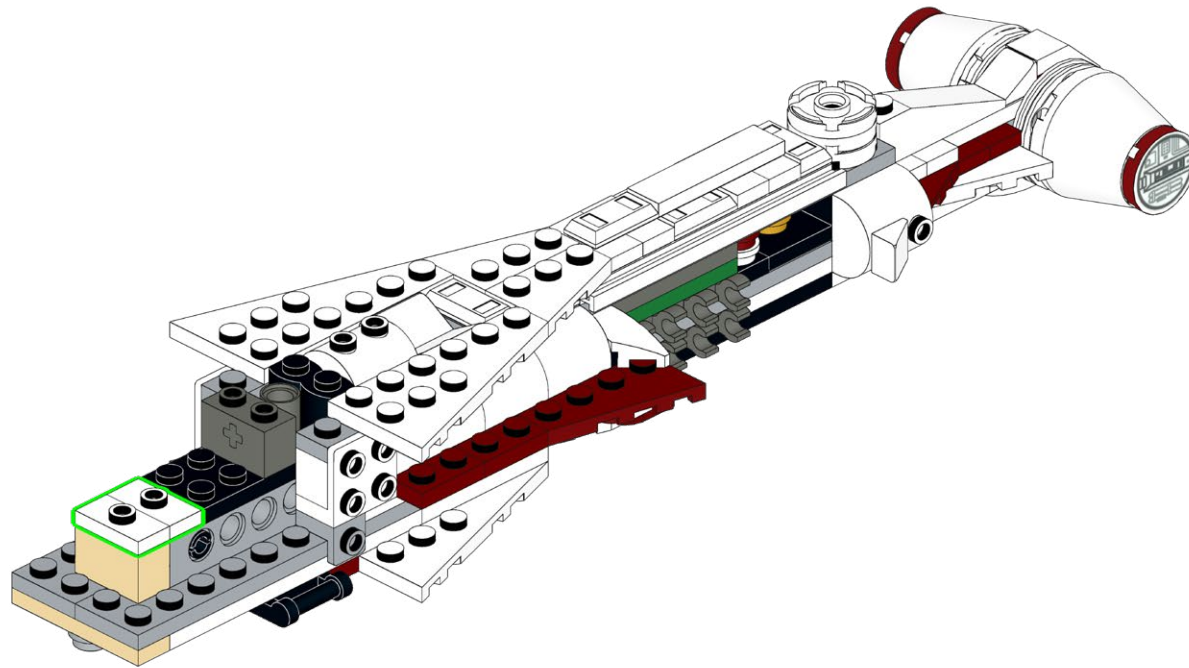

44

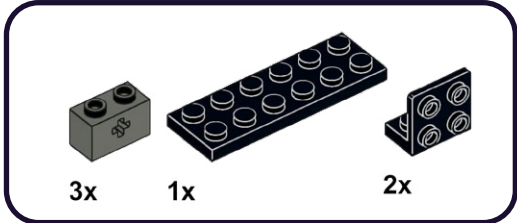

1

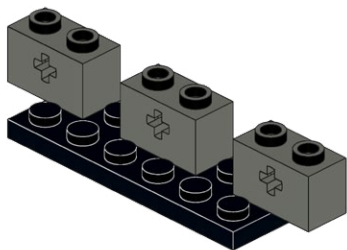

2

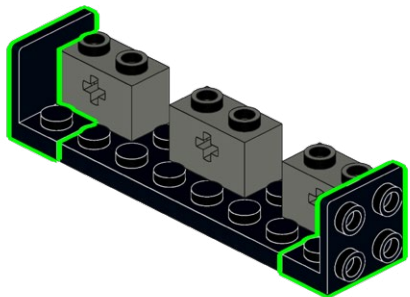

45

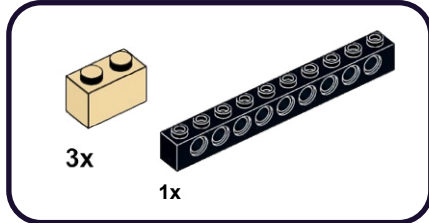

1

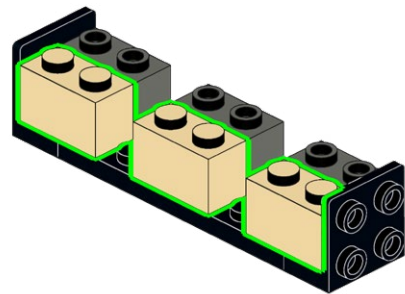

2

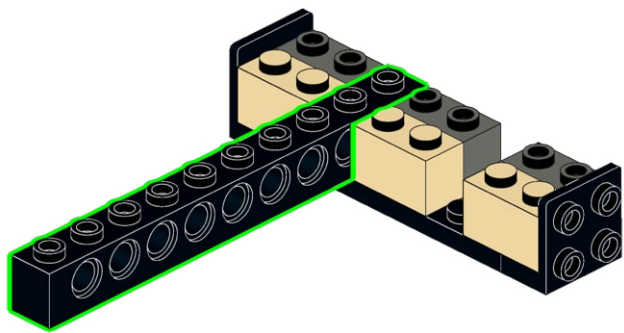

46

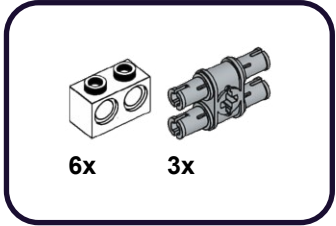

1

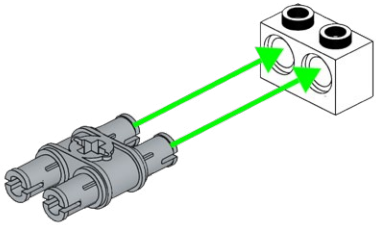

2

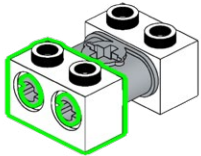

3x

47

1

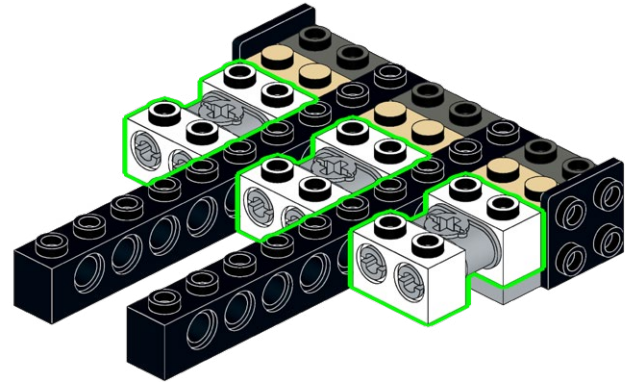

48

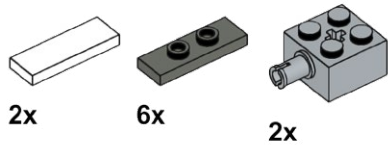

1

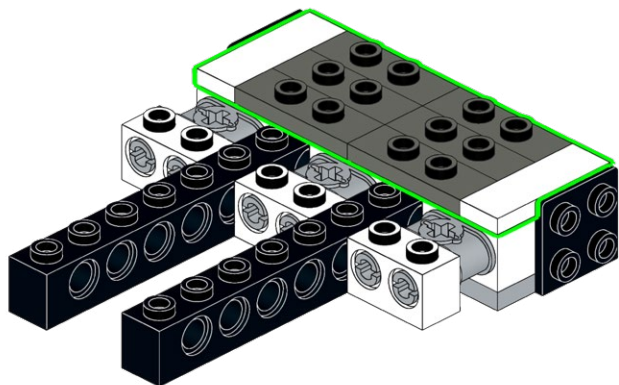

2

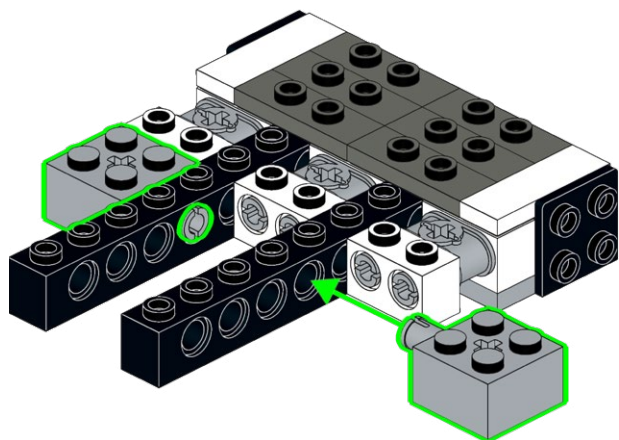

49

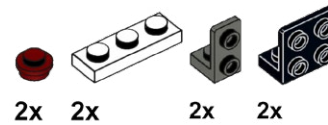

1

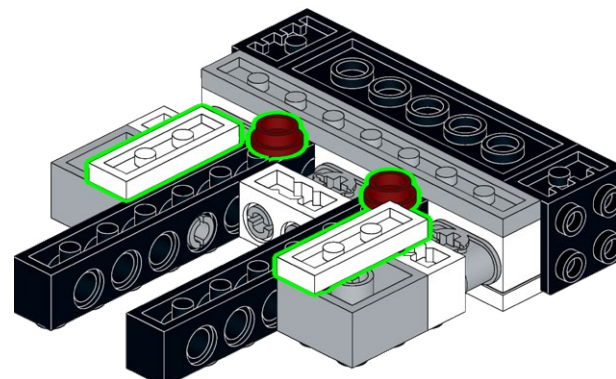

2

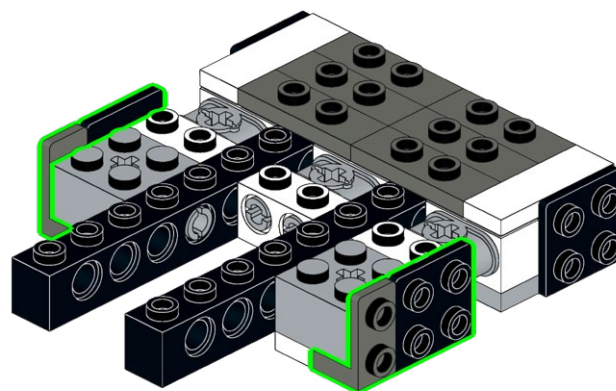

50

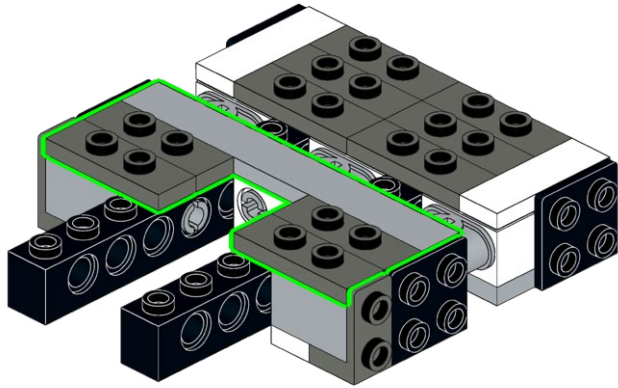
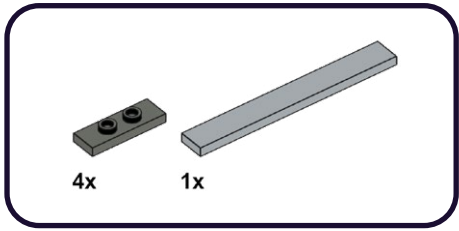

51

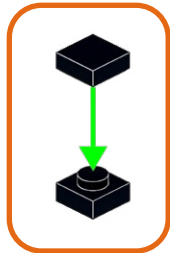
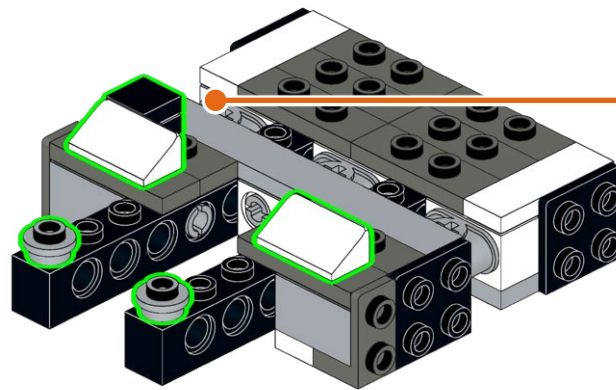

52

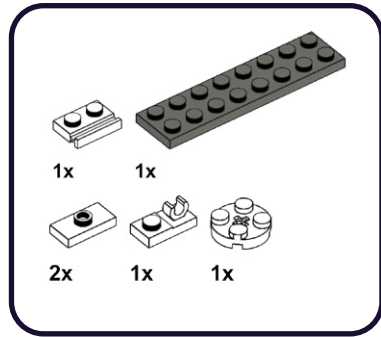

1

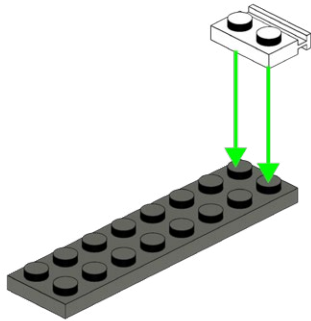

2

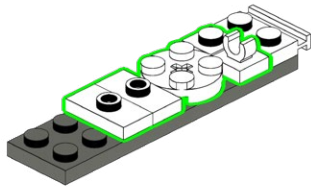

53

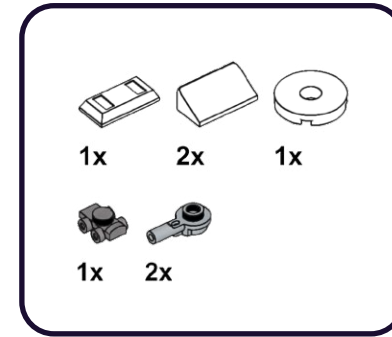

1

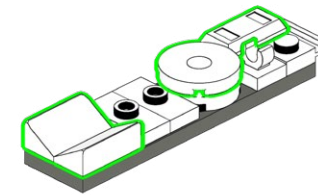

2

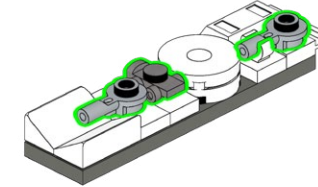

54

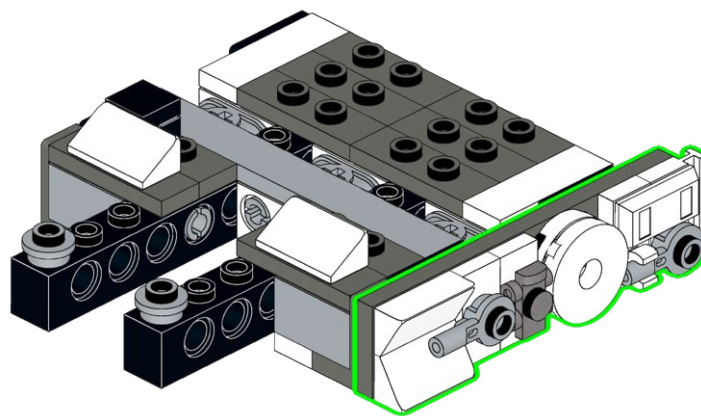

55

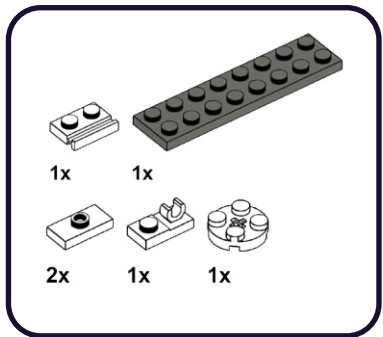

1

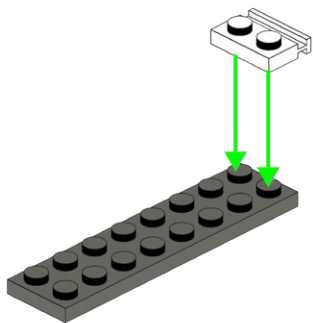

2

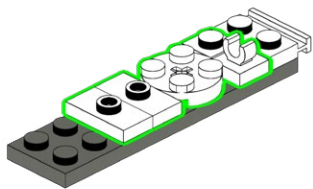

56

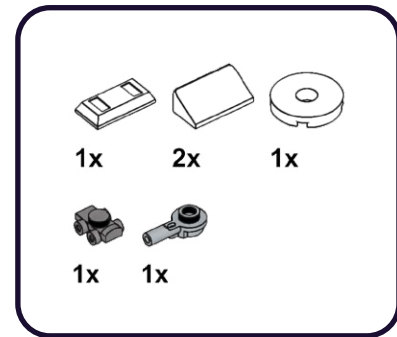

1

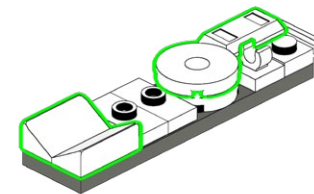

2

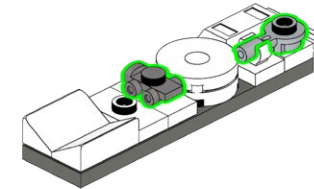

57

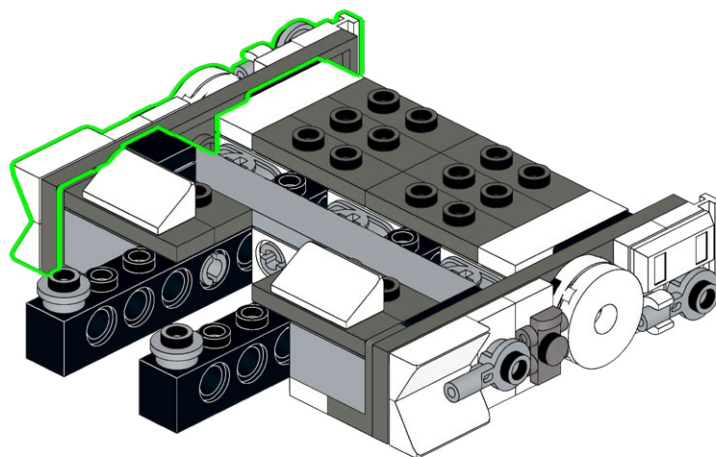

**HOLD UP!**

You might notice some bags aren't in order, as well as left over pieces, but that's ok! We're changing the way you build LEGO!

ATTENDEZ!

Vous remarquerez peut-être que certains sacs, ainsi que certaines pièces, ne sont pas dans le bon ordre. Mais pas de panique! Nous changeons simplement la façon avec laquelle vous construisez vos LEGO!

ASPETTA!

Potresti notare che alcuni sacchetti non sono in ordine, così come i pezzi avanzati, ma va bene così! Stiamo cambiando il modo in cui costruisci i LEGO!

HALT!

Sie werden möglicherweise bemerken, dass einige tüten durcheinander sind und teile übrig bleiben, aber das ist in Ordnung! Wir ändern die art und weise, wie Sie LEGO bauen!

¡ESPERA!

Es posible que notes que algunas bolsas están fuera de servicio, así como piezas sobrantes, ¡pero está bien! ¡Estamos cambiando la forma en que construyes LEGO!

暫停!

你可能会注意到一些袋子顺序错乱, 以及一些剩余的部件, 但没关系! 我们正在改变你搭建乐高的方式!

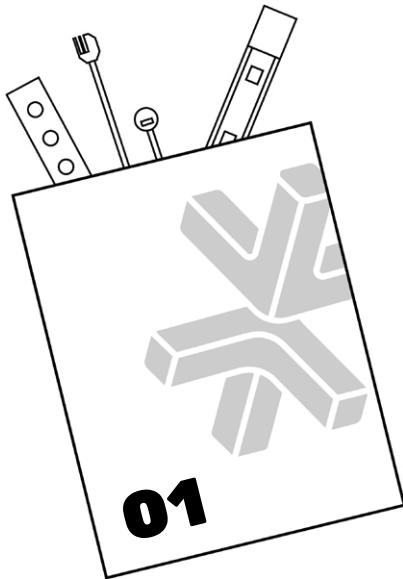
Open LMB Bag 01

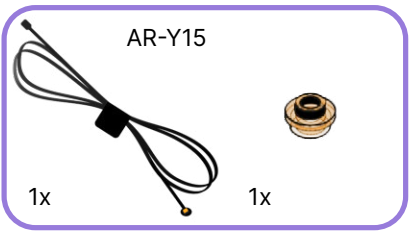

1



2

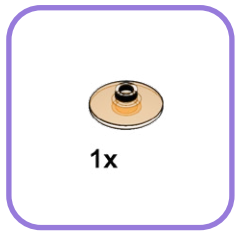
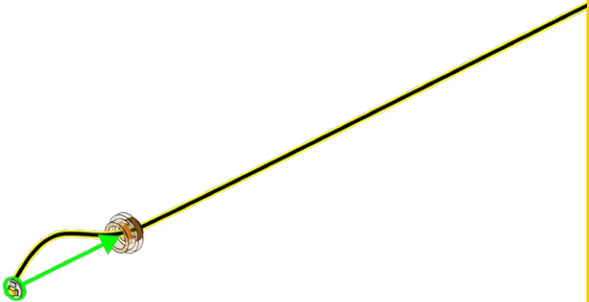

1



2

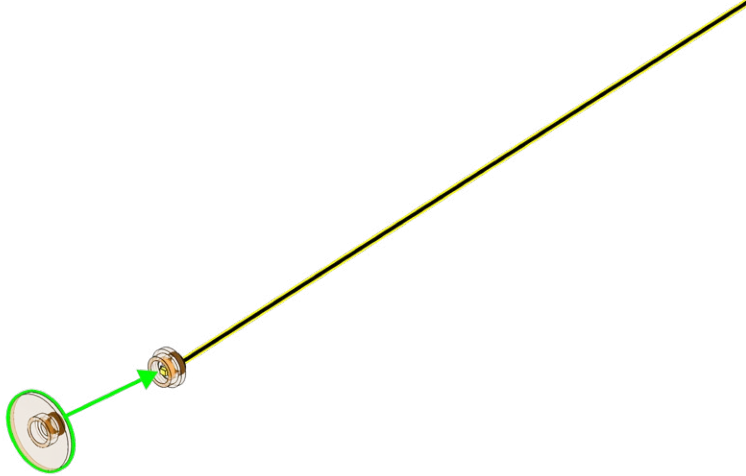

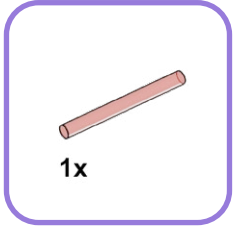

1

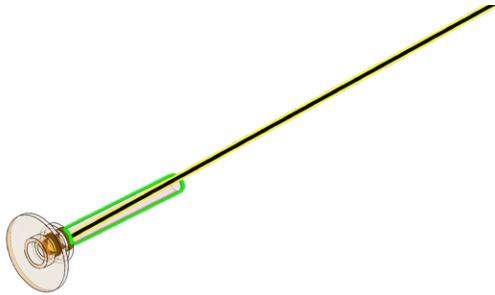

1

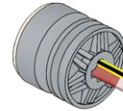

2

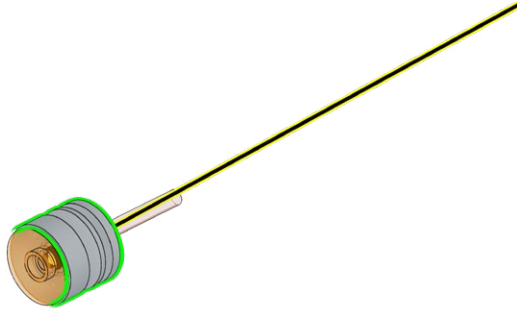

62

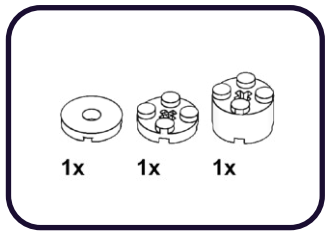

1

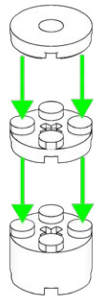

63

1

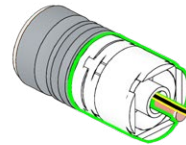

2x

64

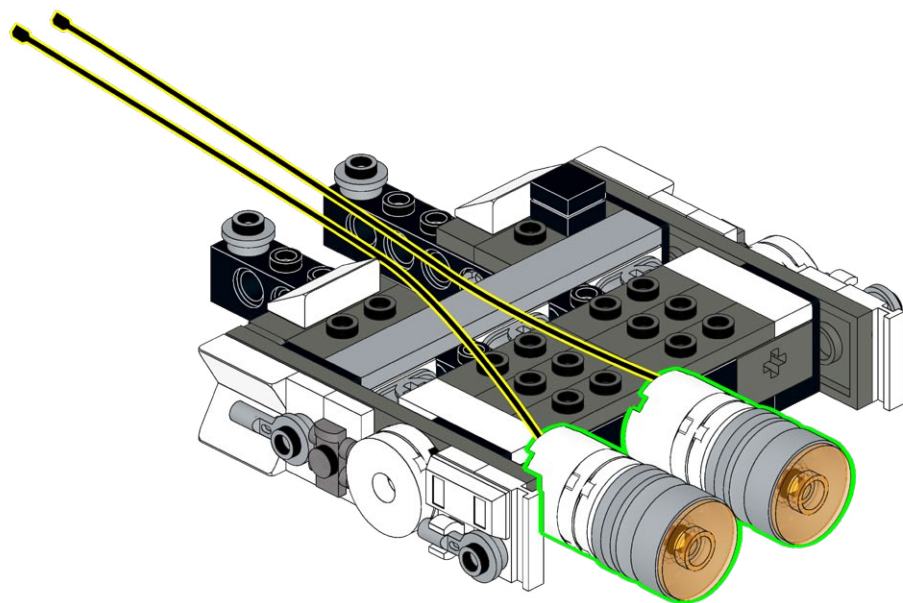

65

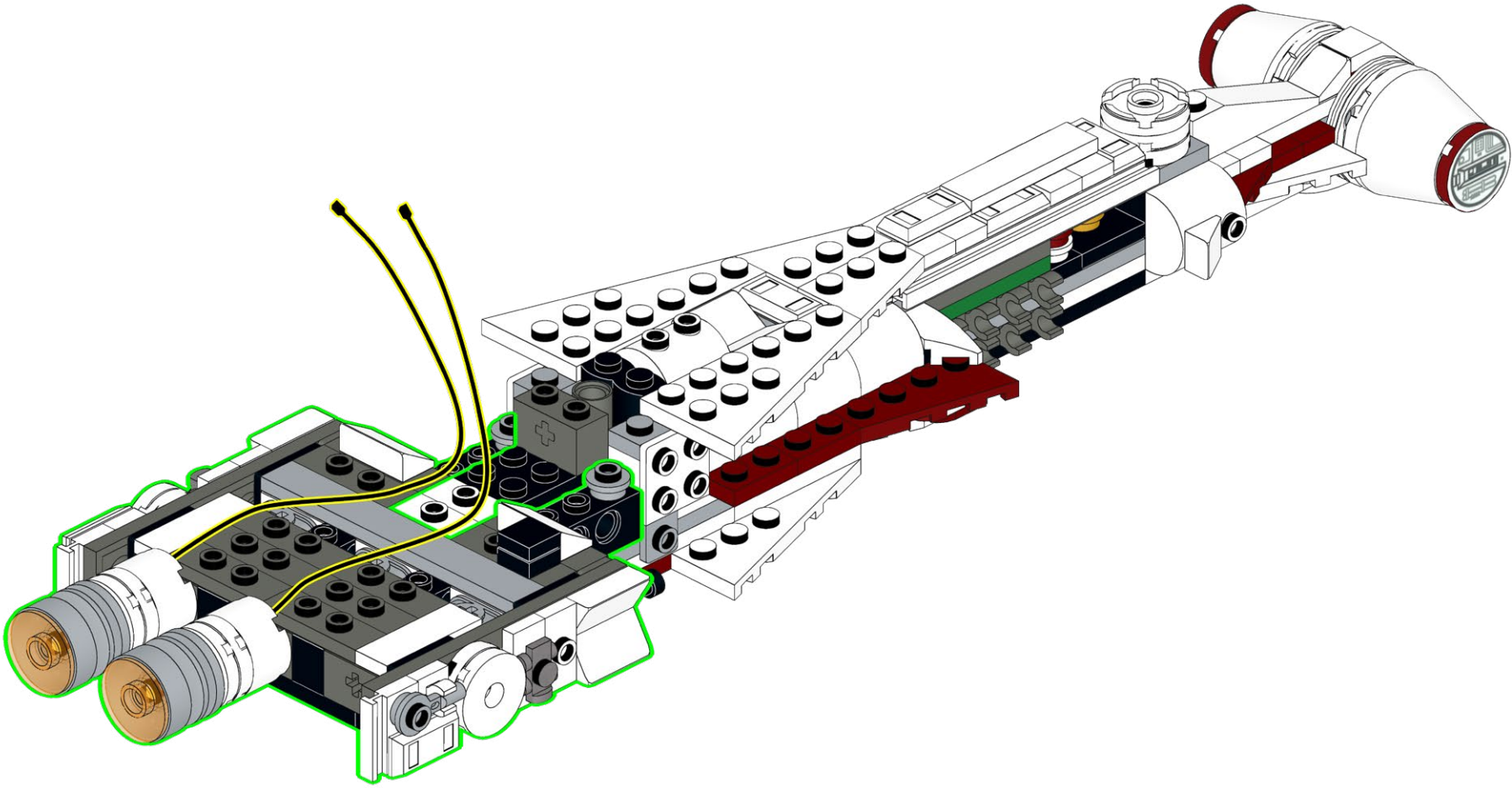

66

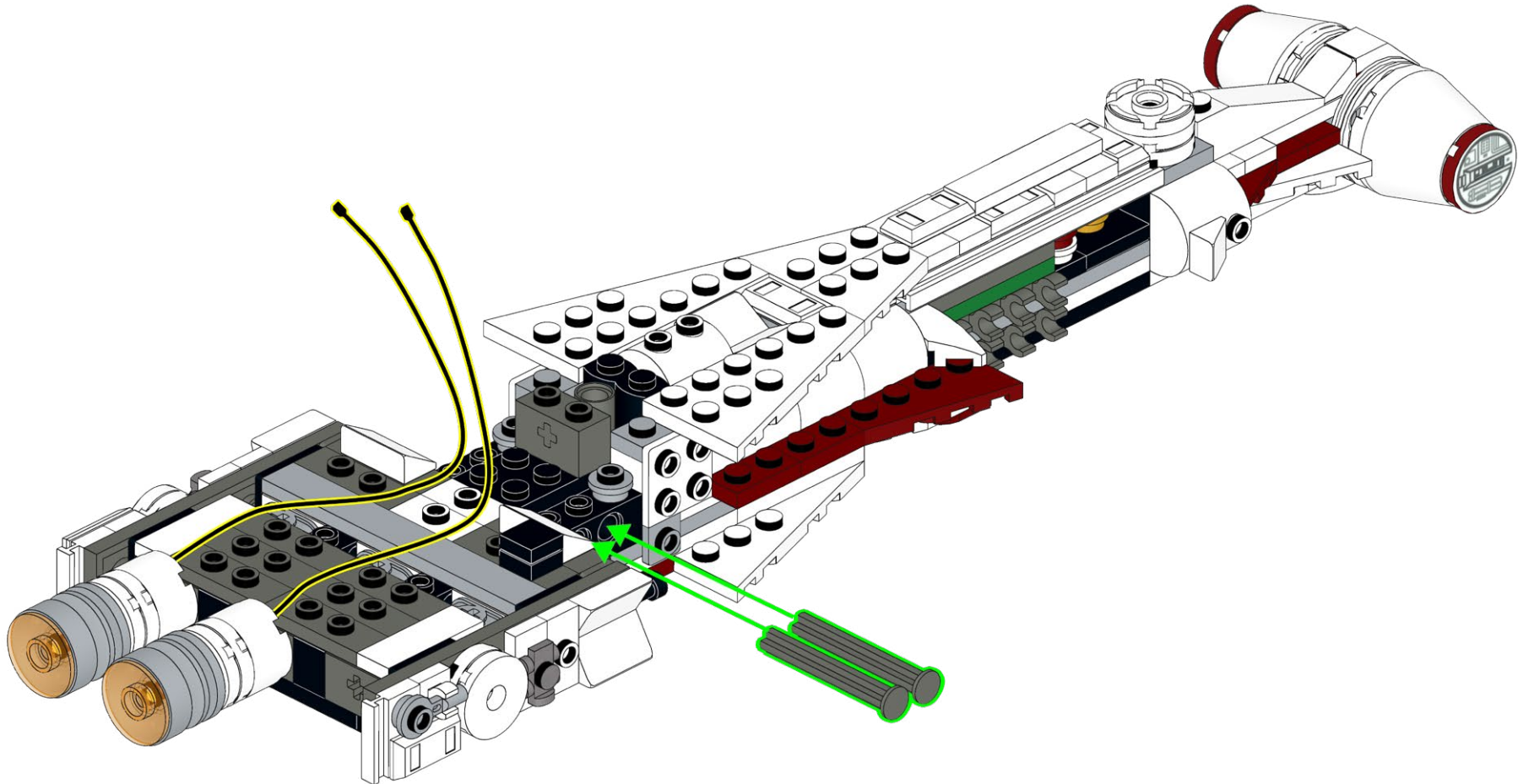
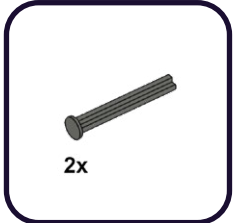

67



2x



4x



2x

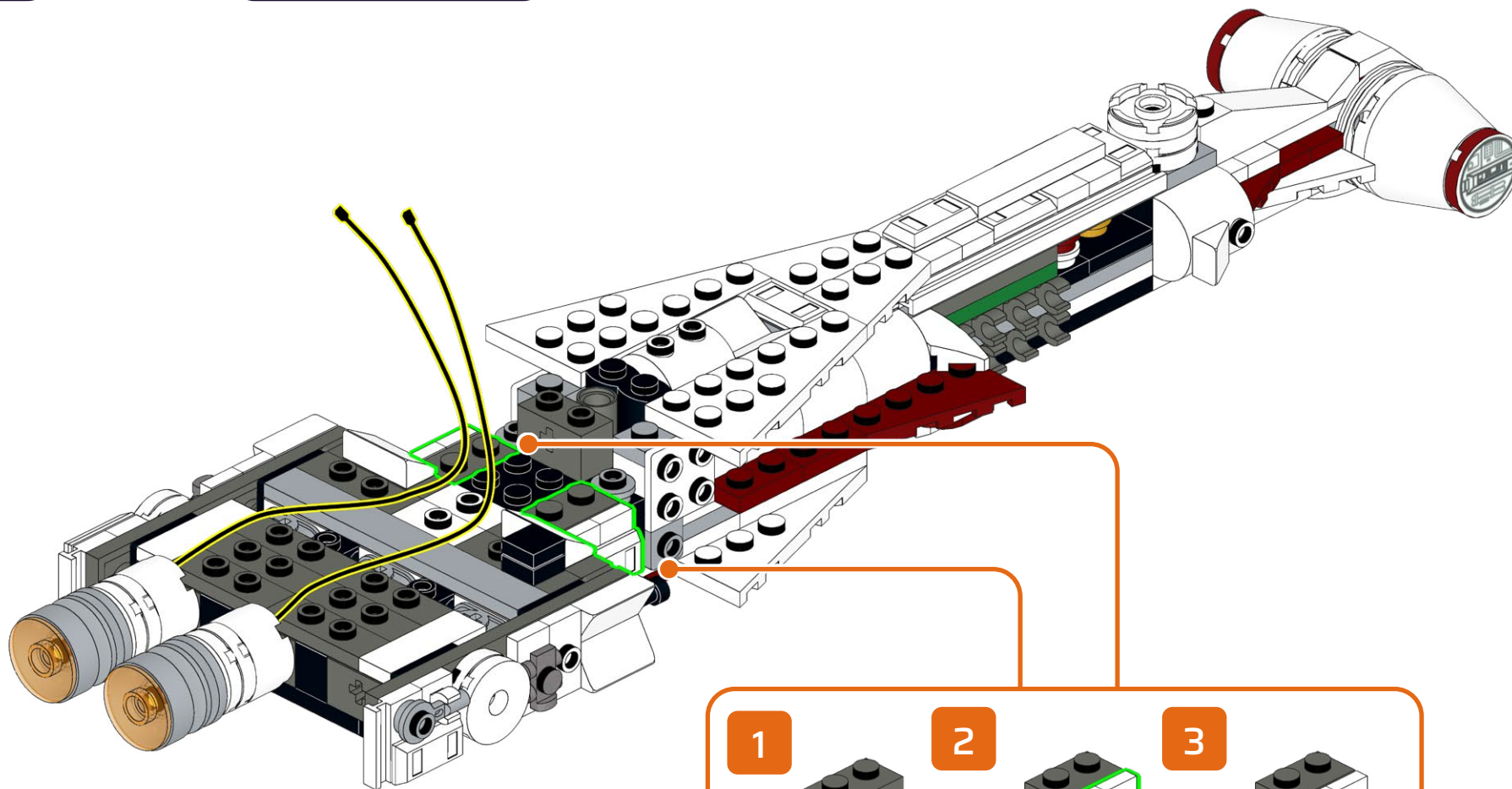

1

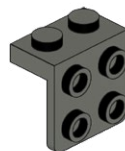

2

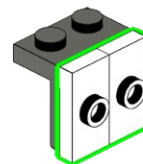

3

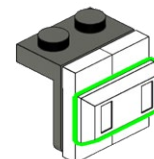

68



2x

2x

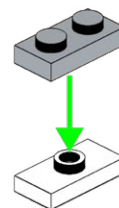
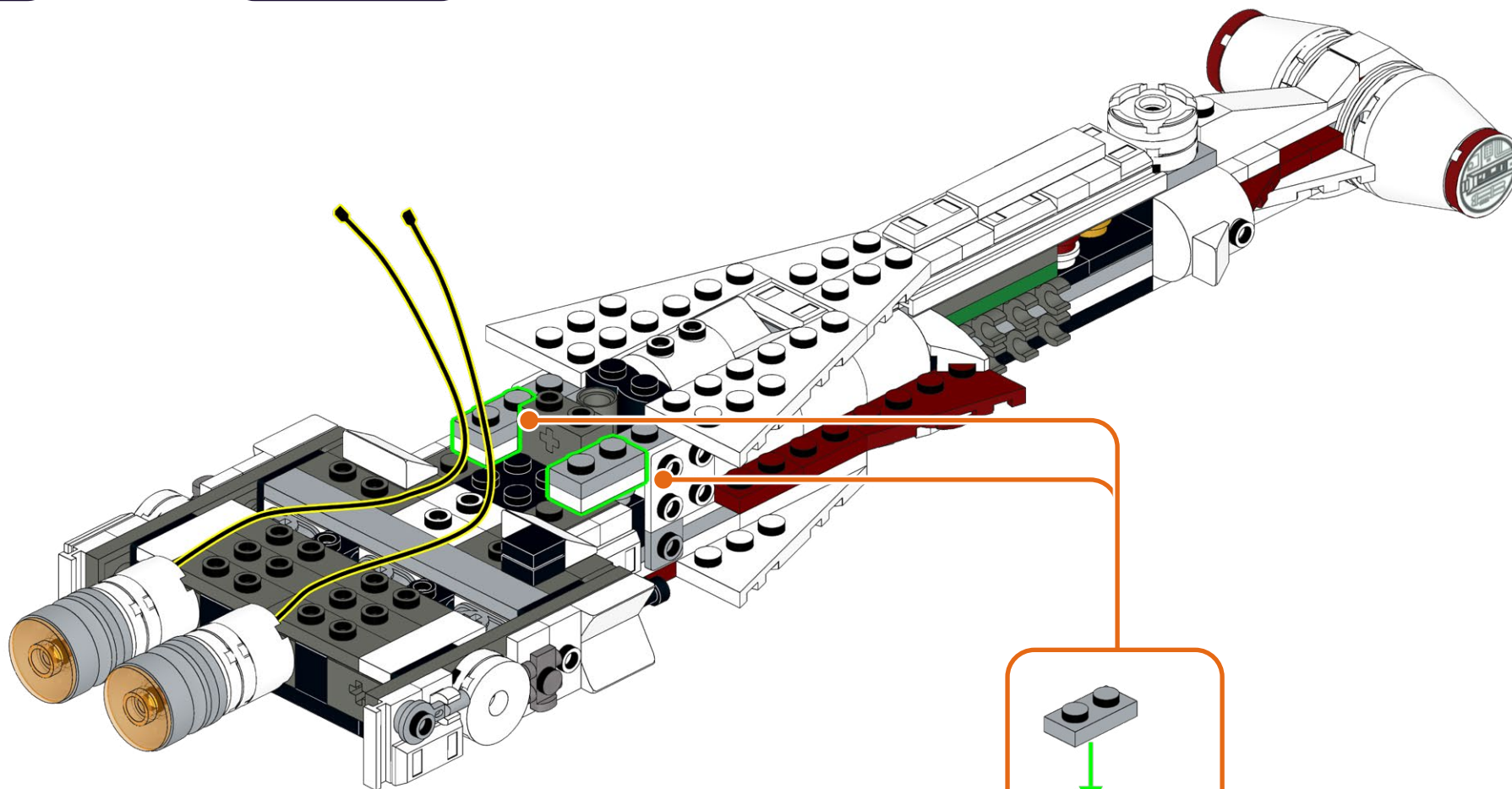

2x

1x **69**

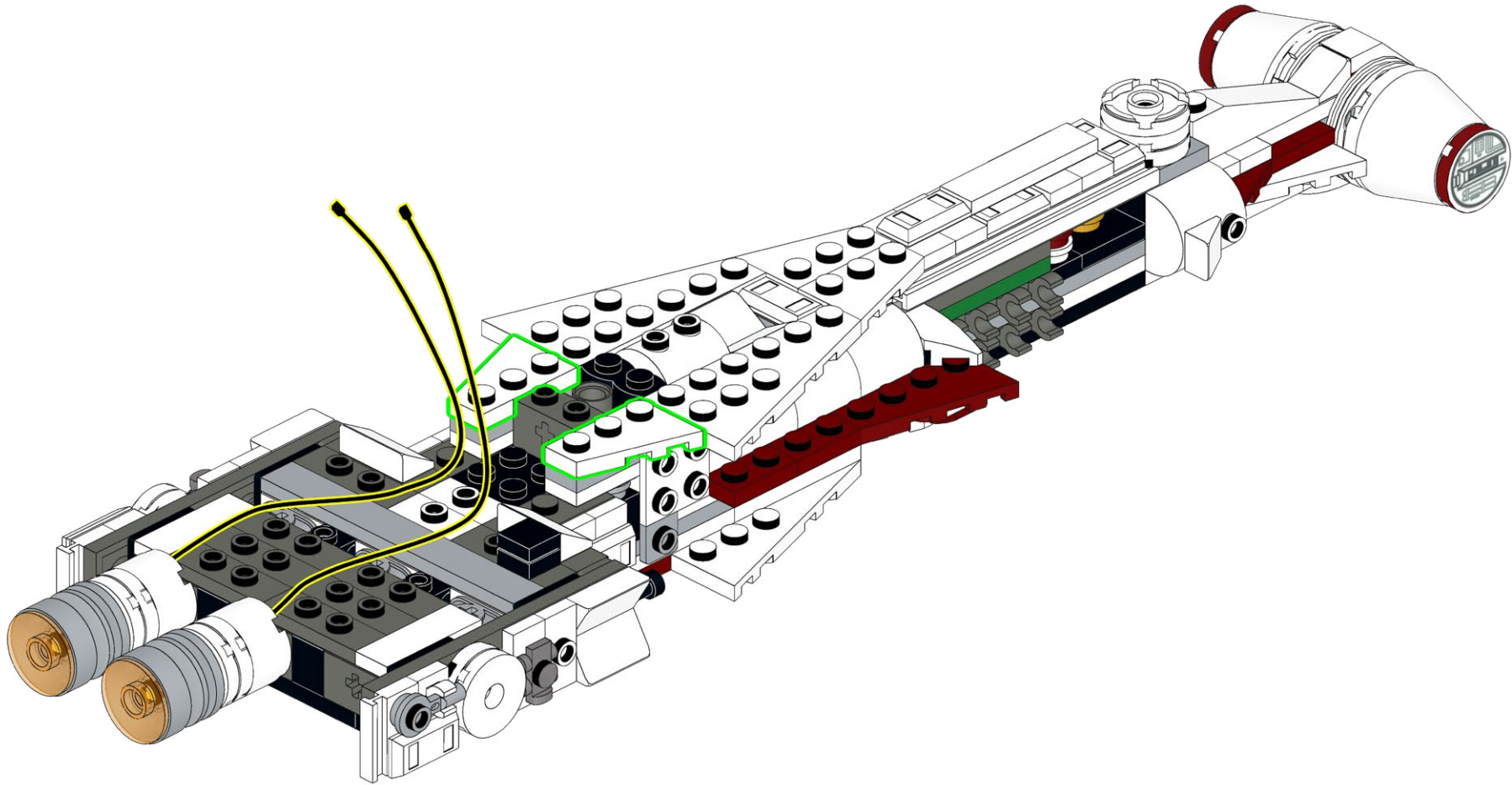
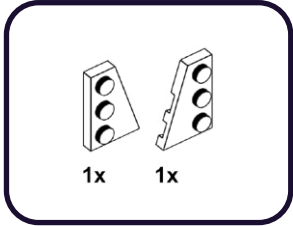

70

2x

1x

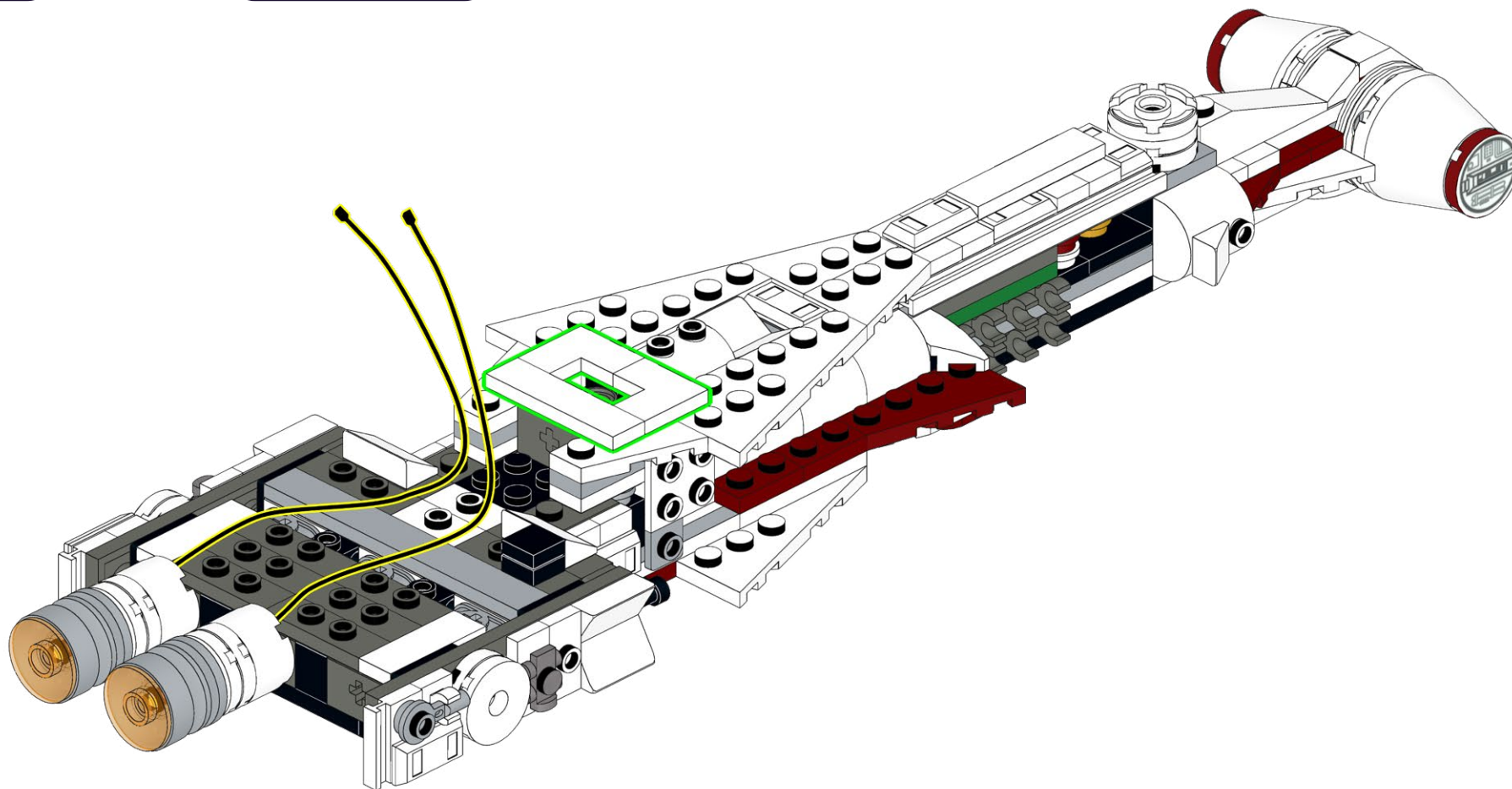

**HOLD UP!**

You might notice some bags aren't in order, as well as left over pieces, but that's ok! We're changing the way you build LEGO!

ATTENDEZ!

Vous remarquerez peut-être que certains sacs, ainsi que certaines pièces, ne sont pas dans le bon ordre. Mais pas de panique! Nous changeons simplement la façon avec laquelle vous construisez vos LEGO!

ASPETTA!

Potresti notare che alcuni sacchetti non sono in ordine, così come i pezzi avanzati, ma va bene così! Stiamo cambiando il modo in cui costruisci i LEGO!

HALT!

Sie werden möglicherweise bemerken, dass einige tüten durcheinander sind und teile übrig bleiben, aber das ist in Ordnung! Wir ändern die art und weise, wie Sie LEGO bauen!

¡ESPERA!

Es posible que notes que algunas bolsas están fuera de servicio, así como piezas sobrantes, ¡pero está bien! ¡Estamos cambiando la forma en que construyes LEGO!

暫停!

你可能会注意到一些袋子顺序错乱, 以及一些剩余的部件, 但没关系! 我们正在改变你搭建乐高的方式!

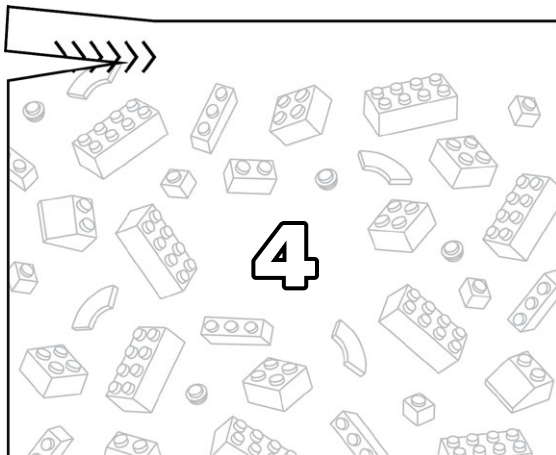
Open LEGO® Bag 4

71

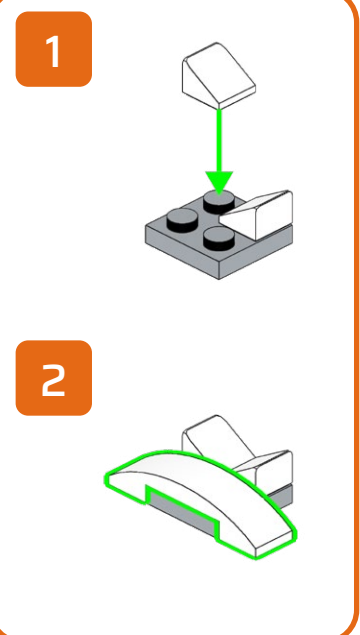
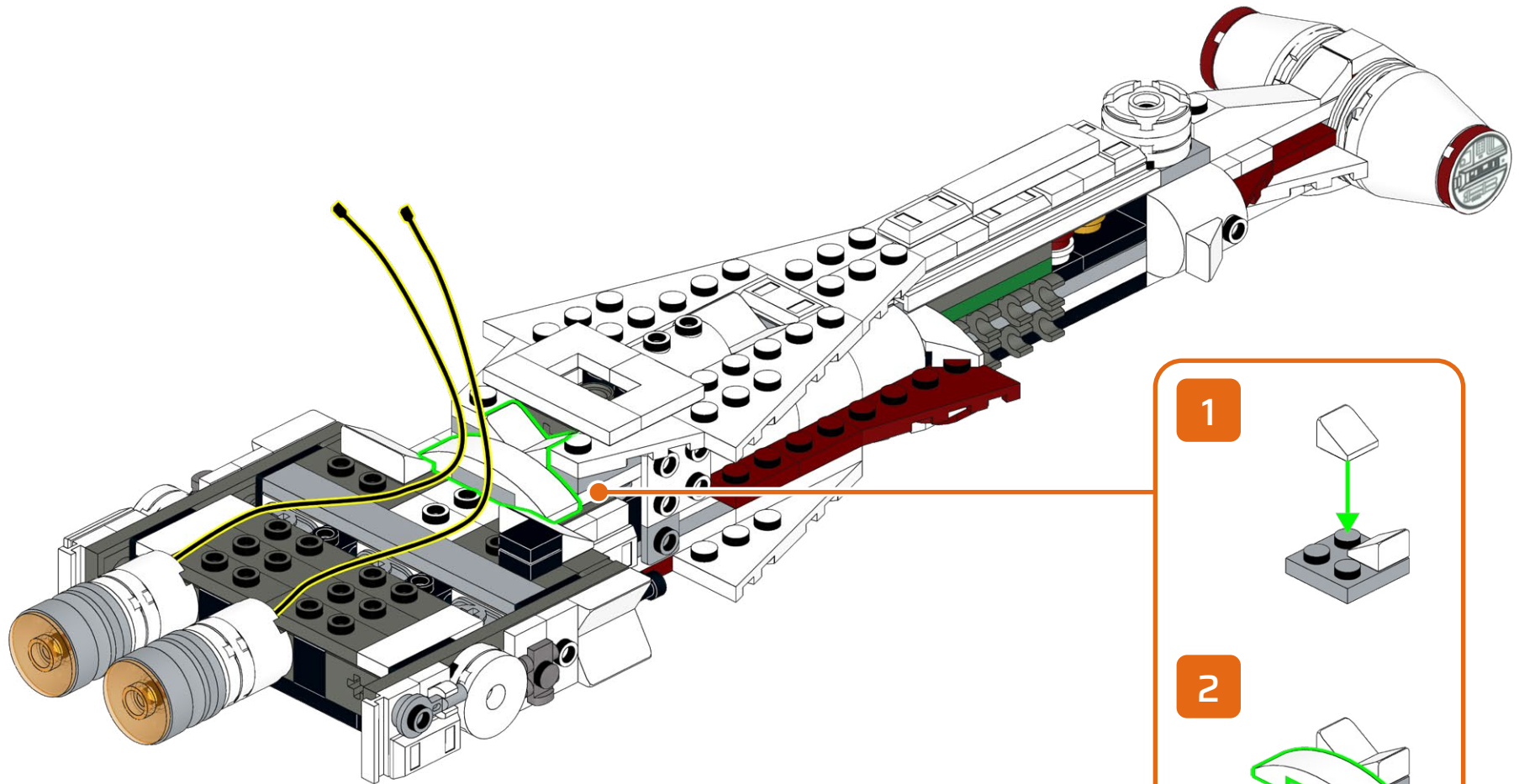
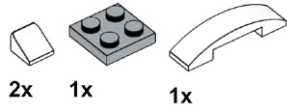

72

1x

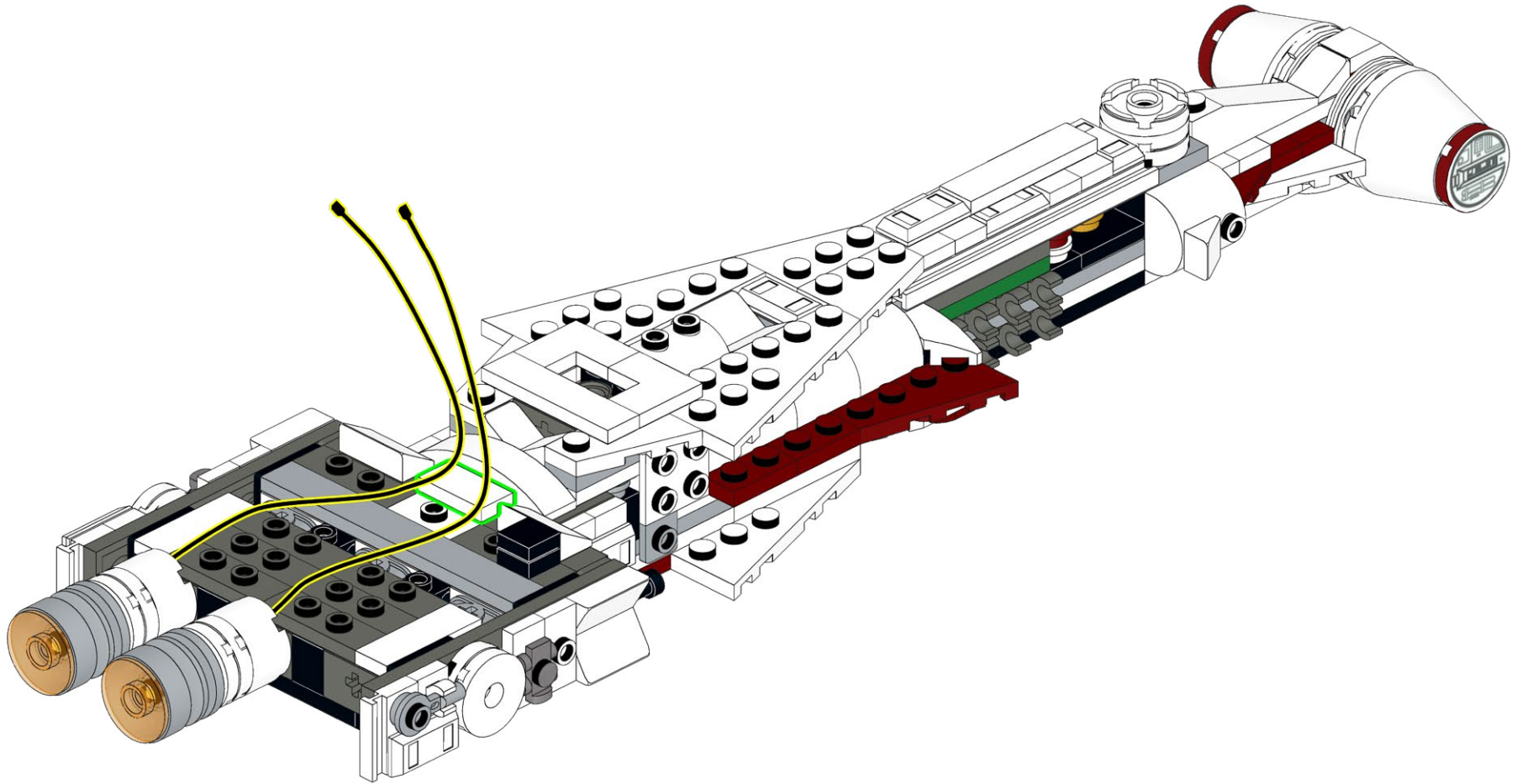

73

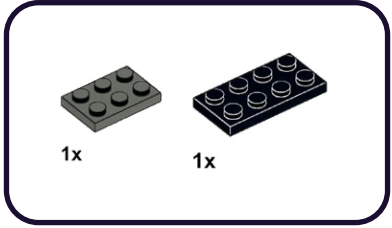

1



2

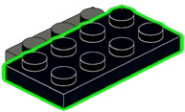

74

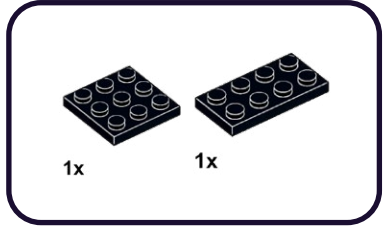

1

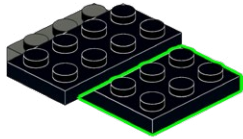

2

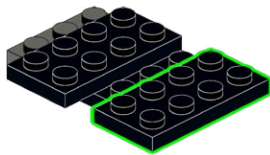

75

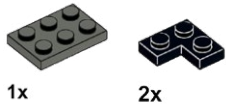

1

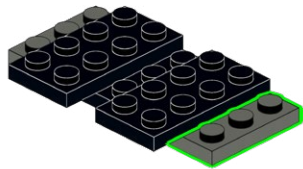

2

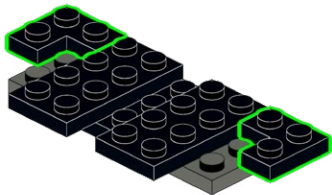

76

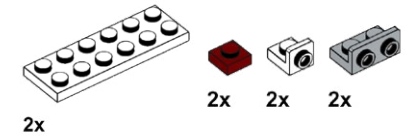

1

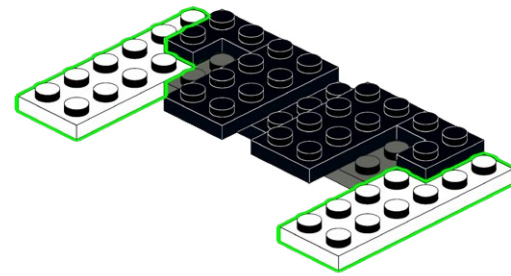

2

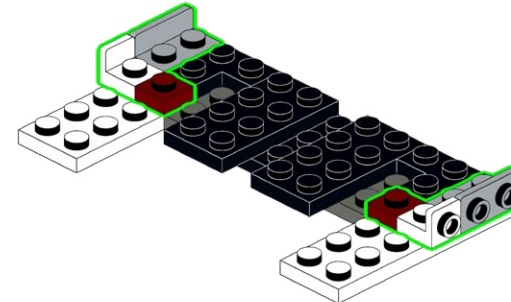

77



6x



4x

1

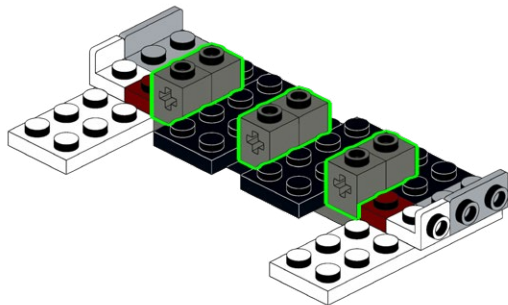

2

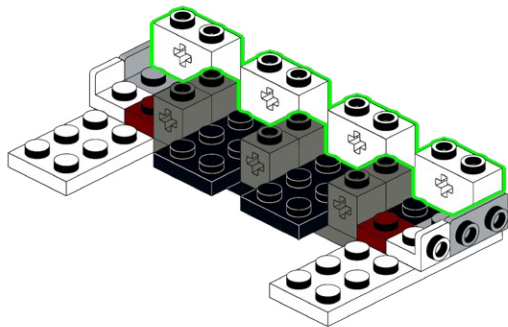

78



4x



1x



4x

1

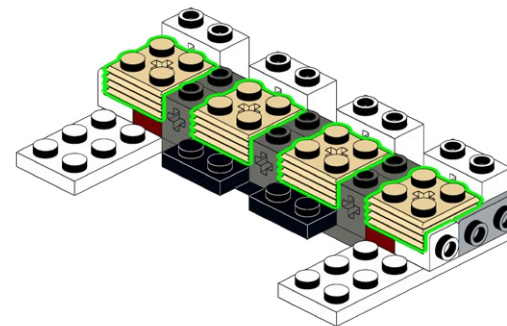

2

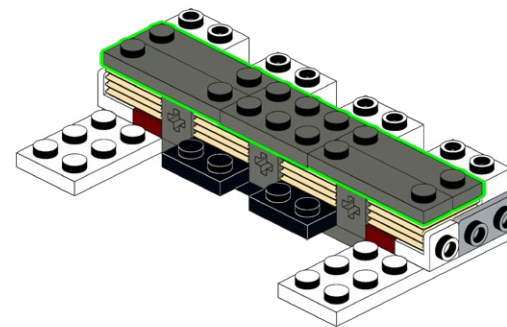

79

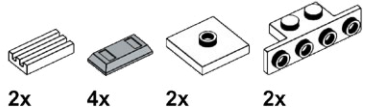

1

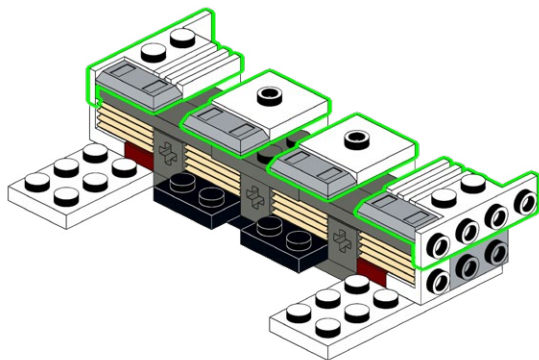

80

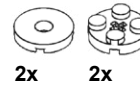

1

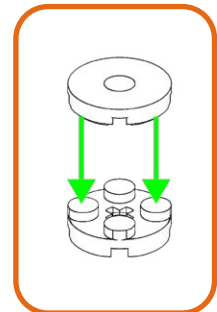
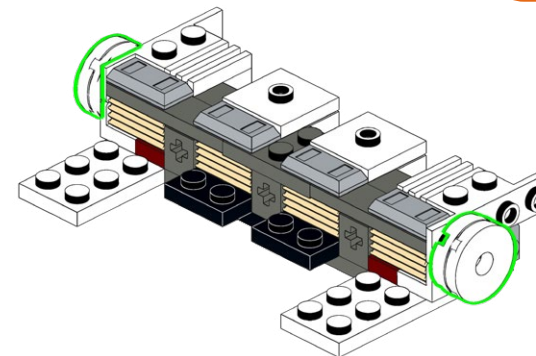

81

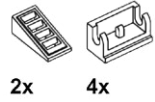

2x

4x

1

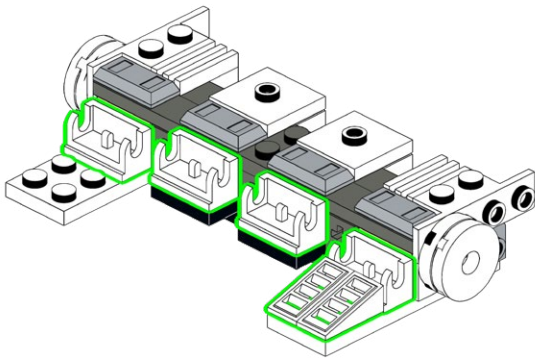

82

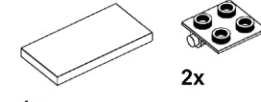

1x

2x

1

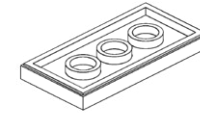

2

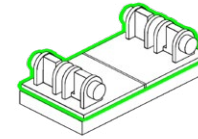

3

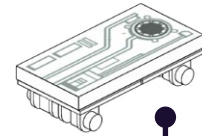

1

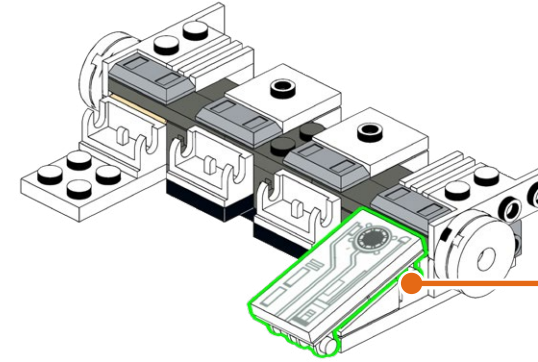

4

83

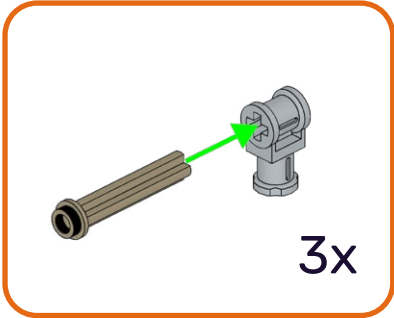
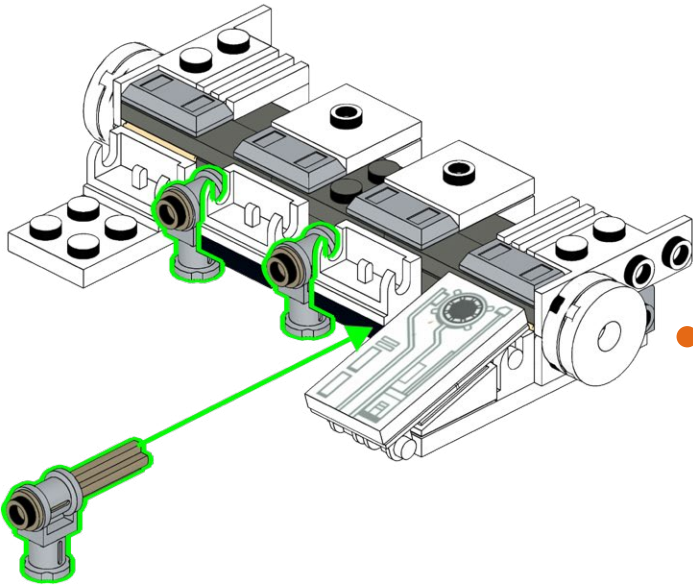
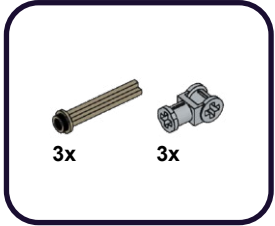

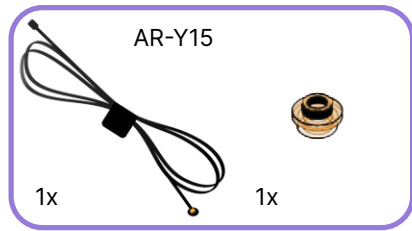

1



2

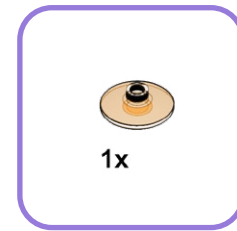
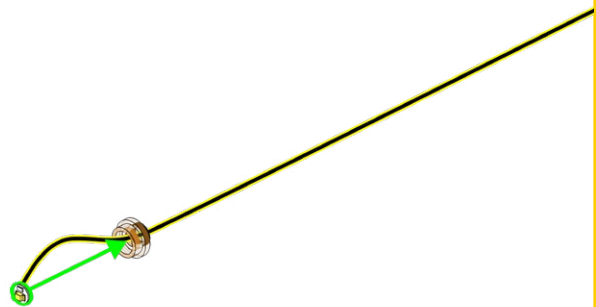

1



2

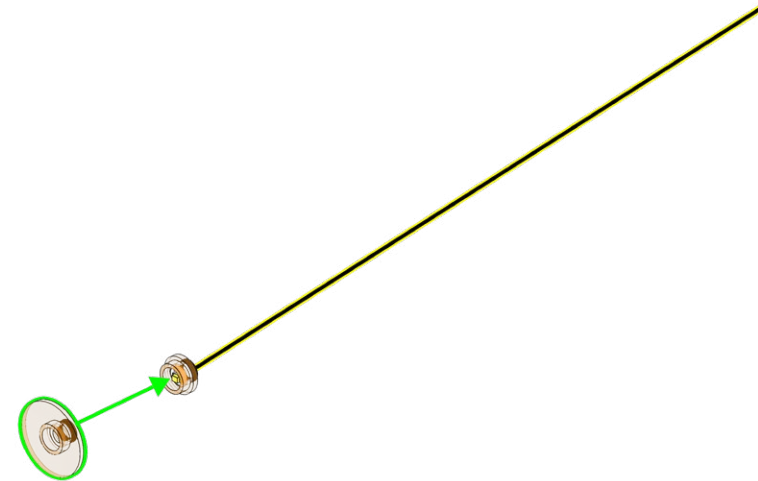



86

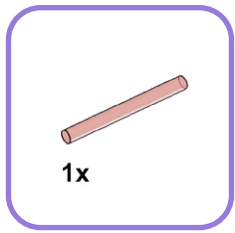

1x

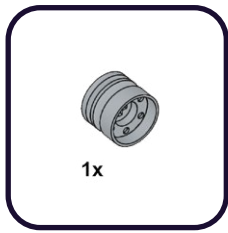

1x



87

1

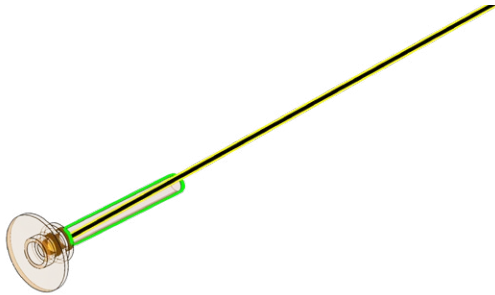

1

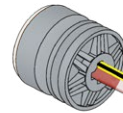

2

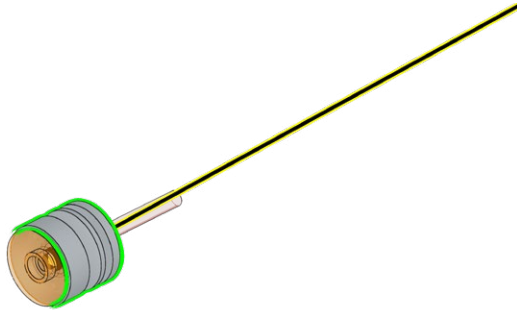

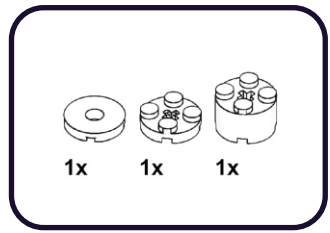

1

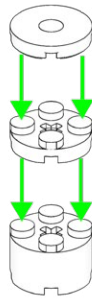

1

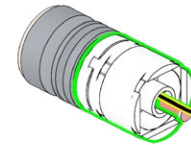

2x

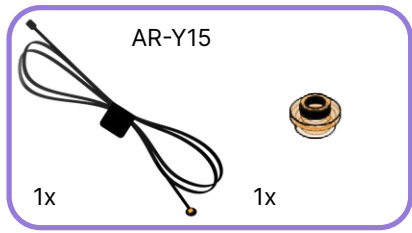

1



2

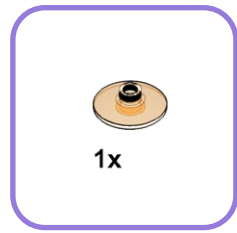
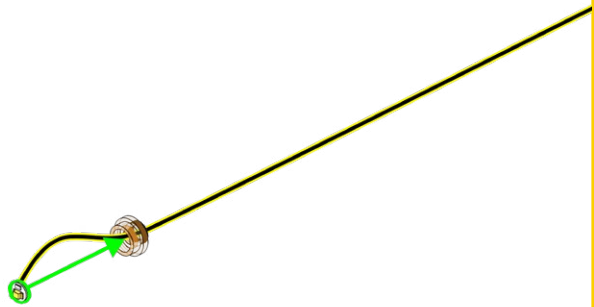

1



2

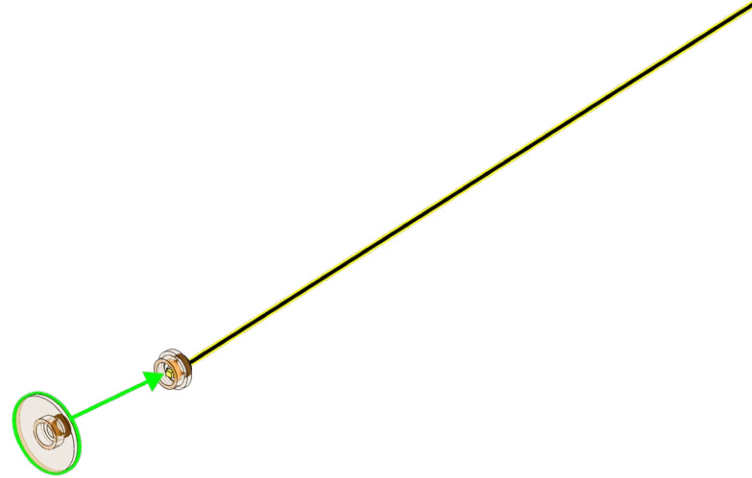

92

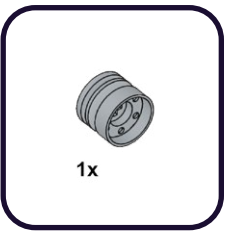
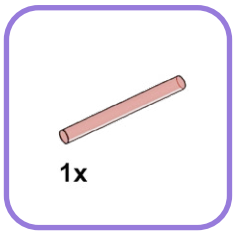

93

1

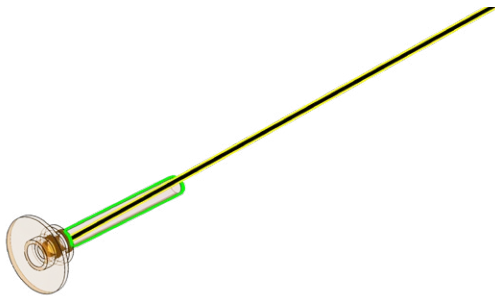

2

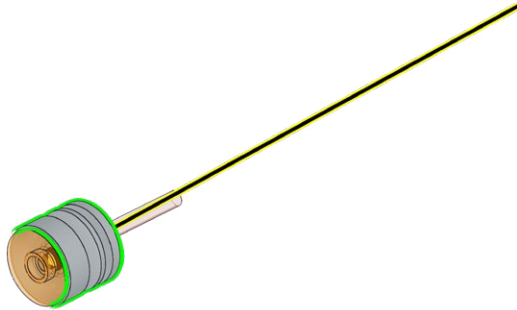

1

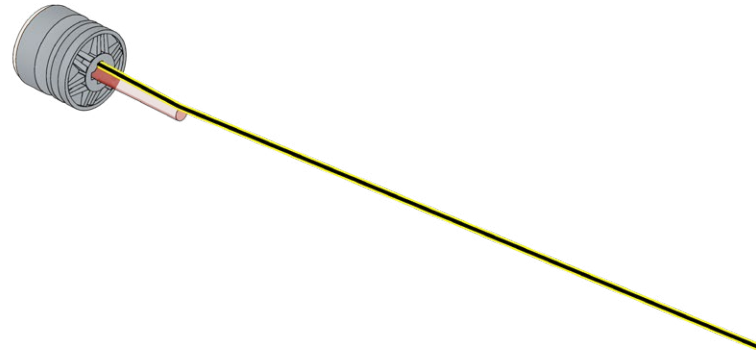

94

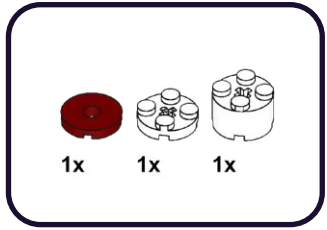

1

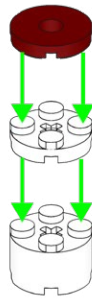

95

1

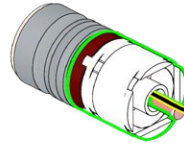

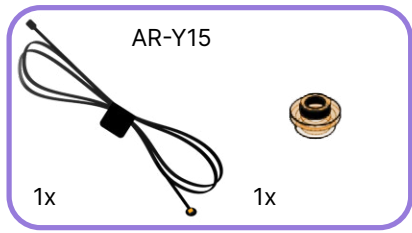

1



2

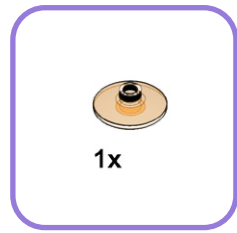
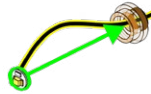

1



2

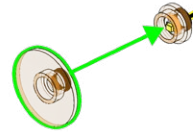

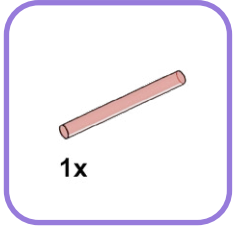

1

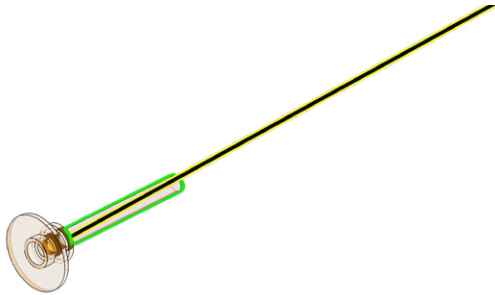

1

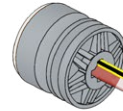

2

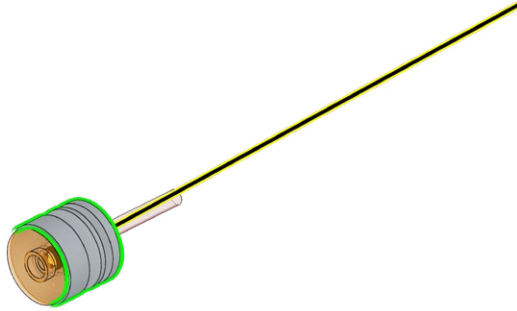

100

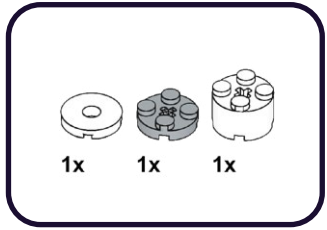

1

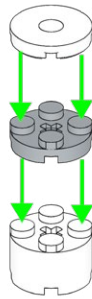

101

1

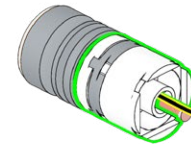

102

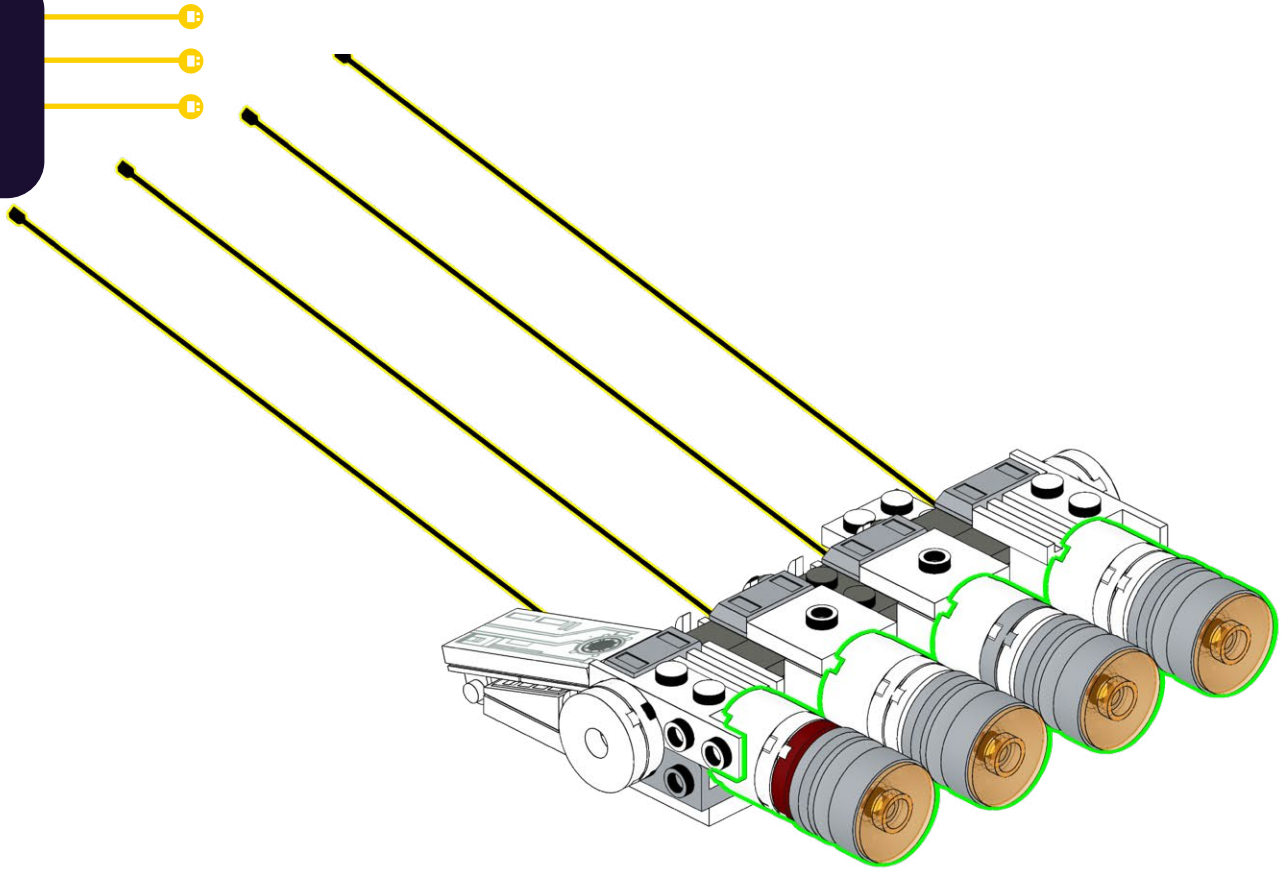

103

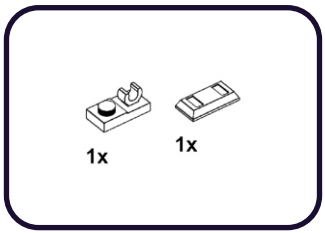

1



2

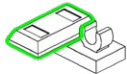

104

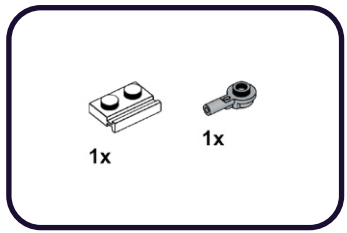

1

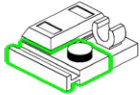

2

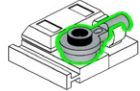

105

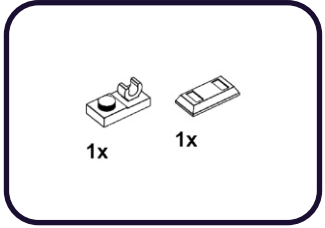

1



2



106

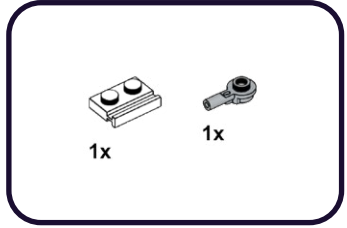

1

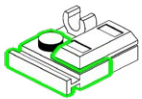

2

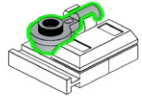

107

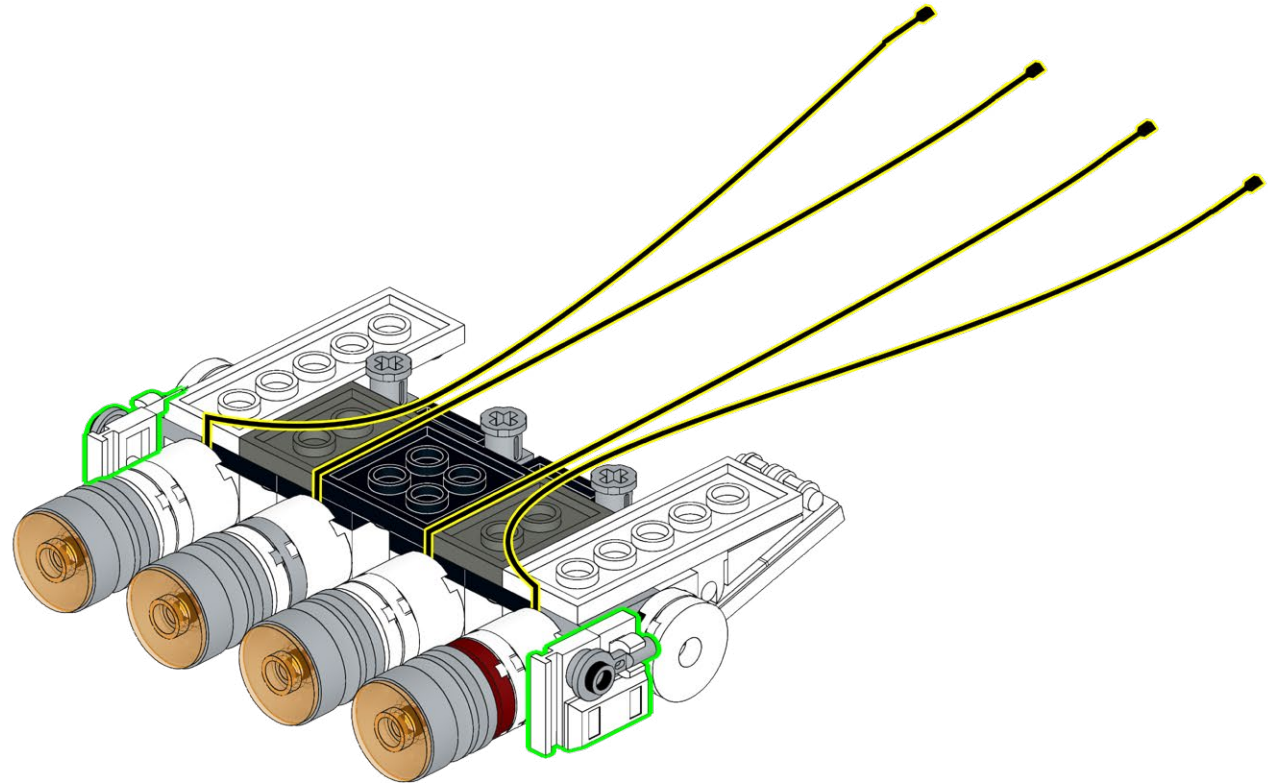

108

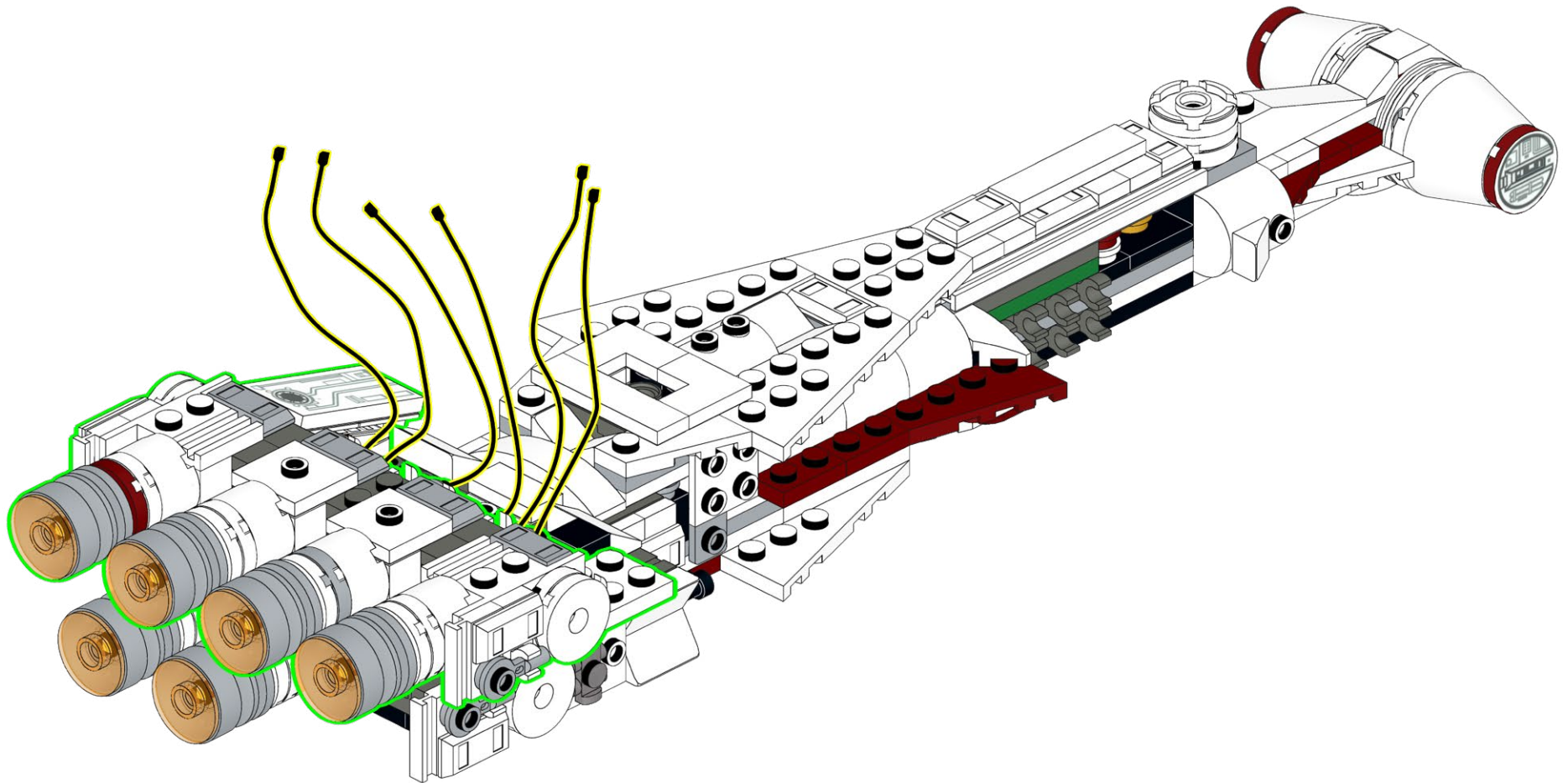

109

D-6

1x

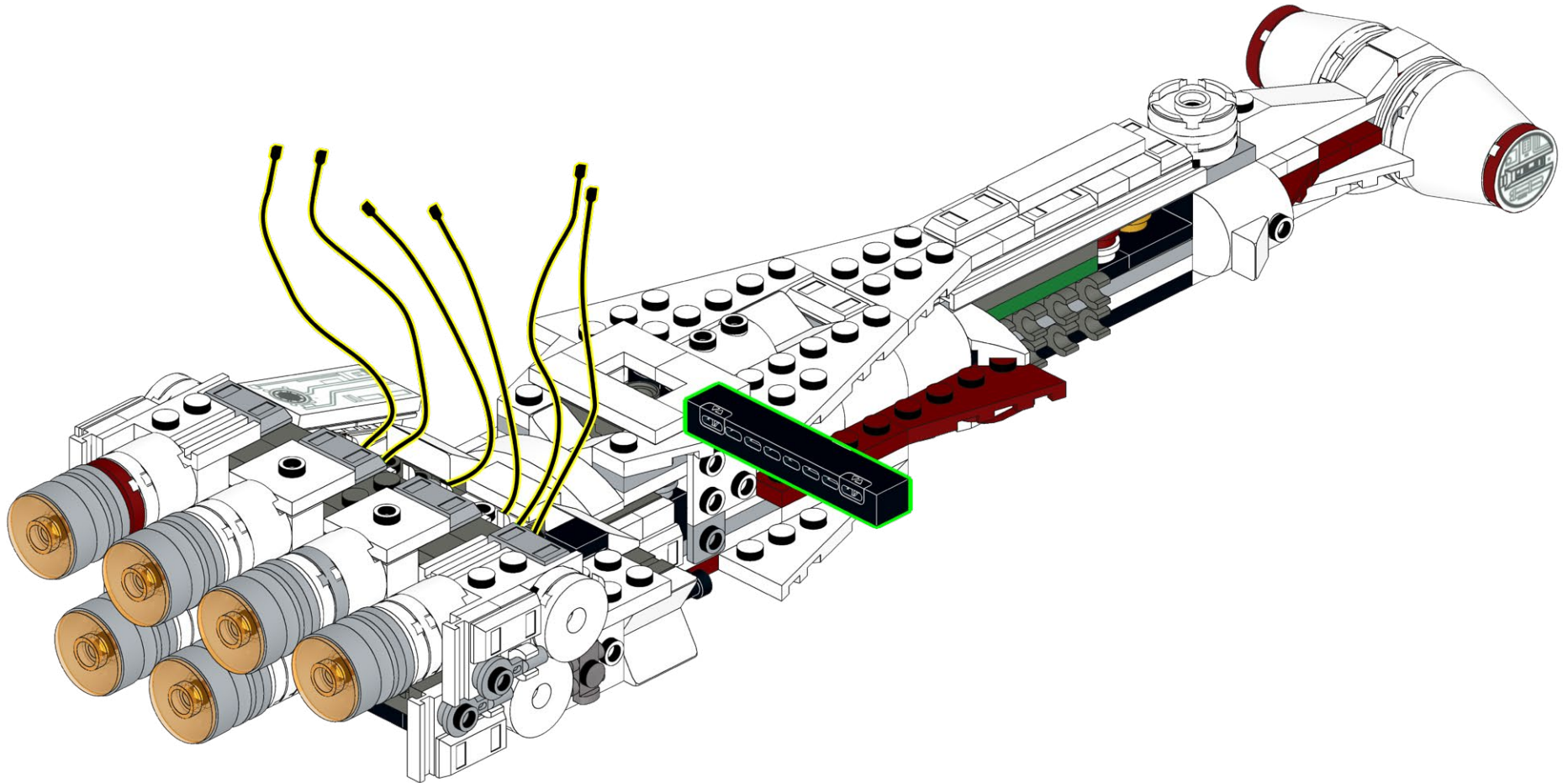

110

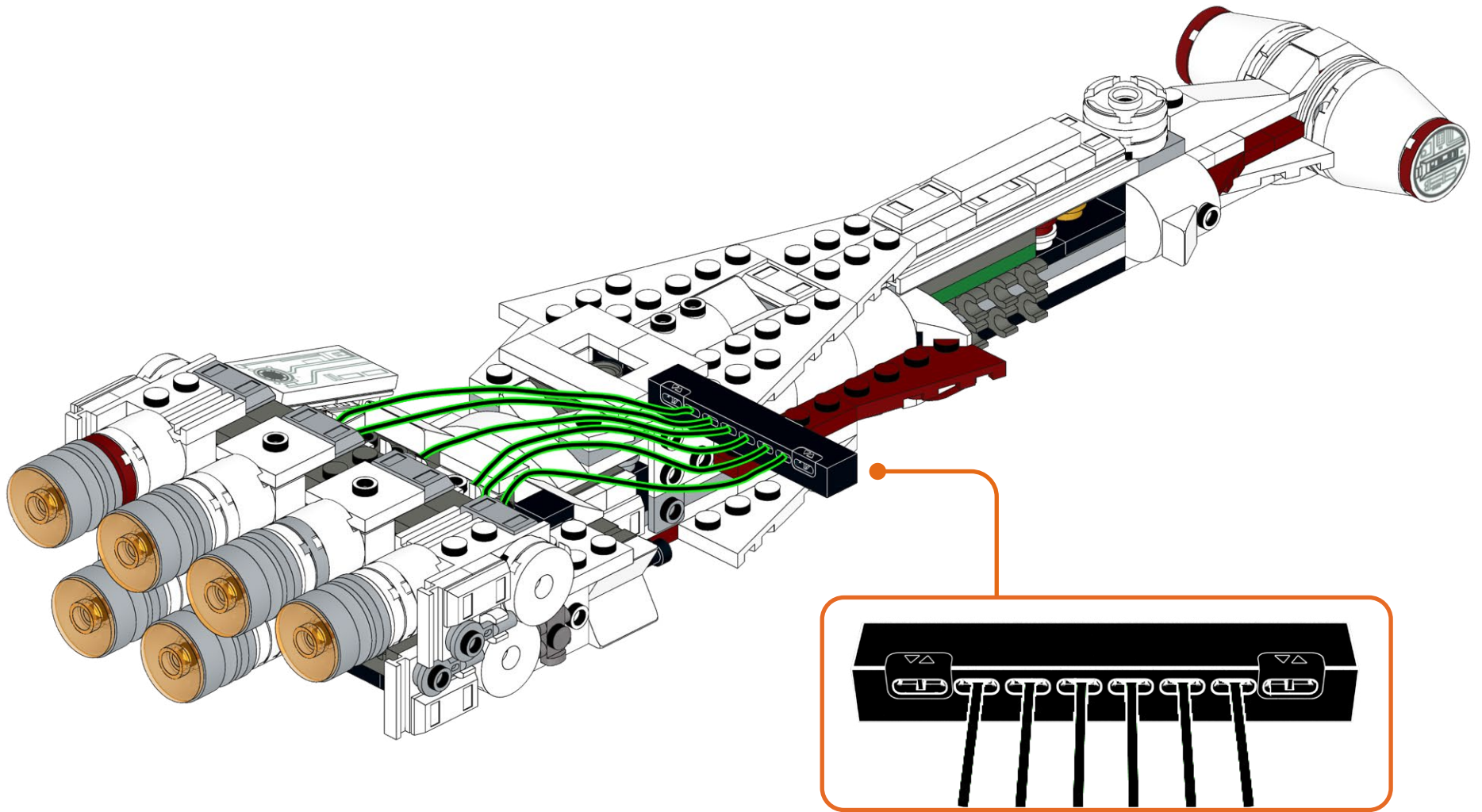

111

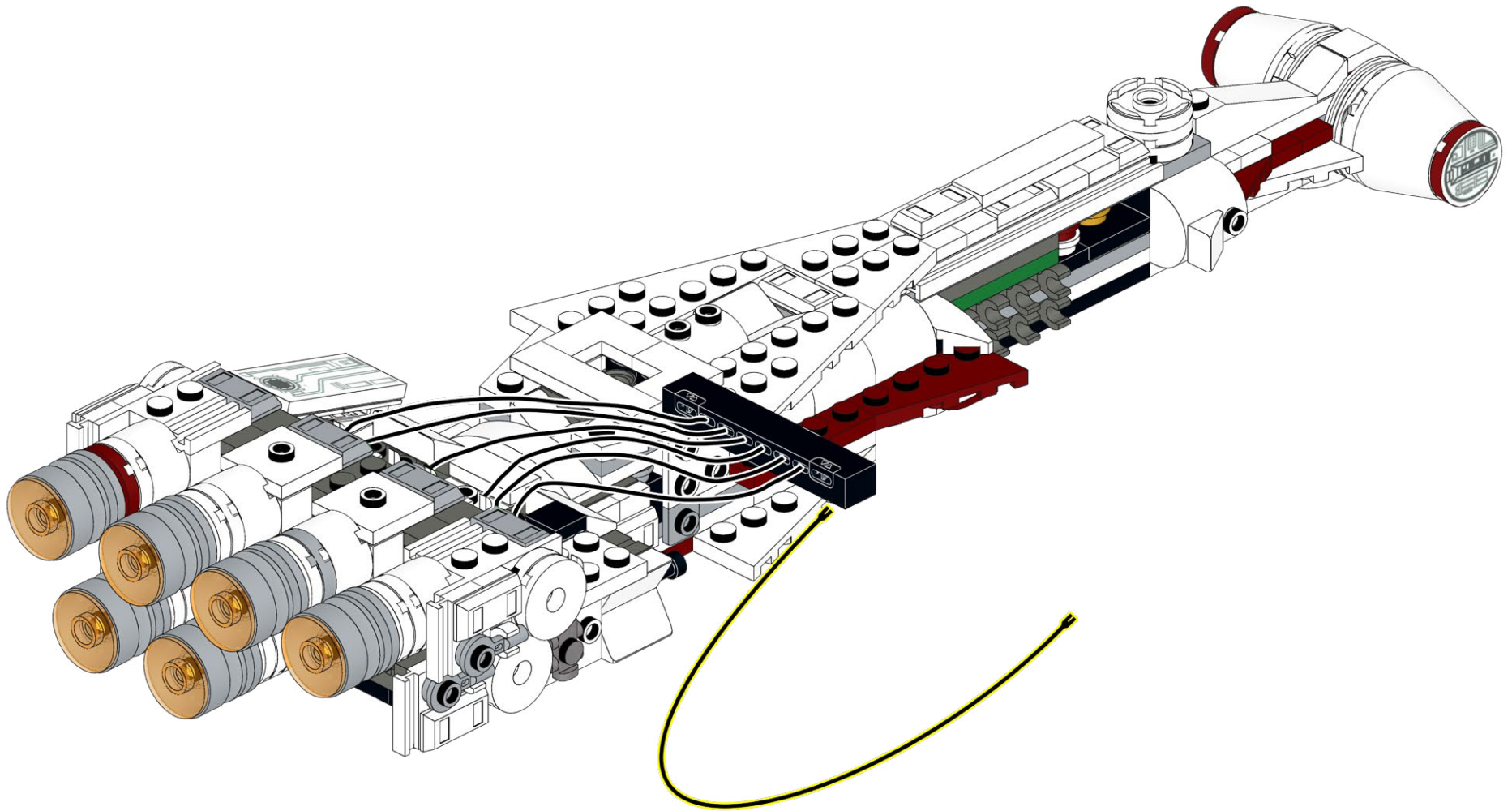
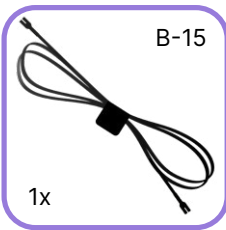

112

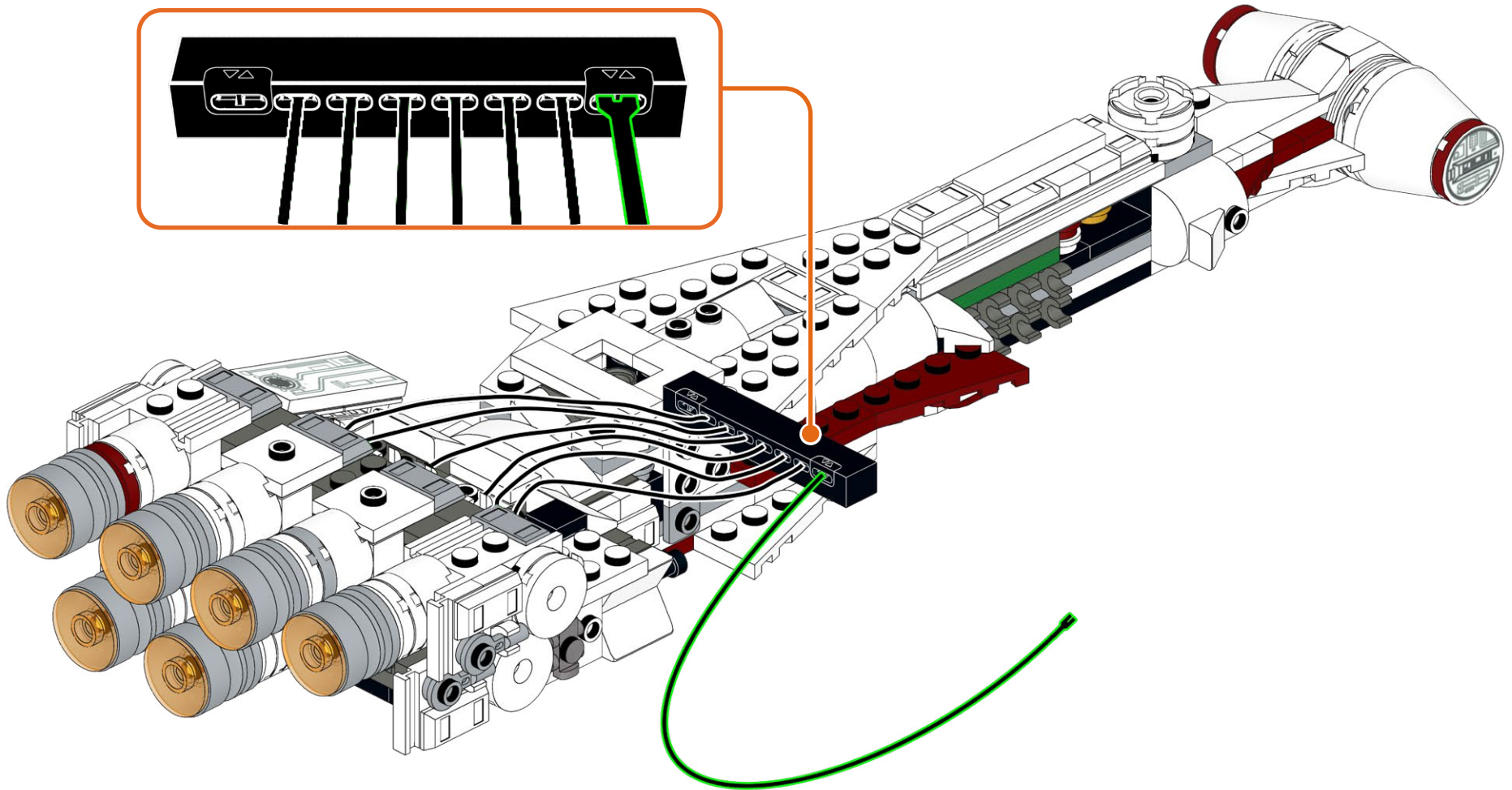
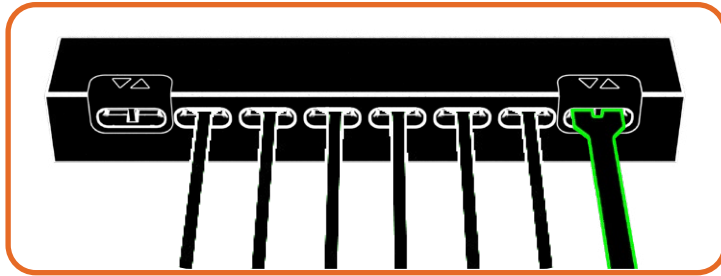

113

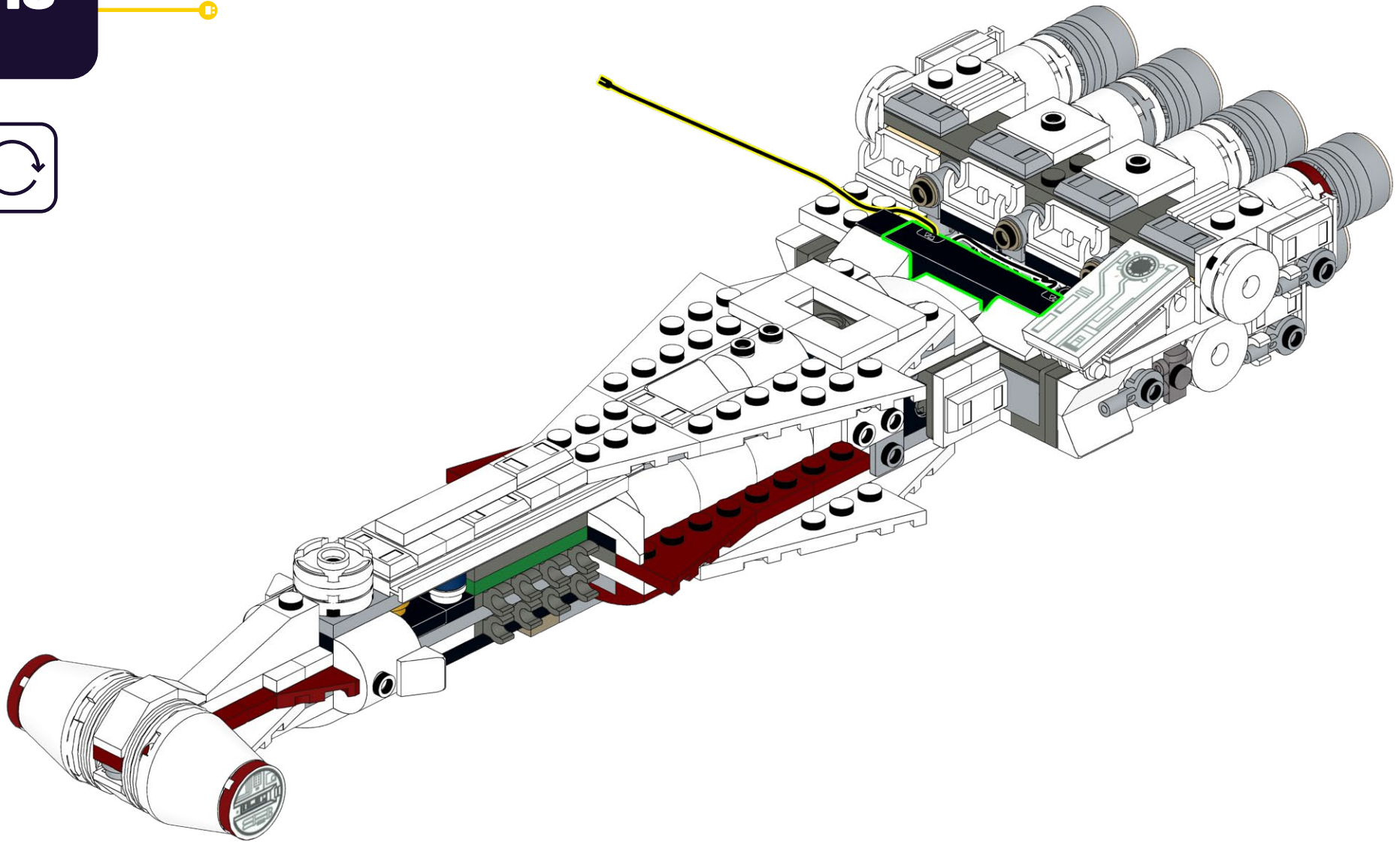

114



2x

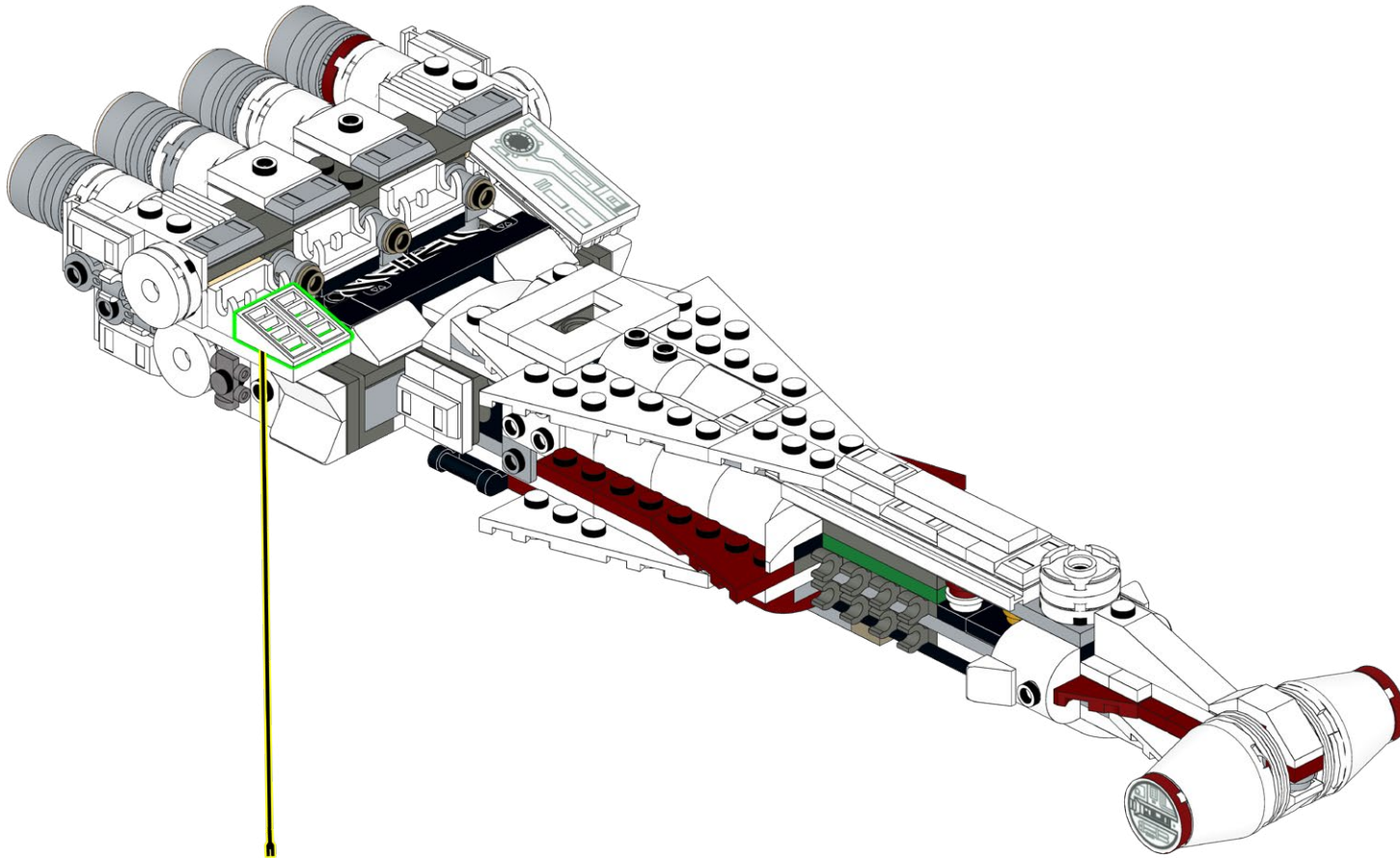

115

1x

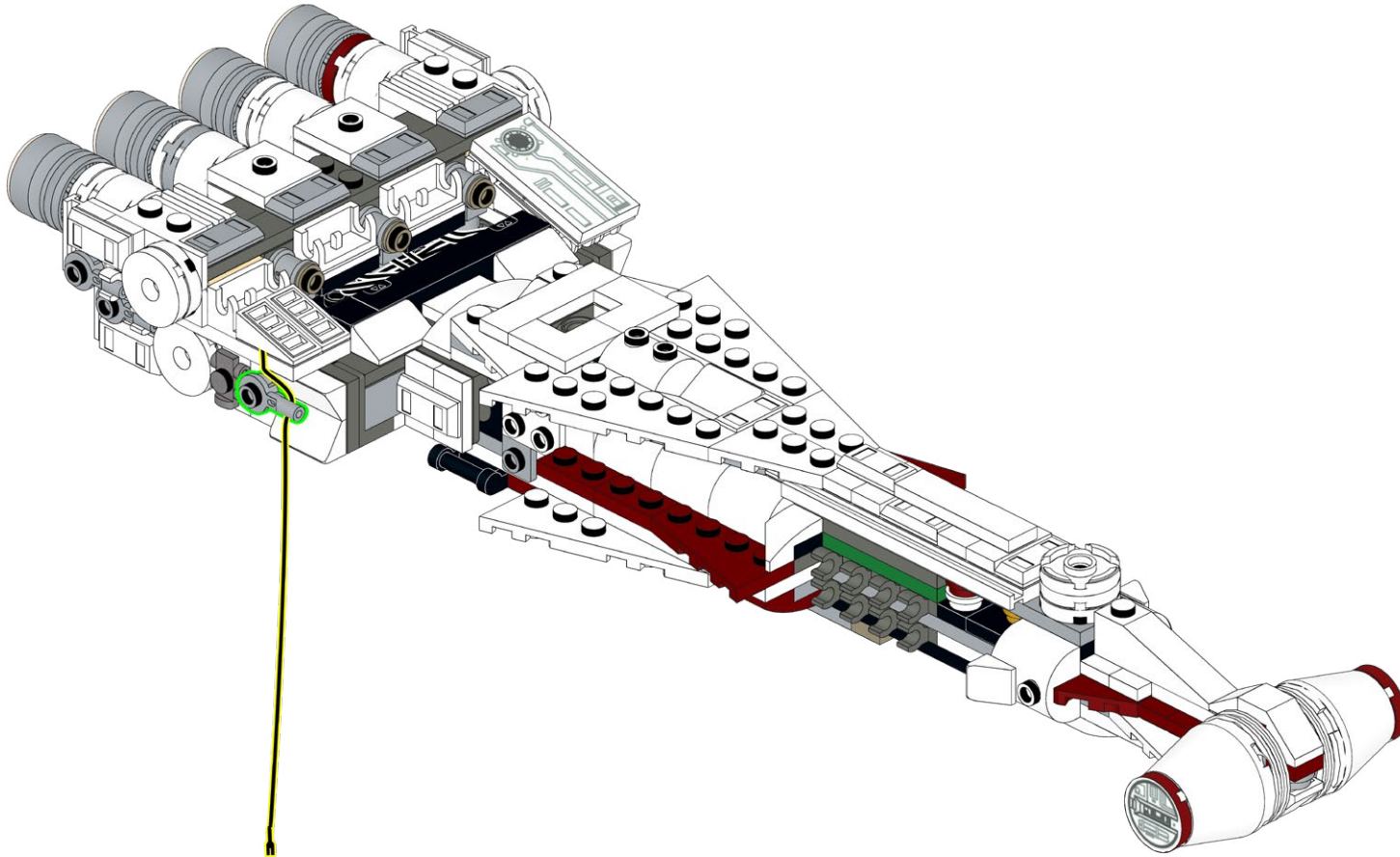

116



1x

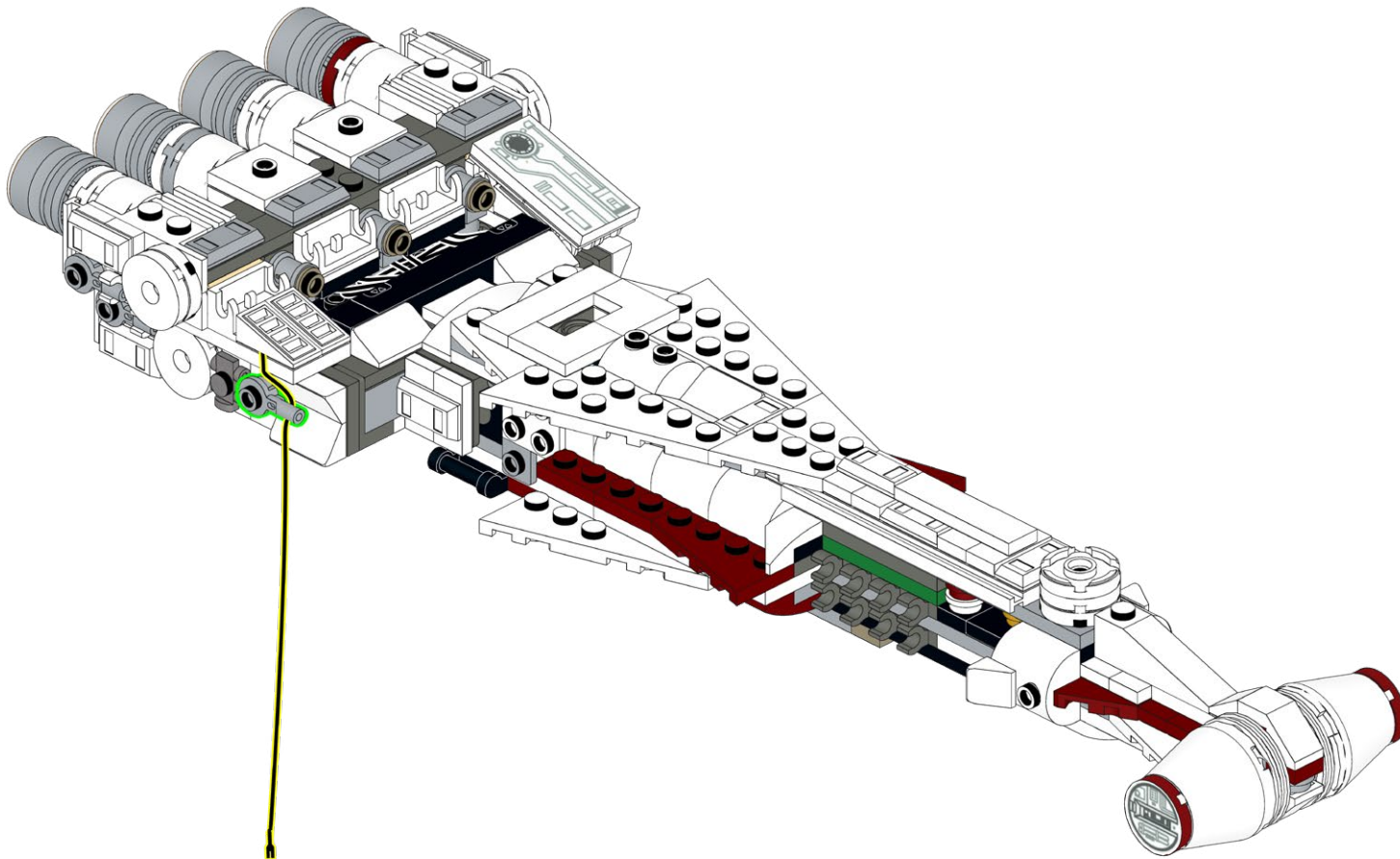

117

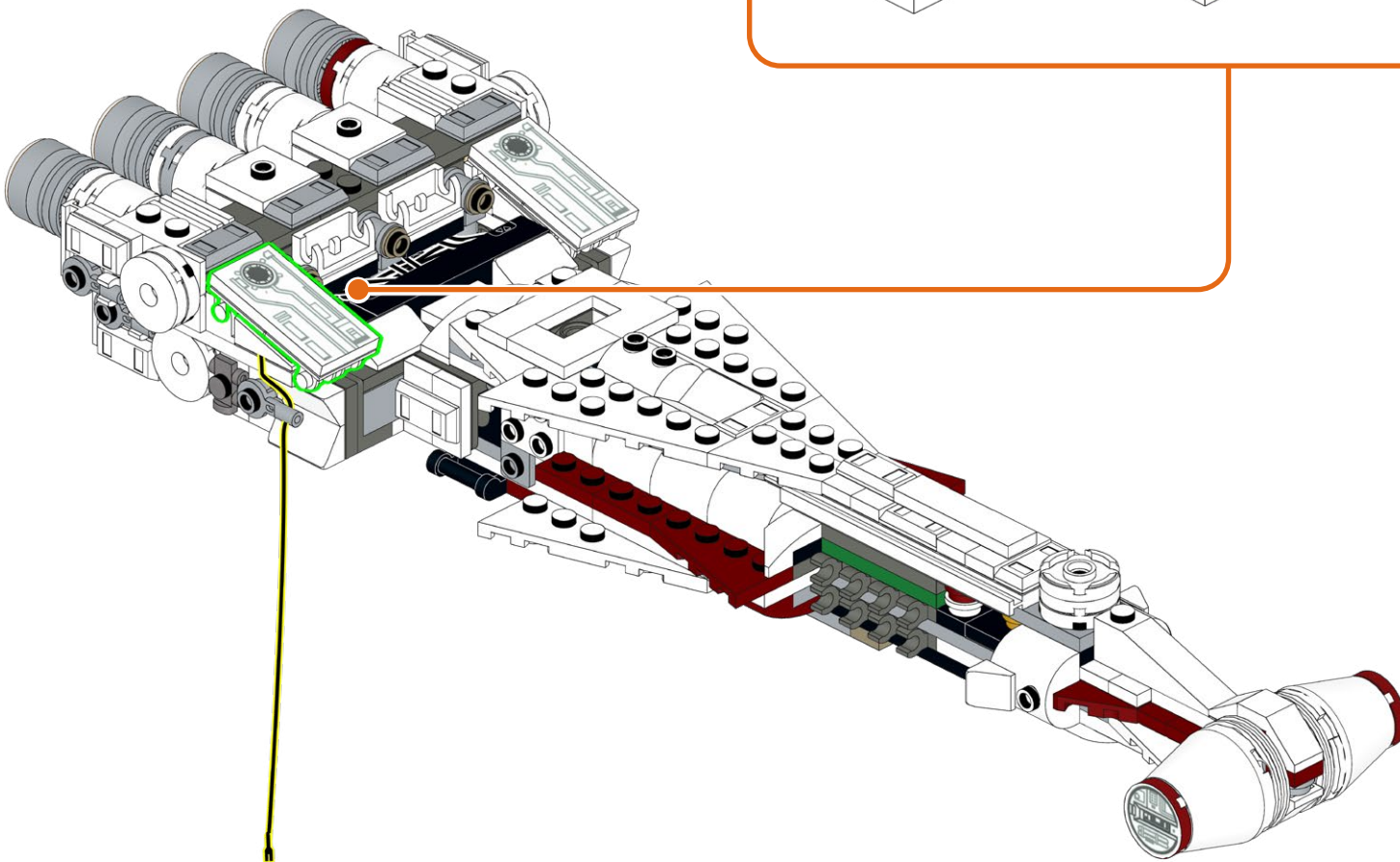
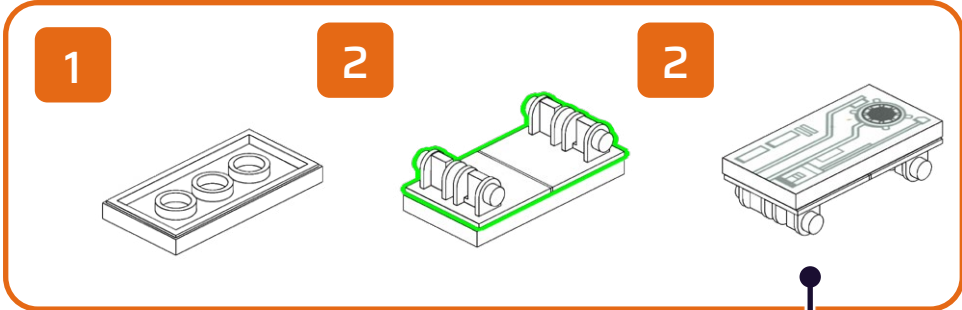
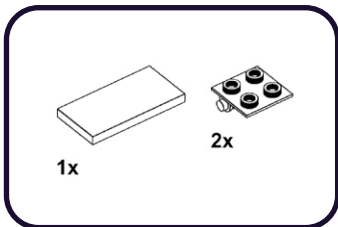

118

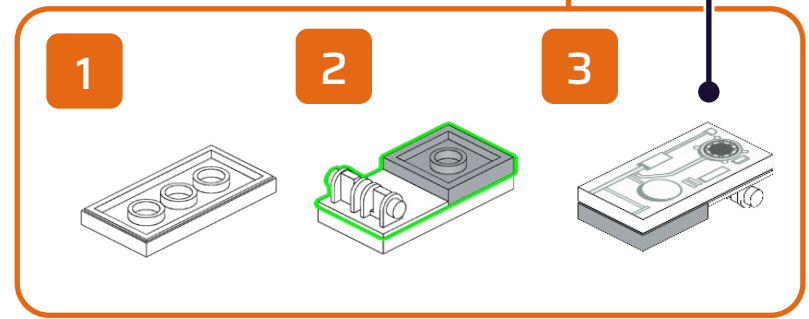
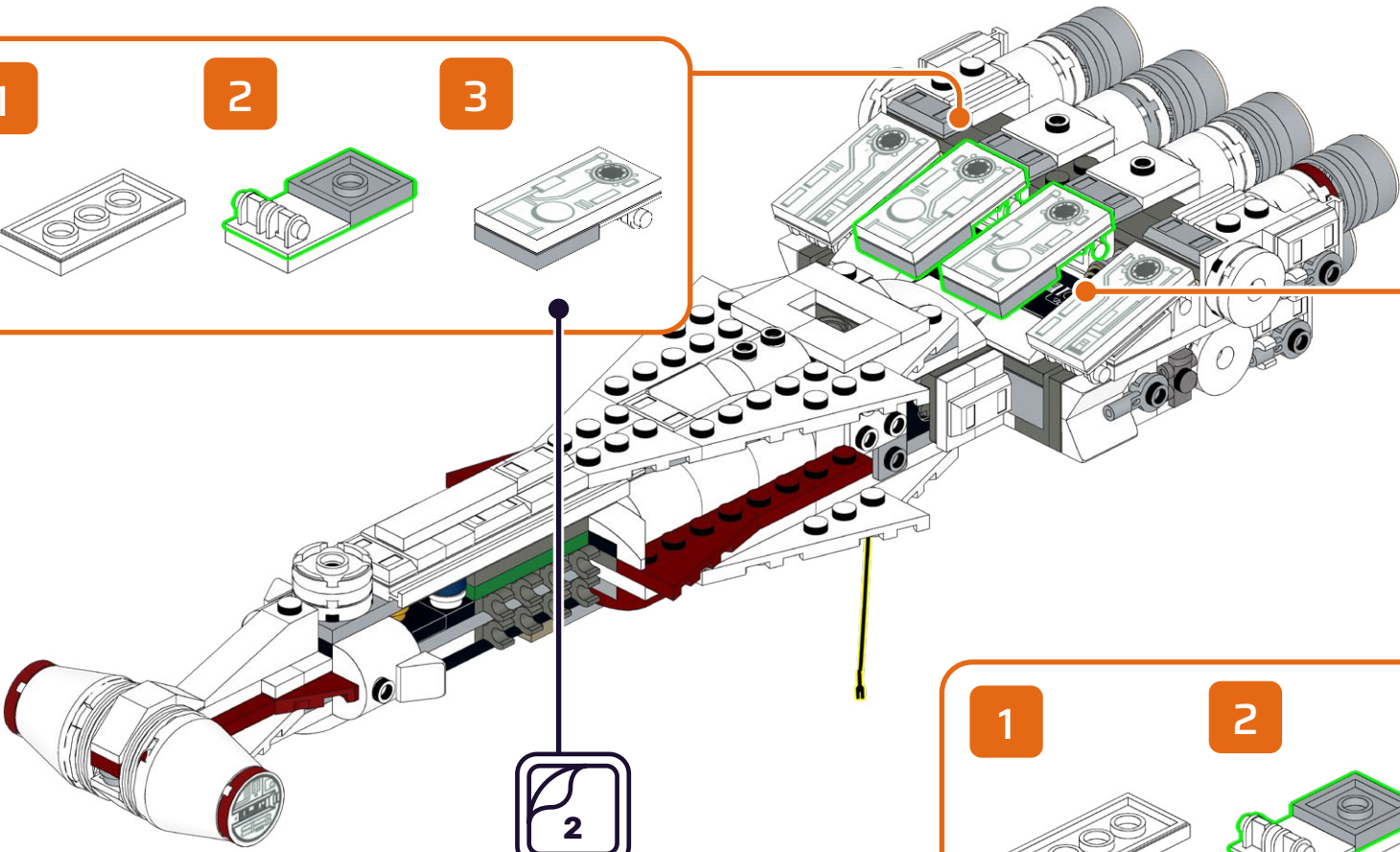
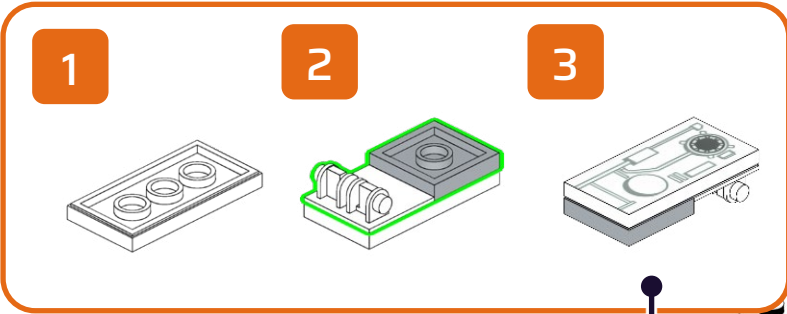
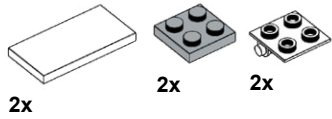

119



1x

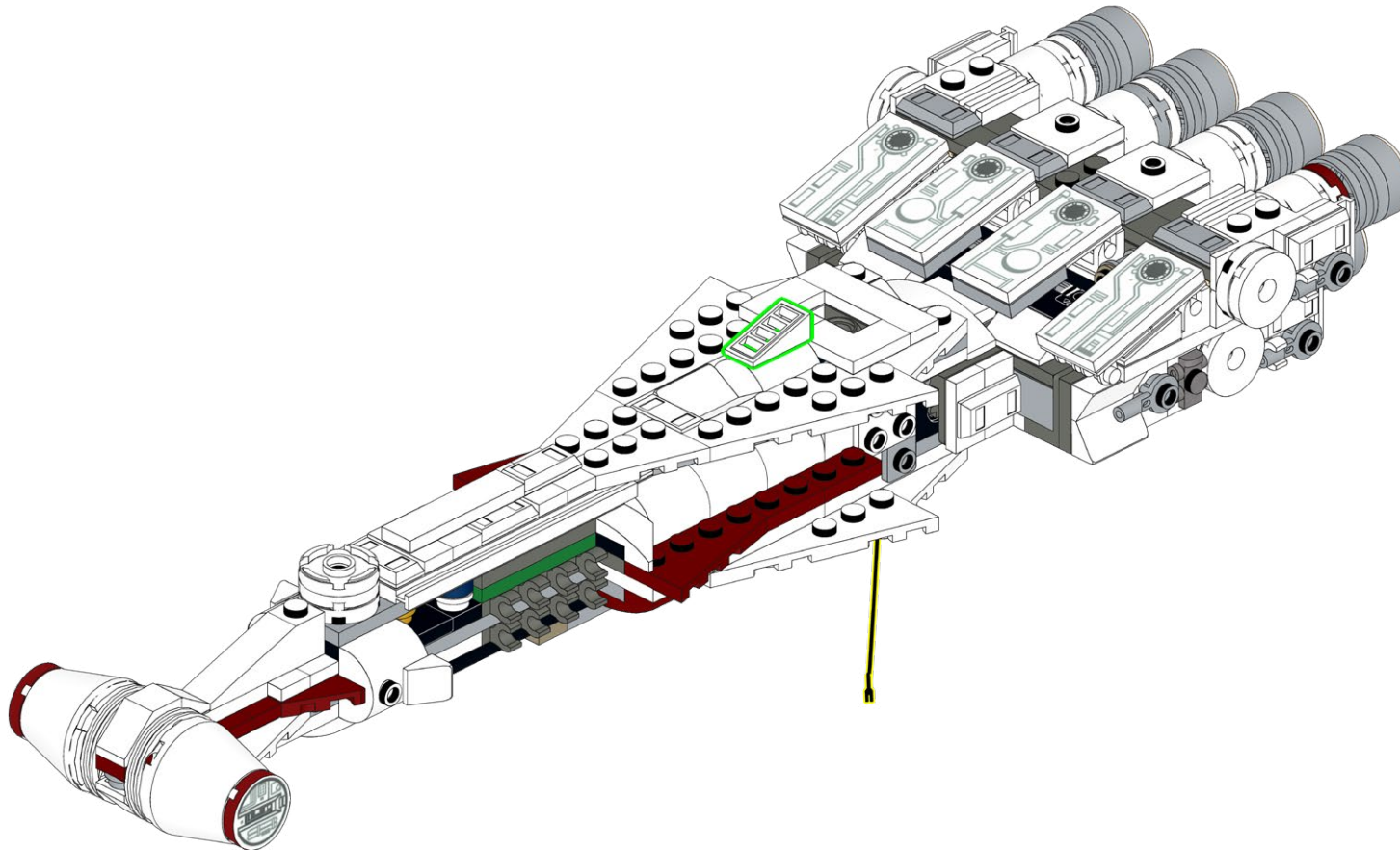

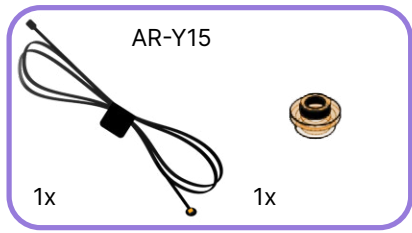

1



2

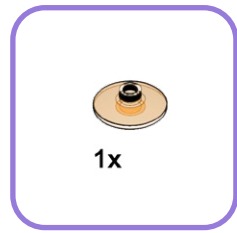
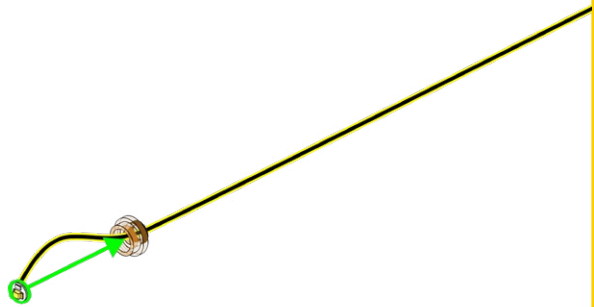

1



2

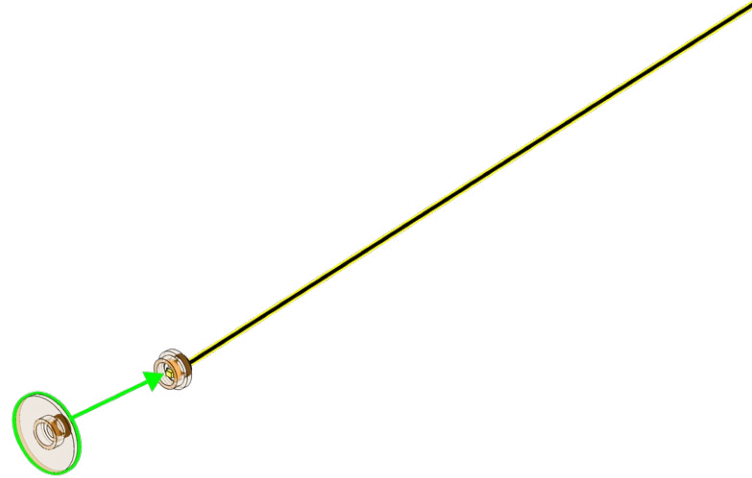

122

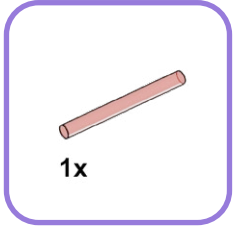

123

1

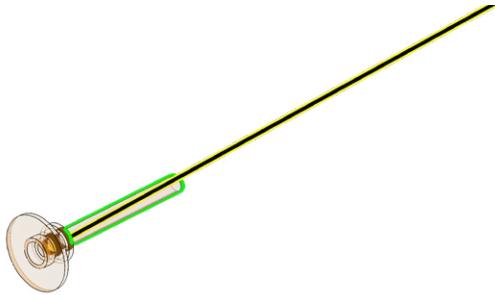

1

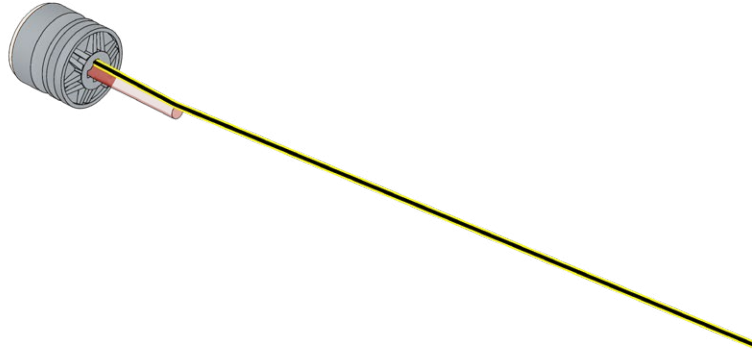

2

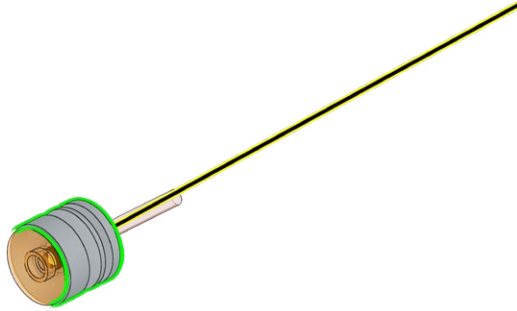

124

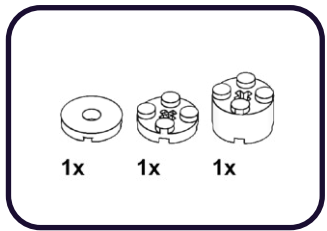

1

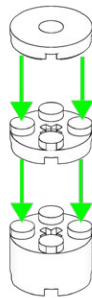

125

1

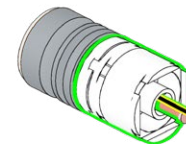

126

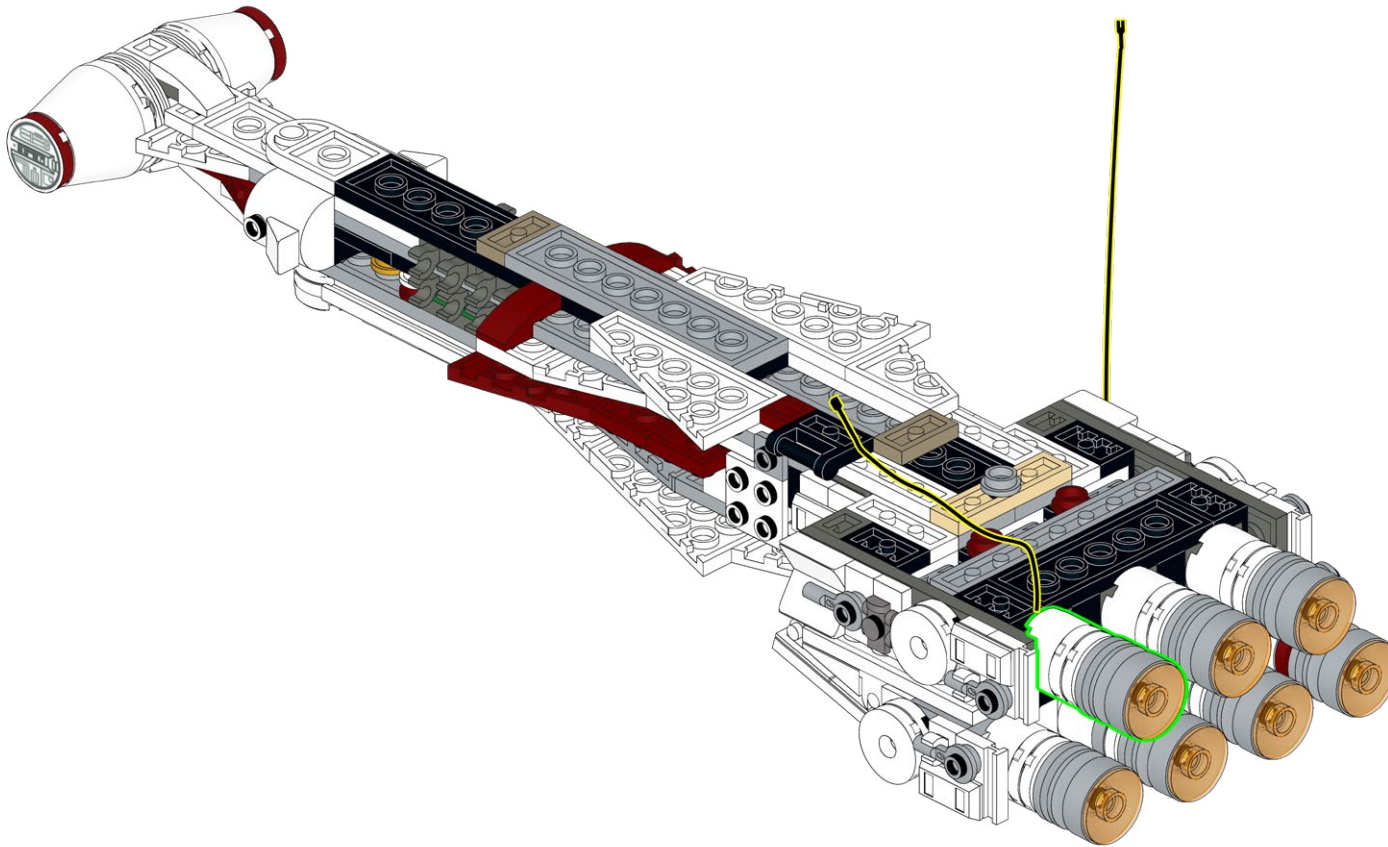

**HOLD UP!**

You might notice some bags aren't in order, as well as left over pieces, but that's ok! We're changing the way you build LEGO!

ATTENDEZ!

Vous remarquerez peut-être que certains sacs, ainsi que certaines pièces, ne sont pas dans le bon ordre. Mais pas de panique! Nous changeons simplement la façon avec laquelle vous construisez vos LEGO!

ASPETTA!

Potresti notare che alcuni sacchetti non sono in ordine, così come i pezzi avanzati, ma va bene così! Stiamo cambiando il modo in cui costruisci i LEGO!

HALT!

Sie werden möglicherweise bemerken, dass einige tüten durcheinander sind und teile übrig bleiben, aber das ist in Ordnung! Wir ändern die art und weise, wie Sie LEGO bauen!

¡ESPERA!

Es posible que notes que algunas bolsas están fuera de servicio, así como piezas sobrantes, ¡pero está bien! ¡Estamos cambiando la forma en que construyes LEGO!

暫停!

你可能会注意到一些袋子顺序错乱, 以及一些剩余的部件, 但没关系! 我们正在改变你搭建乐高的方式!

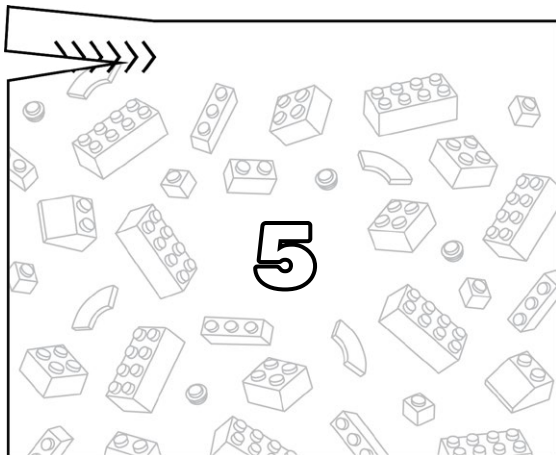
Open LEGO® Bag 5

127



2x

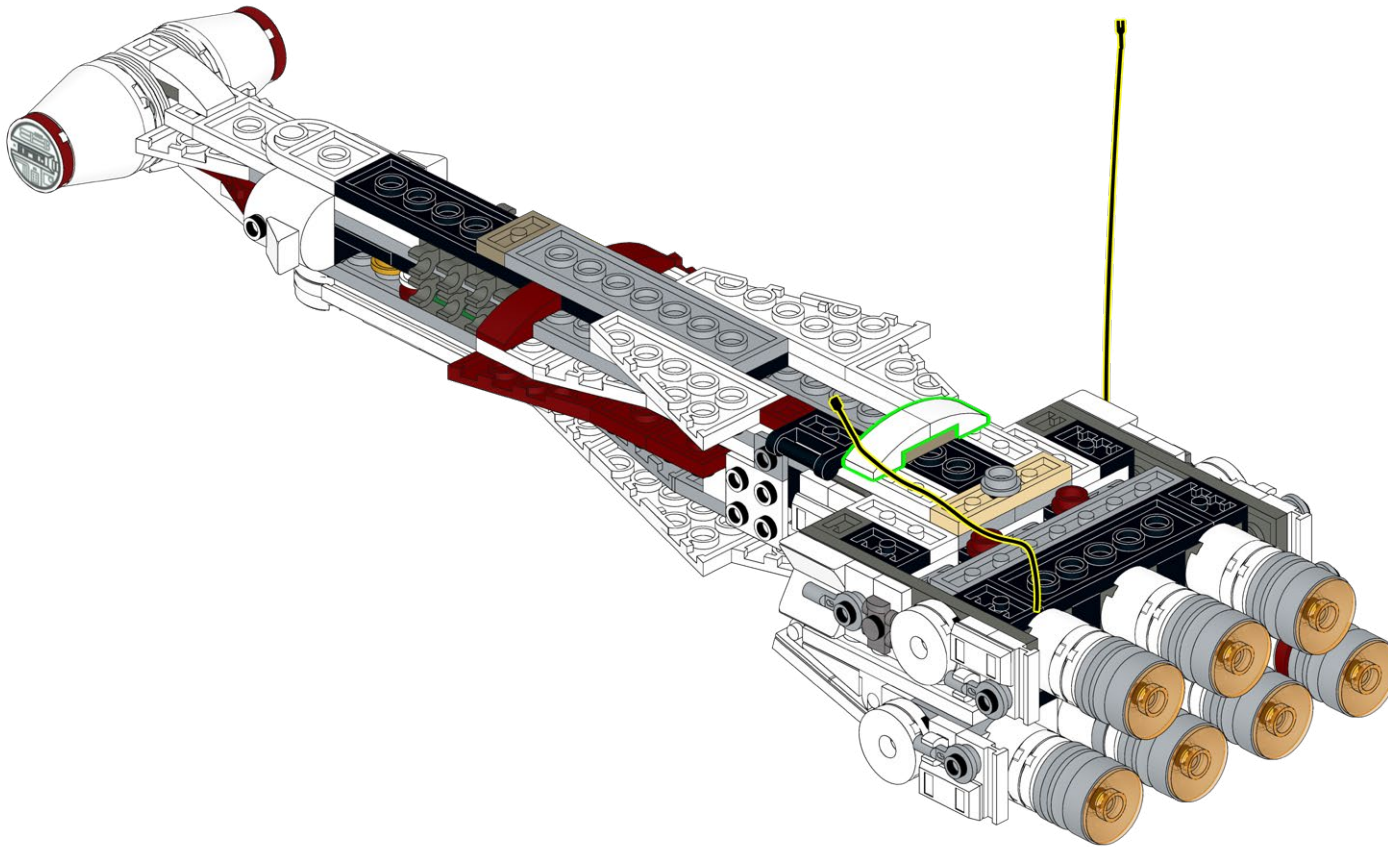

128

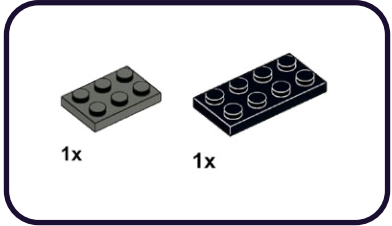

1



2

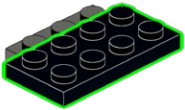

129

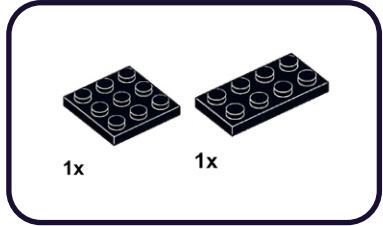

1

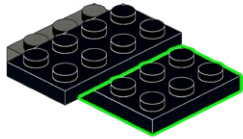

2

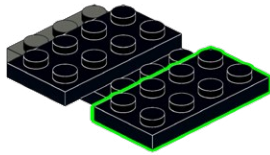

130

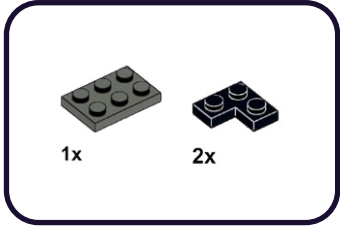

1

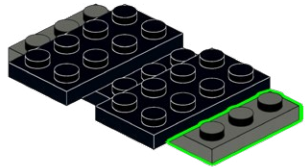

2

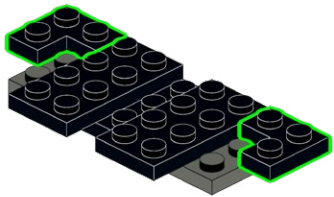

131

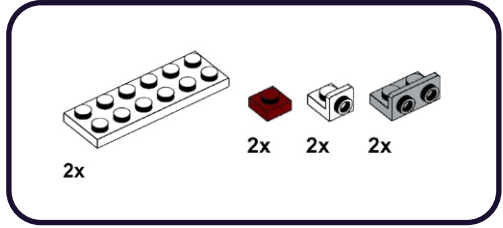

1

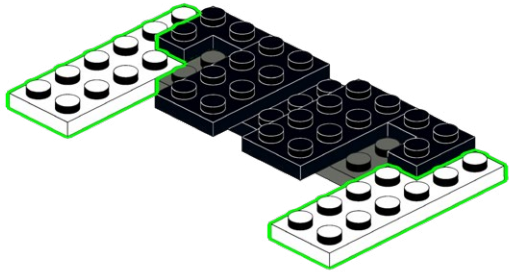

2

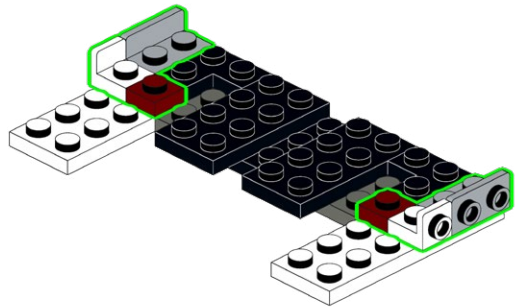

132

6x

4x

1

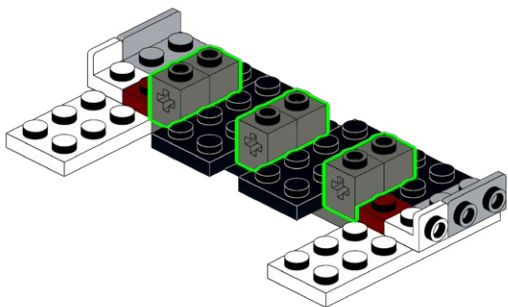

2

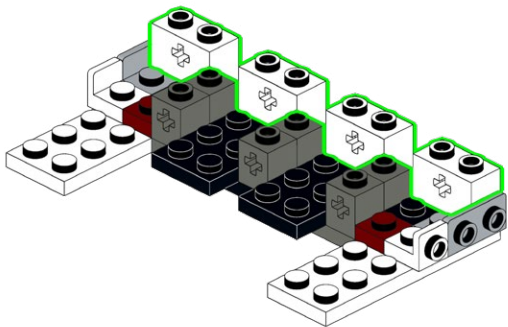

133

4x

1x

4x

1

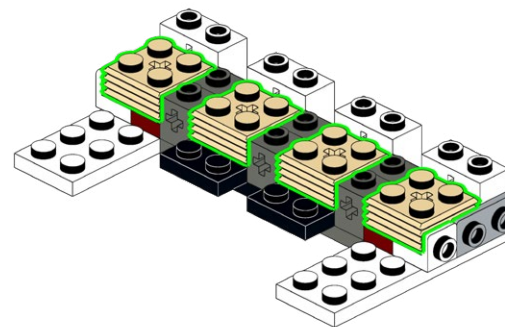

2

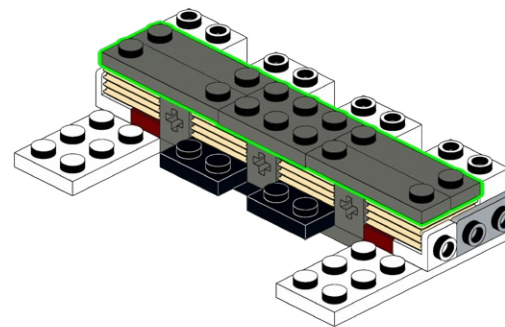

134

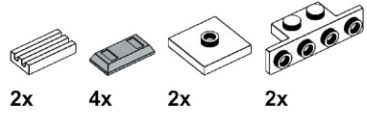

1

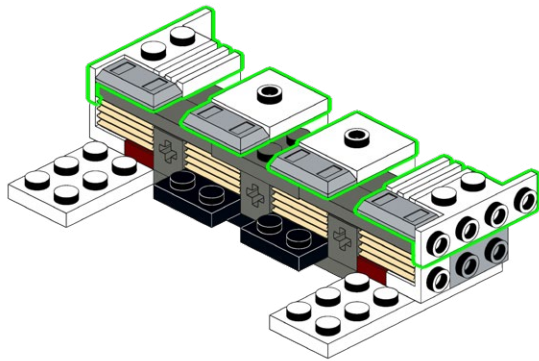

135

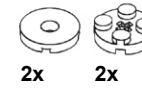

1

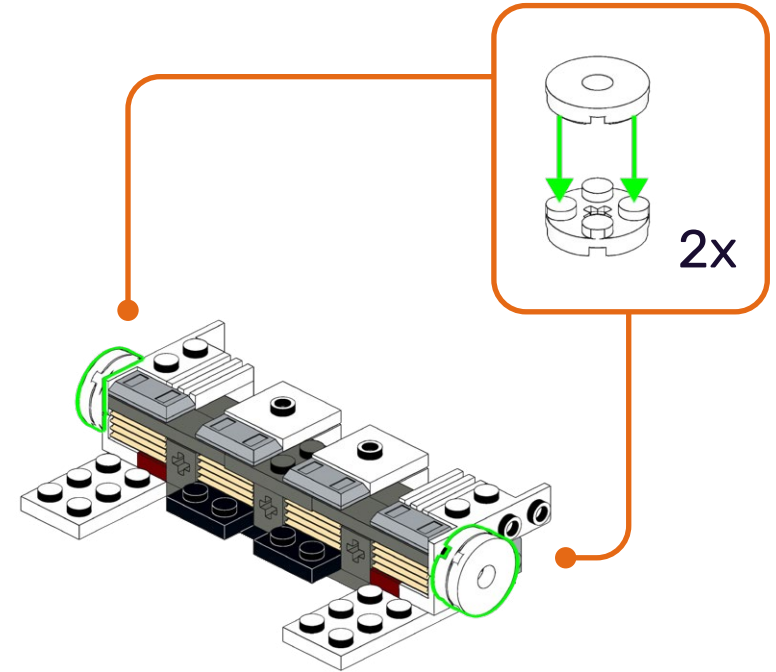

136

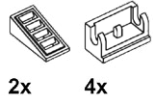

2x

4x

1

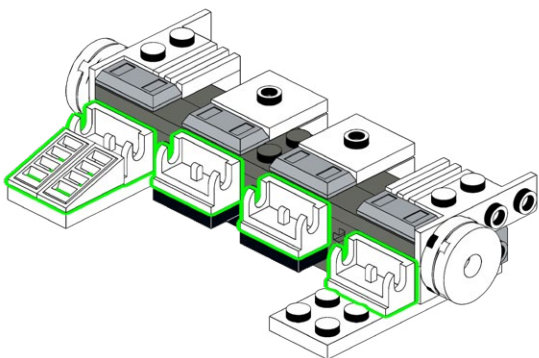

137

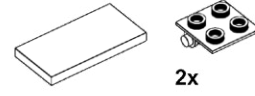

1x

2x

1

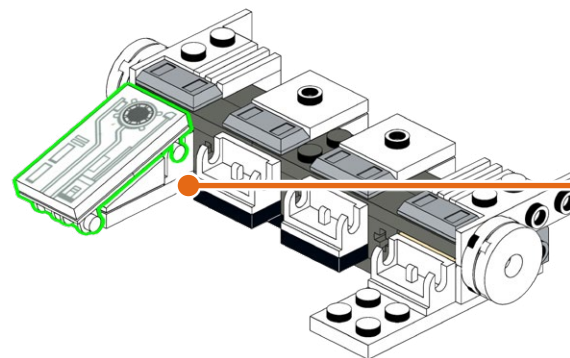

1

1

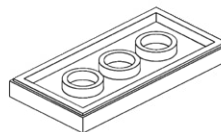

2

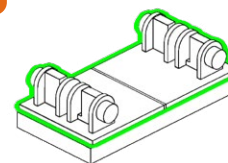

2

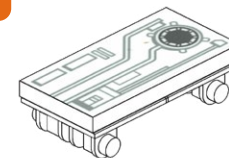

138

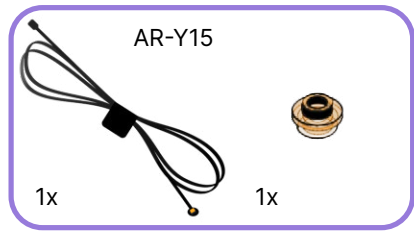

1



2

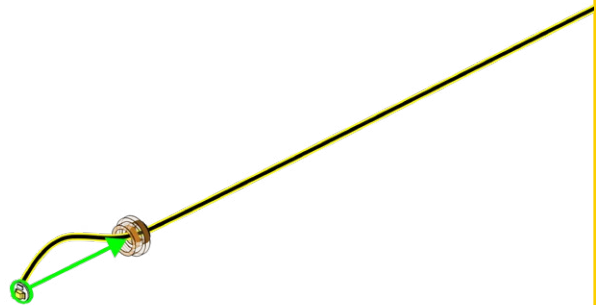

139

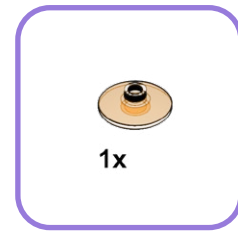

1



2

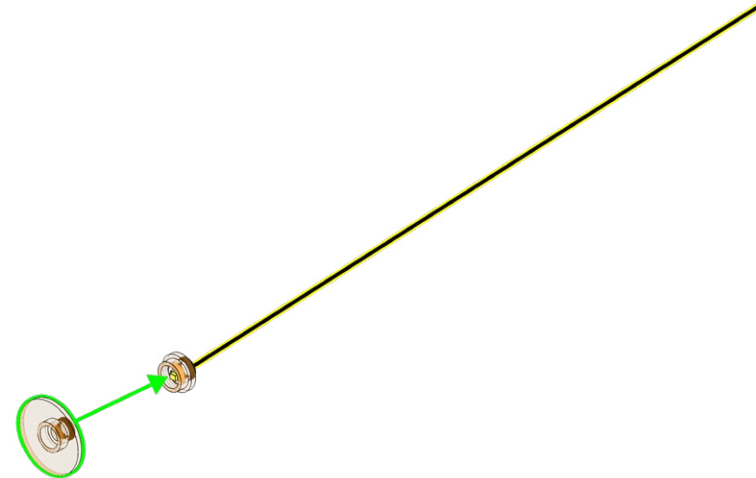

140

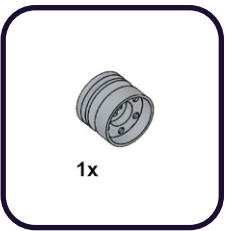
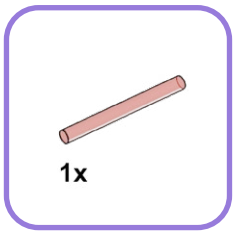

141

1

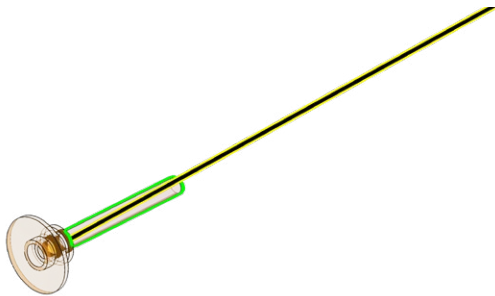

2

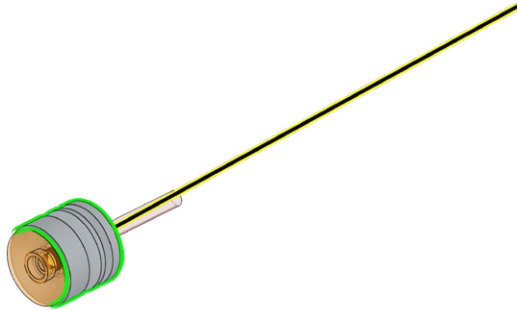

1

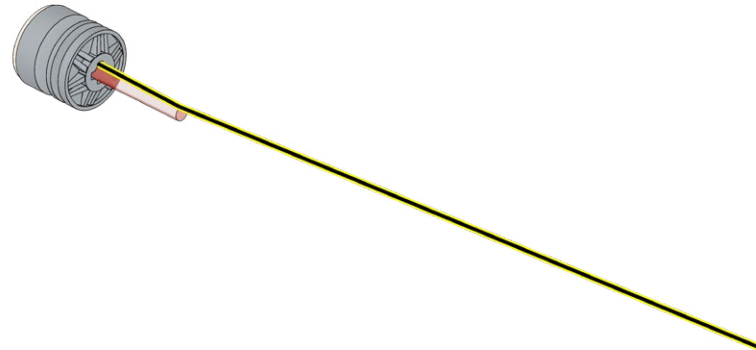

142

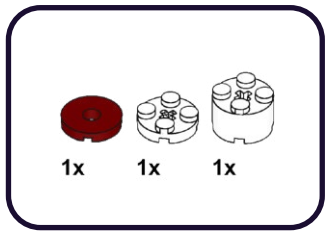

1

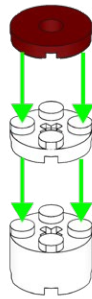

143

1

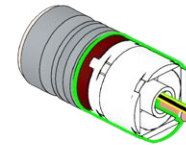

144

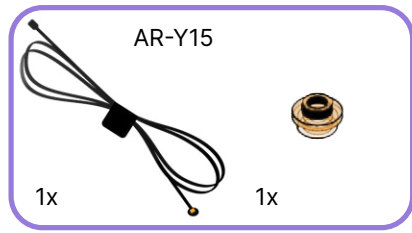

1



2

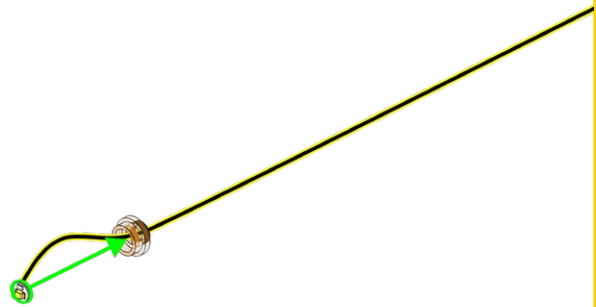

145

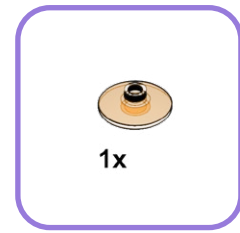

1



2

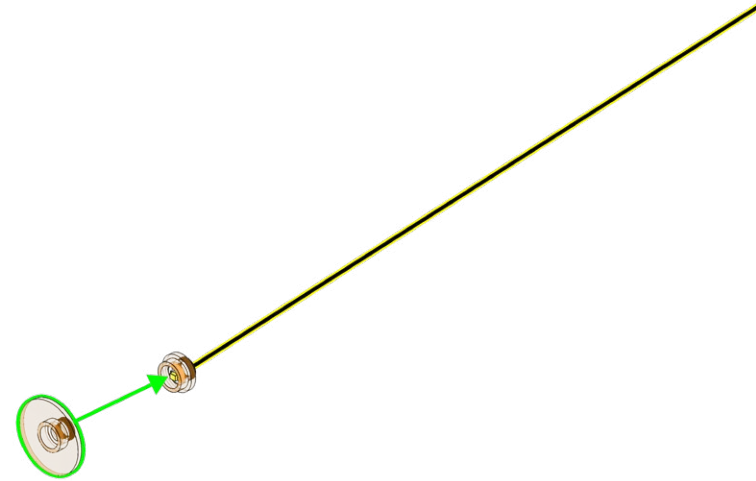

146

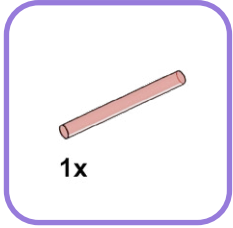

147

1

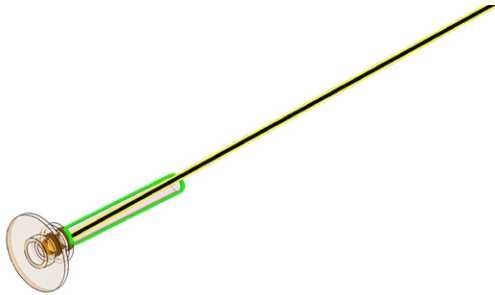

2

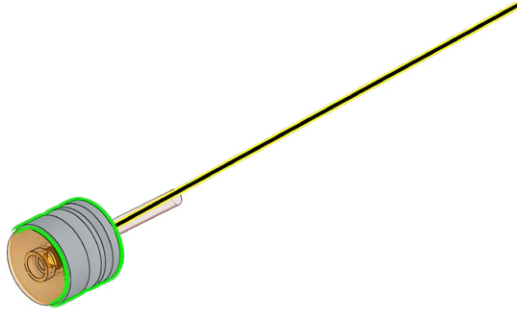

1

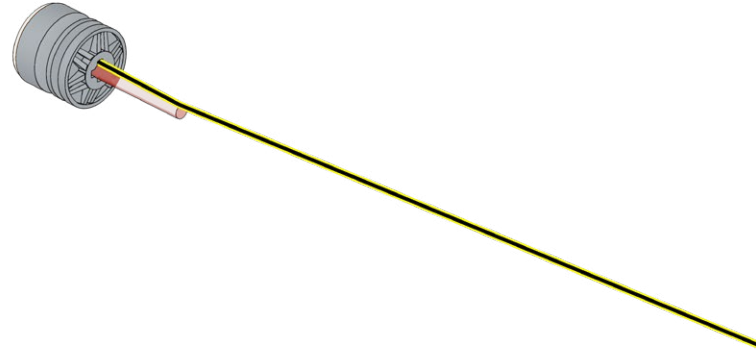

148

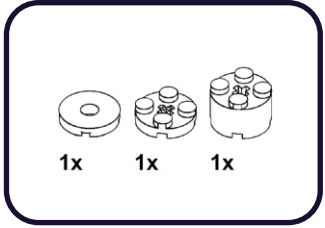

1

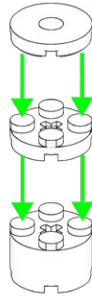

149

1

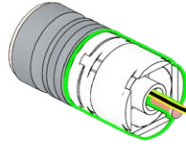

3x

150

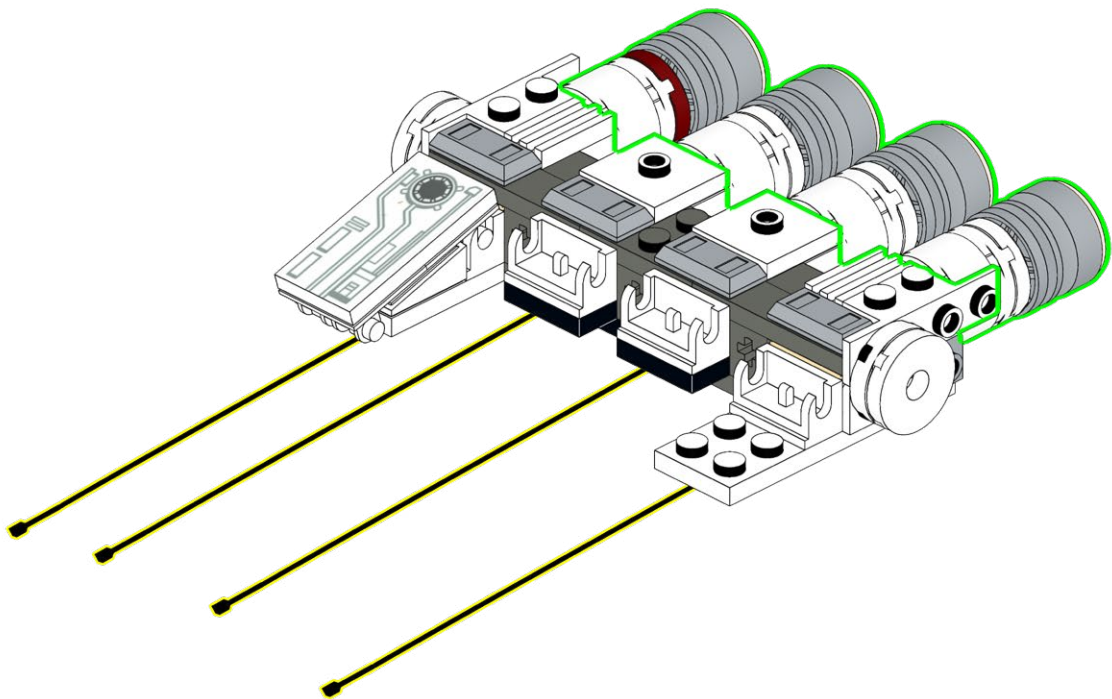

151

3x

3x

3x

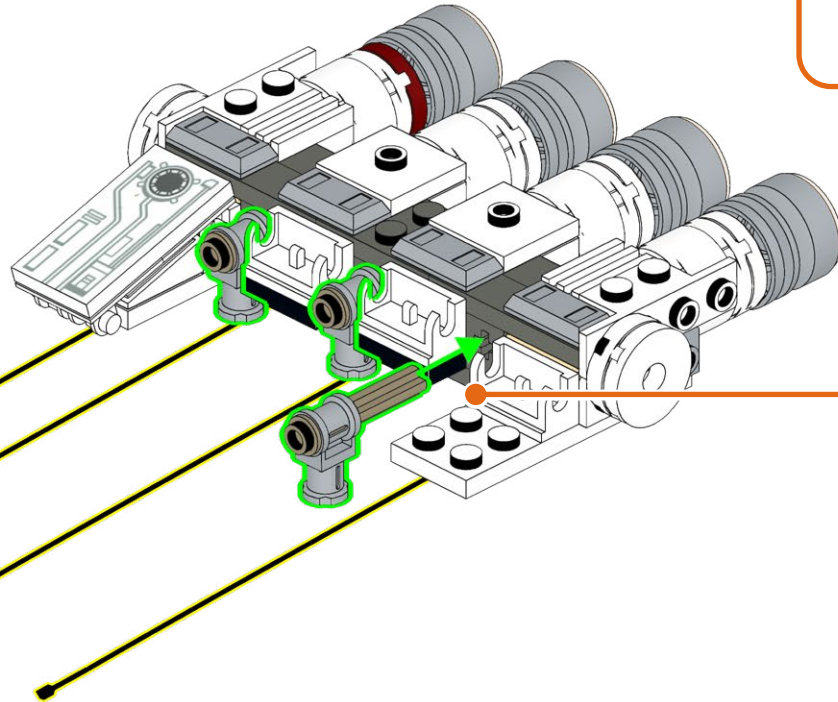

152

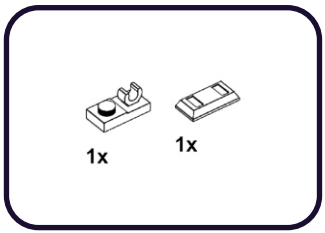

1



2

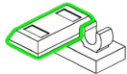

153

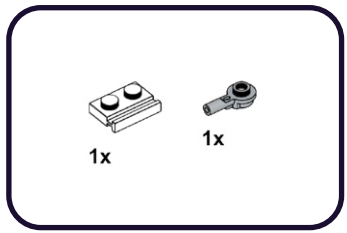

1

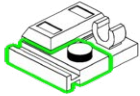

2

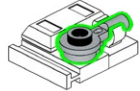

154

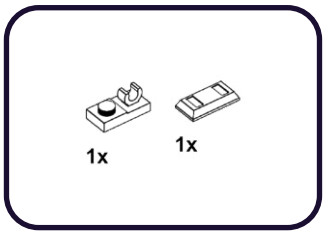

1



2



155

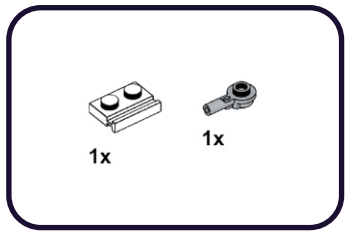

1

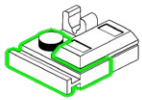

2

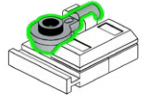

156

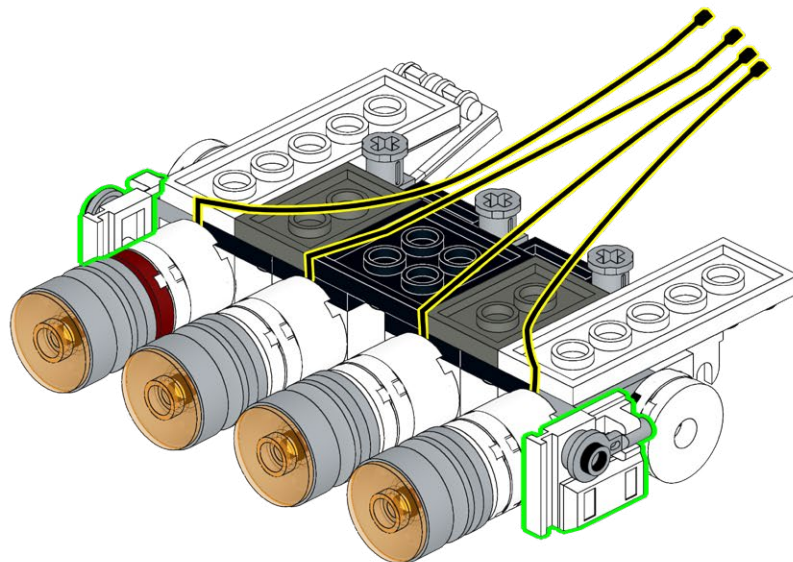

157

3x

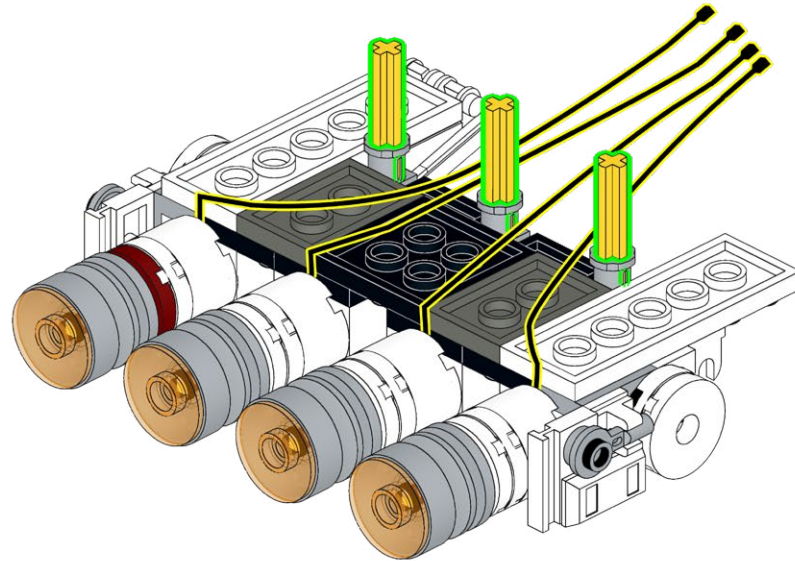

158

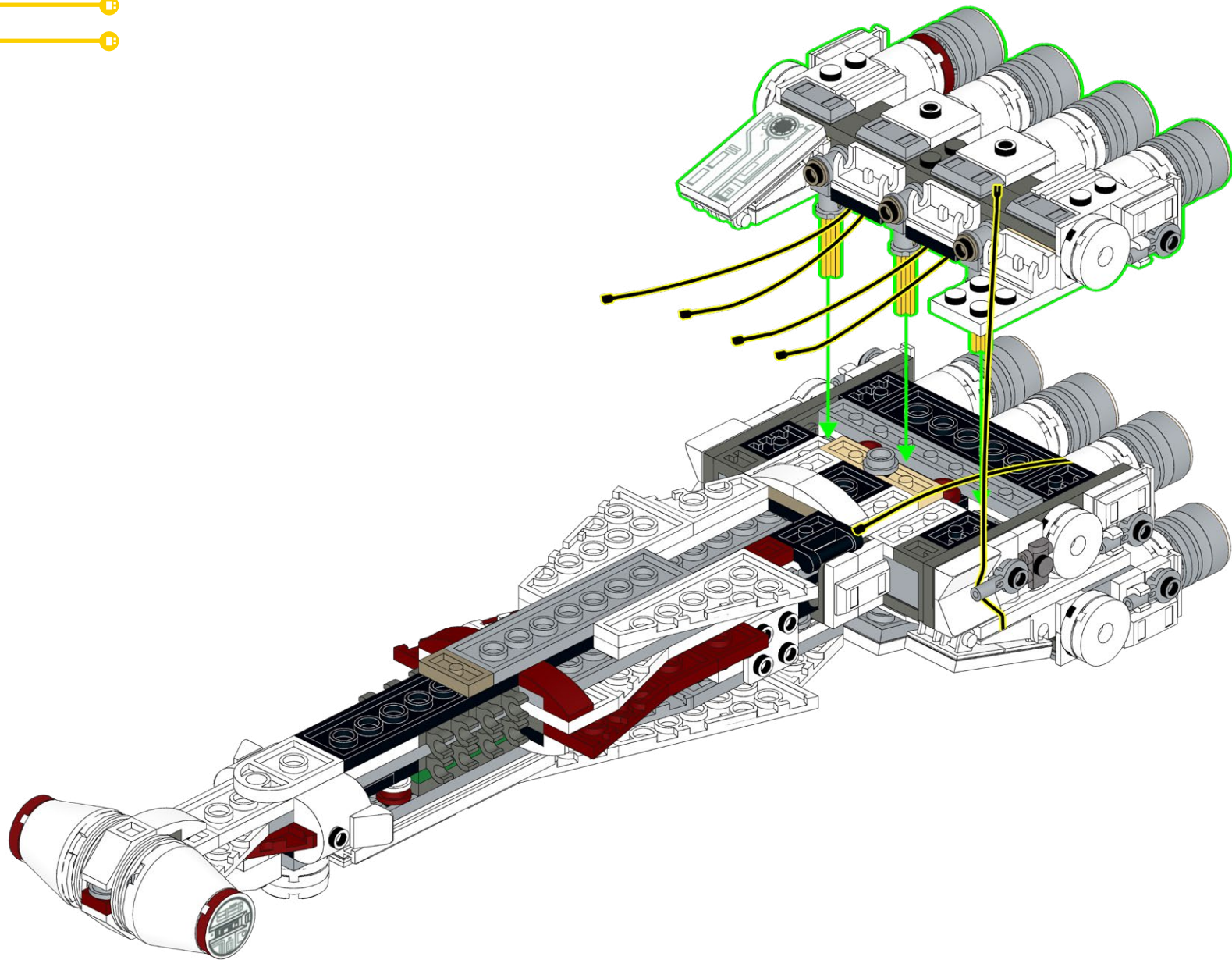

159

D-6

T-1x6

1x

1x

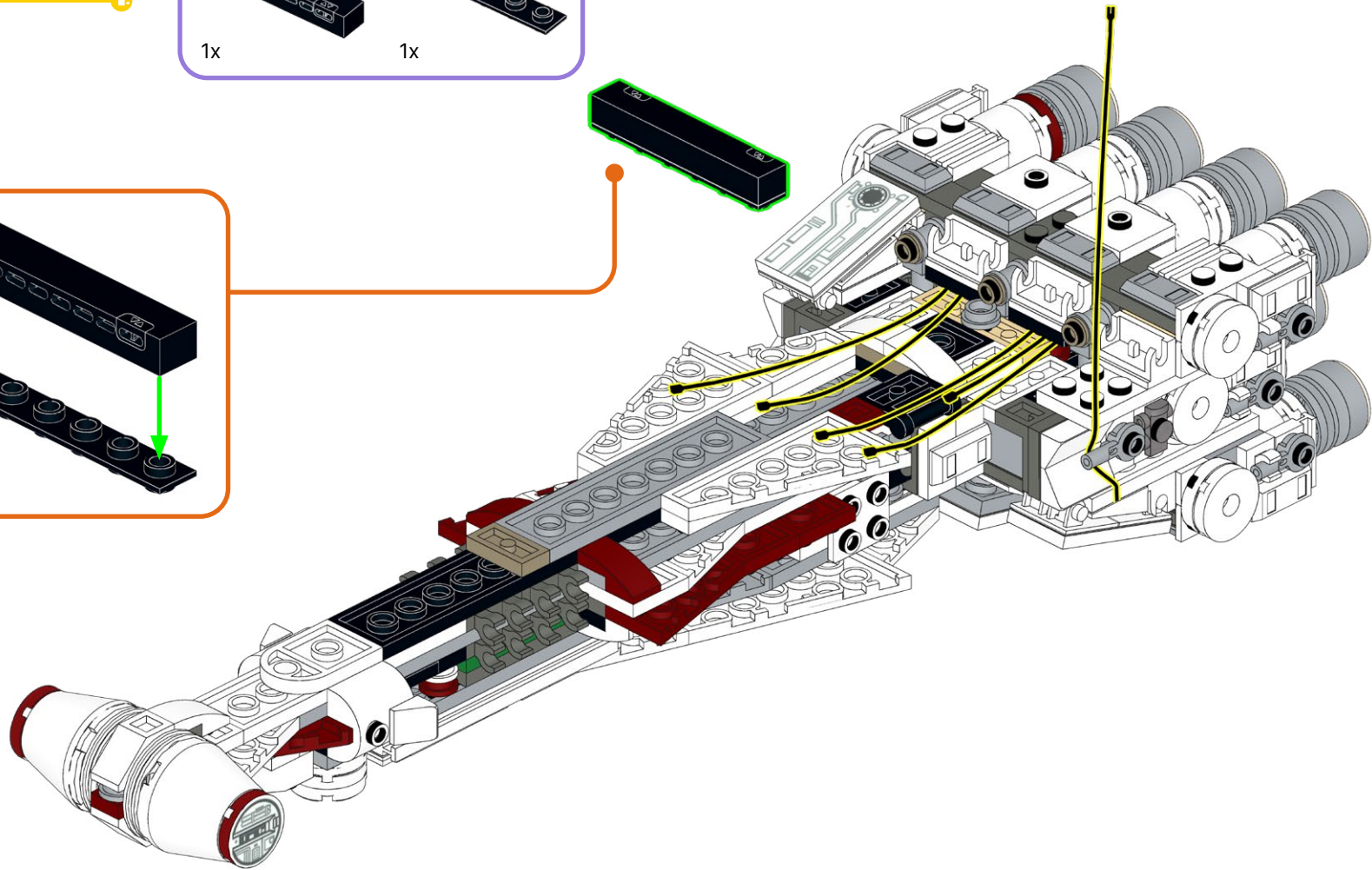
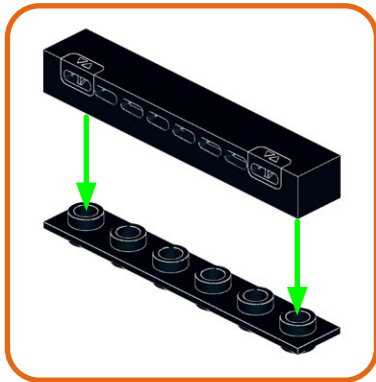

160

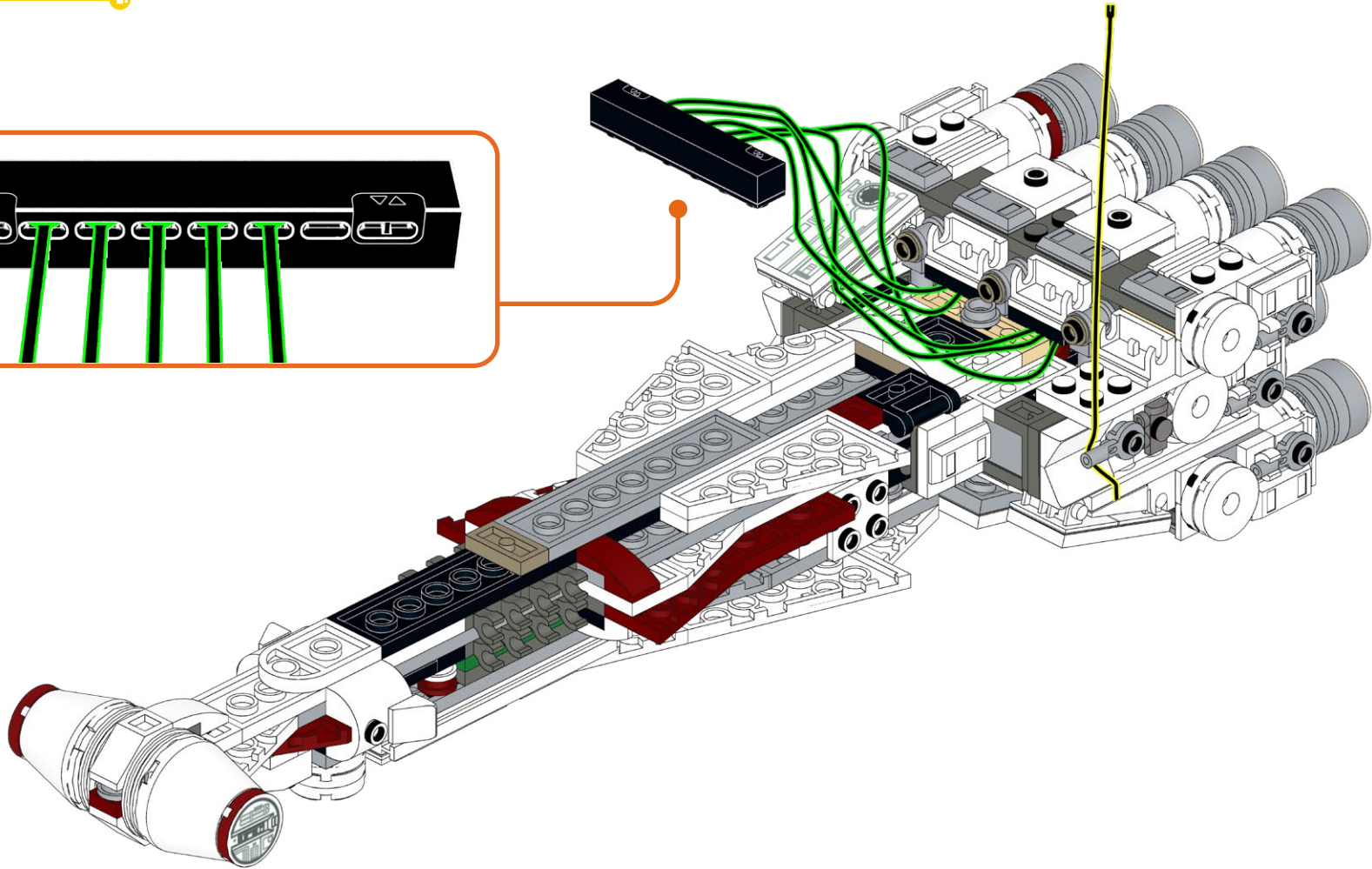
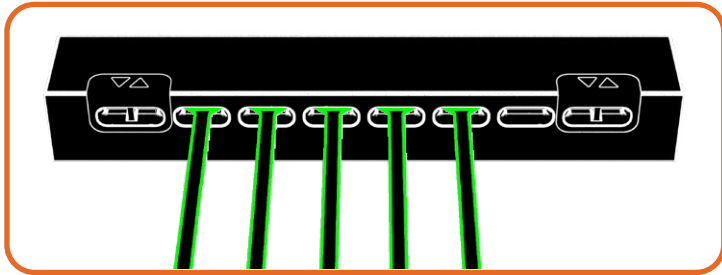

161

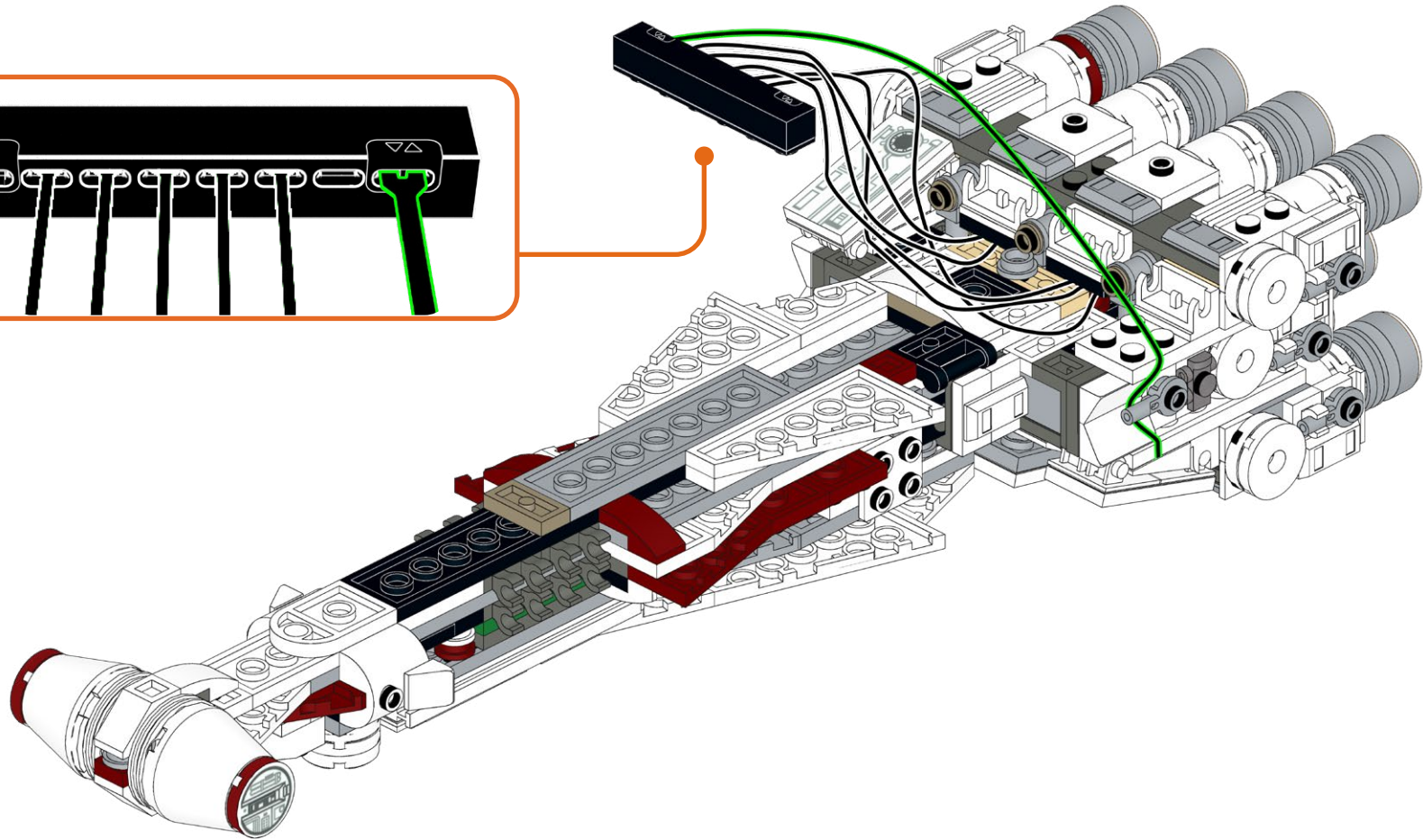
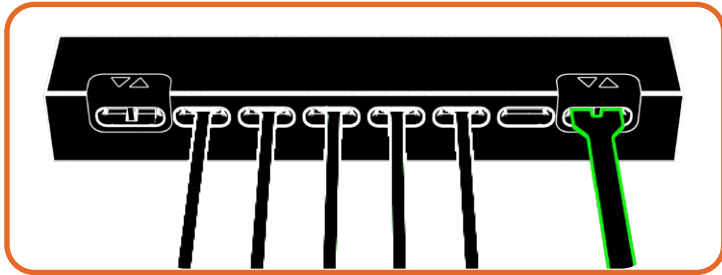

162

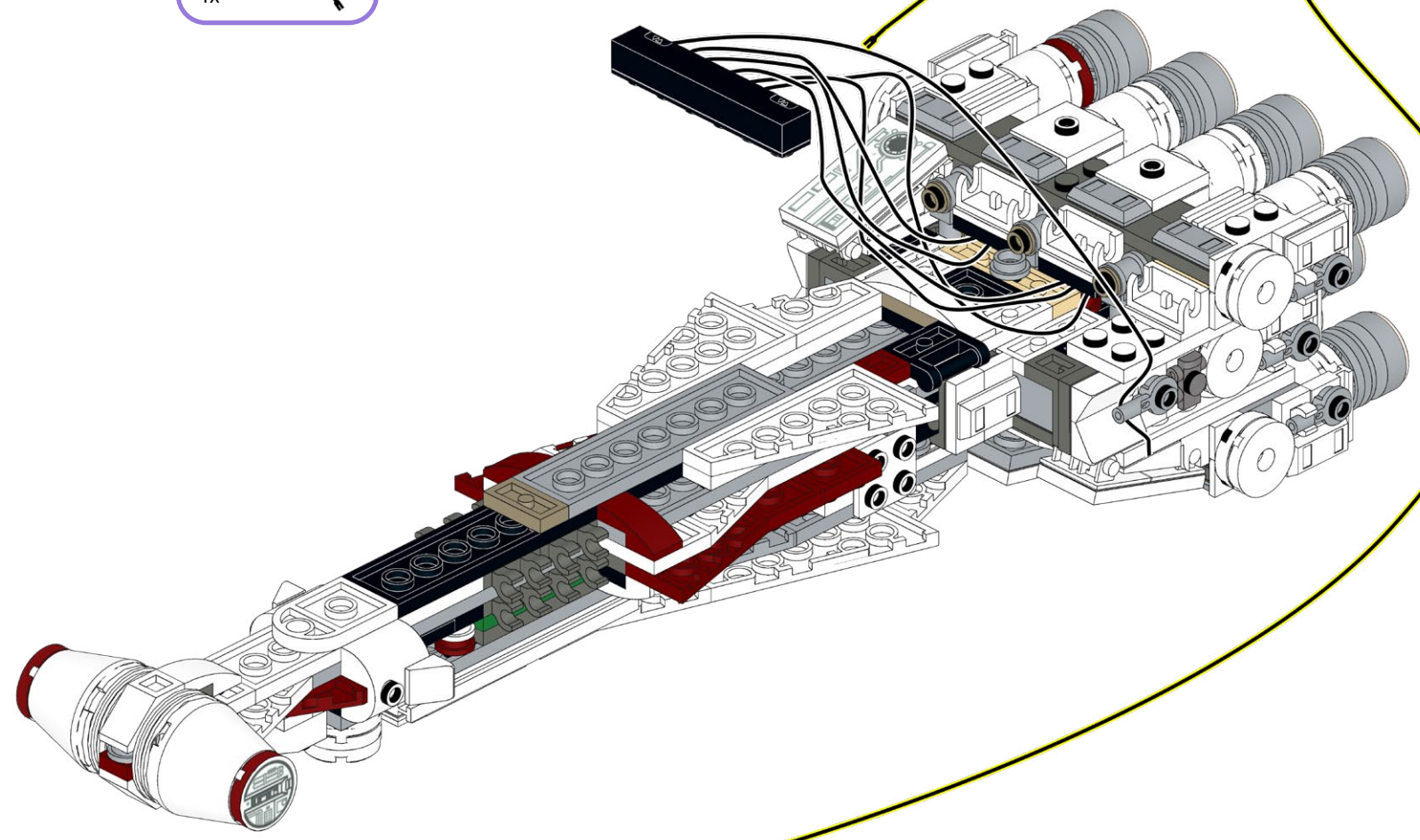
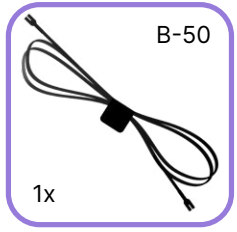

163

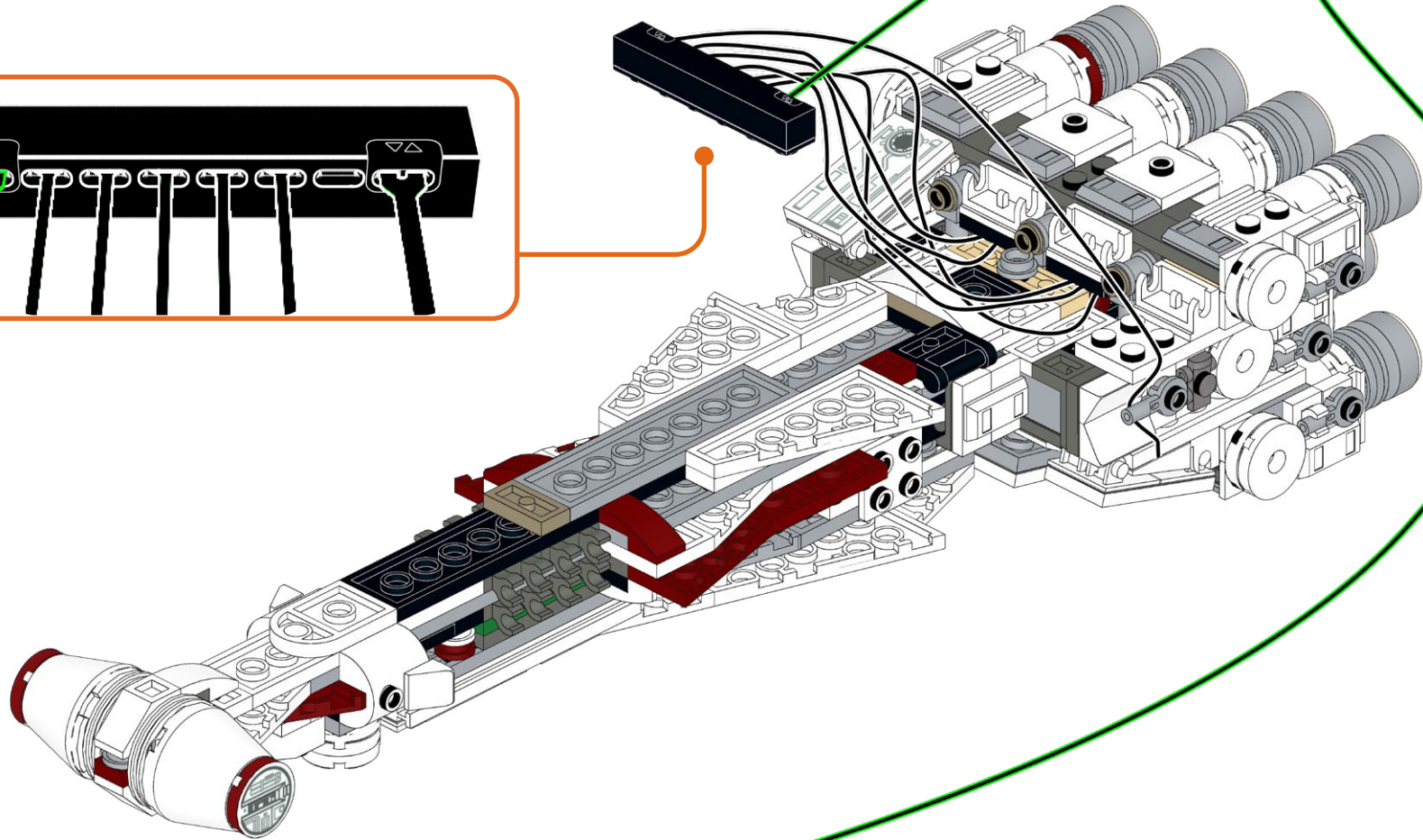
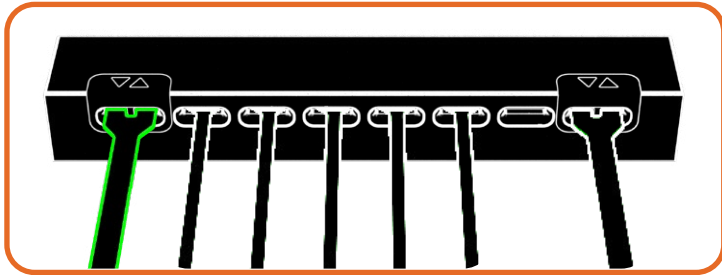

164

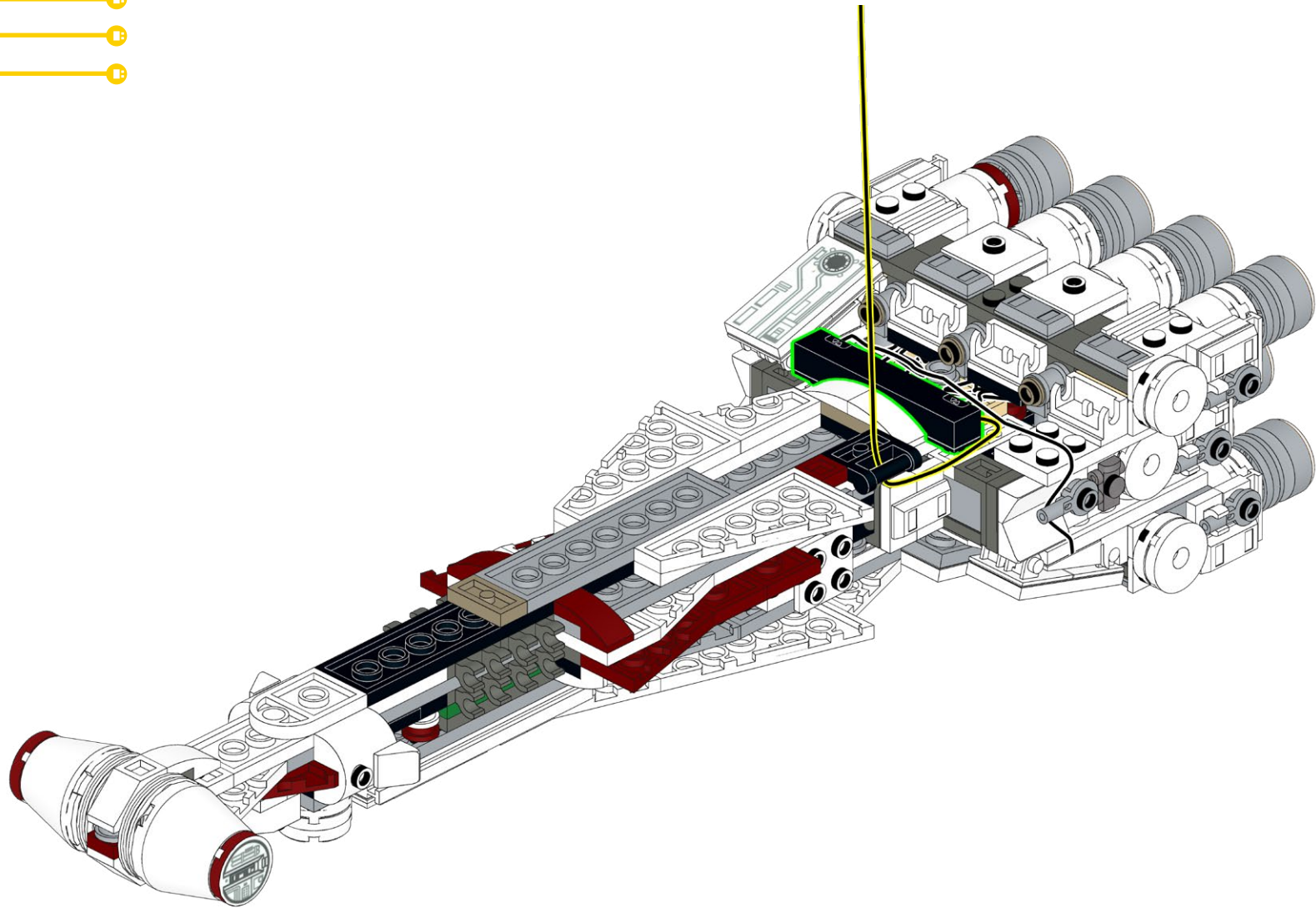

165

FLX-C

1x

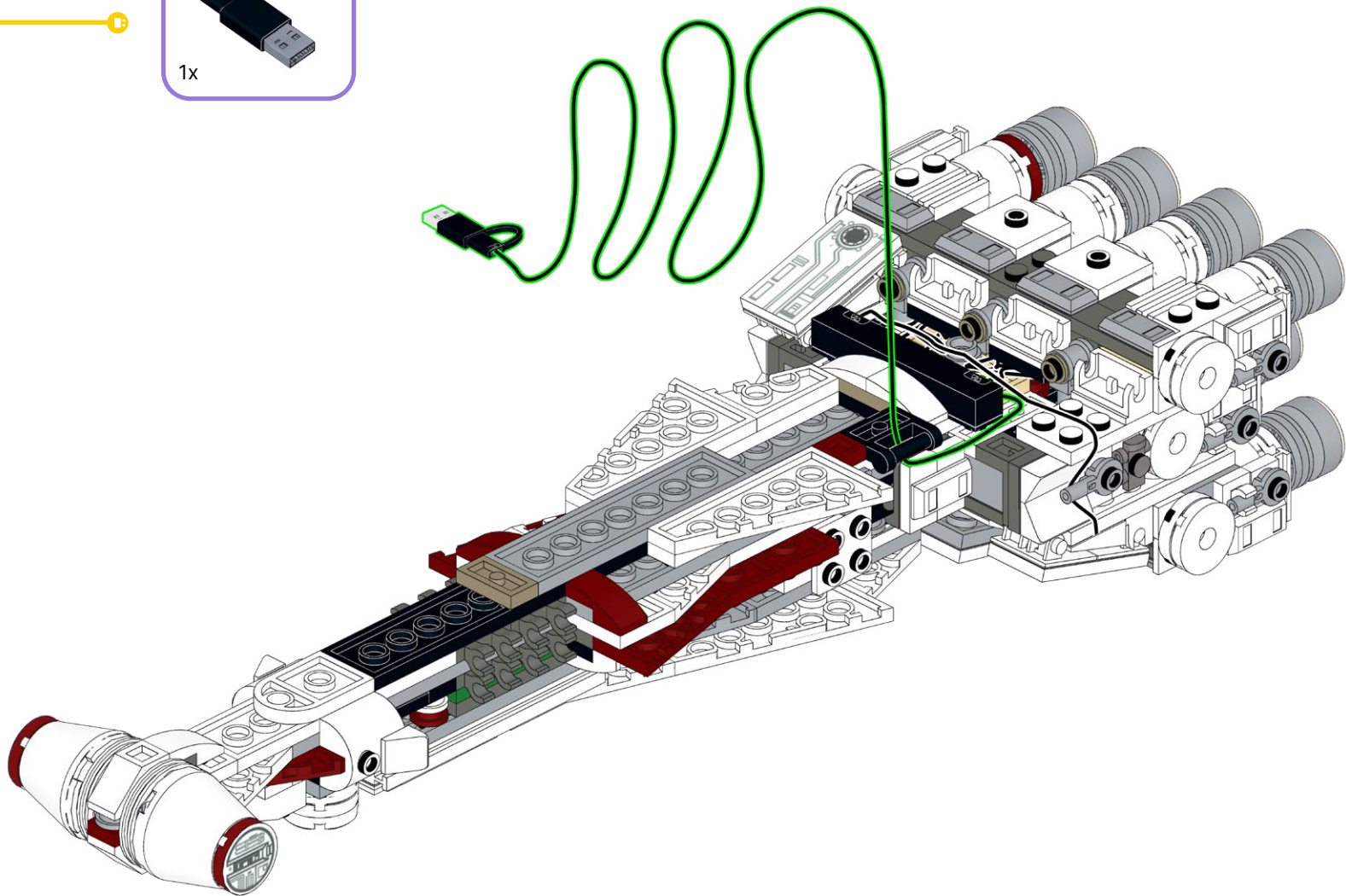

166

2x

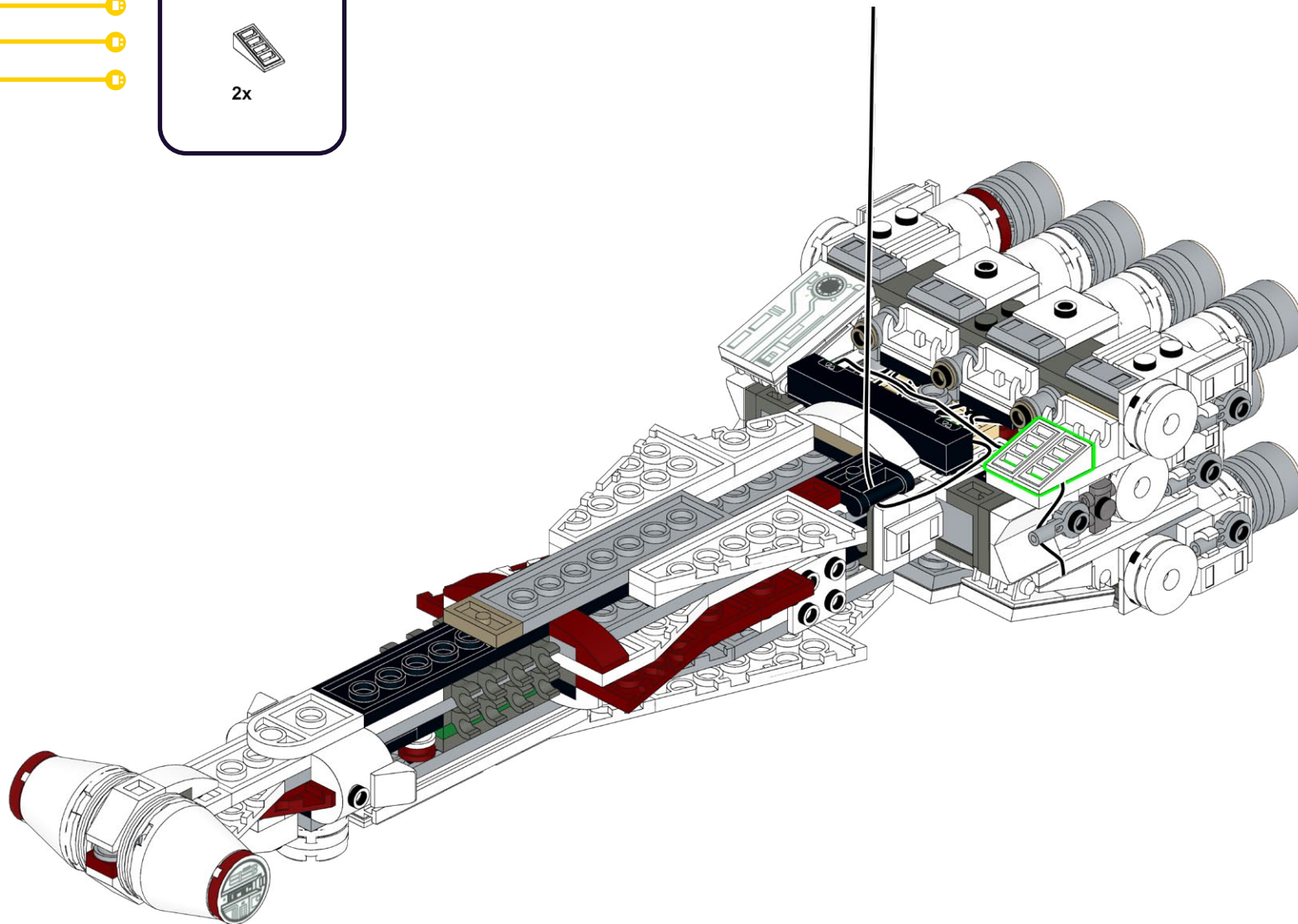

**HOLD UP!**

You might notice some bags aren't in order, as well as left over pieces, but that's ok! We're changing the way you build LEGO!

ATTENDEZ!

Vous remarquerez peut-être que certains sacs, ainsi que certaines pièces, ne sont pas dans le bon ordre. Mais pas de panique! Nous changeons simplement la façon avec laquelle vous construisez vos LEGO!

ASPETTA!

Potresti notare che alcuni sacchetti non sono in ordine, così come i pezzi avanzati, ma va bene così! Stiamo cambiando il modo in cui costruisci i LEGO!

HALT!

Sie werden möglicherweise bemerken, dass einige tüten durcheinander sind und teile übrig bleiben, aber das ist in Ordnung! Wir ändern die art und weise, wie Sie LEGO bauen!

¡ESPERA!

Es posible que notes que algunas bolsas están fuera de servicio, así como piezas sobrantes, ¡pero está bien! ¡Estamos cambiando la forma en que construyes LEGO!

暫停!

你可能会注意到一些袋子顺序错乱, 以及一些剩余的部件, 但没关系! 我们正在改变你搭建乐高的方式!

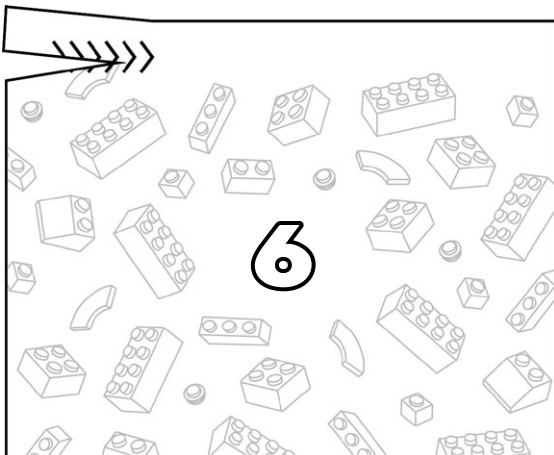
Open LEGO® Bag 6

167

2x

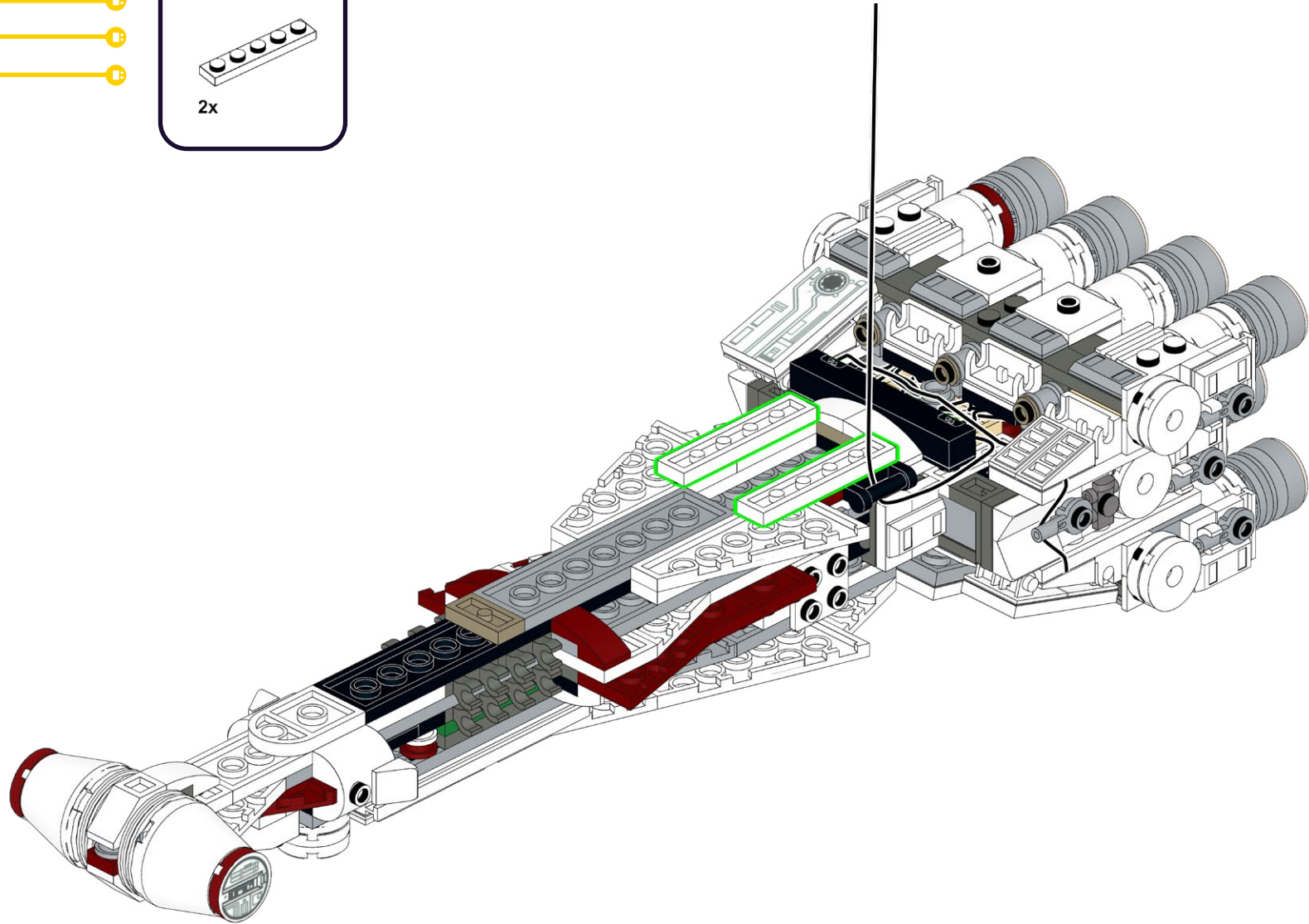

168

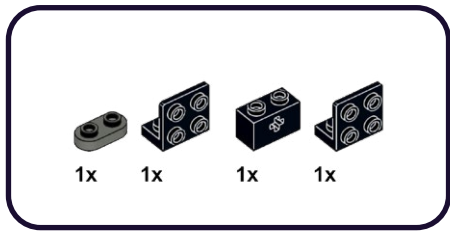

1

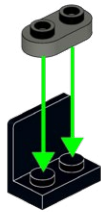

2

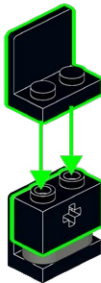

169

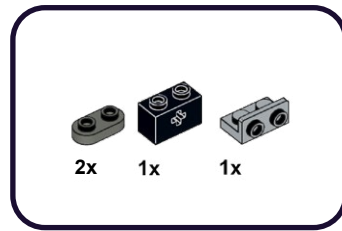

1



2

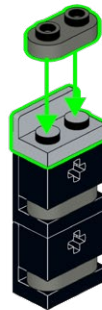

170

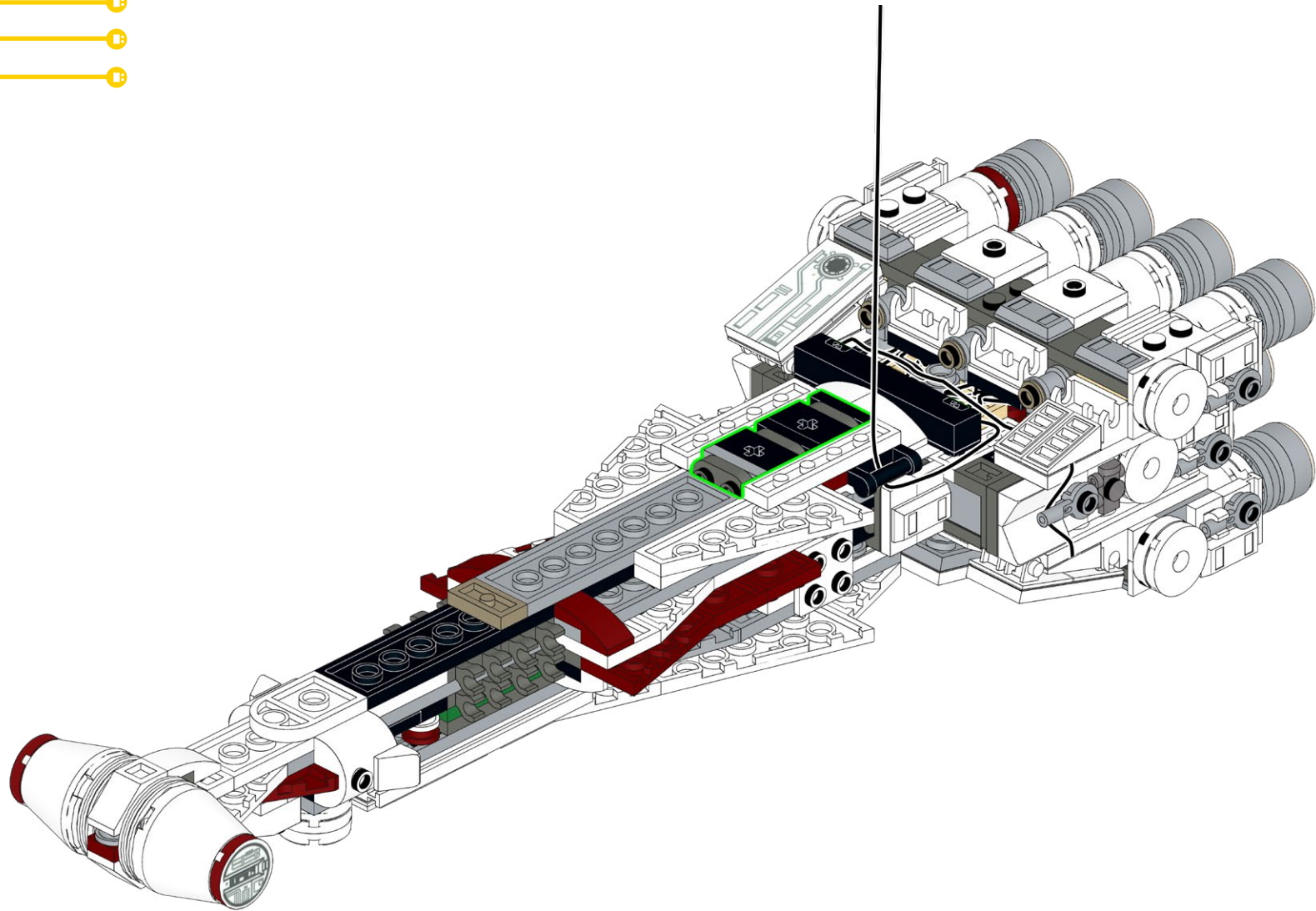

171

2x

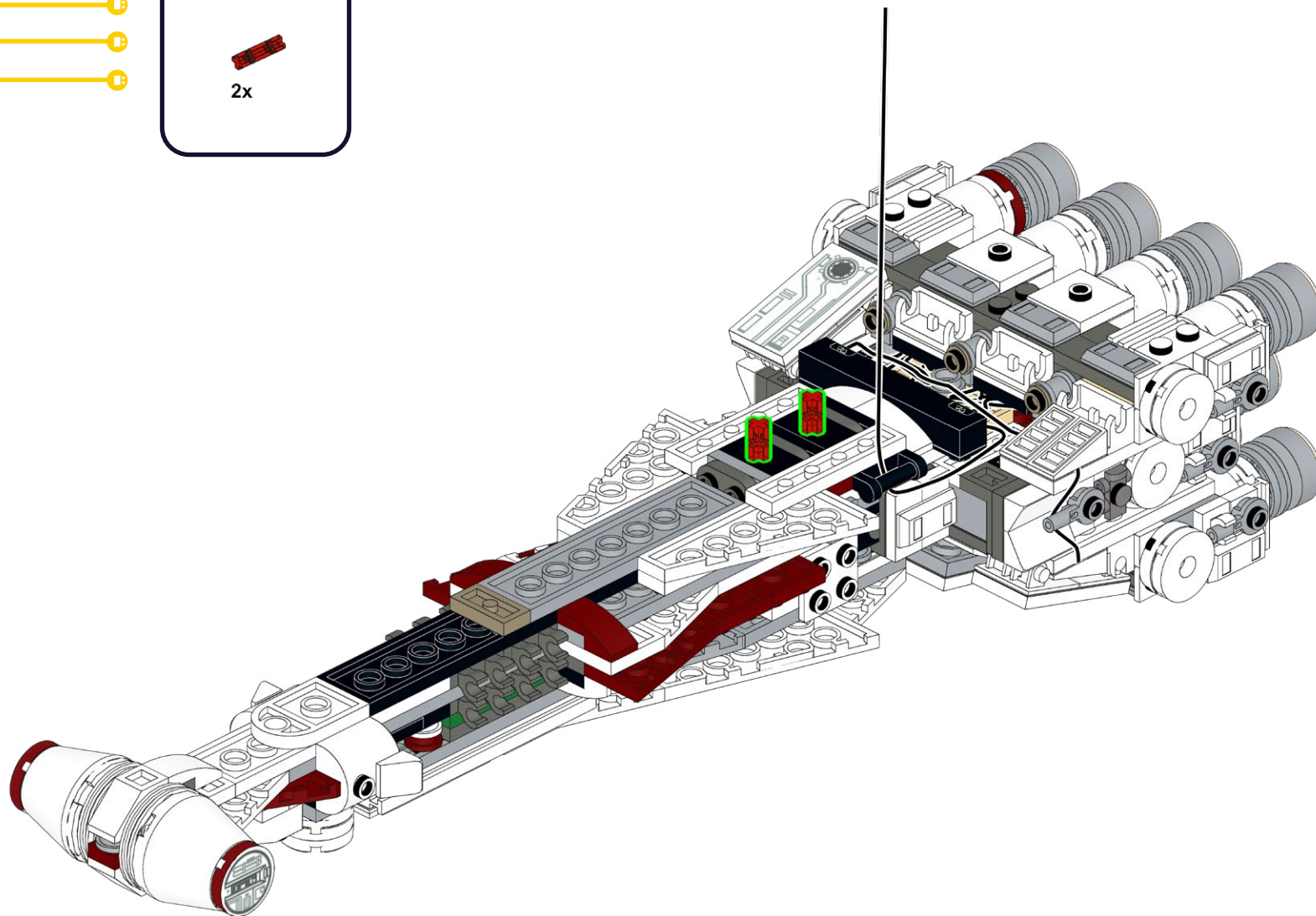

172

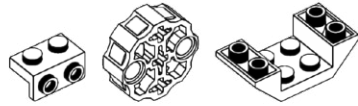

1x

1x

1x

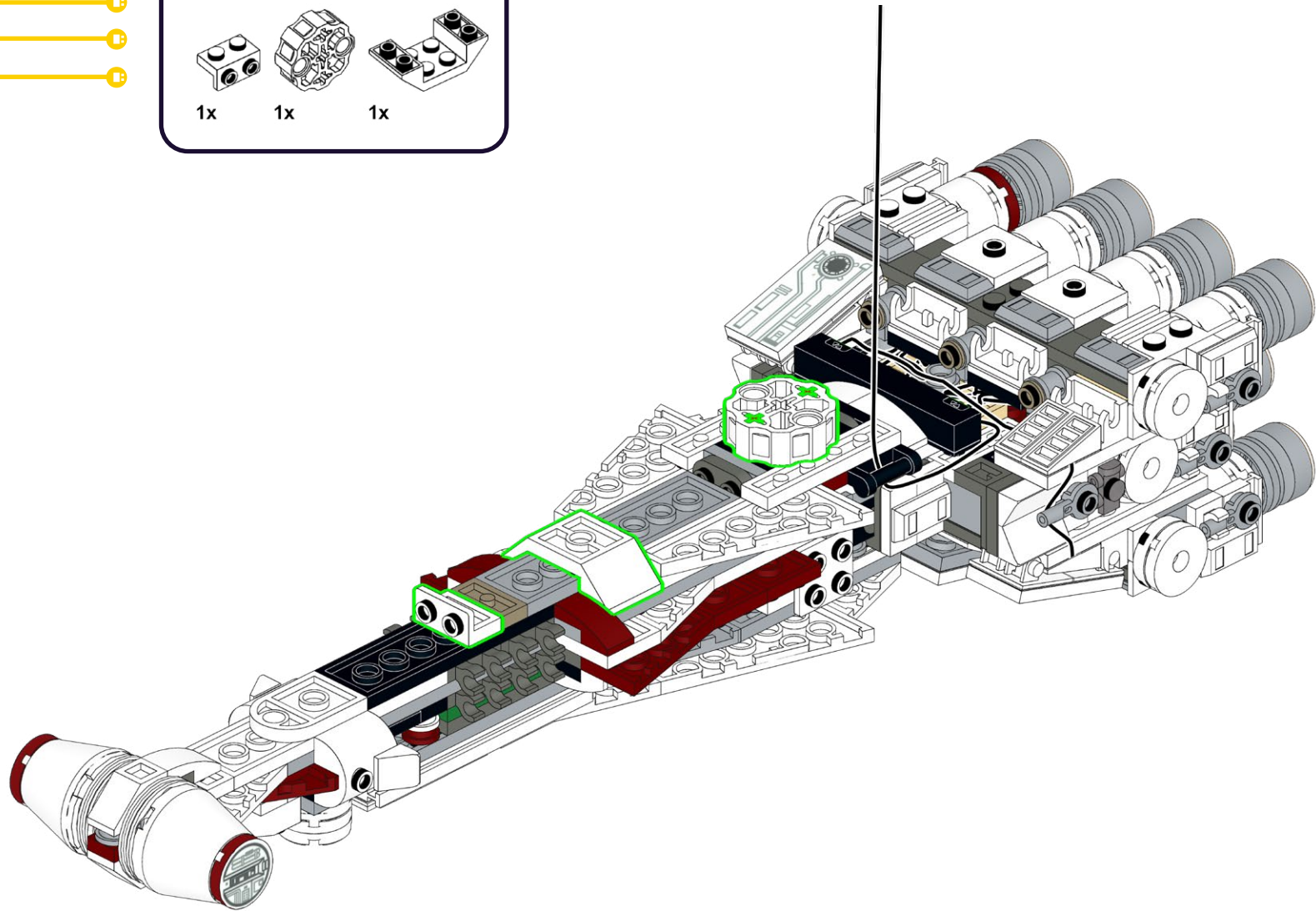

173

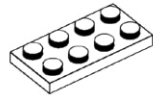

1x

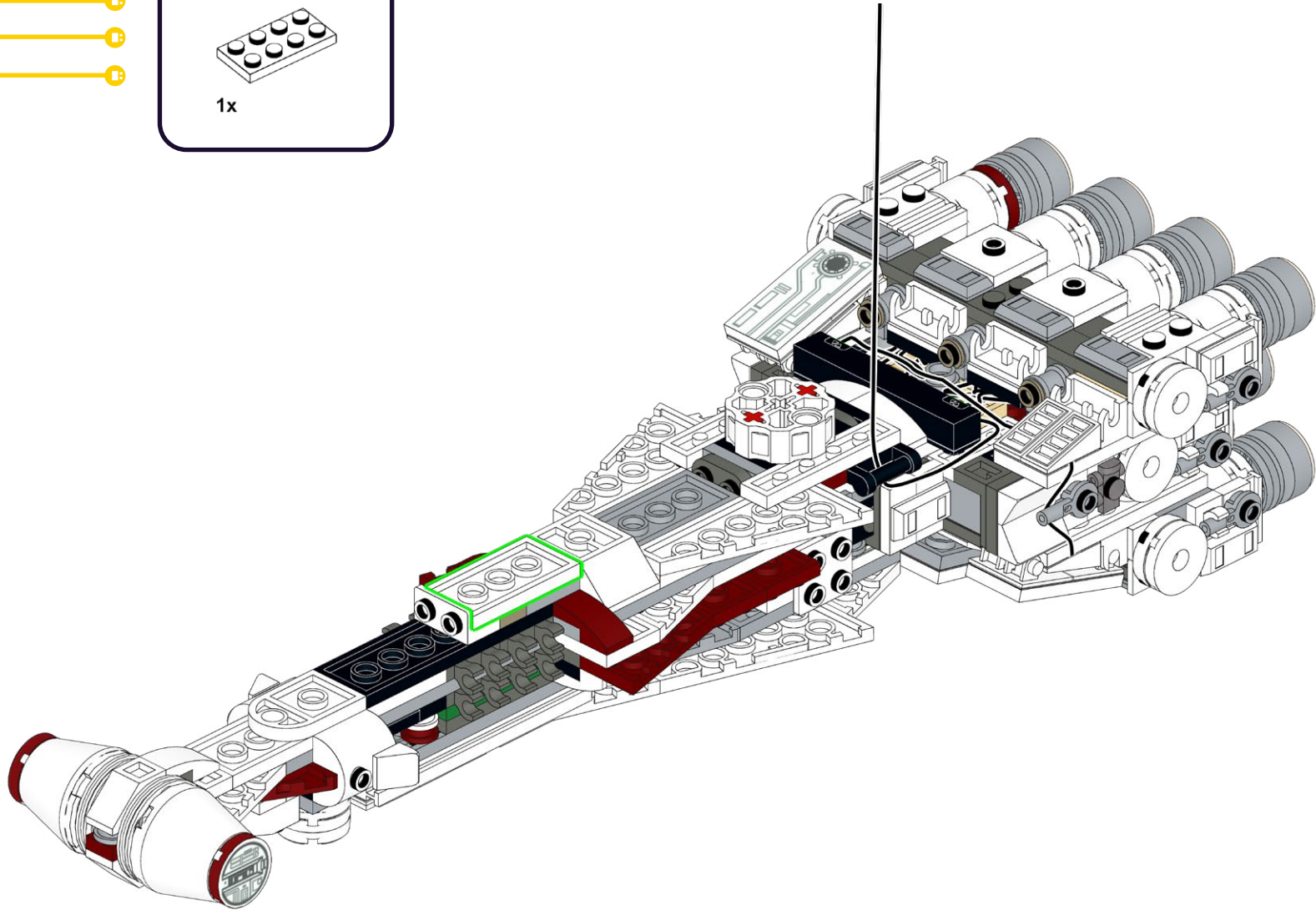

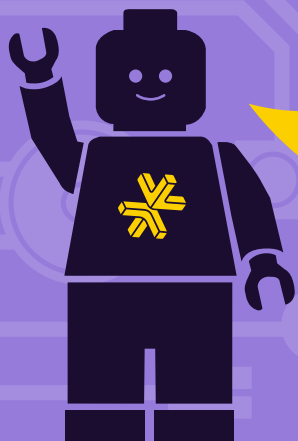
**HOLD UP!**

You might notice some bags aren't in order, as well as left over pieces, but that's ok! We're changing the way you build LEGO!

ATTENDEZ!

Vous remarquerez peut-être que certains sacs, ainsi que certaines pièces, ne sont pas dans le bon ordre. Mais pas de panique! Nous changeons simplement la façon avec laquelle vous construisez vos LEGO!

ASPETTA!

Potresti notare che alcuni sacchetti non sono in ordine, così come i pezzi avanzati, ma va bene così! Stiamo cambiando il modo in cui costruisci i LEGO!

HALT!

Sie werden möglicherweise bemerken, dass einige tüten durcheinander sind und teile übrig bleiben, aber das ist in Ordnung! Wir ändern die art und weise, wie Sie LEGO bauen!

¡ESPERA!

Es posible que notes que algunas bolsas están fuera de servicio, así como piezas sobrantes, ¡pero está bien! ¡Estamos cambiando la forma en que construyes LEGO!

暫停!

你可能会注意到一些袋子顺序错乱, 以及一些剩余的部件, 但没关系! 我们正在改变你搭建乐高的方式!

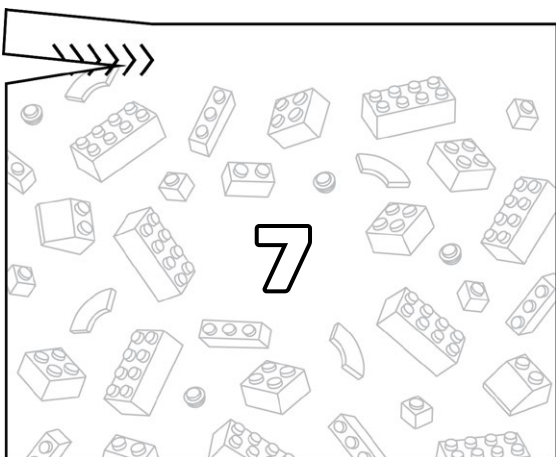
Open LEGO® Bag 7

174

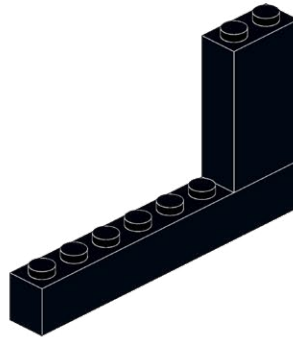
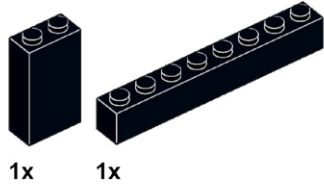

175

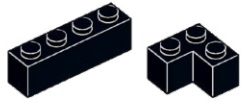

1x

1x

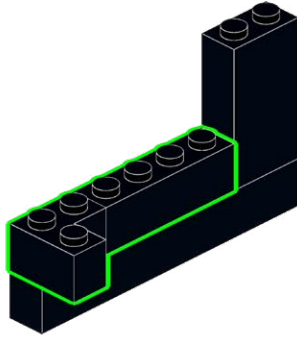

176

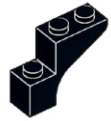

1x

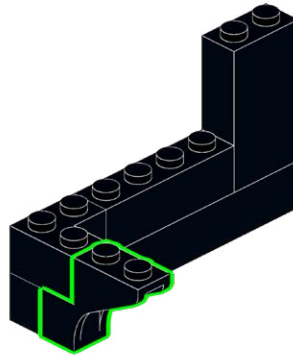

177

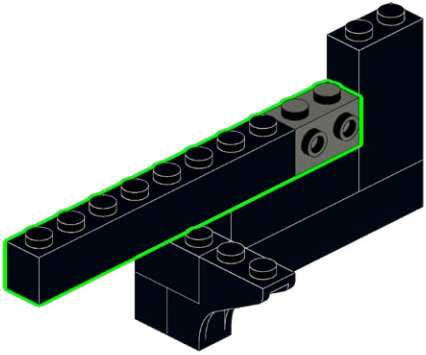
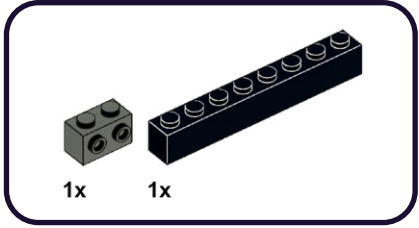

178

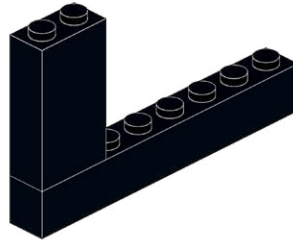

179

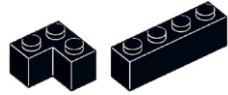

1x

1x

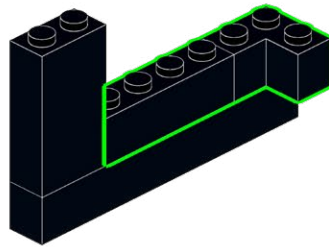

180

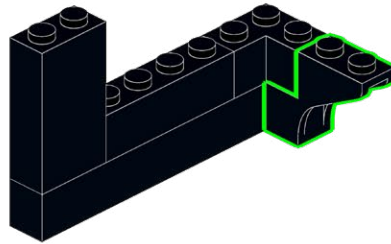
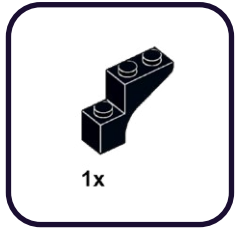

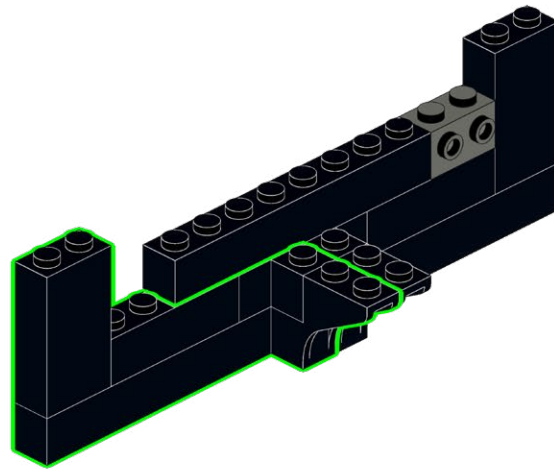

182

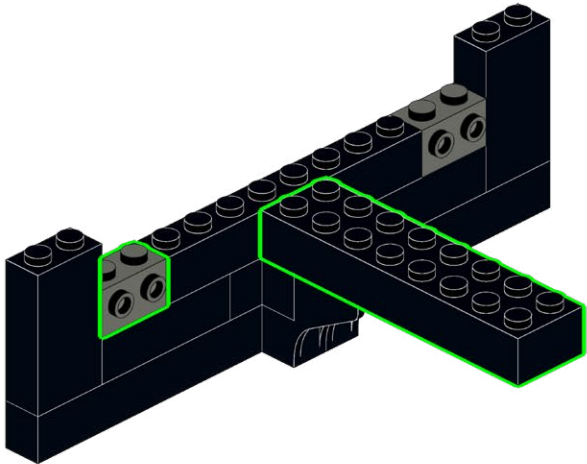
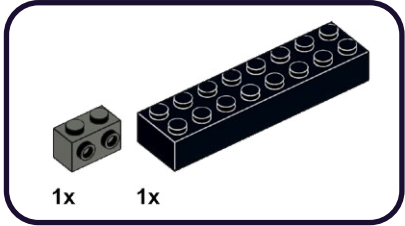

183

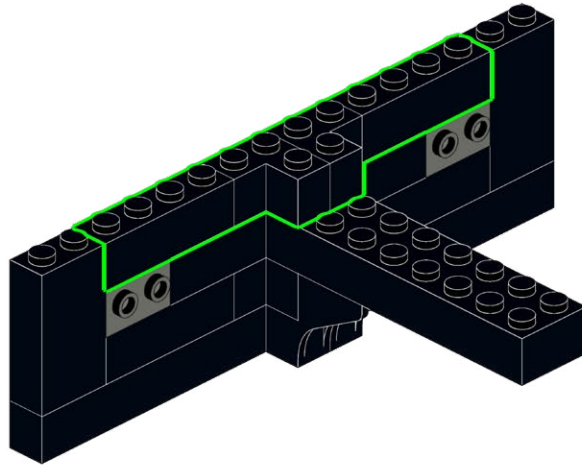
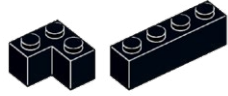

184

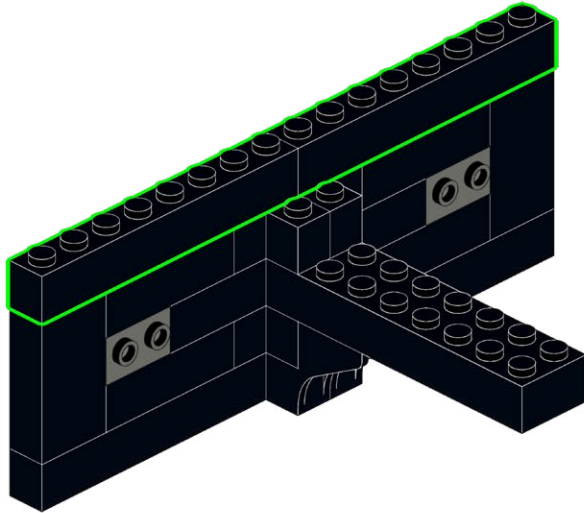
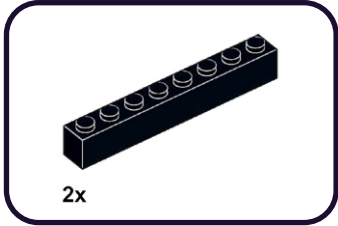

185

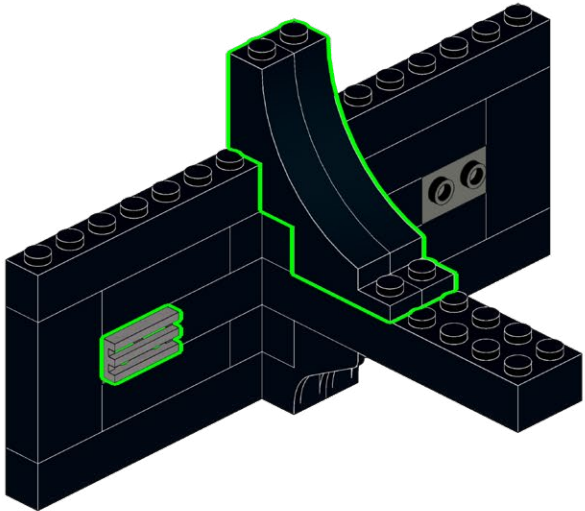
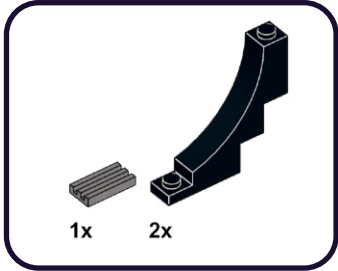

186

1x

2x

2x

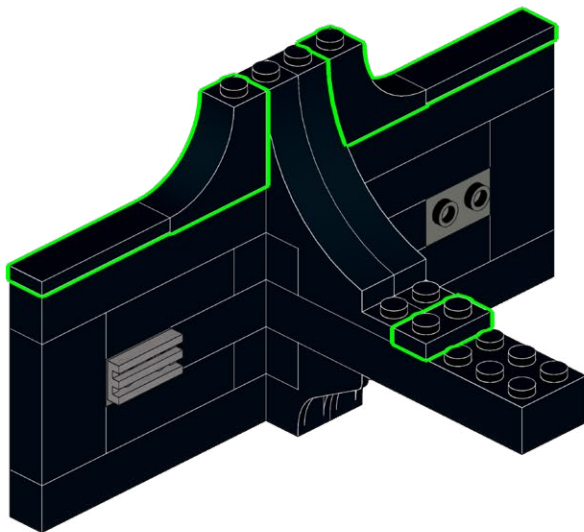

187

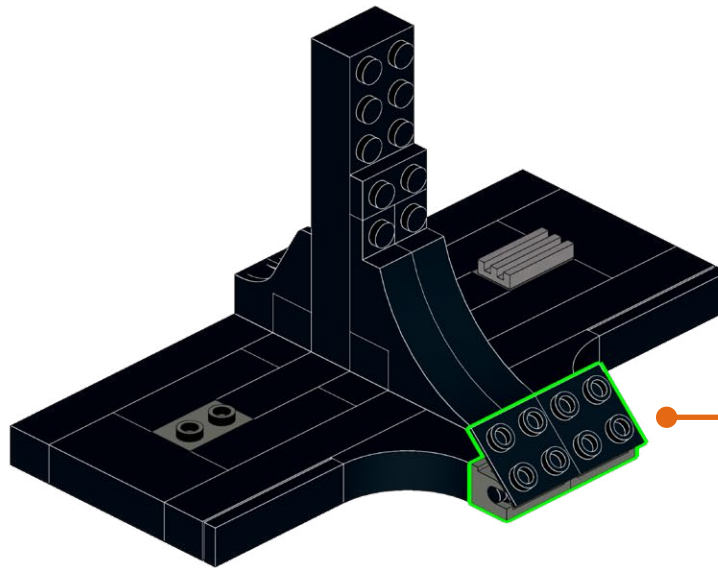
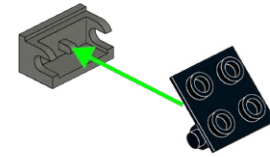
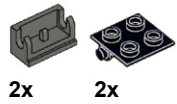

188

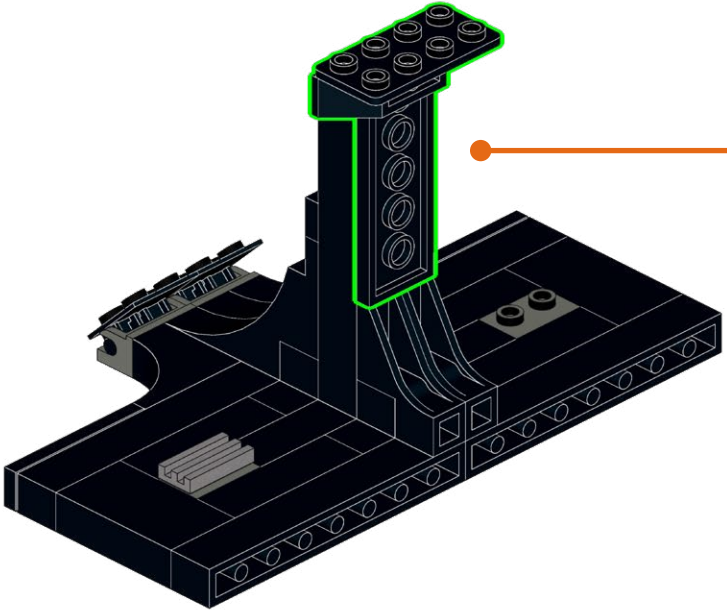
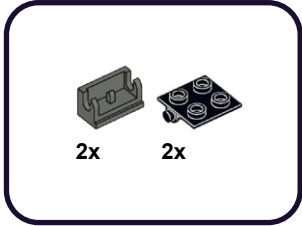

189

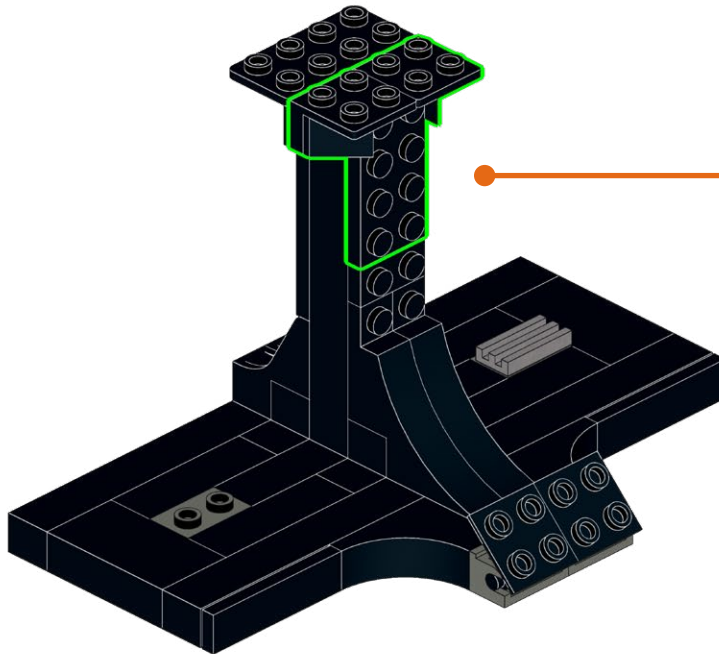
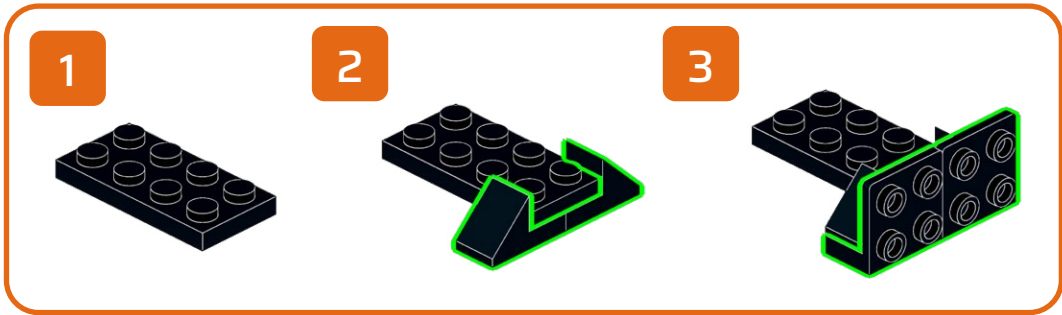
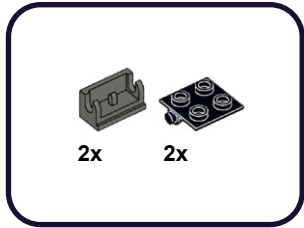

190

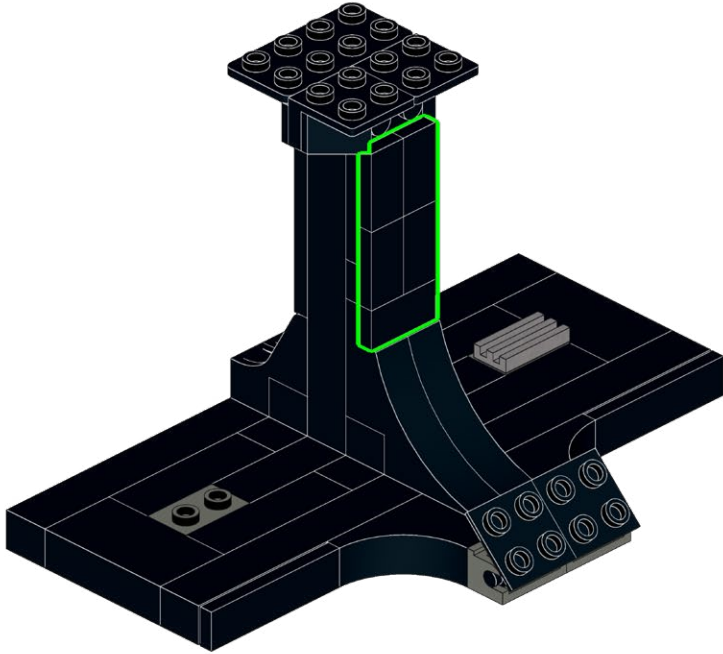
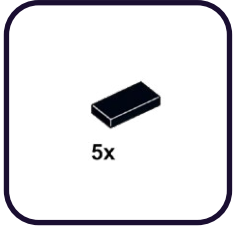



HOLD UP!

You might notice some bags aren't in order, as well as left over pieces, but that's ok! We're changing the way you build LEGO!

ATTENDEZ!

Vous remarquerez peut-être que certains sacs, ainsi que certaines pièces, ne sont pas dans le bon ordre. Mais pas de panique! Nous changeons simplement la façon avec laquelle vous construisez vos LEGO!

ASPETTA!

Potresti notare che alcuni sacchetti non sono in ordine, così come i pezzi avanzati, ma va bene così! Stiamo cambiando il modo in cui costruisci i LEGO!

HALT!

Sie werden möglicherweise bemerken, dass einige tüten durcheinander sind und teile übrig bleiben, aber das ist in Ordnung! Wir ändern die art und weise, wie Sie LEGO bauen!

¡ESPERA!

Es posible que notes que algunas bolsas están fuera de servicio, así como piezas sobrantes, ¡pero está bien! ¡Estamos cambiando la forma en que construyes LEGO!

暫停!

你可能会注意到一些袋子顺序错乱, 以及一些剩余的部件, 但没关系! 我们正在改变你搭建乐高的方式!

Open LMB Bag 03

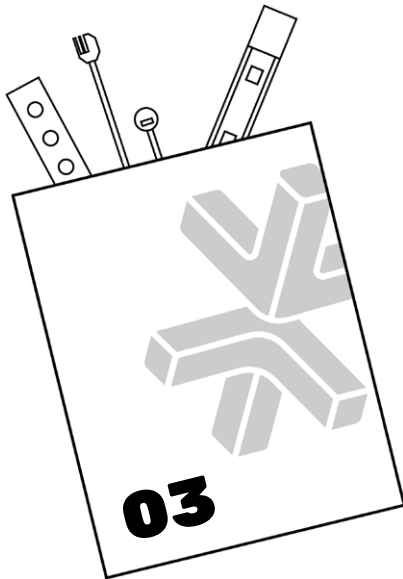

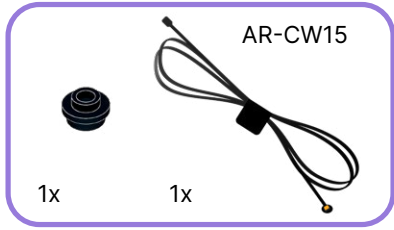

1



2

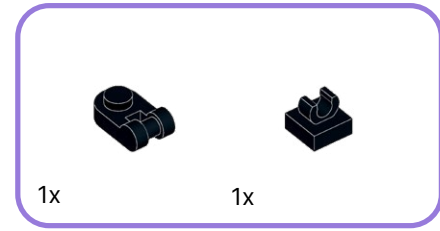

1



2



3



193

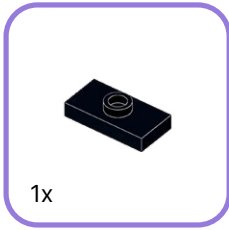

1



194

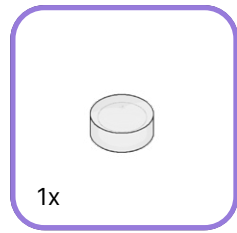

1

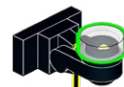

195

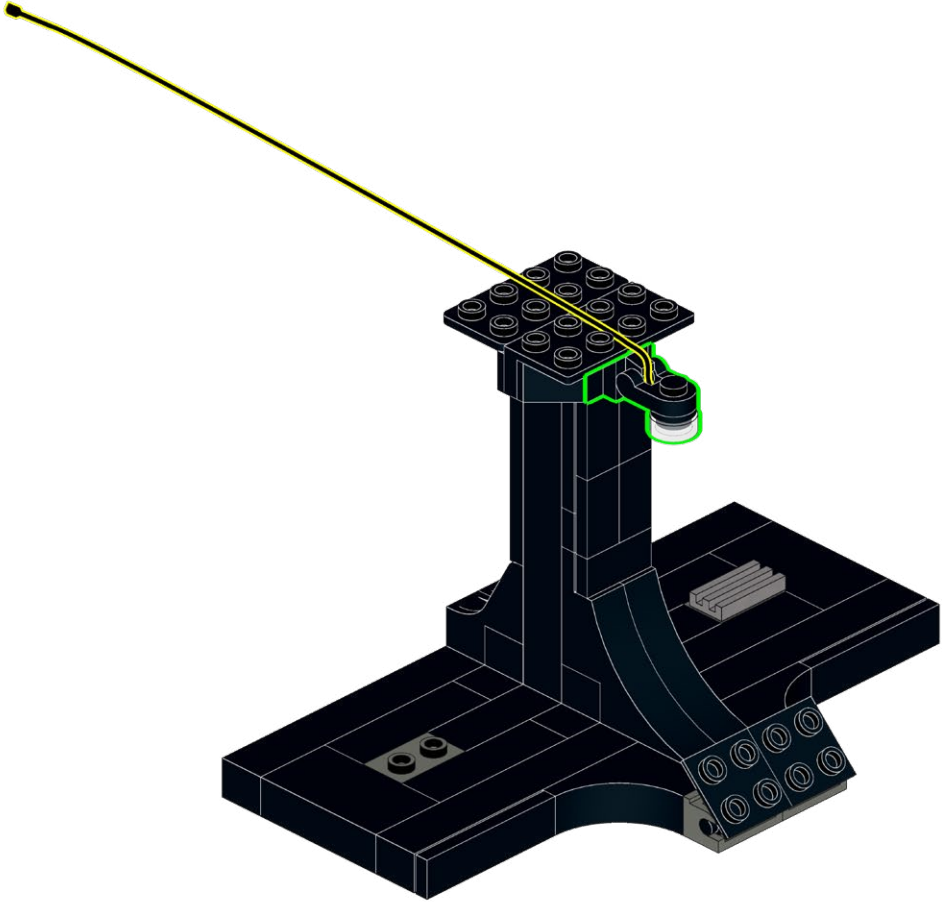

196

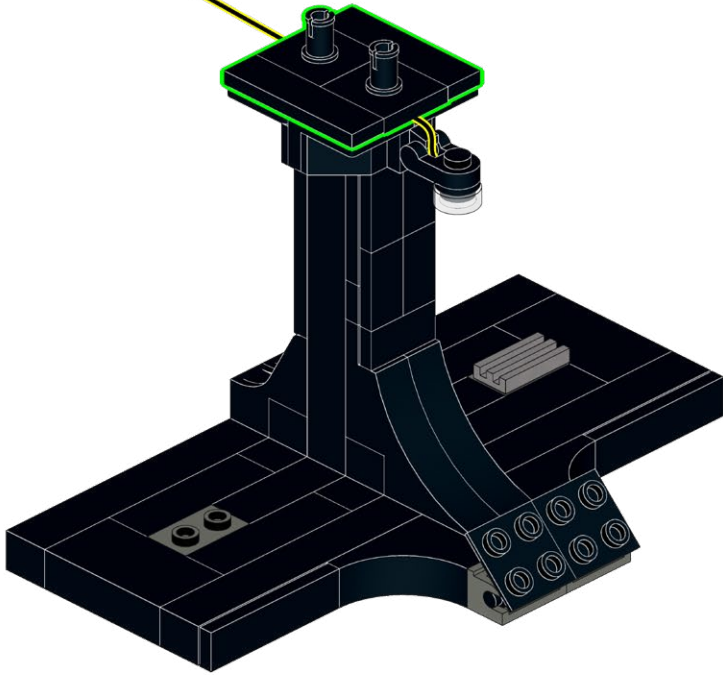
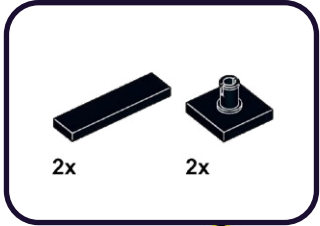

197

1x

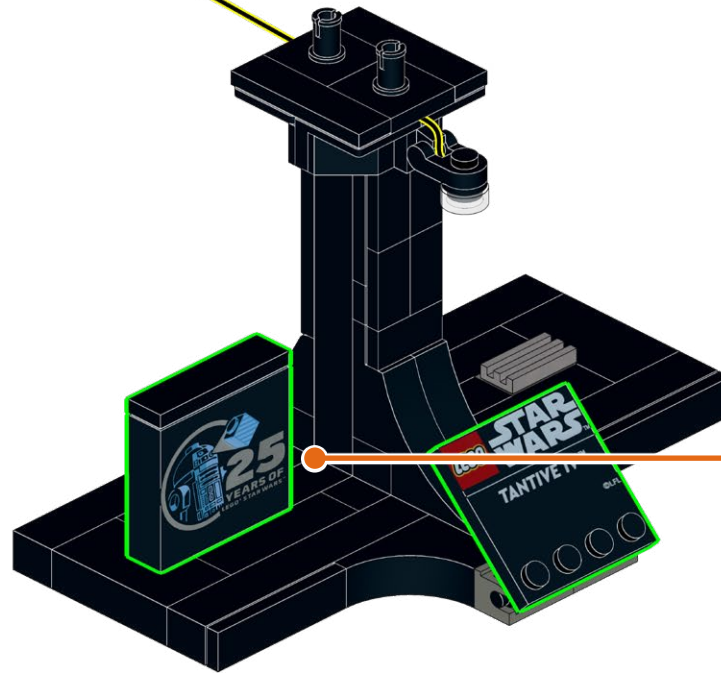

198

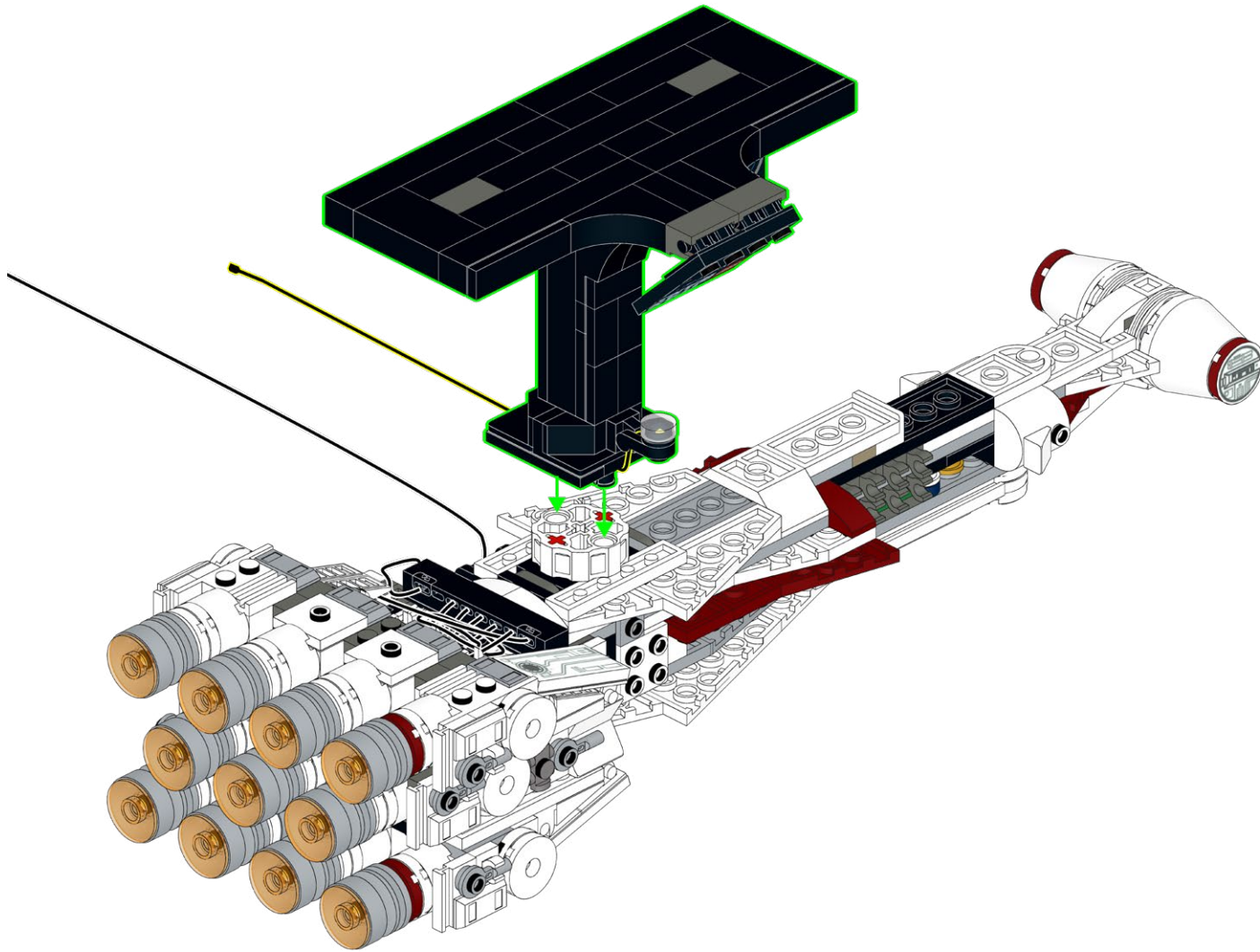

199

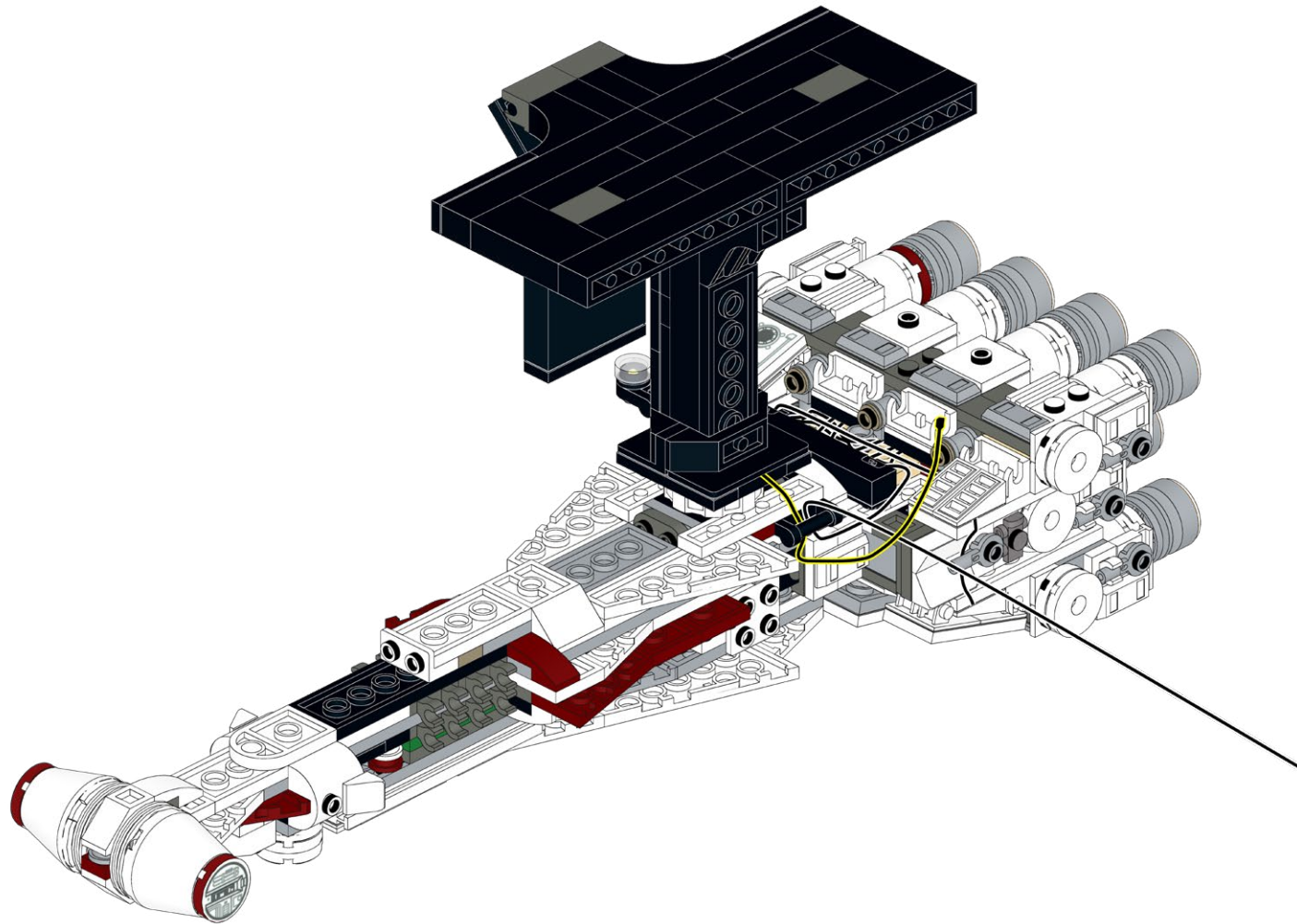

200

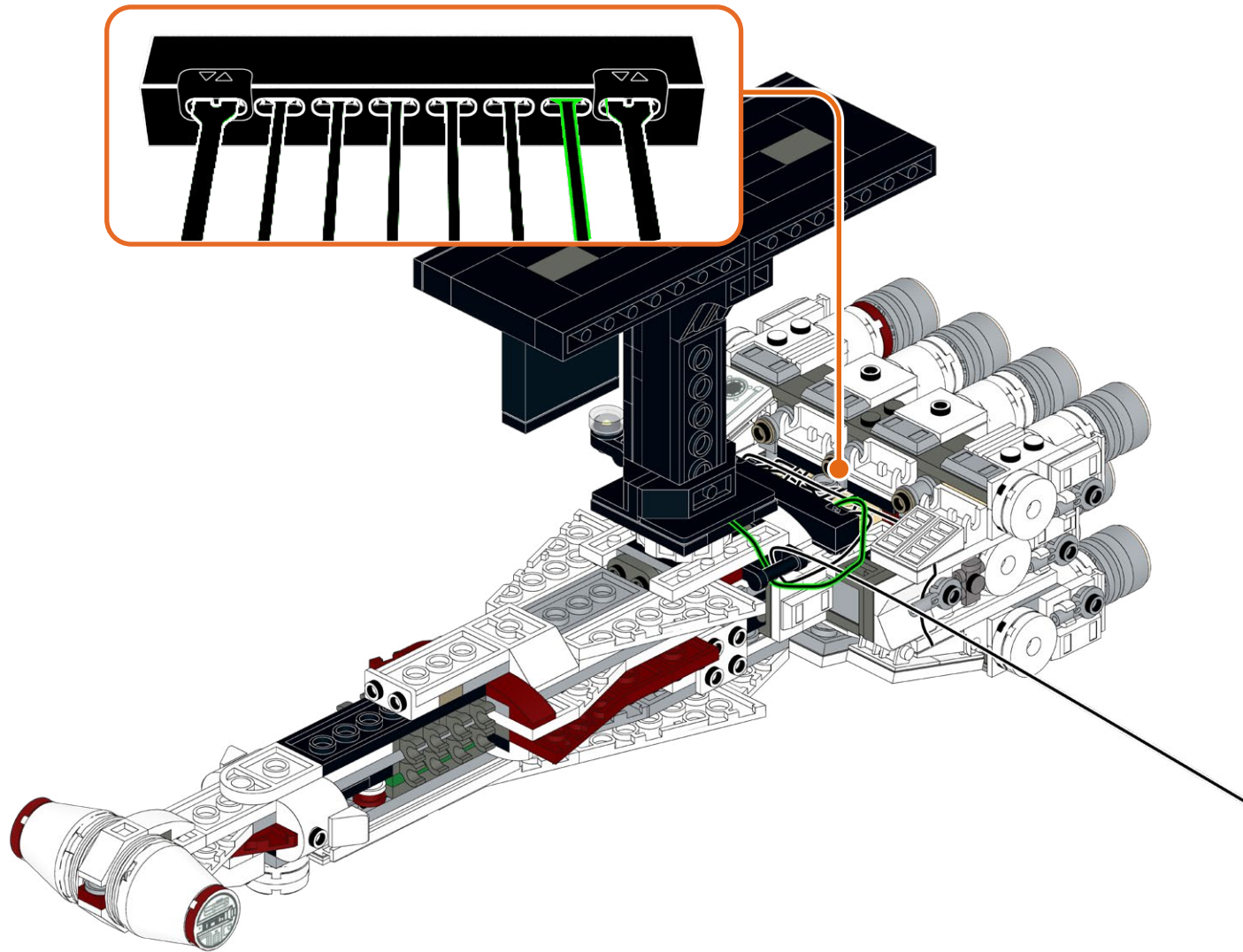

201

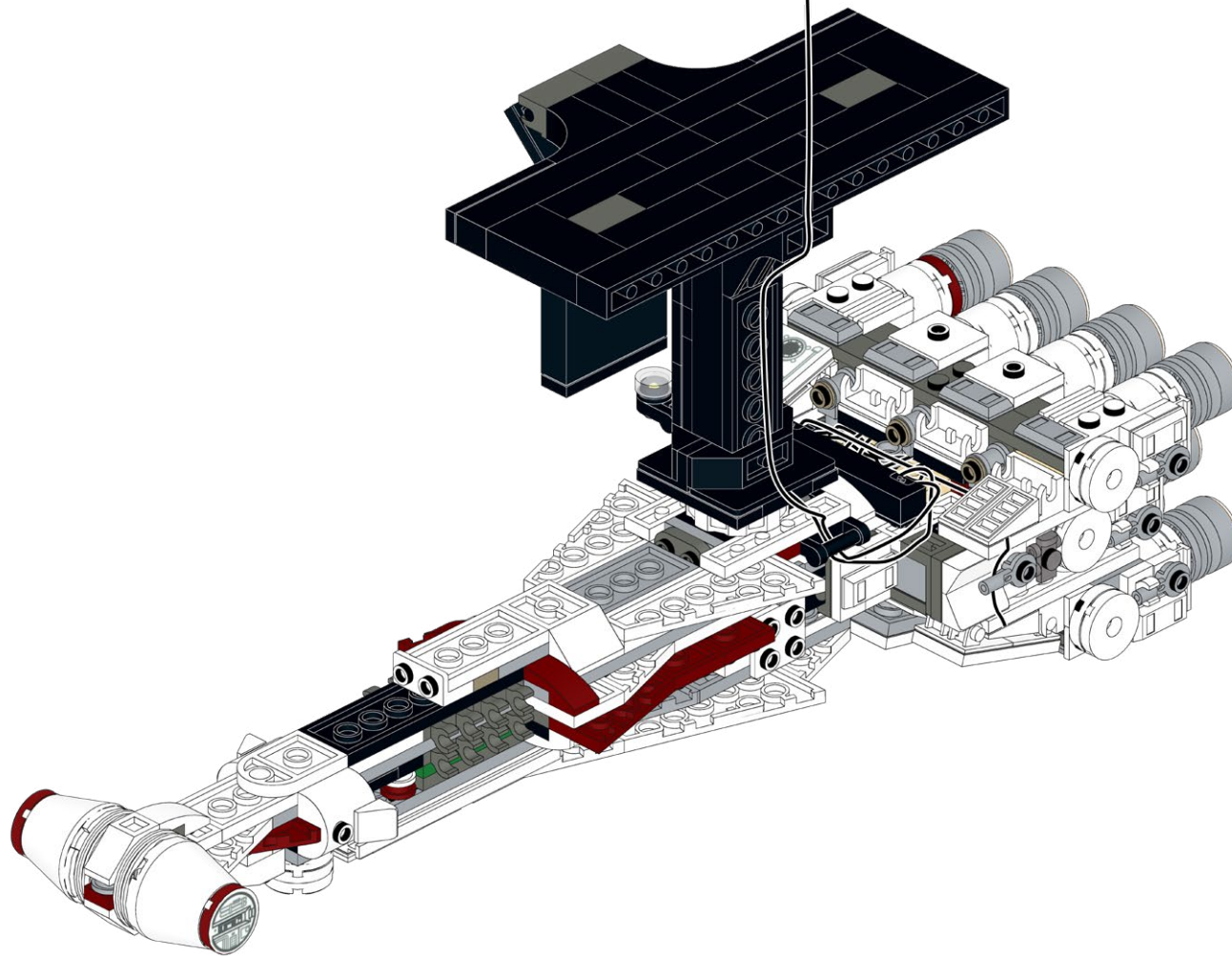

202



2x

1x

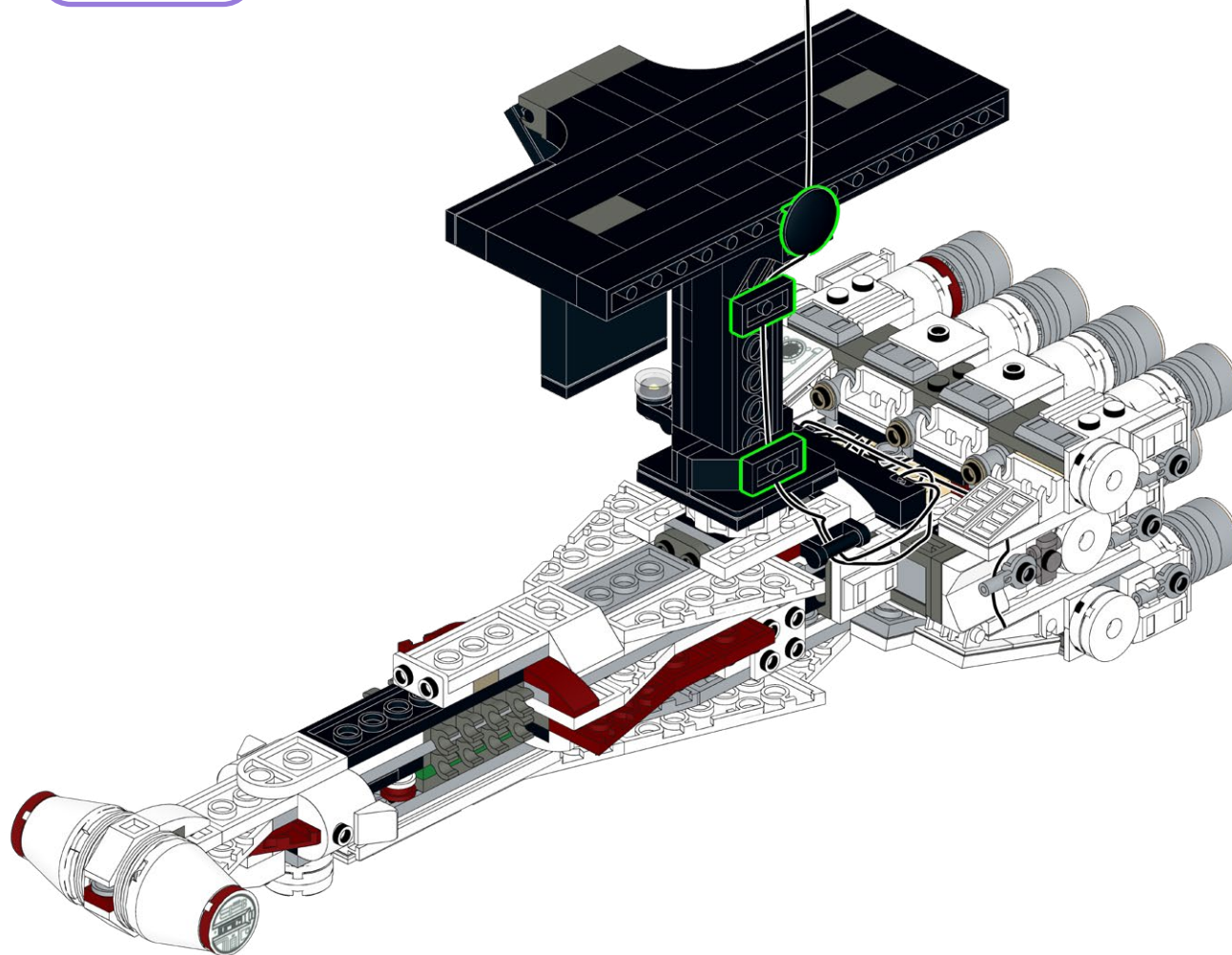

203

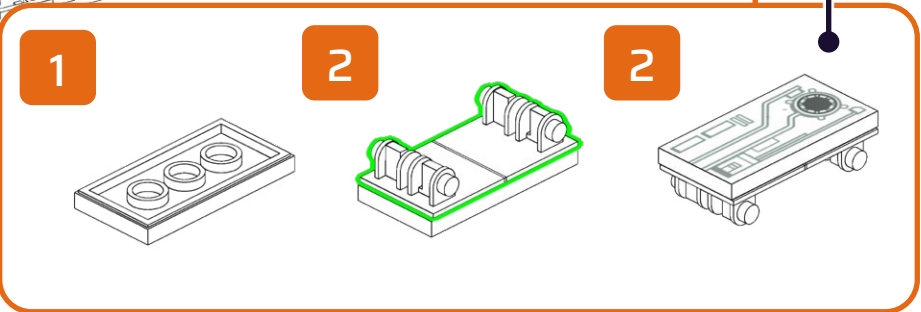
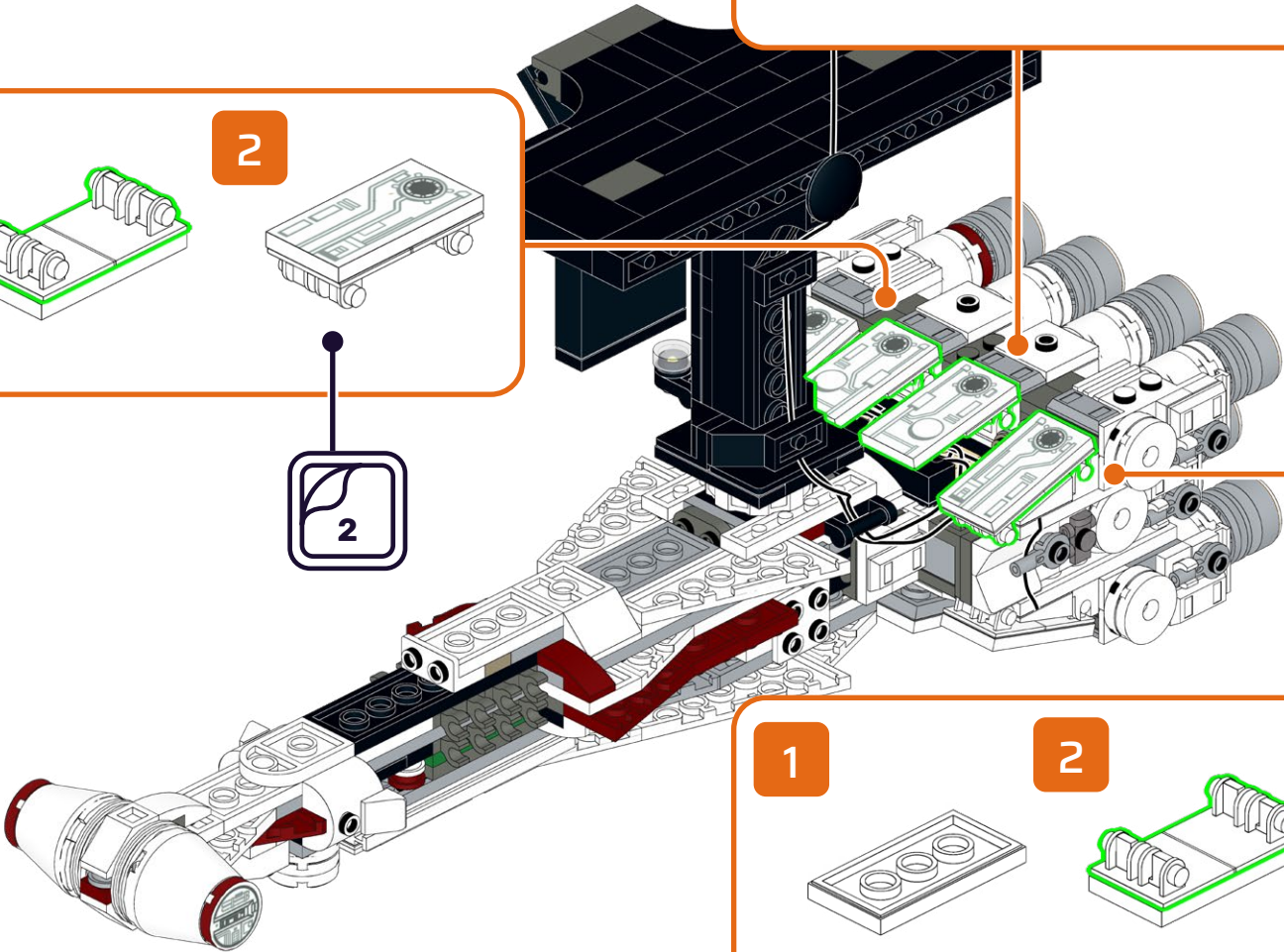
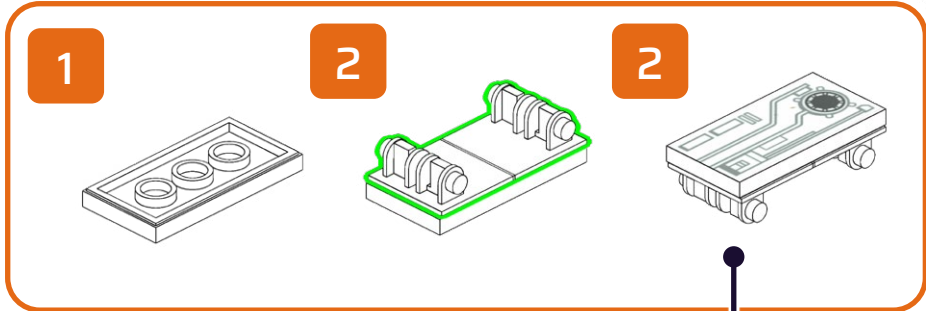
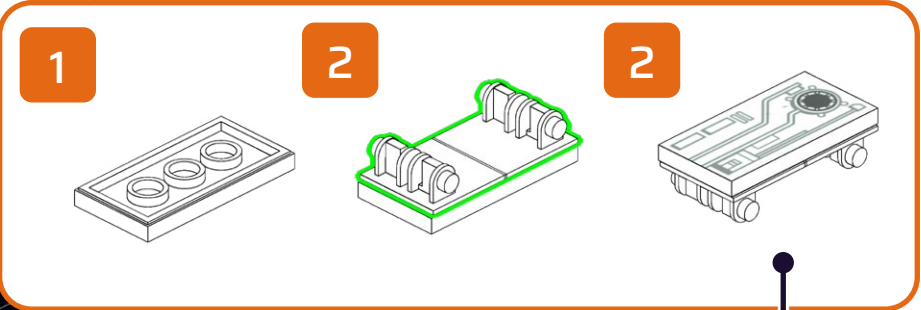
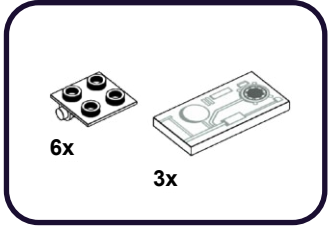

204

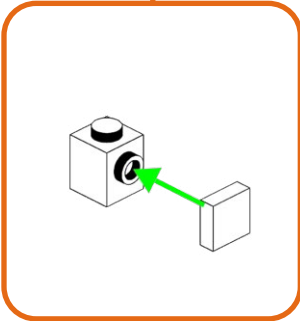
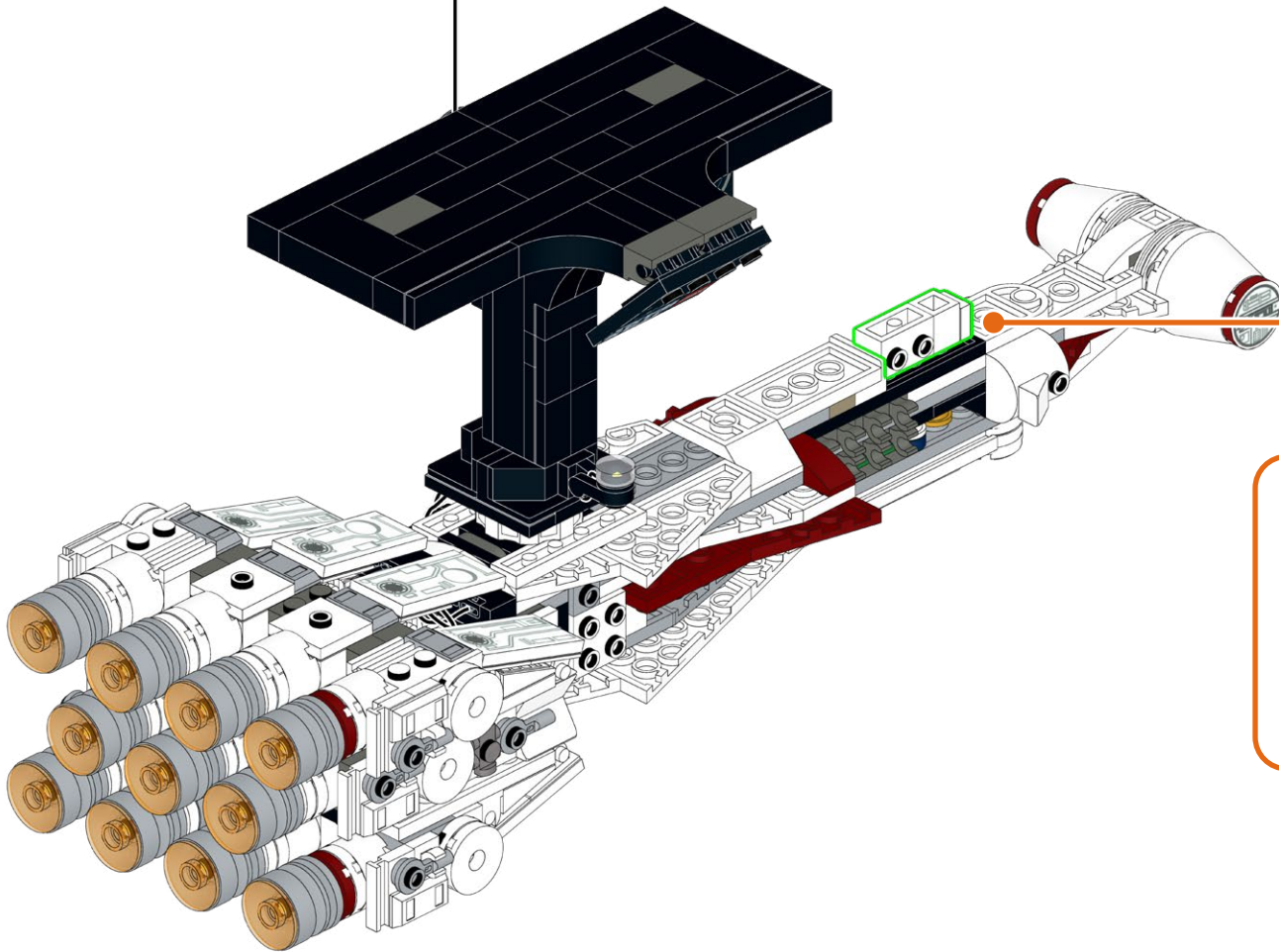
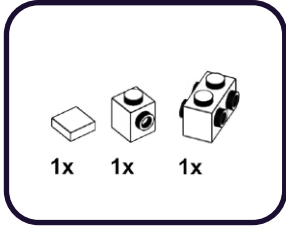

205

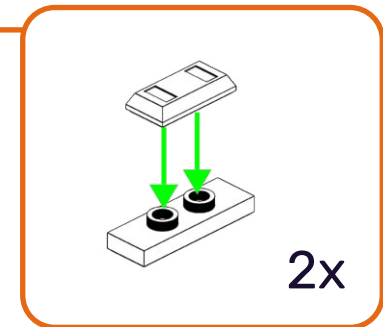
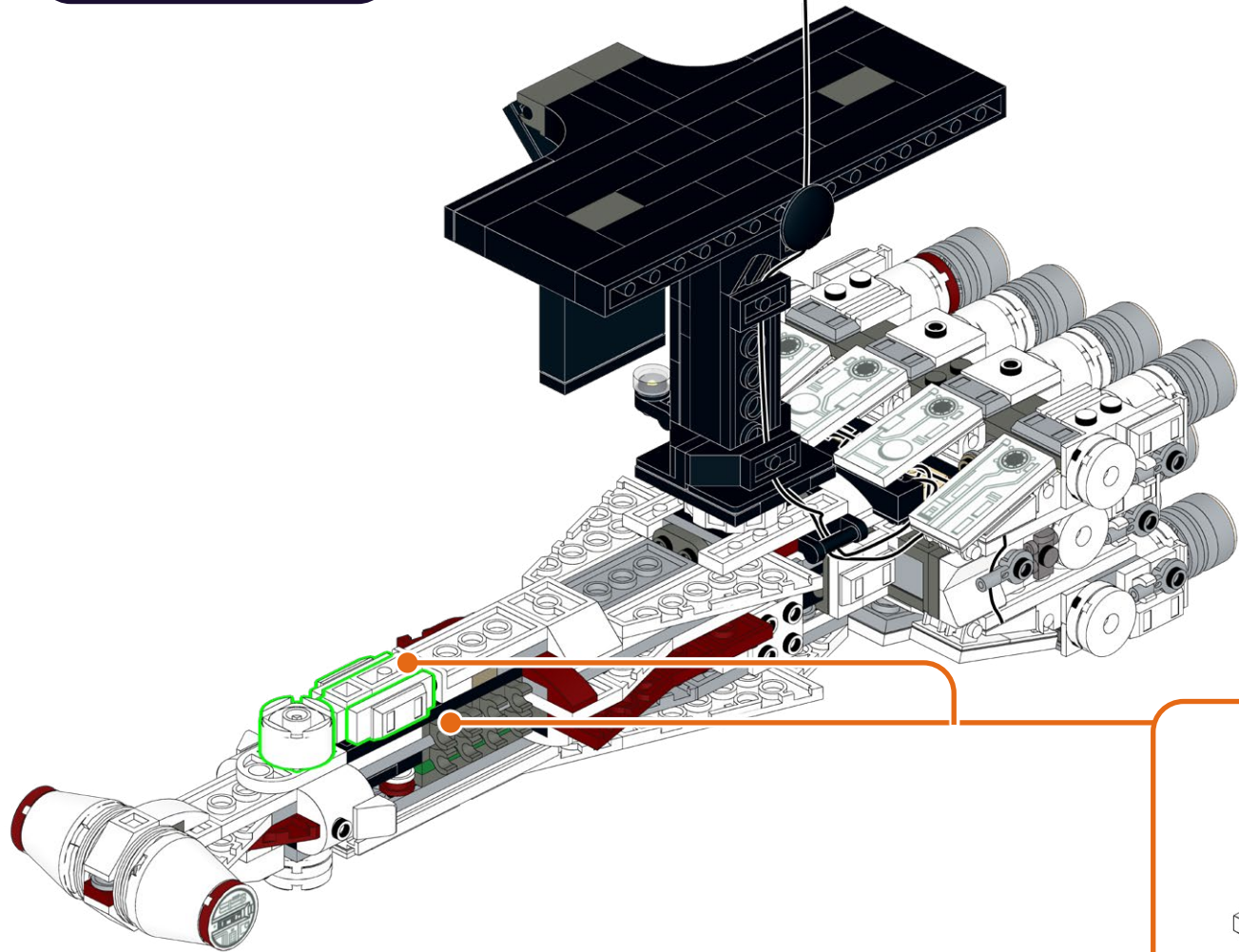
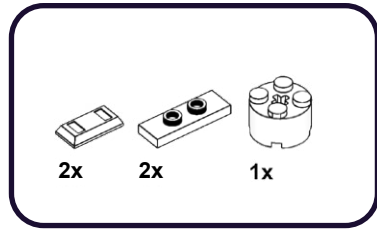

206

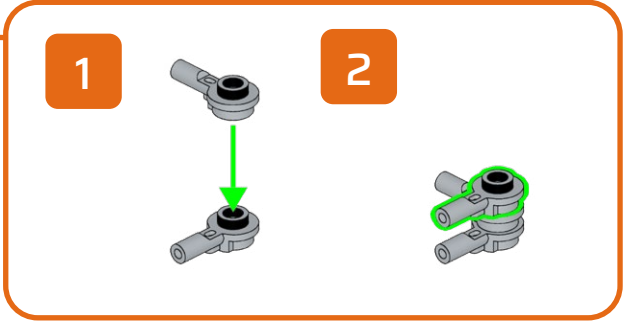
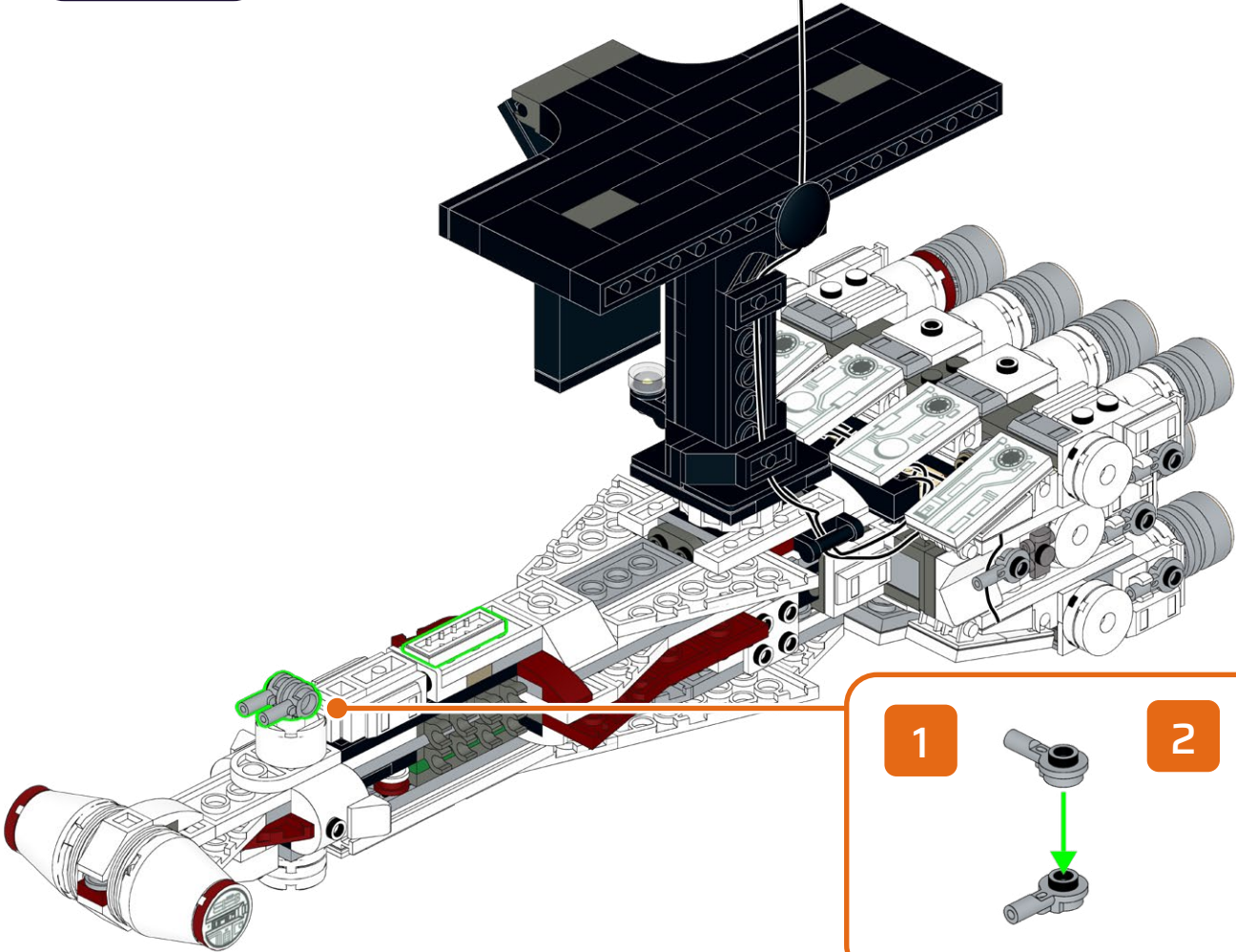
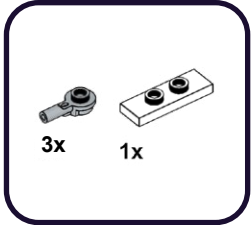

207

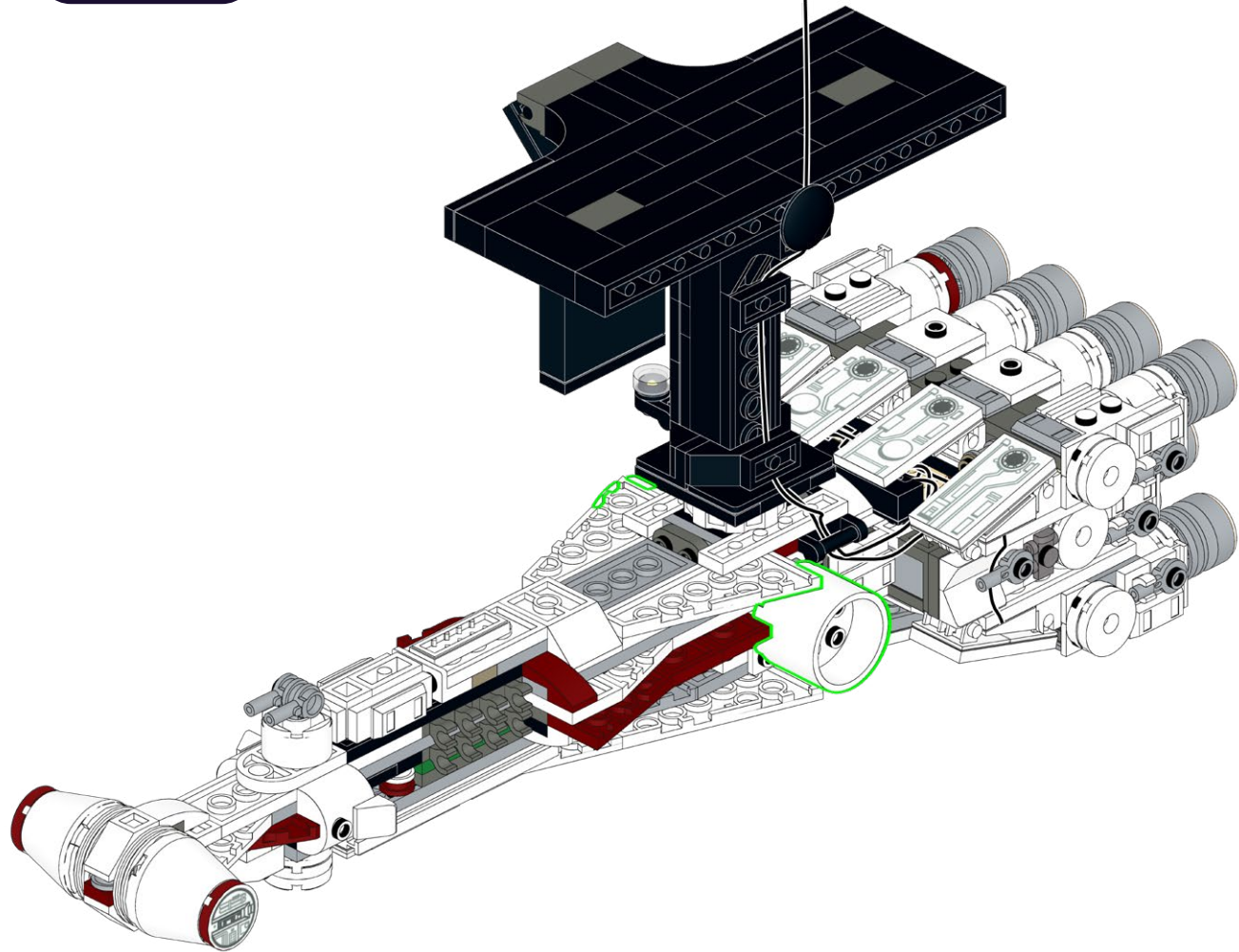
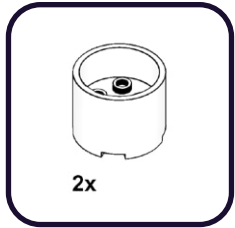

208

2x 2x 2x 2x

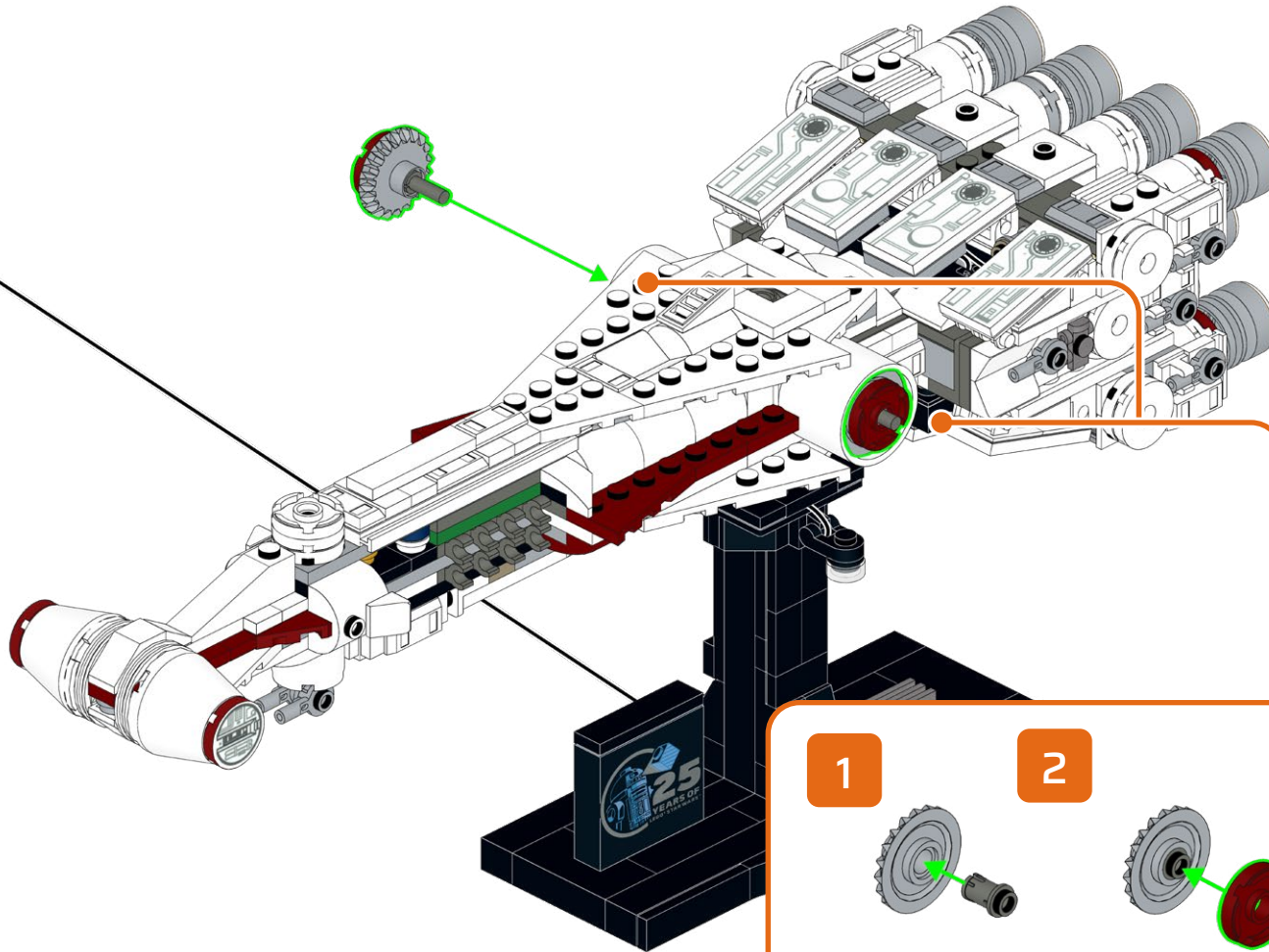

1

2

3

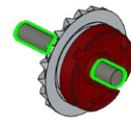
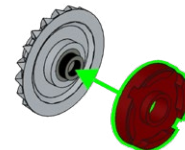
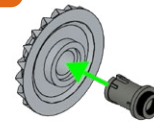

2x

209

1x

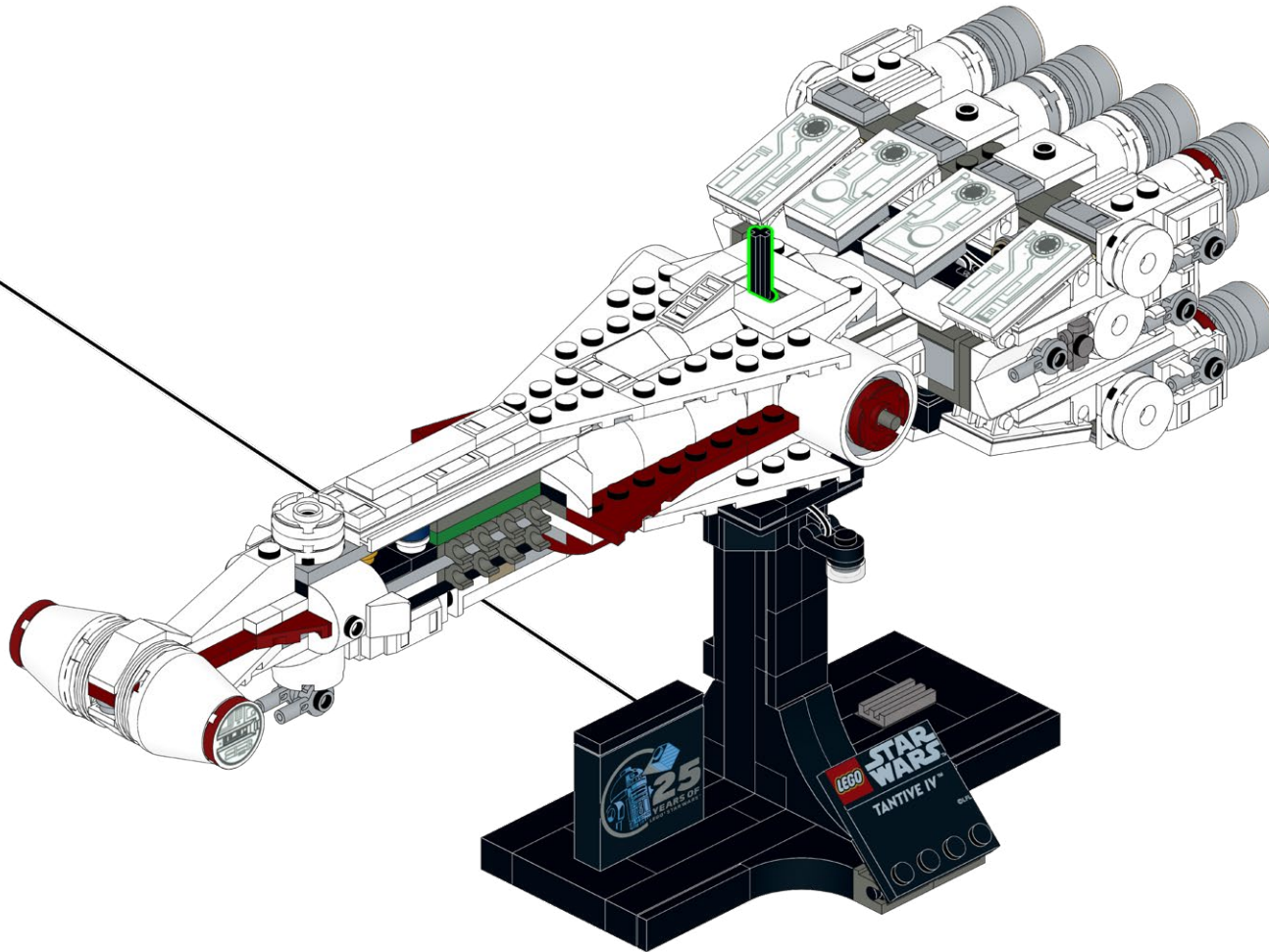

210



1x

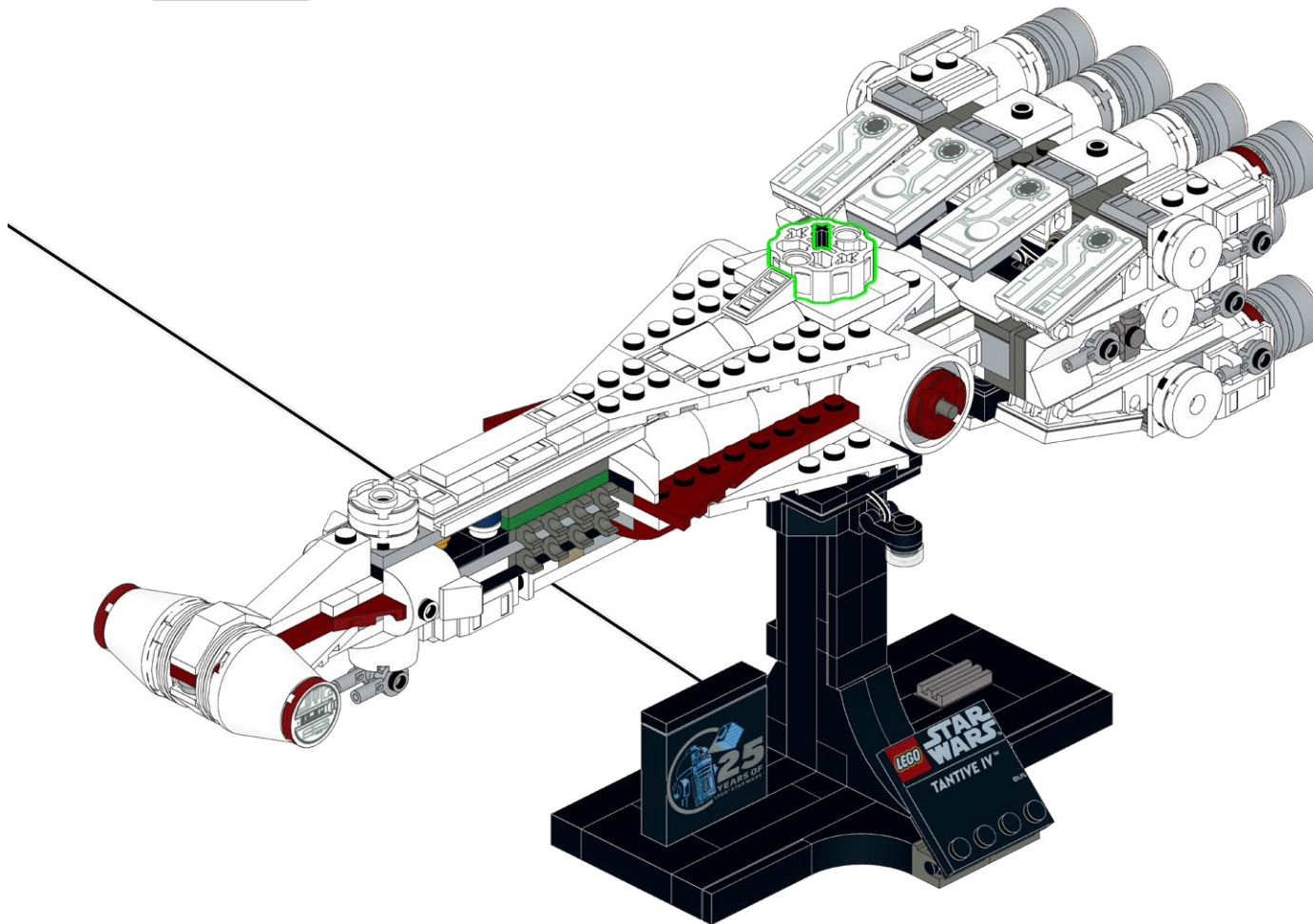

211

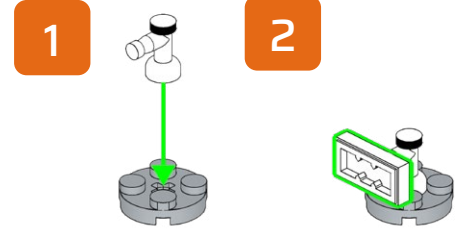
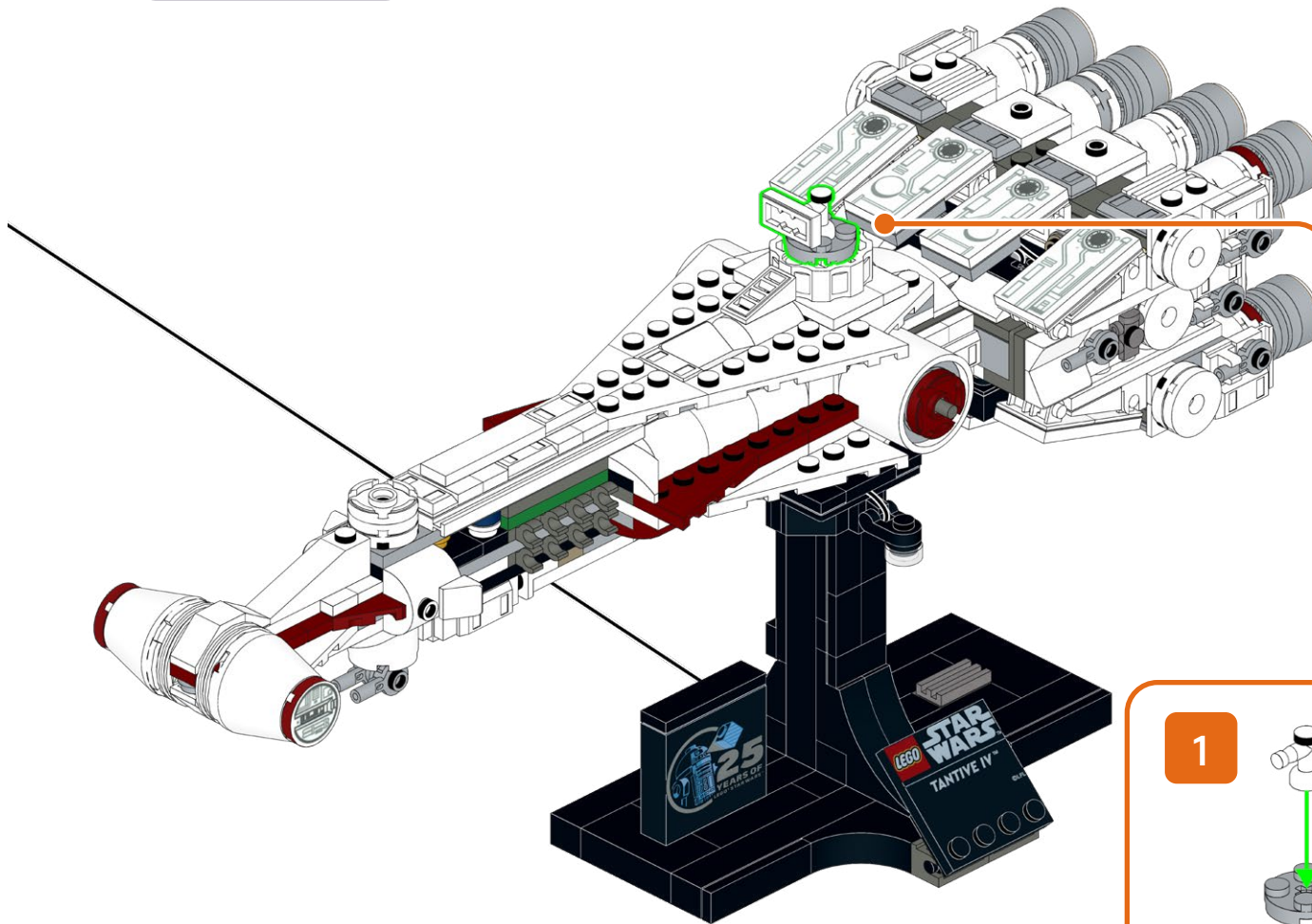
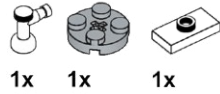

212

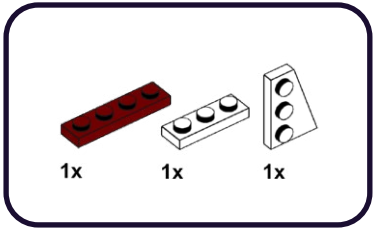

1

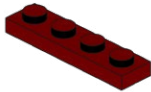

2

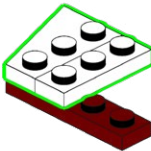

213

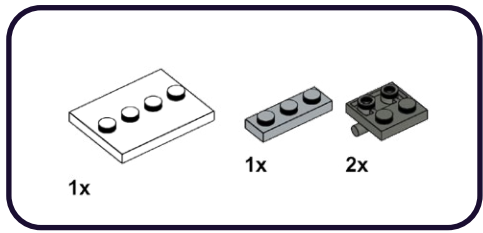

1

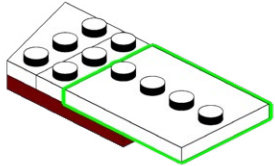

2

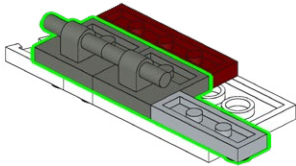

214

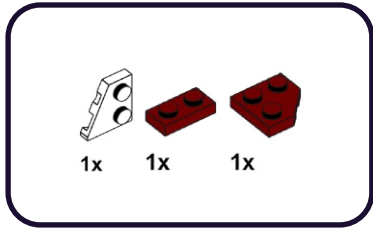

1

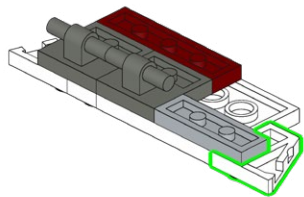

2

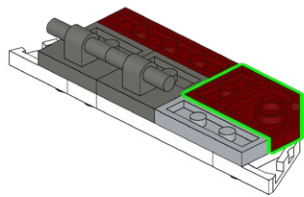

215

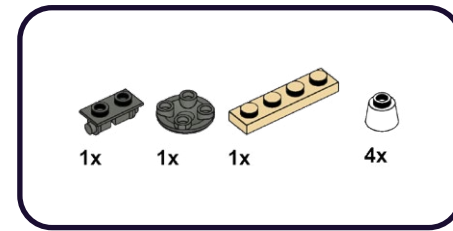

1

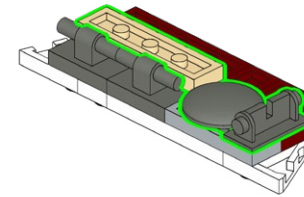

2

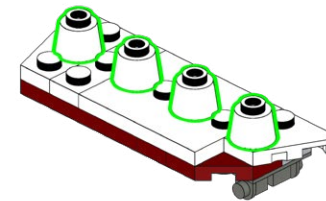

216

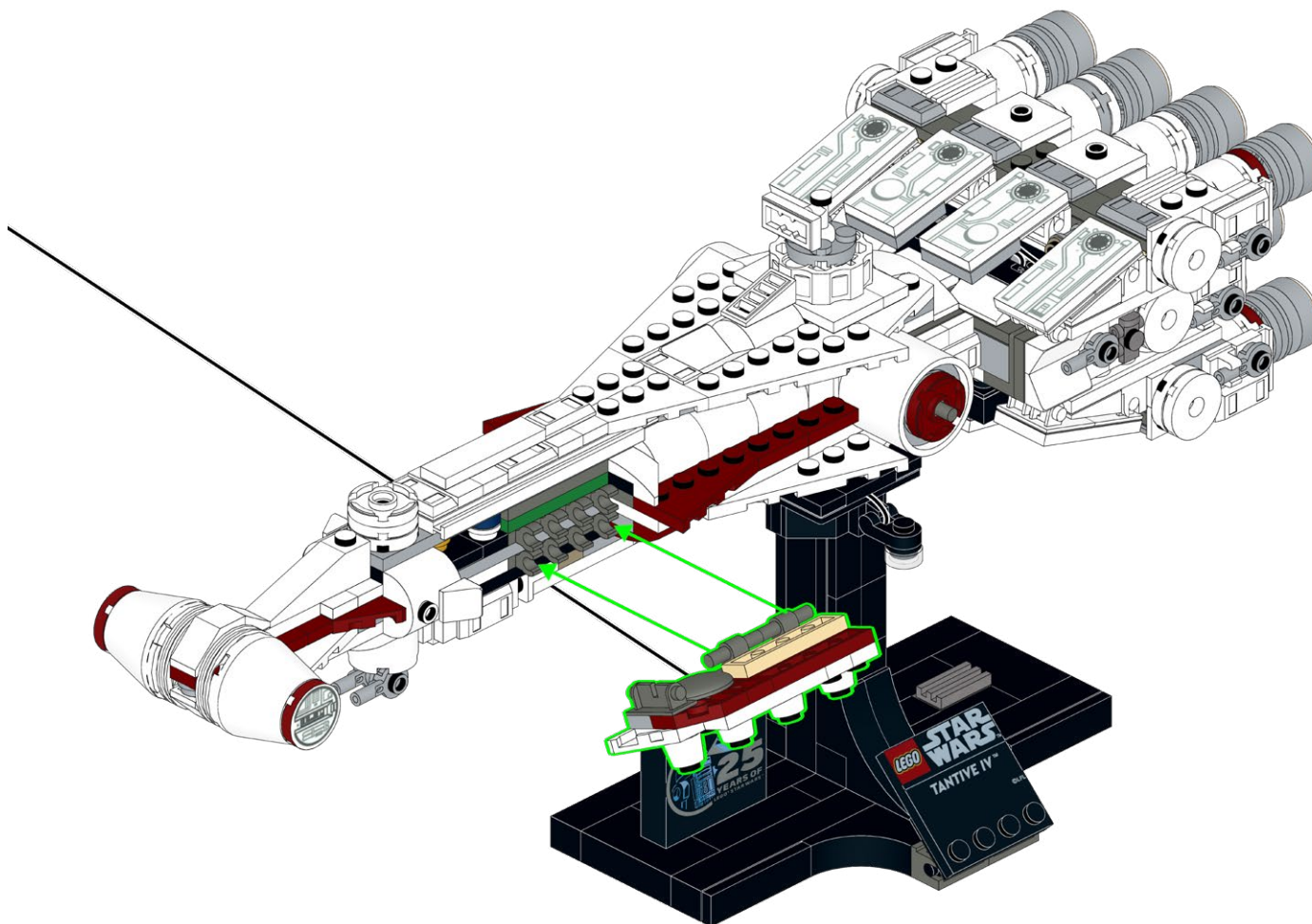

217

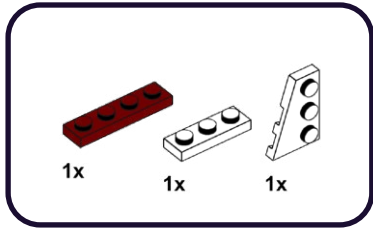

1

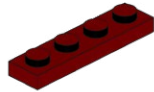

2

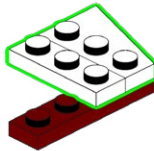

218

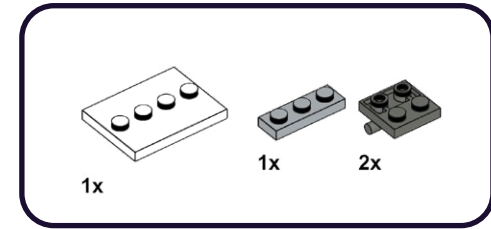

1

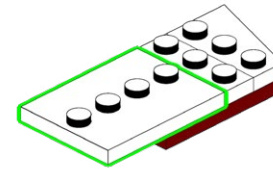

2

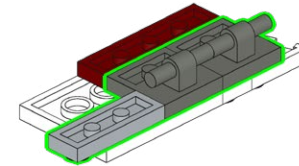

219

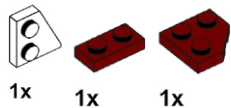

1

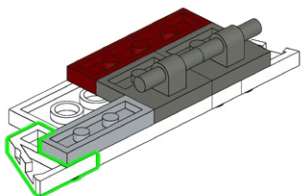

2

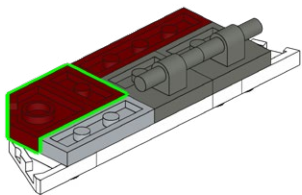

220

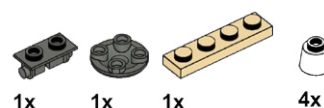

1

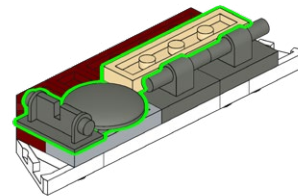

2

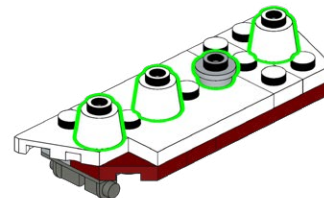

221

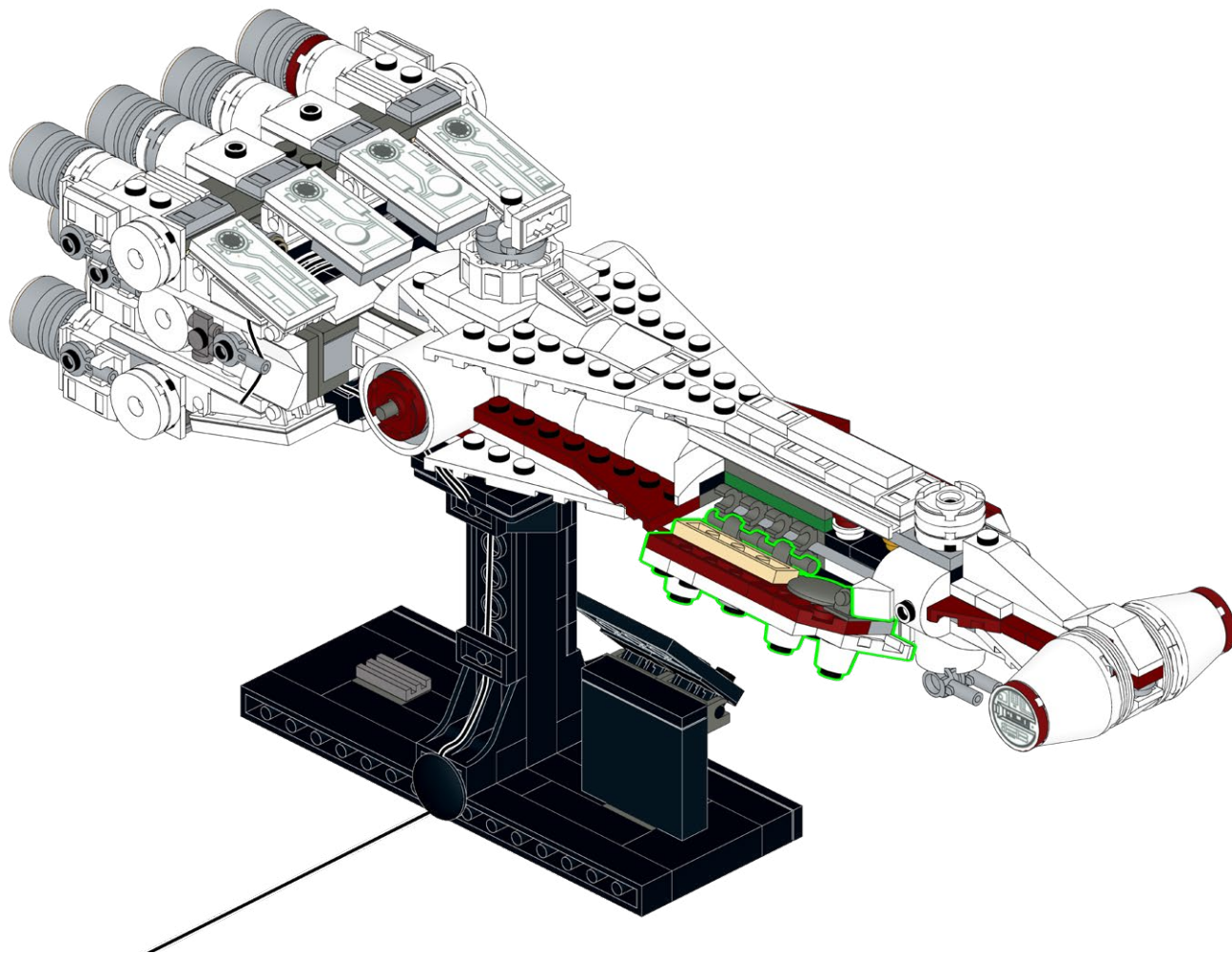

222

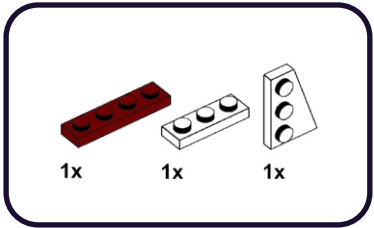

1

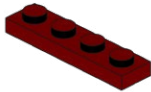

2

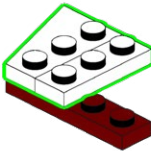

223

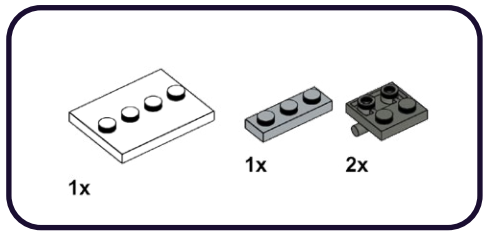

1

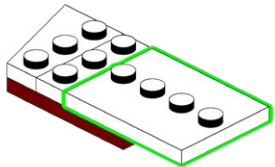

2

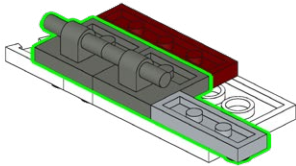

224

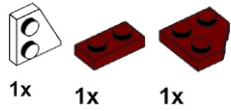

1

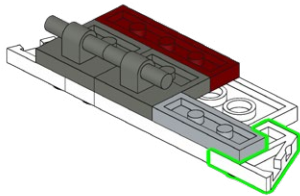

2

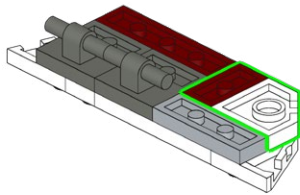

225

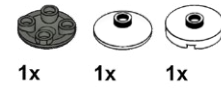

1

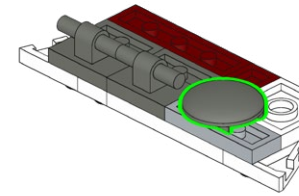

2

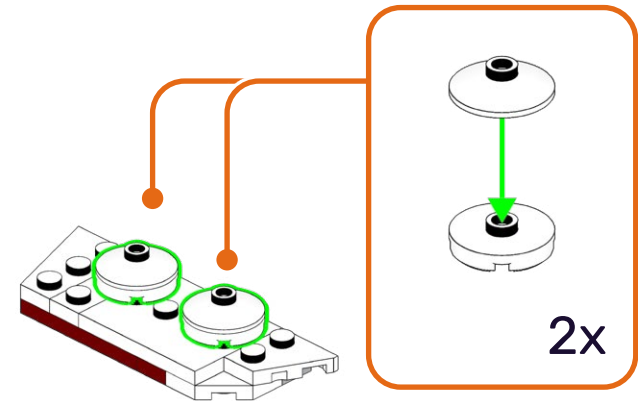

226

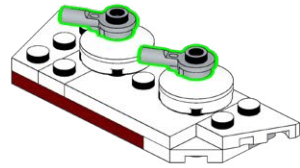

227

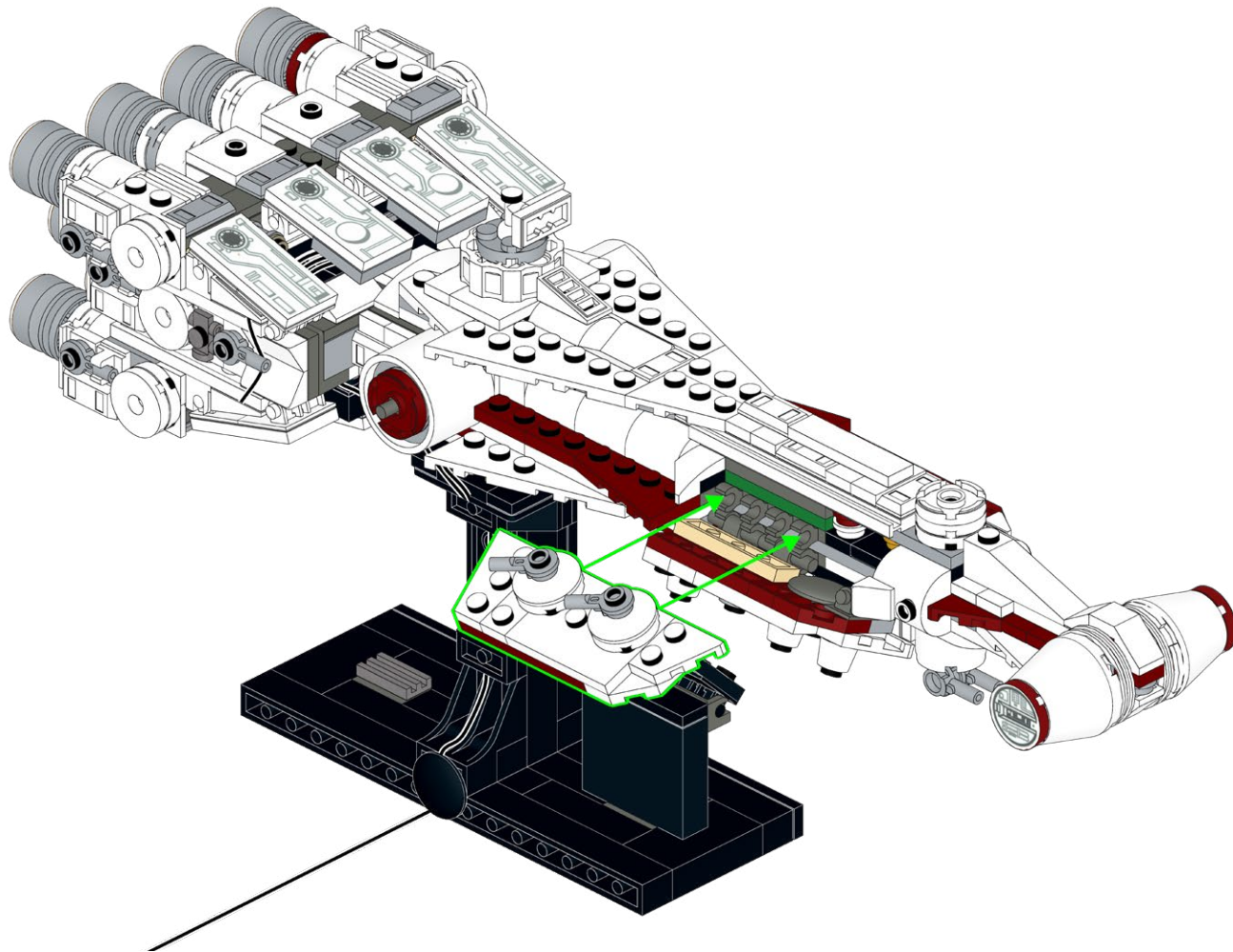

228

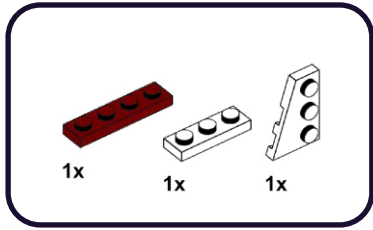

1

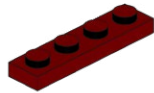

2

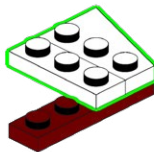

229

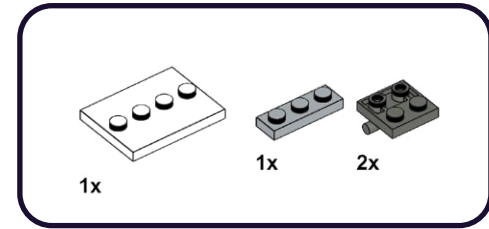

1

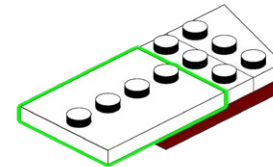

2

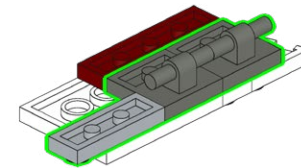

230

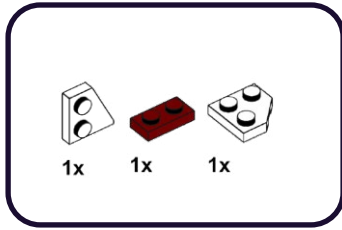

1

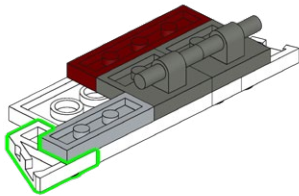

2

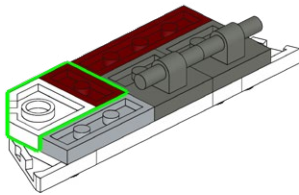

231

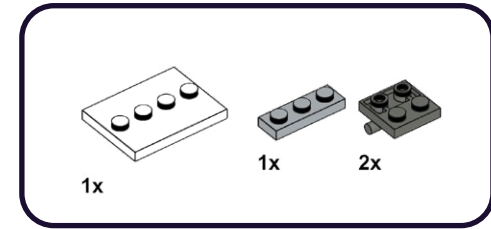

1

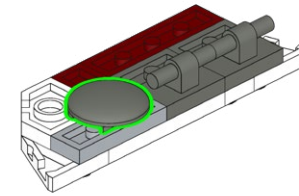

2

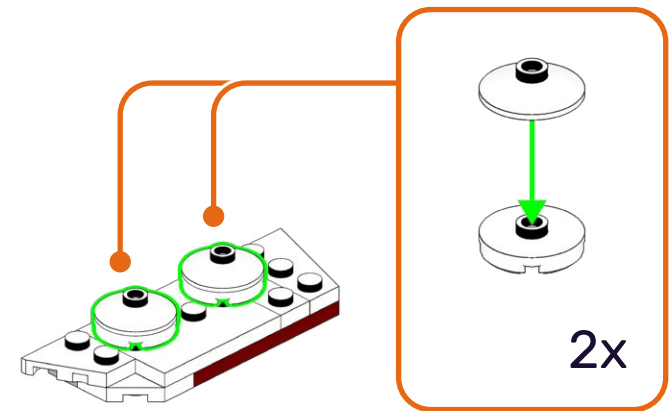

232

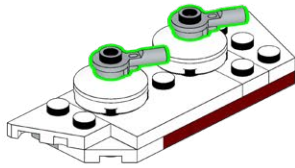
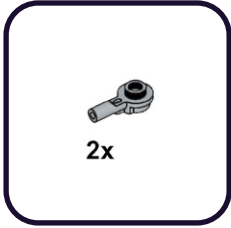

233

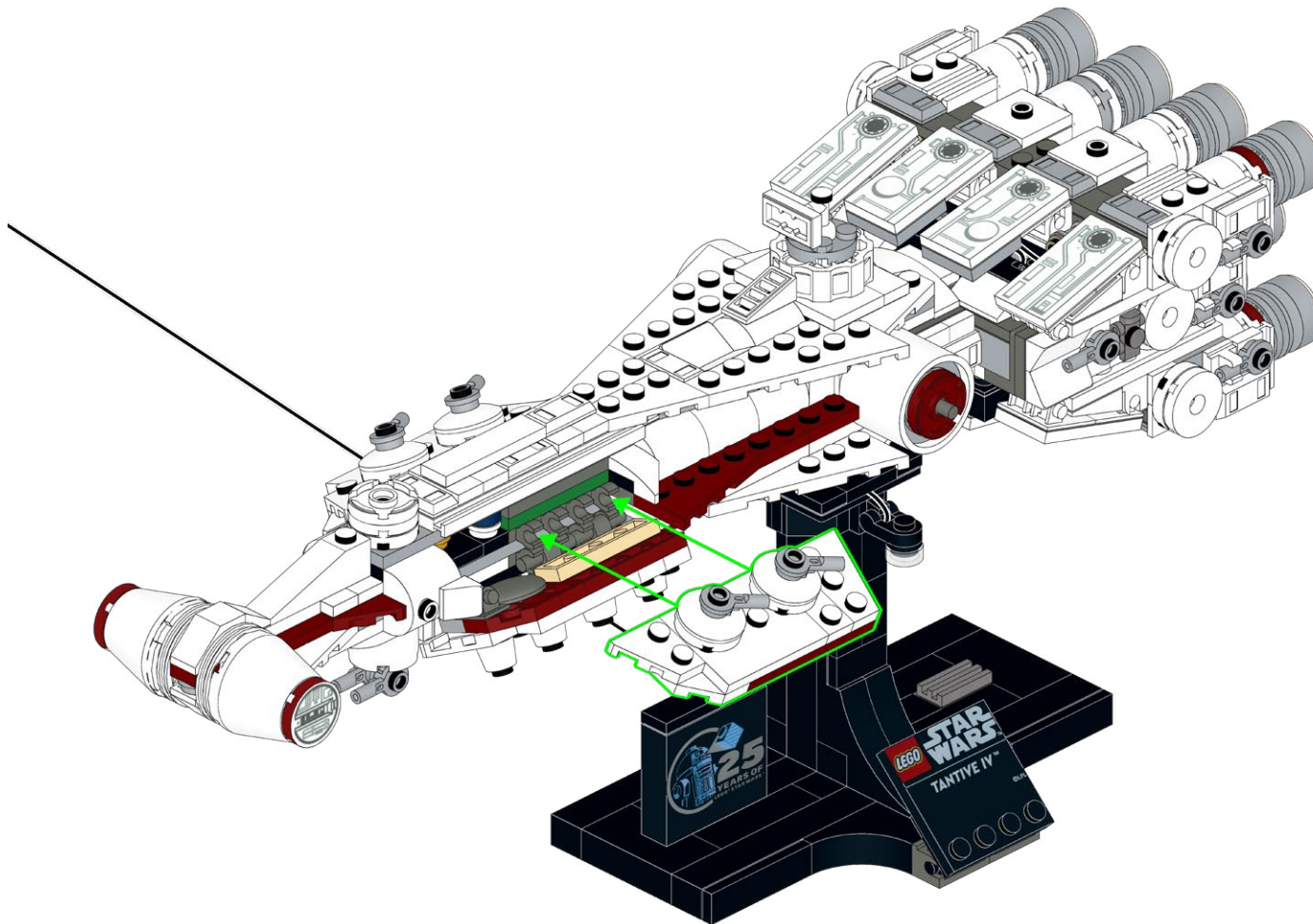

234

3x

1

2

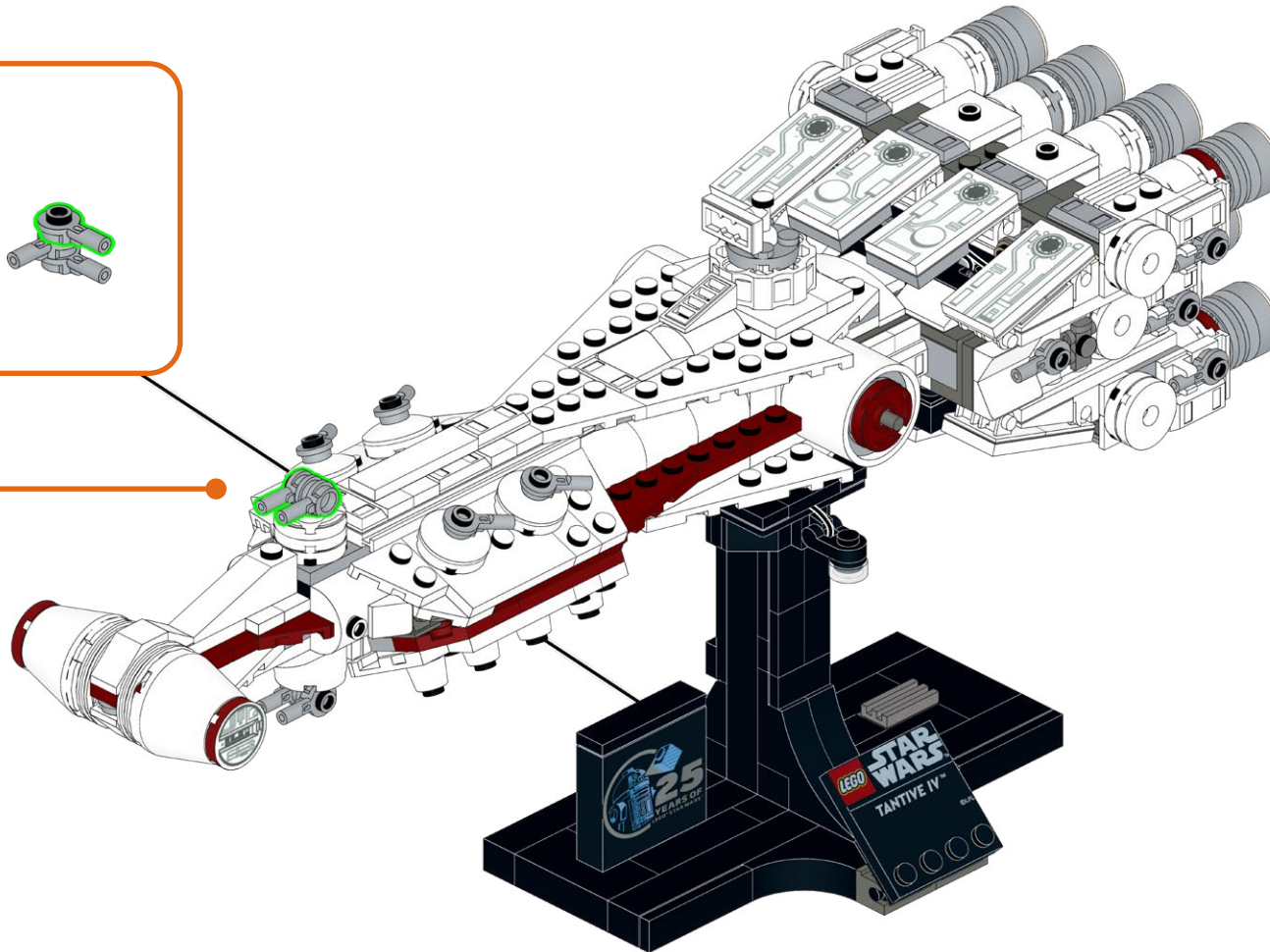

235

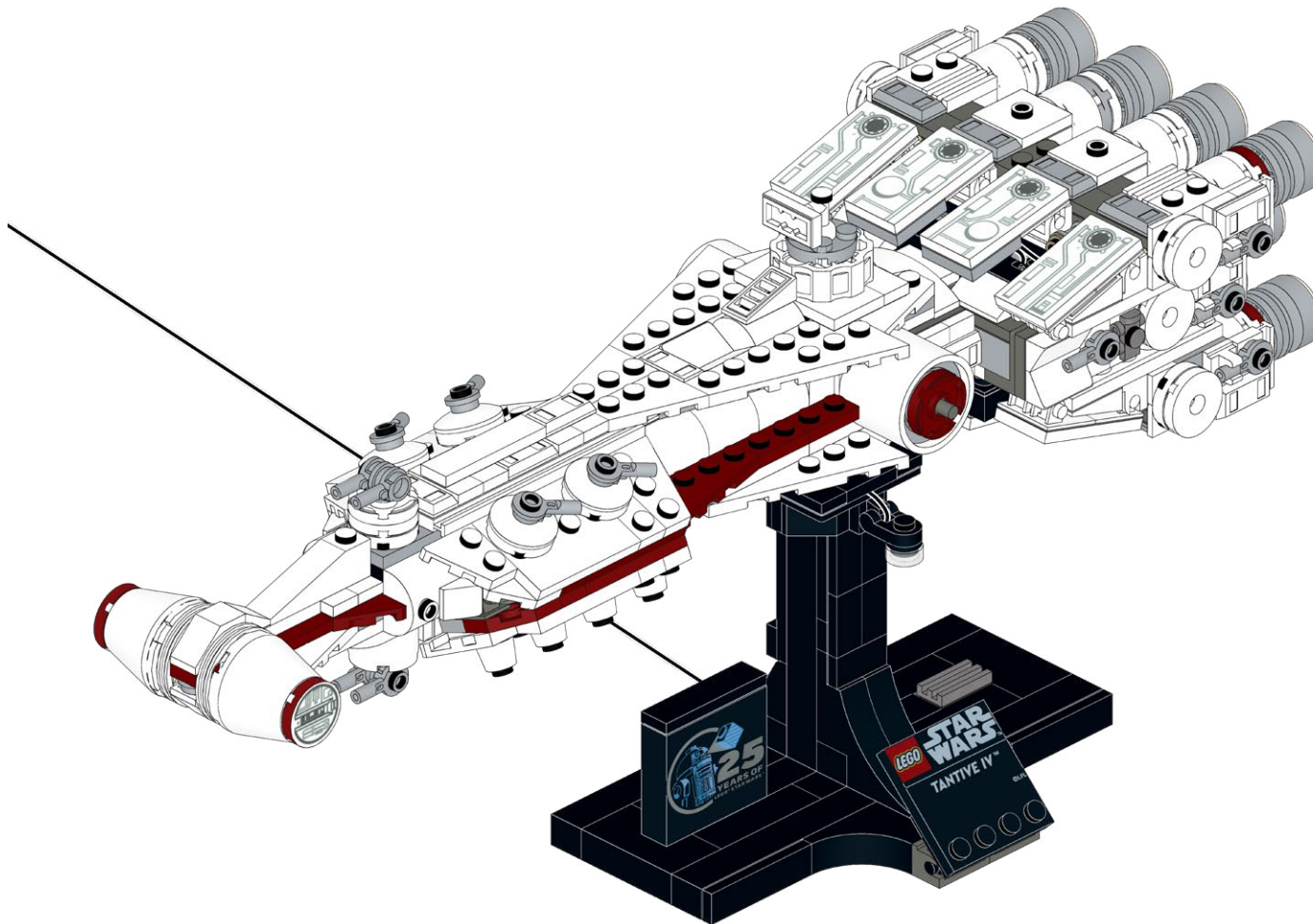

236



Power on Test
Test de mise sous tension
Test di Potenza
Stromtest
Prueba de Energía
电源测试



237



LEGO

STAR WARS™

TANTIVE IV™

OLFL

238



FINAL PRODUCT



PACKAGE CONTENTS



11x AR-Y15
Astro Light Regular
Yellow 15cm



1x T-1x6
Tether 1x6



1x Plate, Round 1 x 1 with
Bar Handle- Black



1x AR-CW15
Astro Light Regular
Cool White 15cm



11x Round Plate 1x1 - Trans-
Orange



1x Tile, Modified 1 x 1 with
Open O Clip- Black



1x B-50
Belt 50cm



11x Dish 2x2 Inverted
(Radar)- Trans- Orange



1x A- CAP
Astro Cap



1x B-15
Belt 15cm

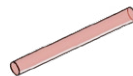

11x Bar 4L- Trans Red

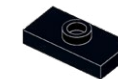

1x Plate, Modified 1x2 with
1 Stud with Groove and
Bottom Stud Holder
(Jumper) - Black



2x D-6
Dock-6



1x Round Plate 1x1 w Open
Stud - Black

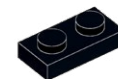

5x Tile 1x2 - Black

PACKAGE CONTENTS



1x FLX-C
Flux Converter



1x Plate, Modified 1x2
with Bar Handle on Side
Closed Ends - Black

CONTACT US

Click below for customer support, or general inquiries.

Cliquez ci-dessous pour accéder au support client ou aux renseignements généraux.

Clicca qui sotto per l'assistenza clienti o per richieste generali.

Contact Us



Contactez-nous



Contattaci



Klicken sie unten für kundensupport oder allgemeine anfragen.

Haga clic a continuación para atención al cliente o consultas generales.

点击下方获取客户支持或一般咨询。

Kontaktieren sie uns



Contáctanos



联系我们



TROUBLESHOOTING

If you're stuck, scan the QR code for troubleshooting.

Se sei bloccato, scansiona il codice QR per la risoluzione dei problemi.

Wenn Sie nicht weiterkommen, scannen Sie den QR-Code zur Fehlerbehebung.

Si vous êtes bloqué, scannez le code QR pour le dépannage

Si está atascado, escanee el código QR para solucionar el problema.

如果遇到问题, 请扫描二维码进行故障排除

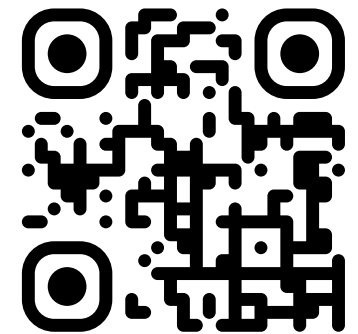



LIGHTMYBRICKS

lightmybricks.com



LEGO® is a trademark of the LEGO Group of companies, which does not sponsor, authorize or endorse this product. All LEGO® sets featured in images are sold separately. This is not a LEGO® product. The LEGO Group is not liable for any loss, injury or damage arising from the use or misuse of this product. ©2024 Light My Bricks Pty Ltd. All rights reserved. www.lightmybricks.com

Our components are designed and packaged in Australia by Light My Bricks Pty Ltd. Components are manufactured in China. 3fl bldg C, Shuanghuan Quanxin Technology Information Industry Park Baolong Street, Longgang District, Shenzhen, China. Imported in Australia by Light My Bricks Pty Ltd, 5/26 Rushdale St, Knoxfield, VIC, 3180, Australia.

WARNING: CHOKING HAZARD - Small parts. Not for children under 3 years.

AVERTISSEMENT : RISQUE D'ÉTOUFFEMENT - Petites pièces. Ne convient pas aux enfants de moins de 3 ans.

ATTENZIONE: PERICOLO DI SOFFOCAMENTO - Piccole parti. Non adatto a bambini di età inferiore a 3 anni.

WARNUNG: ERSTICKUNGSGEFAHR - Kleine Teile. Nicht für Kinder unter 3 Jahren geeignet.

ADVERTENCIA: PELIGRO DE ASFIXIA - Piezas pequeñas. No son apto para niños menores de 3 años.

警告：窒息危险 - 小零件。不适合3岁以下儿童。