

LIGHT KIT INSTALLATION GUIDE

JAWS

FOR LEGO
SET
#21350

CONTENTS



03

Getting Started

- 04 Legend
- 05 Component Handling
- 06 Blueprint

07

Instructions

- 07 LEGO Bag 1
- 27 LEGO Bag 2
- 52 LEGO Bag 3
- 80 LEGO Bag 4
- 97 LEGO Bag 5
- 115 LEGO Bag 6
- 132 LEGO Bag 7
- 148 LMB Bag 1
- 163 LEGO Bag 8
- 188 LEGO Bag 11
- 201 LEGO Bag 13
- 214 LMB Bag 3
- 220 LEGO Bag 12
- 223 LMB Bag 2
- 283 LEGO Bag 9
- 296 LEGO Bag 10

320

Final Product

- 321 Package Contents
- 323 Contact & Troubleshooting

GETTING STARTED



Bold, beautiful and bright, Light My Bricks elevates your favourite LEGO set from knick-knack to statement piece. Create a talking point at home or in the office that speaks to your passions with Light My Bricks. To learn more, click below.

Learn More



Audacieux, beau et lumineux, Light My Bricks élève votre ensemble LEGO préféré du statut de bibelot à celui de pièce maîtresse. Que ce soit à la maison ou au bureau, partagez votre passion des LEGO avec Light My Bricks. Cliquez ci-dessous pour en savoir plus.

En savoir plus



Audace, bello e luminoso, Light My Bricks eleva il tuo set LEGO preferito da soprammobile a pezzo di tendenza. Crea un punto di discussione a casa o in ufficio che parli alle tue passioni con Light My Bricks. Per saperne di più, clicca qui sotto.

Ulteriori Informazioni



Mutig, schön und hell – Light My Bricks verwandelt Ihr Lieblings-LEGO-Set von einem schnickschnack in ein statement-stück. Schaffen sie einen gesprächspunkt zu hause oder im büro, der Ihre leidenschaften widerspiegelt, mit Light My Bricks. Um mehr zu erfahren, klicken sie unten.

Mehr erfahren



Audaz, hermoso y brillante, Light My Bricks eleva tu set LEGO favorito de una chuchería a una pieza llamativa. Crea un tema de conversación en casa o en la oficina que hable de tus pasiones con Light My Bricks. Para obtener más información, haga clic a continuación.

Más información



大胆、美丽而明亮，Light My Bricks 将你喜爱的乐高套装从小摆件提升为引人注目的装饰品。在家或办公室打造一个能表达你激情的话题，了解更多，请点击下方。

了解更多



LEGEND

Rotate Set



Retournez L'ensemble
Ruota Set
Set Drehen
Rotar Conjunto
旋转套件

Add Part



Ajoutez une Pièce
Aggiungi Parte
Teil Hinzufügen
Agregar Pieza
添加零件

Click



Cliquez
Clic
Klicken
Clic
点击

Pinch/Fold



Pincez/Pliez
Pizzicare/Piegare
Kneifen/Falten
Pellizcar/Doblar
折叠

Pull Cable



Tirez le Cable
Tirare il Cavo
Kabel Ziehen
Tirar del Cable
拉动电缆

Repeat Step



Répétez
Ripetere
Wiederholen
Repetir
重复

Sticker



Autocollant
Adesivo
Aufkleber
Pegatina
贴纸

Power On Test



Test de mise sous tension
Test di Potenza
Stromtest
Prueba de Energía
电源测试

Disconnect Power

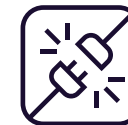

Débranchez L'alimentation
Scollegare L'alimentazione
Strom Trennen
Desconectar la Energía
断开电源

Troubleshoot



Dépanner
Risolvere
Fehlerbehebung
Solución de Problemas
故障排除

COMPONENT HANDLING

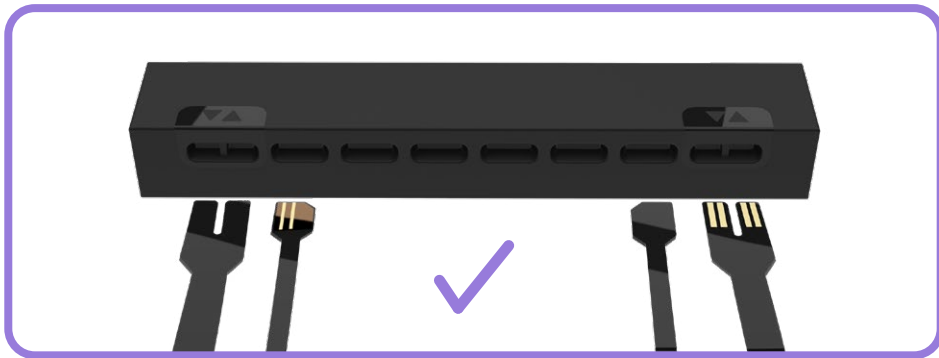
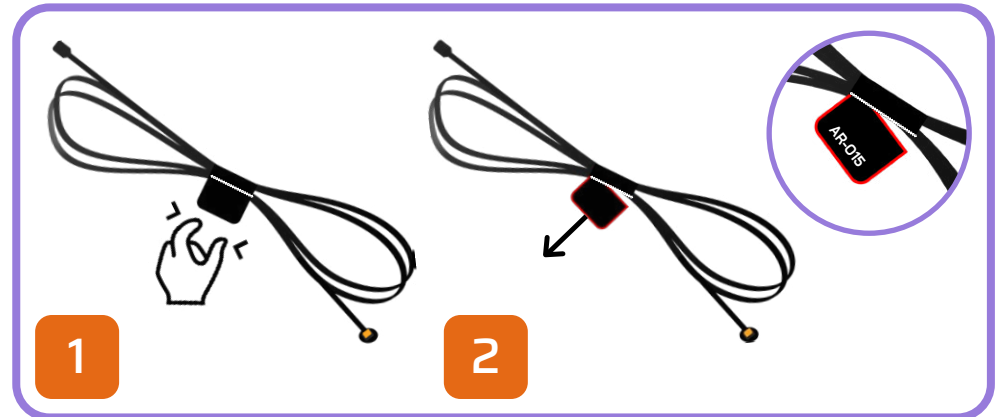
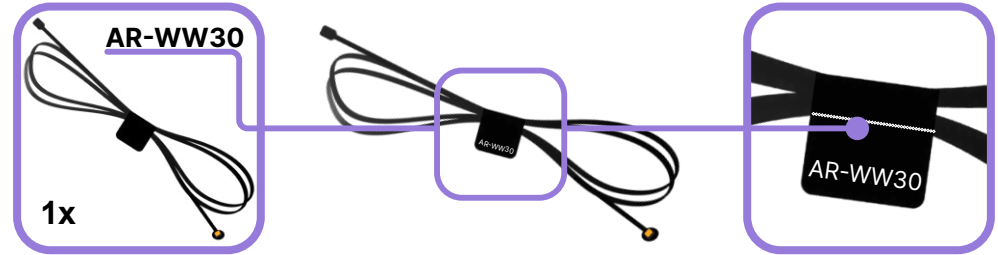
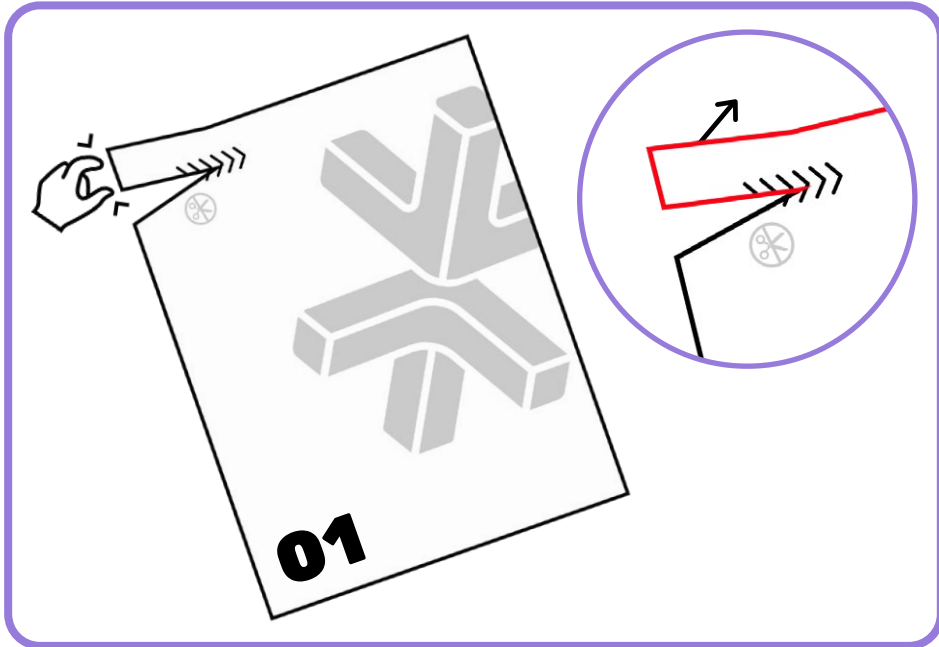

BLUEPRINT

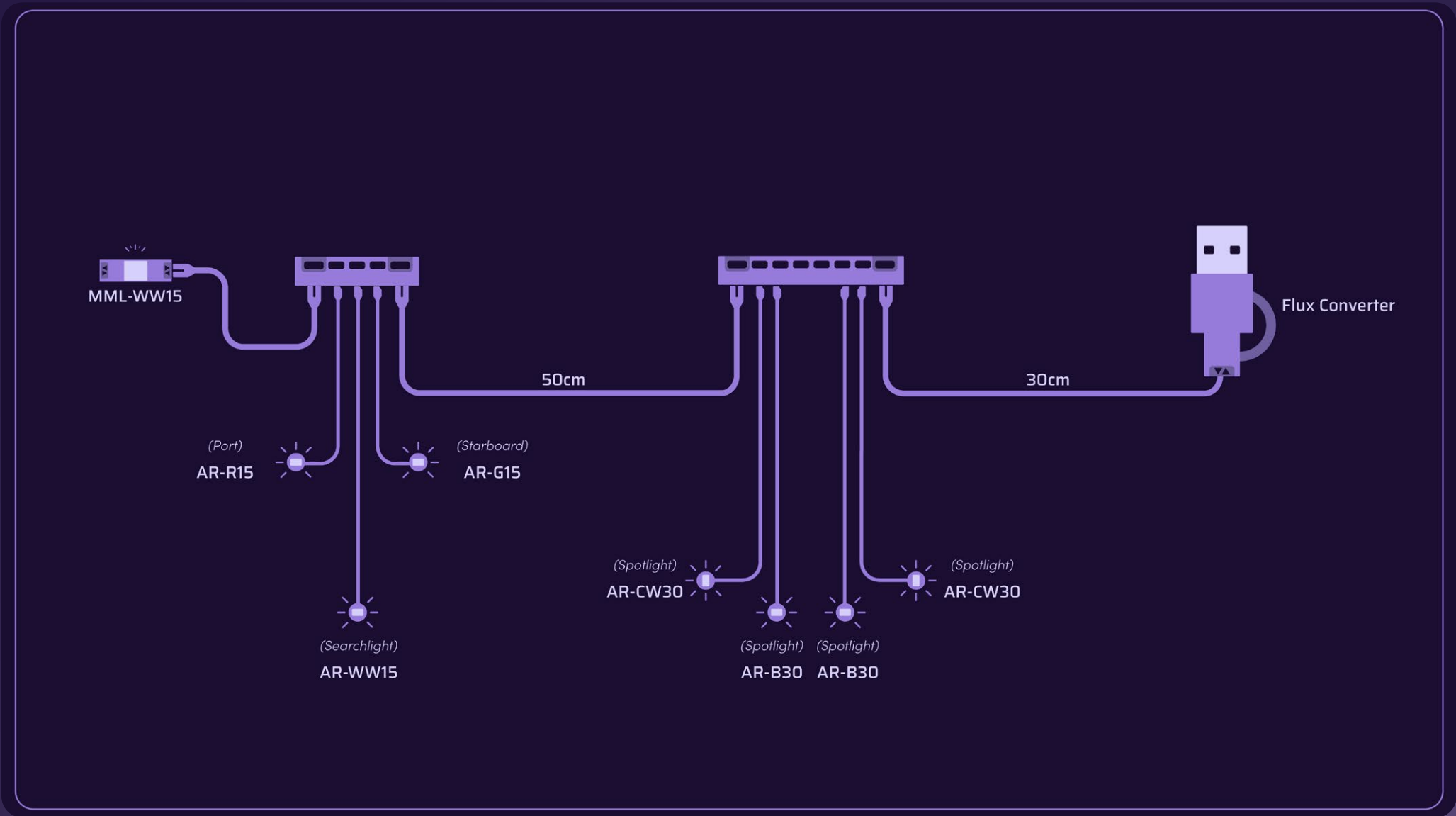

**HOLD UP!**

You might notice some bags aren't in order, as well as left over pieces, but that's ok! We're changing the way you build LEGO!

ATTENDEZ!

Vous remarquerez peut-être que certains sacs, ainsi que certaines pièces, ne sont pas dans le bon ordre. Mais pas de panique! Nous changeons simplement la façon avec laquelle vous construisez vos LEGO!

ASPETTA!

Potresti notare che alcuni sacchetti non sono in ordine, così come i pezzi avanzati, ma va bene così! Stiamo cambiando il modo in cui costruisci i LEGO!

HALT!

Sie werden möglicherweise bemerken, dass einige tüten durcheinander sind und teile übrig bleiben, aber das ist in Ordnung! Wir ändern die art und weise, wie Sie LEGO bauen!

¡ESPERA!

Es posible que notes que algunas bolsas están fuera de servicio, así como piezas sobrantes, ¡pero está bien! ¡Estamos cambiando la forma en que construyes LEGO!

暫停!

你可能会注意到一些袋子顺序错乱, 以及一些剩余的部件, 但没关系! 我们正在改变你搭建乐高的方式!

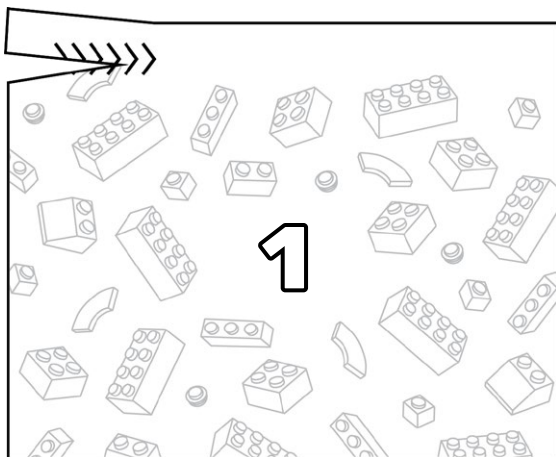
Open LEGO® Bag 1

1

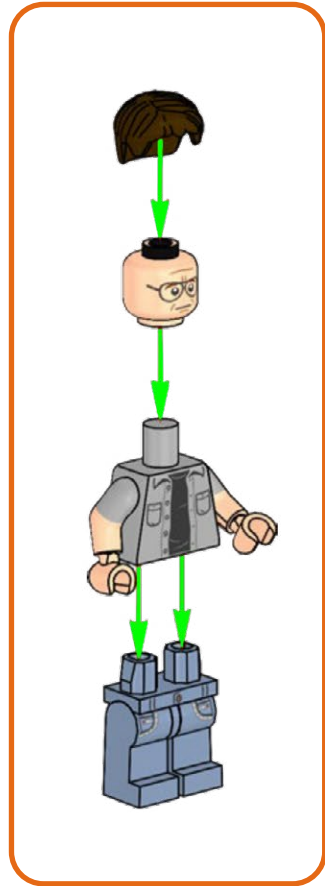

2

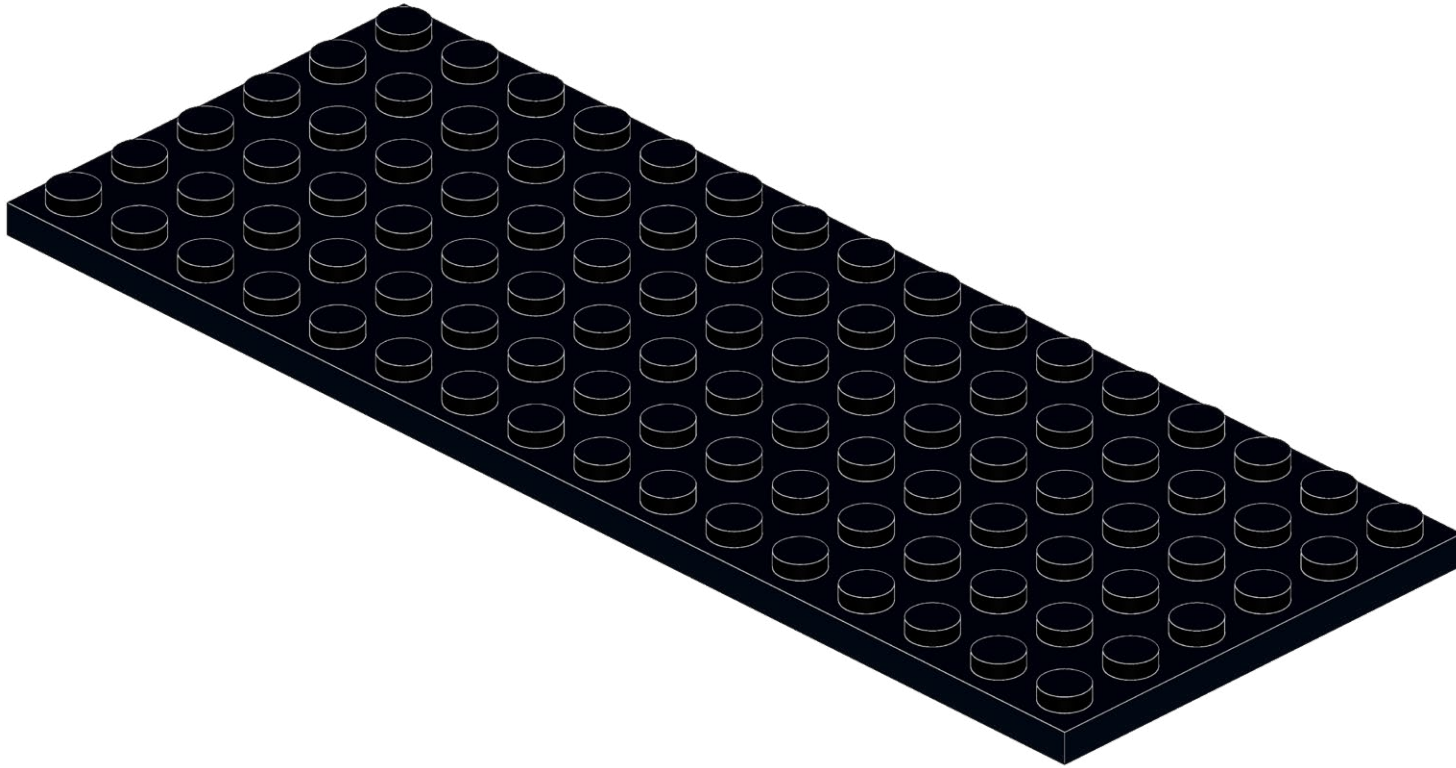
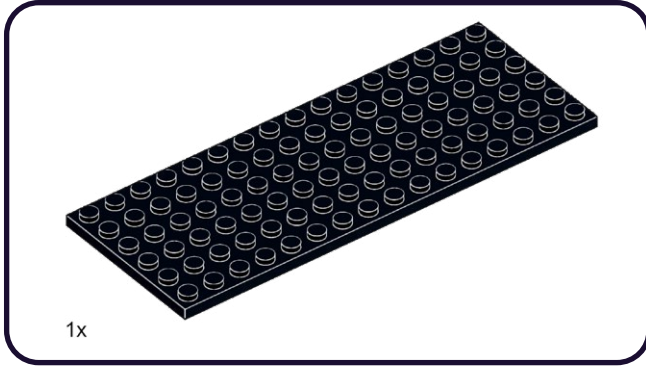

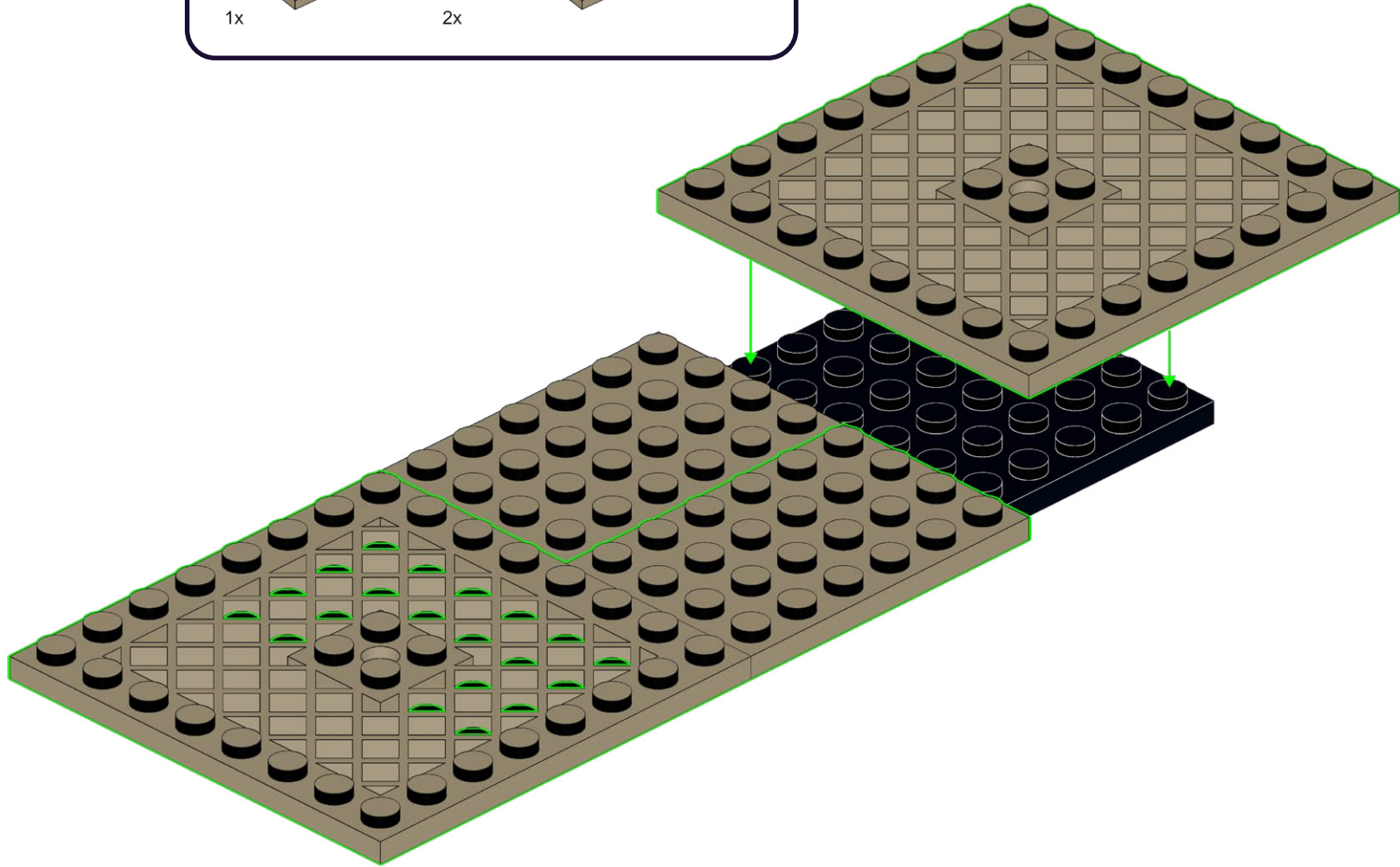
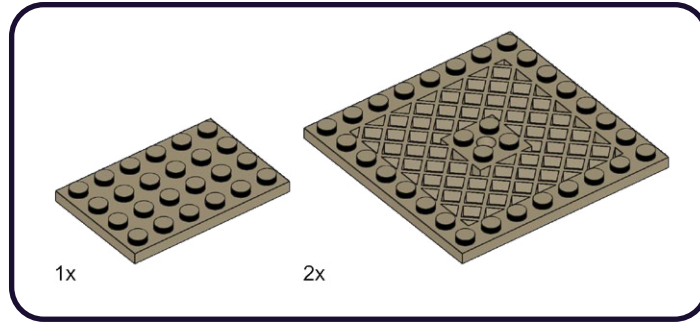

4

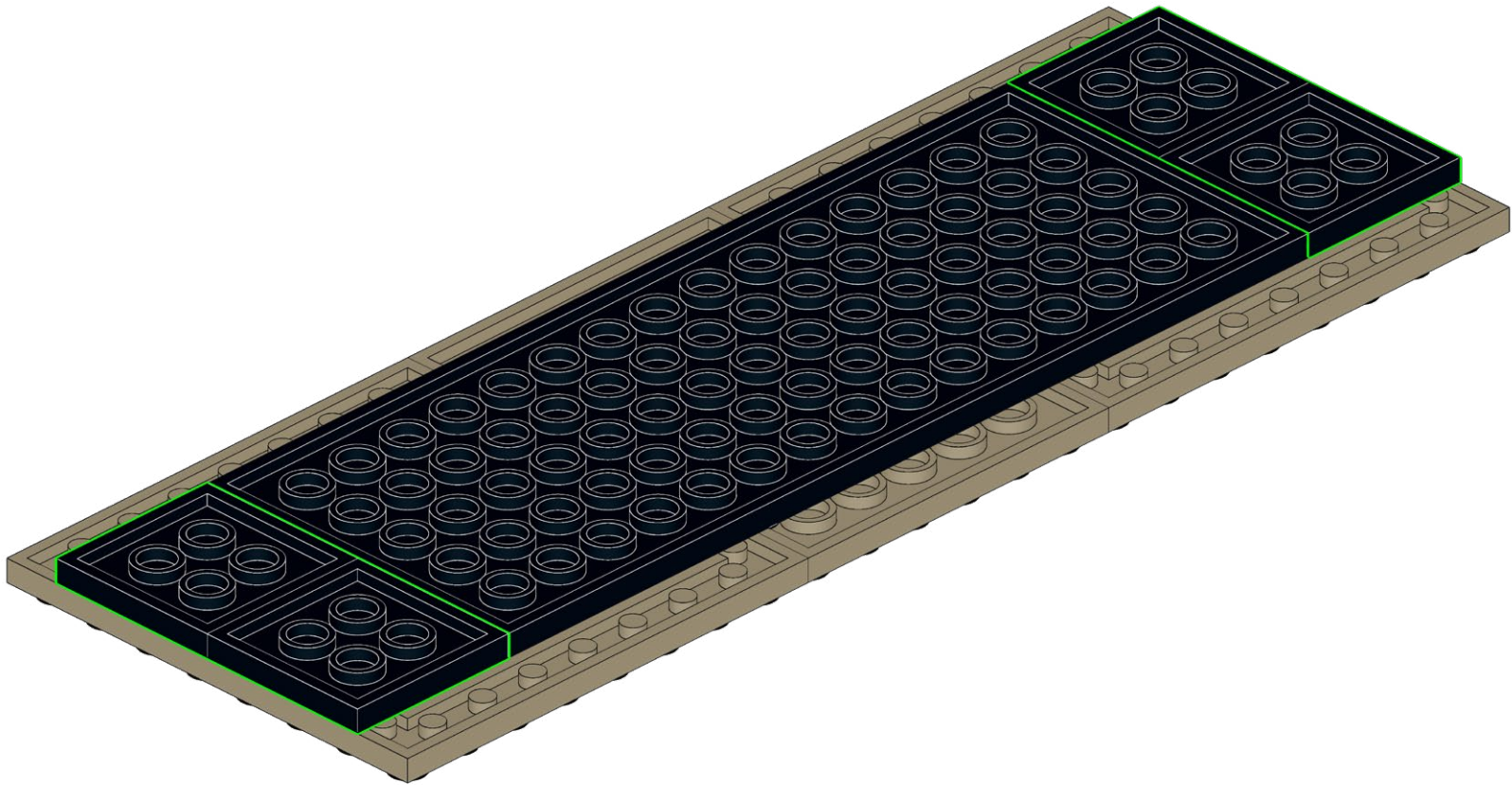
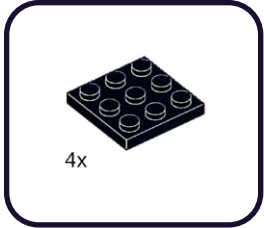

5

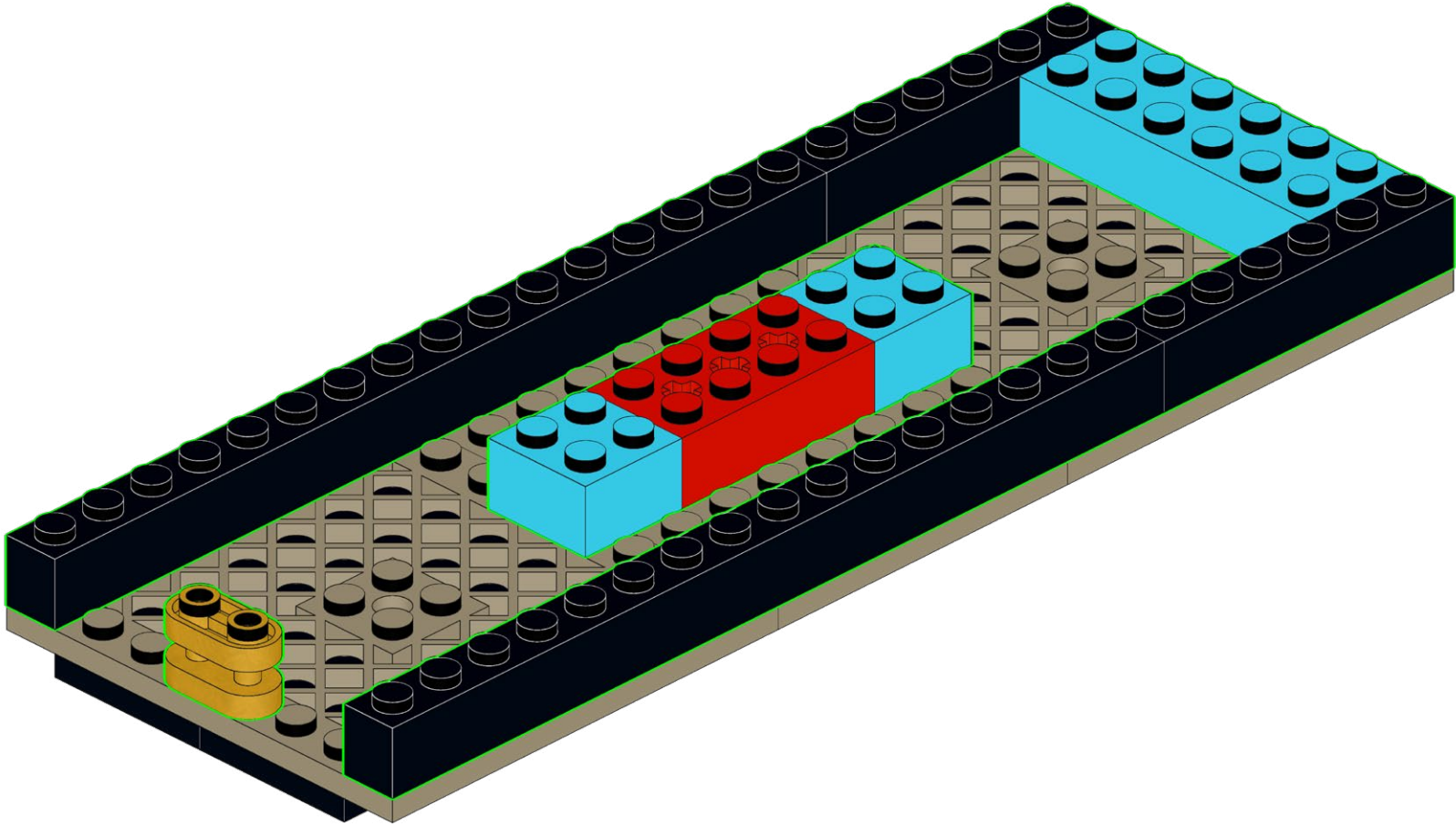
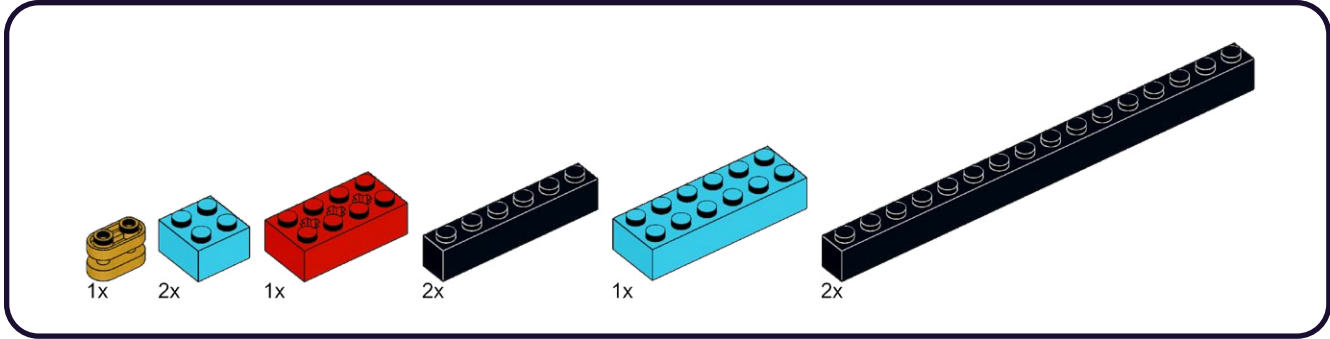

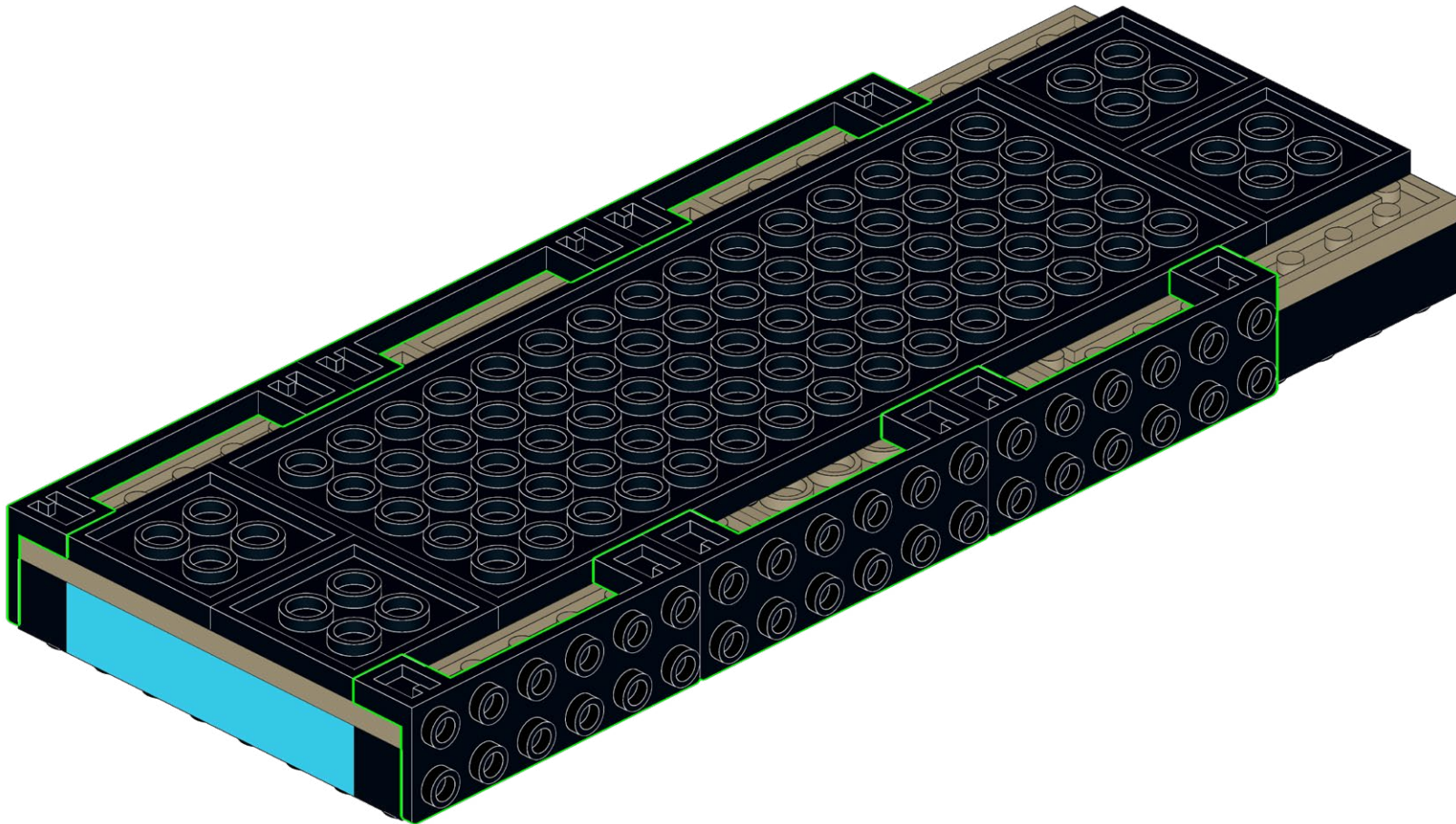
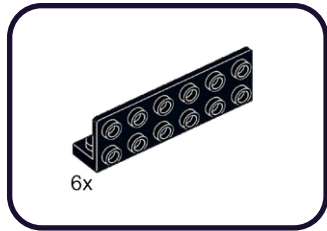

7

4x

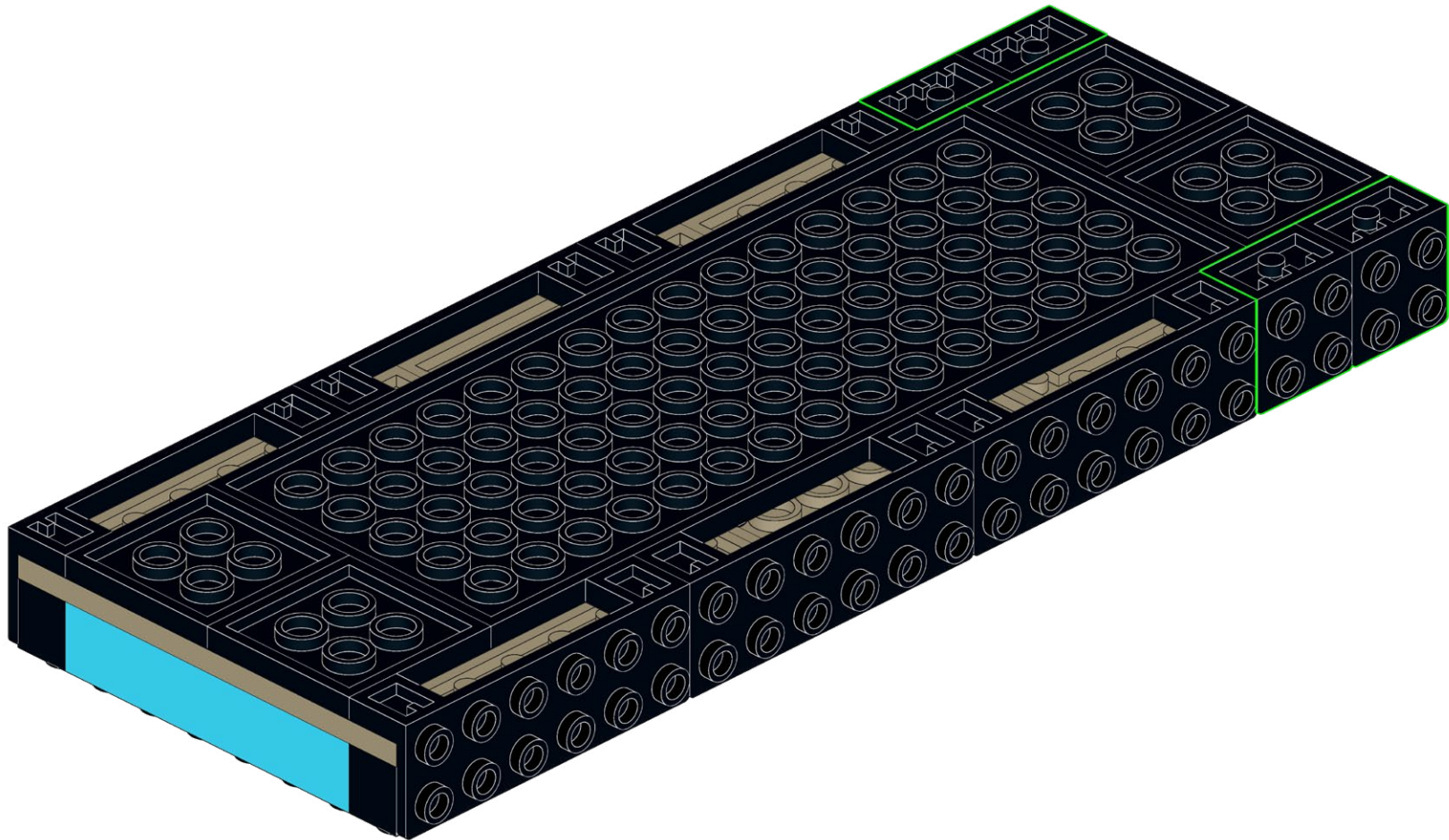

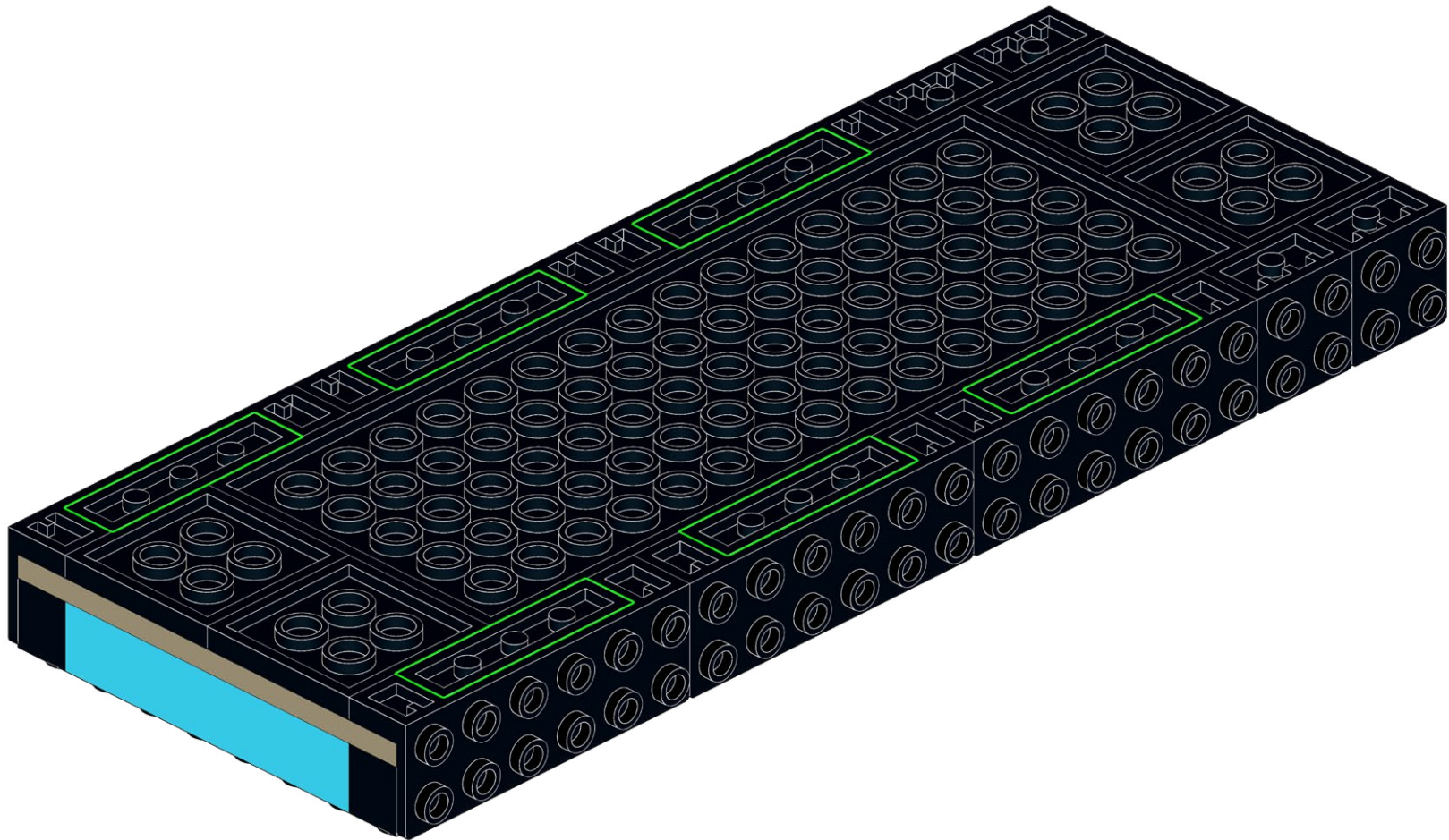
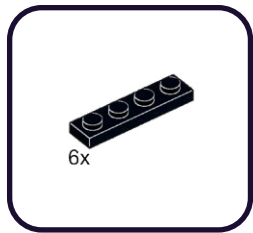

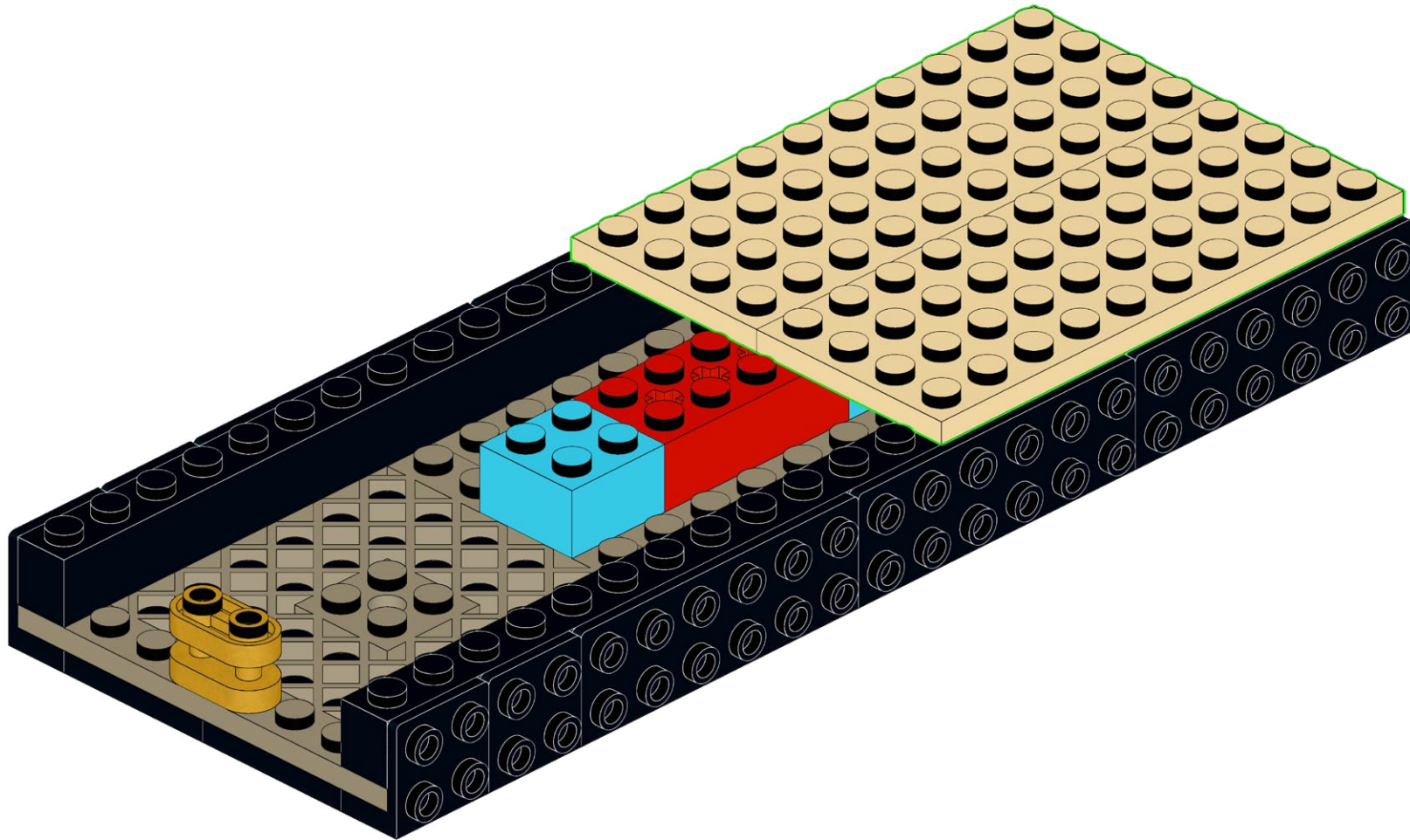
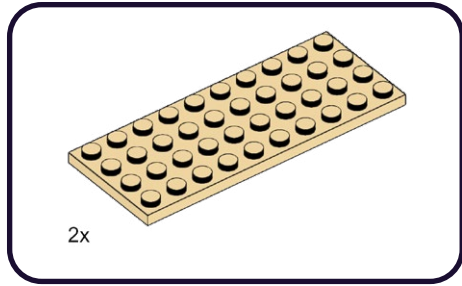

10

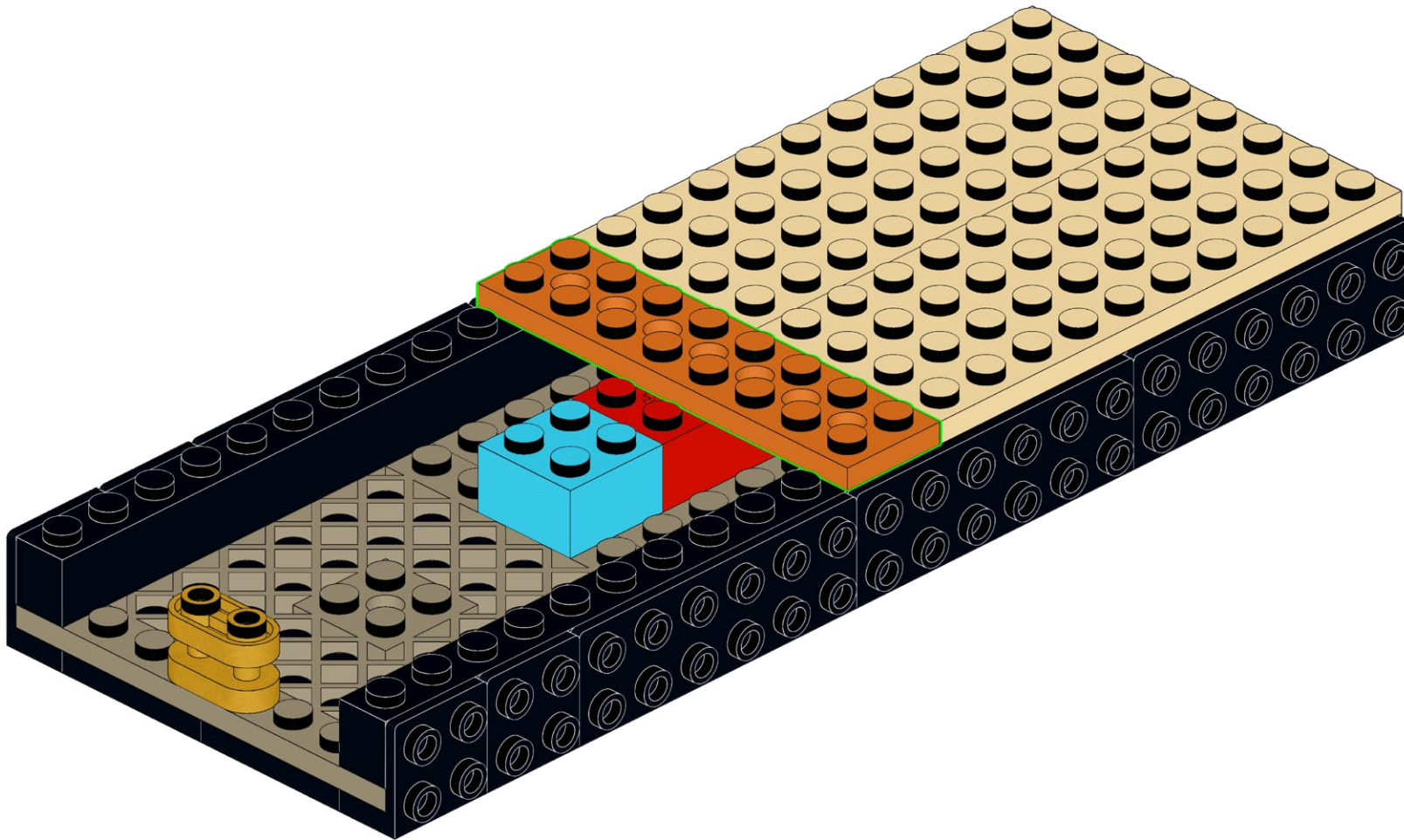
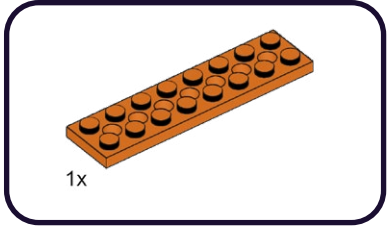

11

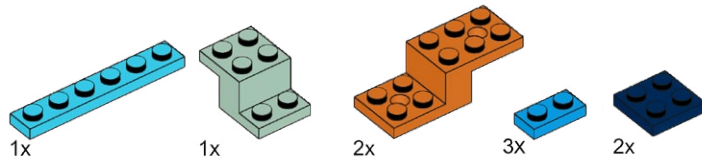

1

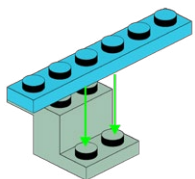

2

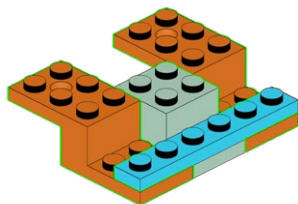

3

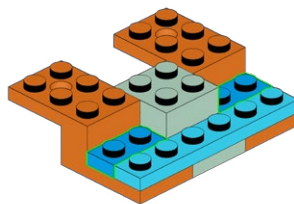

4

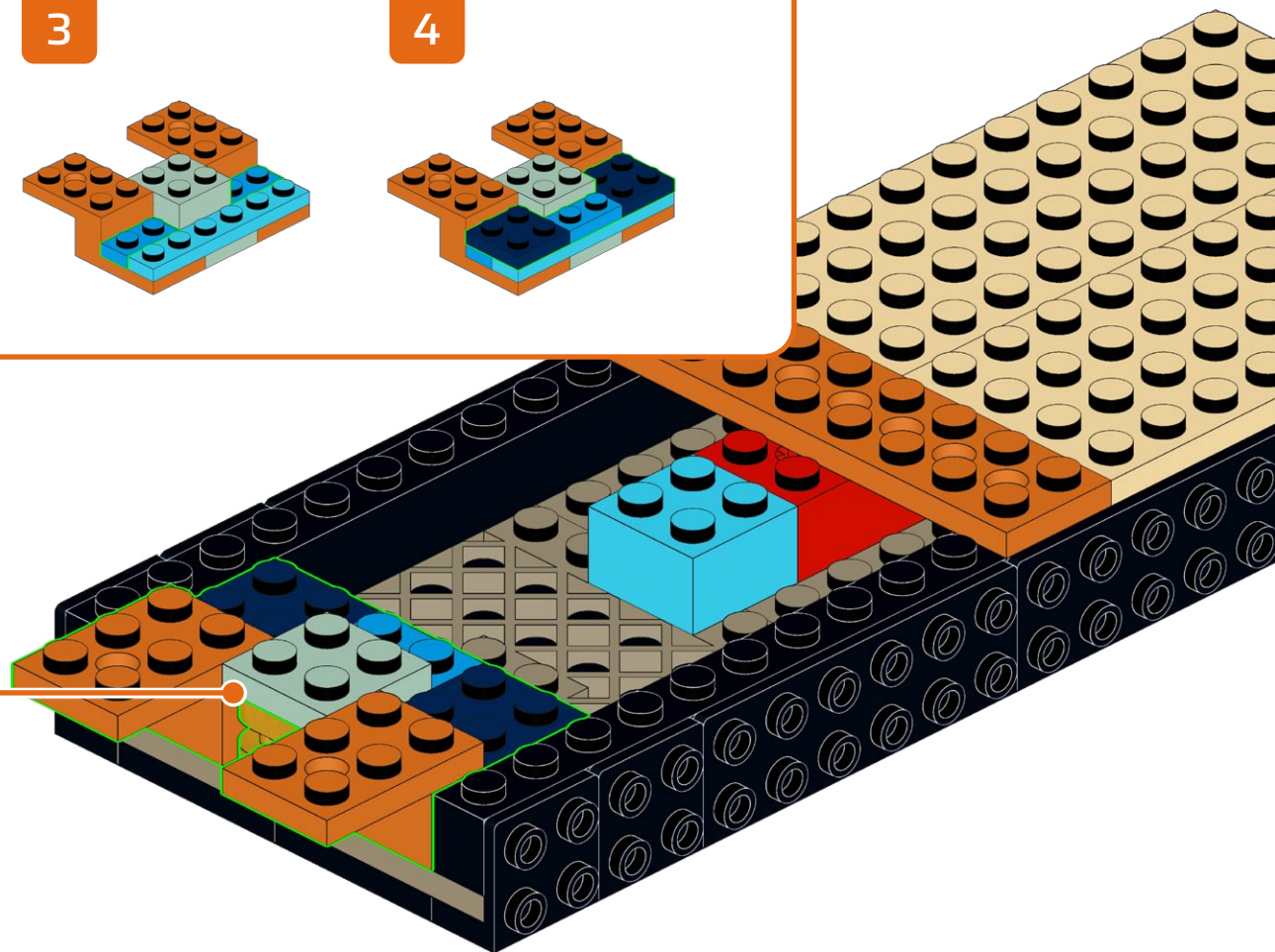
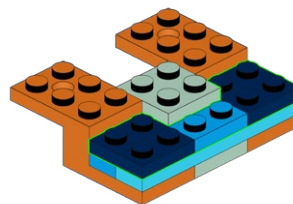

12

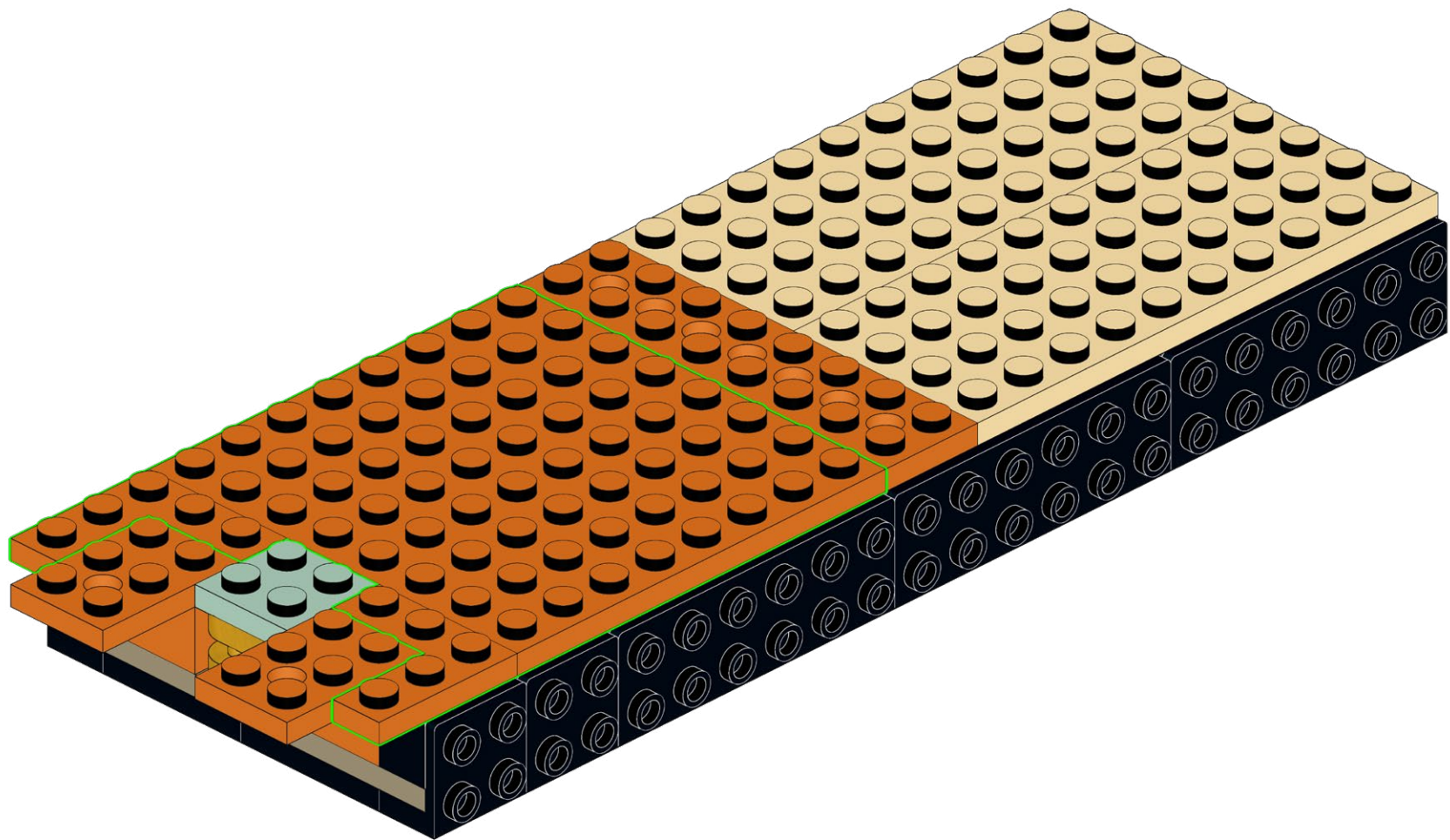
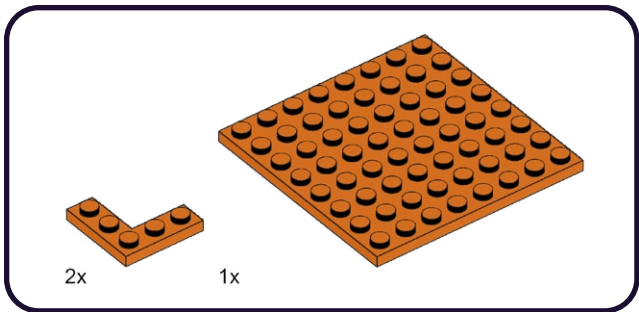

13

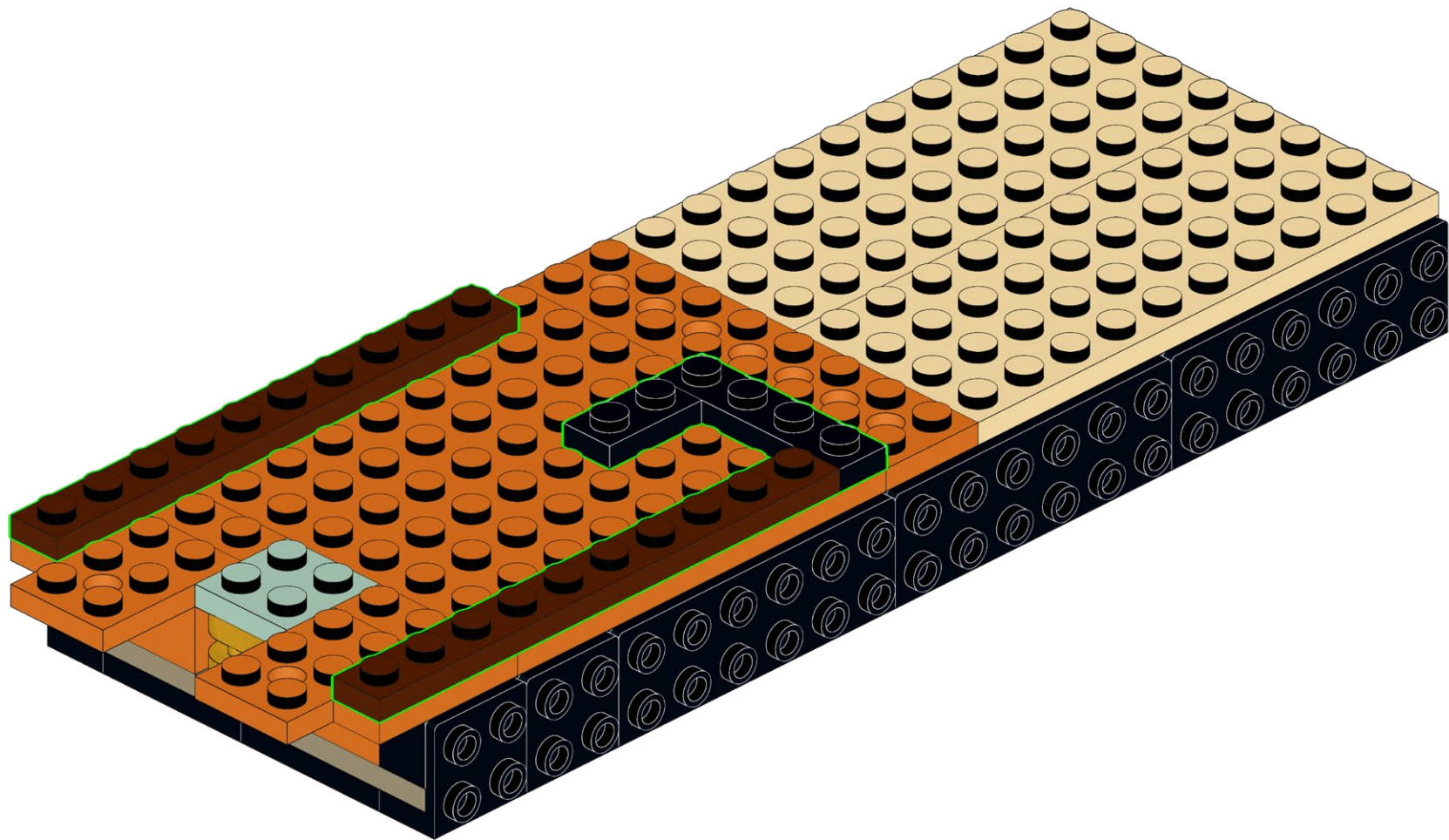
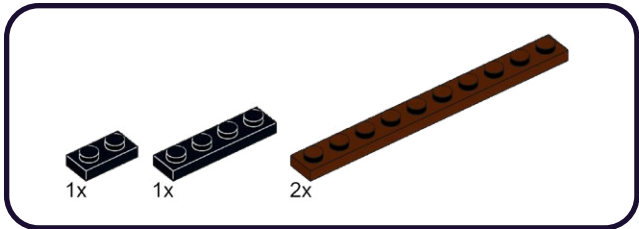

14

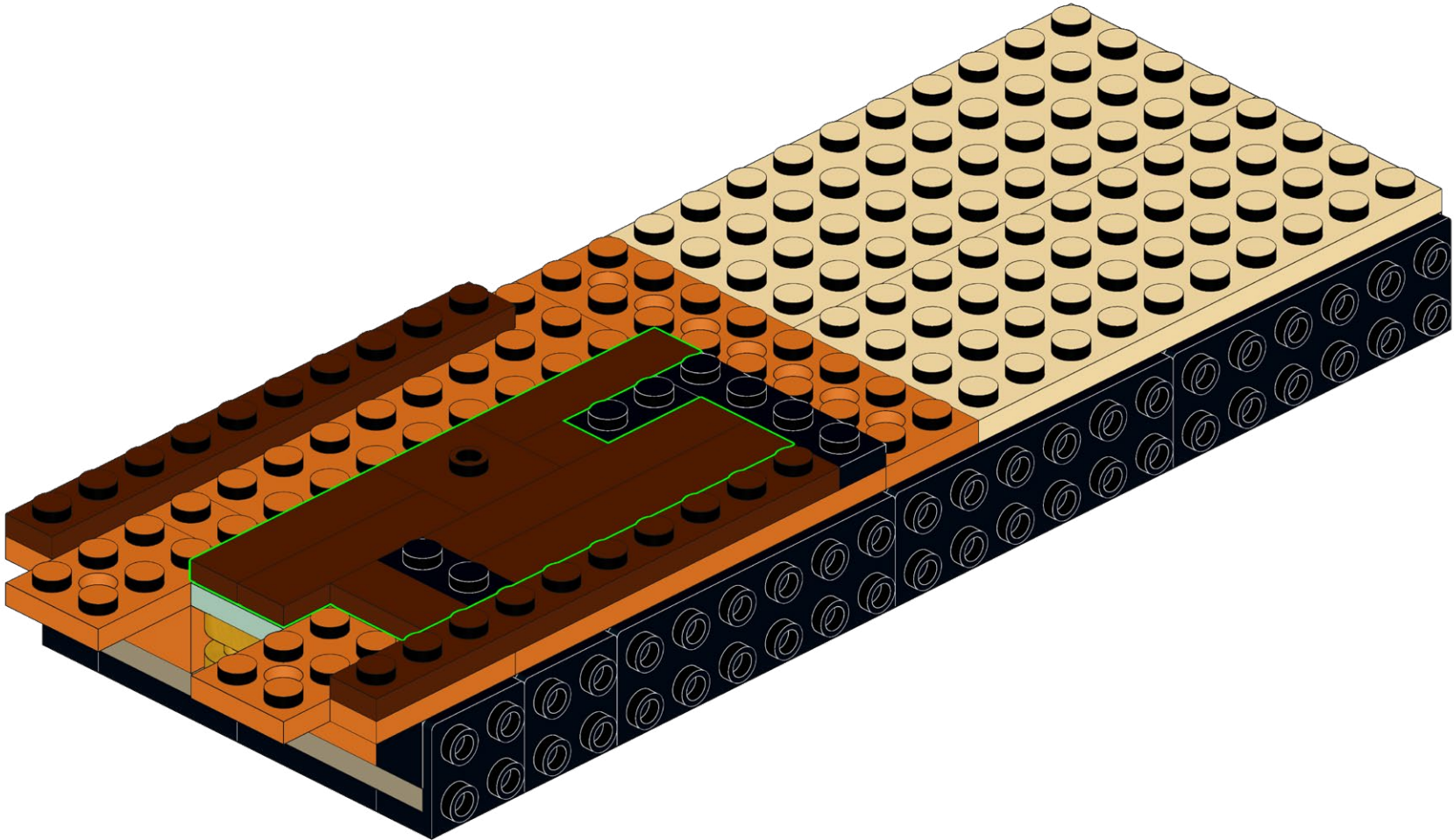
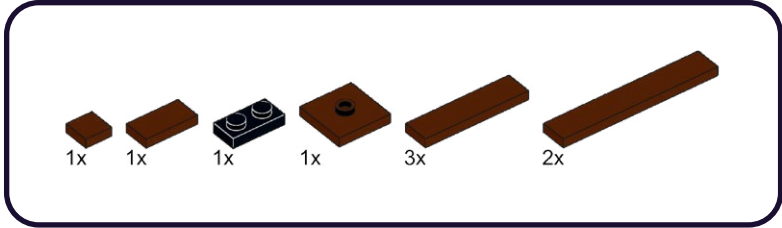

15

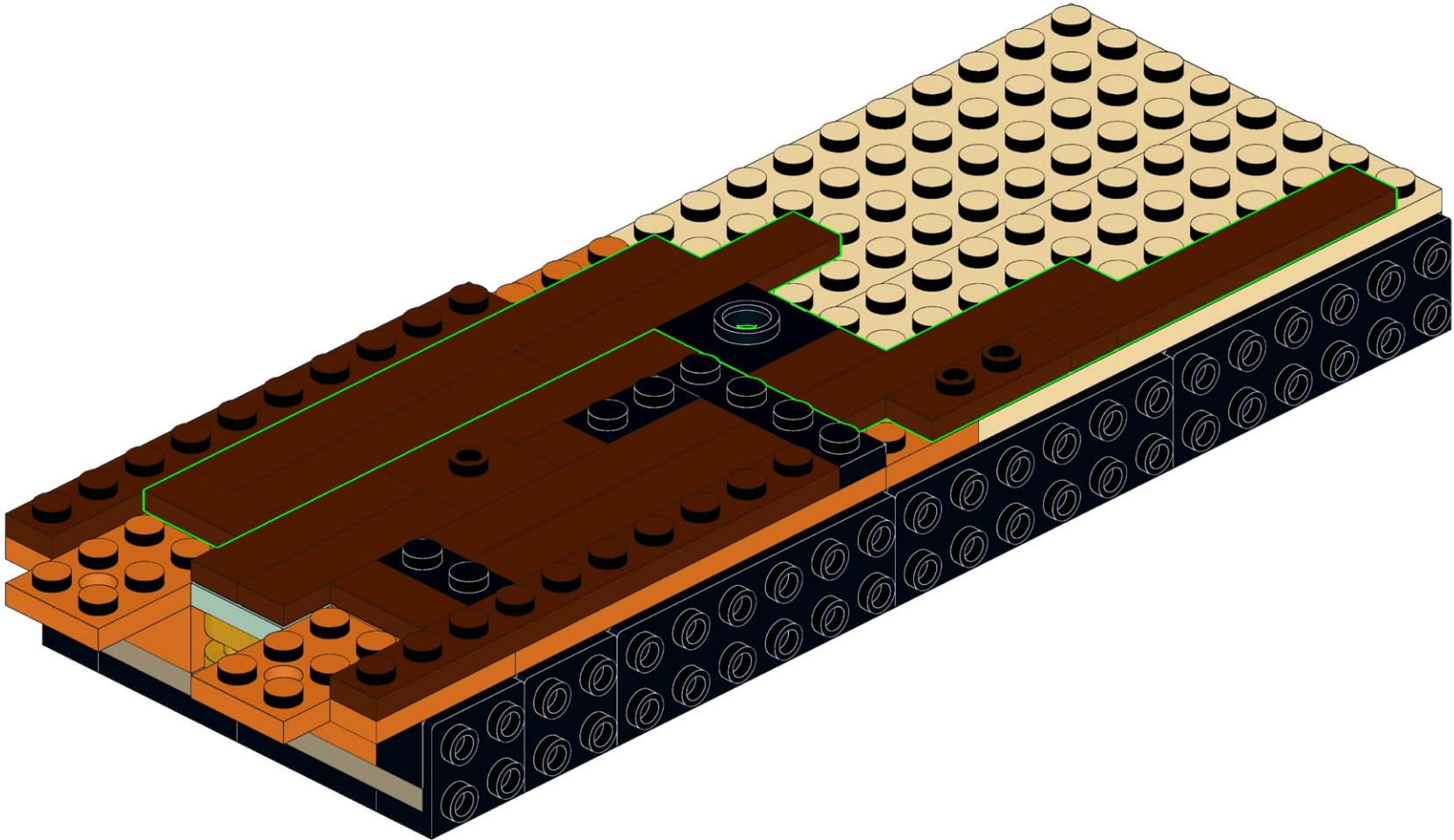
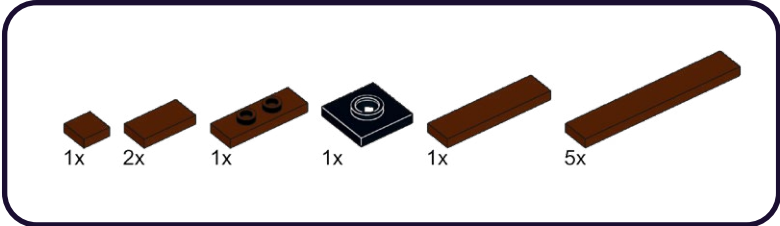

16

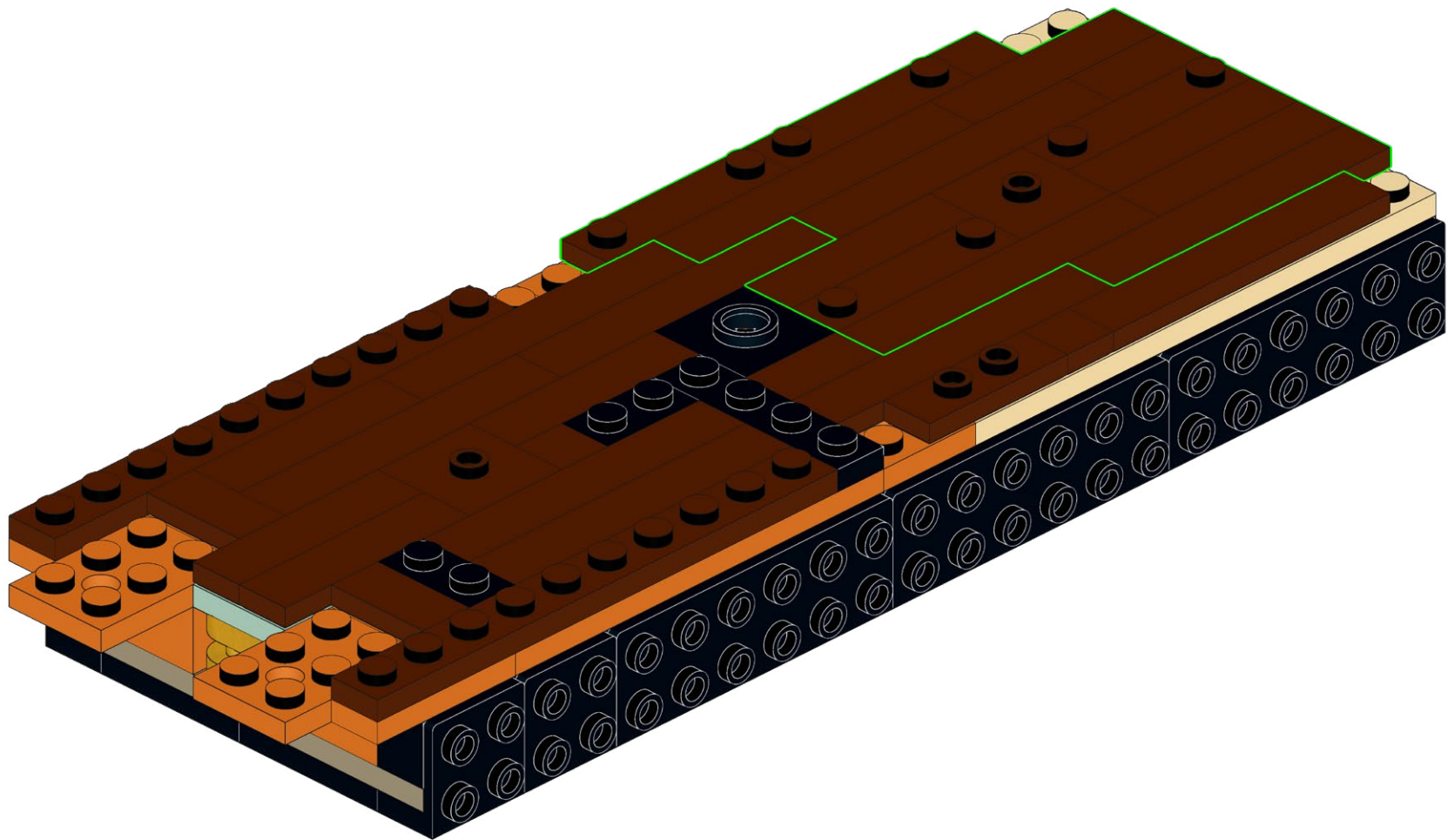
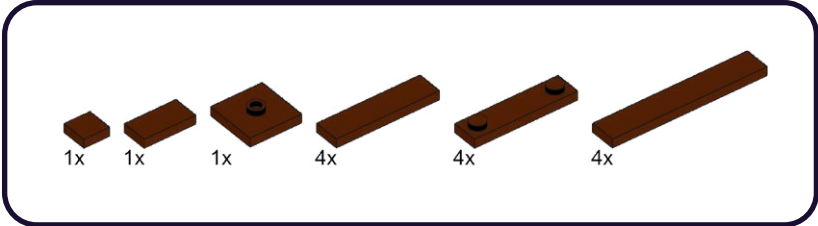

17

3x

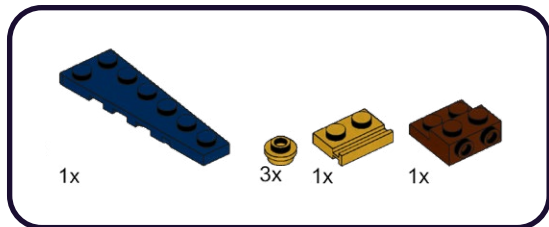

18

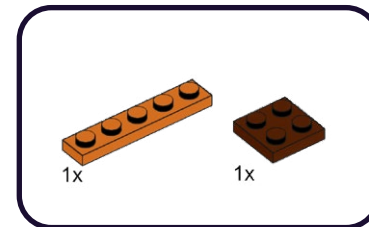

1

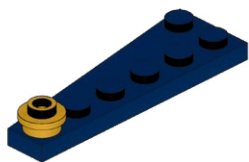

3

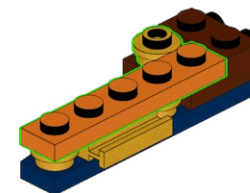

2

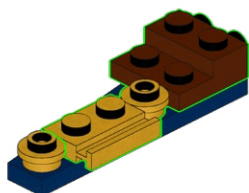

4

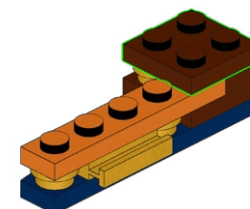

19

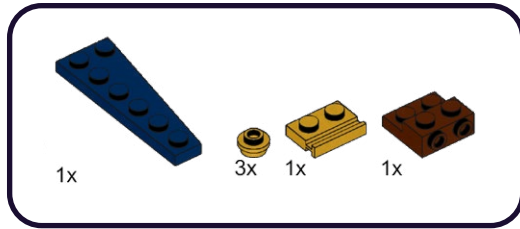

1

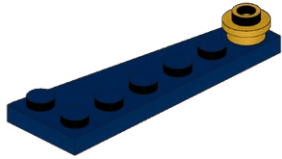

2

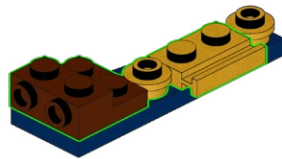

20

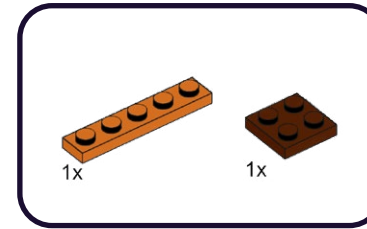

3

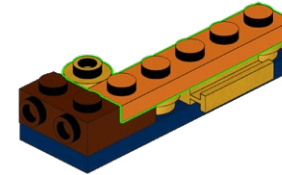

4

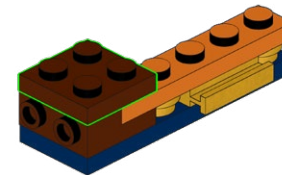

21

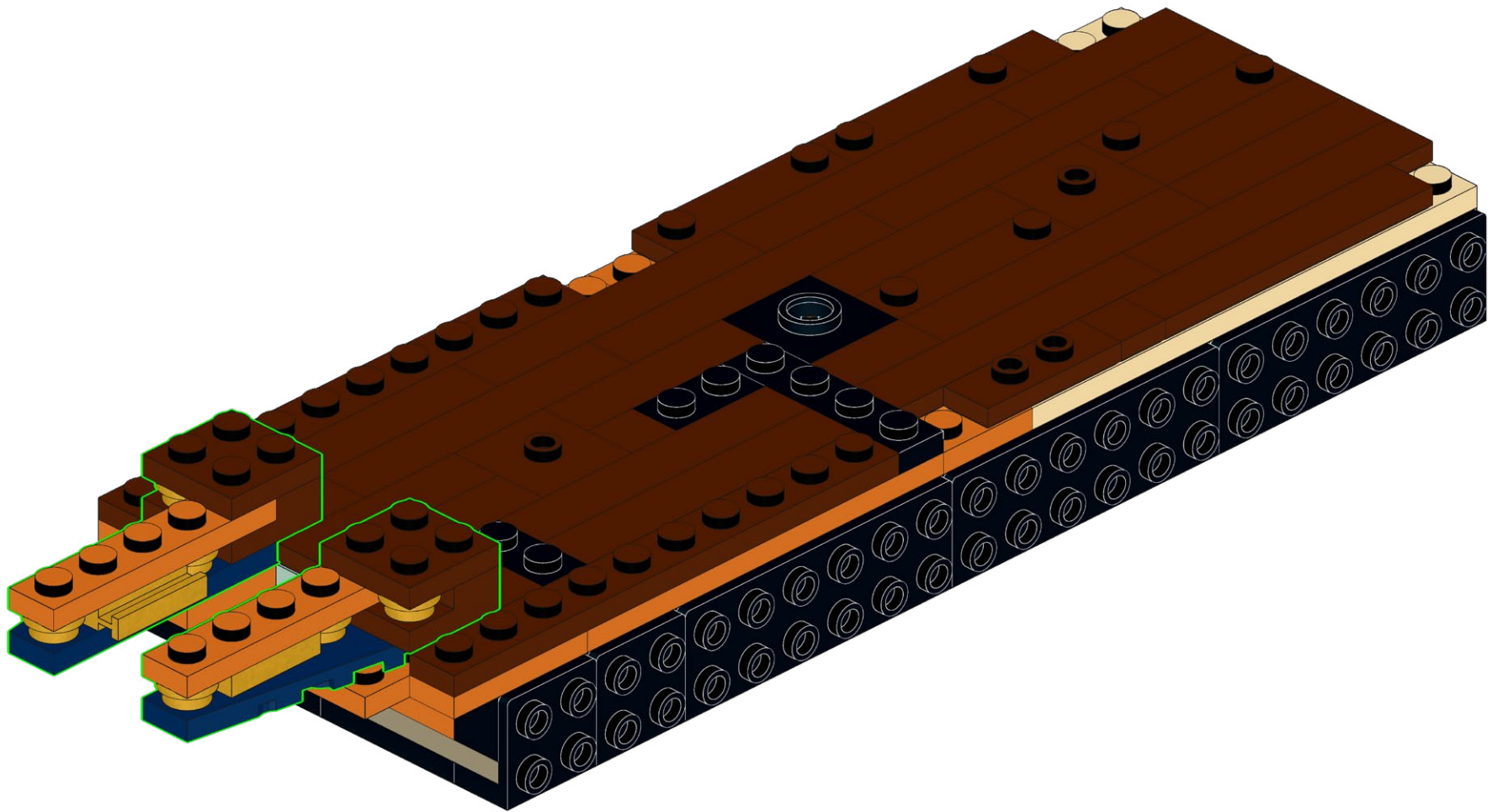

**HOLD UP!**

You might notice some bags aren't in order, as well as left over pieces, but that's ok! We're changing the way you build LEGO!

ATTENDEZ!

Vous remarquerez peut-être que certains sacs, ainsi que certaines pièces, ne sont pas dans le bon ordre. Mais pas de panique! Nous changeons simplement la façon avec laquelle vous construisez vos LEGO!

ASPETTA!

Potresti notare che alcuni sacchetti non sono in ordine, così come i pezzi avanzati, ma va bene così! Stiamo cambiando il modo in cui costruisci i LEGO!

HALT!

Sie werden möglicherweise bemerken, dass einige tüten durcheinander sind und teile übrig bleiben, aber das ist in Ordnung! Wir ändern die art und weise, wie Sie LEGO bauen!

¡ESPERA!

Es posible que notes que algunas bolsas están fuera de servicio, así como piezas sobrantes, ¡pero está bien! ¡Estamos cambiando la forma en que construyes LEGO!

暫停!

你可能会注意到一些袋子顺序错乱, 以及一些剩余的部件, 但没关系! 我们正在改变你搭建乐高的方式!

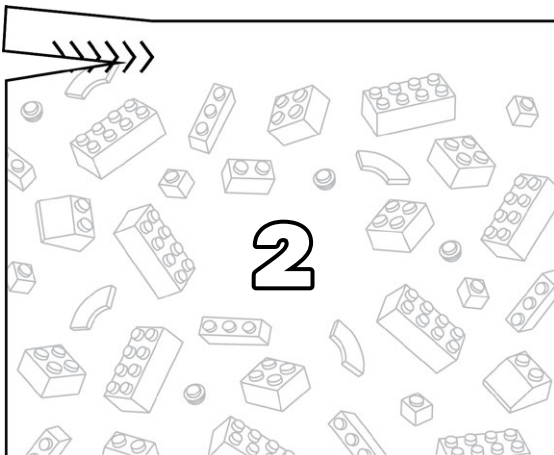
Open LEGO® Bag 2

22

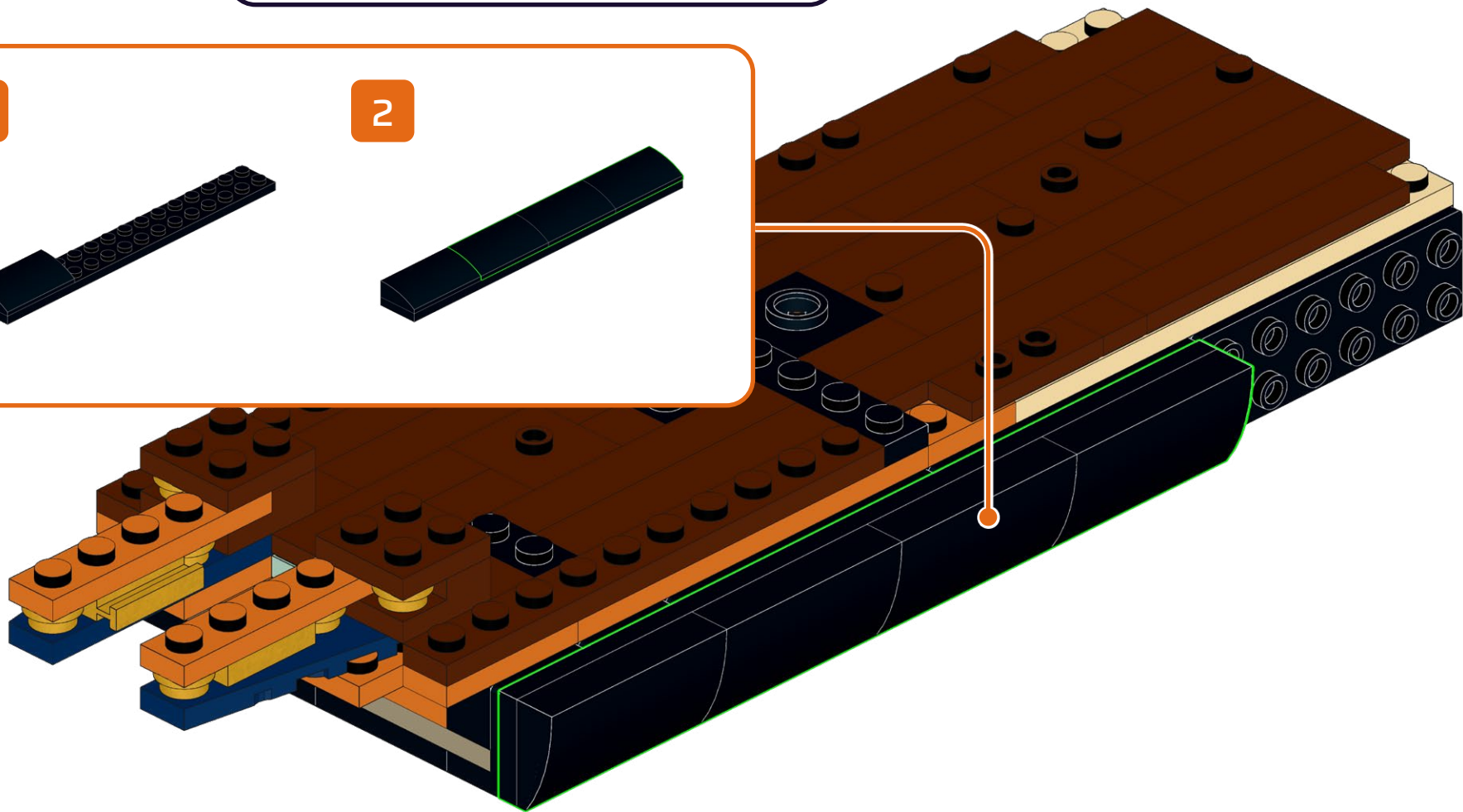
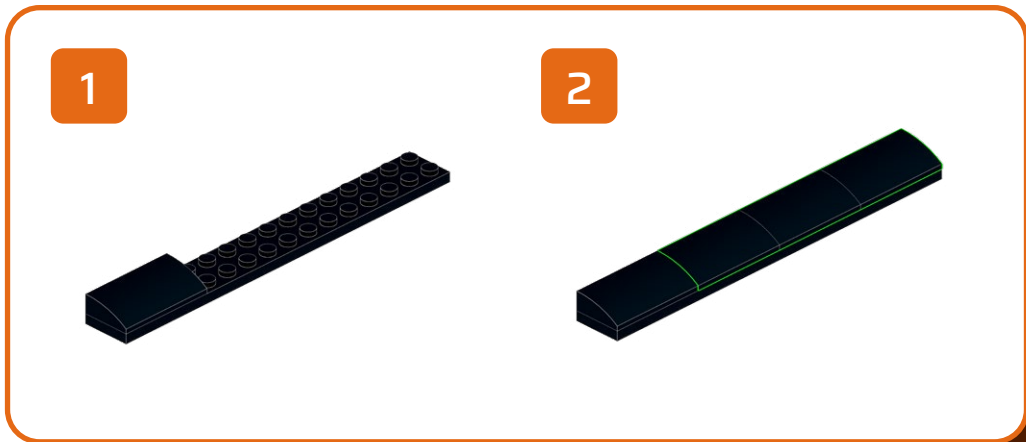
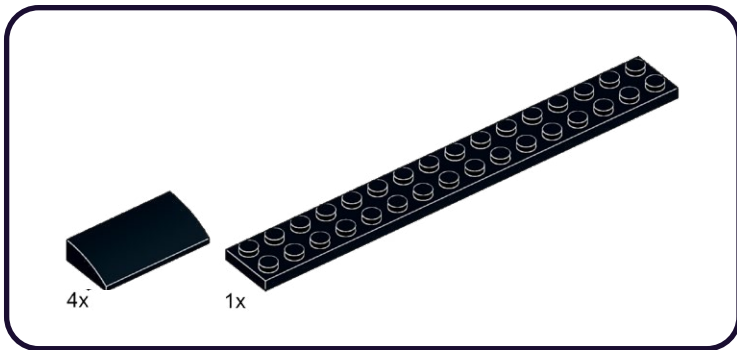

23

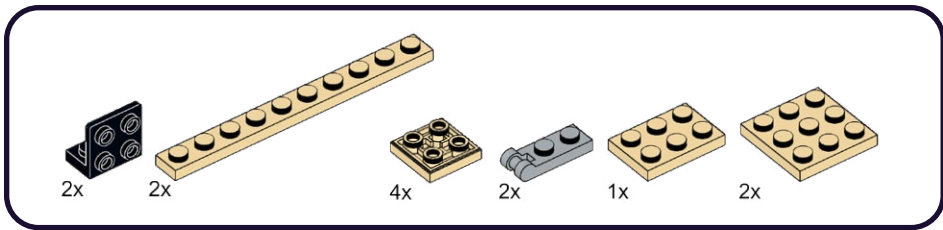

1

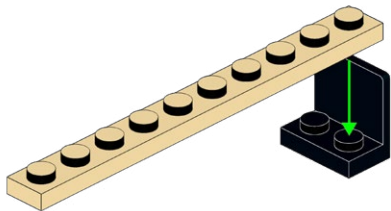

3

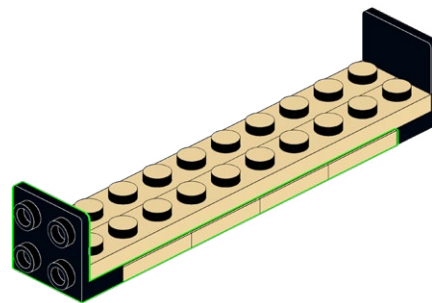

2

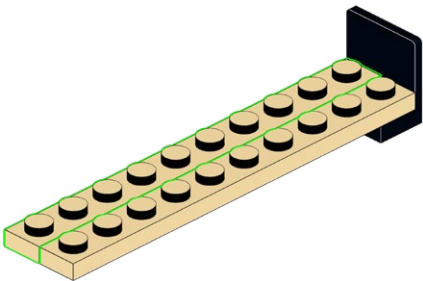

4

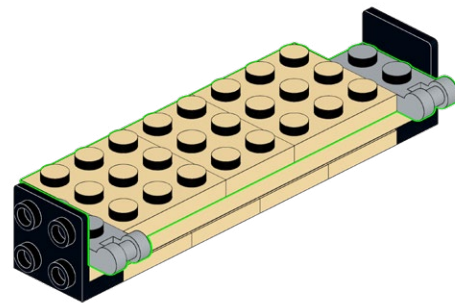

24



1

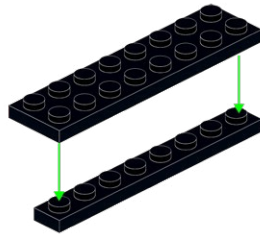

2

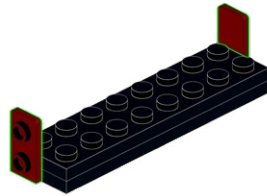

2

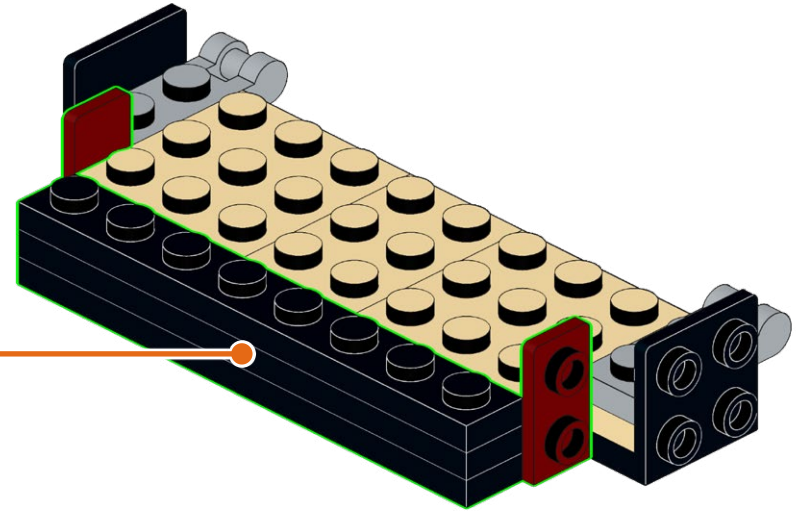
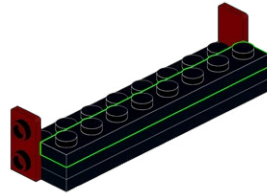

25

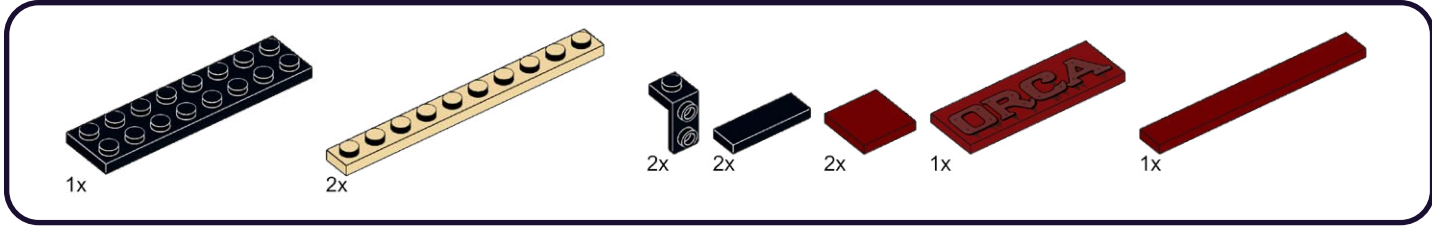

1

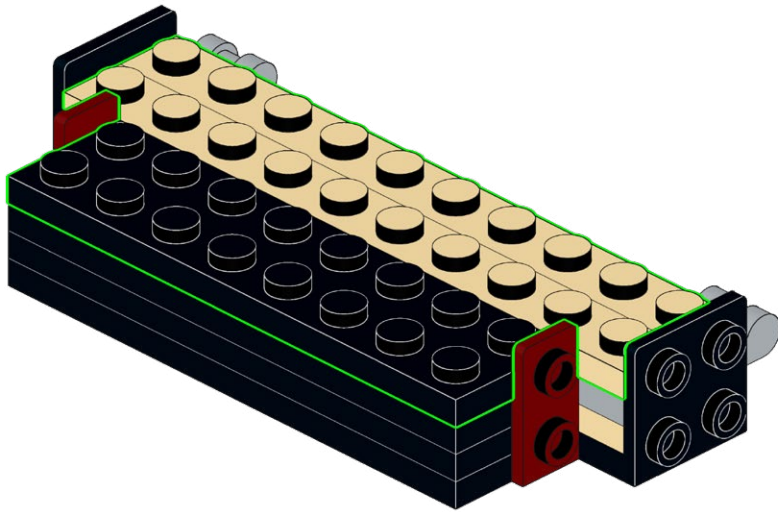

2

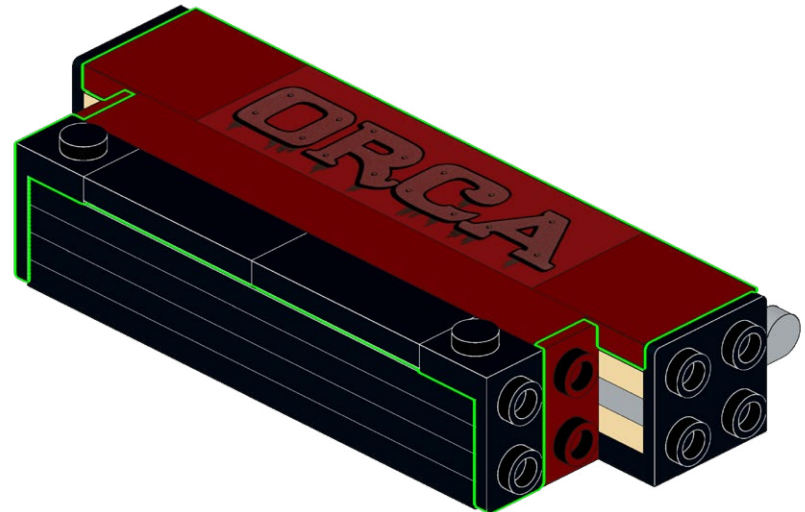

26

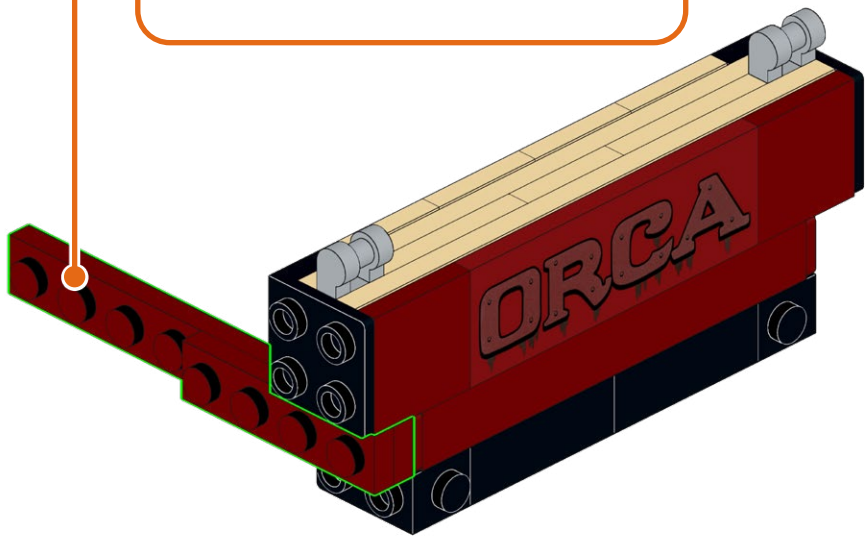
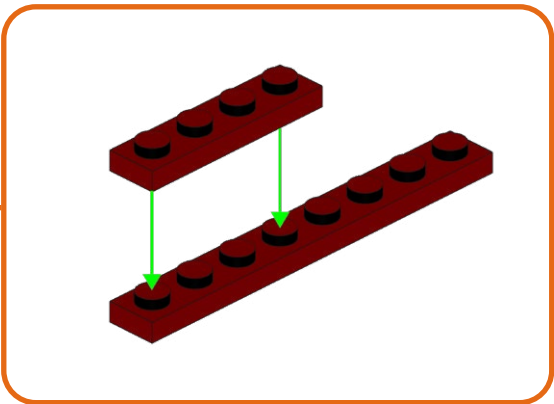
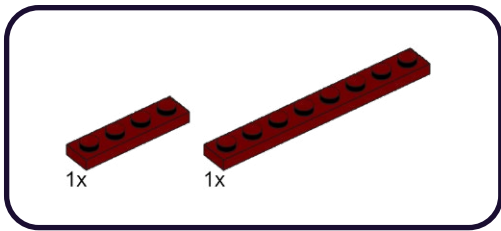

27

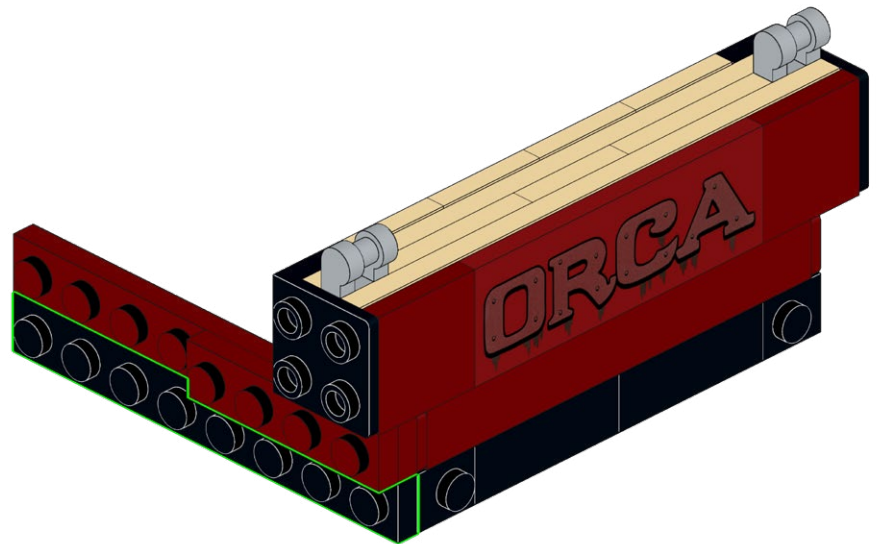
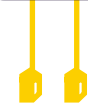
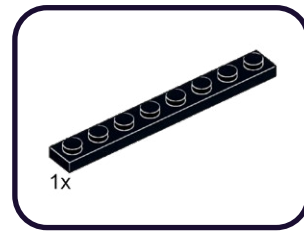

28

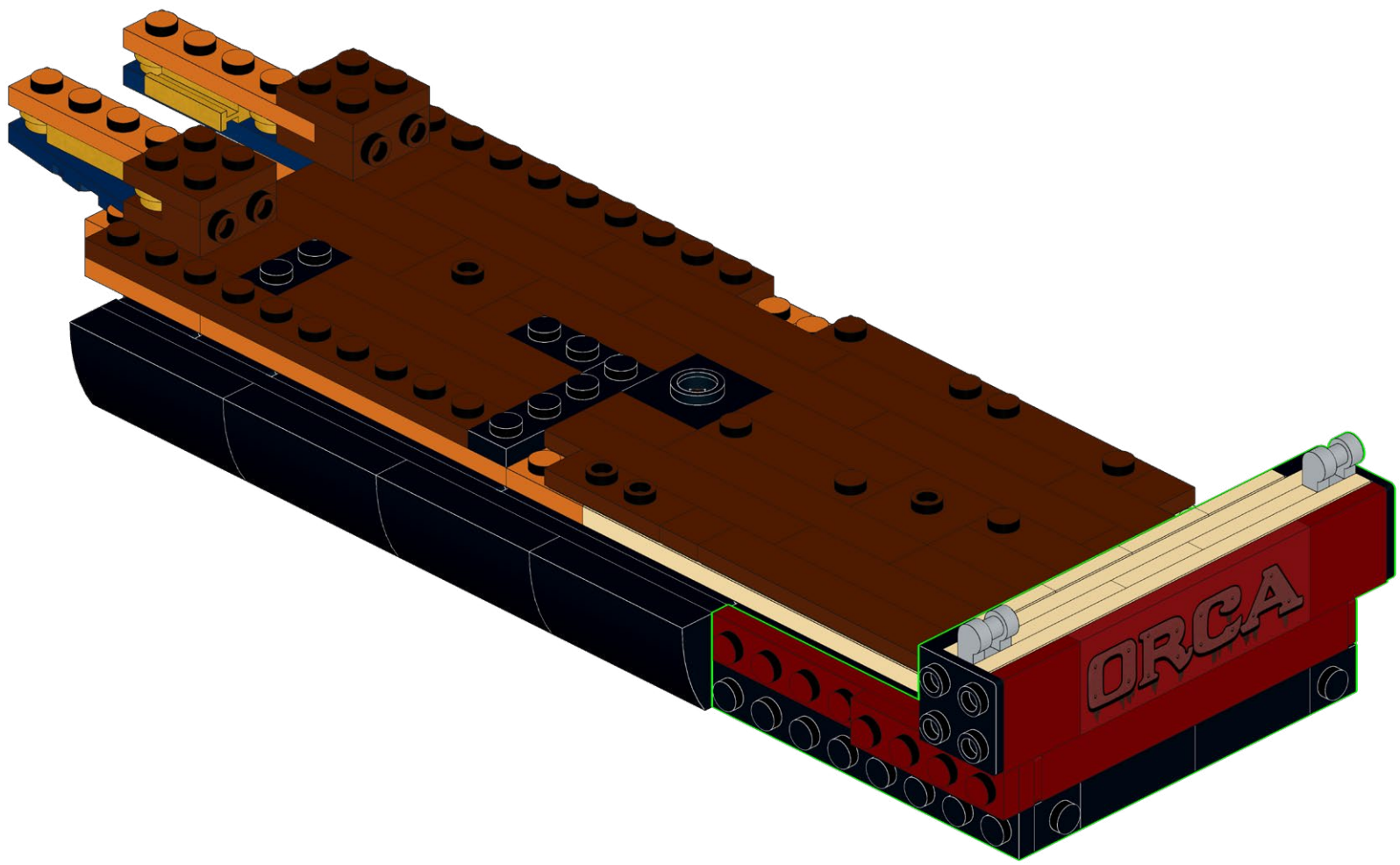

29

2x

1x

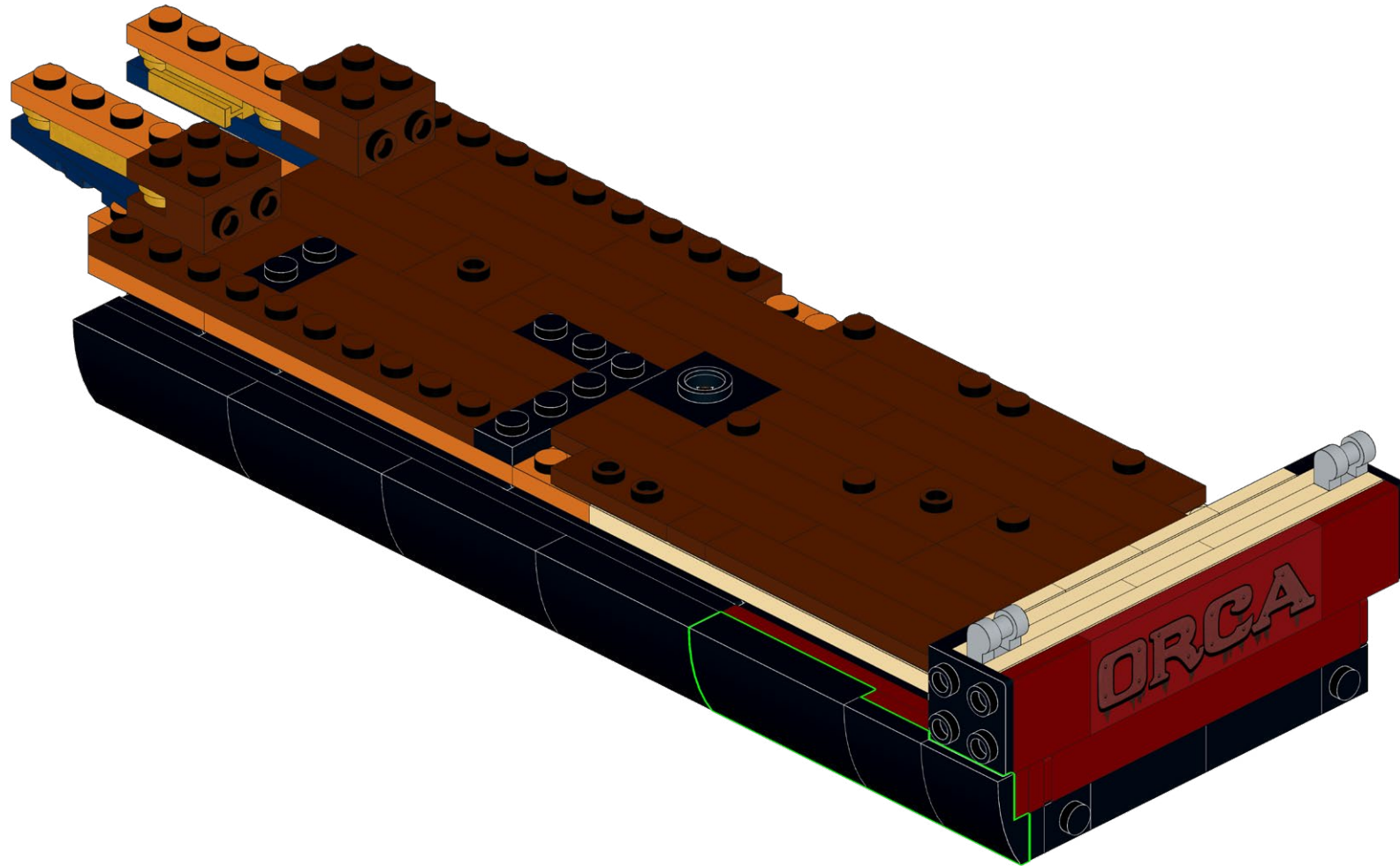

30

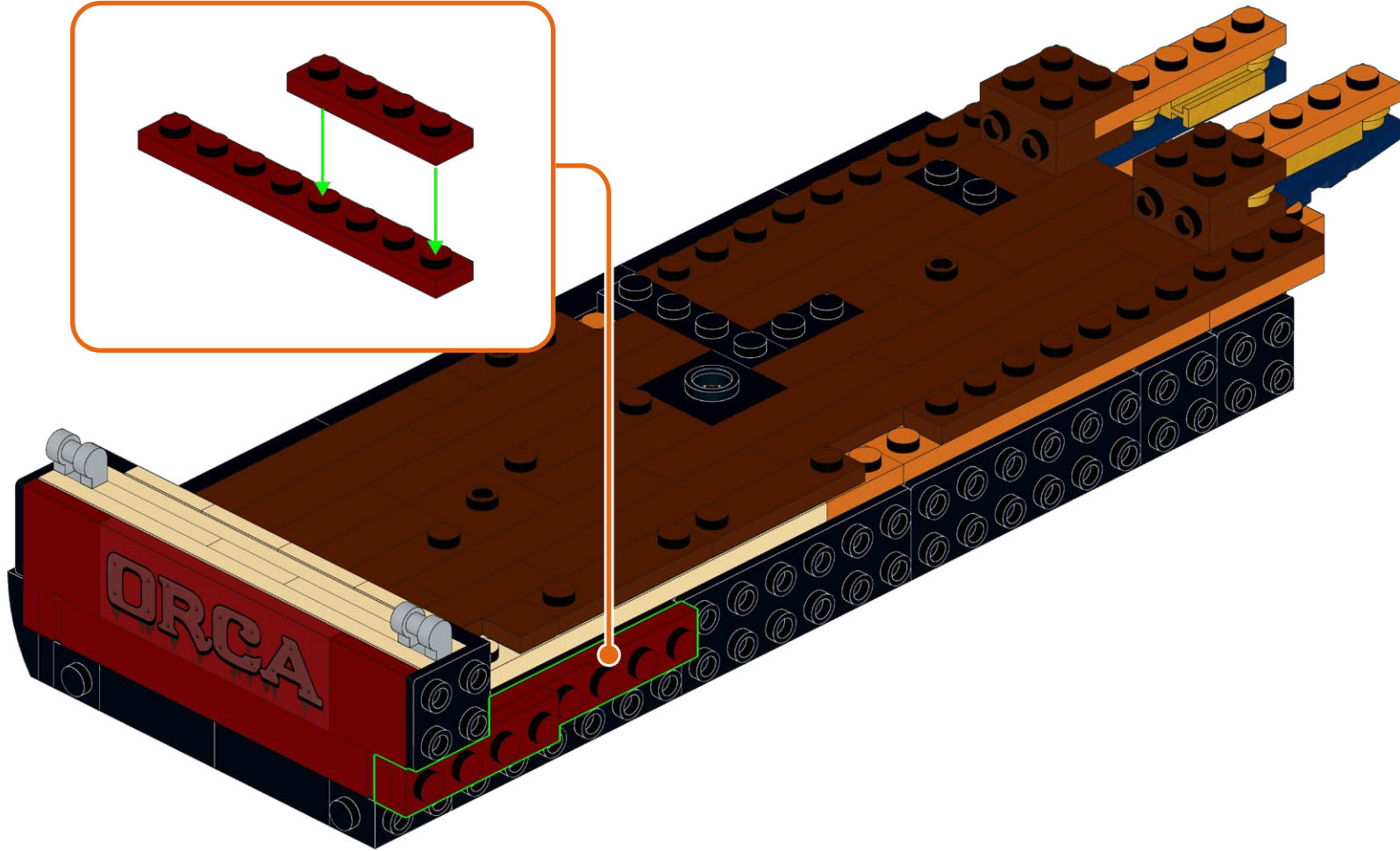
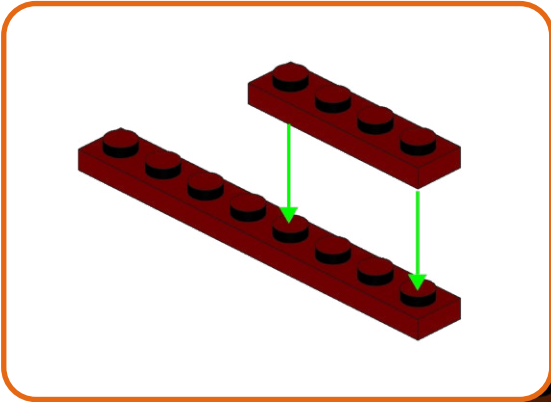
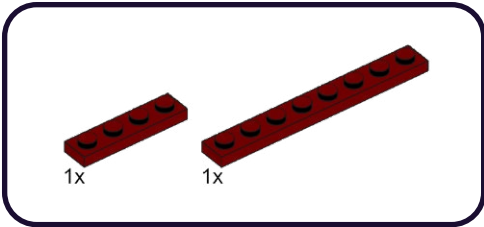

31

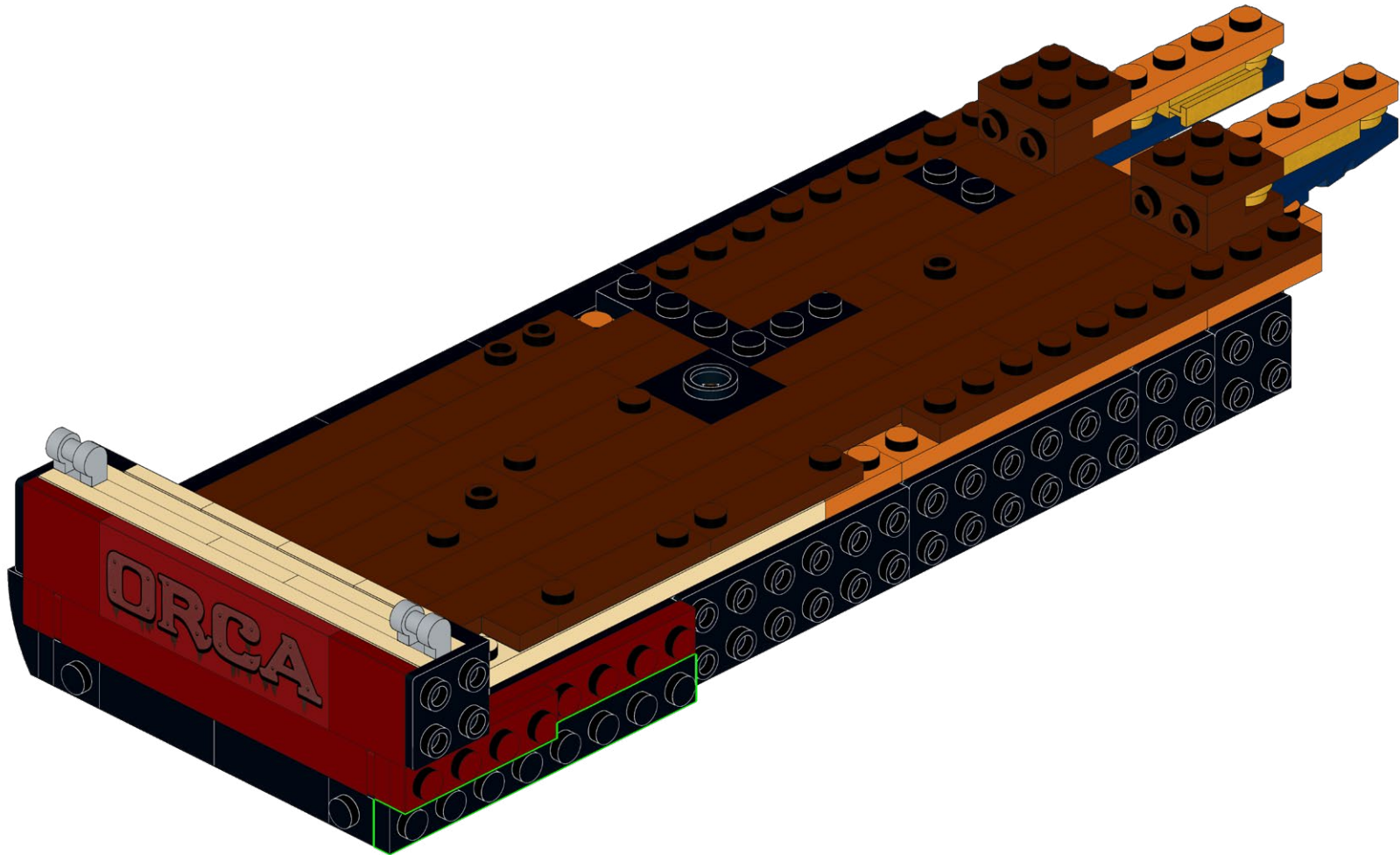
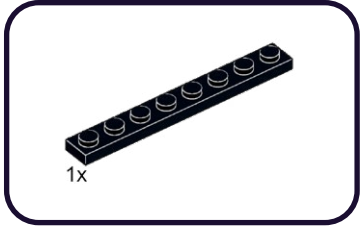

32

2x

1x

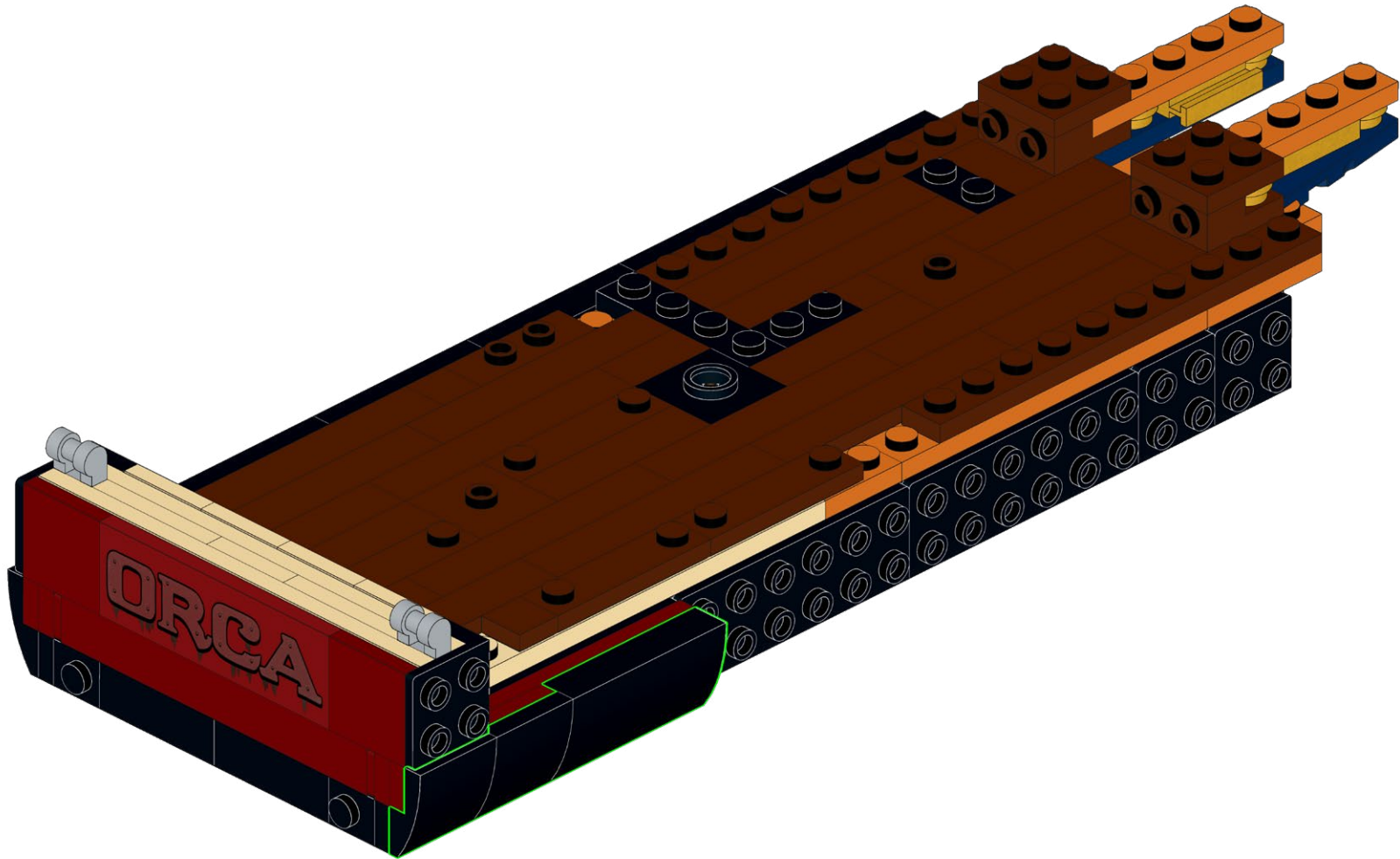

33

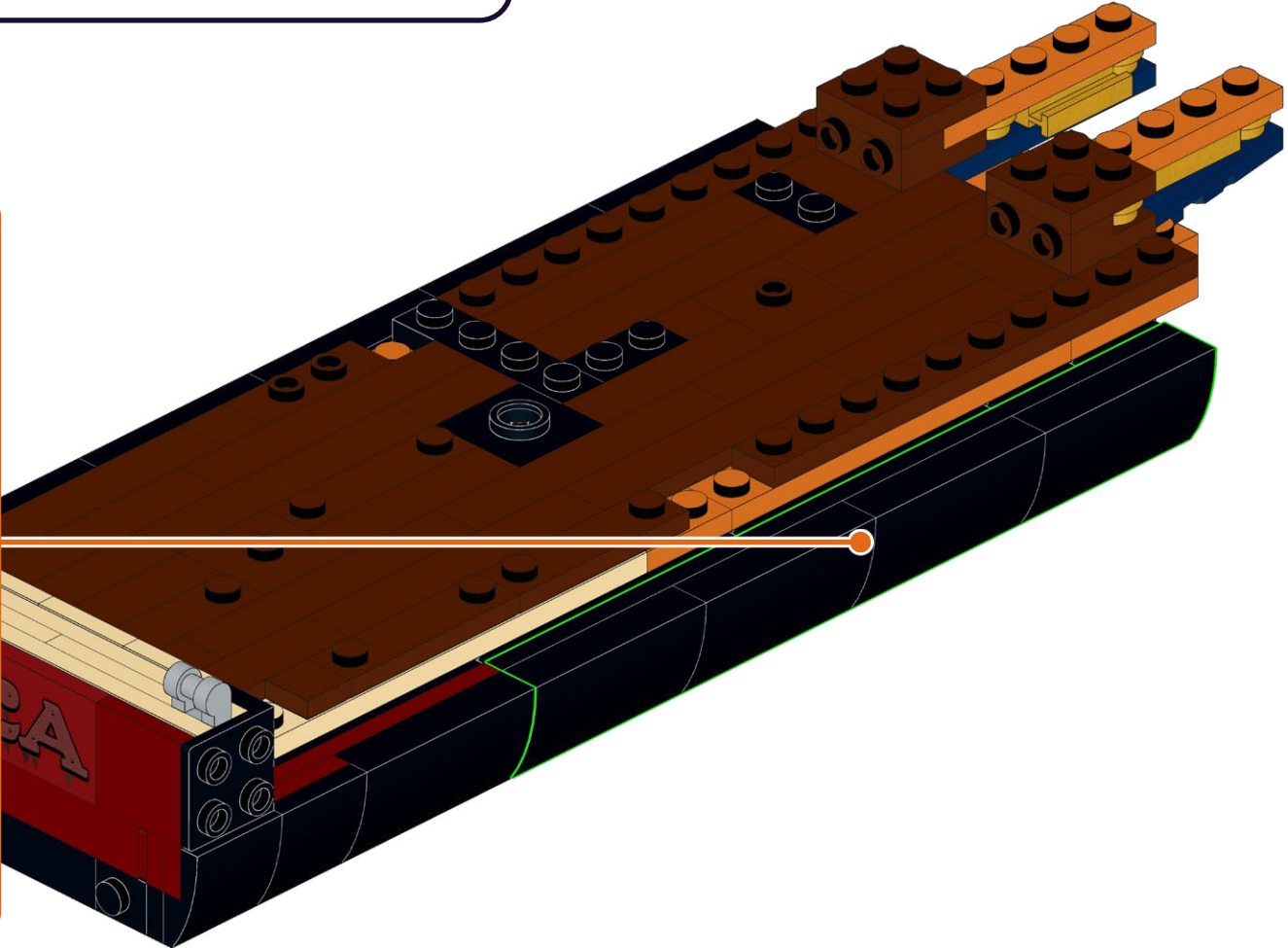
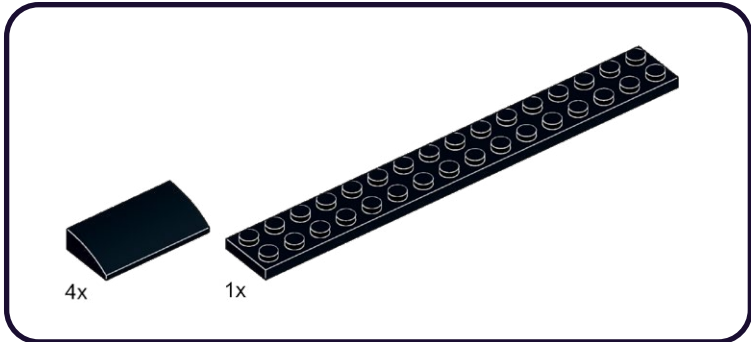

34

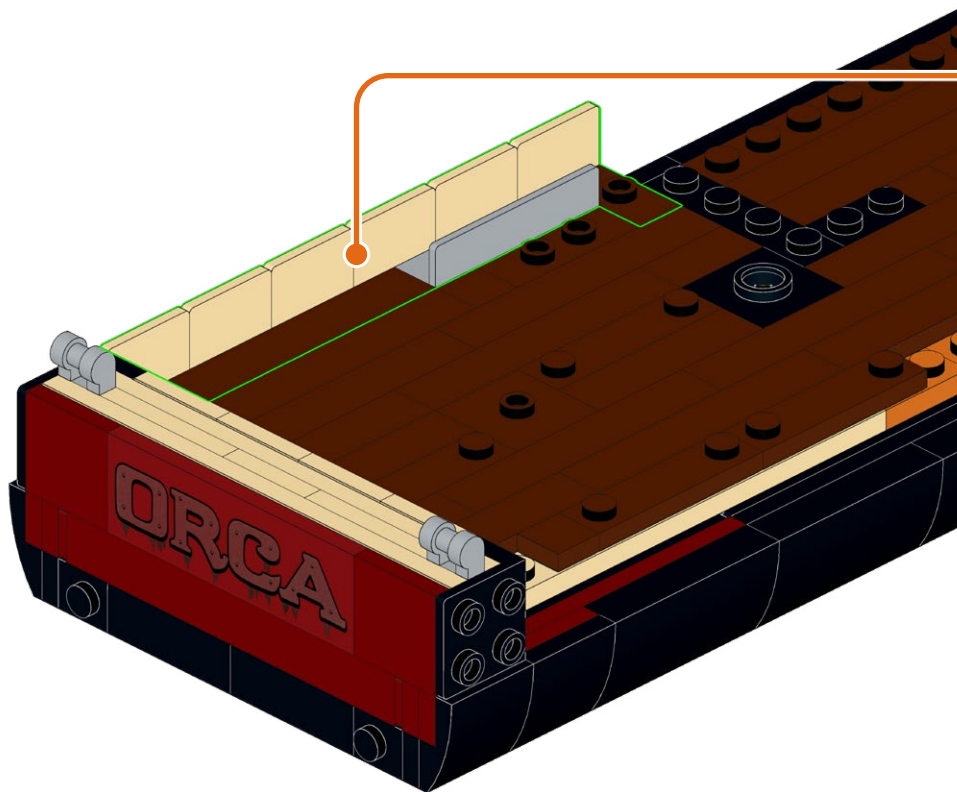
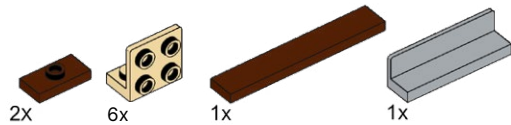

1

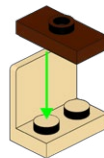

4

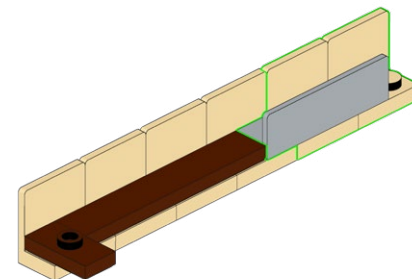

2

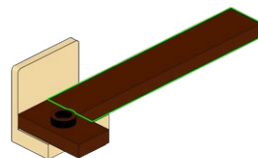

5

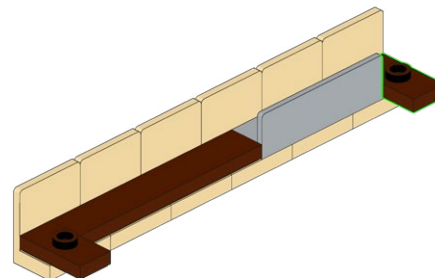

3

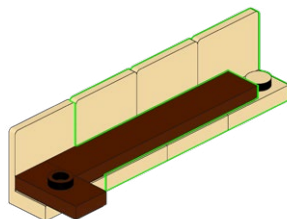

35

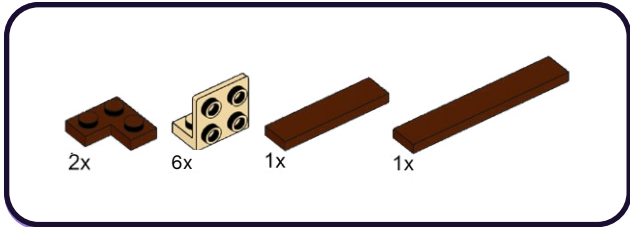

1. A dark brown 2x2 Technic brick is placed on top of a light tan 1x4 Technic Technonut.

2. A dark brown 1x4 Technic Technonut is placed on top of the assembly from step 1.

3. A light tan 1x4 Technic Technonut is placed on top of the assembly from step 2.

4. A dark brown 1x6 Technic Technonut is placed on top of the assembly from step 3.

5. A light tan 1x4 Technic Technonut is placed on top of the assembly from step 4.

6. A dark brown 1x4 Technic Technonut is placed on top of the assembly from step 5.

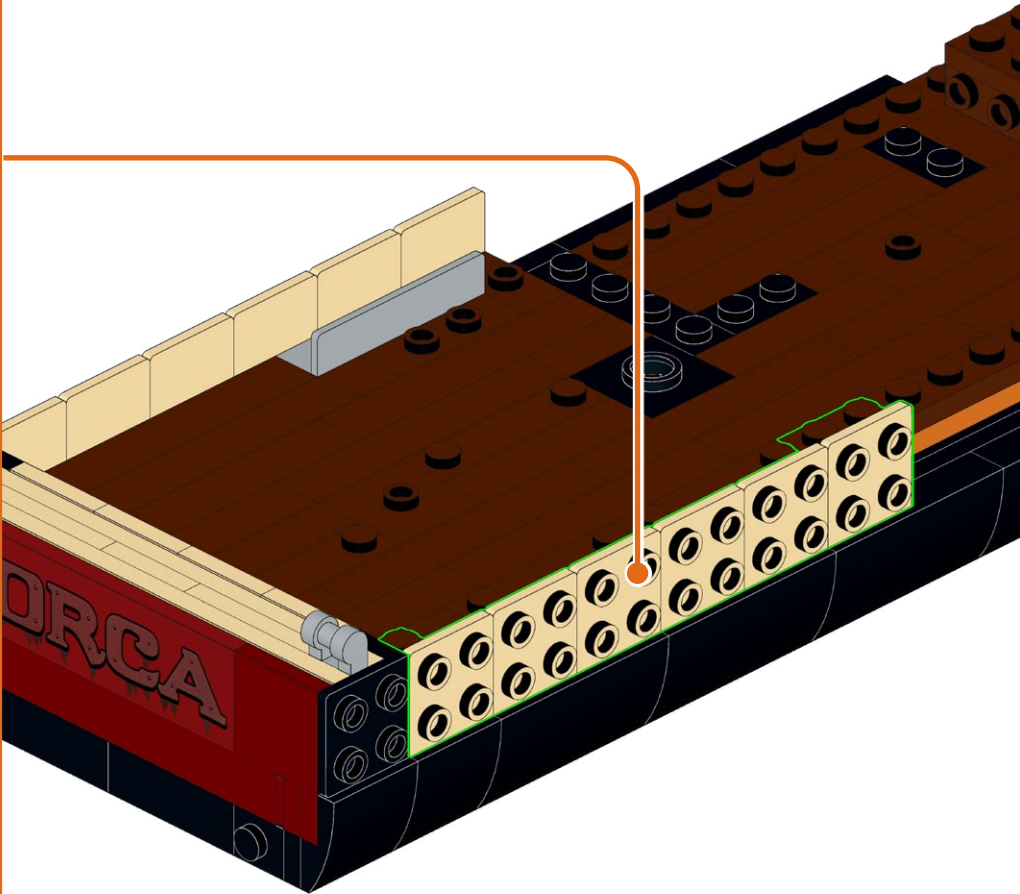

36

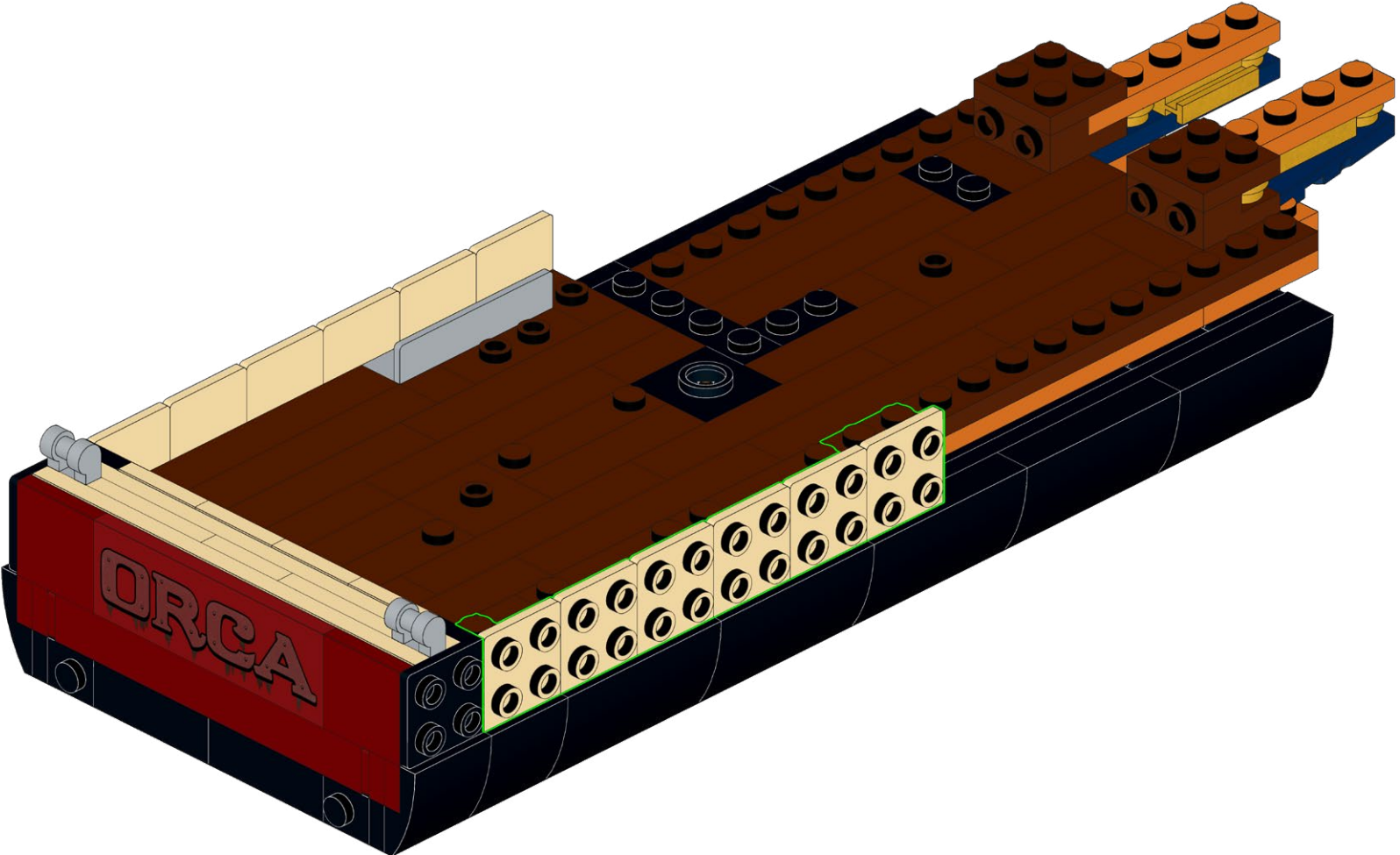

38

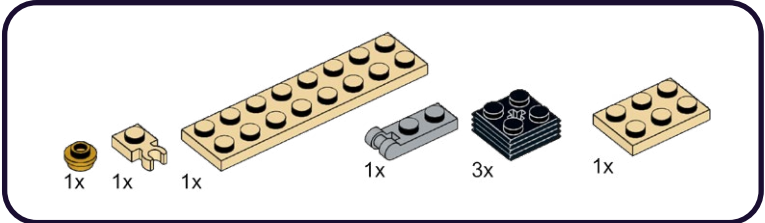

1

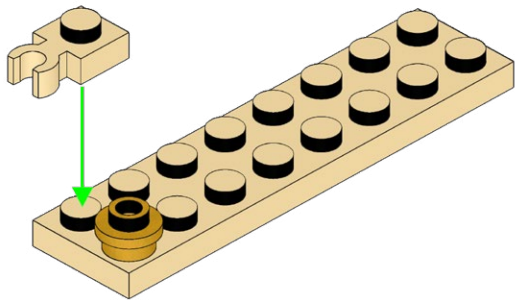

2

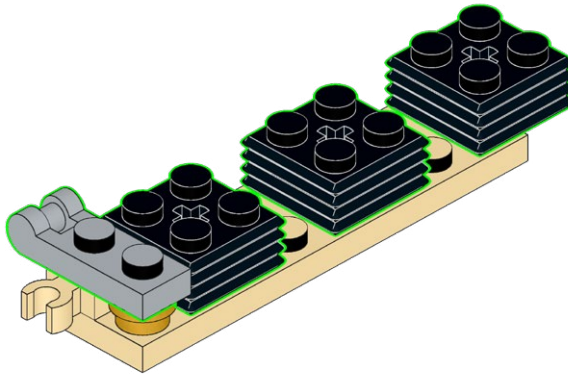

3

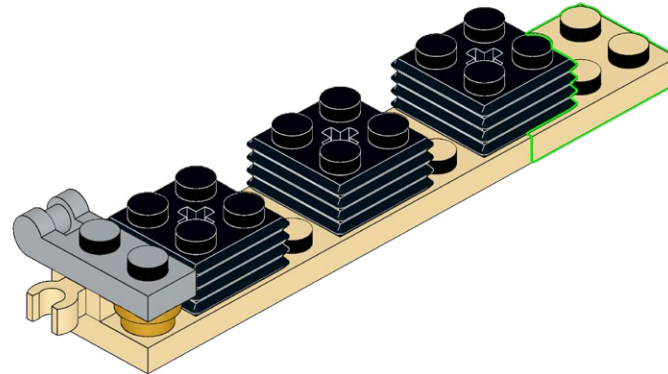

39

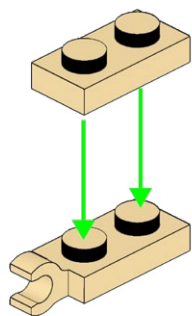
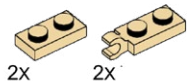

2x

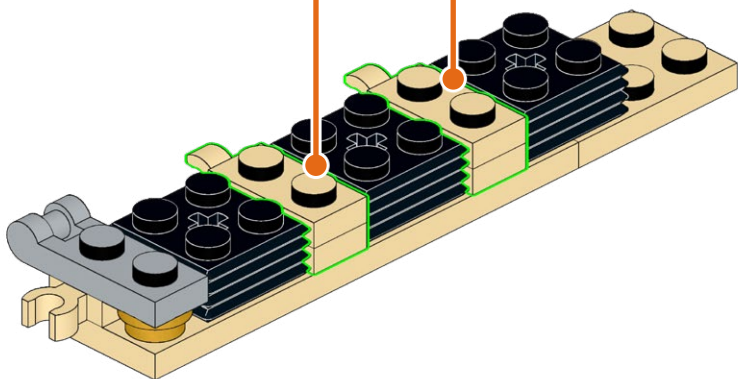

40

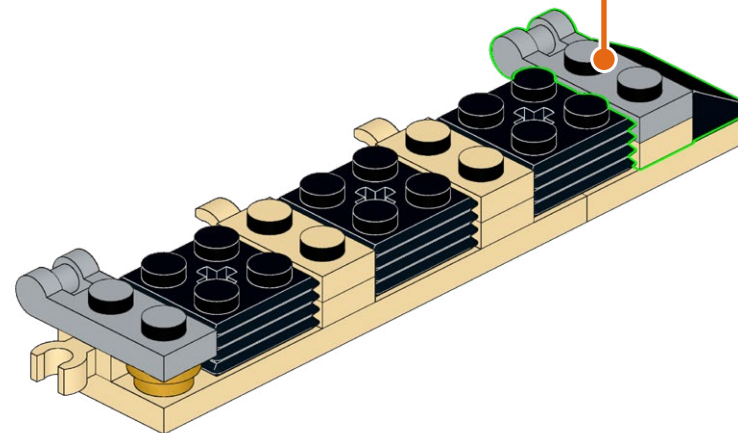
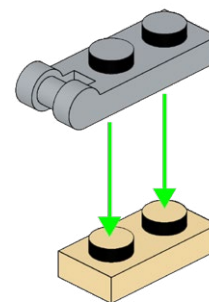
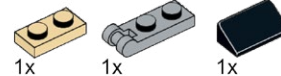

41

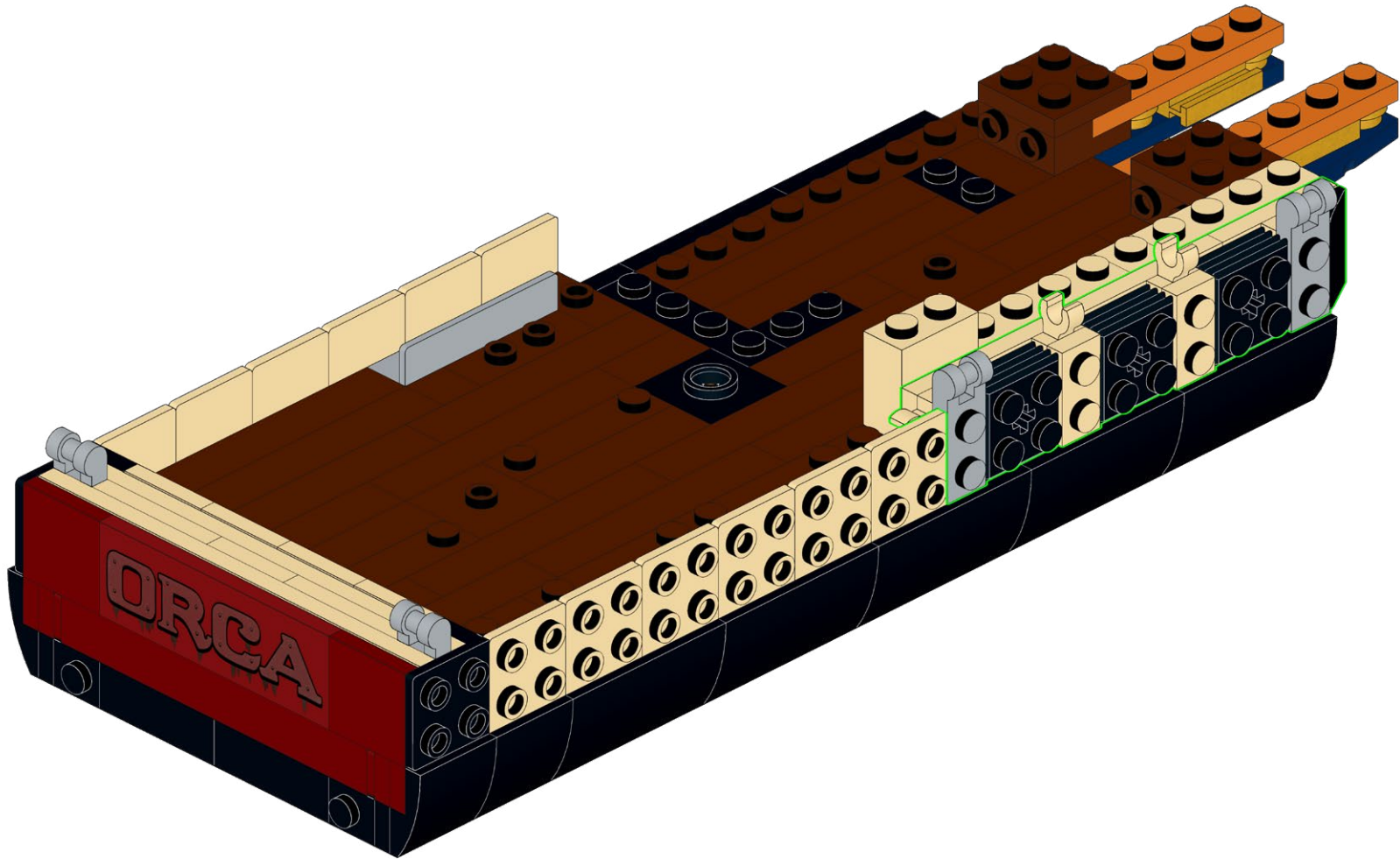

42

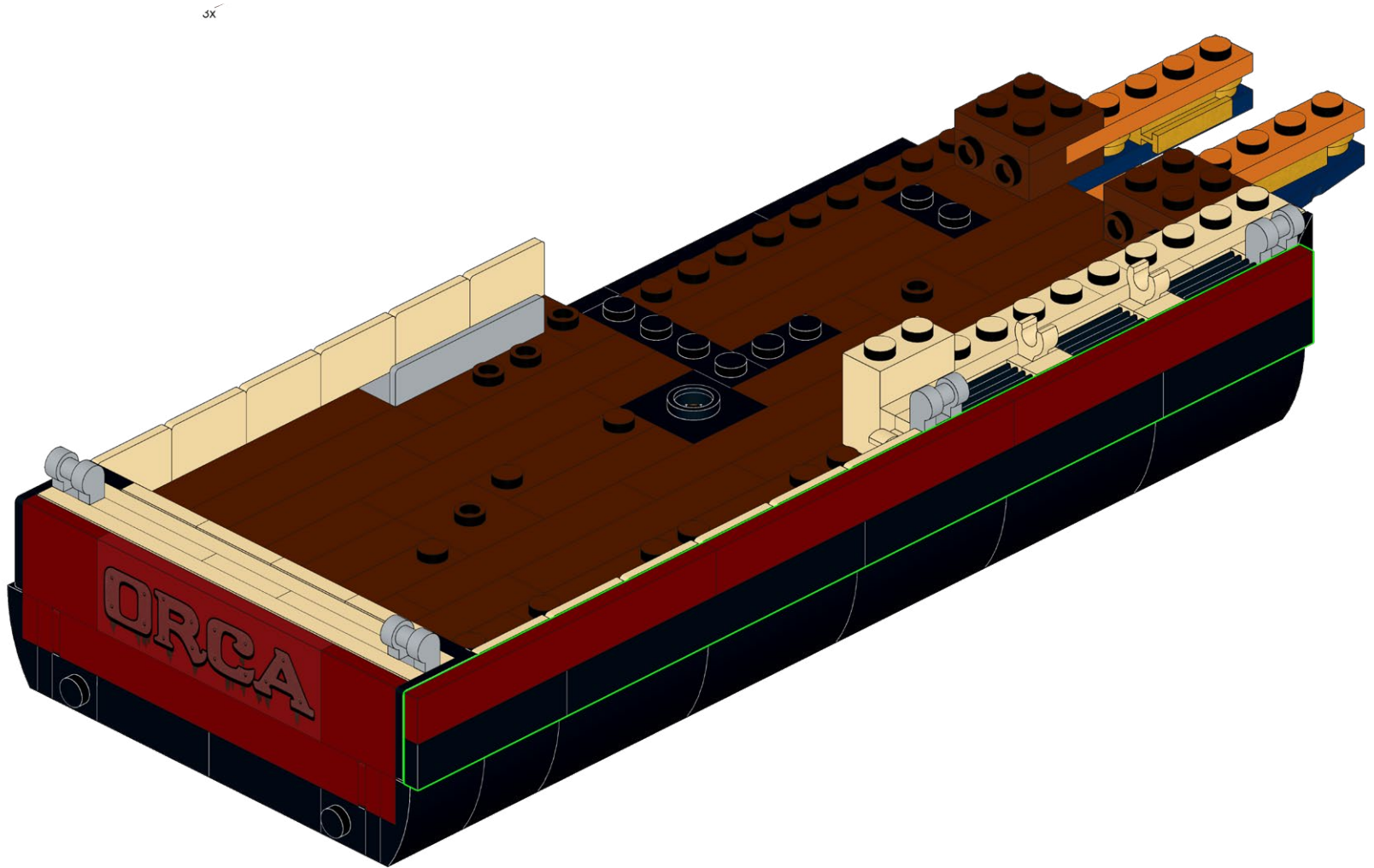
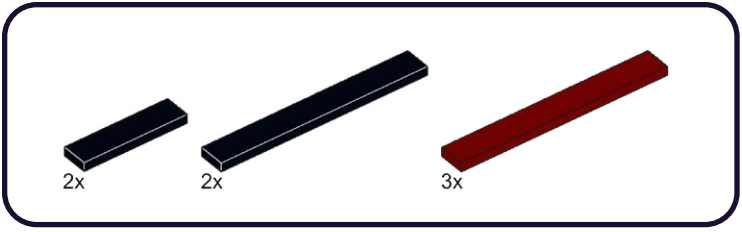

43

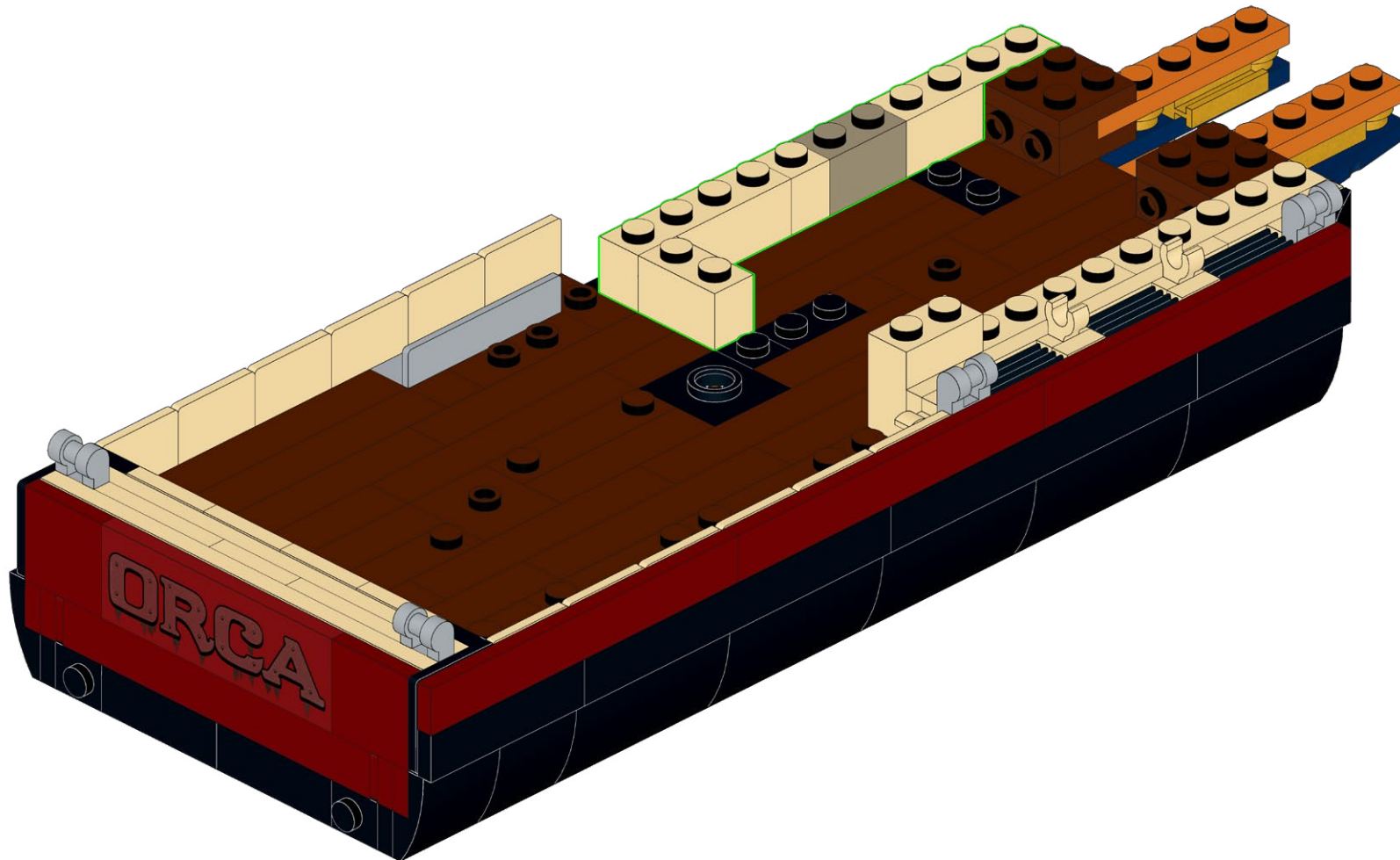
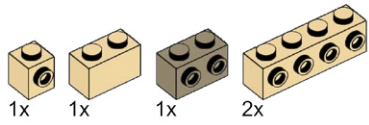

44

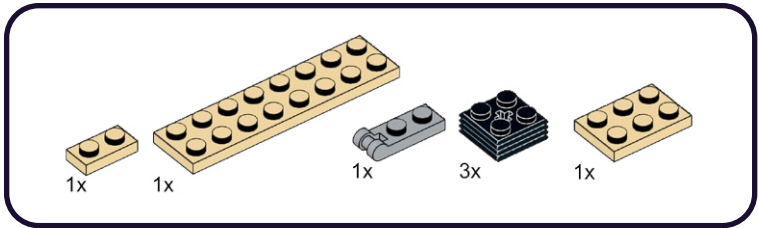

1

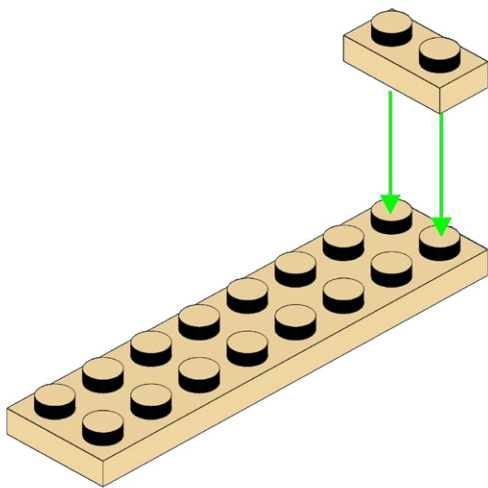

2

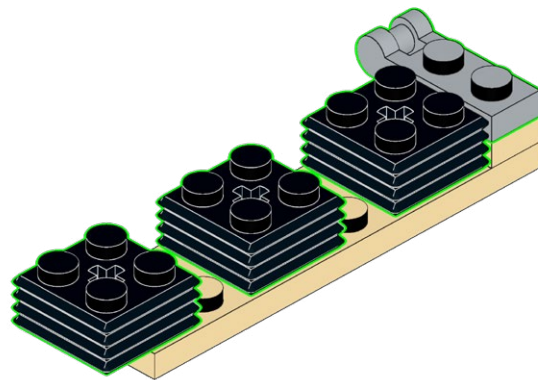

3

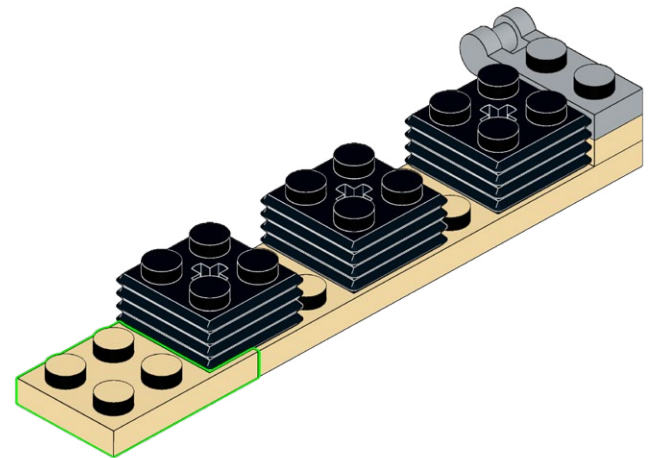

45

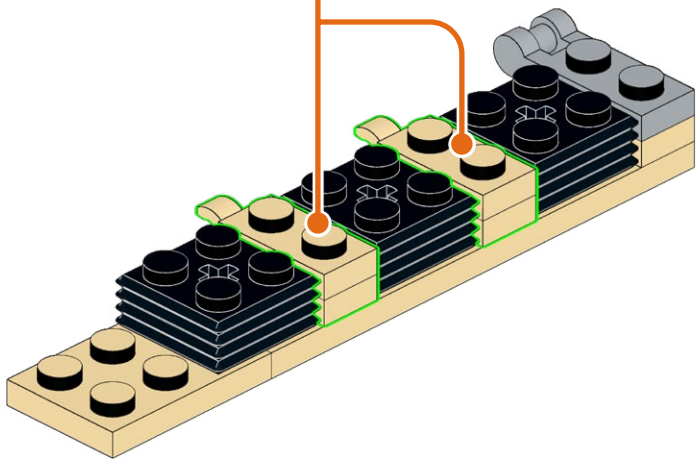
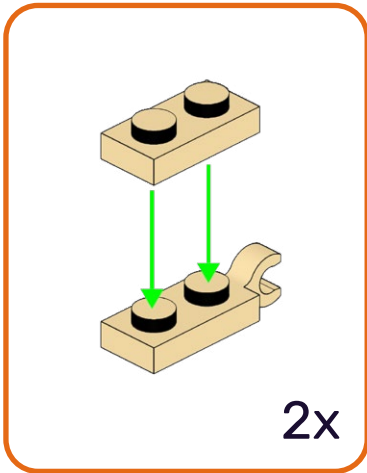
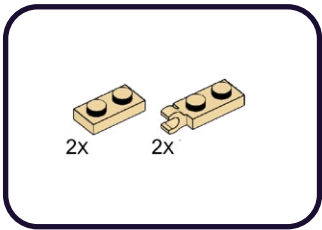

46

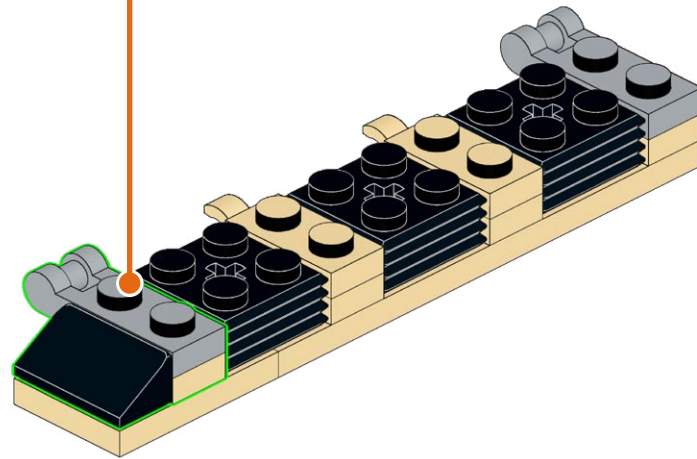
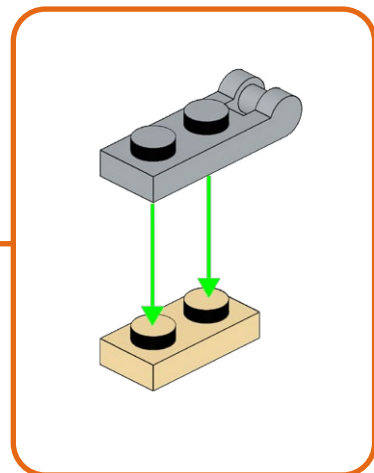
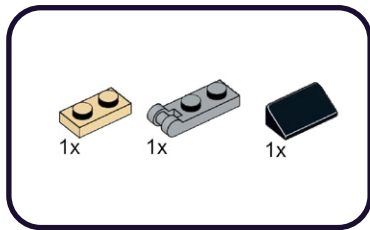

47

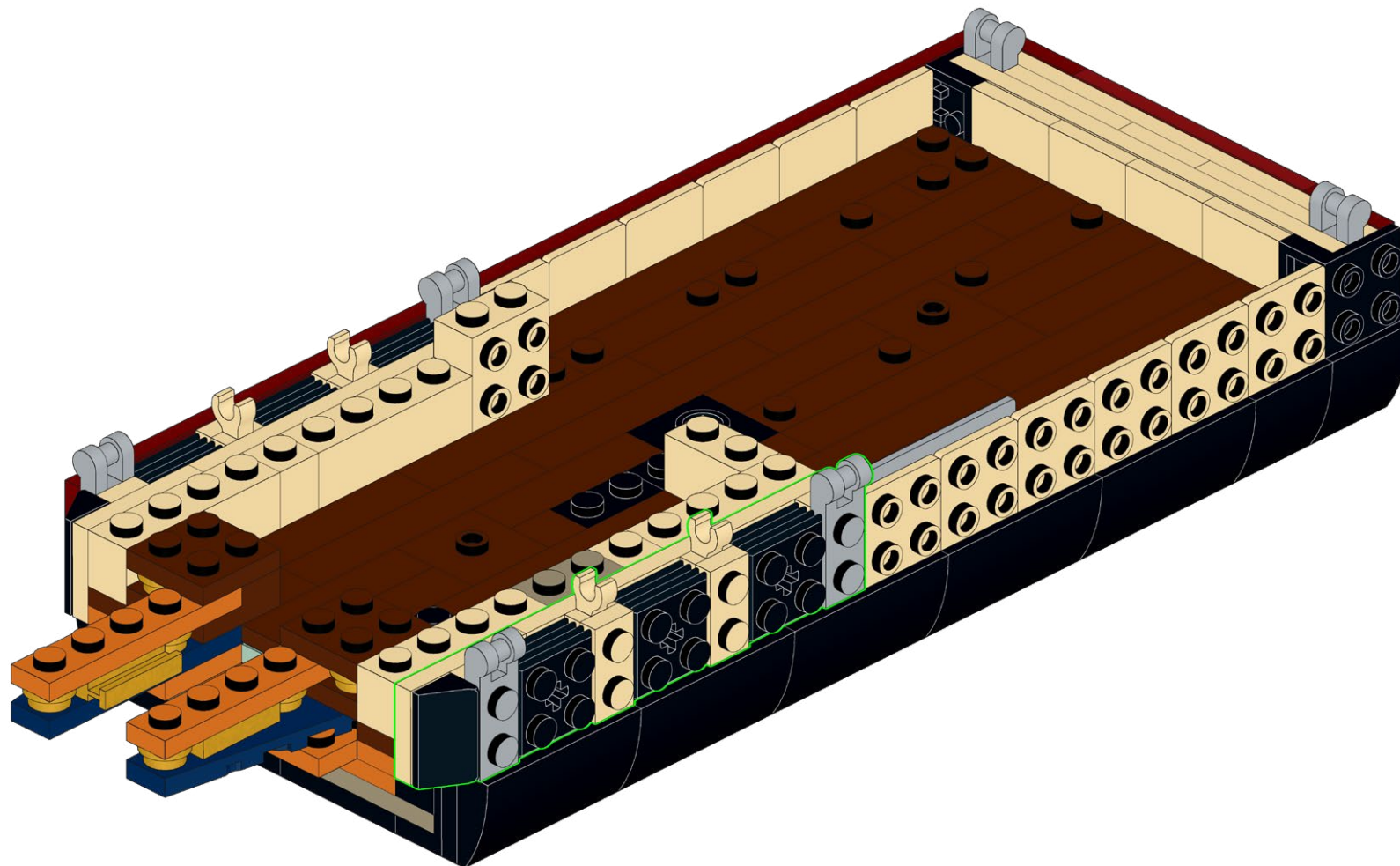

48

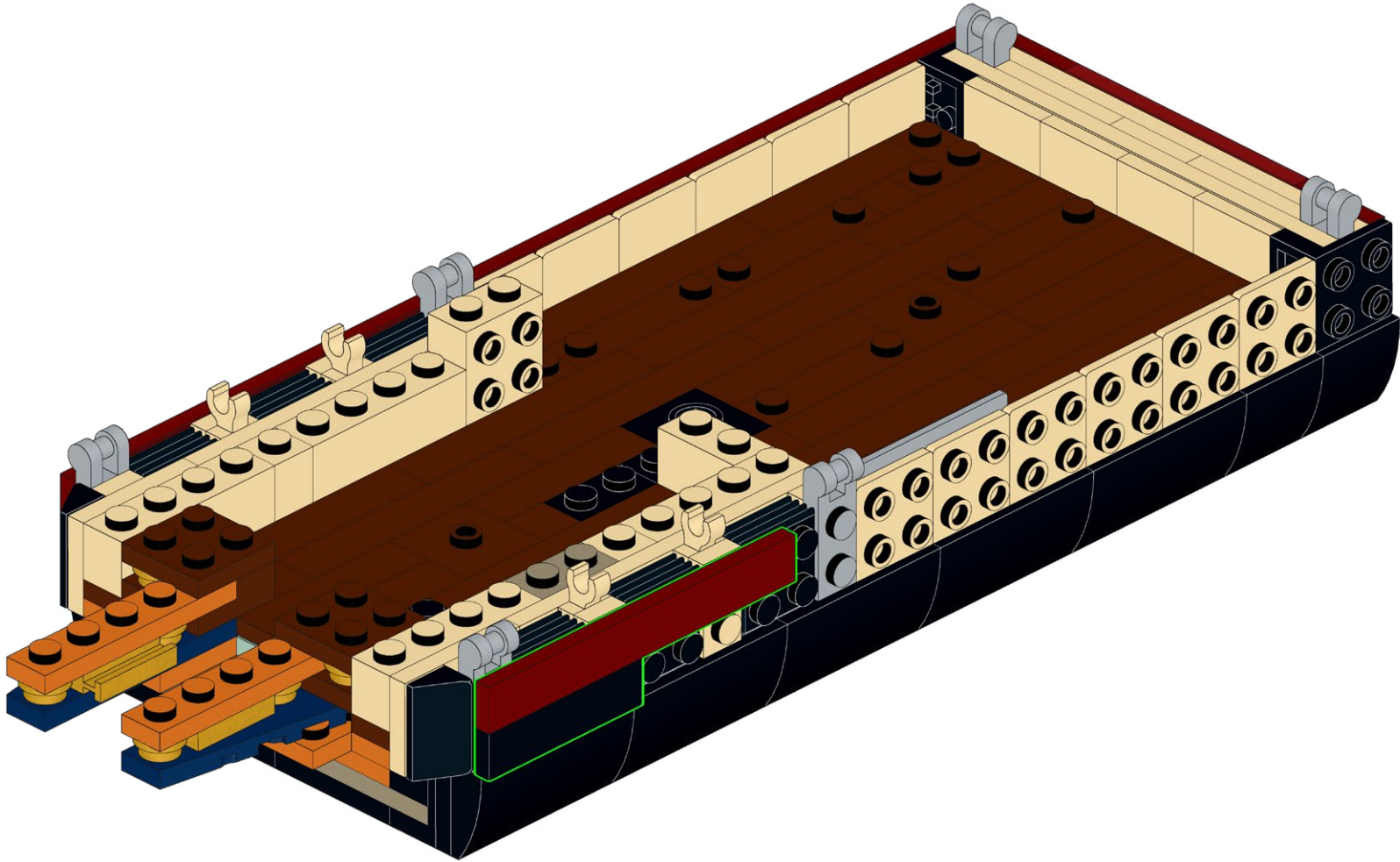
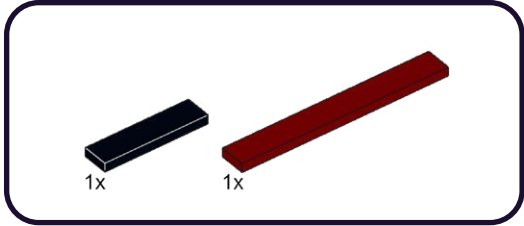



HOLD UP!

You might notice some bags aren't in order, as well as left over pieces, but that's ok! We're changing the way you build LEGO!

ATTENDEZ!

Vous remarquerez peut-être que certains sacs, ainsi que certaines pièces, ne sont pas dans le bon ordre. Mais pas de panique! Nous changeons simplement la façon avec laquelle vous construisez vos LEGO!

ASPETTA!

Potresti notare che alcuni sacchetti non sono in ordine, così come i pezzi avanzati, ma va bene così! Stiamo cambiando il modo in cui costruisci i LEGO!

HALT!

Sie werden möglicherweise bemerken, dass einige tüten durcheinander sind und teile übrig bleiben, aber das ist in Ordnung! Wir ändern die art und weise, wie Sie LEGO bauen!

¡ESPERA!

Es posible que notes que algunas bolsas están fuera de servicio, así como piezas sobrantes, ¡pero está bien! ¡Estamos cambiando la forma en que construyes LEGO!

暫停!

你可能会注意到一些袋子顺序错乱, 以及一些剩余的部件, 但没关系! 我们正在改变你搭建乐高的方式!

Open LEGO® Bag 3

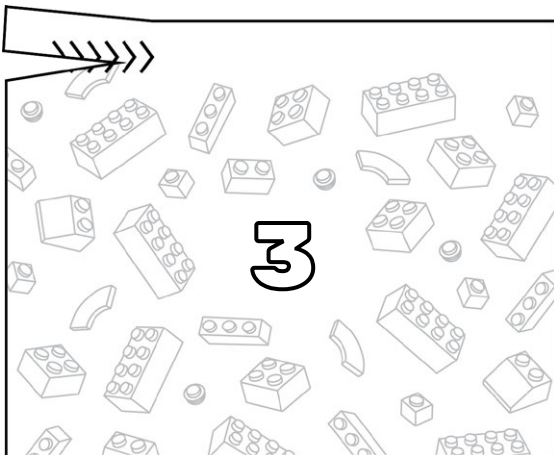

49

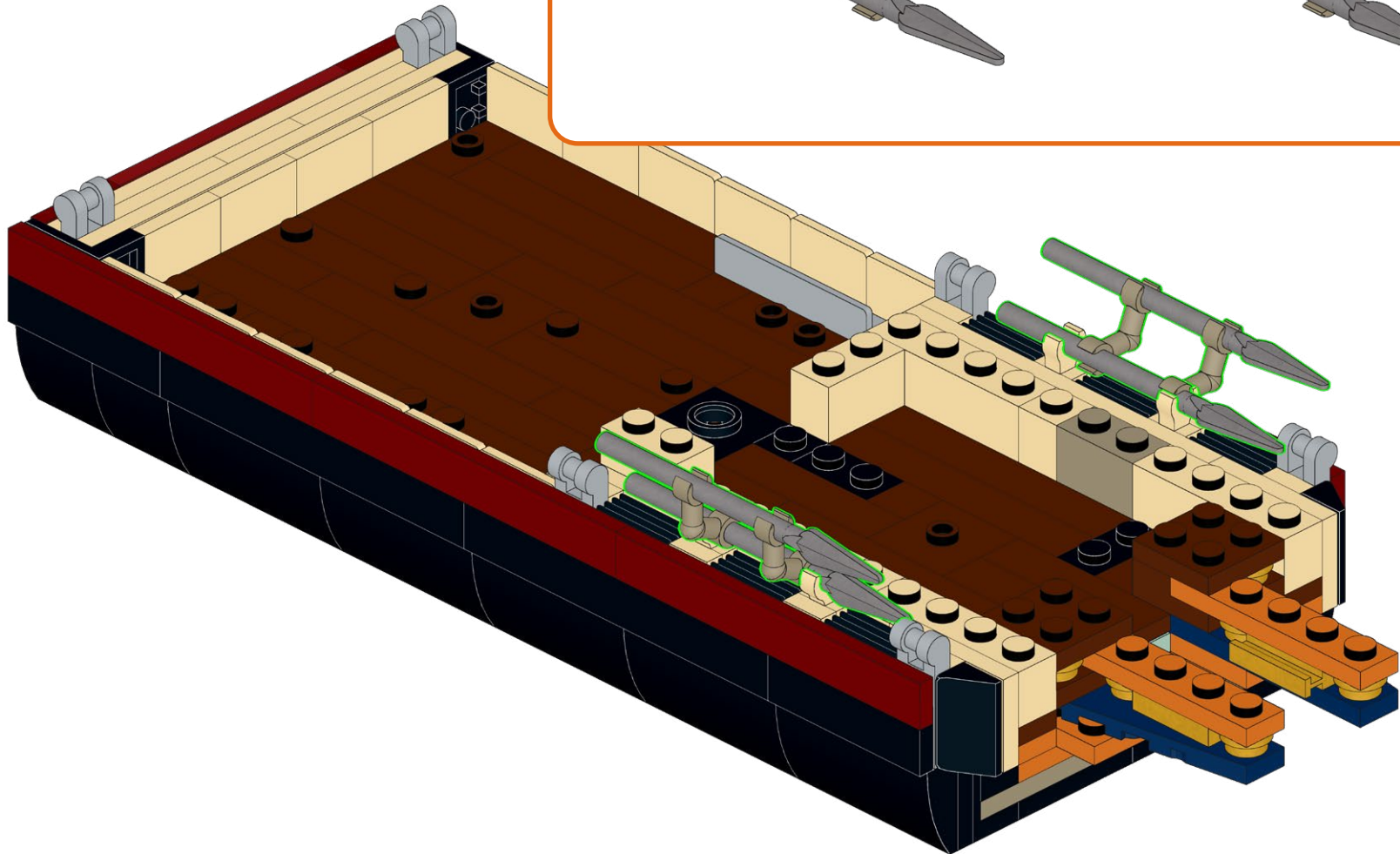
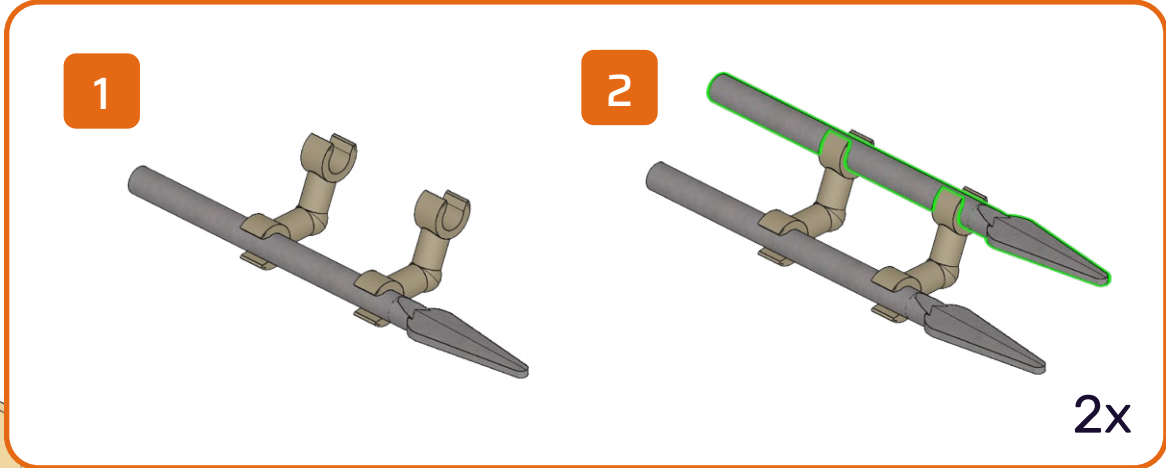
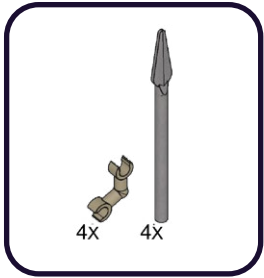

50

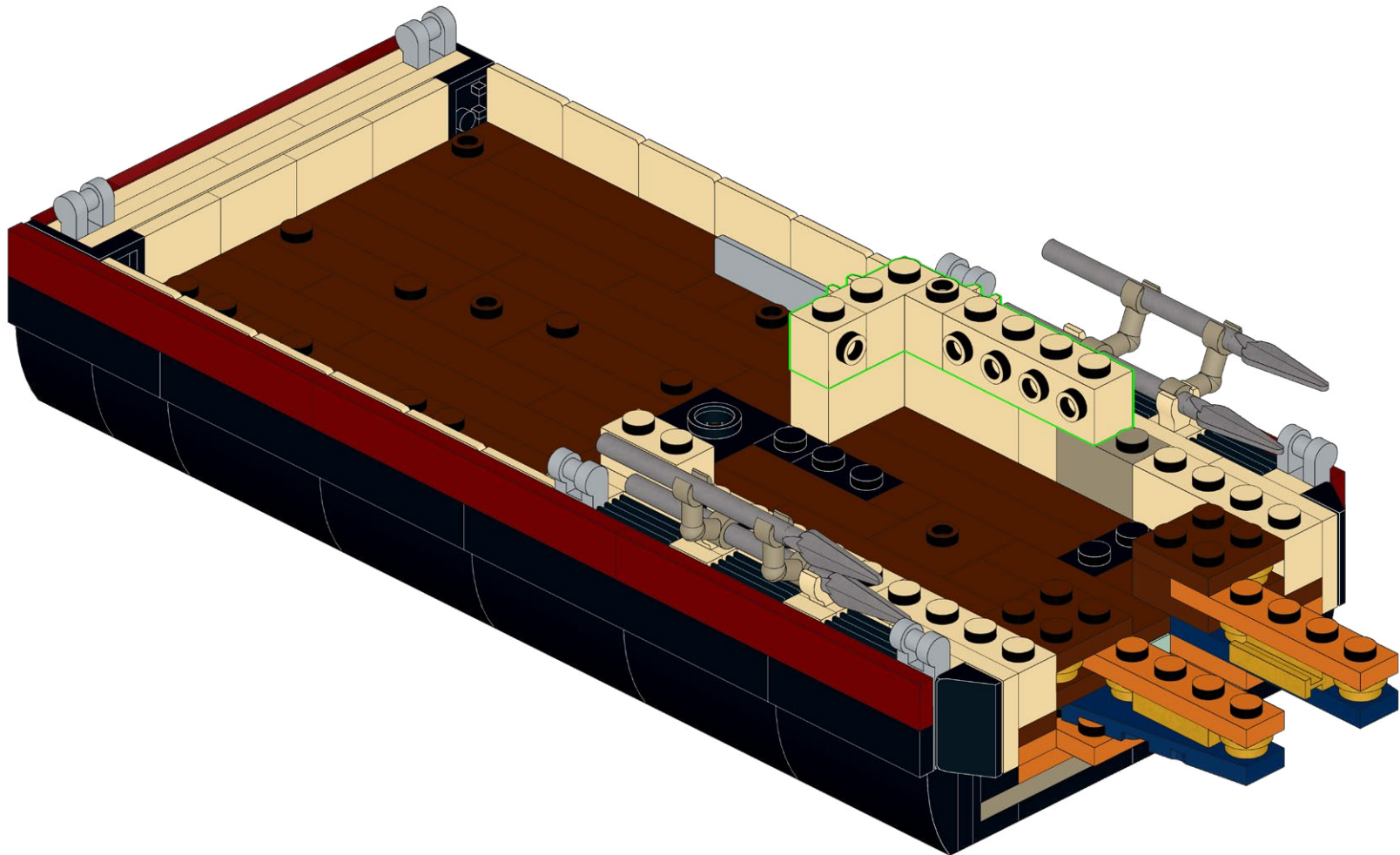
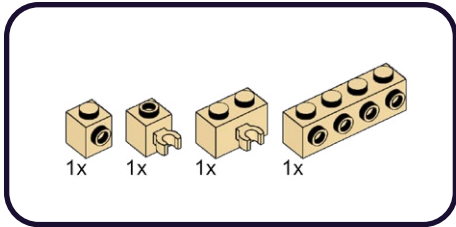

51

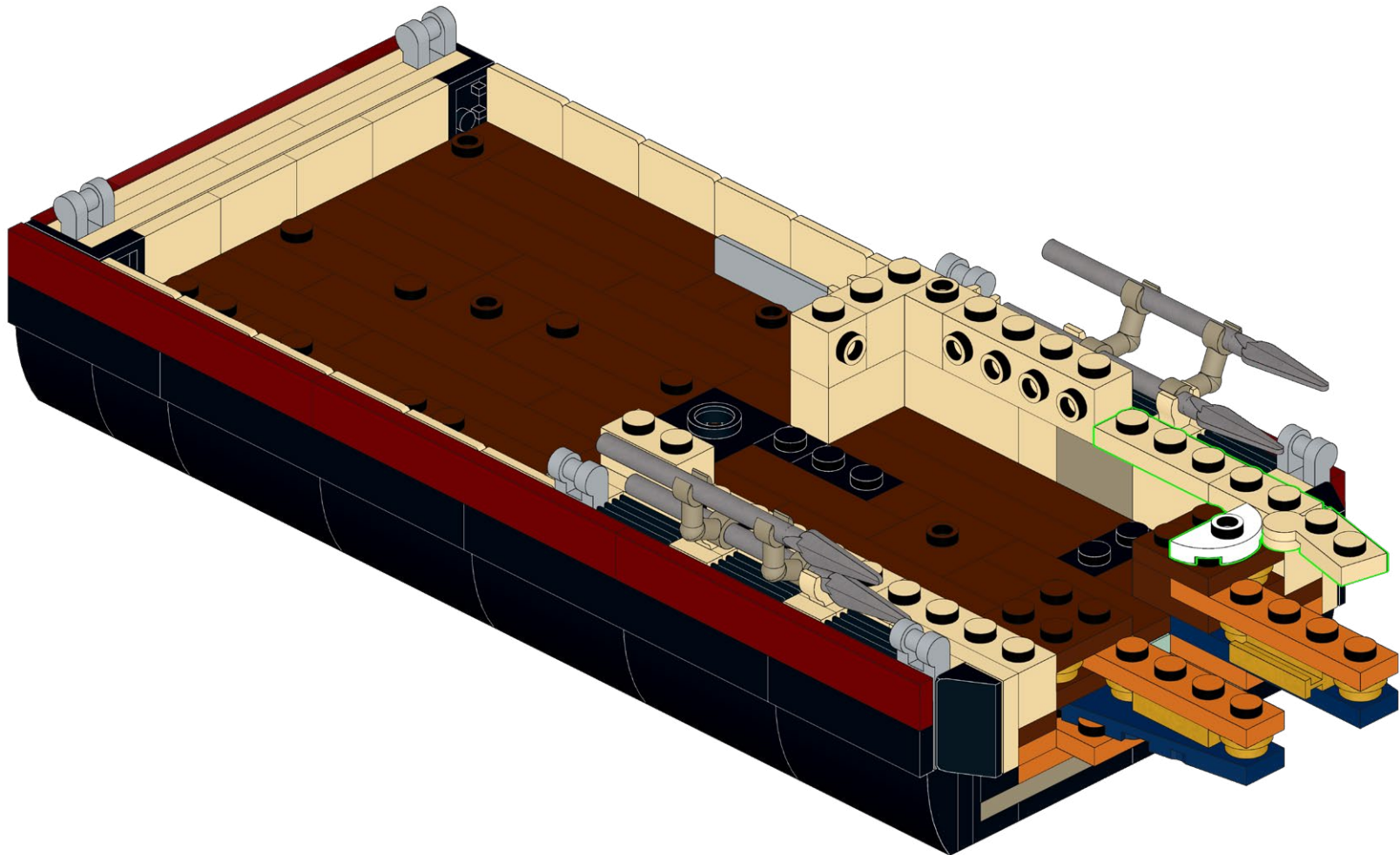
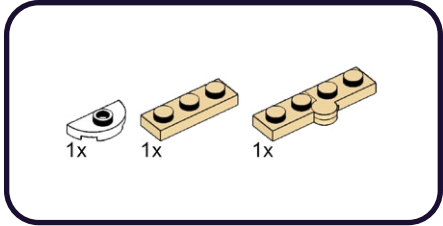

52

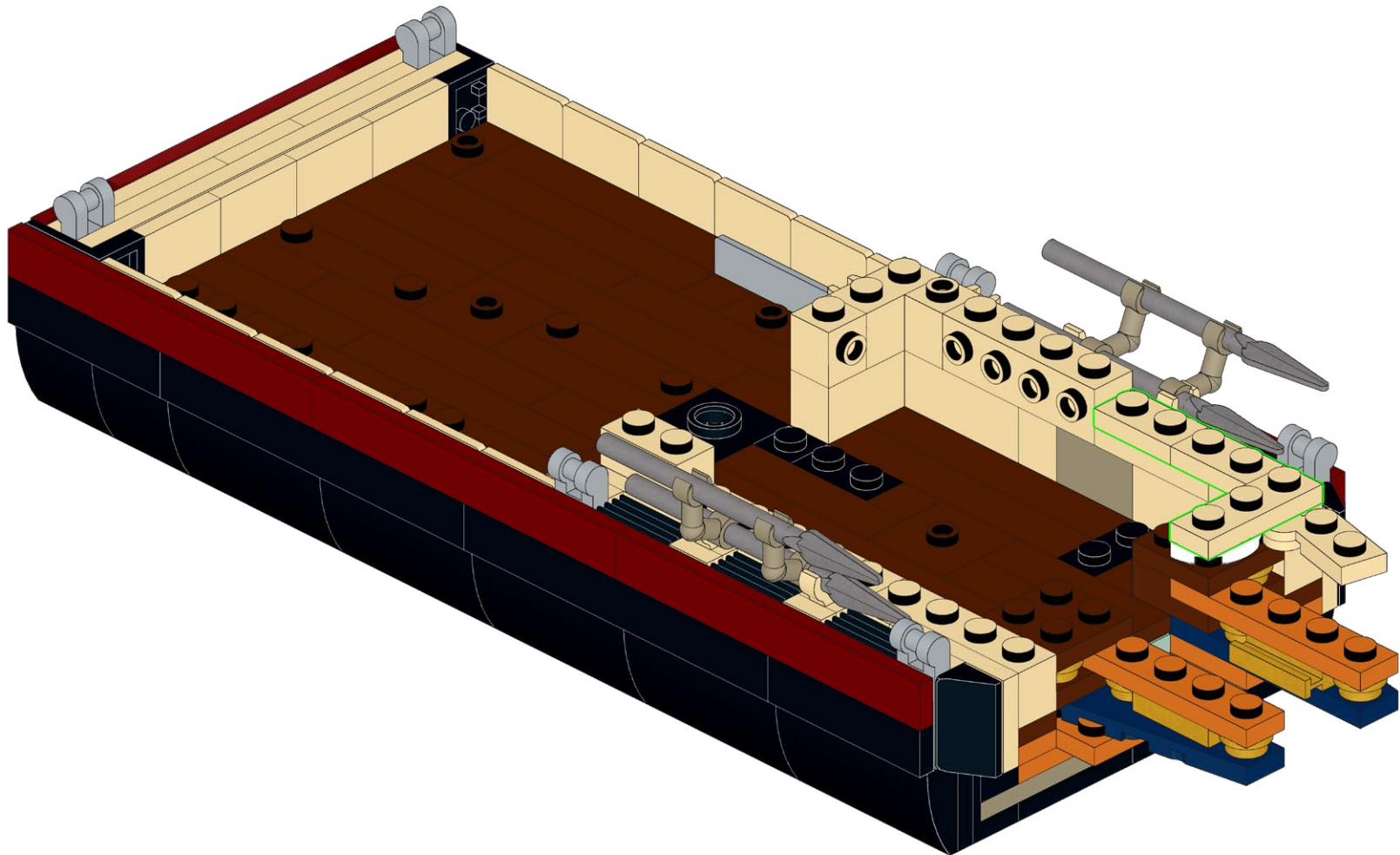
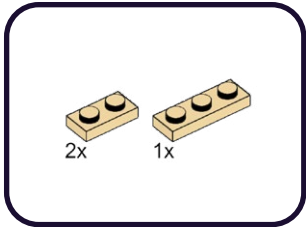

53

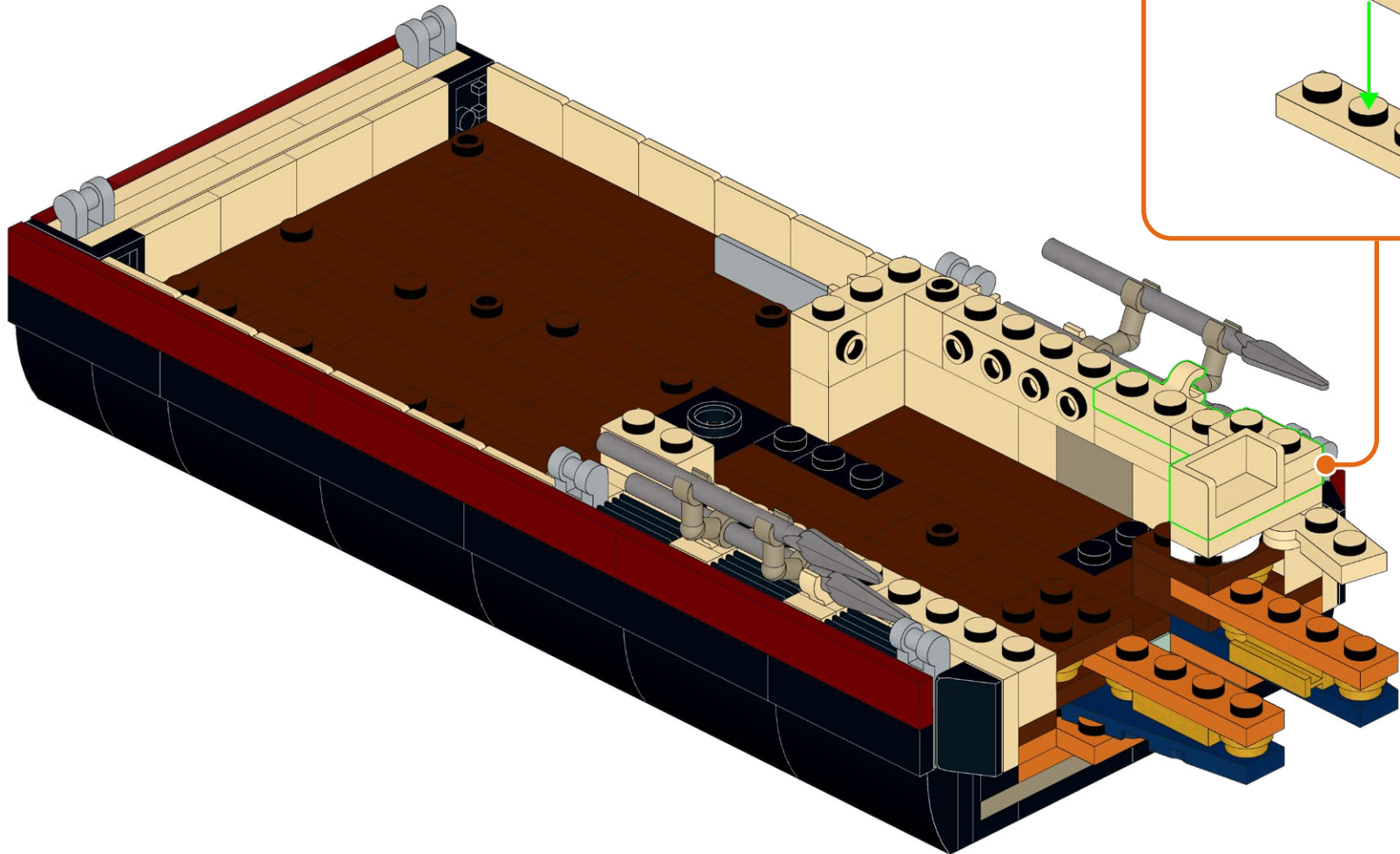
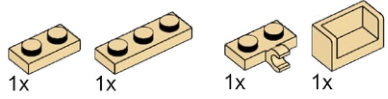

54

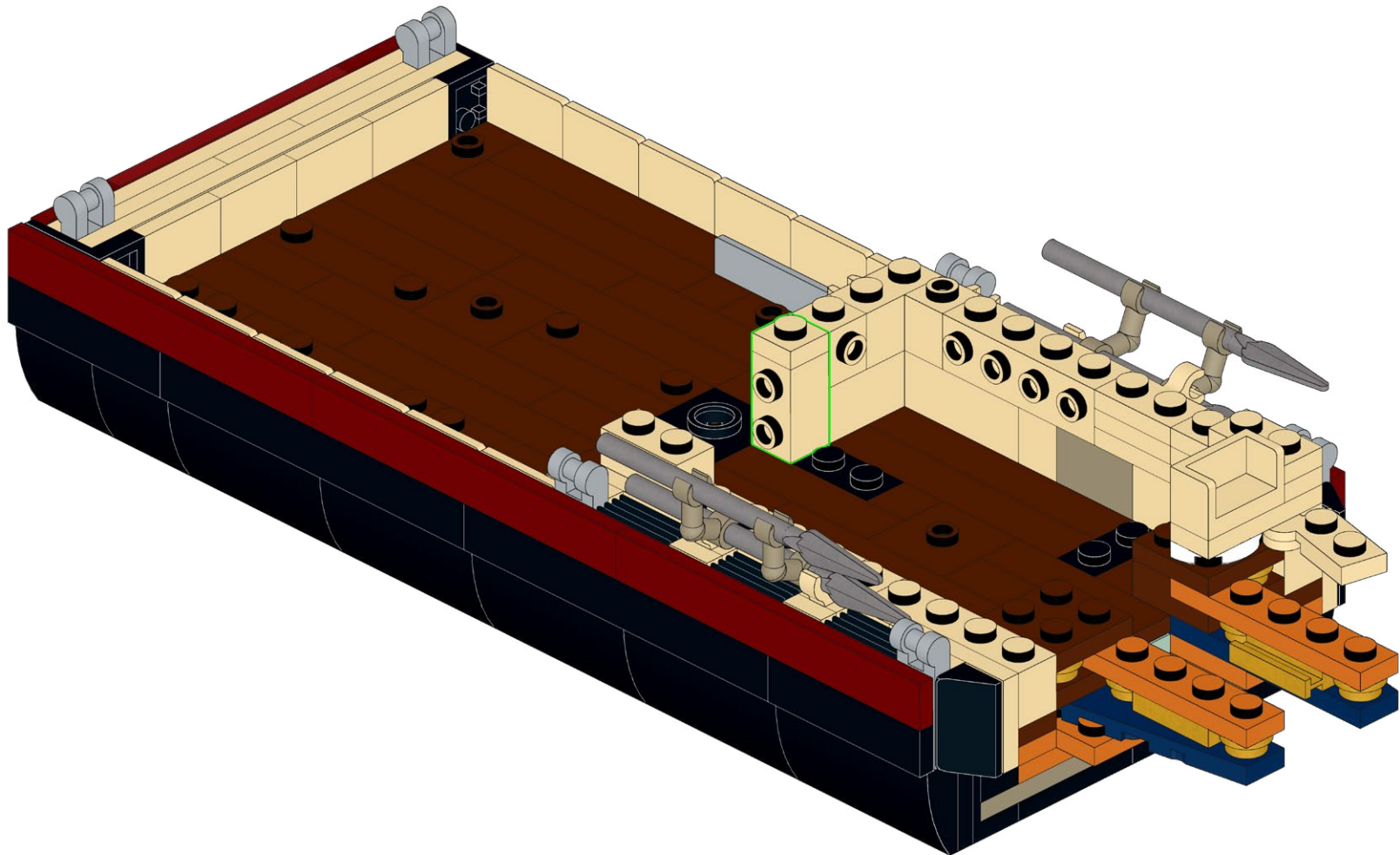
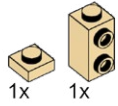

55

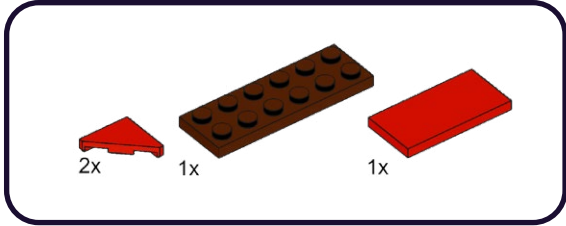

1

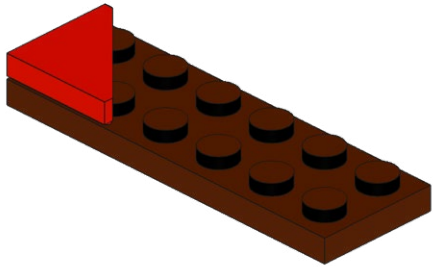

2

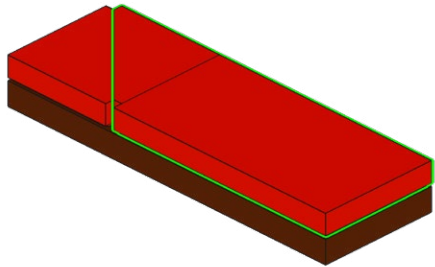

56

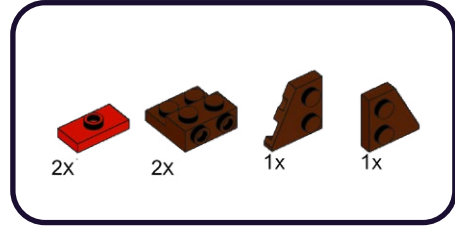

1

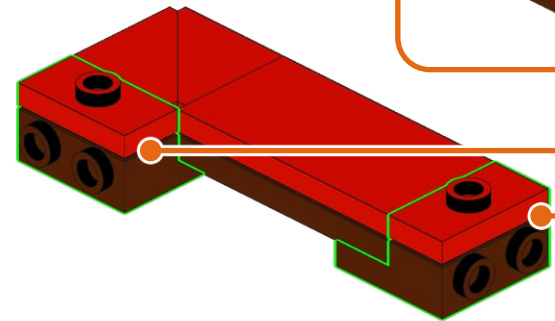

2

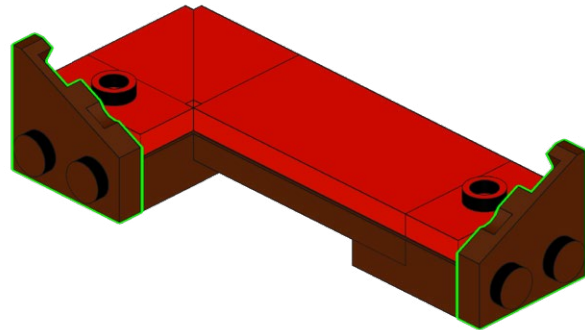

57

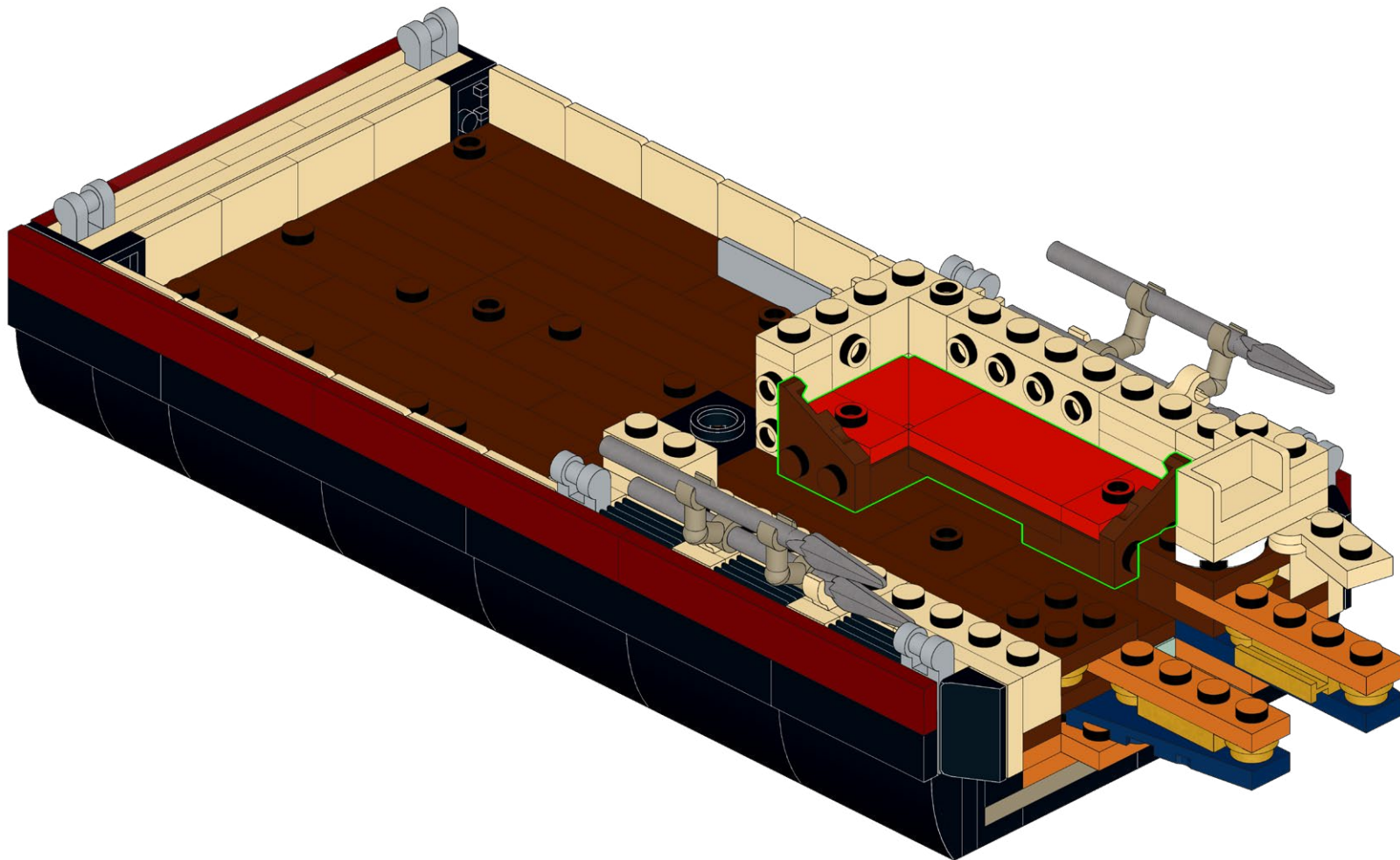

58

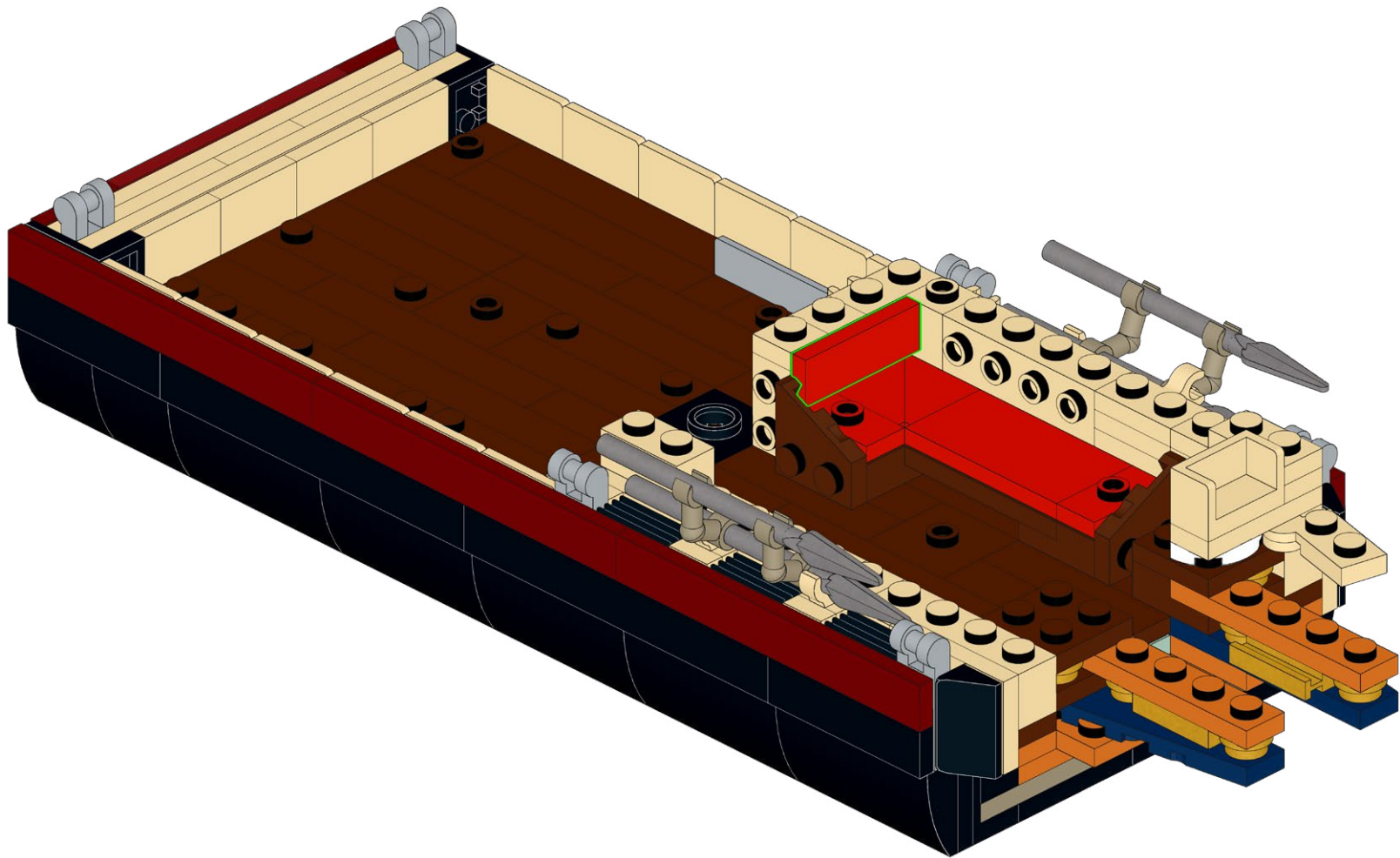
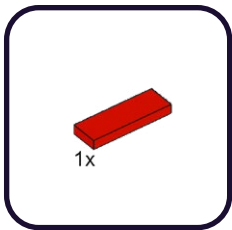

59

1x

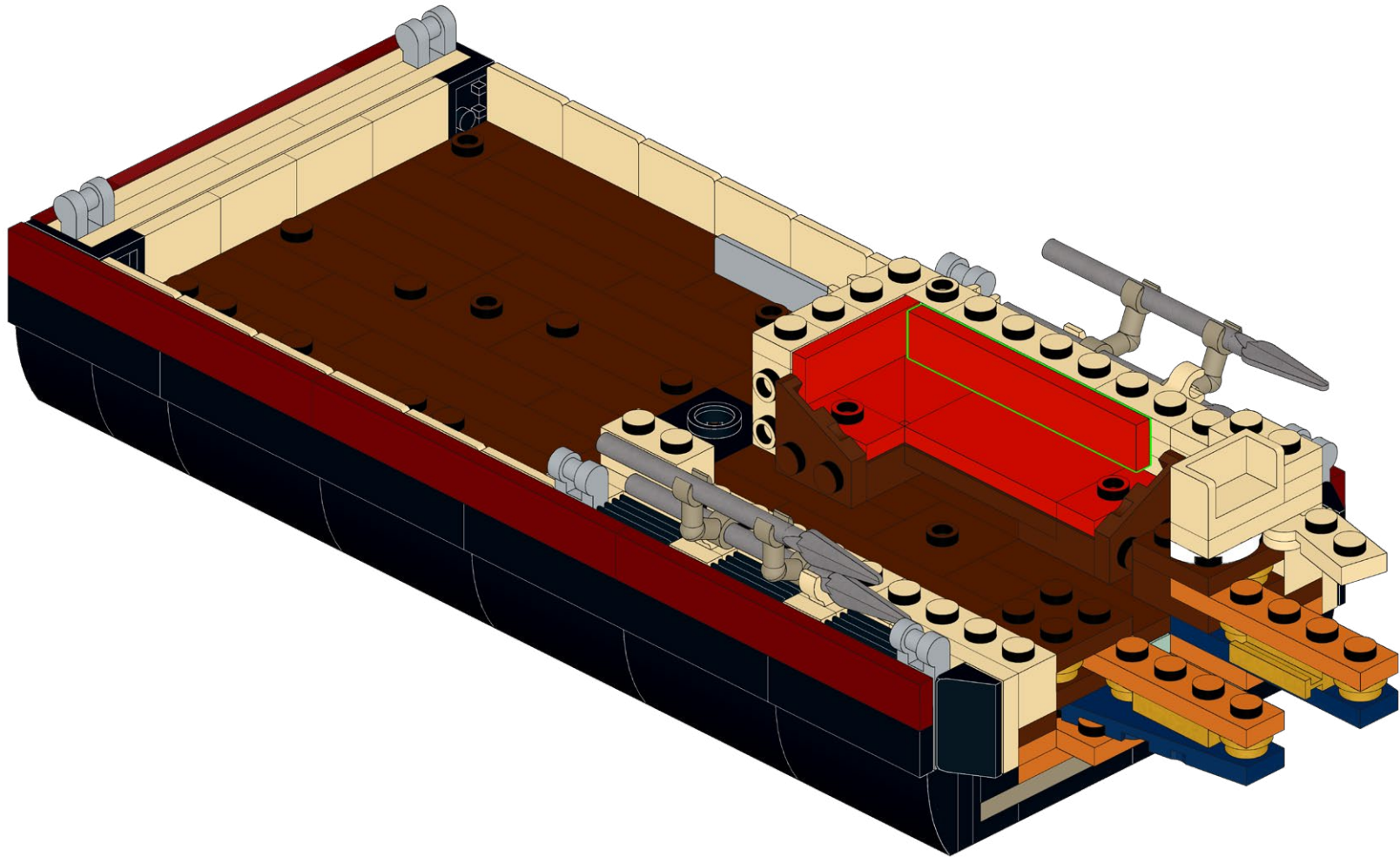

60

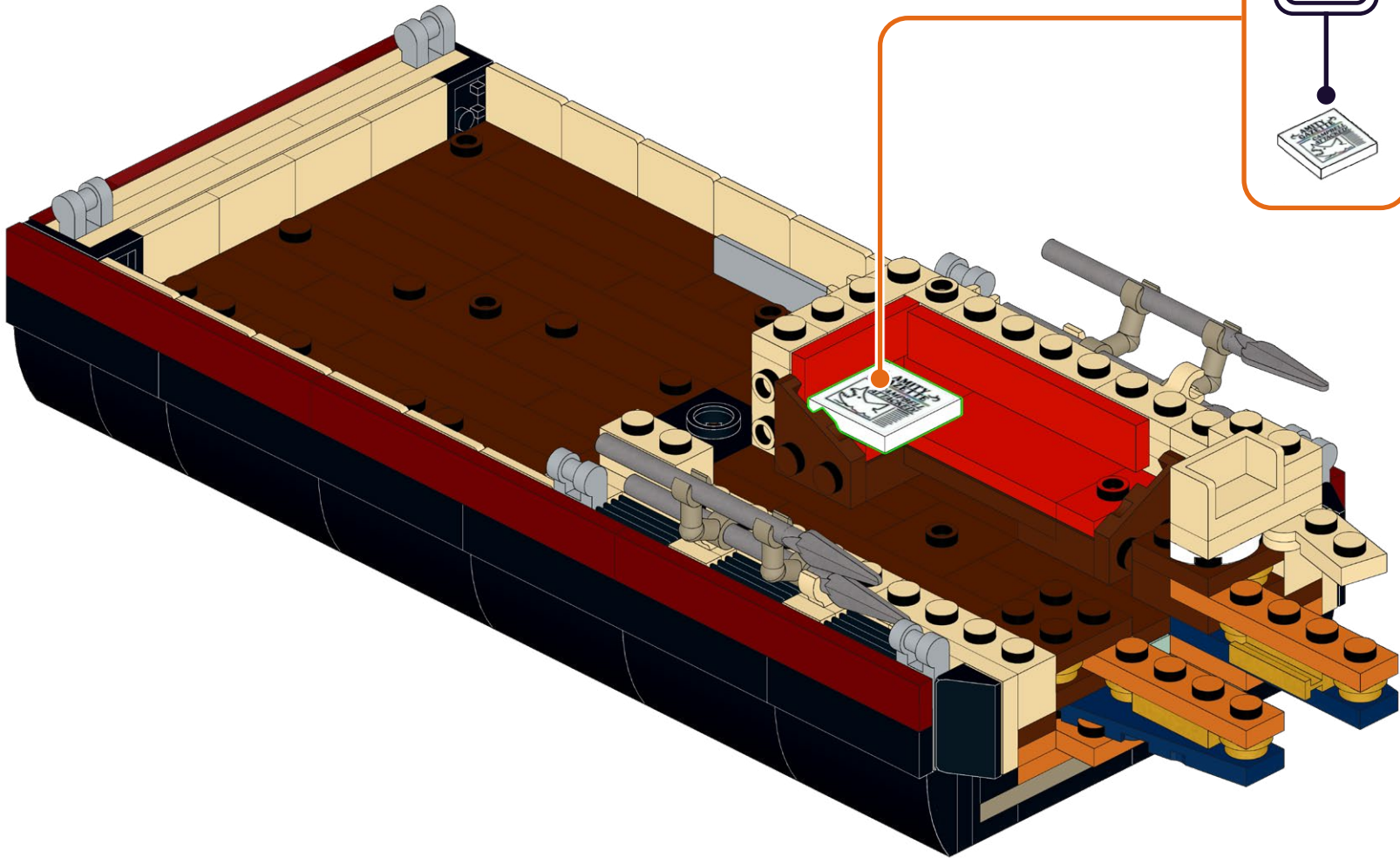
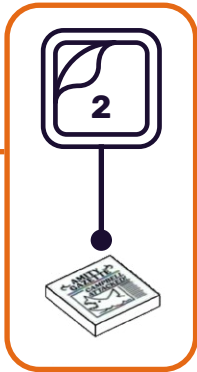
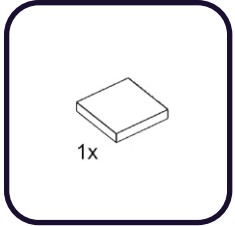

61

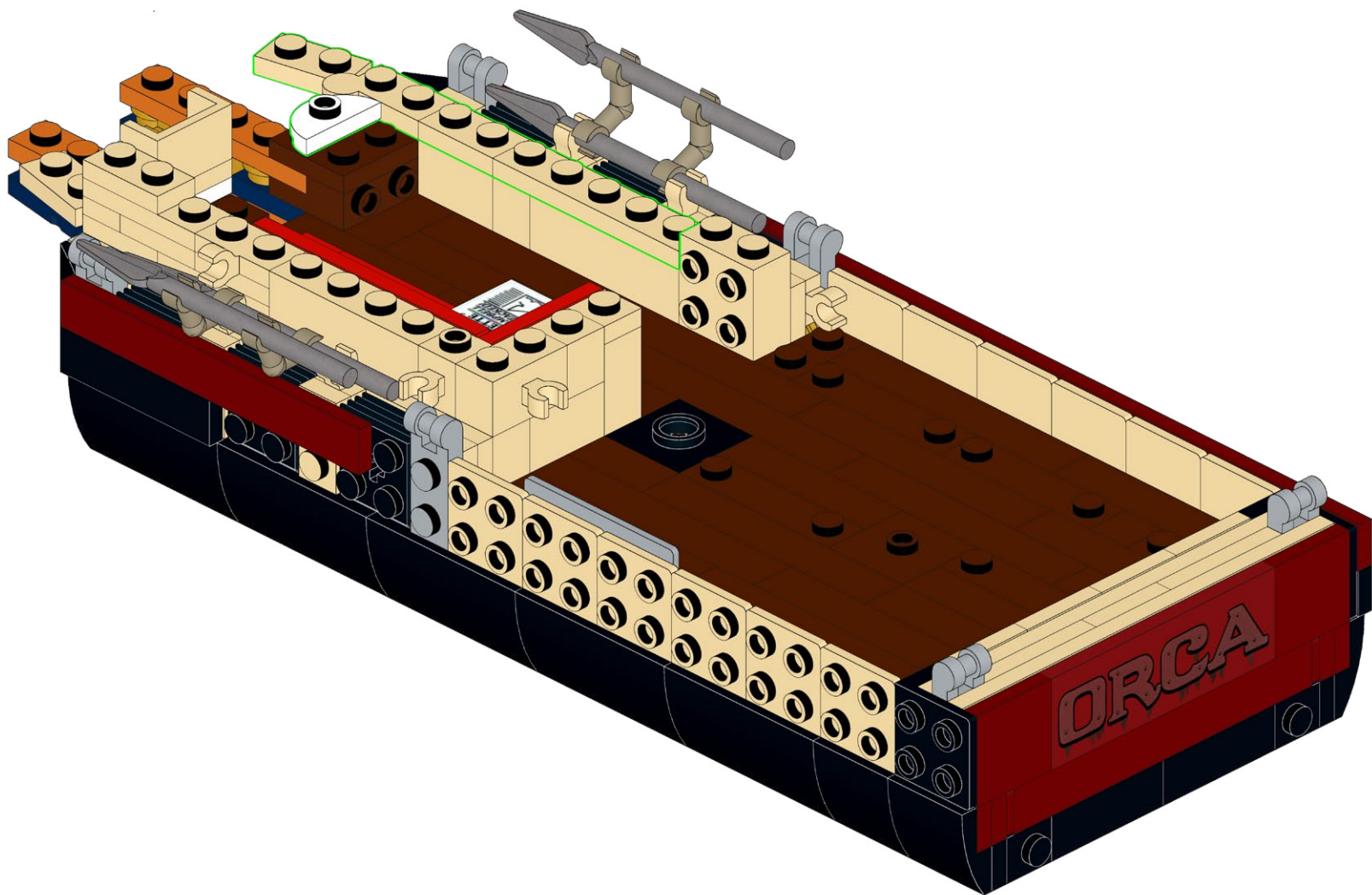
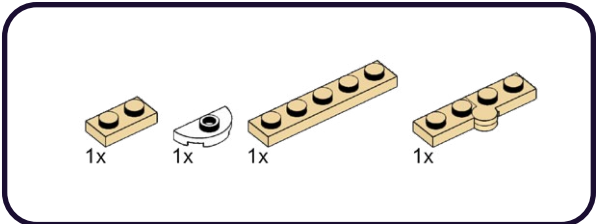

62

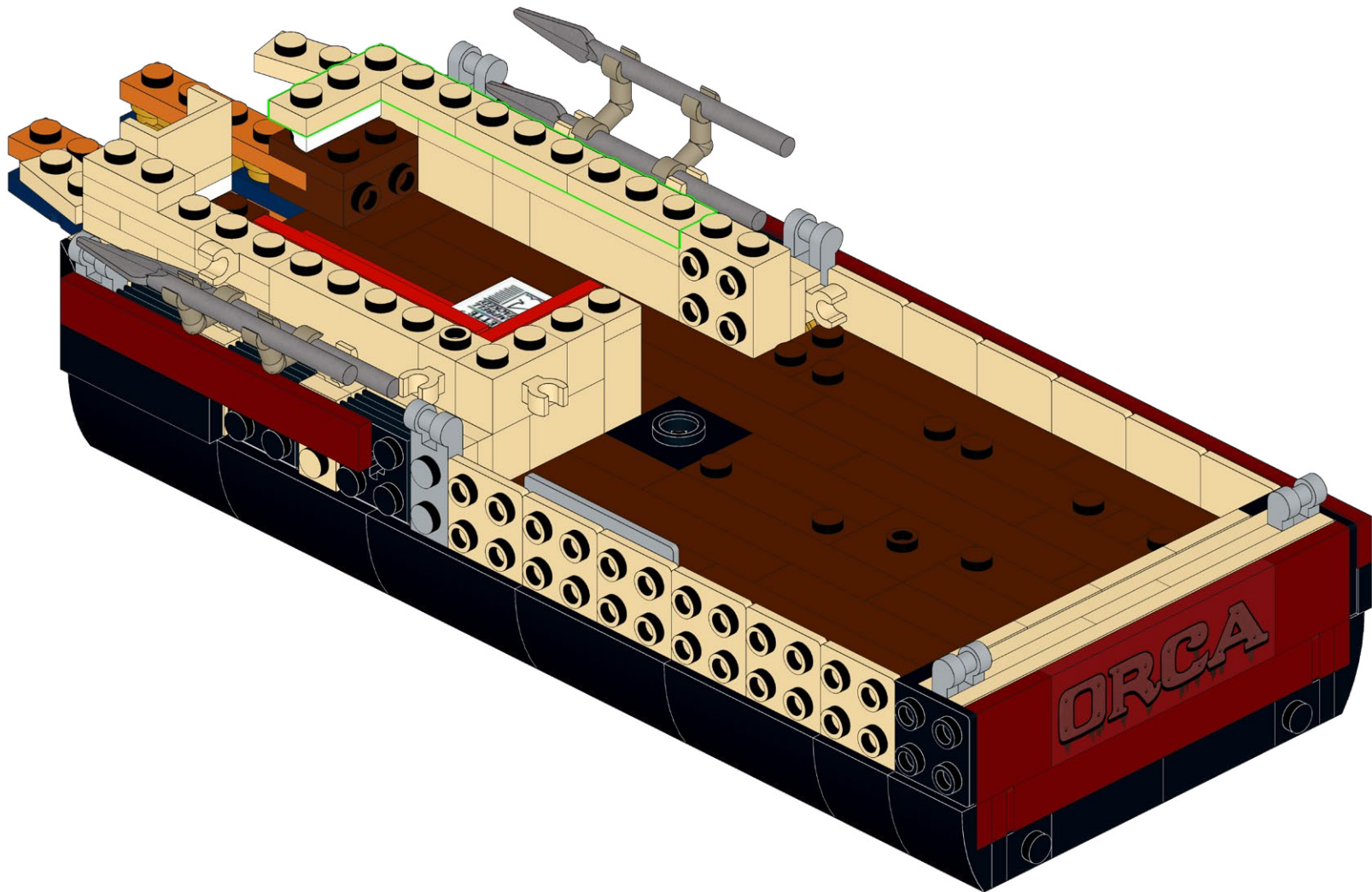
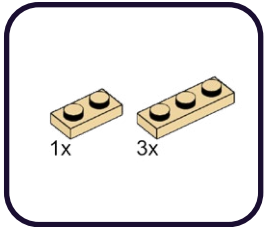

63

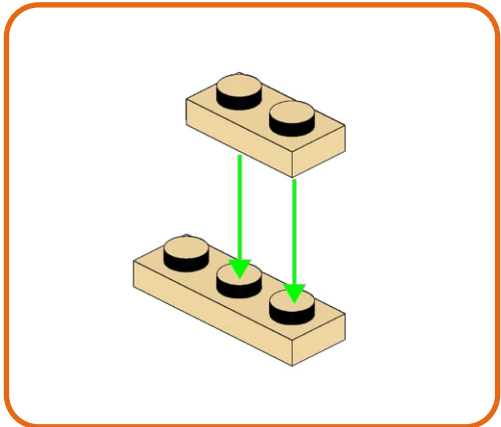
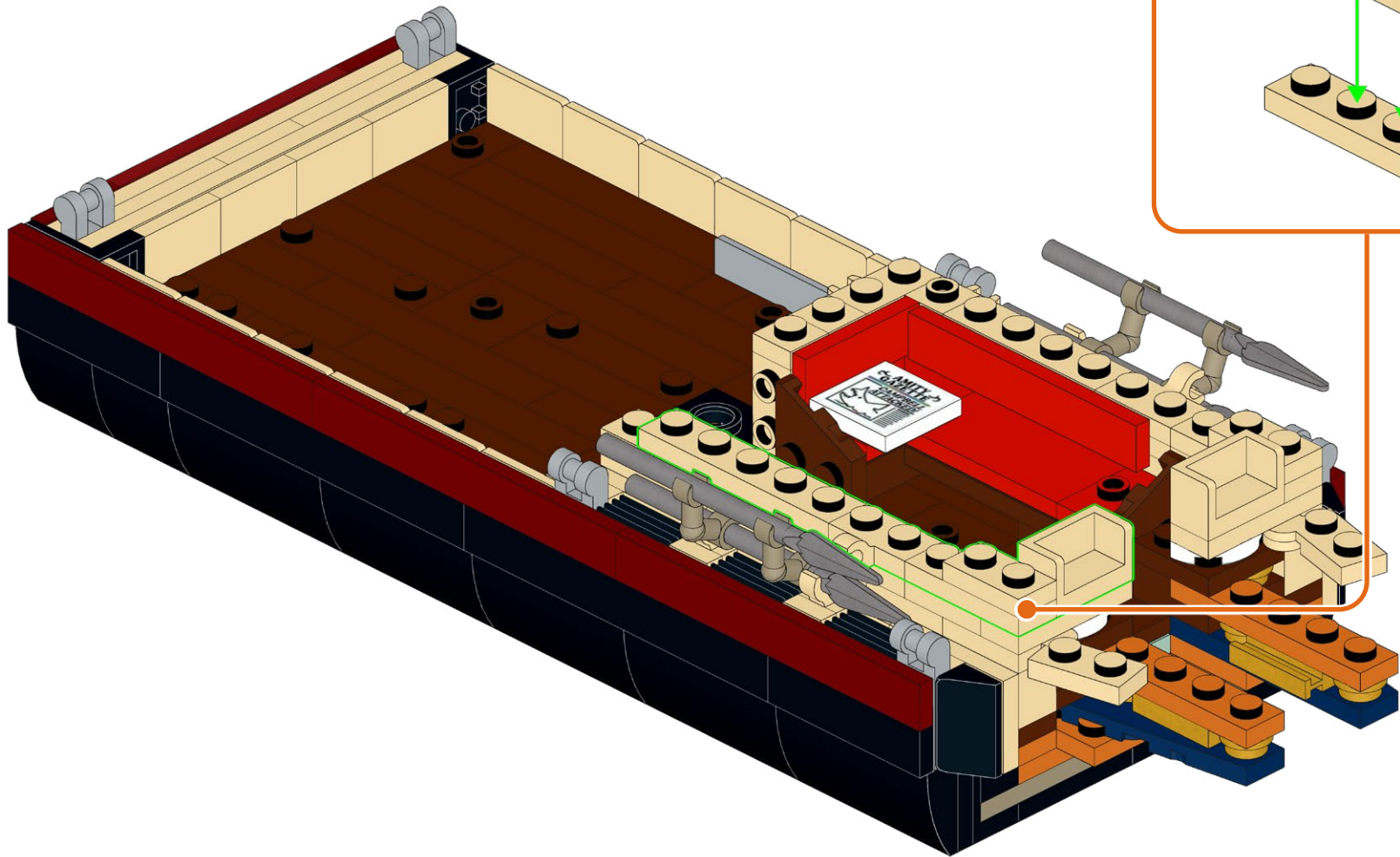
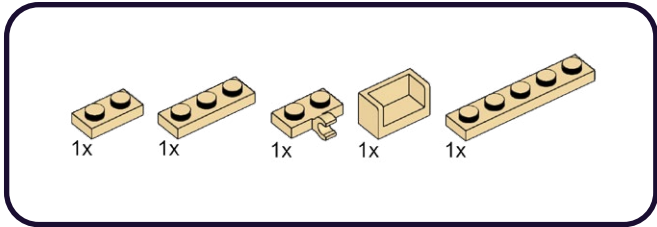

64

- 1x [Brown 2x2 Plate]
- 1x [Grey 1x2 Brick with 2 Holes]
- 1x [Brown 1x2 Brick]
- 1x [Grey 1x2 Brick with 2 Holes]
- 2x [Brown 1x2 Brick]
- 1x [Grey 1x2 Brick with 2 Holes]

1

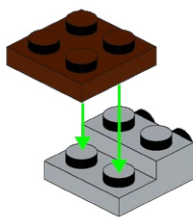

2

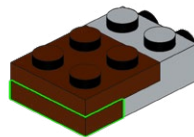

3

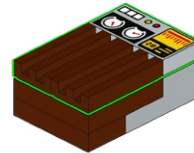

4

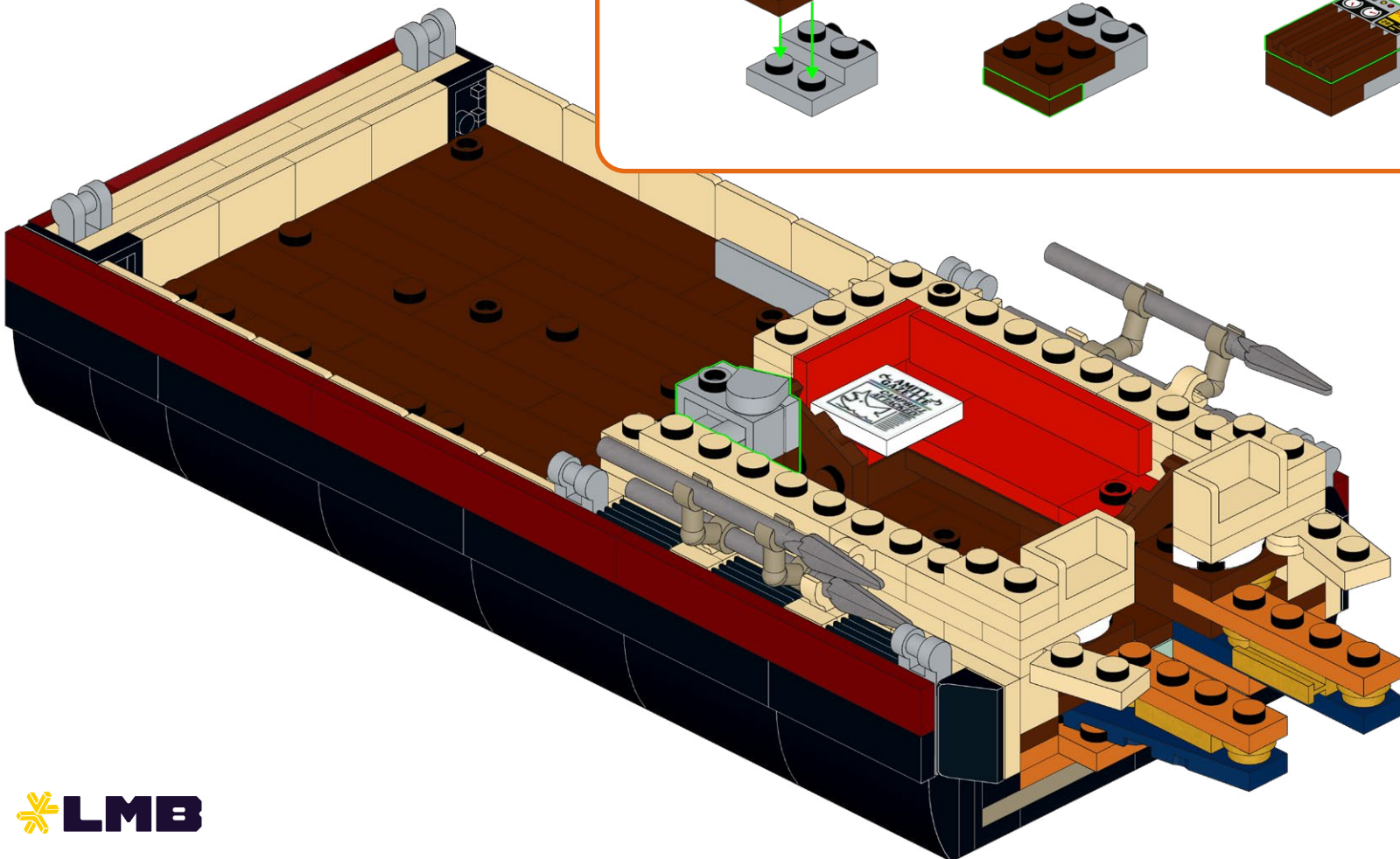

65

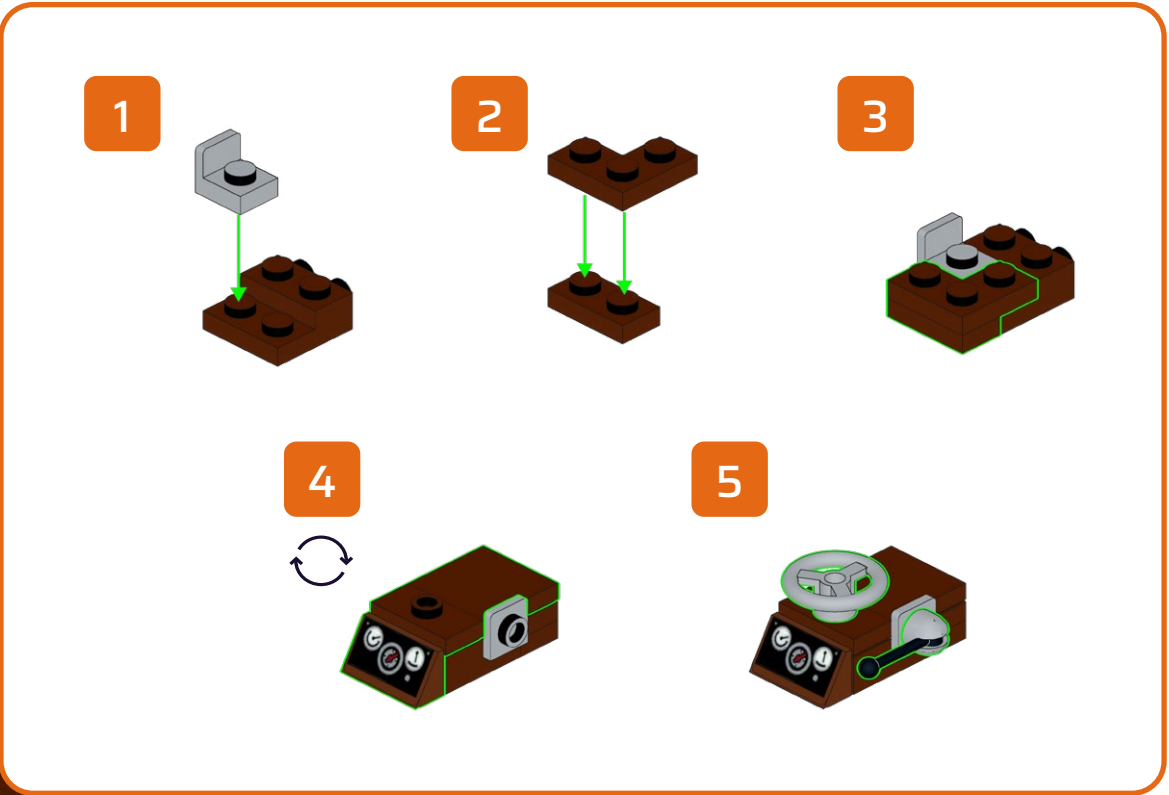
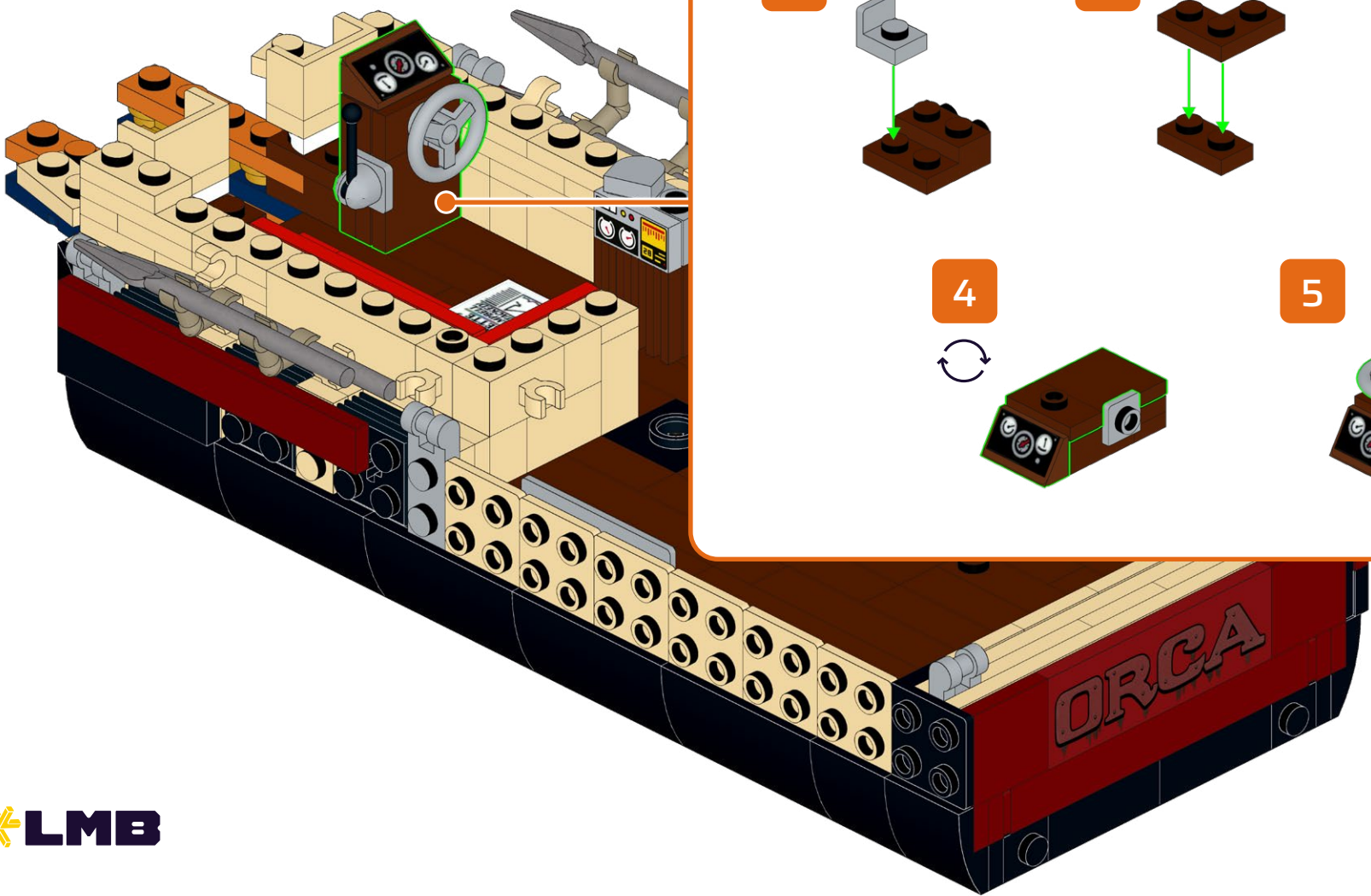
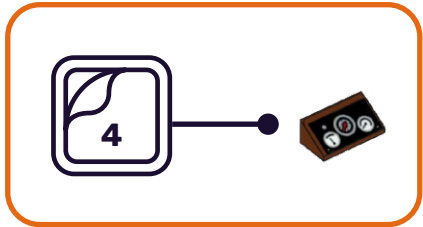
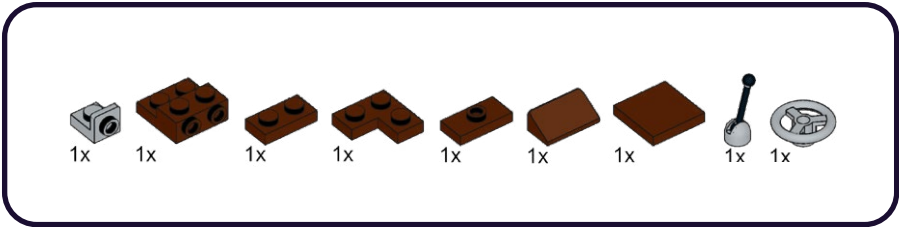

66

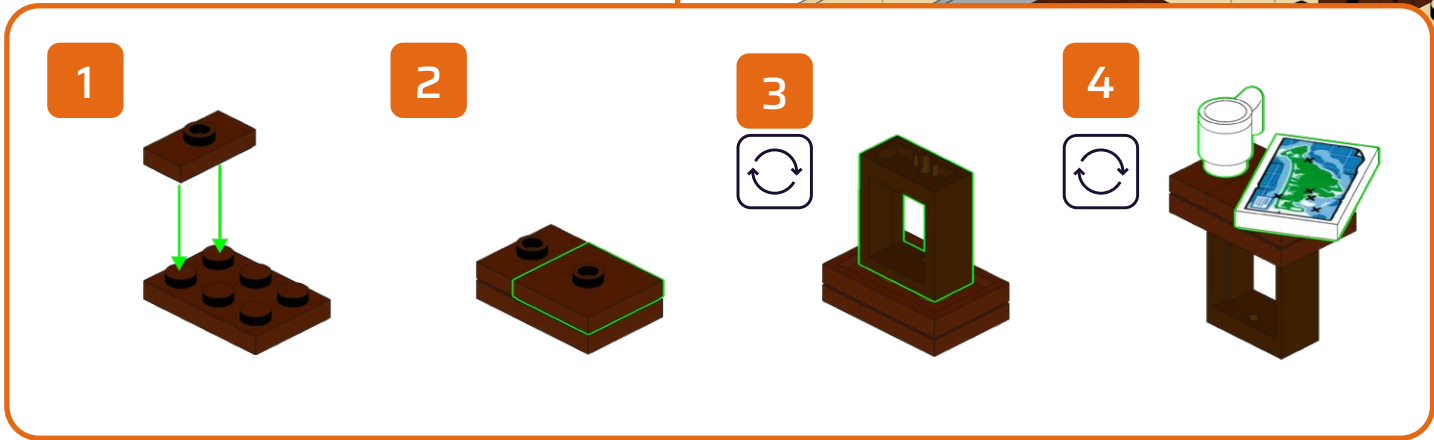
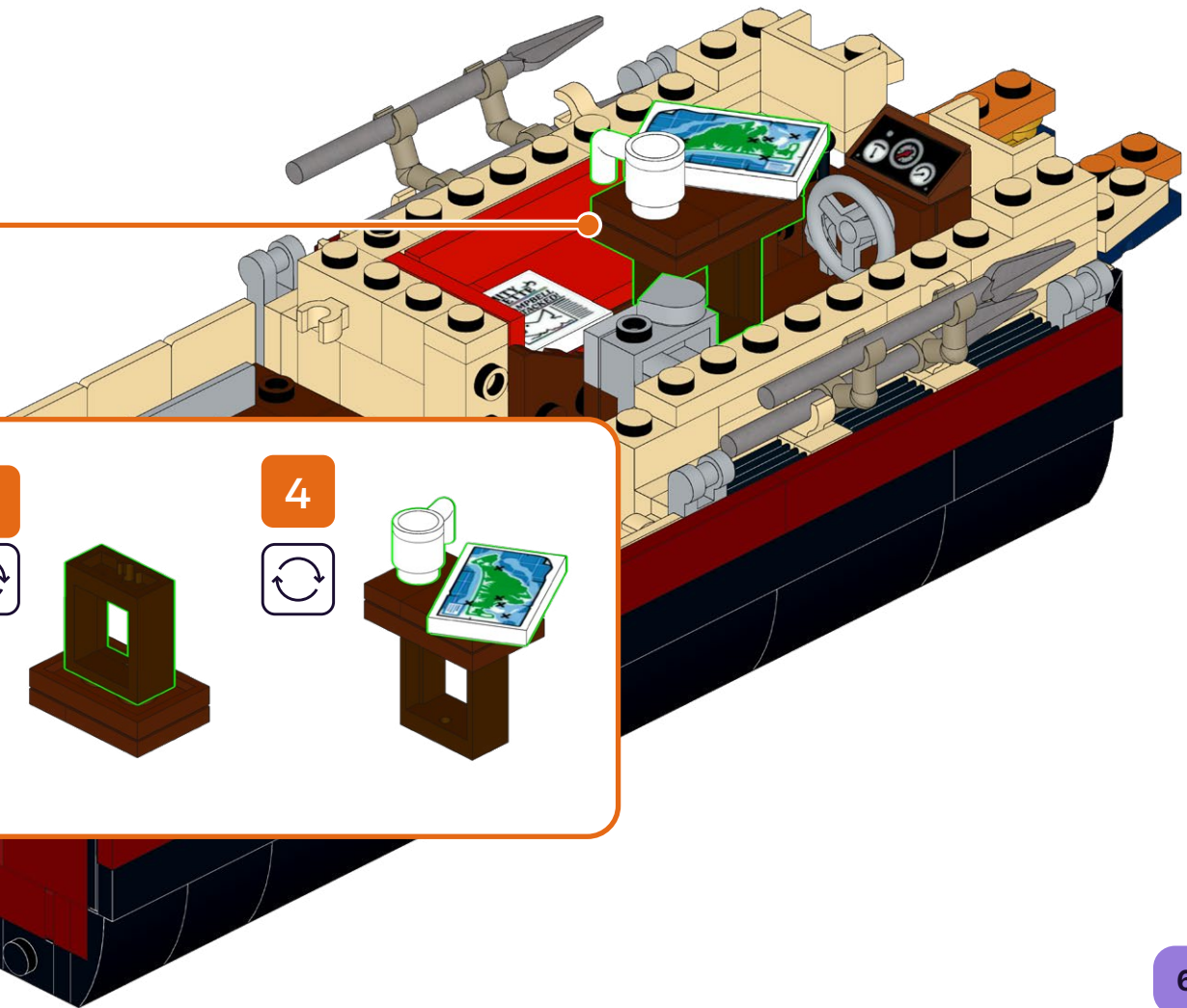
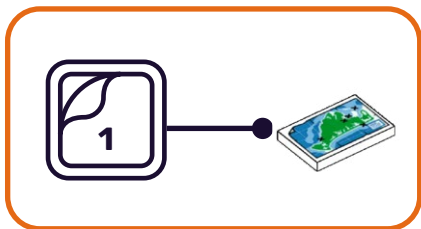
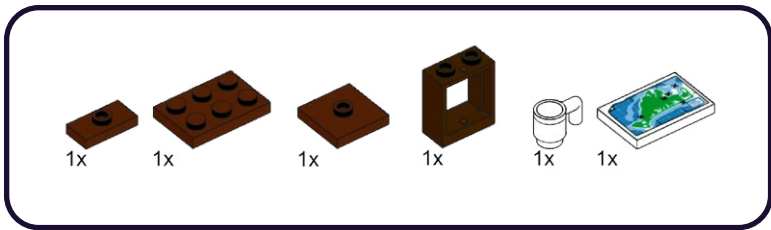

67

1x

1x

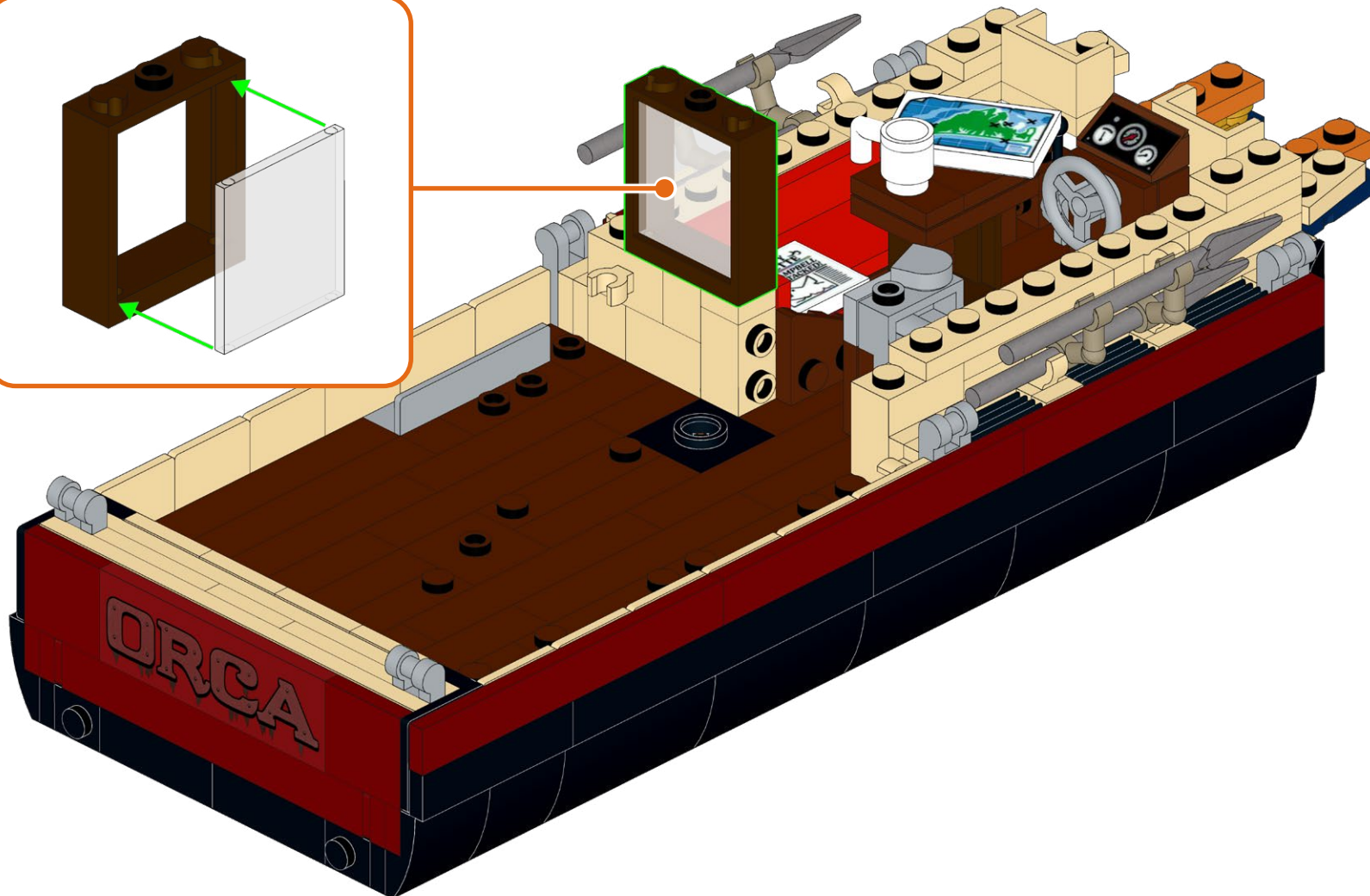
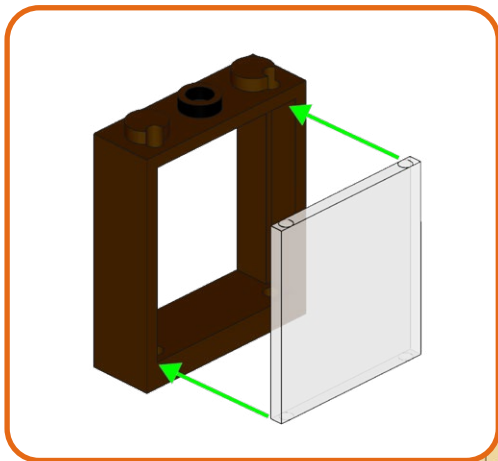

68

1x

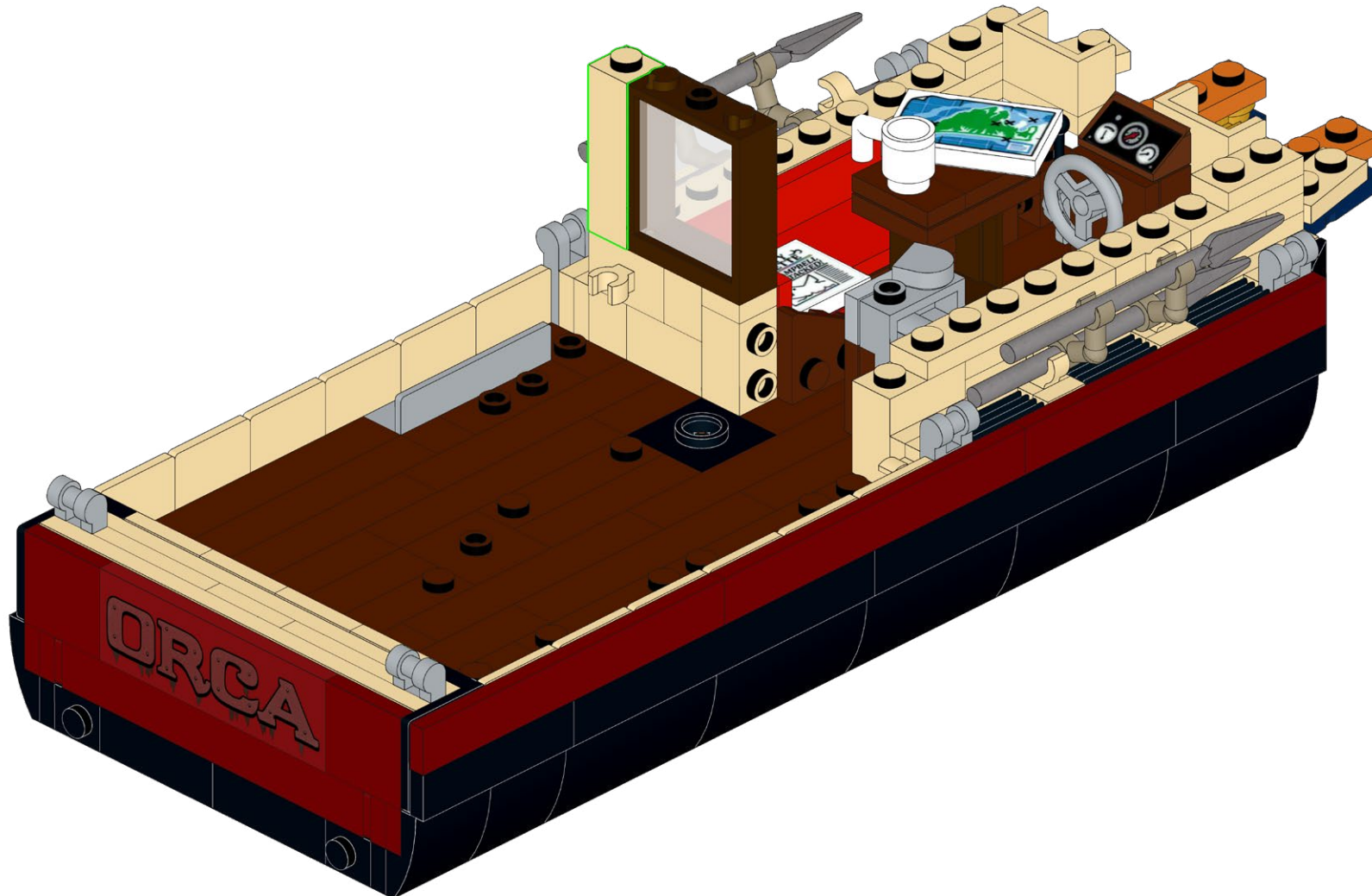

69

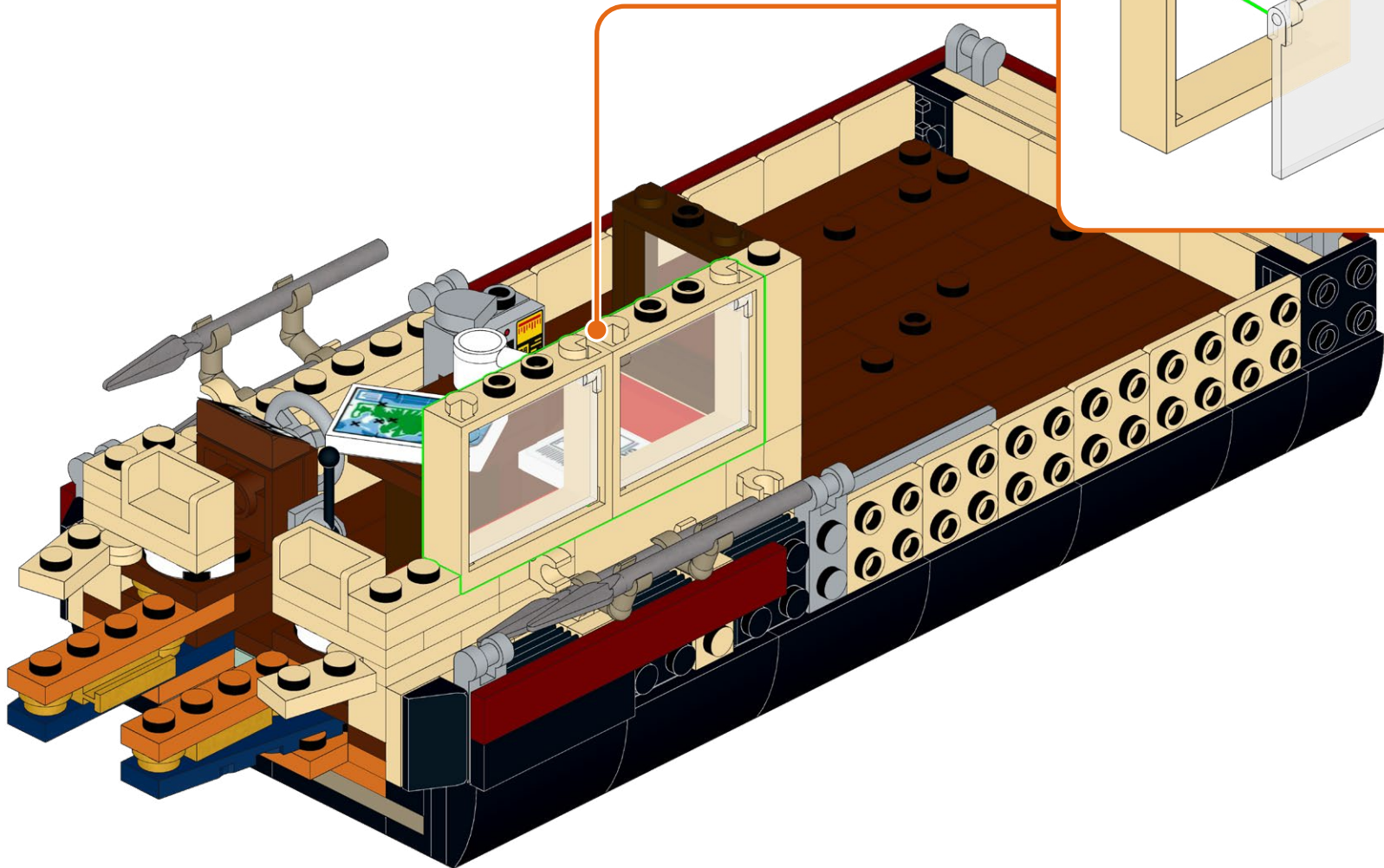
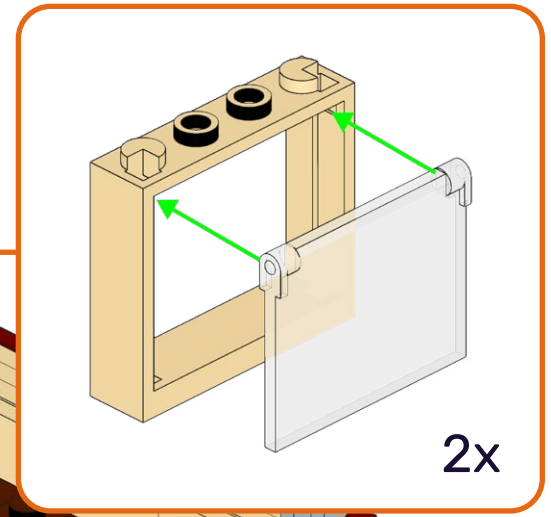
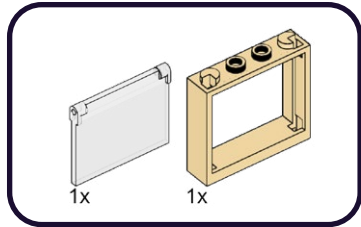

70

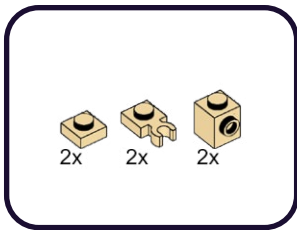

1

2

3

4



71

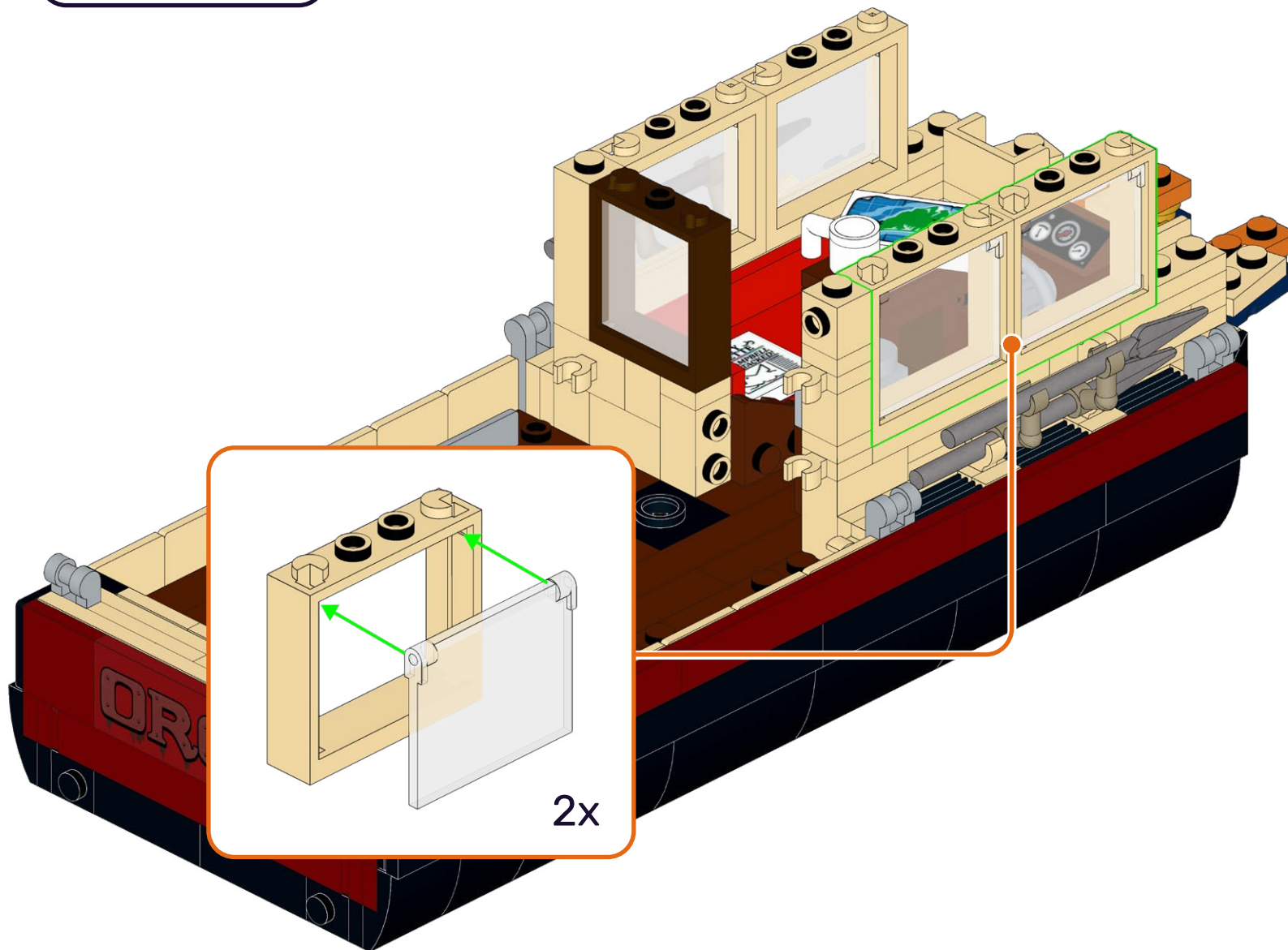
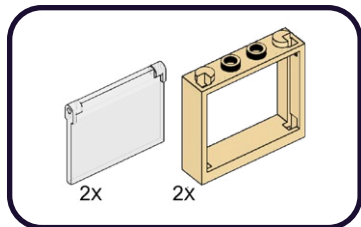

72

2x

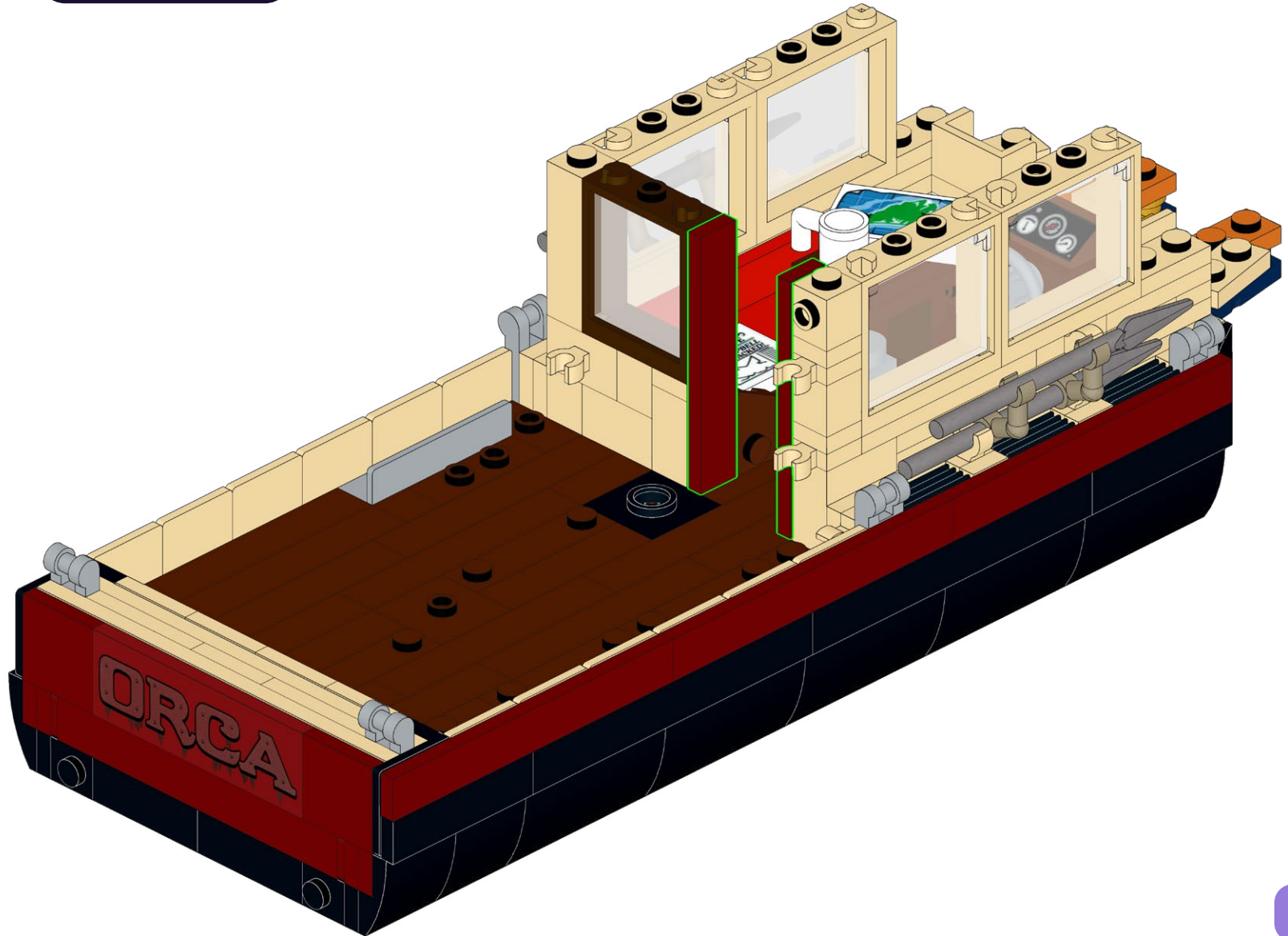

73

1x

2x

2x

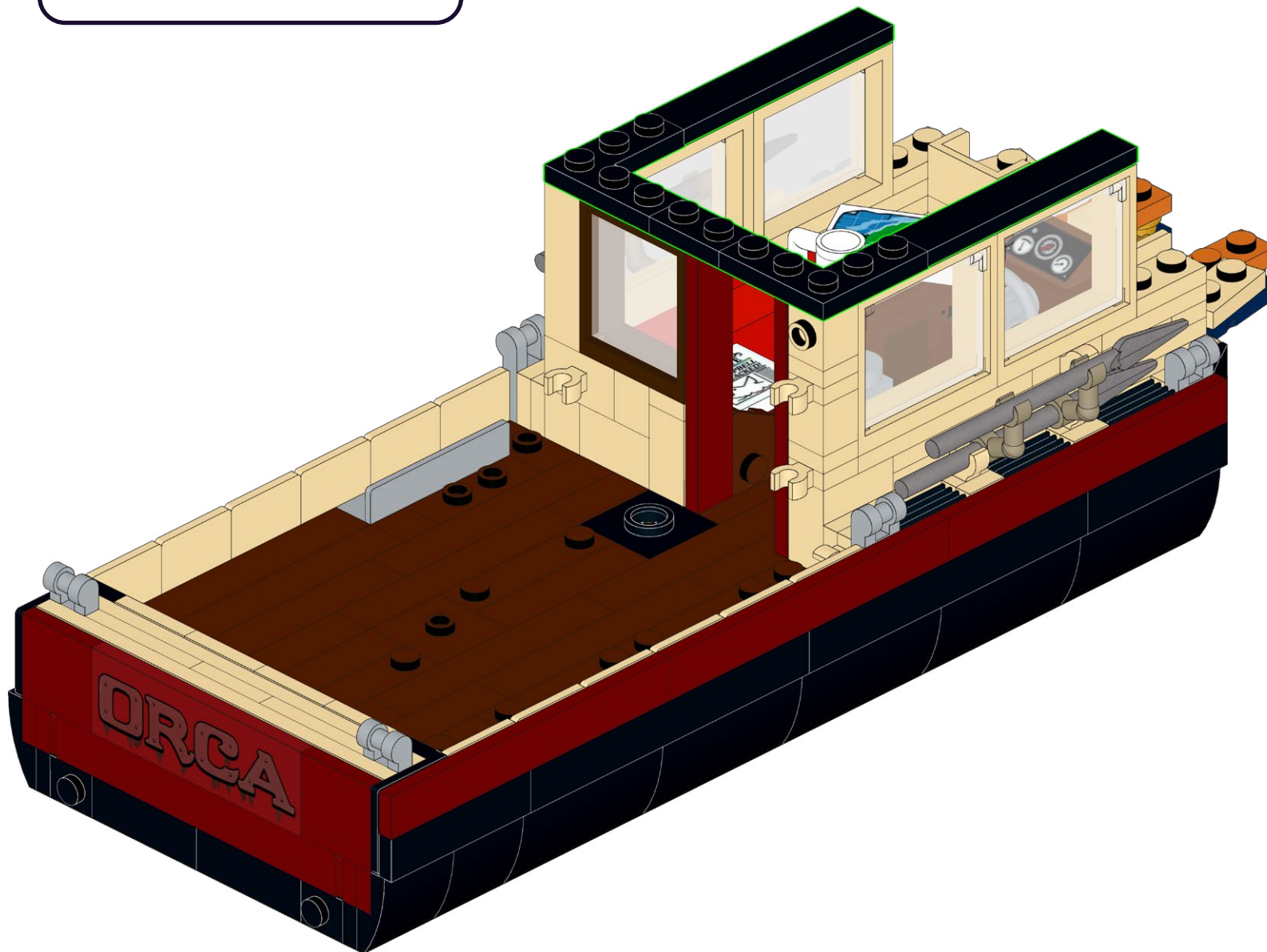

74

2x

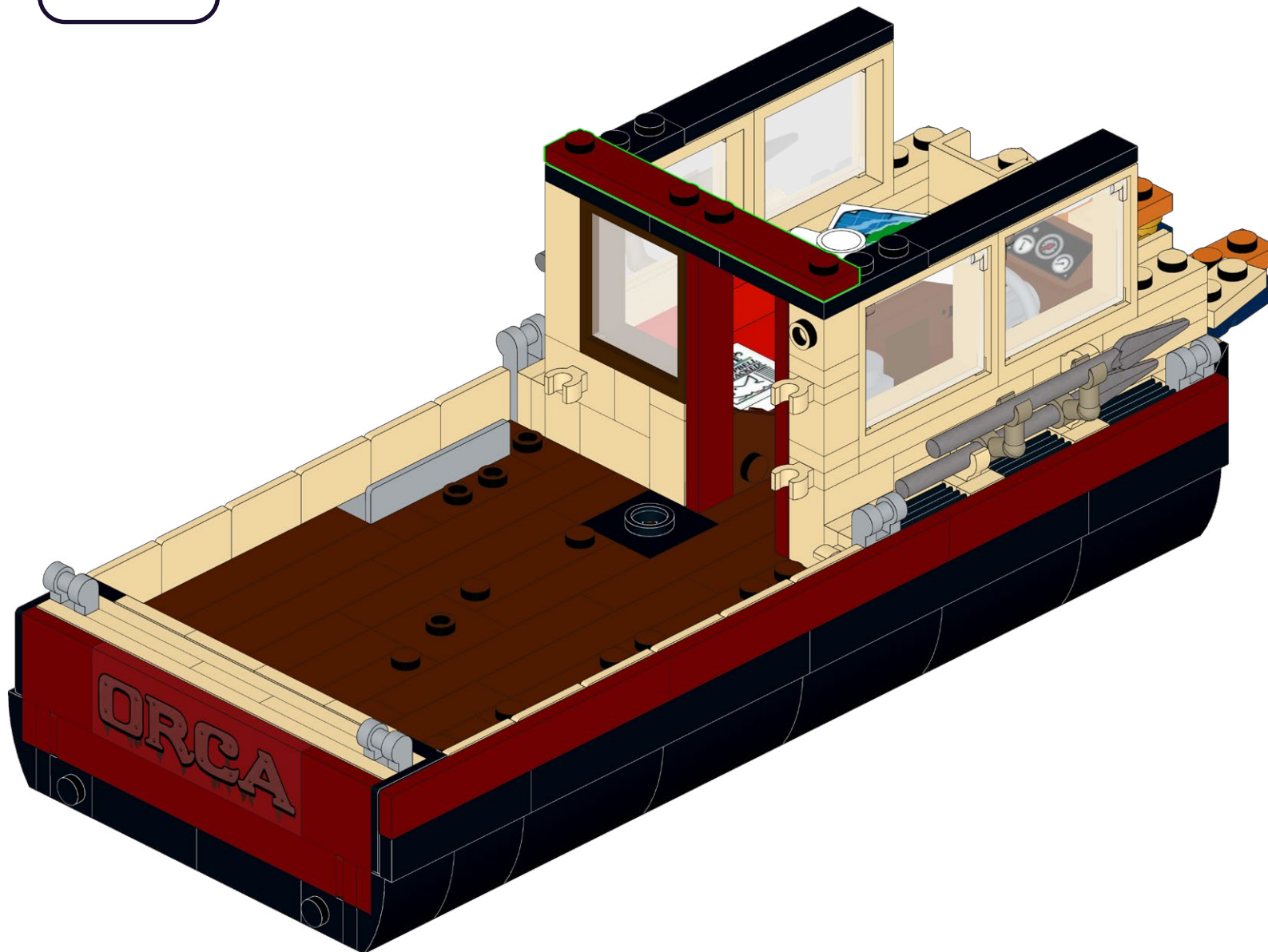

75



2x

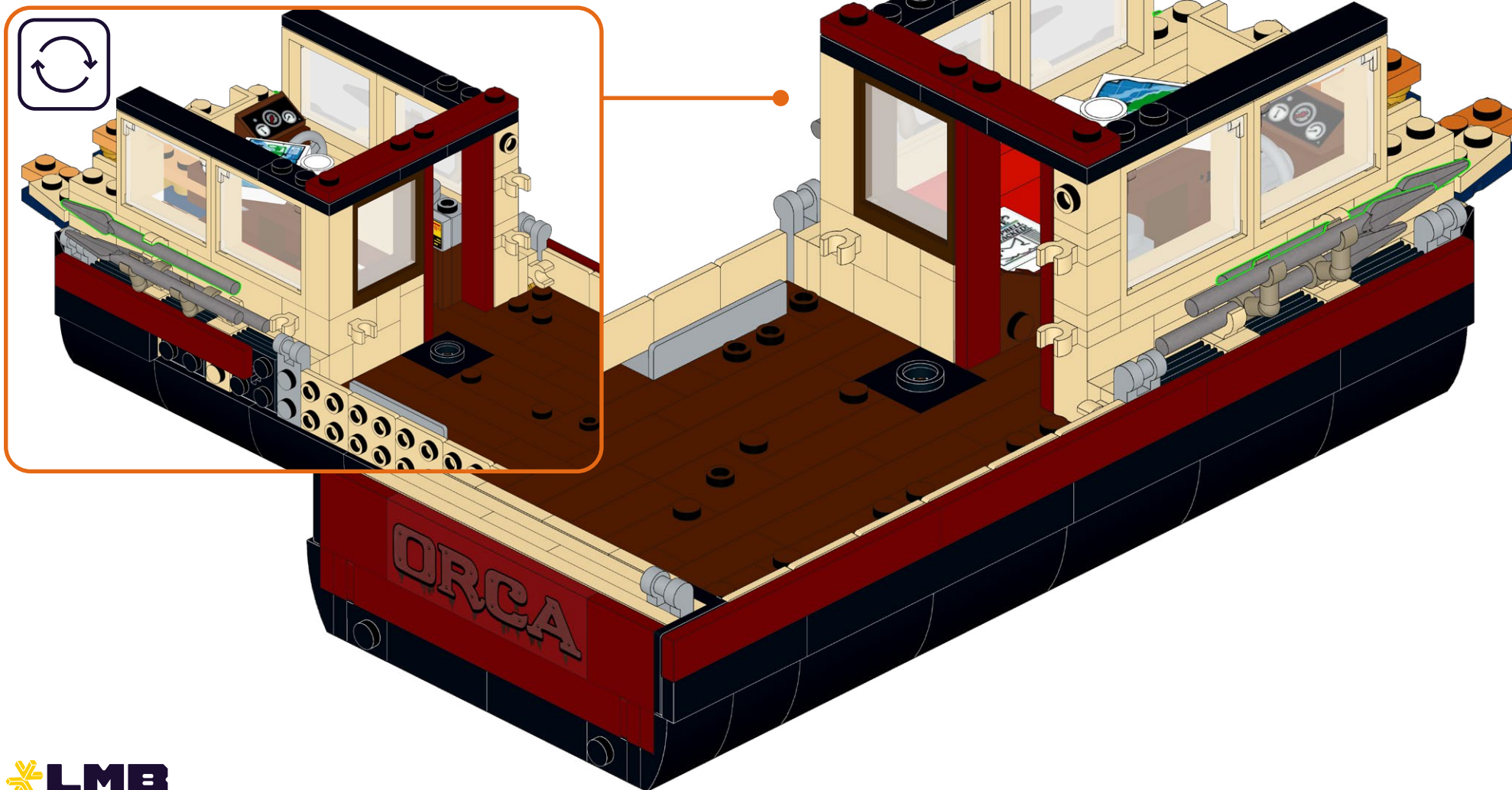

76

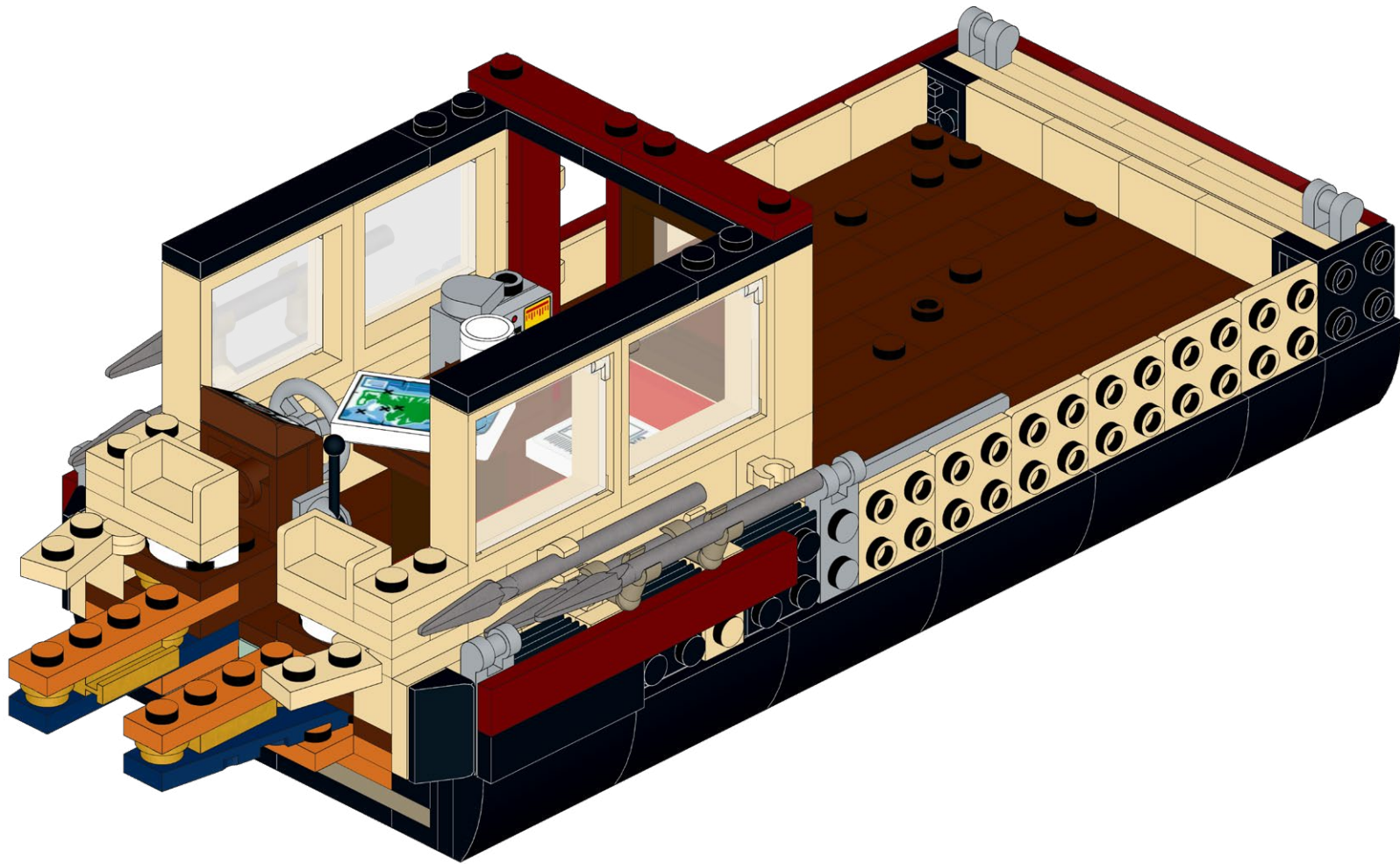

**HOLD UP!**

You might notice some bags aren't in order, as well as left over pieces, but that's ok! We're changing the way you build LEGO!

ATTENDEZ!

Vous remarquerez peut-être que certains sacs, ainsi que certaines pièces, ne sont pas dans le bon ordre. Mais pas de panique! Nous changeons simplement la façon avec laquelle vous construisez vos LEGO!

ASPETTA!

Potresti notare che alcuni sacchetti non sono in ordine, così come i pezzi avanzati, ma va bene così! Stiamo cambiando il modo in cui costruisci i LEGO!

HALT!

Sie werden möglicherweise bemerken, dass einige tüten durcheinander sind und teile übrig bleiben, aber das ist in Ordnung! Wir ändern die art und weise, wie Sie LEGO bauen!

¡ESPERA!

Es posible que notes que algunas bolsas están fuera de servicio, así como piezas sobrantes, ¡pero está bien! ¡Estamos cambiando la forma en que construyes LEGO!

暫停!

你可能会注意到一些袋子顺序错乱, 以及一些剩余的部件, 但没关系! 我们正在改变你搭建乐高的方式!

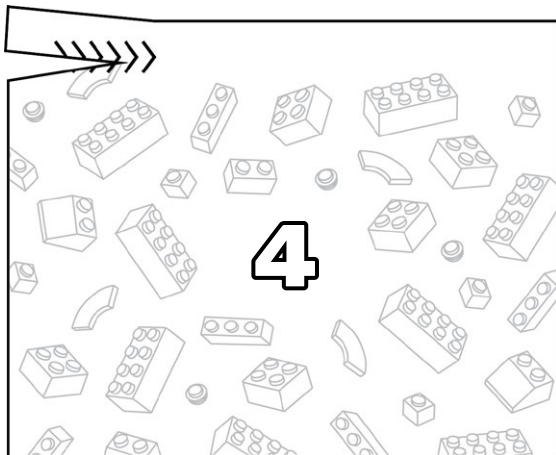
Open LEGO® Bag 4

77

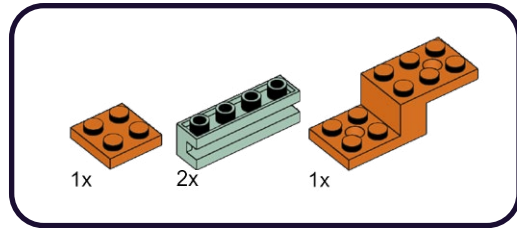

1

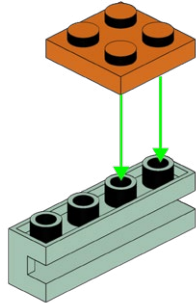

2

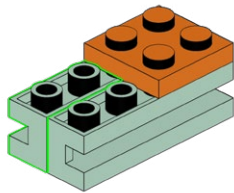

3

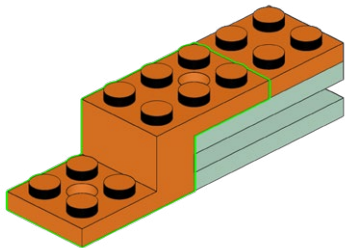

78

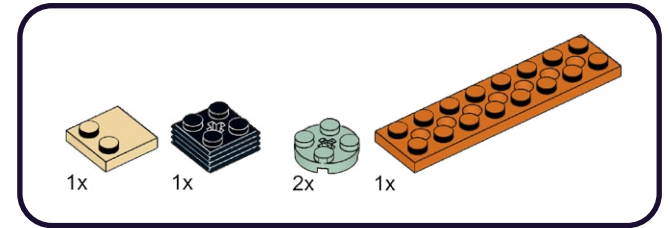

4

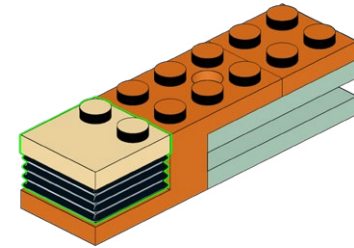

5

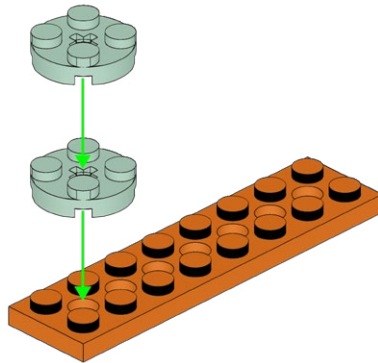

6

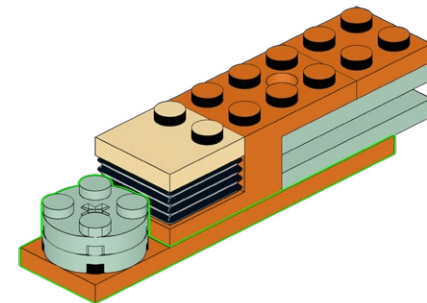

79

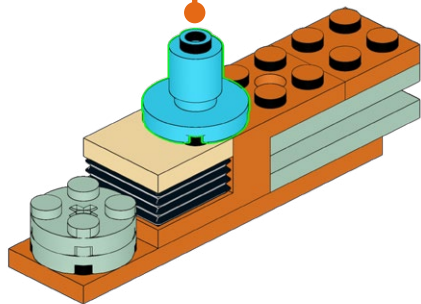
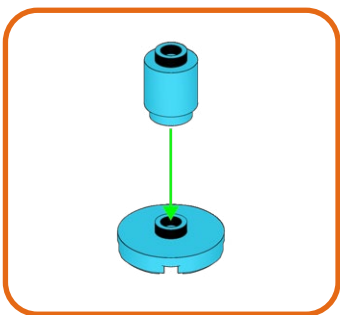
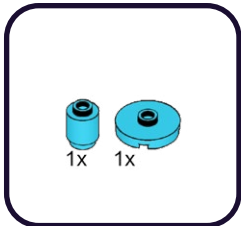

80

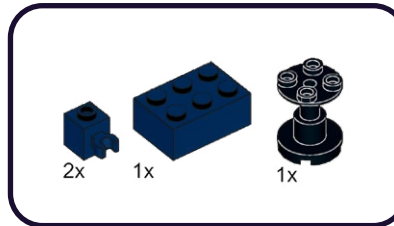

2

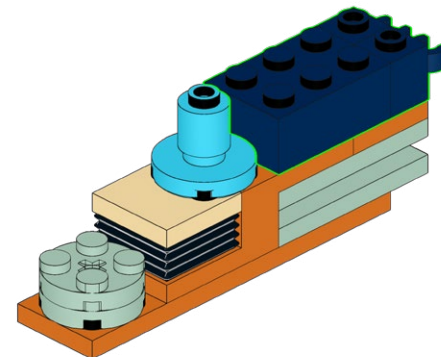

3

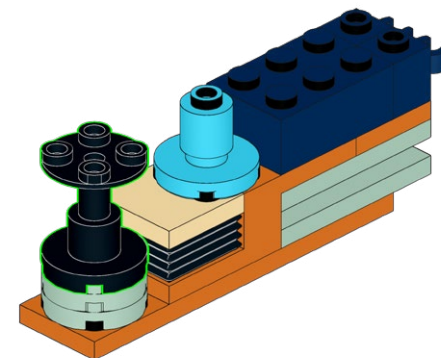

81

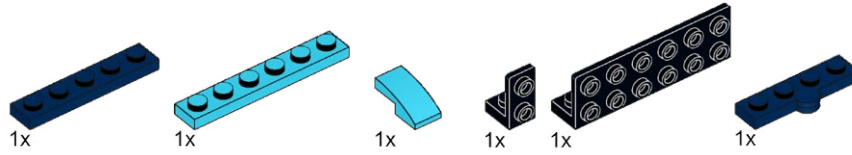

1

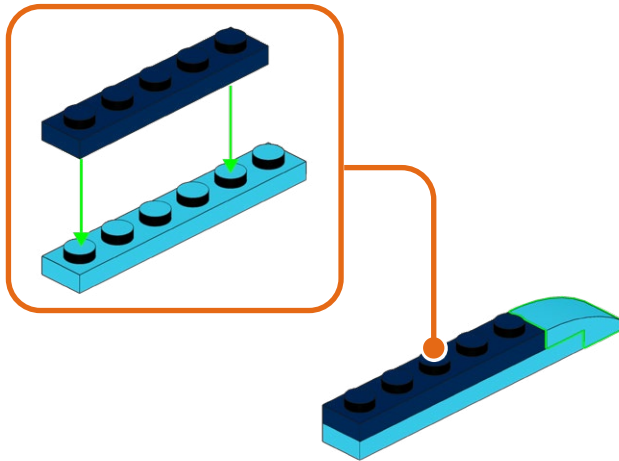

3

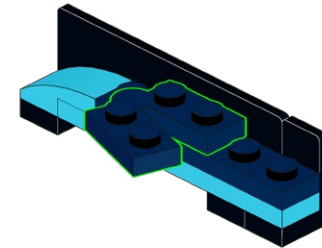

2

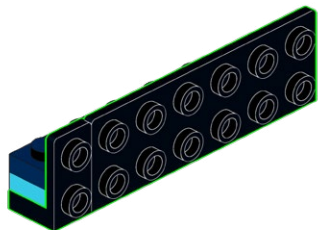

4

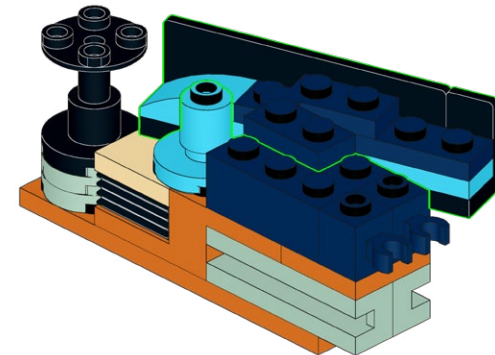

82

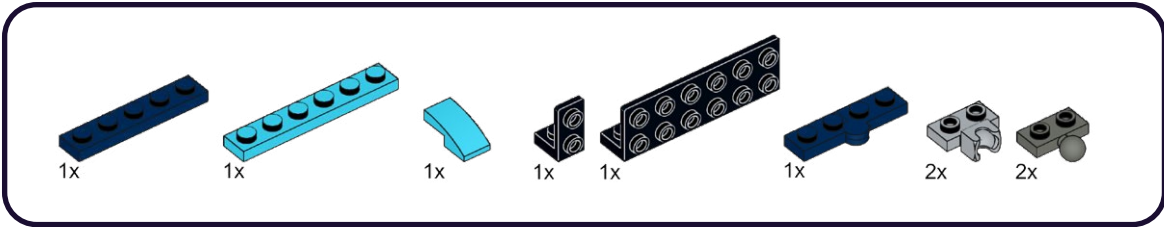

1

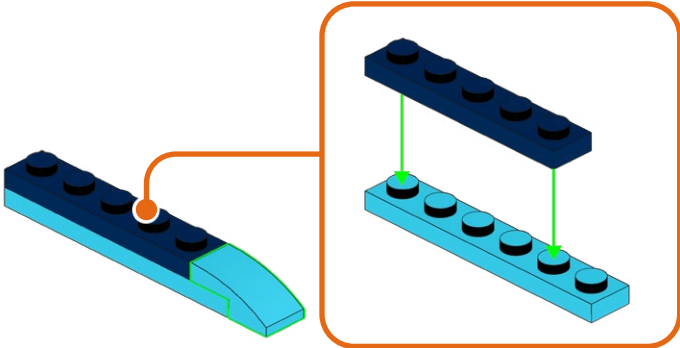

2

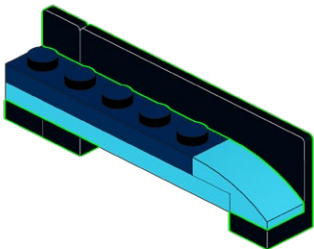

3

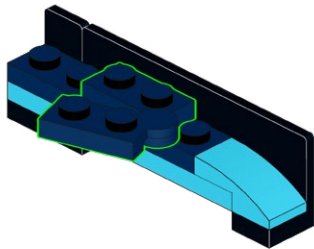

4

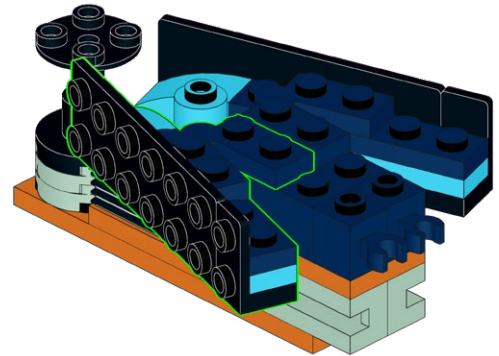

5

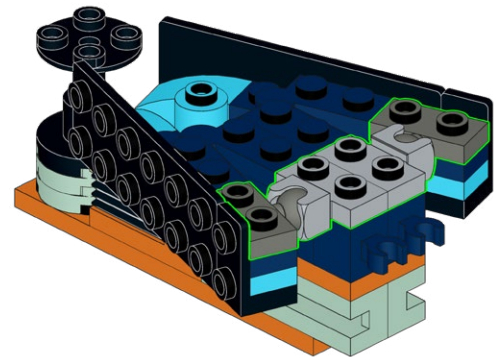

83

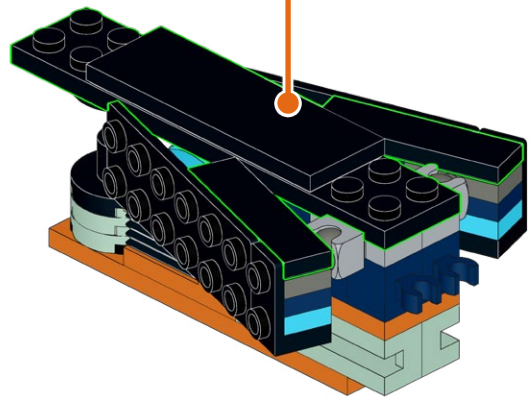
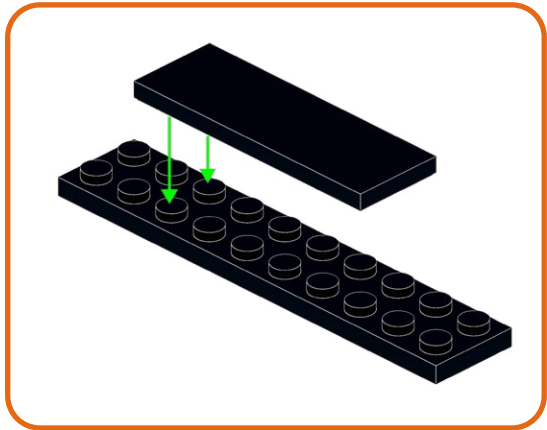
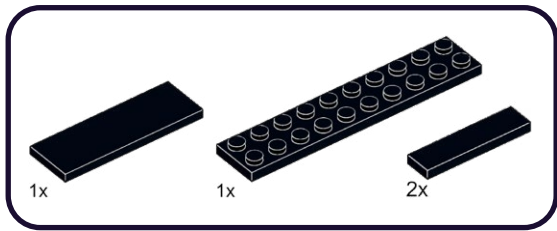

84

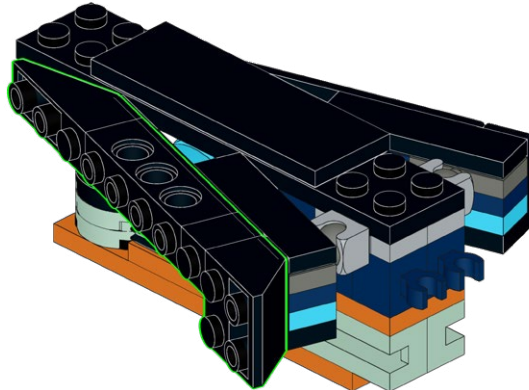
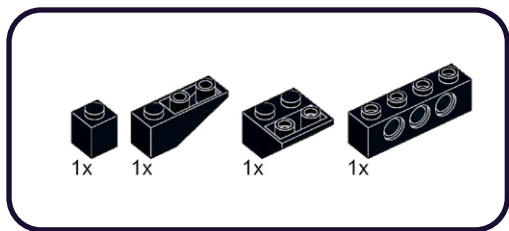

85

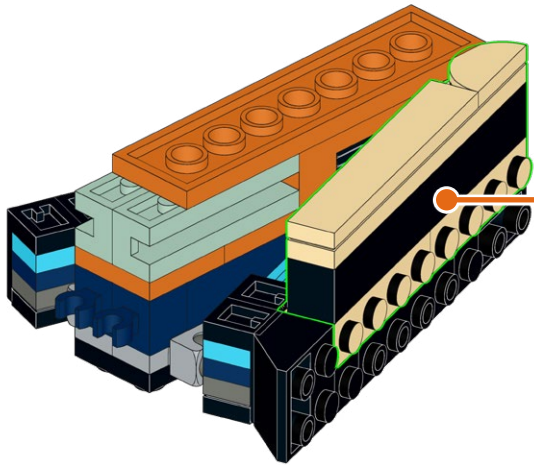
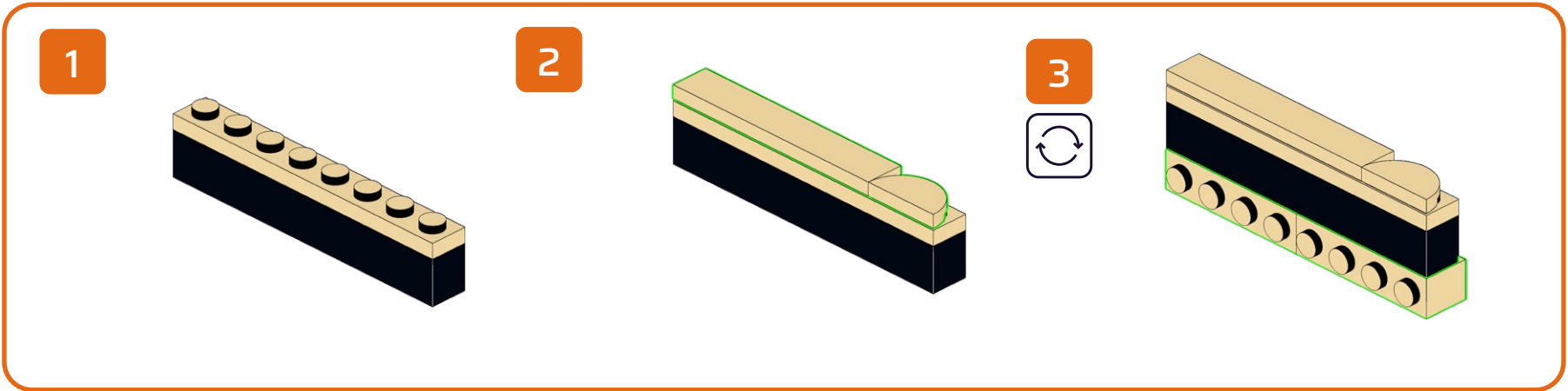
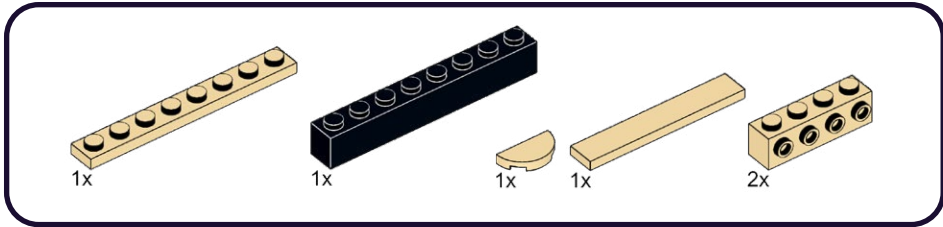

86

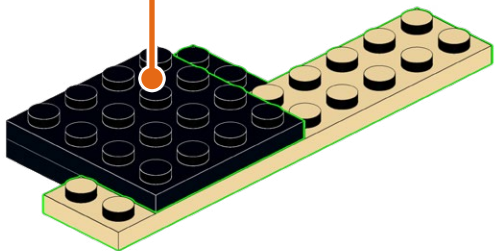
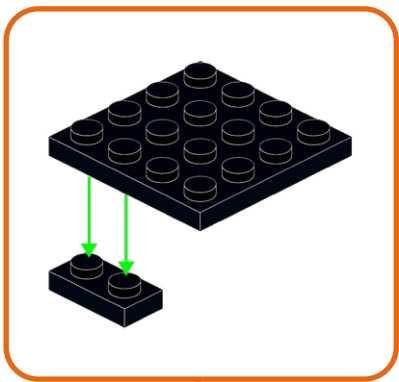
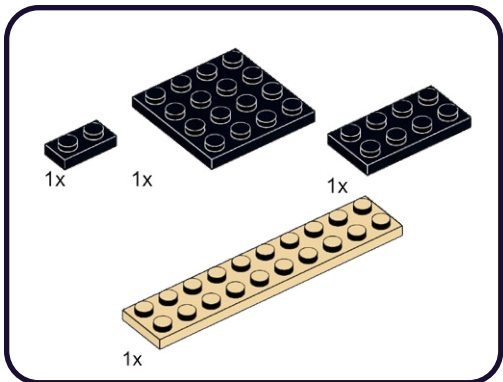

87

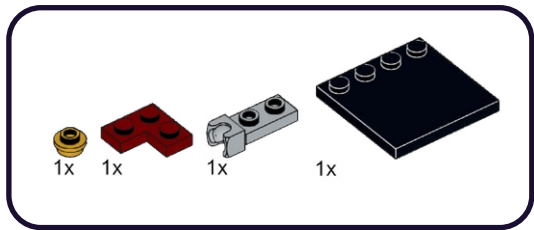

1

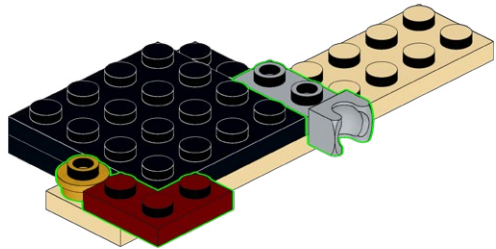

2

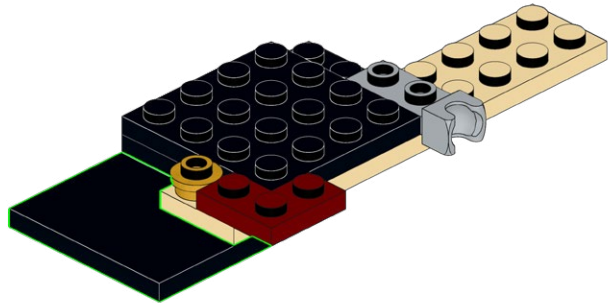

88

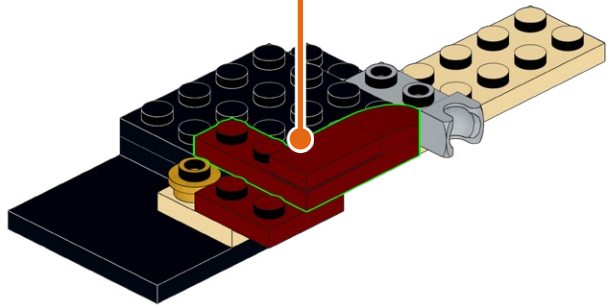
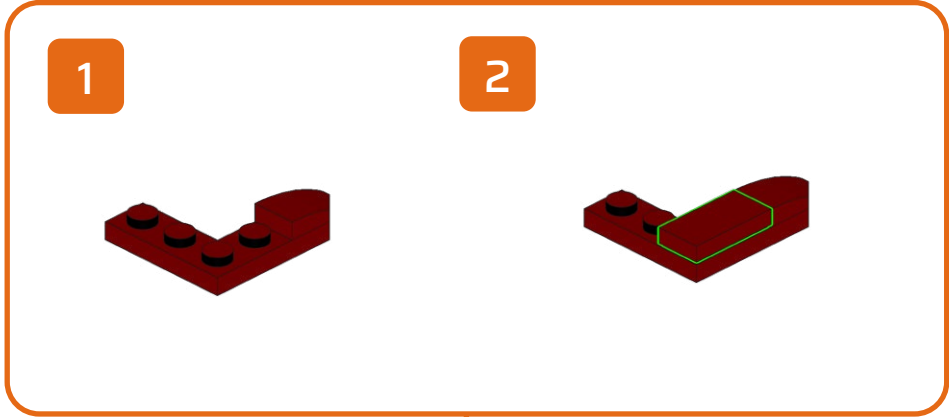
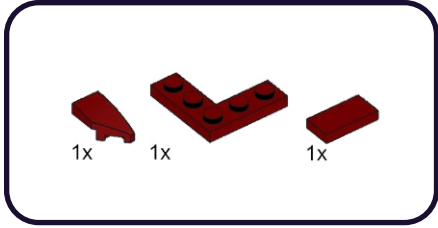

89

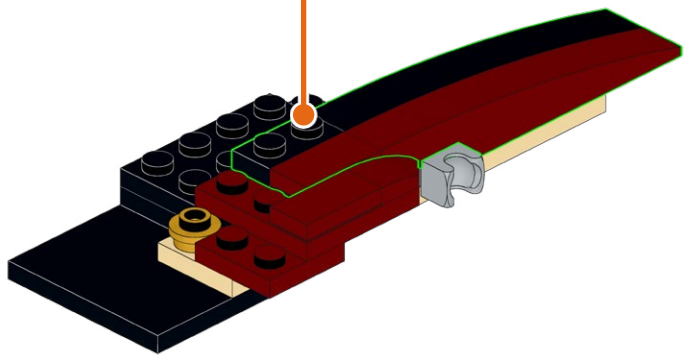
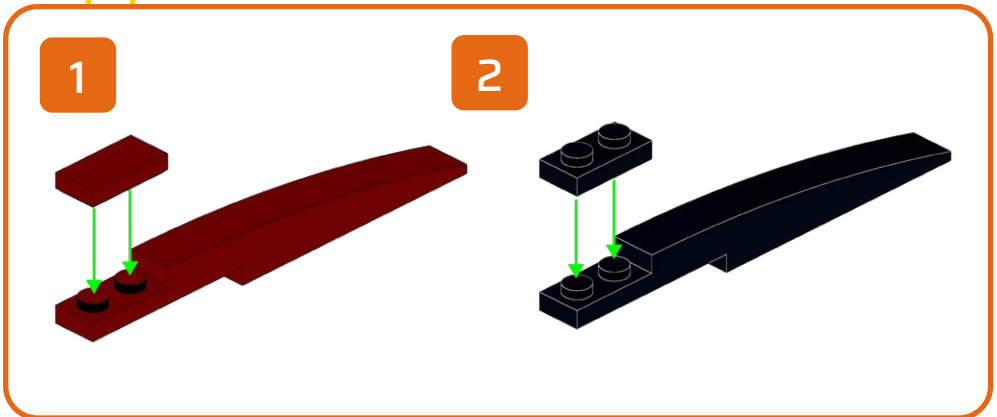
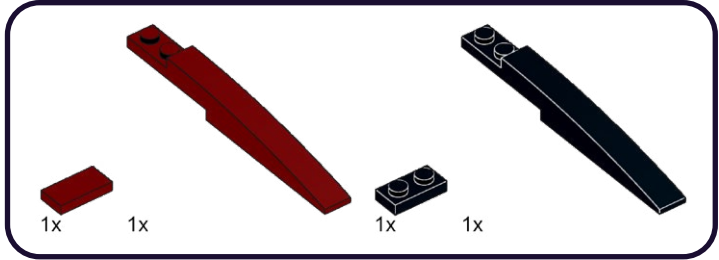

90

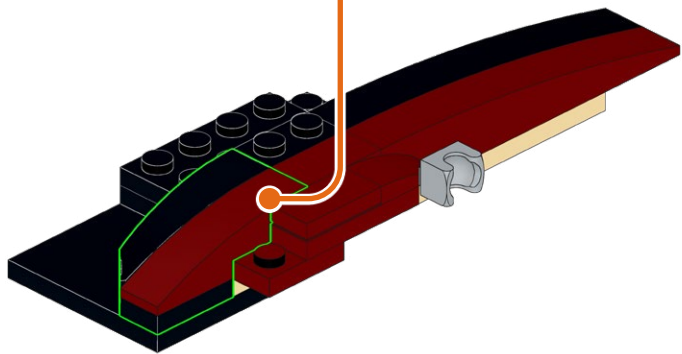
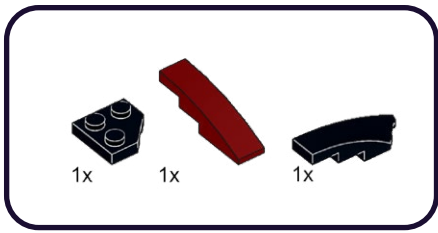

91

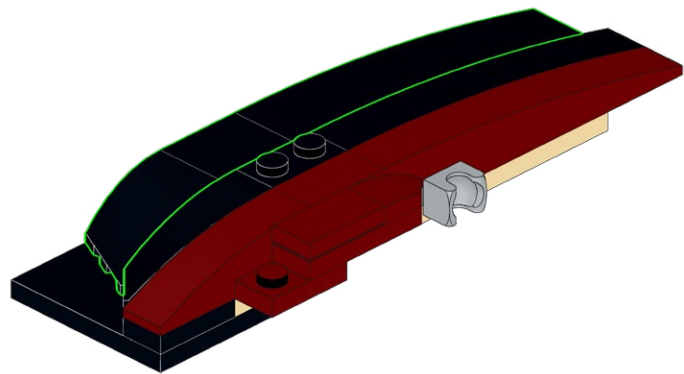
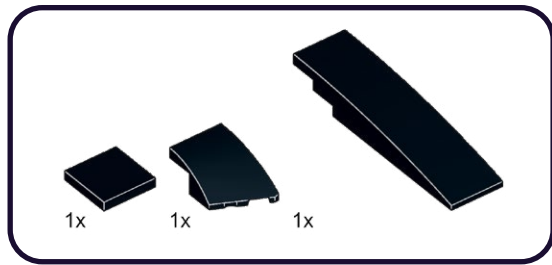

92

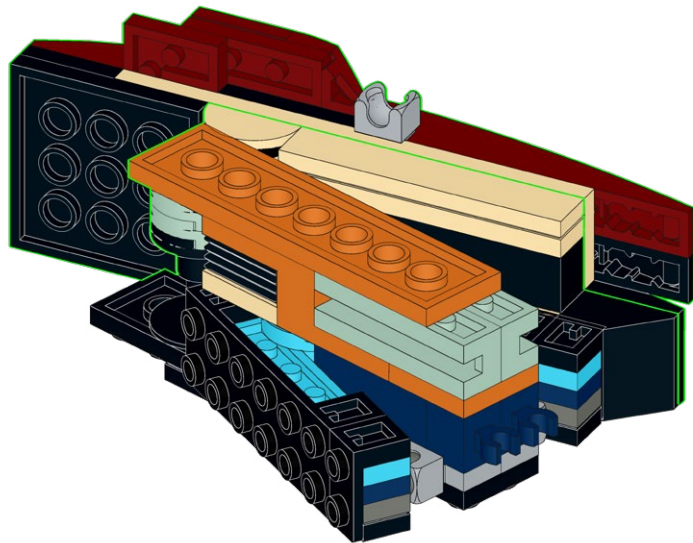

93

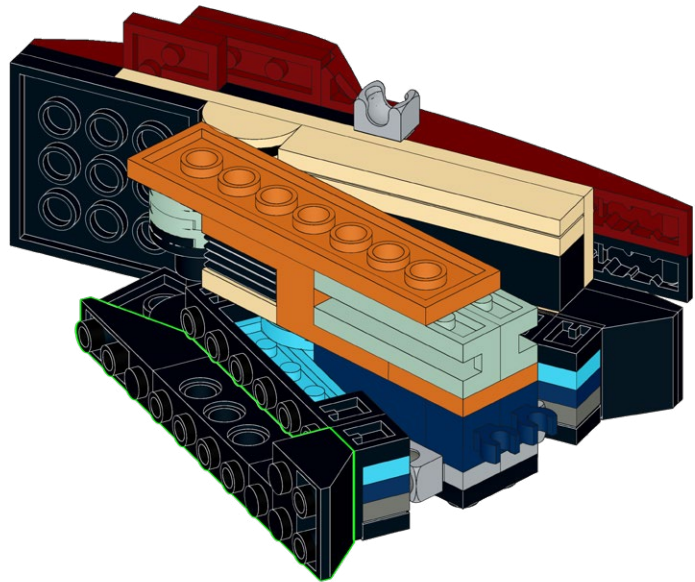
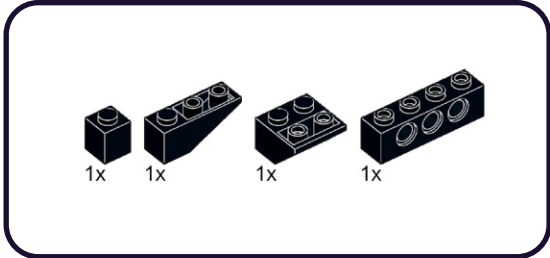

94

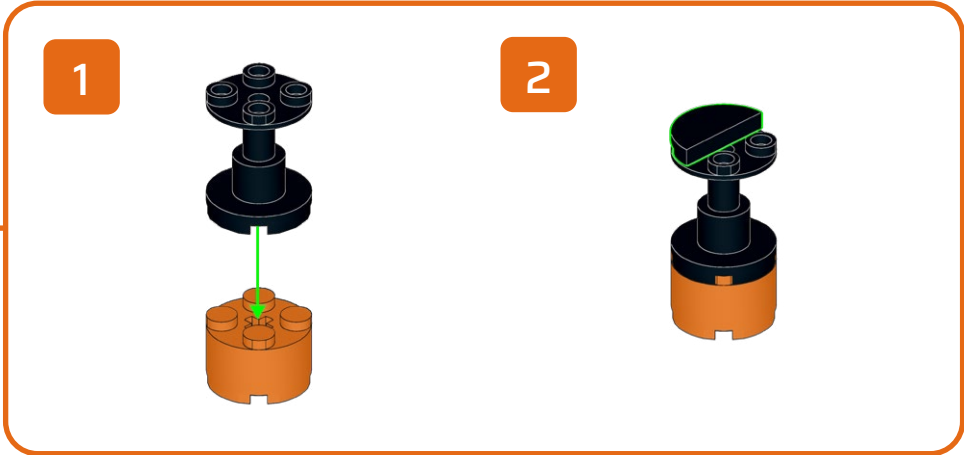
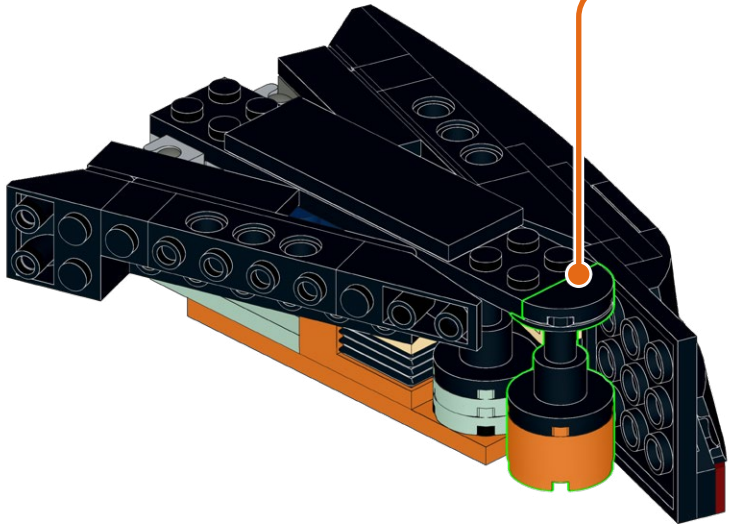
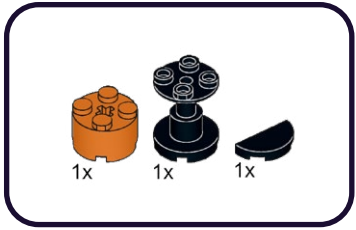

95

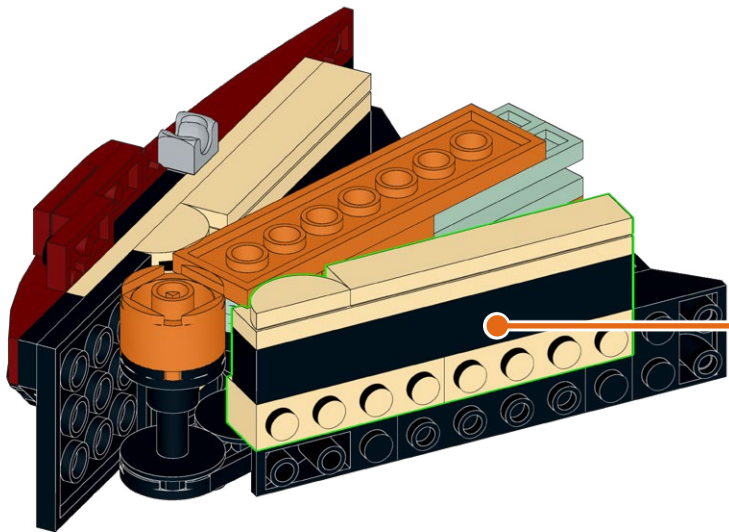
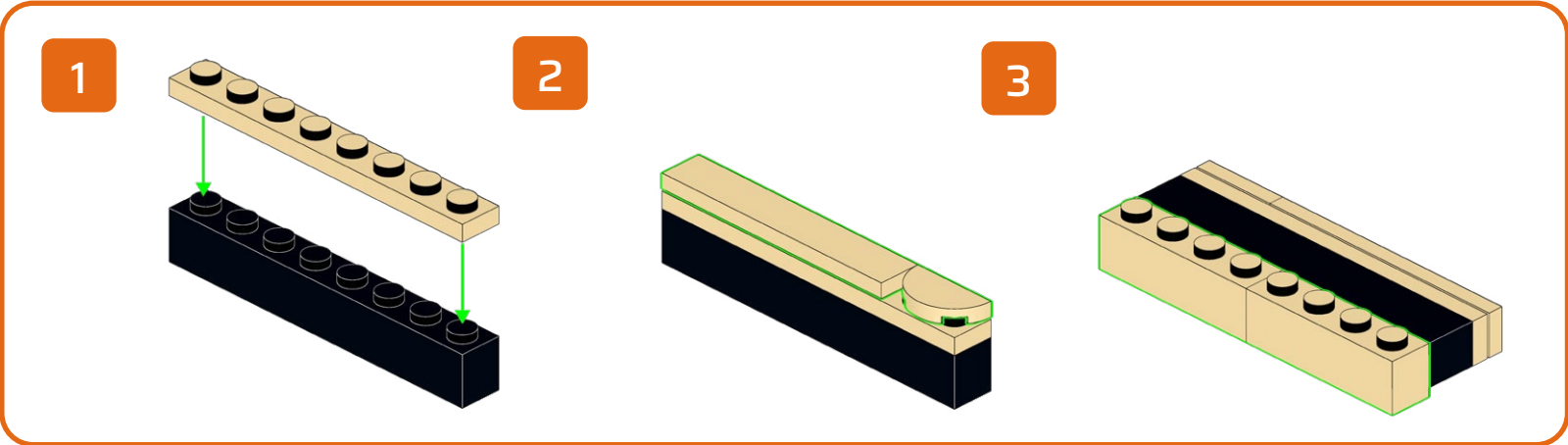
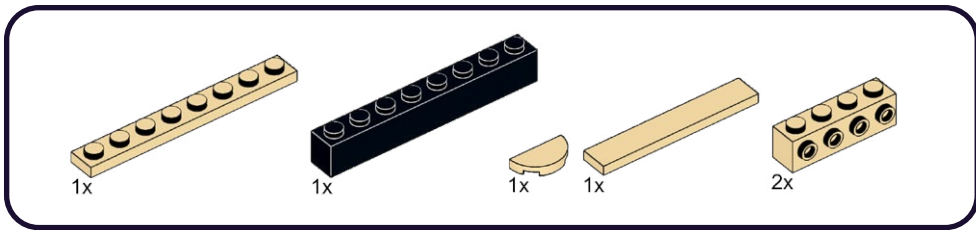

96

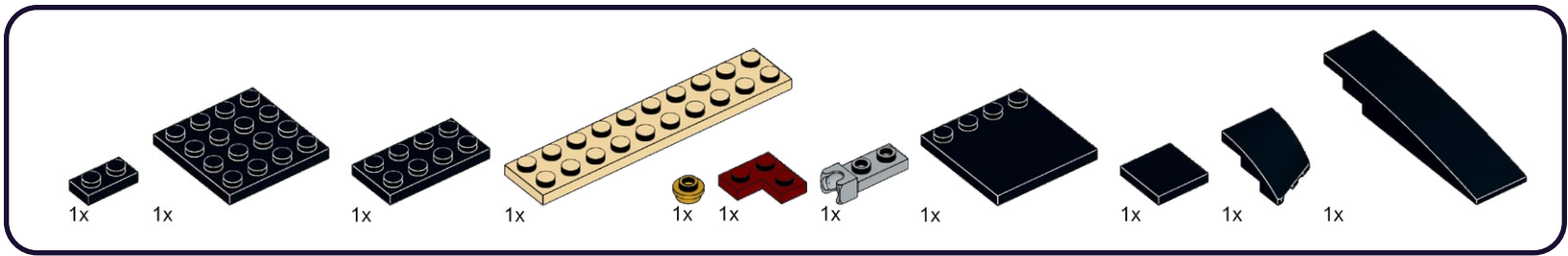

1

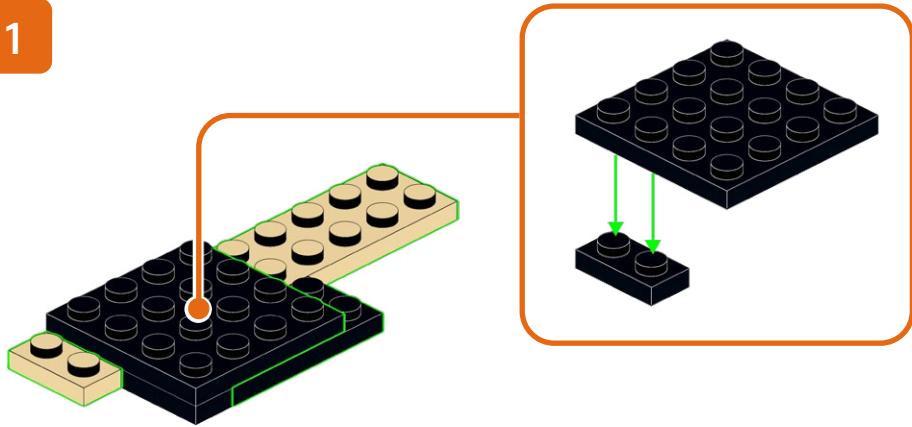

3

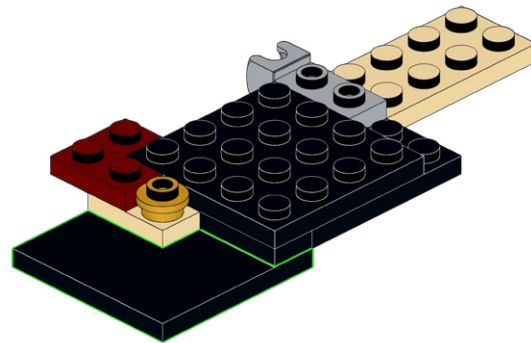

2

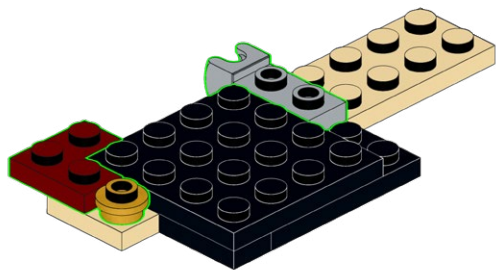

4

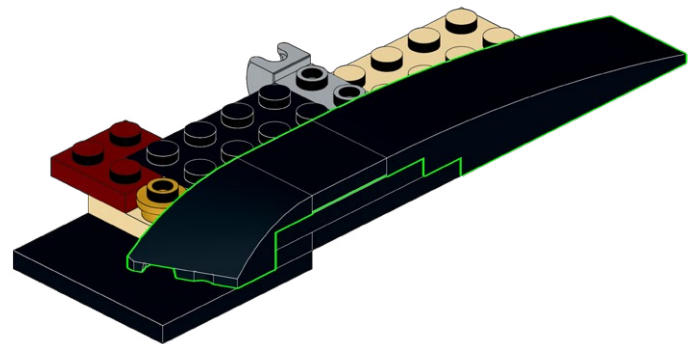

97



1

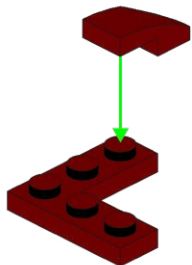

2

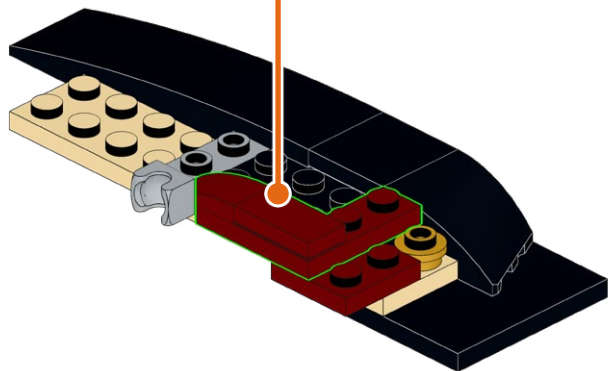
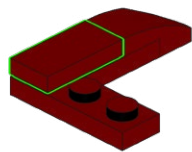

98

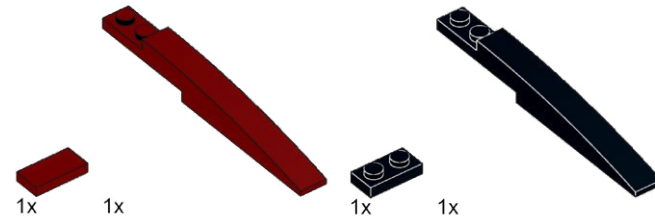

1

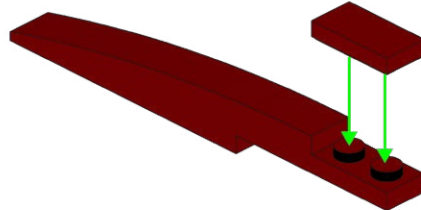

2

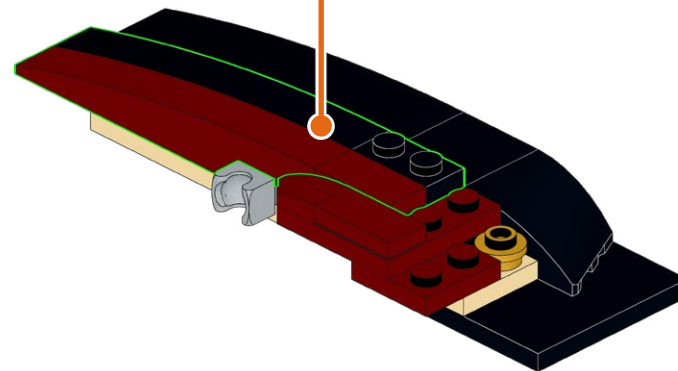
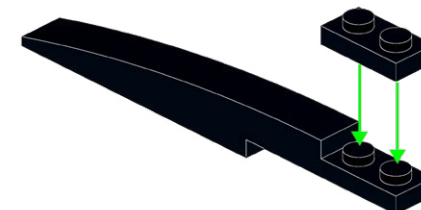

99

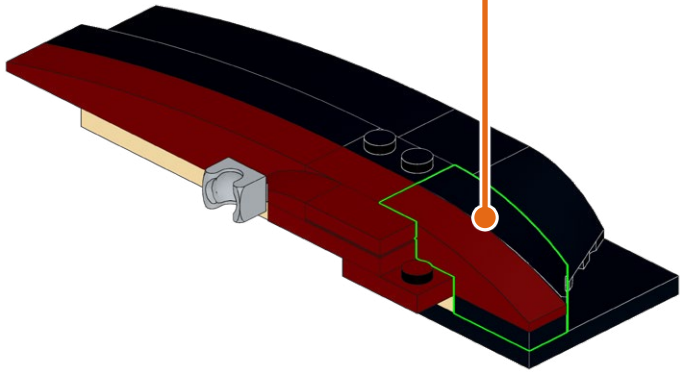
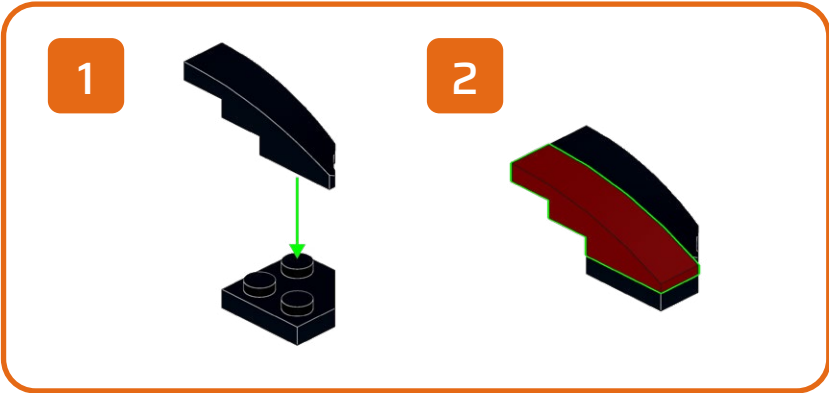
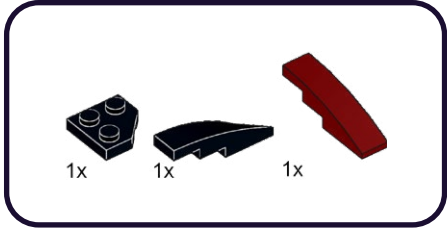

100

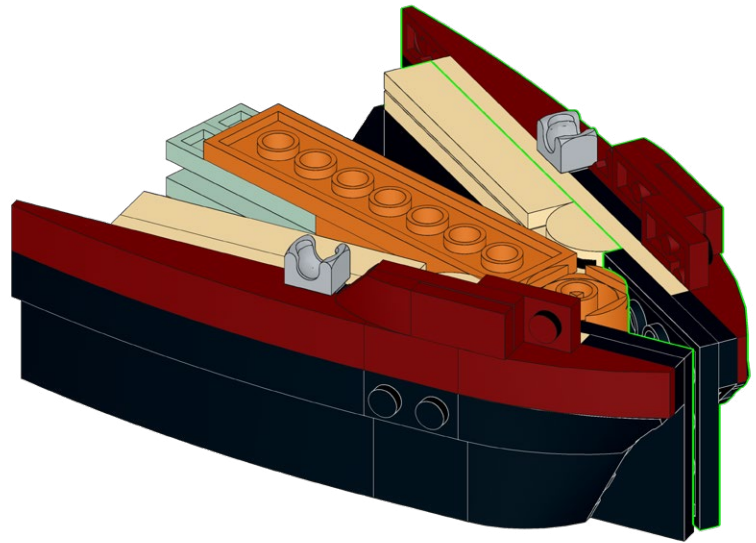
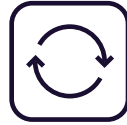

101

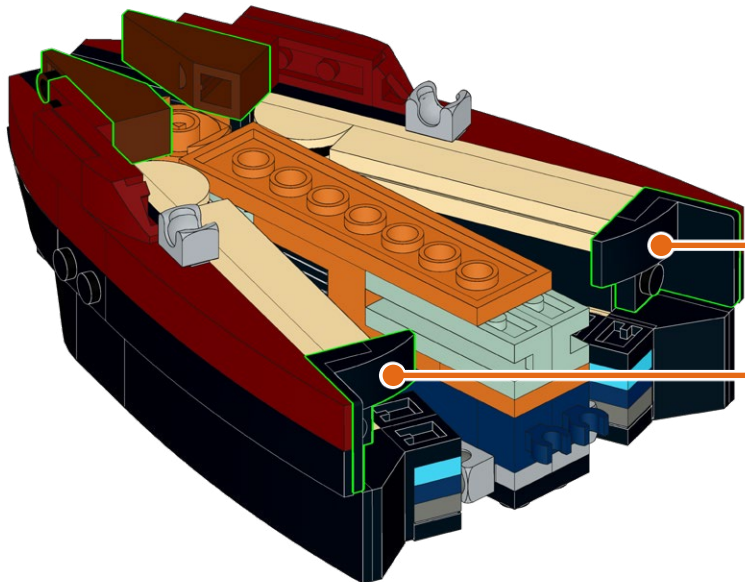
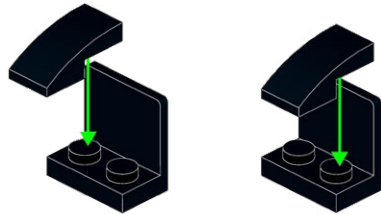
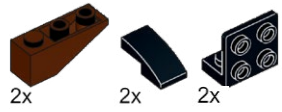

102

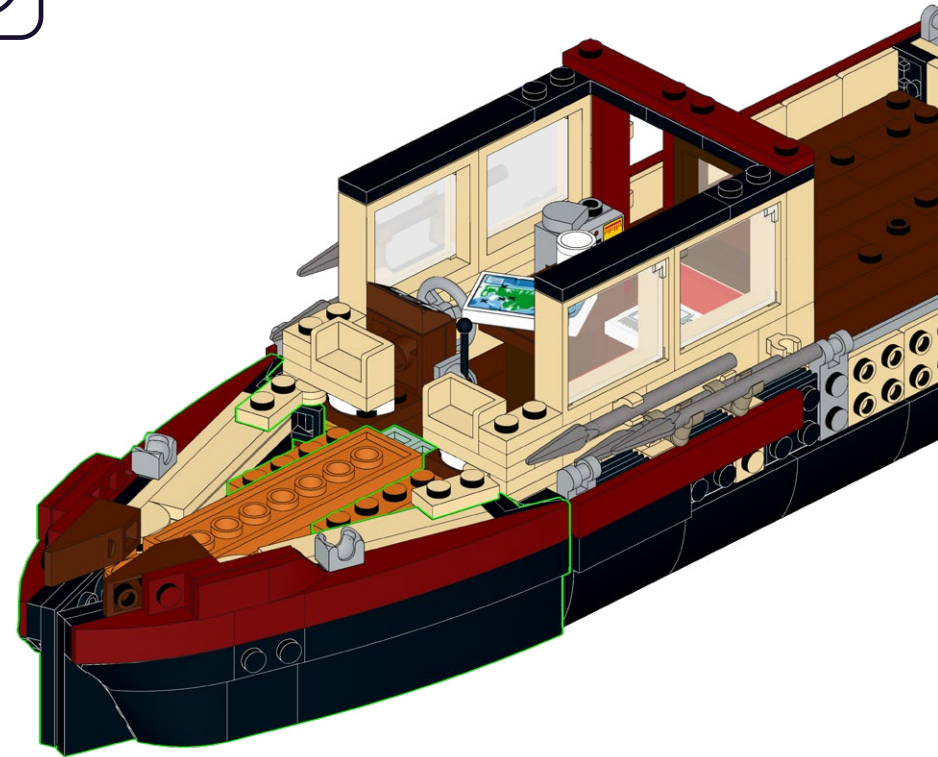
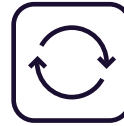

**HOLD UP!**

You might notice some bags aren't in order, as well as left over pieces, but that's ok! We're changing the way you build LEGO!

ATTENDEZ!

Vous remarquerez peut-être que certains sacs, ainsi que certaines pièces, ne sont pas dans le bon ordre. Mais pas de panique! Nous changeons simplement la façon avec laquelle vous construisez vos LEGO!

ASPETTA!

Potresti notare che alcuni sacchetti non sono in ordine, così come i pezzi avanzati, ma va bene così! Stiamo cambiando il modo in cui costruisci i LEGO!

HALT!

Sie werden möglicherweise bemerken, dass einige tüten durcheinander sind und teile übrig bleiben, aber das ist in Ordnung! Wir ändern die art und weise, wie Sie LEGO bauen!

¡ESPERA!

Es posible que notes que algunas bolsas están fuera de servicio, así como piezas sobrantes, ¡pero está bien! ¡Estamos cambiando la forma en que construyes LEGO!

暫停!

你可能会注意到一些袋子顺序错乱, 以及一些剩余的部件, 但没关系! 我们正在改变你搭建乐高的方式!

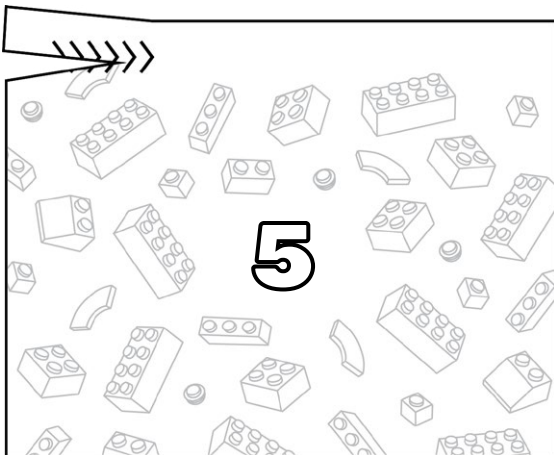
Open LEGO® Bag 5

103

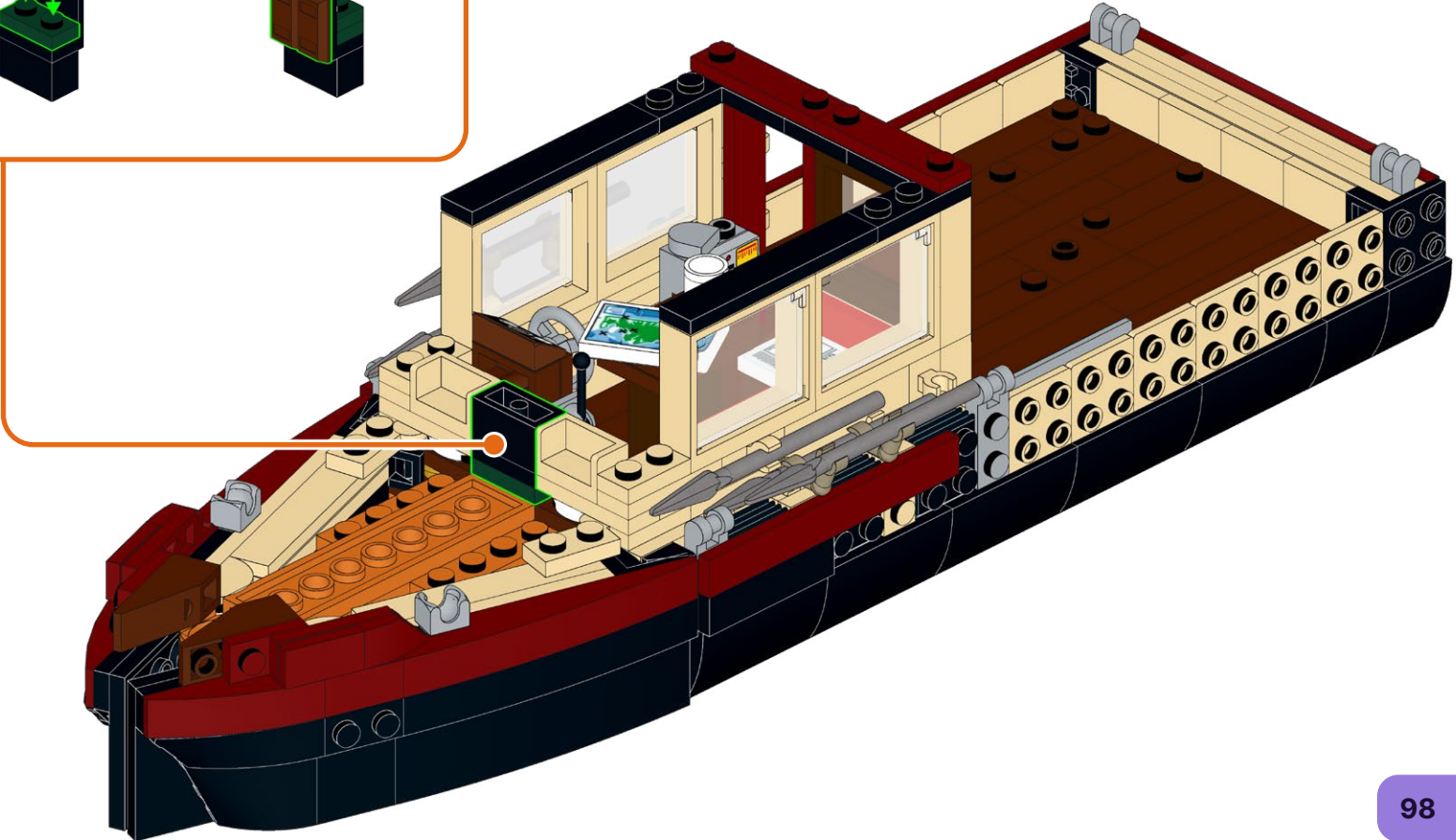
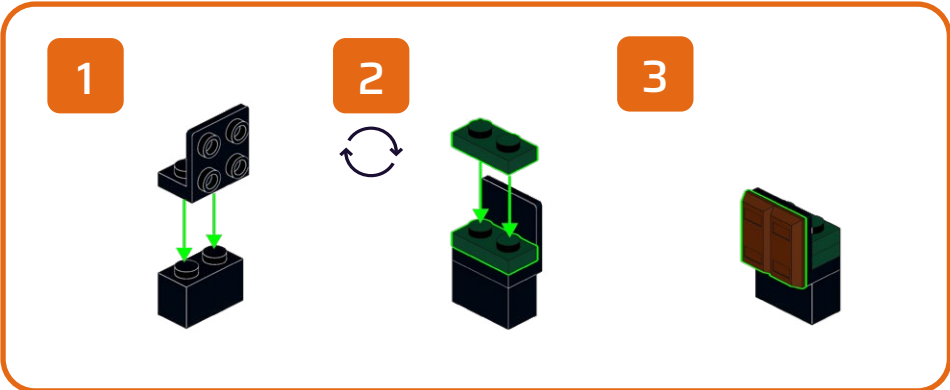
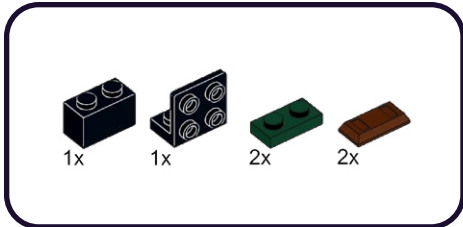

104

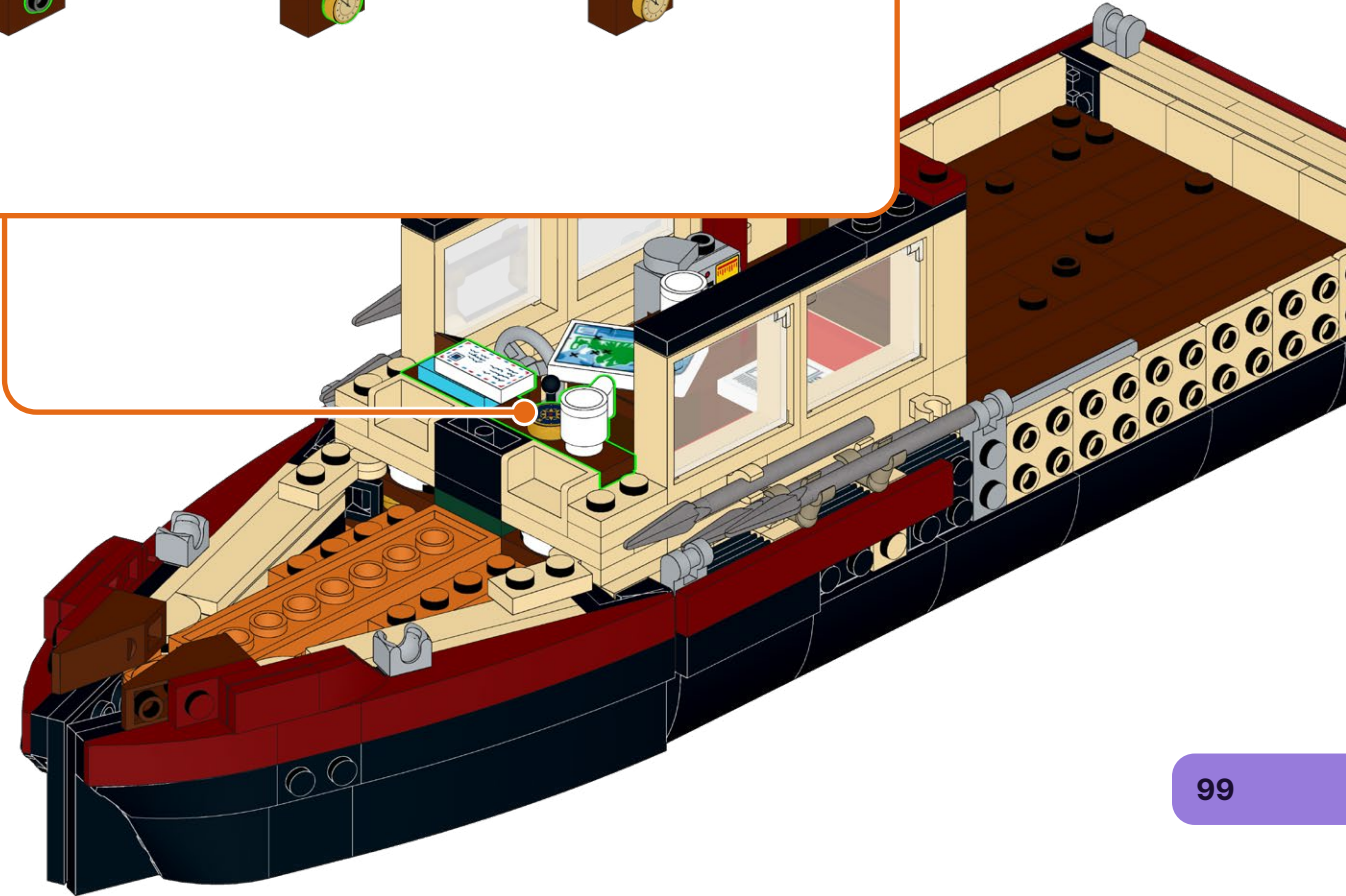
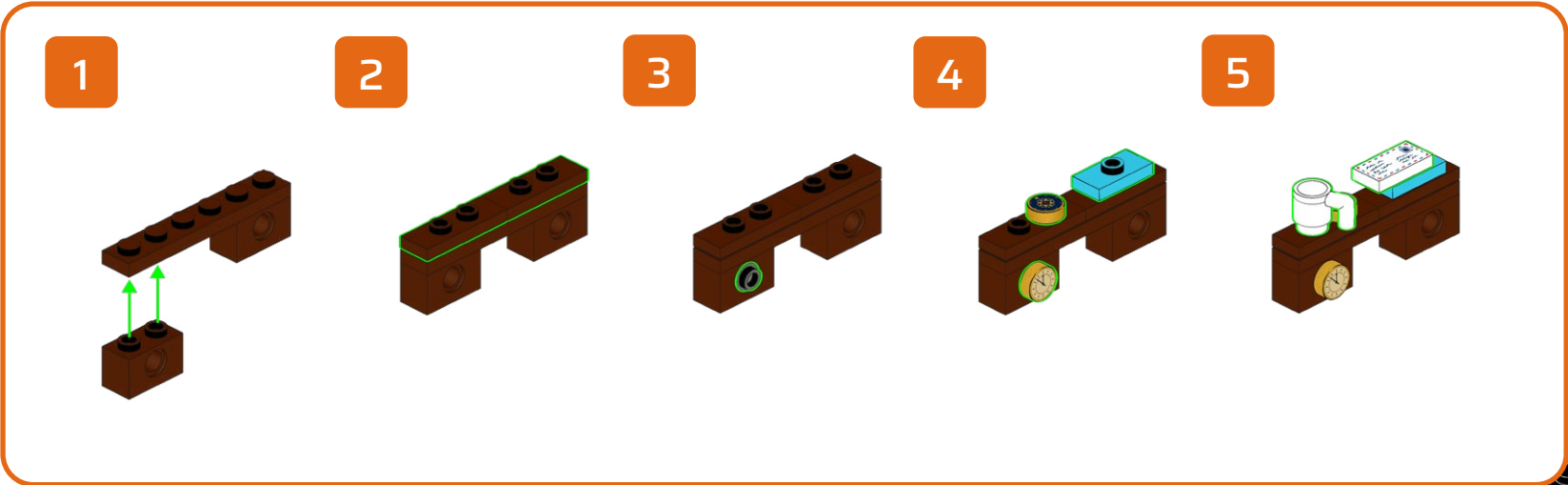
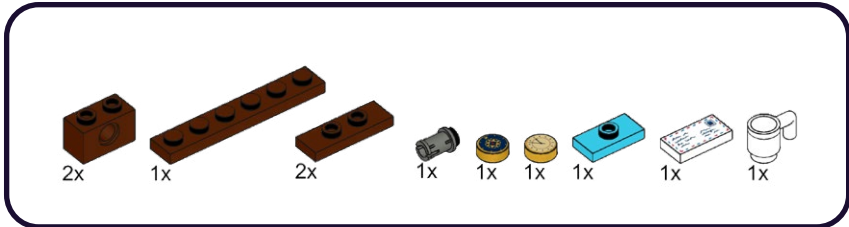

105

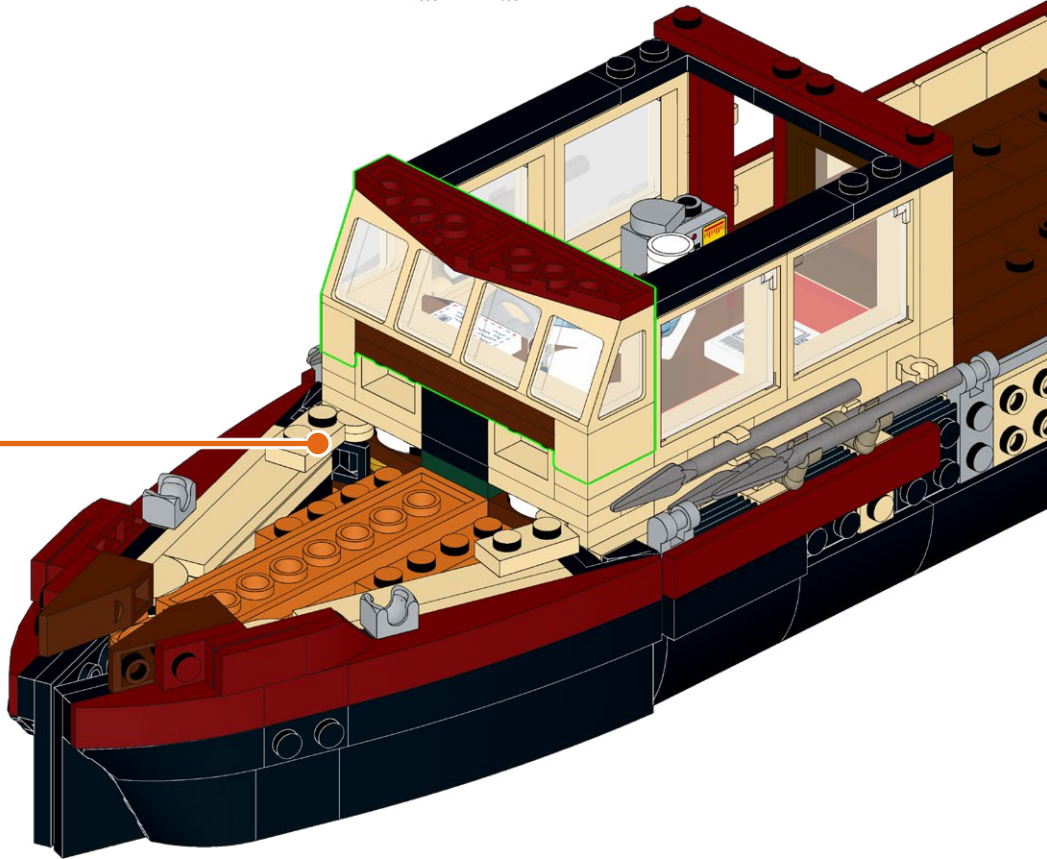
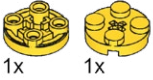
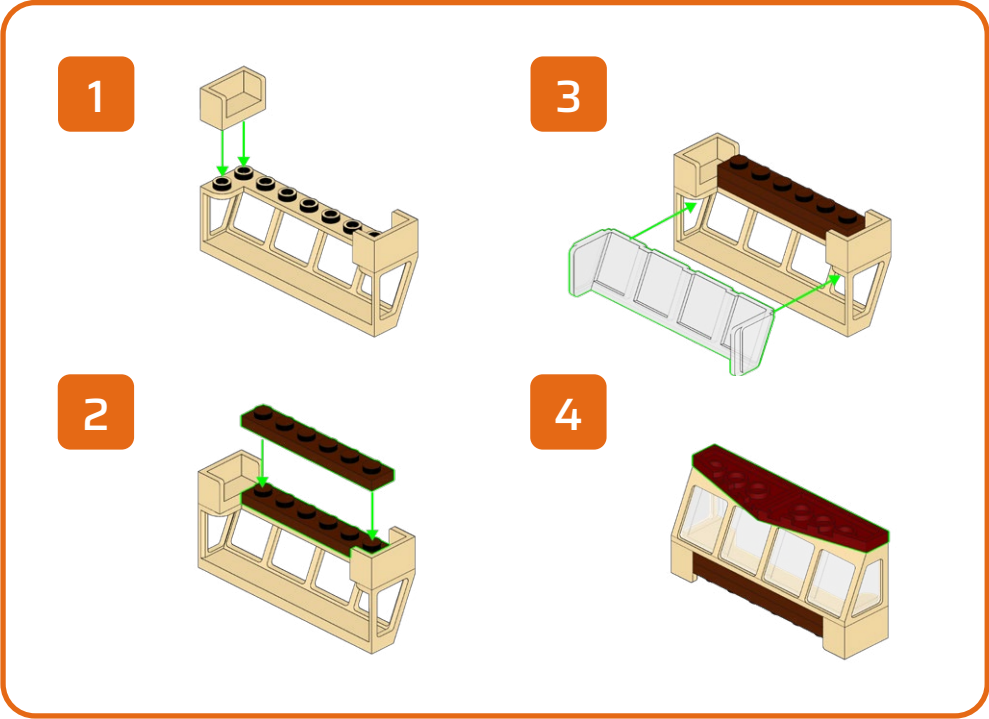
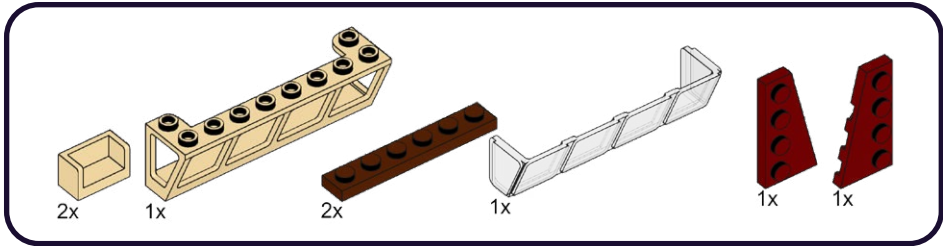

106

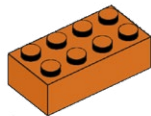

1x



2x



6x



2x

1

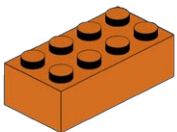

4



2

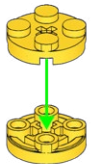

5



3



6

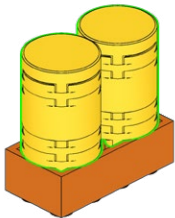

2x

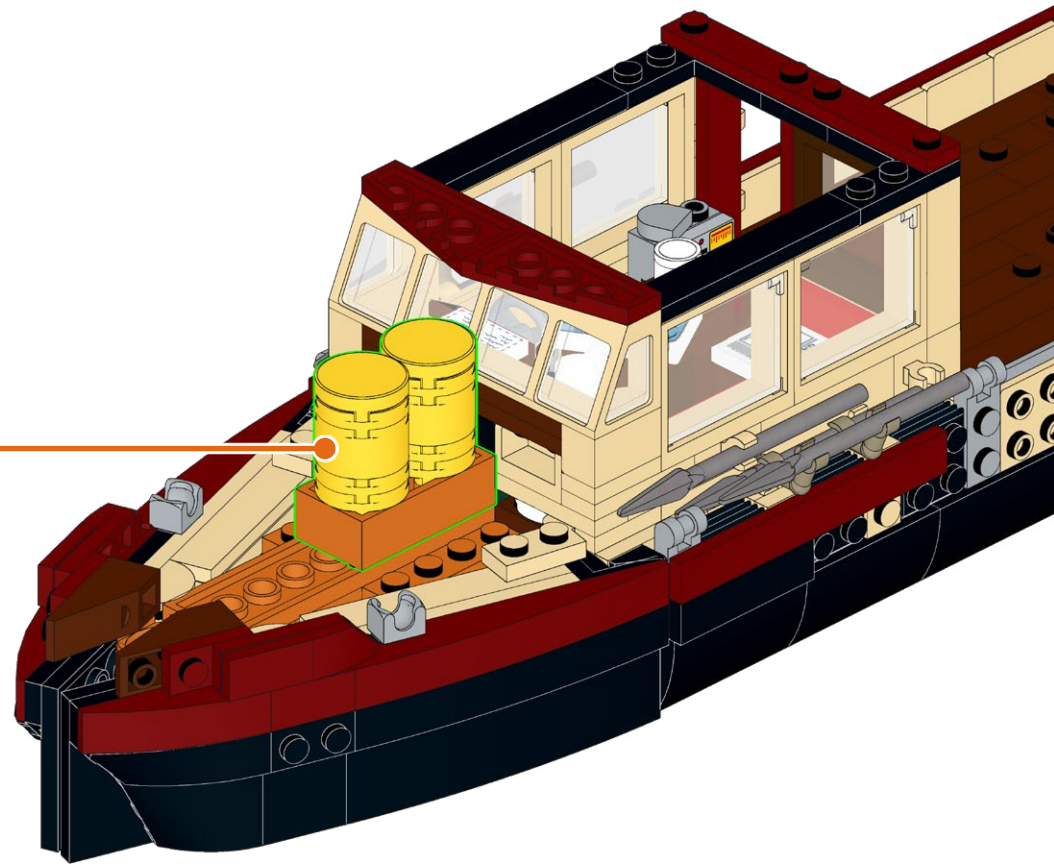

107

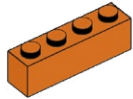

4x

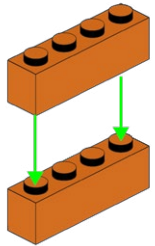

2x

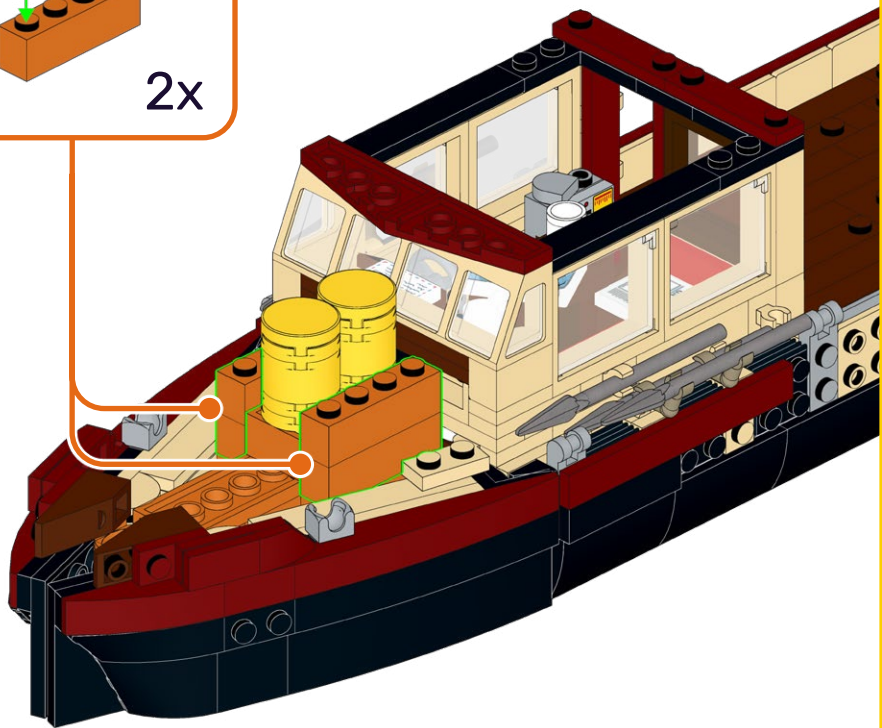

108

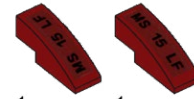

1x

1x

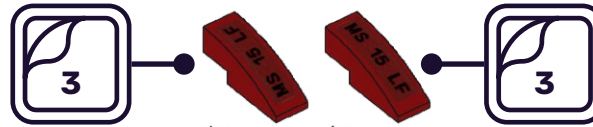

1x

1x

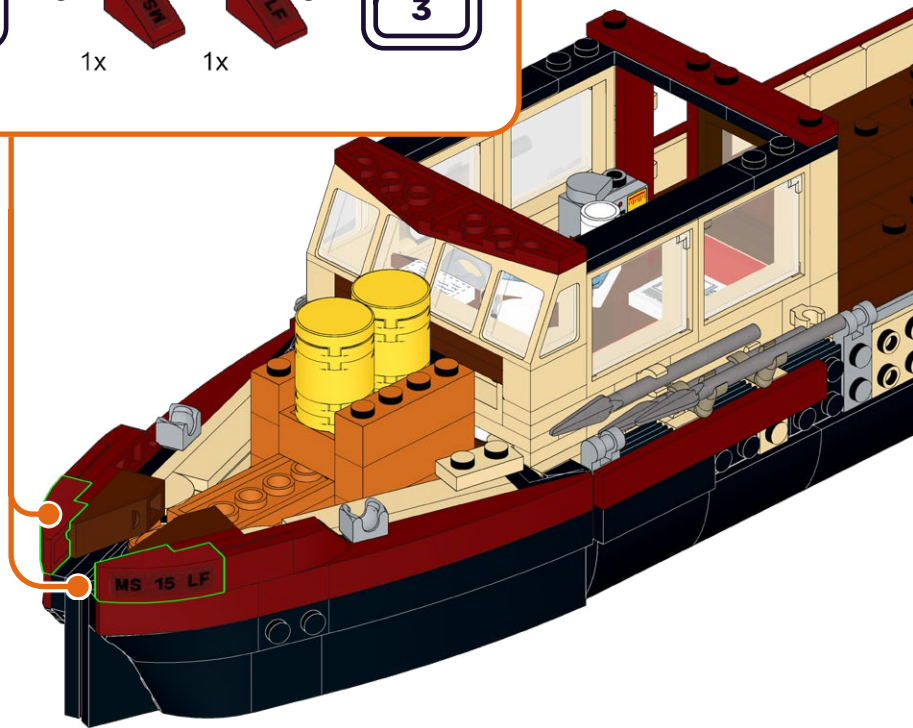

109

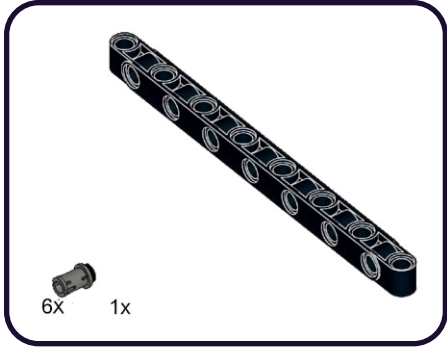

1

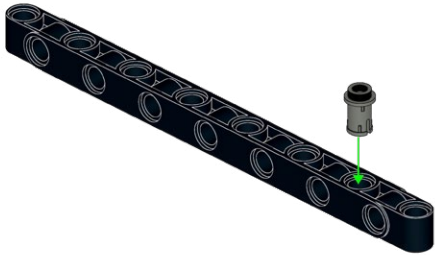

2

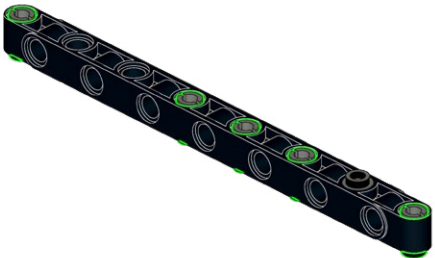

110

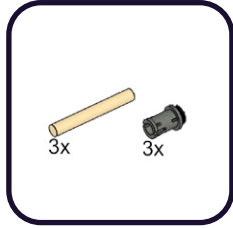

3

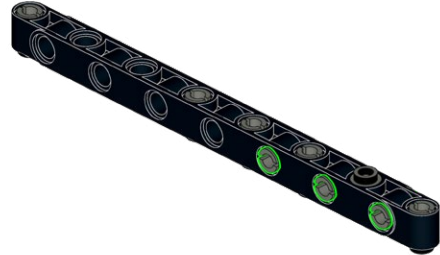

4

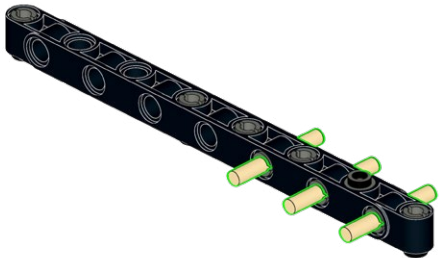

111

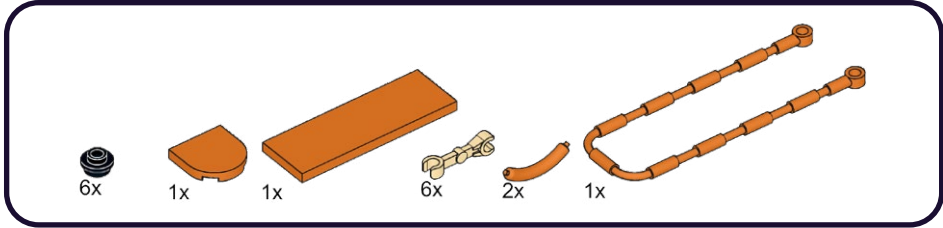

1

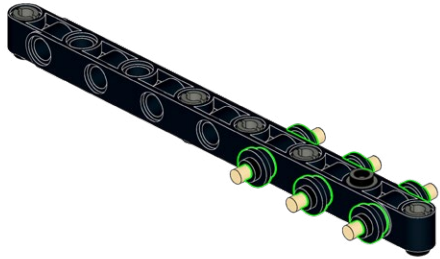

2

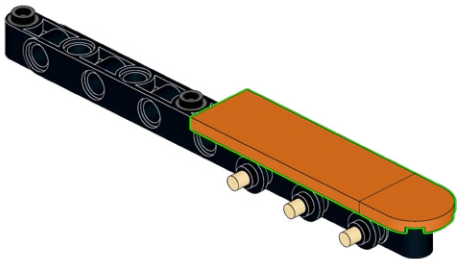

3

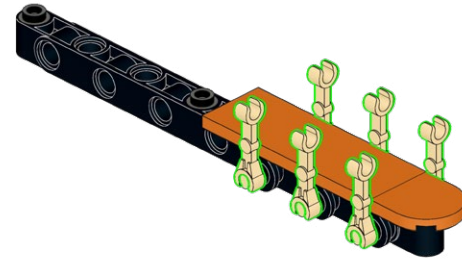

4

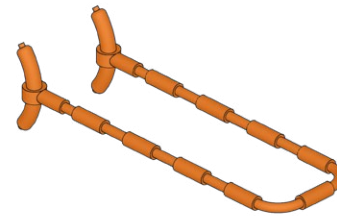

5

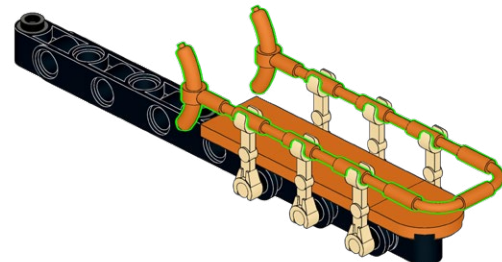

112

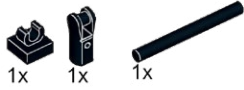

1

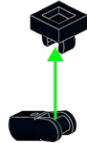

2



3

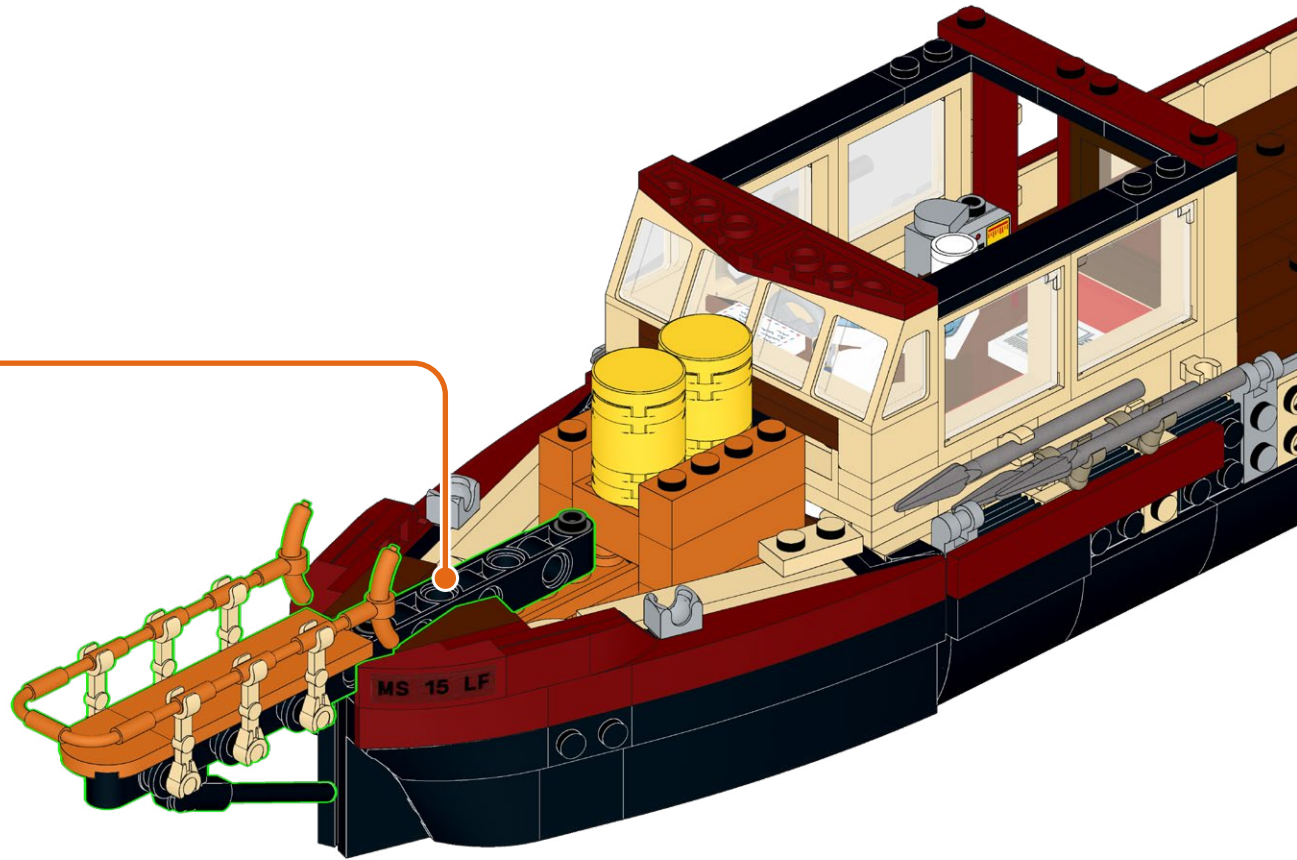
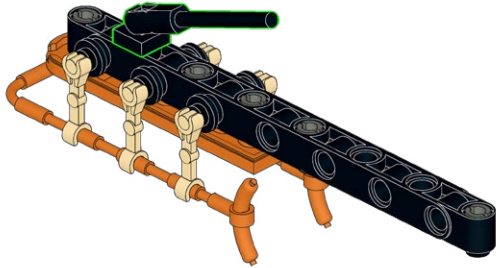

113

2x

2x

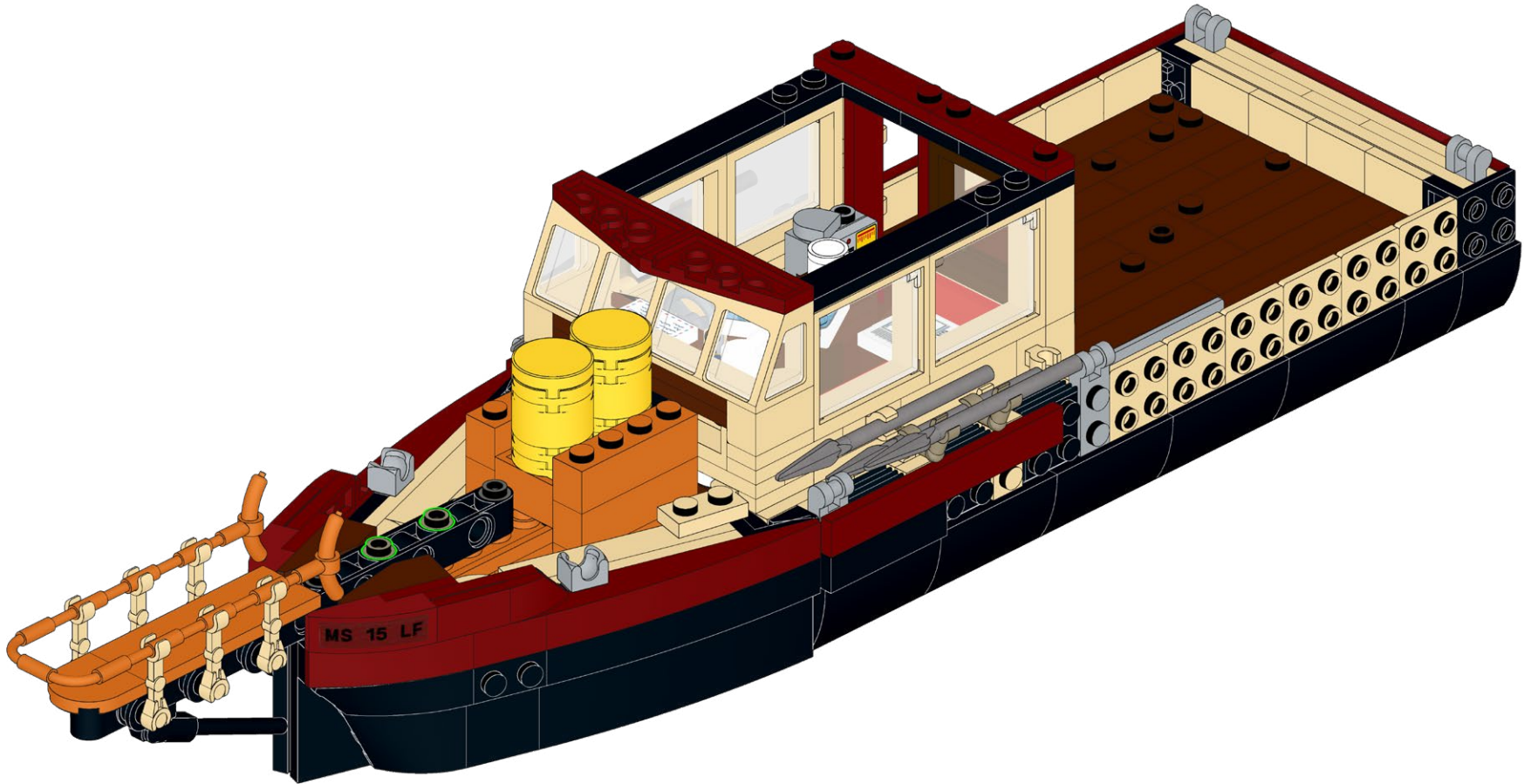

114

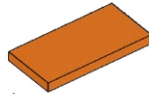

1x

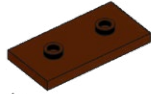

1x

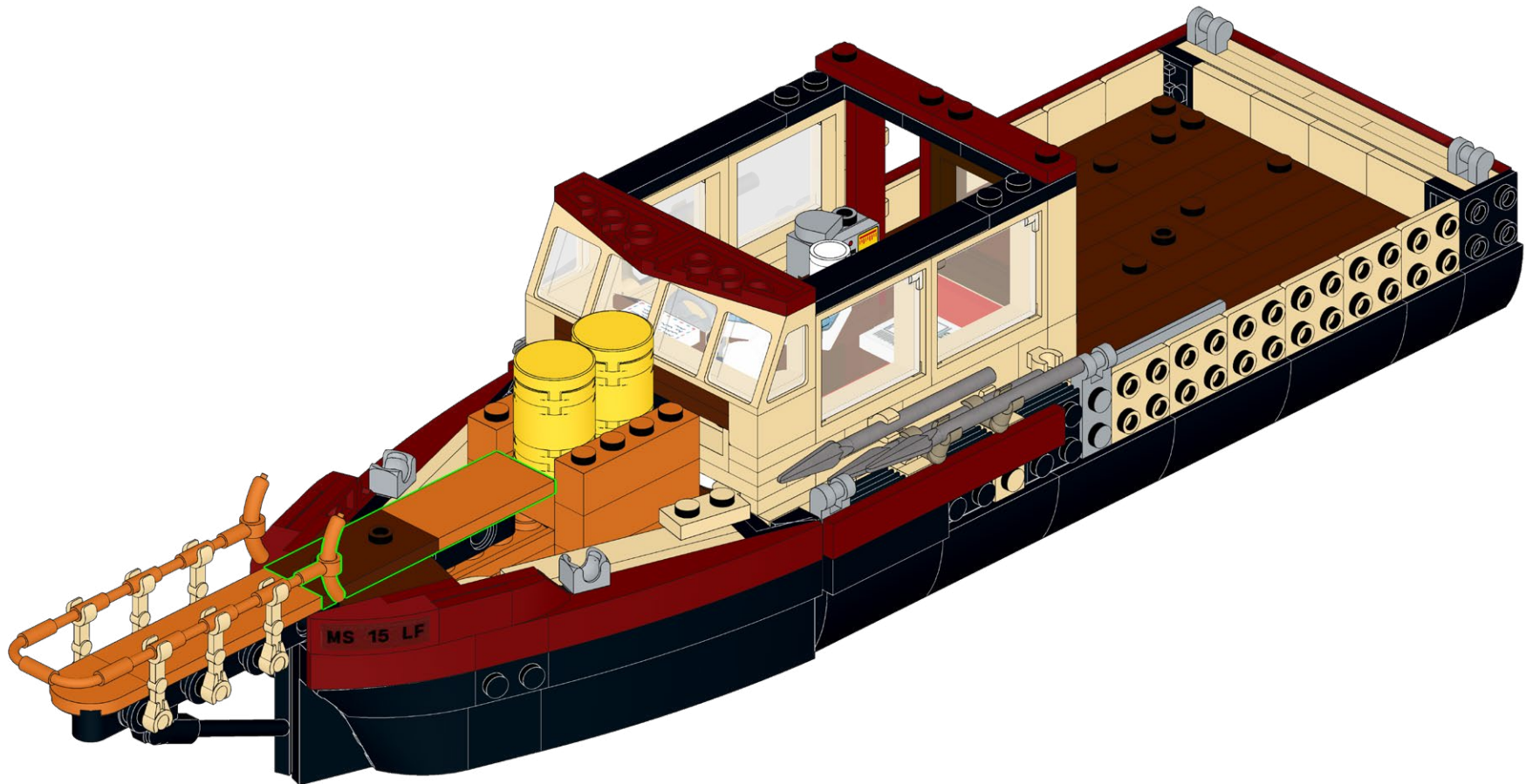

115

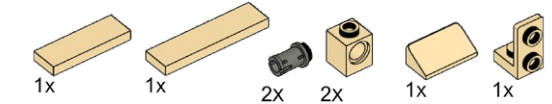
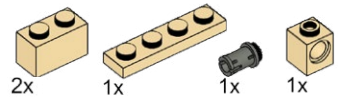

1

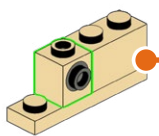

1

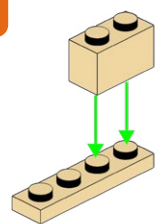

2

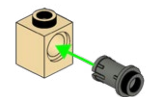

3

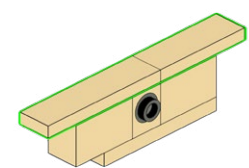

4

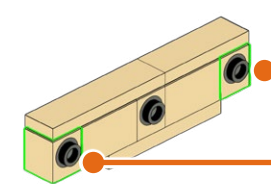

2

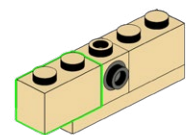

5

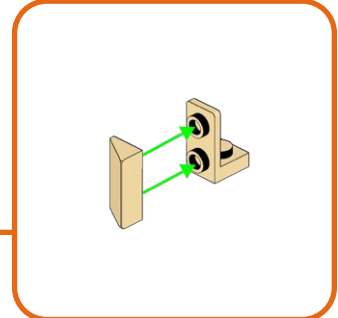
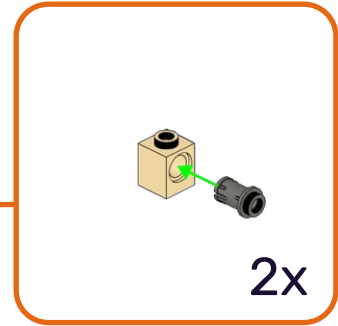
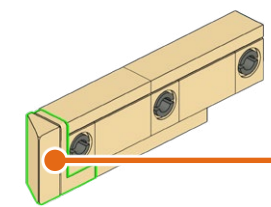
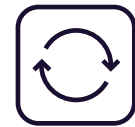

116

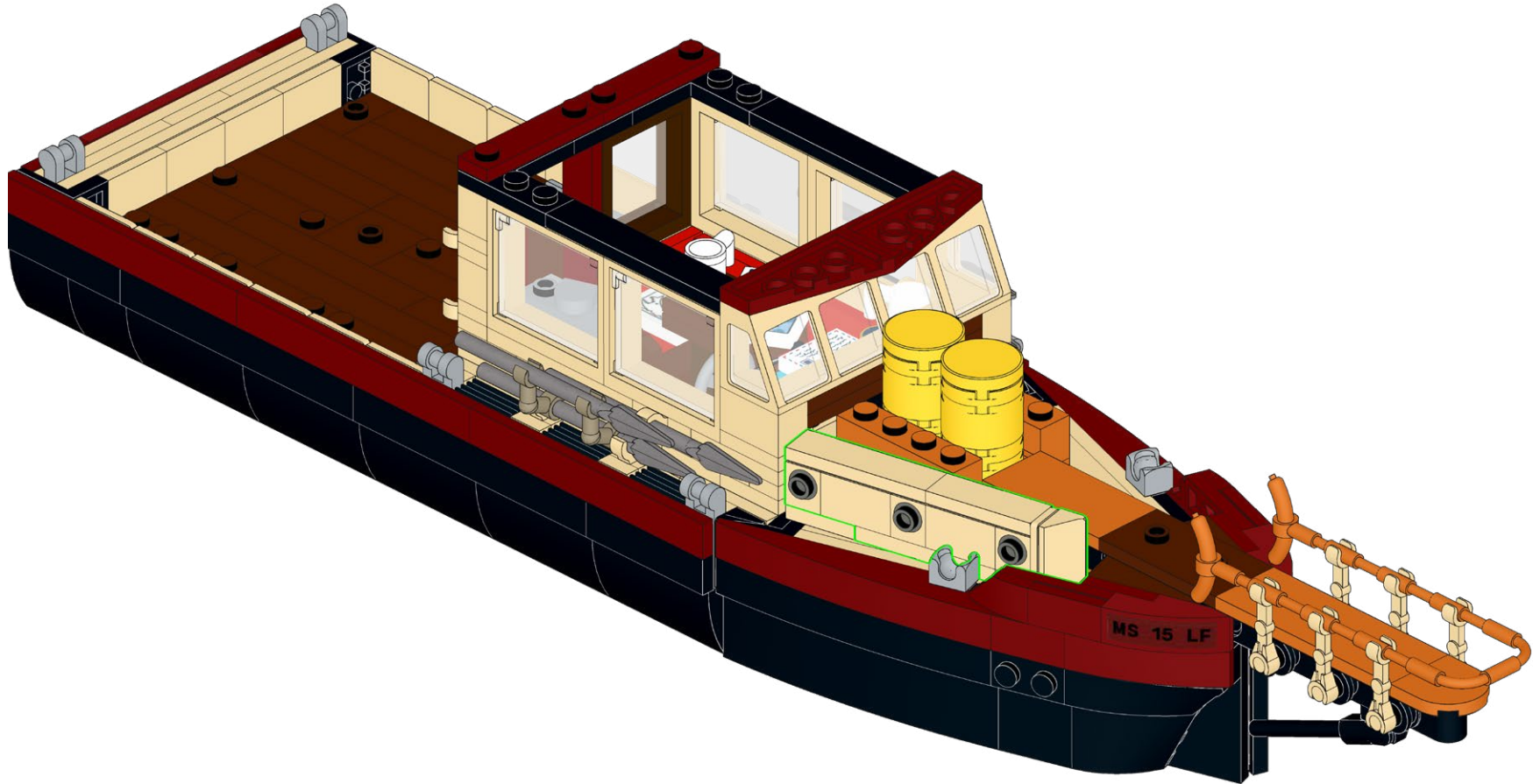

117

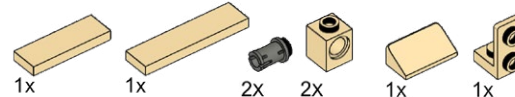
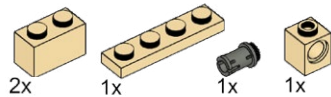

1

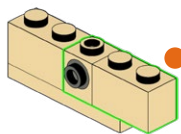

1

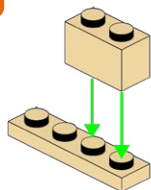

2

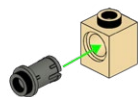

3

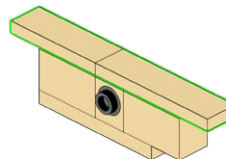

4

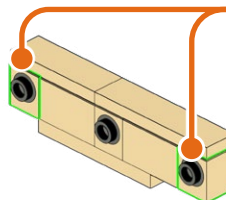

2x

2

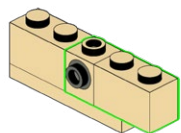

5

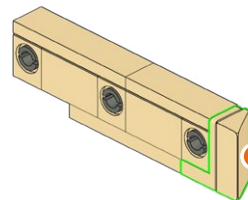
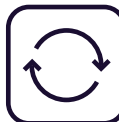

118

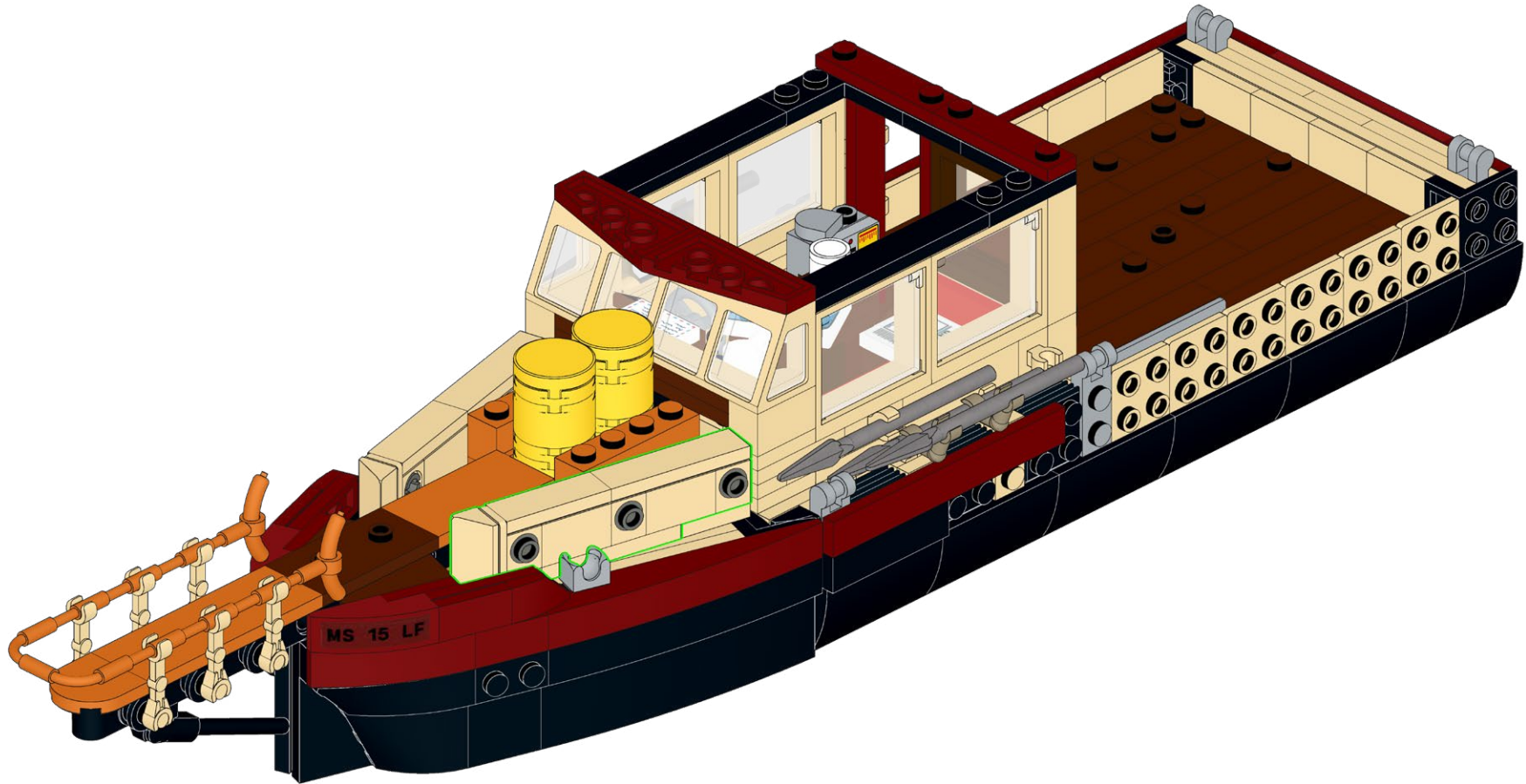

119

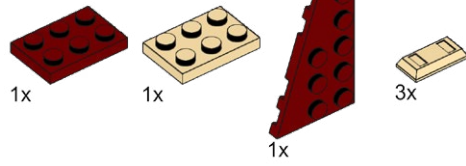

1

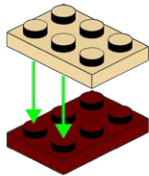

2

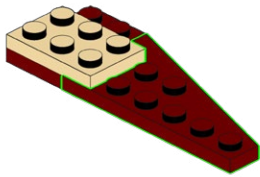

3

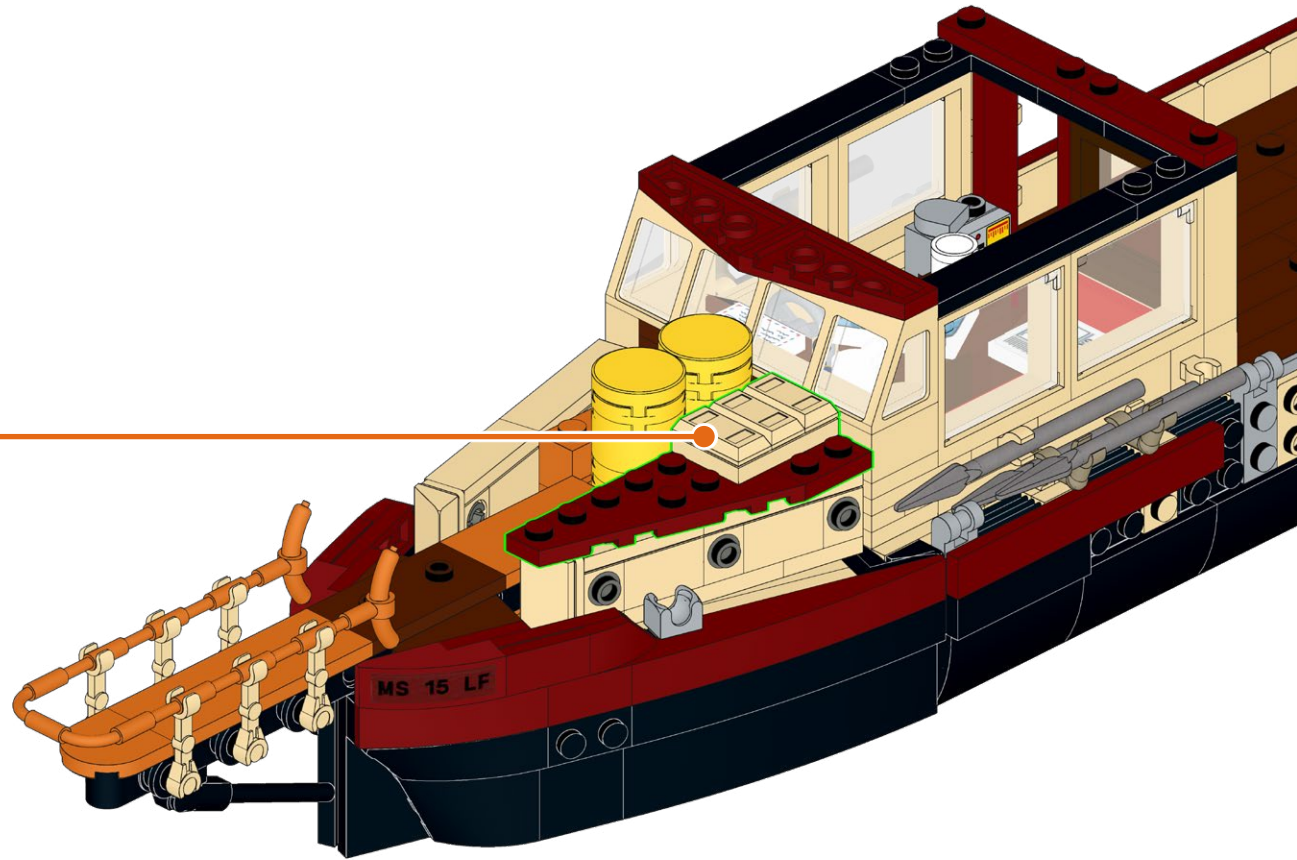
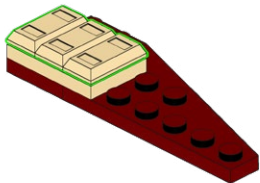

120

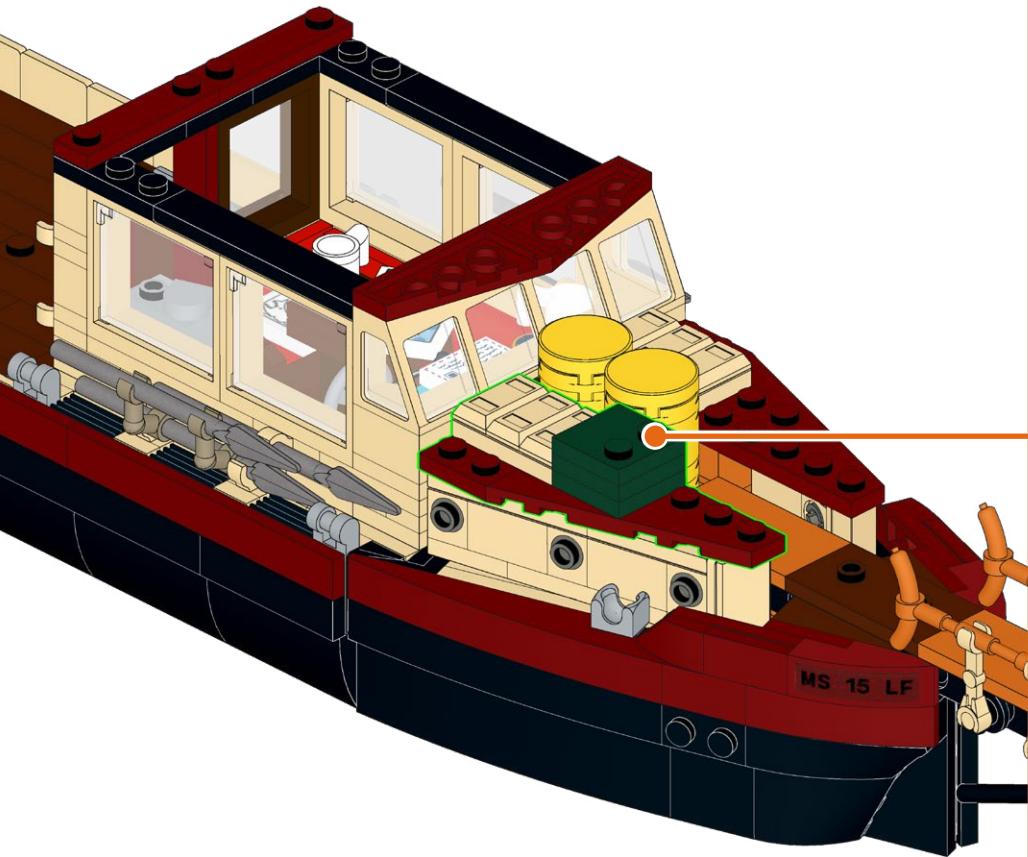
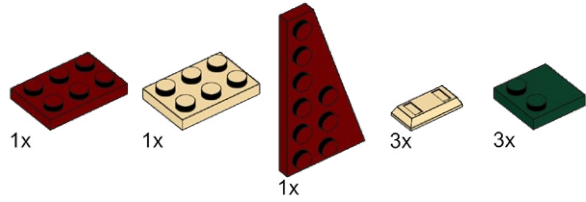

1

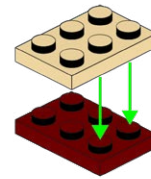

2

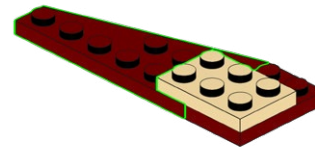

3

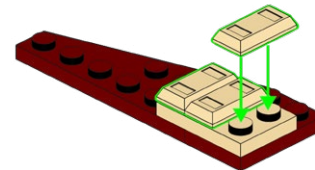

4

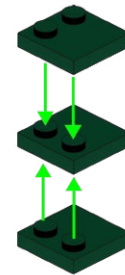

5

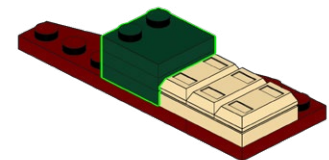

121

6x

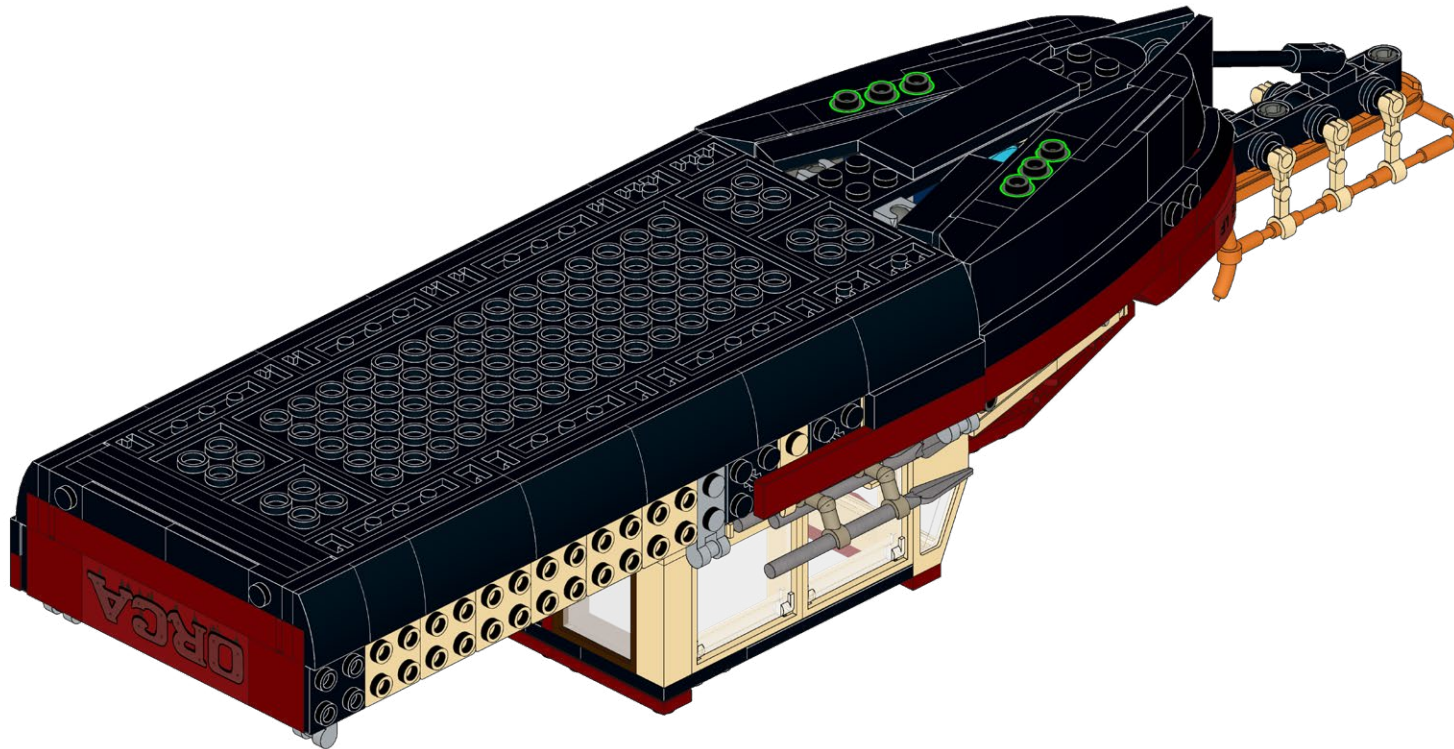

**HOLD UP!**

You might notice some bags aren't in order, as well as left over pieces, but that's ok! We're changing the way you build LEGO!

ATTENDEZ!

Vous remarquerez peut-être que certains sacs, ainsi que certaines pièces, ne sont pas dans le bon ordre. Mais pas de panique! Nous changeons simplement la façon avec laquelle vous construisez vos LEGO!

ASPETTA!

Potresti notare che alcuni sacchetti non sono in ordine, così come i pezzi avanzati, ma va bene così! Stiamo cambiando il modo in cui costruisci i LEGO!

HALT!

Sie werden möglicherweise bemerken, dass einige tüten durcheinander sind und teile übrig bleiben, aber das ist in Ordnung! Wir ändern die art und weise, wie Sie LEGO bauen!

¡ESPERA!

Es posible que notes que algunas bolsas están fuera de servicio, así como piezas sobrantes, ¡pero está bien! ¡Estamos cambiando la forma en que construyes LEGO!

暫停!

你可能会注意到一些袋子顺序错乱, 以及一些剩余的部件, 但没关系! 我们正在改变你搭建乐高的方式!

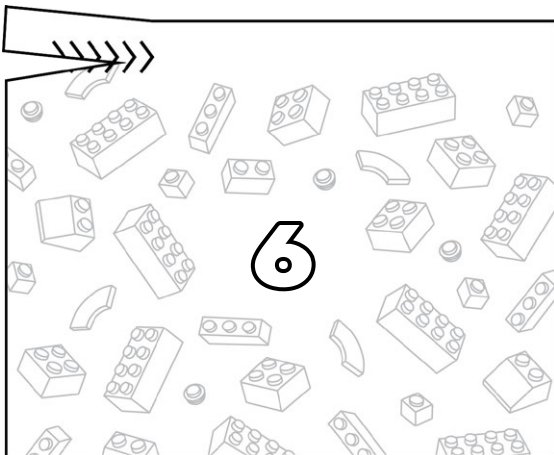
Open LEGO® Bag 6

122

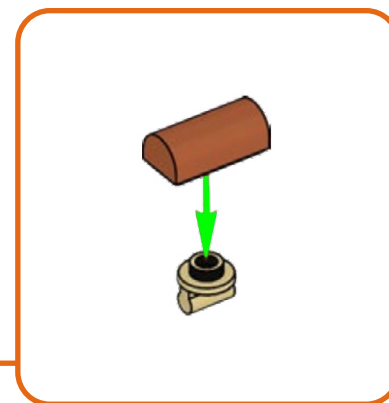
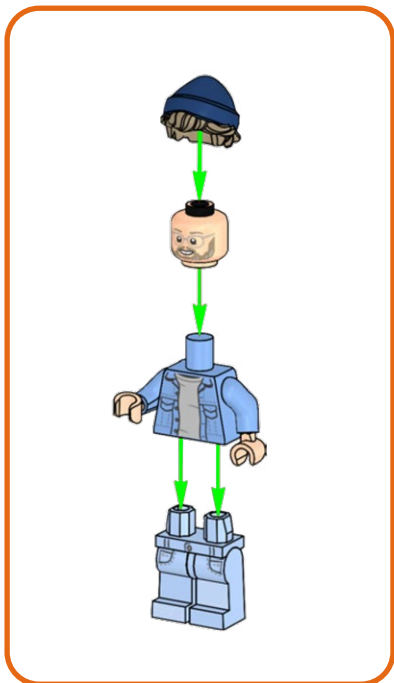

123

1x 1x

1



2



2x

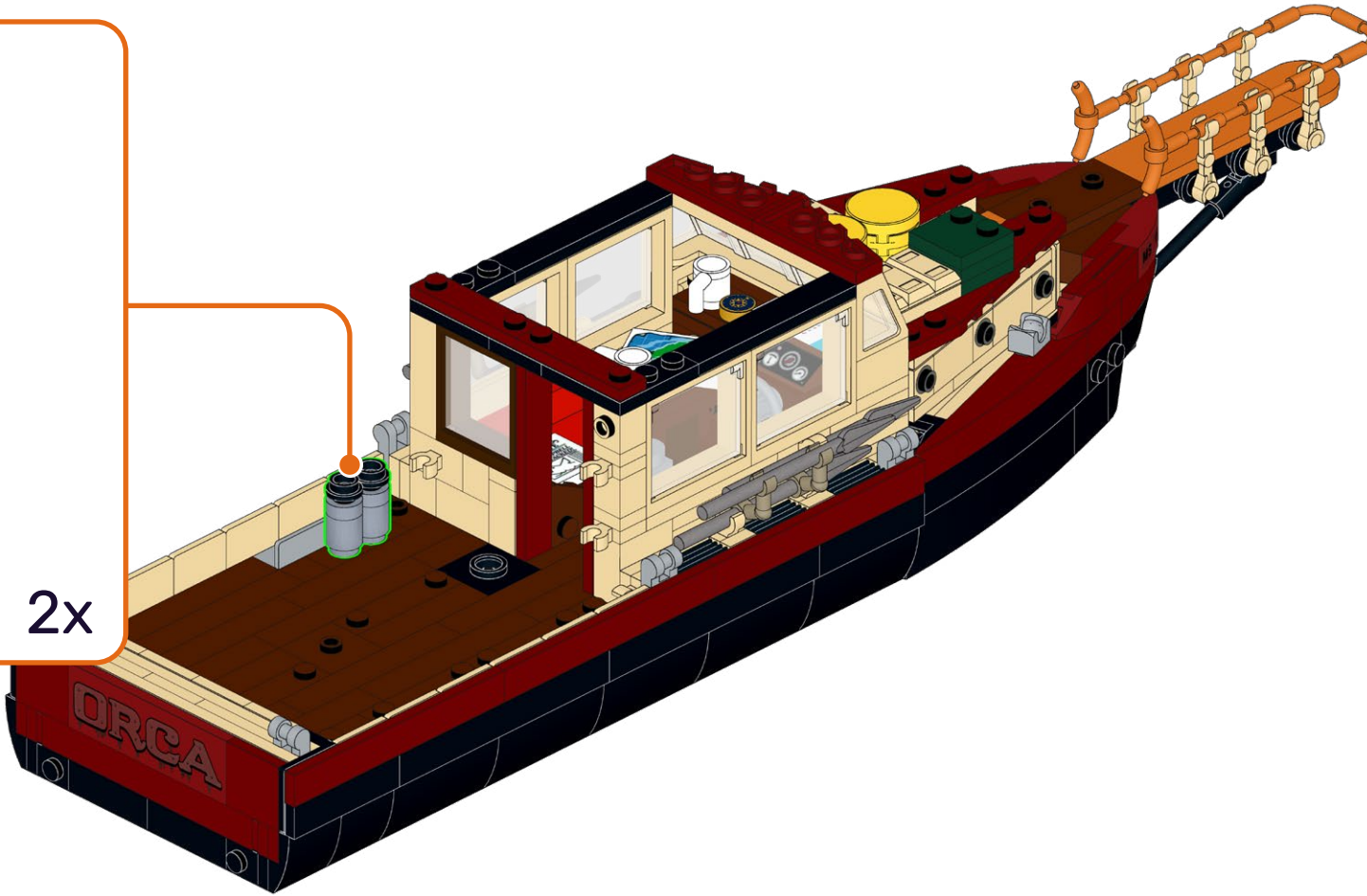

124

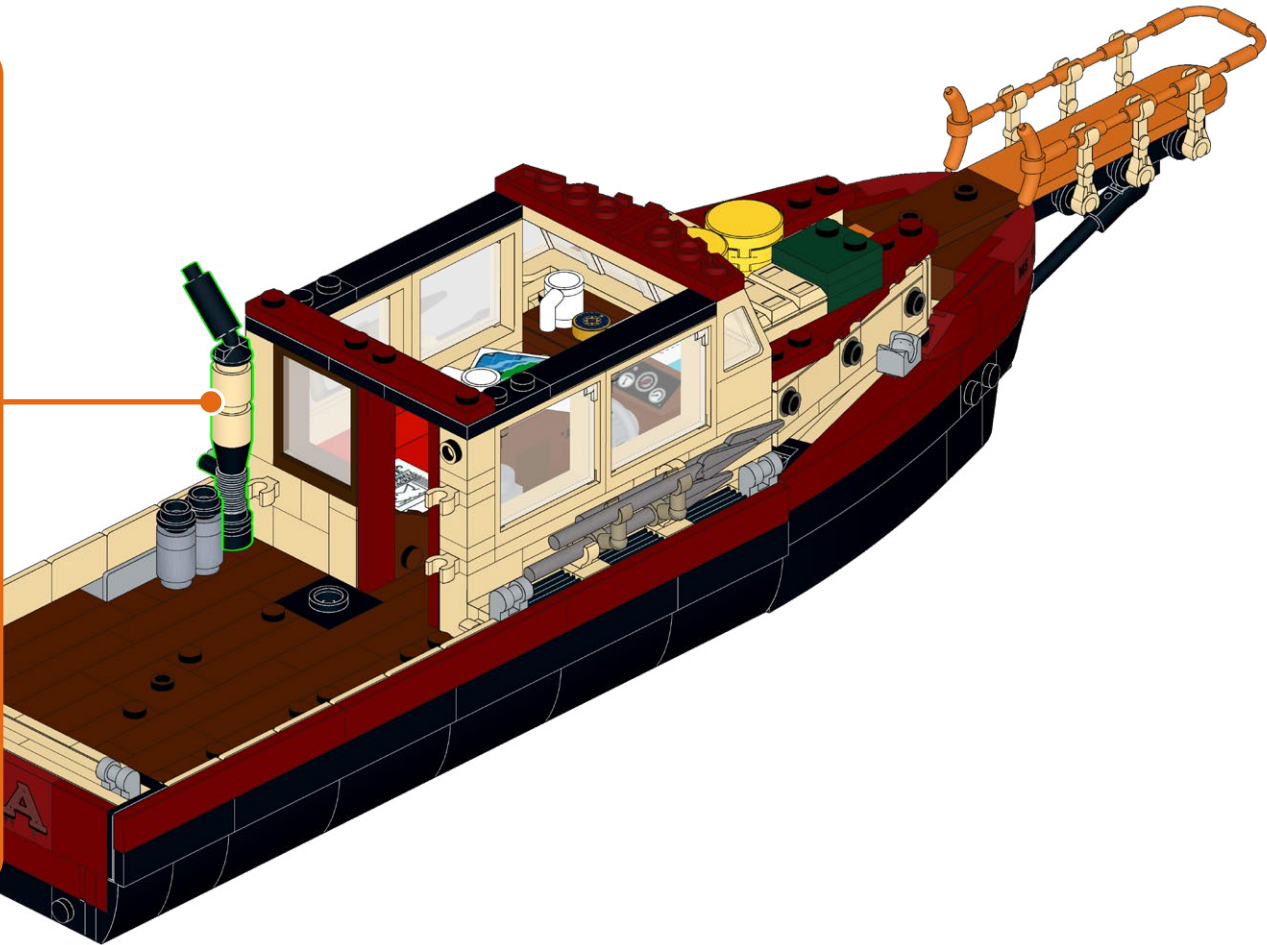
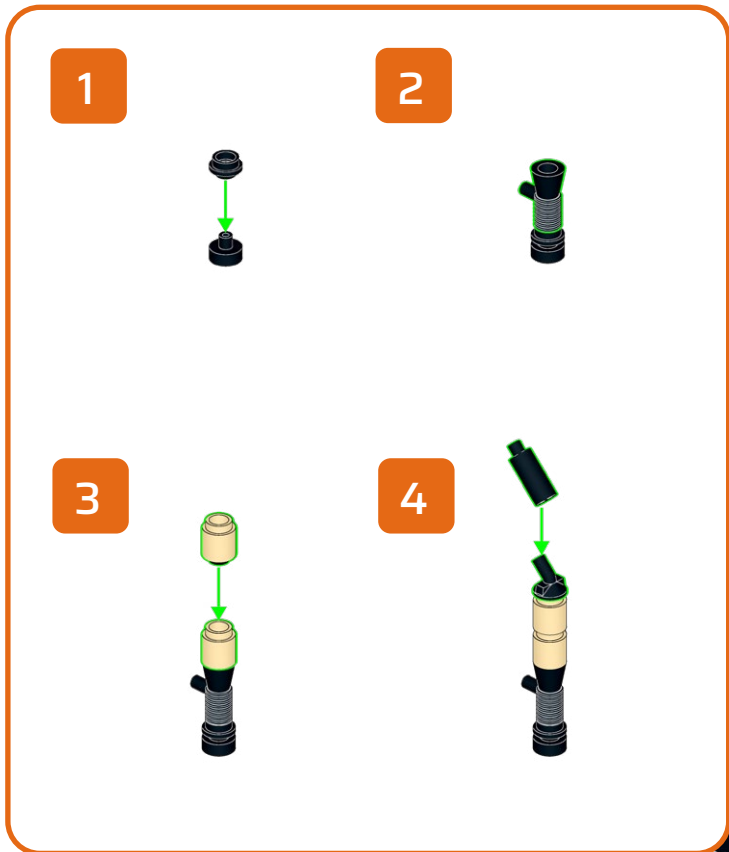
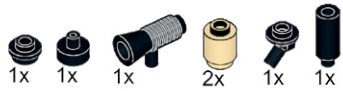

125

1x



126

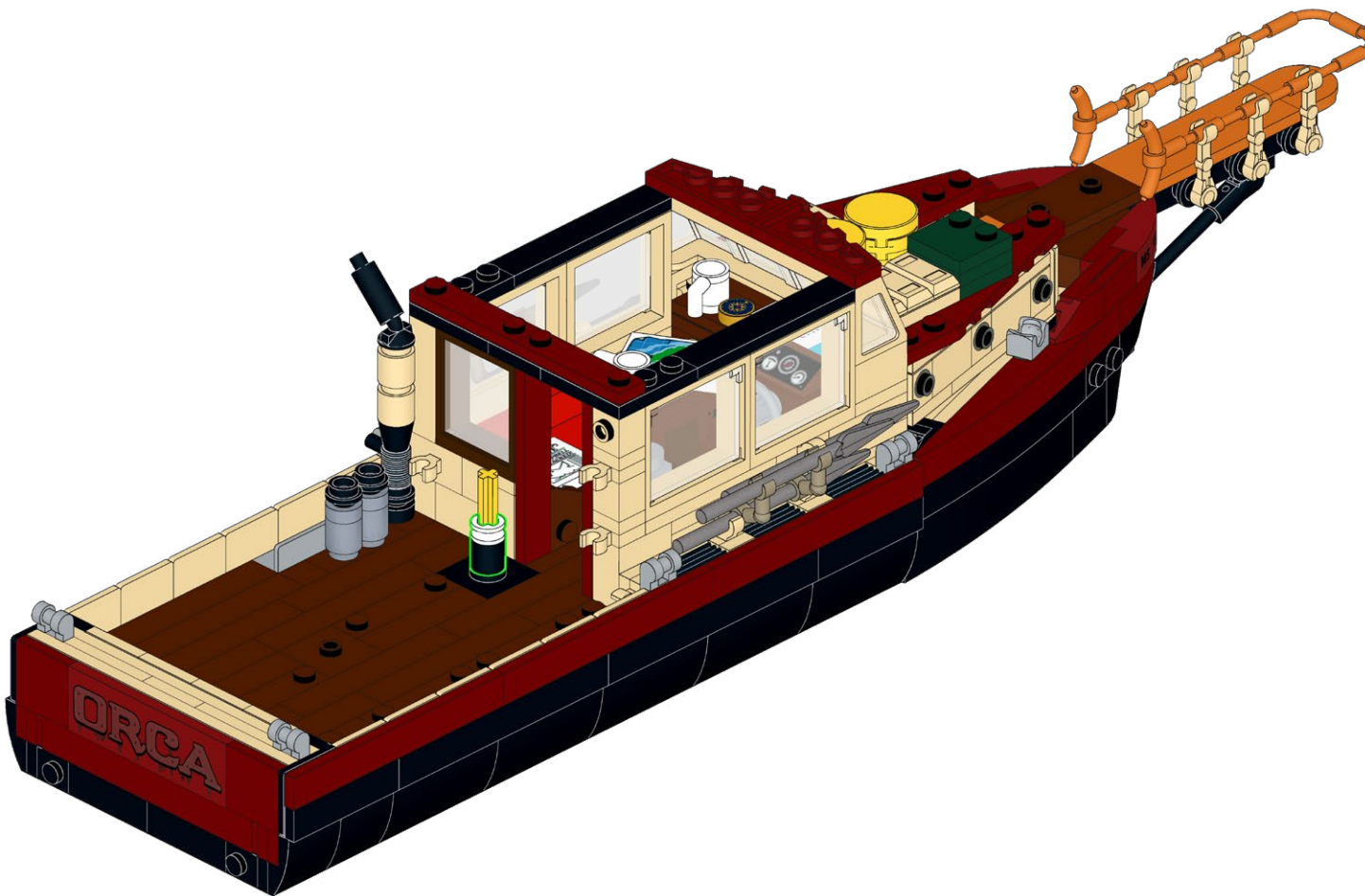

127



1

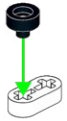

2



3



128

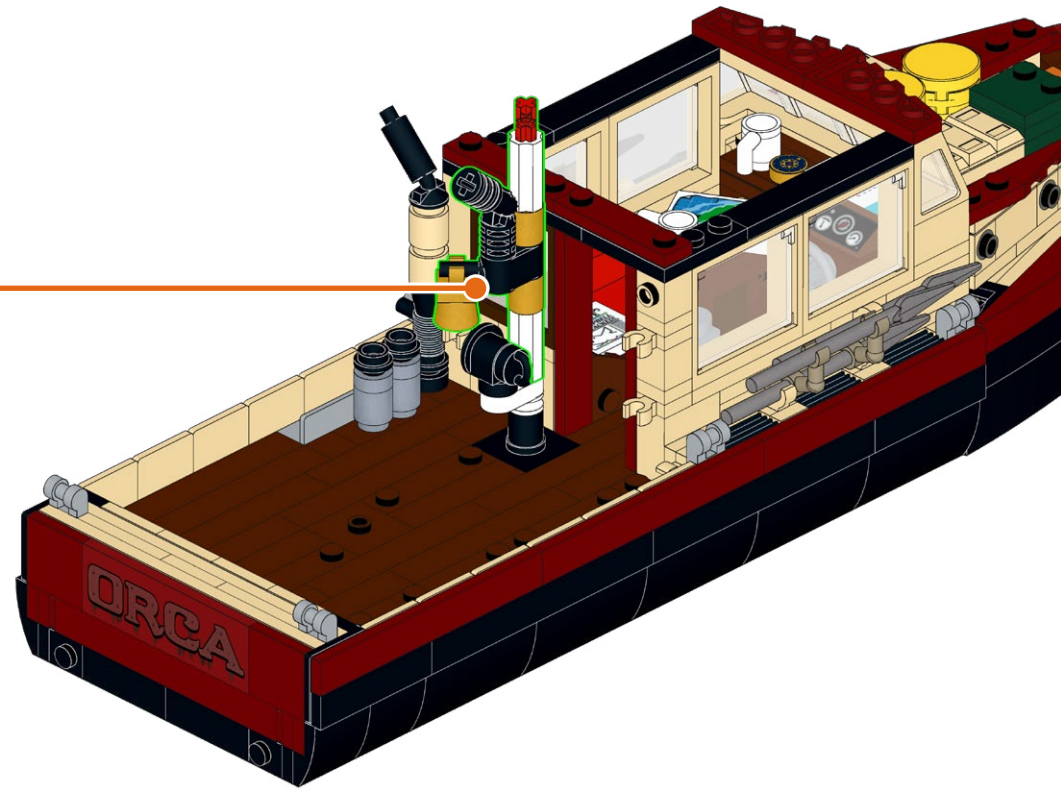
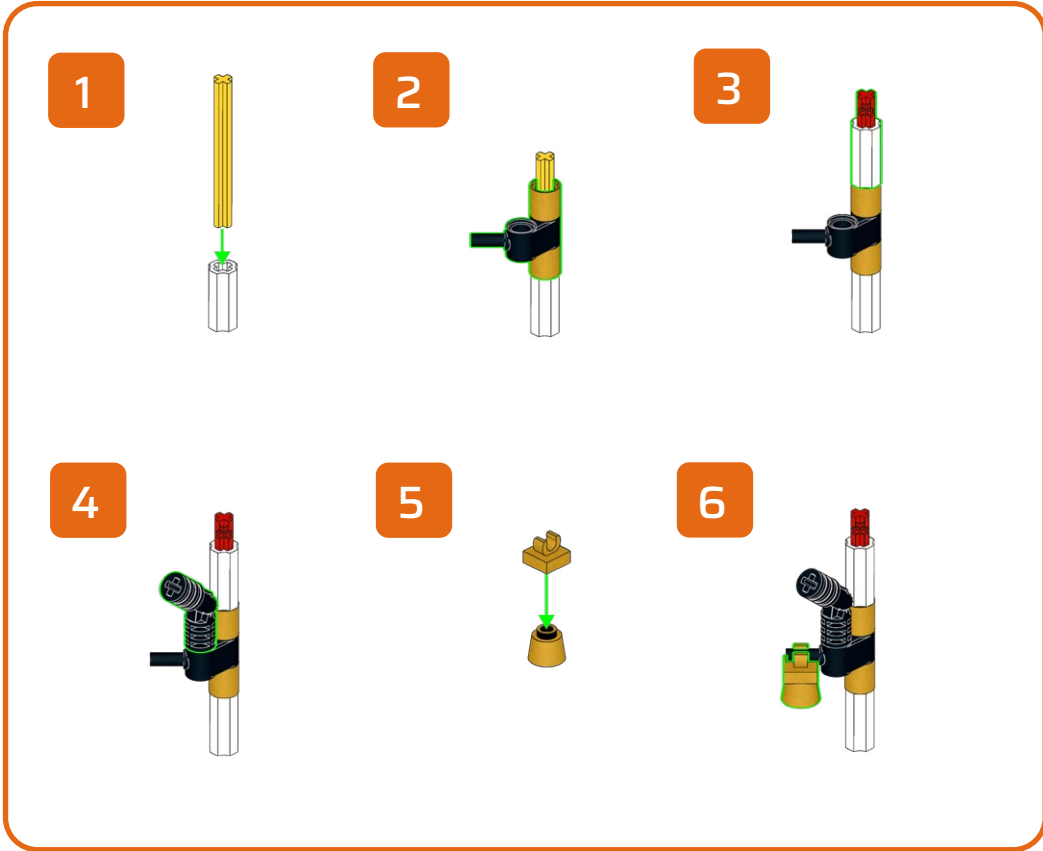
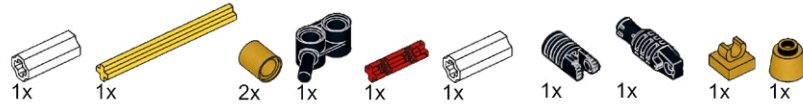

129

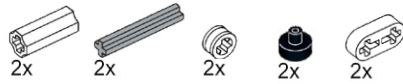

1

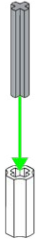

2



3

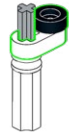

4

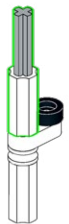

5

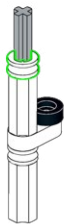

6

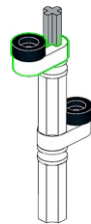

130



1

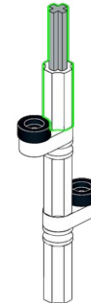

2

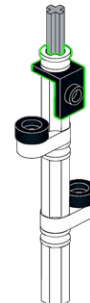

3

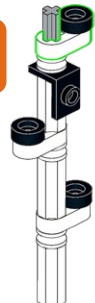

4



5



6



131



132

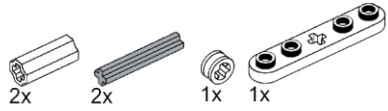

1

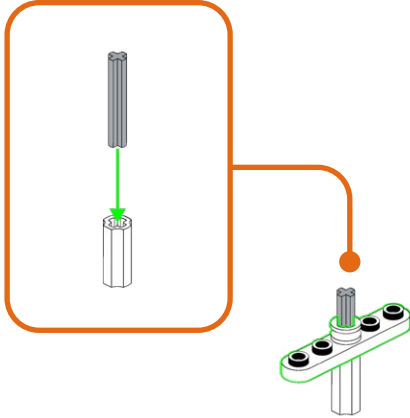

2

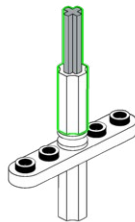

133



1

2

3



1

2

3

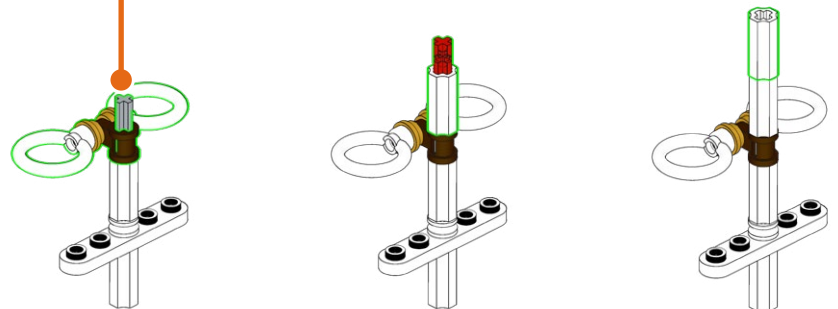

134

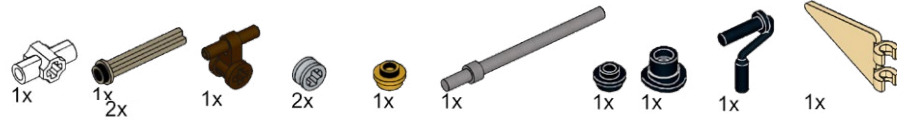

1

2

3

4

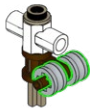
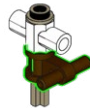
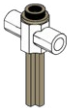

1

2



1

2

3

4

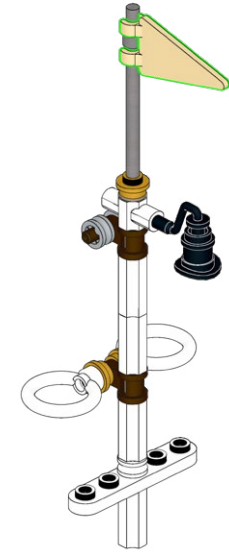
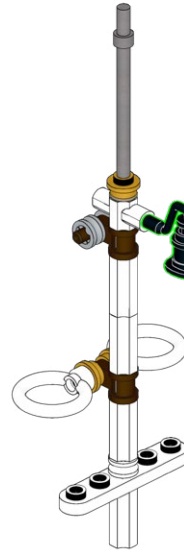
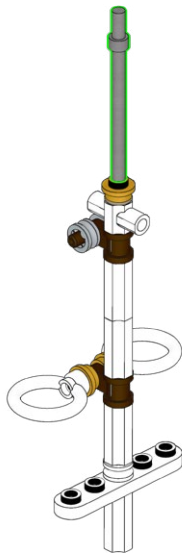
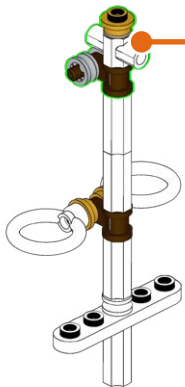

135



136

1x

1x

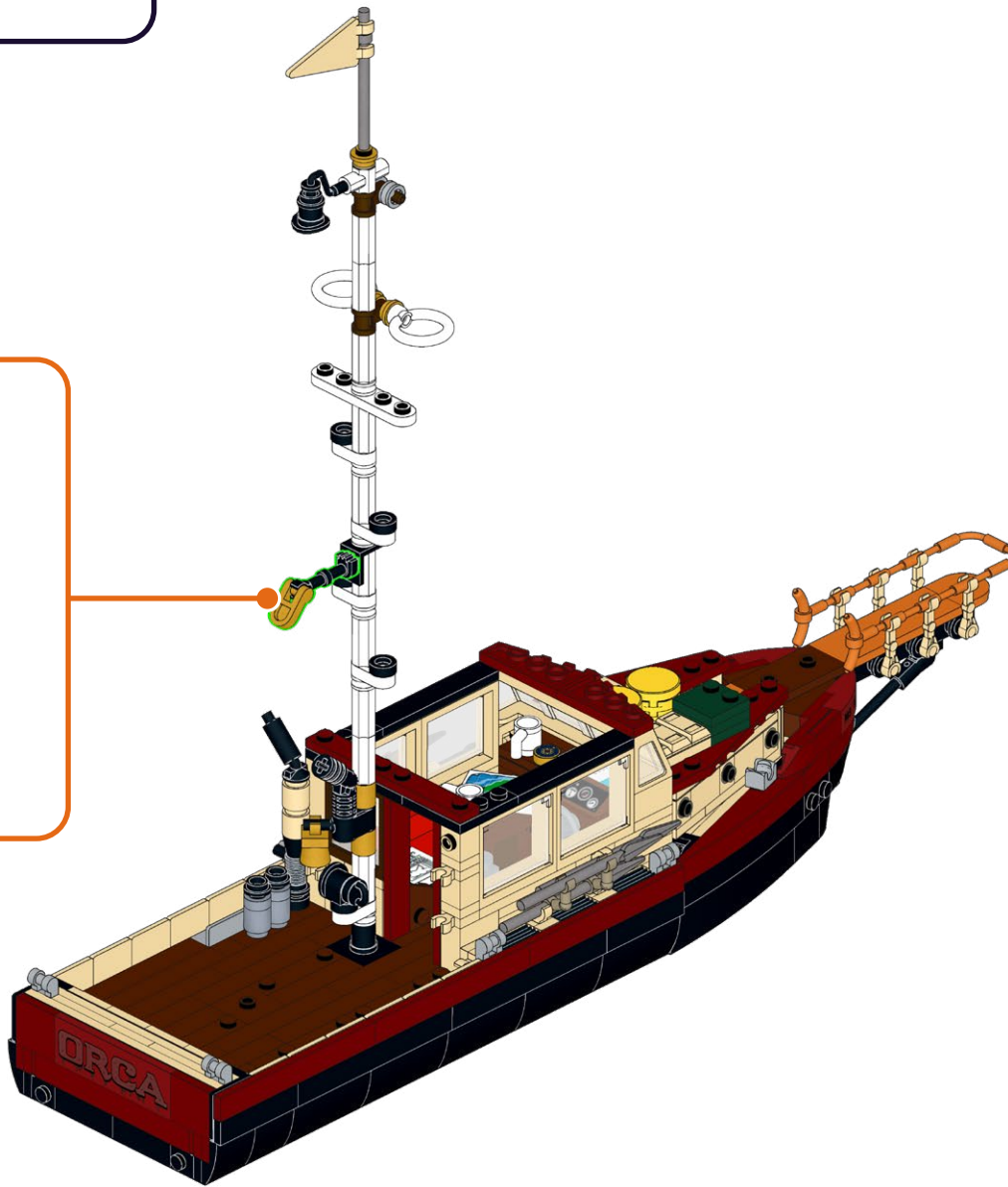

137

- 4x [Brown Pin]
- 1x [Black Pin]
- 1x [Yellow Pin]
- 1x [Grey Technic Arm]
- 1x [Yellow Technic Connector]
- 1x [Grey Technic Connector]

1



2



3

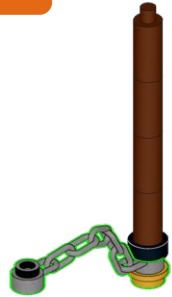

4



5

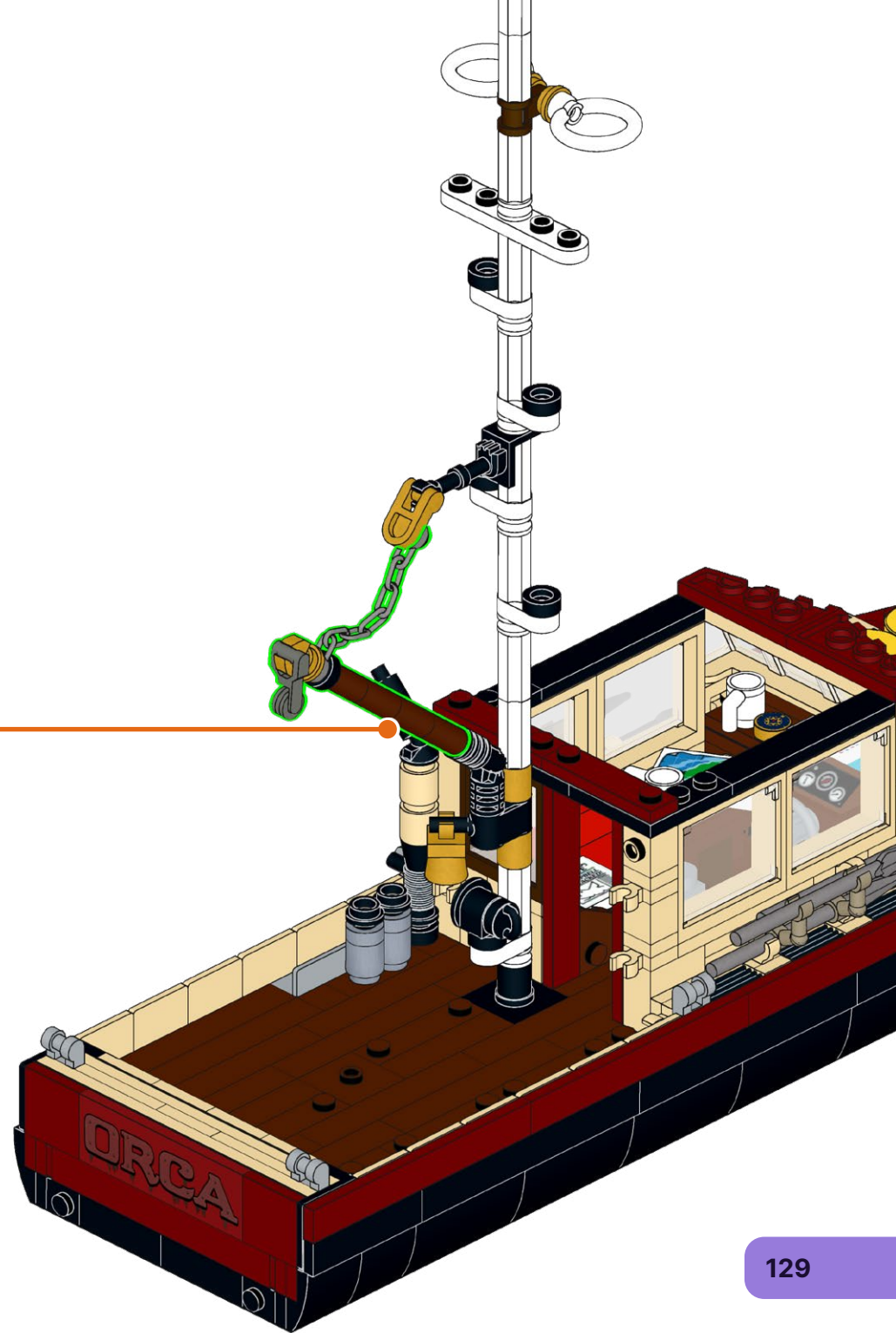
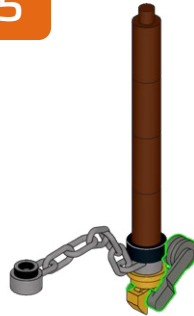

138

2x



139

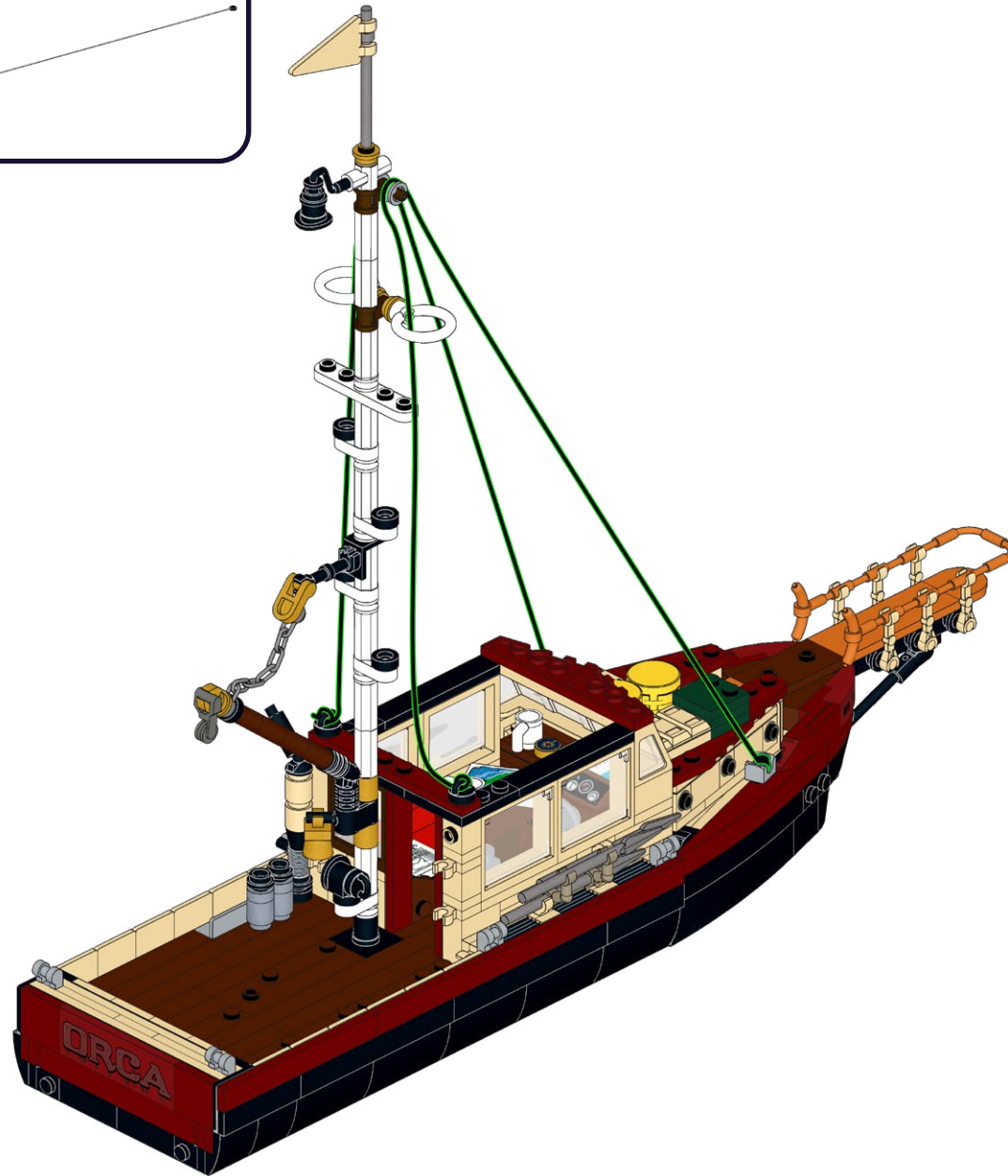
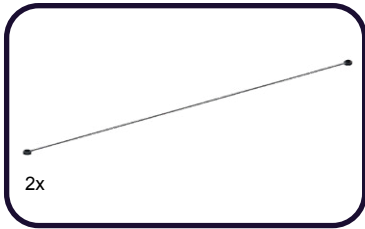

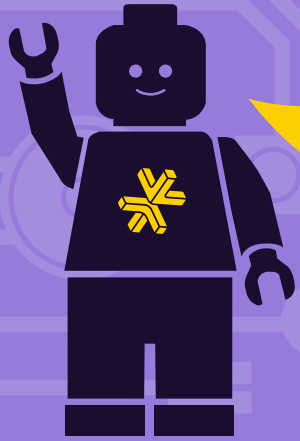
**HOLD UP!**

You might notice some bags aren't in order, as well as left over pieces, but that's ok! We're changing the way you build LEGO!

ATTENDEZ!

Vous remarquerez peut-être que certains sacs, ainsi que certaines pièces, ne sont pas dans le bon ordre. Mais pas de panique! Nous changeons simplement la façon avec laquelle vous construisez vos LEGO!

ASPETTA!

Potresti notare che alcuni sacchetti non sono in ordine, così come i pezzi avanzati, ma va bene così! Stiamo cambiando il modo in cui costruisci i LEGO!

HALT!

Sie werden möglicherweise bemerken, dass einige tüten durcheinander sind und teile übrig bleiben, aber das ist in Ordnung! Wir ändern die art und weise, wie Sie LEGO bauen!

¡ESPERA!

Es posible que notes que algunas bolsas están fuera de servicio, así como piezas sobrantes, ¡pero está bien! ¡Estamos cambiando la forma en que construyes LEGO!

暫停!

你可能会注意到一些袋子顺序错乱, 以及一些剩余的部件, 但没关系! 我们正在改变你搭建乐高的方式!

Open LEGO® Bag 7

140

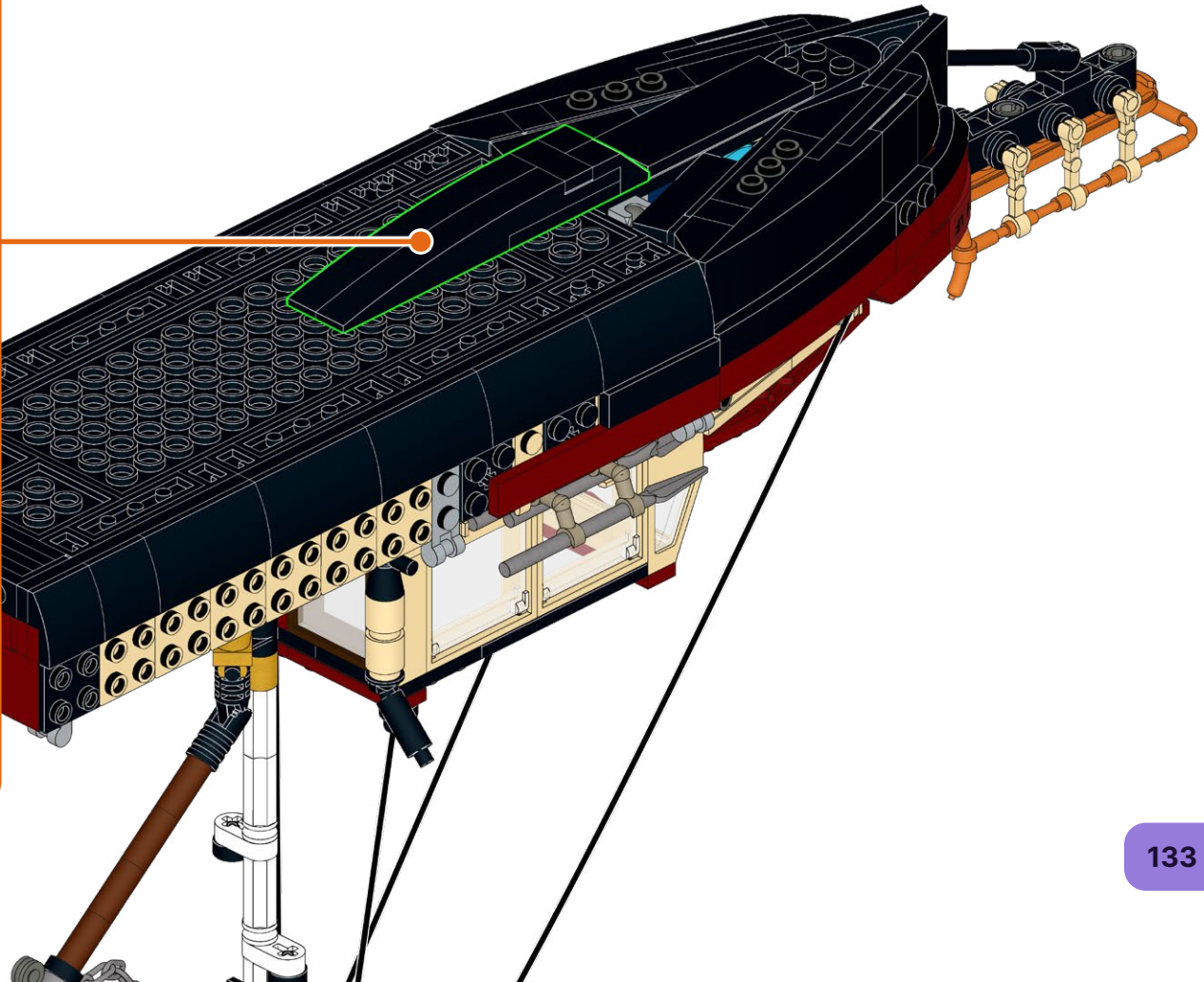
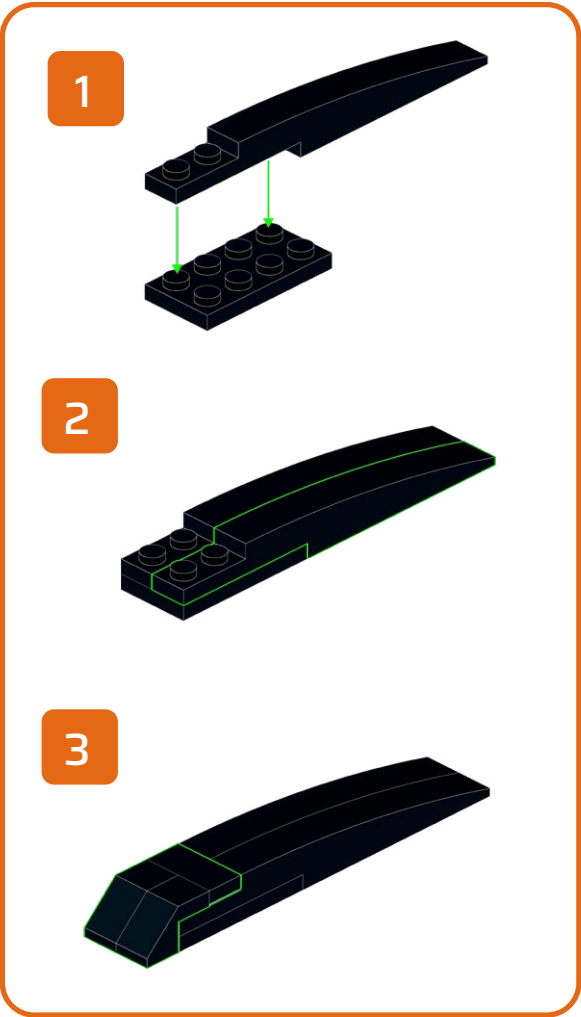

141

1x

1x

1x

1

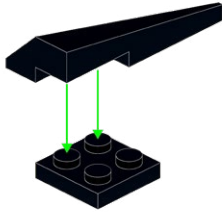

2

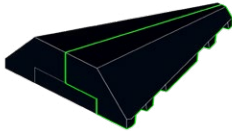

142

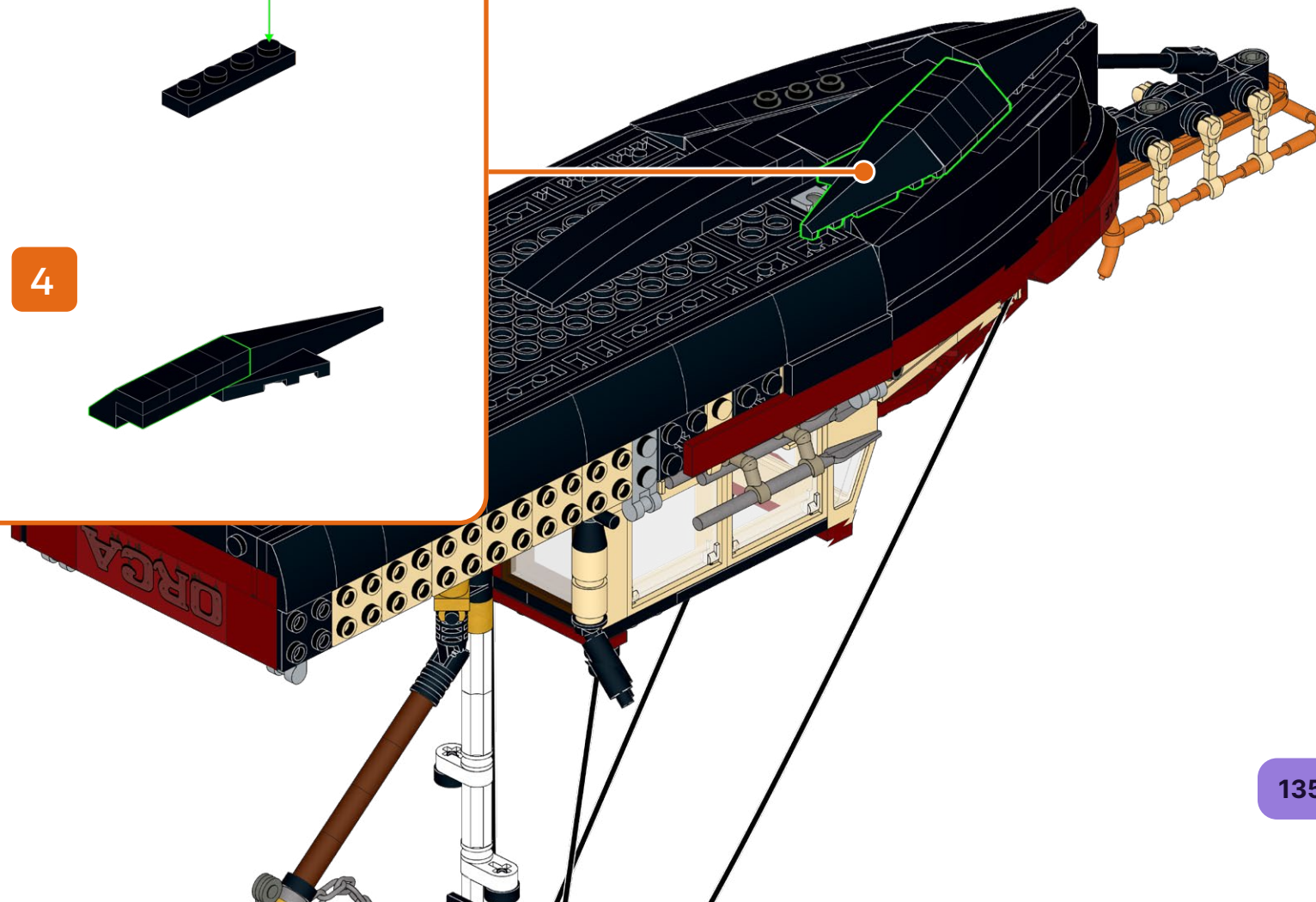
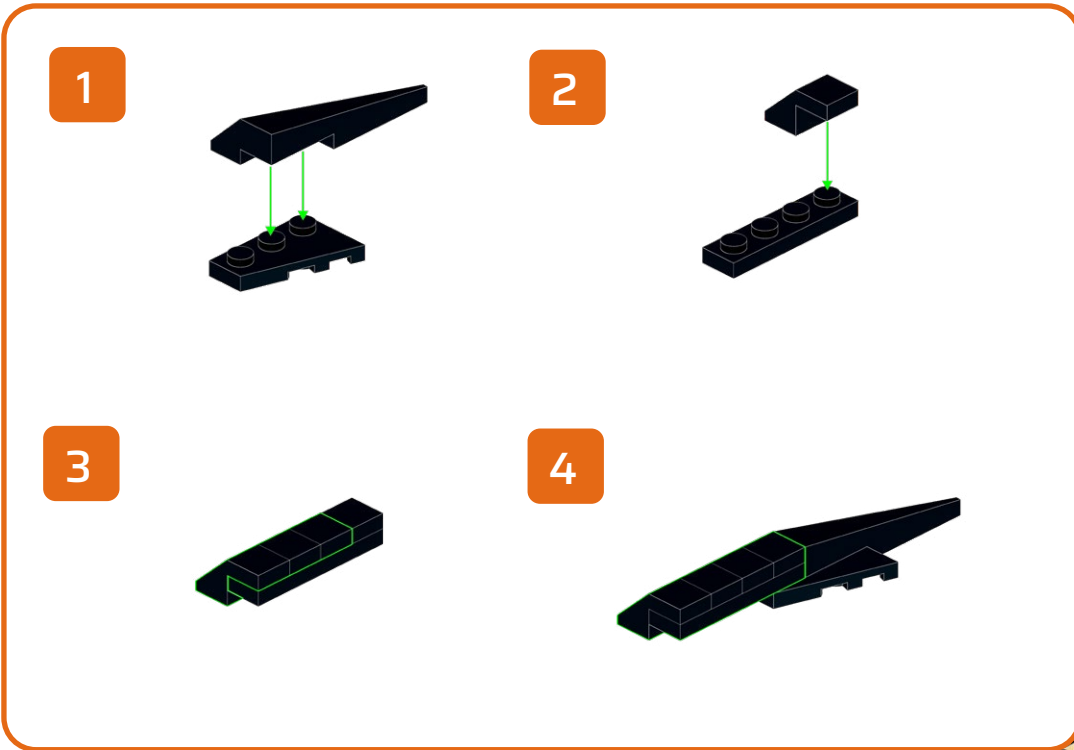
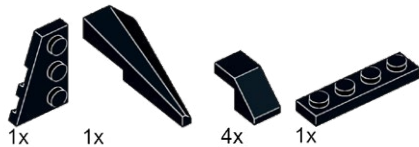

143

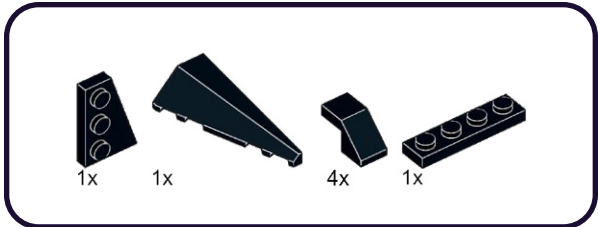

1

2

3

4

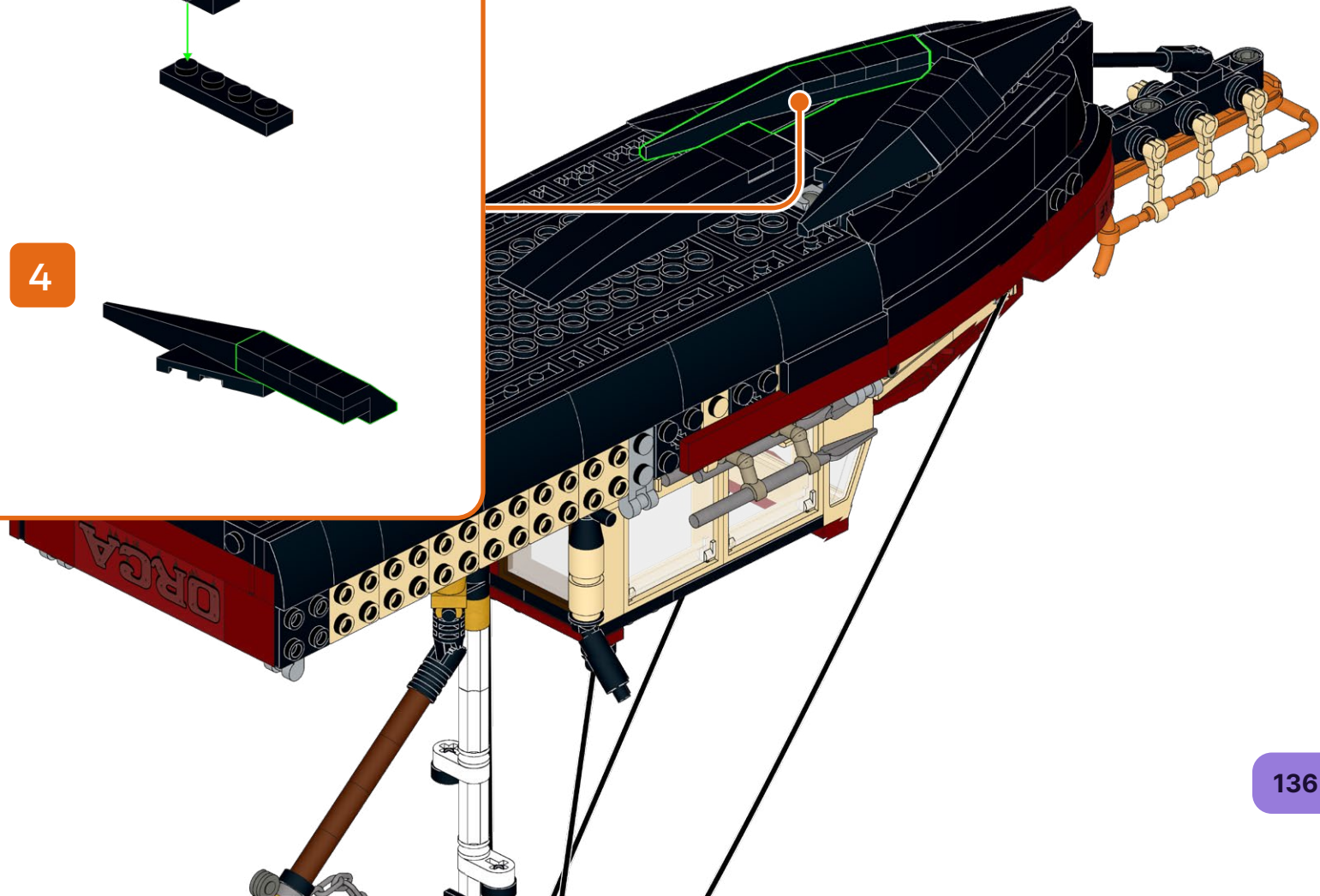

144

6x

2x

2x



1

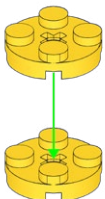

2

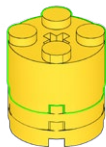

3

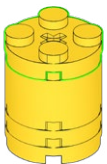

4

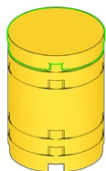

2x

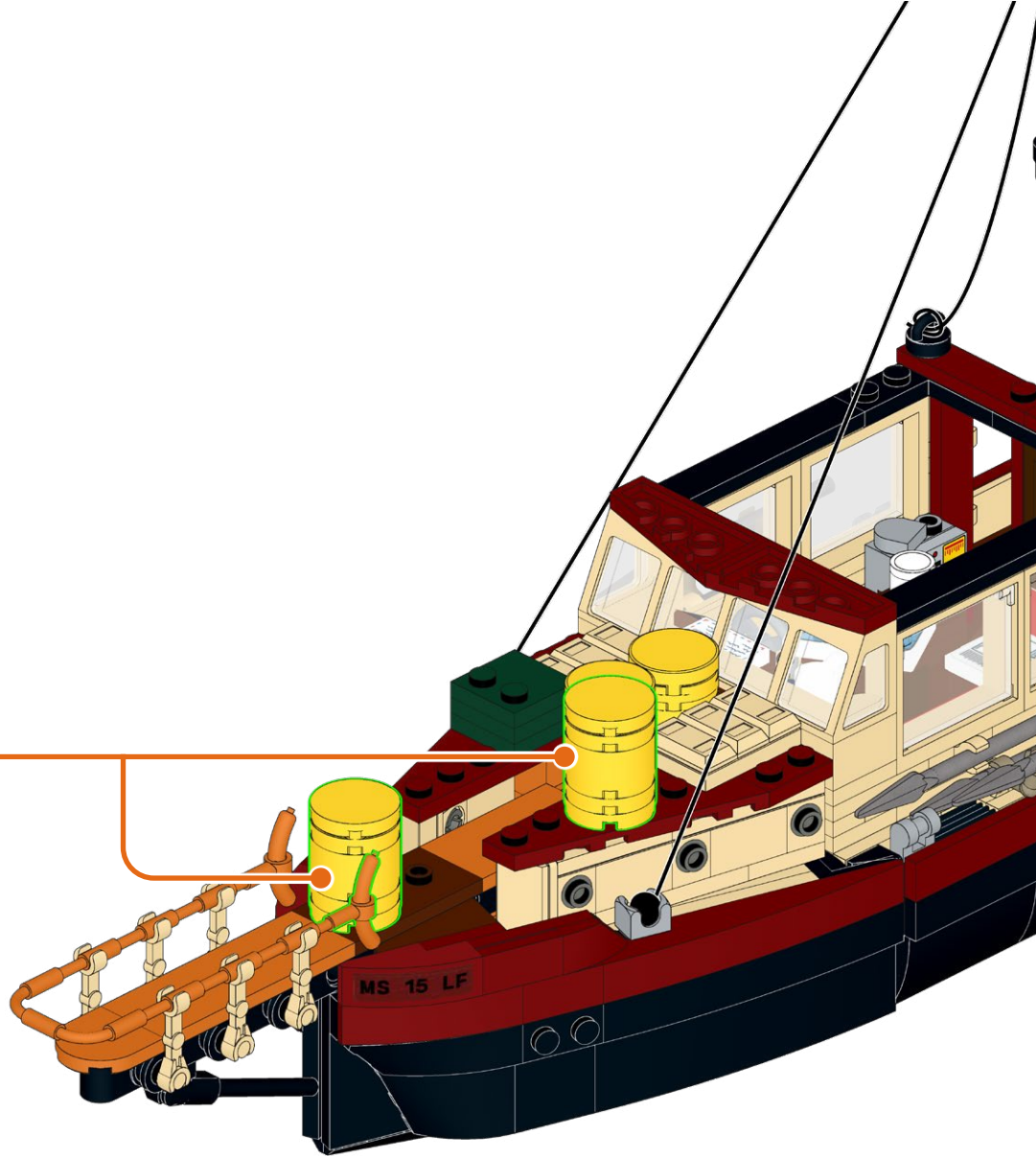

145

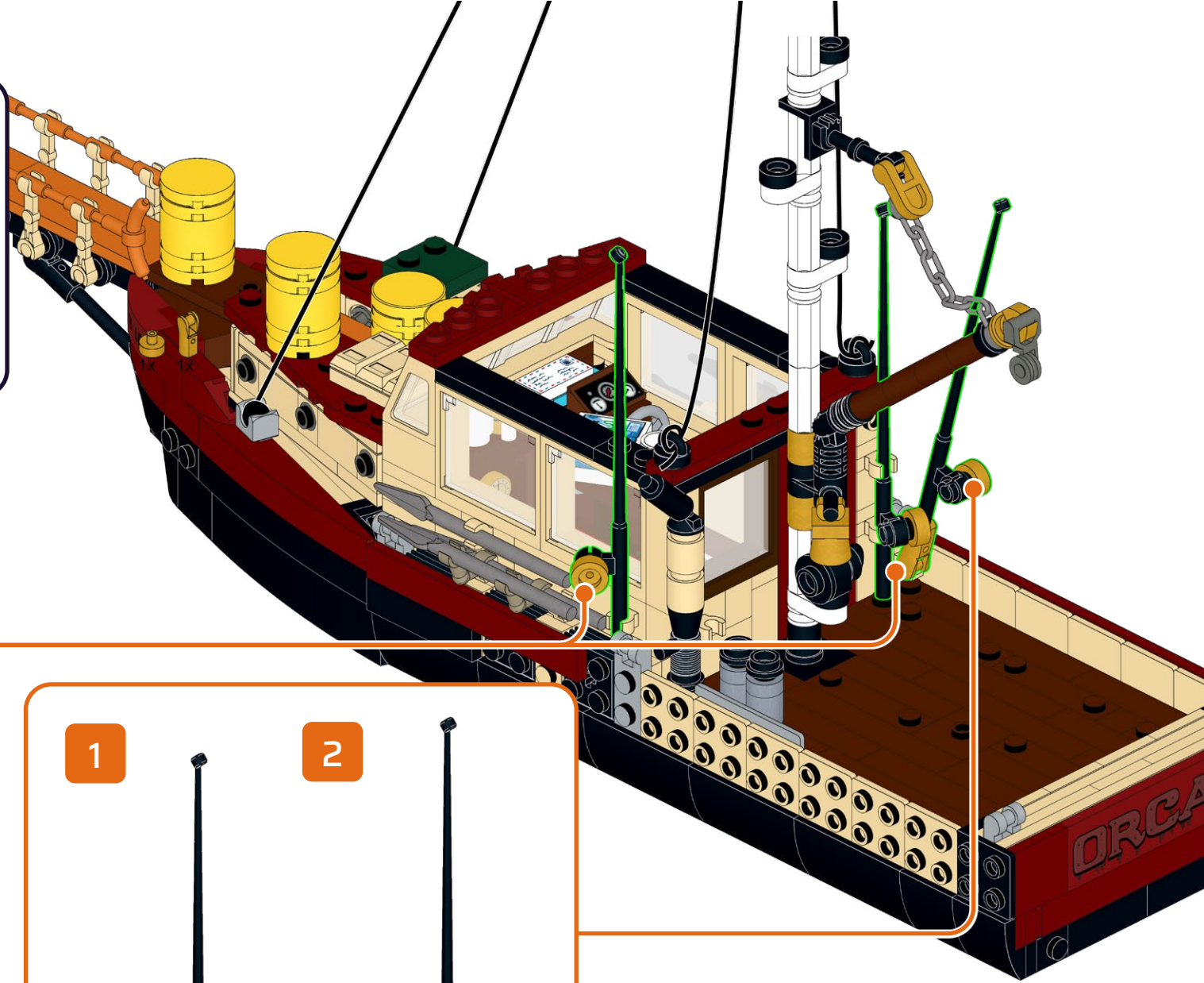
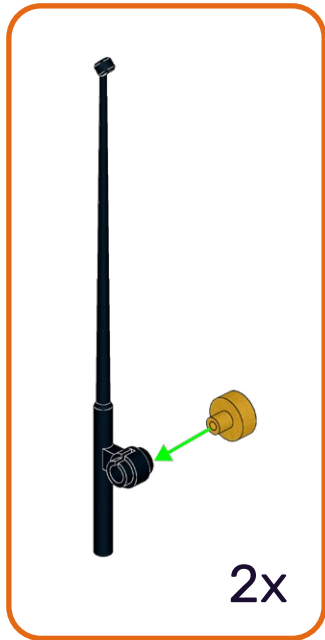

146

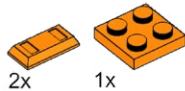

1

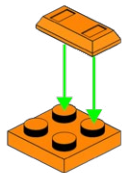

2

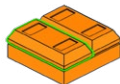

147

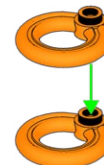

148

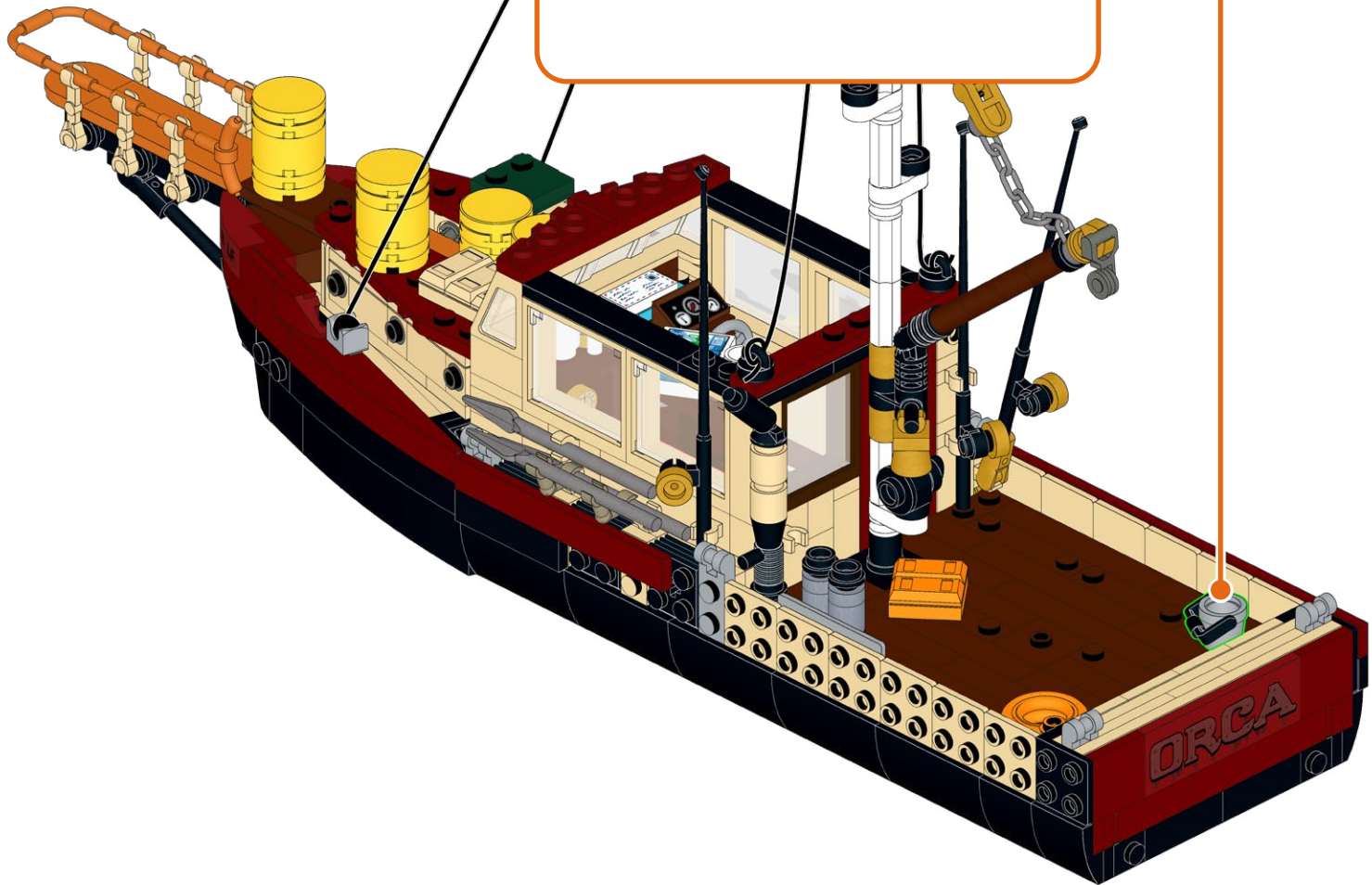
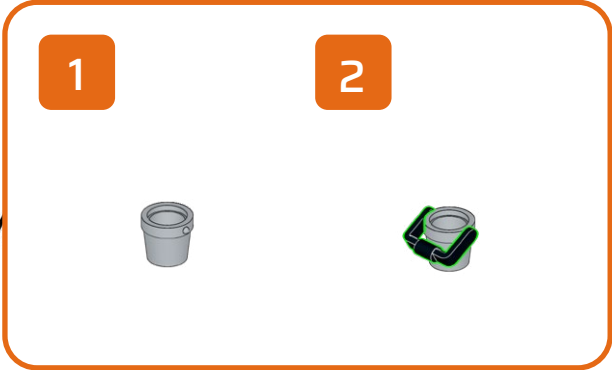
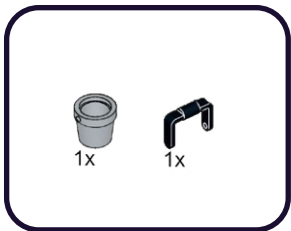

149

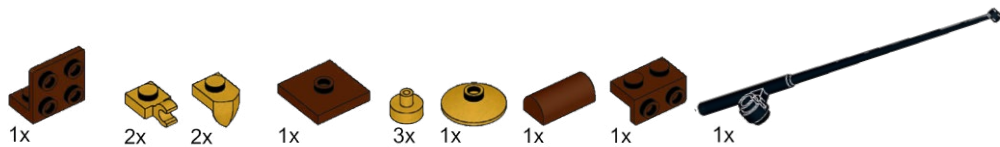

1



2



3



4

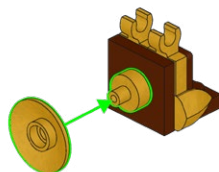

5

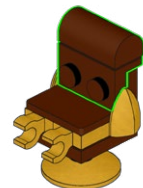

6

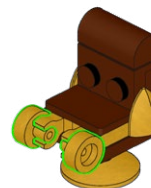

7

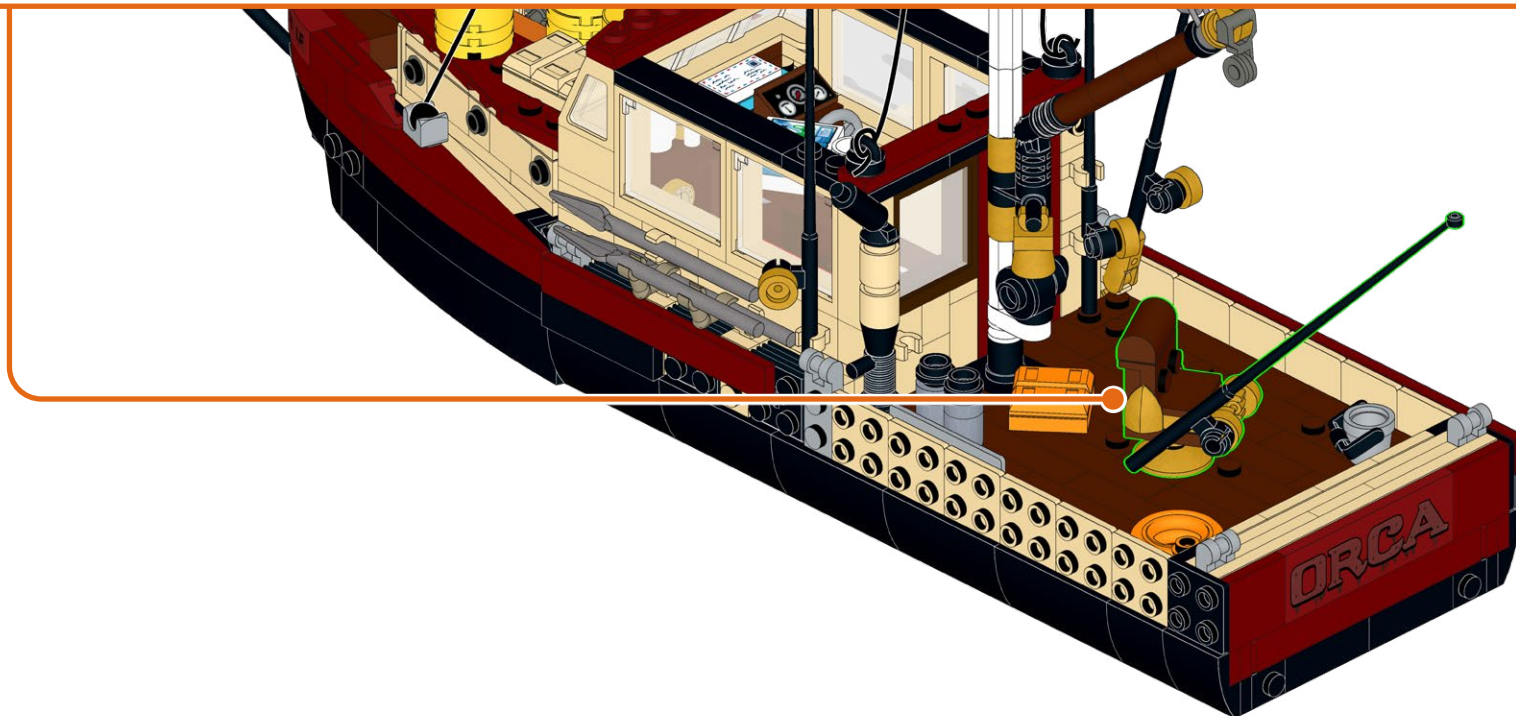
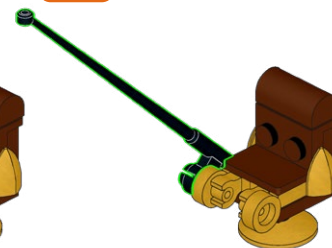

150

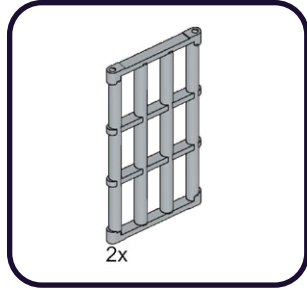

151

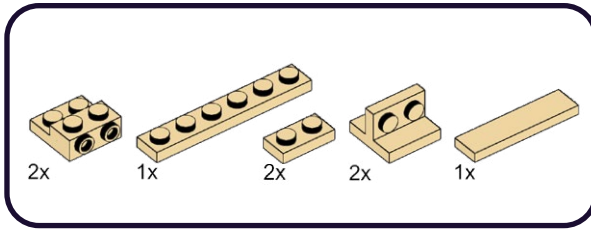

1

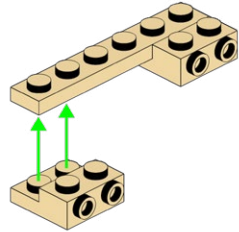

2

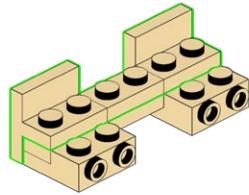

3

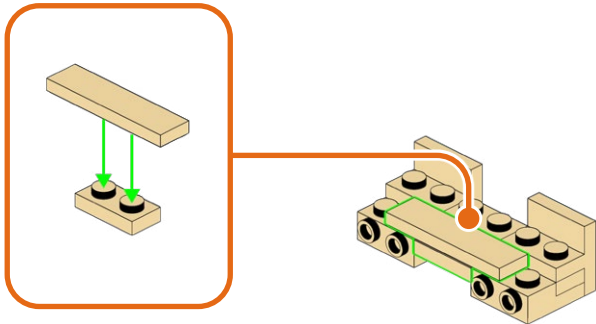

152

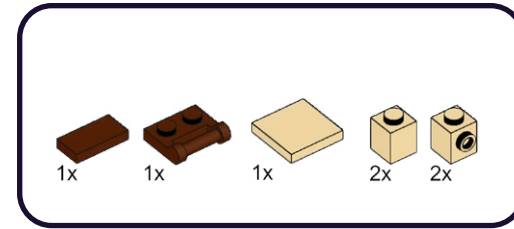

4

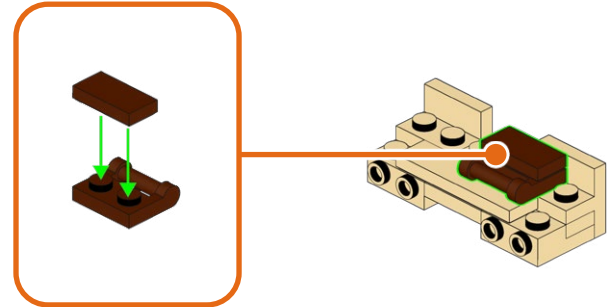

5

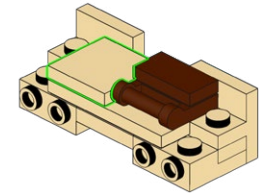

6

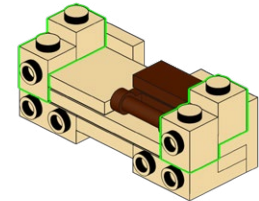

153

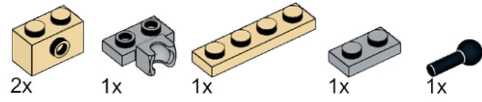

1

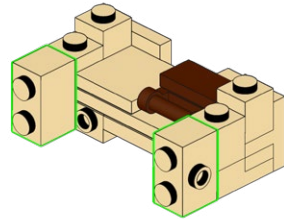

2

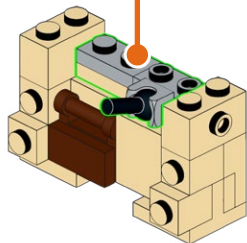
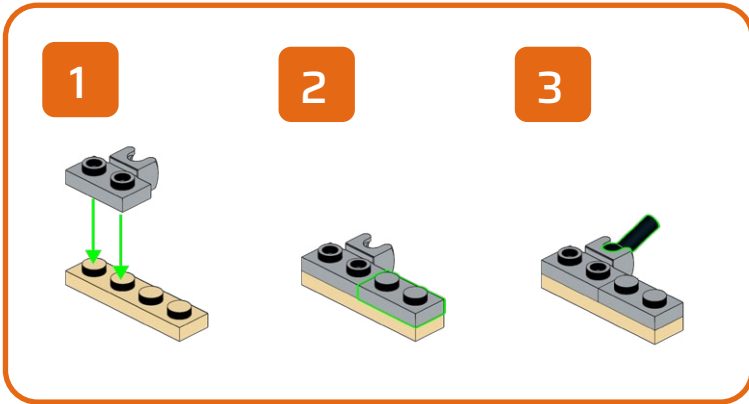

154

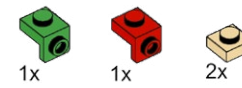

1

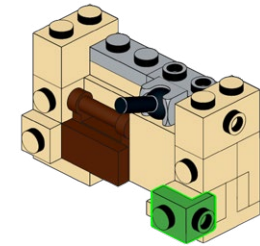

2

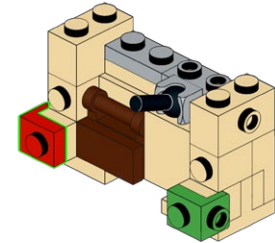

3

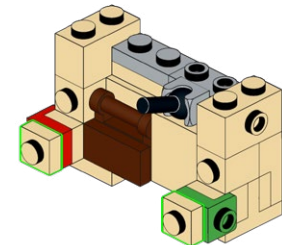

155

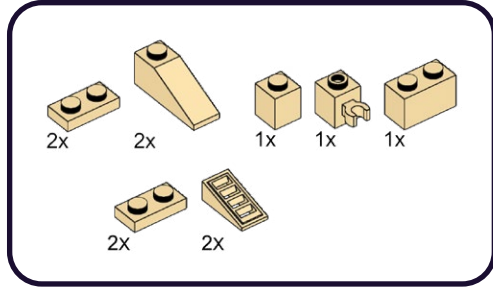

1

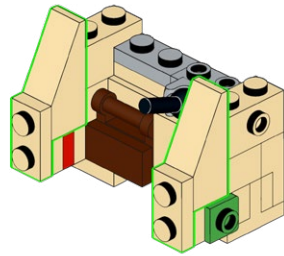

2

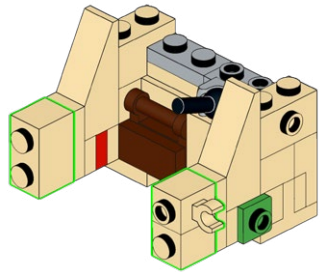

3

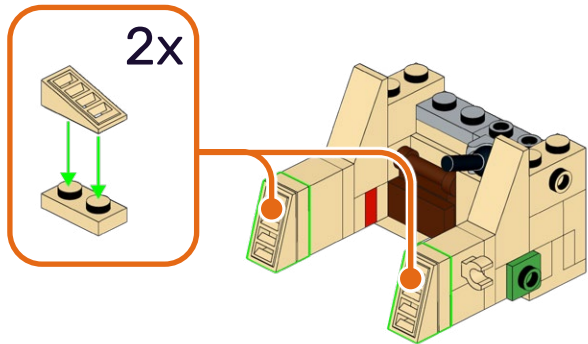

156

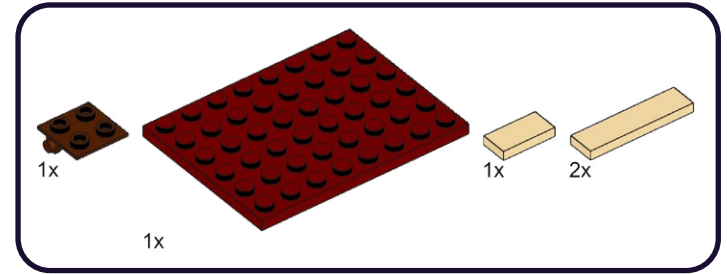

1

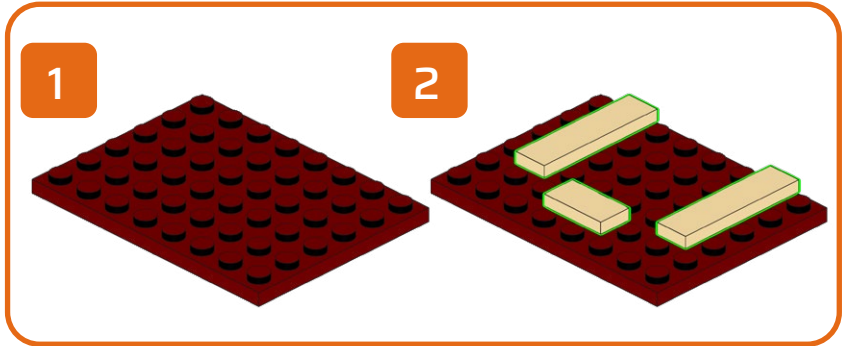
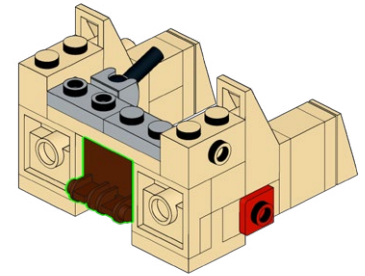

2

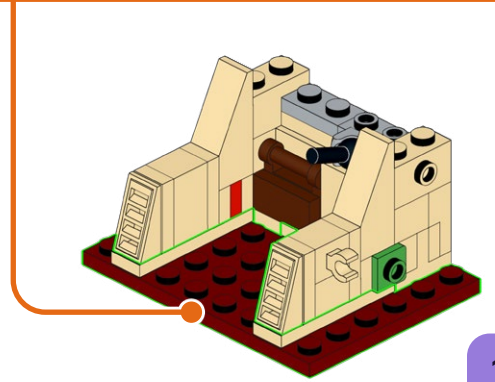

157

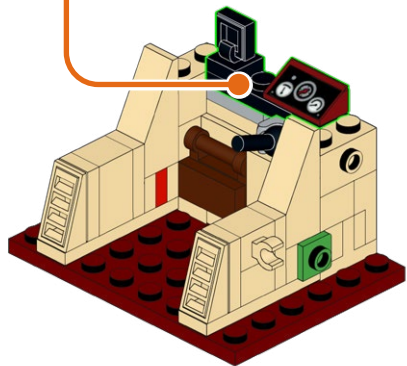
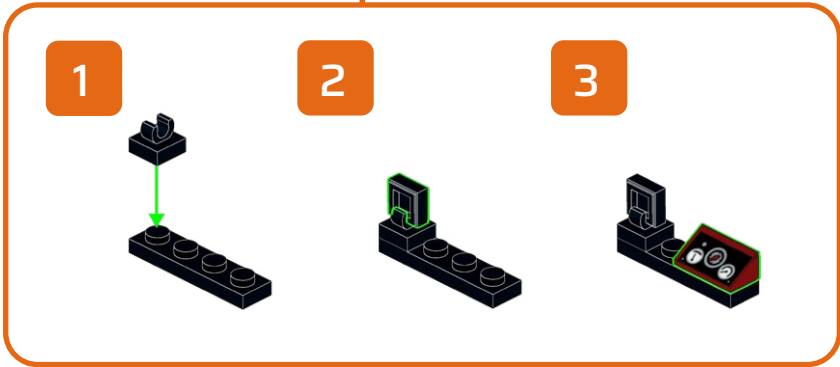
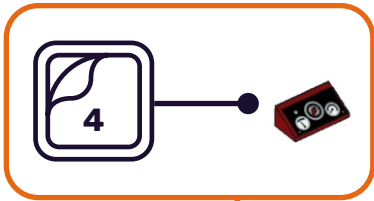
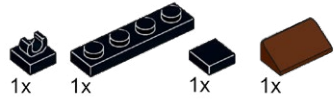

158



1

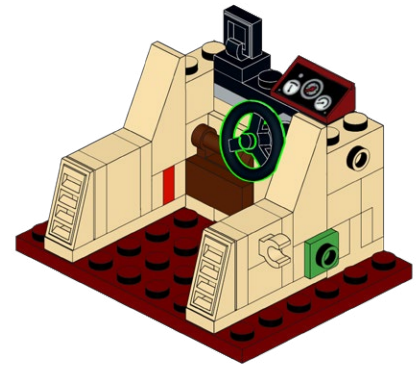

2

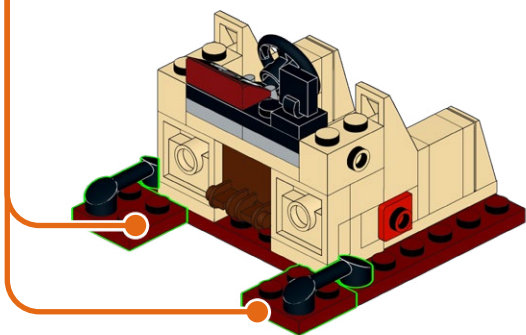
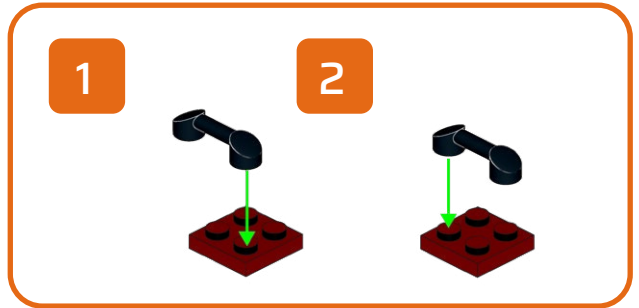

159

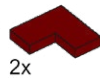
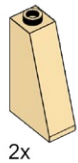

2x

2x

2x

1x

2x

1

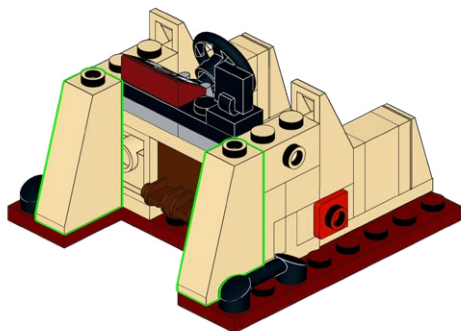

2

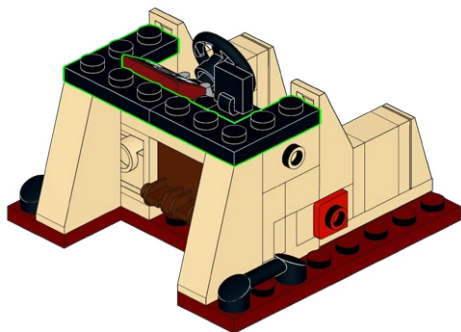

3

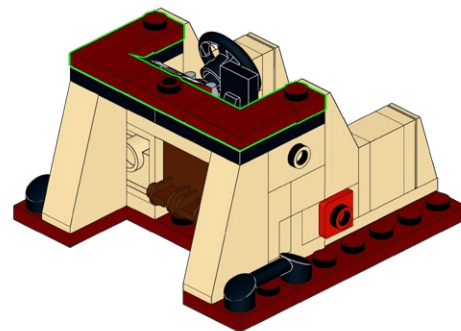

**HOLD UP!**

You might notice some bags aren't in order, as well as left over pieces, but that's ok! We're changing the way you build LEGO!

ATTENDEZ!

Vous remarquerez peut-être que certains sacs, ainsi que certaines pièces, ne sont pas dans le bon ordre. Mais pas de panique! Nous changeons simplement la façon avec laquelle vous construisez vos LEGO!

ASPETTA!

Potresti notare che alcuni sacchetti non sono in ordine, così come i pezzi avanzati, ma va bene così! Stiamo cambiando il modo in cui costruisci i LEGO!

HALT!

Sie werden möglicherweise bemerken, dass einige tüten durcheinander sind und teile übrig bleiben, aber das ist in Ordnung! Wir ändern die art und weise, wie Sie LEGO bauen!

¡ESPERA!

Es posible que notes que algunas bolsas están fuera de servicio, así como piezas sobrantes, ¡pero está bien! ¡Estamos cambiando la forma en que construyes LEGO!

暫停!

你可能会注意到一些袋子顺序错乱, 以及一些剩余的部件, 但没关系! 我们正在改变你搭建乐高的方式!

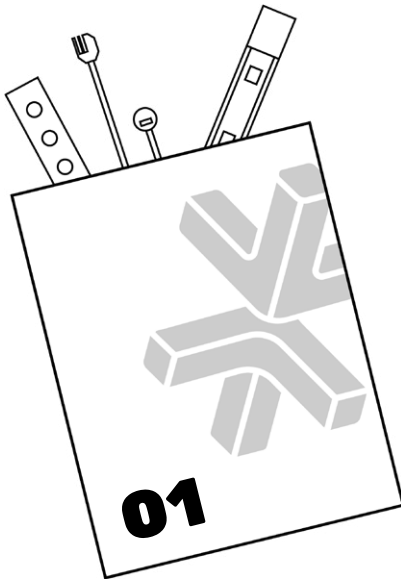
Open LMB Bag 01

160

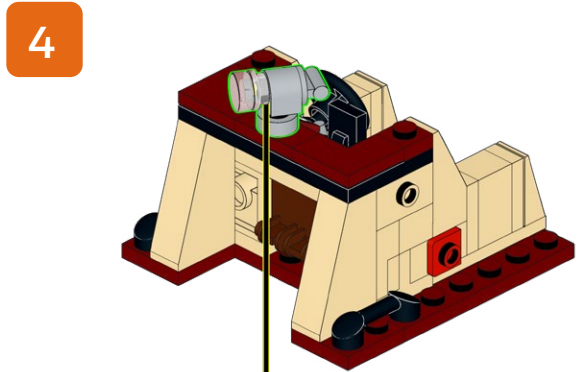
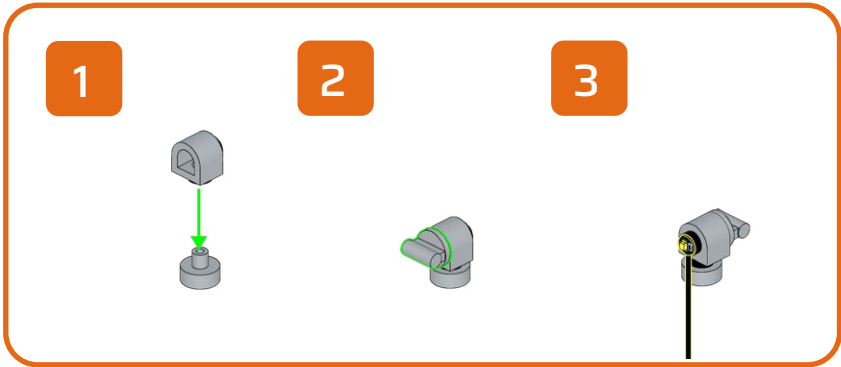
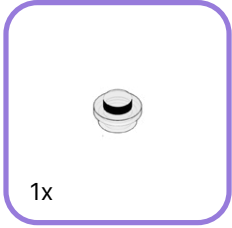
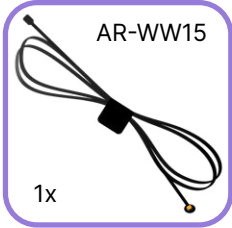
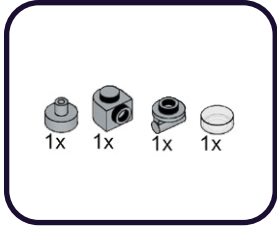

161



1

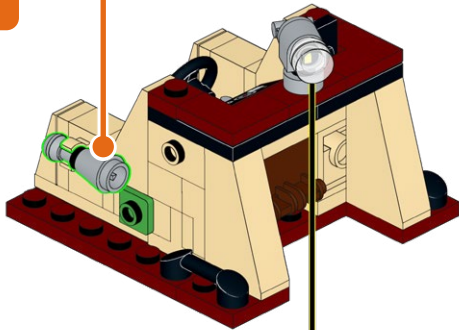

2

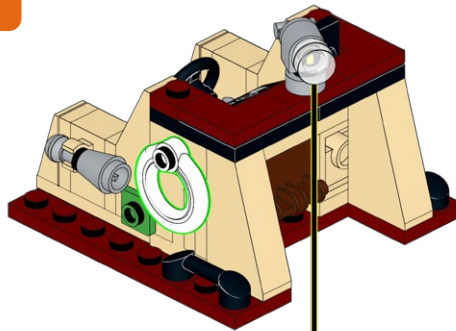

3

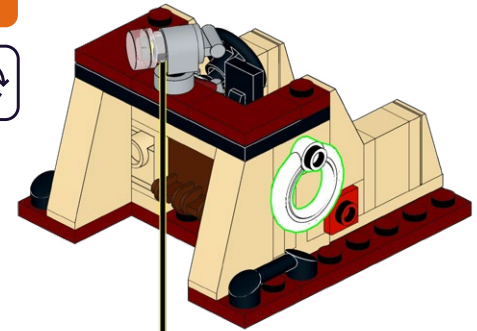

162

1x

1x

AR-R15

1x

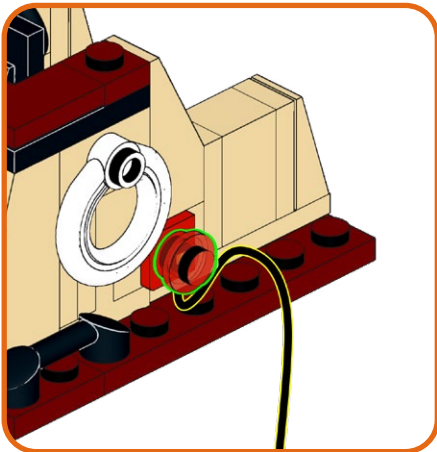

1

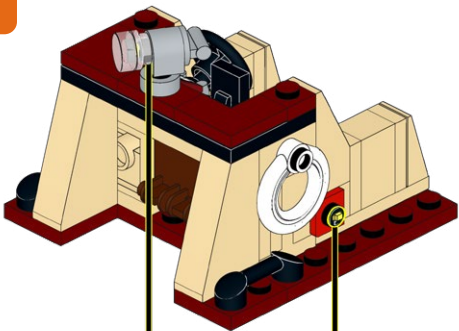

2

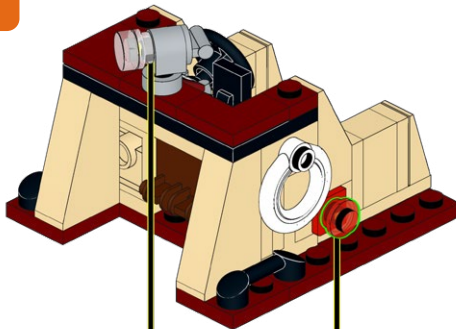

3

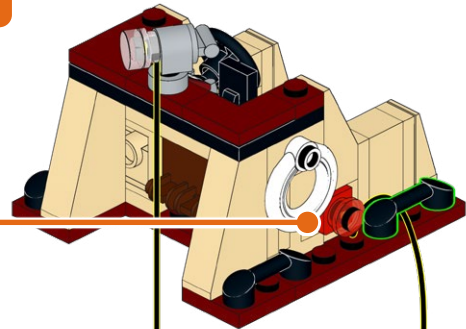

163

1x

1x

AR-G15

1x

1

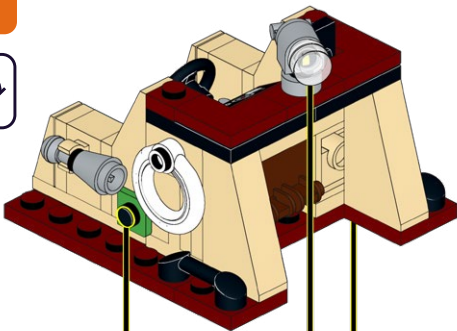

2

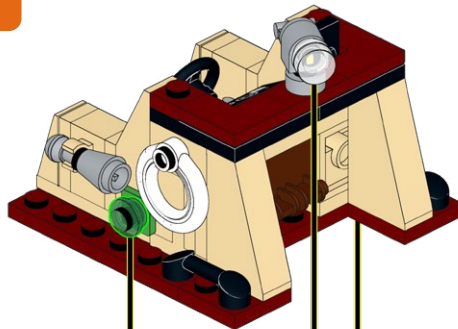

3

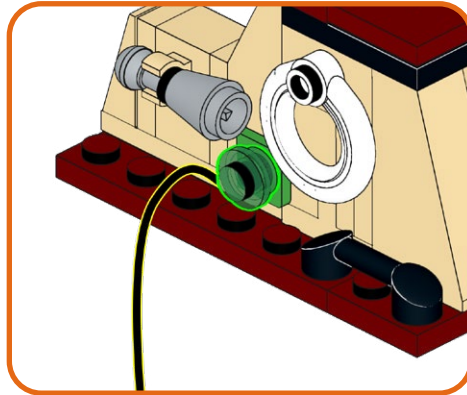
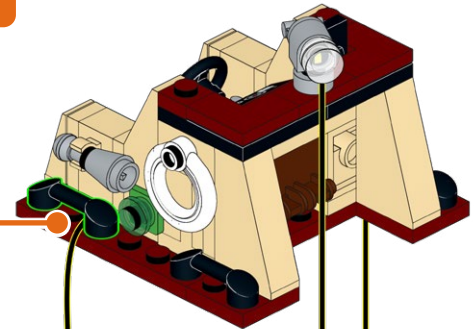

164

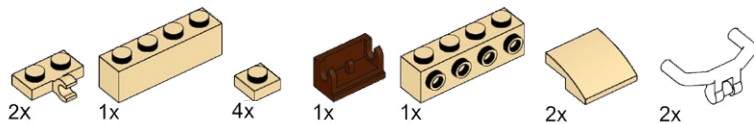

1

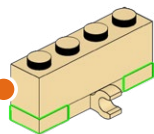
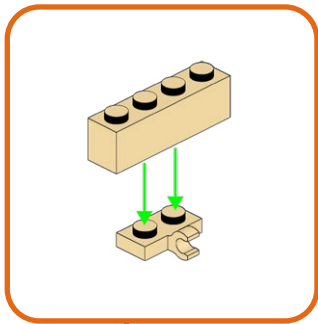

2

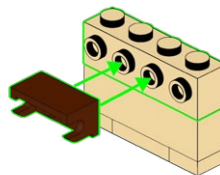

3

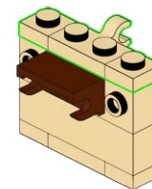

4

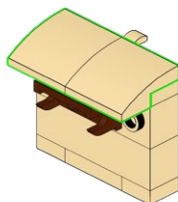

5

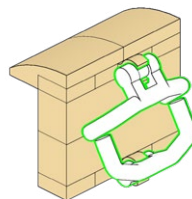

6

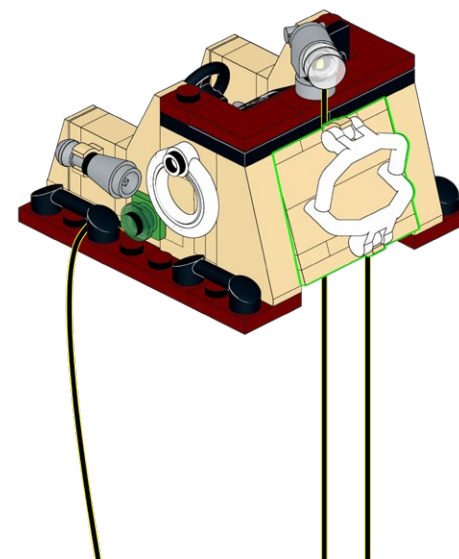

165

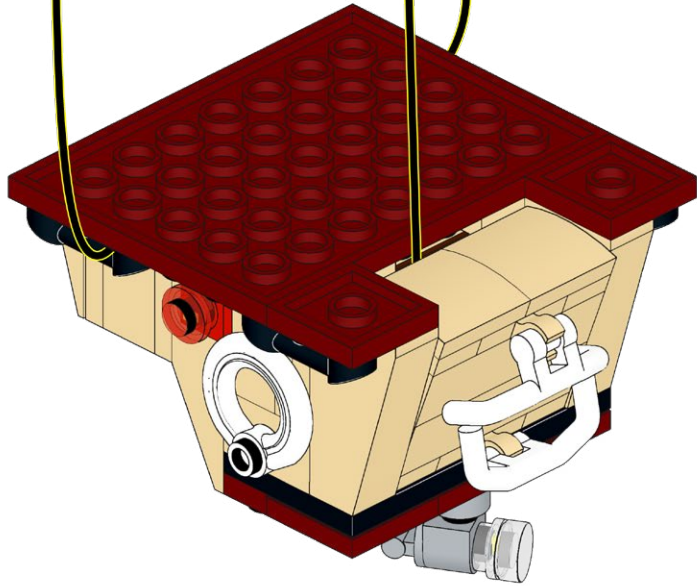

166

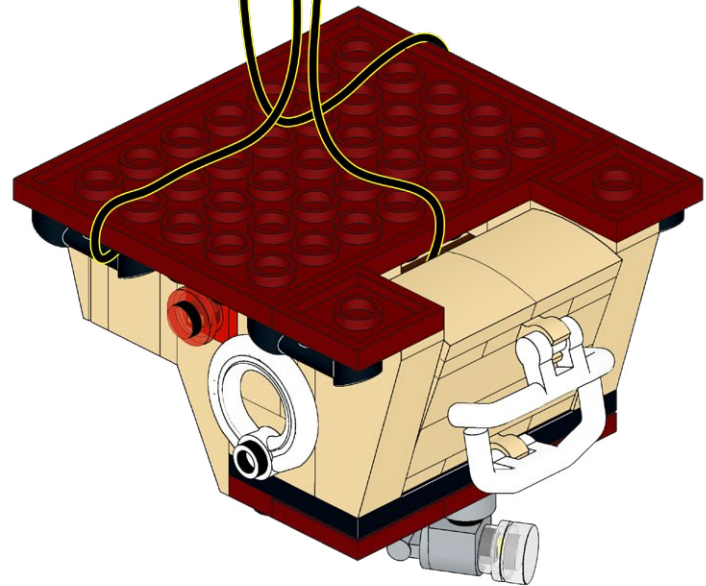

167

1x

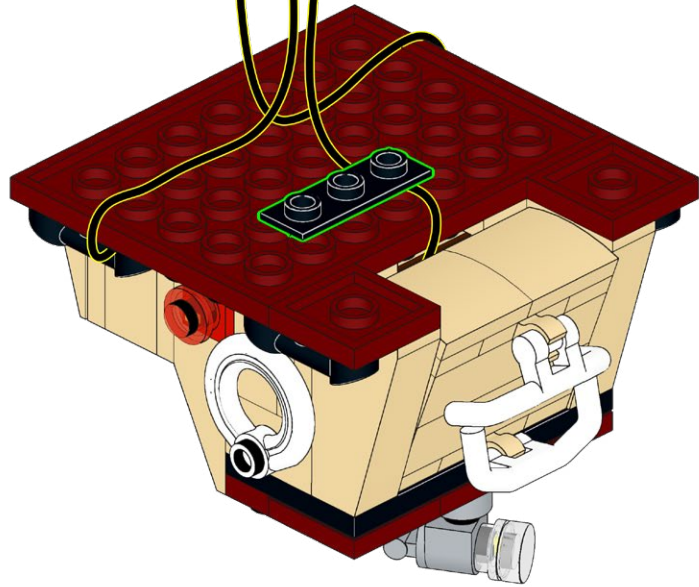

168

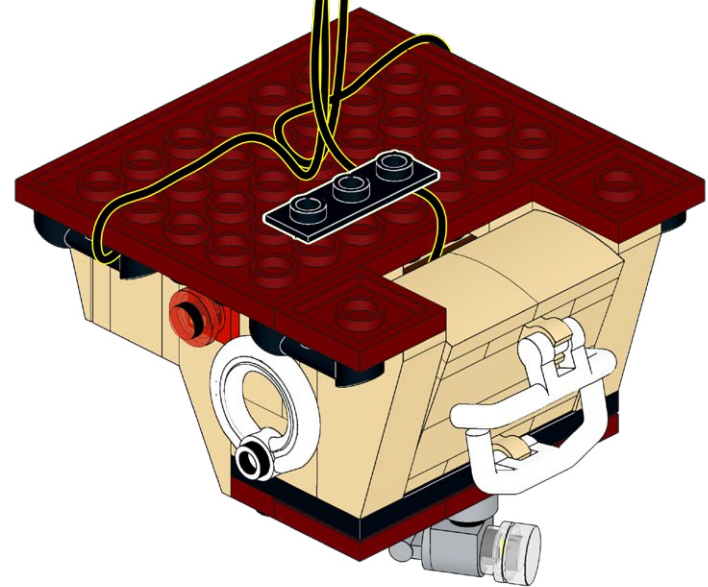

169

1x

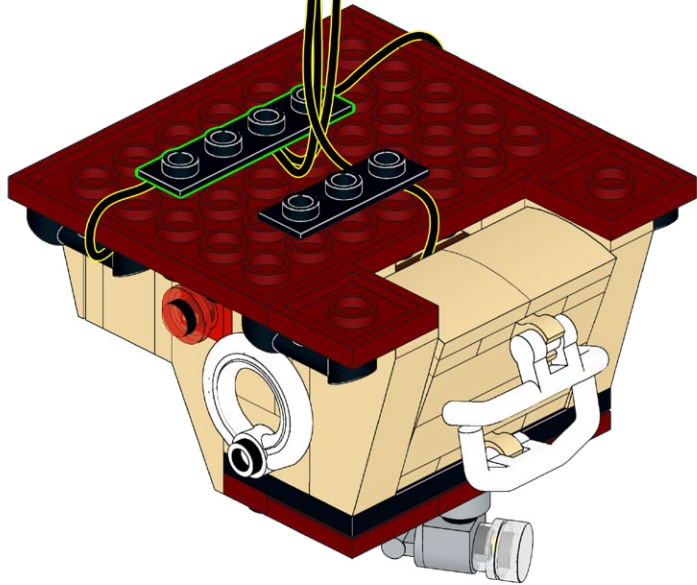

170

1x

MML-WW

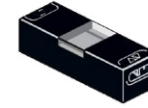

B-5

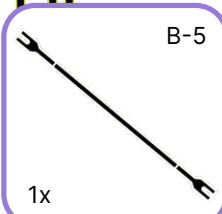

1x

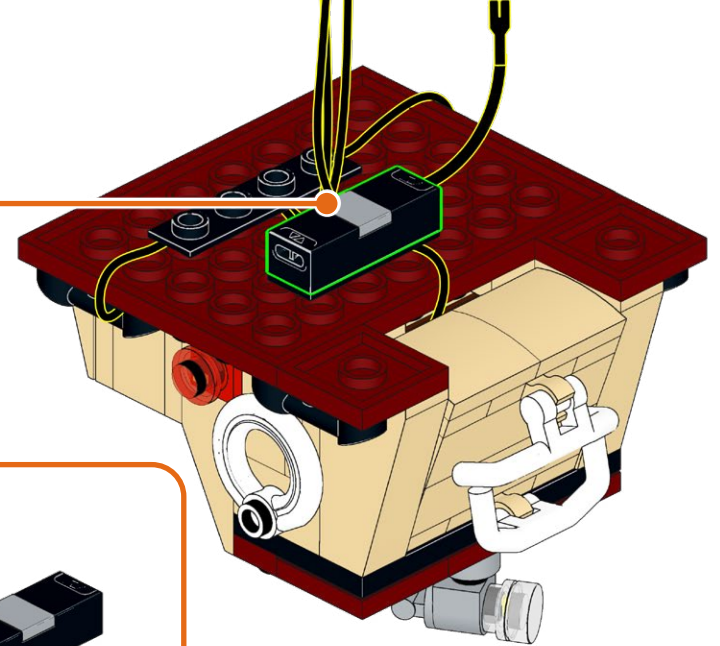
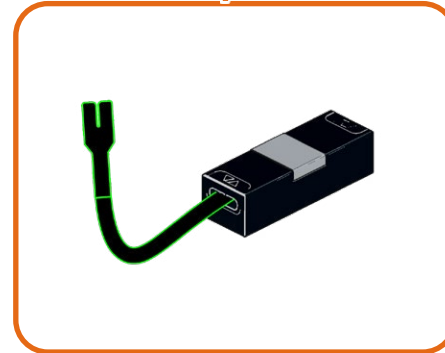

171

D-3

1x

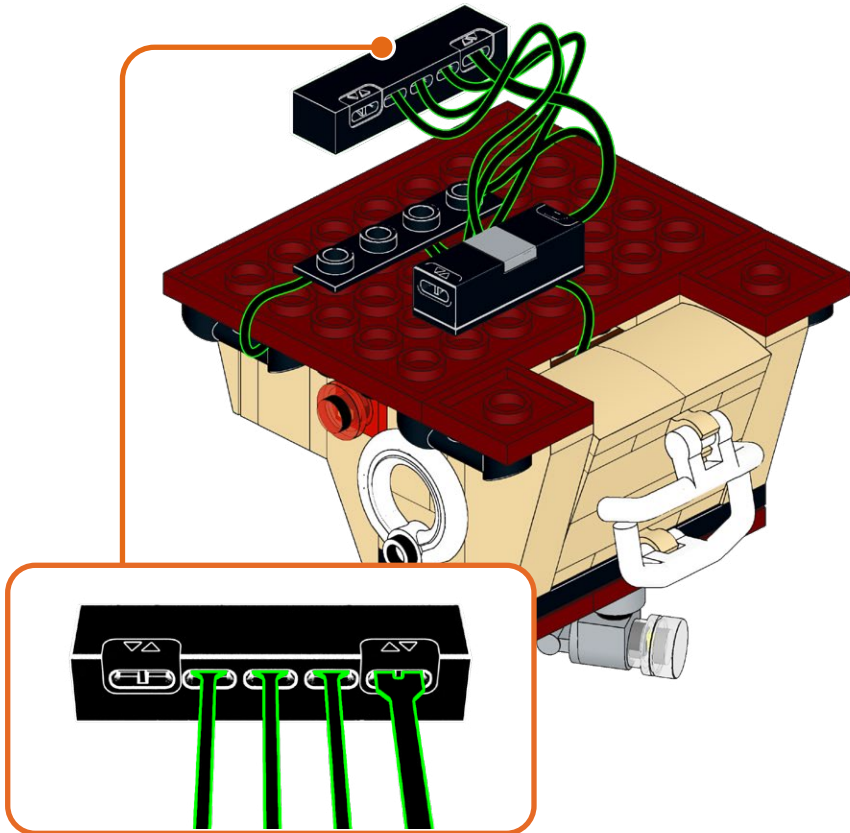

172

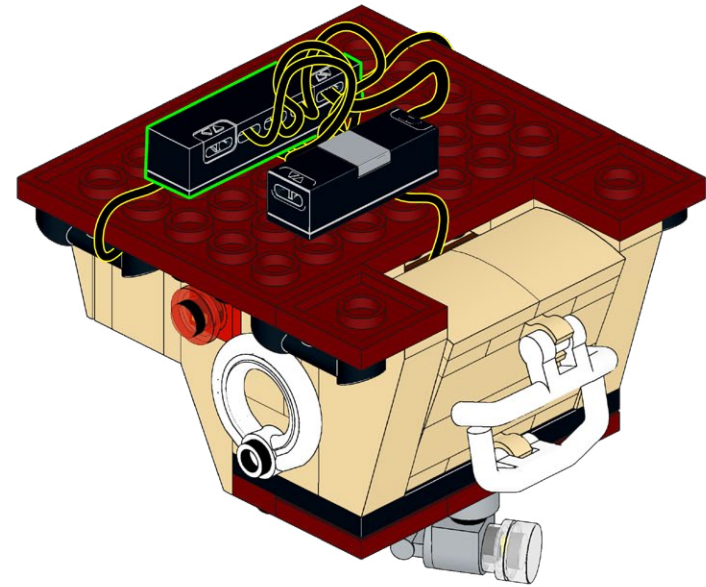

173

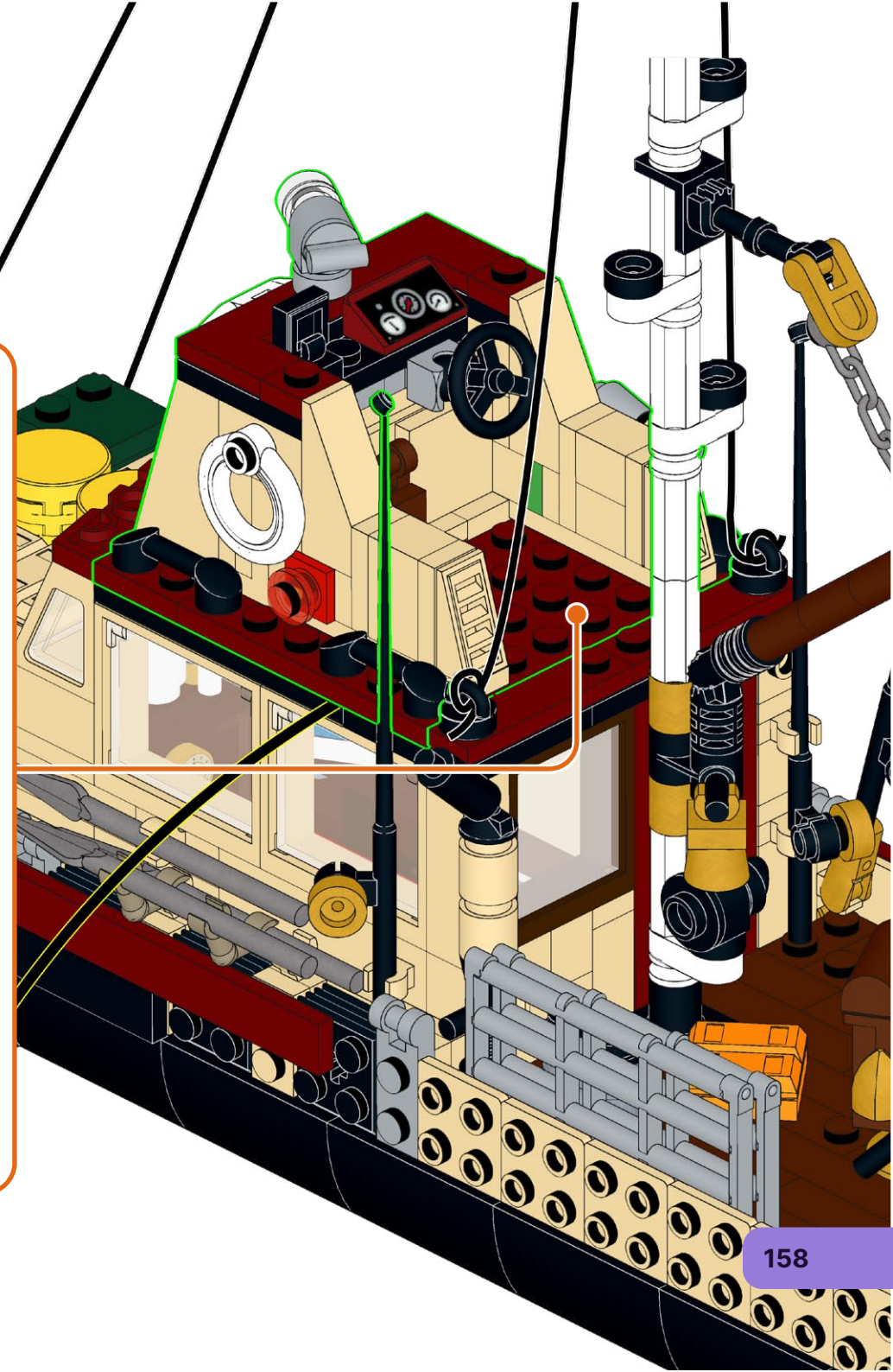
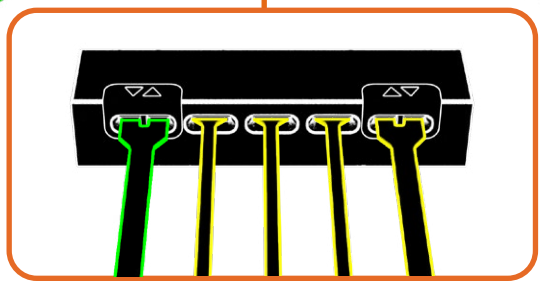
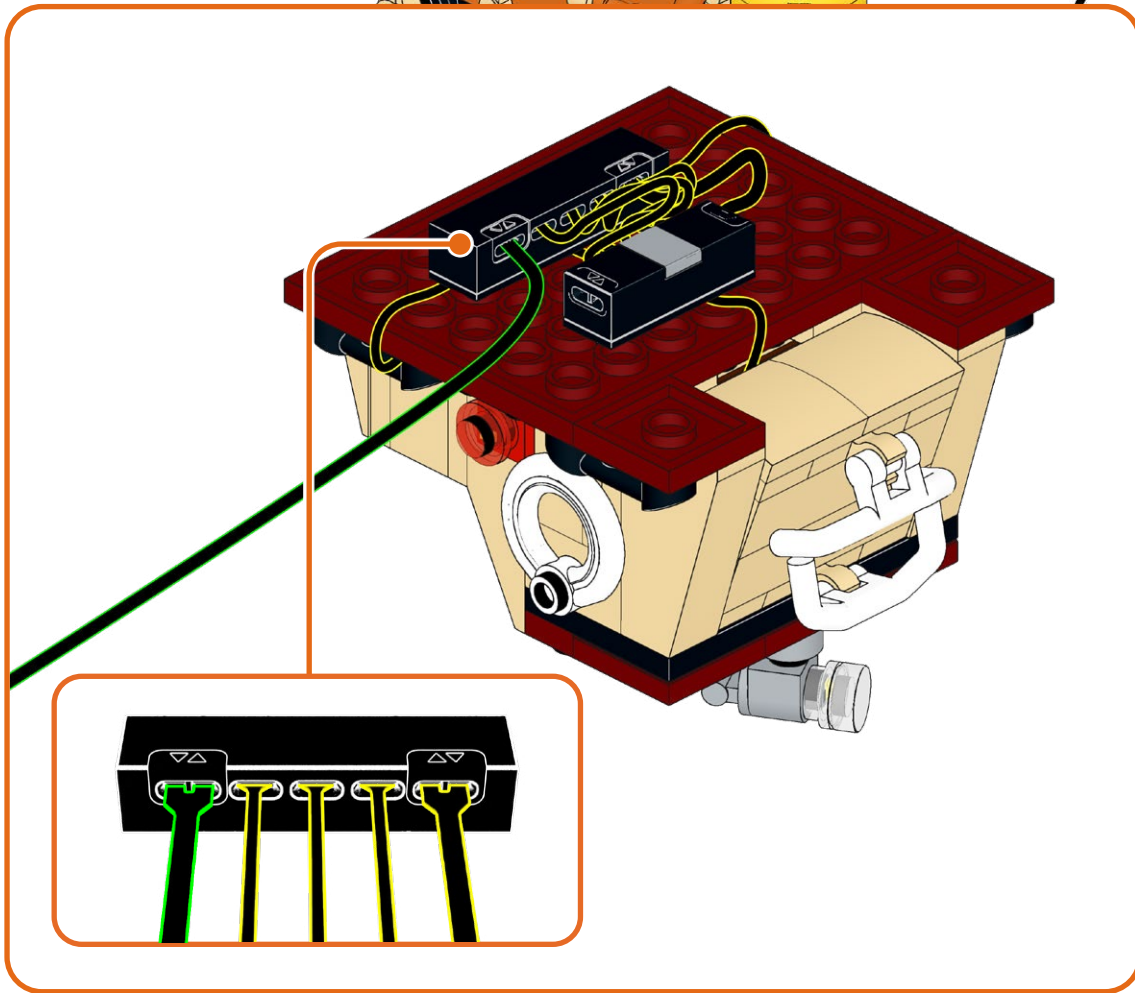
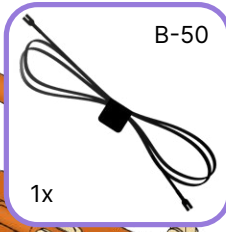

174

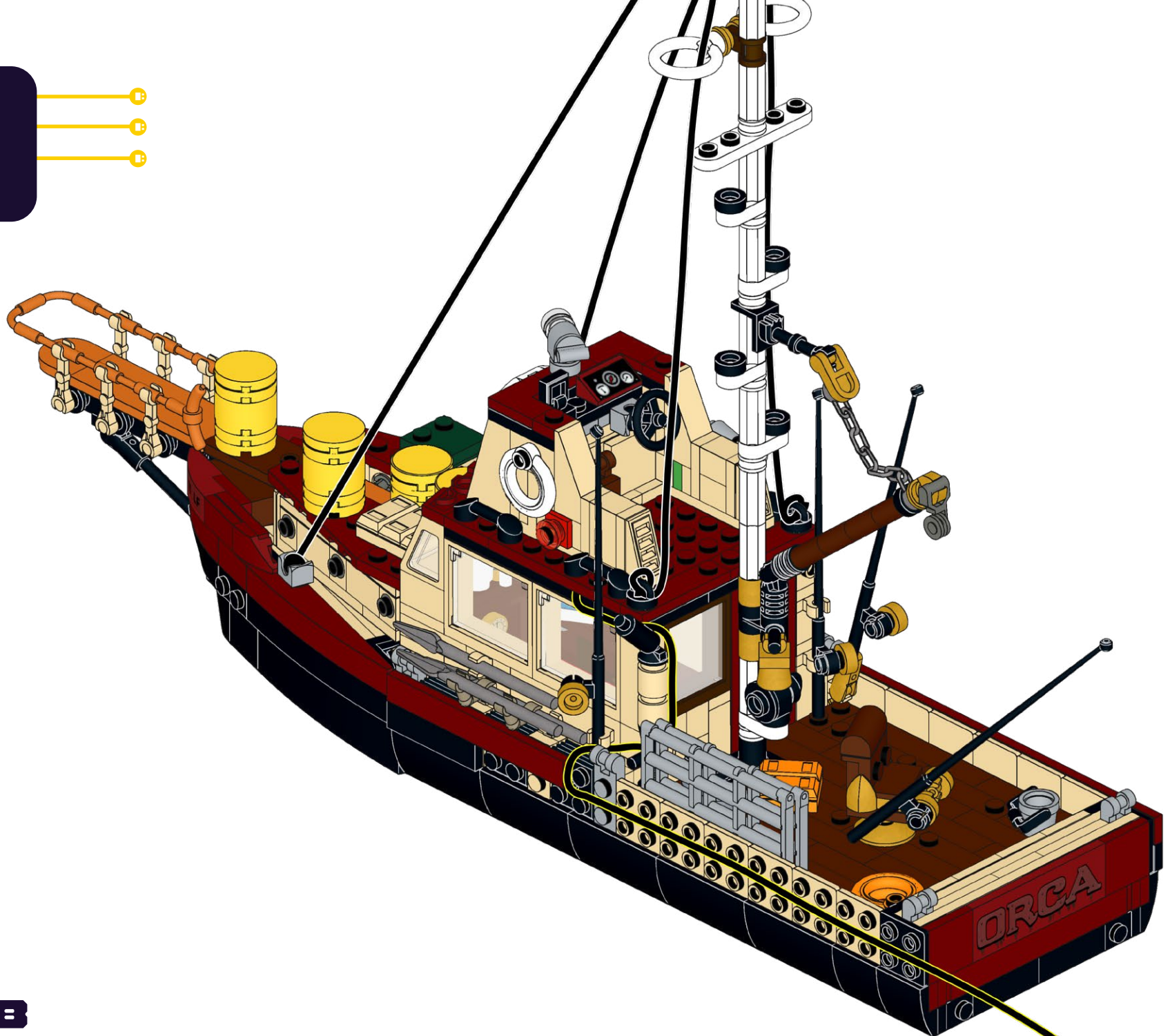

175

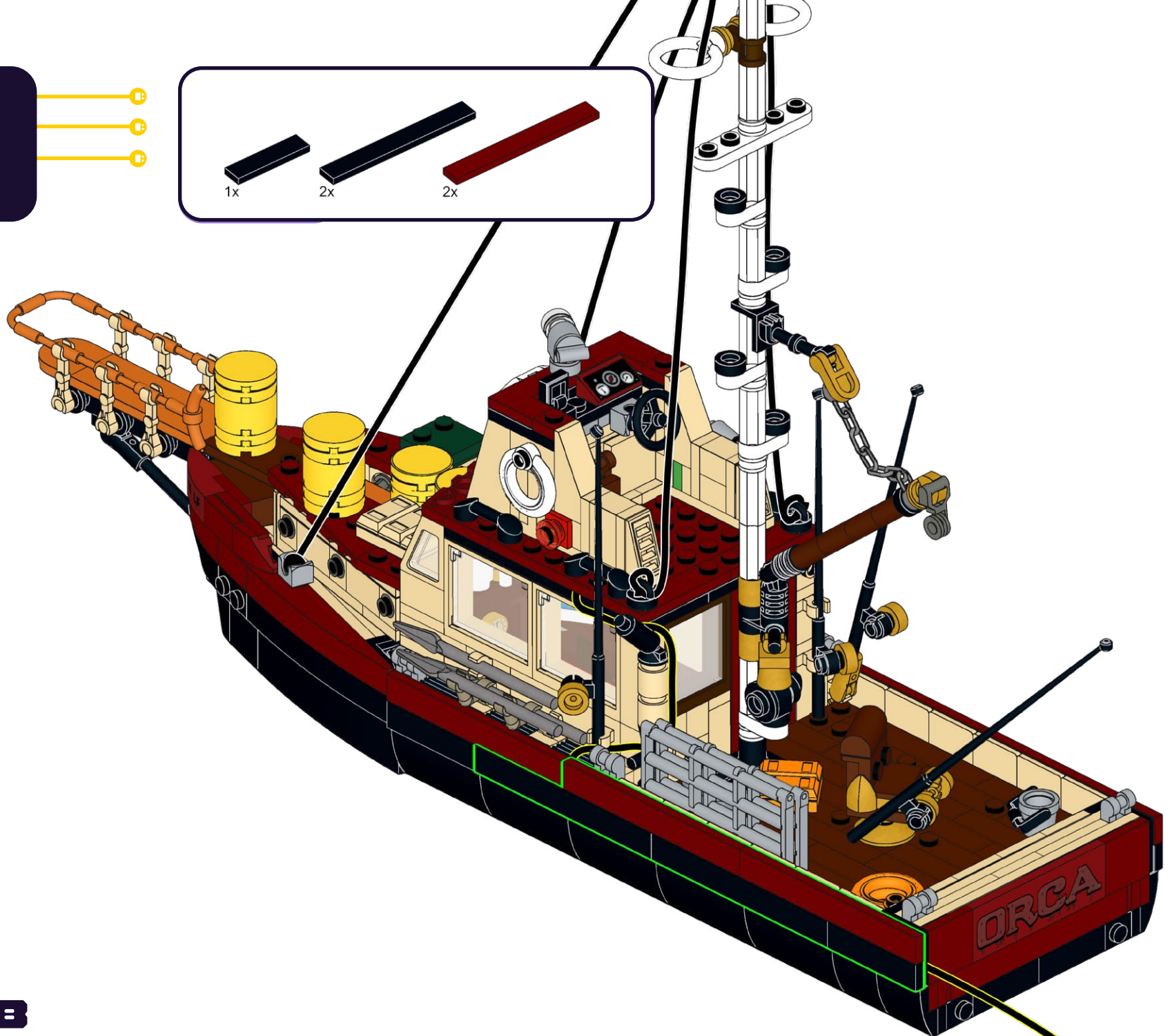
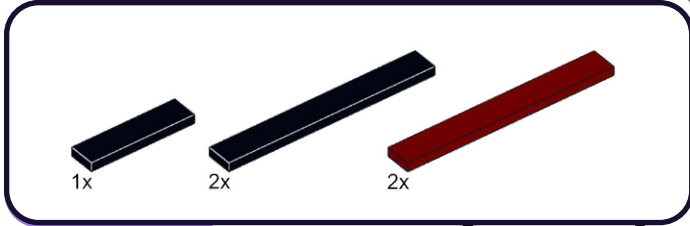

176

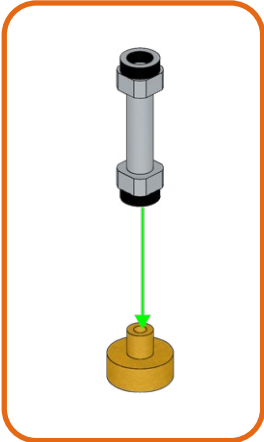
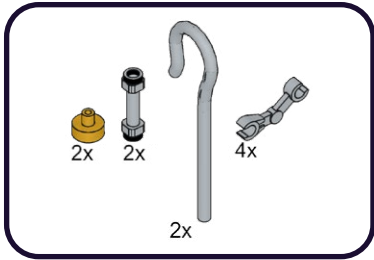

1

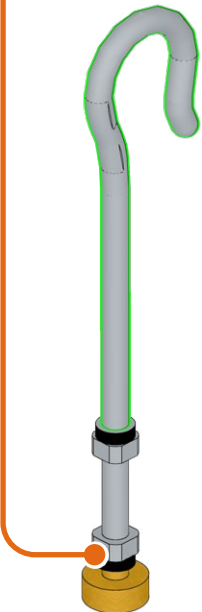

2

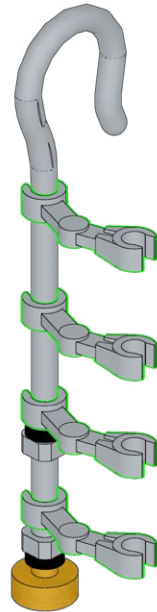

3

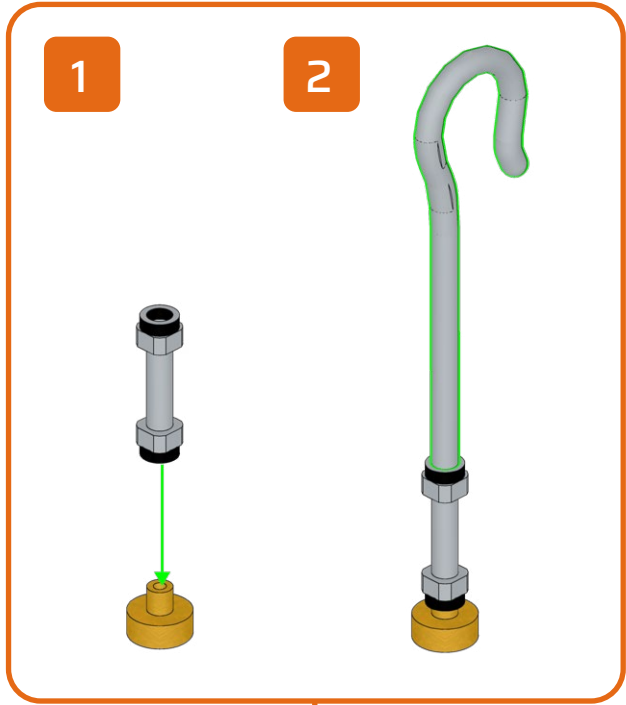
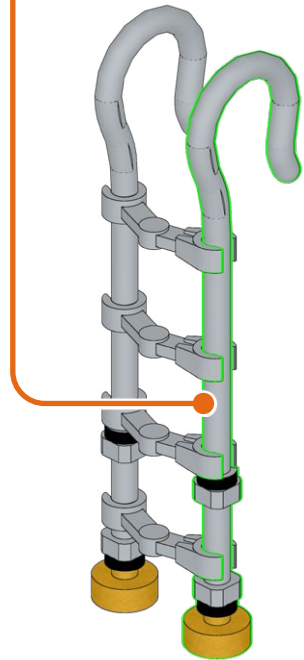

177

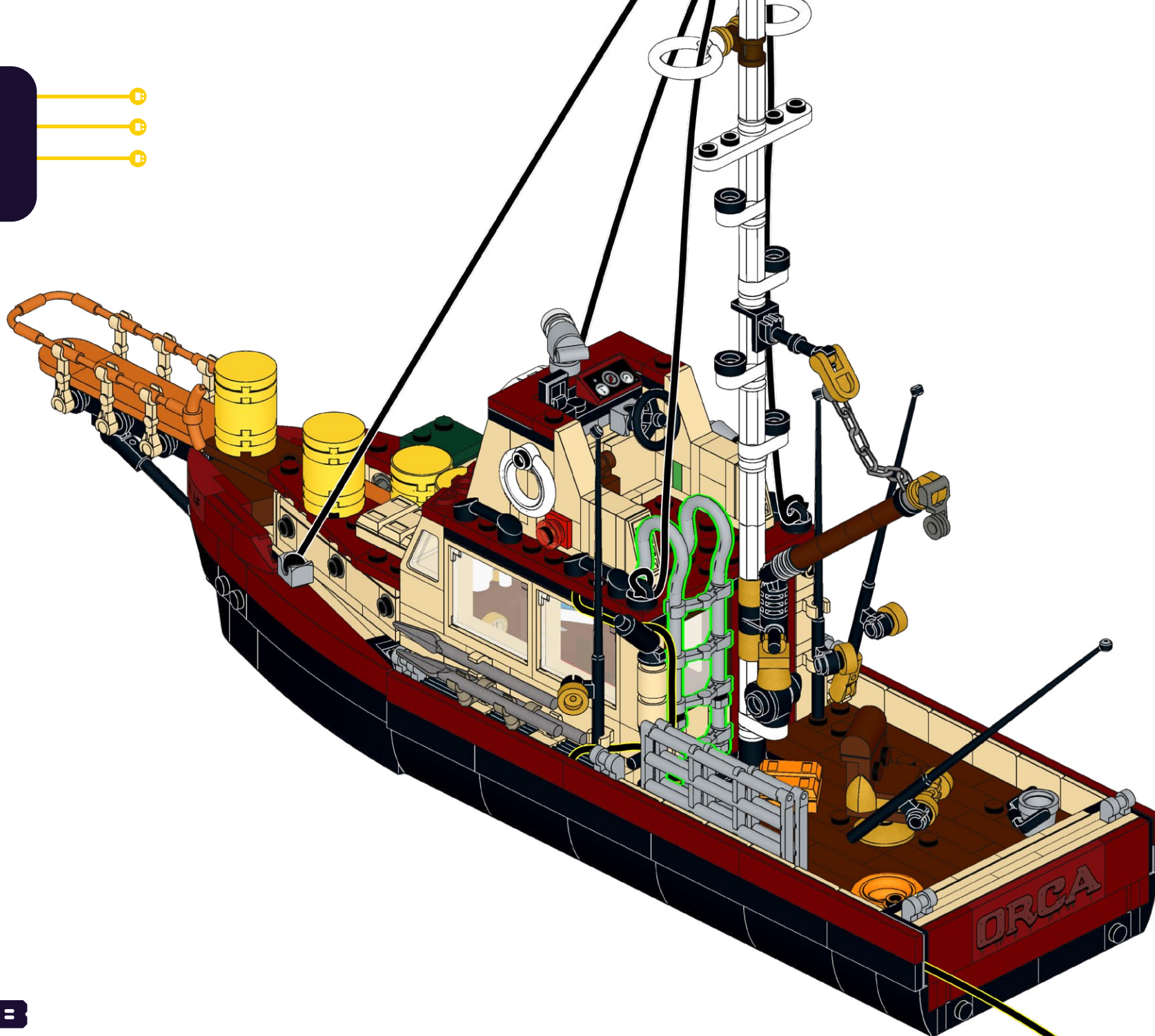

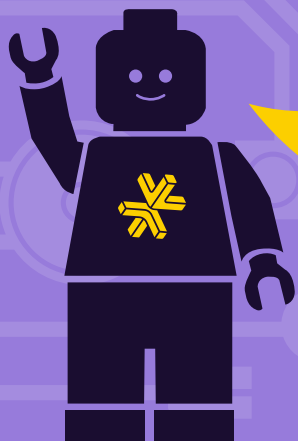
**HOLD UP!**

You might notice some bags aren't in order, as well as left over pieces, but that's ok! We're changing the way you build LEGO!

ATTENDEZ!

Vous remarquerez peut-être que certains sacs, ainsi que certaines pièces, ne sont pas dans le bon ordre. Mais pas de panique! Nous changeons simplement la façon avec laquelle vous construisez vos LEGO!

ASPETTA!

Potresti notare che alcuni sacchetti non sono in ordine, così come i pezzi avanzati, ma va bene così! Stiamo cambiando il modo in cui costruisci i LEGO!

HALT!

Sie werden möglicherweise bemerken, dass einige tüten durcheinander sind und teile übrig bleiben, aber das ist in Ordnung! Wir ändern die art und weise, wie Sie LEGO bauen!

¡ESPERA!

Es posible que notes que algunas bolsas están fuera de servicio, así como piezas sobrantes, ¡pero está bien! ¡Estamos cambiando la forma en que construyes LEGO!

暫停!

你可能会注意到一些袋子顺序错乱, 以及一些剩余的部件, 但没关系! 我们正在改变你搭建乐高的方式!

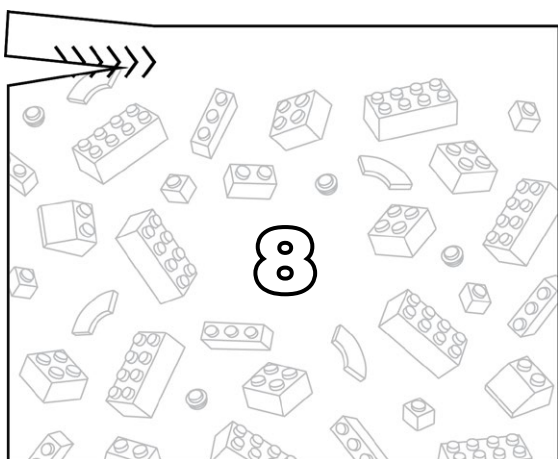
Open LEGO® Bag 8

178

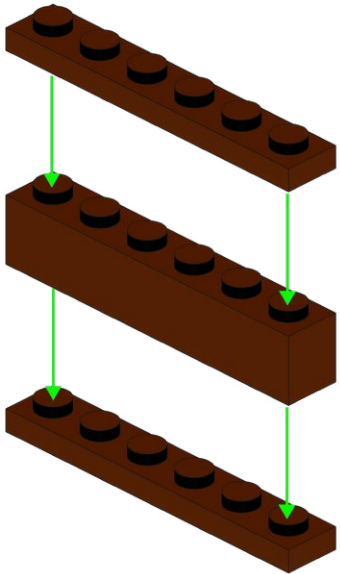
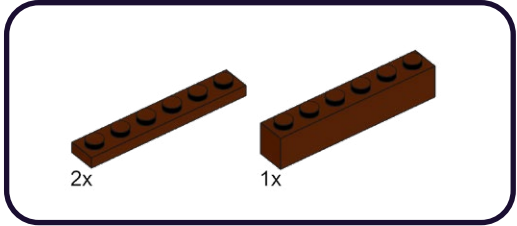

179

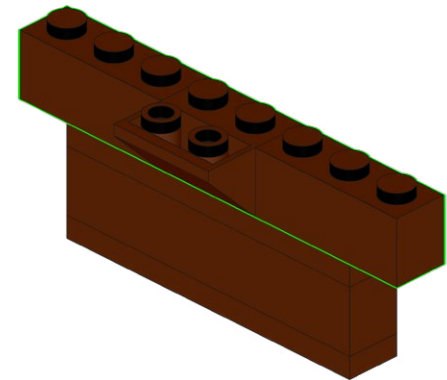
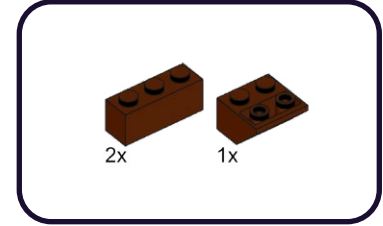

180

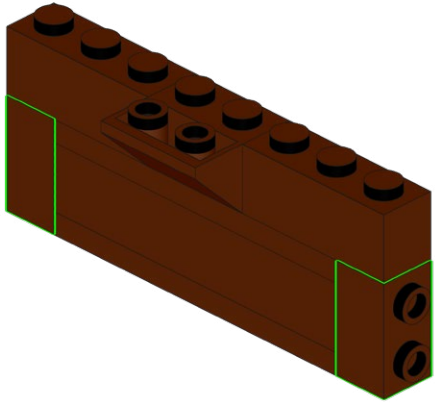
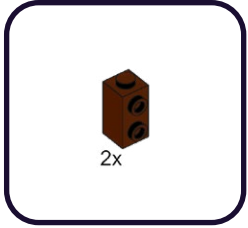

181

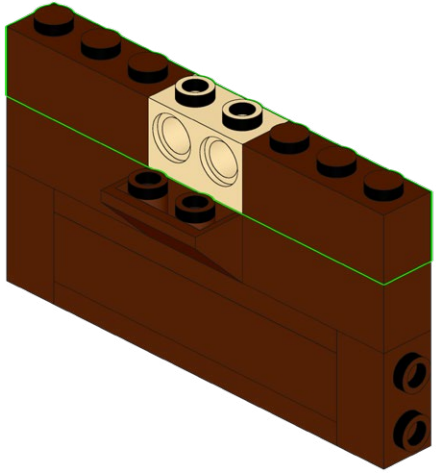
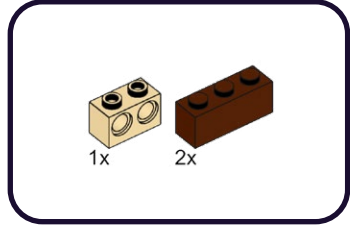

182

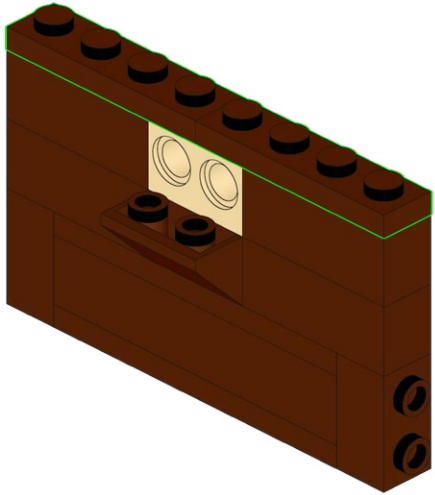
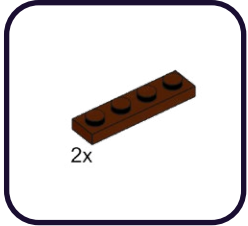

183

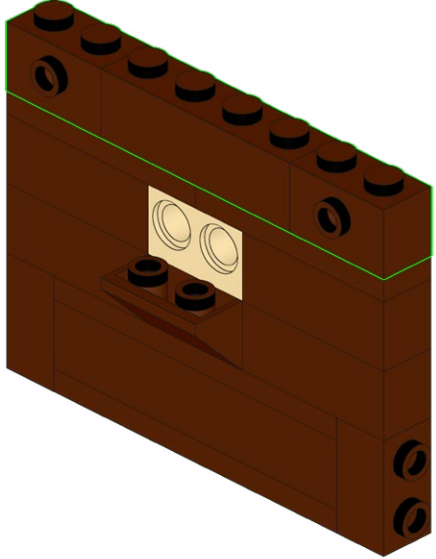
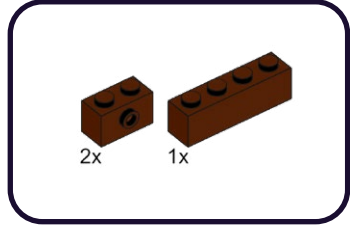

184

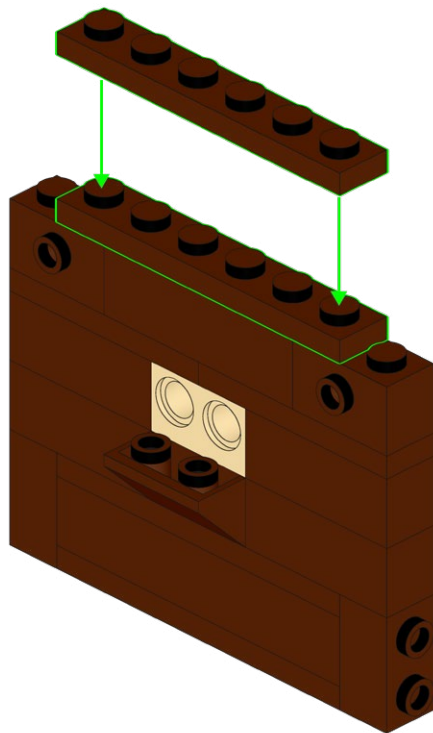
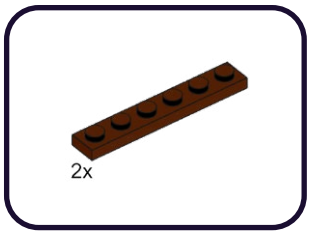

185

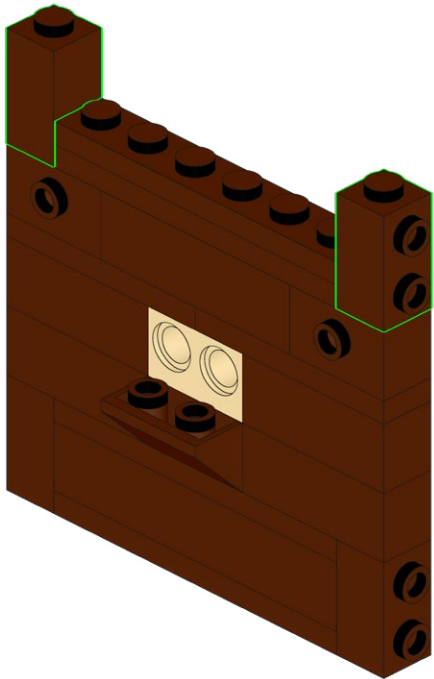
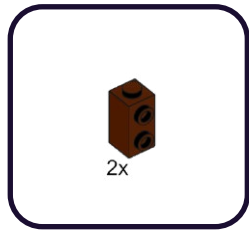

186

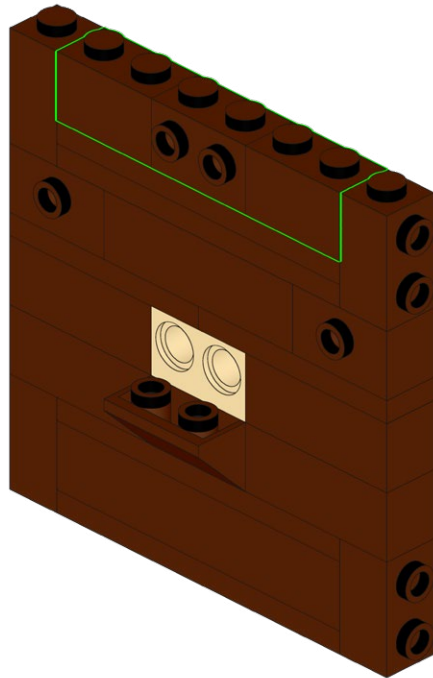
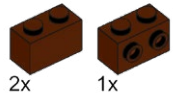

187

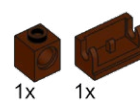

1



2

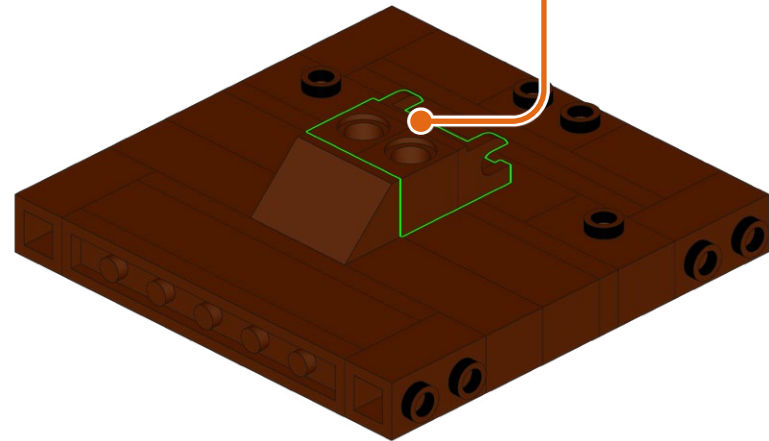
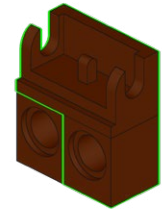

188

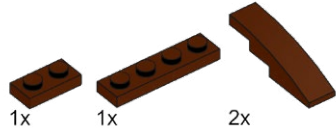

1

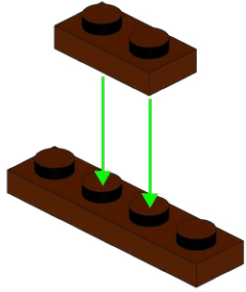

2

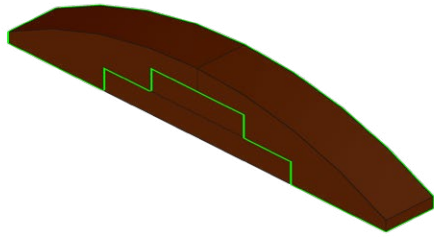

3x

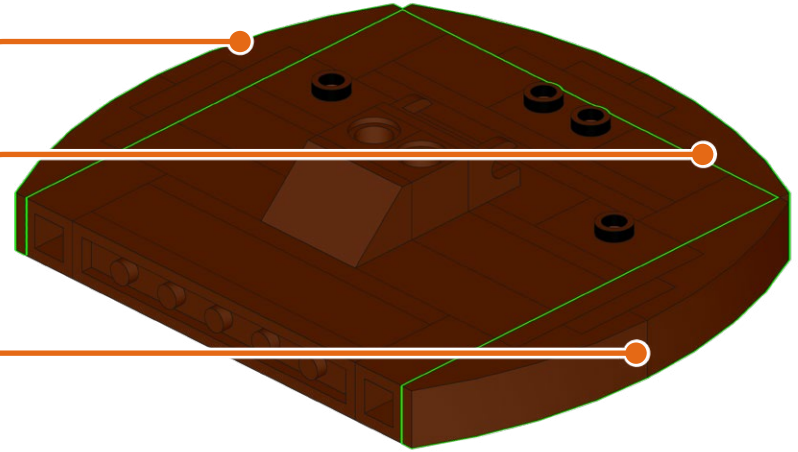

189

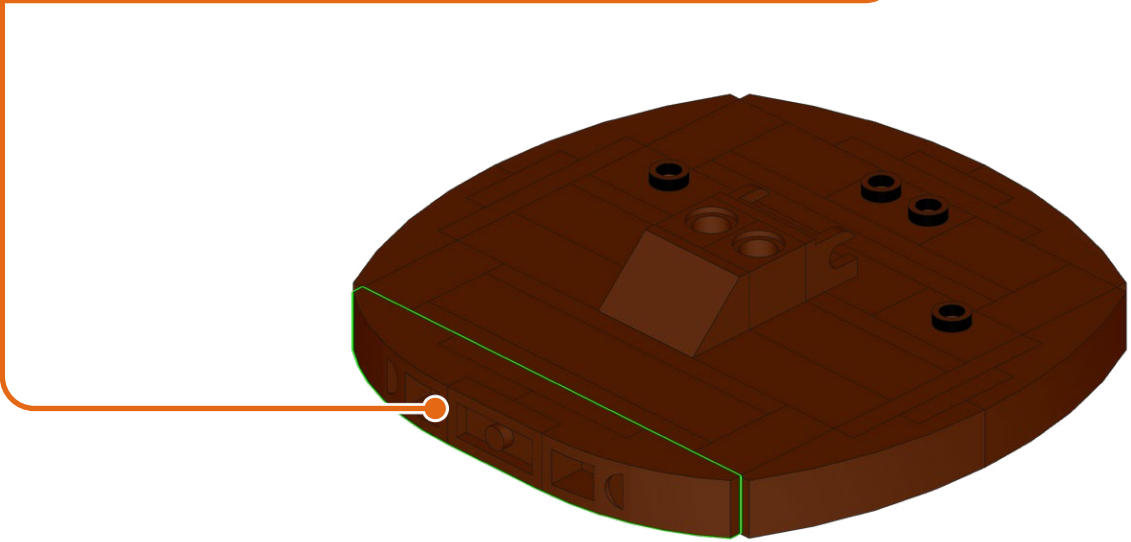
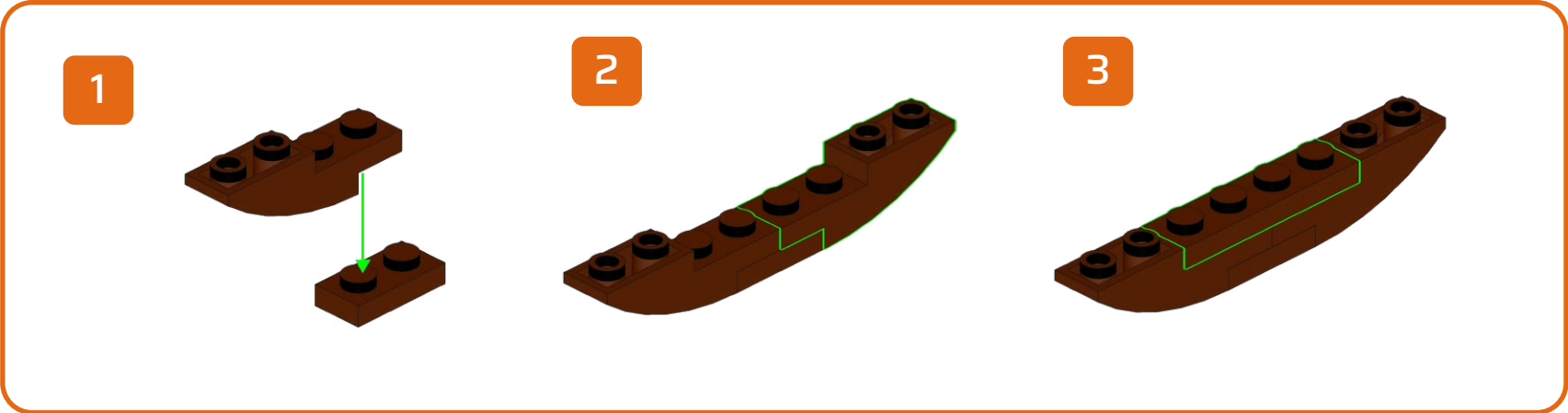
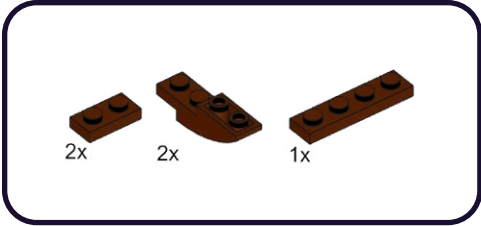

190

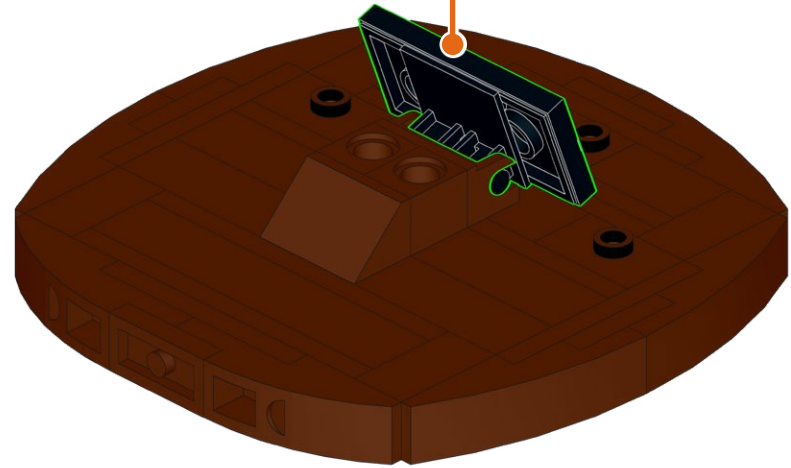
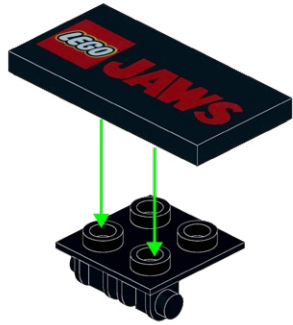
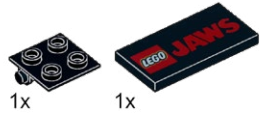

191



1

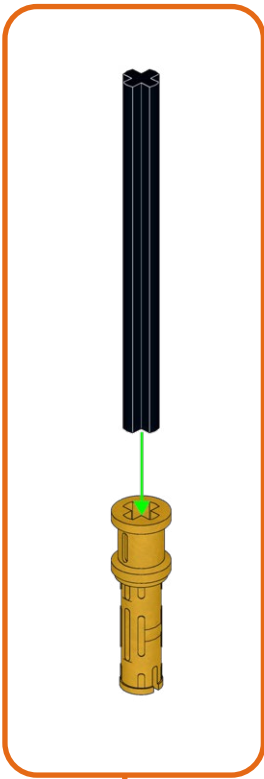

2

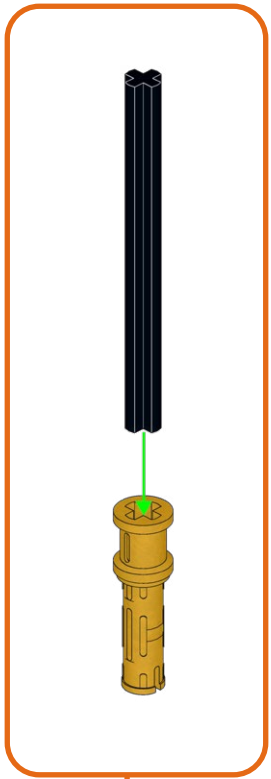

3

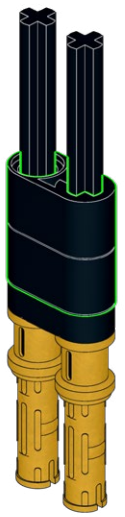
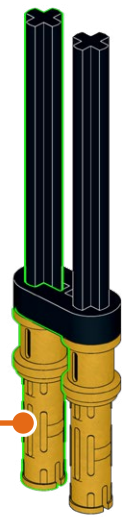

192

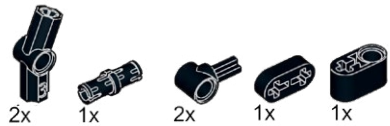

1

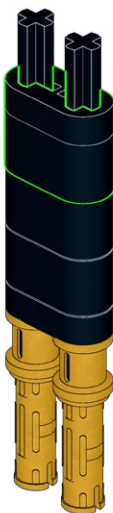

1



2



3



4



2

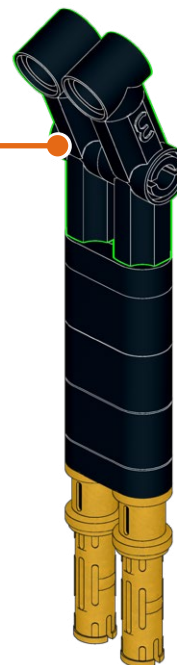

193



194

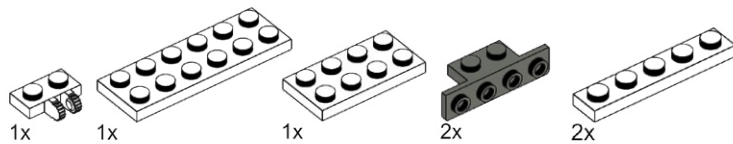

1

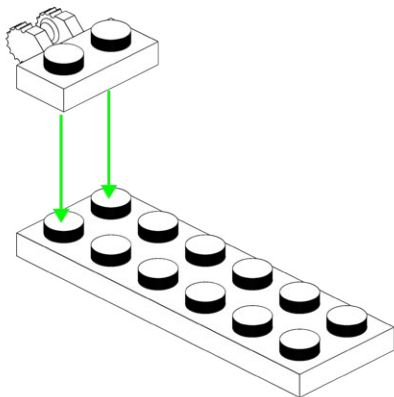

2

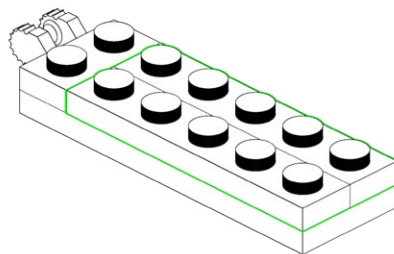

3

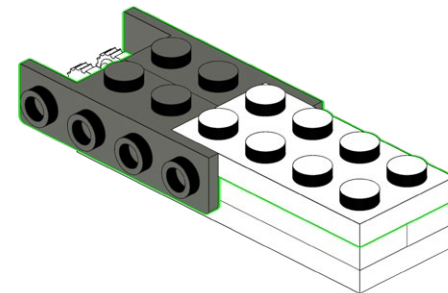

195

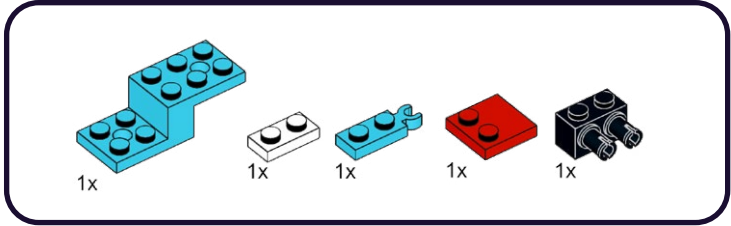

1

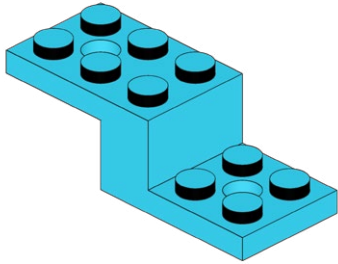

2

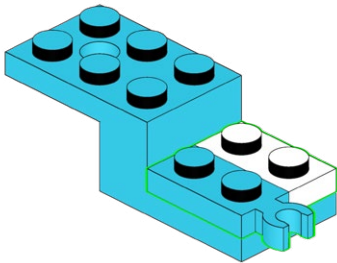

3

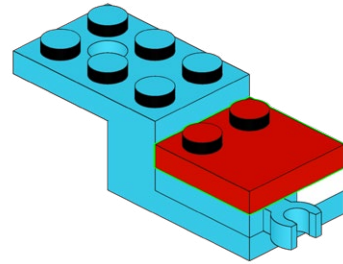

4

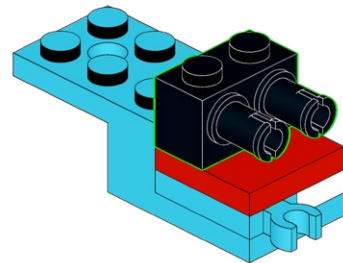

196

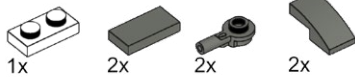

1

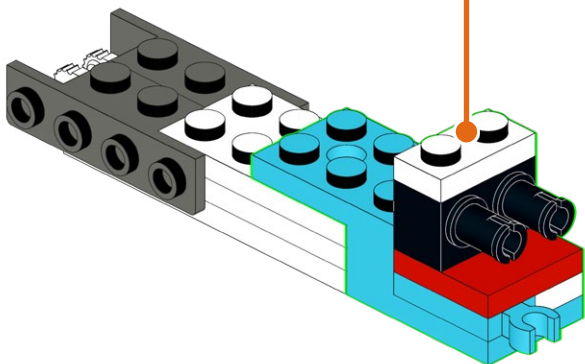
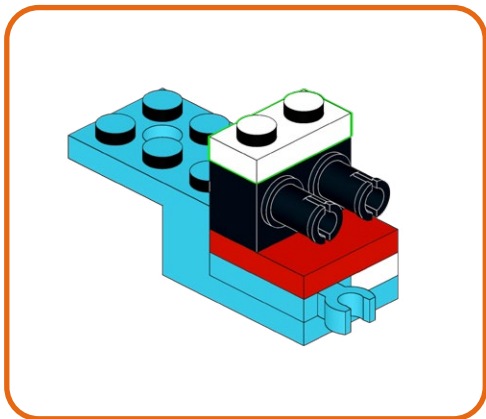

2

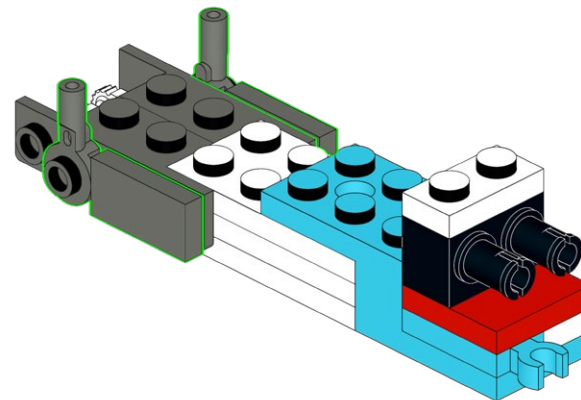

3

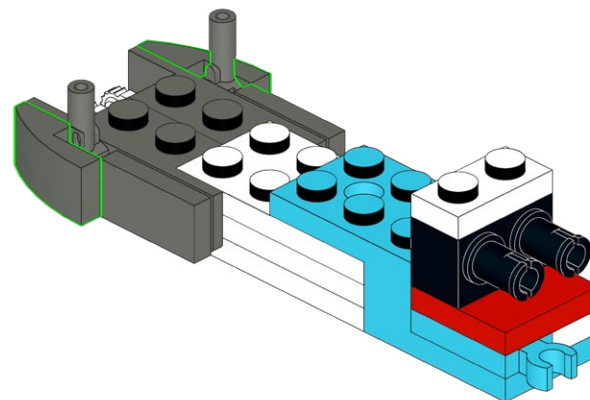

197

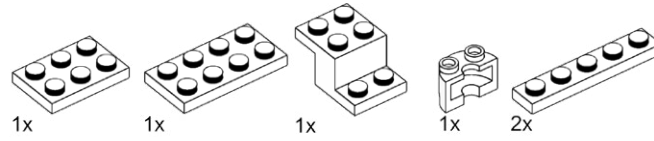

1

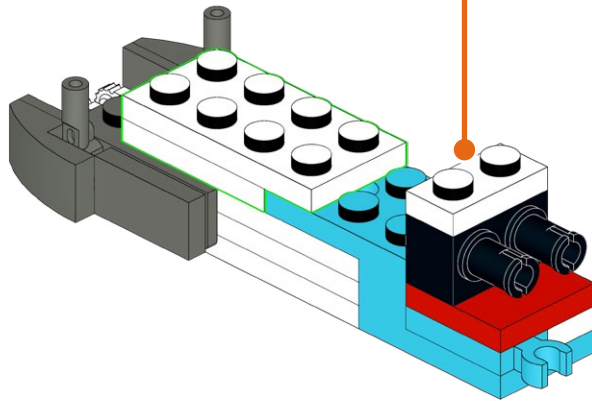
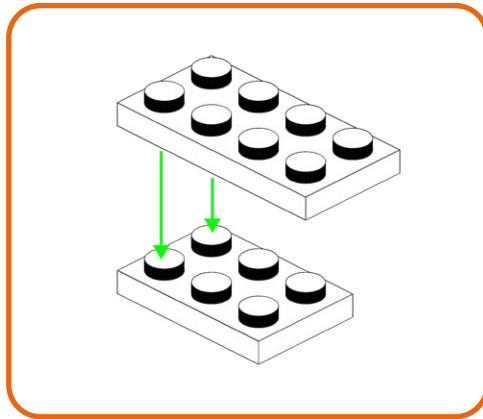

2

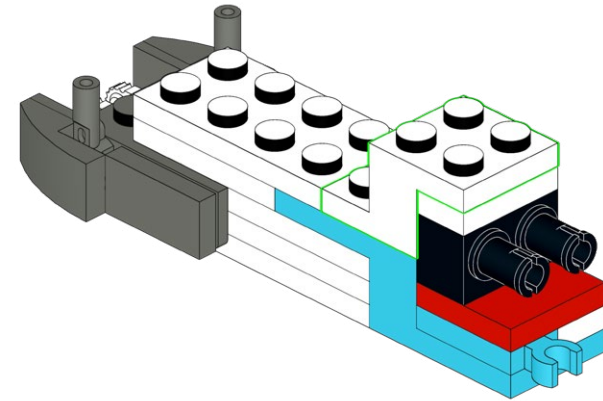

3

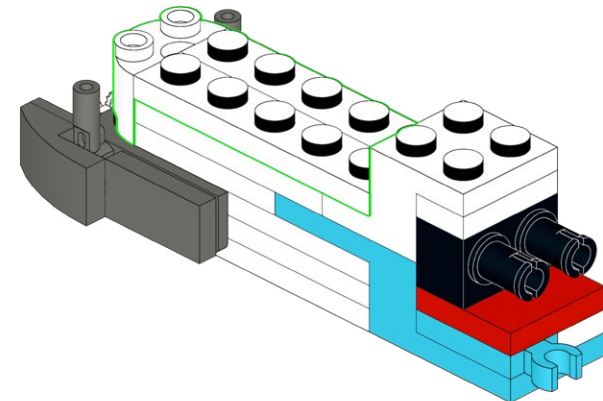

198

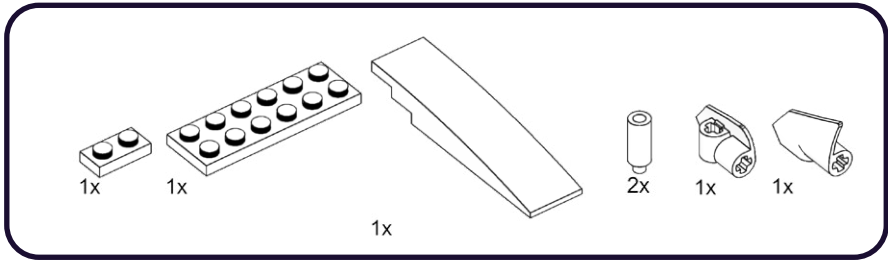

1

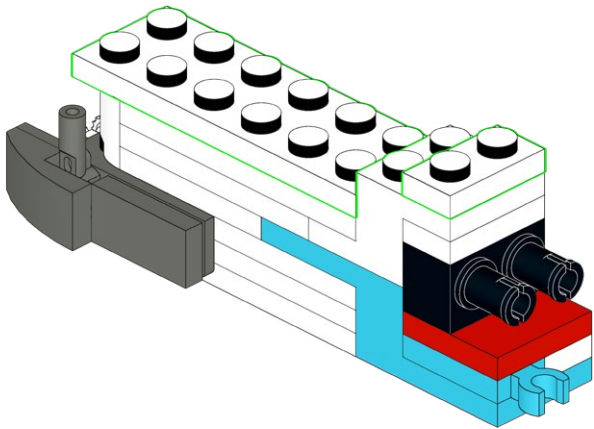

2

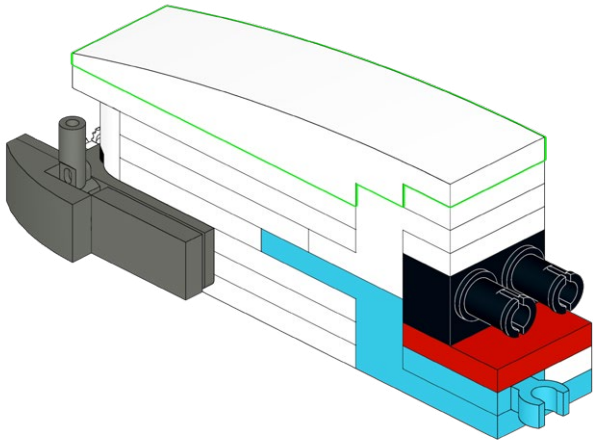

3

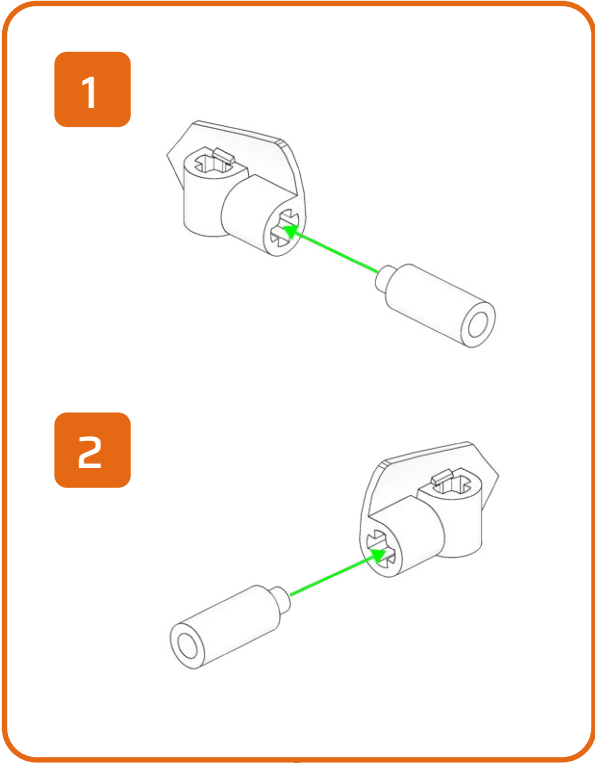

1

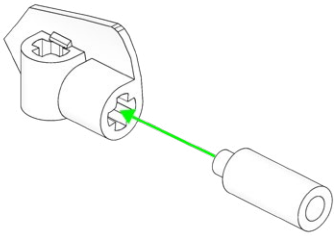

2

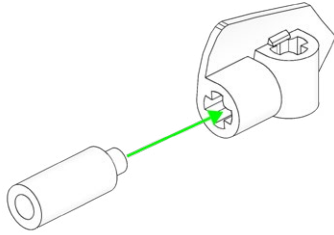

199

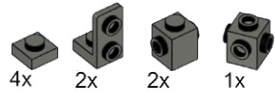

1

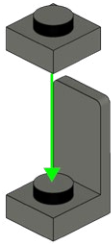

2

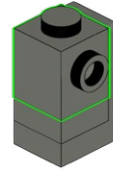

3

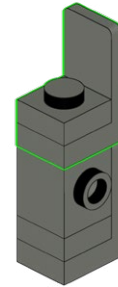

4

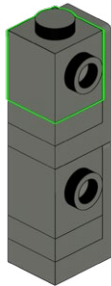

5

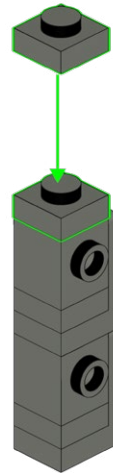

6

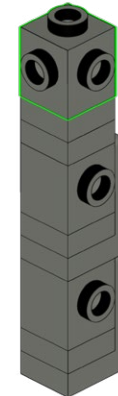

200

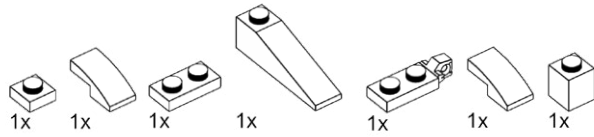

1

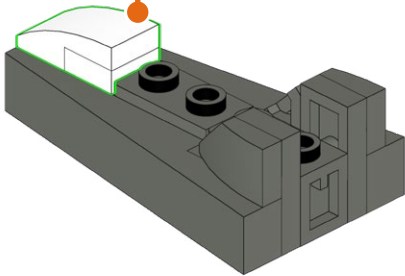
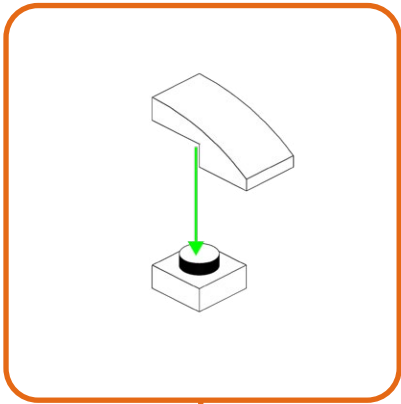

2

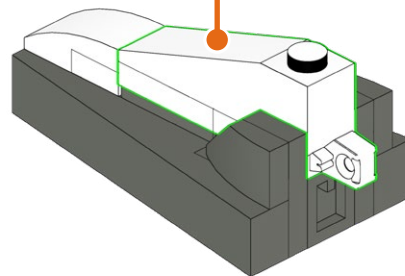
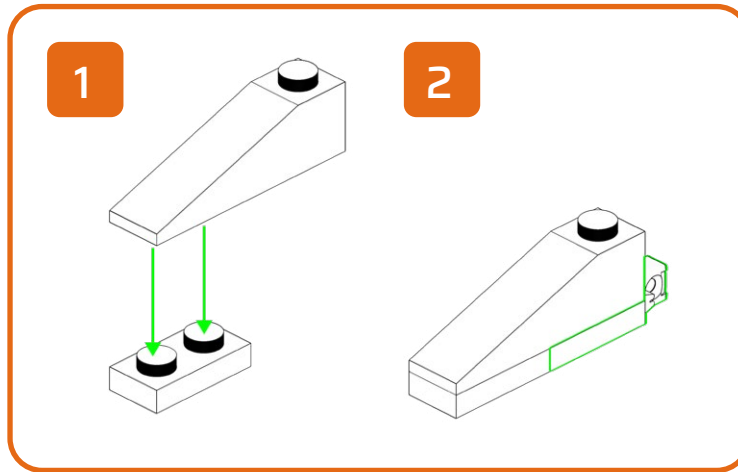

3

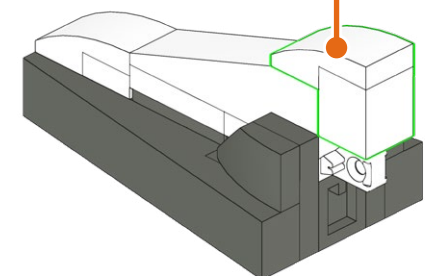
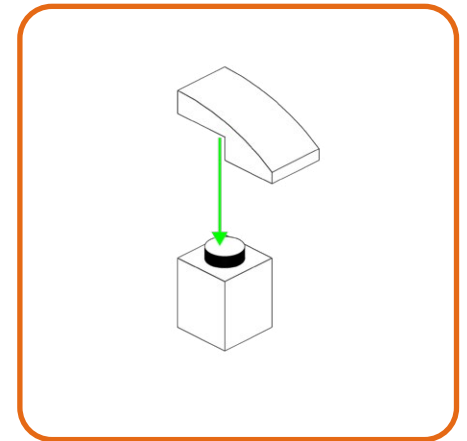

201

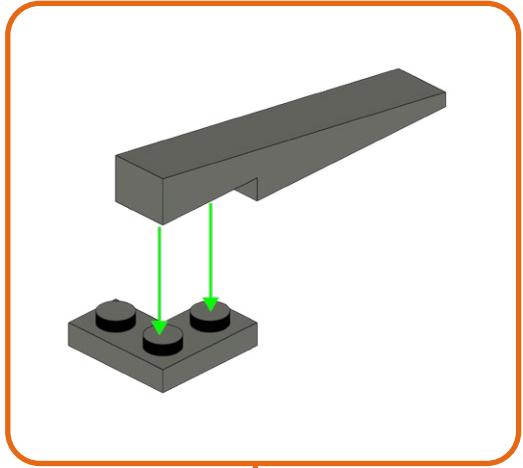
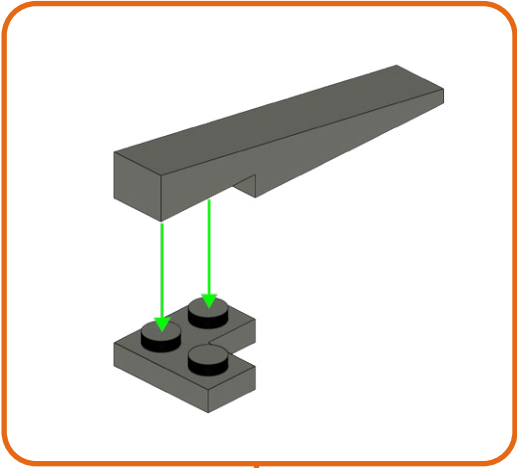
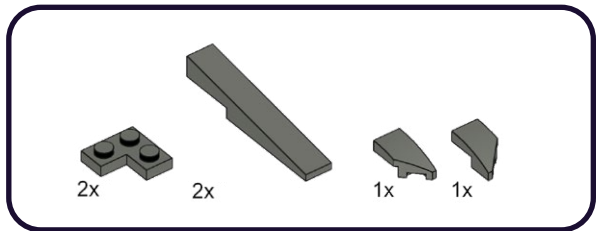

1

2

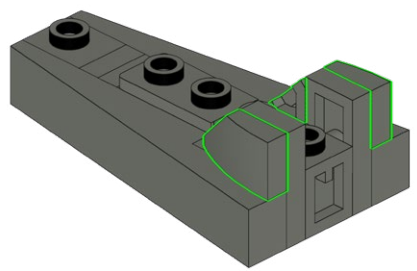
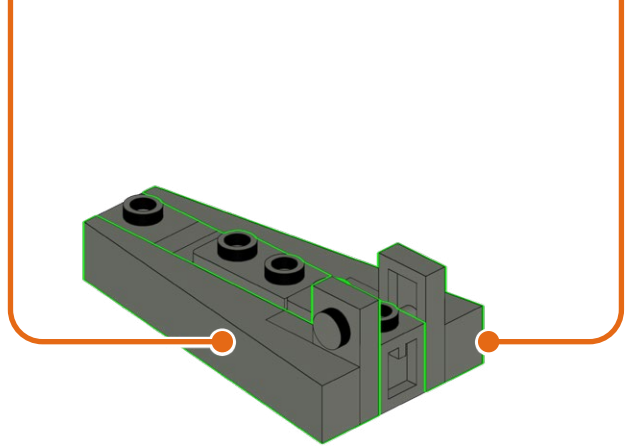

202

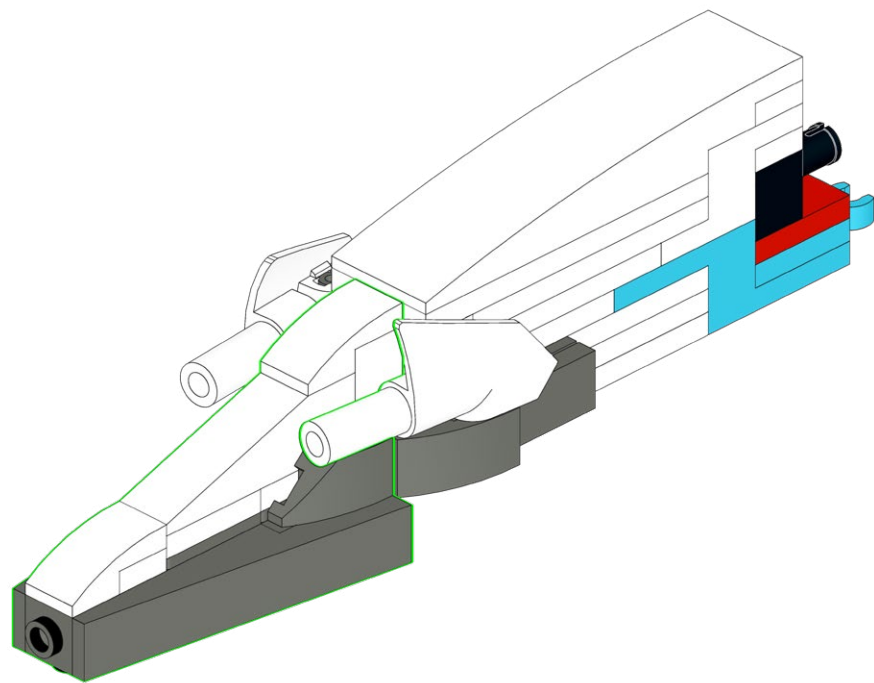

203

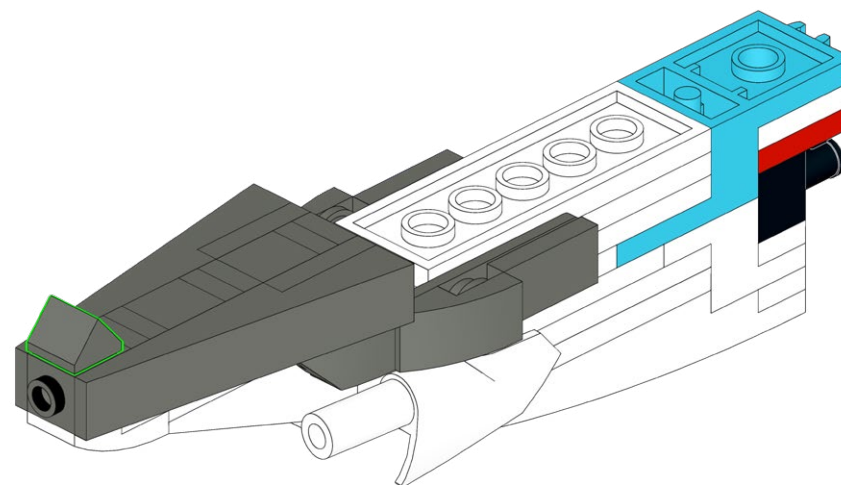
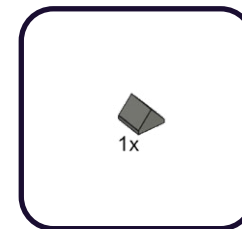
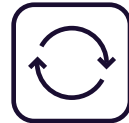

204

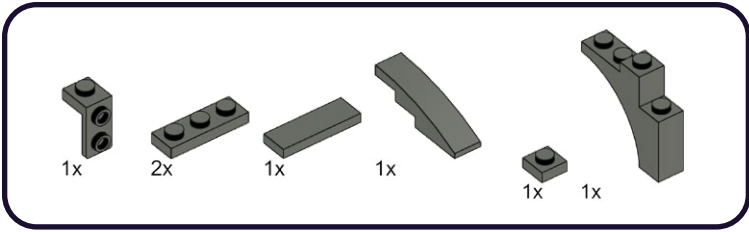

1

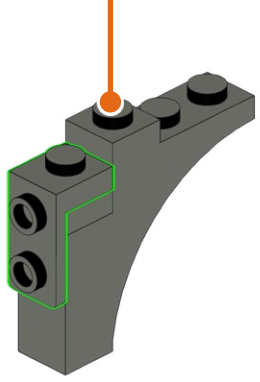
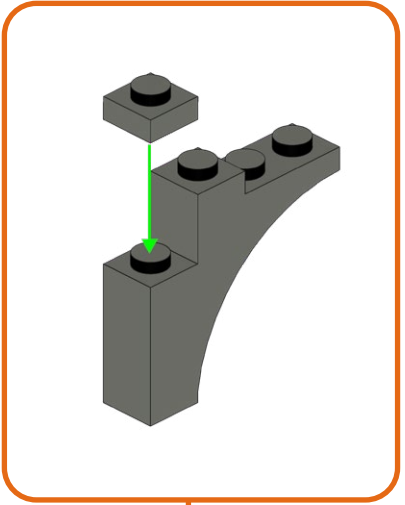

2

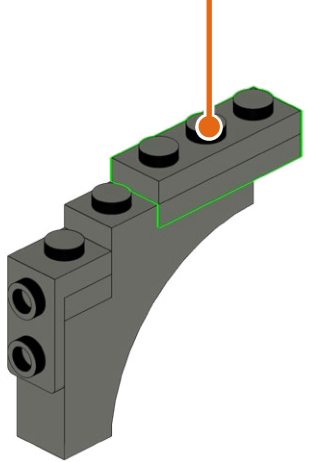
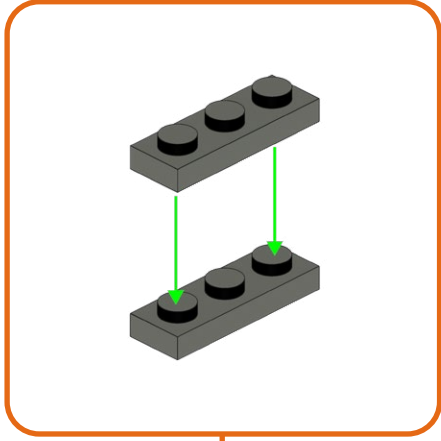

3

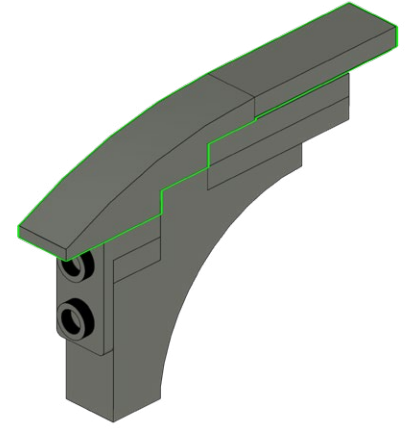

205

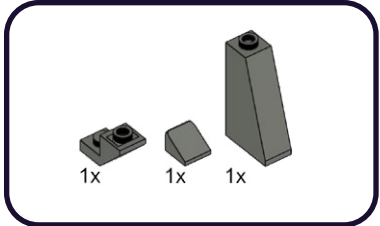

1

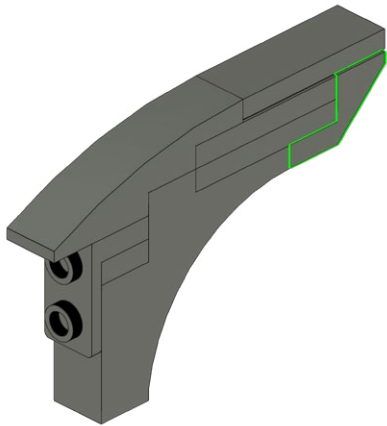

2

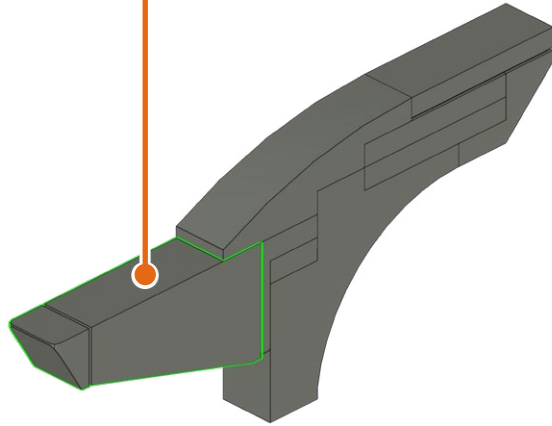
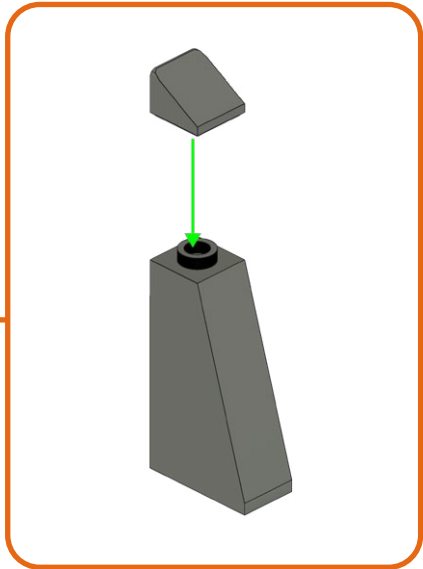

206

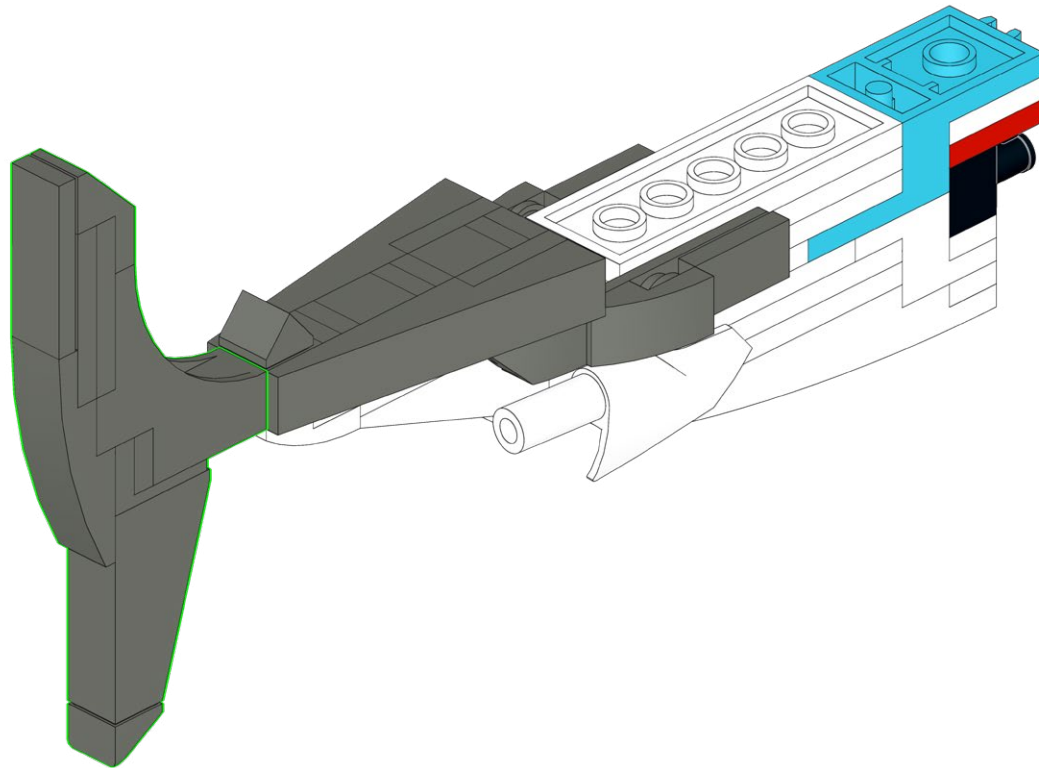

207

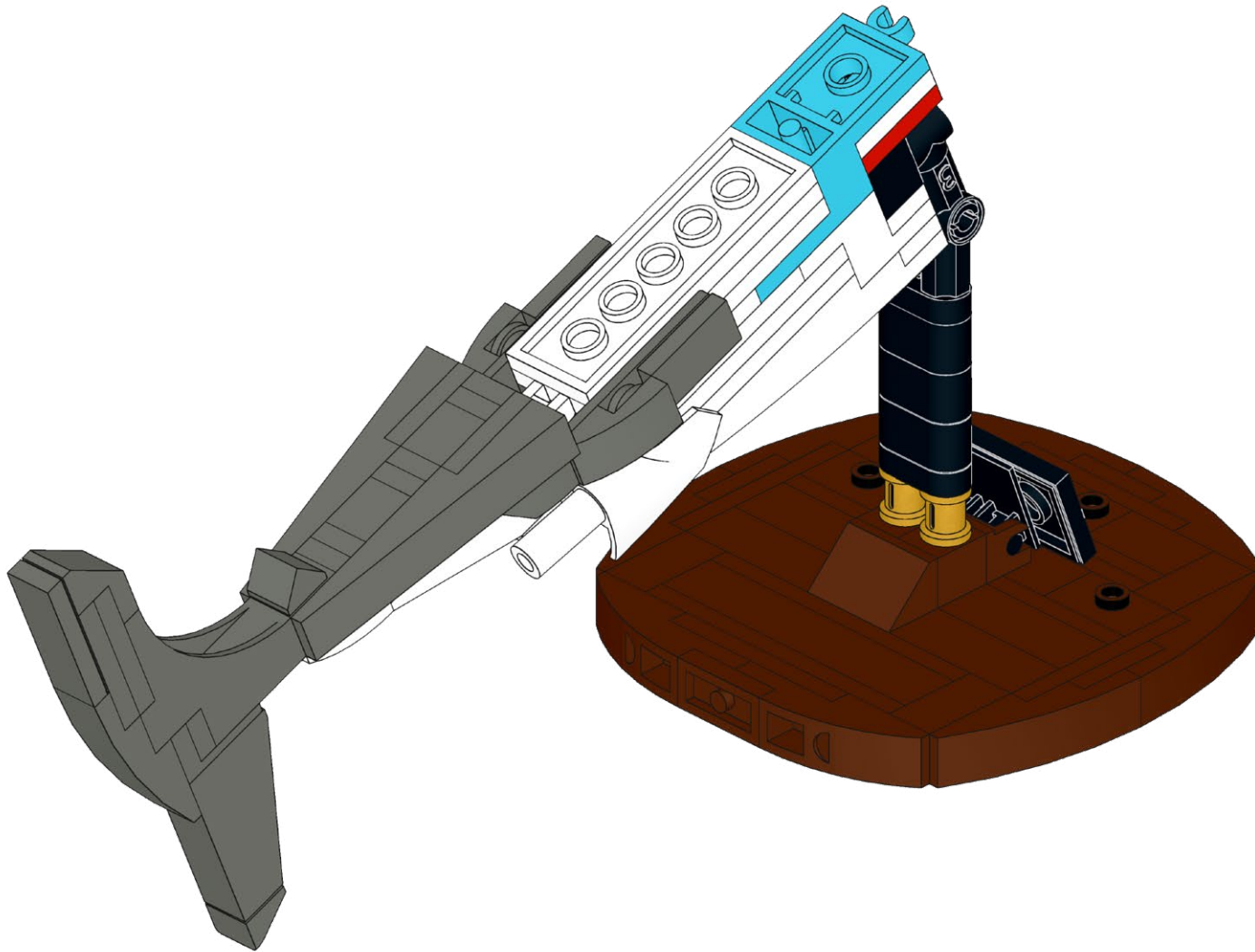

**HOLD UP!**

You might notice some bags aren't in order, as well as left over pieces, but that's ok! We're changing the way you build LEGO!

ATTENDEZ!

Vous remarquerez peut-être que certains sacs, ainsi que certaines pièces, ne sont pas dans le bon ordre. Mais pas de panique! Nous changeons simplement la façon avec laquelle vous construisez vos LEGO!

ASPETTA!

Potresti notare che alcuni sacchetti non sono in ordine, così come i pezzi avanzati, ma va bene così! Stiamo cambiando il modo in cui costruisci i LEGO!

HALT!

Sie werden möglicherweise bemerken, dass einige tüten durcheinander sind und teile übrig bleiben, aber das ist in Ordnung! Wir ändern die art und weise, wie Sie LEGO bauen!

¡ESPERA!

Es posible que notes que algunas bolsas están fuera de servicio, así como piezas sobrantes, ¡pero está bien! ¡Estamos cambiando la forma en que construyes LEGO!

暫停!

你可能会注意到一些袋子顺序错乱, 以及一些剩余的部件, 但没关系! 我们正在改变你搭建乐高的方式!

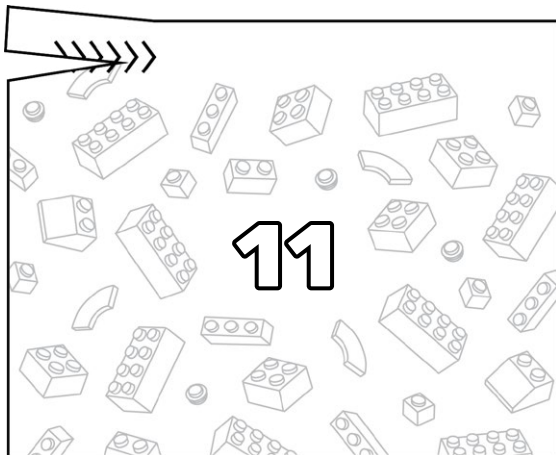
Open LEGO® Bag 11

208

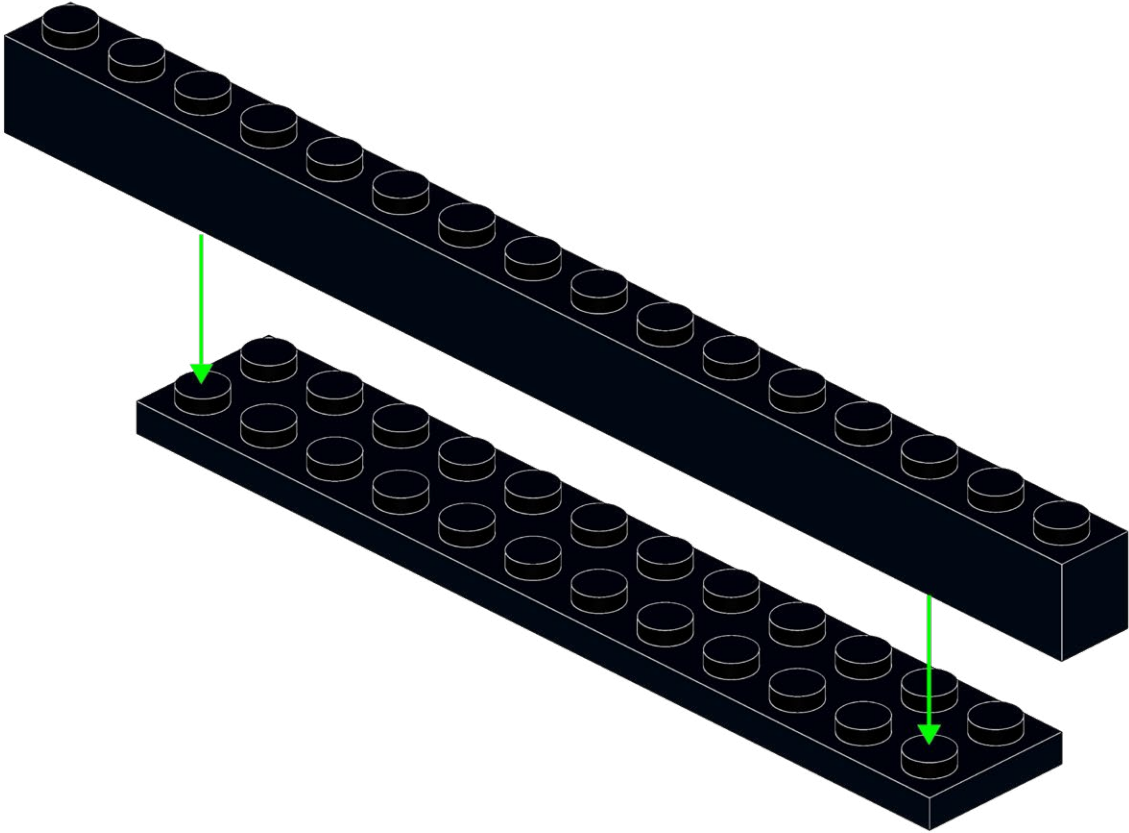
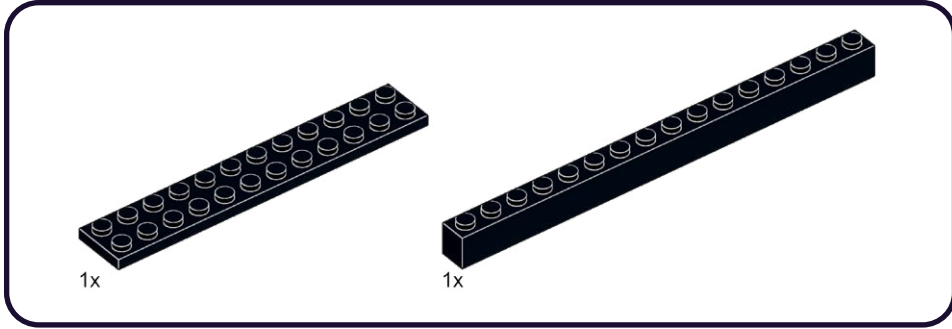

209

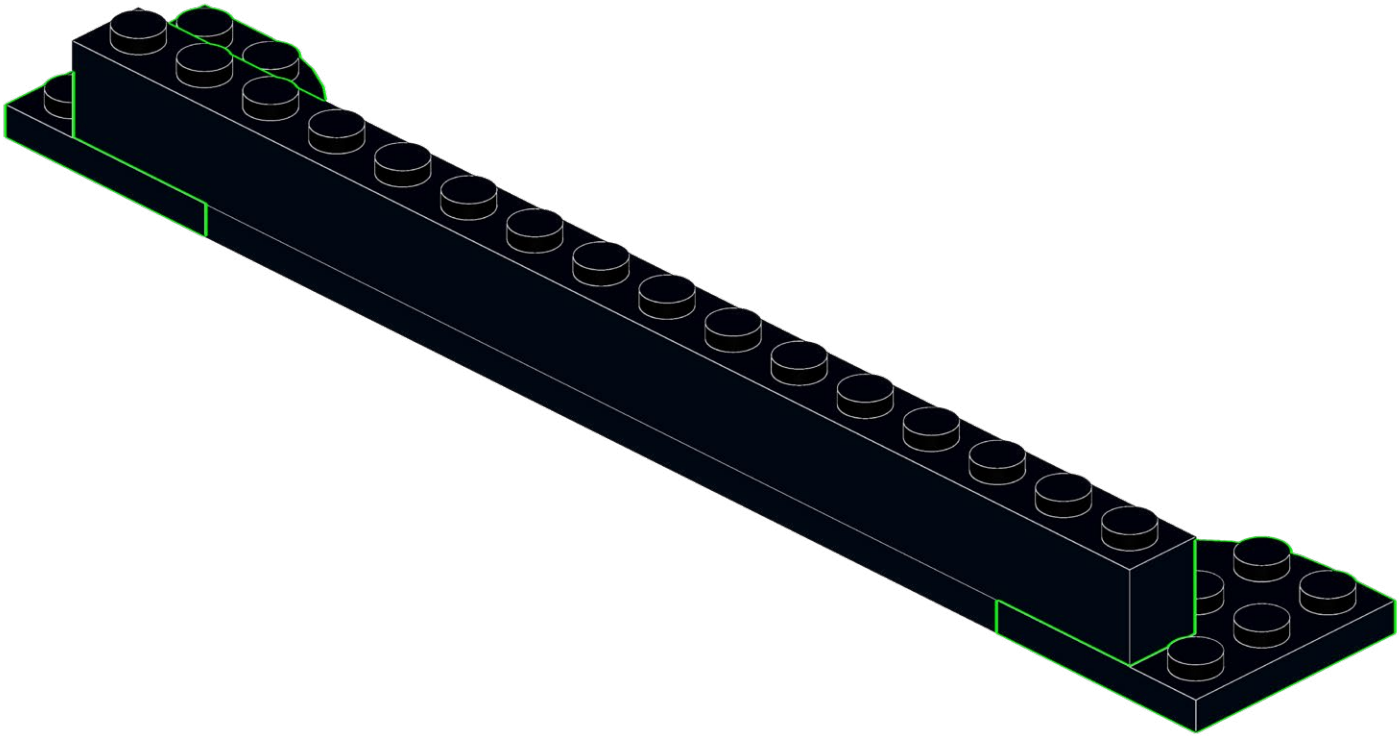
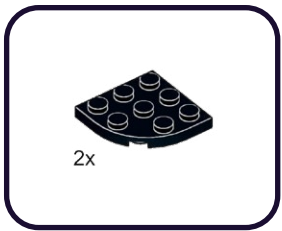

210

2x

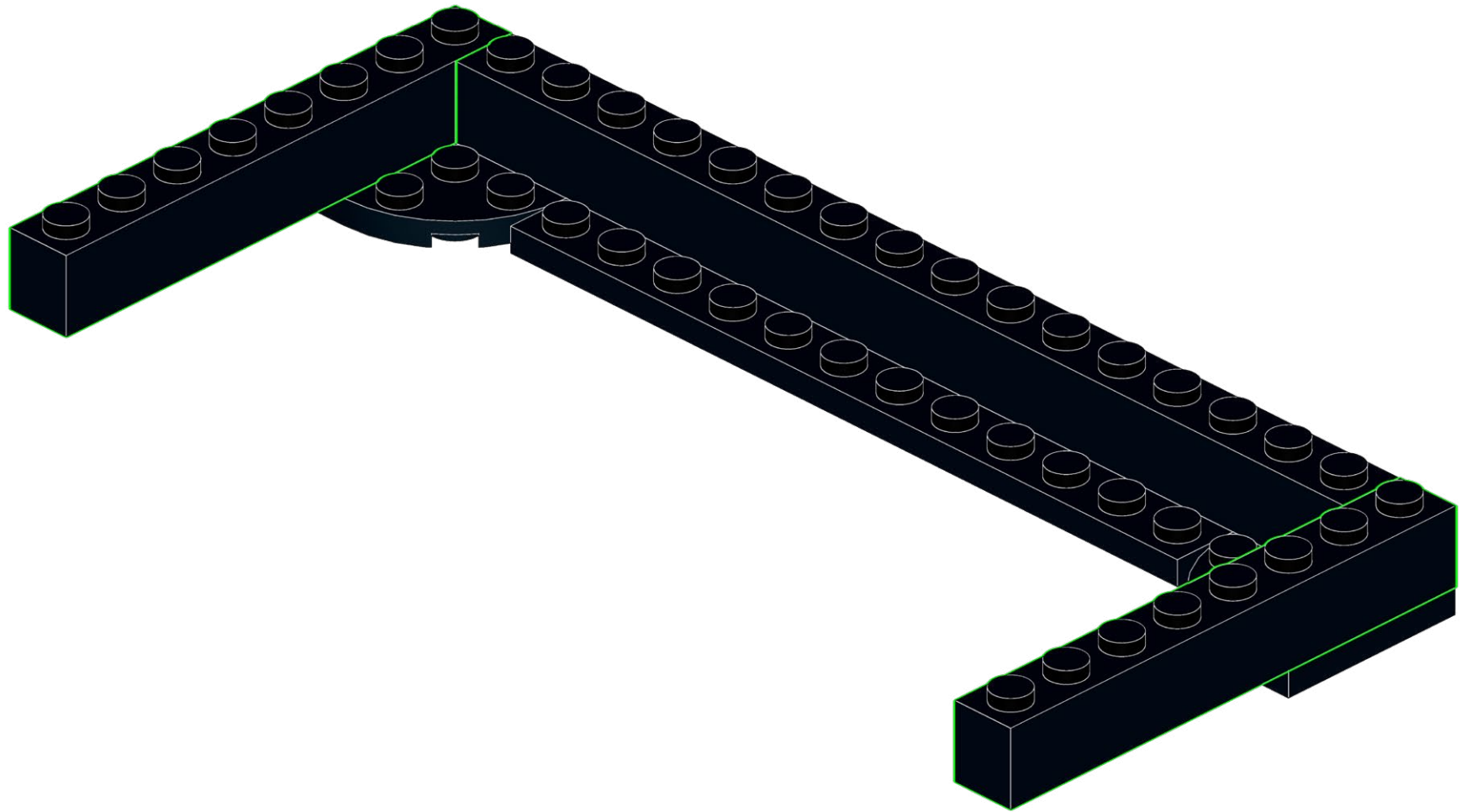

211

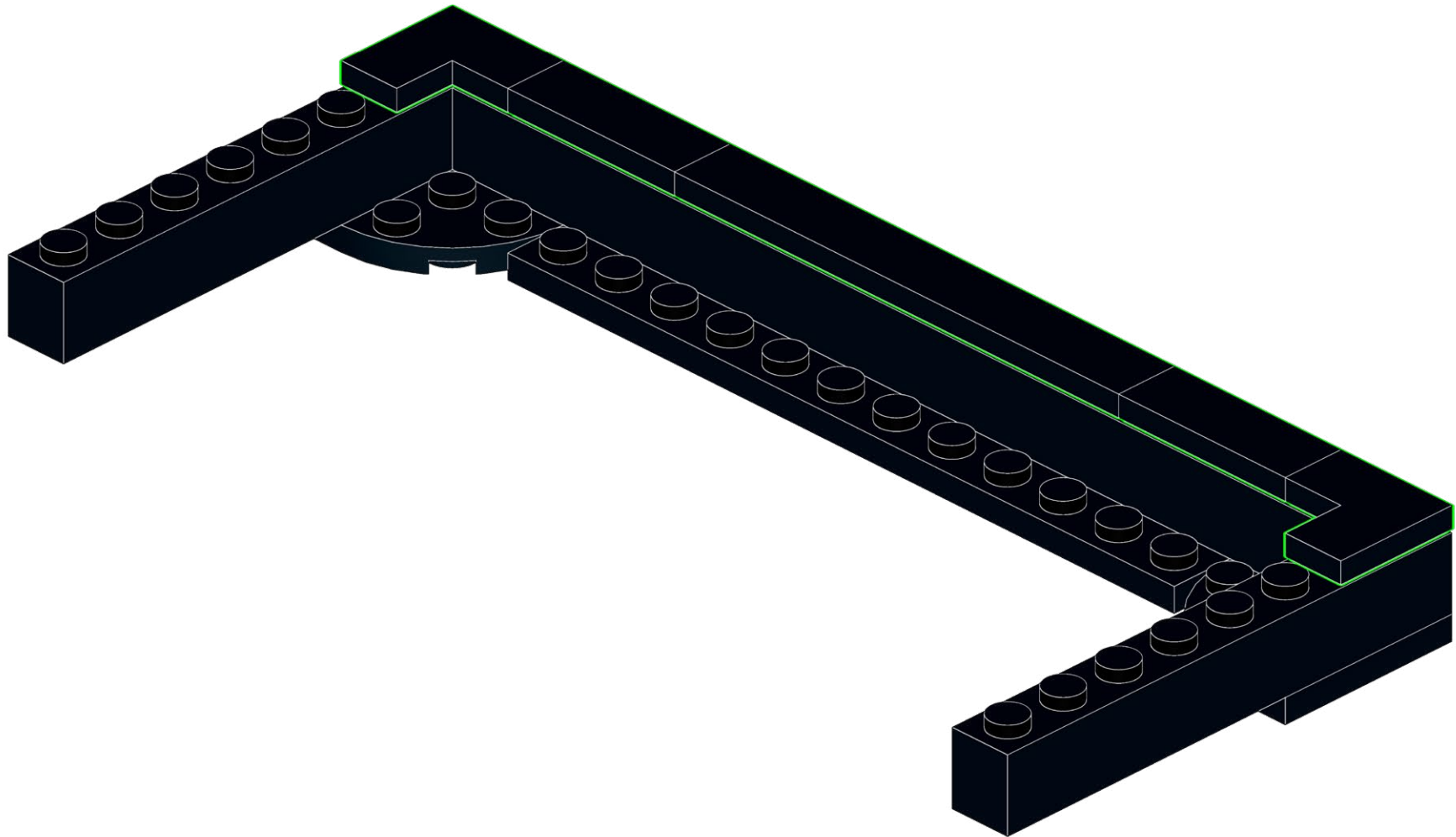
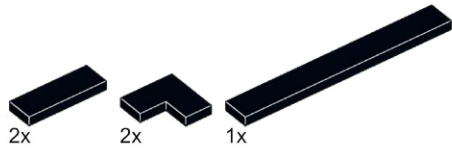

212



2x

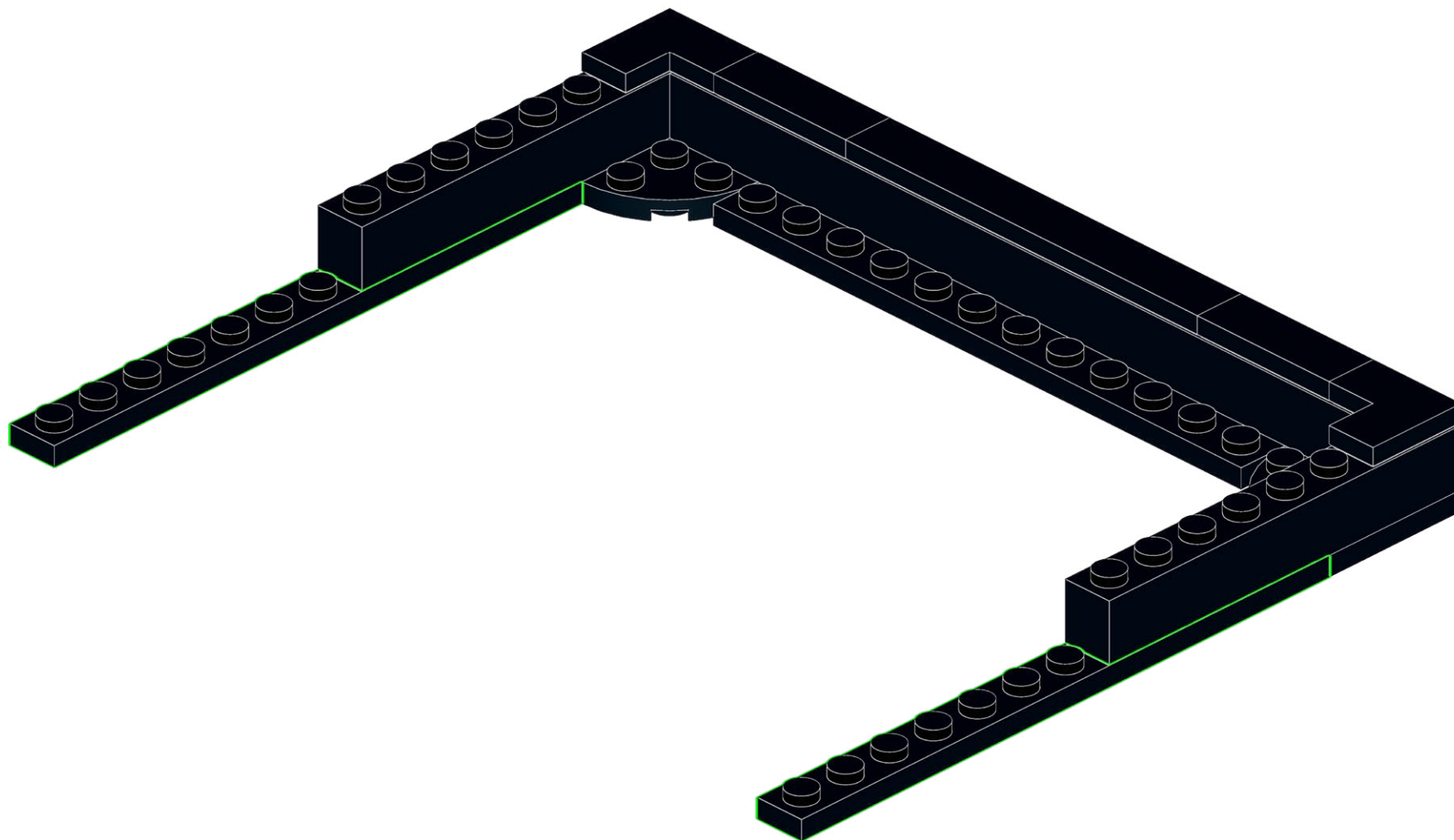

213

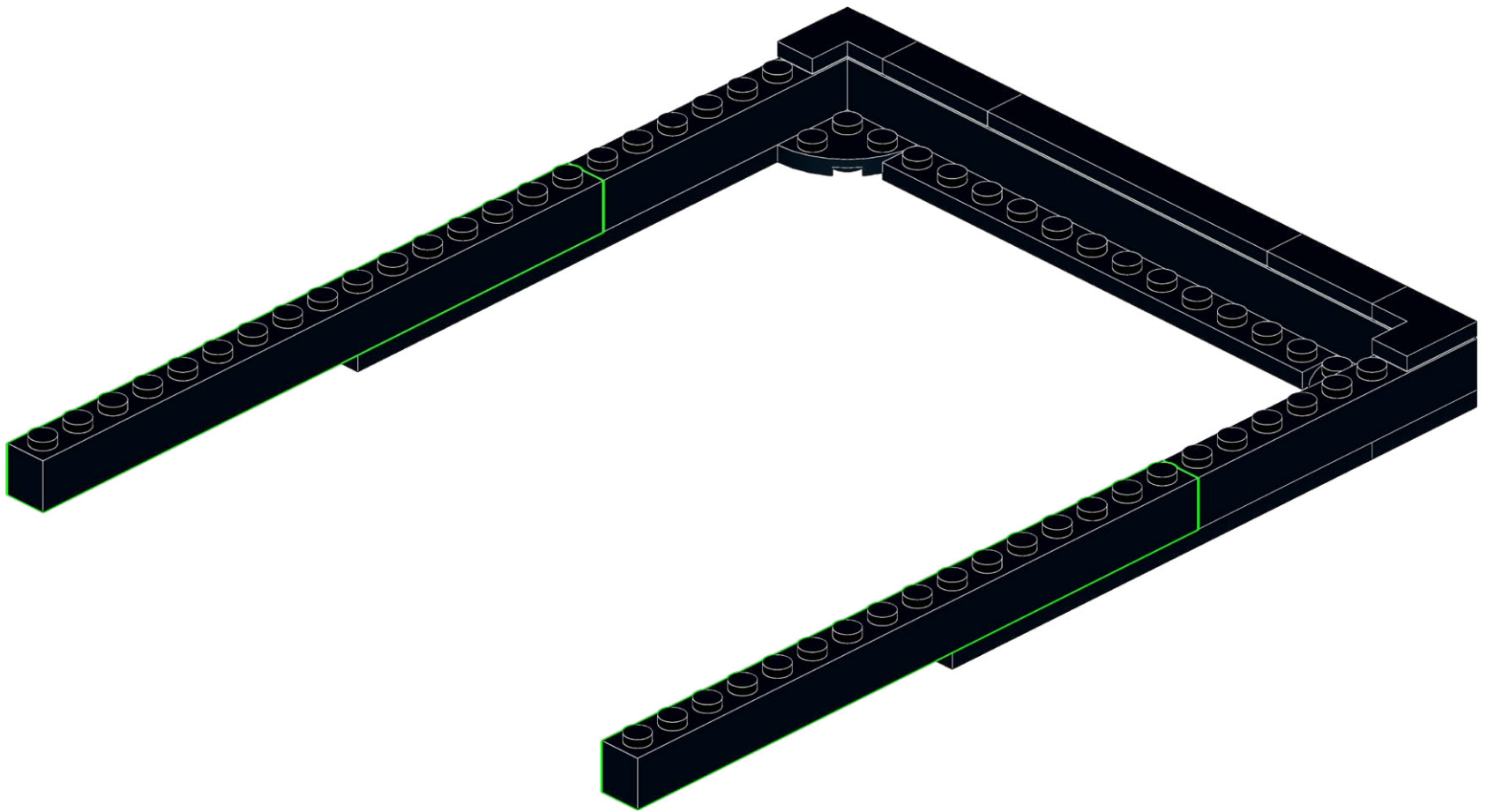
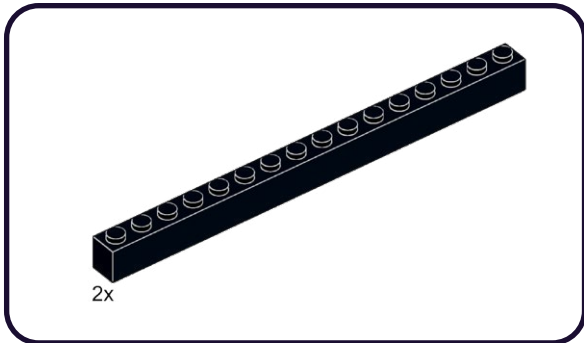

214

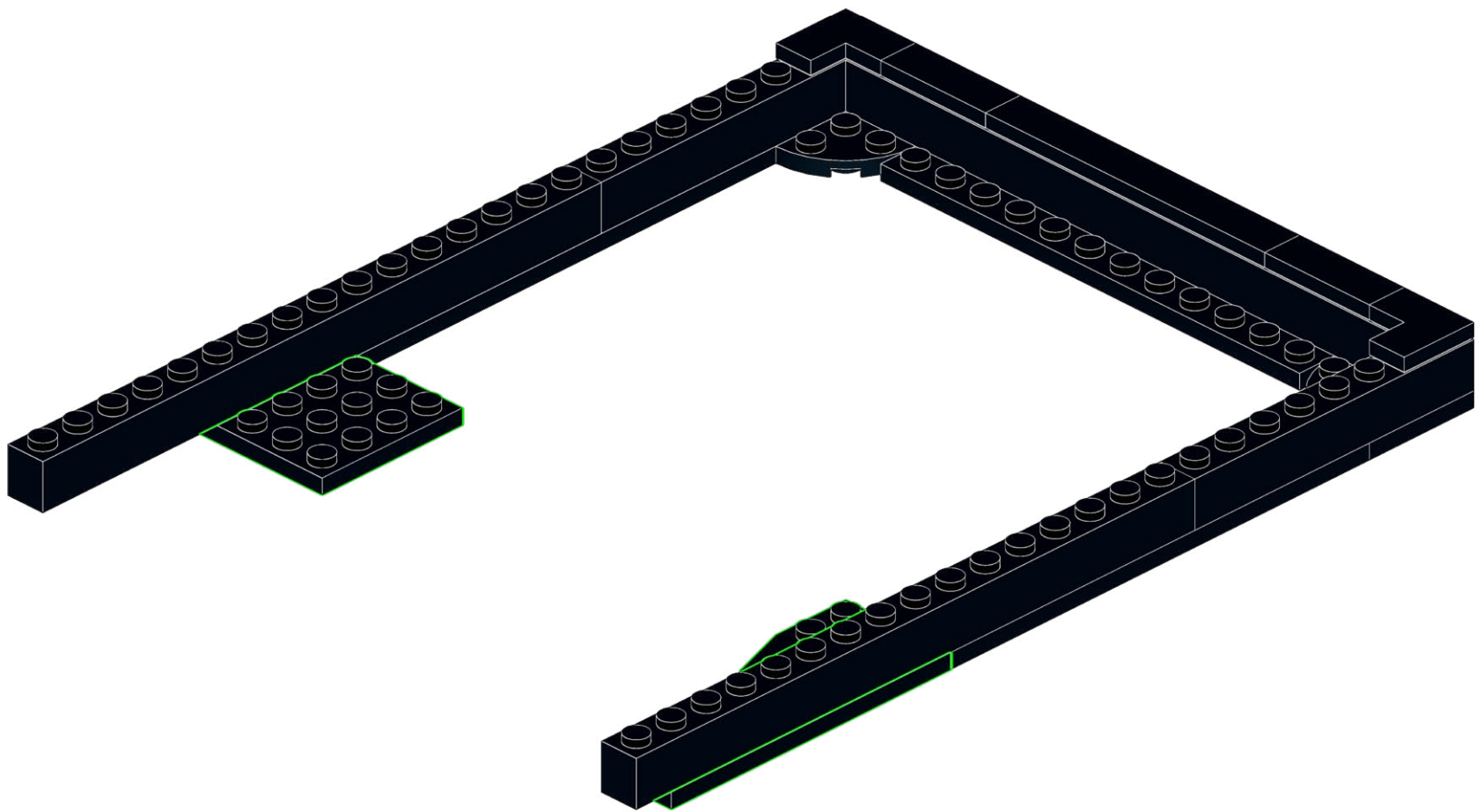
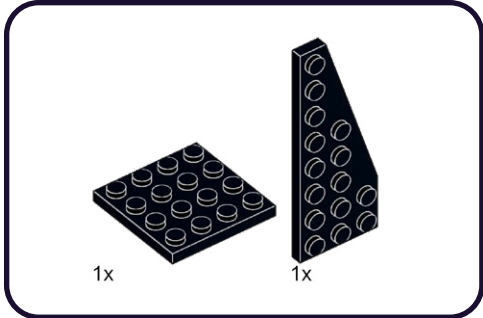

215

2x

4x

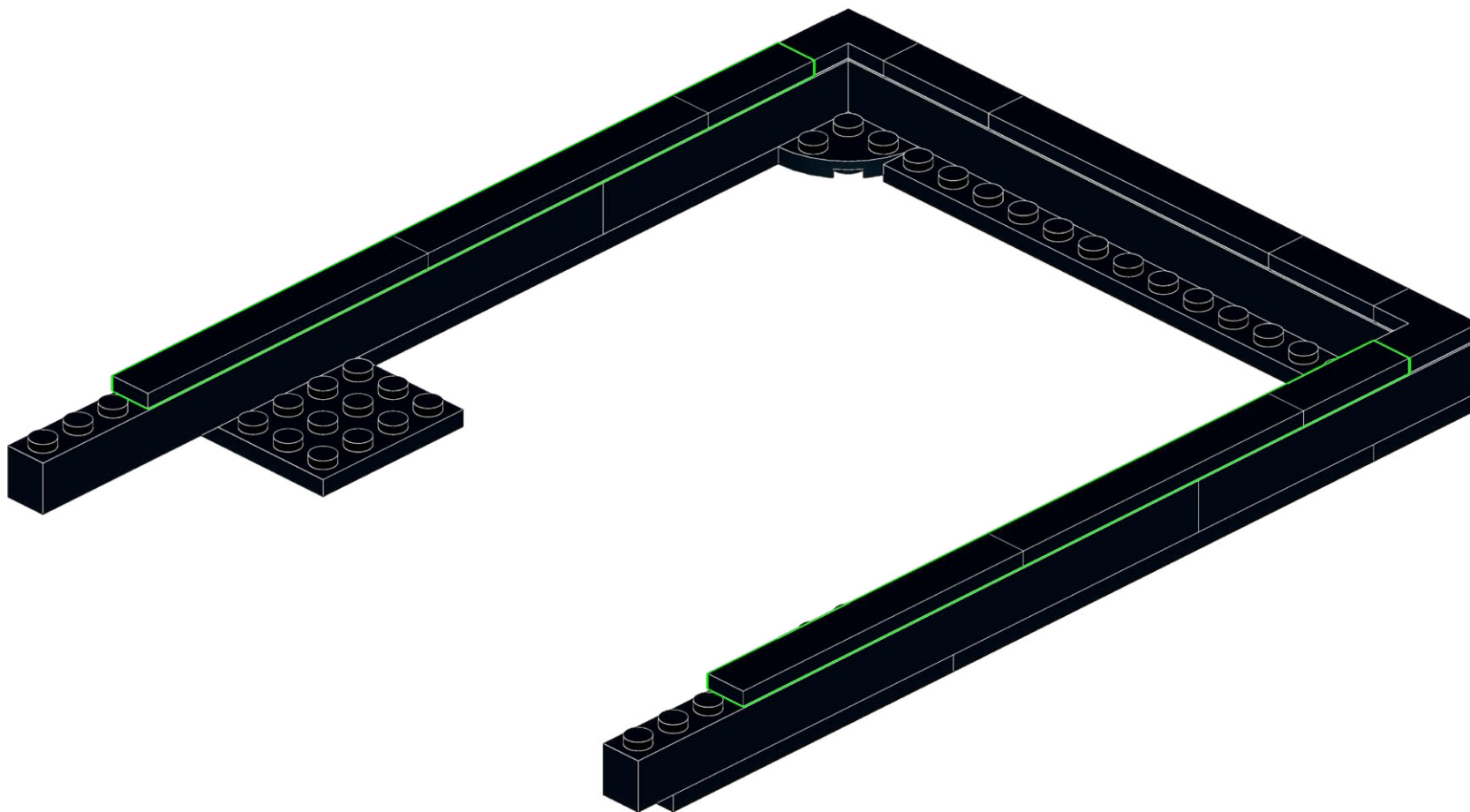

216

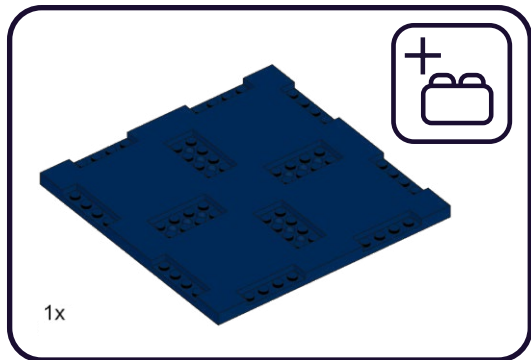

217

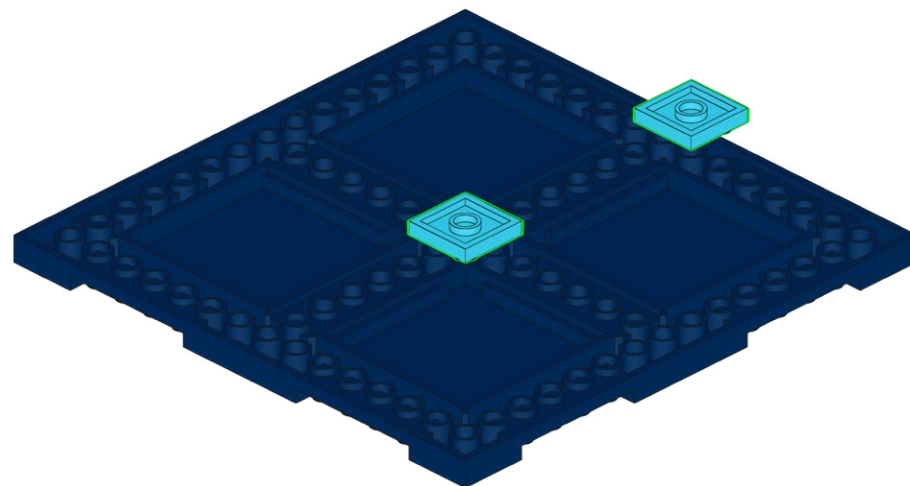
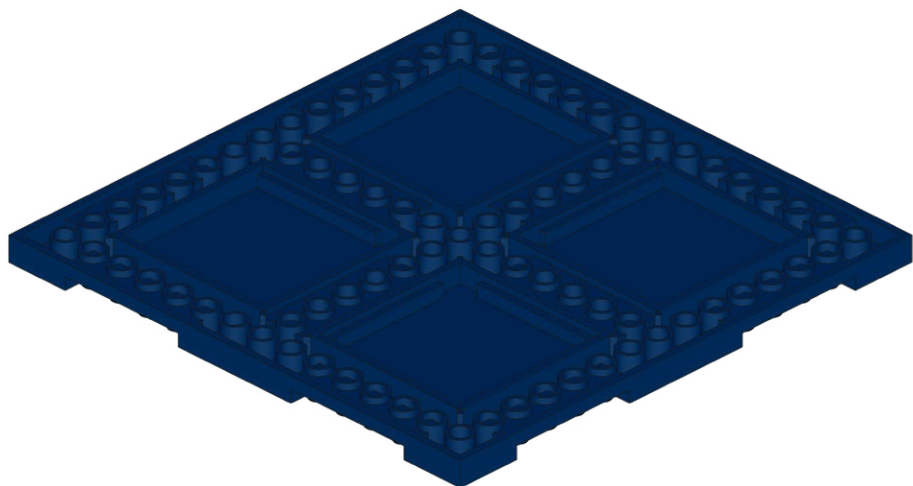
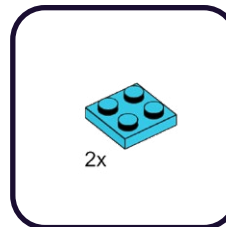

218

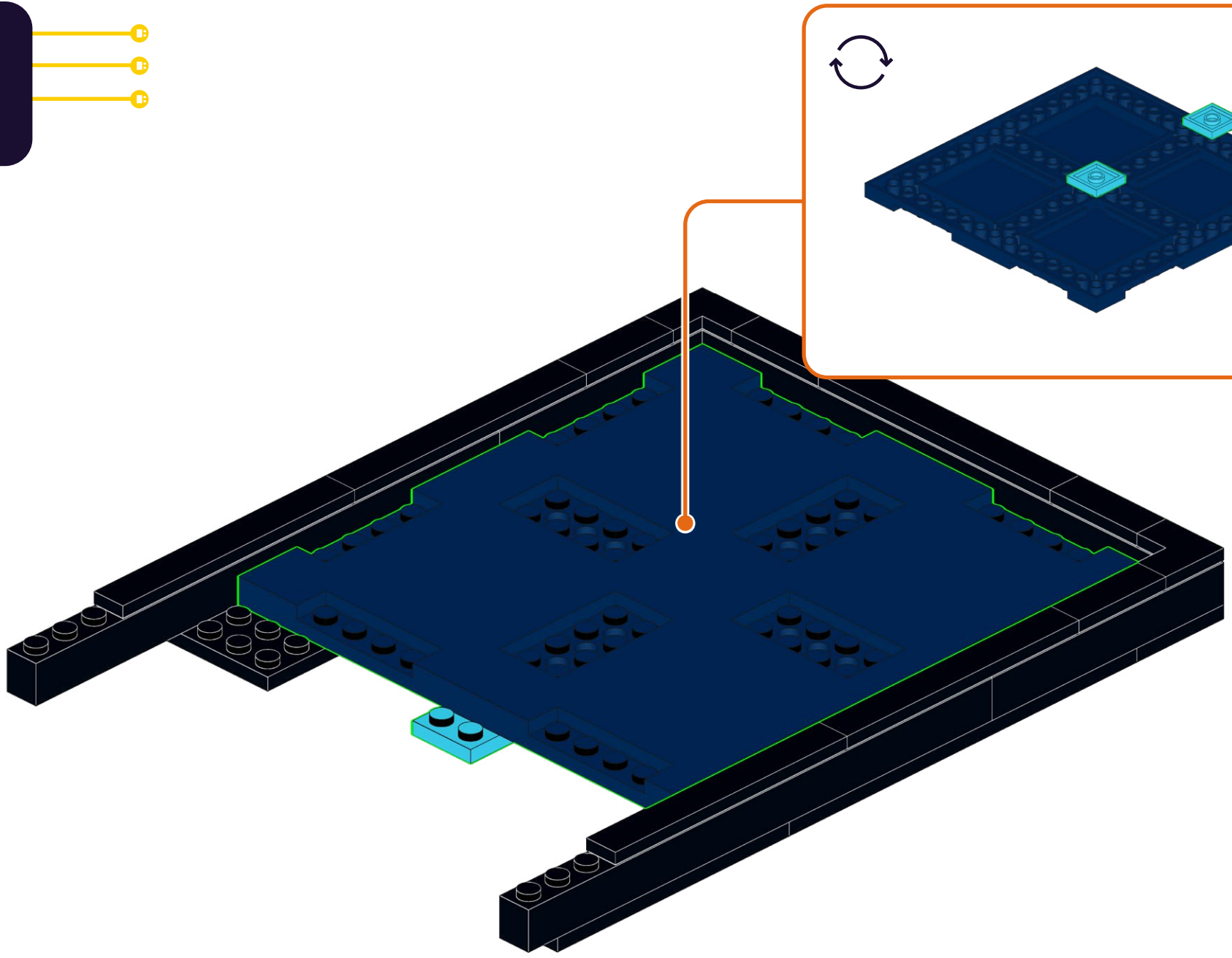
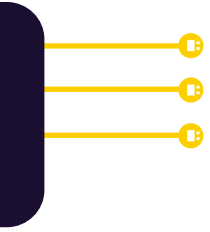

219

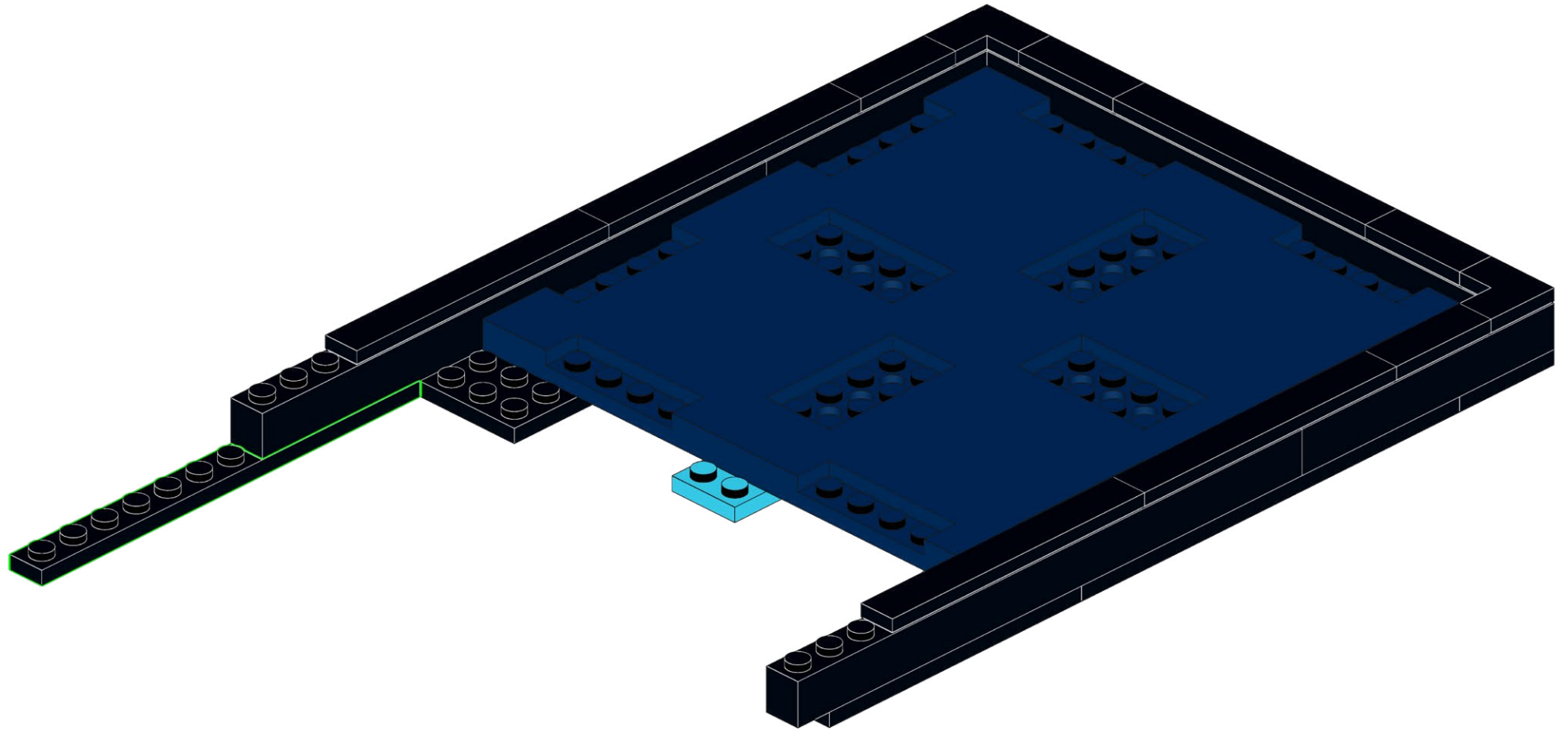
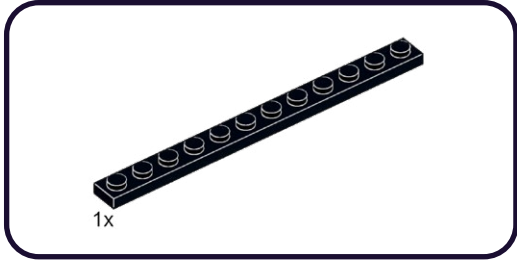

220

1x

2x

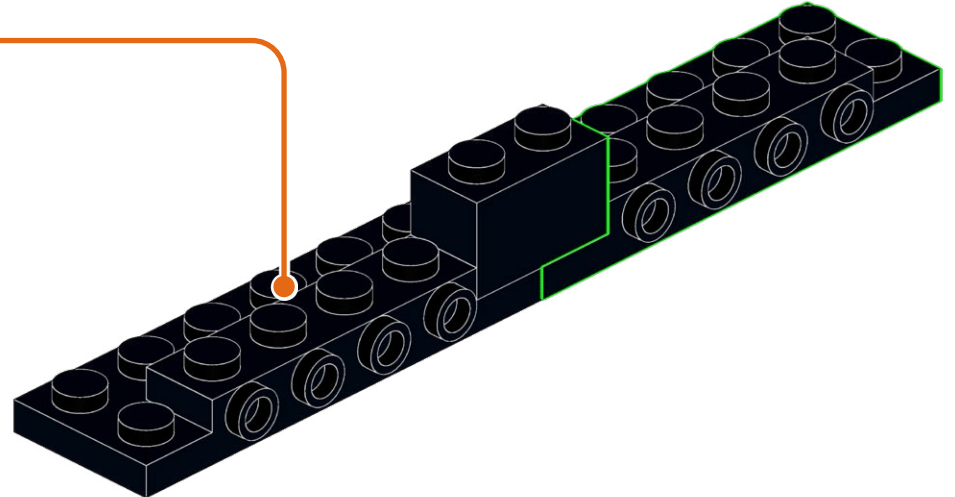
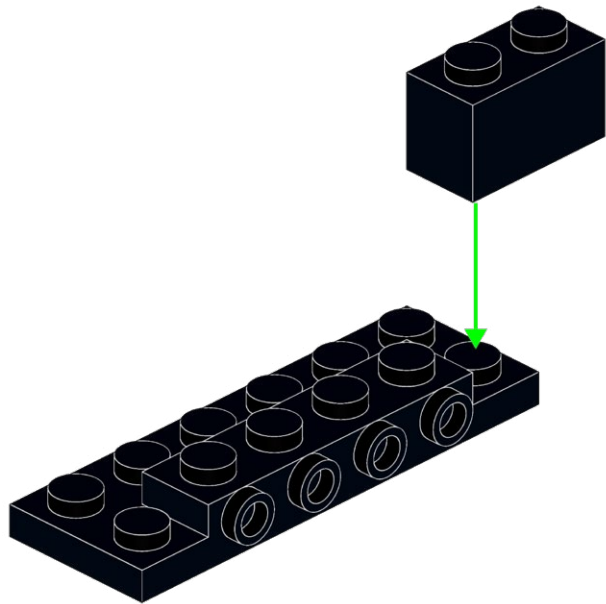

**HOLD UP!**

You might notice some bags aren't in order, as well as left over pieces, but that's ok! We're changing the way you build LEGO!

ATTENDEZ!

Vous remarquerez peut-être que certains sacs, ainsi que certaines pièces, ne sont pas dans le bon ordre. Mais pas de panique! Nous changeons simplement la façon avec laquelle vous construisez vos LEGO!

ASPETTA!

Potresti notare che alcuni sacchetti non sono in ordine, così come i pezzi avanzati, ma va bene così! Stiamo cambiando il modo in cui costruisci i LEGO!

HALT!

Sie werden möglicherweise bemerken, dass einige tüten durcheinander sind und teile übrig bleiben, aber das ist in Ordnung! Wir ändern die art und weise, wie Sie LEGO bauen!

¡ESPERA!

Es posible que notes que algunas bolsas están fuera de servicio, así como piezas sobrantes, ¡pero está bien! ¡Estamos cambiando la forma en que construyes LEGO!

暫停!

你可能会注意到一些袋子顺序错乱, 以及一些剩余的部件, 但没关系! 我们正在改变你搭建乐高的方式!

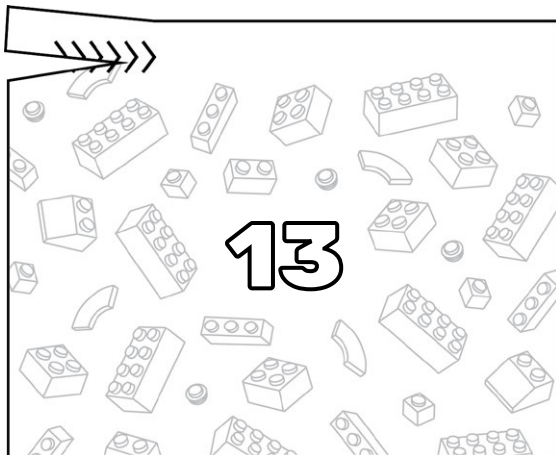
Open LEGO® Bag 13

221

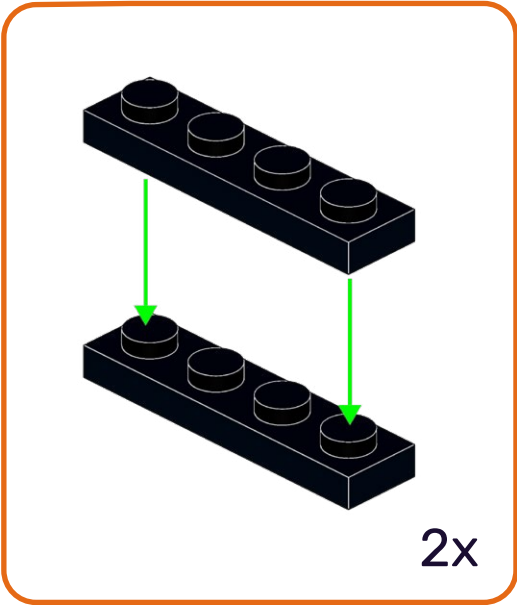
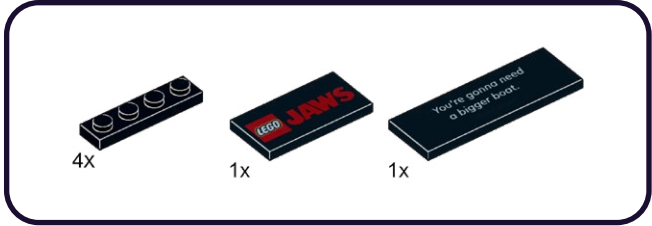

1

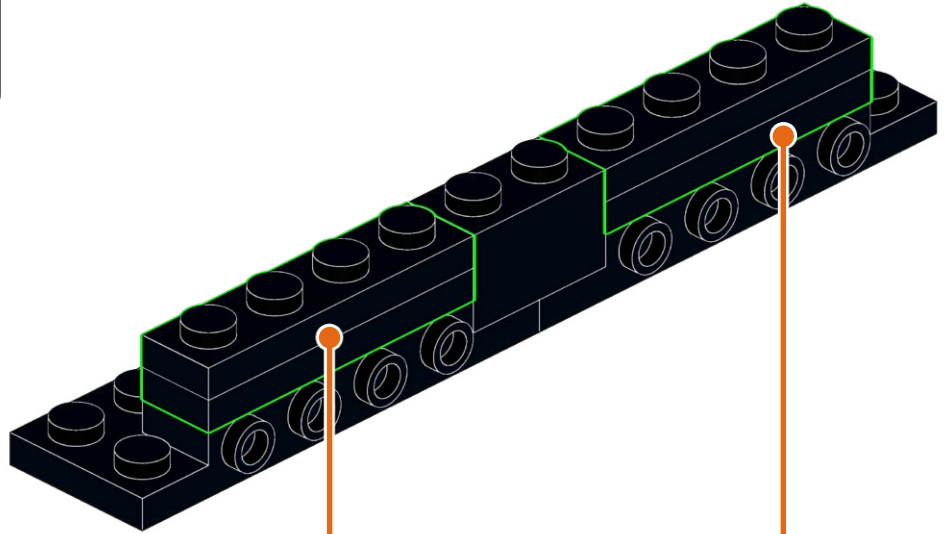

2



222

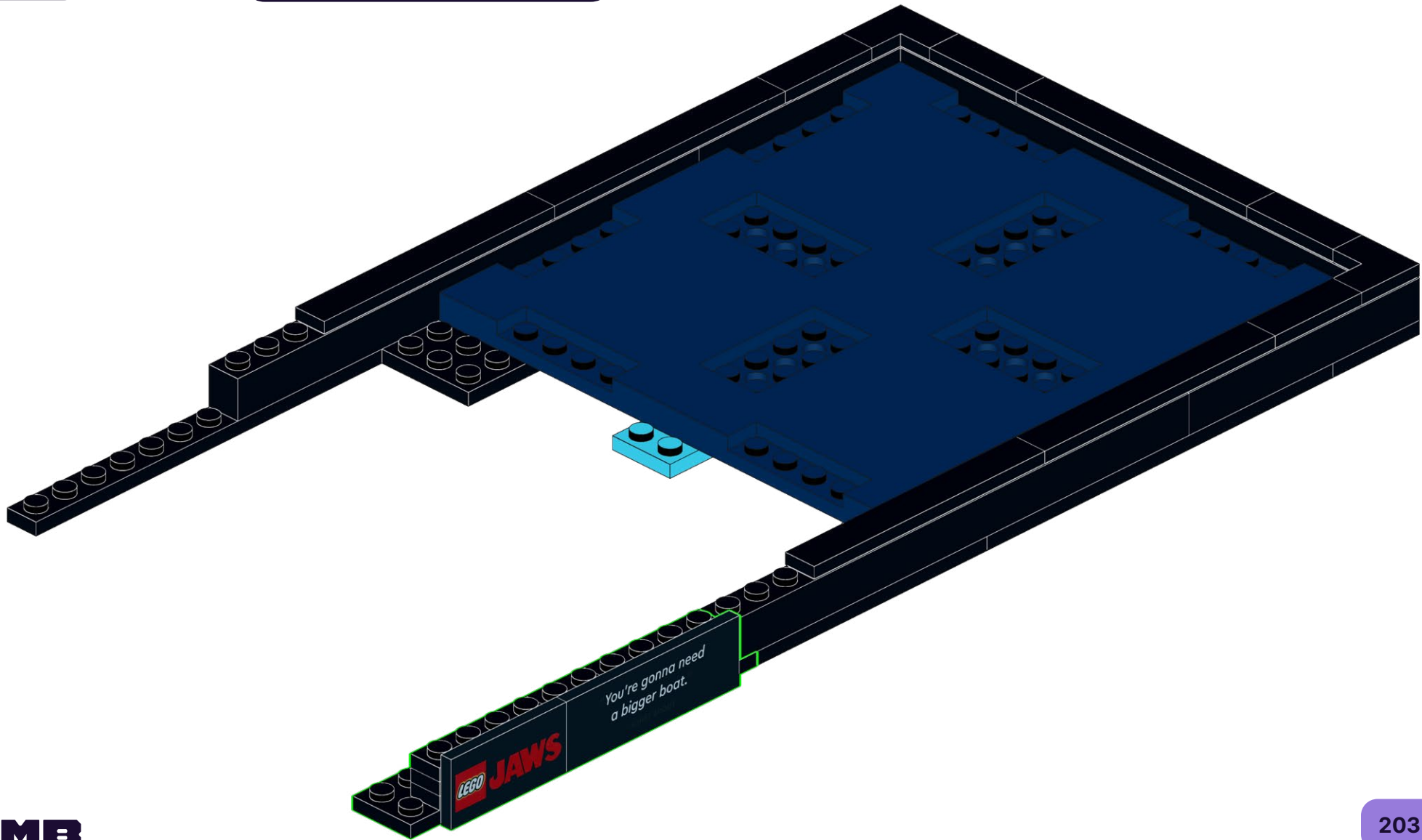
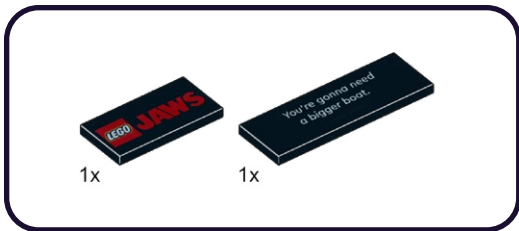

223

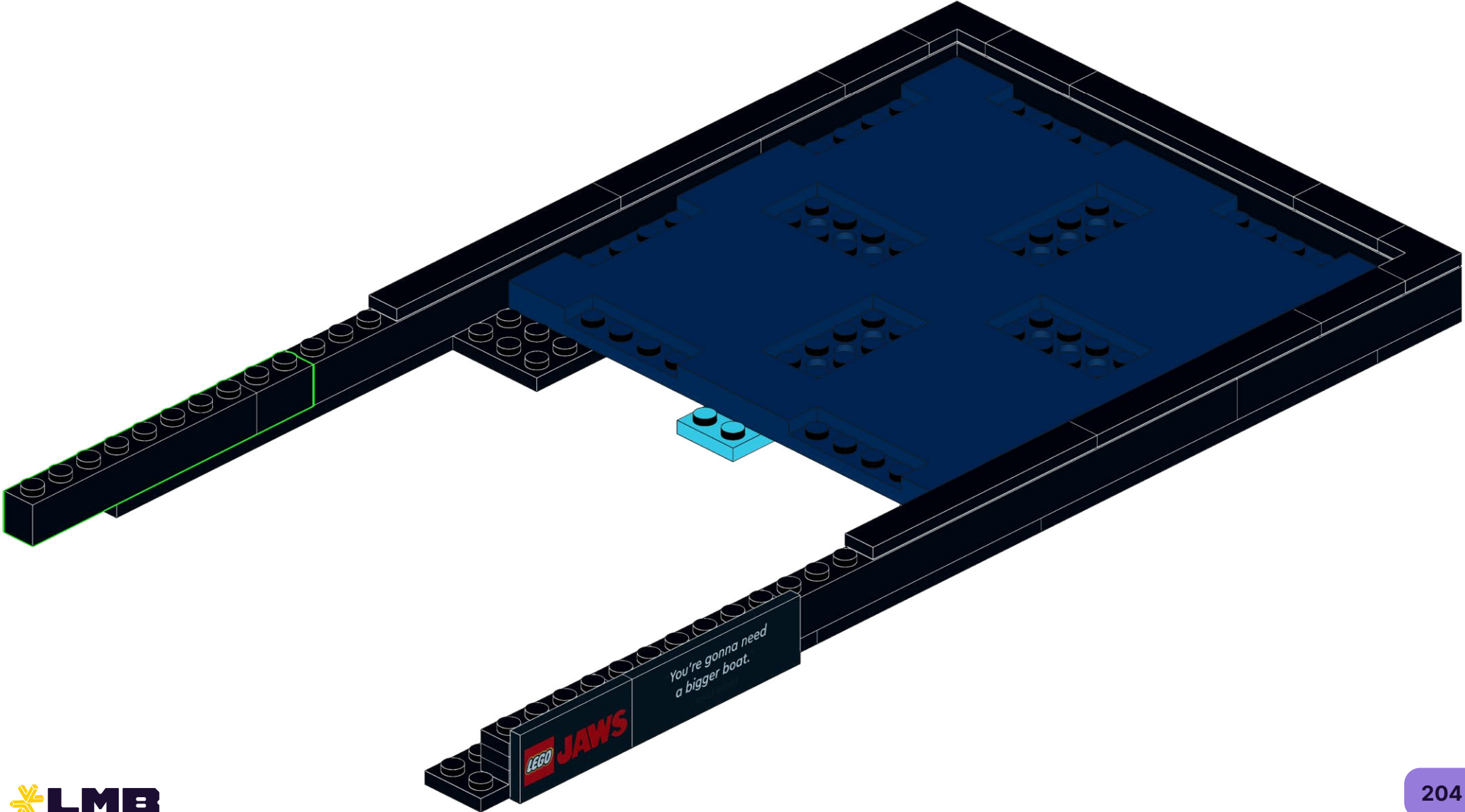
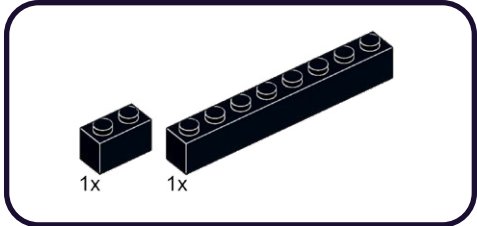

224

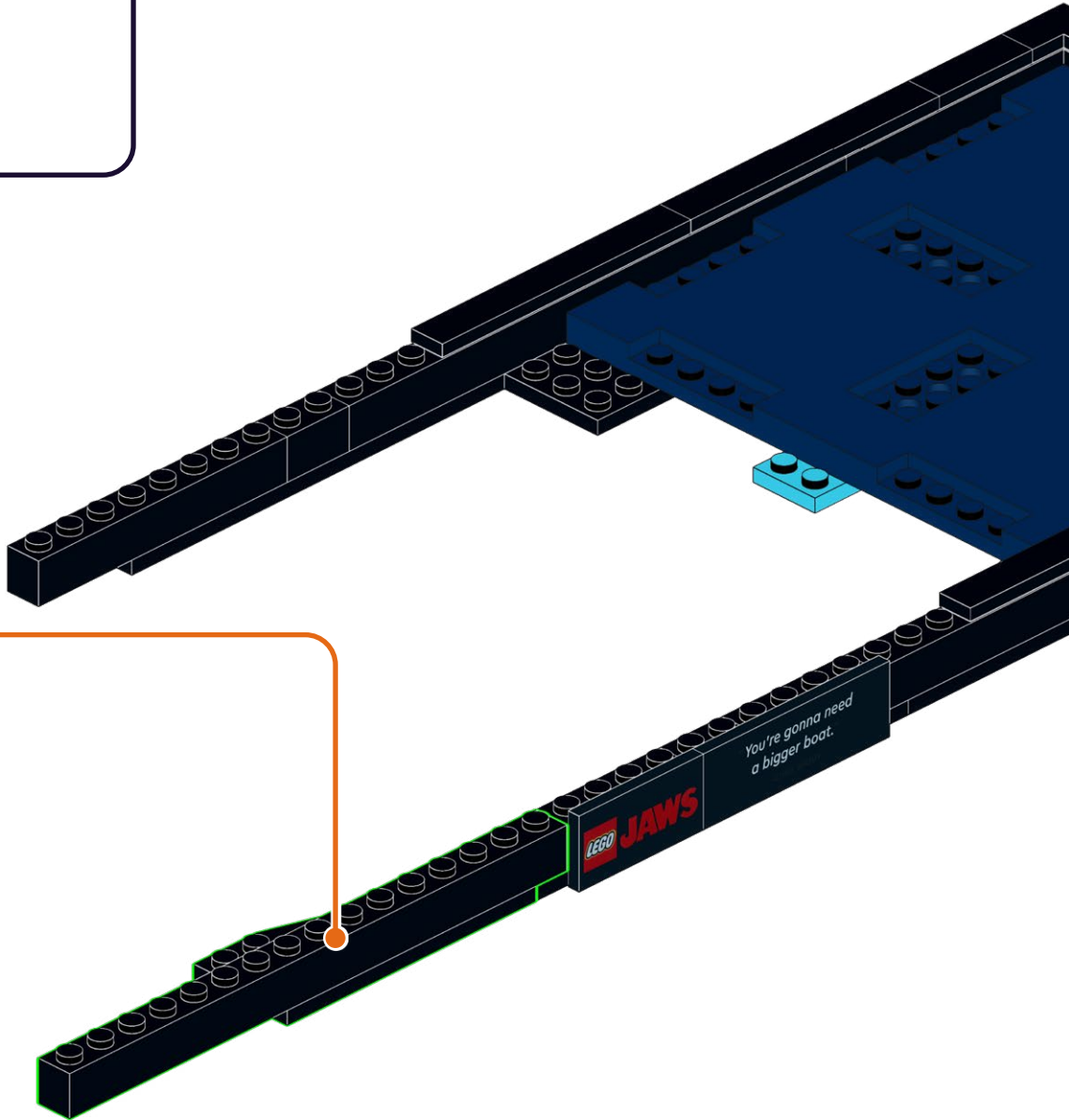
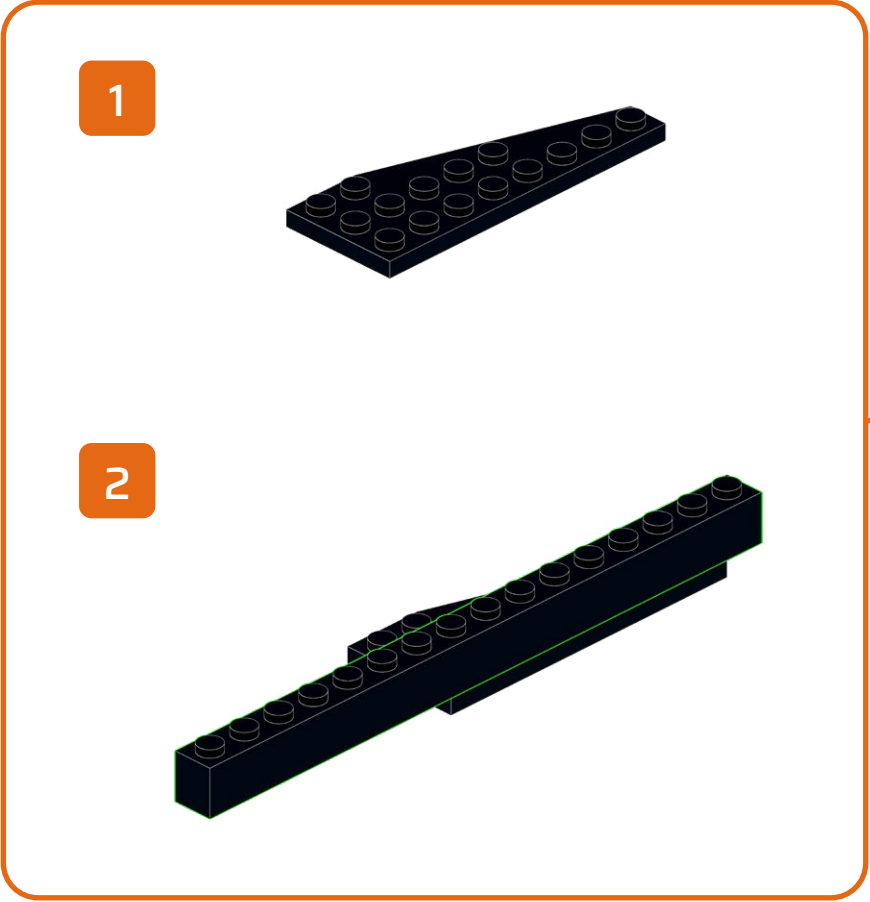
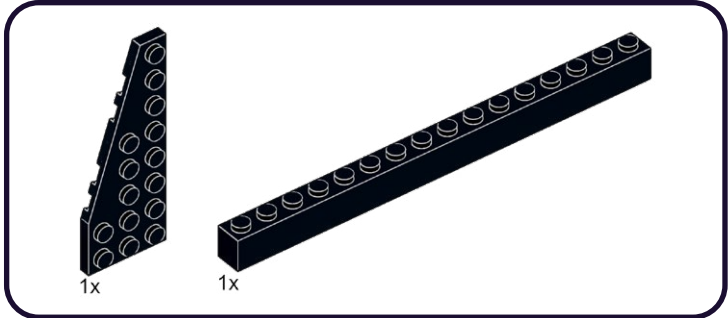

225

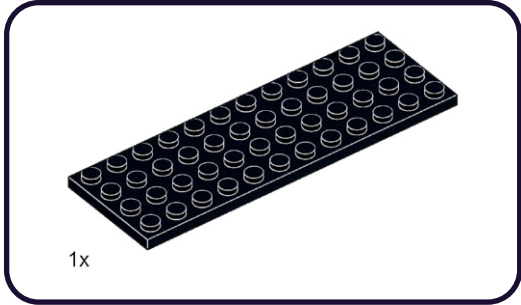

226

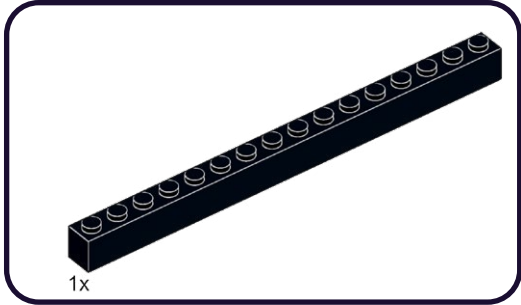

227

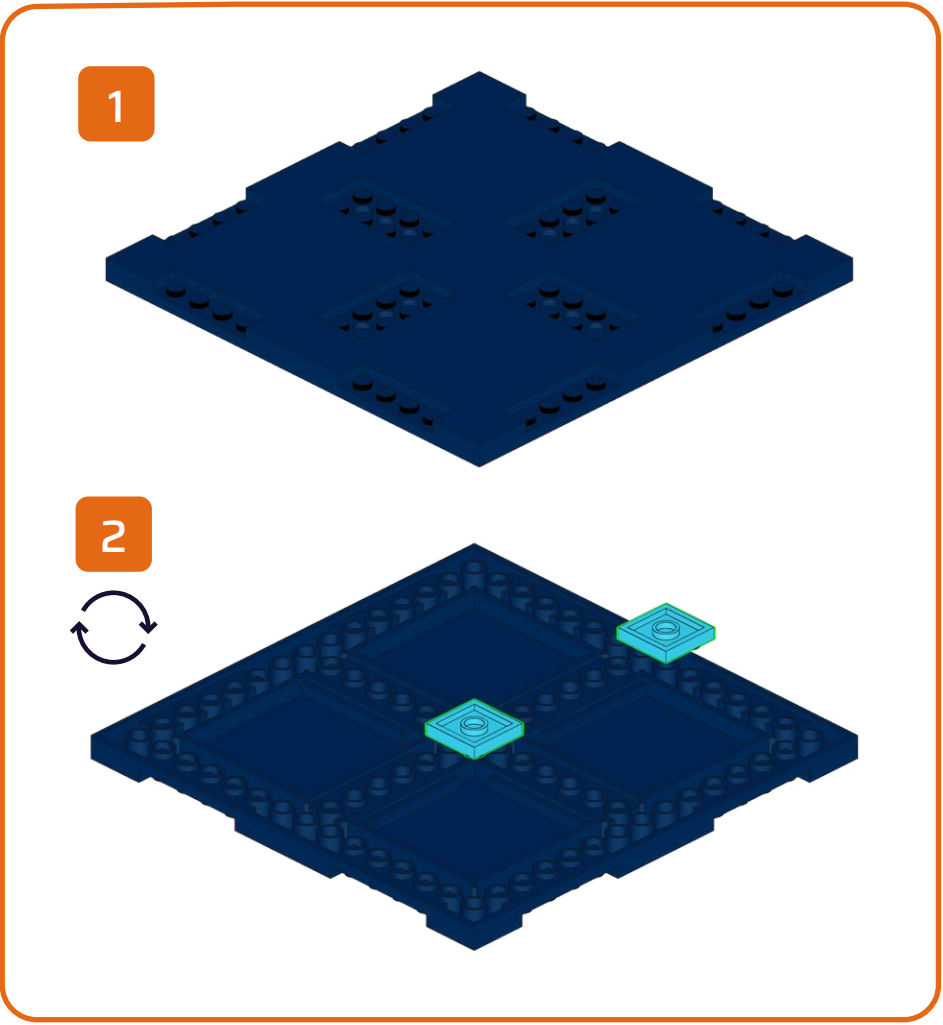
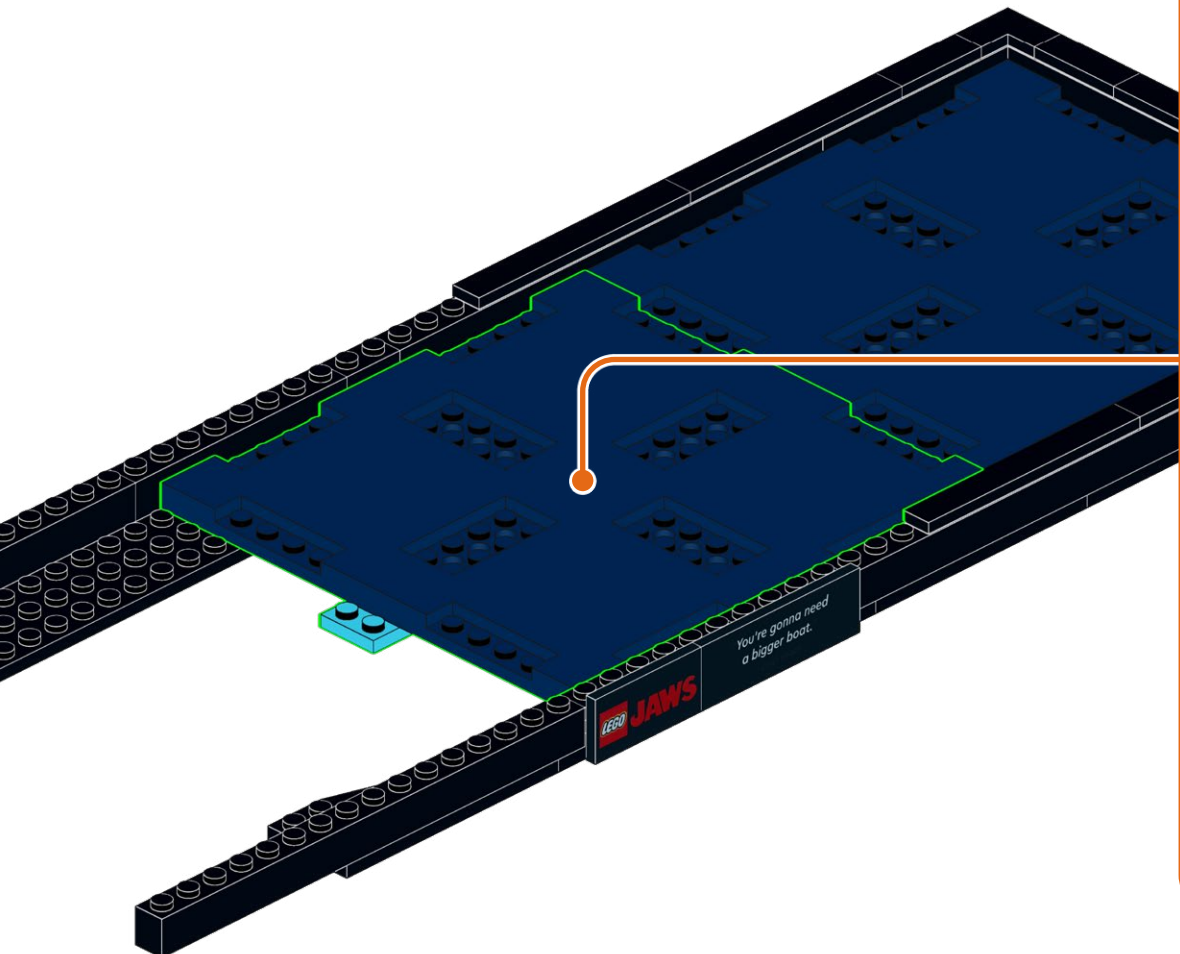
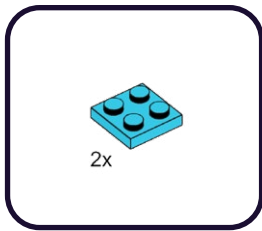
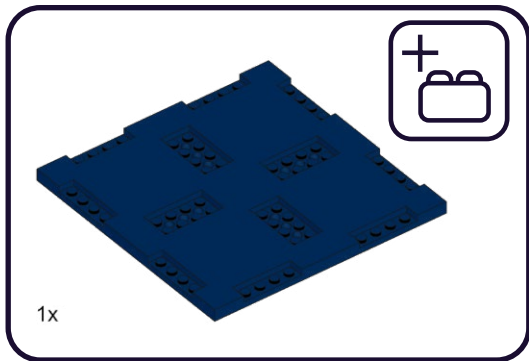

228

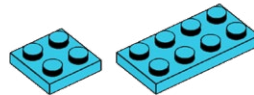

1x

1x

1

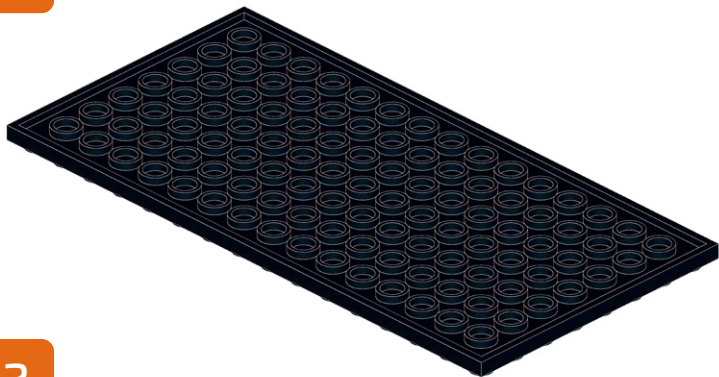

2

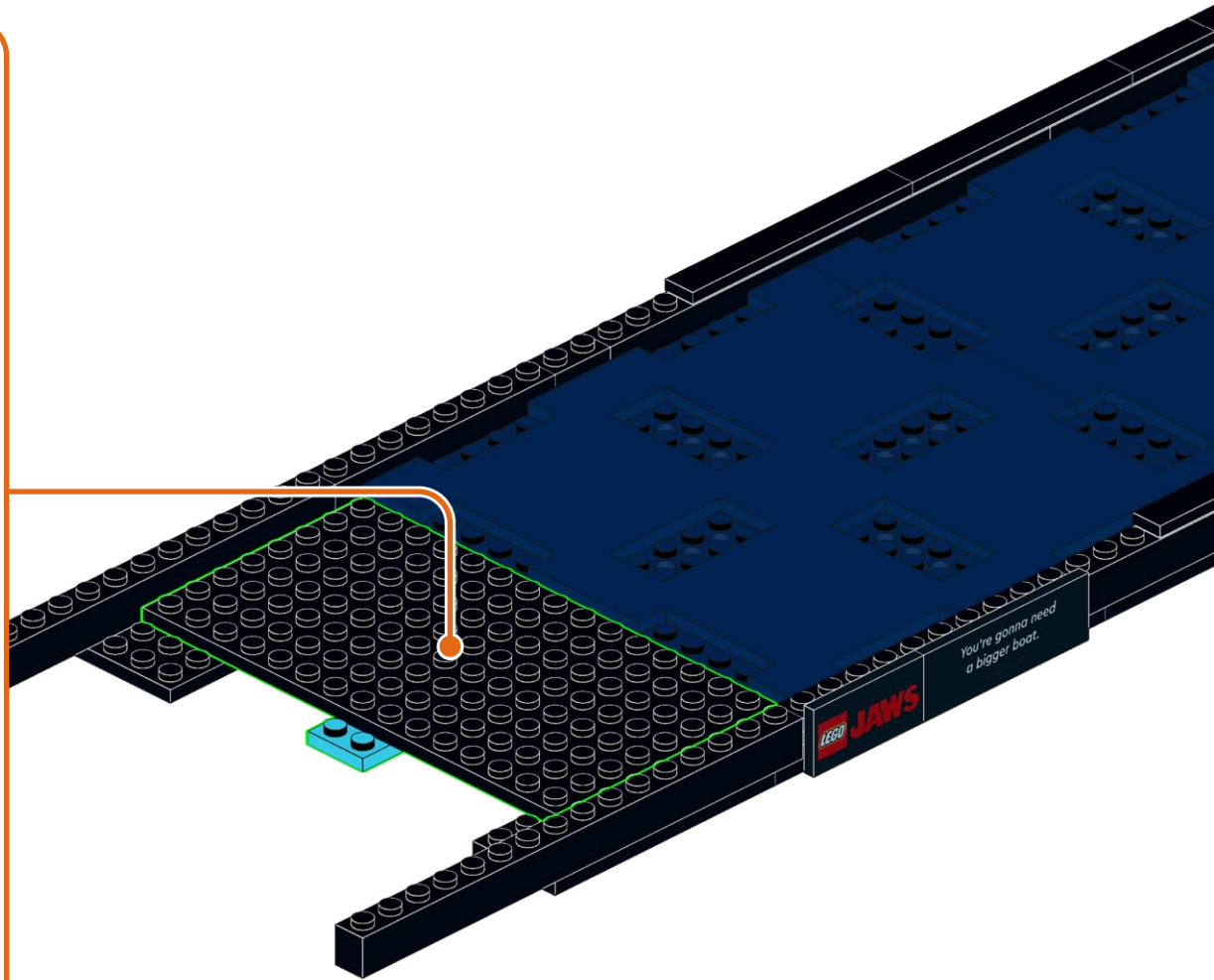
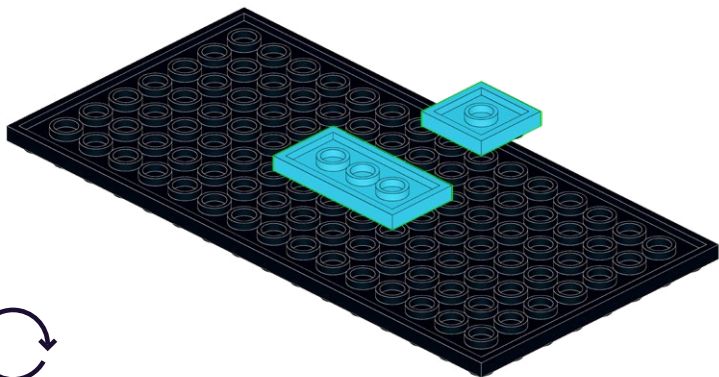

229

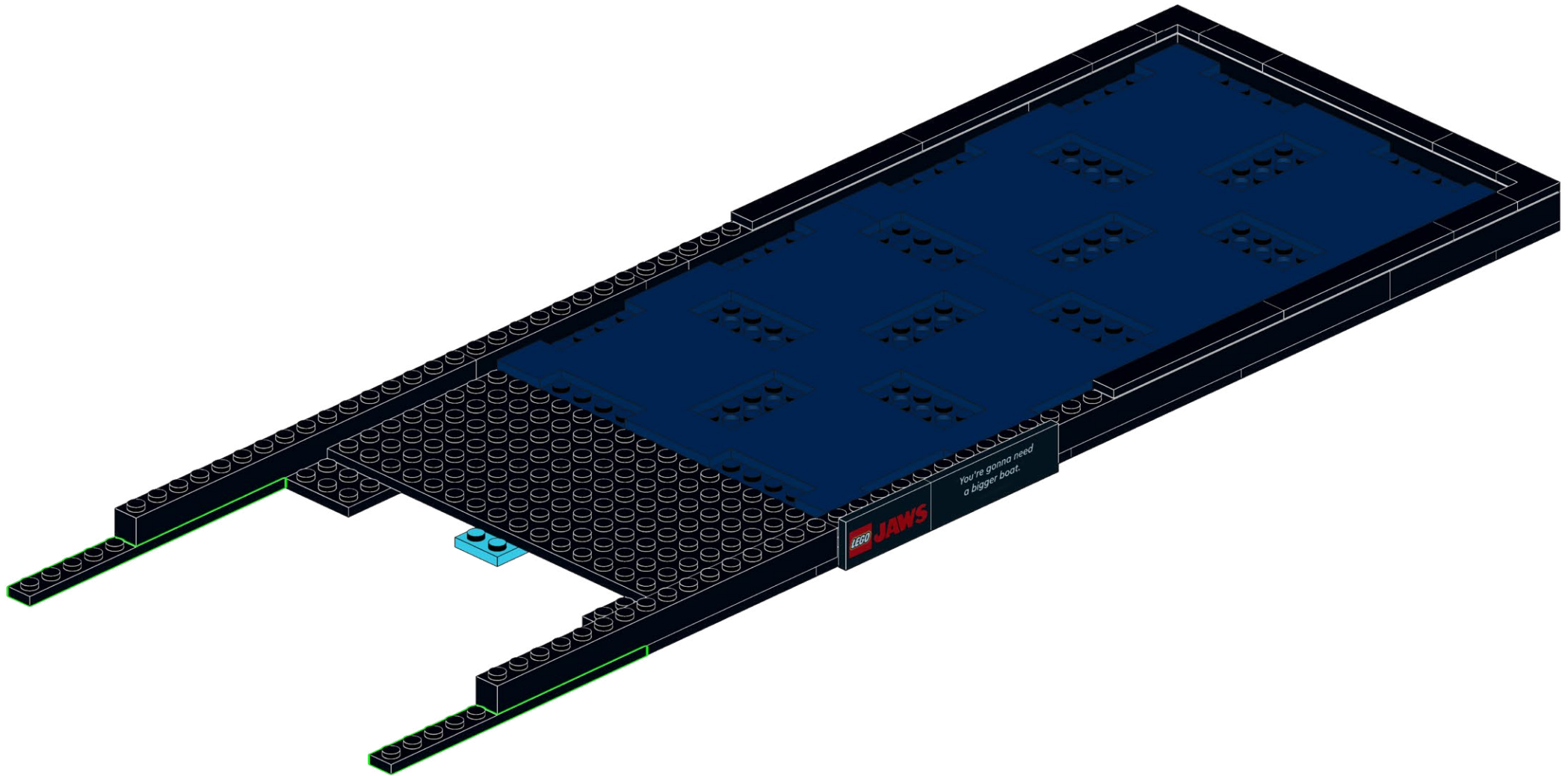
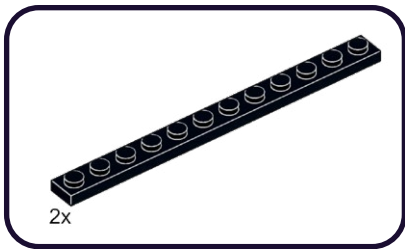

230

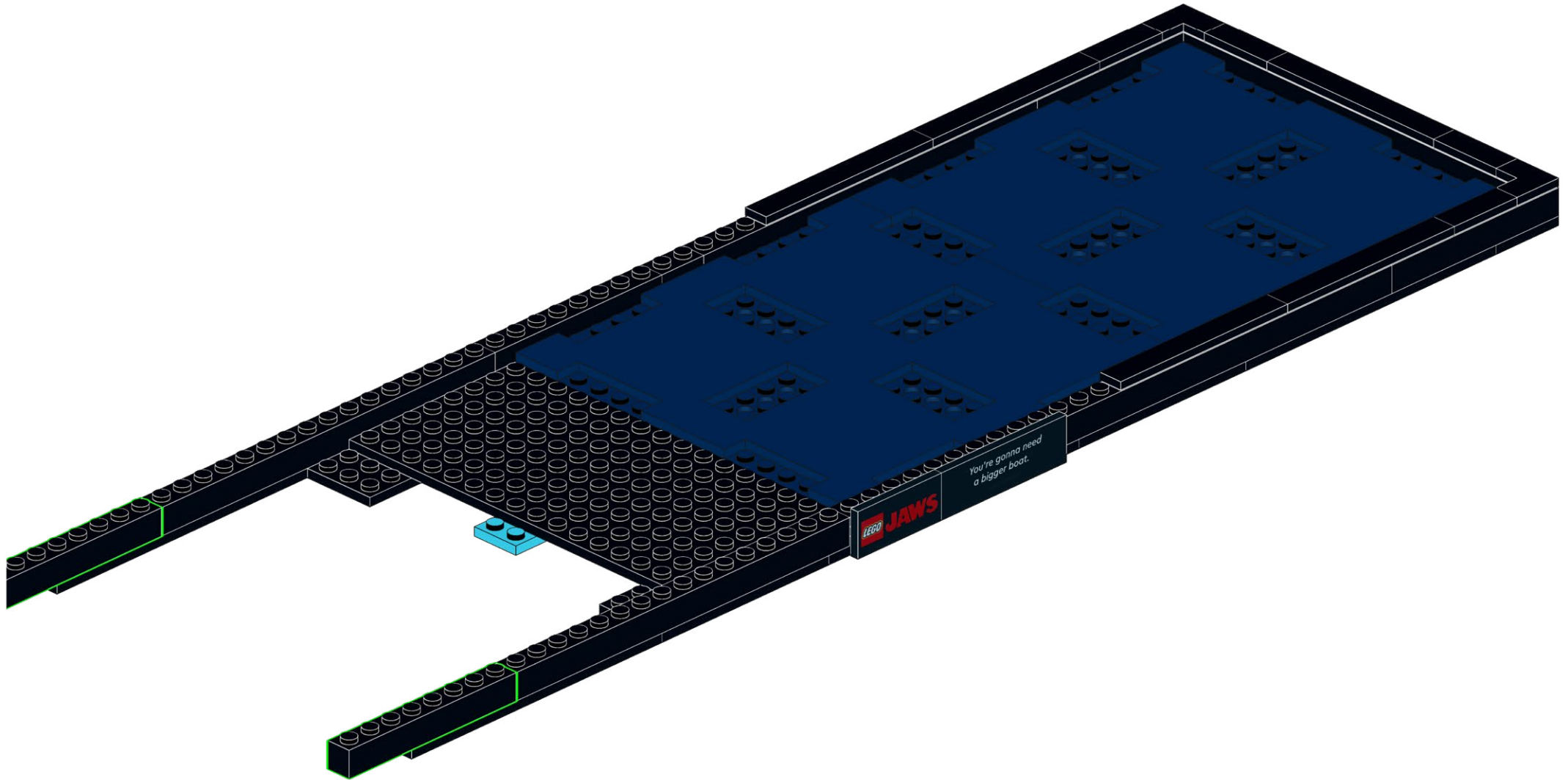
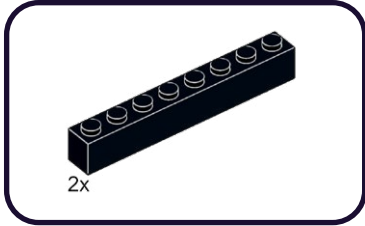

231

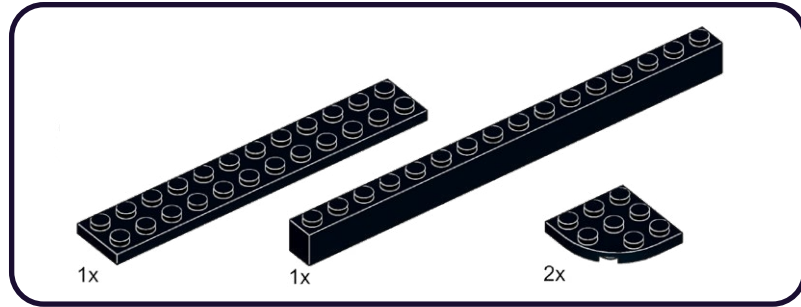

1

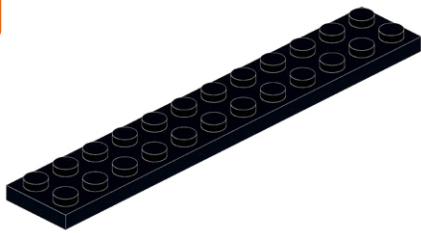

2

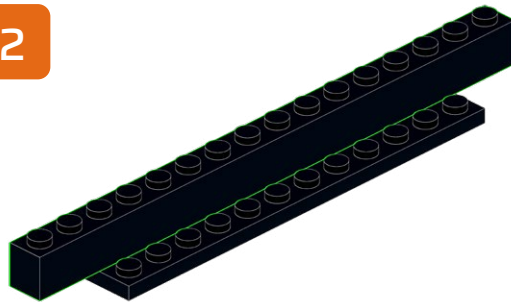

3

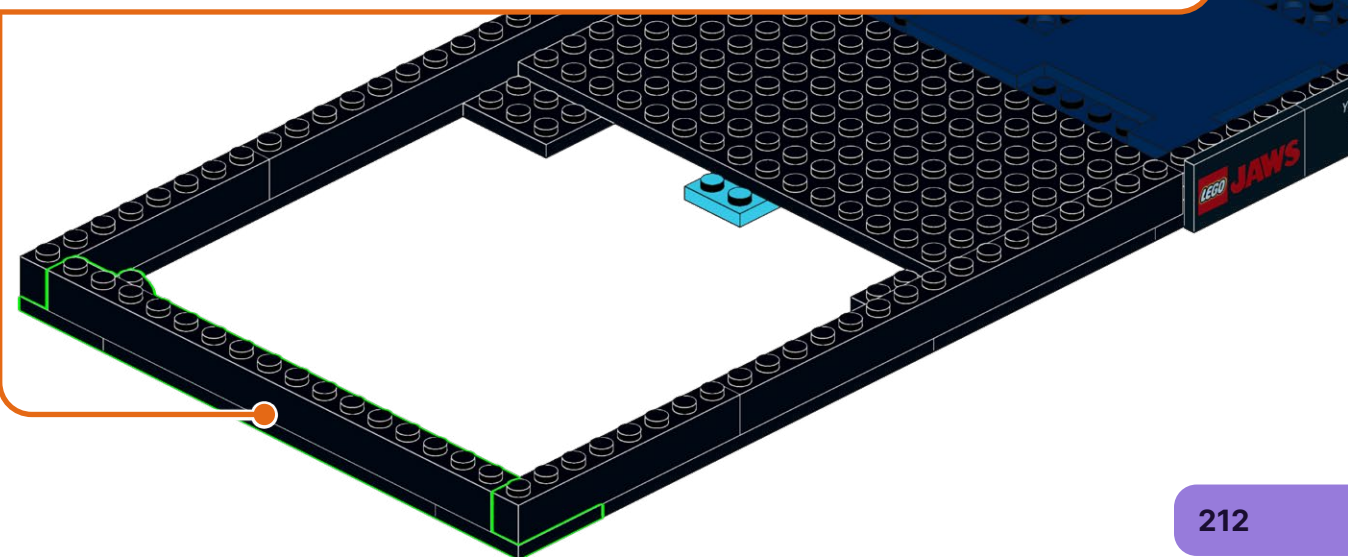
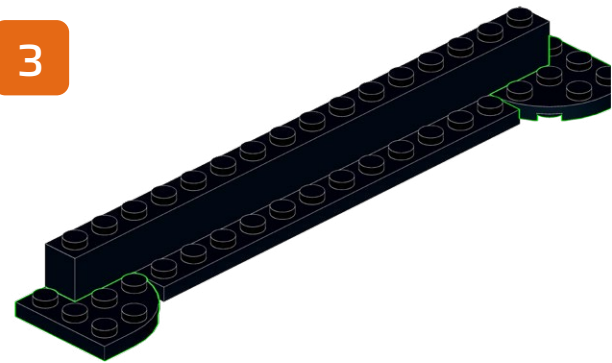

232

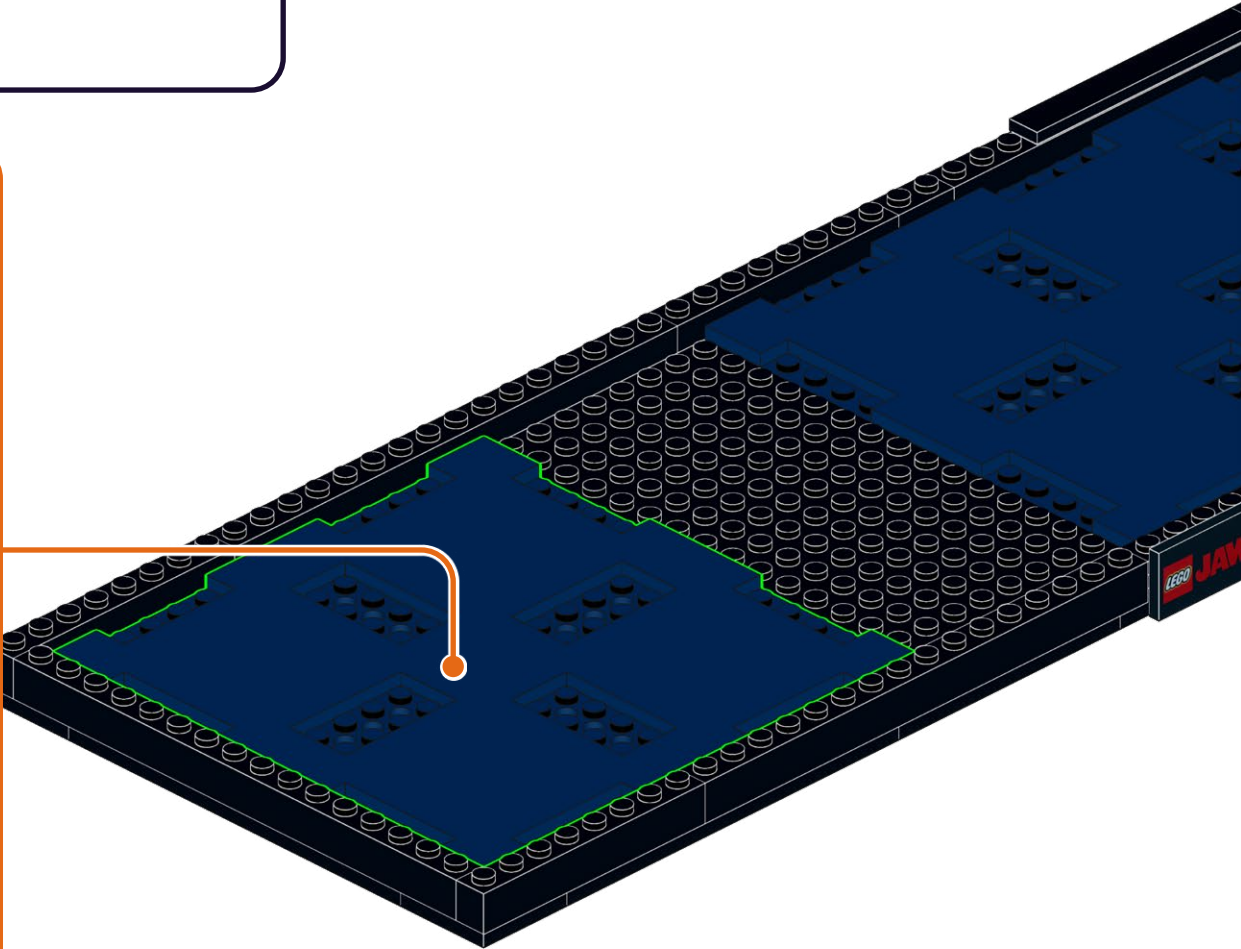
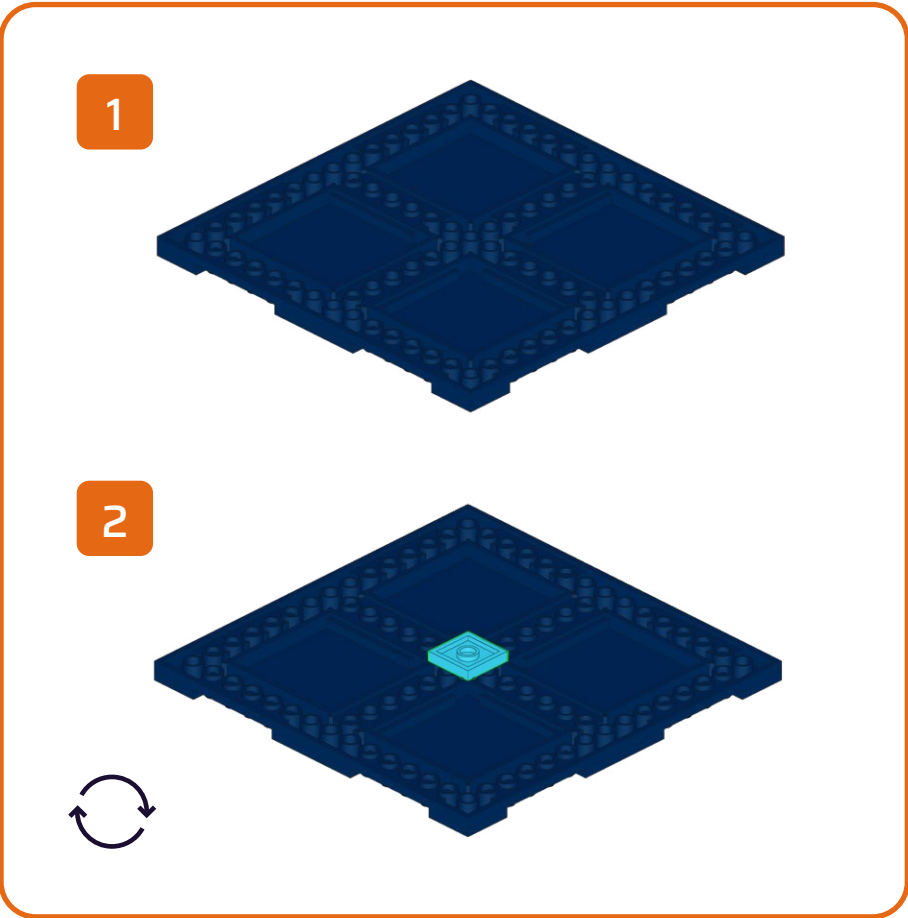
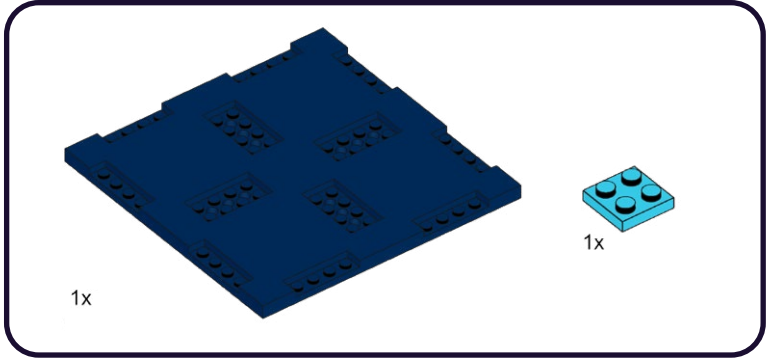



HOLD UP!

You might notice some bags aren't in order, as well as left over pieces, but that's ok! We're changing the way you build LEGO!

ATTENDEZ!

Vous remarquerez peut-être que certains sacs, ainsi que certaines pièces, ne sont pas dans le bon ordre. Mais pas de panique! Nous changeons simplement la façon avec laquelle vous construisez vos LEGO!

ASPETTA!

Potresti notare che alcuni sacchetti non sono in ordine, così come i pezzi avanzati, ma va bene così! Stiamo cambiando il modo in cui costruisci i LEGO!

HALT!

Sie werden möglicherweise bemerken, dass einige tüten durcheinander sind und teile übrig bleiben, aber das ist in Ordnung! Wir ändern die art und weise, wie Sie LEGO bauen!

¡ESPERA!

Es posible que notes que algunas bolsas están fuera de servicio, así como piezas sobrantes, ¡pero está bien! ¡Estamos cambiando la forma en que construyes LEGO!

暫停!

你可能会注意到一些袋子顺序错乱, 以及一些剩余的部件, 但没关系! 我们正在改变你搭建乐高的方式!

Open LMB Bag 03

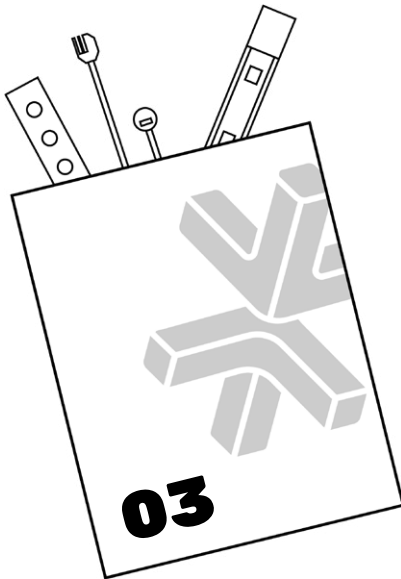

233

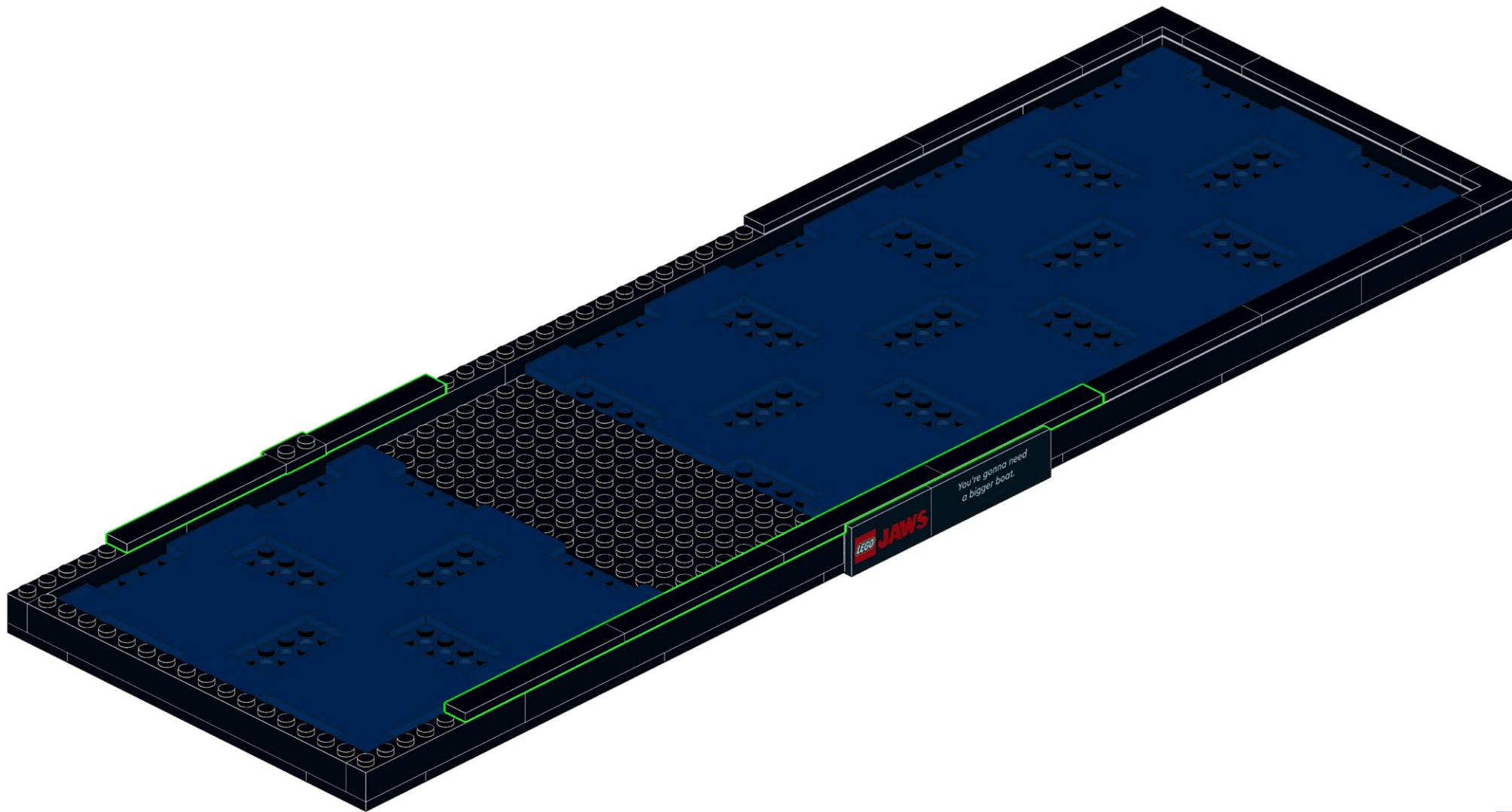
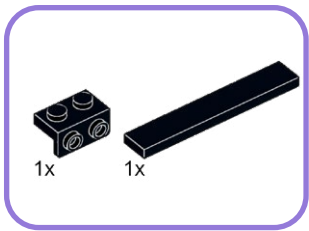

234

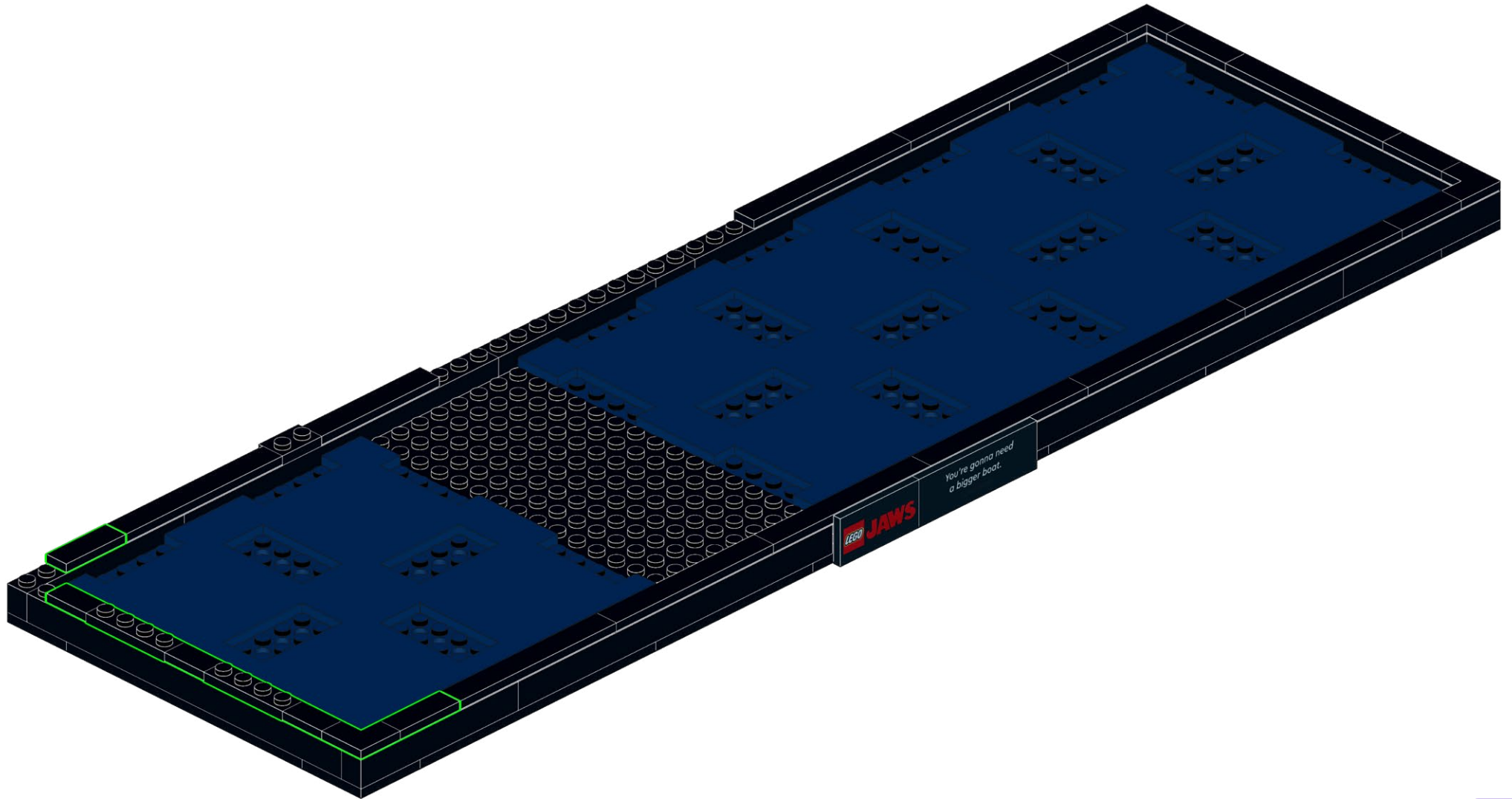
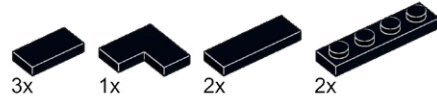

235

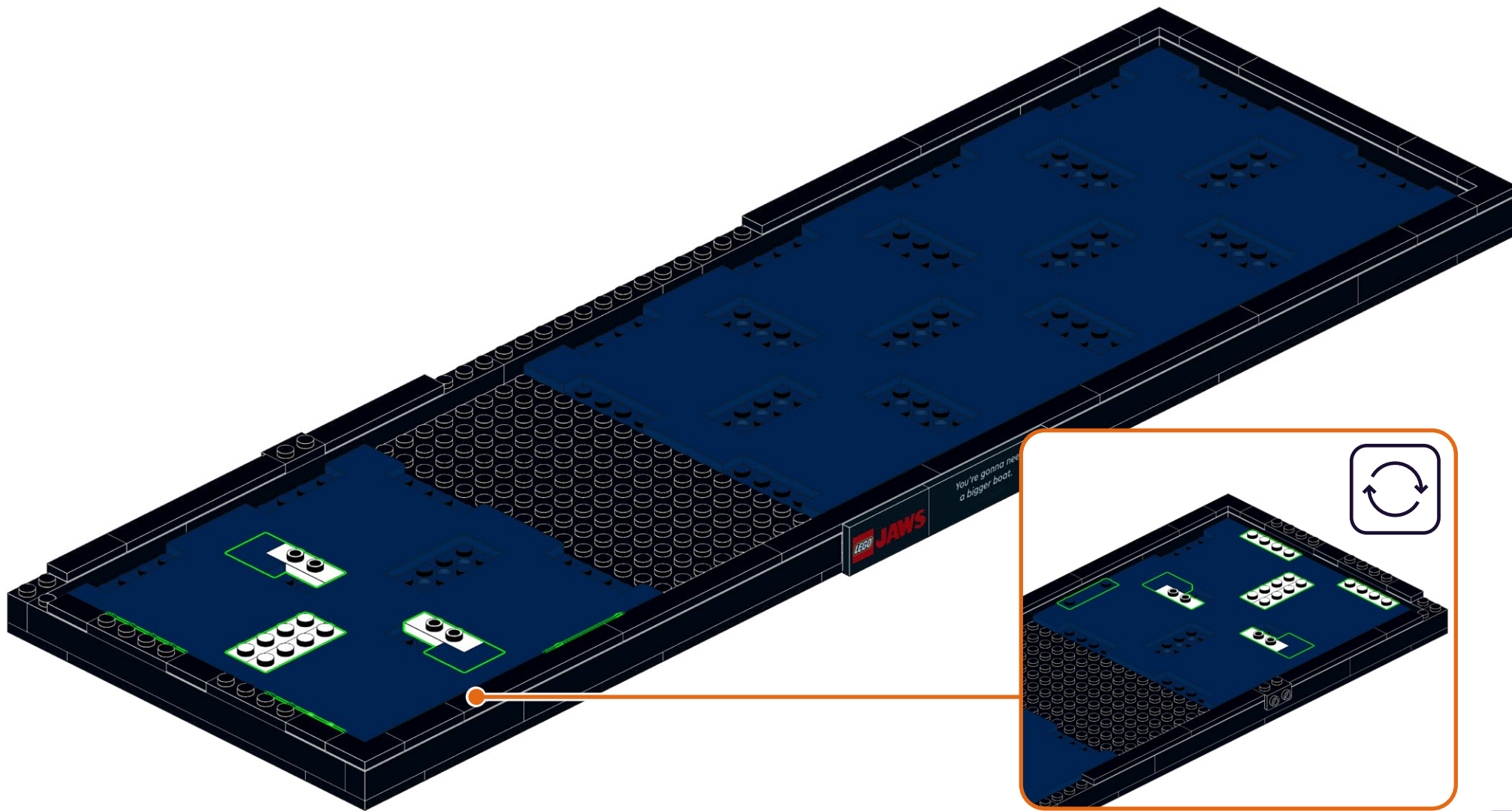
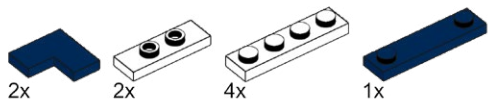

236

- 1x [1x 1x2 grey Technic brick with 2 holes]
- 2x [2x 1x2 grey Technic brick with 2 holes]
- 2x [2x 1x2 grey Technic brick with 2 holes]
- 2x [2x 1x2 grey Technic brick with 2 holes]
- 1x [1x 1x2 grey Technic brick with 2 holes]
- 1x [1x 1x2 grey Technic brick with 2 holes]
- 2x [2x 1x2 grey Technic brick with 2 holes]

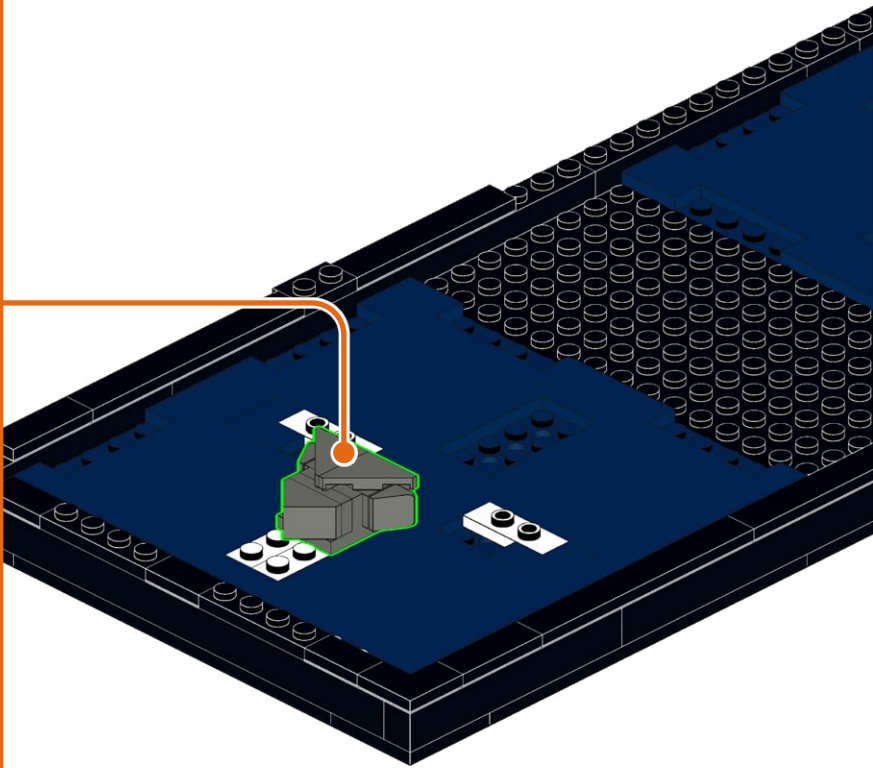
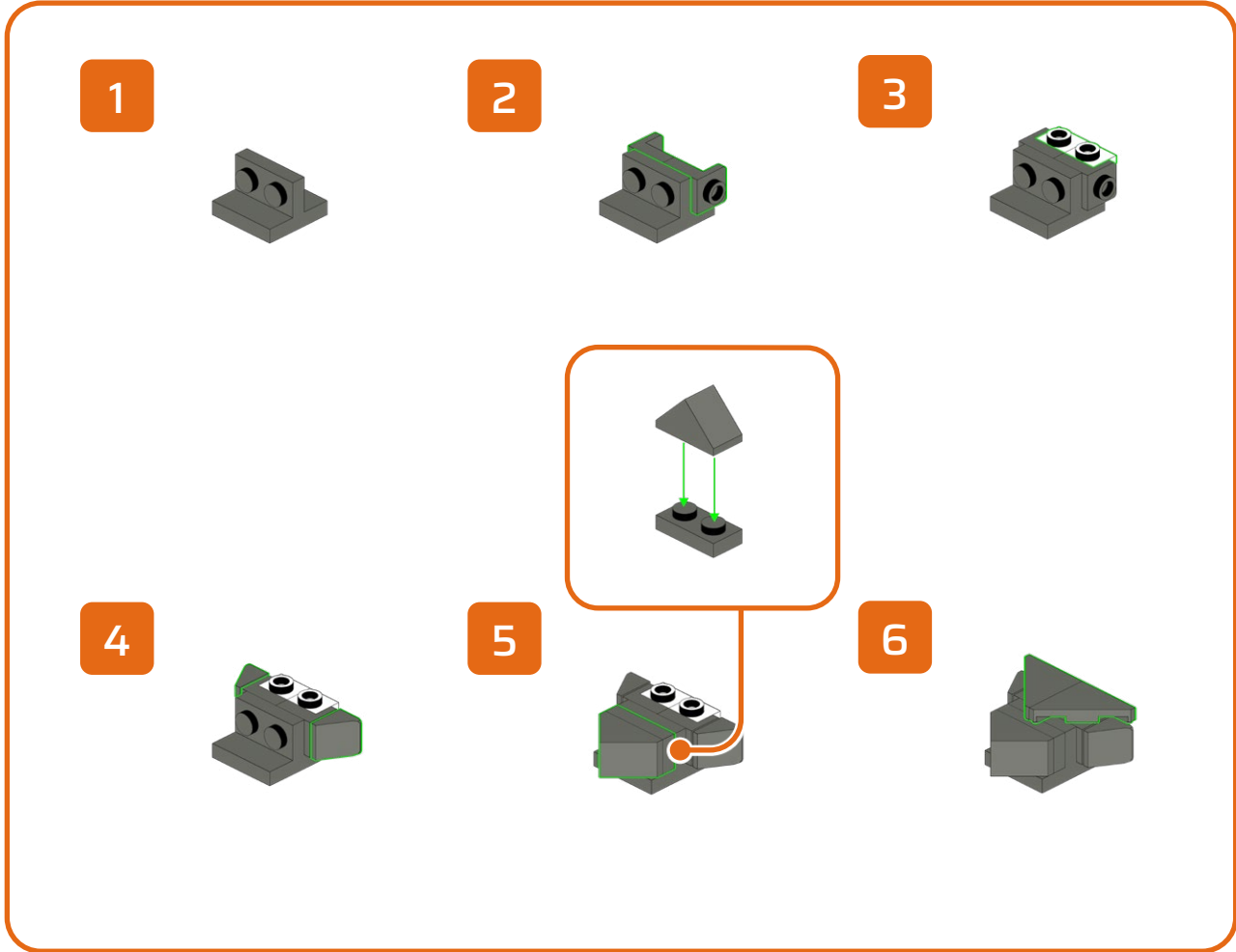

237

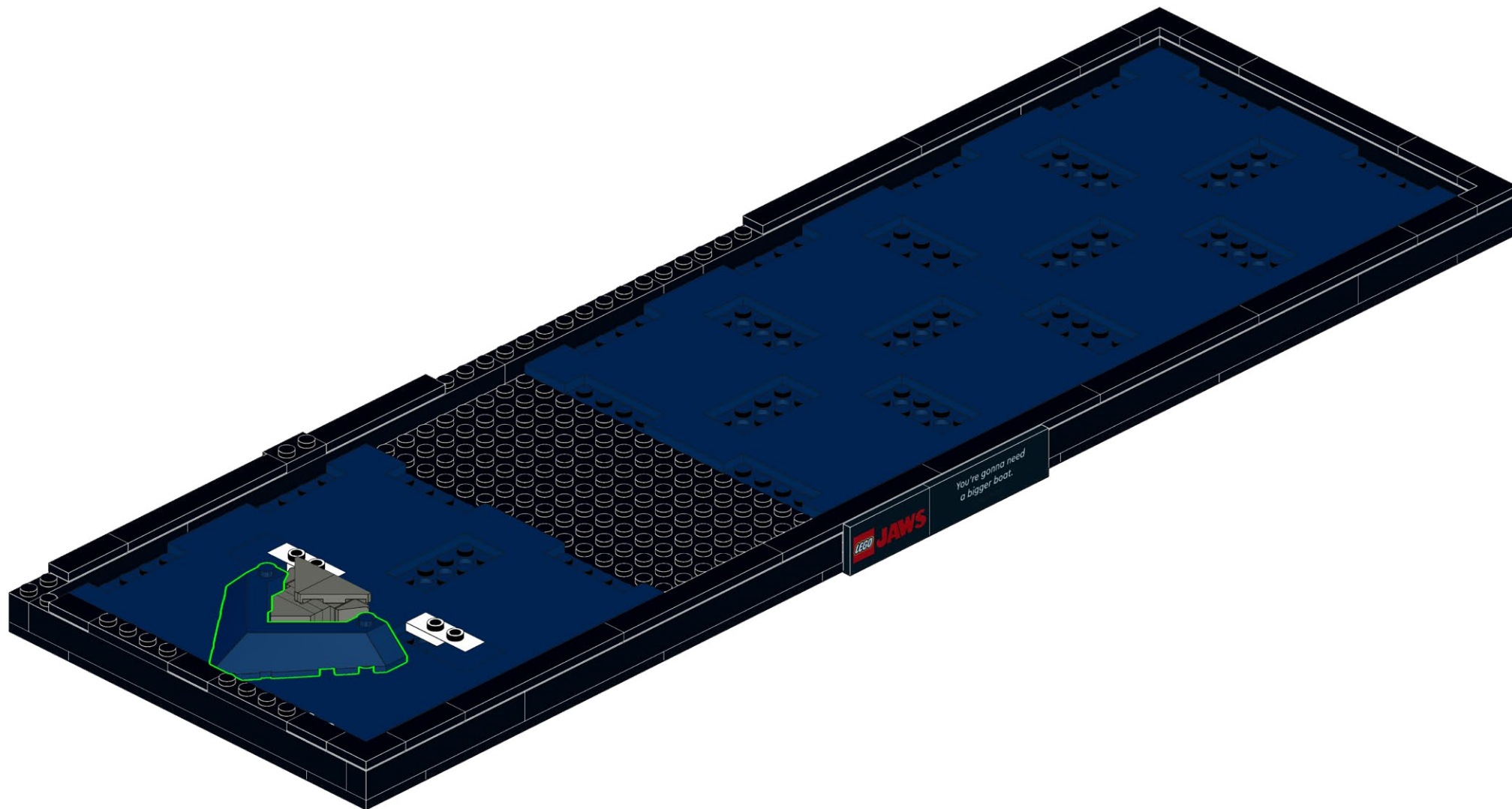
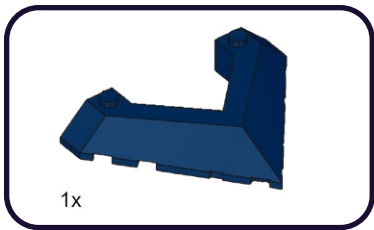

**HOLD UP!**

You might notice some bags aren't in order, as well as left over pieces, but that's ok! We're changing the way you build LEGO!

ATTENDEZ!

Vous remarquerez peut-être que certains sacs, ainsi que certaines pièces, ne sont pas dans le bon ordre. Mais pas de panique! Nous changeons simplement la façon avec laquelle vous construisez vos LEGO!

ASPETTA!

Potresti notare che alcuni sacchetti non sono in ordine, così come i pezzi avanzati, ma va bene così! Stiamo cambiando il modo in cui costruisci i LEGO!

HALT!

Sie werden möglicherweise bemerken, dass einige tüten durcheinander sind und teile übrig bleiben, aber das ist in Ordnung! Wir ändern die art und weise, wie Sie LEGO bauen!

¡ESPERA!

Es posible que notes que algunas bolsas están fuera de servicio, así como piezas sobrantes, ¡pero está bien! ¡Estamos cambiando la forma en que construyes LEGO!

暫停!

你可能会注意到一些袋子顺序错乱, 以及一些剩余的部件, 但没关系! 我们正在改变你搭建乐高的方式!

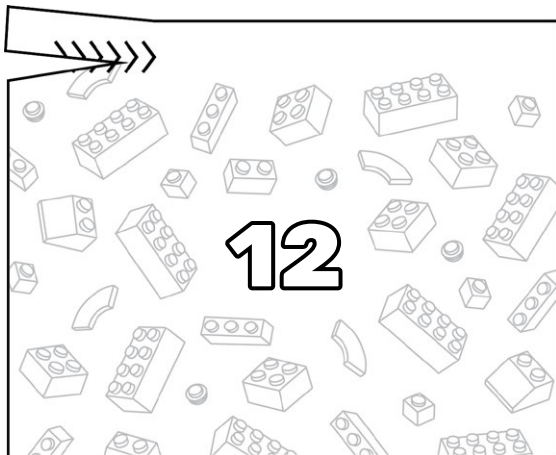
Open LEGO® Bag 12

238

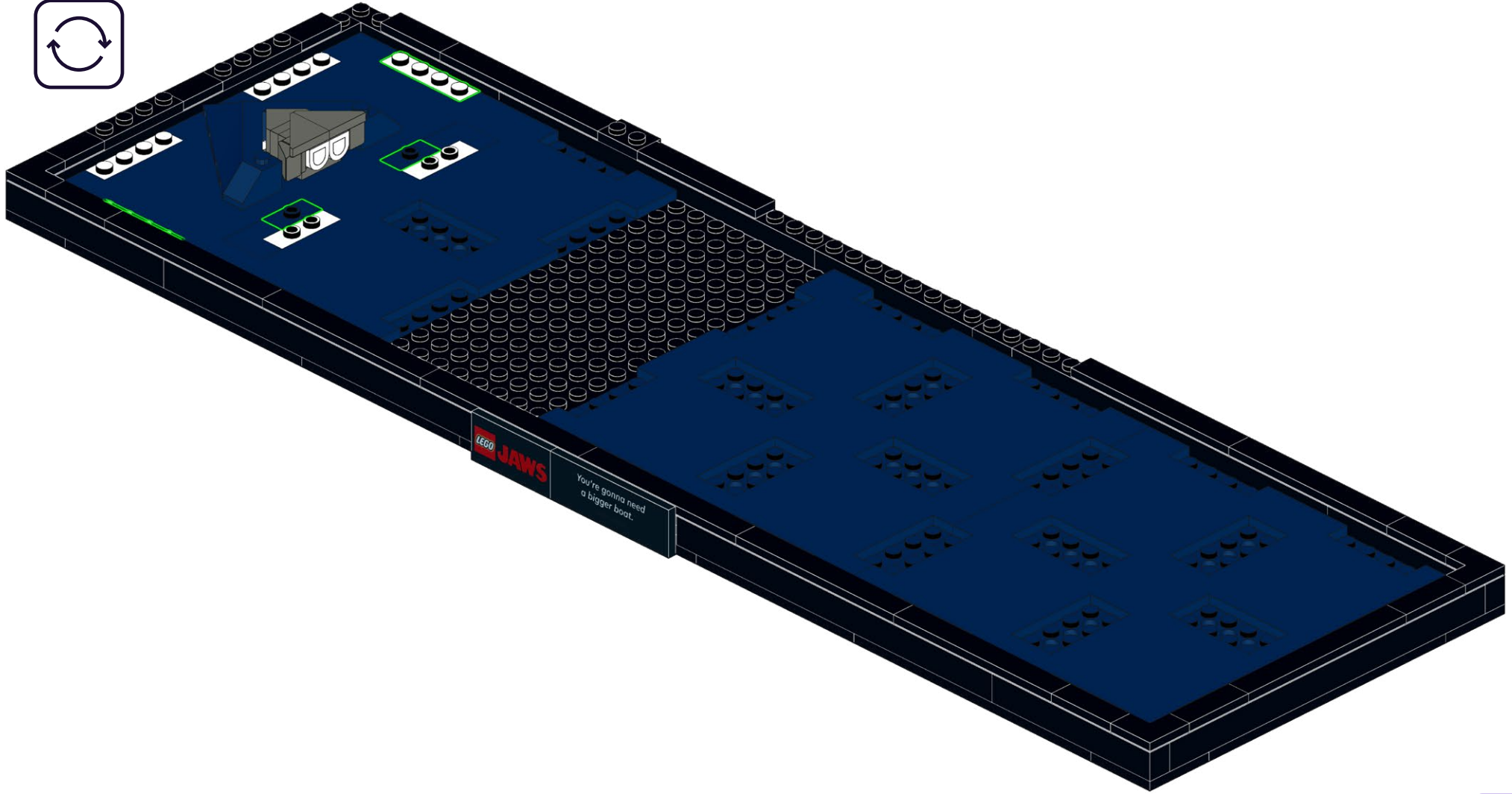
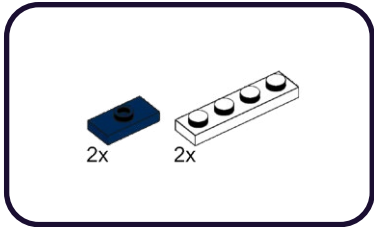

239

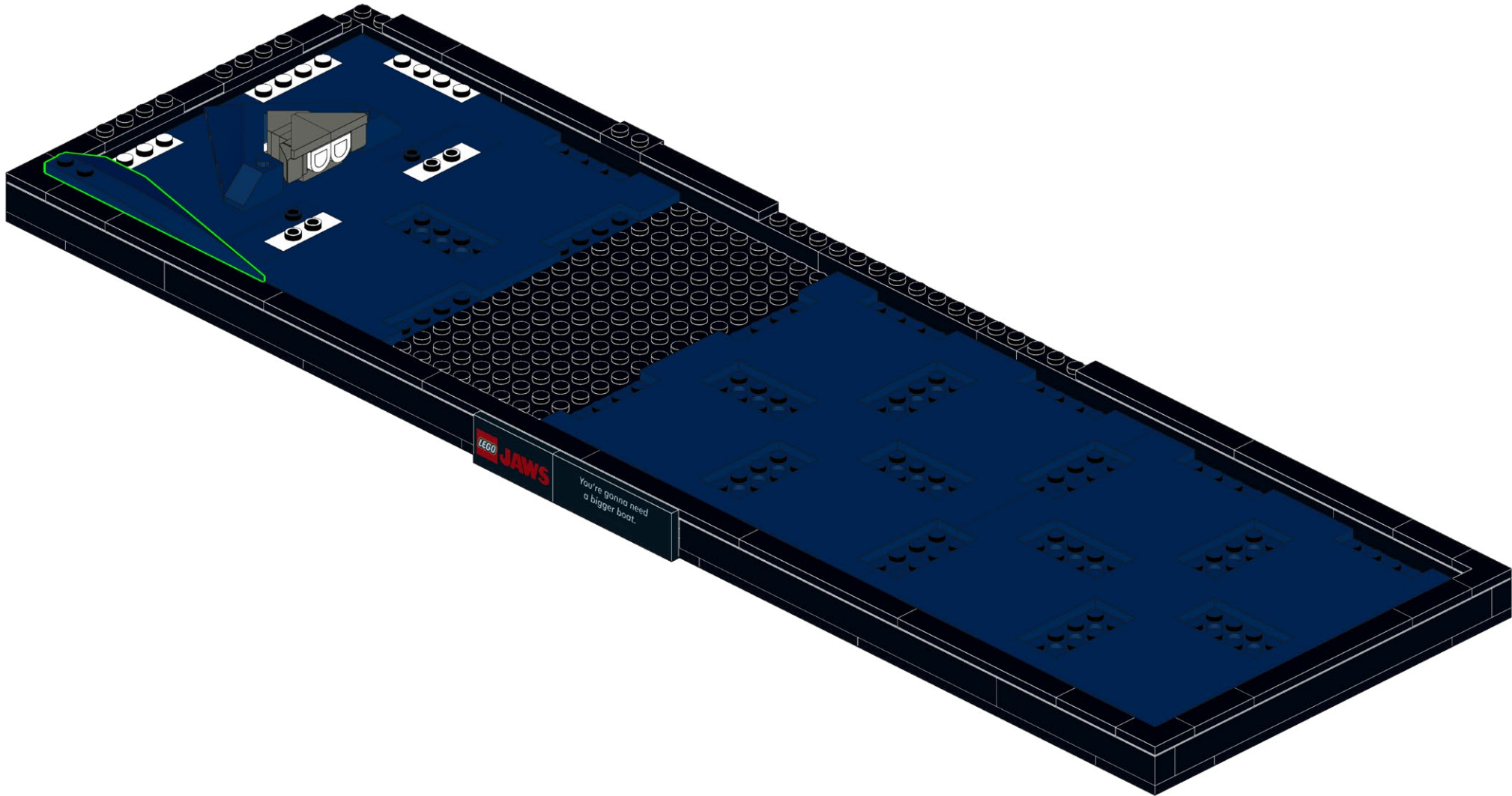
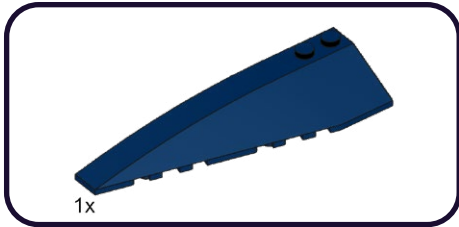

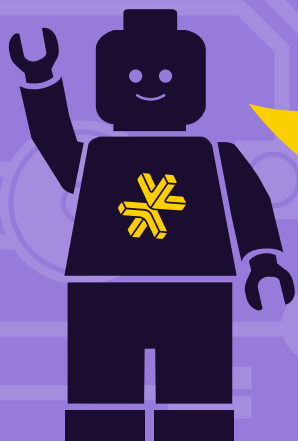

HOLD UP!

You might notice some bags aren't in order, as well as left over pieces, but that's ok! We're changing the way you build LEGO!

ATTENDEZ!

Vous remarquerez peut-être que certains sacs, ainsi que certaines pièces, ne sont pas dans le bon ordre. Mais pas de panique! Nous changeons simplement la façon avec laquelle vous construisez vos LEGO!

ASPETTA!

Potresti notare che alcuni sacchetti non sono in ordine, così come i pezzi avanzati, ma va bene così! Stiamo cambiando il modo in cui costruisci i LEGO!

HALT!

Sie werden möglicherweise bemerken, dass einige tüten durcheinander sind und teile übrig bleiben, aber das ist in Ordnung! Wir ändern die art und weise, wie Sie LEGO bauen!

¡ESPERA!

Es posible que notes que algunas bolsas están fuera de servicio, así como piezas sobrantes, ¡pero está bien! ¡Estamos cambiando la forma en que construyes LEGO!

暫停!

你可能会注意到一些袋子顺序错乱, 以及一些剩余的部件, 但没关系! 我们正在改变你搭建乐高的方式!

Open LMB Bag 02

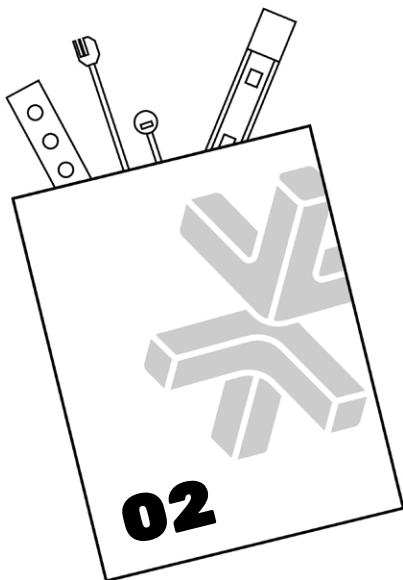

240

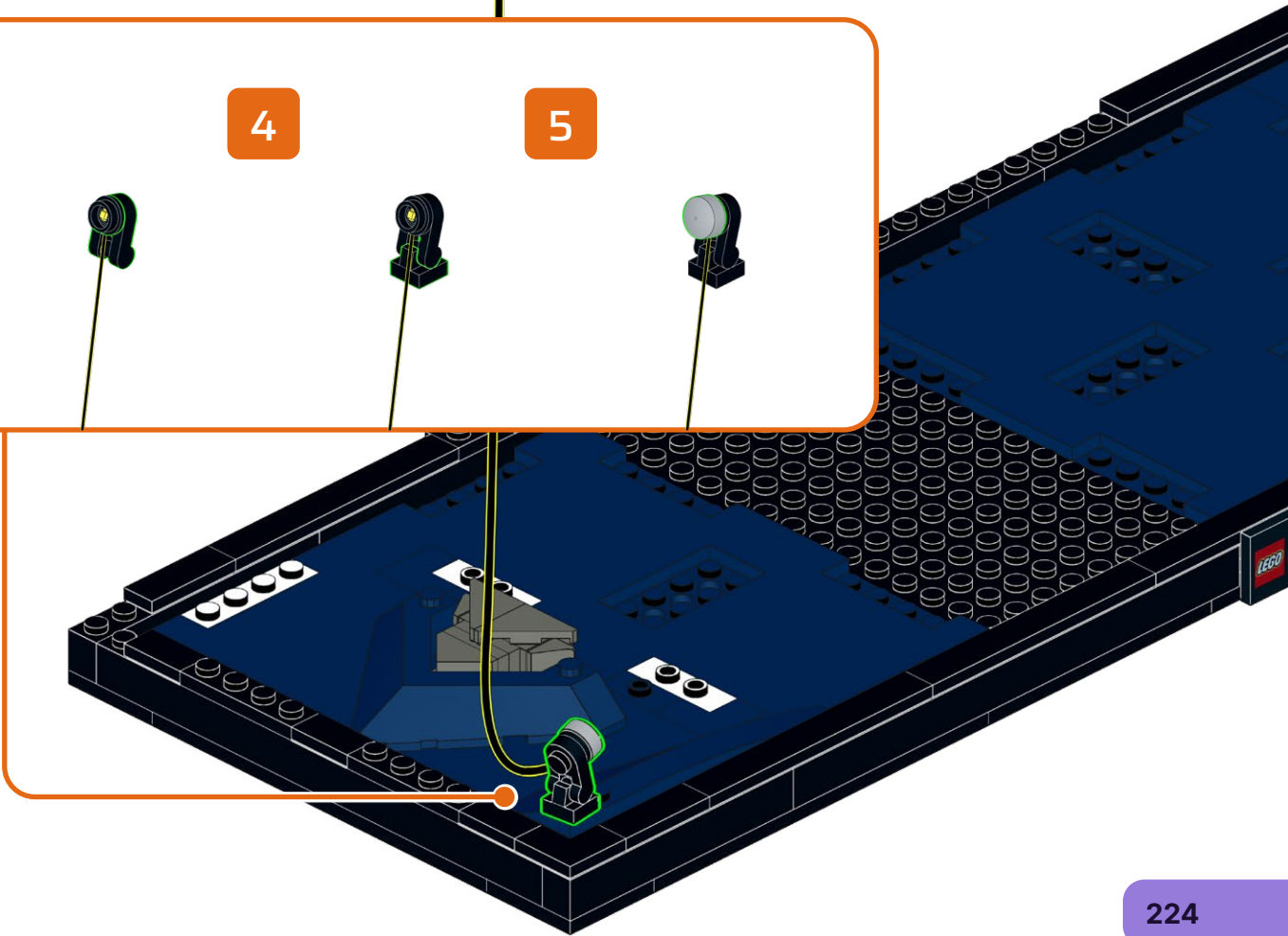
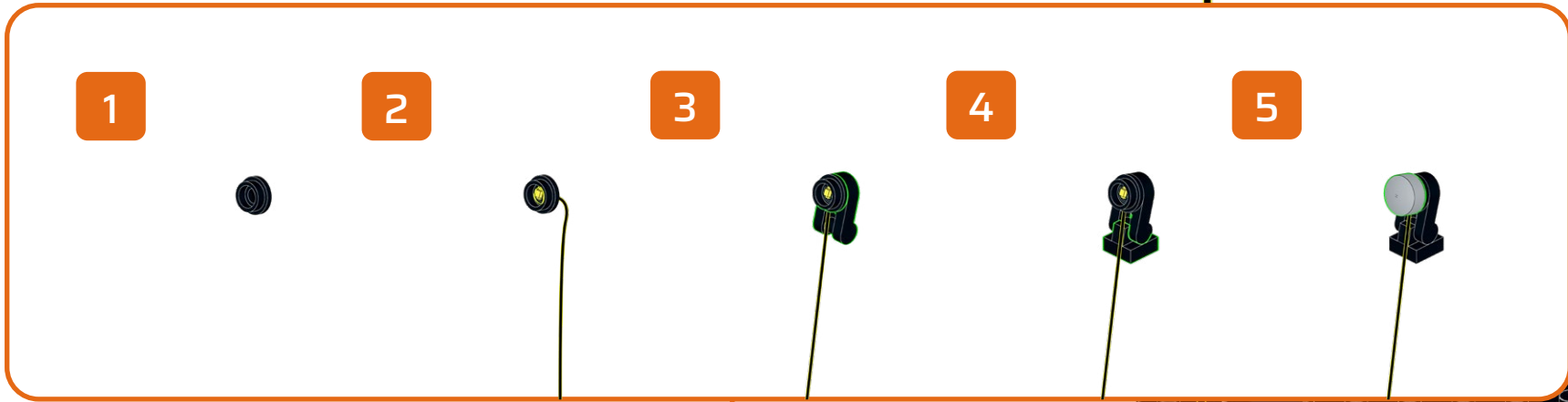
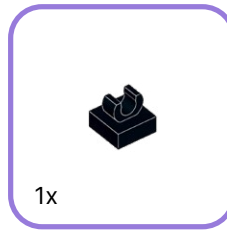
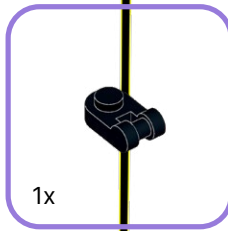
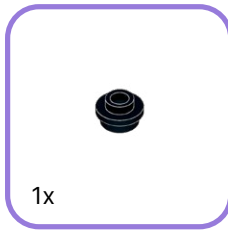
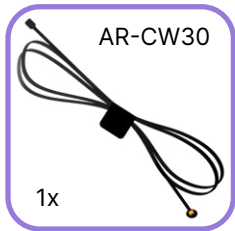
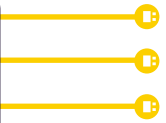

241

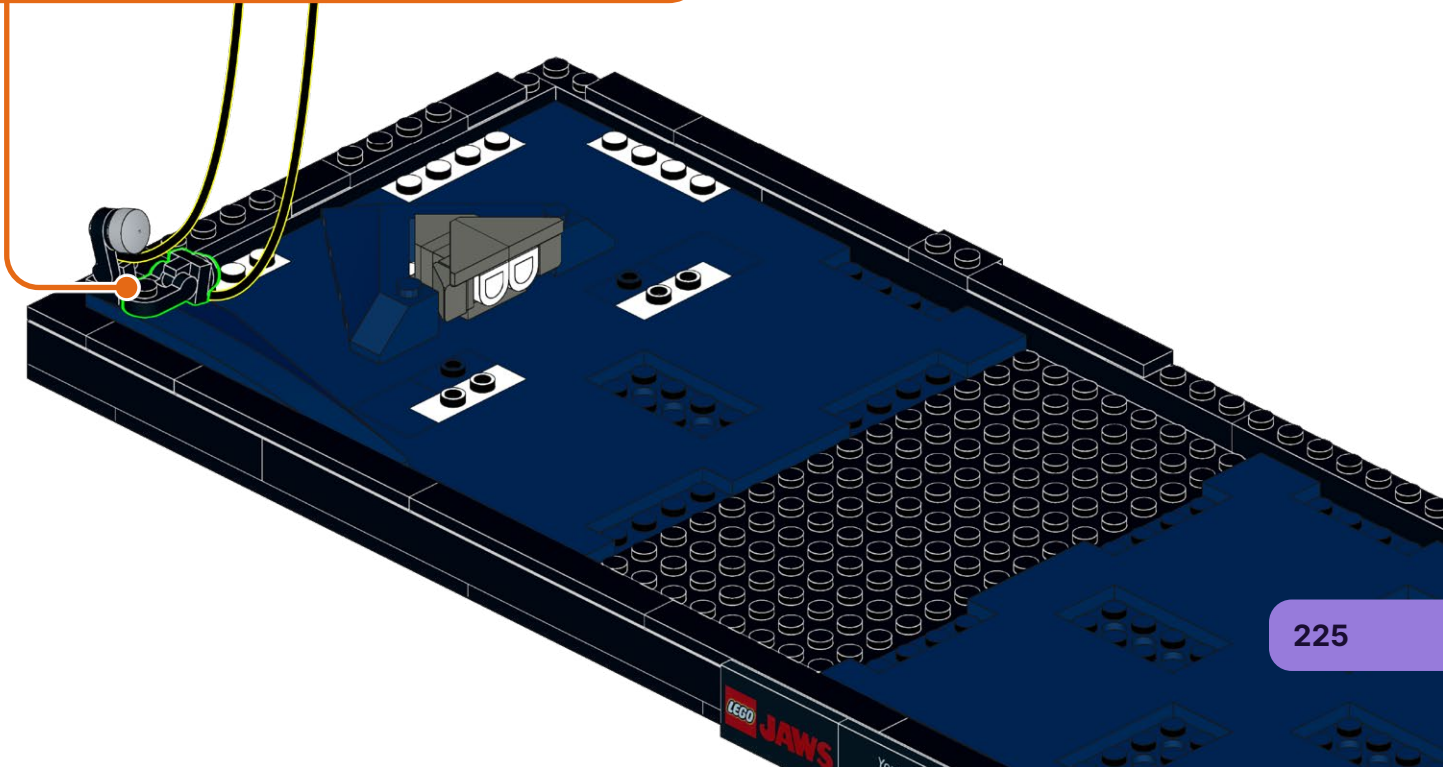
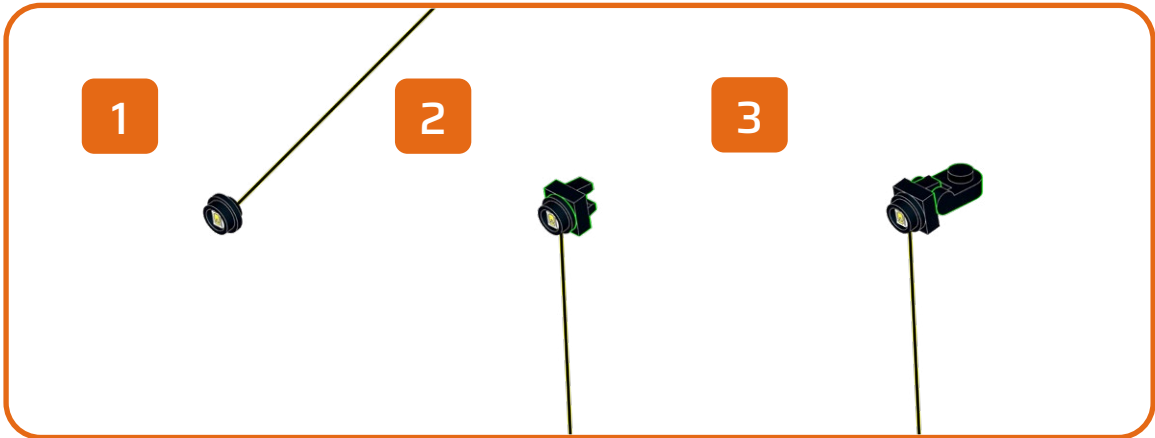
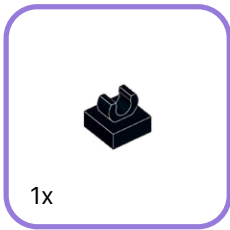
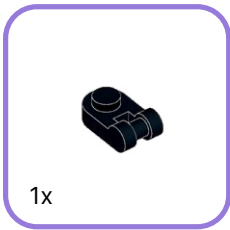
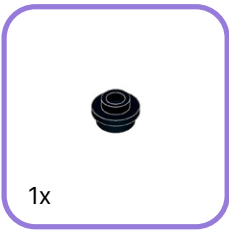
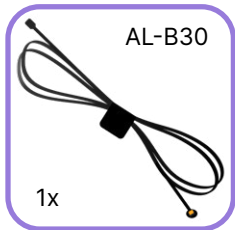

242

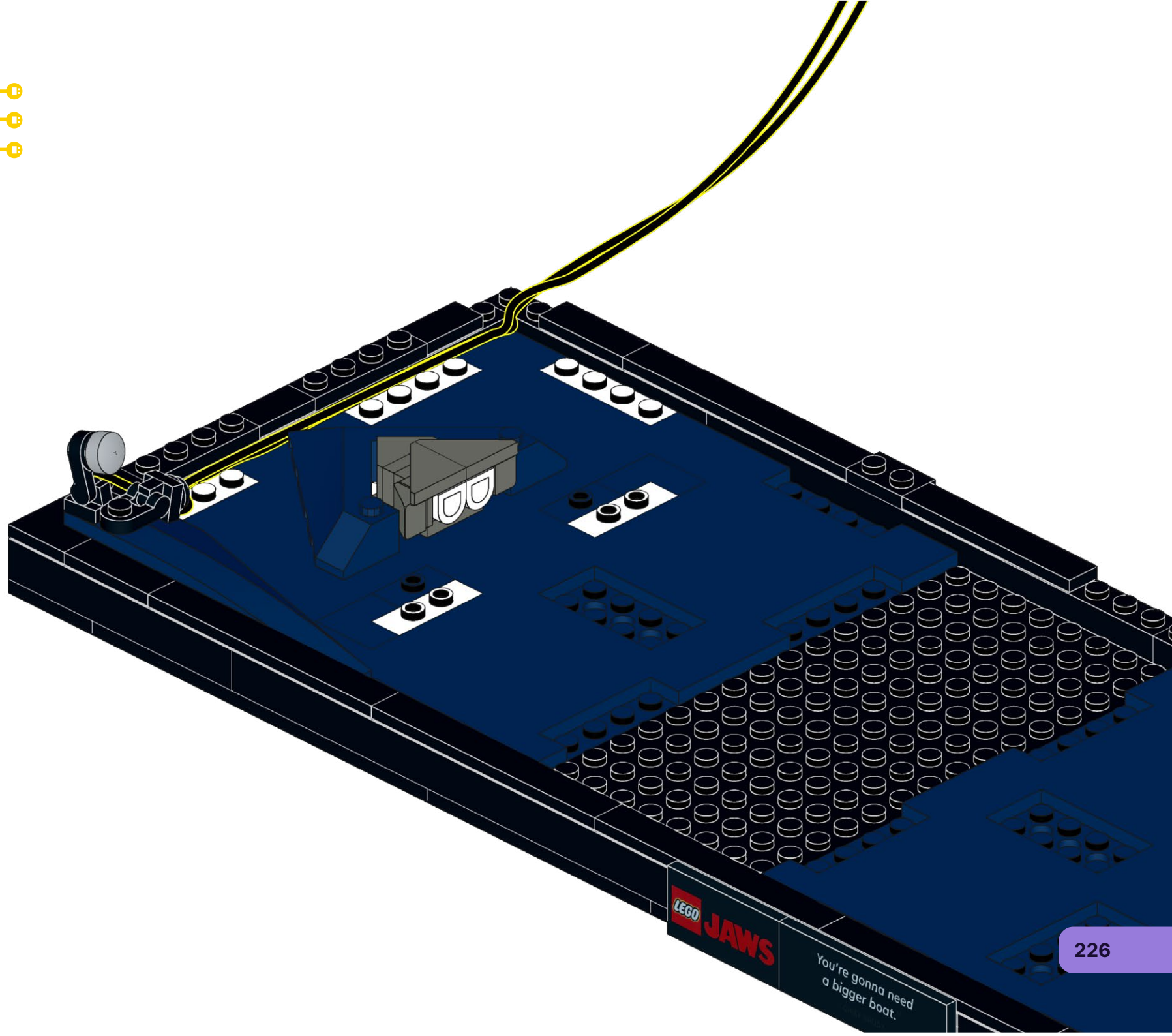

243

2x

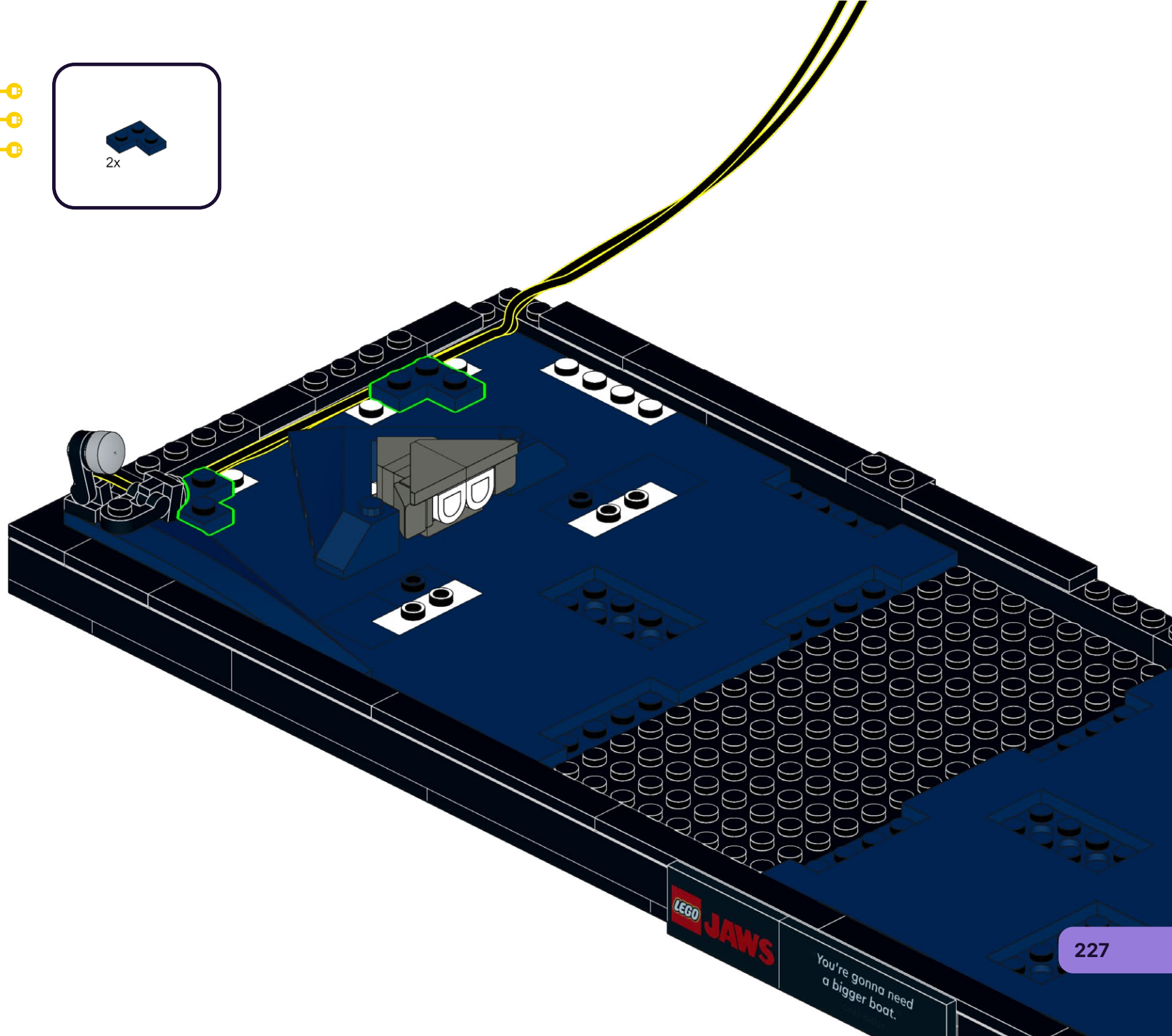

244

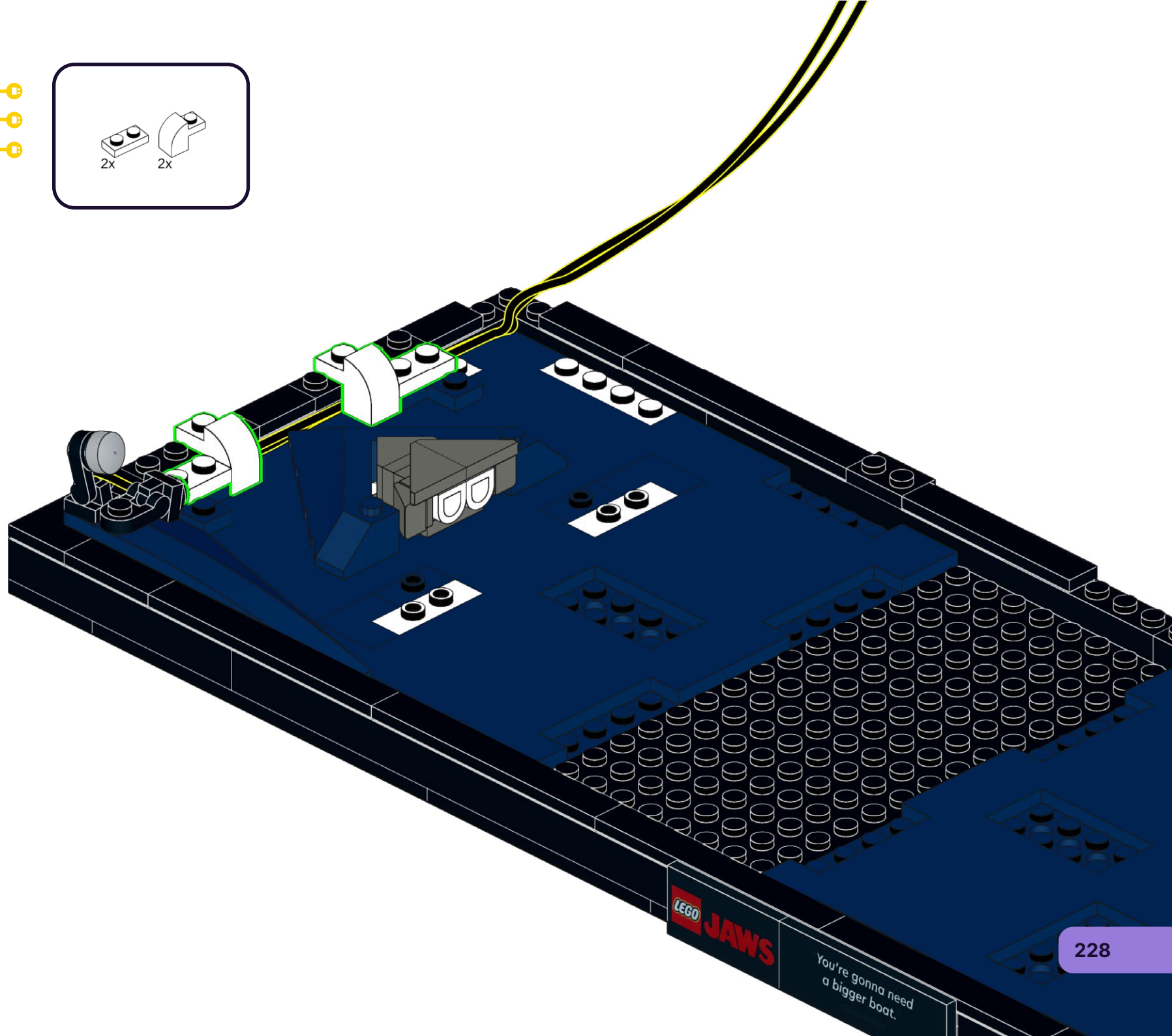
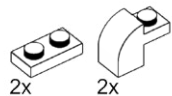

245

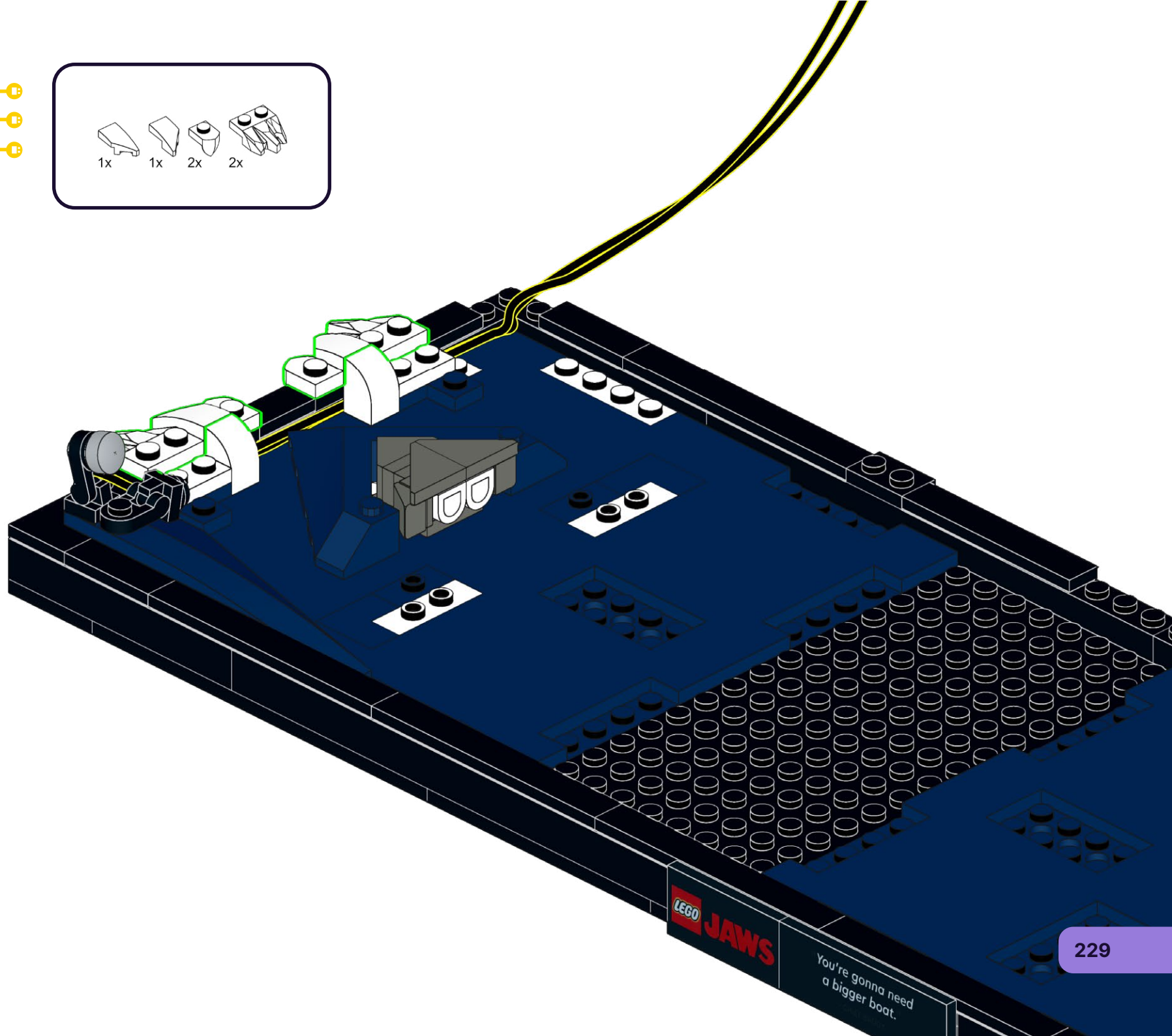
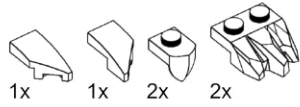

246

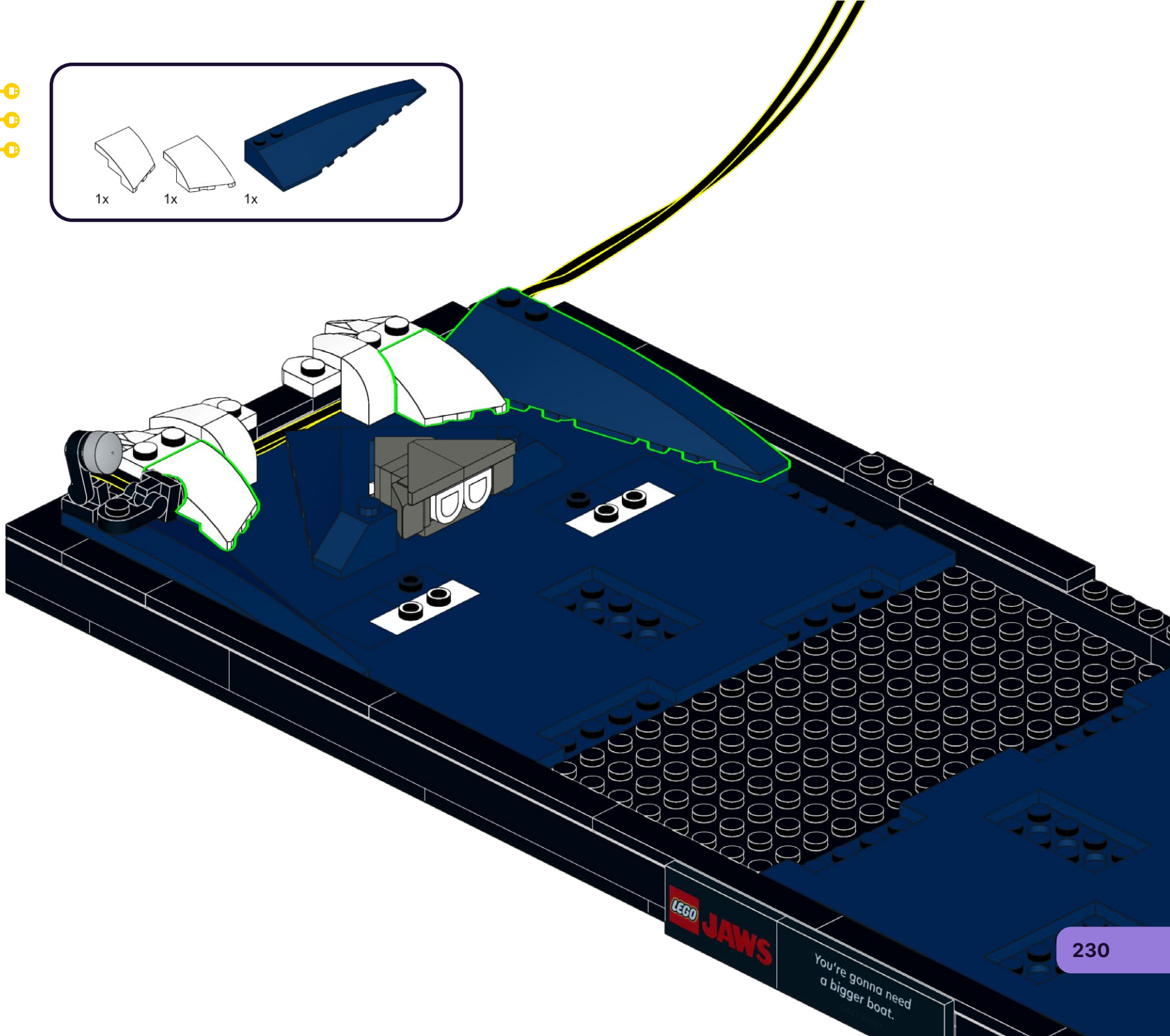
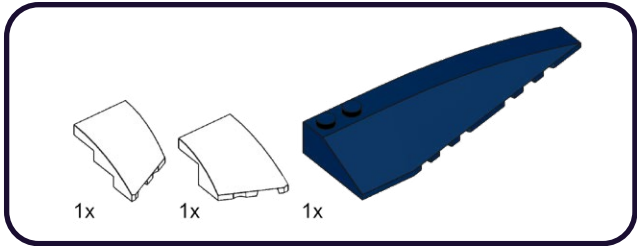

247

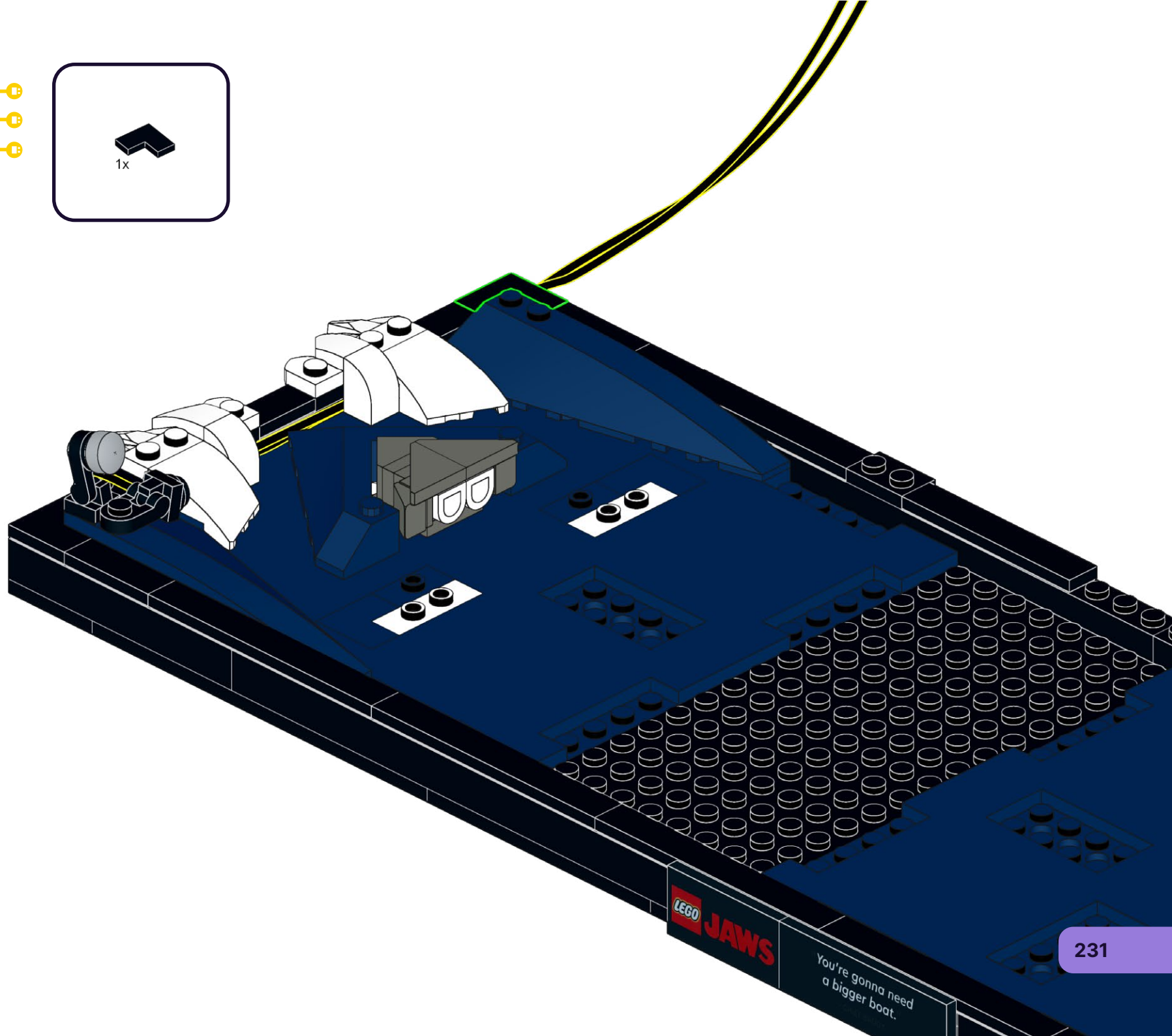

248

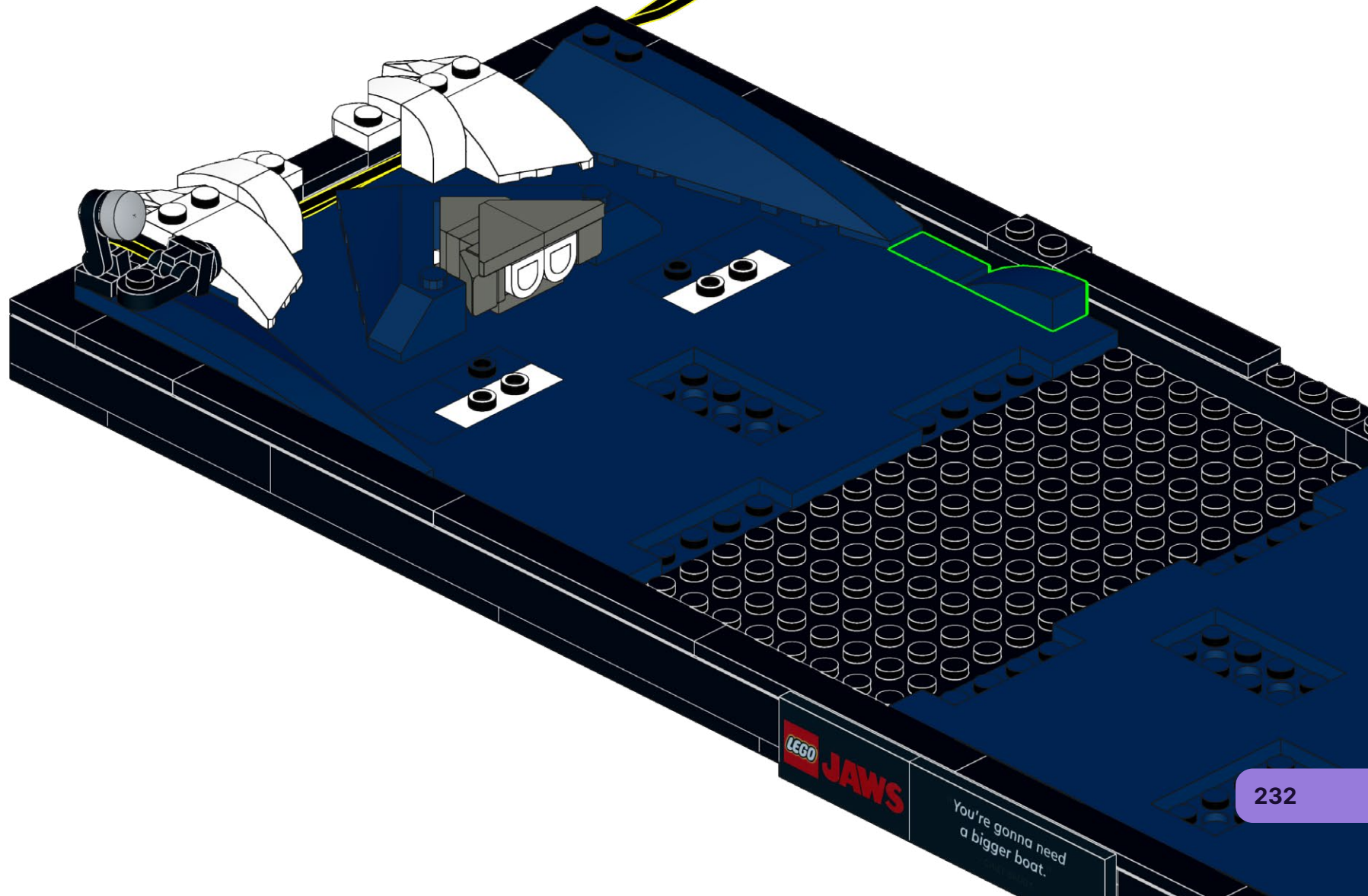
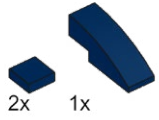

249

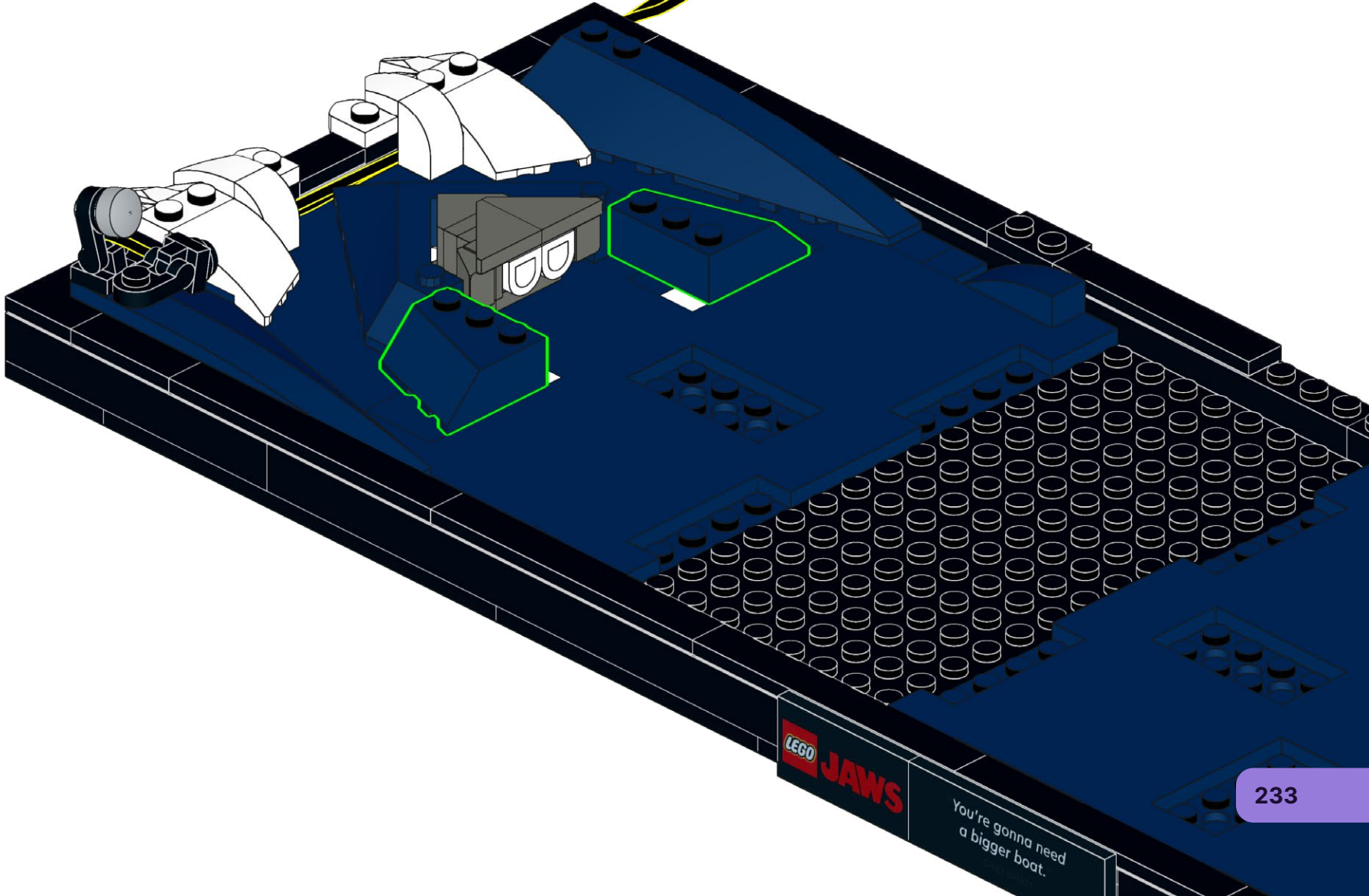
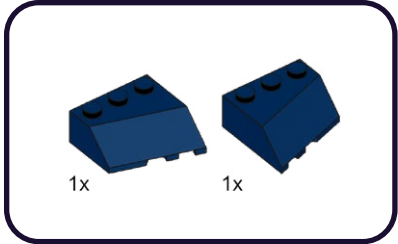

250

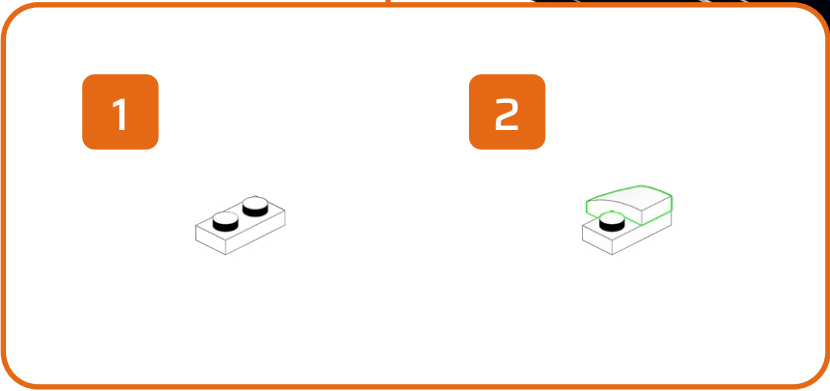
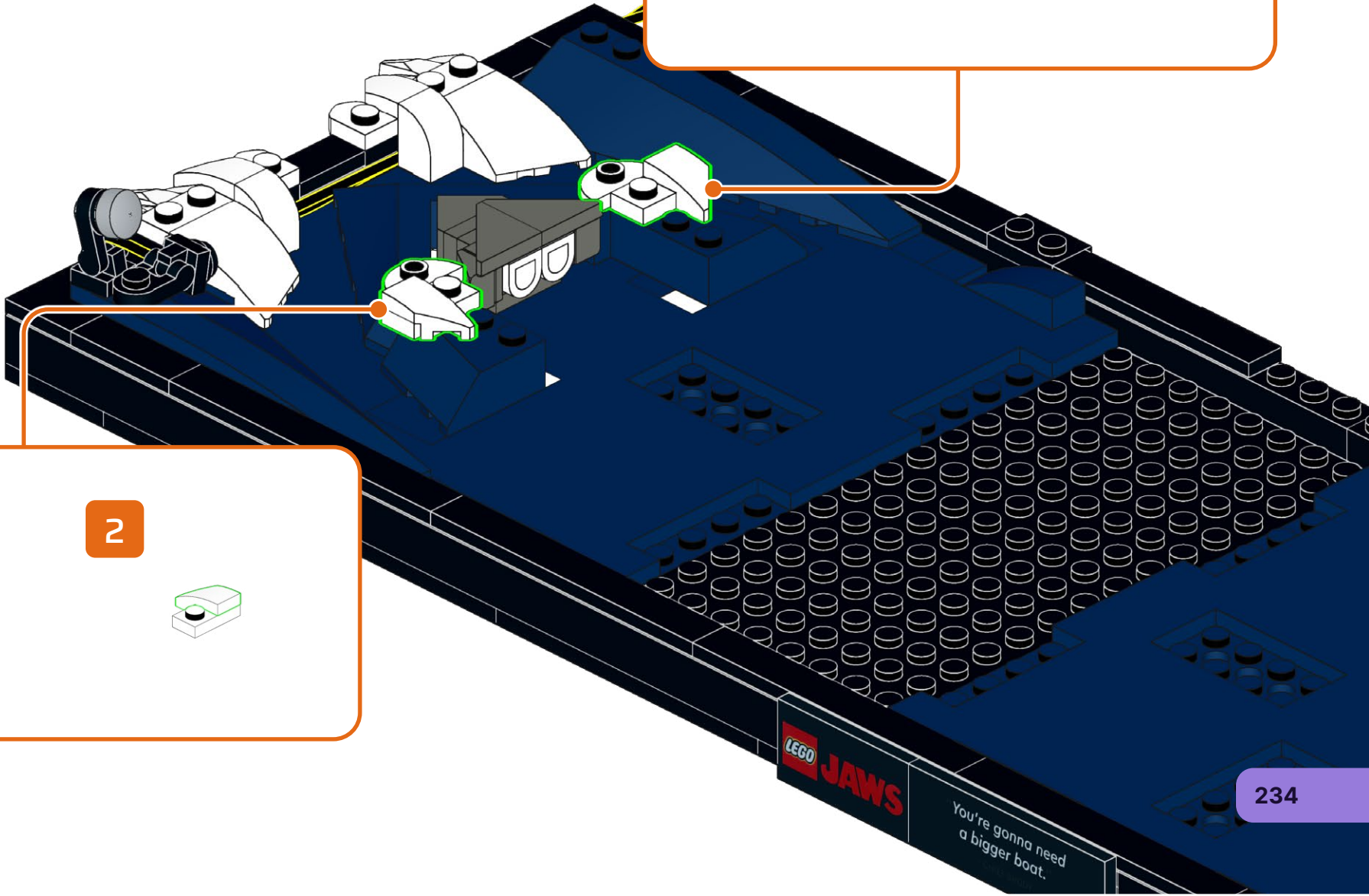
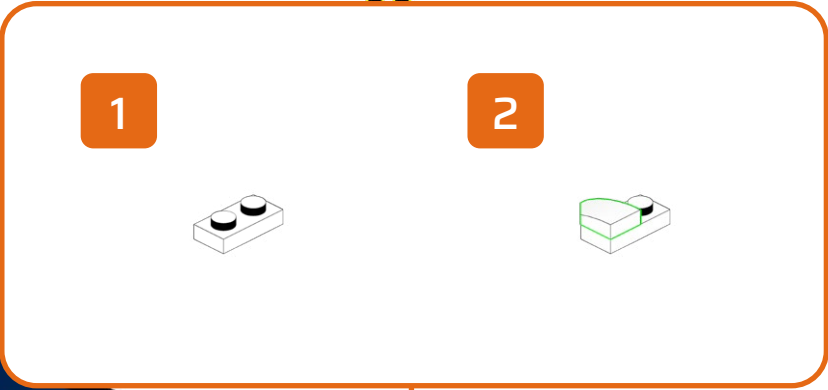
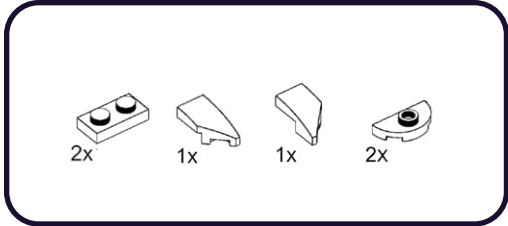

251

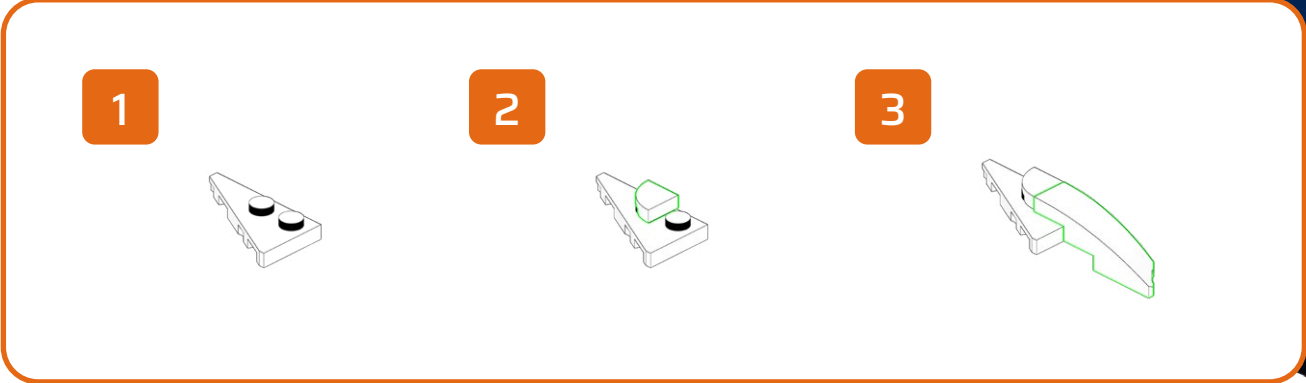
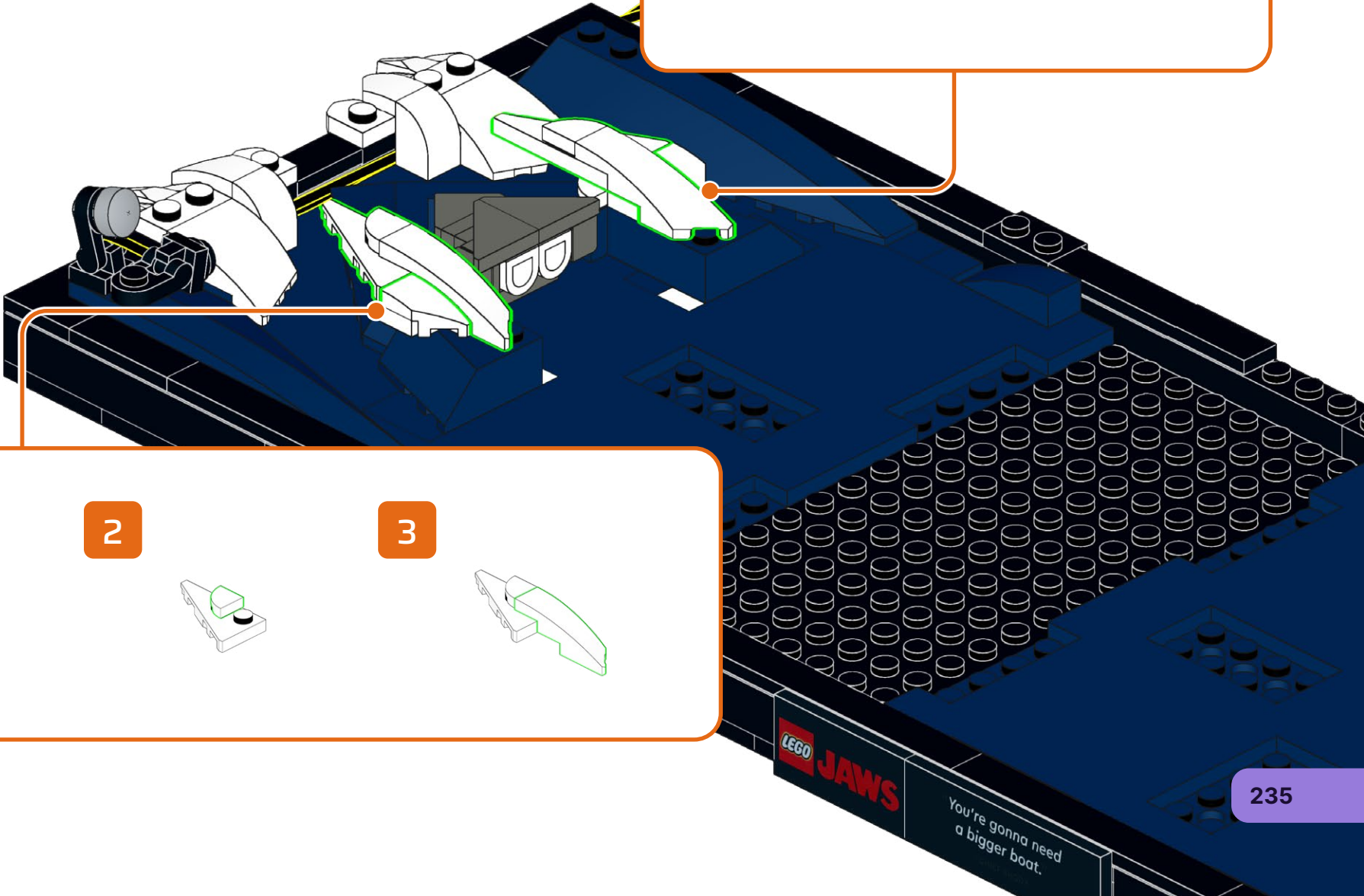
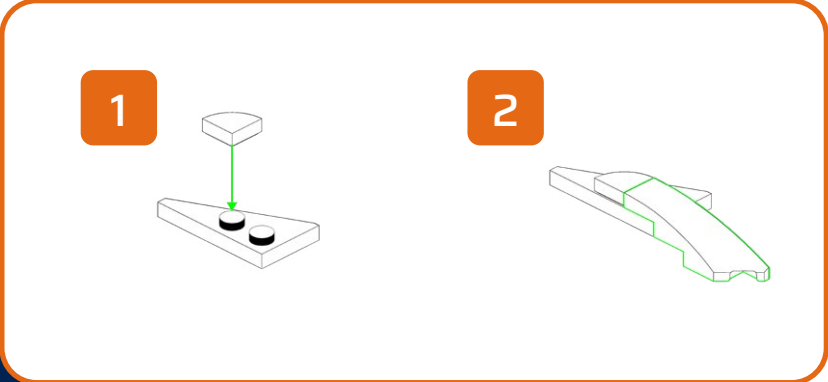
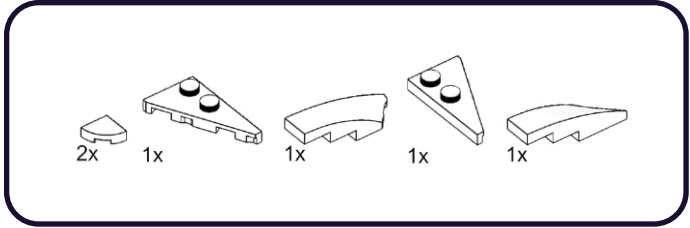

252

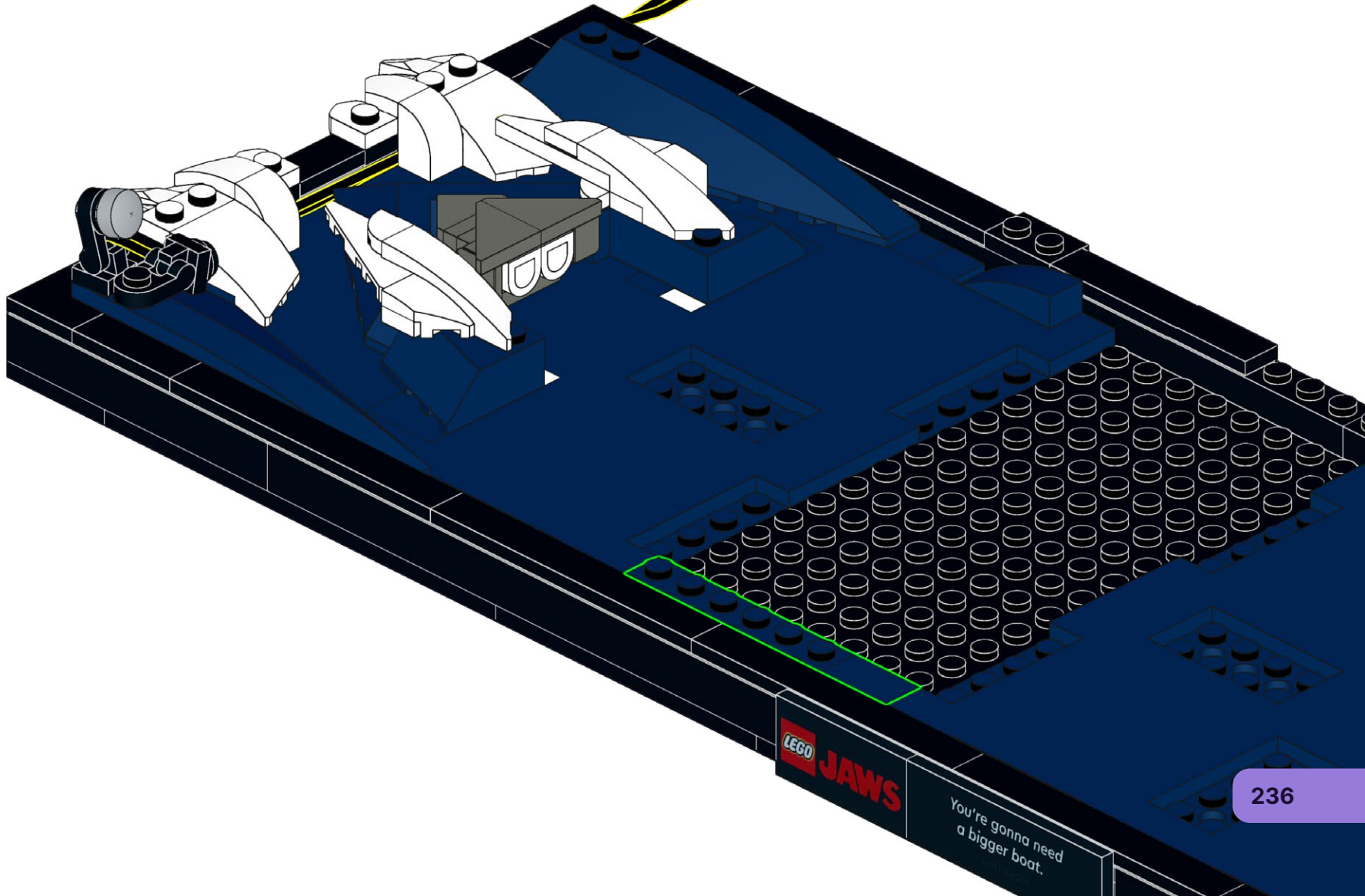
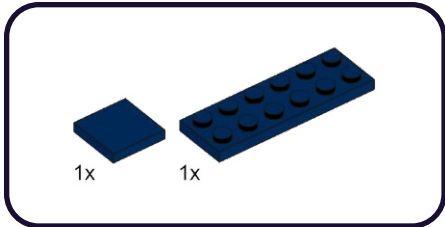

253

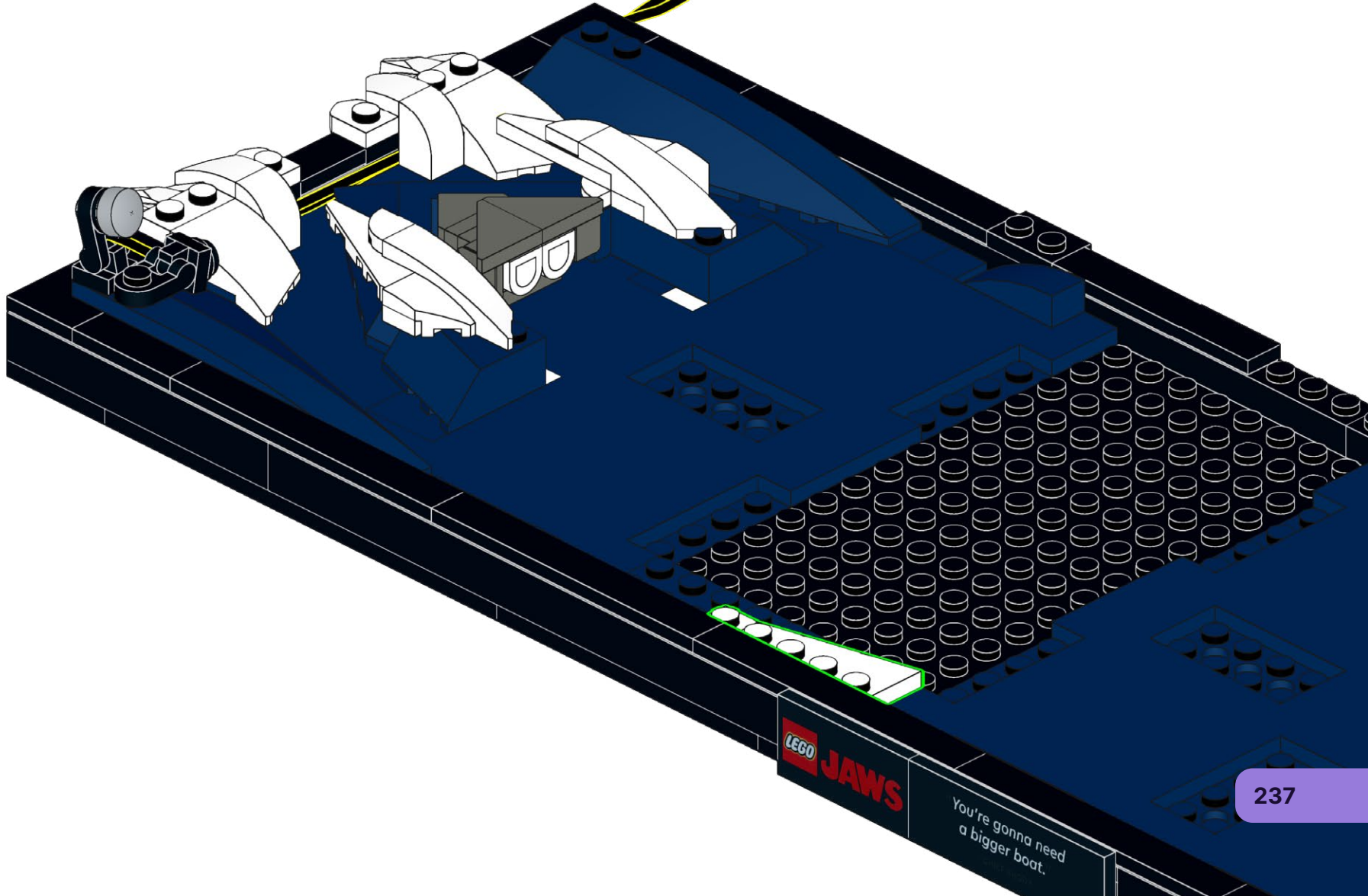
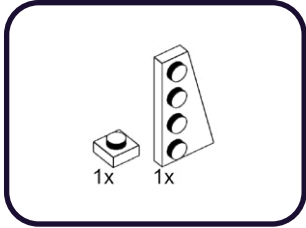

254

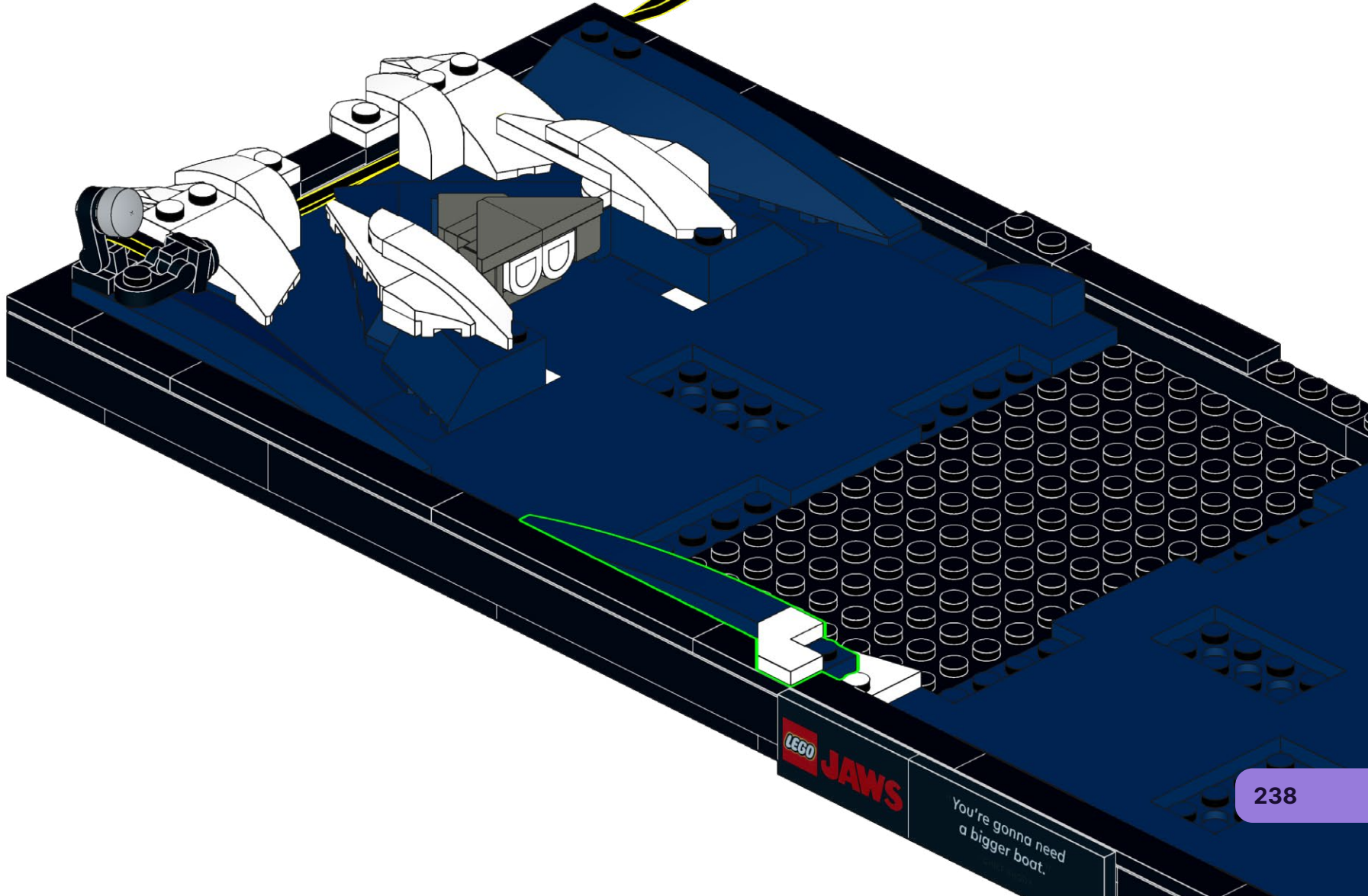
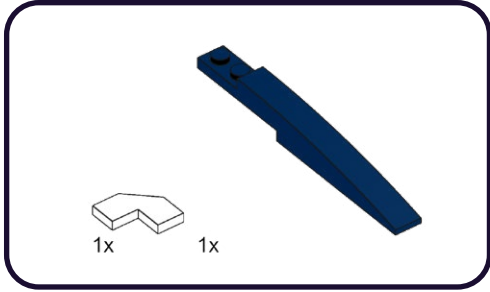

255

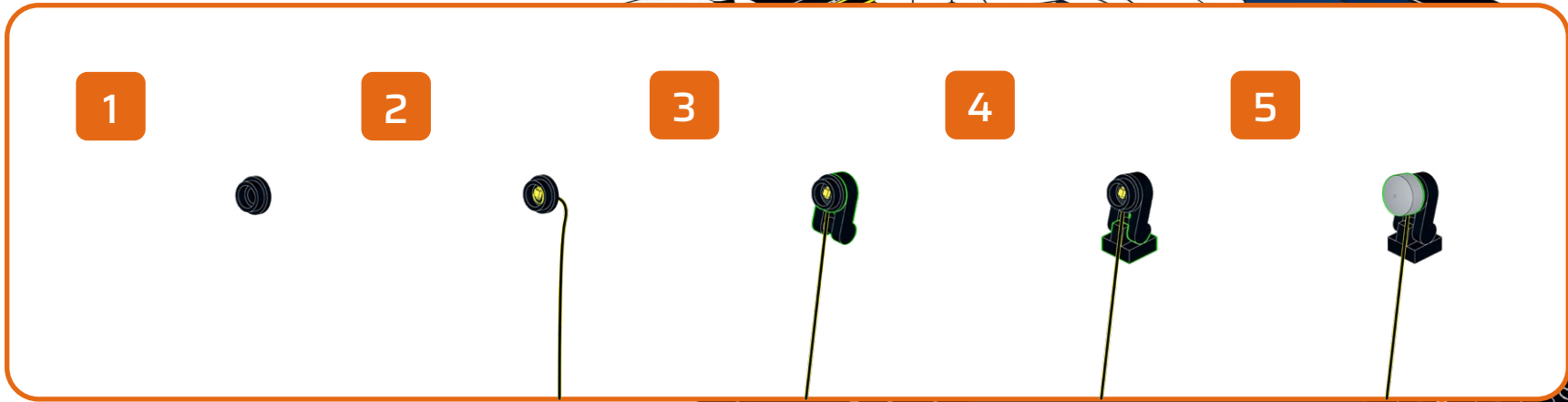
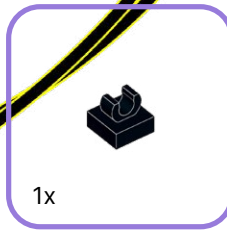
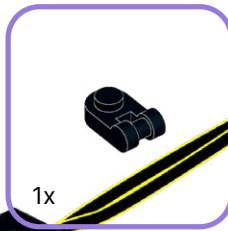
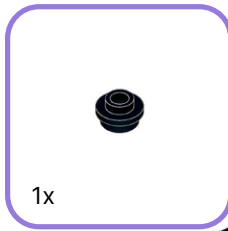
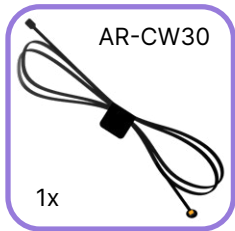

256

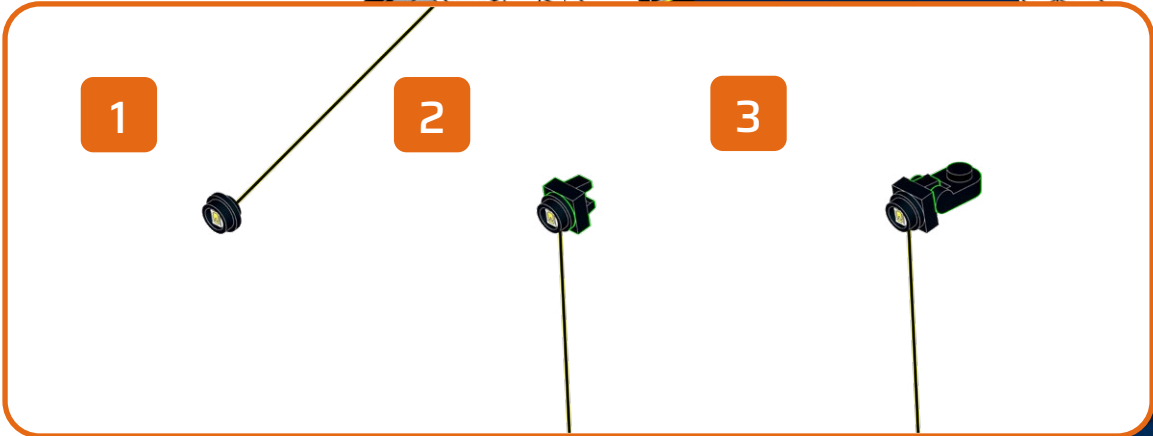
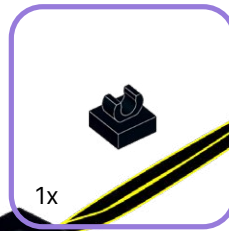
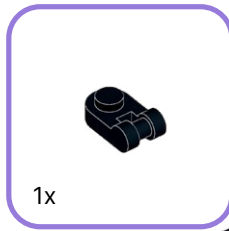
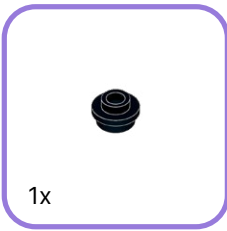
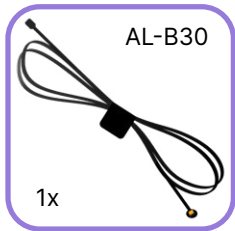

257

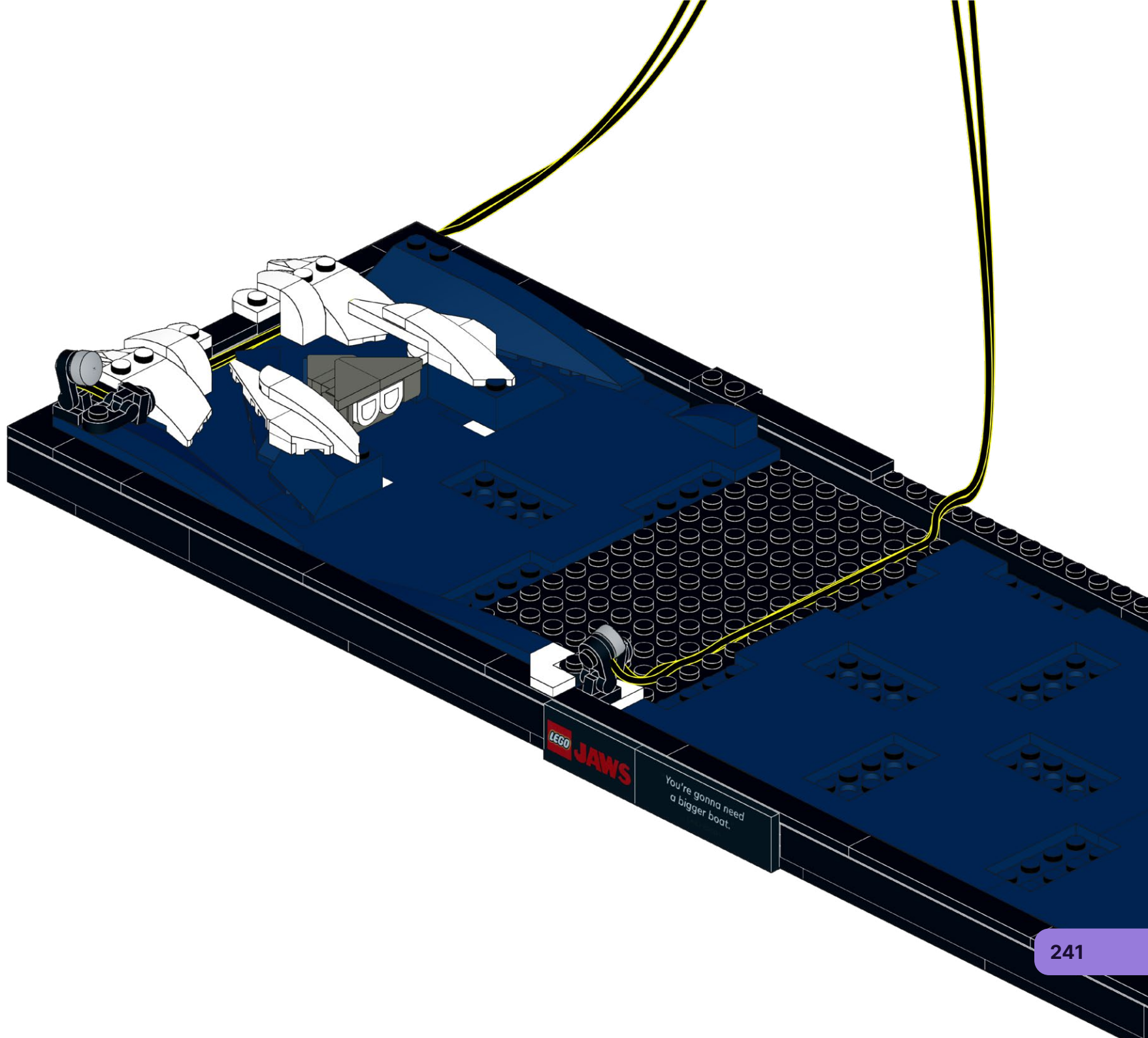

258

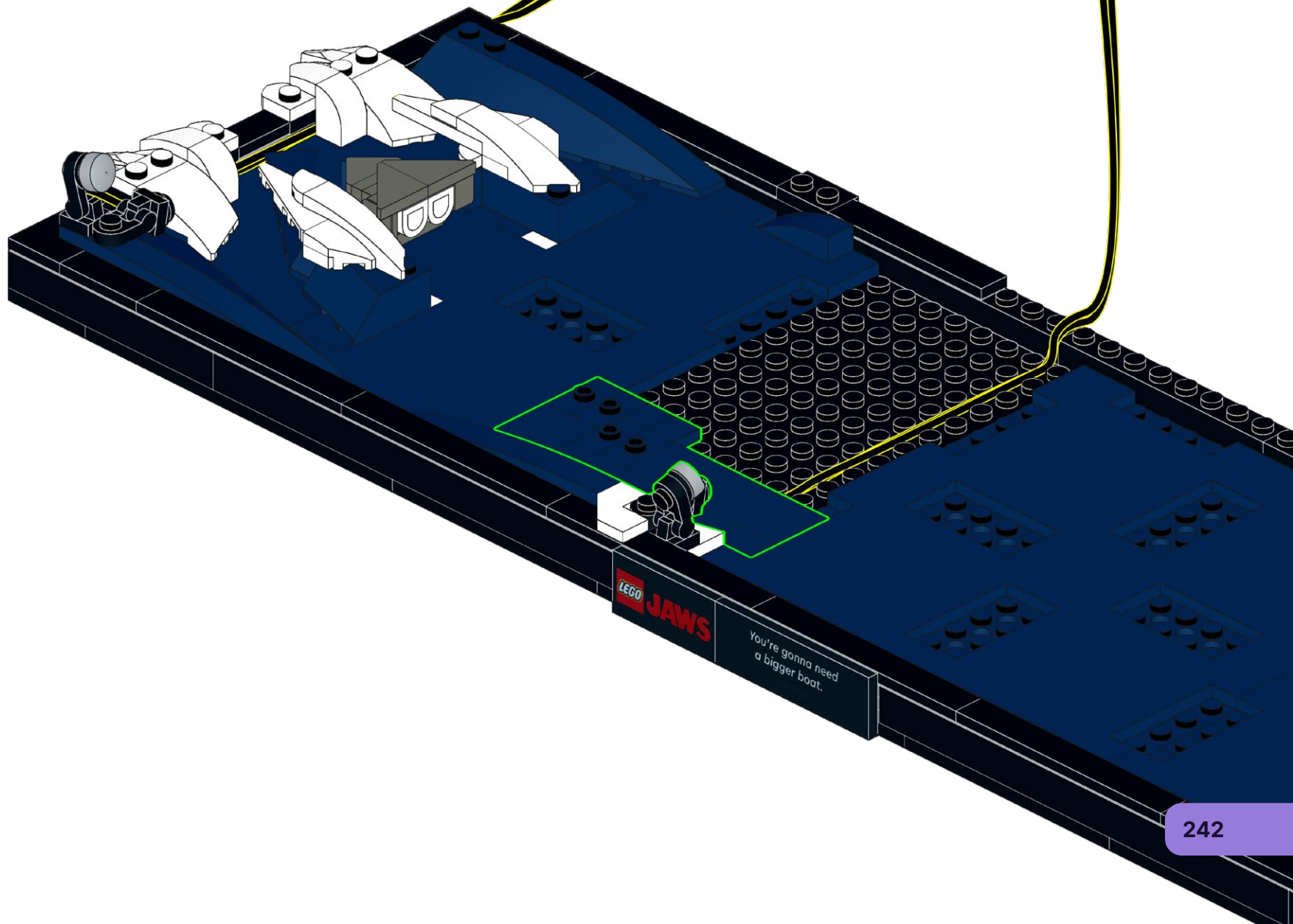
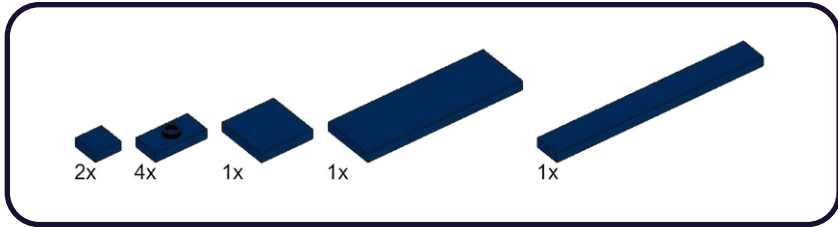

259

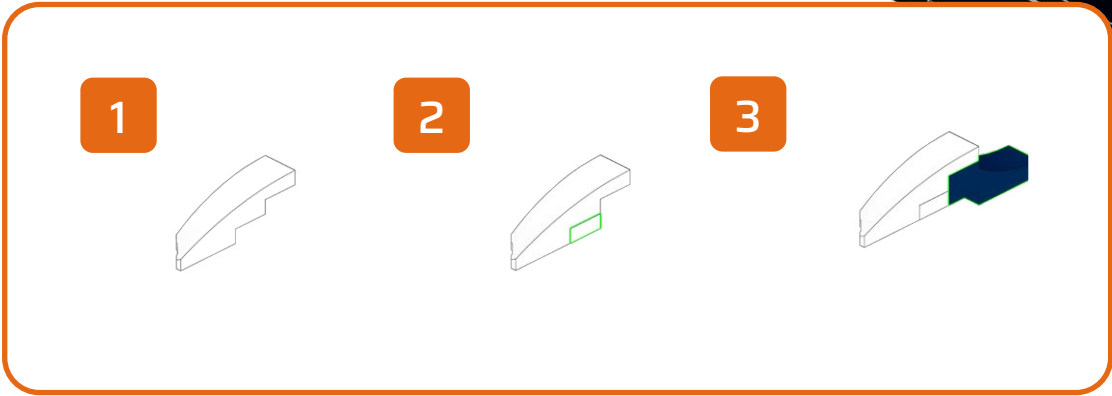
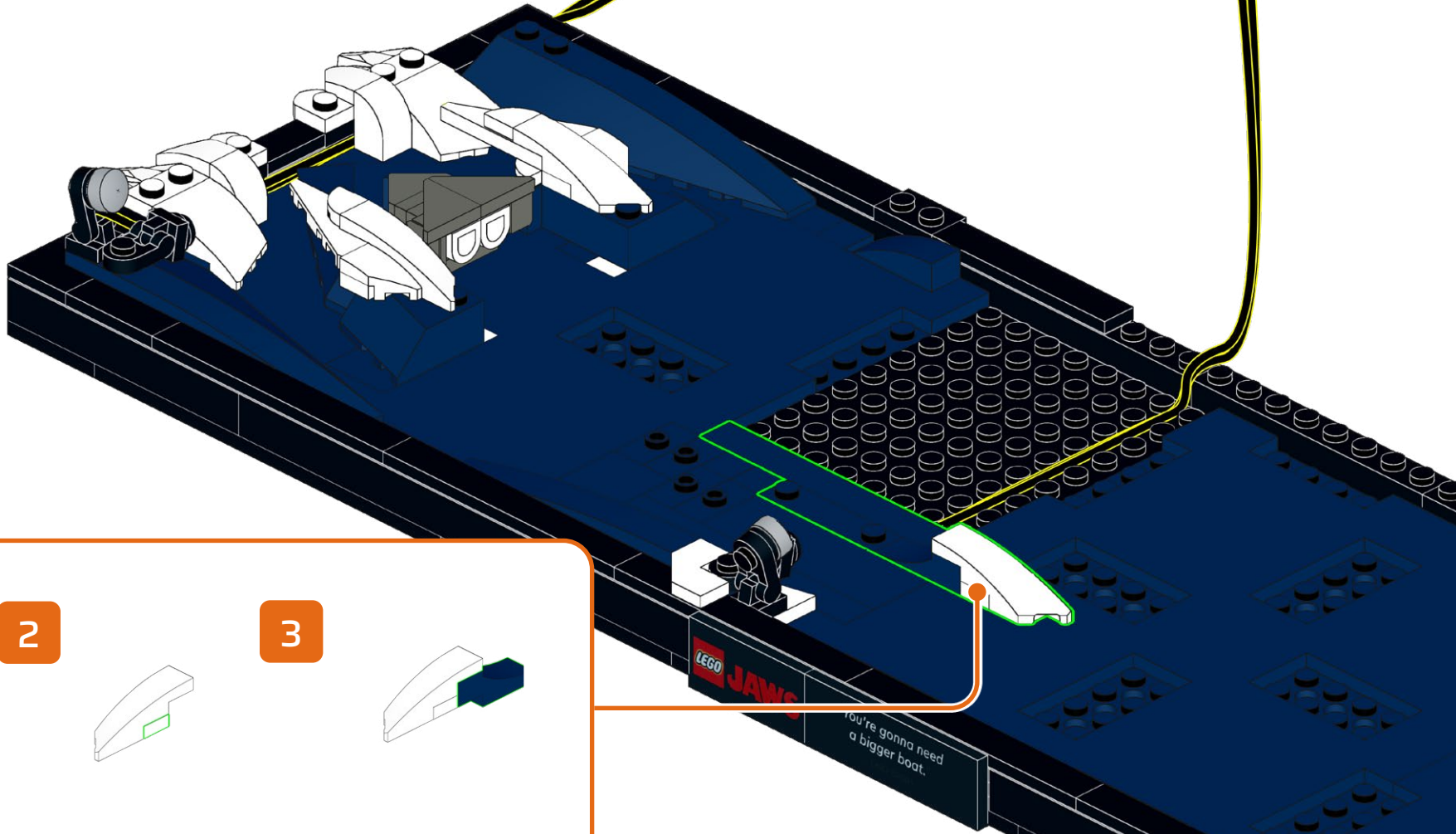
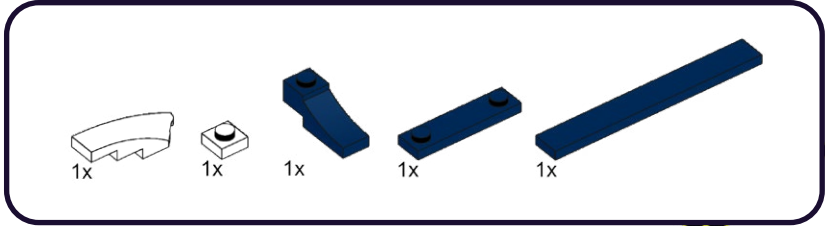

260

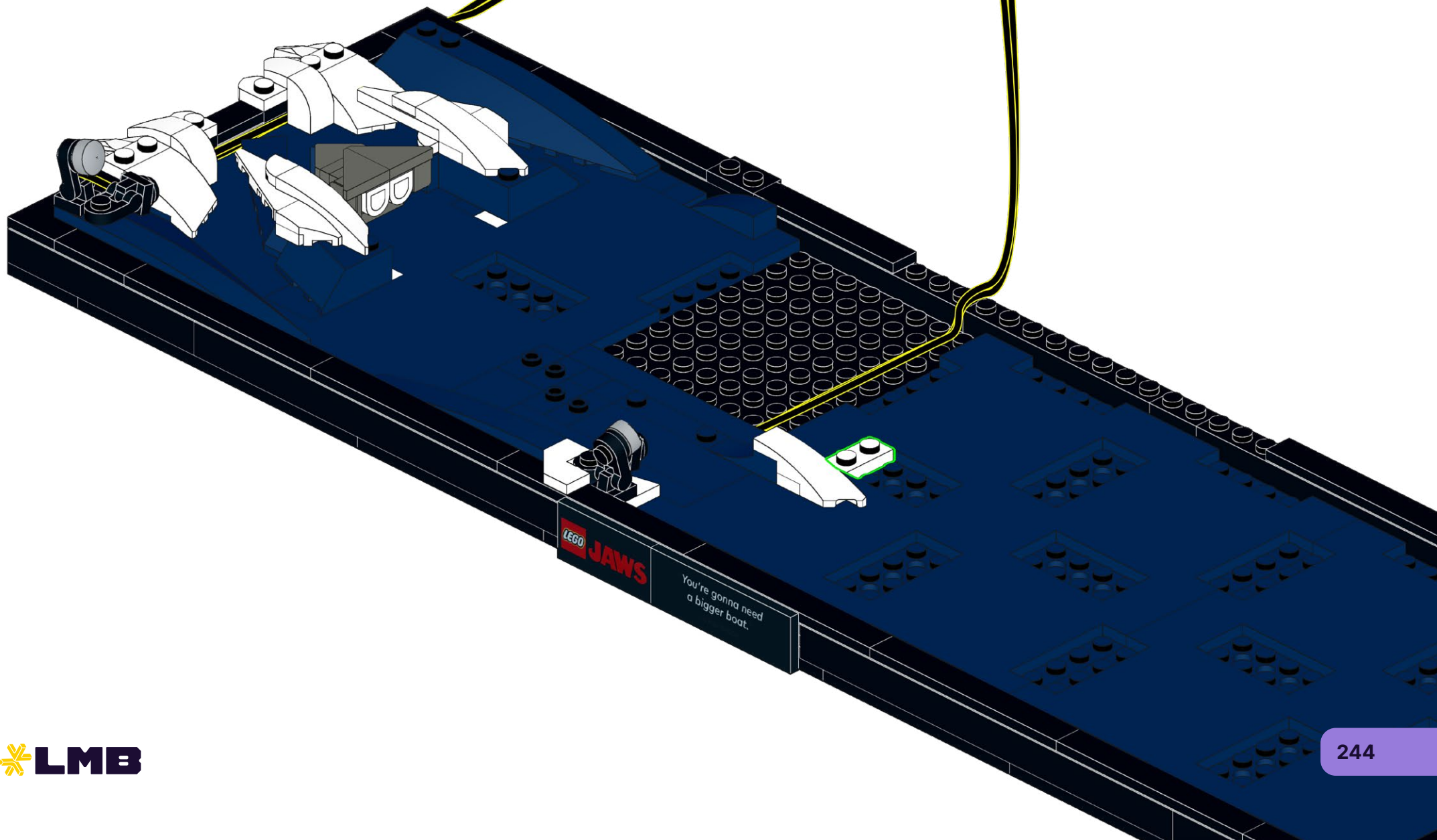
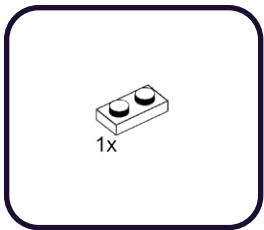

LEGO JAWS

You're gonna need
a bigger boat.

261

1x

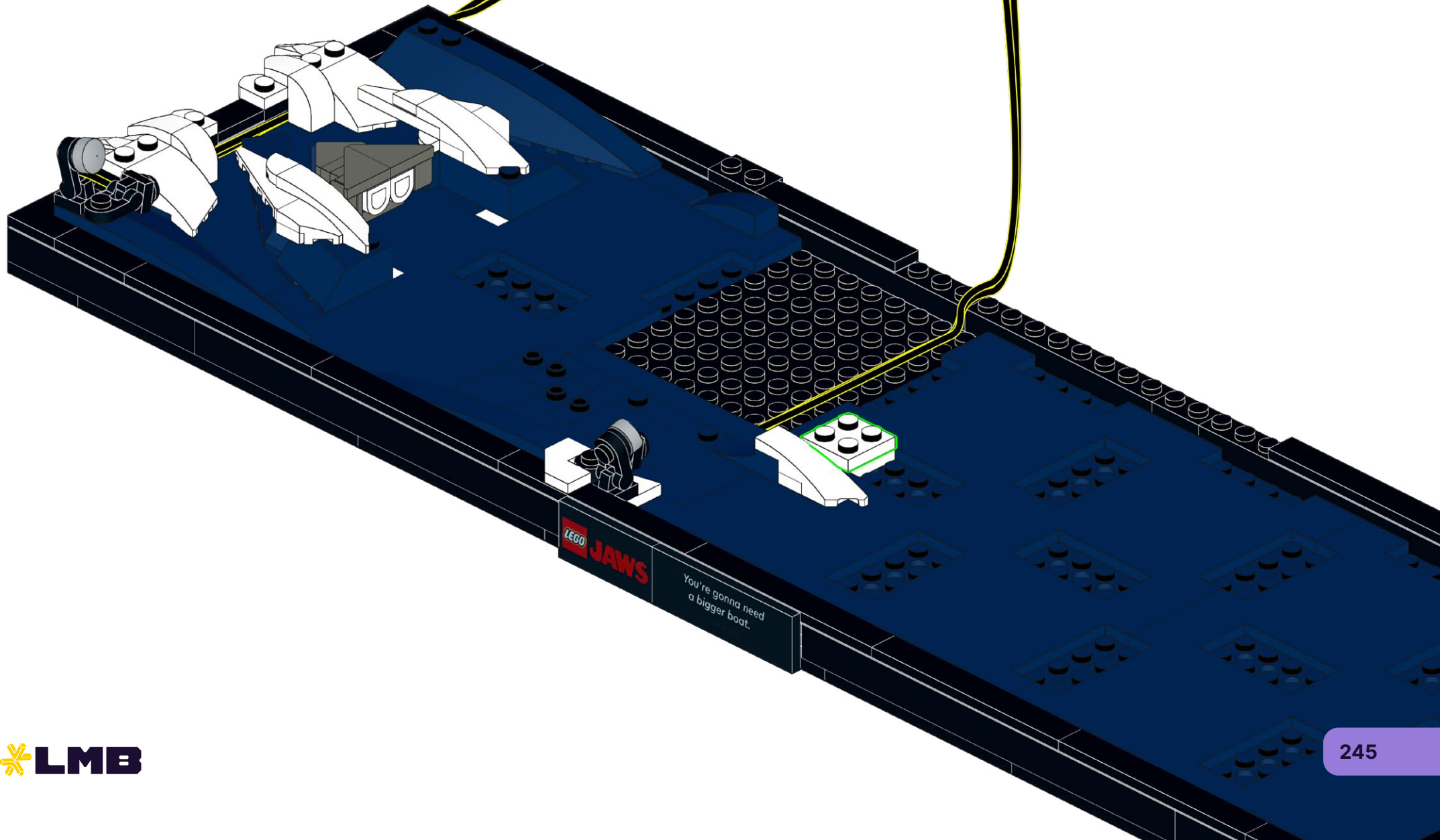

262

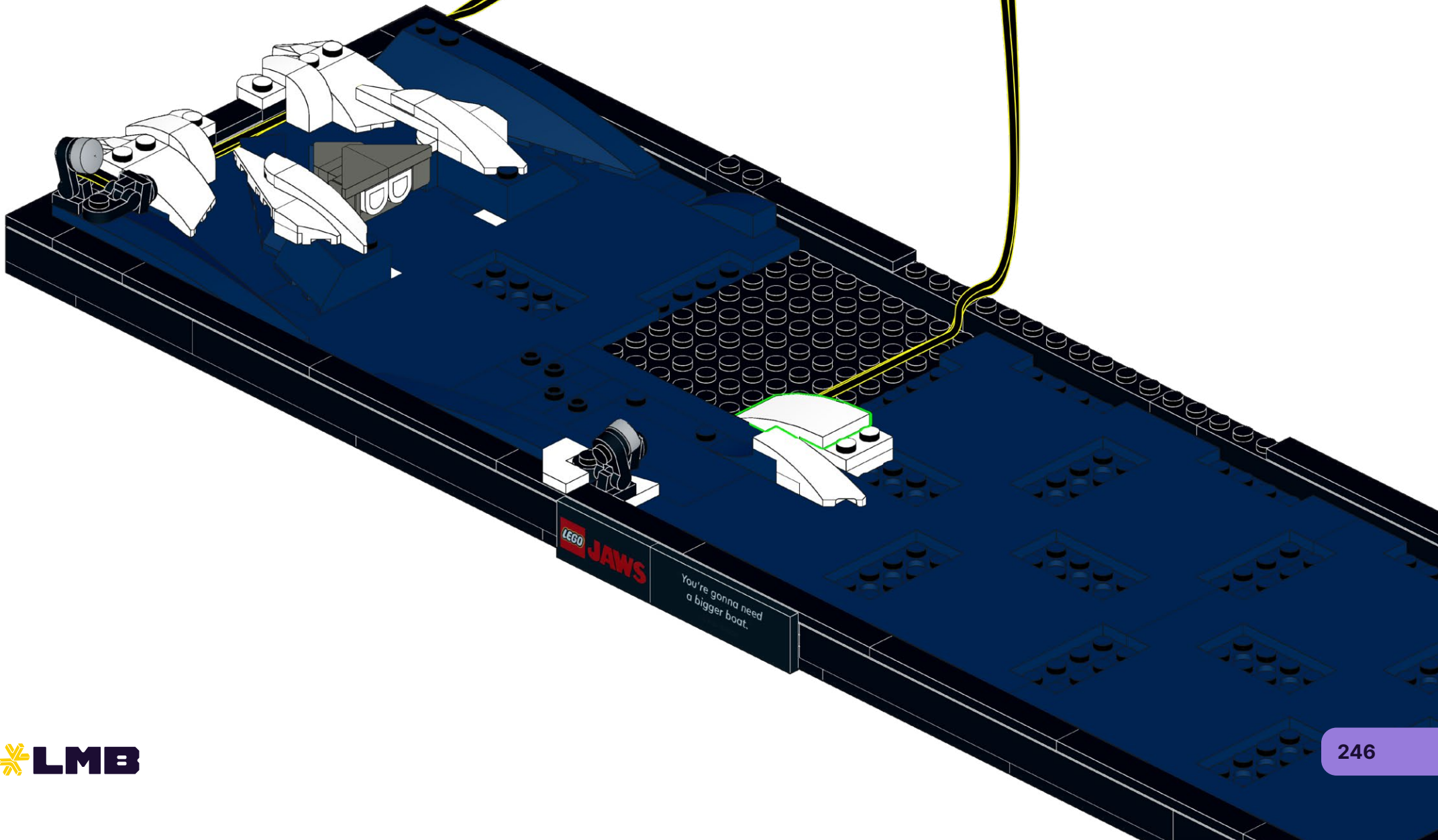
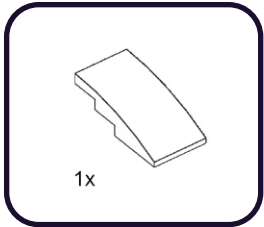

263

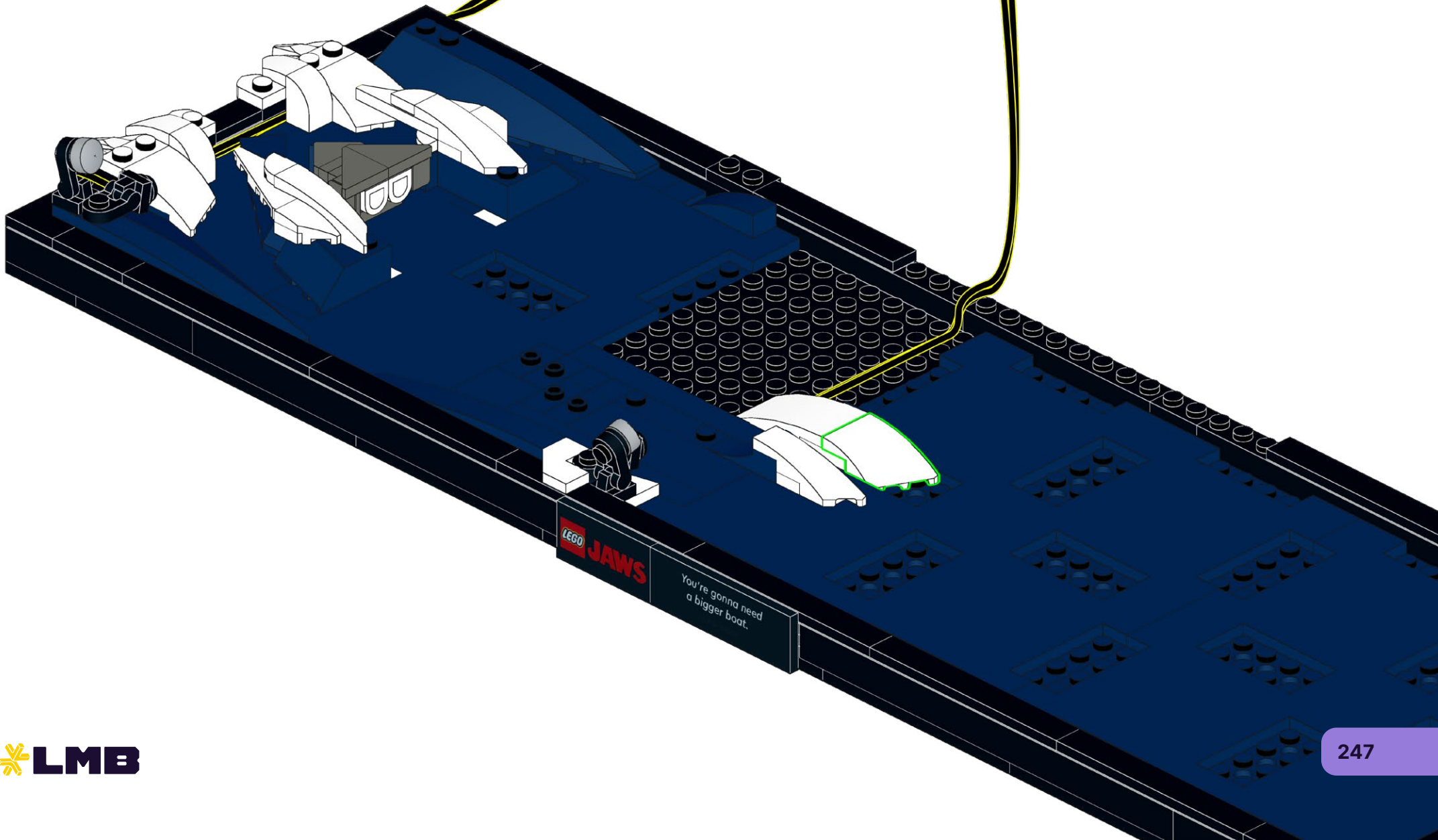
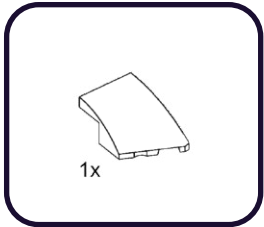

264

1x

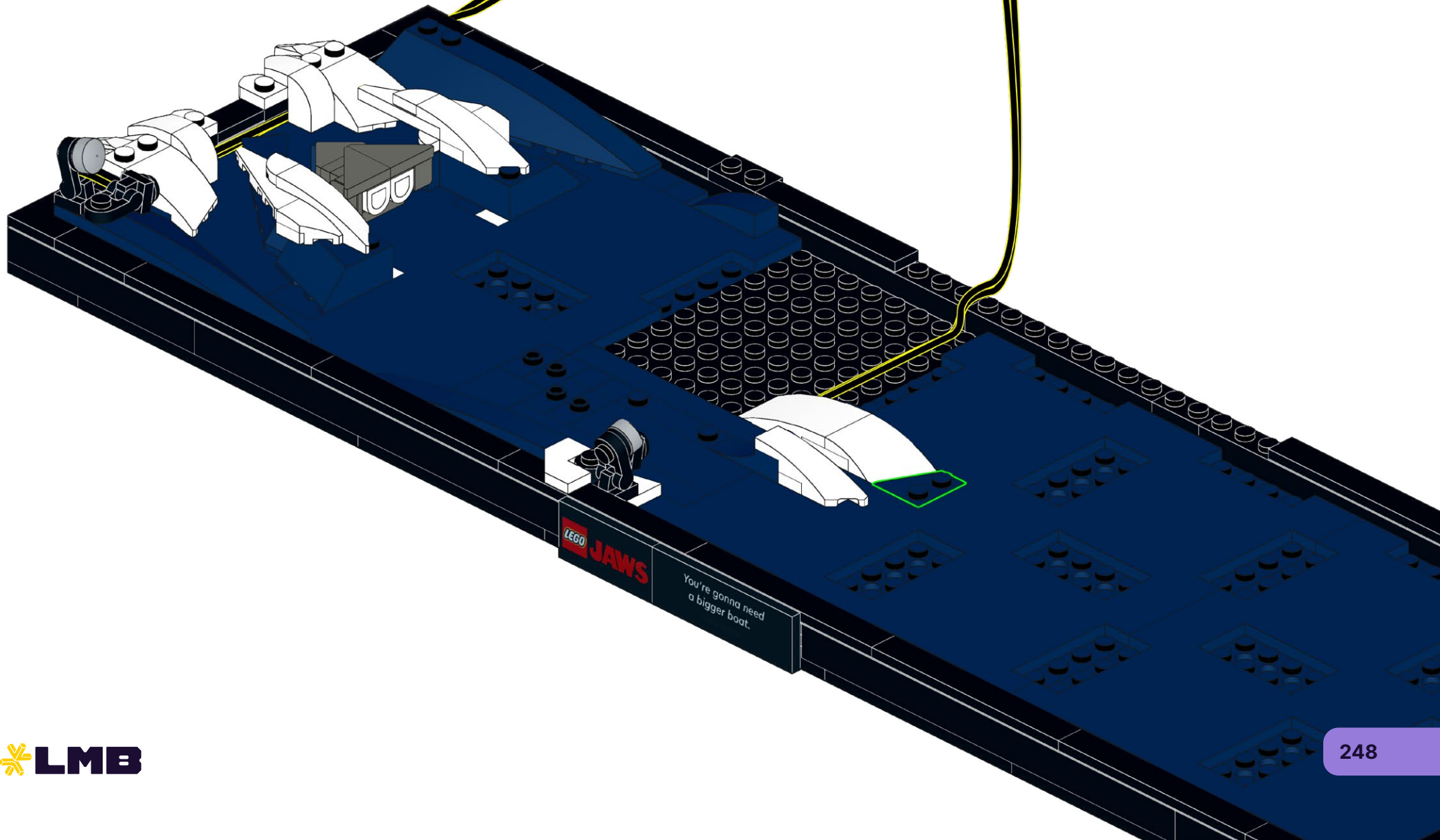

265

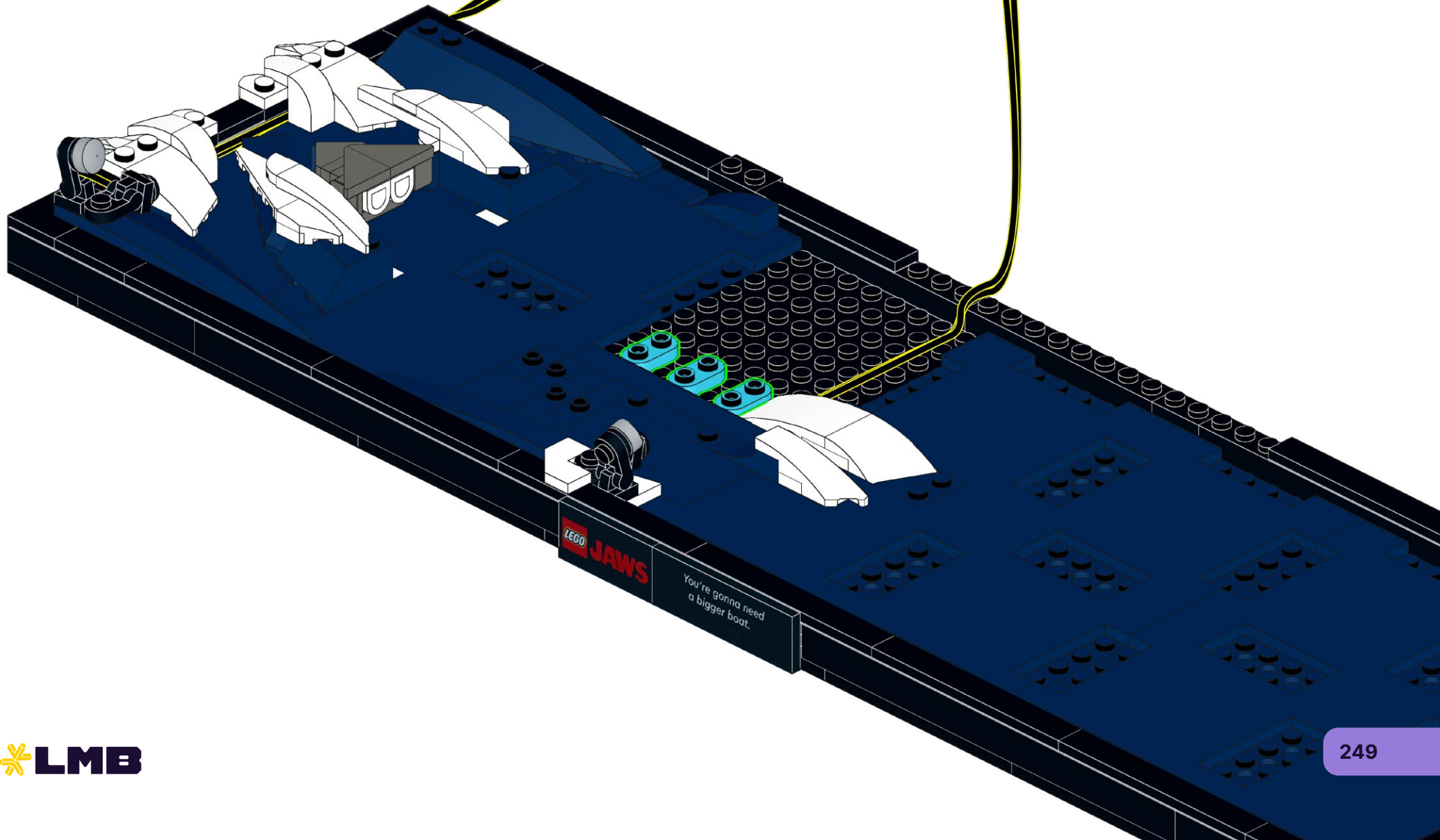
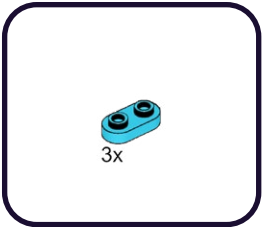

266

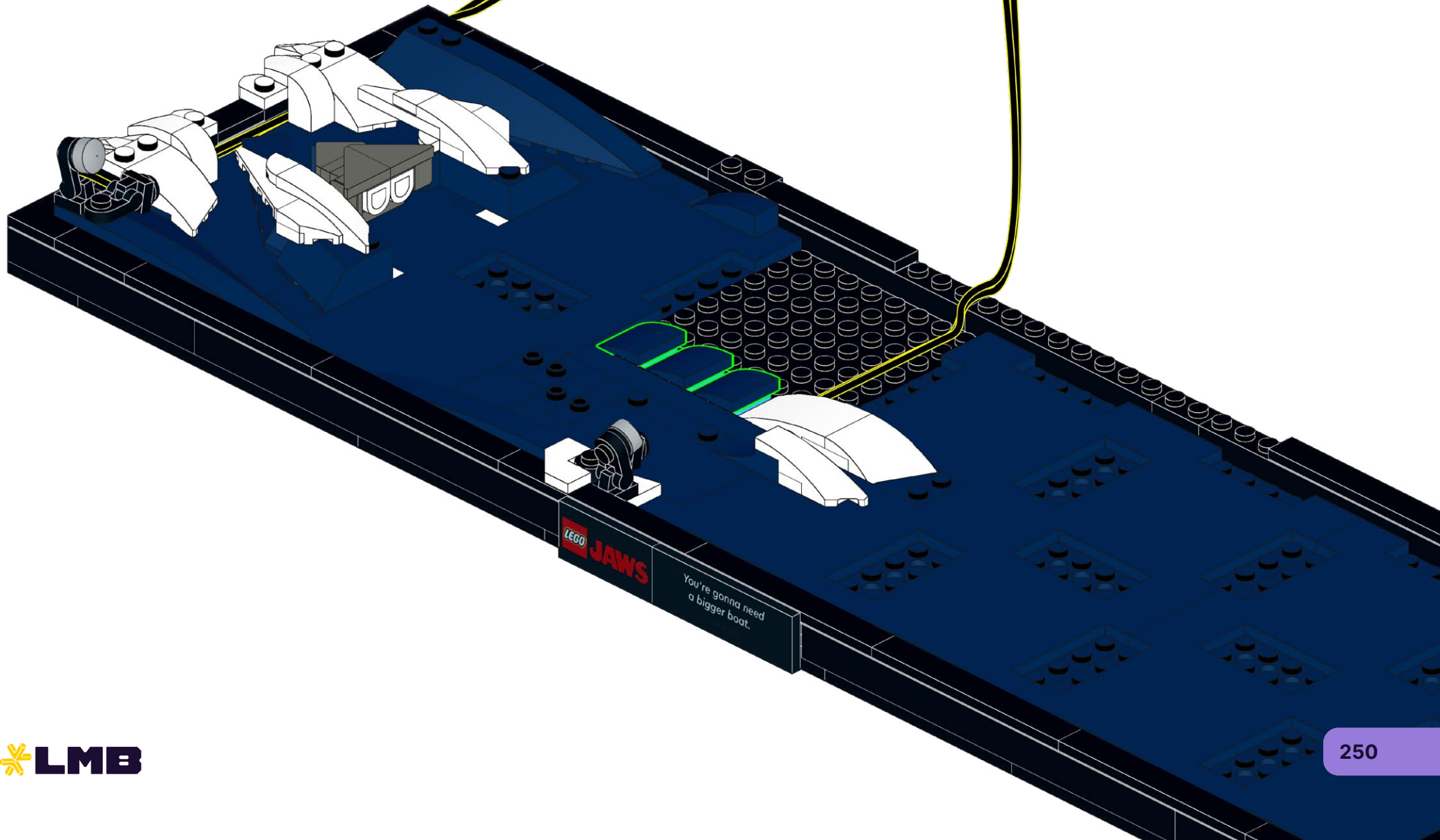
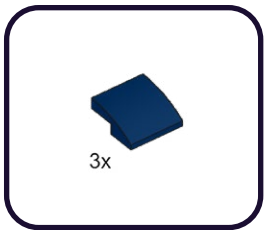

267

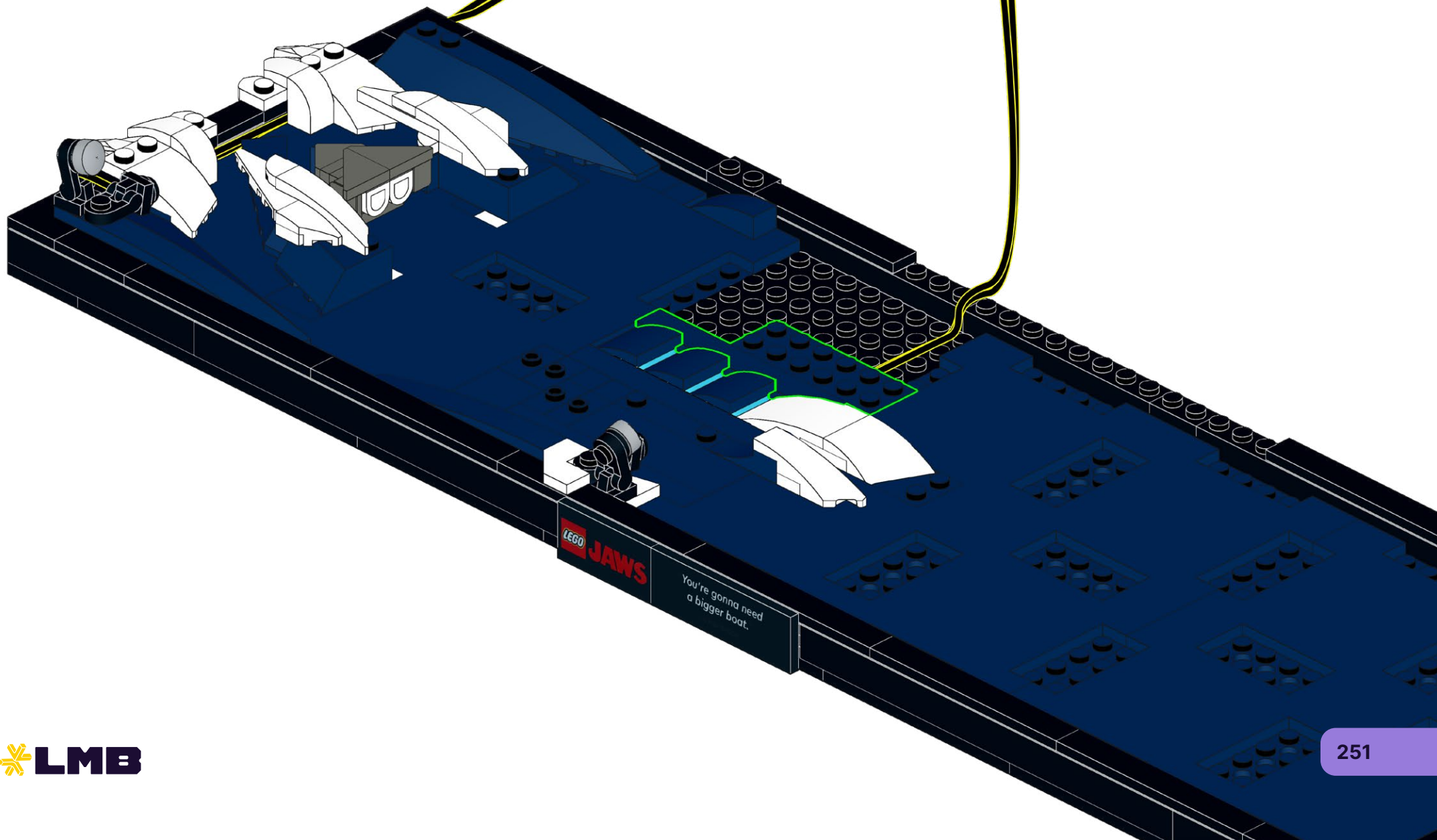
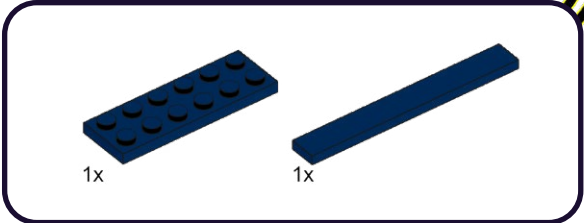

268

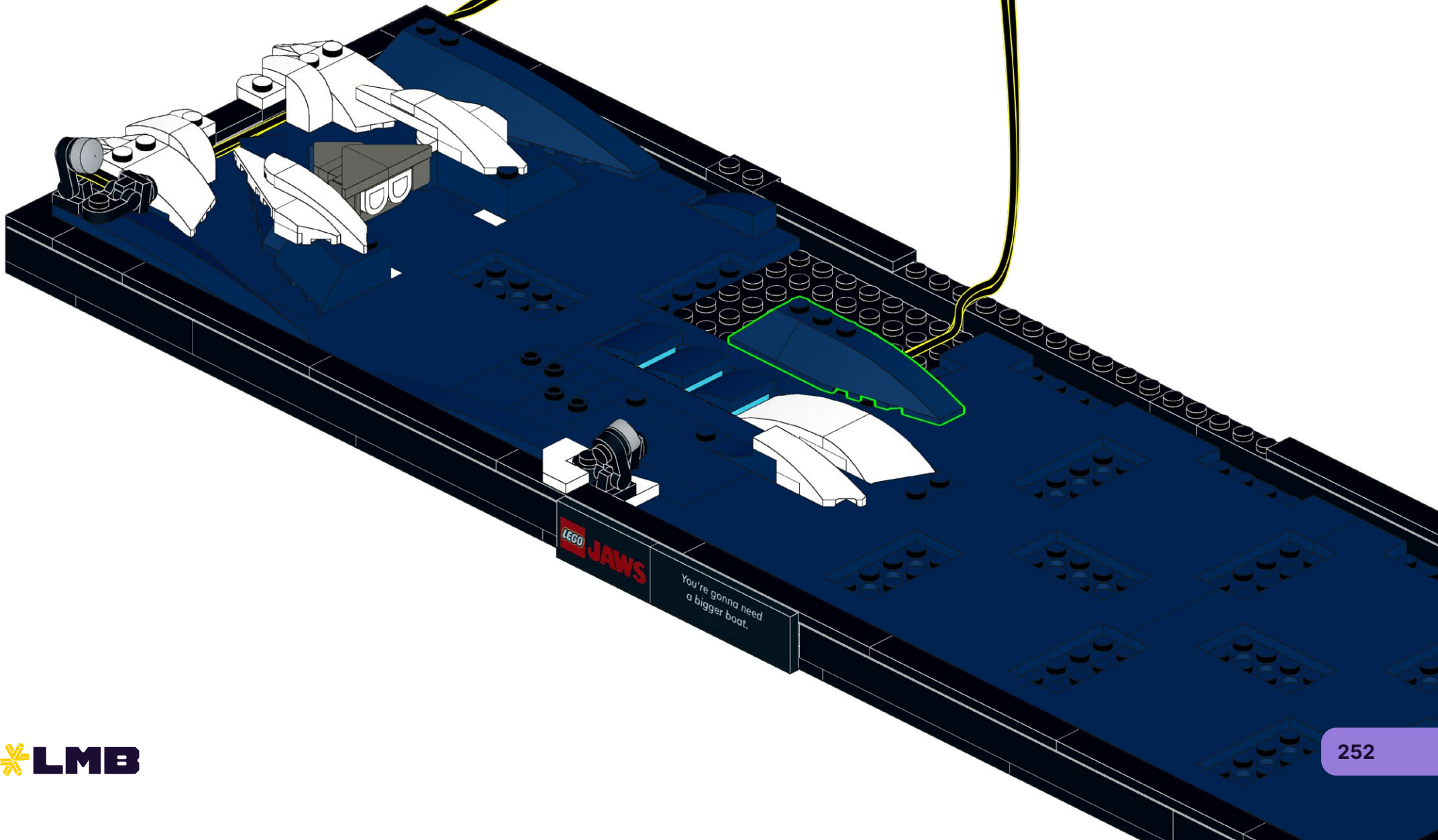
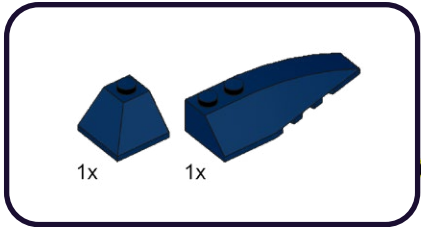

269

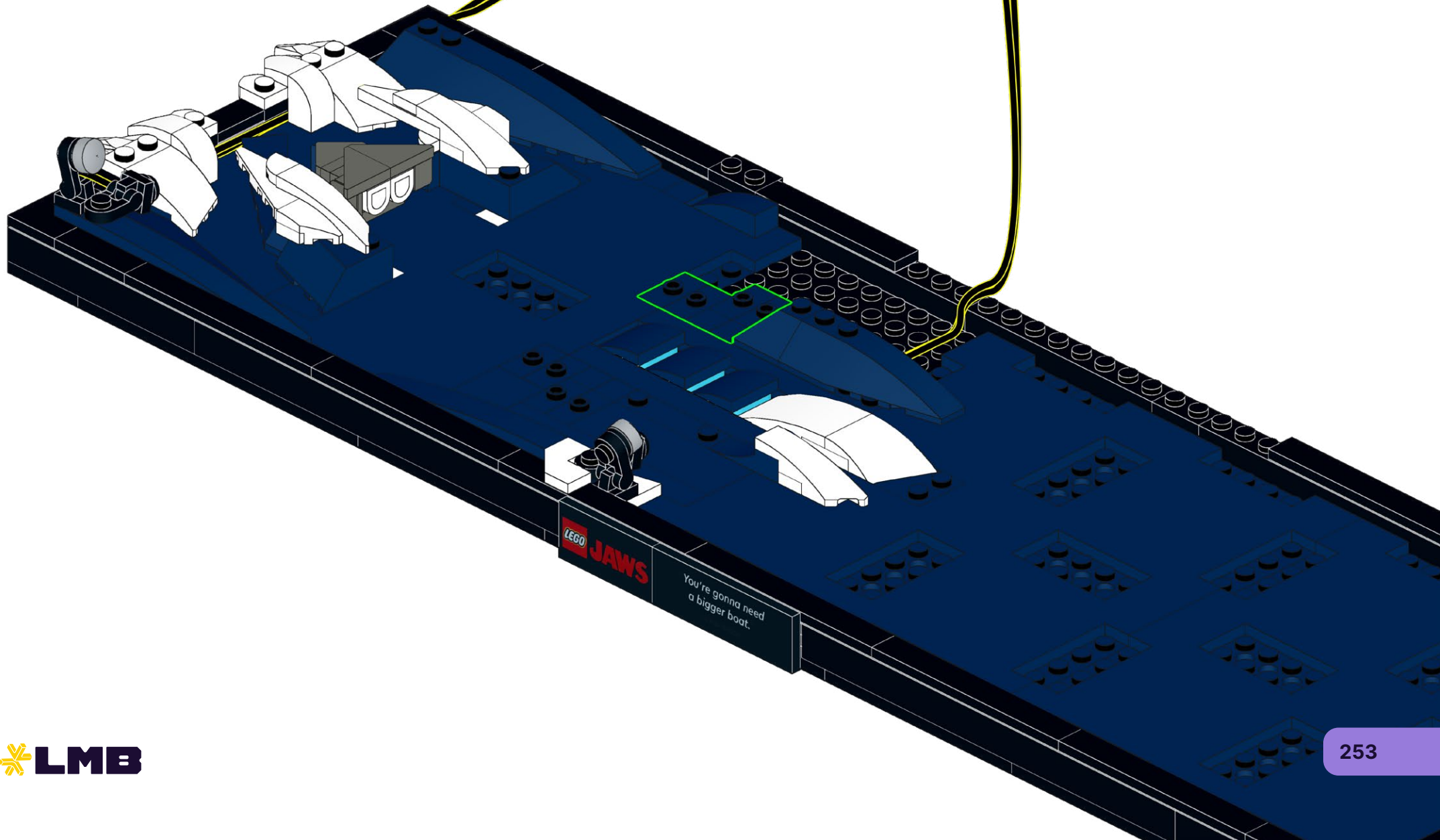
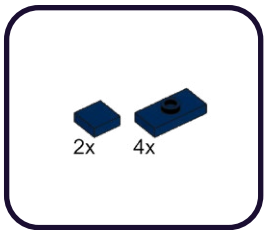

270

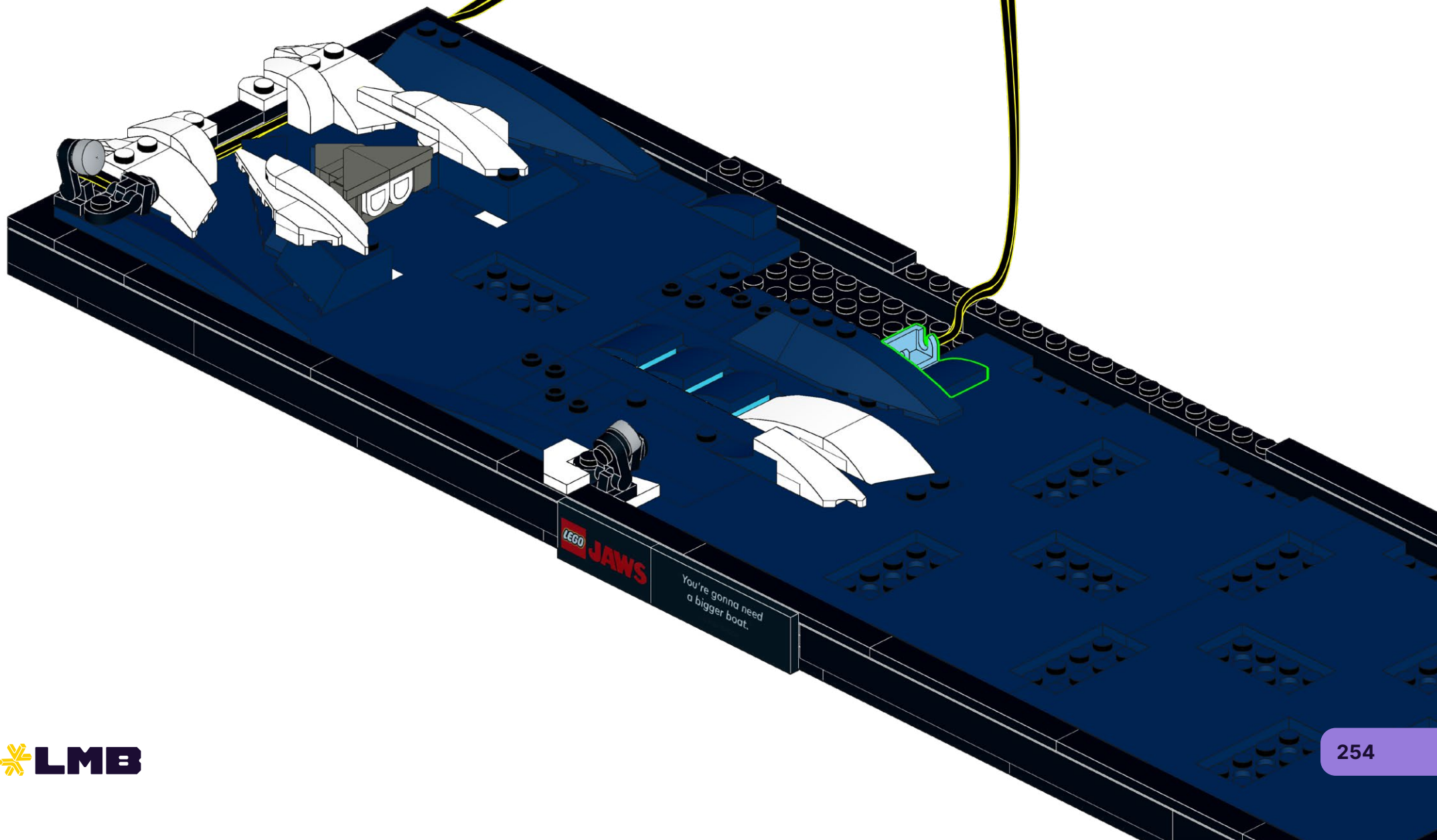
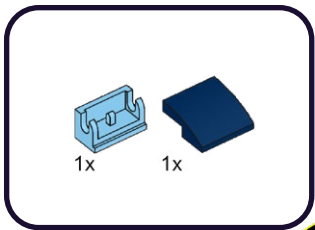

271

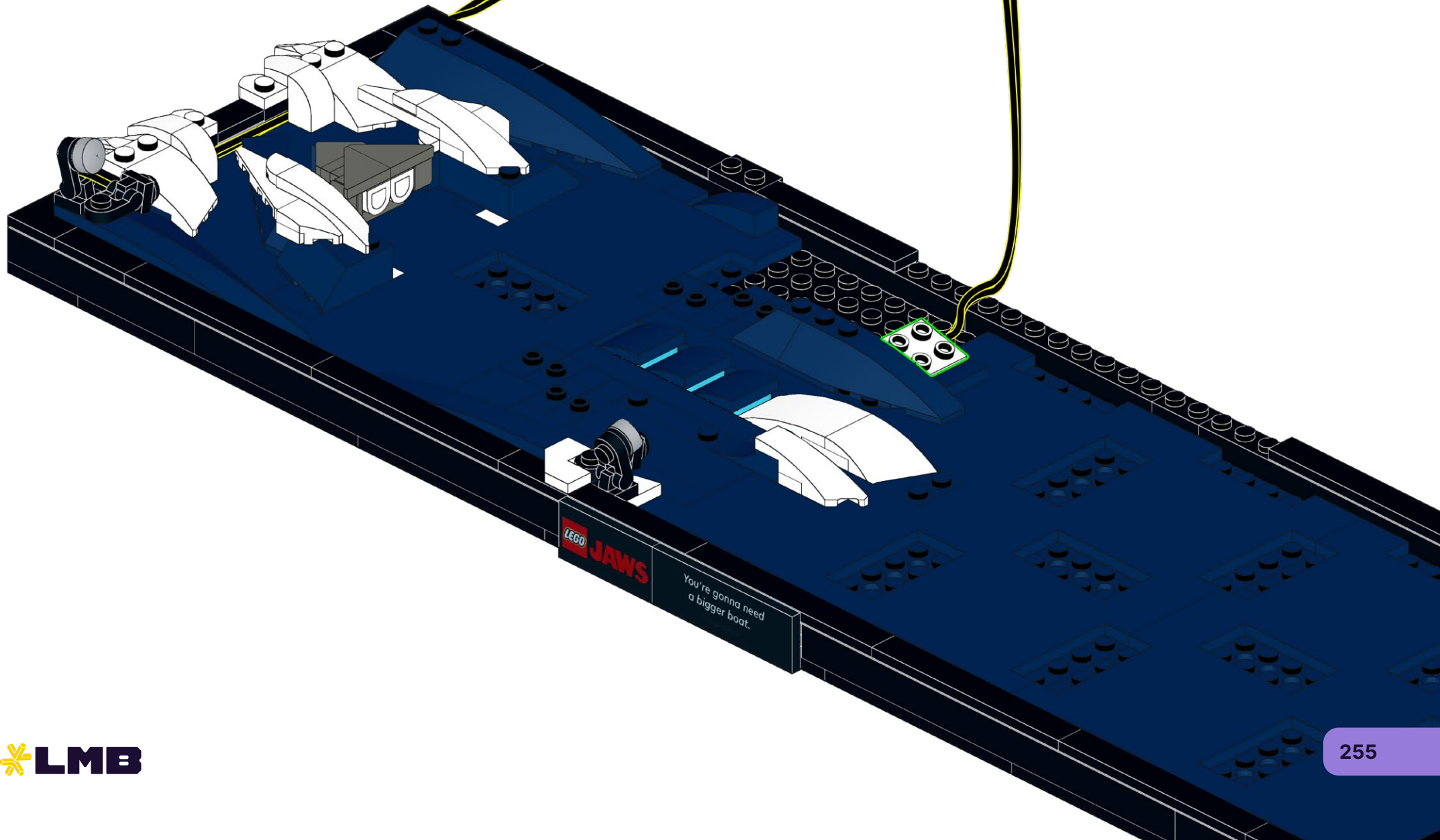

272

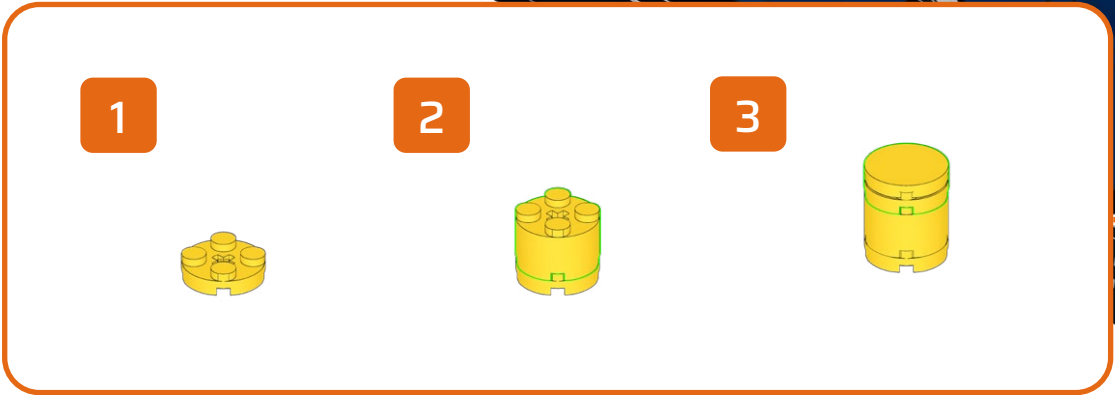
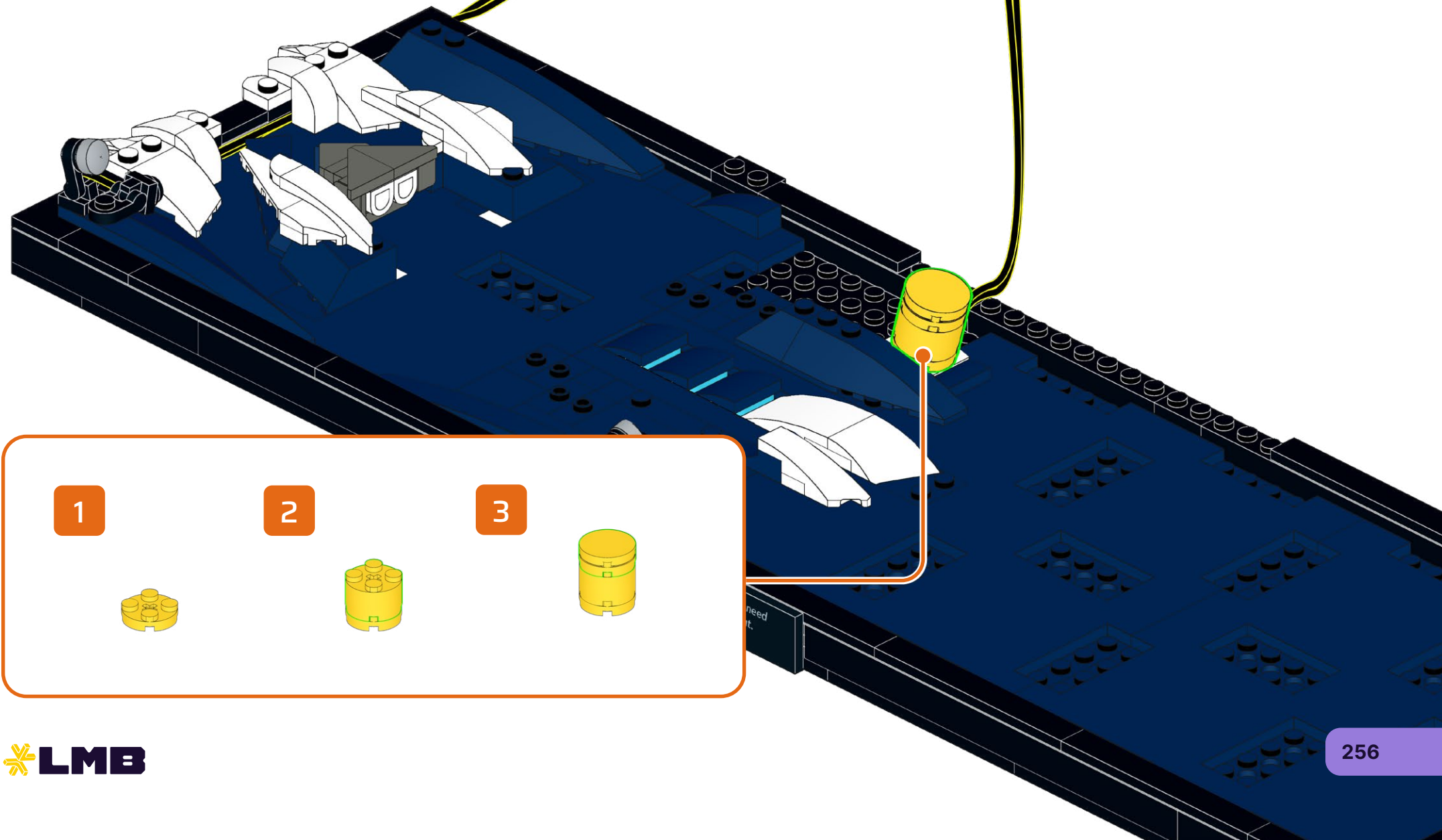
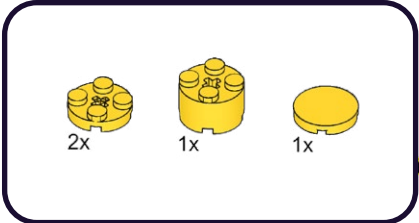

273

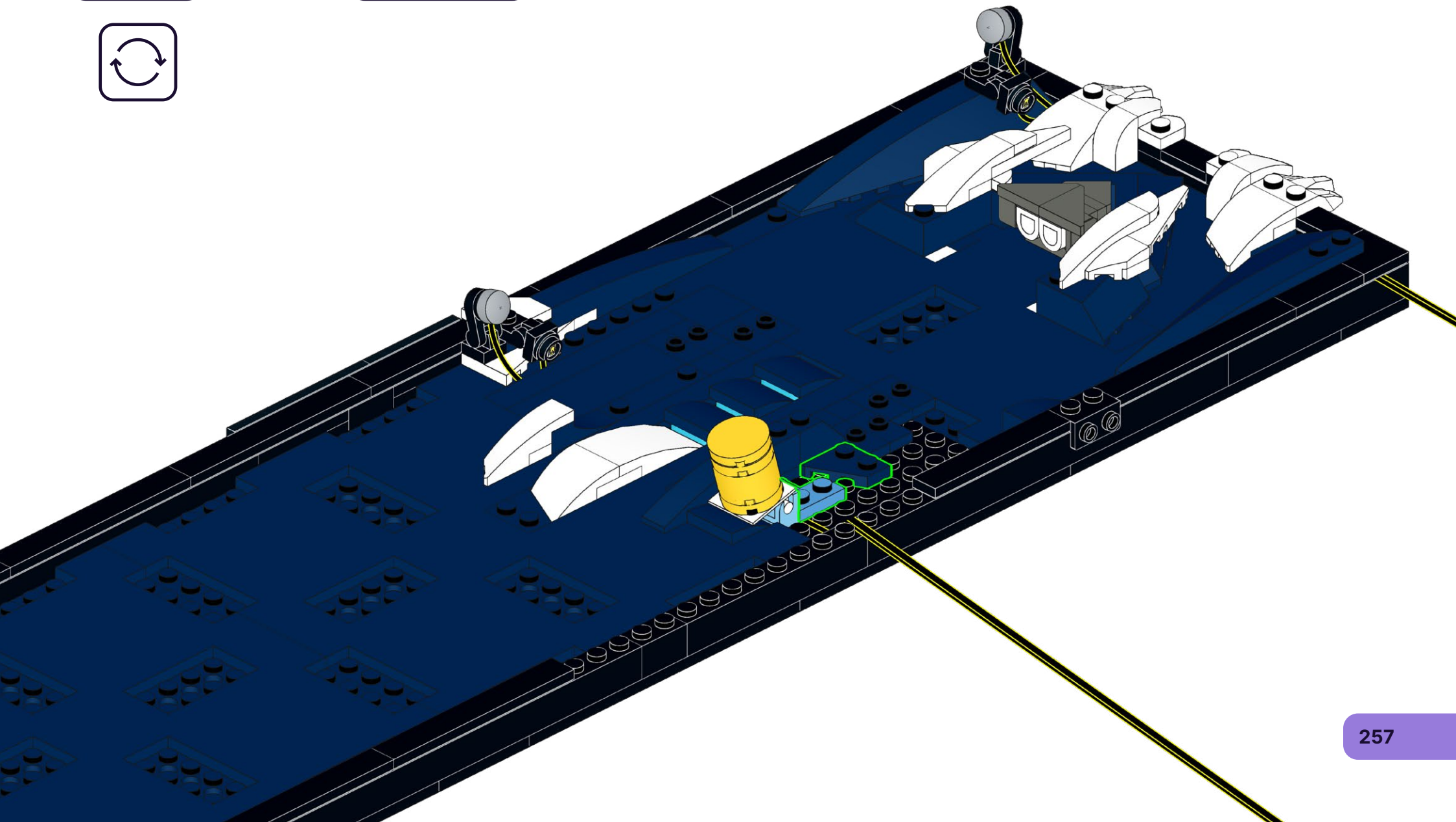
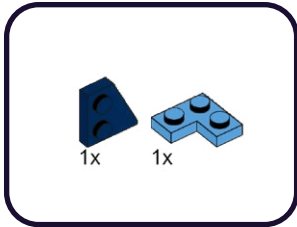

274

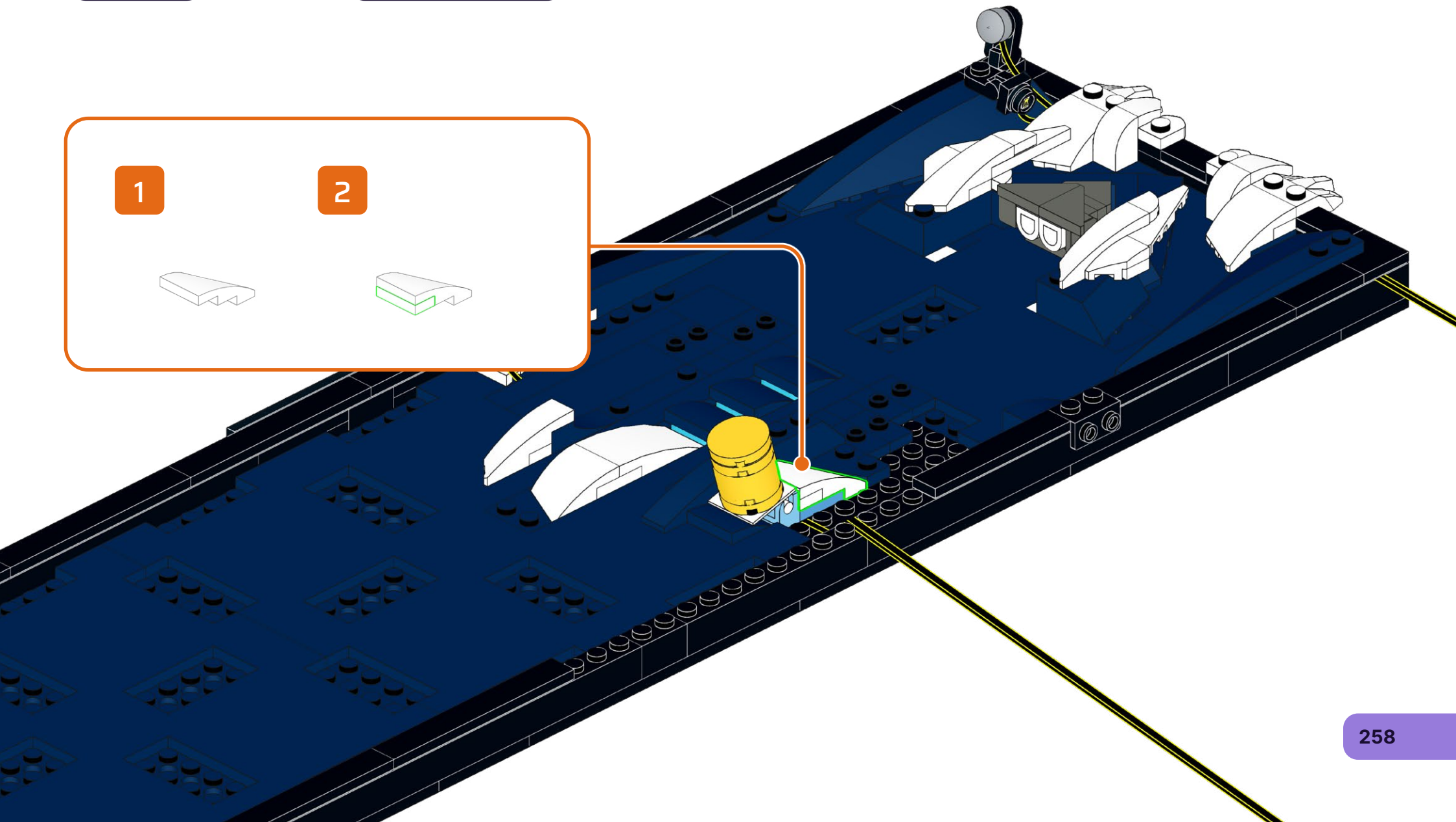
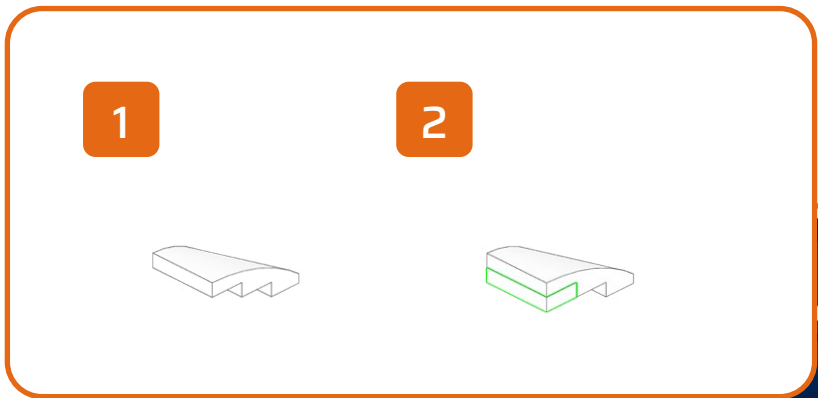
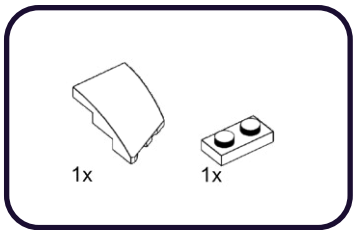

275

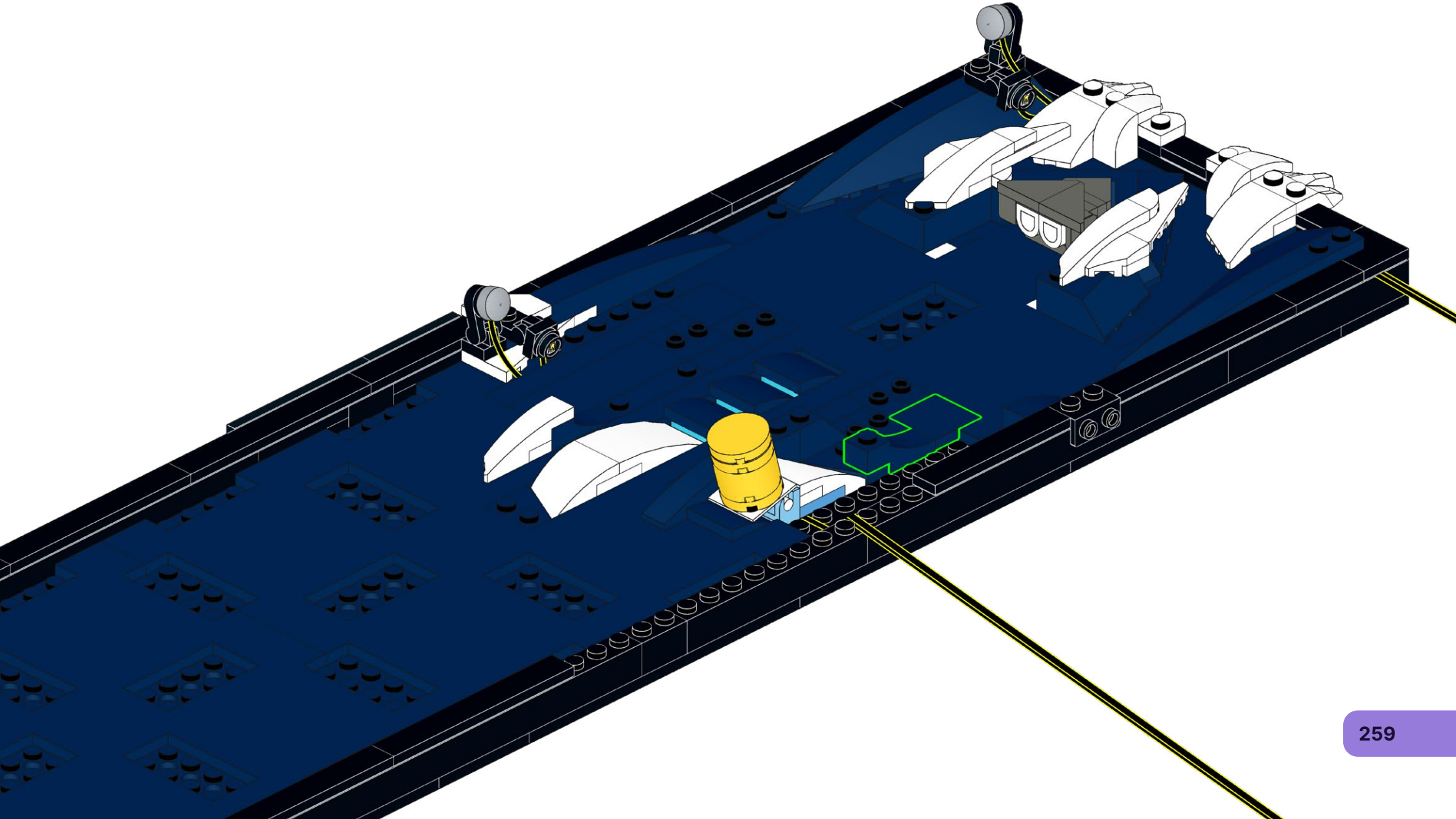
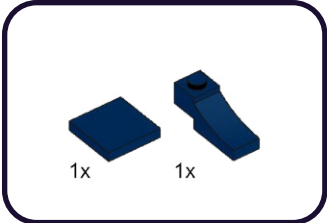

276

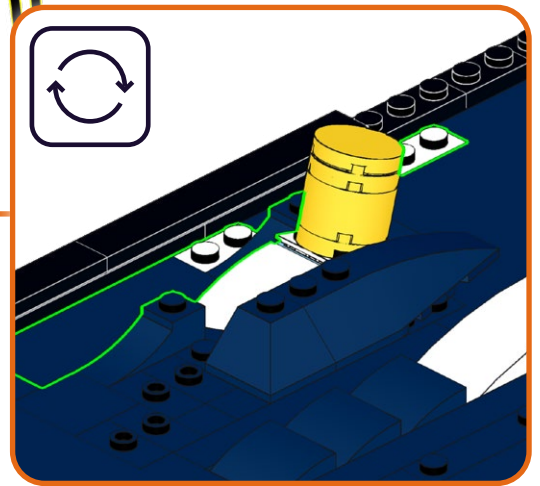
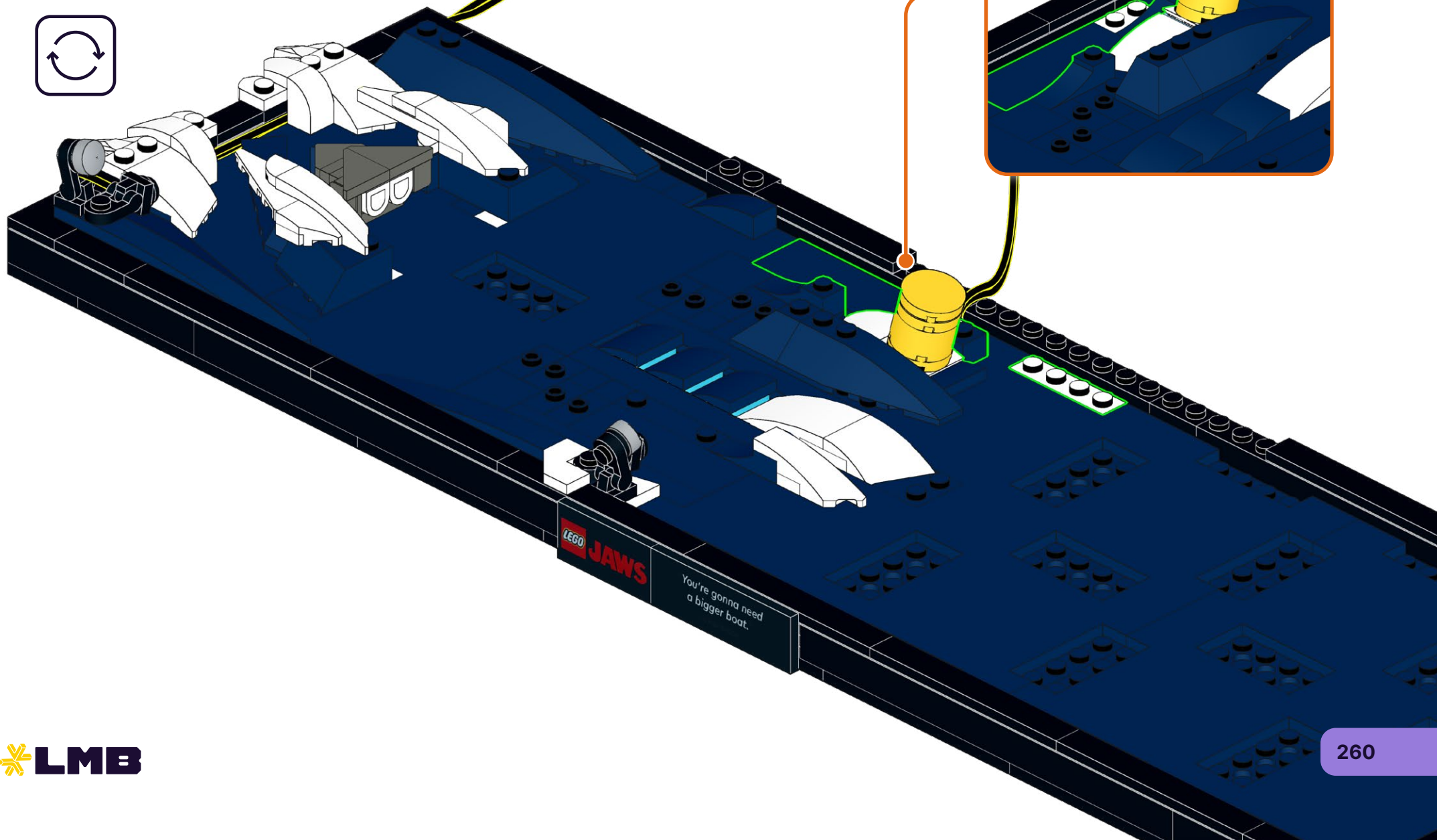
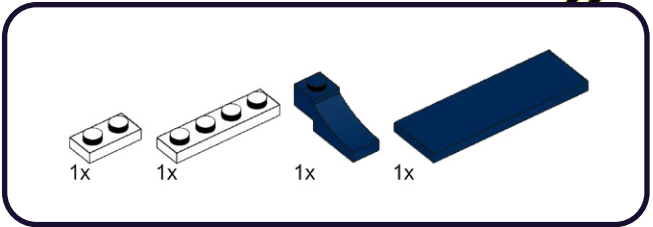

277

1x

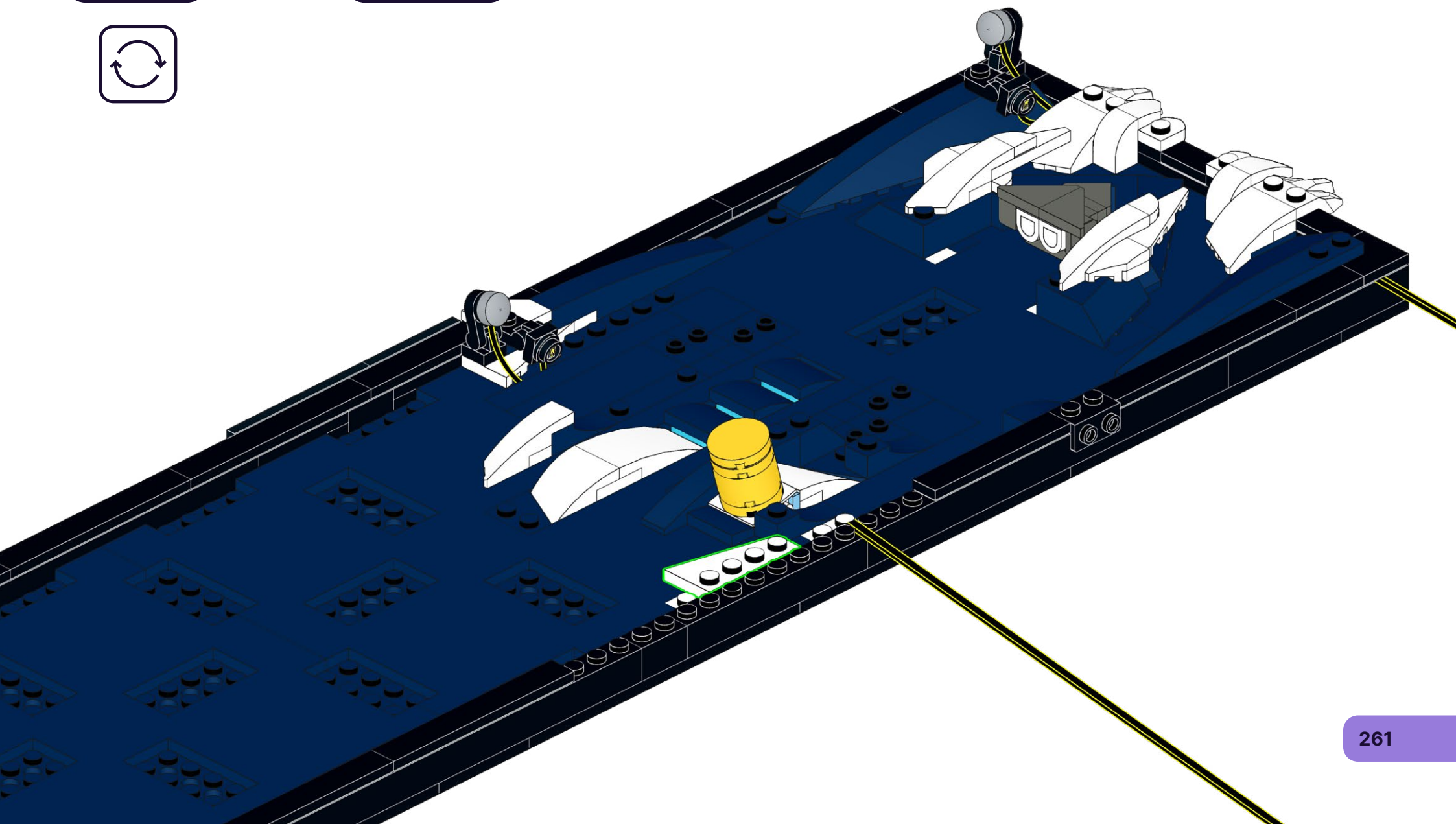

278

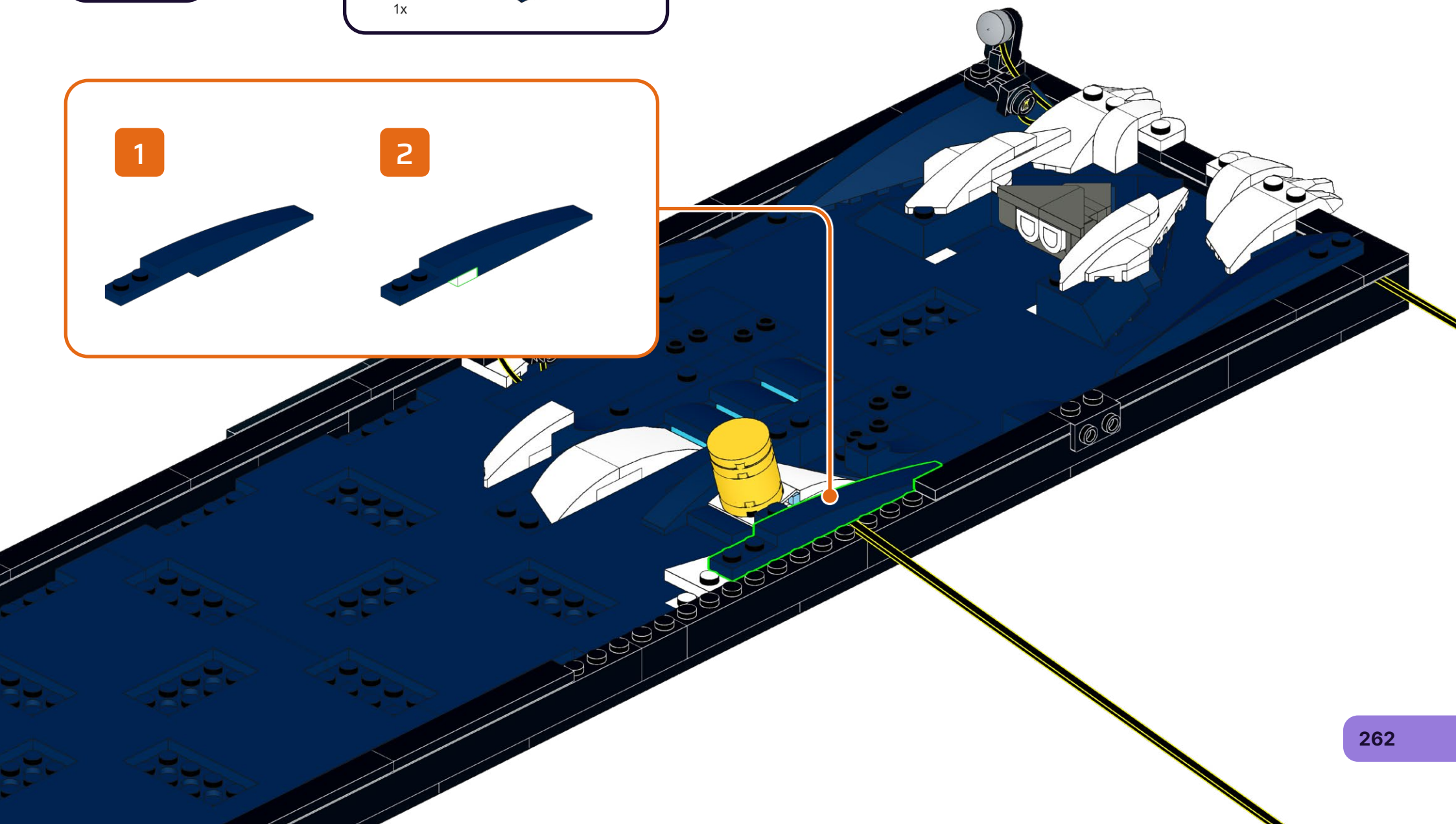
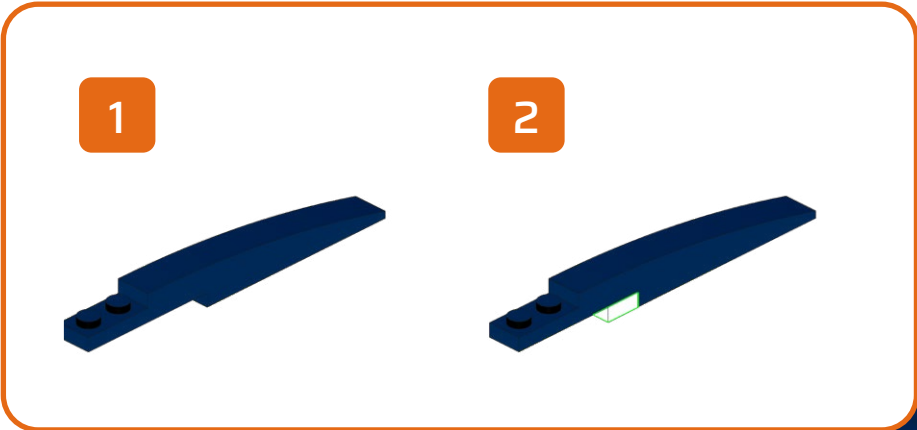
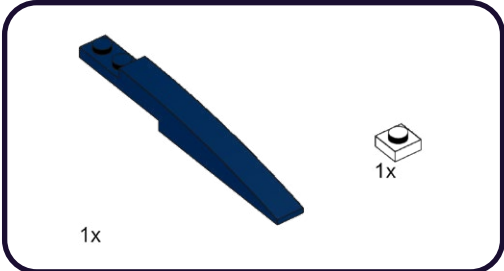

279

1x

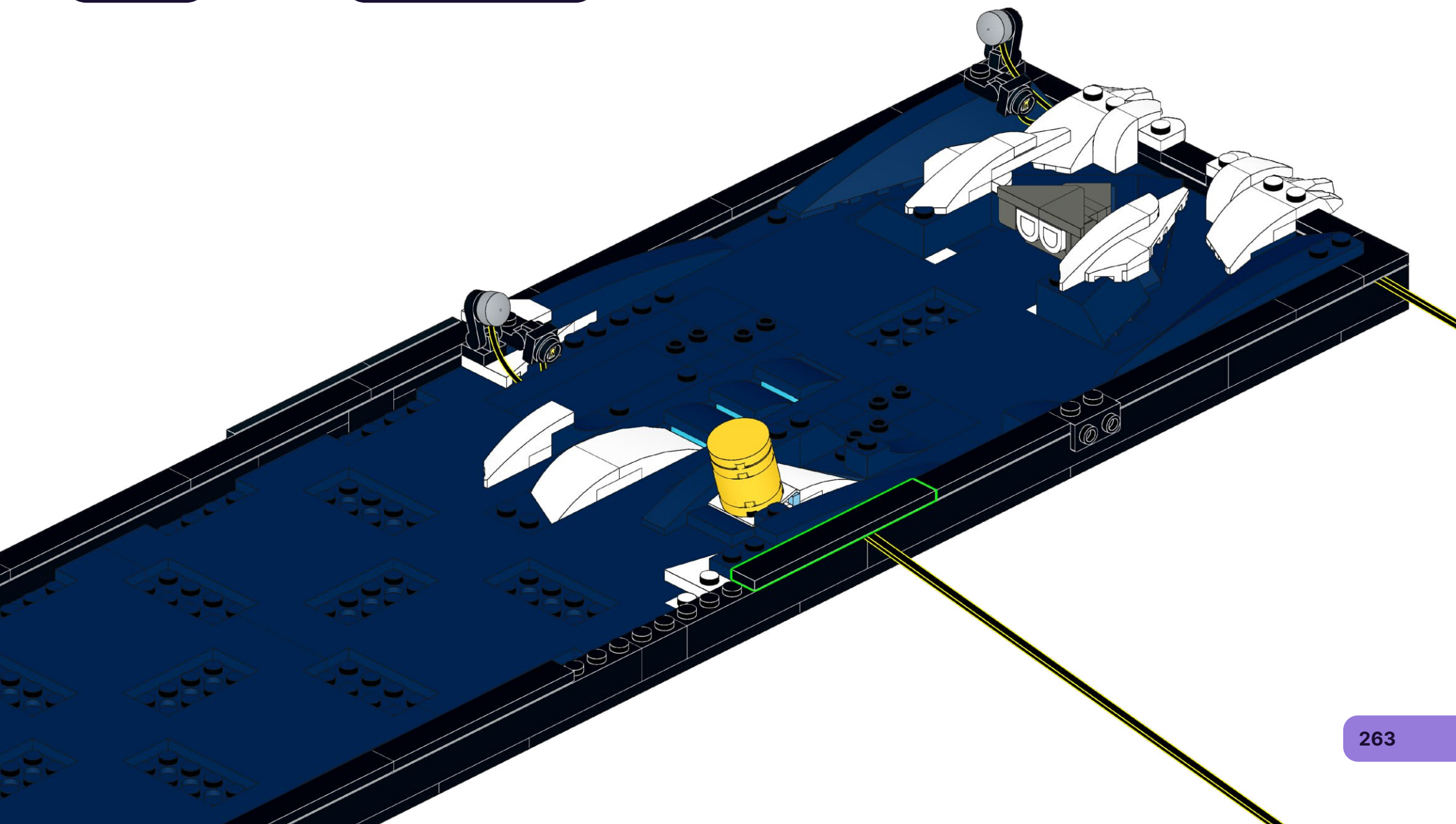

280

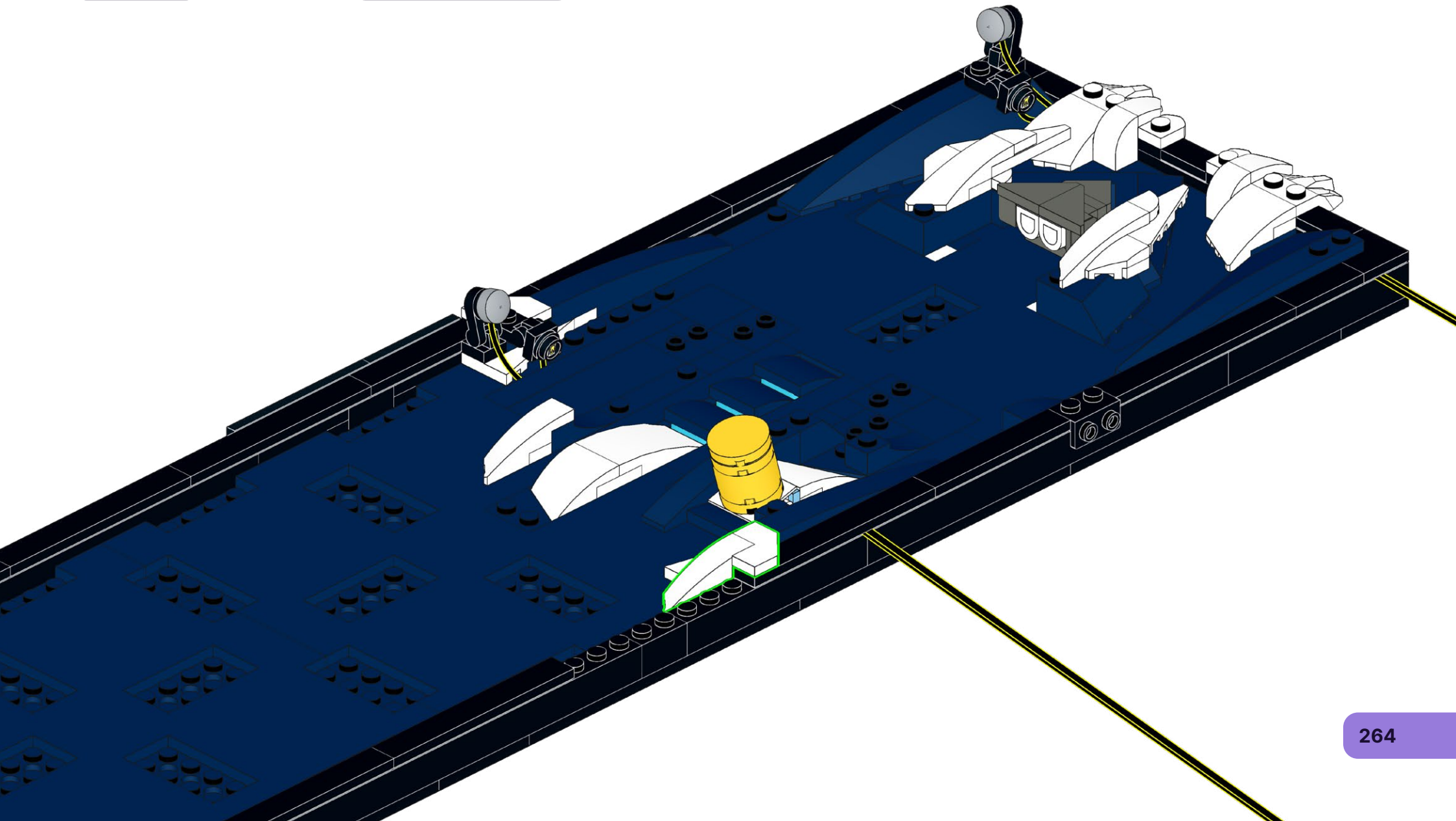
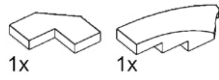

281

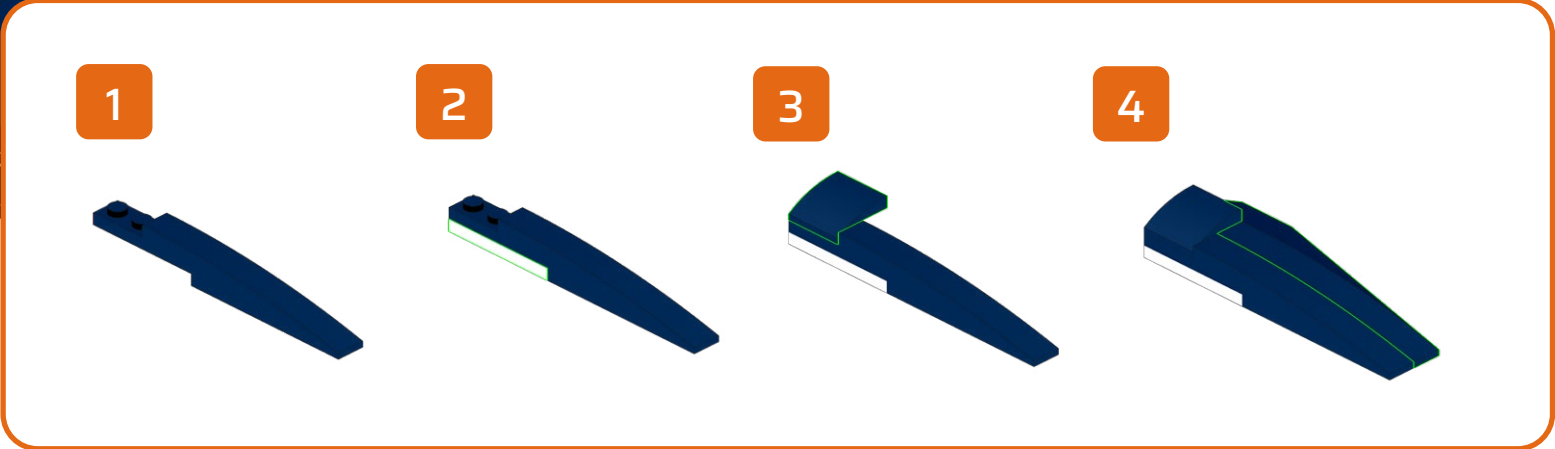
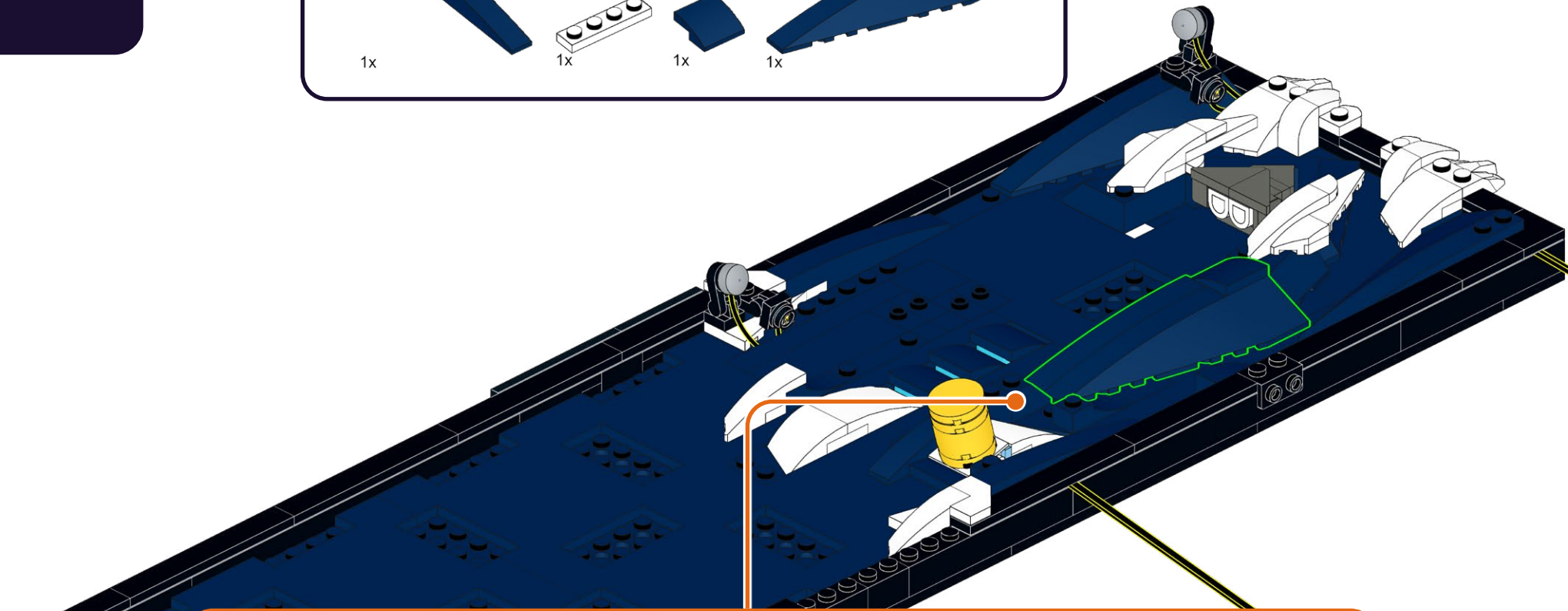
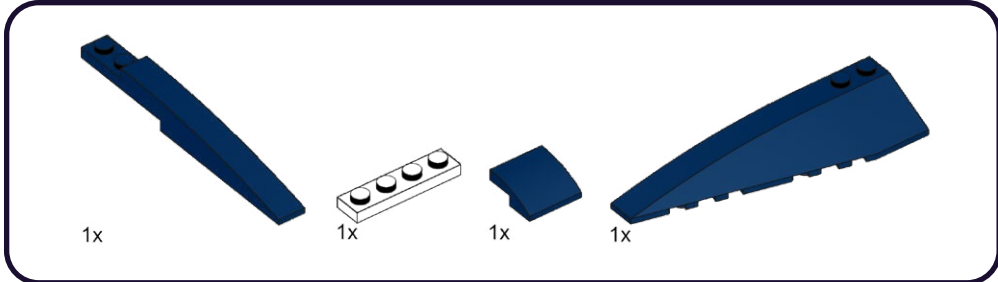

282

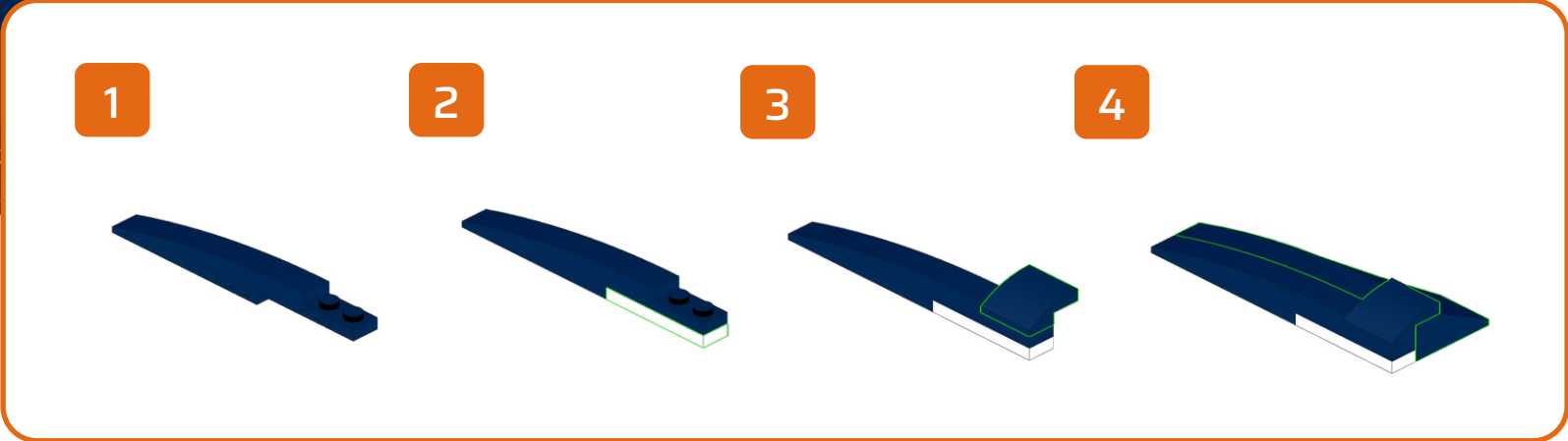
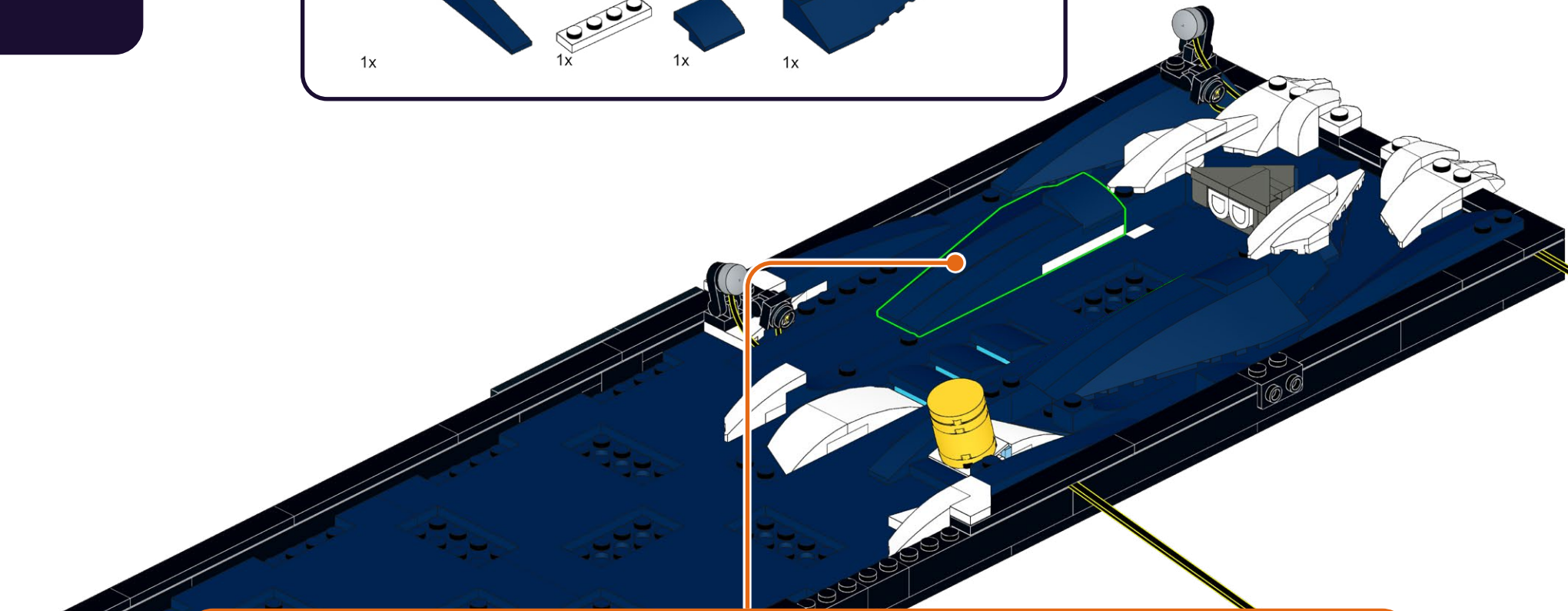
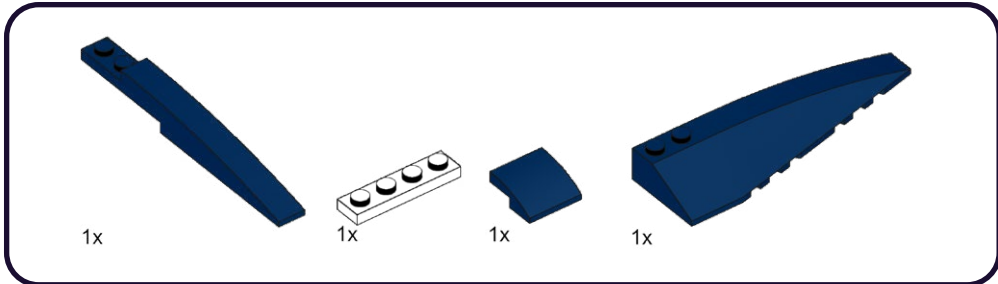

283

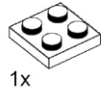

1

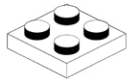

2

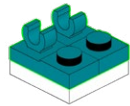

284



1x

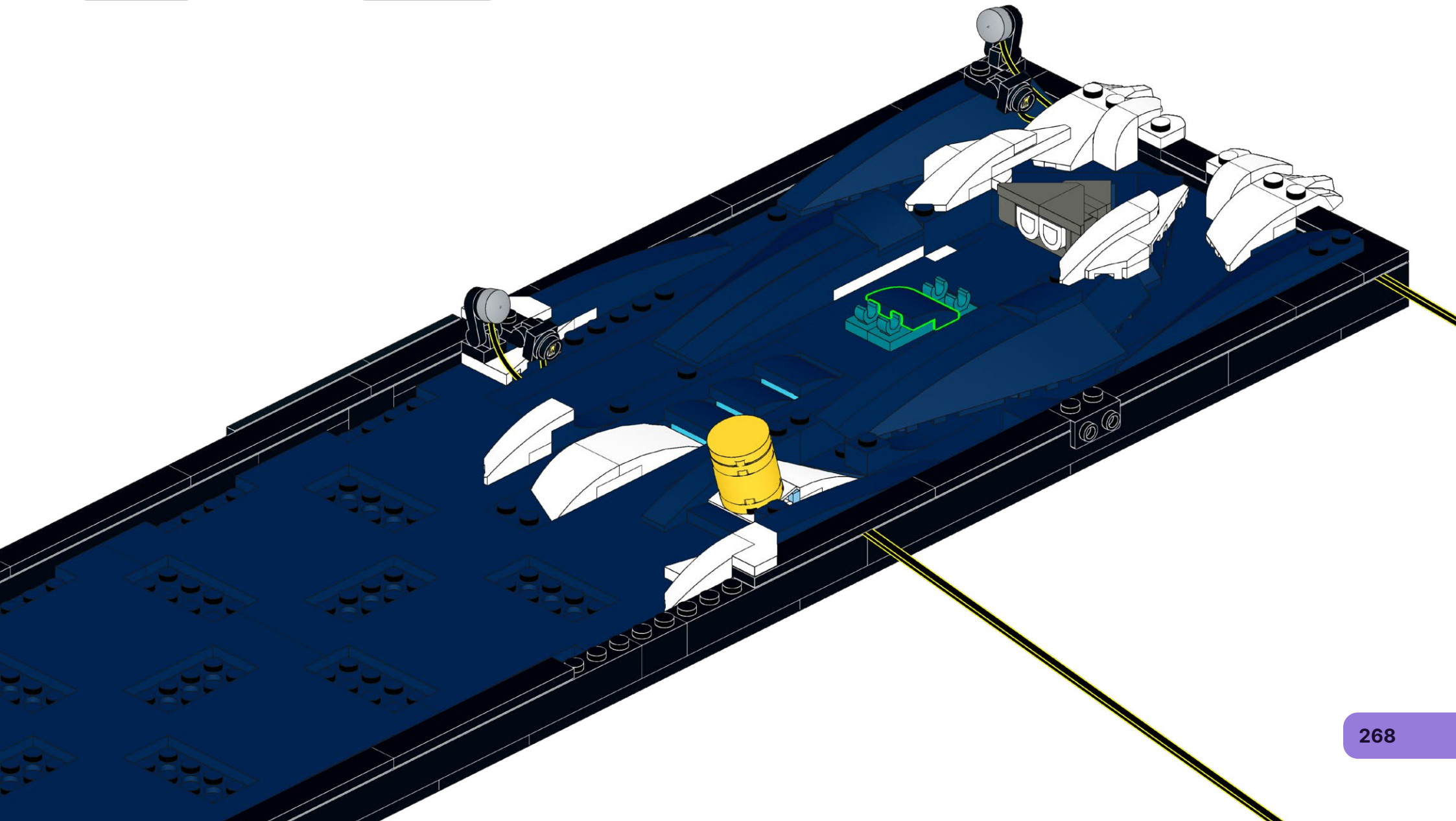

285

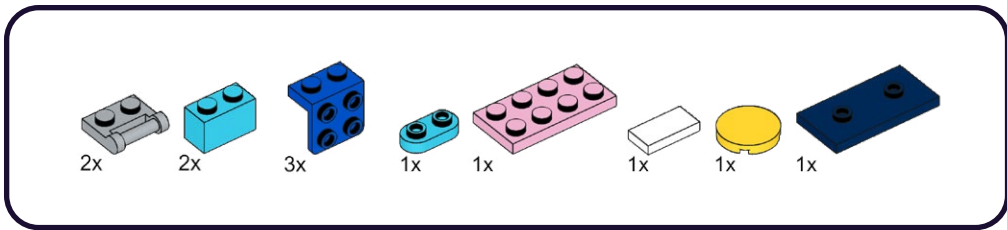

1

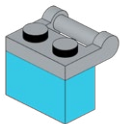

2

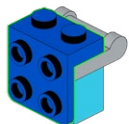

3

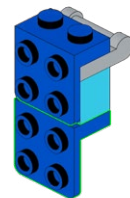

4

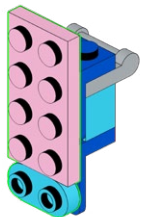

5

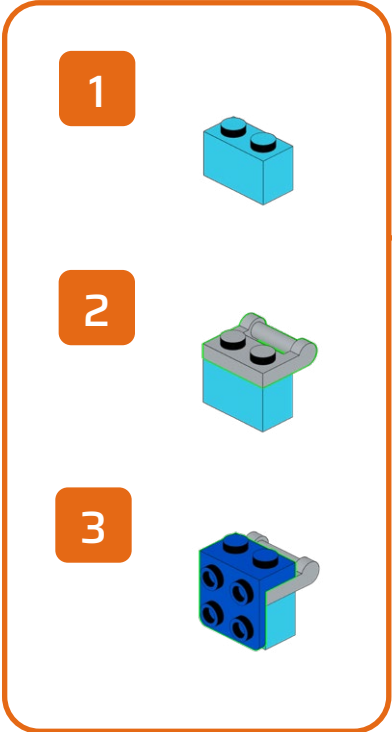
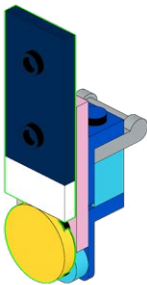

6

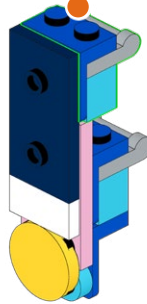

286

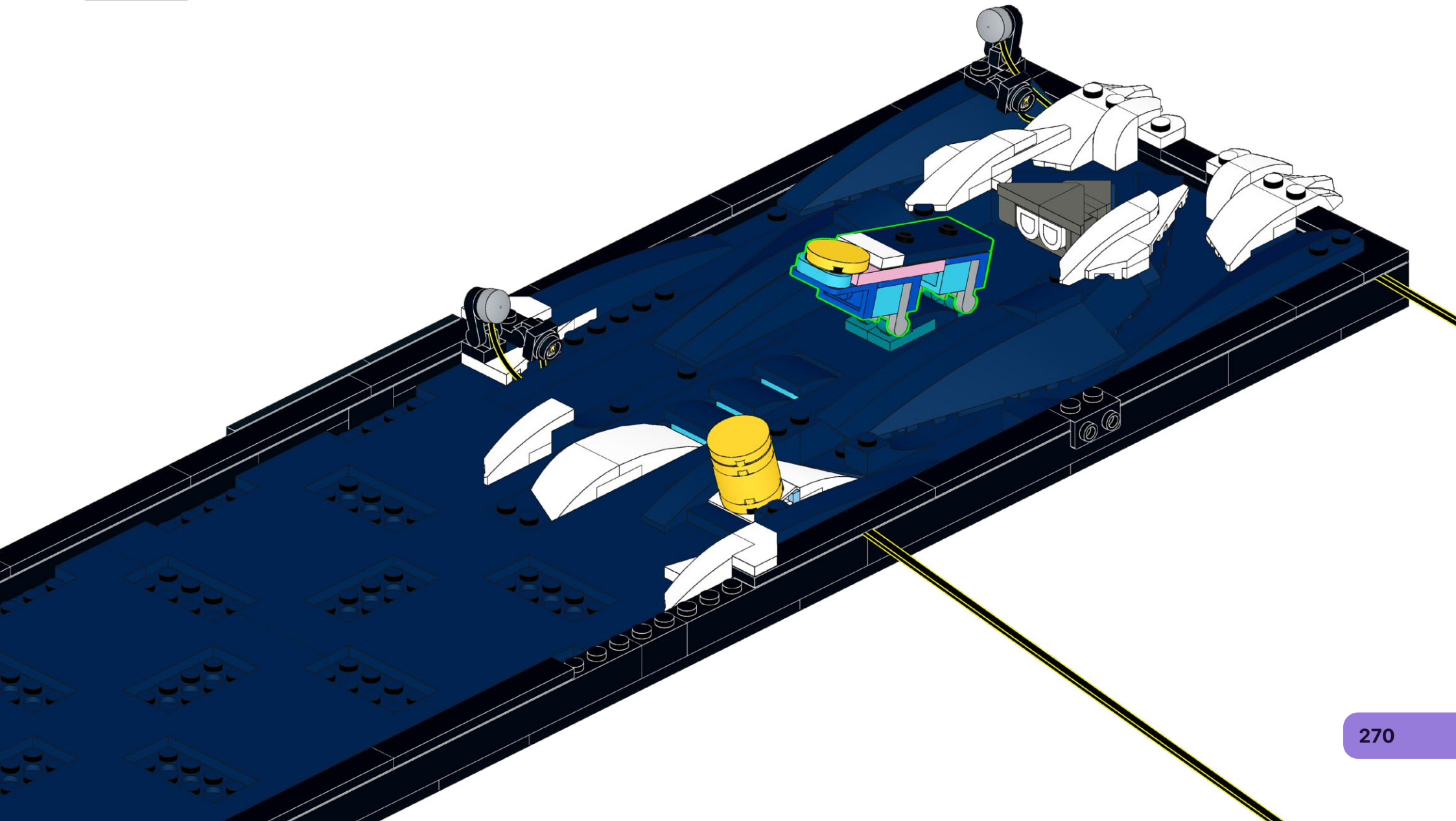

287

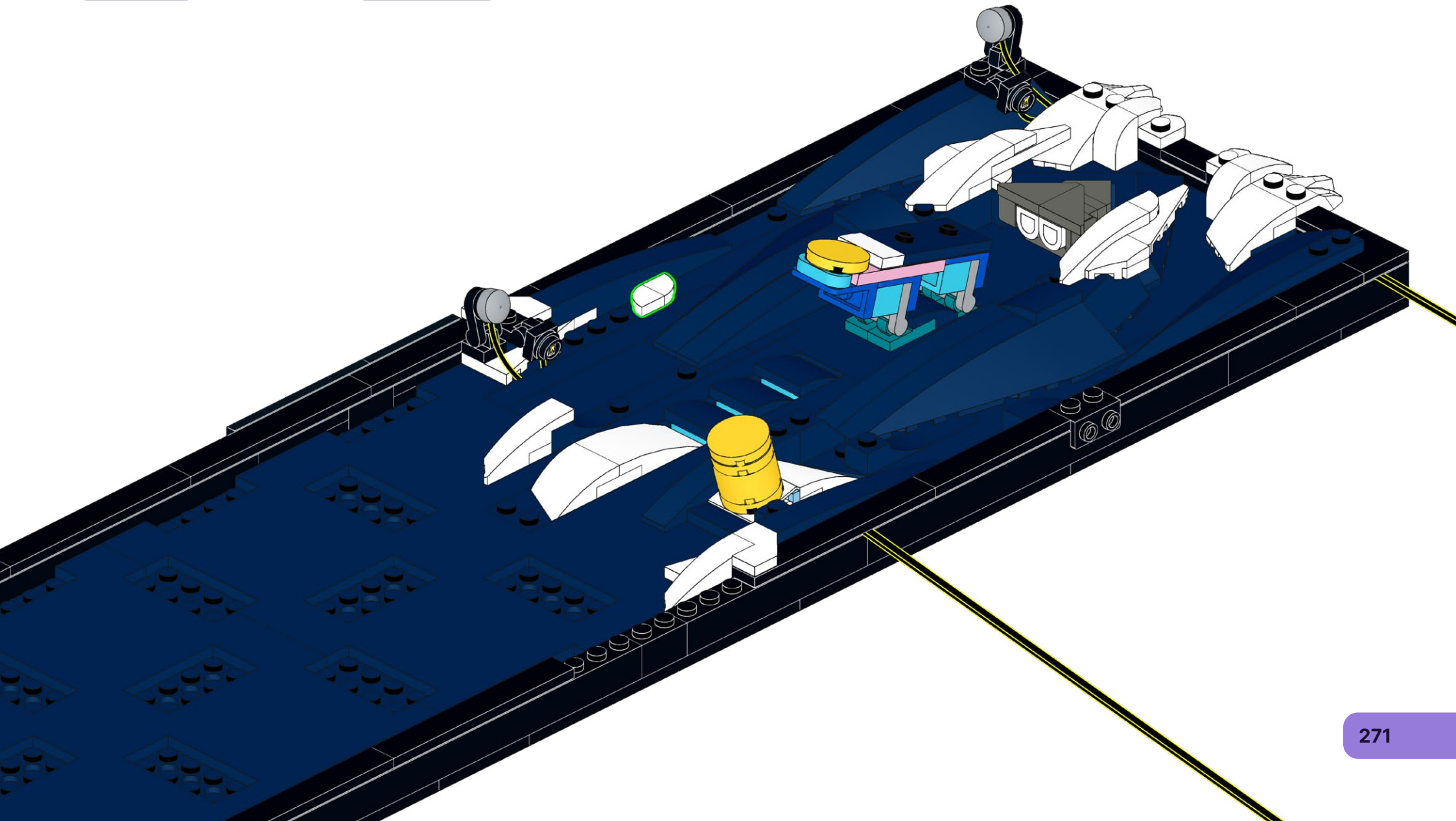

289

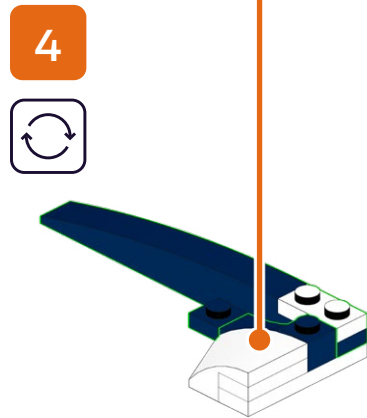
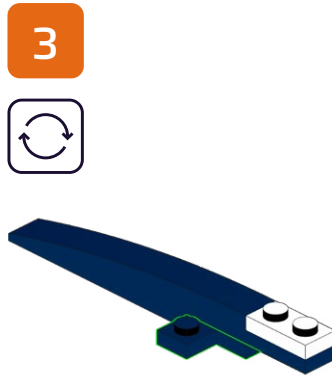
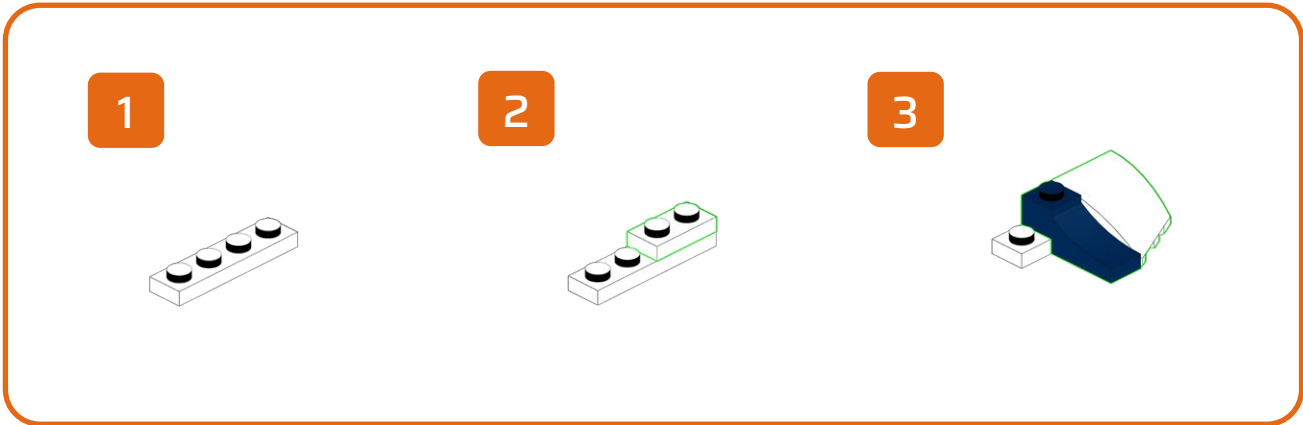
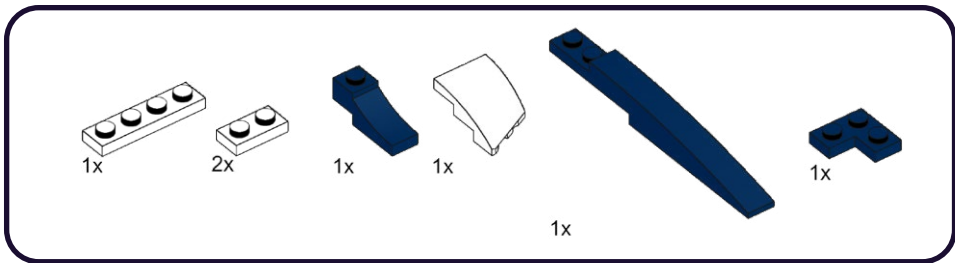

290

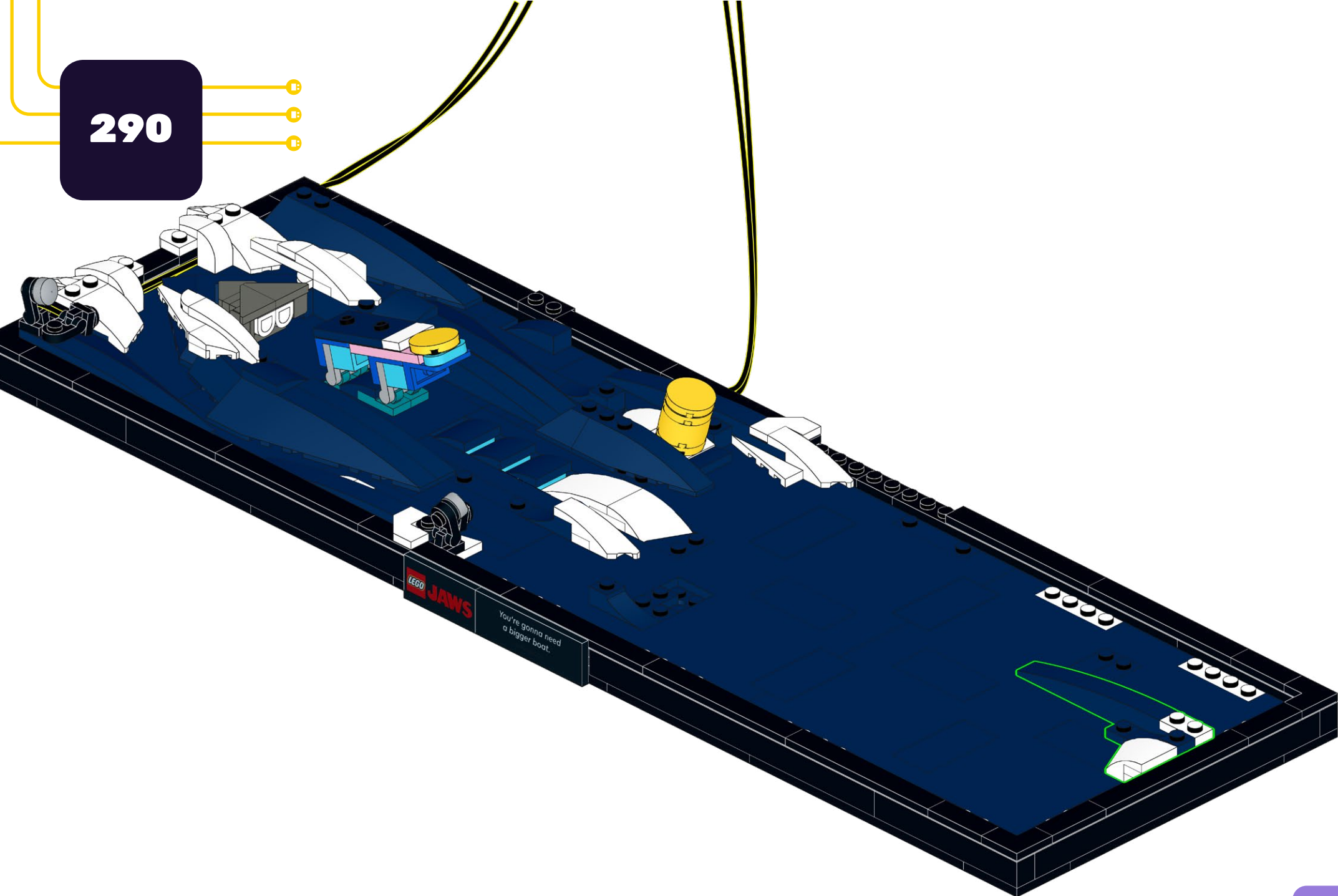

291

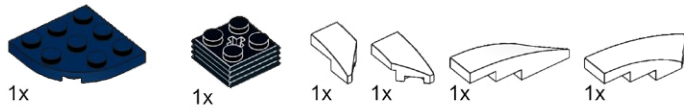

1



2

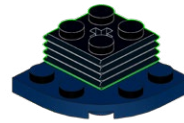

3

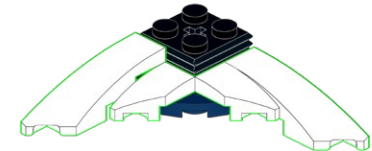

292

- 1x [white 1x4 Technic beam]
- 2x [white 1x2 Technic Technifit]
- 1x [white 1x2 Technic Technifit]
- 1x [white 1x2 Technic Technifit]
- 1x [white 1x2 Technic Technifit]
- 1x [white 1x2 Technic Technifit]
- 1x [white 1x2 Technic Technifit]
- 1x [dark blue 1x2 Technic Technifit]

1 [white 1x2 Technic Technifit]

2 [white 1x2 Technic Technifit]

1 [white 1x4 Technic beam]

2 [white 1x4 Technic beam with green Technifit]

3 [white 1x4 Technic beam with green Technifit]

1 [white 1x2 Technic Technifit]

2 [dark blue 1x2 Technic Technifit]

3 [dark blue 1x2 Technic Technifit]

293

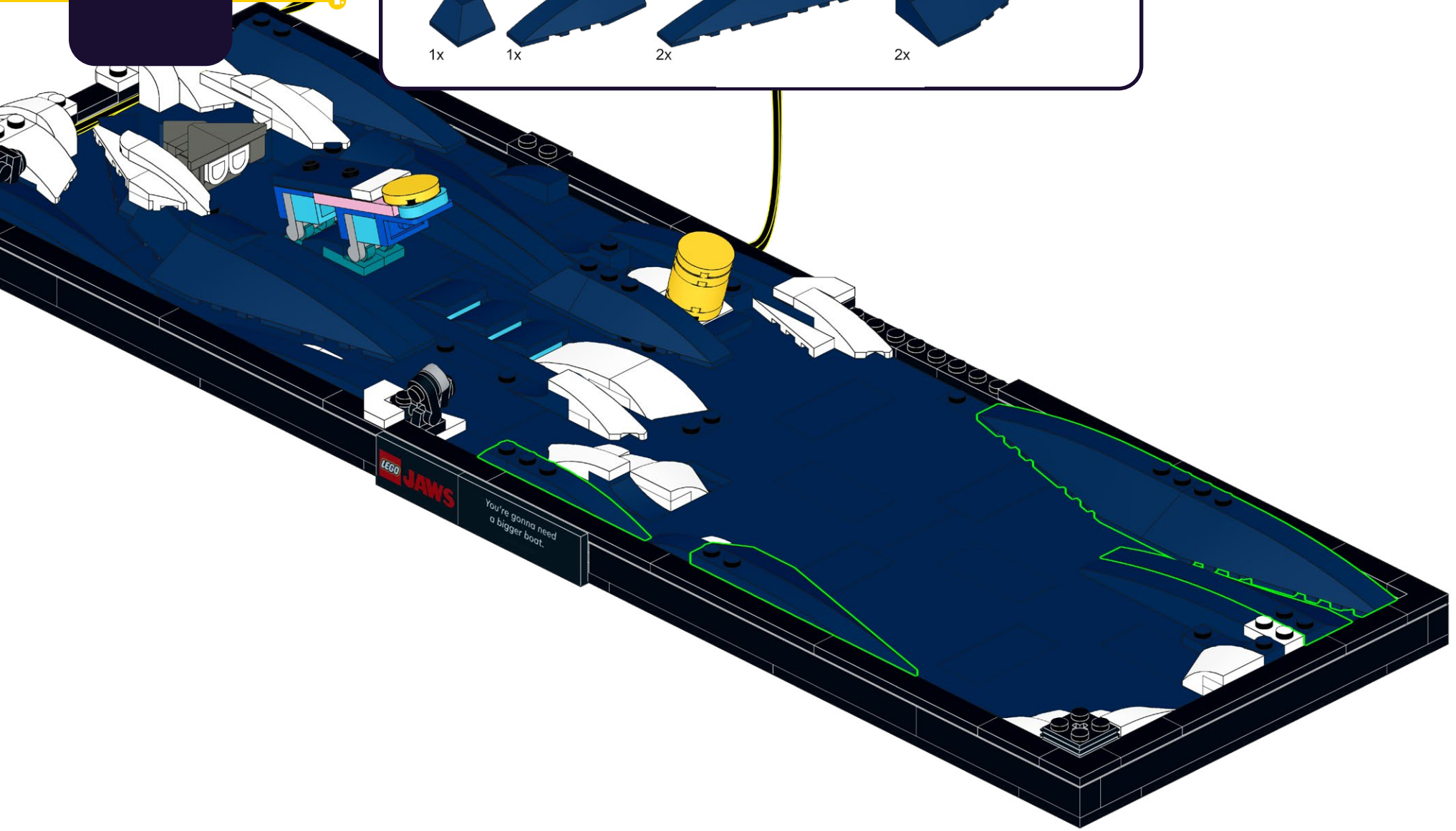
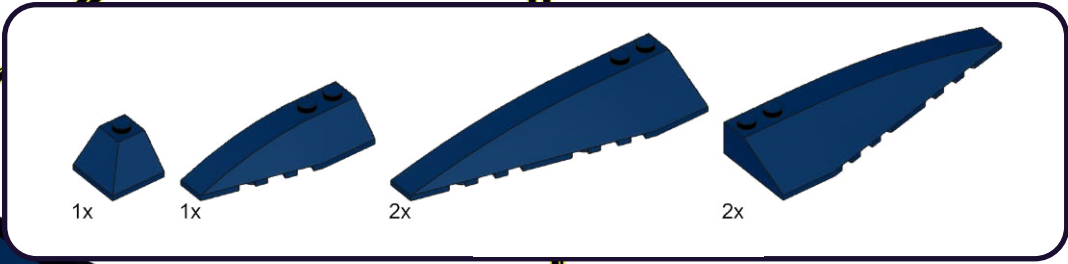

294

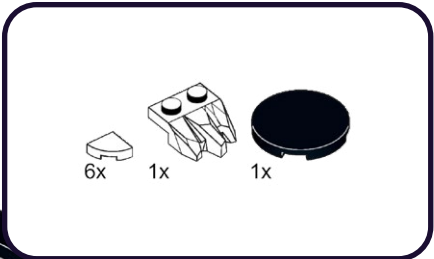

295

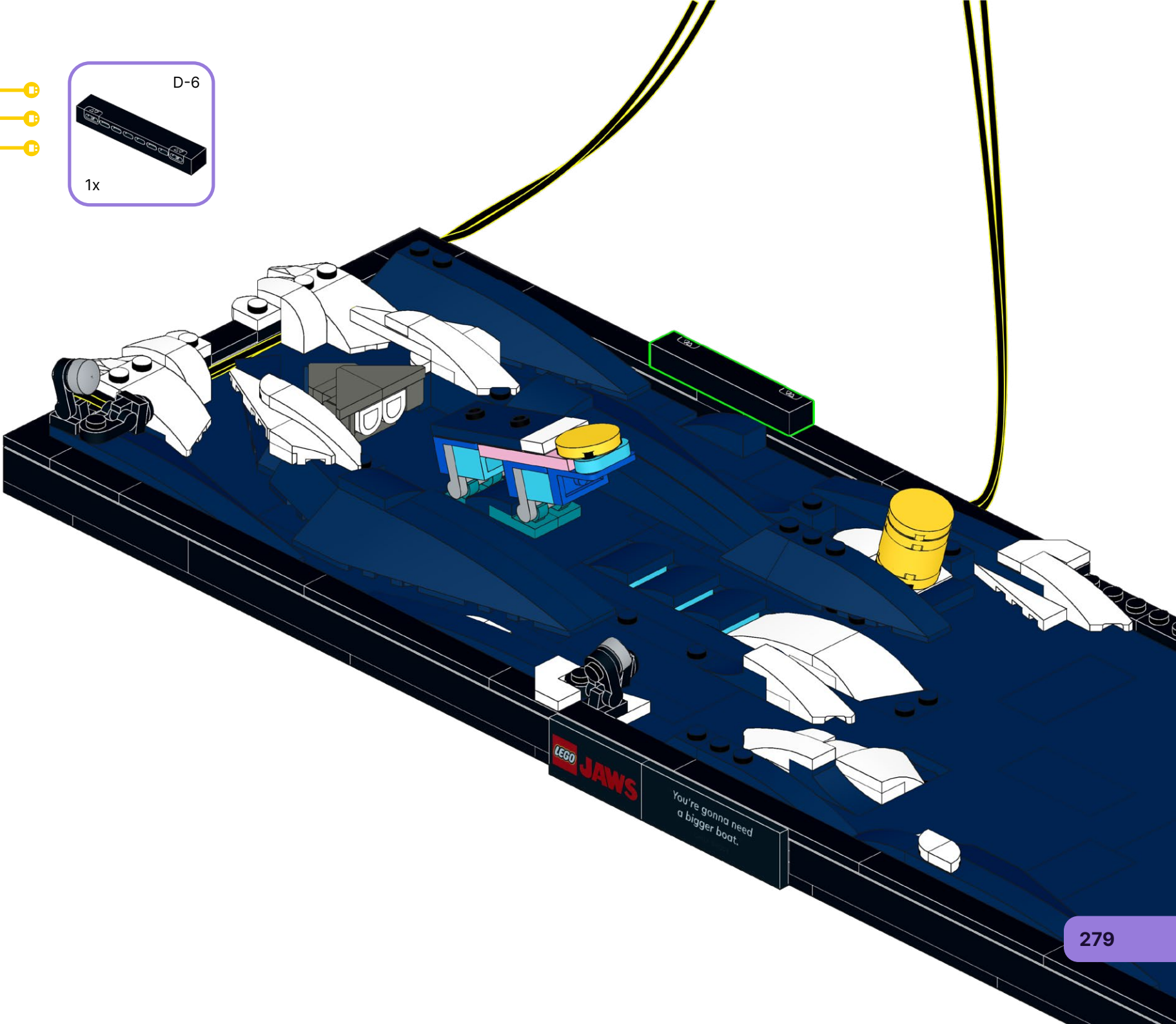
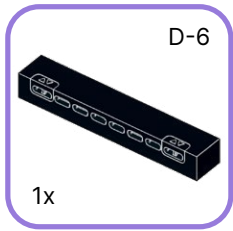

296

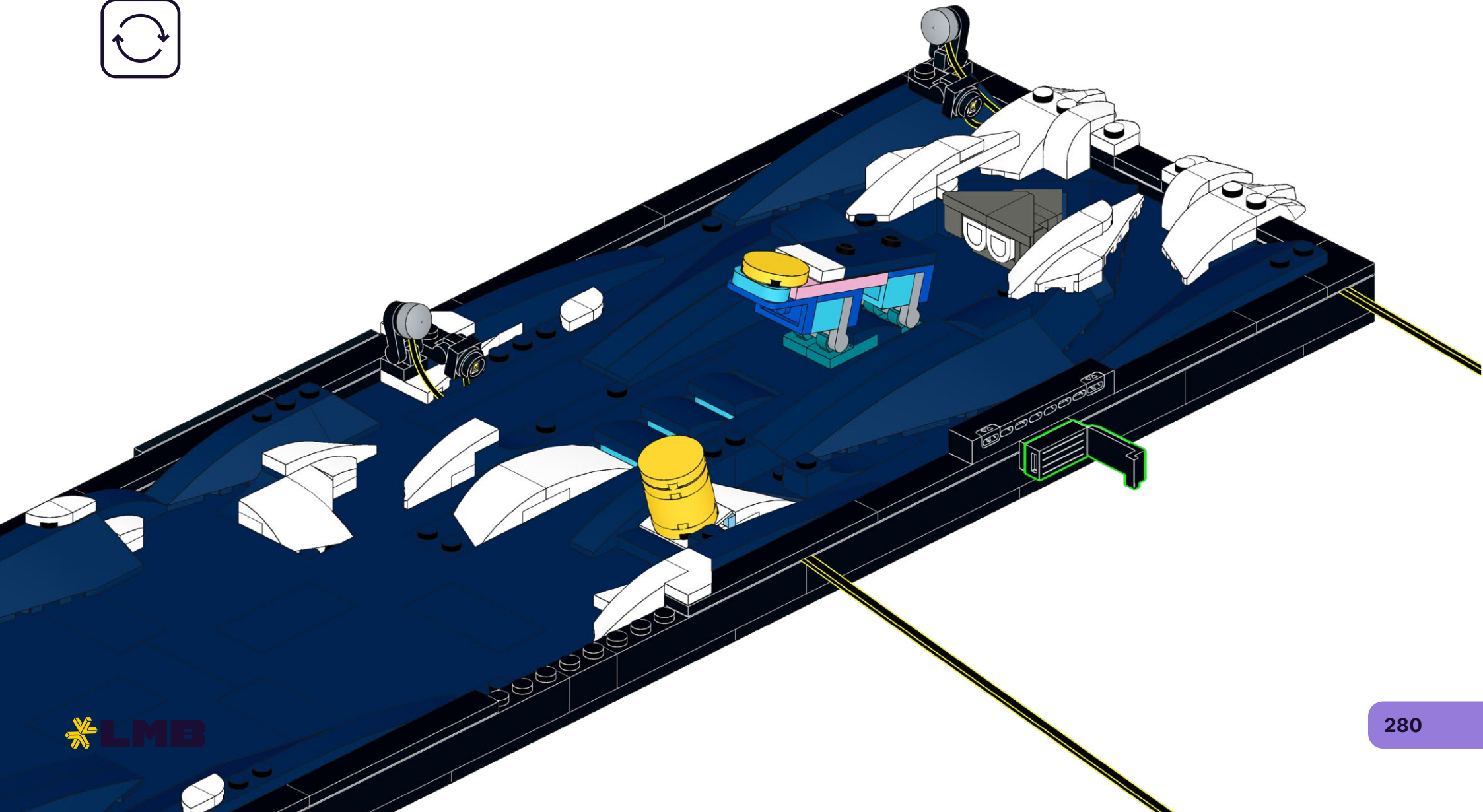
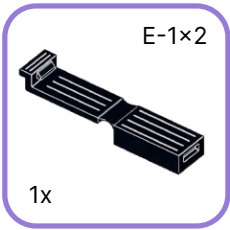

297

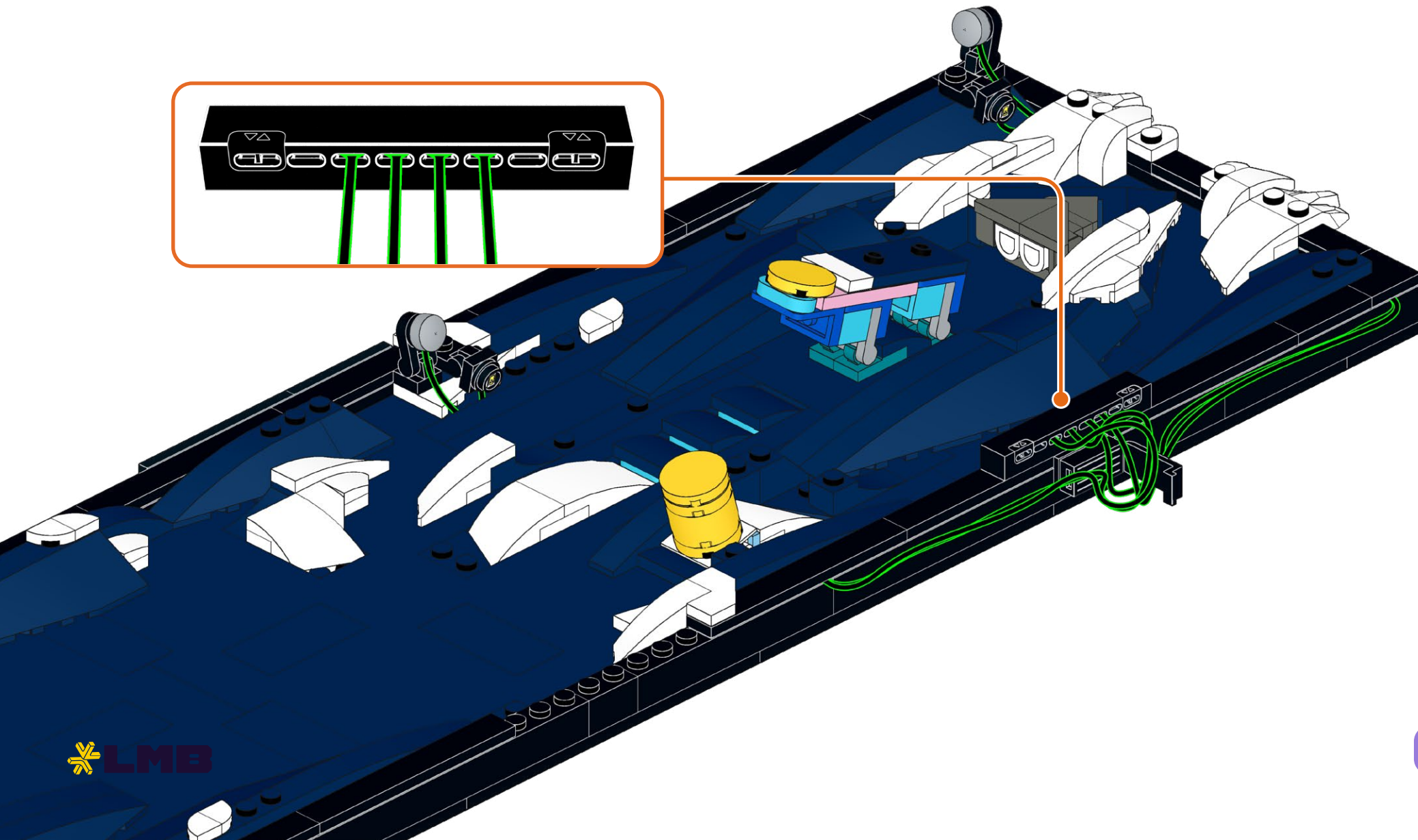

298

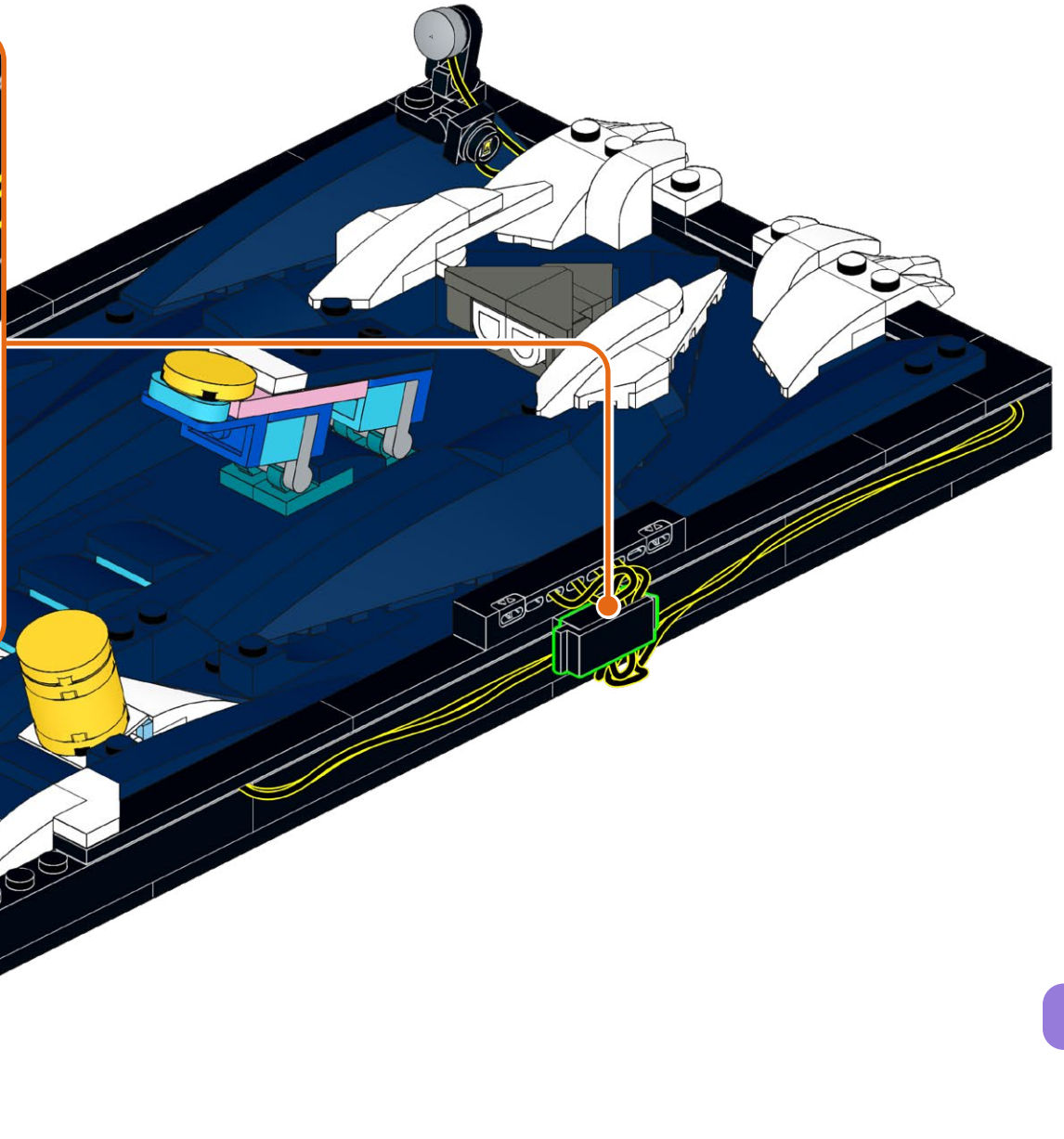
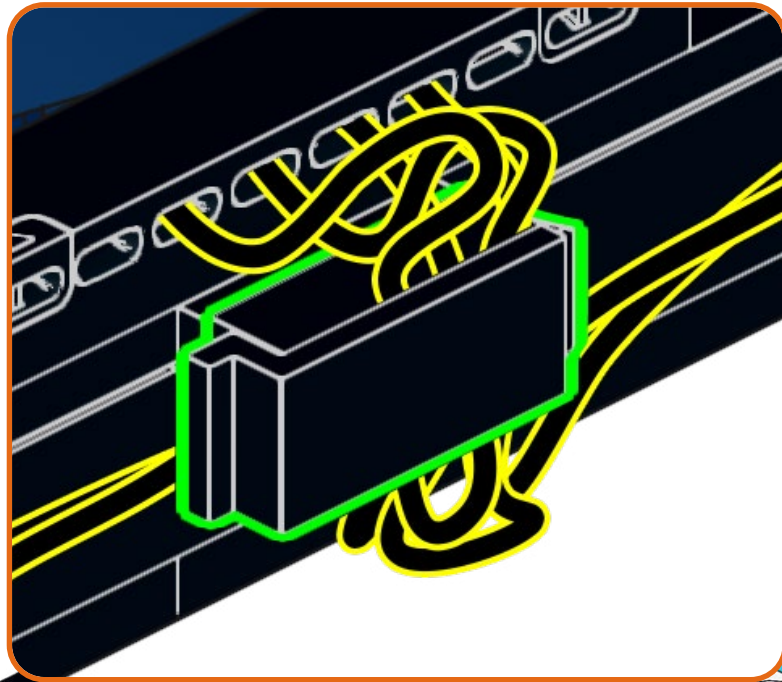

**HOLD UP!**

You might notice some bags aren't in order, as well as left over pieces, but that's ok! We're changing the way you build LEGO!

ATTENDEZ!

Vous remarquerez peut-être que certains sacs, ainsi que certaines pièces, ne sont pas dans le bon ordre. Mais pas de panique! Nous changeons simplement la façon avec laquelle vous construisez vos LEGO!

ASPETTA!

Potresti notare che alcuni sacchetti non sono in ordine, così come i pezzi avanzati, ma va bene così! Stiamo cambiando il modo in cui costruisci i LEGO!

HALT!

Sie werden möglicherweise bemerken, dass einige tüten durcheinander sind und teile übrig bleiben, aber das ist in Ordnung! Wir ändern die art und weise, wie Sie LEGO bauen!

¡ESPERA!

Es posible que notes que algunas bolsas están fuera de servicio, así como piezas sobrantes, ¡pero está bien! ¡Estamos cambiando la forma en que construyes LEGO!

暫停!

你可能会注意到一些袋子顺序错乱, 以及一些剩余的部件, 但没关系! 我们正在改变你搭建乐高的方式!

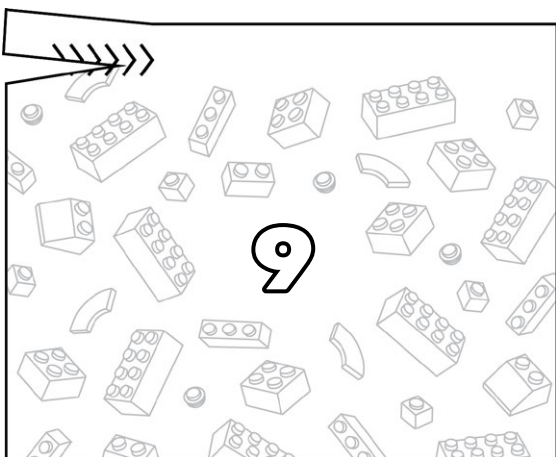
Open LEGO® Bag 9

299

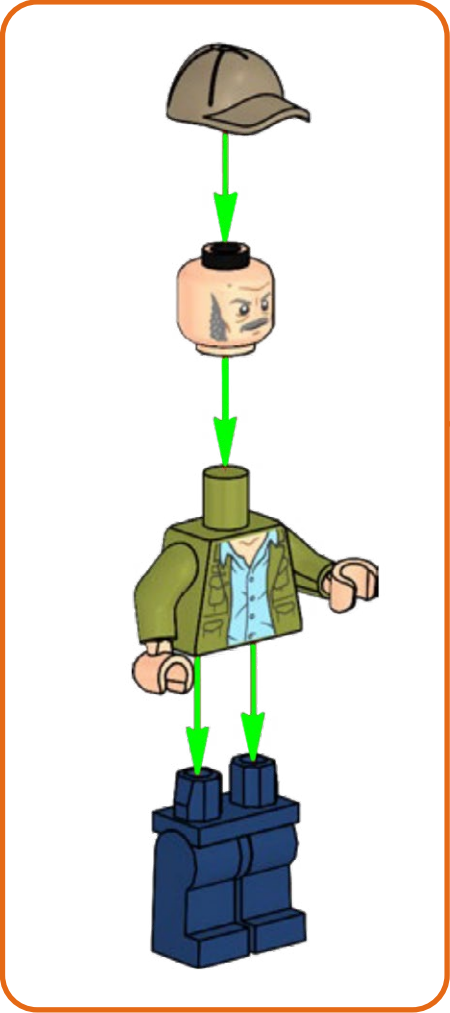

300

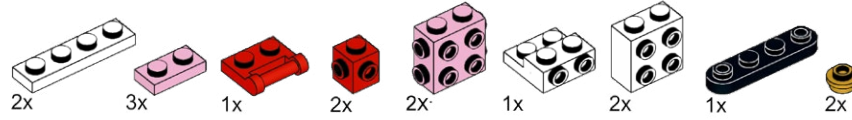

1

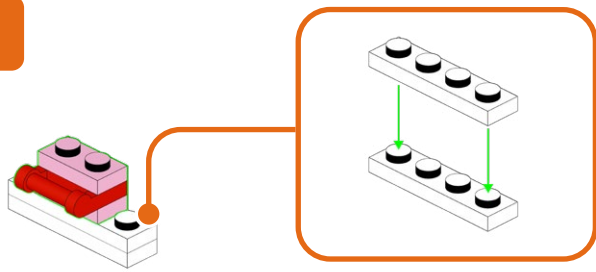

2

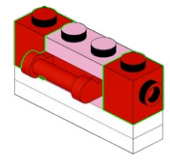

3

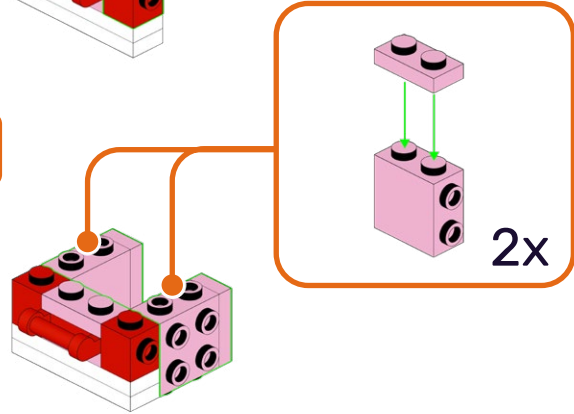

4

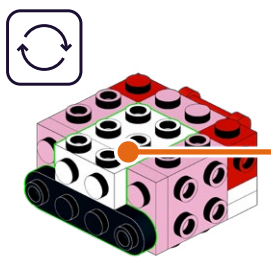

5

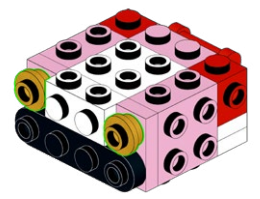

1

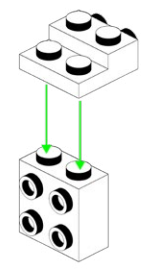

2

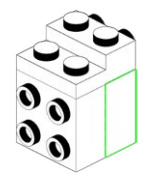

3

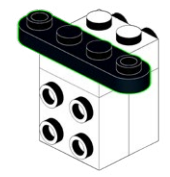

301

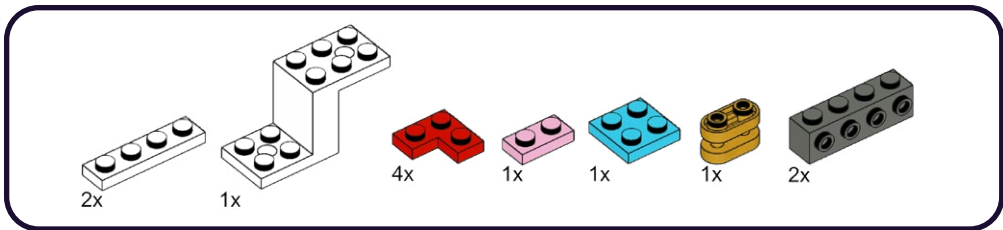

1

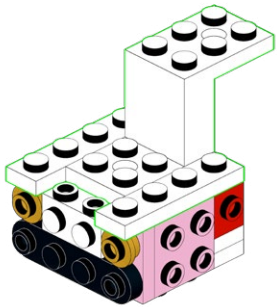

2

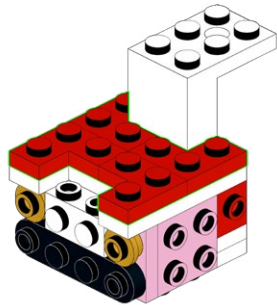

3

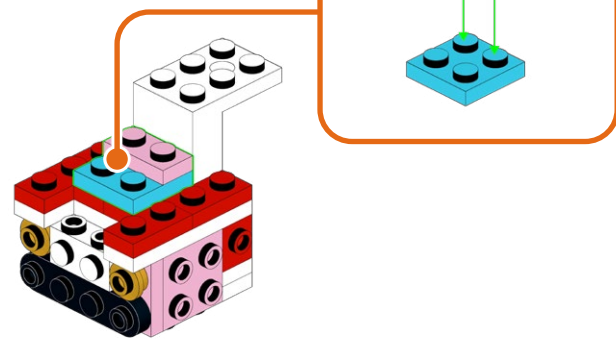

4

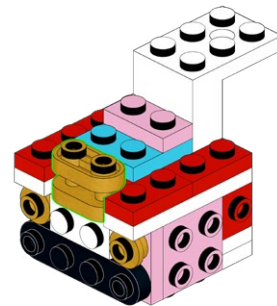

5

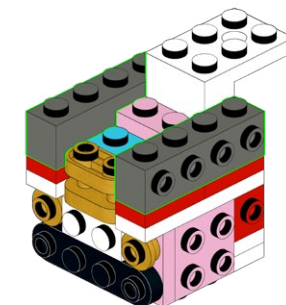

302

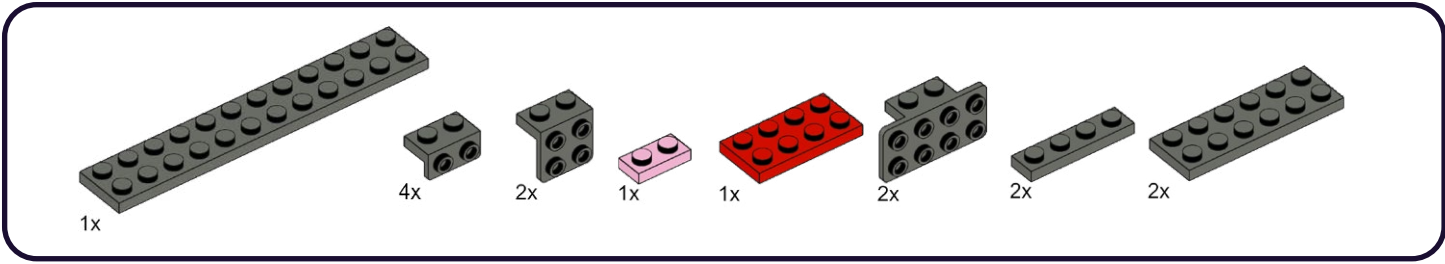

1

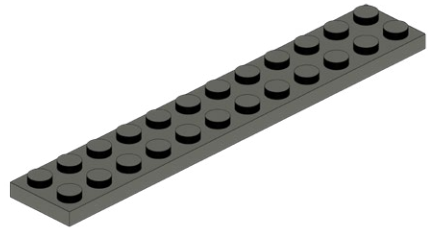

2

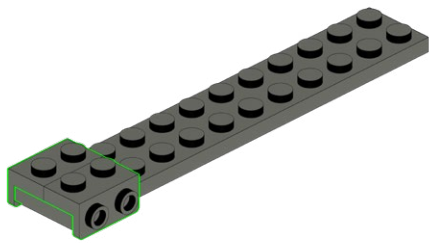

3

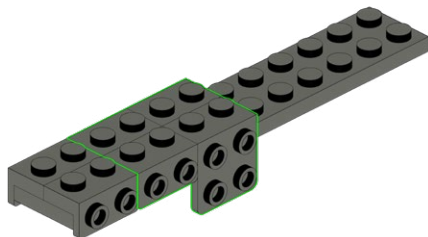

4

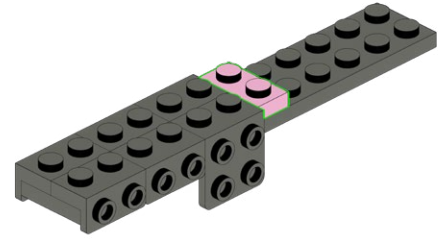

5

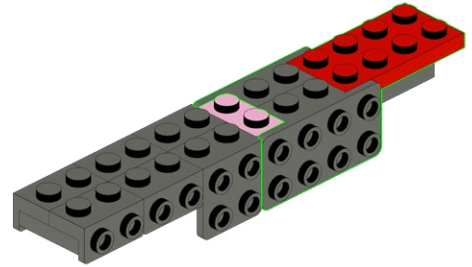

6

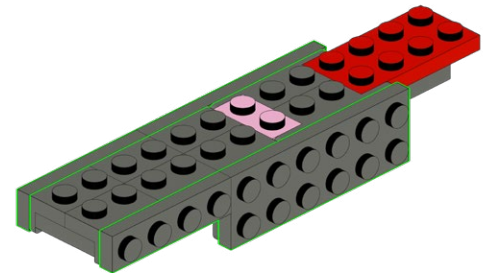

303

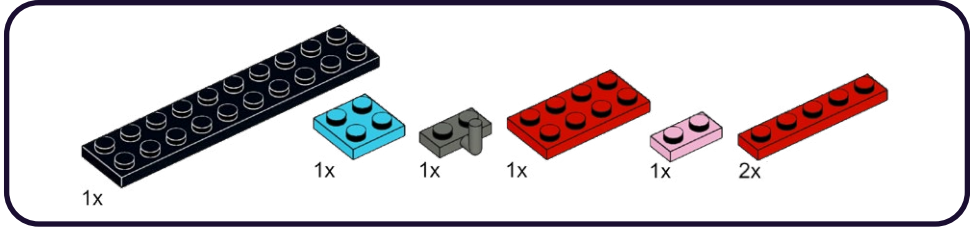

1

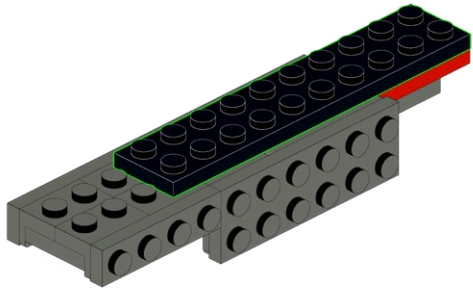

2

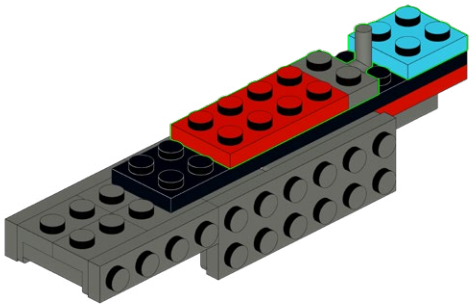

3

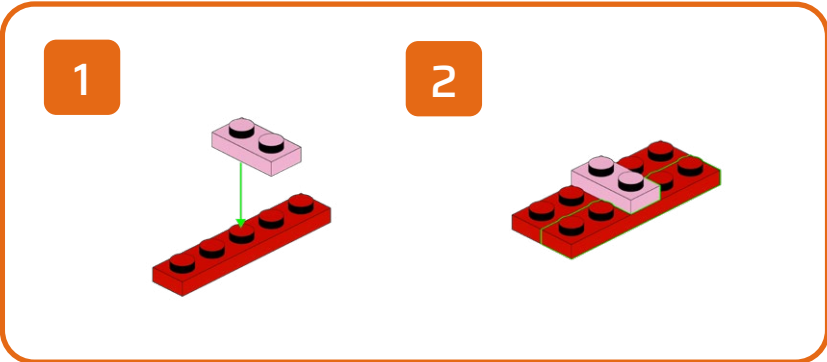
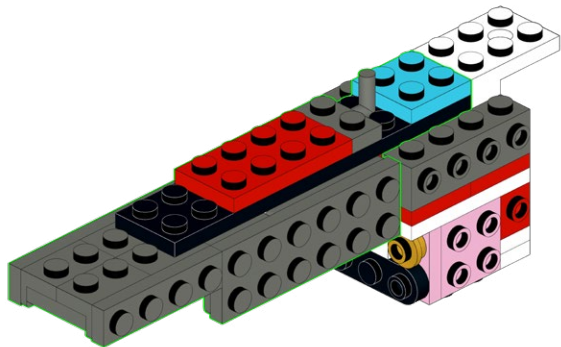

4

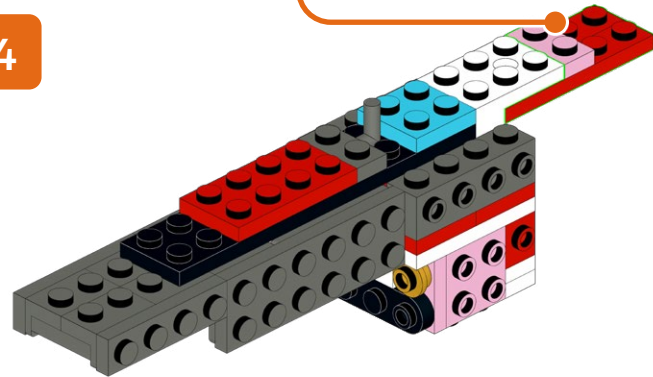

304

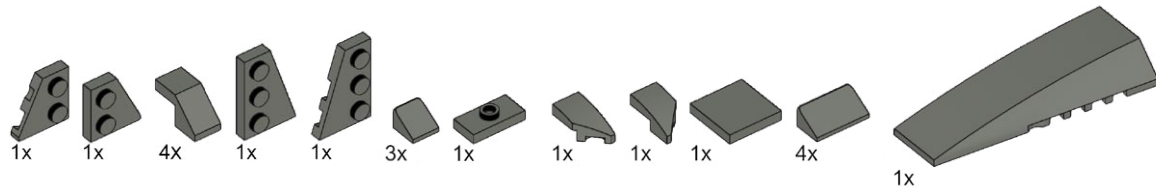

1

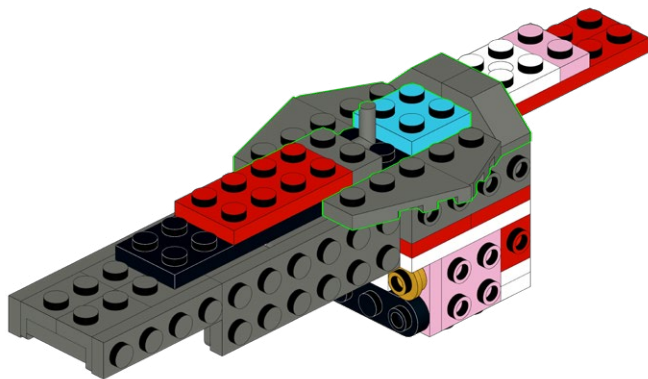

3

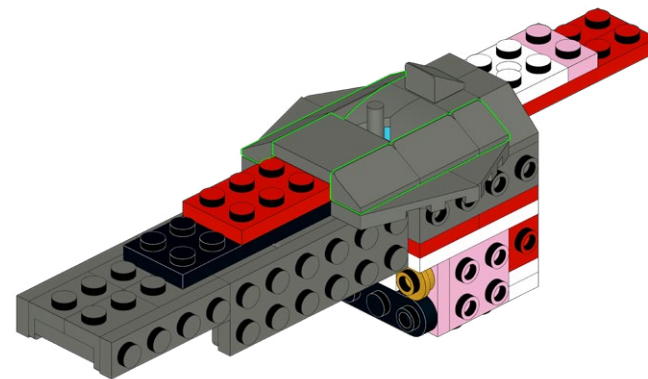

2

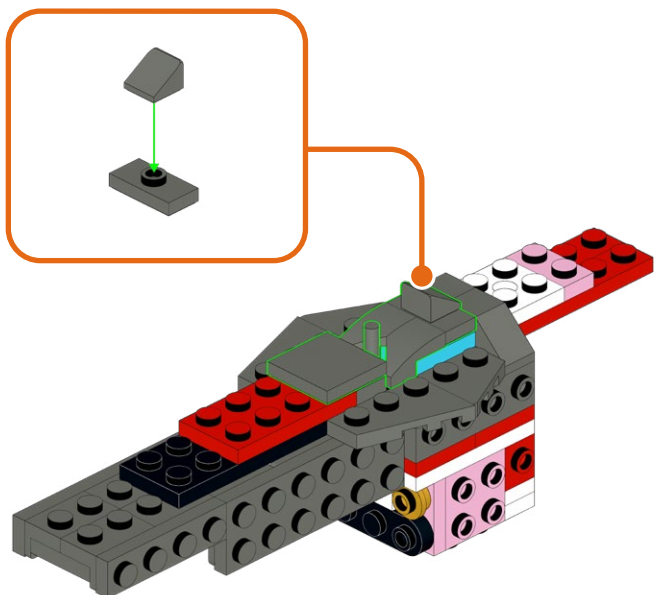

4

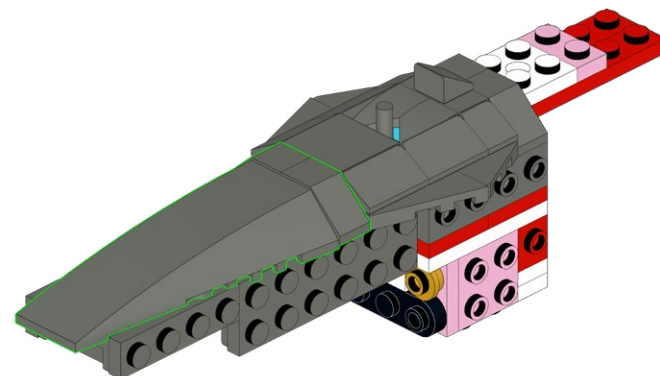

305

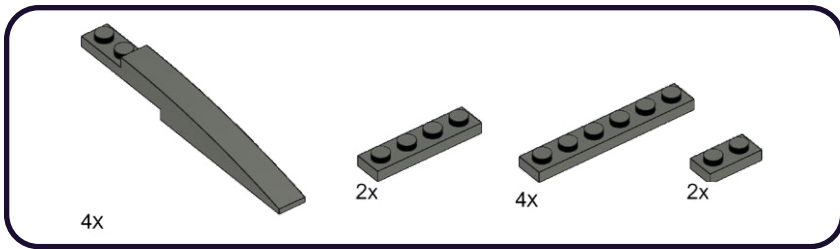

1 2 3 4 5

2x

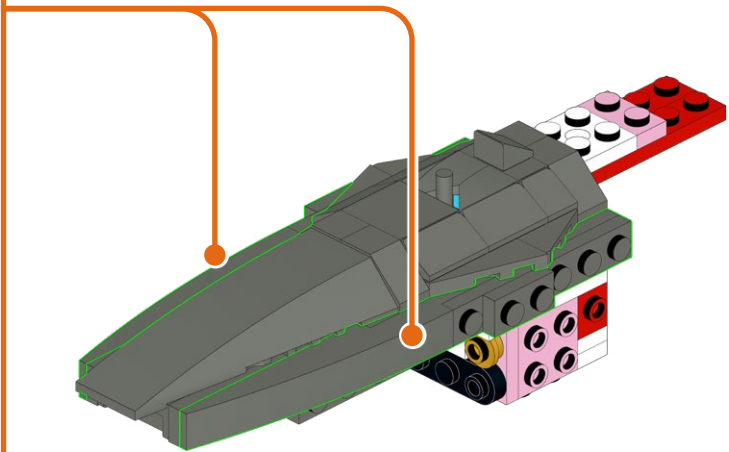

306

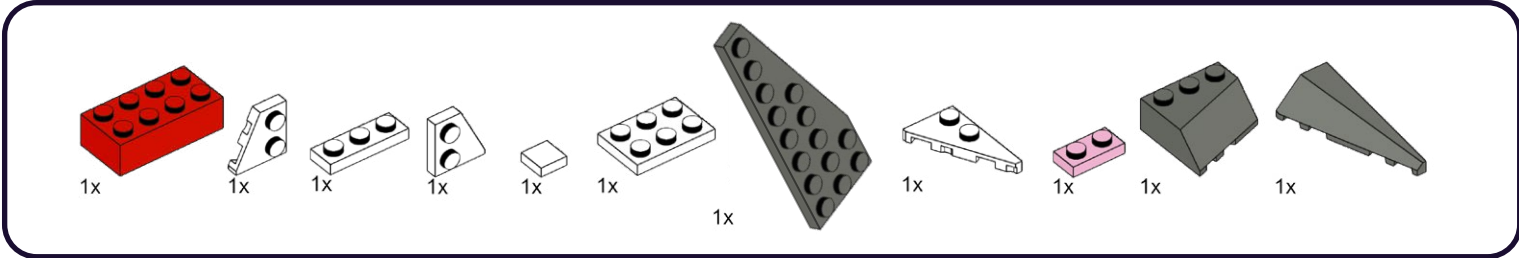

1

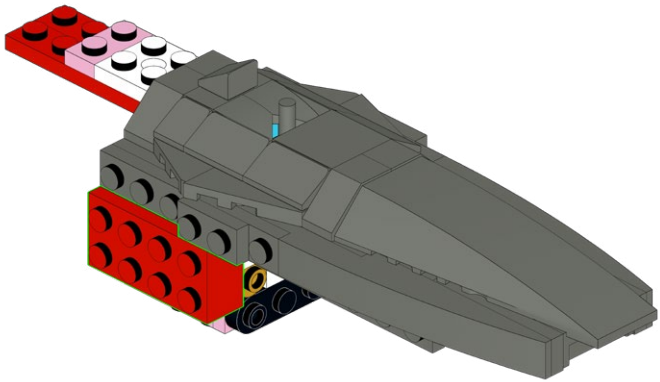

1

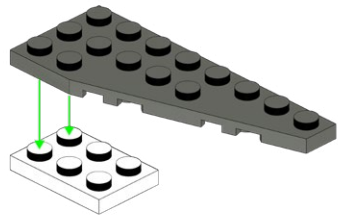

2

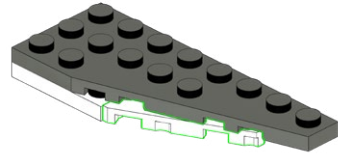

3

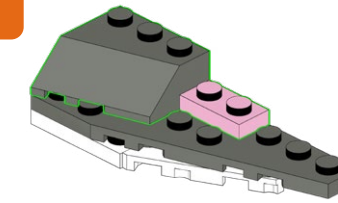

4

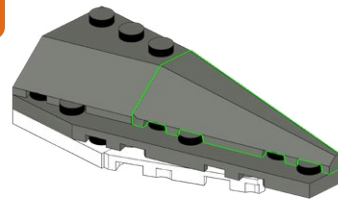

1

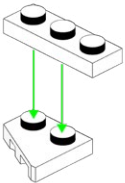

2

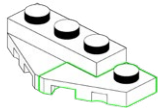

3

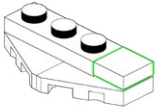

2

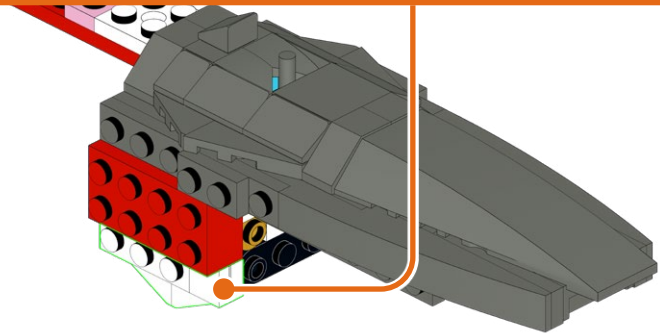

3

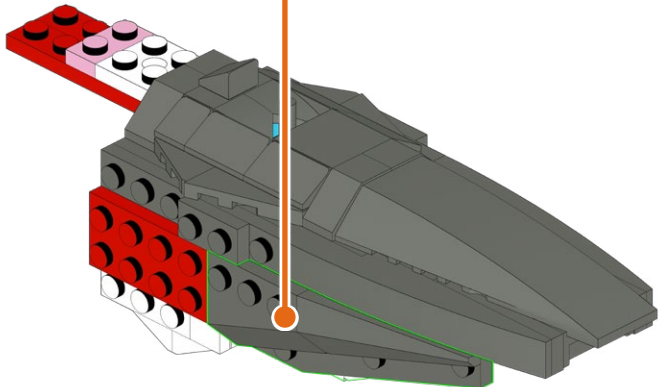

307

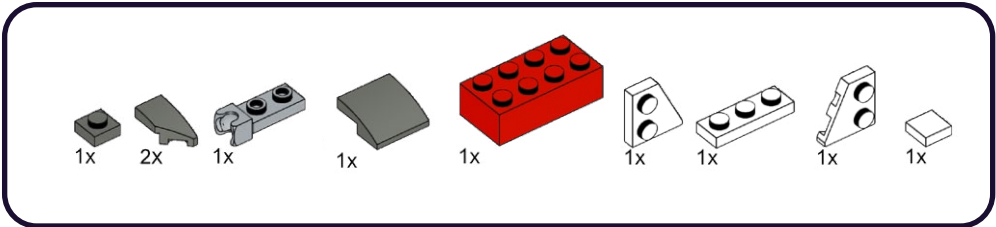

1

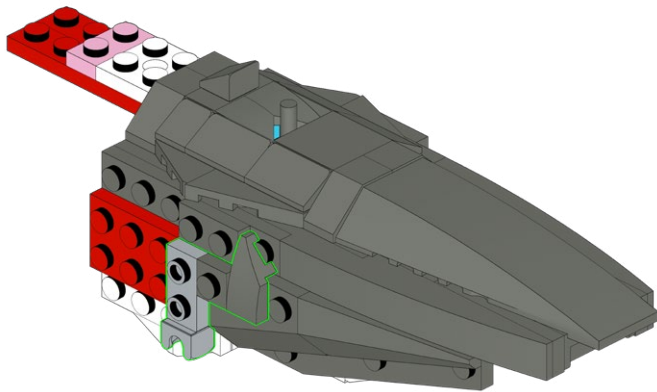

2

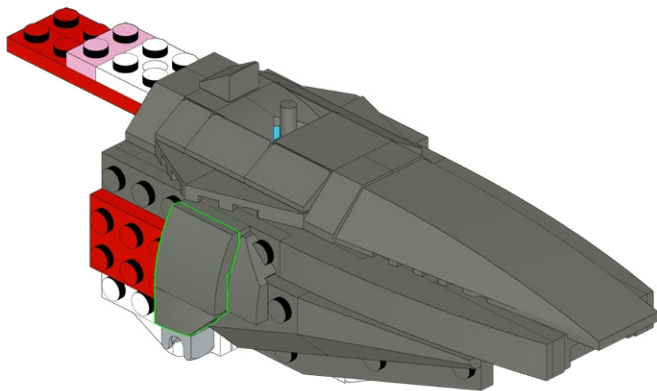

3

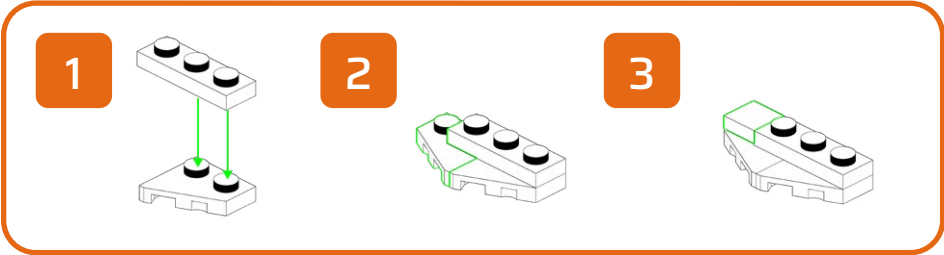
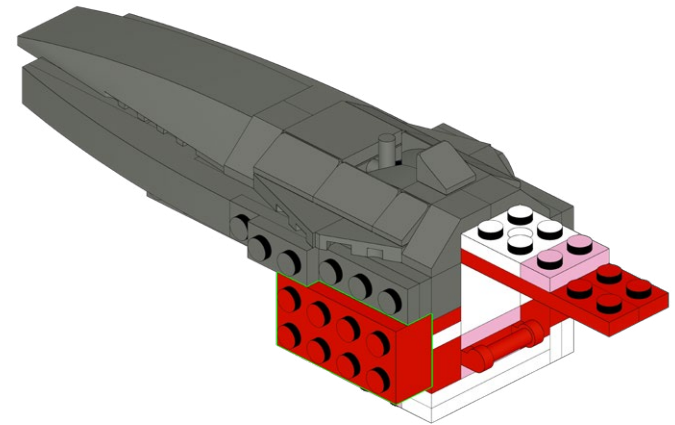

4

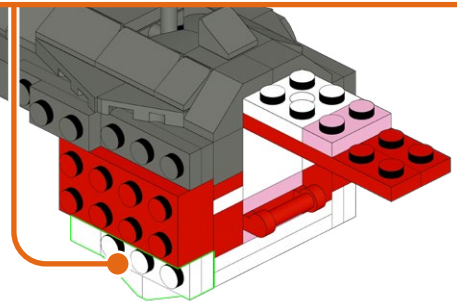

308

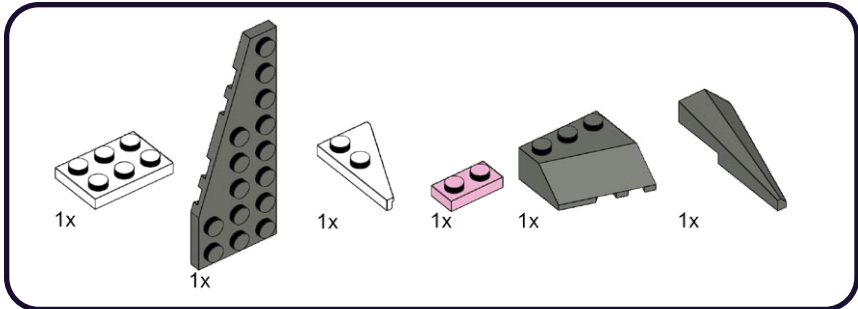

1

2

3

4

2x

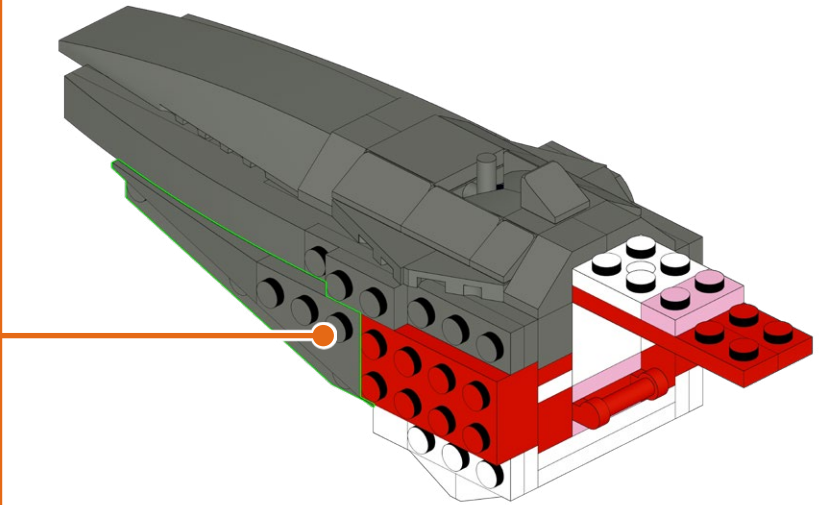

309

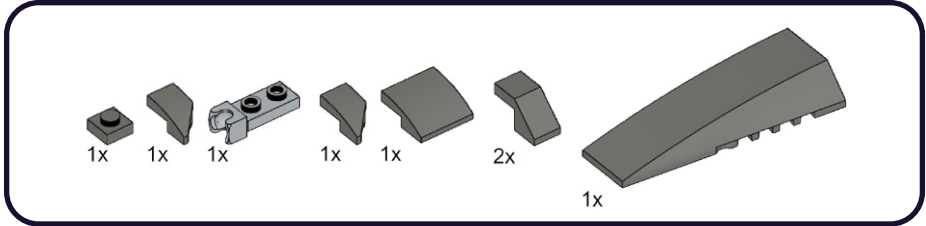

1

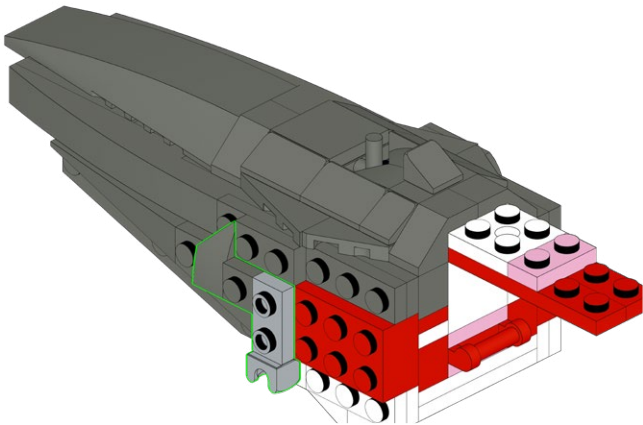

2

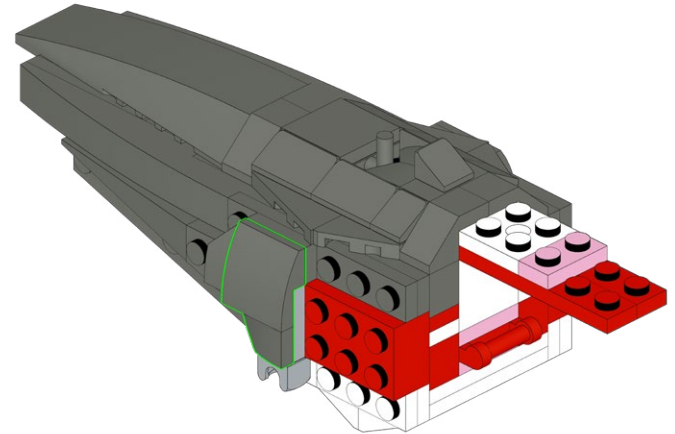

3

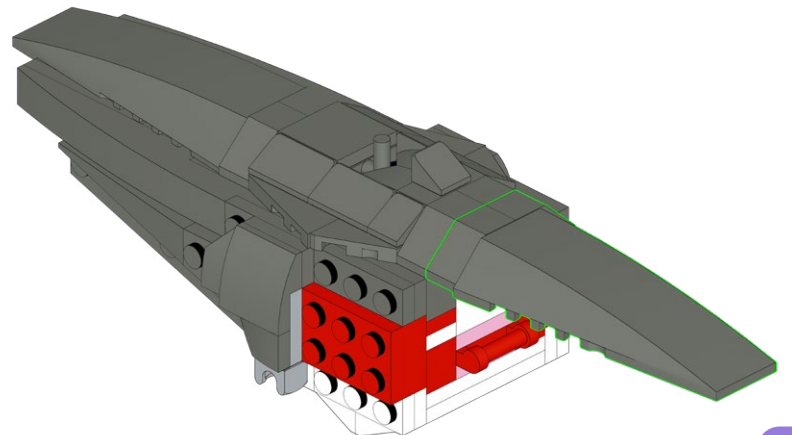

310

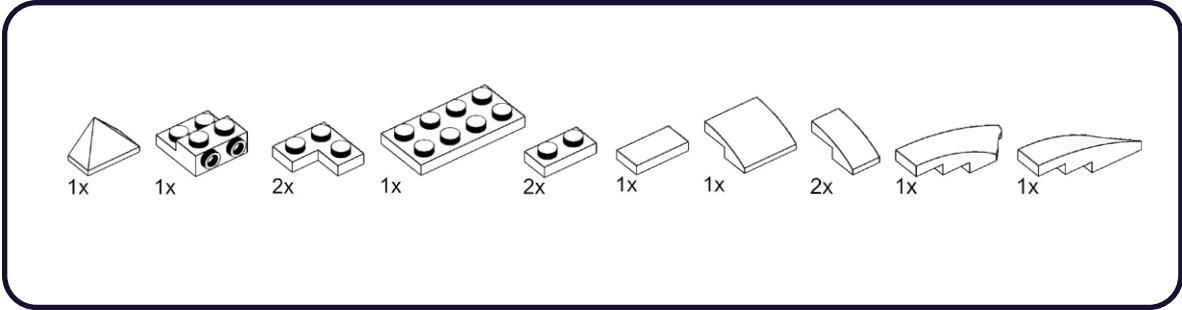

1

2

3

4

5

6

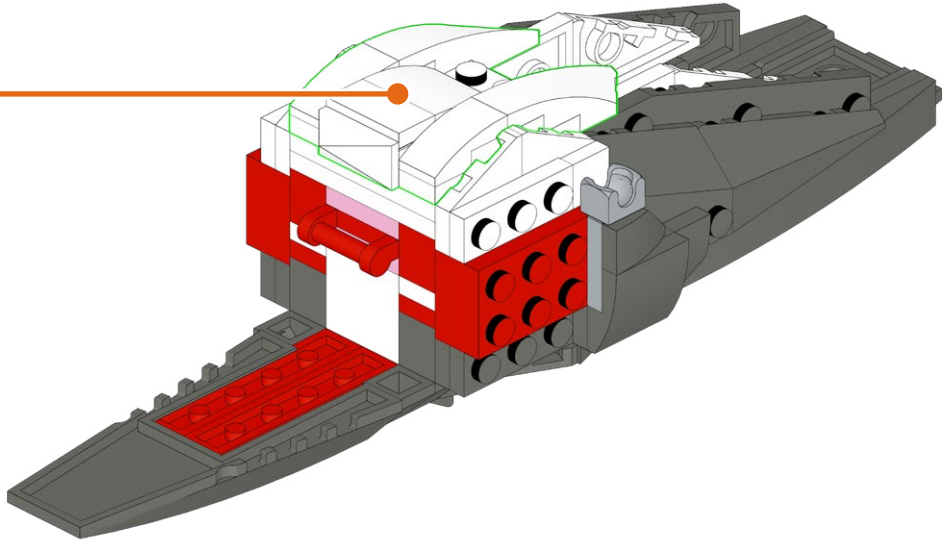

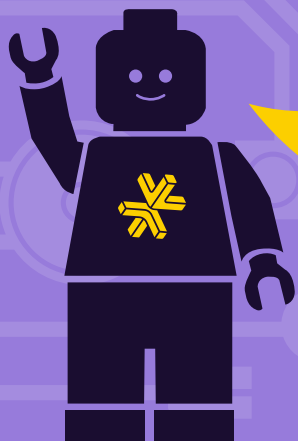
**HOLD UP!**

You might notice some bags aren't in order, as well as left over pieces, but that's ok! We're changing the way you build LEGO!

ATTENDEZ!

Vous remarquerez peut-être que certains sacs, ainsi que certaines pièces, ne sont pas dans le bon ordre. Mais pas de panique! Nous changeons simplement la façon avec laquelle vous construisez vos LEGO!

ASPETTA!

Potresti notare che alcuni sacchetti non sono in ordine, così come i pezzi avanzati, ma va bene così! Stiamo cambiando il modo in cui costruisci i LEGO!

HALT!

Sie werden möglicherweise bemerken, dass einige tüten durcheinander sind und teile übrig bleiben, aber das ist in Ordnung! Wir ändern die art und weise, wie Sie LEGO bauen!

¡ESPERA!

Es posible que notes que algunas bolsas están fuera de servicio, así como piezas sobrantes, ¡pero está bien! ¡Estamos cambiando la forma en que construyes LEGO!

暫停!

你可能会注意到一些袋子顺序错乱, 以及一些剩余的部件, 但没关系! 我们正在改变你搭建乐高的方式!

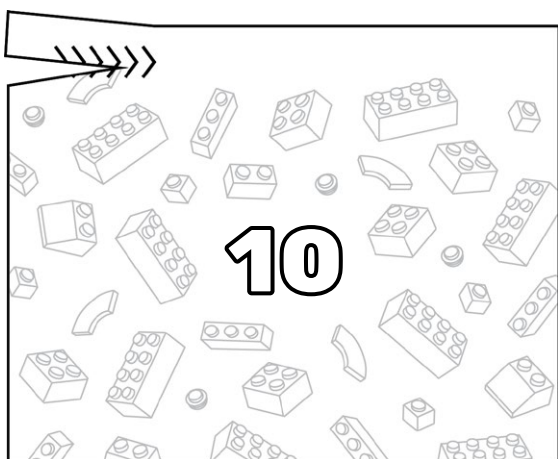
Open LEGO® Bag 10

311

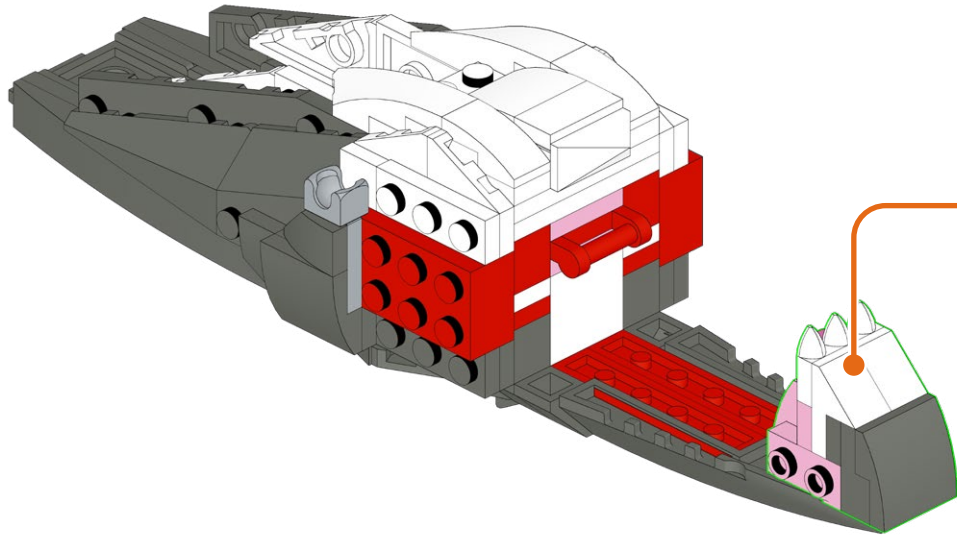
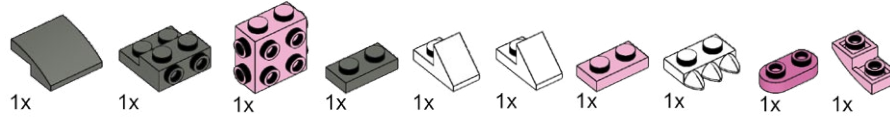

1

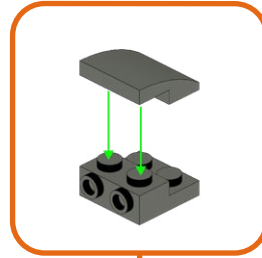

2

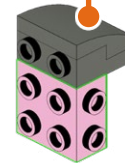

3

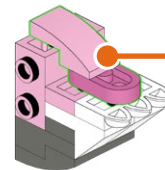

1

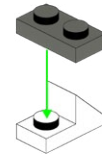

2

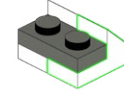

3

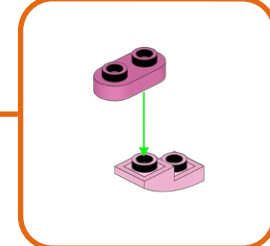
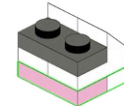

312

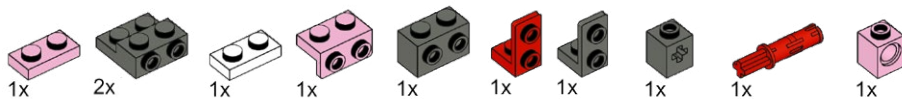

1

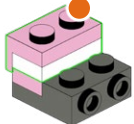
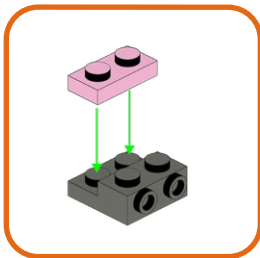

2

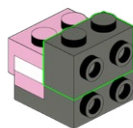

3

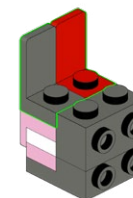

4

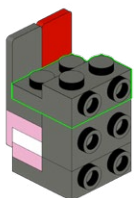

5

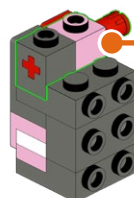

1



2

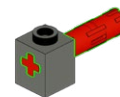

3

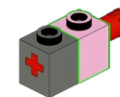

313

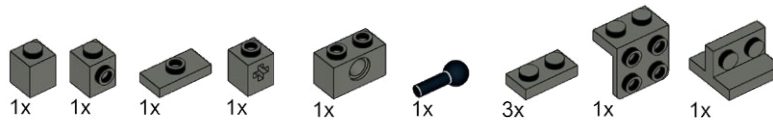

1

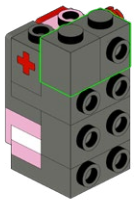

2

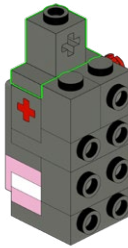

3

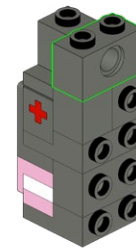

4

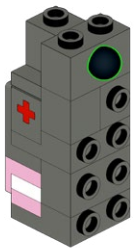

5

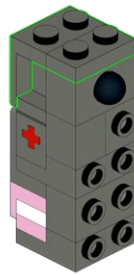

1

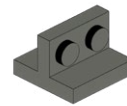

2

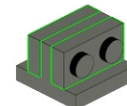

6

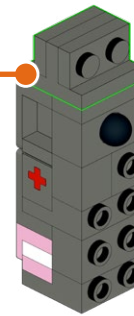

314

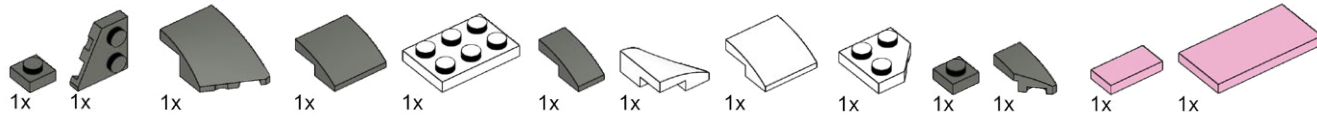

1

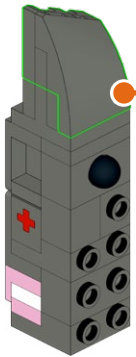

1

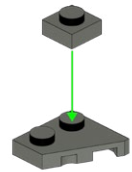

2

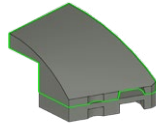

2

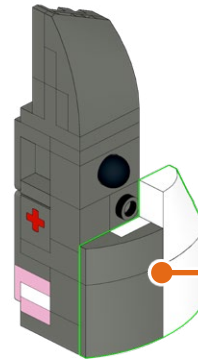

1

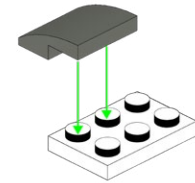

2

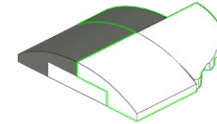

3

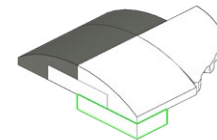

3

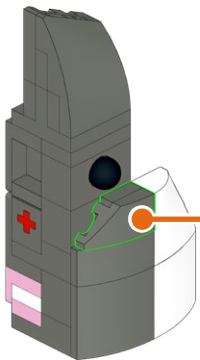

4

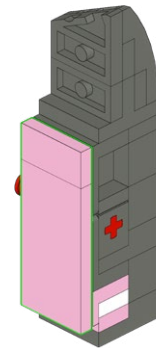

315

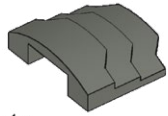

1x

1

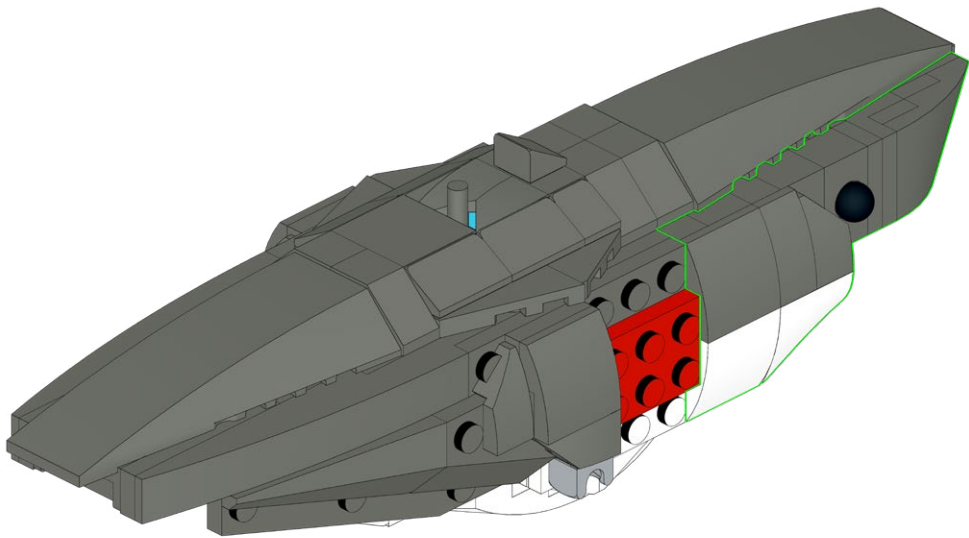

2

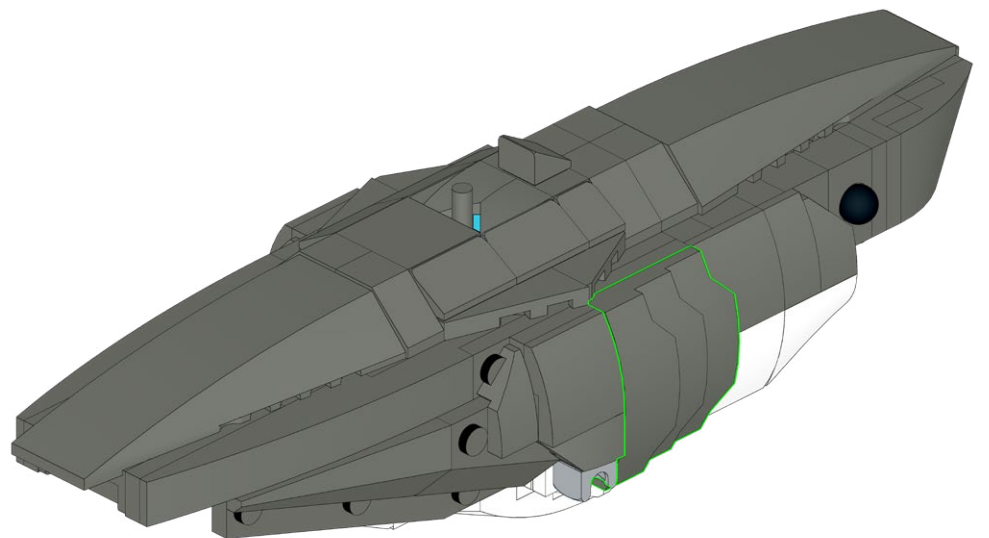

316

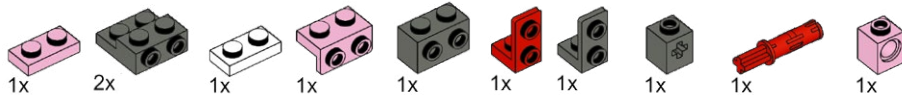

1

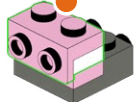
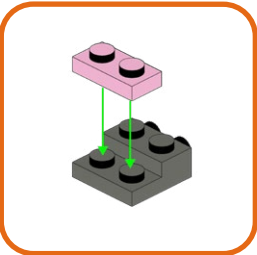

2

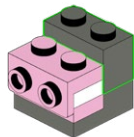

3

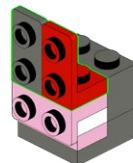

4

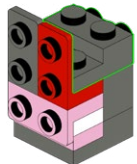

5

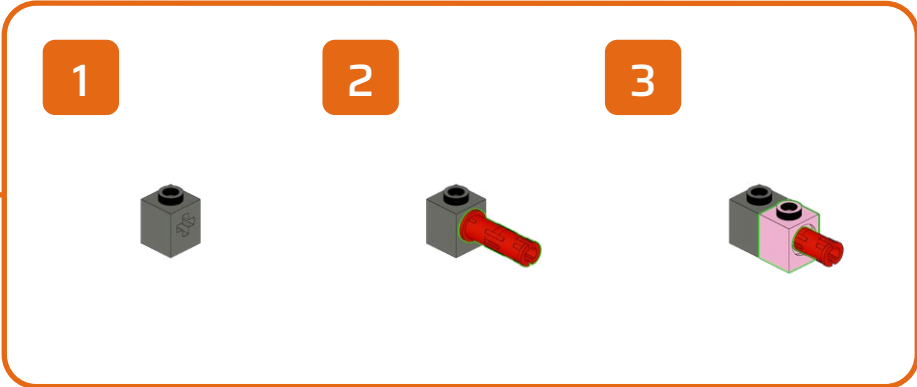
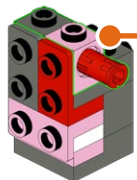

317

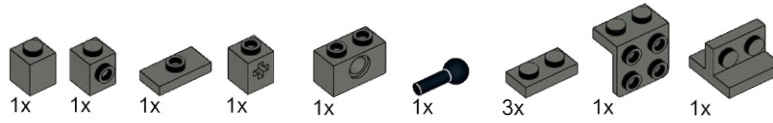

1

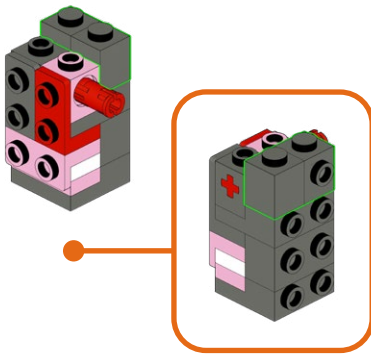

2

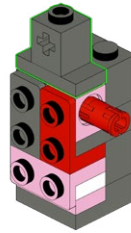

3

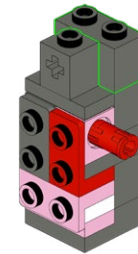

4

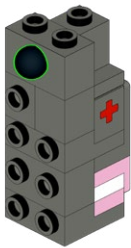

5

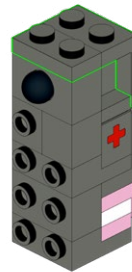

1

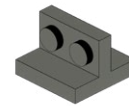

2

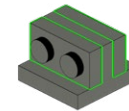

6

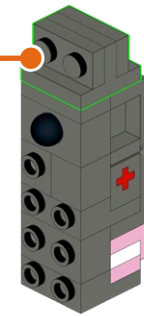

318

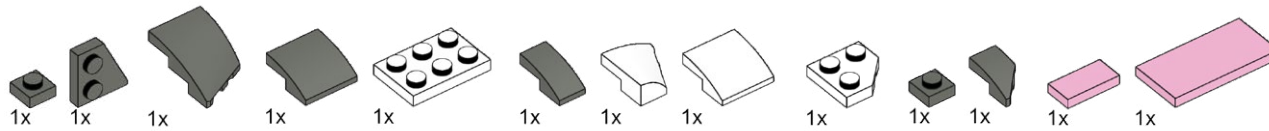

1

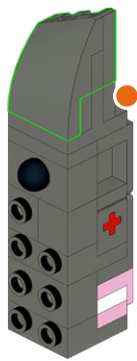

1

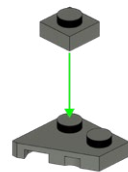

2

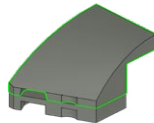

2

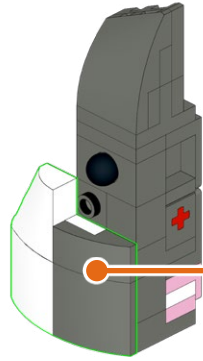

1

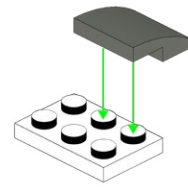

2

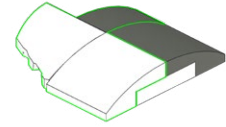

3

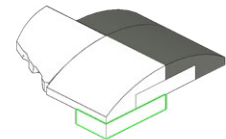

3

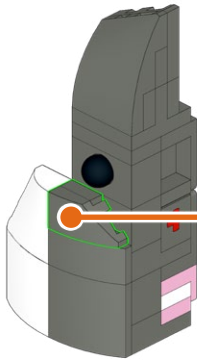

4

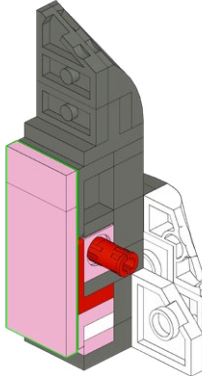

319

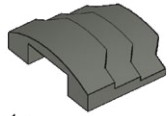

1x

1

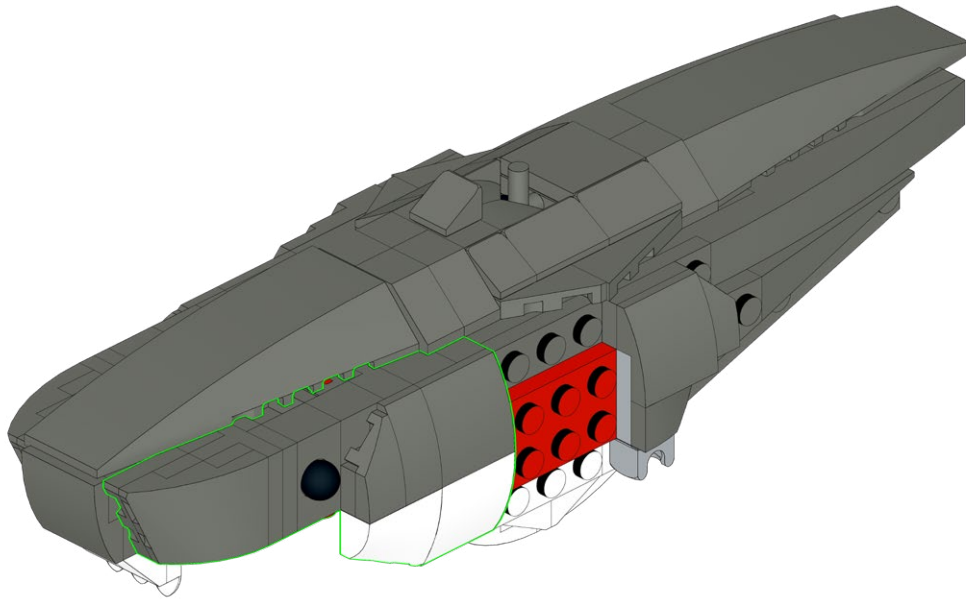

2

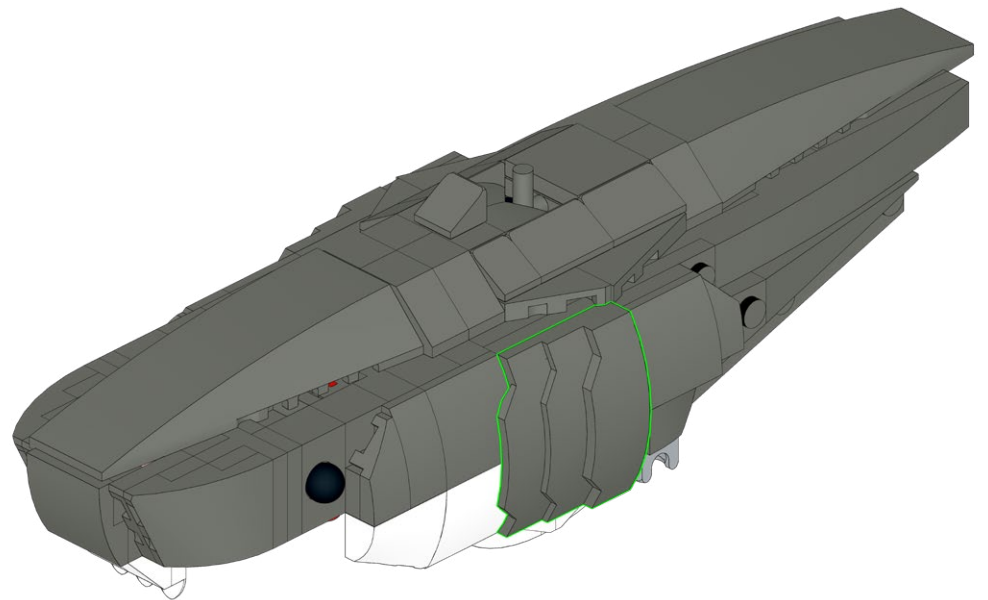

320

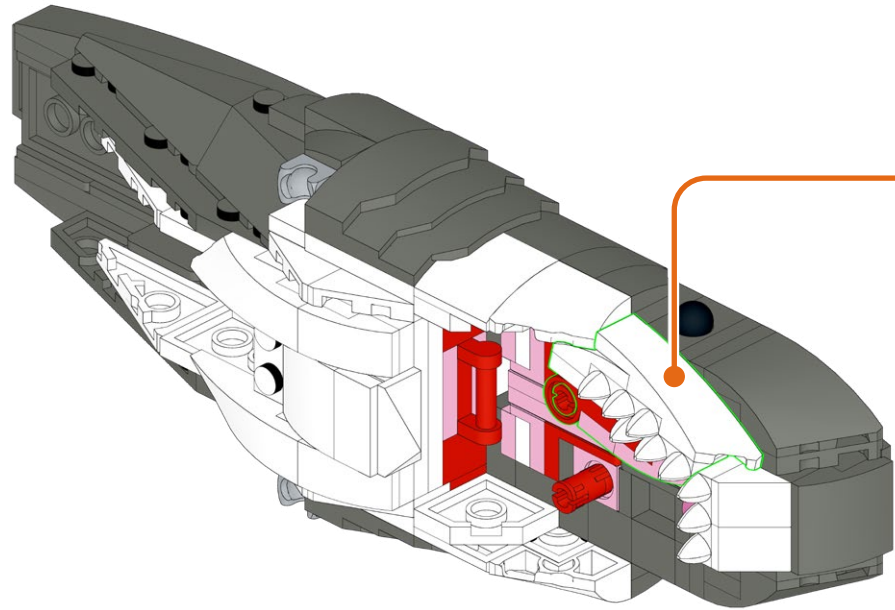
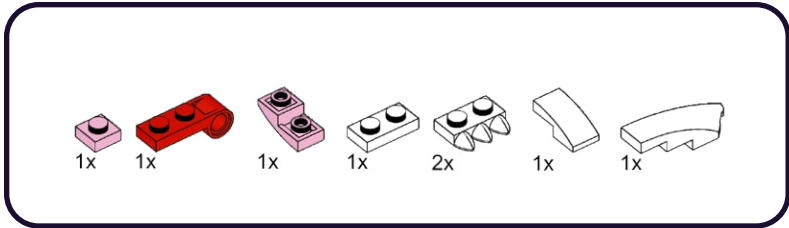

1

2

3

4

5

321

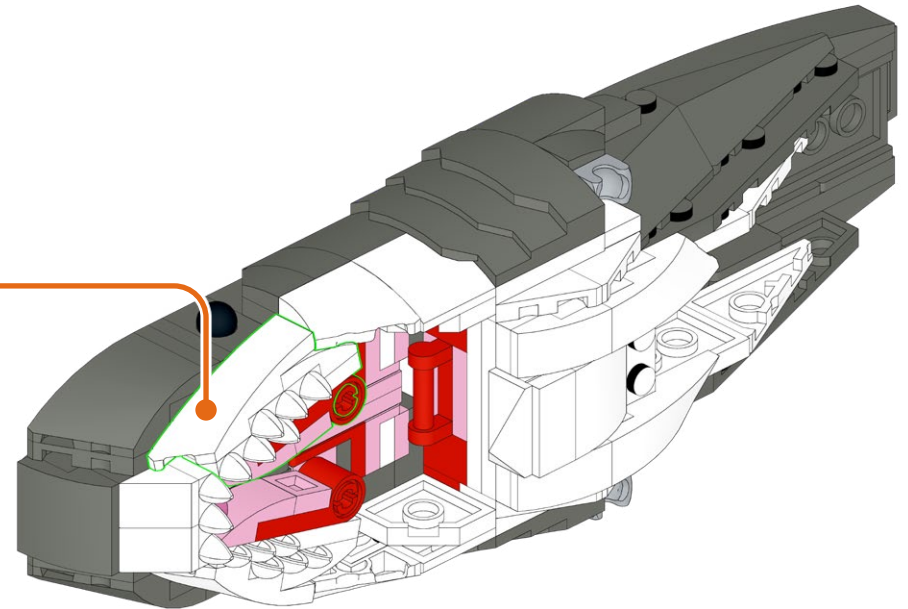
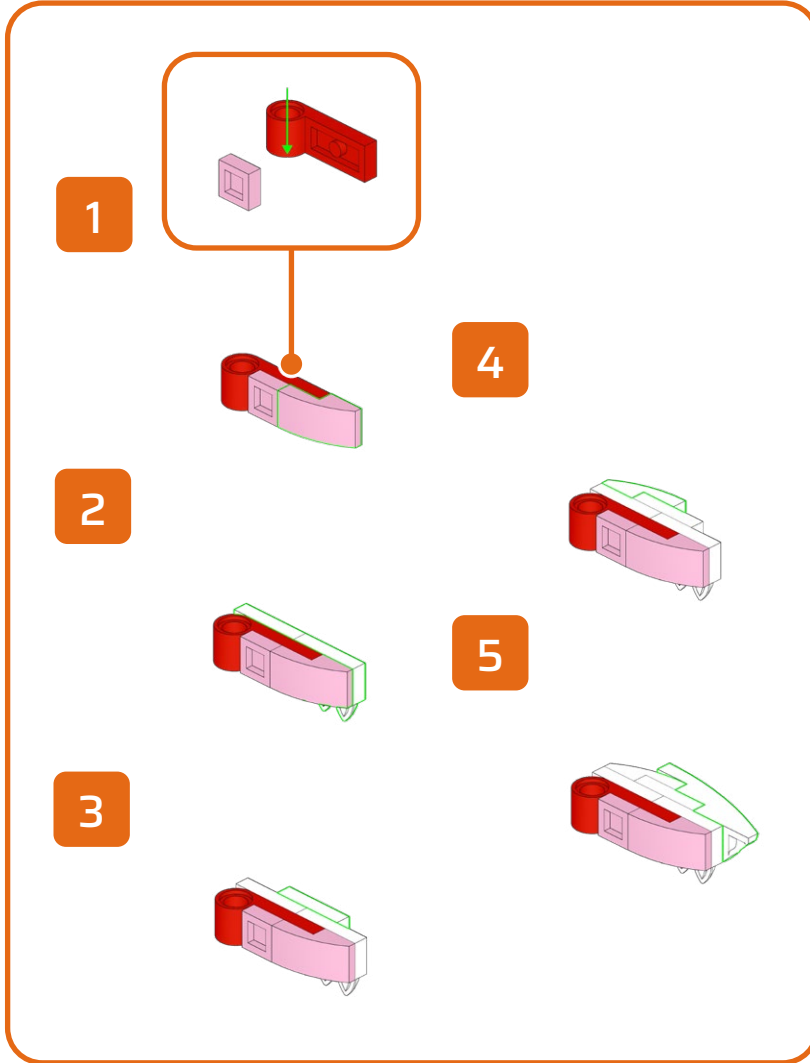
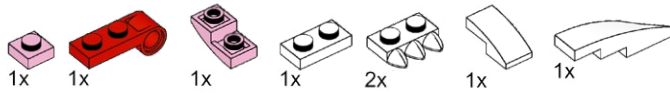

322

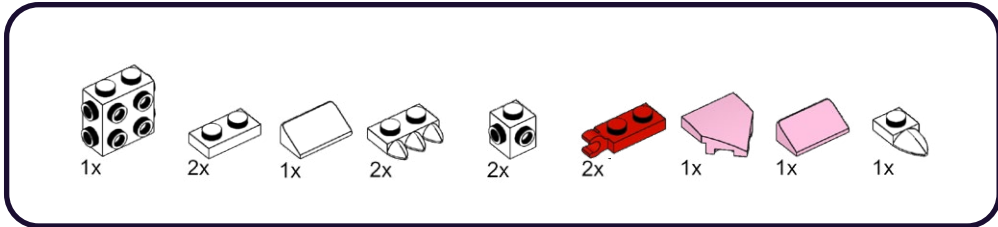

1

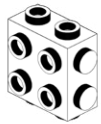

2

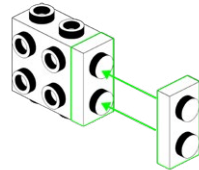

3

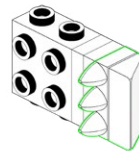

4

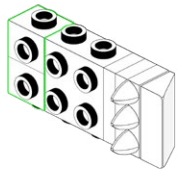

5

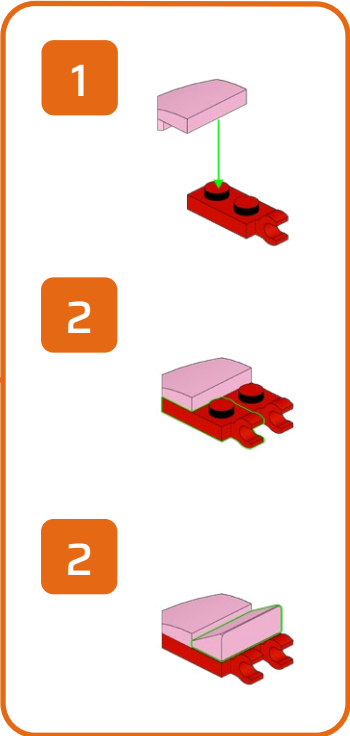
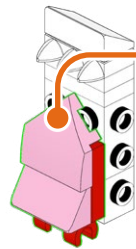

6

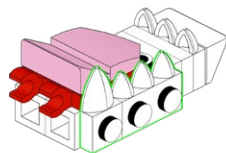

323

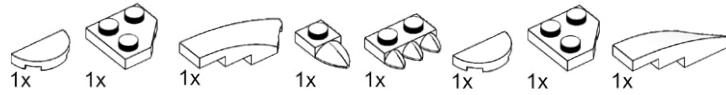

1

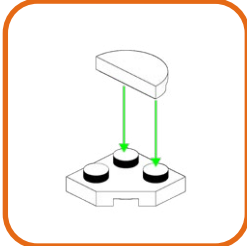

2

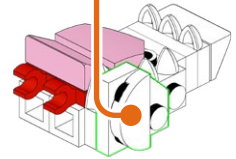

3

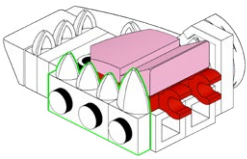
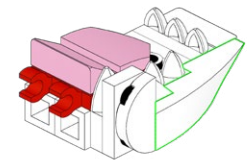

4

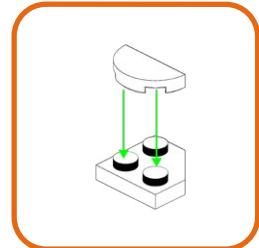

5

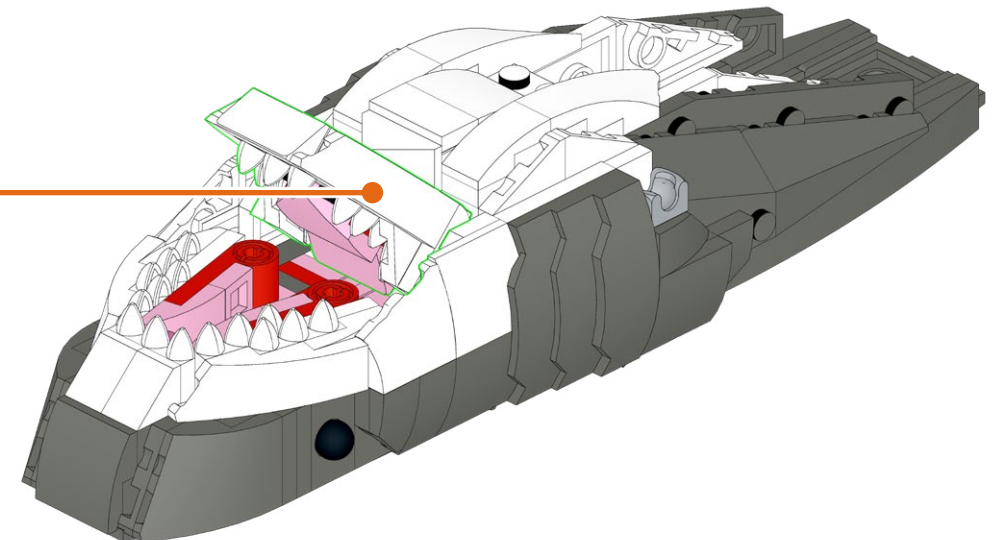
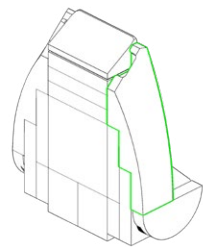
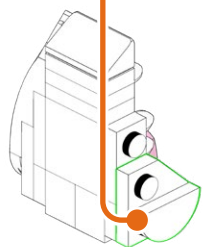

324

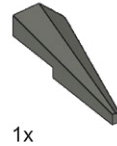
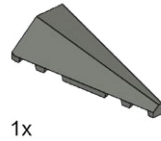

1

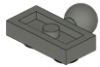

4

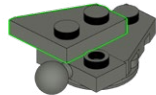

2

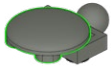

5

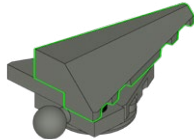

3

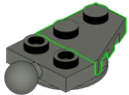

1

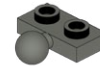

2

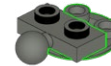

3



4

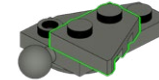

5

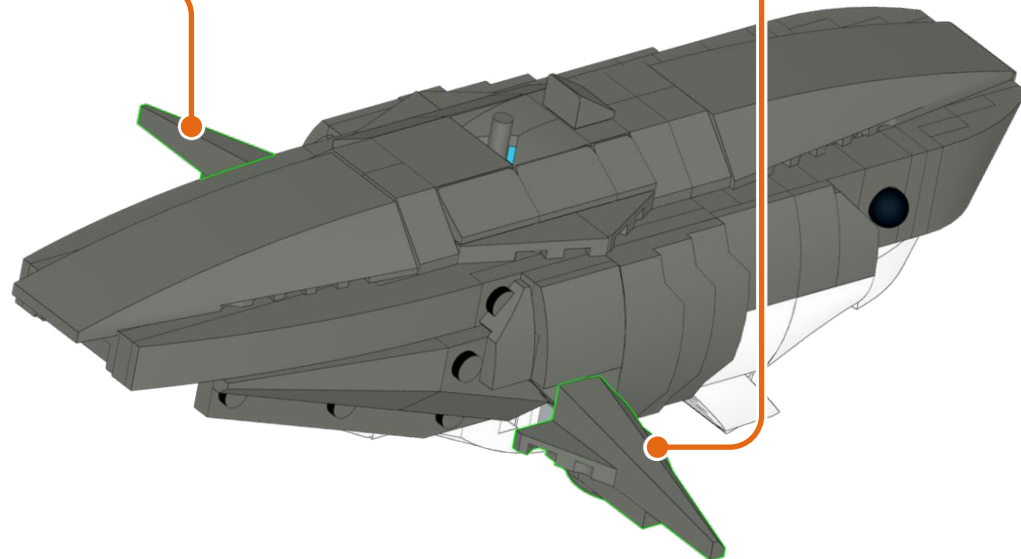
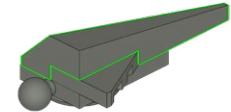

325

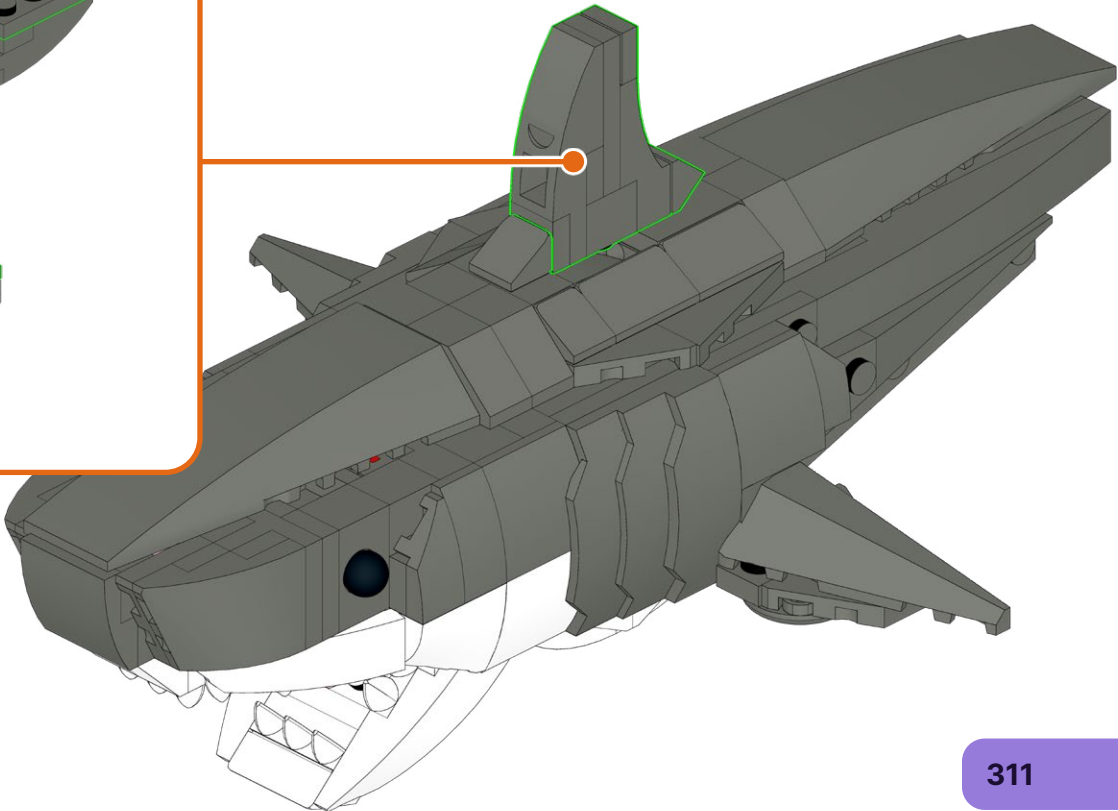
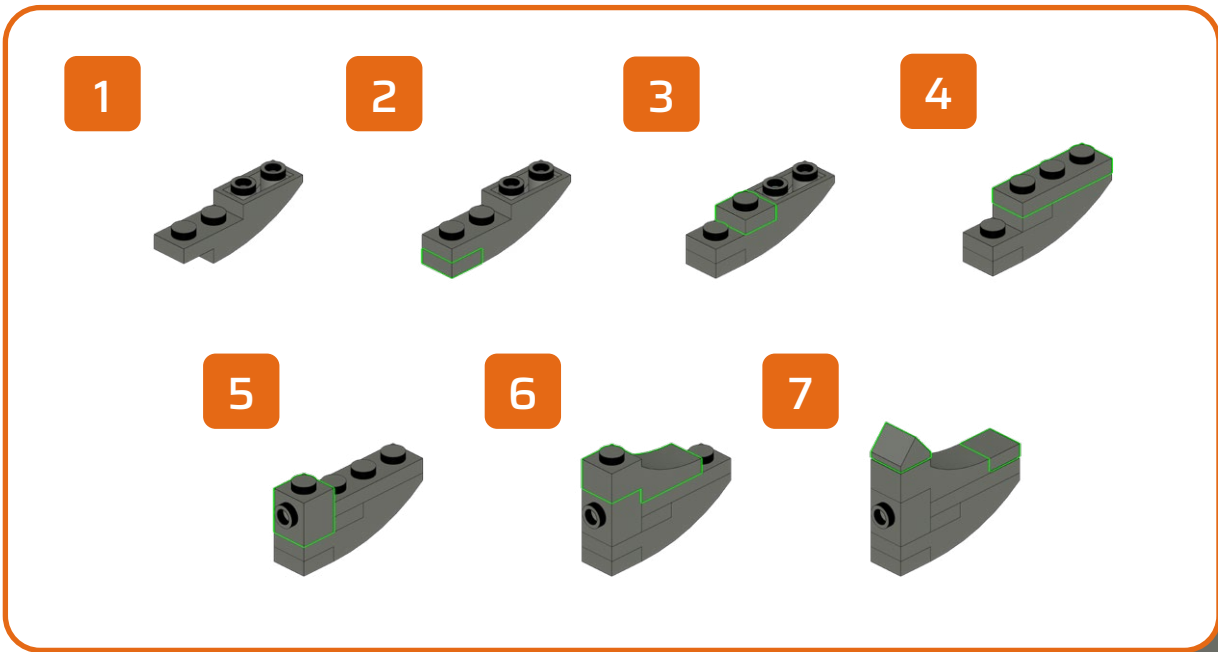
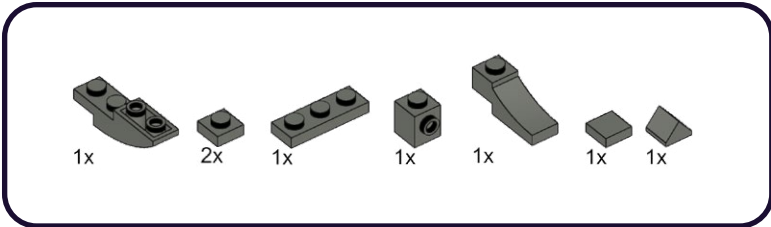

326



1x
327

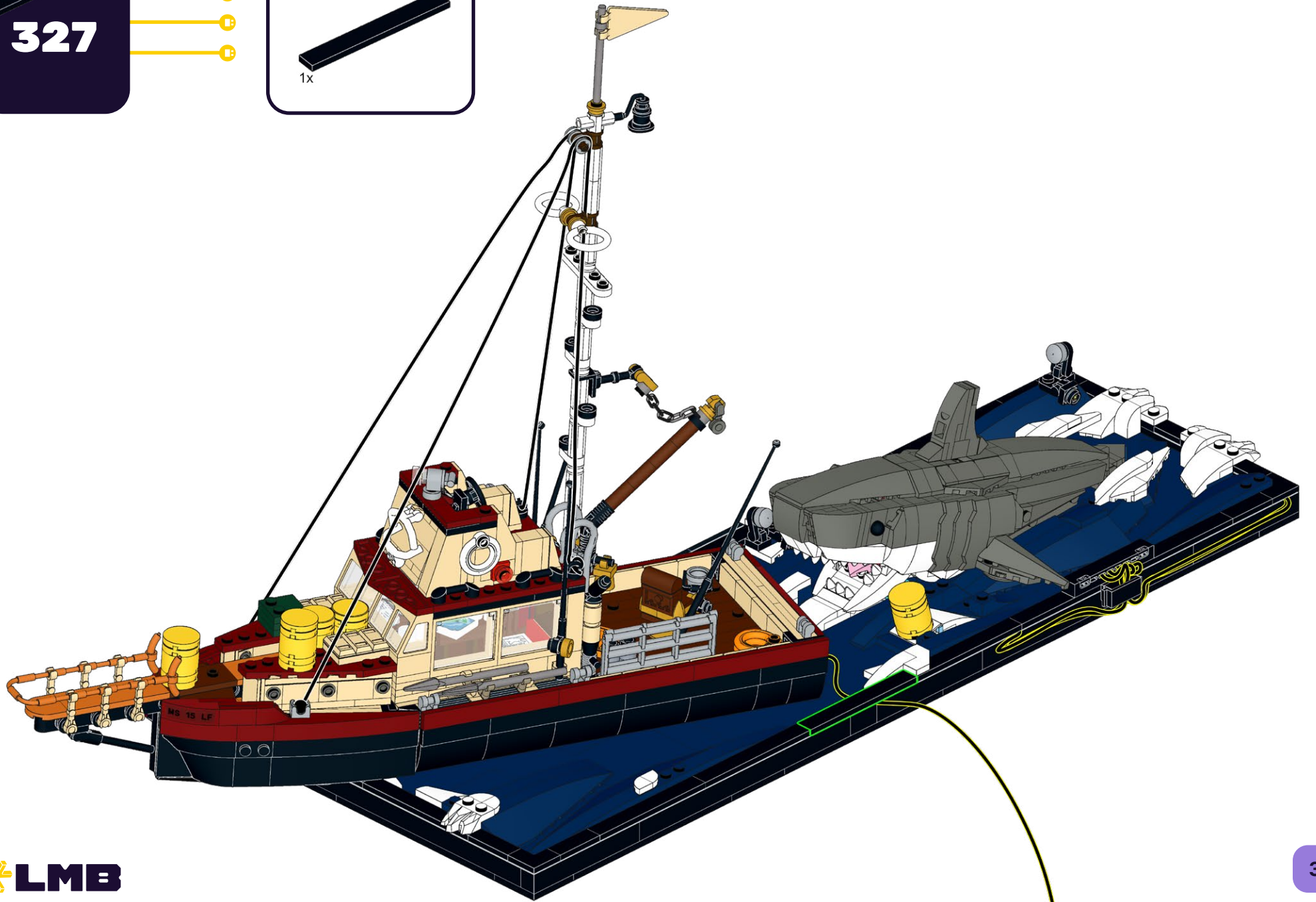
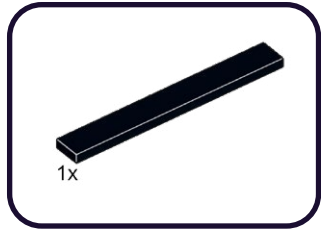

328



329

B-30

1x

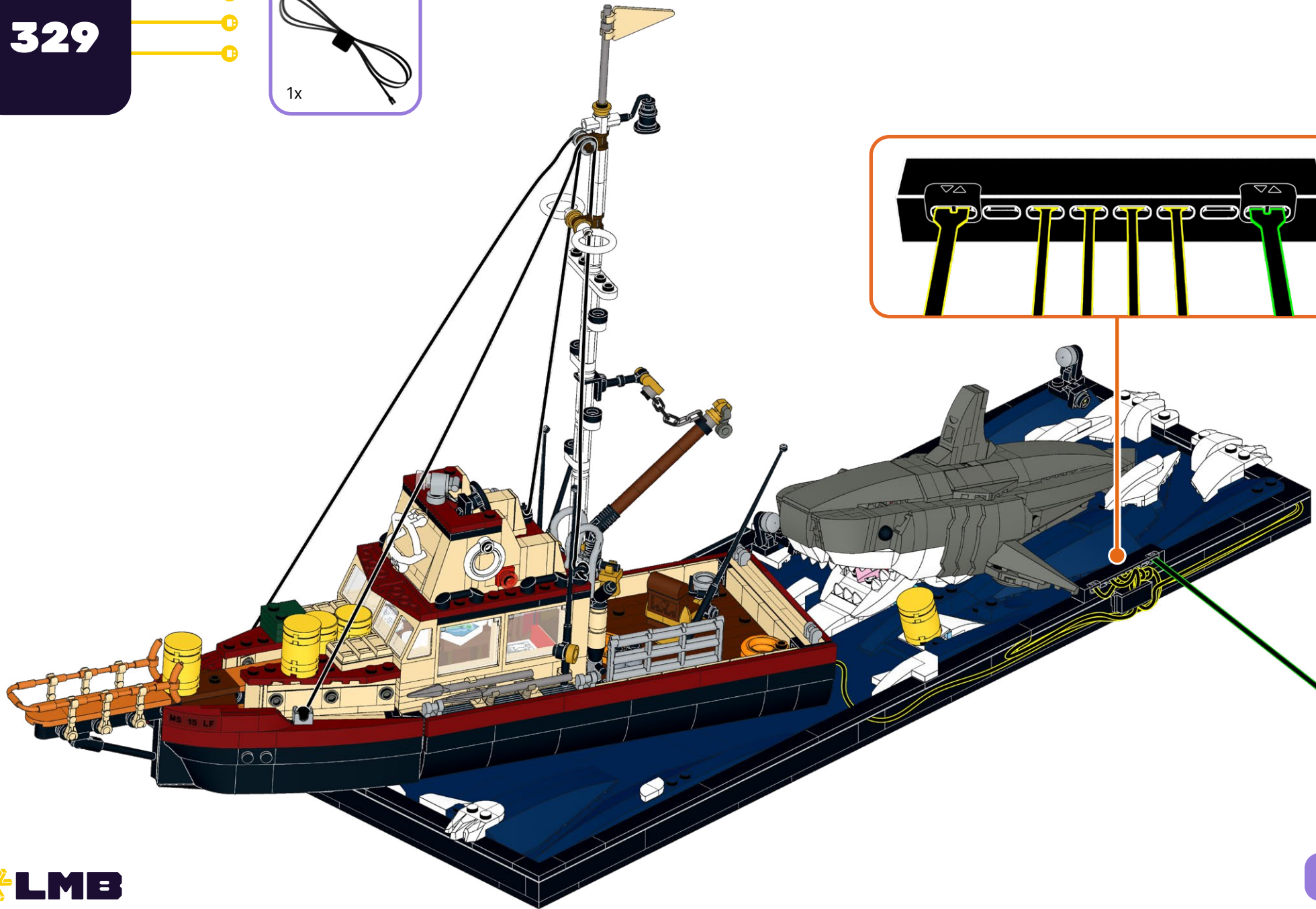
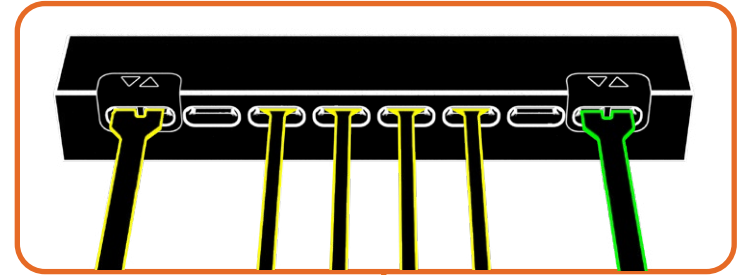
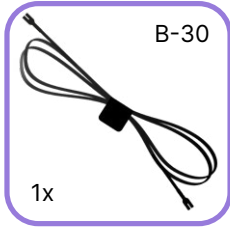

330



331



Power on Test
Test de mise sous tension
Test di Potenza
Stromtest
Prueba de Energía
电源测试

332



333



FINAL PRODUCT



PACKAGE CONTENTS



1x MML-WW
Micro Meteor Light
Warm White



2x AL-B30
Astro Large
Blue - 30cm



1x B-50
Belt - 50cm



1x AR-WW15
Astro Regular
Warm White - 15cm



1x D-3
Dock-3



1x T-1x3
Tether 1x3



1x AR-R15
Astro Regular
Red - 15cm



1x D-6
Dock-6



1x T-1x4
Tether 1x4



1x AR-G15
Astro Regular
Green - 15cm



1x B-5
Belt - 5cm

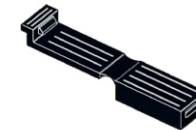

1x E-1x2
Eclipse 1x2



2x AR-CW30
Astro Regular
Cool White - 30cm



1x B-30
Belt - 30cm



2x Astro Cap

PACKAGE CONTENTS



1x FLX-C
Flux Converter

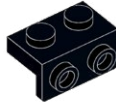

1x Bracket 1x2 - 1x2
Black



4x Round Plate 1x1
with Bar Handle
Black



1x Tile 1x6
Black



4x Round Plate 1 x 1
with Open Stud
Black



1x Round Plate 1x1
Trans Clear



4x Modified Tile 1x1
with Open O Clip
Black



1x Round Plate 1x1
Trans Dark Green



1x Round Plate 1x1
Trans Red

CONTACT US

Click below for customer support, or general inquiries.

Cliquez ci-dessous pour accéder au support client ou aux renseignements généraux.

Clicca qui sotto per l'assistenza clienti o per richieste generali.

Contact Us



Contactez-nous



Contattaci



Klicken sie unten für kundensupport oder allgemeine anfragen.

Haga clic a continuación para atención al cliente o consultas generales.

点击下方获取客户支持或一般咨询。

Kontaktieren sie uns



Contáctanos



联系我们



TROUBLESHOOTING

If you're stuck, scan the QR code for troubleshooting.

Se sei bloccato, scansiona il codice QR per la risoluzione dei problemi.

Wenn Sie nicht weiterkommen, scannen Sie den QR-Code zur Fehlerbehebung.

Si vous êtes bloqué, scannez le code QR pour le dépannage

Si está atascado, escanee el código QR para solucionar el problema.

如果遇到问题, 请扫描二维码进行故障排除

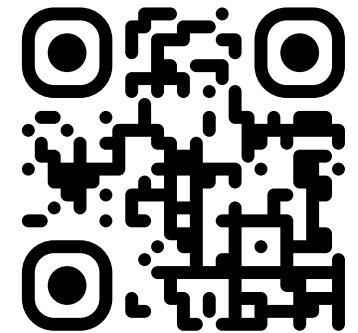



LIGHTMYBRICKS

lightmybricks.com



LEGO® is a trademark of the LEGO Group of companies, which does not sponsor, authorize or endorse this product. All LEGO® sets featured in images are sold separately. This is not a LEGO® product. The LEGO Group is not liable for any loss, injury or damage arising from the use or misuse of this product. ©2024 Light My Bricks Pty Ltd. All rights reserved. www.lightmybricks.com

Our components are designed and packaged in Australia by Light My Bricks Pty Ltd. Components are manufactured in China. 3fl bldg C, Shuanghuan Quanxin Technology Information Industry Park Baolong Street, Longgang District, Shenzhen, China. Imported in Australia by Light My Bricks Pty Ltd, 5/26 Rushdale St, Knoxfield, VIC, 3180, Australia.

WARNING: CHOKING HAZARD - Small parts. Not for children under 3 years.

AVERTISSEMENT : RISQUE D'ÉTOUFFEMENT - Petites pièces. Ne convient pas aux enfants de moins de 3 ans.

ATTENZIONE: PERICOLO DI SOFFOCAMENTO - Piccole parti. Non adatto a bambini di età inferiore a 3 anni.

WARNUNG: ERSTICKUNGSGEFAHR - Kleine Teile. Nicht für Kinder unter 3 Jahren geeignet.

ADVERTENCIA: PELIGRO DE ASFIXIA - Piezas pequeñas. No son apto para niños menores de 3 años.

警告：窒息危险 - 小零件。不适合3岁以下儿童。