



**LIGHT  
BRICKS™**



# LIGHT KIT INSTALLATION GUIDE

**DUNGEONS & DRAGONS:  
RED DRAGON'S TALE**

FOR LEGO  
SET  
#21348



# CONTENTS



**03**

Getting Started

- 04** Legend
- 05** Component Handling
- 06** Blueprint

**07**

Instructions

- 27** LMB Bag 01
- 78** LMB Bag 03
- 155** LMB Bag 02
- 220** LMB Bag 04
- 269** LMB Bag 05

**285**

Final Product

- 286** Package Contents
- 289** Contact & Troubleshooting



# GETTING STARTED



Bold, beautiful and bright, Light My Bricks elevates your favourite LEGO set from knick-knack to statement piece. Create a talking point at home or in the office that speaks to your passions with Light My Bricks. To learn more, click below.

[Learn More](#)



Audacieux, beau et lumineux, Light My Bricks élève votre ensemble LEGO préféré du statut de bibelot à celui de pièce maîtresse. Que ce soit à la maison ou au bureau, partagez votre passion des LEGO avec Light My Bricks. Cliquez ci-dessous pour en savoir plus.

[En savoir plus](#)



Audace, bello e luminoso, Light My Bricks eleva il tuo set LEGO preferito da soprammobile a pezzo di tendenza. Crea un punto di discussione a casa o in ufficio che parli alle tue passioni con Light My Bricks. Per saperne di più, clicca qui sotto.

[Ulteriori Informazioni](#)



Mutig, schön und hell – Light My Bricks verwandelt Ihr Lieblings-LEGO-Set von einem schnickschnack in ein statement-stück. Schaffen sie einen gesprächspunkt zu hause oder im büro, der Ihre leidenschaften widerspiegelt, mit Light My Bricks. Um mehr zu erfahren, klicken sie unten.

[Mehr erfahren](#)



Audaz, hermoso y brillante, Light My Bricks eleva tu set LEGO favorito de una chuchería a una pieza llamativa. Crea un tema de conversación en casa o en la oficina que hable de tus pasiones con Light My Bricks. Para obtener más información, haga clic a continuación.

[Más información](#)



大胆、美丽而明亮，Light My Bricks 将你喜爱的乐高套装从小摆件提升为引人注目的装饰品。在家或办公室打造一个能表达你激情的话题，了解更多，请点击下方。

[了解更多](#)



# LEGEND

## Rotate Set



Retournez L'ensemble  
Ruota Set  
Set Drehen  
Rotar Conjunto  
旋转套件

## Add Part



Ajoutez une Pièce  
Aggiungi Parte  
Teil Hinzufügen  
Agregar Pieza  
添加零件

## Click



Cliquez  
Clic  
Klicken  
Clic  
点击

## Pinch/Fold



Pincez/Pliez  
Pizzicare/Piegare  
Kneifen/Falten  
Pellizcar/Doblar  
折叠

## Pull Cable



Tirez le Cable  
Tirare il Cavo  
Kabel Ziehen  
Tirar del Cable  
拉动电缆

## Repeat Step



Répétez  
Ripetere  
Wiederholen  
Repetir  
重复

## Sticker



Autocollant  
Adesivo  
Aufkleber  
Pegatina  
贴纸

## Power On Test



Test de mise sous tension  
Test di Potenza  
Stromtest  
Prueba de Energía  
电源测试

## Disconnect Power



Débranchez L'alimentation  
Scollegare L'alimentazione  
Strom Trennen  
Desconectar la Energía  
断开电源

## Troubleshoot



Dépanner  
Risolvere  
Fehlerbehebung  
Solución de Problemas  
故障排除

# COMPONENT HANDLING

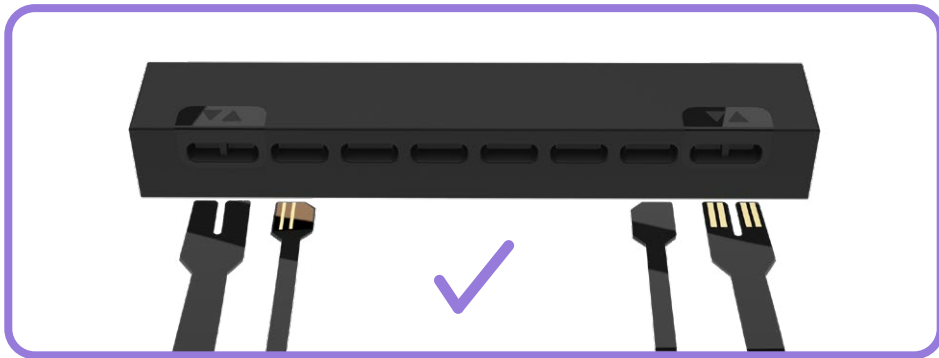
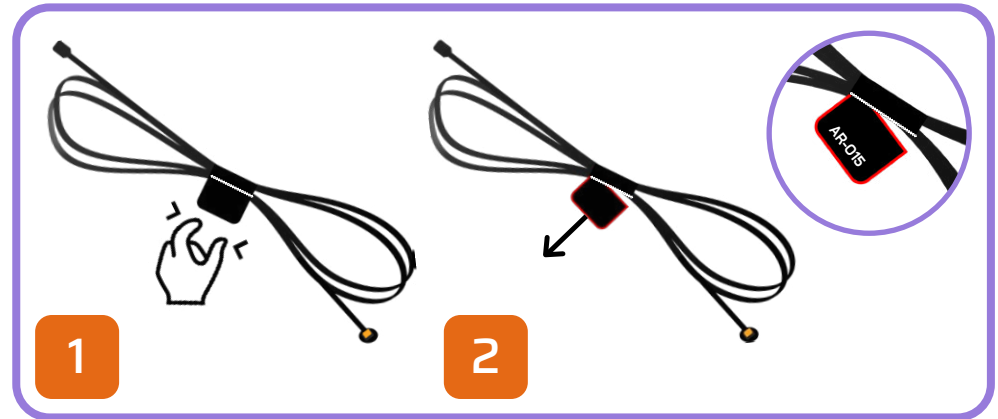
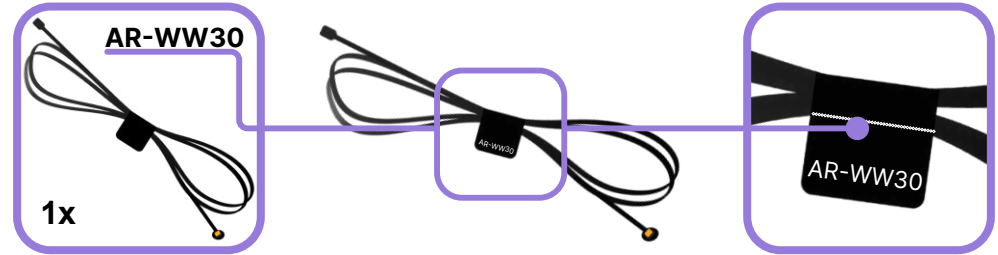
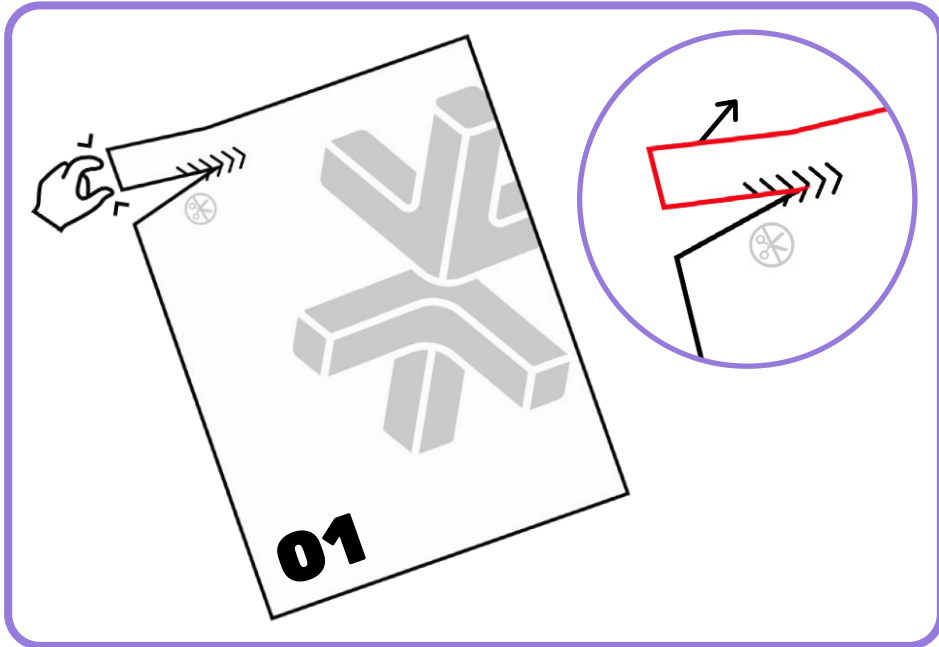

# BLUEPRINT

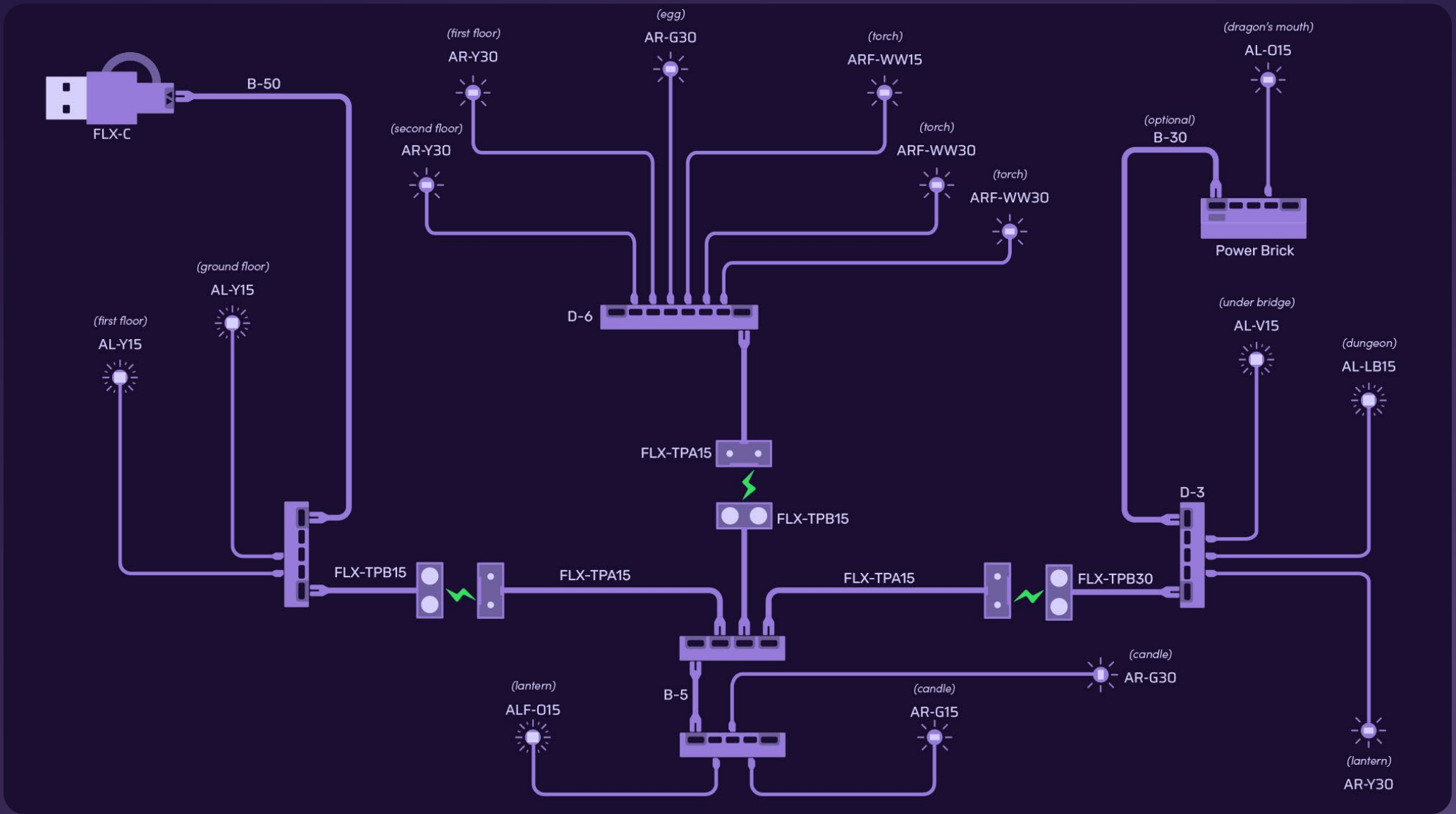



1



2





3



4





5



6



7



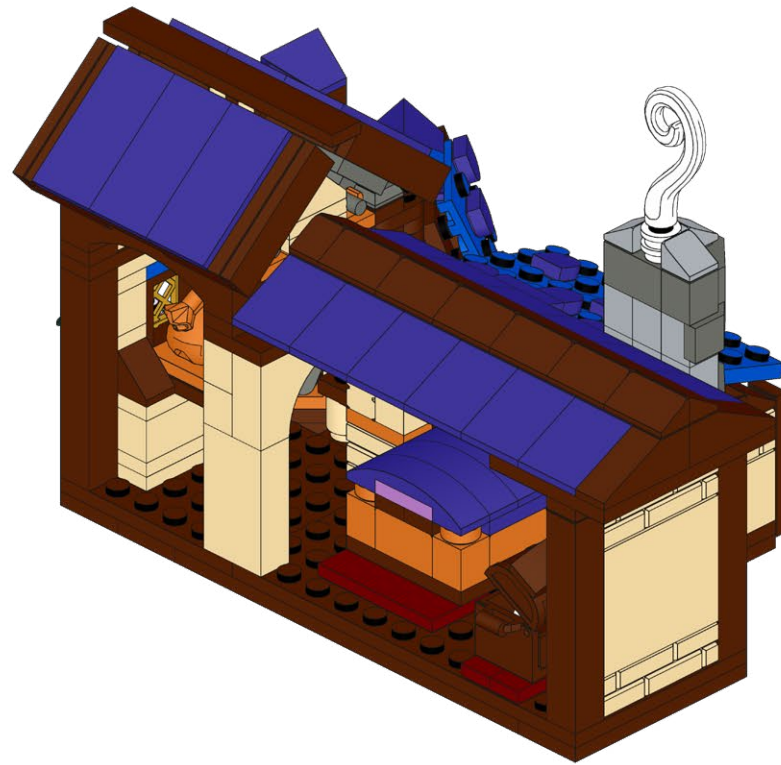
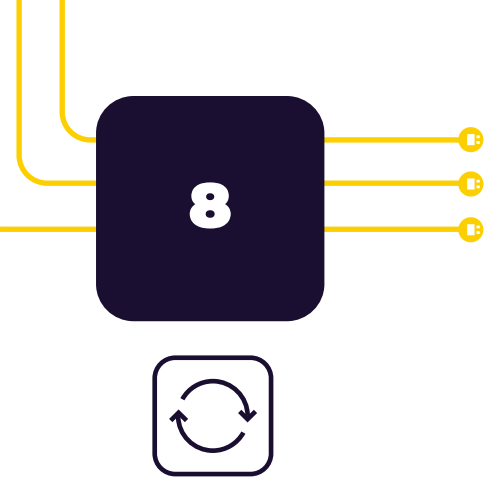



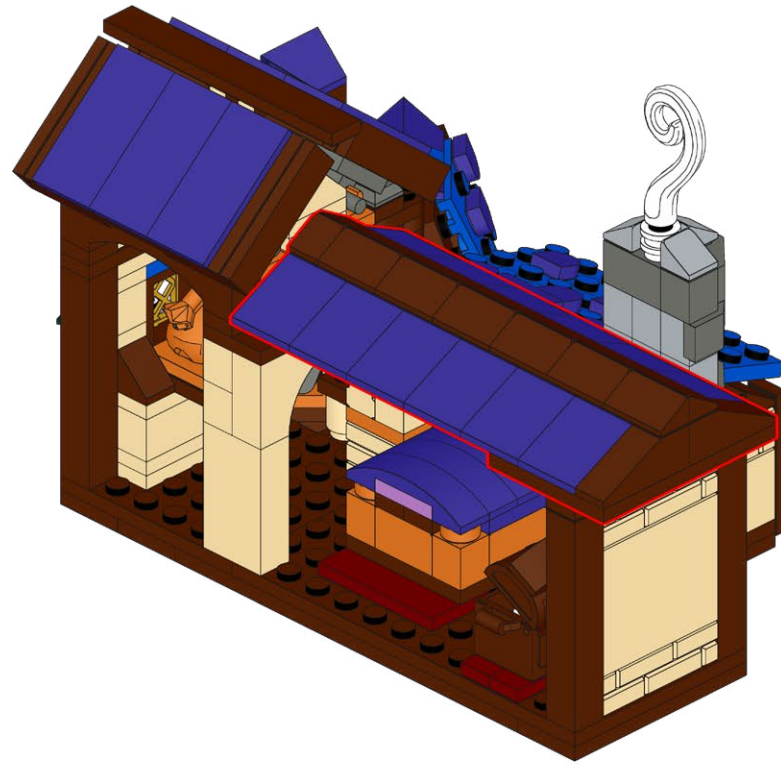
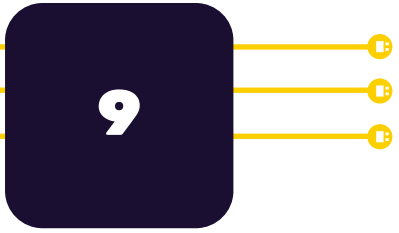

10

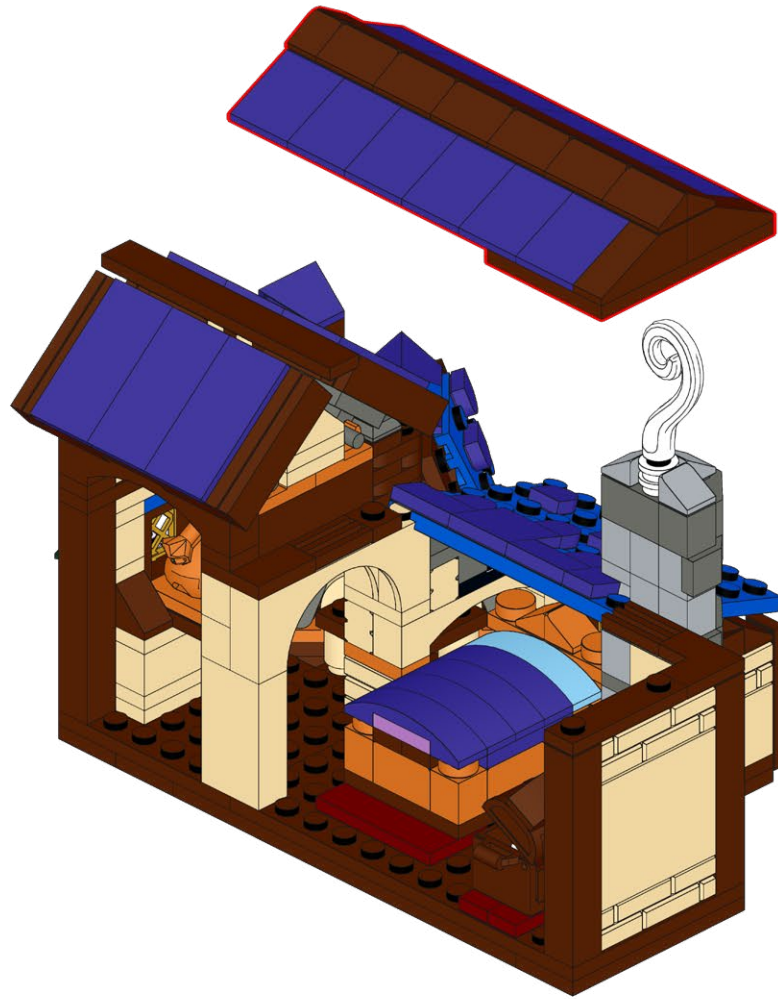

11

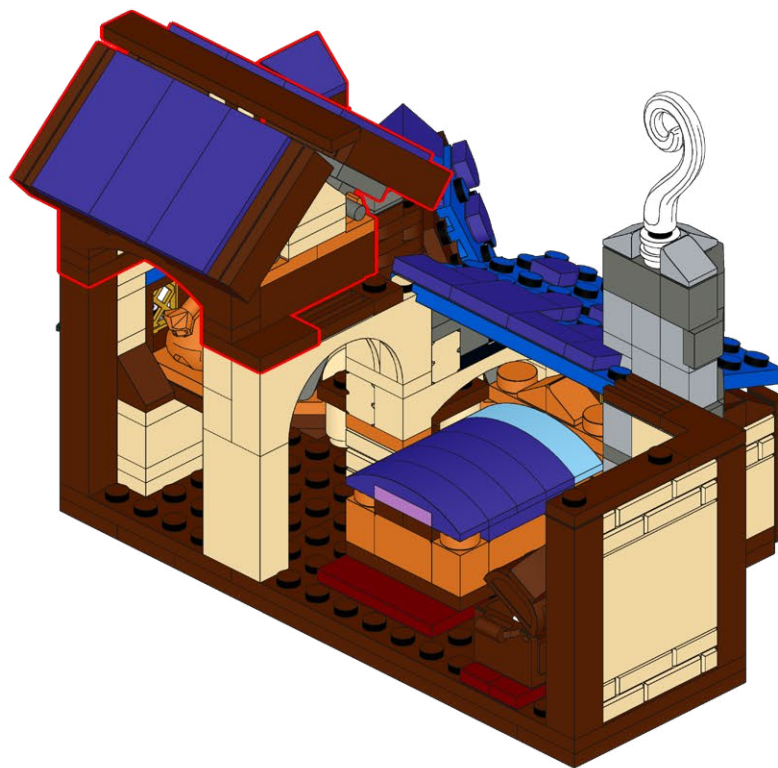

12

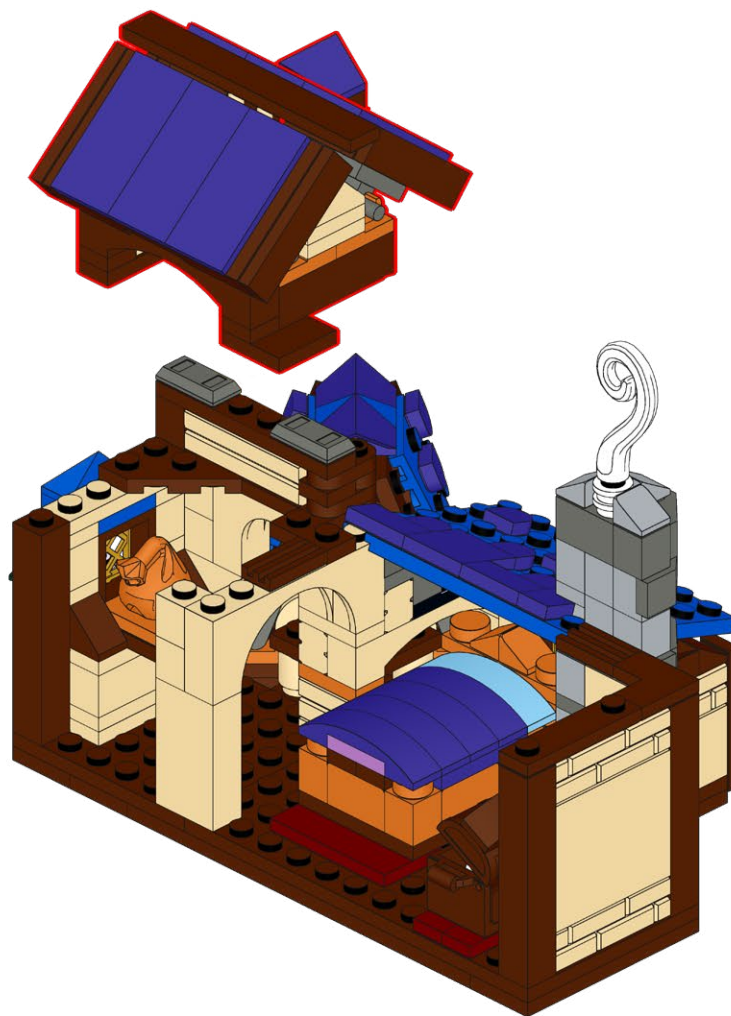



13

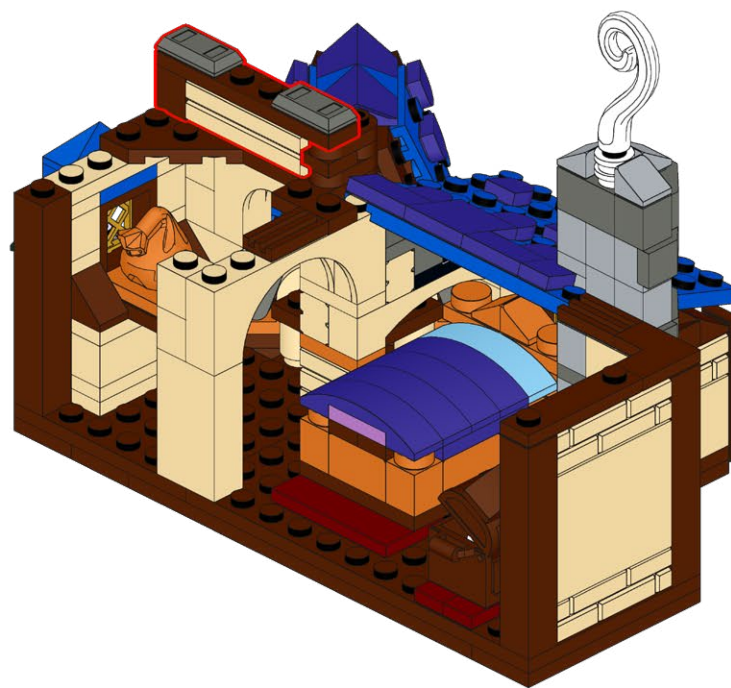

14

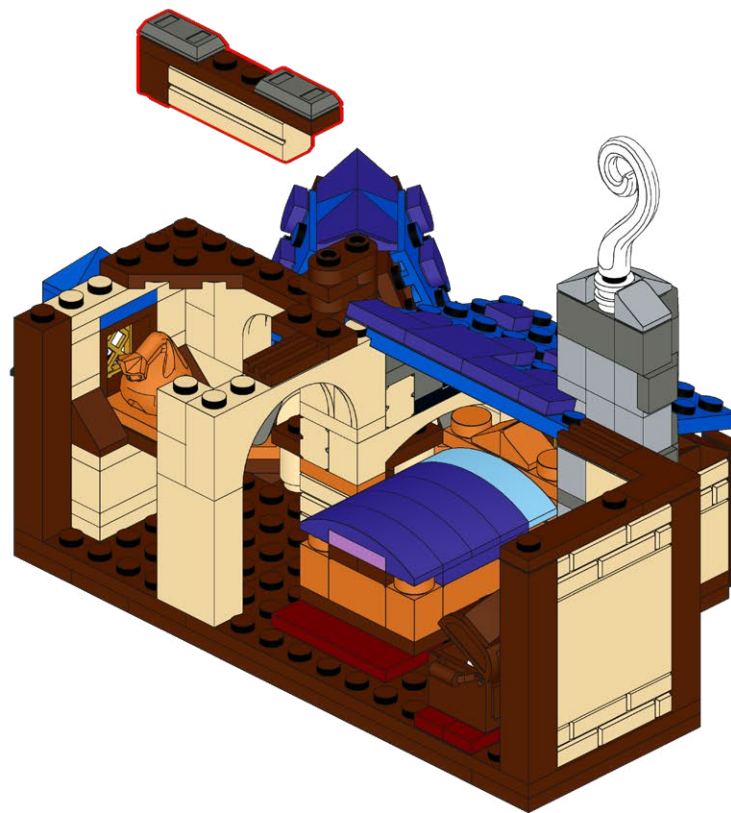

15

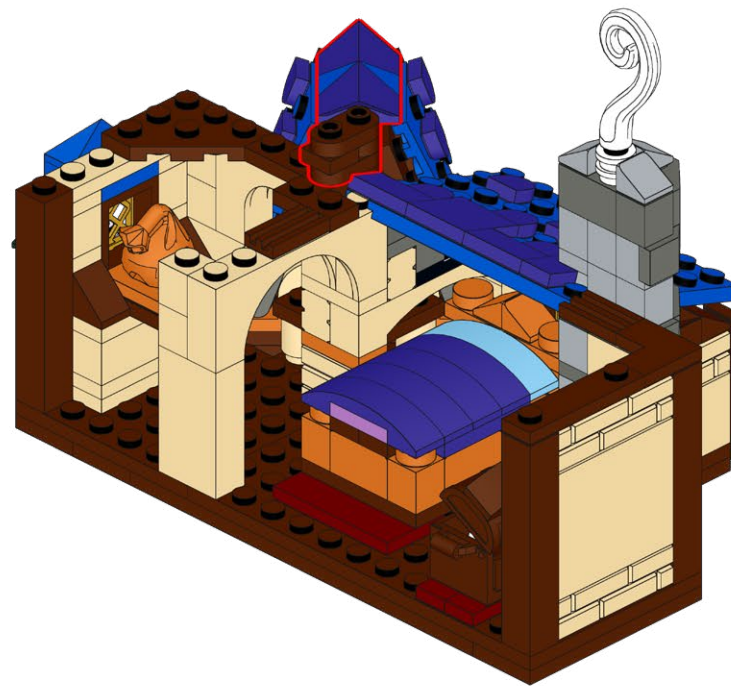

16



17

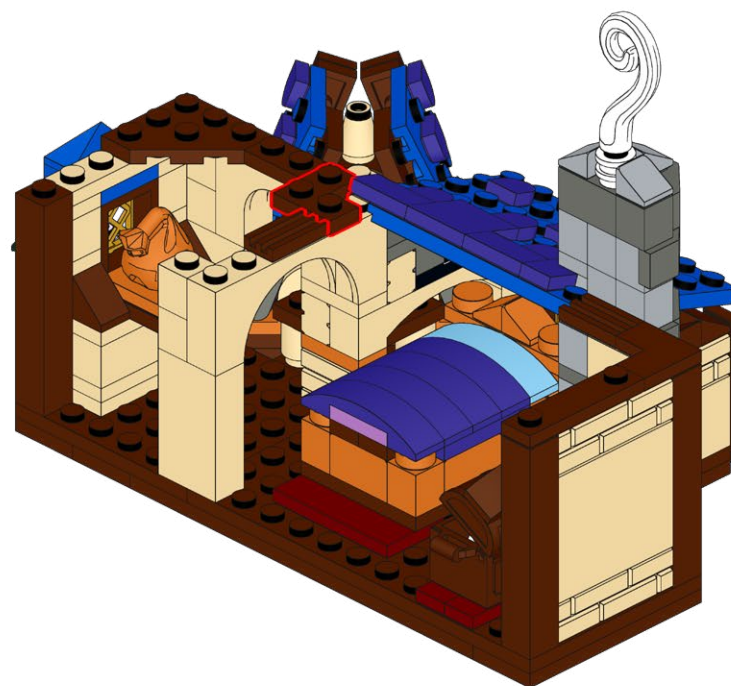



18

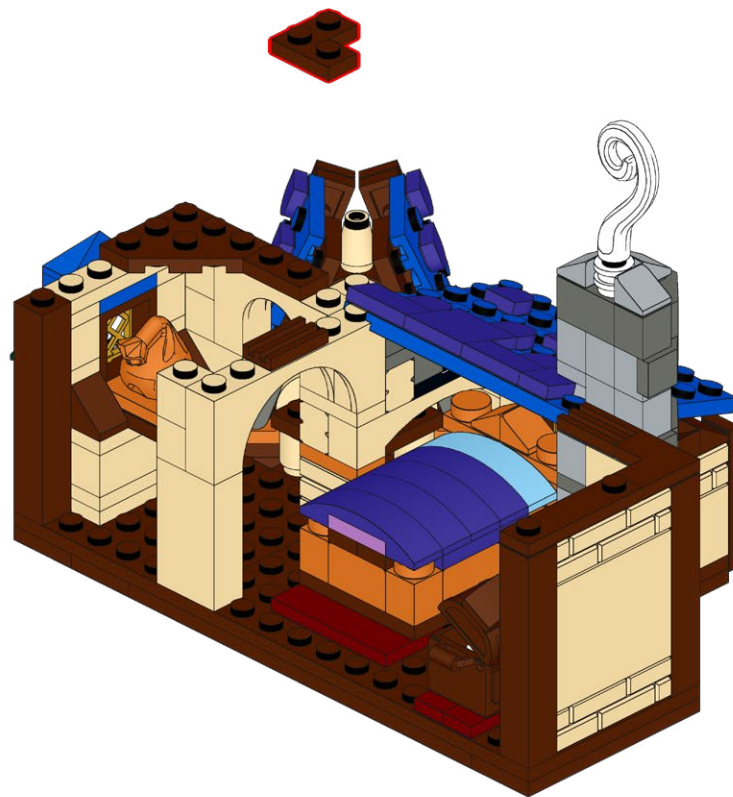

19

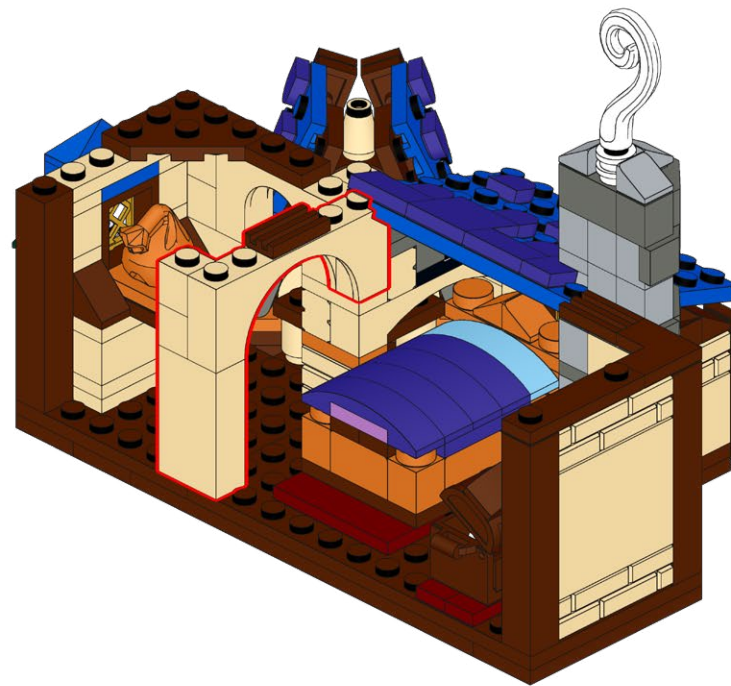

20

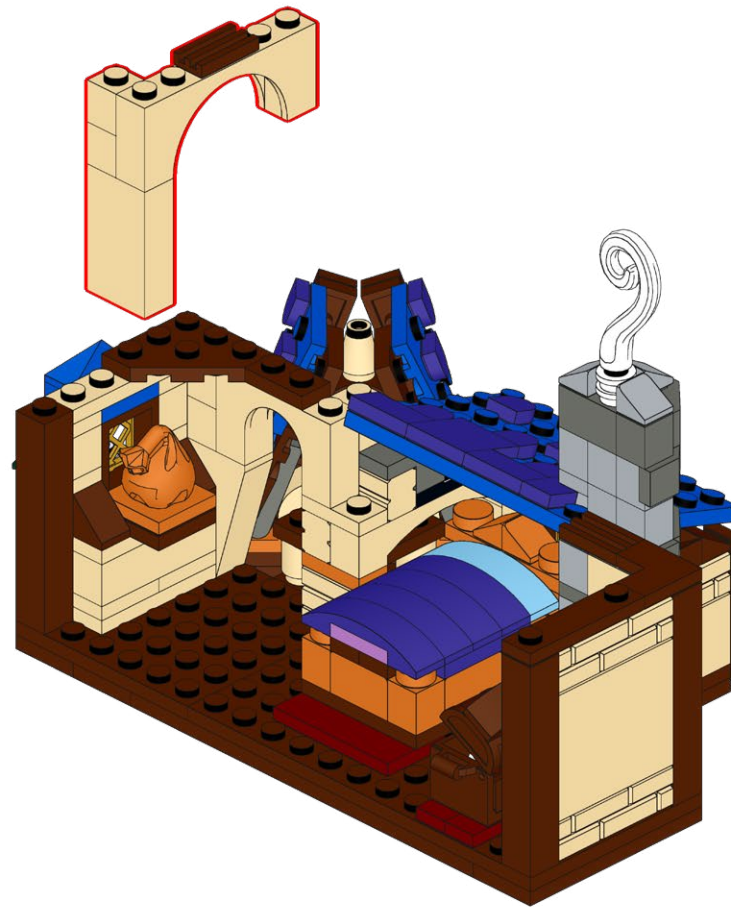

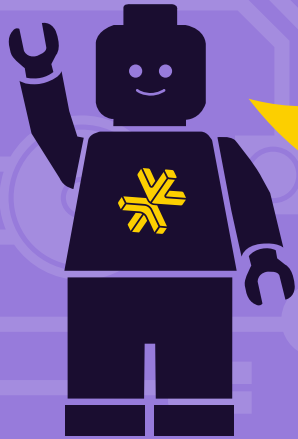
**HOLD UP!**

You might notice some bags aren't in order, as well as left over pieces, but that's ok! We're changing the way you build LEGO!

**ATTENDEZ!**

Vous remarquerez peut-être que certains sacs, ainsi que certaines pièces, ne sont pas dans le bon ordre. Mais pas de panique! Nous changeons simplement la façon avec laquelle vous construisez vos LEGO!

**ASPETTA!**

Potresti notare che alcuni sacchetti non sono in ordine, così come i pezzi avanzati, ma va bene così! Stiamo cambiando il modo in cui costruisci i LEGO!

**HALT!**

Sie werden möglicherweise bemerken, dass einige tüten durcheinander sind und teile übrig bleiben, aber das ist in Ordnung! Wir ändern die art und weise, wie Sie LEGO bauen!

**¡ESPERA!**

Es posible que notes que algunas bolsas están fuera de servicio, así como piezas sobrantes, ¡pero está bien! ¡Estamos cambiando la forma en que construyes LEGO!

**暫停!**

你可能会注意到一些袋子顺序错乱, 以及一些剩余的部件, 但没关系! 我们正在改变你搭建乐高的方式!

Open LMB Bag 01

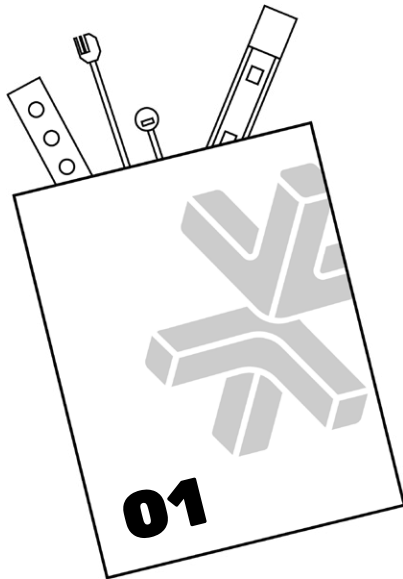

21

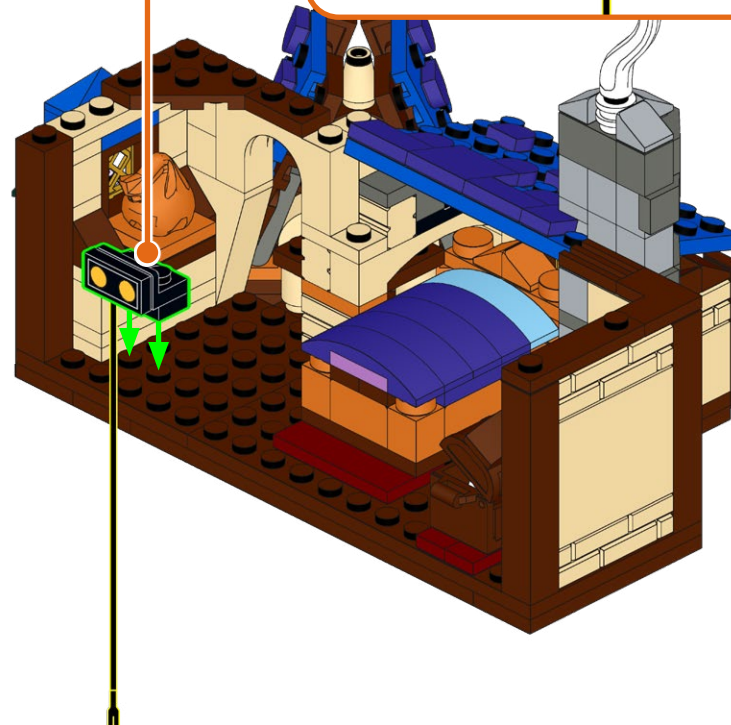
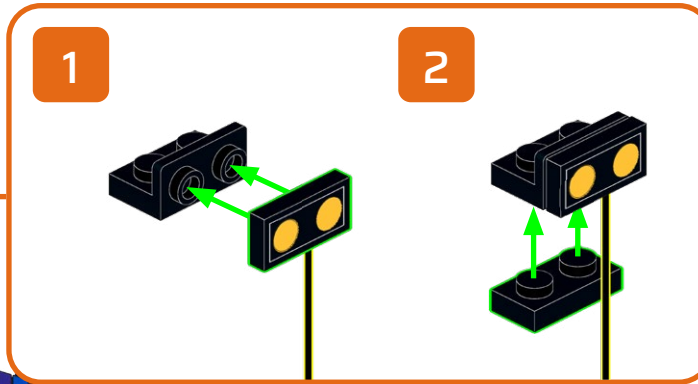
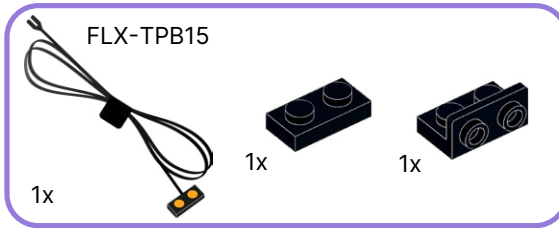



22

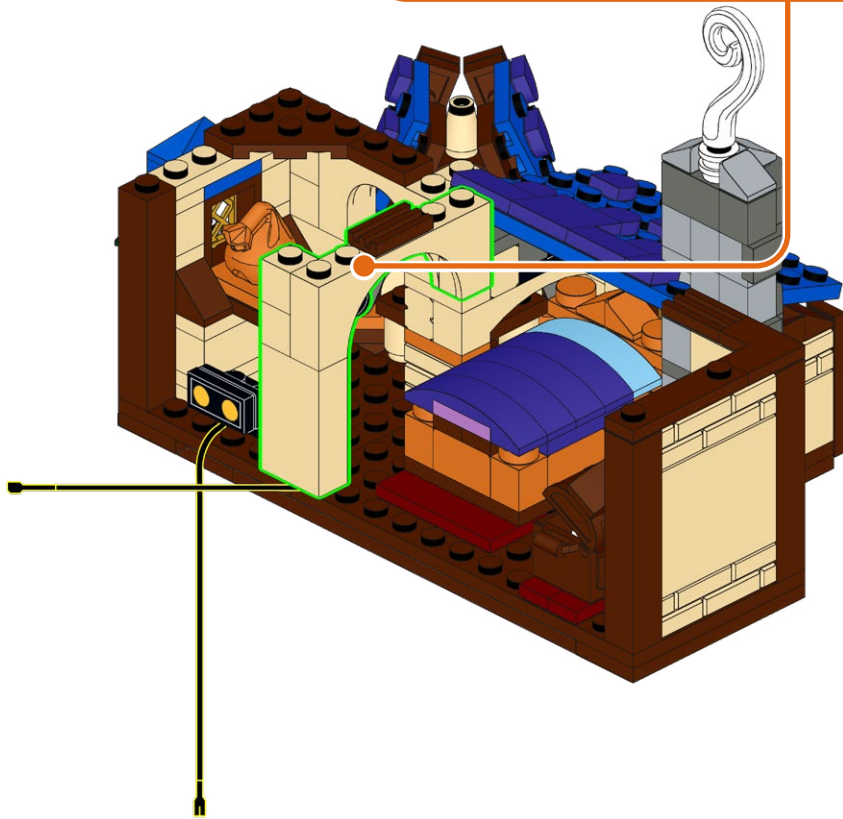
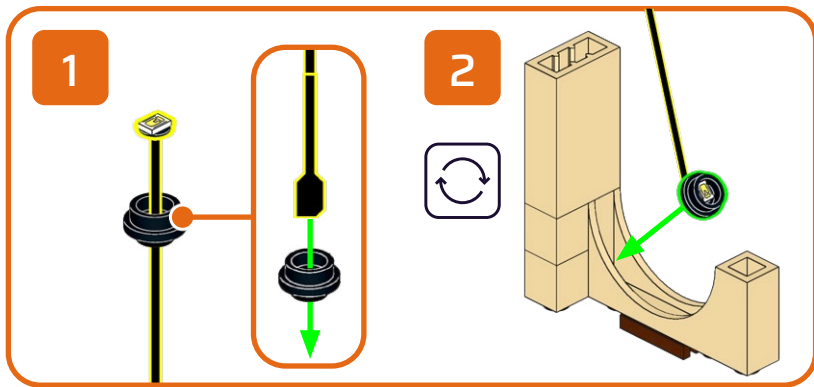
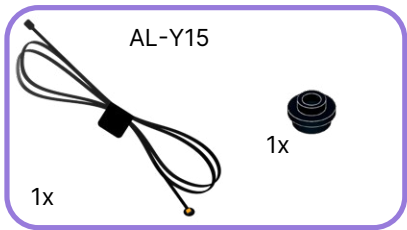

23

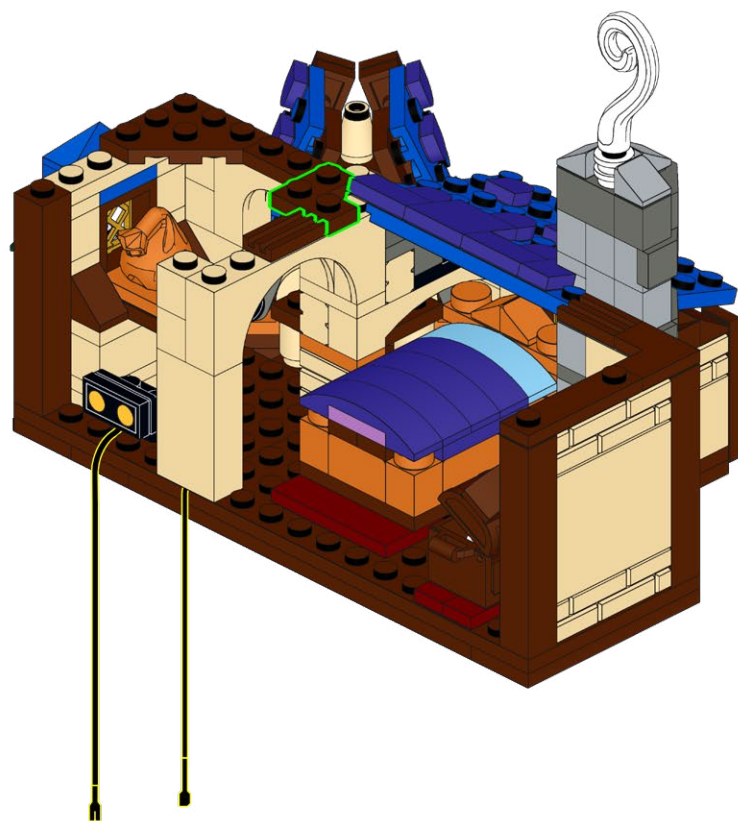

24

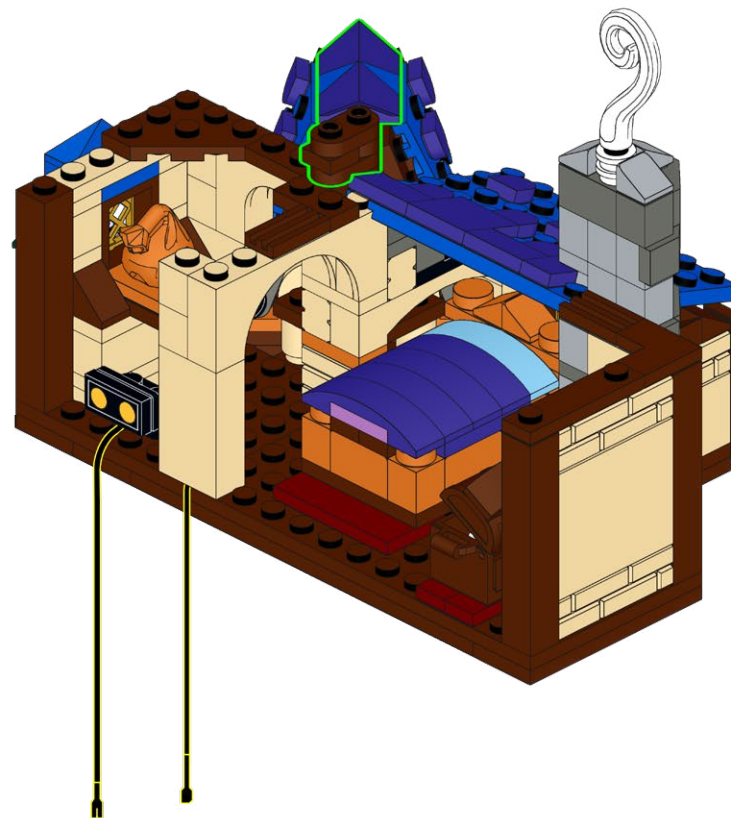

25

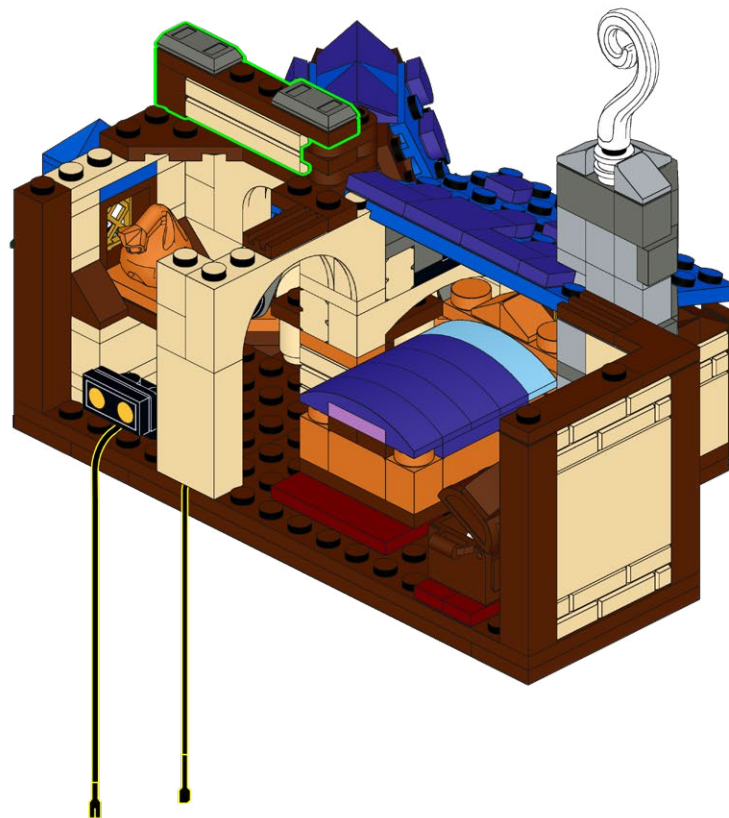

26

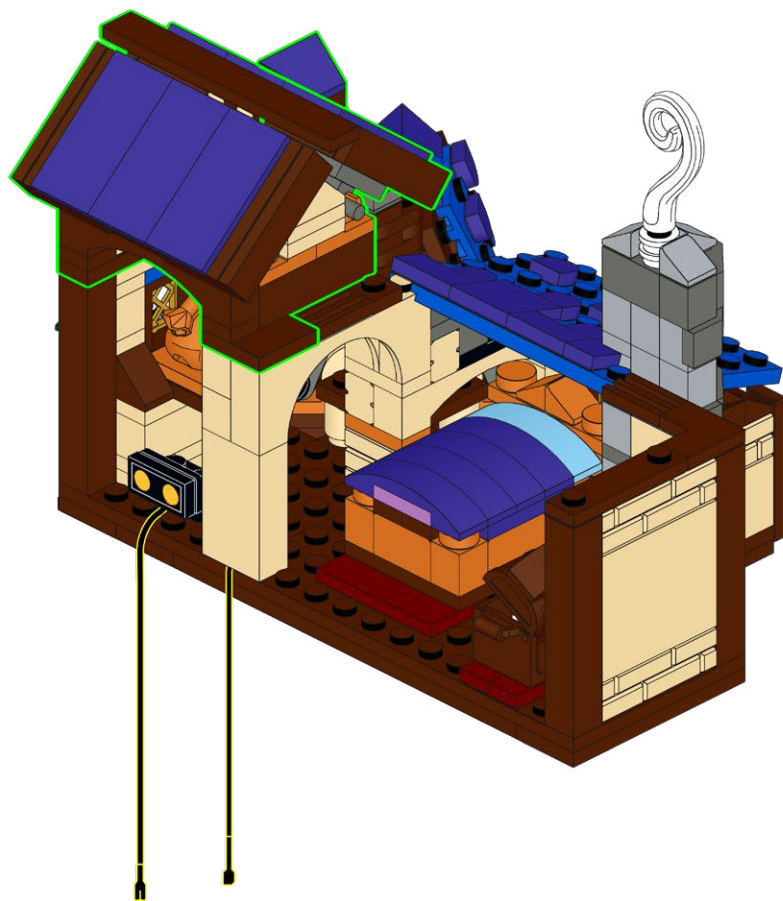



27

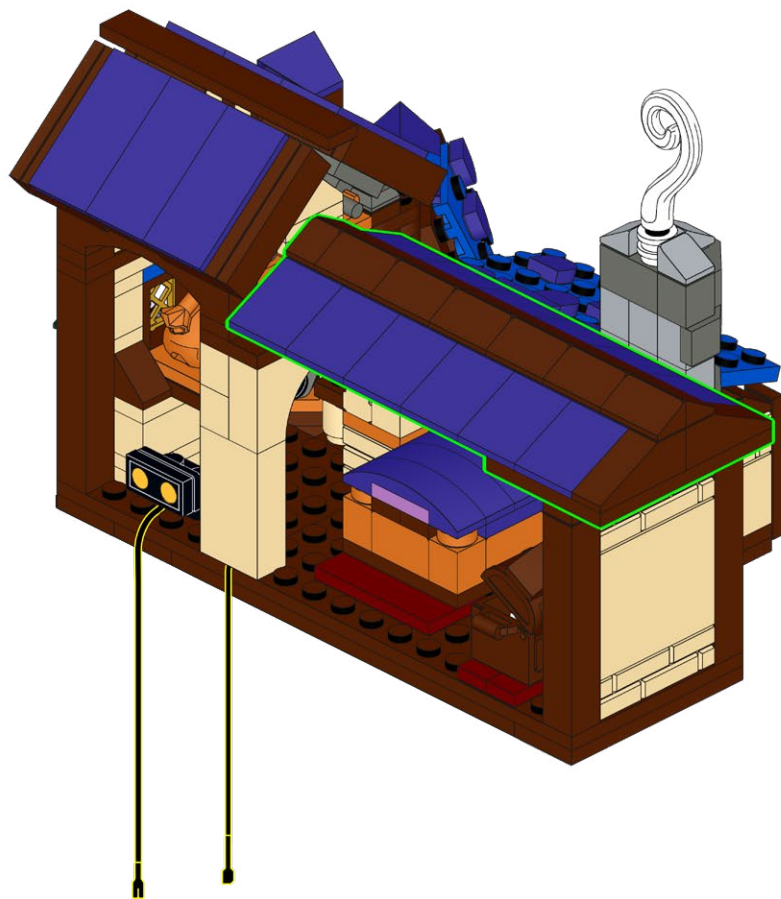

28

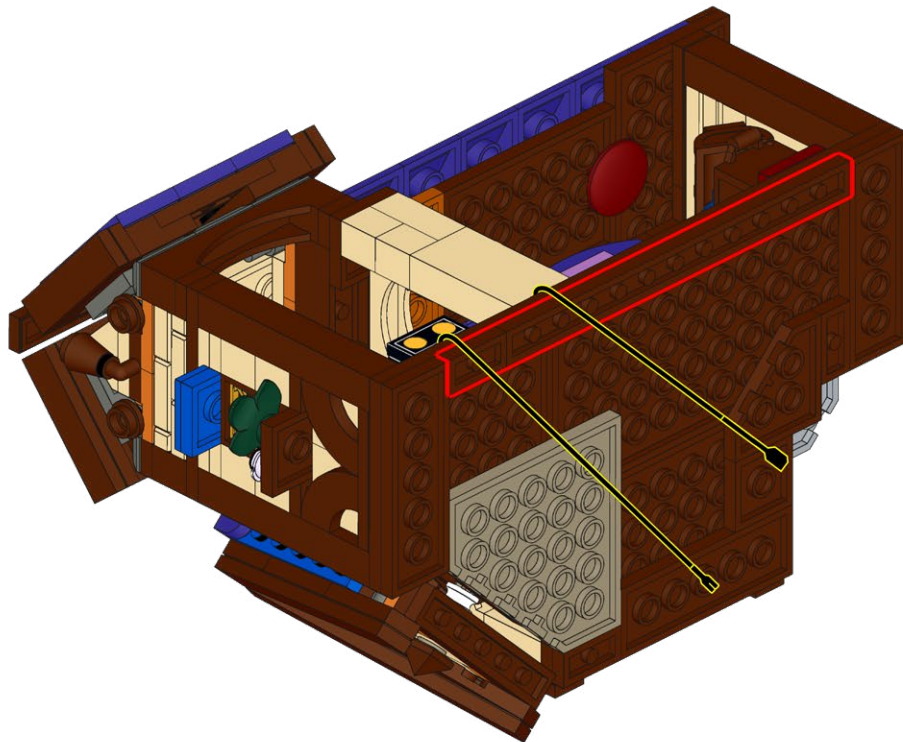

29

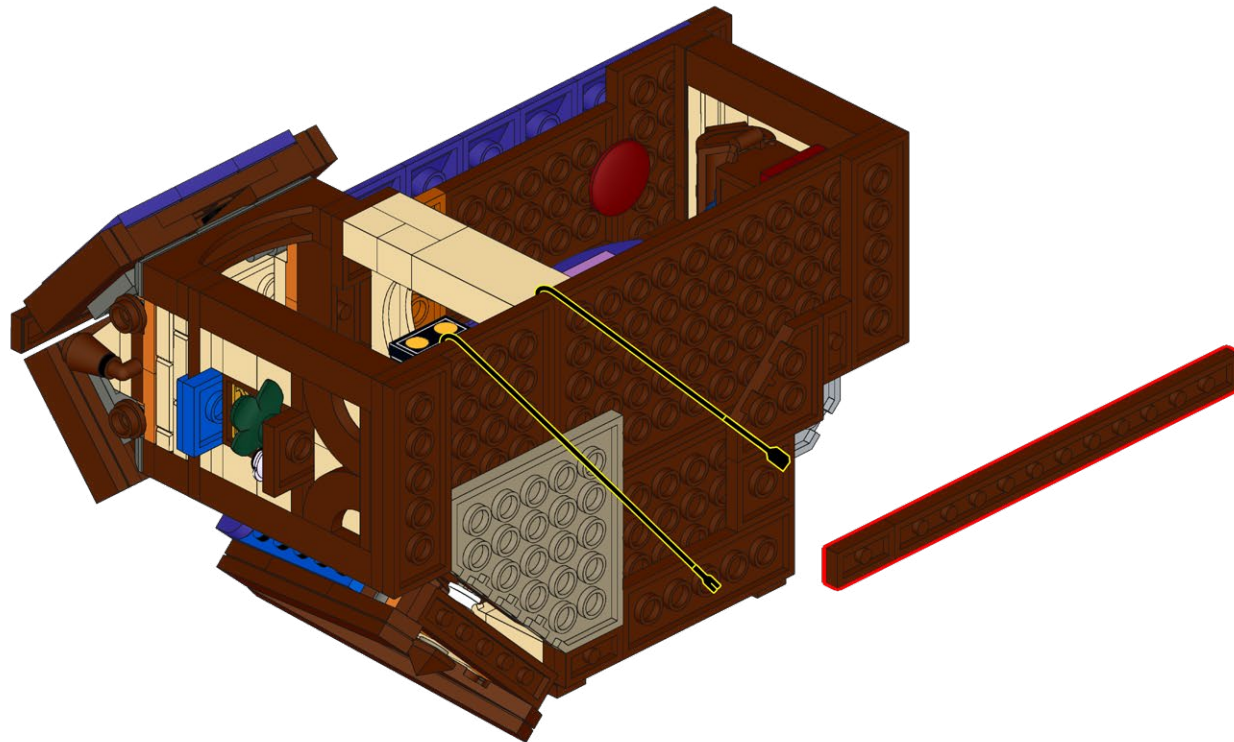

30

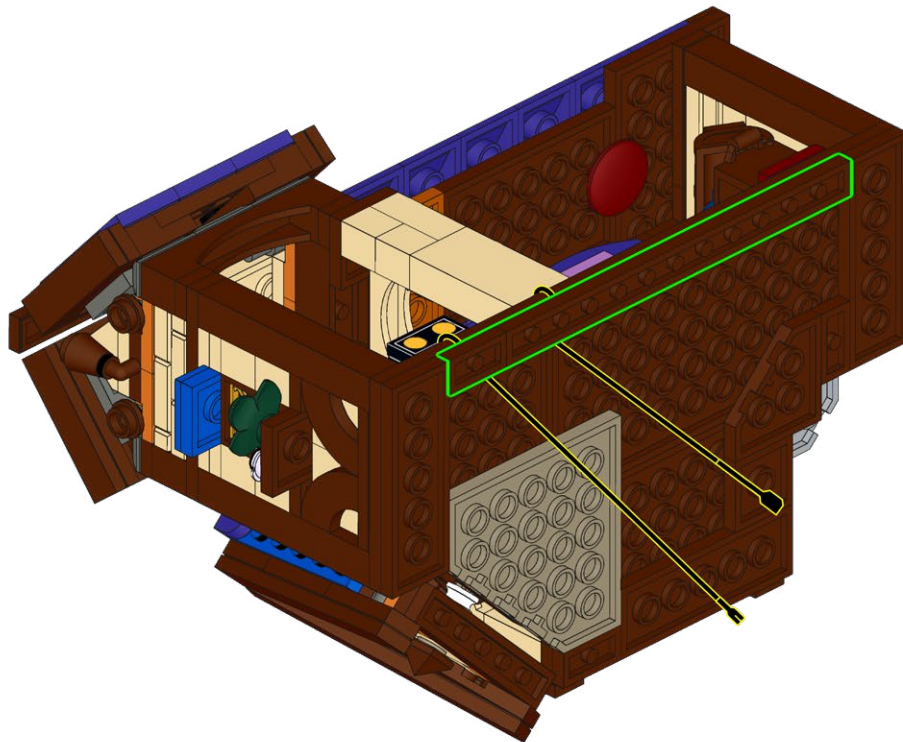

31

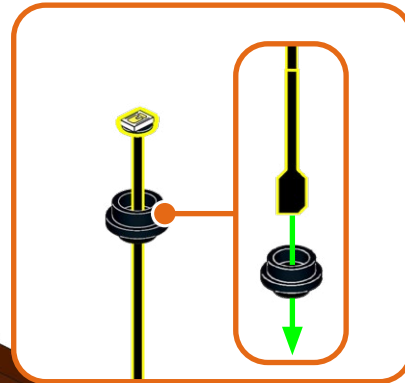
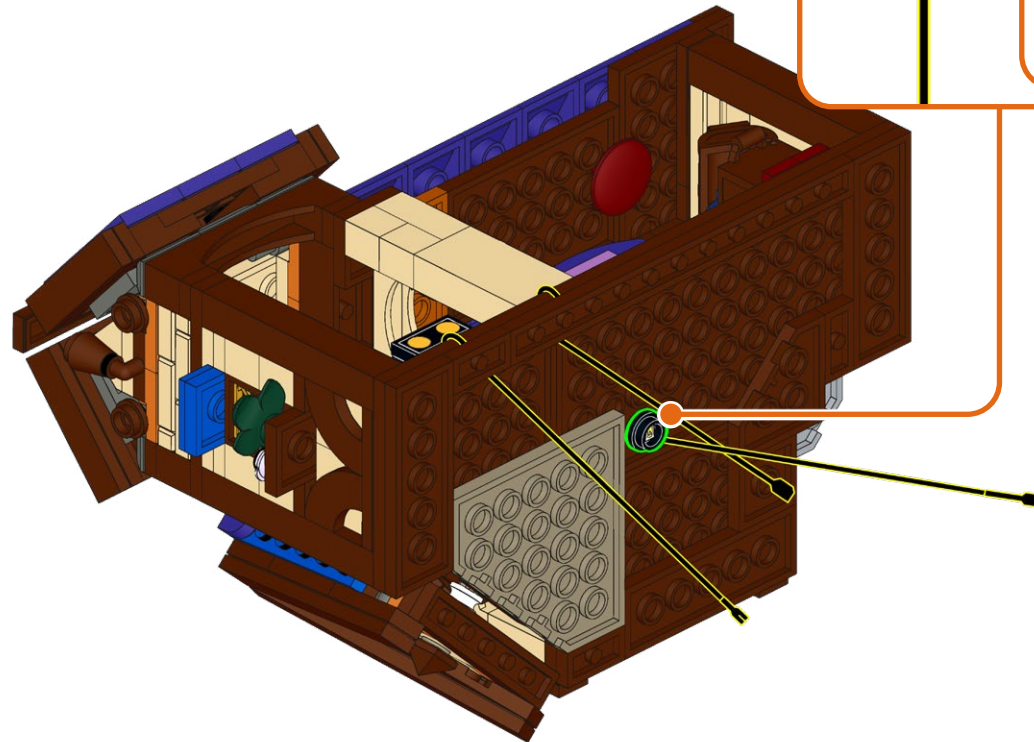
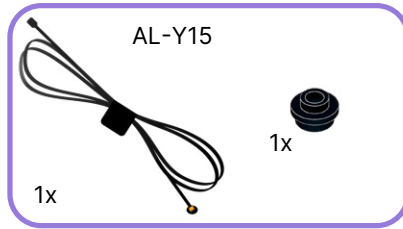



32

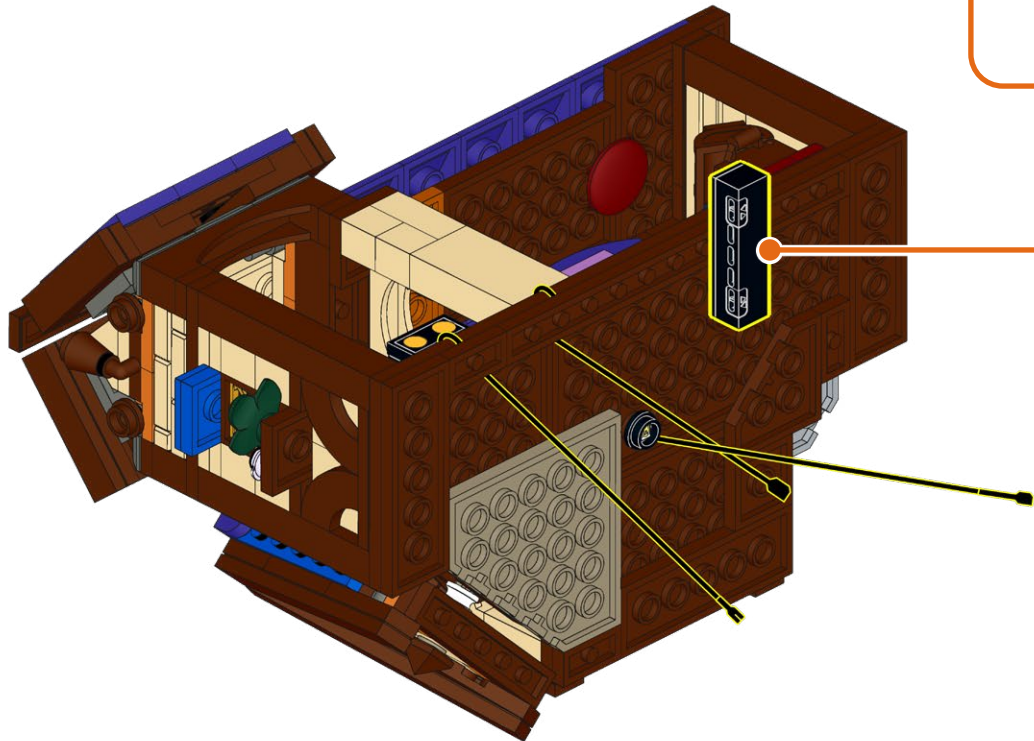
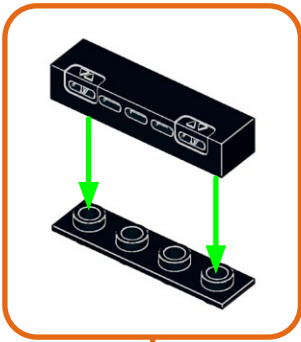
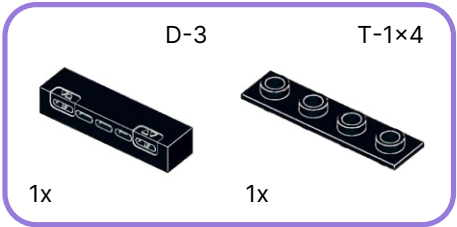

33

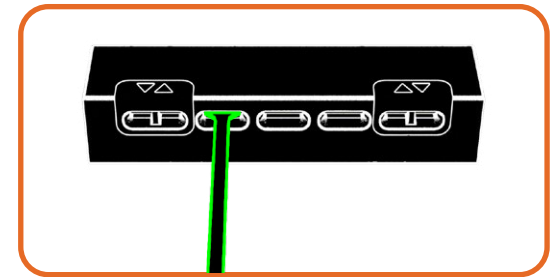
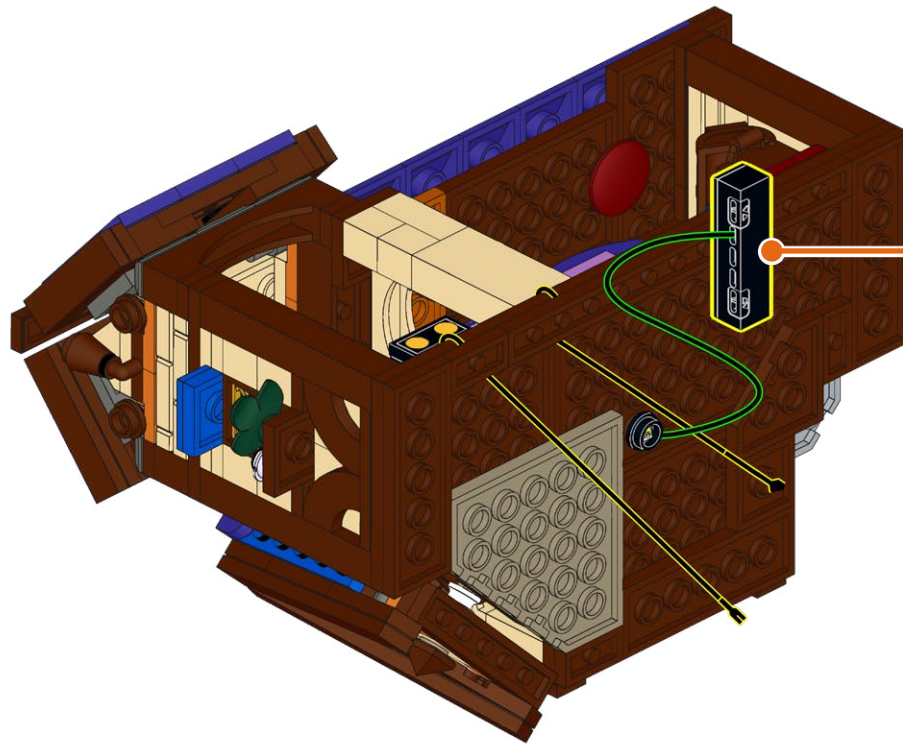

34

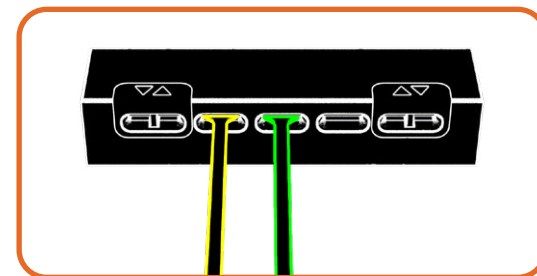
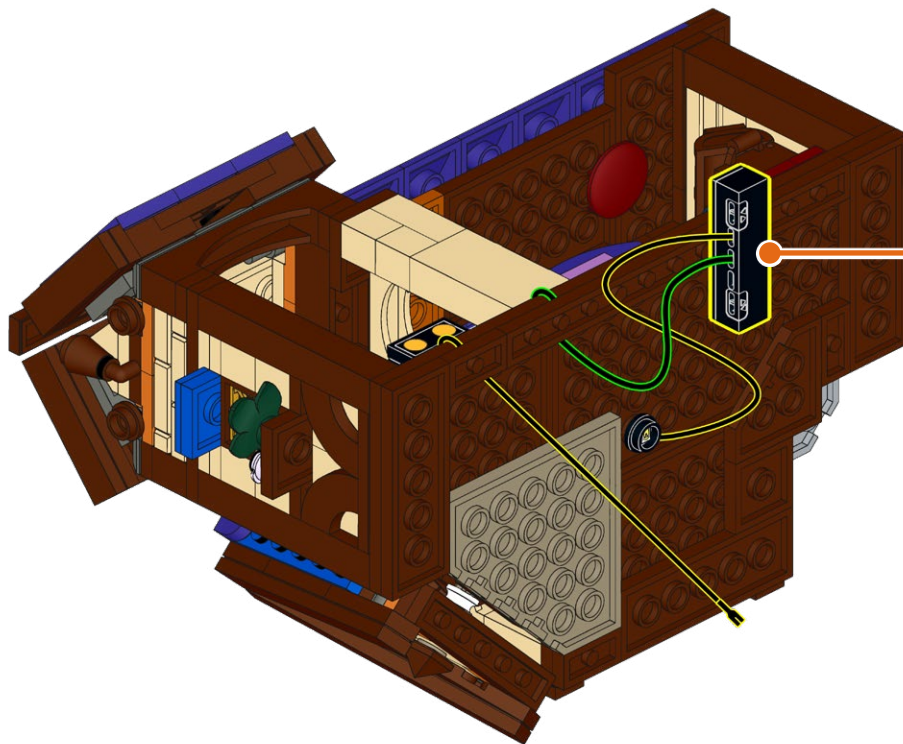

35

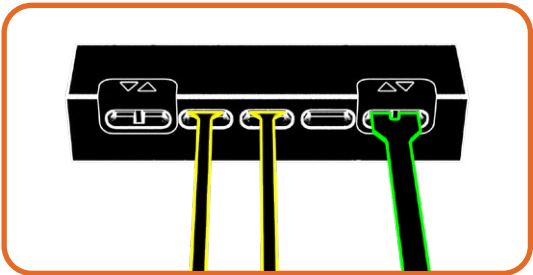
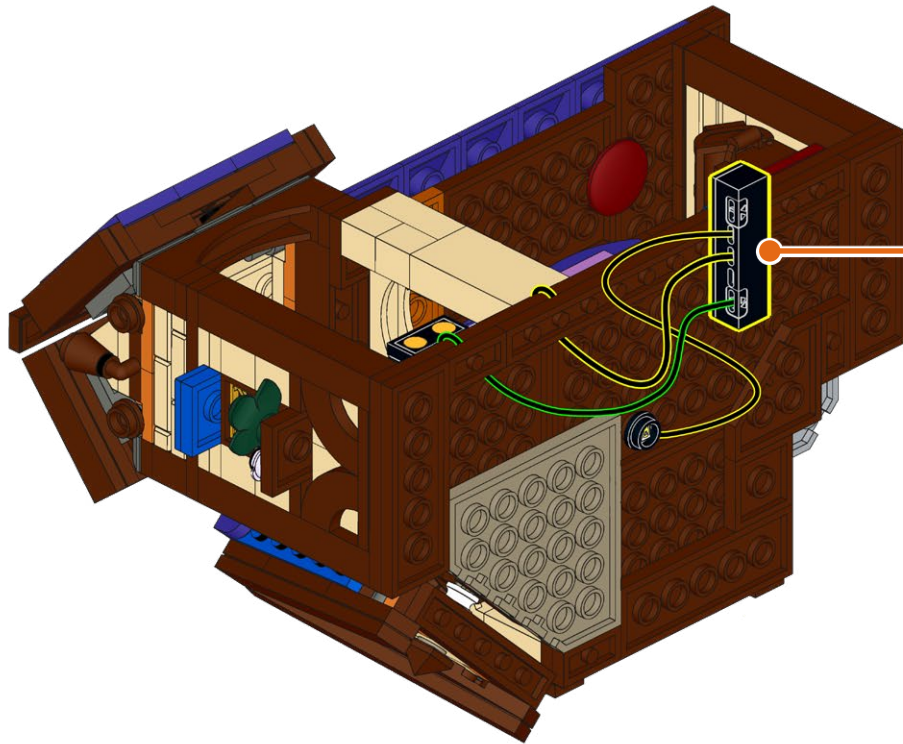

36

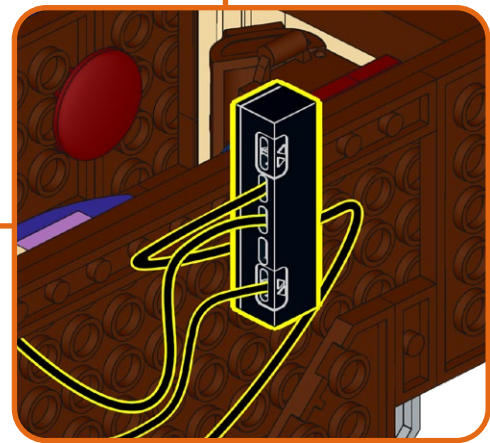
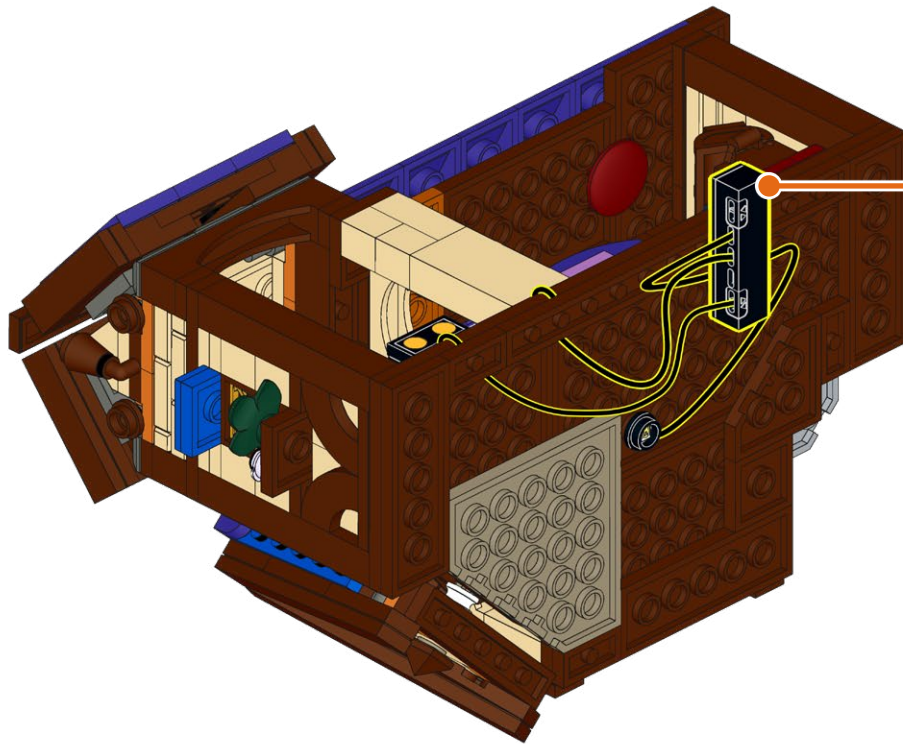



37

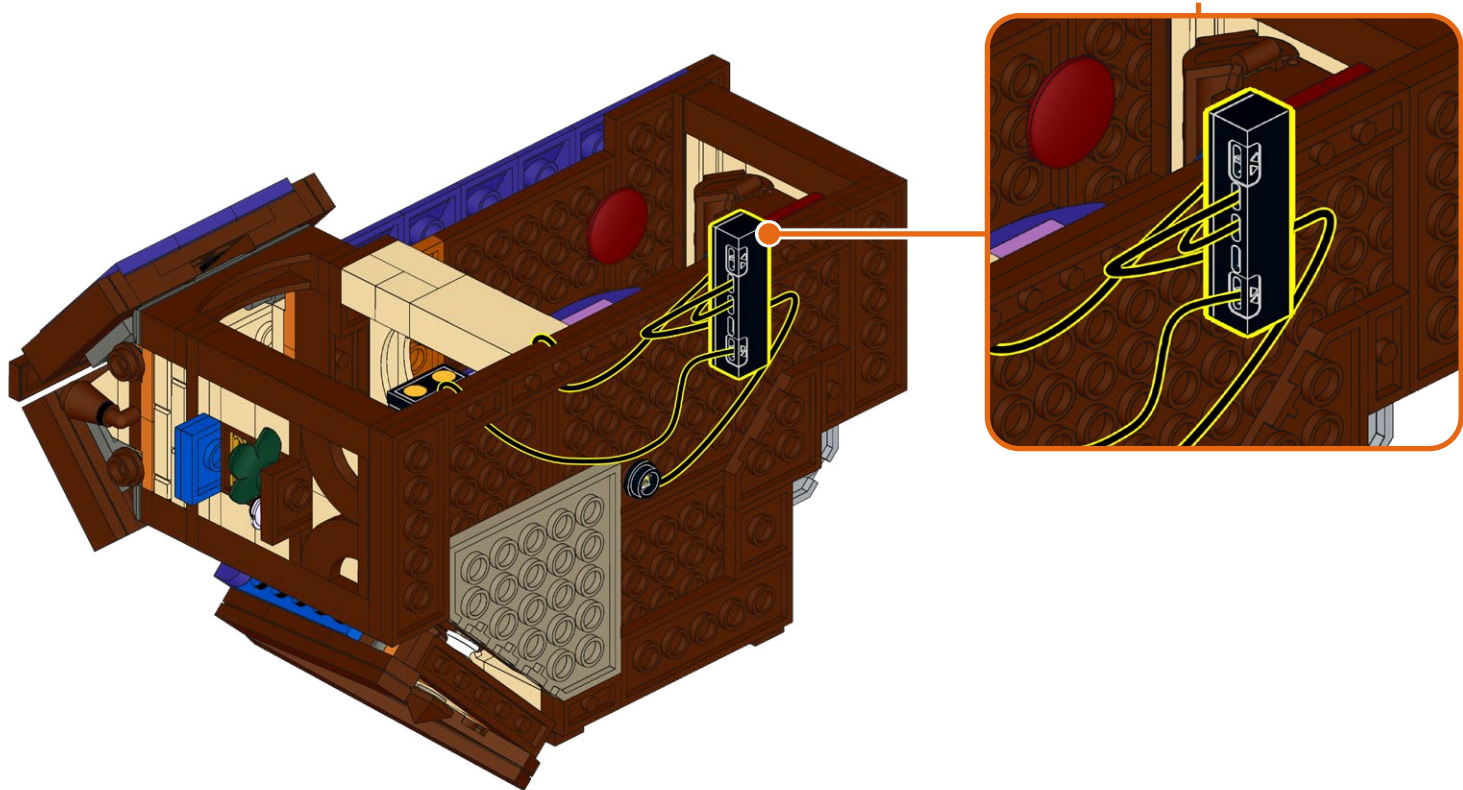



38

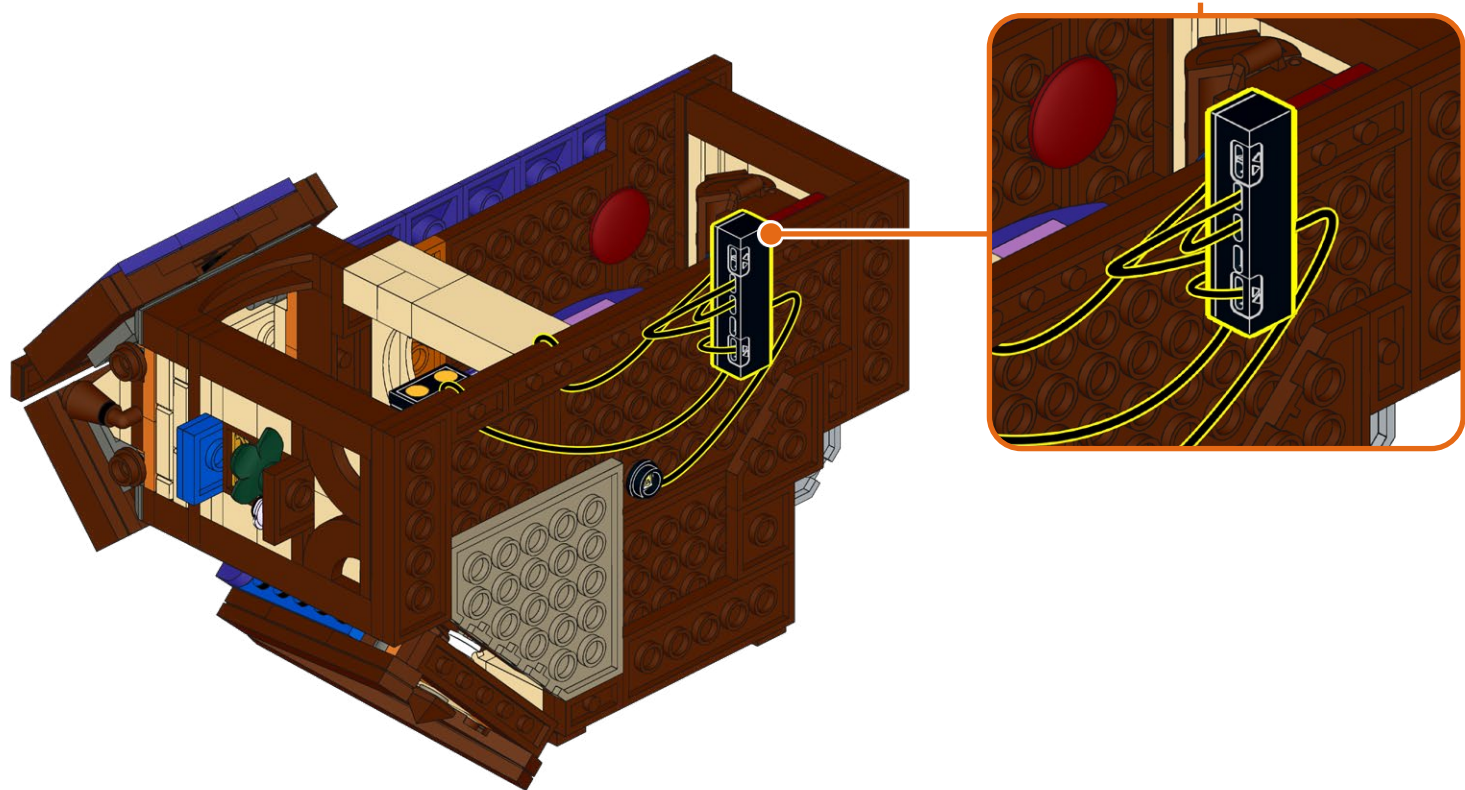

39

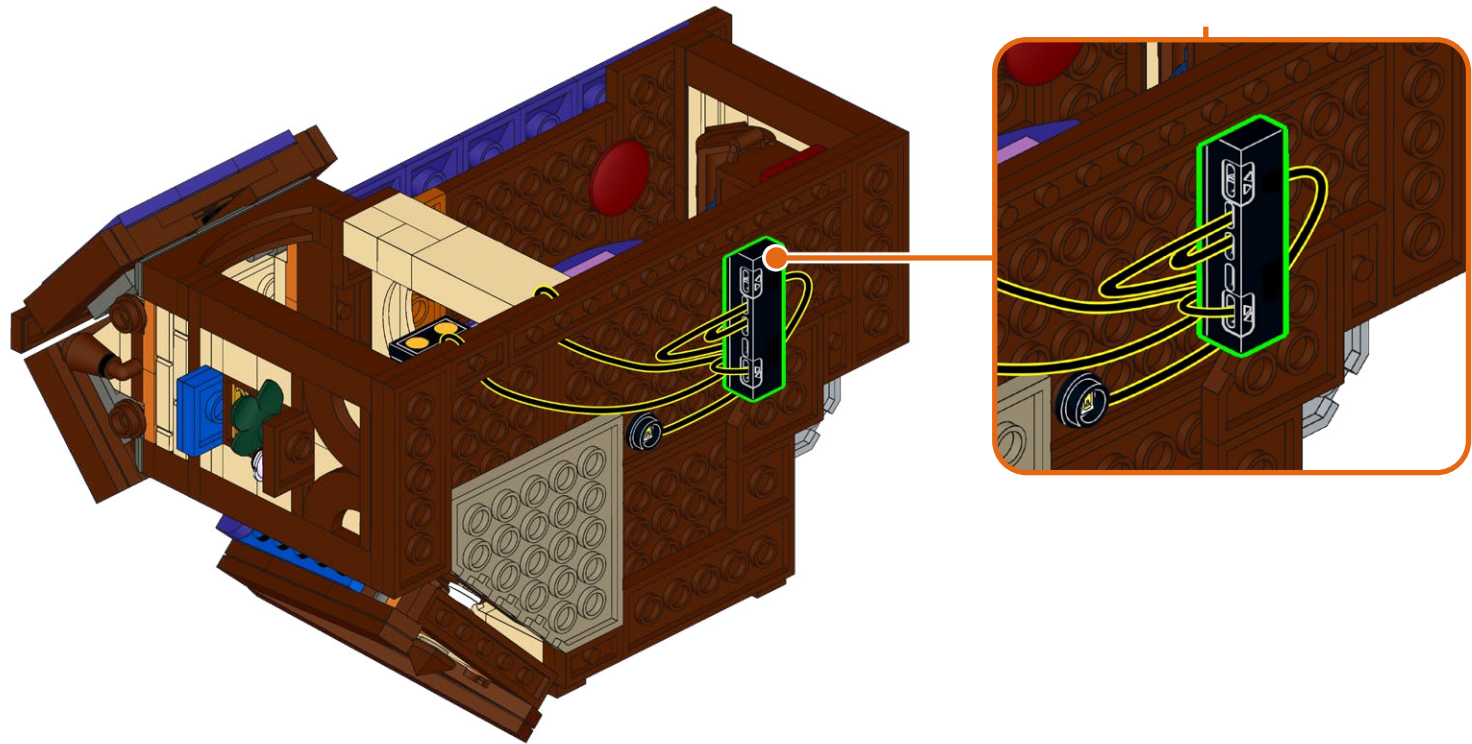

40

B-50  
1x

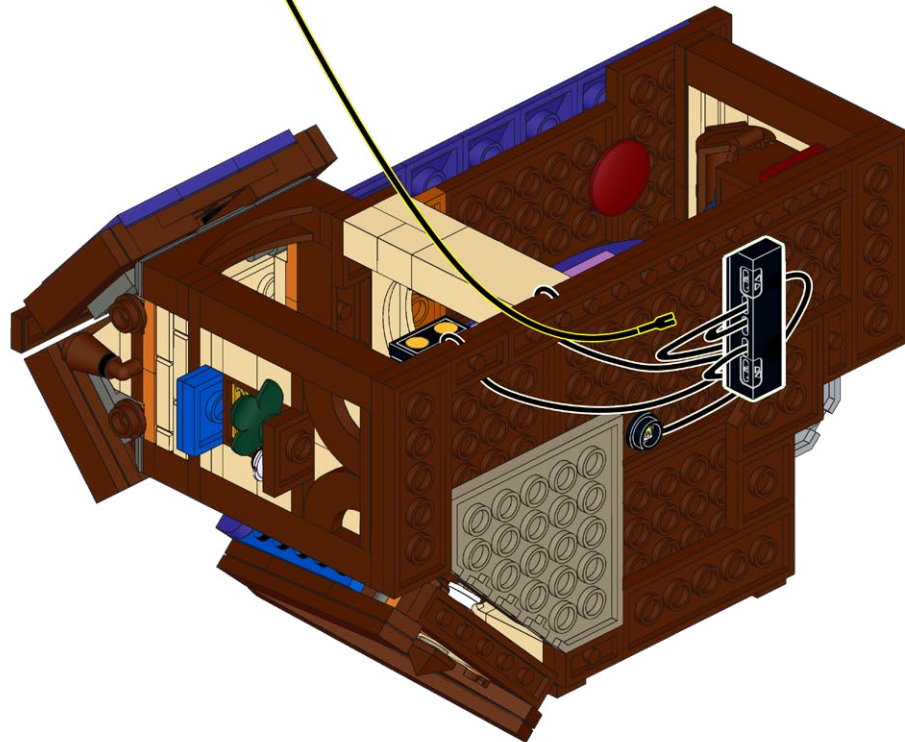

41

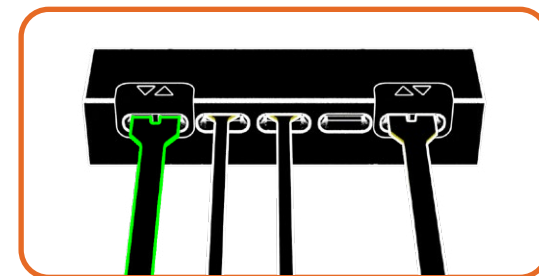
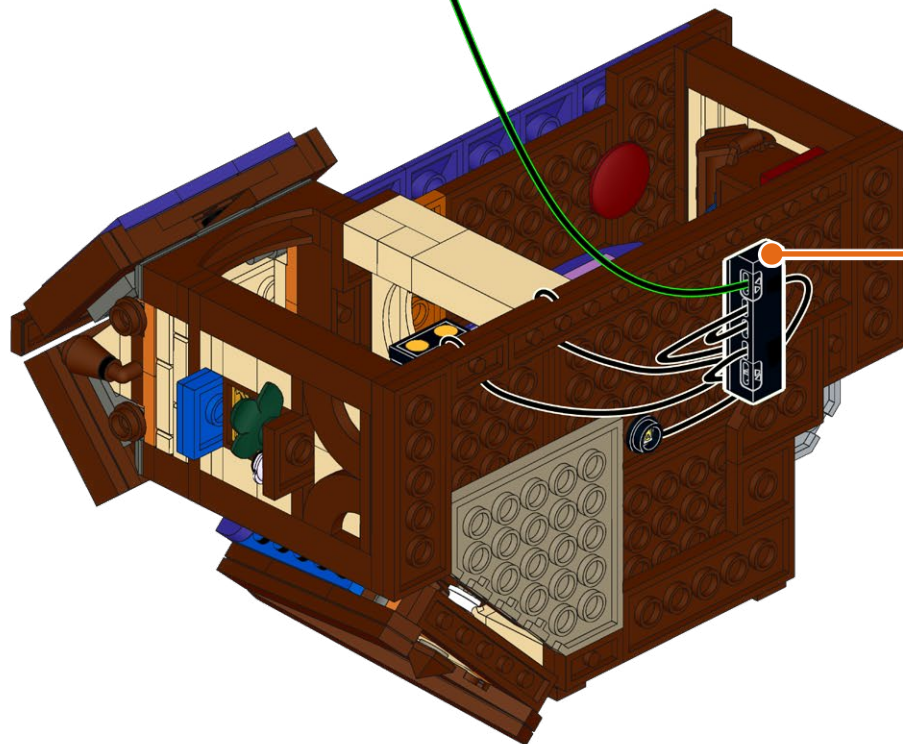

42

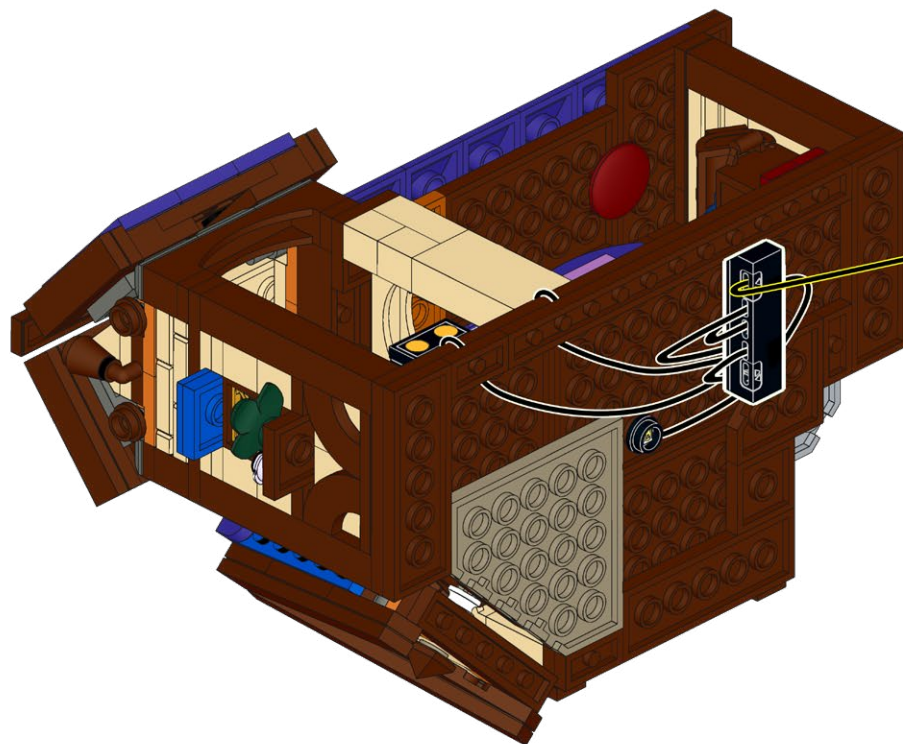



43





44



45

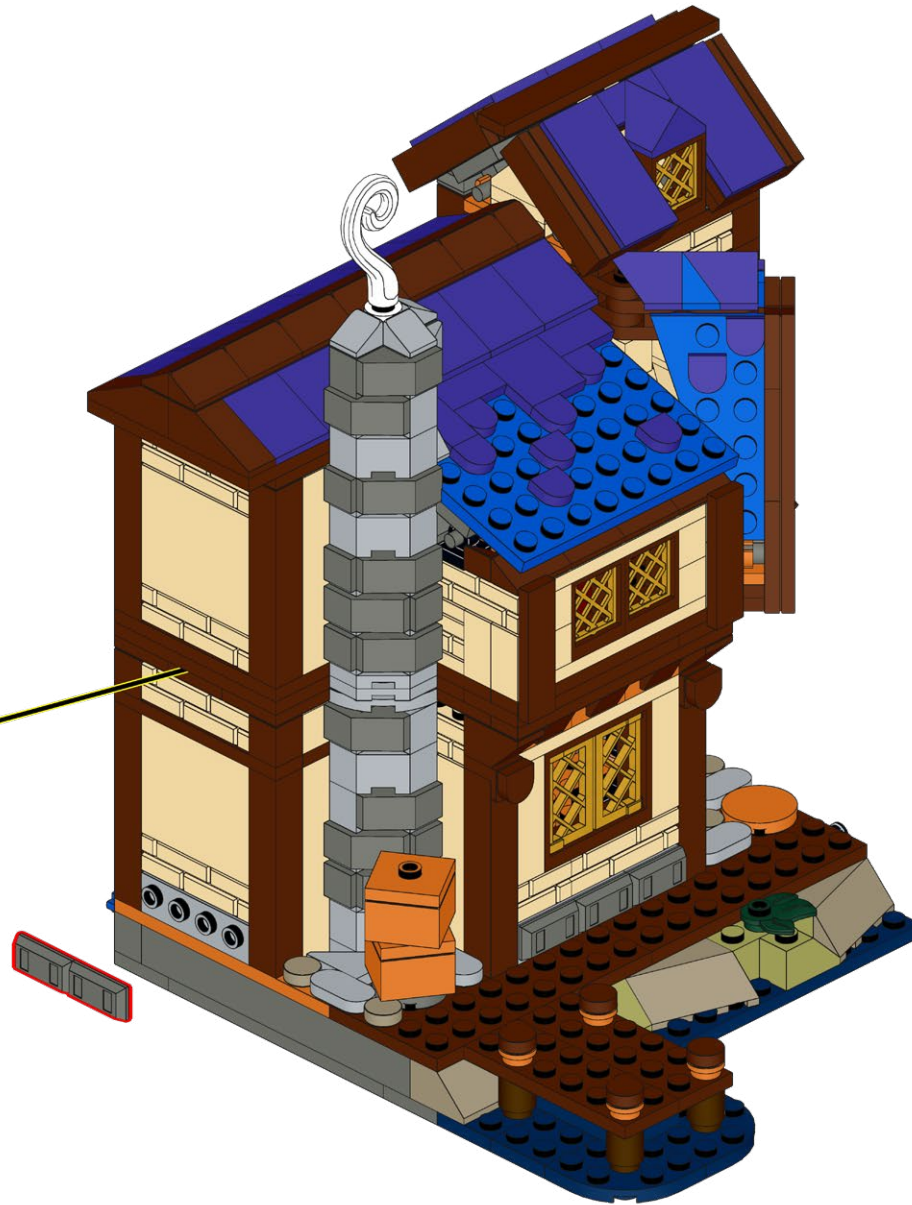

46

FLX-C

1x



47

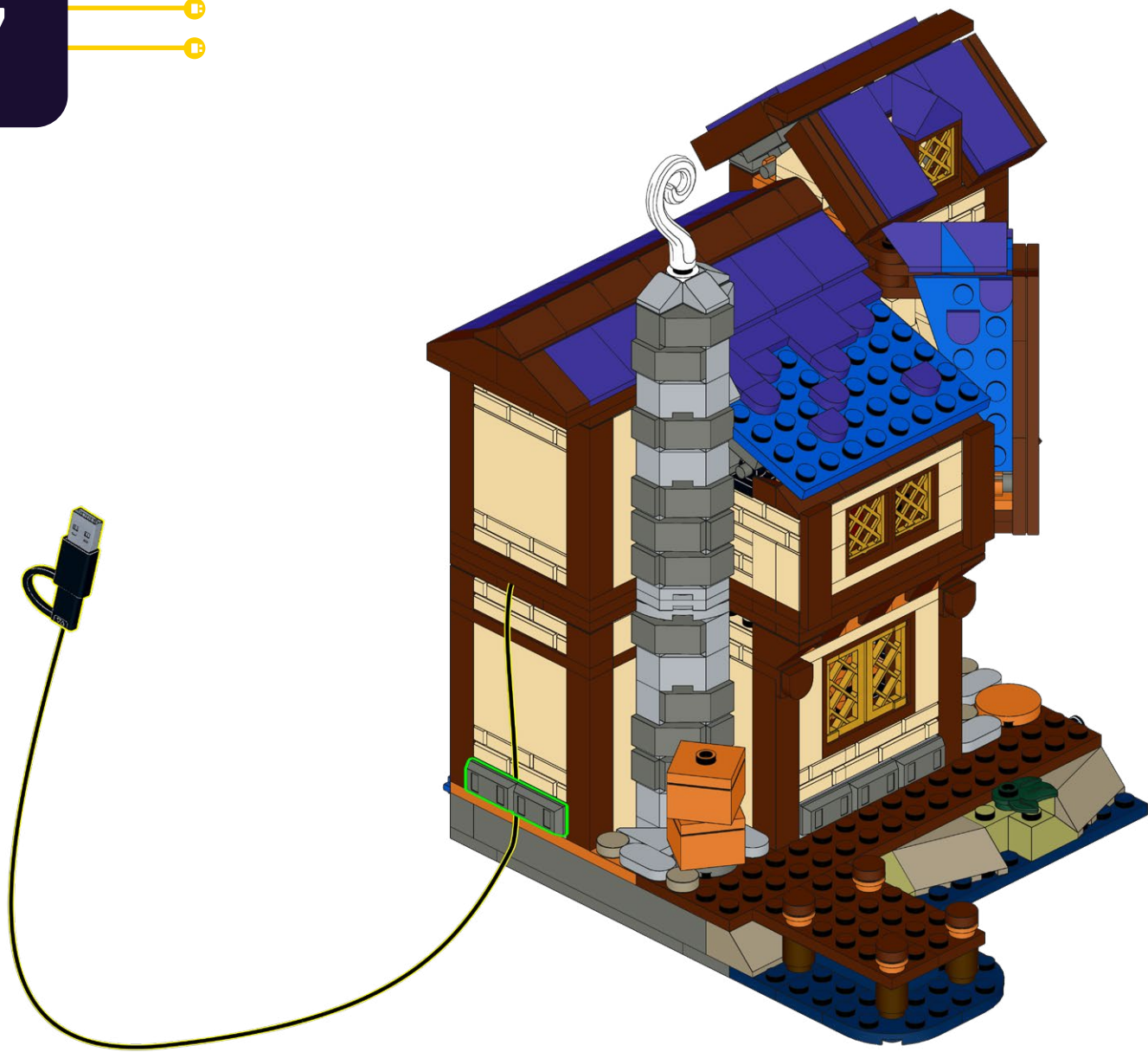



48 <sup>2x</sup>



Power on Test  
Test de mise sous tension  
Test di Potenza  
Stromtest  
Prueba de Energía  
电源测试



49

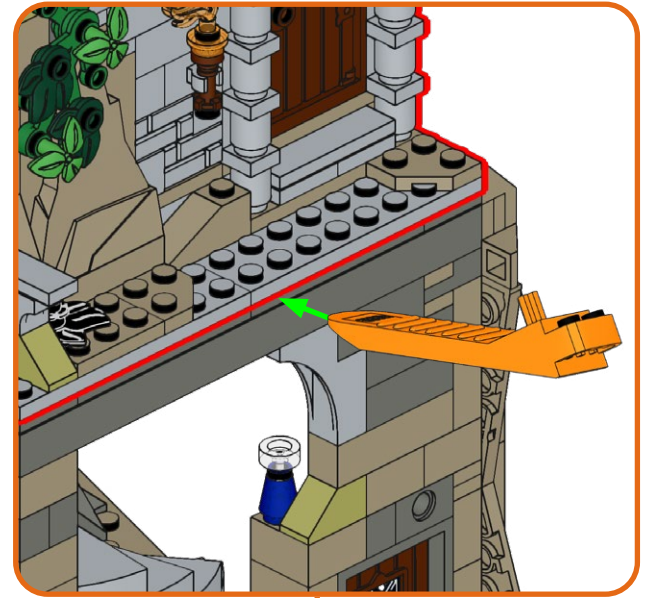



50

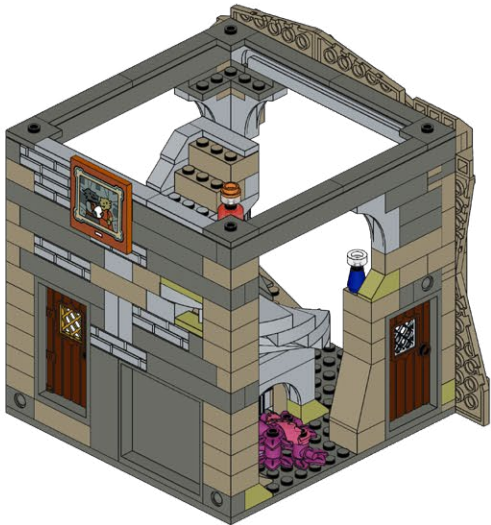

51

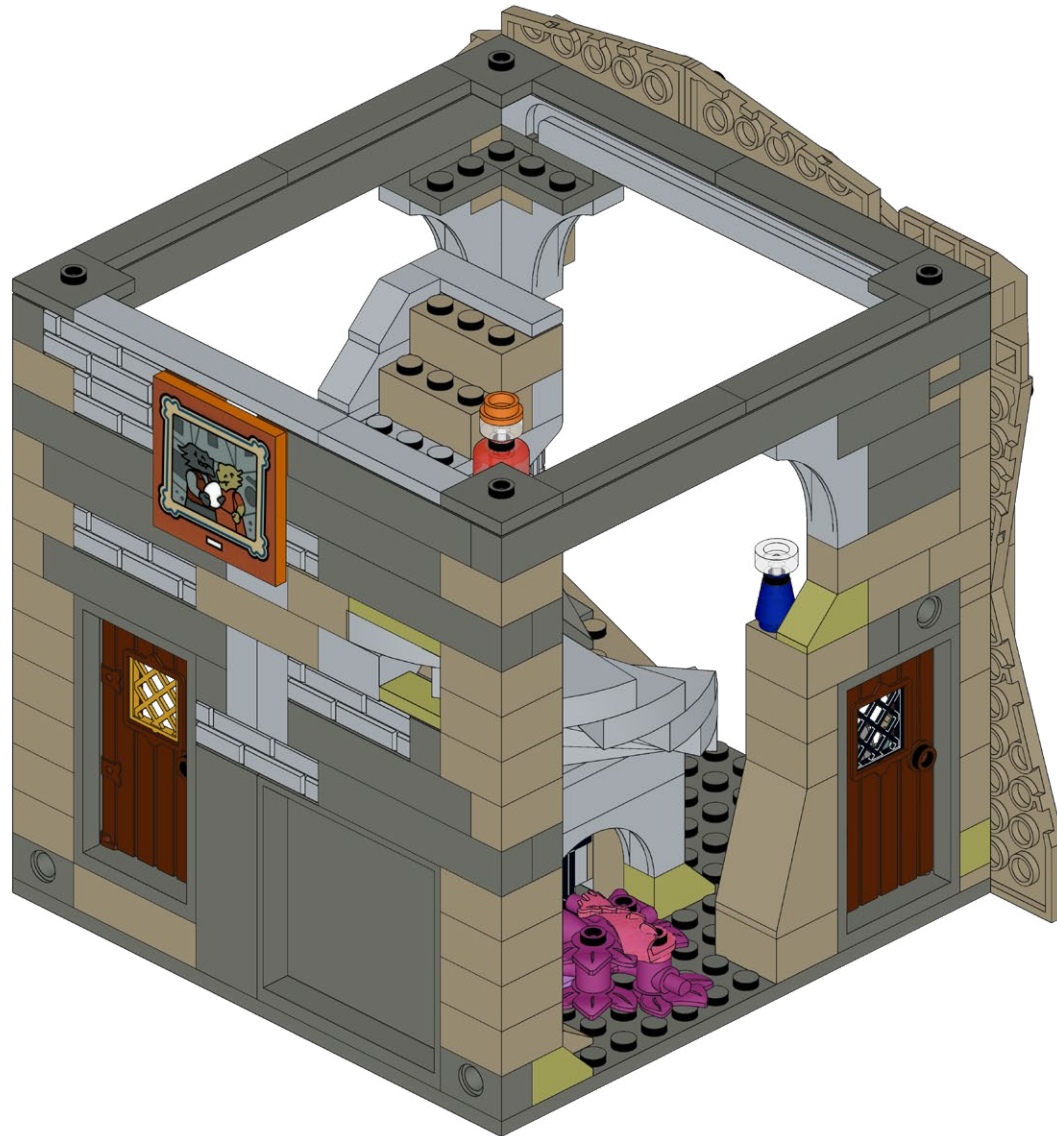

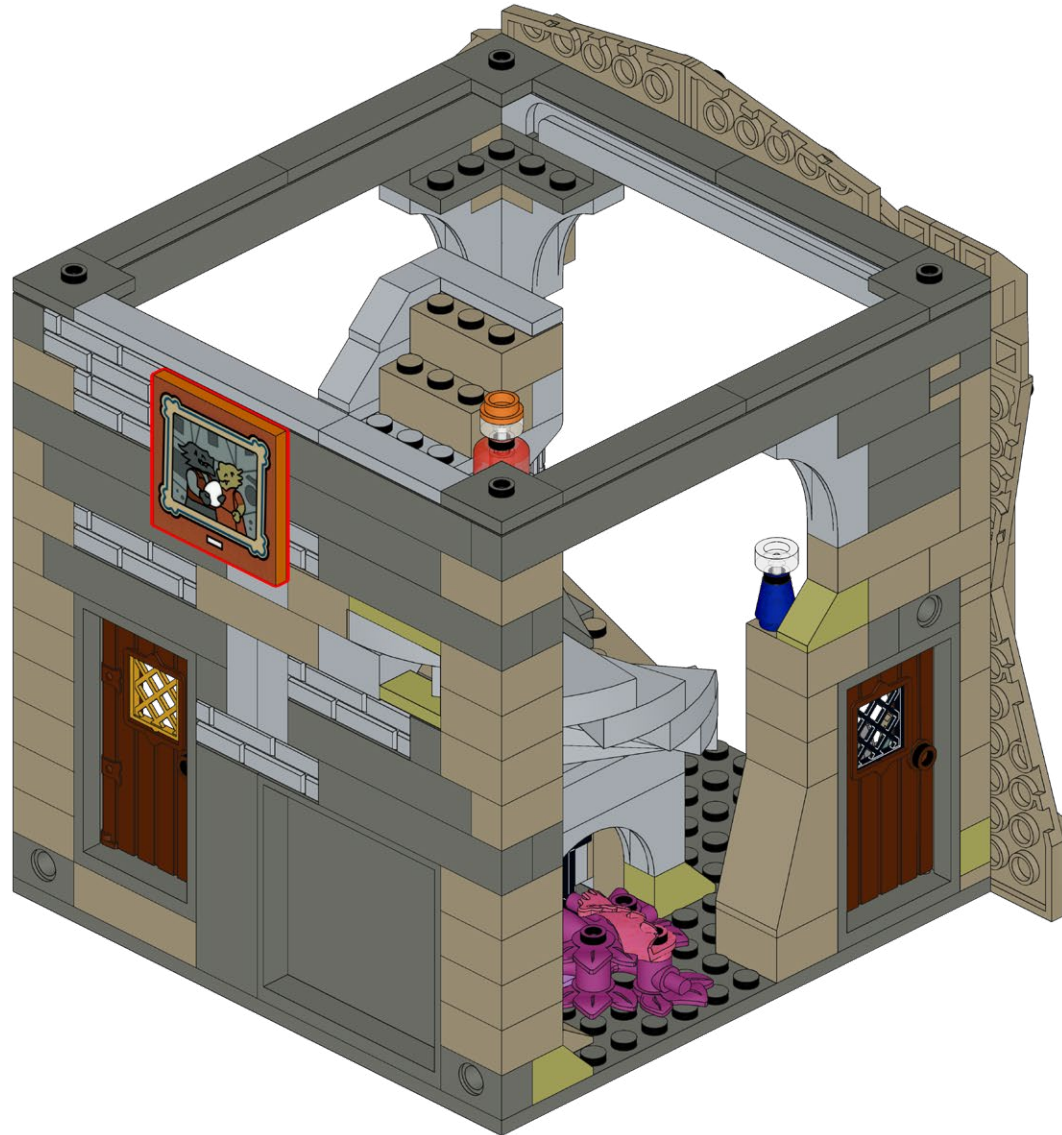

53

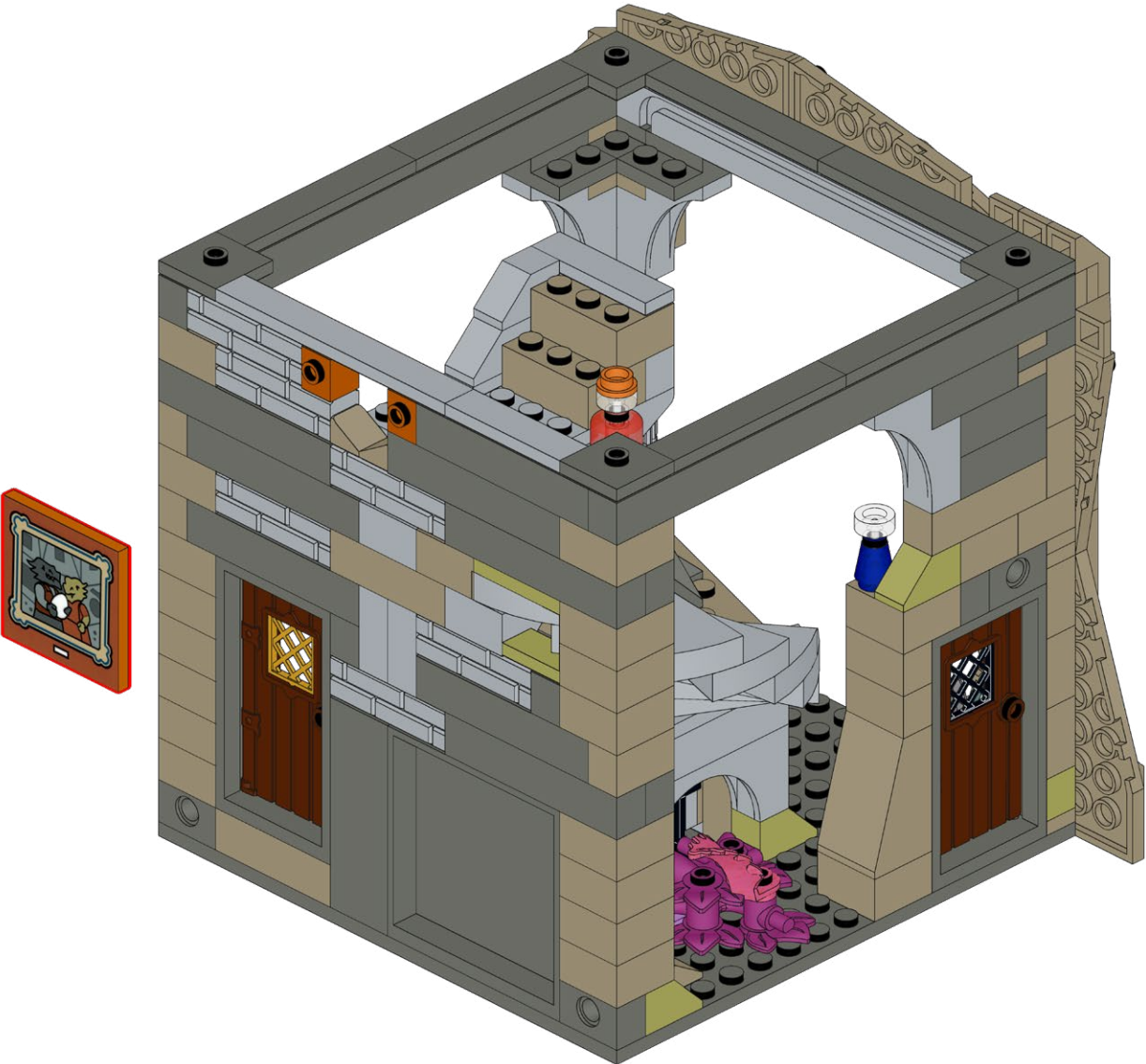



54

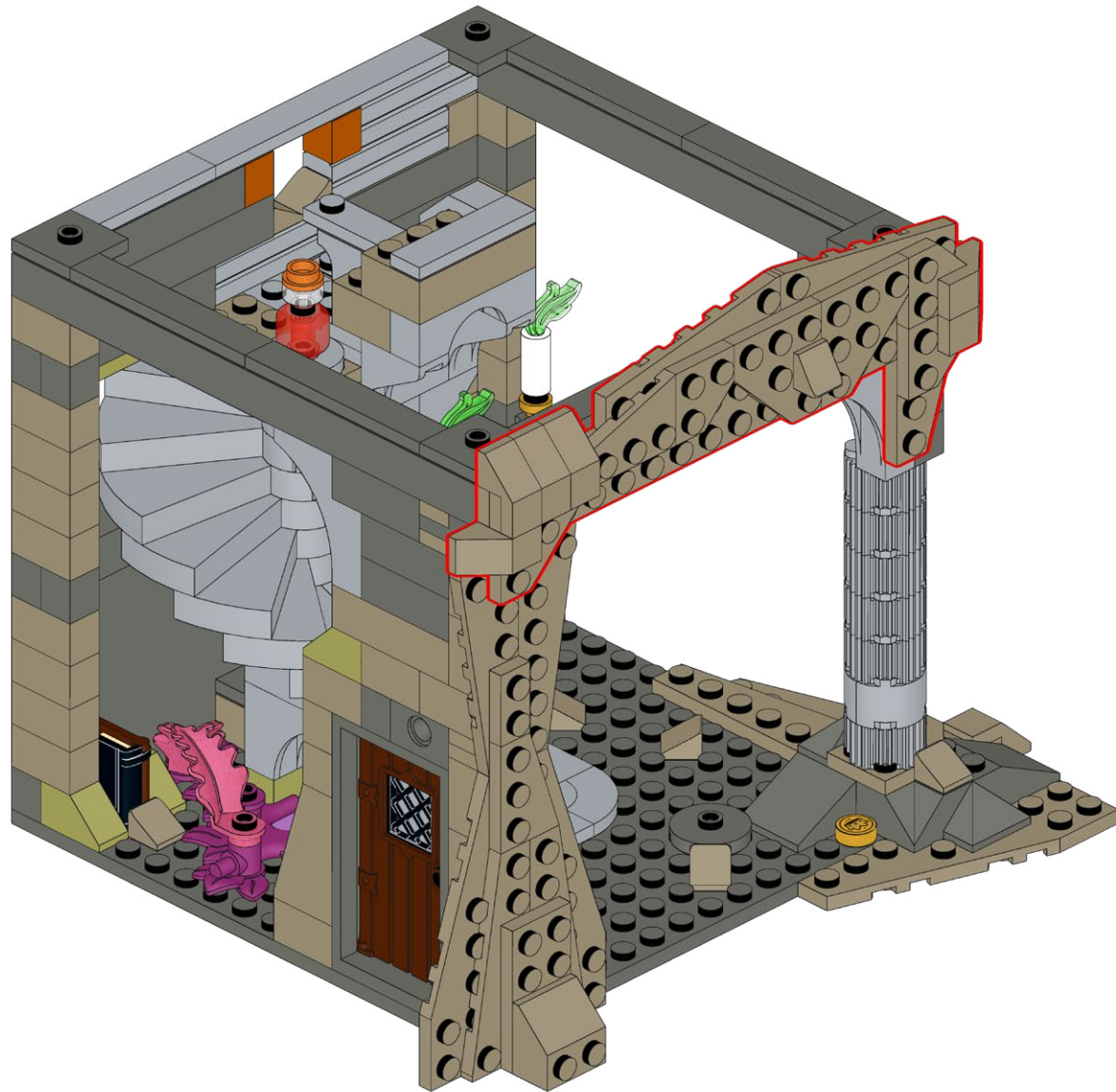

55

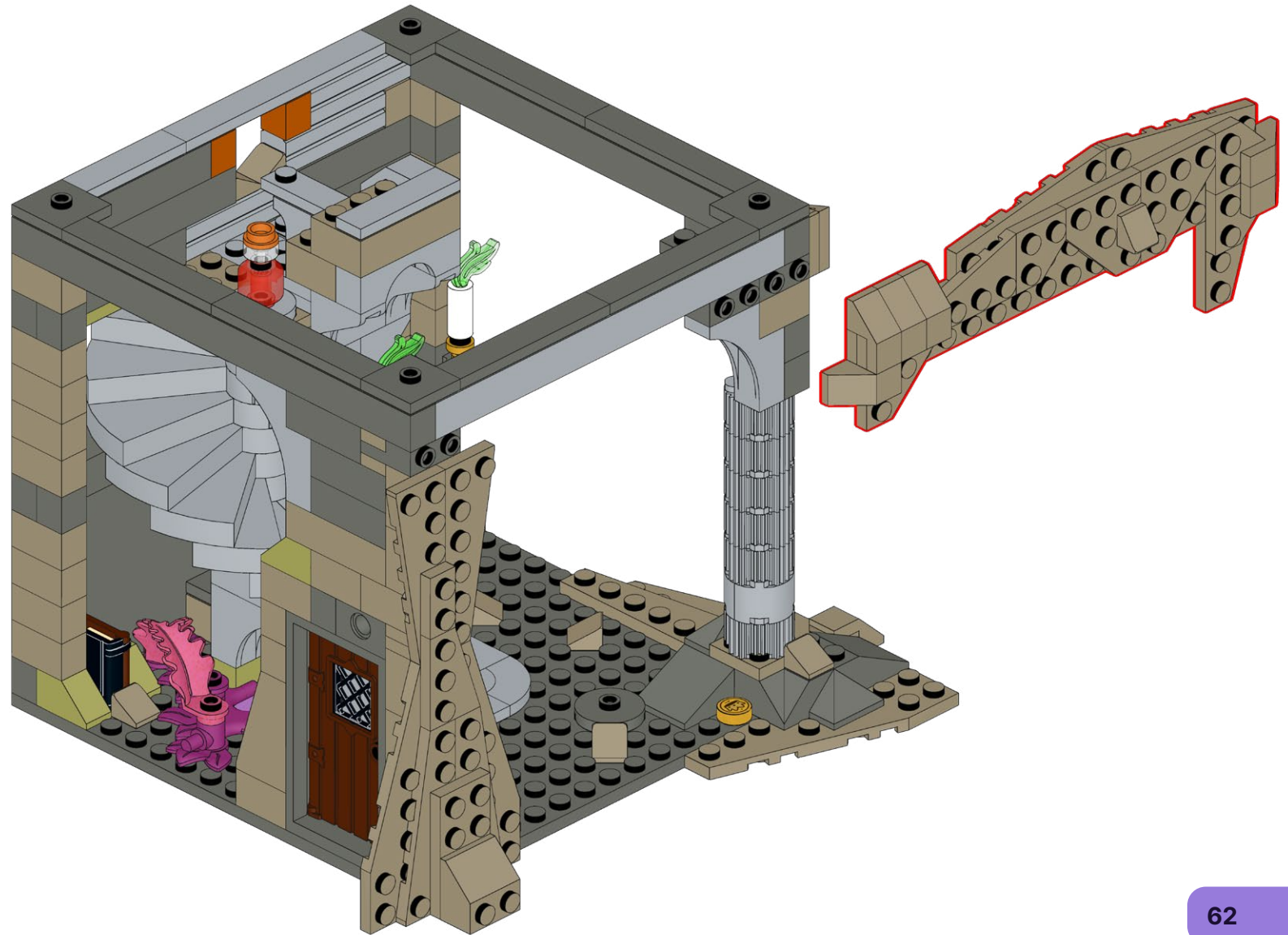



56

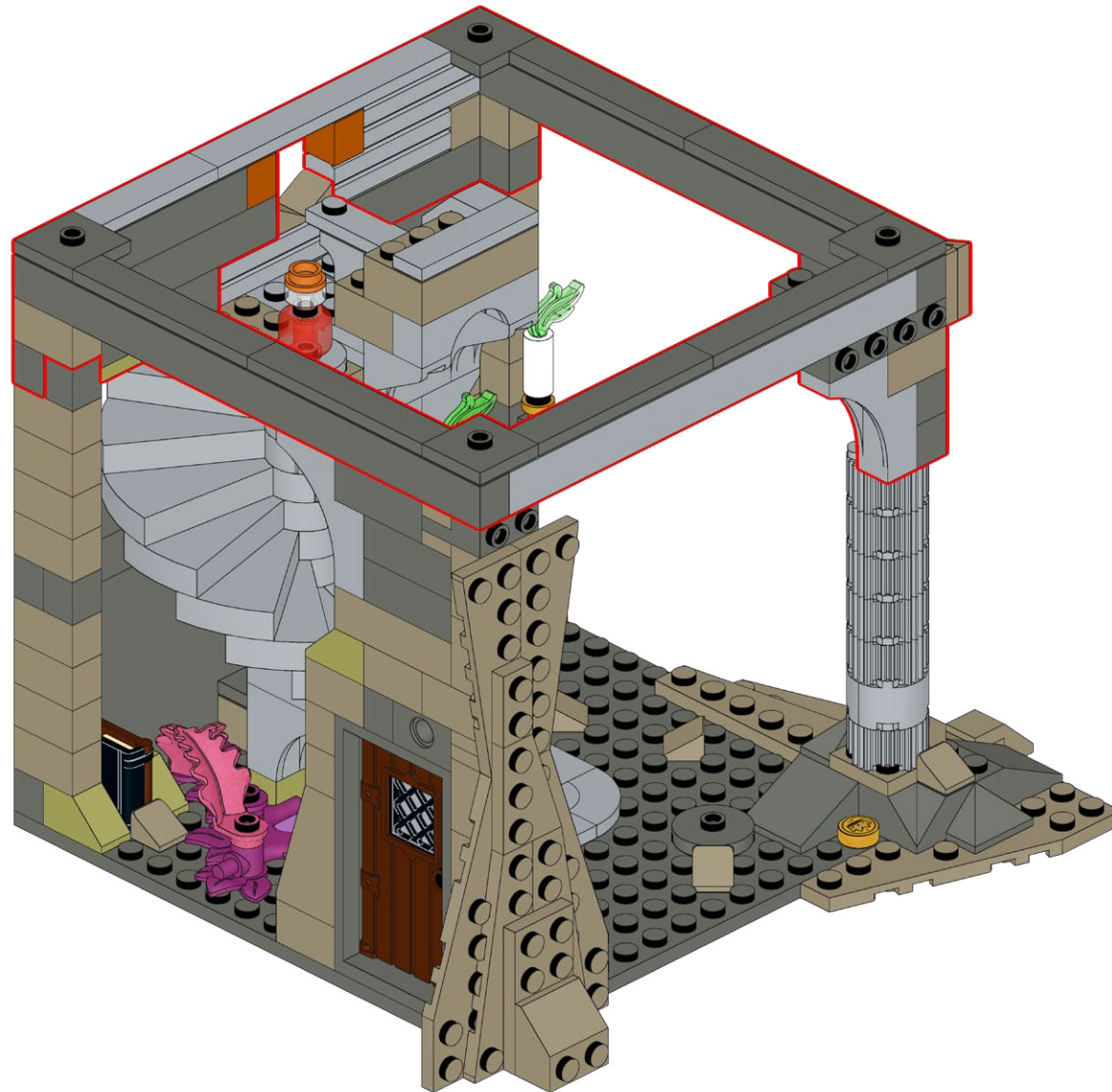

57

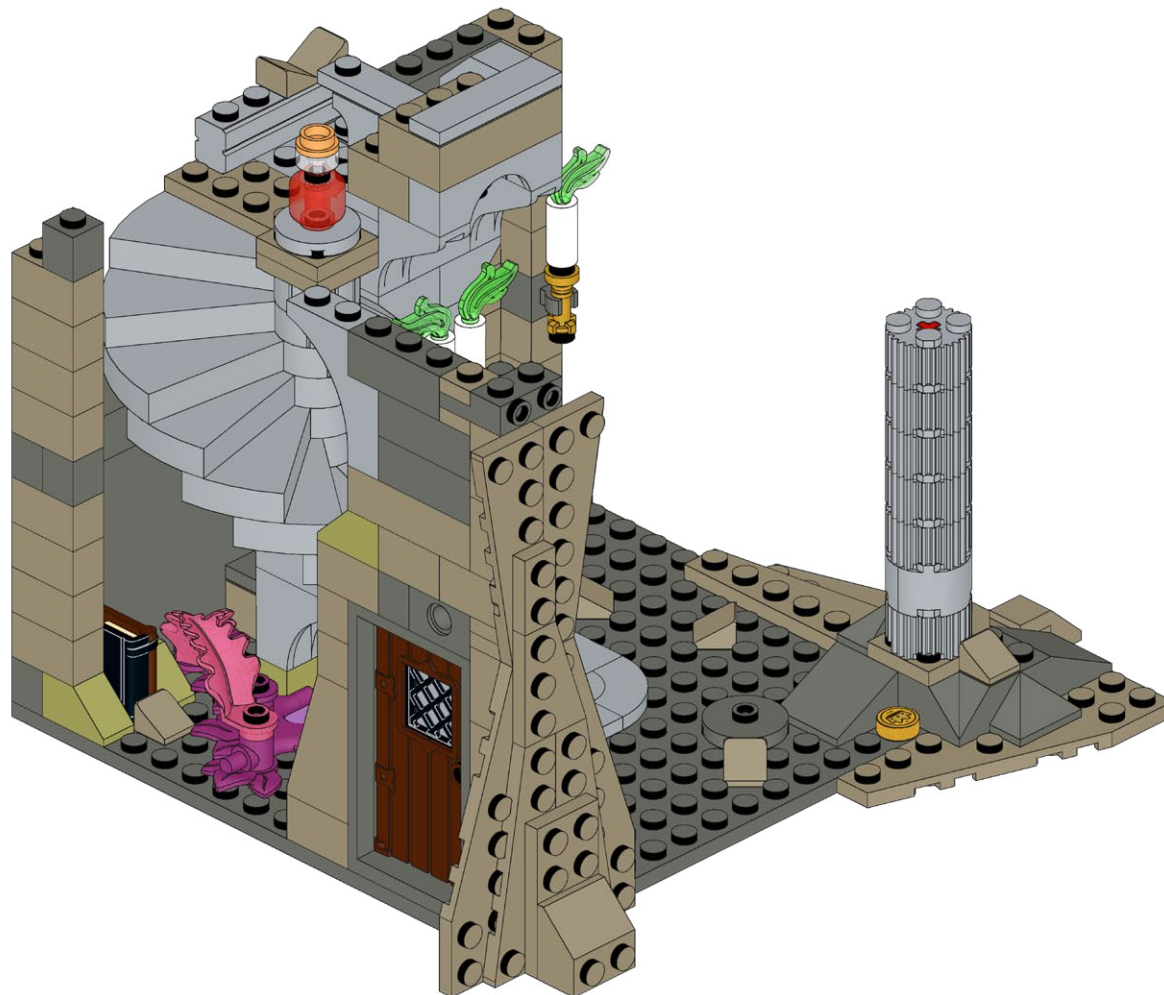
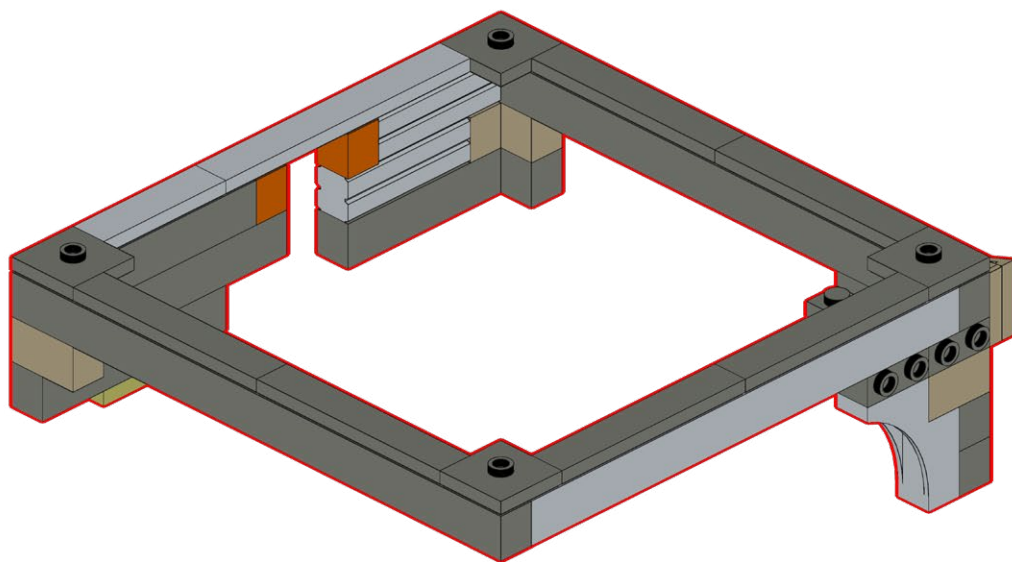

58

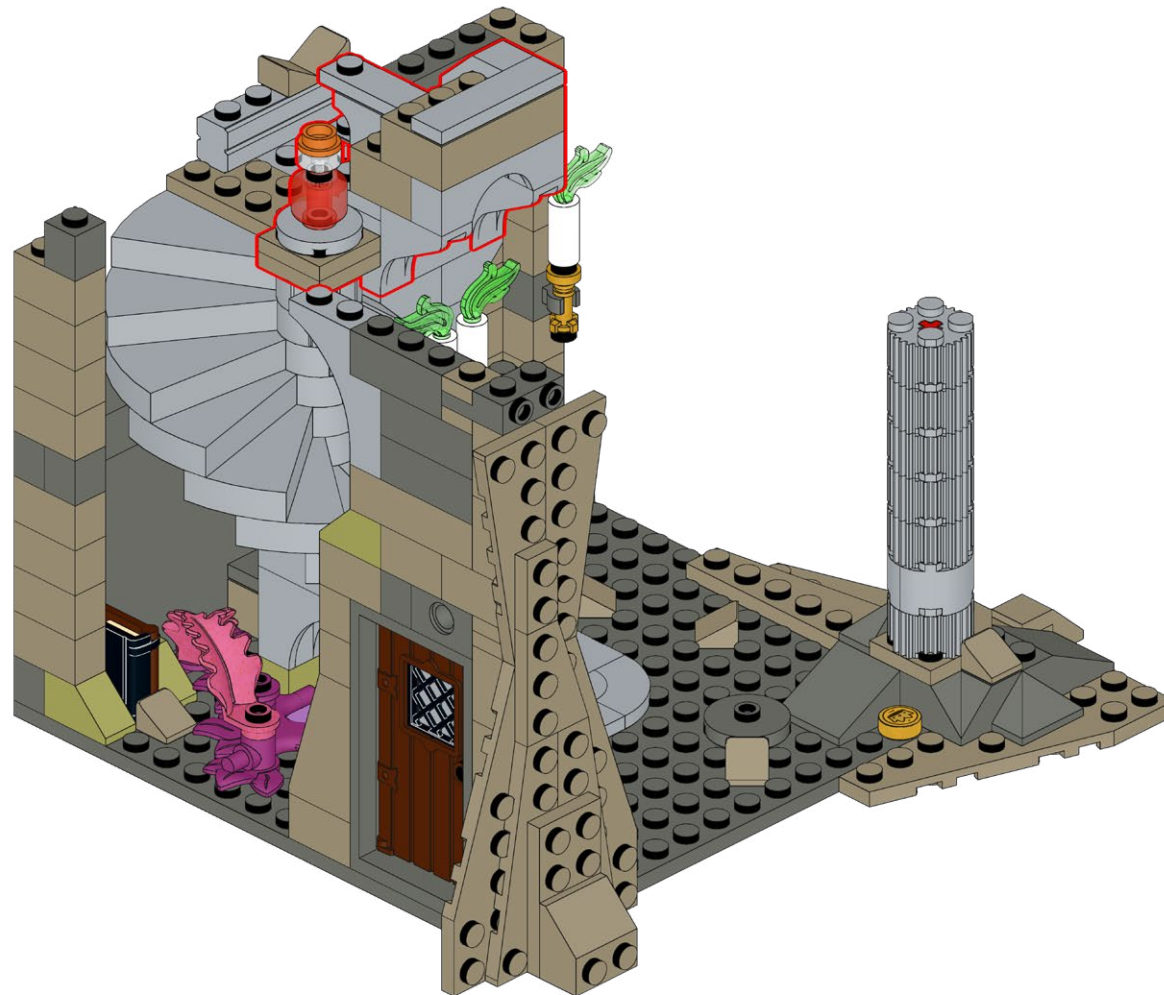

59





60

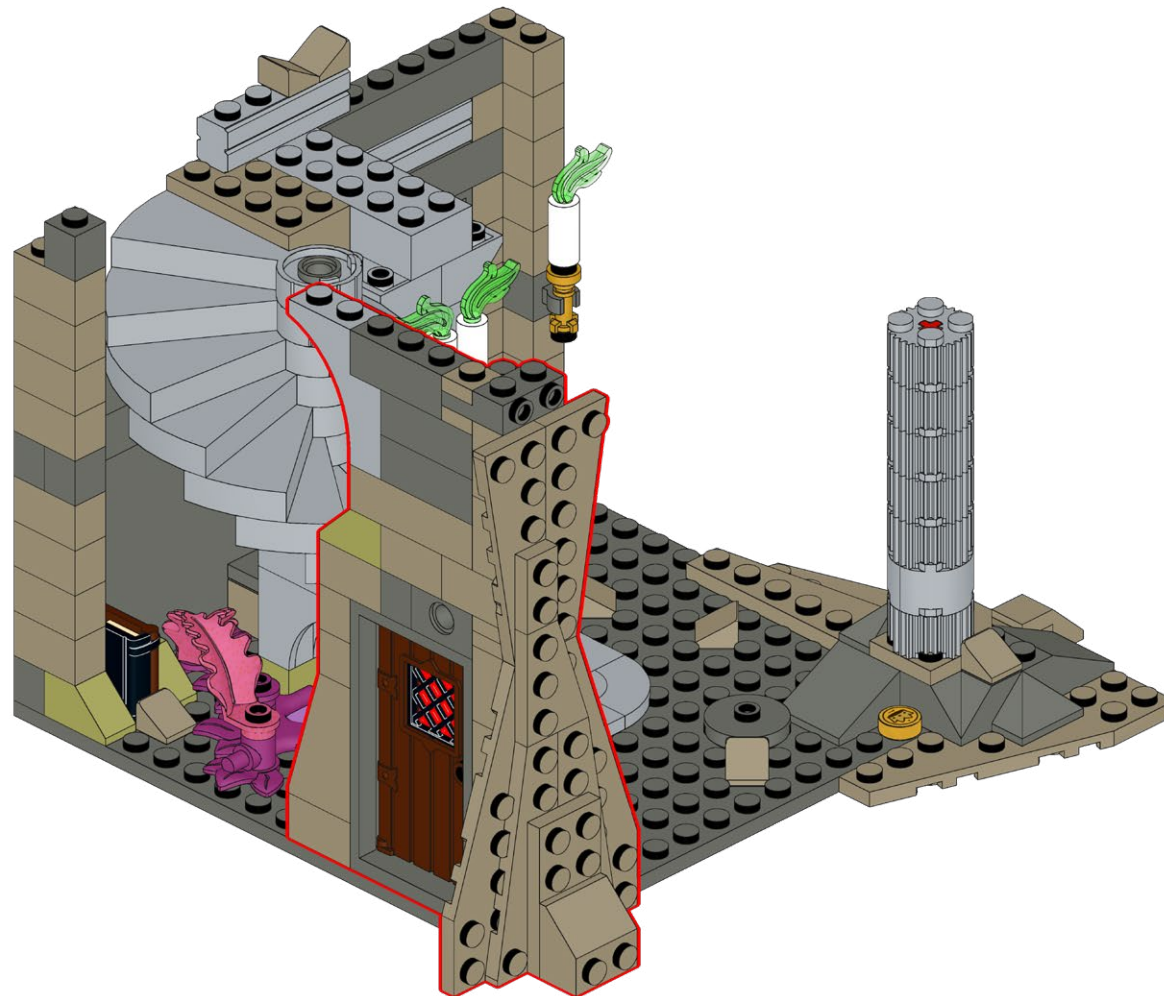



61



62



63



64

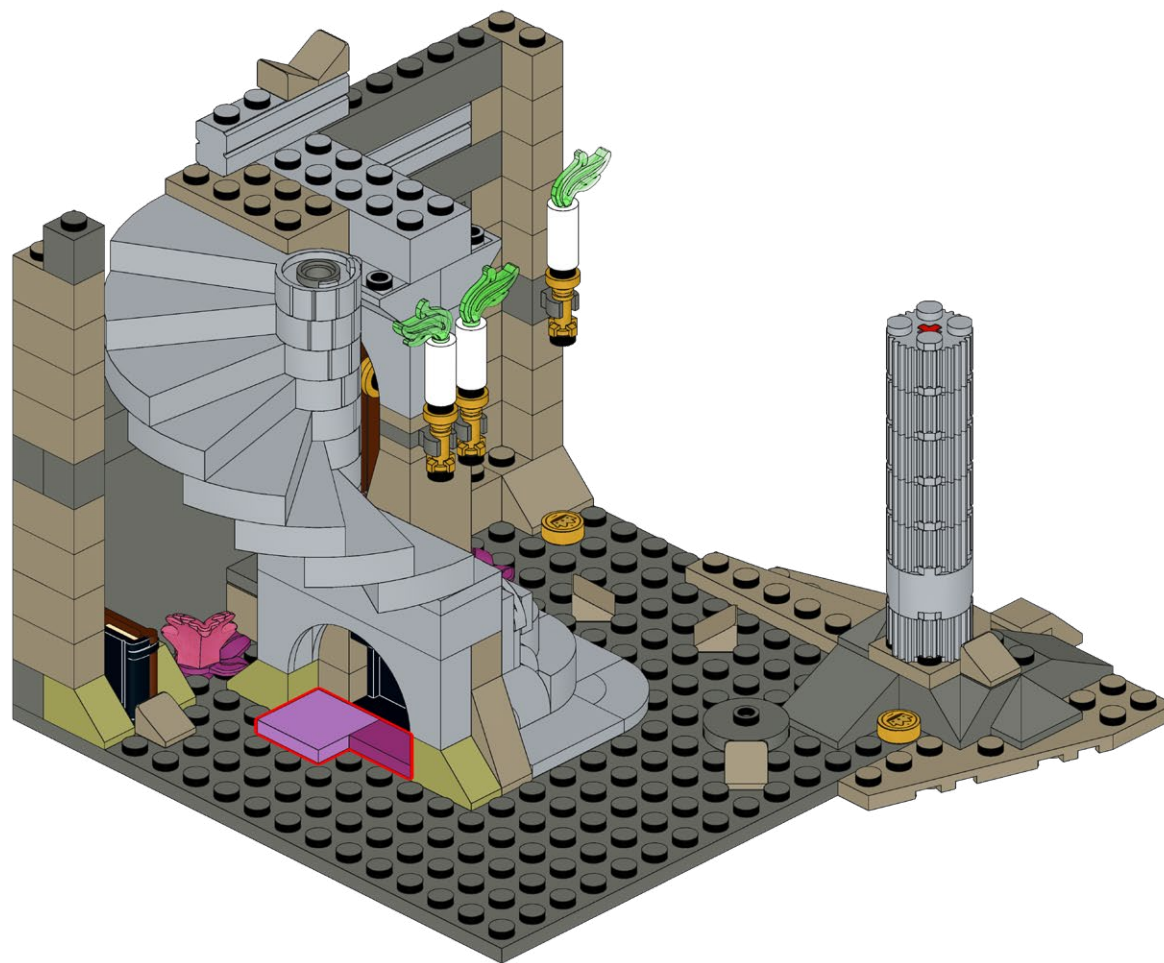



65





66

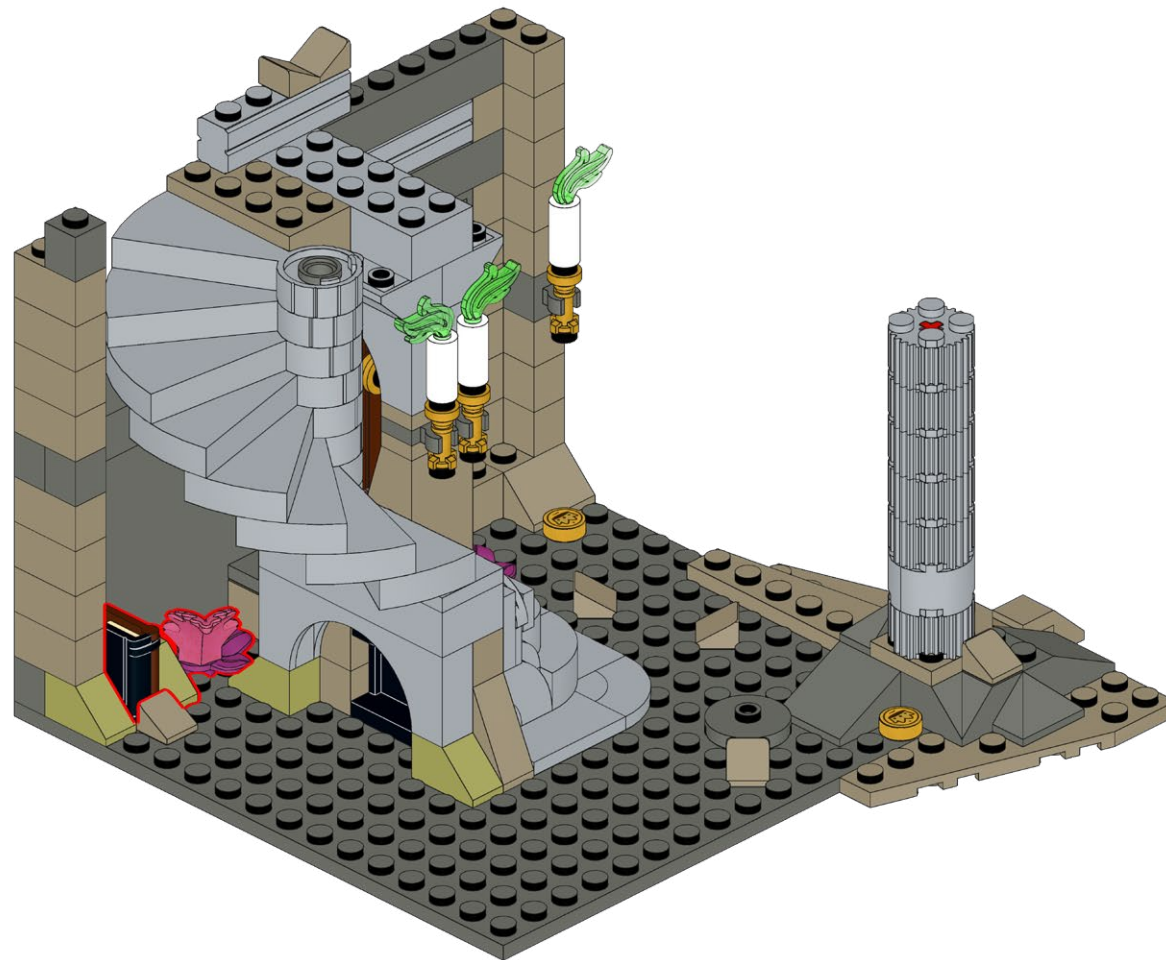

67

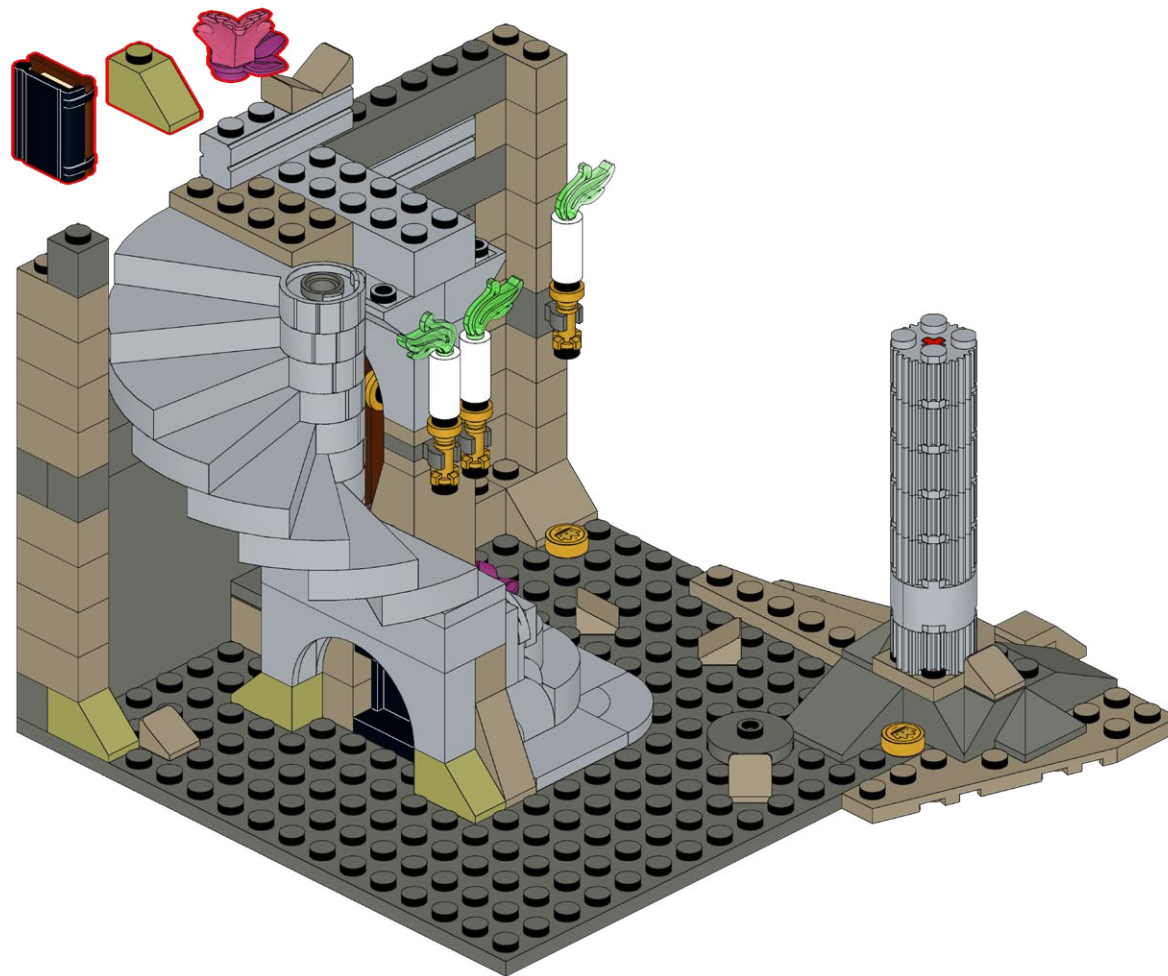

68

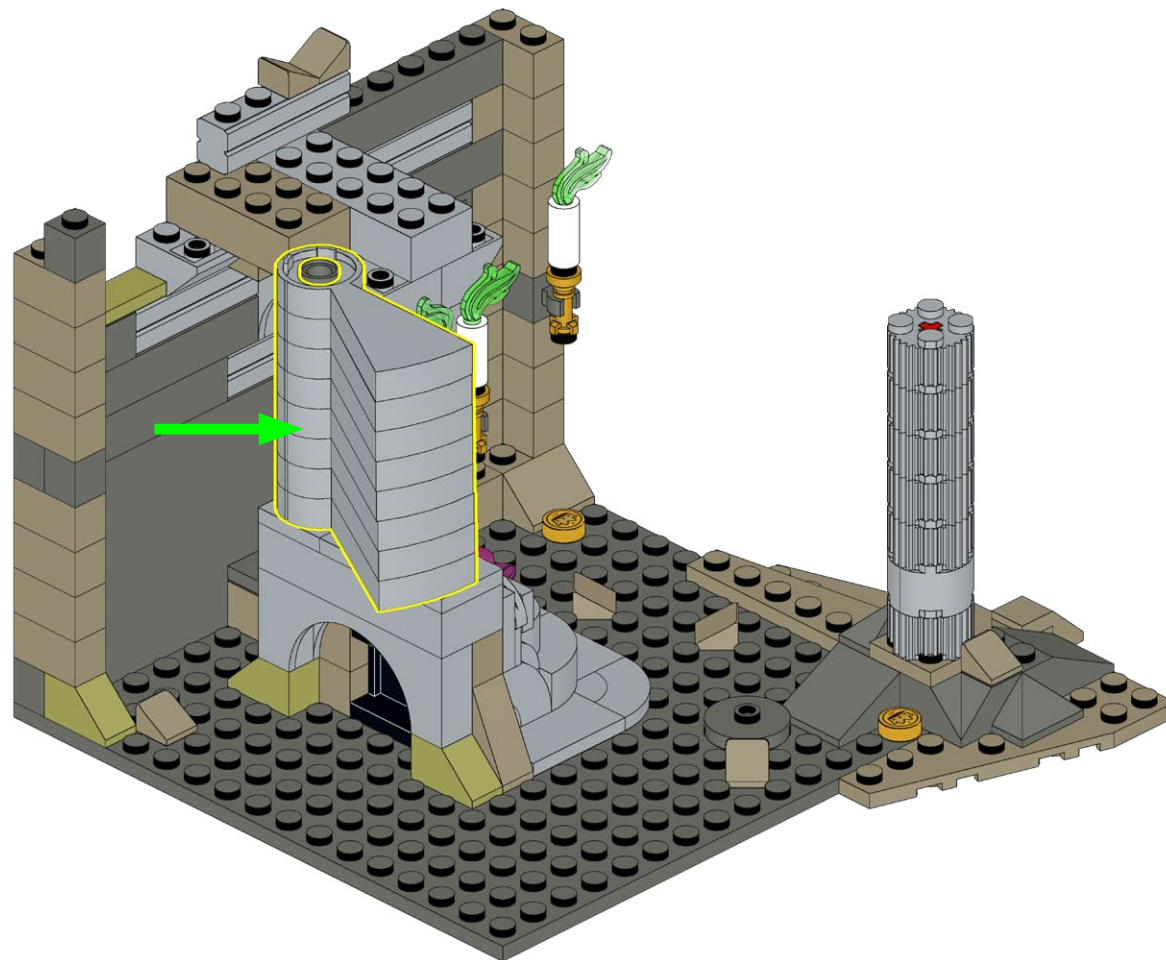

69



70

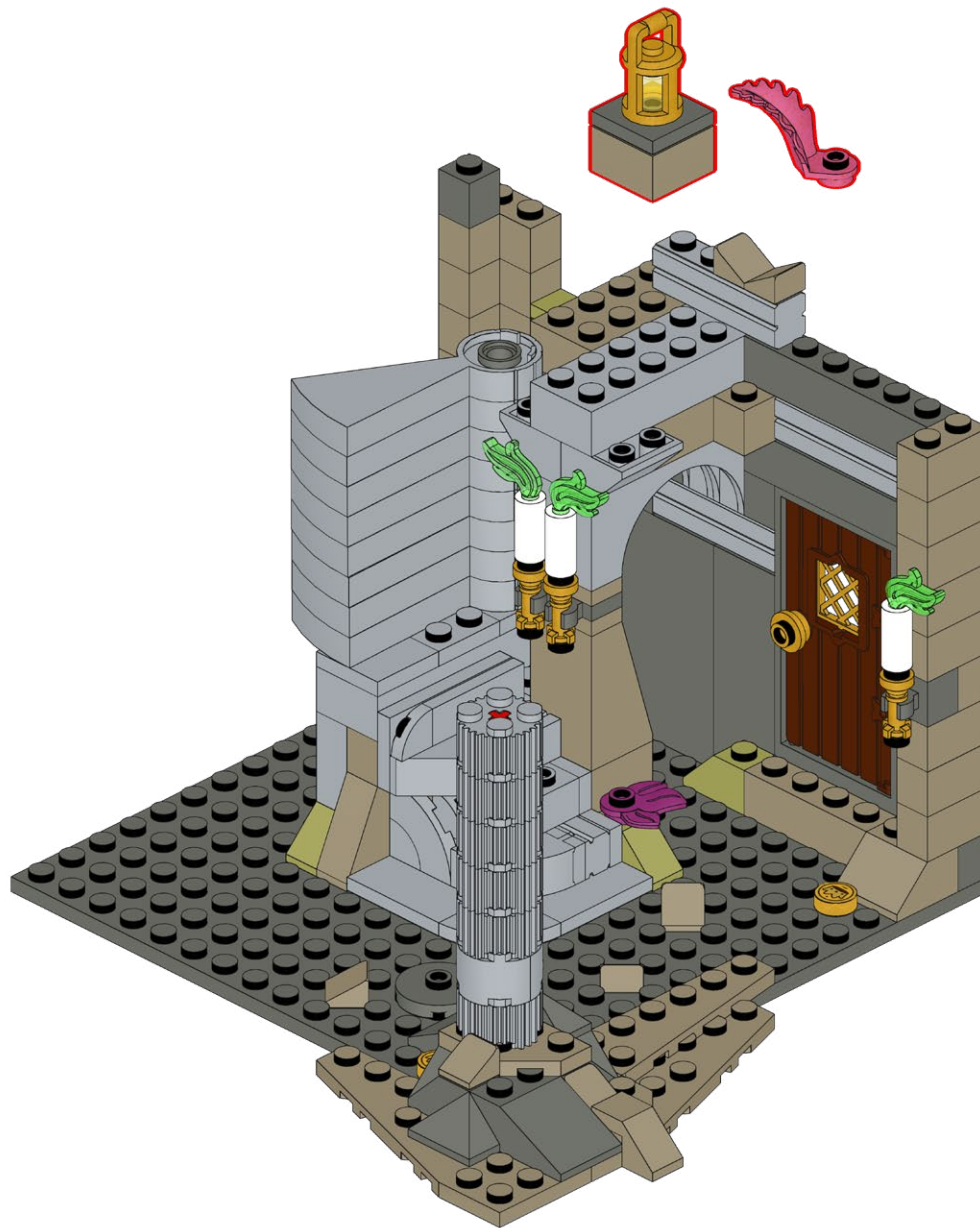





### **HOLD UP!**

You might notice some bags aren't in order, as well as left over pieces, but that's ok! We're changing the way you build LEGO!

### **ATTENDEZ!**

Vous remarquerez peut-être que certains sacs, ainsi que certaines pièces, ne sont pas dans le bon ordre. Mais pas de panique! Nous changeons simplement la façon avec laquelle vous construisez vos LEGO!

### **ASPETTA!**

Potresti notare che alcuni sacchetti non sono in ordine, così come i pezzi avanzati, ma va bene così! Stiamo cambiando il modo in cui costruisci i LEGO!

### **HALT!**

Sie werden möglicherweise bemerken, dass einige tüten durcheinander sind und teile übrig bleiben, aber das ist in Ordnung! Wir ändern die art und weise, wie Sie LEGO bauen!

### **¡ESPERA!**

Es posible que notes que algunas bolsas están fuera de servicio, así como piezas sobrantes, ¡pero está bien! ¡Estamos cambiando la forma en que construyes LEGO!

### **暫停!**

你可能会注意到一些袋子顺序错乱, 以及一些剩余的部件, 但没关系! 我们正在改变你搭建乐高的方式!

#### Open LMB Bag 03

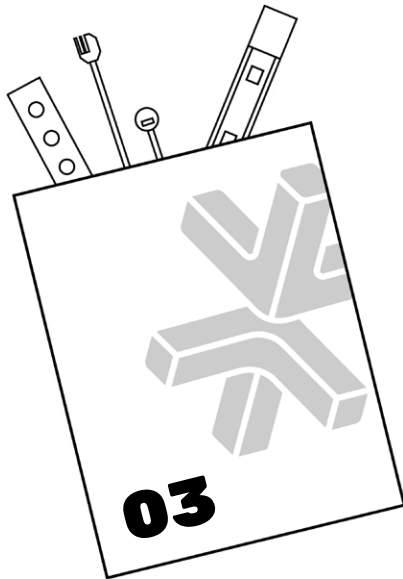



1



2

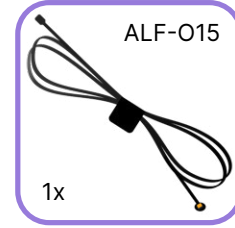
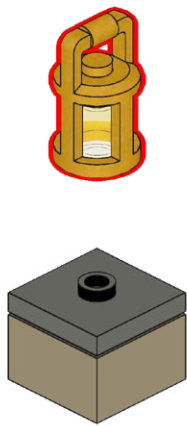

1

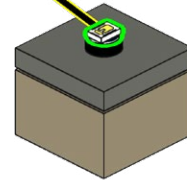

2

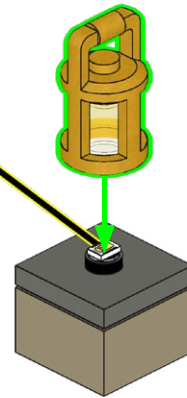

73

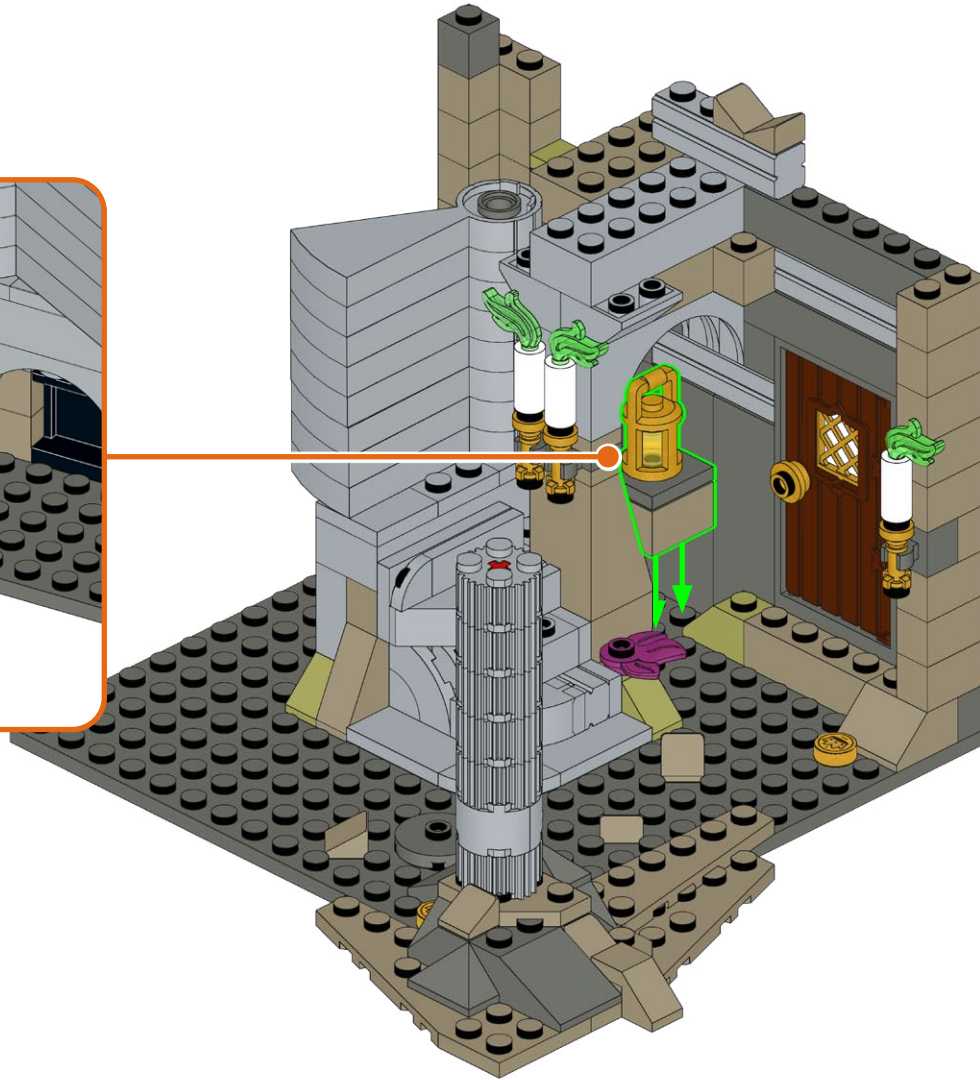
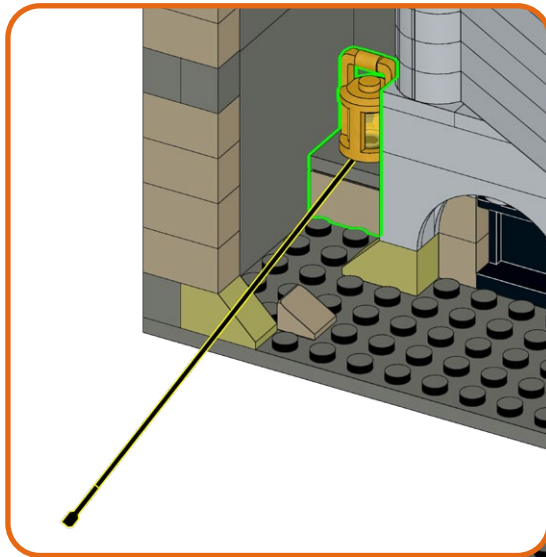

74



# 75

1

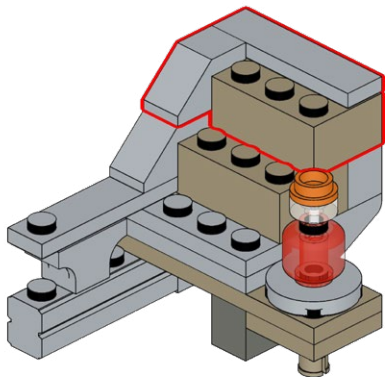

2

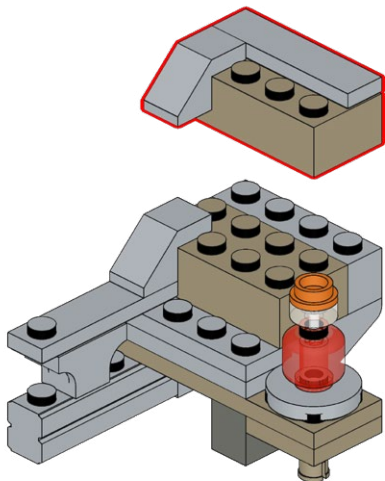

# 76

1

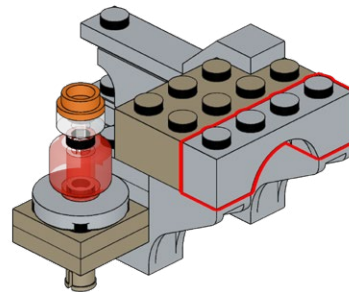
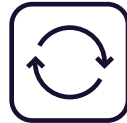

2

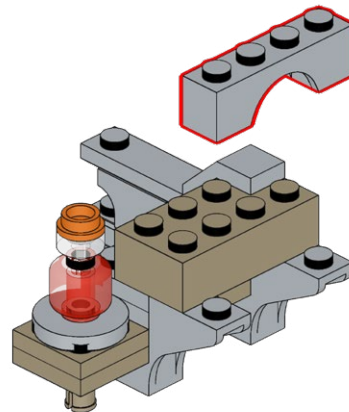



77

1

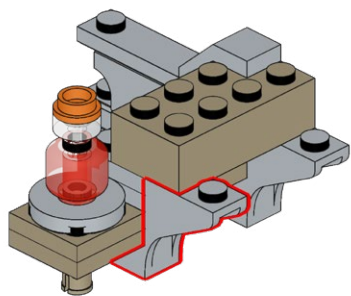

2

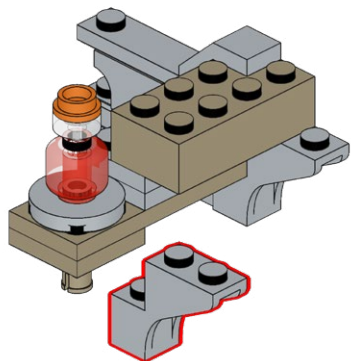

78

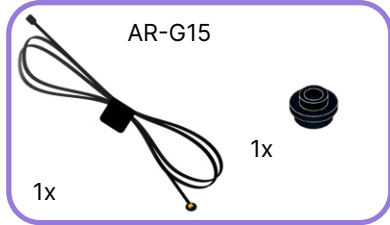

1

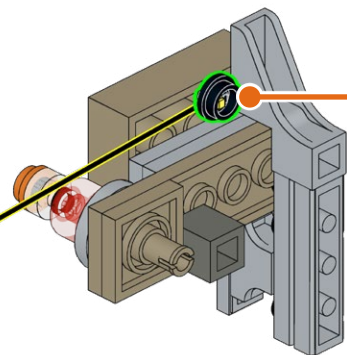
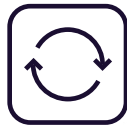

2

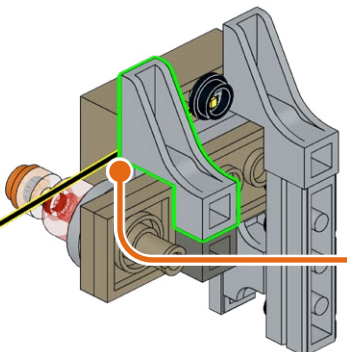

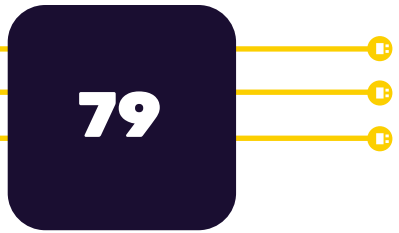

1

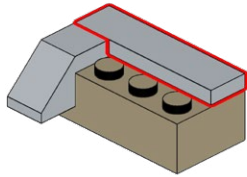

2

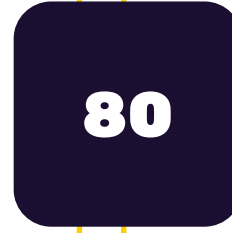
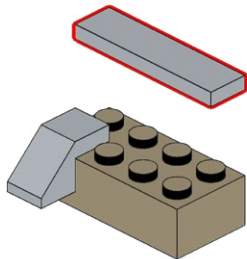

1

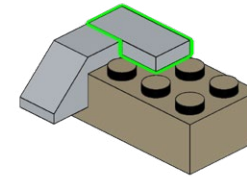

2

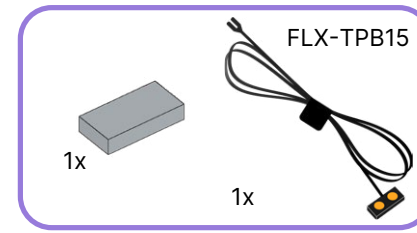
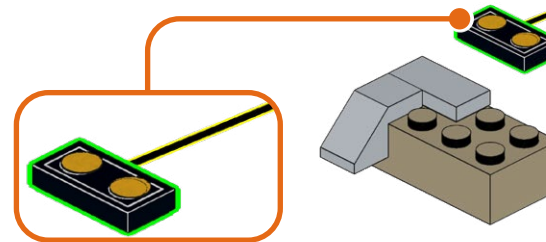

81

1

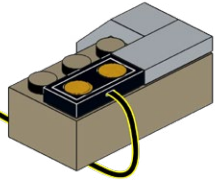

2

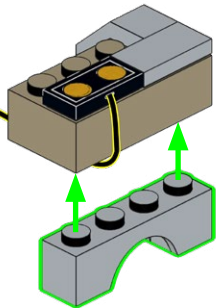

82

1

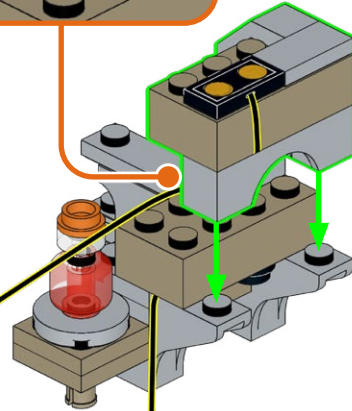
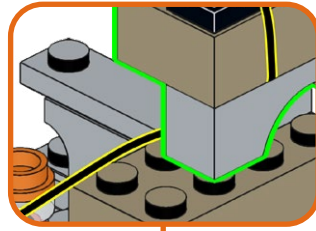

2

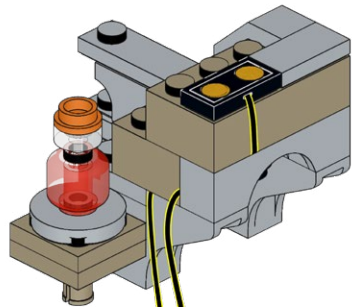

83

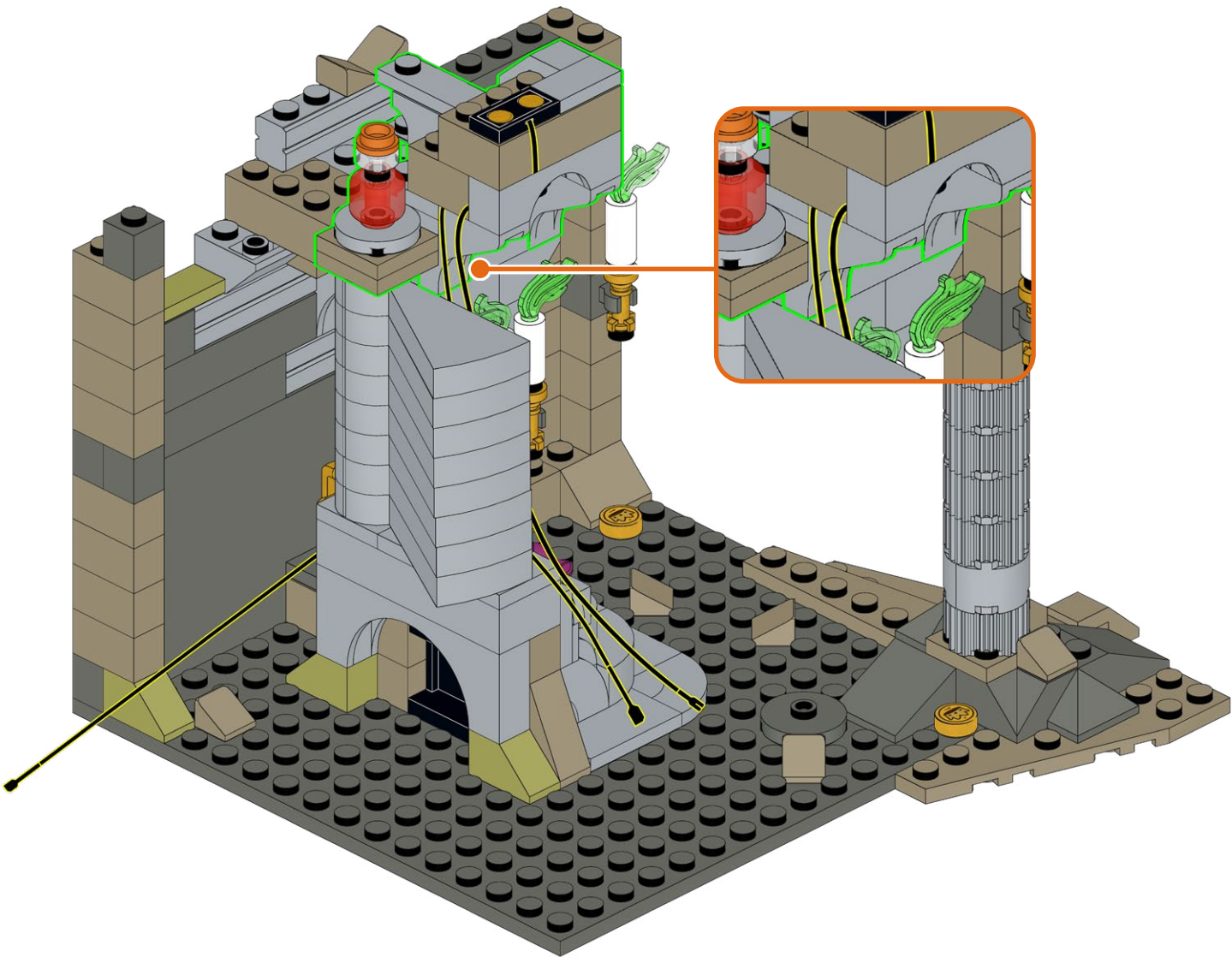

84

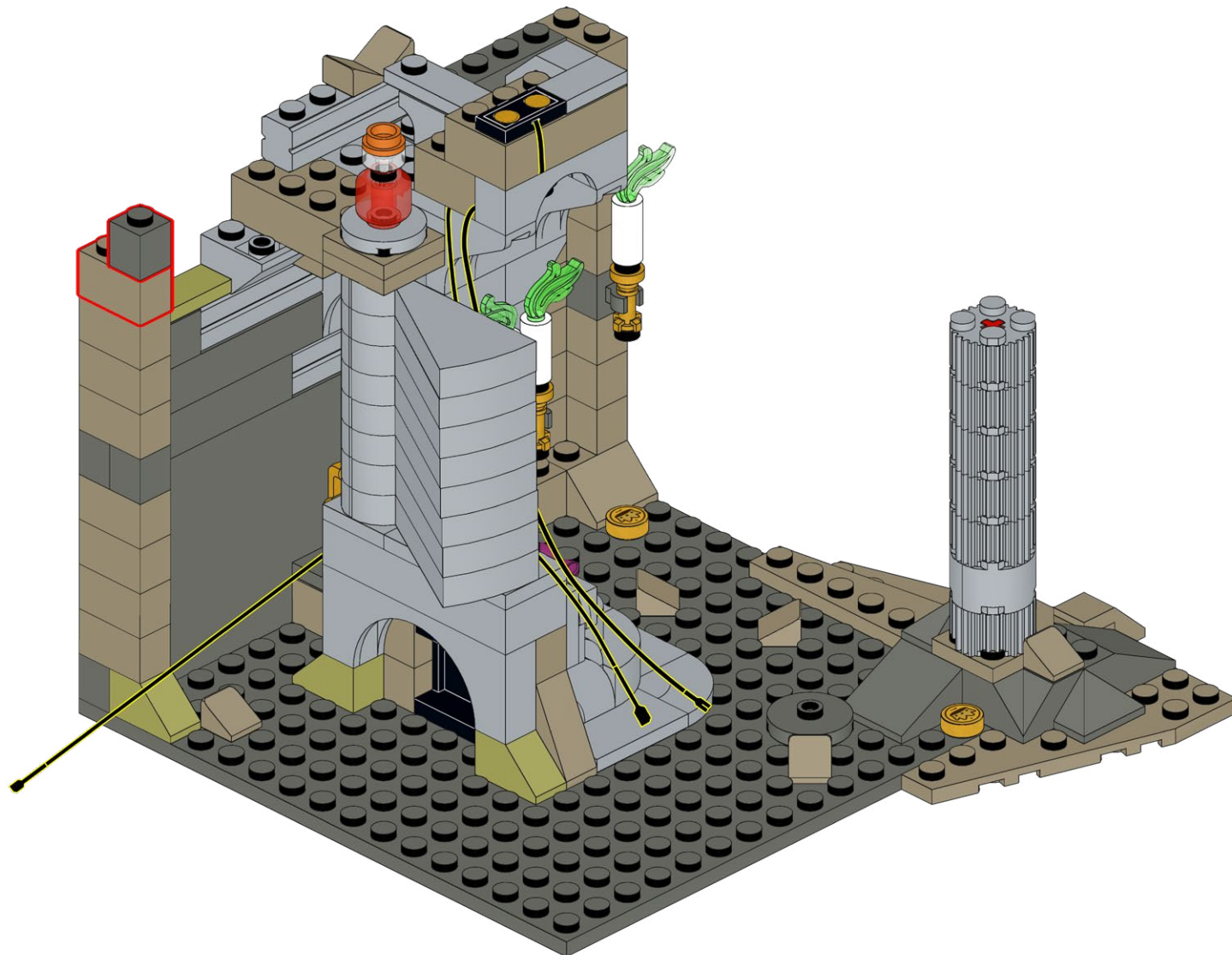



85

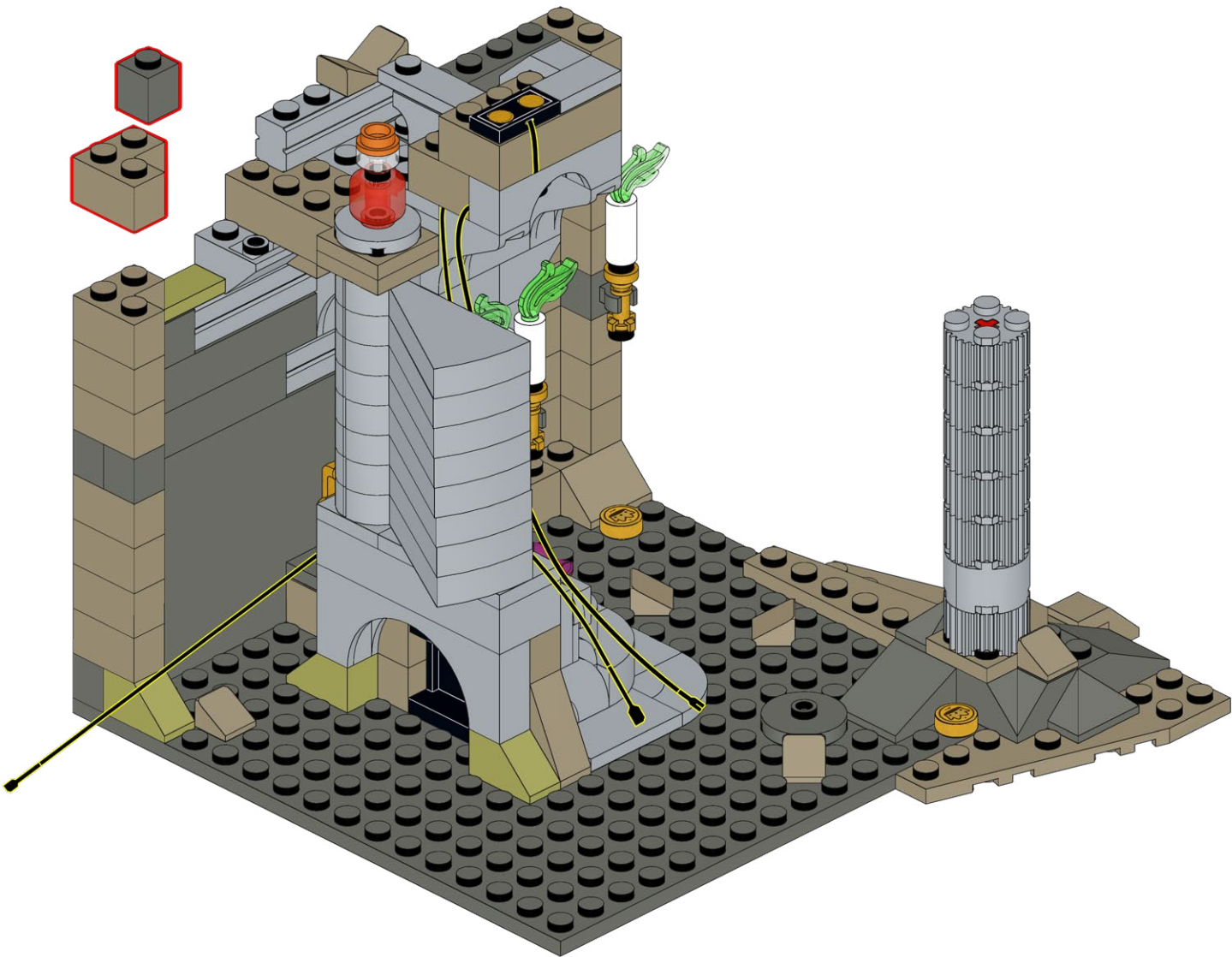

86

FLX-TPA15



1x



2x

1

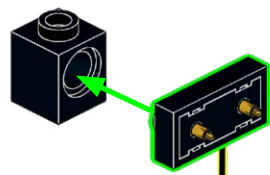

2

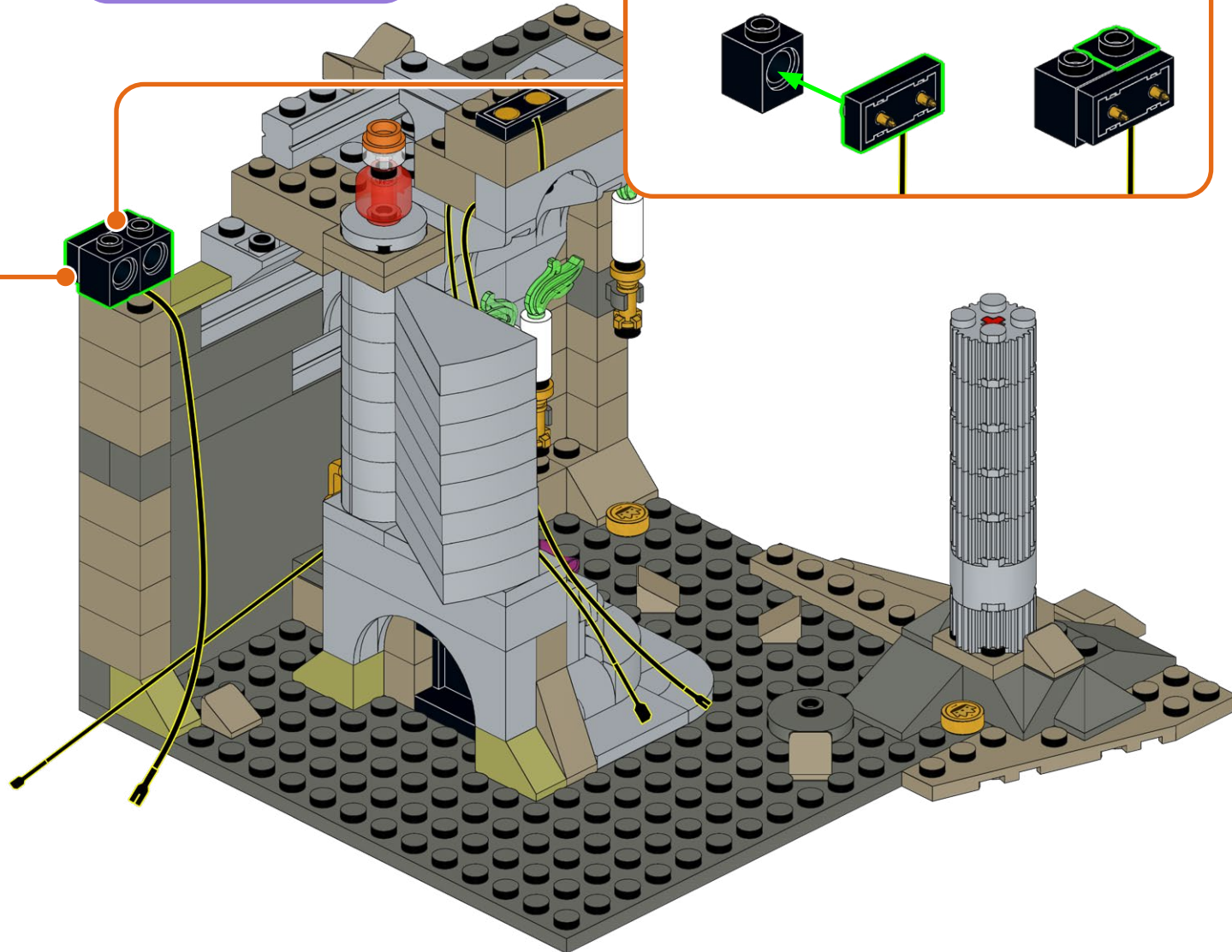
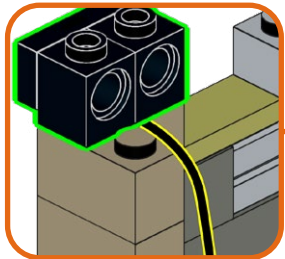
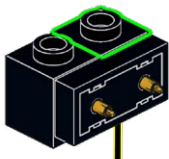

87

1x





88

2x



89

D-3



1x

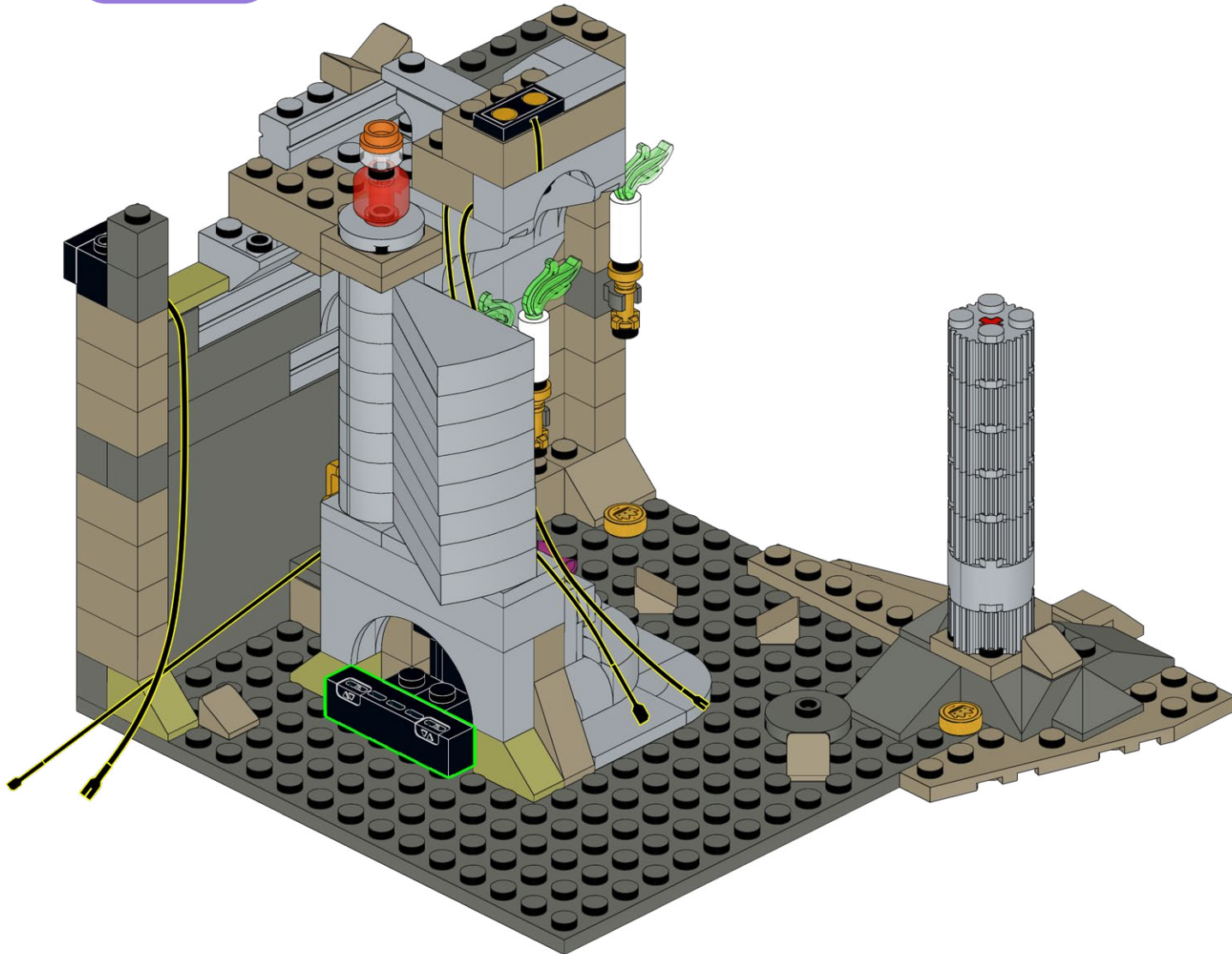



90

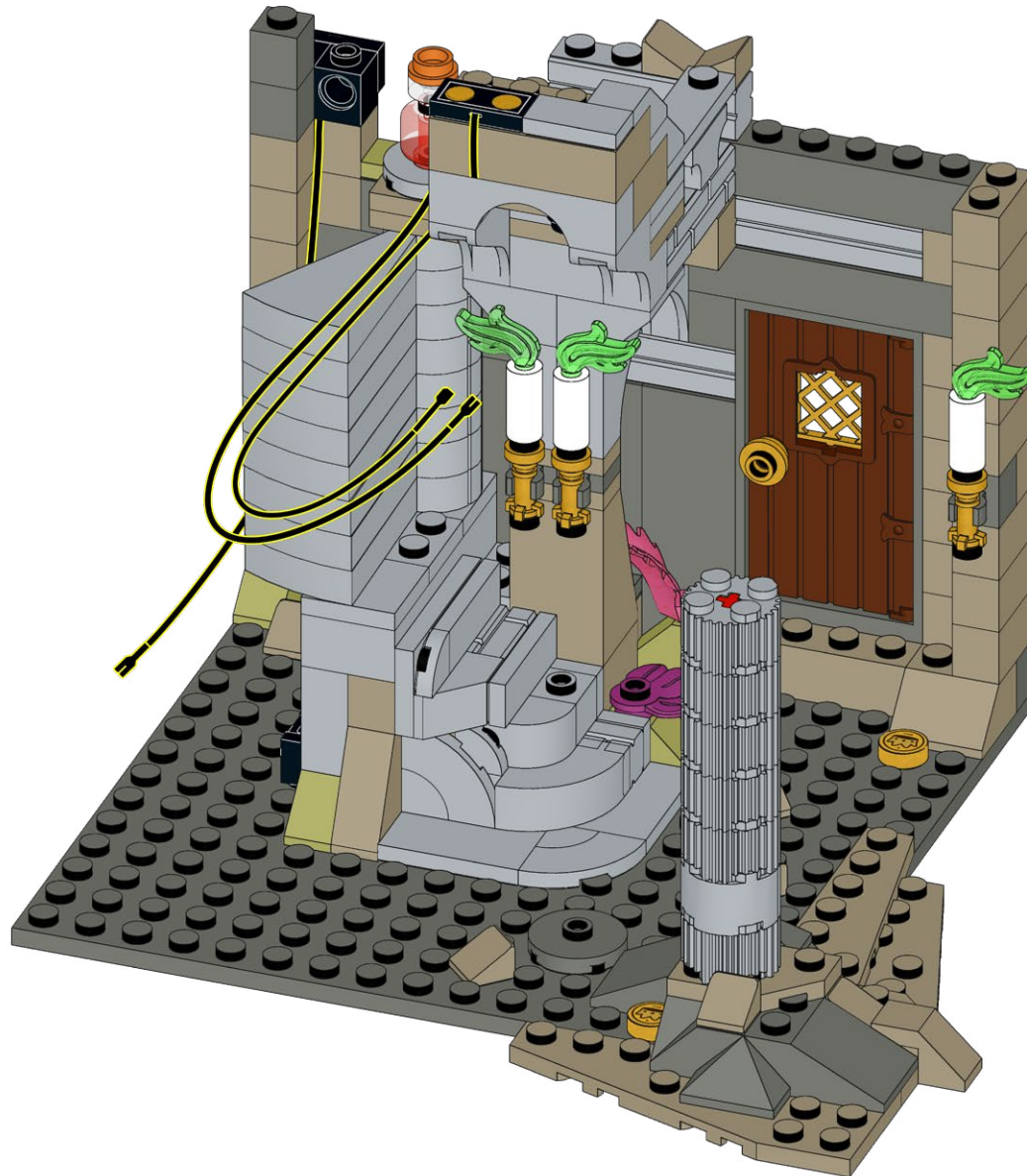

91

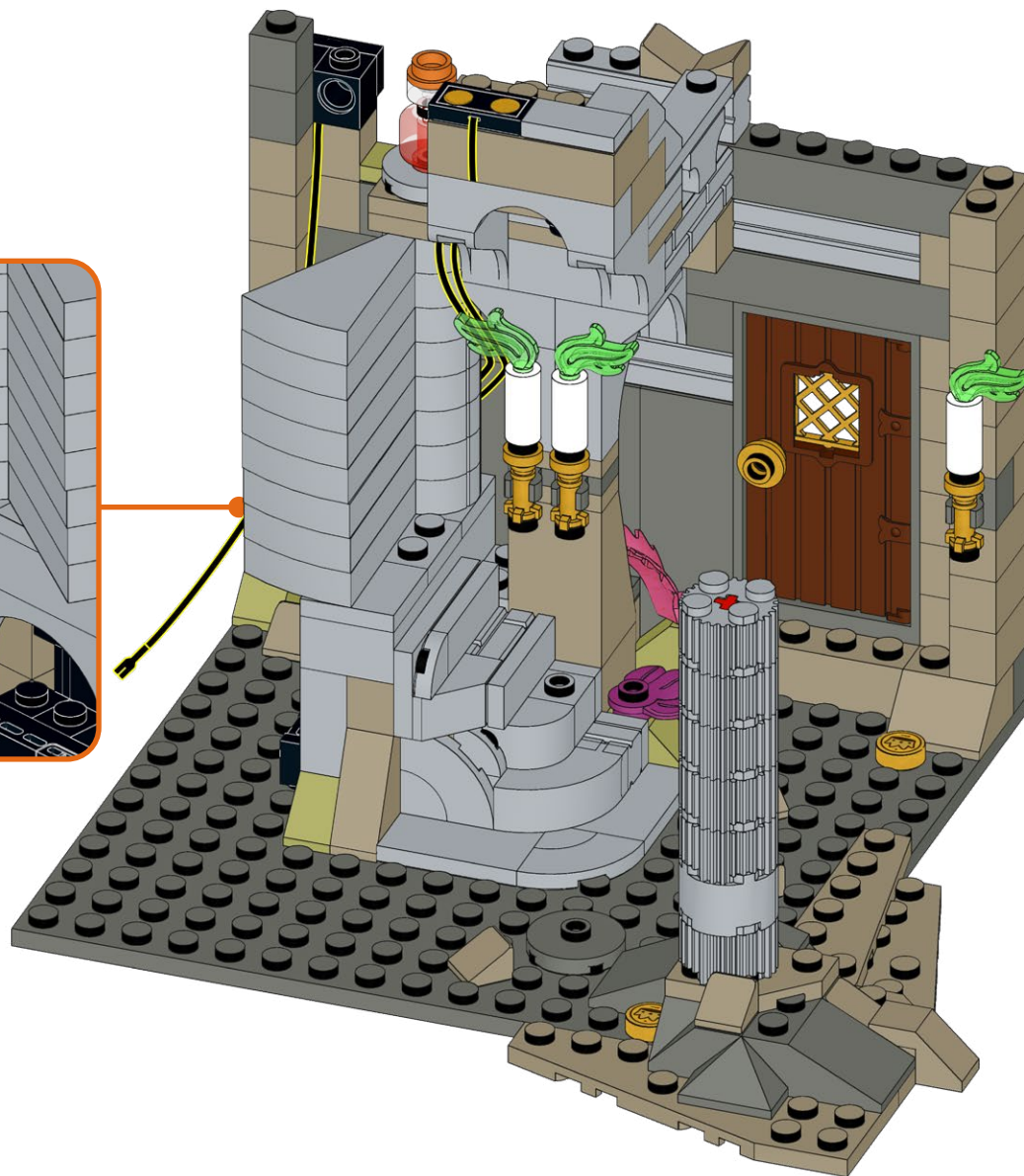
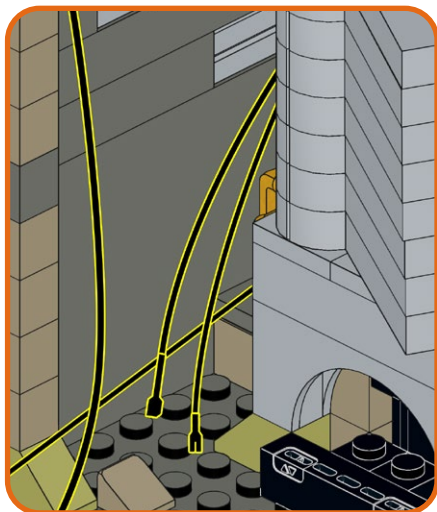

92

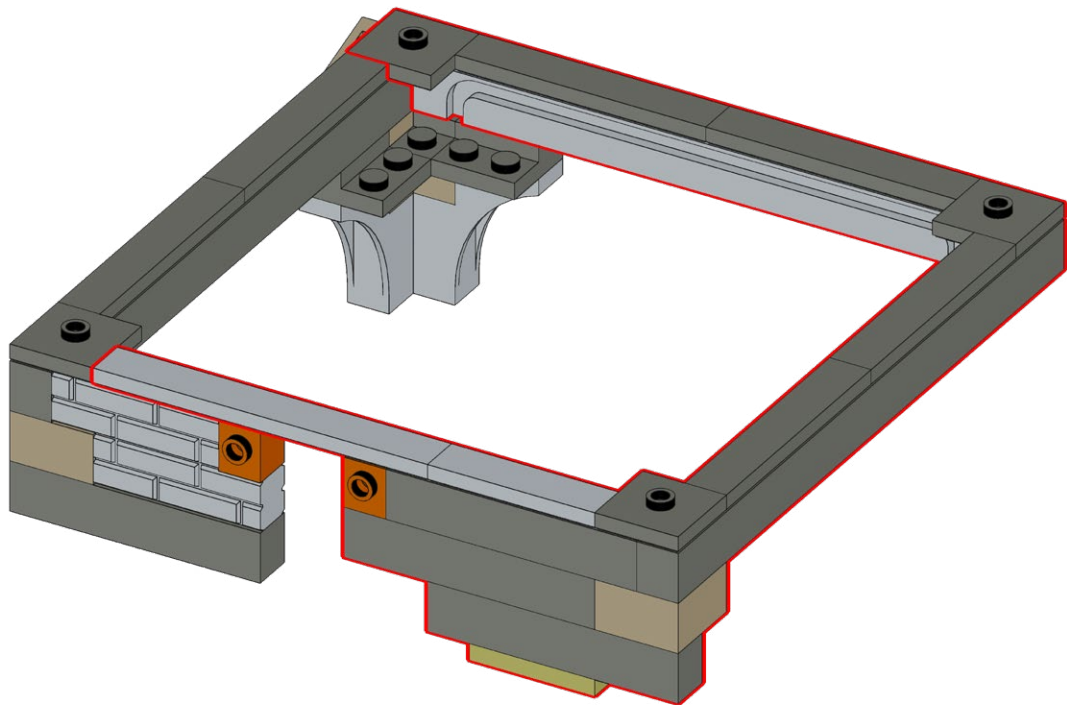

93

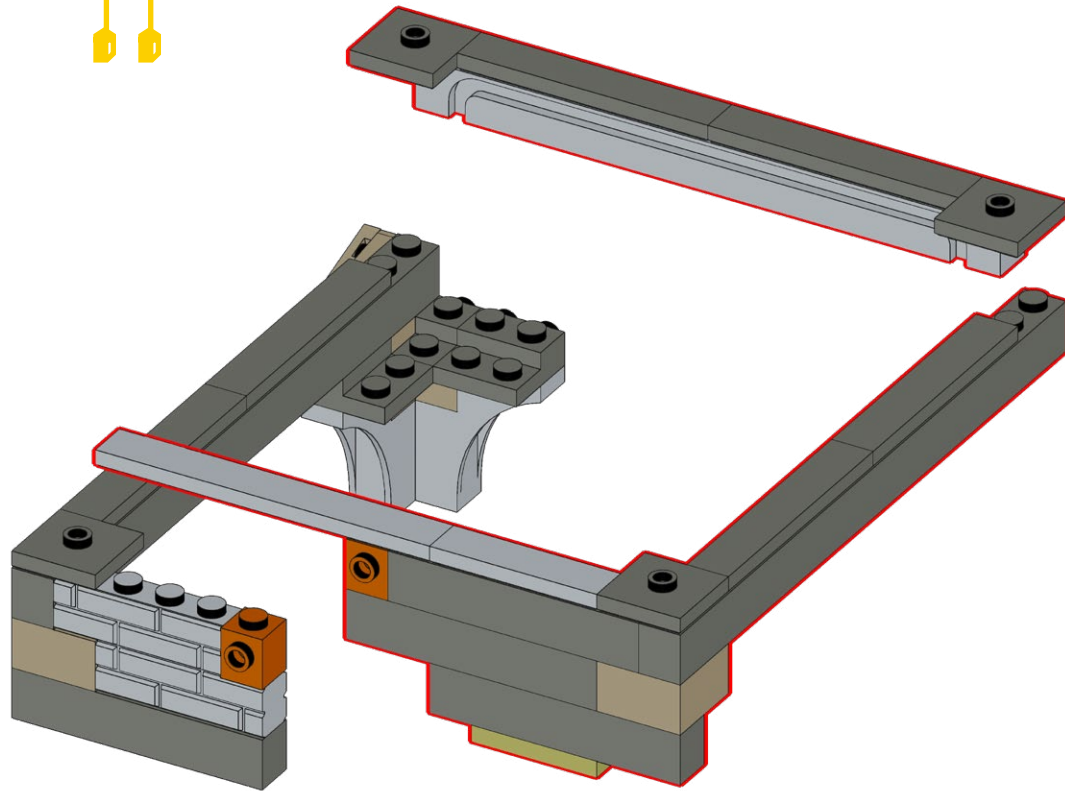

**94**

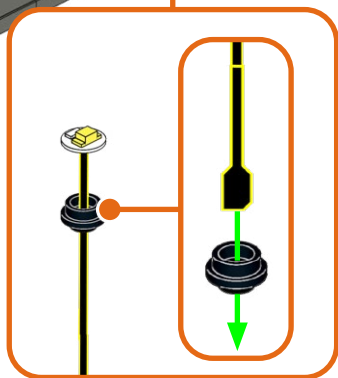
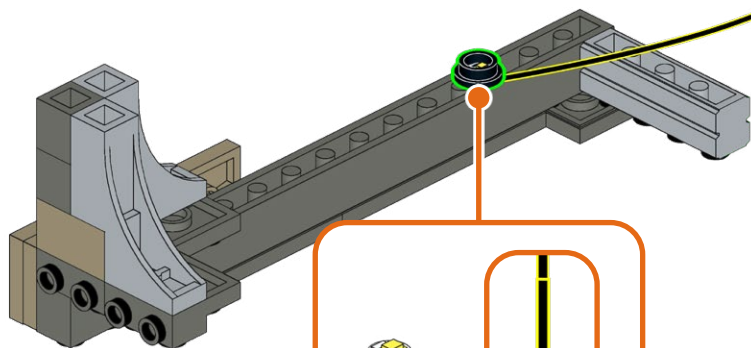
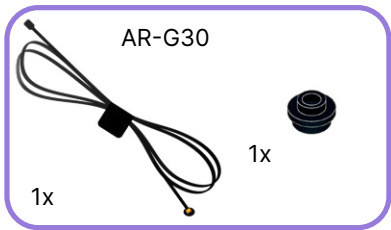

**95**

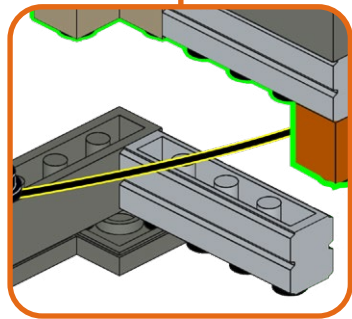
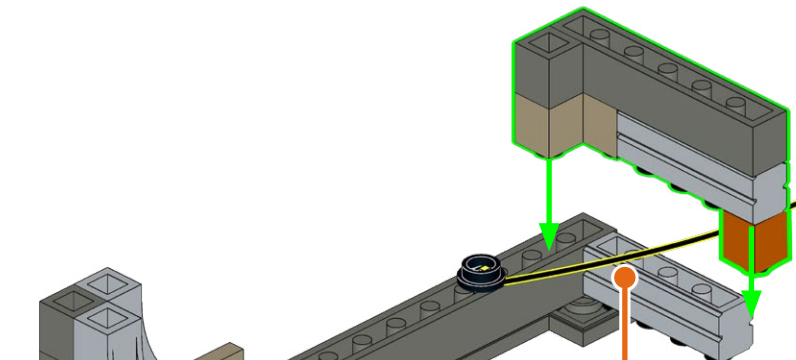

96

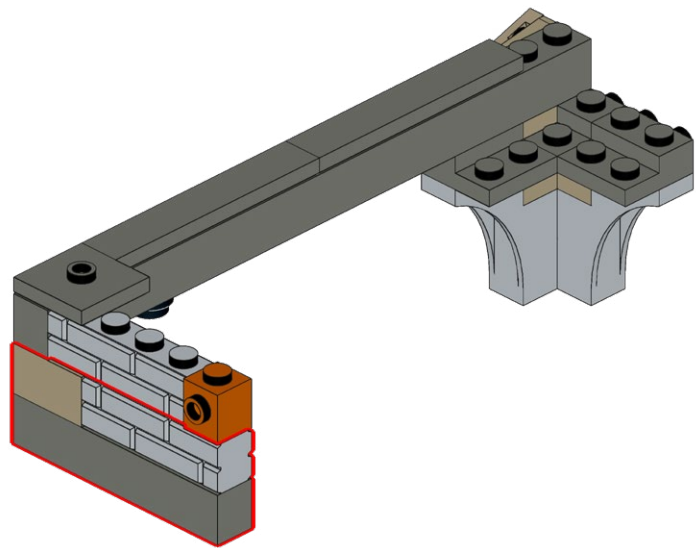

97

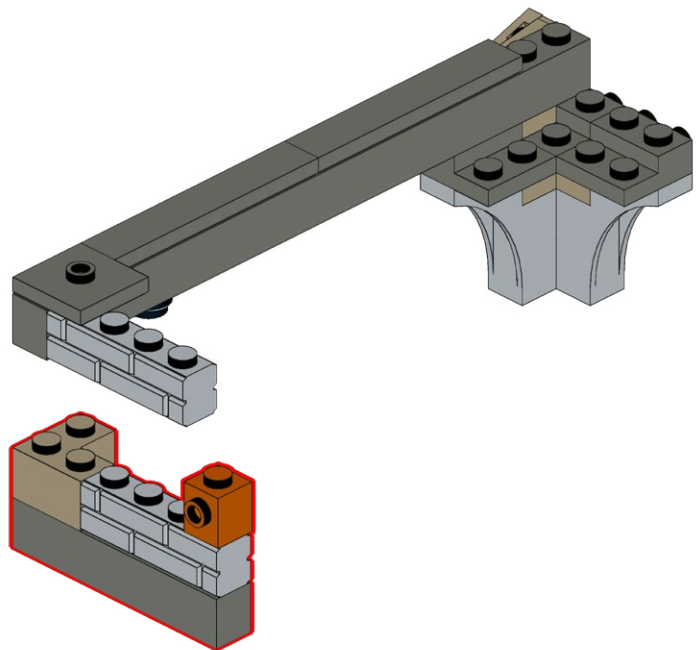



98

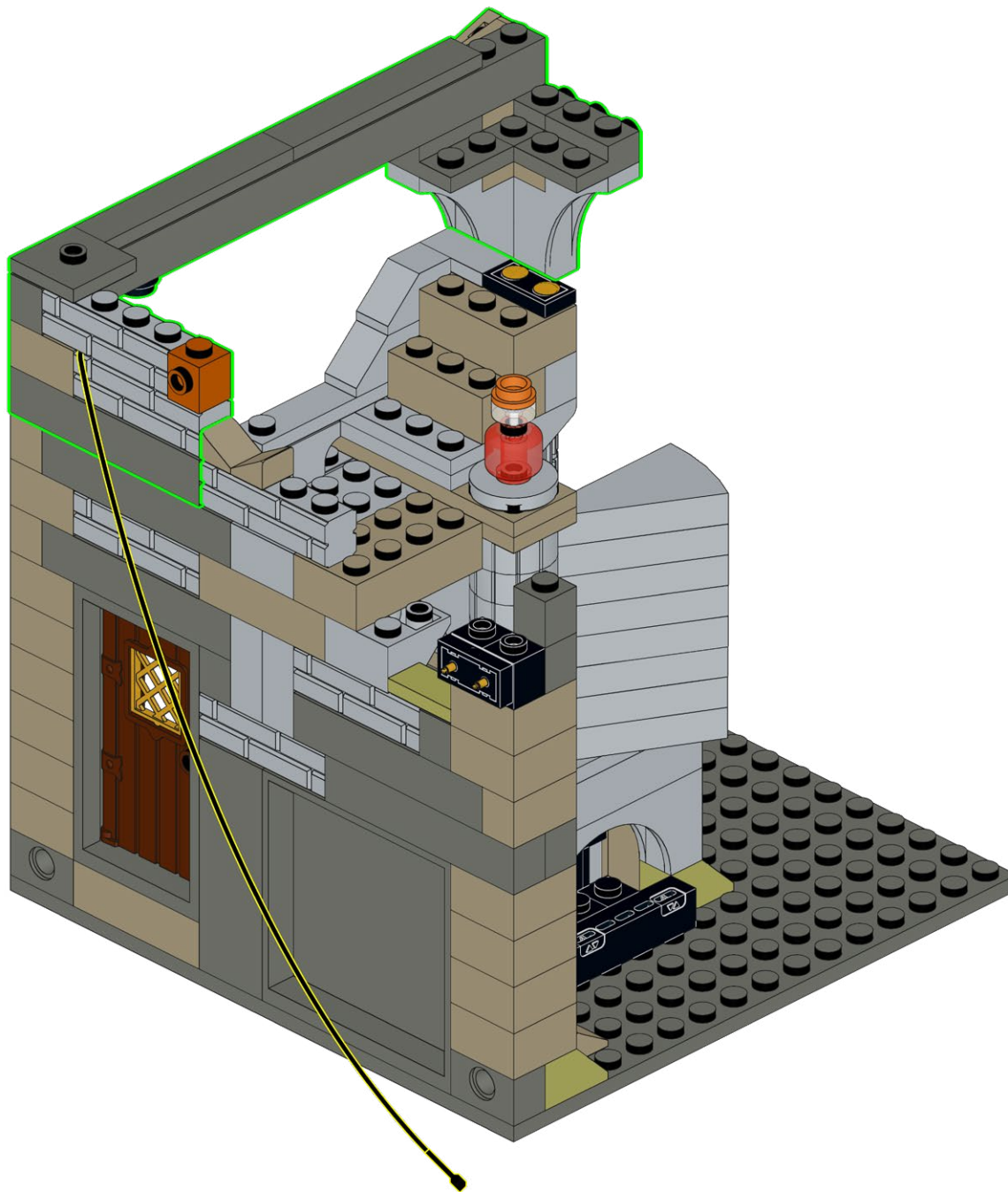

99

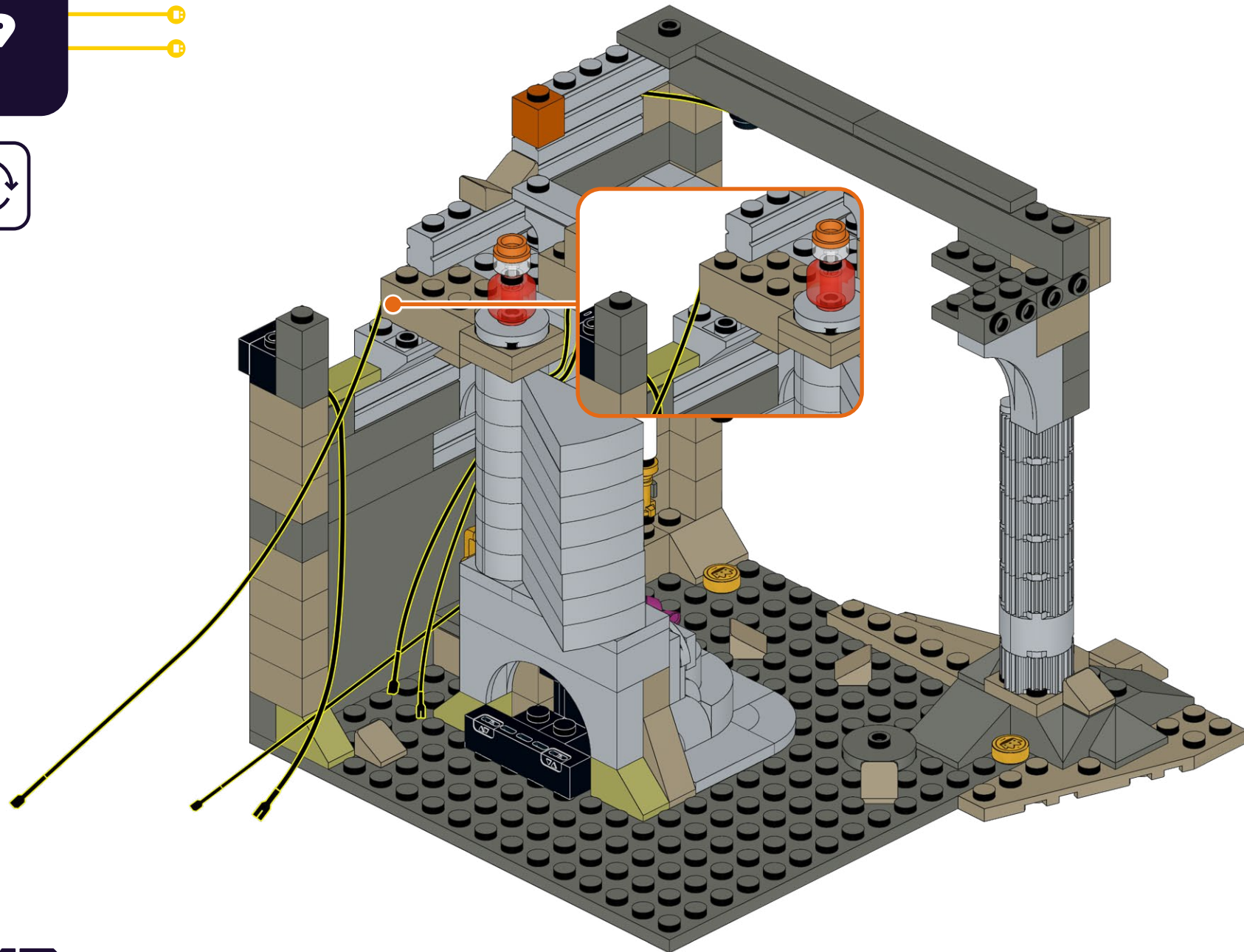

100

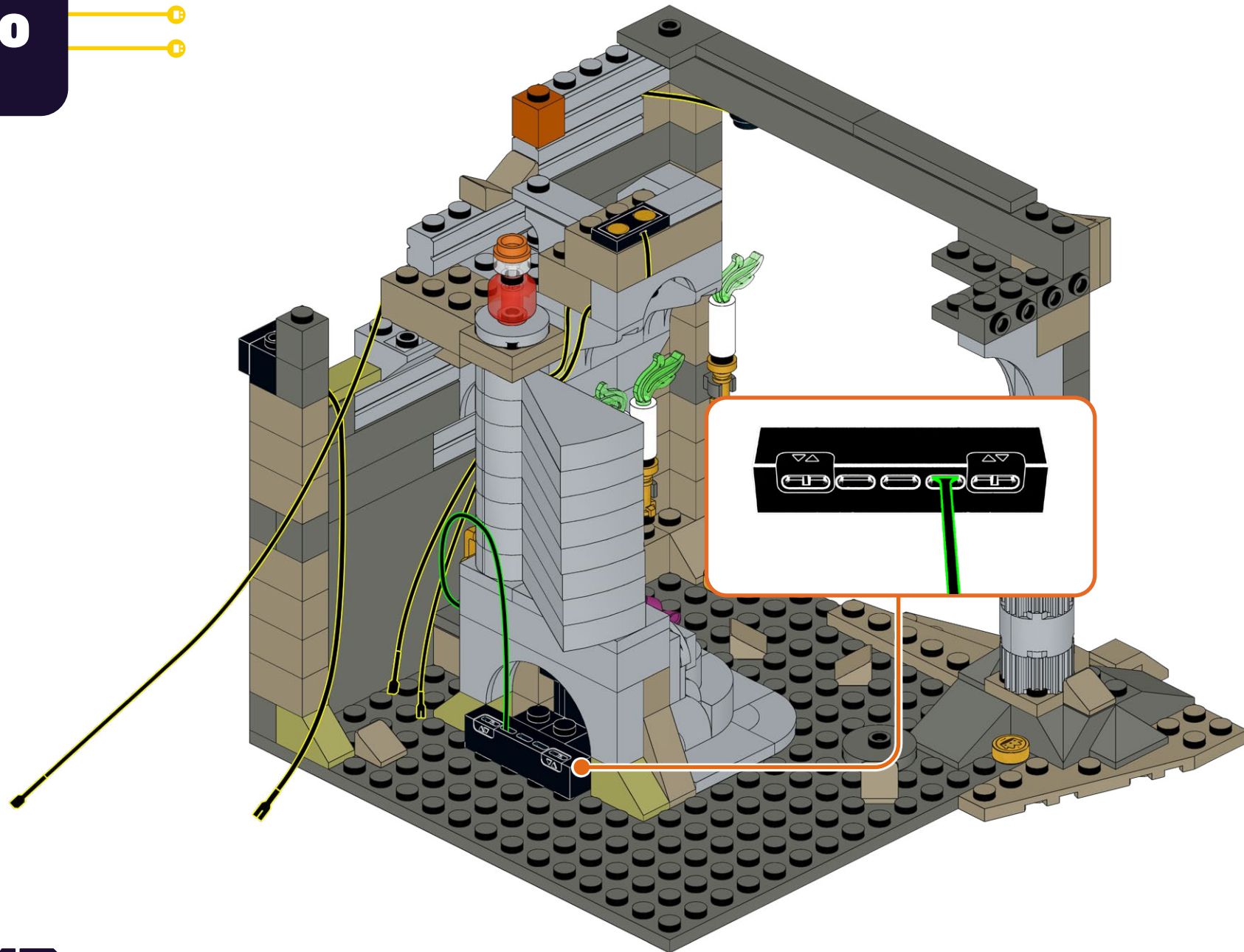





102

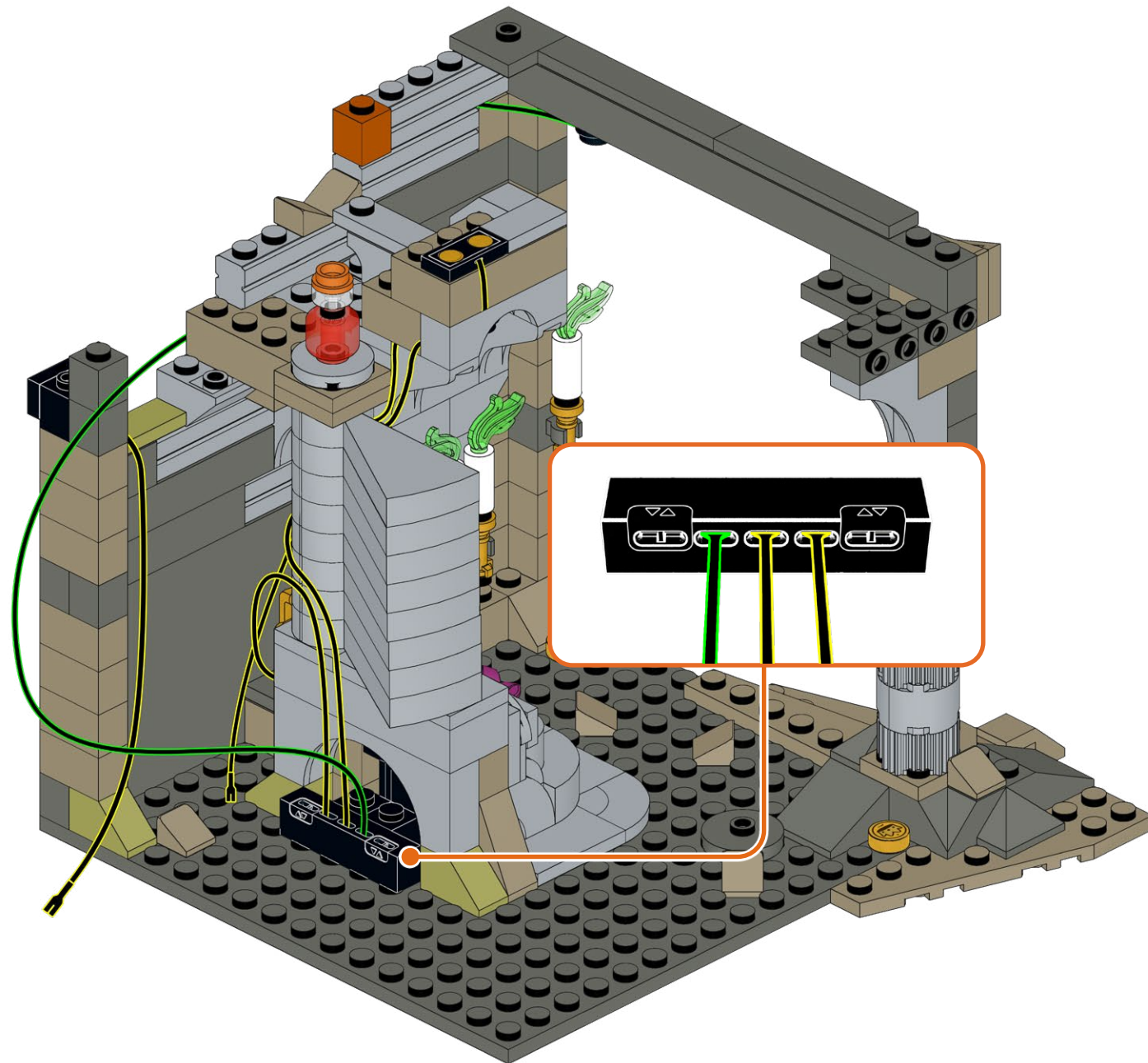



103

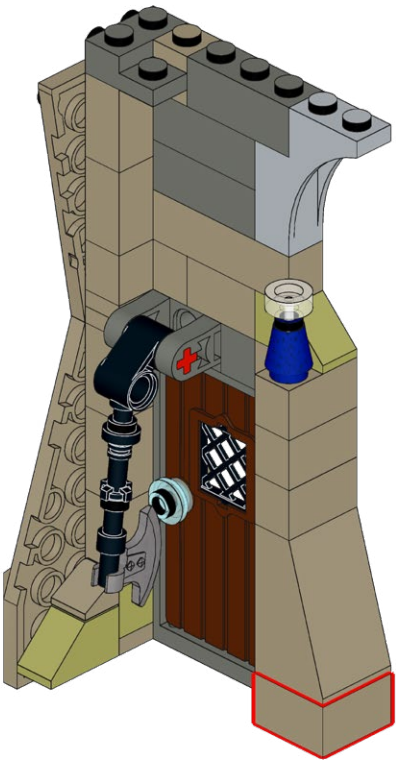

104

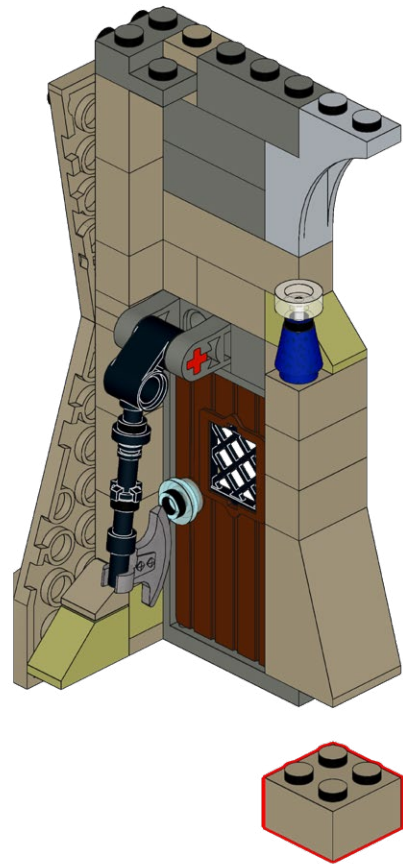

**105**

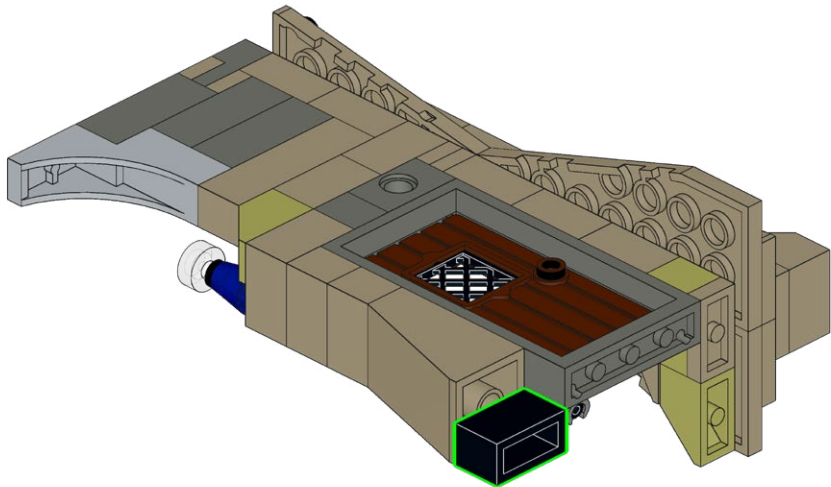
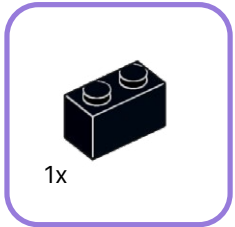

**106**

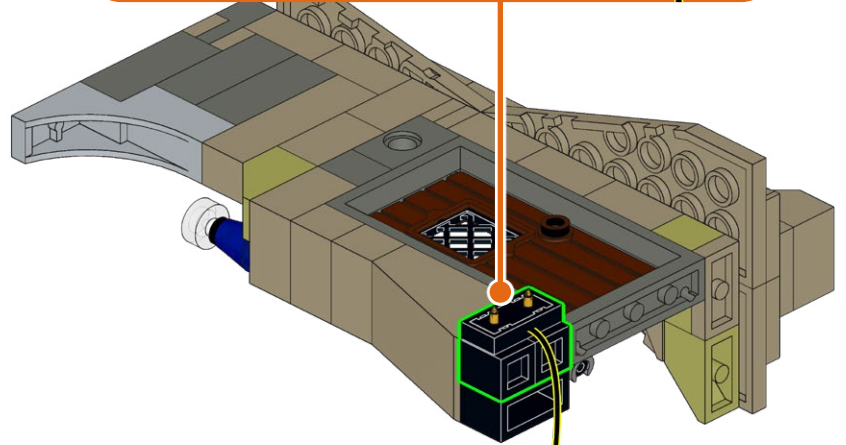
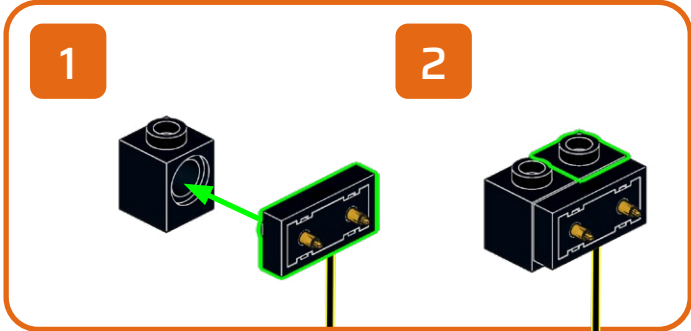
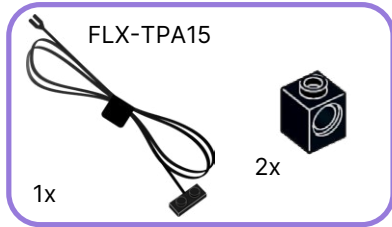

107

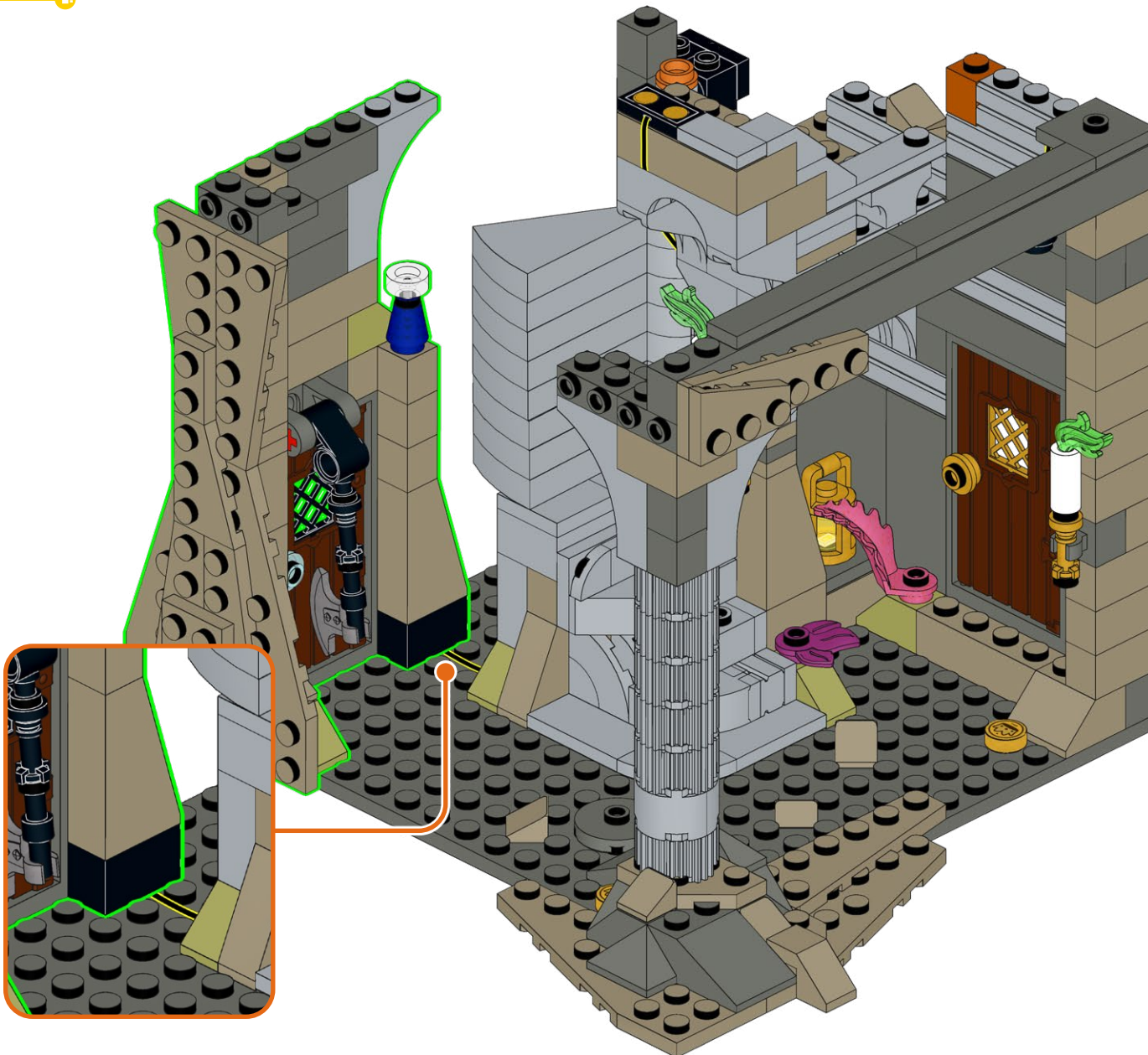

108



DS-4

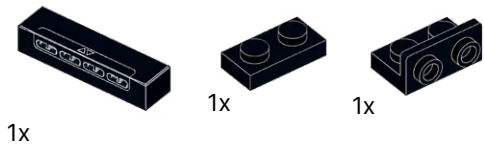

1x

1x

1x

1

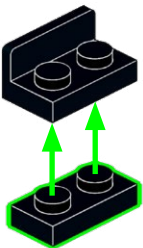

2

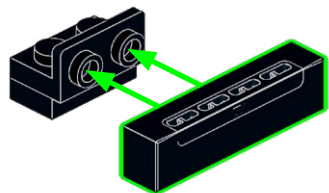



109

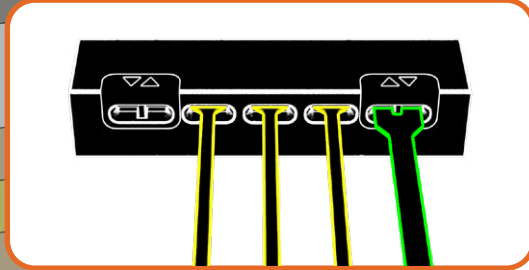
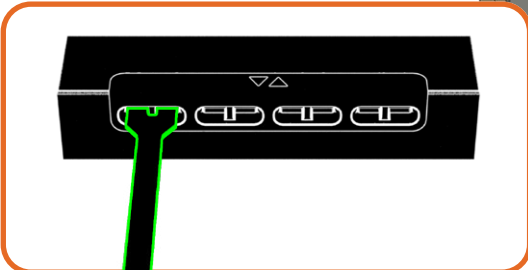
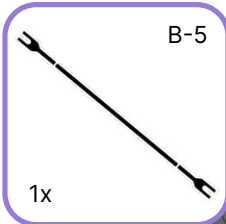



110

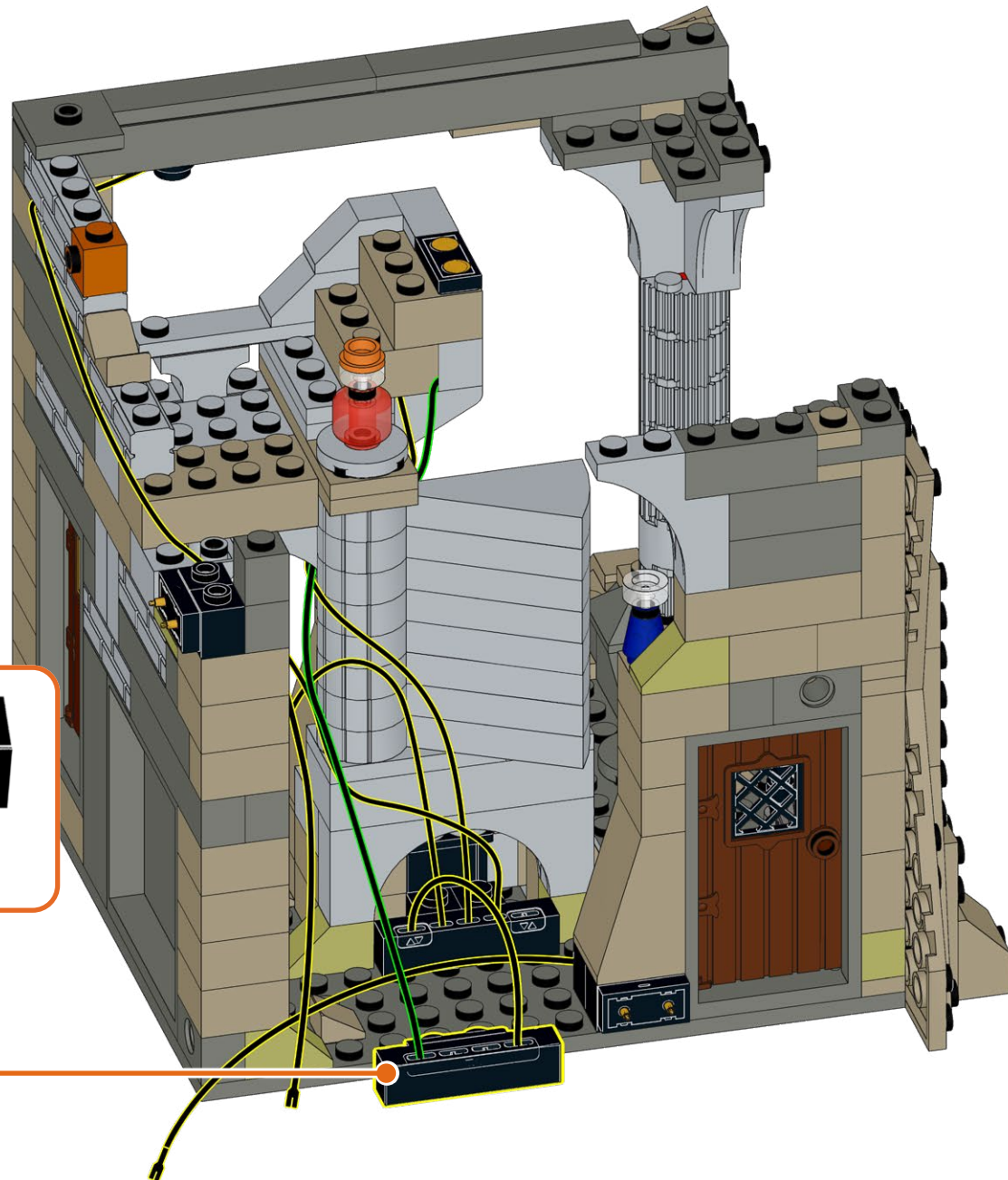
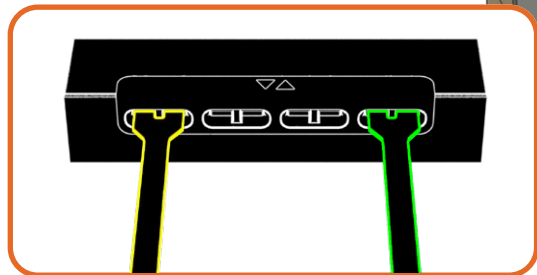

111

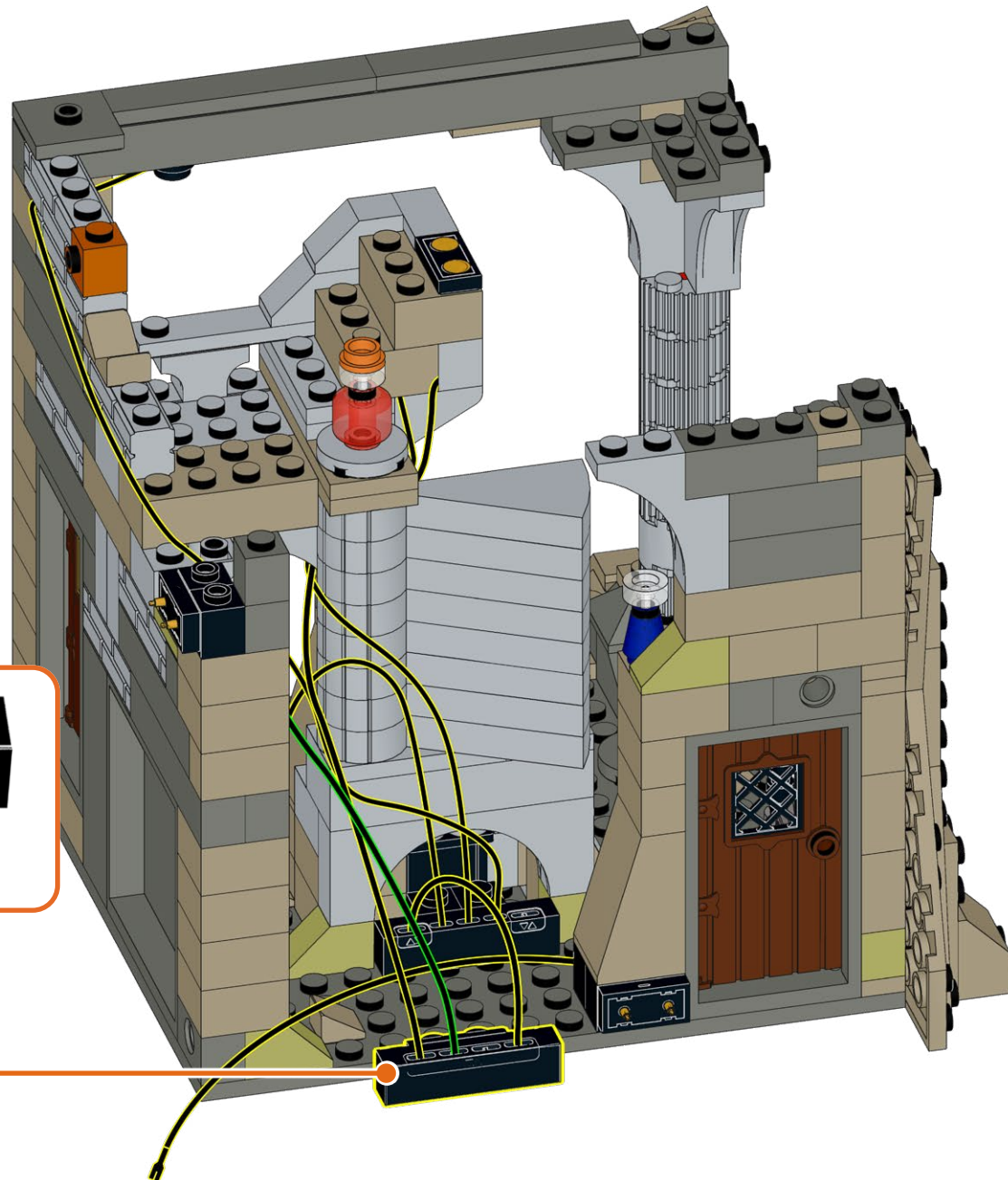
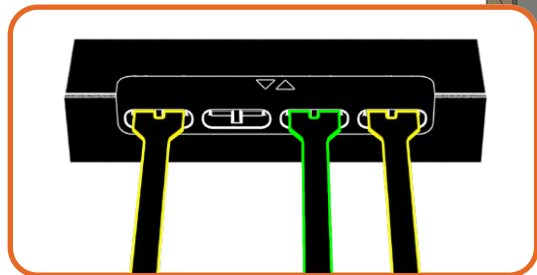

112

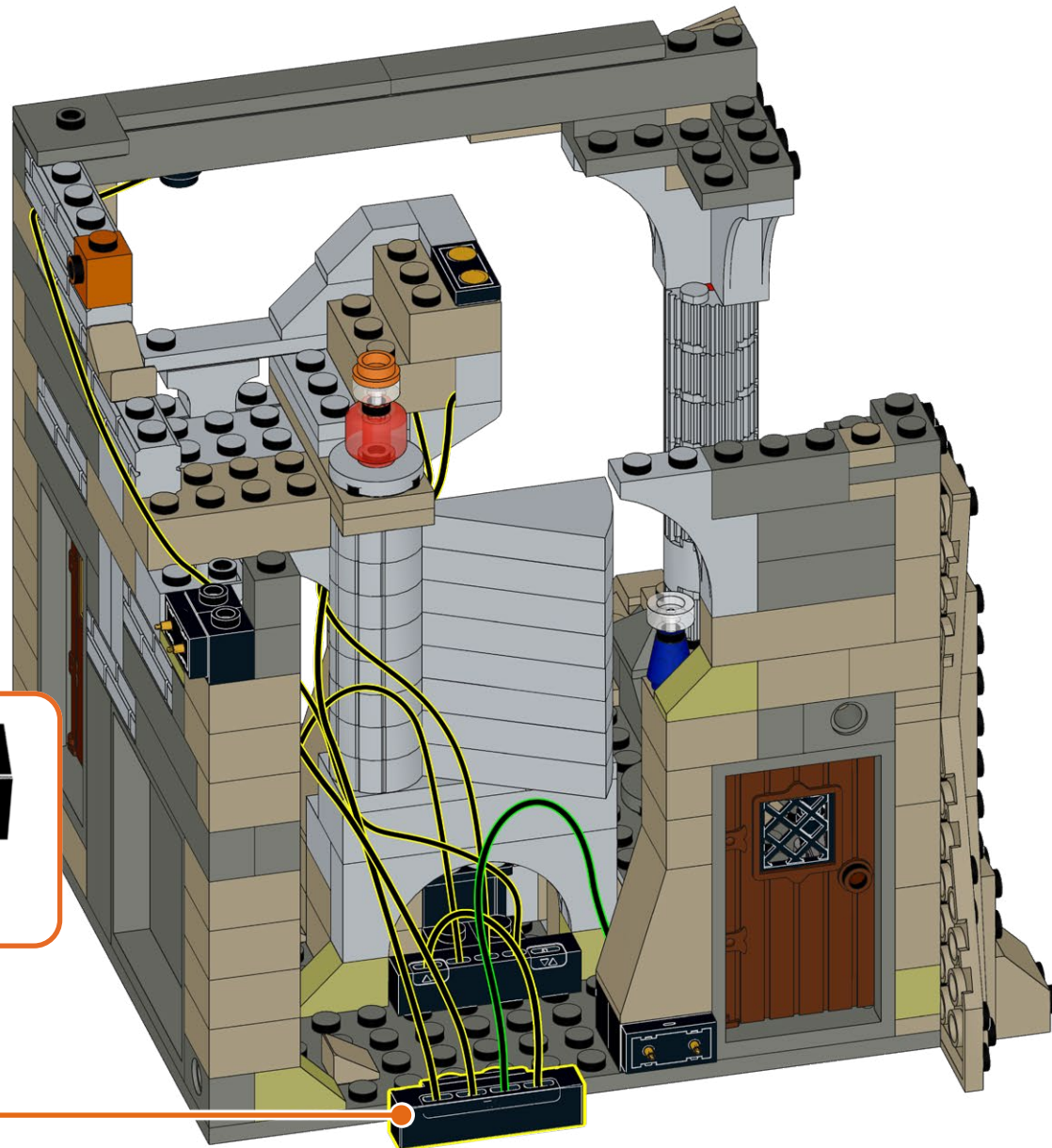
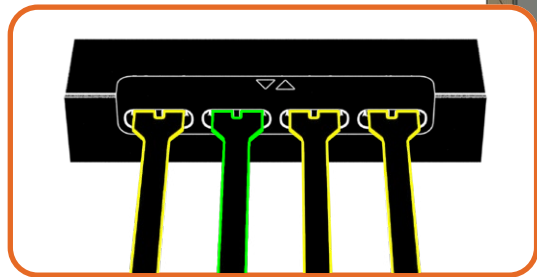



113

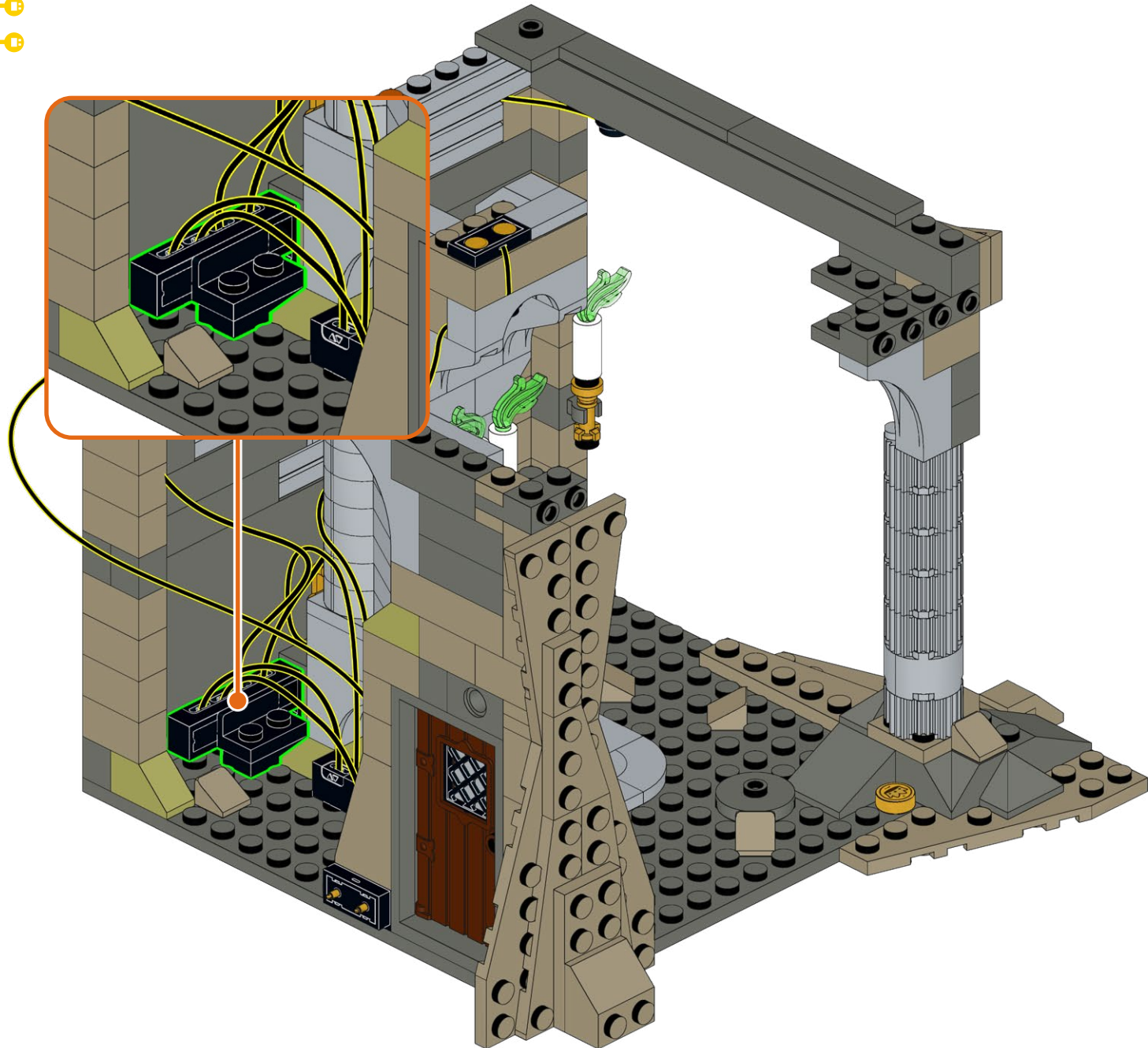



114

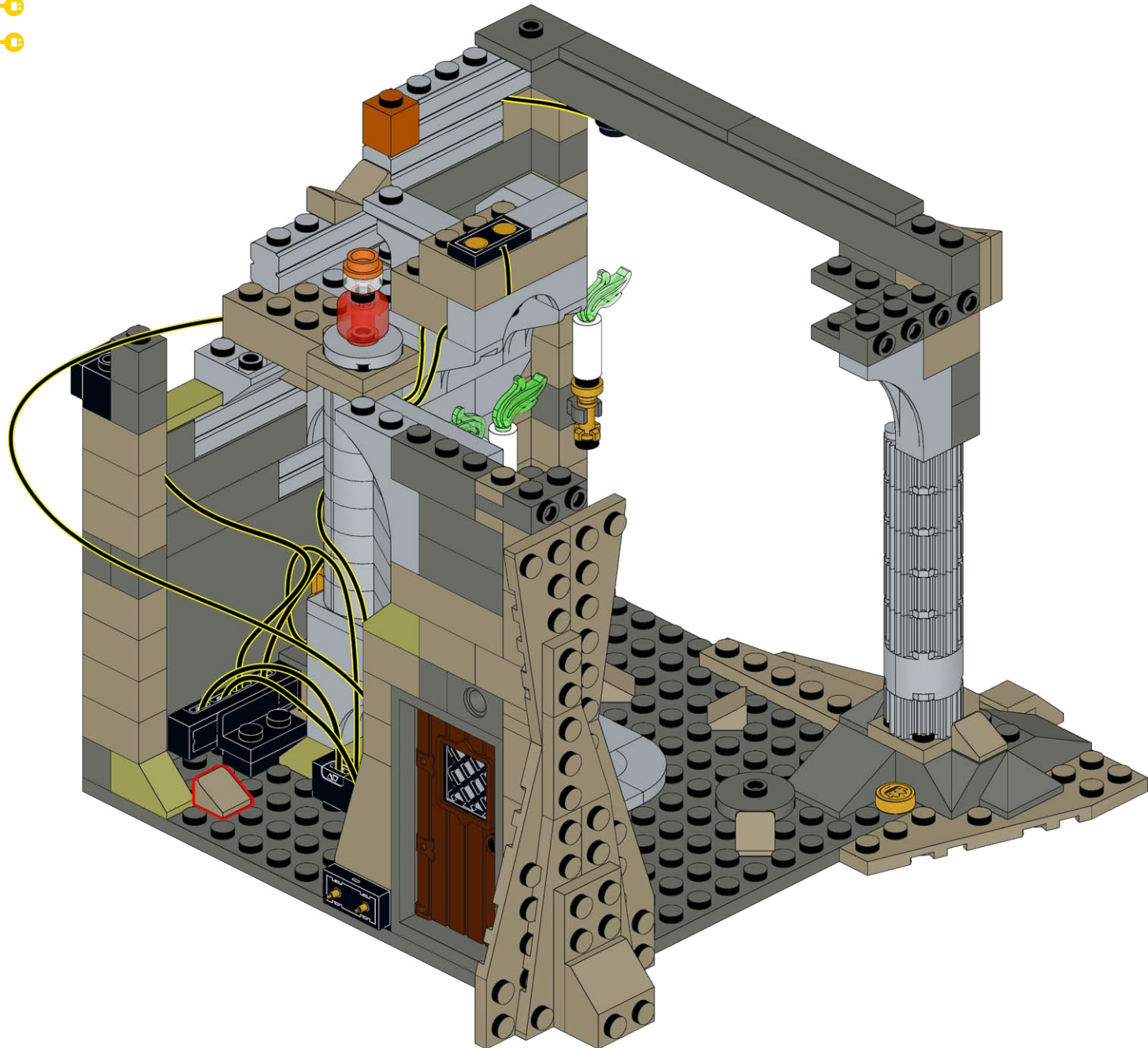

115

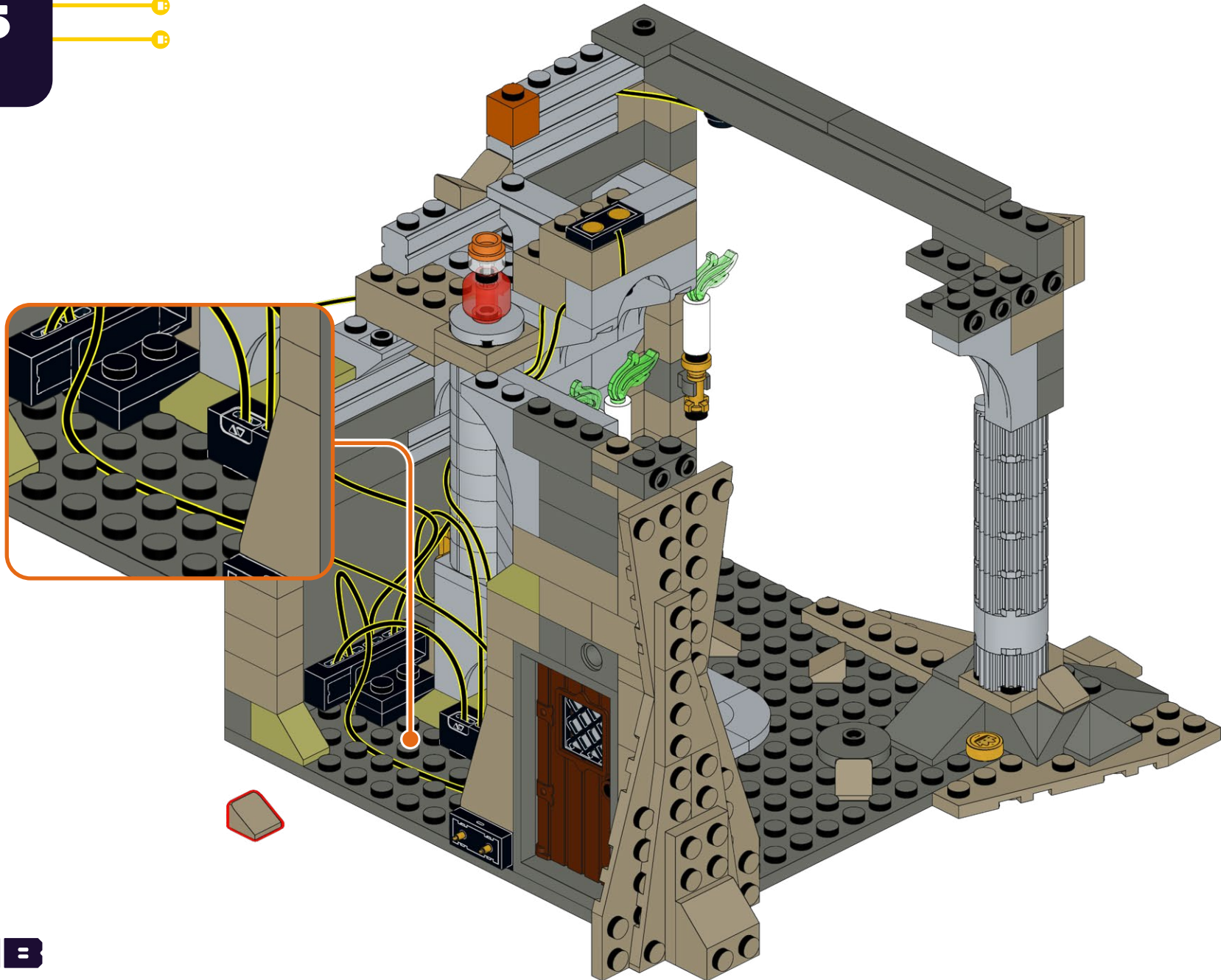

116

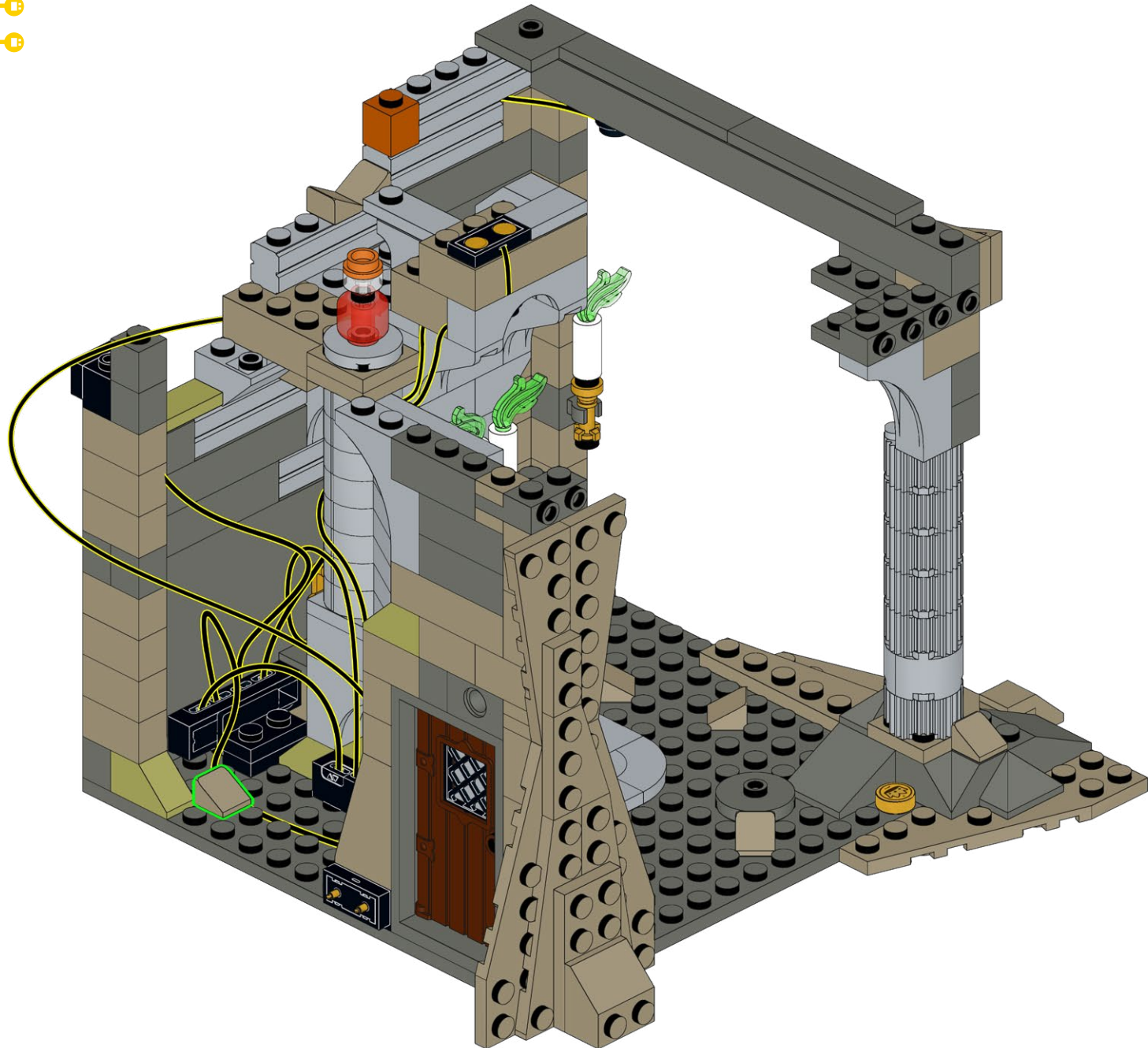



117

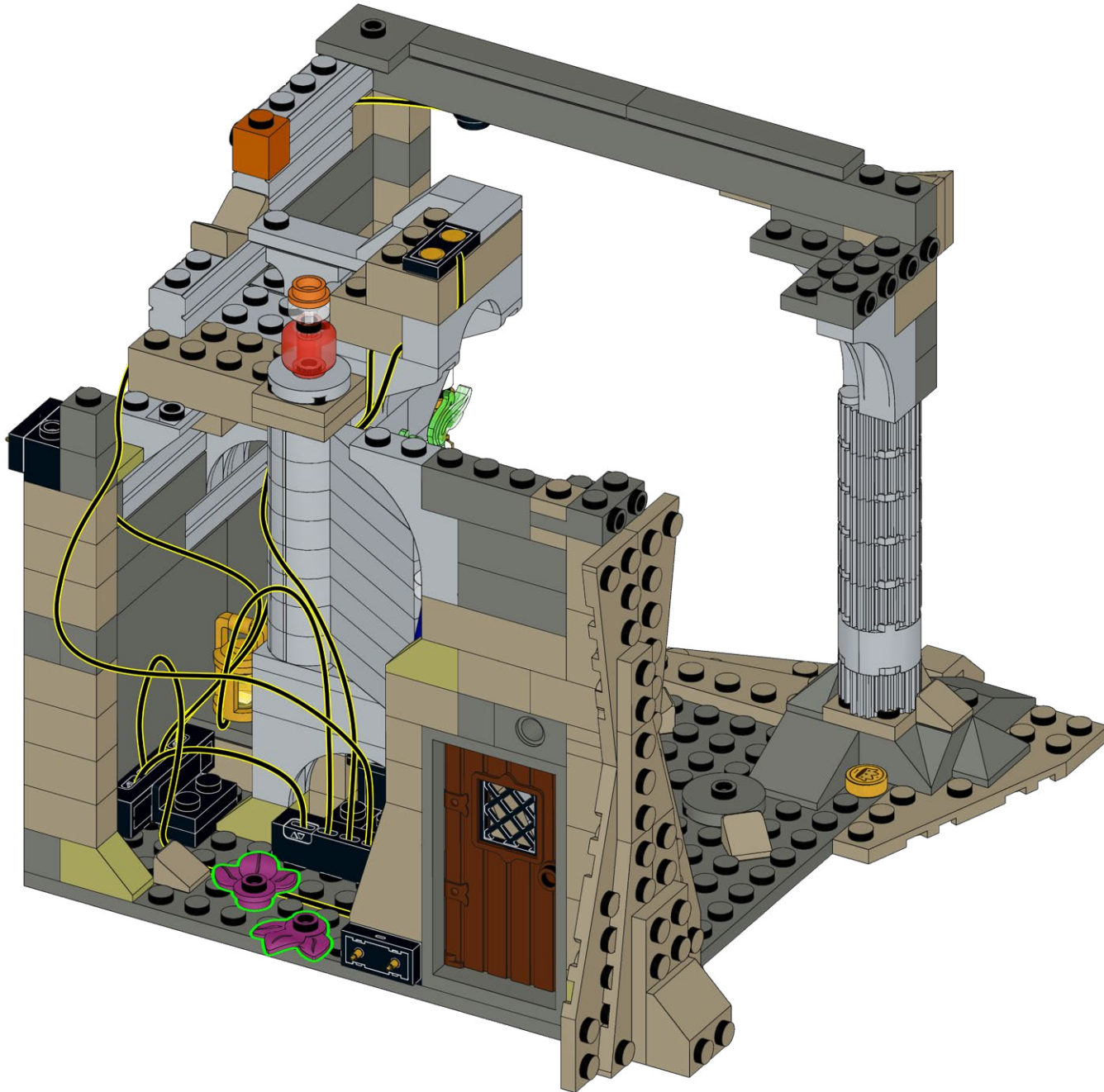



118

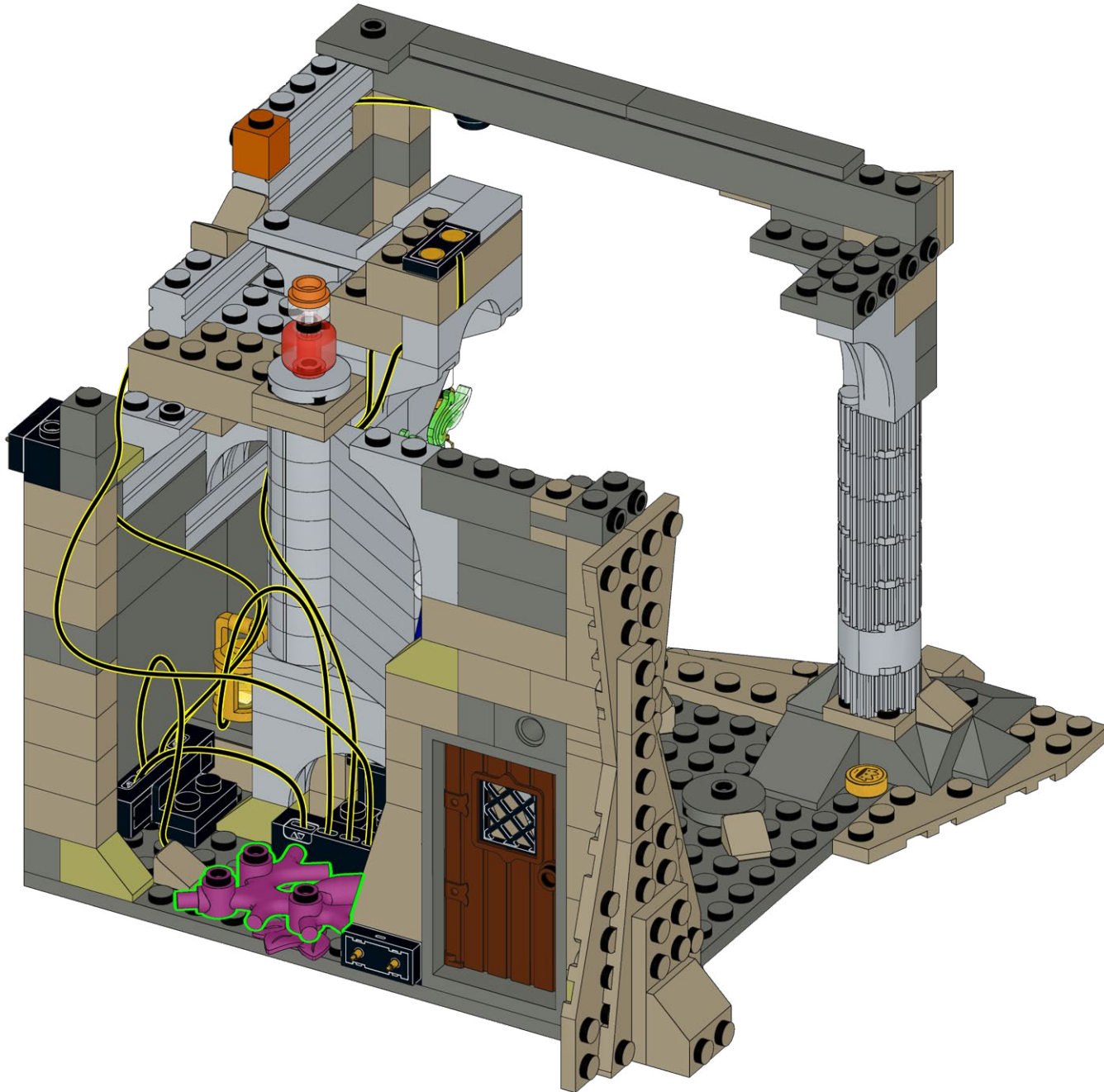

119

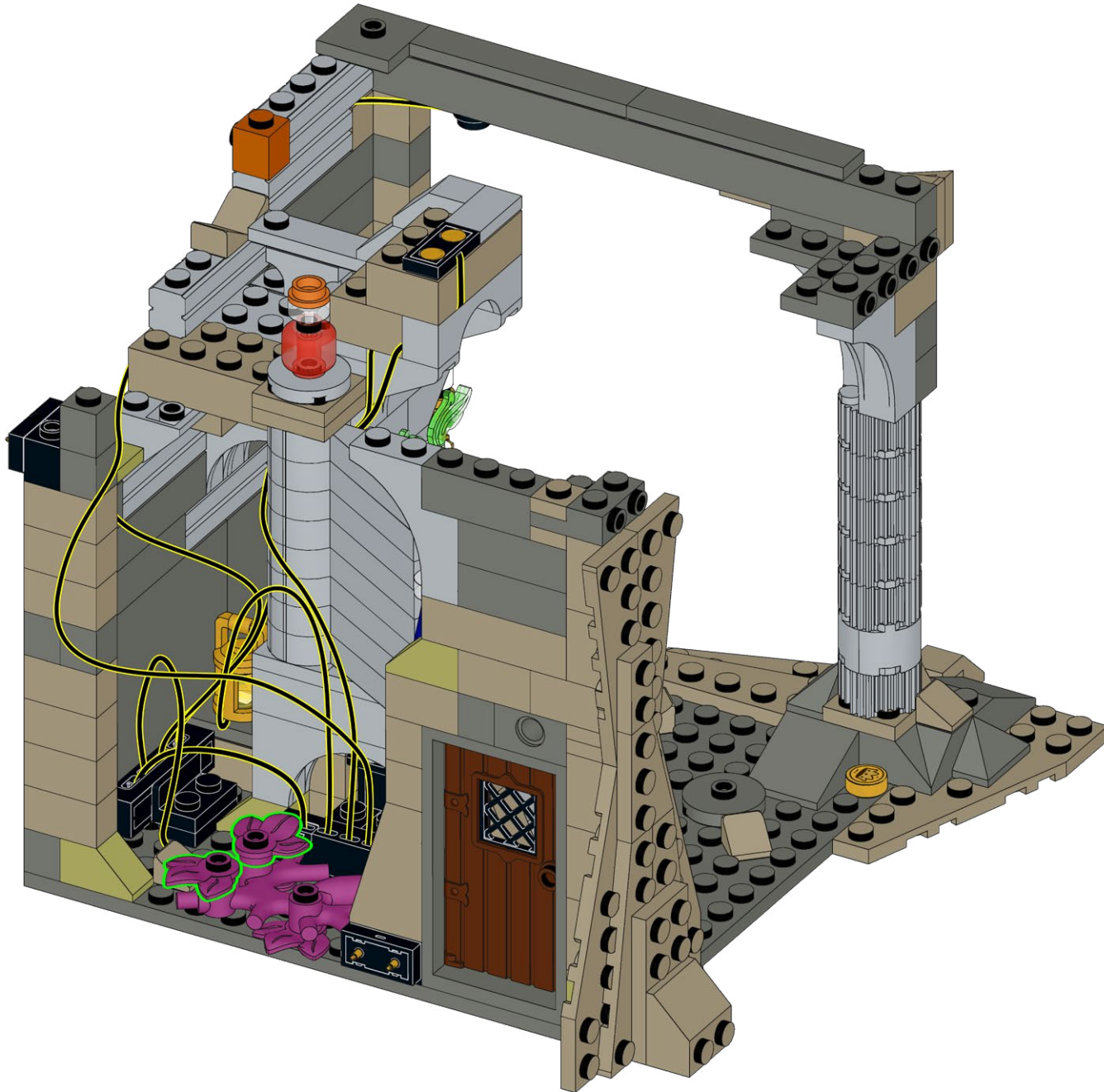

120

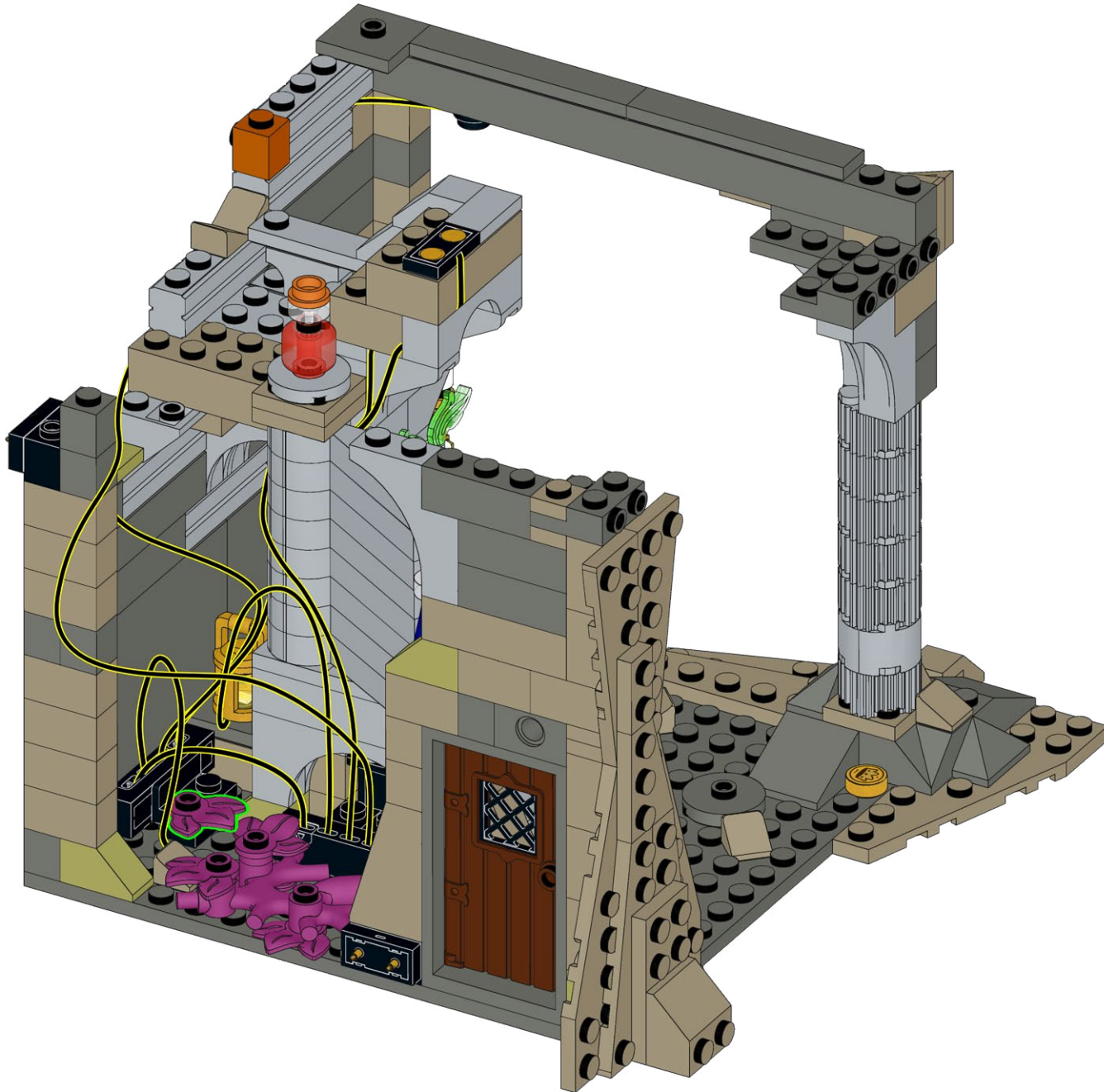



121

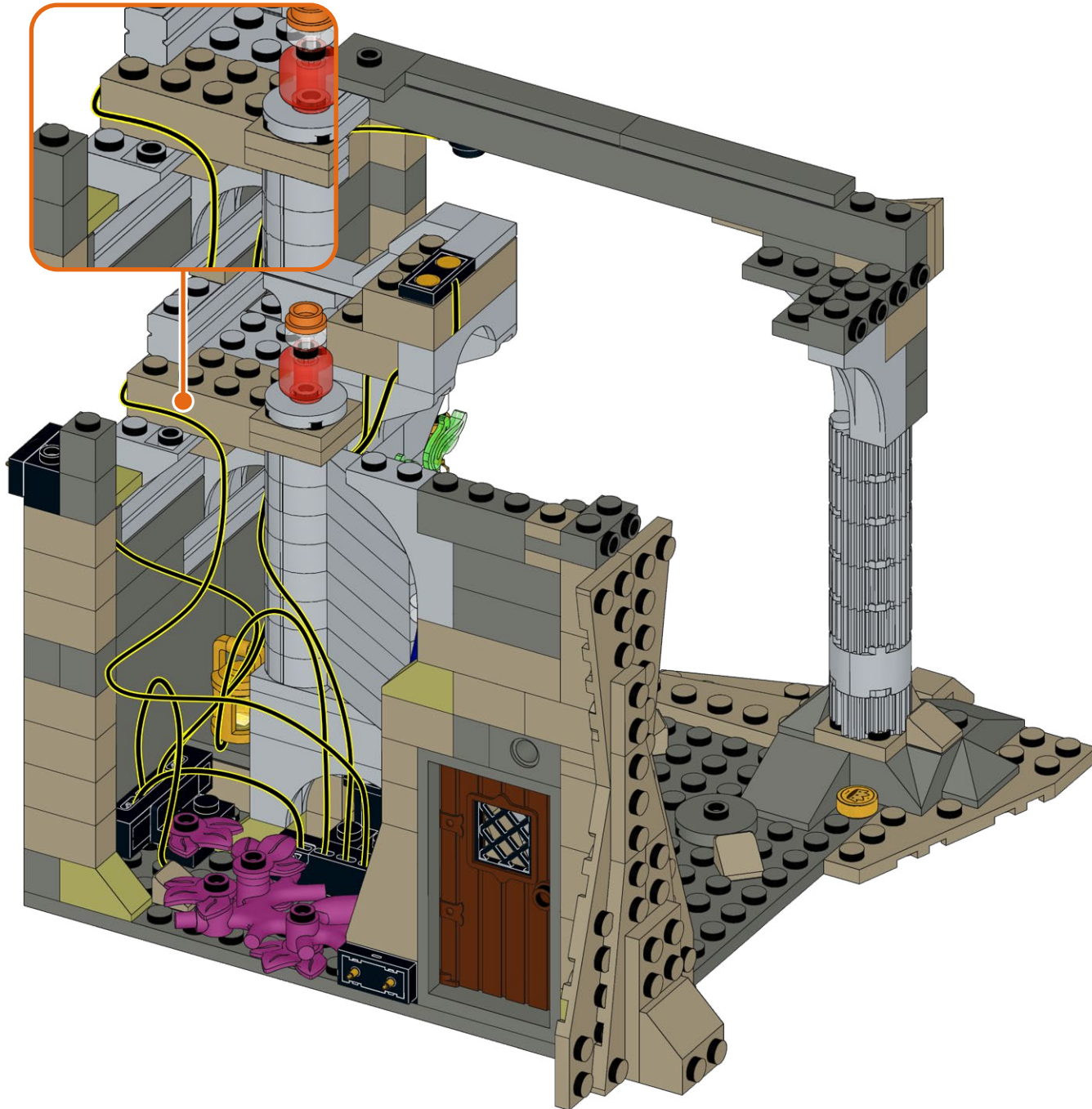



122

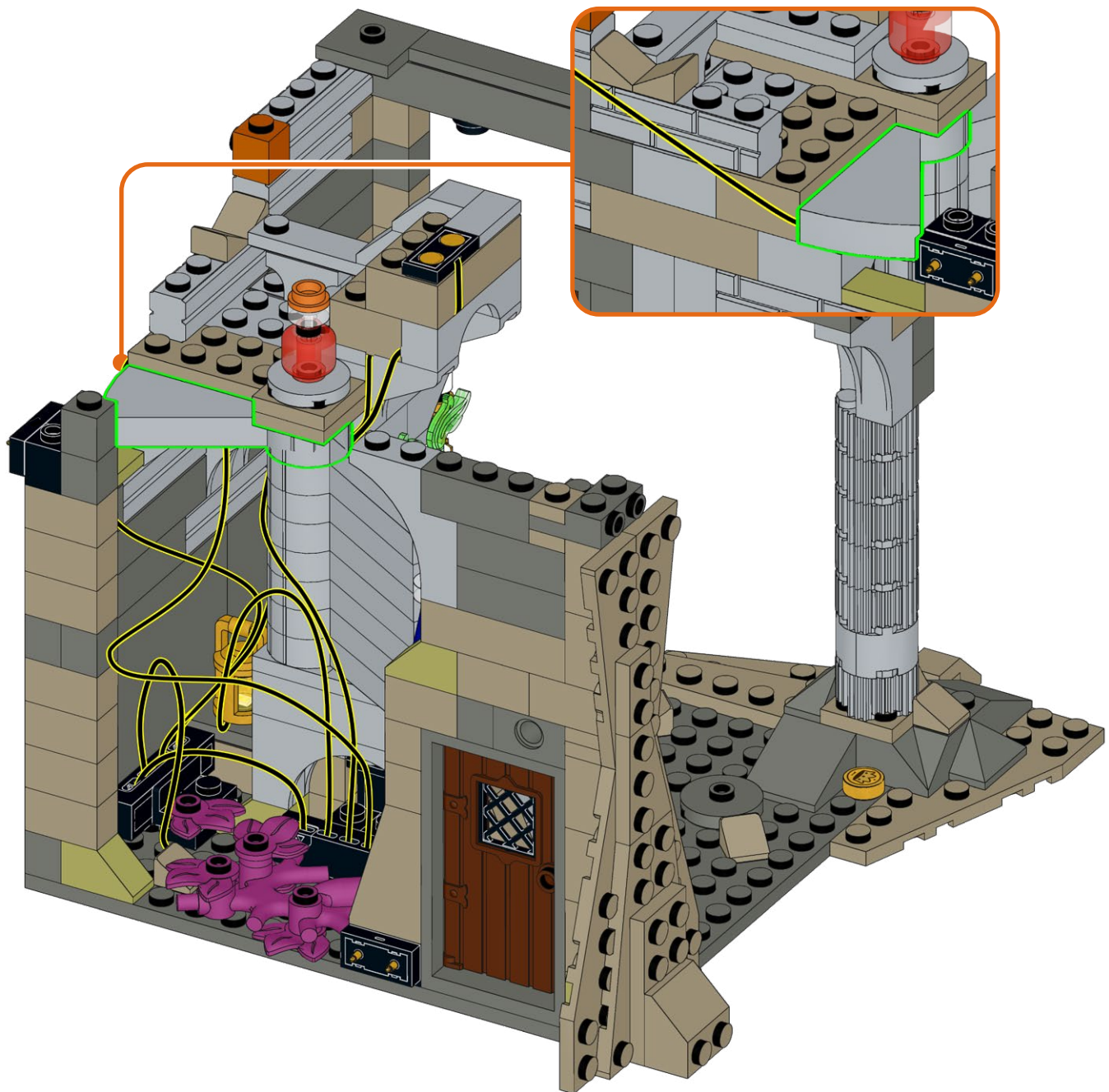

123

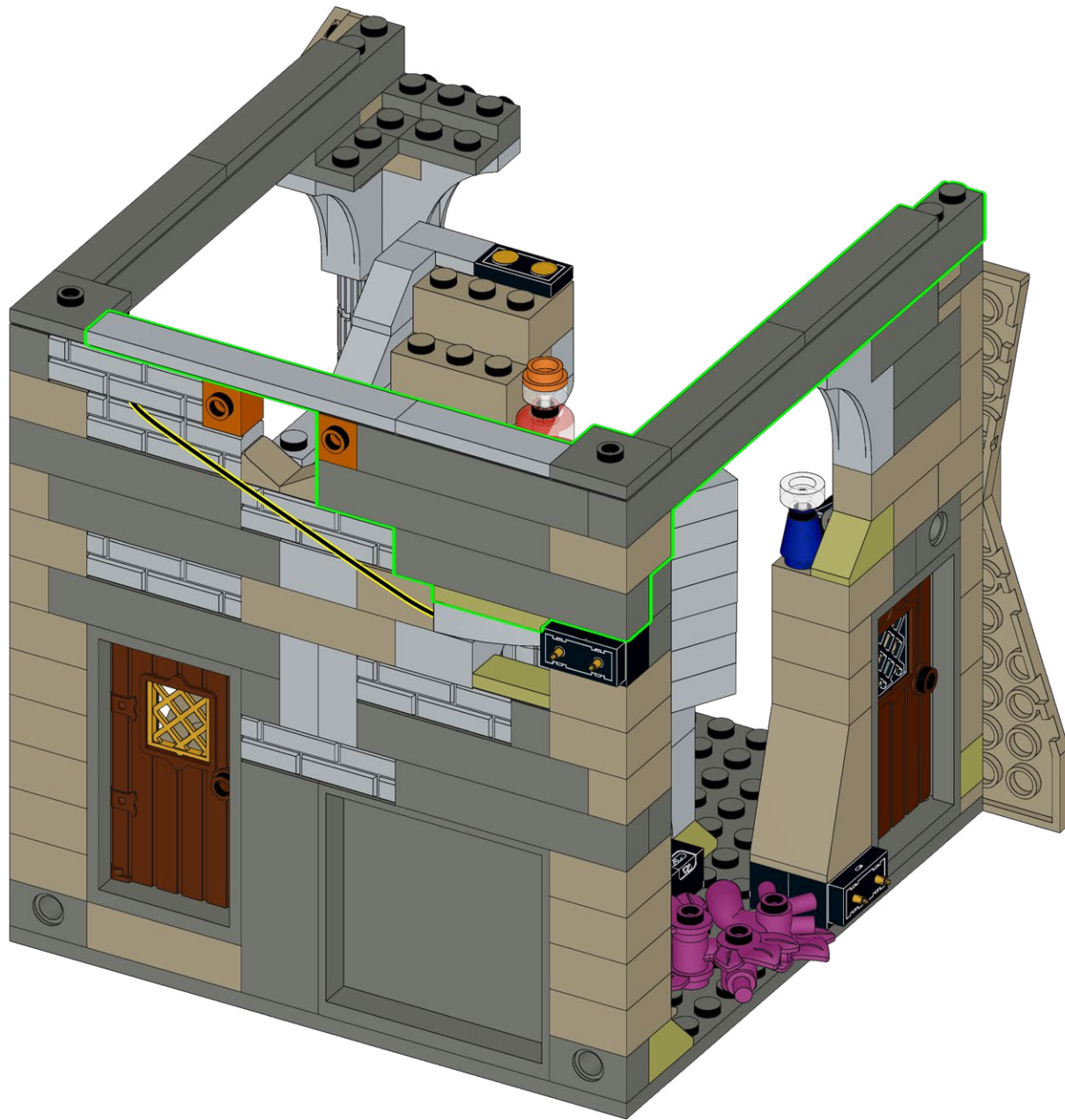

124

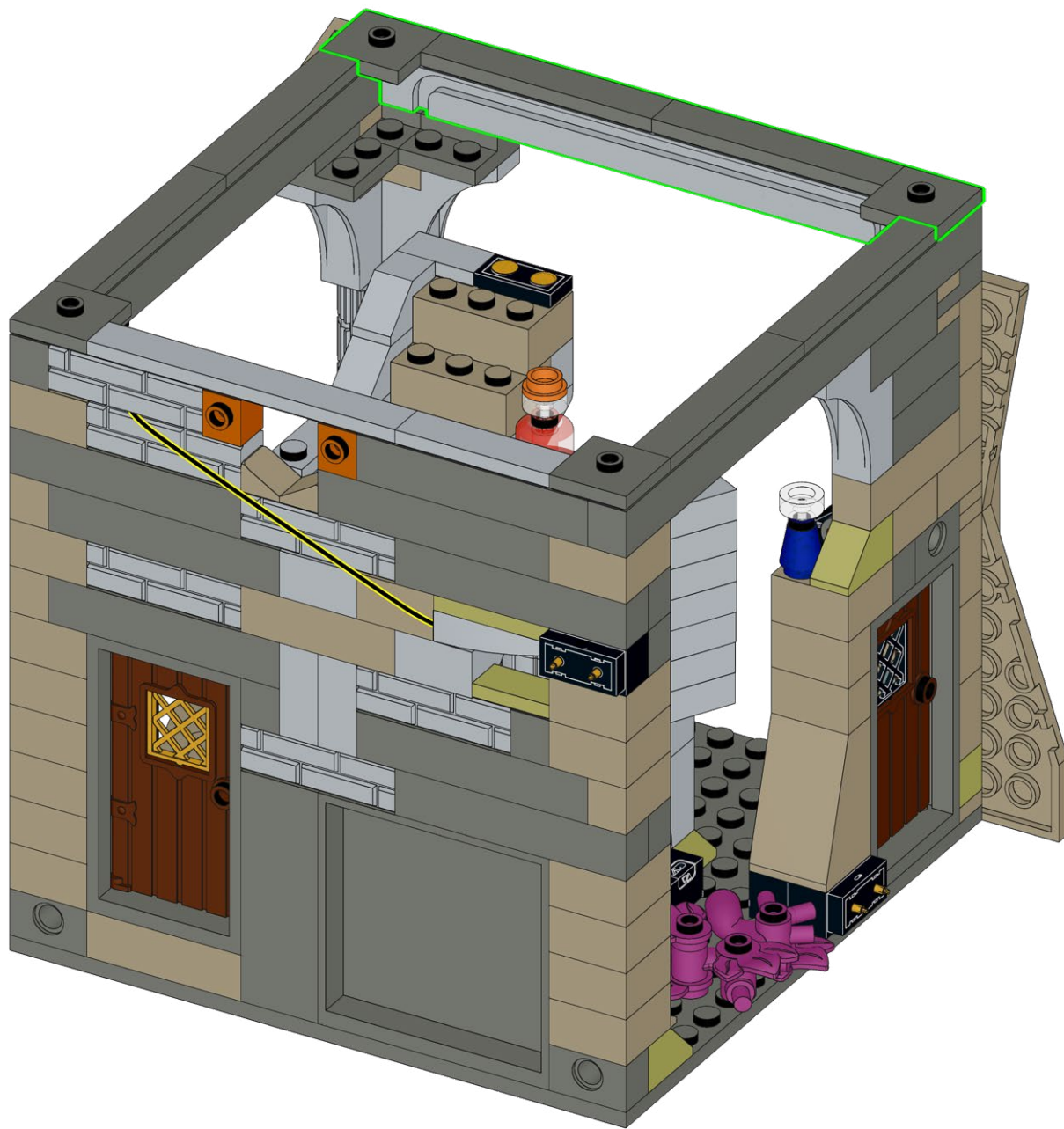



125

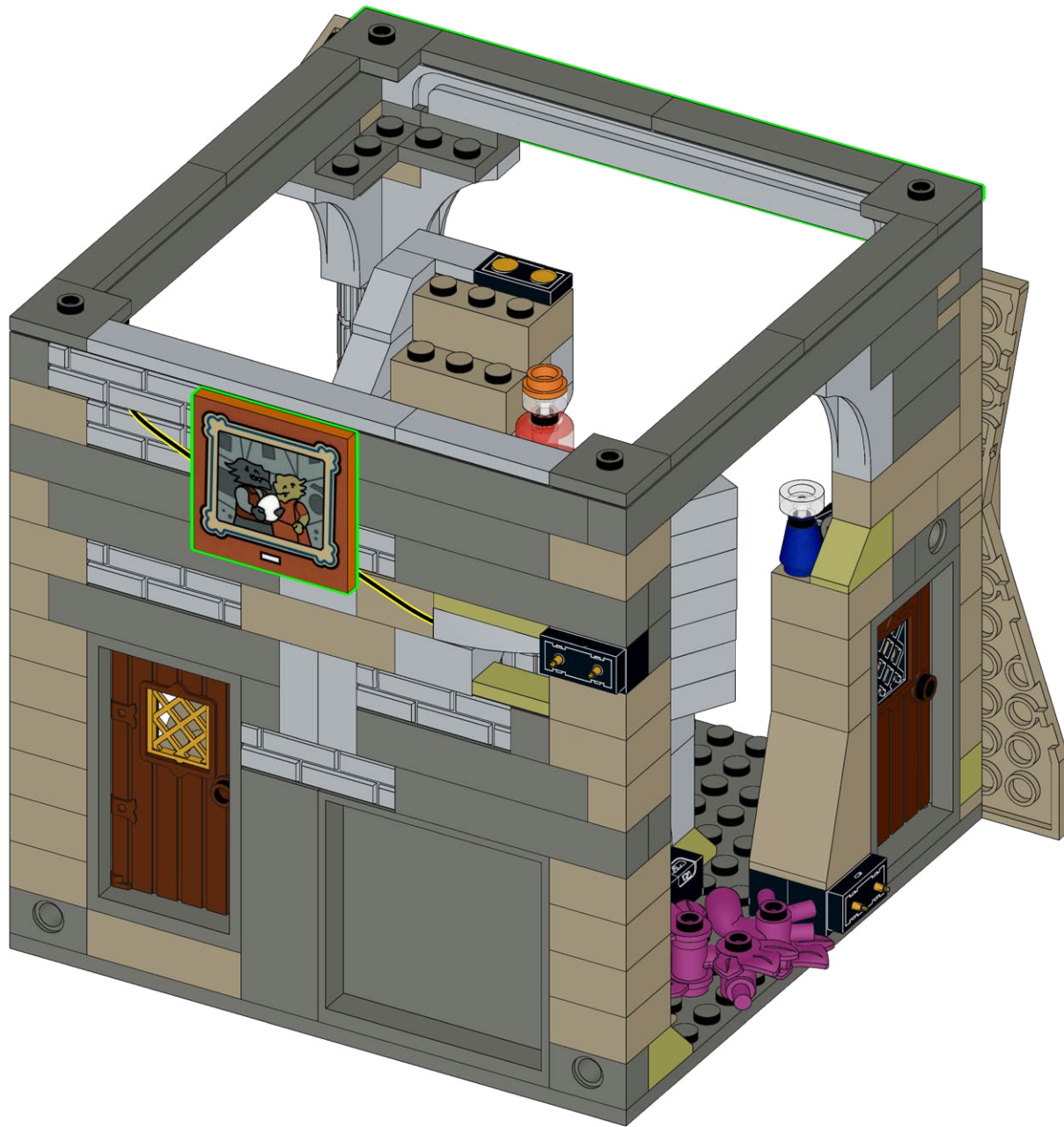



126

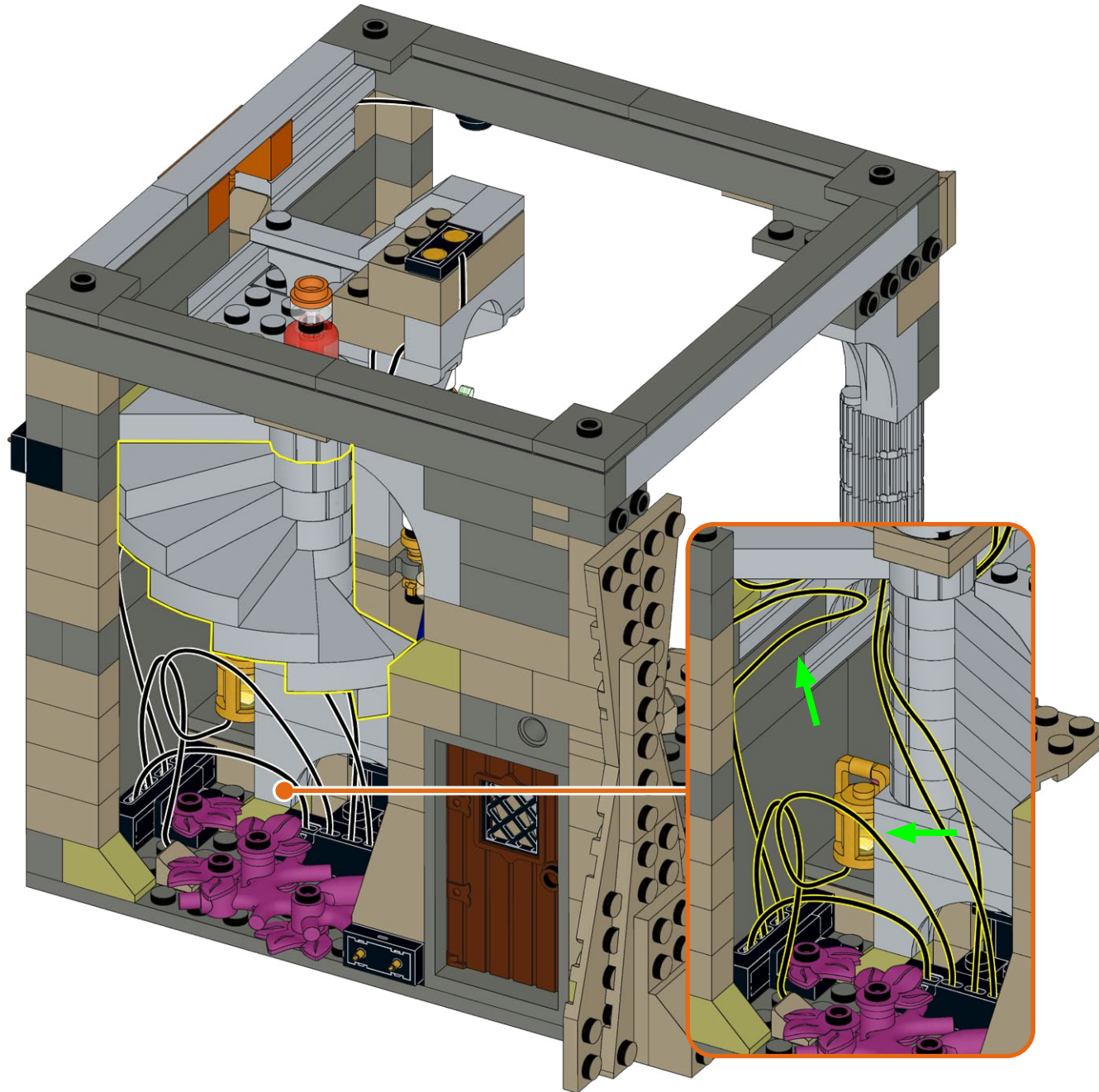

127



128





129





130



Power on Test  
Test de mise sous tension  
Test di Potenza  
Stromtest  
Prueba de Energía  
电源测试



131





132



133





134



135





136

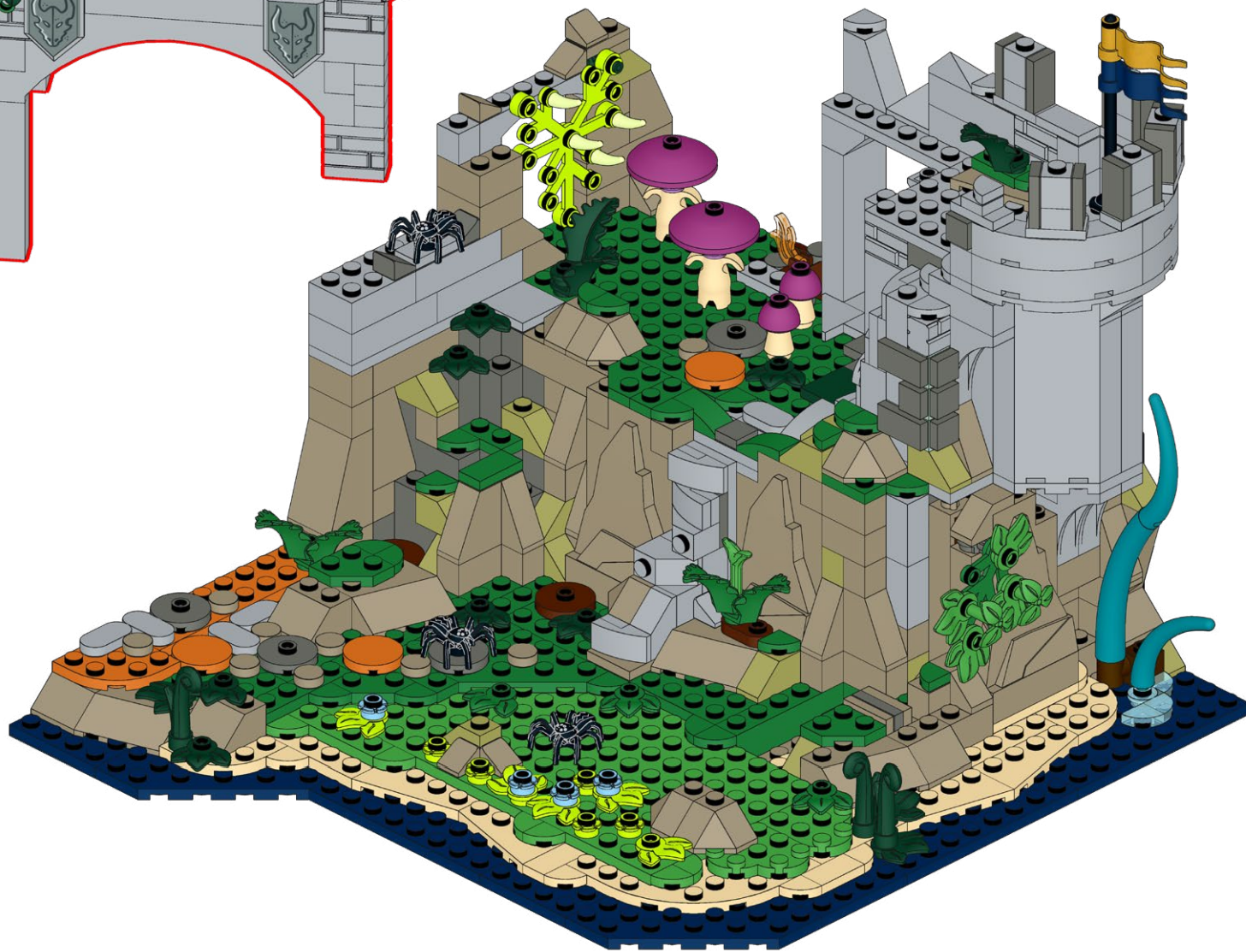
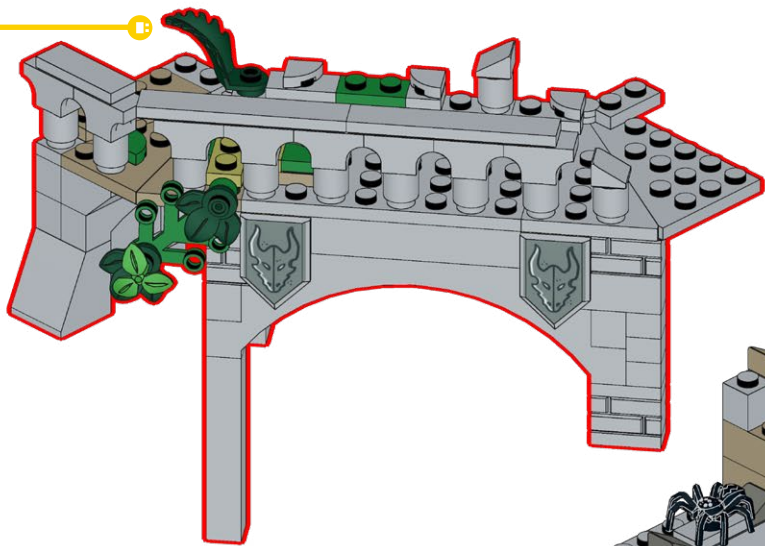

137





138



139





140



141





142

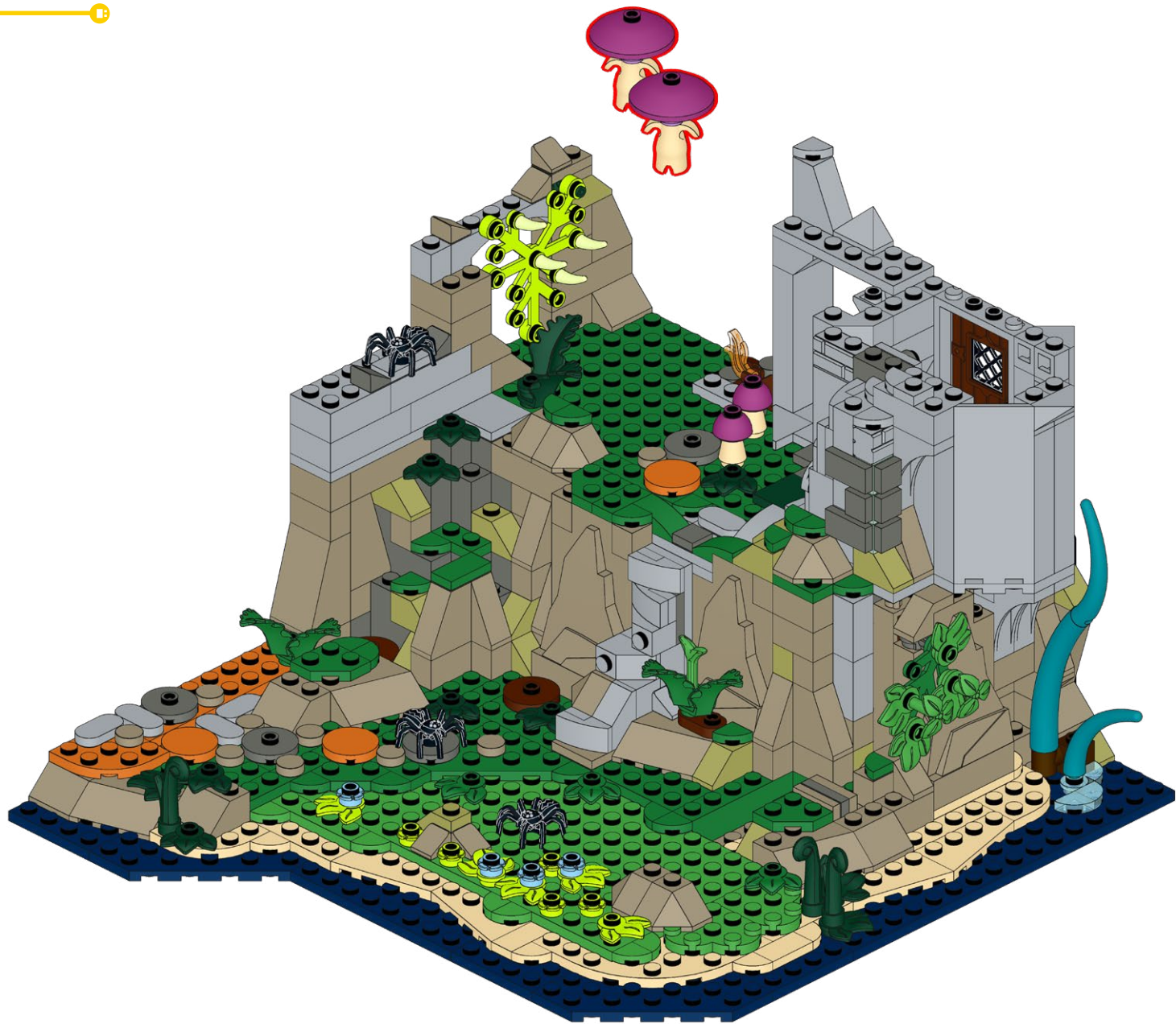

143





144



145





146



147





148

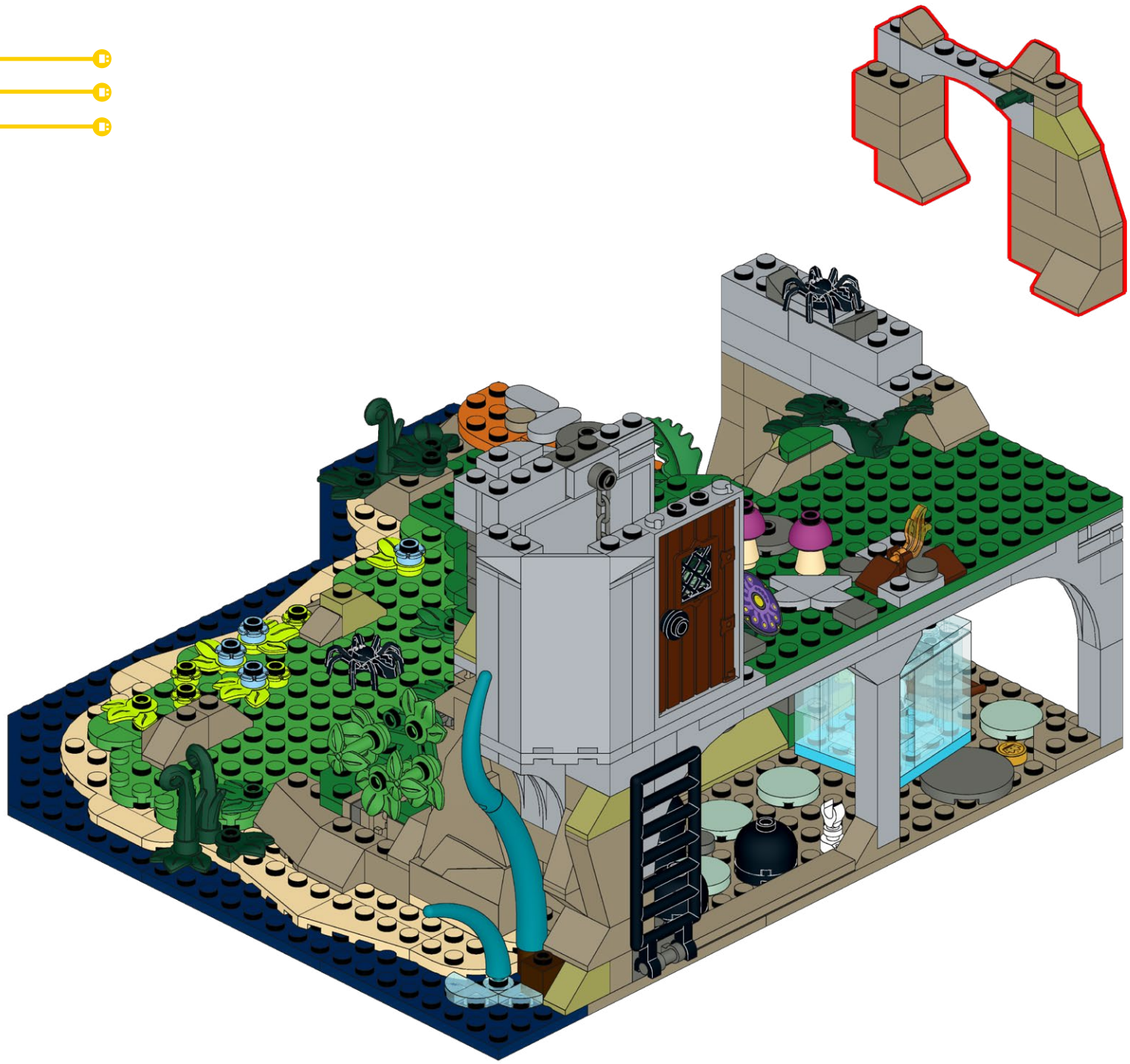

149





150



151





152



153

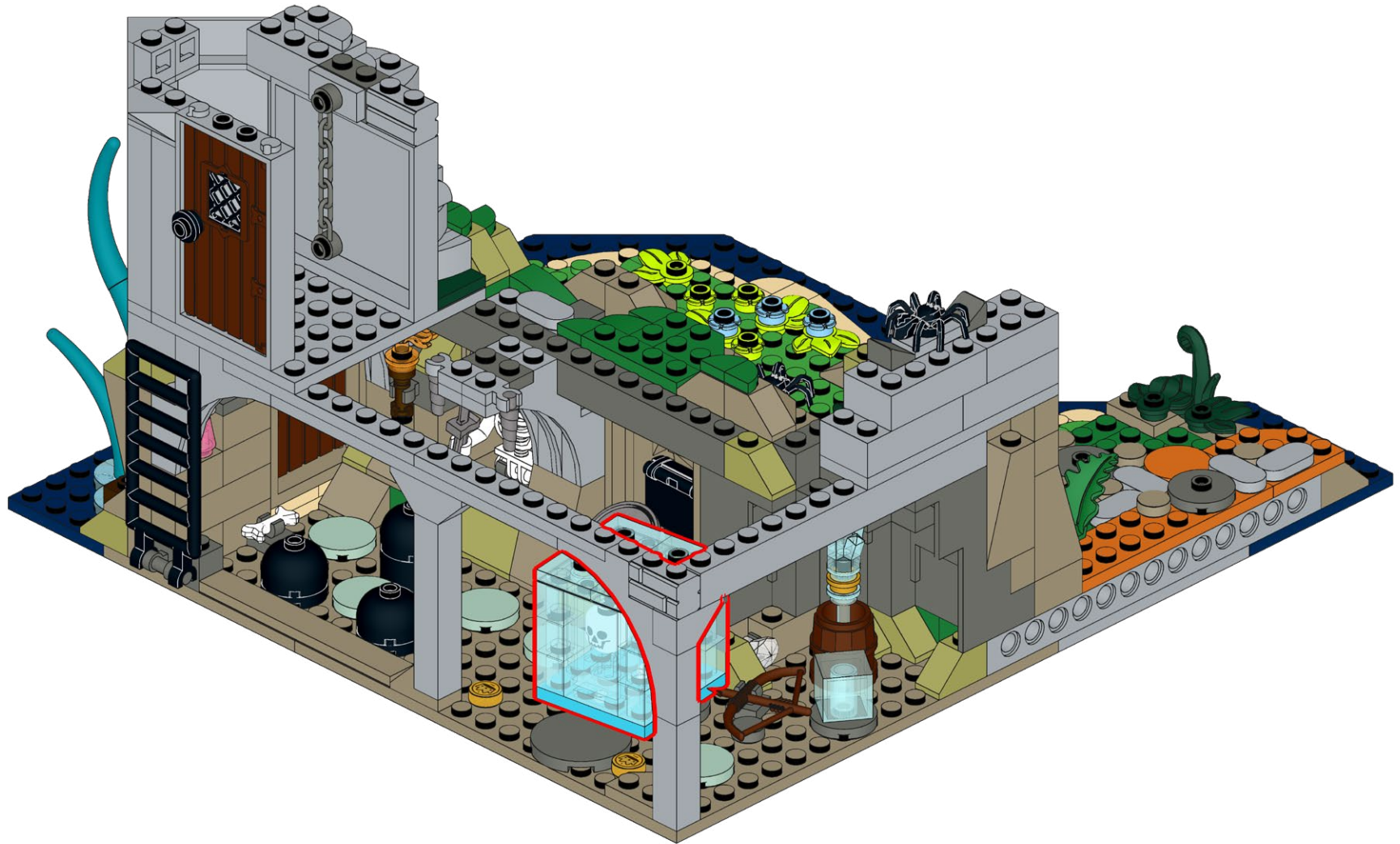



154



155

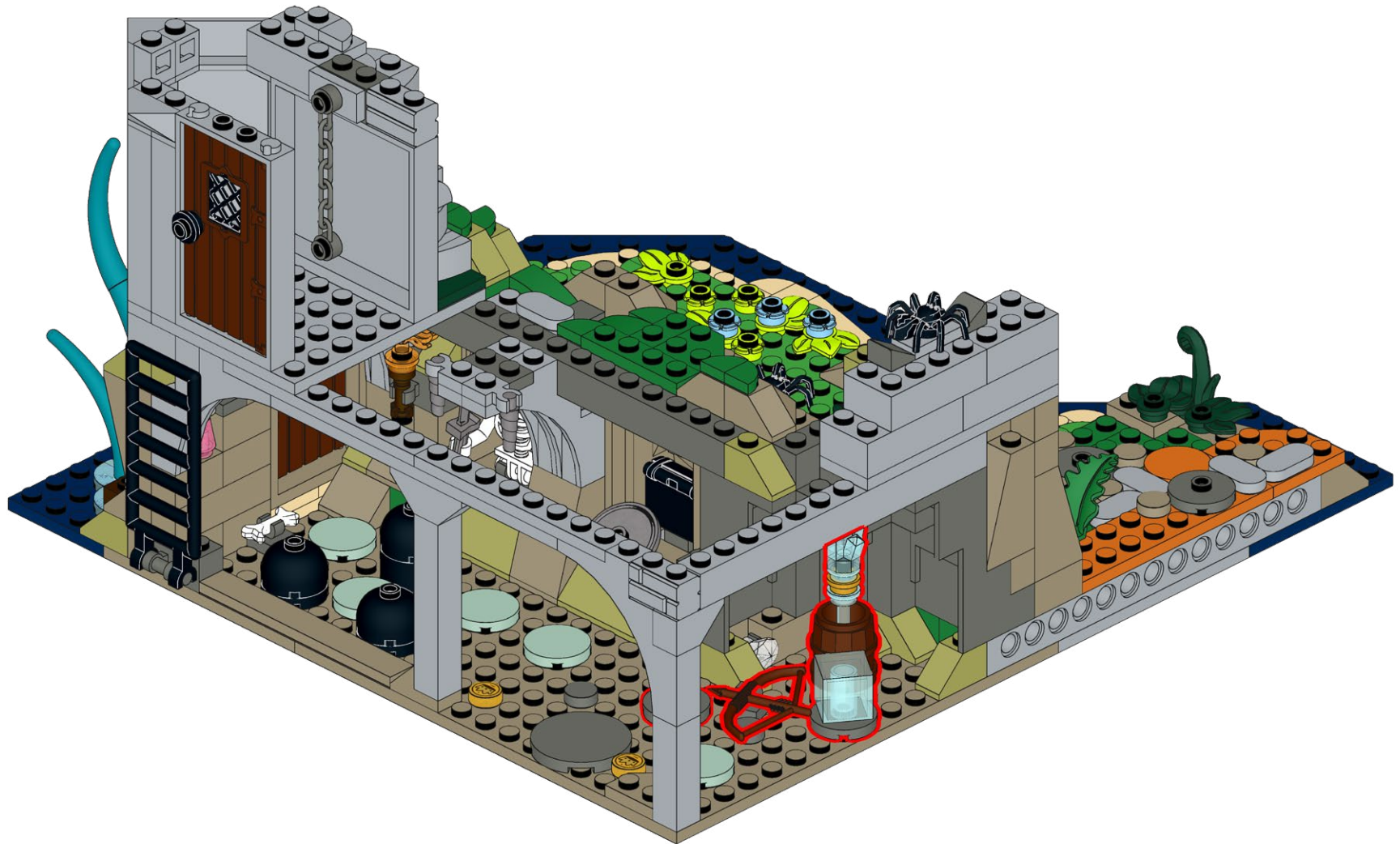



156

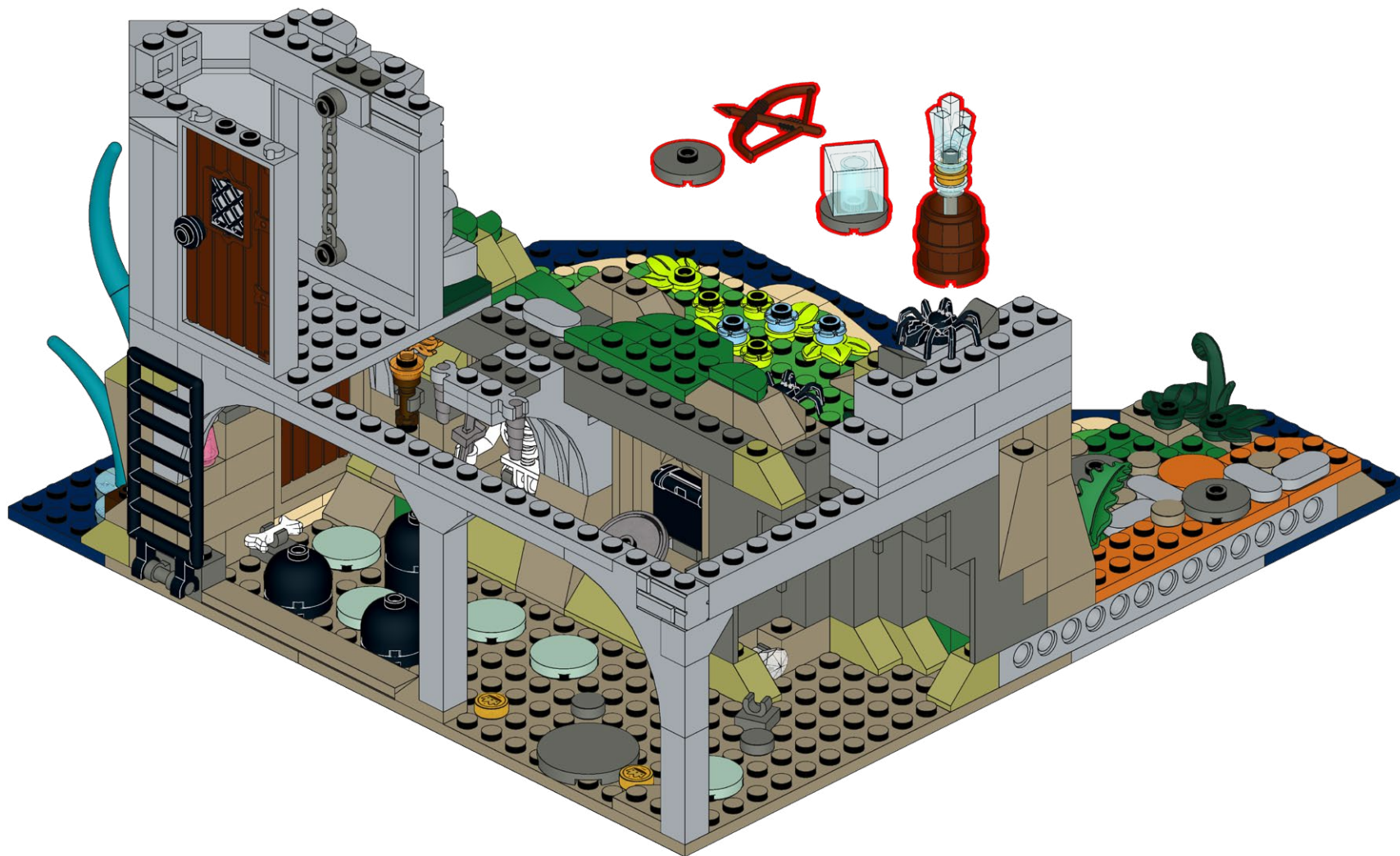



### **HOLD UP!**

You might notice some bags aren't in order, as well as left over pieces, but that's ok! We're changing the way you build LEGO!

### **ATTENDEZ!**

Vous remarquerez peut-être que certains sacs, ainsi que certaines pièces, ne sont pas dans le bon ordre. Mais pas de panique! Nous changeons simplement la façon avec laquelle vous construisez vos LEGO!

### **ASPETTA!**

Potresti notare che alcuni sacchetti non sono in ordine, così come i pezzi avanzati, ma va bene così! Stiamo cambiando il modo in cui costruisci i LEGO!

### **HALT!**

Sie werden möglicherweise bemerken, dass einige tüten durcheinander sind und teile übrig bleiben, aber das ist in Ordnung! Wir ändern die art und weise, wie Sie LEGO bauen!

### **¡ESPERA!**

Es posible que notes que algunas bolsas están fuera de servicio, así como piezas sobrantes, ¡pero está bien! ¡Estamos cambiando la forma en que construyes LEGO!

### **暫停!**

你可能会注意到一些袋子顺序错乱, 以及一些剩余的部件, 但没关系! 我们正在改变你搭建乐高的方式!

#### Open LMB Bag 02

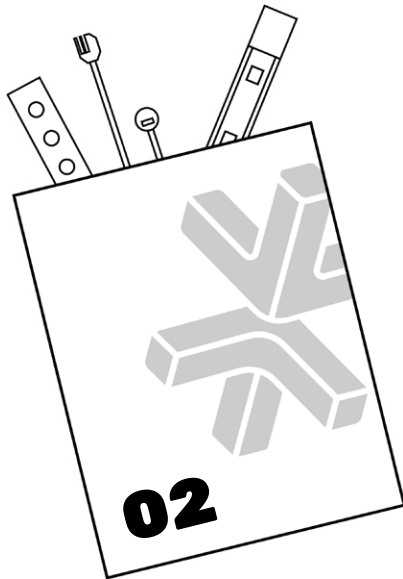



157

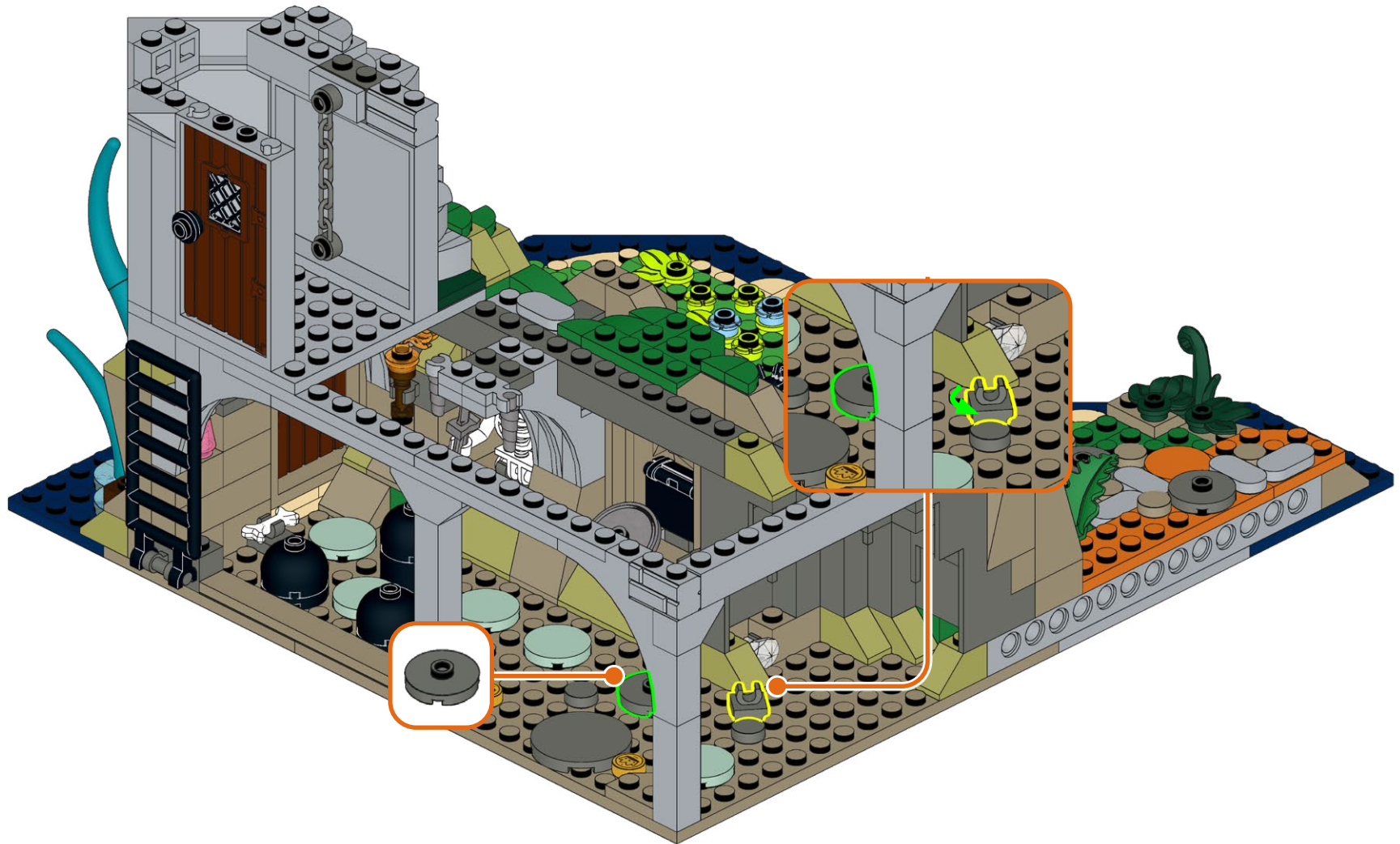

158

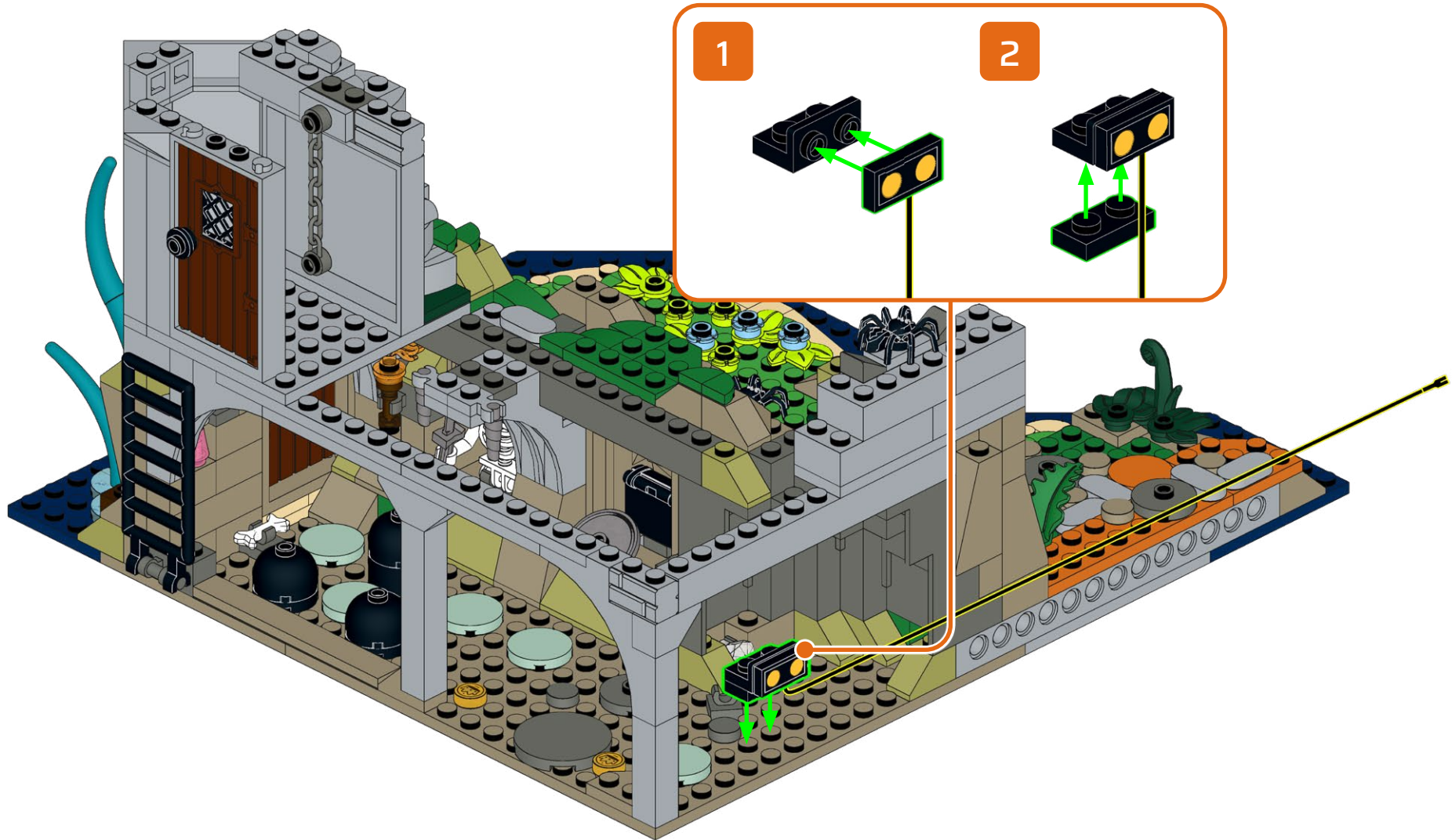
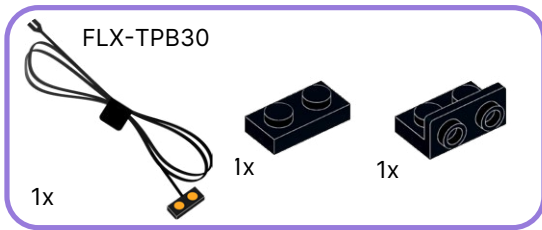



159

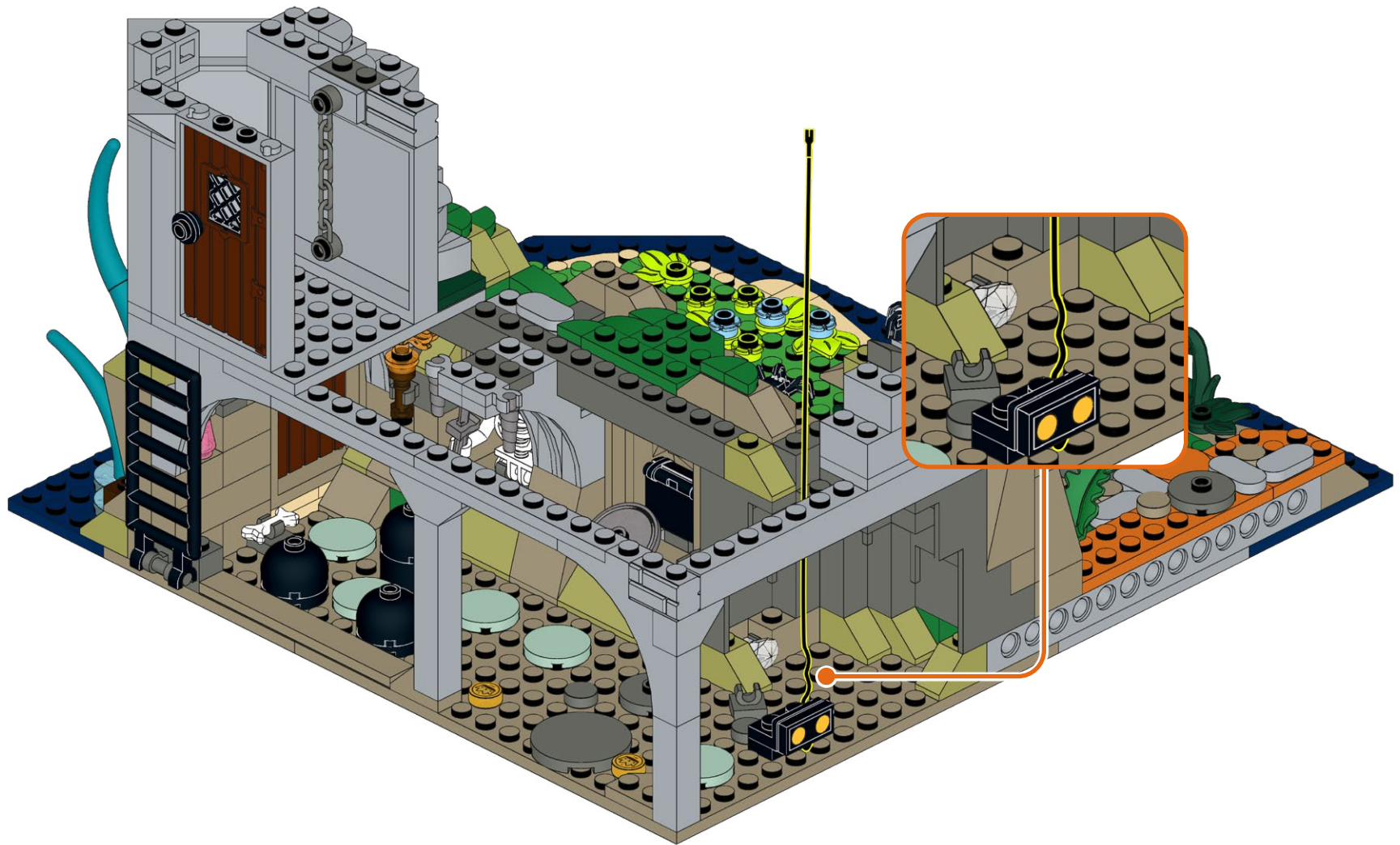

160

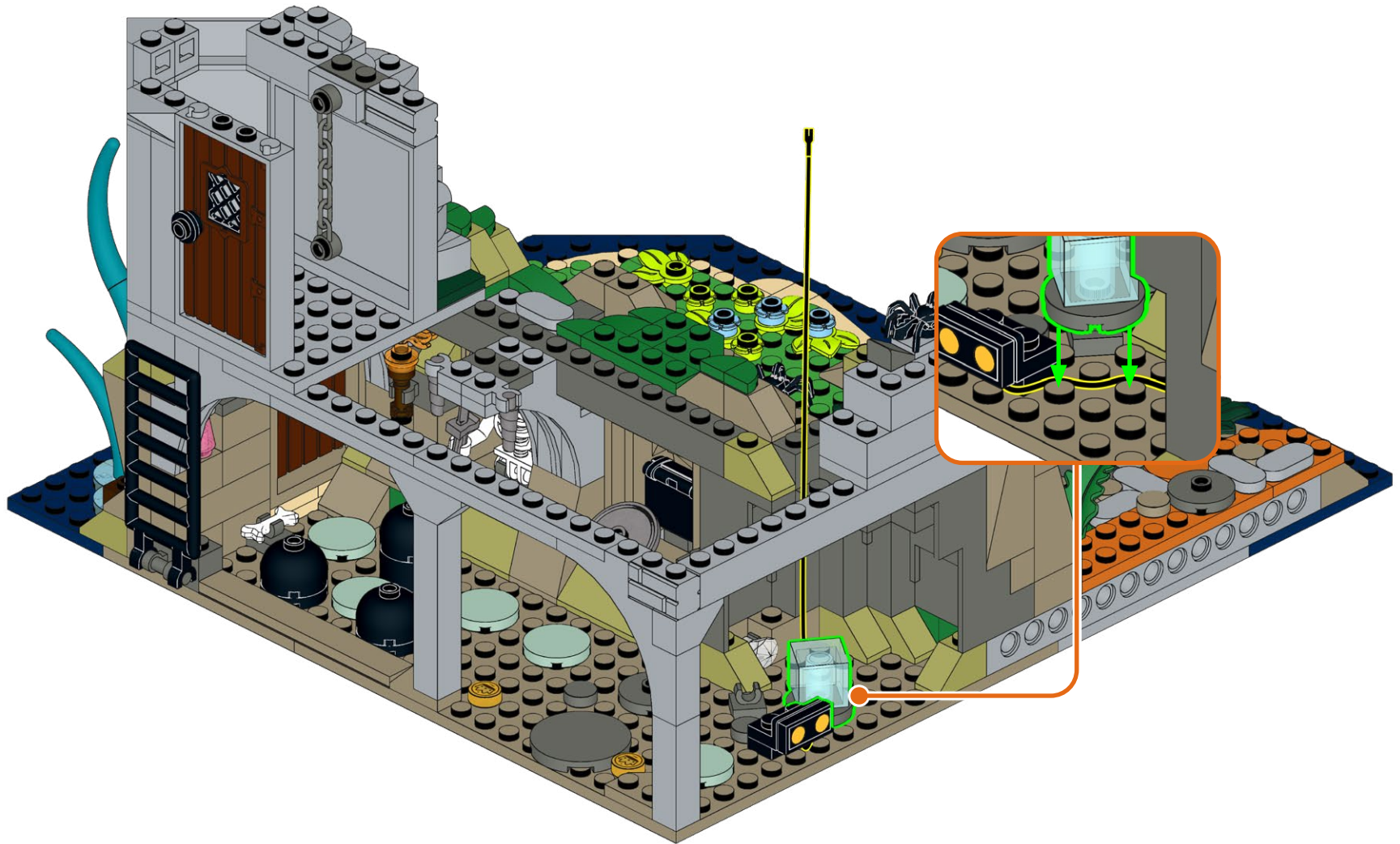



161



162



163

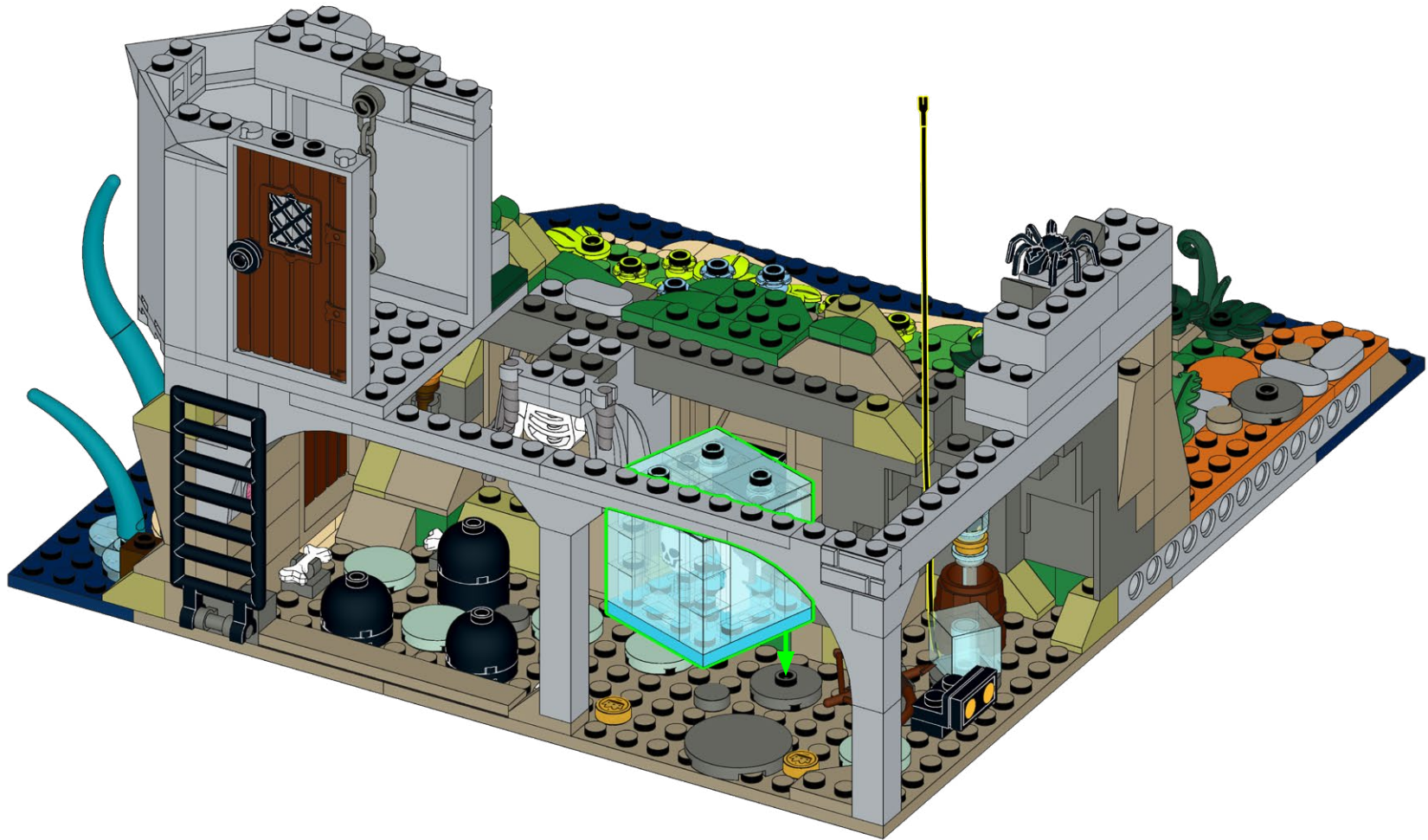



**164**

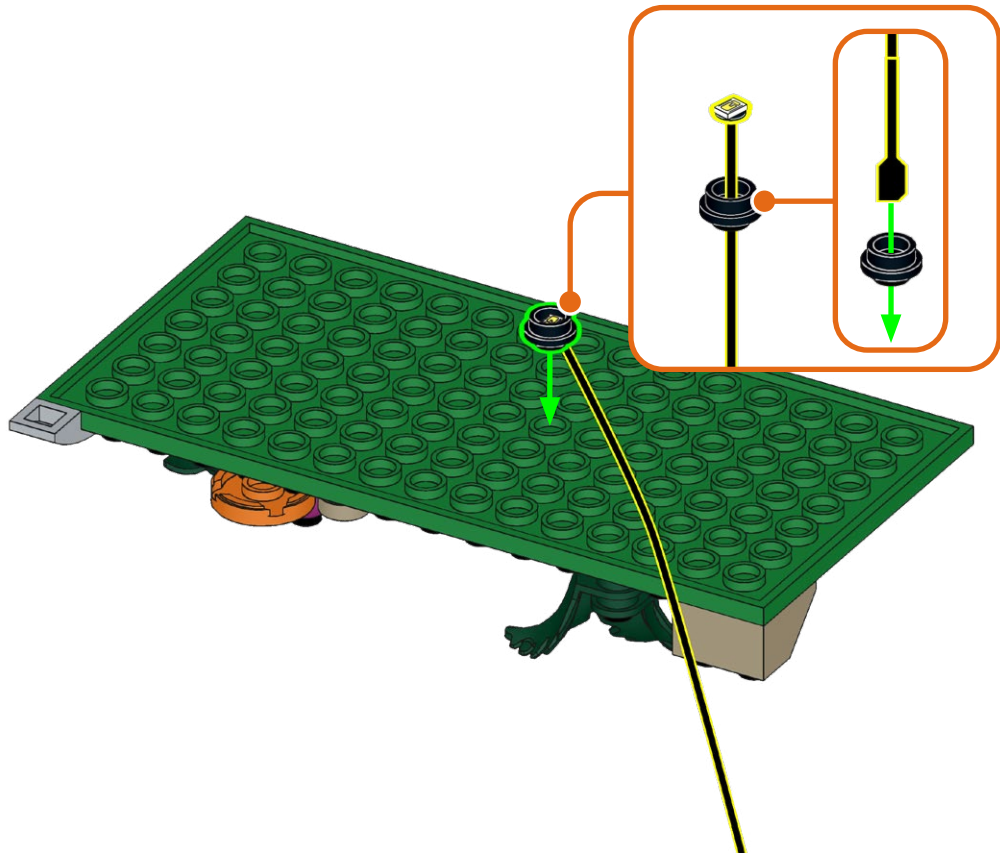
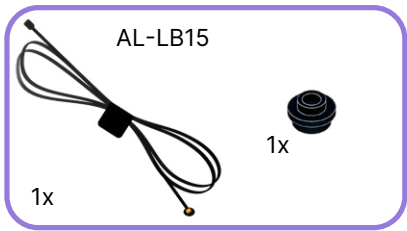

**165**

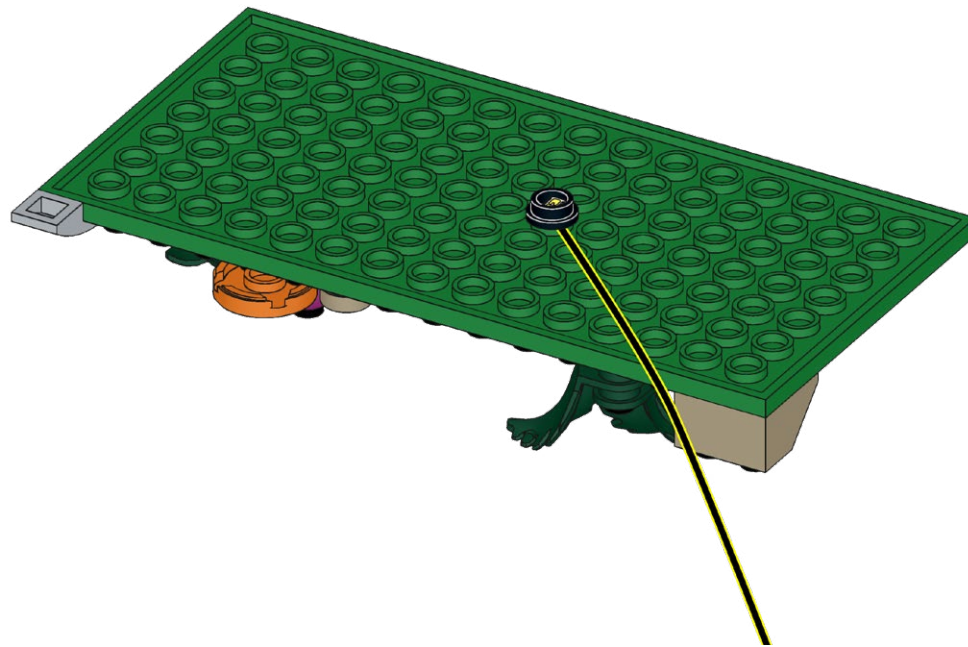



166

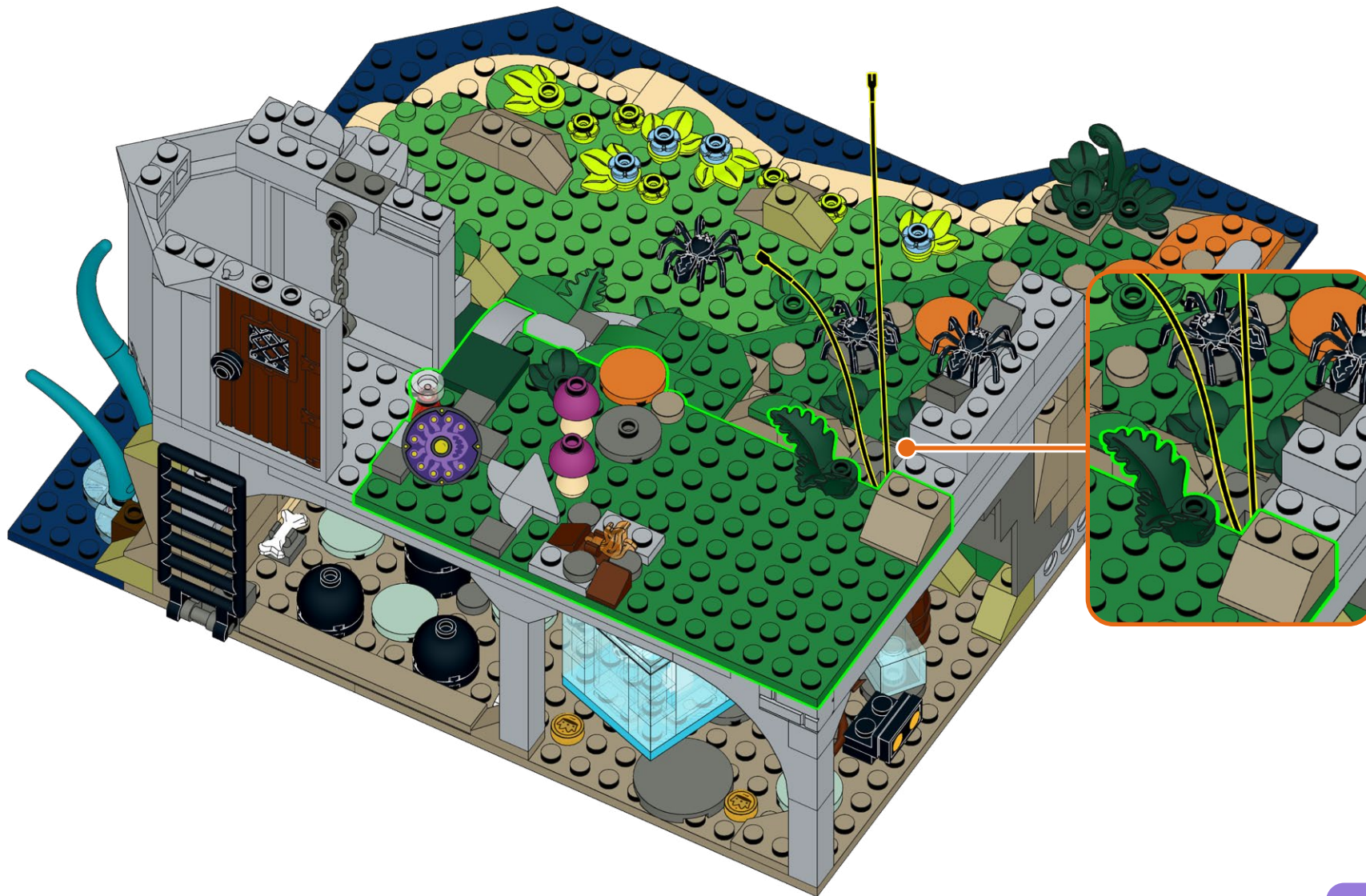

167





168



169

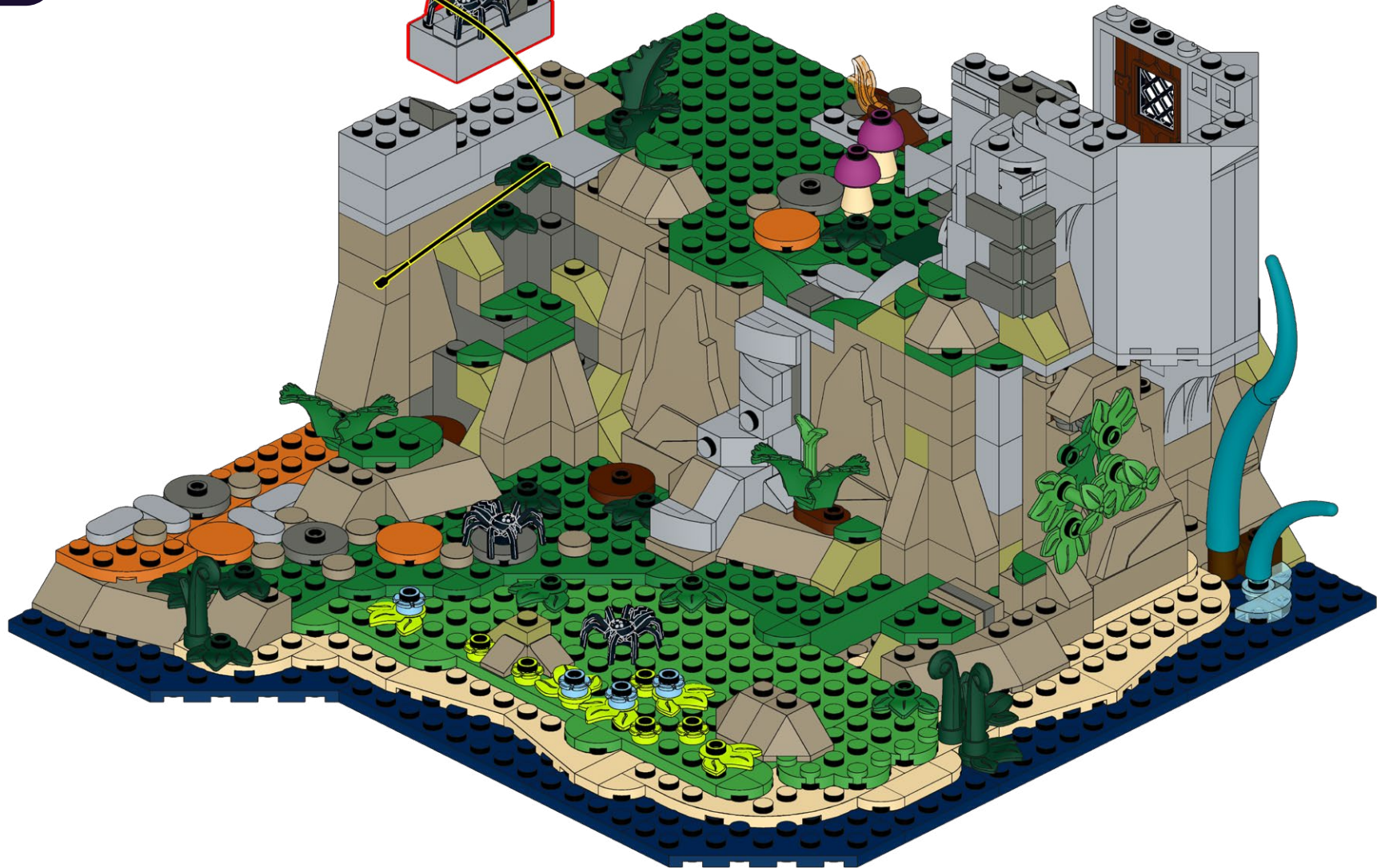



170

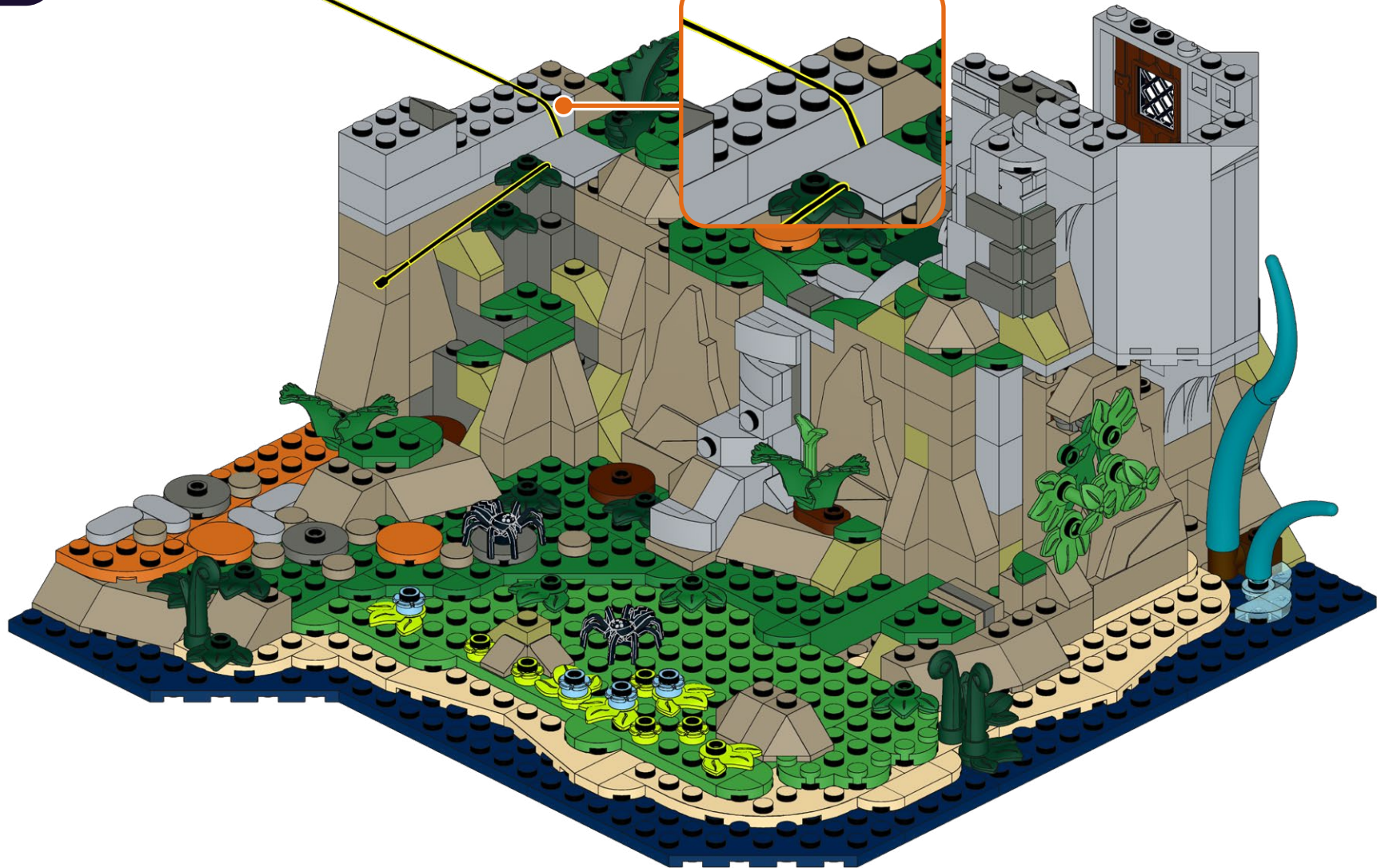

# 171

1



2

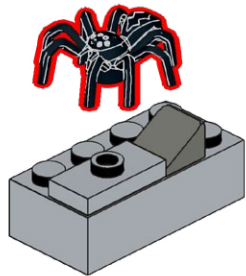

# 172

1

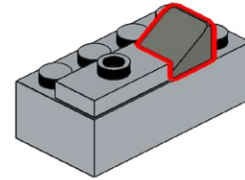

2

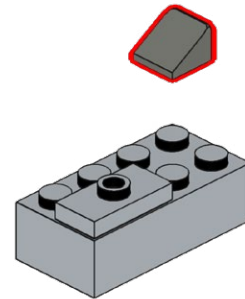

173

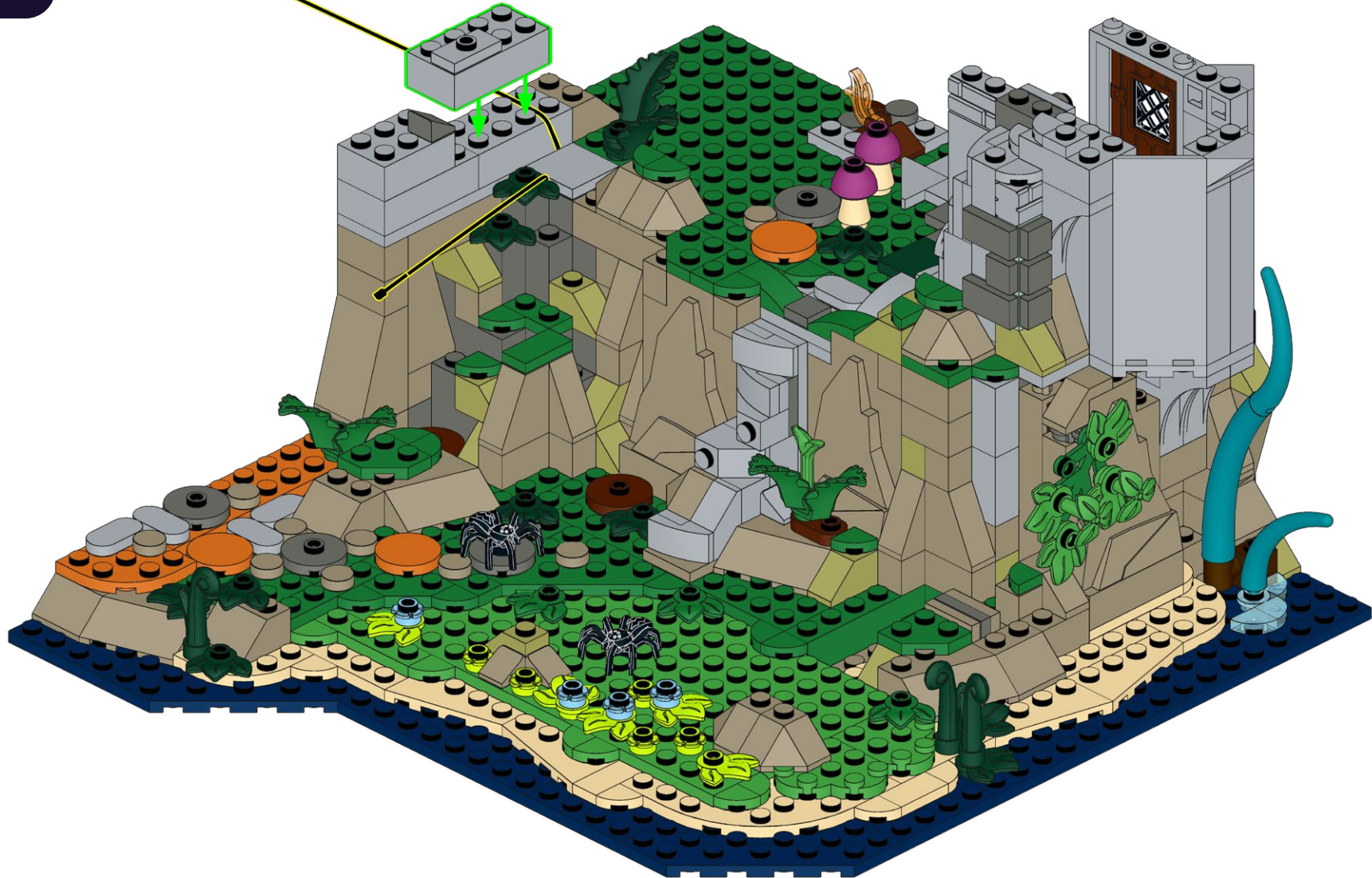



174

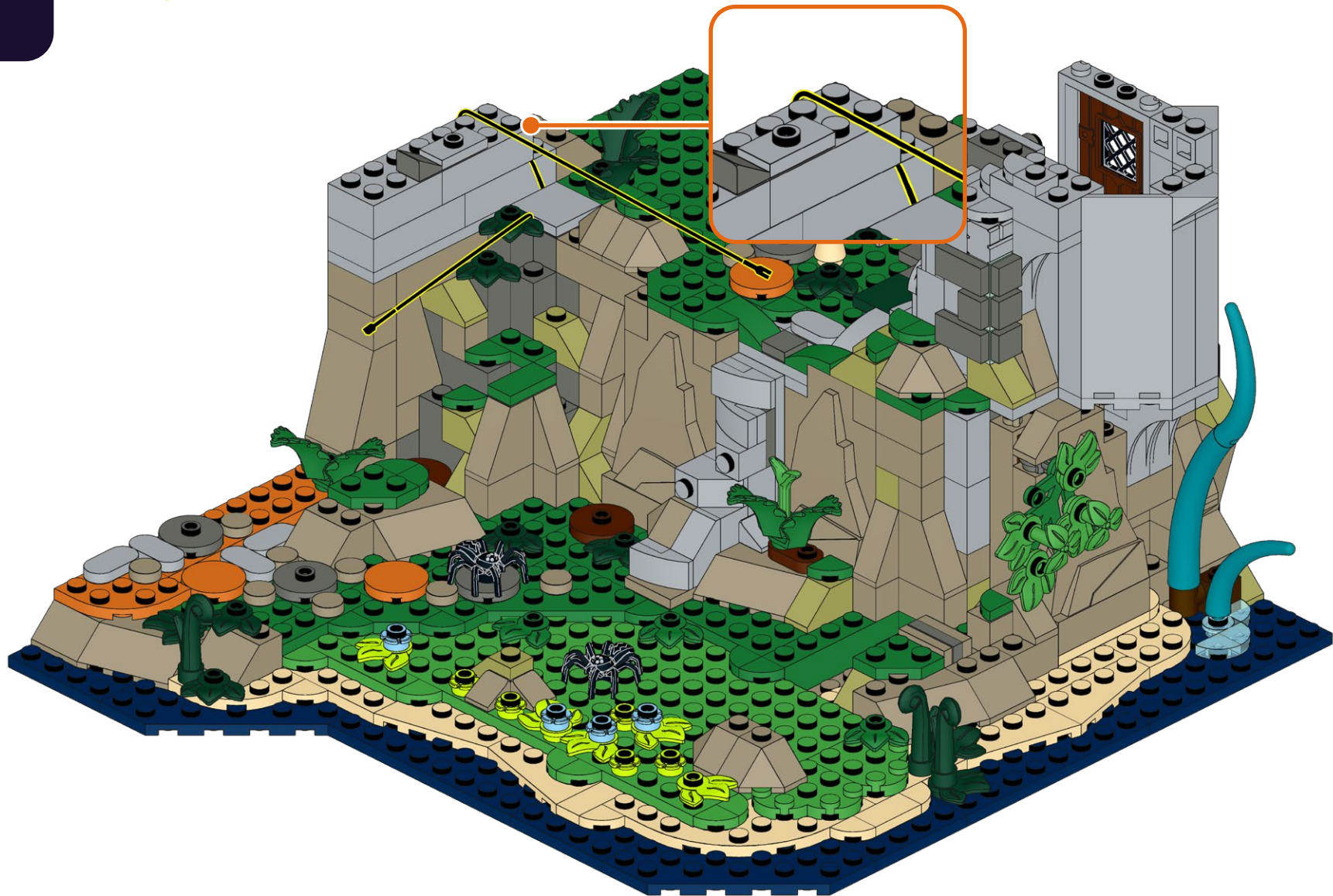



175



176

1

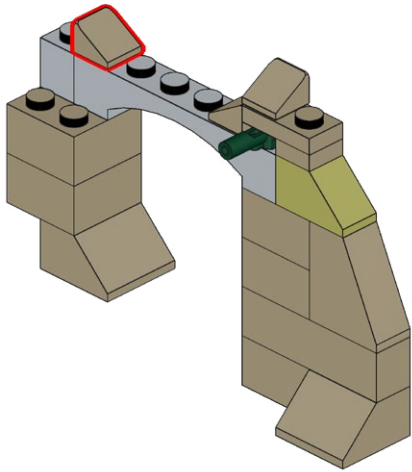

2

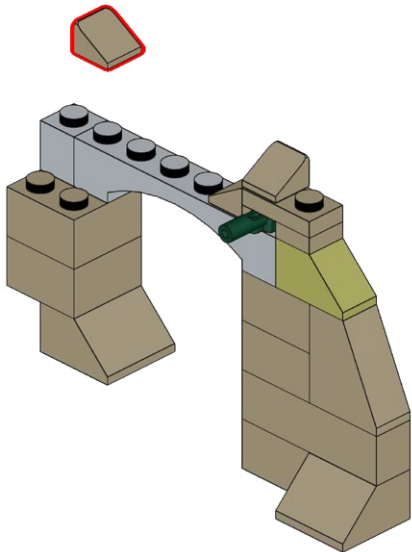

177

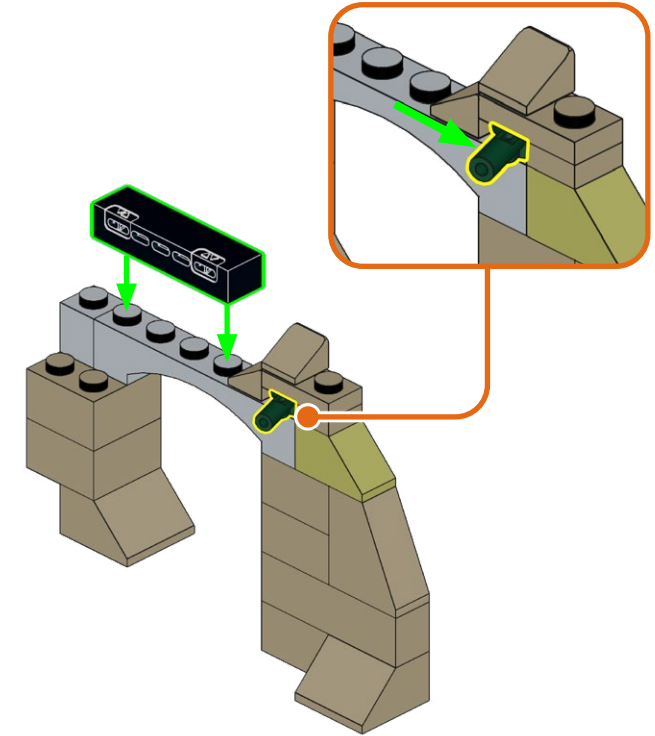
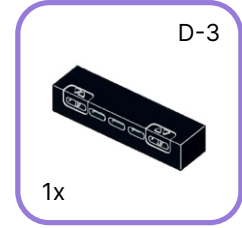



178





179

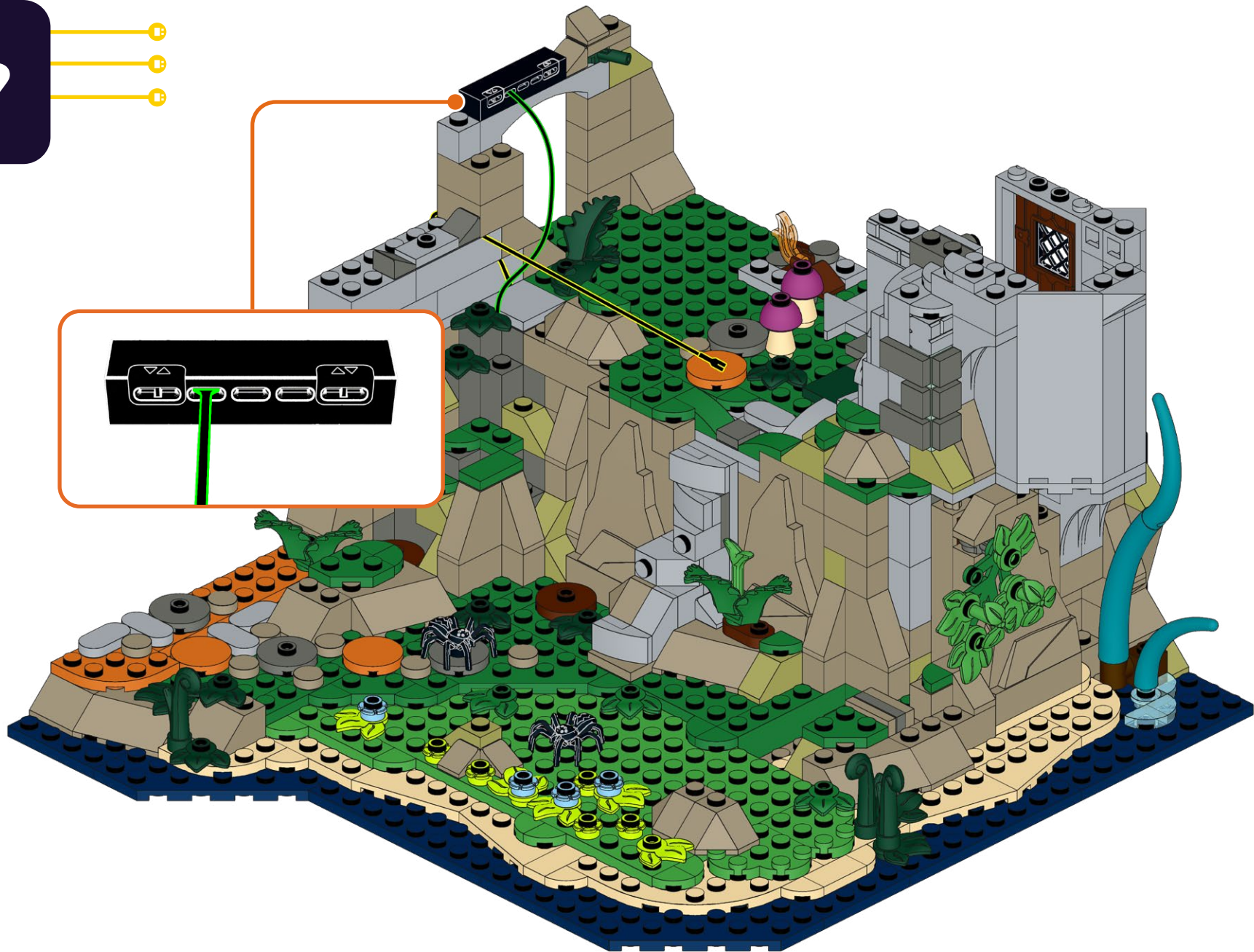

180

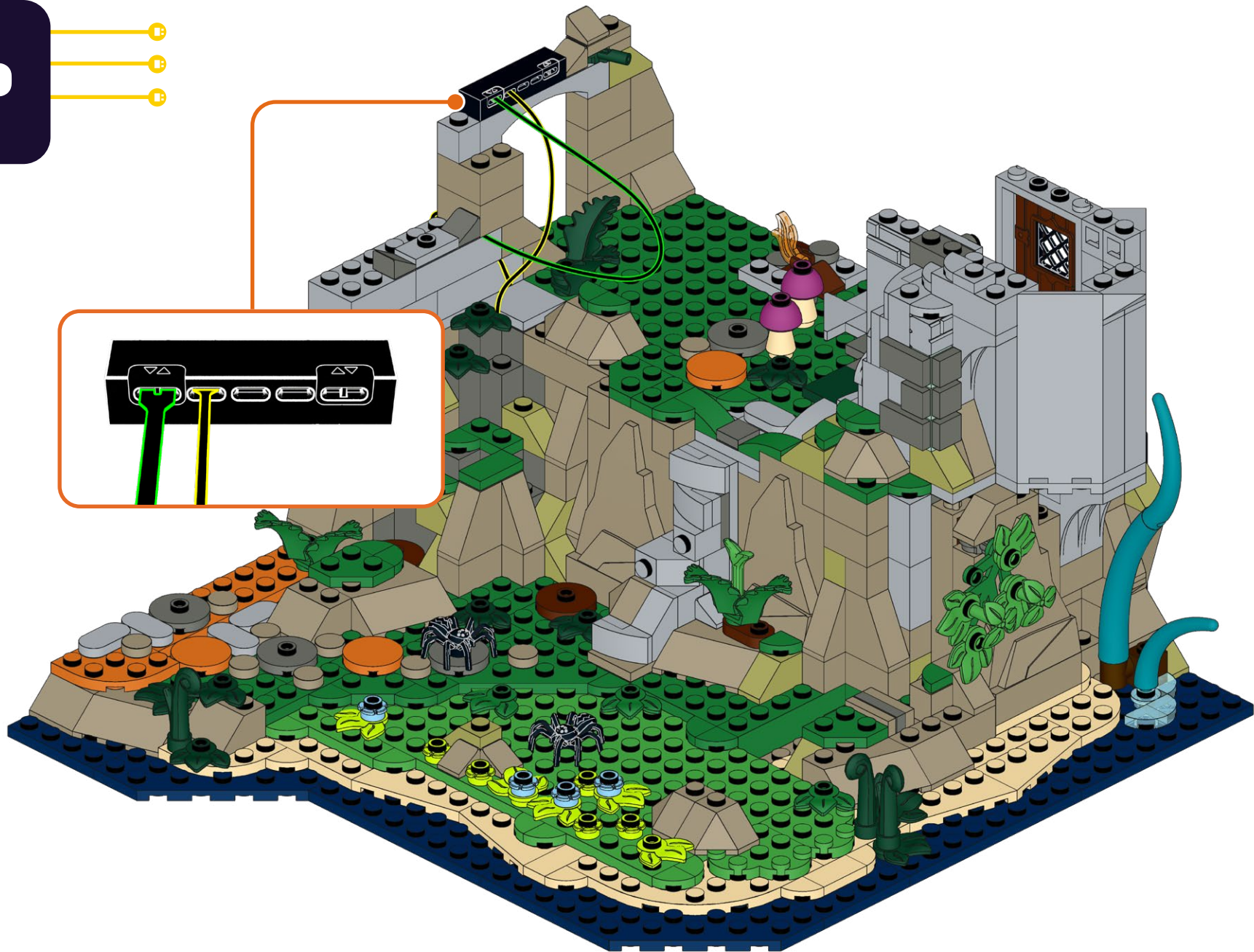



181





182



183





184





185



186

1

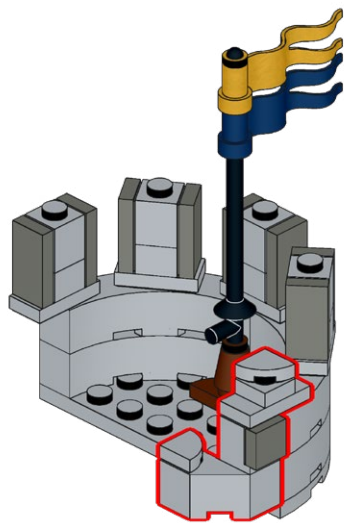

2

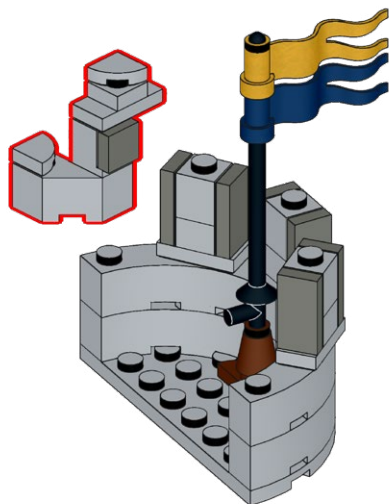

187

1

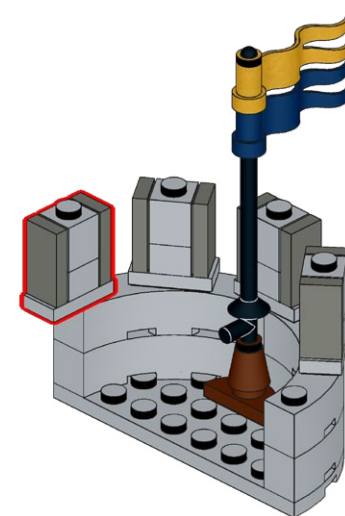

2

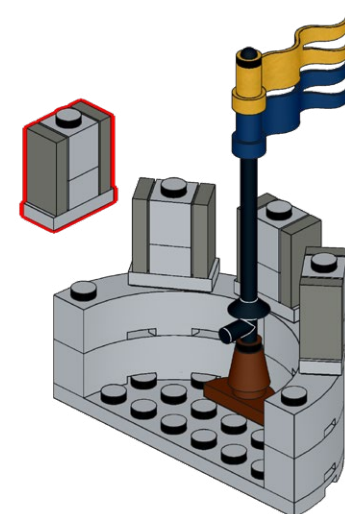

188





# 189

1

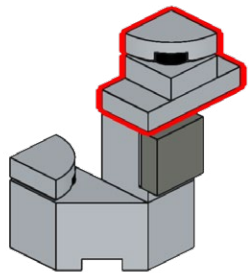

2

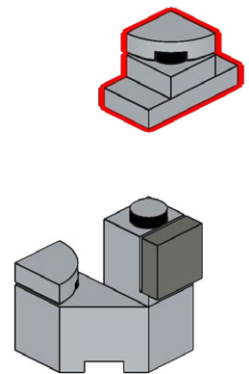

# 190

1

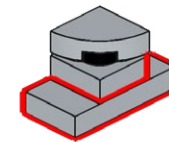

2

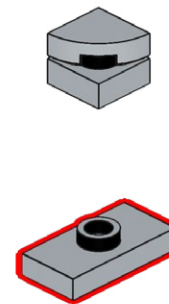

# 191

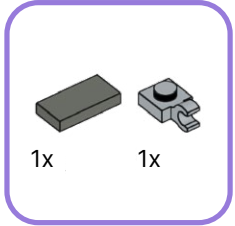

1

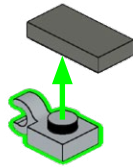

2

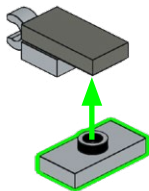

# 192

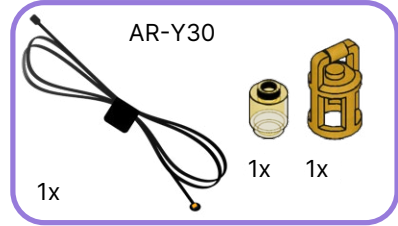

1

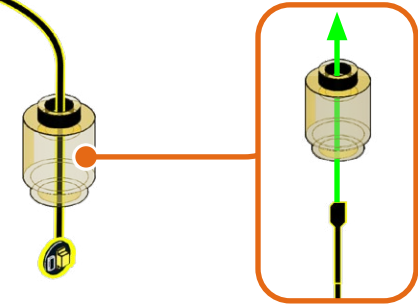

2

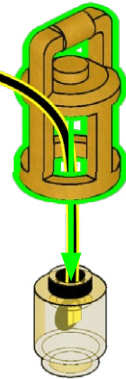

193

194

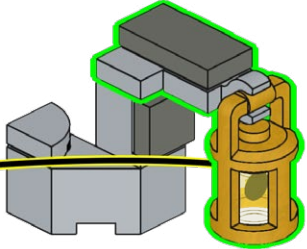
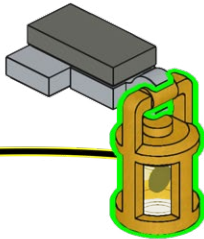



195

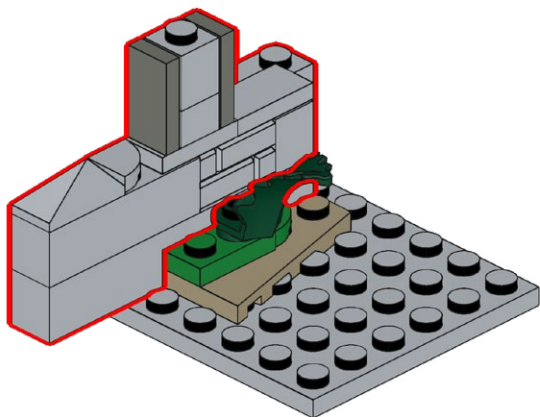

196

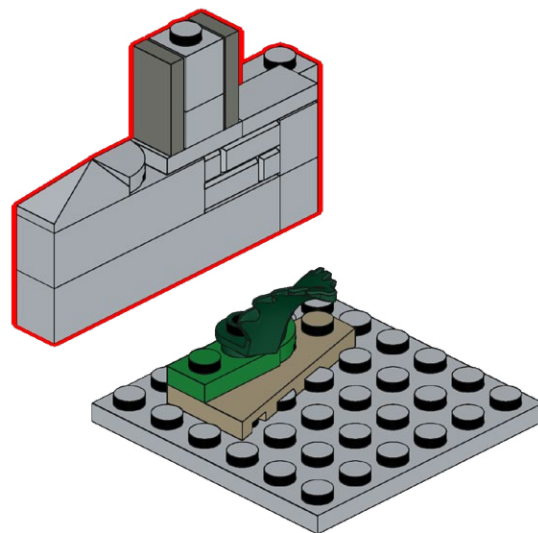

197

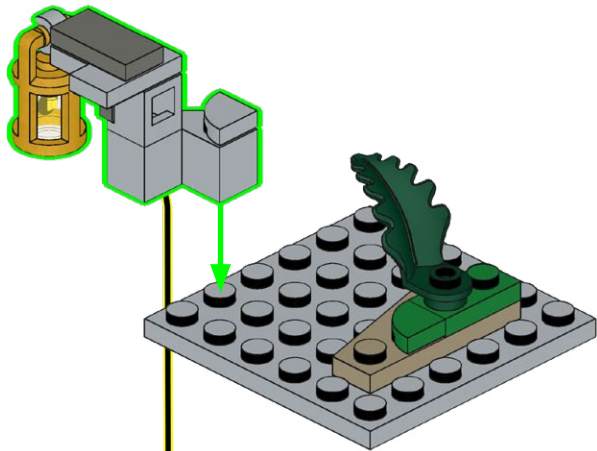

198

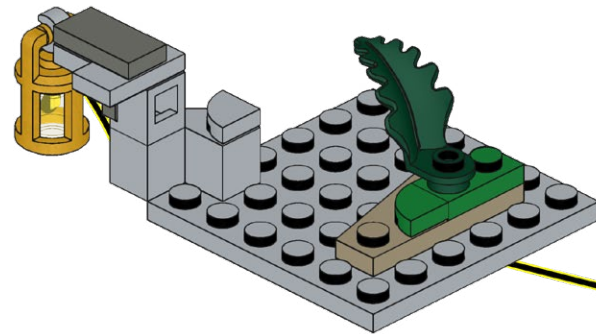

199

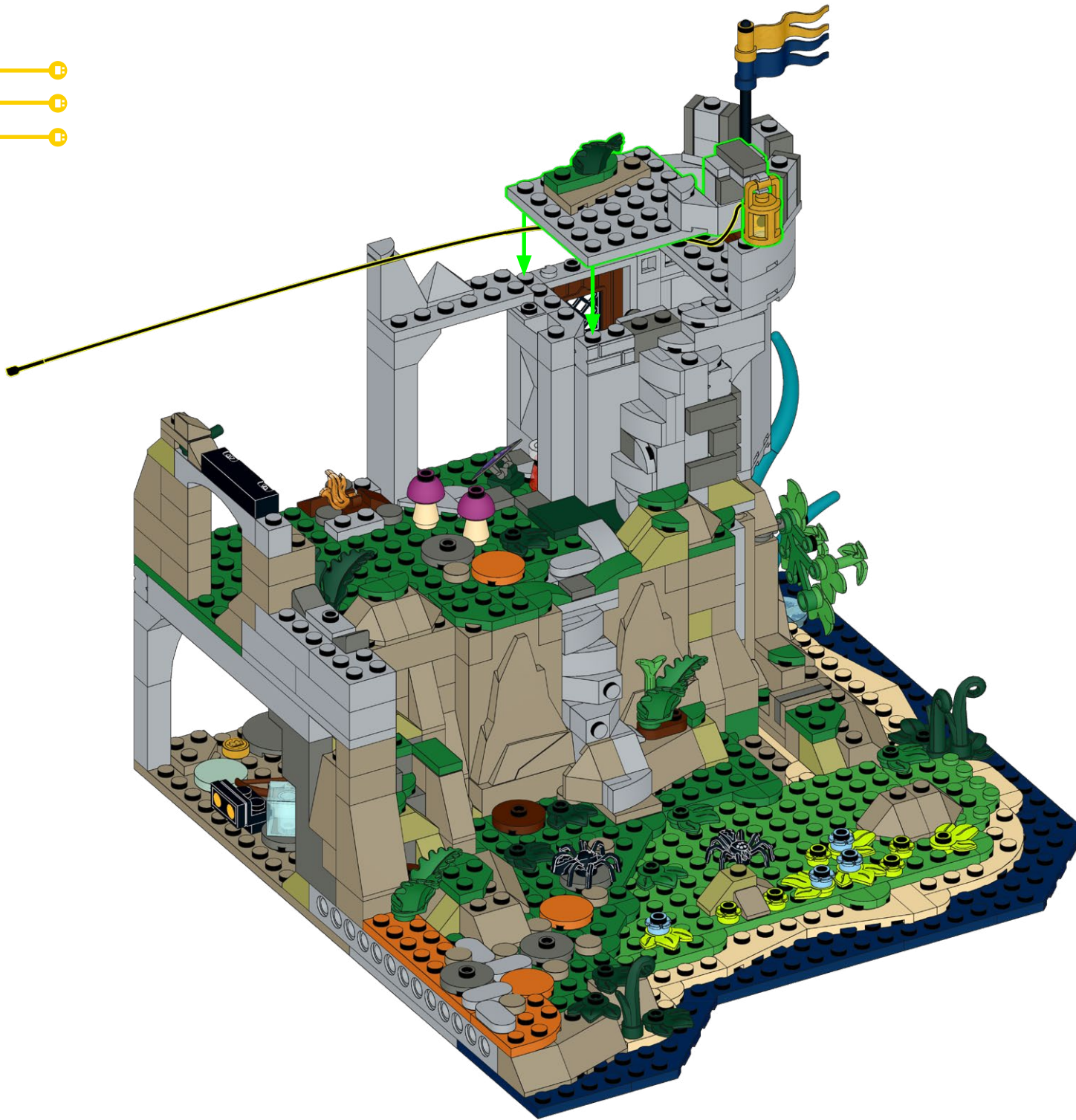



200

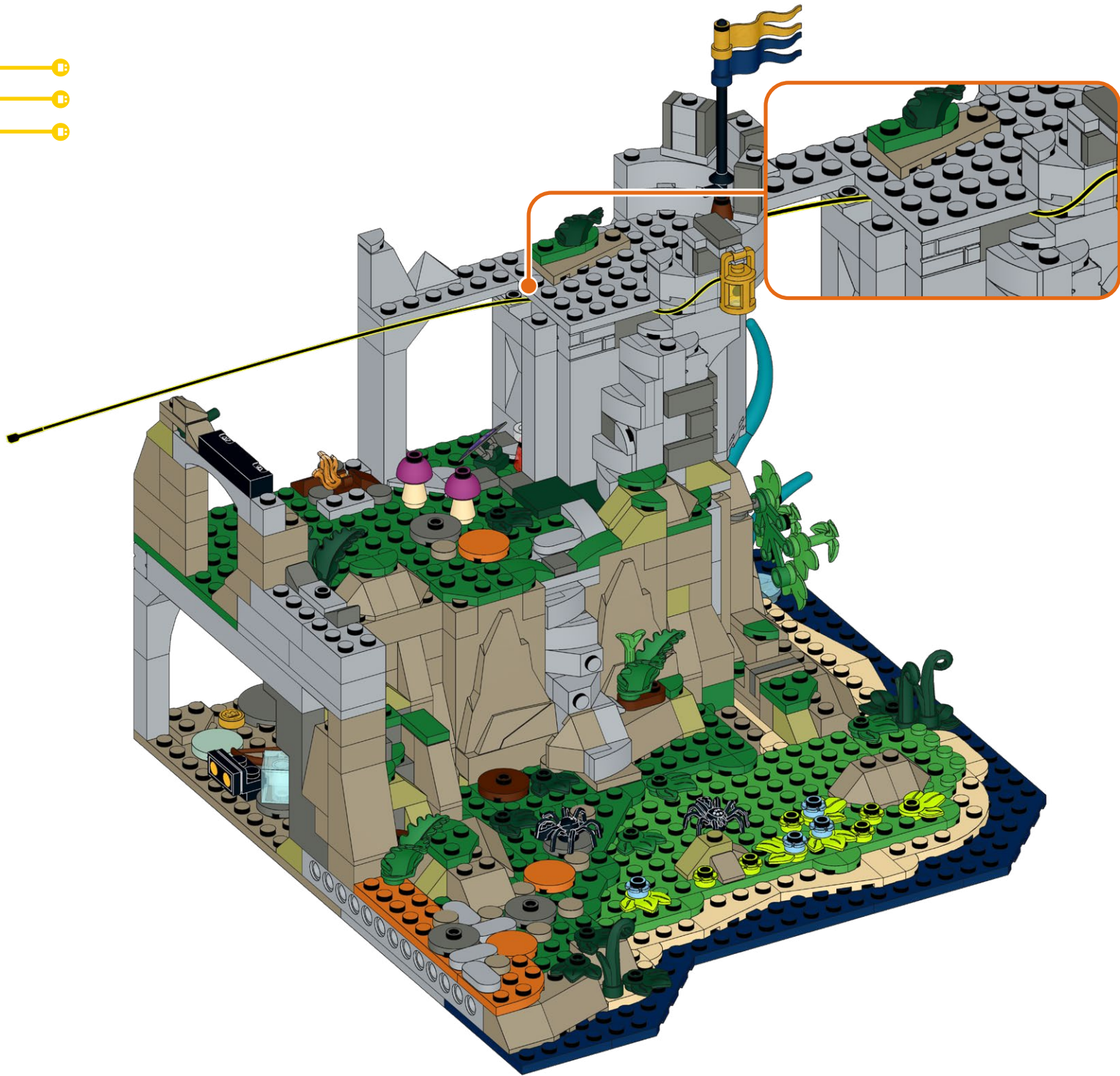

201

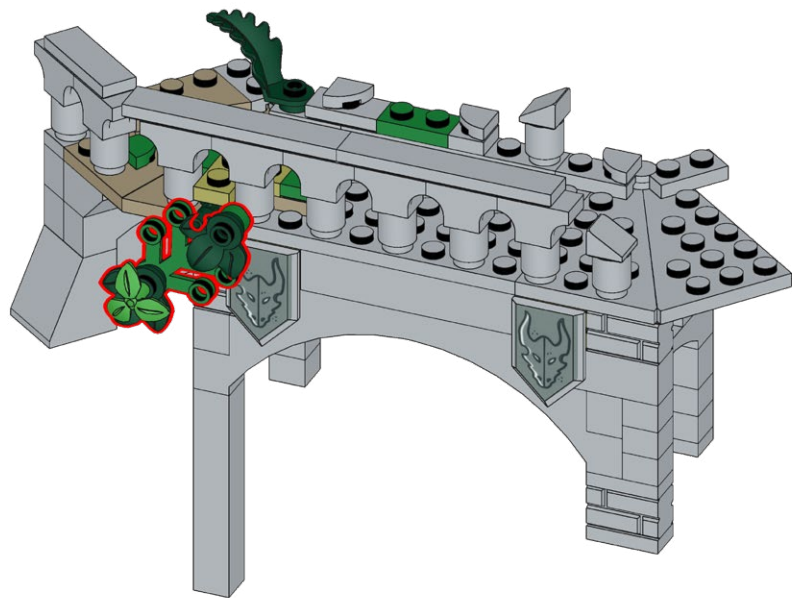

202

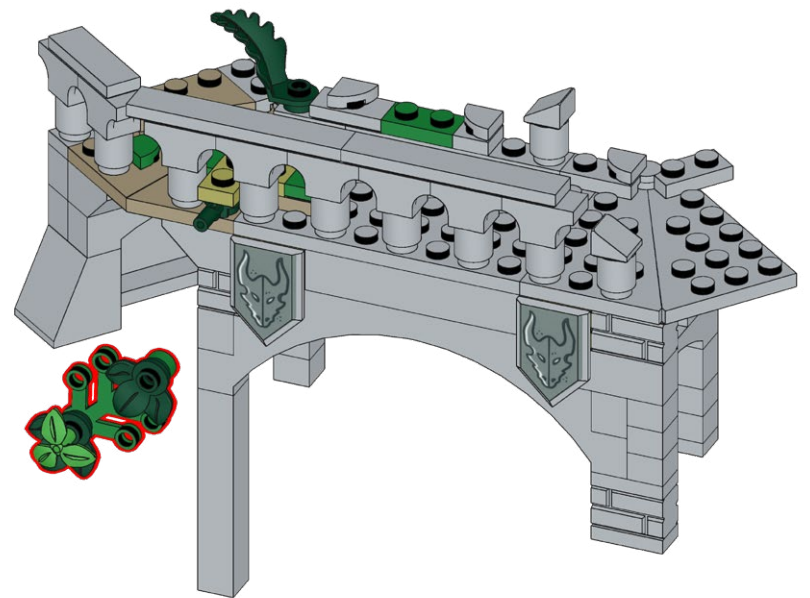

**203**

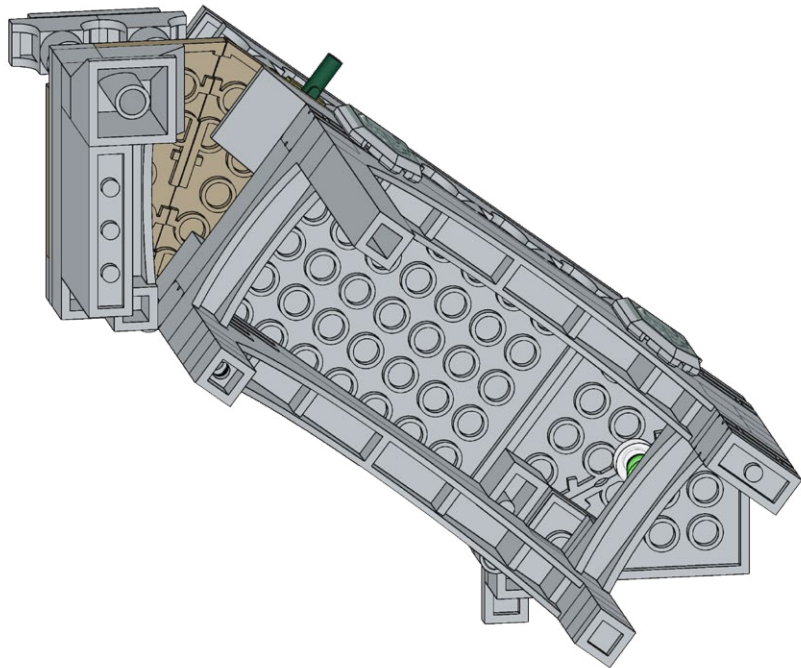

**204**

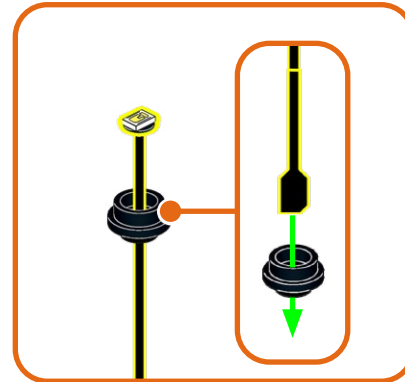
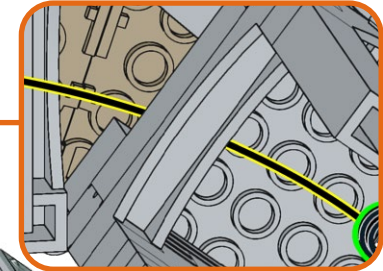
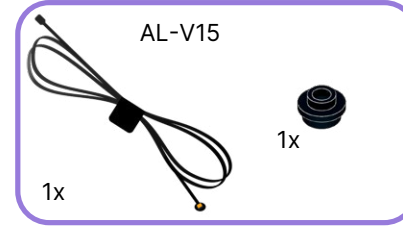



205

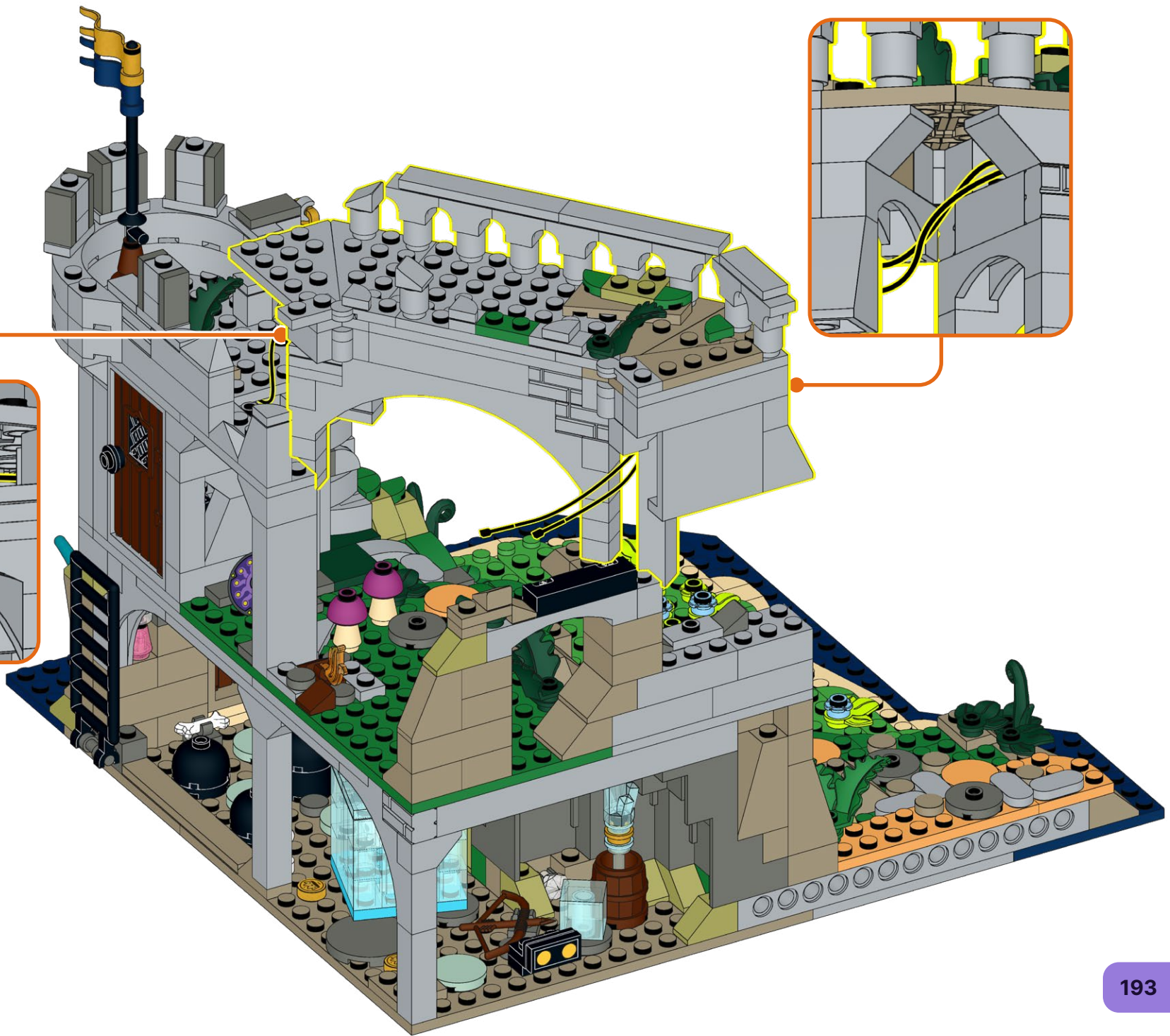
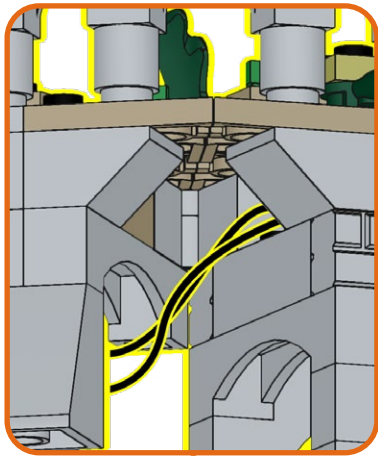
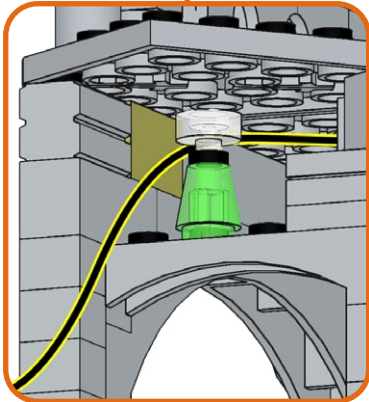

206

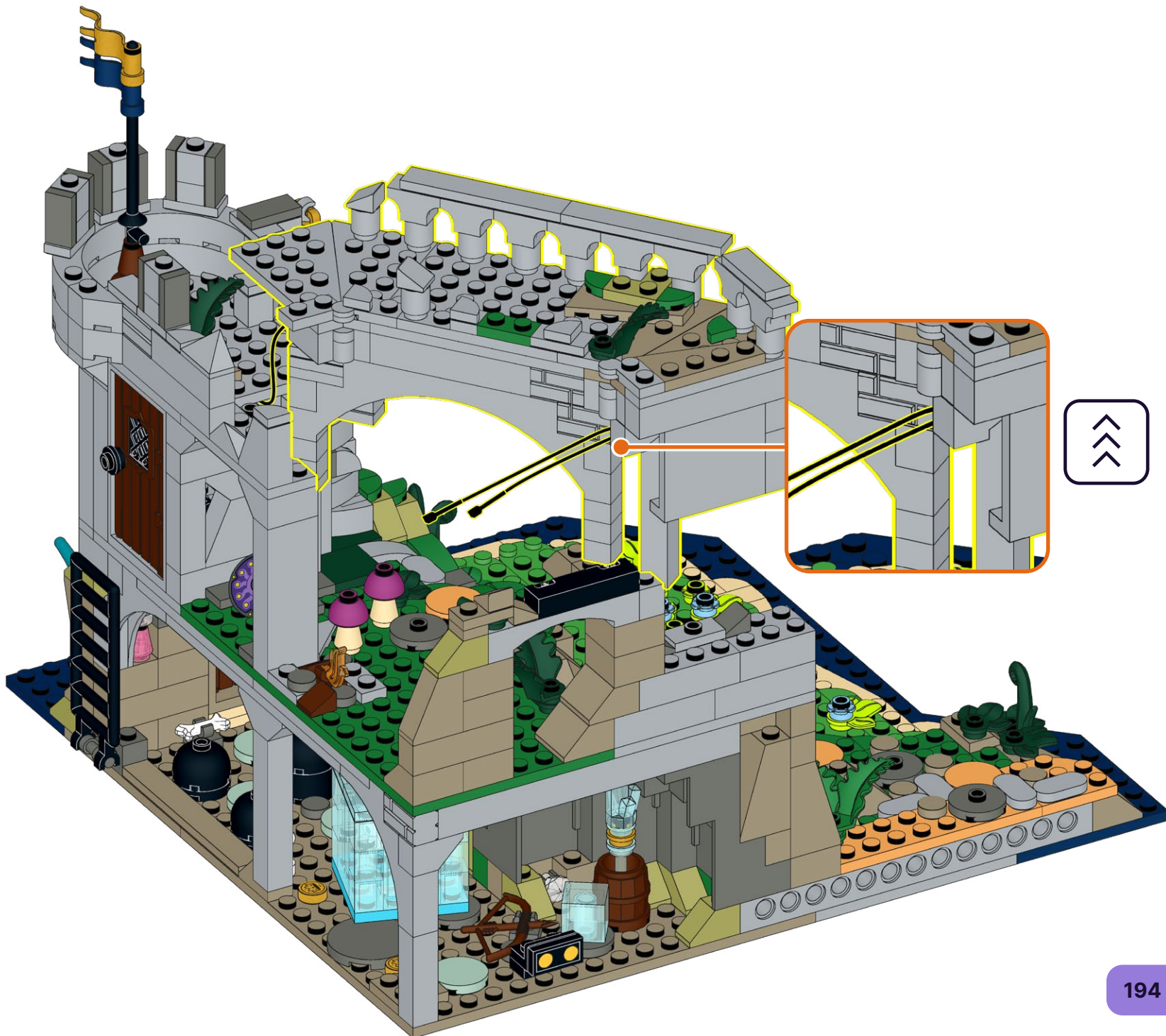



207

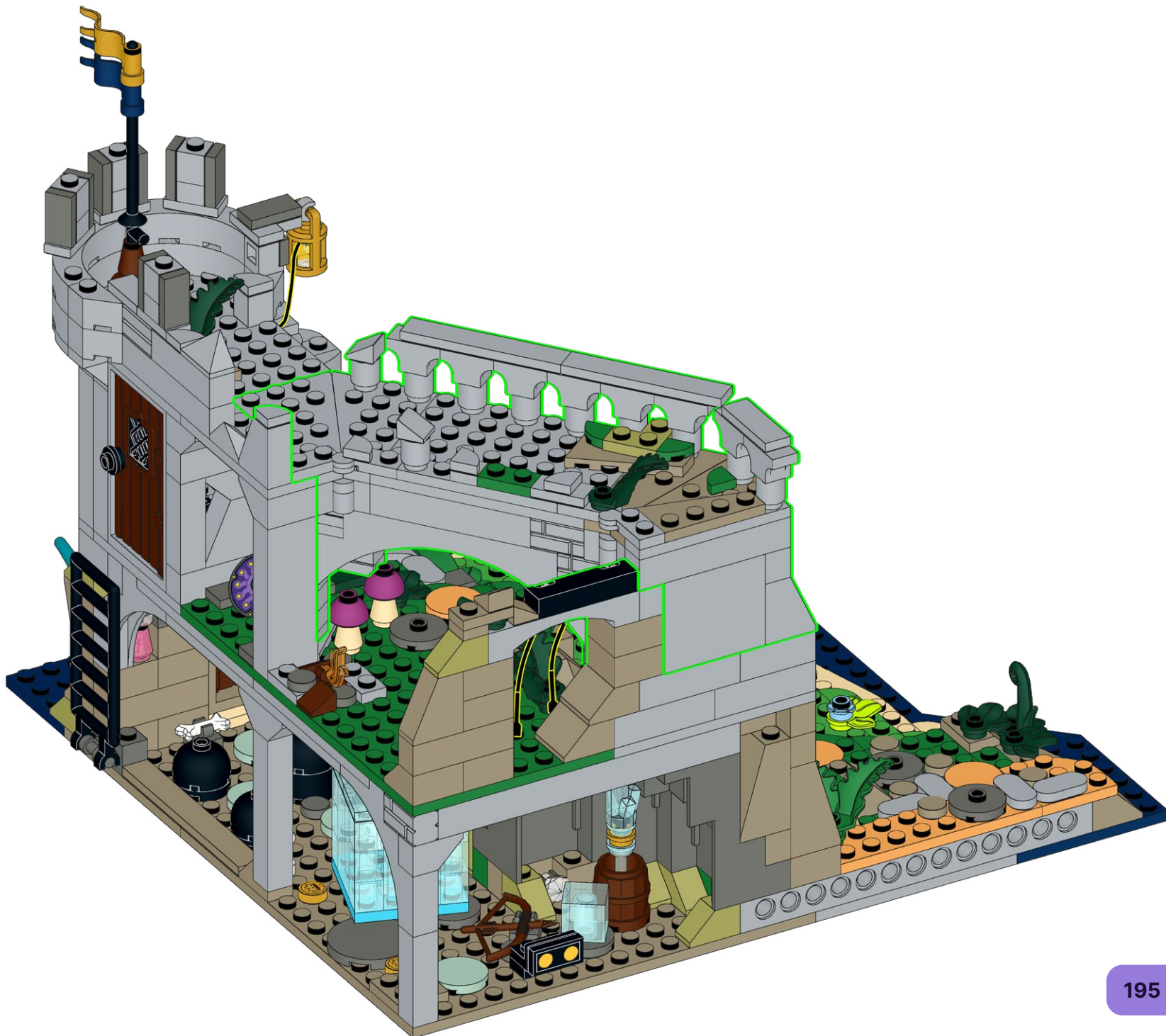



208



209

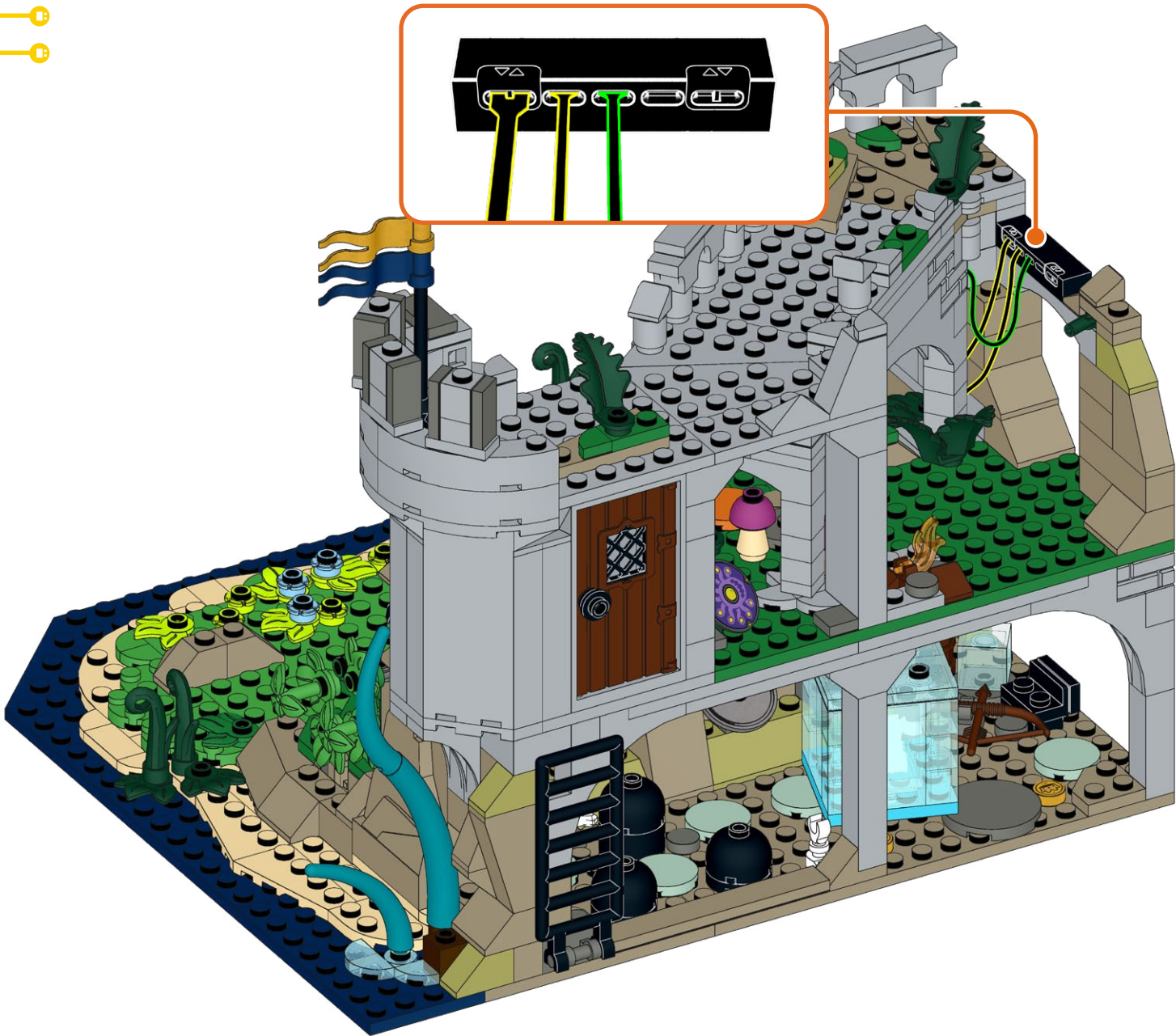



210

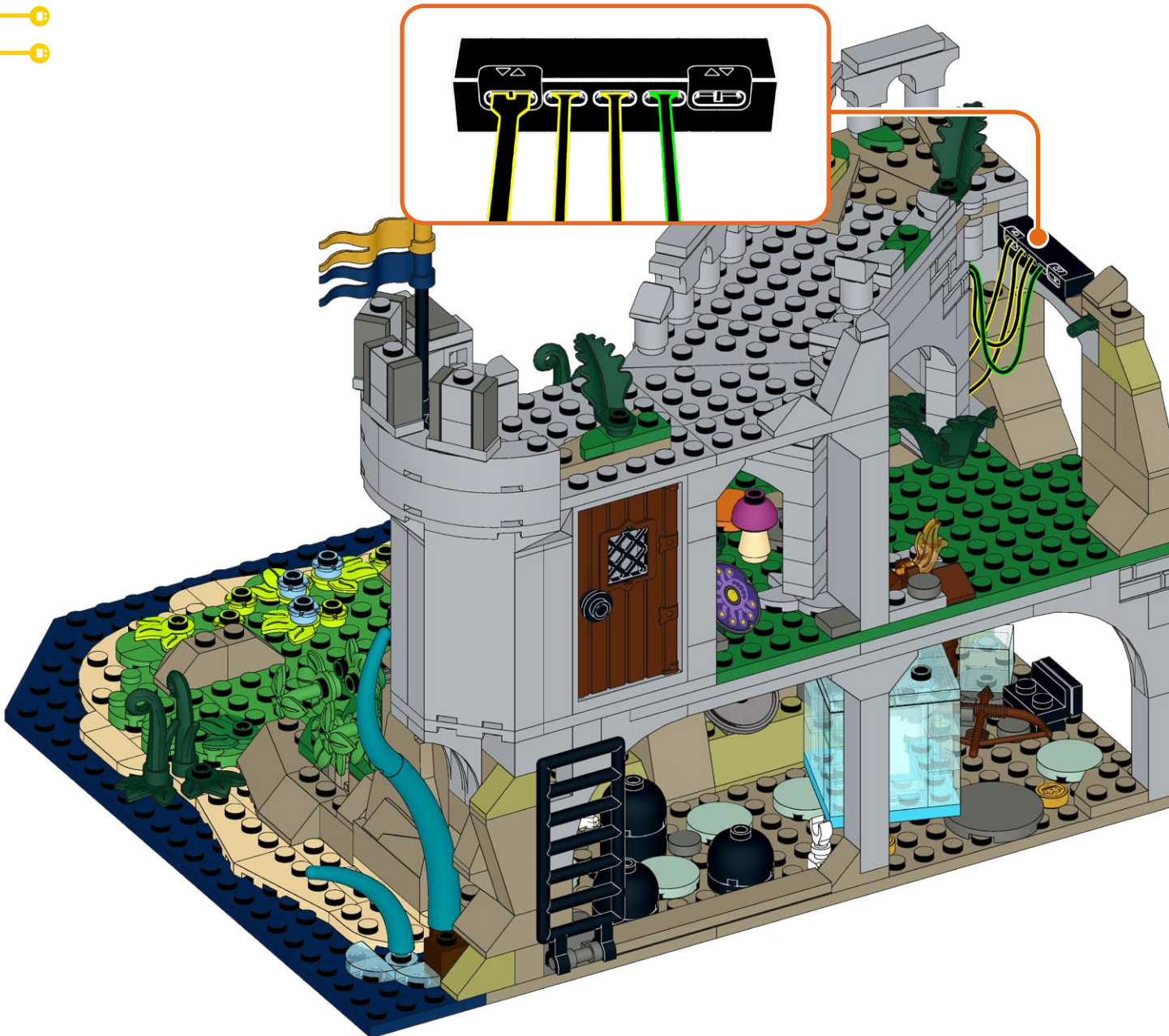



211

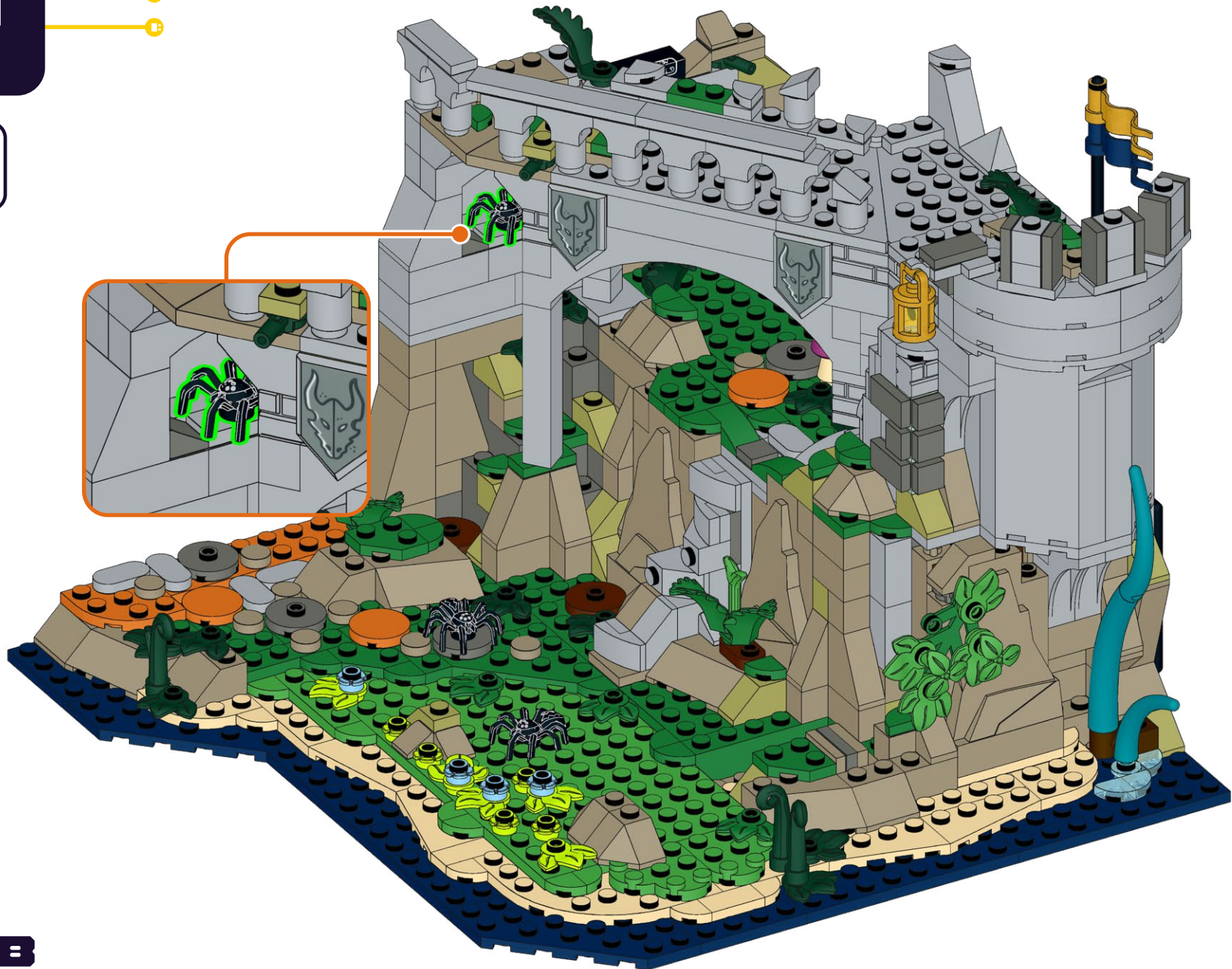

212





213

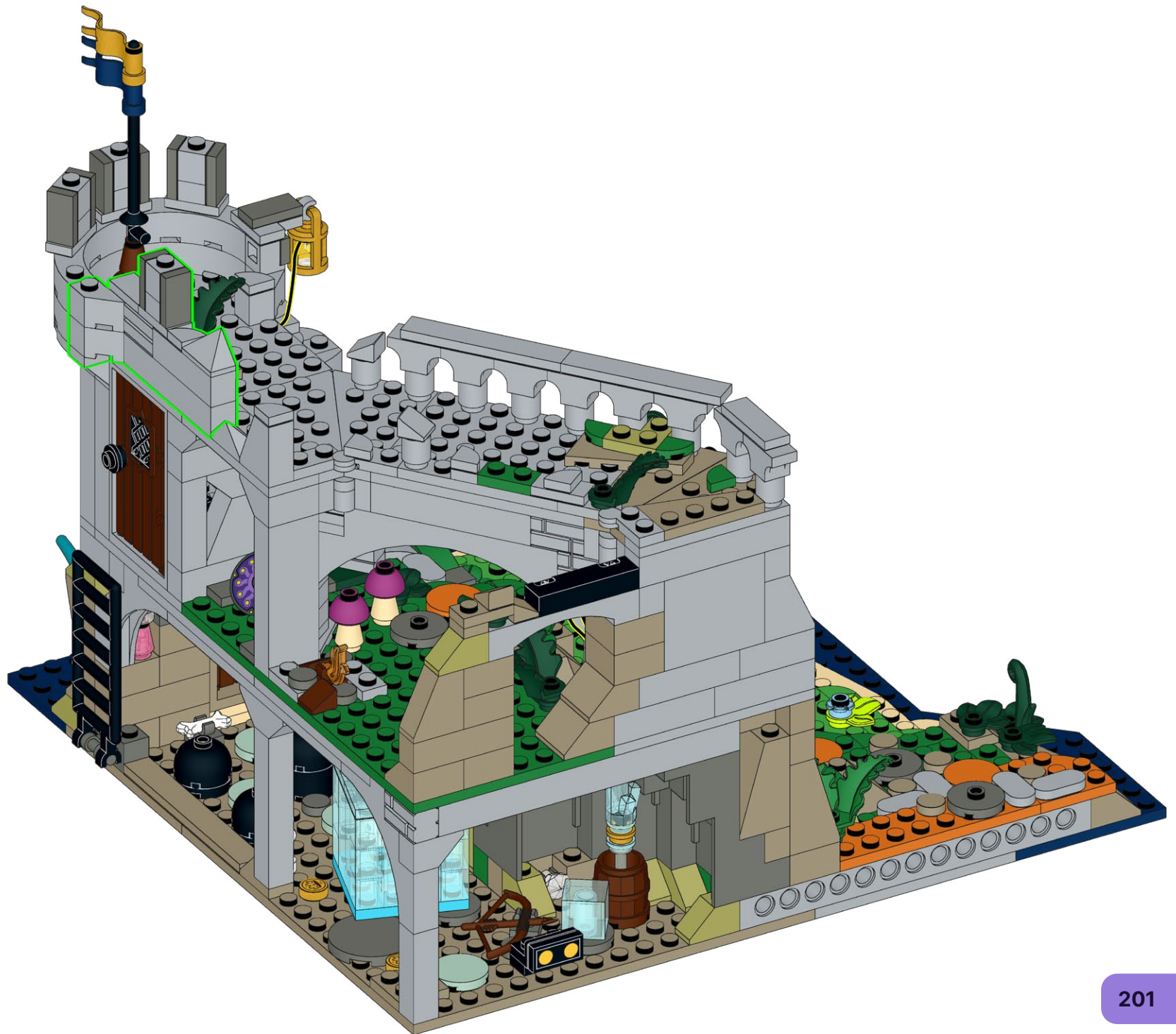



214



215





216





217



218





219



Power on Test  
Test de mise sous tension  
Test di Potenza  
Stromtest  
Prueba de Energía  
电源测试





220



221



222





223



224



225





226



227



228

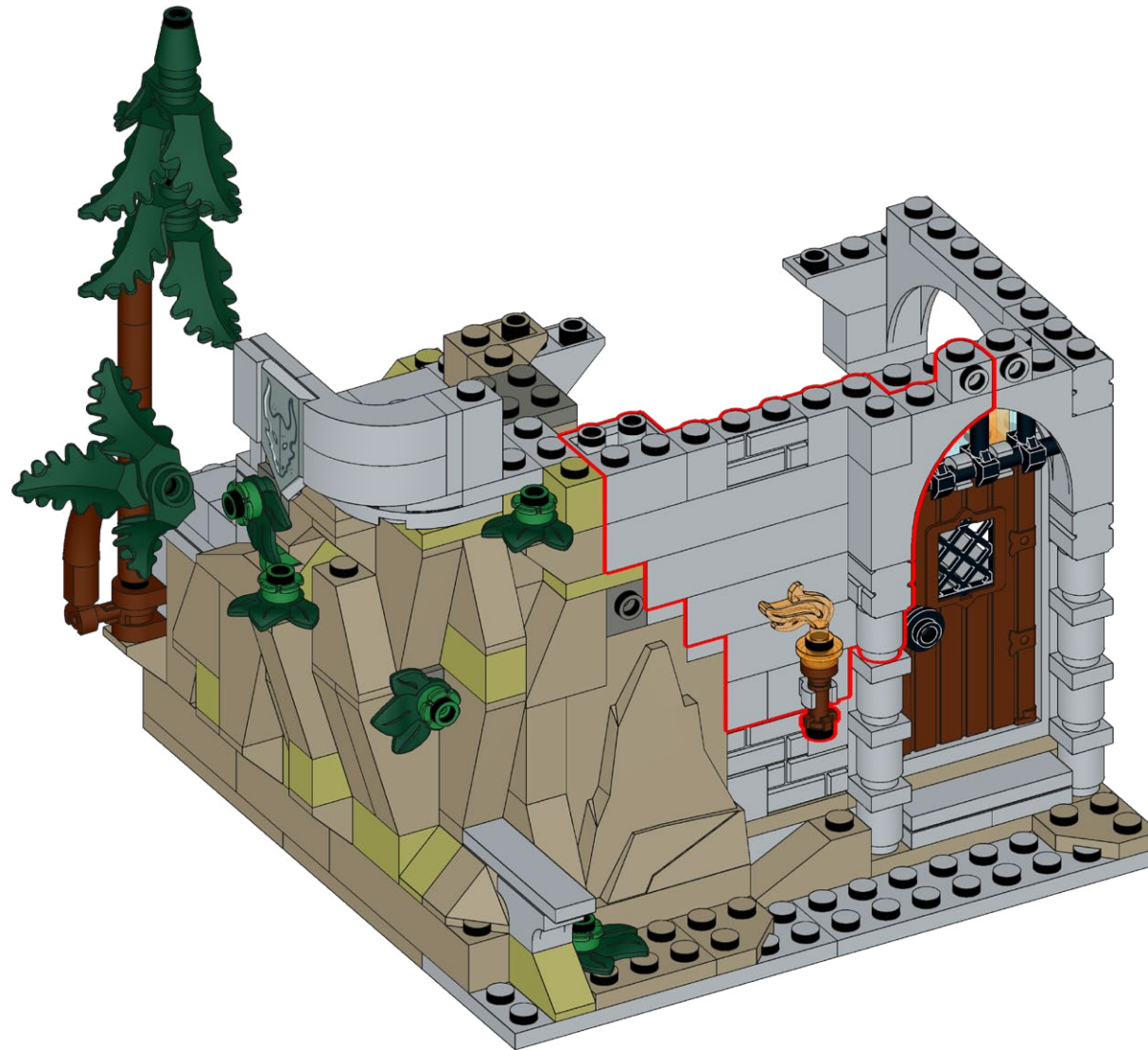



229



230

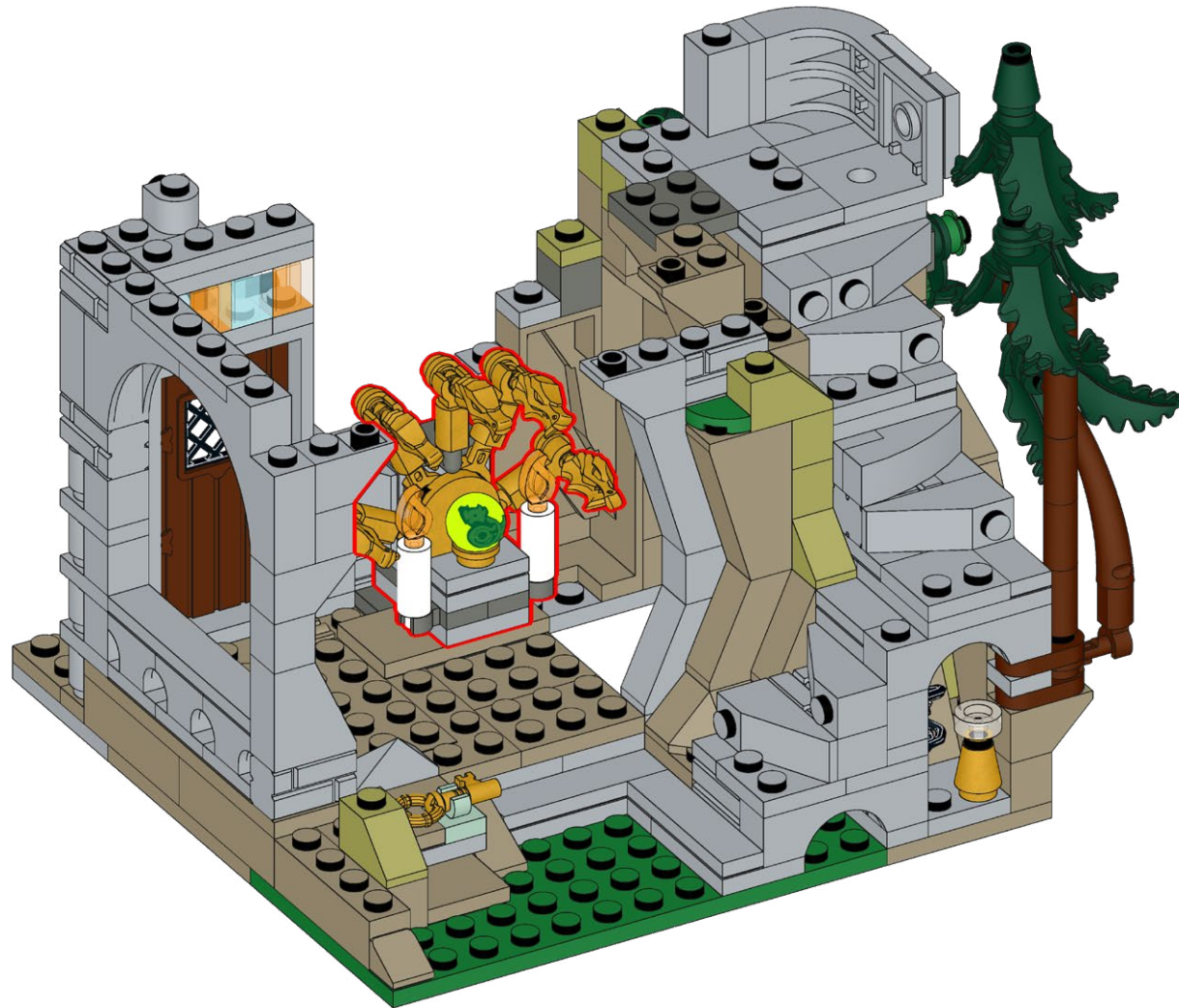

231







### **HOLD UP!**

You might notice some bags aren't in order, as well as left over pieces, but that's ok! We're changing the way you build LEGO!

### **ATTENDEZ!**

Vous remarquerez peut-être que certains sacs, ainsi que certaines pièces, ne sont pas dans le bon ordre. Mais pas de panique! Nous changeons simplement la façon avec laquelle vous construisez vos LEGO!

### **ASPETTA!**

Potresti notare che alcuni sacchetti non sono in ordine, così come i pezzi avanzati, ma va bene così! Stiamo cambiando il modo in cui costruisci i LEGO!

### **HALT!**

Sie werden möglicherweise bemerken, dass einige tüten durcheinander sind und teile übrig bleiben, aber das ist in Ordnung! Wir ändern die art und weise, wie Sie LEGO bauen!

### **¡ESPERA!**

Es posible que notes que algunas bolsas están fuera de servicio, así como piezas sobrantes, ¡pero está bien! ¡Estamos cambiando la forma en que construyes LEGO!

### **暫停!**

你可能会注意到一些袋子顺序错乱, 以及一些剩余的部件, 但没关系! 我们正在改变你搭建乐高的方式!

#### Open LMB Bag 04

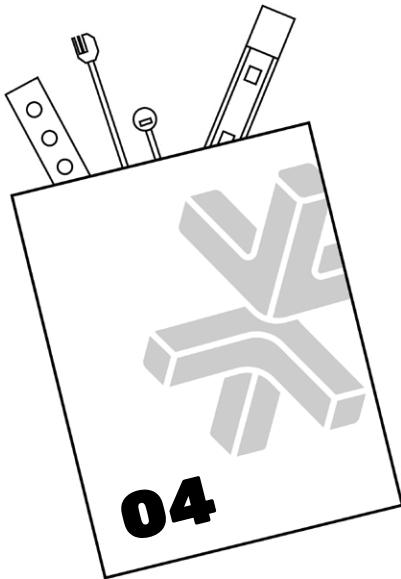

# 232

1

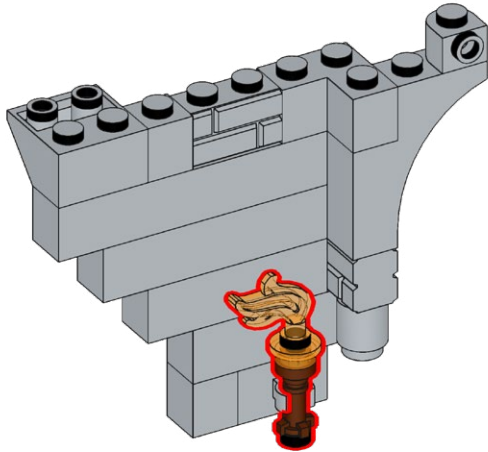

2

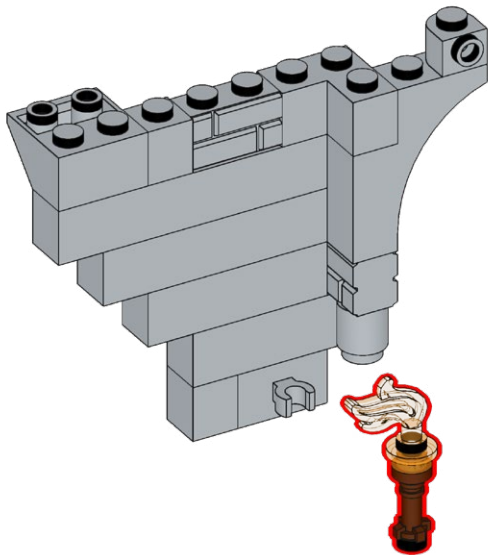

# 233

1



2

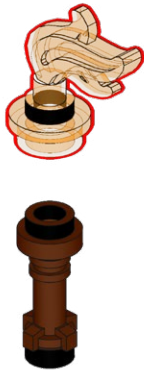

**234**

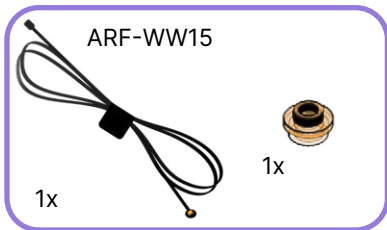

**235**

**1**



**2**

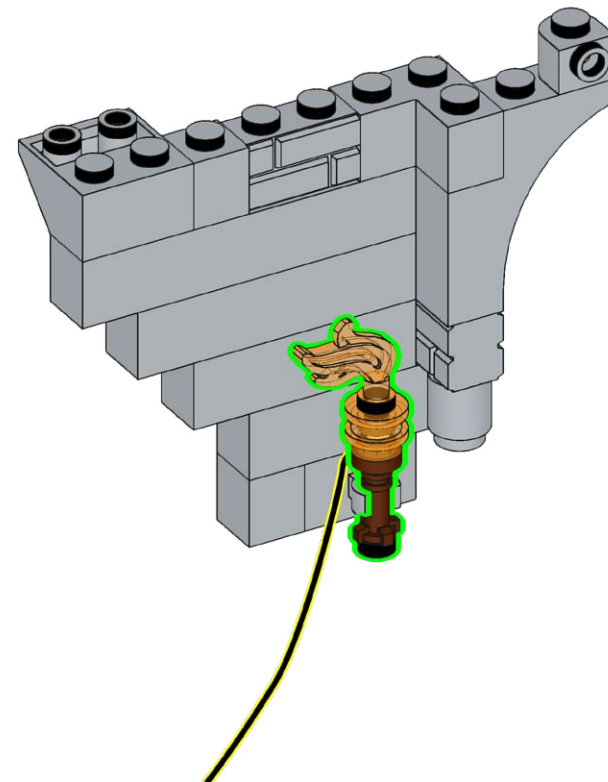
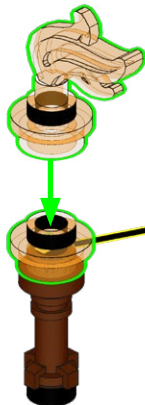



236

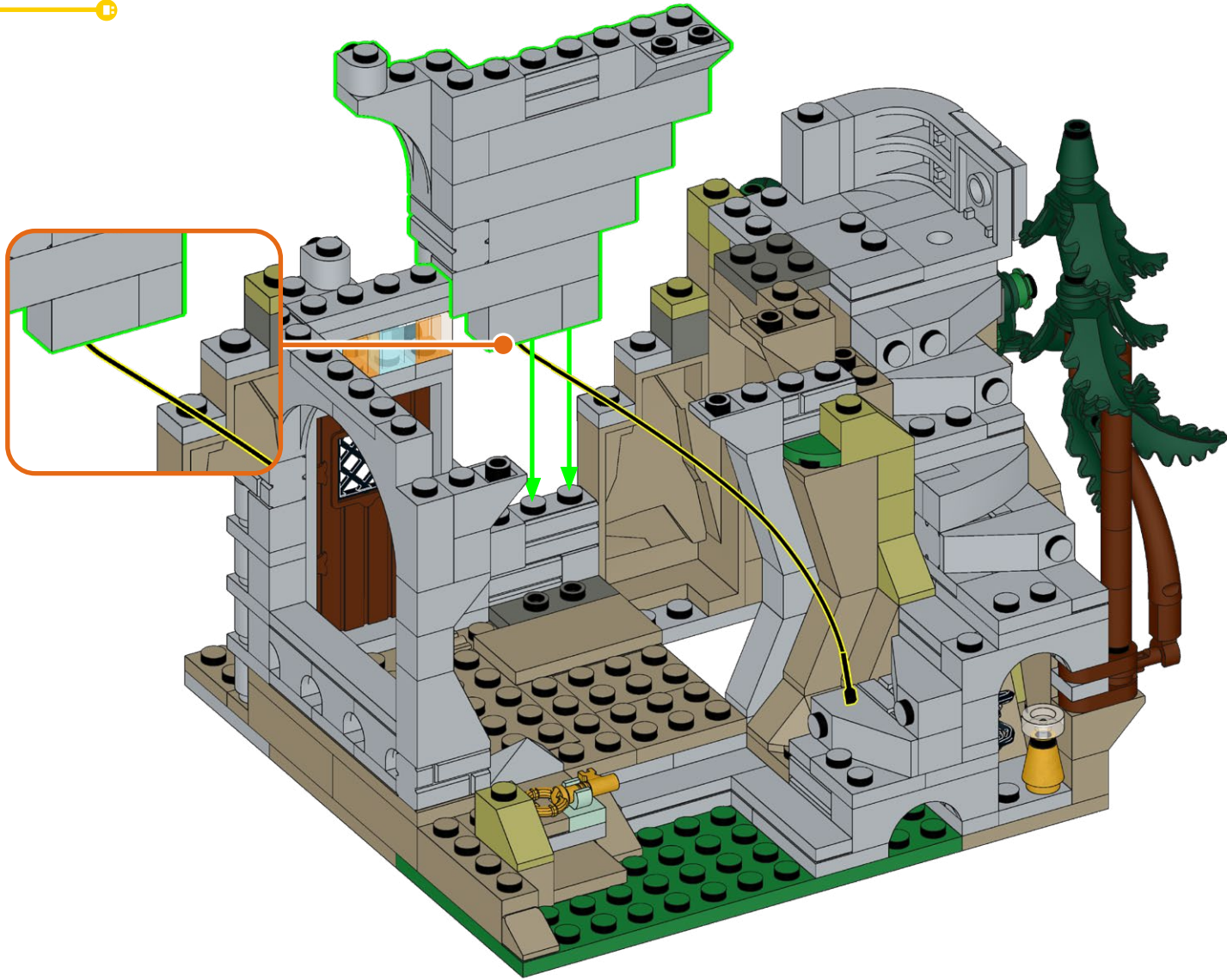

237

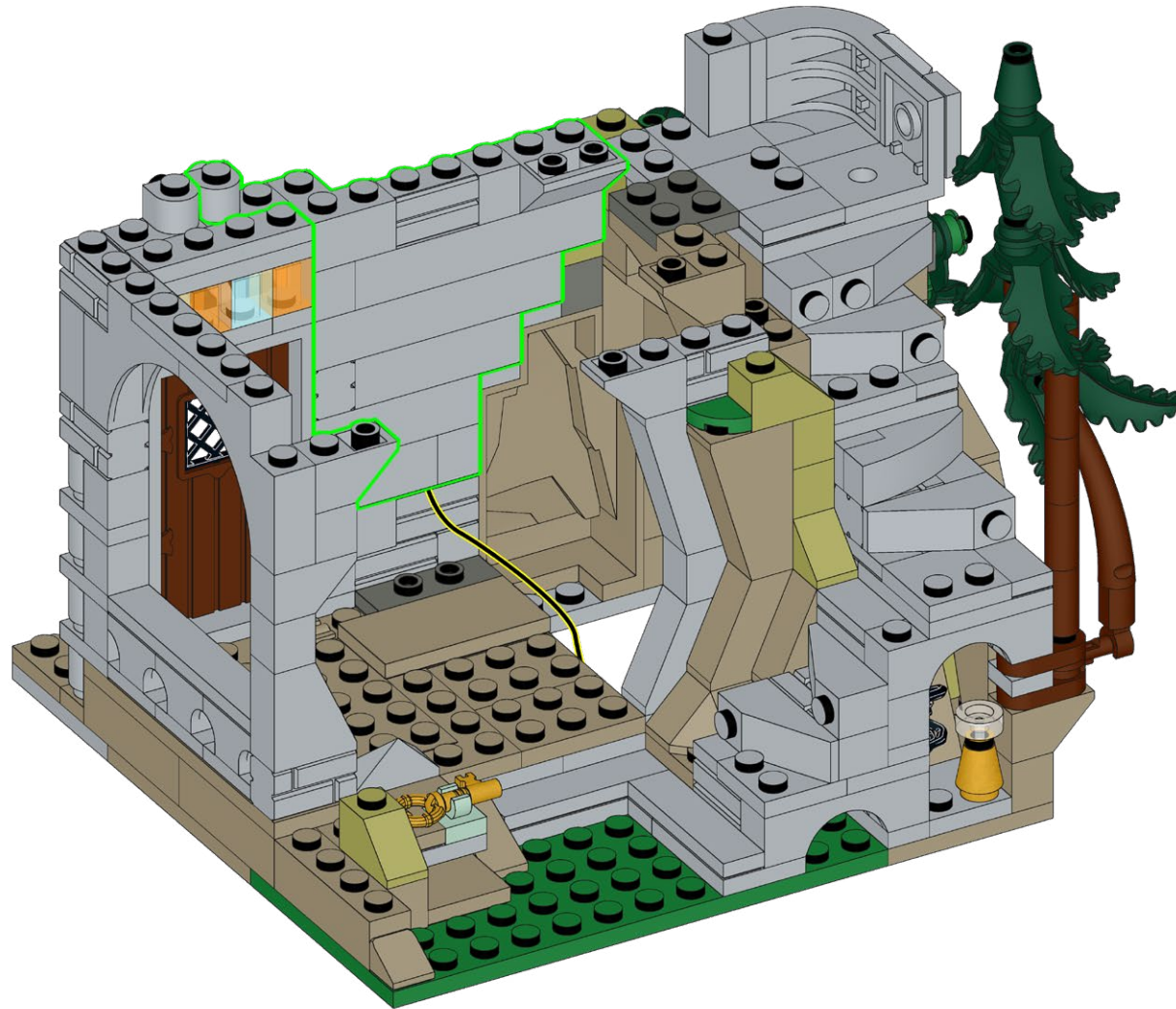

238





239

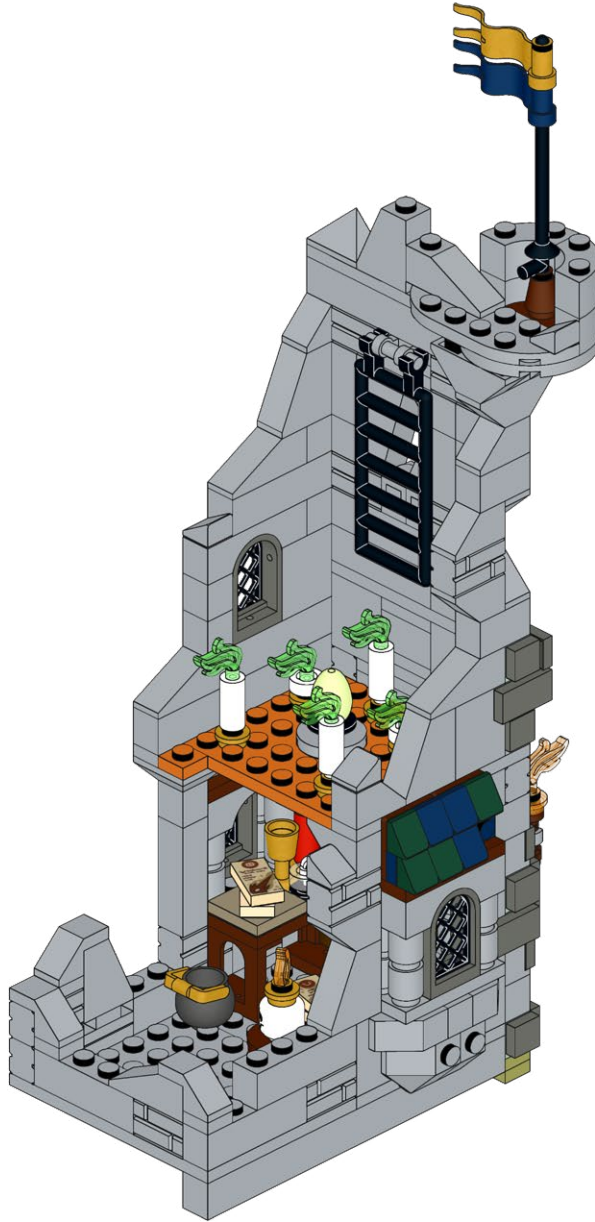

240

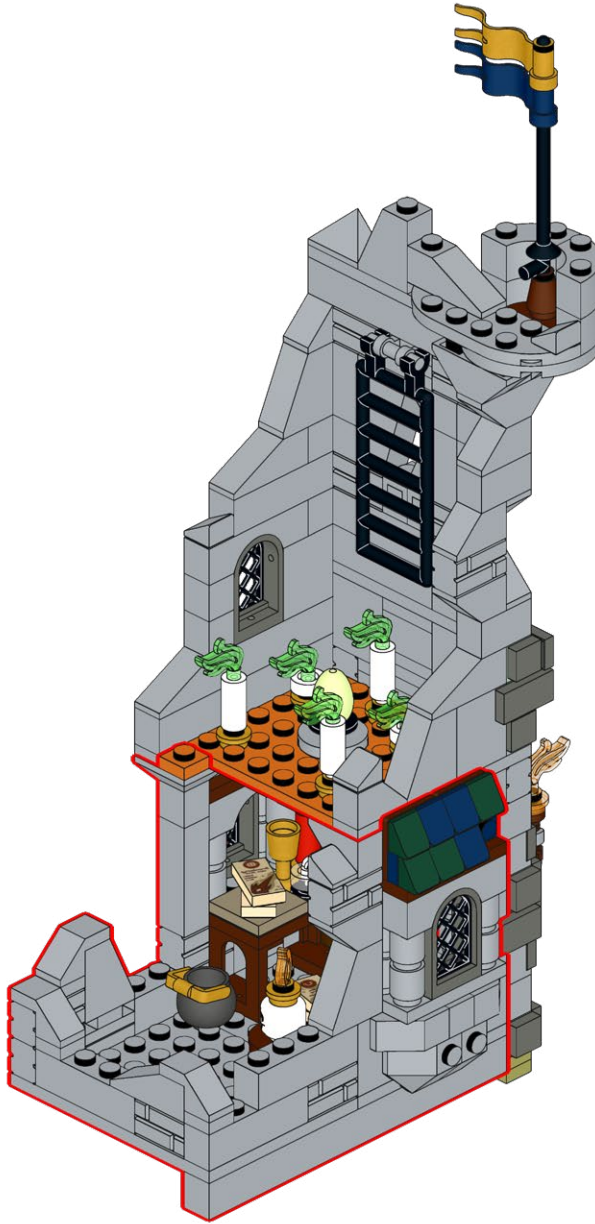

241

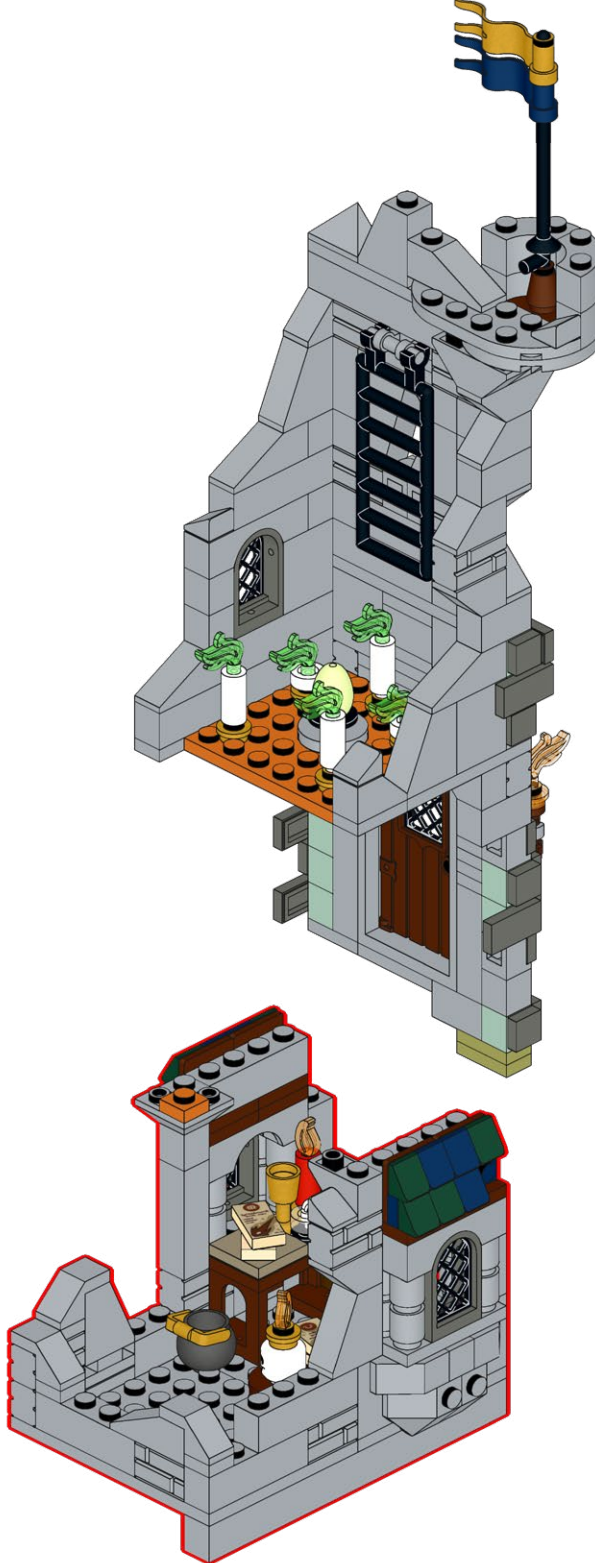



242

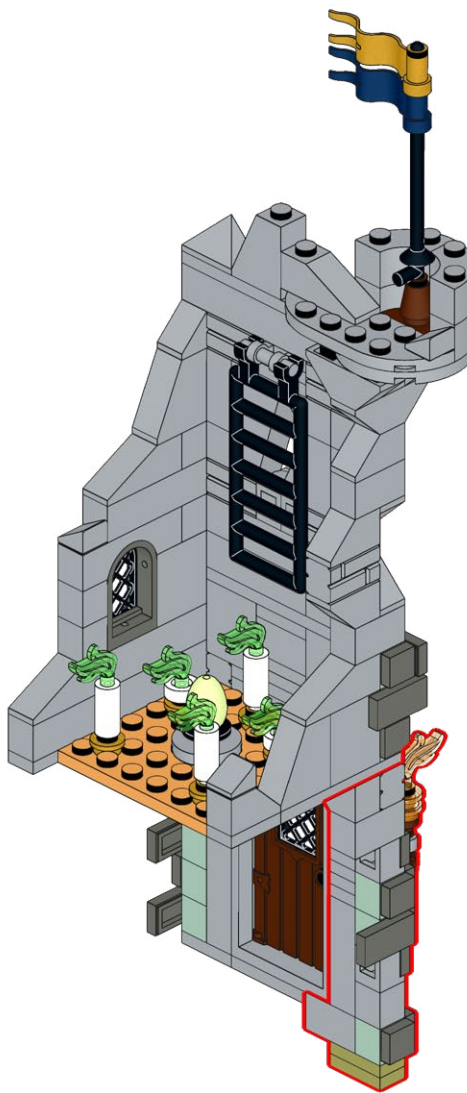

243

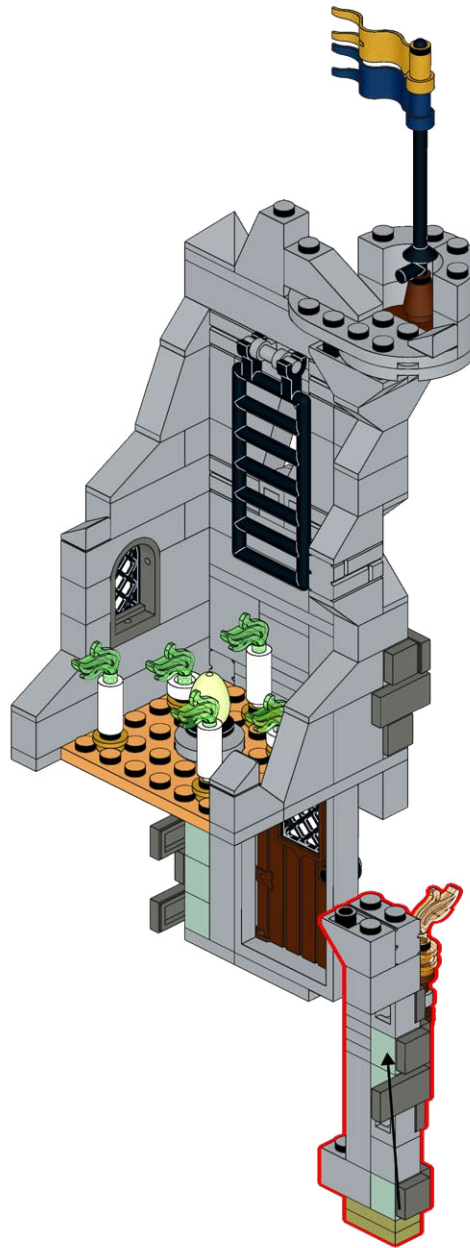

244

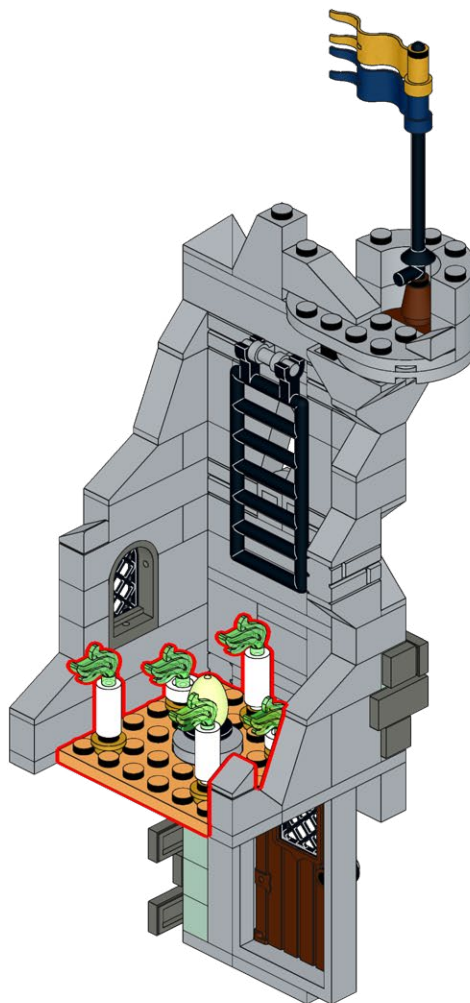



245

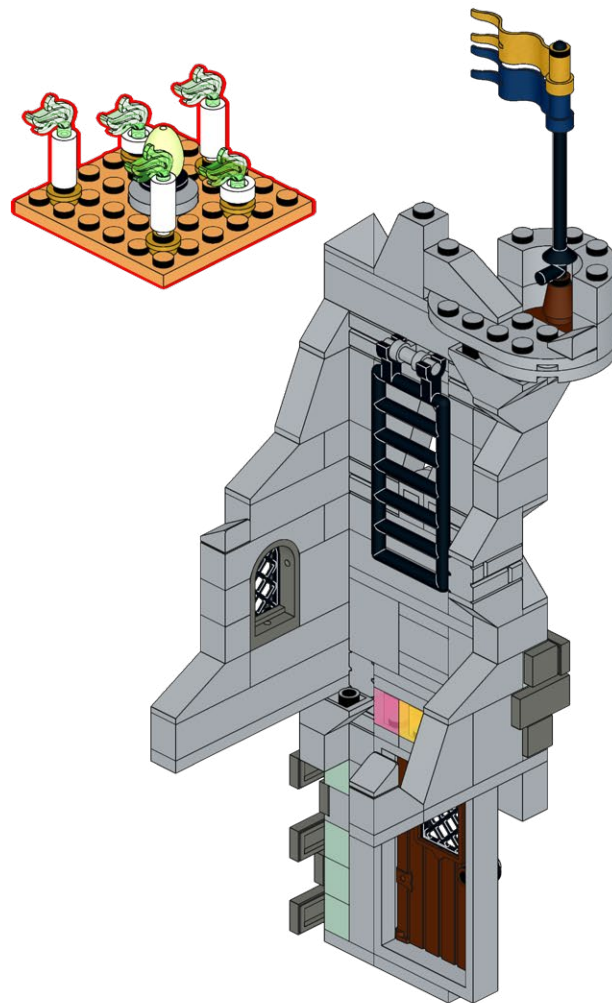

# 246

1

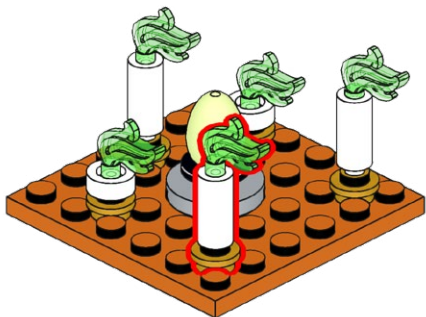

2

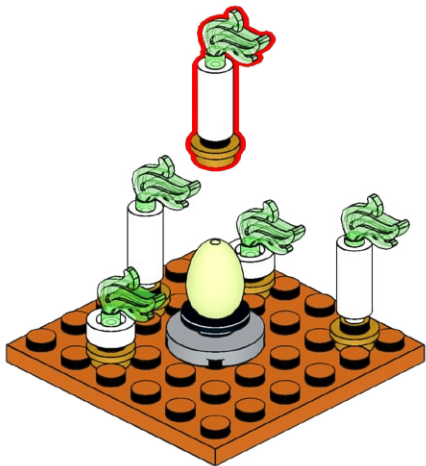

# 247

1

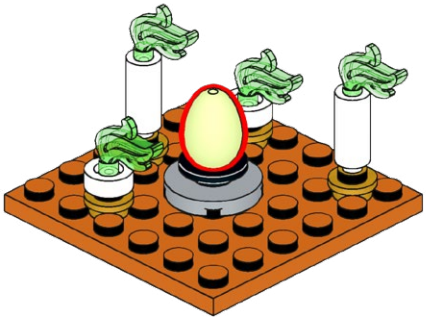

2

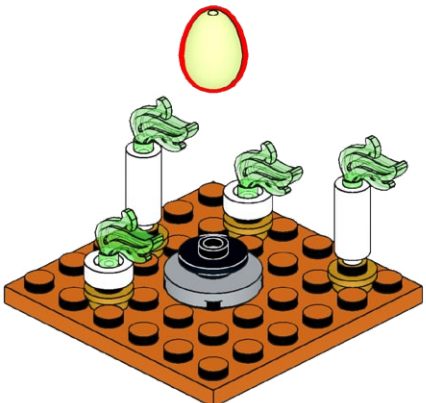

**248**

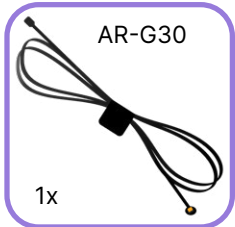

**1**

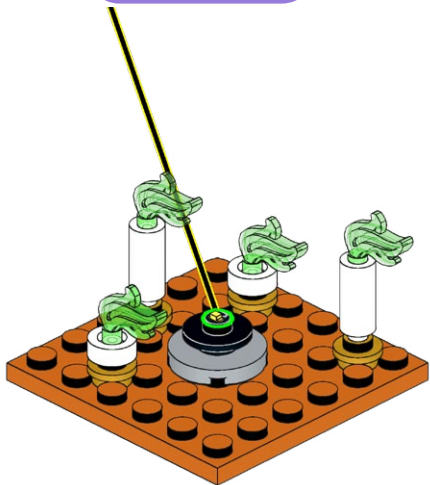

**2**

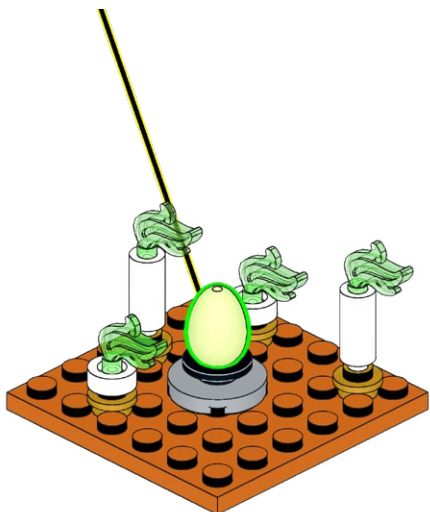

**249**

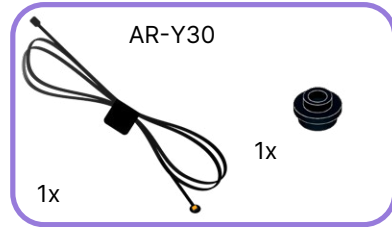

**1**

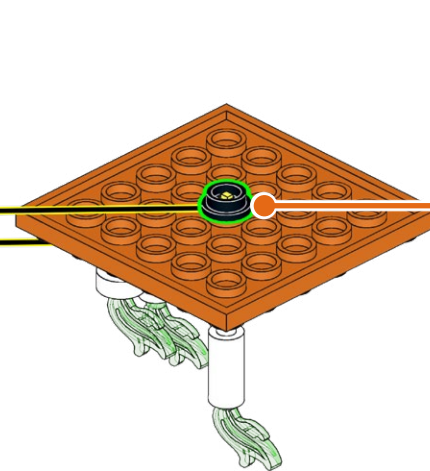
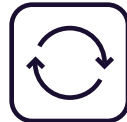

**2**

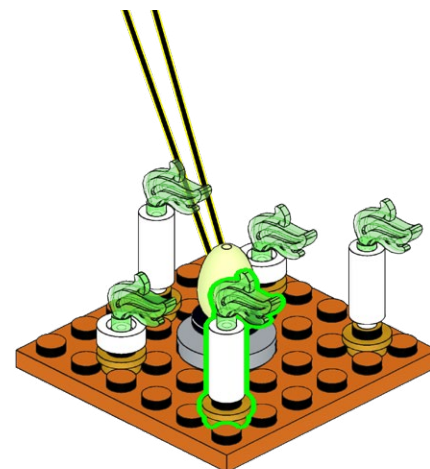



250

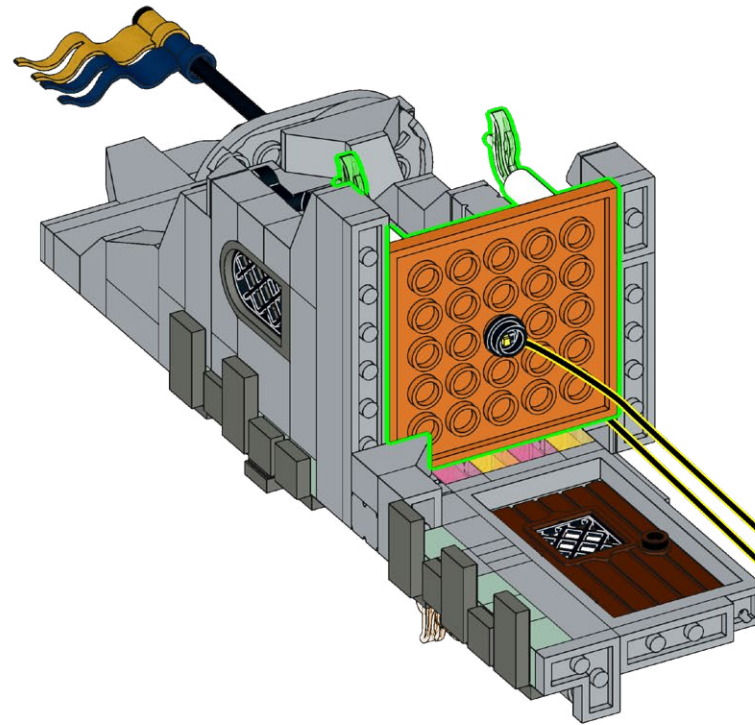

# 251

1

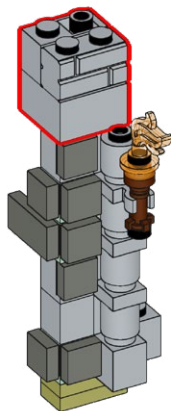

2

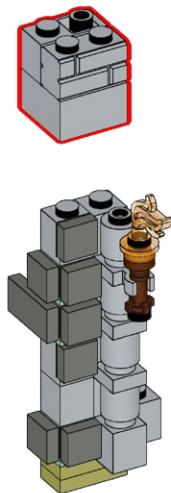

# 252

1

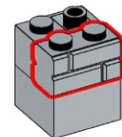

2

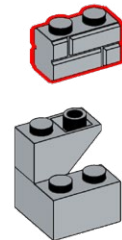

253

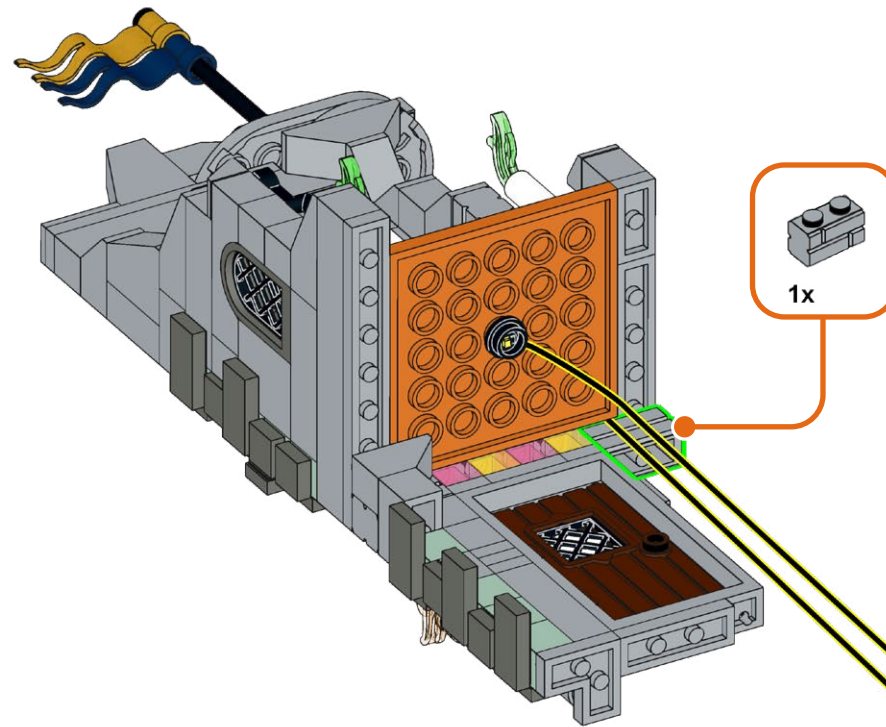



254

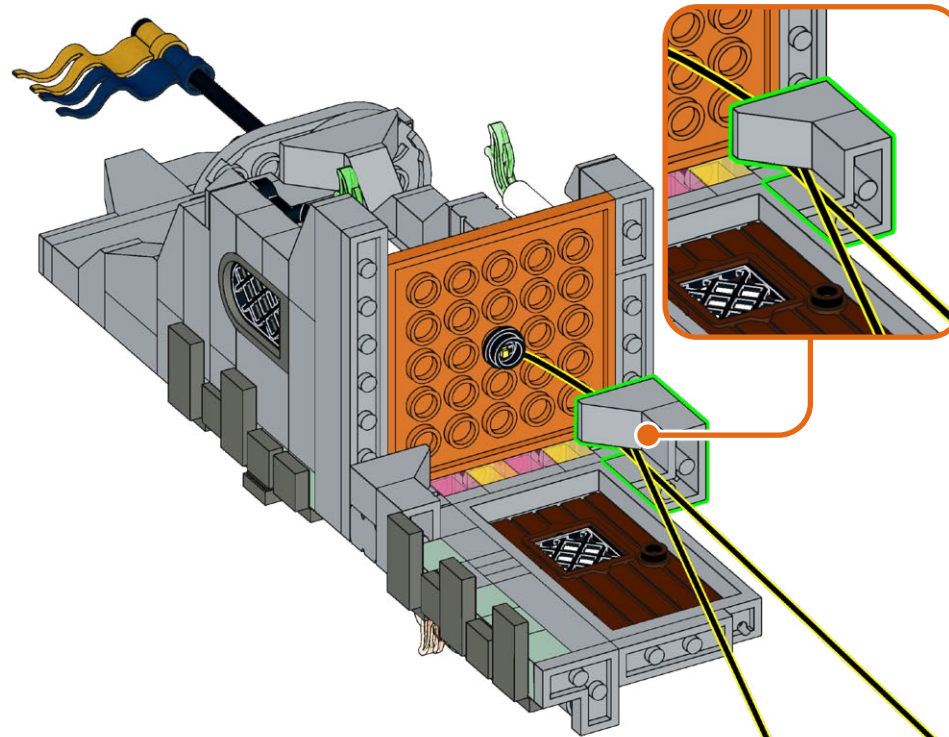

# 255

1

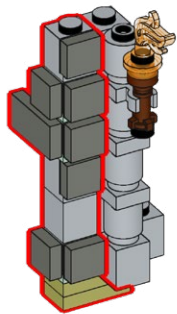

2

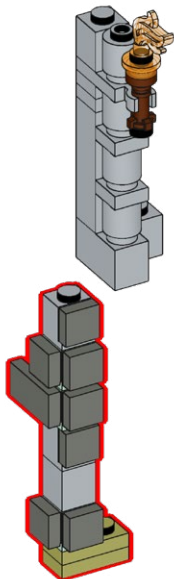

# 256

1

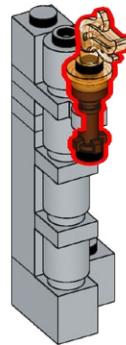

2

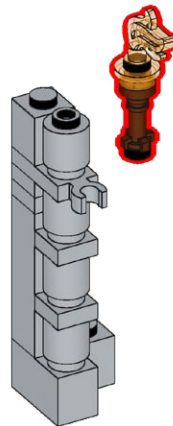

**257**

**1**



**2**

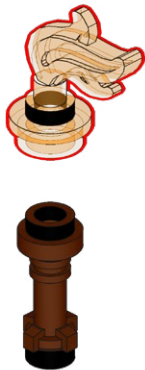

**258**

**1**

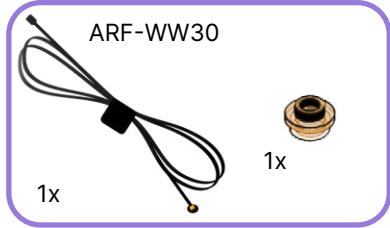

**2**

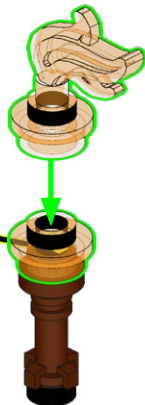



259

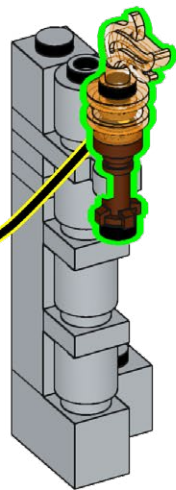

260

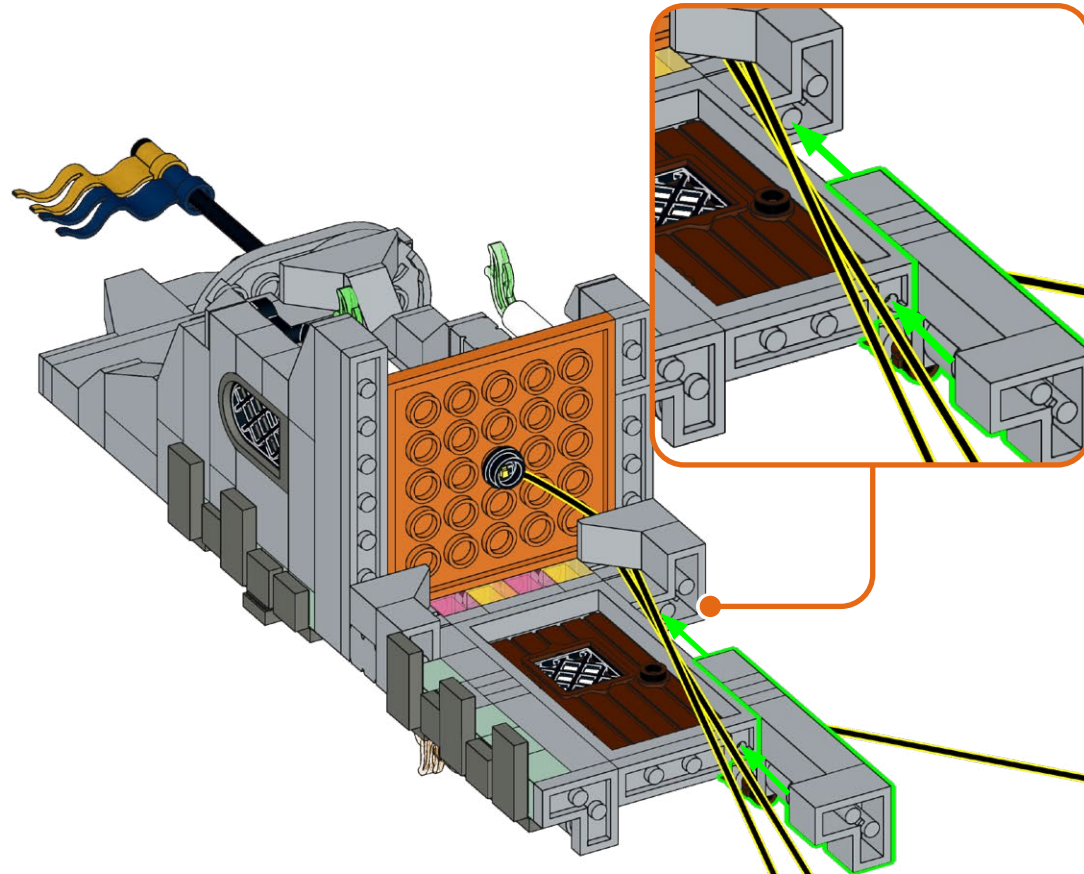

261

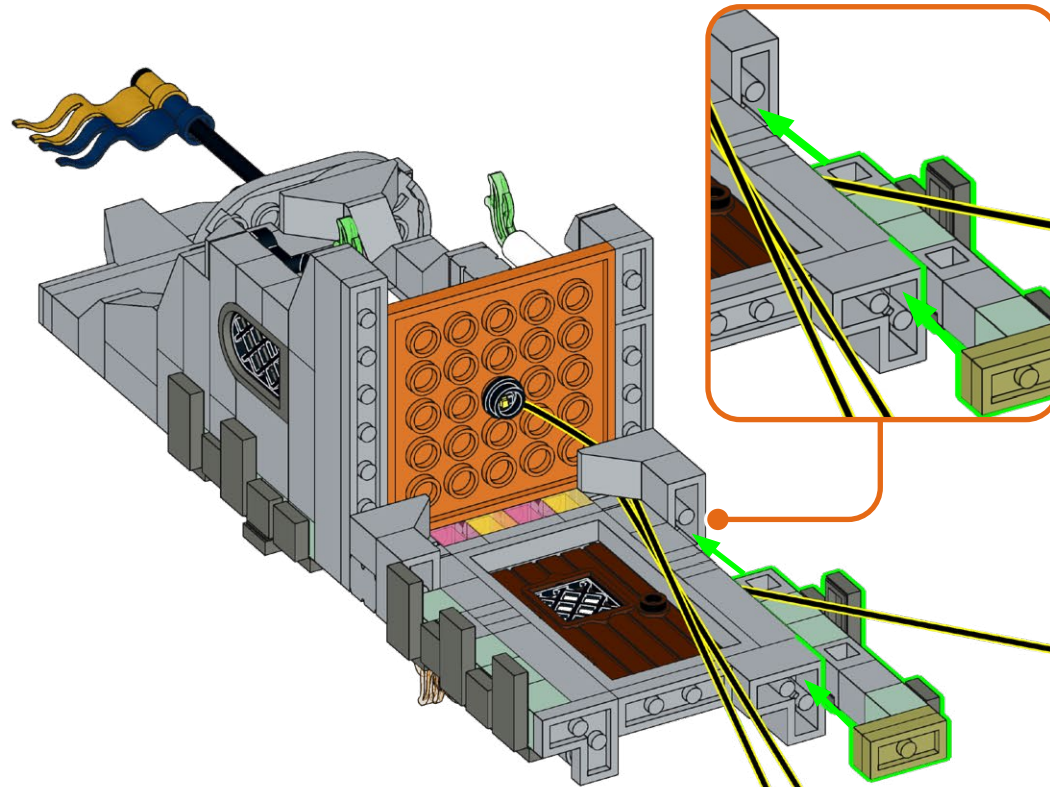



262

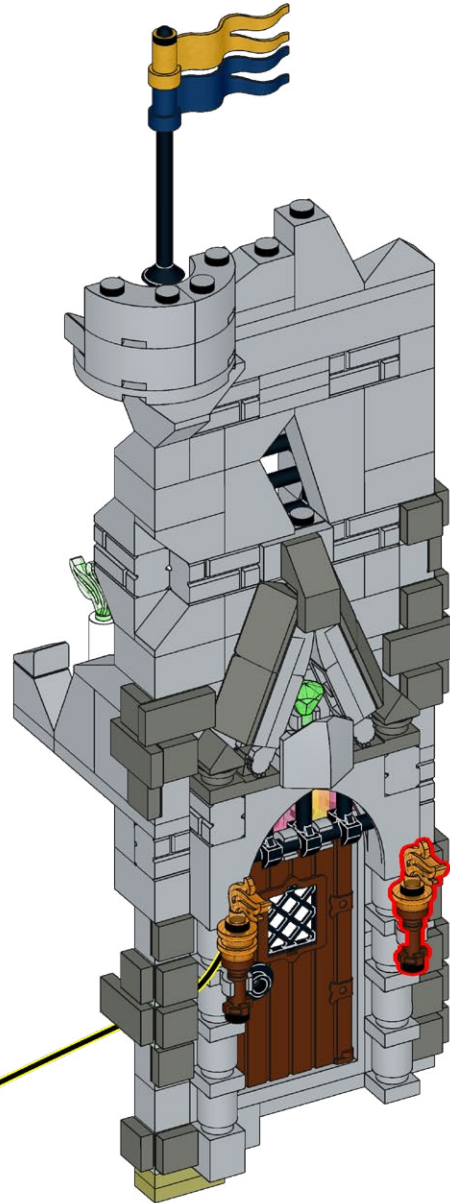

263

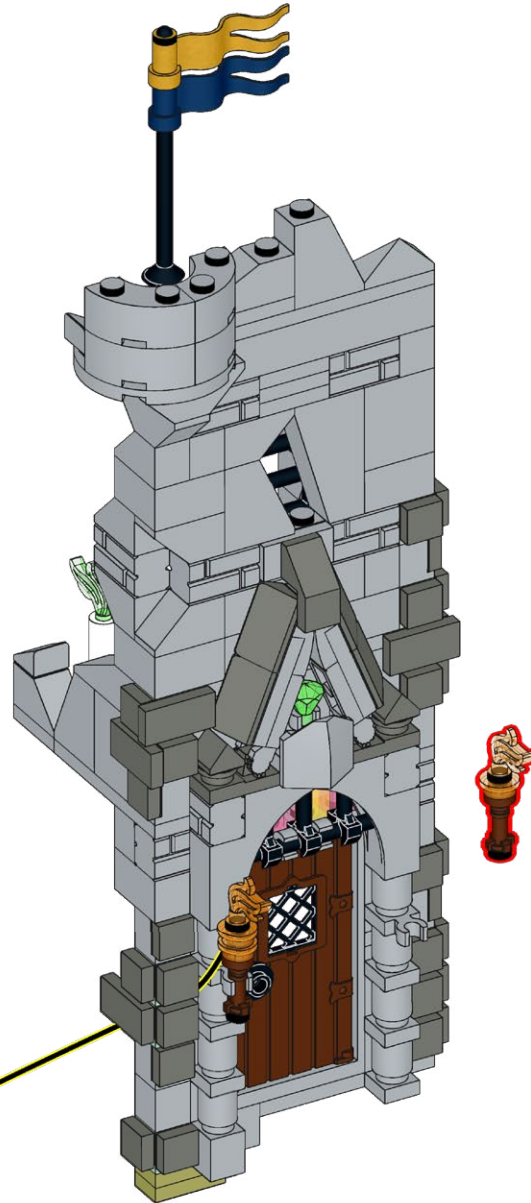

264

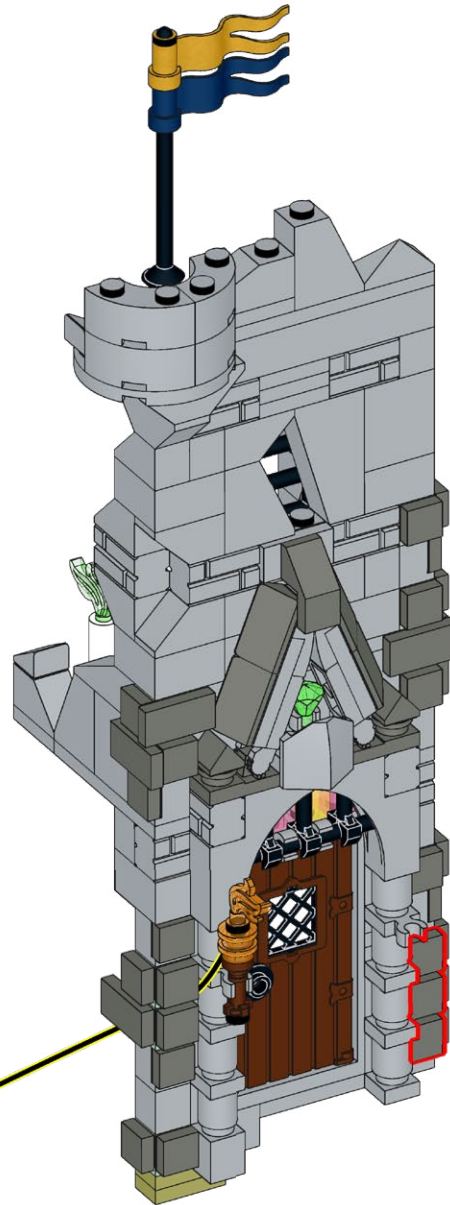



265

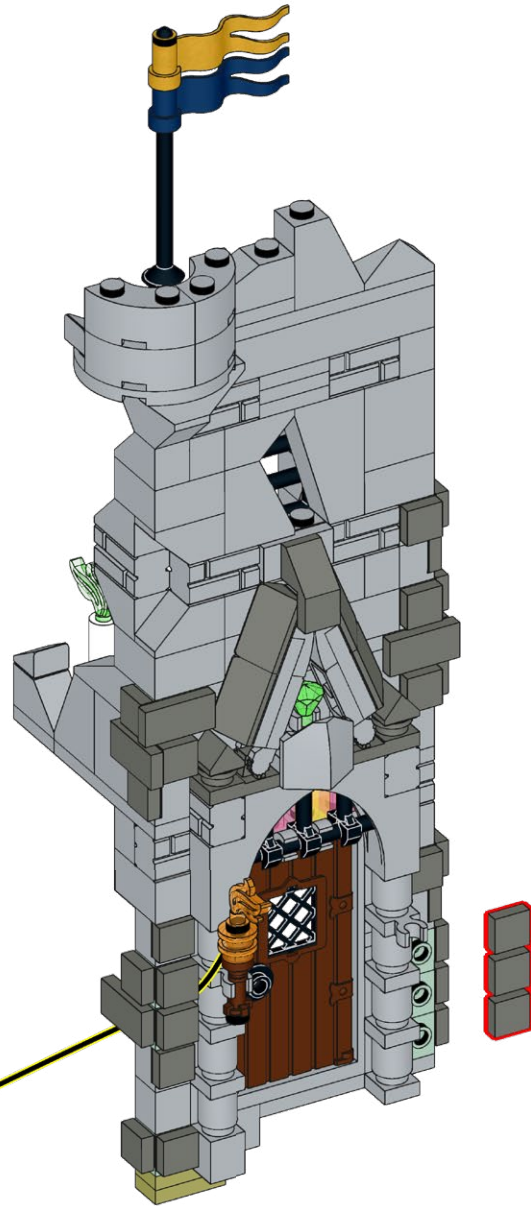

# 266

1



2

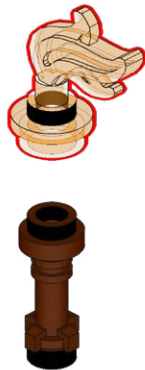

# 267

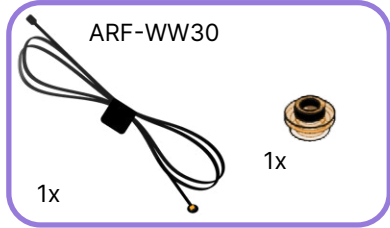

1



2

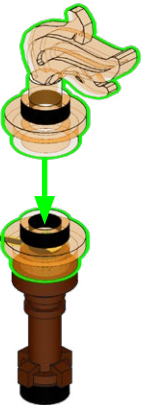

268

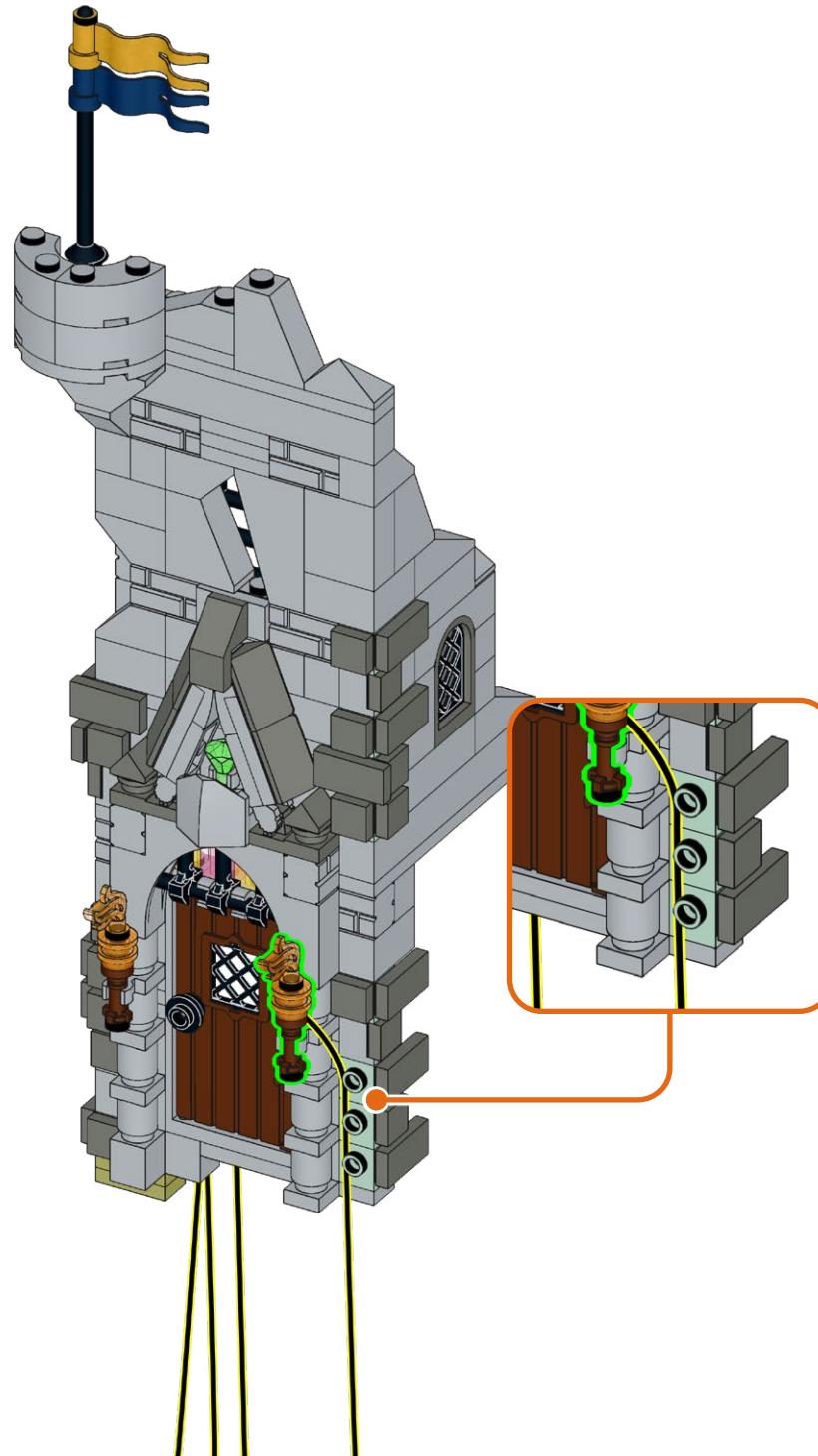



269

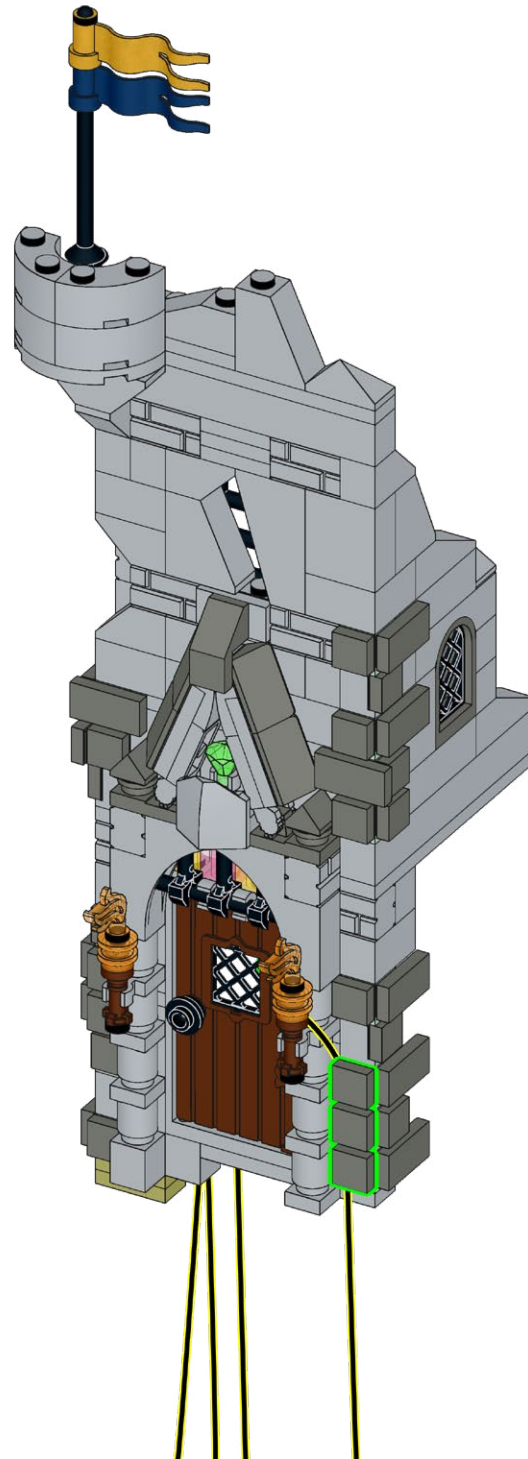

270



271

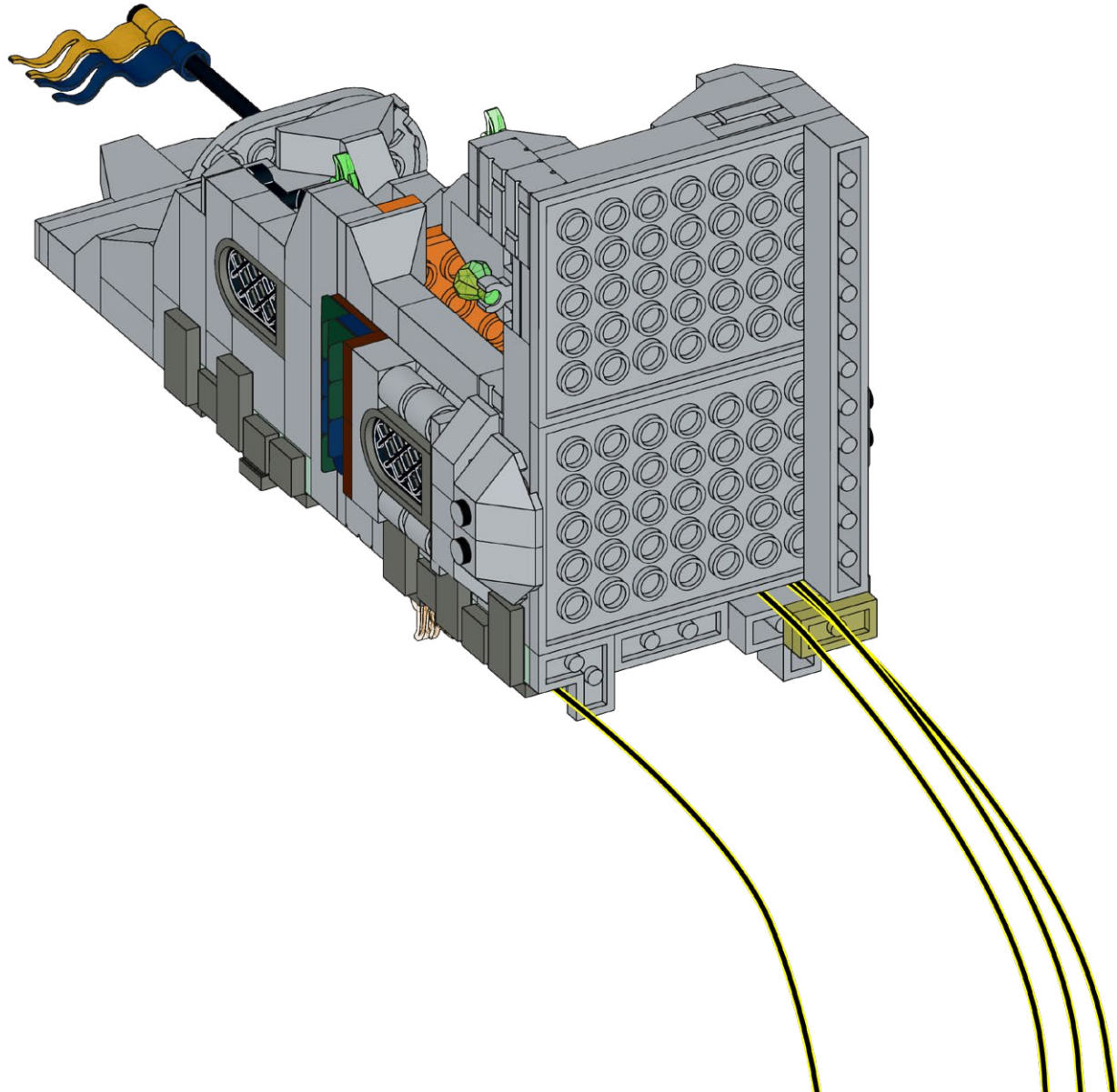



**272**

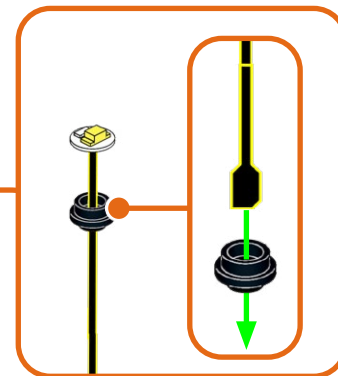
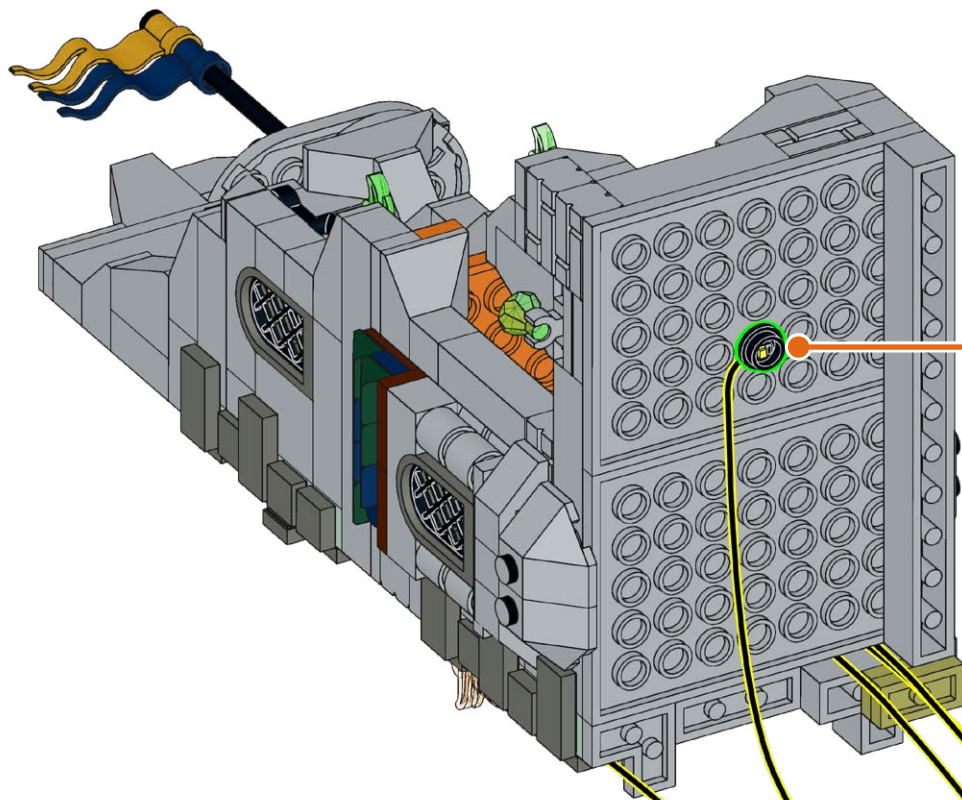
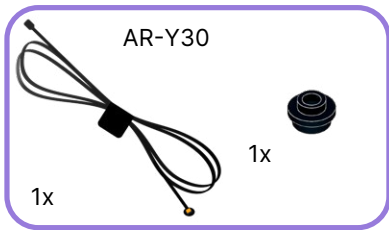

273

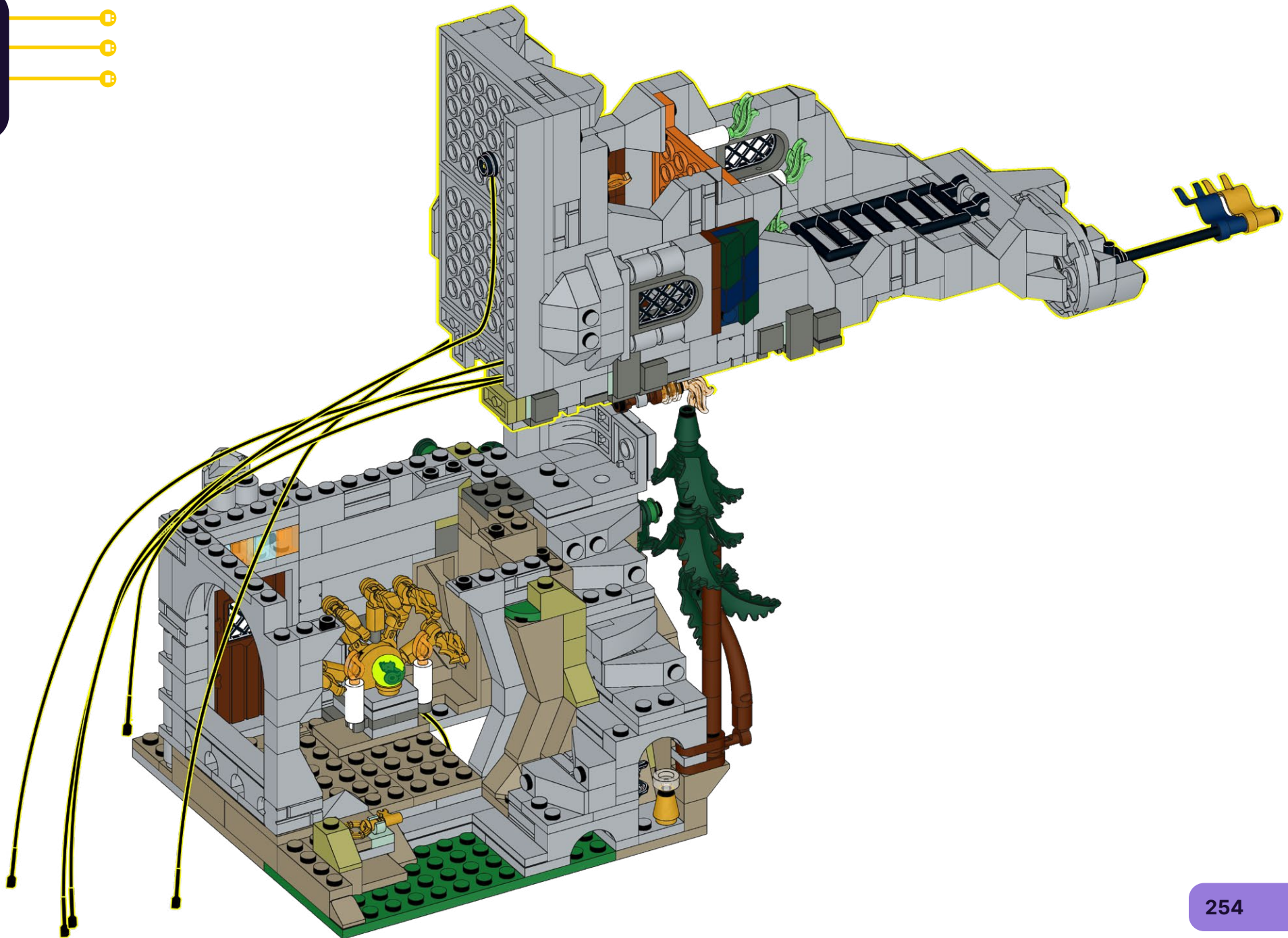
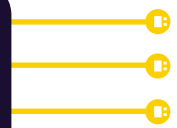



274

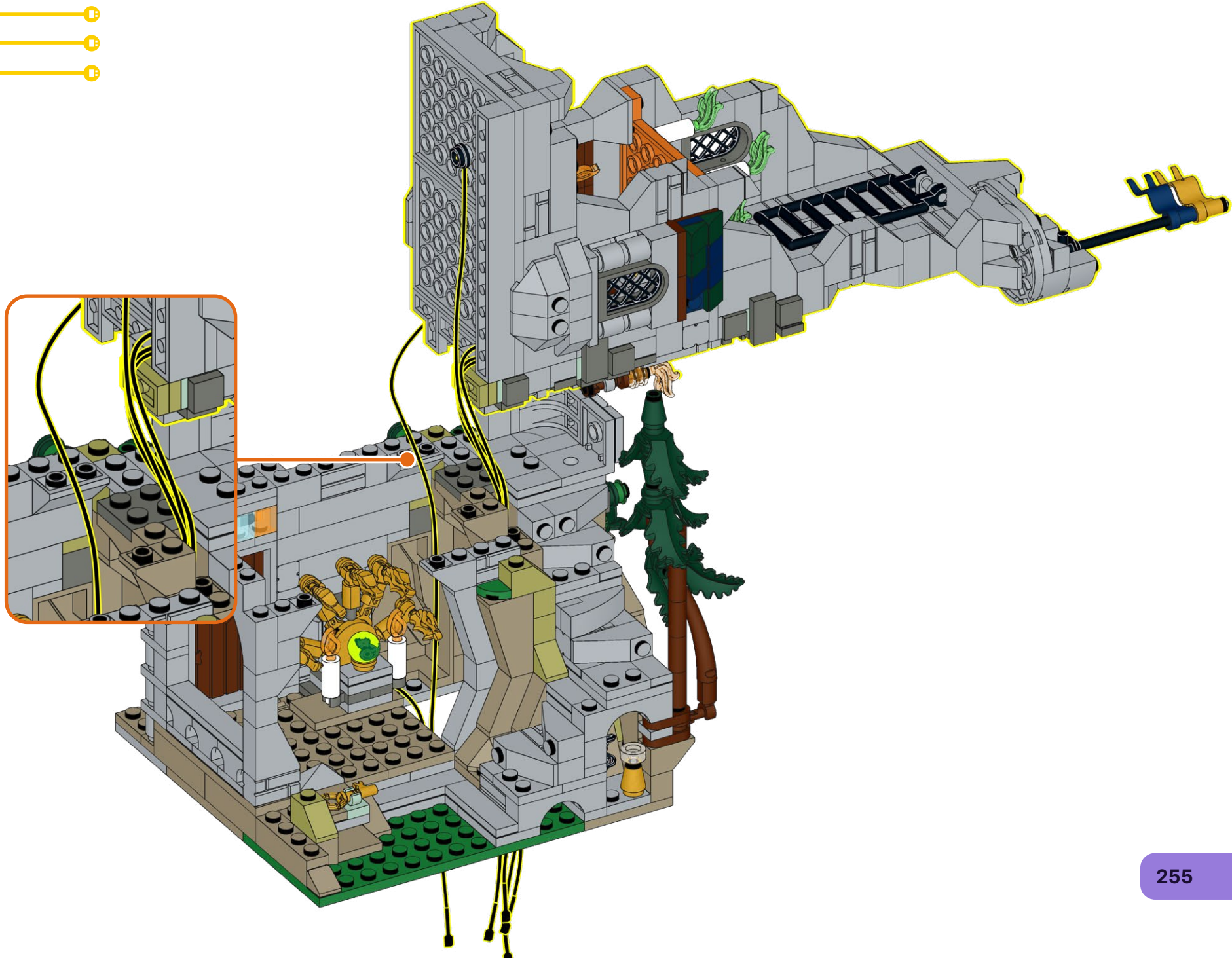
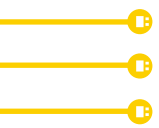



275



276



277

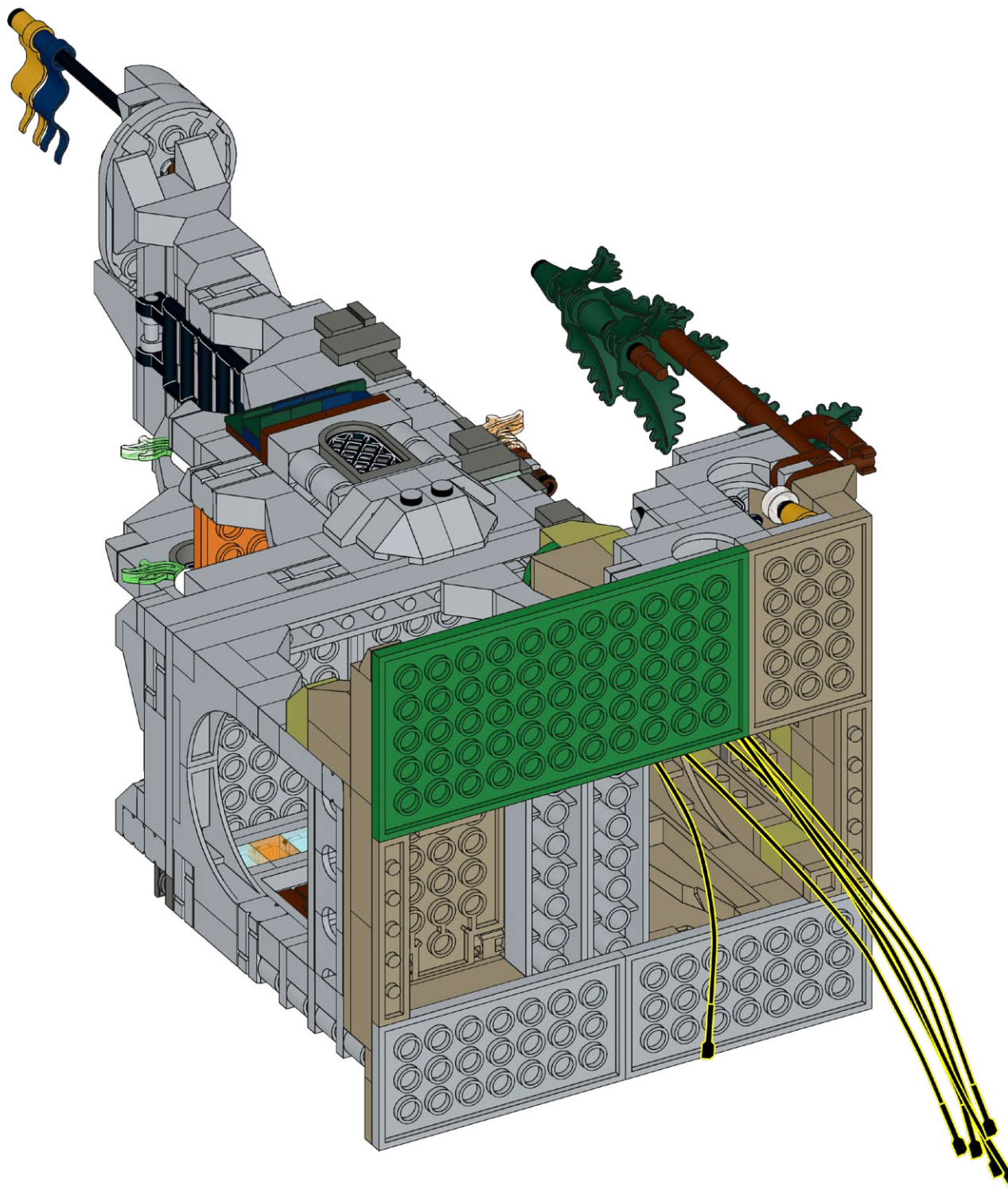



278

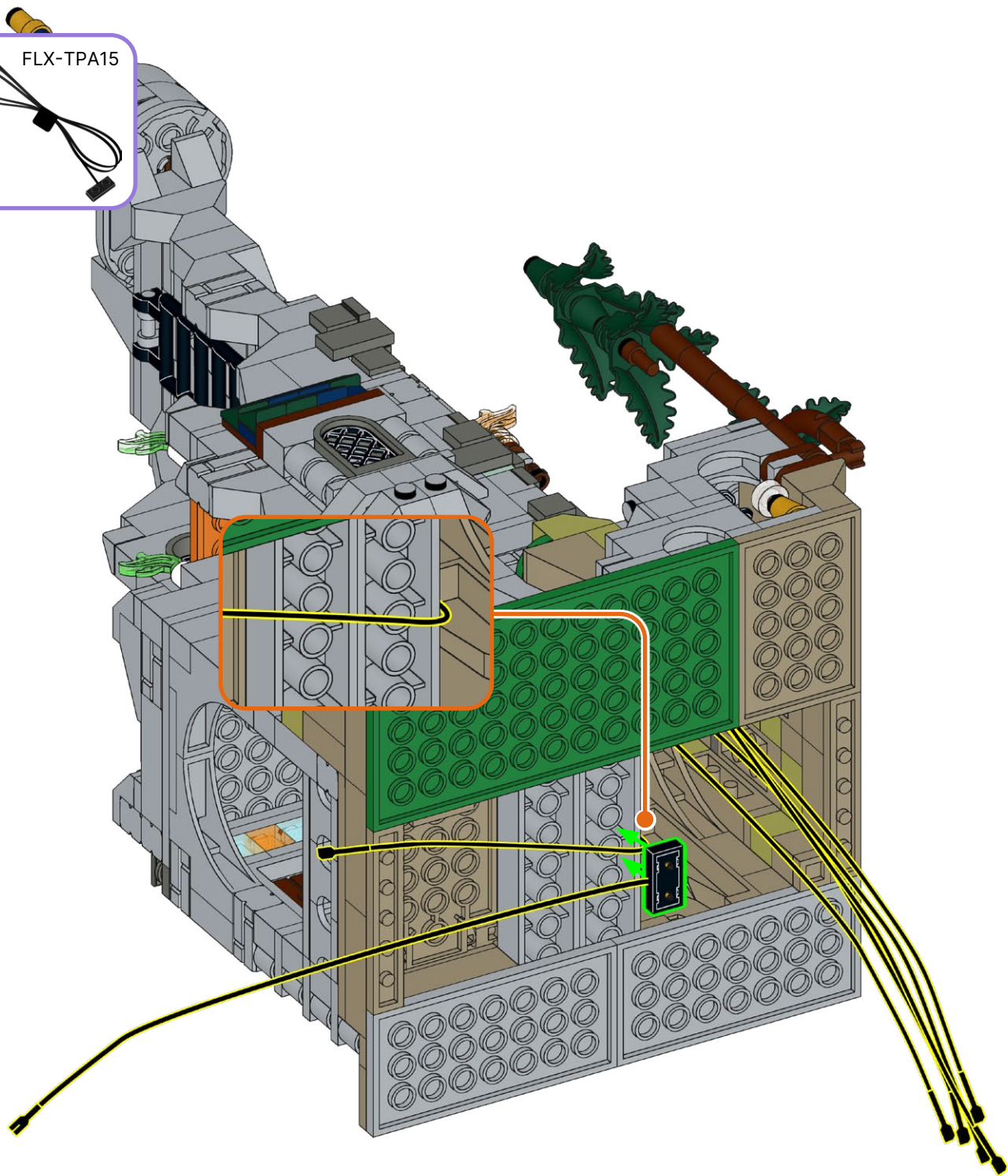
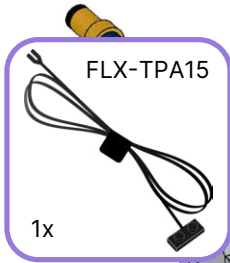

279

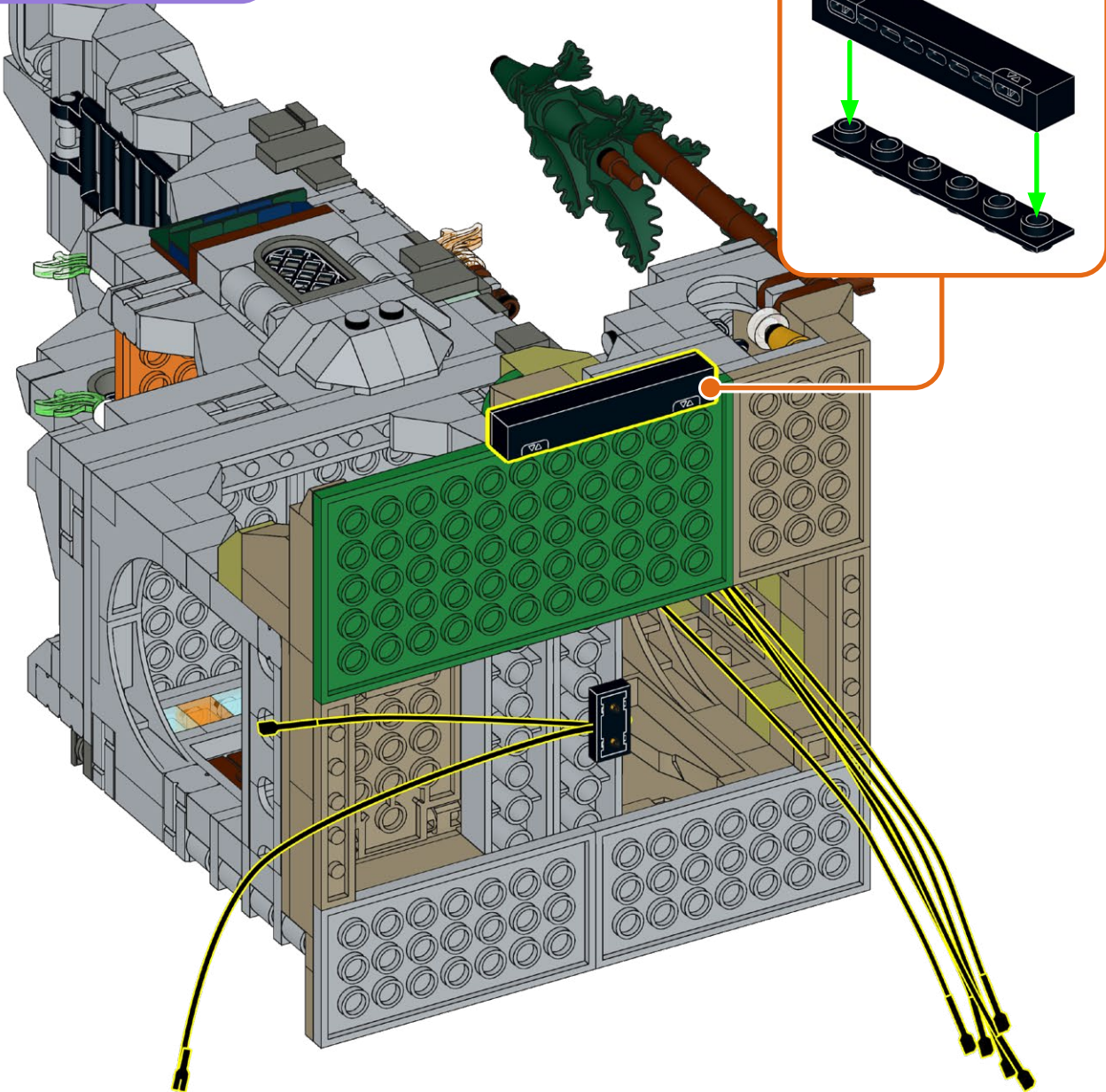
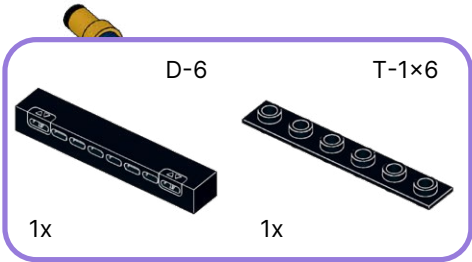



280

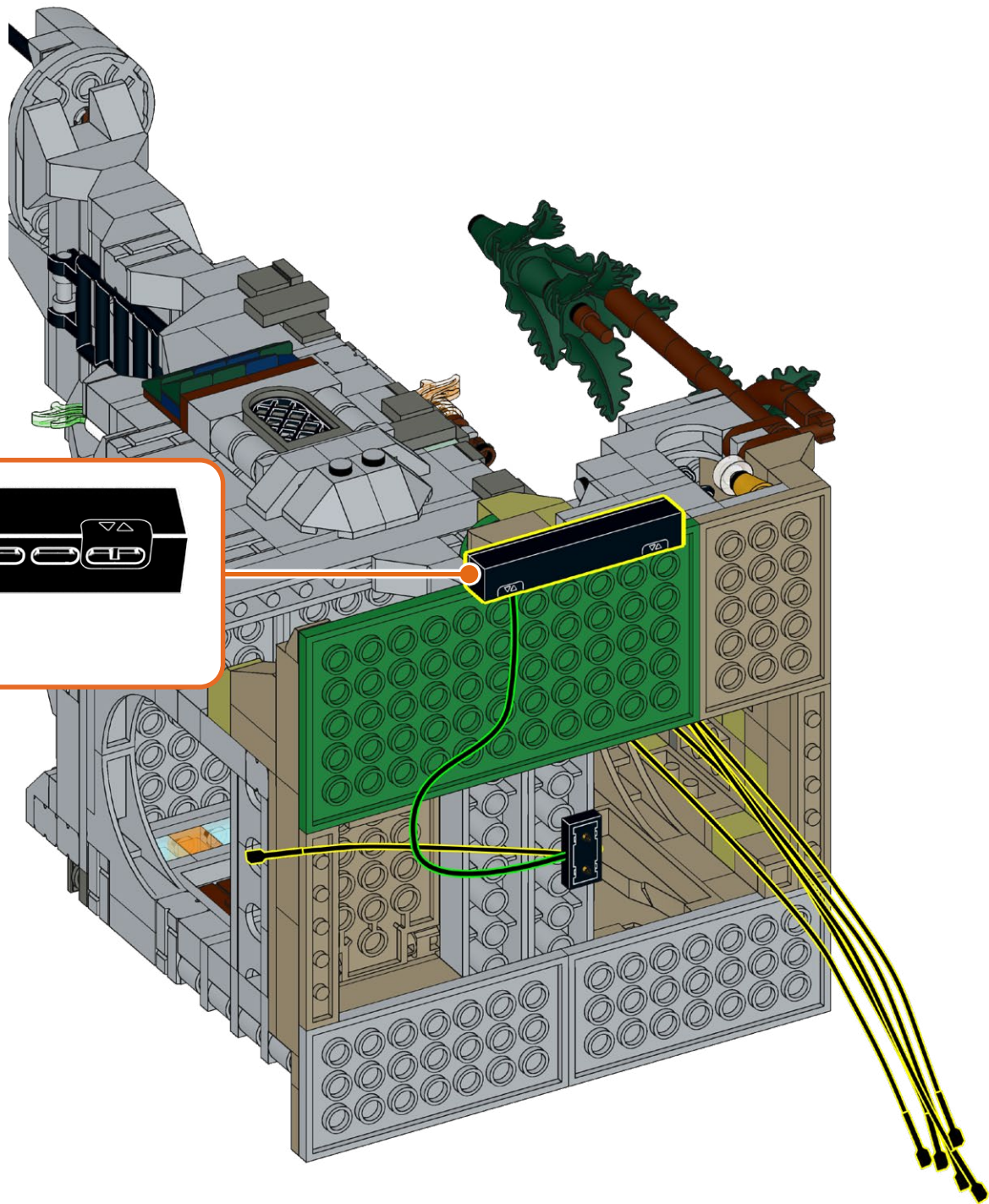



281

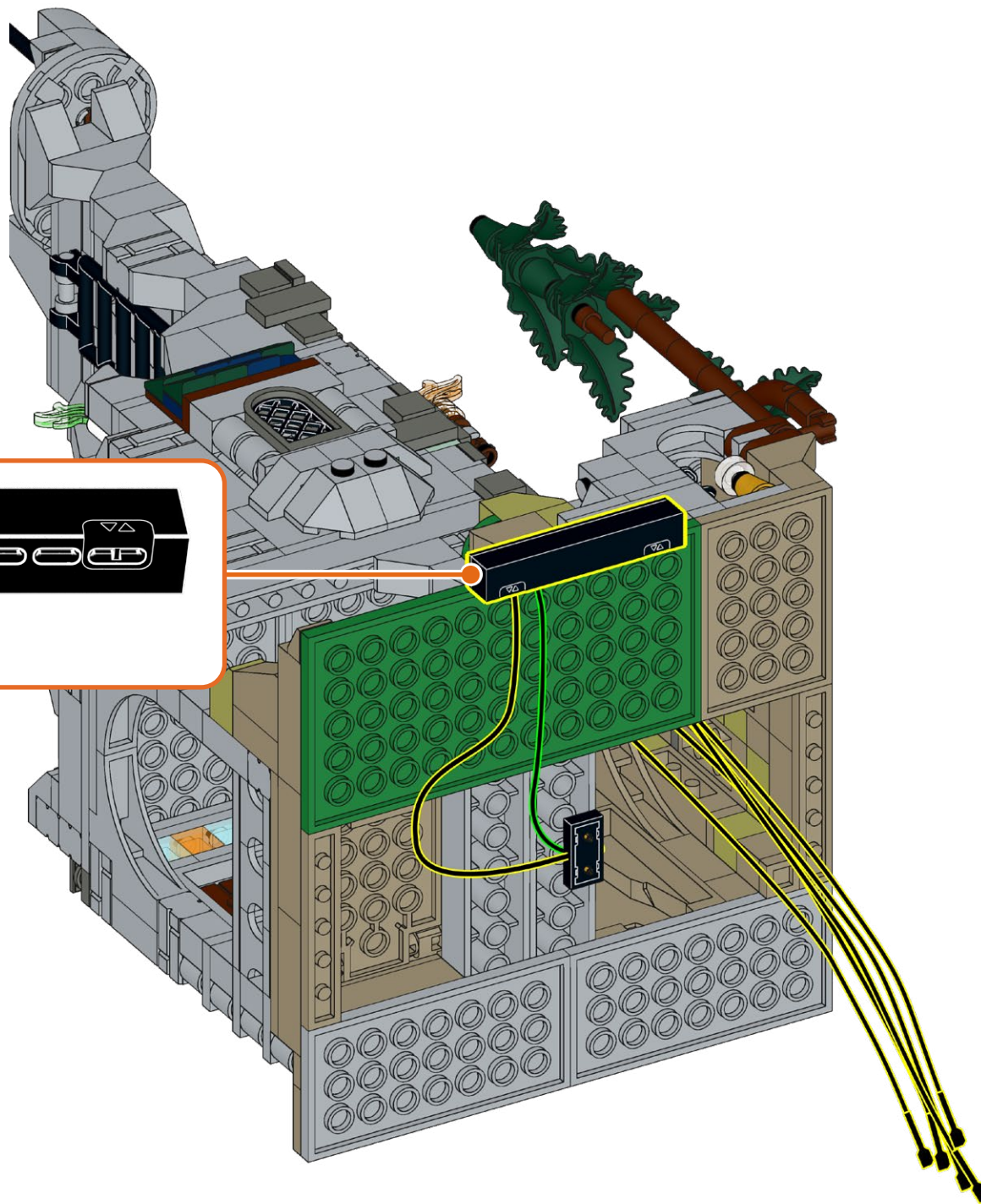

282

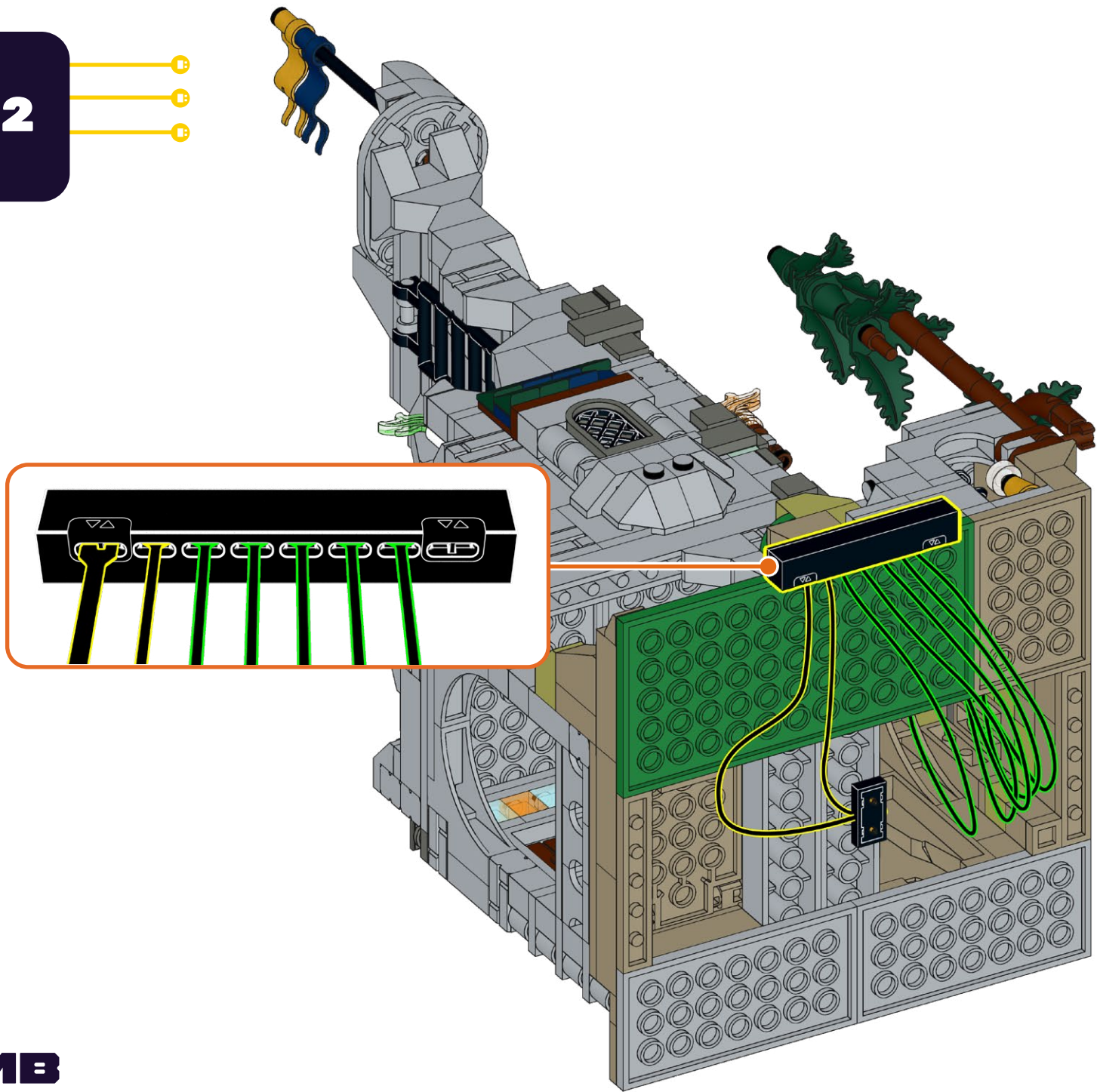



283

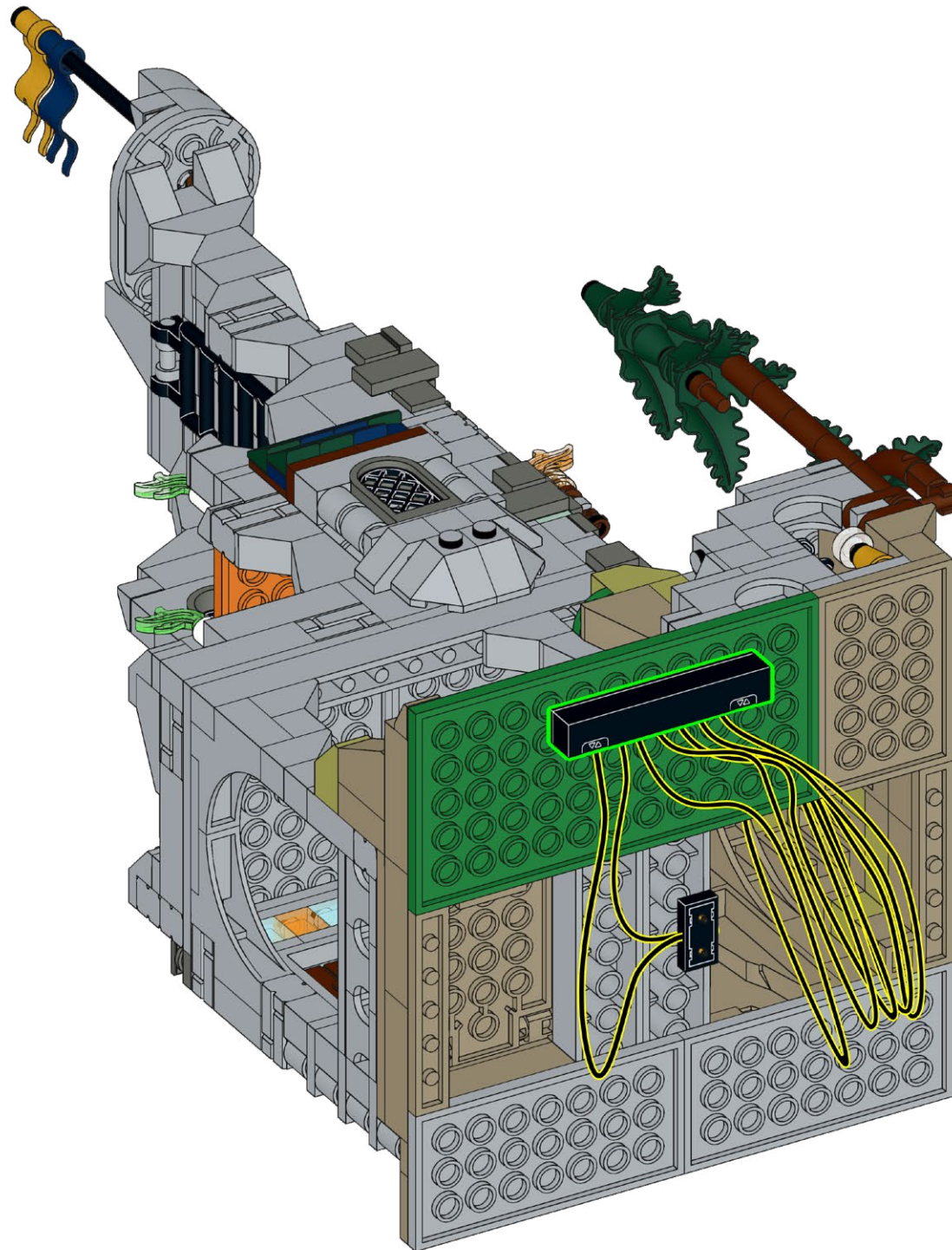



284

E-1x2      T-1x2

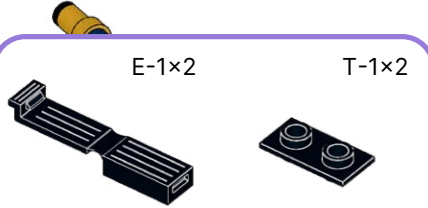

1x                      1x

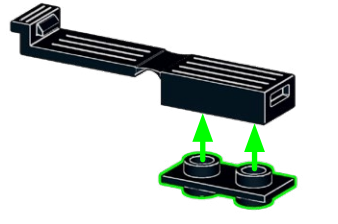
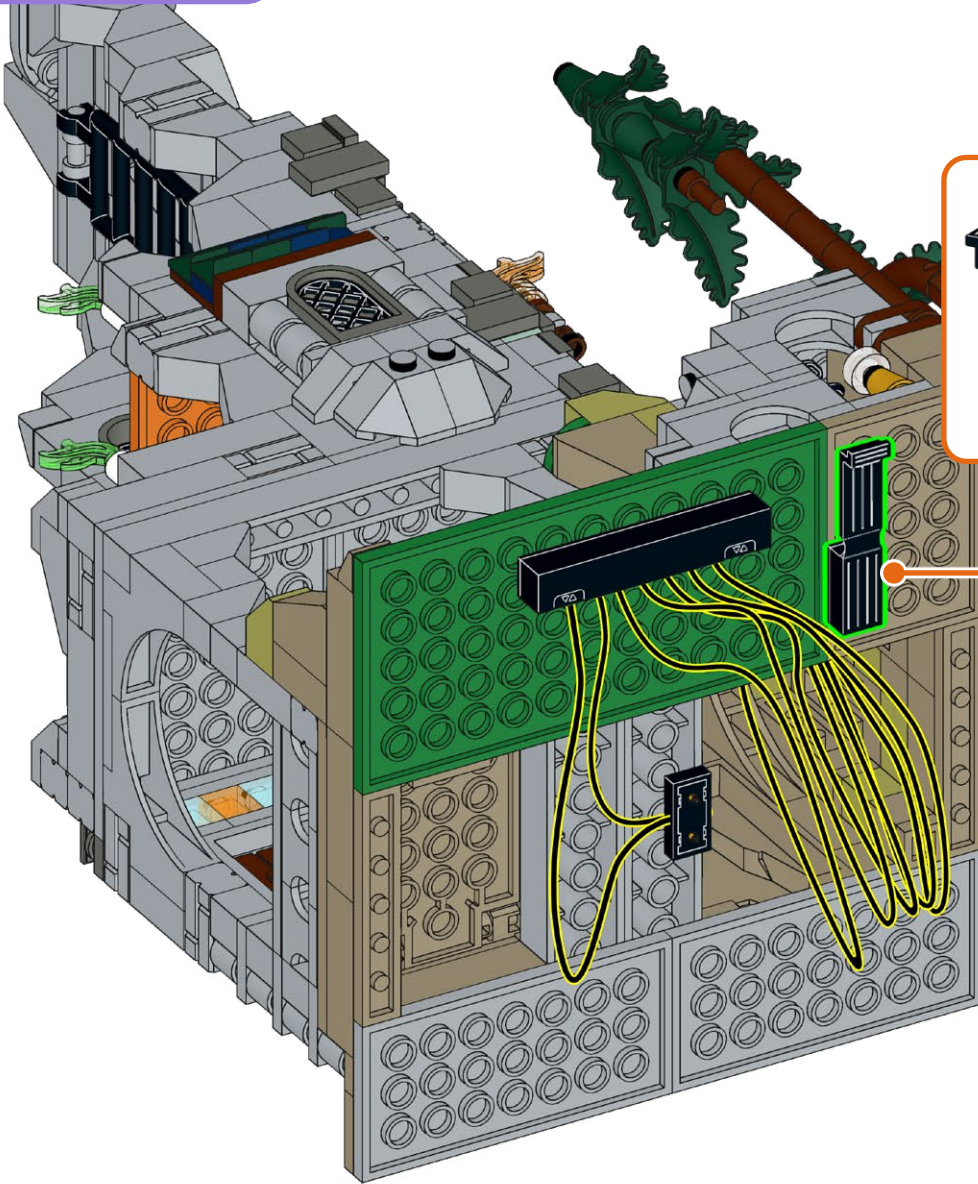

285

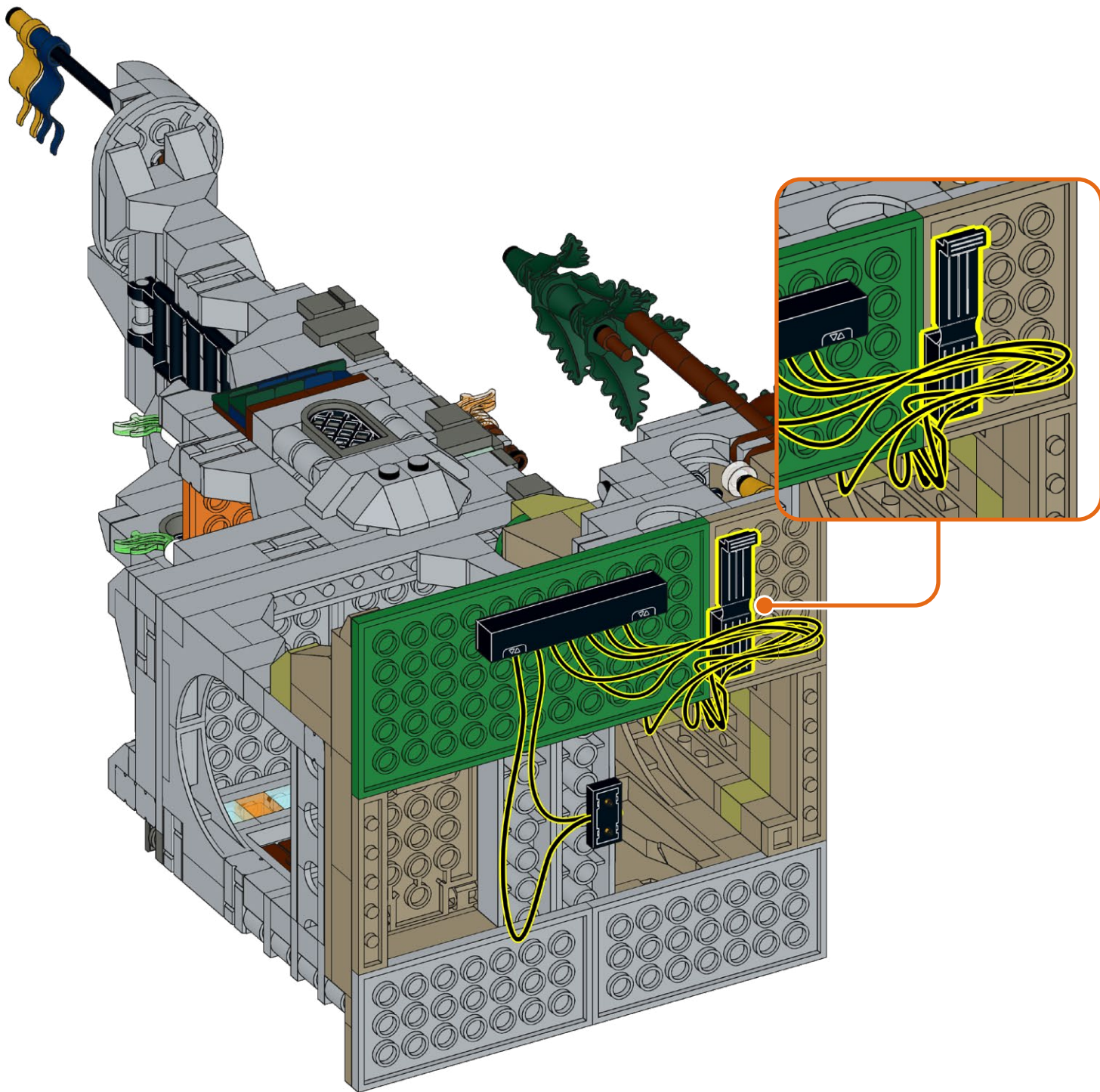



286

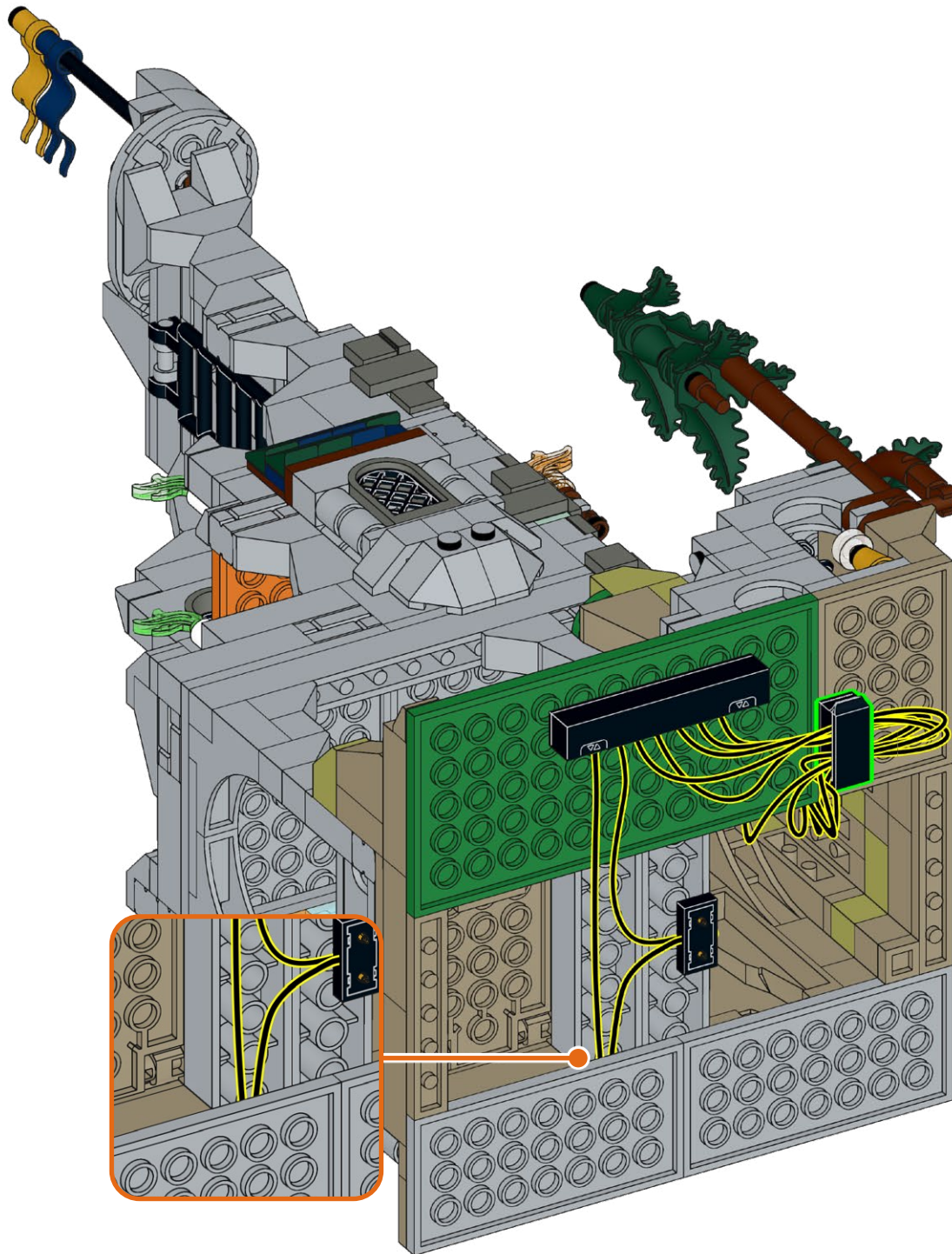



287



Power on Test  
Test de mise sous tension  
Test di Potenza  
Stromtest  
Prueba de Energía  
电源测试





### **HOLD UP!**

You might notice some bags aren't in order, as well as left over pieces, but that's ok! We're changing the way you build LEGO!

### **ATTENDEZ!**

Vous remarquerez peut-être que certains sacs, ainsi que certaines pièces, ne sont pas dans le bon ordre. Mais pas de panique! Nous changeons simplement la façon avec laquelle vous construisez vos LEGO!

### **ASPETTA!**

Potresti notare che alcuni sacchetti non sono in ordine, così come i pezzi avanzati, ma va bene così! Stiamo cambiando il modo in cui costruisci i LEGO!

### **HALT!**

Sie werden möglicherweise bemerken, dass einige tüten durcheinander sind und teile übrig bleiben, aber das ist in Ordnung! Wir ändern die art und weise, wie Sie LEGO bauen!

### **¡ESPERA!**

Es posible que notes que algunas bolsas están fuera de servicio, así como piezas sobrantes, ¡pero está bien! ¡Estamos cambiando la forma en que construyes LEGO!

### **暫停!**

你可能会注意到一些袋子顺序错乱, 以及一些剩余的部件, 但没关系! 我们正在改变你搭建乐高的方式!

#### Open LMB Bag 05

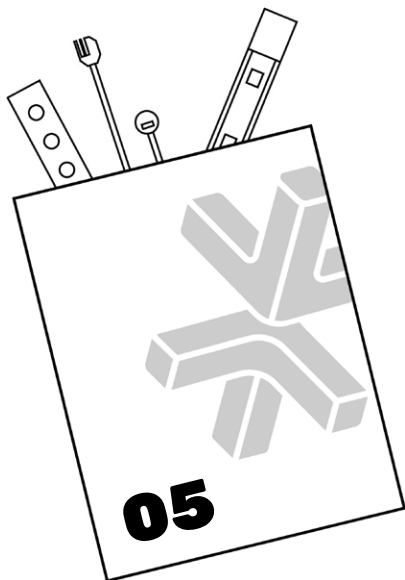

288

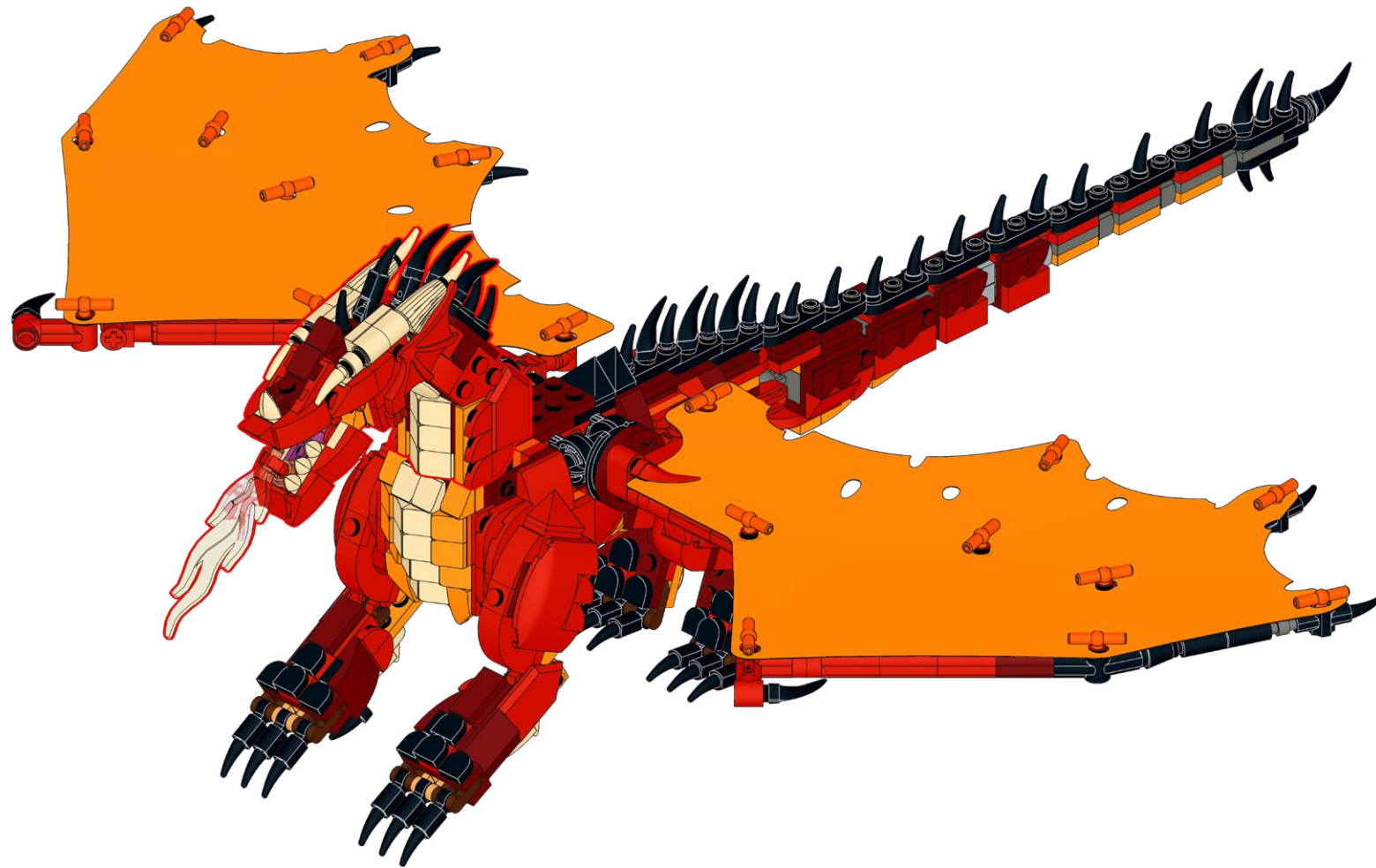



289

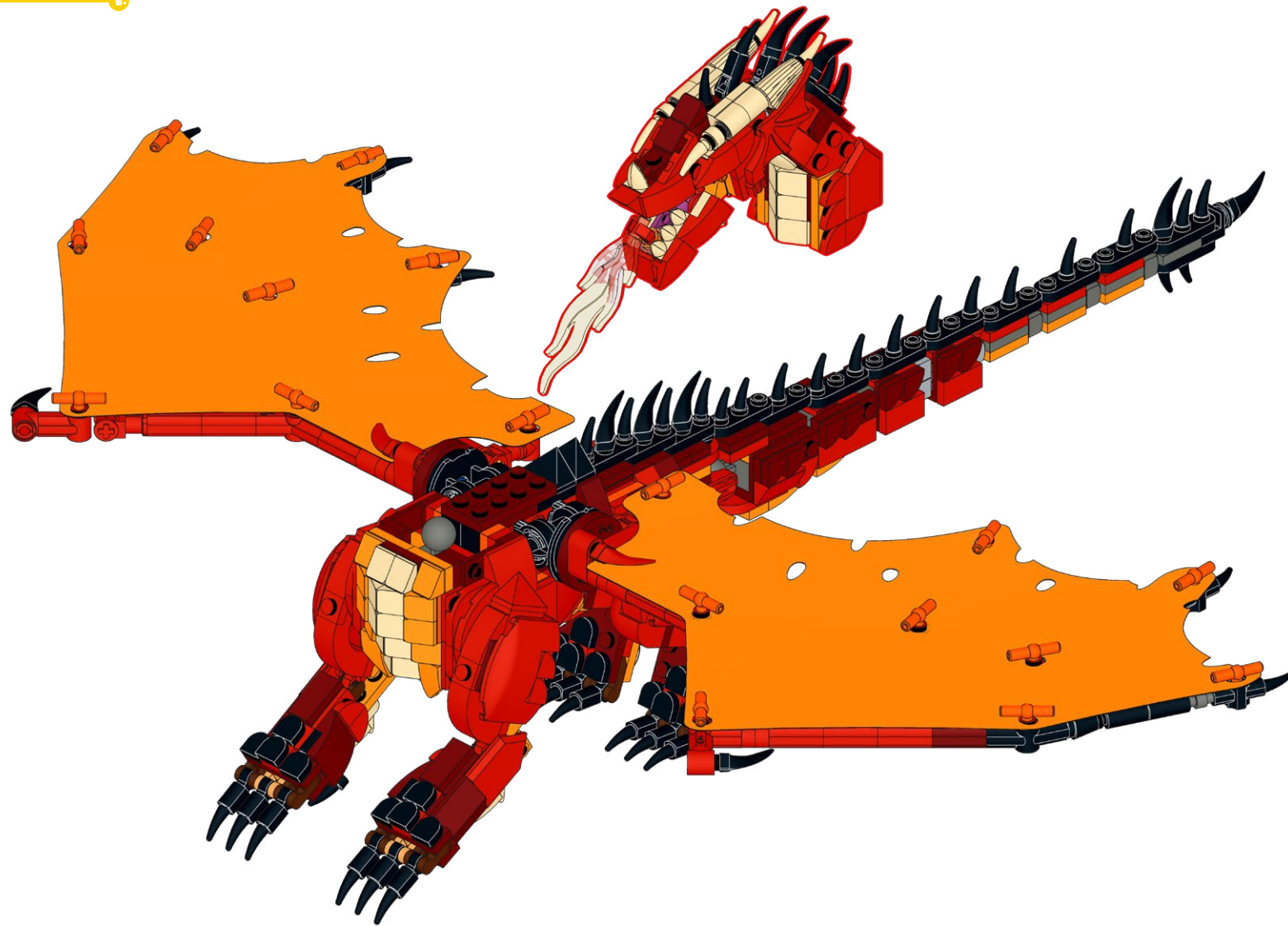

290

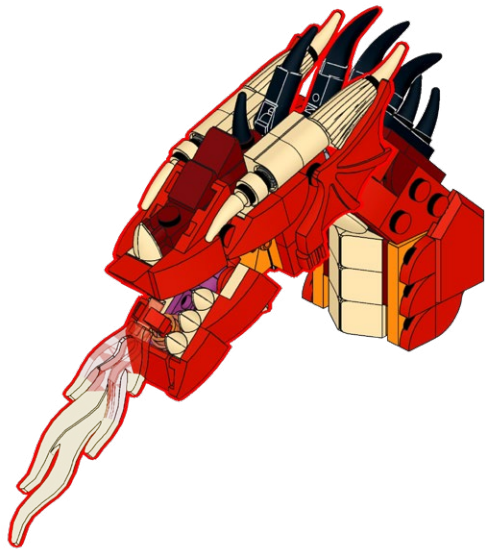

291

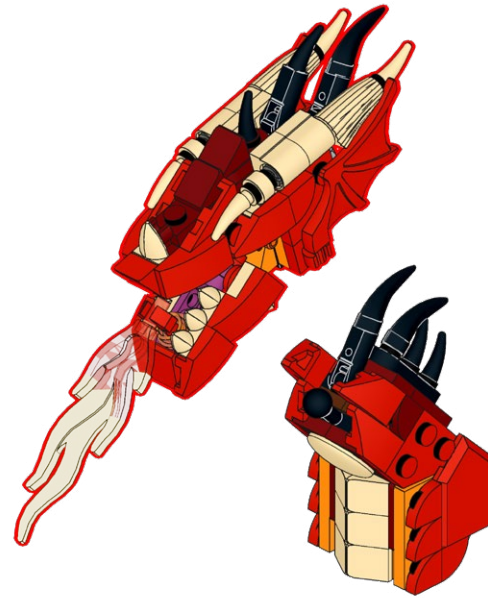

292



293

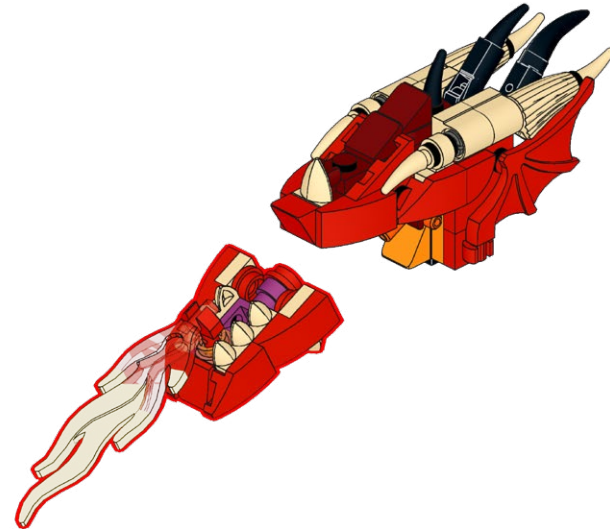



294

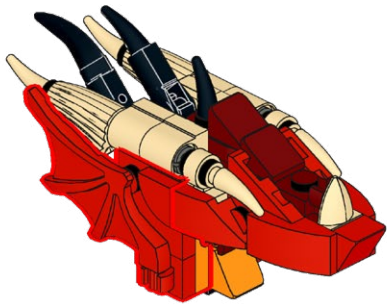

295

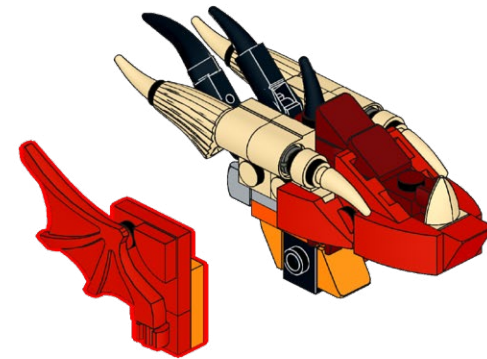

296

AL-O15

1x

1x

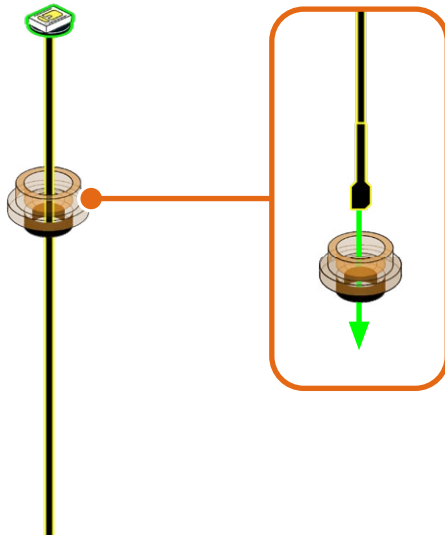

297

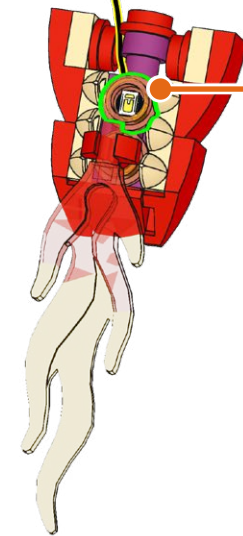
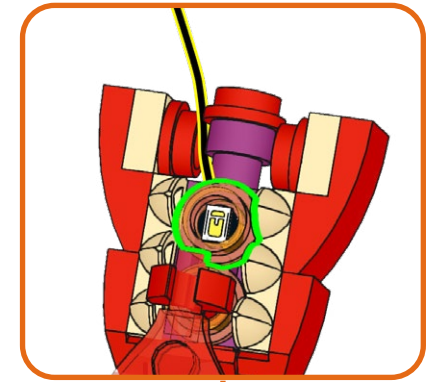

298

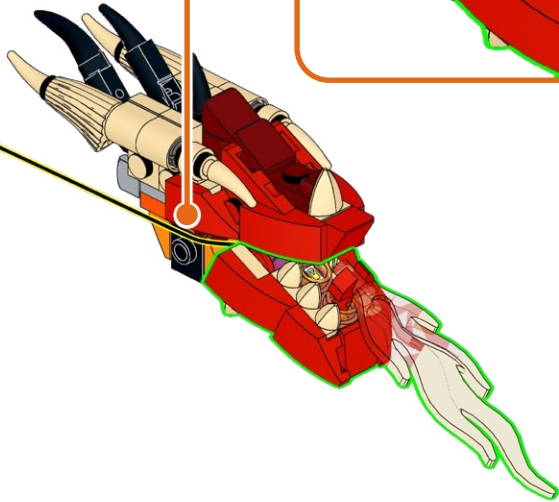
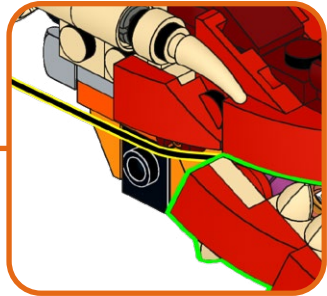
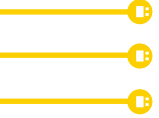

299

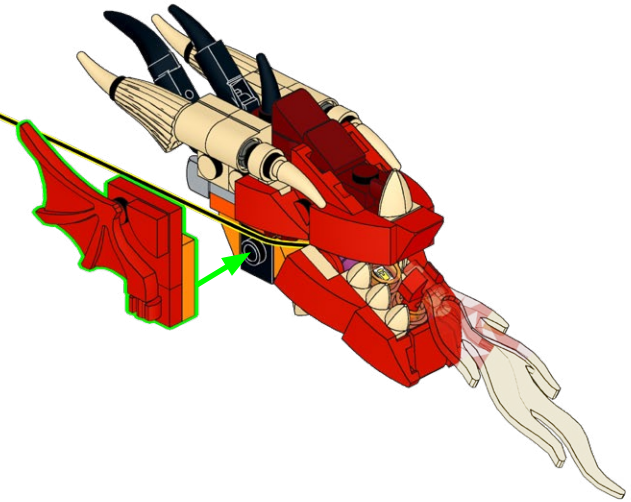



300

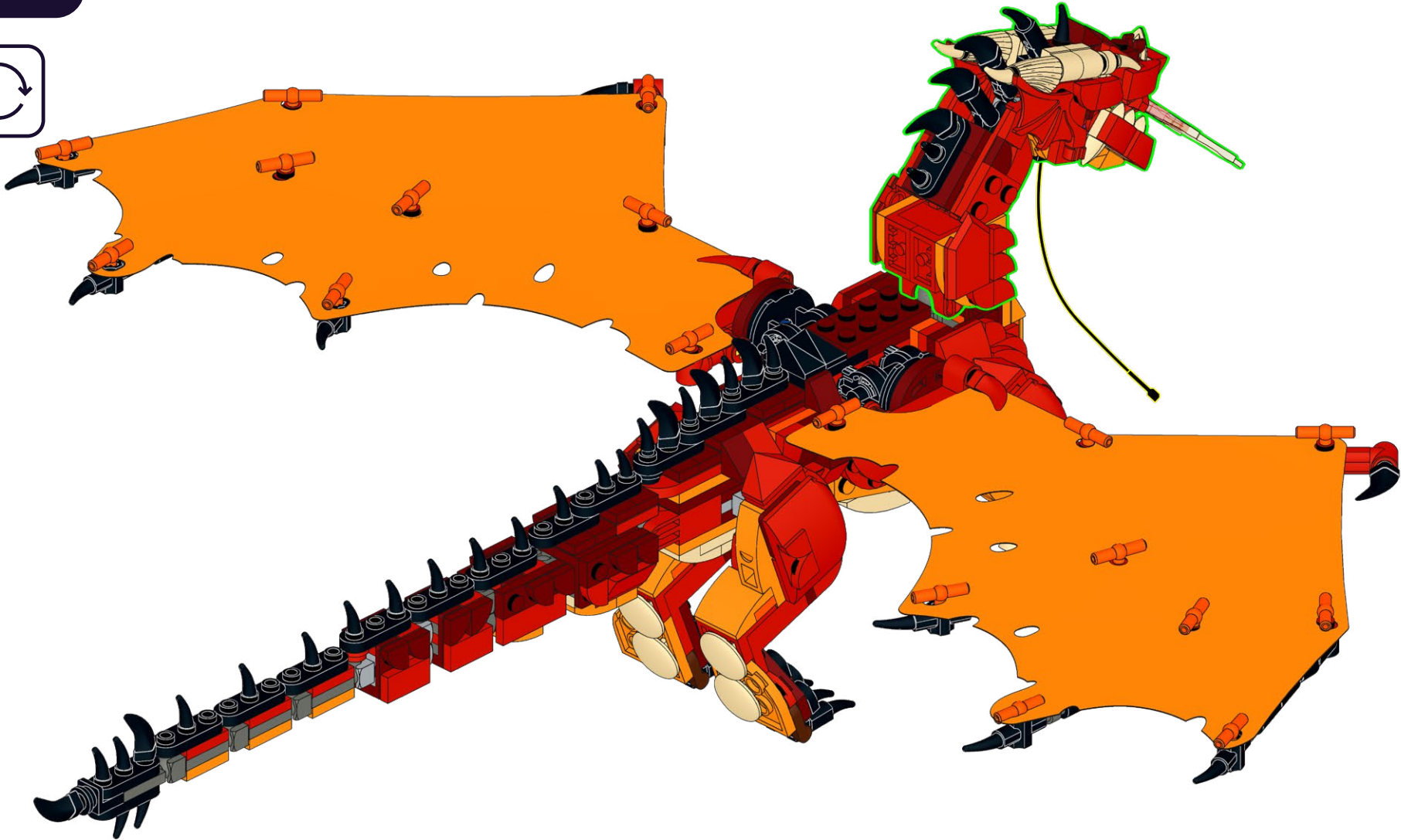

301

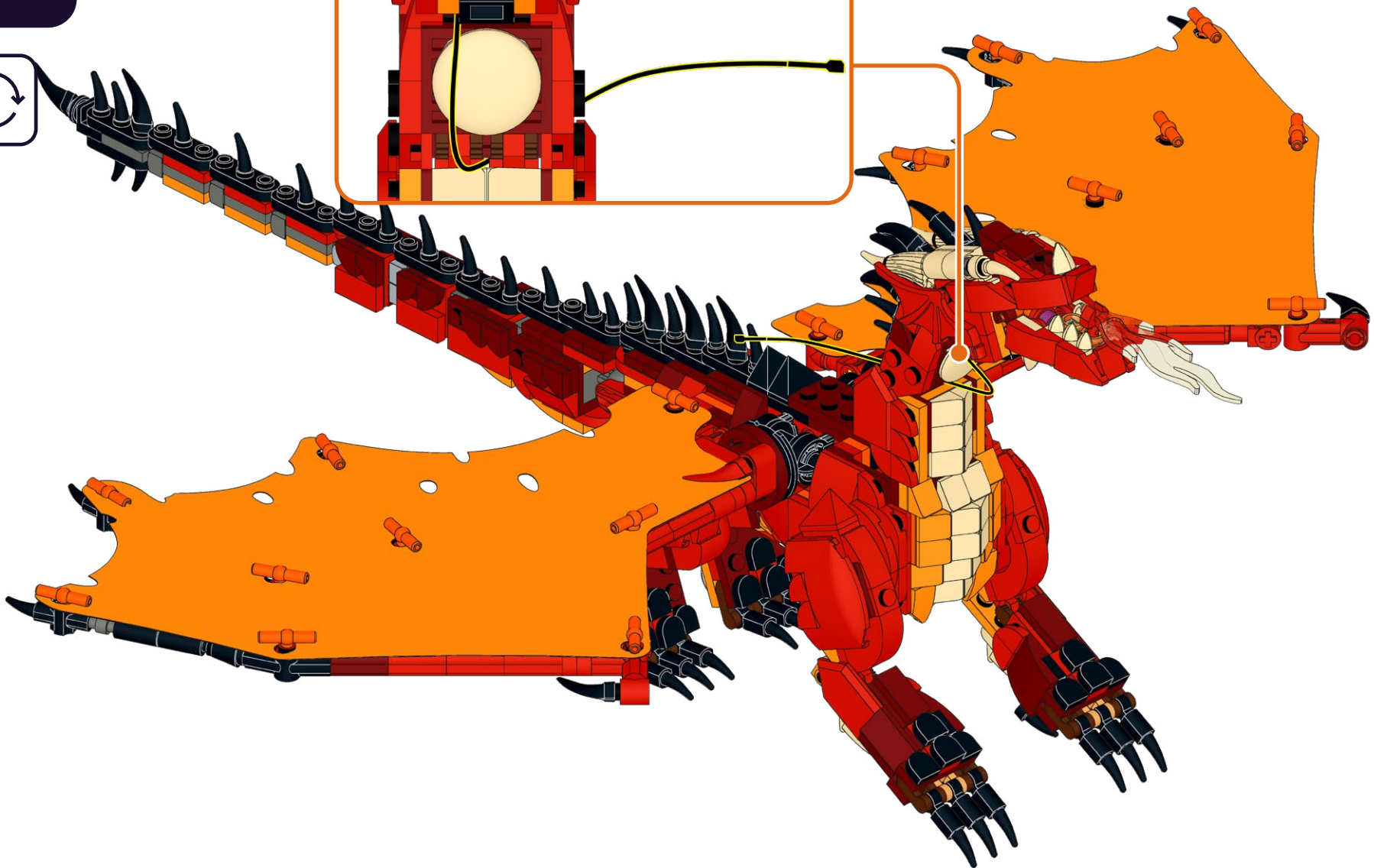
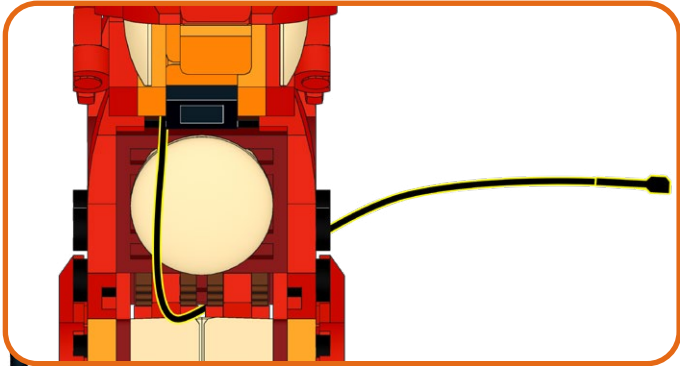

**302**

Power Brick  
1x





303

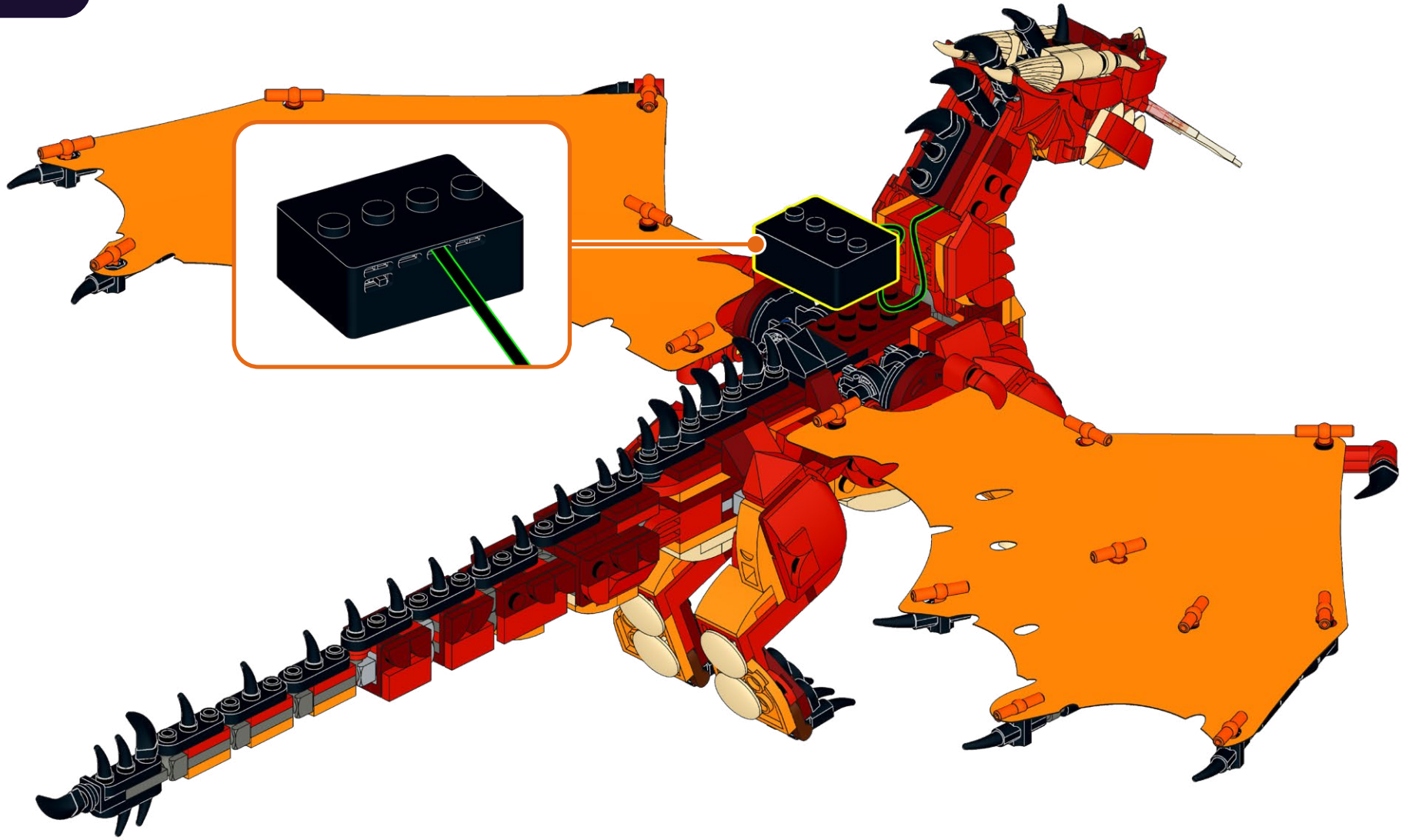

304

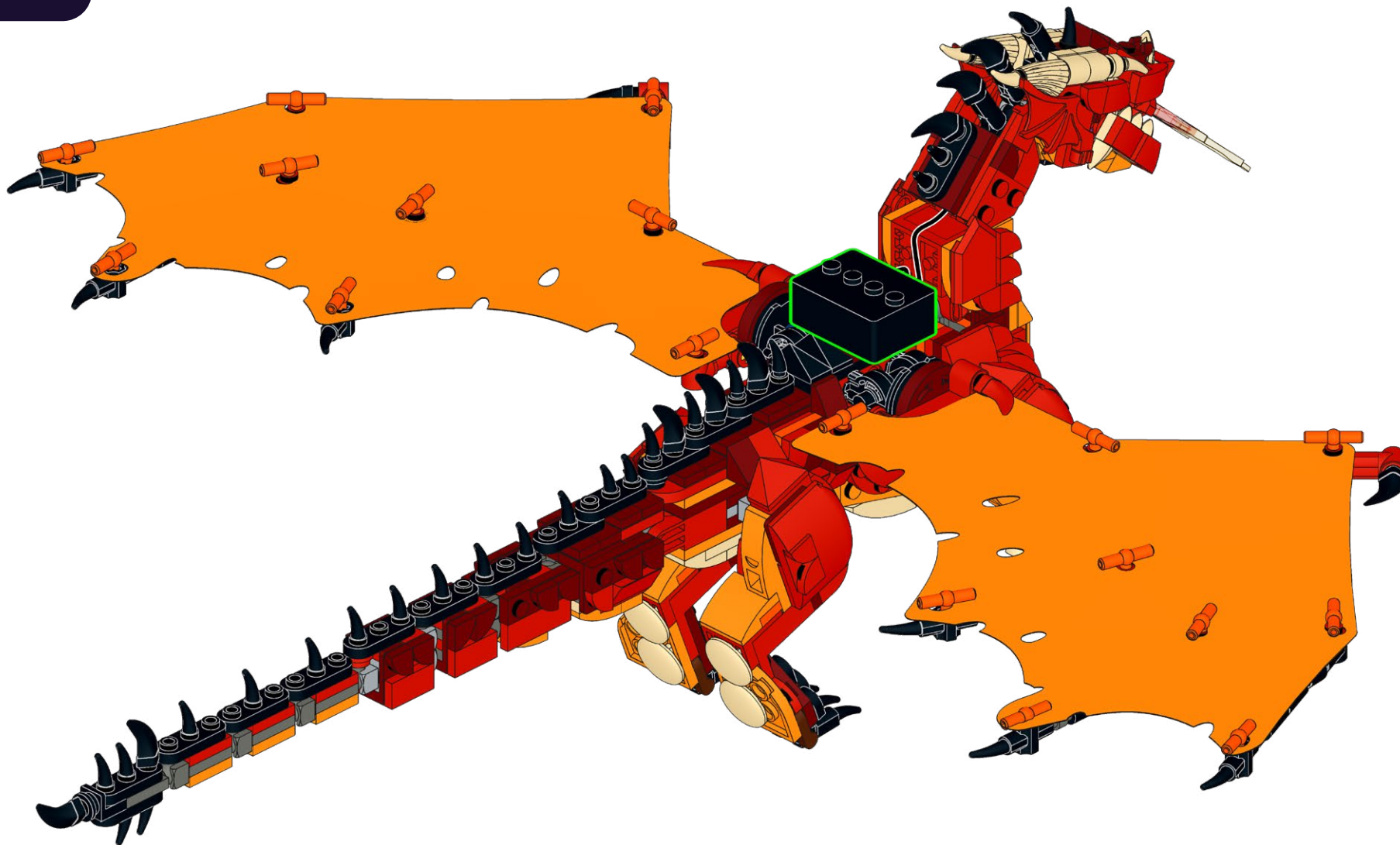

305

B-30

1x

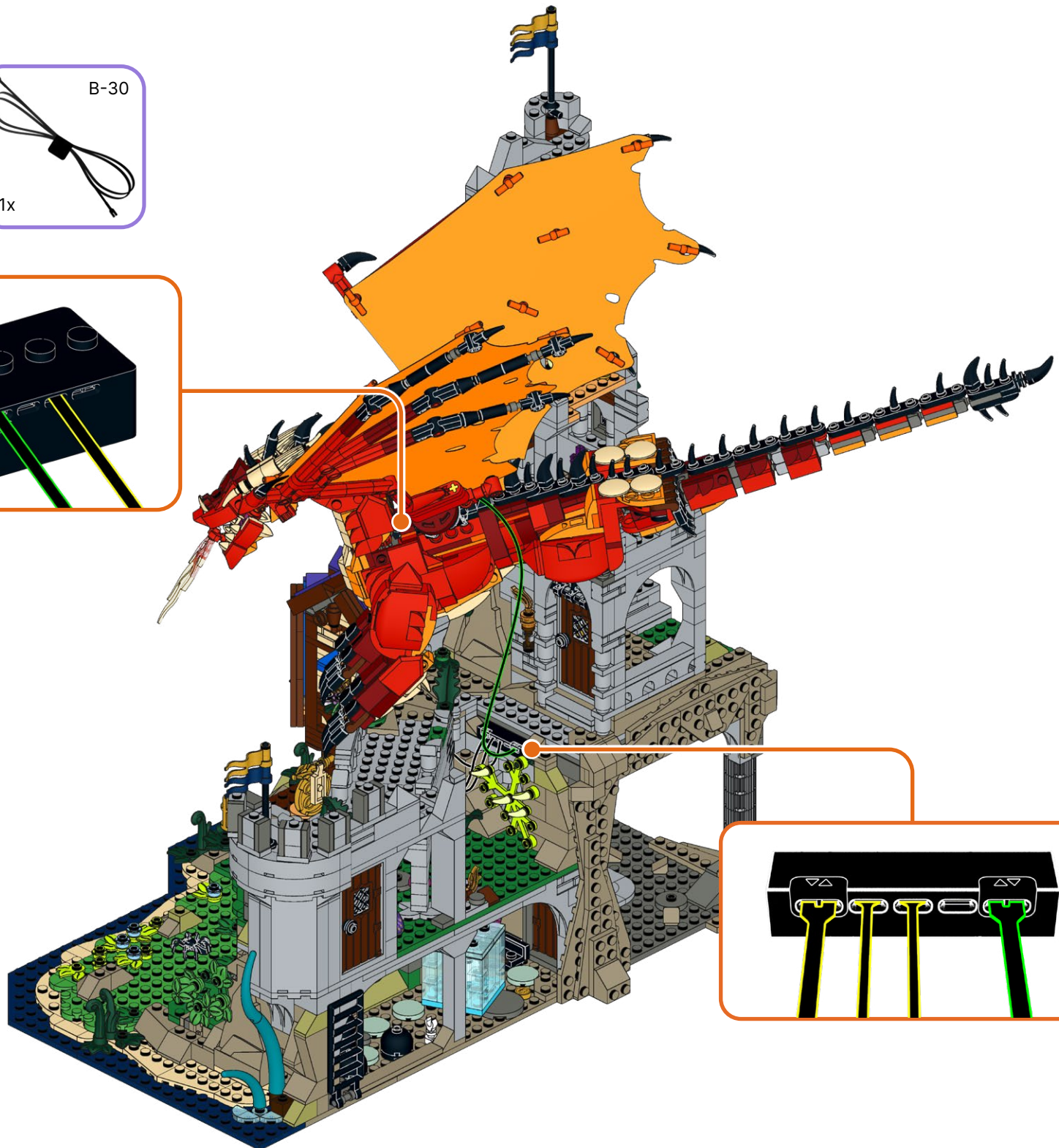
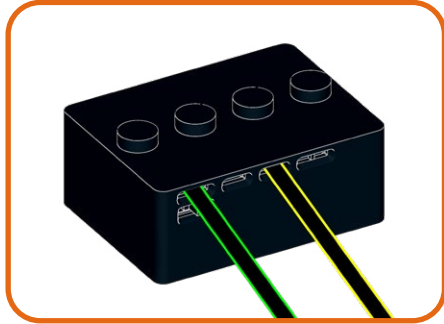

Optional Step

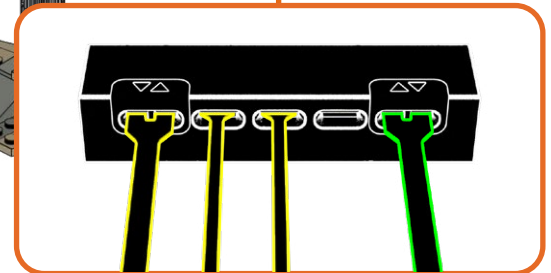
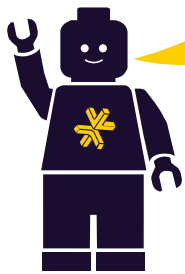



306





307





# FINAL PRODUCT





# PACKAGE CONTENTS



**1x** ARF-WW15  
Astro Light Regular  
Flickering Warm White  
15cm



**2x** ARF-WW30  
Astro Light Regular  
Flickering Warm White  
30cm



**3x** AR-Y30  
Astro Light Regular  
Yellow 30cm



**2x** AL-Y15  
Astro Light Large  
Yellow 15cm



**1x** ALF-O15  
Astro Light Large  
Flickering Orange 15cm



**1x** AR-G15  
Astro Light Regular  
Green 15cm



**2x** AR-G30  
Astro Light Regular  
Green 30cm



**1x** AL-V15  
Astro Light Large  
Violet 15cm



**1x** AL-LB15  
Astro Light Large  
Light Blue 15cm



**1x** AL-O15  
Astro Light Large  
Orange 15cm



**1x** B-5  
Belt 5cm

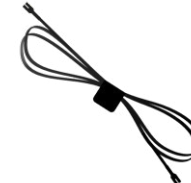

**2x** B-30  
Belt 30cm

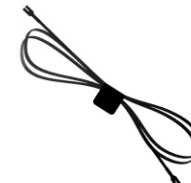

**1x** B-50  
Belt 50cm



**1x** FLX-C  
Flux Converter



**3x** D-3  
3 Dock

# PACKAGE CONTENTS



1x D-6  
6 Dock



1x T-1x6  
Tether 1x6



8x Plate, Round 1x1 w Open Stud  
Black



1x DS-4  
Split Dock



1x E-1x2  
Eclipse 1x2



4x Plate, Round 1x1 w Open Stud  
Trans Orange



1x Power Brick



3x FLX-TPA15  
Flux Touch Plate A 15cm



3x Plate, 1x2  
Black

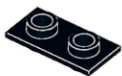

1x T-1x2  
Tether 1x2



2x FLX-TPB15  
Flux Touch Plate B 30cm



1x Plate, Modified 1x1 w Open  
O Clip (Horizontal Grip)  
Light Bluish Gray



1x T-1x4  
Tether 1x4



1x FLX-TPB30  
Flux Touch Plate B 30cm

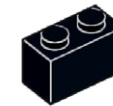

1x Brick 1x2  
Black

# PACKAGE CONTENTS



**1x** Brick 1x1  
Dark Bluish Gray



**1x** Tile 1x2  
Dark Bluish Gray



**1x** Tile 1x2  
Light Bluish Gray



**1x** Brick, Round 1x1  
Trans Yellow



**2x** Brick, Modified 1x1 w  
Stud on Side  
Black



**1x** Minifigure, Utensil  
Lantern  
Pearl Gold



**4x** Technic, Brick 1x1 w  
Hole  
Black



**3x** Bracket 1x2 - 1x2  
Inverted  
Black



# CONTACT US

Click below for customer support, or general inquiries.

Cliquez ci-dessous pour accéder au support client ou aux renseignements généraux.

Clicca qui sotto per l'assistenza clienti o per richieste generali.

Contact Us



Contactez-nous



Contattaci



Klicken sie unten für kundensupport oder allgemeine anfragen.

Haga clic a continuación para atención al cliente o consultas generales.

点击下方获取客户支持或一般咨询。

Kontaktieren sie uns



Contáctanos



联系我们



## TROUBLESHOOTING

If you're stuck, scan the QR code for troubleshooting.

Se sei bloccato, scansiona il codice QR per la risoluzione dei problemi.

Wenn Sie nicht weiterkommen, scannen Sie den QR-Code zur Fehlerbehebung.

Si vous êtes bloqué, scannez le code QR pour le dépannage

Si está atascado, escanee el código QR para solucionar el problema.

如果遇到问题, 请扫描二维码进行故障排除

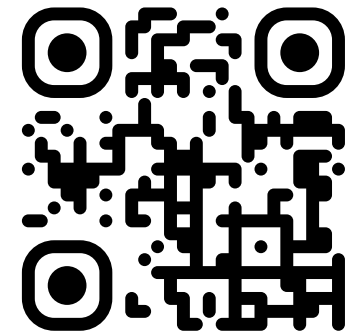



# LIGHTMYBRICKS

[lightmybricks.com](https://lightmybricks.com)



LEGO® is a trademark of the LEGO Group of companies, which does not sponsor, authorize or endorse this product. All LEGO® sets featured in images are sold separately. This is not a LEGO® product. The LEGO Group is not liable for any loss, injury or damage arising from the use or misuse of this product. ©2024 Light My Bricks Pty Ltd. All rights reserved. [www.lightmybricks.com](https://www.lightmybricks.com)

Our components are designed and packaged in Australia by Light My Bricks Pty Ltd. Components are manufactured in China. 3fl bldg C, Shuanghuan Quanxin Technology Information Industry Park Baolong Street, Longgang District, Shenzhen, China. Imported in Australia by Light My Bricks Pty Ltd, 5/26 Rushdale St, Knoxfield, VIC, 3180, Australia.

WARNING: CHOKING HAZARD - Small parts. Not for children under 3 years.

AVERTISSEMENT : RISQUE D'ÉTOUFFEMENT - Petites pièces. Ne convient pas aux enfants de moins de 3 ans.

ATTENZIONE: PERICOLO DI SOFFOCAMENTO - Piccole parti. Non adatto a bambini di età inferiore a 3 anni.

WARNUNG: ERSTICKUNGSGEFAHR - Kleine Teile. Nicht für Kinder unter 3 Jahren geeignet.

ADVERTENCIA: PELIGRO DE ASFIXIA - Piezas pequeñas. No son apto para niños menores de 3 años.

警告：窒息危險 - 小零件。不适合3岁以下儿童。