

LIGHT KIT INSTALLATION GUIDE

A-FRAME CABIN

FOR LEGO
SET
#21338



03

Getting Started

- 04 Legend
- 05 Component Handling
- 06 Blueprint

07

Instructions

- 07 LEGO Bag 1
- 34 LEGO Bag 2
- 50 LEGO Bag 3
- 56 LEGO Bag 4
- 132 LEGO Bag 5 & 6- LMB Bag 01 & 03
- 194 LEGO Bag 8
- 224 LMB Bag 02
- 232 LEGO Bag 9
- 265 LEGO Bag 7
- 263 LMB Bag 03
- 328 LEGO Bag 12
- 335 LEGO Bag 13
- 351 LEGO Bag 15
- 393 LEGO Bag 14
- 405 LEGO Bag 10
- 431 LEGO Bag 11

467

Final Product

- 468 Package Contents
- 469 Contact & Troubleshooting

GETTING STARTED



Bold, beautiful and bright, Light My Bricks elevates your favourite LEGO set from knick-knack to statement piece. Create a talking point at home or in the office that speaks to your passions with Light My Bricks. To learn more, click below.

[Learn More](#)



Audacieux, beau et lumineux, Light My Bricks élève votre ensemble LEGO préféré du statut de bibelot à celui de pièce maîtresse. Que ce soit à la maison ou au bureau, partagez votre passion des LEGO avec Light My Bricks. Cliquez ci-dessous pour en savoir plus.

[En savoir plus](#)



Audace, bello e luminoso, Light My Bricks eleva il tuo set LEGO preferito da soprammobile a pezzo di tendenza. Crea un punto di discussione a casa o in ufficio che parli alle tue passioni con Light My Bricks. Per saperne di più, clicca qui sotto.

[Ulteriori Informazioni](#)



Mutig, schön und hell – Light My Bricks verwandelt Ihr Lieblings-LEGO-Set von einem schnickschnack in ein statement-stück. Schaffen sie einen gesprächspunkt zu hause oder im büro, der Ihre leidenschaften widerspiegelt, mit Light My Bricks. Um mehr zu erfahren, klicken sie unten.

[Mehr erfahren](#)



Audaz, hermoso y brillante, Light My Bricks eleva tu set LEGO favorito de una chuchería a una pieza llamativa. Crea un tema de conversación en casa o en la oficina que hable de tus pasiones con Light My Bricks. Para obtener más información, haga clic a continuación.

[Más información](#)



大胆、美丽而明亮，Light My Bricks 将你喜爱的乐高套装从小摆件提升为引人注目的装饰品。在家或办公室打造一个能表达你激情的话题，了解更多，请点击下方。

[了解更多](#)



LEGEND

Rotate Set



Retournez L'ensemble
Ruota Set
Set Drehen
Rotar Conjunto
旋转套件

Add Part



Ajoutez une Pièce
Aggiungi Parte
Teil Hinzufügen
Agregar Pieza
添加零件

Click



Cliquez
Clic
Klicken
Clic
点击

Pinch/Fold



Pincez/Pliez
Pizzicare/Piegare
Kneifen/Falten
Pellizcar/Doblar
折叠

Pull Cable



Tirez le Cable
Tirare il Cavo
Kabel Ziehen
Tirar del Cable
拉动电缆

Repeat Step



Répétez
Ripetere
Wiederholen
Repetir
重复

Sticker



Autocollant
Adesivo
Aufkleber
Pegatina
贴纸

Power On Test



Test de mise sous tension
Test di Potenza
Stromtest
Prueba de Energía
电源测试

Disconnect Power



Débranchez L'alimentation
Scollegare L'alimentazione
Strom Trennen
Desconectar la Energía
断开电源

Troubleshoot



Dépanner
Risolvere
Fehlerbehebung
Solución de Problemas
故障排除

COMPONENT HANDLING

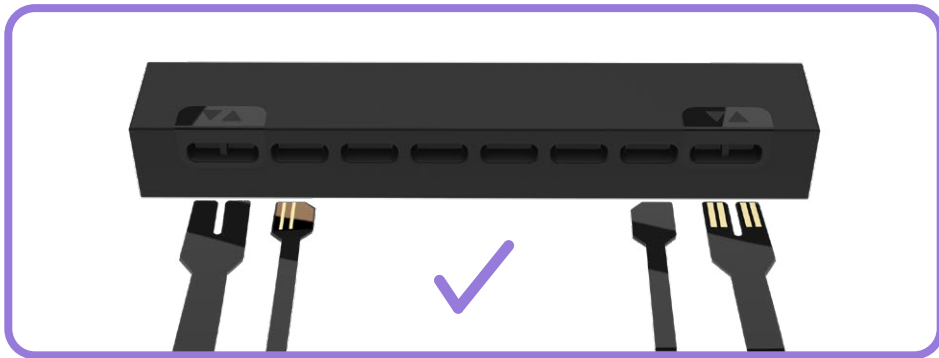
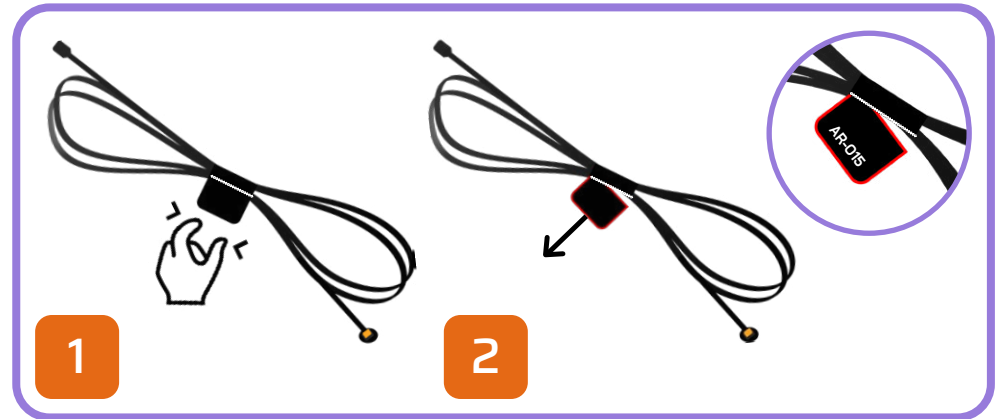
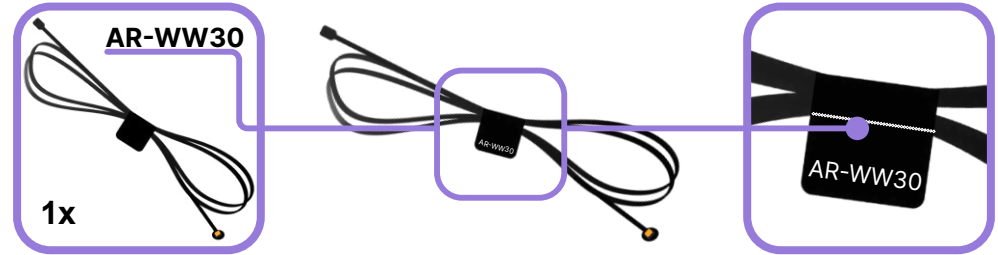
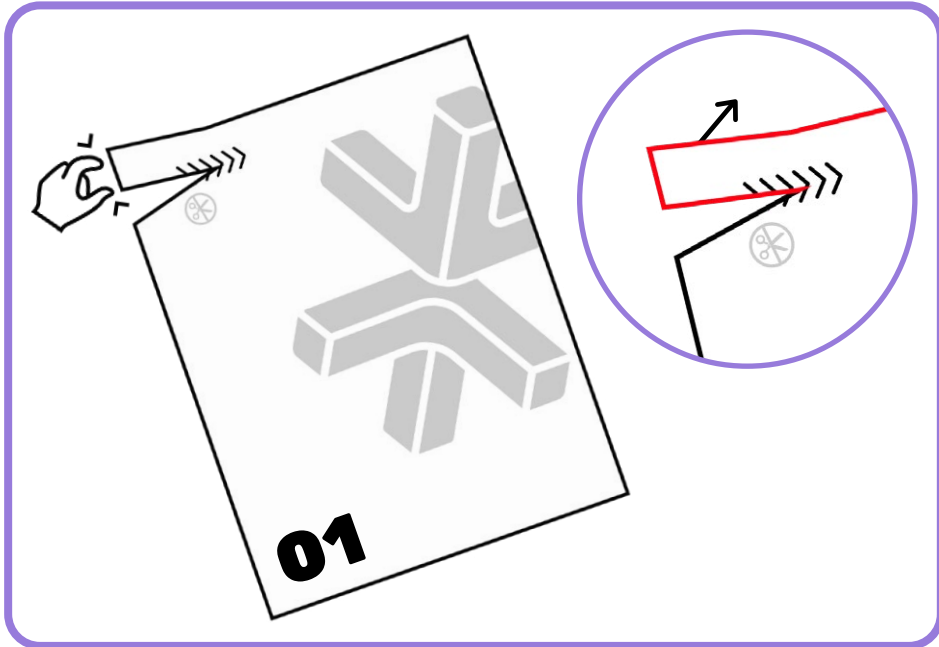

BLUEPRINT

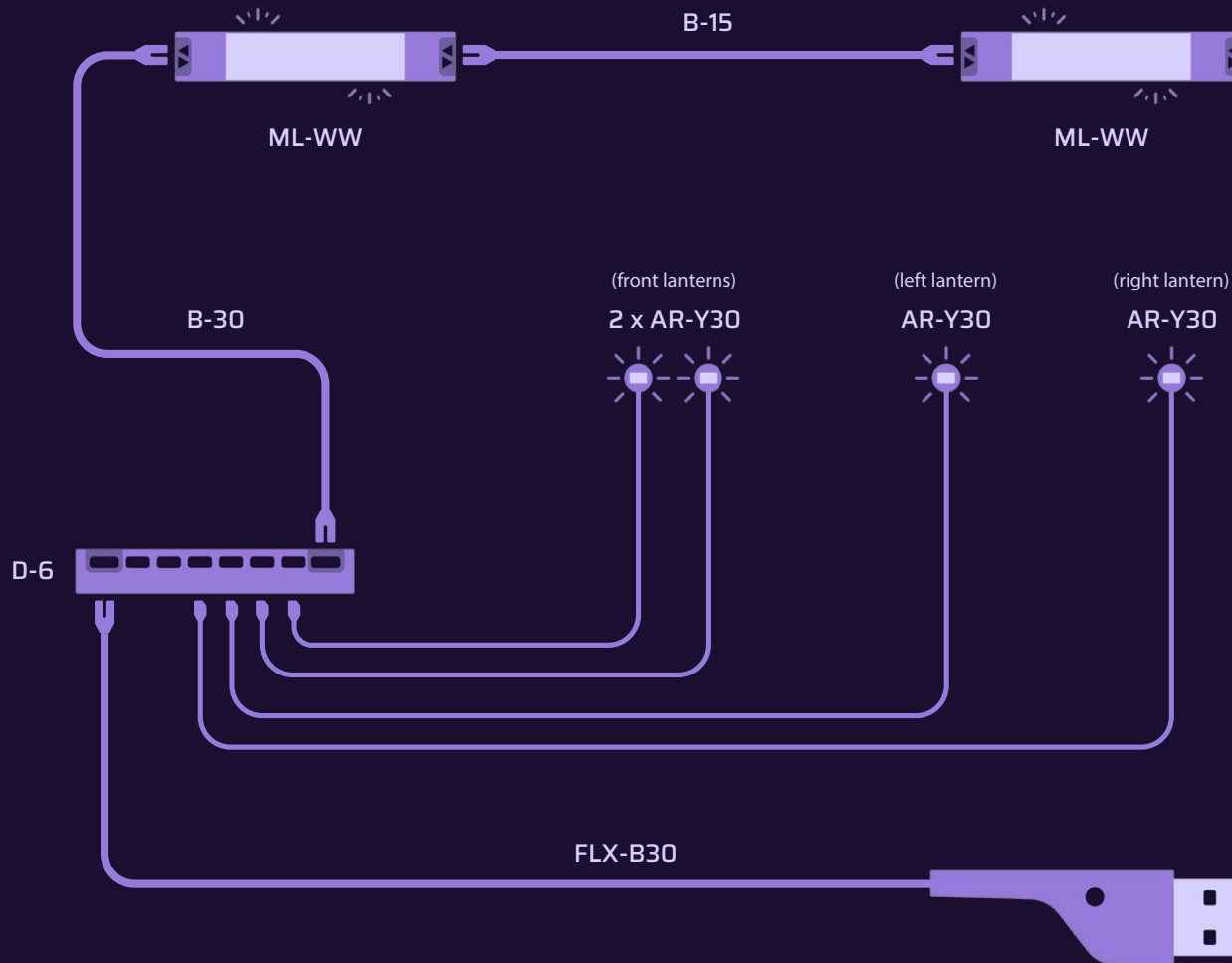

**HOLD UP!**

You might notice some bags aren't in order, as well as left over pieces, but that's ok! We're changing the way you build LEGO!

ATTENDEZ!

Vous remarquerez peut-être que certains sacs, ainsi que certaines pièces, ne sont pas dans le bon ordre. Mais pas de panique! Nous changeons simplement la façon avec laquelle vous construisez vos LEGO!

ASPETTA!

Potresti notare che alcuni sacchetti non sono in ordine, così come i pezzi avanzati, ma va bene così! Stiamo cambiando il modo in cui costruisci i LEGO!

HALT!

Sie werden möglicherweise bemerken, dass einige tüten durcheinander sind und teile übrig bleiben, aber das ist in Ordnung! Wir ändern die art und weise, wie Sie LEGO bauen!

¡ESPERA!

Es posible que notes que algunas bolsas están fuera de servicio, así como piezas sobrantes, ¡pero está bien! ¡Estamos cambiando la forma en que construyes LEGO!

暫停!

你可能会注意到一些袋子顺序错乱, 以及一些剩余的部件, 但没关系! 我们正在改变你搭建乐高的方式!

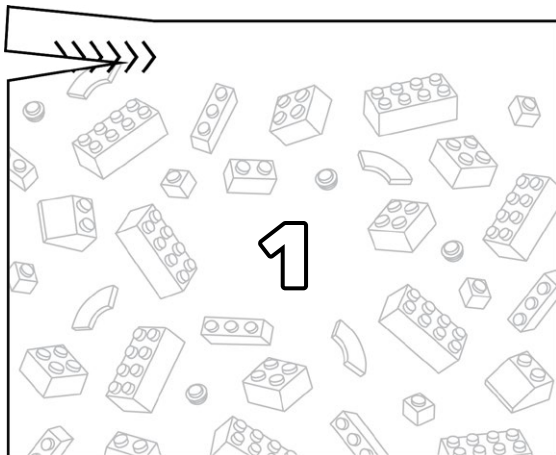
Open LEGO® Bag 1

1

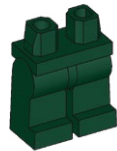
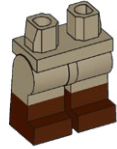

2

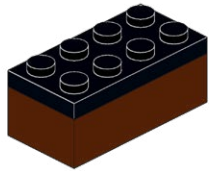
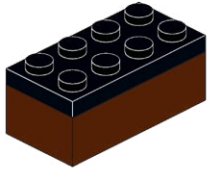
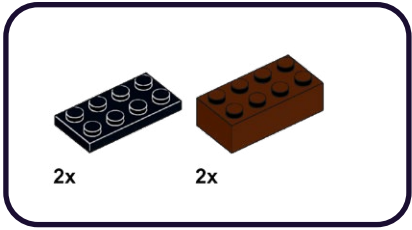

3

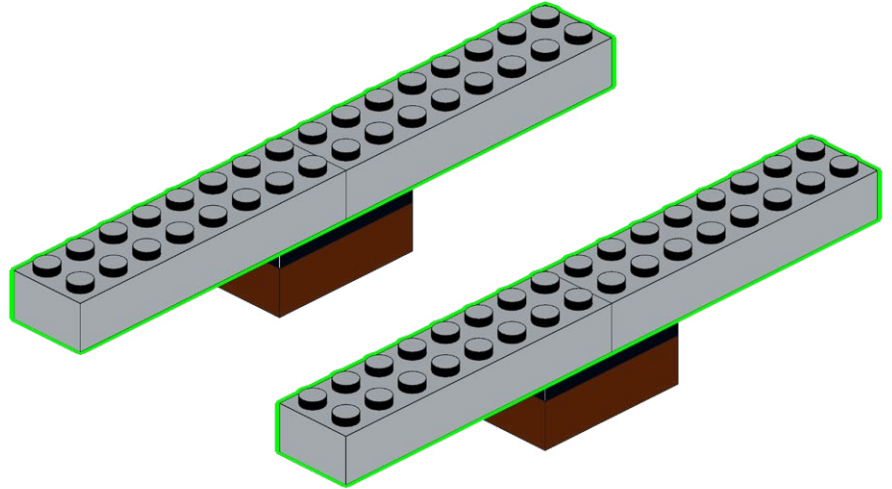
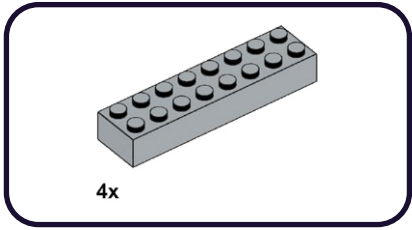

4

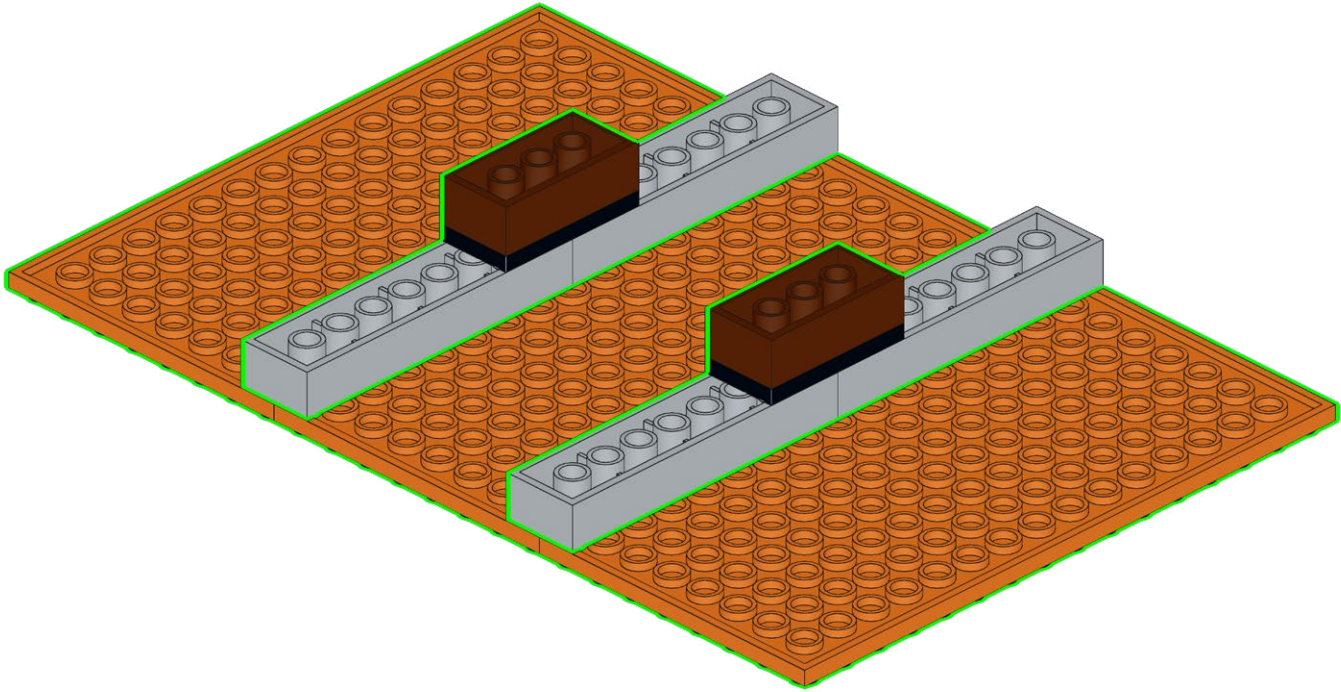
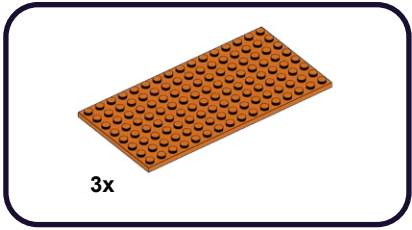

5

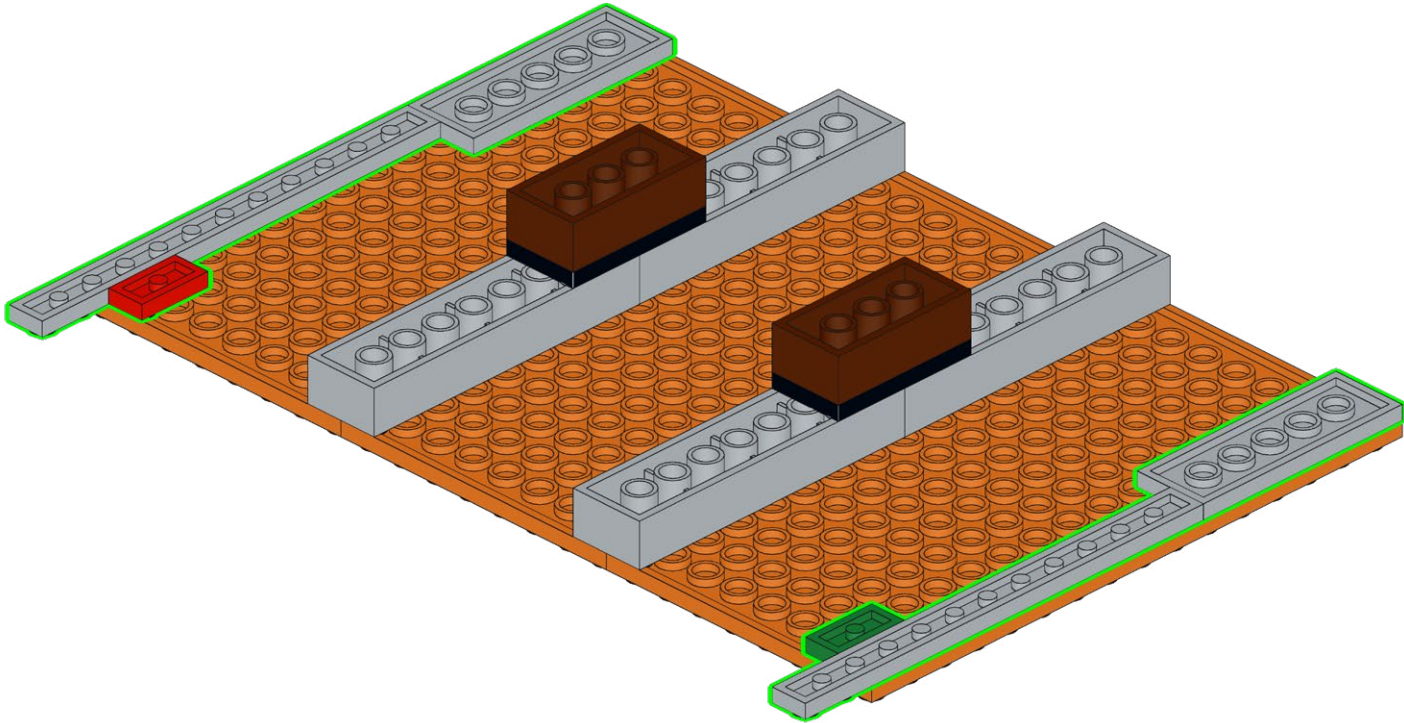
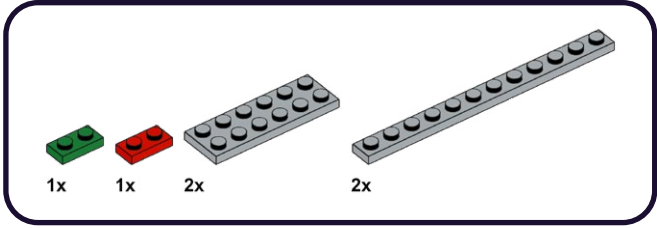

6

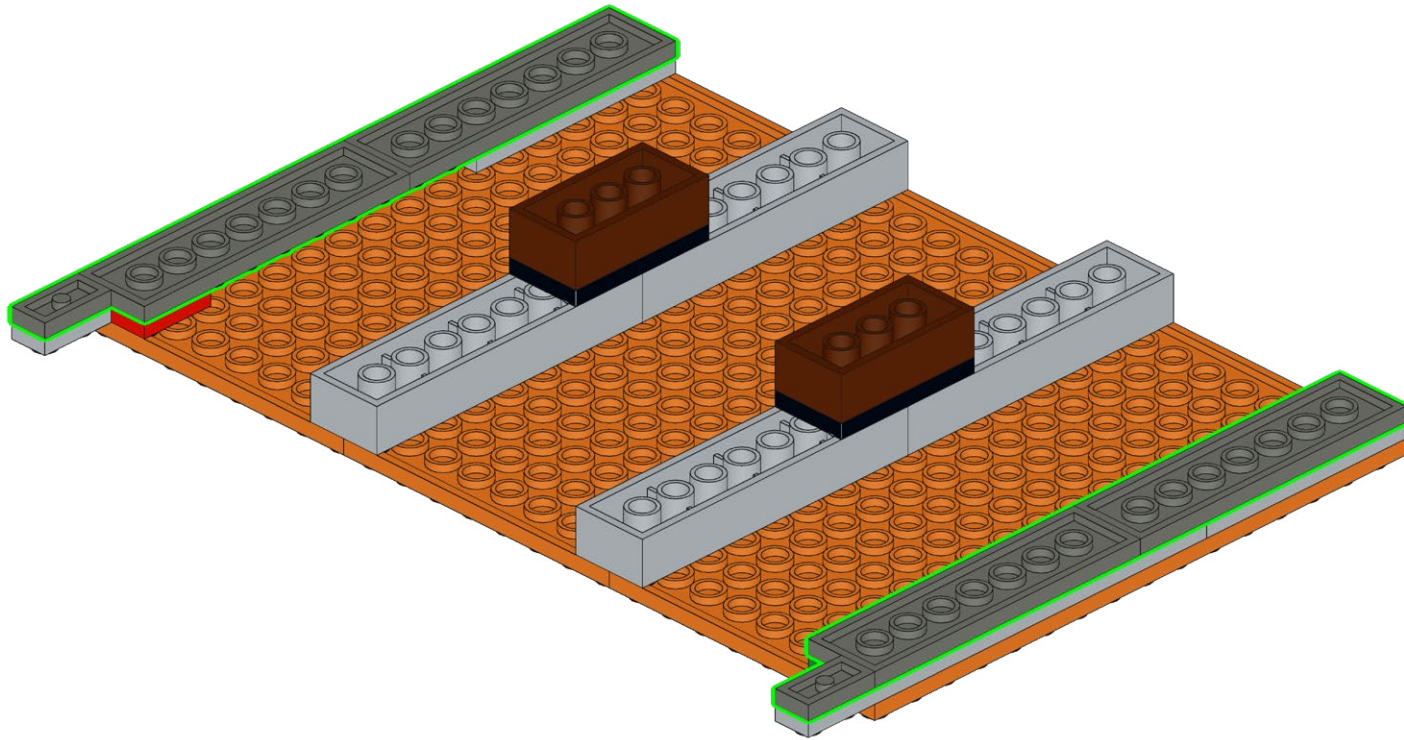
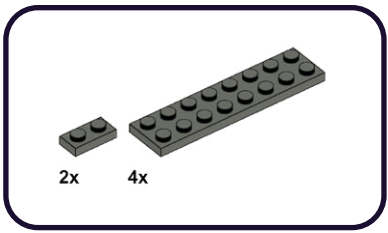

7

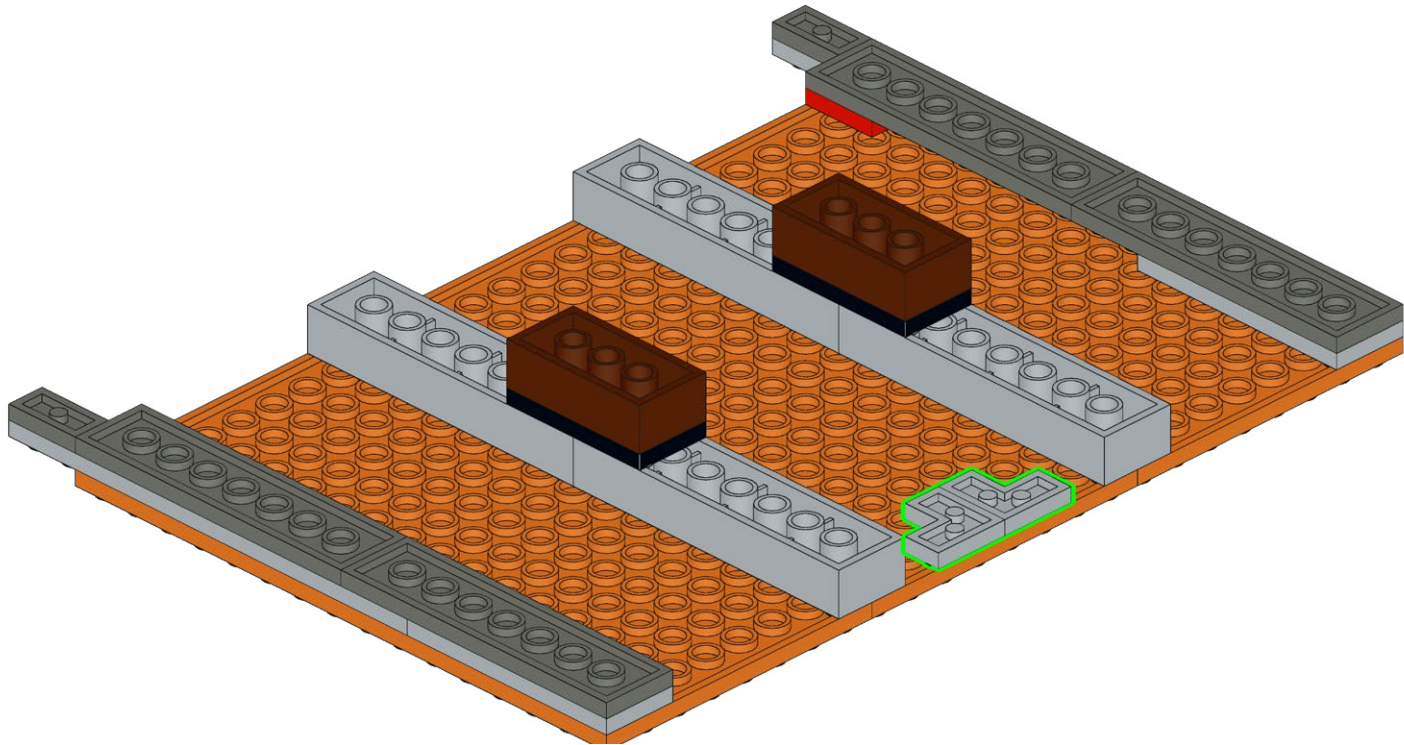
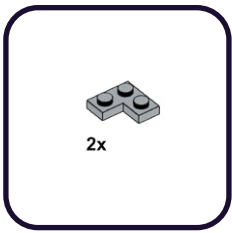

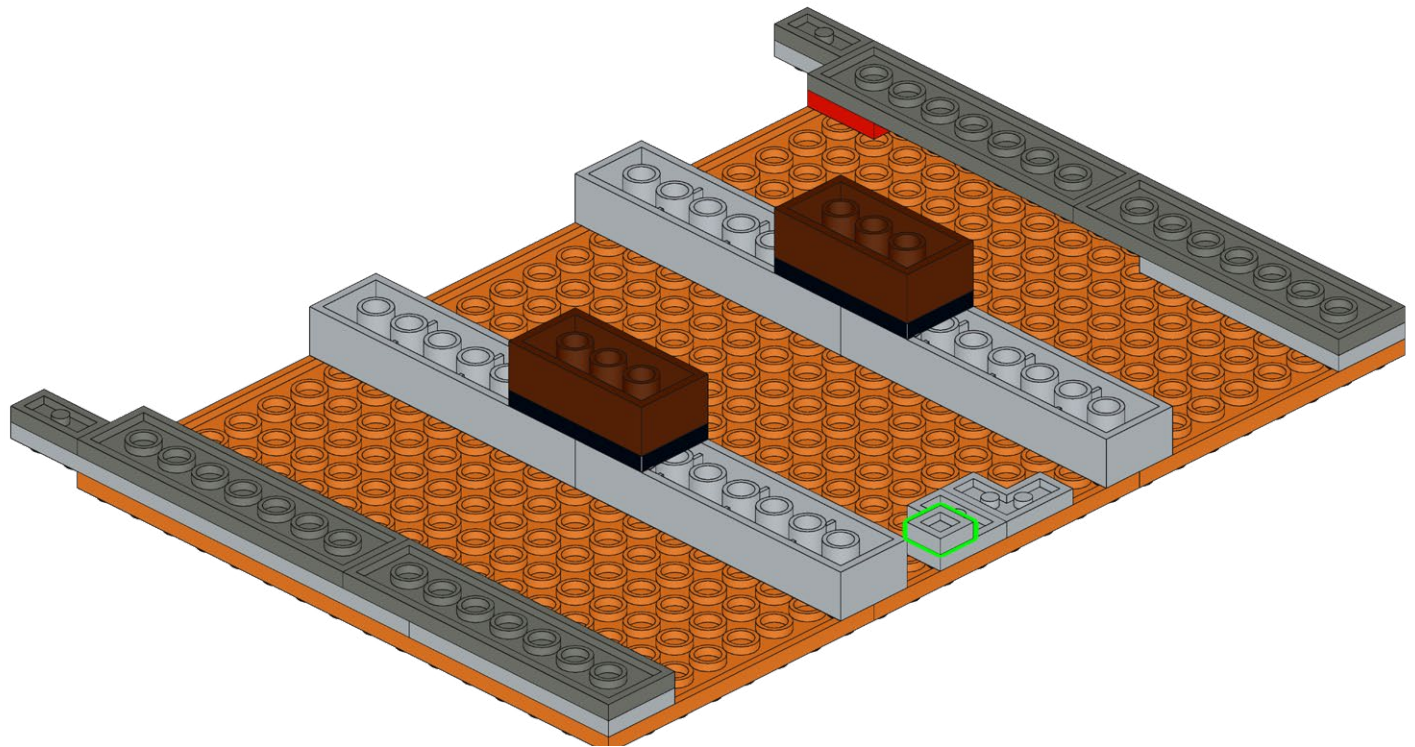
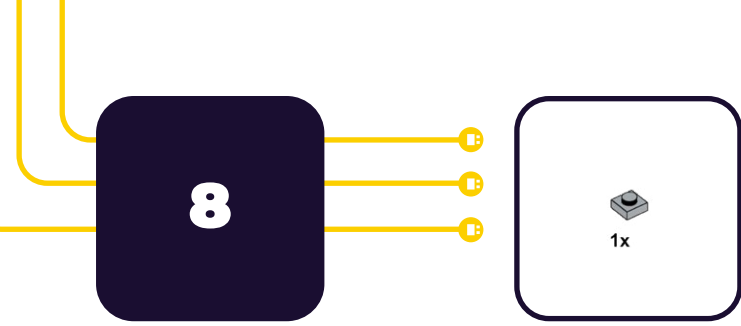

9

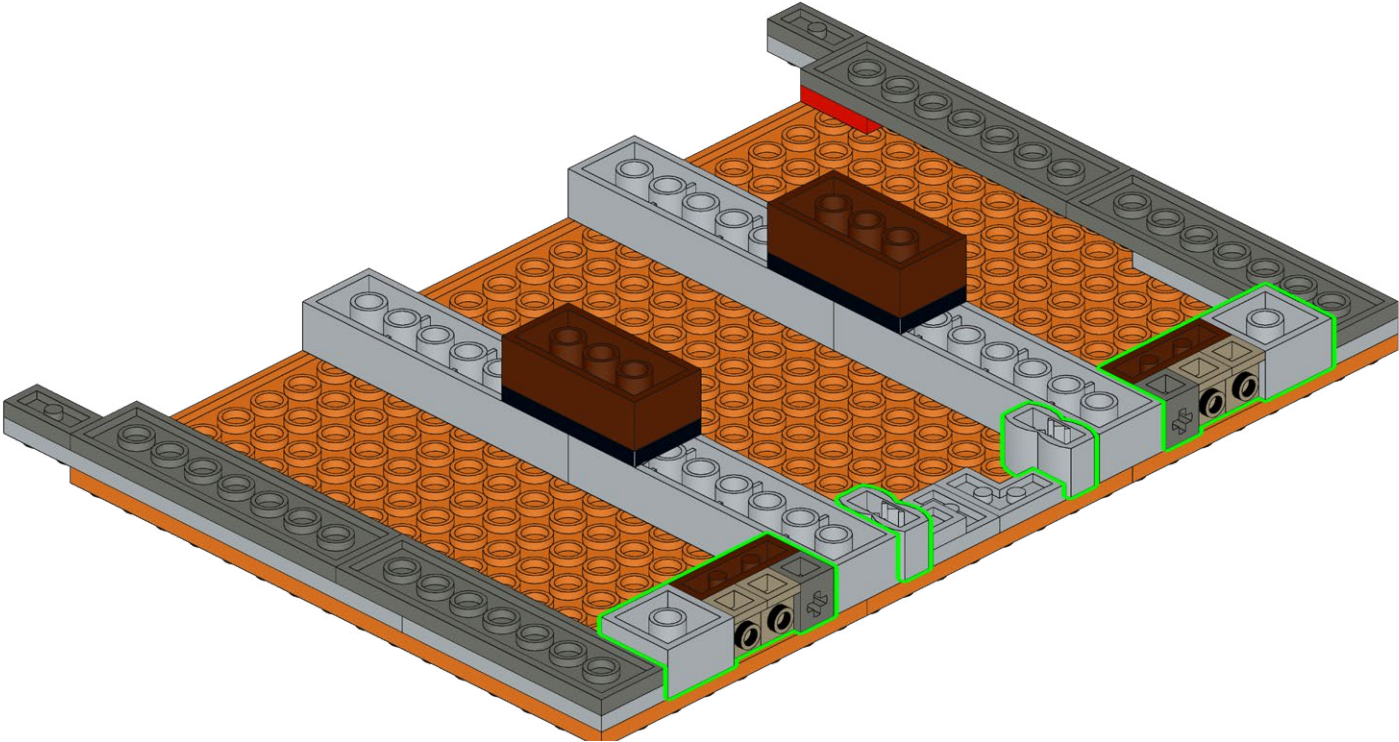
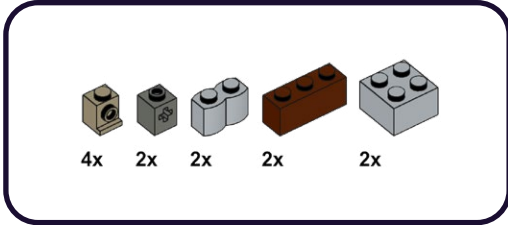

10

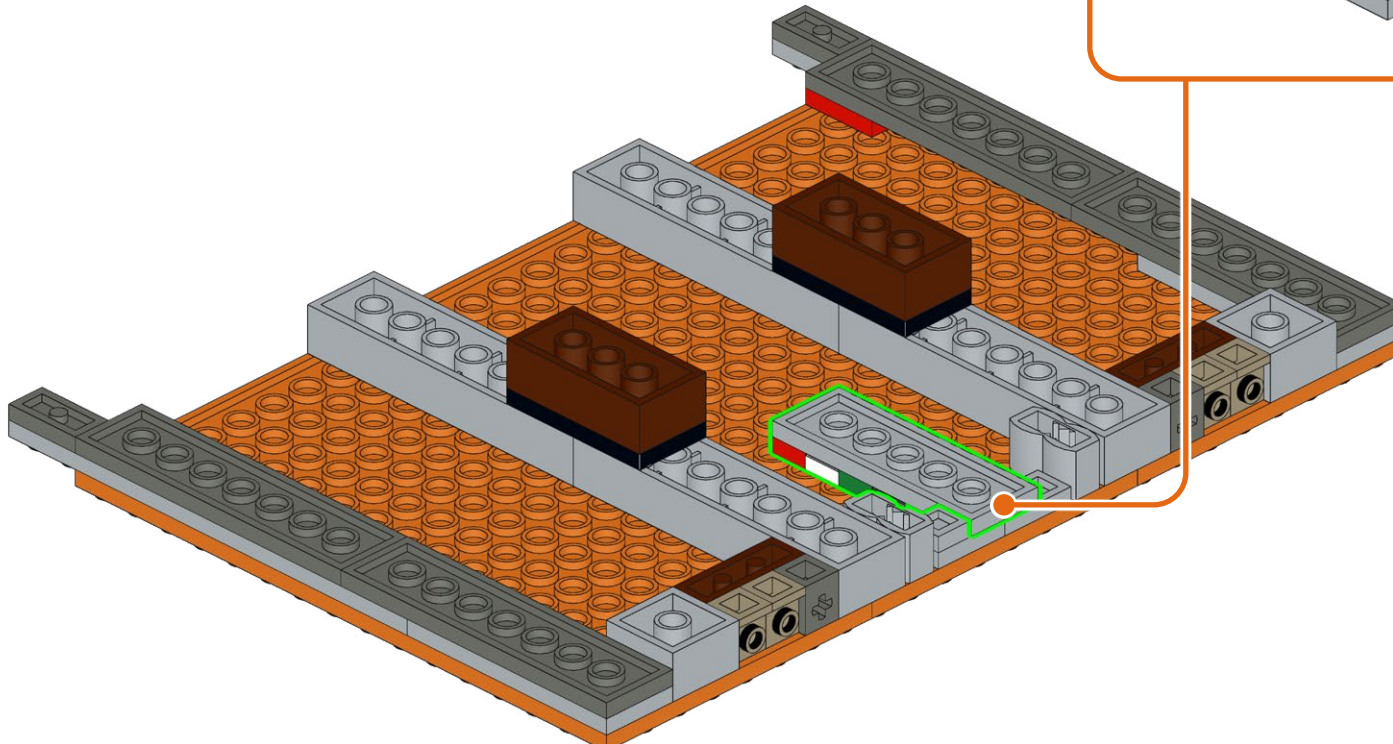
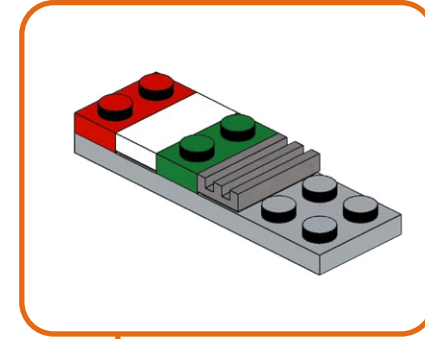
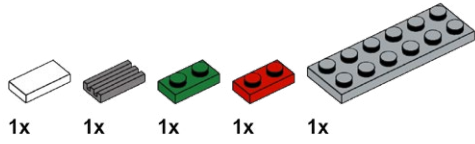

11

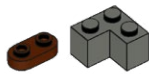

1x

2x

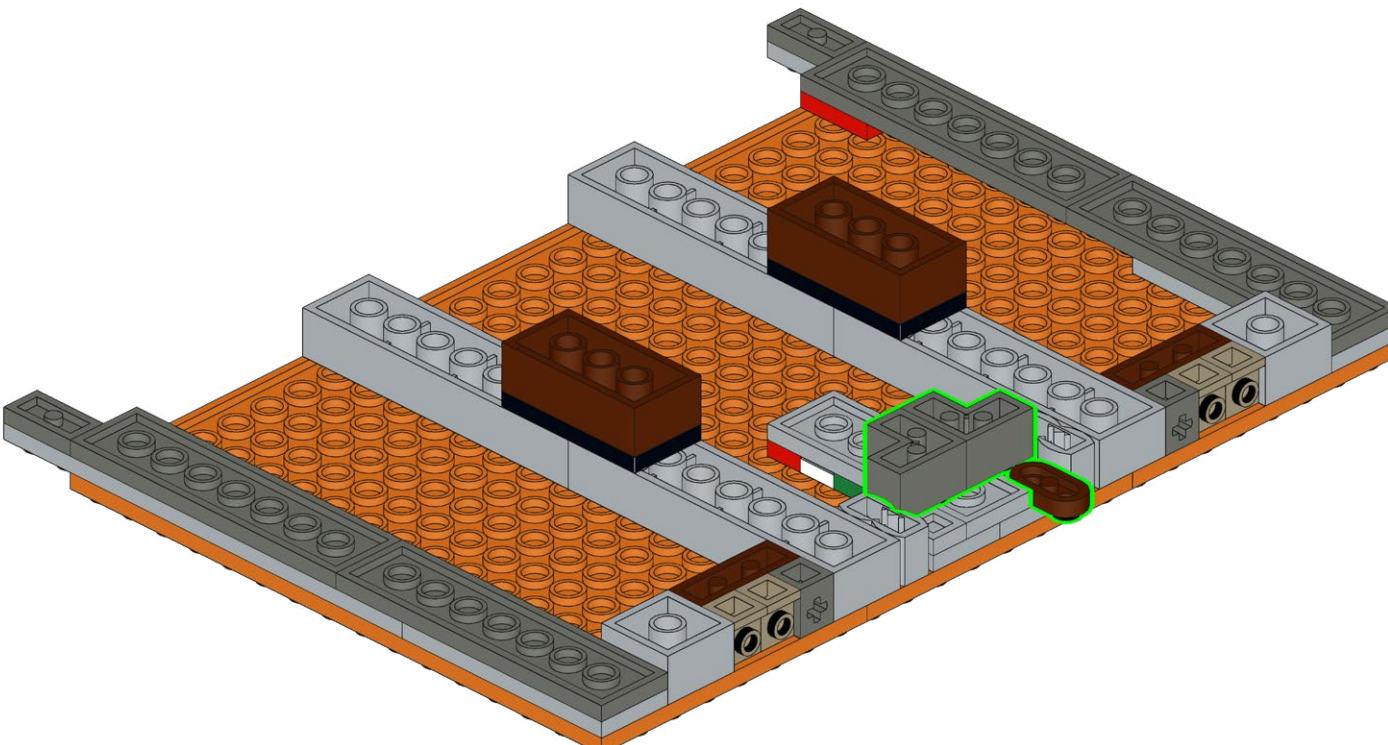

12

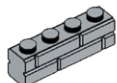

1x

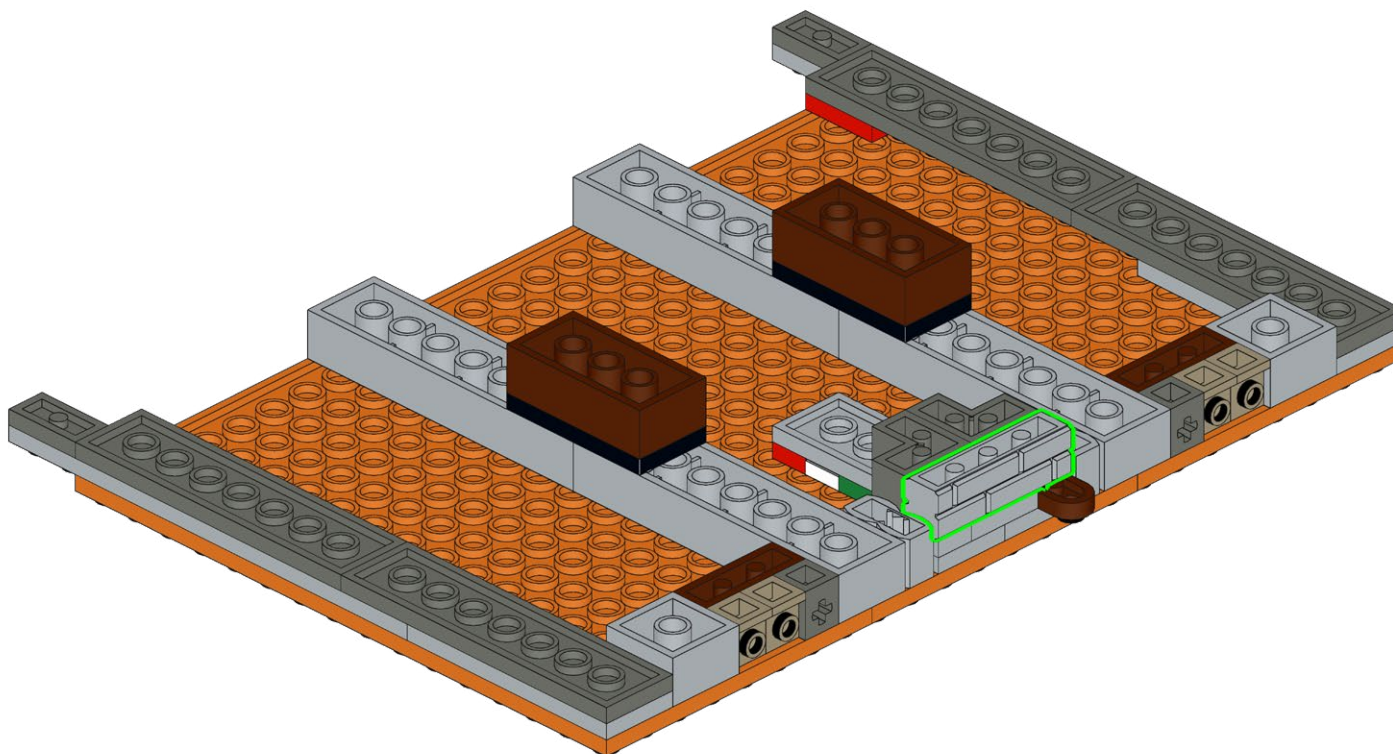

13



1x

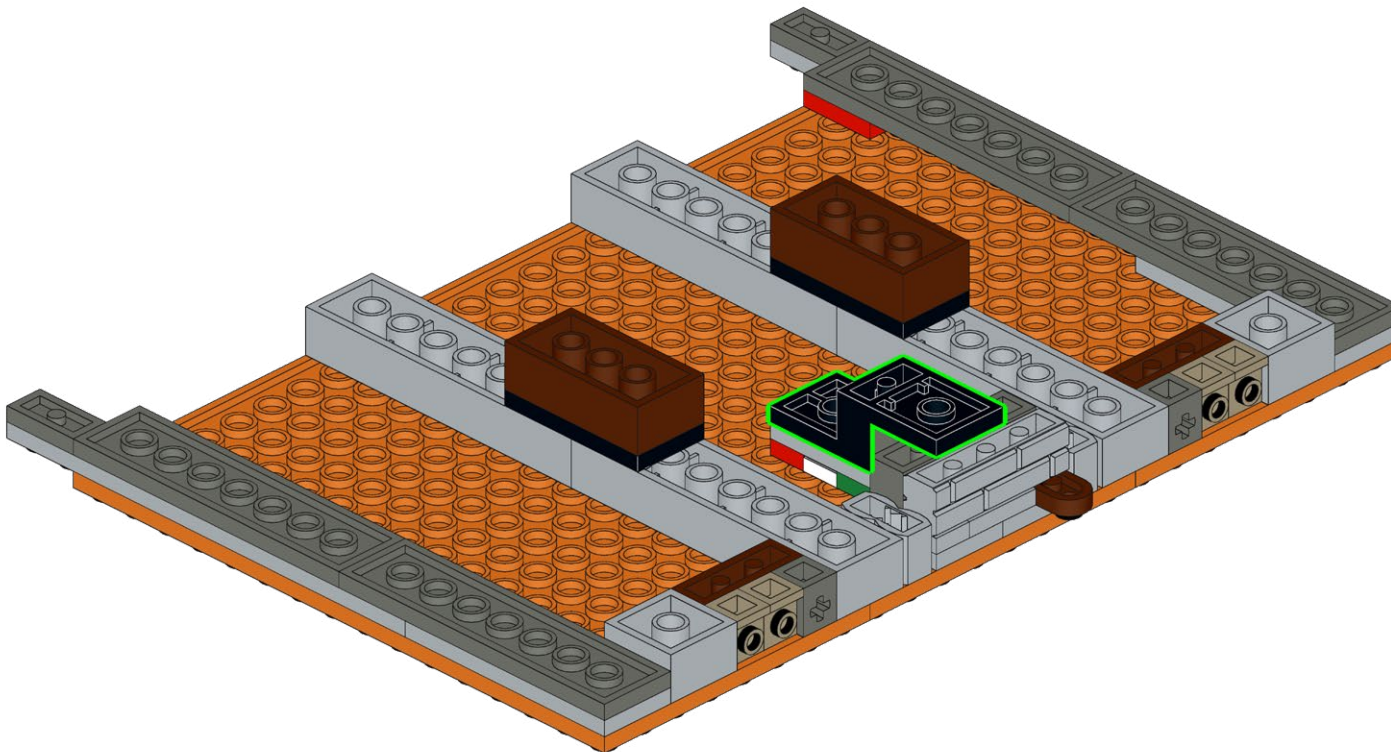

14



2x

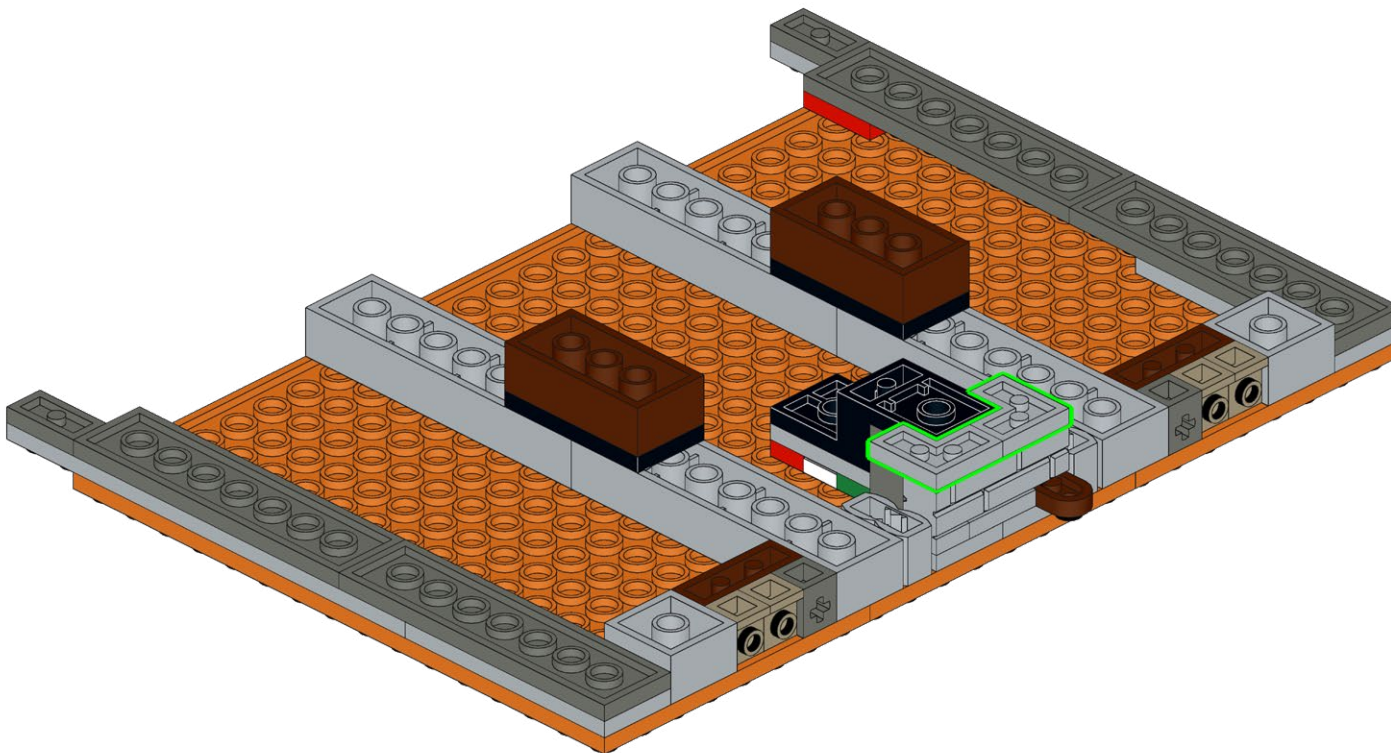

15

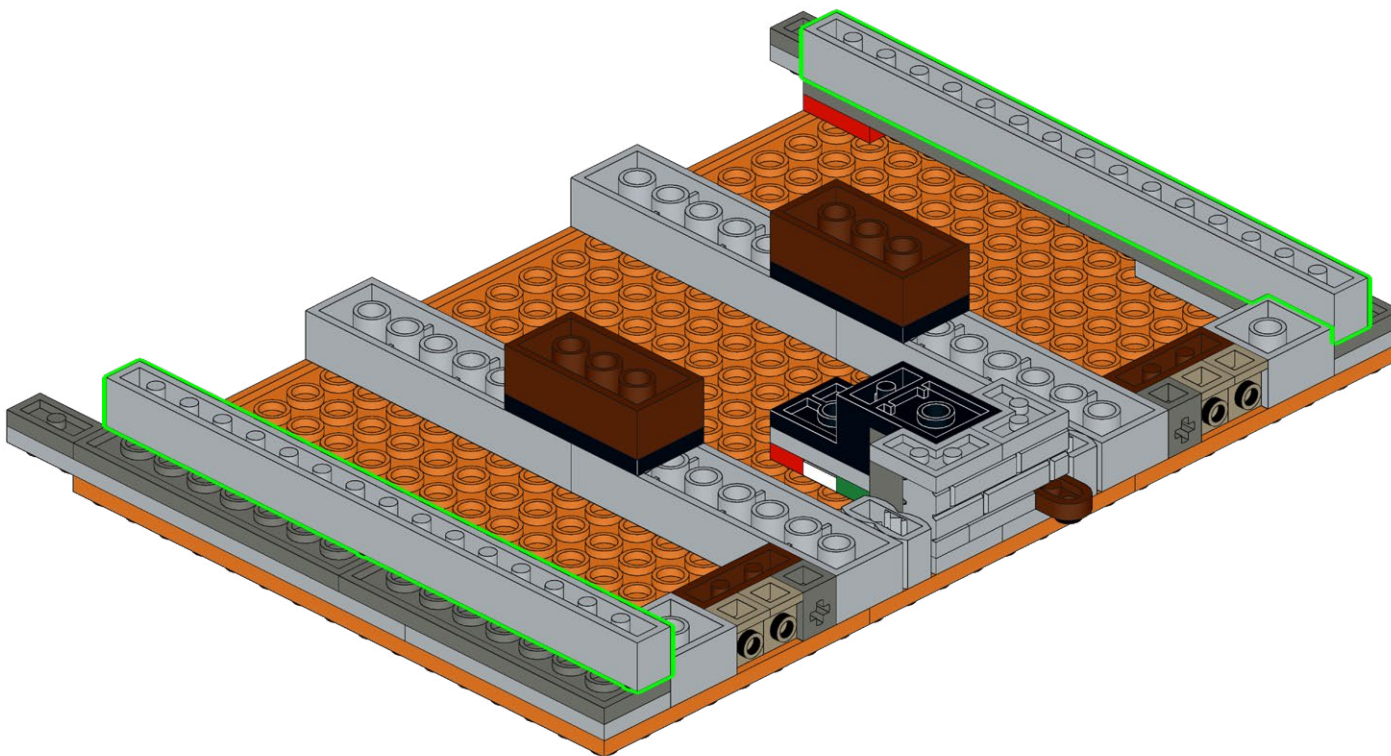
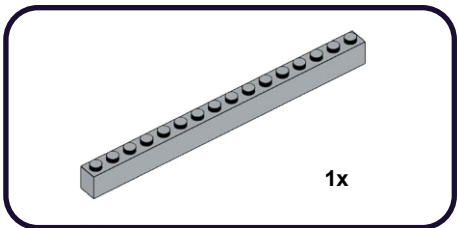

16

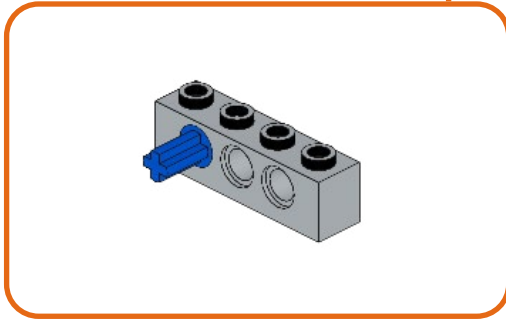
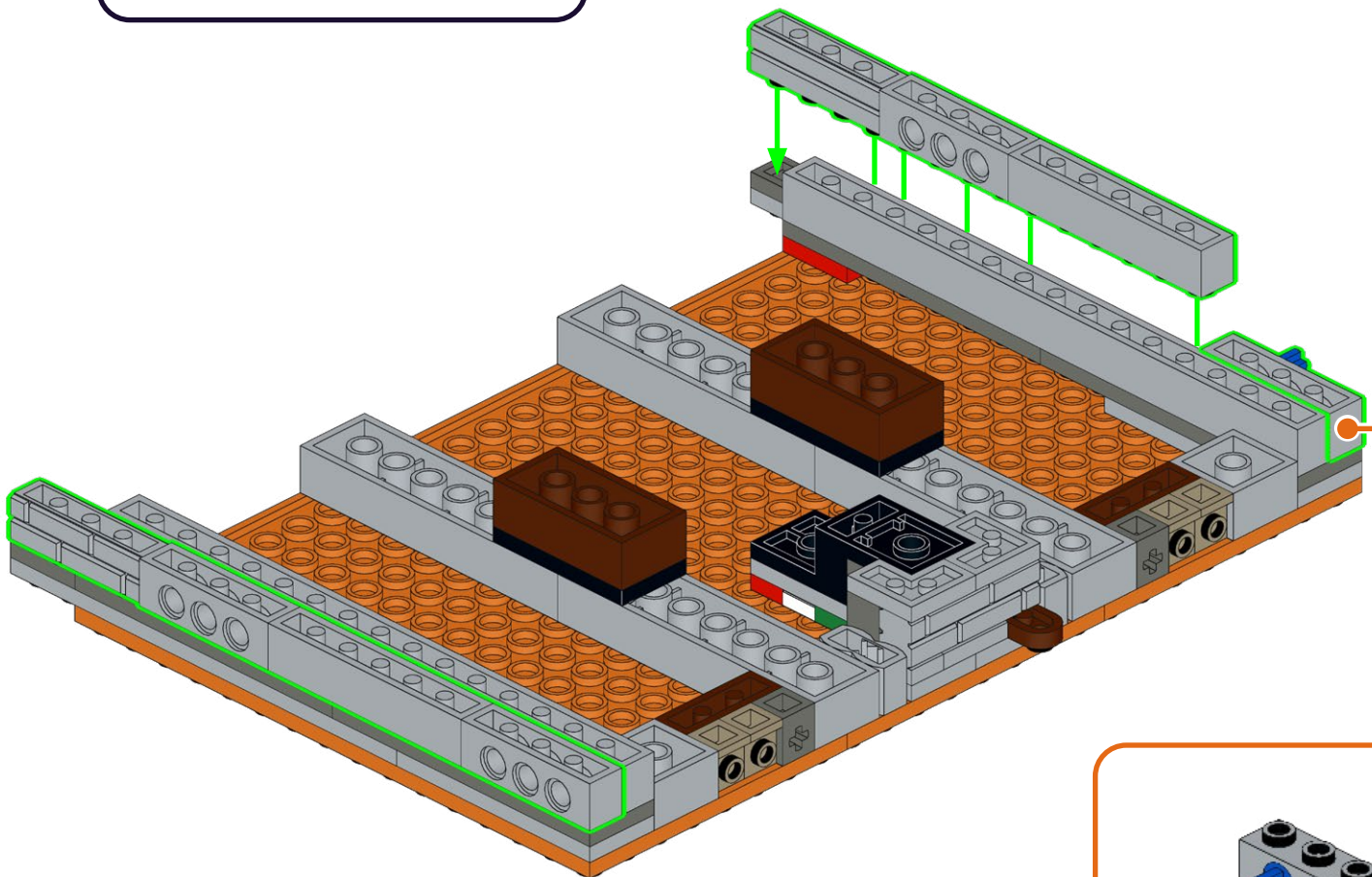
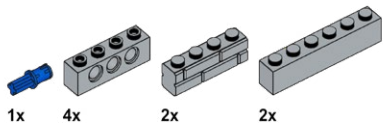

17

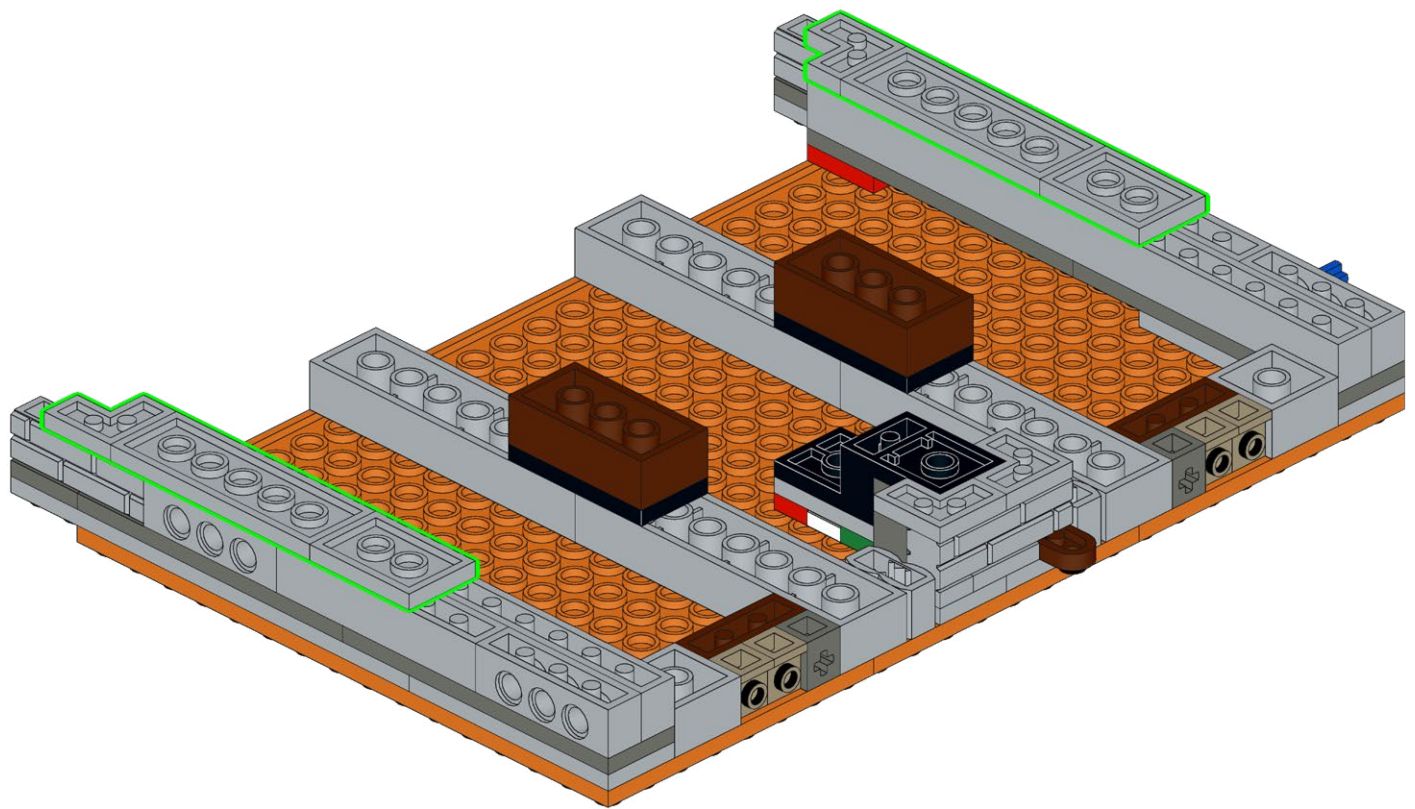
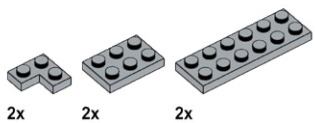

18



2x

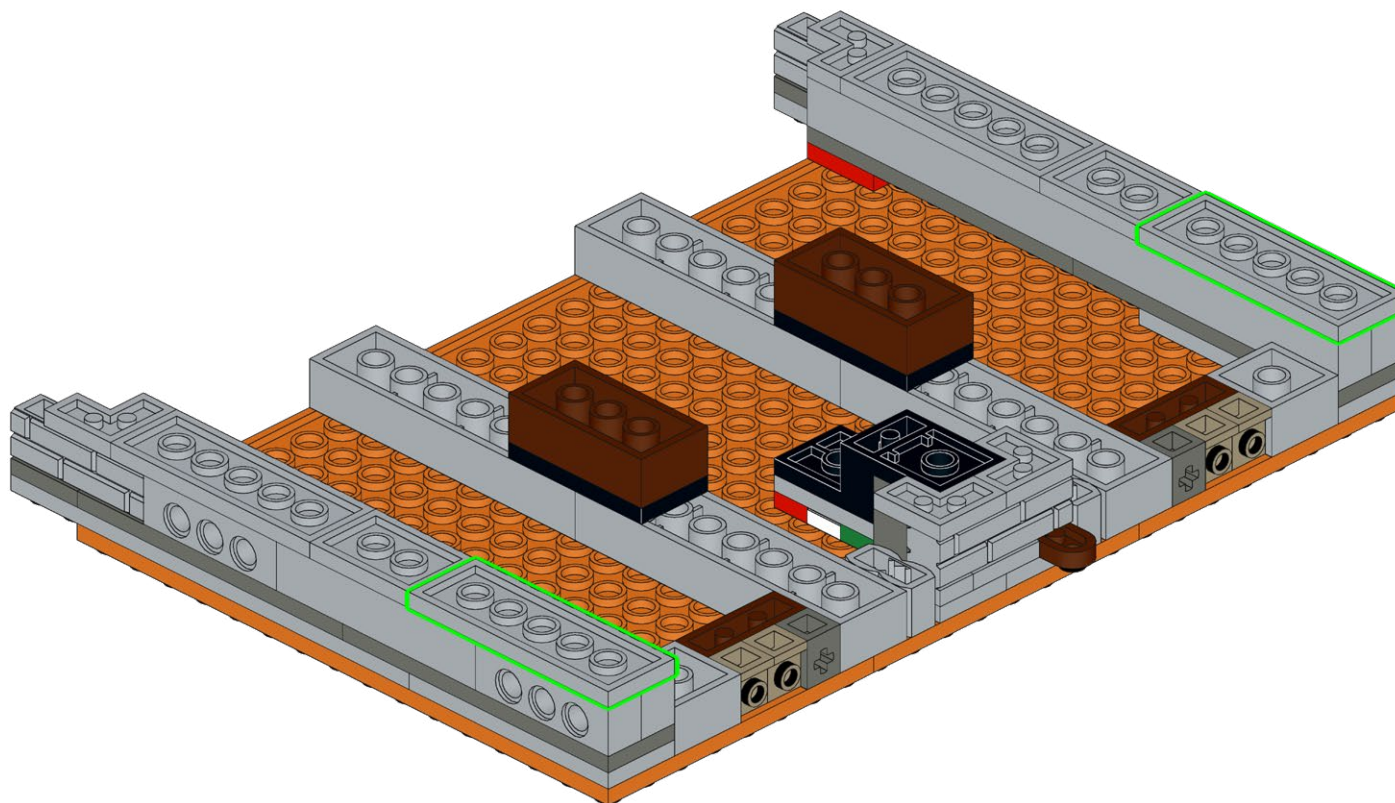

19

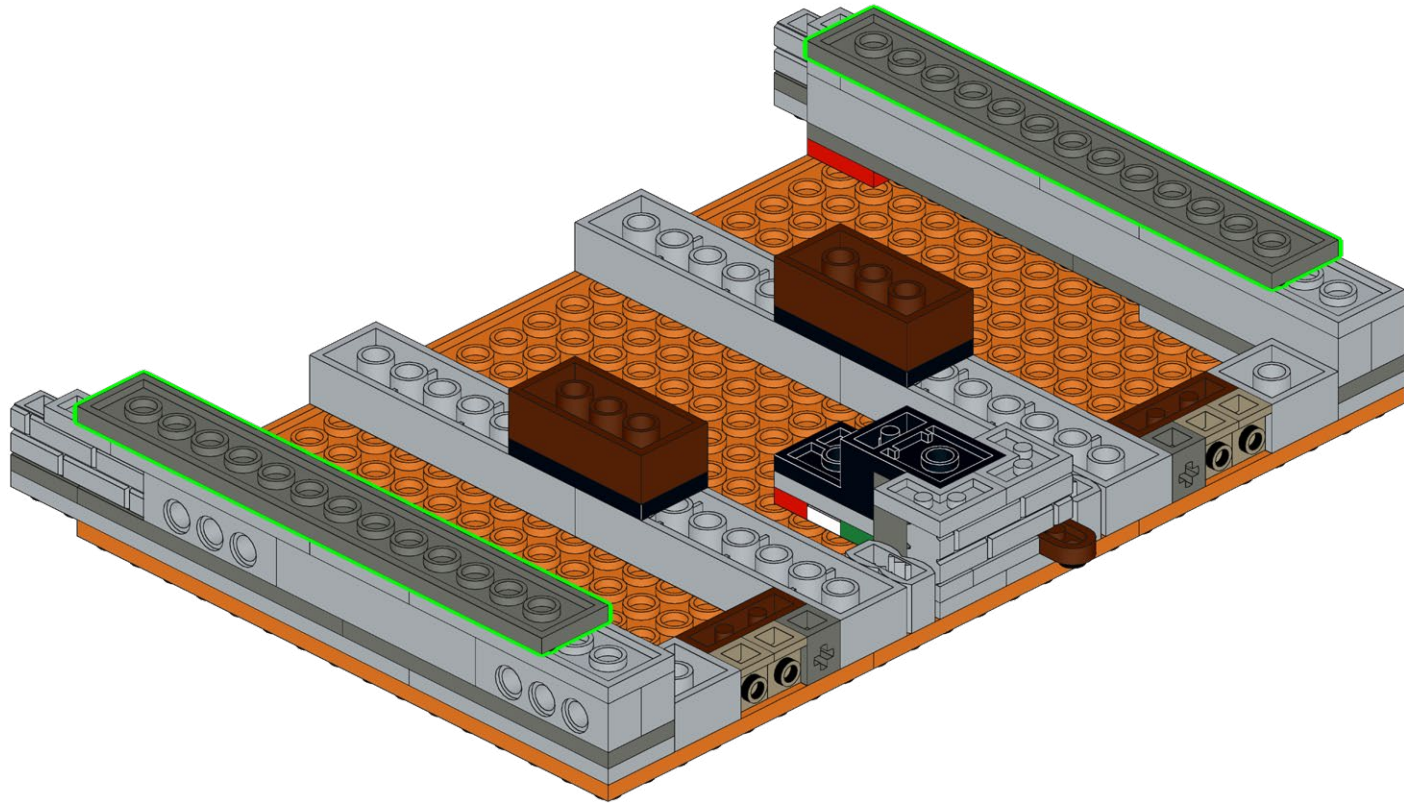
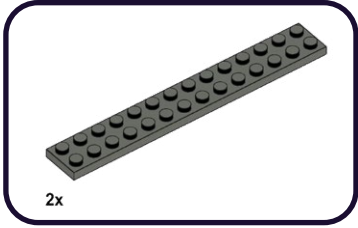

20

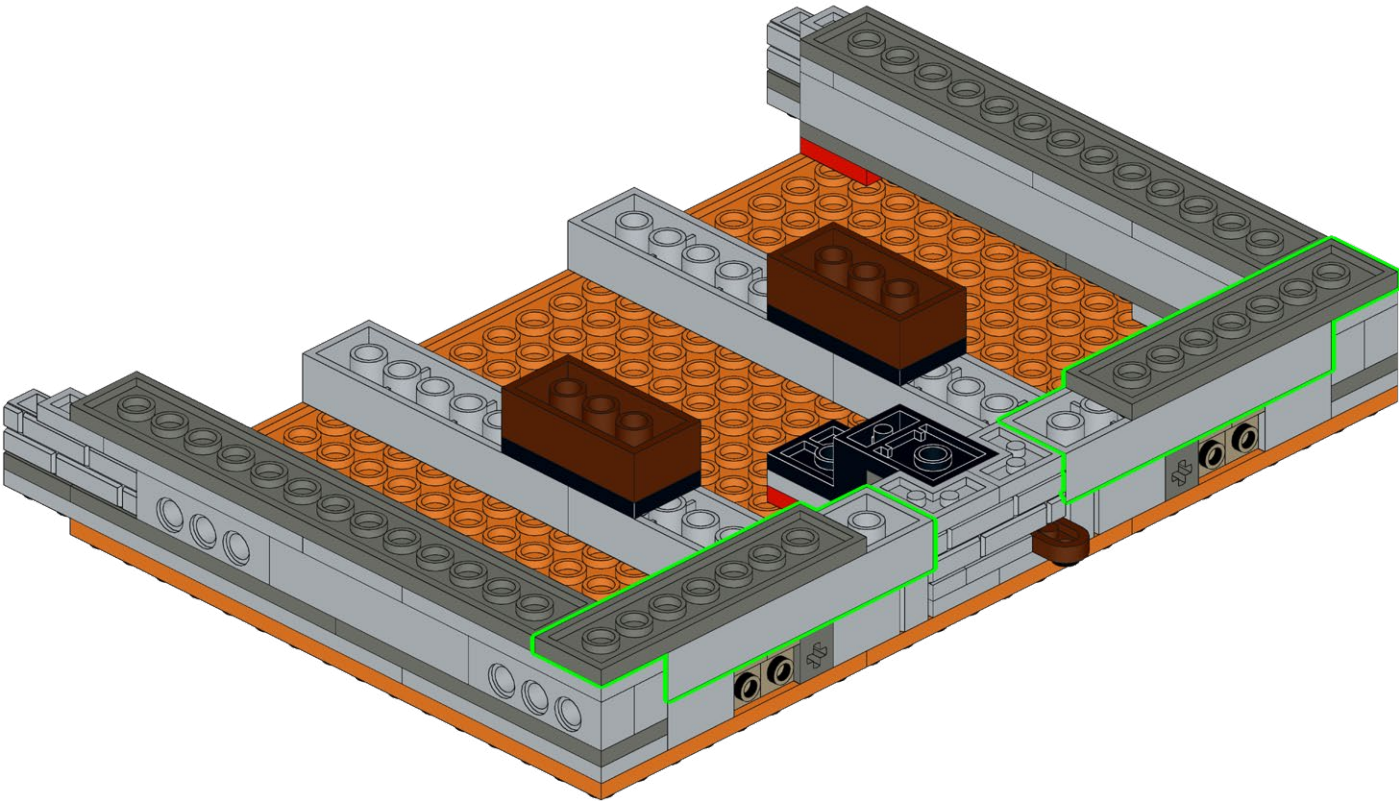
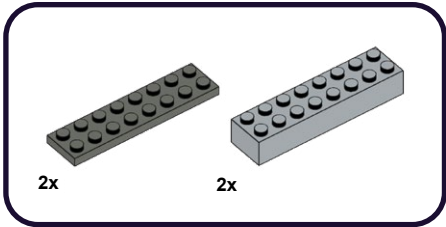

21

2x

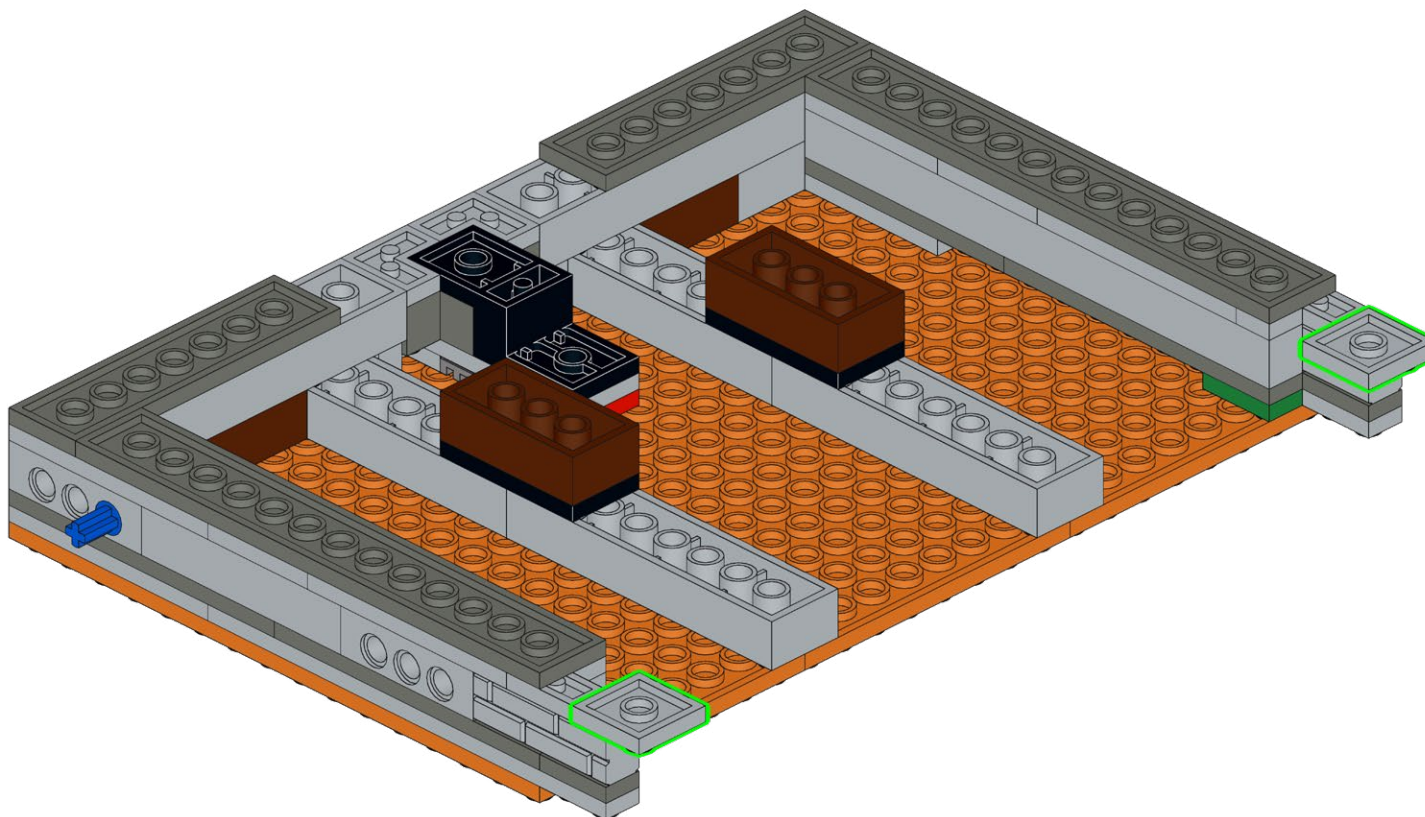

22

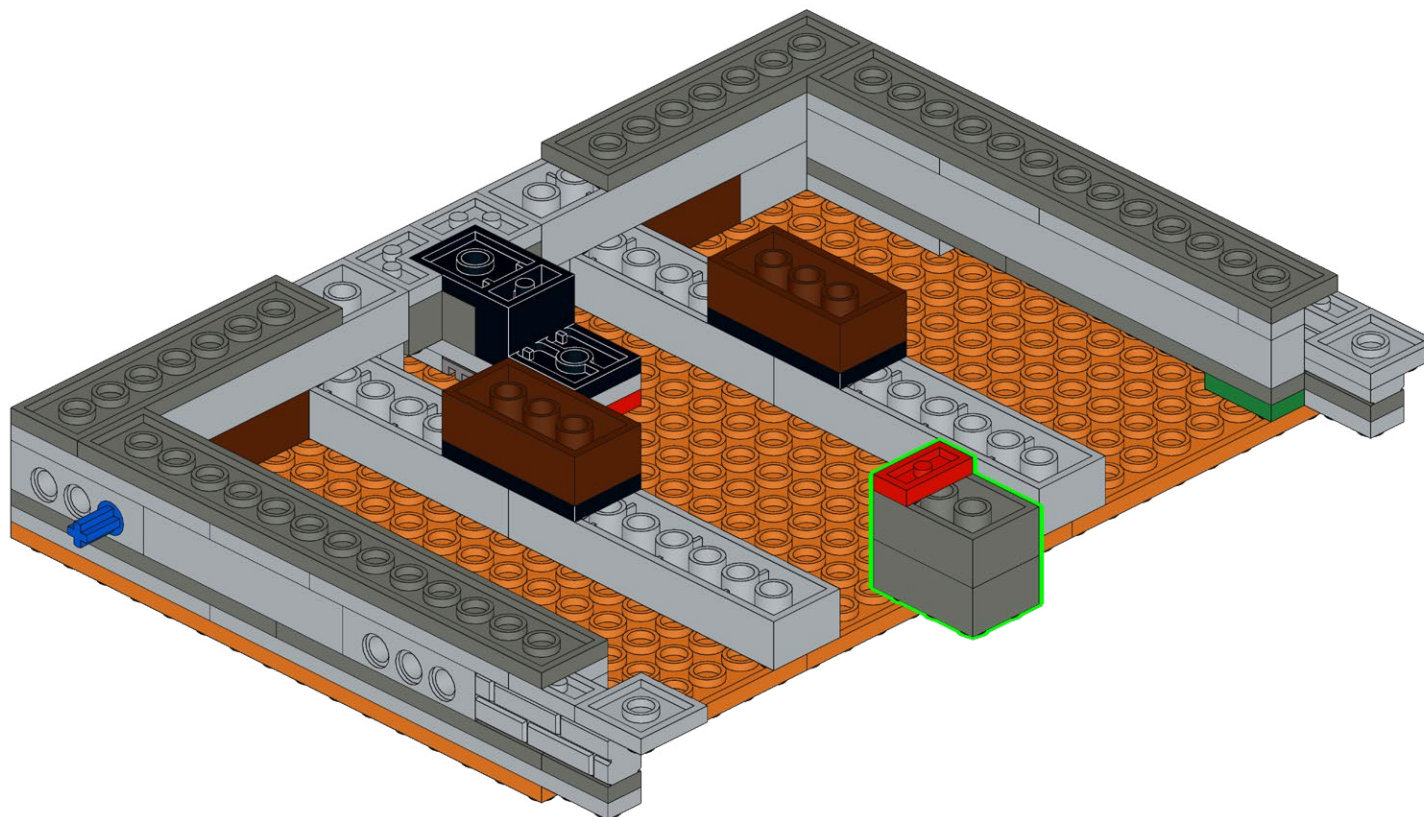
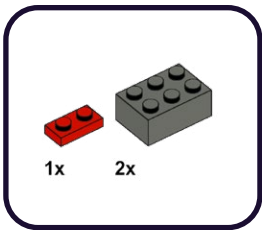

23

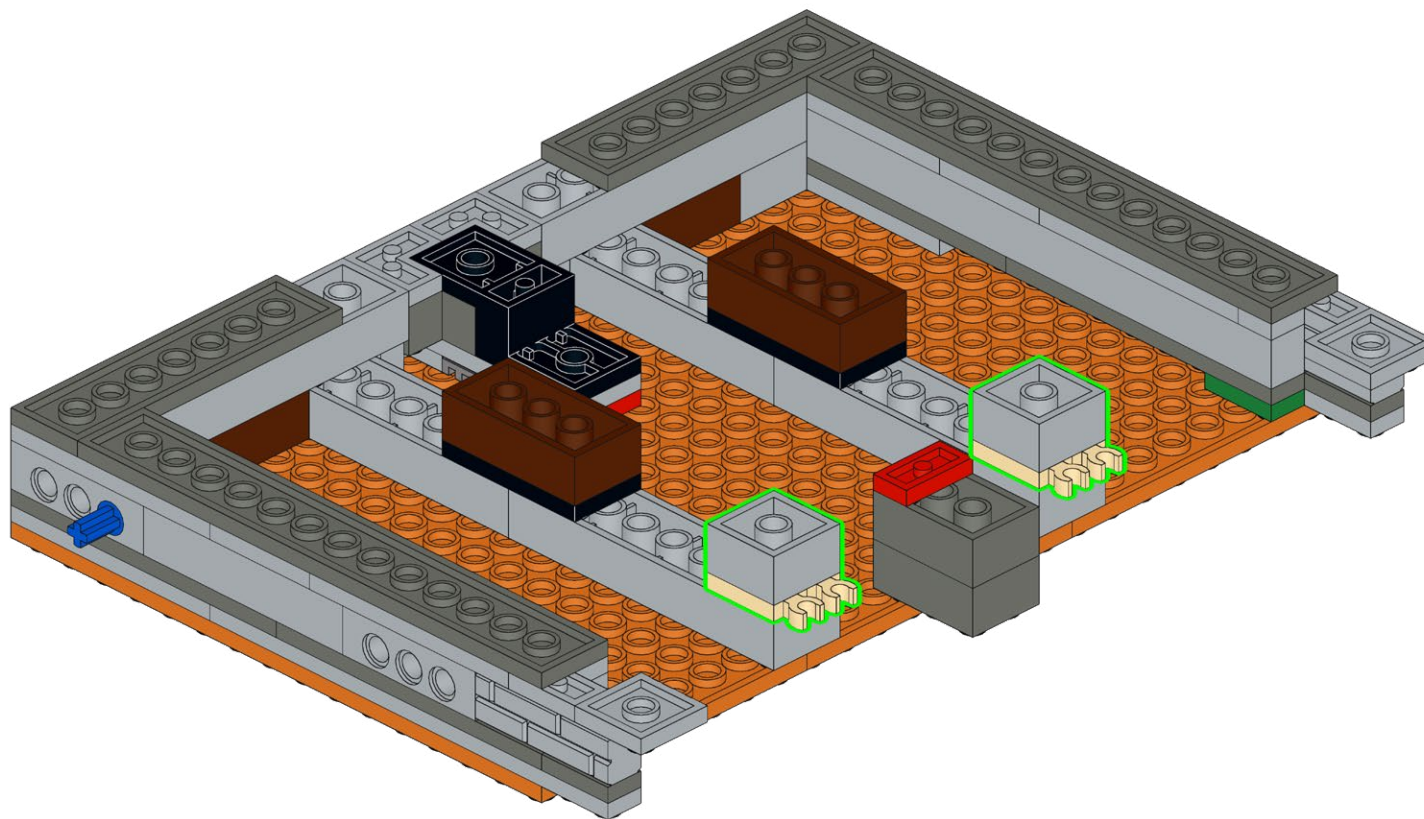
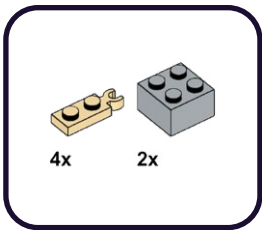

24

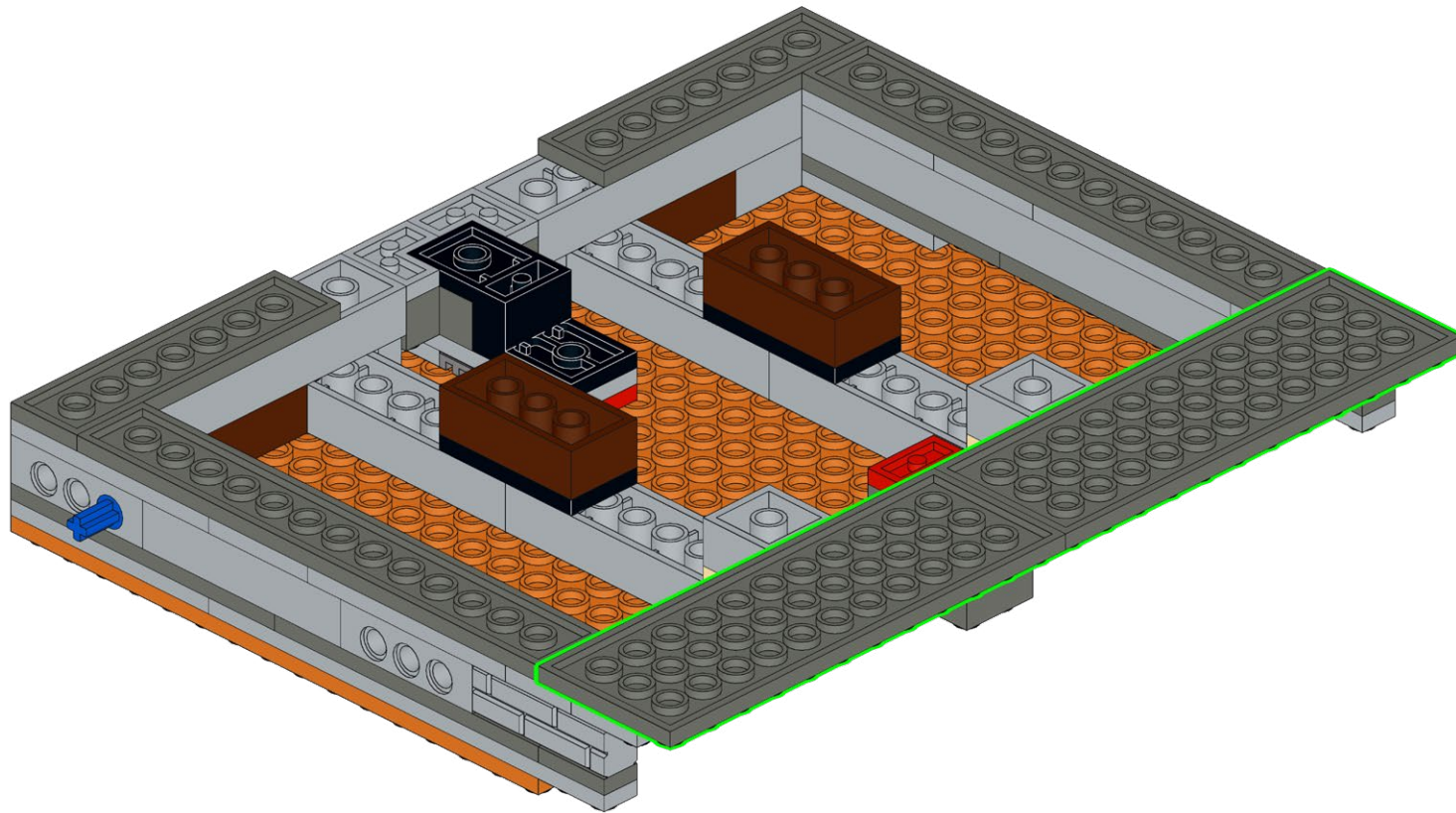
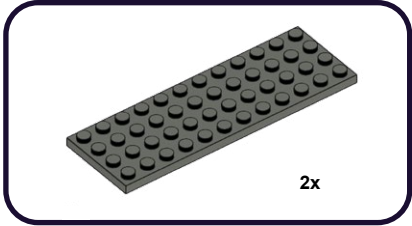

25

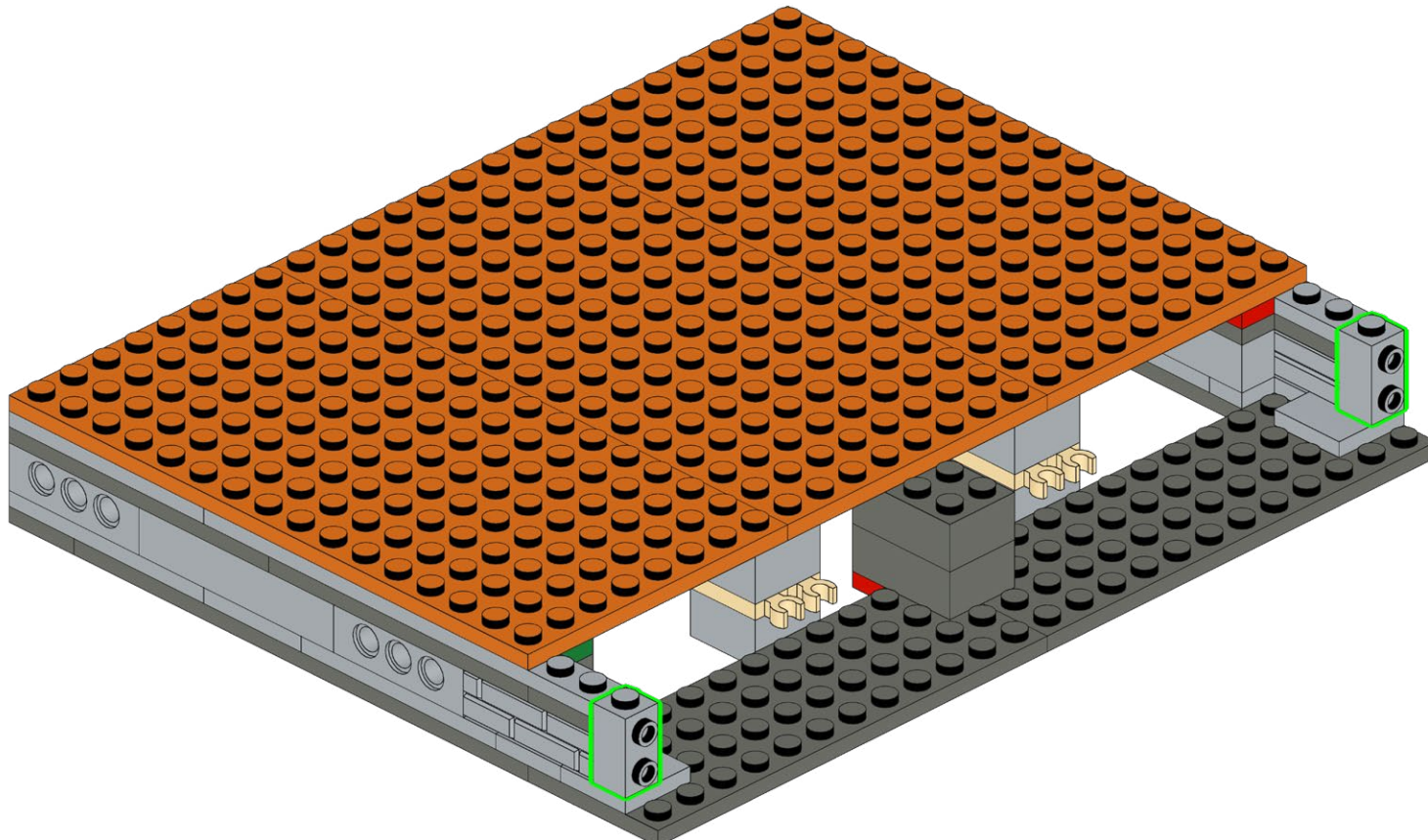
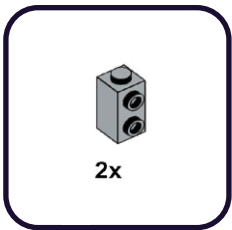

26

2x

5x

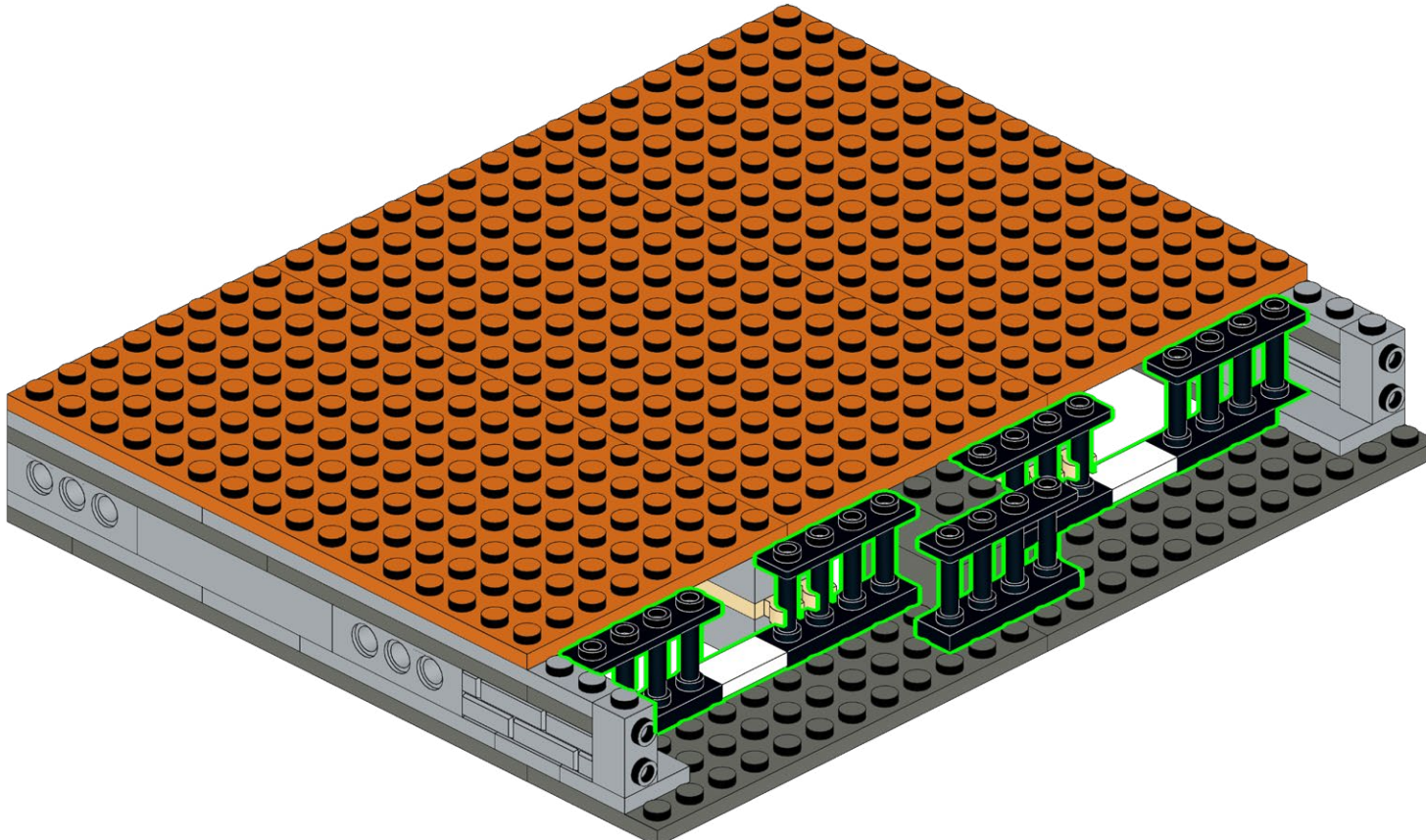

27

4x

3x

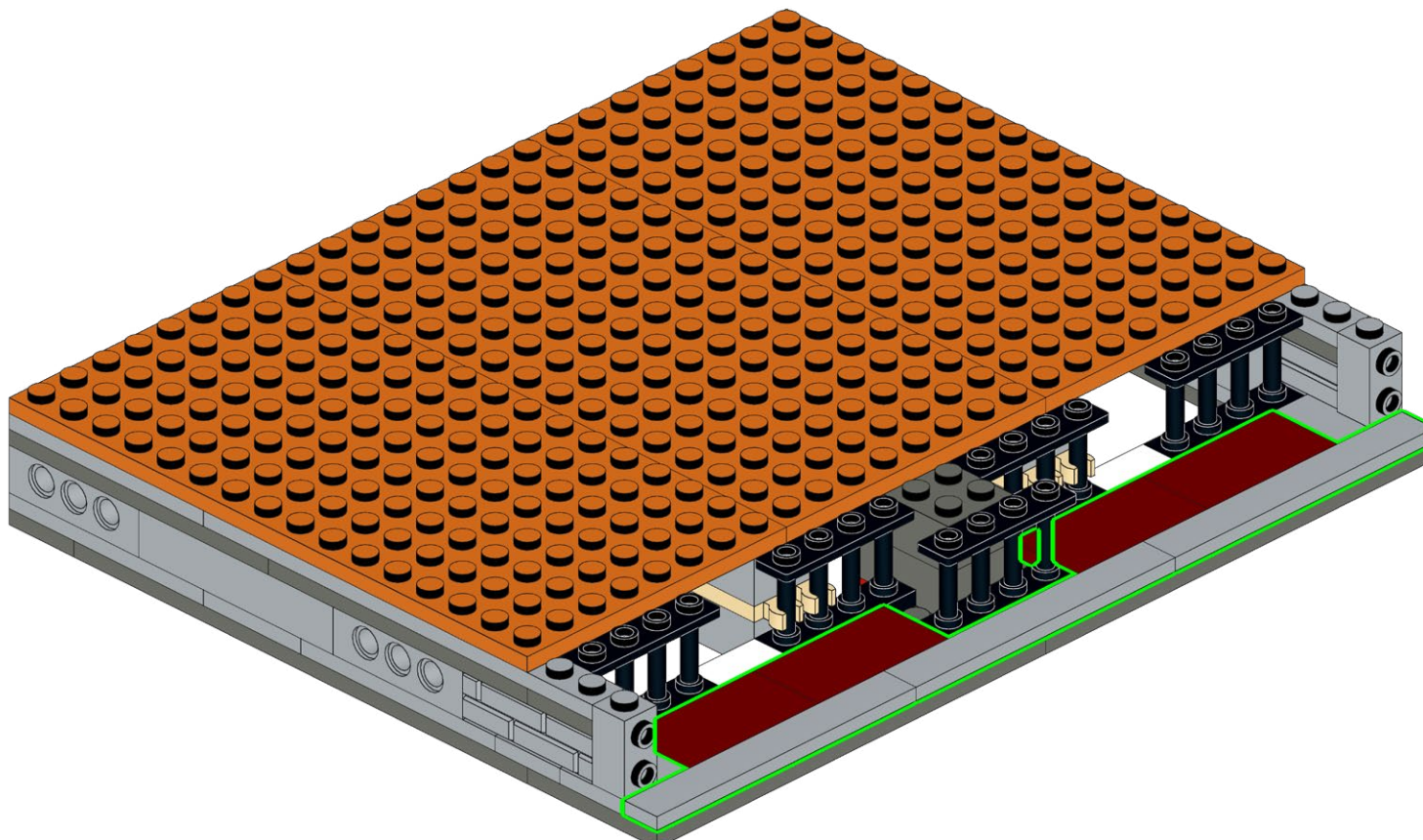

**HOLD UP!**

You might notice some bags aren't in order, as well as left over pieces, but that's ok! We're changing the way you build LEGO!

ATTENDEZ!

Vous remarquerez peut-être que certains sacs, ainsi que certaines pièces, ne sont pas dans le bon ordre. Mais pas de panique! Nous changeons simplement la façon avec laquelle vous construisez vos LEGO!

ASPETTA!

Potresti notare che alcuni sacchetti non sono in ordine, così come i pezzi avanzati, ma va bene così! Stiamo cambiando il modo in cui costruisci i LEGO!

HALT!

Sie werden möglicherweise bemerken, dass einige tüten durcheinander sind und teile übrig bleiben, aber das ist in Ordnung! Wir ändern die art und weise, wie Sie LEGO bauen!

¡ESPERA!

Es posible que notes que algunas bolsas están fuera de servicio, así como piezas sobrantes, ¡pero está bien! ¡Estamos cambiando la forma en que construyes LEGO!

暫停!

你可能会注意到一些袋子顺序错乱, 以及一些剩余的部件, 但没关系! 我们正在改变你搭建乐高的方式!

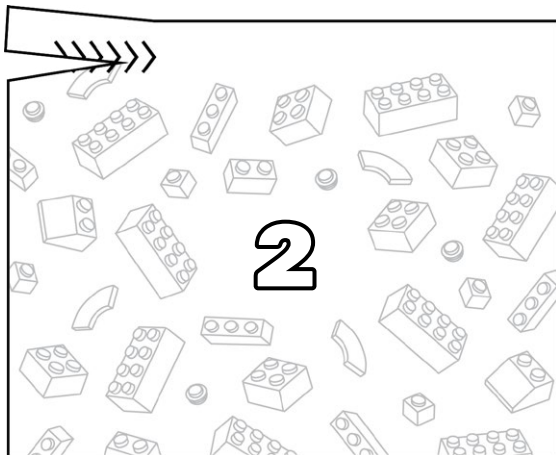
Open LEGO® Bag 2

28

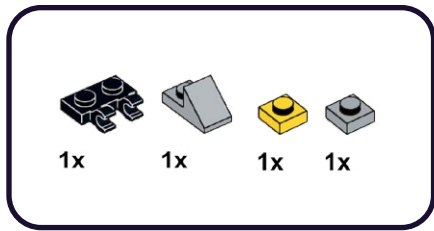

1

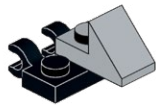

2

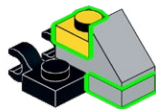

29

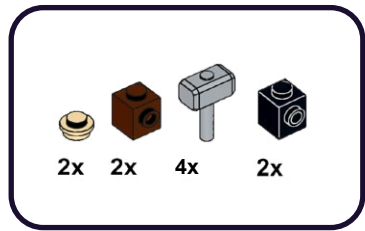

3

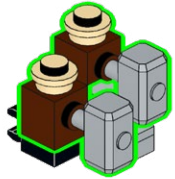

4

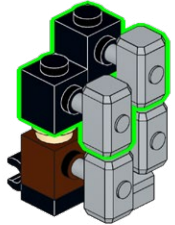

30

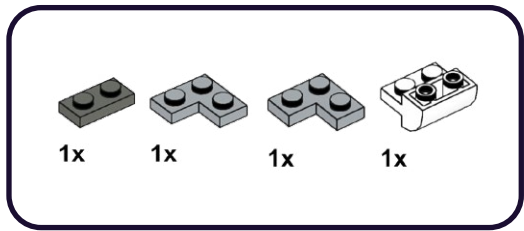

1

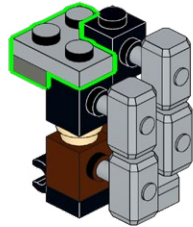

2

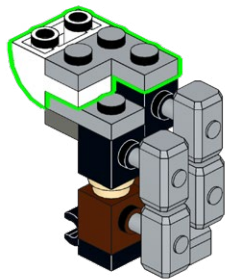

31

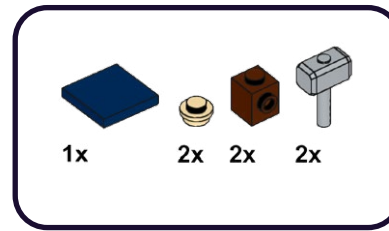

3

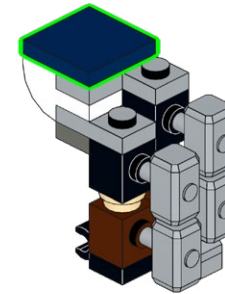

4

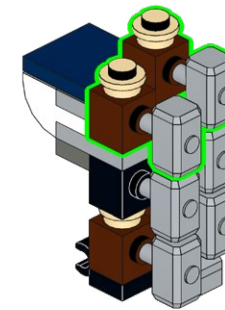

32

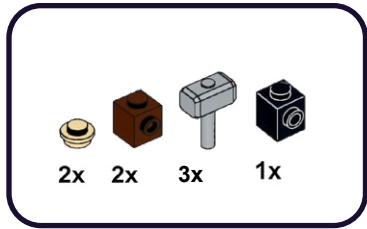

1

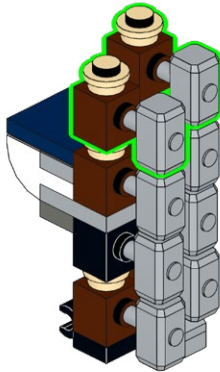

2

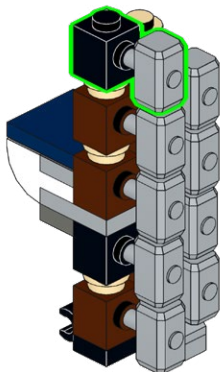

33

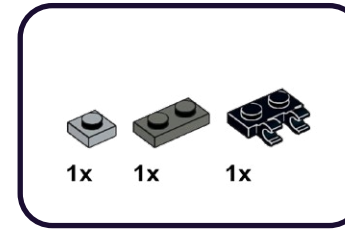

3

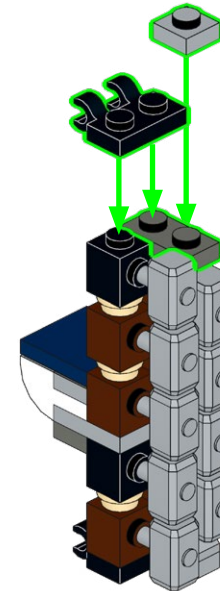

34

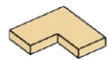

1x

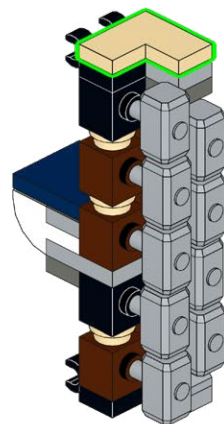

35

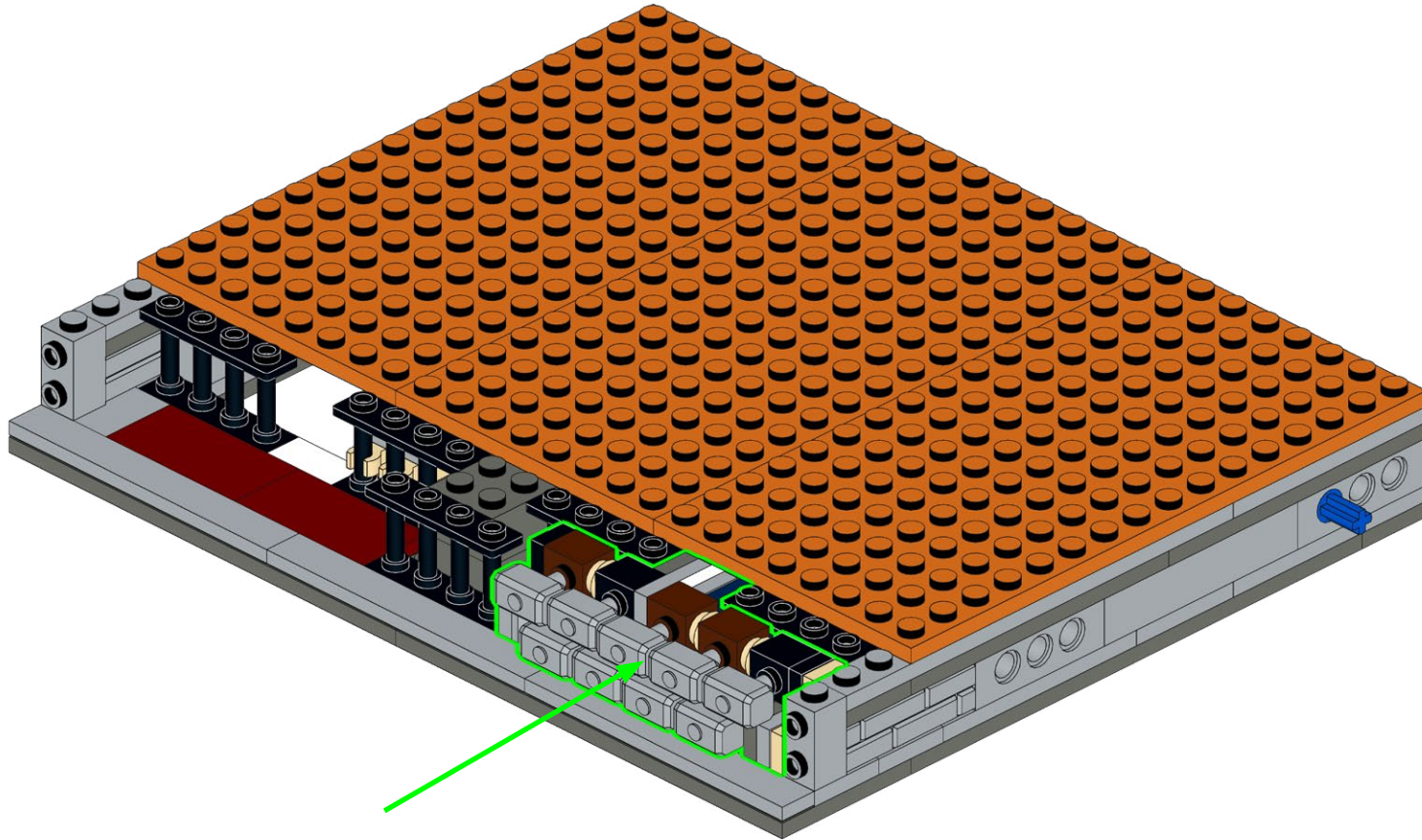

36

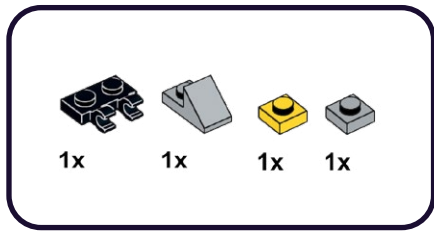

1

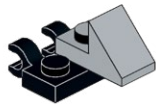

2

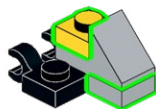

37

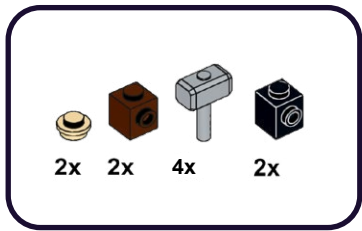

3

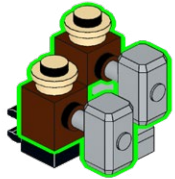

4

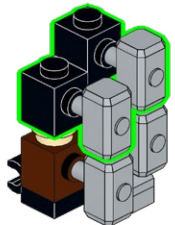

38

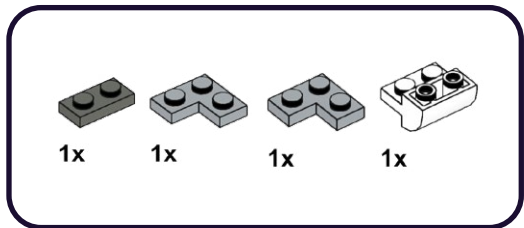

1

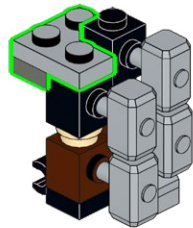

2

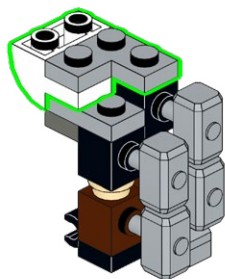

39

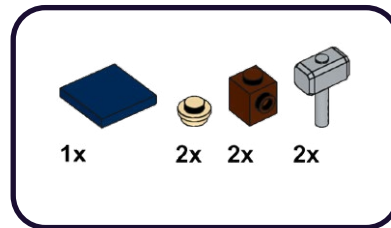

3

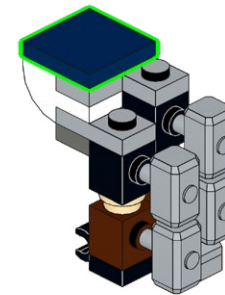

4

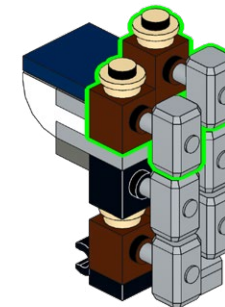

40

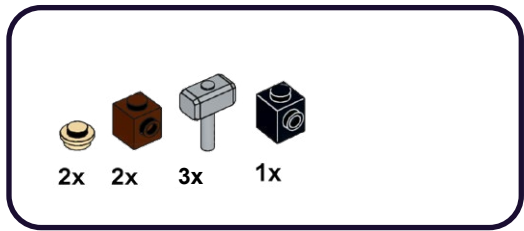

1

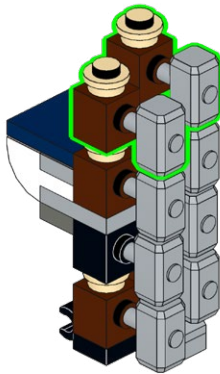

2

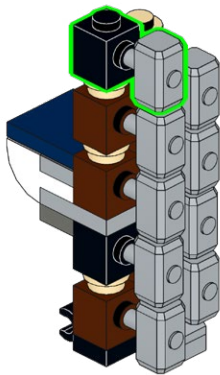

41

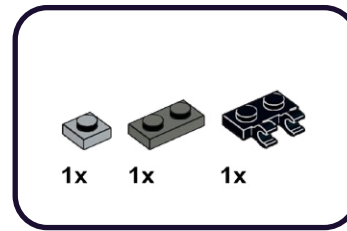

3

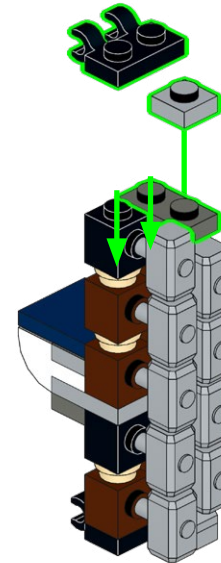

42

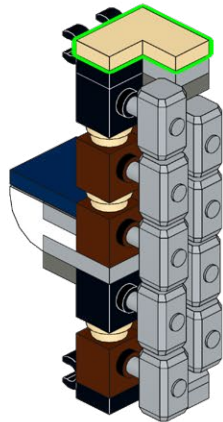
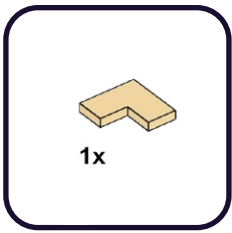

43

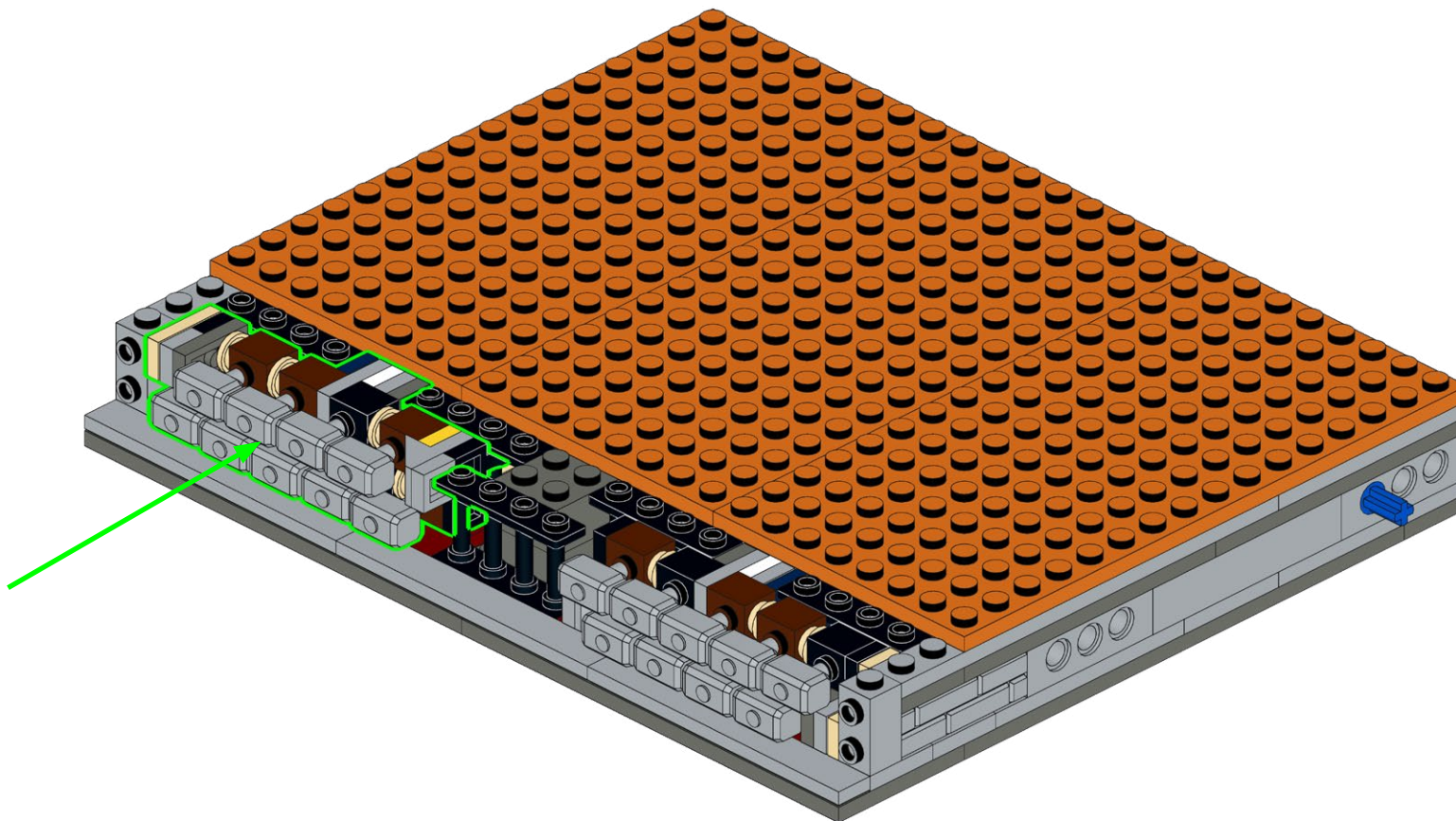

44

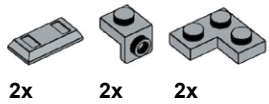

1

2

2x

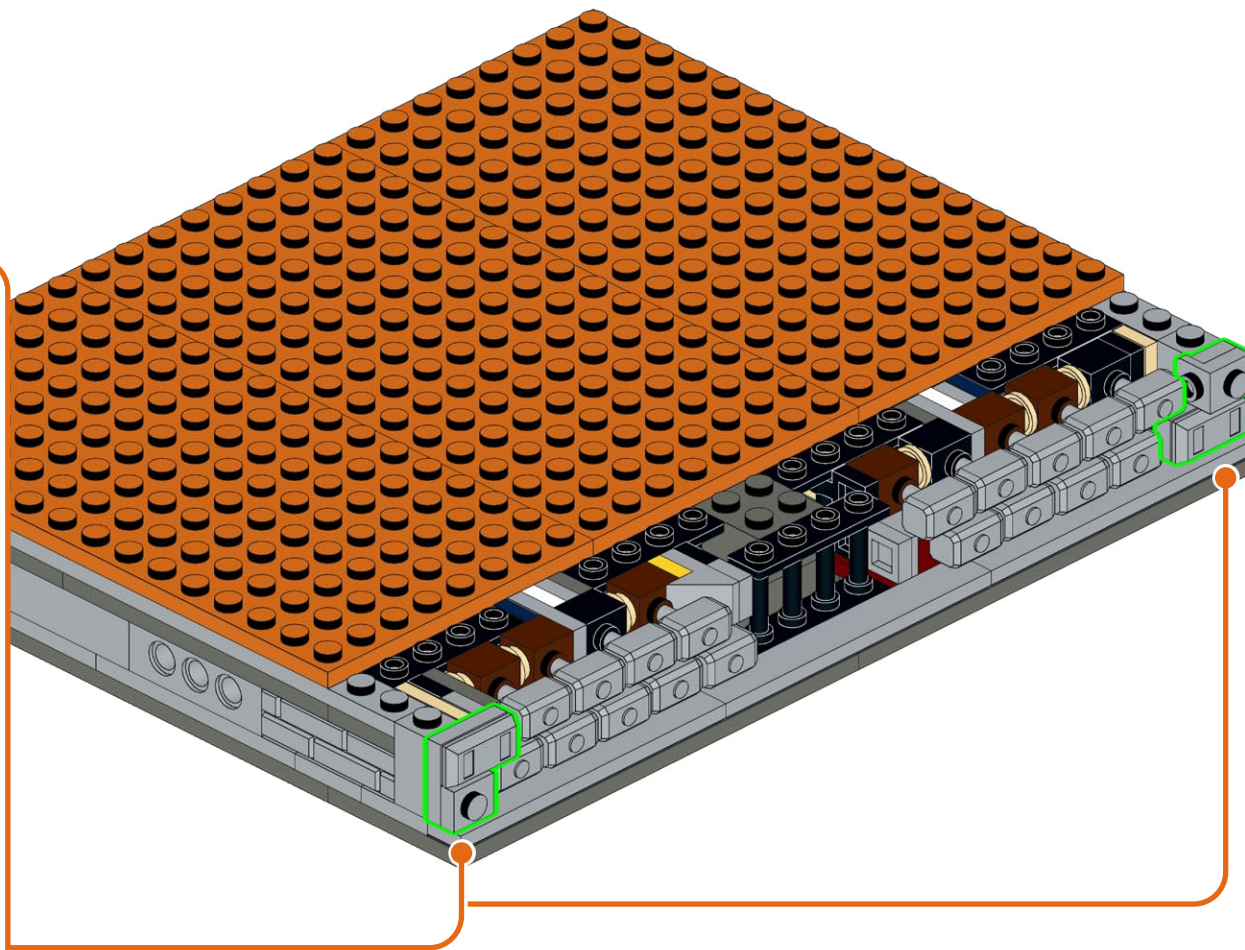

45

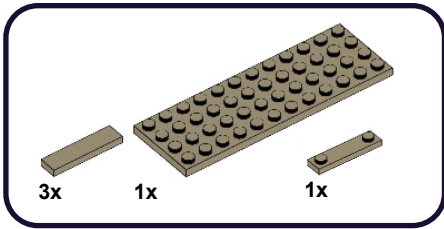

1

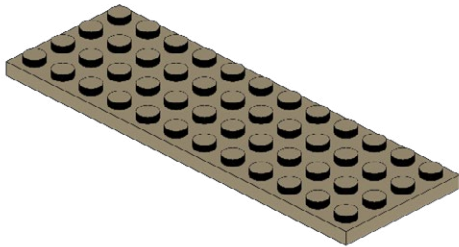

2

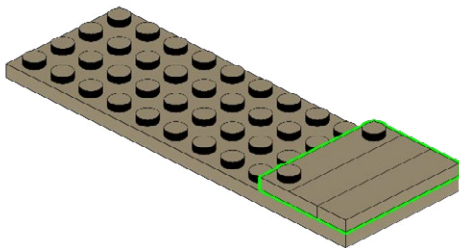

46

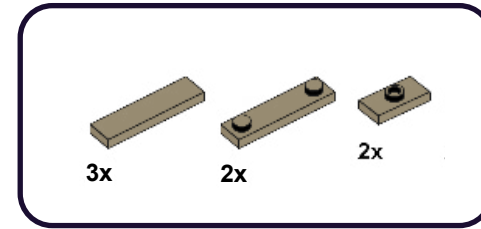

4

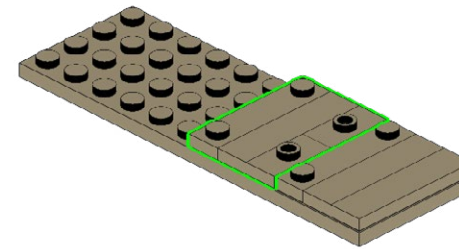

5

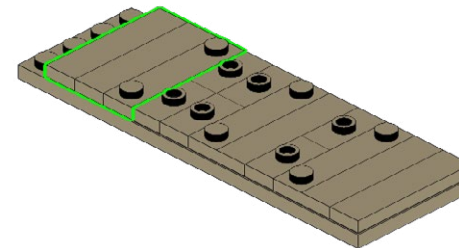

2x

47

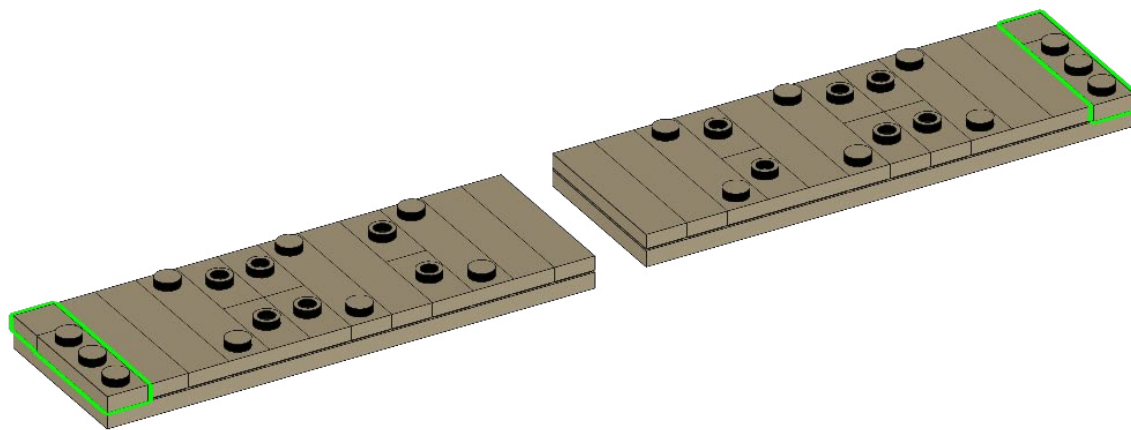
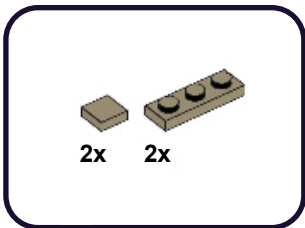

48

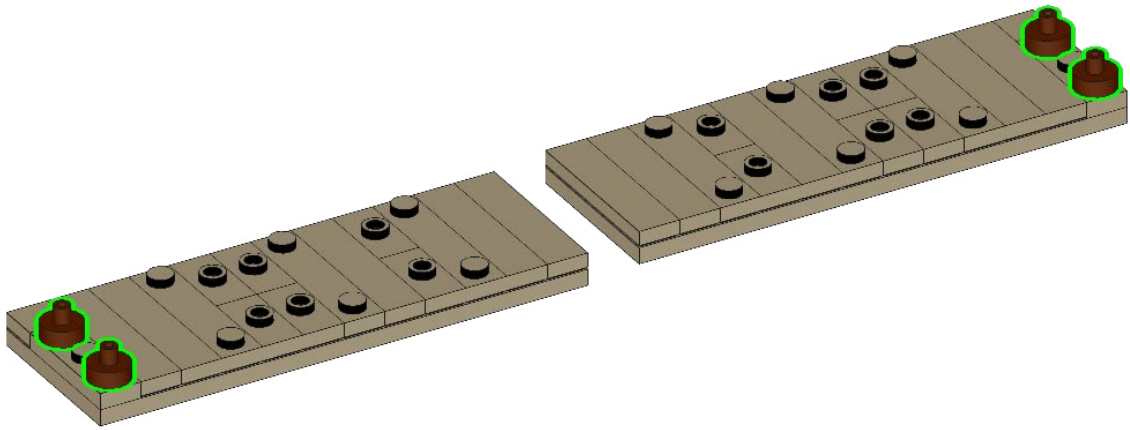

49

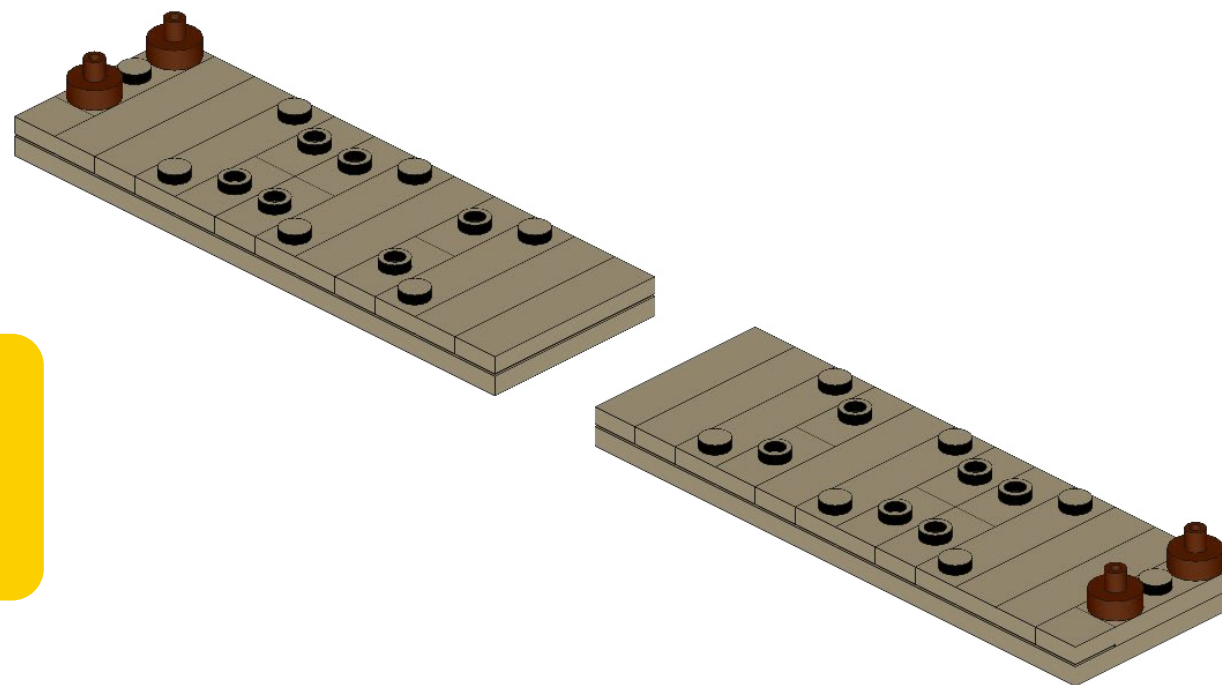

To be used later
A utilisar plus tard
Da utilizzare dopo
Zur späteren Verwendung
Para ser utilizado más tarde
稍后使用

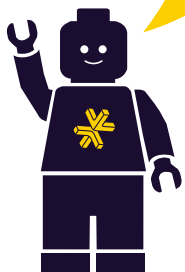

 **LMB**



HOLD UP!

You might notice some bags aren't in order, as well as left over pieces, but that's ok! We're changing the way you build LEGO!

ATTENDEZ!

Vous remarquerez peut-être que certains sacs, ainsi que certaines pièces, ne sont pas dans le bon ordre. Mais pas de panique! Nous changeons simplement la façon avec laquelle vous construisez vos LEGO!

ASPETTA!

Potresti notare che alcuni sacchetti non sono in ordine, così come i pezzi avanzati, ma va bene così! Stiamo cambiando il modo in cui costruisci i LEGO!

HALT!

Sie werden möglicherweise bemerken, dass einige tüten durcheinander sind und teile übrig bleiben, aber das ist in Ordnung! Wir ändern die art und weise, wie Sie LEGO bauen!

¡ESPERA!

Es posible que notes que algunas bolsas están fuera de servicio, así como piezas sobrantes, ¡pero está bien! ¡Estamos cambiando la forma en que construyes LEGO!

暫停!

你可能会注意到一些袋子顺序错乱, 以及一些剩余的部件, 但没关系! 我们正在改变你搭建乐高的方式!

Open LEGO® Bag 3

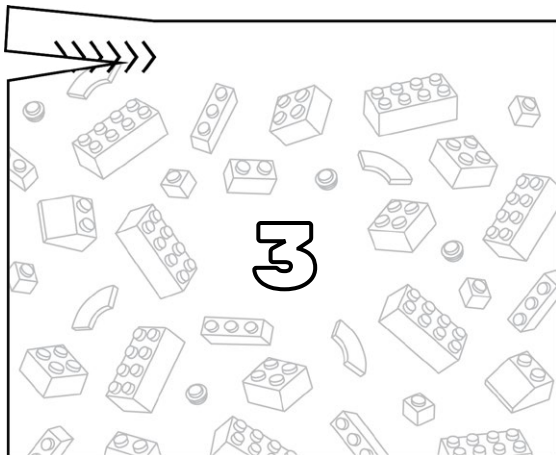

50

1x



1x

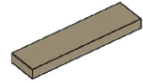

2x

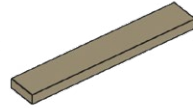

4x

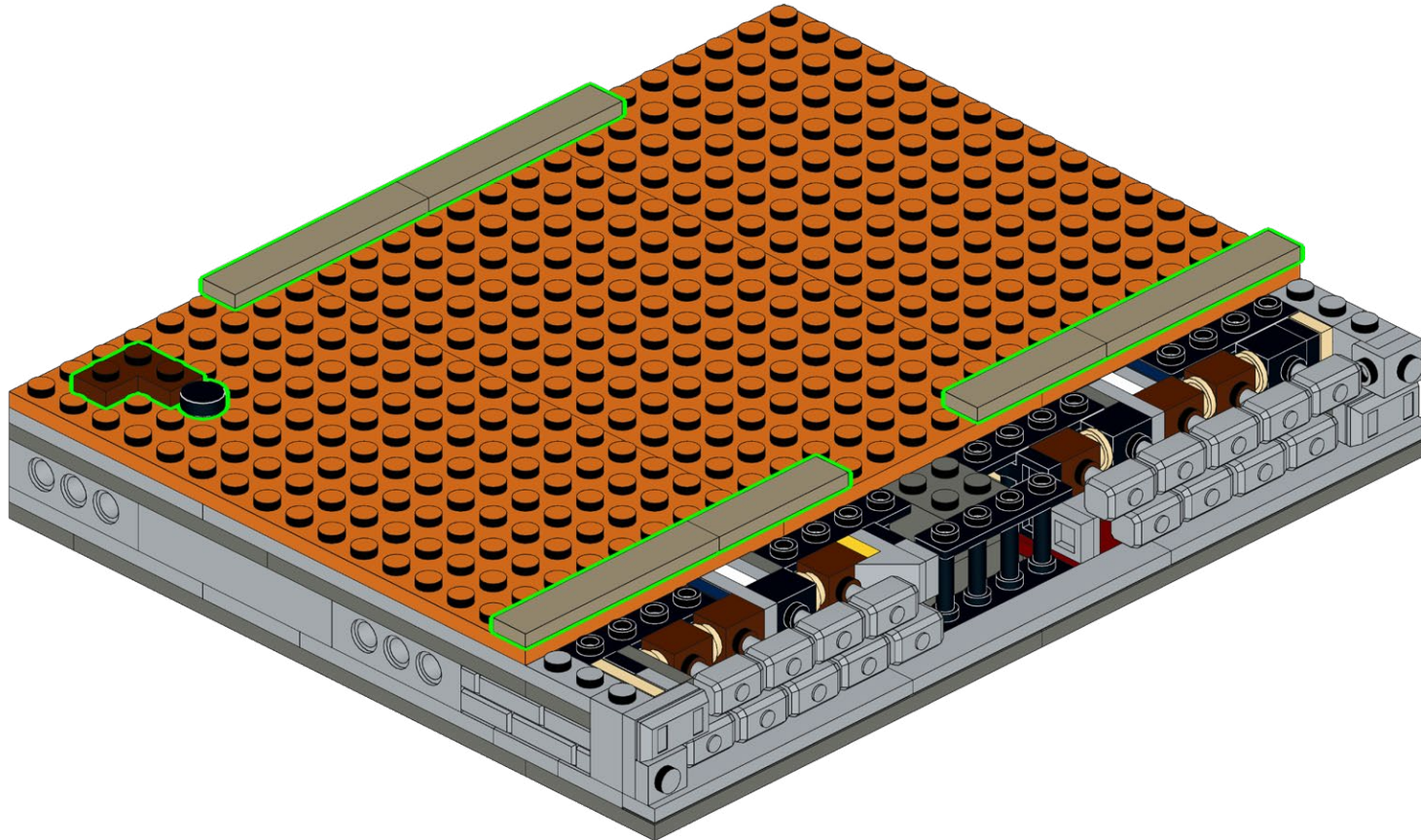

51

2x

1x

1

2

3

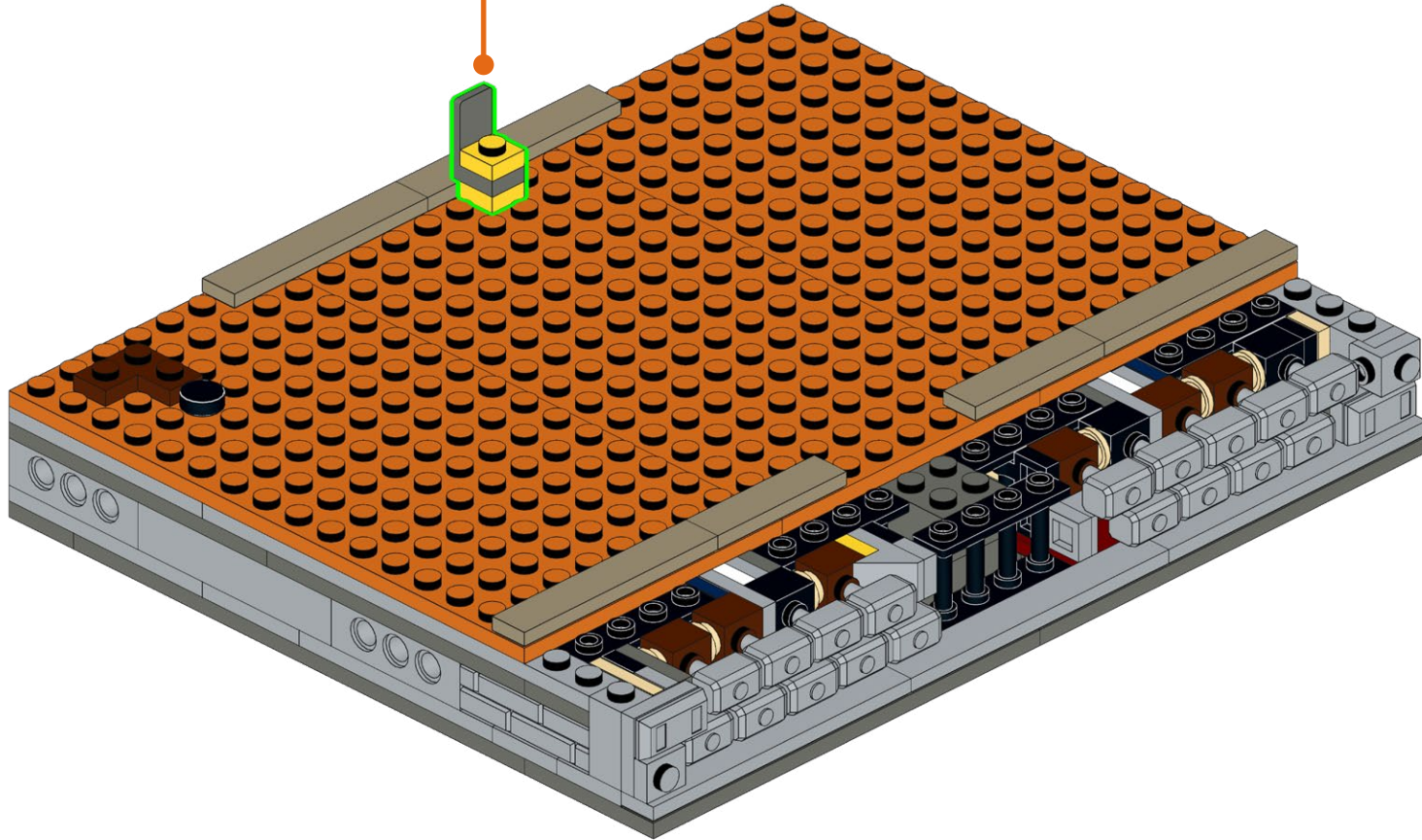

52

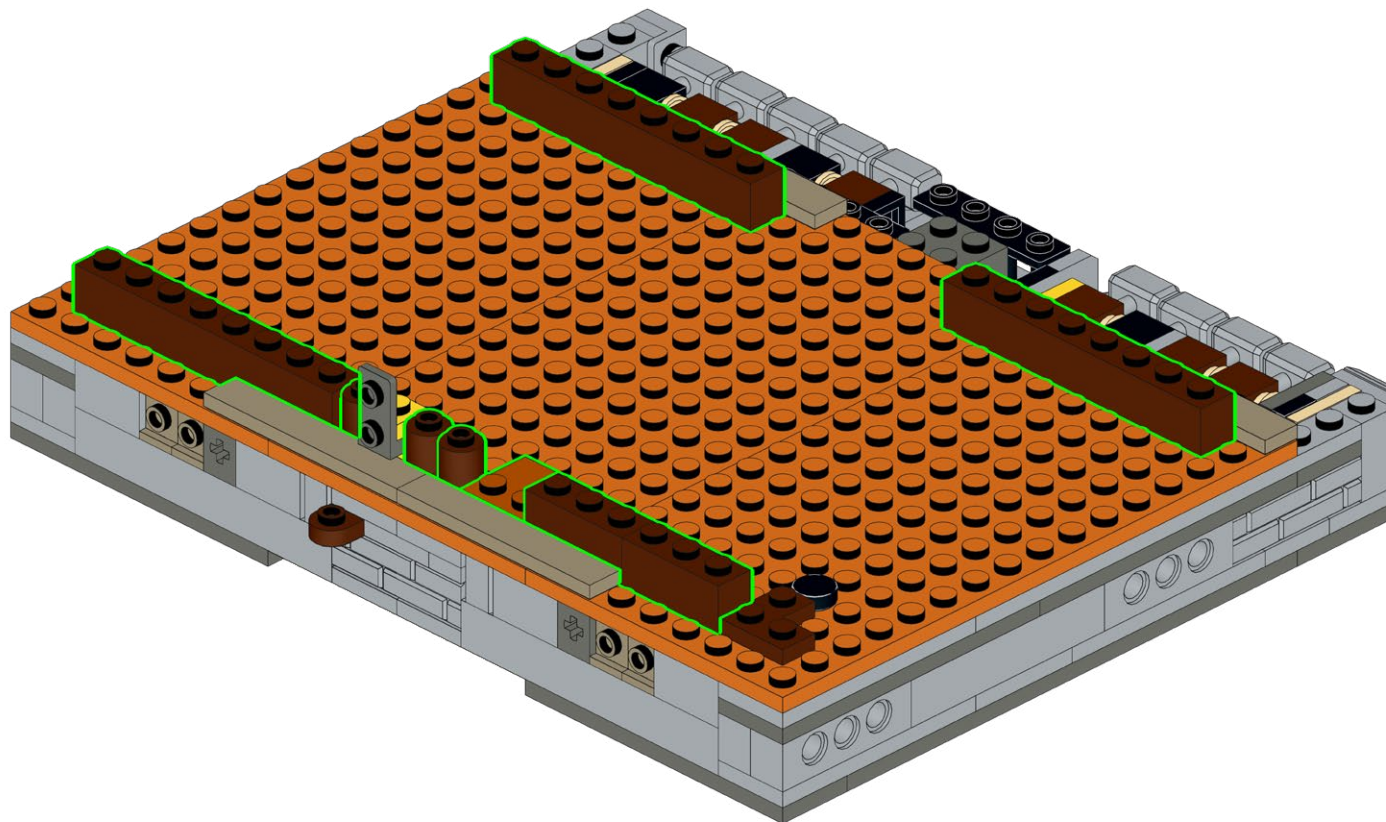
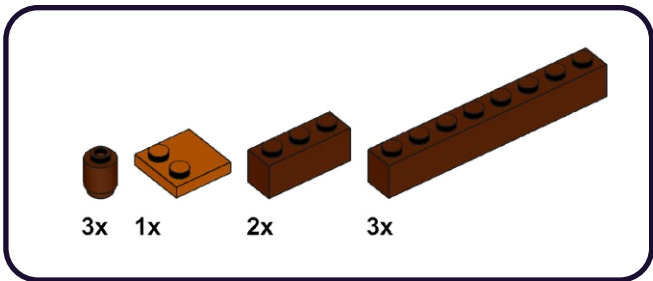

53

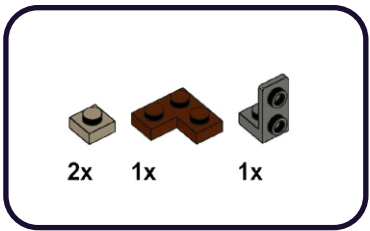

1

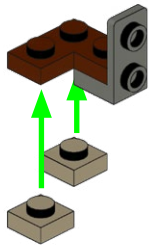

2

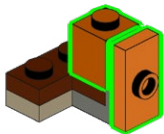

54

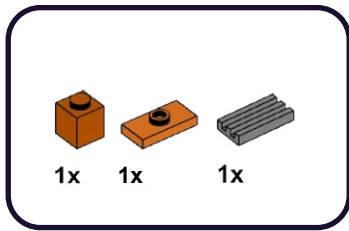

1

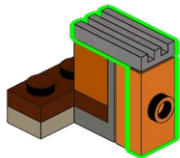

55

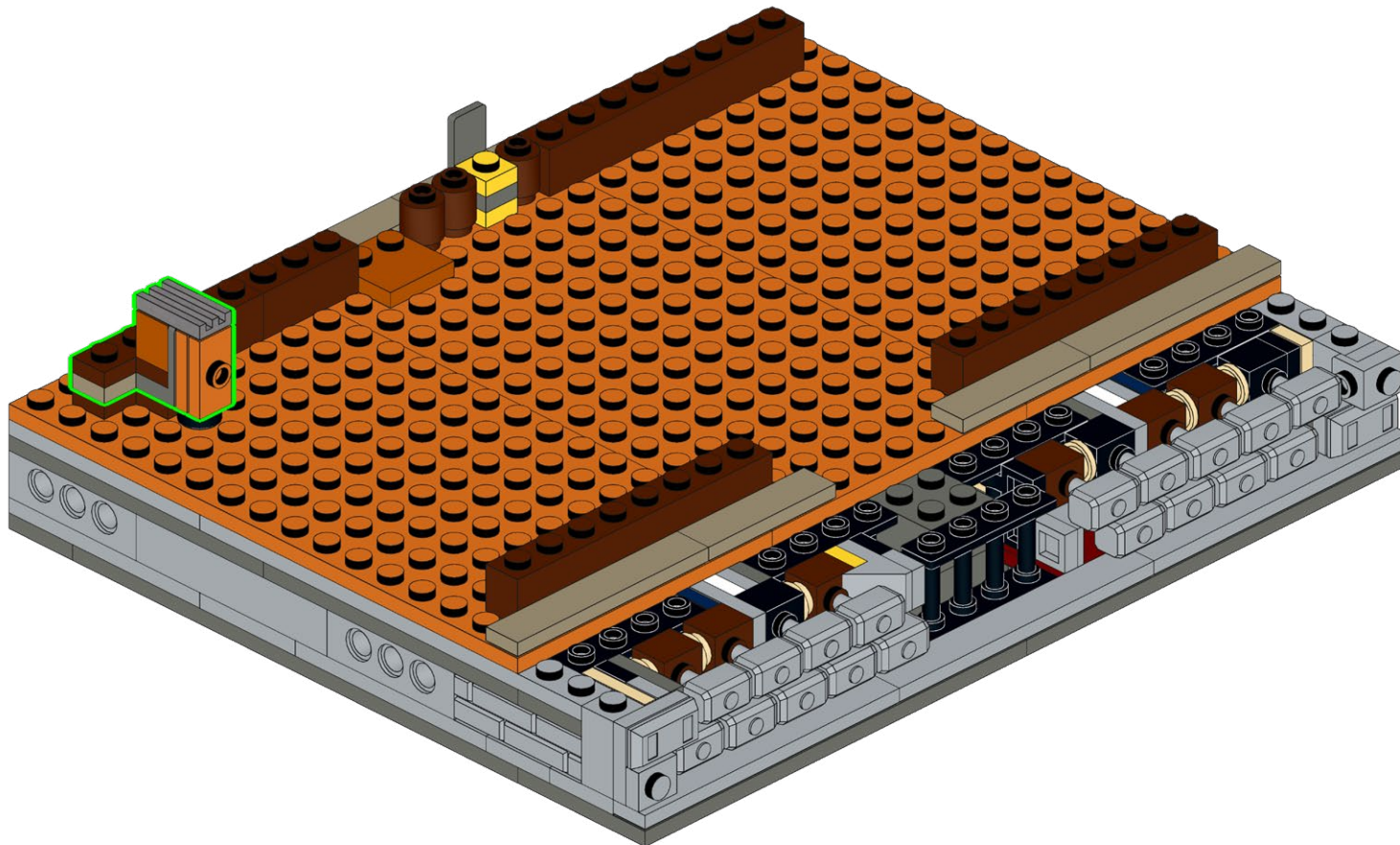

**HOLD UP!**

You might notice some bags aren't in order, as well as left over pieces, but that's ok! We're changing the way you build LEGO!

ATTENDEZ!

Vous remarquerez peut-être que certains sacs, ainsi que certaines pièces, ne sont pas dans le bon ordre. Mais pas de panique! Nous changeons simplement la façon avec laquelle vous construisez vos LEGO!

ASPETTA!

Potresti notare che alcuni sacchetti non sono in ordine, così come i pezzi avanzati, ma va bene così! Stiamo cambiando il modo in cui costruisci i LEGO!

HALT!

Sie werden möglicherweise bemerken, dass einige tüten durcheinander sind und teile übrig bleiben, aber das ist in Ordnung! Wir ändern die art und weise, wie Sie LEGO bauen!

¡ESPERA!

Es posible que notes que algunas bolsas están fuera de servicio, así como piezas sobrantes, ¡pero está bien! ¡Estamos cambiando la forma en que construyes LEGO!

暫停!

你可能会注意到一些袋子顺序错乱, 以及一些剩余的部件, 但没关系! 我们正在改变你搭建乐高的方式!

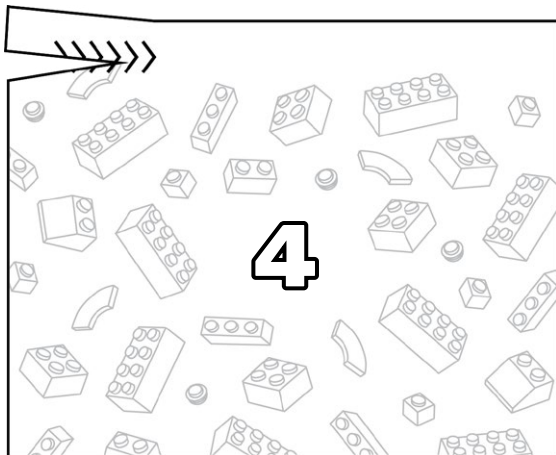
Open LEGO® Bag 4

56

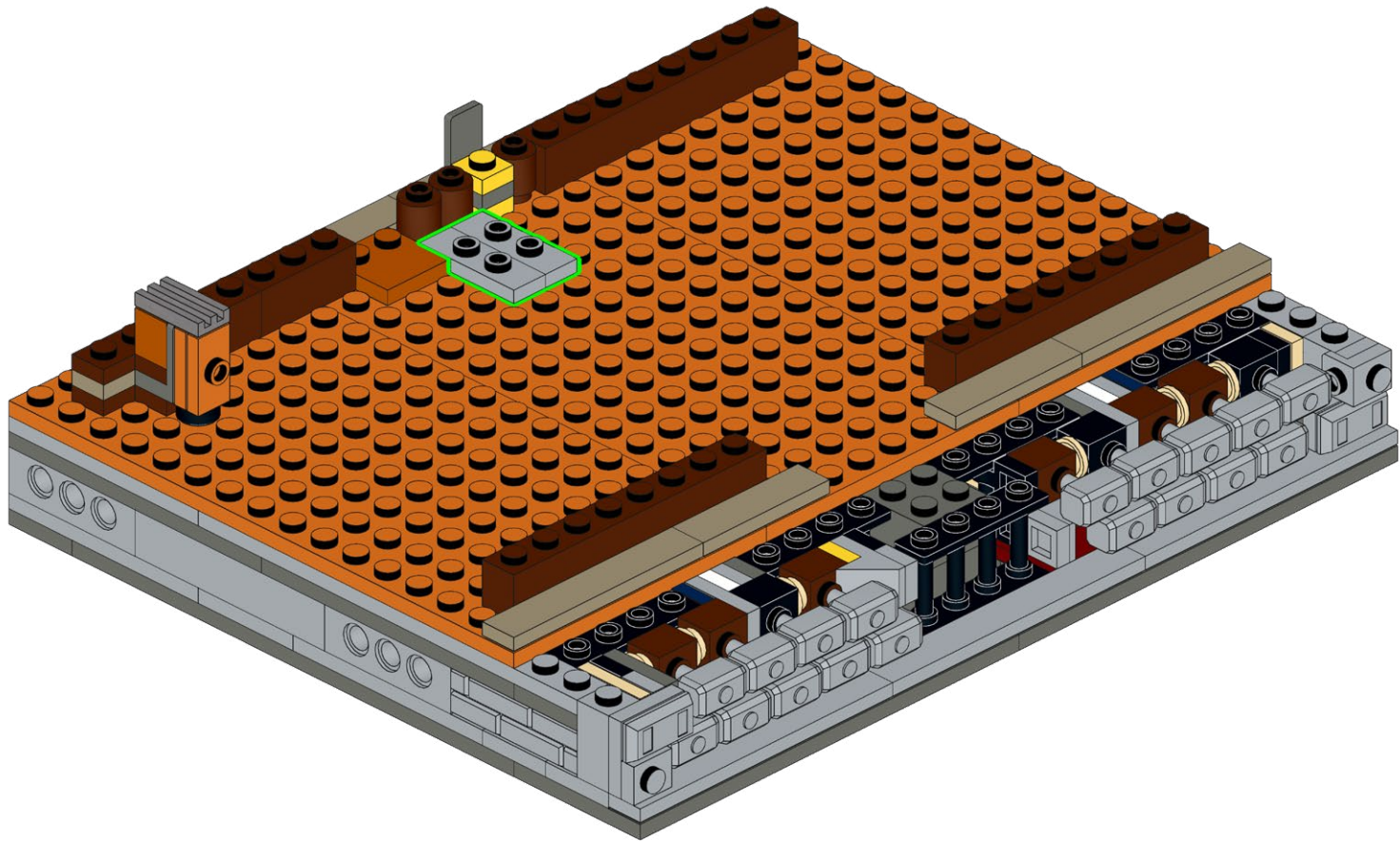
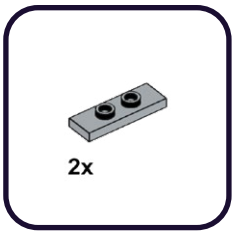

57

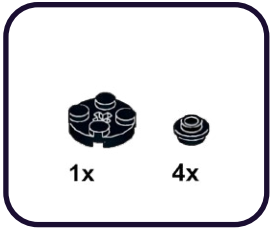

1



2

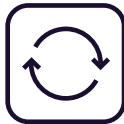

3



58

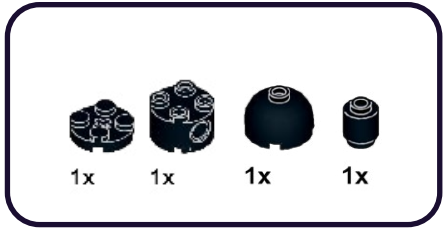

4

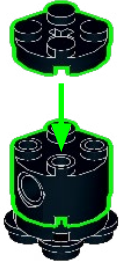

5



6



59

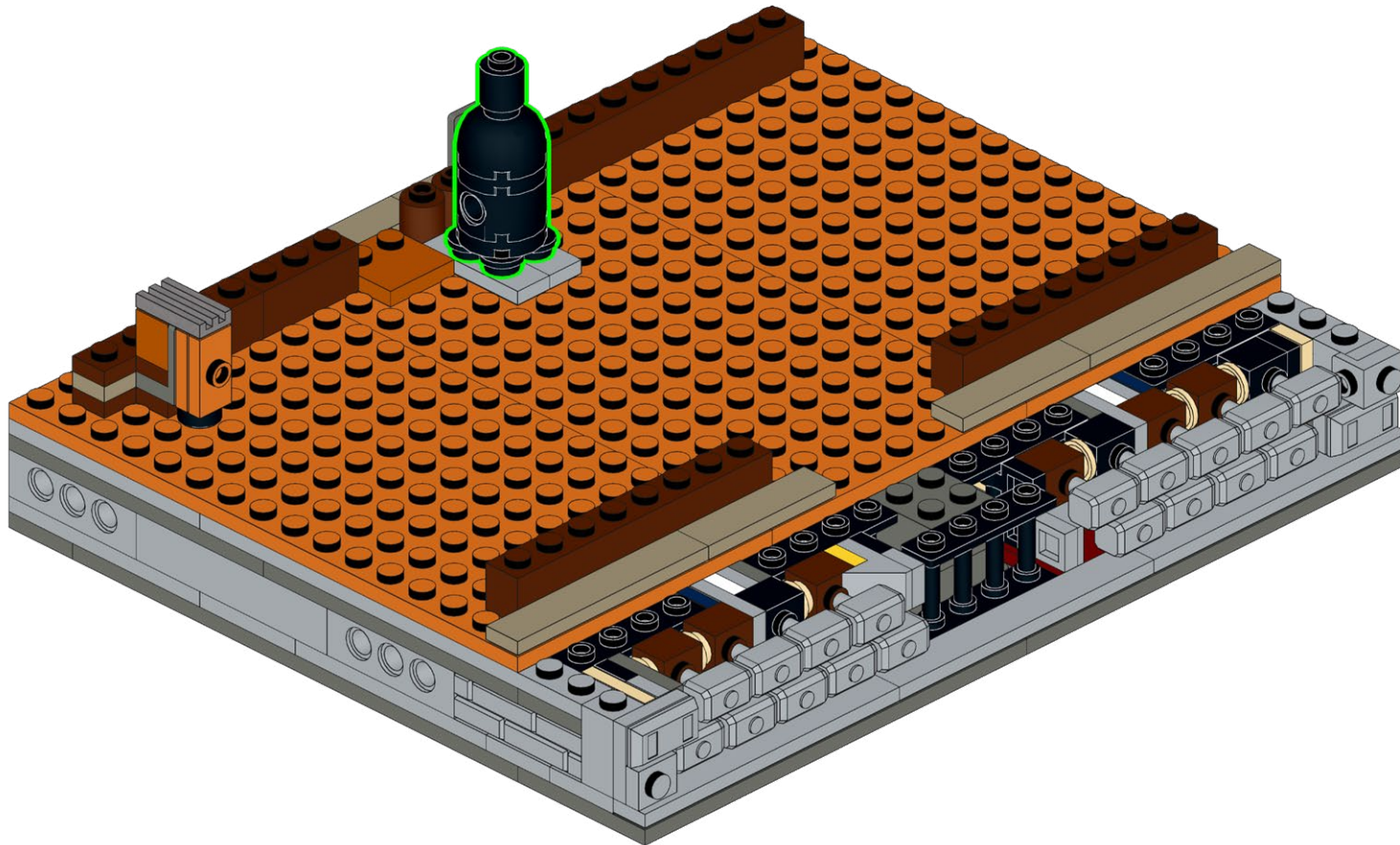

60

- 1x [Black Pin]
- 2x [Black Technic Brick 1x2 with Hole]
- 1x [Black Technic Brick 1x3 with Hole]
- 1x [Black Technic Brick 1x4 with 4 Holes]

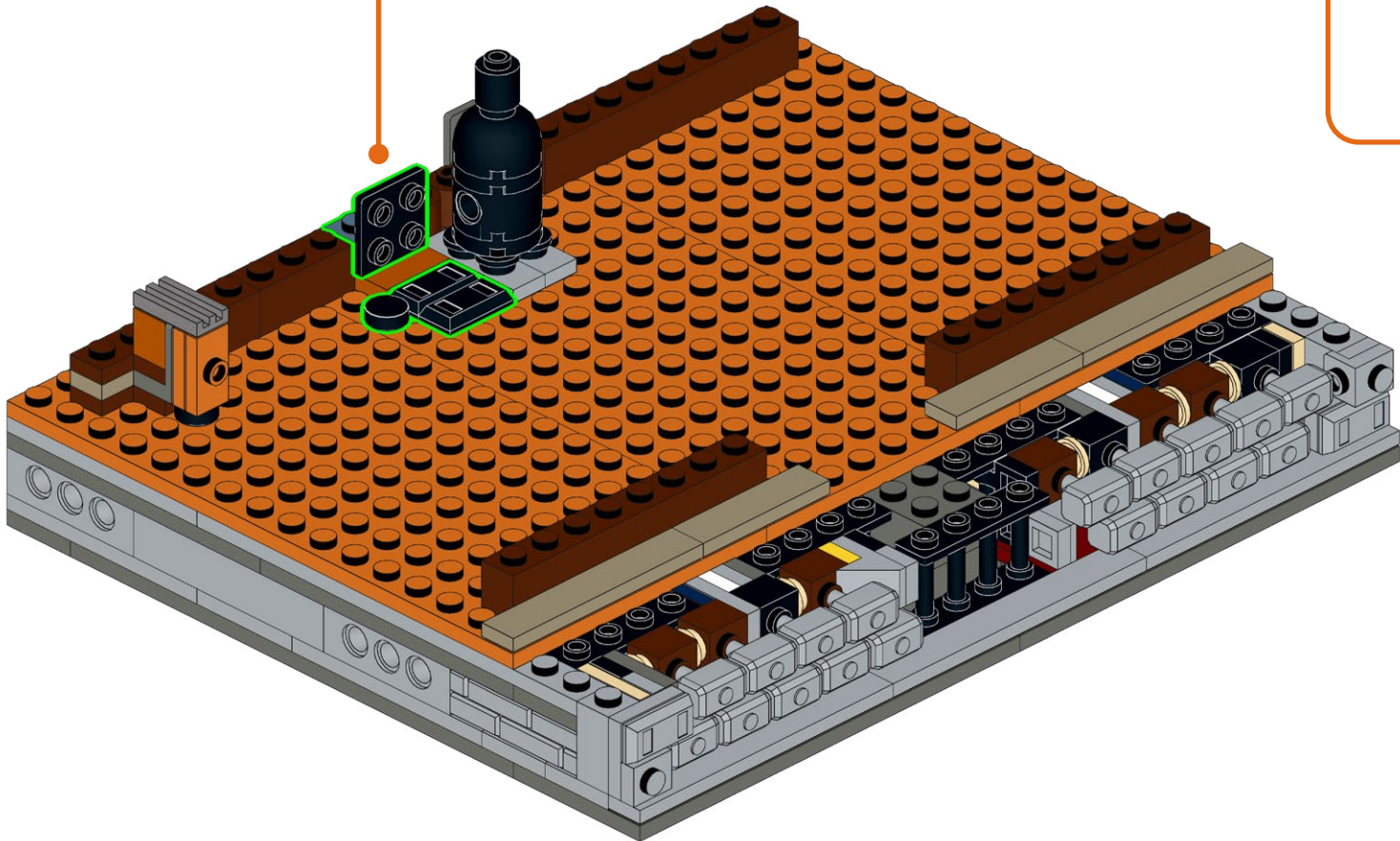
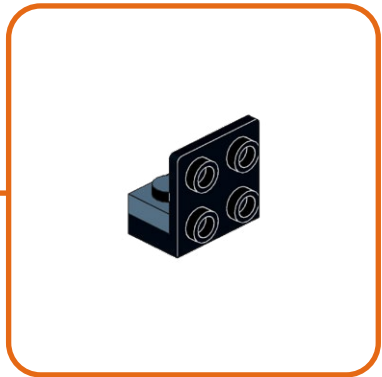

61

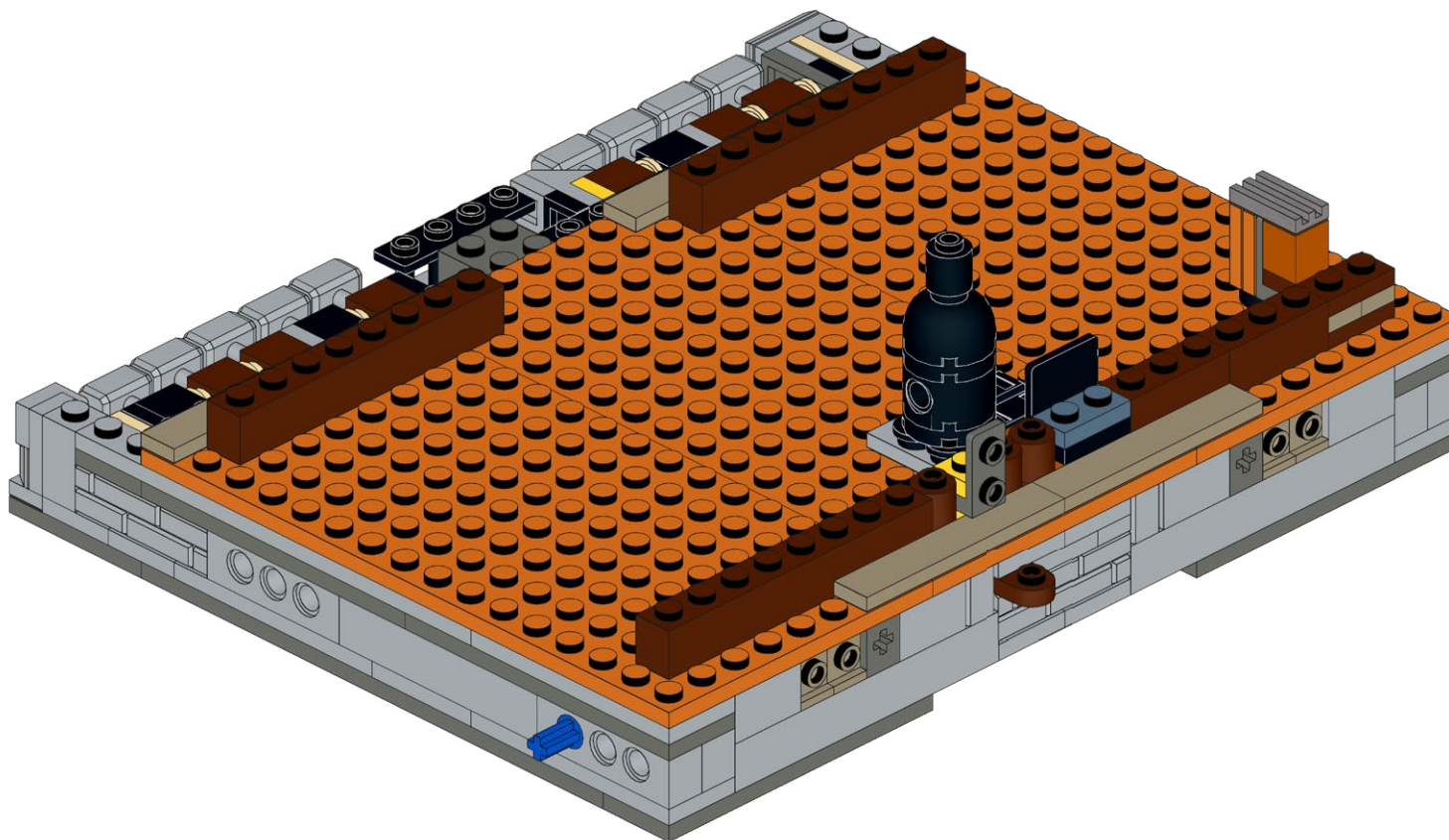

62

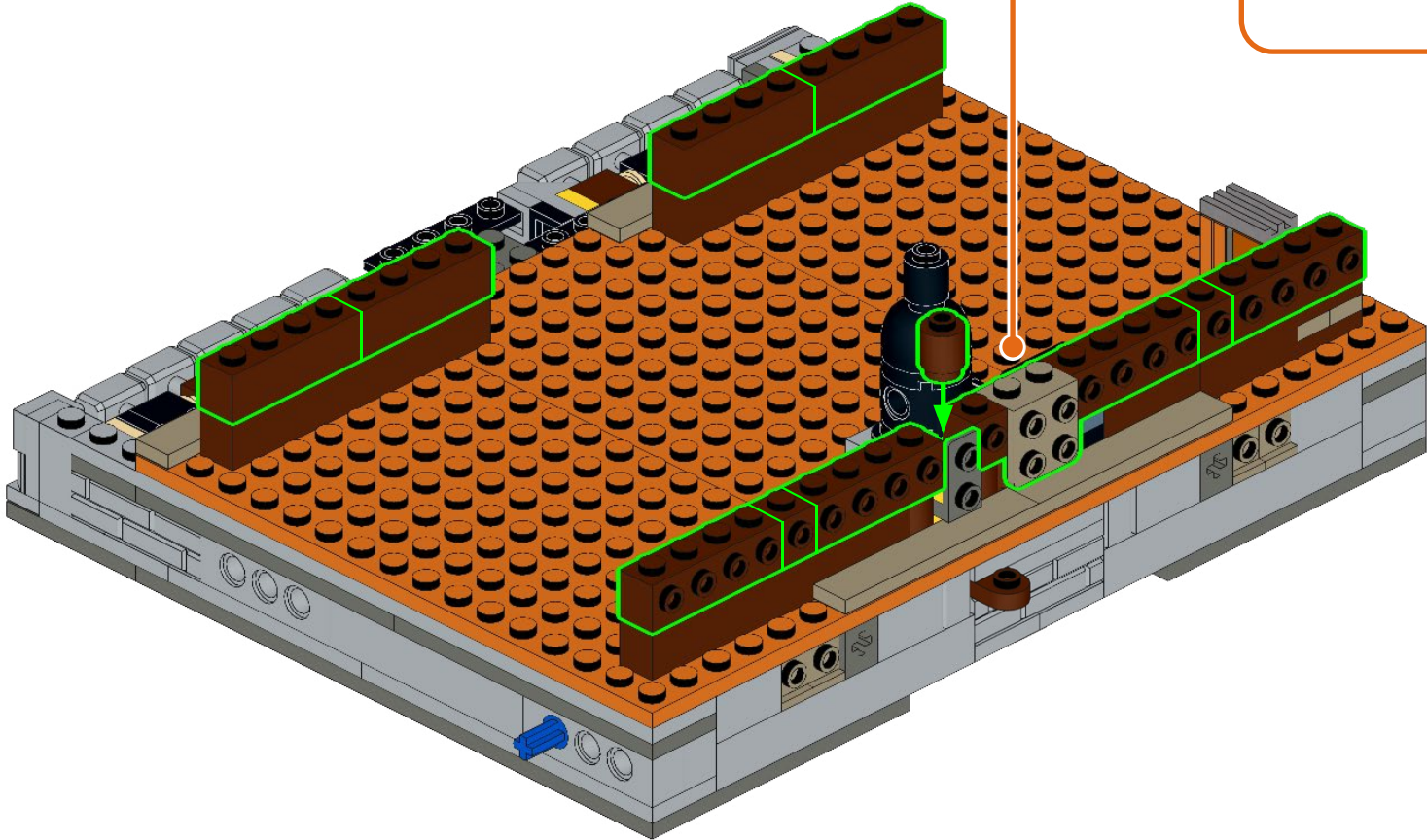
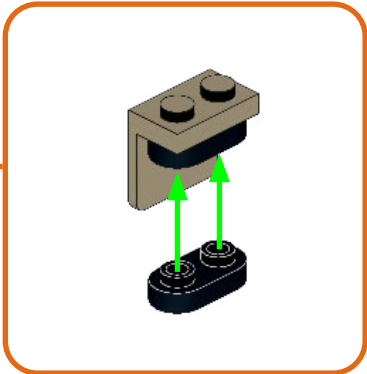
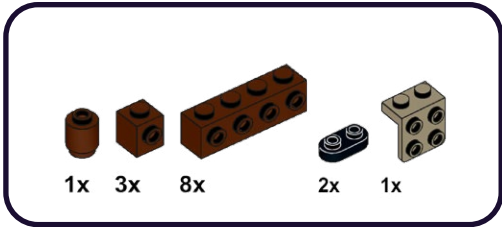

63

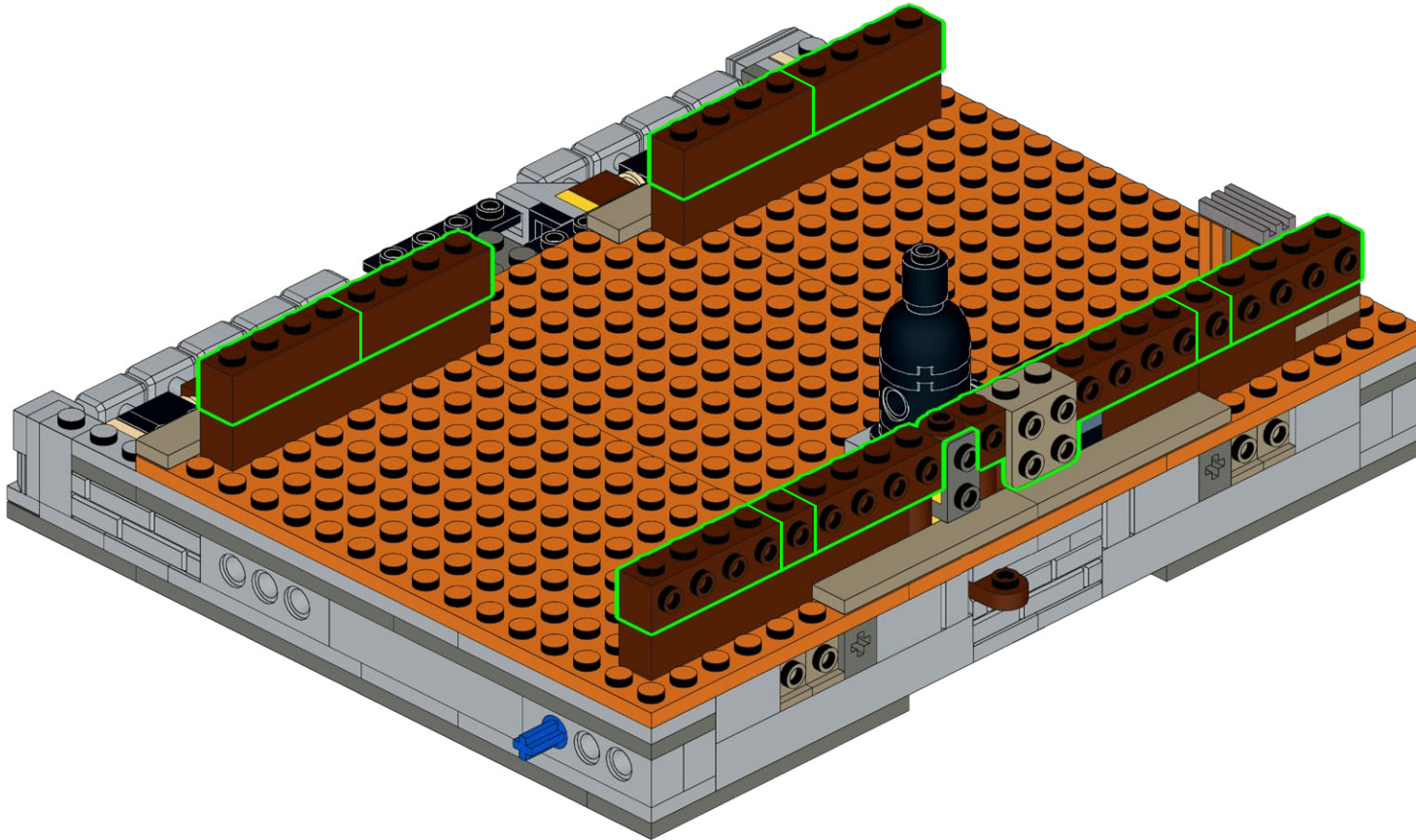

64

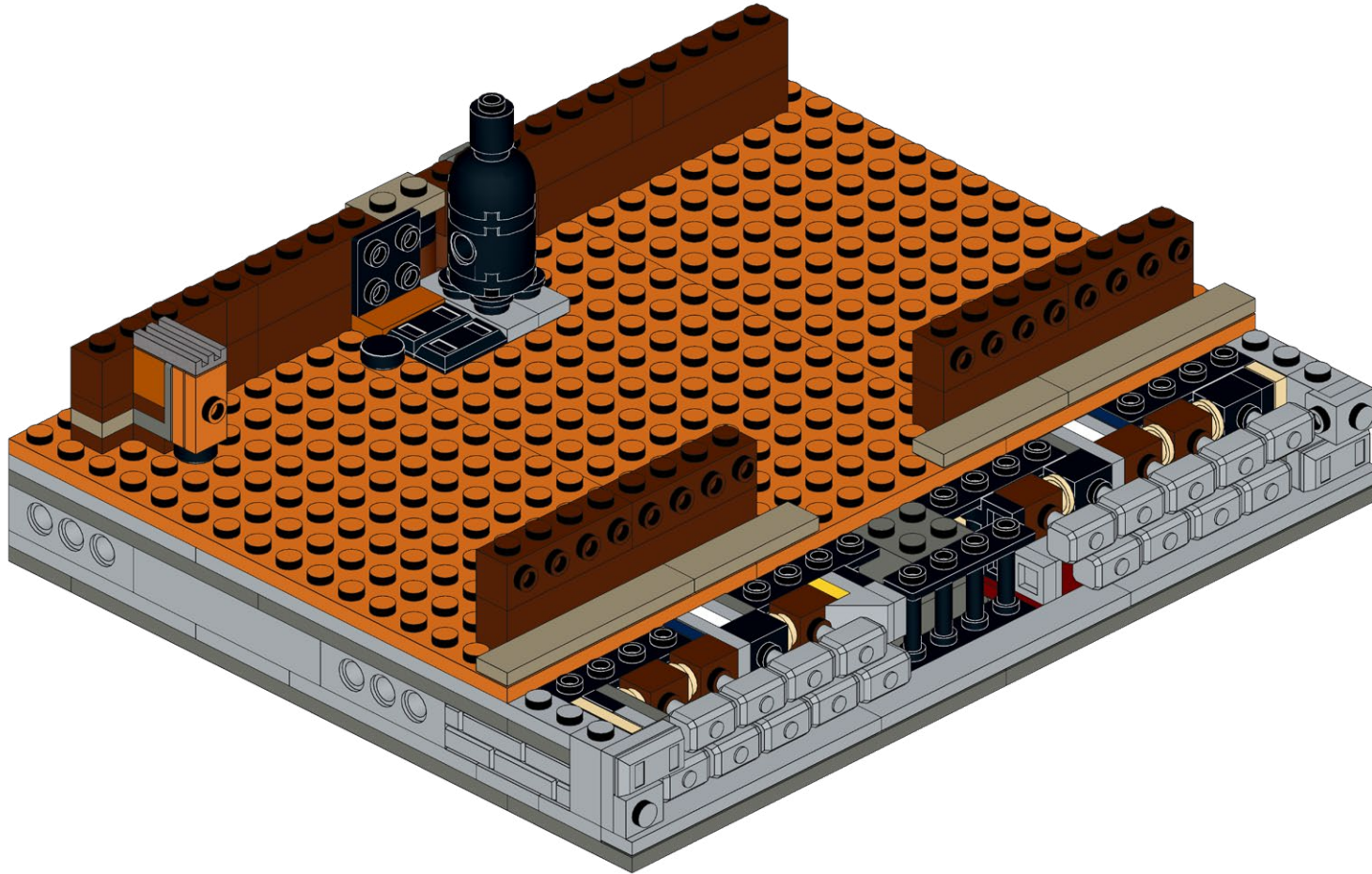

65

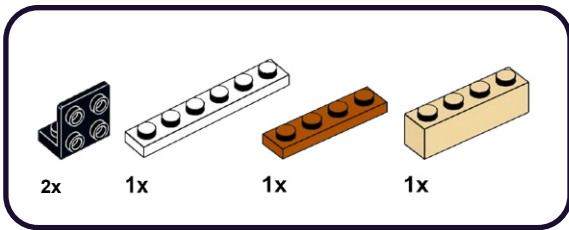

1

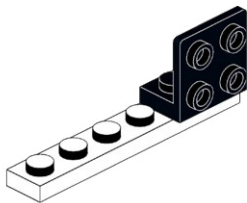

2

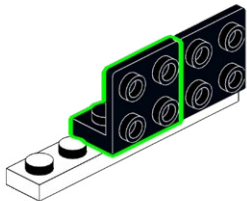

3

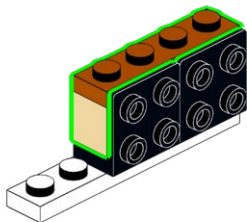

66

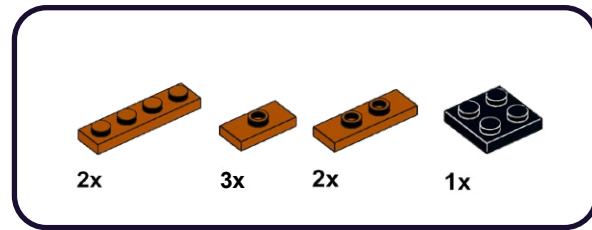

4

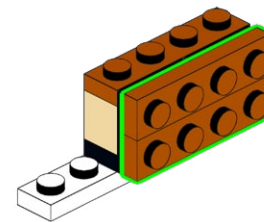

5

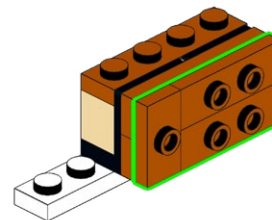

6

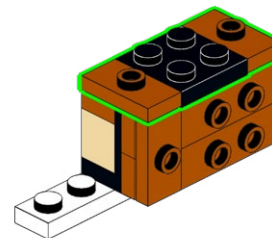

67

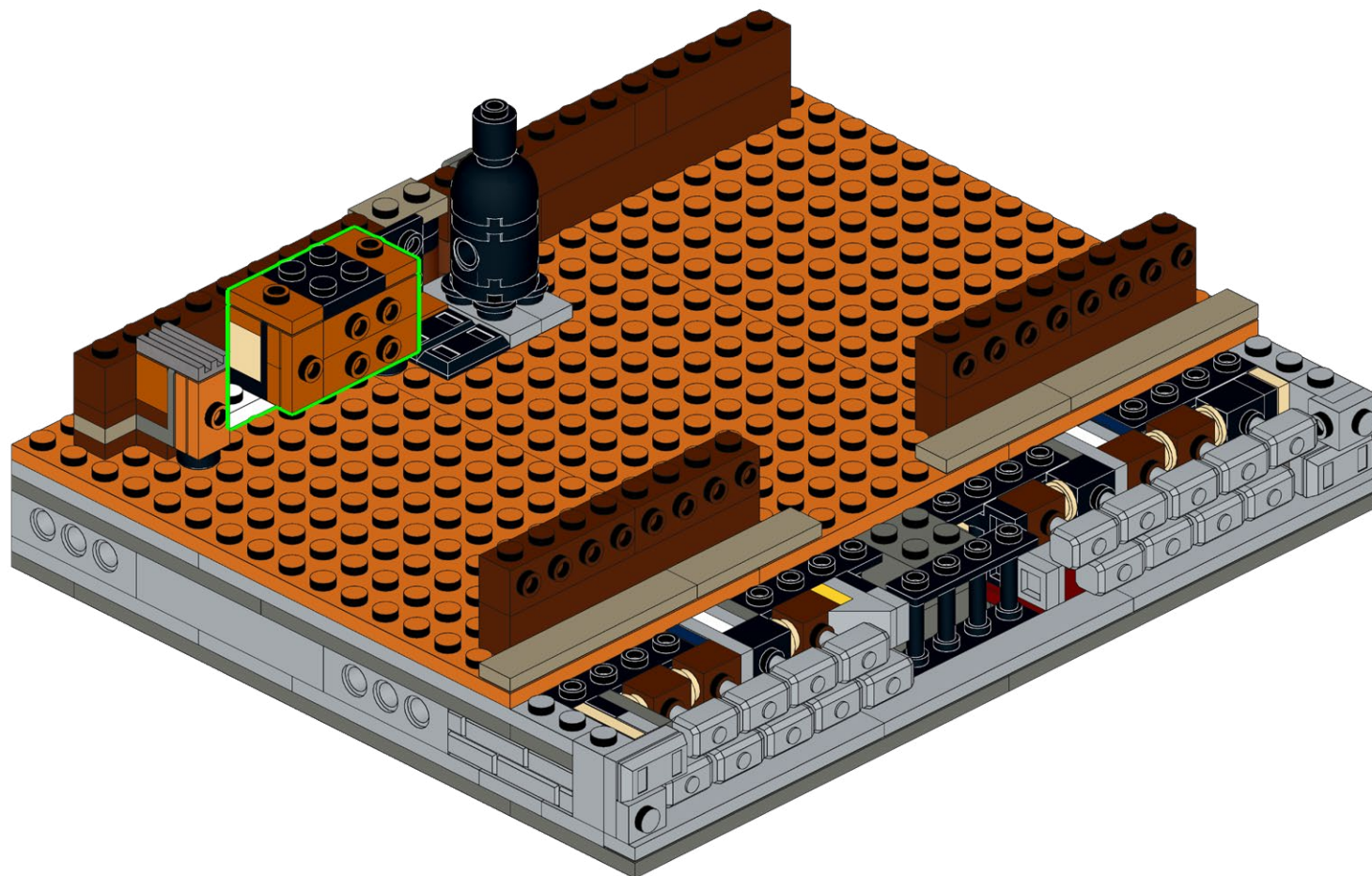

68

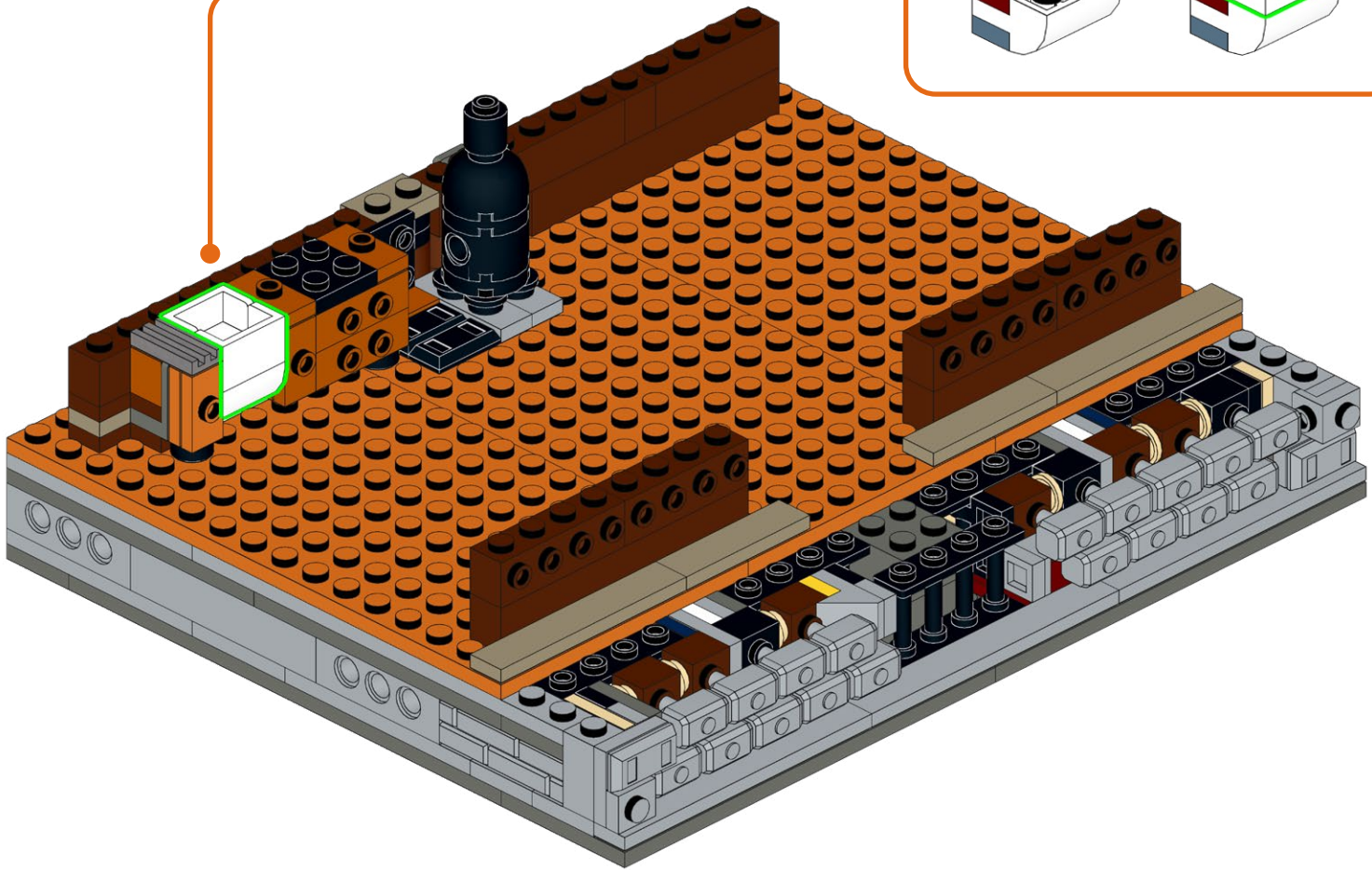
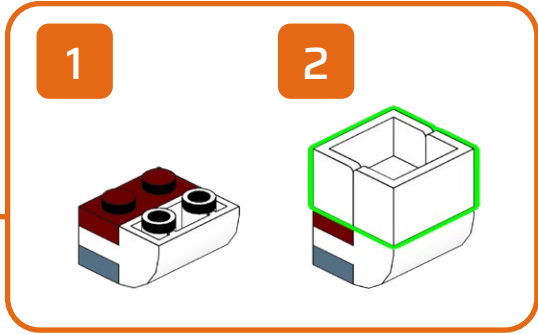
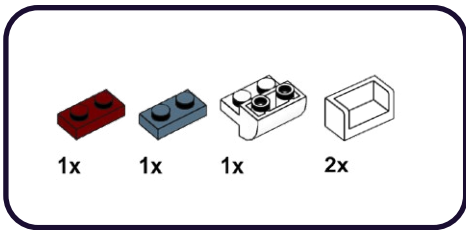

69



1



2



70

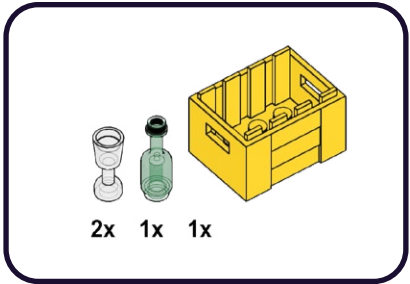

3



4

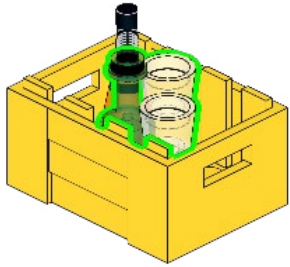

71

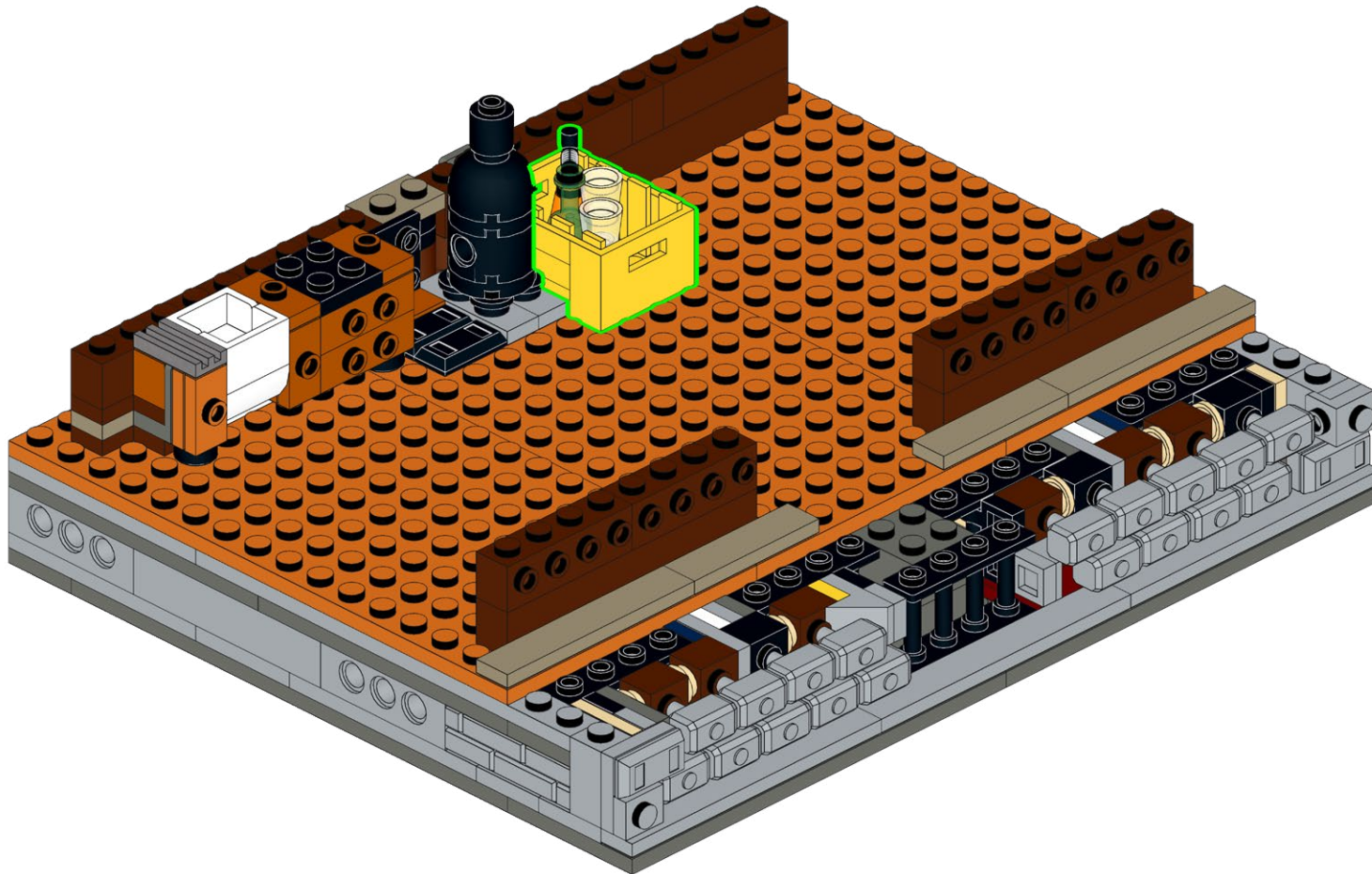

72

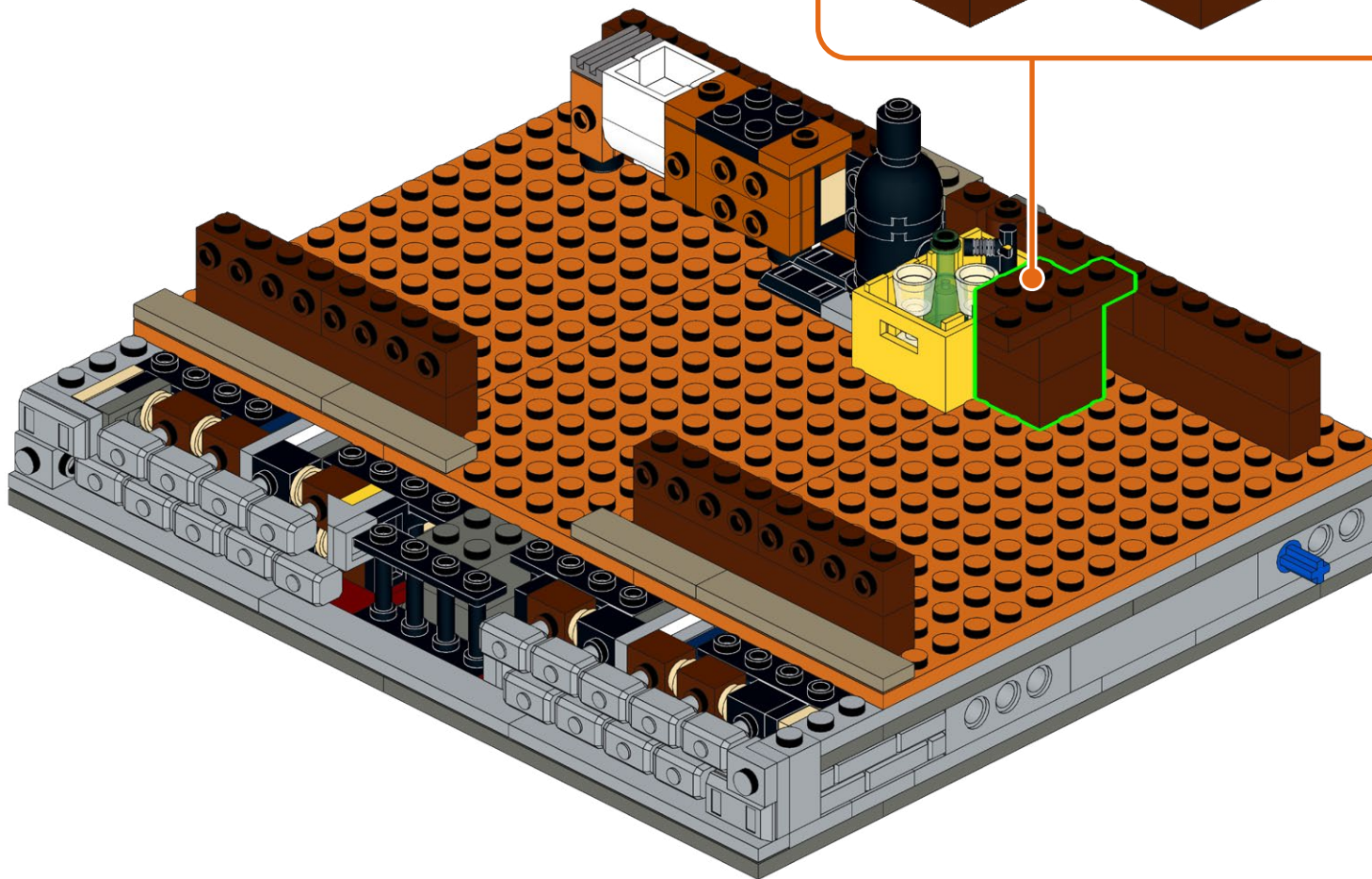
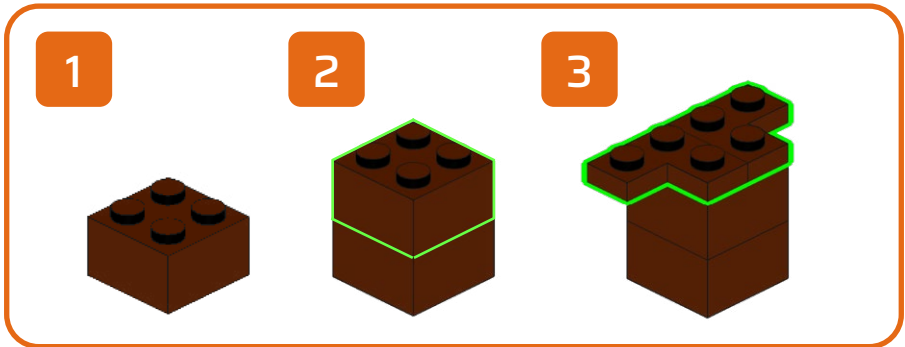
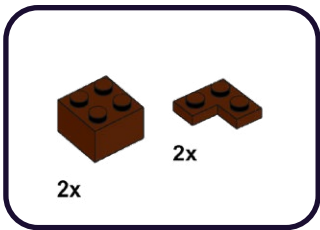

73

1x

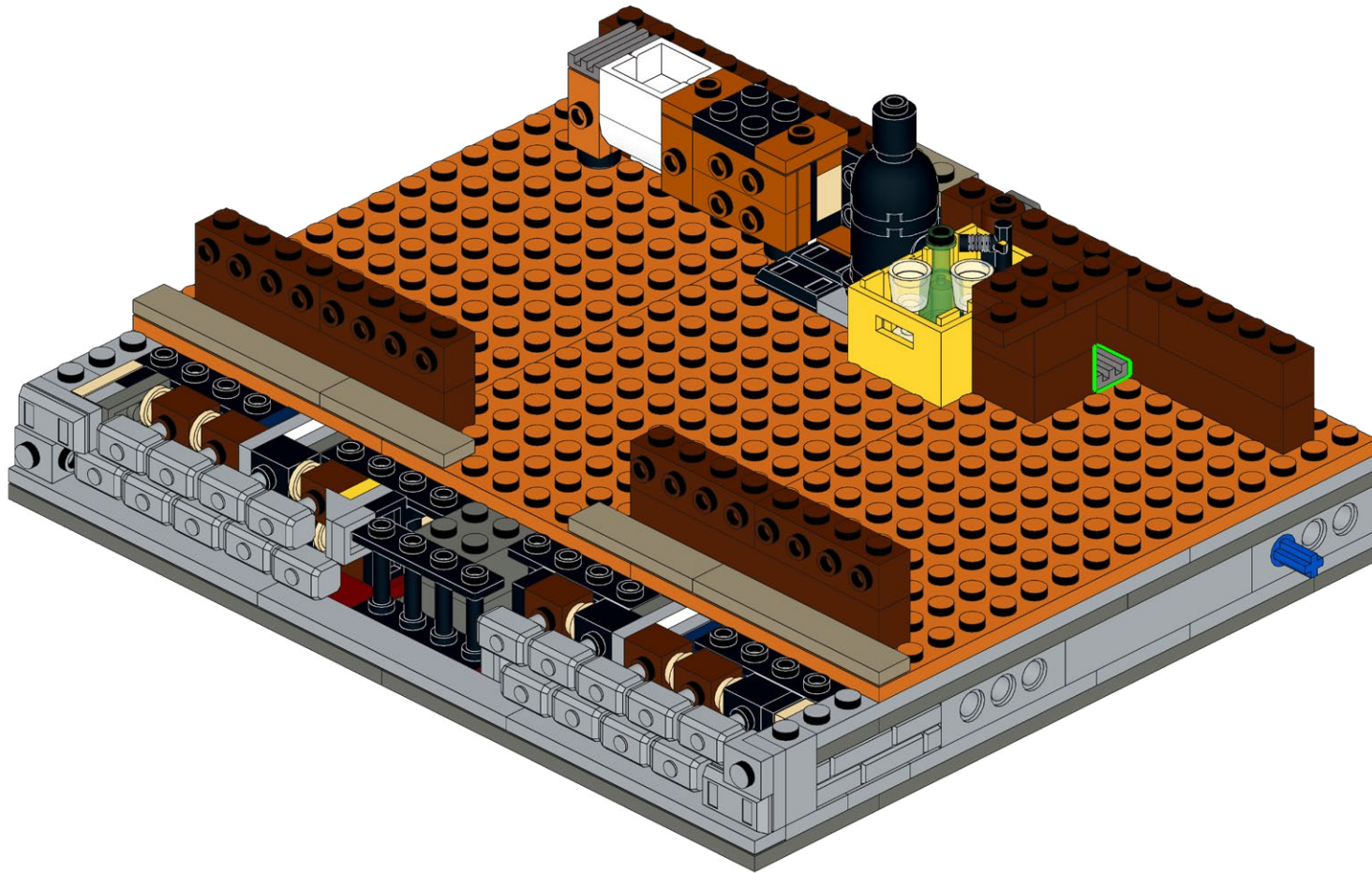

74

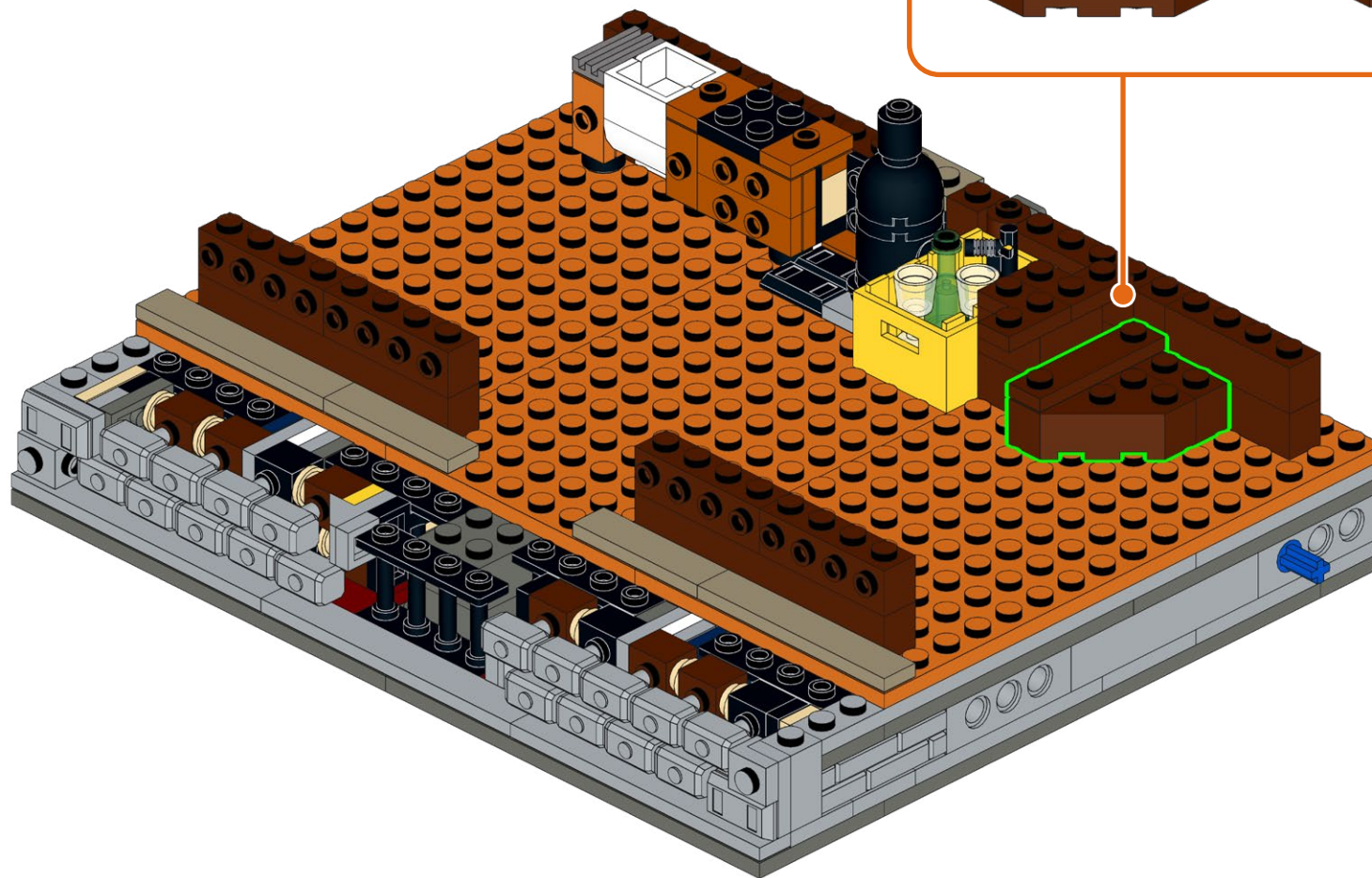
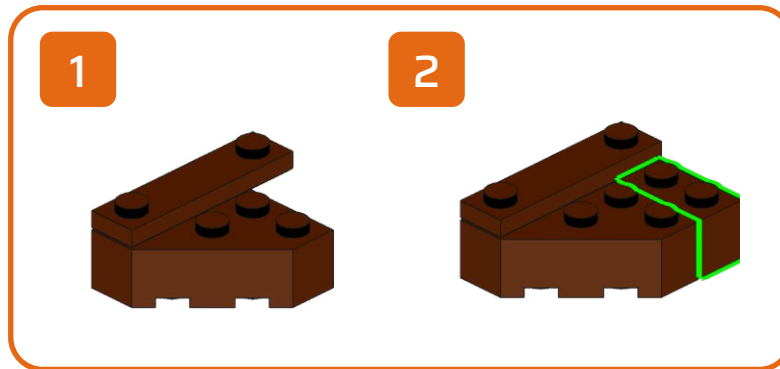
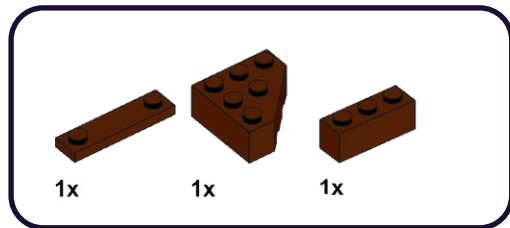

75

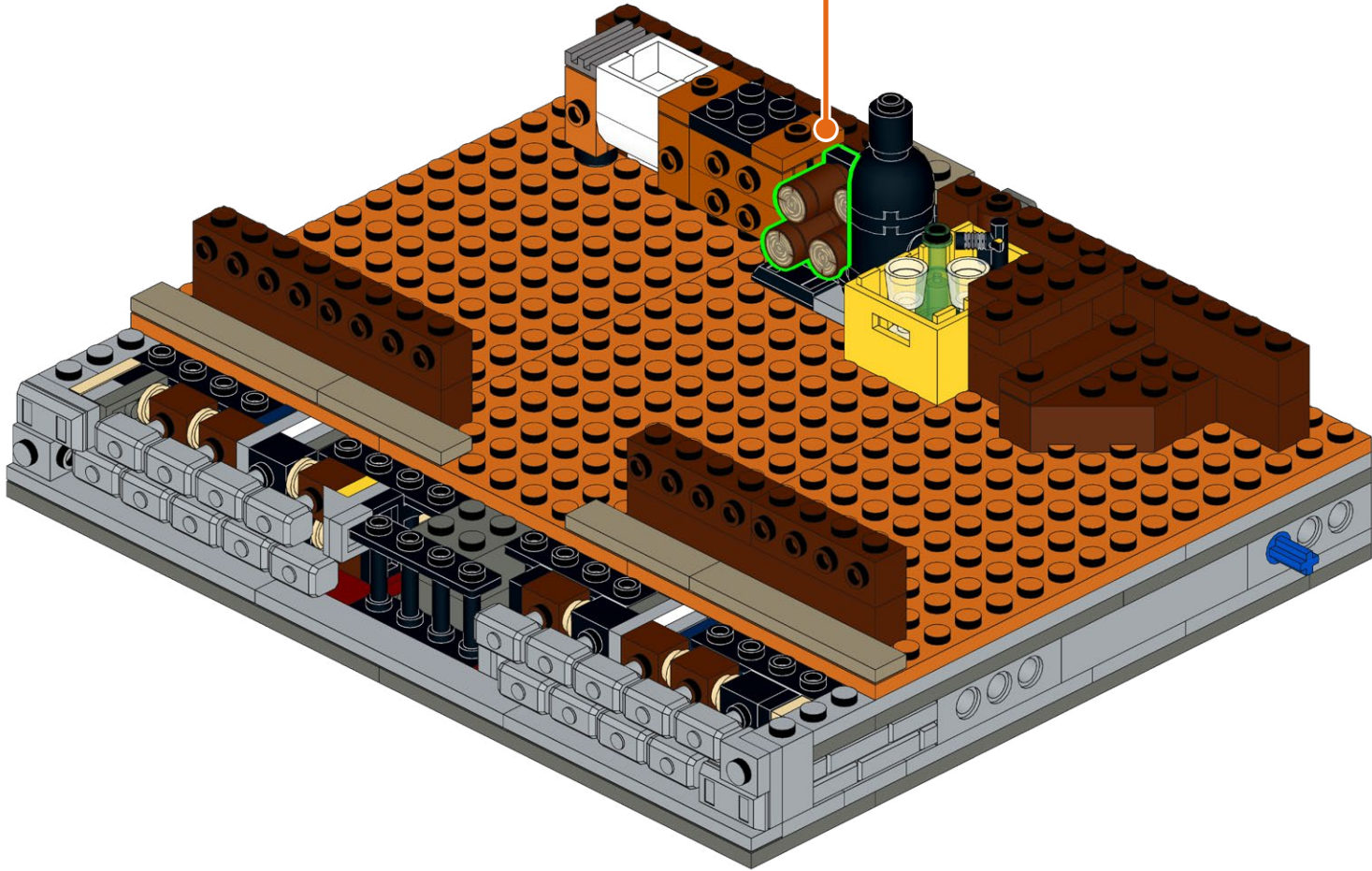
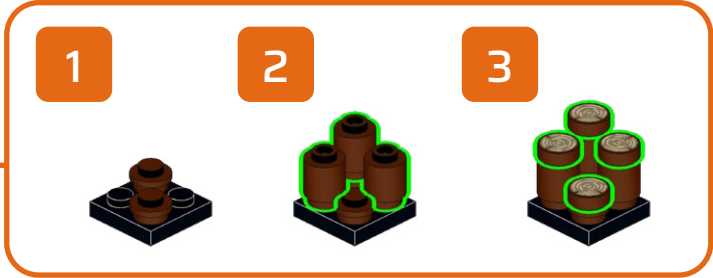
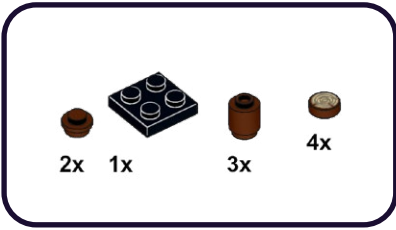

76



1x 1x

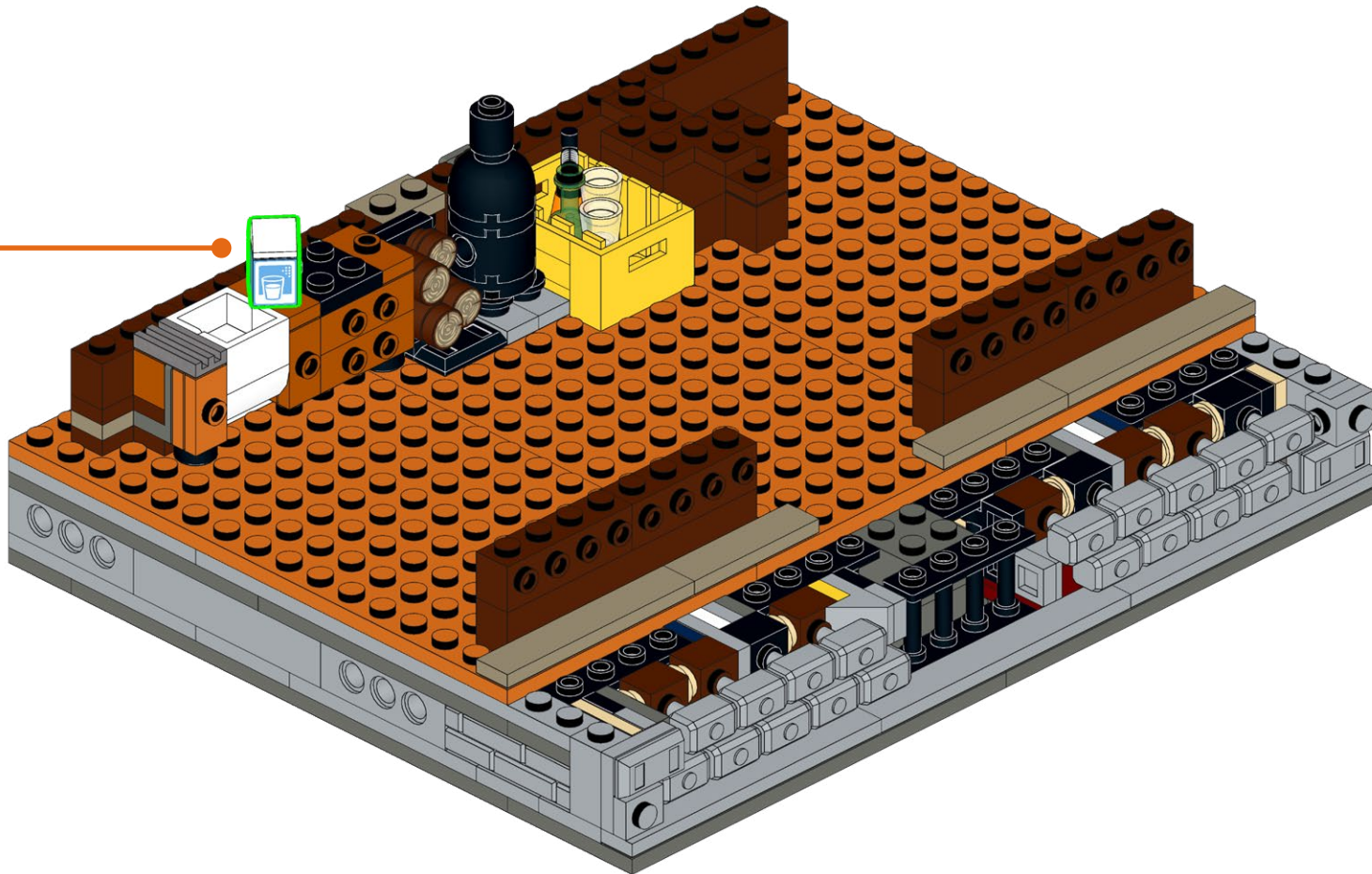
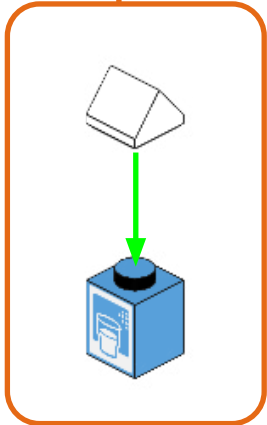

77



1x

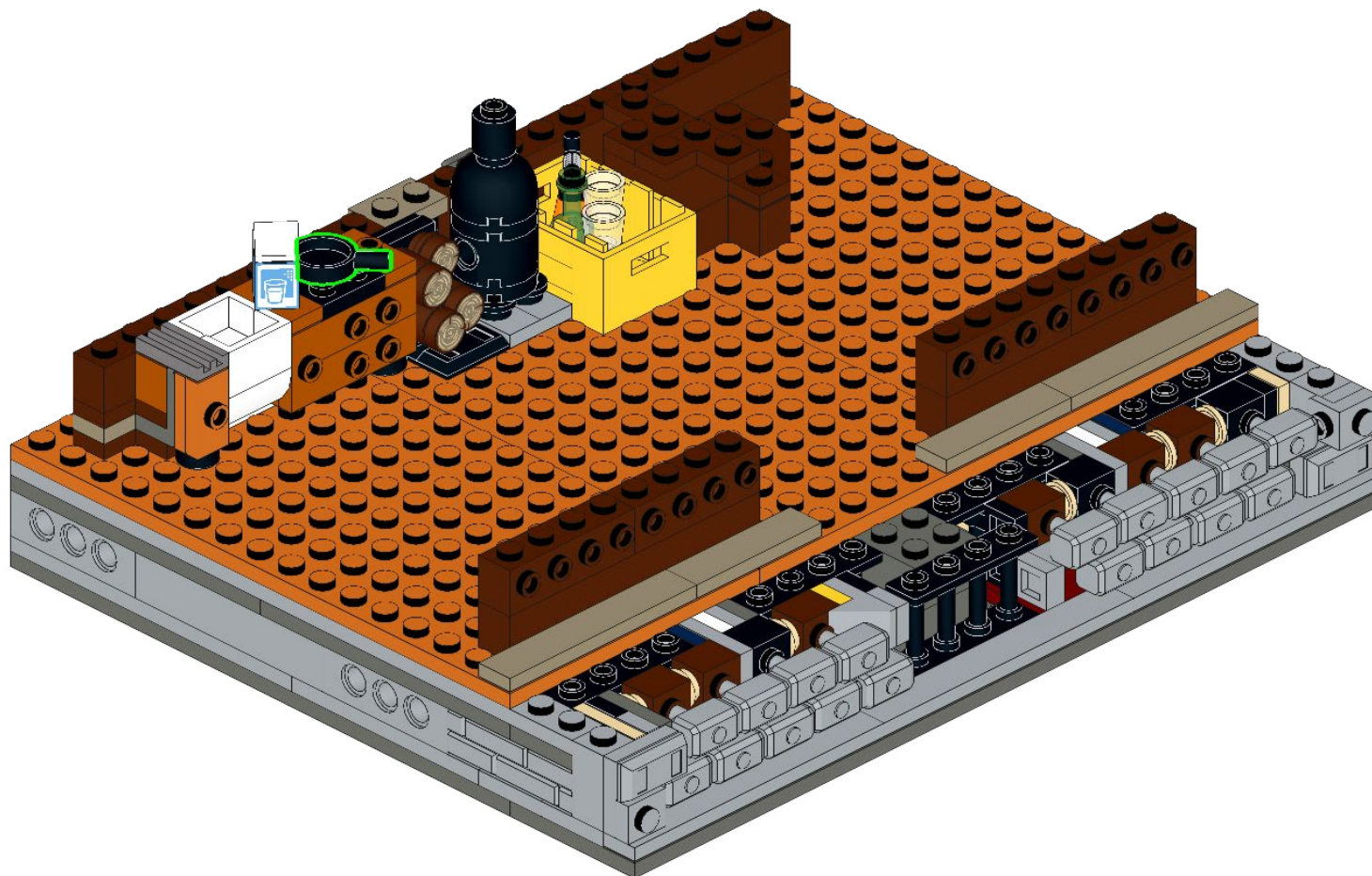

78

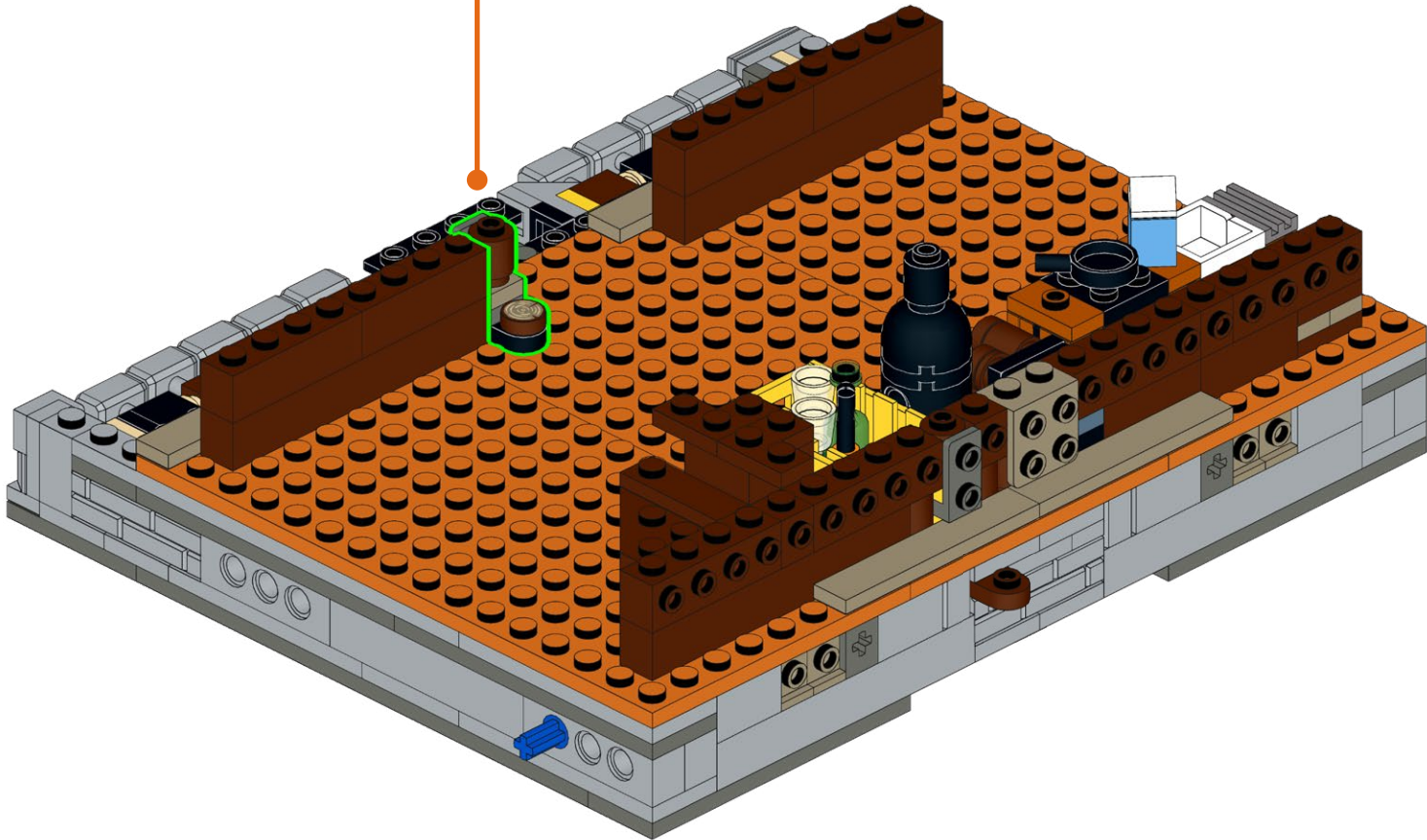
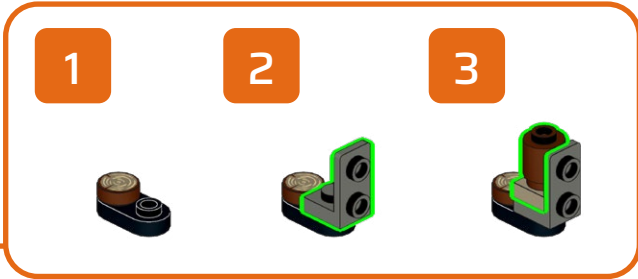
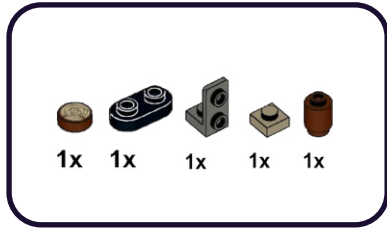

79

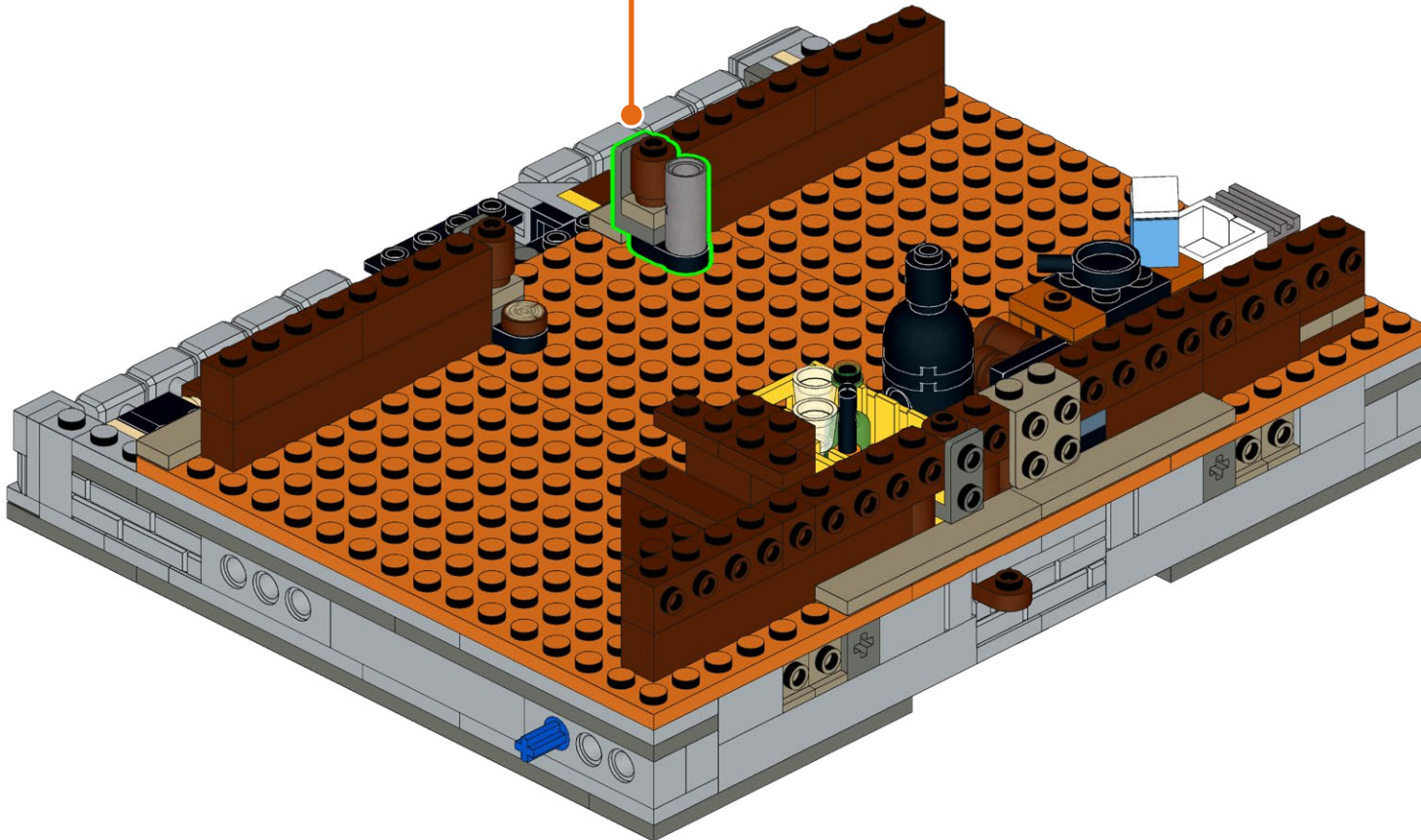
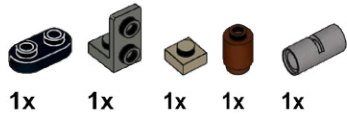

80

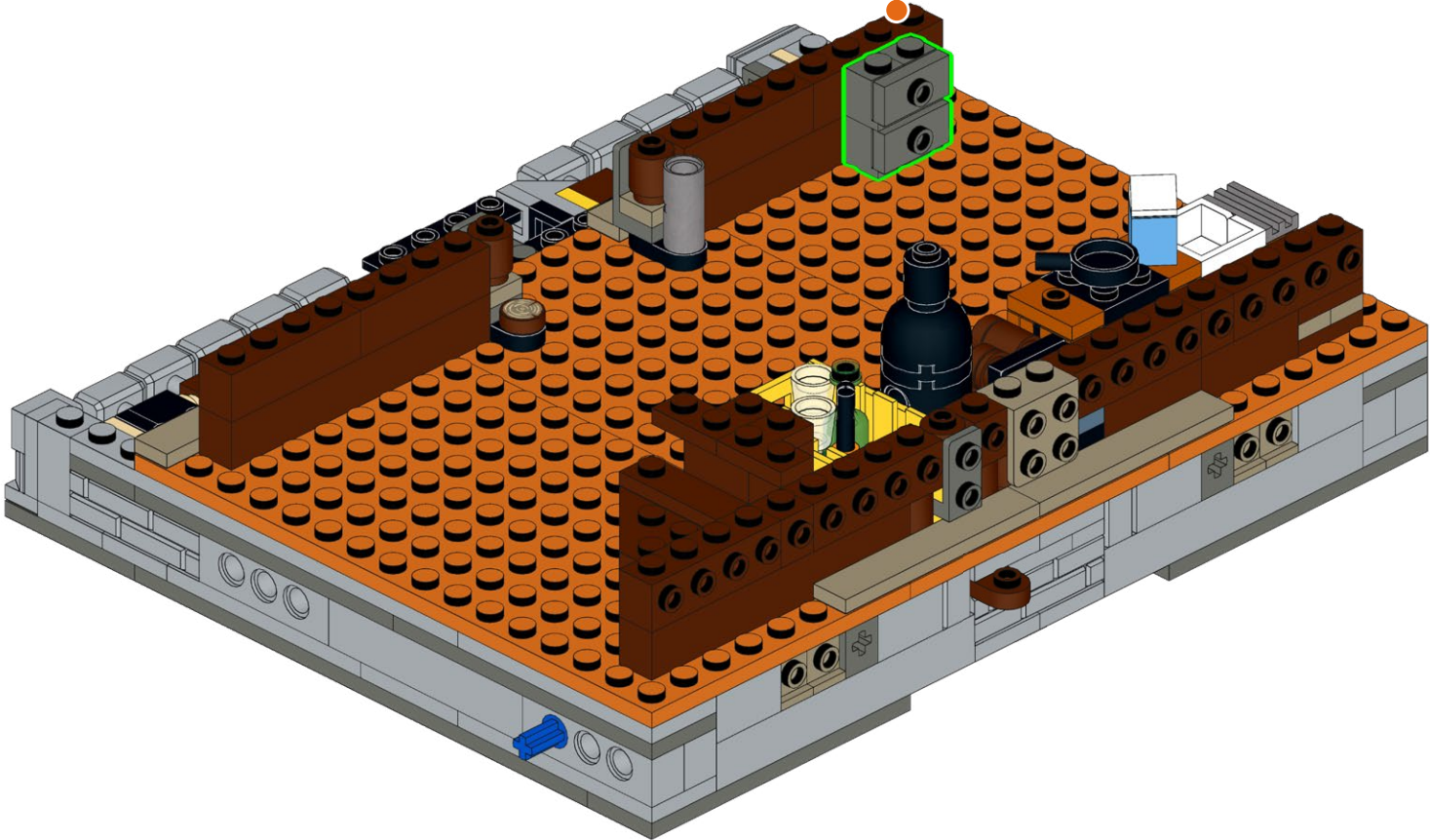
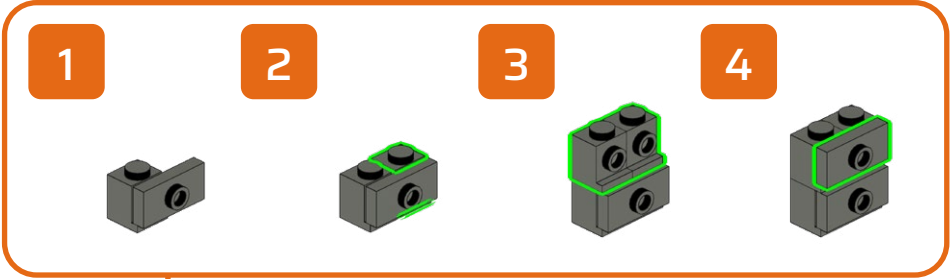
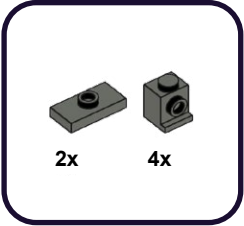

81

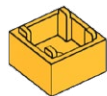

1x

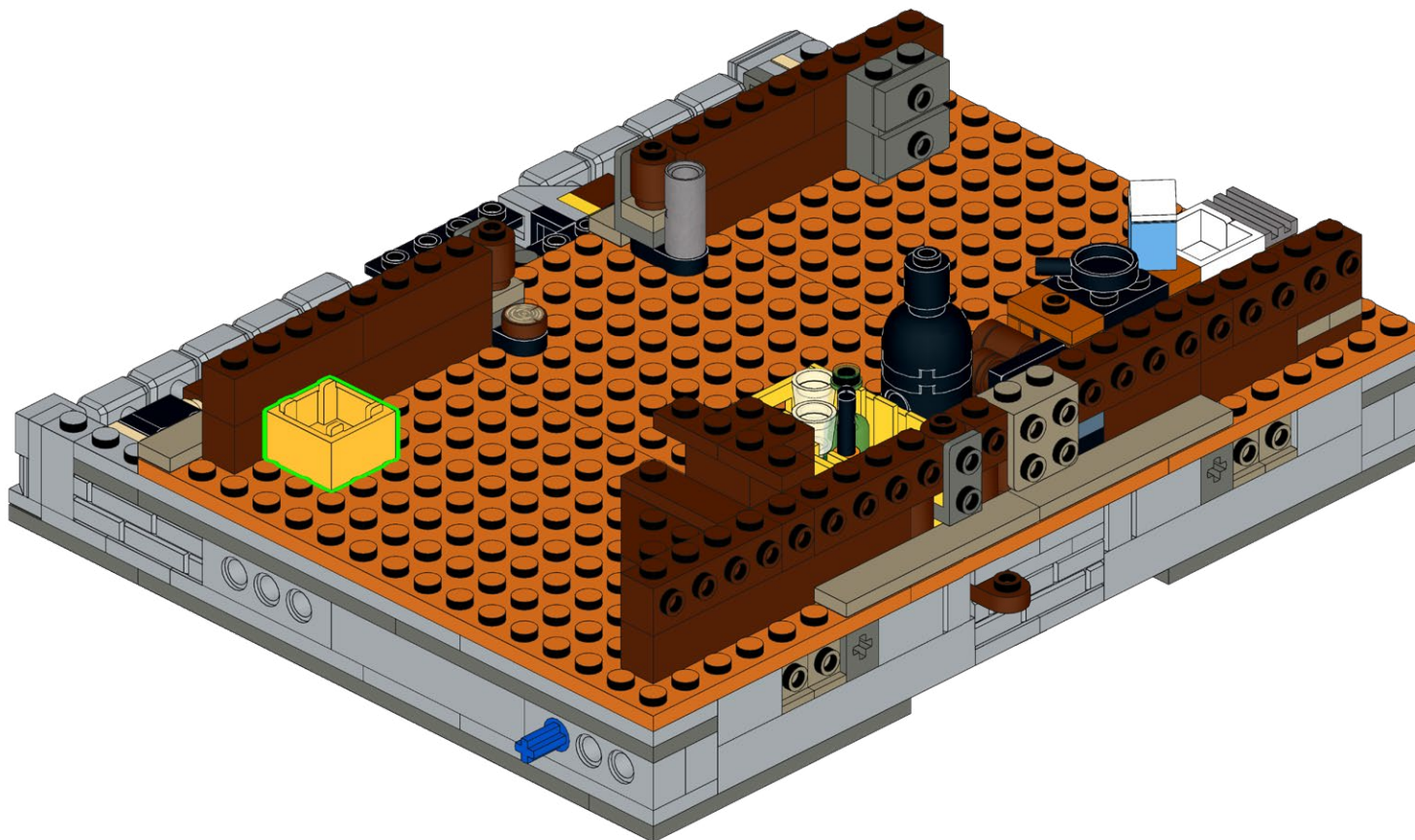

82

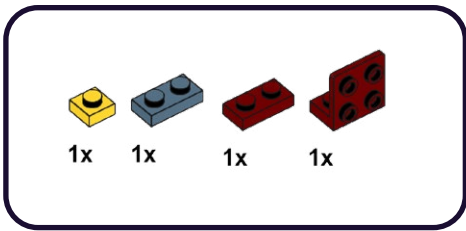

1

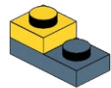

2

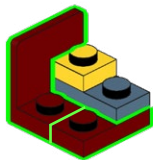

83

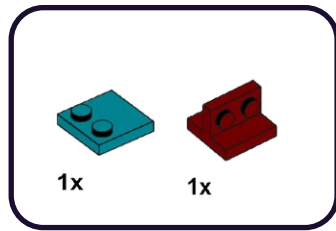

3

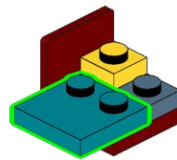

4

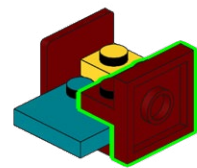

84

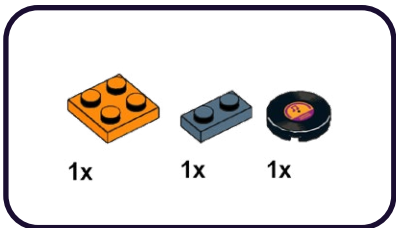

1

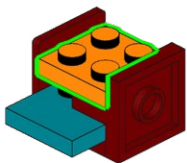

2

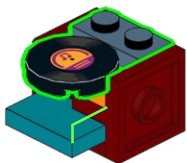

85

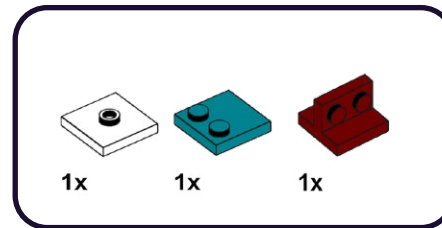

3

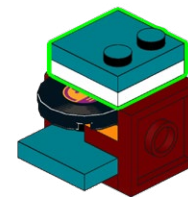

4

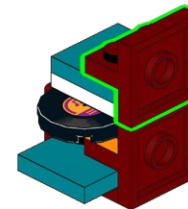

86

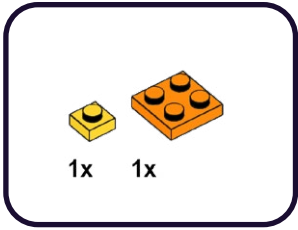

87

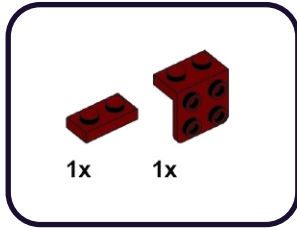

1

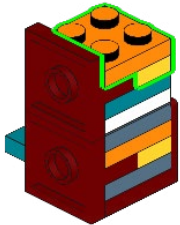

2

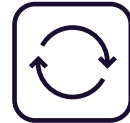
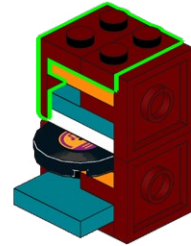

88

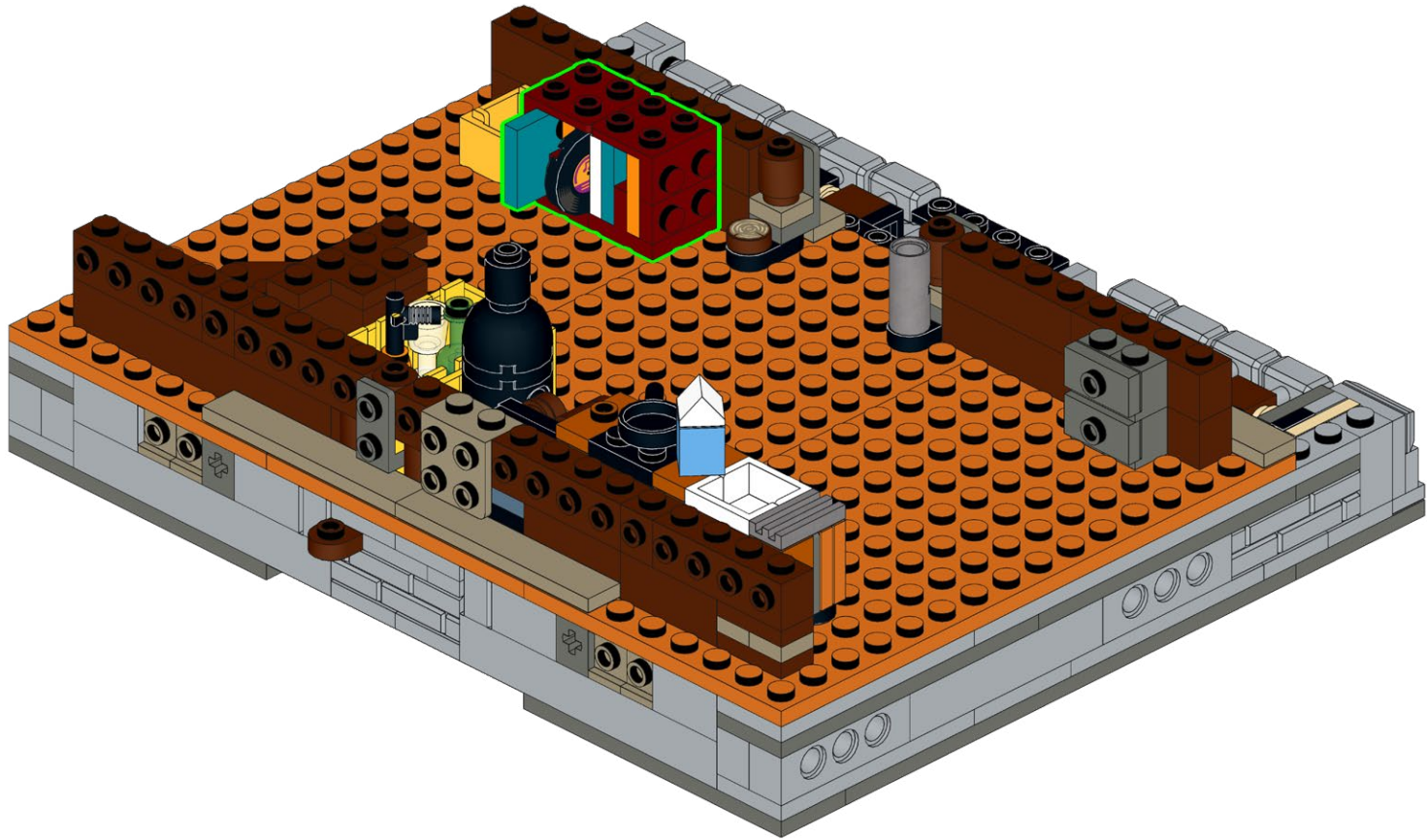

89

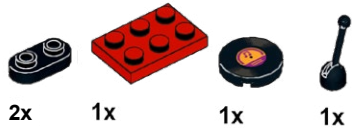

1



2

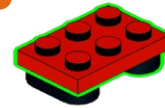

3



4

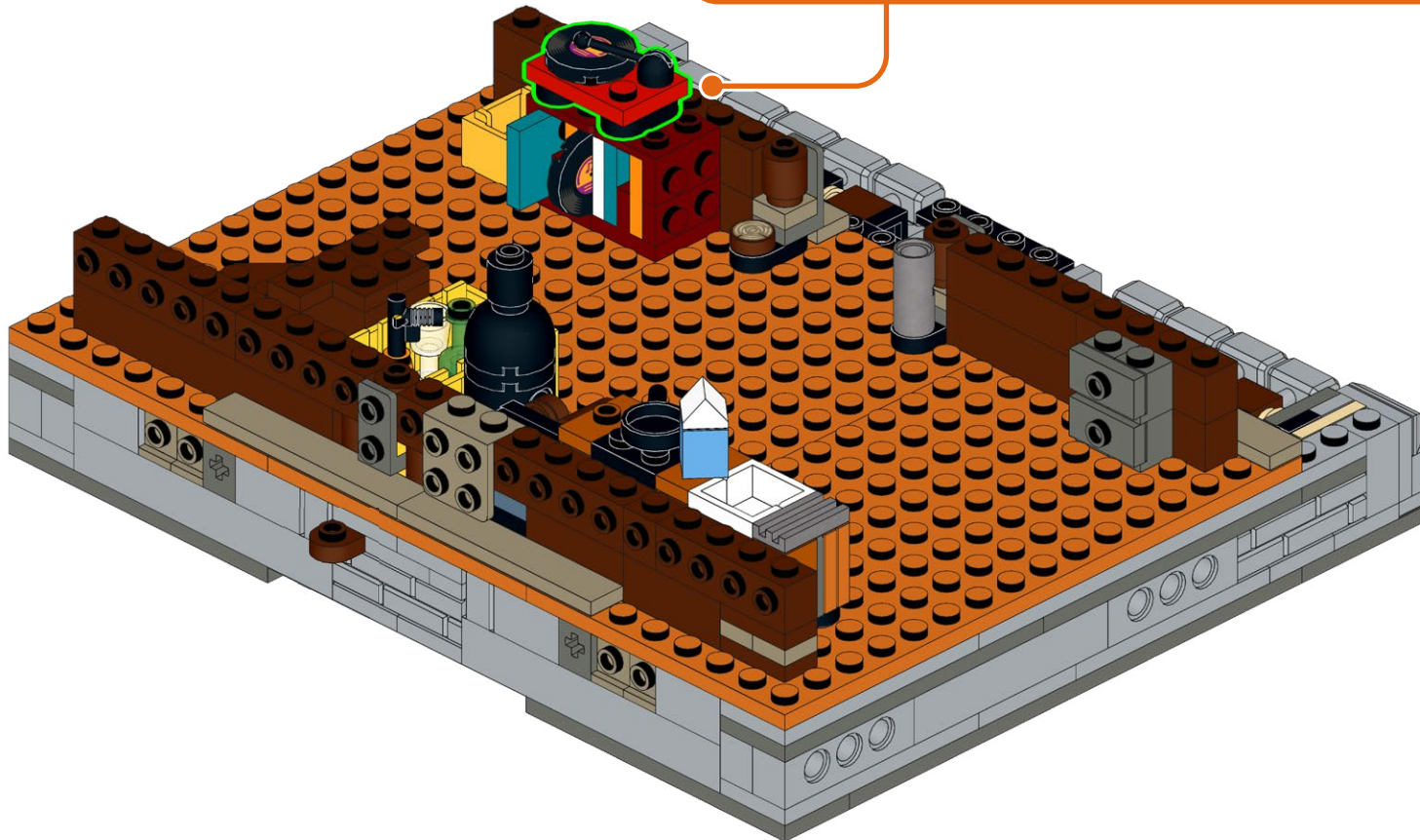

90

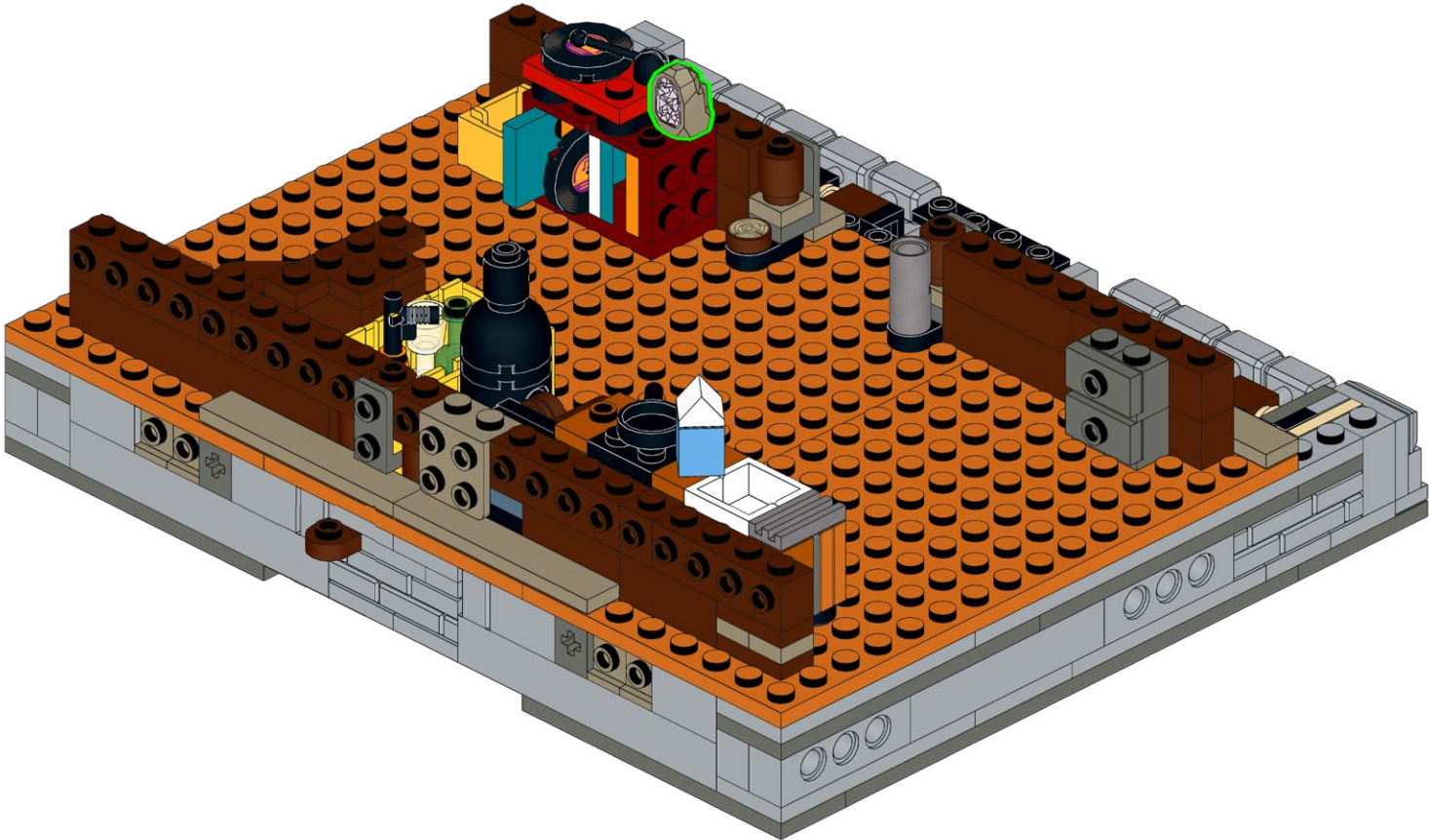

91

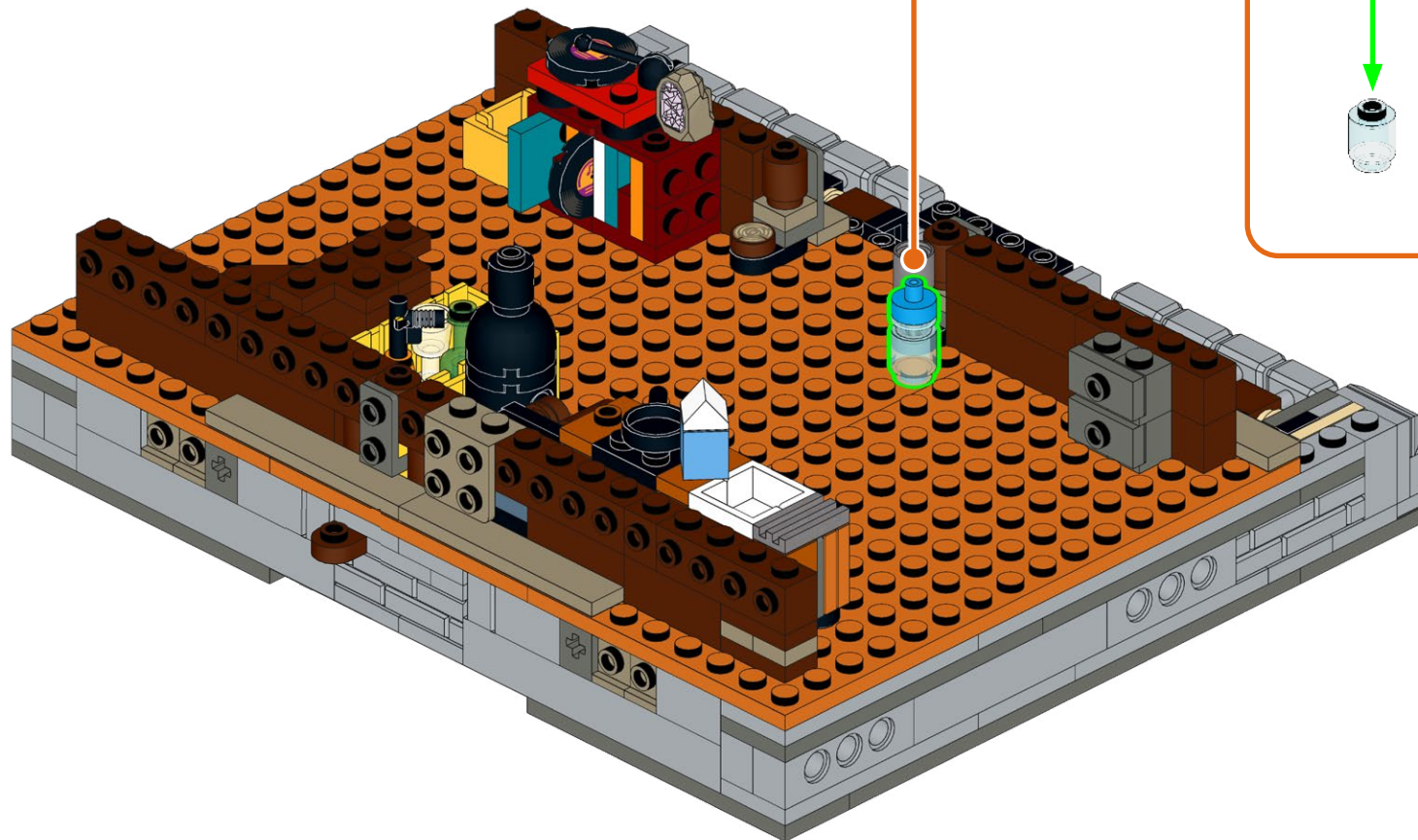
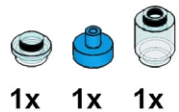

92

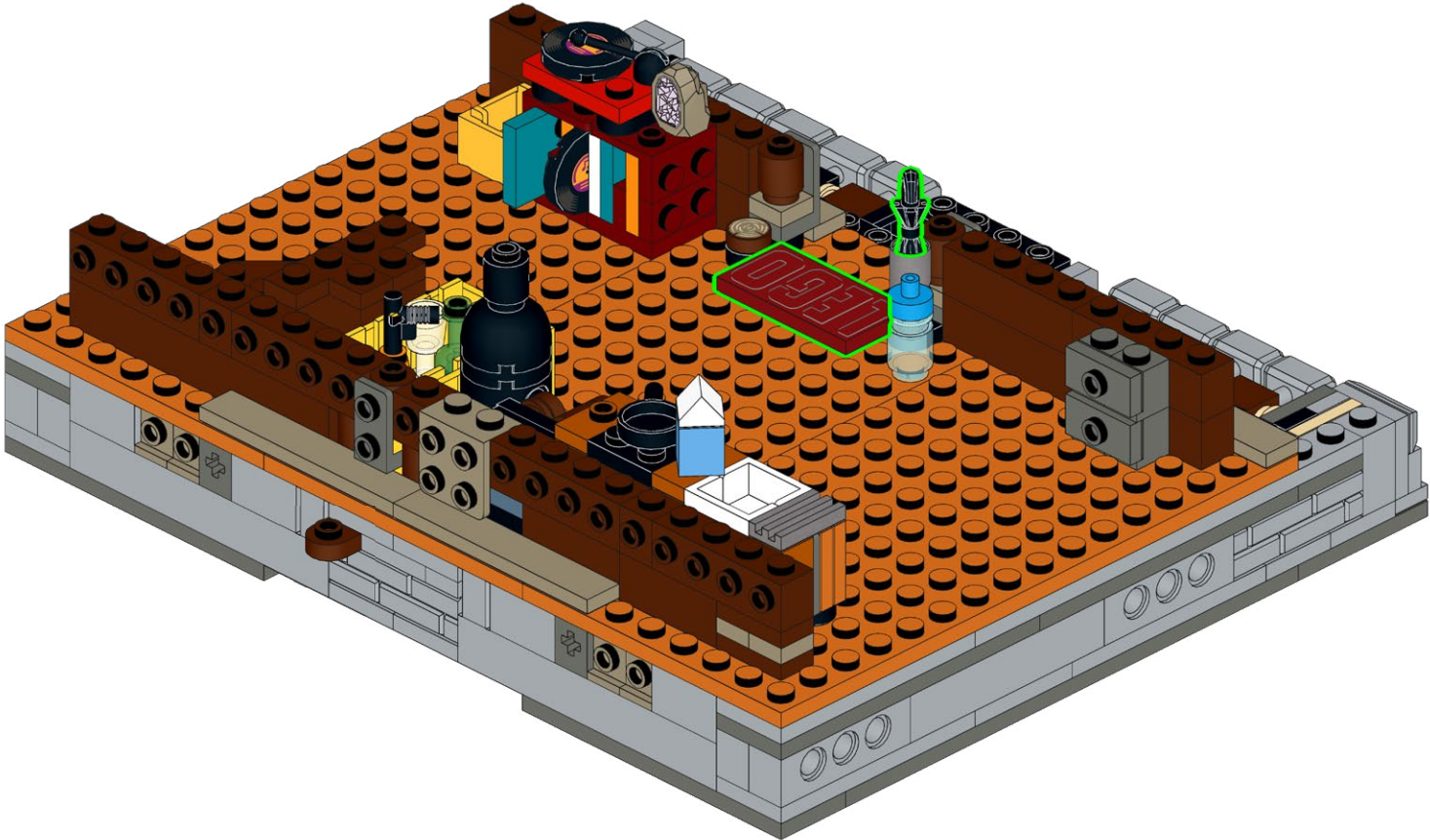
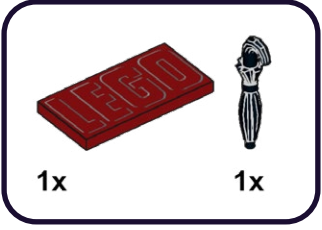

93

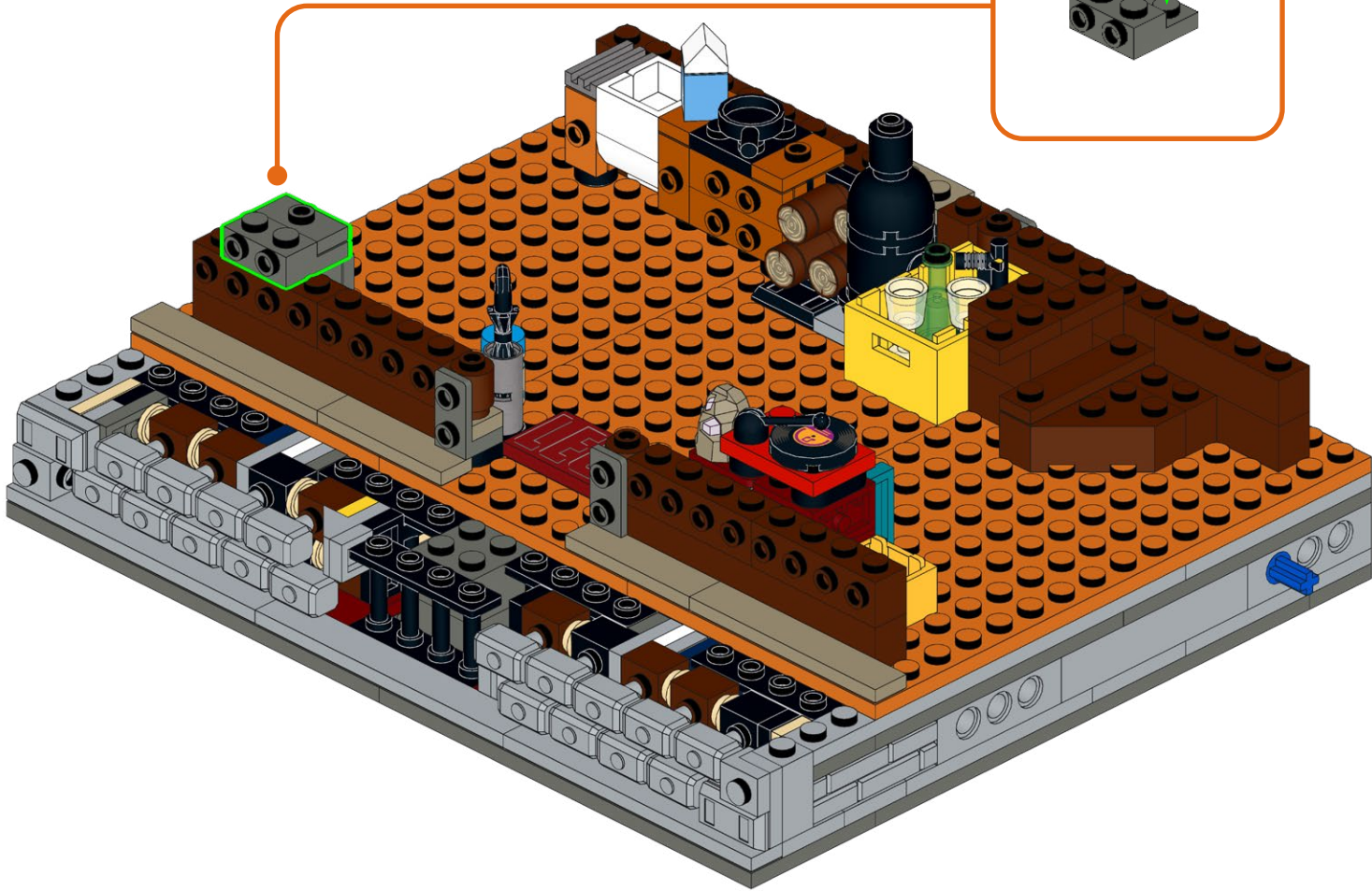
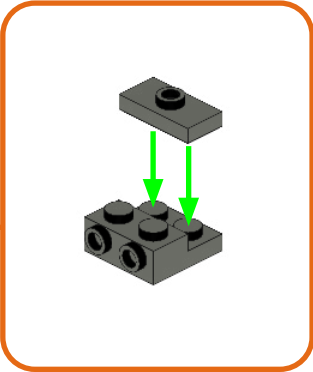
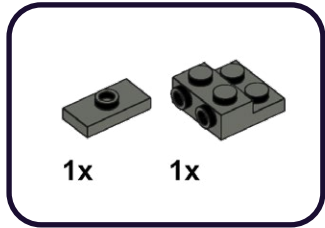

94

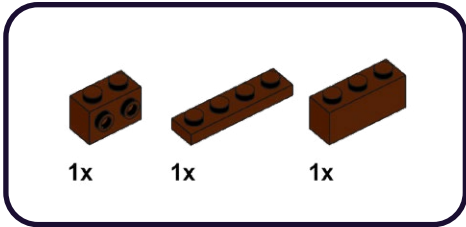

1

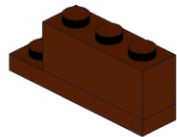

2

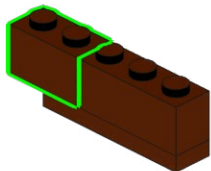

95

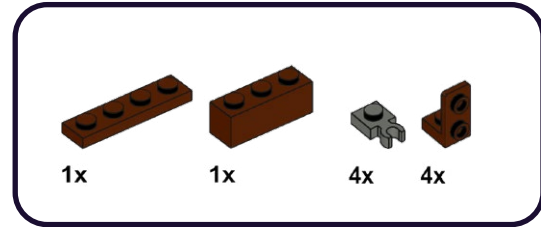

3

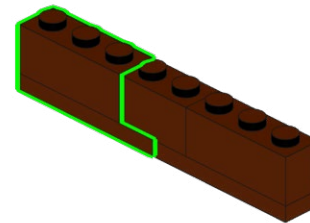

4

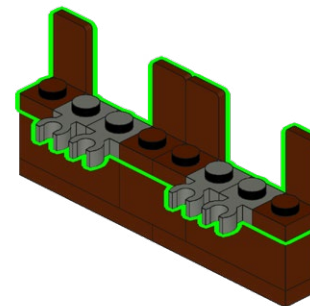

96

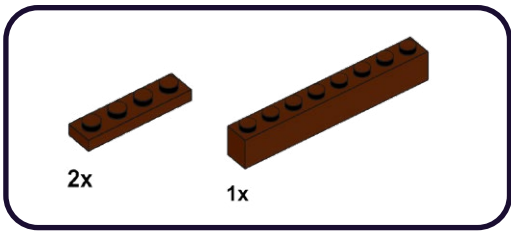

1

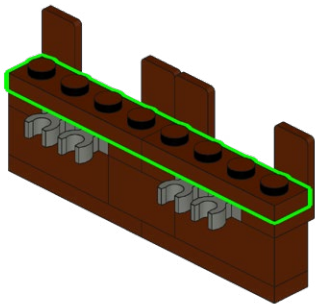

2

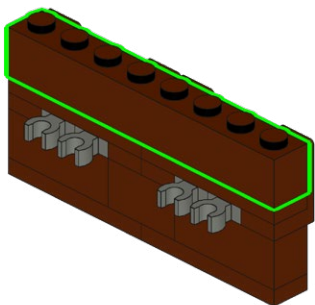

97

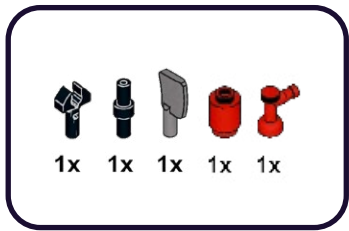

3



4

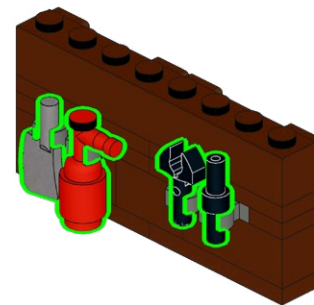

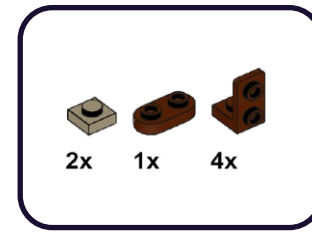
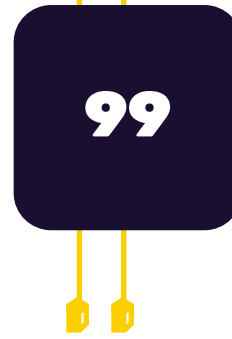

1

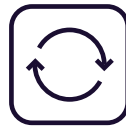
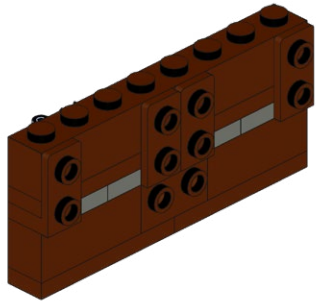

2

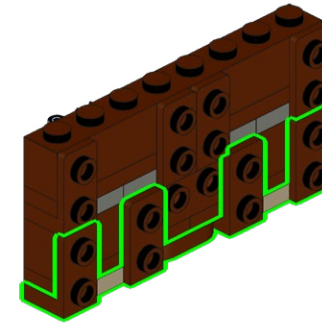

100

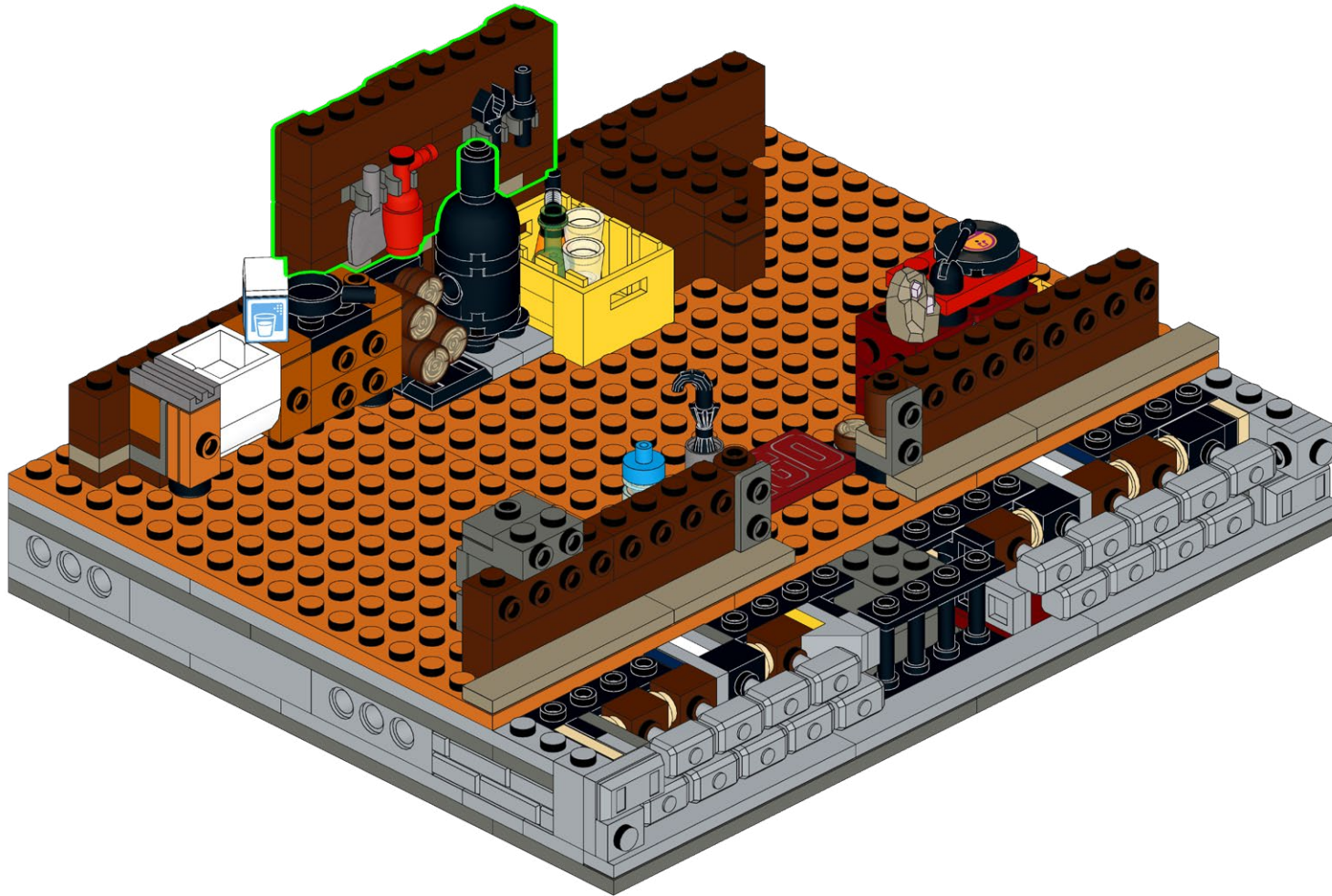

101

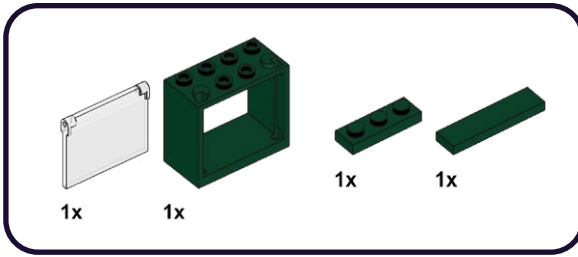

1

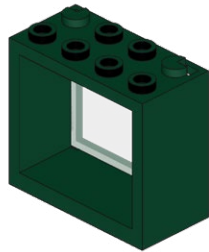

2

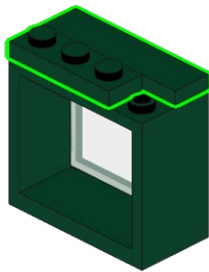

102

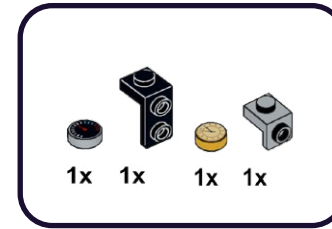

3

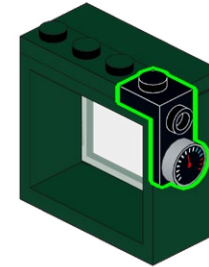

4

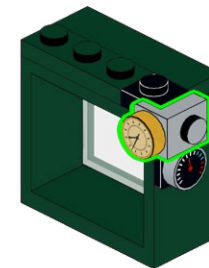

103

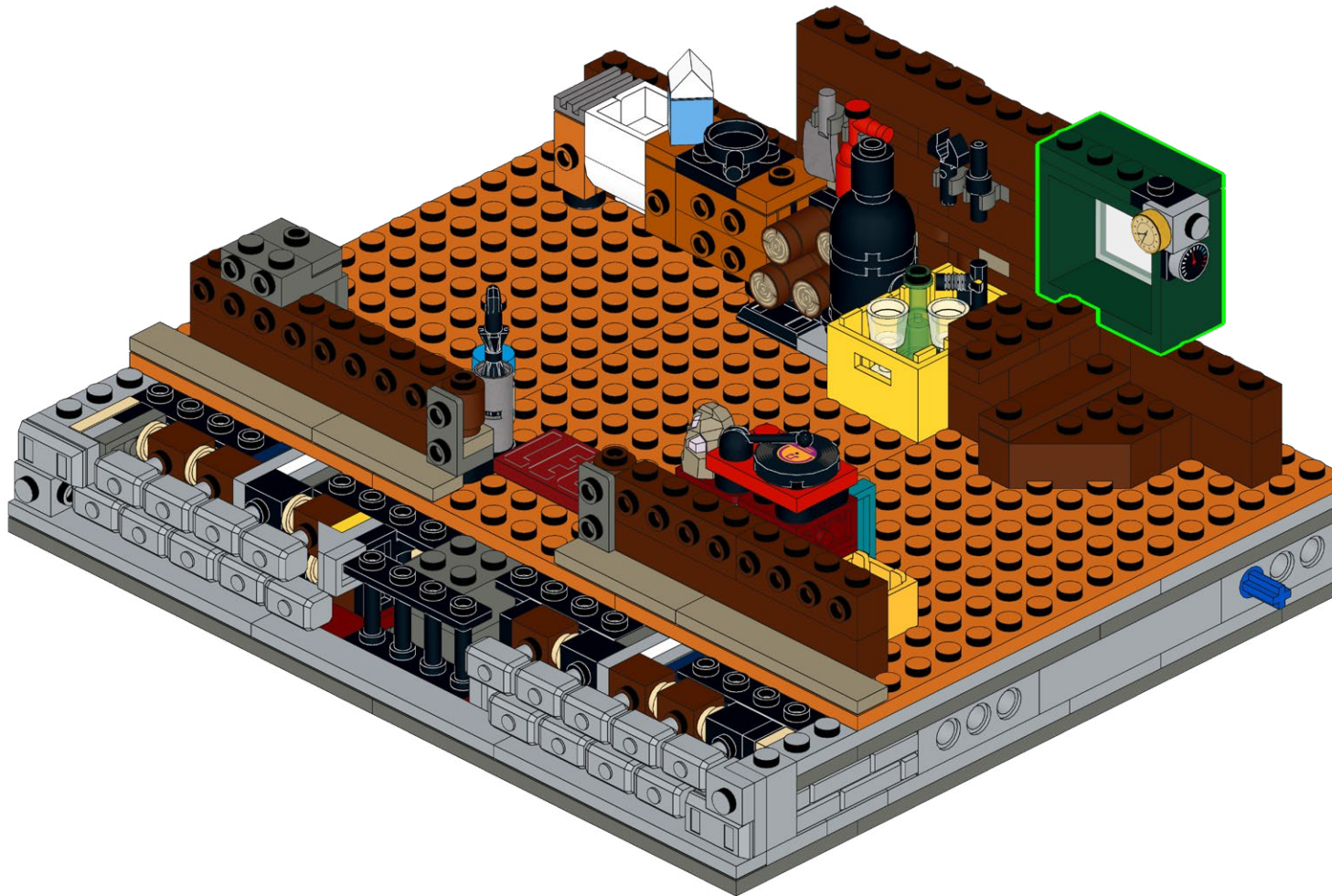

104

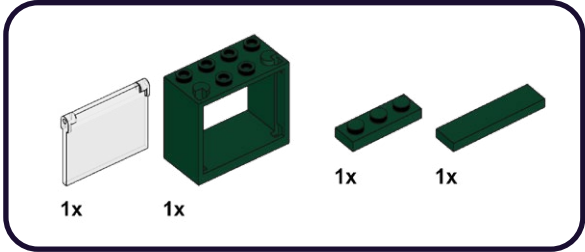

1



2

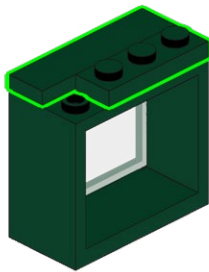

105

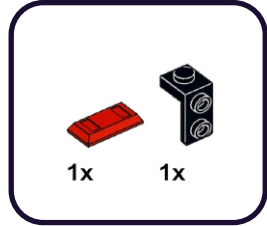

3

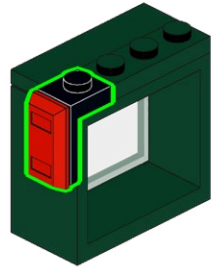

106

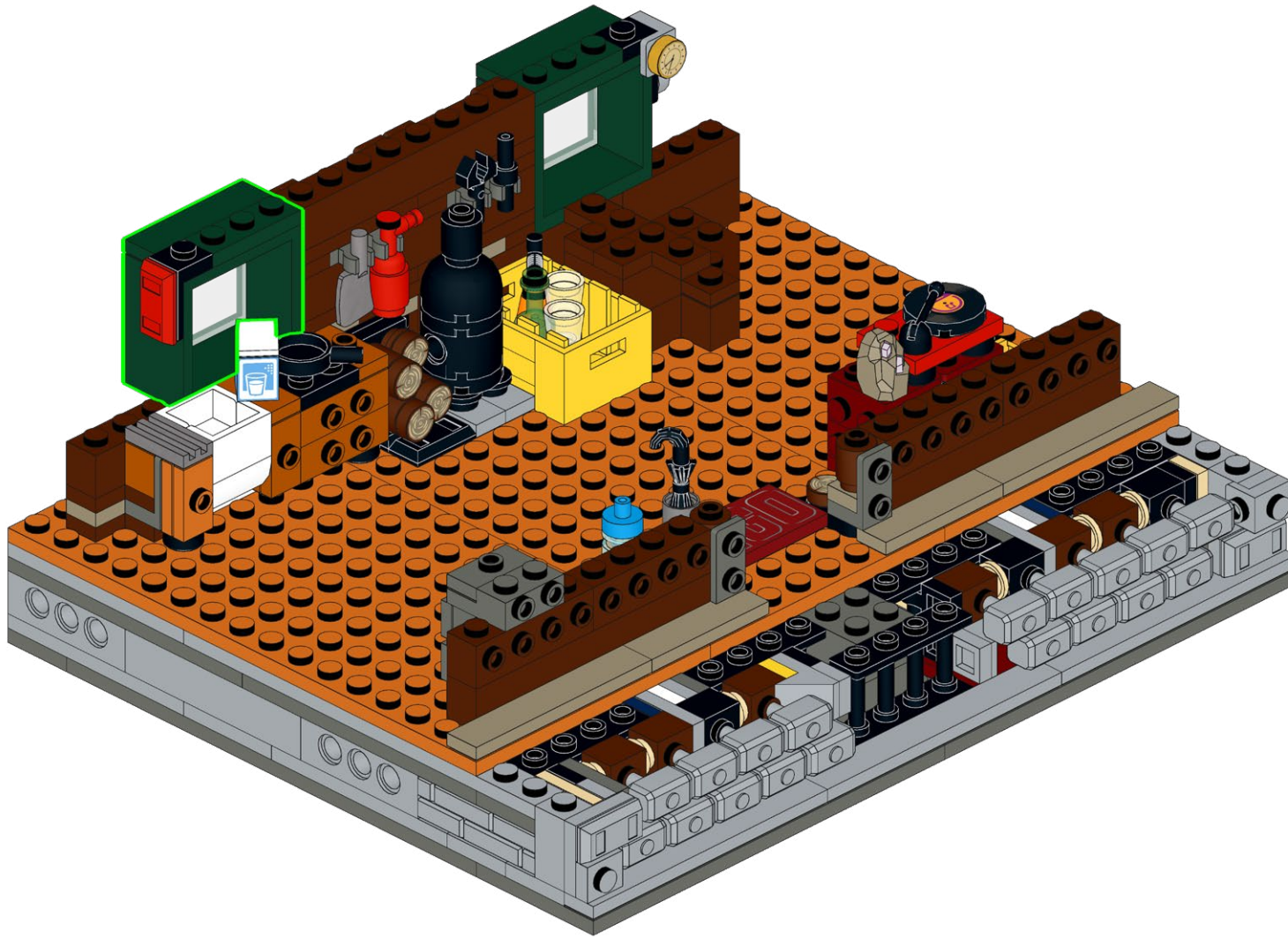

107

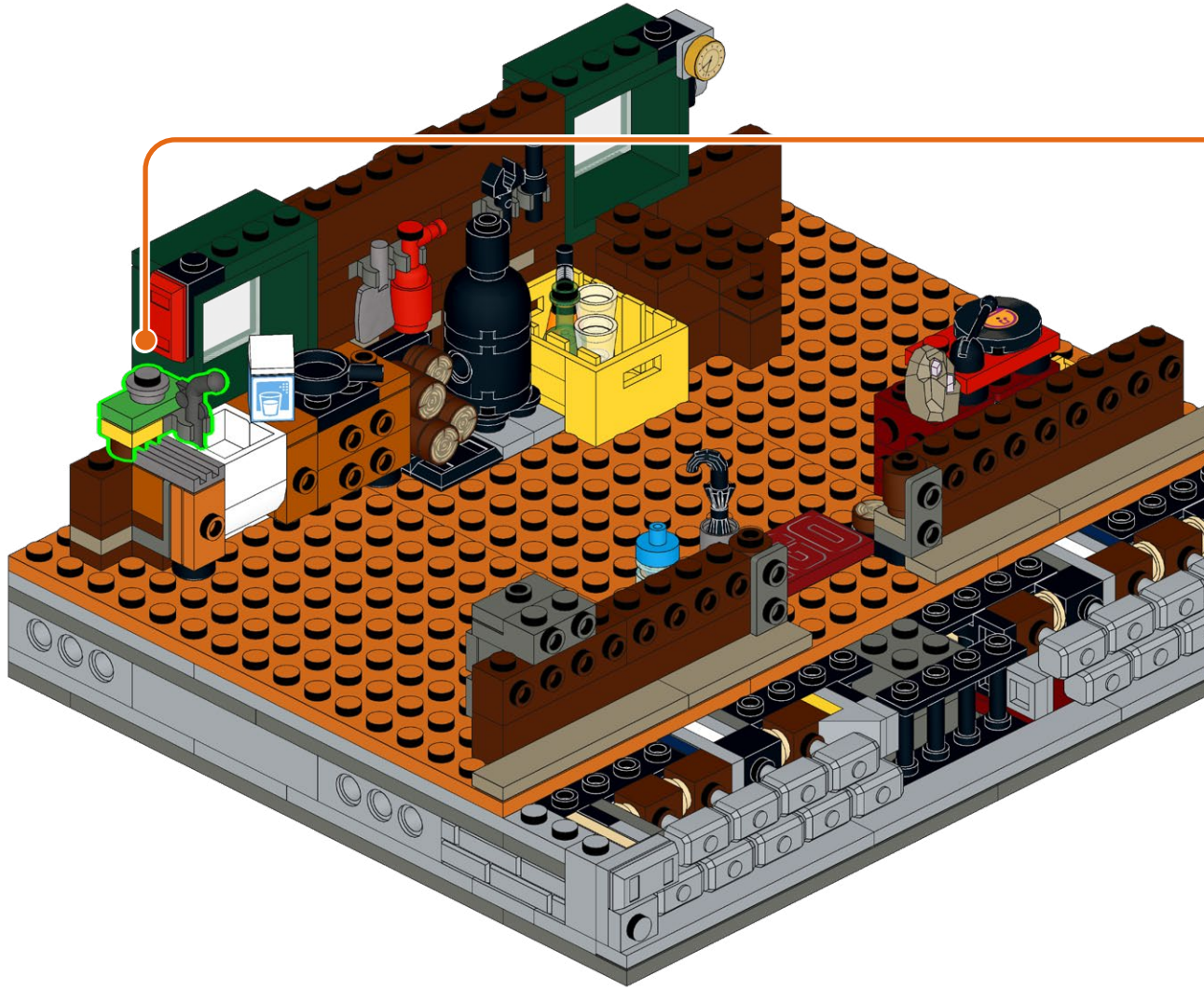
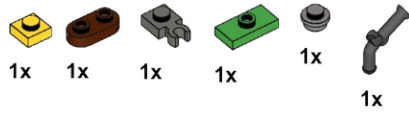

1

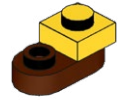

2

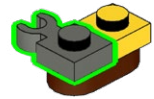

3

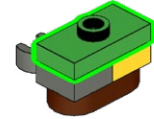

4

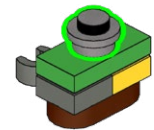

5

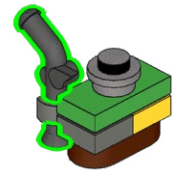

108

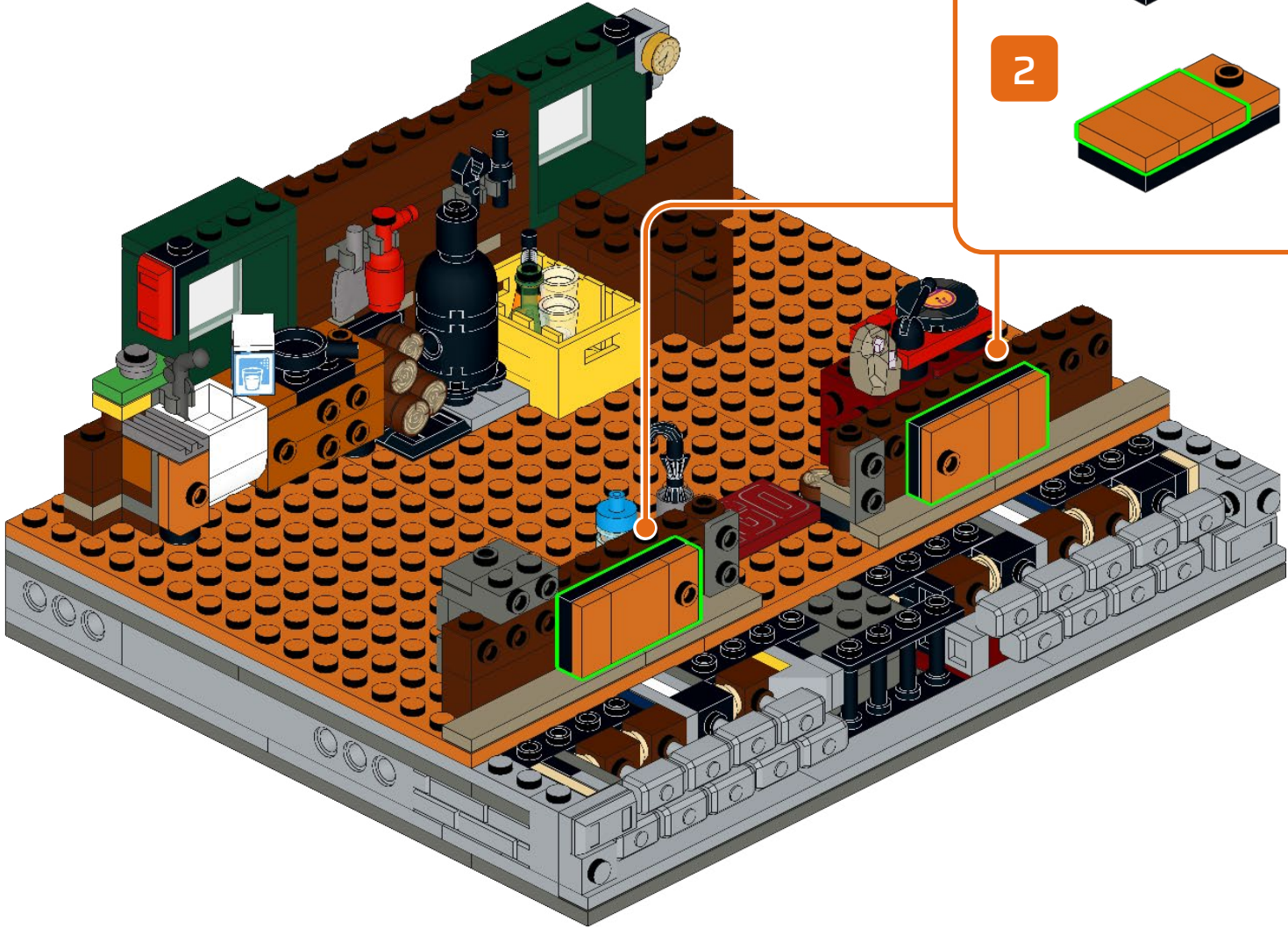
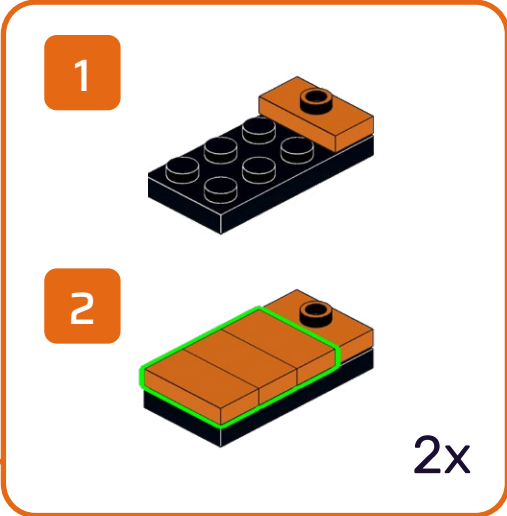
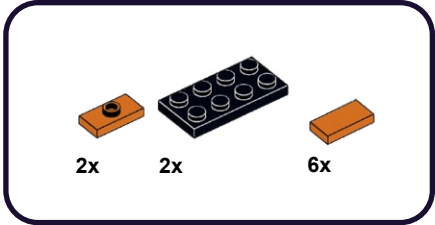

109

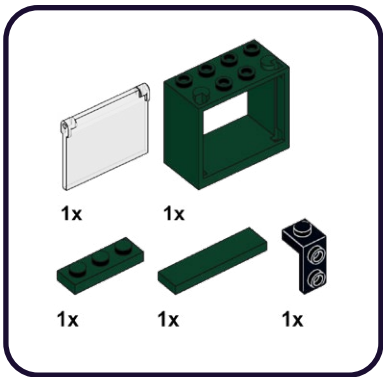

1



2



110

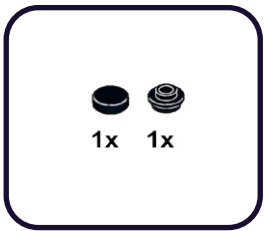

3



111

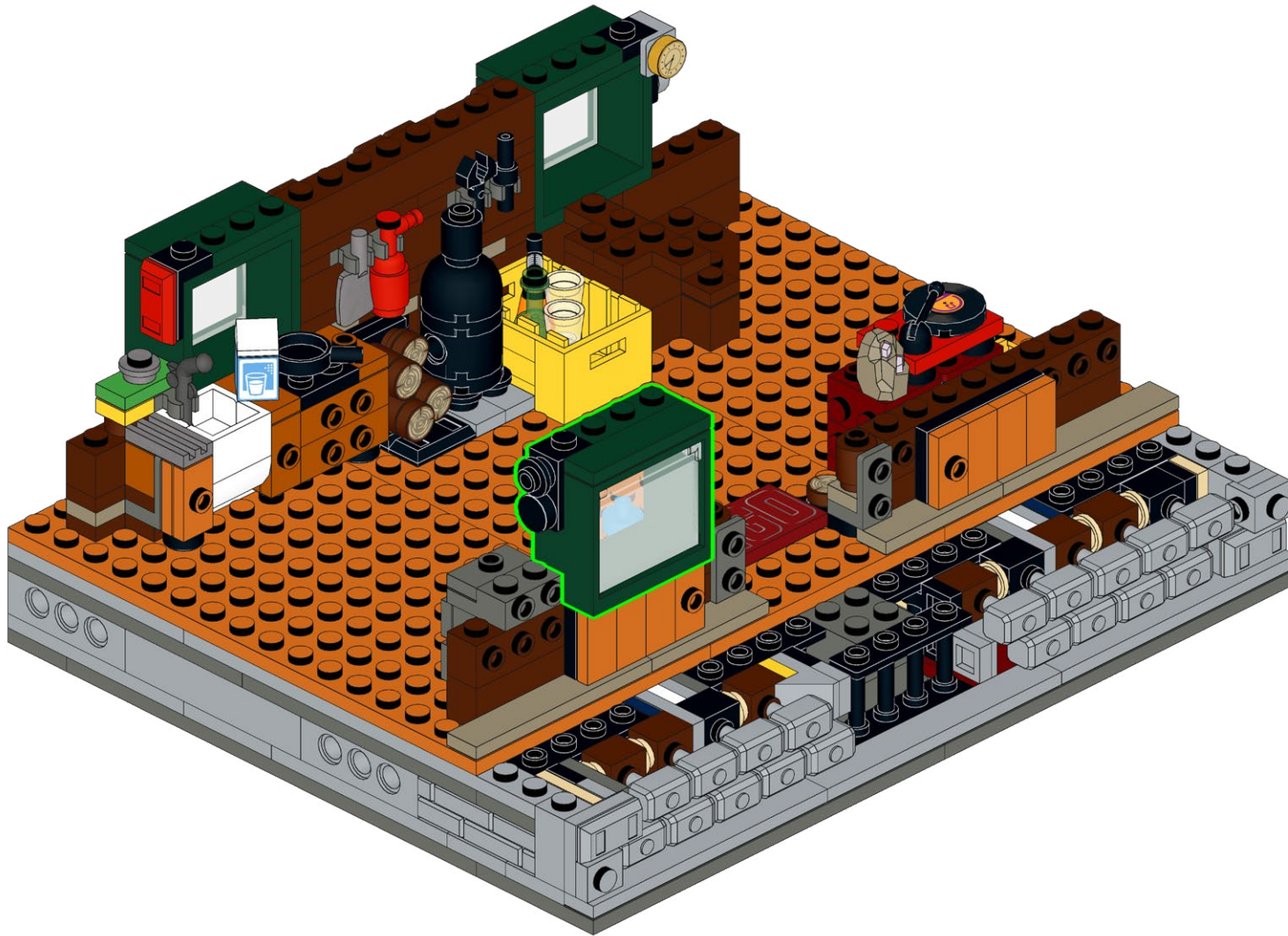

112

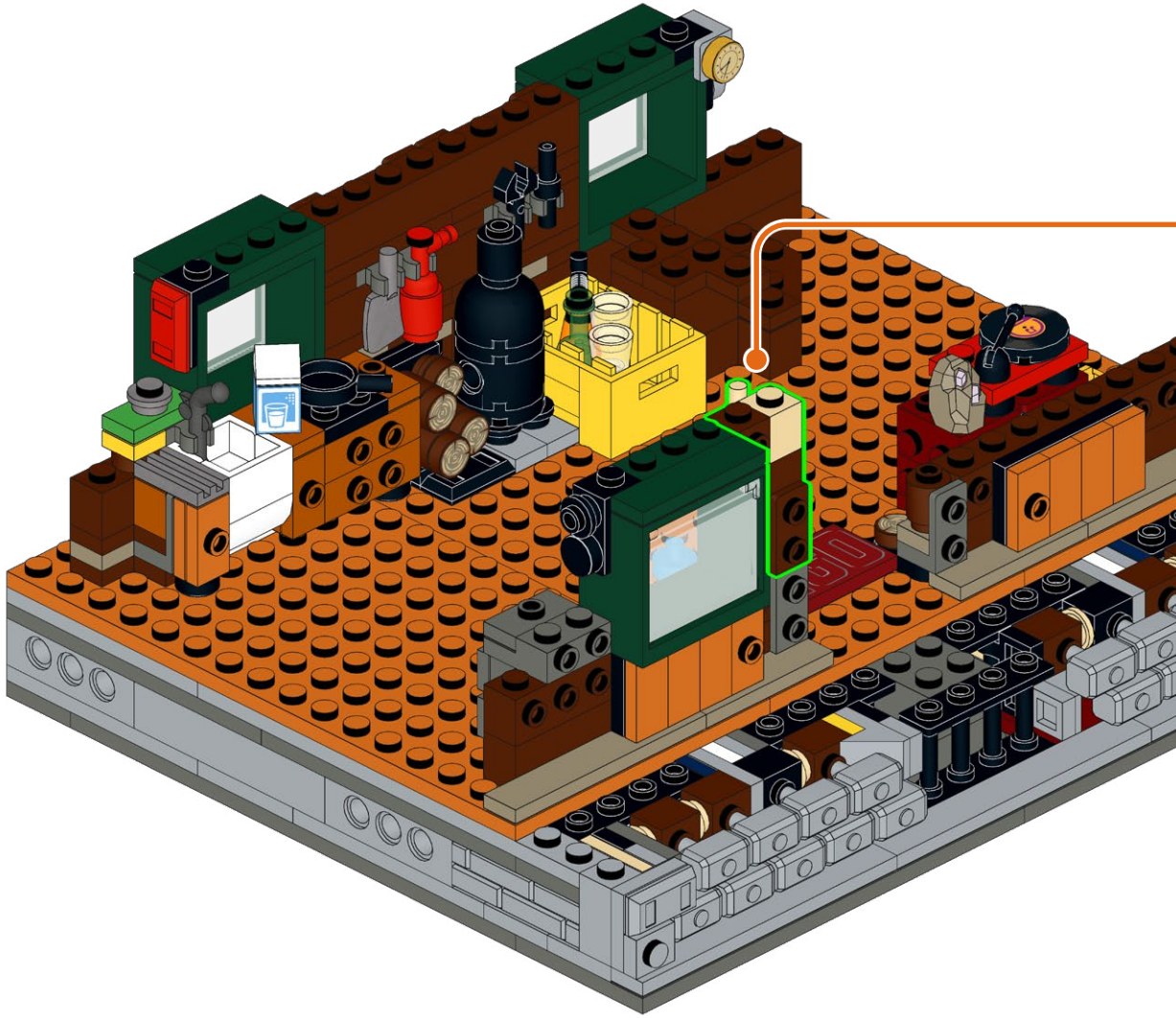
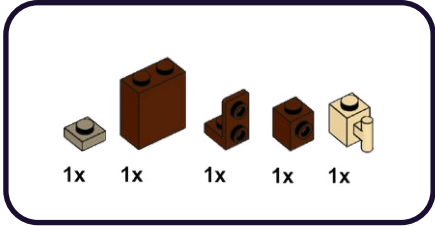

113

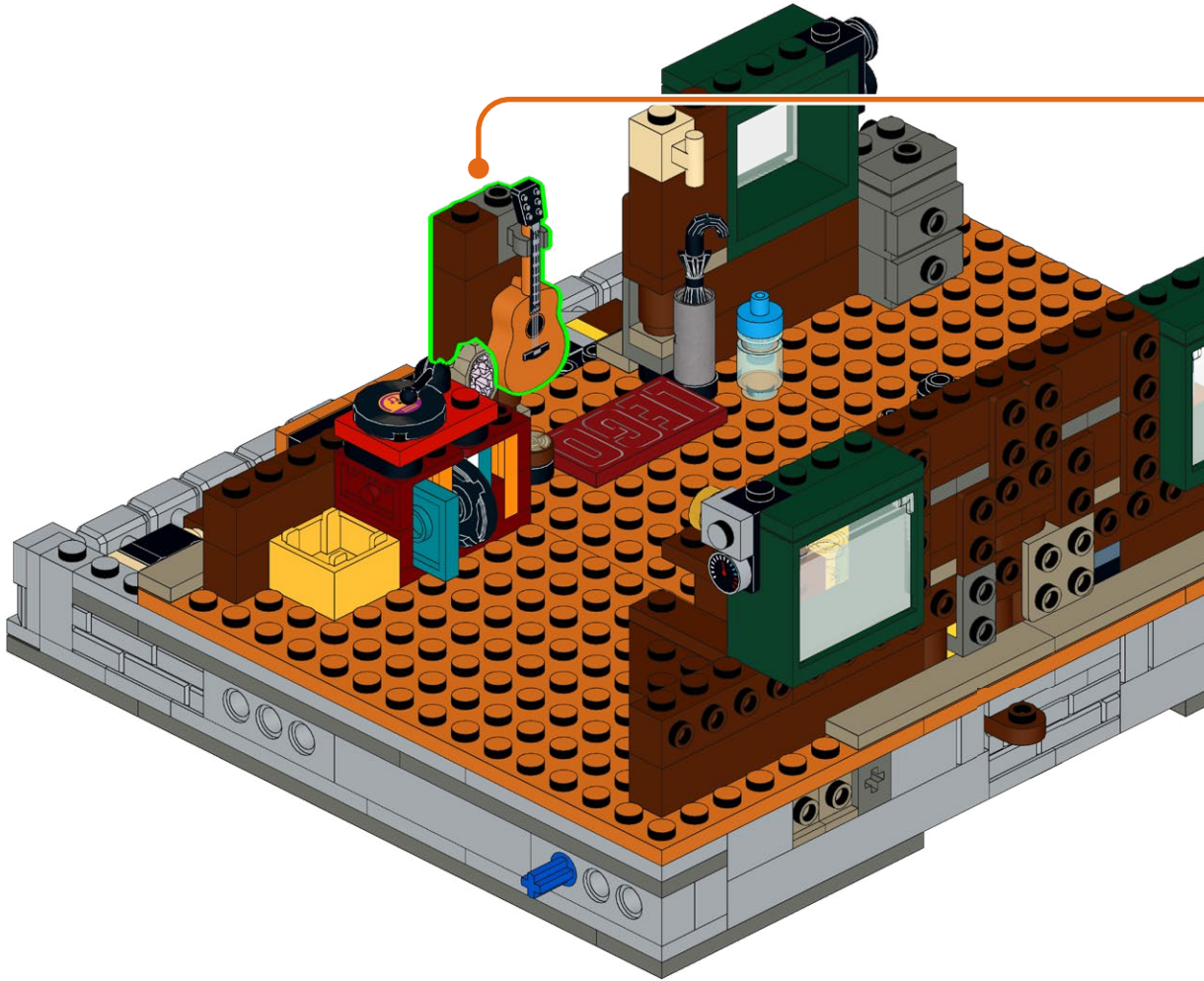
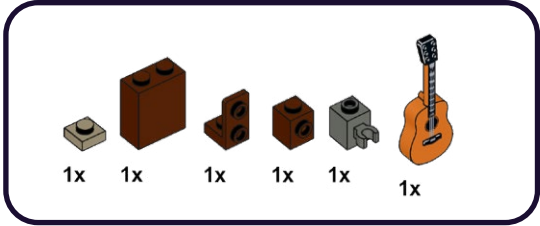

1

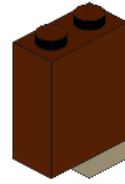

2

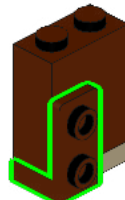

3

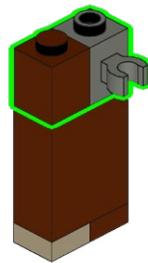

4

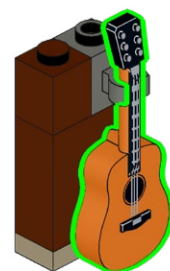

114

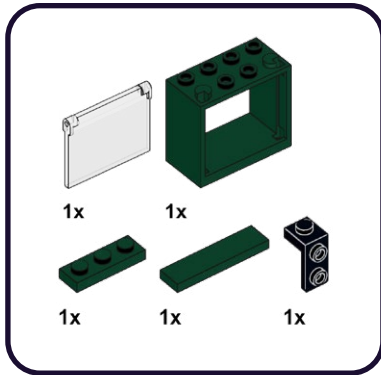

1

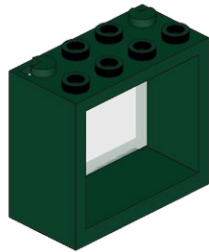

2

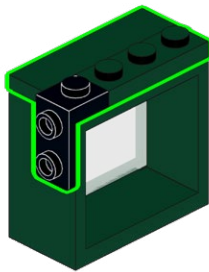

115

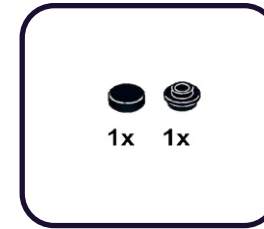

3

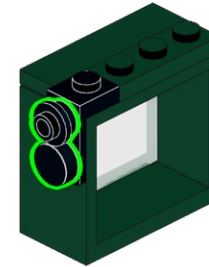

116

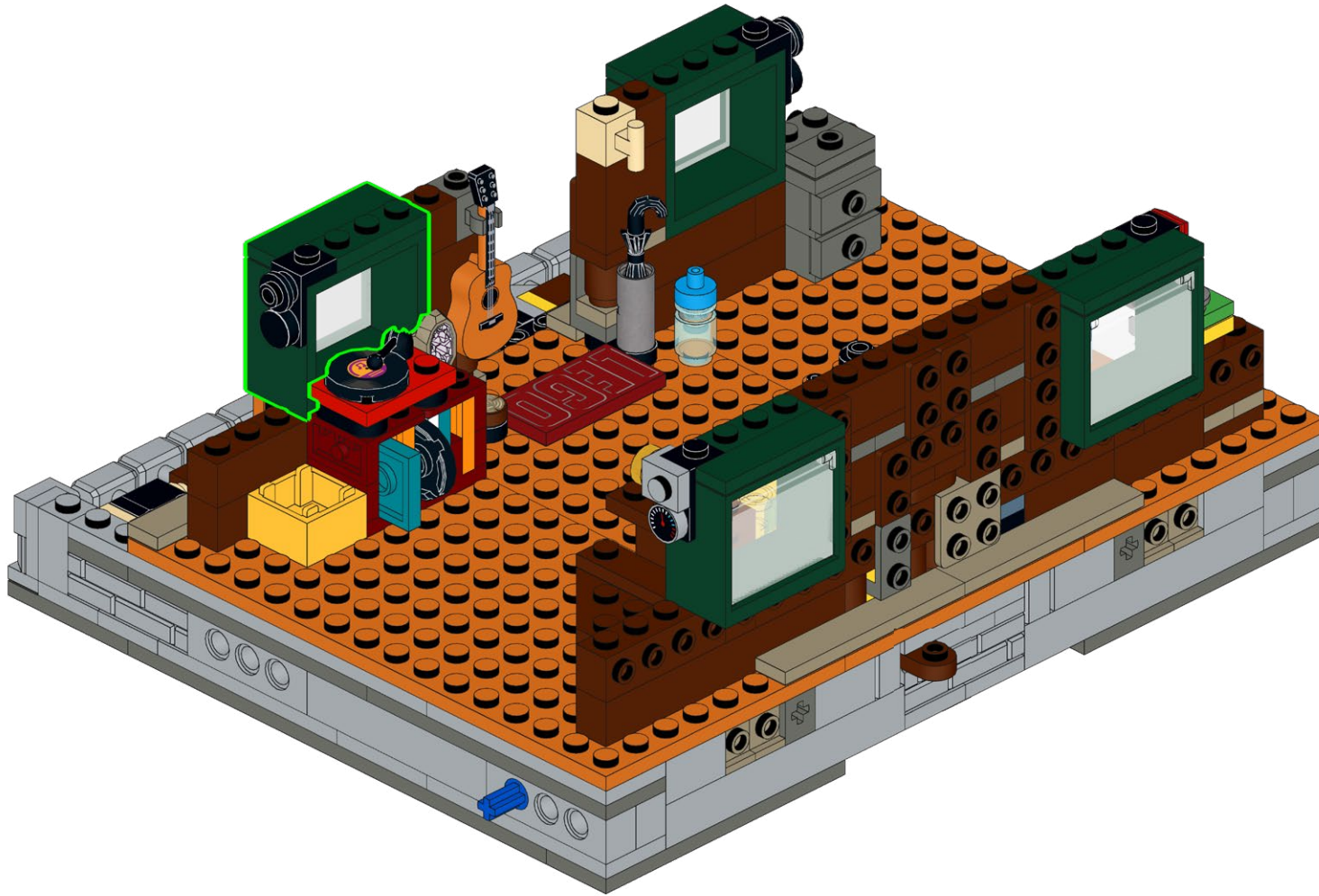

117

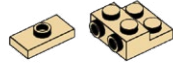

1x

1x

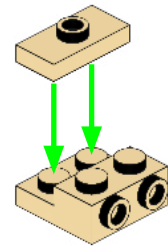
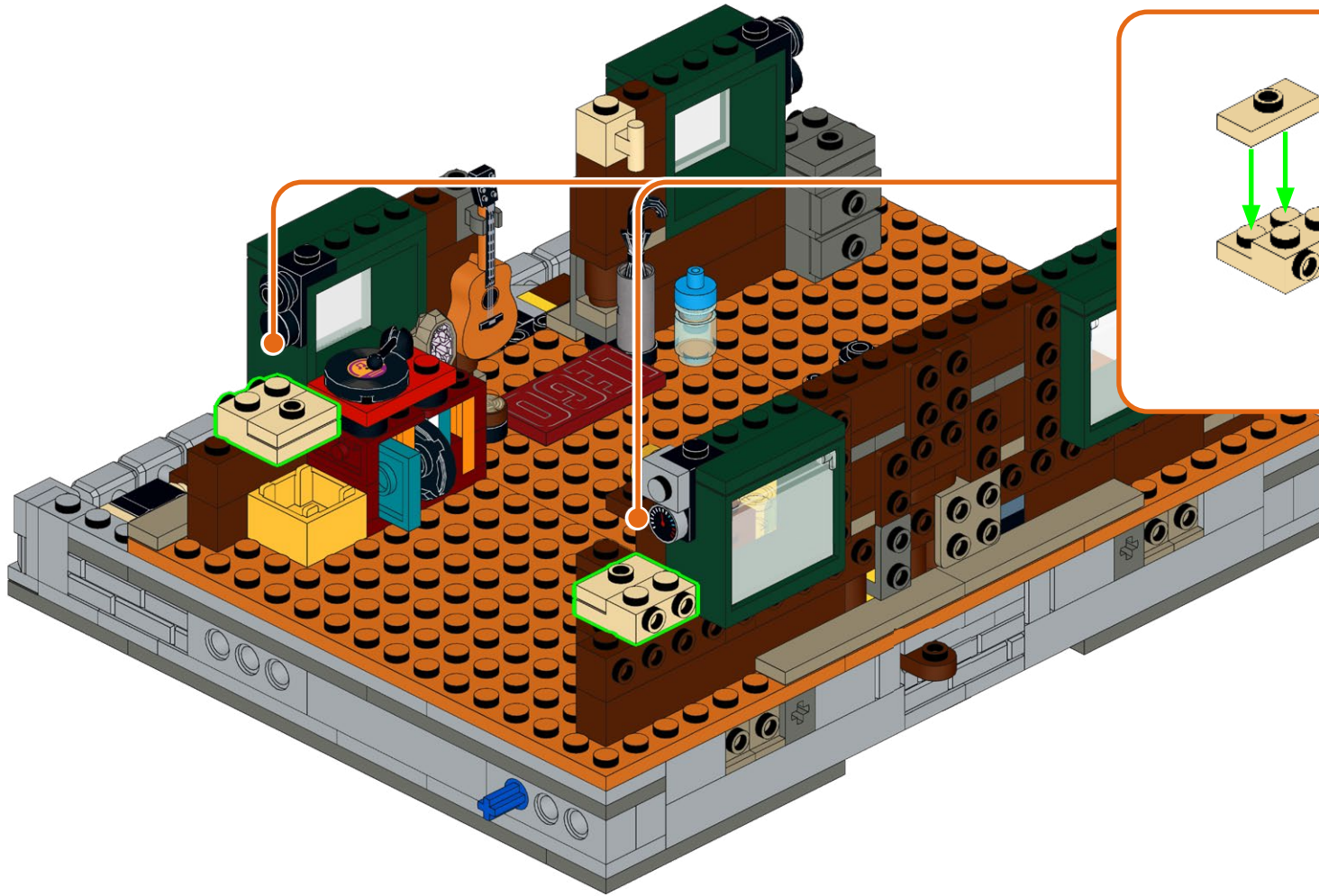

2x

118

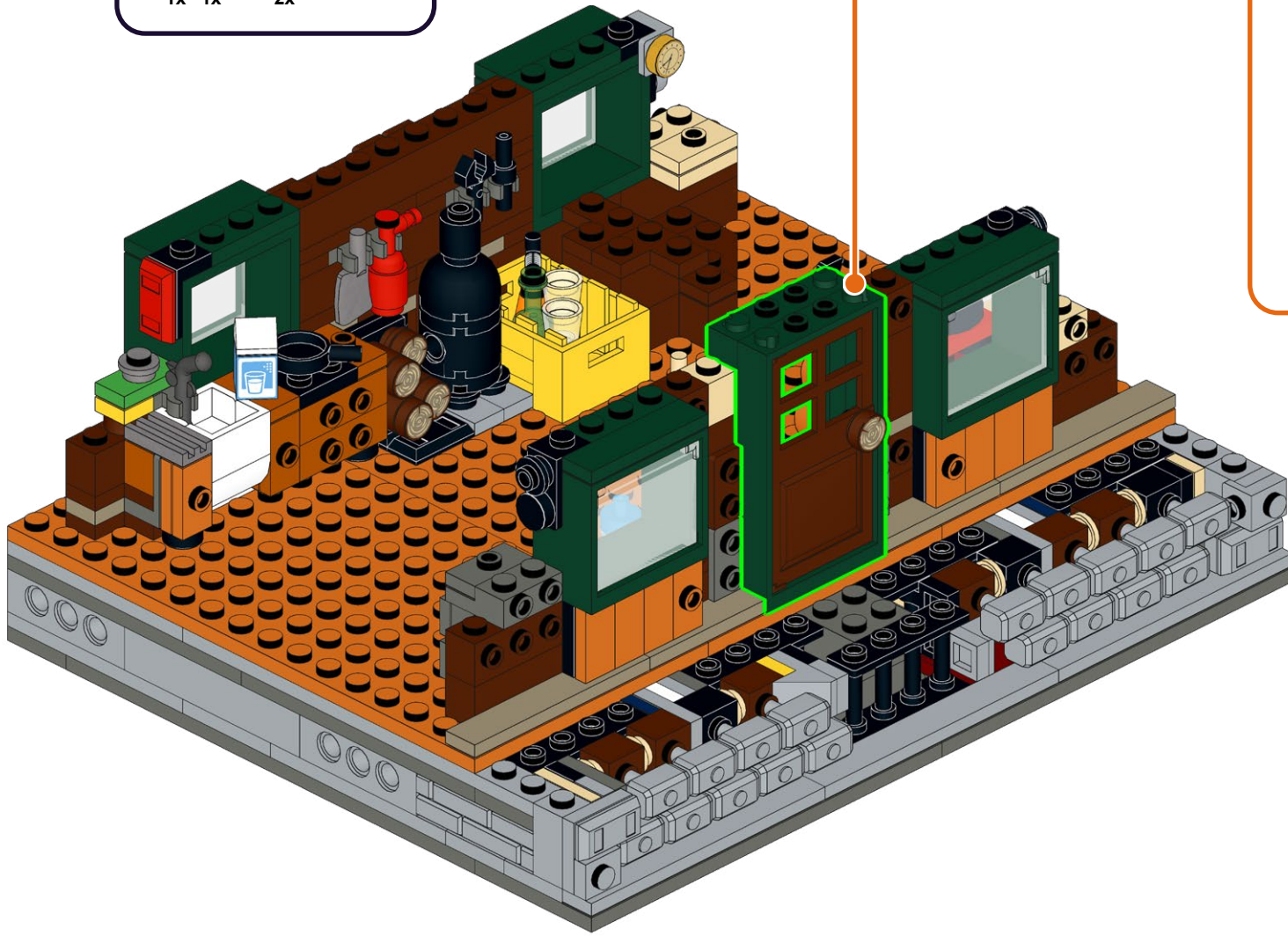
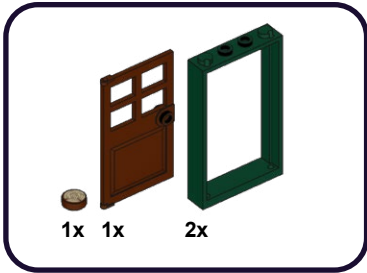

119

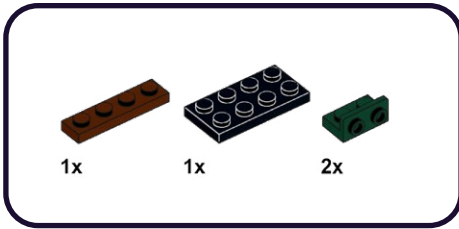

1

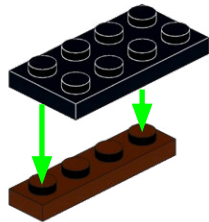

2

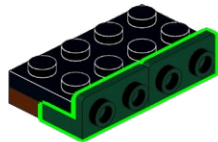

120

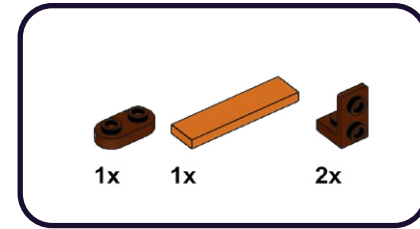

3

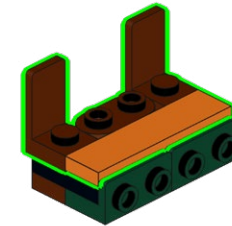

121

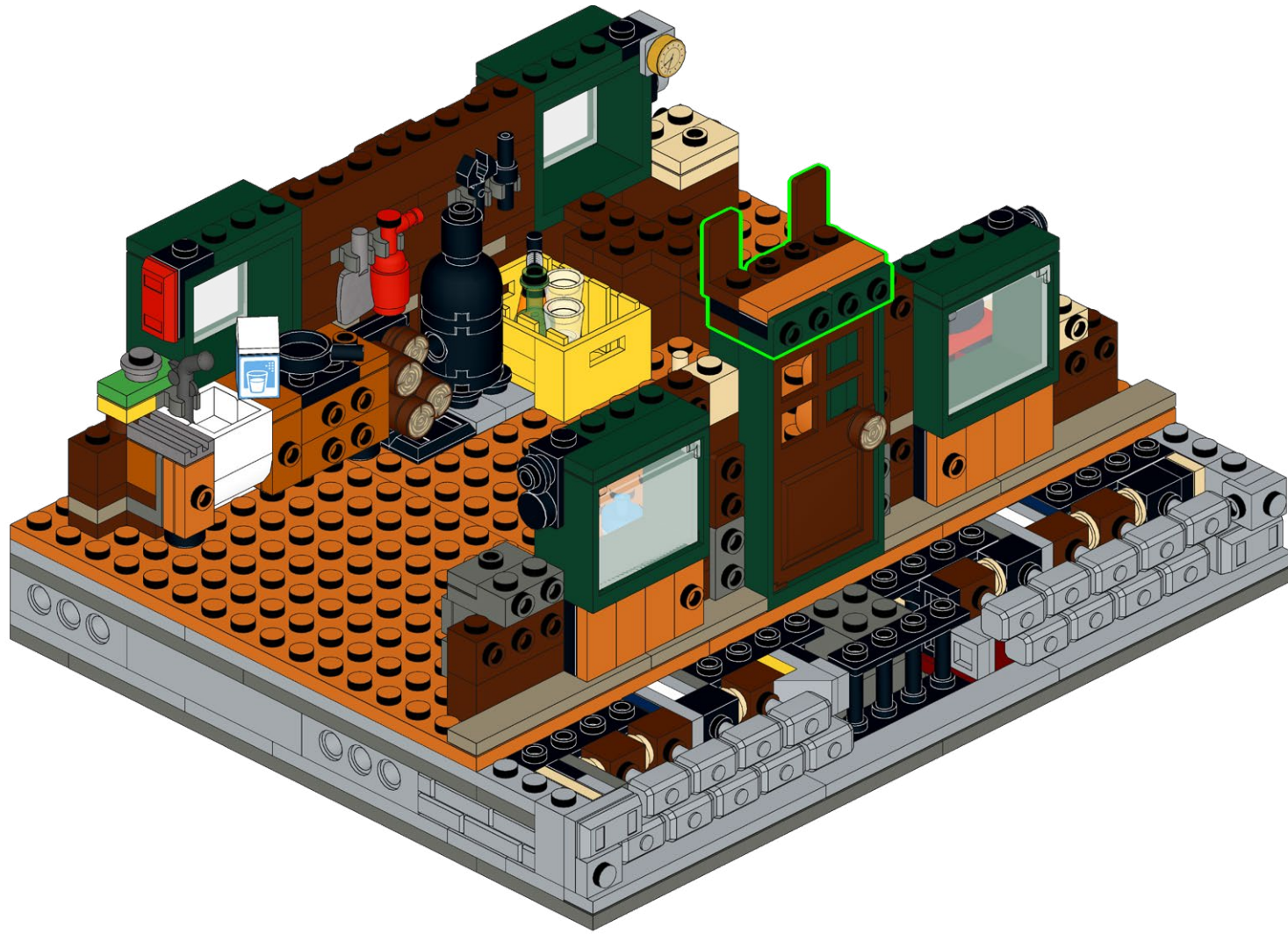

122

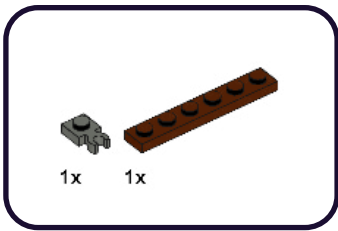

1

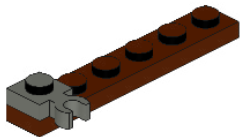

123

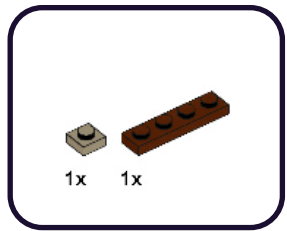

2

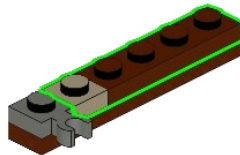

124

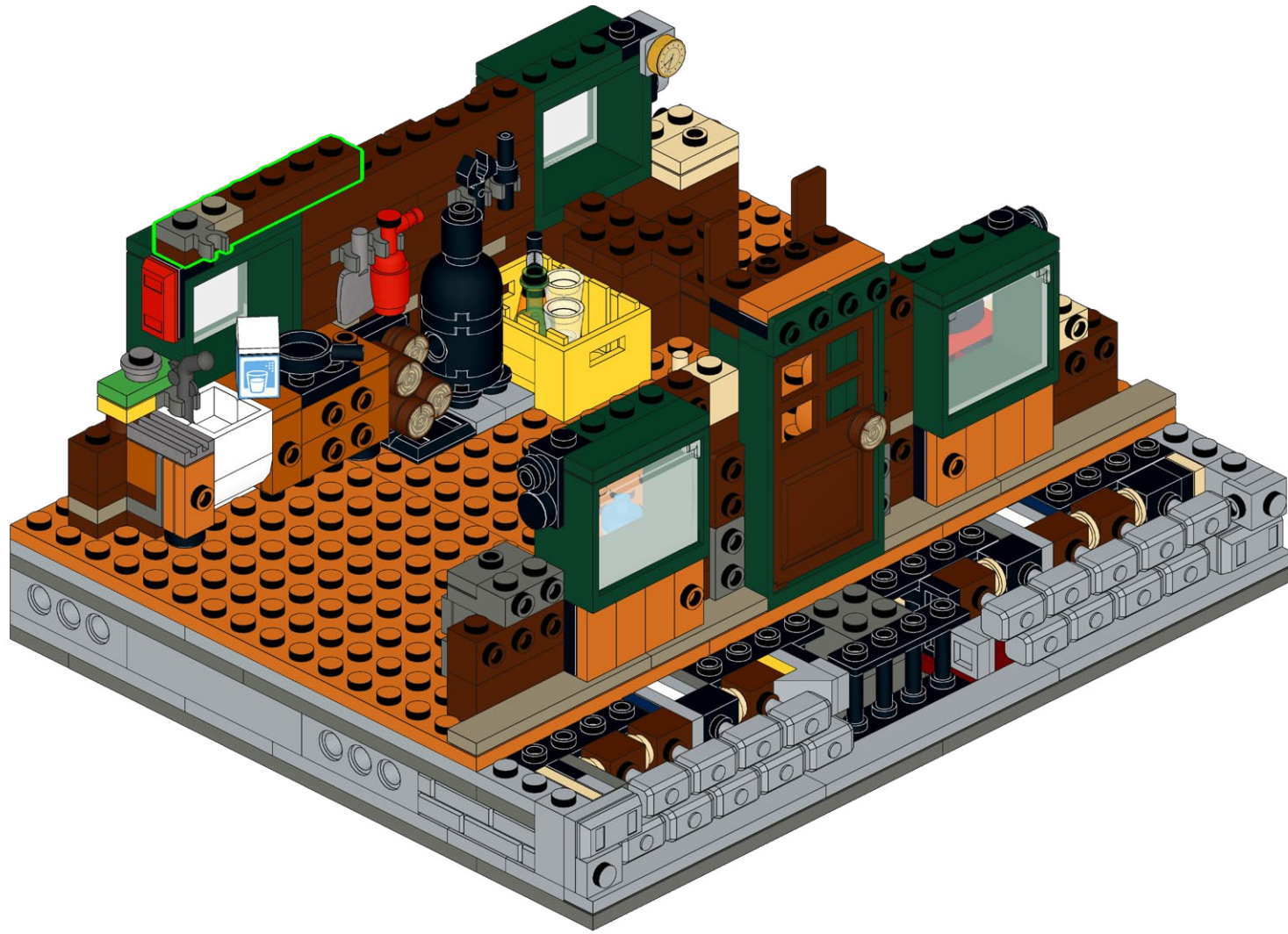

125

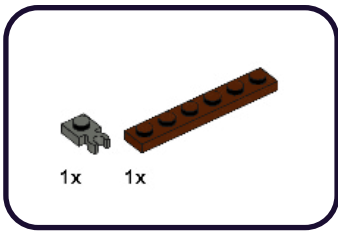

1

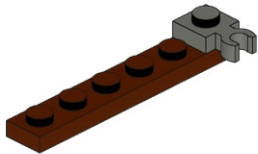

126

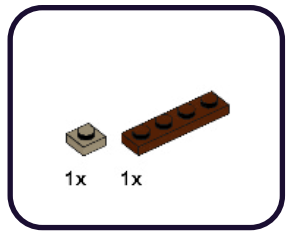

2

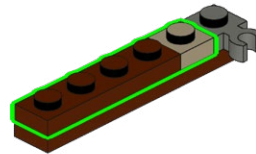

127

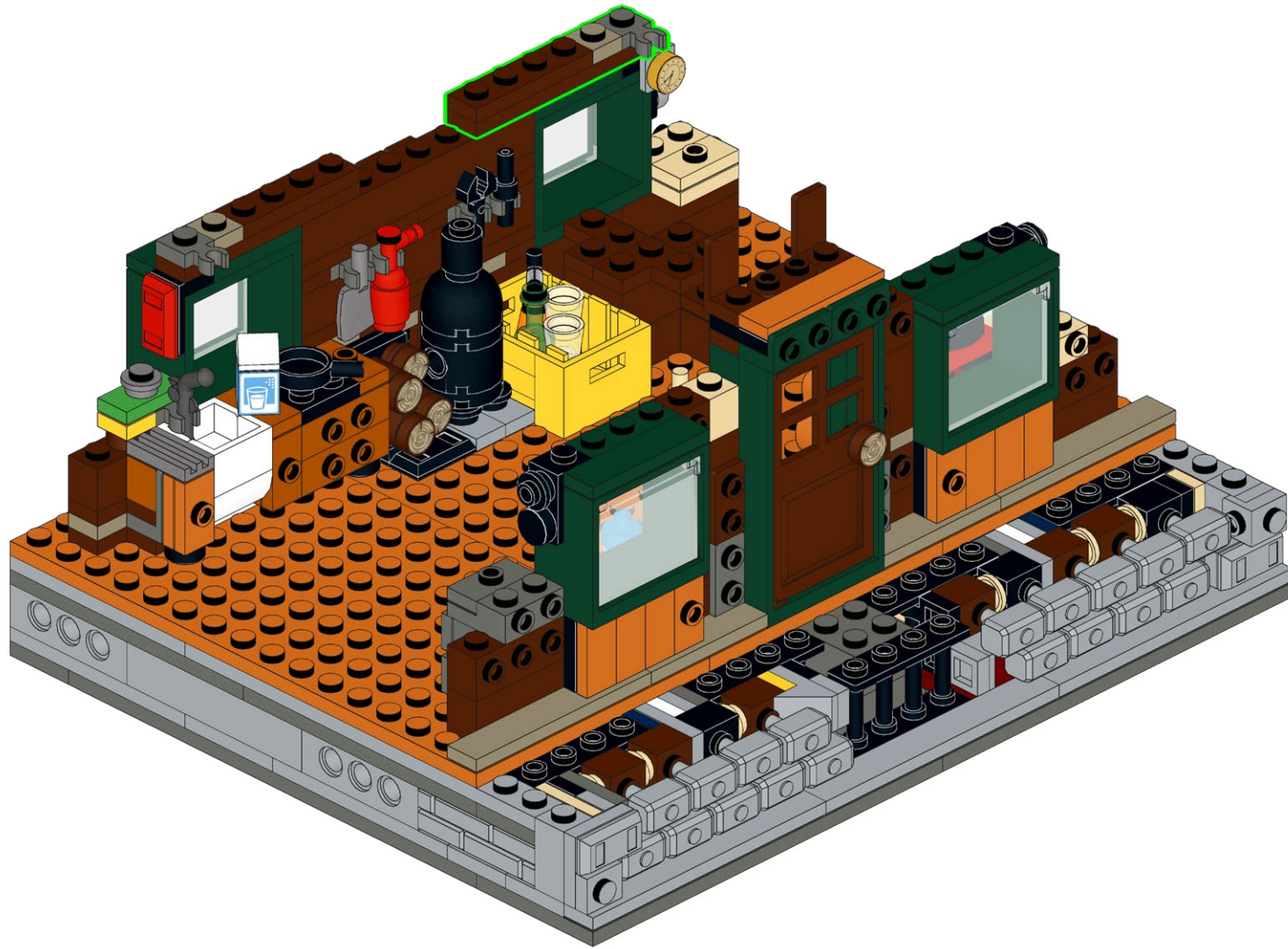

128

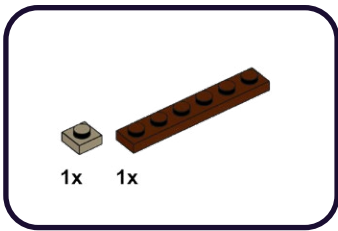

1

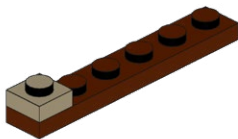

129

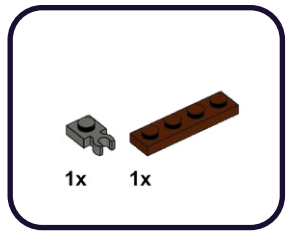

2

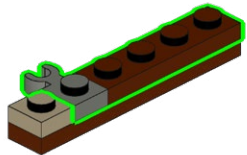

130

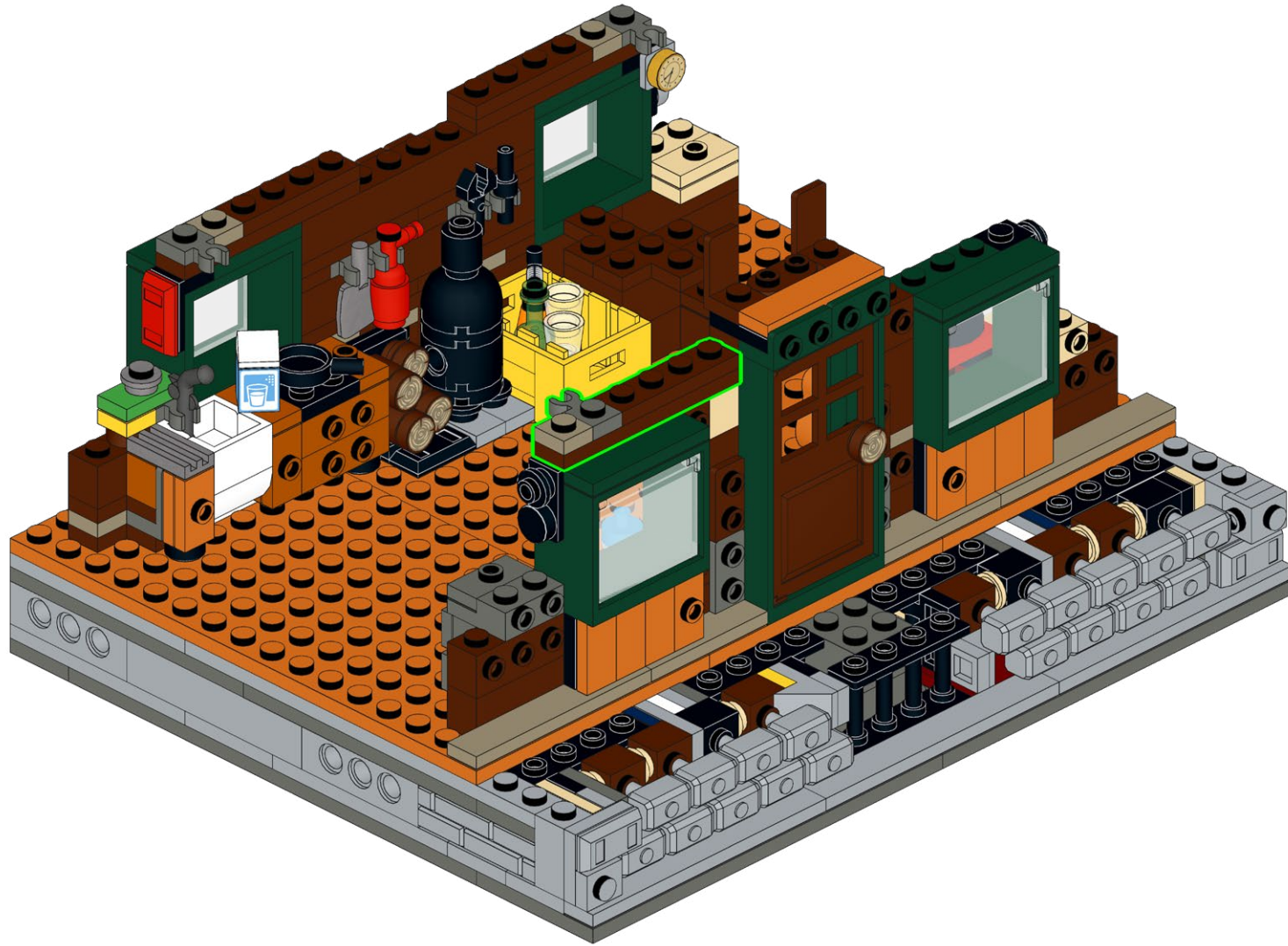

131

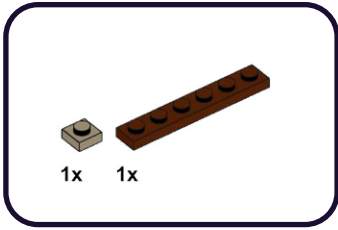

1

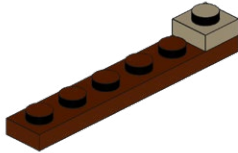

132

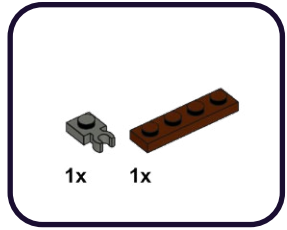

2

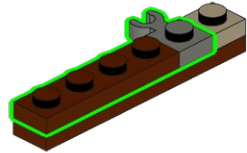

133

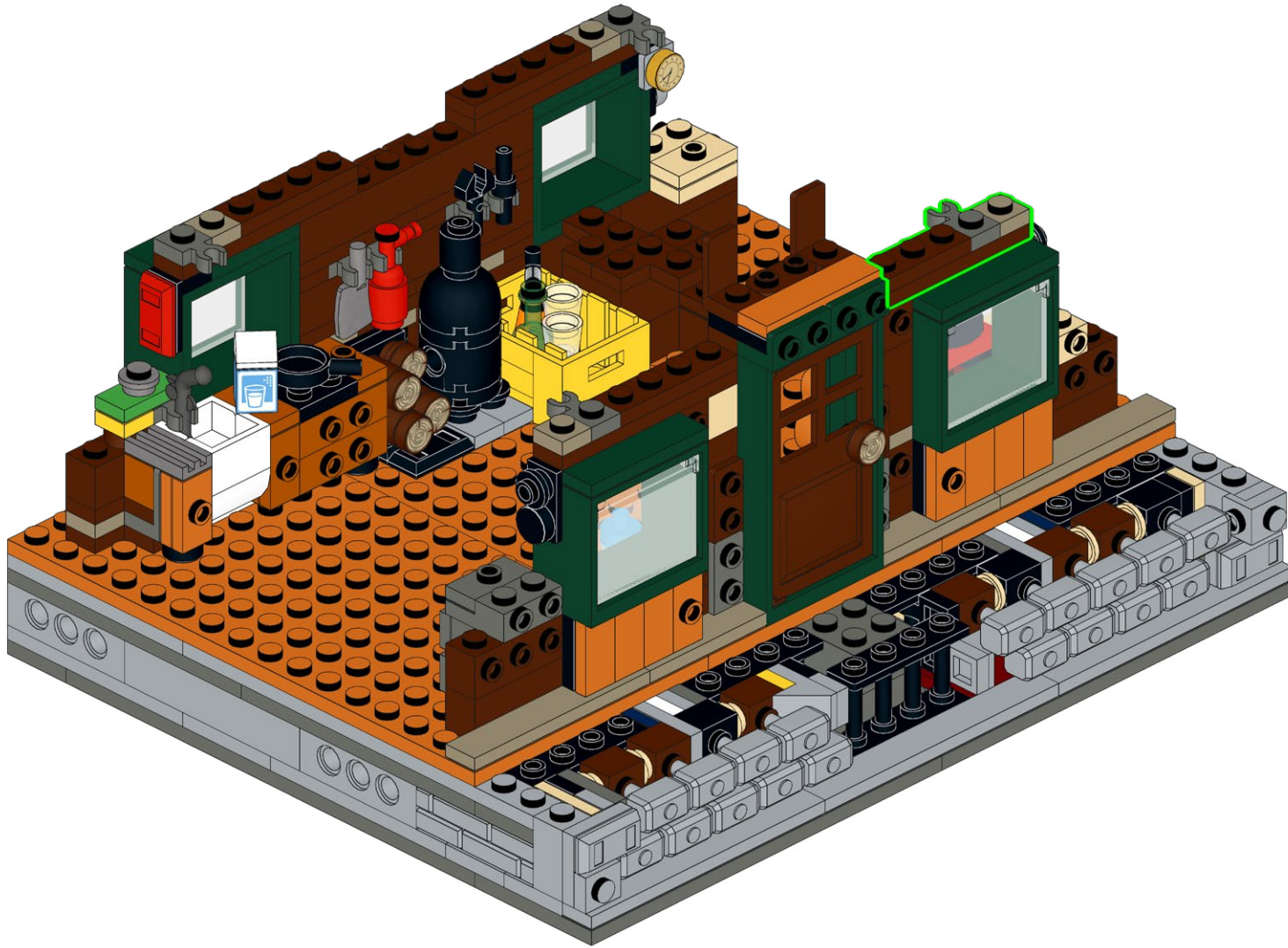

134

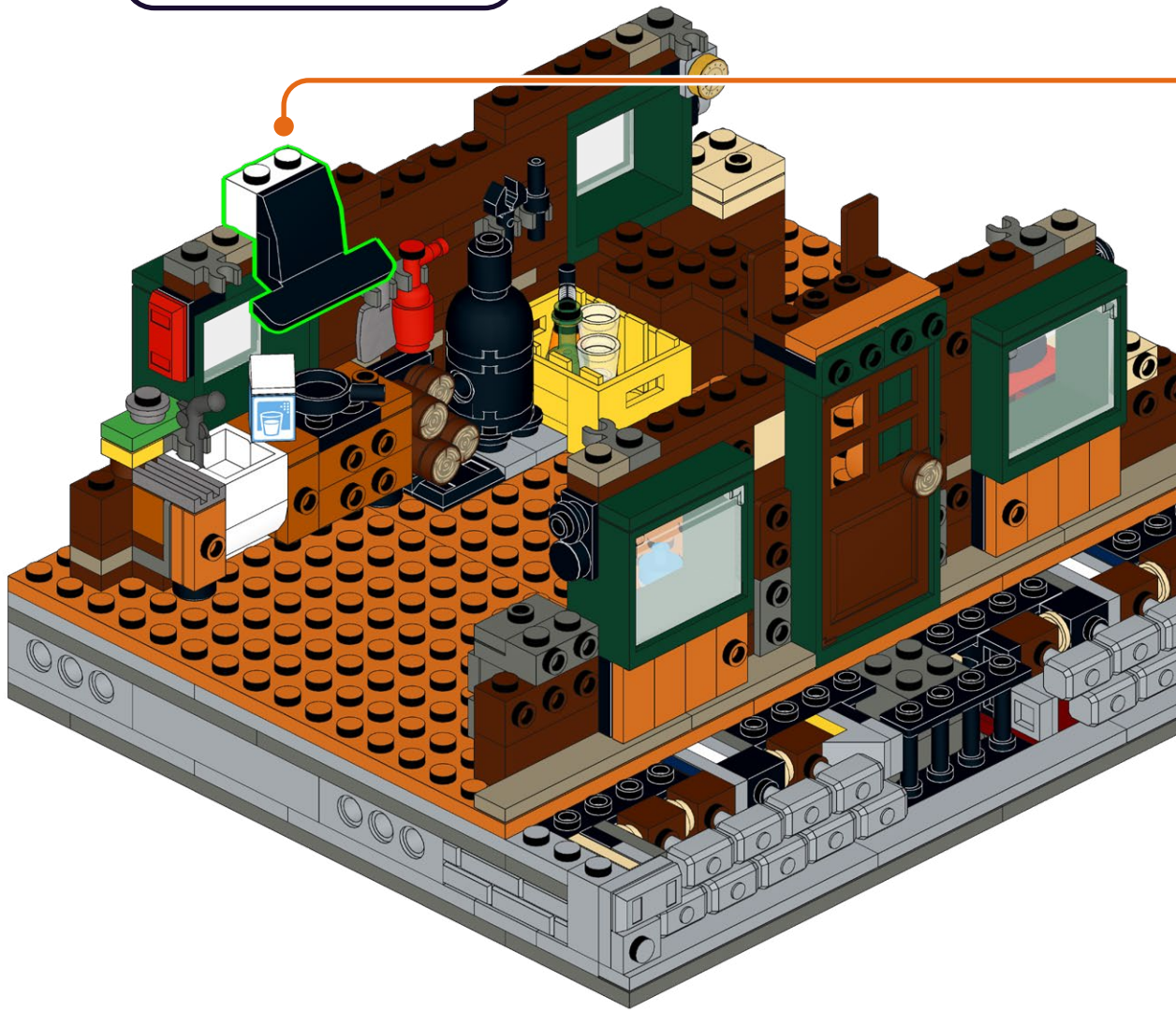
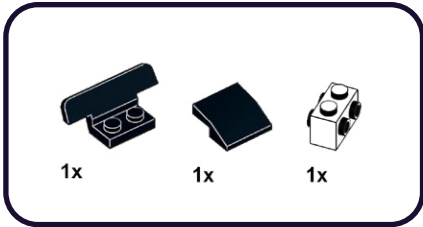

135

4x



136

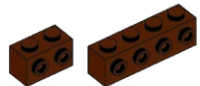

5x

3x



137



2x 2x



2x

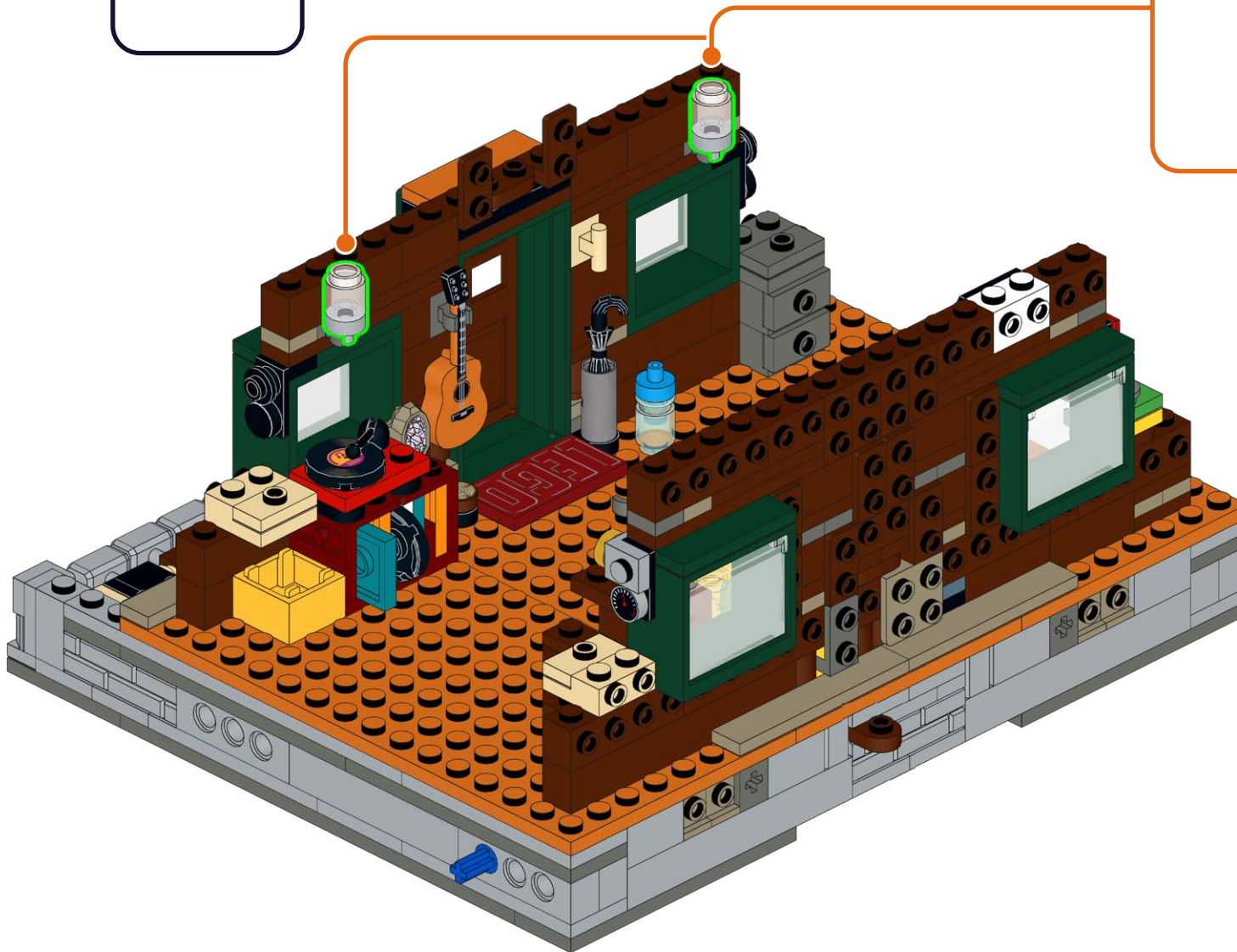

138



1x

1x

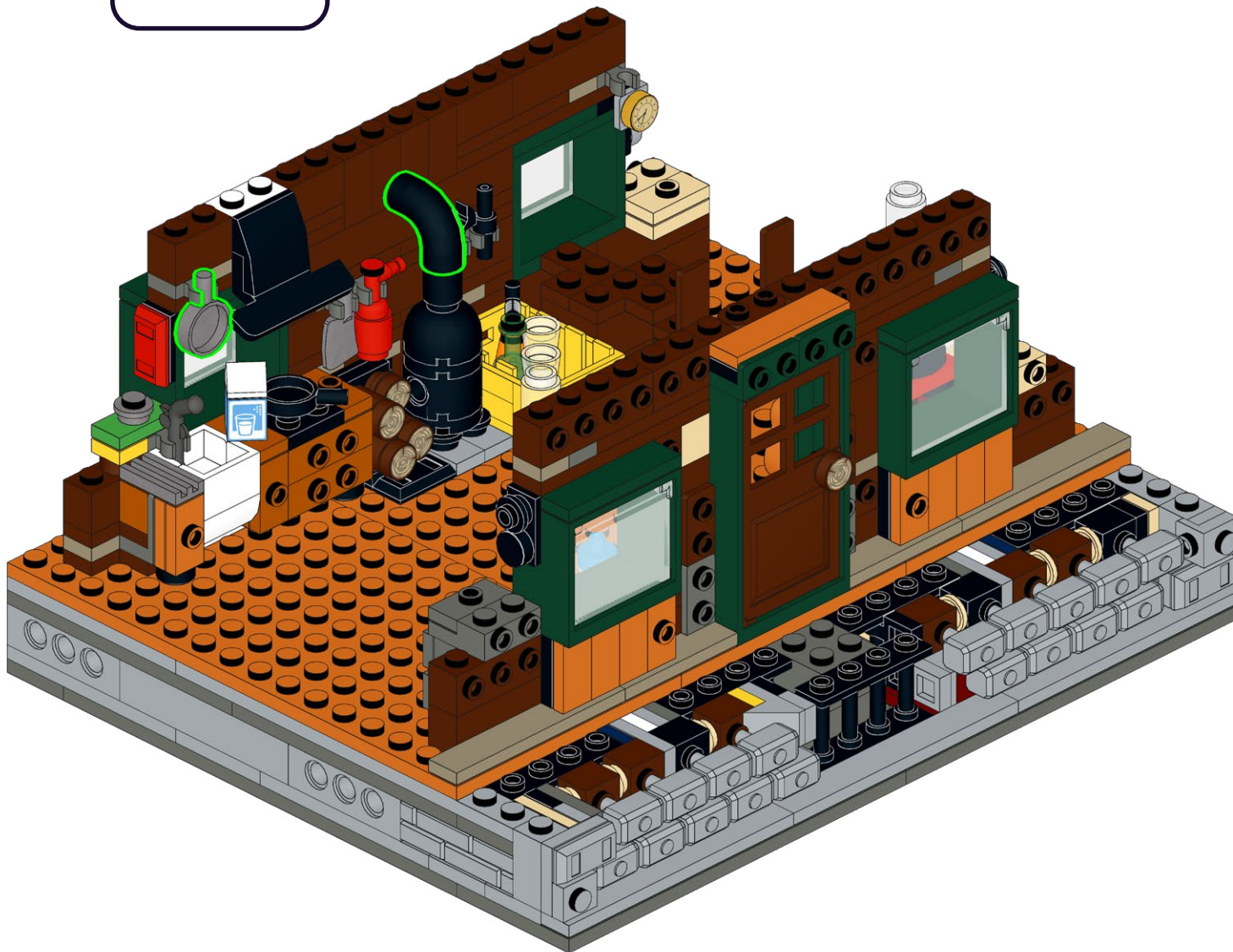

139

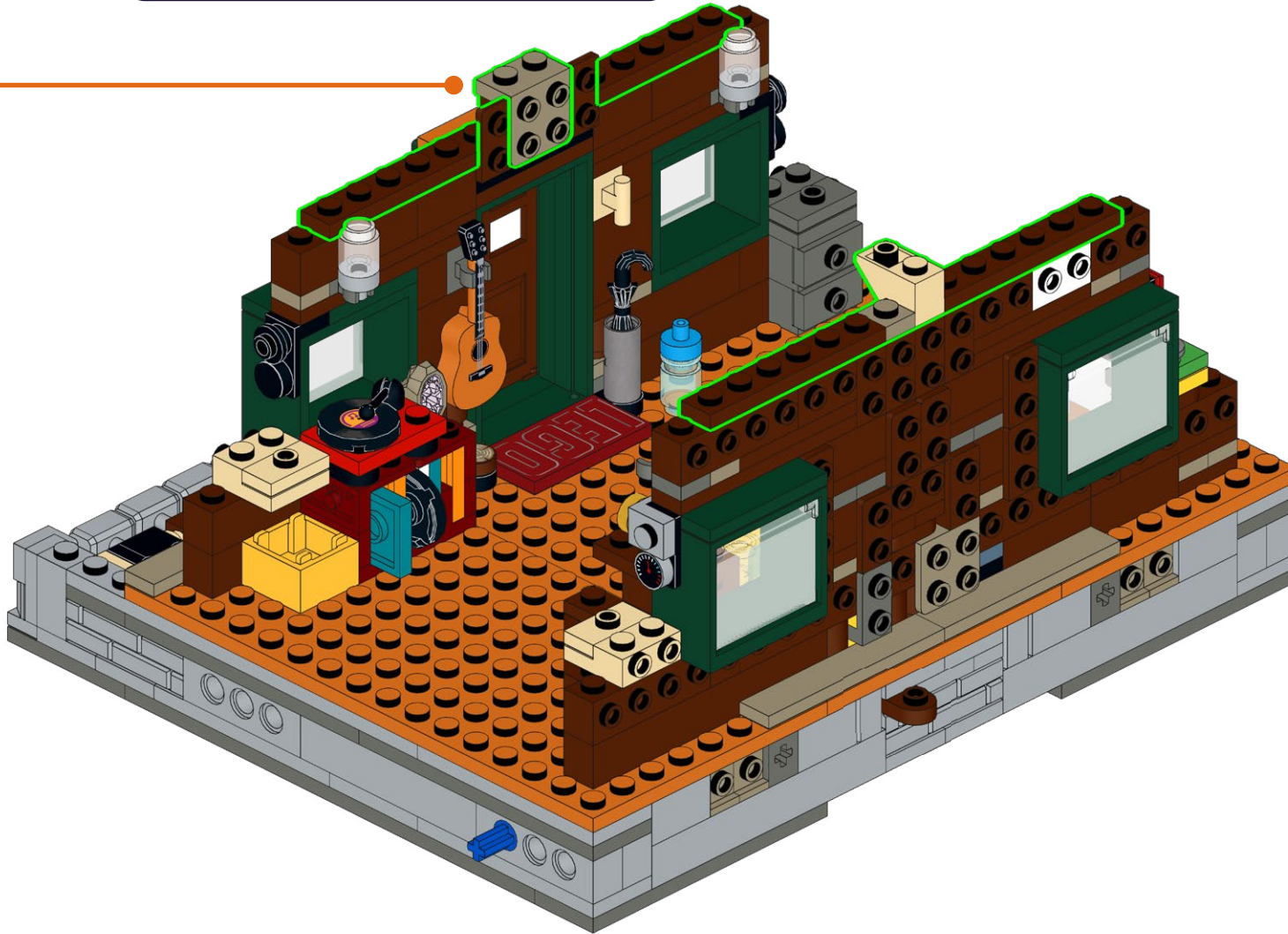
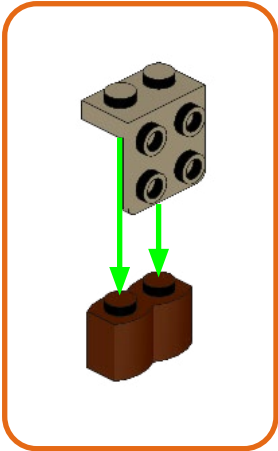
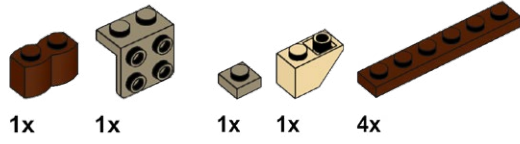

140

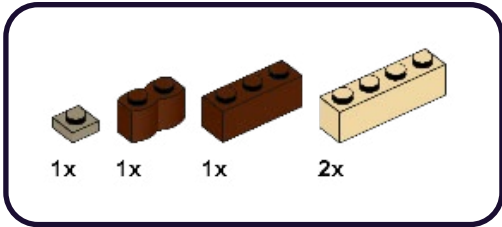

141

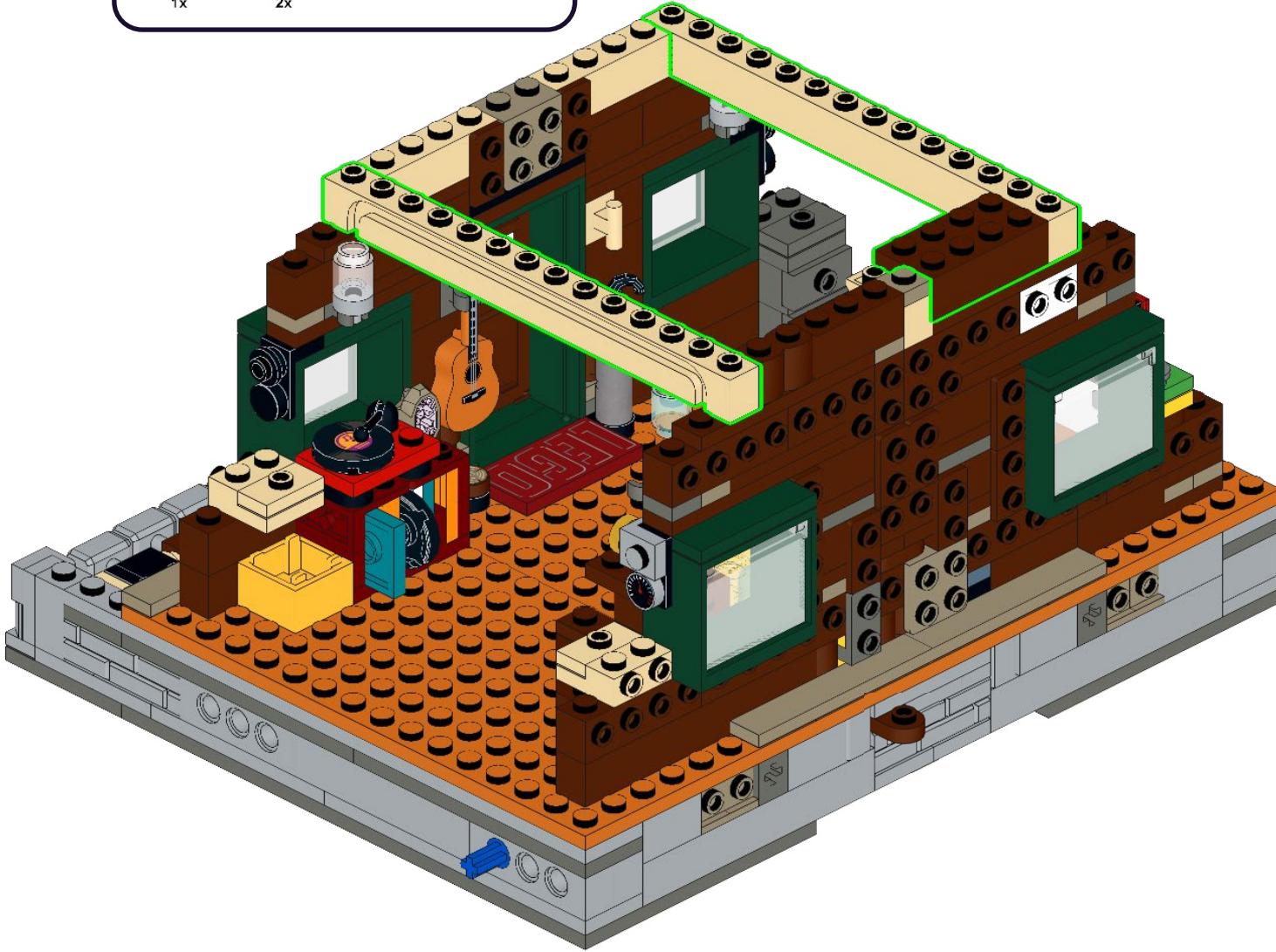
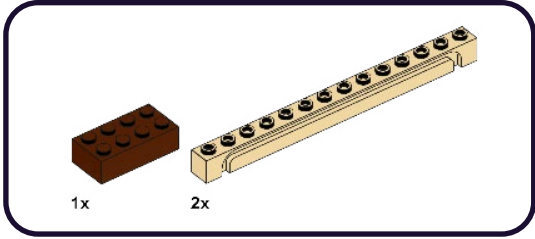

142

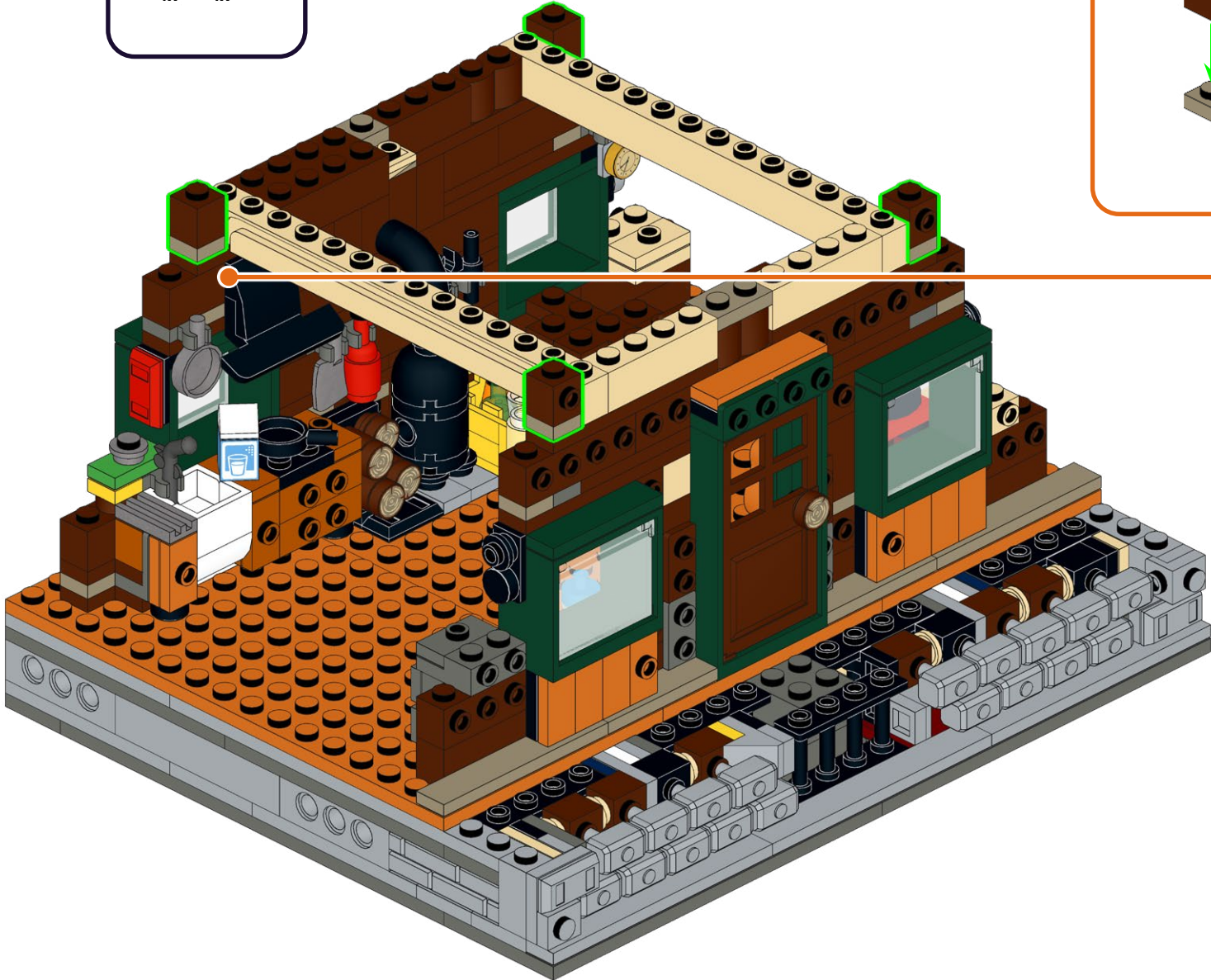
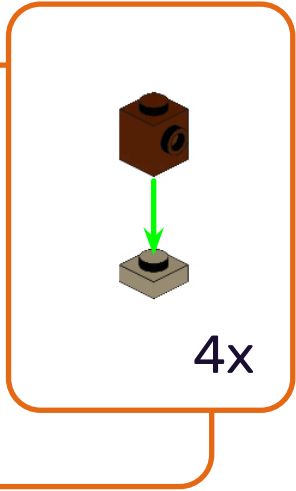
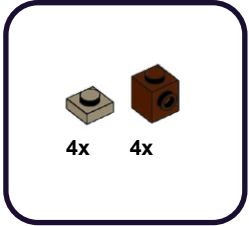

143

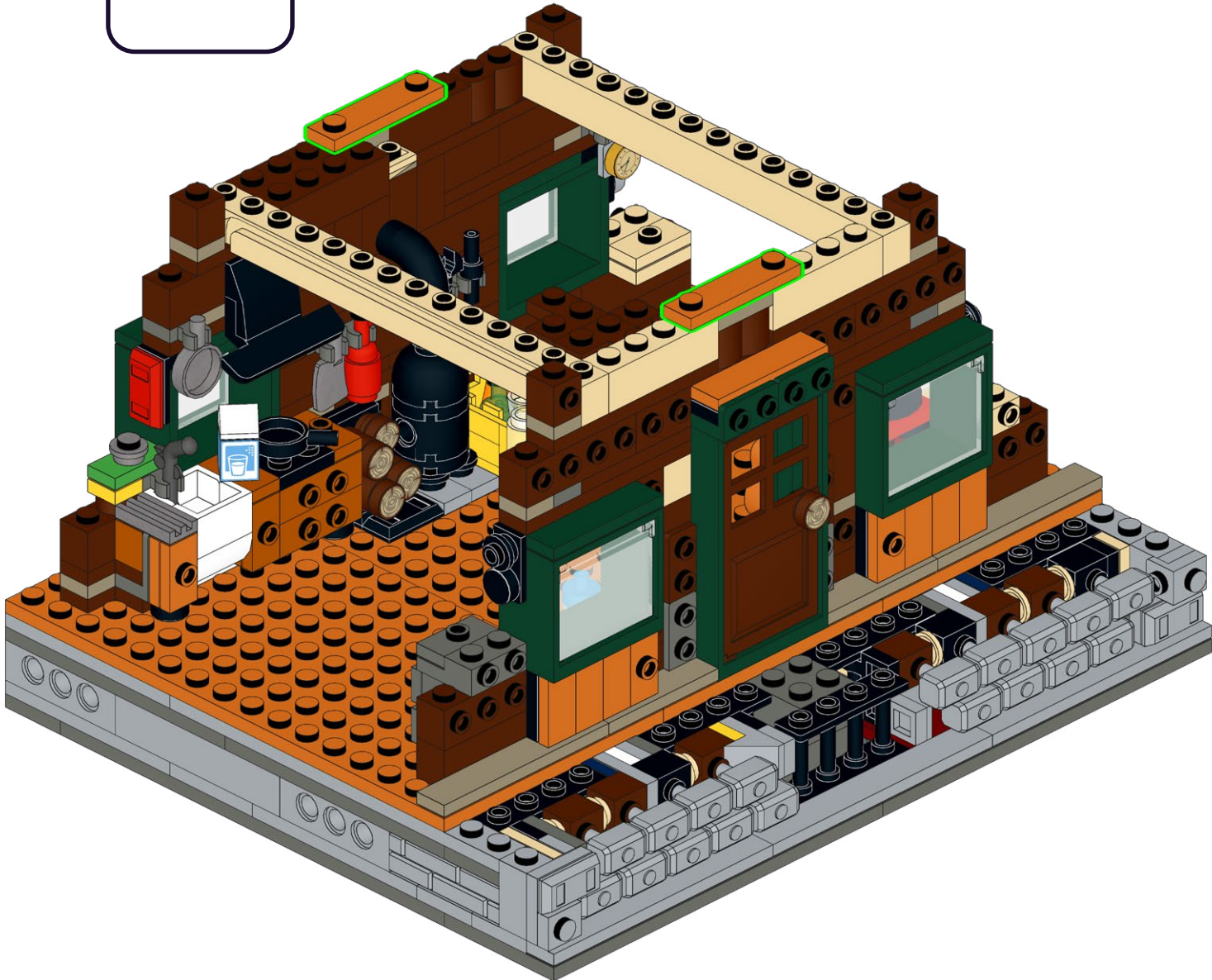
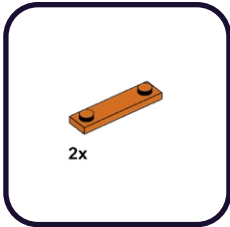

144

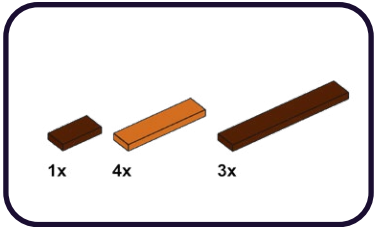

145

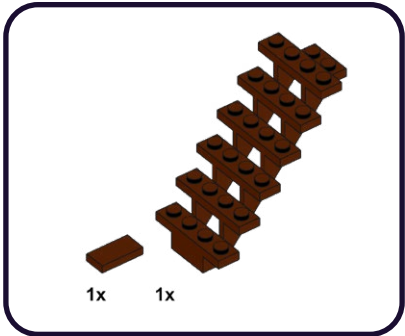

1

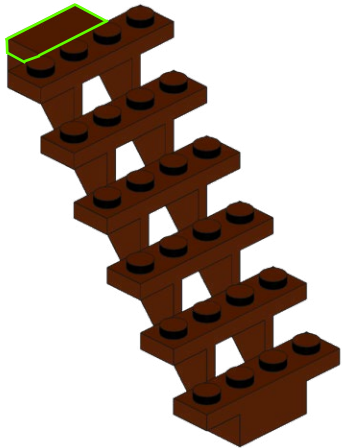

146

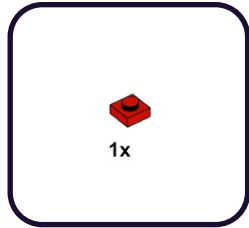

2

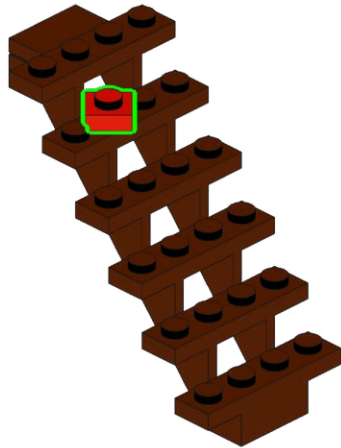

147



148

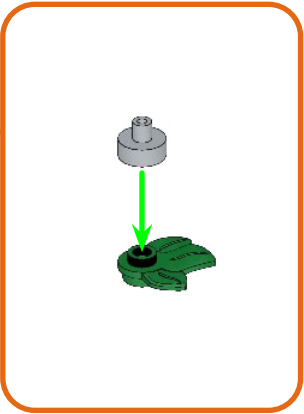
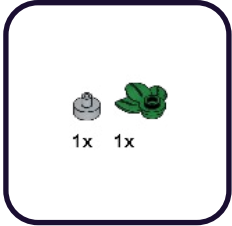

149

2x

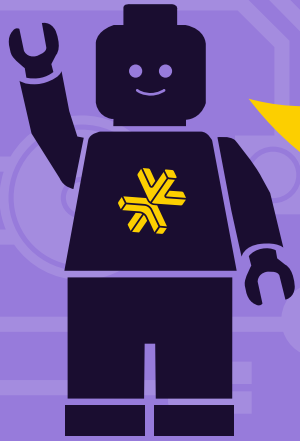

**HOLD UP!**

You might notice some bags aren't in order, as well as left over pieces, but that's ok! We're changing the way you build LEGO!

ATTENDEZ!

Vous remarquerez peut-être que certains sacs, ainsi que certaines pièces, ne sont pas dans le bon ordre. Mais pas de panique! Nous changeons simplement la façon avec laquelle vous construisez vos LEGO!

ASPETTA!

Potresti notare che alcuni sacchetti non sono in ordine, così come i pezzi avanzati, ma va bene così! Stiamo cambiando il modo in cui costruisci i LEGO!

HALT!

Sie werden möglicherweise bemerken, dass einige tüten durcheinander sind und teile übrig bleiben, aber das ist in Ordnung! Wir ändern die art und weise, wie Sie LEGO bauen!

¡ESPERA!

Es posible que notes que algunas bolsas están fuera de servicio, así como piezas sobrantes, ¡pero está bien! ¡Estamos cambiando la forma en que construyes LEGO!

暫停!

你可能会注意到一些袋子顺序错乱, 以及一些剩余的部件, 但没关系! 我们正在改变你搭建乐高的方式!

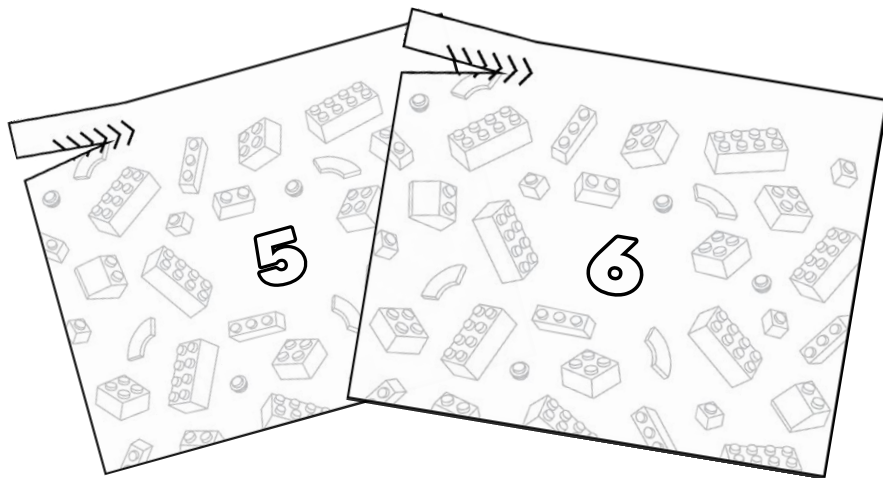
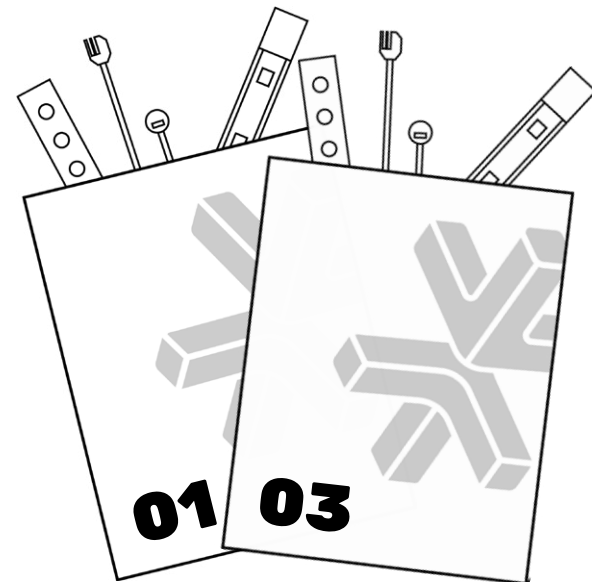
Open LEGO® Bag 5 and 6**Open LMB Bag 01 and 03**

150

1x



151

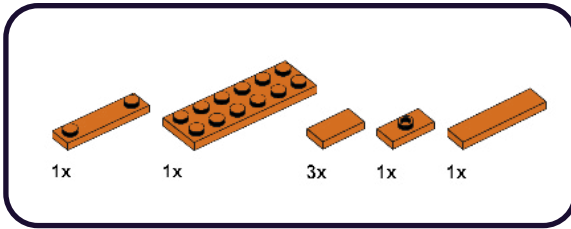

1

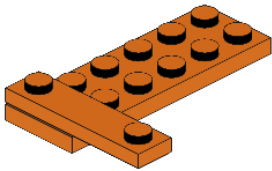

2

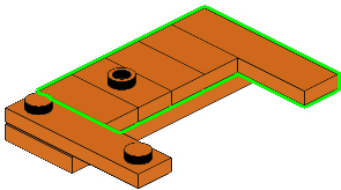

152

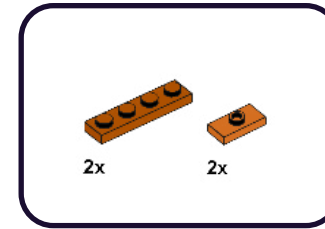

3

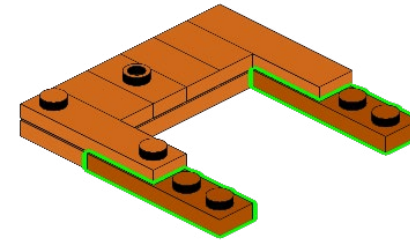

4

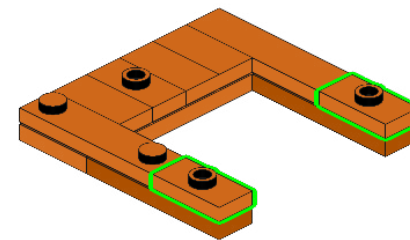

153

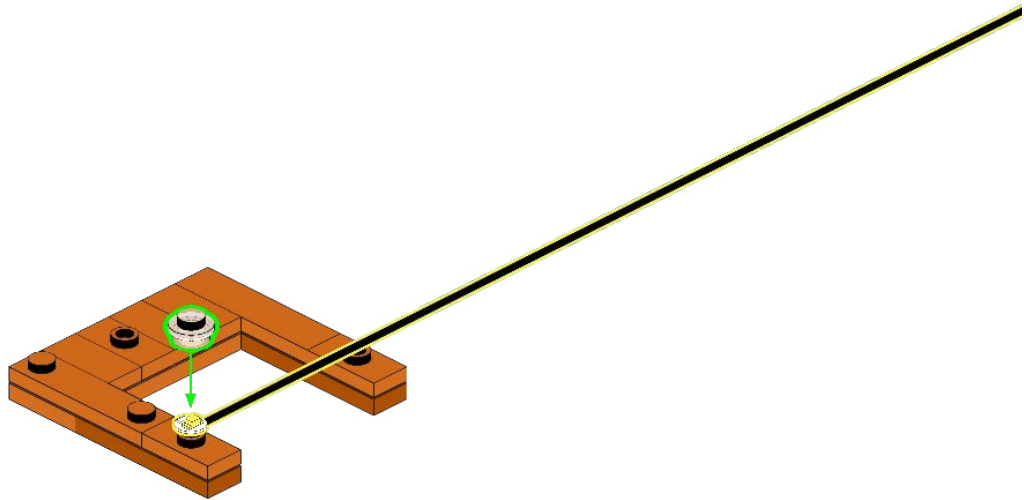
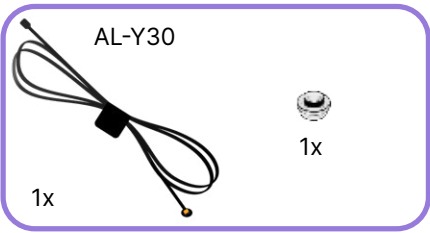

154

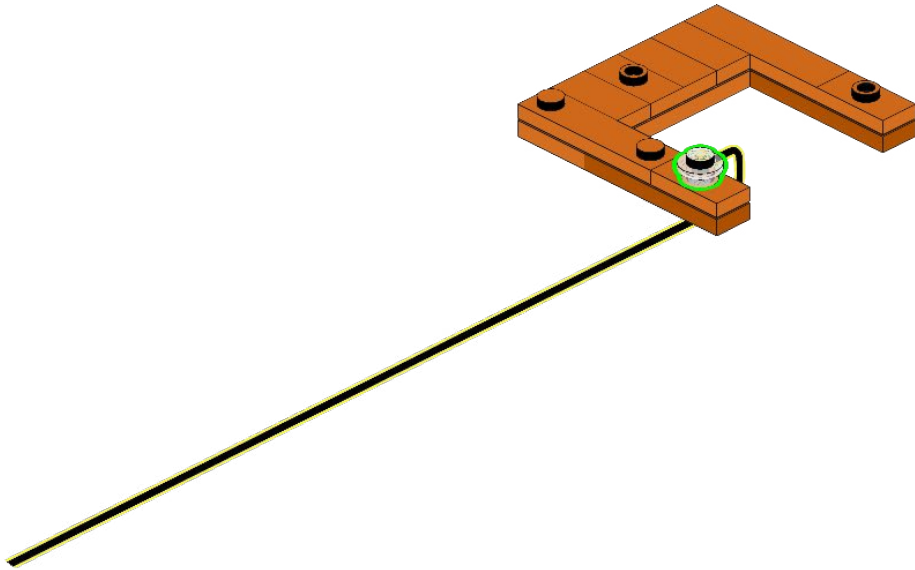
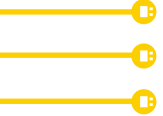

155

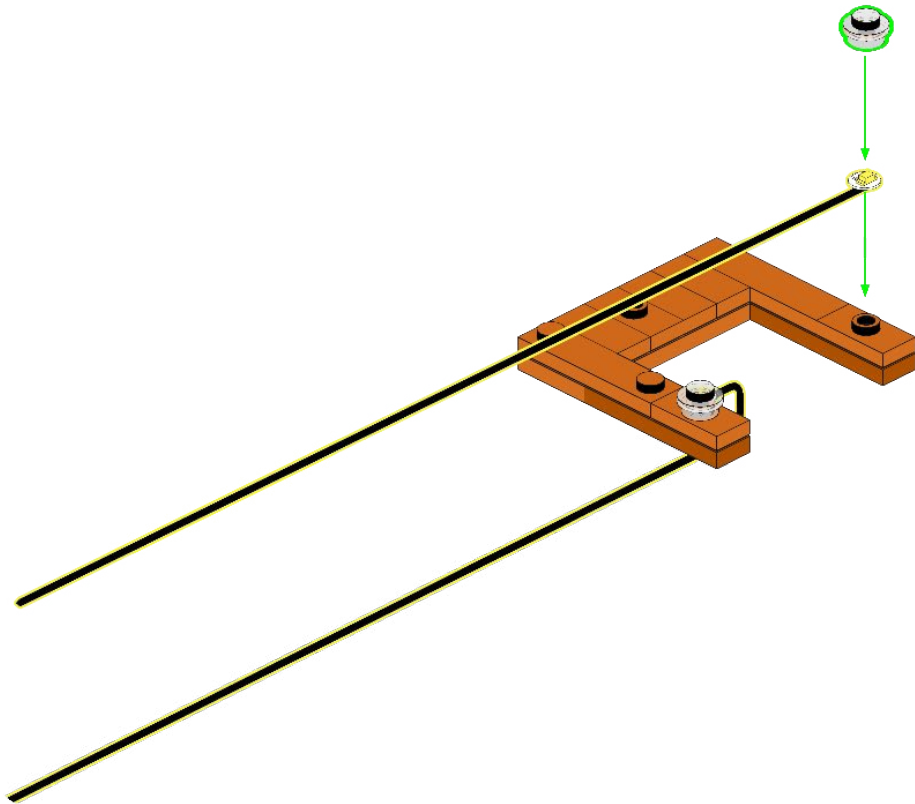
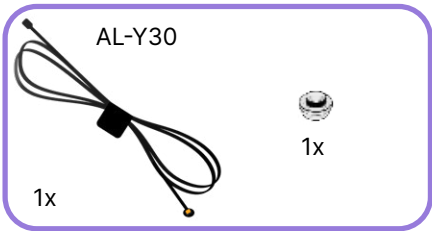

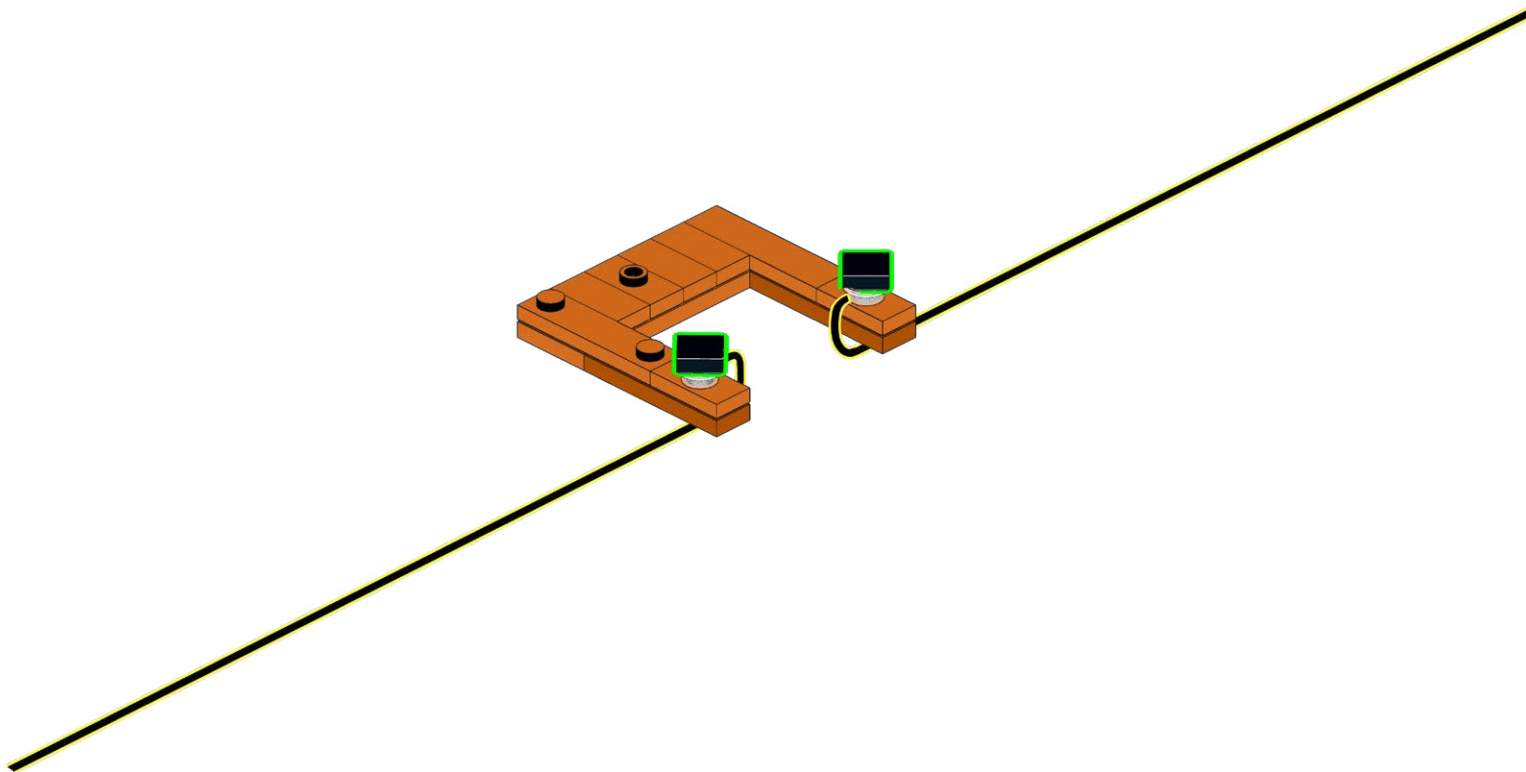
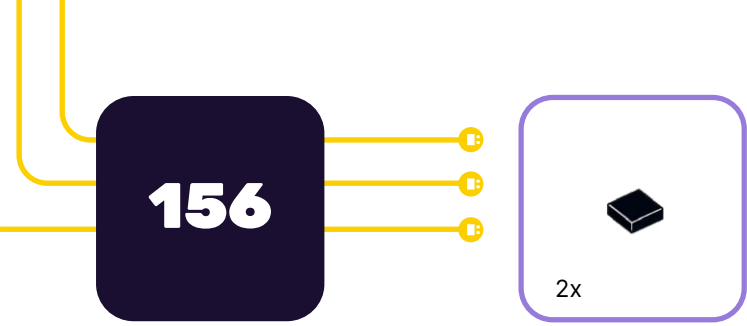

157

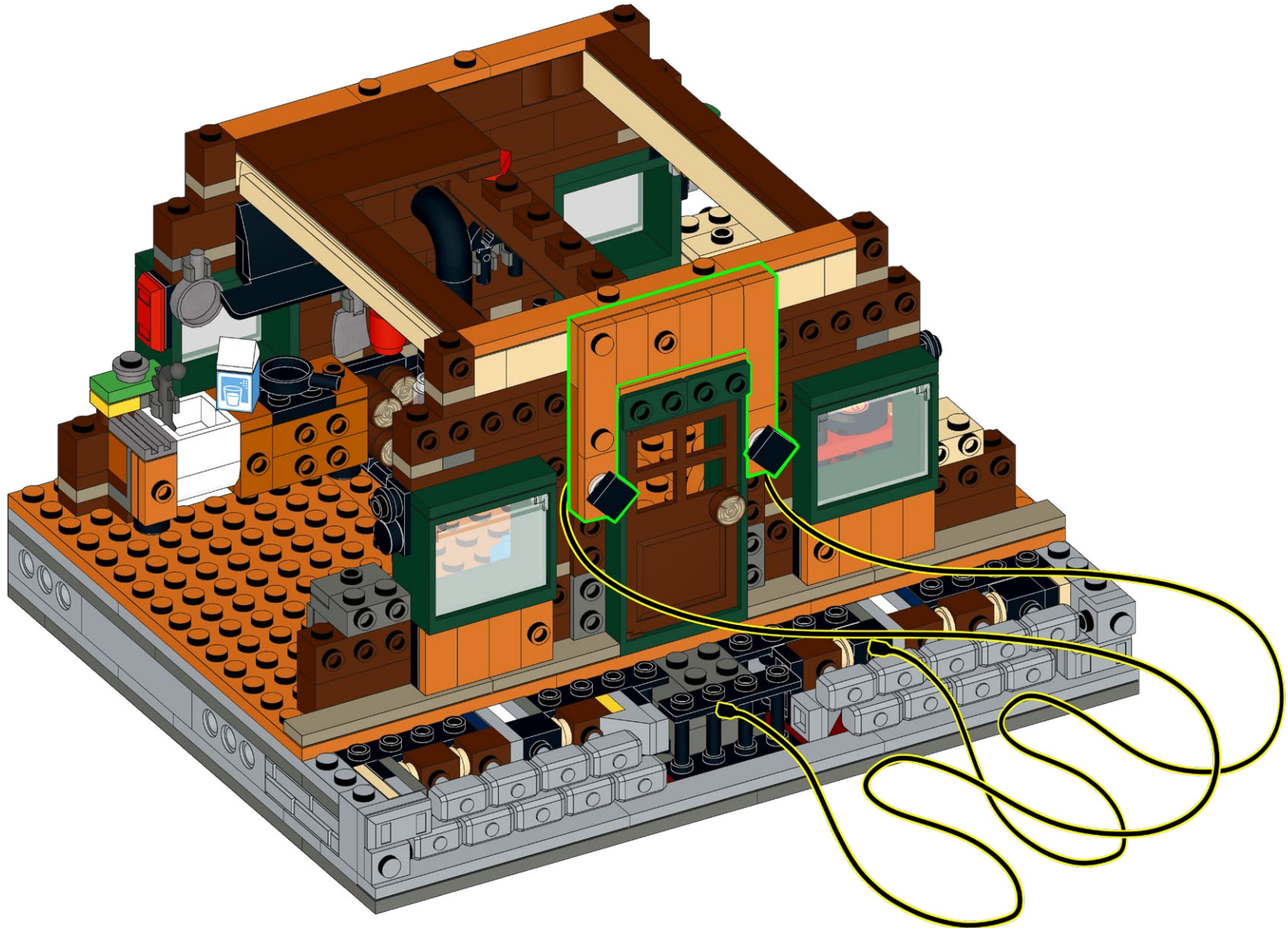

158

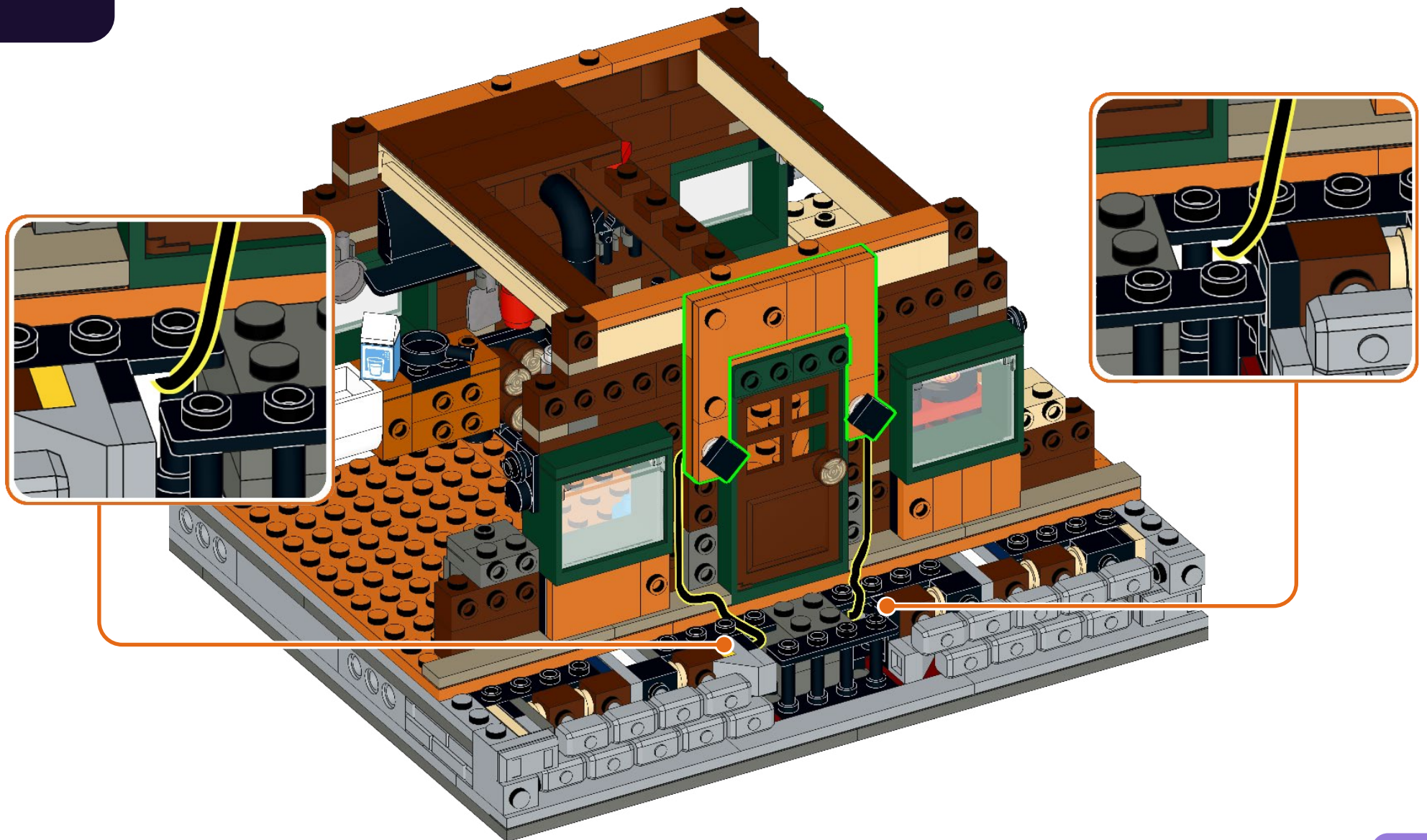

159

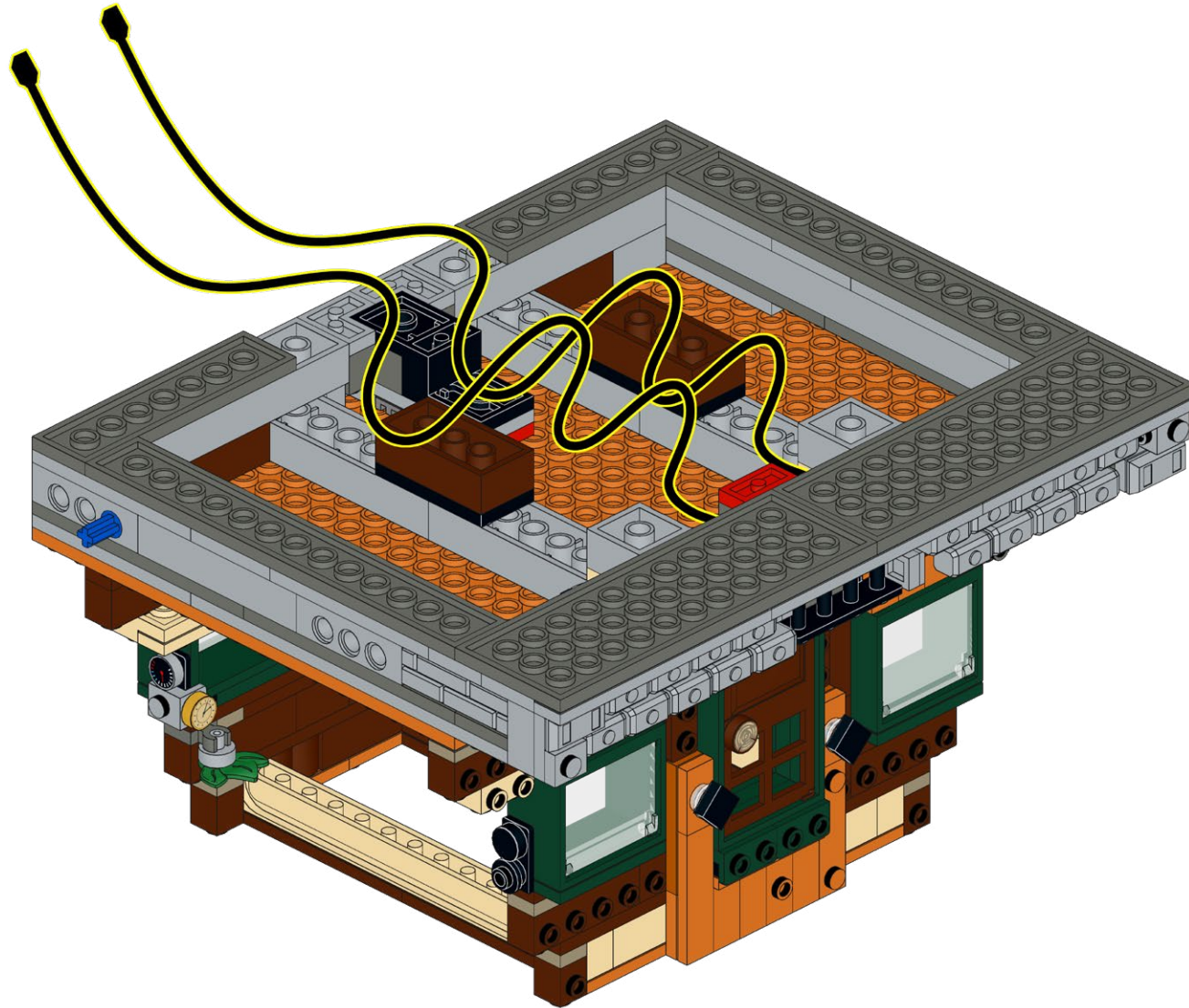

160

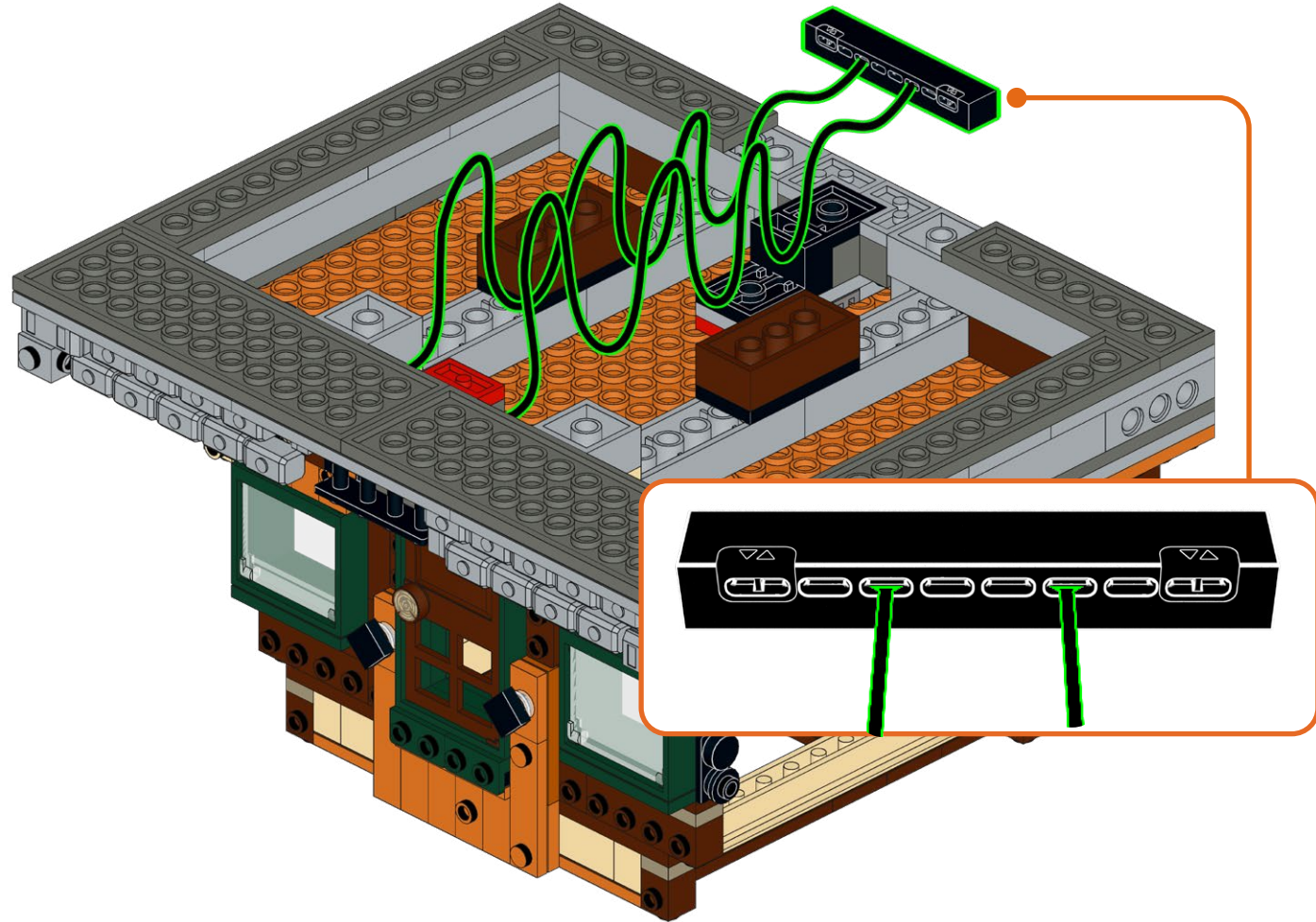

161

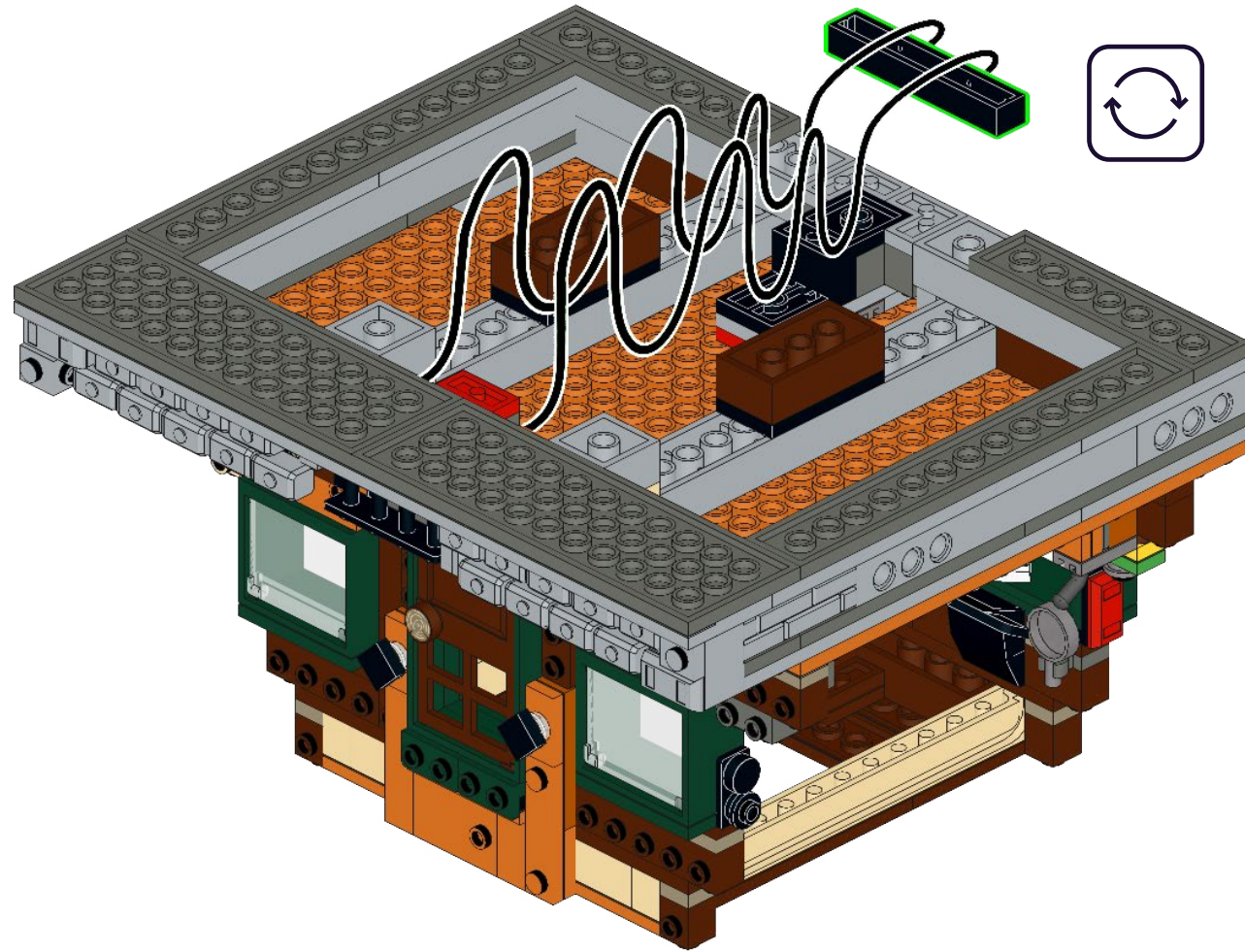

162

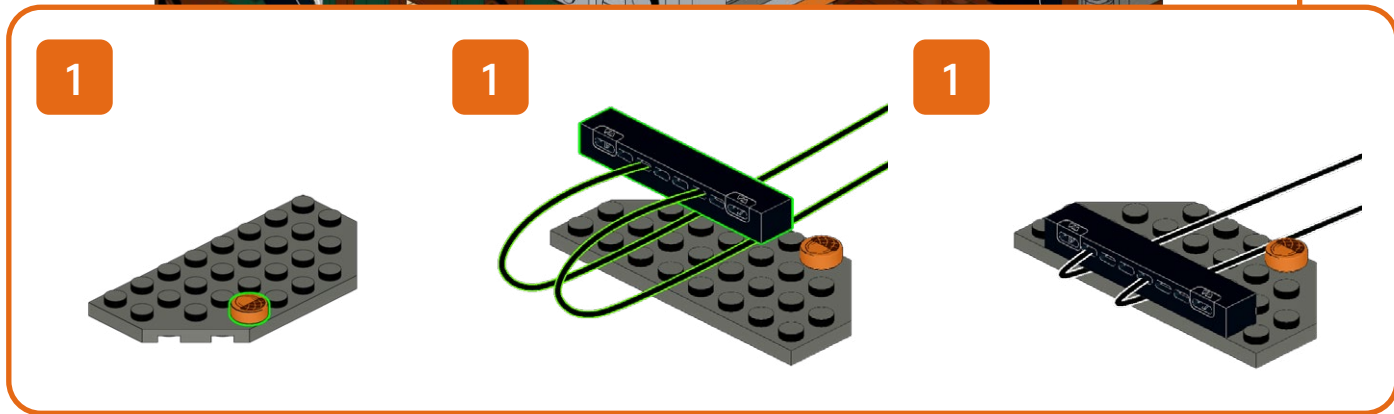
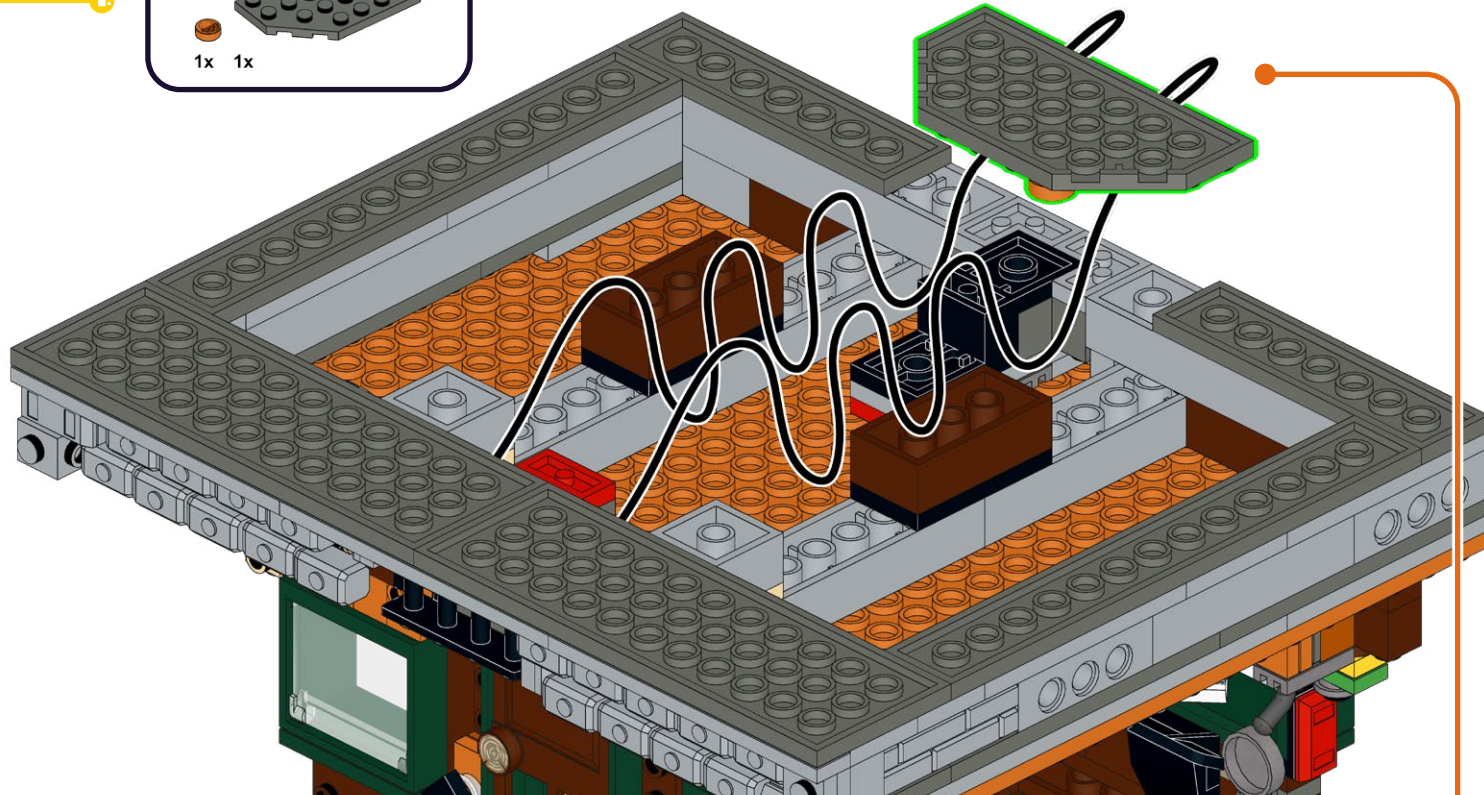
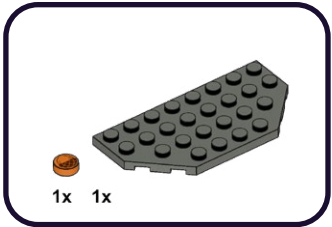

163

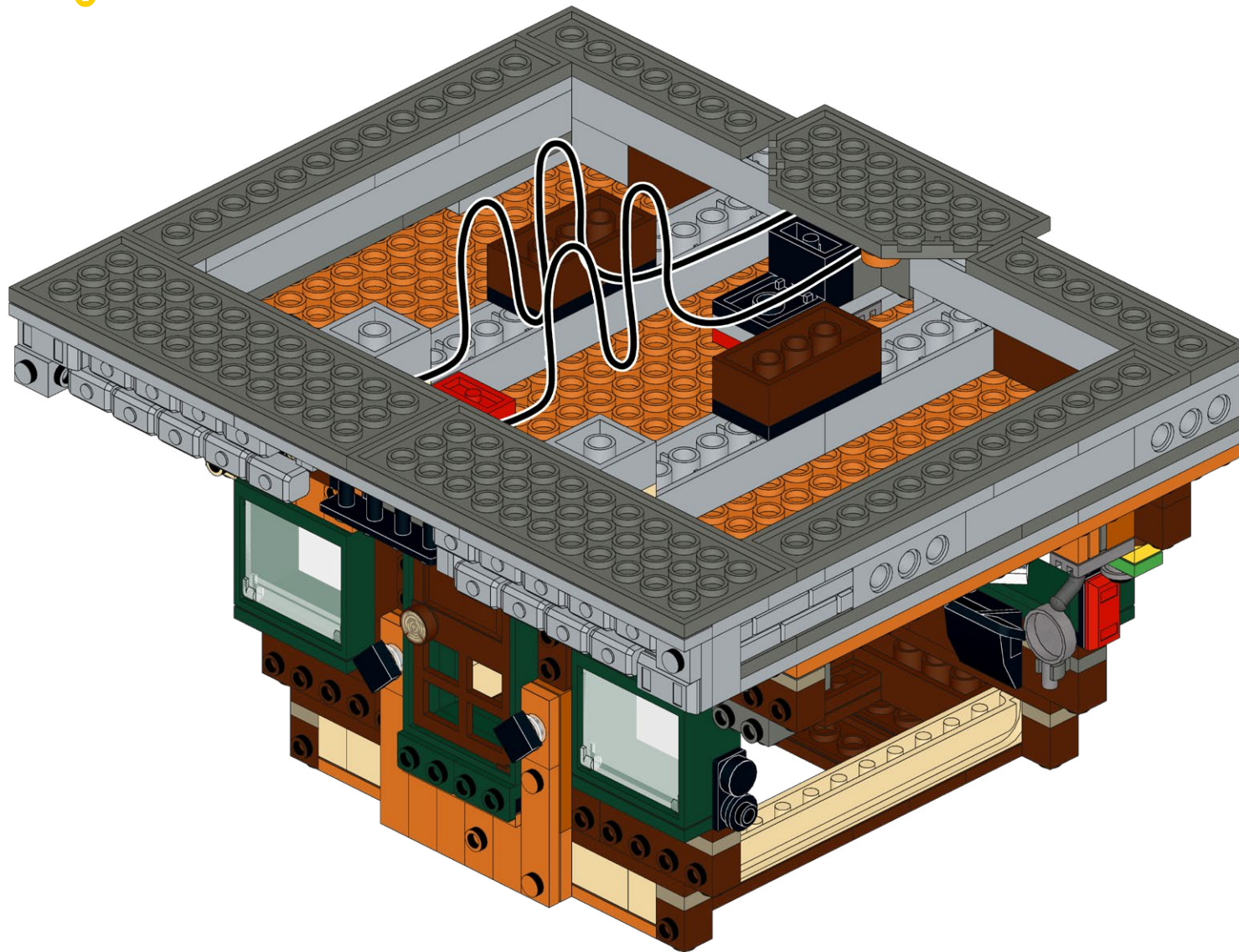

164

T-1x2

1x



165

E-1x2



1x



166



167

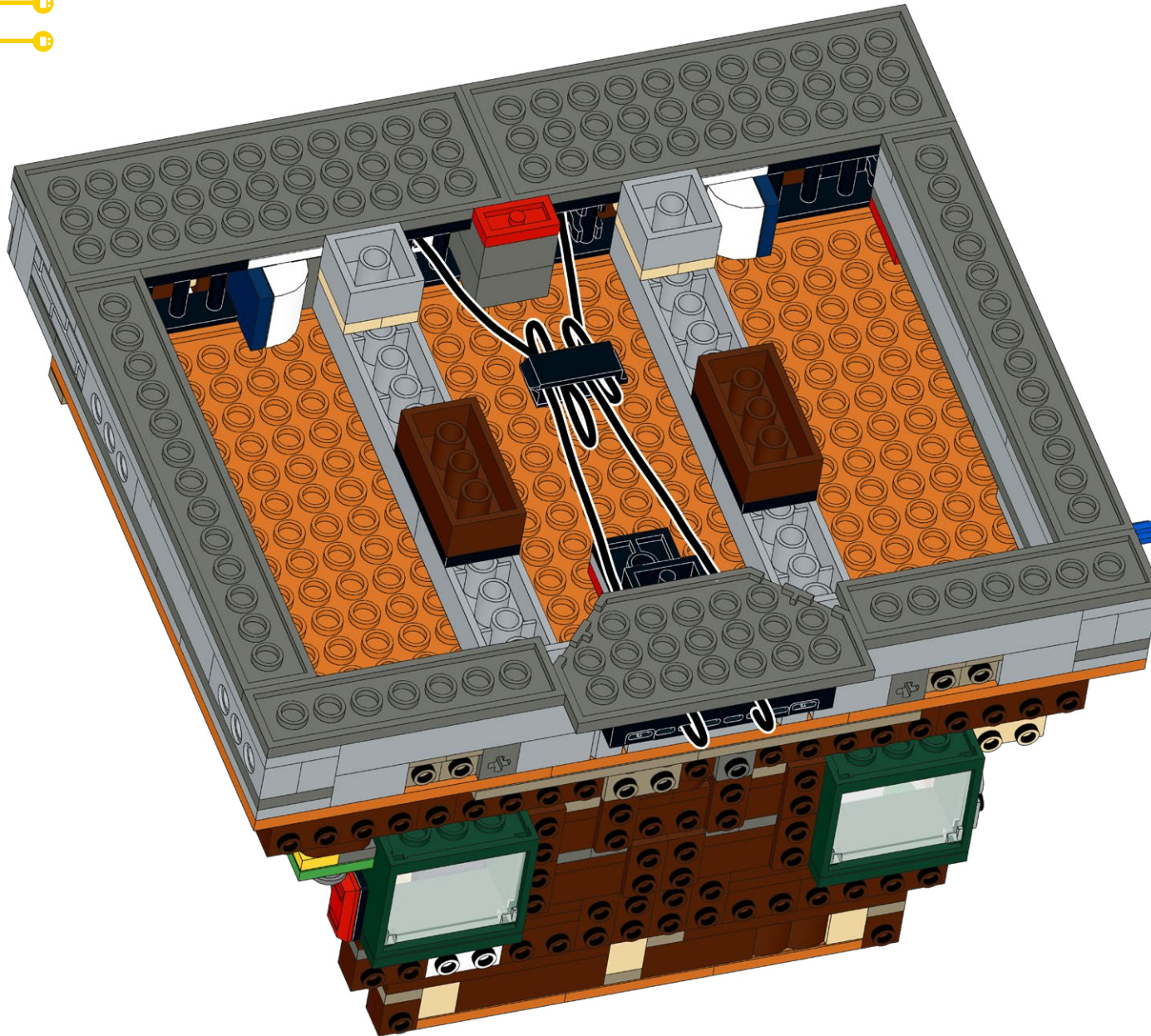

168

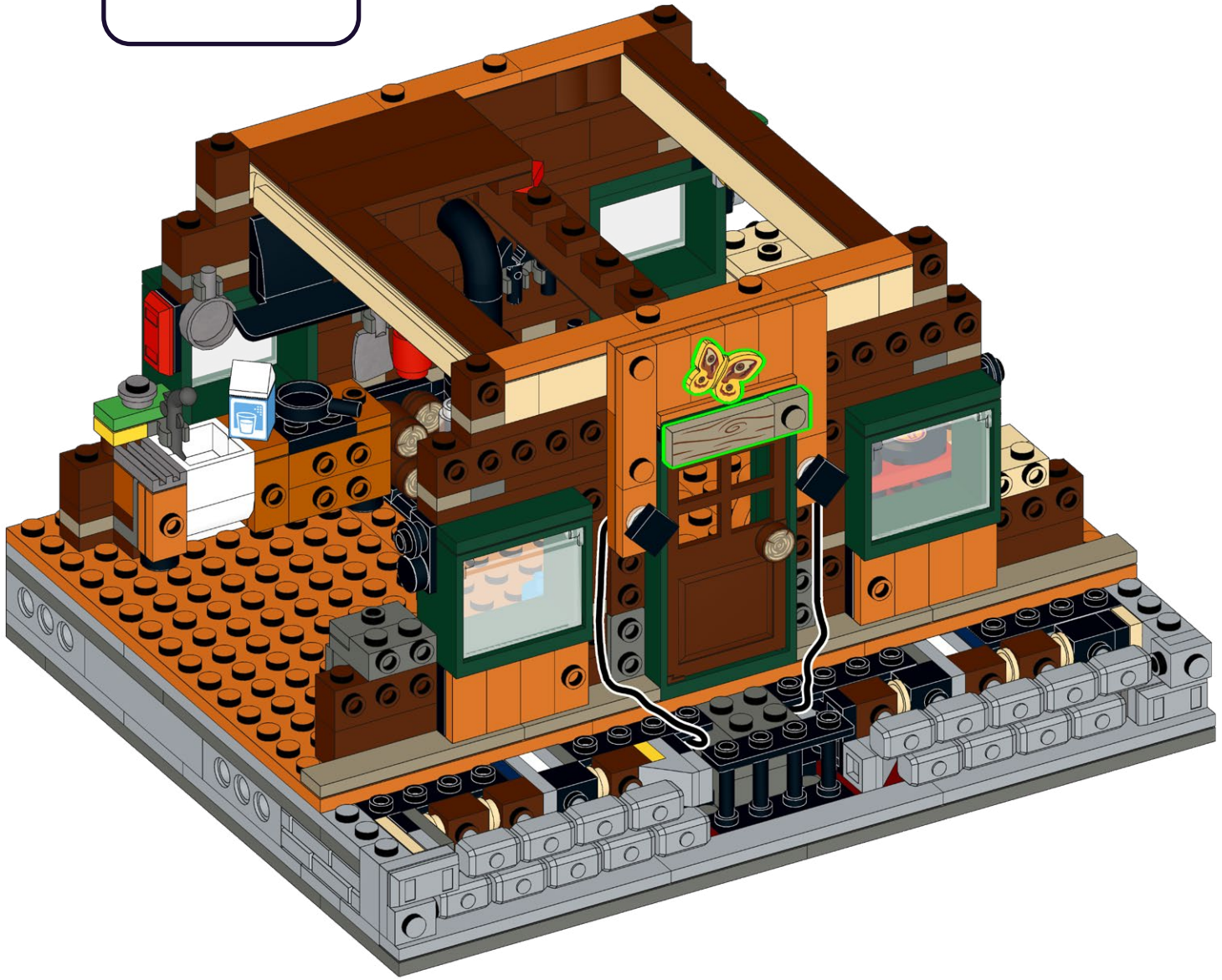
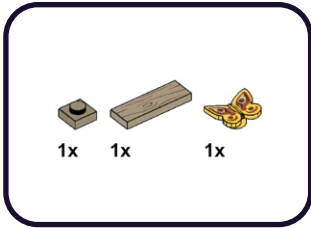

169

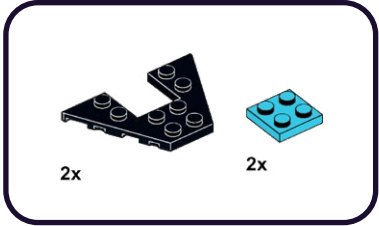

170

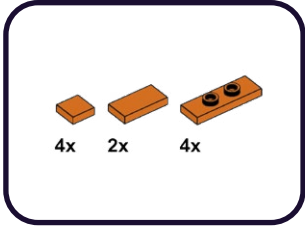

171

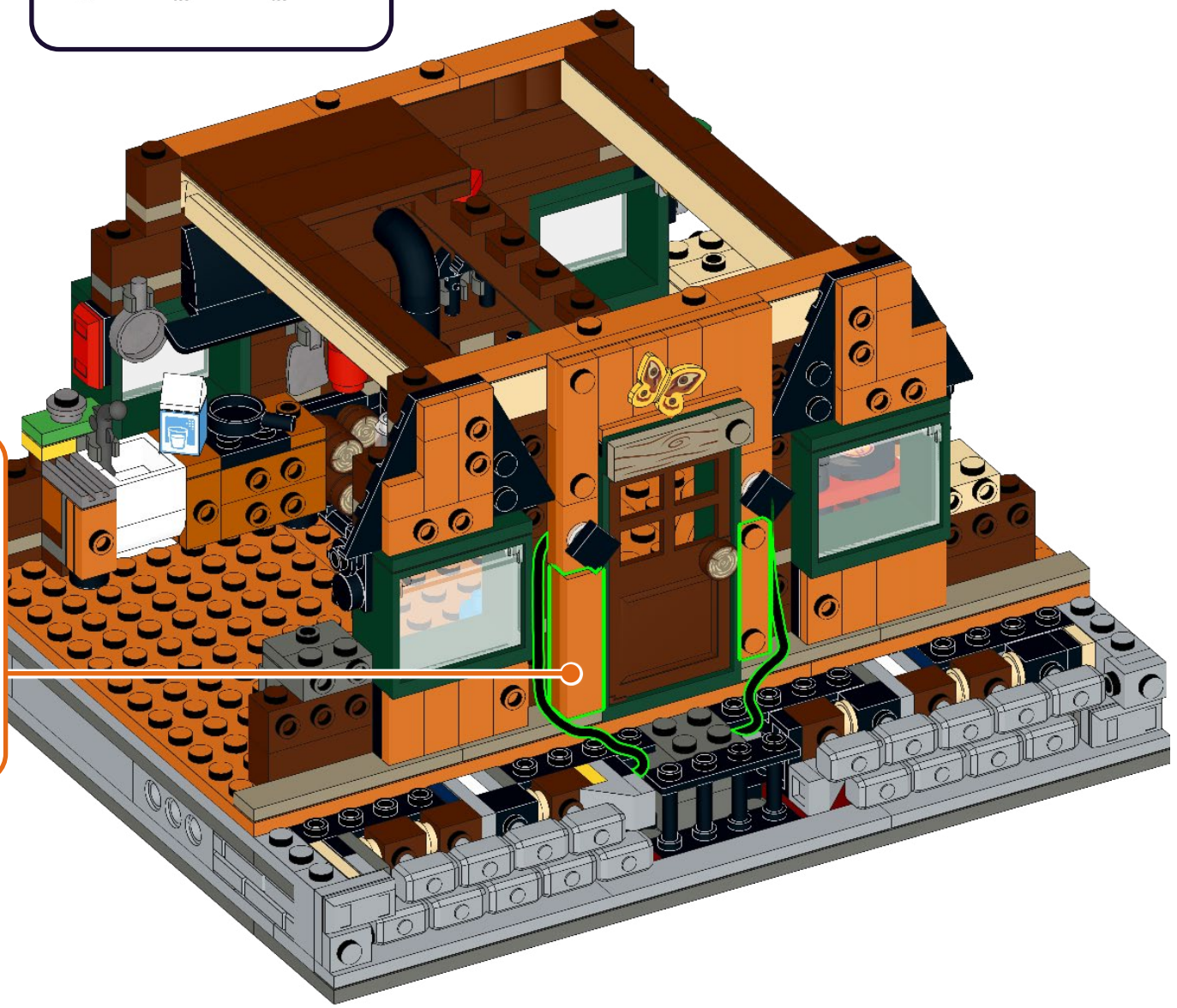
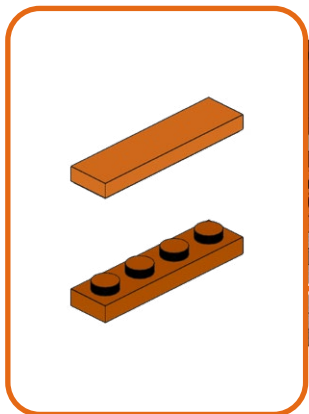
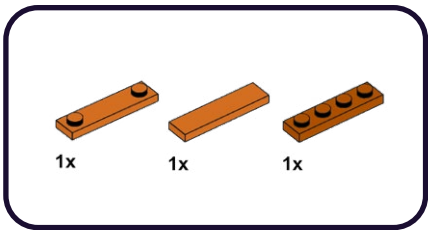

172

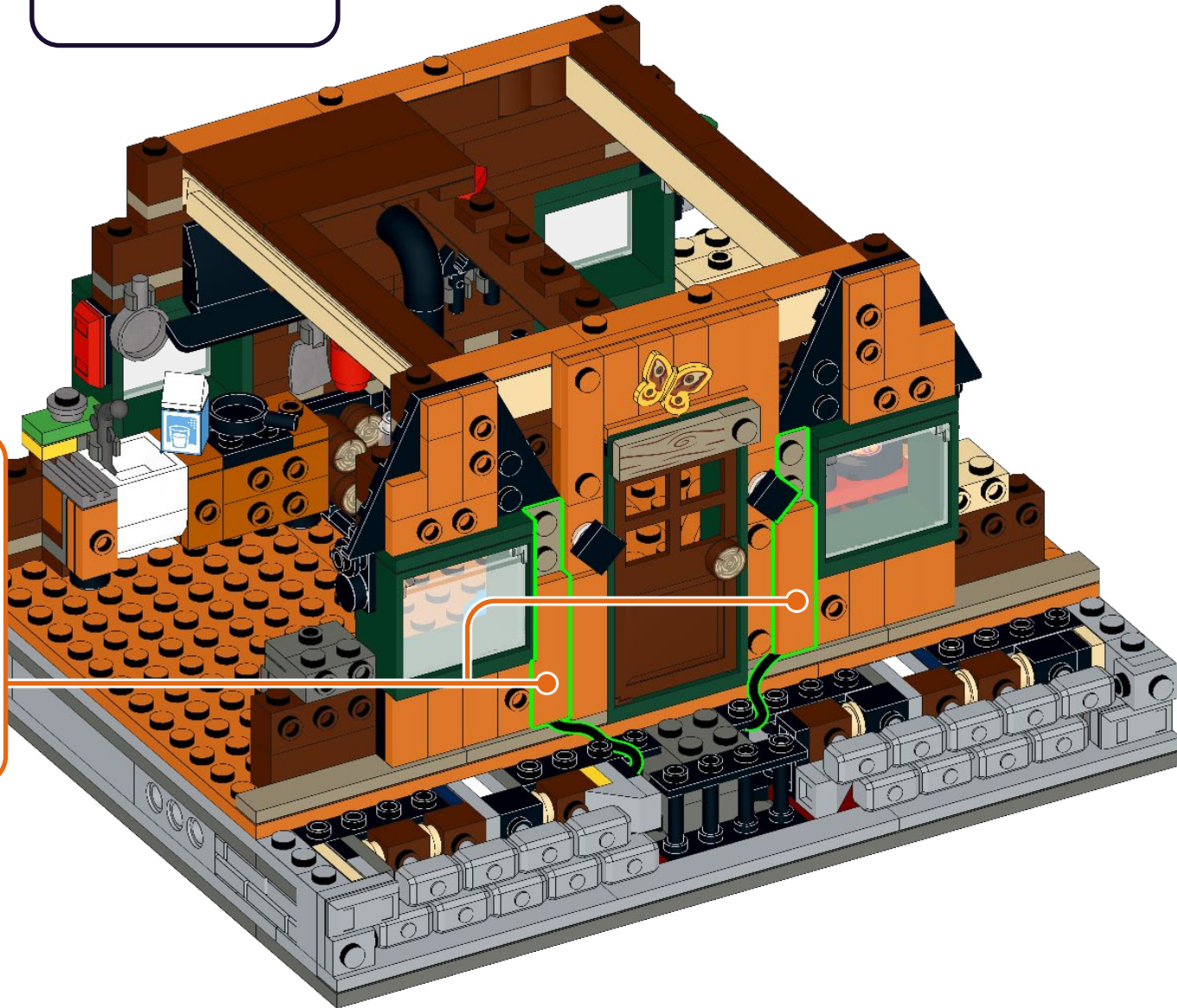
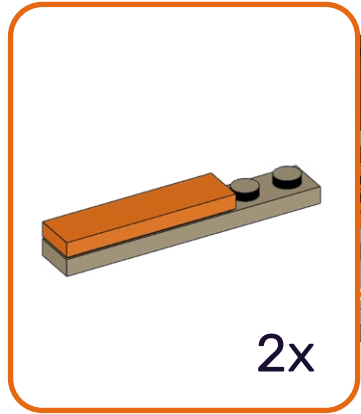
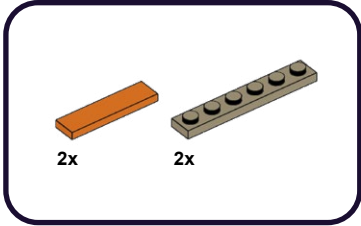

173

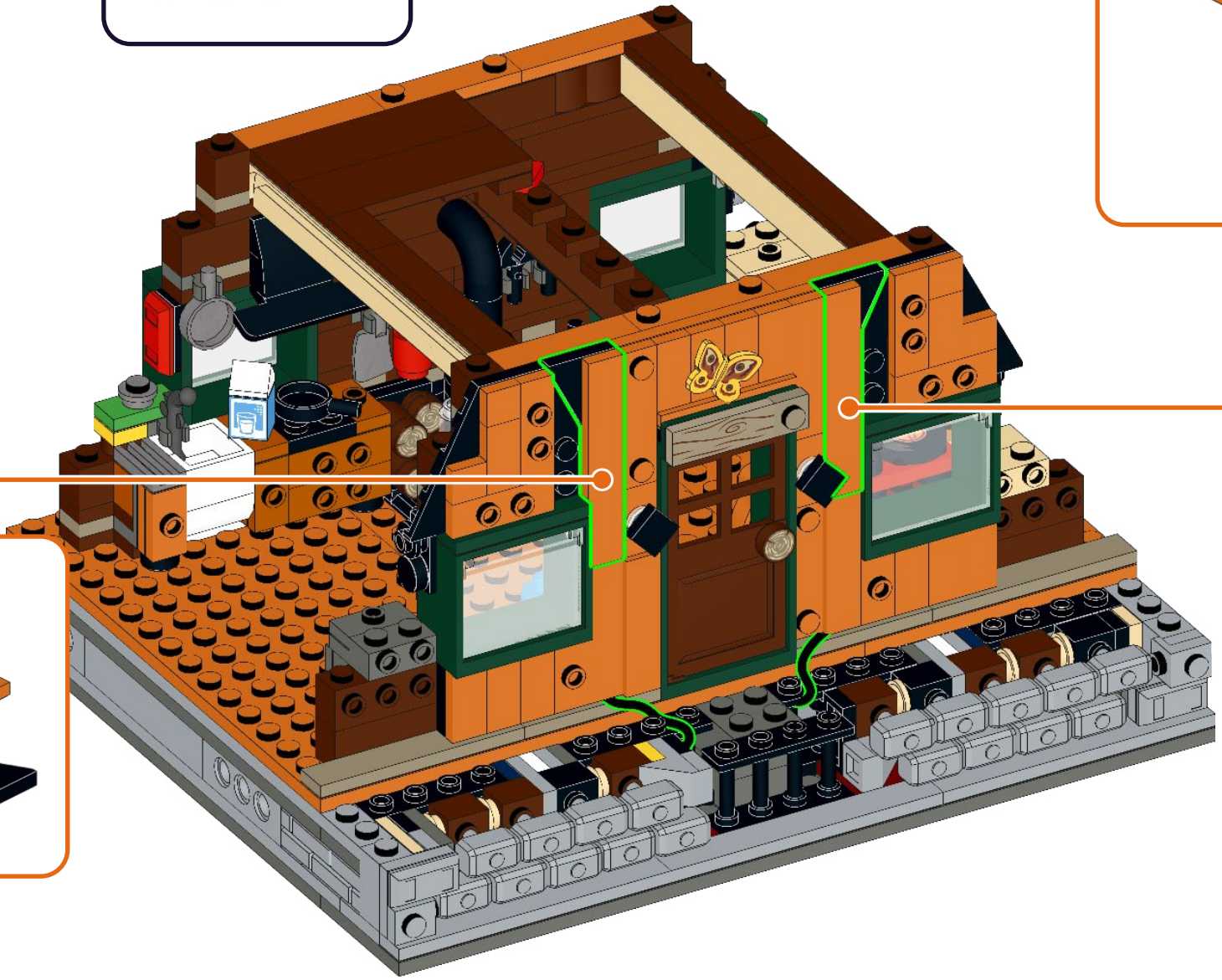
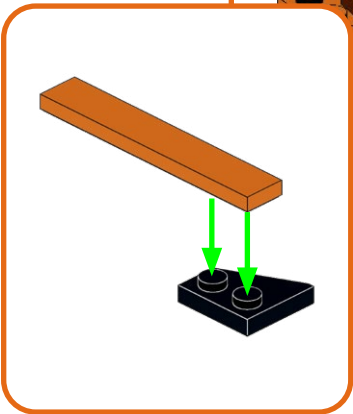
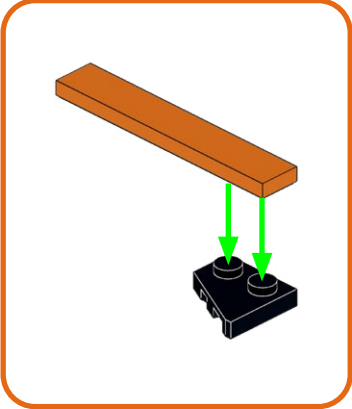
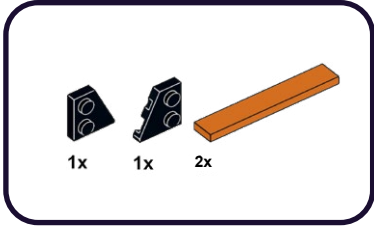

174

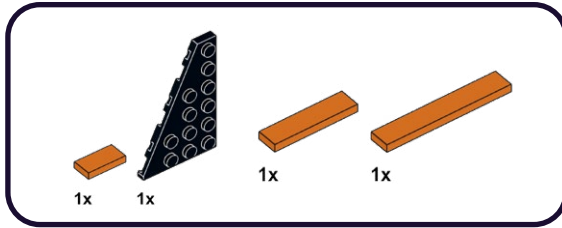

1

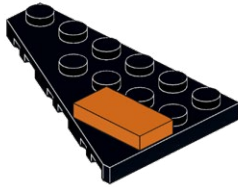

2

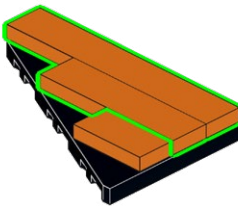

175

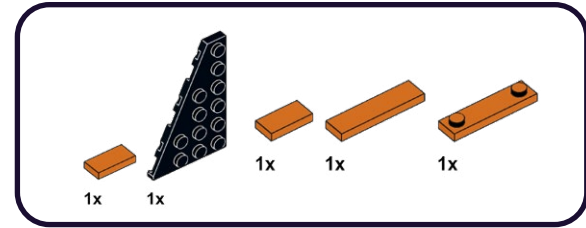

3

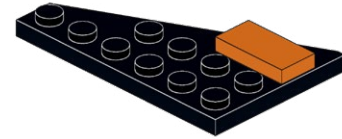

4

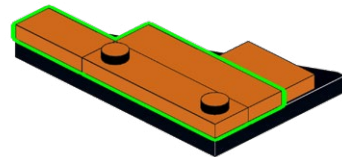

176

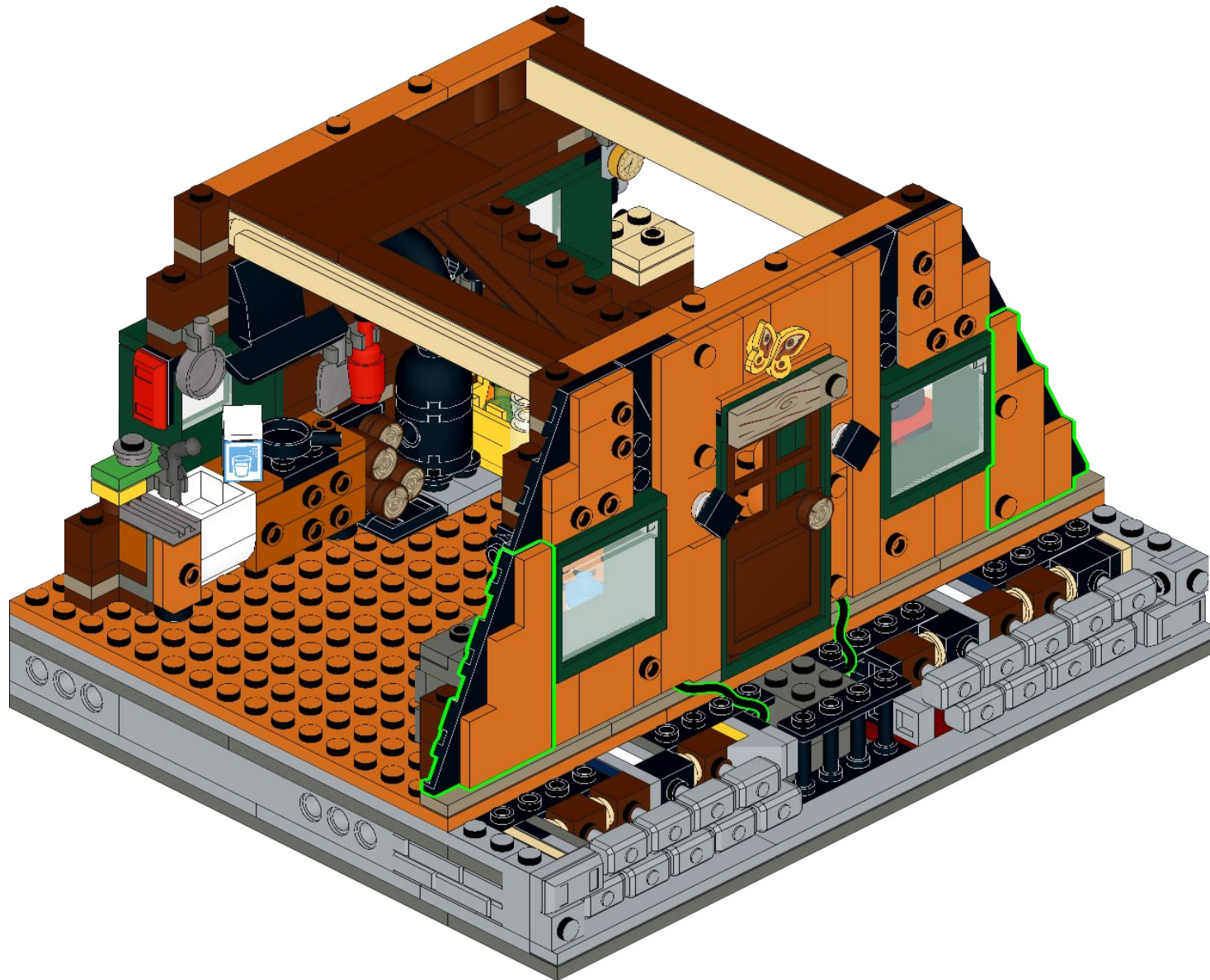

177

2x



178

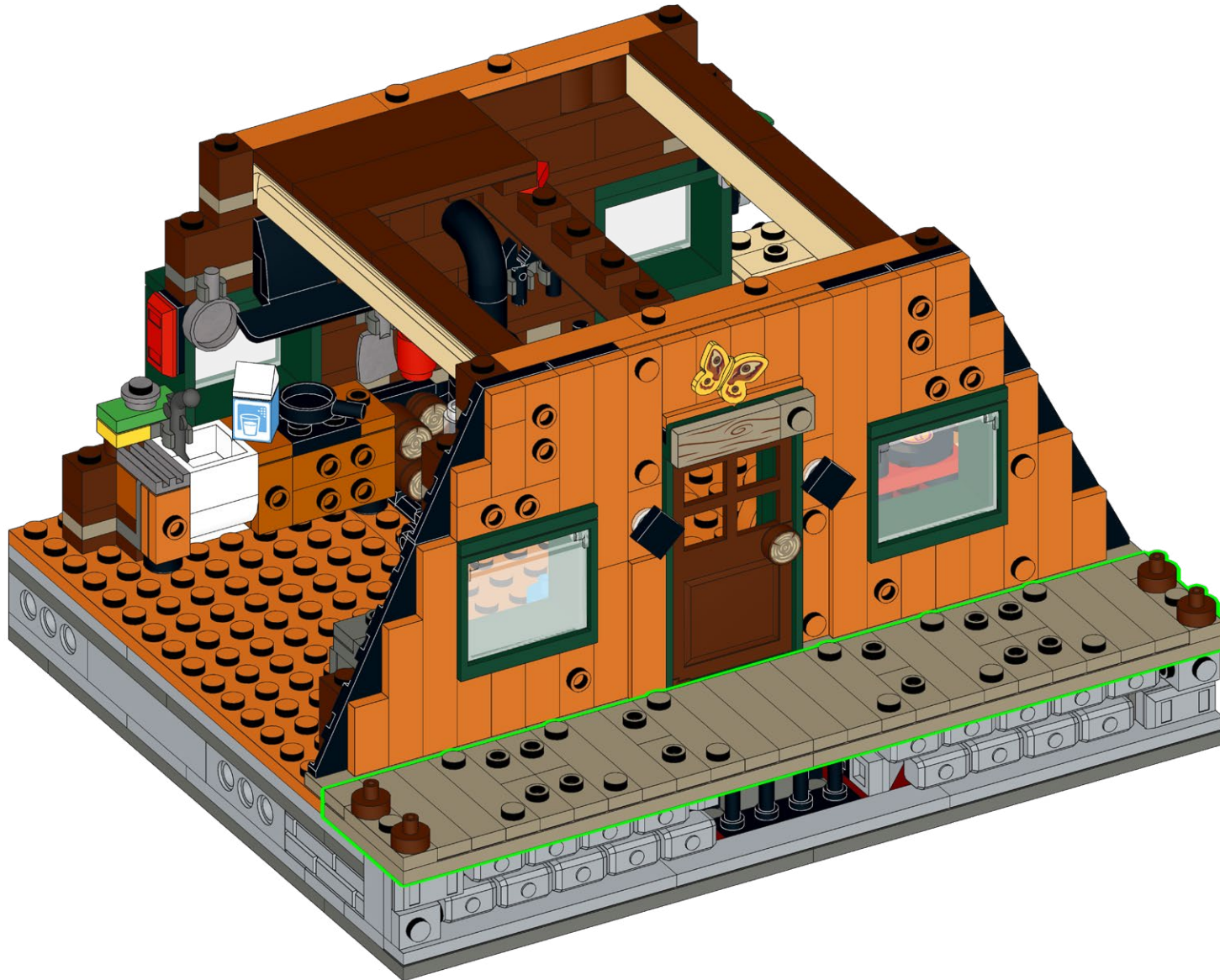

179



1x

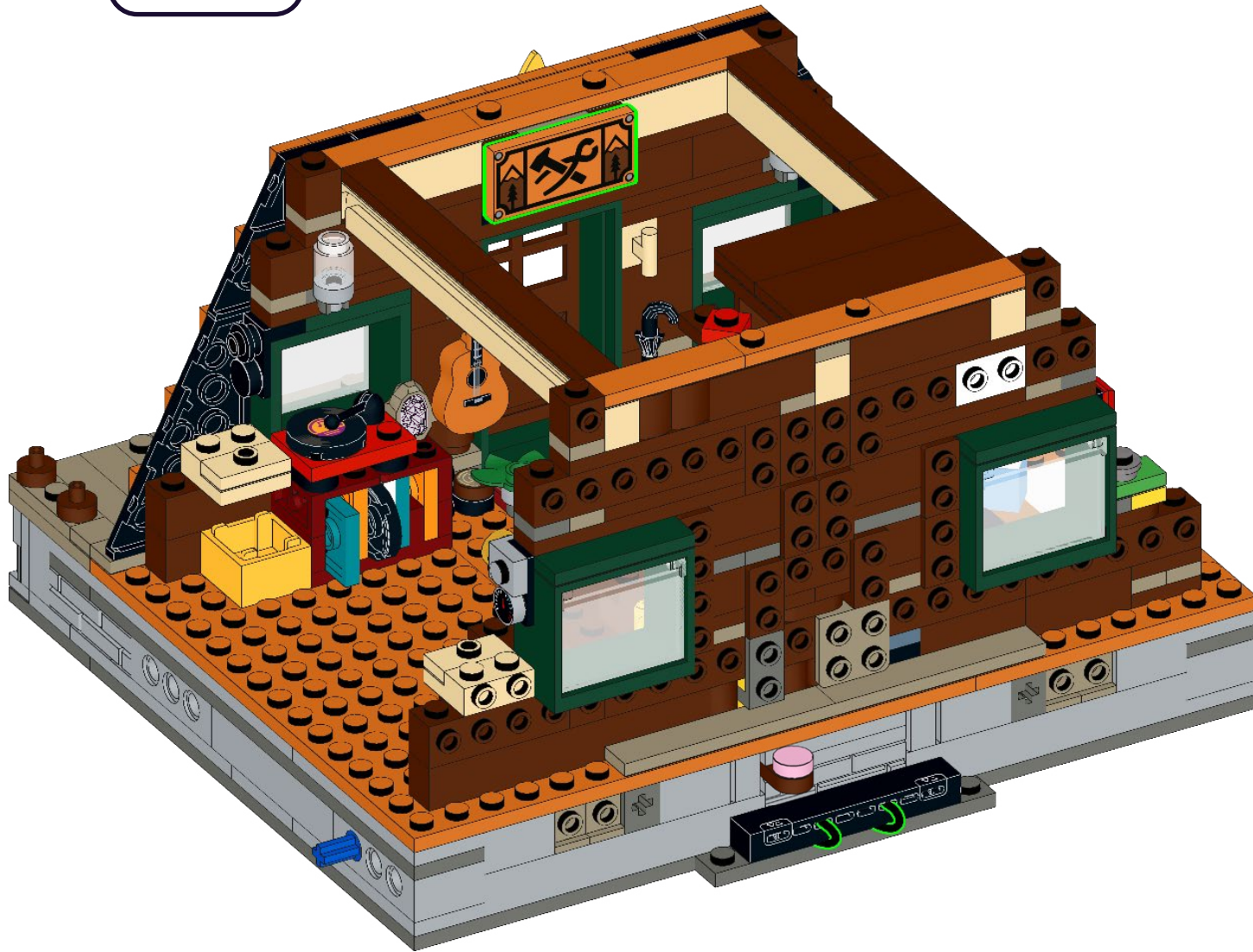

180

2x

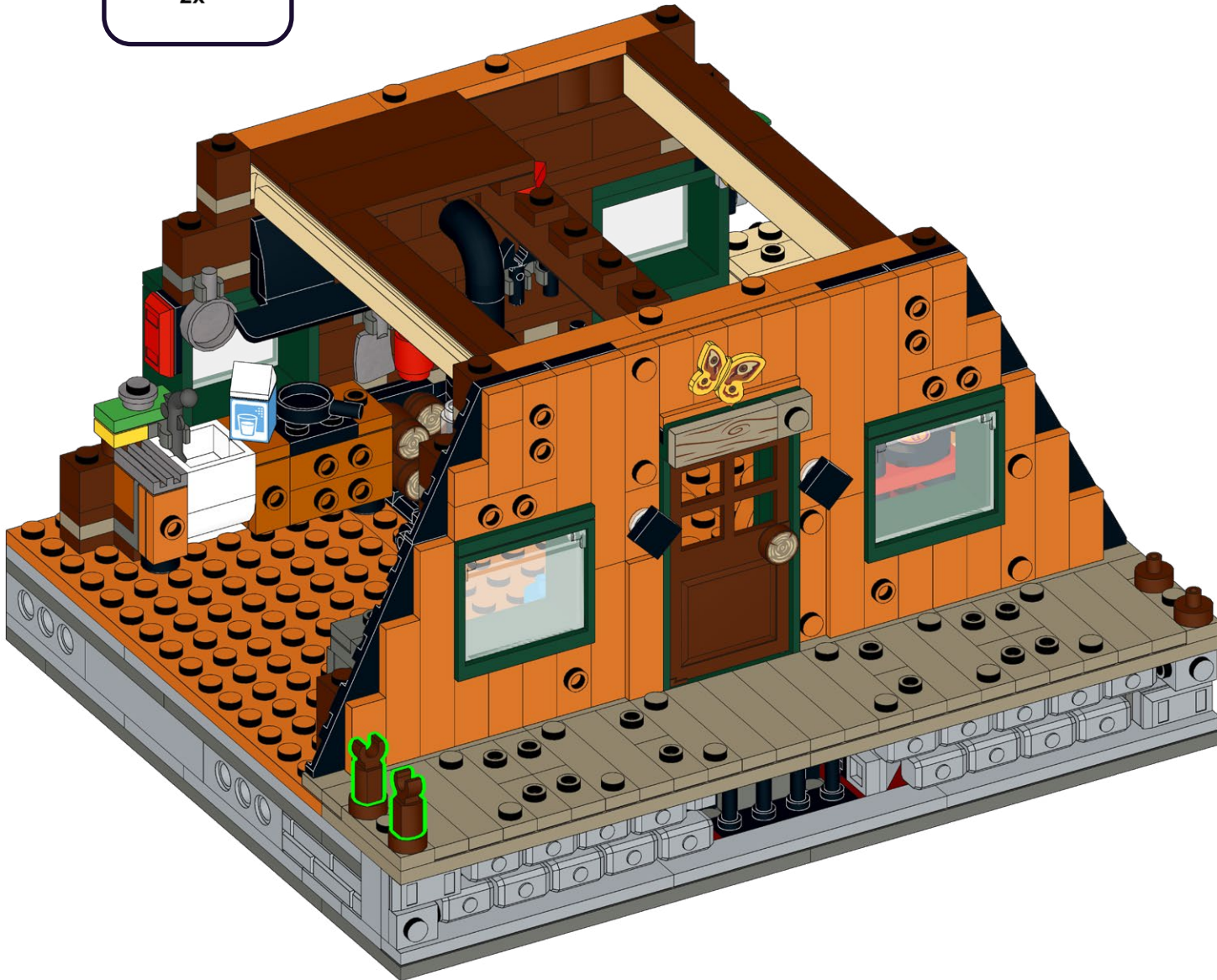

181

1x

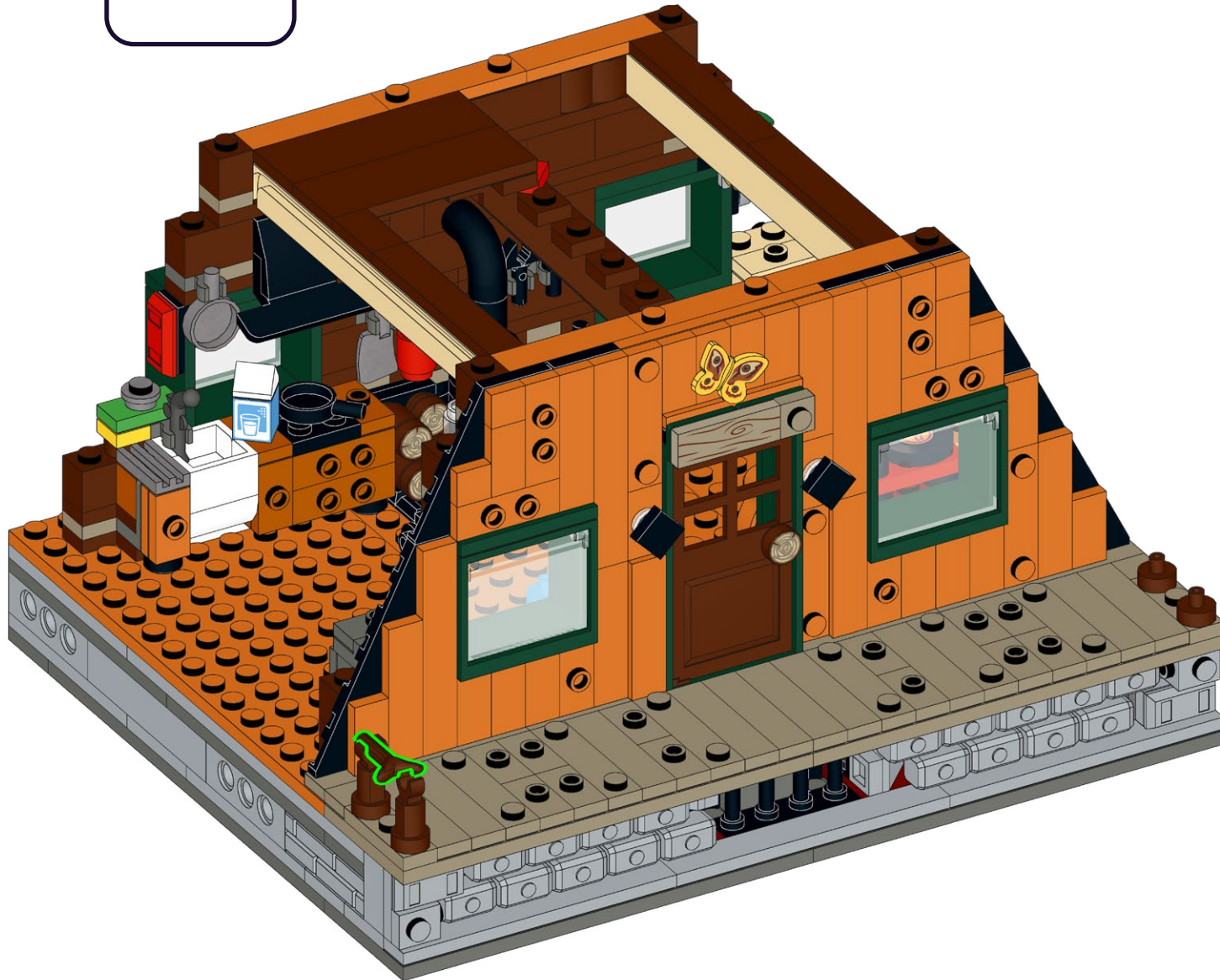

182



2x

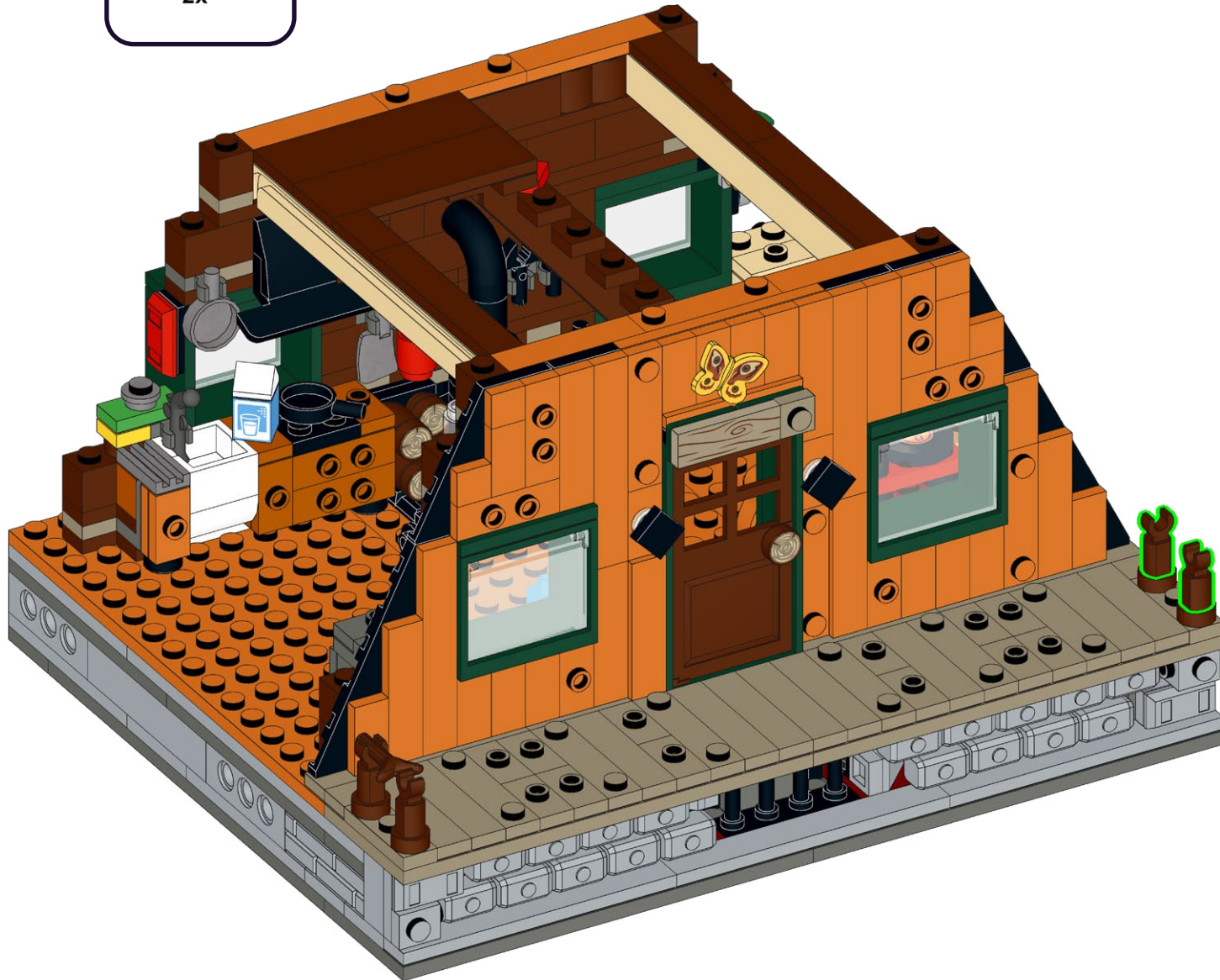

183

1x

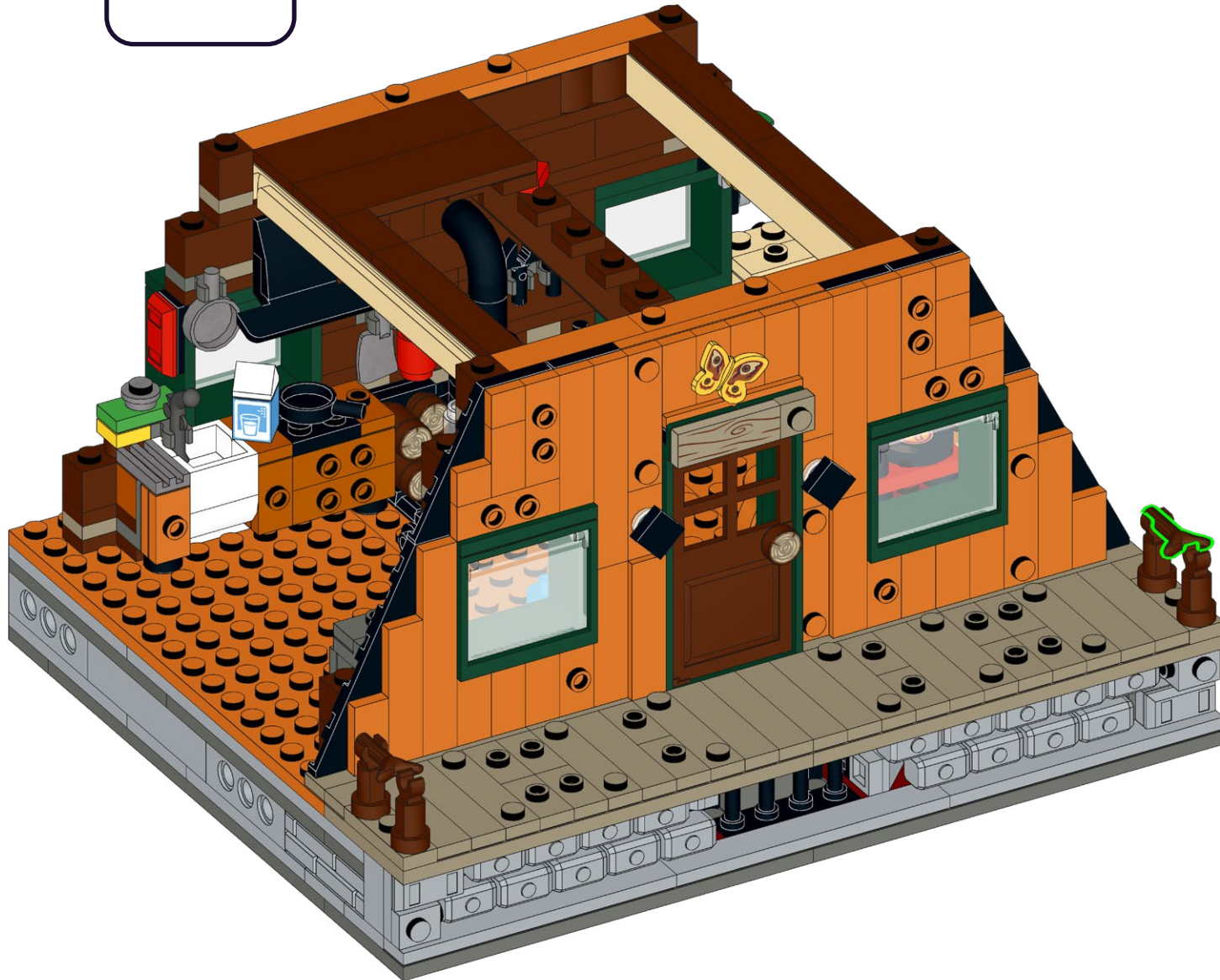

184

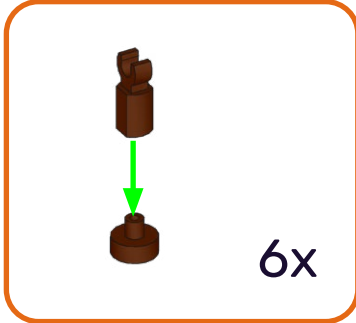
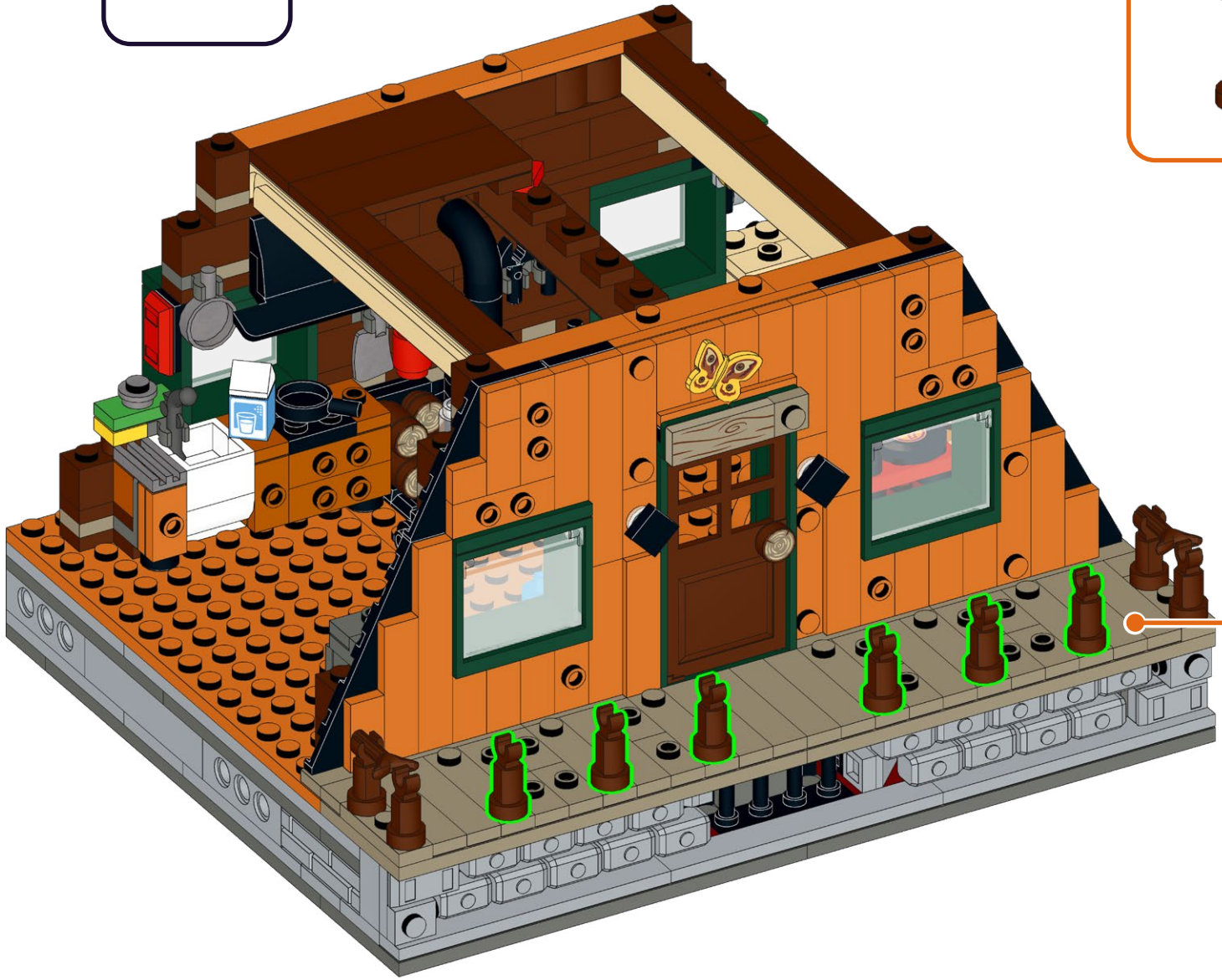
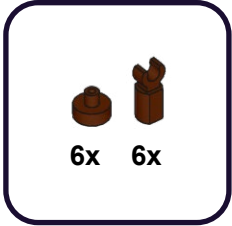

185

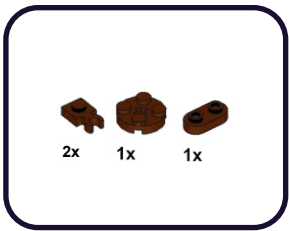

1



2



186

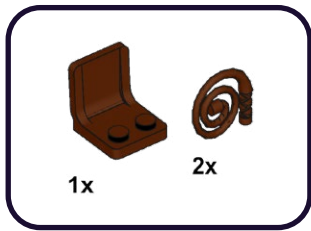

3



4

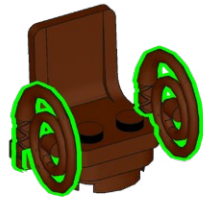

187

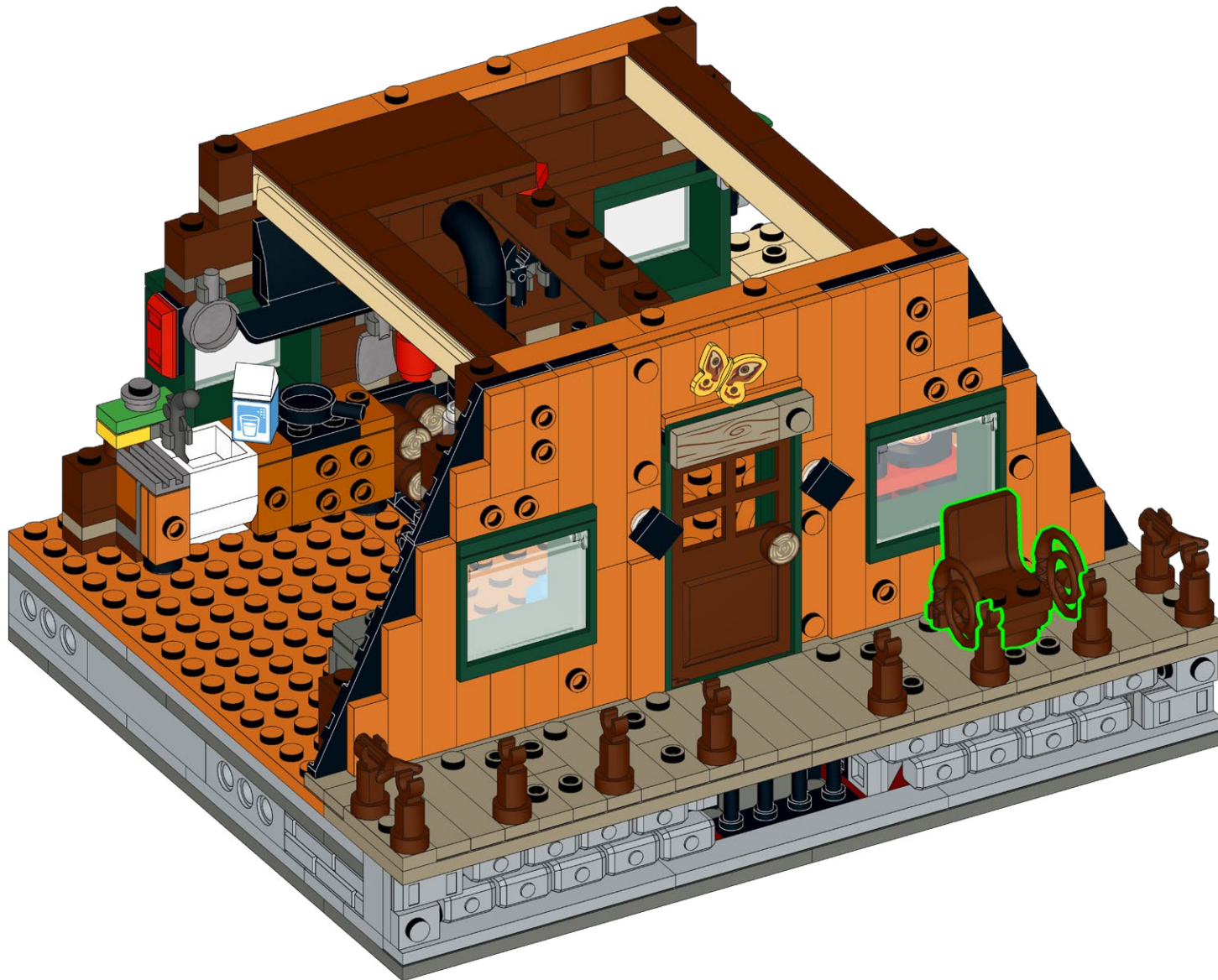

188

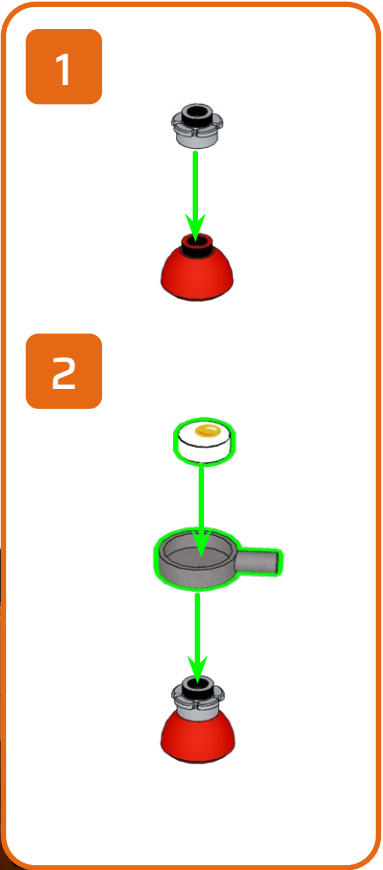
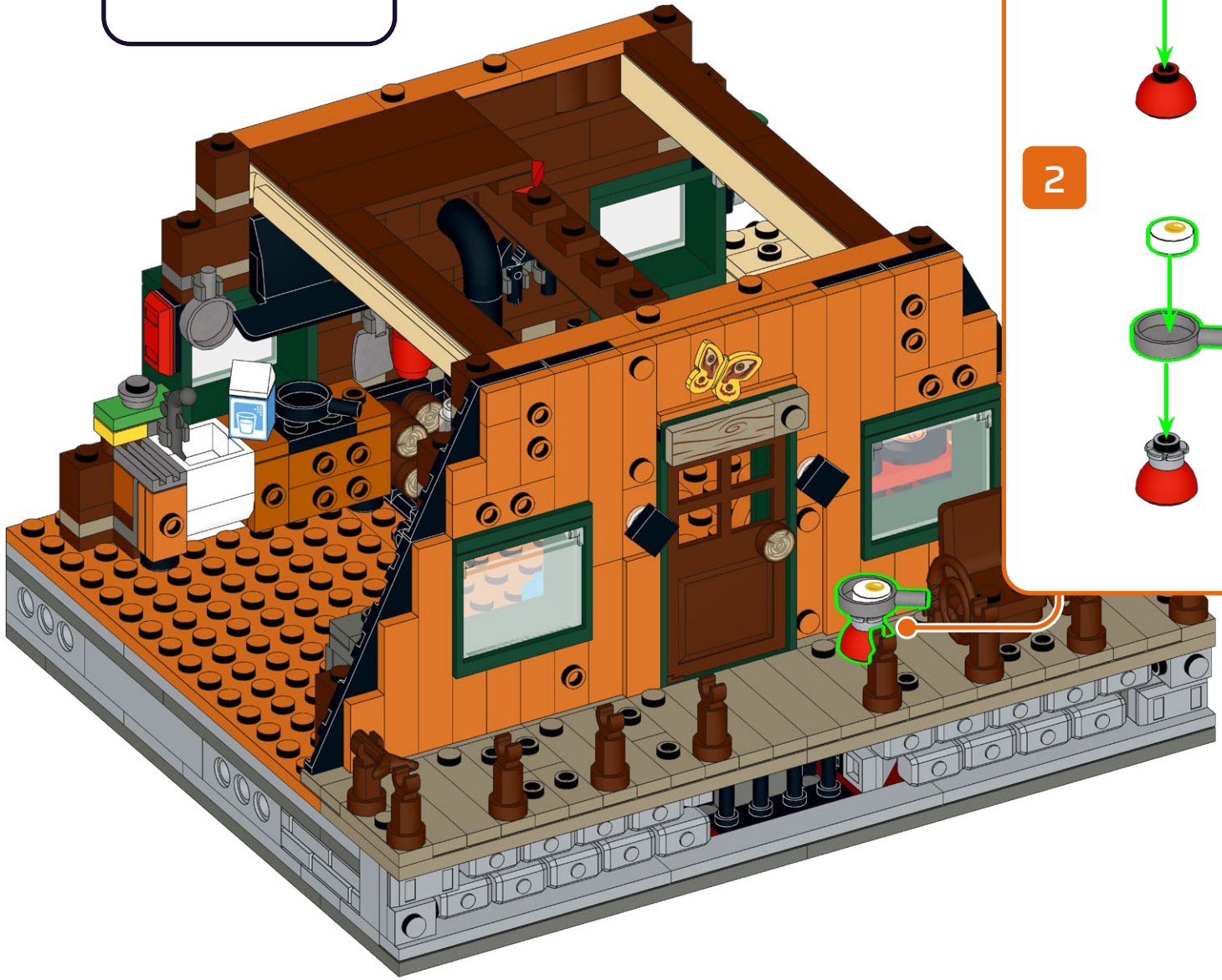
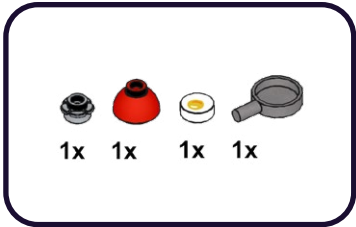

189

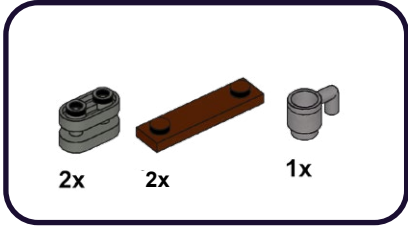

1

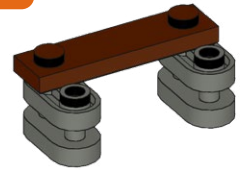

2

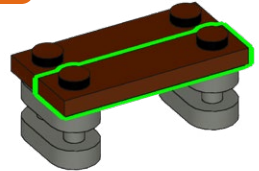

3

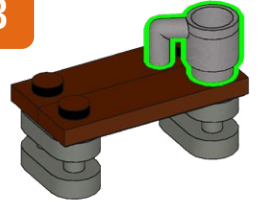

190

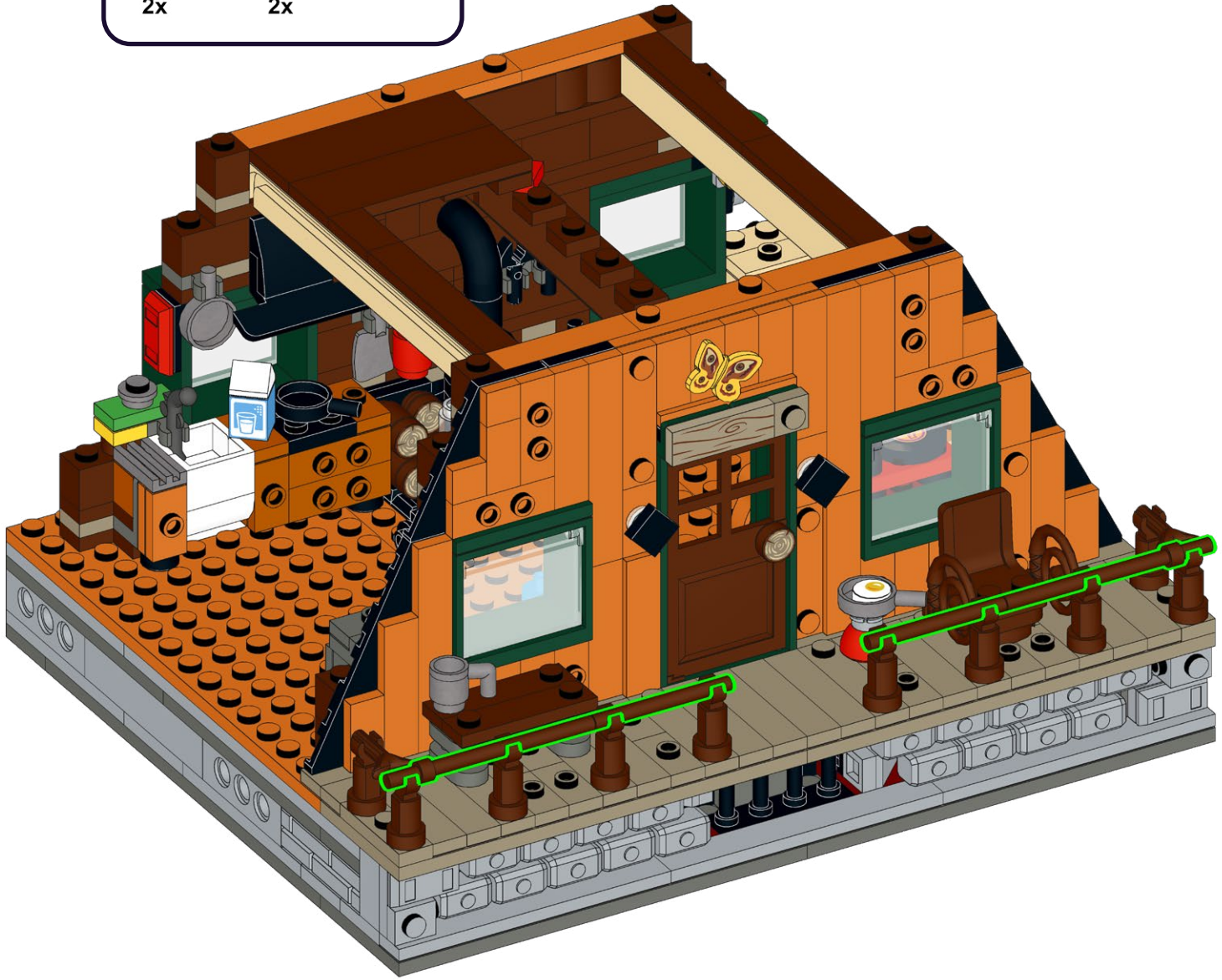
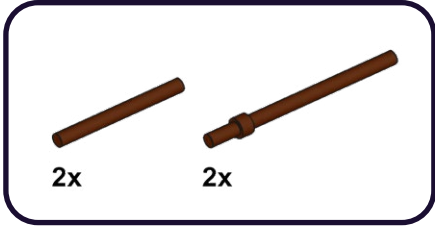

191

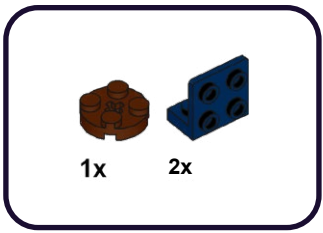

1

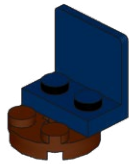

2

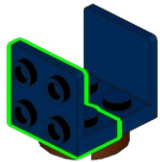

192

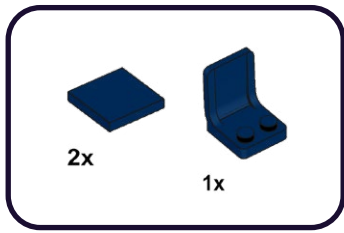

3

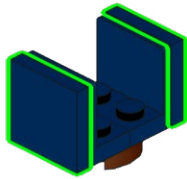

4

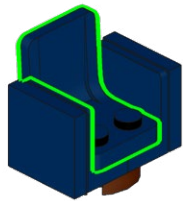

193



1x



194

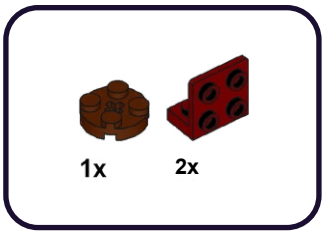

1



2

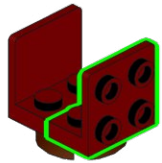

195

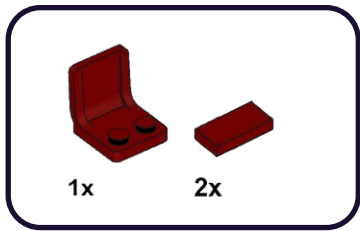

3

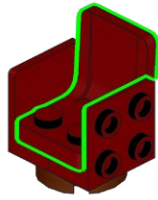

4

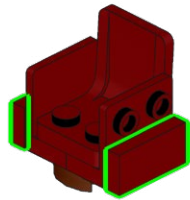

196

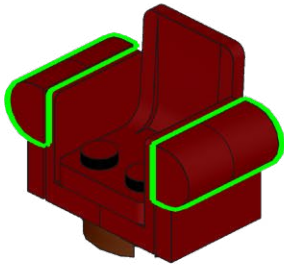
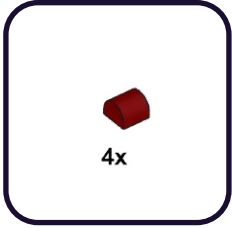

197



198

- 1x 
- 1x 
- 2x 
- 1x 

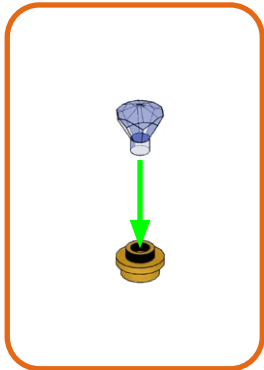
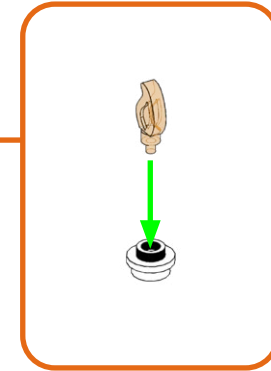

199



1x



200

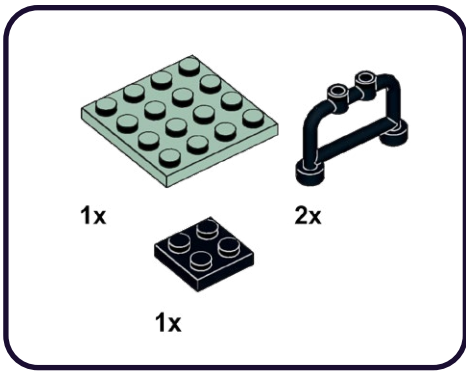

1

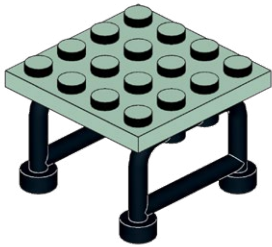

2

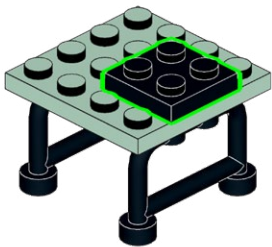

201

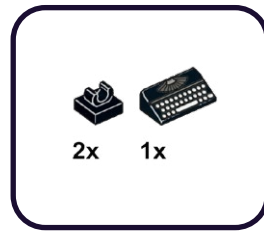

3

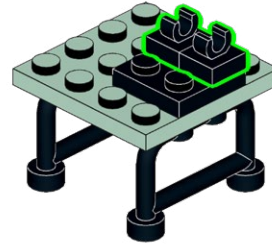

4



202

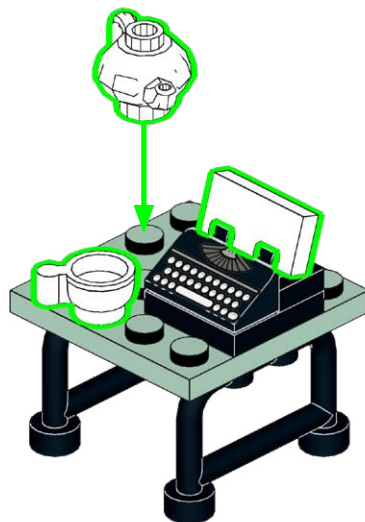
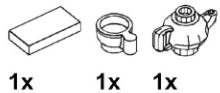

203



204

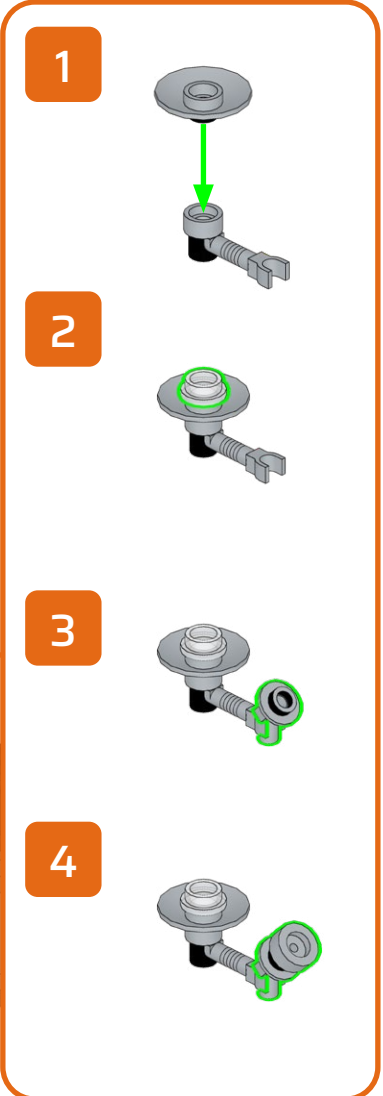
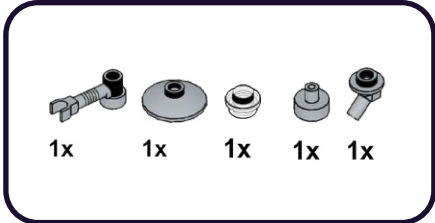

205

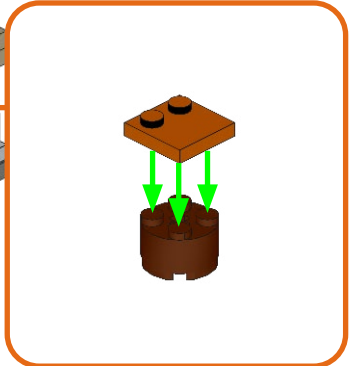
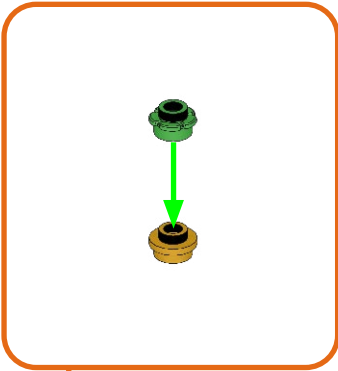

206

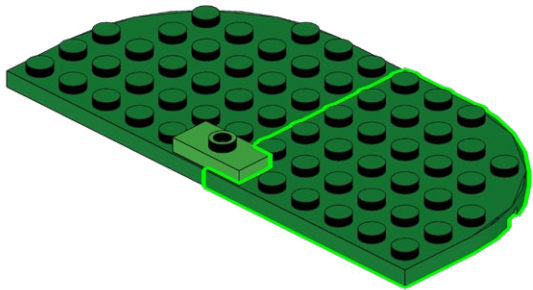
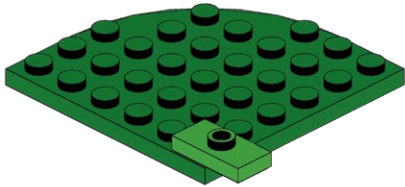
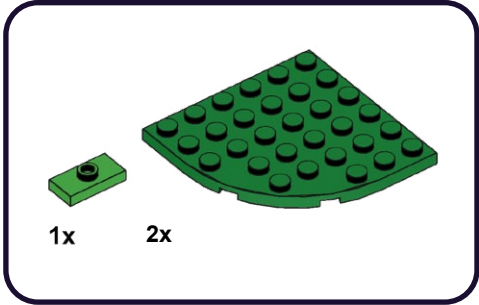

207

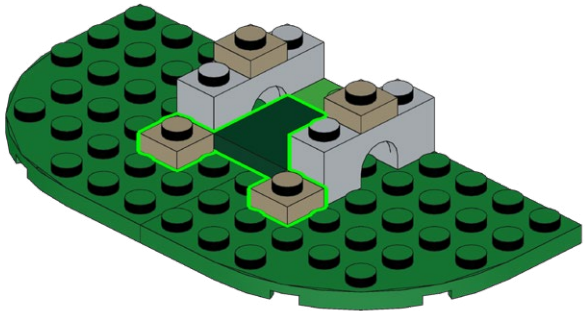
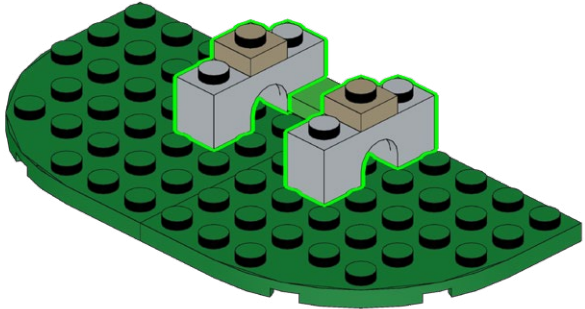
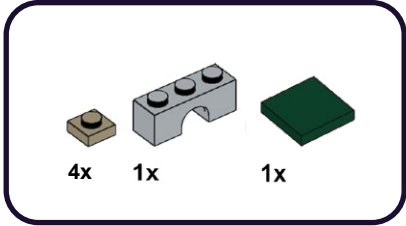

208

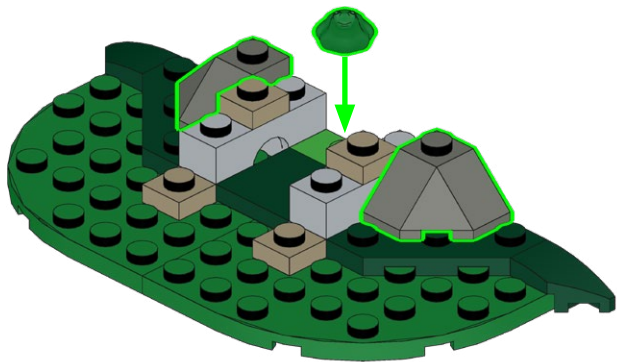
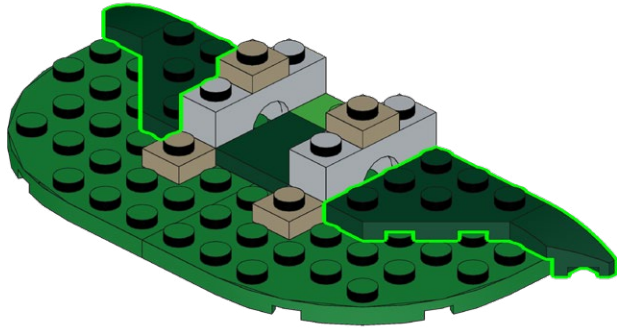
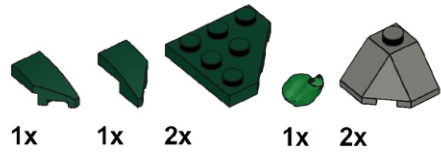

209

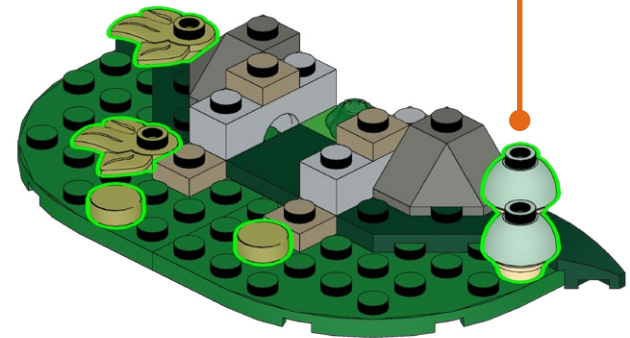
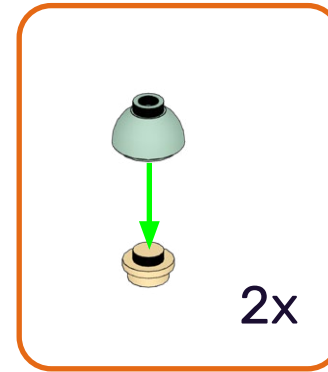
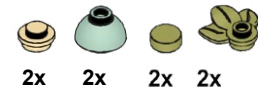

210

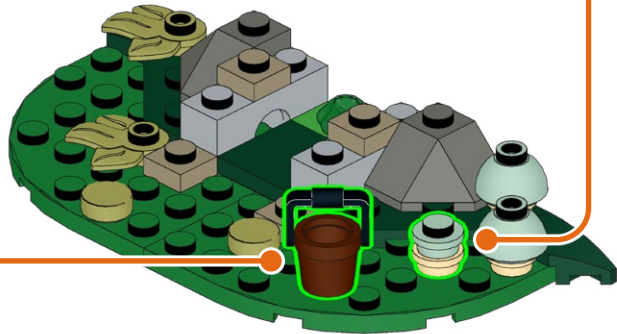
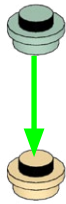
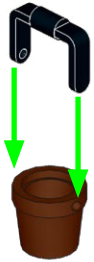

211

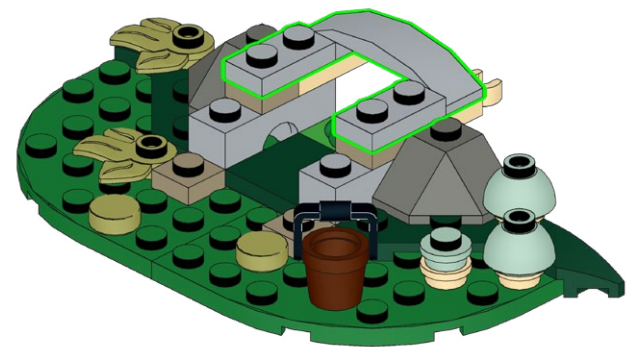
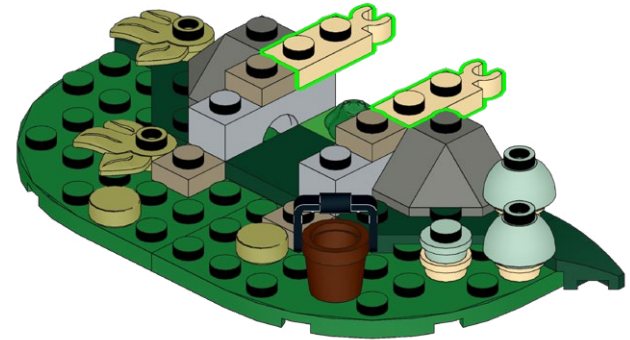
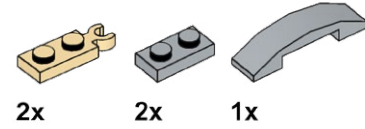

212

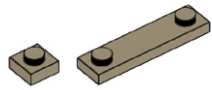

2x 1x

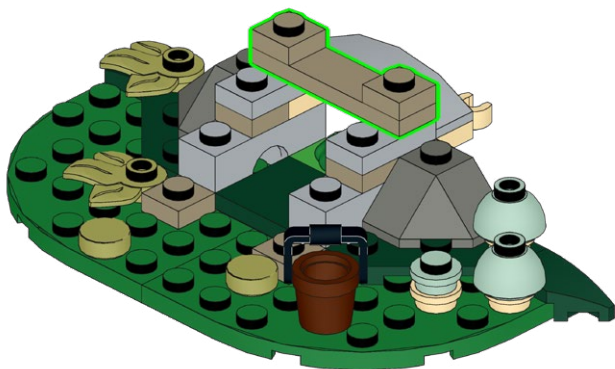

213

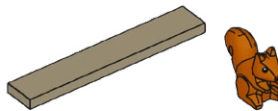

4x 1x

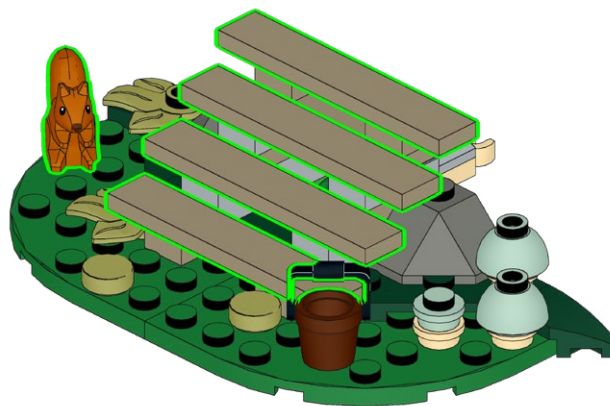

214

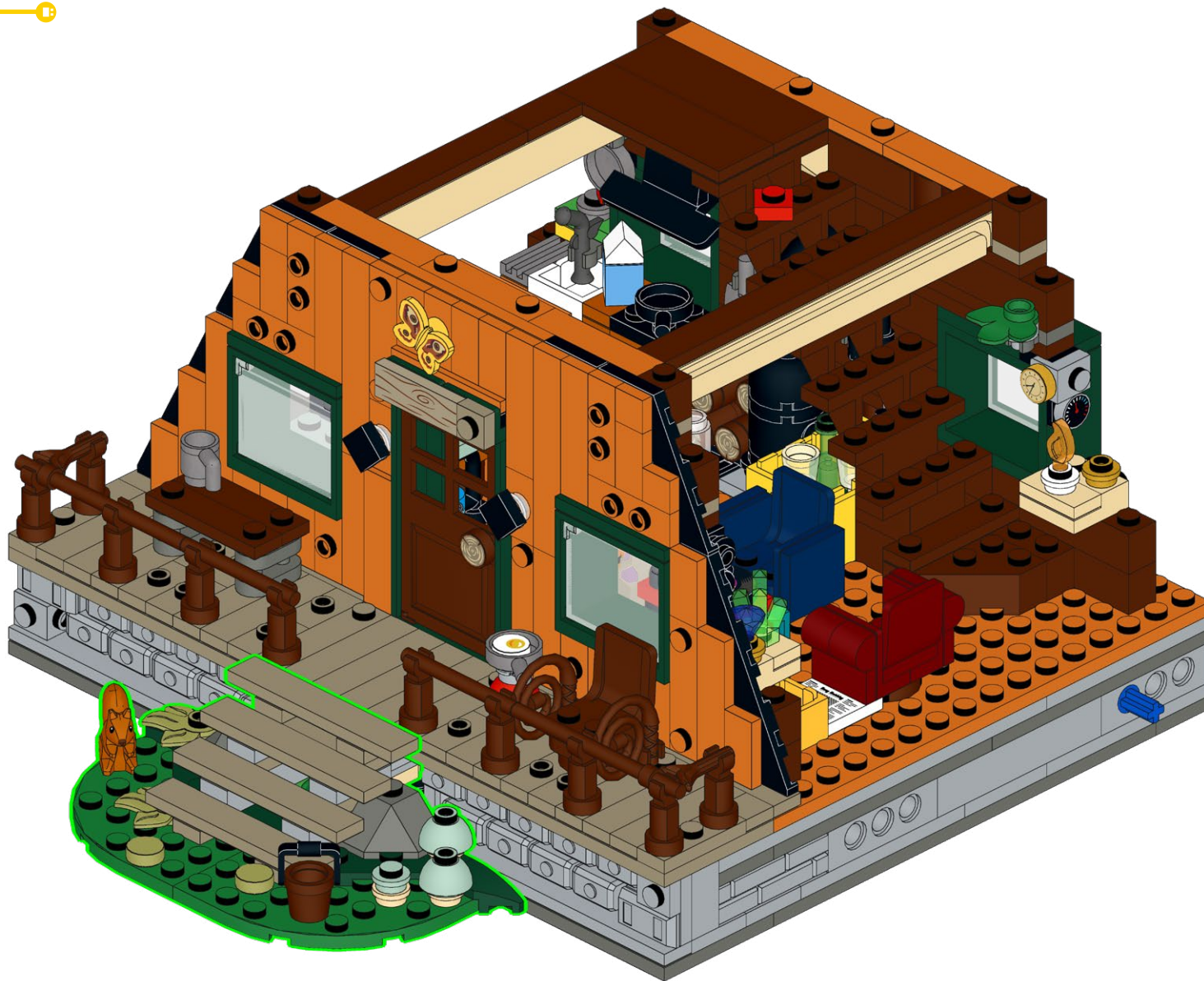

215

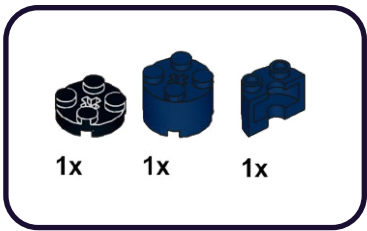

1

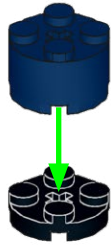

2



216

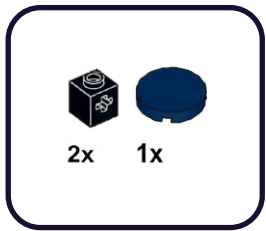

3



4

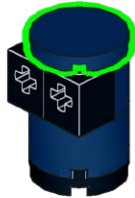

217

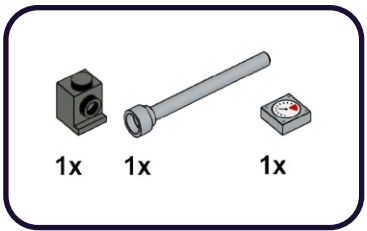

1

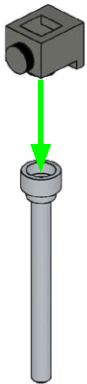

2

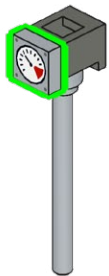

218

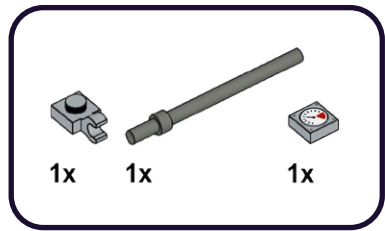

1



2

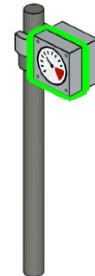

219

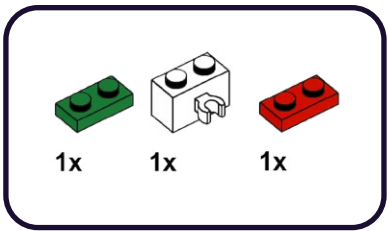

1

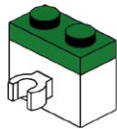

2

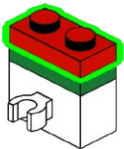

220

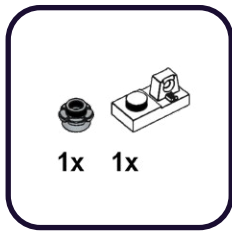

3

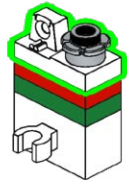

221

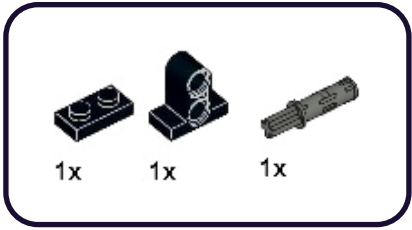

1

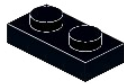
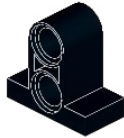

2

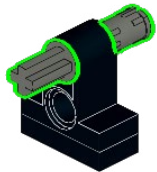

222



1

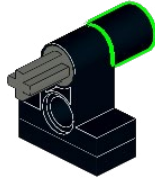

2

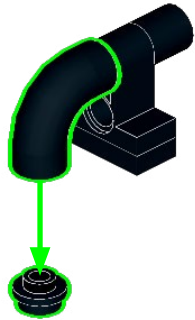

223

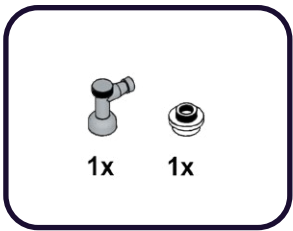

1

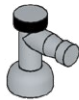

1



224

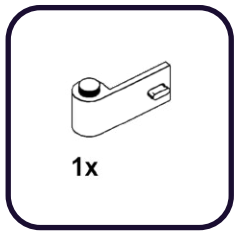

1

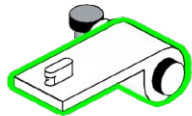

225

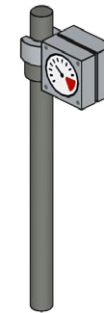
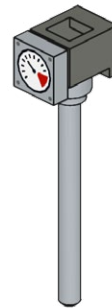

To be used later
A utiliser plus tard
Da utilizzare dopo
Zur späteren Verwendung
Para ser utilizado más tarde
稍后使用

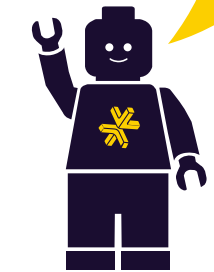
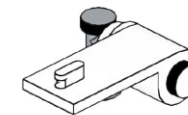

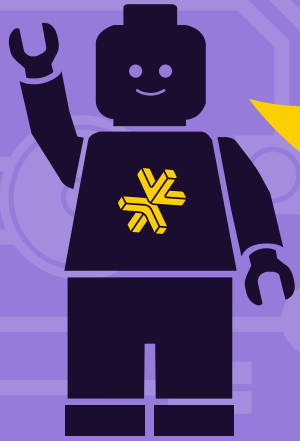
**HOLD UP!**

You might notice some bags aren't in order, as well as left over pieces, but that's ok! We're changing the way you build LEGO!

ATTENDEZ!

Vous remarquerez peut-être que certains sacs, ainsi que certaines pièces, ne sont pas dans le bon ordre. Mais pas de panique! Nous changeons simplement la façon avec laquelle vous construisez vos LEGO!

ASPETTA!

Potresti notare che alcuni sacchetti non sono in ordine, così come i pezzi avanzati, ma va bene così! Stiamo cambiando il modo in cui costruisci i LEGO!

HALT!

Sie werden möglicherweise bemerken, dass einige tüten durcheinander sind und teile übrig bleiben, aber das ist in Ordnung! Wir ändern die art und weise, wie Sie LEGO bauen!

¡ESPERA!

Es posible que notes que algunas bolsas están fuera de servicio, así como piezas sobrantes, ¡pero está bien! ¡Estamos cambiando la forma en que construyes LEGO!

暫停!

你可能会注意到一些袋子顺序错乱, 以及一些剩余的部件, 但没关系! 我们正在改变你搭建乐高的方式!

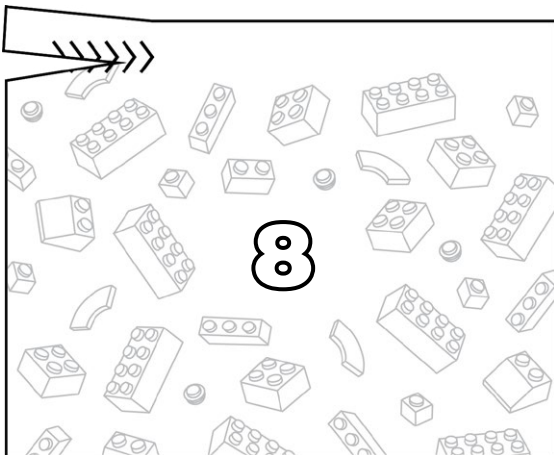
Open LEGO® Bag 8

226

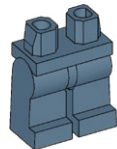
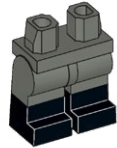

227

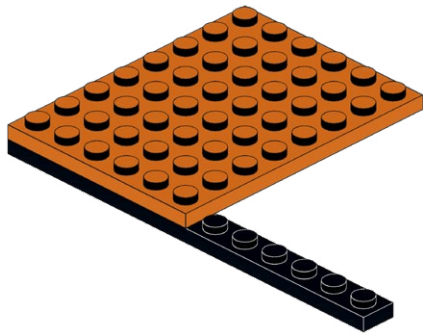
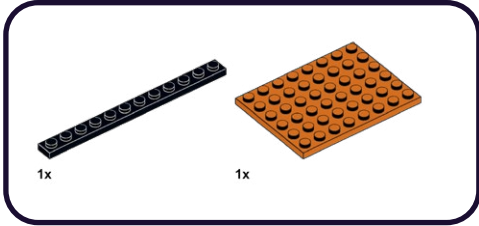

228

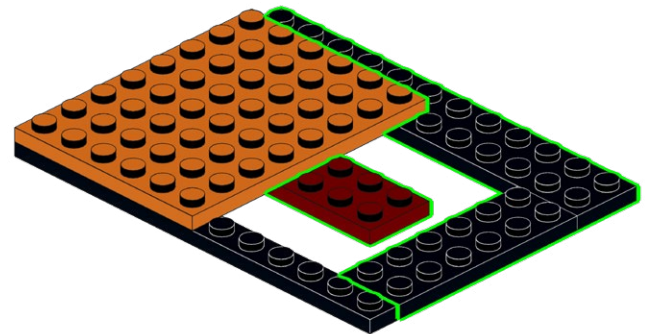
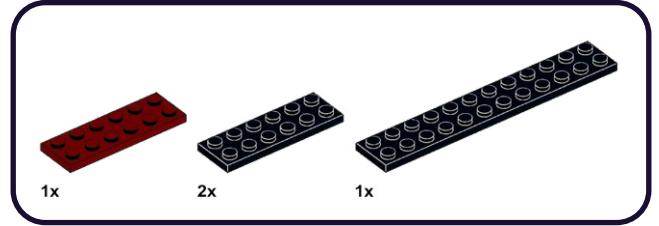

229

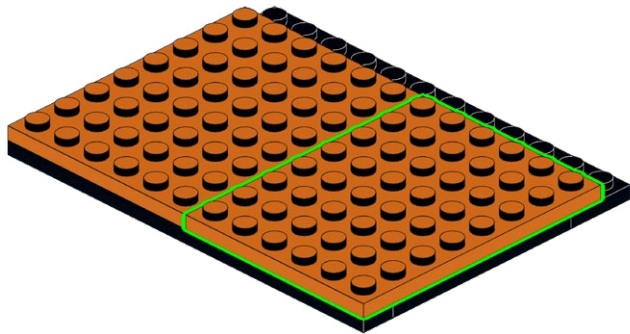
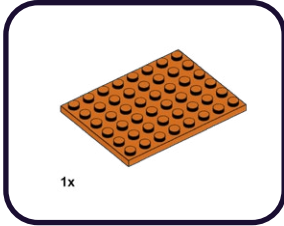

230

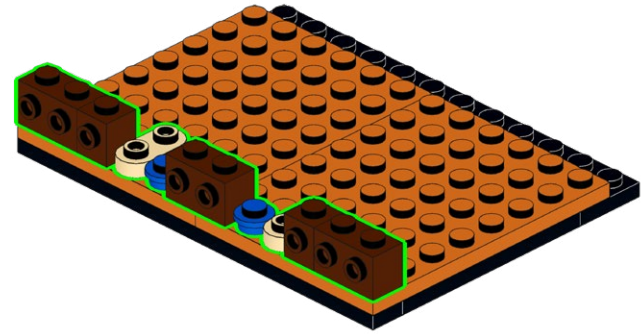
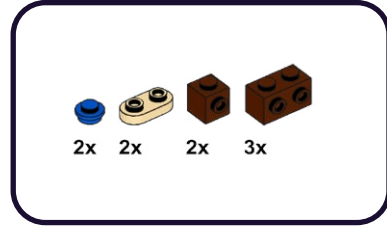

231

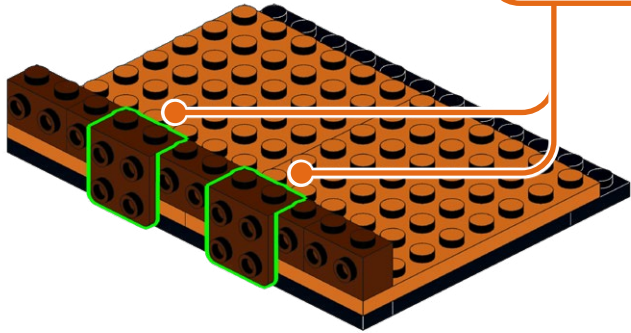
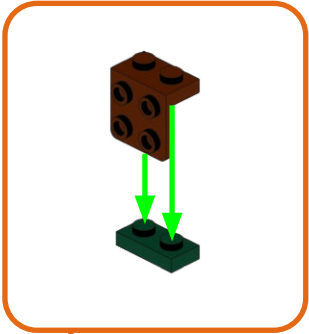
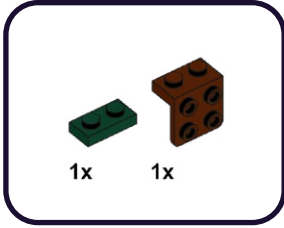

232

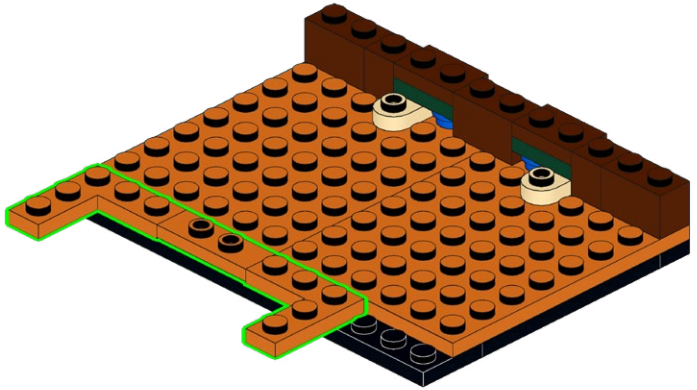
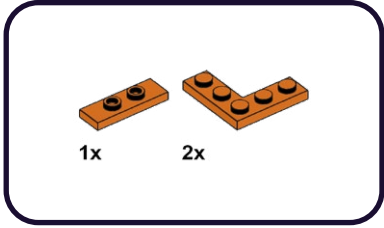

233

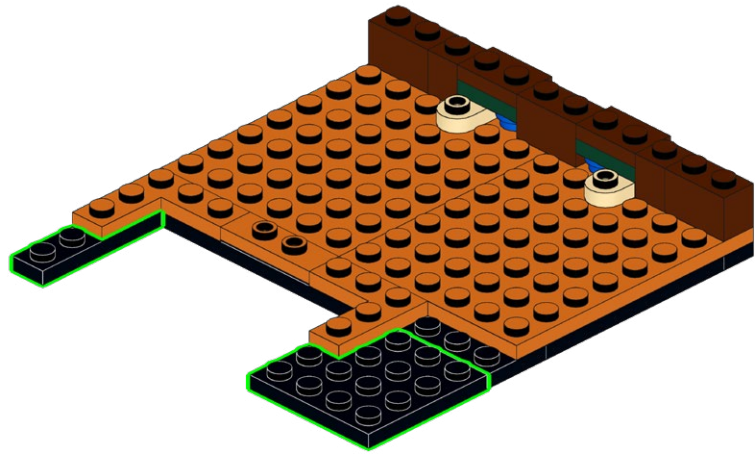
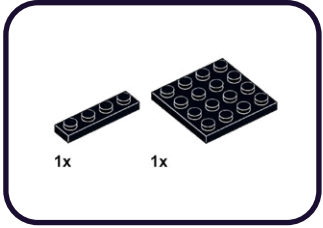

234

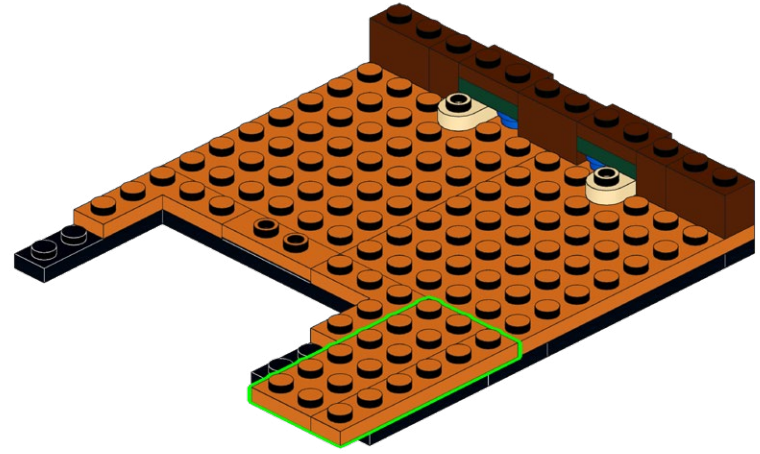
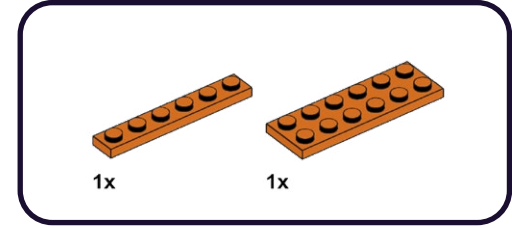

235

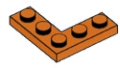

2x

236



1x

1x

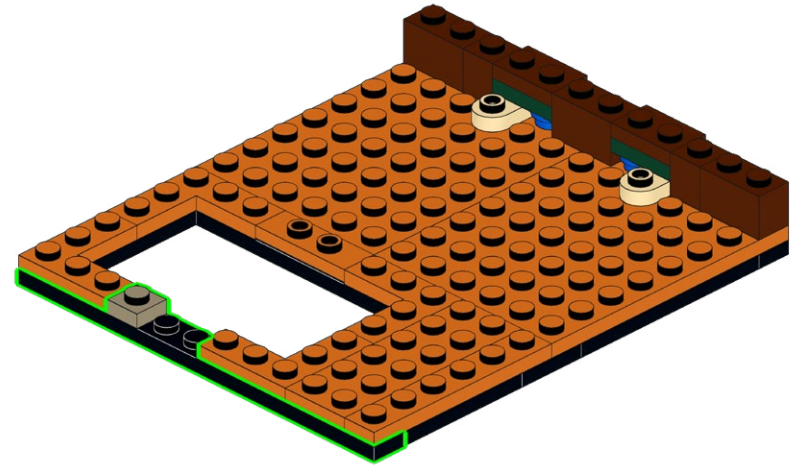
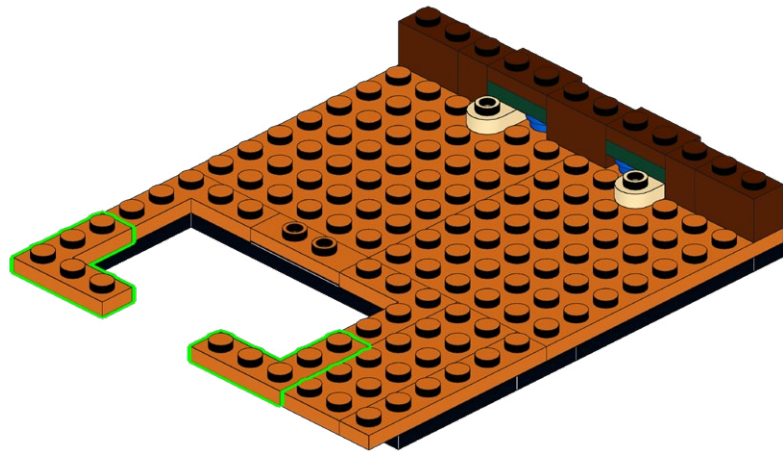

237

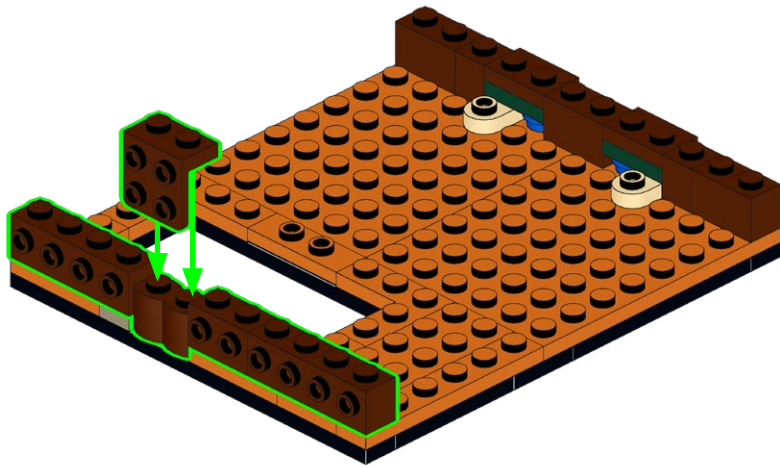
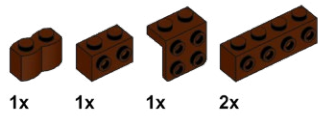

238

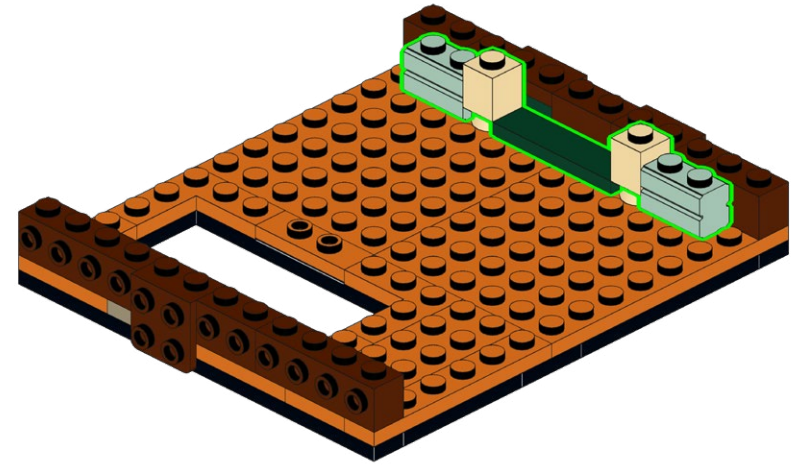
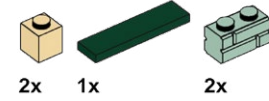

239

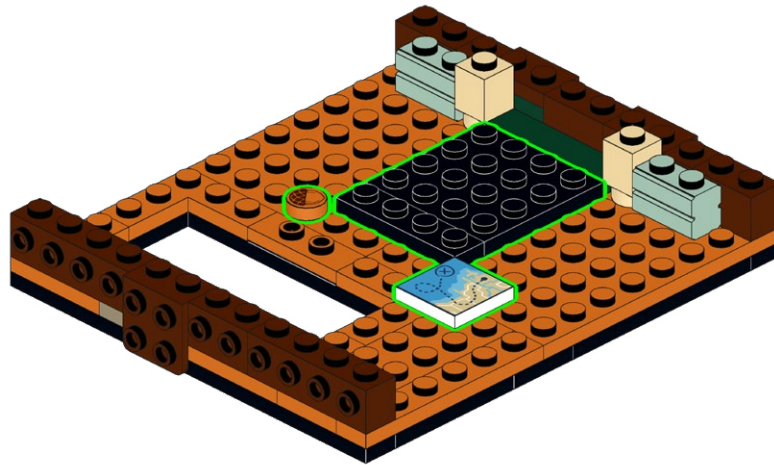
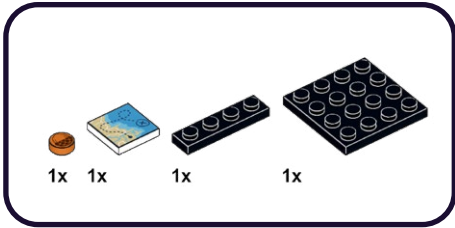

240

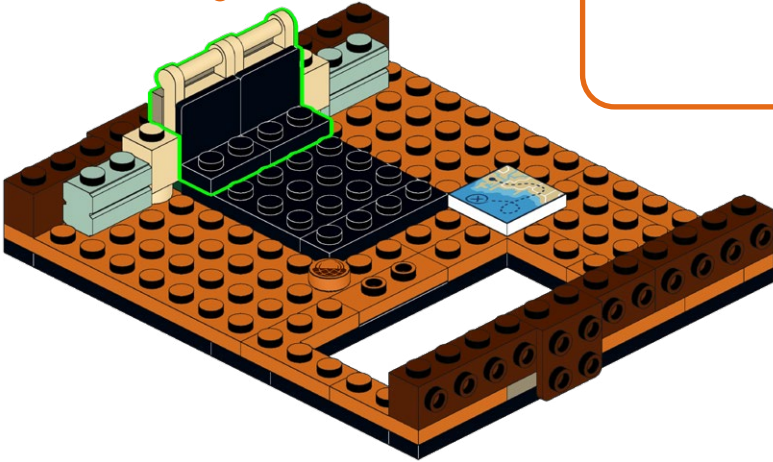
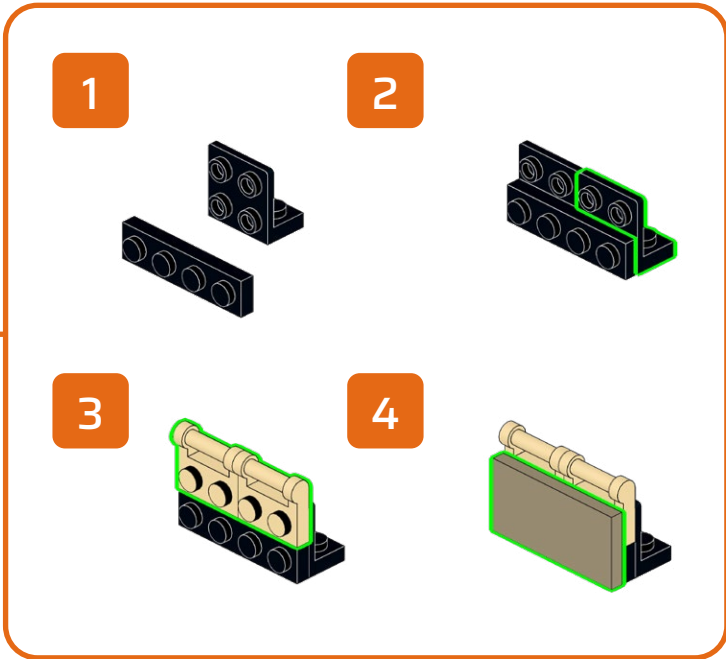
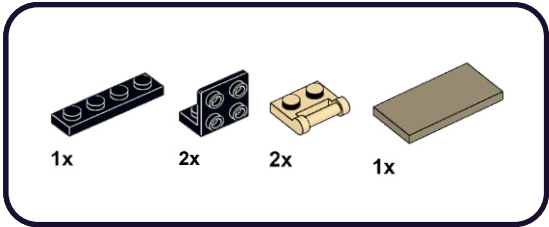

241

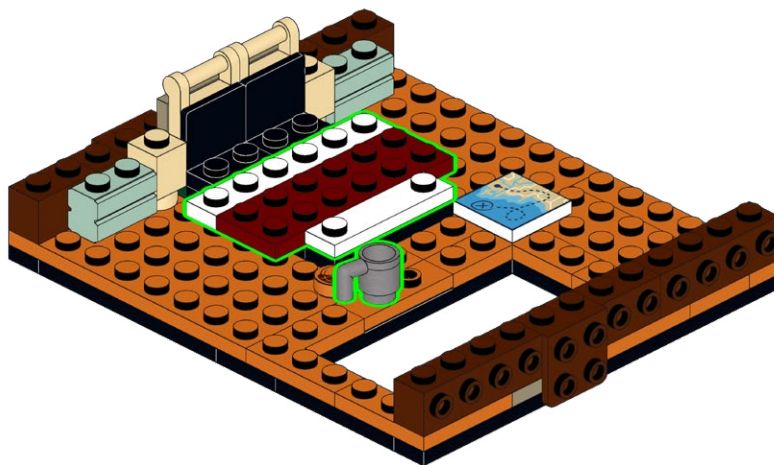
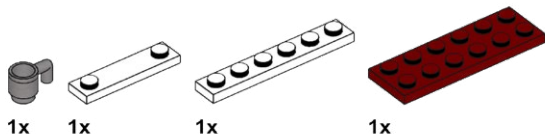

242

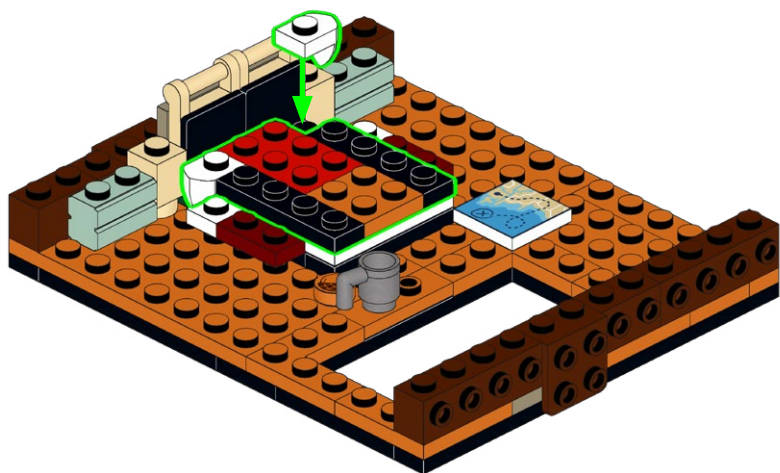
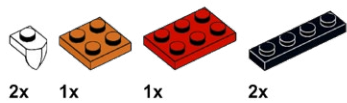

243

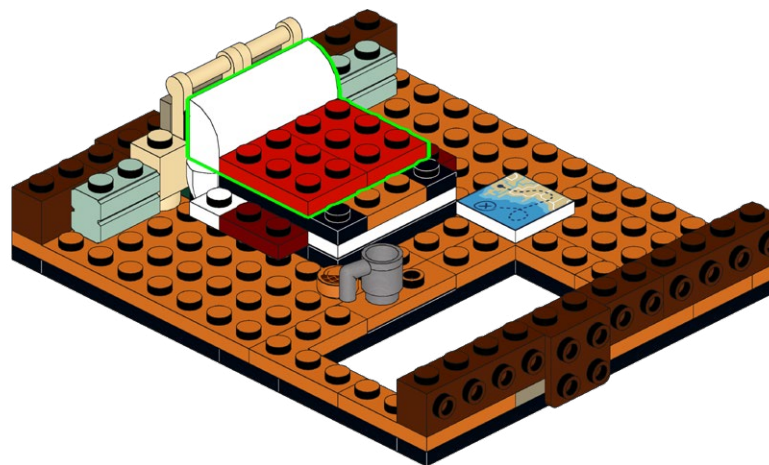
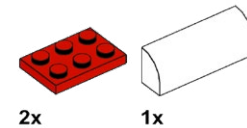

244

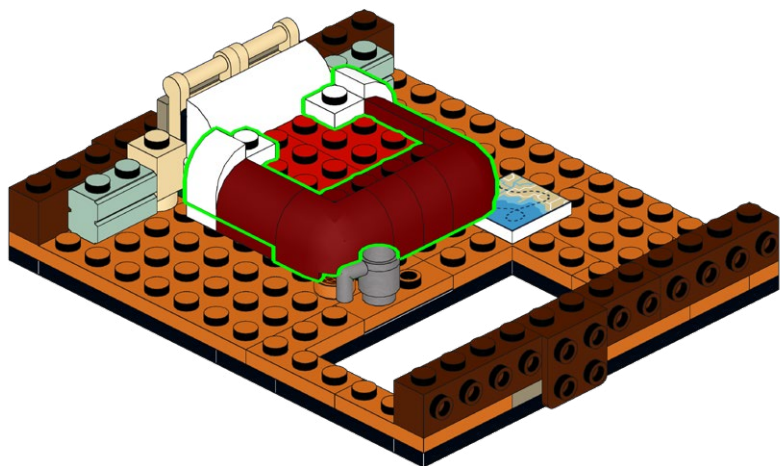
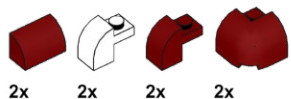

245

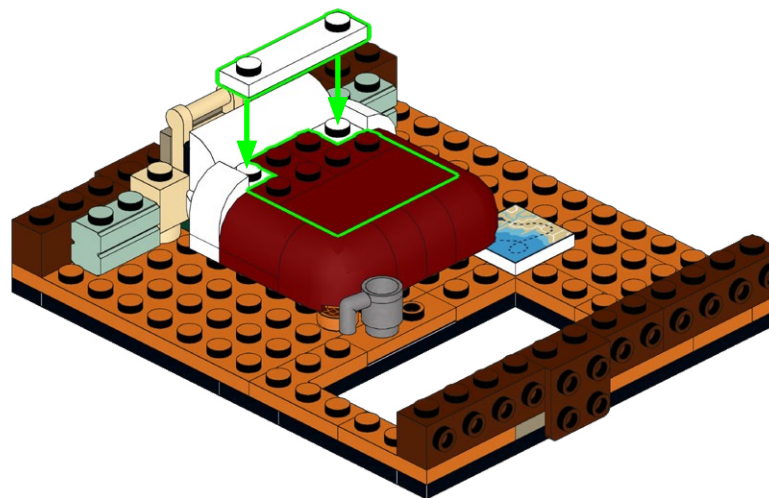
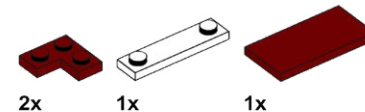

246

1x

1x

2x

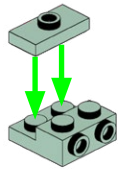

2x

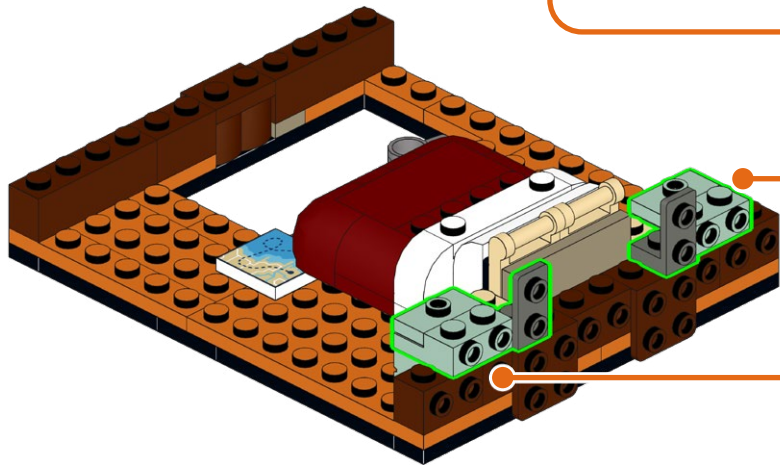

247

2x

4x

2x

1

2

3

4

2x

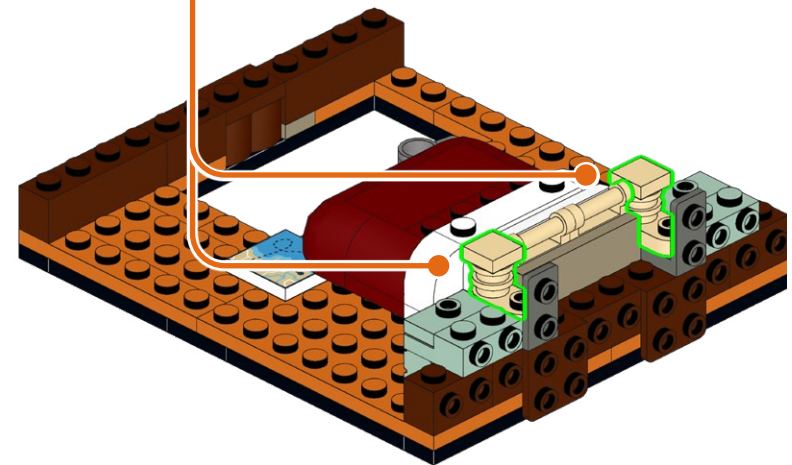

248

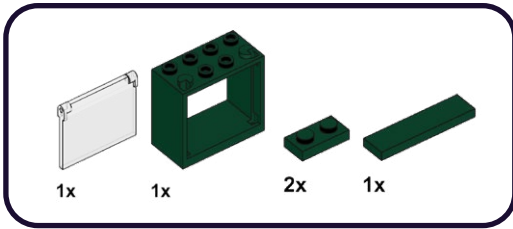

1



2



249

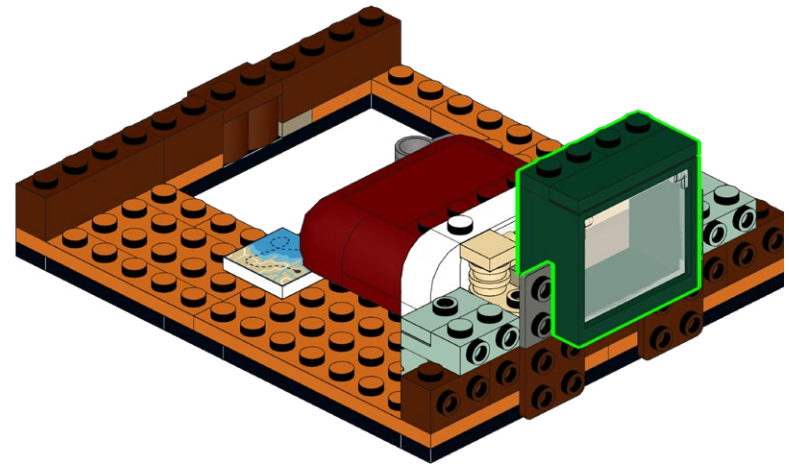

250

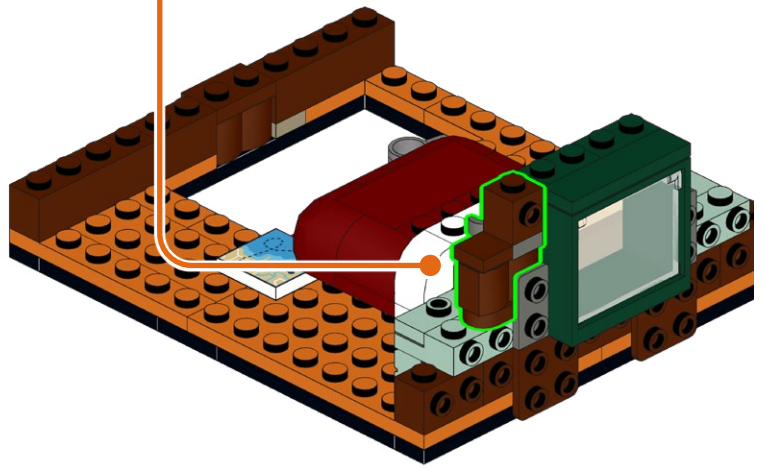
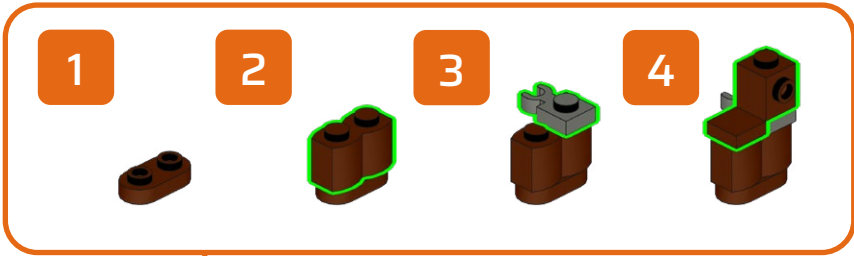
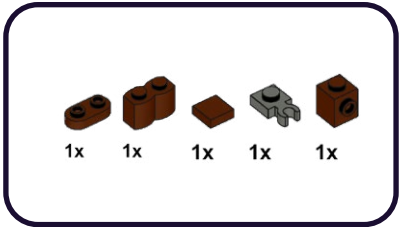

251

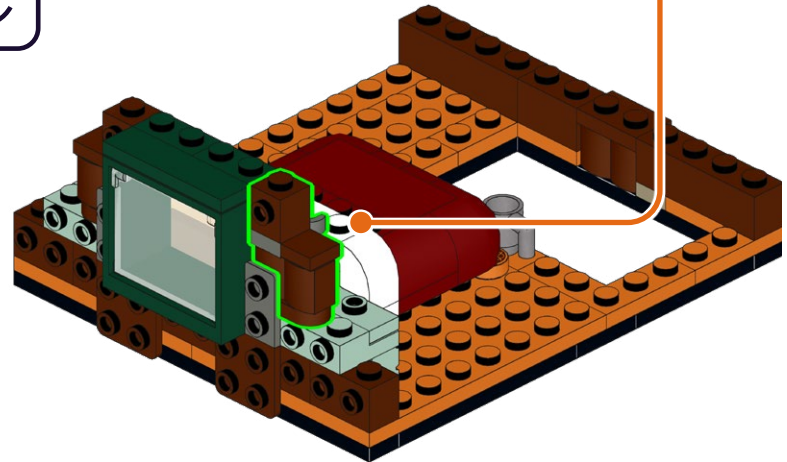
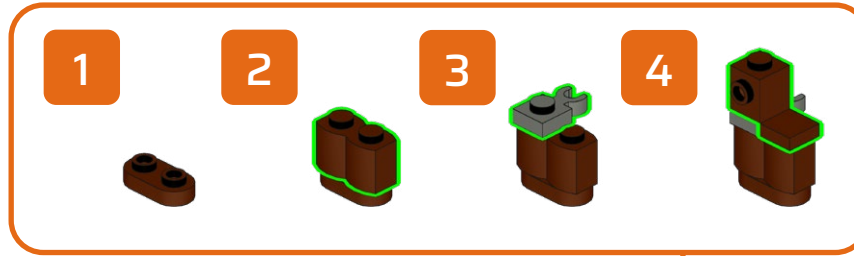
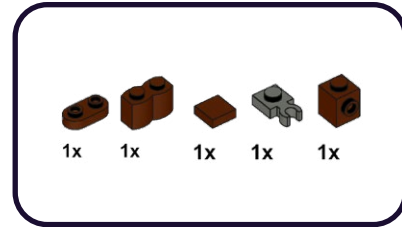

252

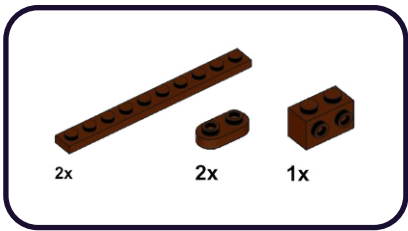

1

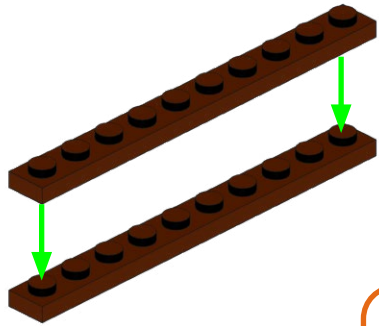

2

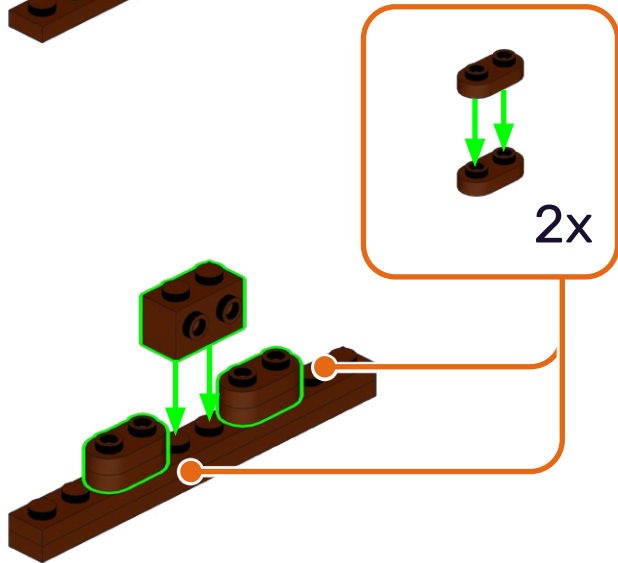

253

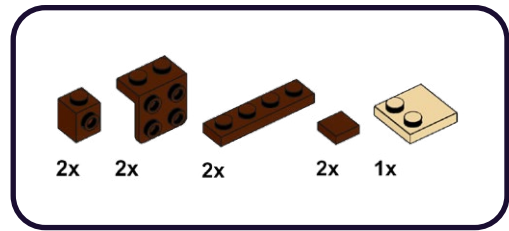

1

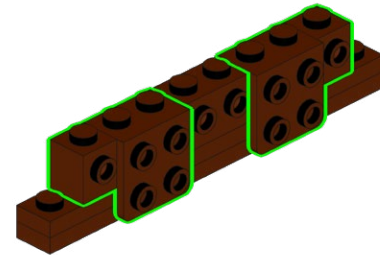

2

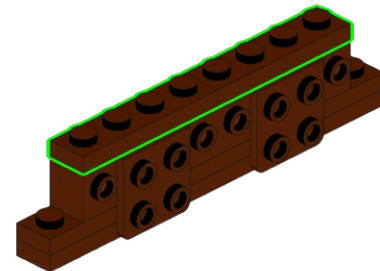

2

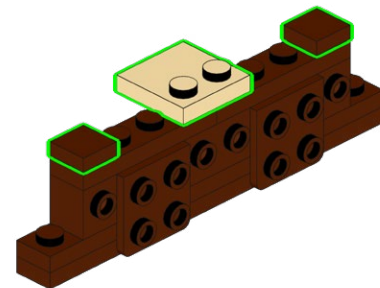

254

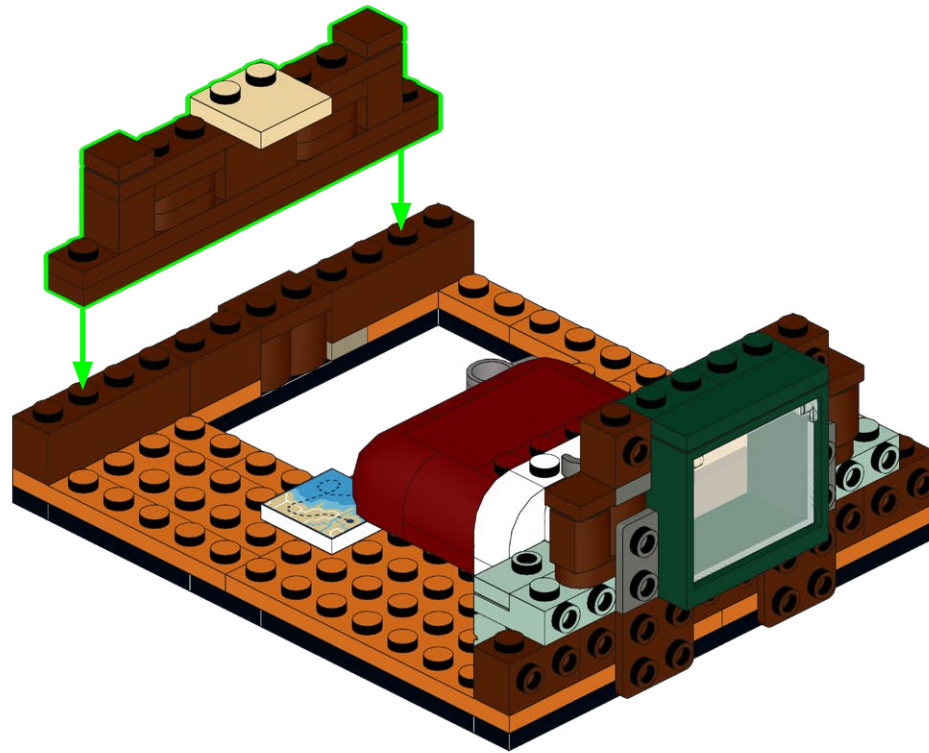

255

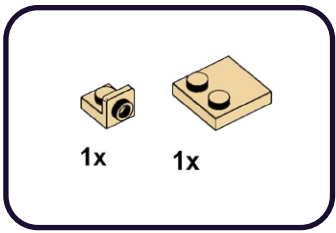

1



1

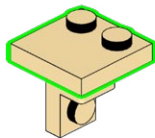

256

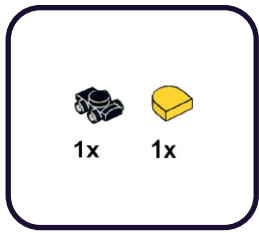

1

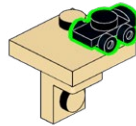

1

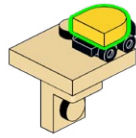

257

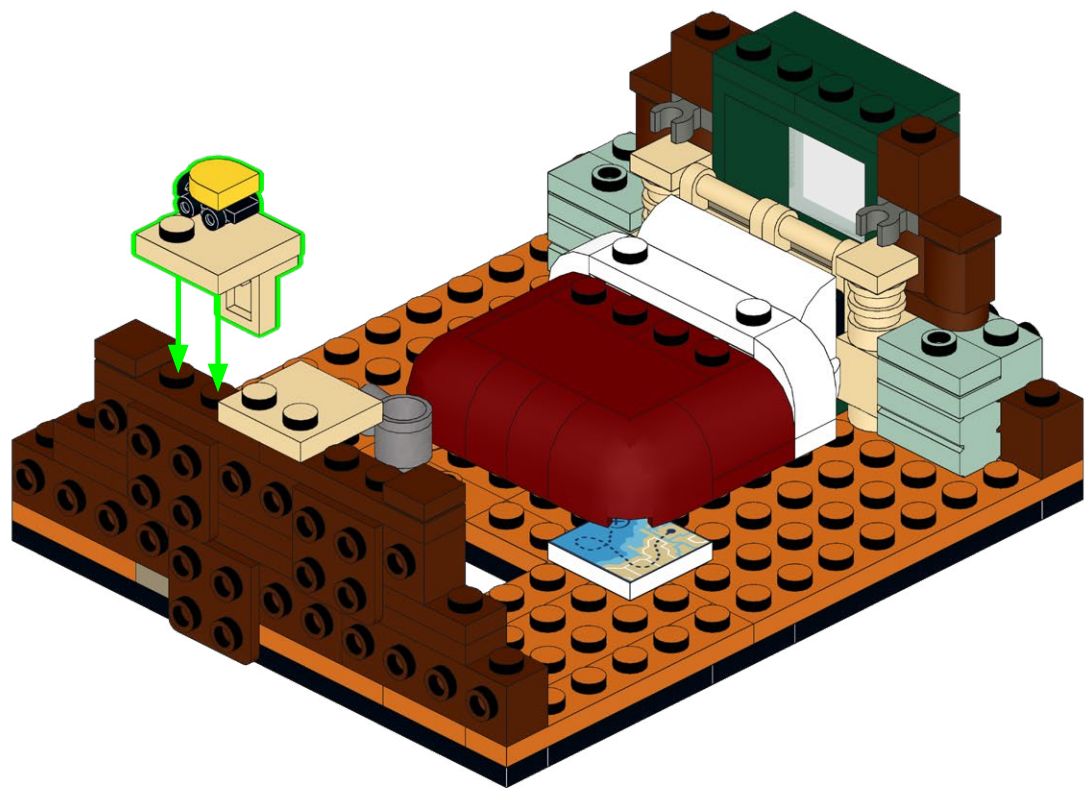

258

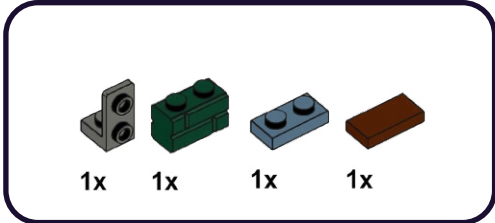

1

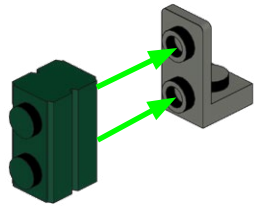

2

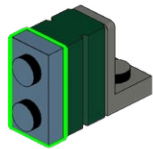

3

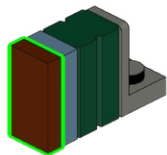

259

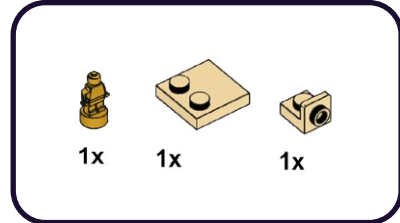

4

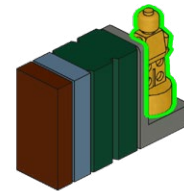

5

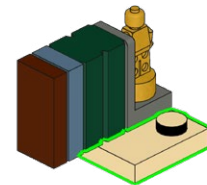

6

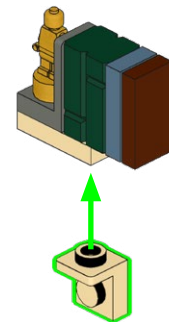

260

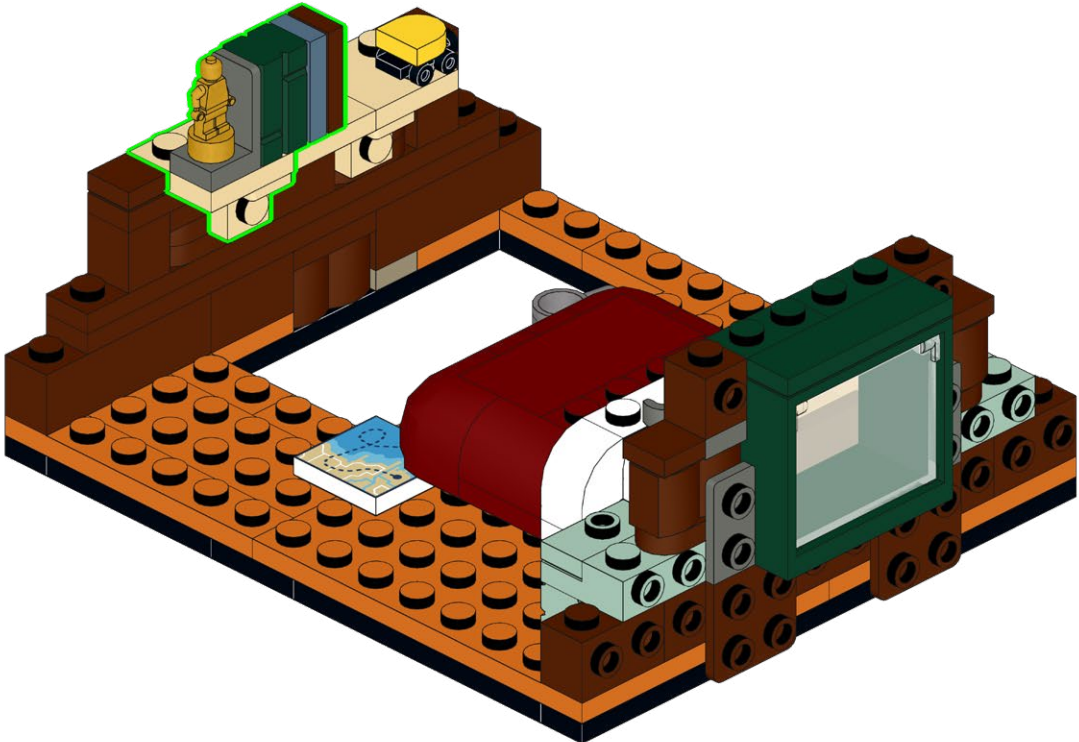

261

2x

1x

1

2

3

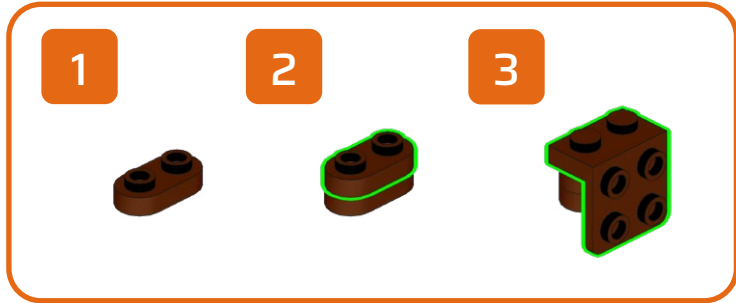
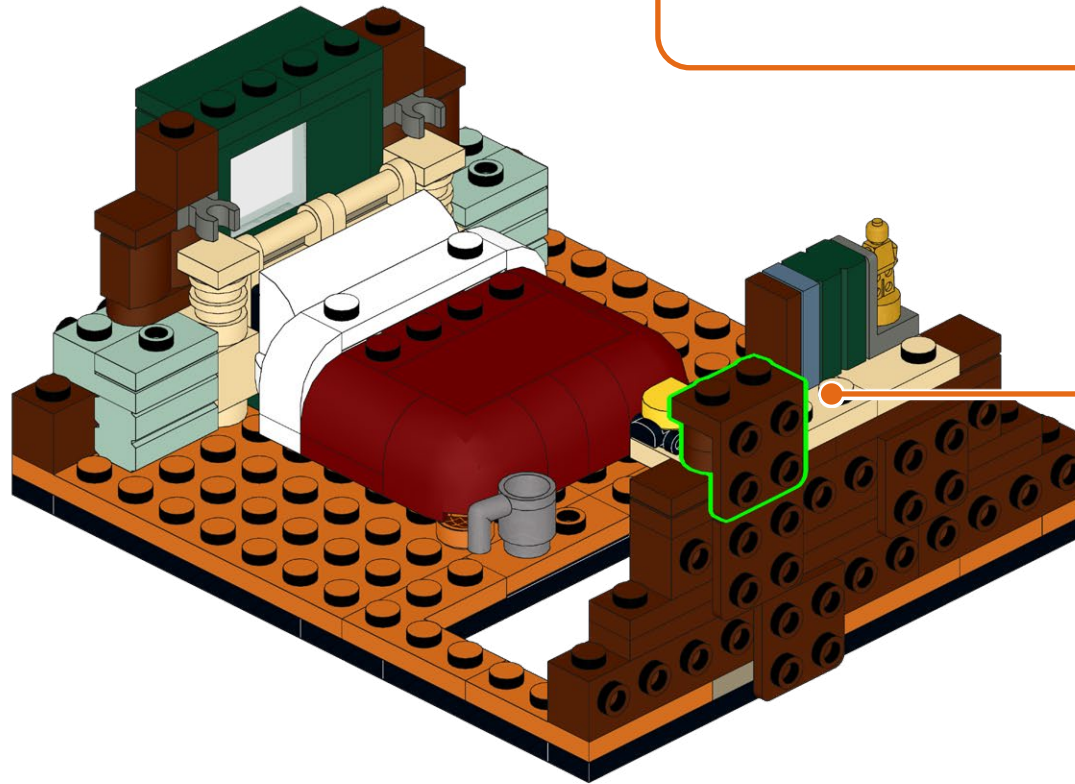

262

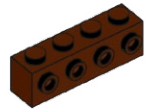

1x

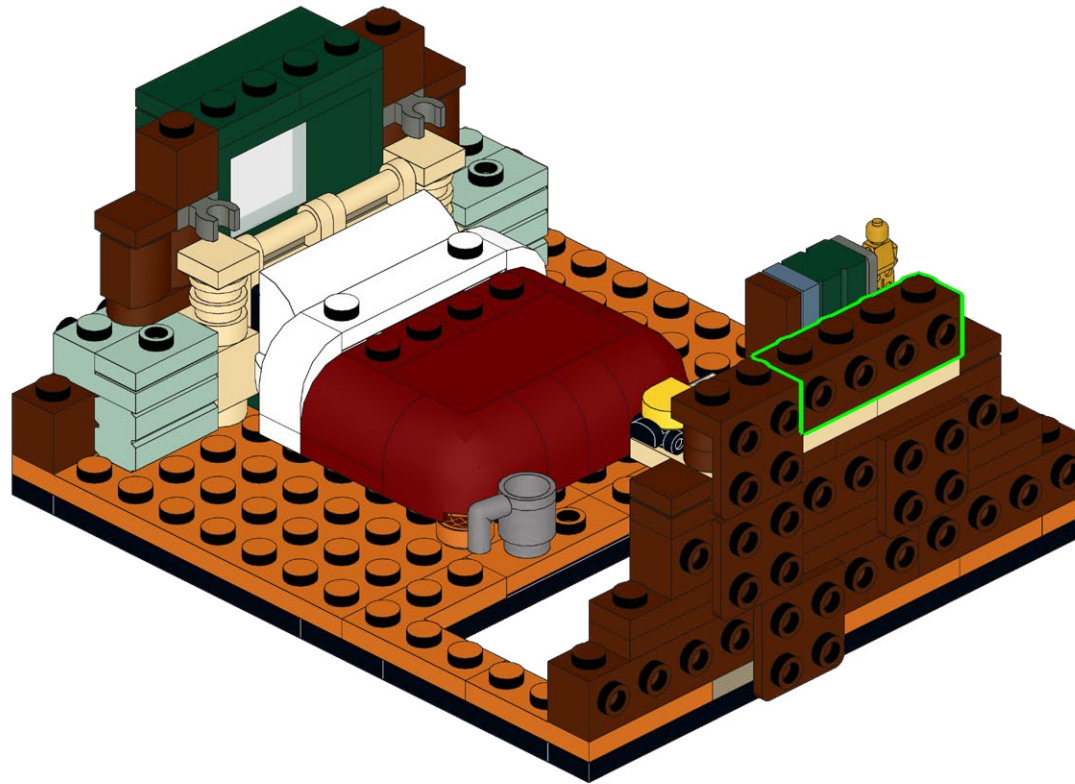

263

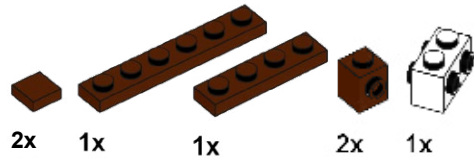

1

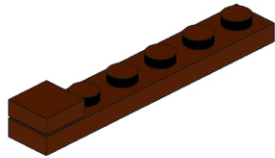

2

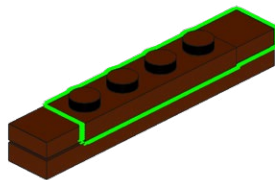

3

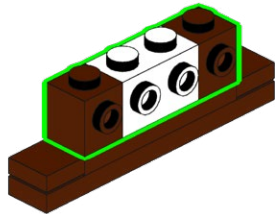

264

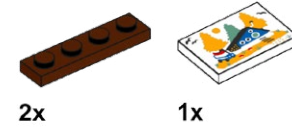

4

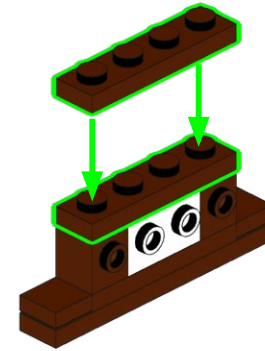

5

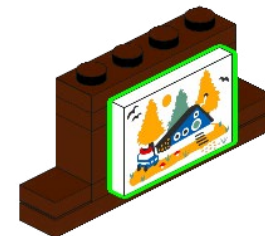

265

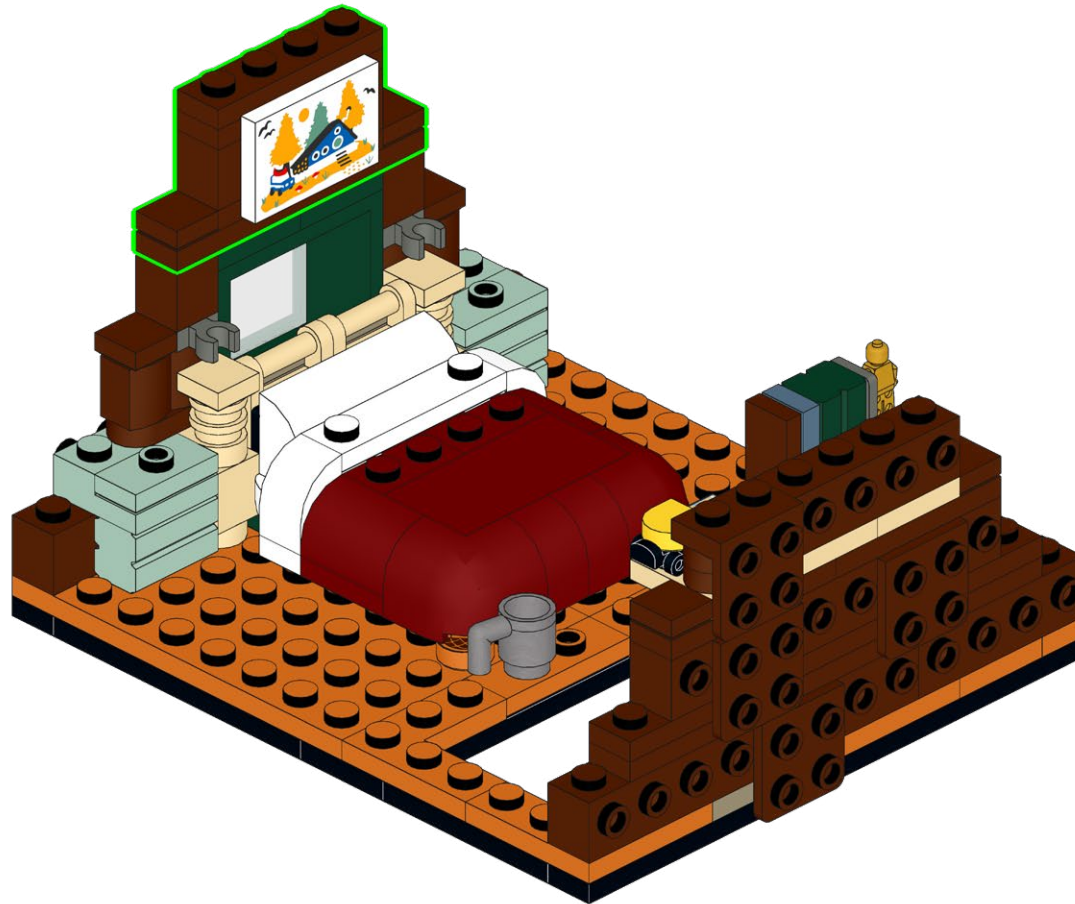

266

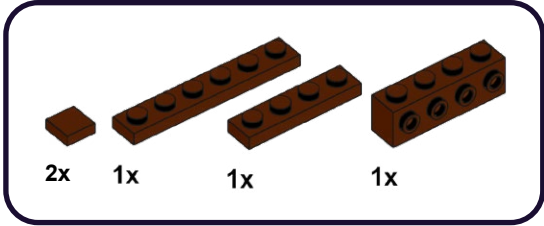

1

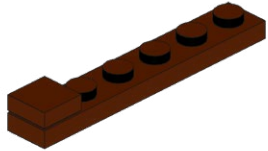

2

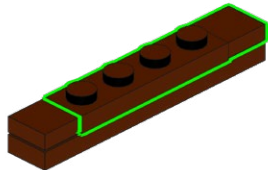

3

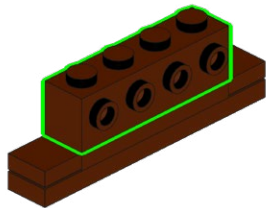

267

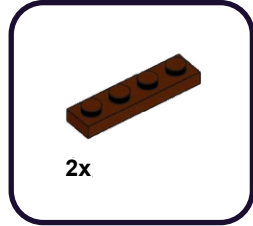

4

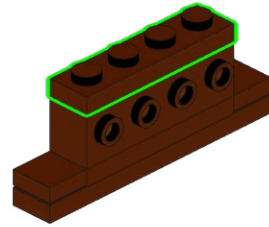

5

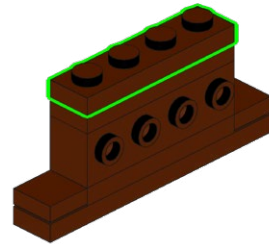

268

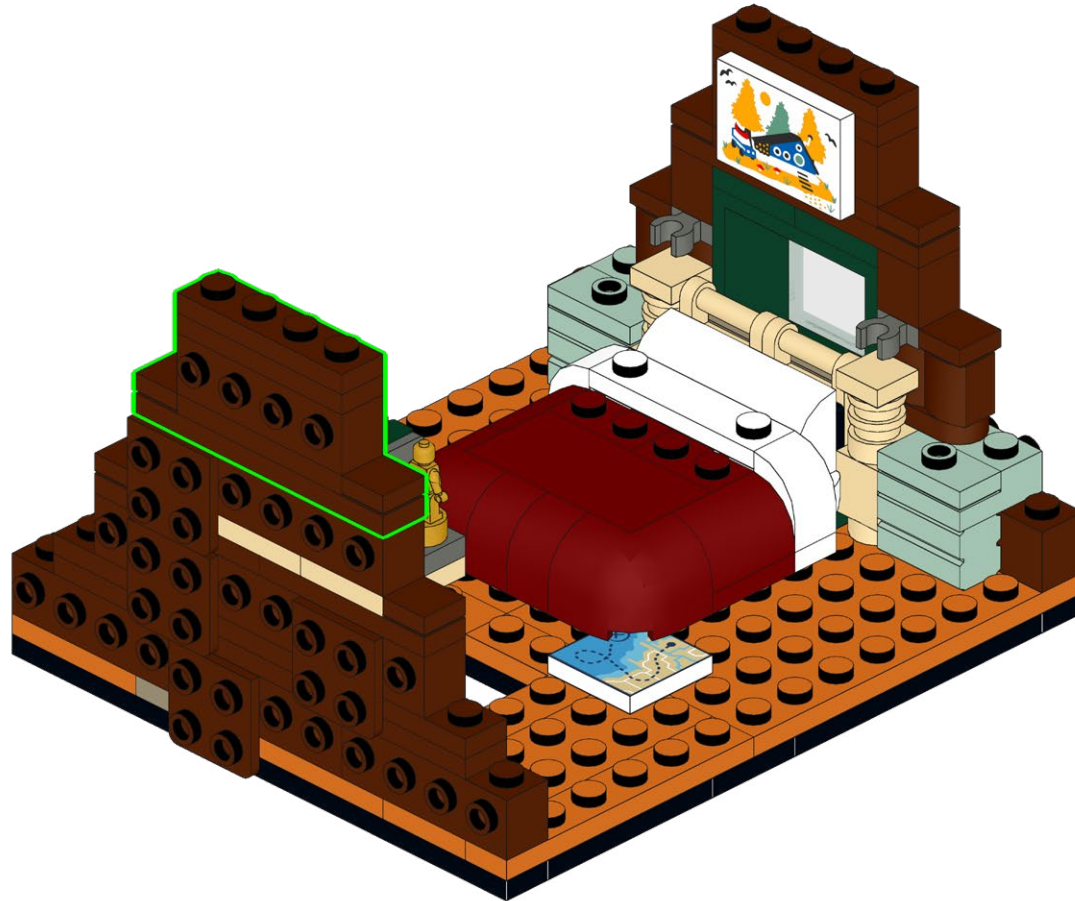

269

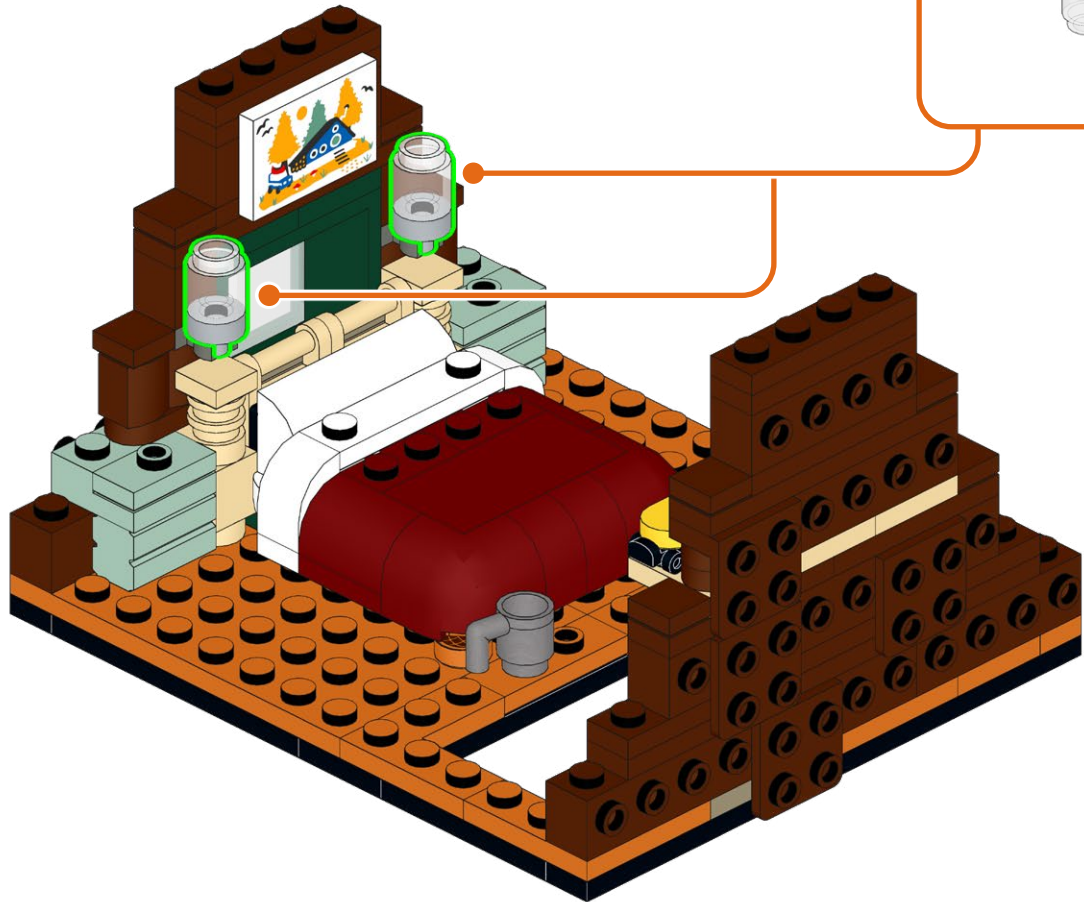
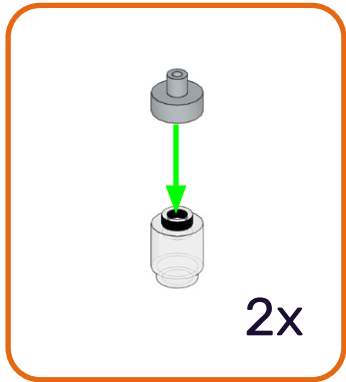
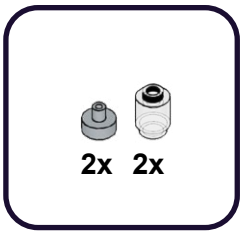

270

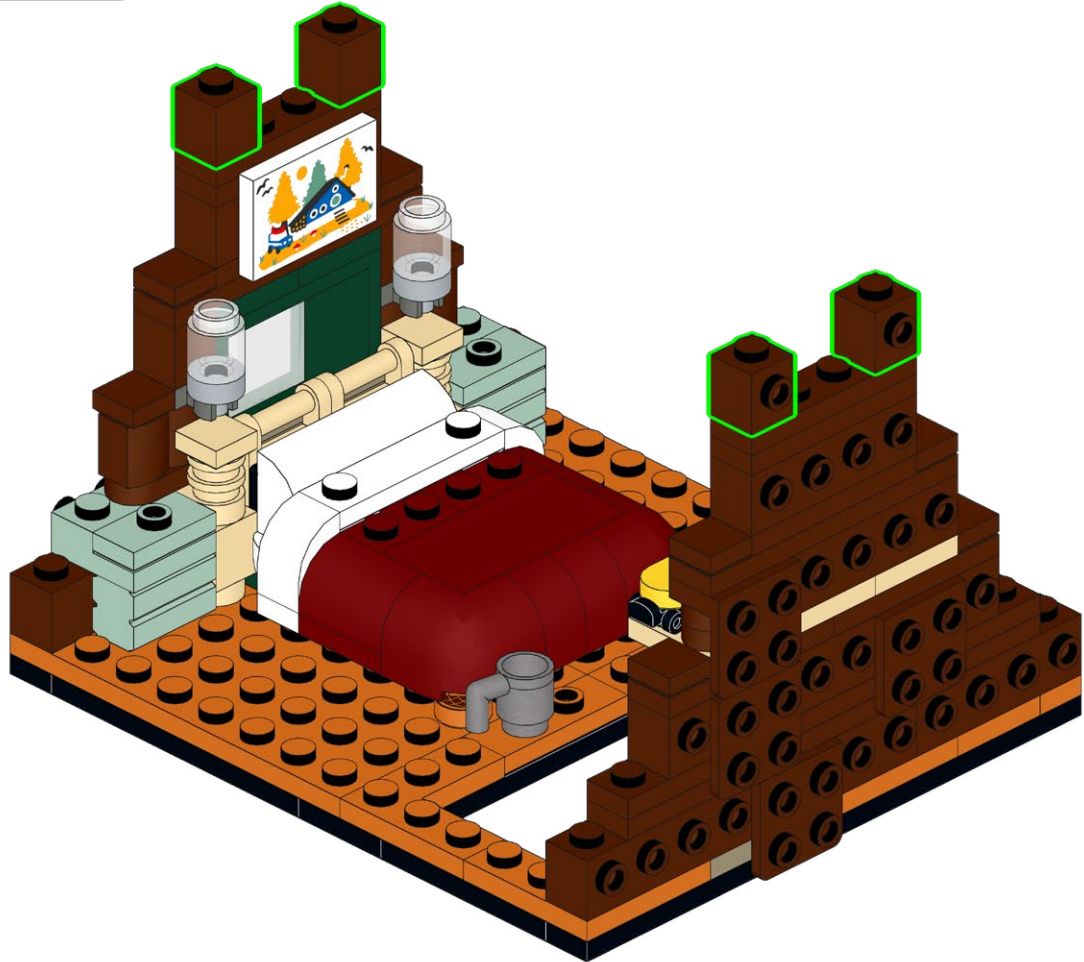
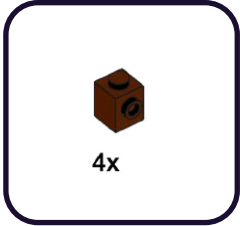

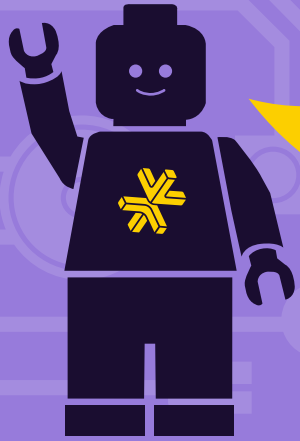

HOLD UP!

You might notice some bags aren't in order, as well as left over pieces, but that's ok! We're changing the way you build LEGO!

ATTENDEZ!

Vous remarquerez peut-être que certains sacs, ainsi que certaines pièces, ne sont pas dans le bon ordre. Mais pas de panique! Nous changeons simplement la façon avec laquelle vous construisez vos LEGO!

ASPETTA!

Potresti notare che alcuni sacchetti non sono in ordine, così come i pezzi avanzati, ma va bene così! Stiamo cambiando il modo in cui costruisci i LEGO!

HALT!

Sie werden möglicherweise bemerken, dass einige tüten durcheinander sind und teile übrig bleiben, aber das ist in Ordnung! Wir ändern die art und weise, wie Sie LEGO bauen!

¡ESPERA!

Es posible que notes que algunas bolsas están fuera de servicio, así como piezas sobrantes, ¡pero está bien! ¡Estamos cambiando la forma en que construyes LEGO!

暫停!

你可能会注意到一些袋子顺序错乱, 以及一些剩余的部件, 但没关系! 我们正在改变你搭建乐高的方式!

Open LMB Bag 02

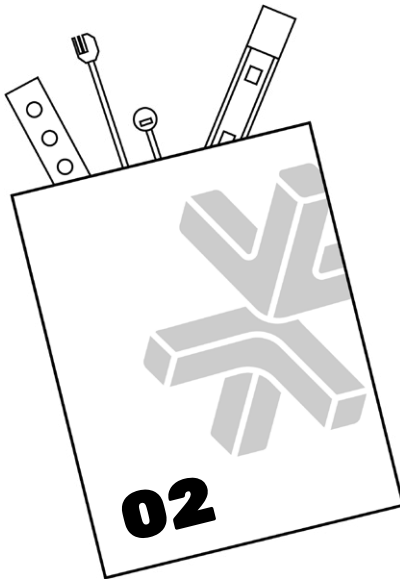

271

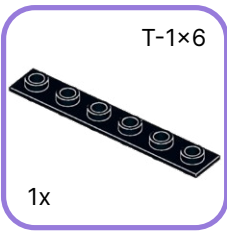

1



1

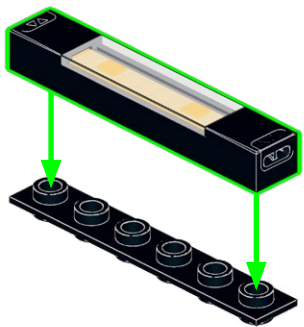

272

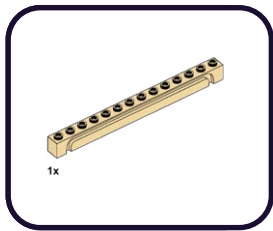

1

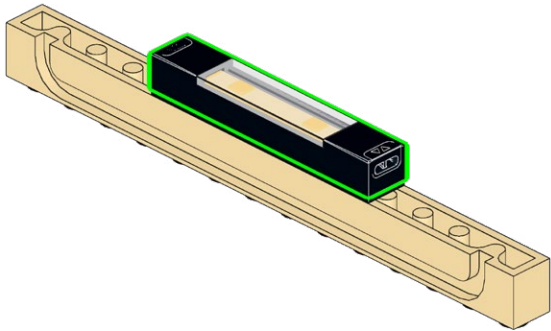

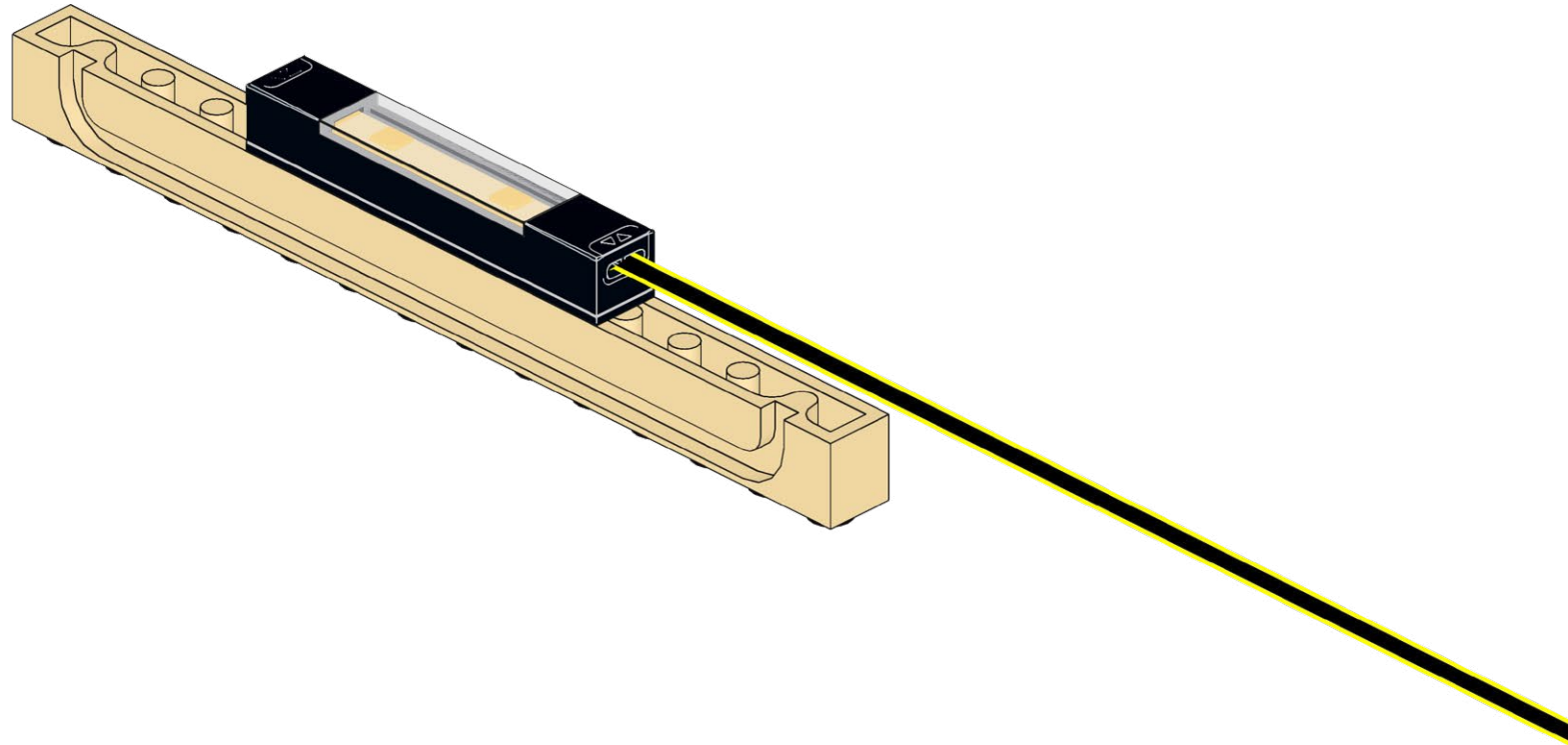
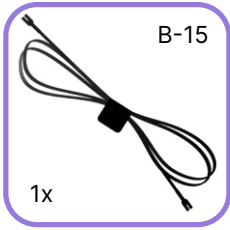
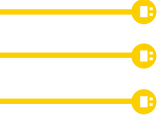

274

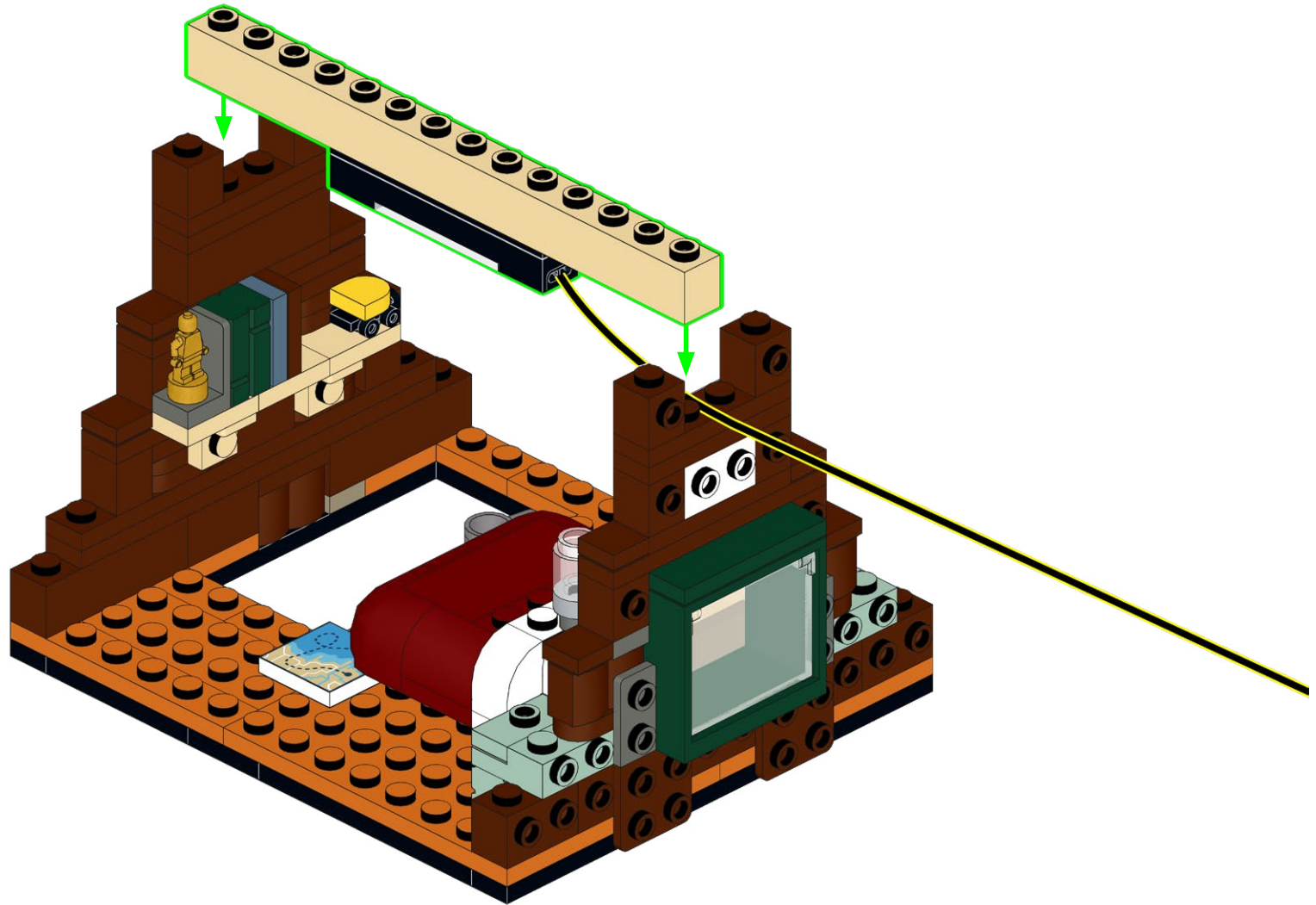

275

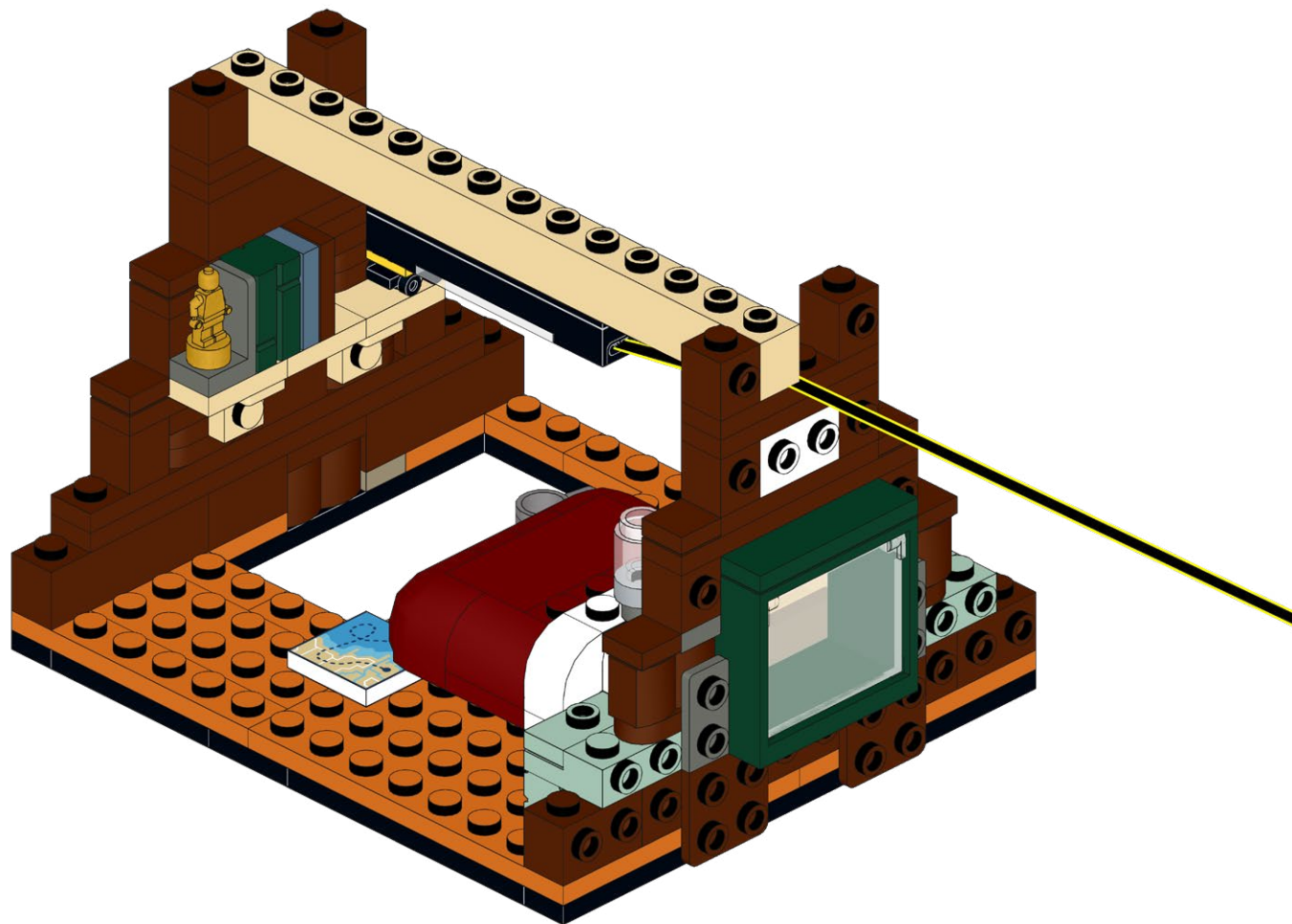

276

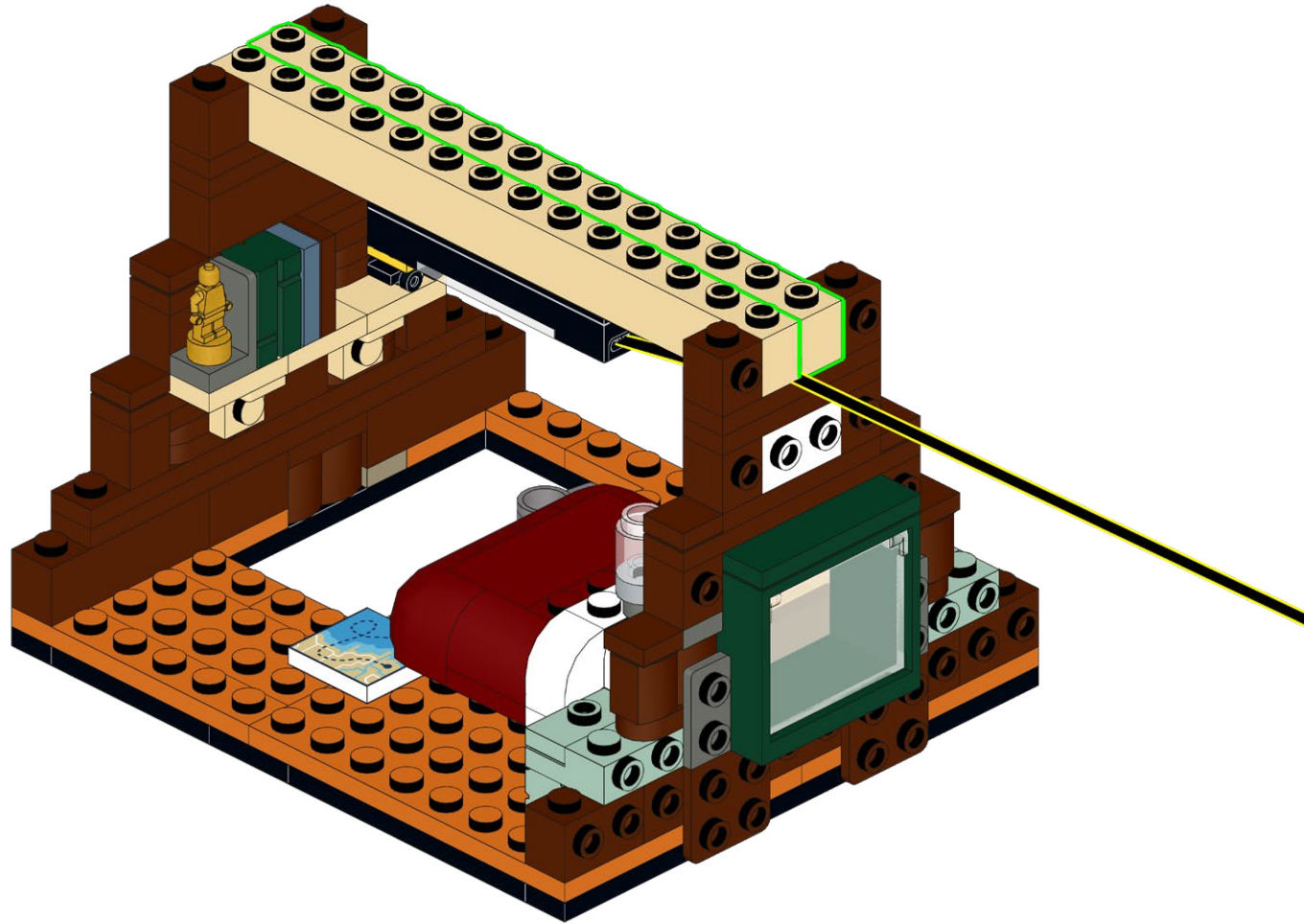
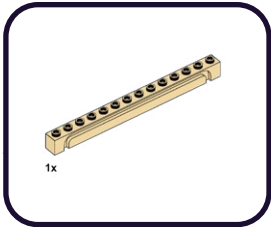

277

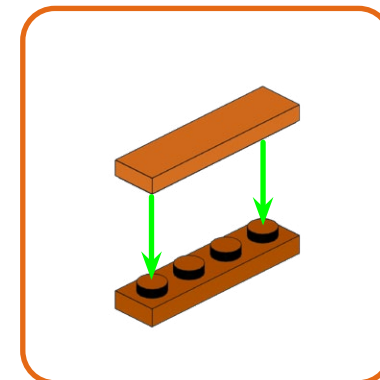
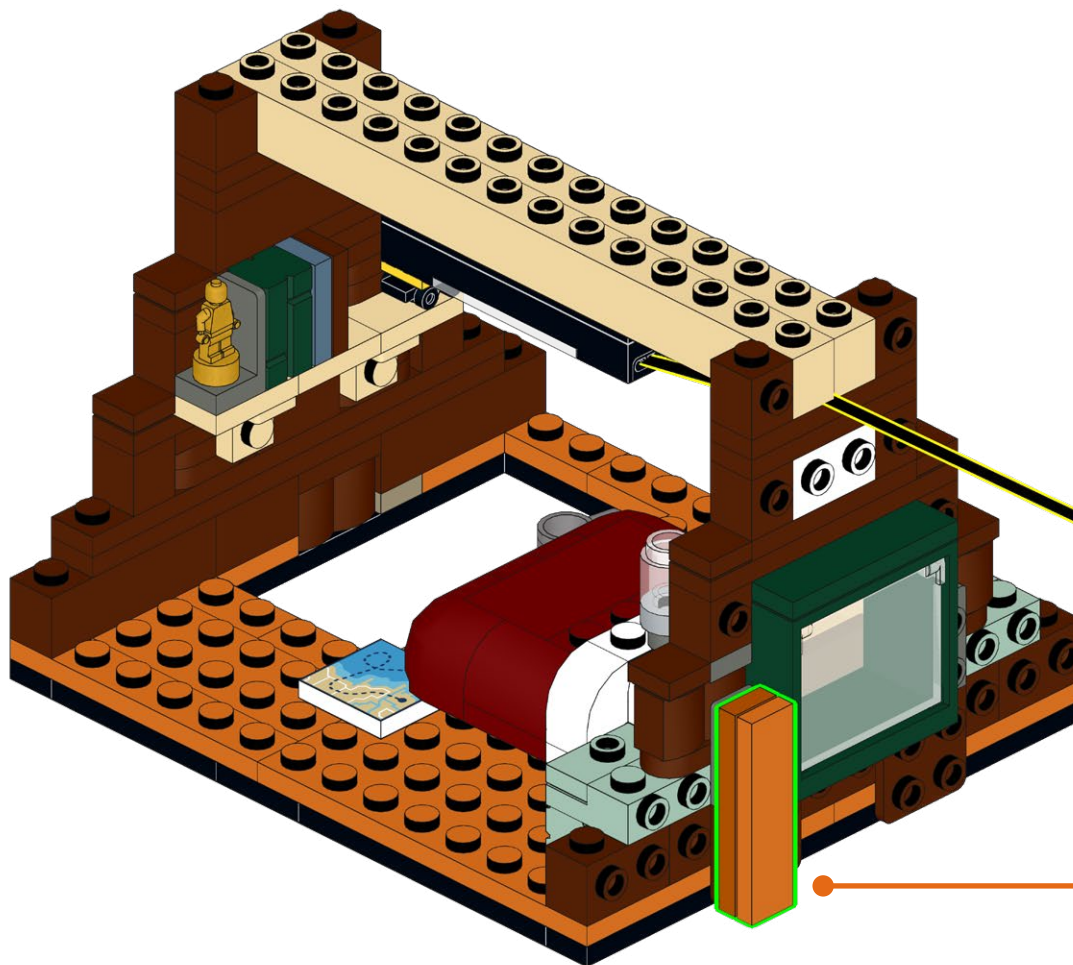
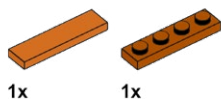

278

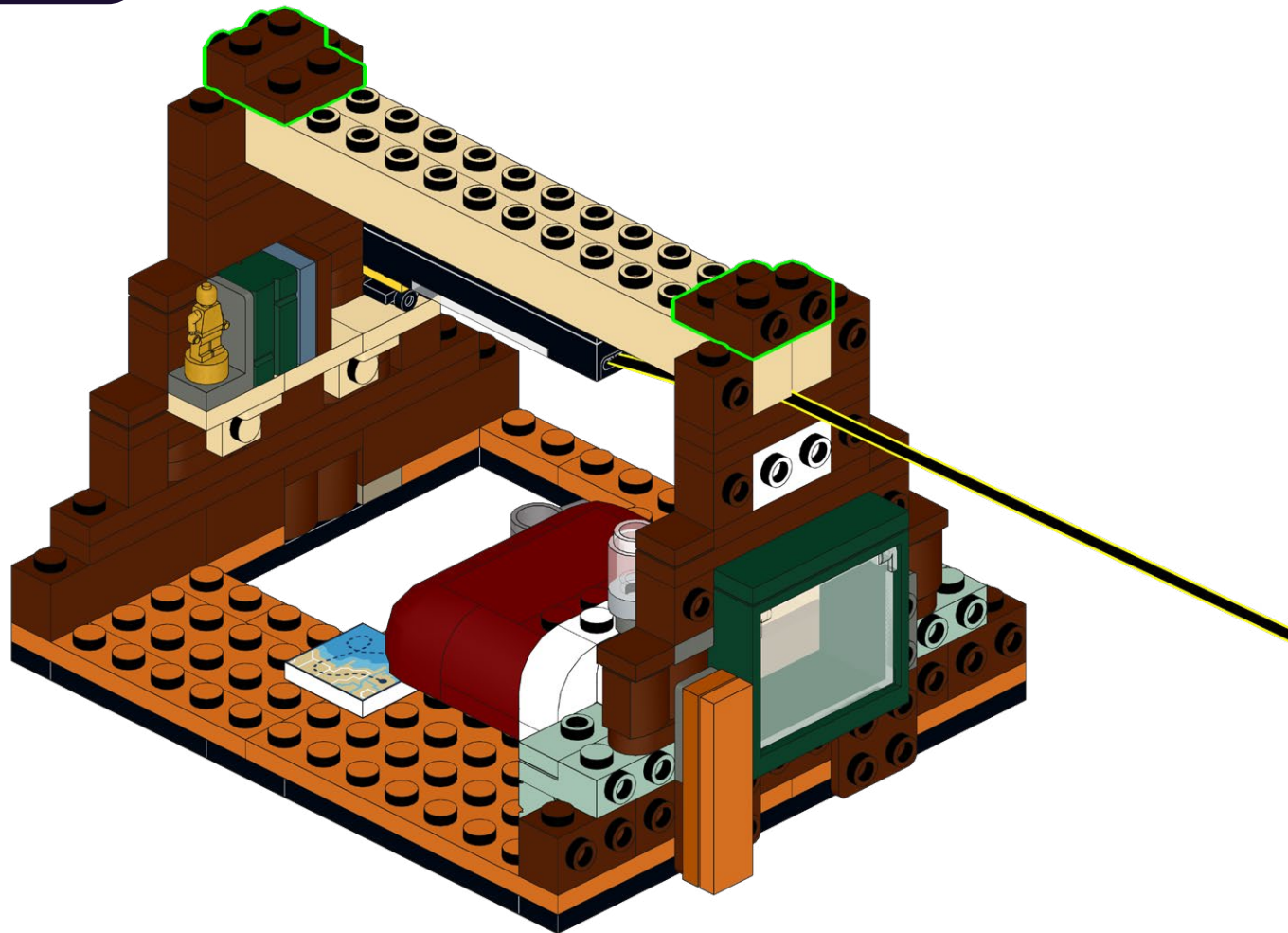

**HOLD UP!**

You might notice some bags aren't in order, as well as left over pieces, but that's ok! We're changing the way you build LEGO!

ATTENDEZ!

Vous remarquerez peut-être que certains sacs, ainsi que certaines pièces, ne sont pas dans le bon ordre. Mais pas de panique! Nous changeons simplement la façon avec laquelle vous construisez vos LEGO!

ASPETTA!

Potresti notare che alcuni sacchetti non sono in ordine, così come i pezzi avanzati, ma va bene così! Stiamo cambiando il modo in cui costruisci i LEGO!

HALT!

Sie werden möglicherweise bemerken, dass einige tüten durcheinander sind und teile übrig bleiben, aber das ist in Ordnung! Wir ändern die art und weise, wie Sie LEGO bauen!

¡ESPERA!

Es posible que notes que algunas bolsas están fuera de servicio, así como piezas sobrantes, ¡pero está bien! ¡Estamos cambiando la forma en que construyes LEGO!

暫停!

你可能会注意到一些袋子顺序错乱, 以及一些剩余的部件, 但没关系! 我们正在改变你搭建乐高的方式!

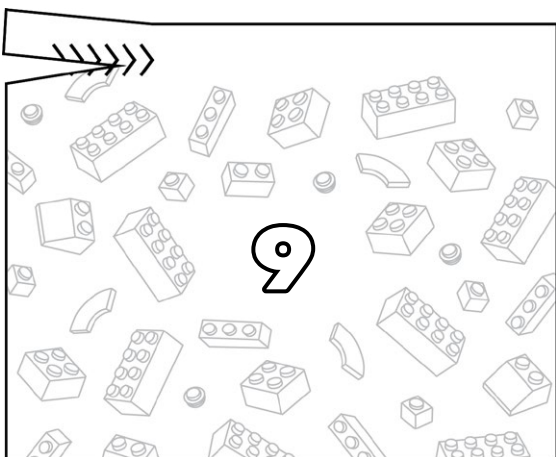
Open LEGO® Bag 9

279



1x

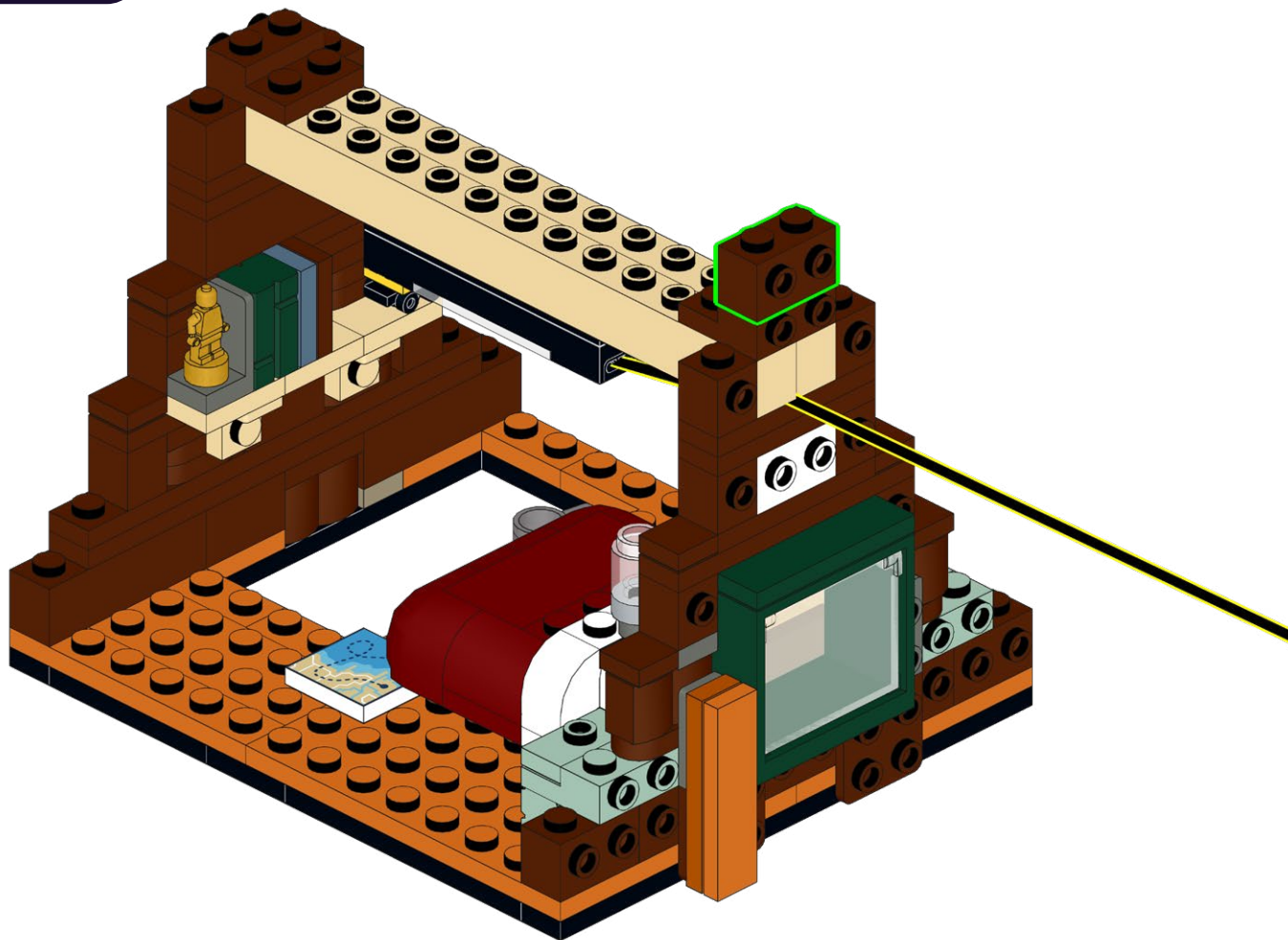

280

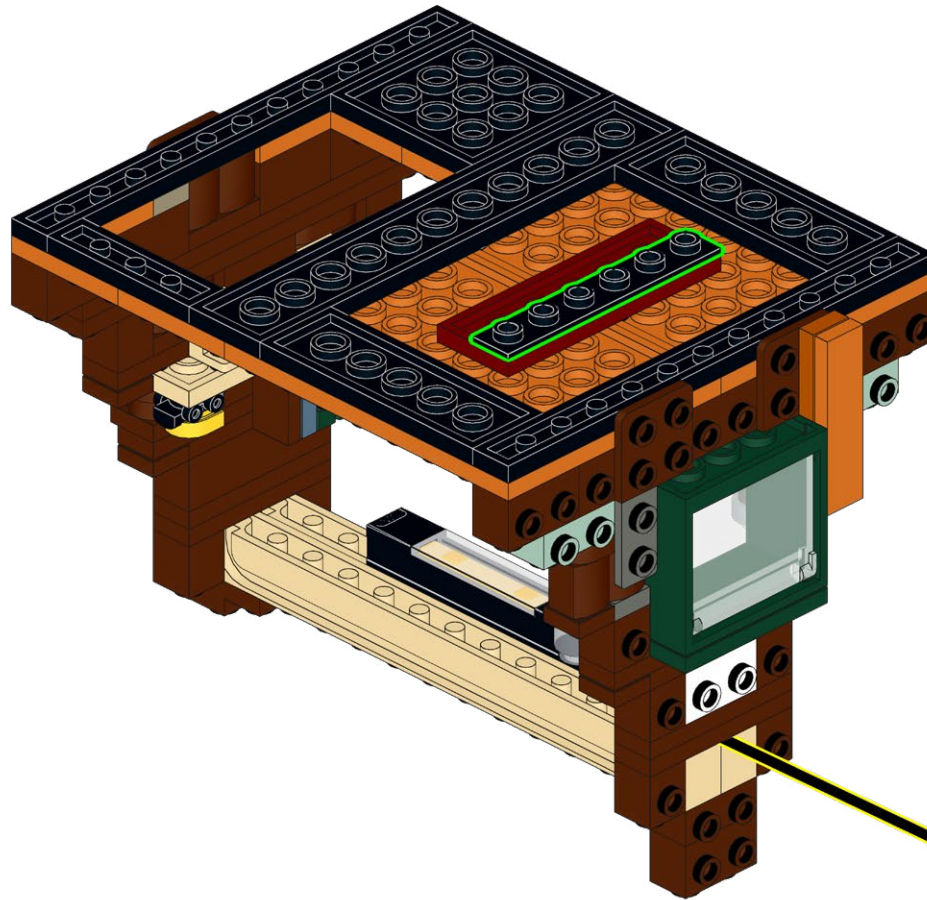
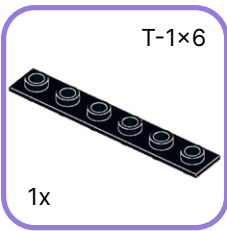

281

ML-WW



1x

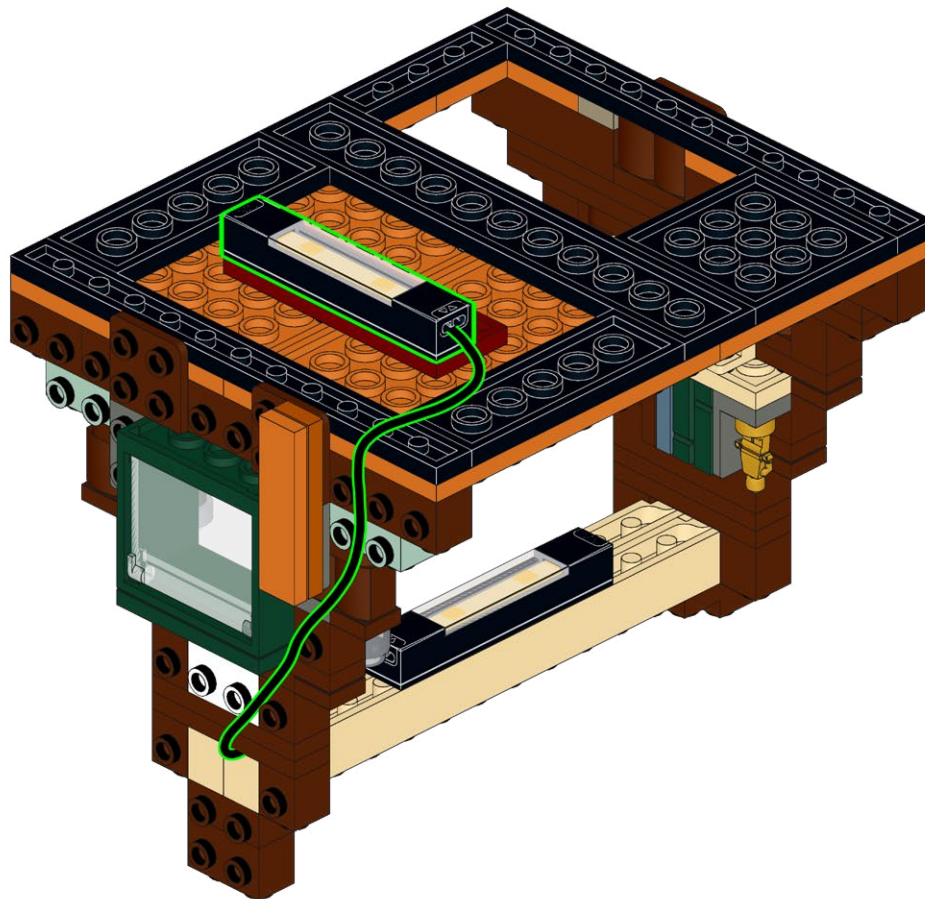

282

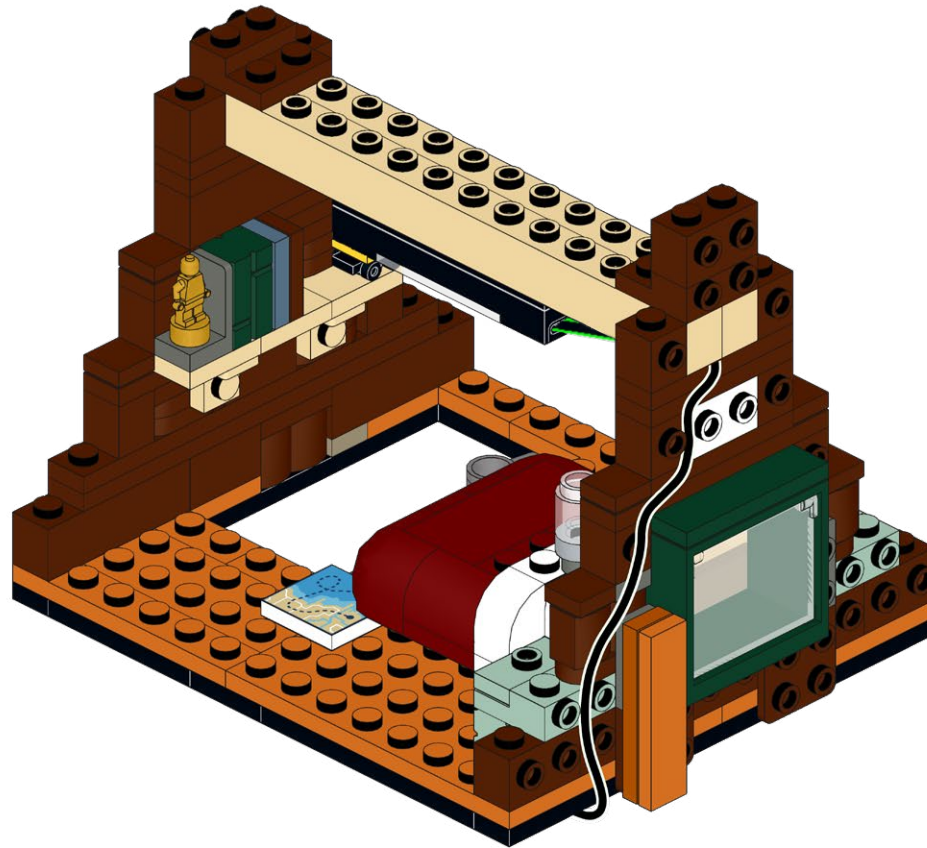

283

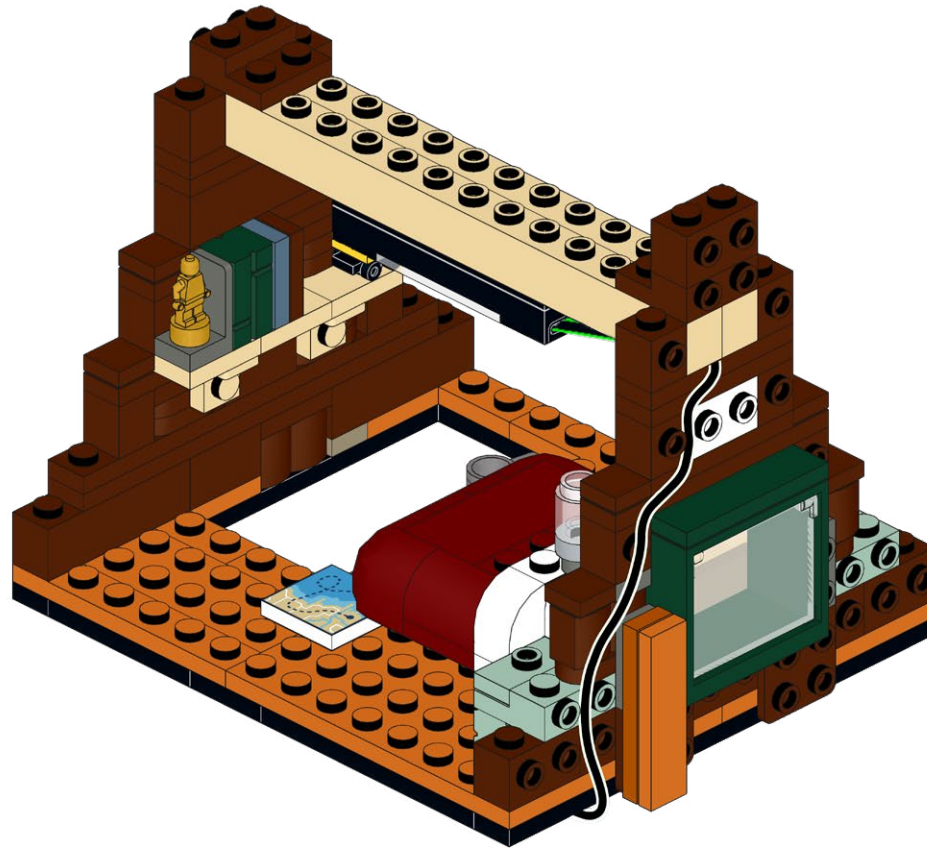

284

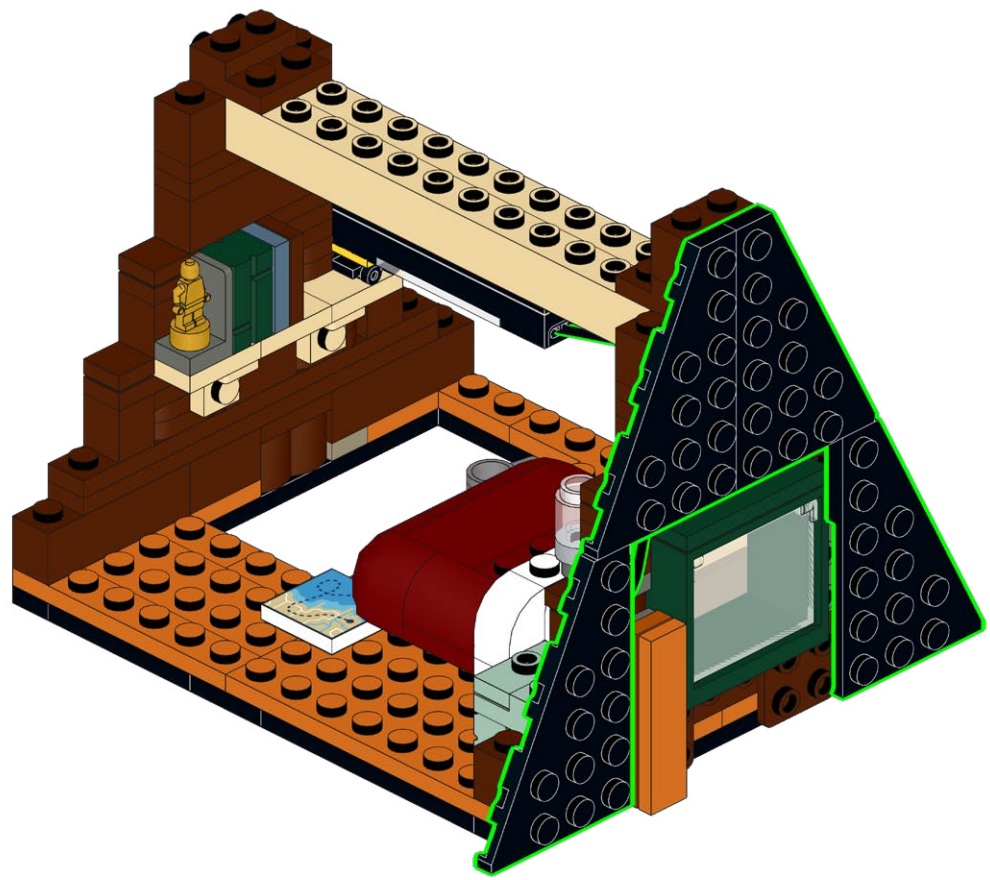

285

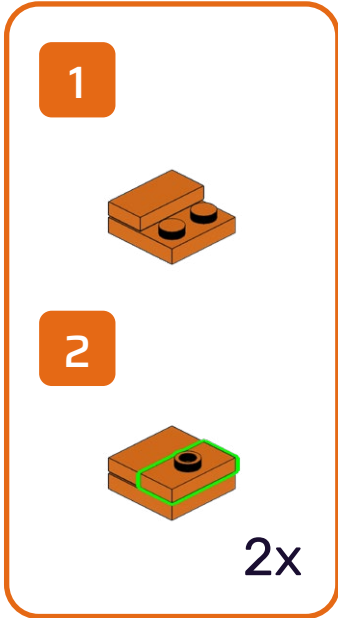
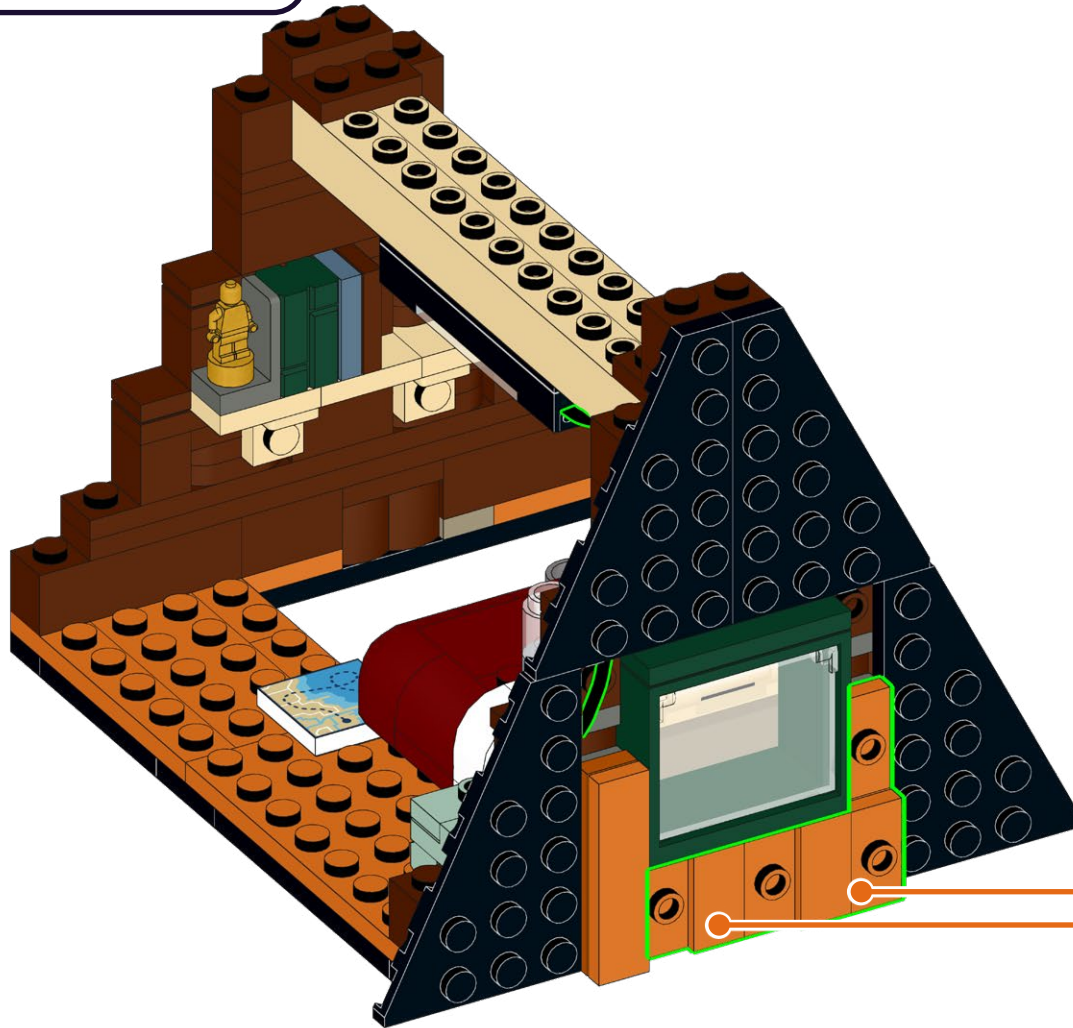
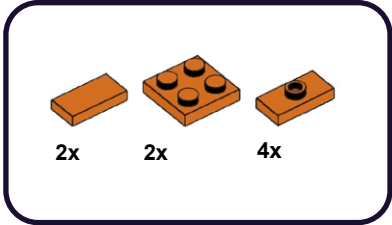

286



1x

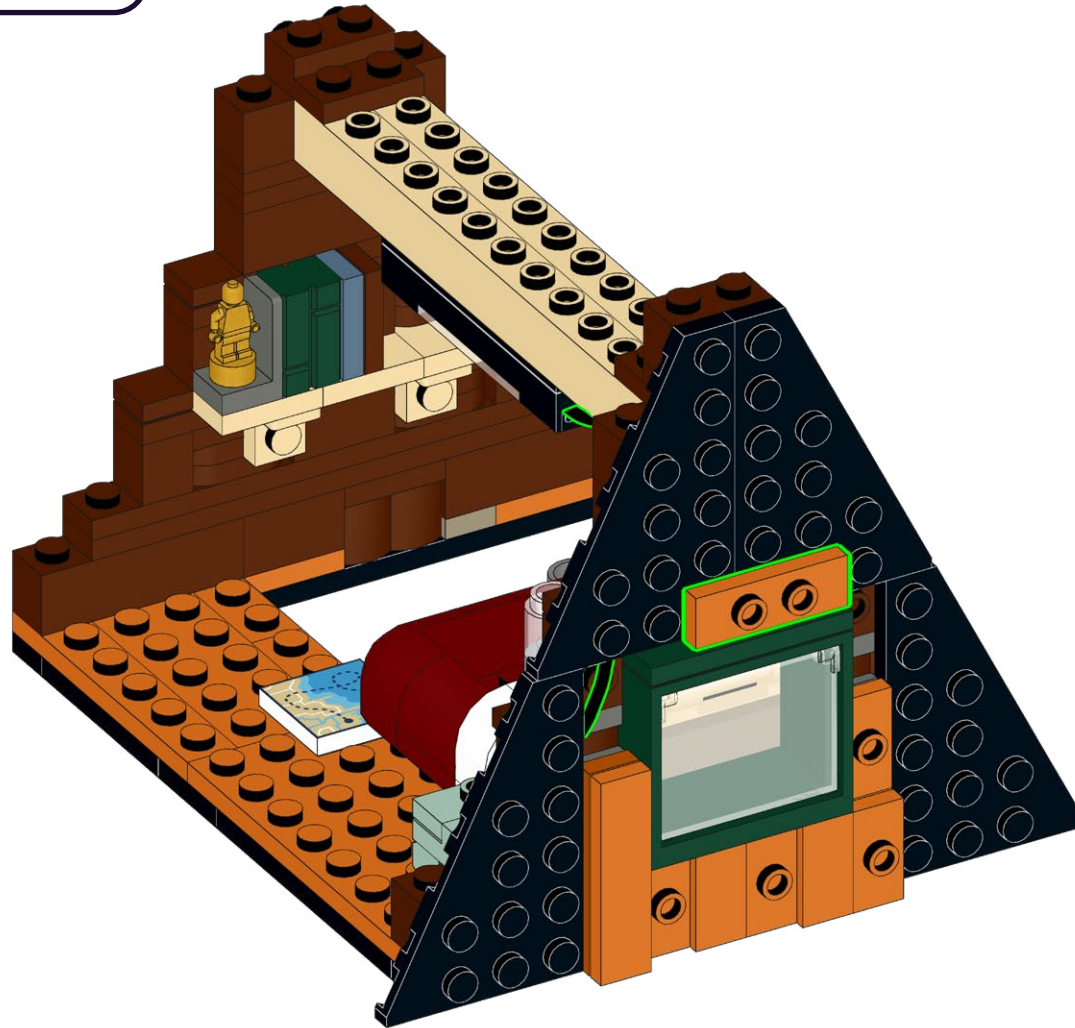

287

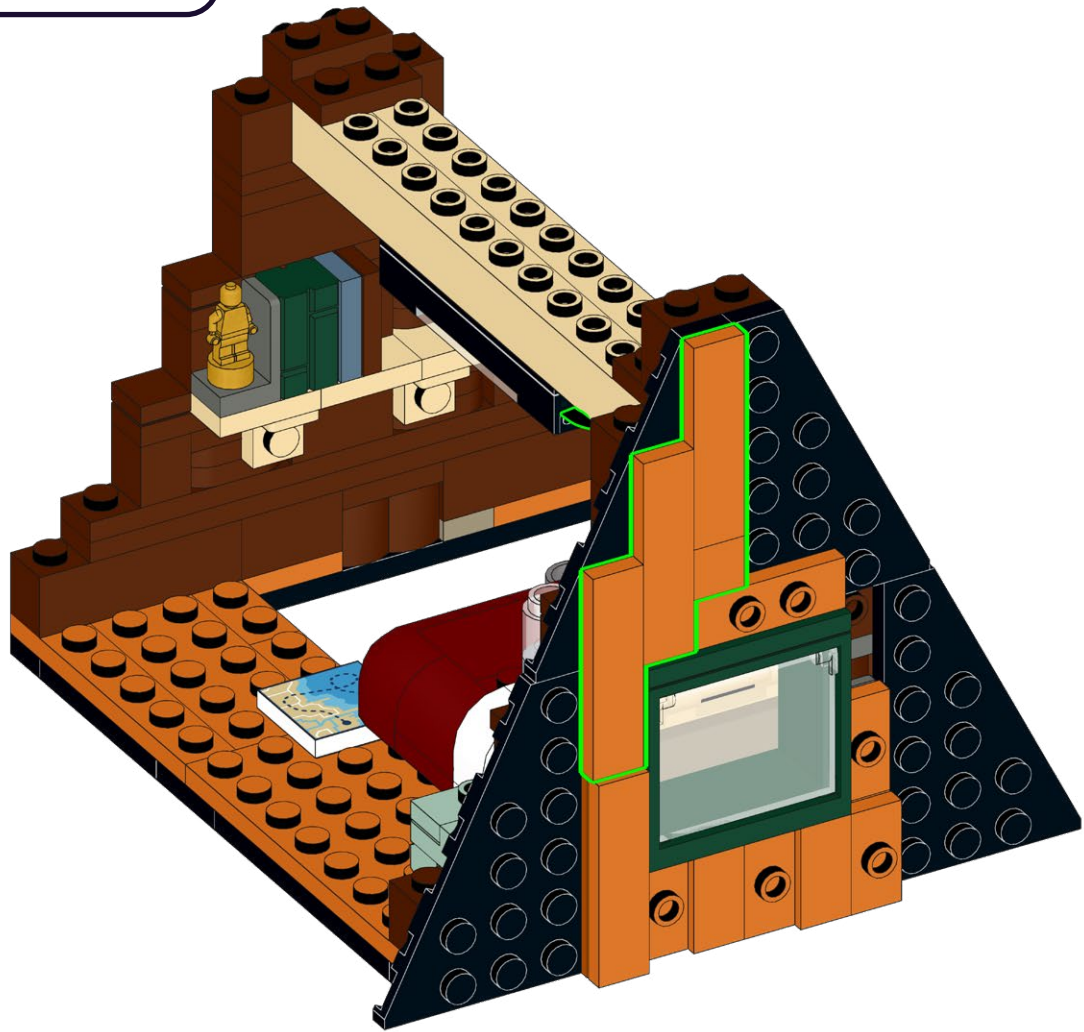
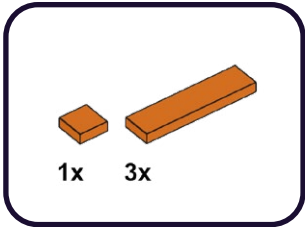

288

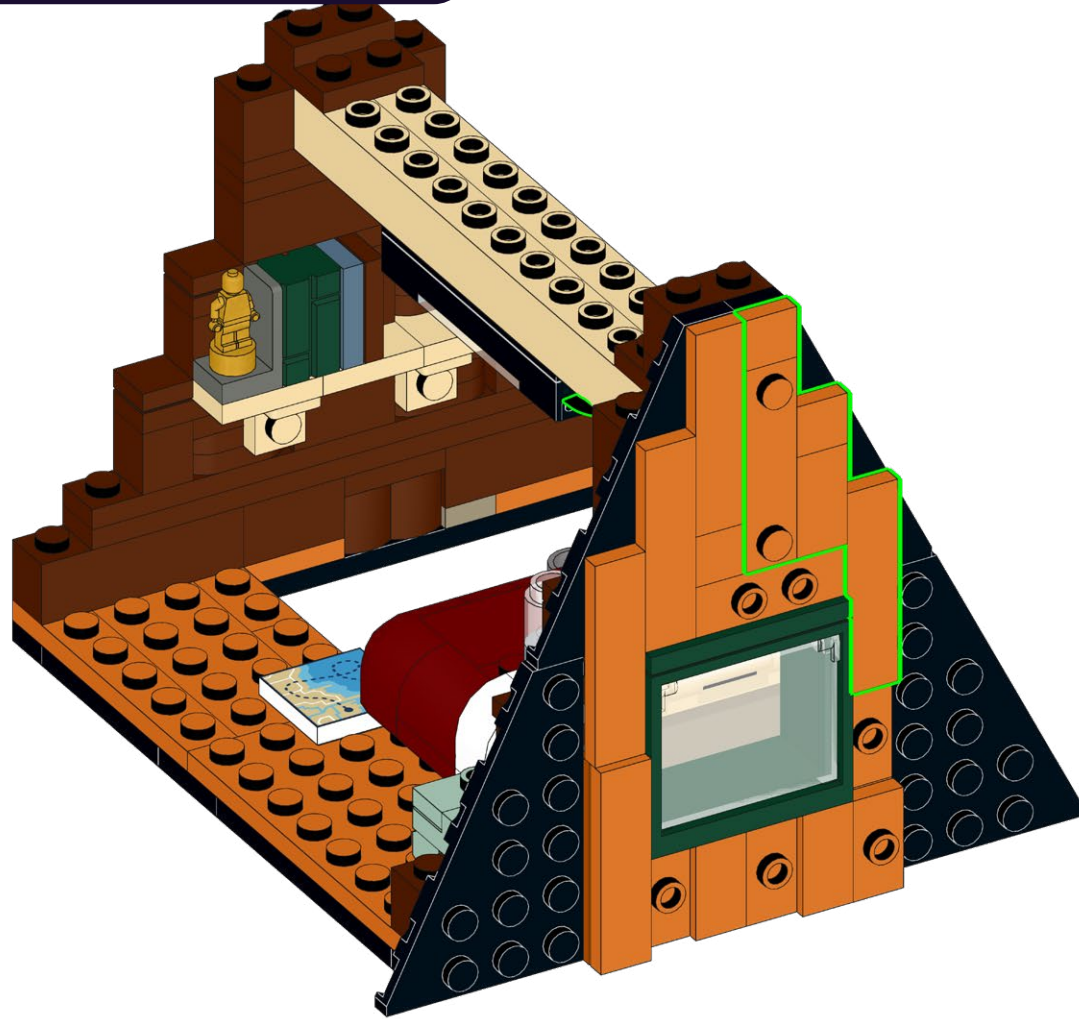
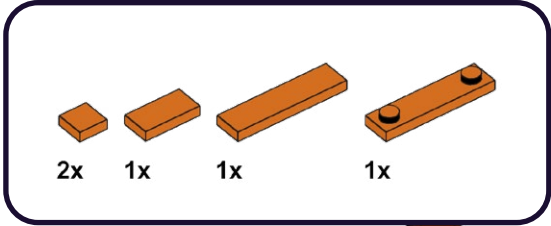

289

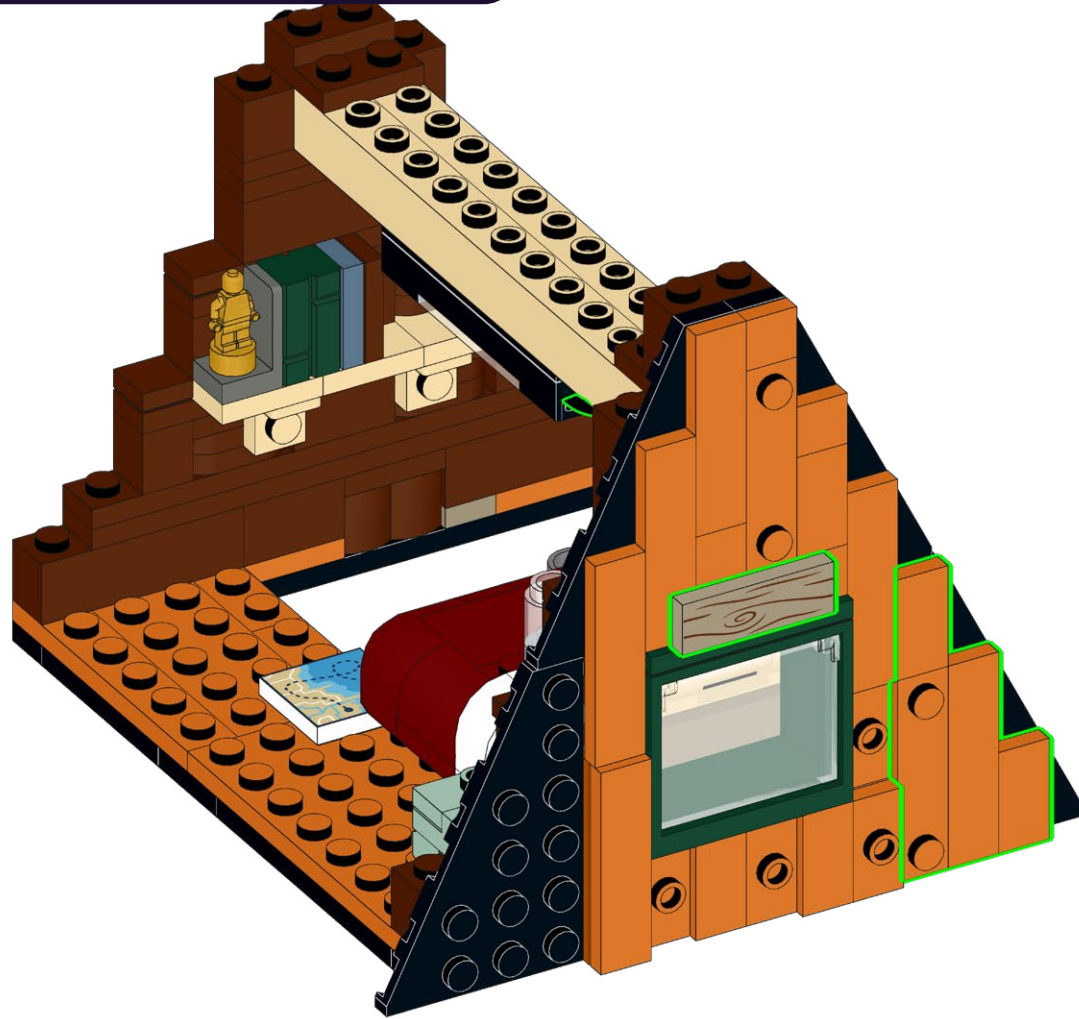
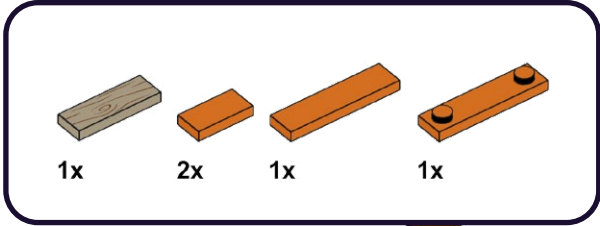

290

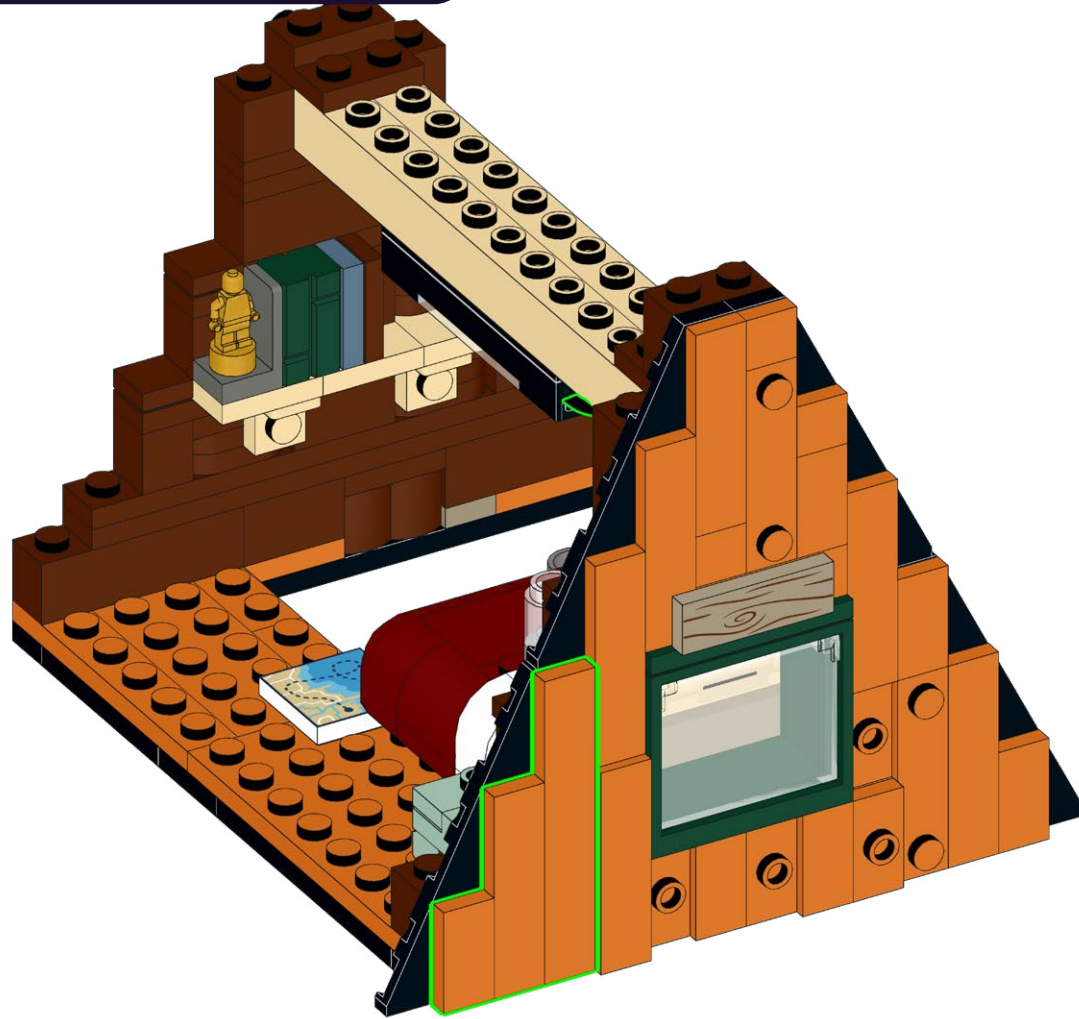
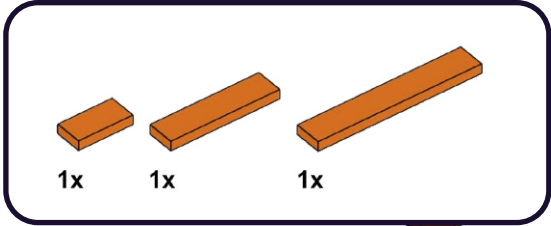

291

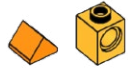

1x 1x



292

2x

4x

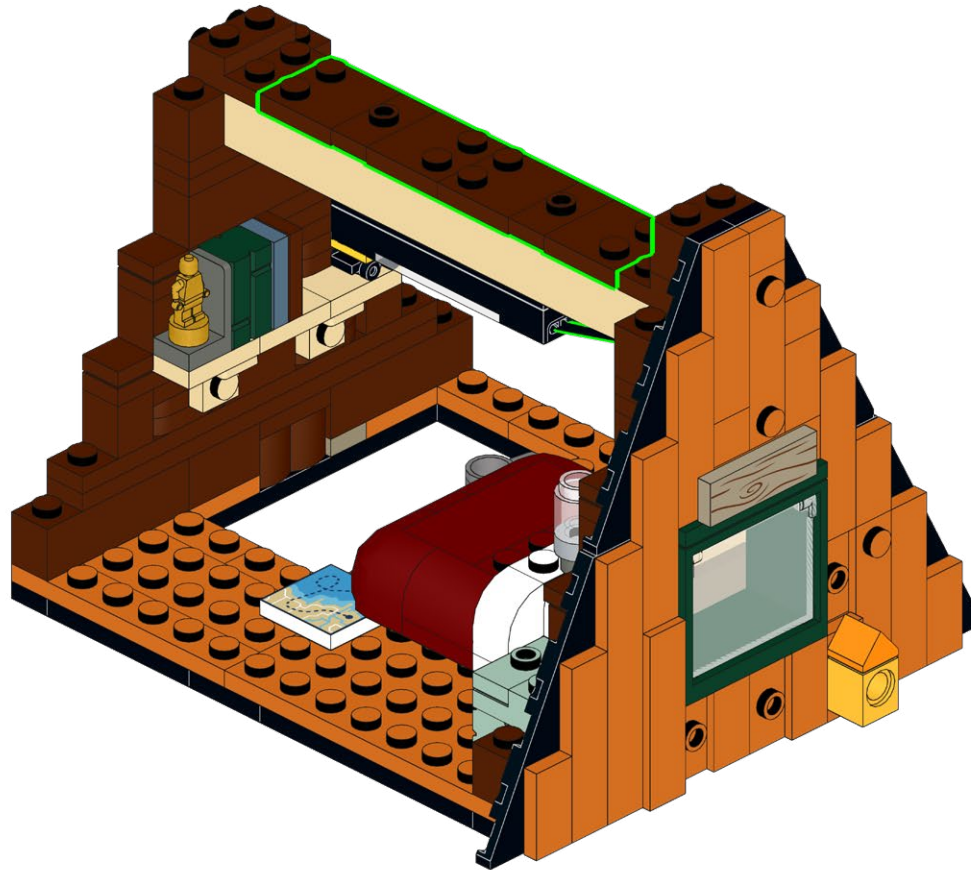

293



3x

1x

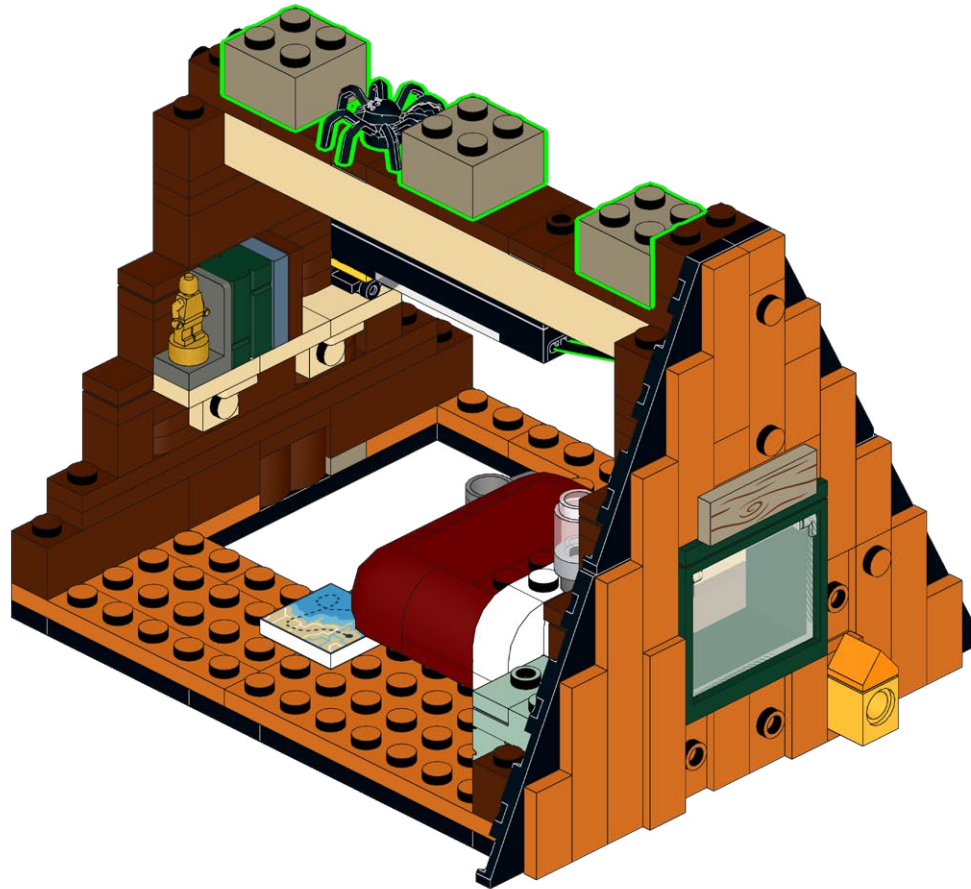

294

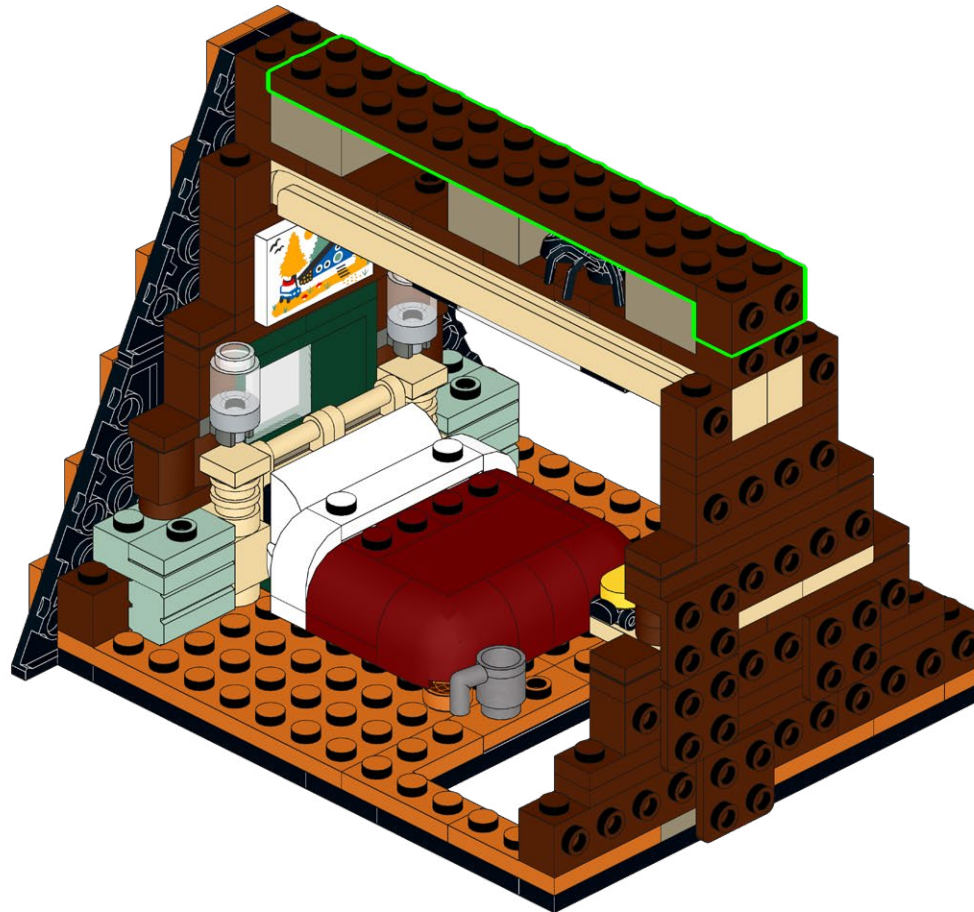
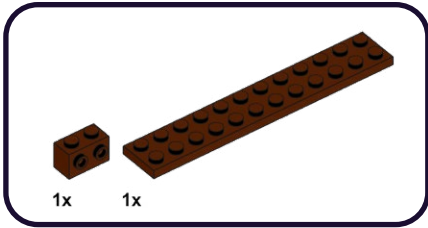

295

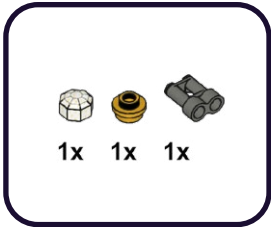

296

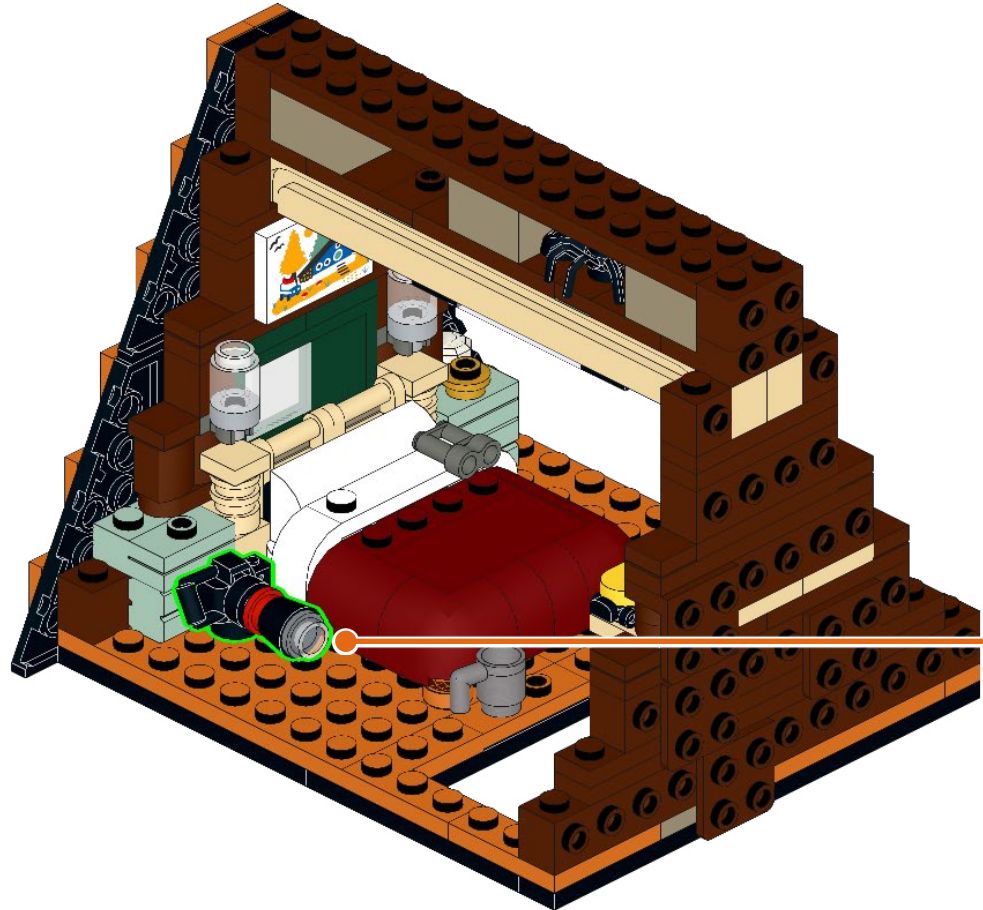

- 1 A black motor is shown above a black pin. A green arrow points from the motor to the pin, indicating they are to be joined.
- 2 The black motor and pin are joined together.
- 3 A red bush is added to the side of the motor and pin assembly.
- 4 A black bush is added to the side of the motor and pin assembly, next to the red bush.
- 5 A grey bush is added to the side of the motor and pin assembly, next to the other bushes.

297

- 1x 
- 1x 
- 1x 
- 1x 

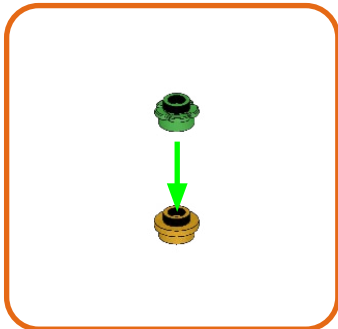

298

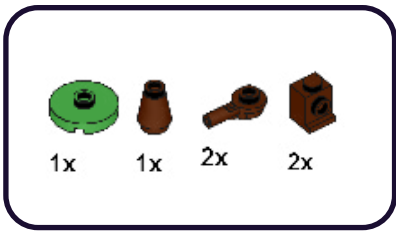

1

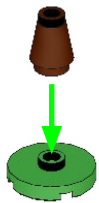

2

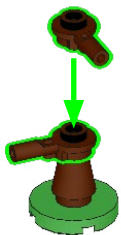

3

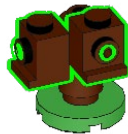

299

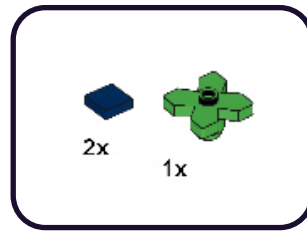

4

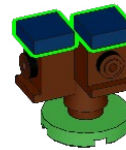





5



300



301

- 1x 
- 1x 
- 1x 
- 1x 
- 2x 

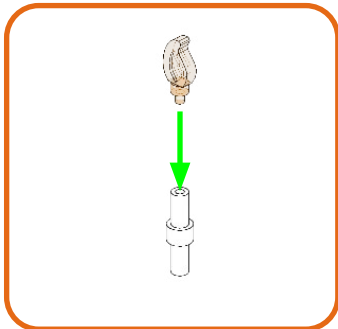
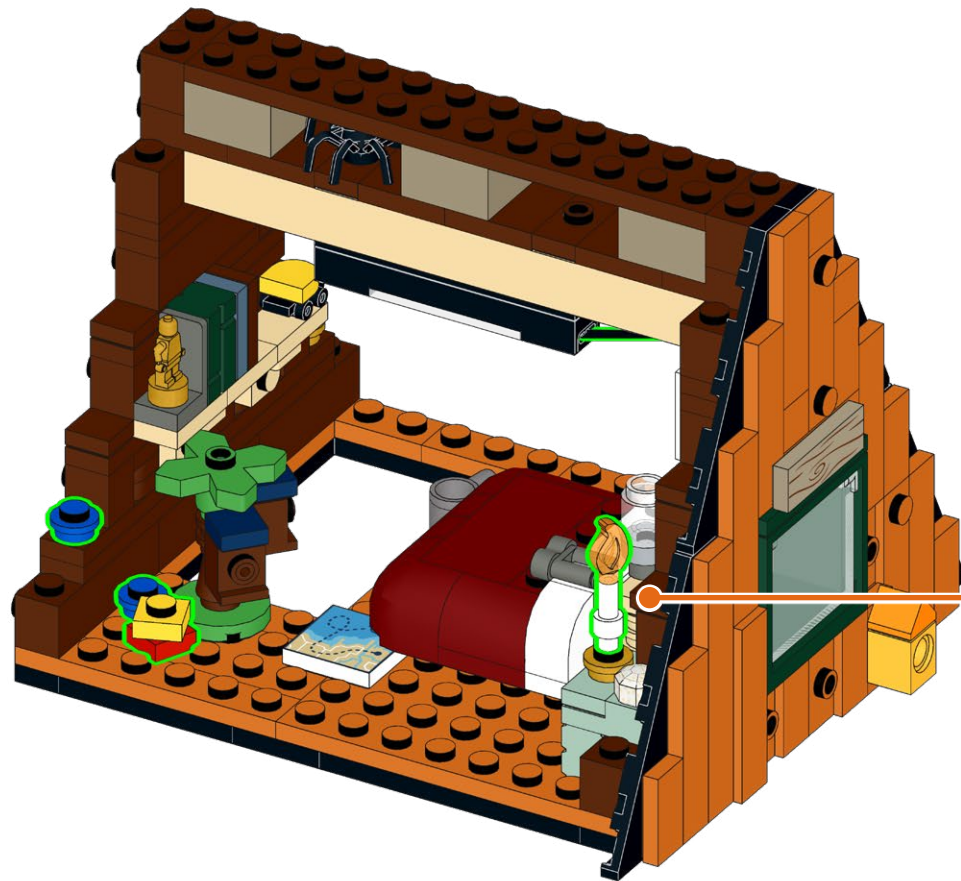

302

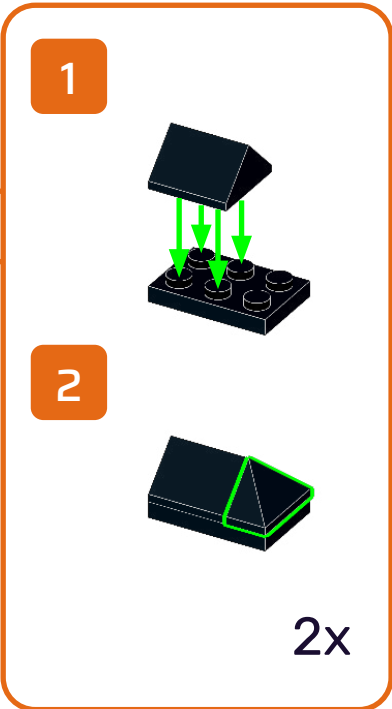
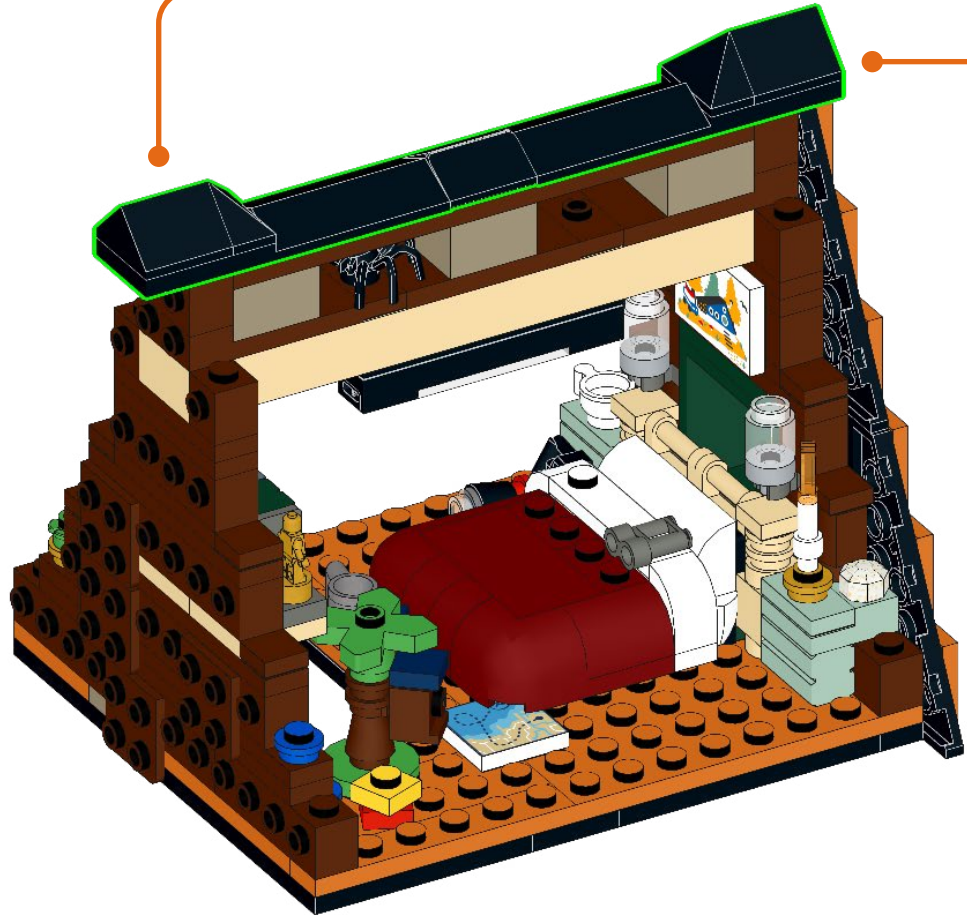
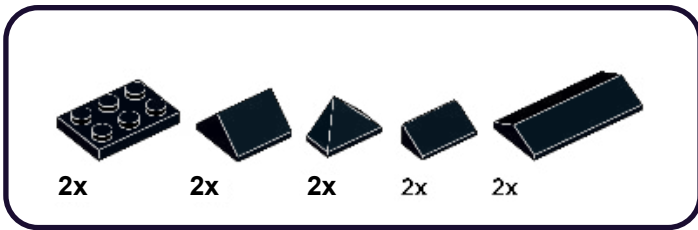

303

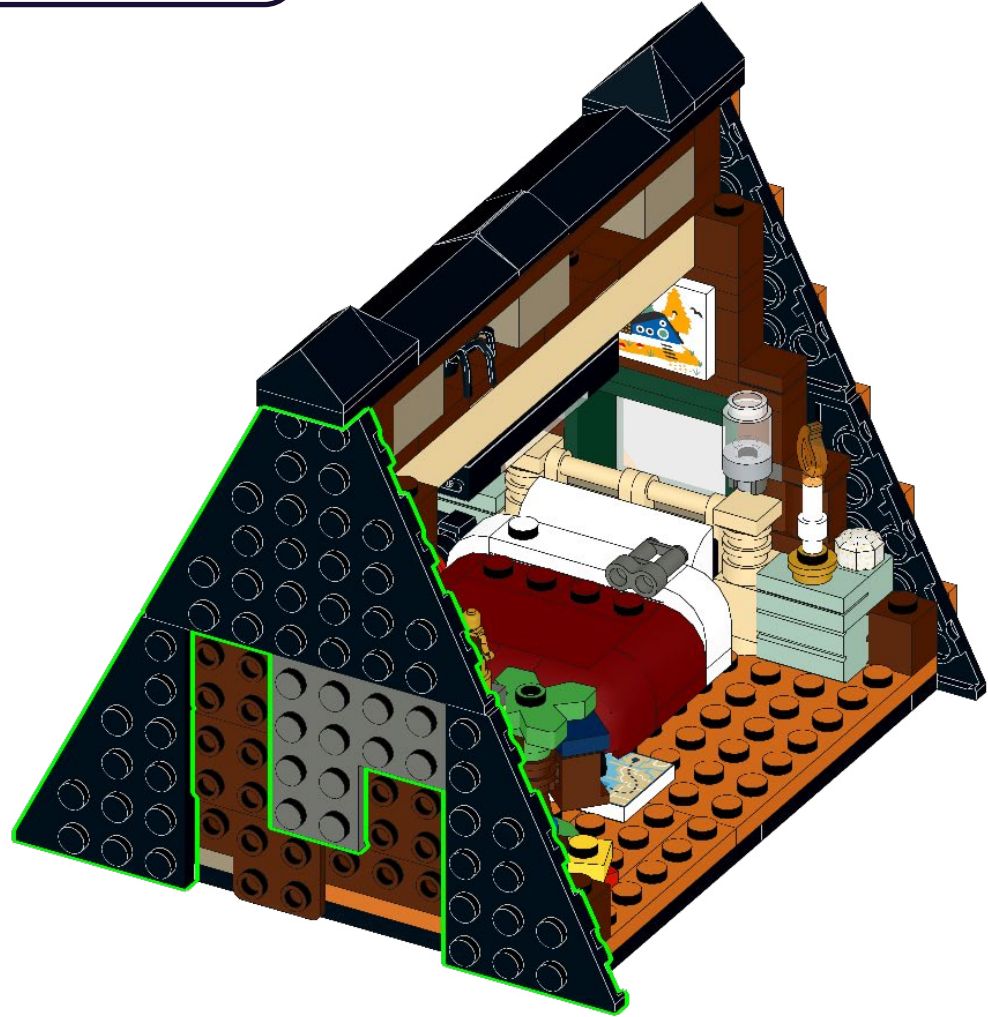
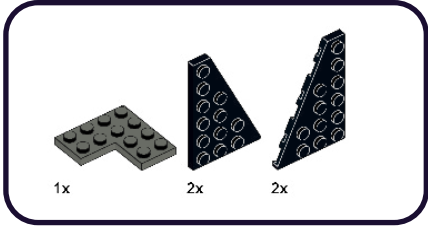

304

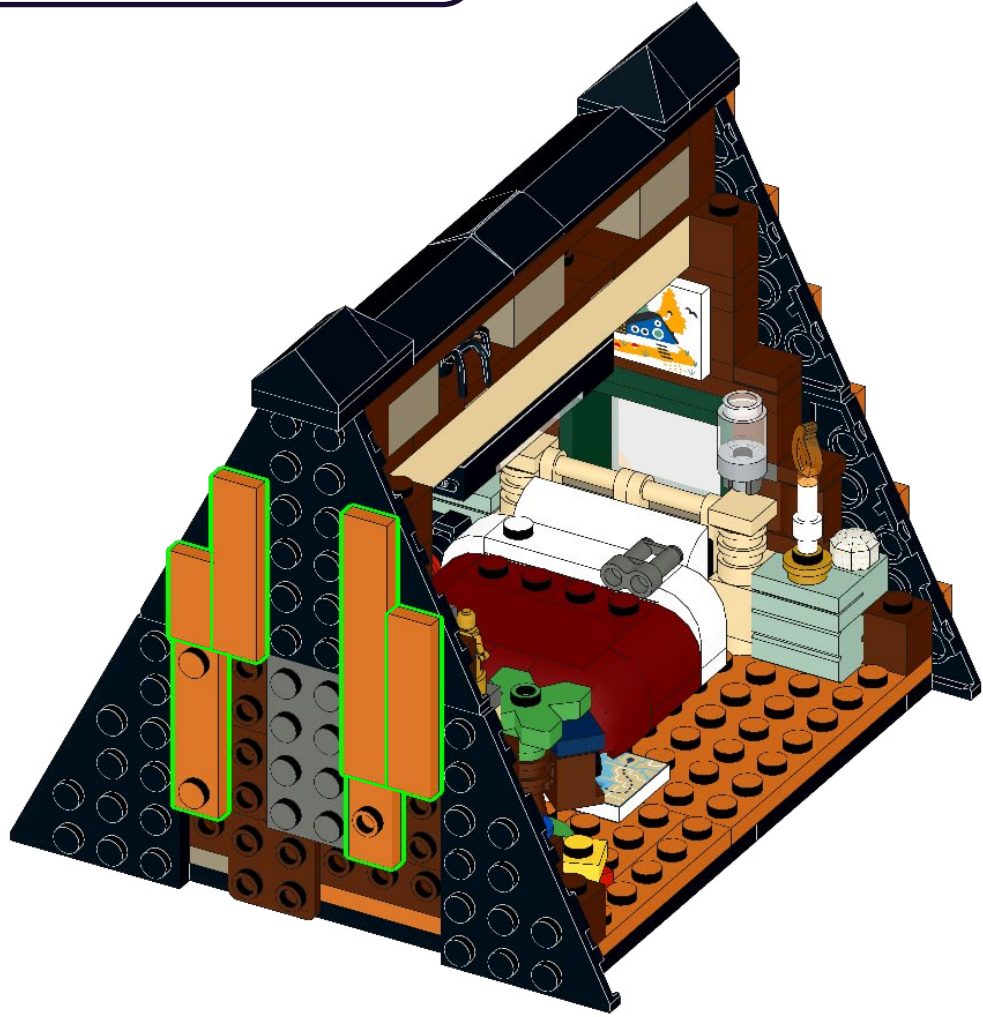
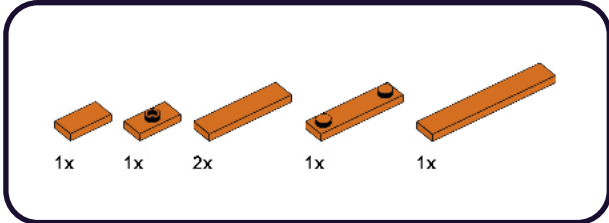

305

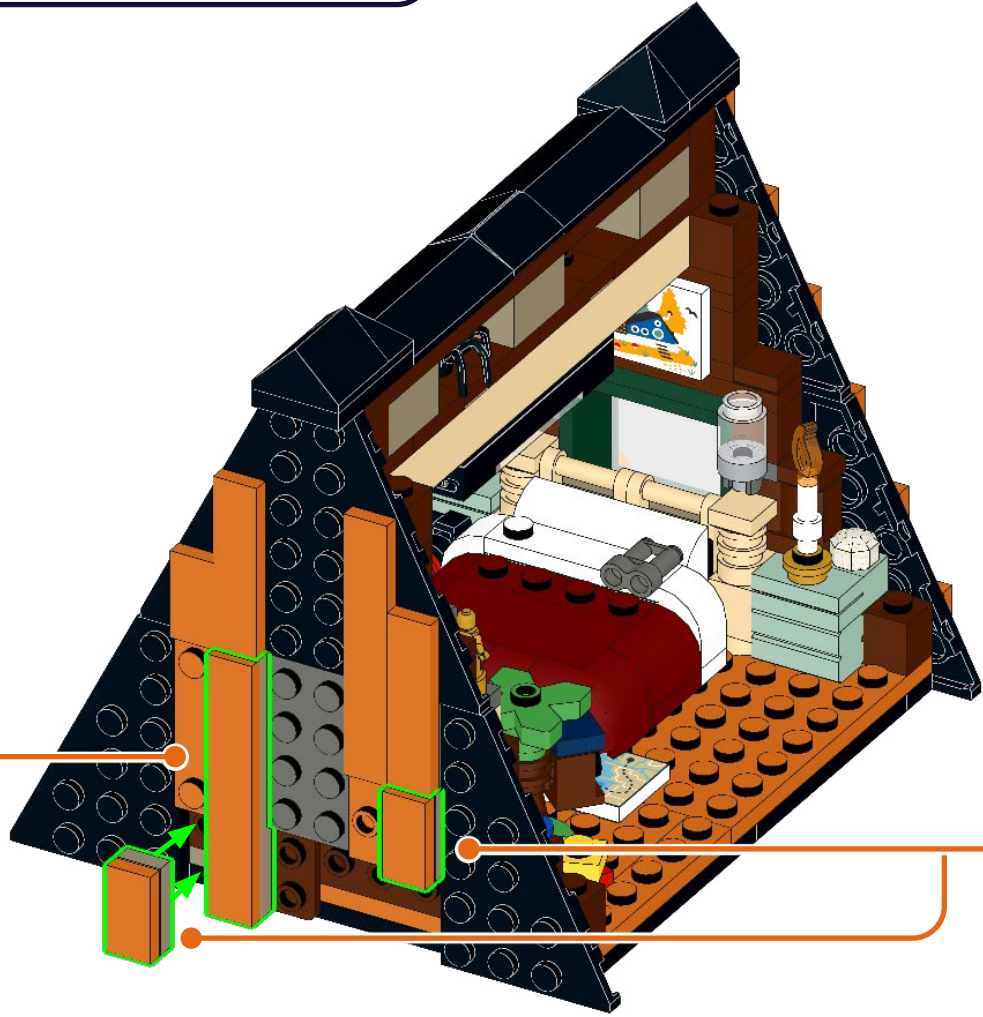
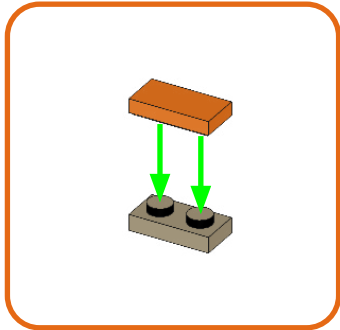
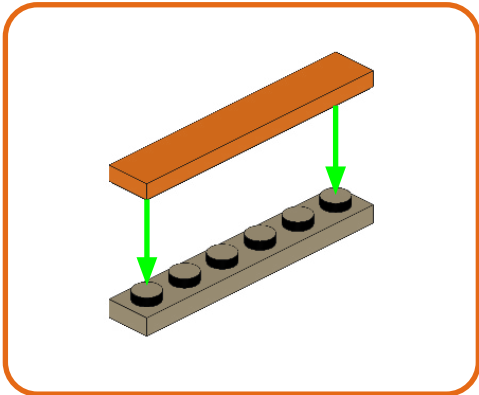
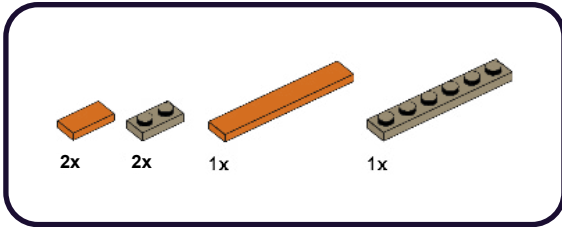

306

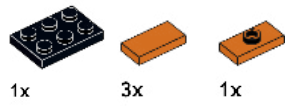

1

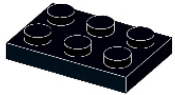

2

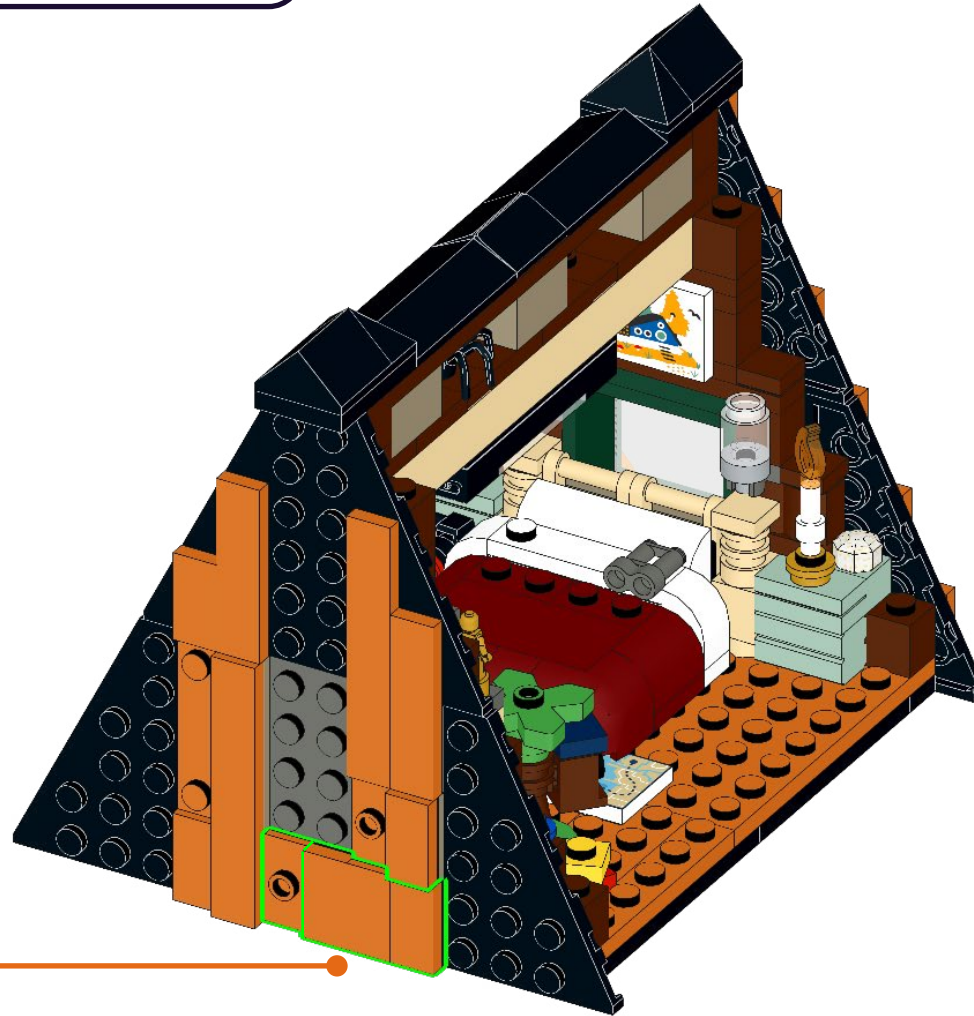
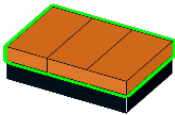

307

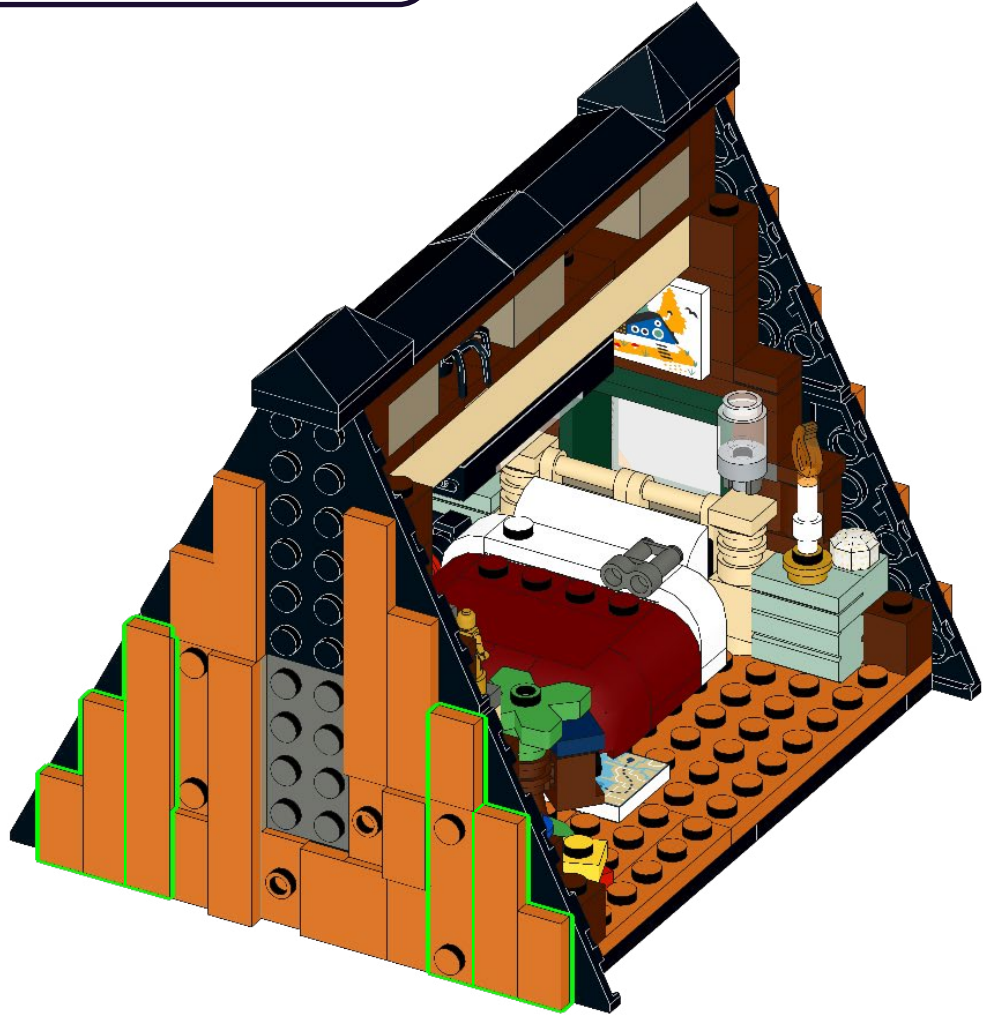
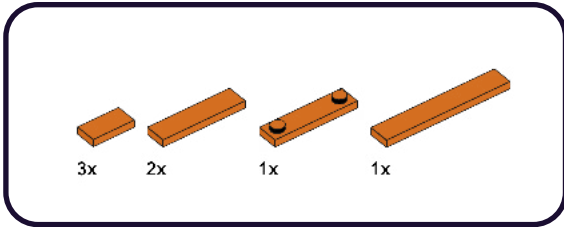

308

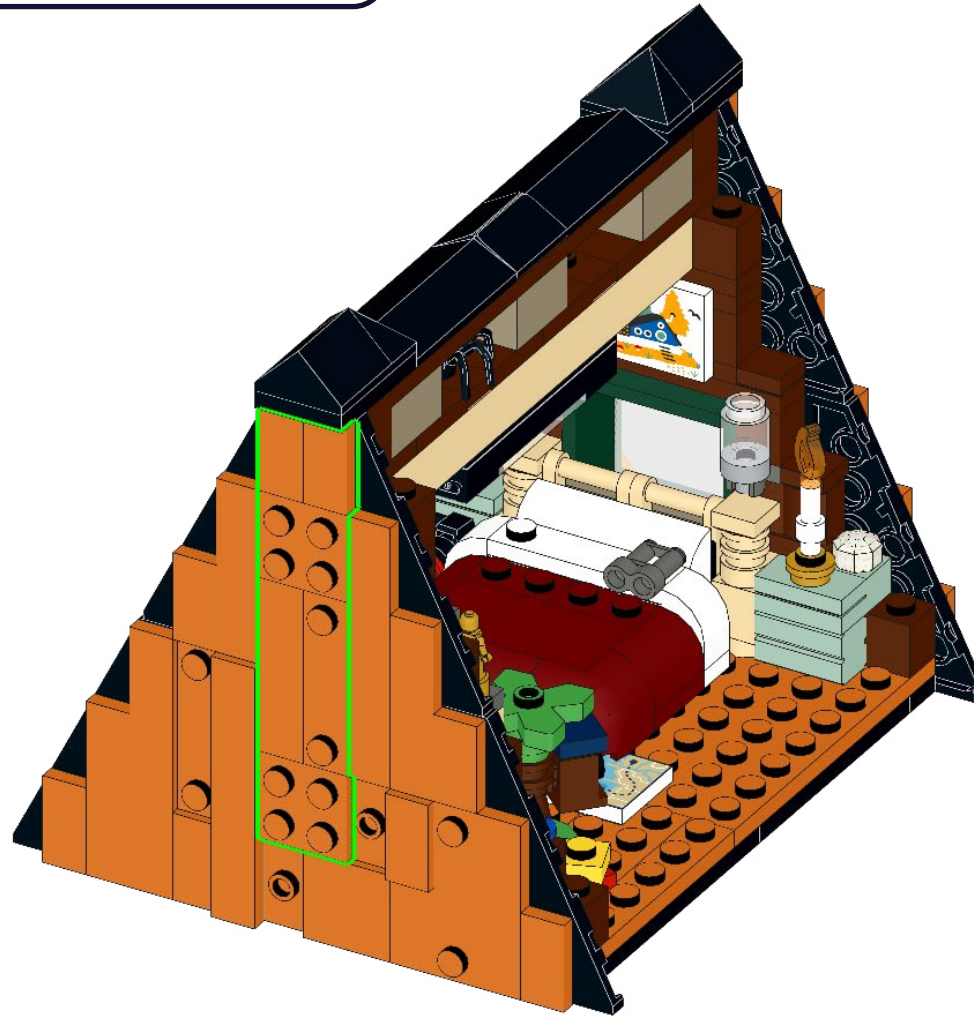
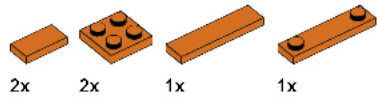

309

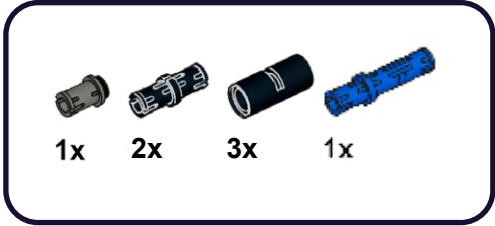

1

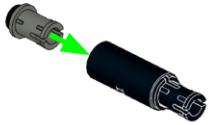

2



2



310

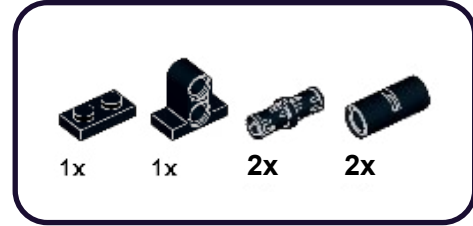

1

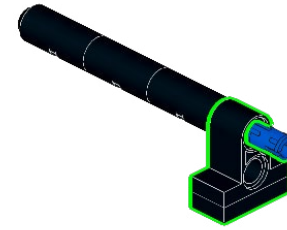

2

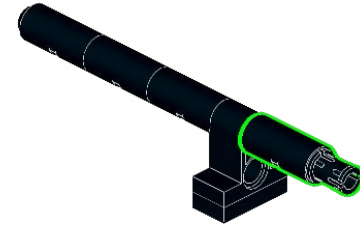

2

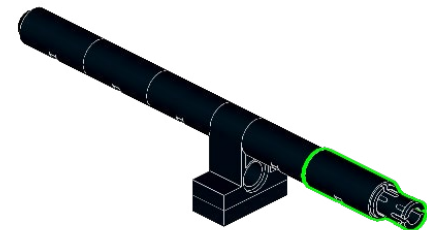

311

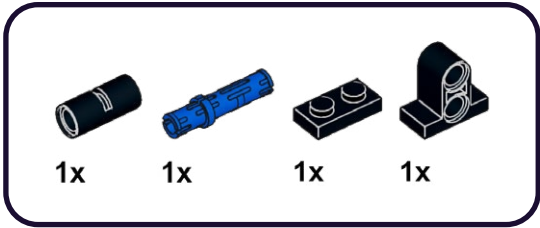

1

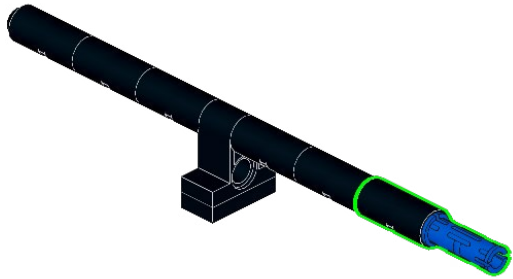

2

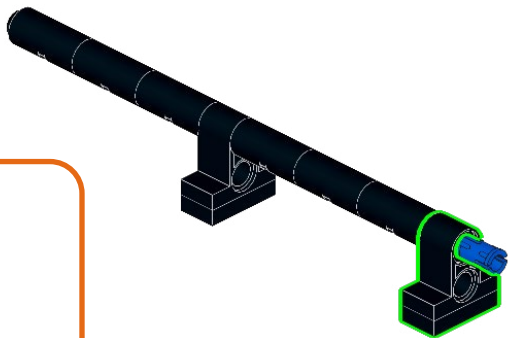
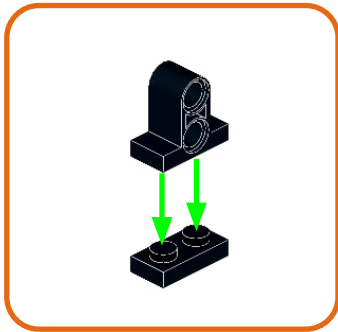

312

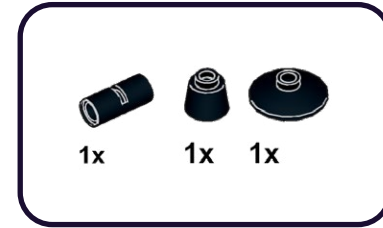

1

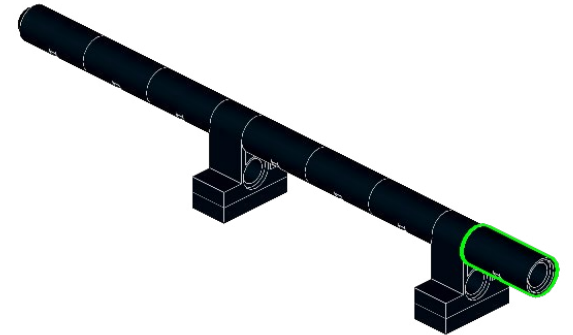

2

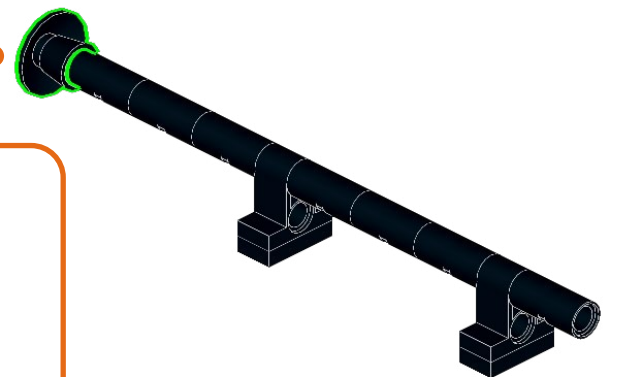
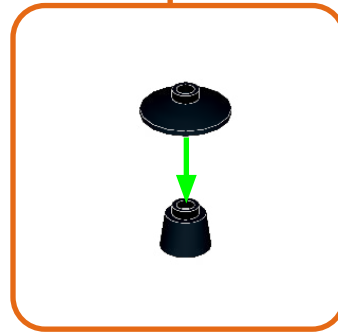

313

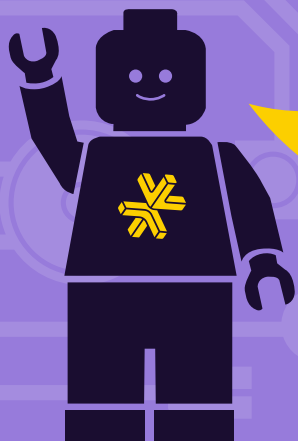

**HOLD UP!**

You might notice some bags aren't in order, as well as left over pieces, but that's ok! We're changing the way you build LEGO!

ATTENDEZ!

Vous remarquerez peut-être que certains sacs, ainsi que certaines pièces, ne sont pas dans le bon ordre. Mais pas de panique! Nous changeons simplement la façon avec laquelle vous construisez vos LEGO!

ASPETTA!

Potresti notare che alcuni sacchetti non sono in ordine, così come i pezzi avanzati, ma va bene così! Stiamo cambiando il modo in cui costruisci i LEGO!

HALT!

Sie werden möglicherweise bemerken, dass einige tüten durcheinander sind und teile übrig bleiben, aber das ist in Ordnung! Wir ändern die art und weise, wie Sie LEGO bauen!

¡ESPERA!

Es posible que notes que algunas bolsas están fuera de servicio, así como piezas sobrantes, ¡pero está bien! ¡Estamos cambiando la forma en que construyes LEGO!

暫停!

你可能会注意到一些袋子顺序错乱, 以及一些剩余的部件, 但没关系! 我们正在改变你搭建乐高的方式!

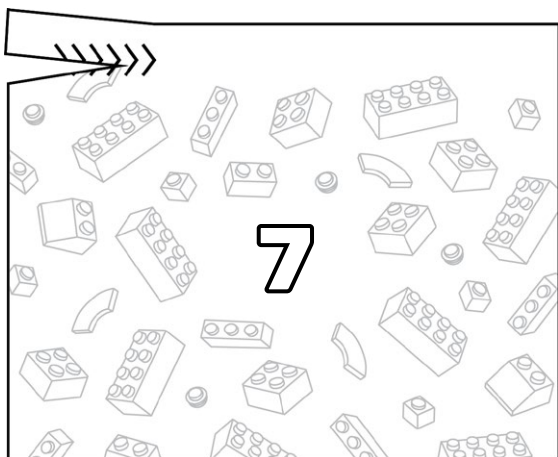
Open LEGO® Bag 7

314

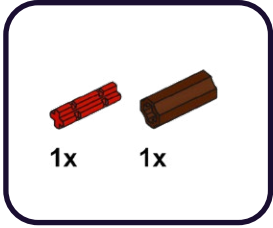

315

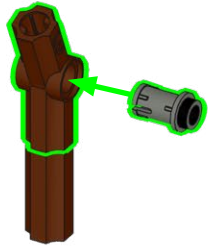
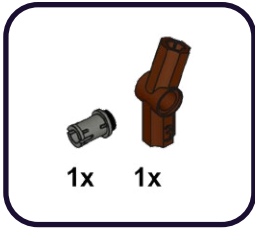

316

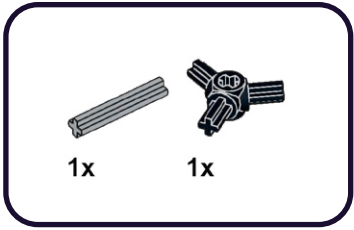

317



3x

1x



318

1x

1x



319

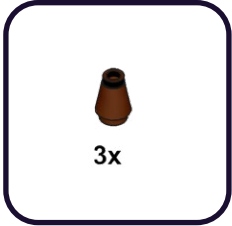

320

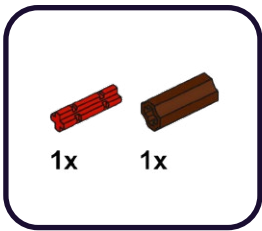

321

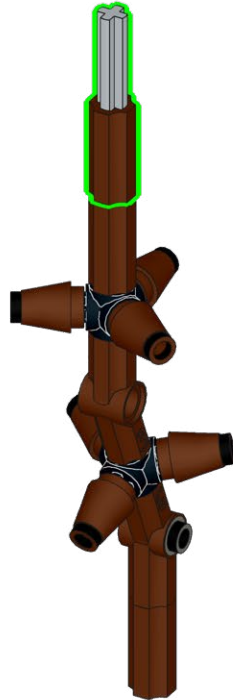
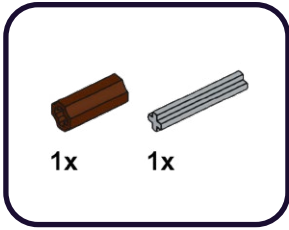

322

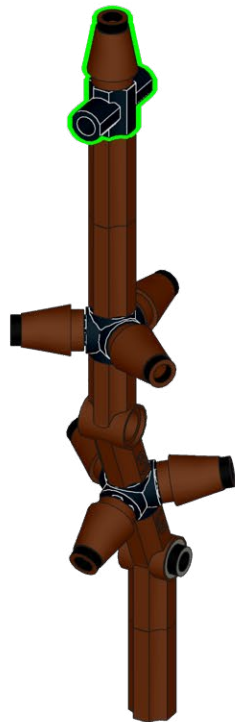

323

6x

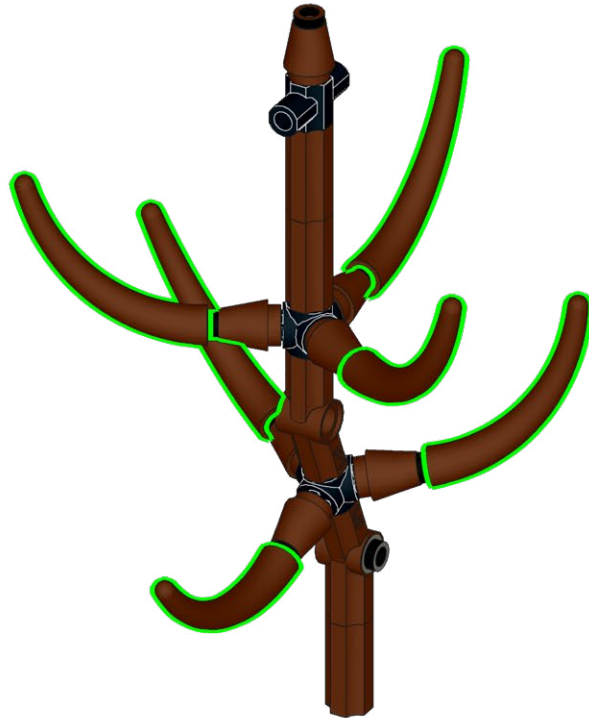

324



1x



325

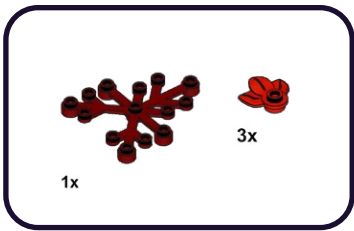

1

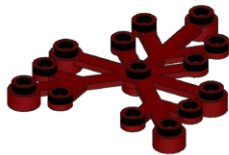

2

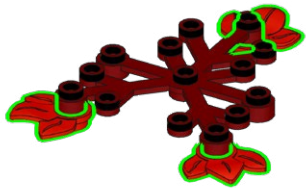

326

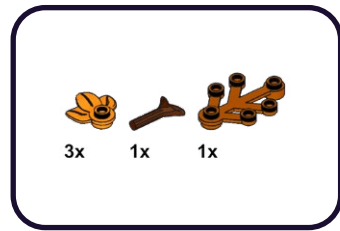

1

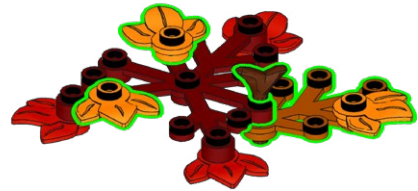

6x

327



328

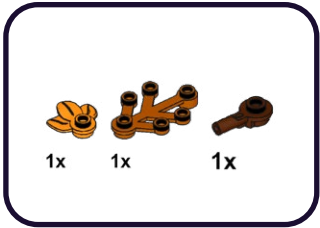

1

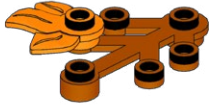

2

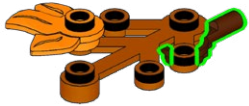

329

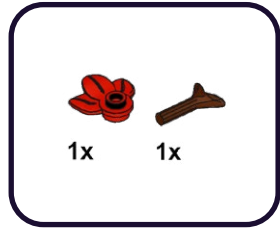

1

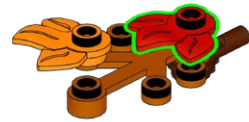

2

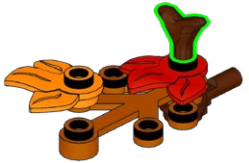

2x

330



331



1

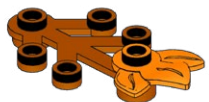

2

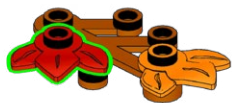

1

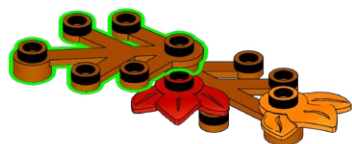

332



2

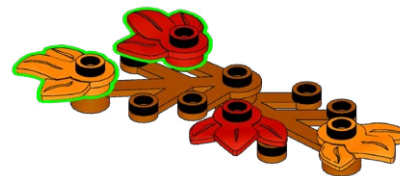

2

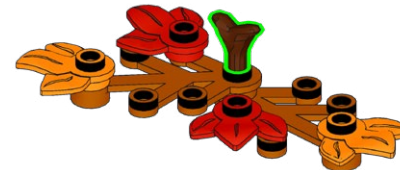

333



334



1x



335



To be used later
A utiliser plus tard
Da utilizzare dopo
Zur späteren Verwendung
Para ser utilizado más tarde
稍后使用

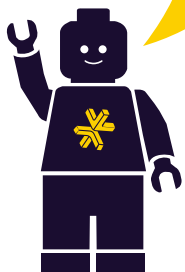

 LMB

336

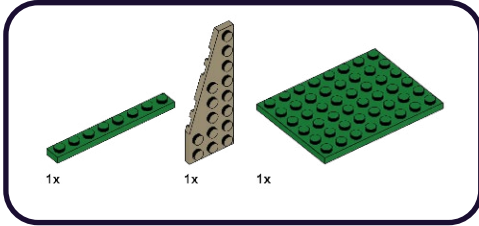

1

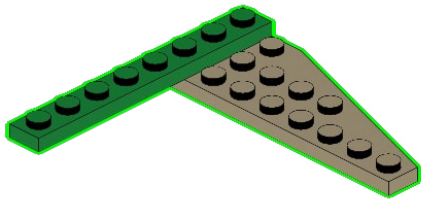

2

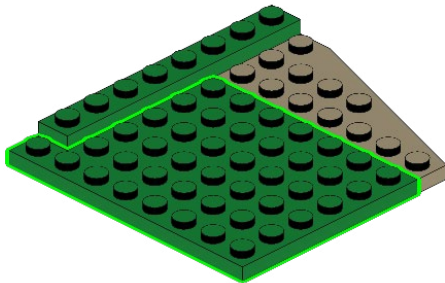

337

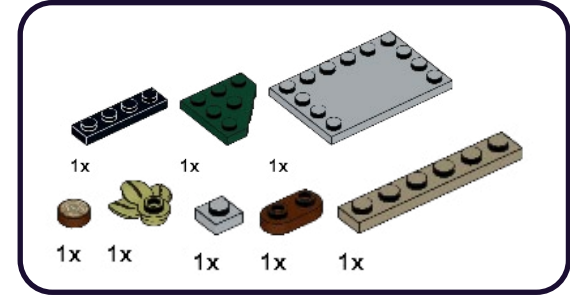

1

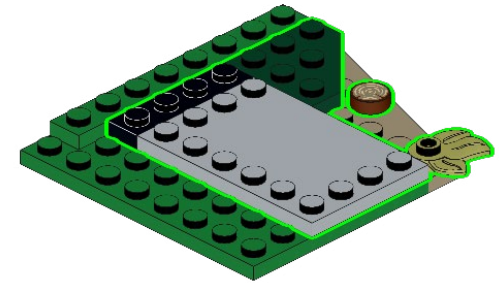

2

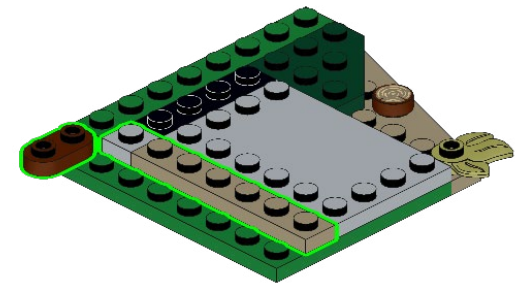

338

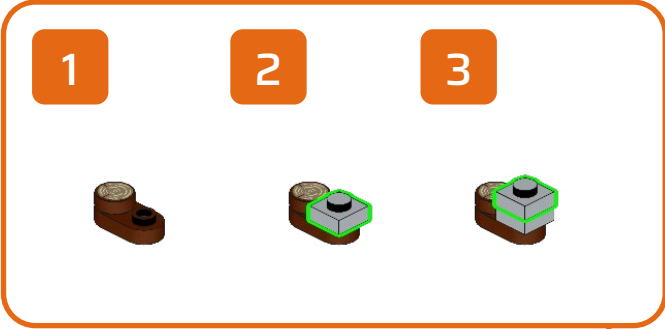
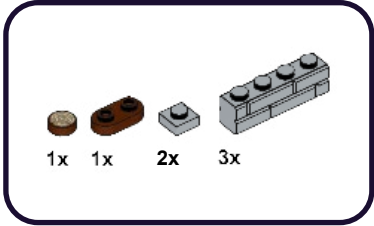

1

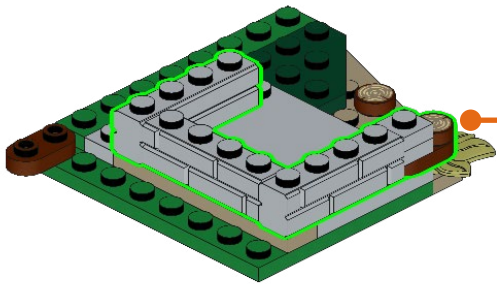

339

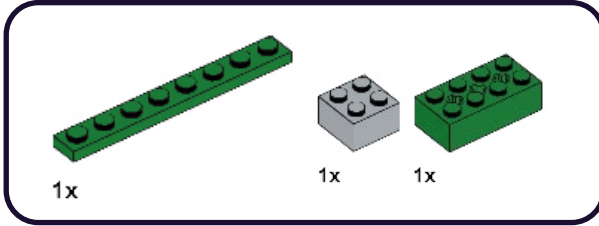

1

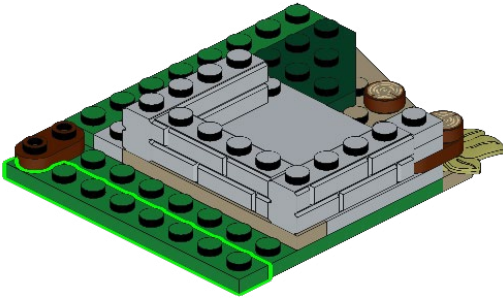

2

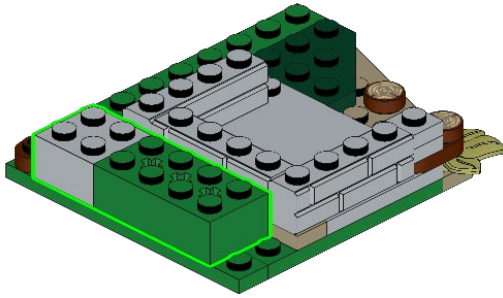

340

1x 1x 1x

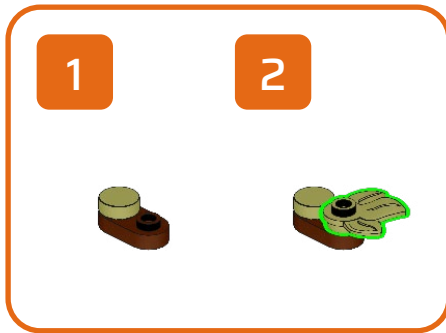

1

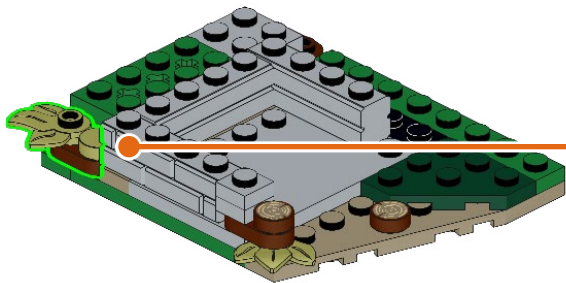

341

2x 2x 1x

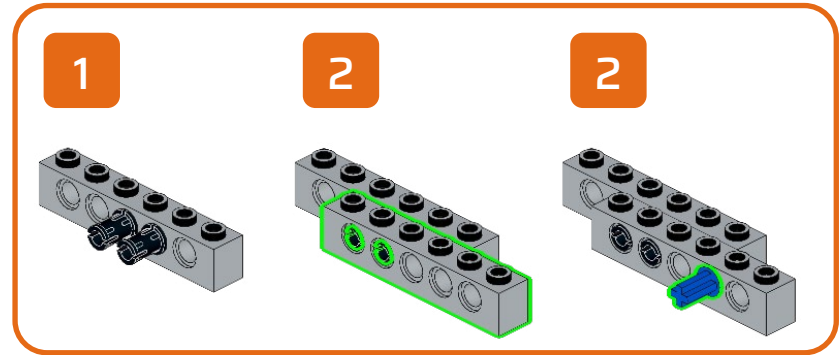

1

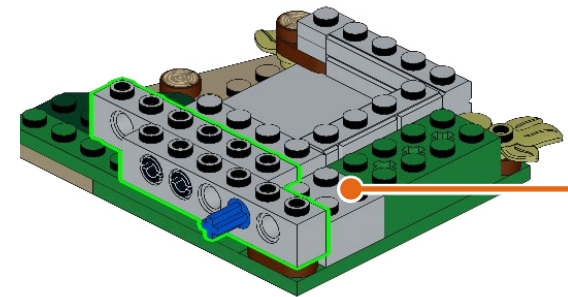

342



1x



1x

1

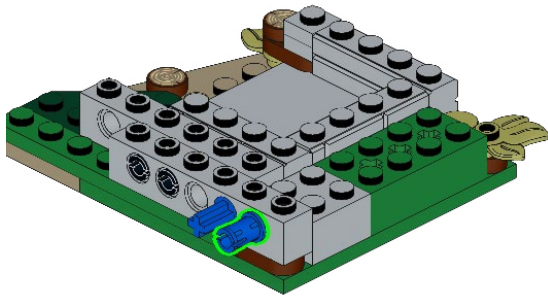

2

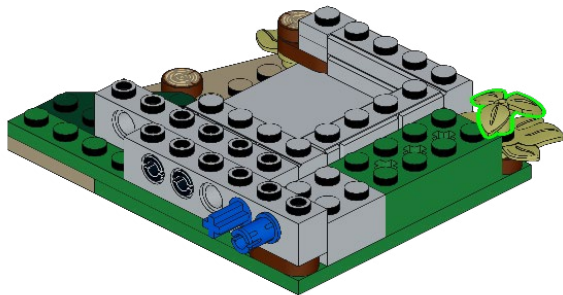

343



1x



1x



1x



1x



1x

1

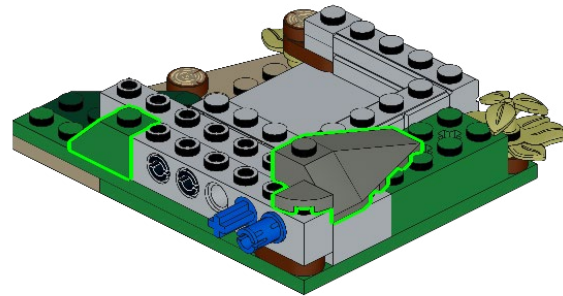

2

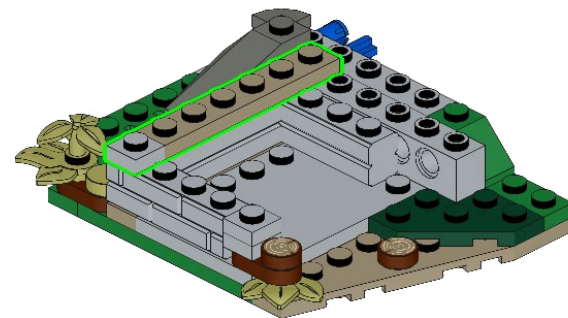

344



1x 2x

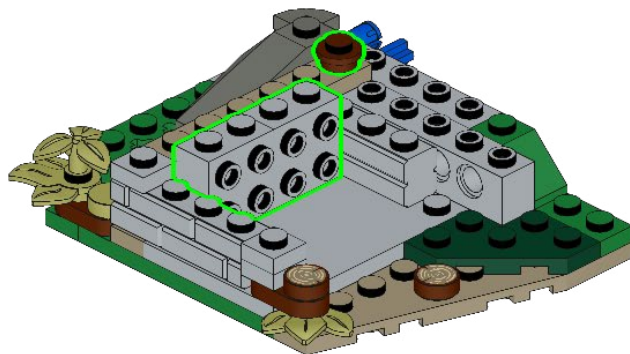

345

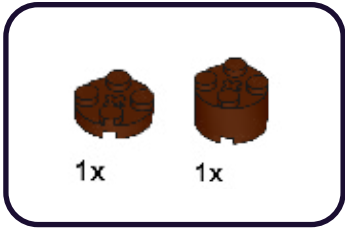

1



2



346



1



347



1

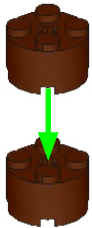

348



1



349

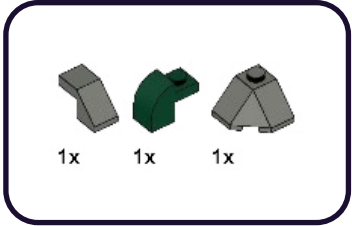

1

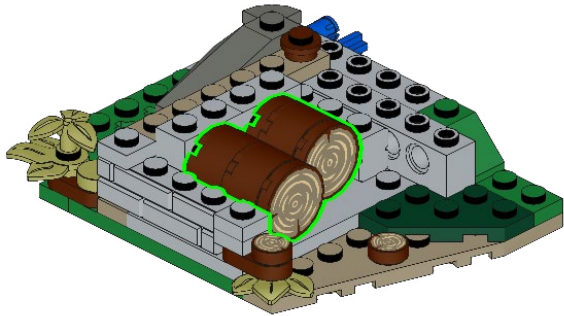

2

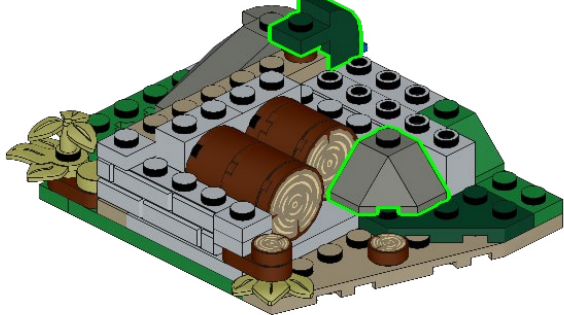

350

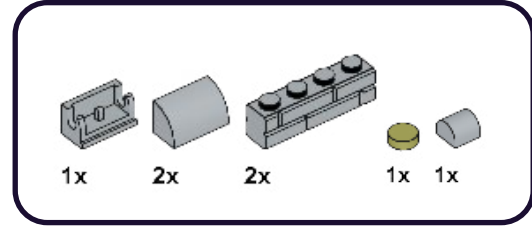

1

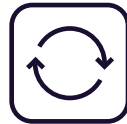
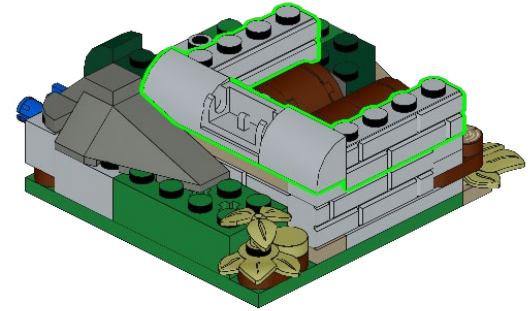

2

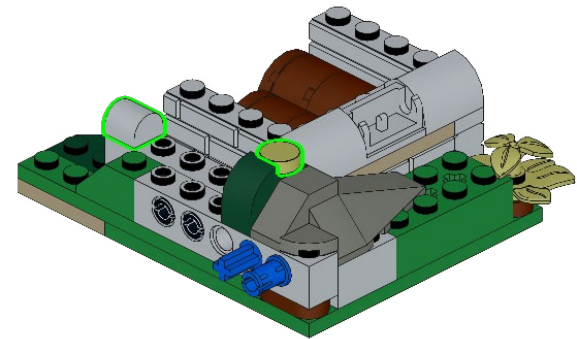

351



1x

2x

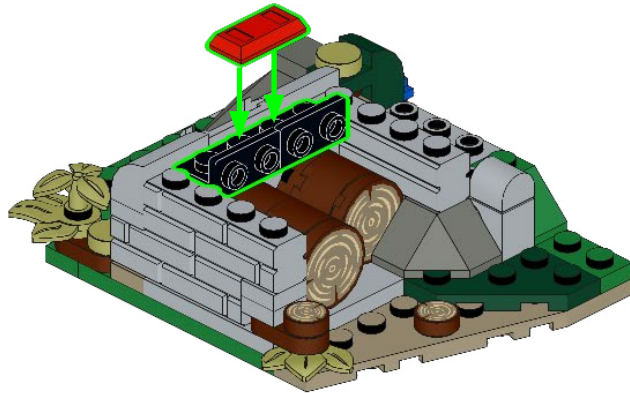

352

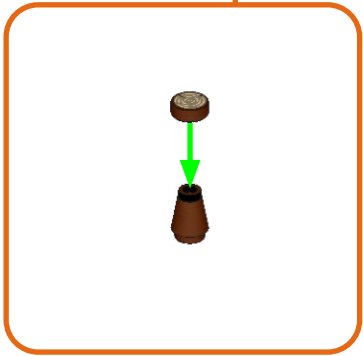
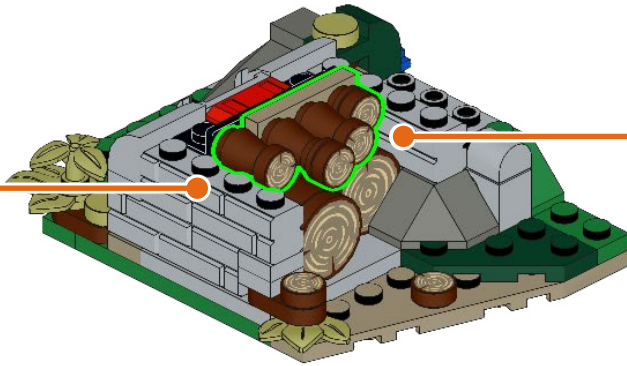
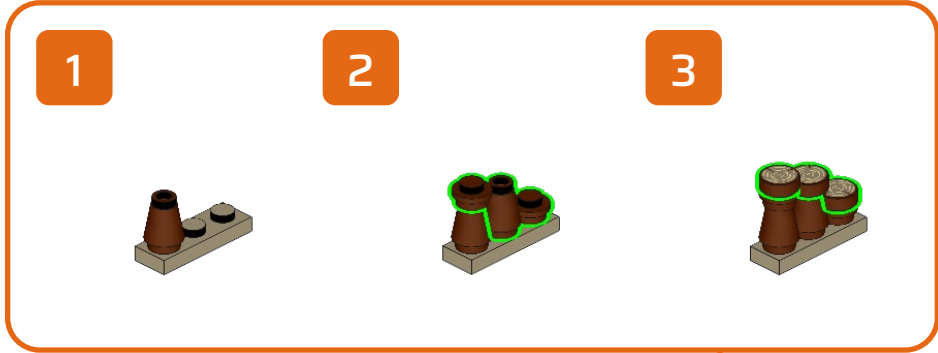
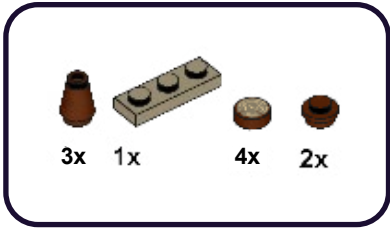

353

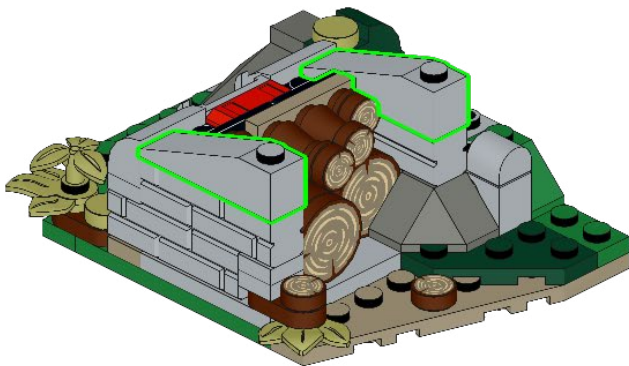
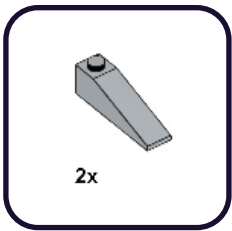

354

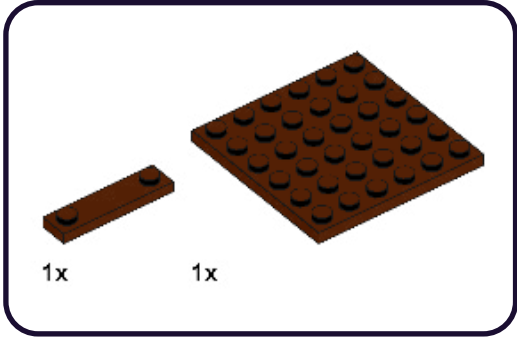

1

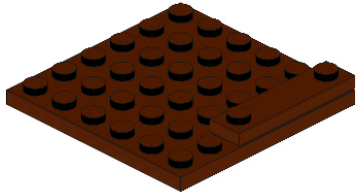

355

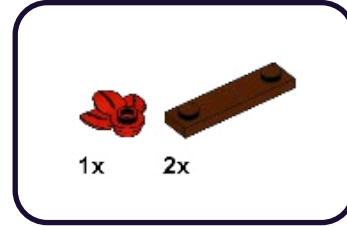

2

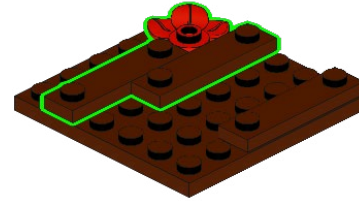

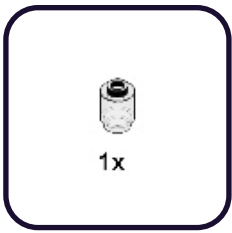

1

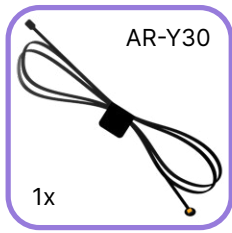

1



358

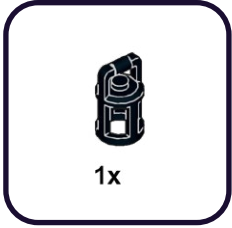

1



359

1



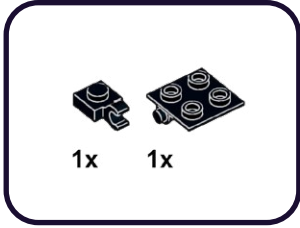

1



1

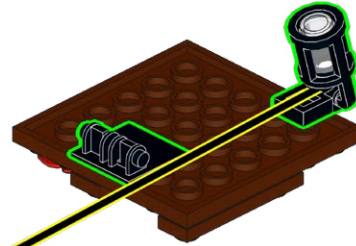

362



1

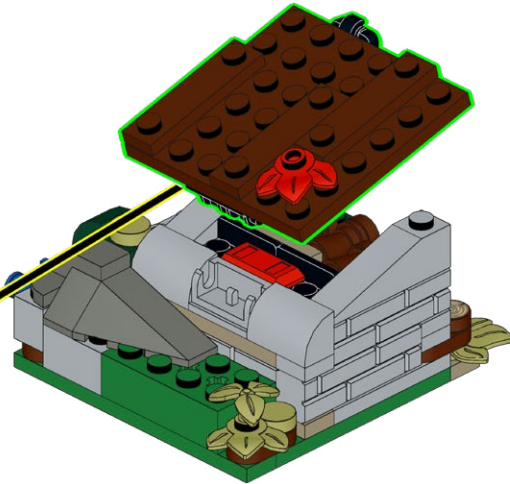

363

1

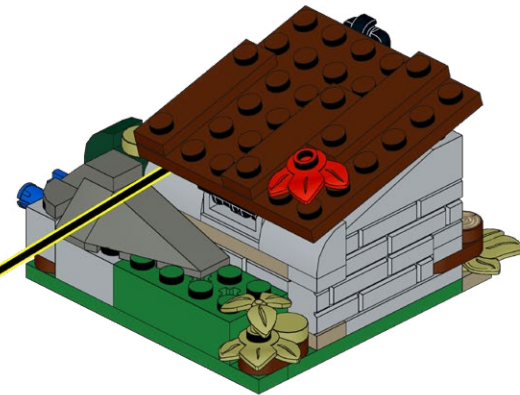

364

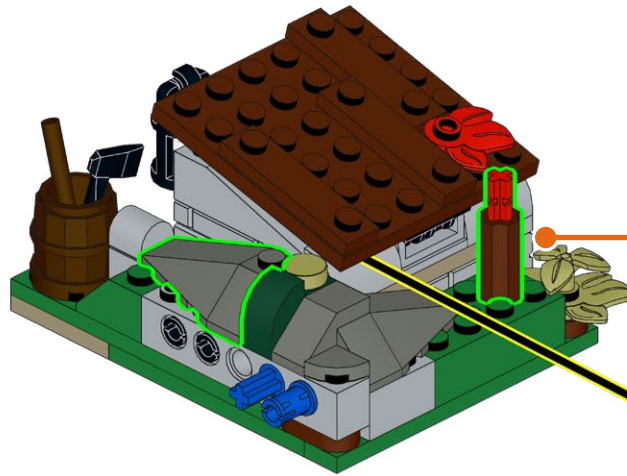
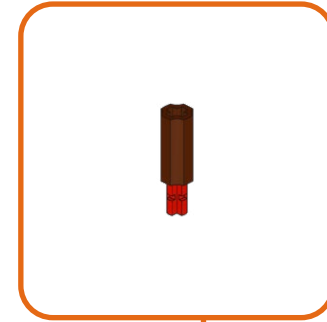
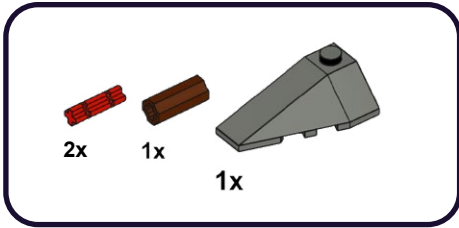

365

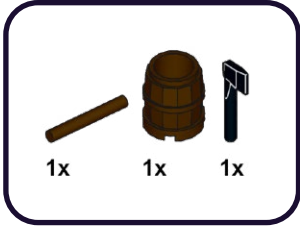

1

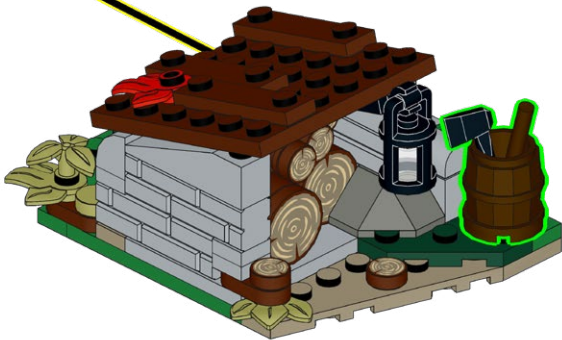

366

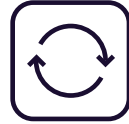
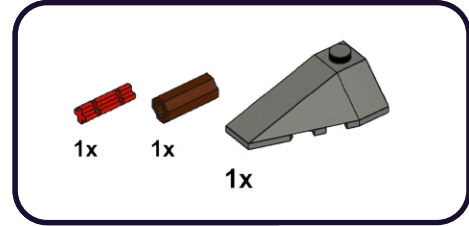

1

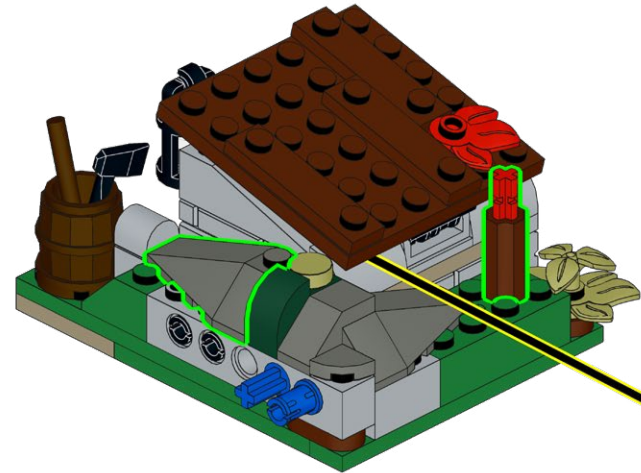

367

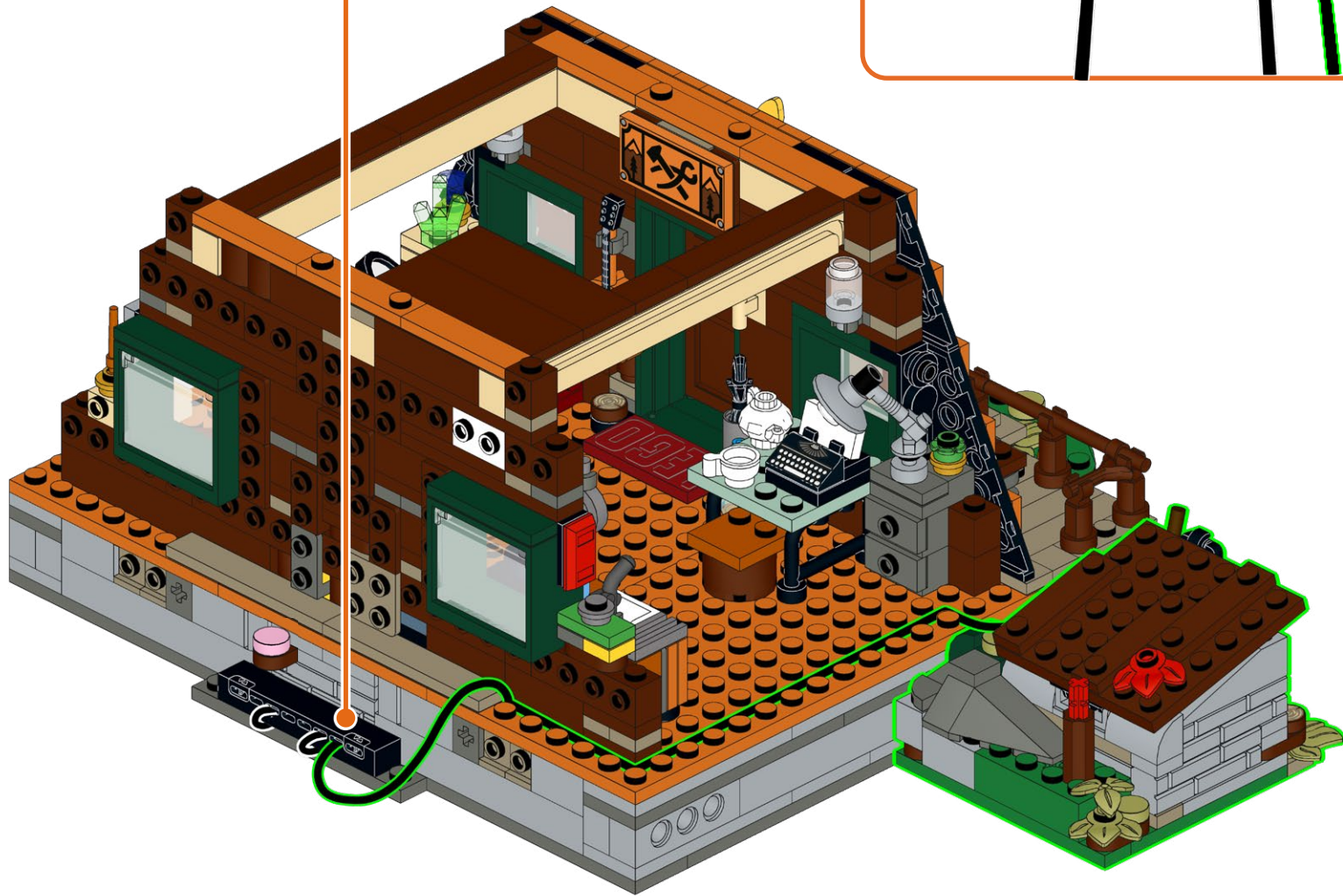
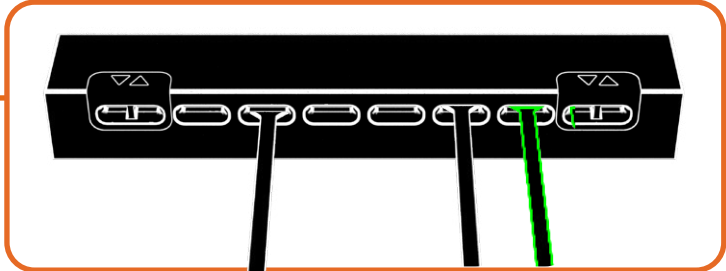

368

1x



369

7x



370

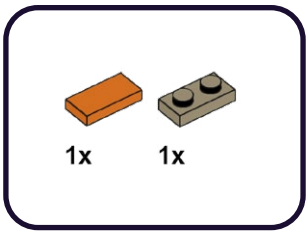

1

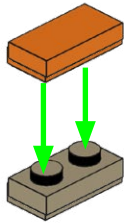

371

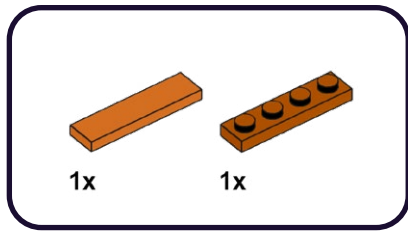

1

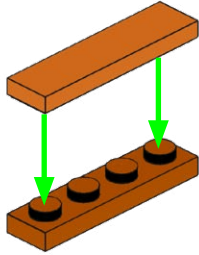

372

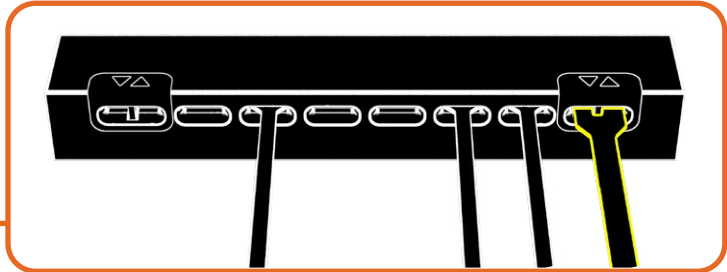
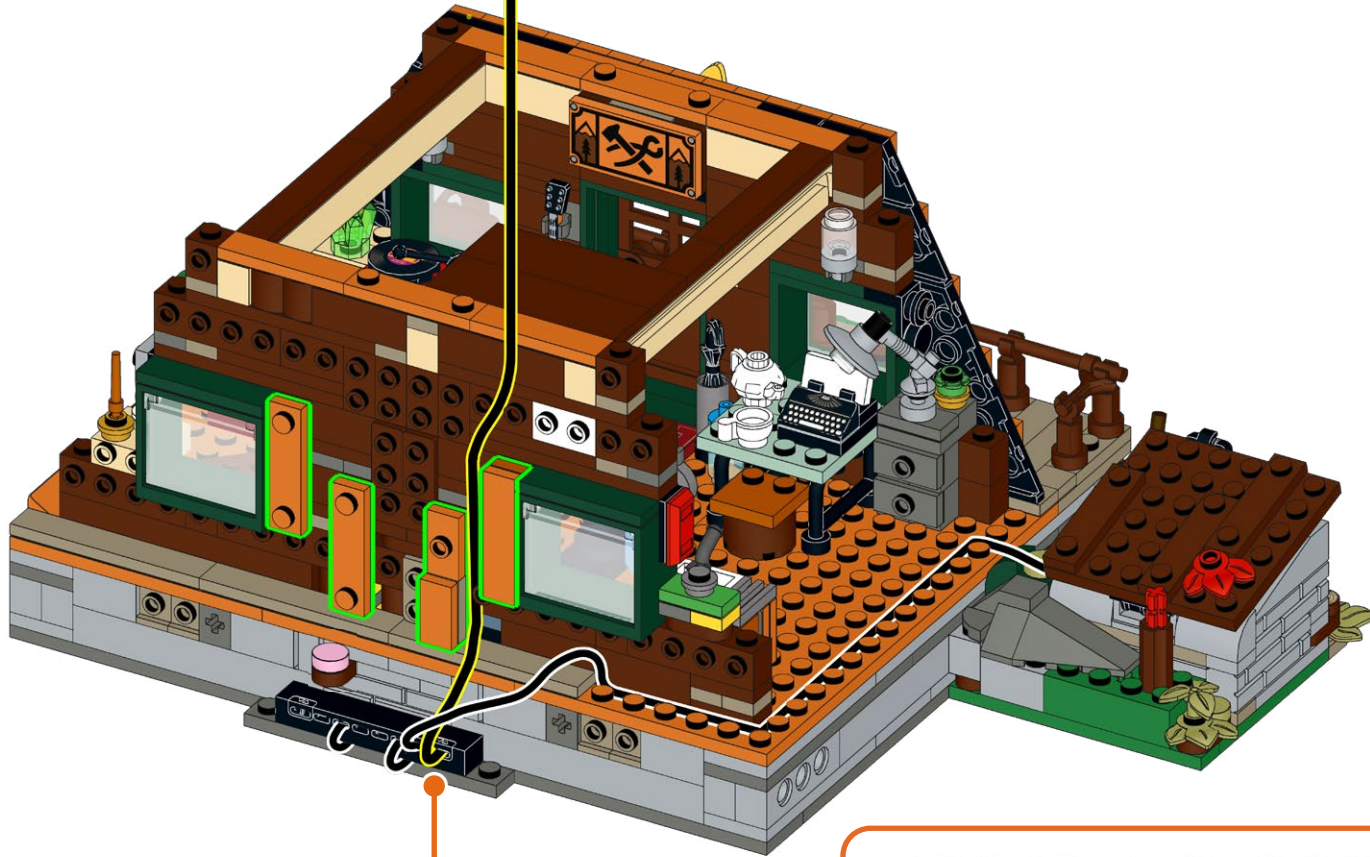
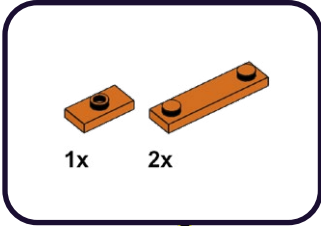
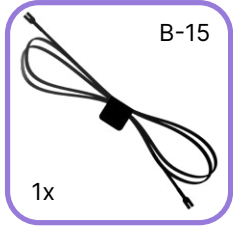

373

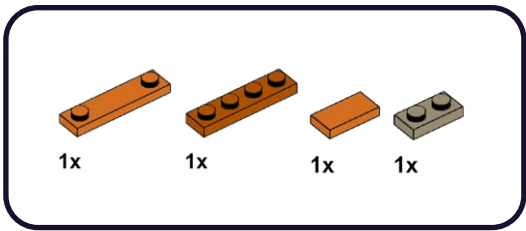

1

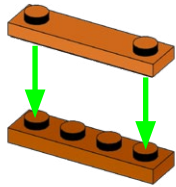

2

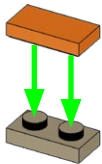

374

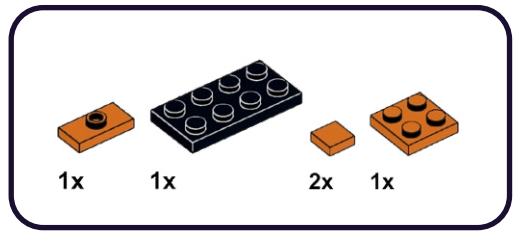

1

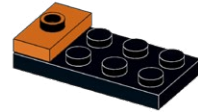

2

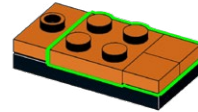

375

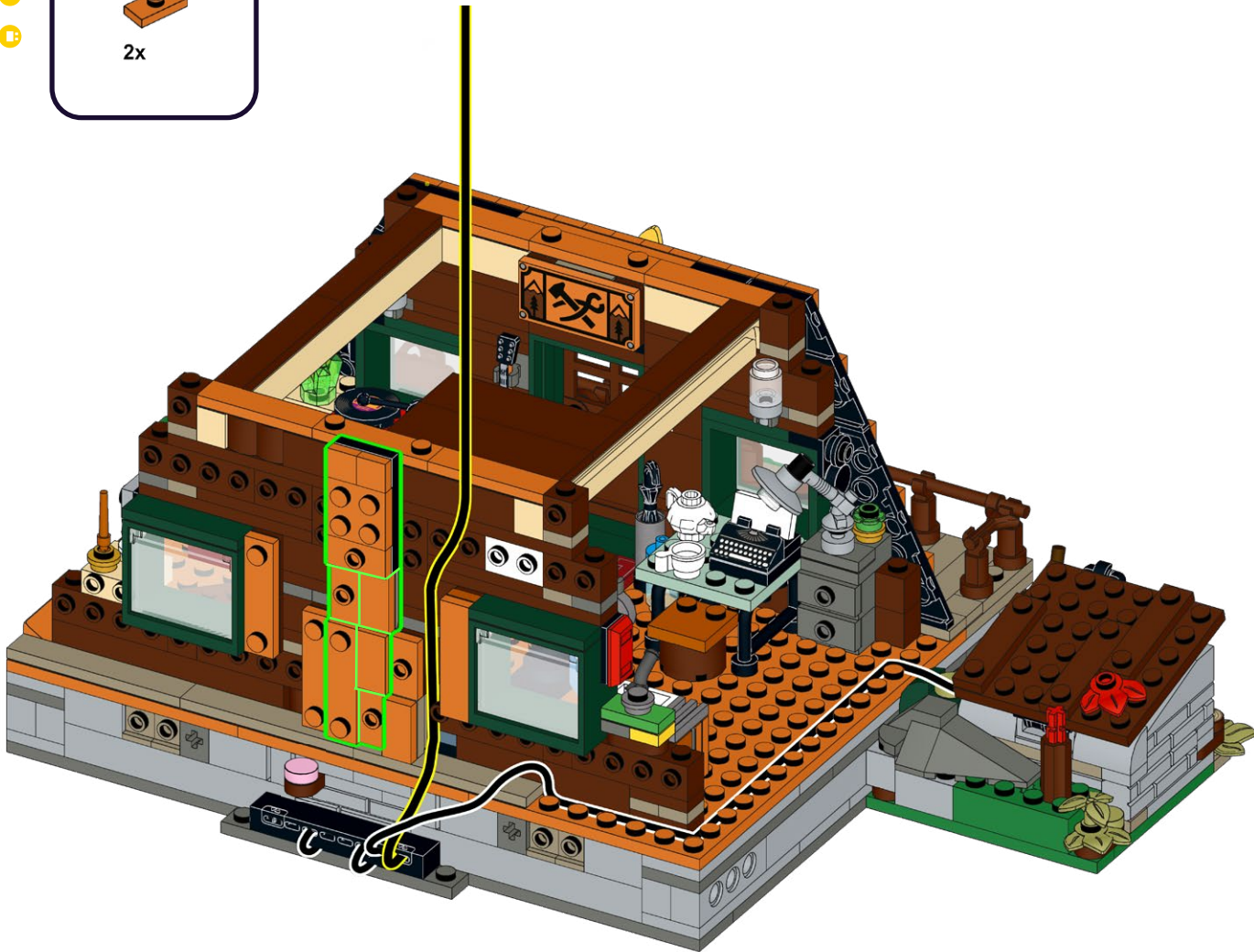
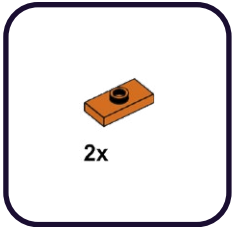

376

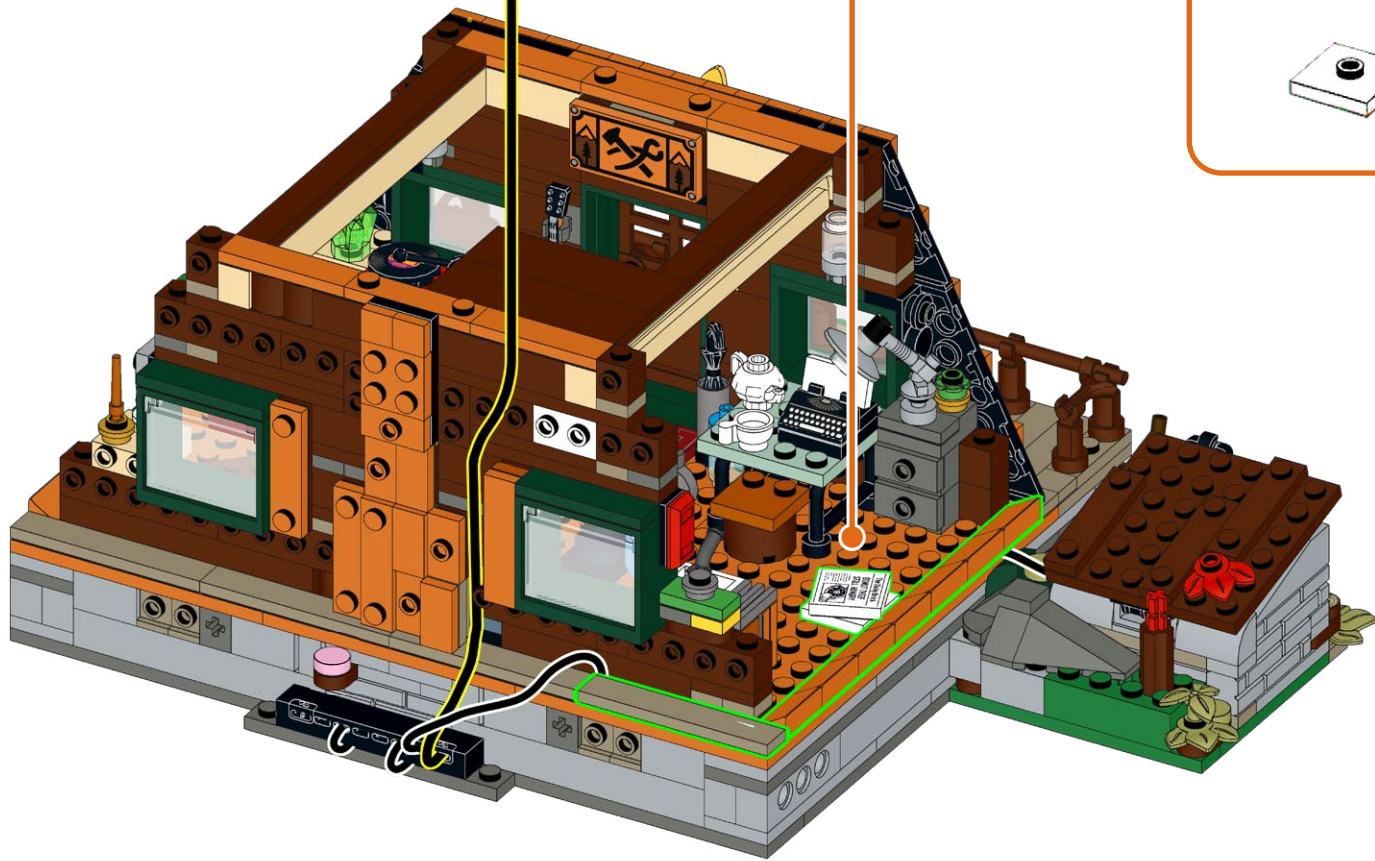
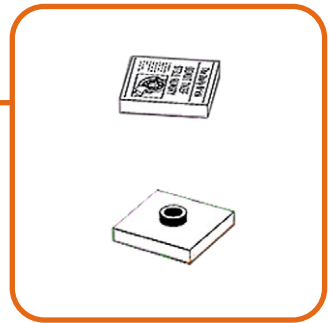
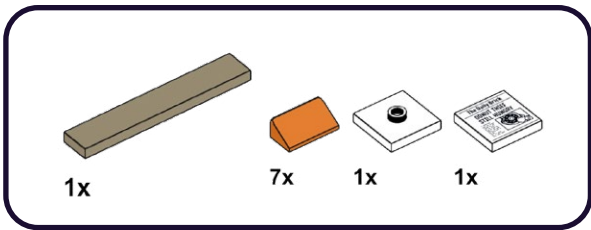

377

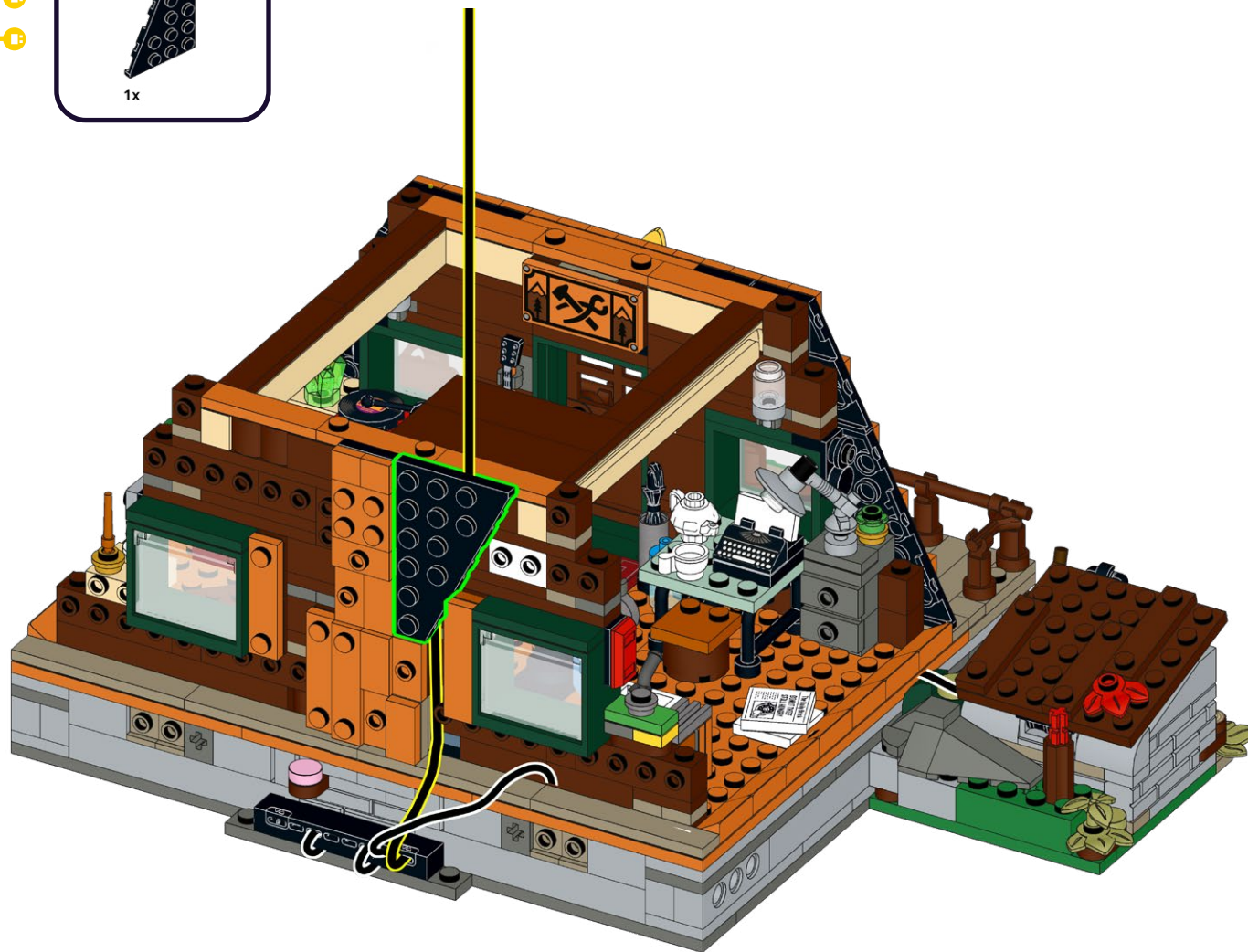
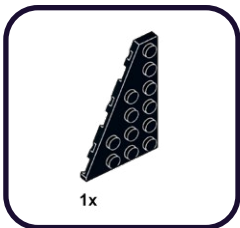

378

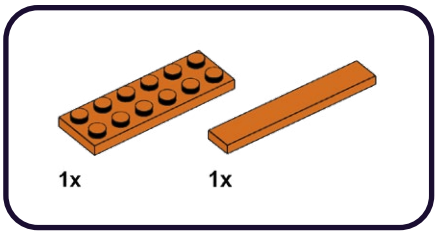

1

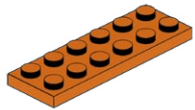

2

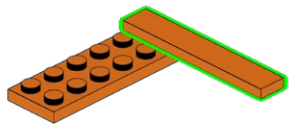

379

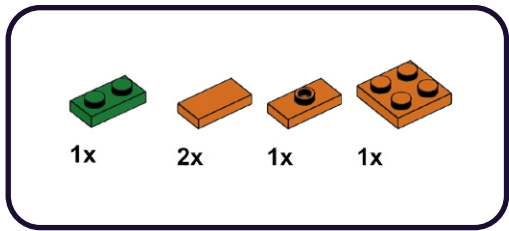

1

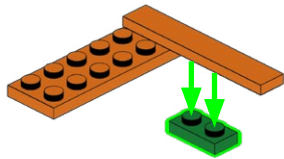

2

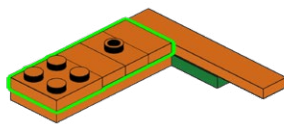

380

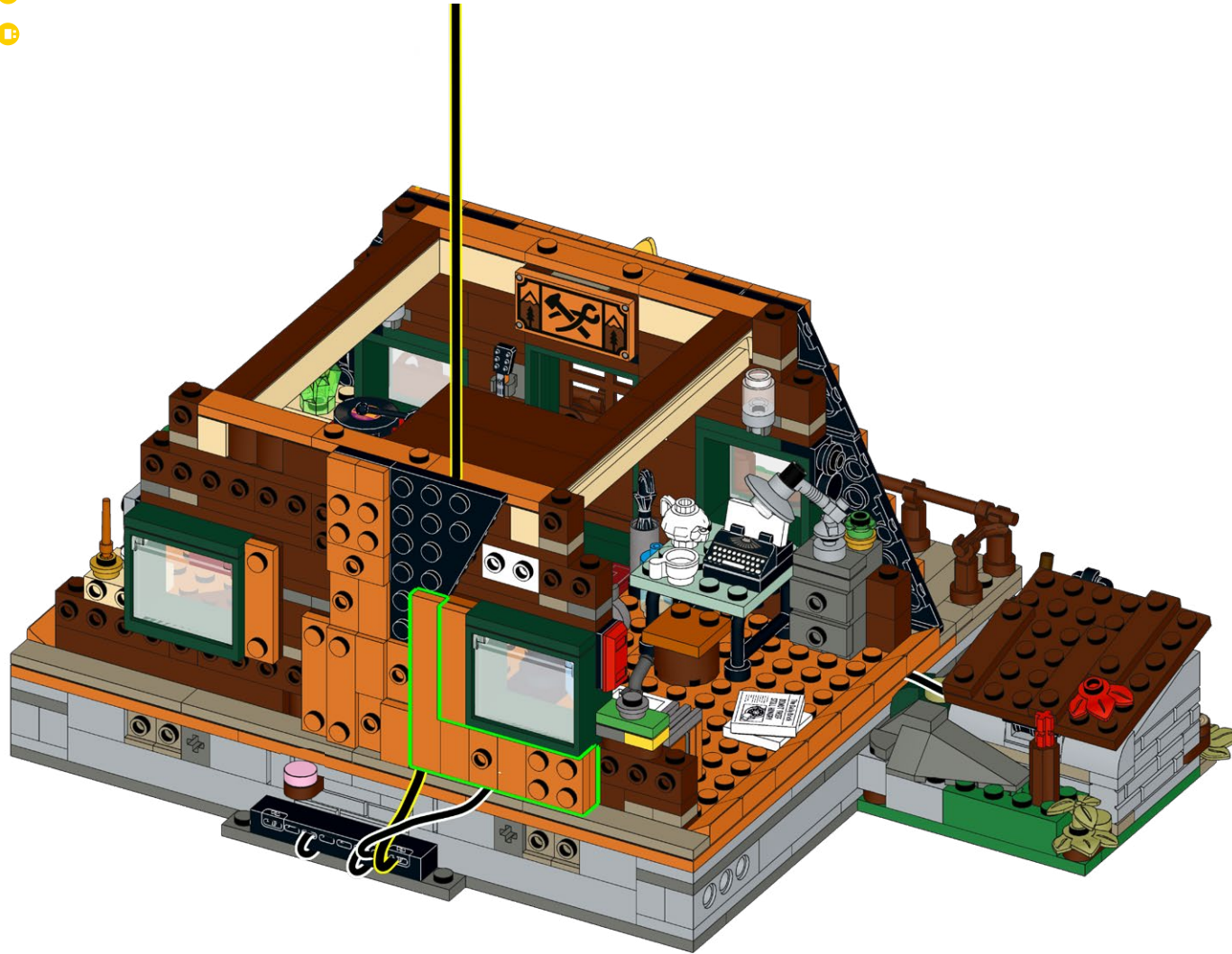

381

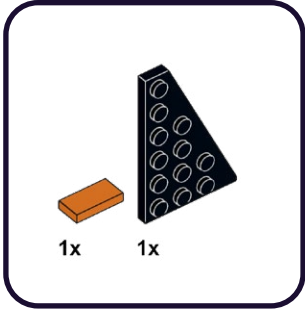

1

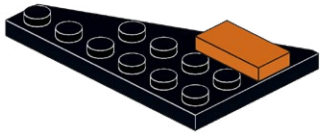

382

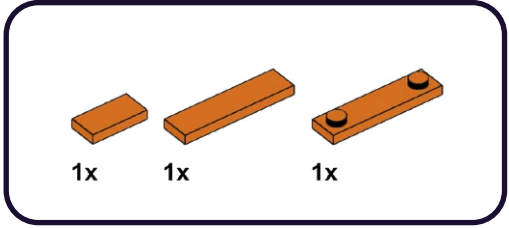

1

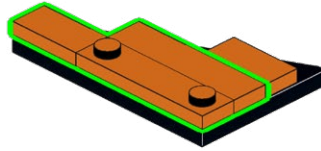

383

1x

1x

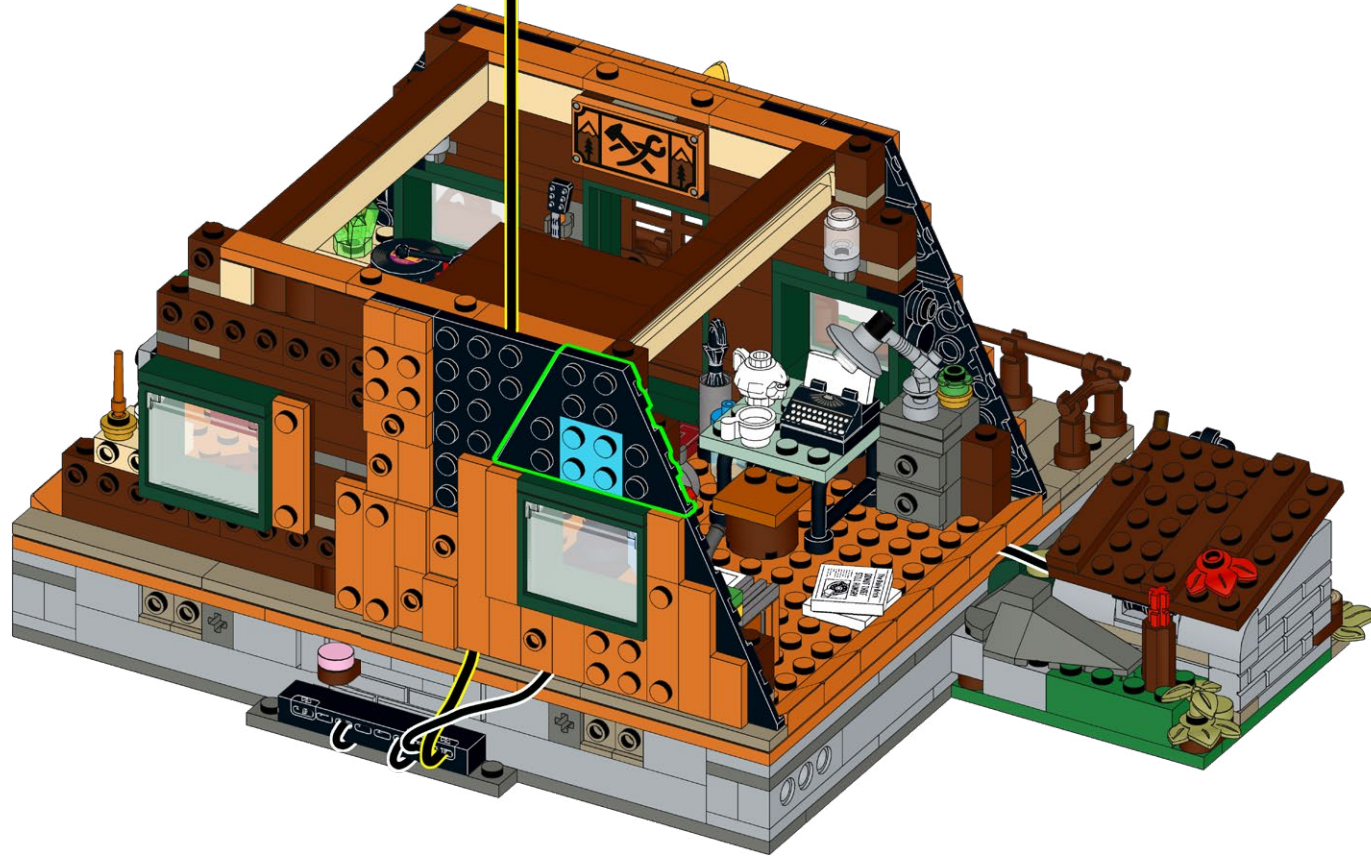

384

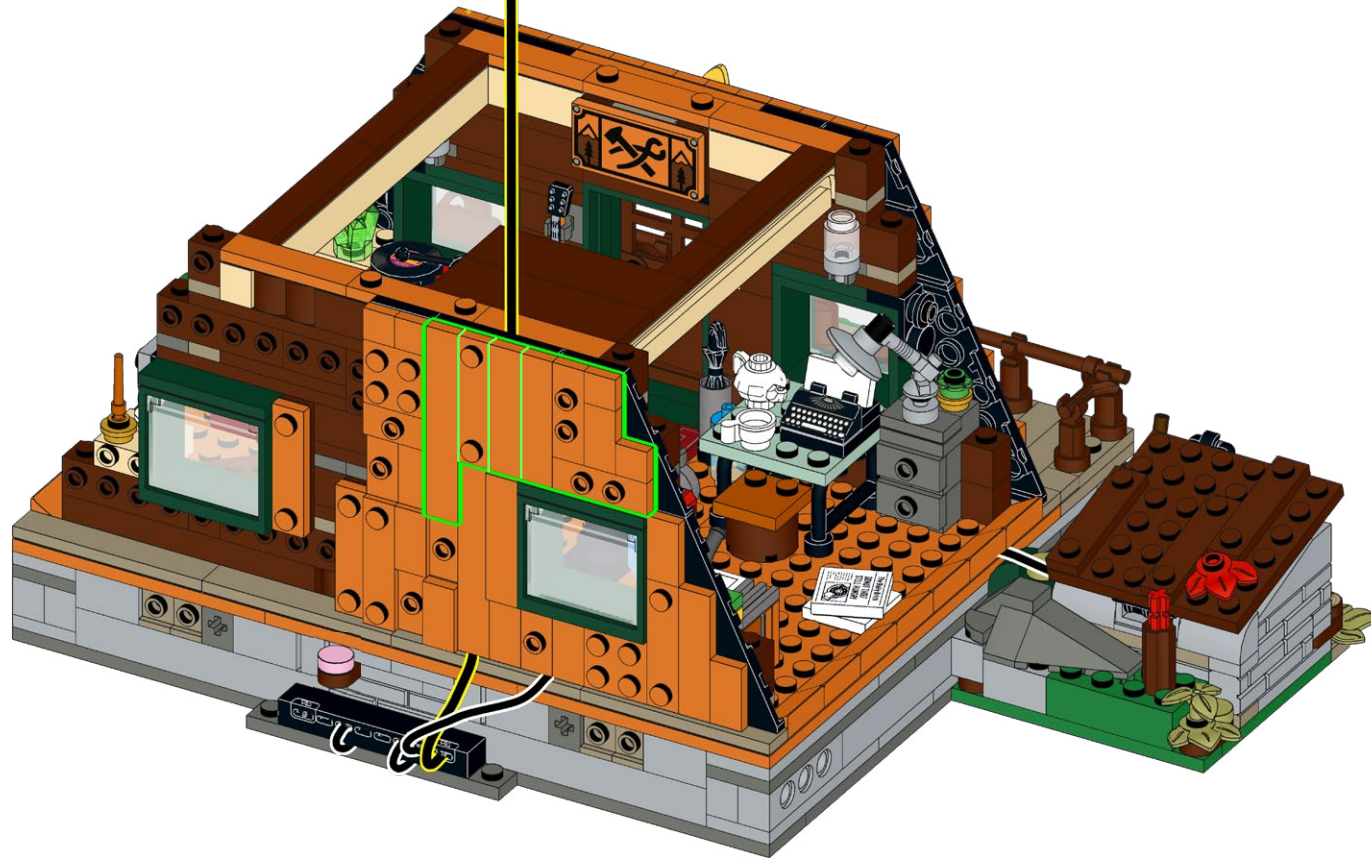
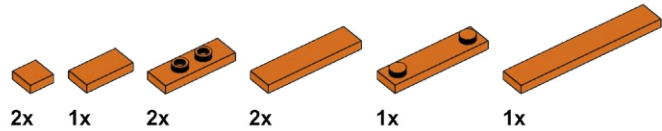

385

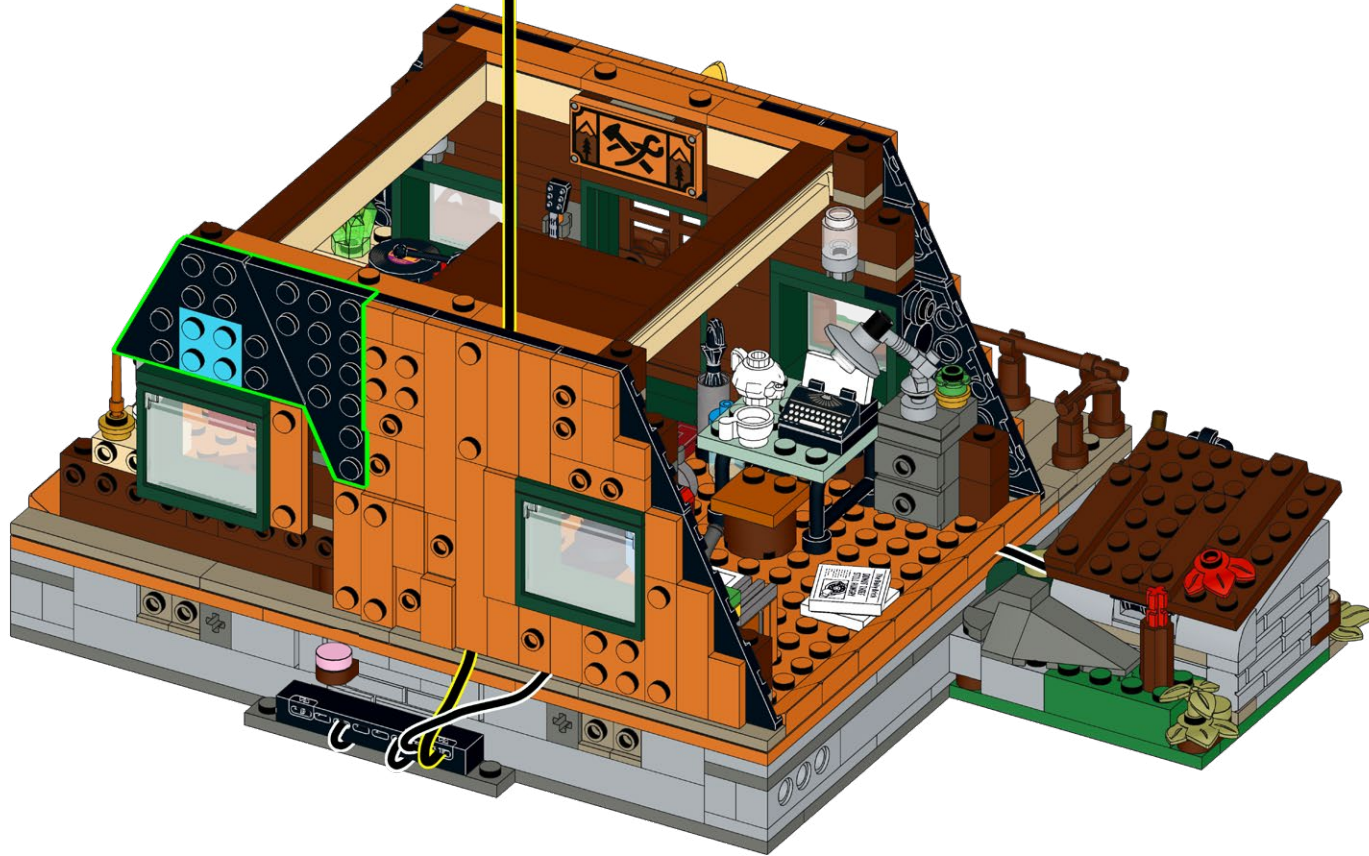
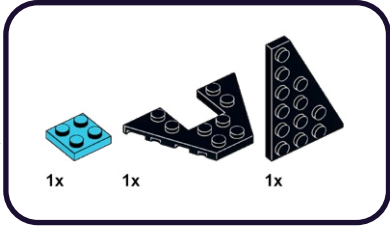

386

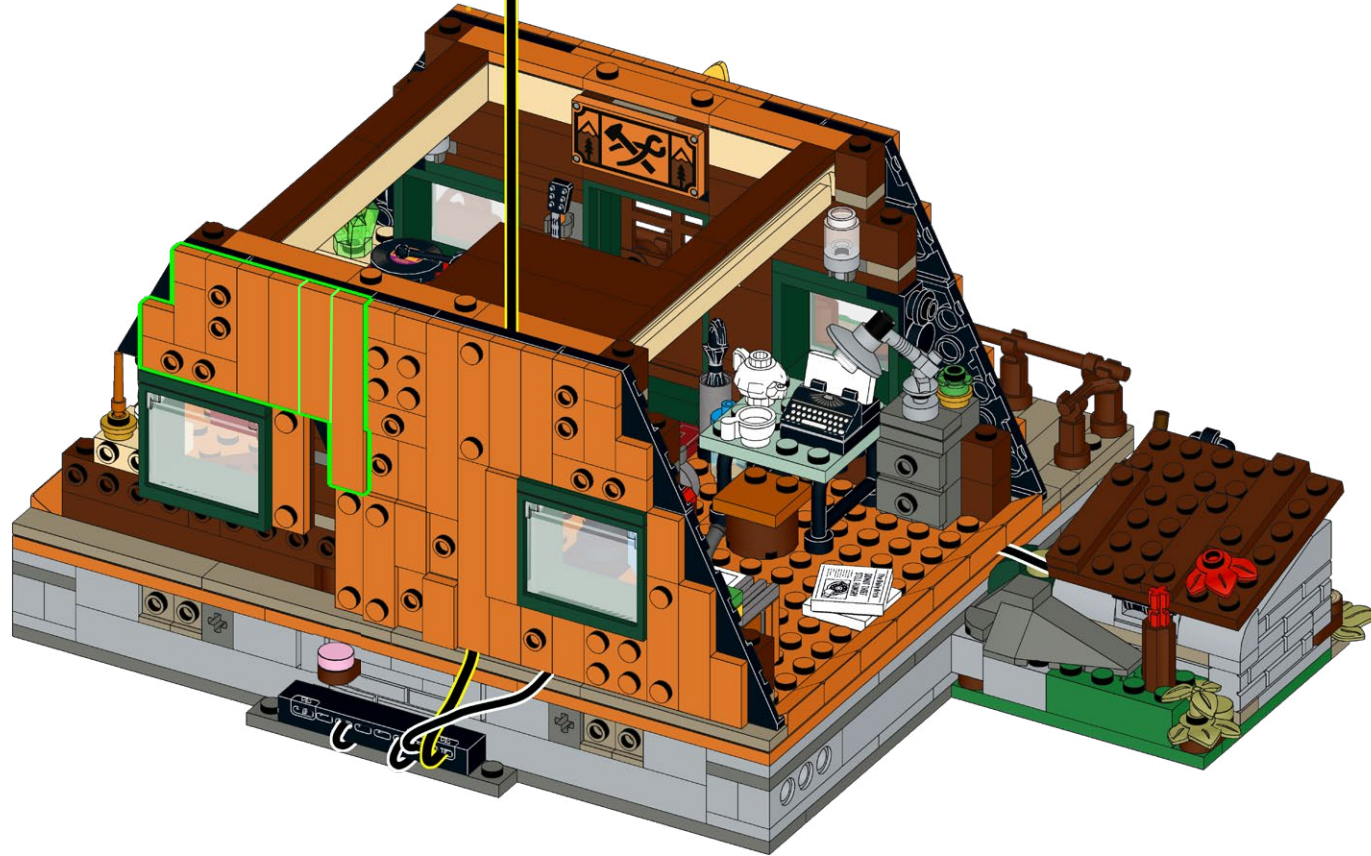
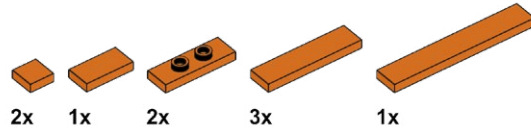

387

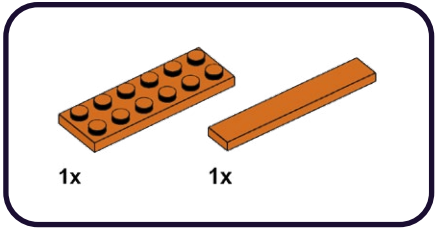

1

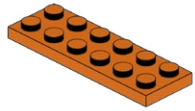

2

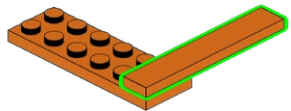

388

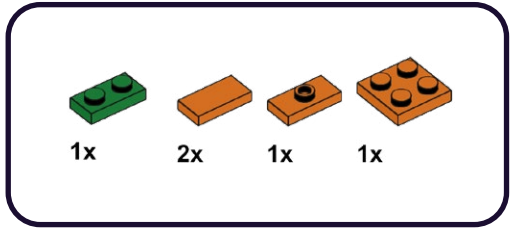

1

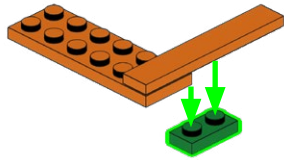

2

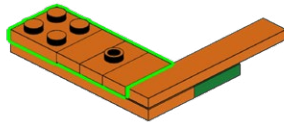

389

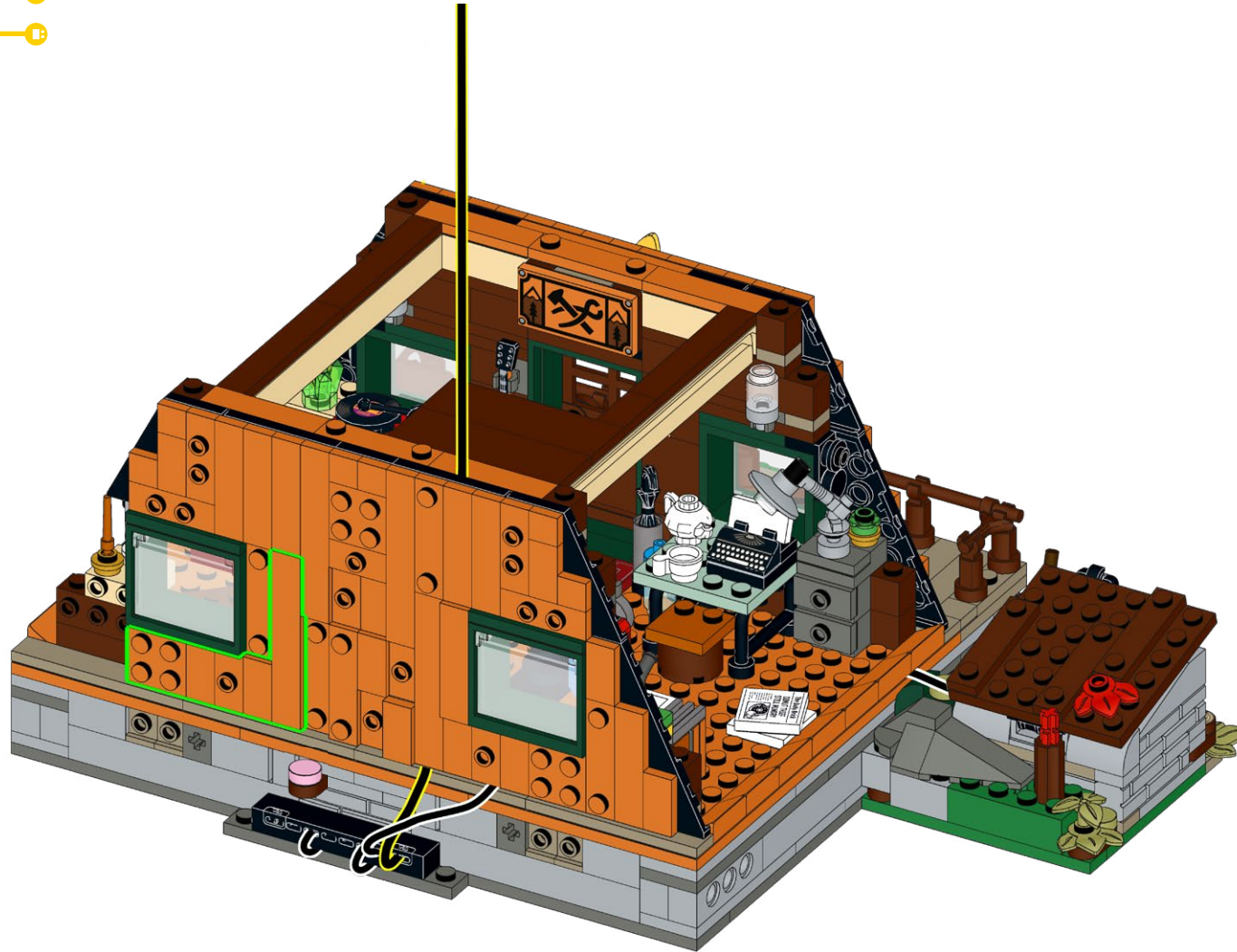

390

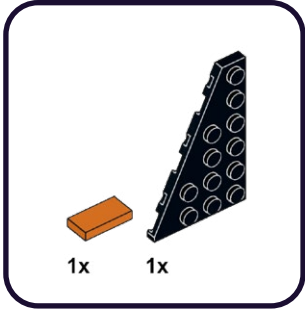

1

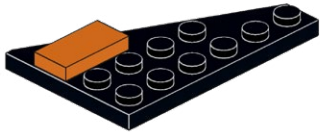

391

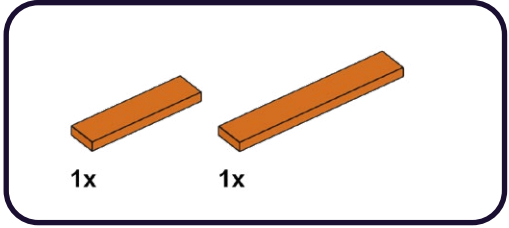

1

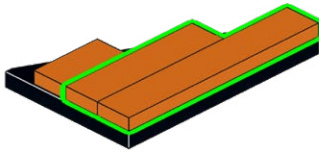

392

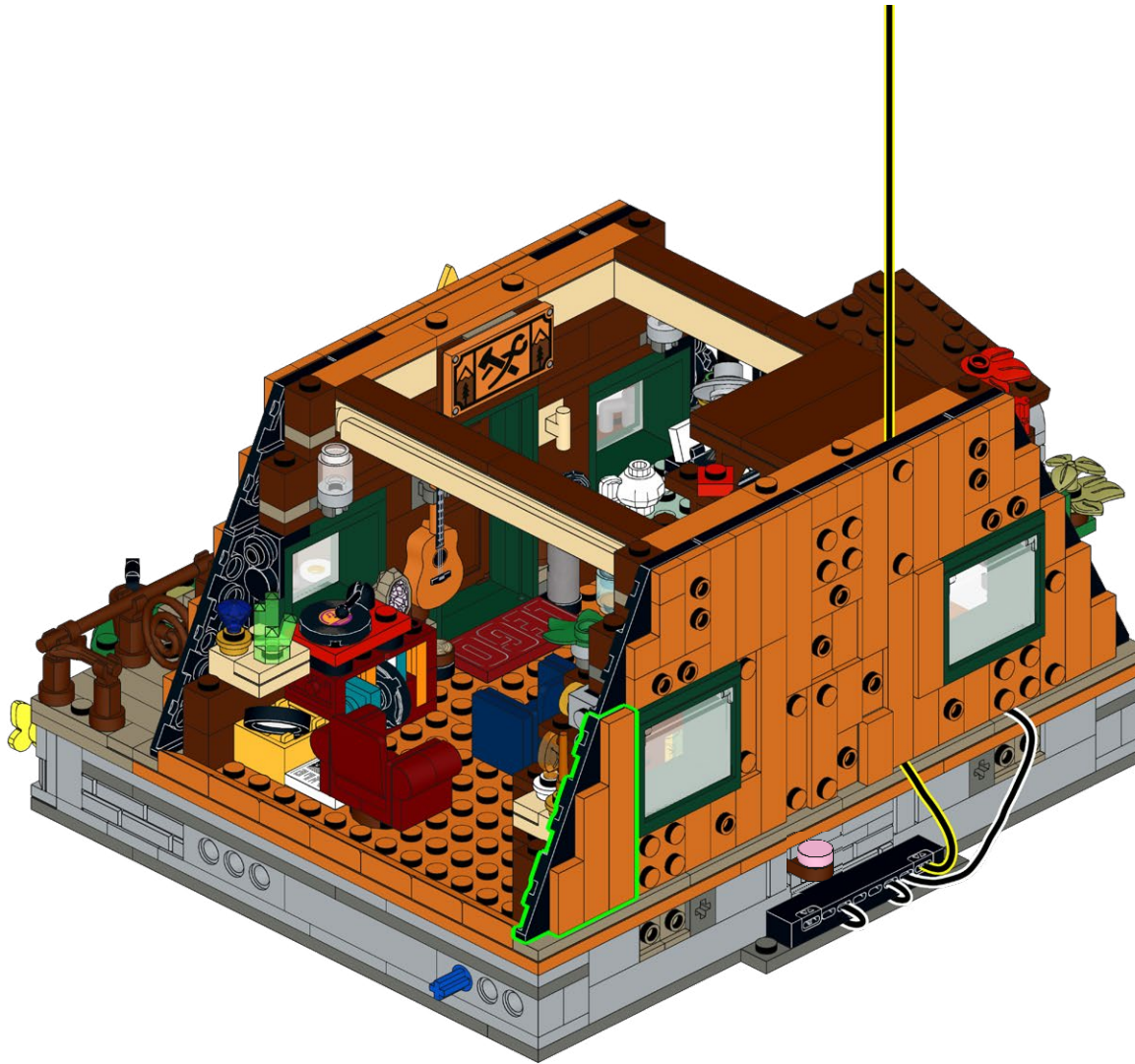

393

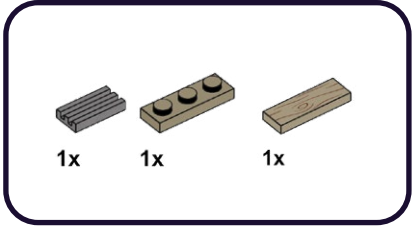

394

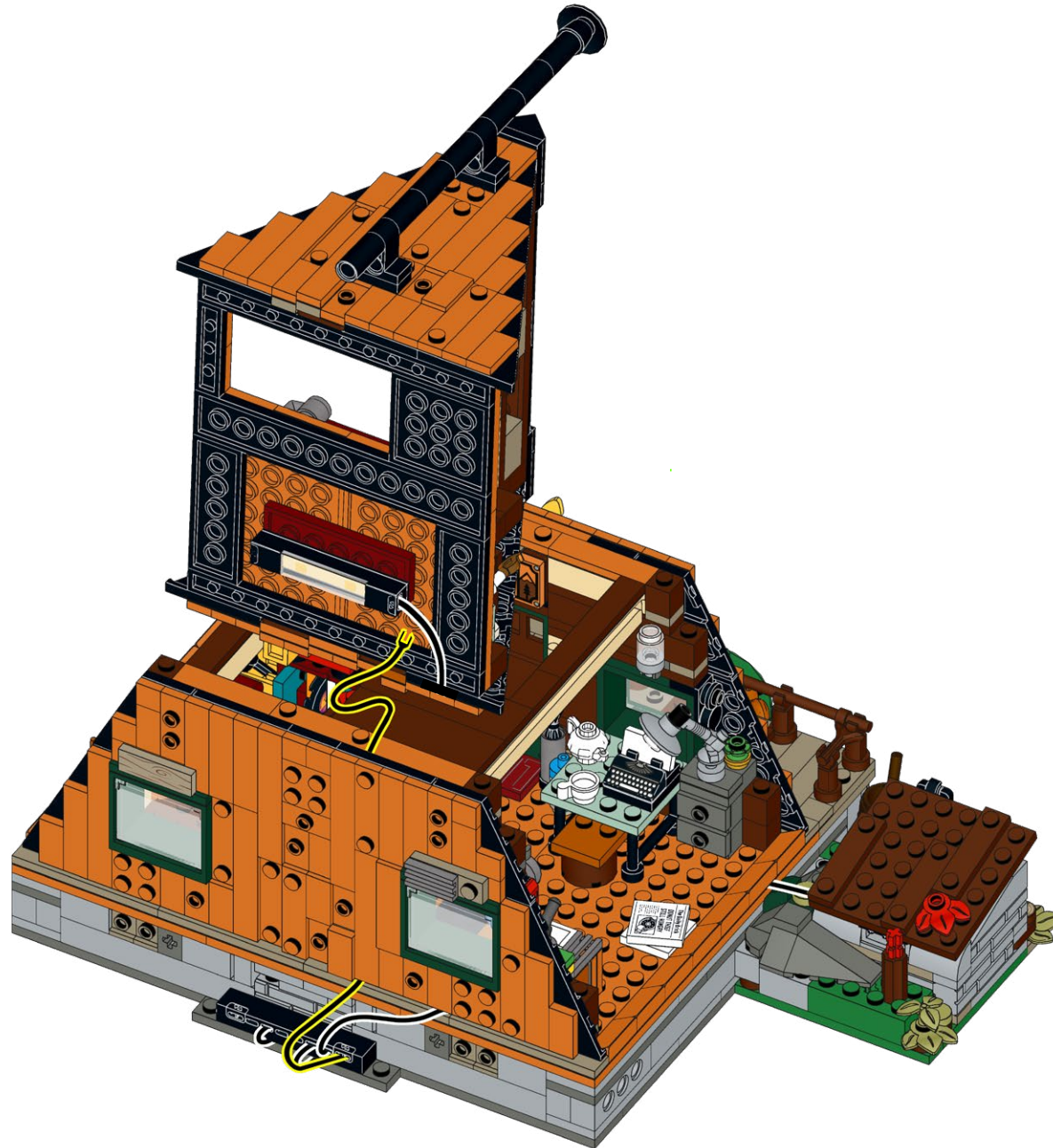

395

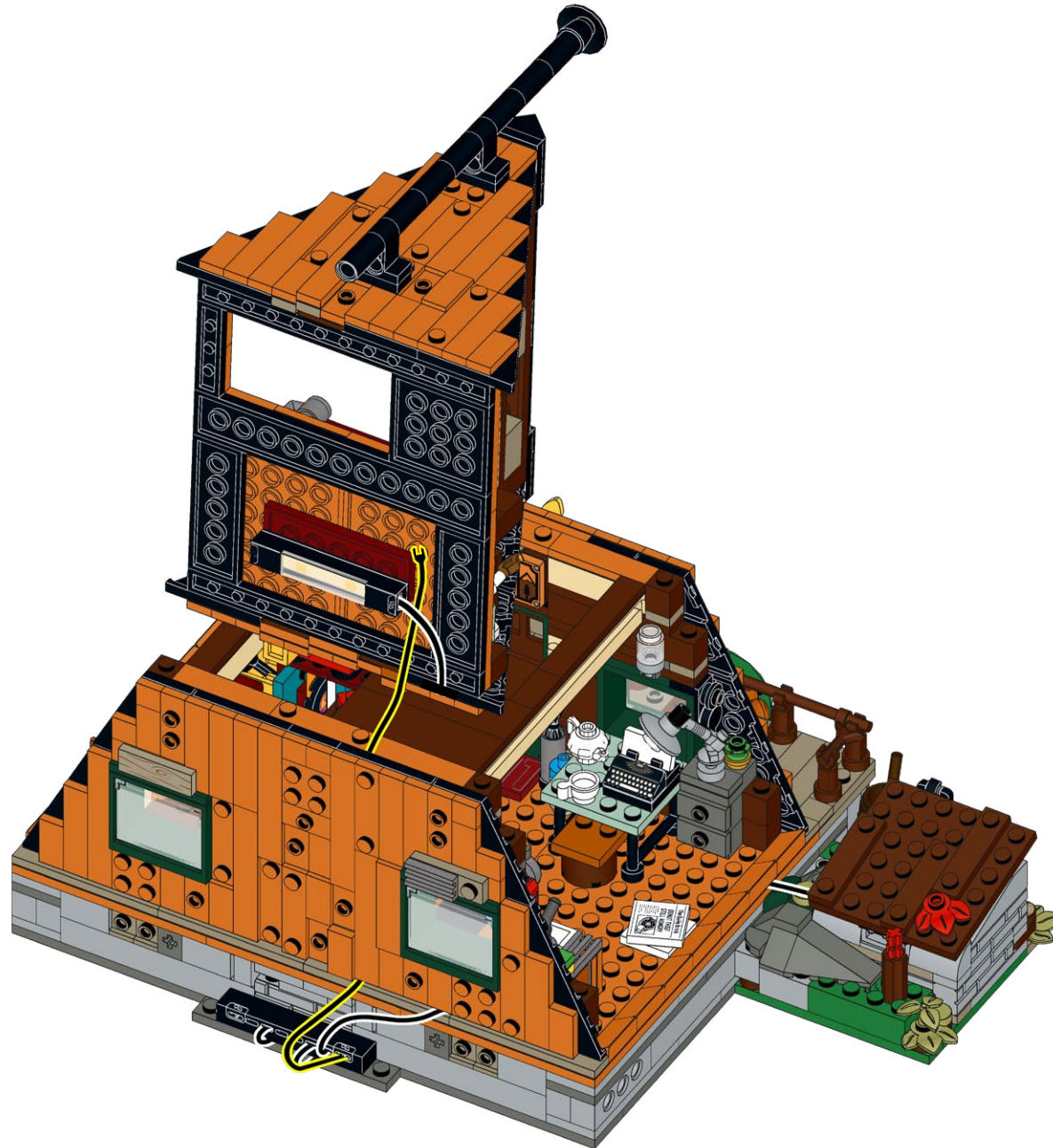

396

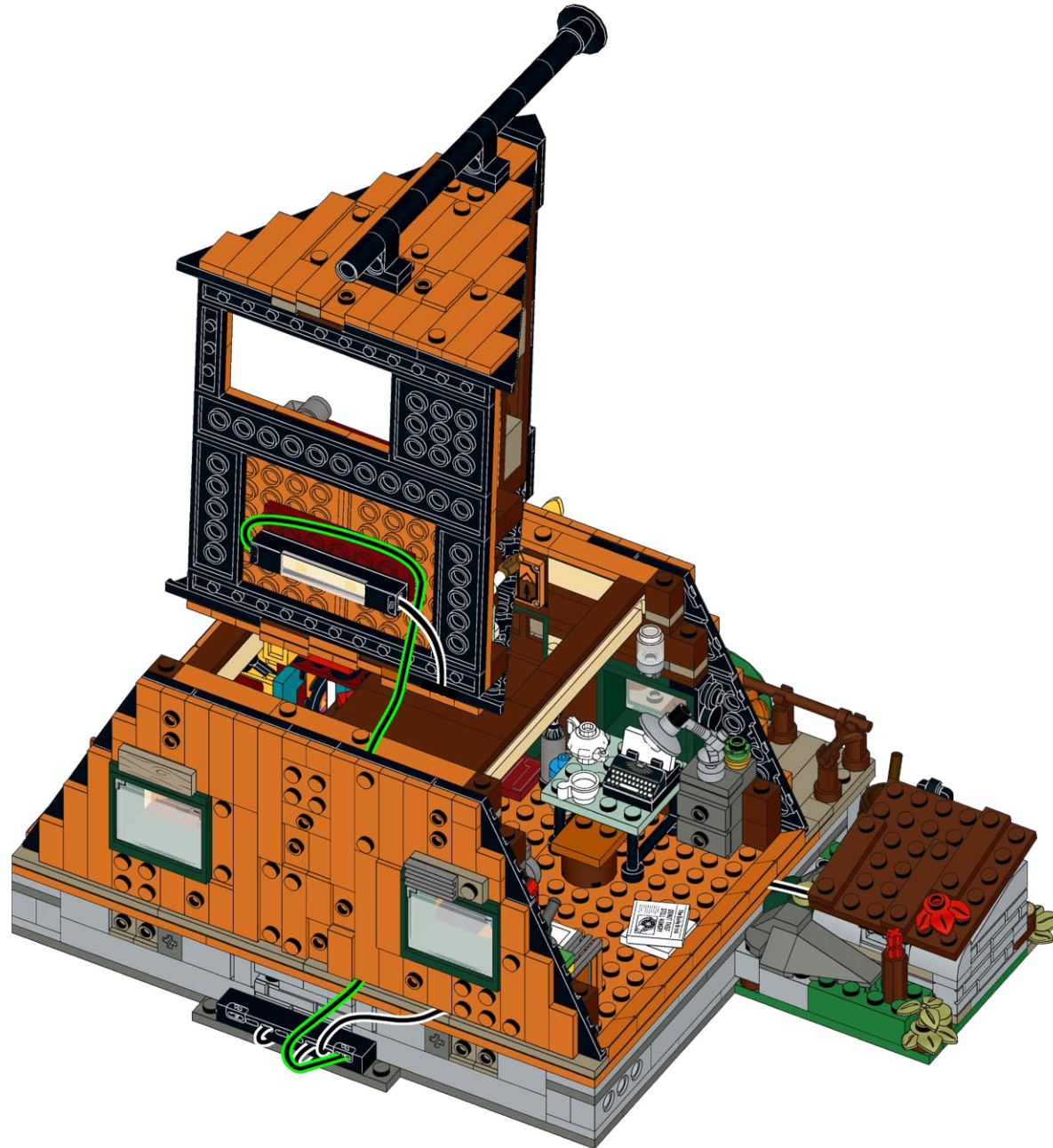

397

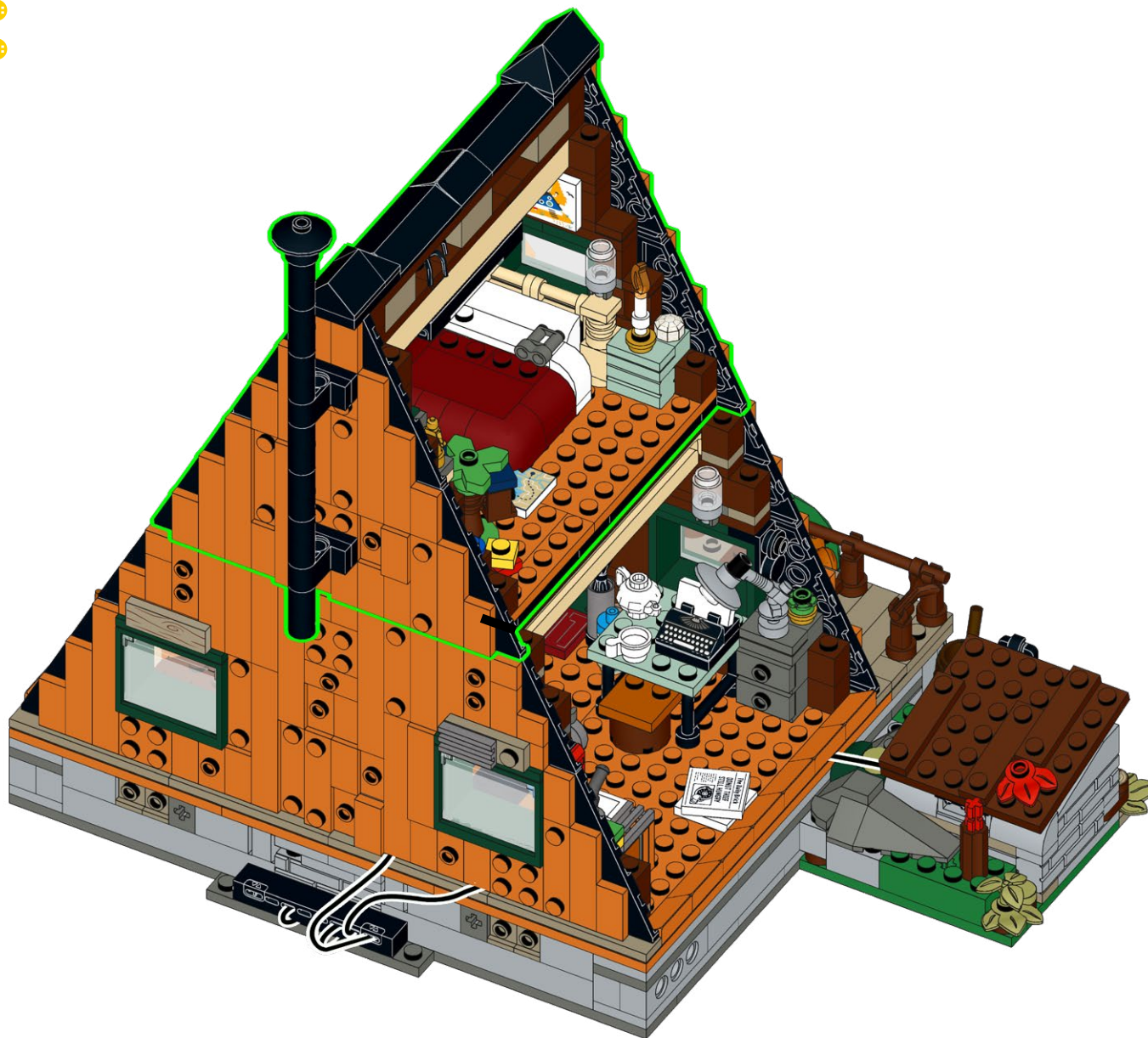

**HOLD UP!**

You might notice some bags aren't in order, as well as left over pieces, but that's ok! We're changing the way you build LEGO!

ATTENDEZ!

Vous remarquerez peut-être que certains sacs, ainsi que certaines pièces, ne sont pas dans le bon ordre. Mais pas de panique! Nous changeons simplement la façon avec laquelle vous construisez vos LEGO!

ASPETTA!

Potresti notare che alcuni sacchetti non sono in ordine, così come i pezzi avanzati, ma va bene così! Stiamo cambiando il modo in cui costruisci i LEGO!

HALT!

Sie werden möglicherweise bemerken, dass einige tüten durcheinander sind und teile übrig bleiben, aber das ist in Ordnung! Wir ändern die art und weise, wie Sie LEGO bauen!

¡ESPERA!

Es posible que notes que algunas bolsas están fuera de servicio, así como piezas sobrantes, ¡pero está bien! ¡Estamos cambiando la forma en que construyes LEGO!

暫停!

你可能会注意到一些袋子顺序错乱, 以及一些剩余的部件, 但没关系! 我们正在改变你搭建乐高的方式!

Open LEGO® Bag 12

398

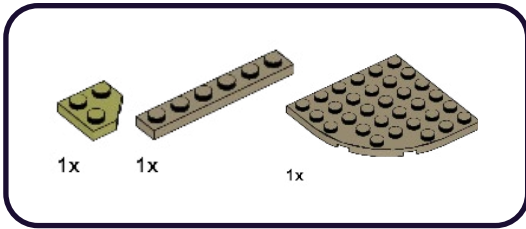

1

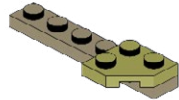

2

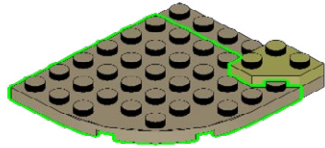

399

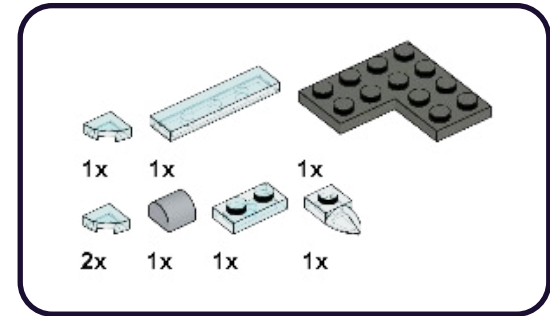

1

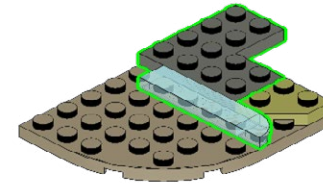

2

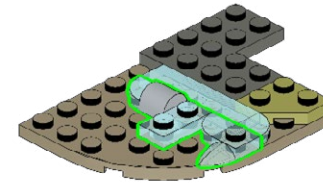

400

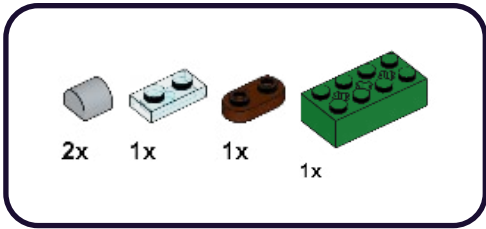

1

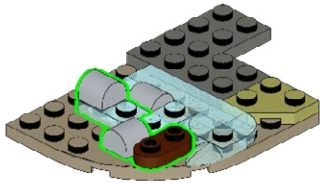

2

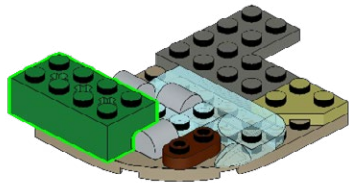

401

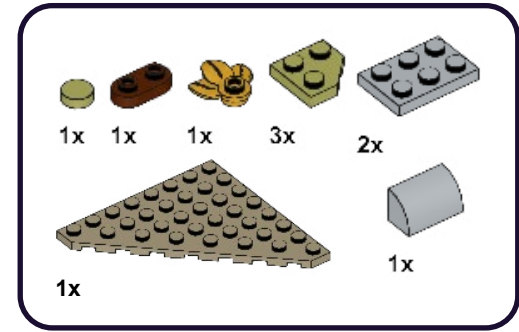

1

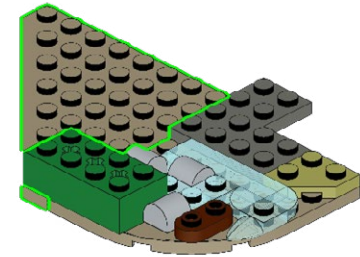

2

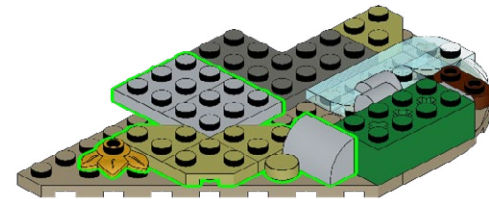

402

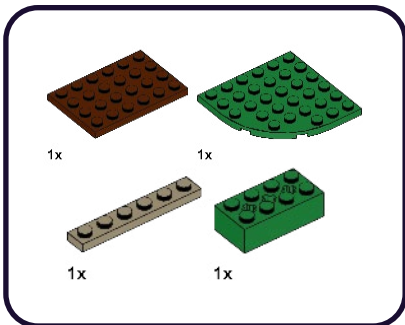

1

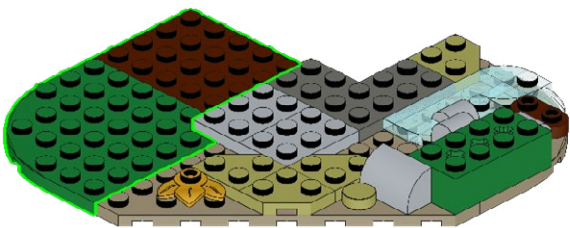

2

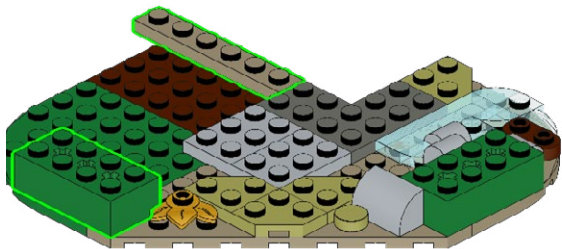

403

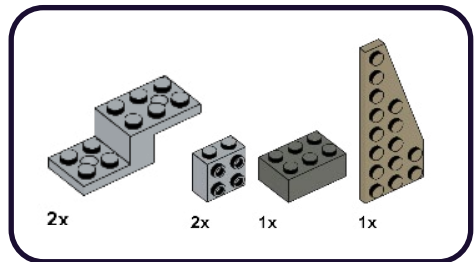

1

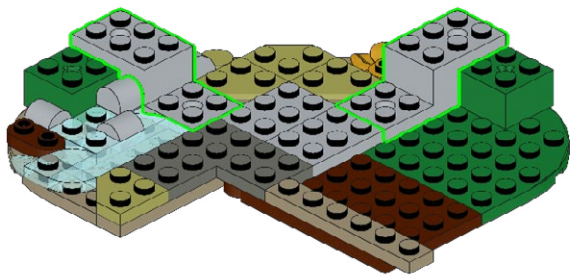
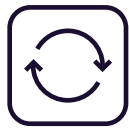

2

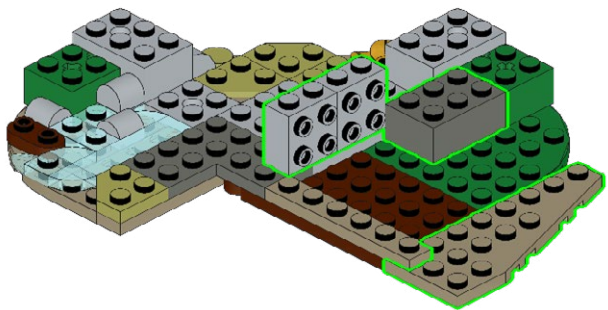

404

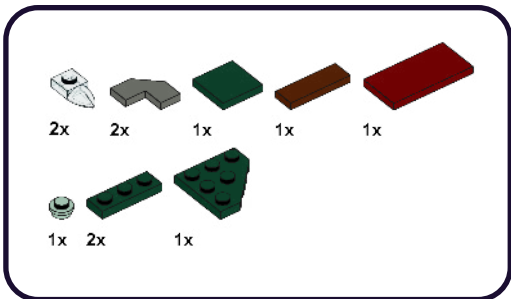

1

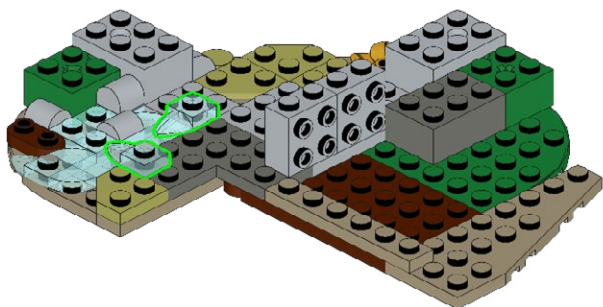

2

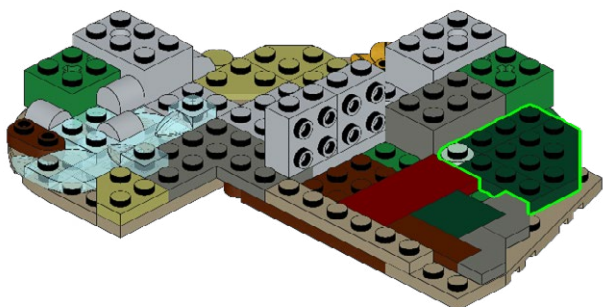

405

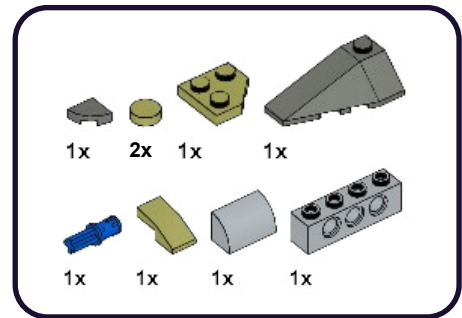

1

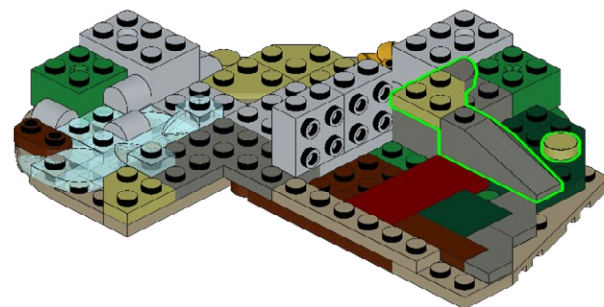

2

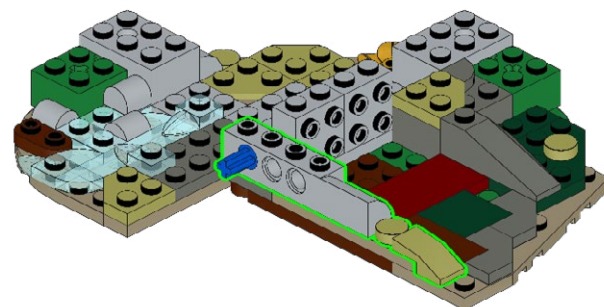

406

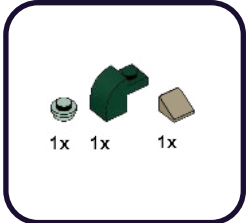

1

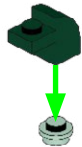

2

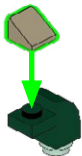

407

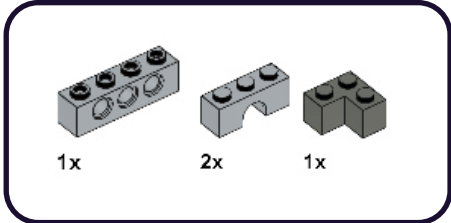

1

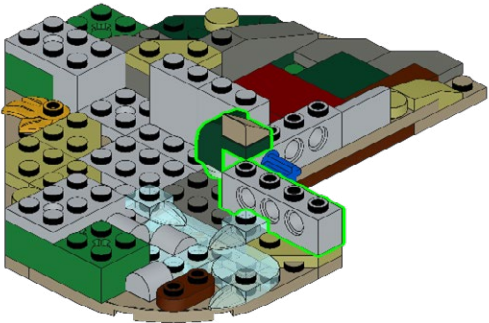

2

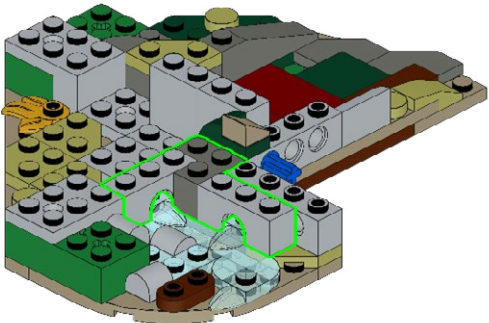

408

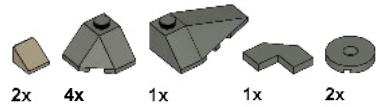

1

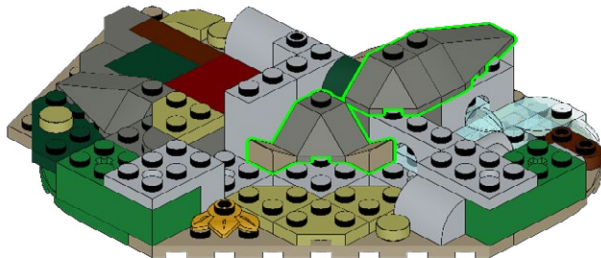

2

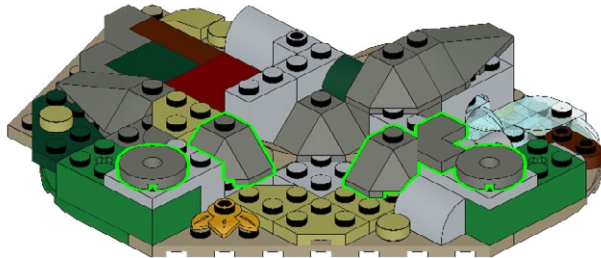

409

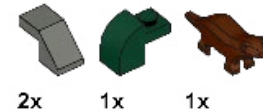

1

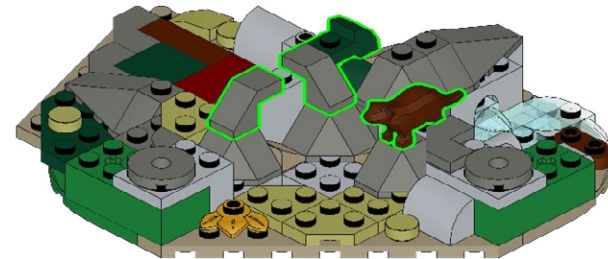

**HOLD UP!**

You might notice some bags aren't in order, as well as left over pieces, but that's ok! We're changing the way you build LEGO!

ATTENDEZ!

Vous remarquerez peut-être que certains sacs, ainsi que certaines pièces, ne sont pas dans le bon ordre. Mais pas de panique! Nous changeons simplement la façon avec laquelle vous construisez vos LEGO!

ASPETTA!

Potresti notare che alcuni sacchetti non sono in ordine, così come i pezzi avanzati, ma va bene così! Stiamo cambiando il modo in cui costruisci i LEGO!

HALT!

Sie werden möglicherweise bemerken, dass einige tüten durcheinander sind und teile übrig bleiben, aber das ist in Ordnung! Wir ändern die art und weise, wie Sie LEGO bauen!

¡ESPERA!

Es posible que notes que algunas bolsas están fuera de servicio, así como piezas sobrantes, ¡pero está bien! ¡Estamos cambiando la forma en que construyes LEGO!

暫停!

你可能会注意到一些袋子顺序错乱, 以及一些剩余的部件, 但没关系! 我们正在改变你搭建乐高的方式!

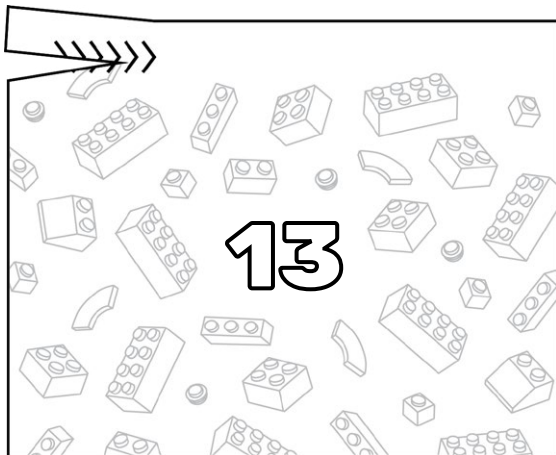
Open LEGO® Bag 13

410

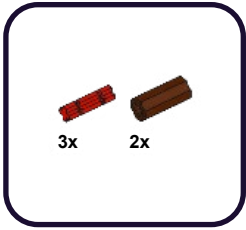

1



1



411

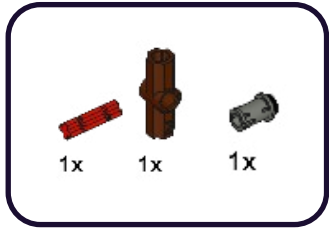

1

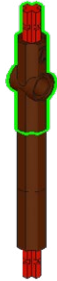

1





1

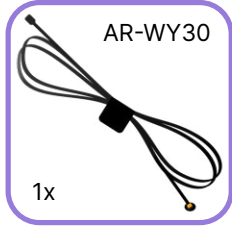

1



414

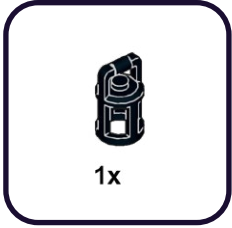

1



415



1





1



1



418

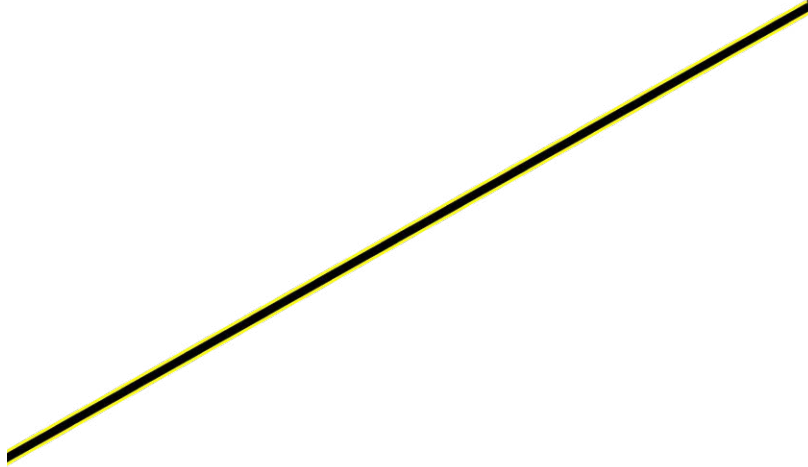
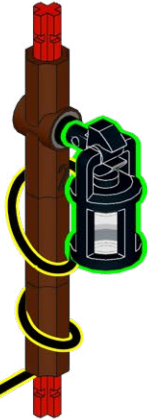
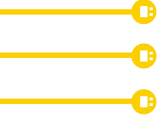

419

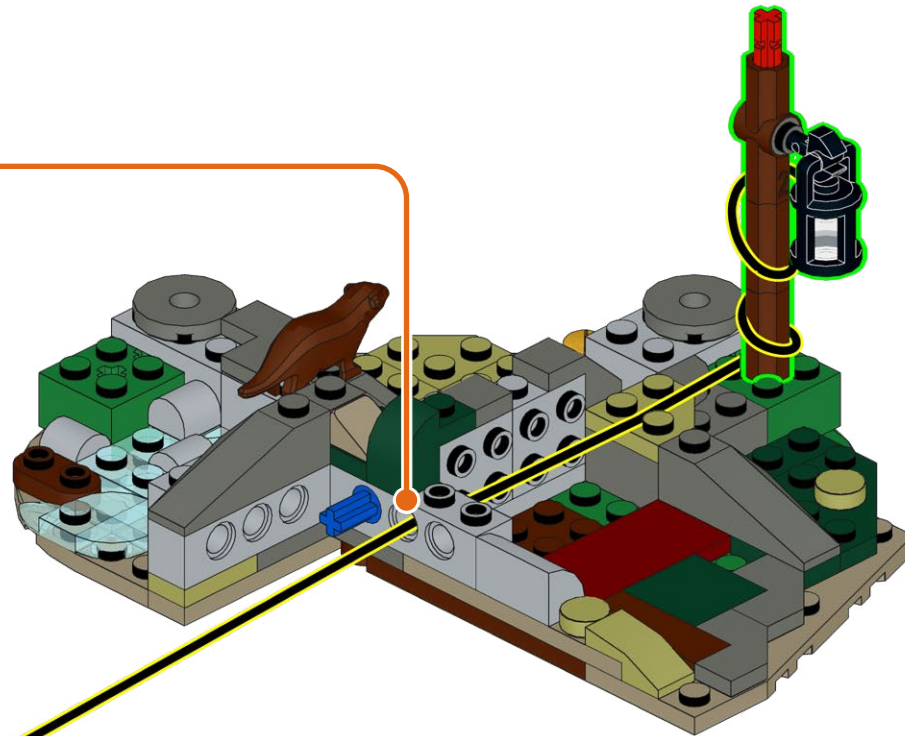
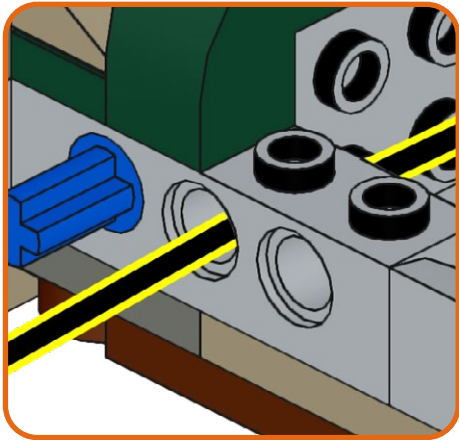

420

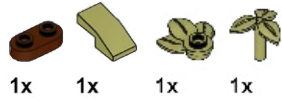

1

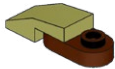

2

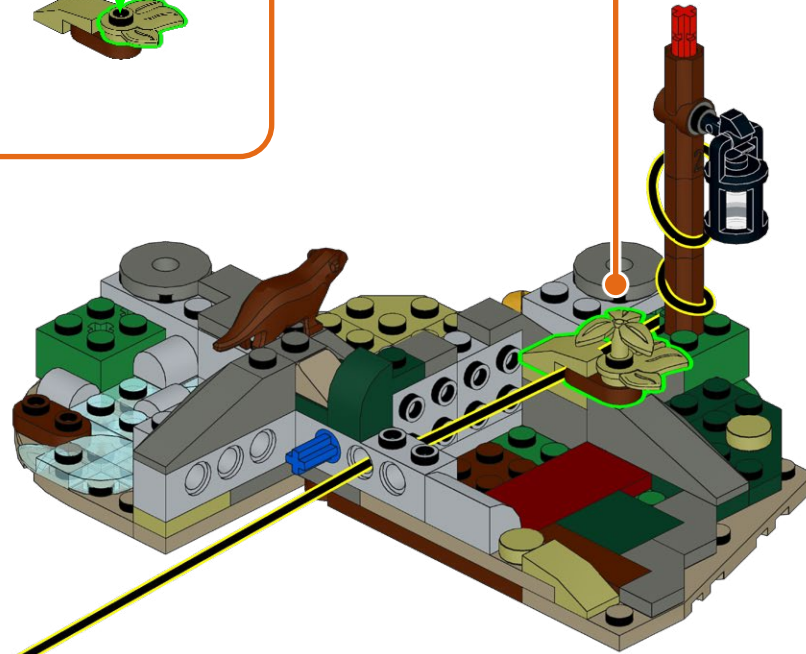
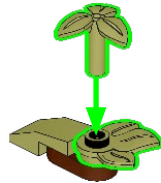

421

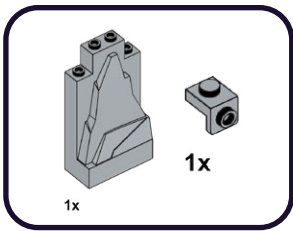

1

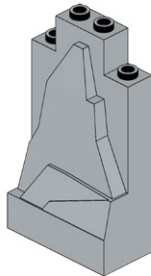

1

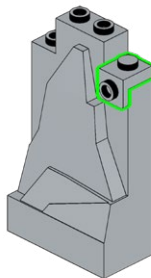

422

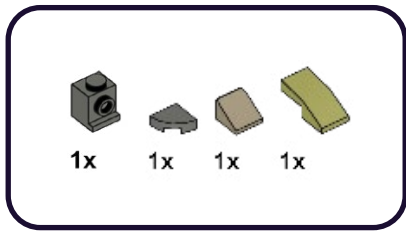

1

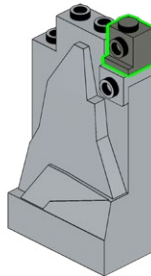

1

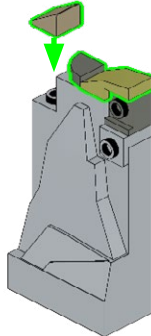

423

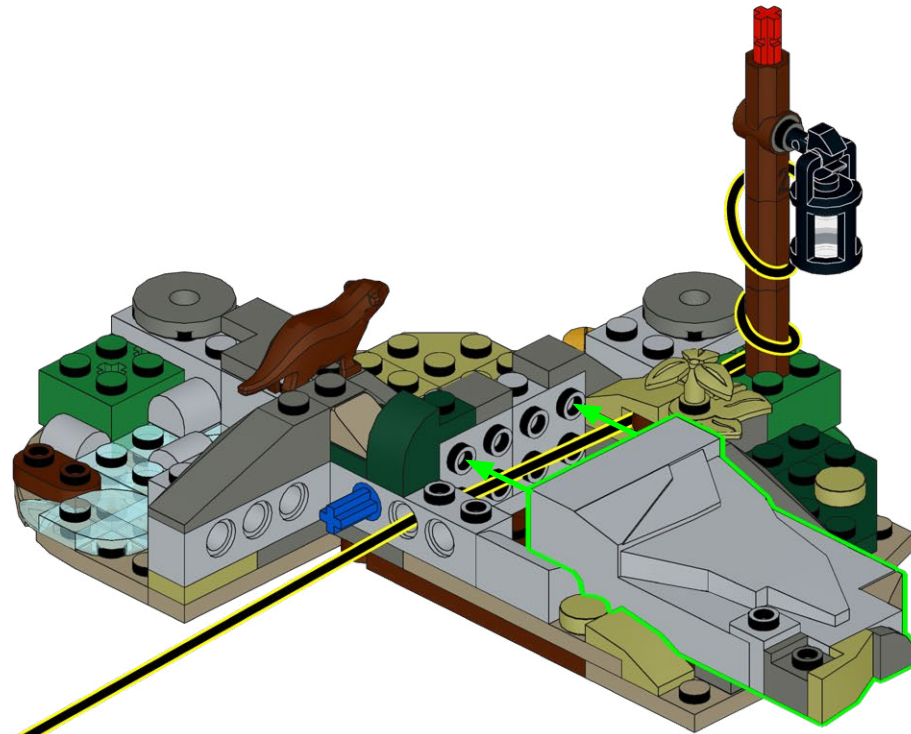

424

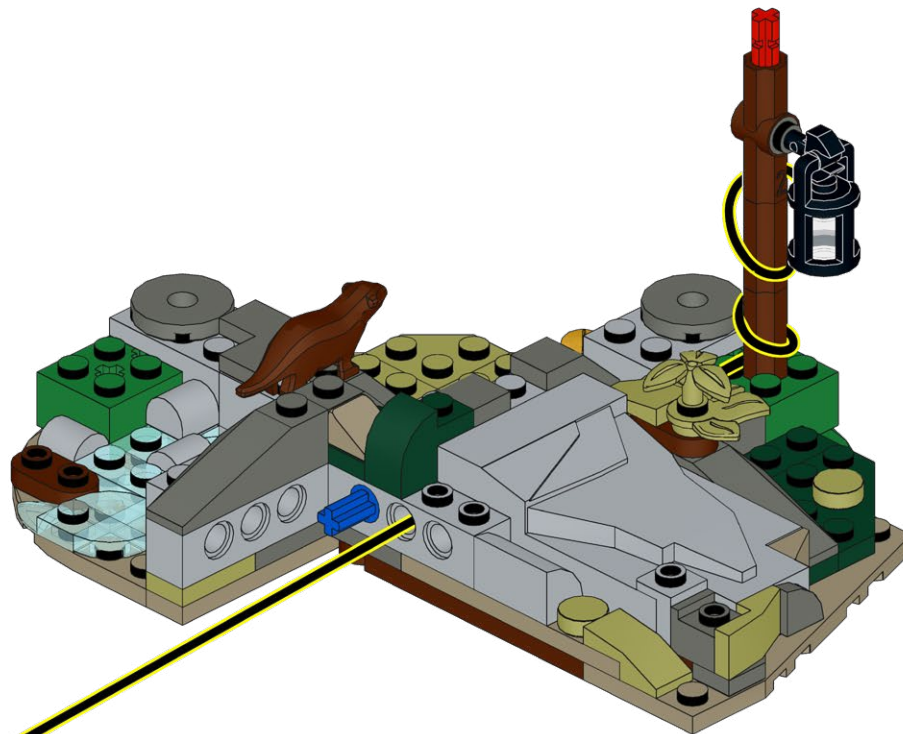

425

1x

1x

1x

426

1x

1x

1

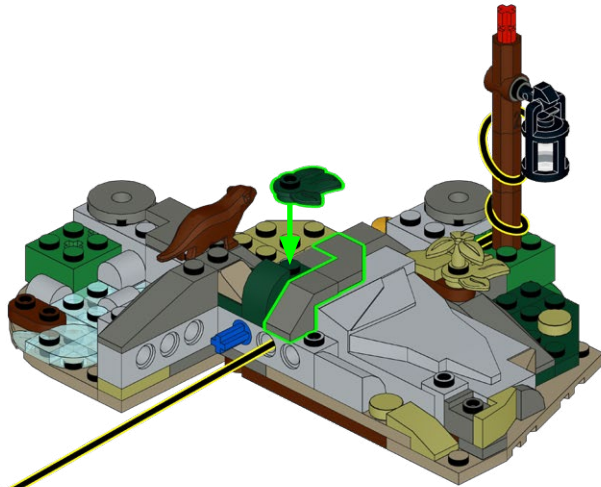

1

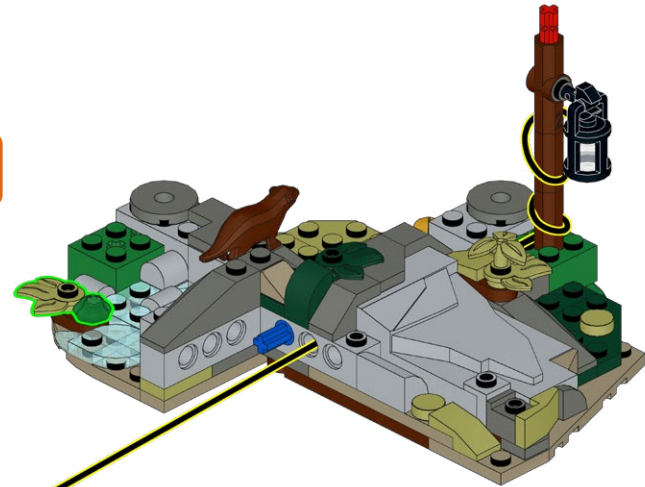

427



1x 1x 1x

1

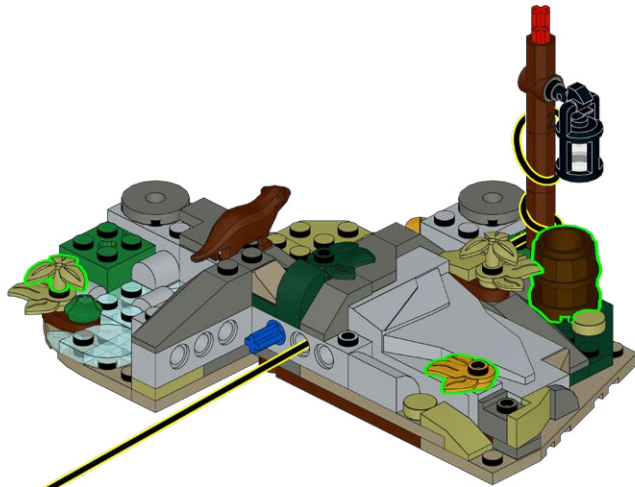

428



3x 2x 1x

1

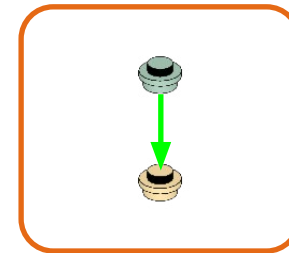
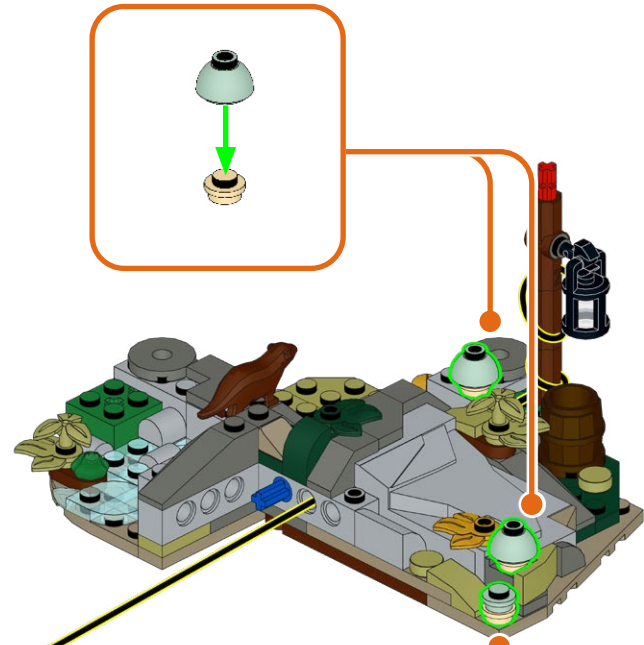

429

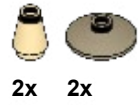

2x 2x

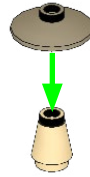

2x

1

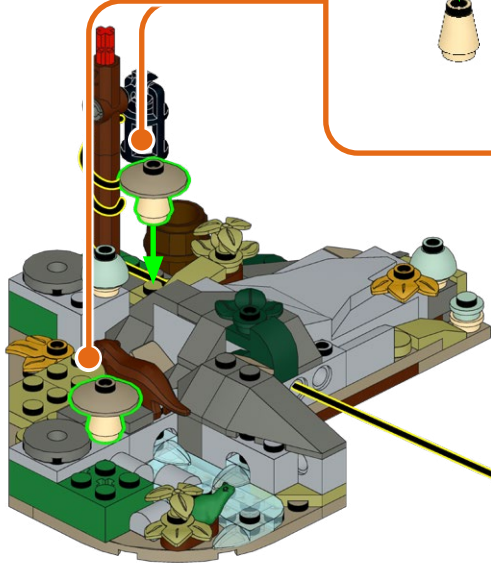

430

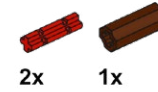

2x 1x

1

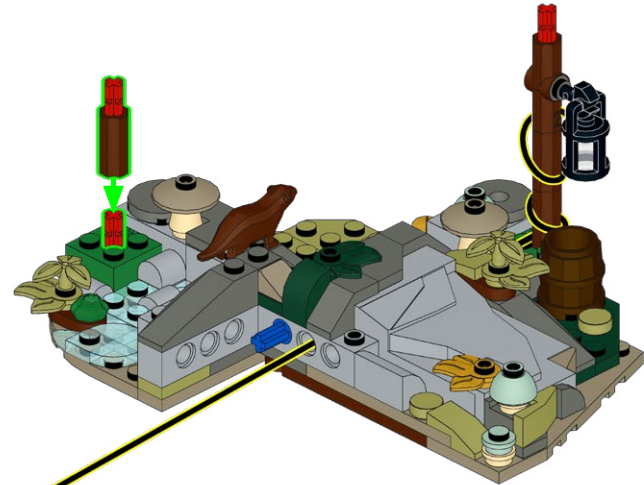

431

1x

1x

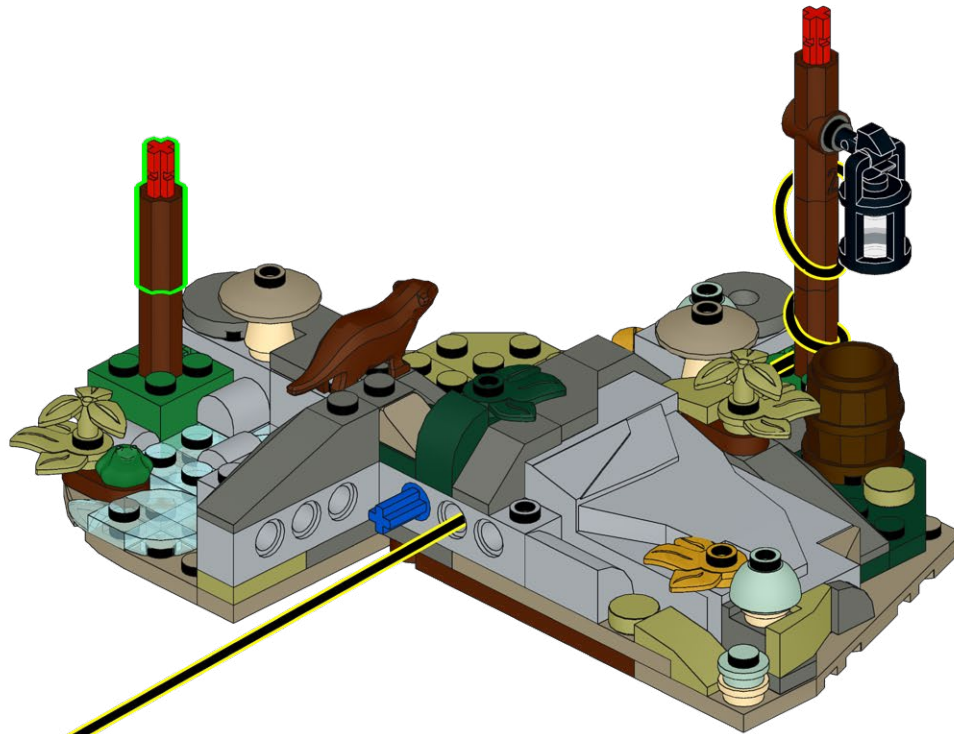

432

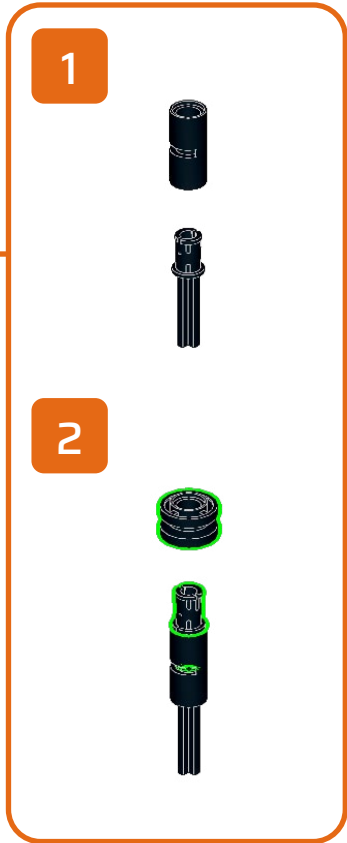
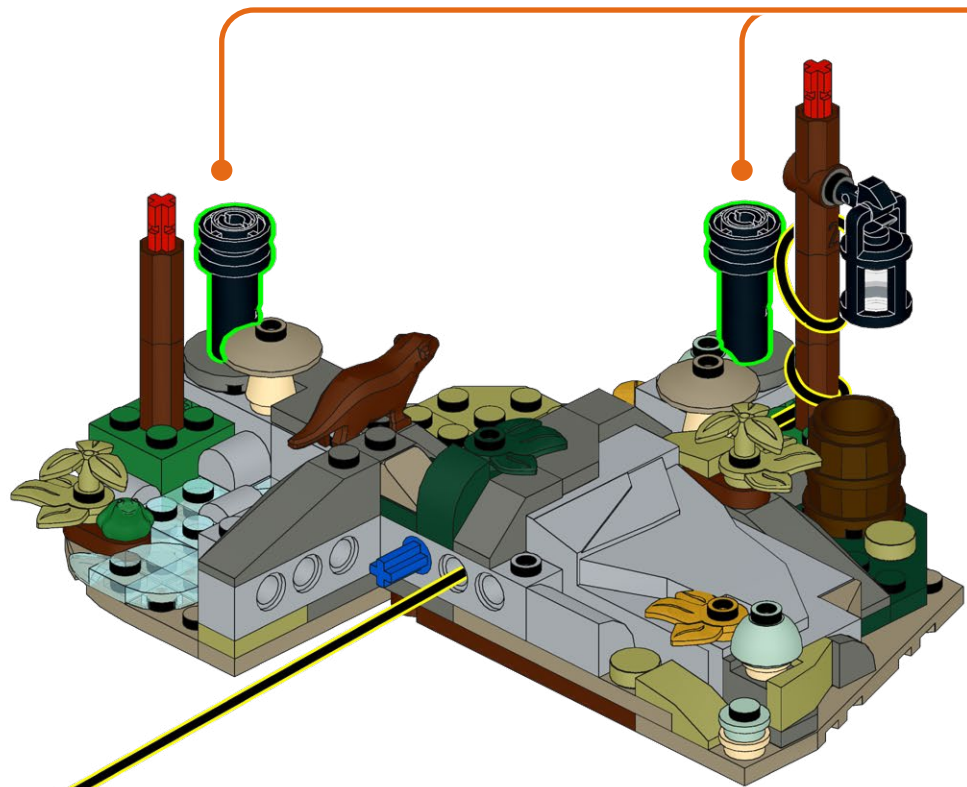

**HOLD UP!**

You might notice some bags aren't in order, as well as left over pieces, but that's ok! We're changing the way you build LEGO!

ATTENDEZ!

Vous remarquerez peut-être que certains sacs, ainsi que certaines pièces, ne sont pas dans le bon ordre. Mais pas de panique! Nous changeons simplement la façon avec laquelle vous construisez vos LEGO!

ASPETTA!

Potresti notare che alcuni sacchetti non sono in ordine, così come i pezzi avanzati, ma va bene così! Stiamo cambiando il modo in cui costruisci i LEGO!

HALT!

Sie werden möglicherweise bemerken, dass einige tüten durcheinander sind und teile übrig bleiben, aber das ist in Ordnung! Wir ändern die art und weise, wie Sie LEGO bauen!

¡ESPERA!

Es posible que notes que algunas bolsas están fuera de servicio, así como piezas sobrantes, ¡pero está bien! ¡Estamos cambiando la forma en que construyes LEGO!

暫停!

你可能会注意到一些袋子顺序错乱, 以及一些剩余的部件, 但没关系! 我们正在改变你搭建乐高的方式!

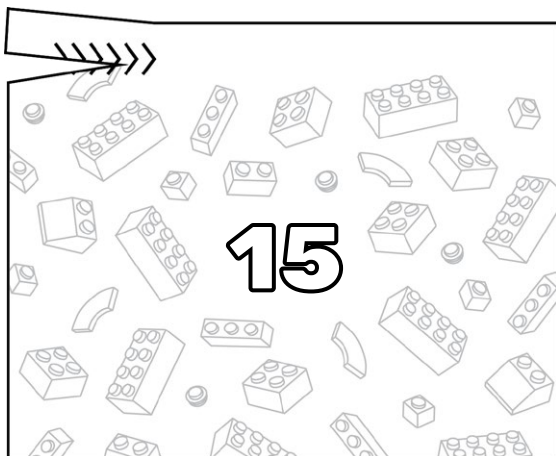
Open LEGO® Bag 15

433



1



1



1



434

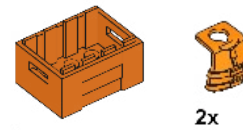

1

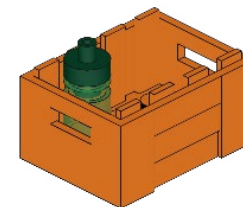

1

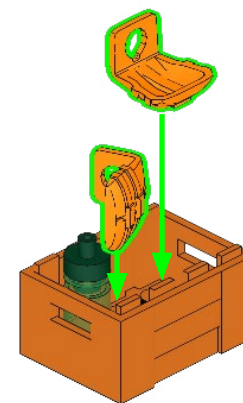

435

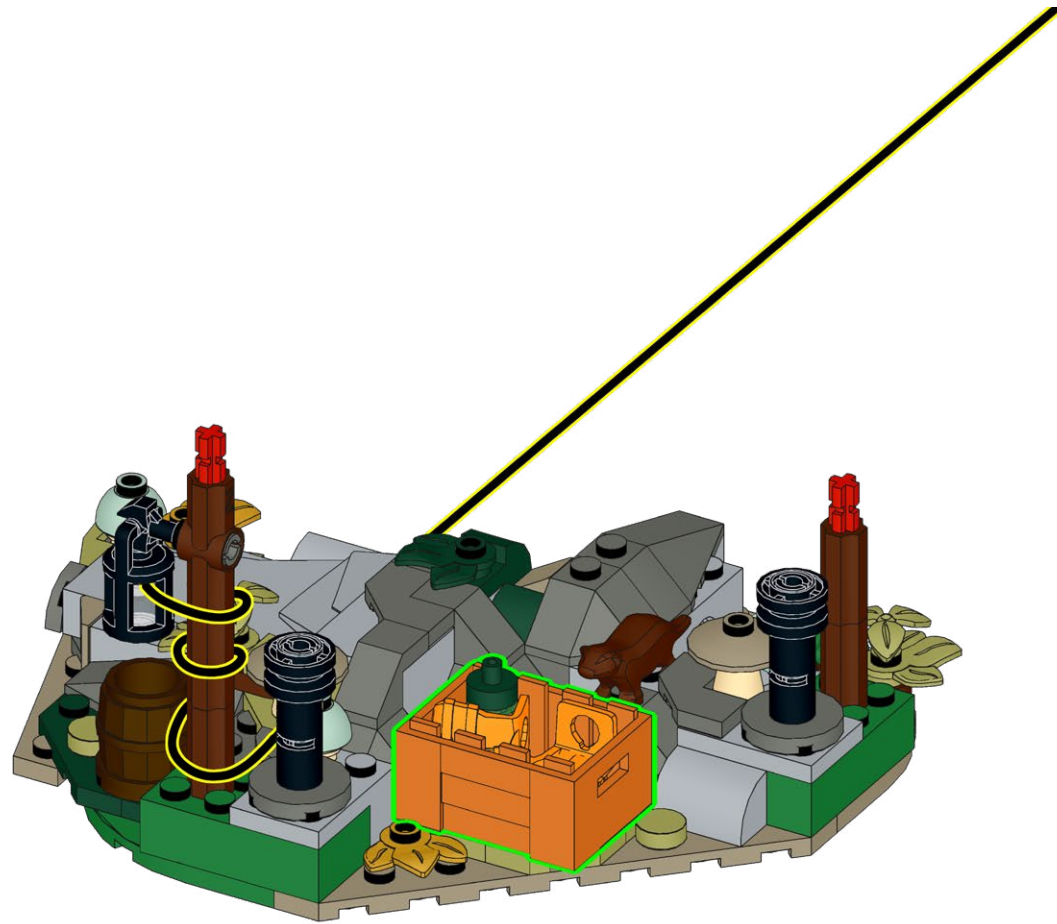

436



2x

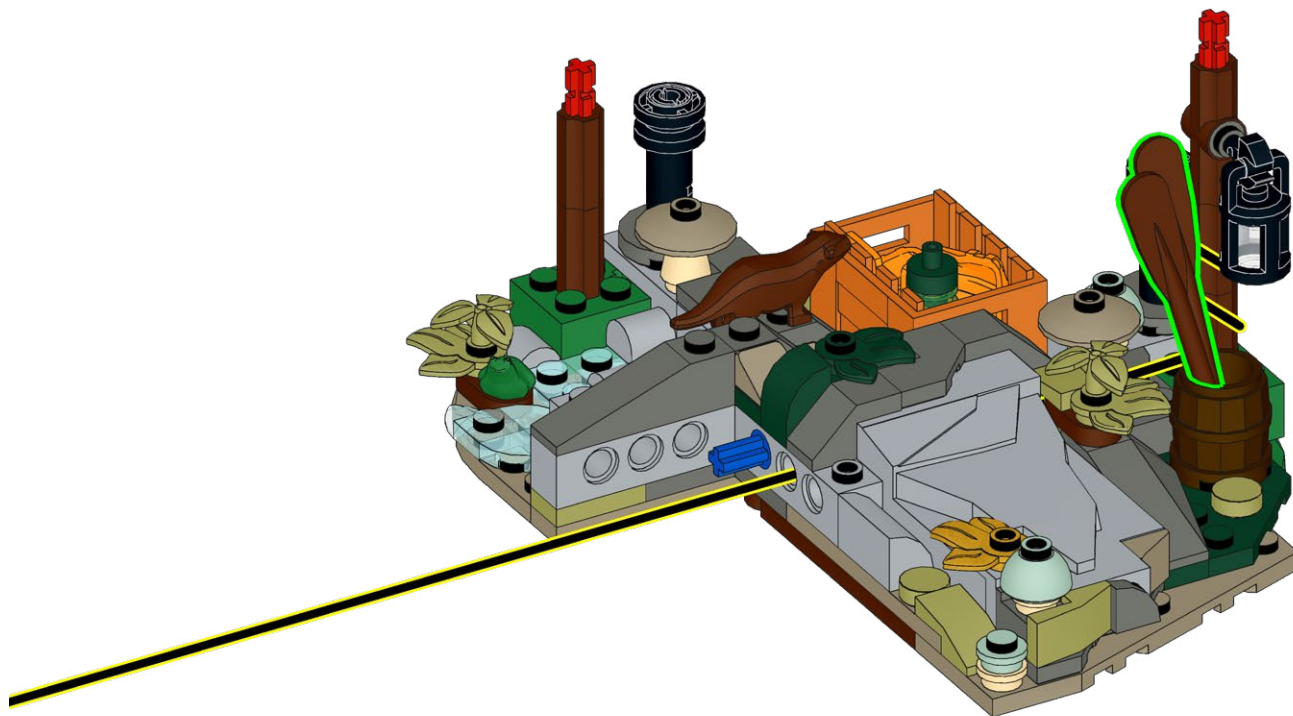

437

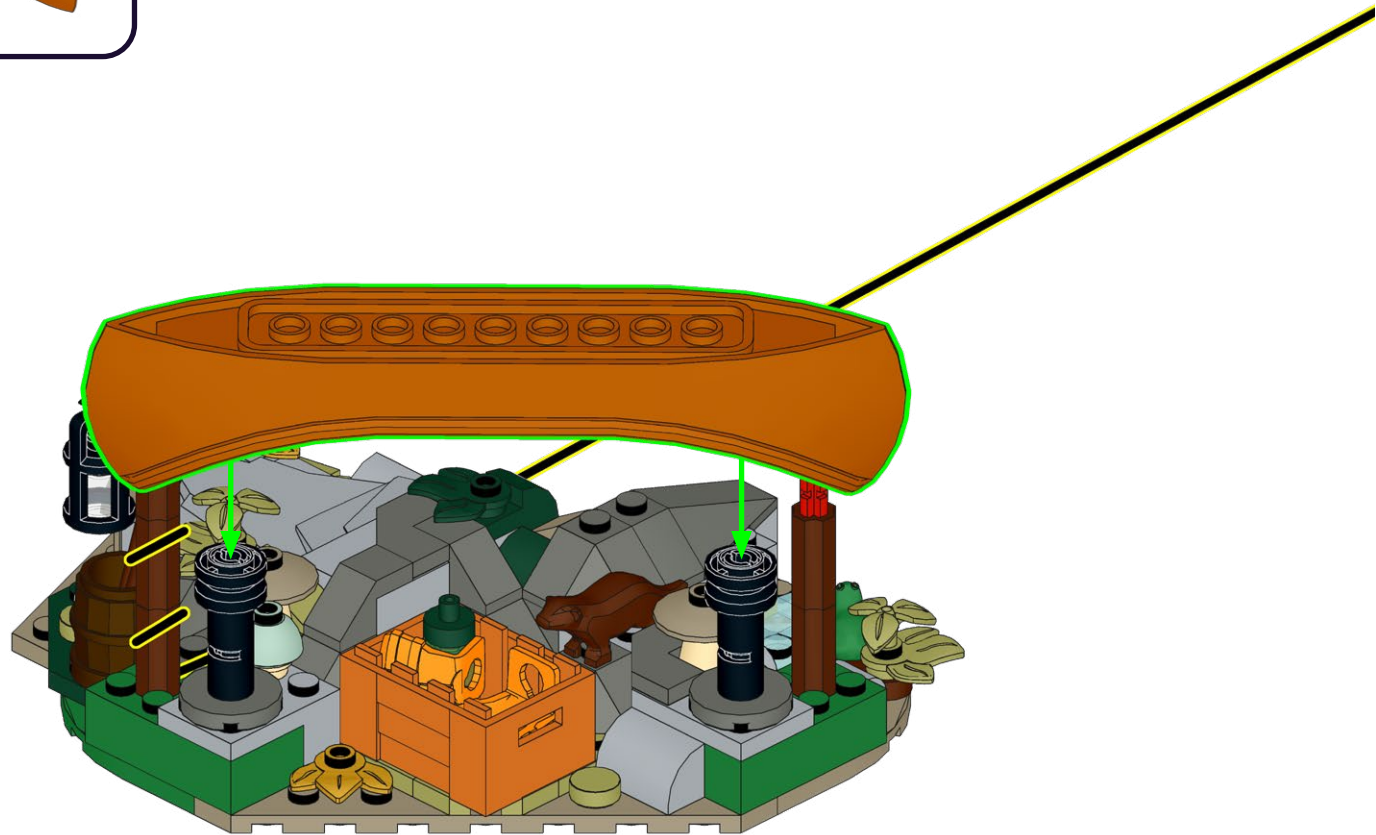
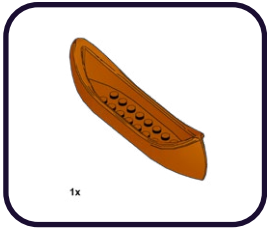

438

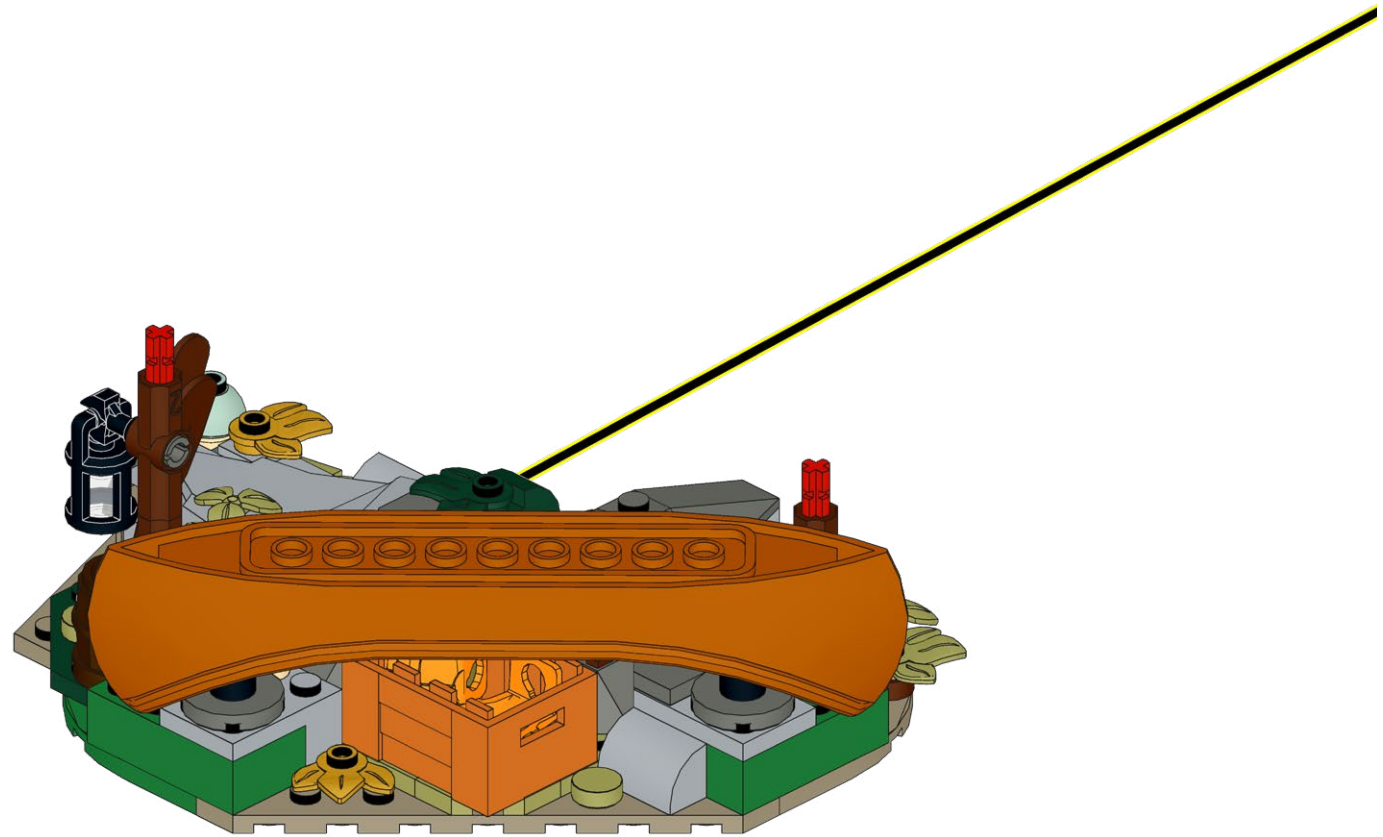

439

1x

1x



440

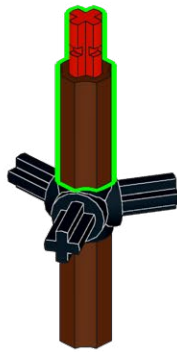
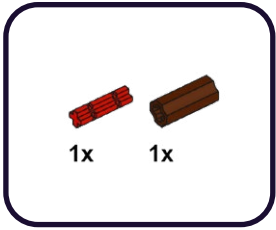

441

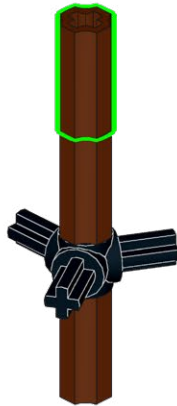
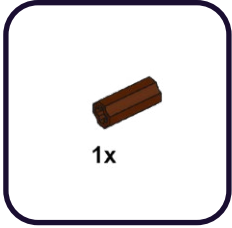

442

1x

1x

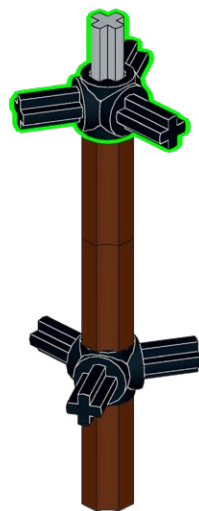

443

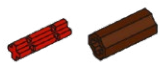

1x

1x



444

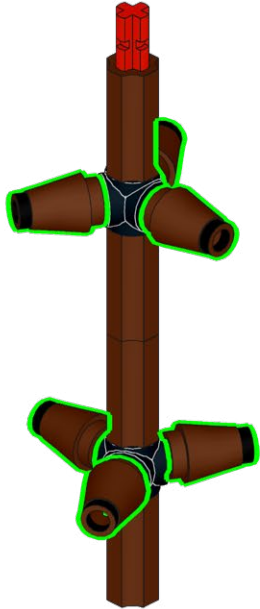
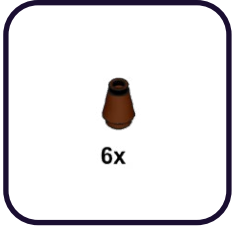

445

6x

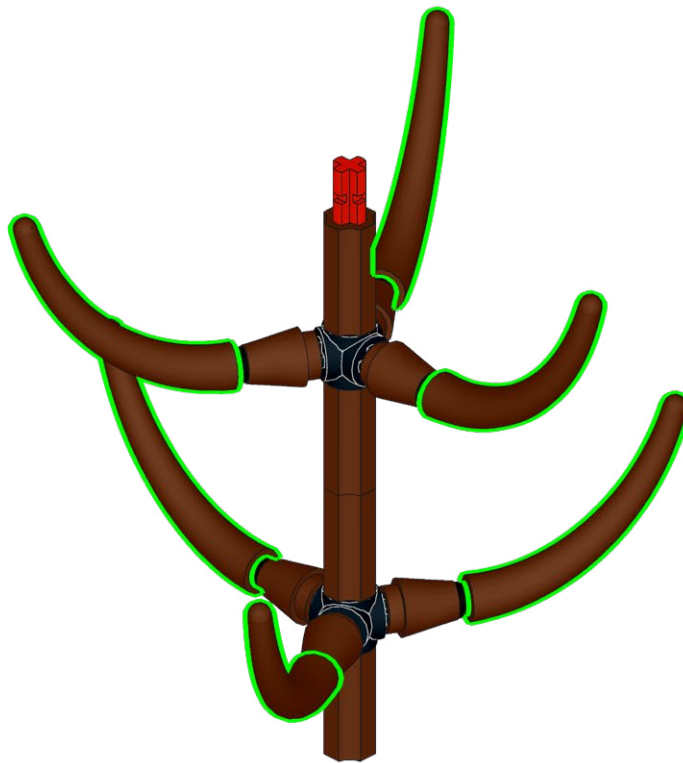

446



1x



1x

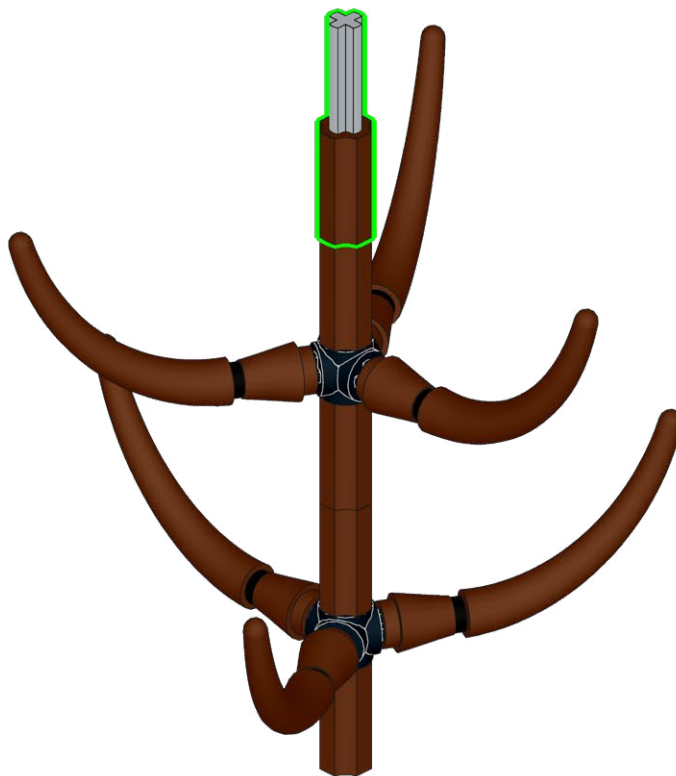

447

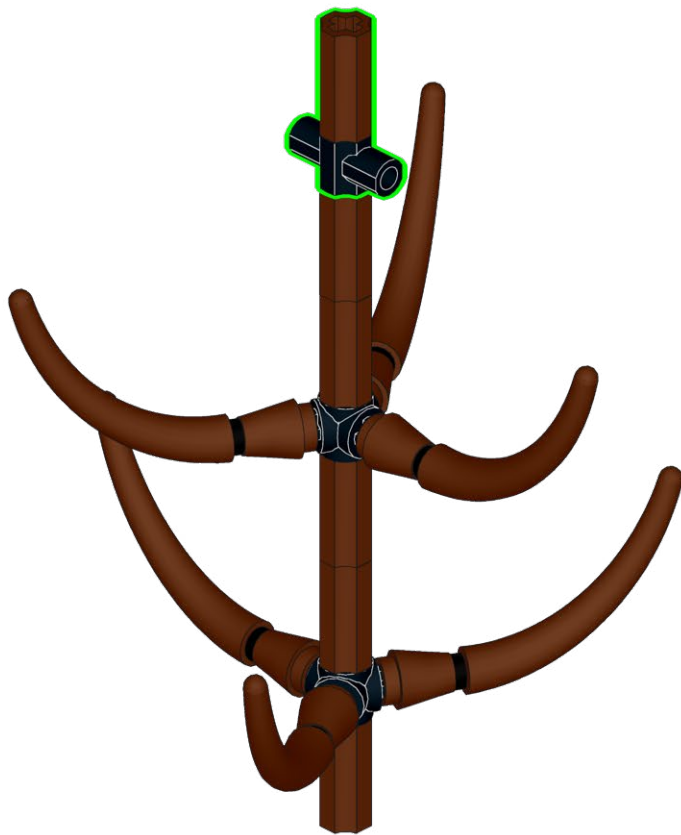
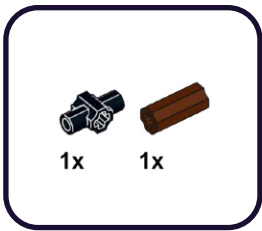

448

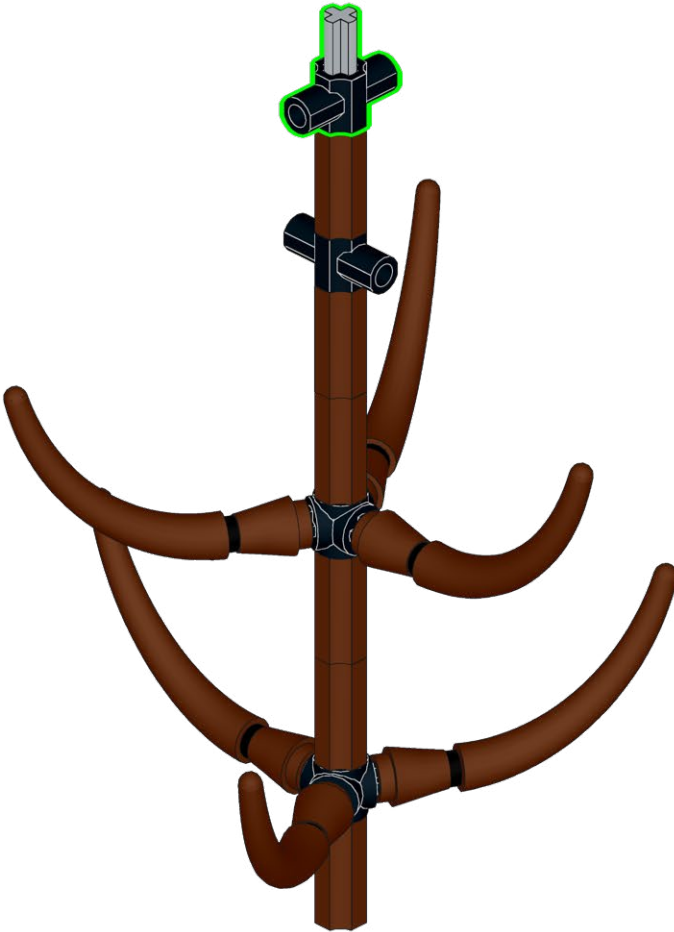
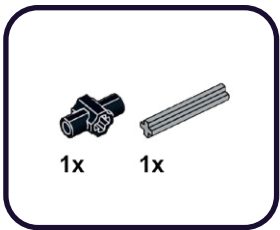

449

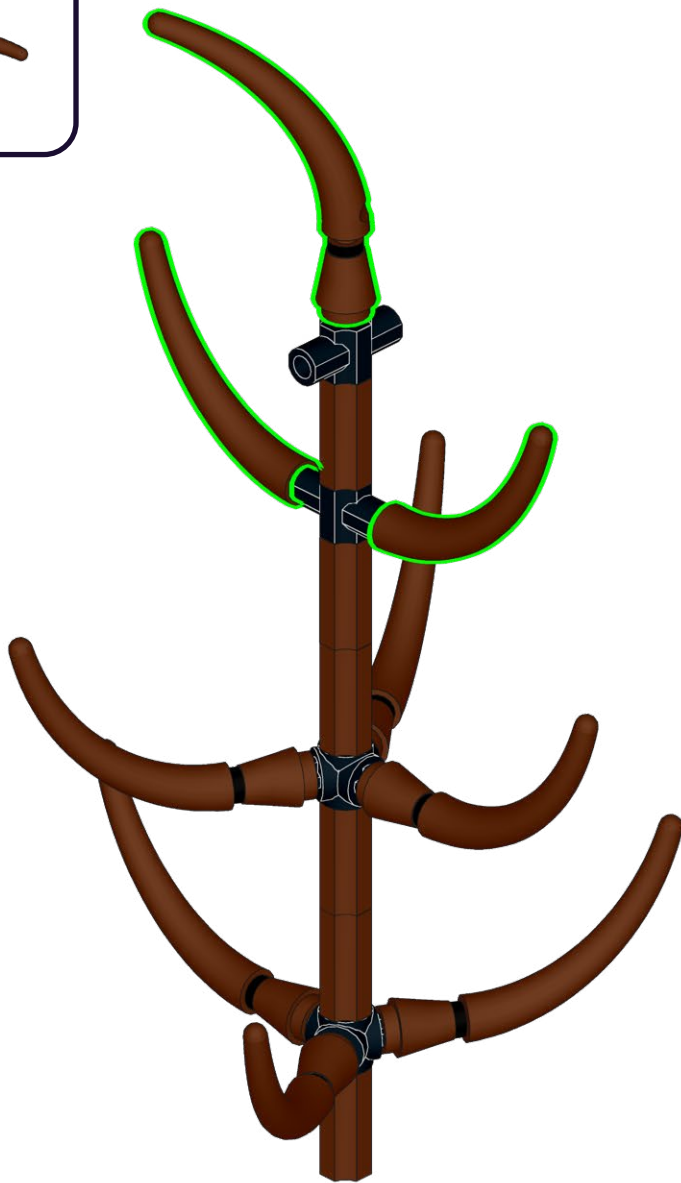

450

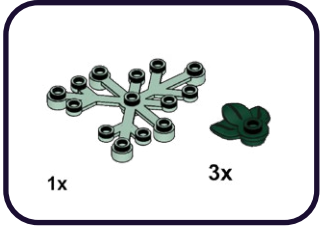

1

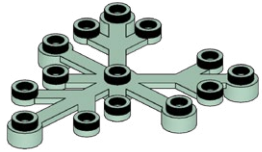

2

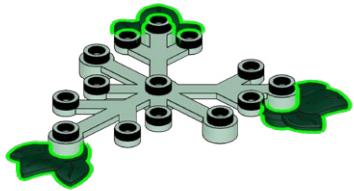

451

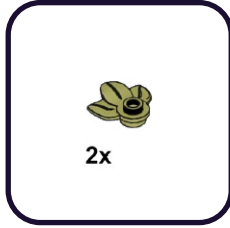

1

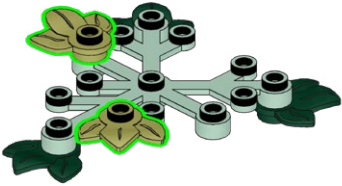

5x

452

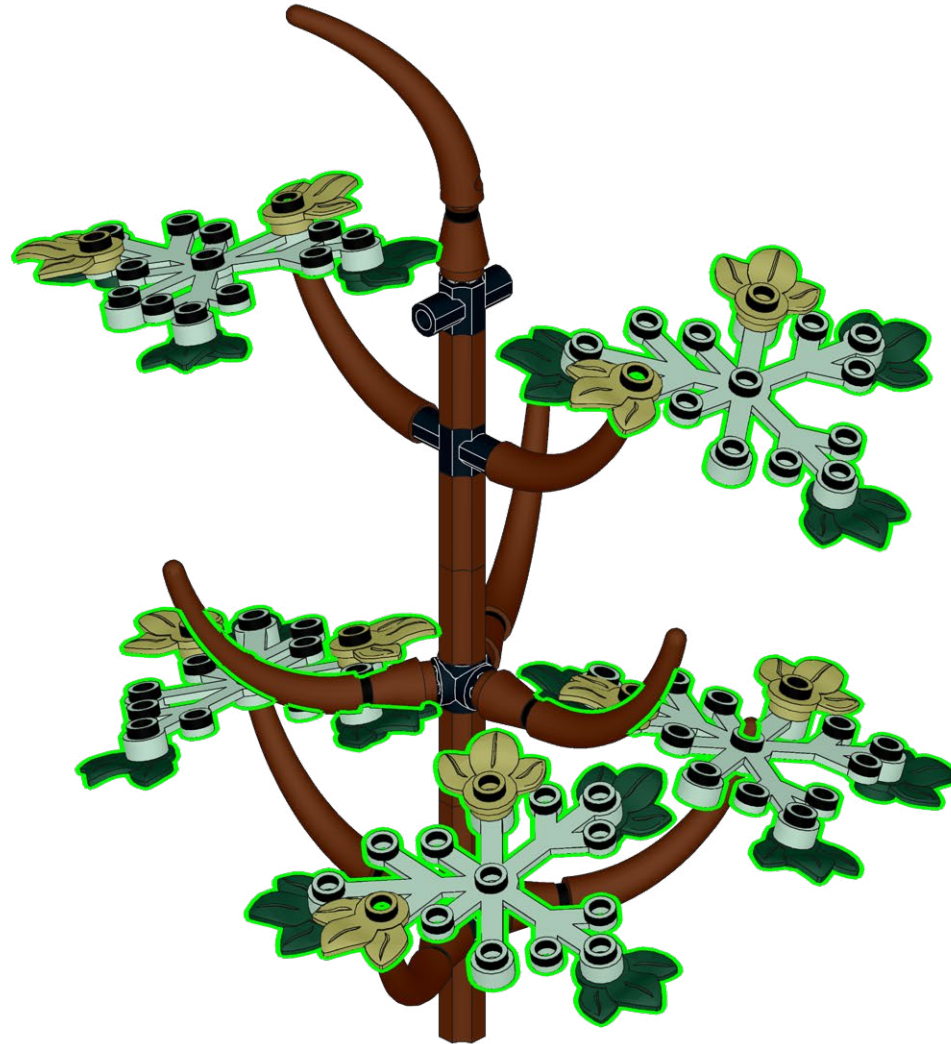

453

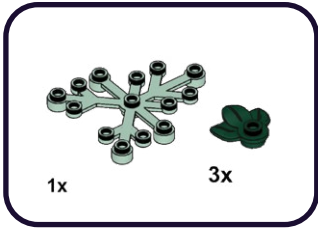

1

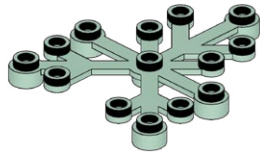

2

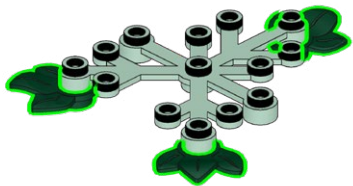

454

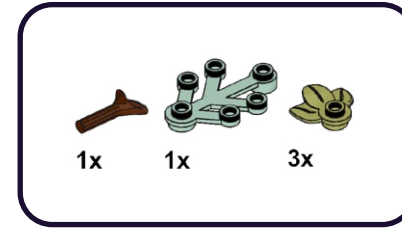

1

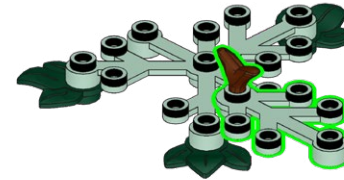

1

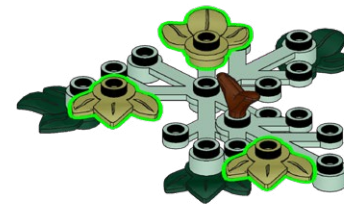

3x

455

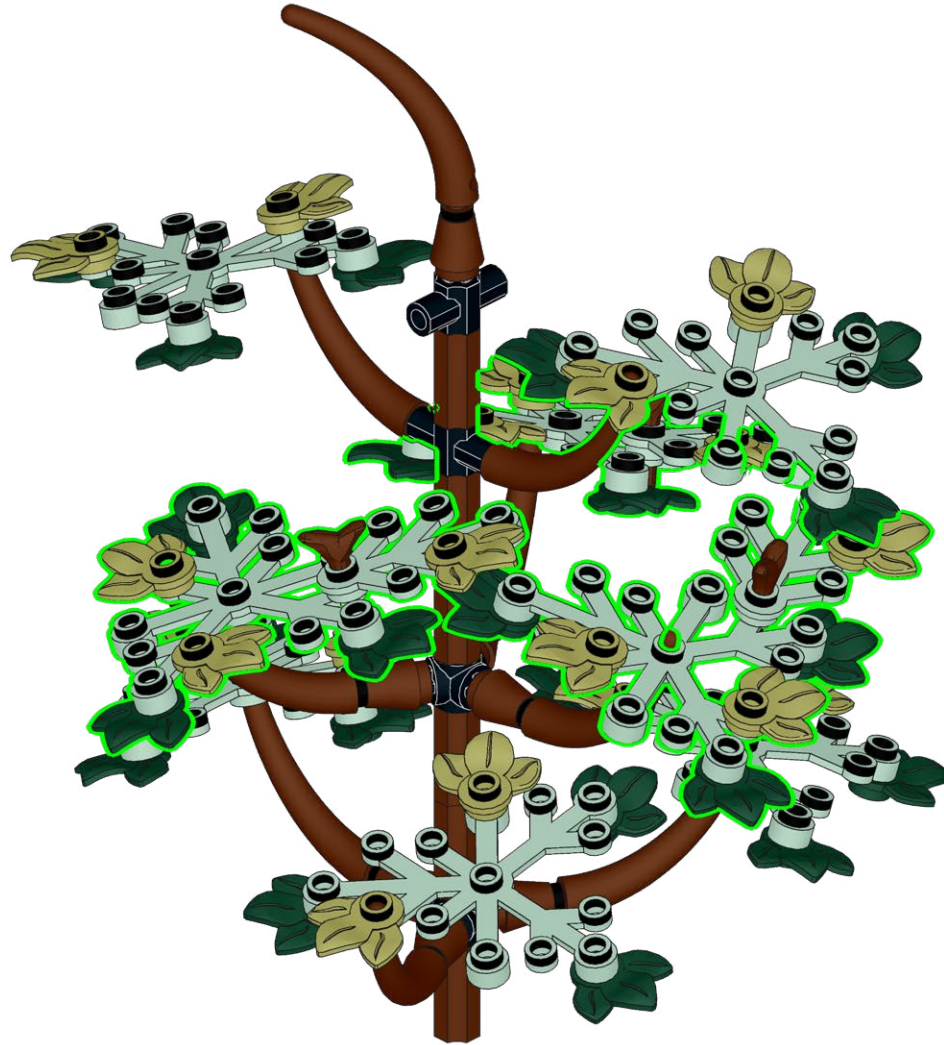

456



1

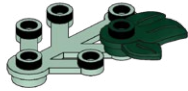

2

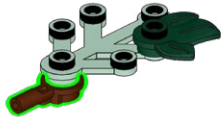

457

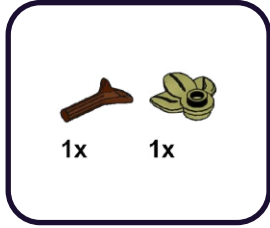

1

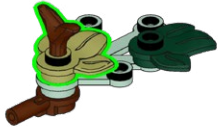

2x

458

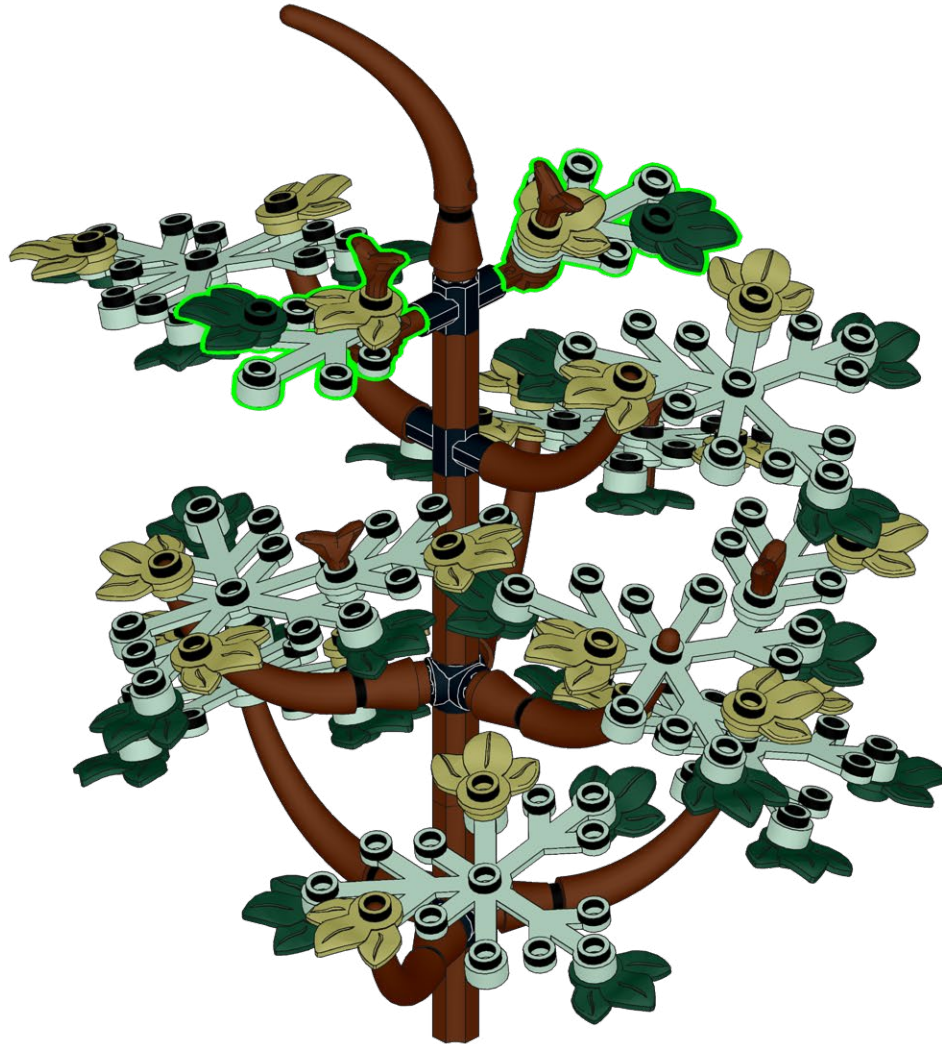

459

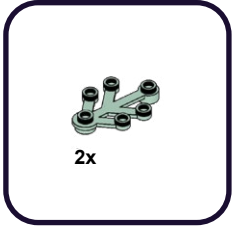

1

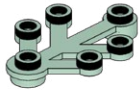

2

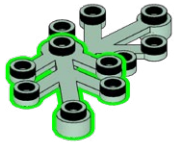

460



1

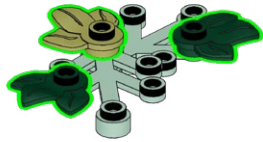

461



462

To be used later
A utiliser plus tard
Da utilizzare dopo
Zur späteren Verwendung
Para ser utilizado más tarde
稍后使用

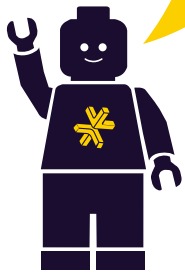

 LMB



463

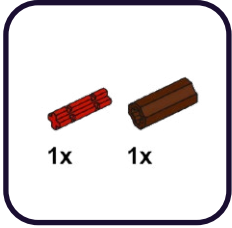

464

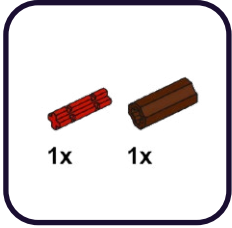

465

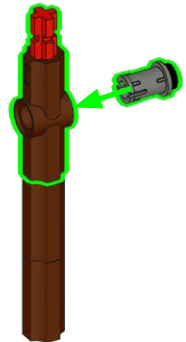
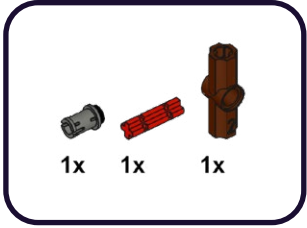

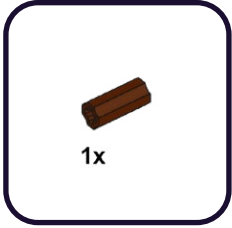

467

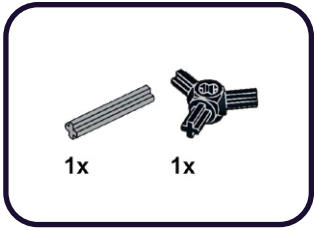

468

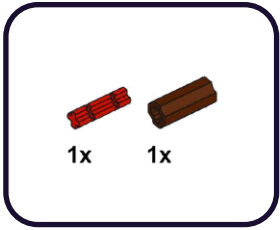

469

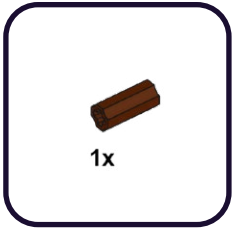

470

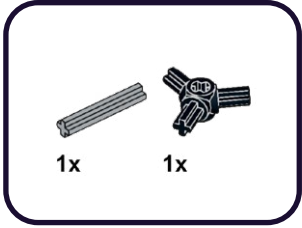

471

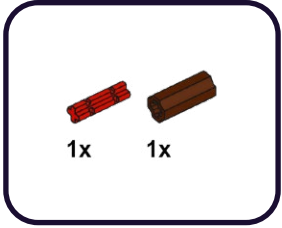

472

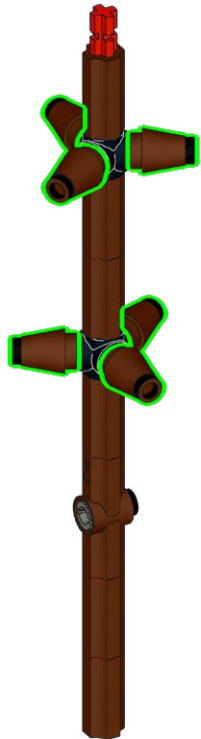
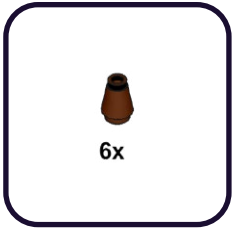

473

6x

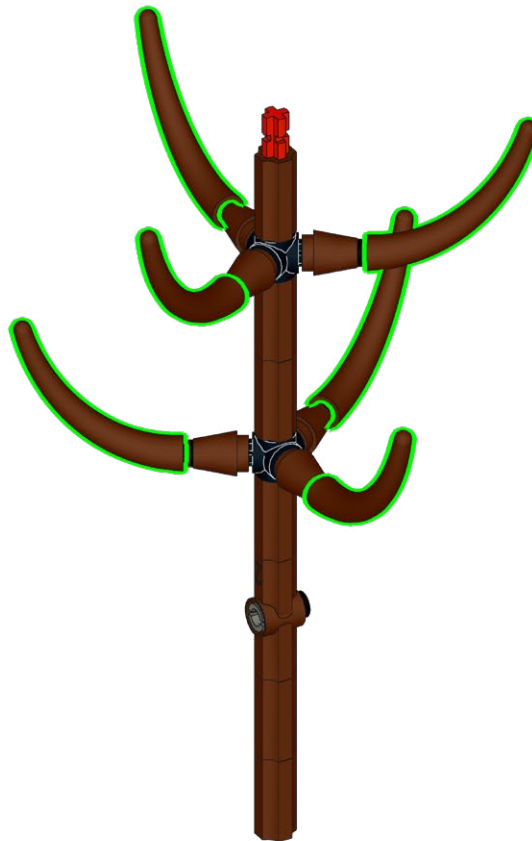

474

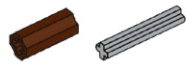

1x

1x



475

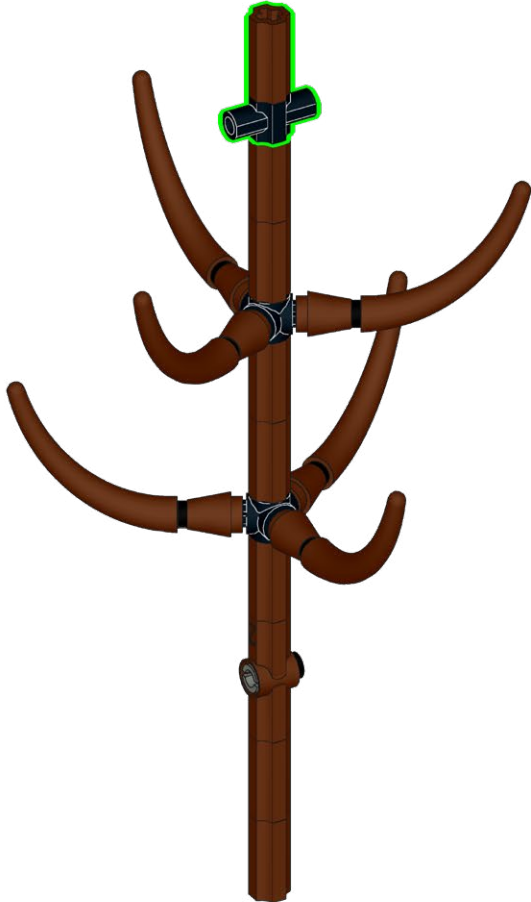
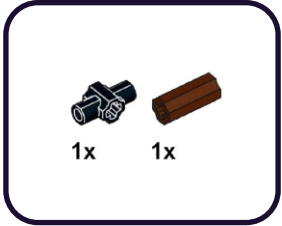

476

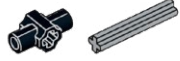

1x

1x

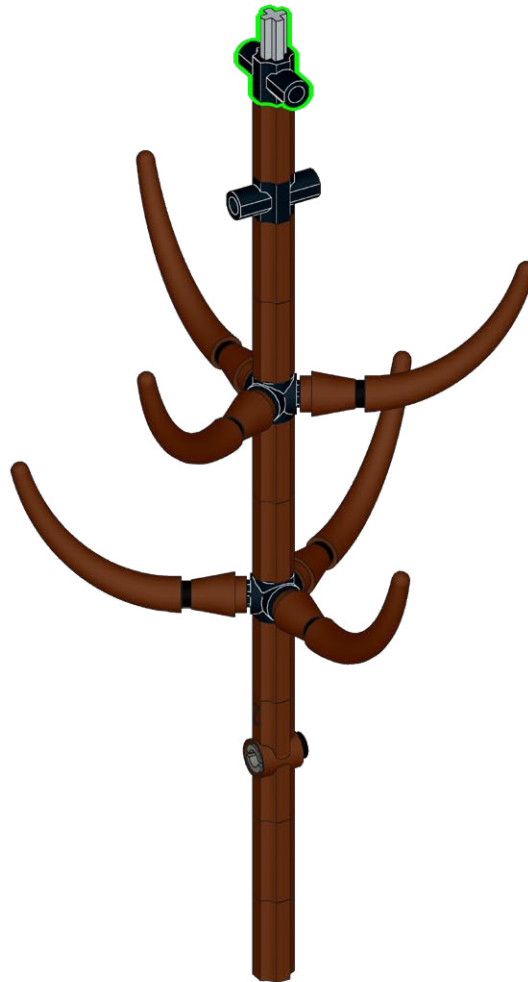

477



1x 3x

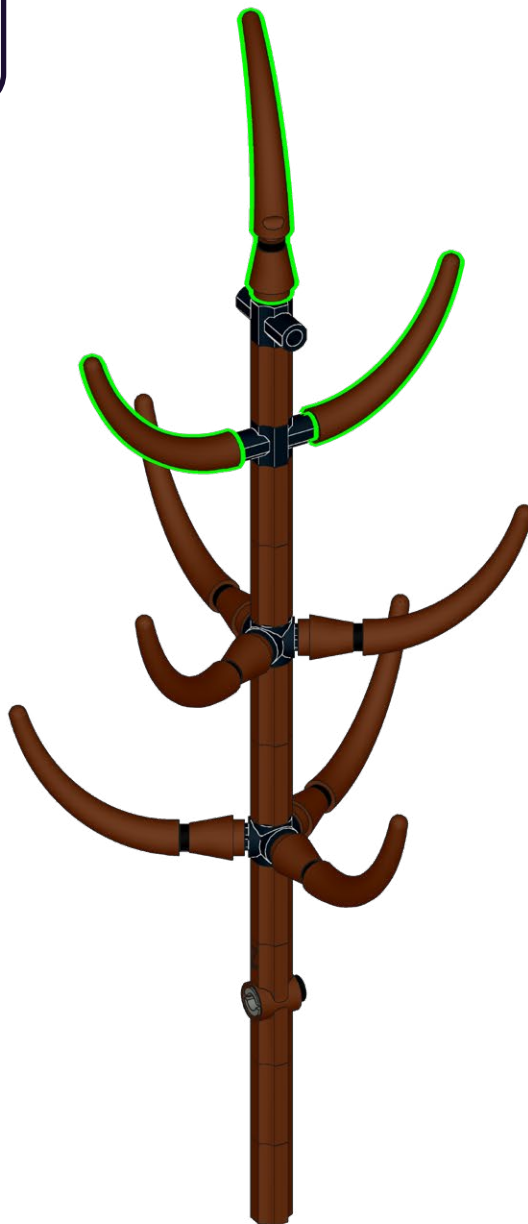

478

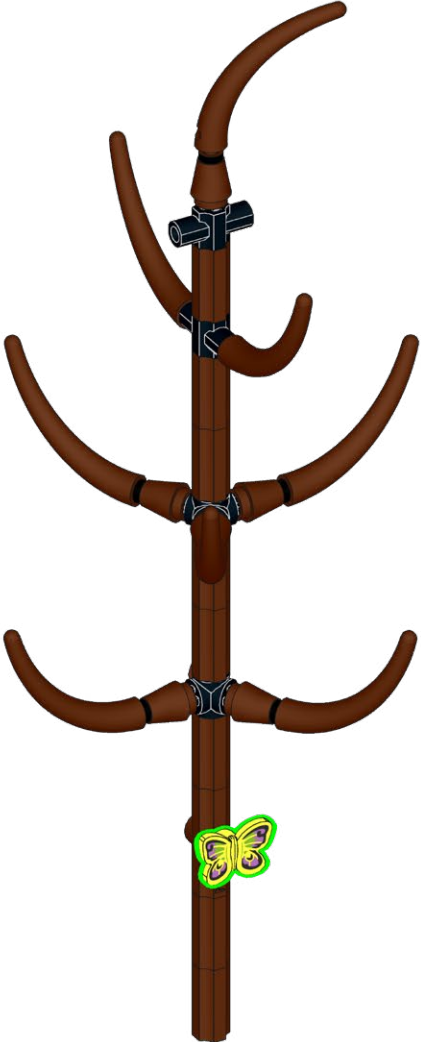
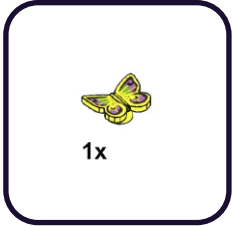

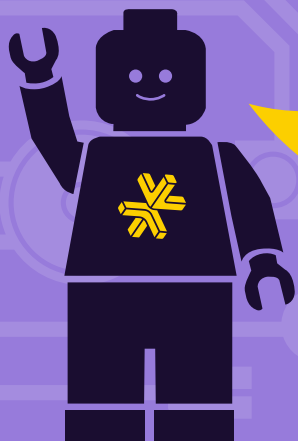
**HOLD UP!**

You might notice some bags aren't in order, as well as left over pieces, but that's ok! We're changing the way you build LEGO!

ATTENDEZ!

Vous remarquerez peut-être que certains sacs, ainsi que certaines pièces, ne sont pas dans le bon ordre. Mais pas de panique! Nous changeons simplement la façon avec laquelle vous construisez vos LEGO!

ASPETTA!

Potresti notare che alcuni sacchetti non sono in ordine, così come i pezzi avanzati, ma va bene così! Stiamo cambiando il modo in cui costruisci i LEGO!

HALT!

Sie werden möglicherweise bemerken, dass einige tüten durcheinander sind und teile übrig bleiben, aber das ist in Ordnung! Wir ändern die art und weise, wie Sie LEGO bauen!

¡ESPERA!

Es posible que notes que algunas bolsas están fuera de servicio, así como piezas sobrantes, ¡pero está bien! ¡Estamos cambiando la forma en que construyes LEGO!

暫停!

你可能会注意到一些袋子顺序错乱, 以及一些剩余的部件, 但没关系! 我们正在改变你搭建乐高的方式!

Open LEGO® Bag 14

479

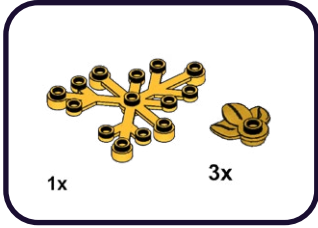

1



2

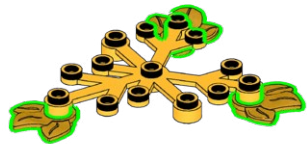

480

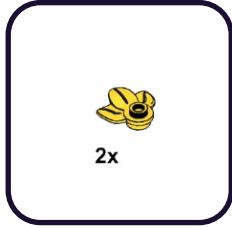

1

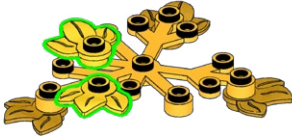

5x

481



1x

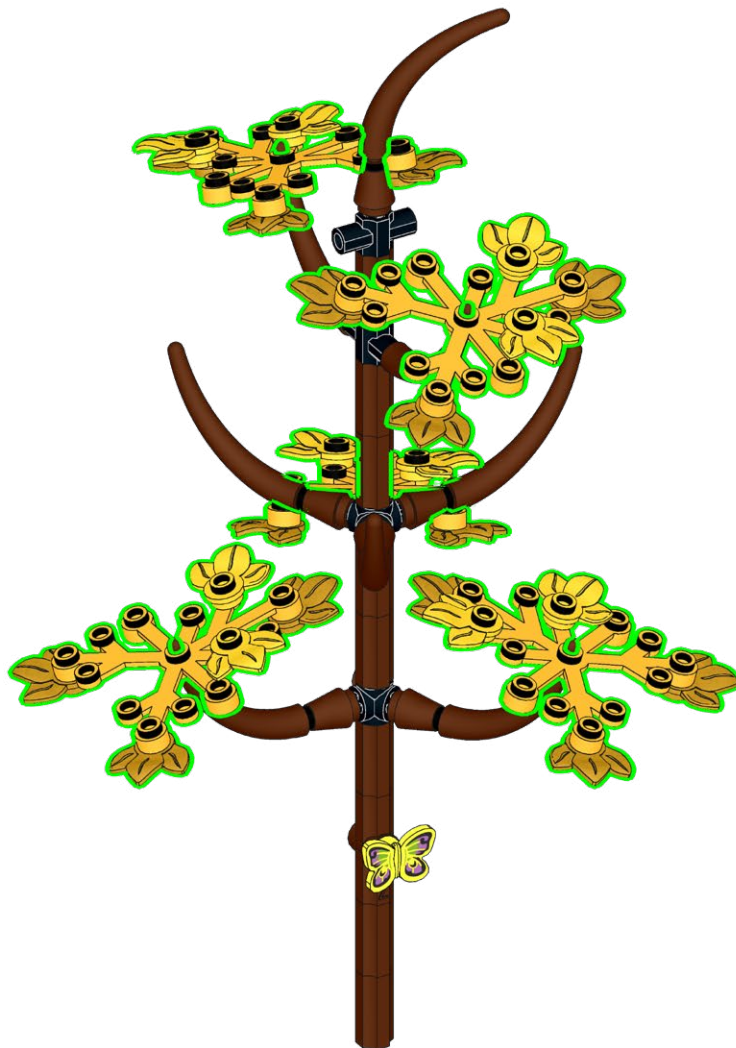

482

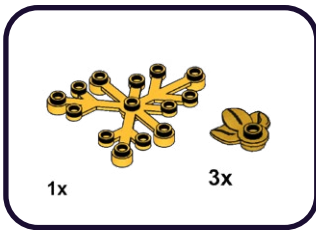

1

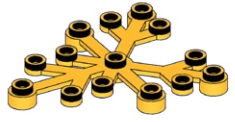

2

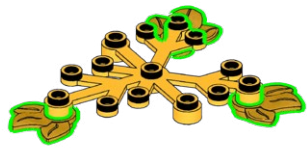

483

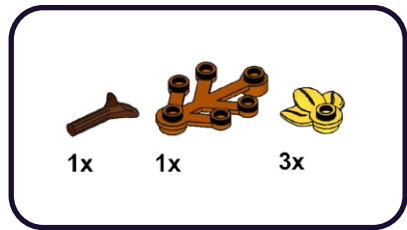

1



1



3x

484



485

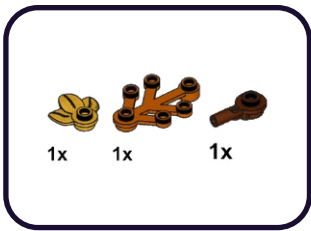

1



2



486

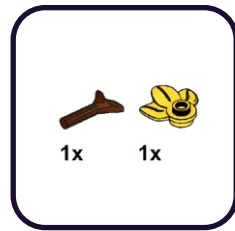

1



2x

487

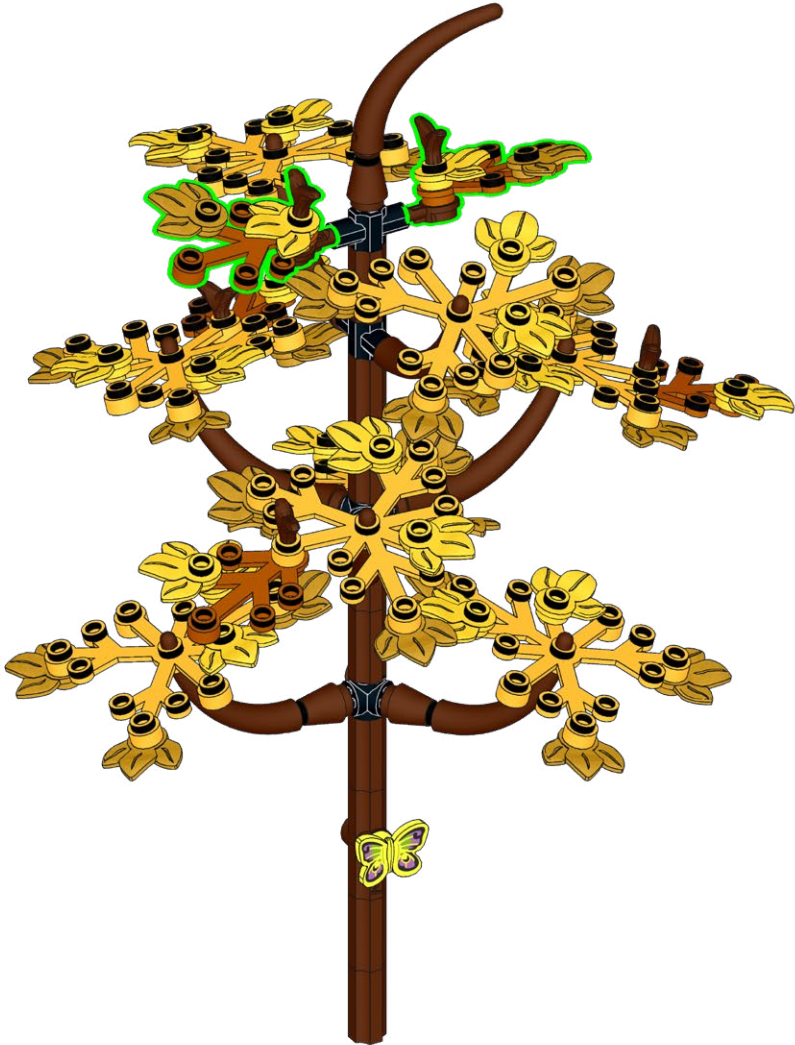

488

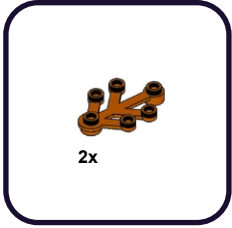

1



2



489

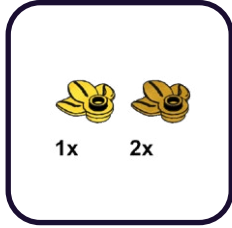

1



490



491



To be used later
A utiliser plus tard
Da utilizzare dopo
Zur späteren Verwendung
Para ser utilizado más tarde
稍后使用

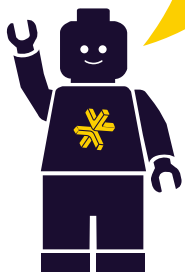

 **LMB**

492

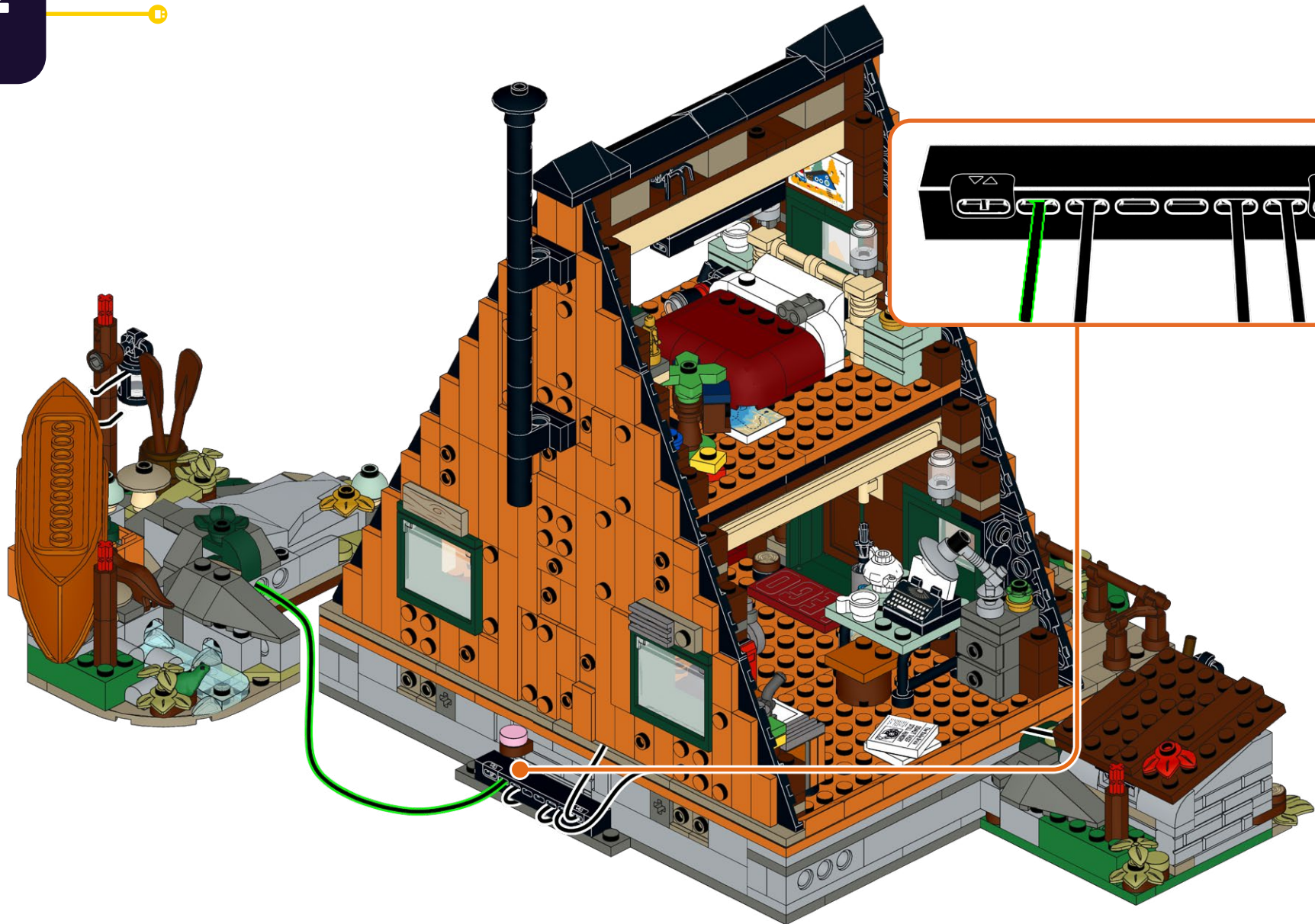

493



**HOLD UP!**

You might notice some bags aren't in order, as well as left over pieces, but that's ok! We're changing the way you build LEGO!

ATTENDEZ!

Vous remarquerez peut-être que certains sacs, ainsi que certaines pièces, ne sont pas dans le bon ordre. Mais pas de panique! Nous changeons simplement la façon avec laquelle vous construisez vos LEGO!

ASPETTA!

Potresti notare che alcuni sacchetti non sono in ordine, così come i pezzi avanzati, ma va bene così! Stiamo cambiando il modo in cui costruisci i LEGO!

HALT!

Sie werden möglicherweise bemerken, dass einige tüten durcheinander sind und teile übrig bleiben, aber das ist in Ordnung! Wir ändern die art und weise, wie Sie LEGO bauen!

¡ESPERA!

Es posible que notes que algunas bolsas están fuera de servicio, así como piezas sobrantes, ¡pero está bien! ¡Estamos cambiando la forma en que construyes LEGO!

暫停!

你可能会注意到一些袋子顺序错乱, 以及一些剩余的部件, 但没关系! 我们正在改变你搭建乐高的方式!

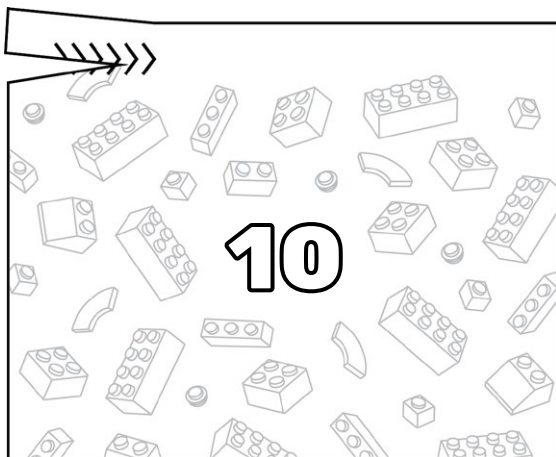
Open LEGO® Bag 10

494

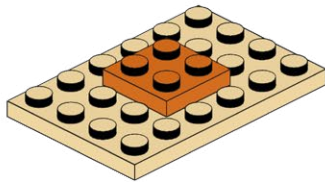
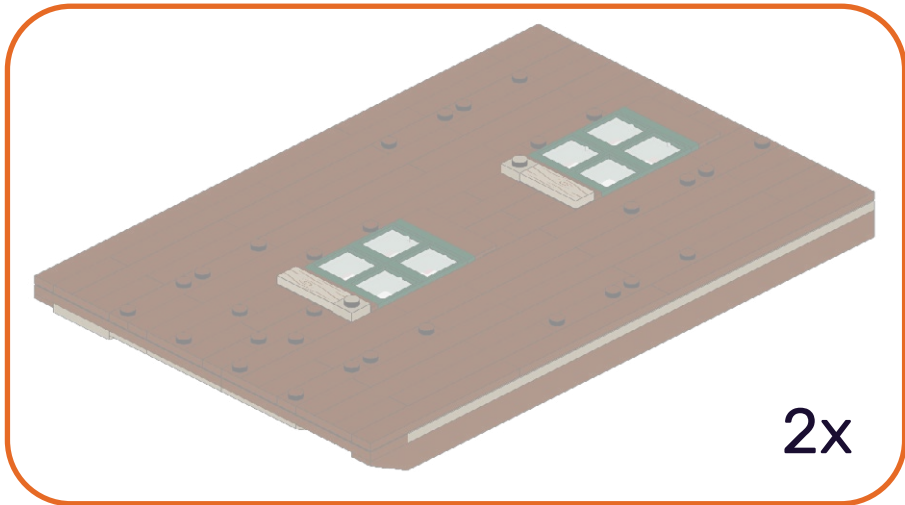
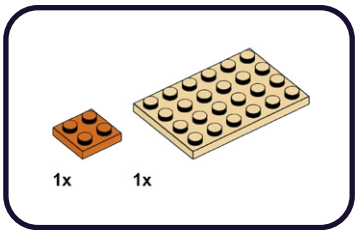

495

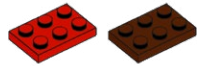

2x

1x

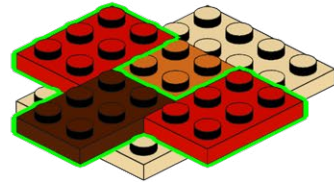

496

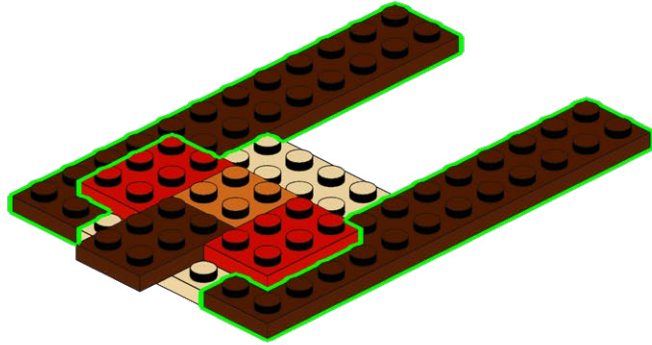
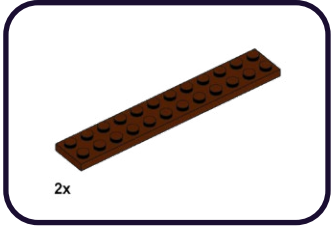

497

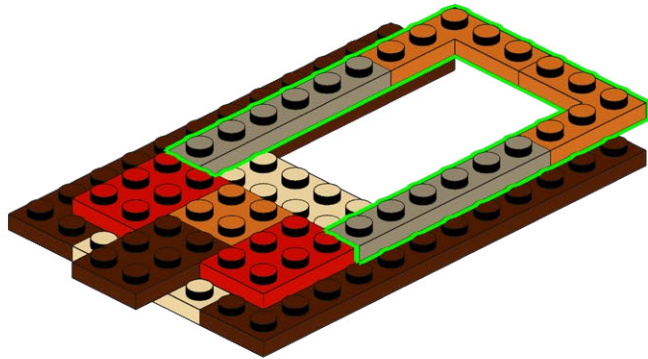
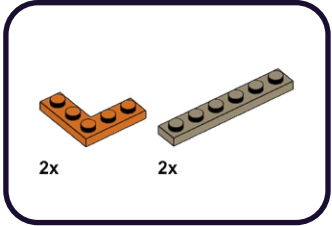

498

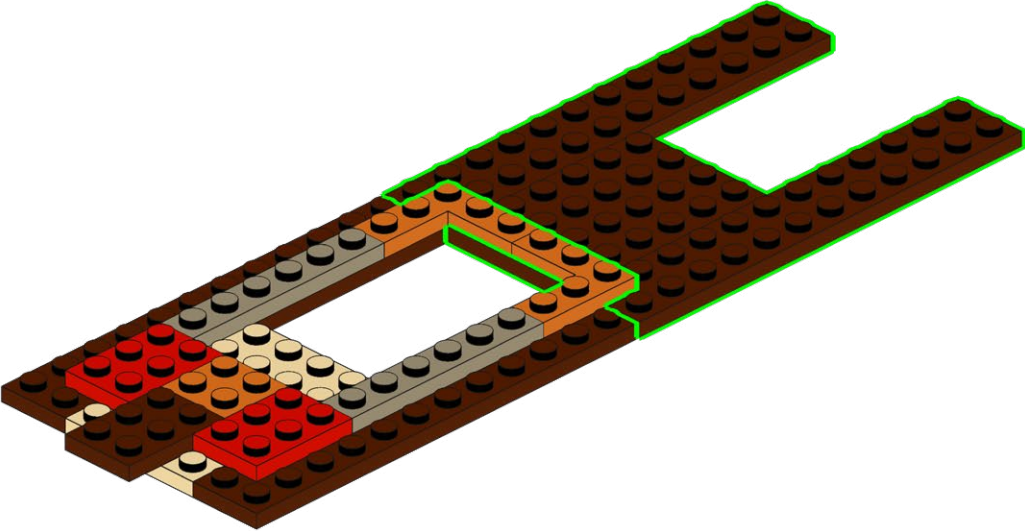
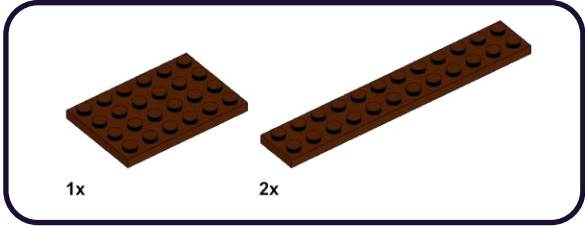

499

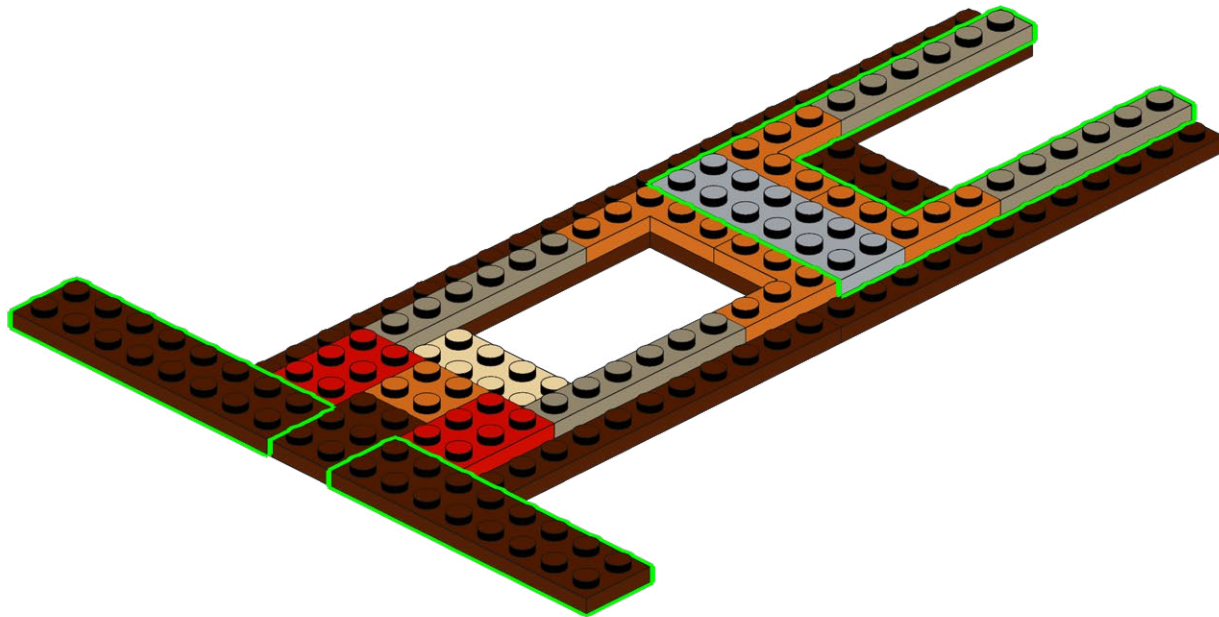
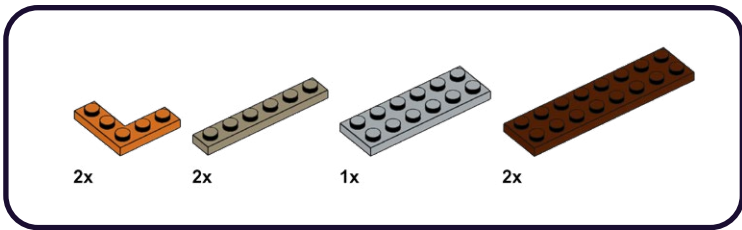

500

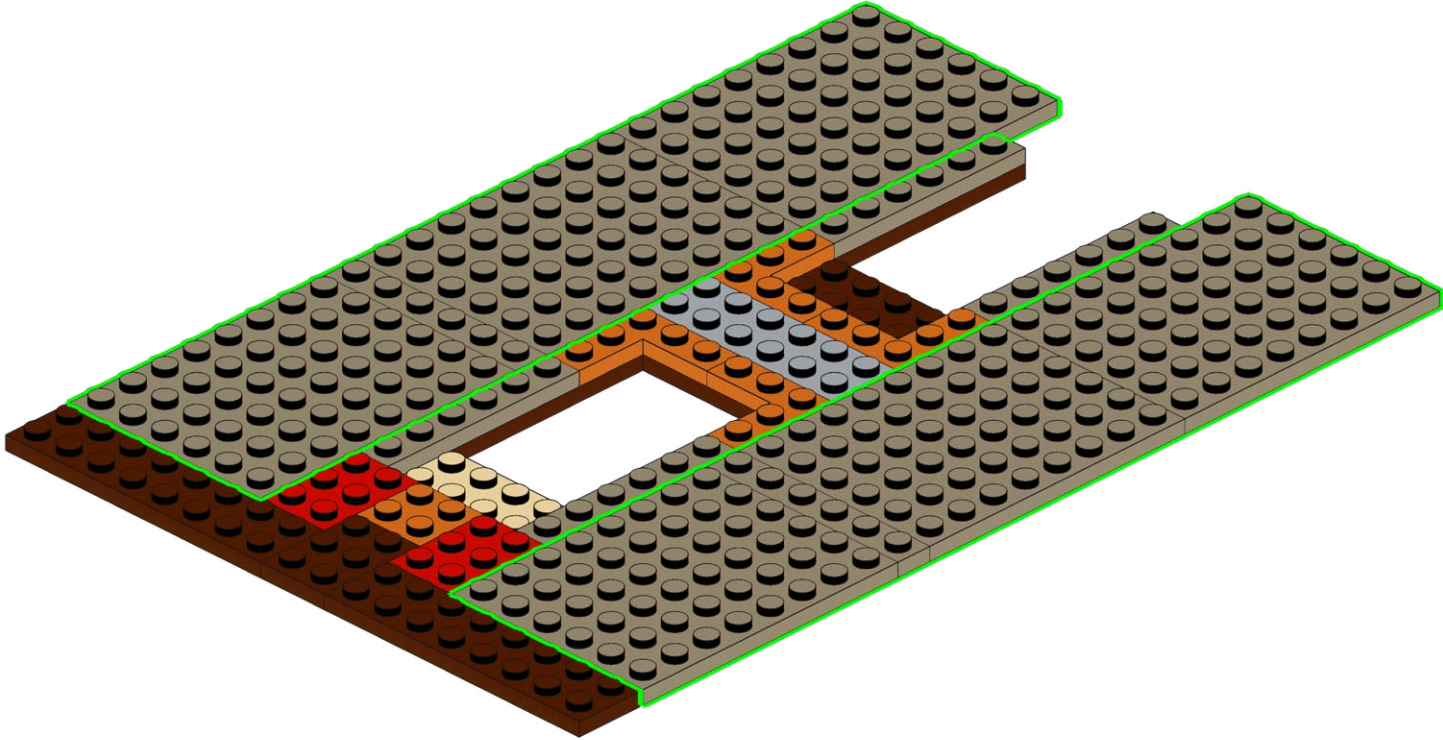
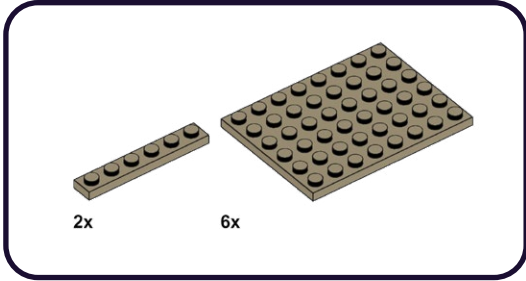

501

2x

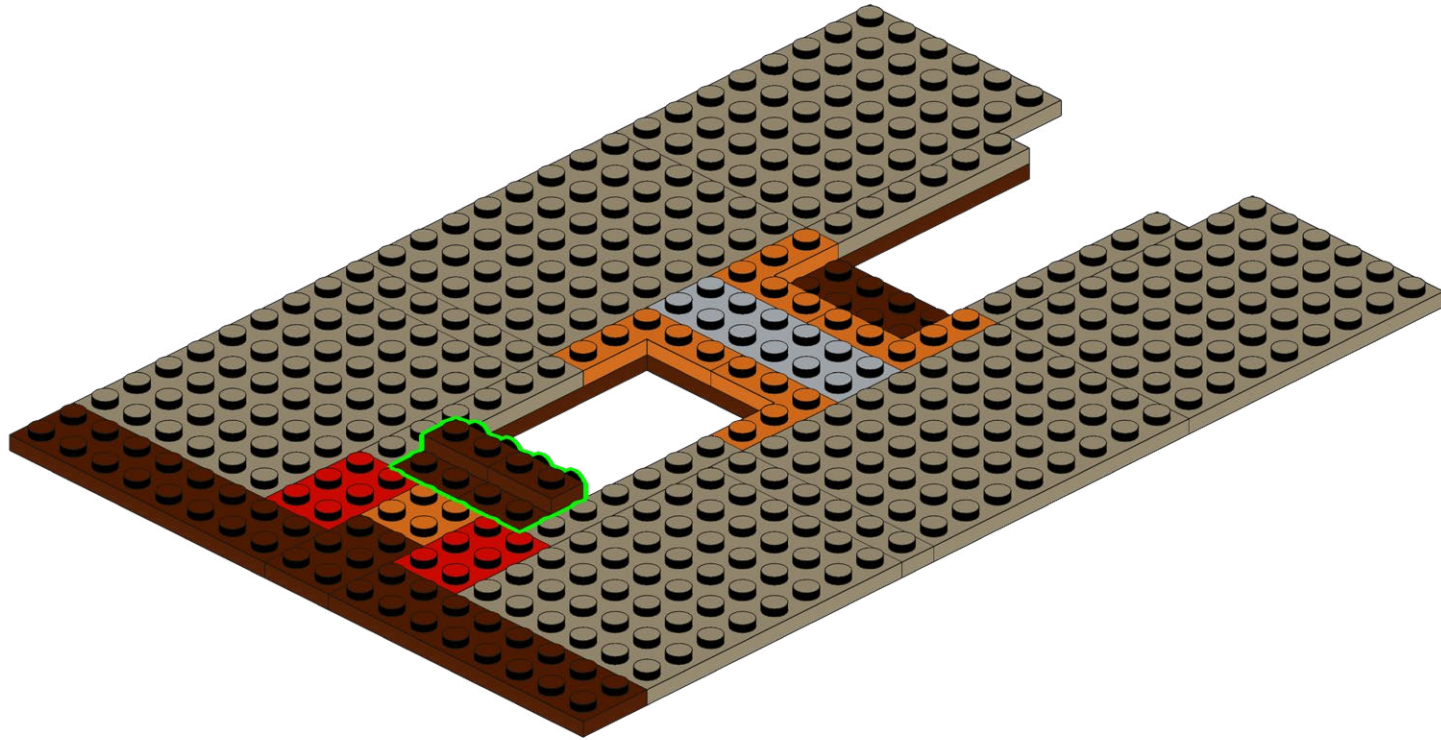

502

3x

2x

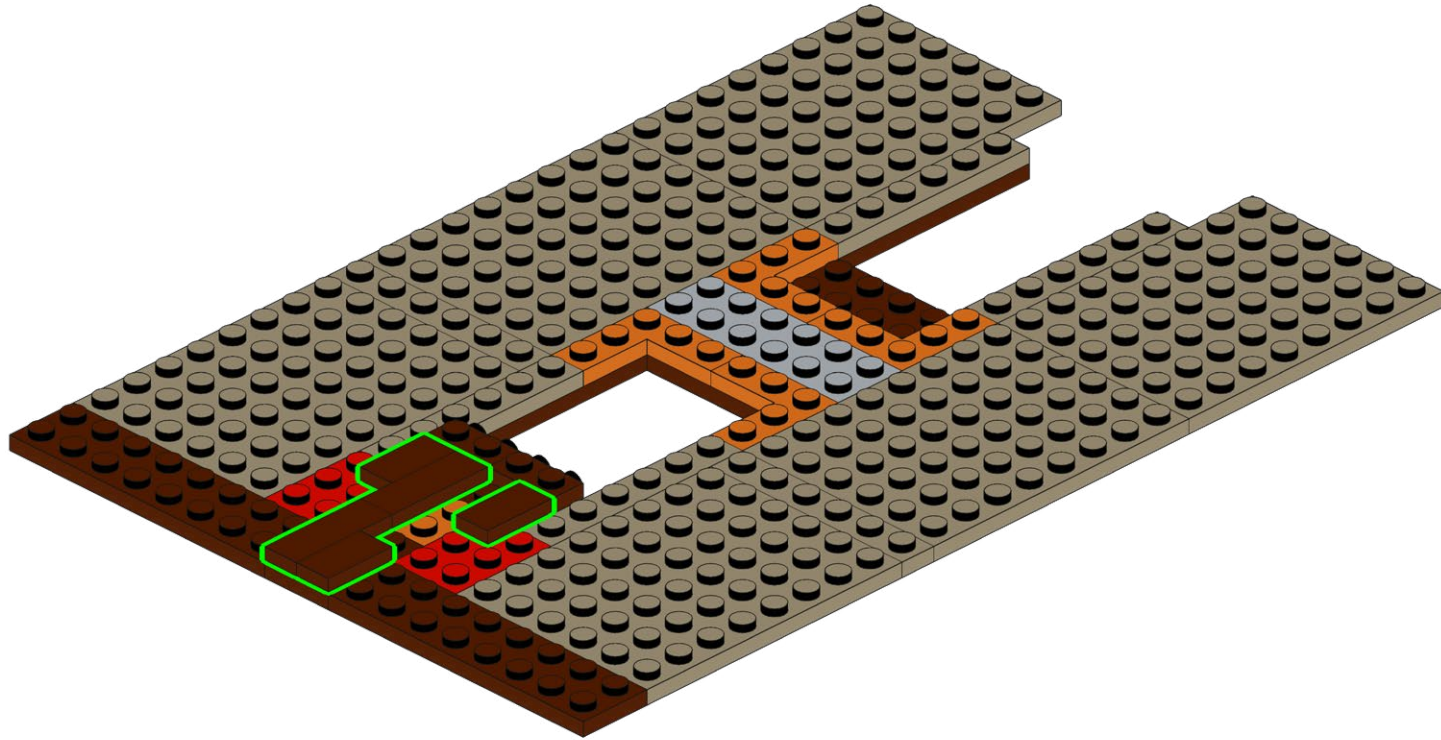

503

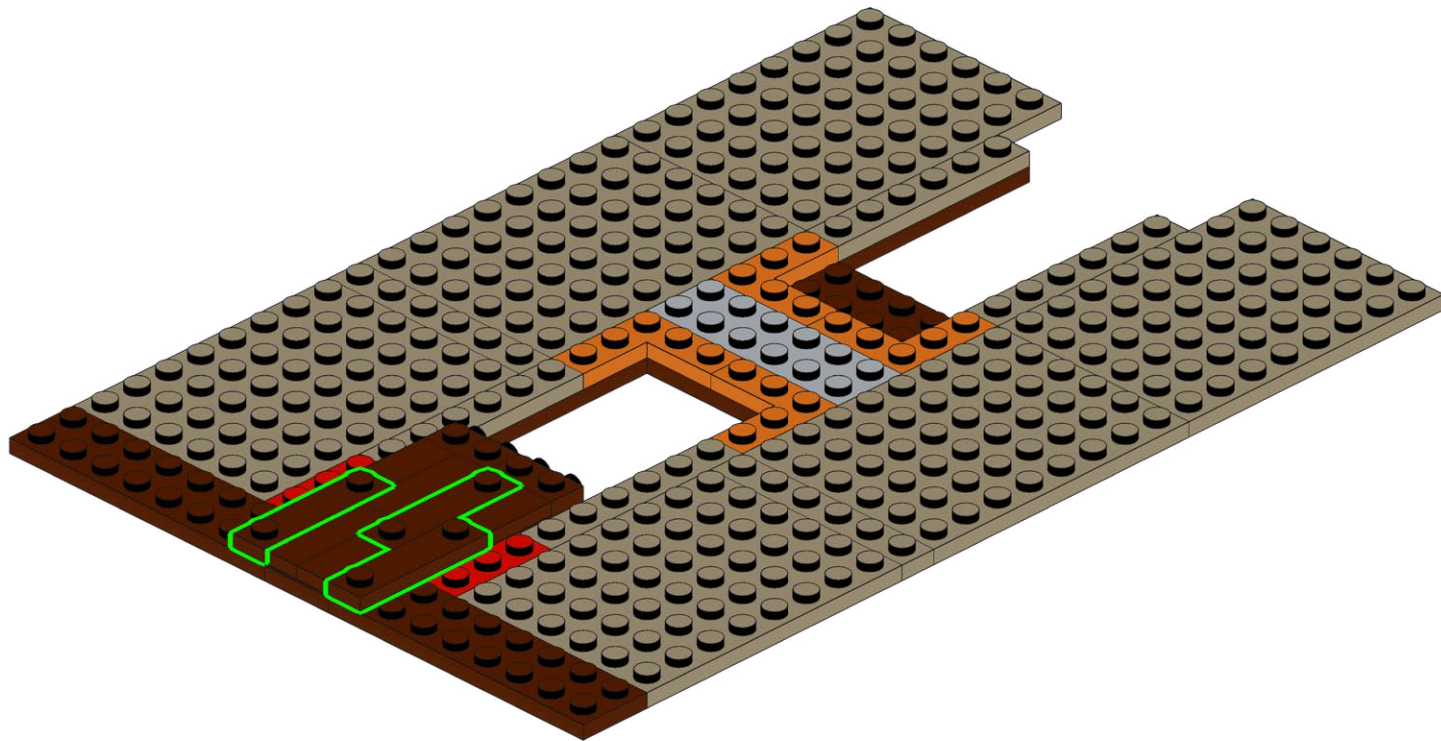
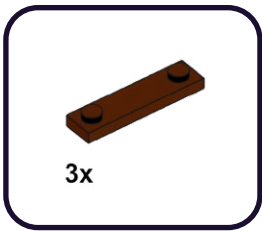

504

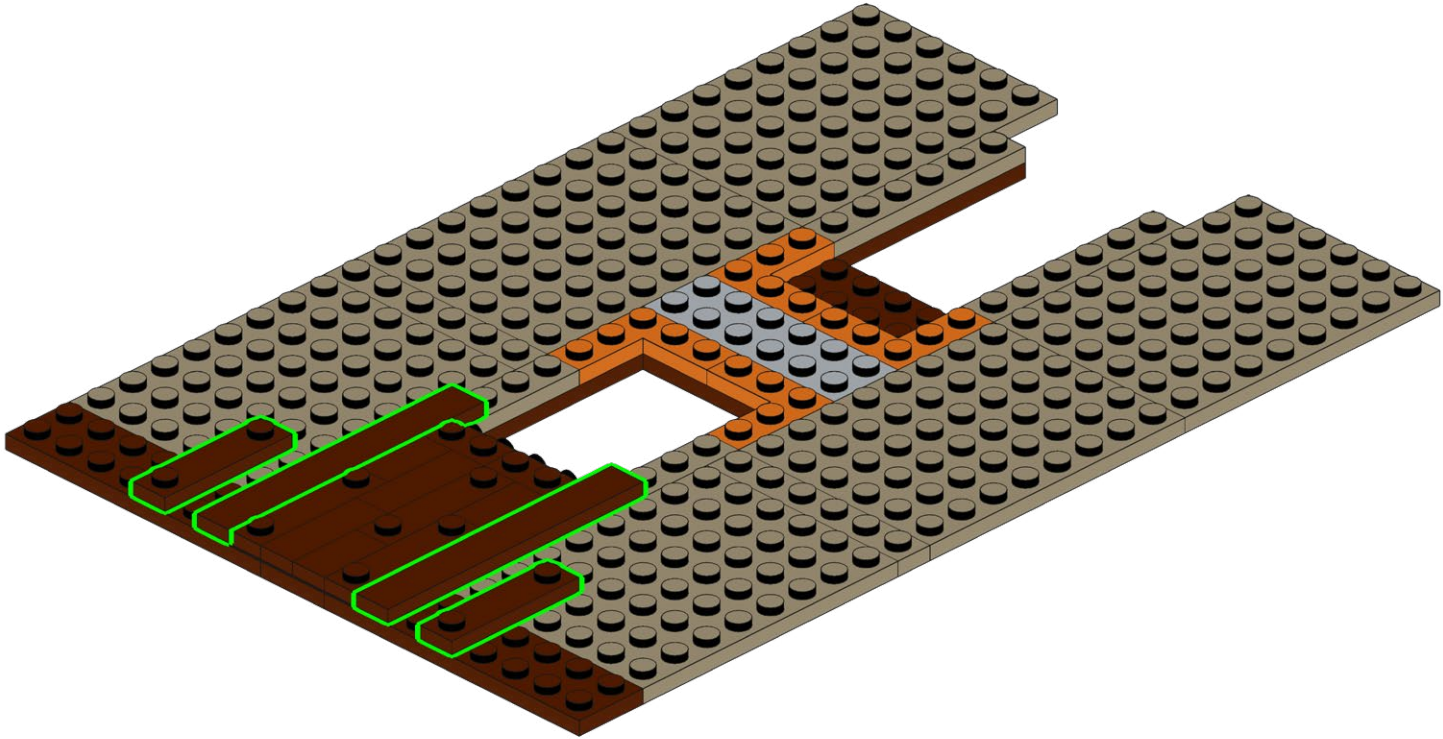
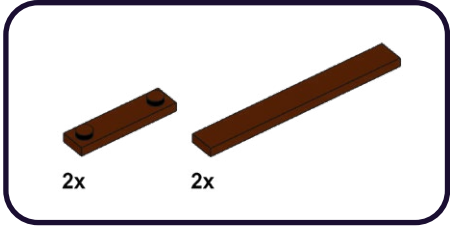

505

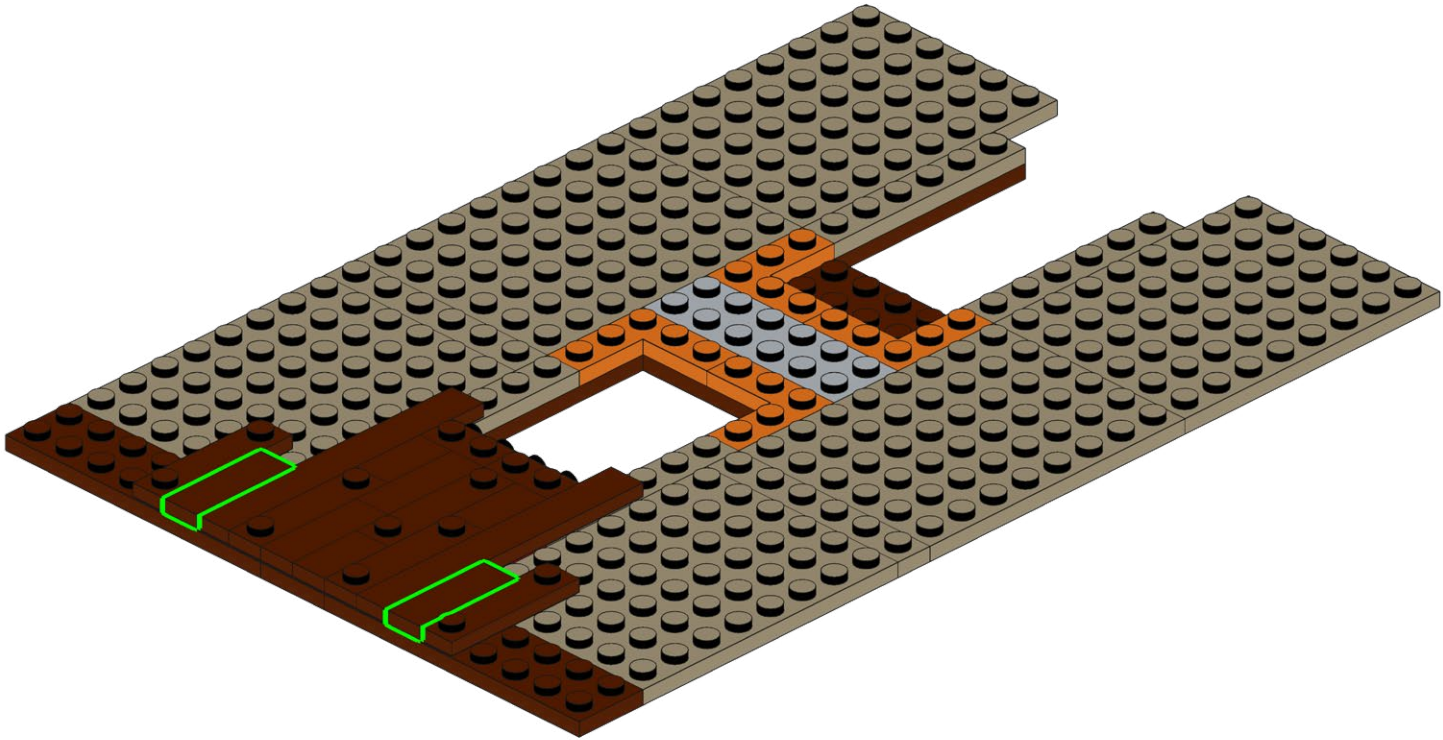
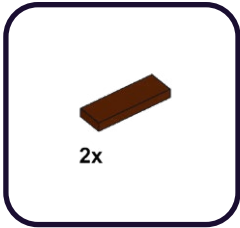

506

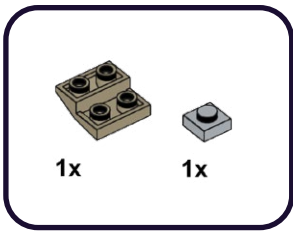

1



1

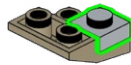

507

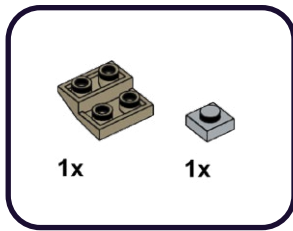

1



1

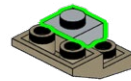

508

1x

3x

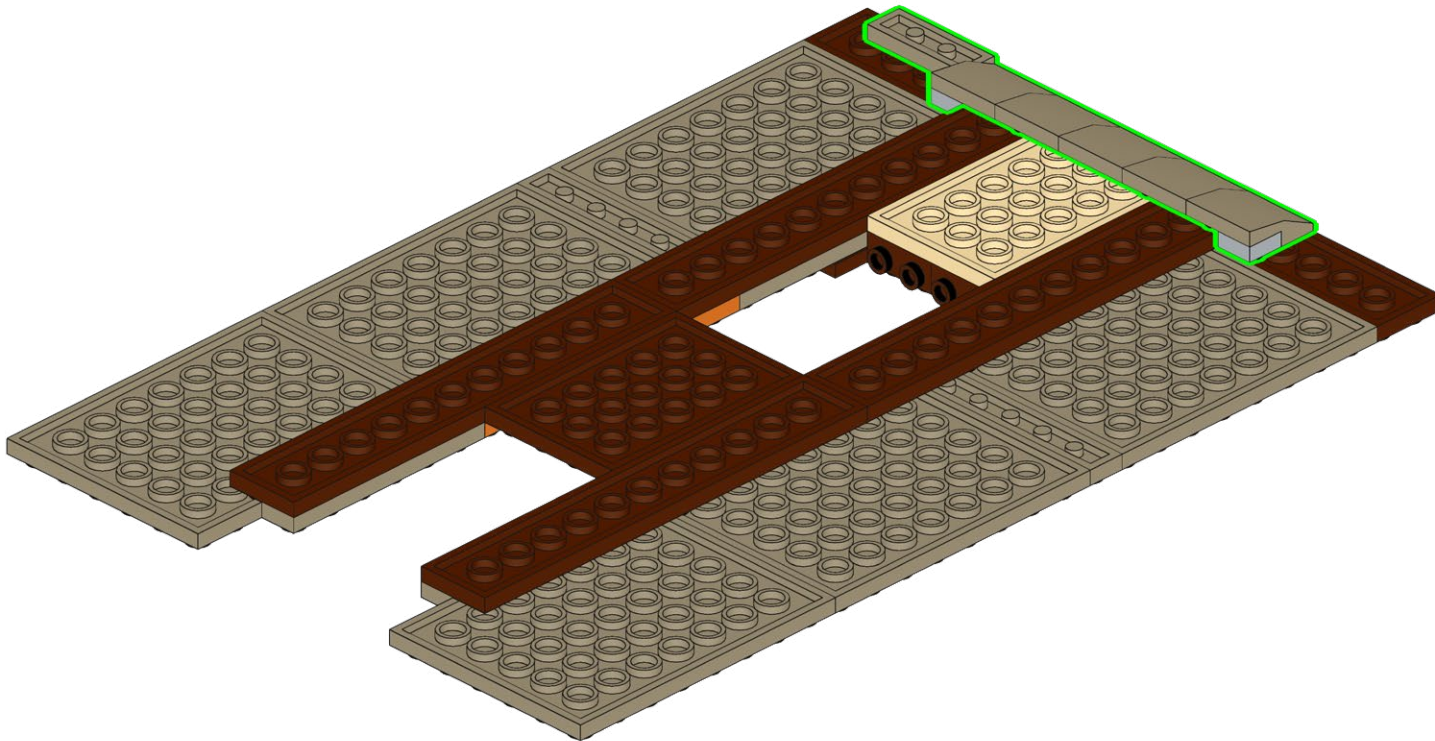

509

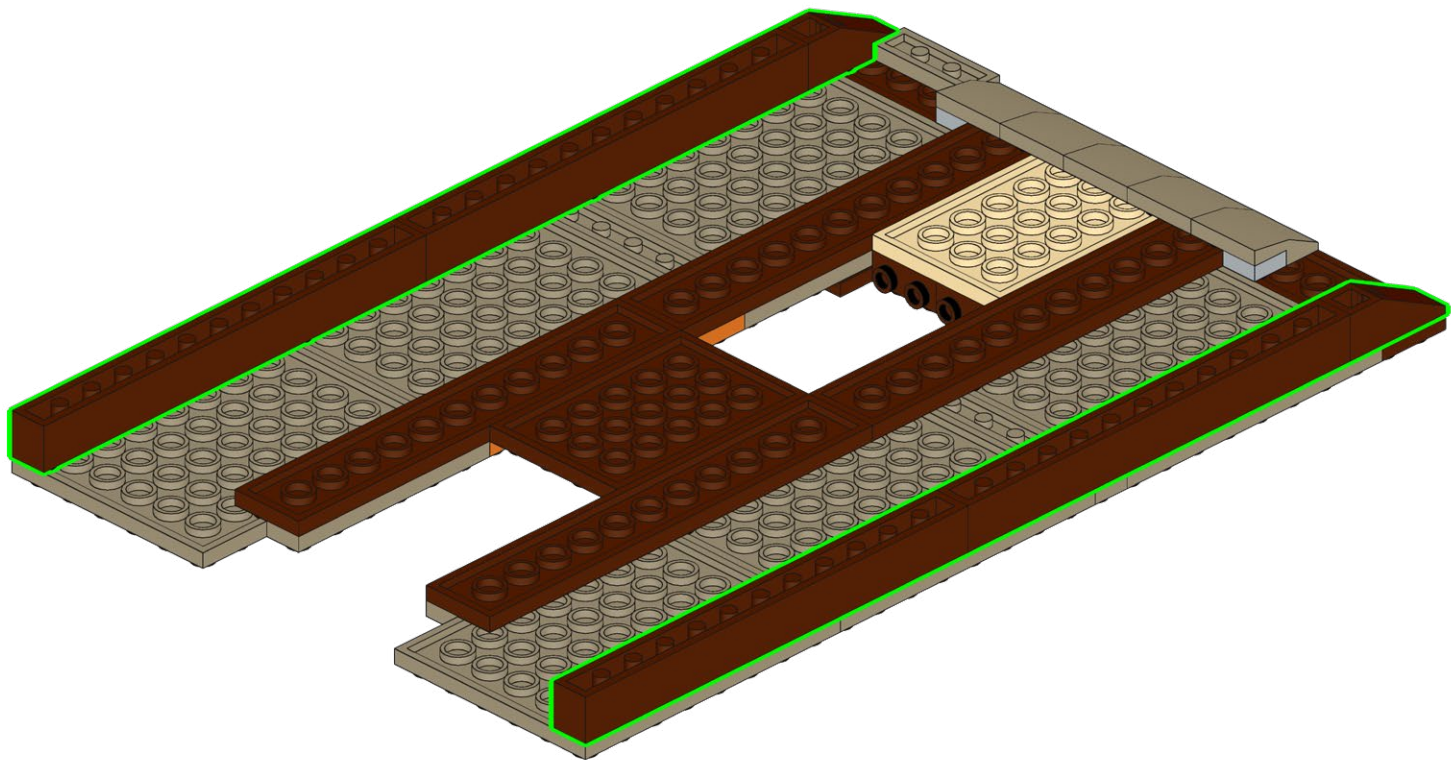
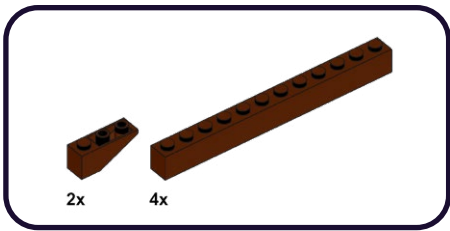

510

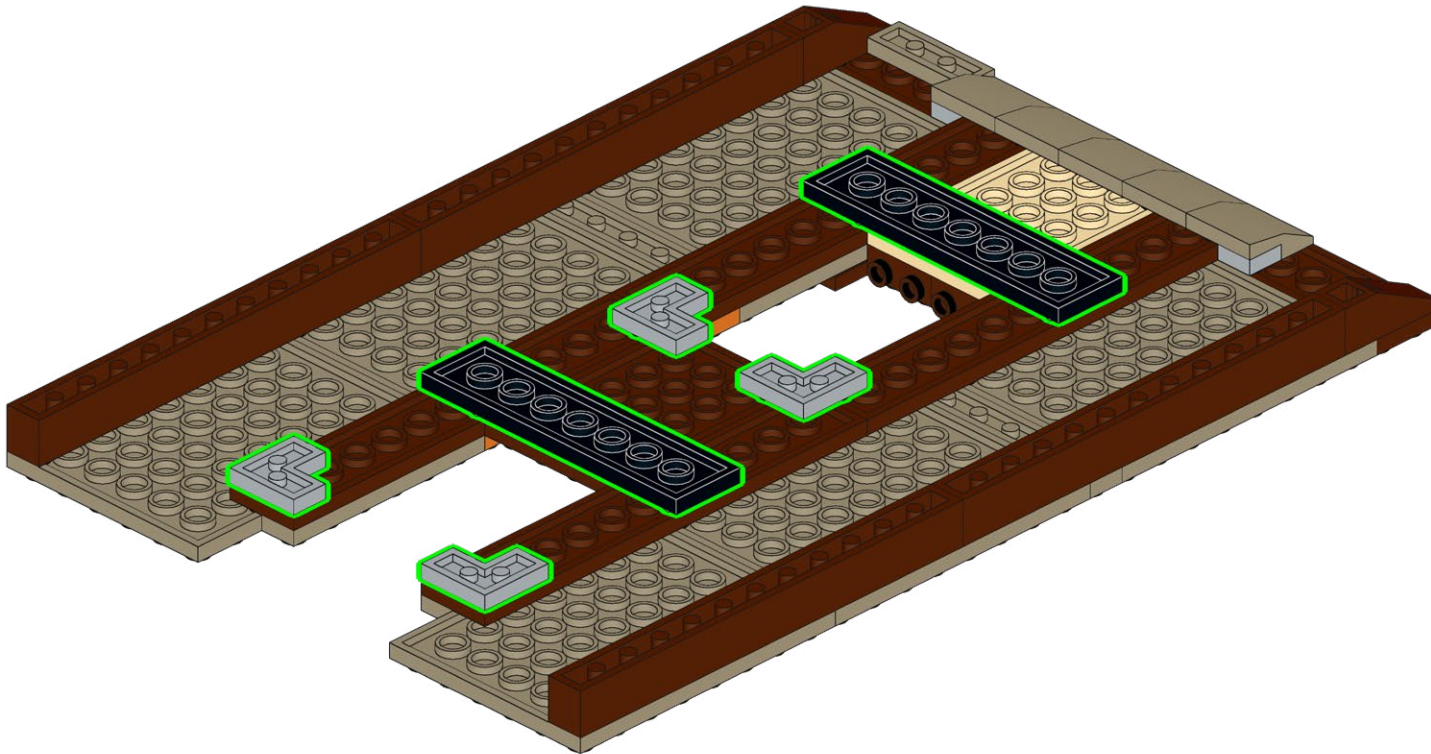
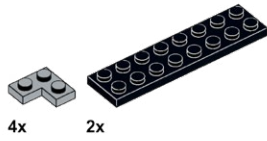

511

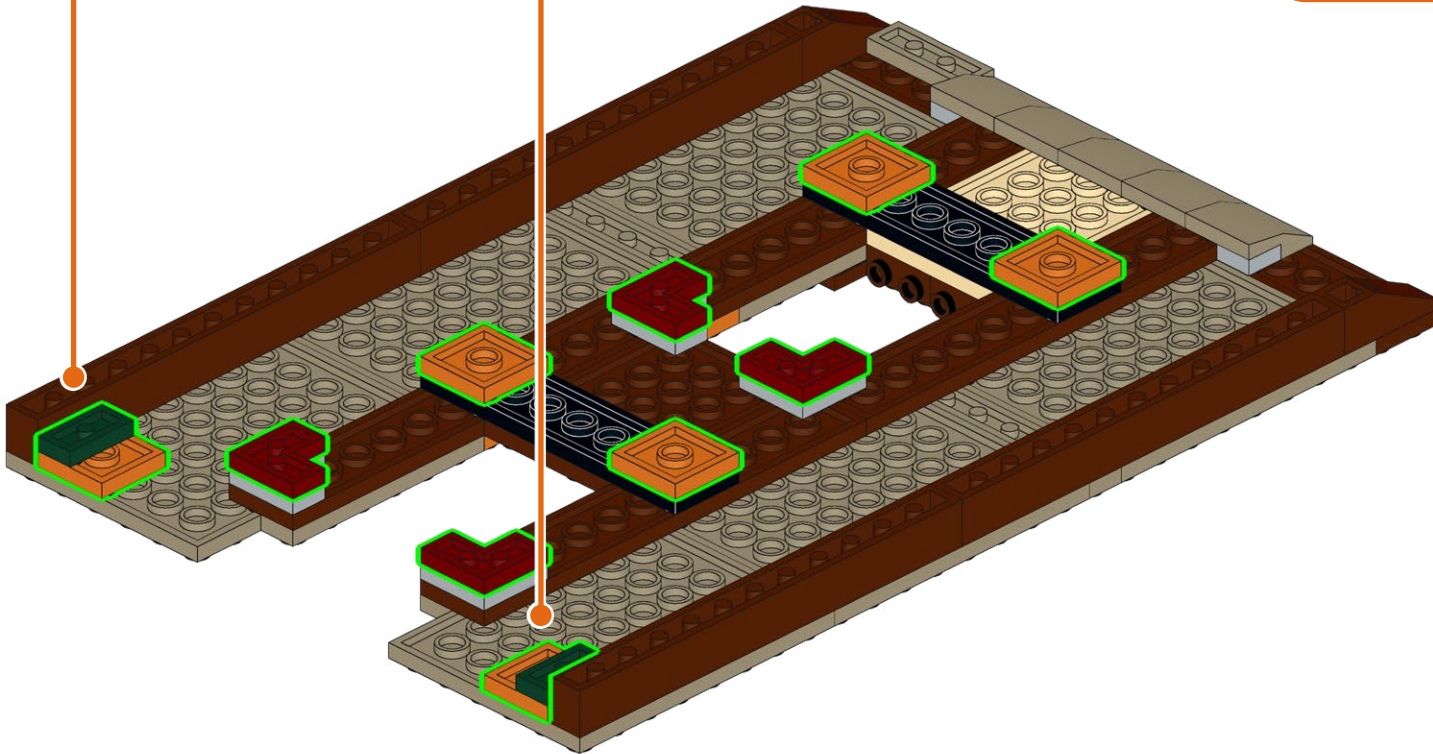
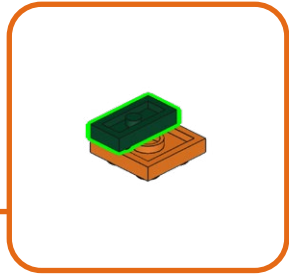
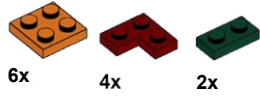

512

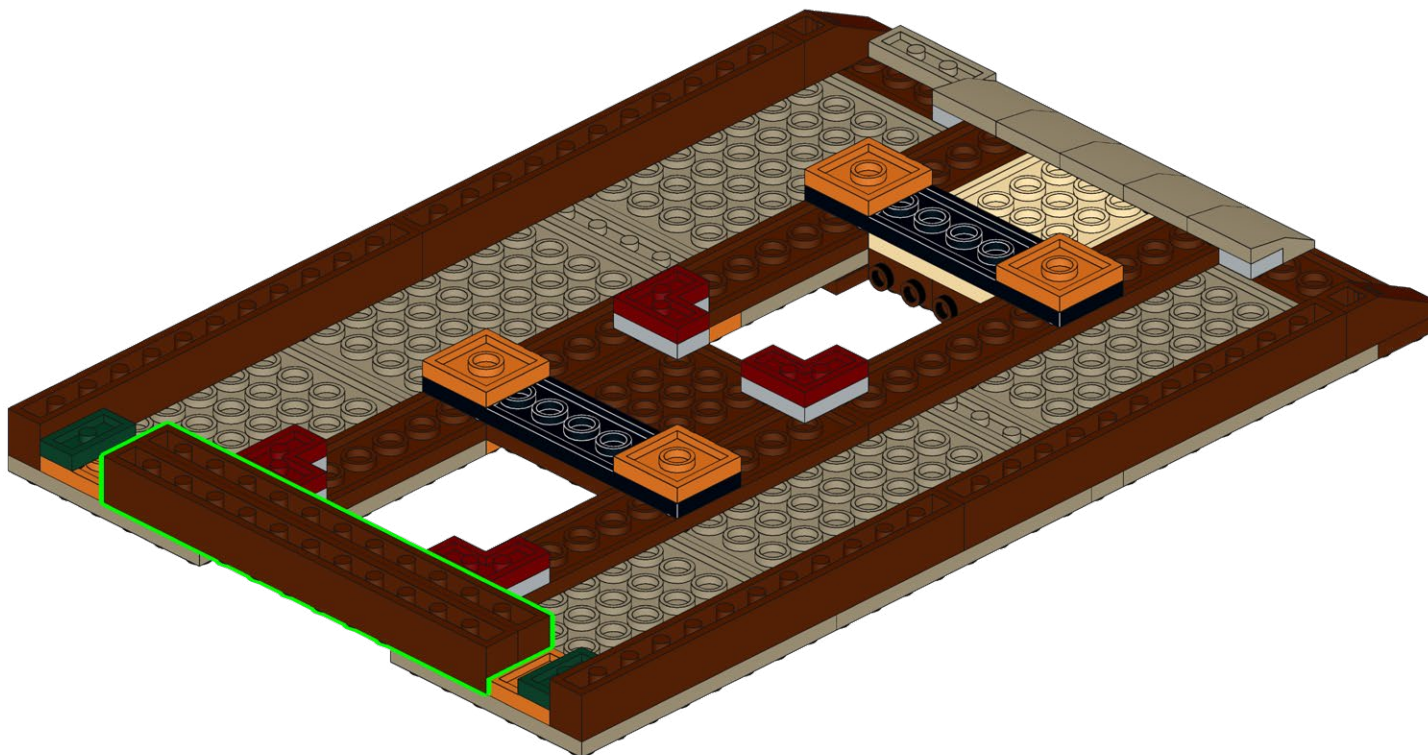
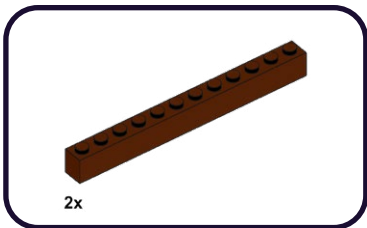

513

2x

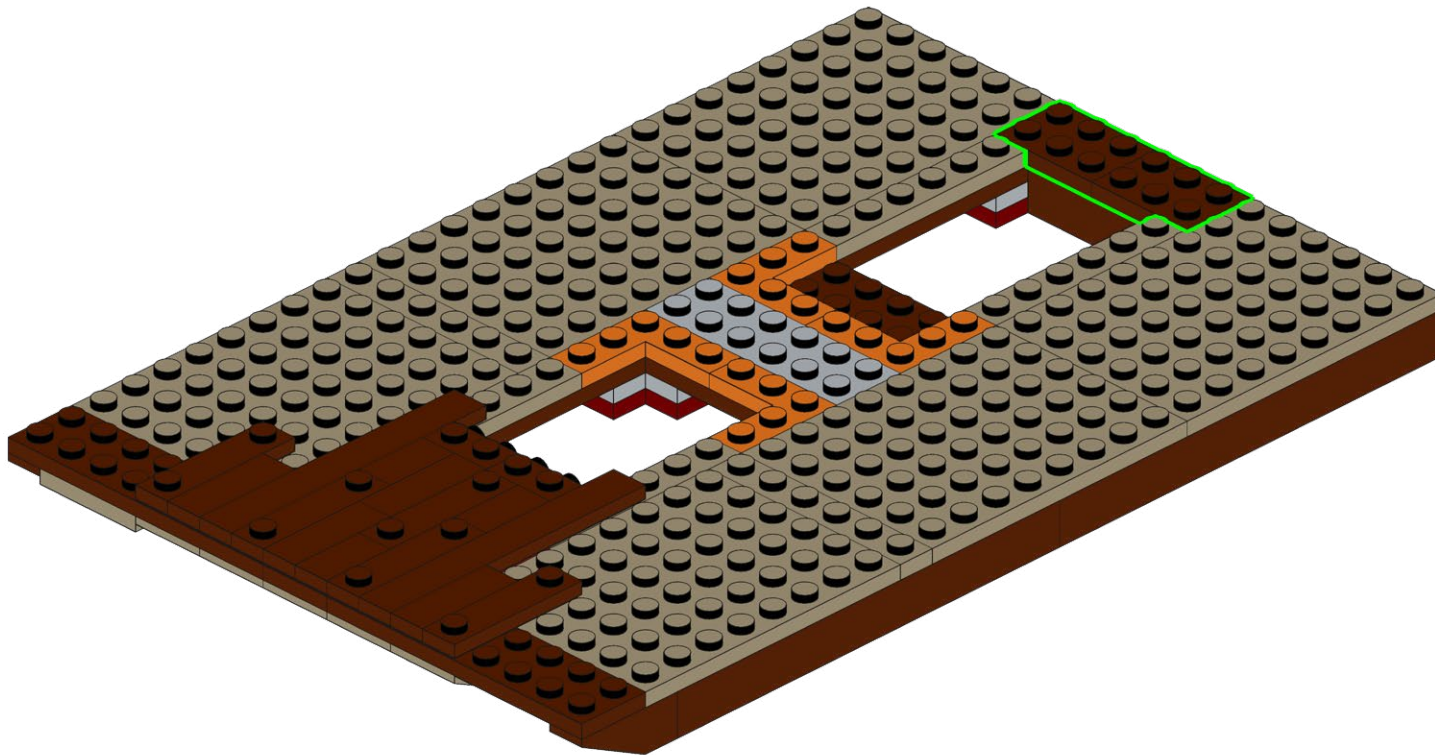

514

4x

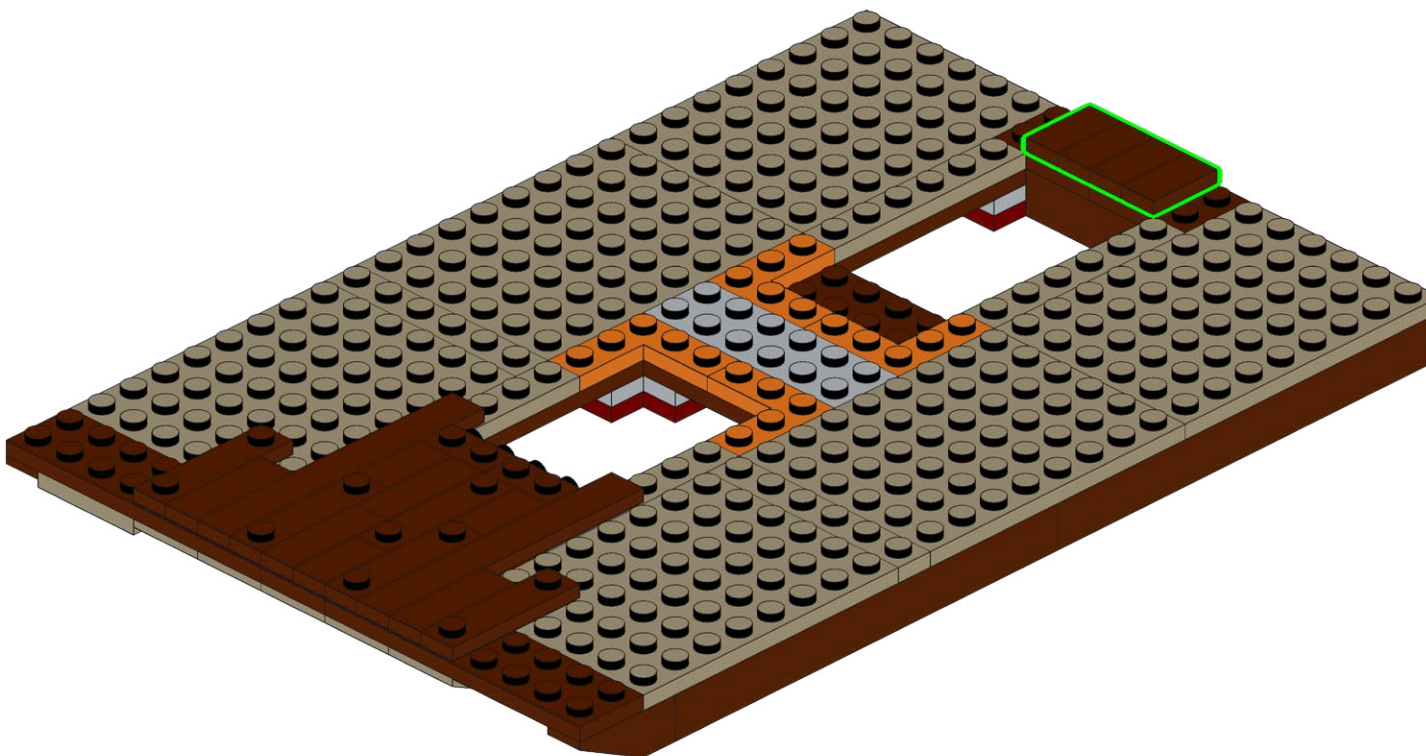

515

2x

2x

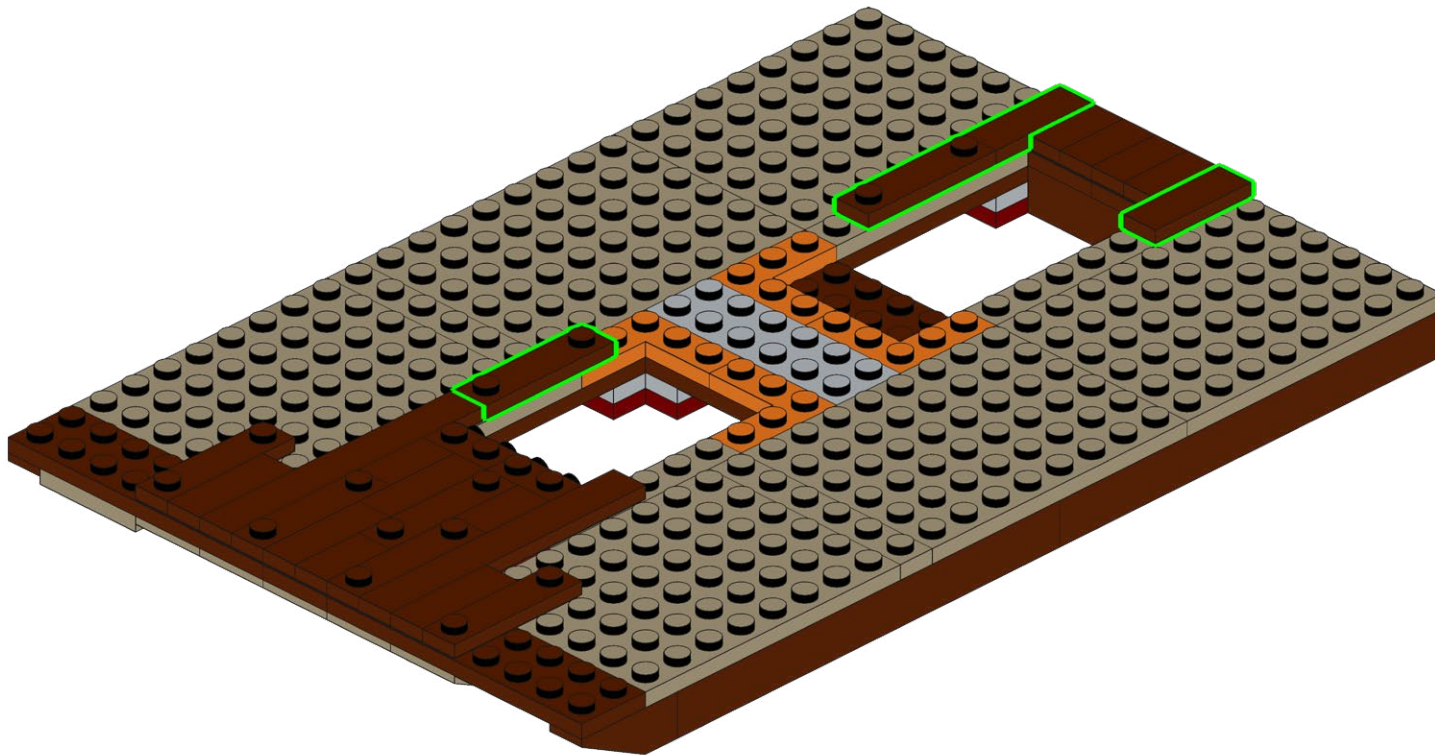

516

3x

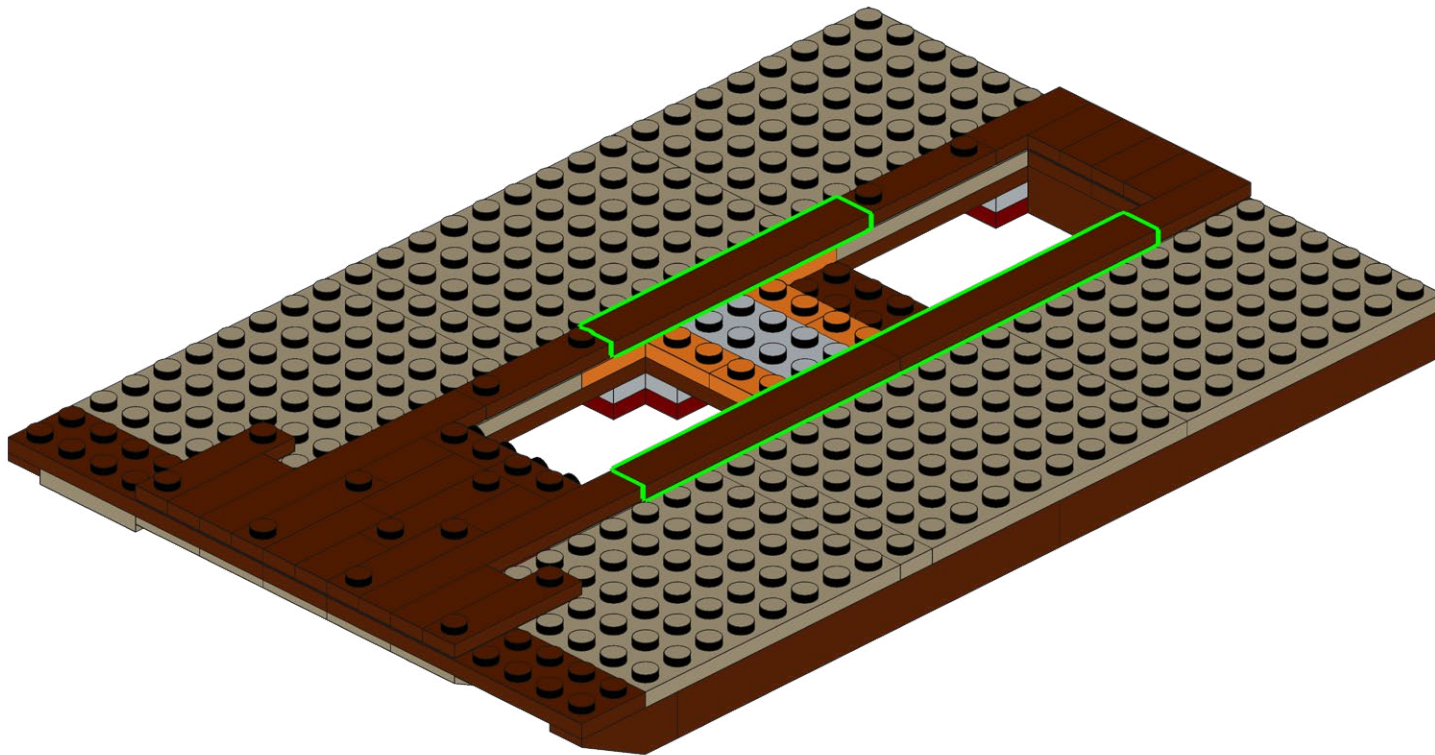

517



2x

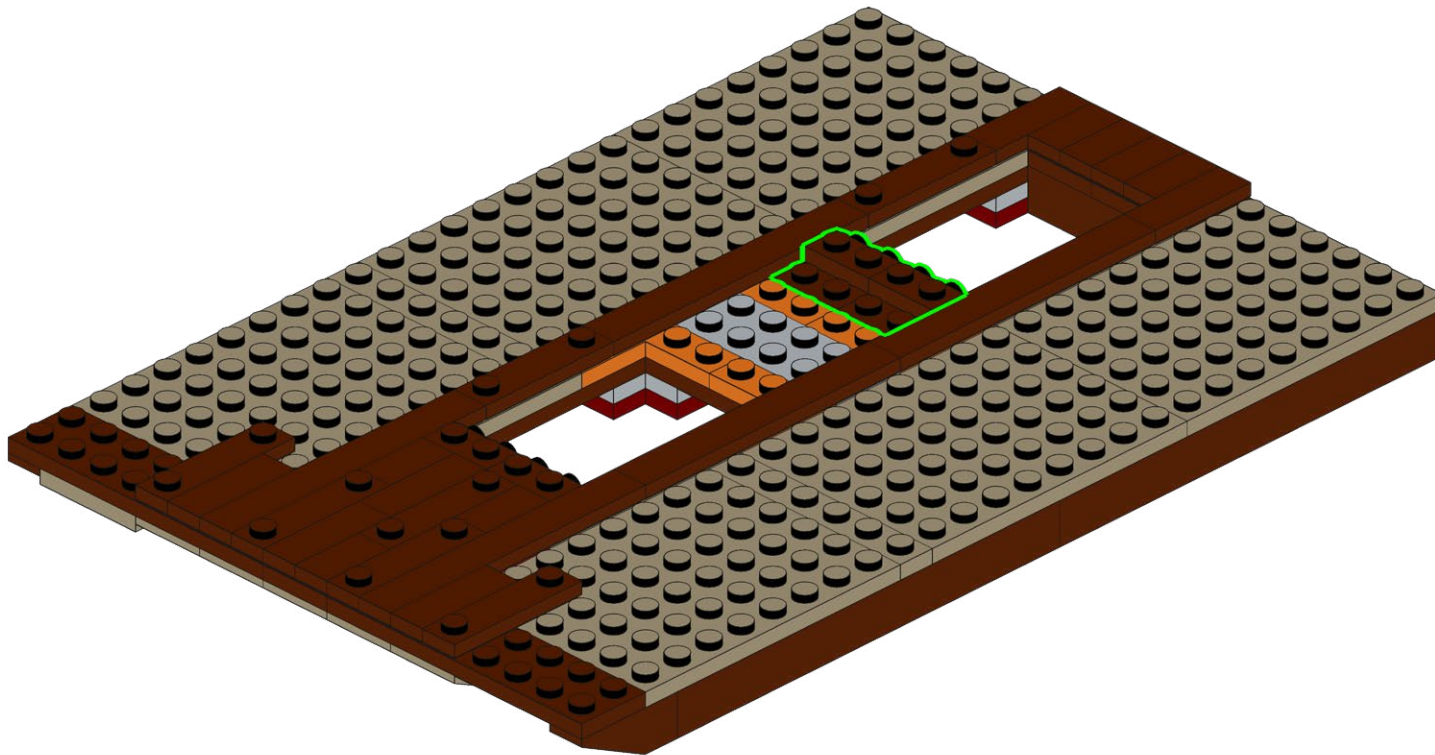

518

4x

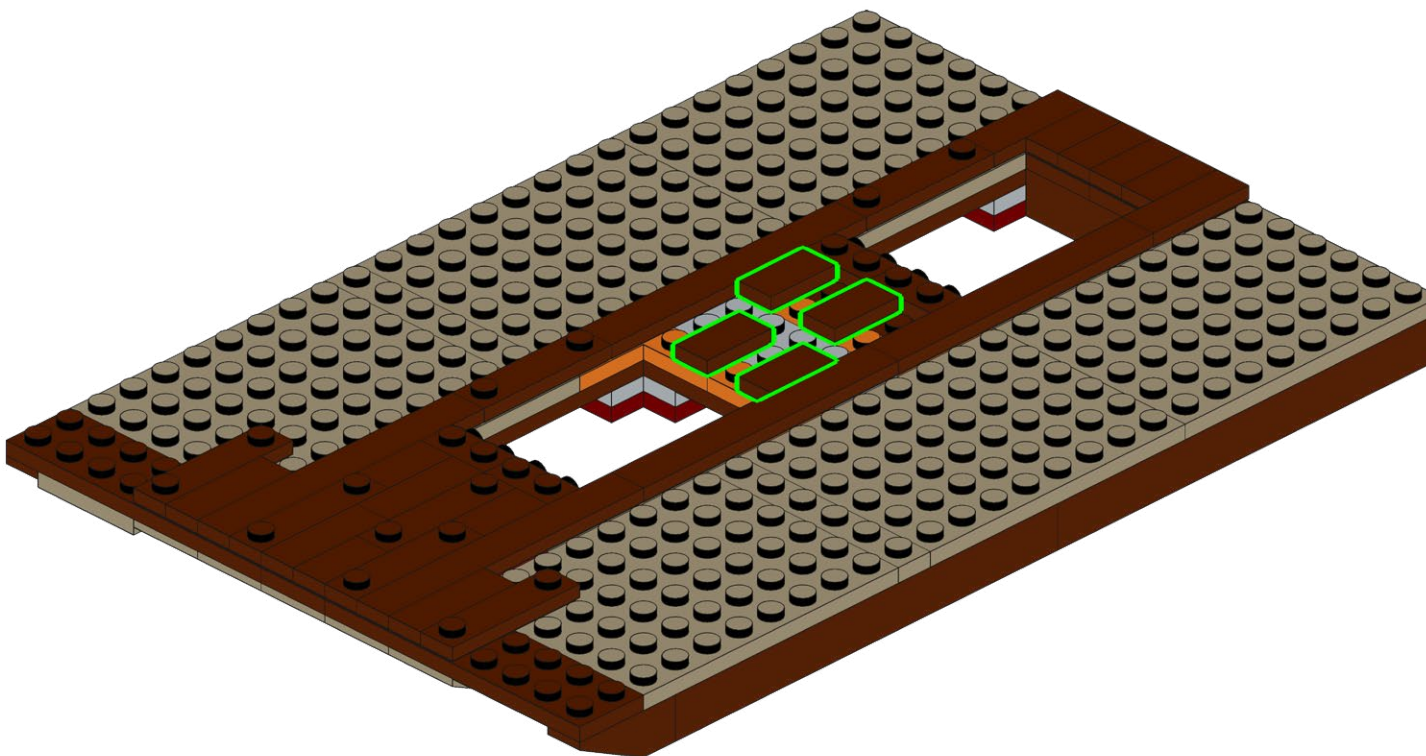

519

4x

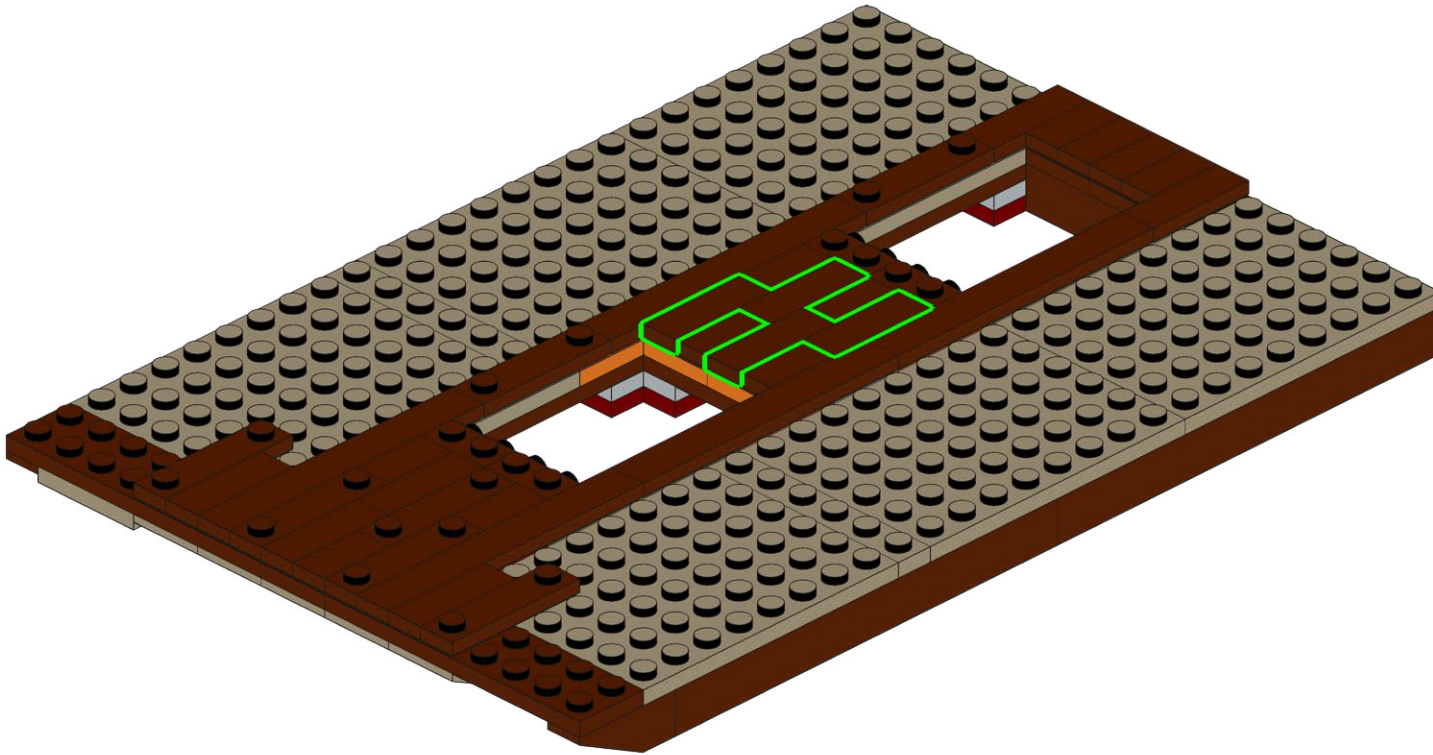

**HOLD UP!**

You might notice some bags aren't in order, as well as left over pieces, but that's ok! We're changing the way you build LEGO!

ATTENDEZ!

Vous remarquerez peut-être que certains sacs, ainsi que certaines pièces, ne sont pas dans le bon ordre. Mais pas de panique! Nous changeons simplement la façon avec laquelle vous construisez vos LEGO!

ASPETTA!

Potresti notare che alcuni sacchetti non sono in ordine, così come i pezzi avanzati, ma va bene così! Stiamo cambiando il modo in cui costruisci i LEGO!

HALT!

Sie werden möglicherweise bemerken, dass einige tüten durcheinander sind und teile übrig bleiben, aber das ist in Ordnung! Wir ändern die art und weise, wie Sie LEGO bauen!

¡ESPERA!

Es posible que notes que algunas bolsas están fuera de servicio, así como piezas sobrantes, ¡pero está bien! ¡Estamos cambiando la forma en que construyes LEGO!

暫停!

你可能会注意到一些袋子顺序错乱, 以及一些剩余的部件, 但没关系! 我们正在改变你搭建乐高的方式!

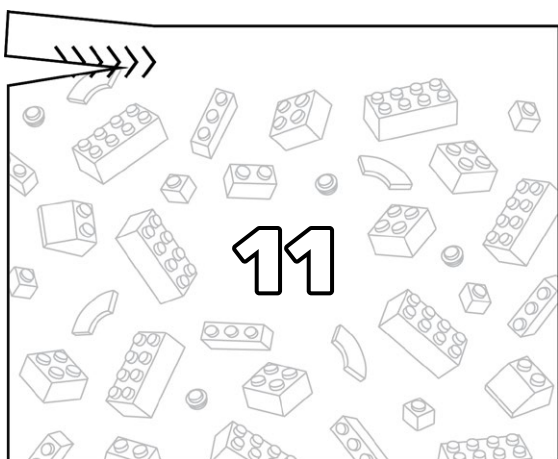
Open LEGO® Bag 11

520

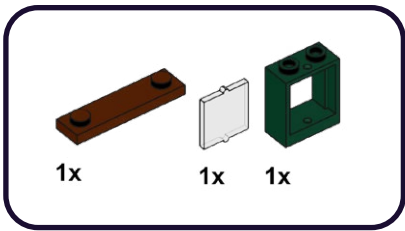

1



1

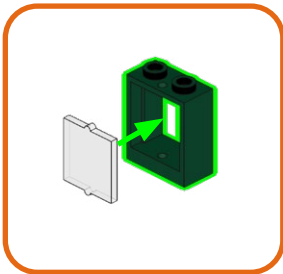
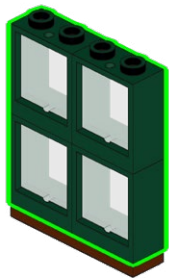

521

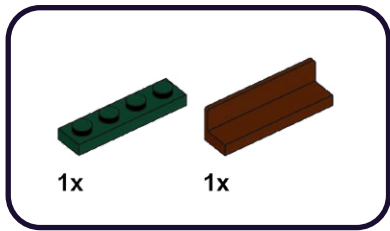

1

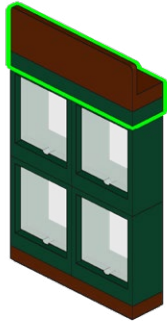

4x

522

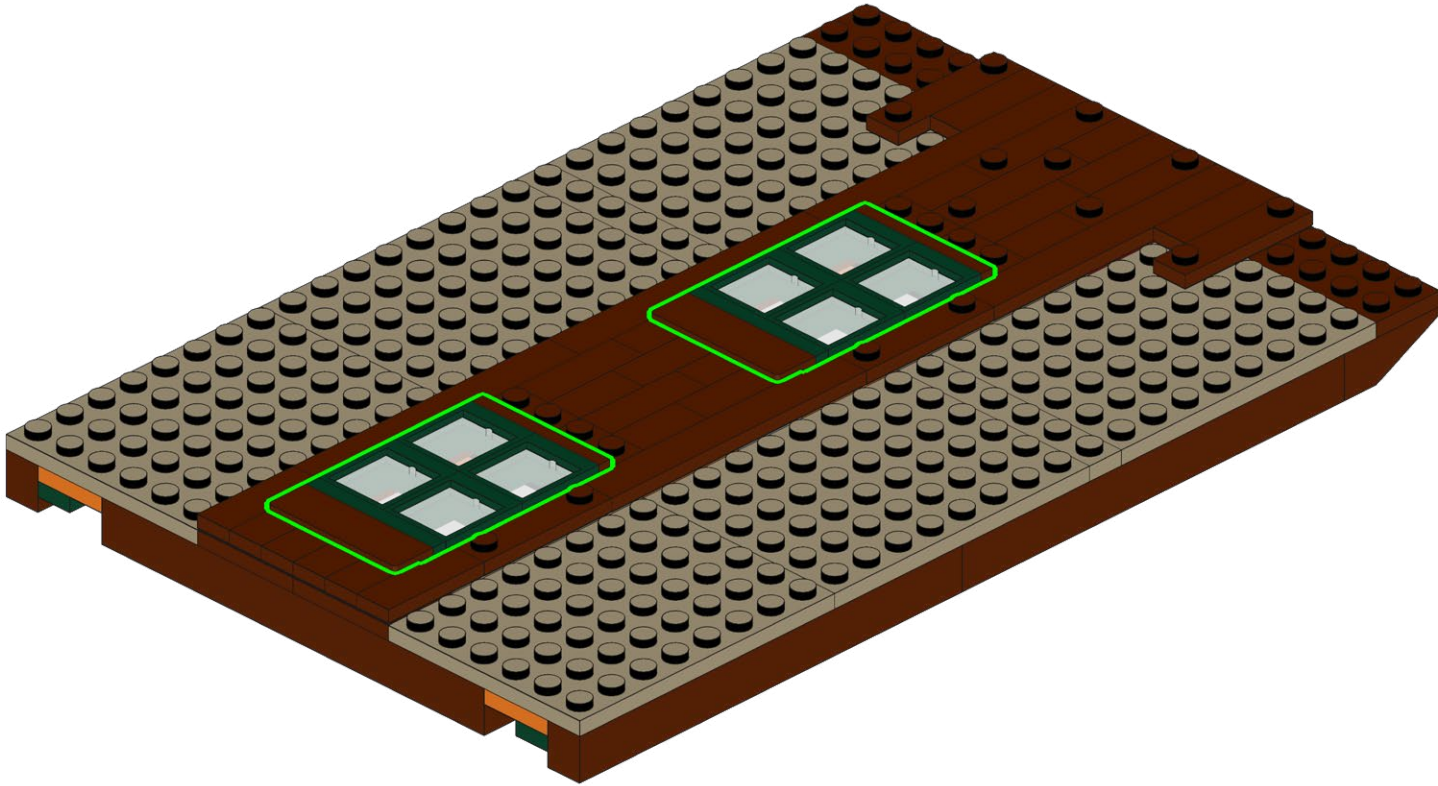

523

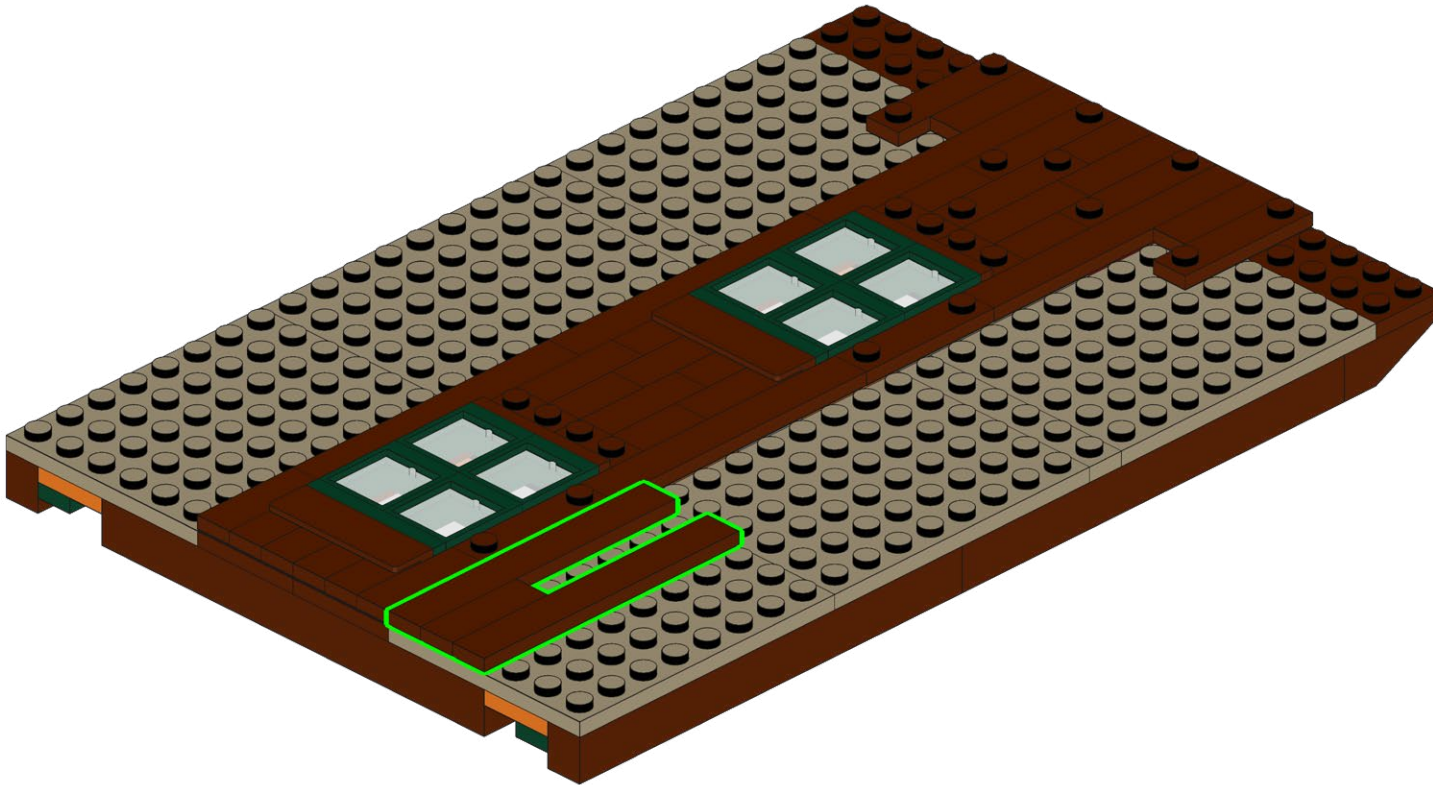
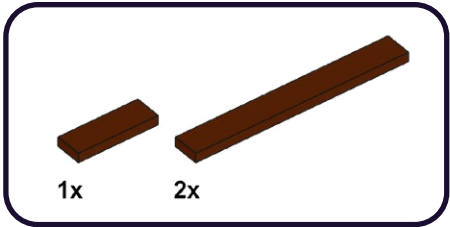

524

3x

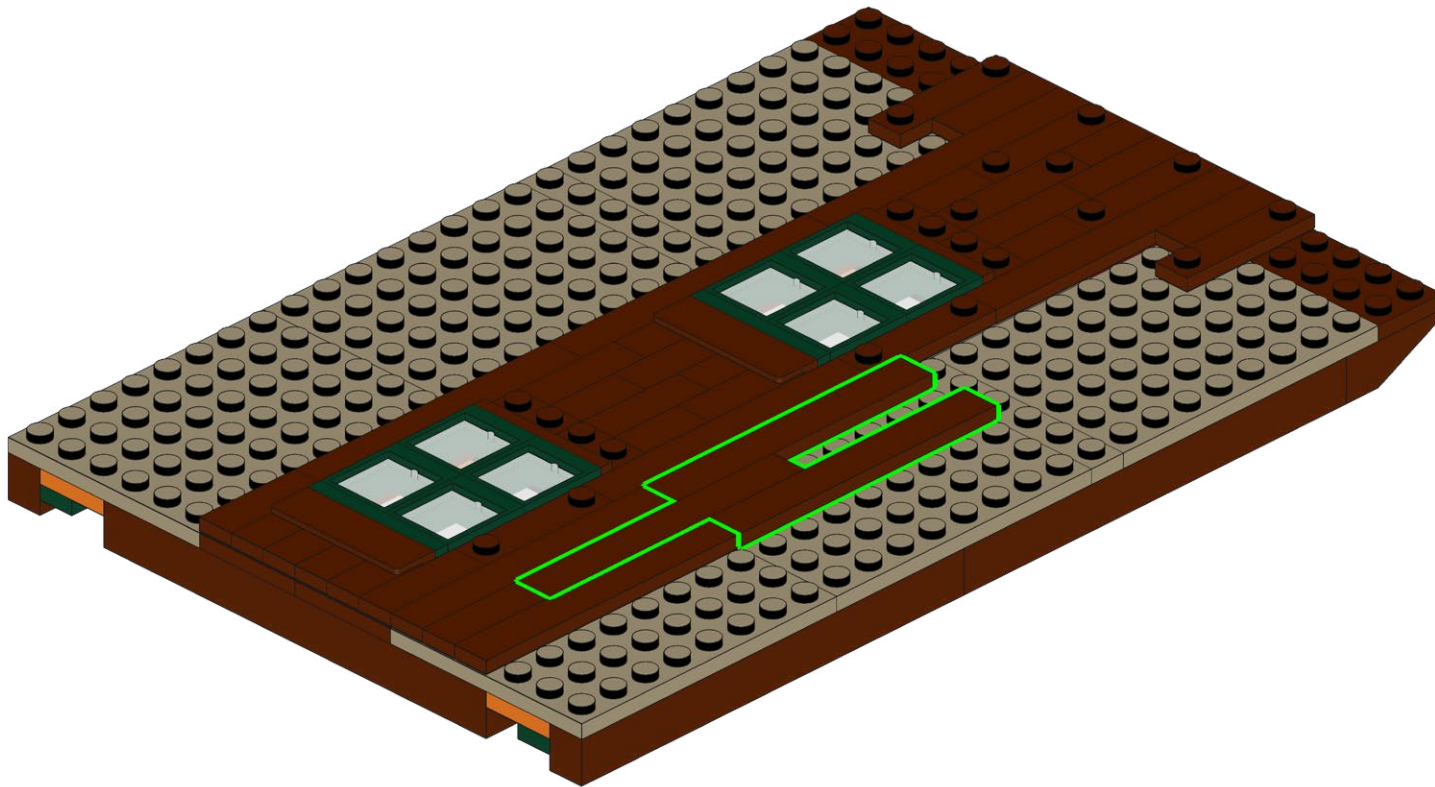

525

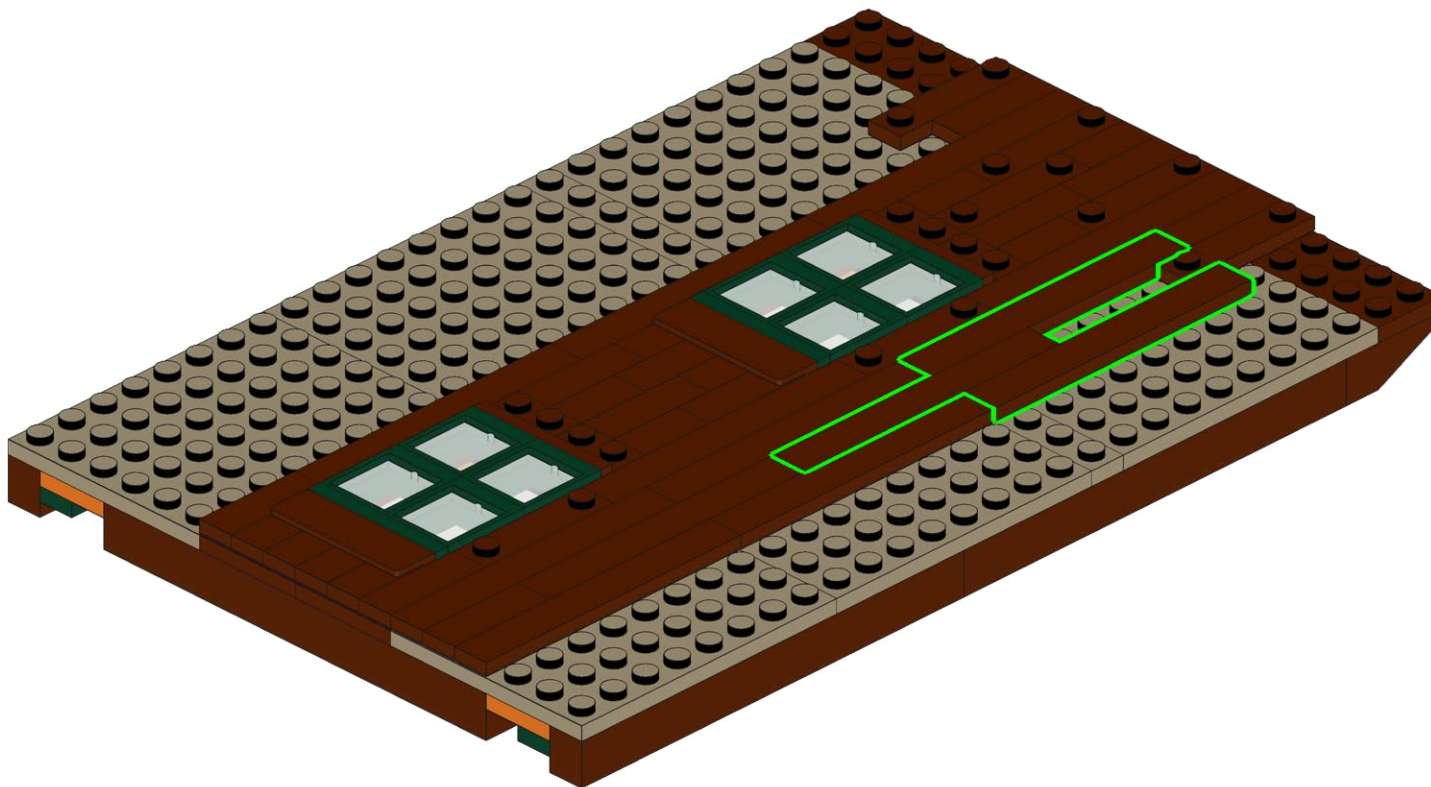
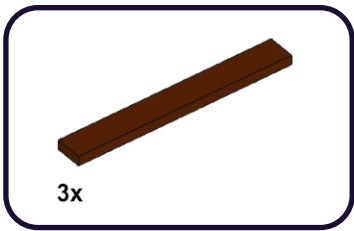

526

1x

1x

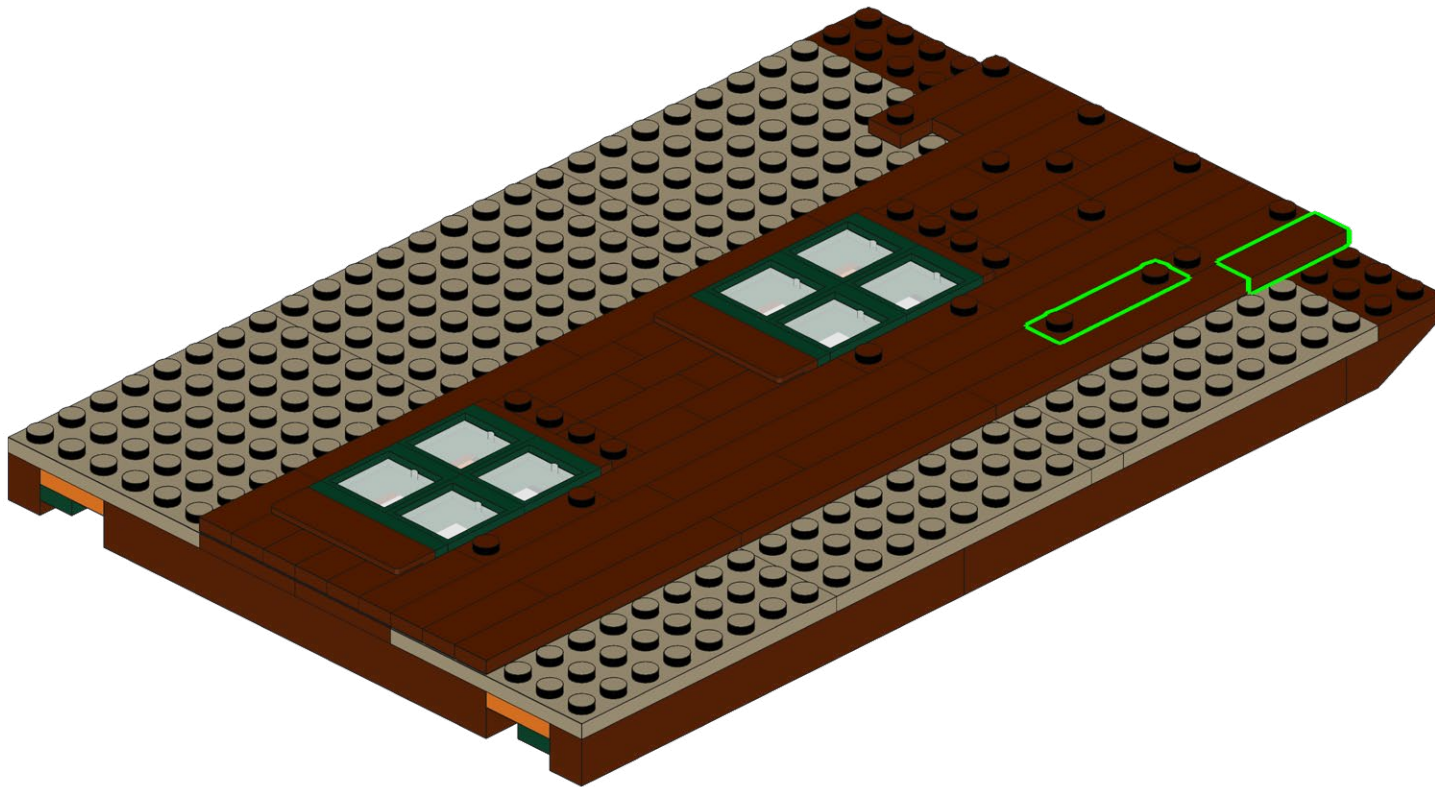

527

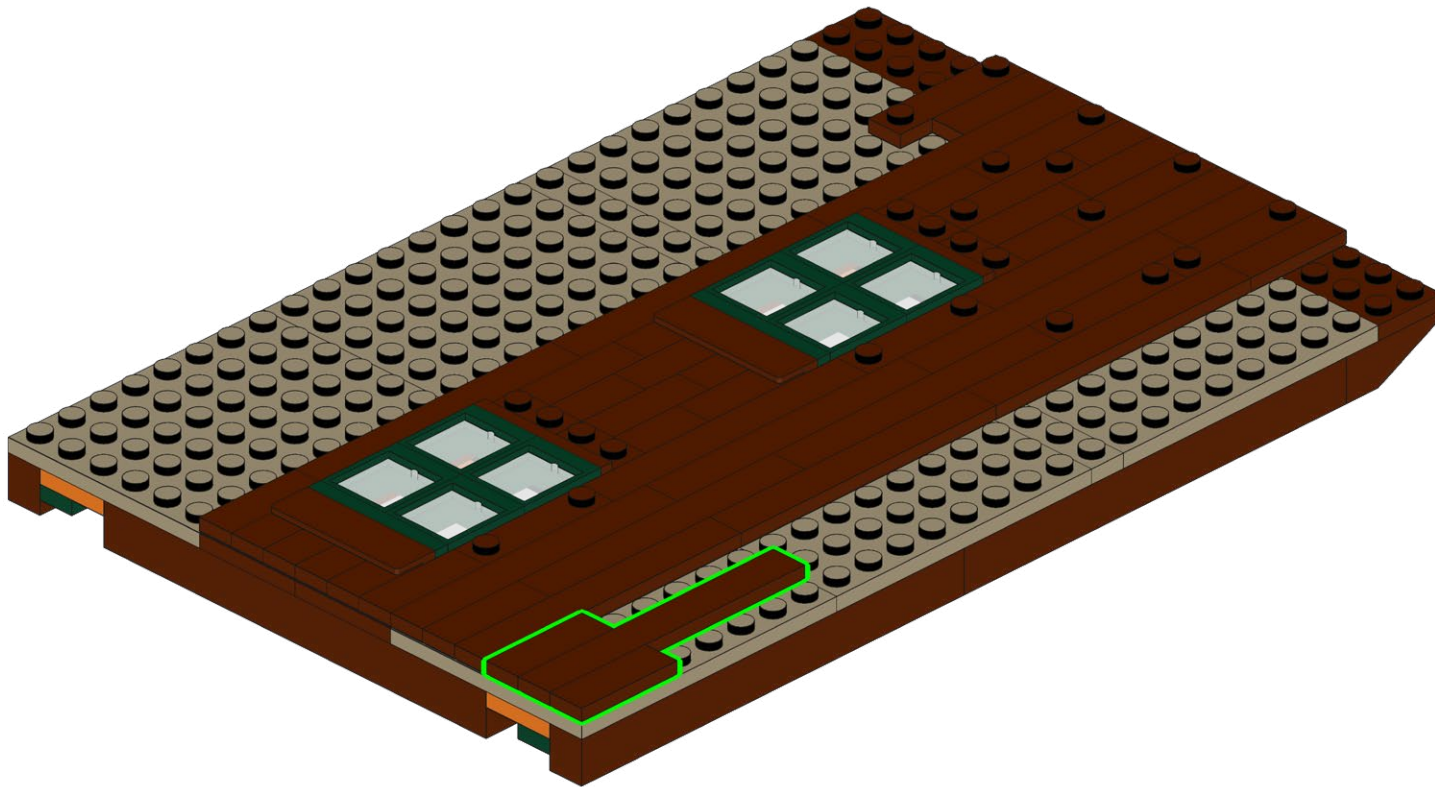
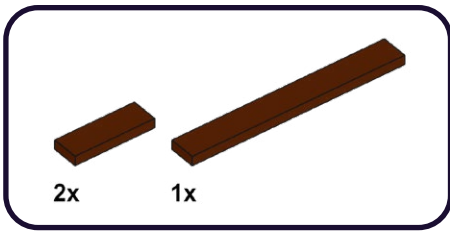

528

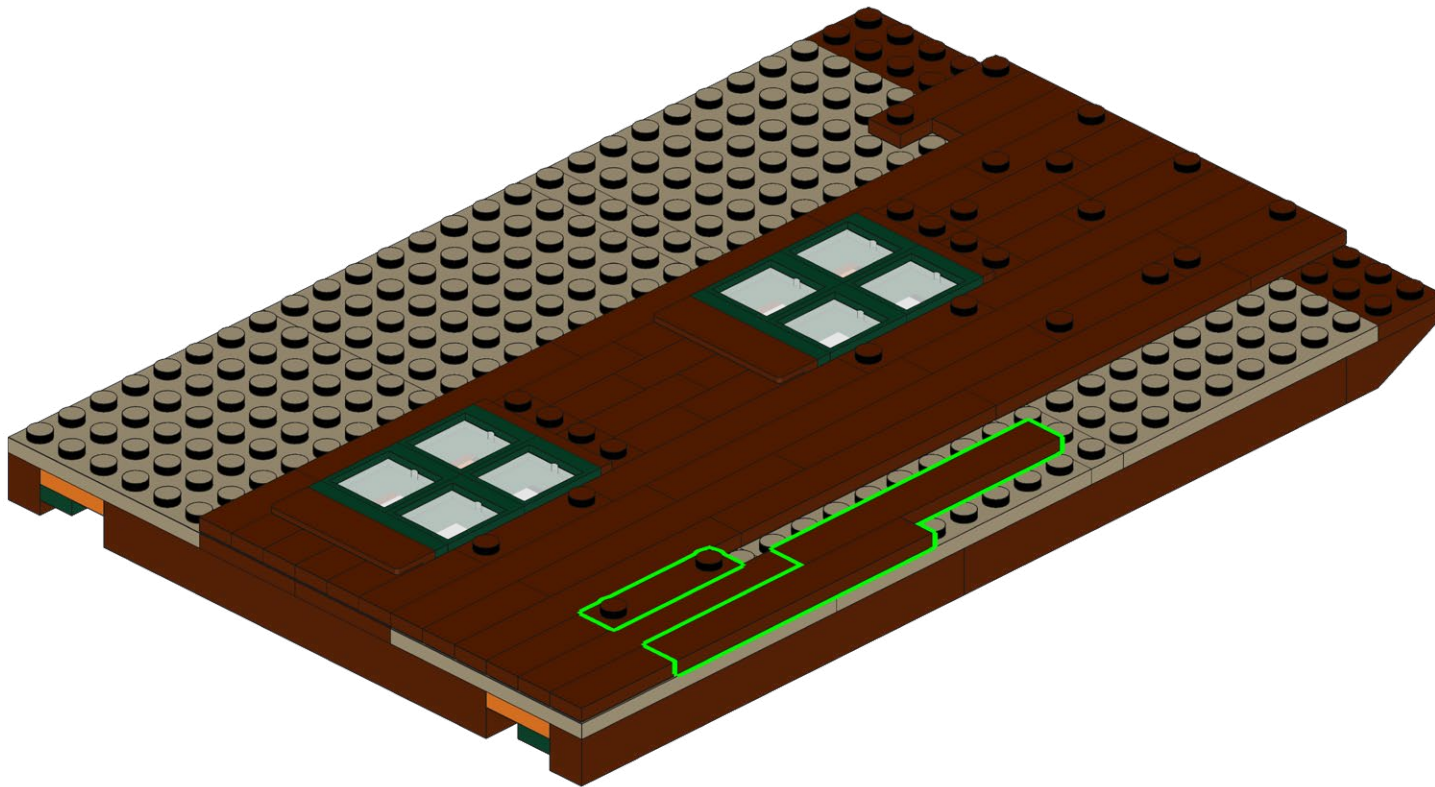
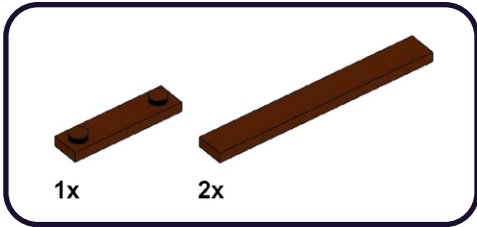

529

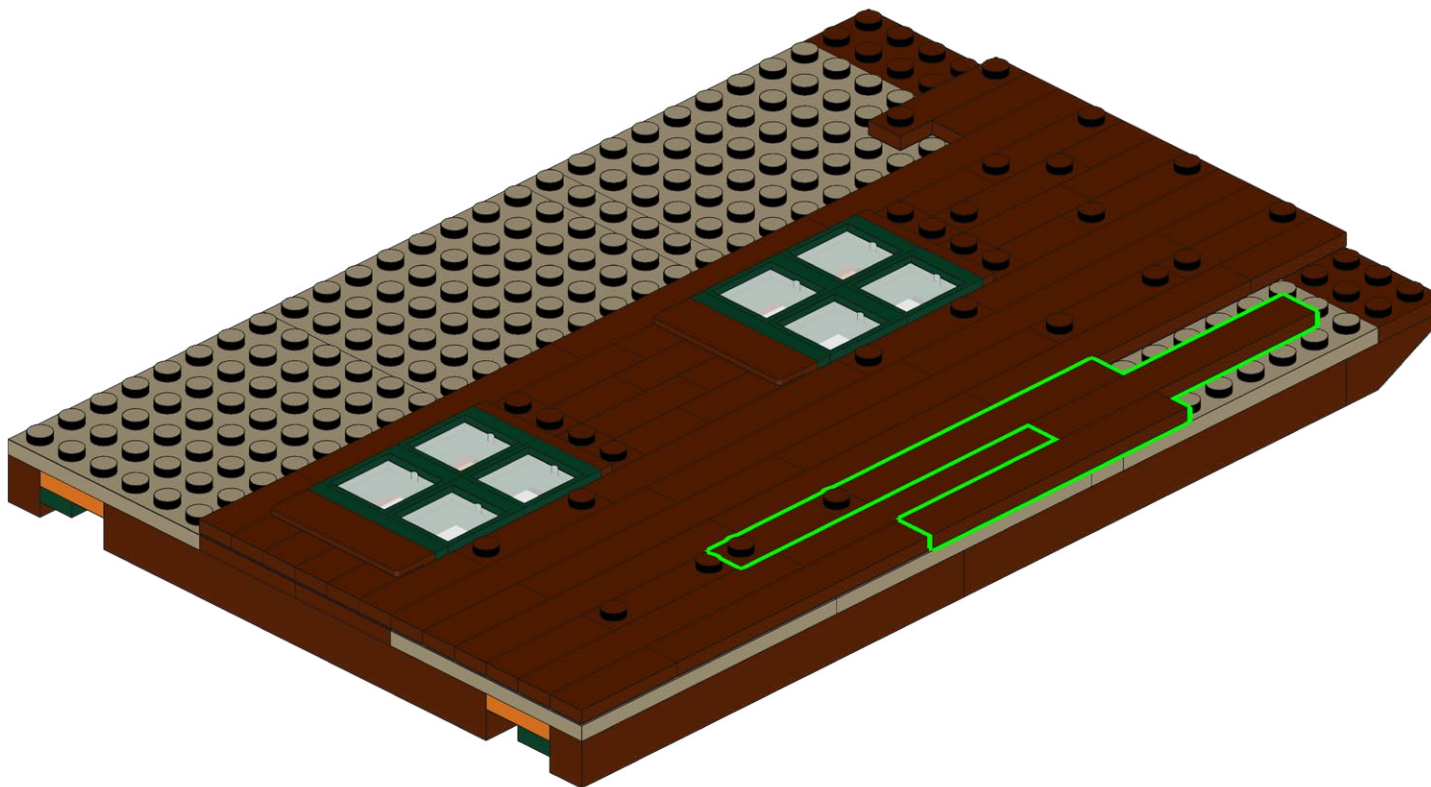
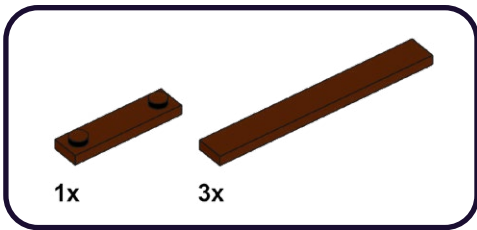

530

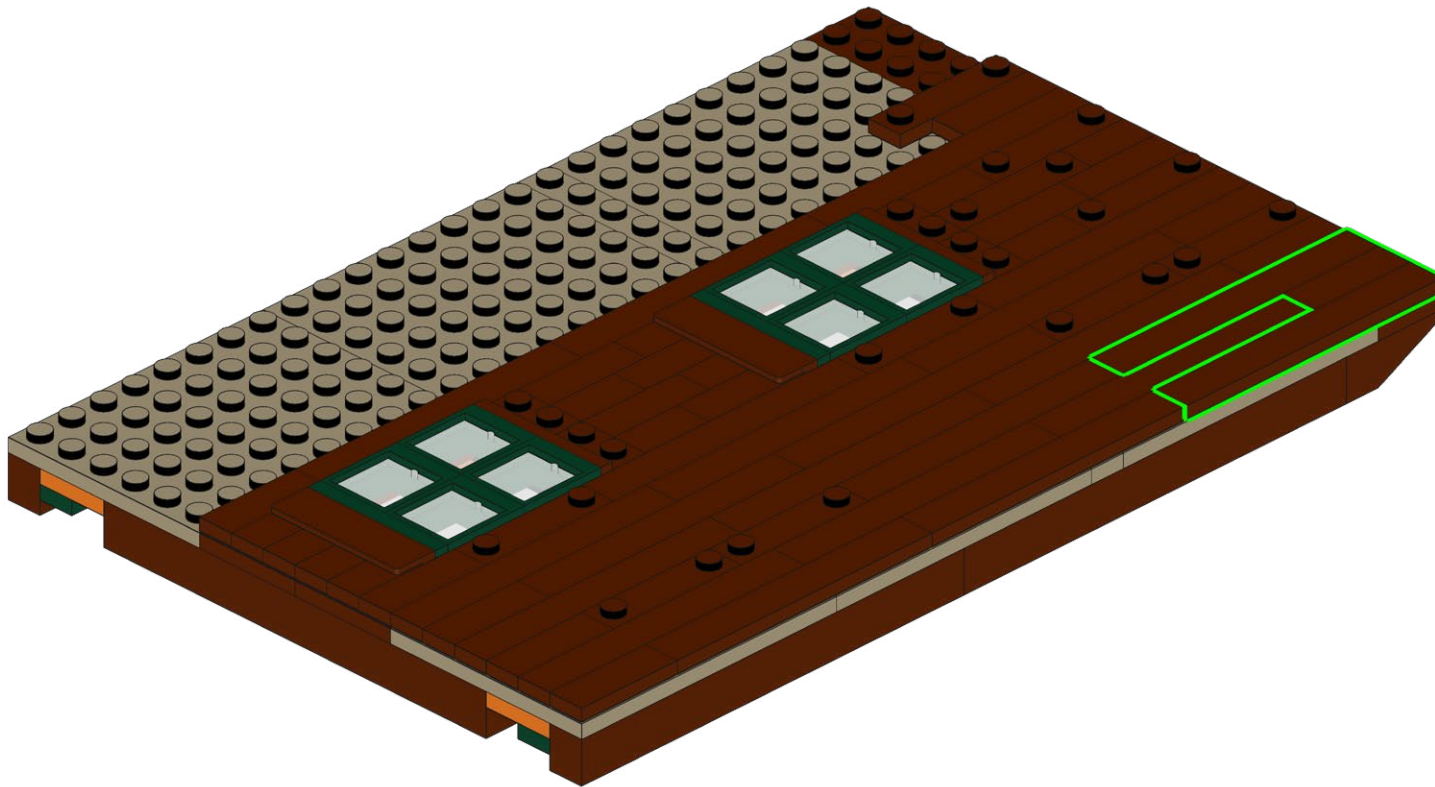
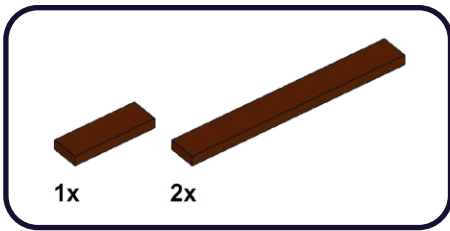

531

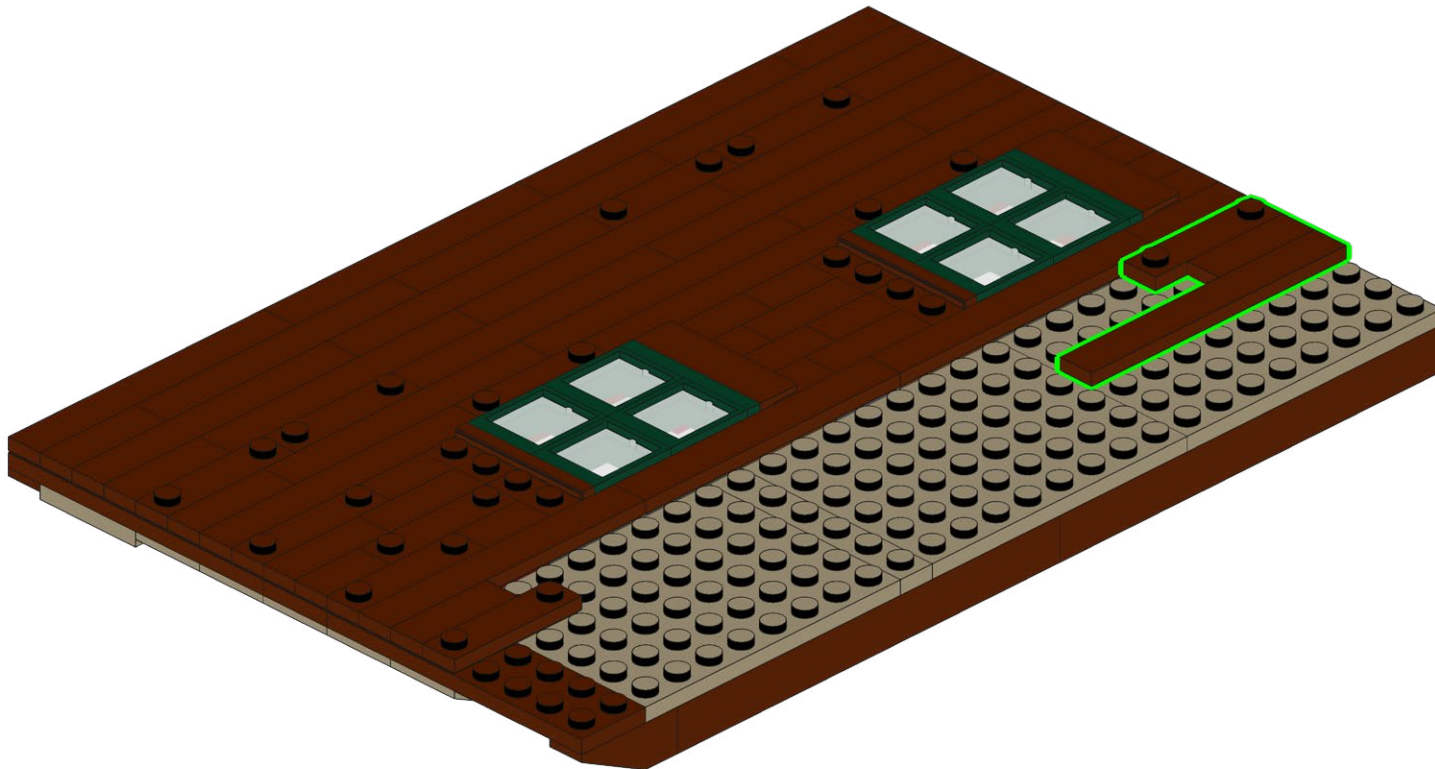
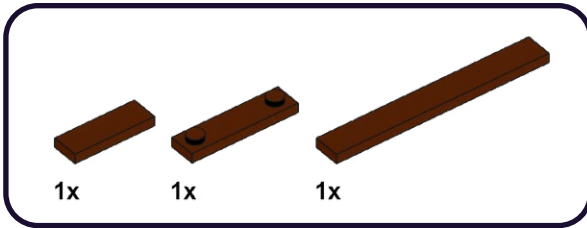

532

1x

2x

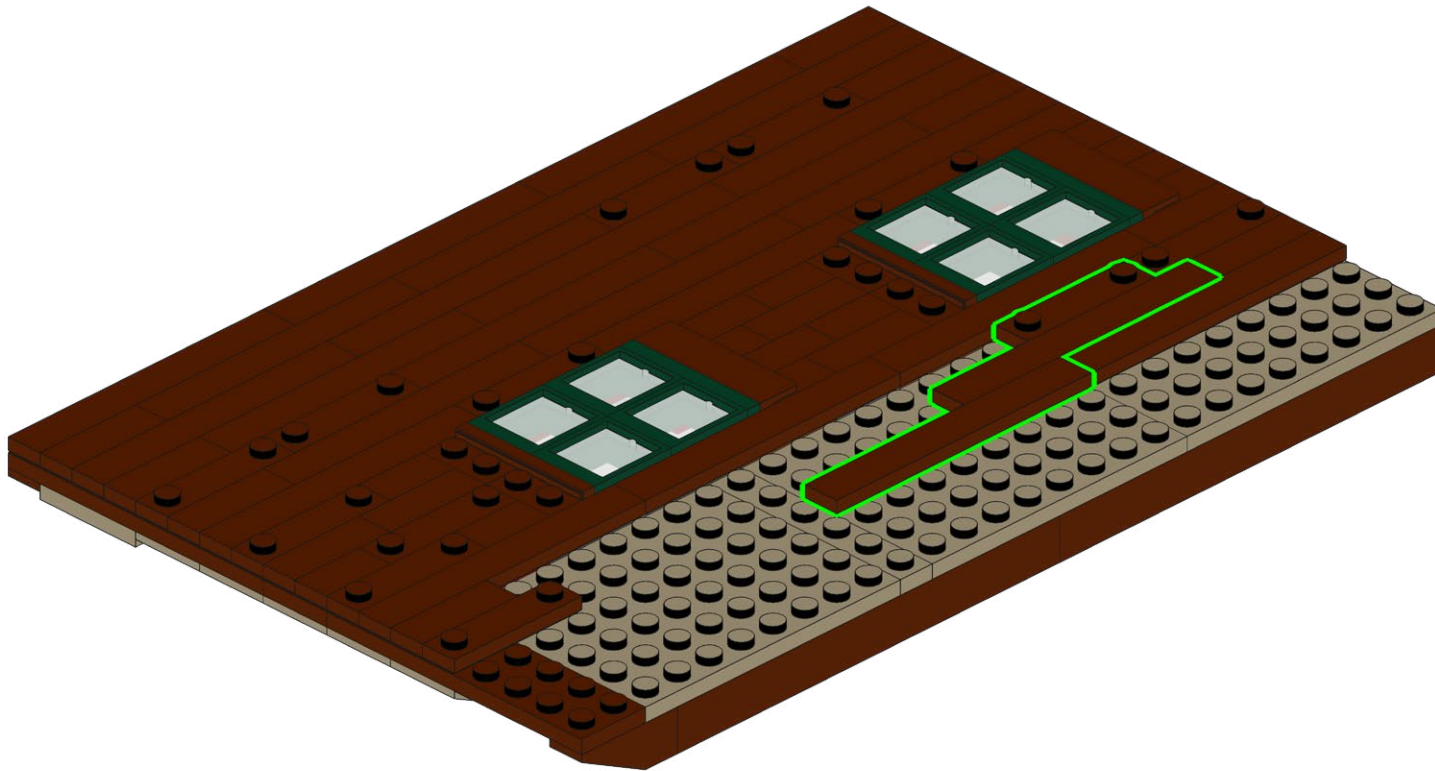

533

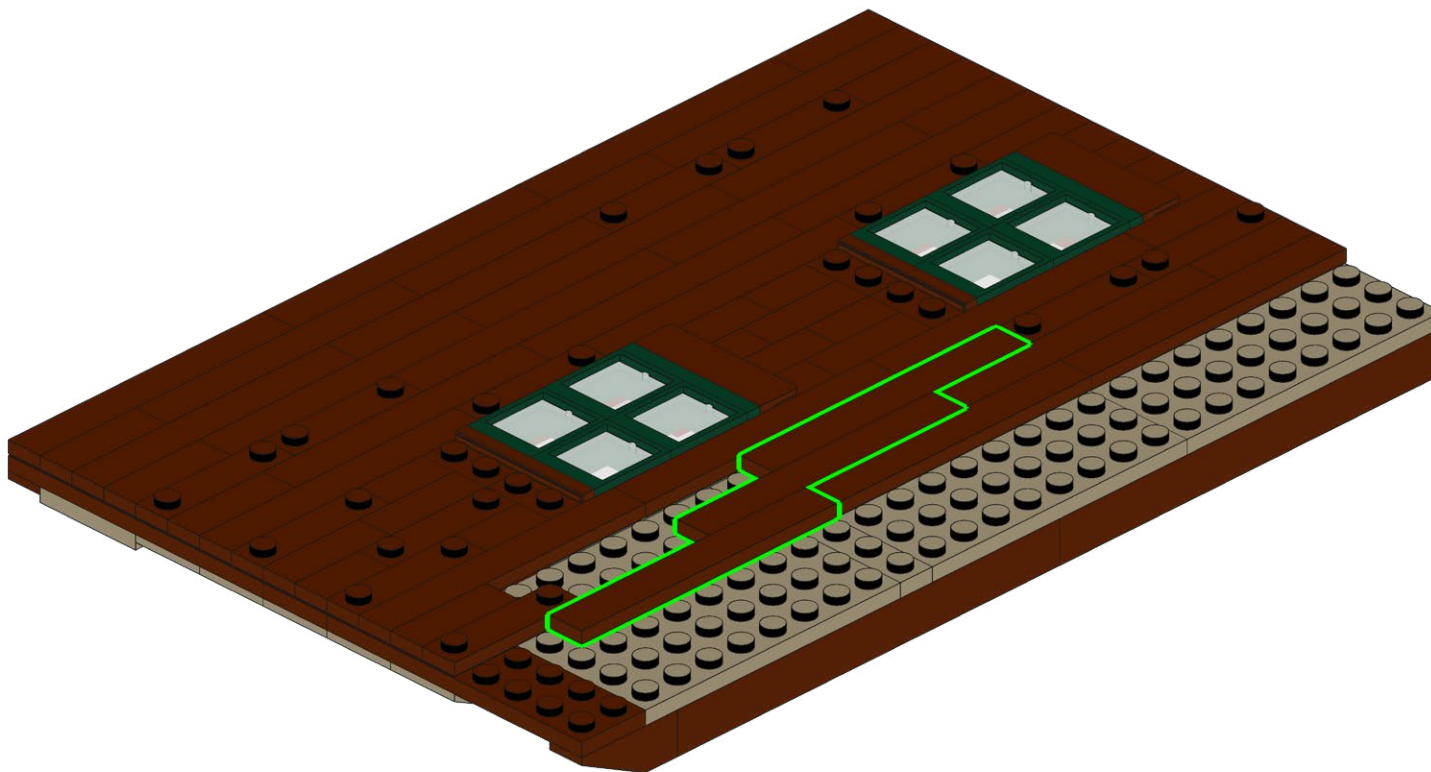
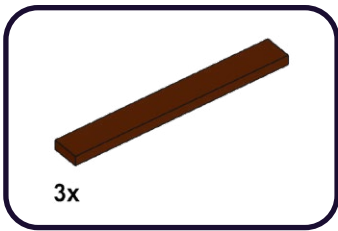

534

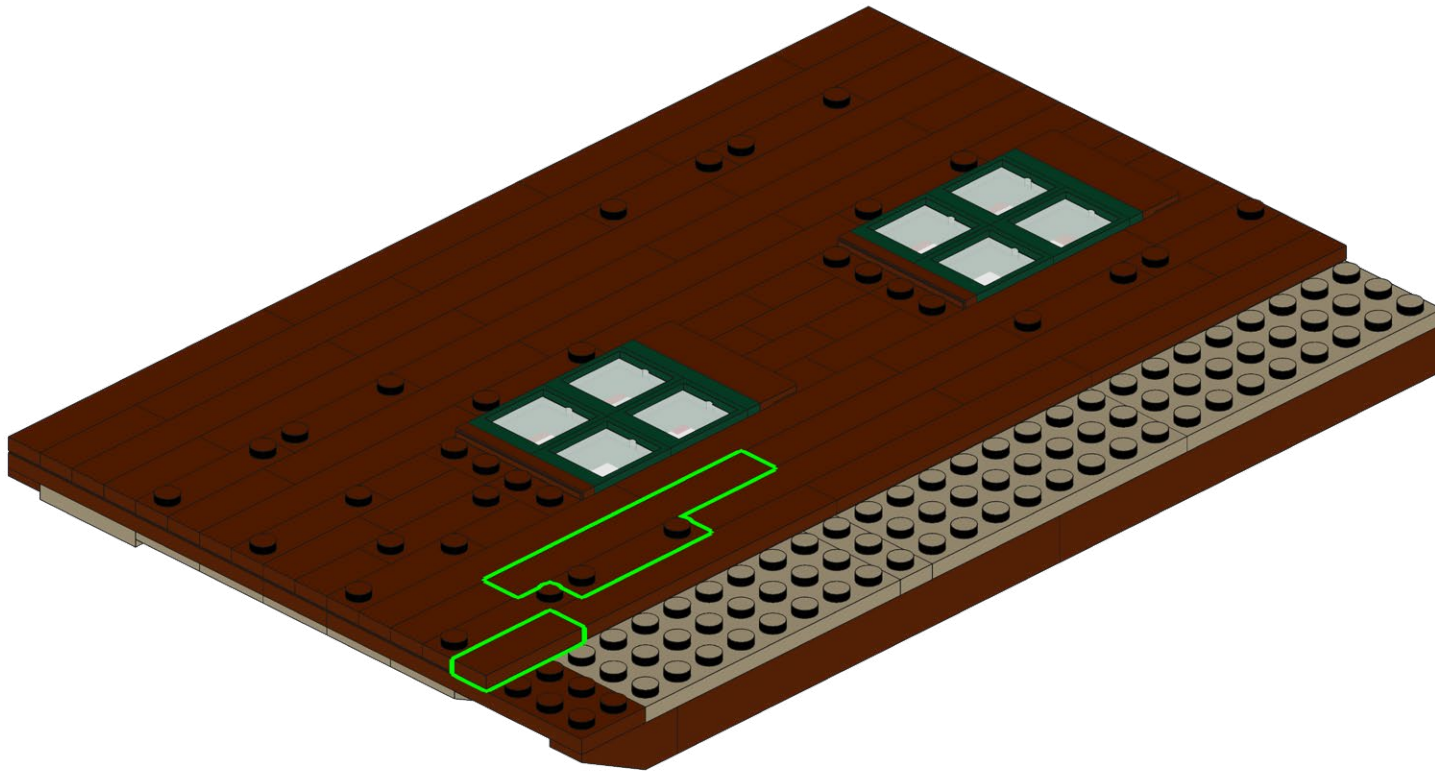
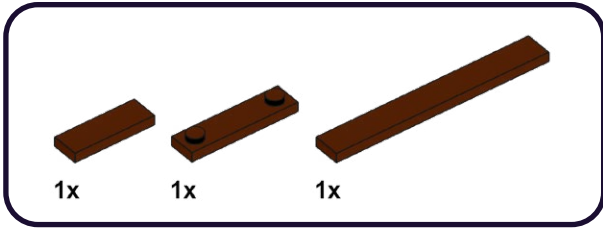

535

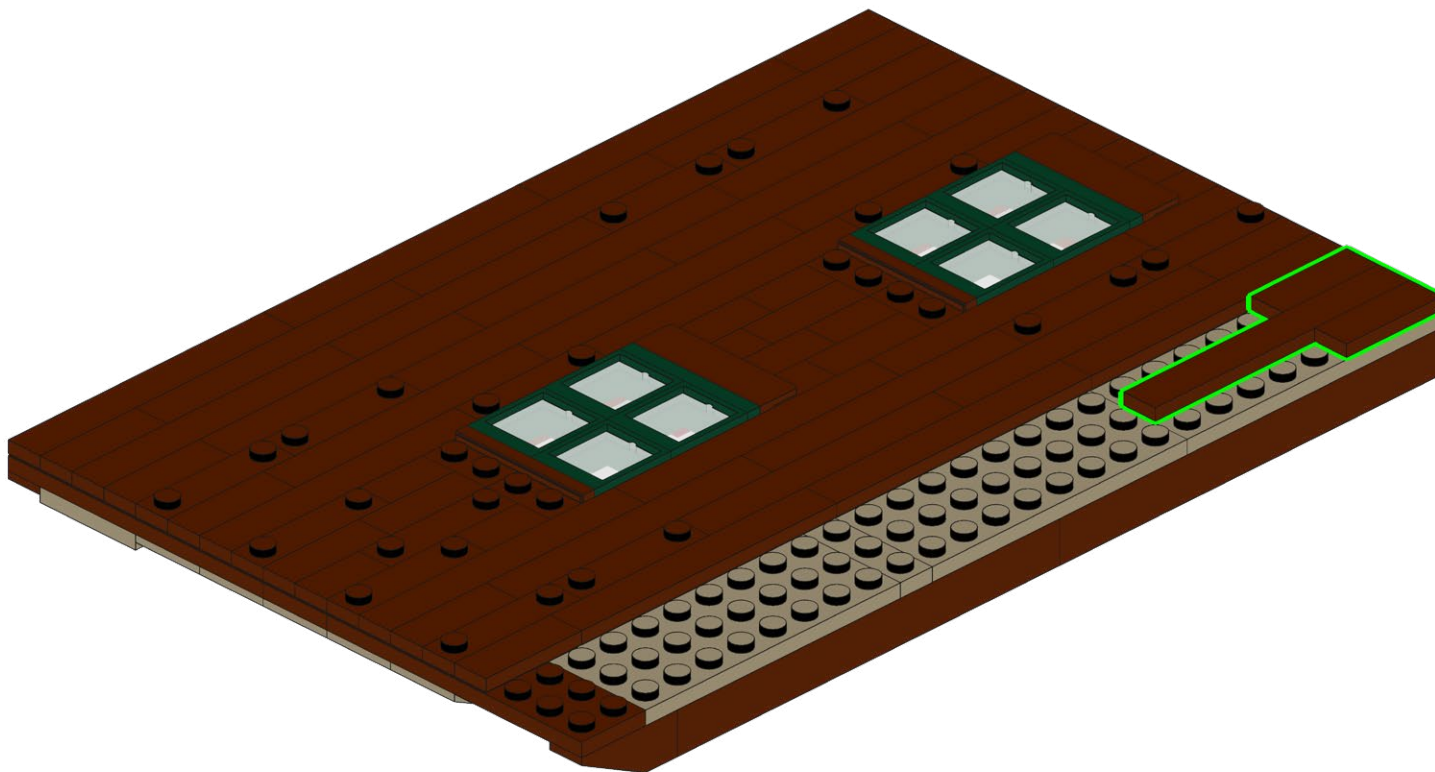
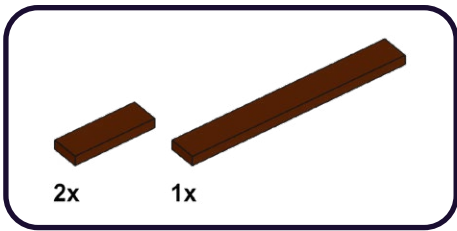

536

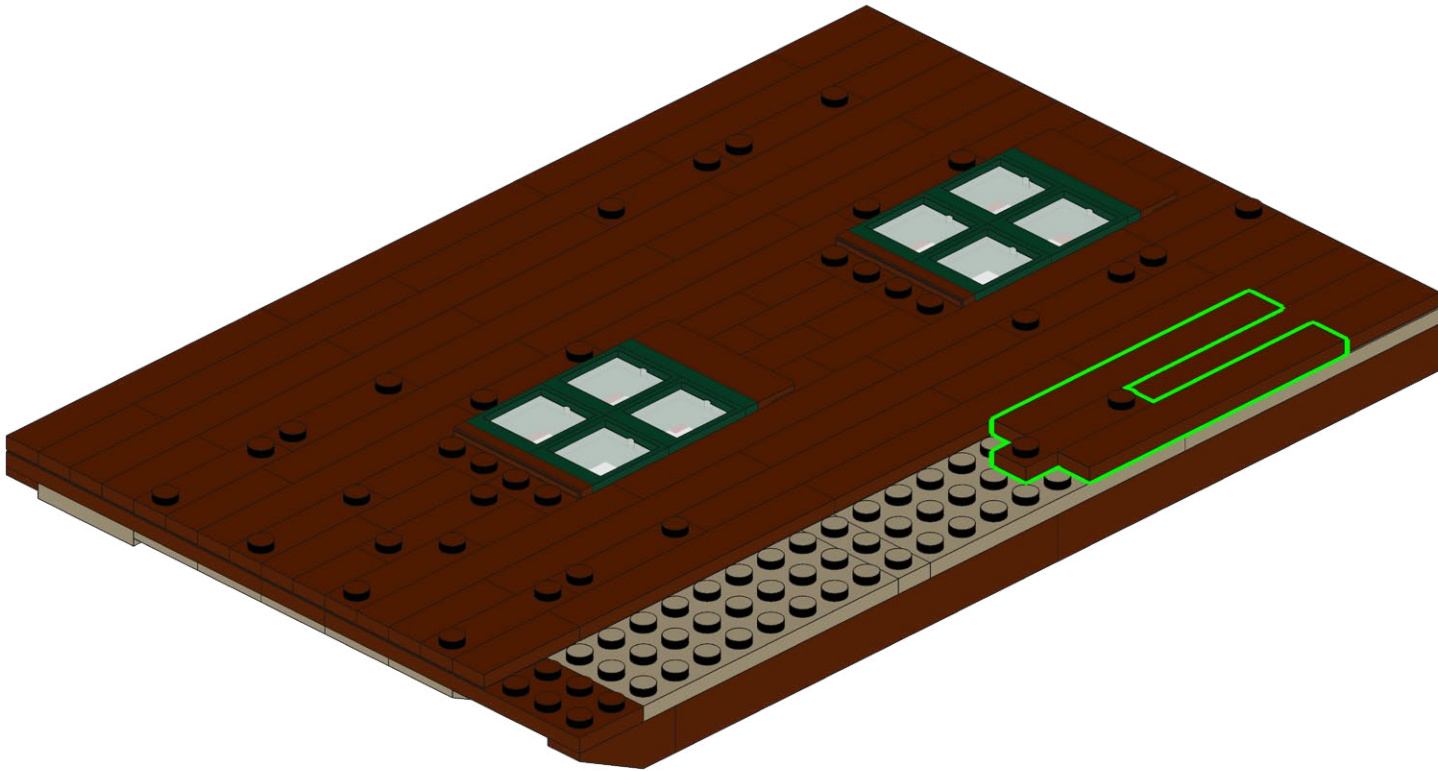
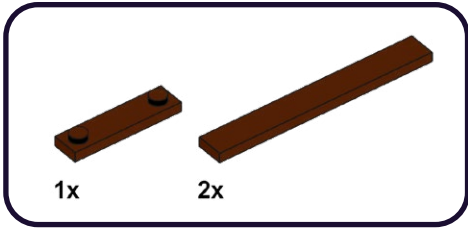

537

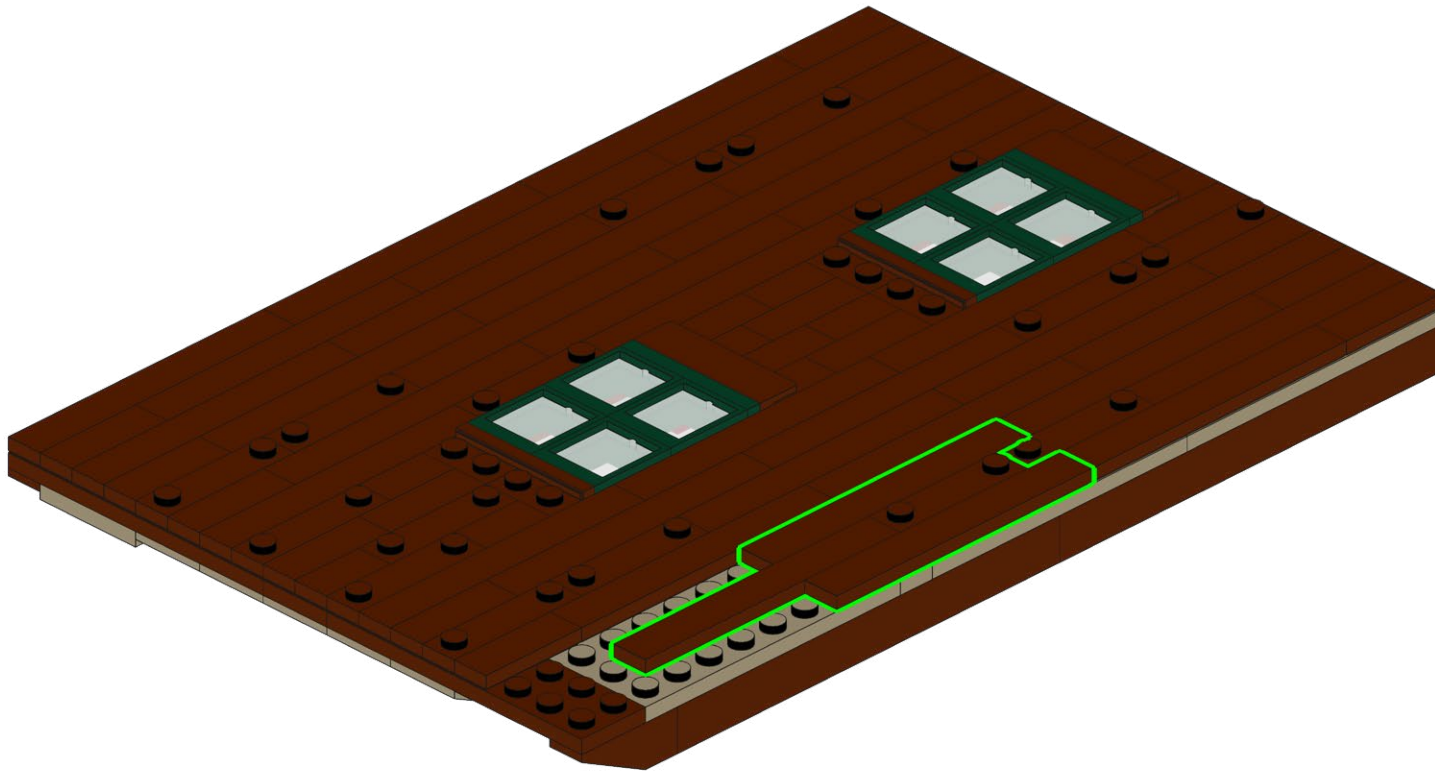
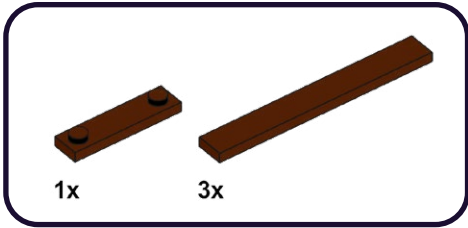

538

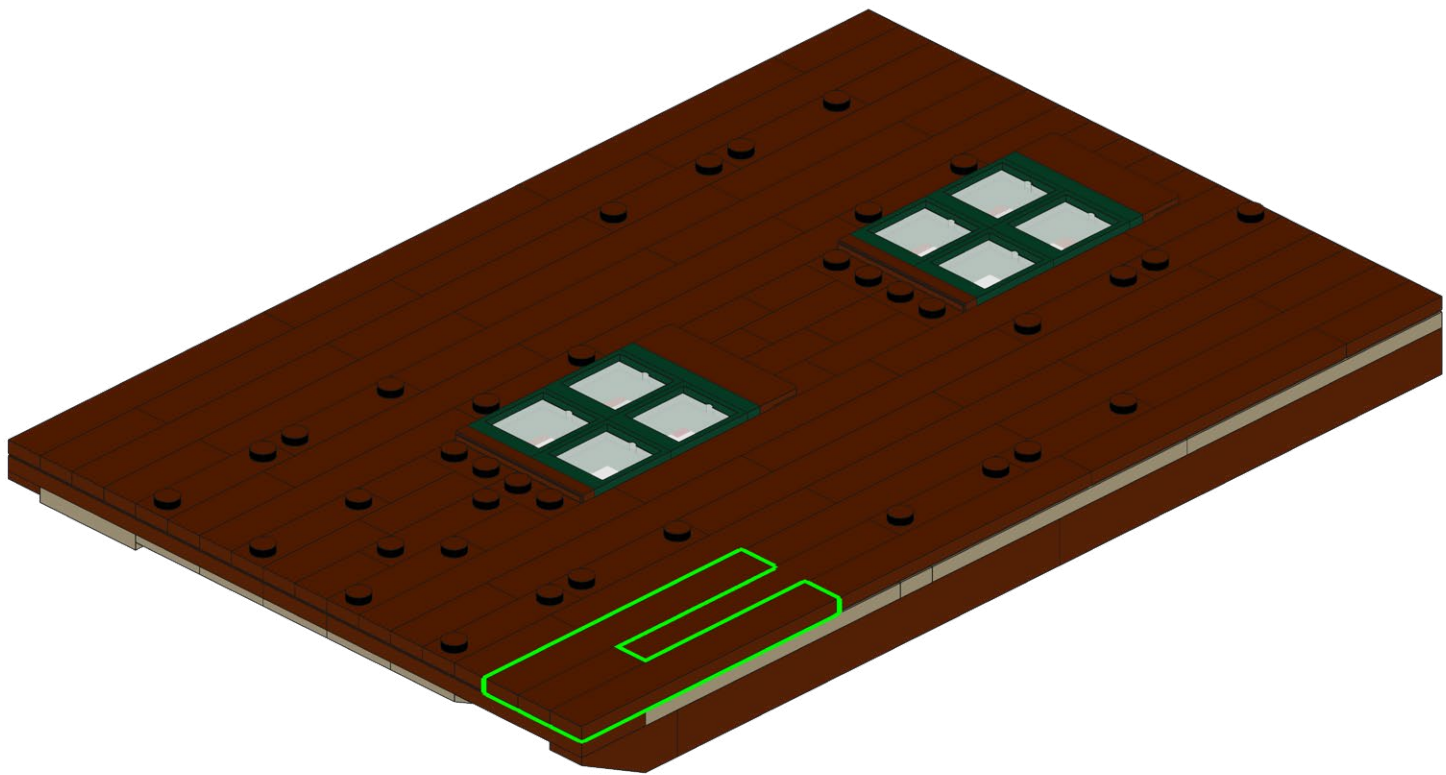
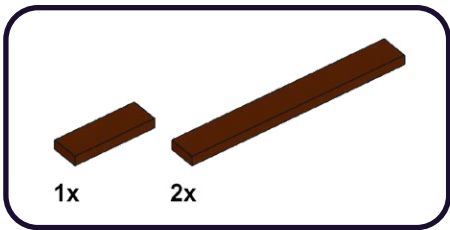

539

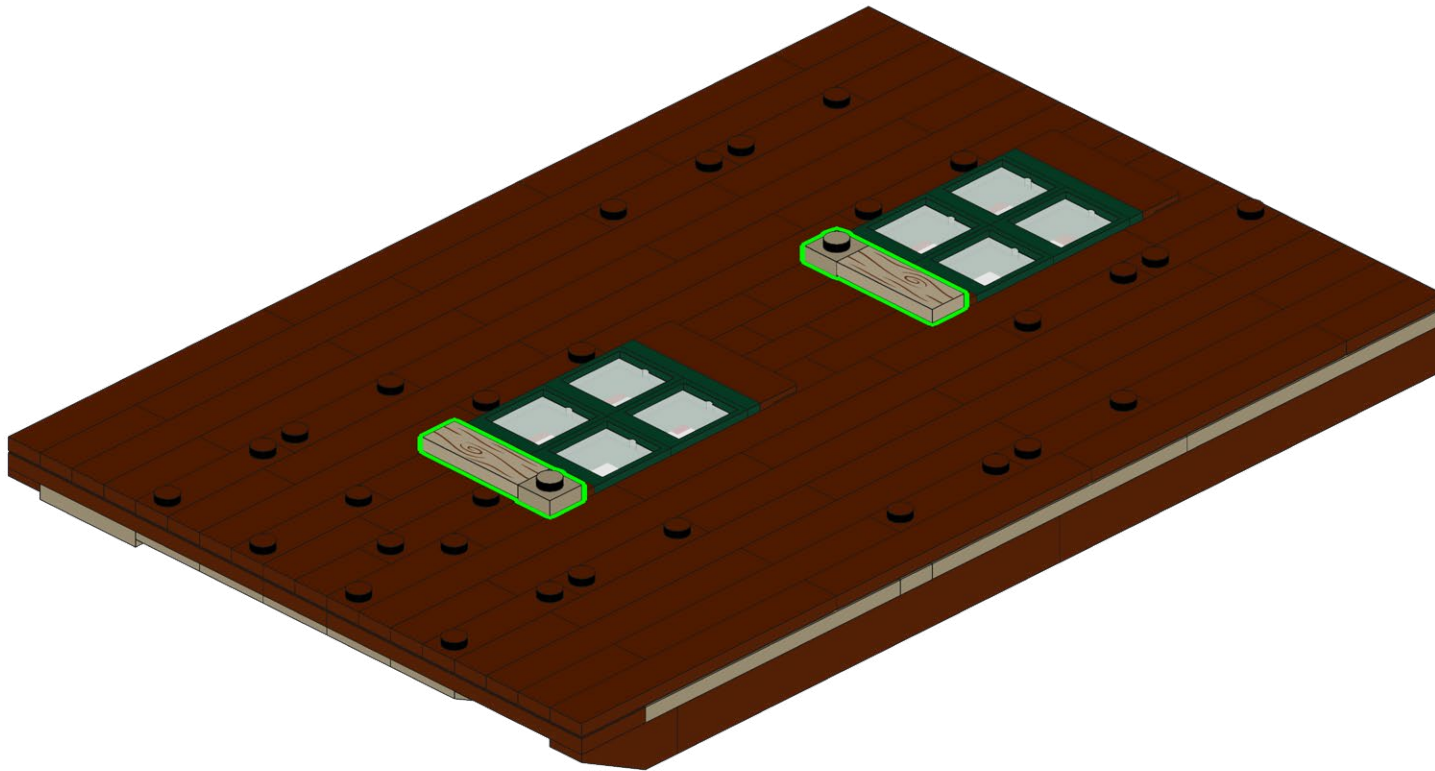
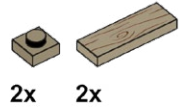

540

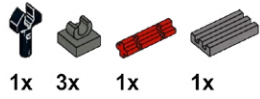

541



542



543

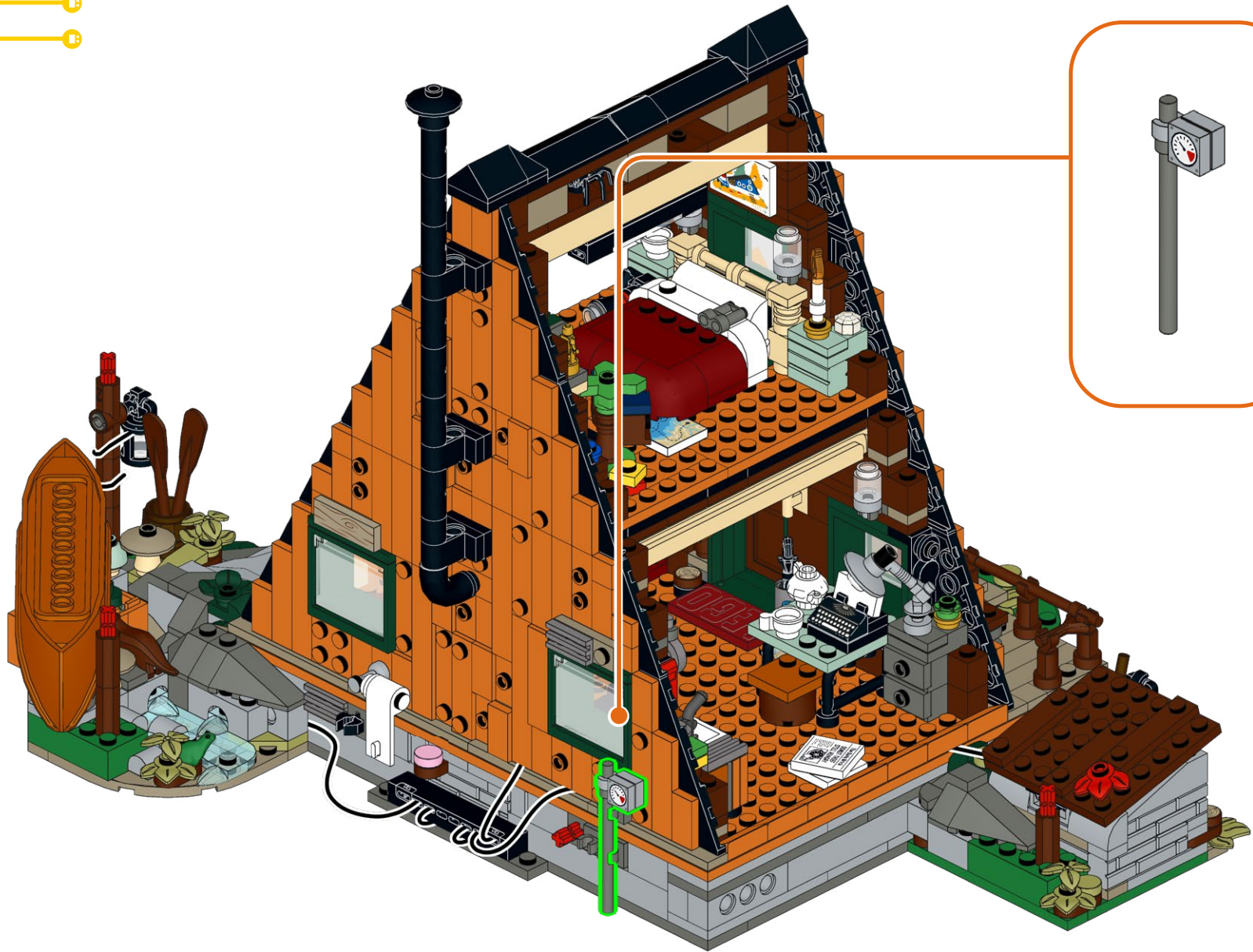

544



545

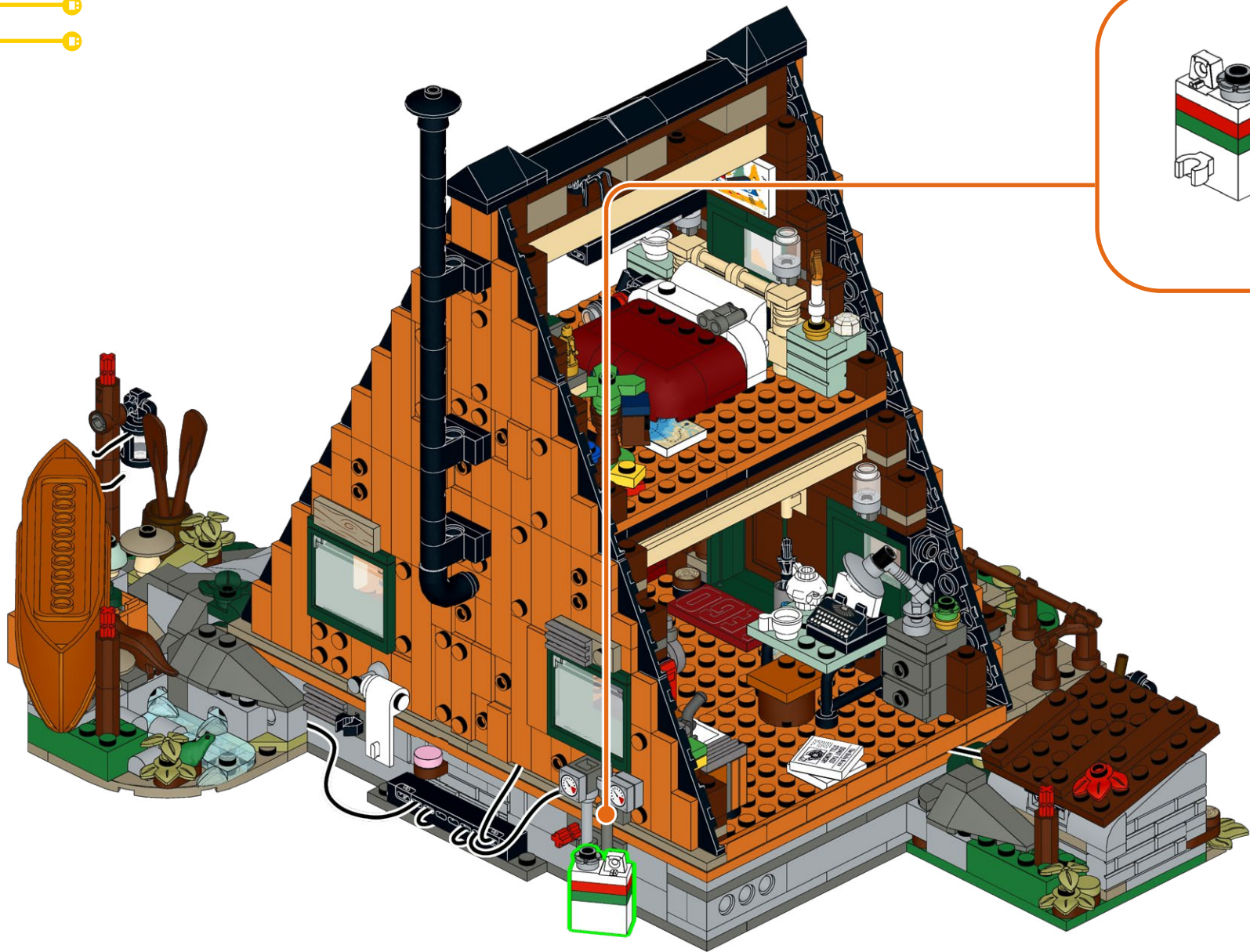

546

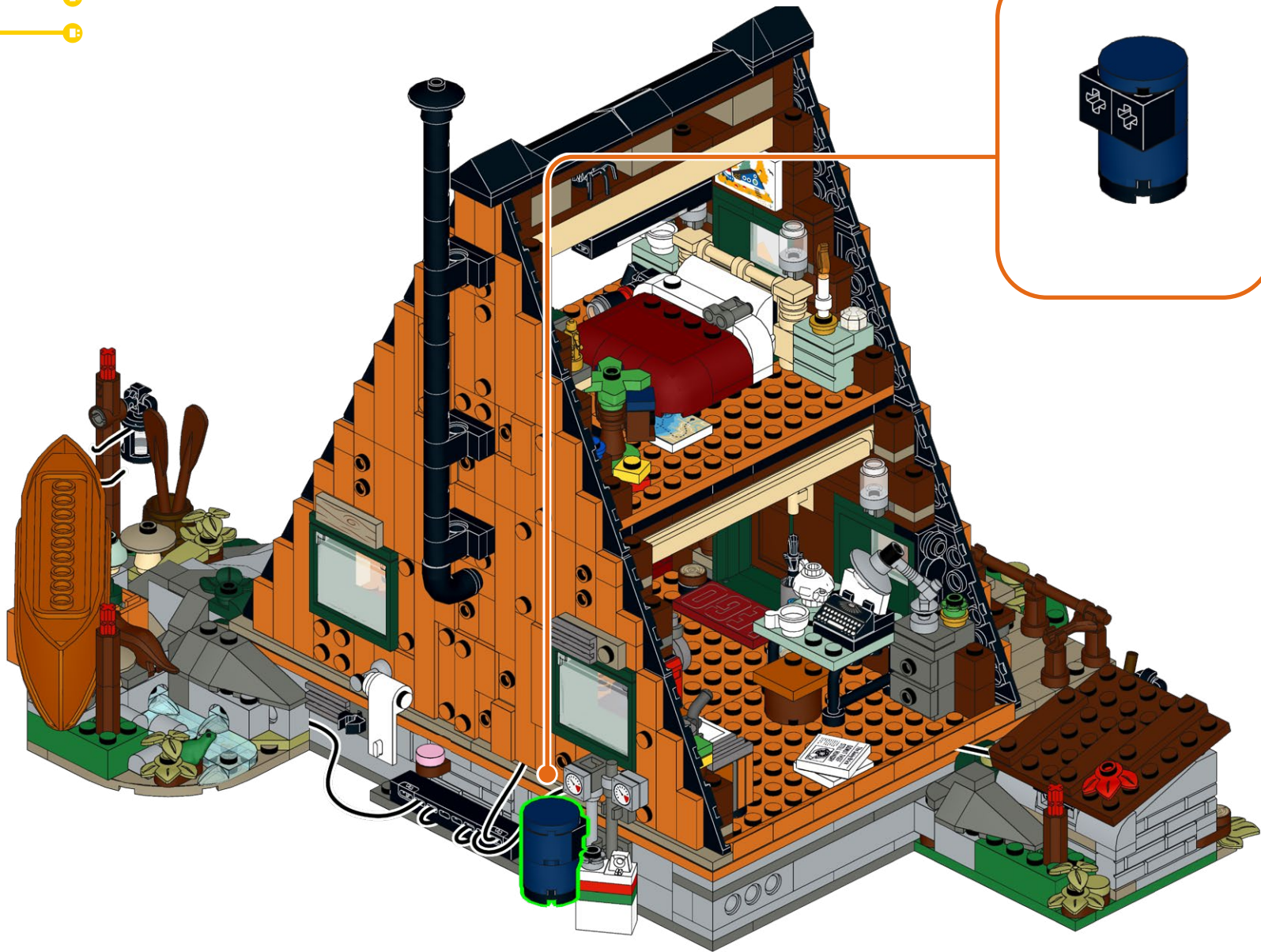

547

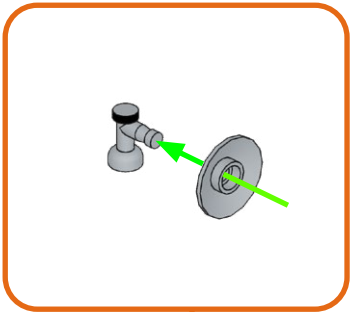
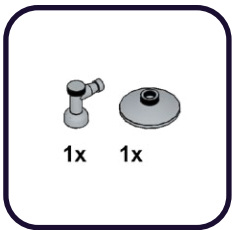

548



1x 1x



549

FLX-B30

1x



550

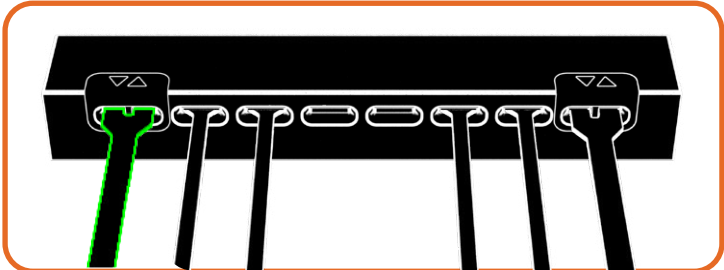

551



552



553



554



555



FINAL PRODUCT



PACKAGE CONTENTS



4x AR-Y30
Astro Light Regular
Yellow 30cm



1x FLX-B30
Flux Belt 30cm



2x Tile 1x1 - Black



2x ML-WW
Meteor Light
Warm White

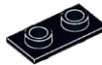

1x T-1x2
Tether 1x2



1x D-6
Dock 6



3x T-1x6
Tether 1x6



1x B-15
Belt 15cm

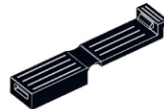

1x E-1x2
Eclipse 1x2



1x B-30
Belt 30cm

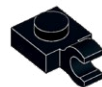

1x Plate, Modified 1x1
with Open O Clip
(Horizontal Grip) - Black

CONTACT US

Click below for customer support, or general inquiries.

Cliquez ci-dessous pour accéder au support client ou aux renseignements généraux.

Clicca qui sotto per l'assistenza clienti o per richieste generali.

Contact Us



Contactez-nous



Contattaci



Klicken sie unten für kundensupport oder allgemeine anfragen.

Haga clic a continuación para atención al cliente o consultas generales.

点击下方获取客户支持或一般咨询。

Kontaktieren sie uns



Contáctanos



联系我们



TROUBLESHOOTING

If you're stuck, scan the QR code for troubleshooting.

Se sei bloccato, scansiona il codice QR per la risoluzione dei problemi.

Wenn Sie nicht weiterkommen, scannen Sie den QR-Code zur Fehlerbehebung.

Si vous êtes bloqué, scannez le code QR pour le dépannage

Si está atascado, escanee el código QR para solucionar el problema.

如果遇到问题, 请扫描二维码进行故障排除

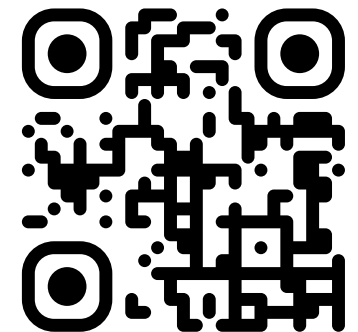



LIGHTMYBRICKS

lightmybricks.com



LEGO® is a trademark of the LEGO Group of companies, which does not sponsor, authorize or endorse this product. All LEGO® sets featured in images are sold separately. This is not a LEGO® product. The LEGO Group is not liable for any loss, injury or damage arising from the use or misuse of this product. ©2024 Light My Bricks Pty Ltd. All rights reserved. www.lightmybricks.com

Our components are designed and packaged in Australia by Light My Bricks Pty Ltd. Components are manufactured in China. 3fl bldg C, Shuanghuan Quanxin Technology Information Industry Park Baolong Street, Longgang District, Shenzhen, China. Imported in Australia by Light My Bricks Pty Ltd, 5/26 Rushdale St, Knoxfield, VIC, 3180, Australia.

WARNING: CHOKING HAZARD - Small parts. Not for children under 3 years.

AVERTISSEMENT : RISQUE D'ÉTOUFFEMENT - Petites pièces. Ne convient pas aux enfants de moins de 3 ans.

ATTENZIONE: PERICOLO DI SOFFOCAMENTO - Piccole parti. Non adatto a bambini di età inferiore a 3 anni.

WARNUNG: ERSTICKUNGSGEFAHR - Kleine Teile. Nicht für Kinder unter 3 Jahren geeignet.

ADVERTENCIA: PELIGRO DE ASFIXIA - Piezas pequeñas. No son apto para niños menores de 3 años.

警告：窒息危险 - 小零件。不适合3岁以下儿童。