

# LIGHT KIT INSTALLATION GUIDE

**CONCORDE**

FOR LEGO  
SET  
#10318

## 03

### Getting Started

- 04** Legend
- 05** Component Handling
- 06** Blueprint

## 07

### Instructions

- 07** LEGO Bag 1
- 22** LEGO Bag 2
- 44** LEGO Bag 3
- 66** LEGO Bag 4 and 13- LMB Bag 02
- 91** LEGO Bag 5
- 125** LEGO Bag 6
- 141** LEGO Bag 7- LMB Bag 03
- 167** LEGO Bag 8
- 196** LEGO Bag 10
- 227** LEGO Bag 9
- 262** LEGO Bag 11
- 278** LEGO Bag 12
- 304** LEGO Bag 14
- 319** LEGO Bag 15
- 378** LEGO Bag 16
- 387** LEGO Bag 17
- 409** LMB Bag 01
- 449** LEGO Bag 18 and 19
- 489** LEGO Bag 20
- 555** LEGO Bag 21 - LMB Bag 04

## 620

### Final Product

- 621** Package Contents
- 622** Package Contents
- 623** Contact & Troubleshooting

# GETTING STARTED



Bold, beautiful and bright, Light My Bricks elevates your favourite LEGO set from knick-knack to statement piece. Create a talking point at home or in the office that speaks to your passions with Light My Bricks. To learn more, click below.

[Learn More](#)



Audacieux, beau et lumineux, Light My Bricks élève votre ensemble LEGO préféré du statut de bibelot à celui de pièce maîtresse. Que ce soit à la maison ou au bureau, partagez votre passion des LEGO avec Light My Bricks. Cliquez ci-dessous pour en savoir plus.

[En savoir plus](#)



Audace, bello e luminoso, Light My Bricks eleva il tuo set LEGO preferito da soprammobile a pezzo di tendenza. Crea un punto di discussione a casa o in ufficio che parli alle tue passioni con Light My Bricks. Per saperne di più, clicca qui sotto.

[Ulteriori Informazioni](#)



Mutig, schön und hell – Light My Bricks verwandelt Ihr Lieblings-LEGO-Set von einem schnickschnack in ein statement-stück. Schaffen sie einen gesprächspunkt zu hause oder im büro, der Ihre leidenschaften widerspiegelt, mit Light My Bricks. Um mehr zu erfahren, klicken sie unten.

[Mehr erfahren](#)



Audaz, hermoso y brillante, Light My Bricks eleva tu set LEGO favorito de una chuchería a una pieza llamativa. Crea un tema de conversación en casa o en la oficina que hable de tus pasiones con Light My Bricks. Para obtener más información, haga clic a continuación.

[Más información](#)



大胆、美丽而明亮，Light My Bricks 将你喜爱的乐高套装从小摆件提升为引人注目的装饰品。在家或办公室打造一个能表达你激情的话题，了解更多，请点击下方。

[了解更多](#)



# LEGEND

## Rotate Set



Retournez L'ensemble  
Ruota Set  
Set Drehen  
Rotar Conjunto  
旋转套件

## Add Part



Ajoutez une Pièce  
Aggiungi Parte  
Teil Hinzufügen  
Agregar Pieza  
添加零件

## Click



Cliquez  
Clic  
Klicken  
Clic  
点击

## Pinch/Fold



Pincez/Pliez  
Pizzicare/Piegare  
Kneifen/Falten  
Pellizcar/Doblar  
折叠

## Pull Cable



Tirez le Cable  
Tirare il Cavo  
Kabel Ziehen  
Tirar del Cable  
拉动电缆

## Repeat Step



Répétez  
Ripetere  
Wiederholen  
Repetir  
重复

## Sticker



Autocollant  
Adesivo  
Aufkleber  
Pegatina  
贴纸

## Power On Test



Test de mise sous tension  
Test di Potenza  
Stromtest  
Prueba de Energía  
电源测试

## Disconnect Power

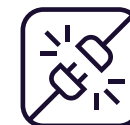

Débranchez L'alimentation  
Scollegare L'alimentazione  
Strom Trennen  
Desconectar la Energía  
断开电源

## Troubleshoot



Dépanner  
Risolvere  
Fehlerbehebung  
Solución de Problemas  
故障排除

# COMPONENT HANDLING

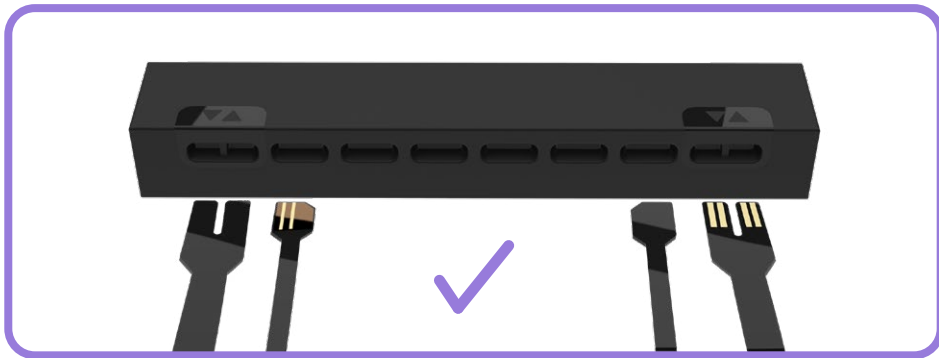
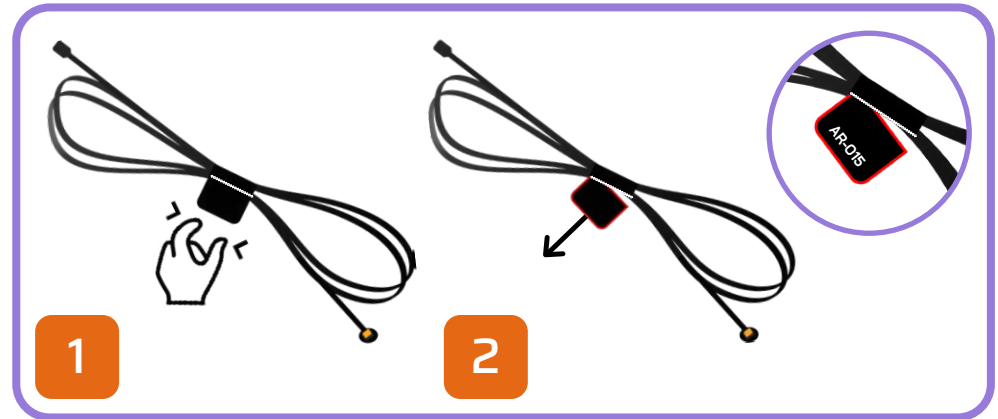
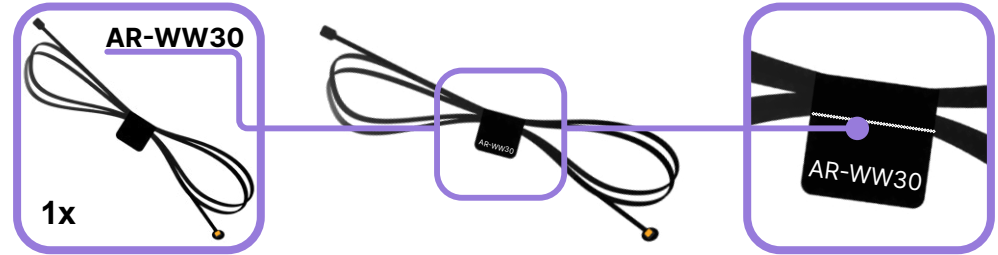
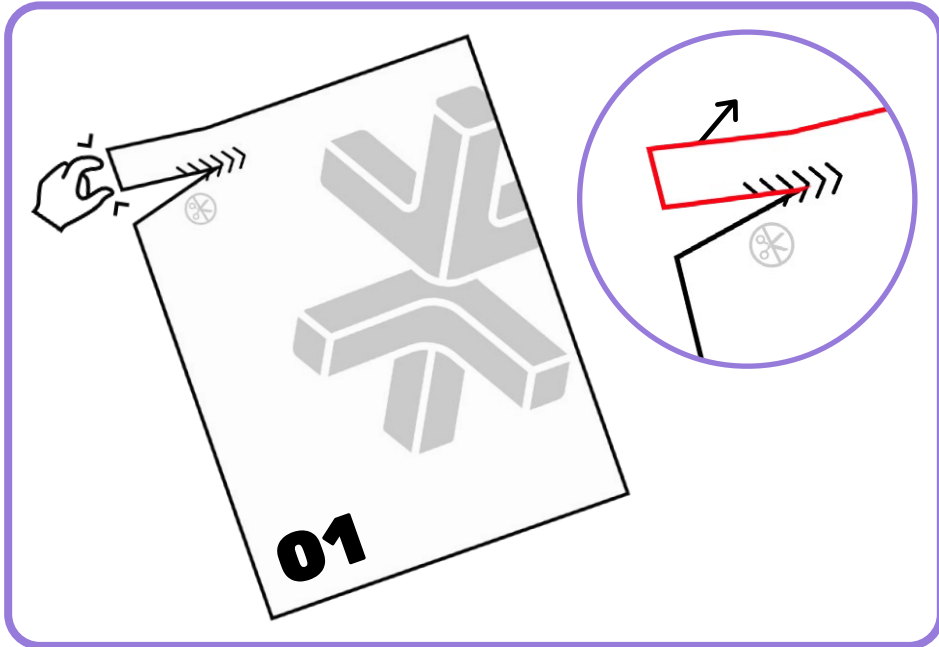

# BLUEPRINT

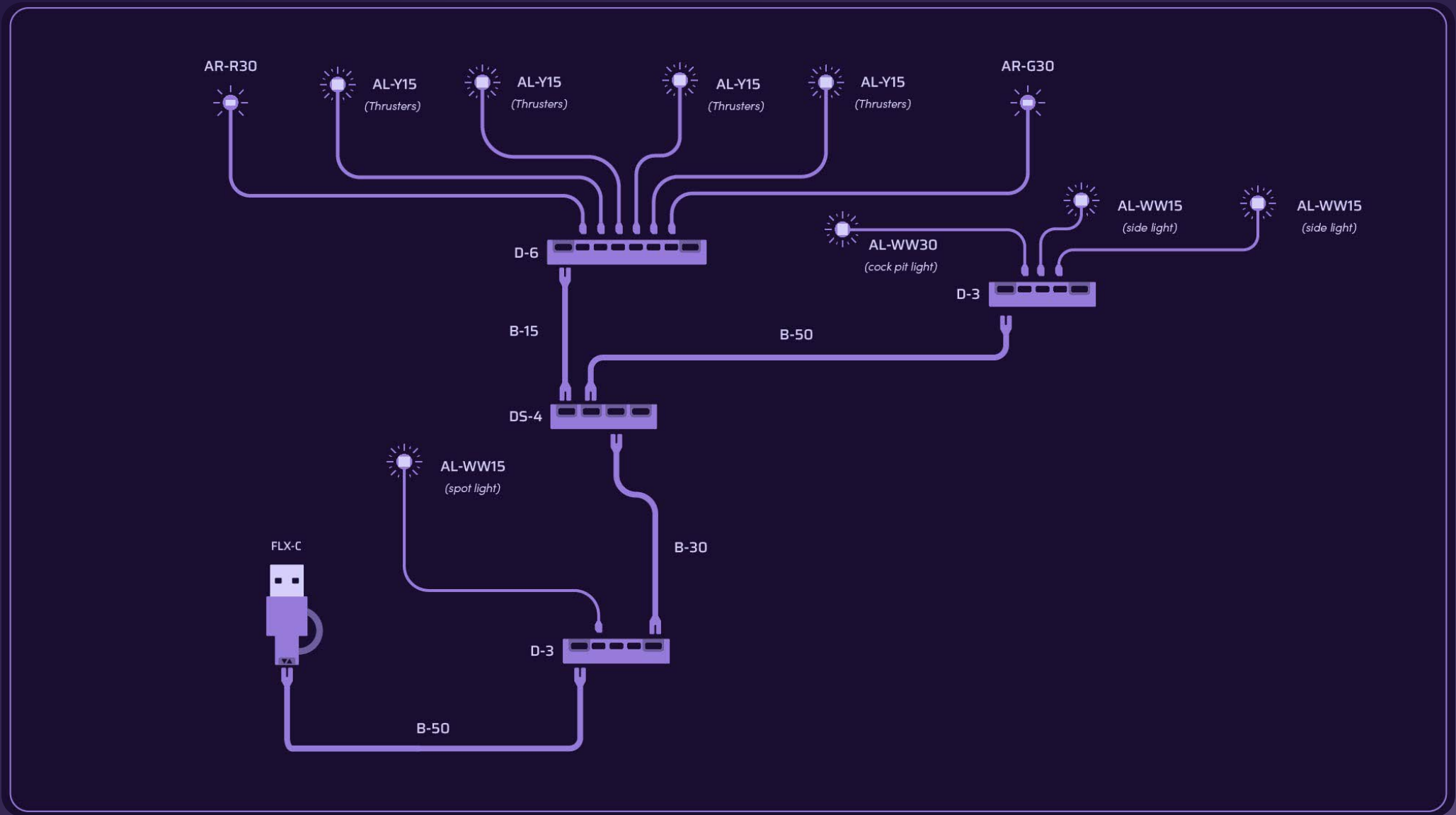

**HOLD UP!**

You might notice some bags aren't in order, as well as left over pieces, but that's ok! We're changing the way you build LEGO!

**ATTENDEZ!**

Vous remarquerez peut-être que certains sacs, ainsi que certaines pièces, ne sont pas dans le bon ordre. Mais pas de panique! Nous changeons simplement la façon avec laquelle vous construisez vos LEGO!

**ASPETTA!**

Potresti notare che alcuni sacchetti non sono in ordine, così come i pezzi avanzati, ma va bene così! Stiamo cambiando il modo in cui costruisci i LEGO!

**HALT!**

Sie werden möglicherweise bemerken, dass einige tüten durcheinander sind und teile übrig bleiben, aber das ist in Ordnung! Wir ändern die art und weise, wie Sie LEGO bauen!

**¡ESPERA!**

Es posible que notes que algunas bolsas están fuera de servicio, así como piezas sobrantes, ¡pero está bien! ¡Estamos cambiando la forma en que construyes LEGO!

**暫停!**

你可能会注意到一些袋子顺序错乱, 以及一些剩余的部件, 但没关系! 我们正在改变你搭建乐高的方式!

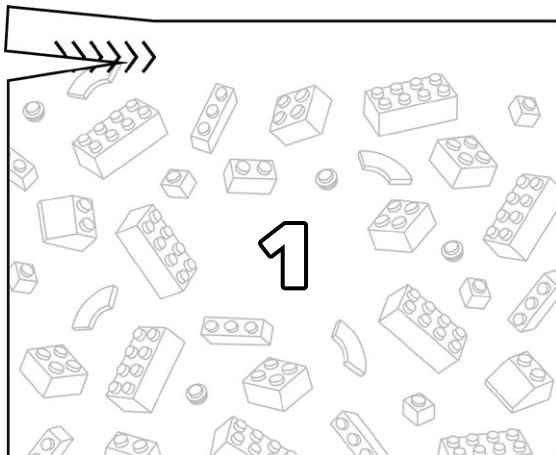
**Open LEGO® Bag 1**

1

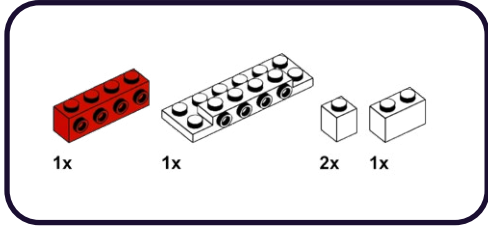

1

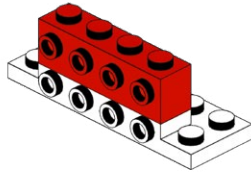

2

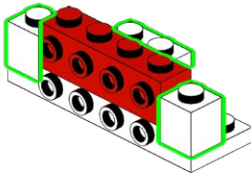



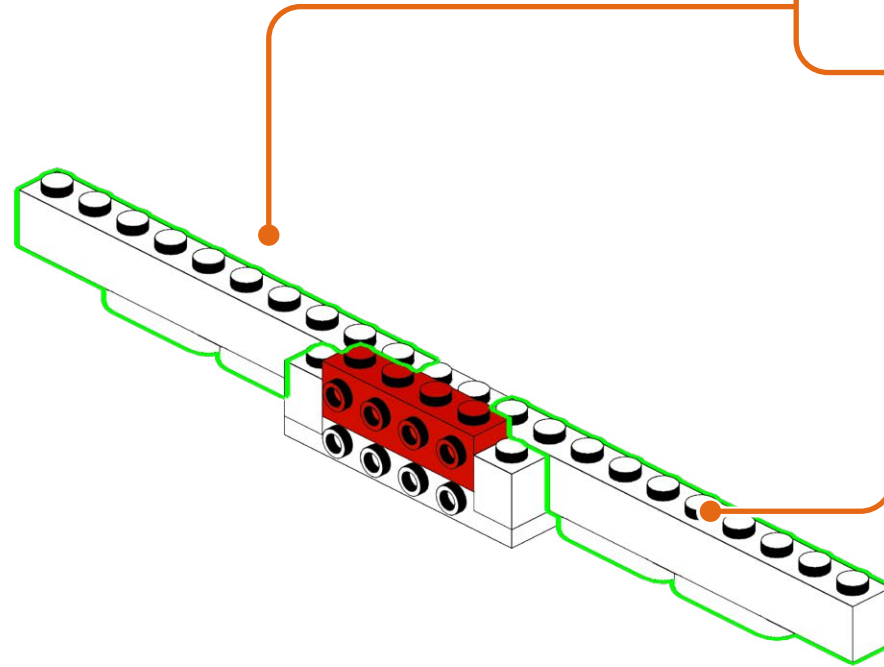
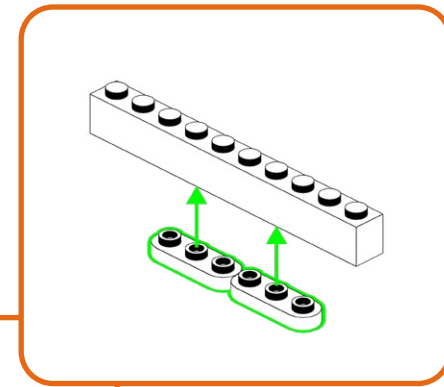
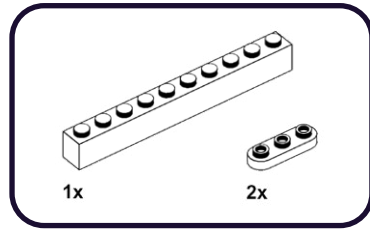
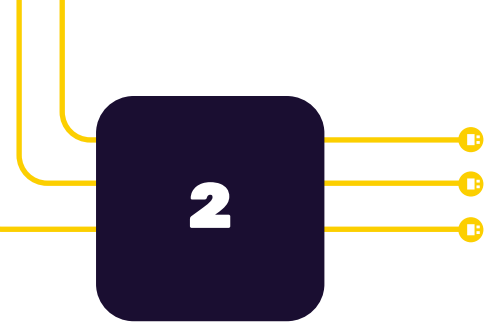

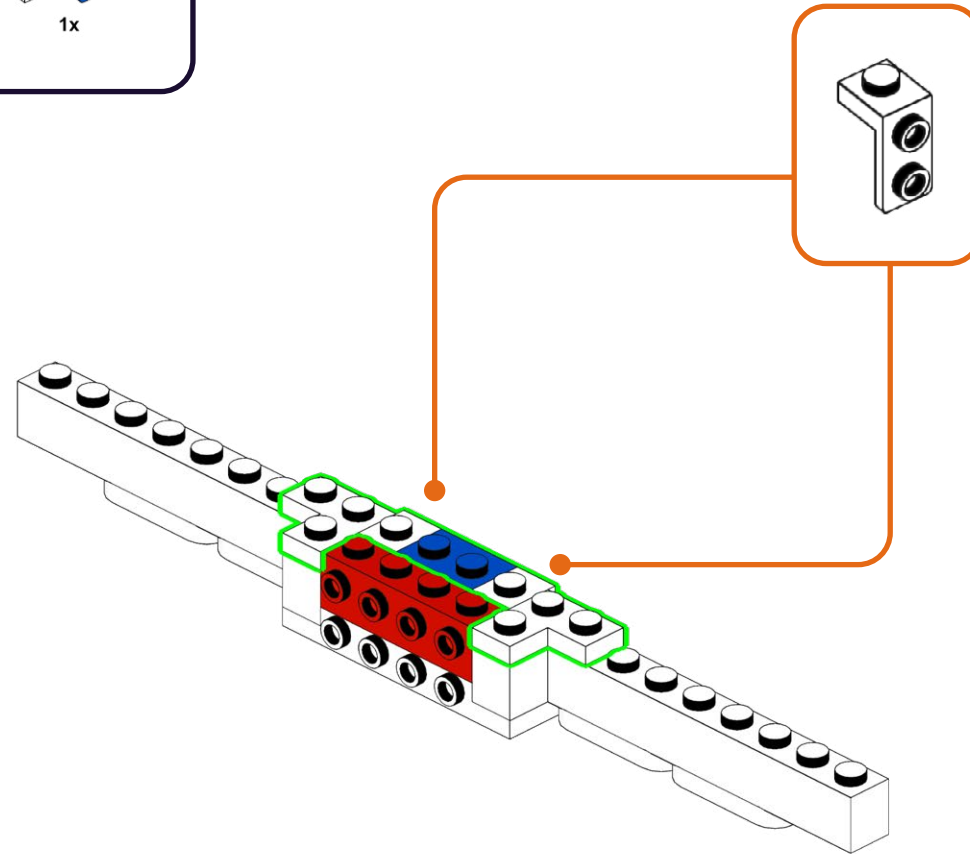
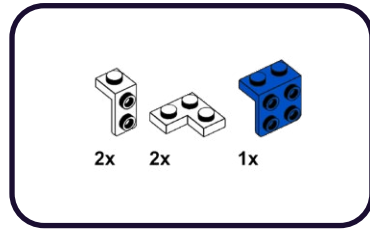

4

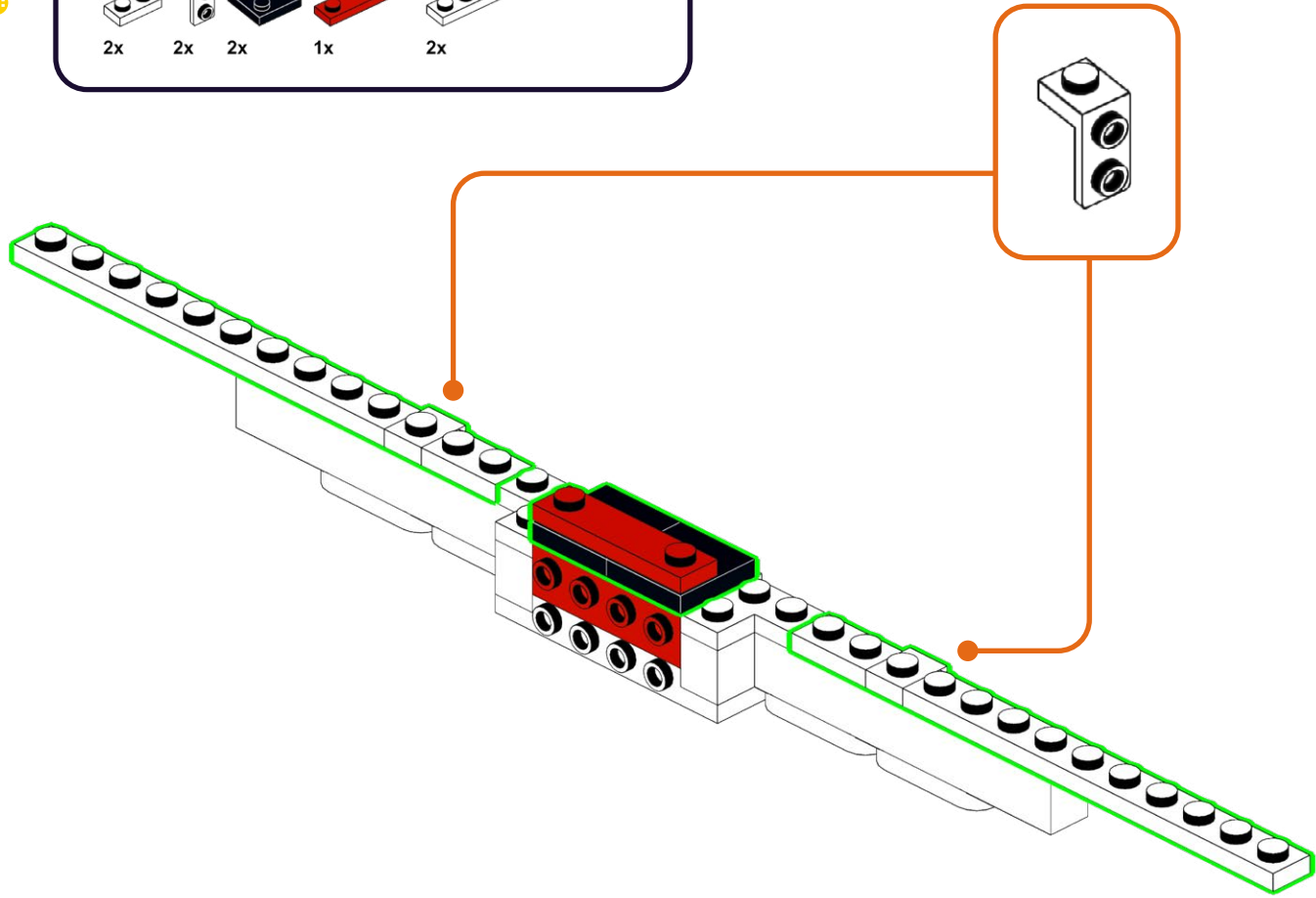
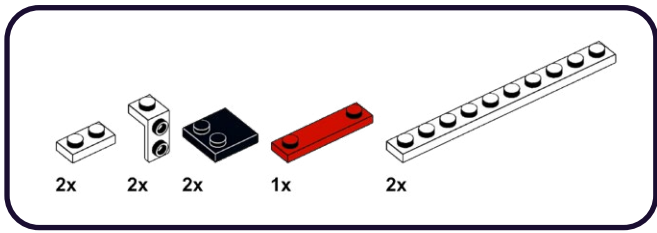

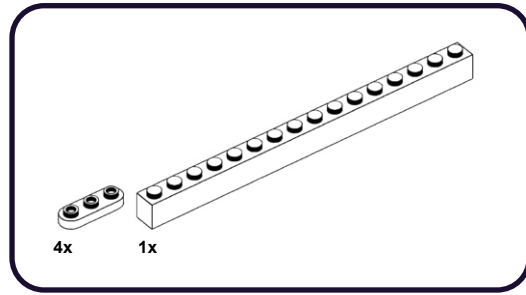

1

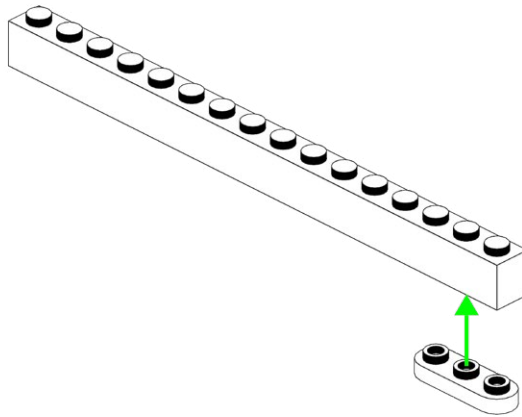

2

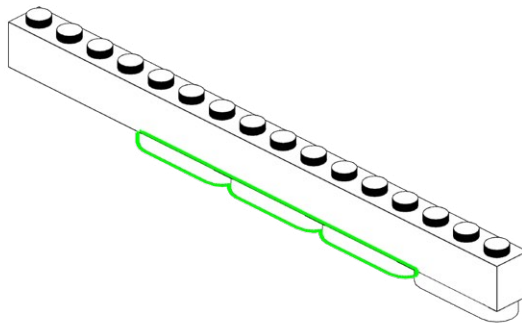

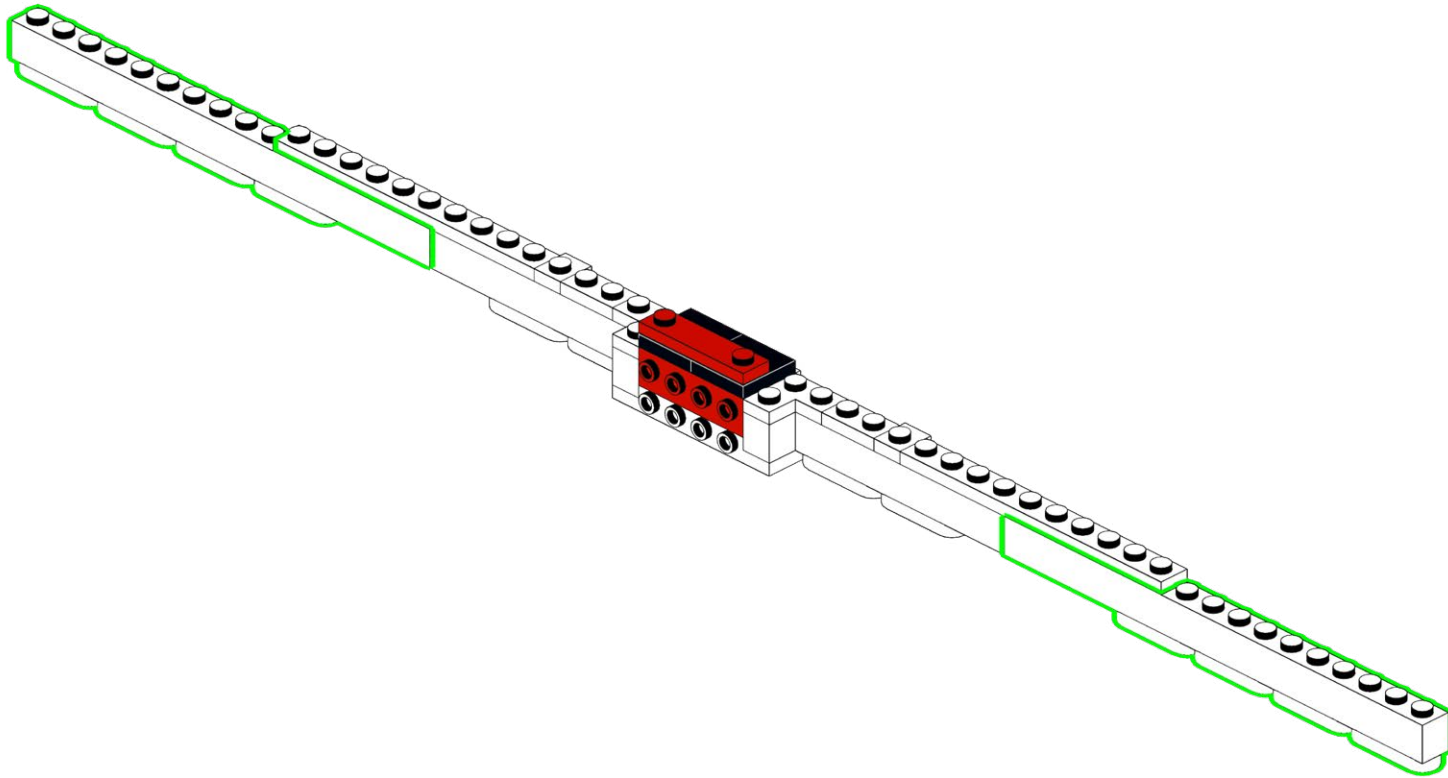

7

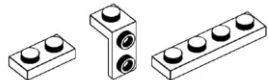

2x

4x

2x

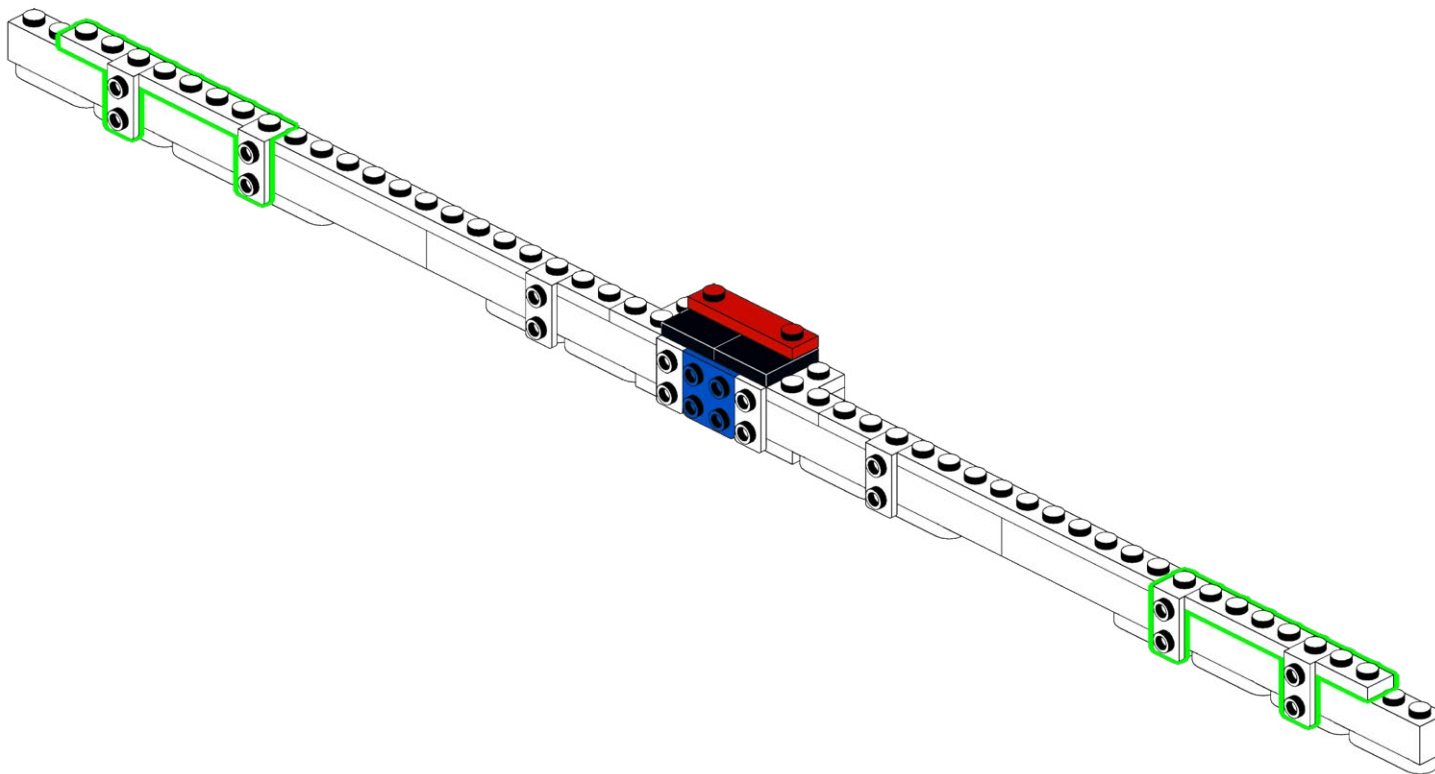

8

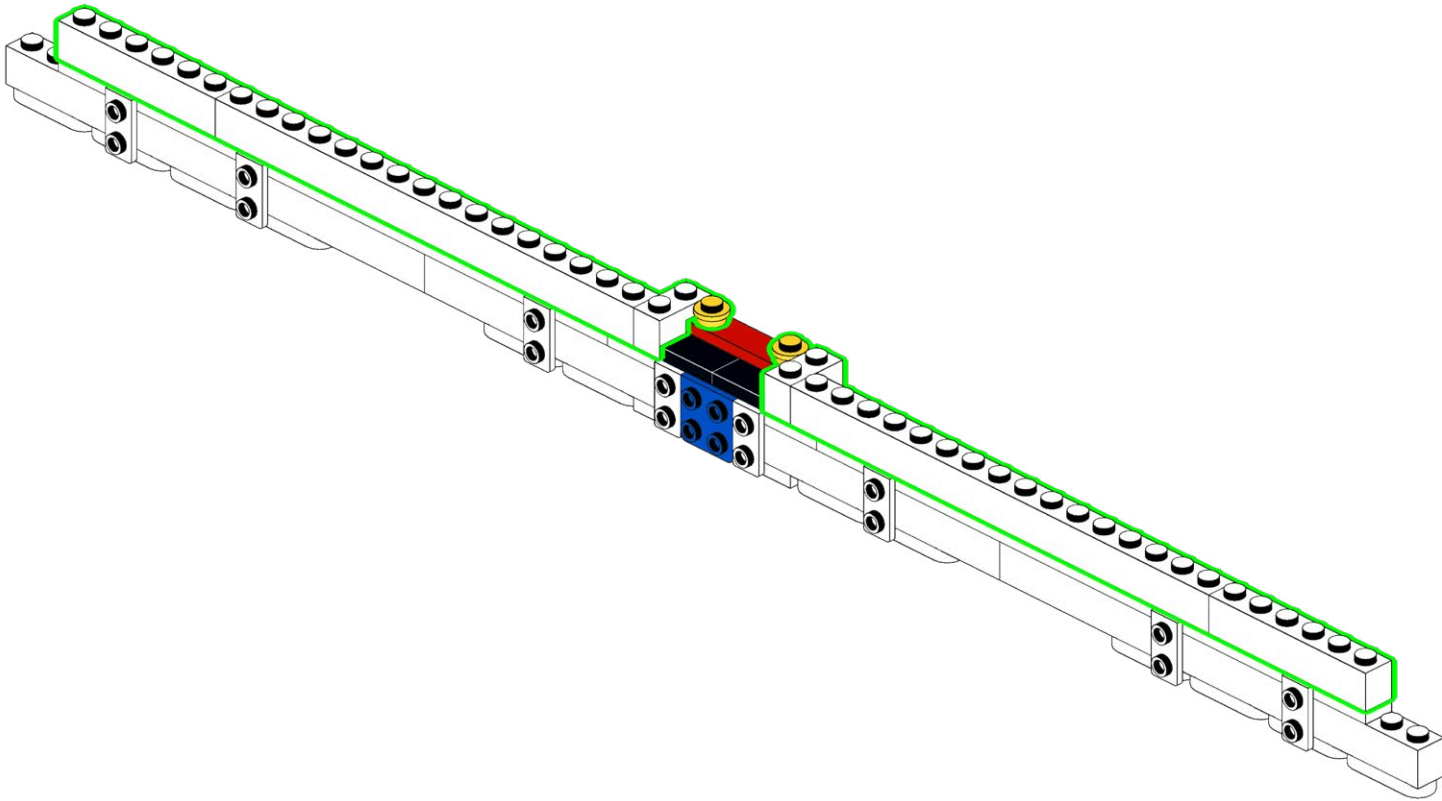
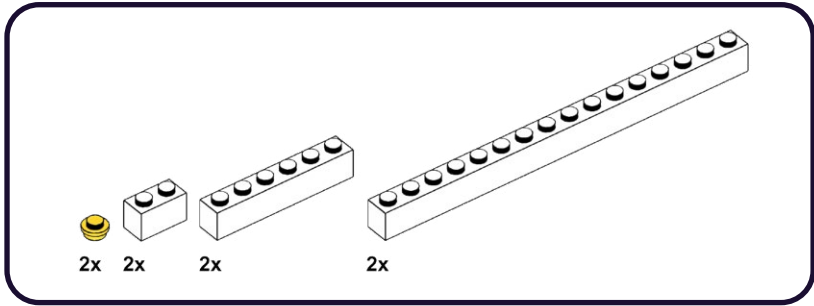
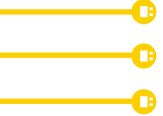

9

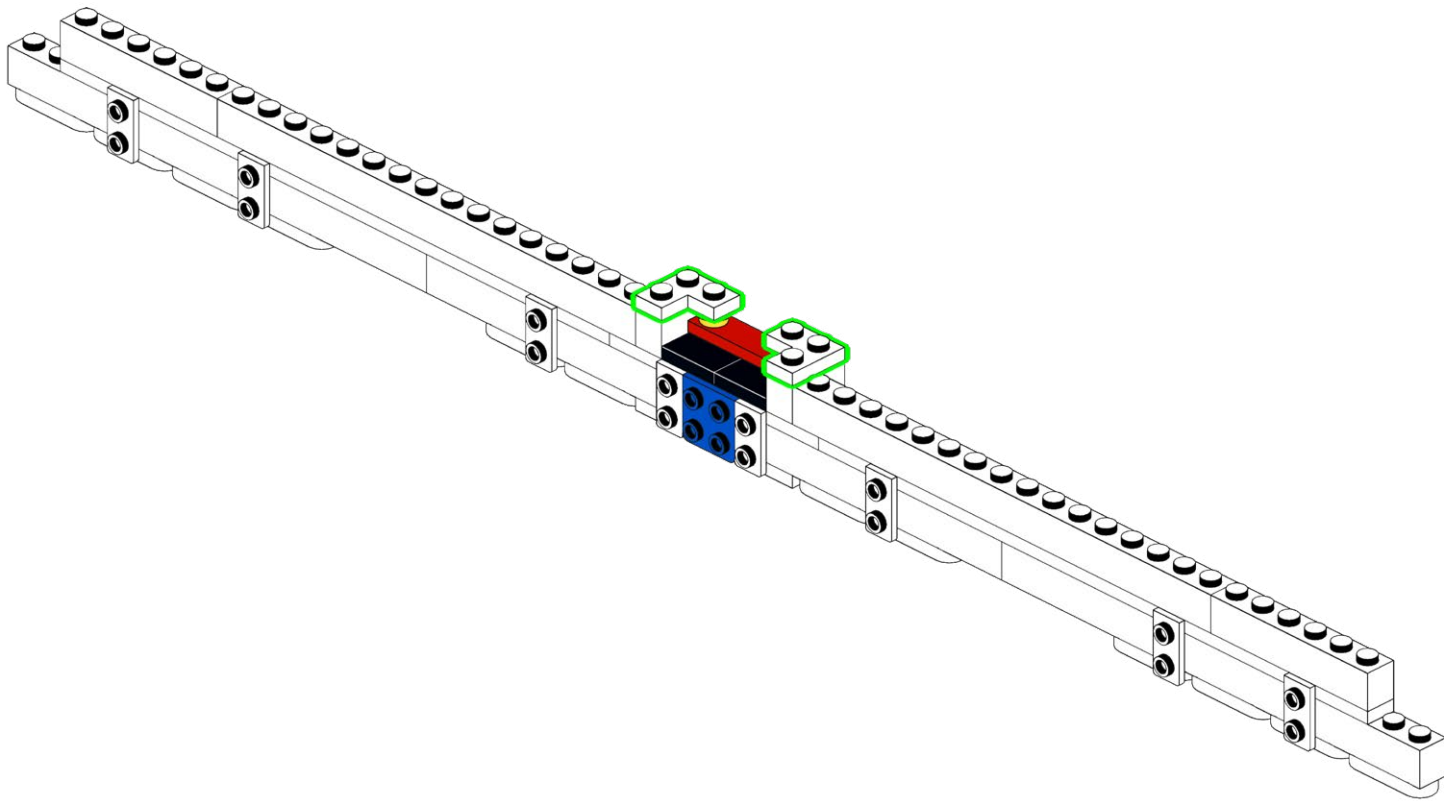
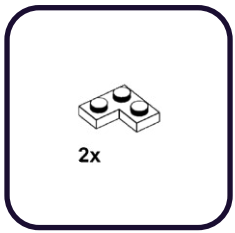



10

2x 2x 2x

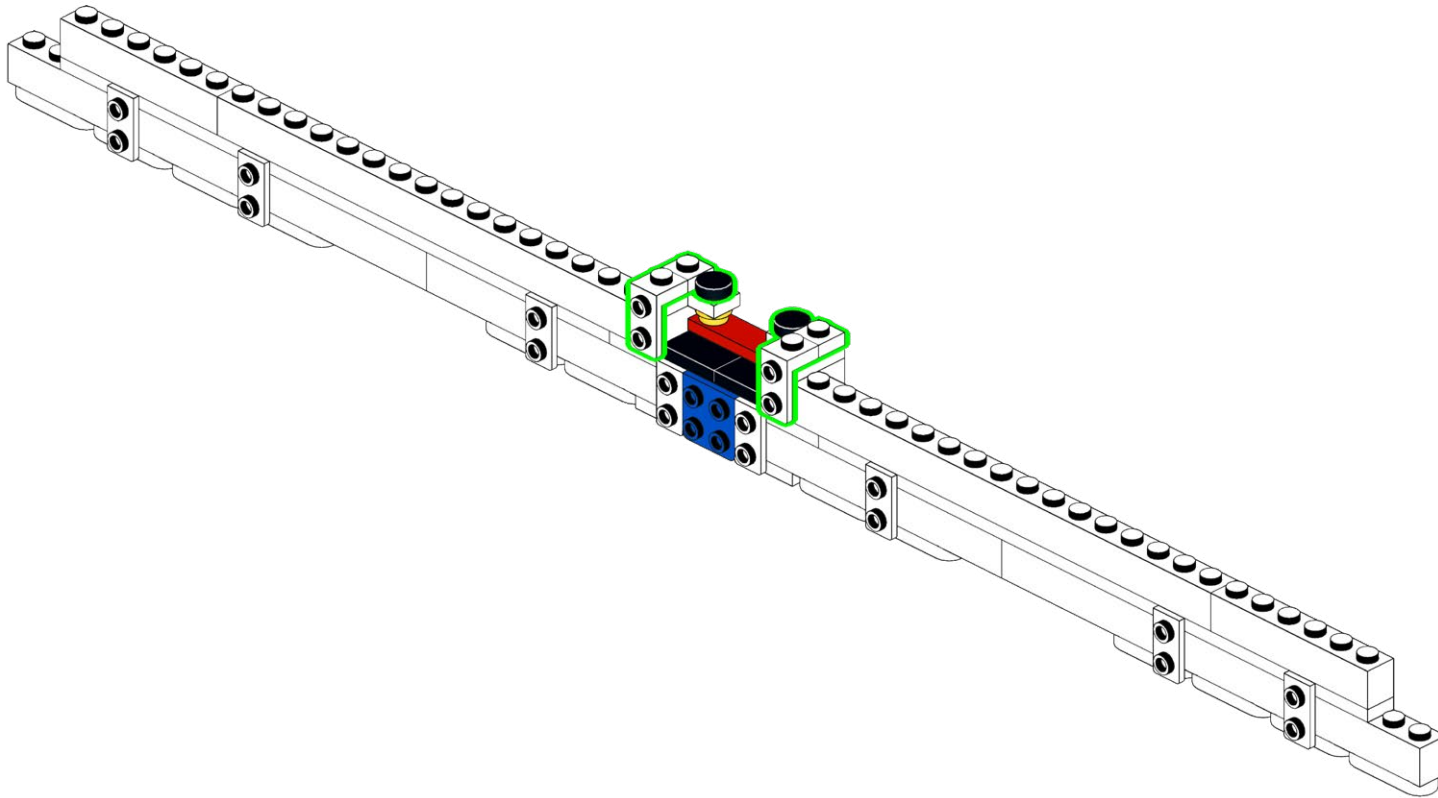

11

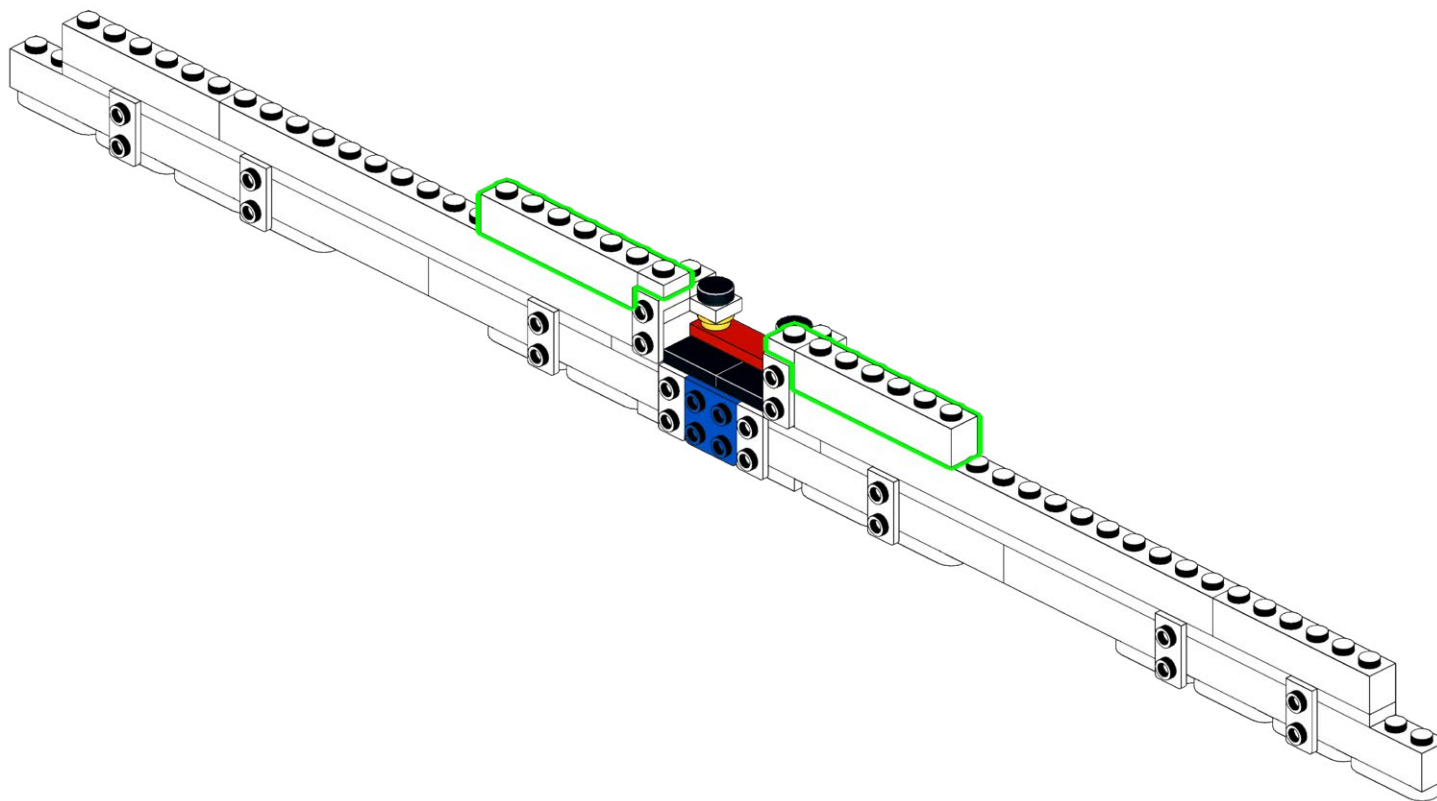
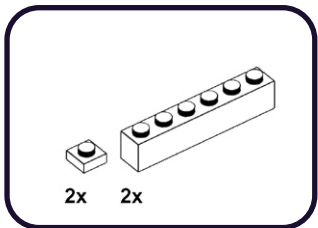

12

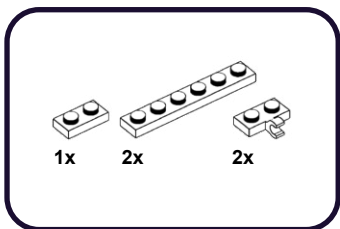

1

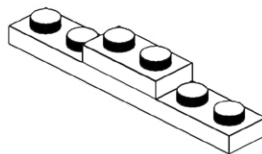

2

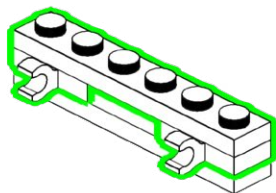

13

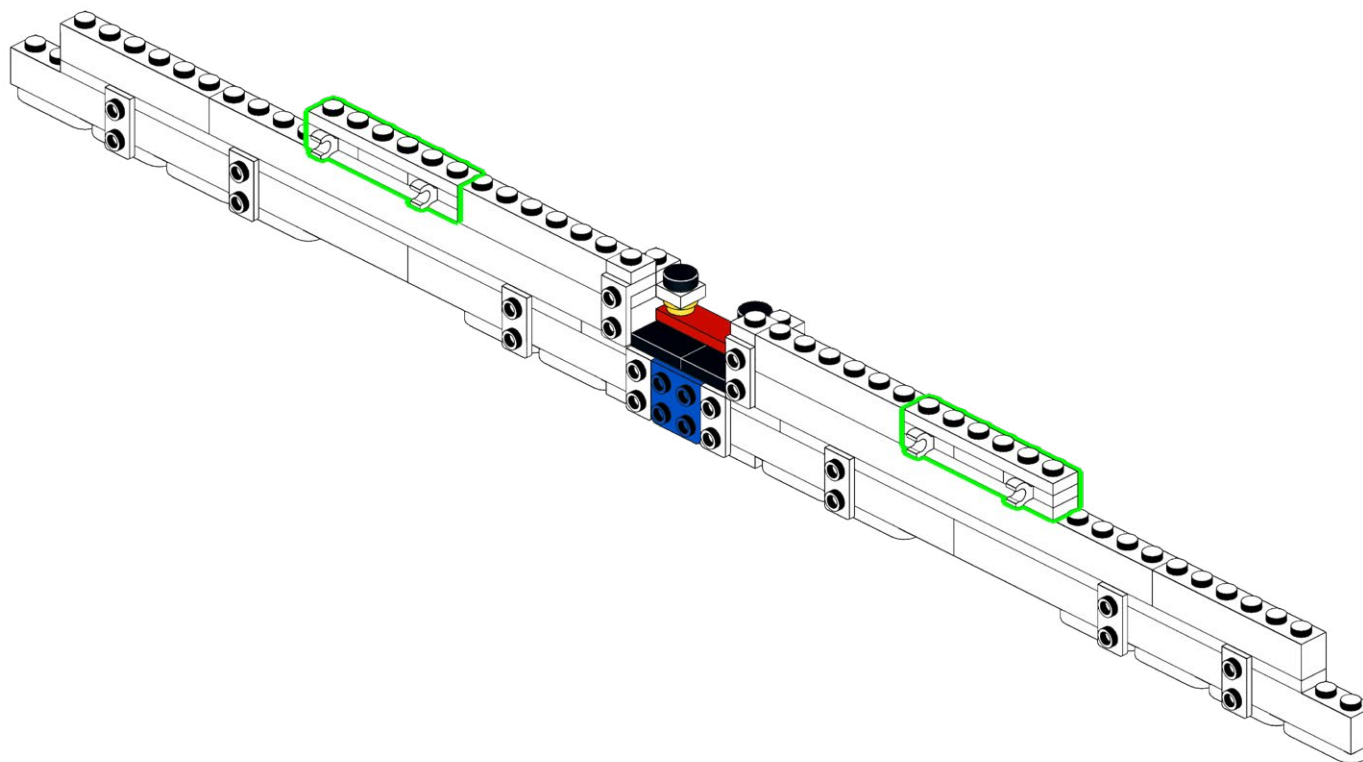

14

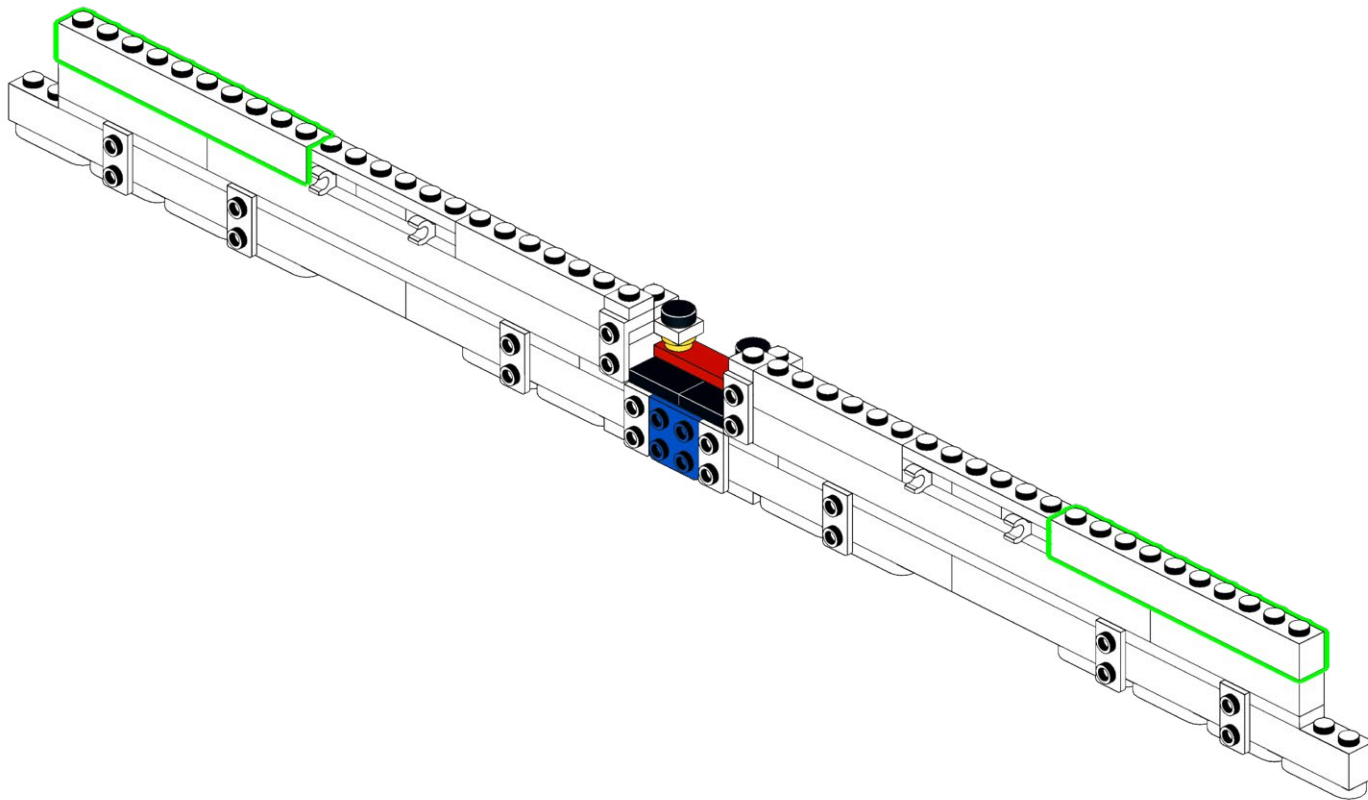
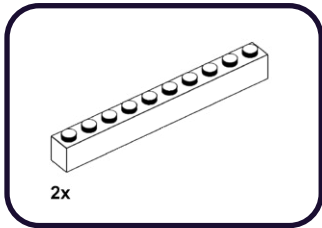

15

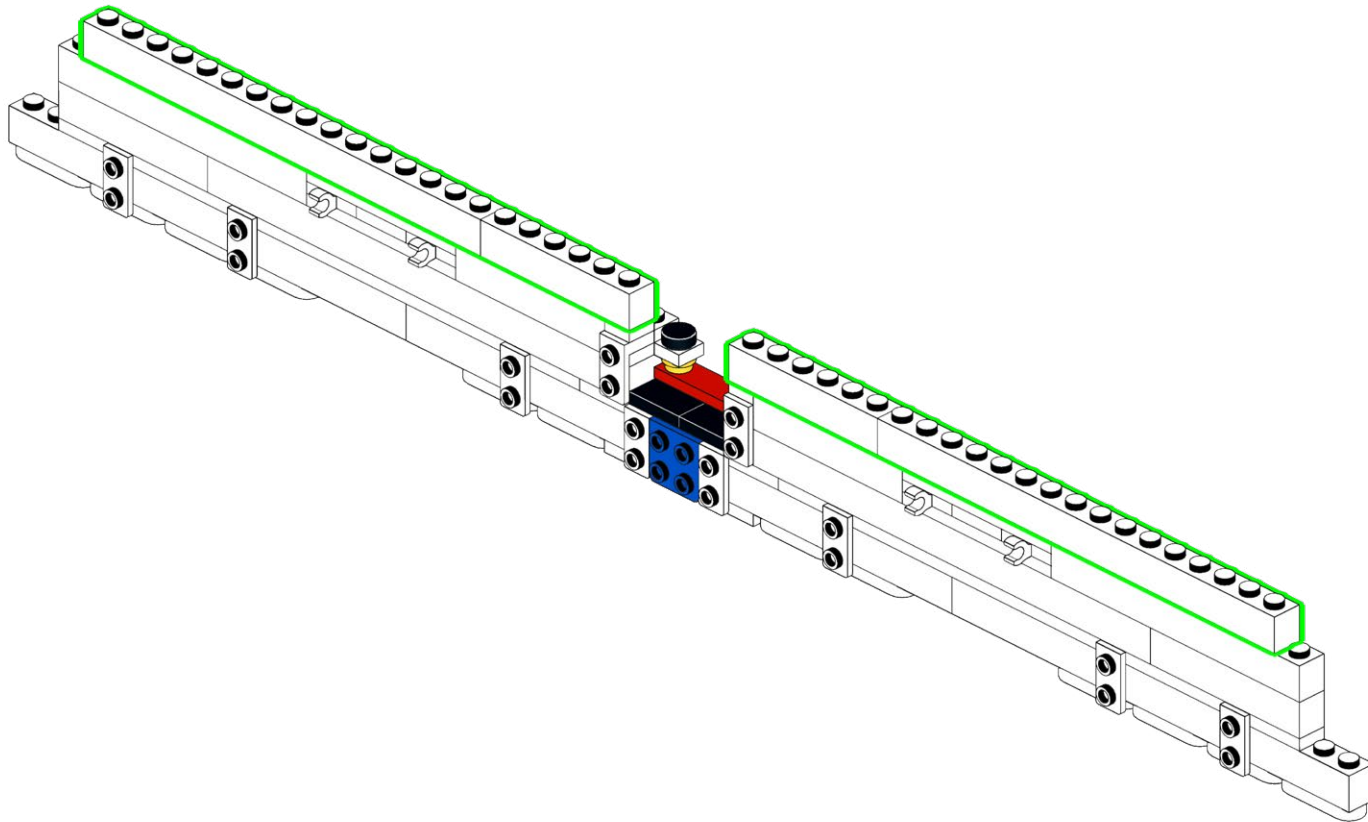
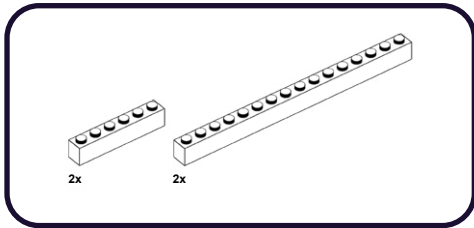

**HOLD UP!**

You might notice some bags aren't in order, as well as left over pieces, but that's ok! We're changing the way you build LEGO!

**ATTENDEZ!**

Vous remarquerez peut-être que certains sacs, ainsi que certaines pièces, ne sont pas dans le bon ordre. Mais pas de panique! Nous changeons simplement la façon avec laquelle vous construisez vos LEGO!

**ASPETTA!**

Potresti notare che alcuni sacchetti non sono in ordine, così come i pezzi avanzati, ma va bene così! Stiamo cambiando il modo in cui costruisci i LEGO!

**HALT!**

Sie werden möglicherweise bemerken, dass einige tüten durcheinander sind und teile übrig bleiben, aber das ist in Ordnung! Wir ändern die art und weise, wie Sie LEGO bauen!

**¡ESPERA!**

Es posible que notes que algunas bolsas están fuera de servicio, así como piezas sobrantes, ¡pero está bien! ¡Estamos cambiando la forma en que construyes LEGO!

**暫停!**

你可能会注意到一些袋子顺序错乱, 以及一些剩余的部件, 但没关系! 我们正在改变你搭建乐高的方式!

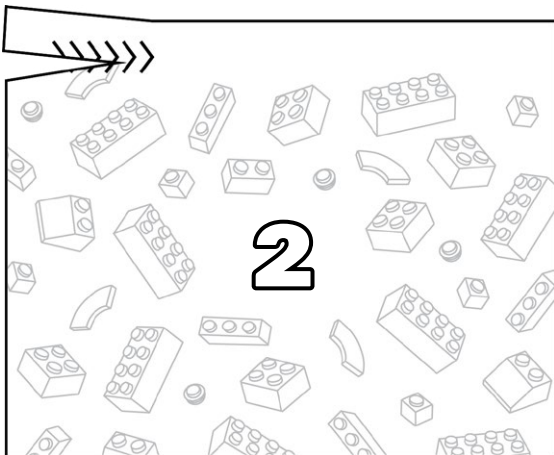
**Open LEGO® Bag 2**

16

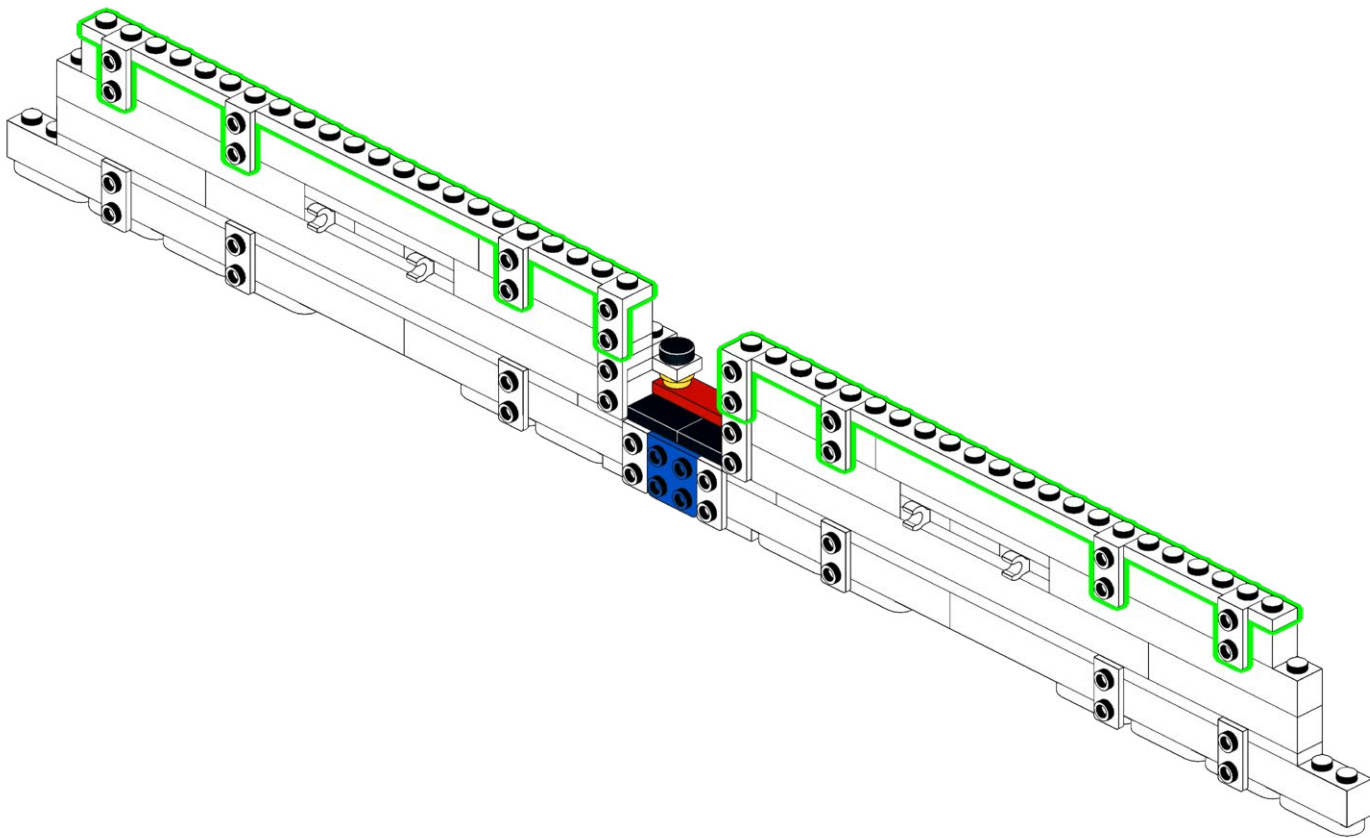
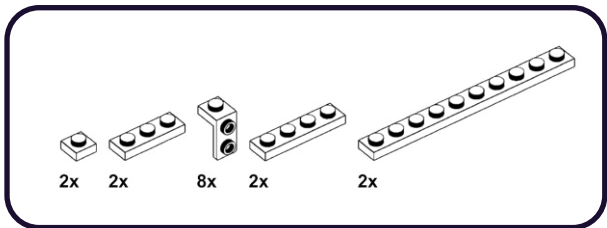



17

2x

2x

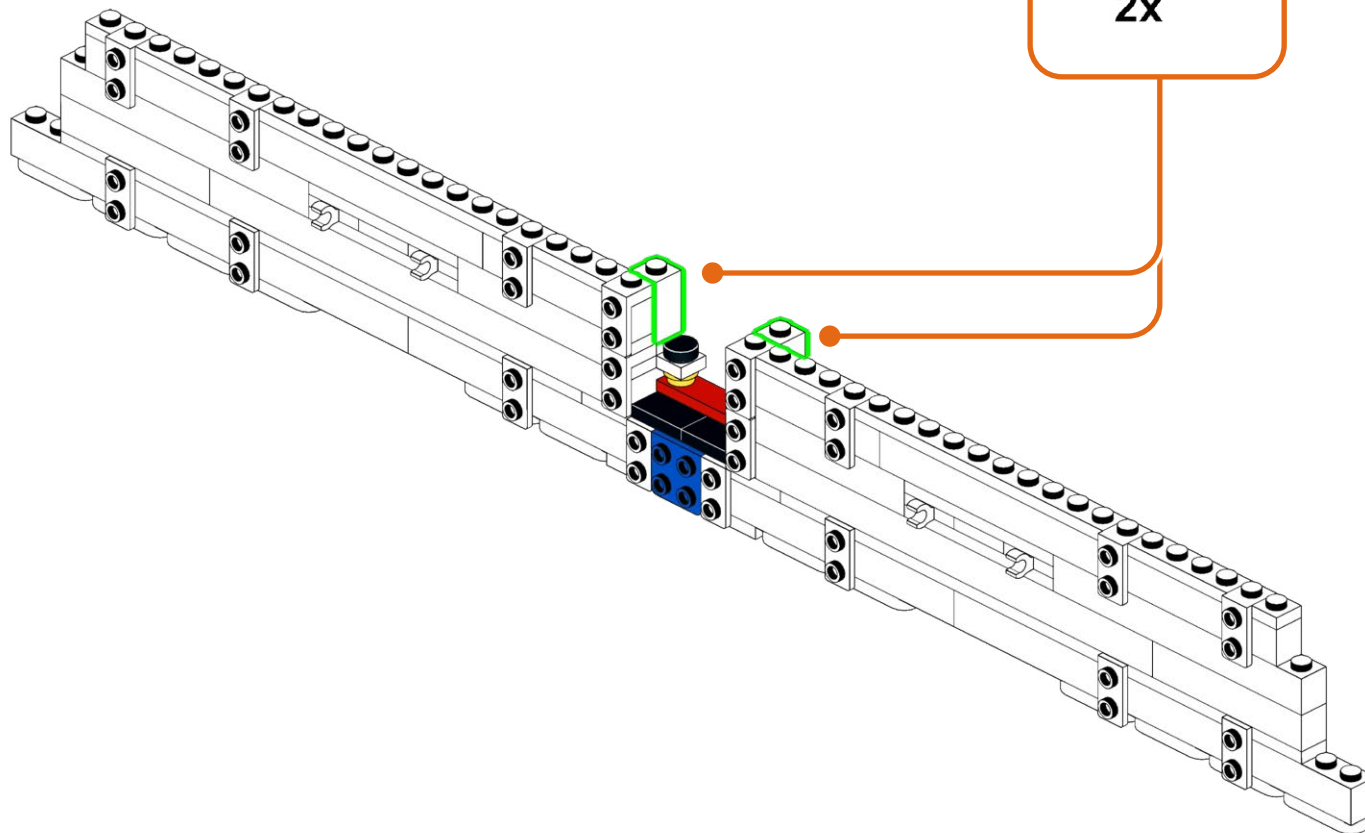

18

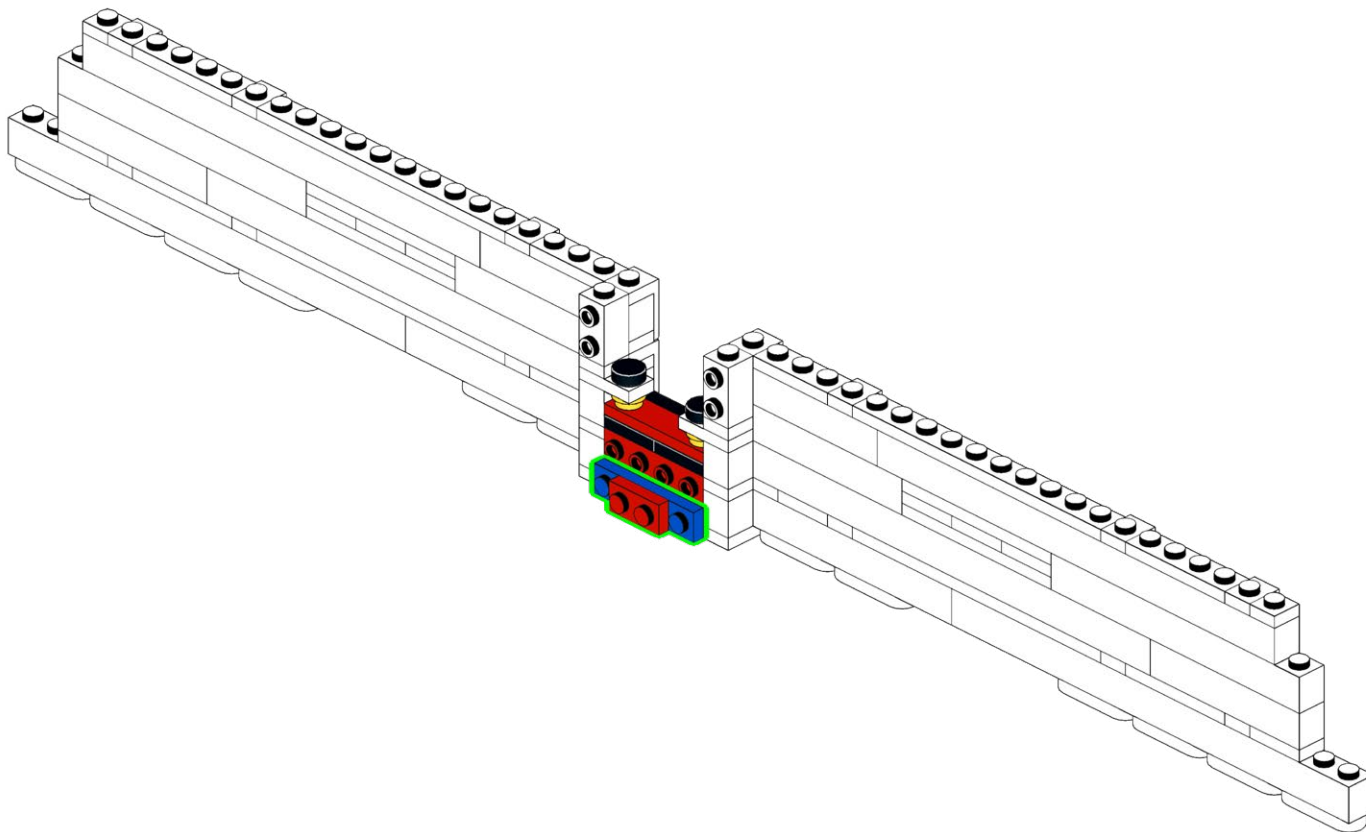
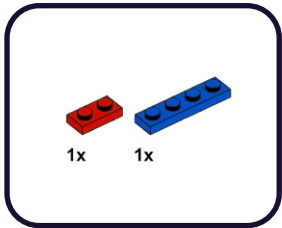

19

2x

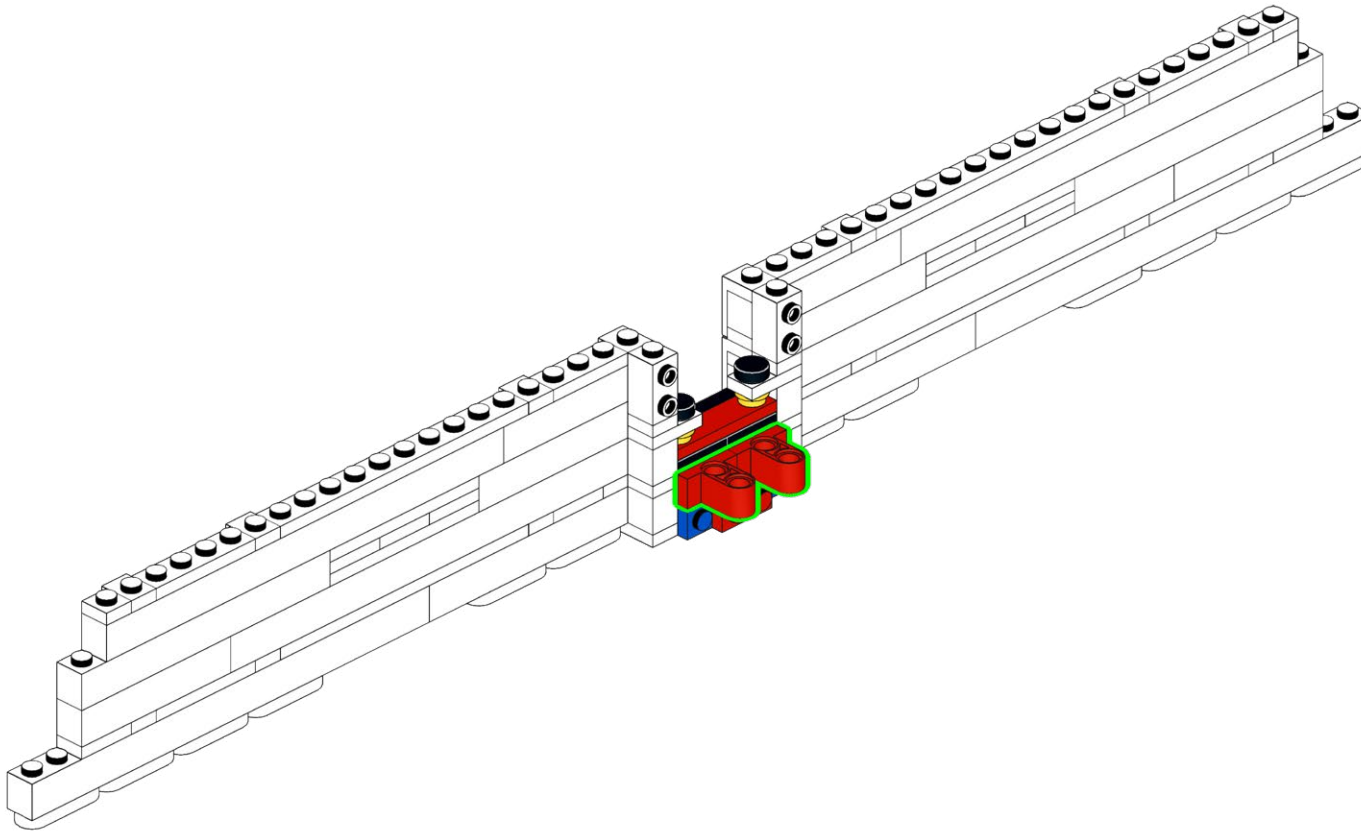

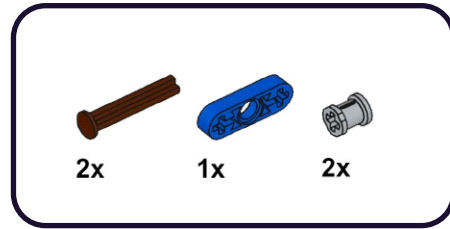
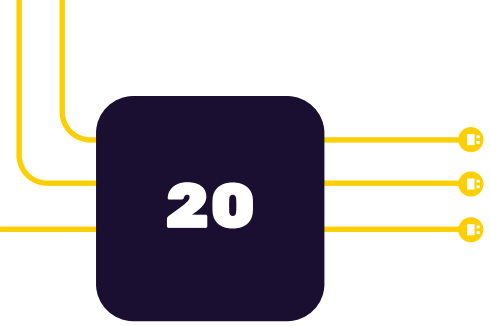

1

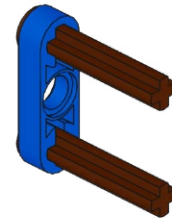

2

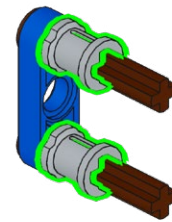

21

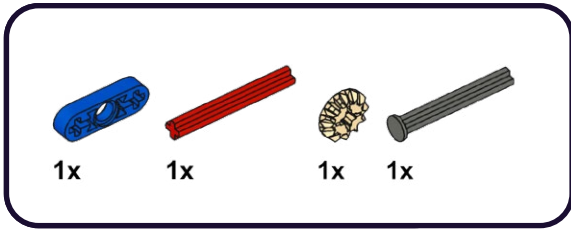

1

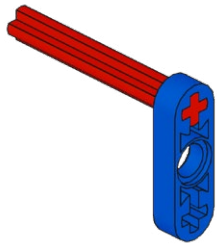

2

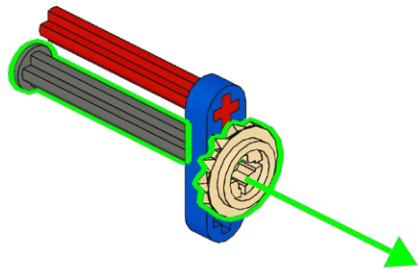

22

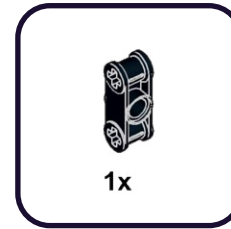

1

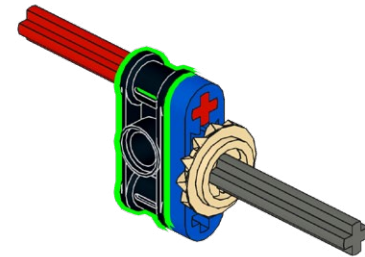

2x

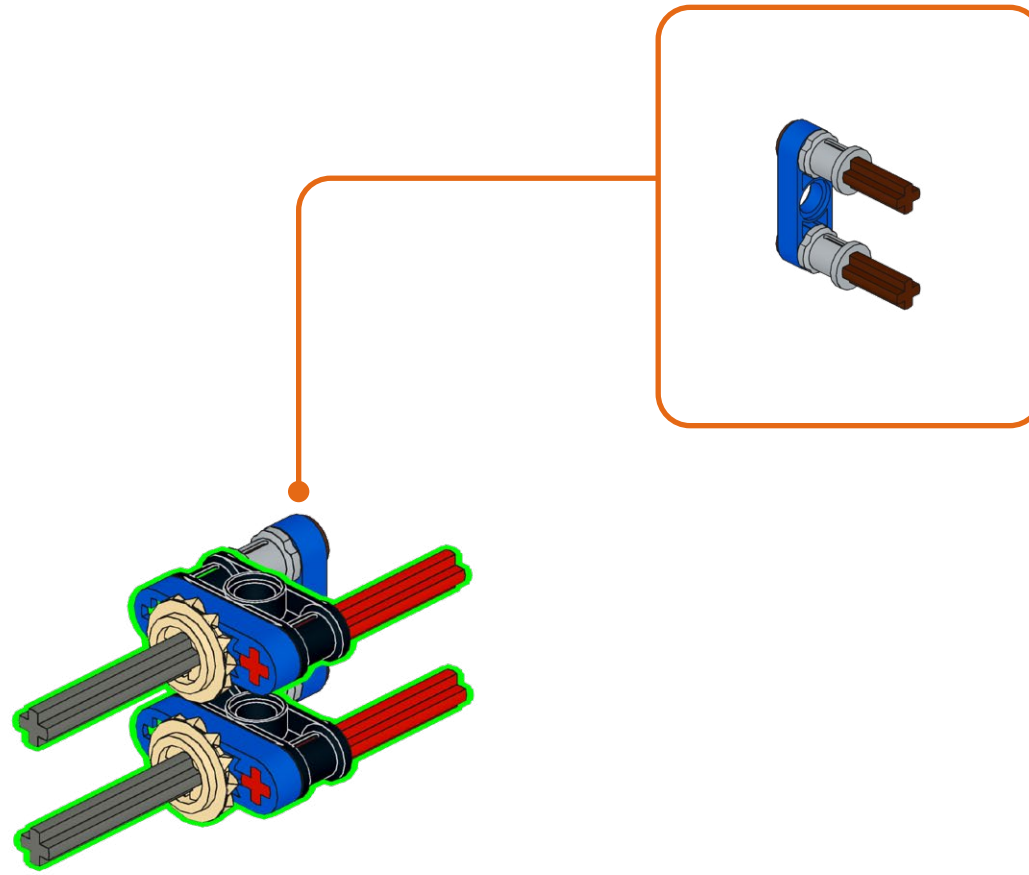
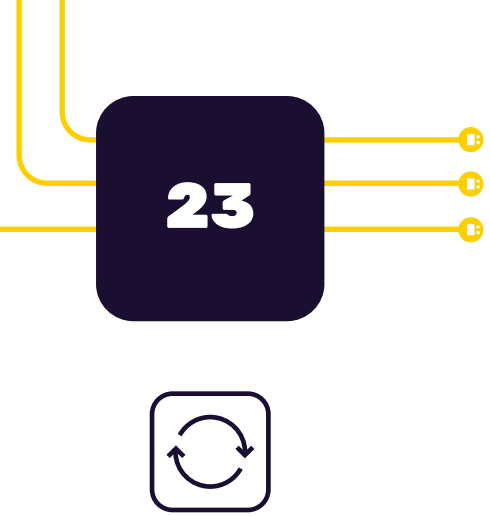

24

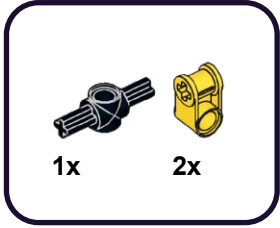

1

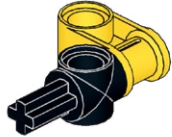

2



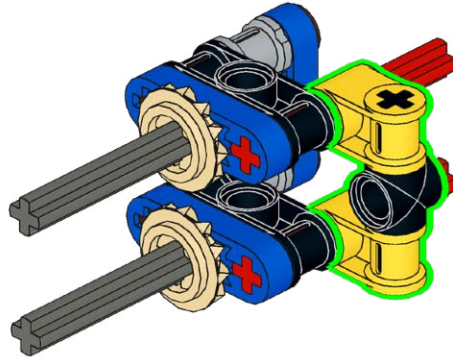



26

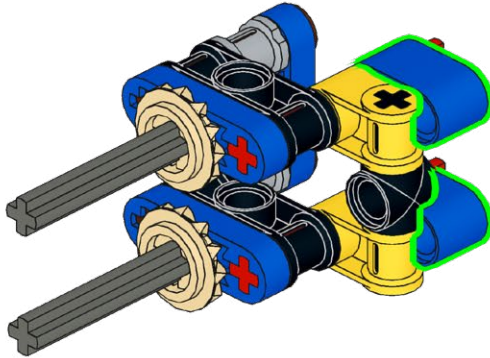
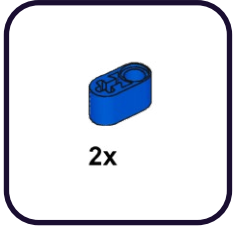

27

2x

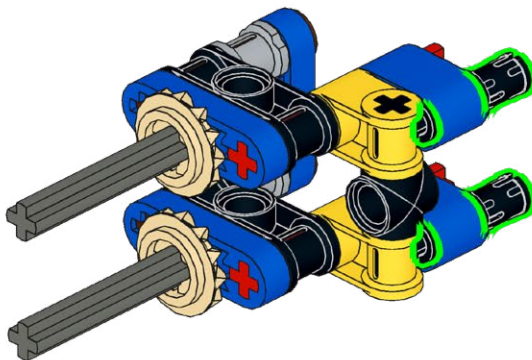

28

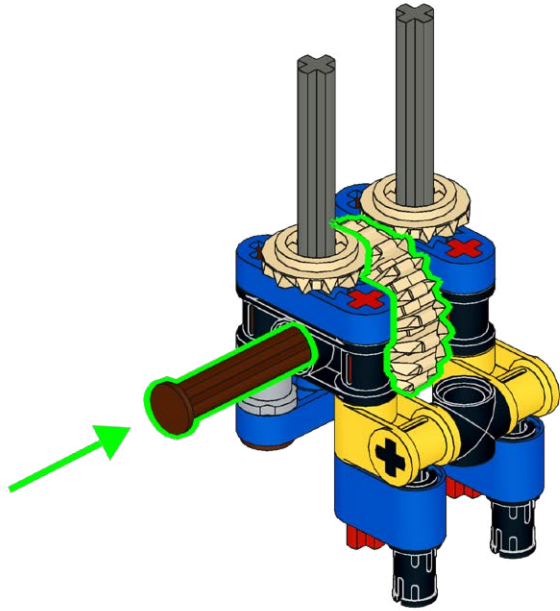
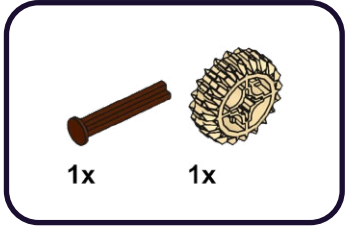

29

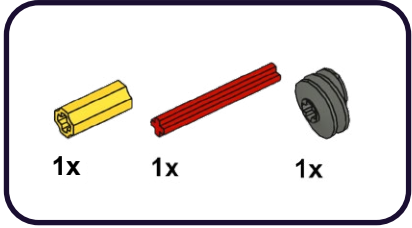

1

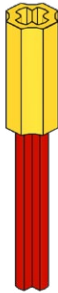

2

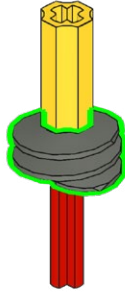

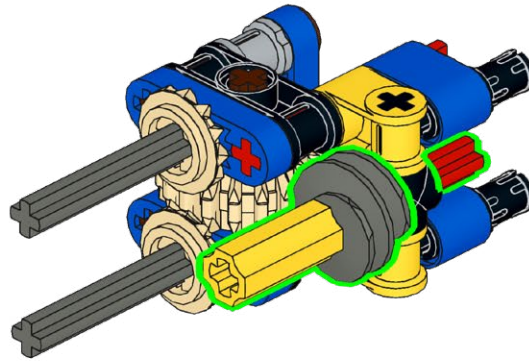

31

1x

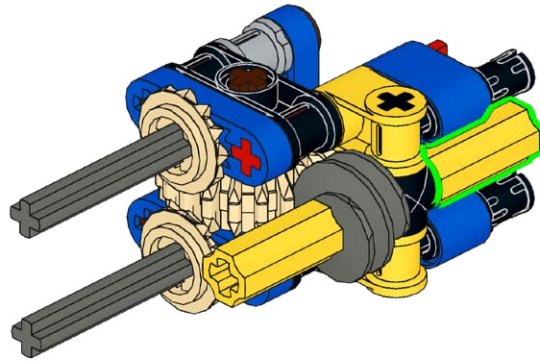

32

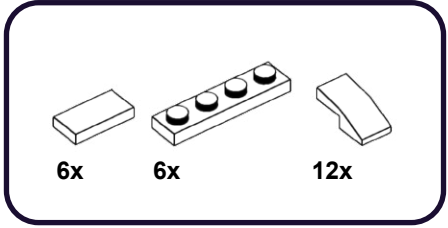

1

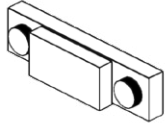

2

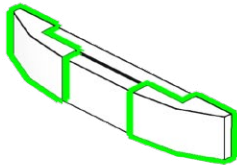

33

To be used later  
A utiliser plus tard  
Da utilizzare dopo  
Zur späteren Verwendung  
Para ser utilizado más tarde  
稍后使用

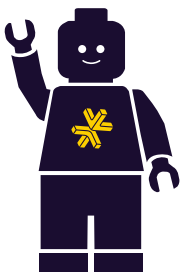

 LMB

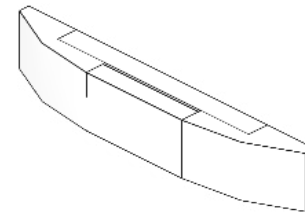
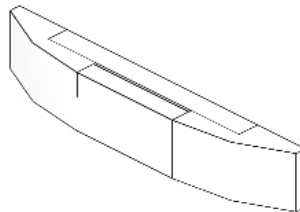
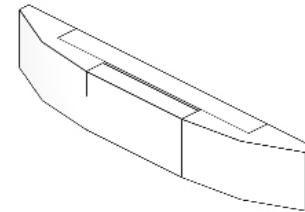
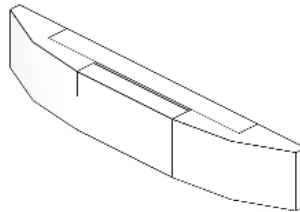
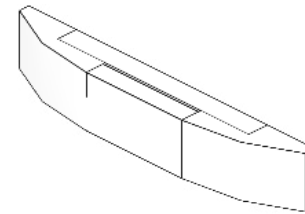
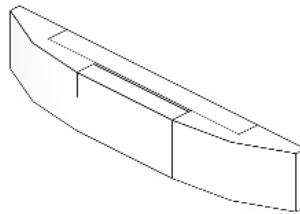

6x



34

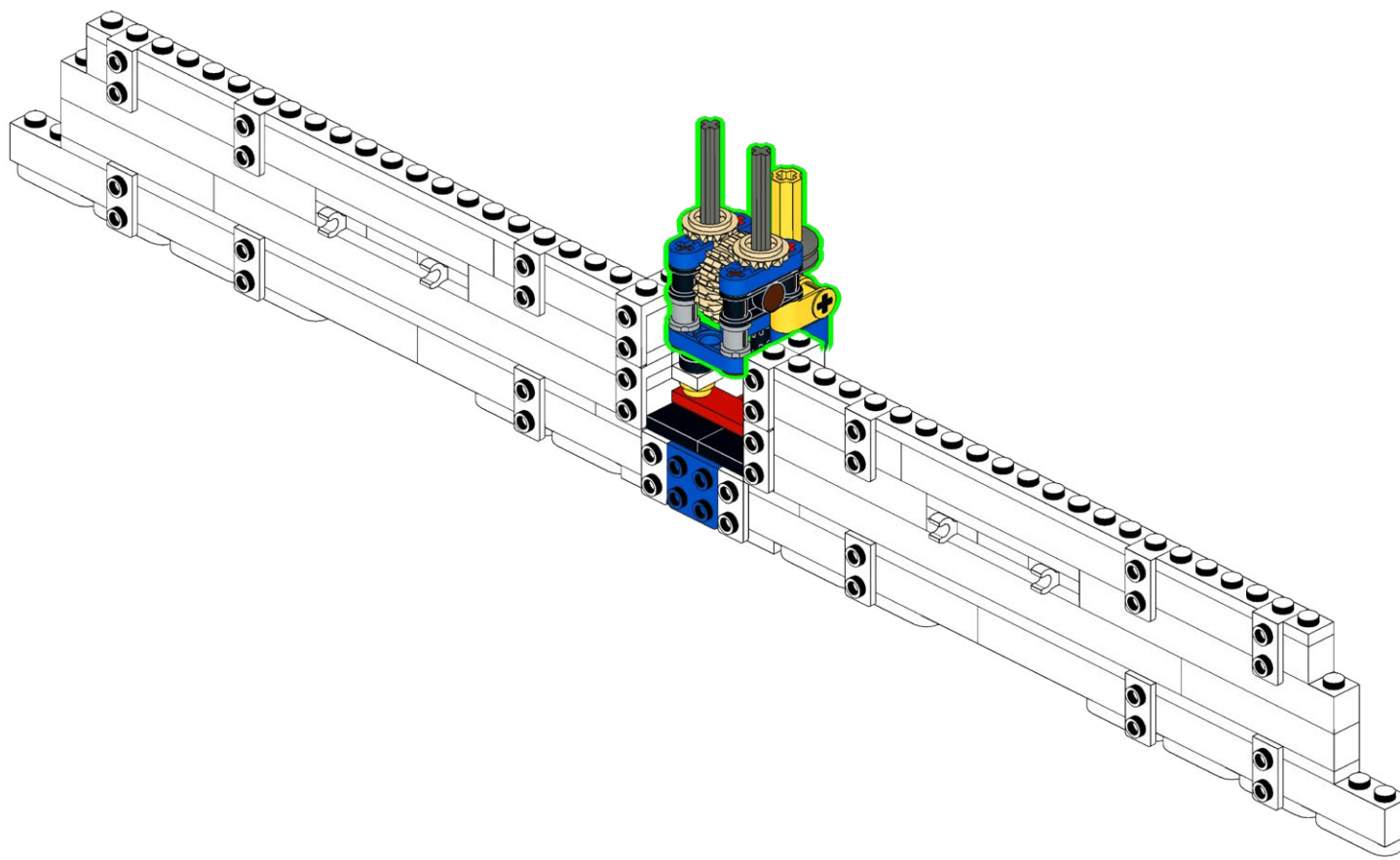

35

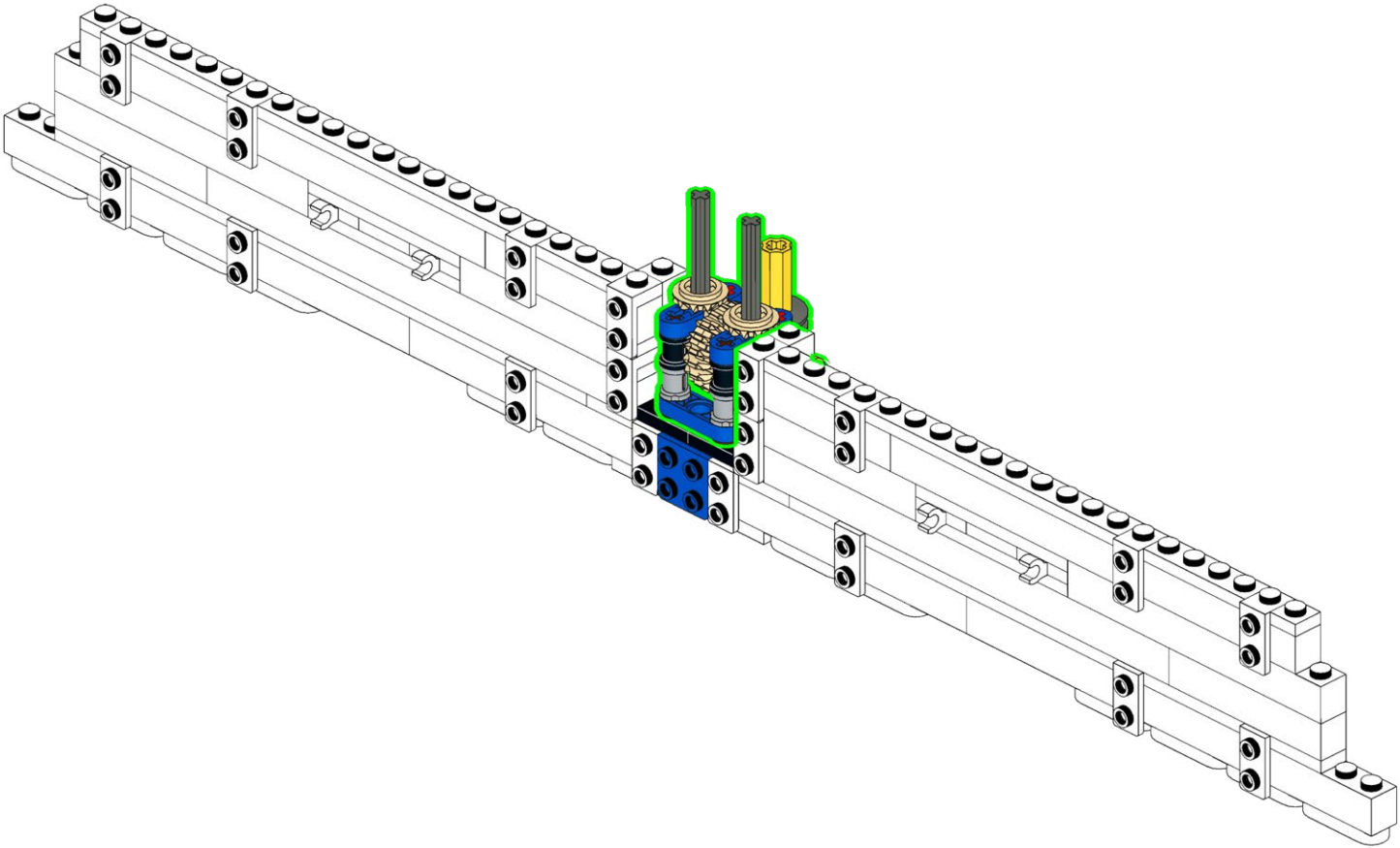
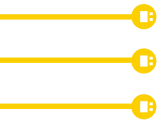

36

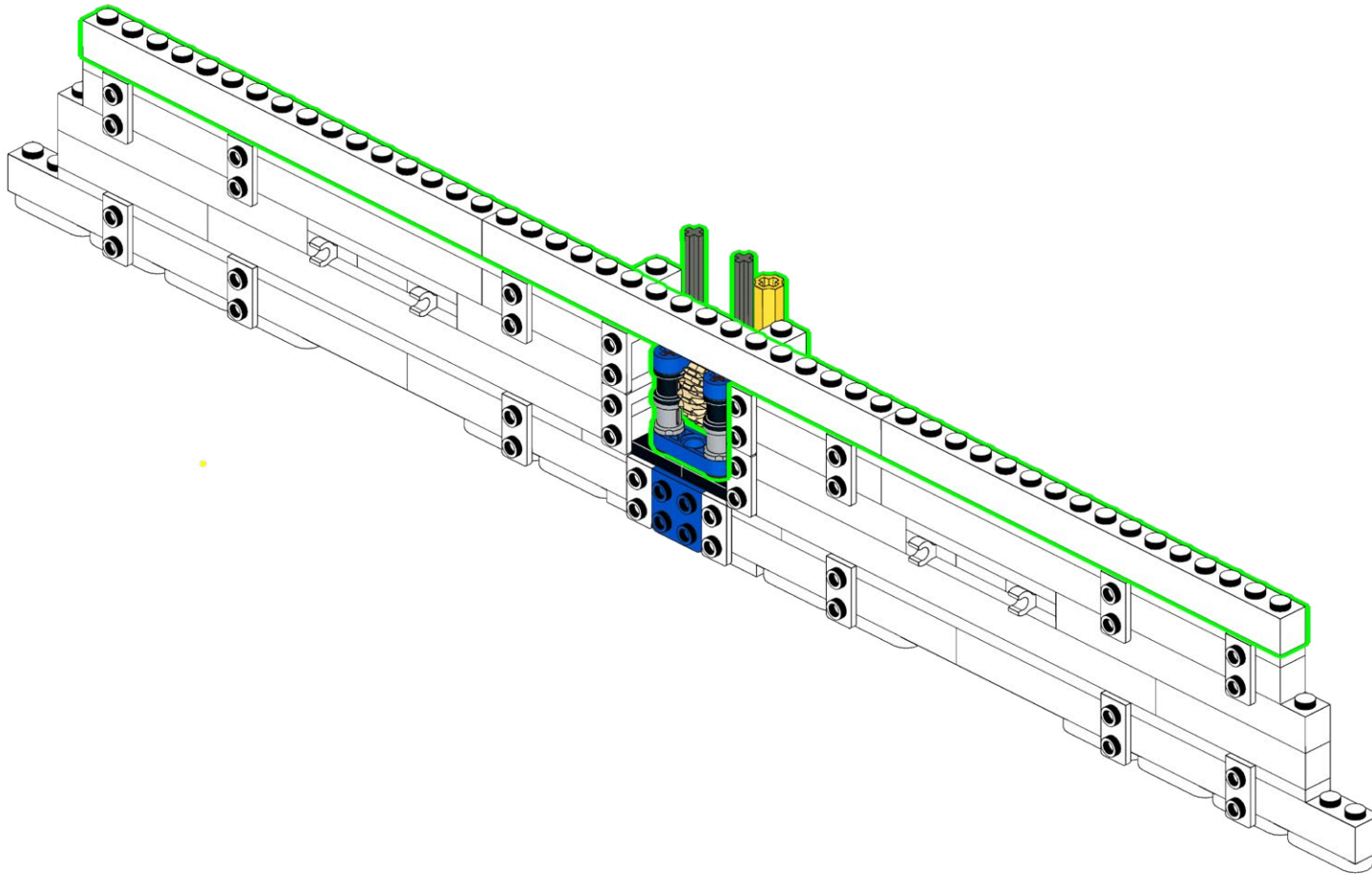
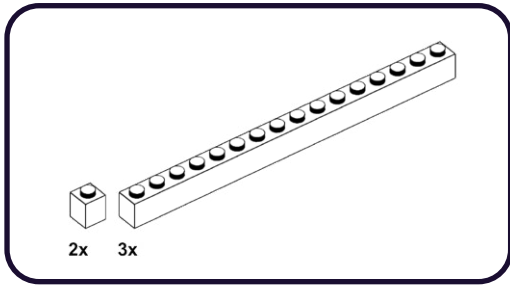

**HOLD UP!**

You might notice some bags aren't in order, as well as left over pieces, but that's ok! We're changing the way you build LEGO!

**ATTENDEZ!**

Vous remarquerez peut-être que certains sacs, ainsi que certaines pièces, ne sont pas dans le bon ordre. Mais pas de panique! Nous changeons simplement la façon avec laquelle vous construisez vos LEGO!

**ASPETTA!**

Potresti notare che alcuni sacchetti non sono in ordine, così come i pezzi avanzati, ma va bene così! Stiamo cambiando il modo in cui costruisci i LEGO!

**HALT!**

Sie werden möglicherweise bemerken, dass einige tüten durcheinander sind und teile übrig bleiben, aber das ist in Ordnung! Wir ändern die art und weise, wie Sie LEGO bauen!

**¡ESPERA!**

Es posible que notes que algunas bolsas están fuera de servicio, así como piezas sobrantes, ¡pero está bien! ¡Estamos cambiando la forma en que construyes LEGO!

**暫停!**

你可能会注意到一些袋子顺序错乱, 以及一些剩余的部件, 但没关系! 我们正在改变你搭建乐高的方式!

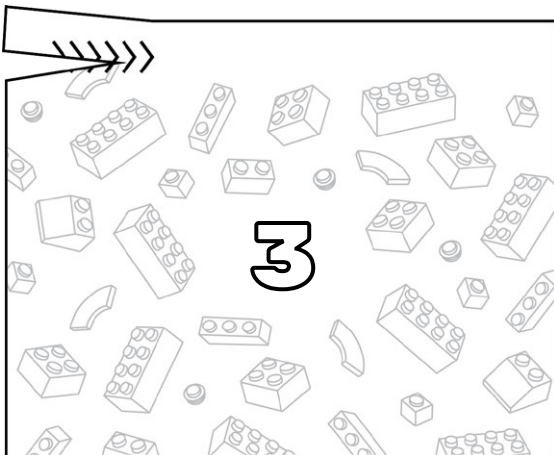
**Open LEGO® Bag 3**

37

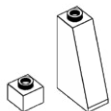

2x 2x

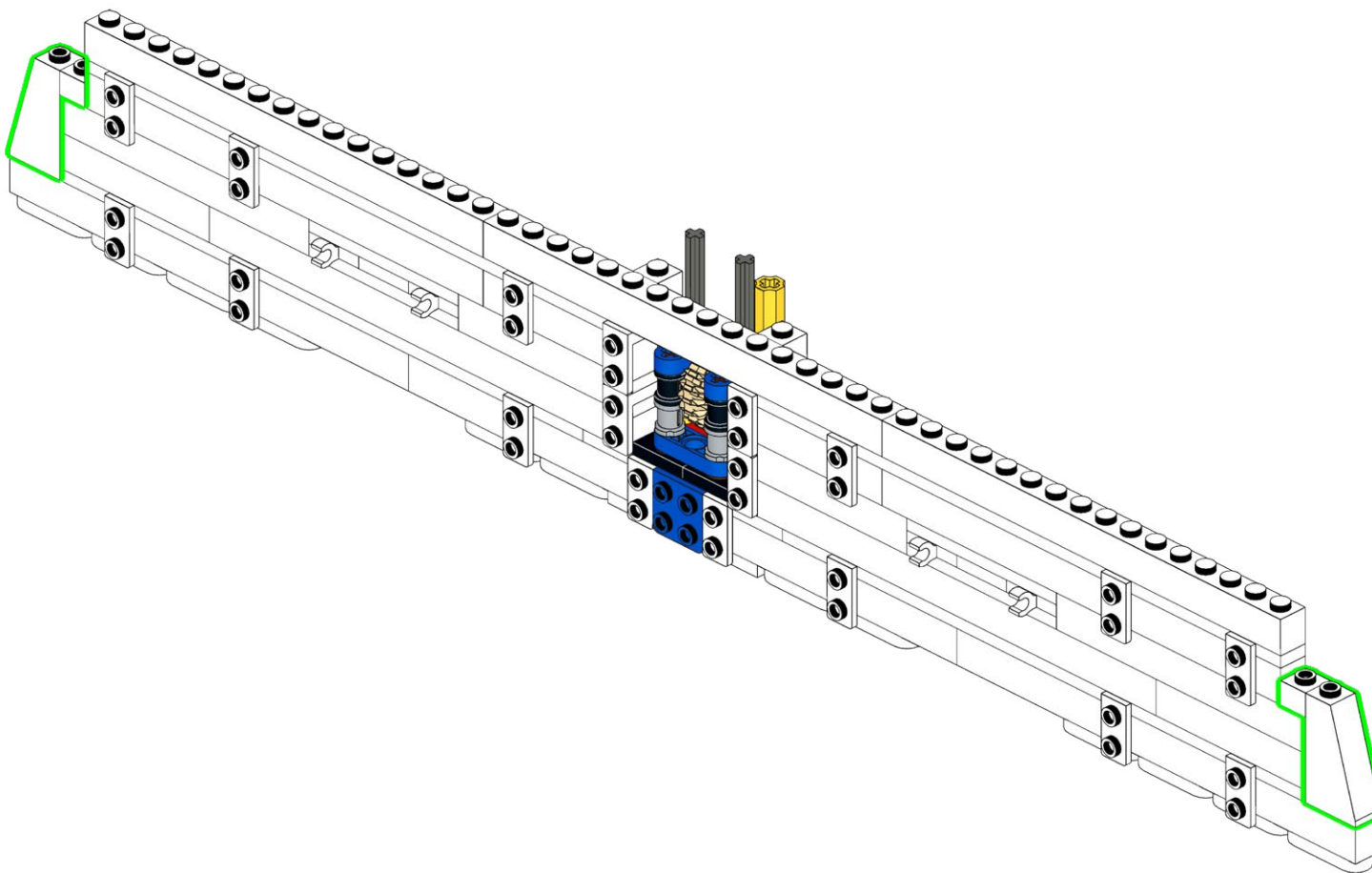

38

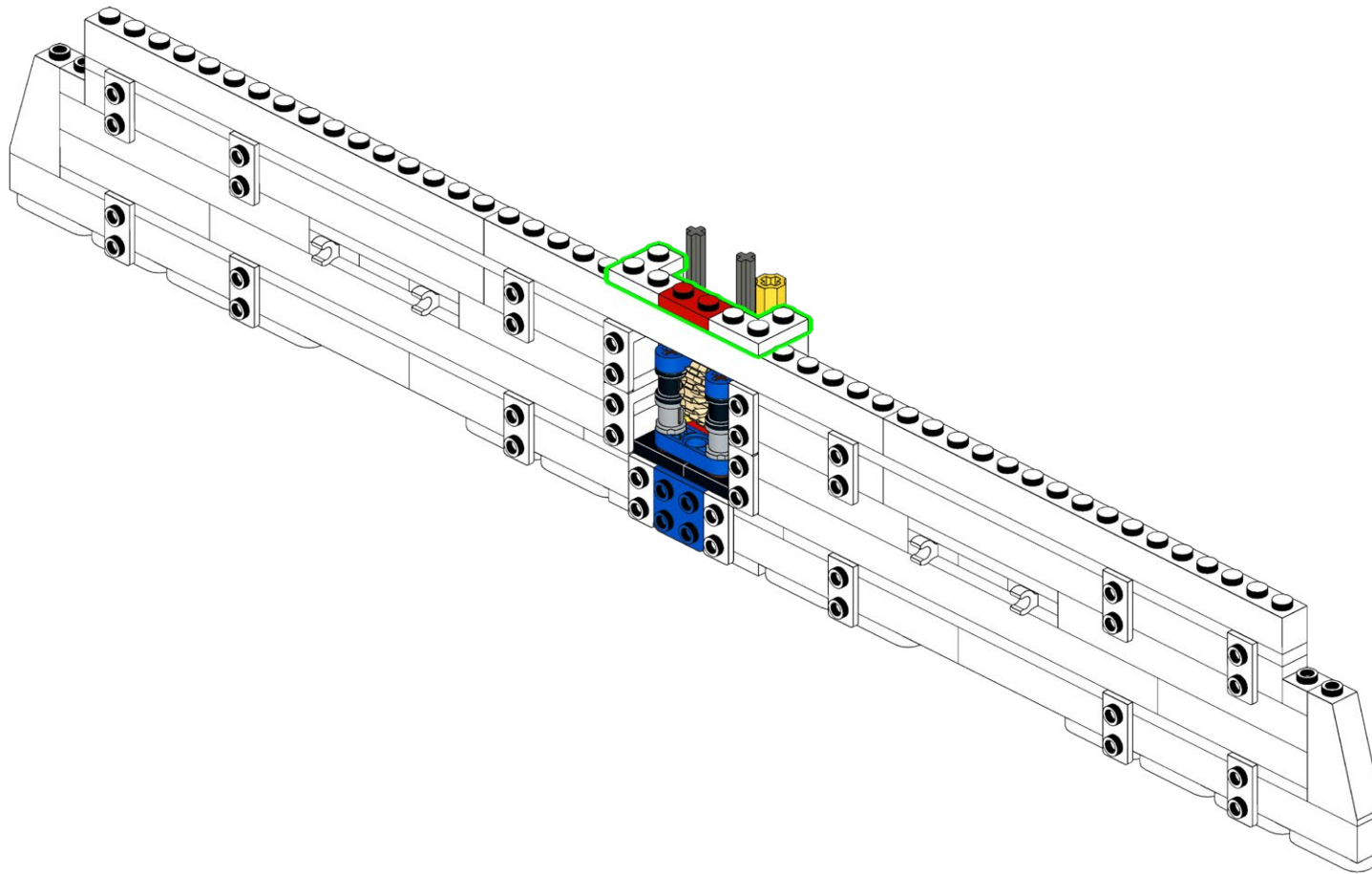
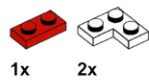

39

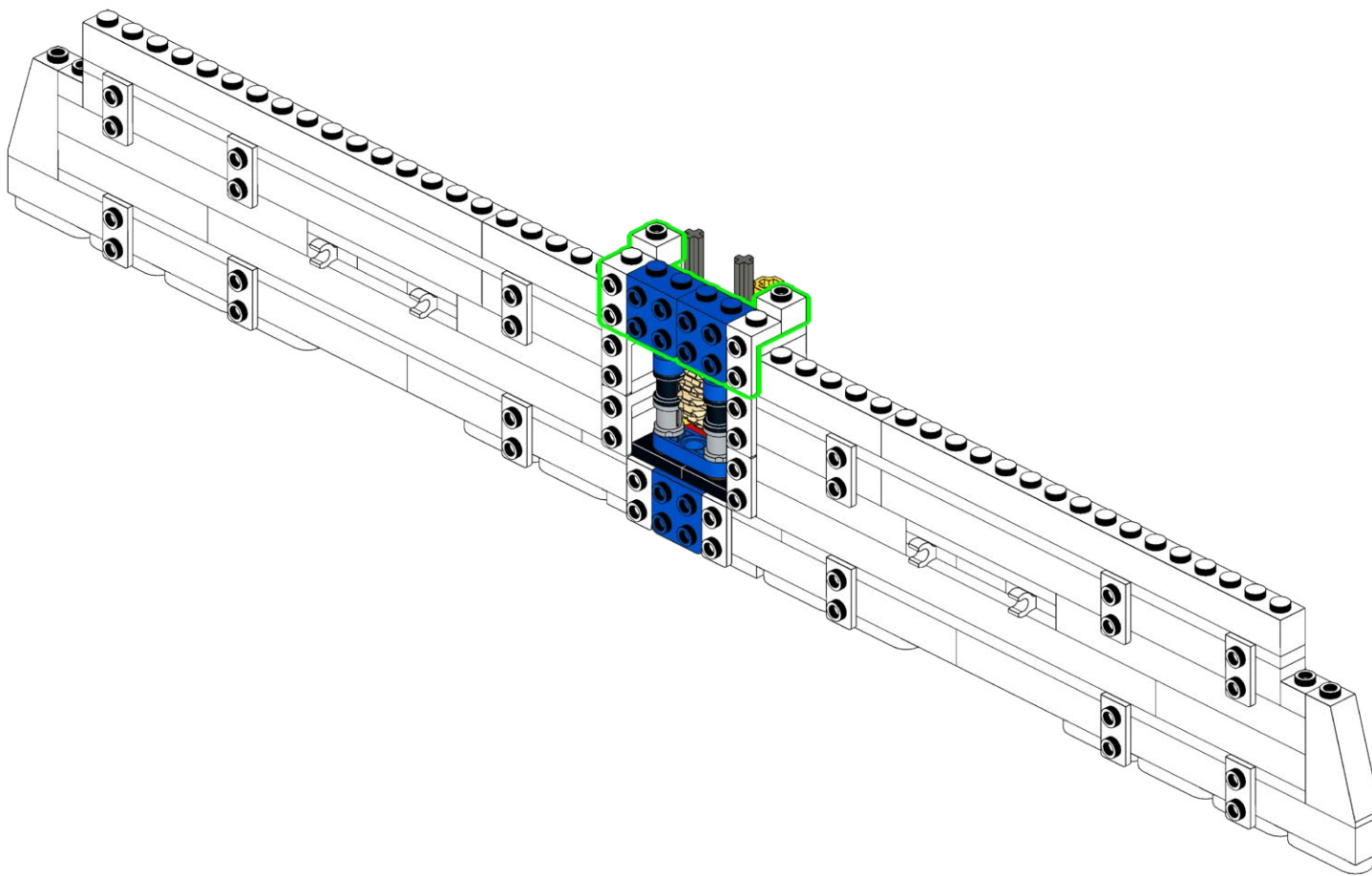
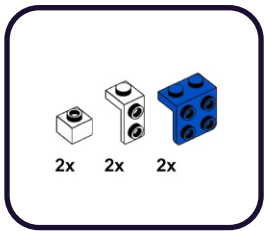

# 40

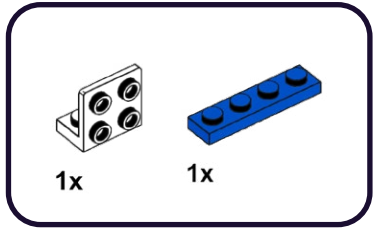

1

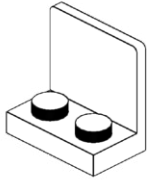

2

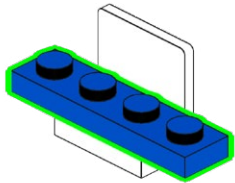

# 41

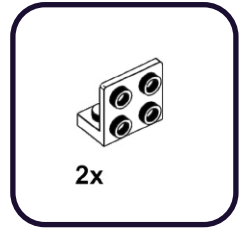

1

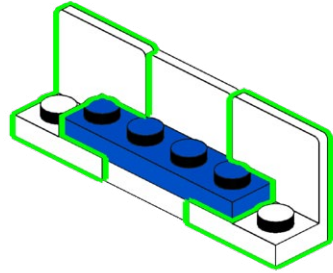



42

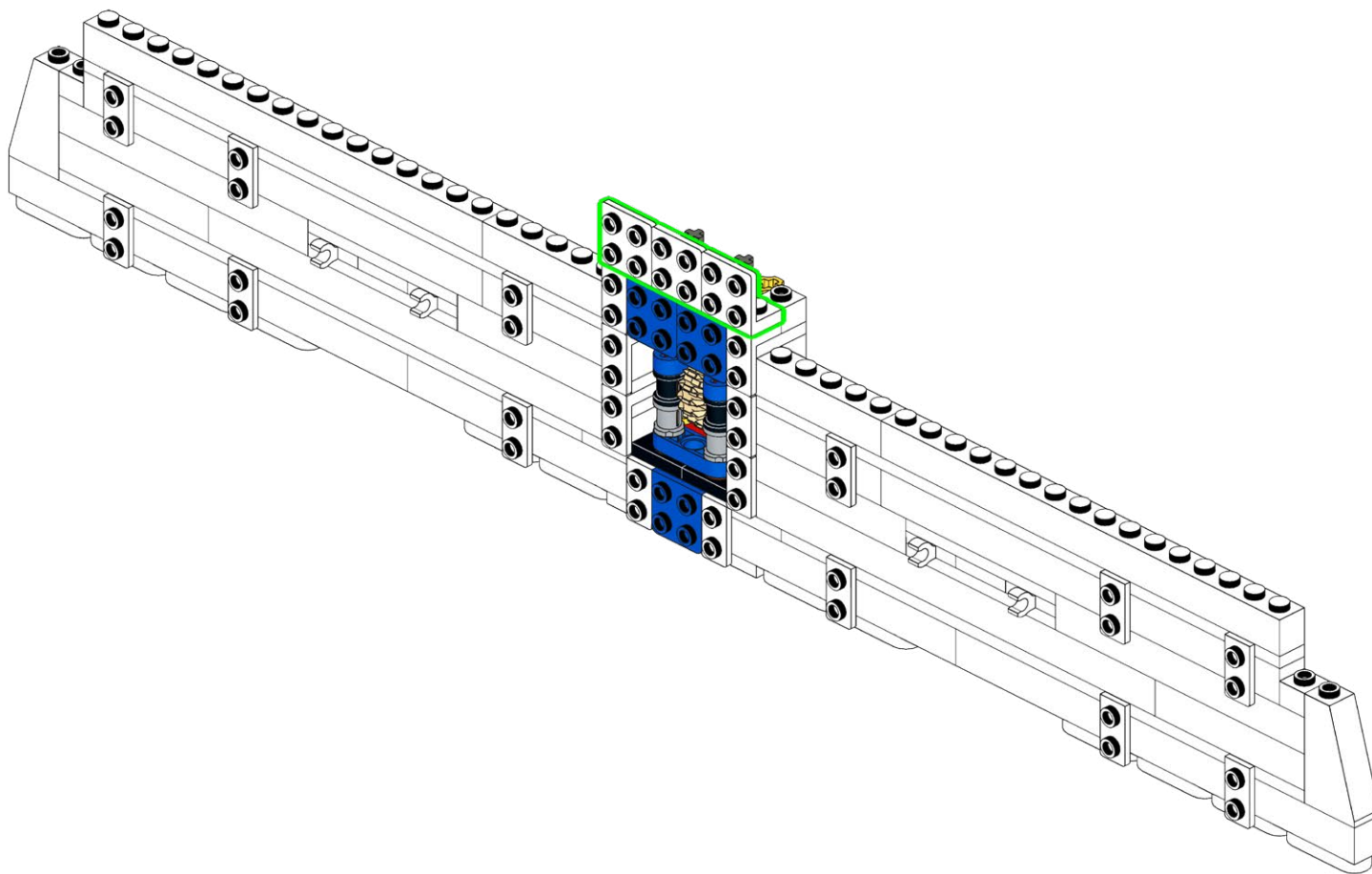

43

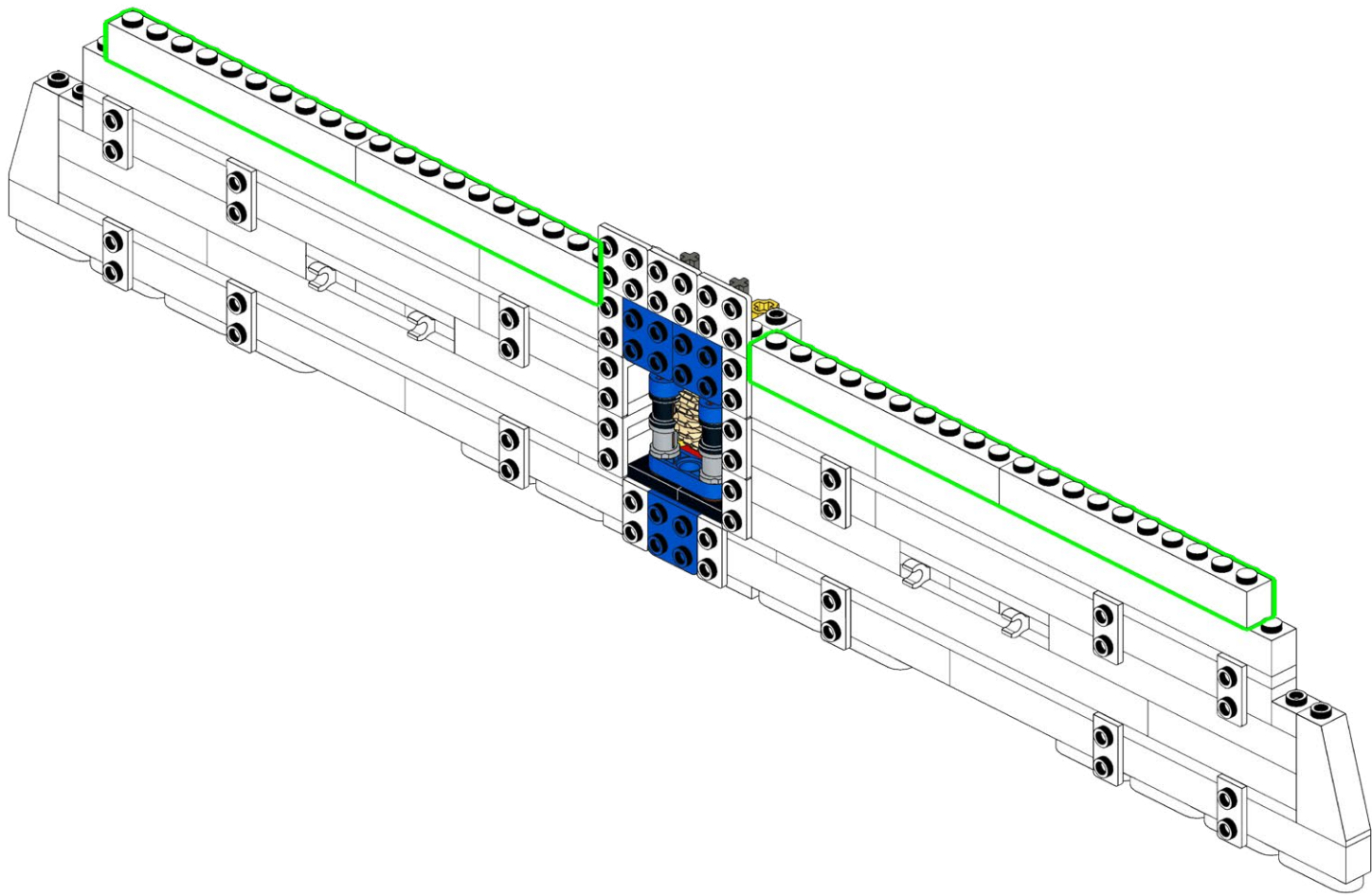
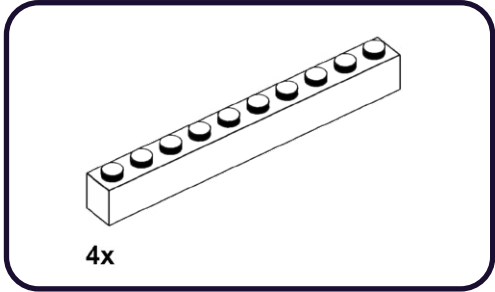

44

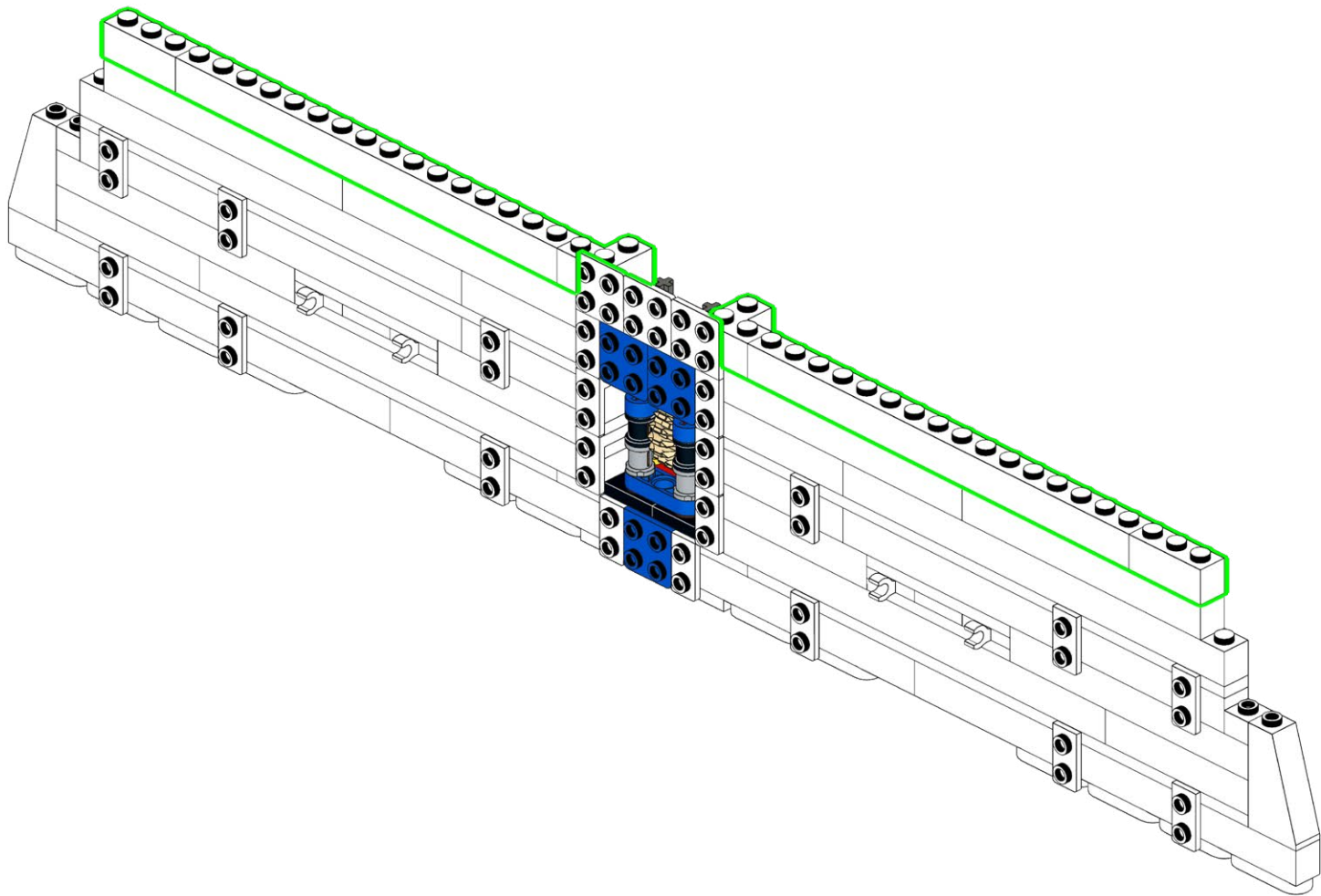
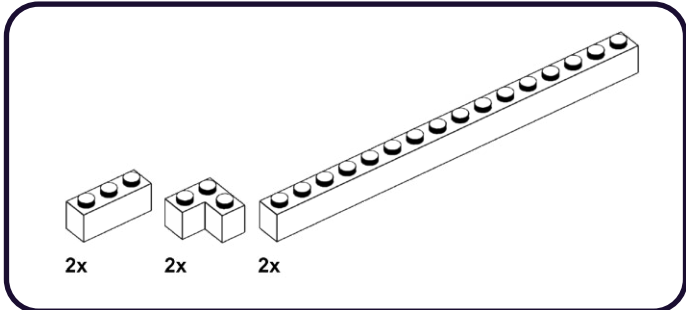

45

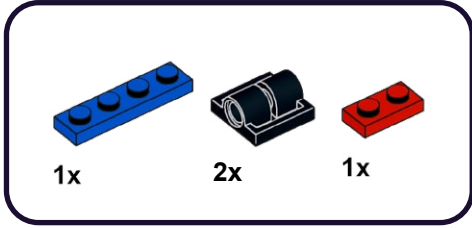

1

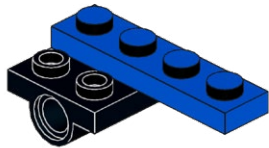

2

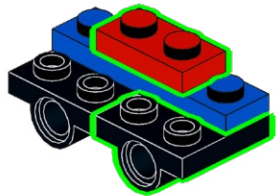

46

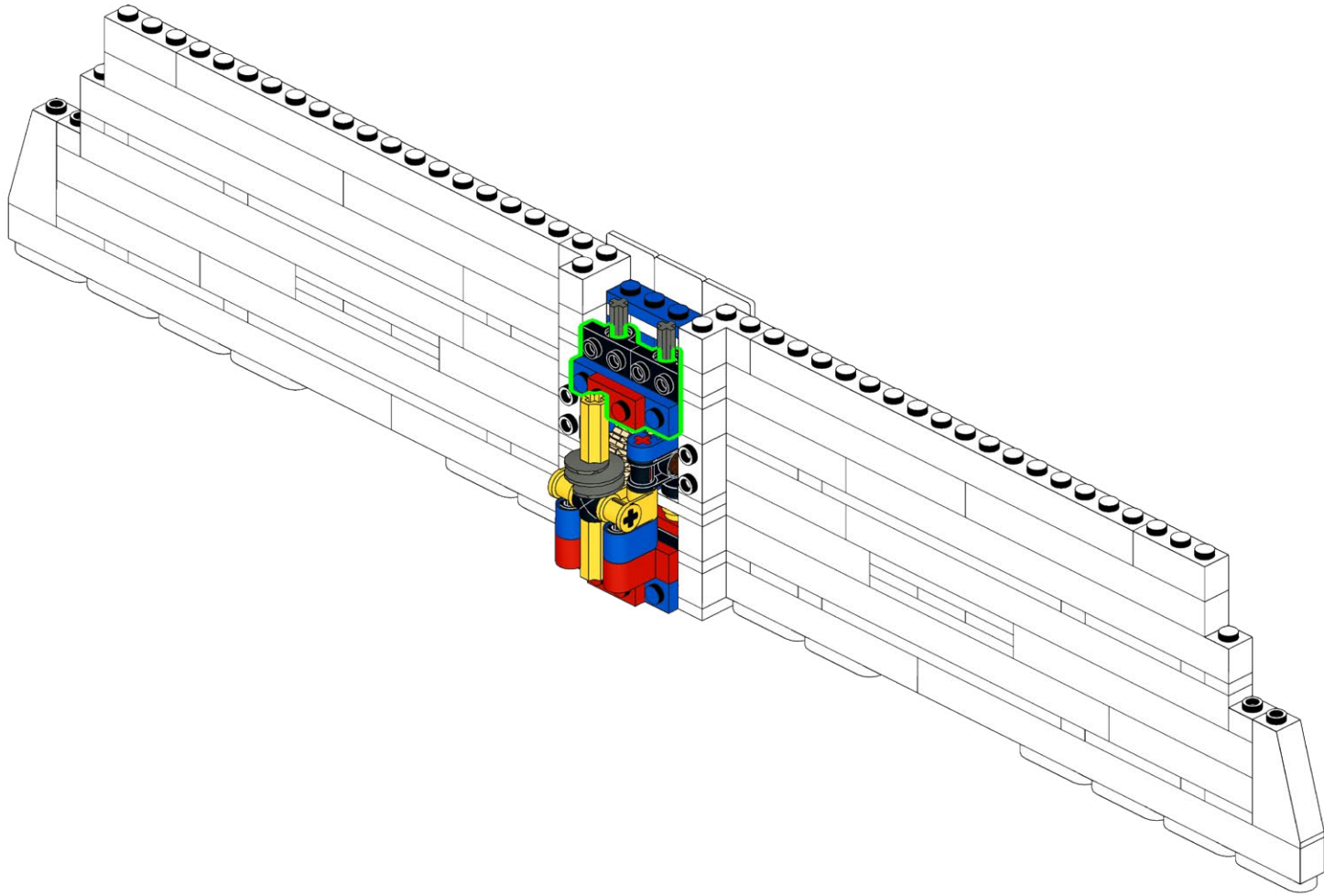

# 47

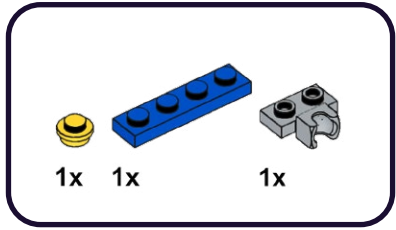

1

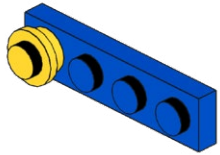

2

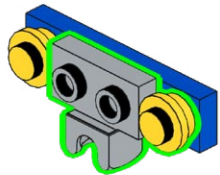

# 48

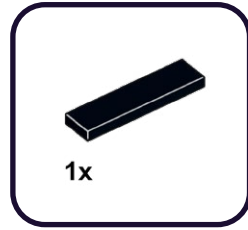

1

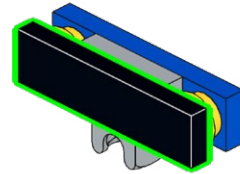

49

2x

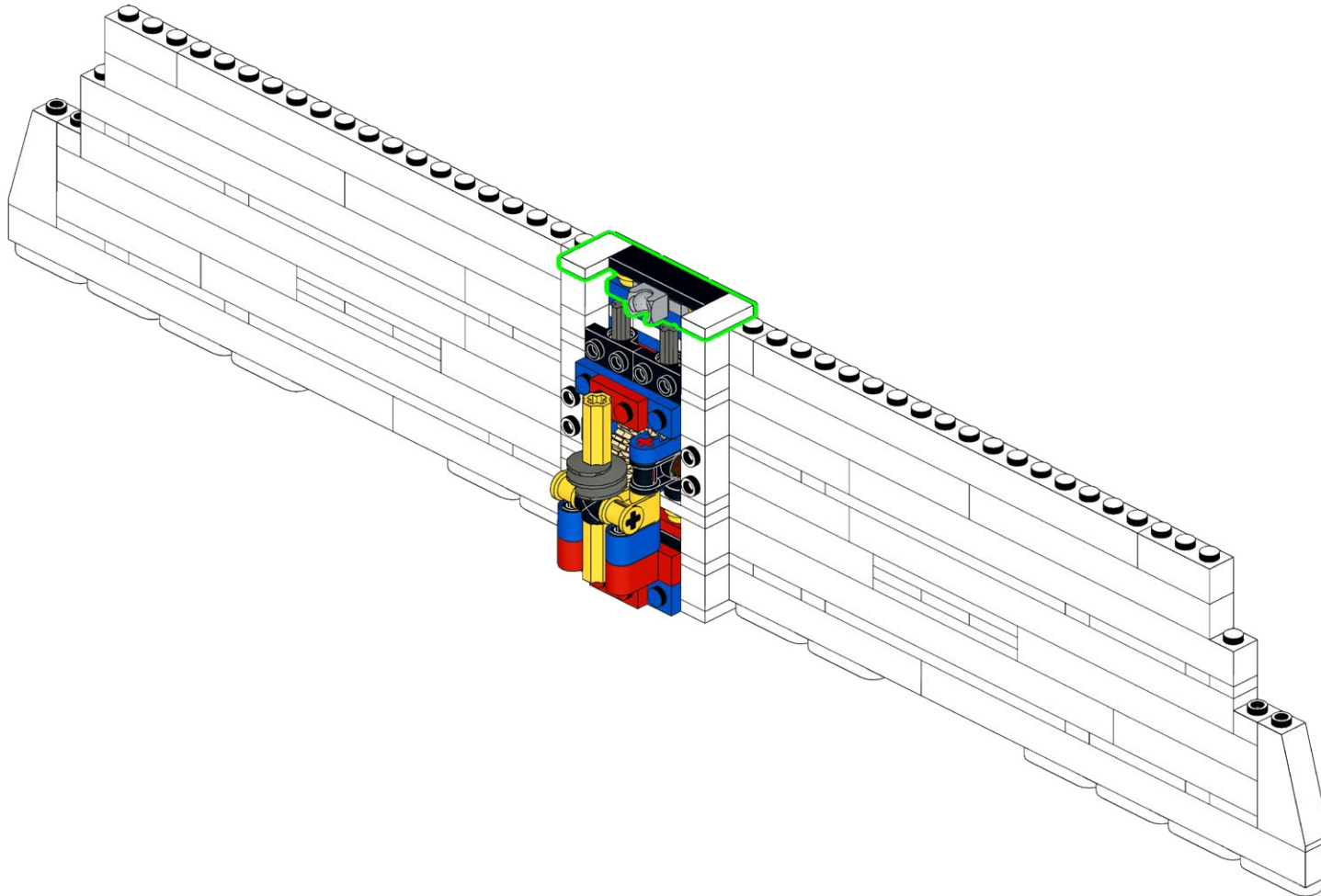

50



2x

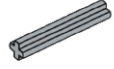

2x

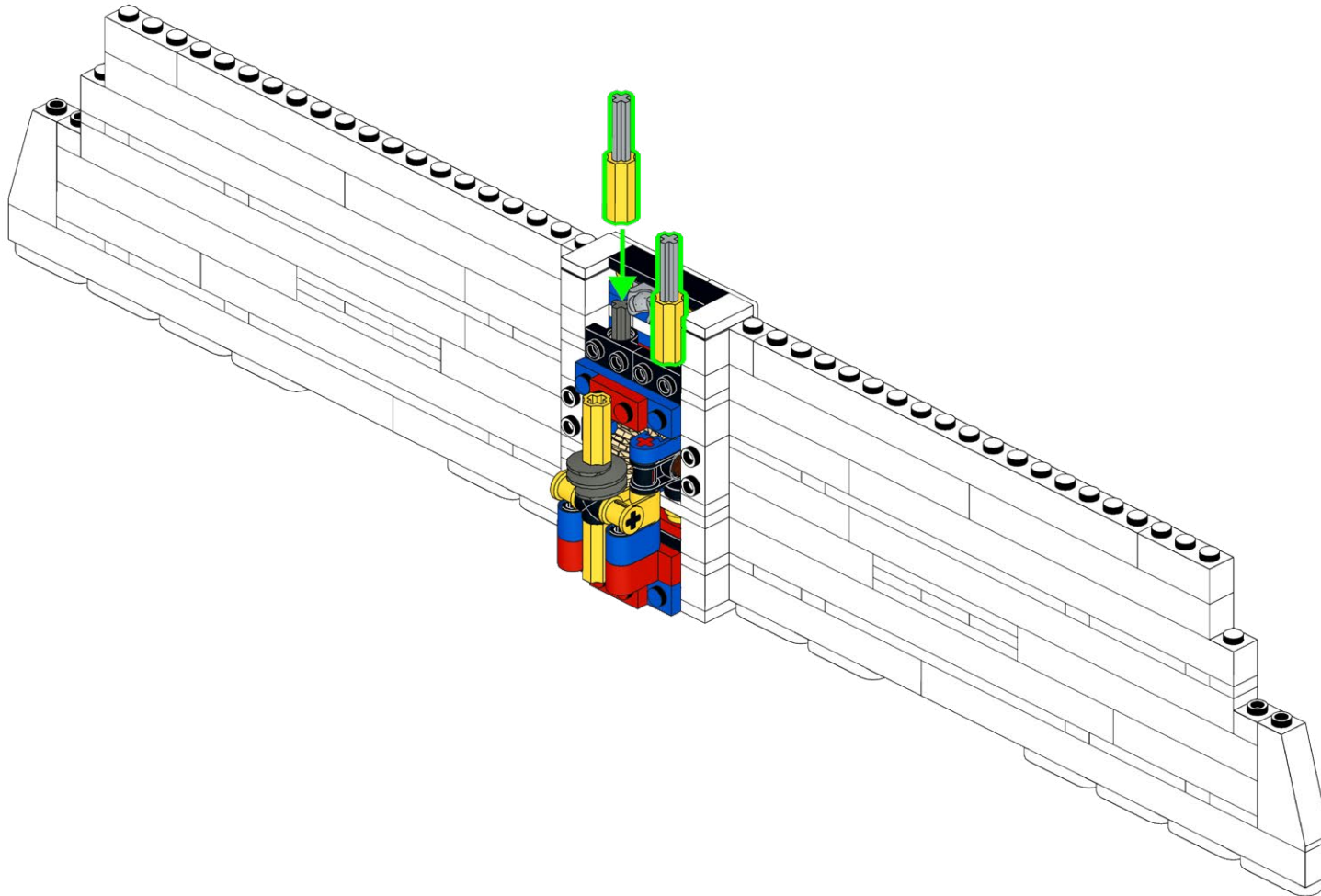



51

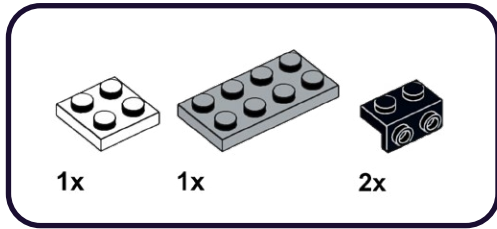

1

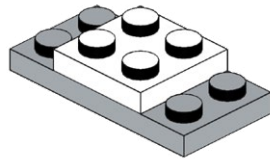

2

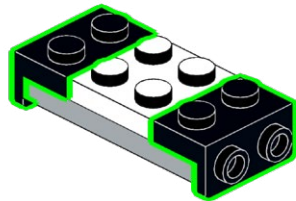

52

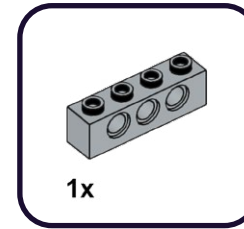

1

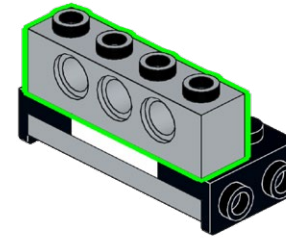

53

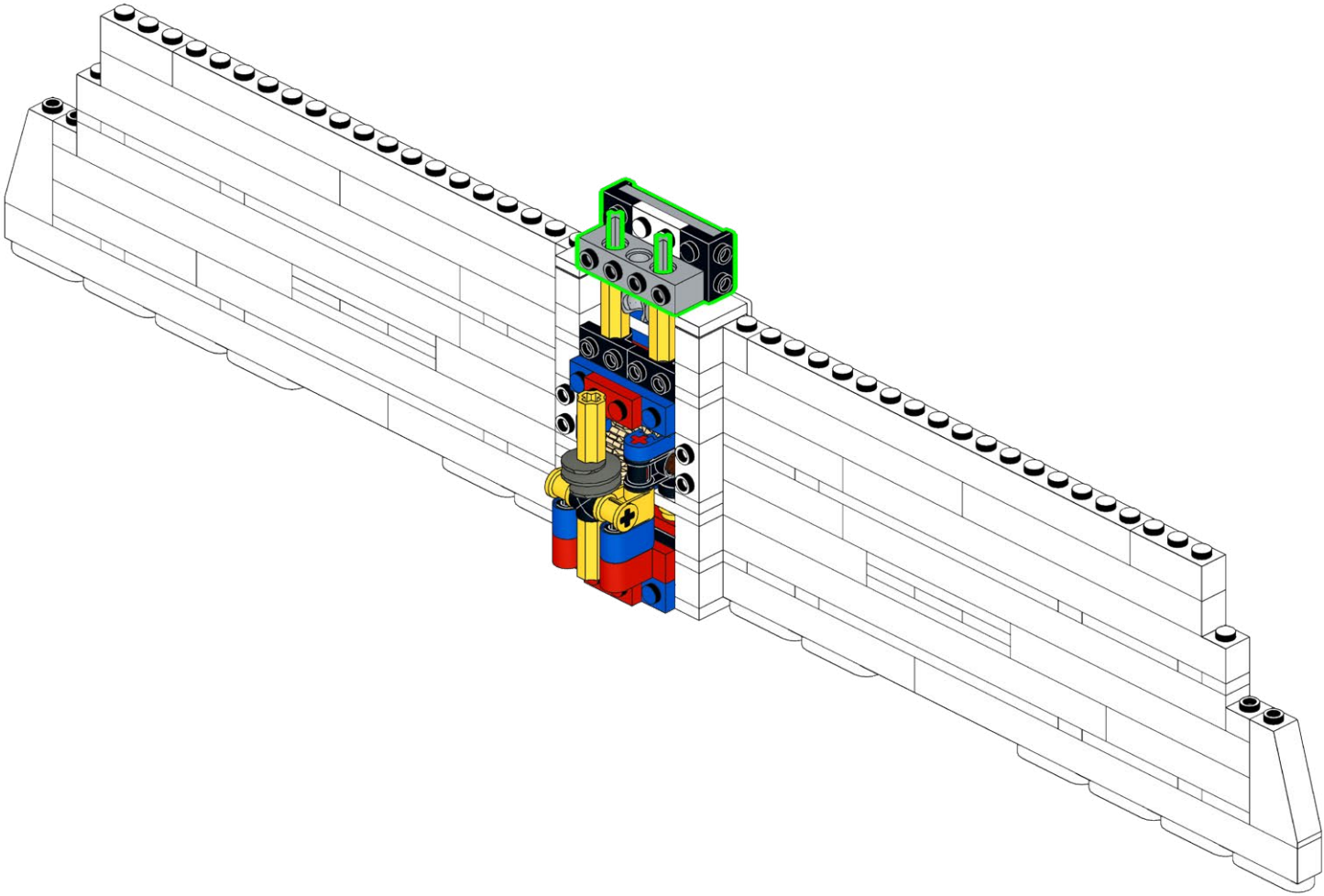
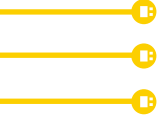

54

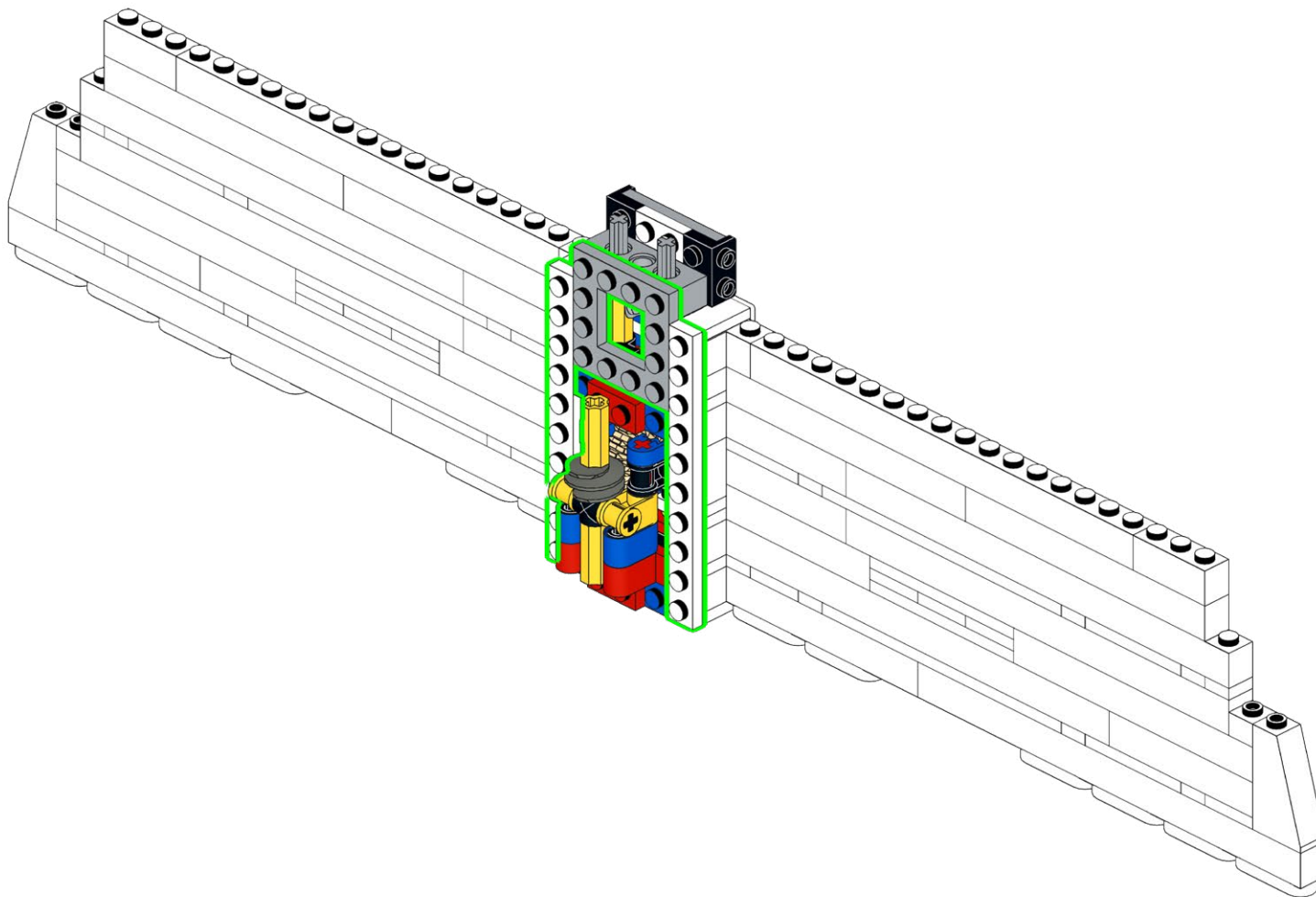
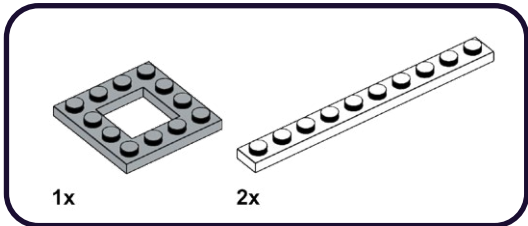

55

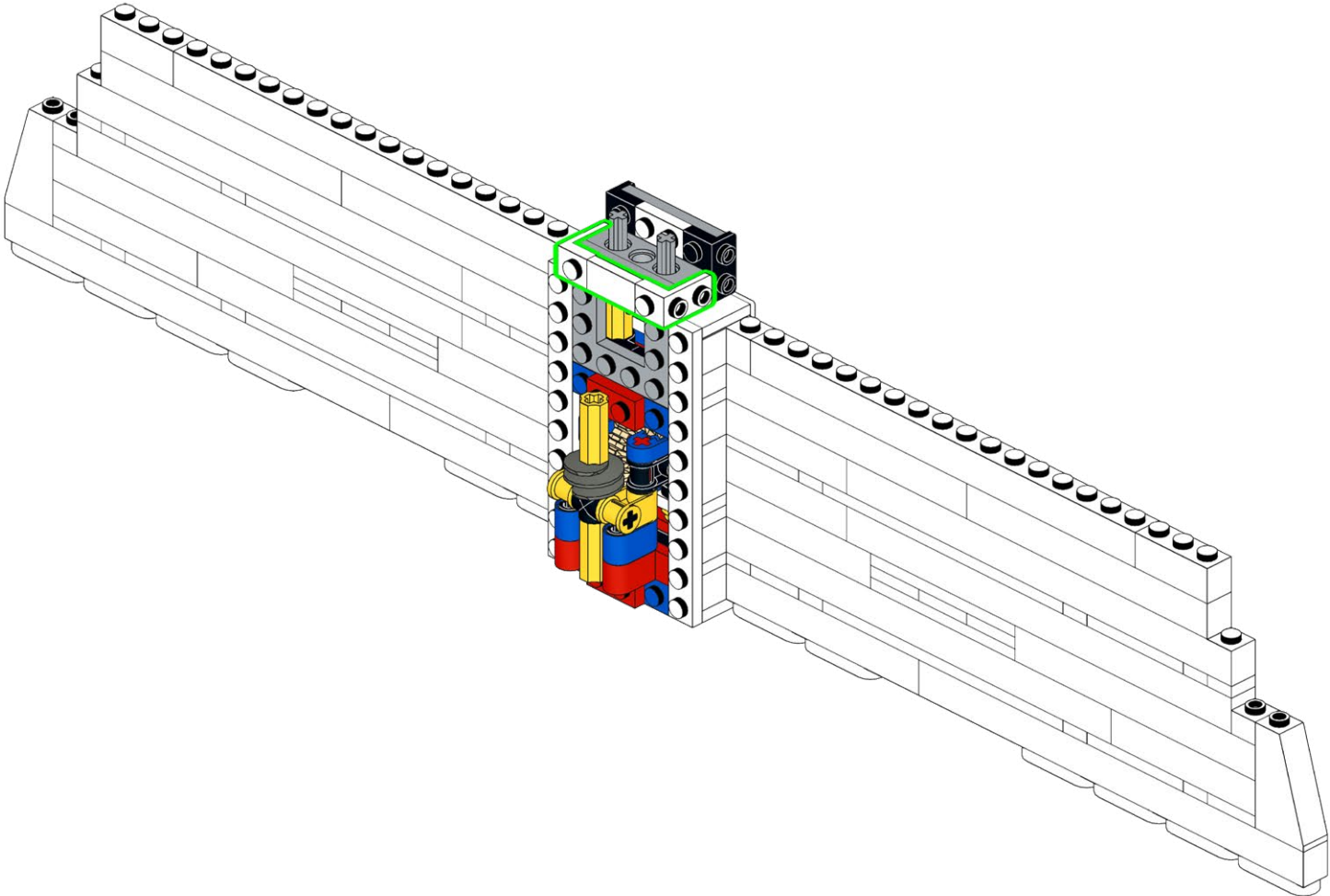
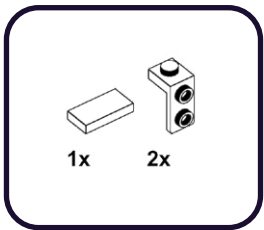

56

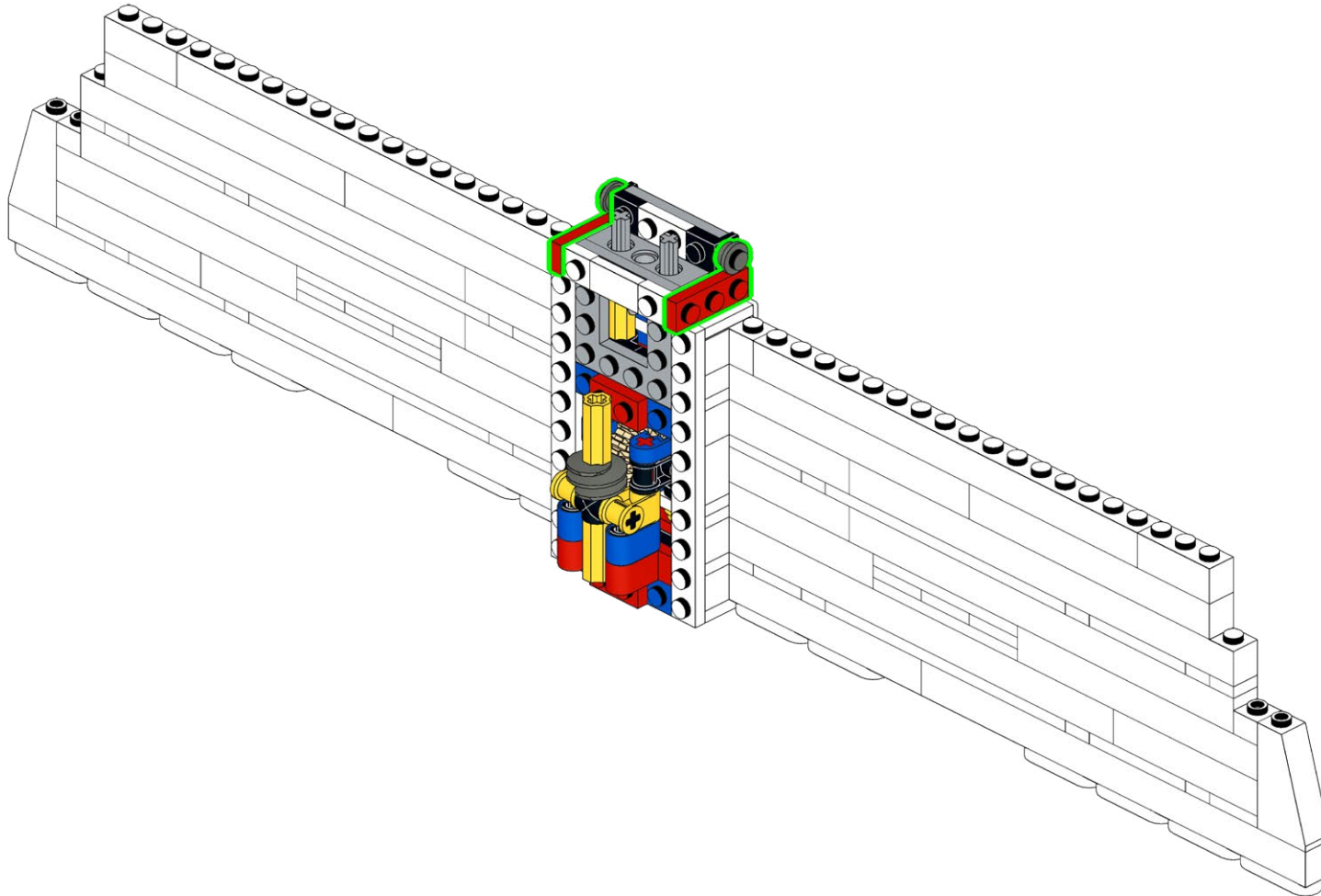
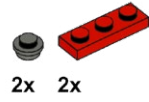

57

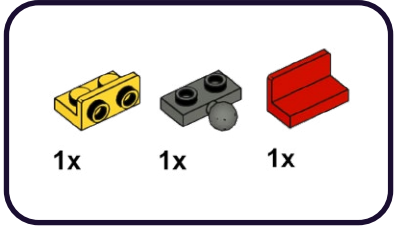

1



2

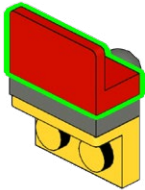

58

2x

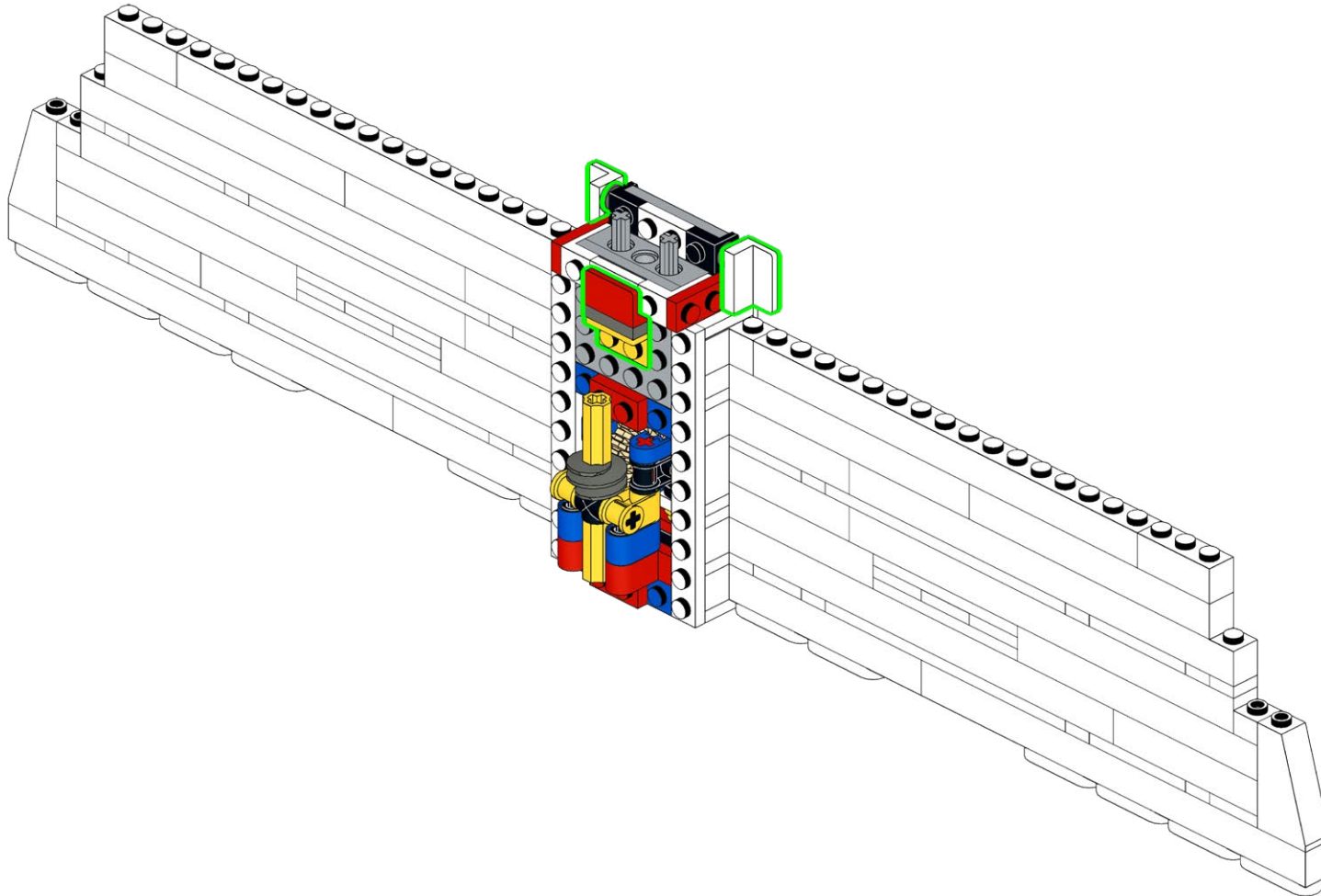

59

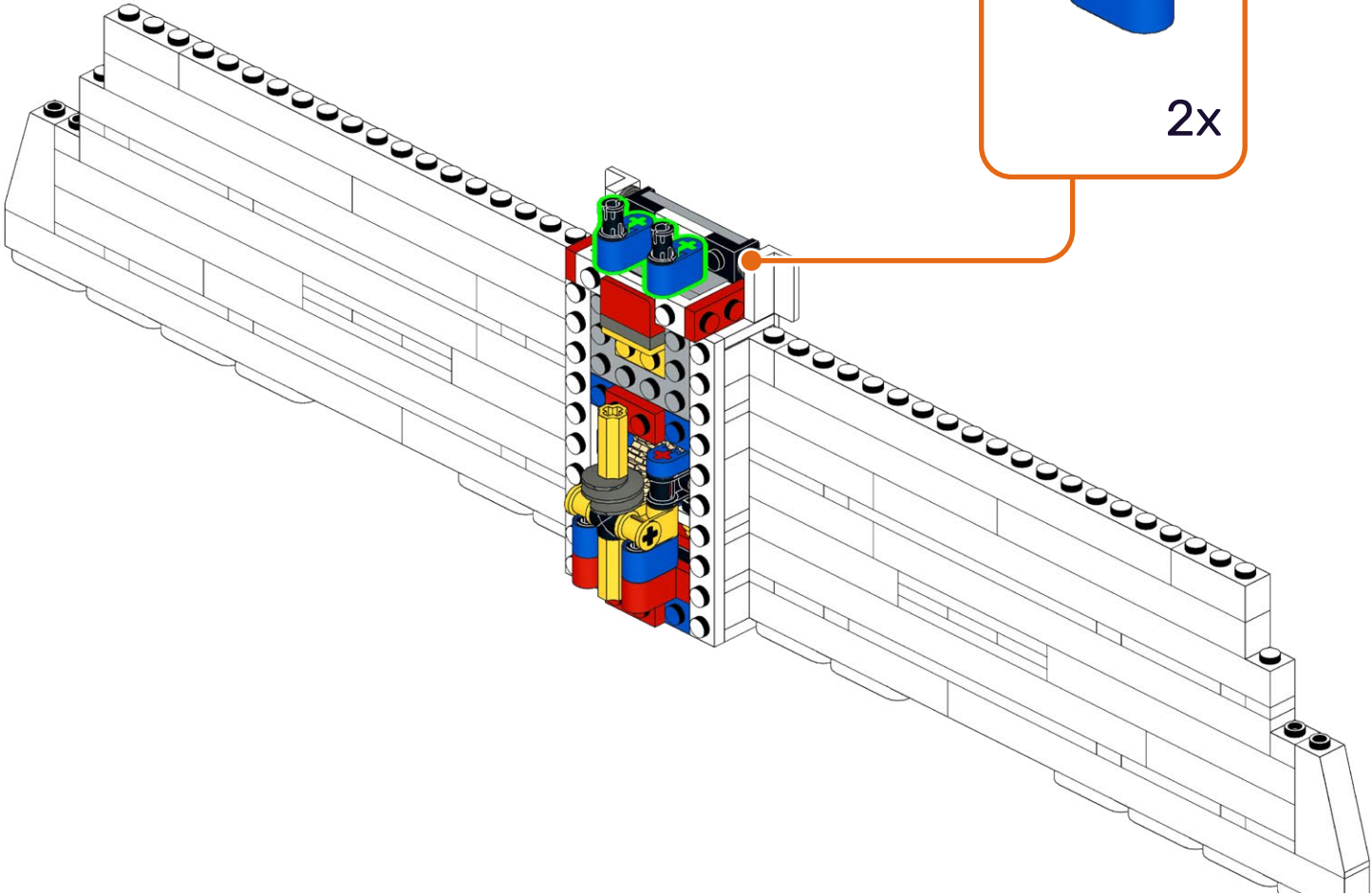
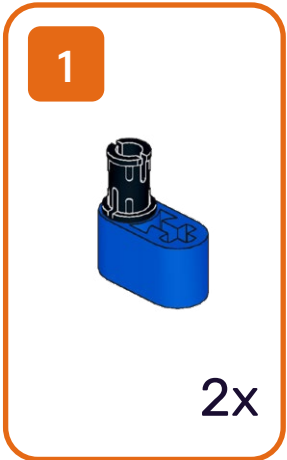



60

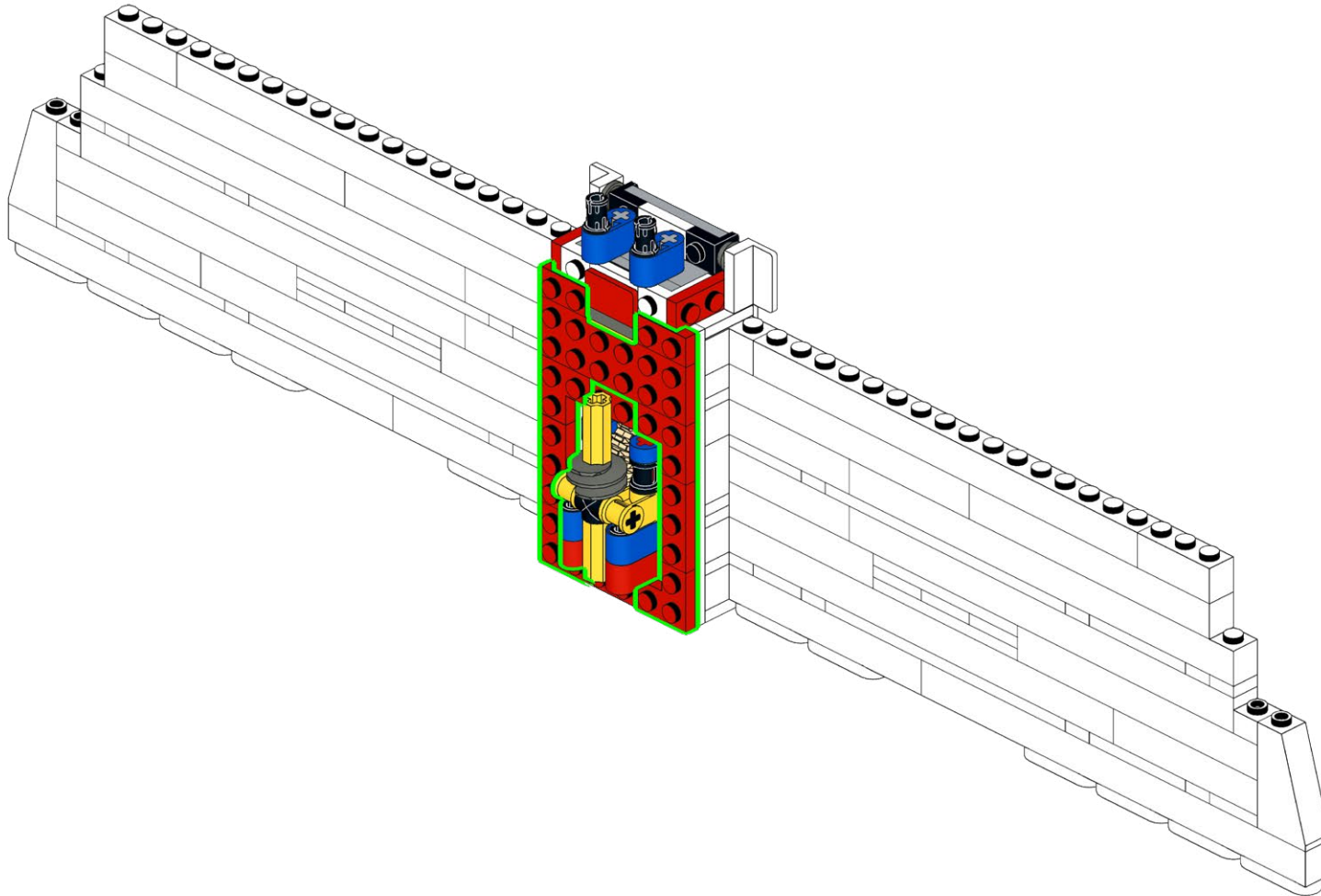
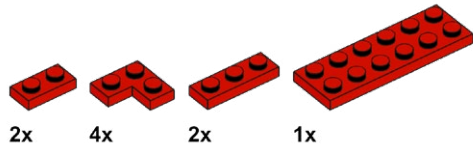

**HOLD UP!**

You might notice some bags aren't in order, as well as left over pieces, but that's ok! We're changing the way you build LEGO!

**ATTENDEZ!**

Vous remarquerez peut-être que certains sacs, ainsi que certaines pièces, ne sont pas dans le bon ordre. Mais pas de panique! Nous changeons simplement la façon avec laquelle vous construisez vos LEGO!

**ASPETTA!**

Potresti notare che alcuni sacchetti non sono in ordine, così come i pezzi avanzati, ma va bene così! Stiamo cambiando il modo in cui costruisci i LEGO!

**HALT!**

Sie werden möglicherweise bemerken, dass einige tüten durcheinander sind und teile übrig bleiben, aber das ist in Ordnung! Wir ändern die art und weise, wie Sie LEGO bauen!

**¡ESPERA!**

Es posible que notes que algunas bolsas están fuera de servicio, así como piezas sobrantes, ¡pero está bien! ¡Estamos cambiando la forma en que construyes LEGO!

**暫停!**

你可能会注意到一些袋子顺序错乱, 以及一些剩余的部件, 但没关系! 我们正在改变你搭建乐高的方式!

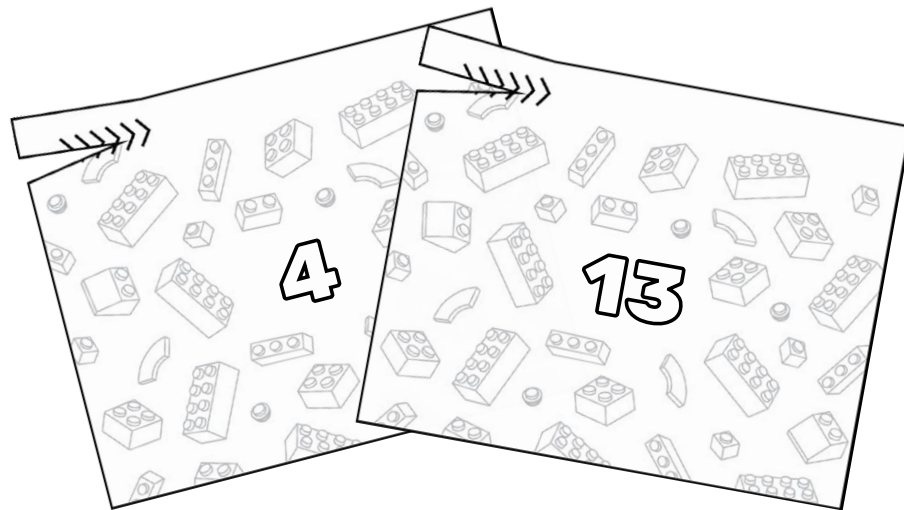
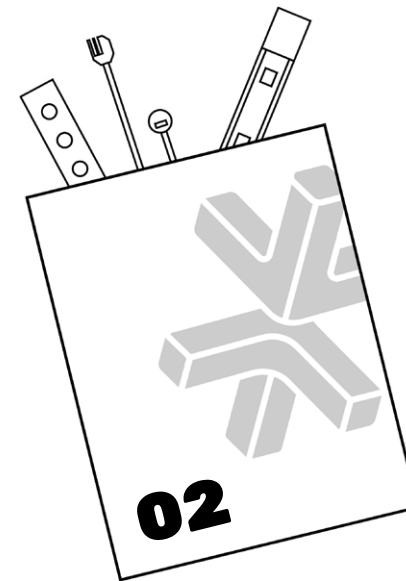
**Open LEGO® Bag 4 and 13****Open LMB Bag 02**

61

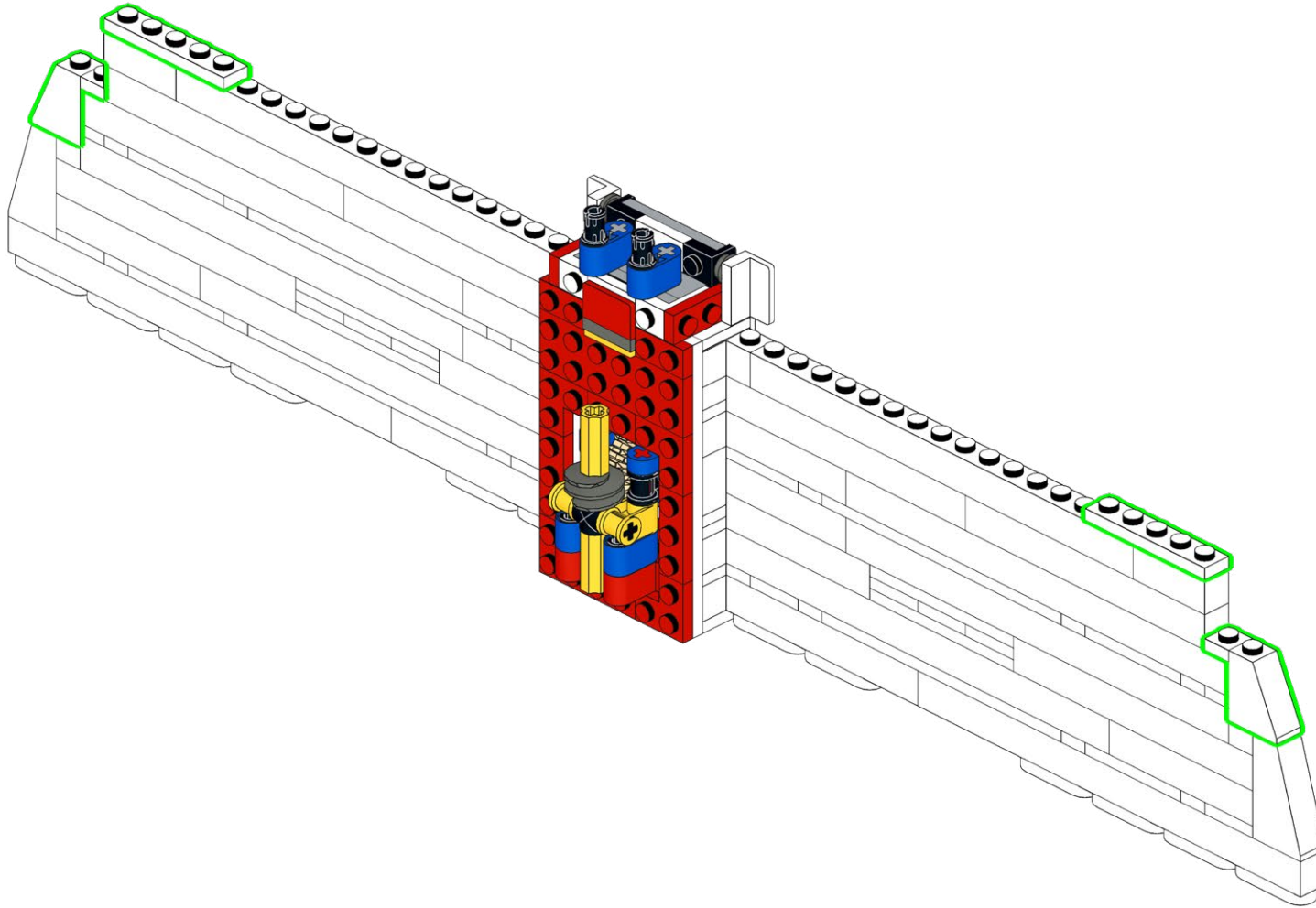
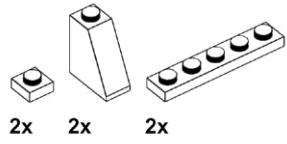

62

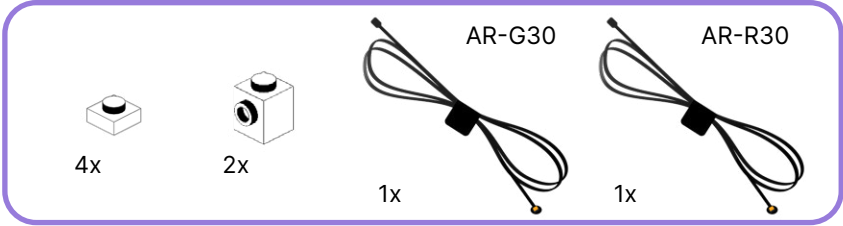

AR-R30



AR-G30

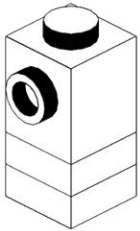
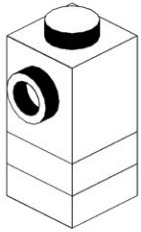

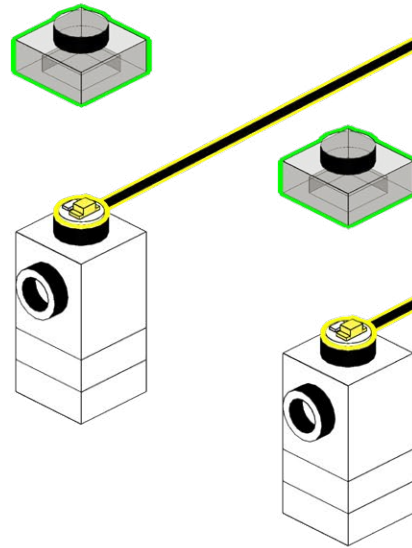
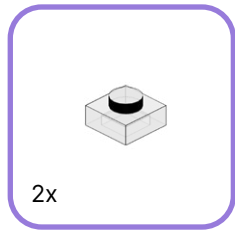
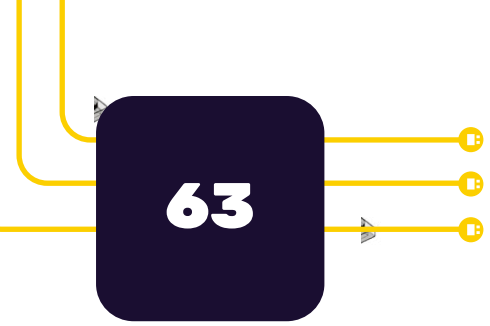

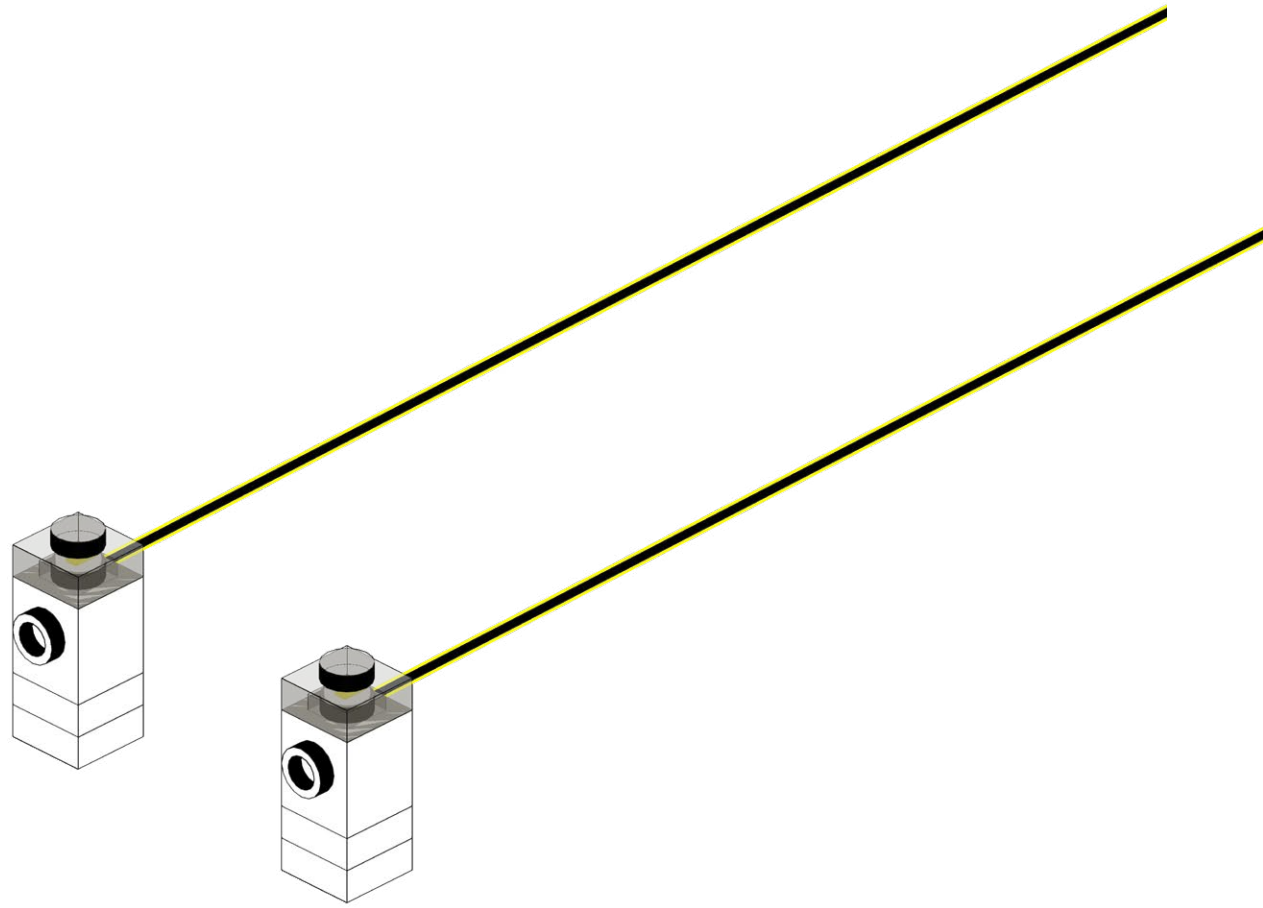
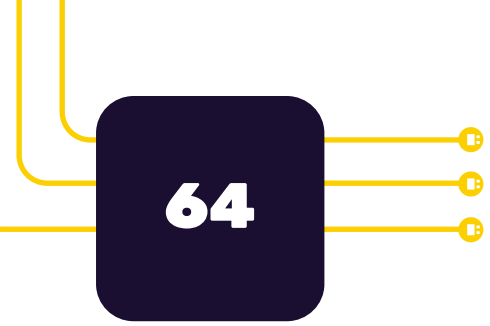

65



AR-R30

AR-G30

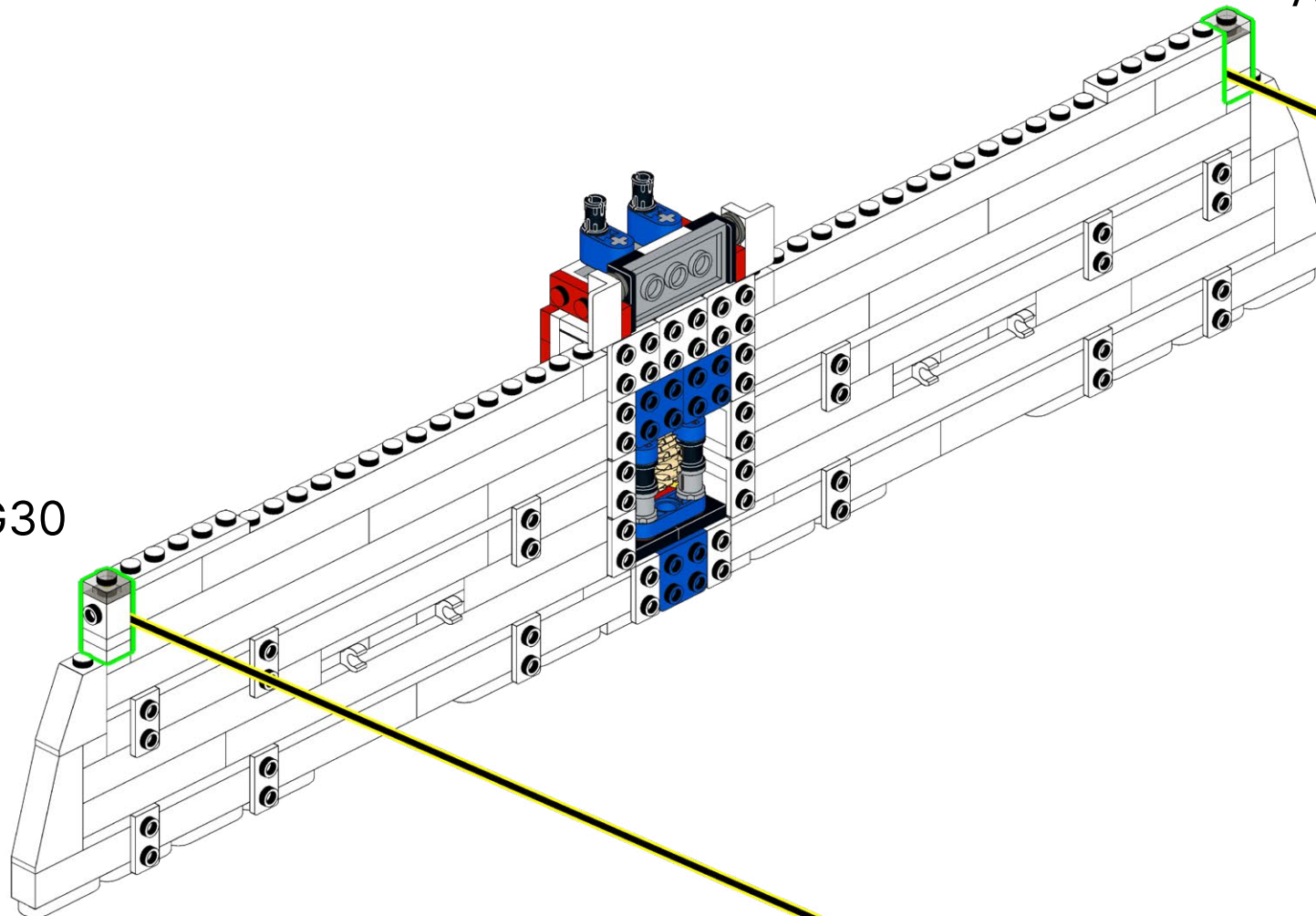

66

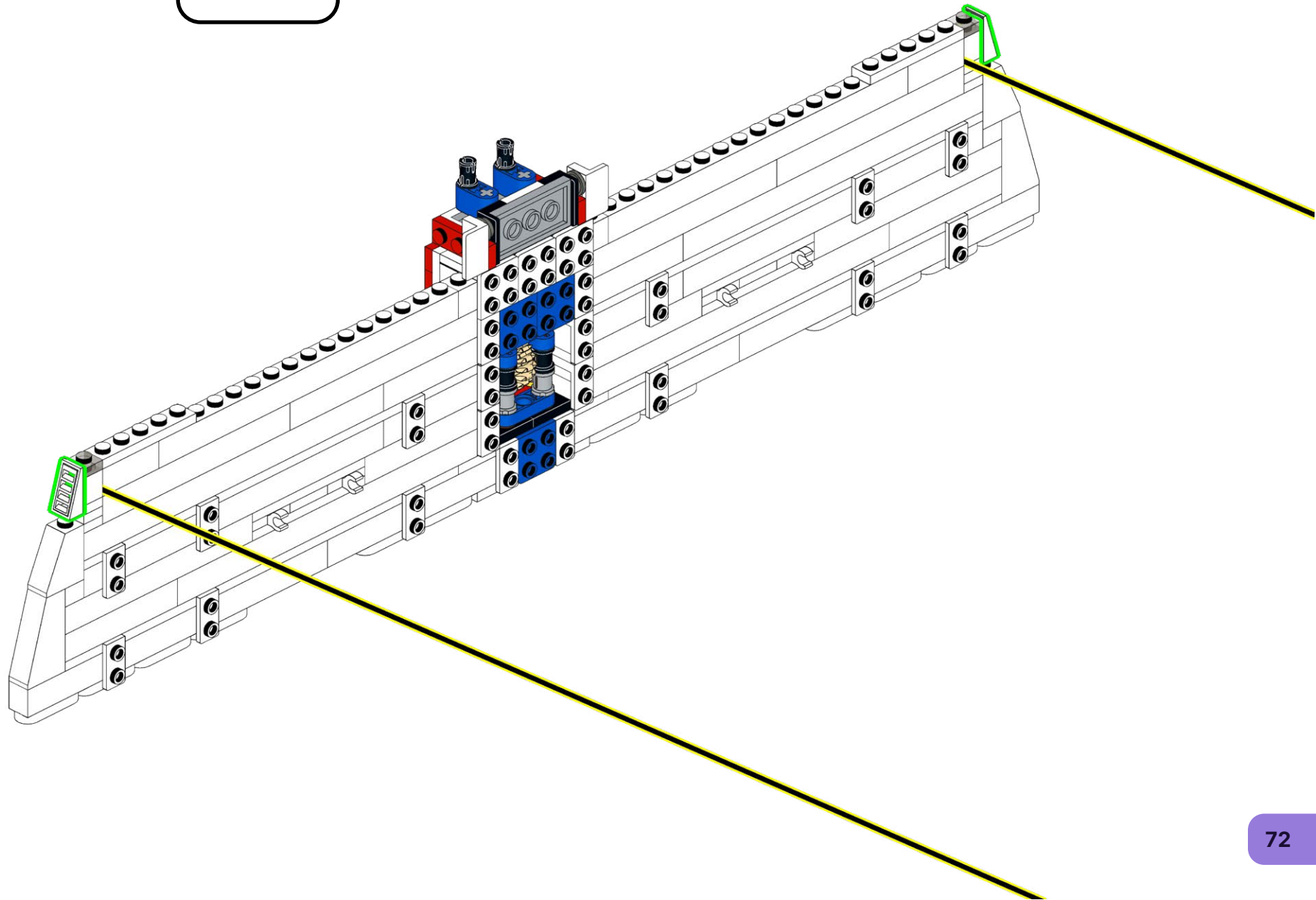
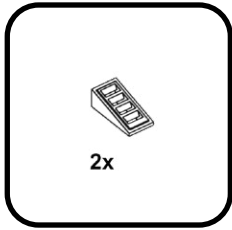



67

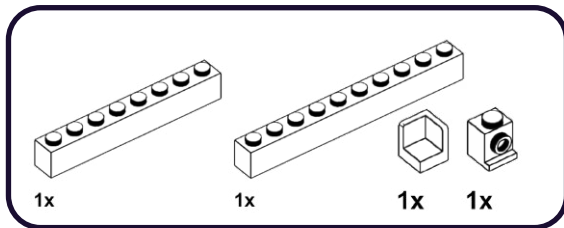

1

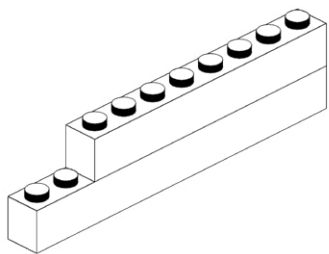

1



68

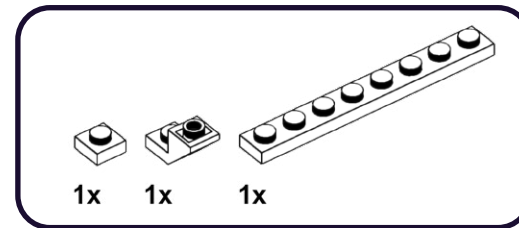

1

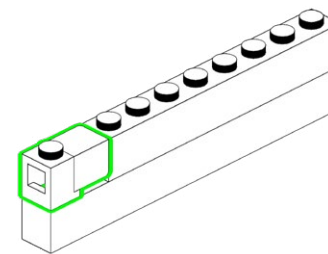

1

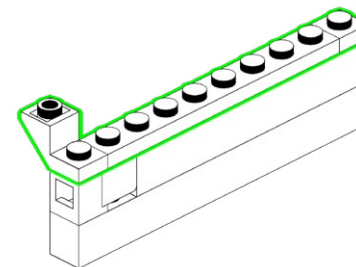

# 69

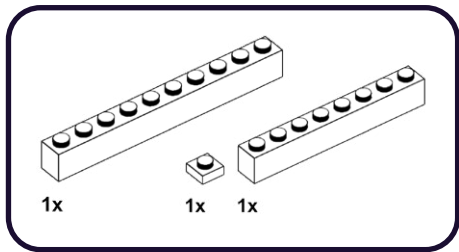

1

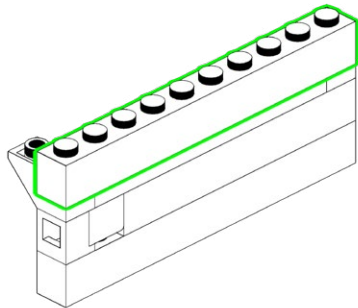

1

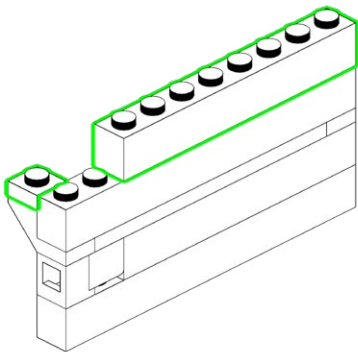

# 70

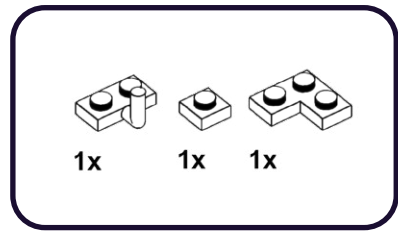

1

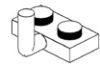

1

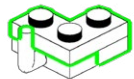

**71**

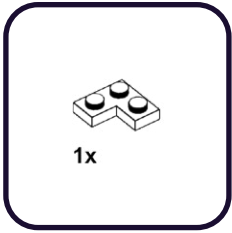

**1**

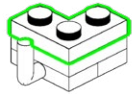

**1**

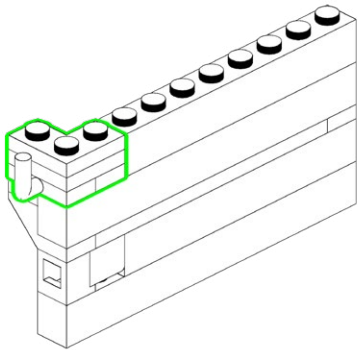

**72**

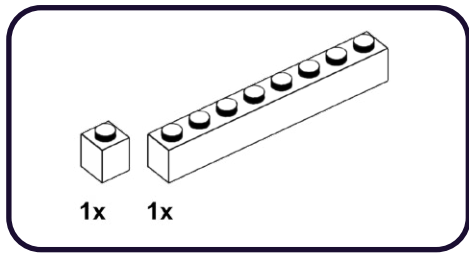

**1**

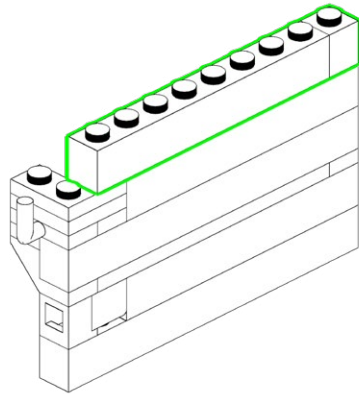

73

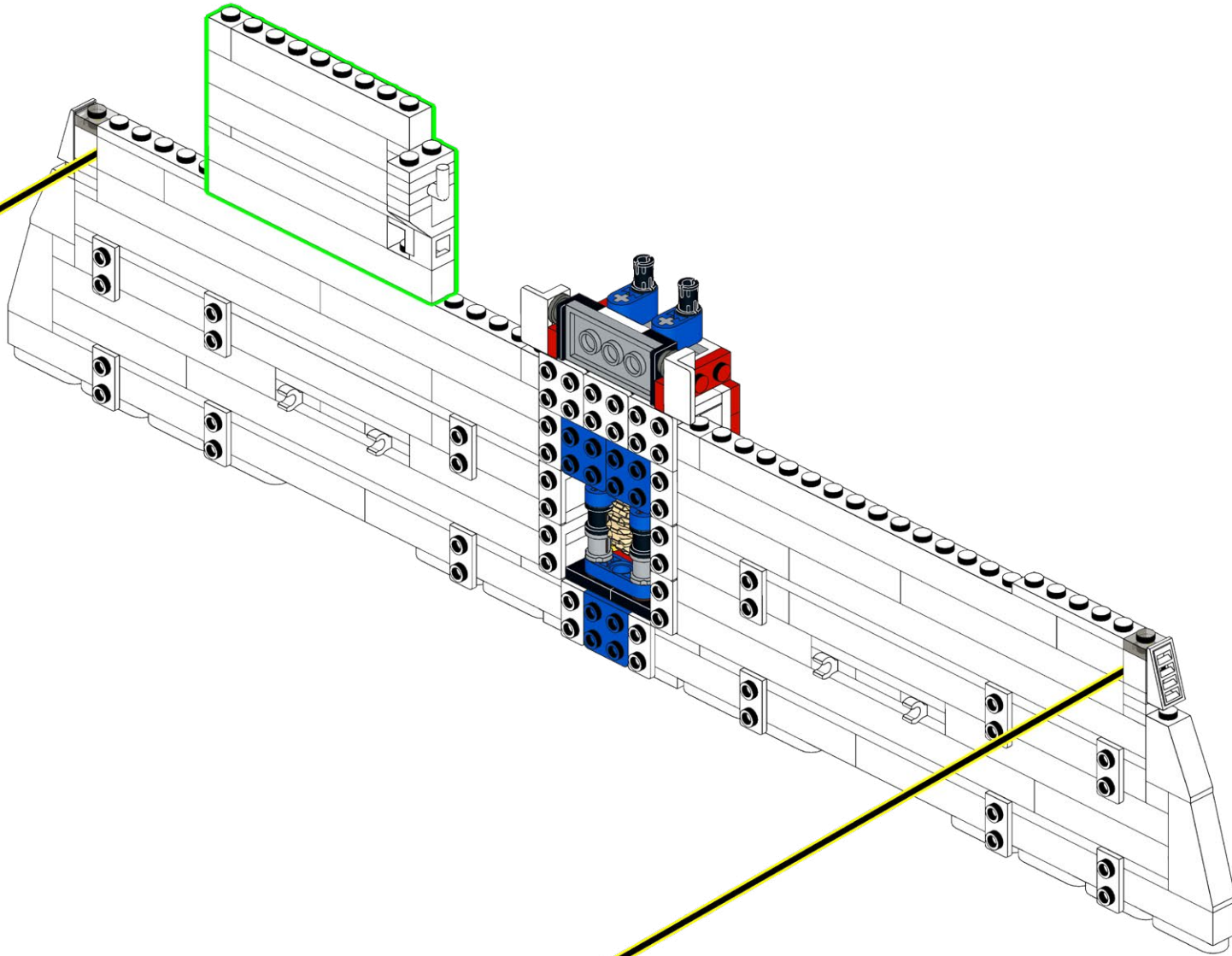

# 74

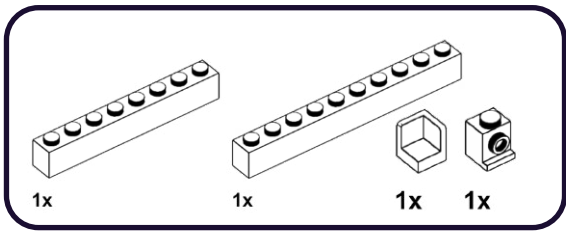

1

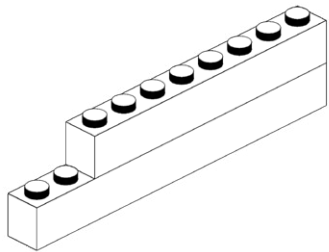

1



# 75

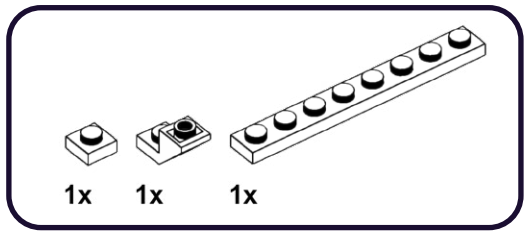

1

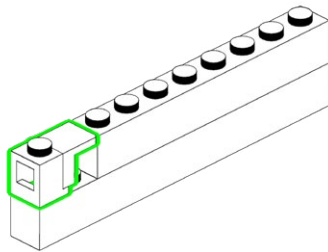

1

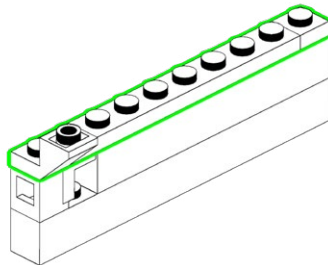

# 76

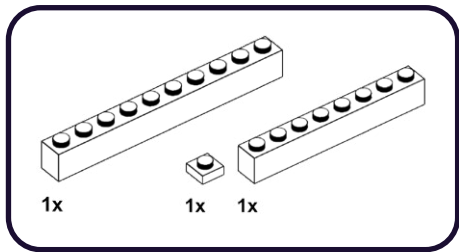

1

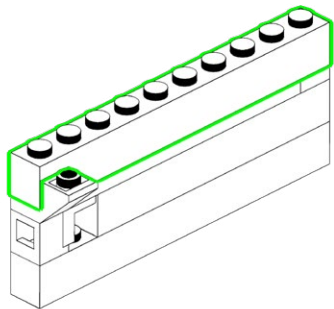

1

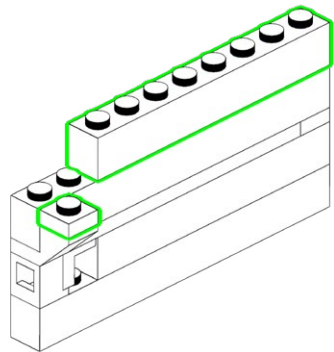

# 77

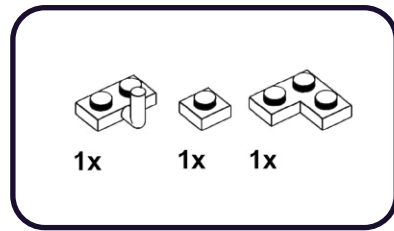

1



1

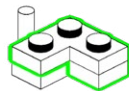

**78**

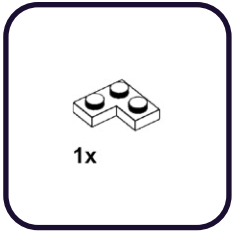

**1**

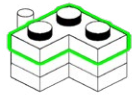

**1**

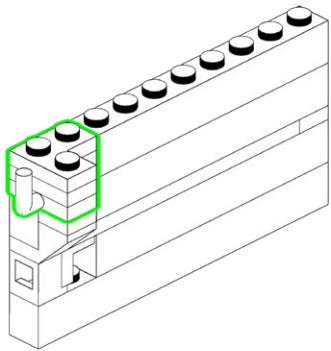

**79**

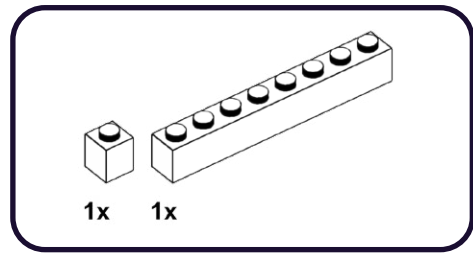

**1**

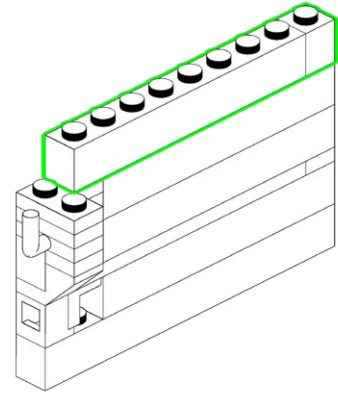

80

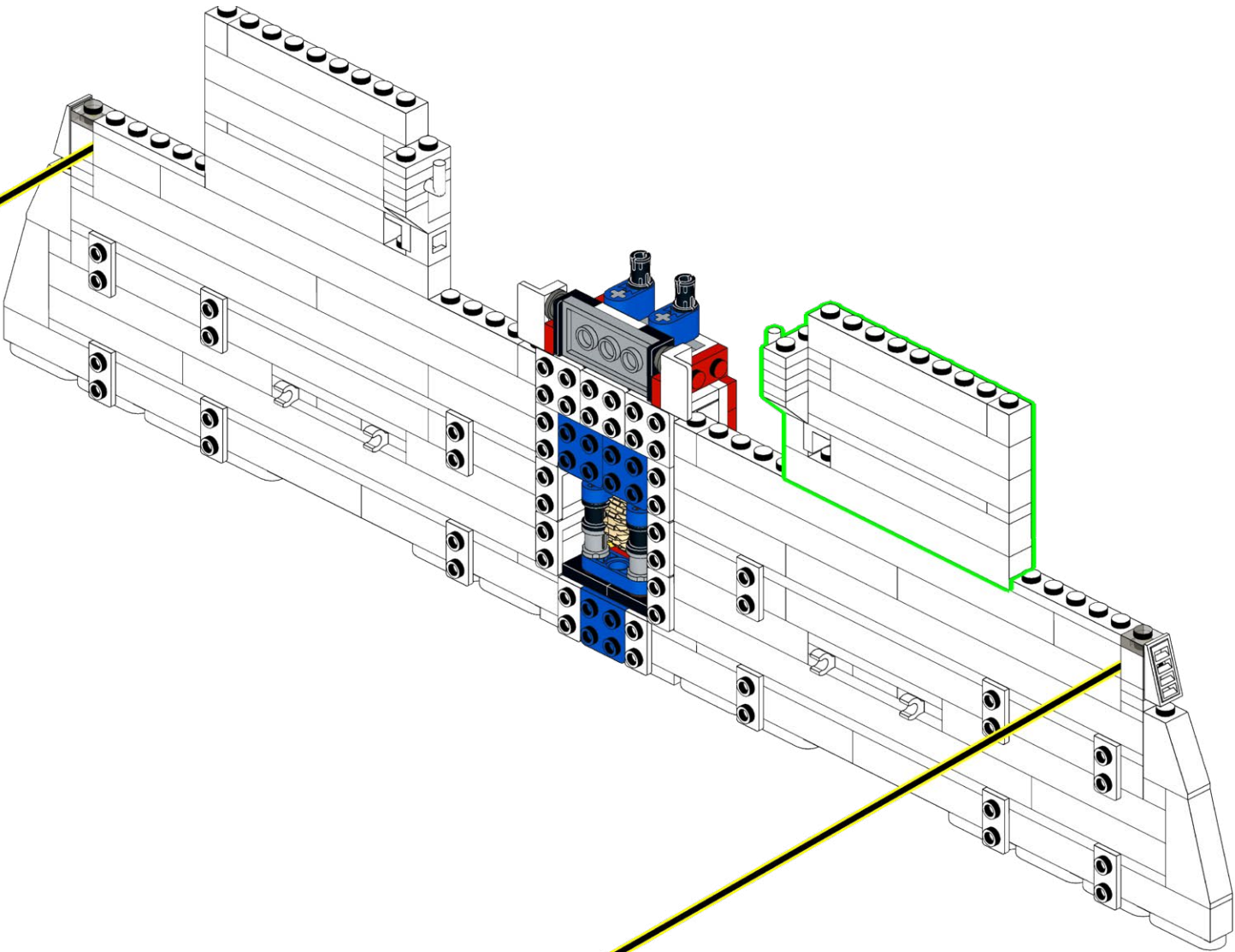



81

2x

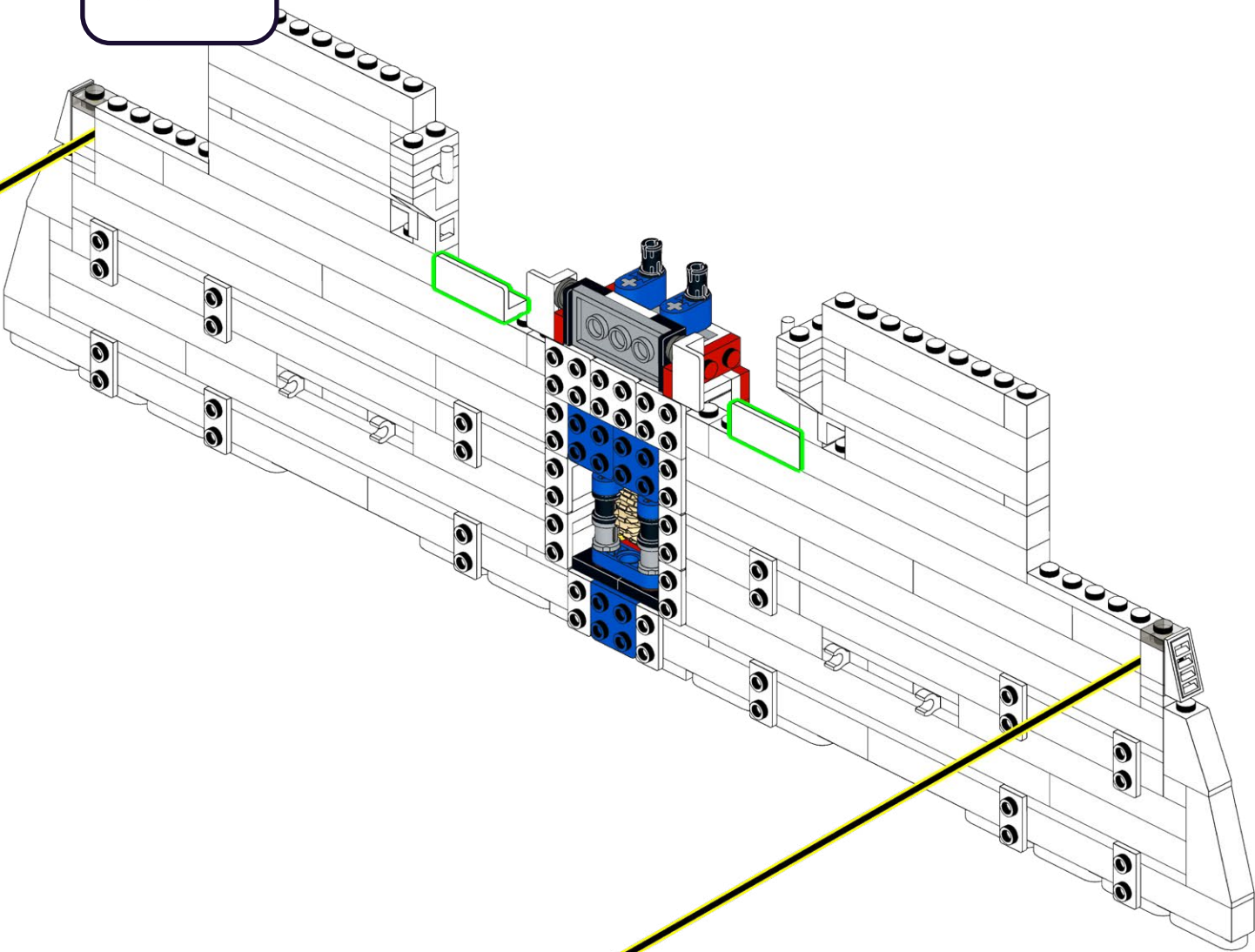

82

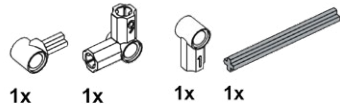

1

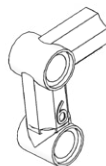

1

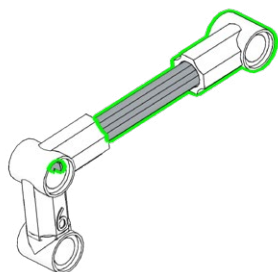

83

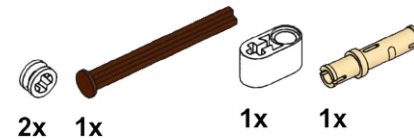

1

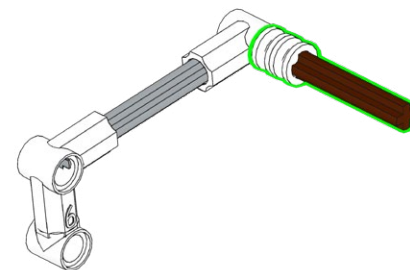

1

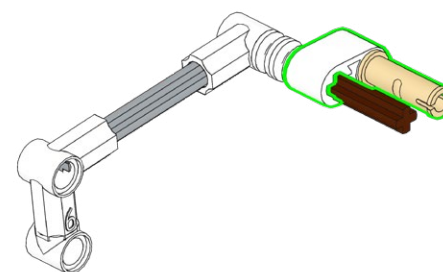

84

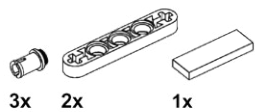

1

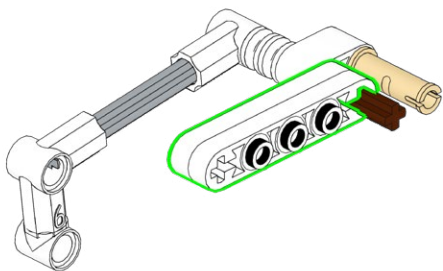

1

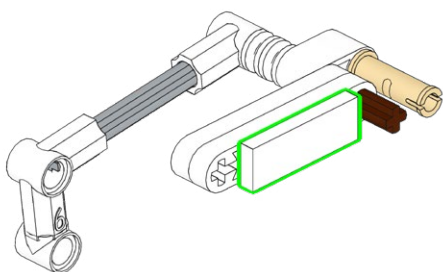

85

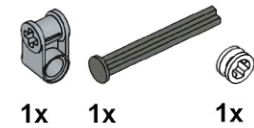

1

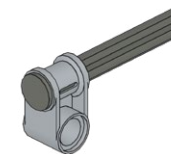

1

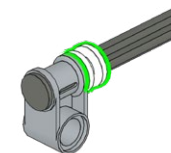

# 86

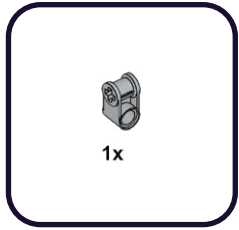

1

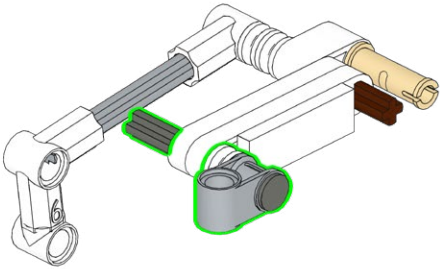

1

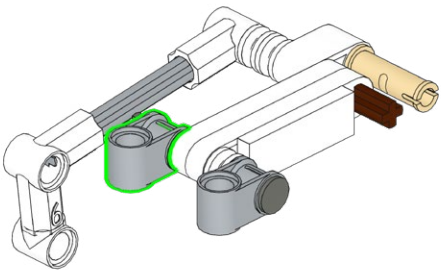

# 87

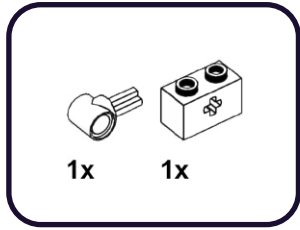

1

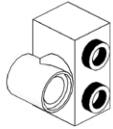

1

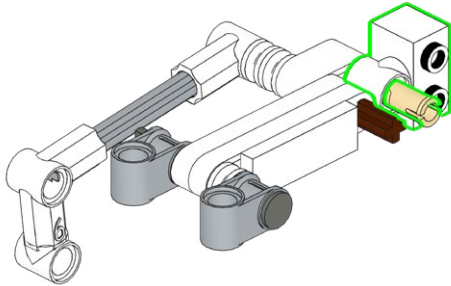

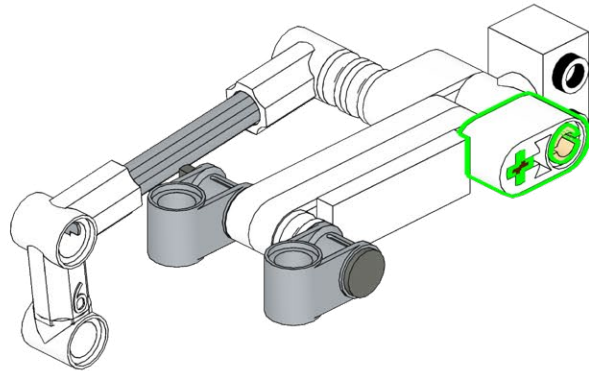
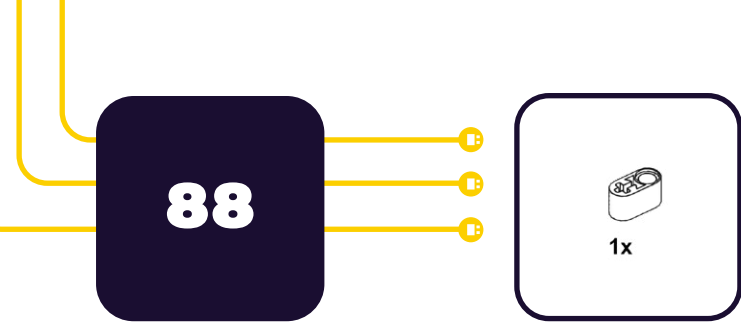

89

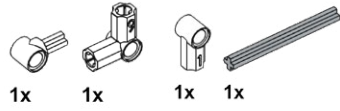

1



1

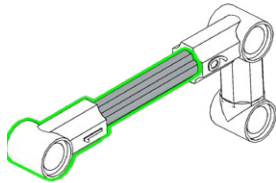

90

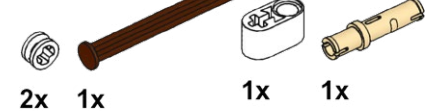

1

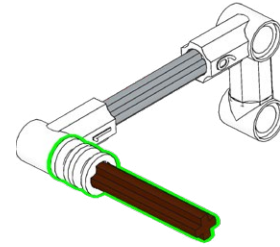

1

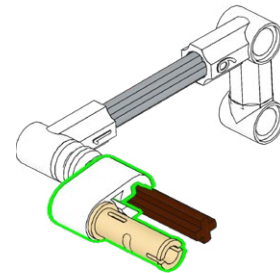

91

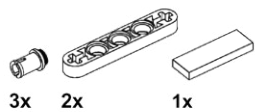

1

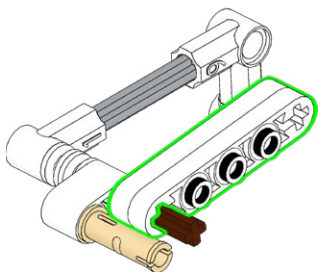

1

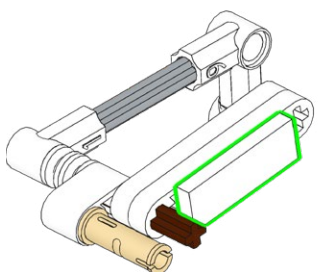

92

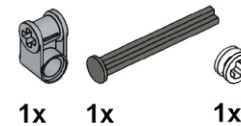

1

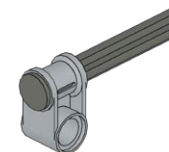

1

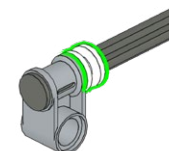

93

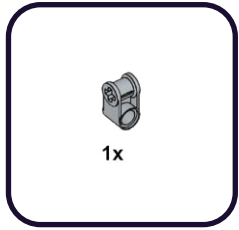

1

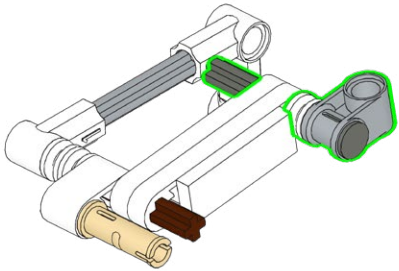

1

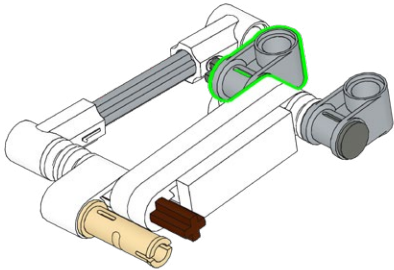

94

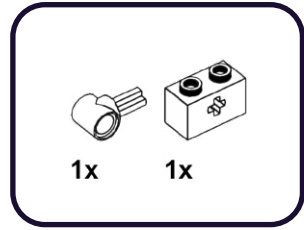

1

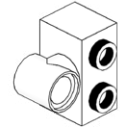

1

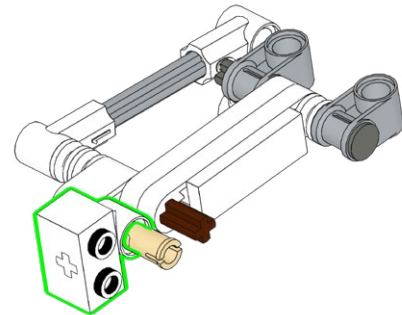



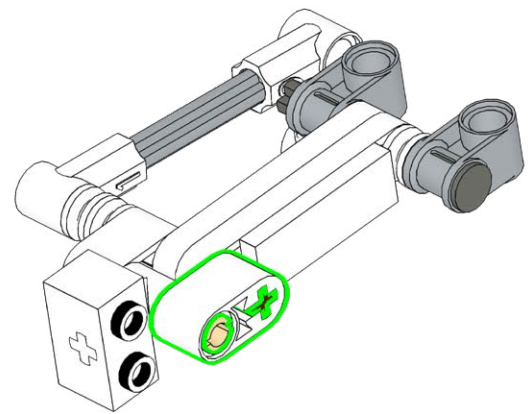

96

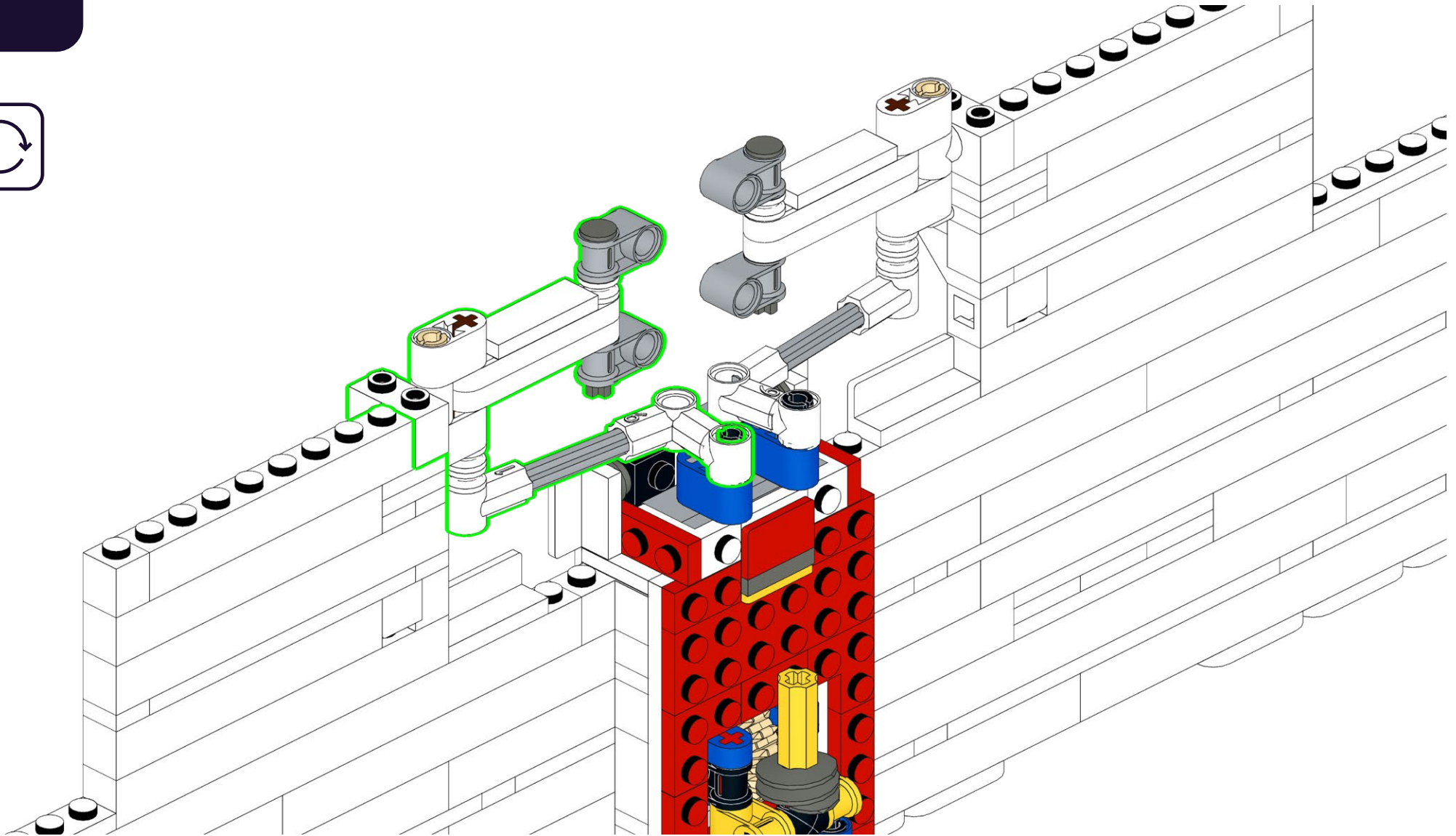

**HOLD UP!**

You might notice some bags aren't in order, as well as left over pieces, but that's ok! We're changing the way you build LEGO!

**ATTENDEZ!**

Vous remarquerez peut-être que certains sacs, ainsi que certaines pièces, ne sont pas dans le bon ordre. Mais pas de panique! Nous changeons simplement la façon avec laquelle vous construisez vos LEGO!

**ASPETTA!**

Potresti notare che alcuni sacchetti non sono in ordine, così come i pezzi avanzati, ma va bene così! Stiamo cambiando il modo in cui costruisci i LEGO!

**HALT!**

Sie werden möglicherweise bemerken, dass einige tüten durcheinander sind und teile übrig bleiben, aber das ist in Ordnung! Wir ändern die art und weise, wie Sie LEGO bauen!

**¡ESPERA!**

Es posible que notes que algunas bolsas están fuera de servicio, así como piezas sobrantes, ¡pero está bien! ¡Estamos cambiando la forma en que construyes LEGO!

**暫停!**

你可能会注意到一些袋子顺序错乱, 以及一些剩余的部件, 但没关系! 我们正在改变你搭建乐高的方式!

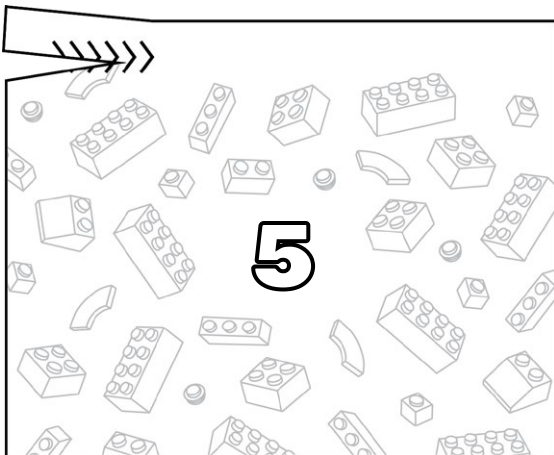
**Open LEGO® Bag 5**

97

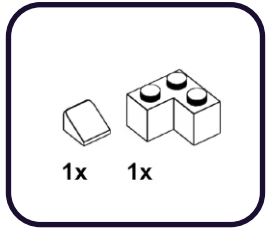

1

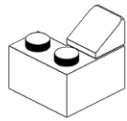

98

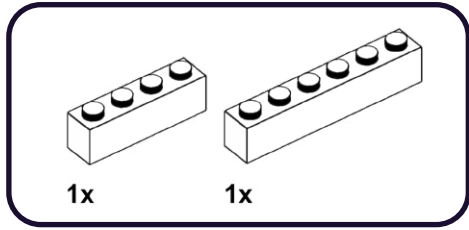

1

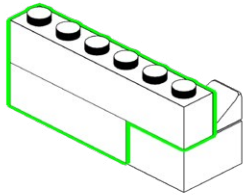

99

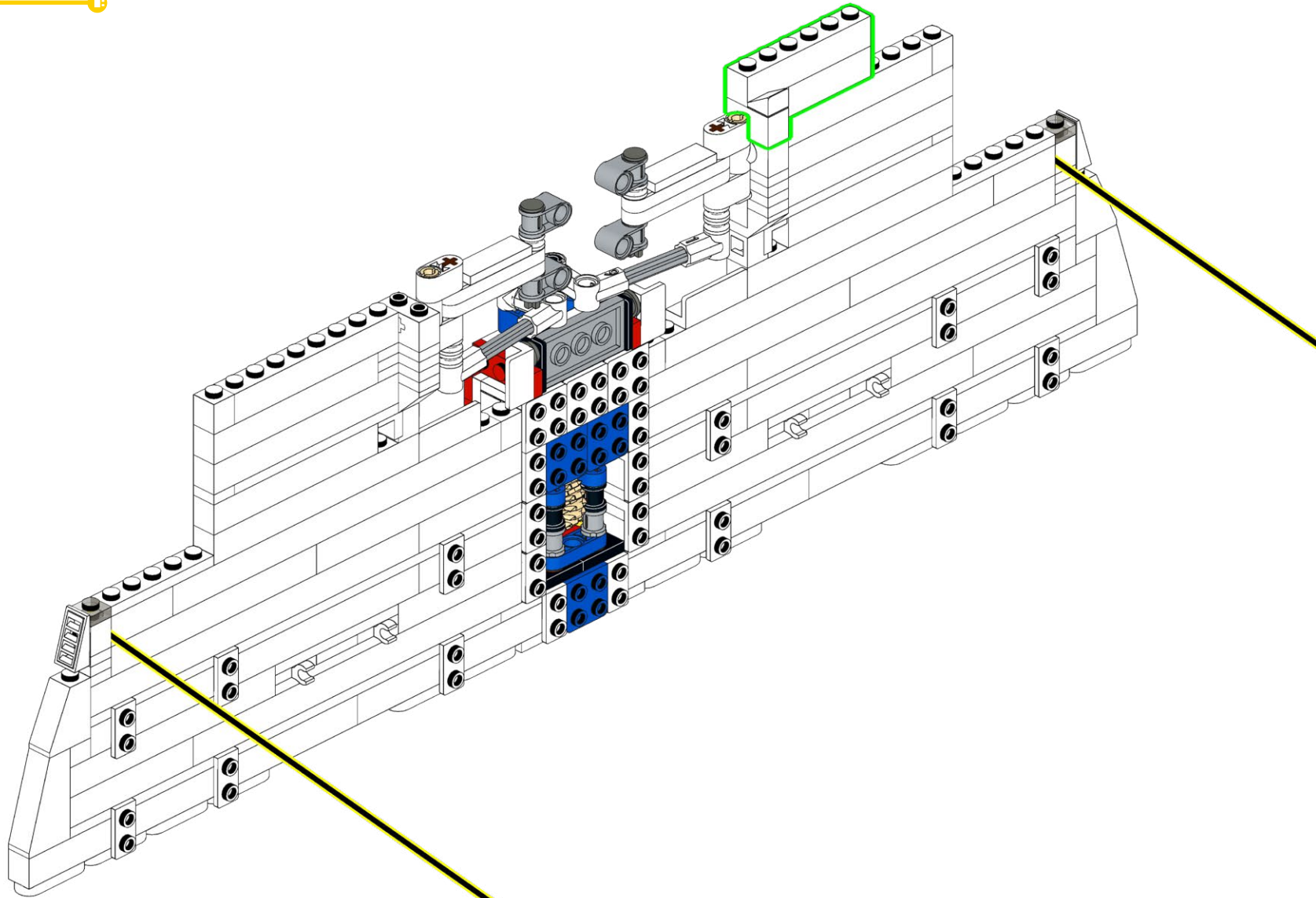

**100**

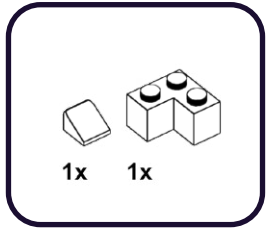

**1**

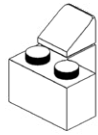

**101**

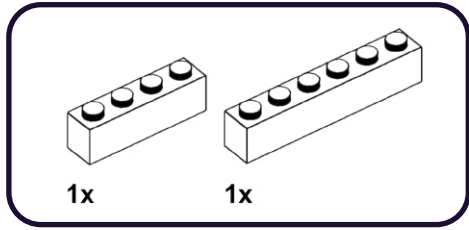

**1**

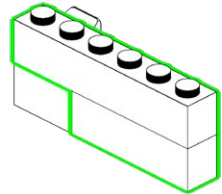

102

2x

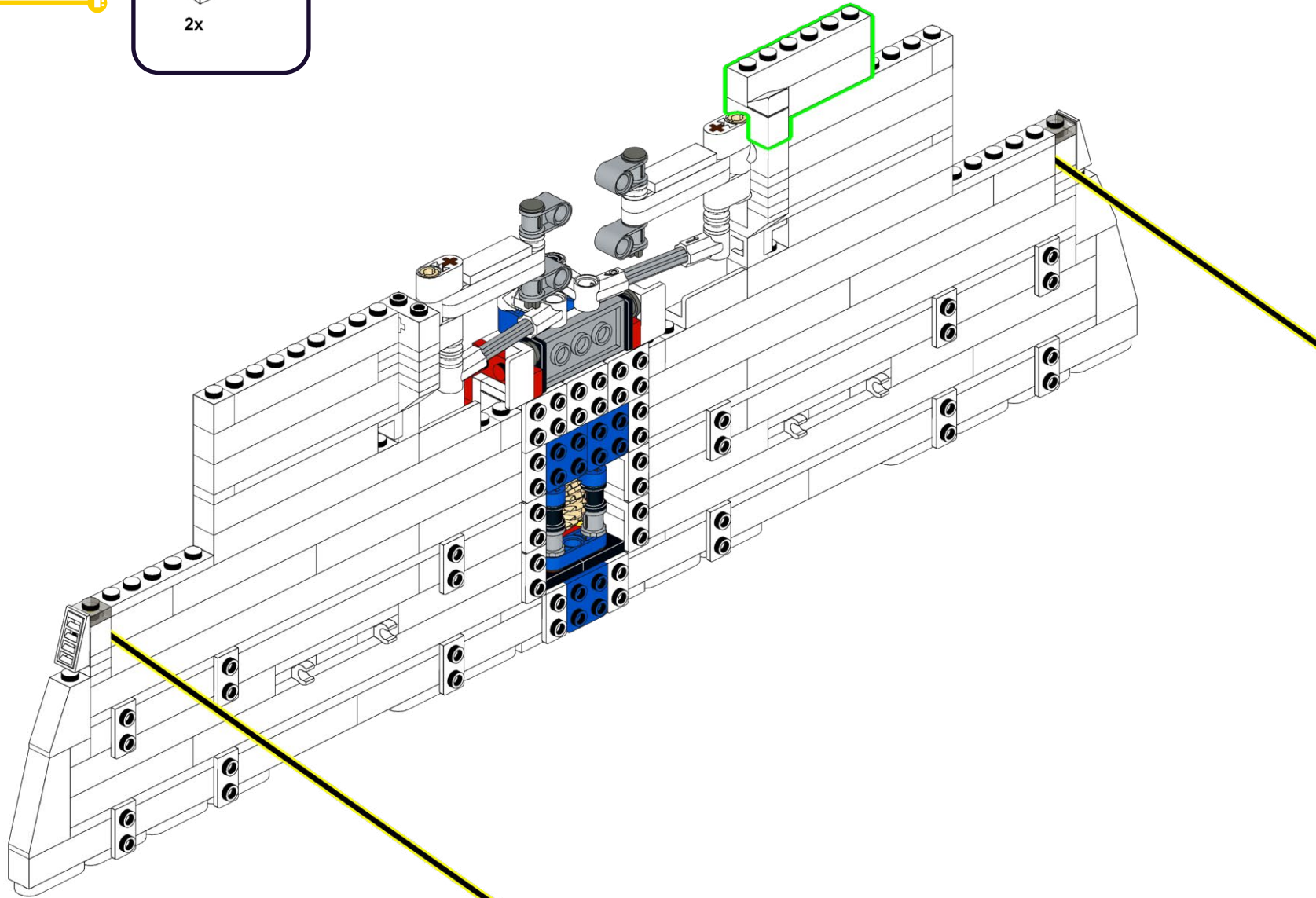

# 103

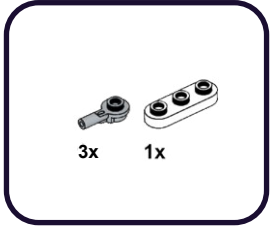

1

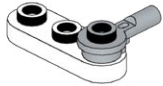

1

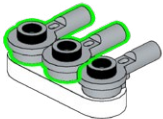

# 104

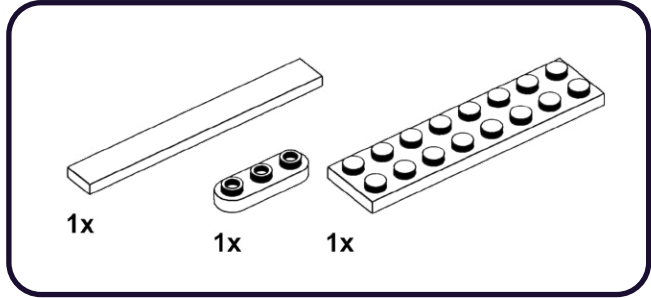

1

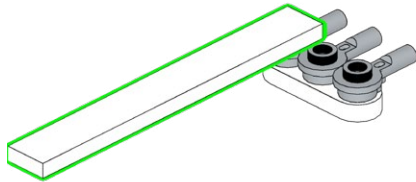

1

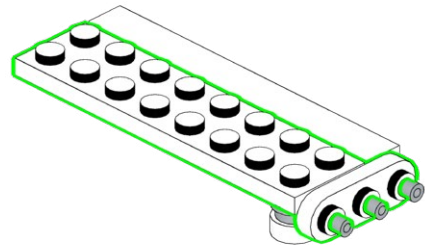



**105**



**1**

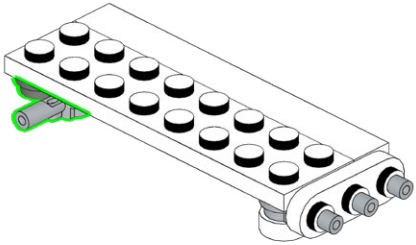

**106**

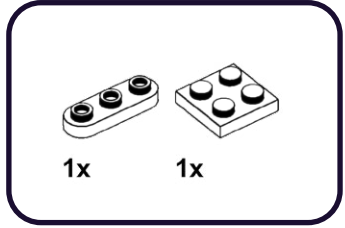

**1**

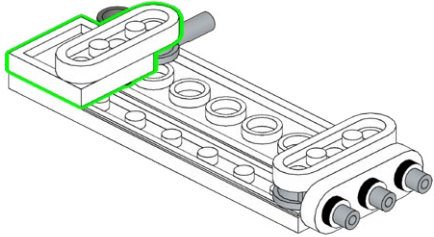

107

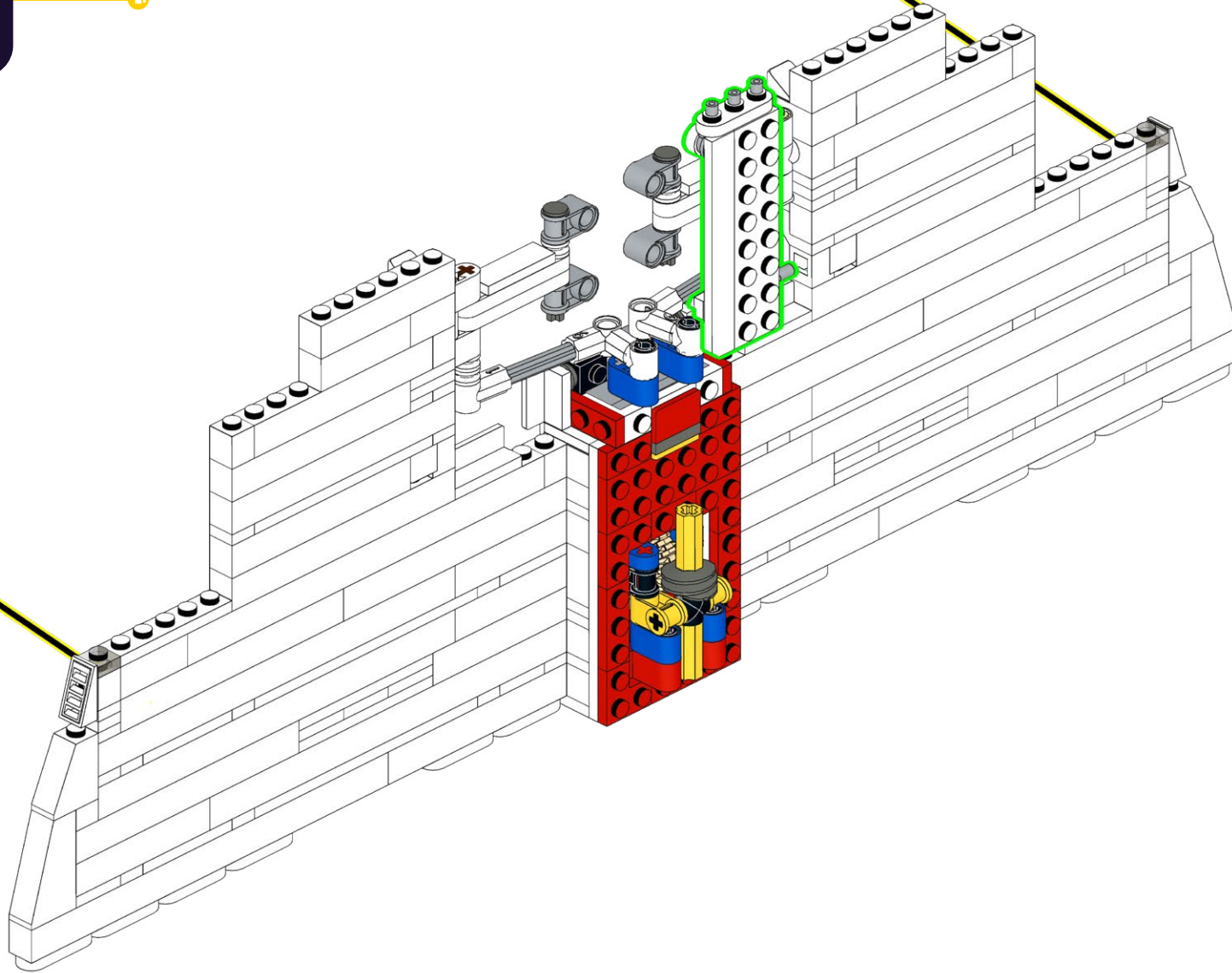

108

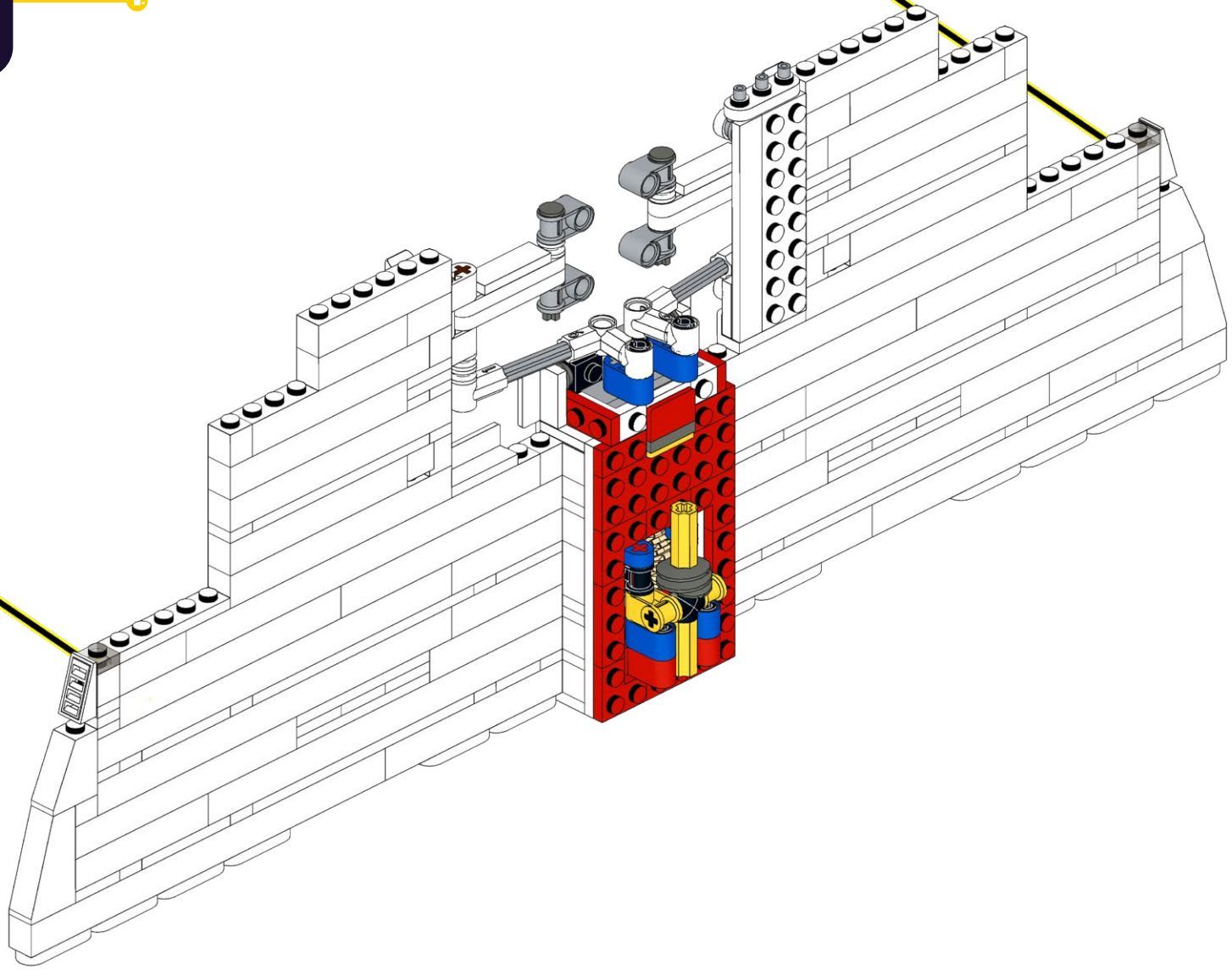

# 109

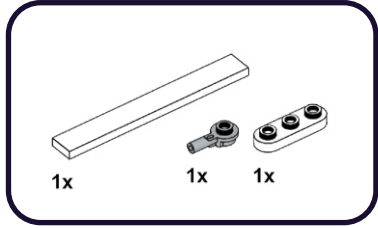

1

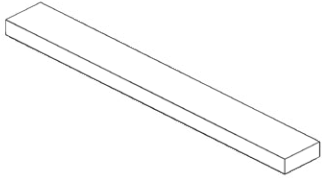

1

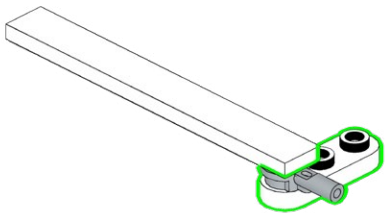

# 110

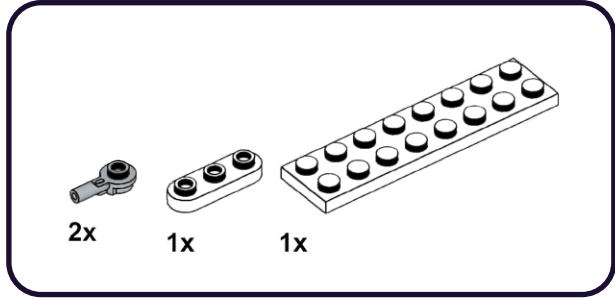

1

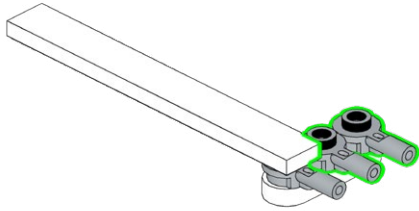

1

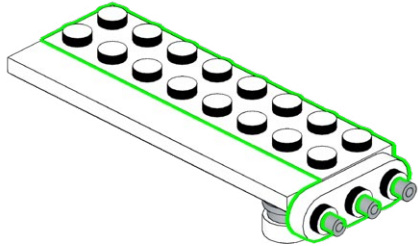

111

1x 1x



1

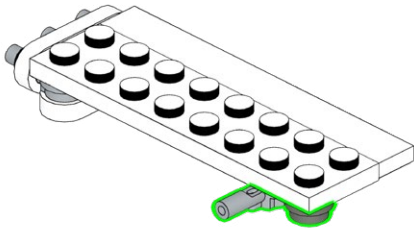

112

1x 1x

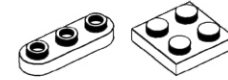

1

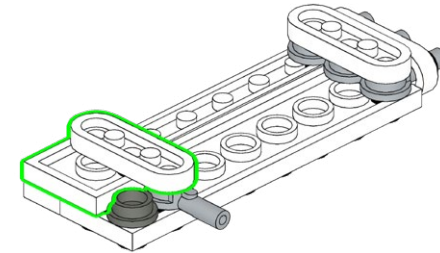

113

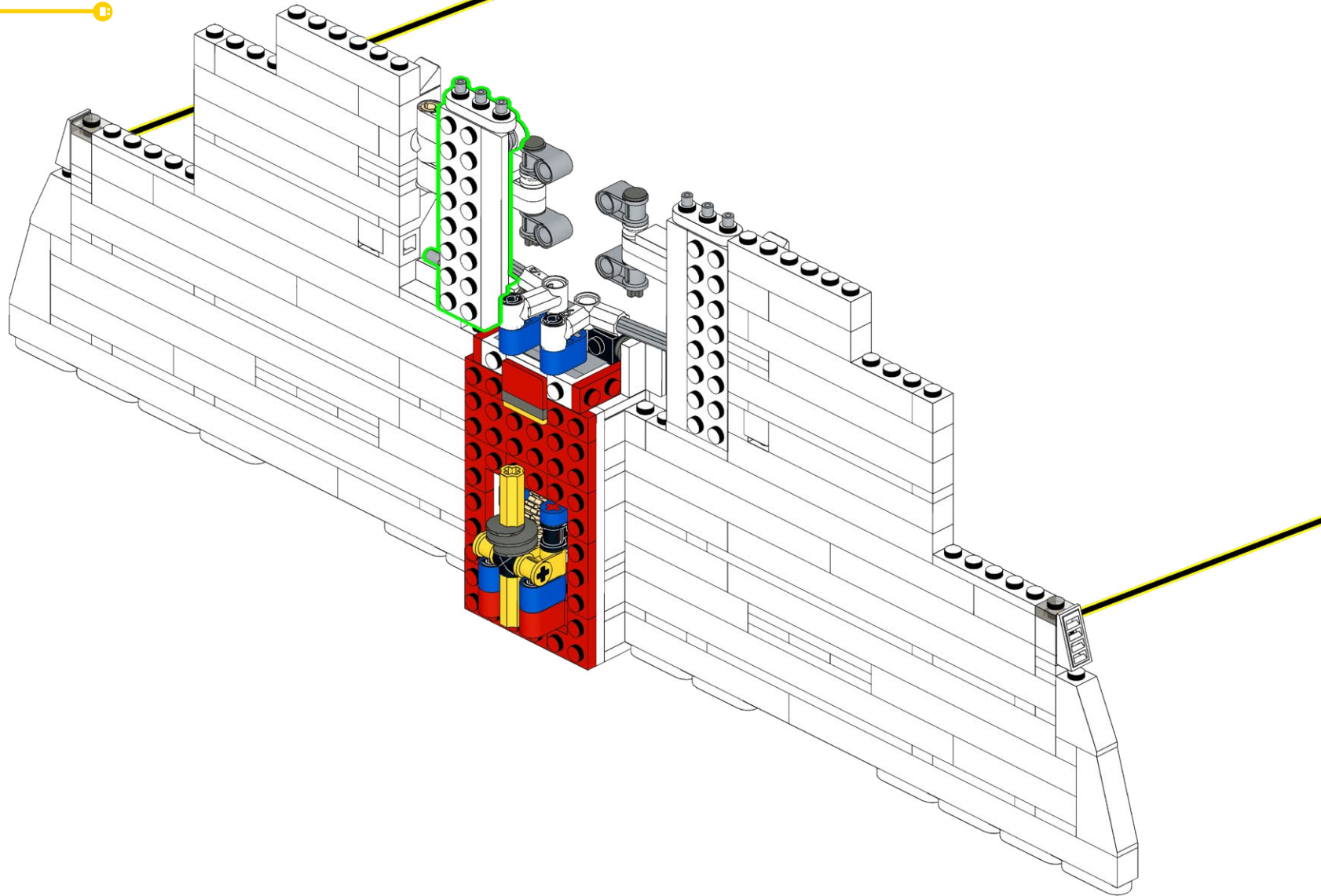

114

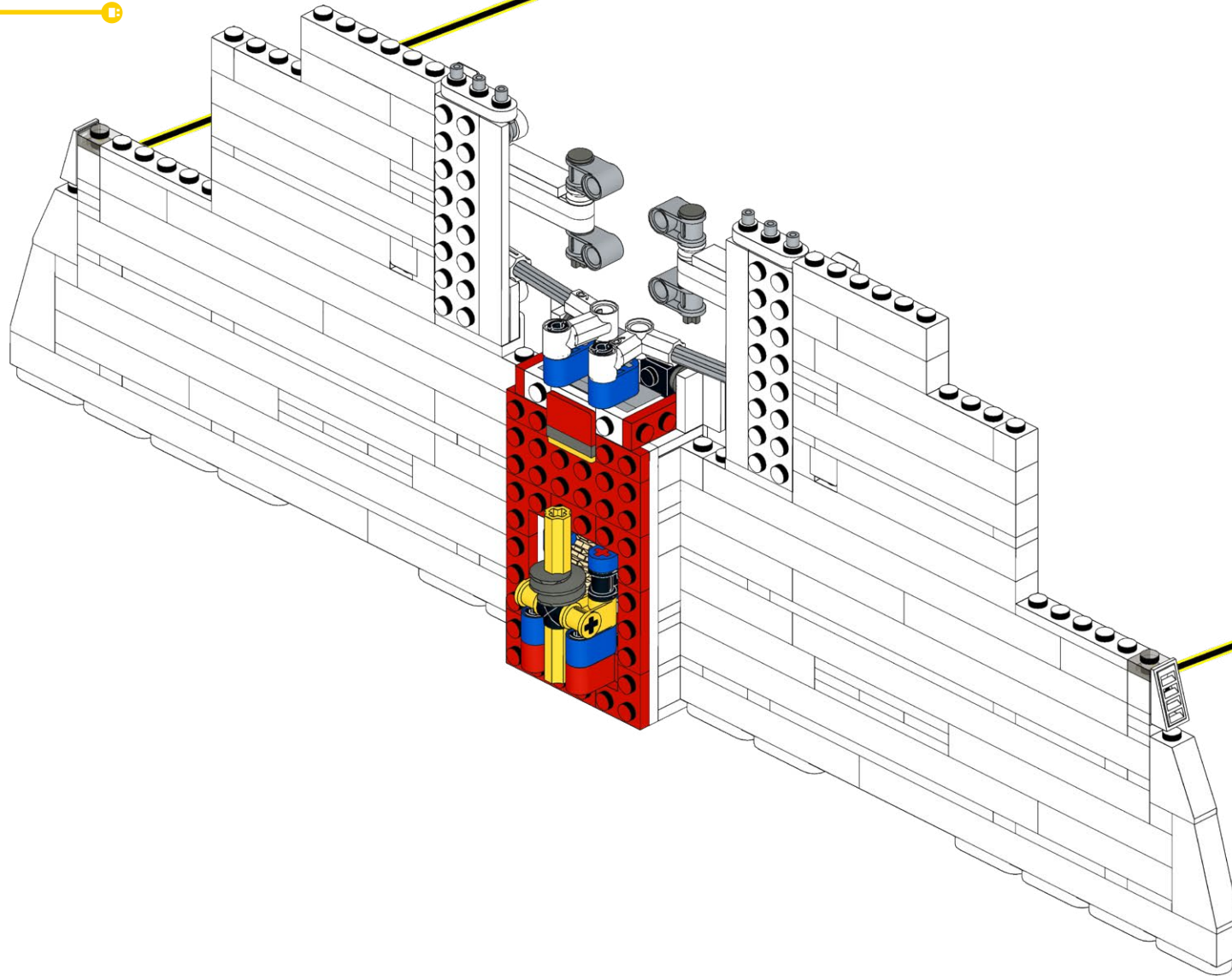

115

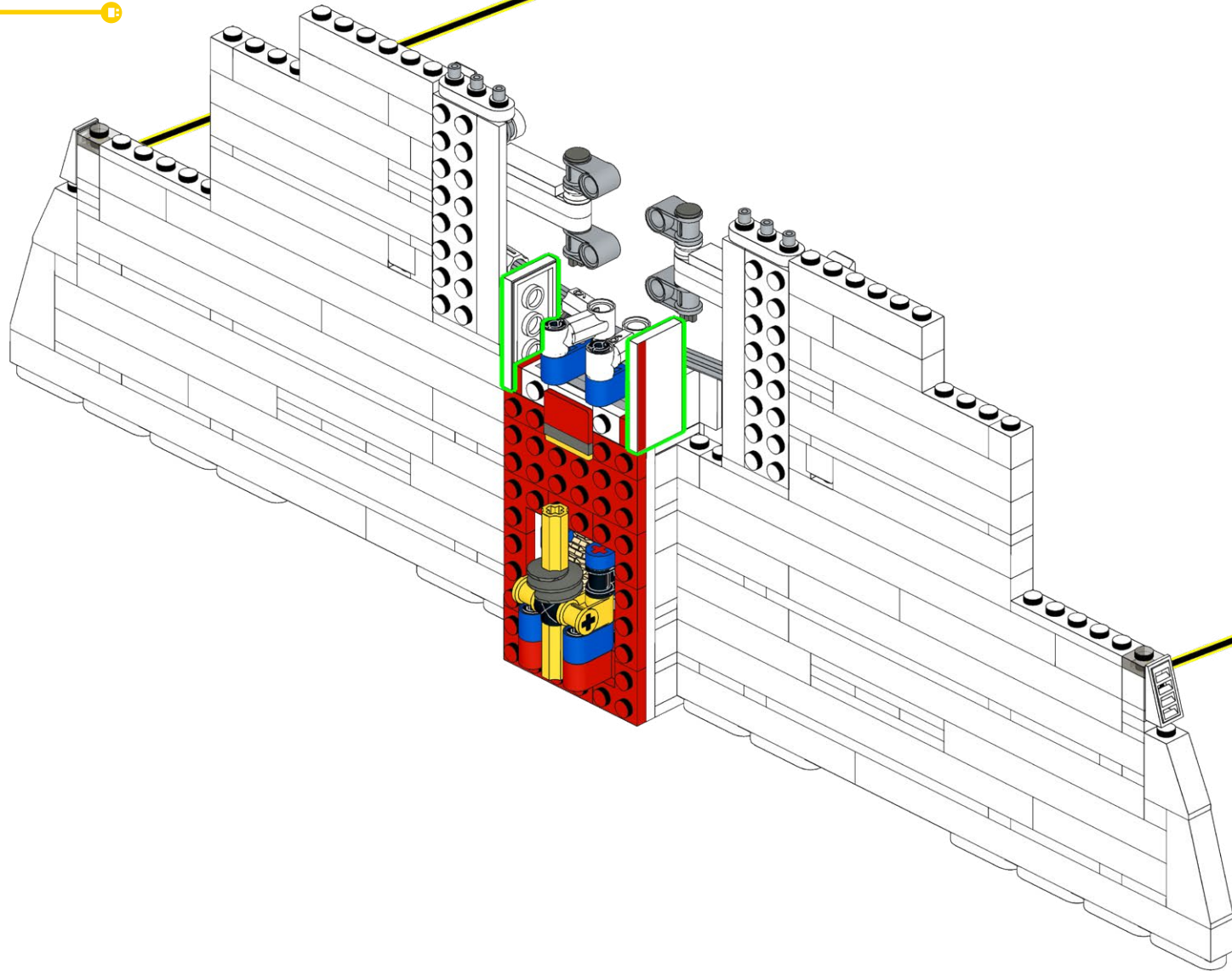



116

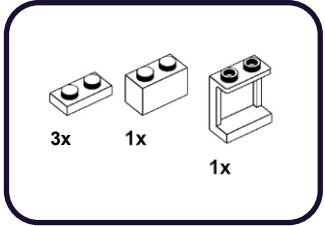

1

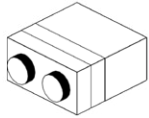

1

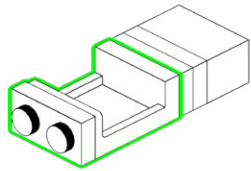

117

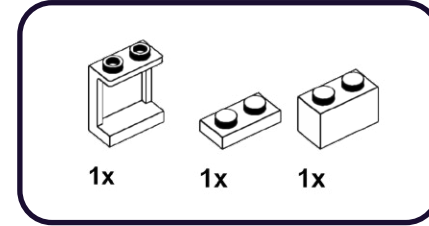

1

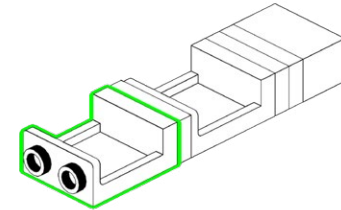

1

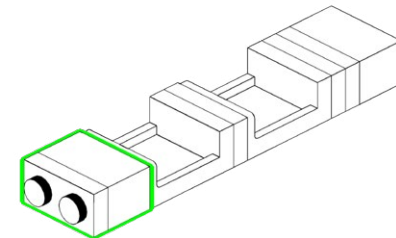

2x

118

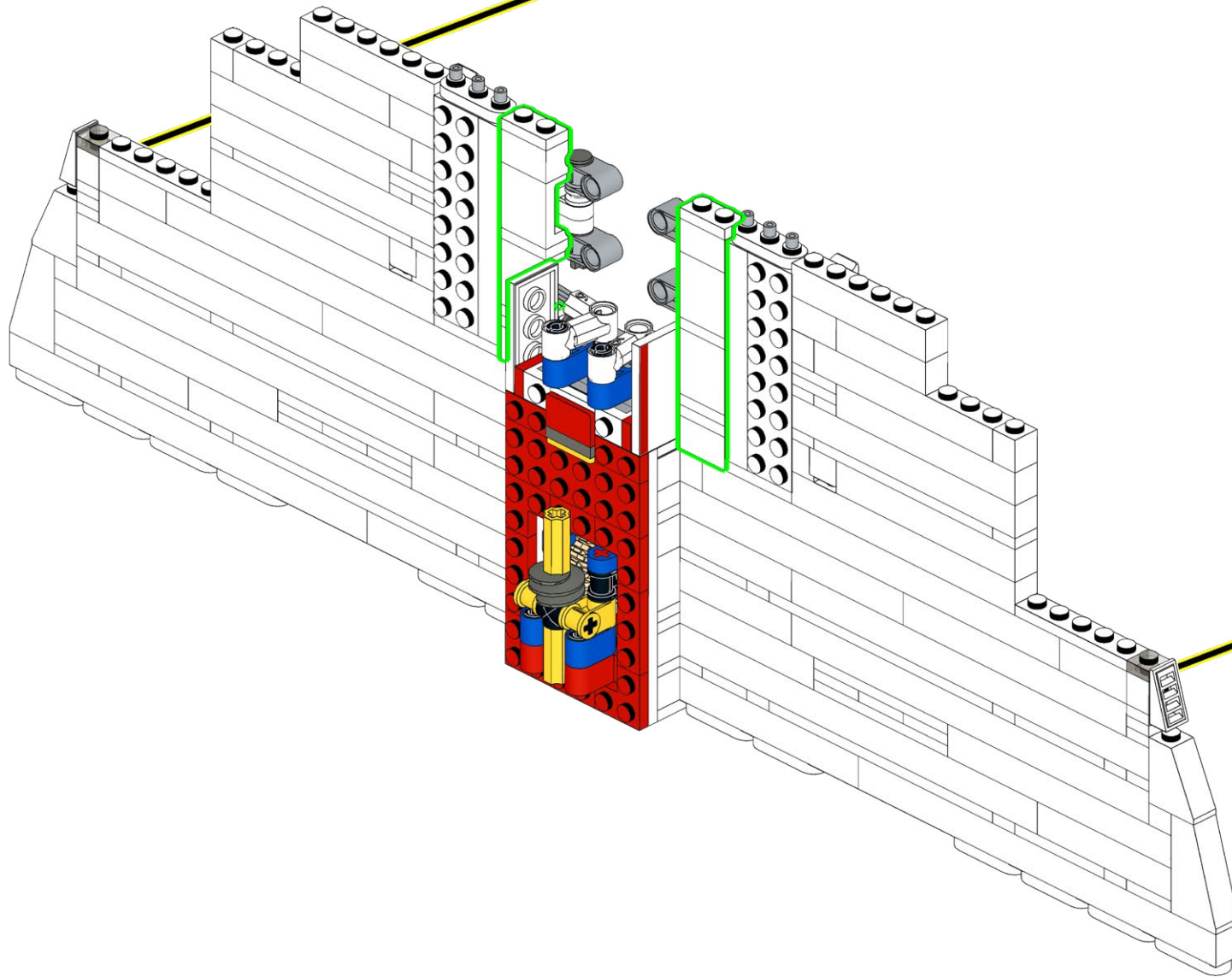

119

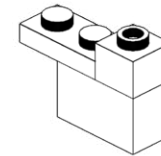
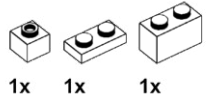

120

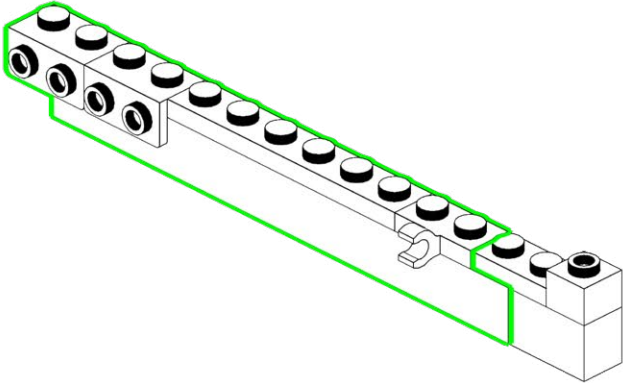
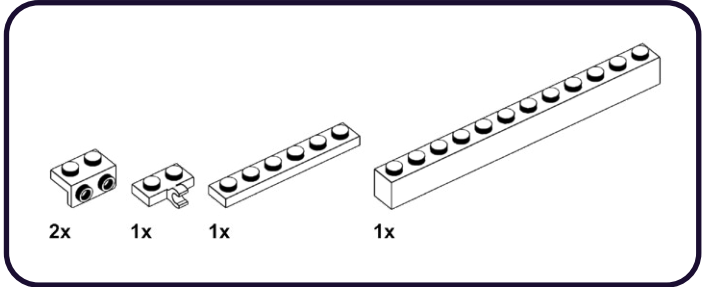

121

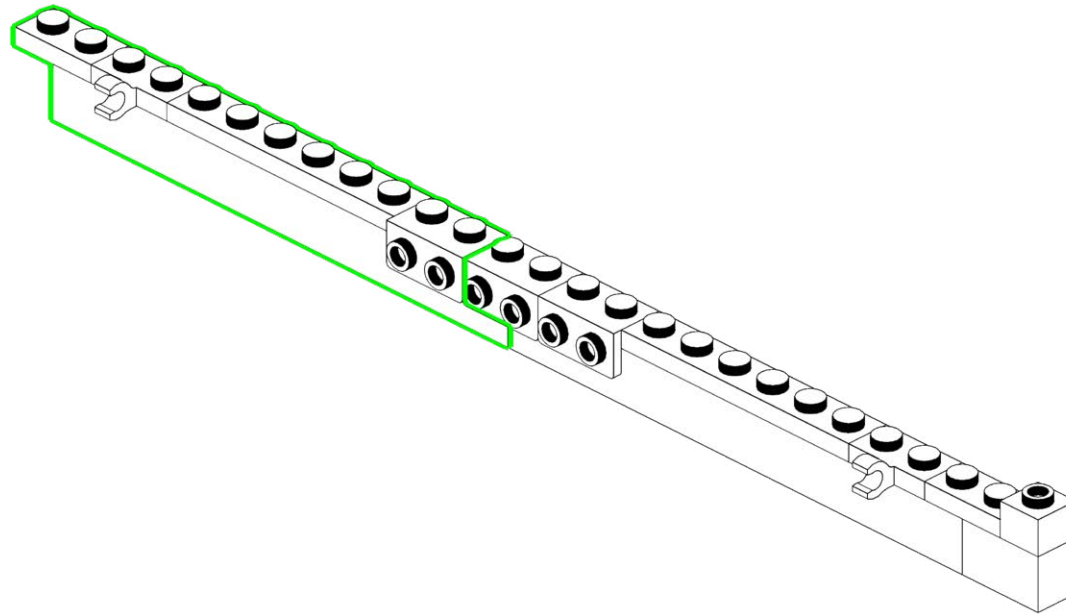
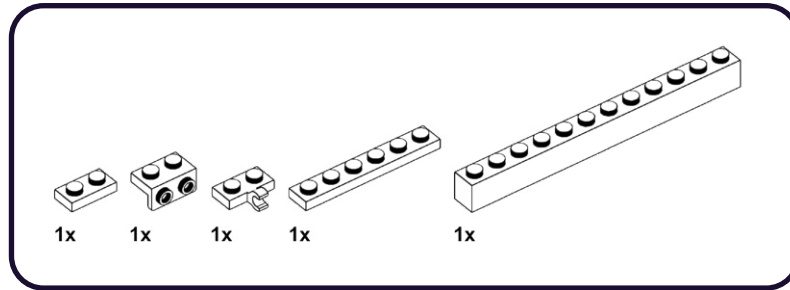

122

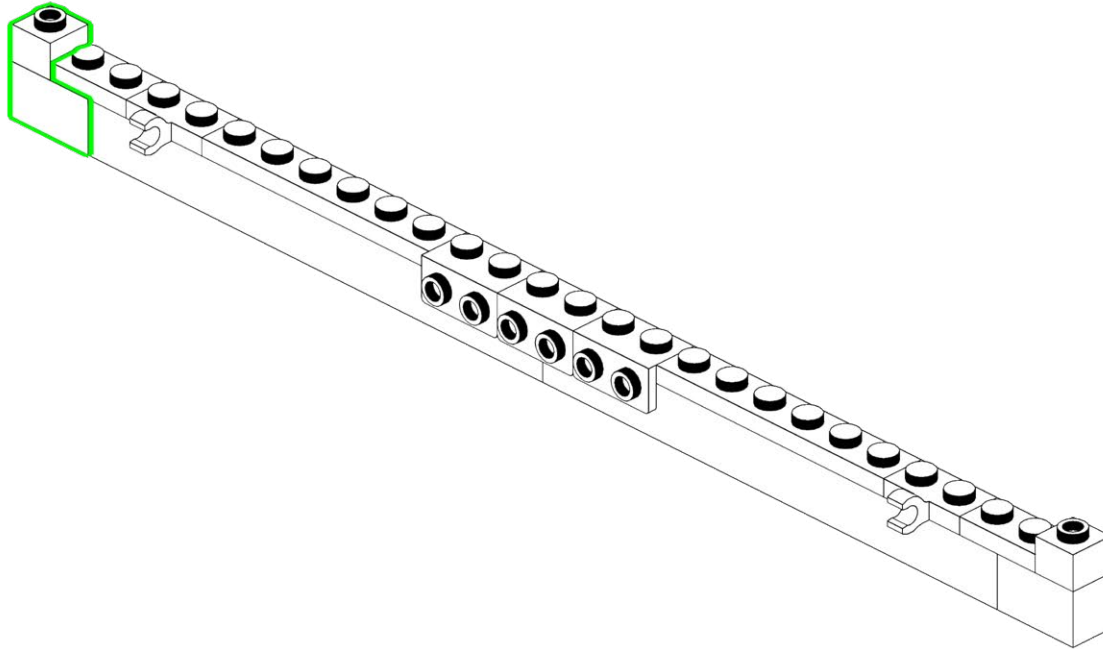
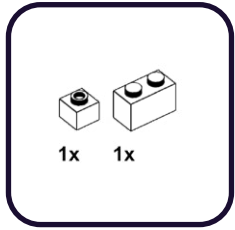

123

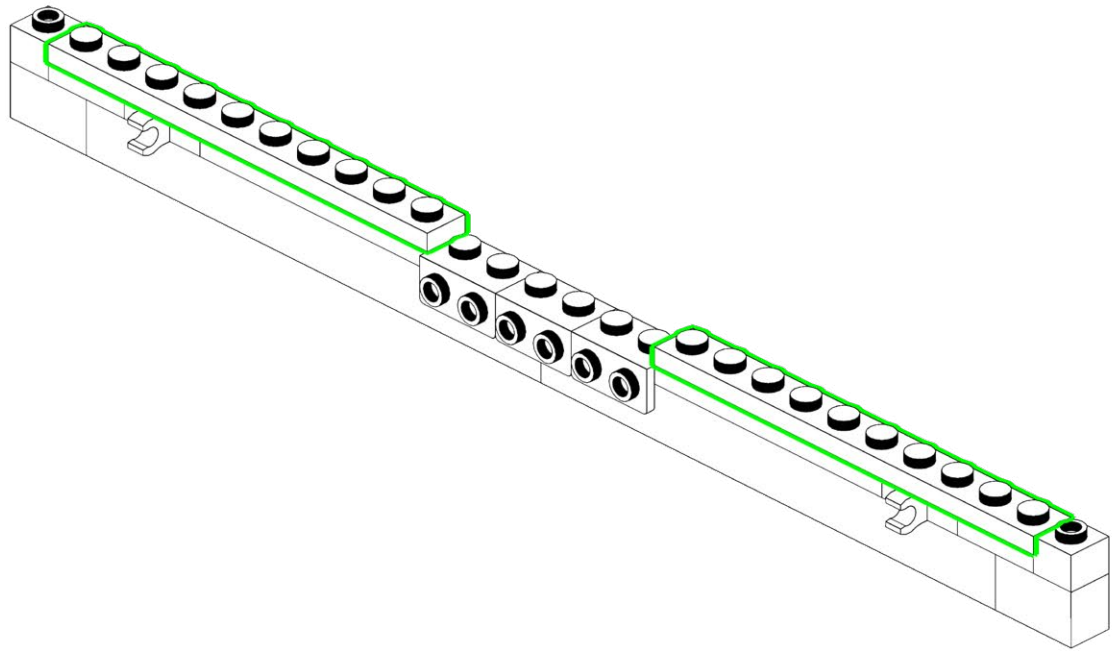
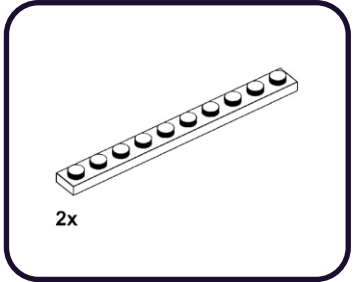

124

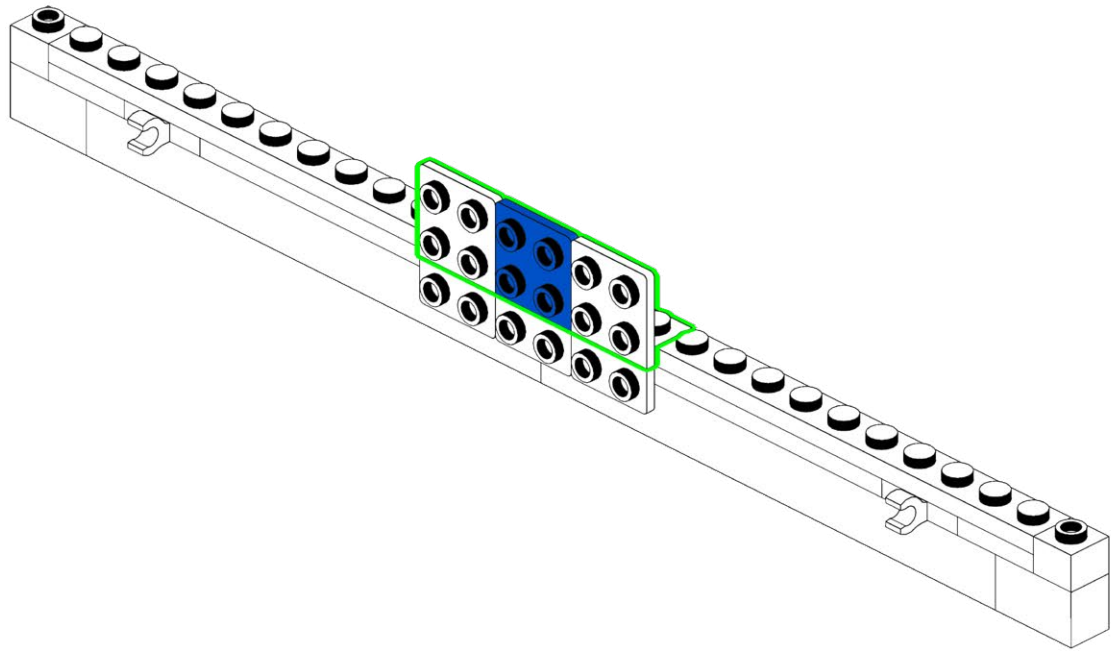
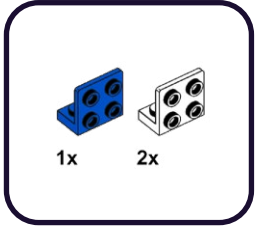



125

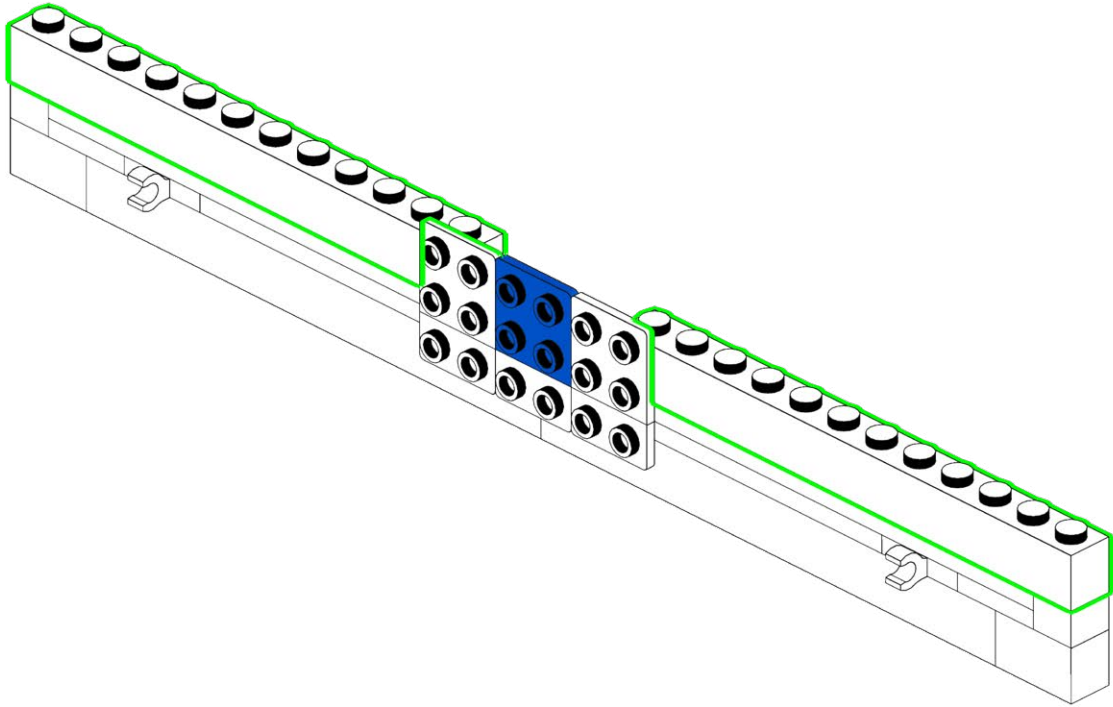
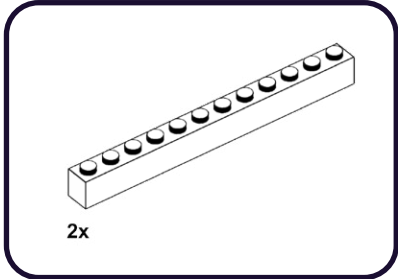

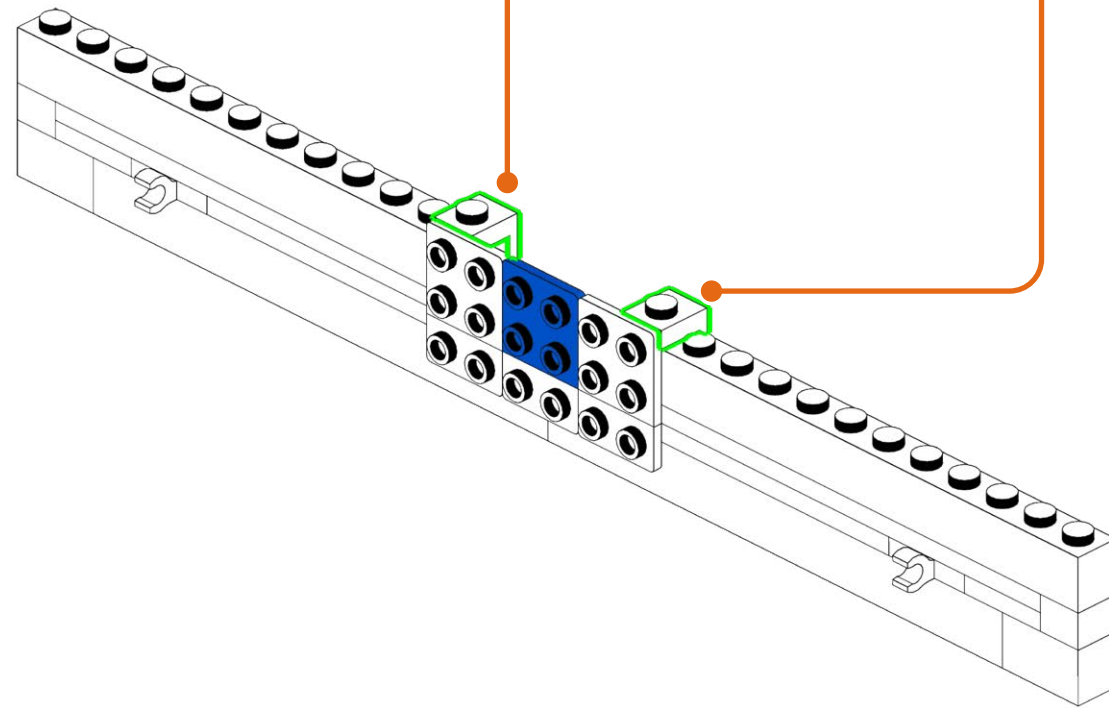
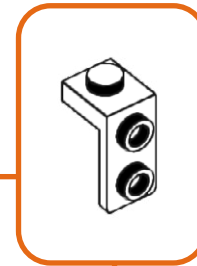
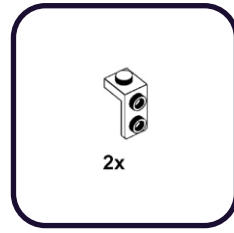
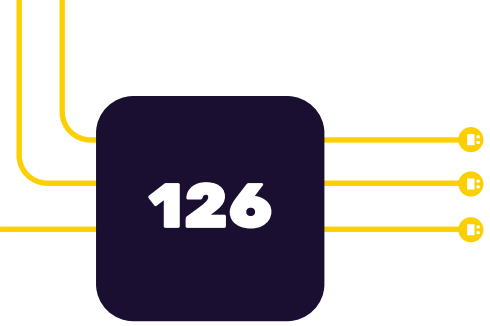

127

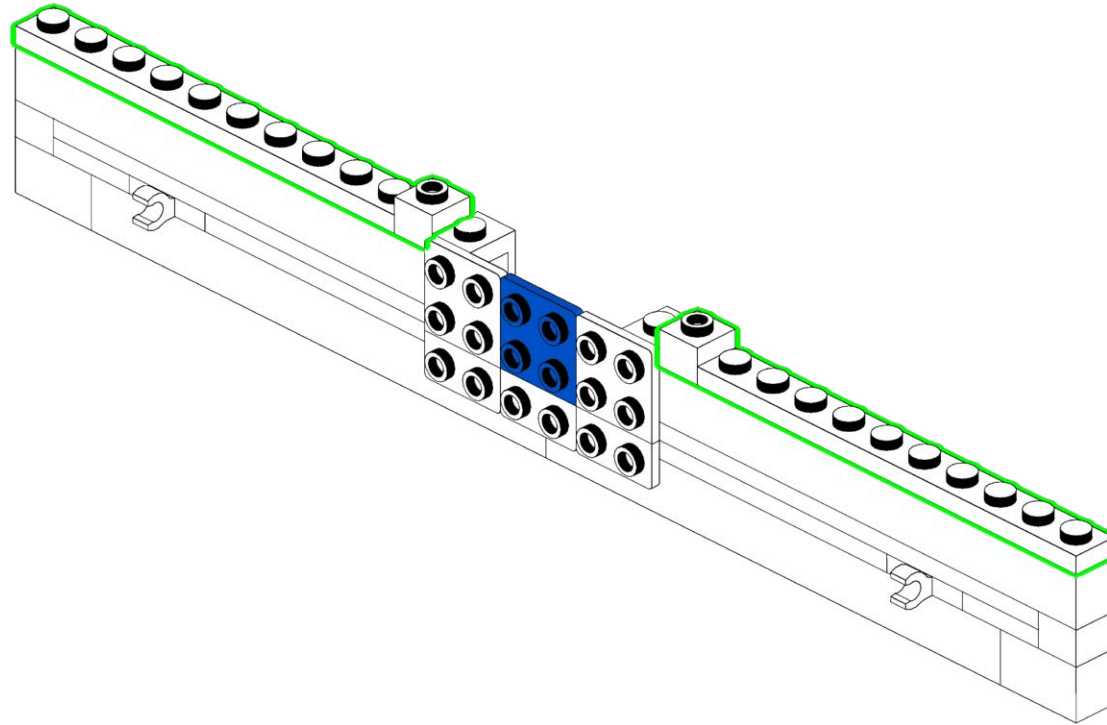
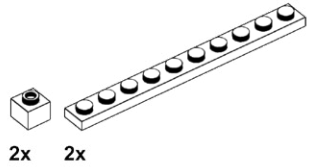

# 128

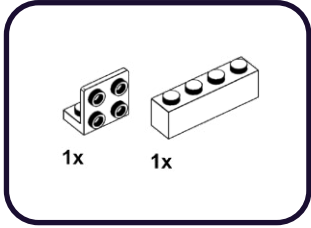

1

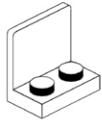

1

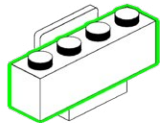

# 129

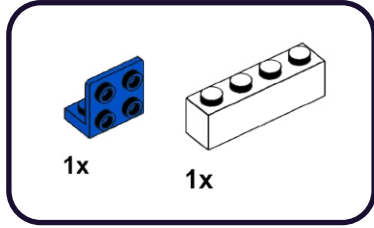

1

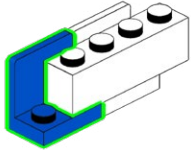

1

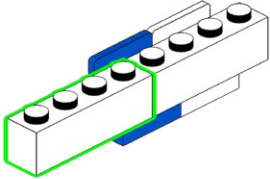

# 130

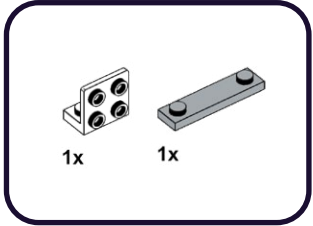

1

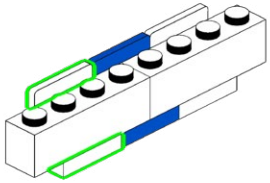

1

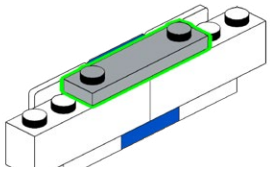

# 131

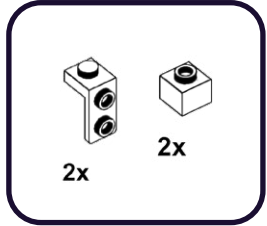

1

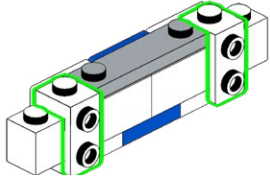

1

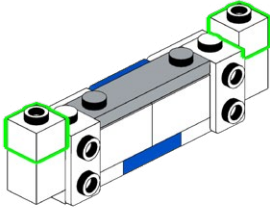

132

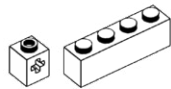

4x 4x

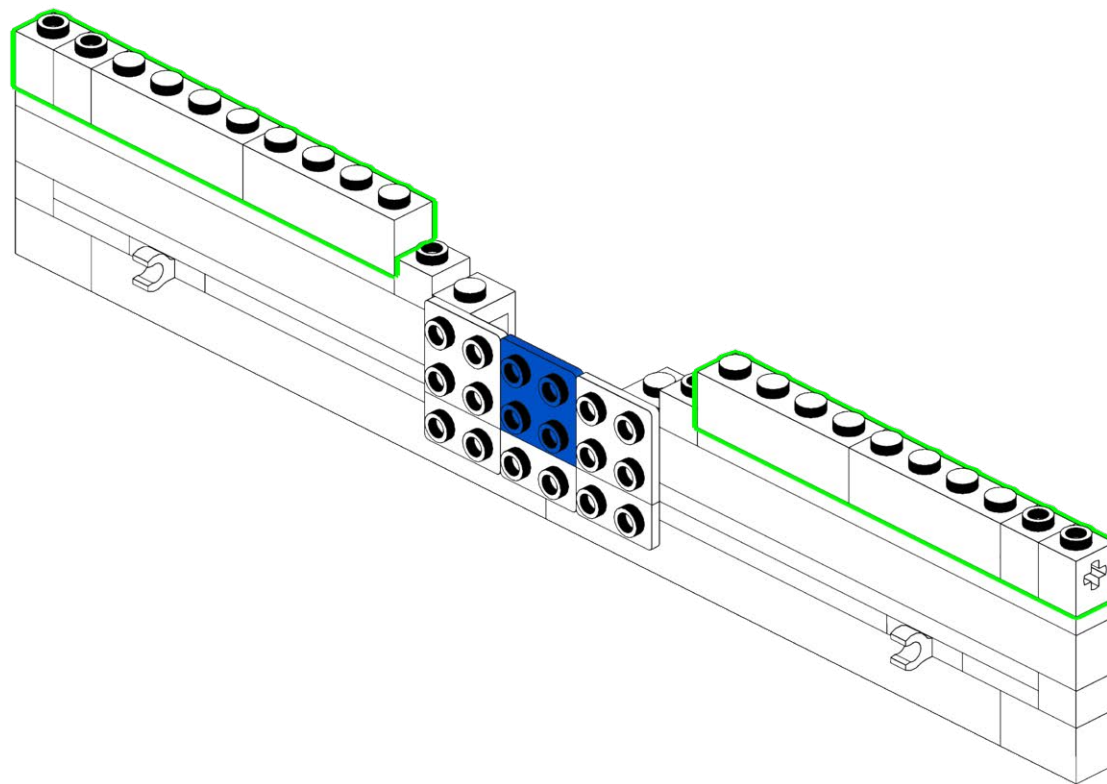

133

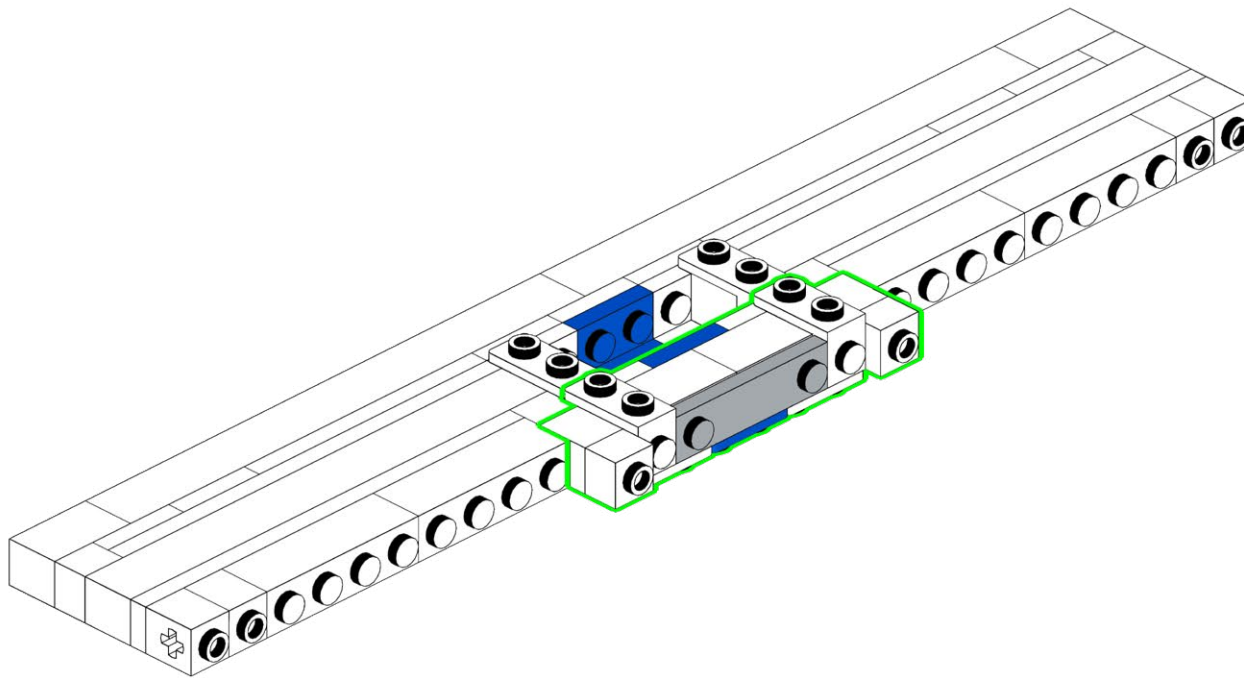

# 134

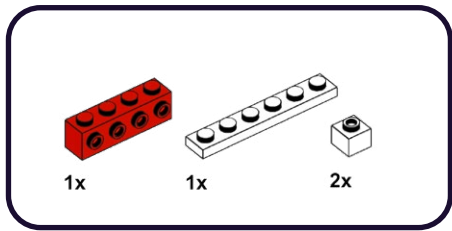

1

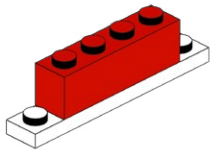

1

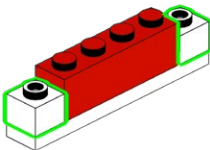

# 135

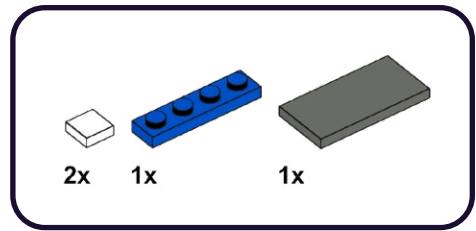

1

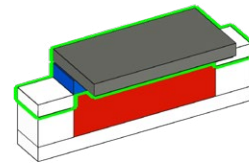



136

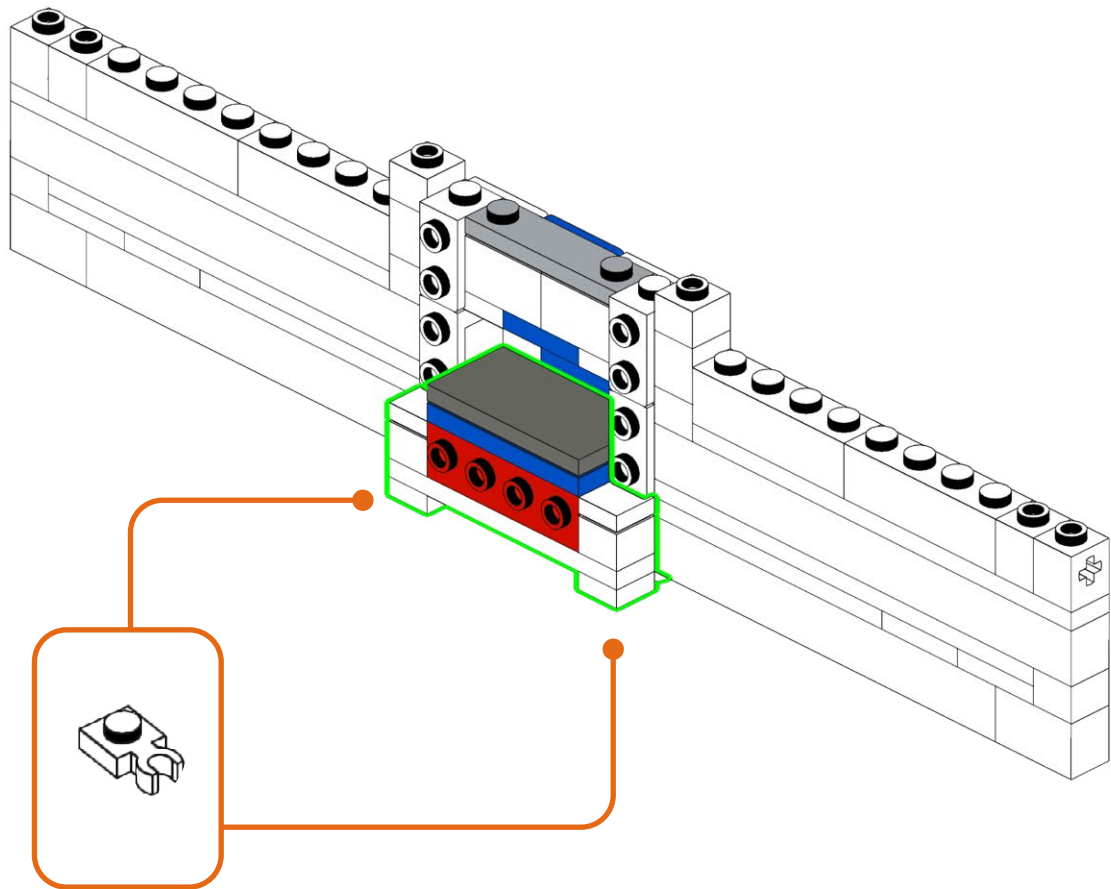
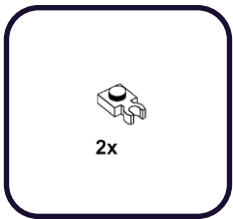

**137**

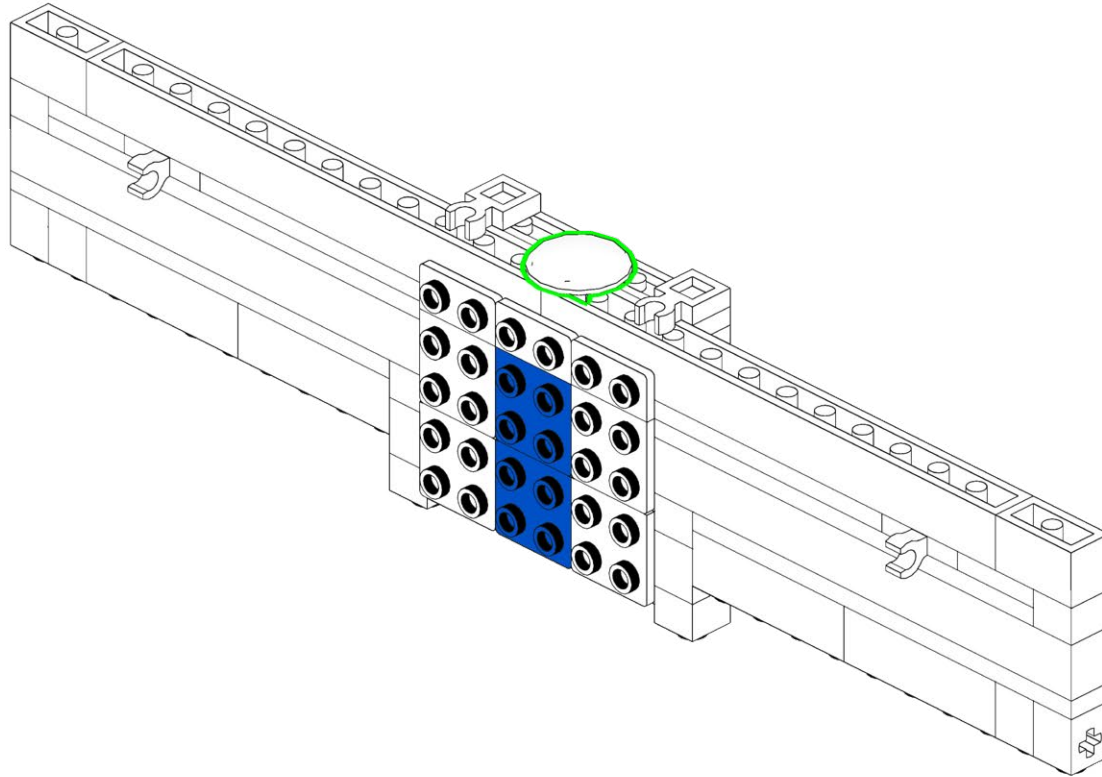
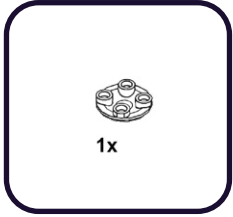

138

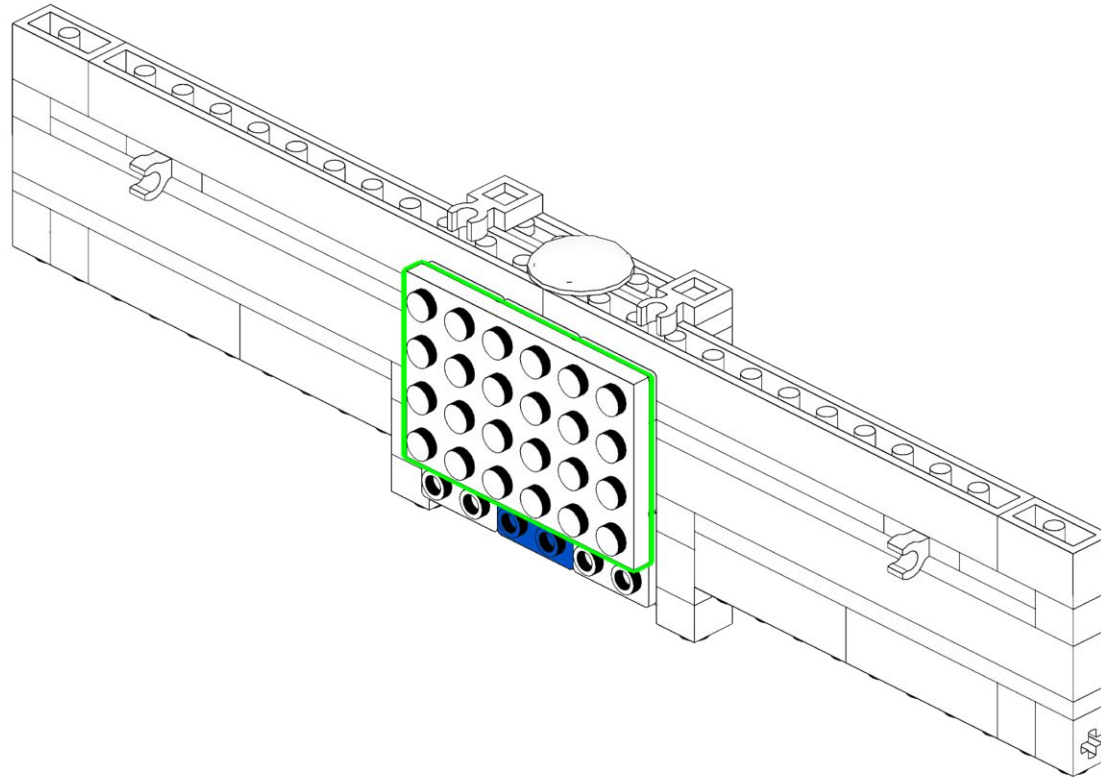
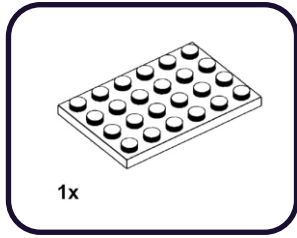

139

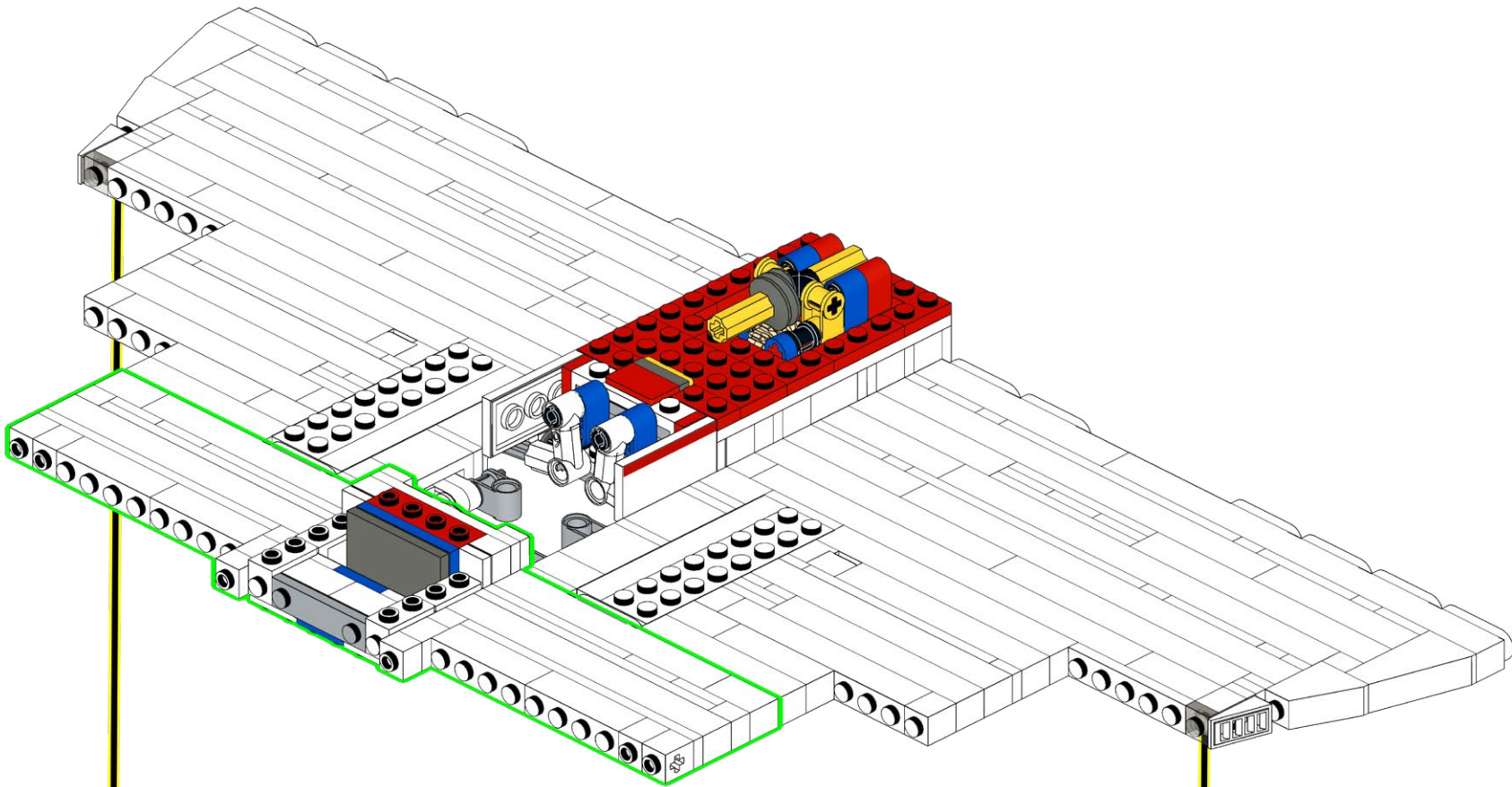

**HOLD UP!**

You might notice some bags aren't in order, as well as left over pieces, but that's ok! We're changing the way you build LEGO!

**ATTENDEZ!**

Vous remarquerez peut-être que certains sacs, ainsi que certaines pièces, ne sont pas dans le bon ordre. Mais pas de panique! Nous changeons simplement la façon avec laquelle vous construisez vos LEGO!

**ASPETTA!**

Potresti notare che alcuni sacchetti non sono in ordine, così come i pezzi avanzati, ma va bene così! Stiamo cambiando il modo in cui costruisci i LEGO!

**HALT!**

Sie werden möglicherweise bemerken, dass einige tüten durcheinander sind und teile übrig bleiben, aber das ist in Ordnung! Wir ändern die art und weise, wie Sie LEGO bauen!

**¡ESPERA!**

Es posible que notes que algunas bolsas están fuera de servicio, así como piezas sobrantes, ¡pero está bien! ¡Estamos cambiando la forma en que construyes LEGO!

**暫停!**

你可能会注意到一些袋子顺序错乱, 以及一些剩余的部件, 但没关系! 我们正在改变你搭建乐高的方式!

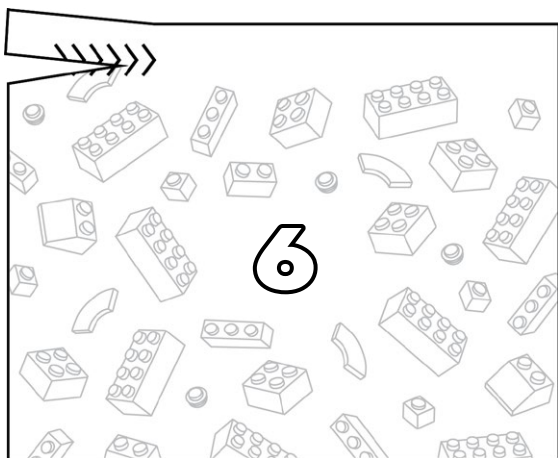
**Open LEGO® Bag 6**

**140**

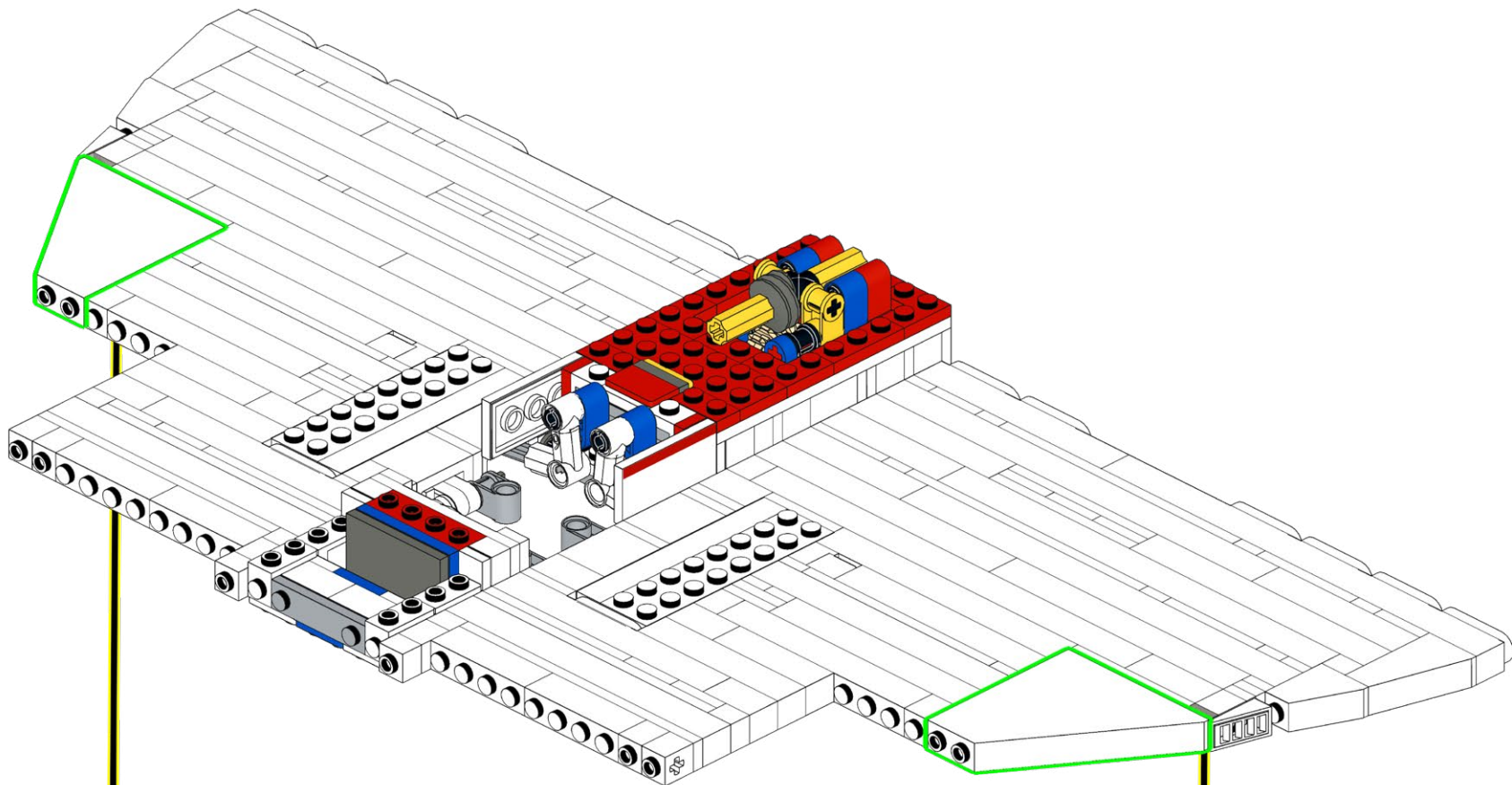
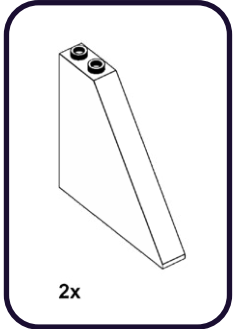

141

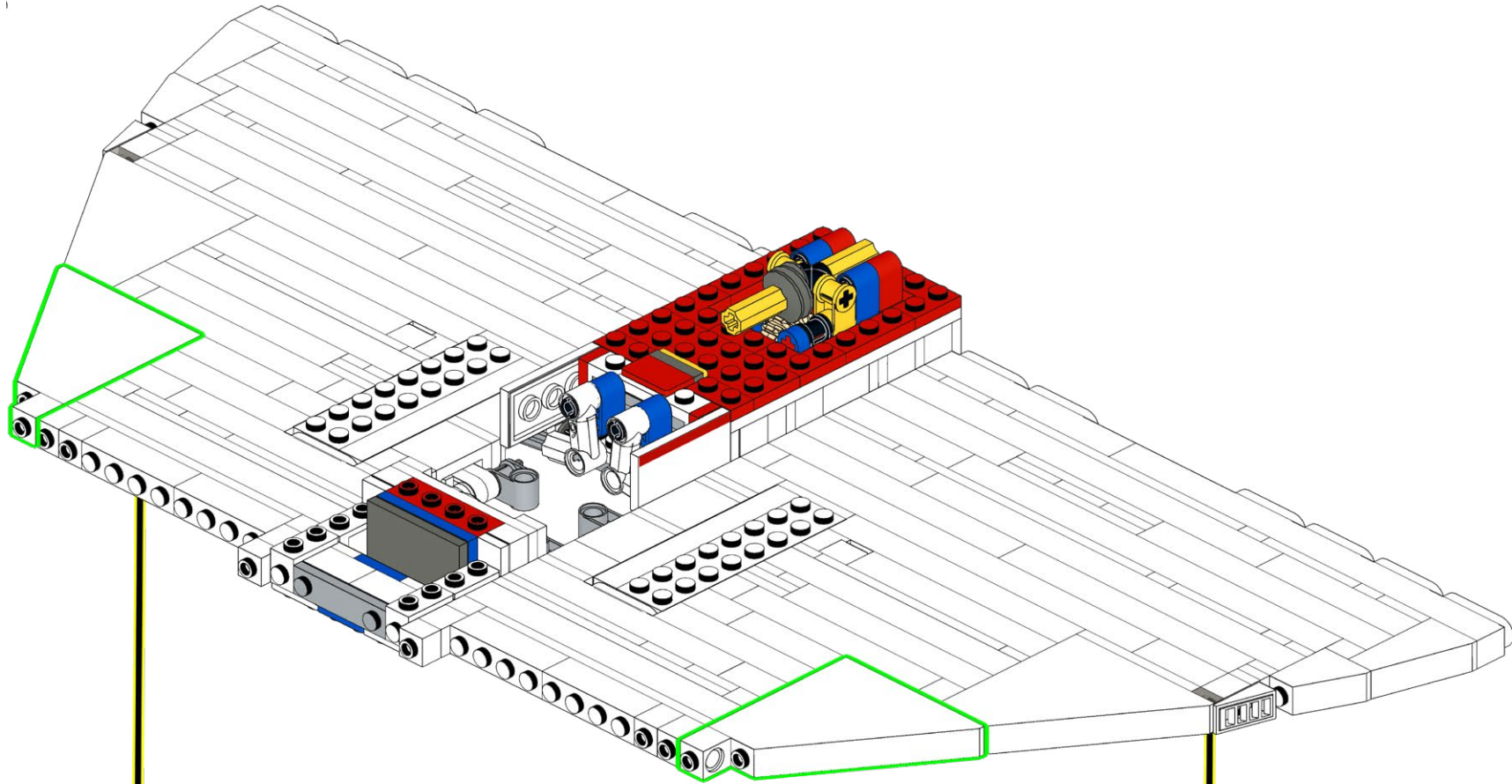
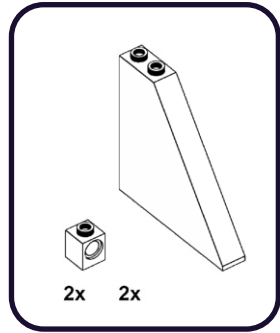

142

2x

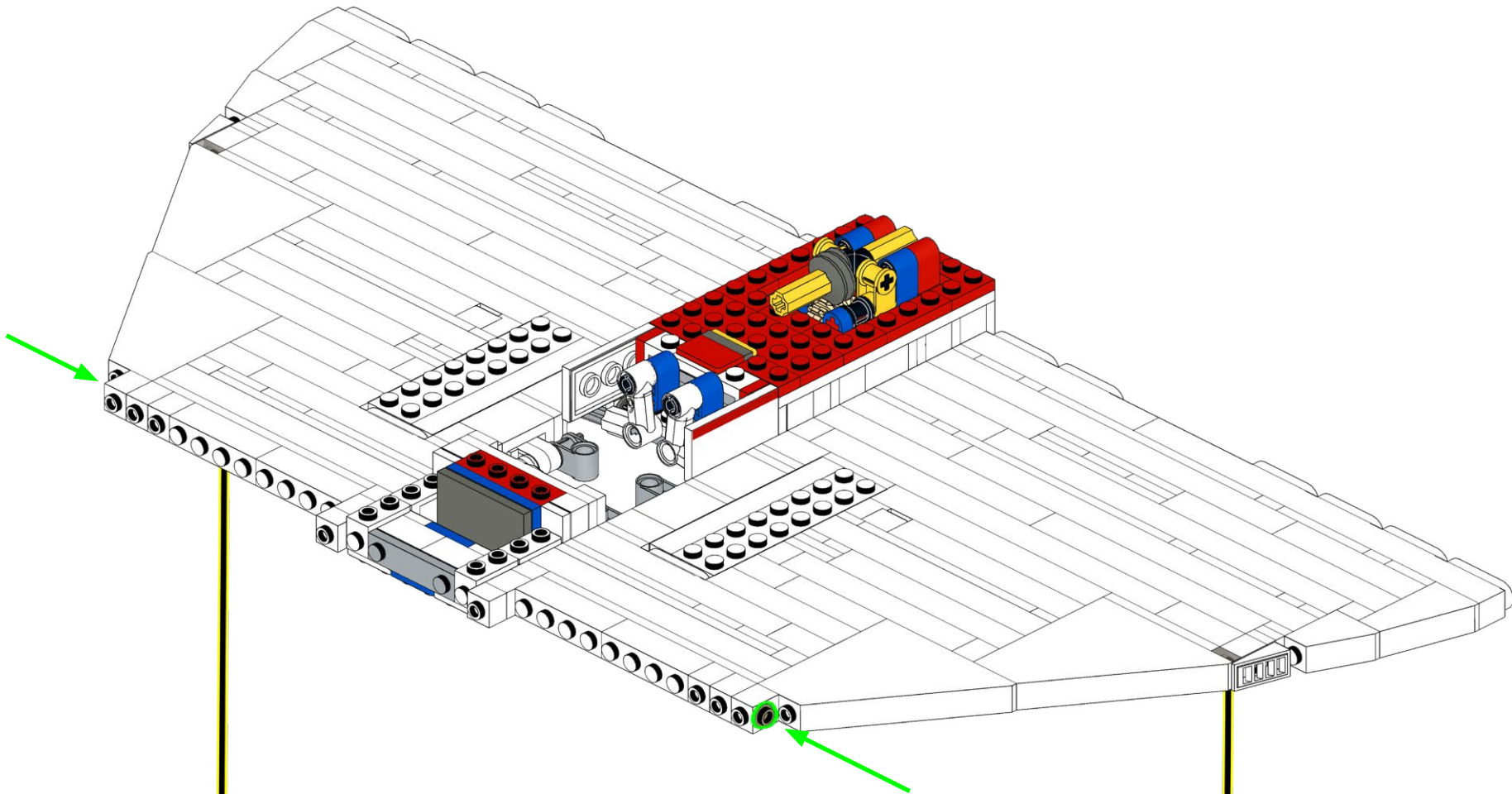



143

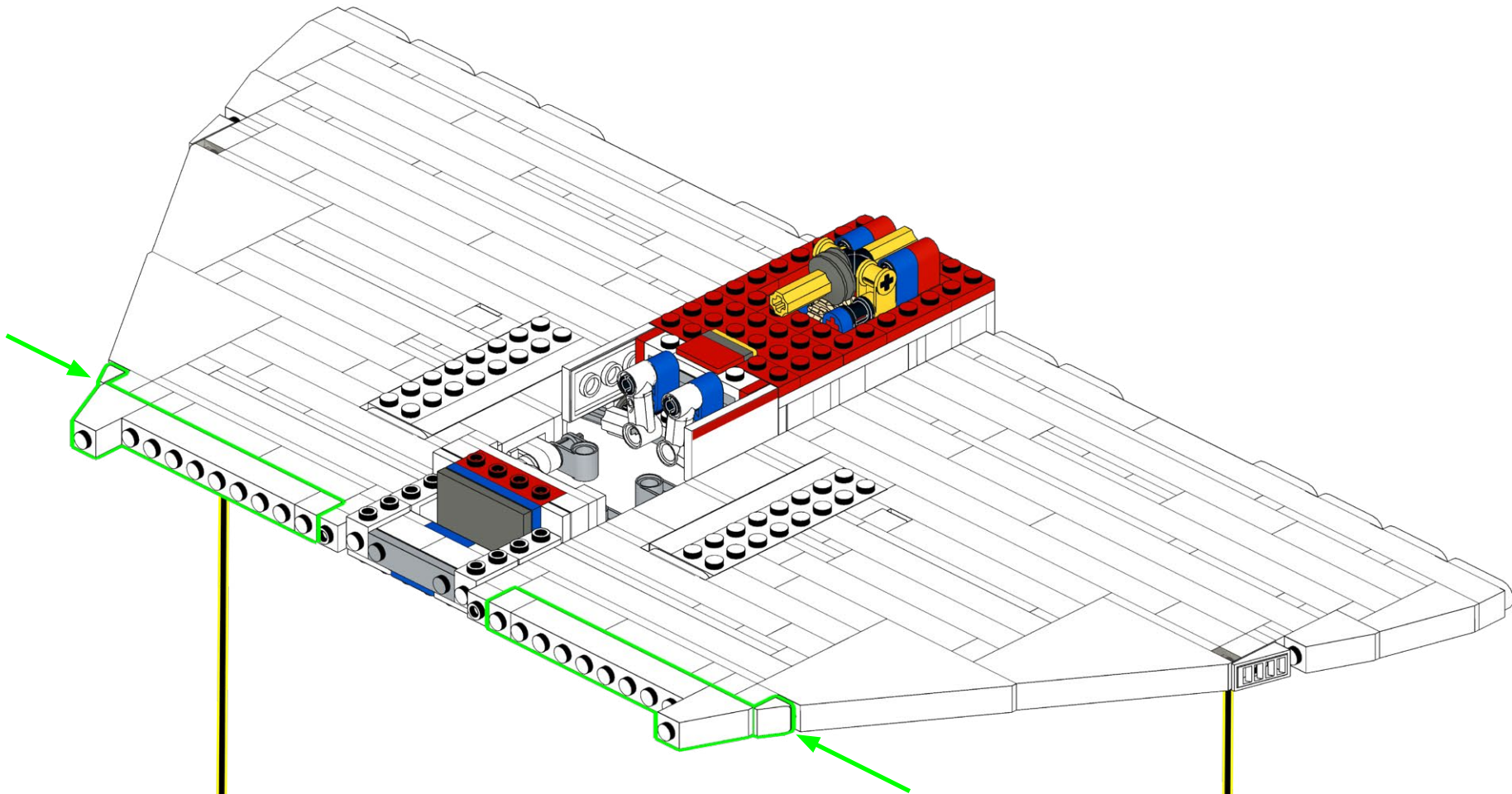
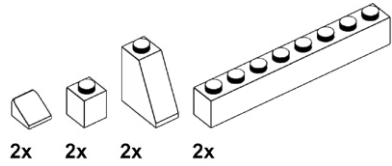

# 144

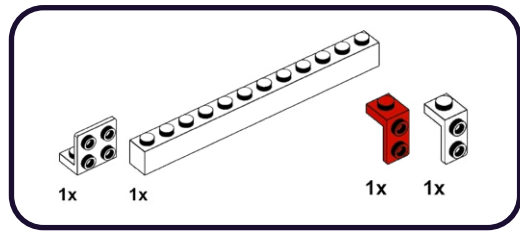

1

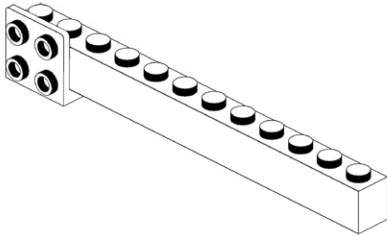

1

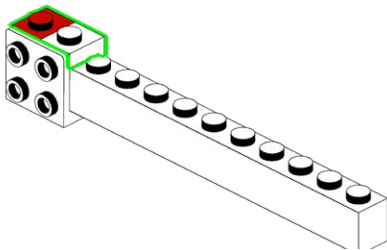

# 145

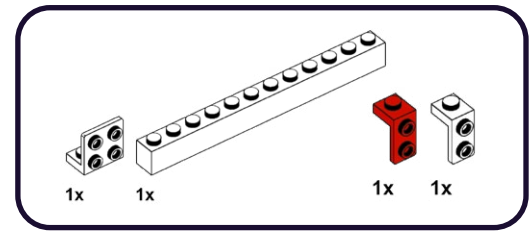

1

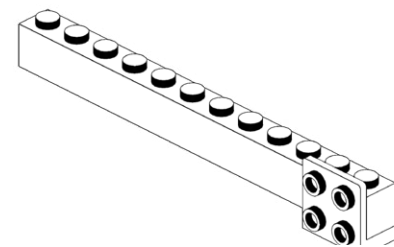

1

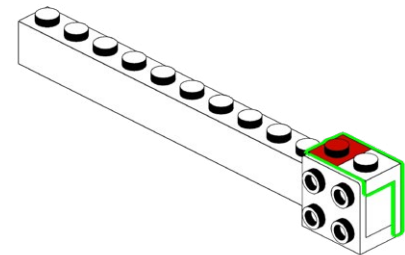

146

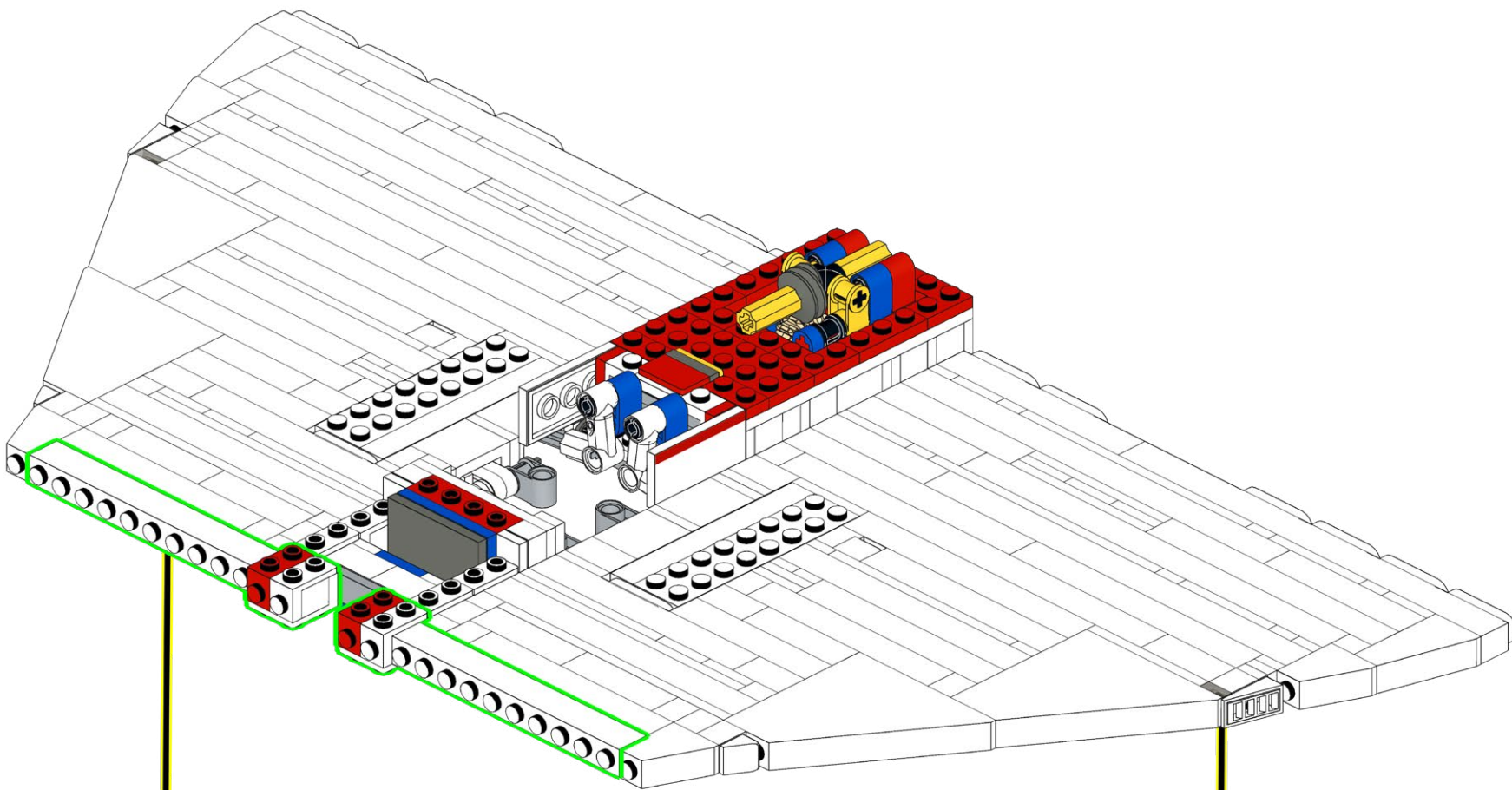

147

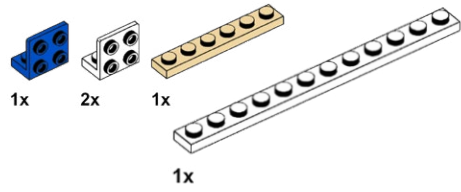

1

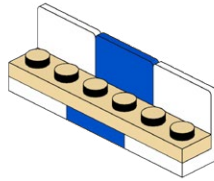

2

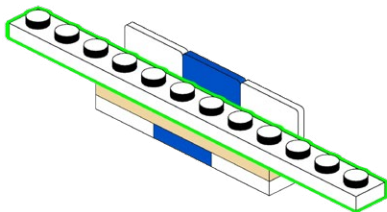

148

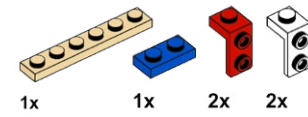

1

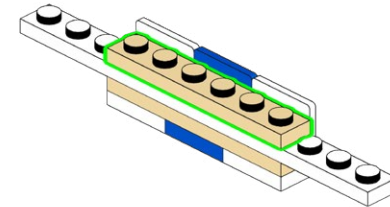

2

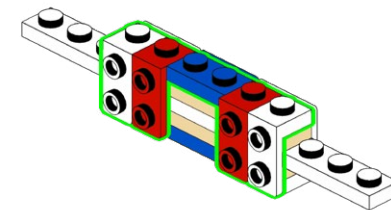

149



4x

1

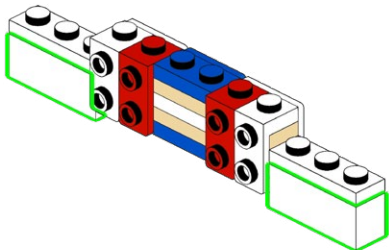

2

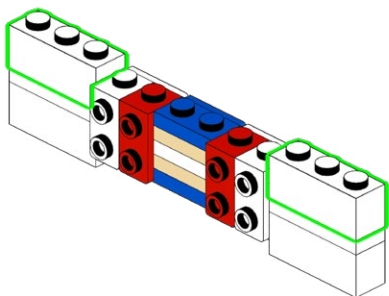

150

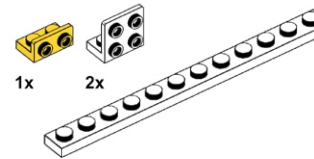

1x

2x

2x

1

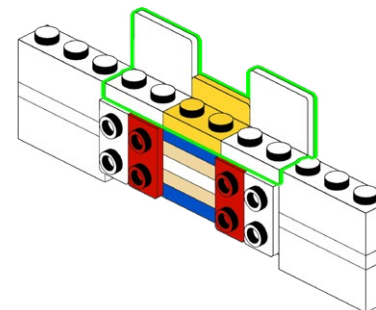

2

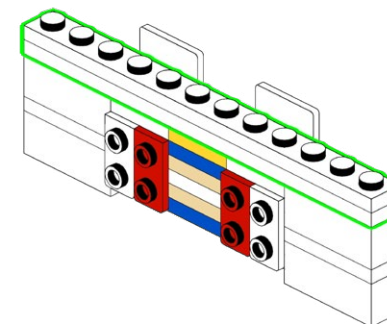

**151**

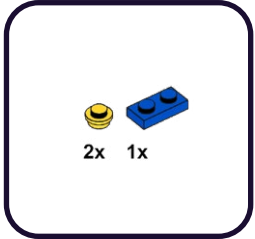

**1**

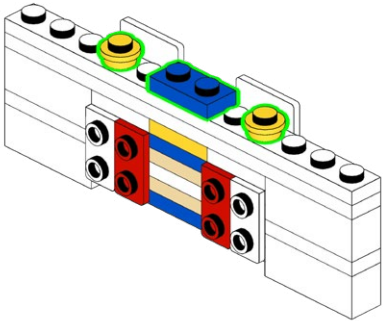

**152**

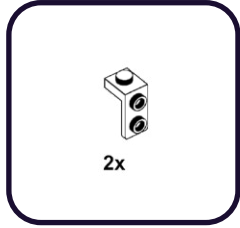

**1**

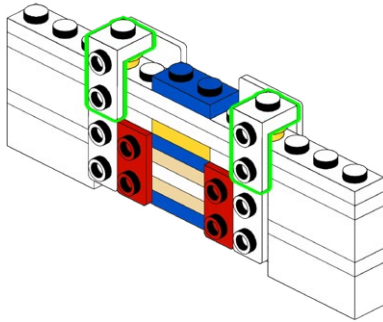

153

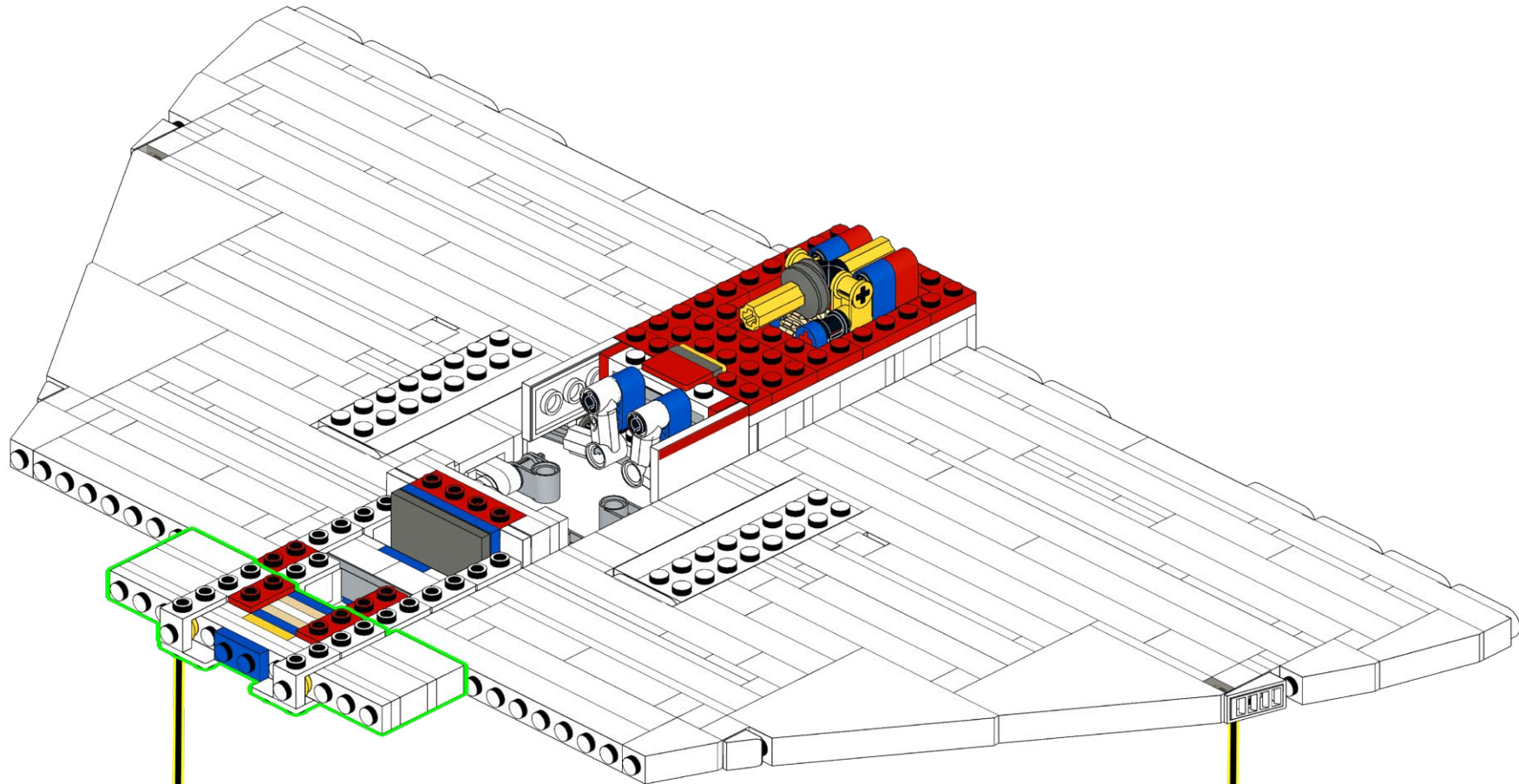

154

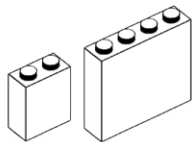

2x

2x

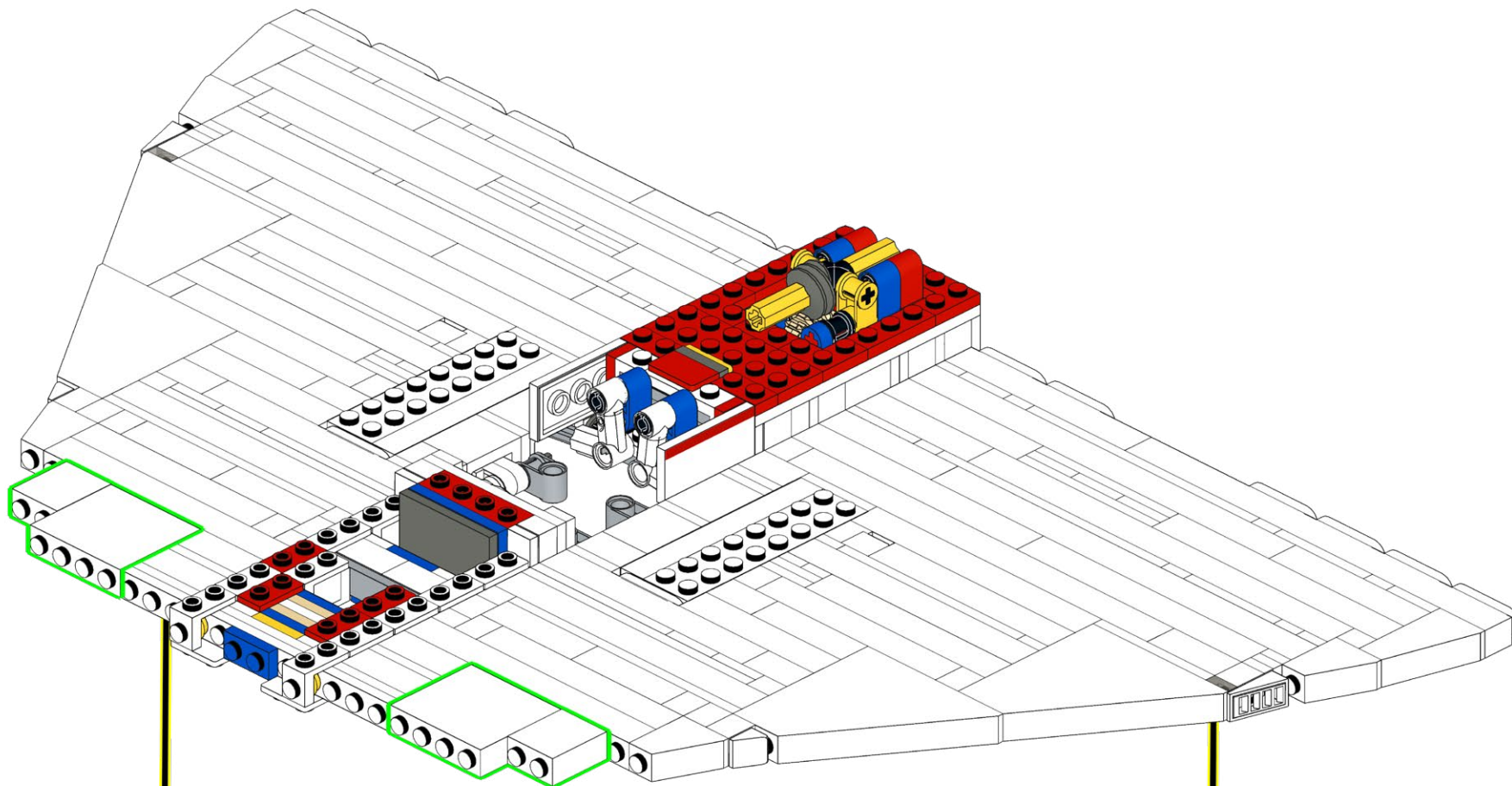



155

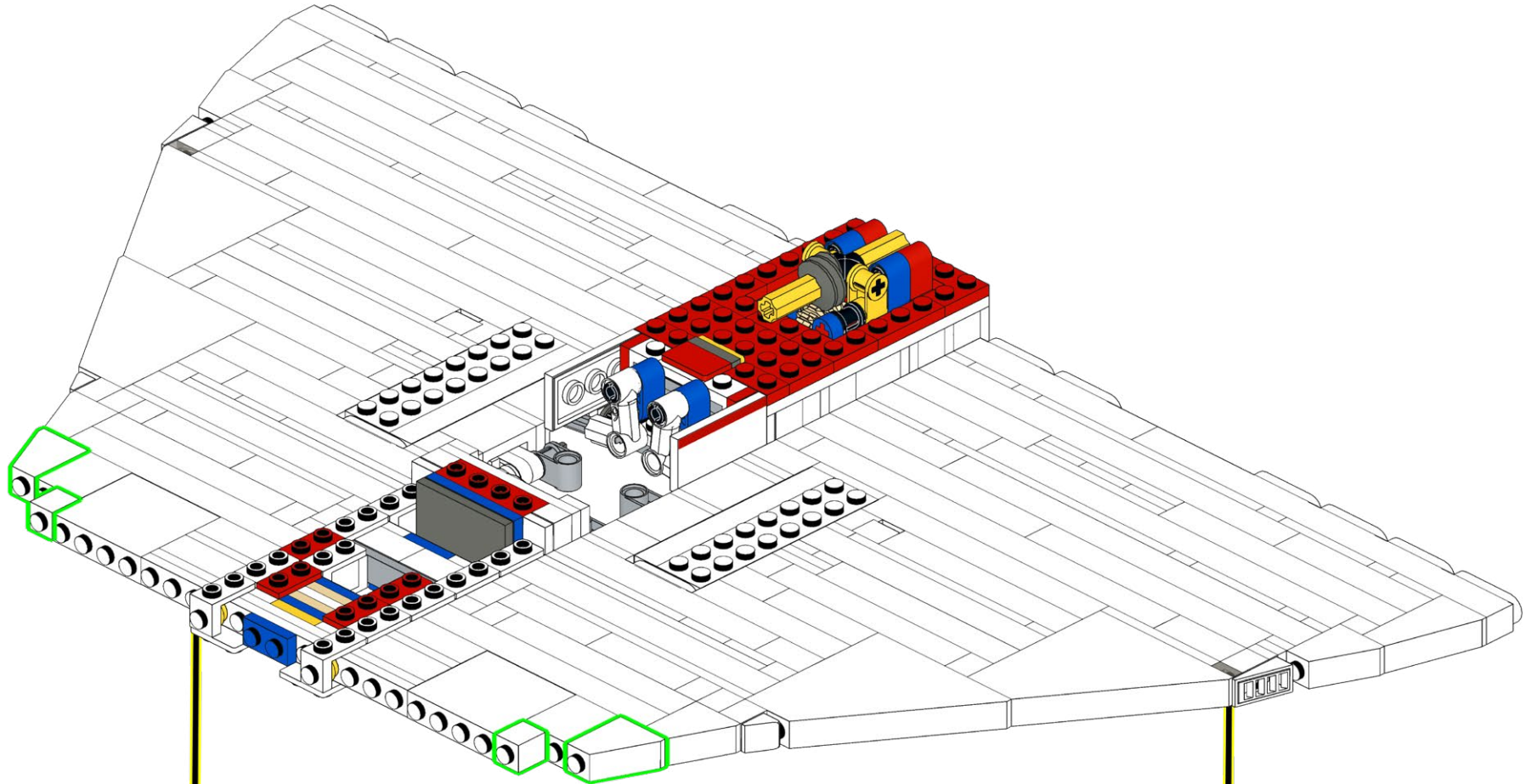
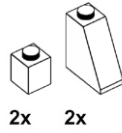

156



2x

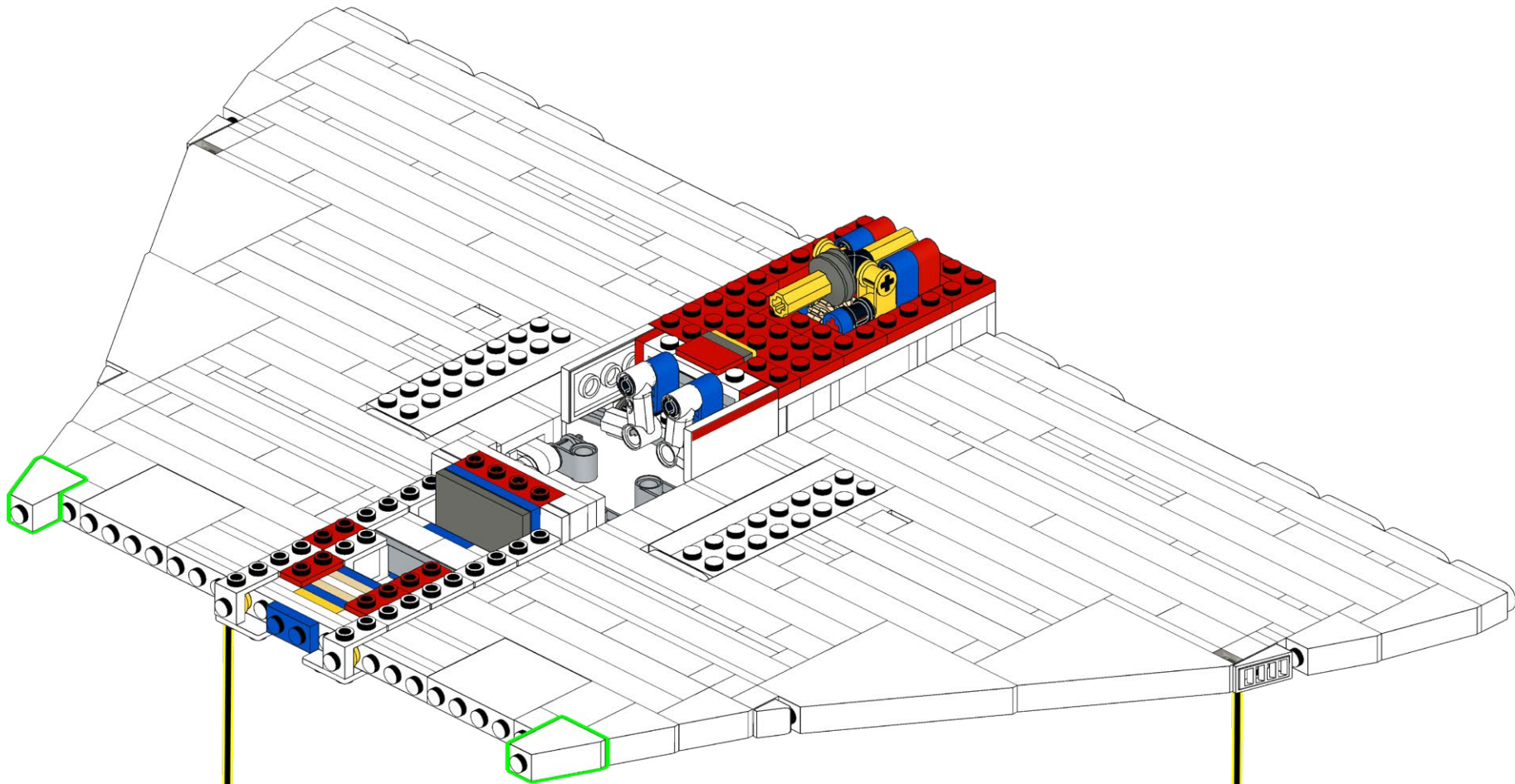

157

2x

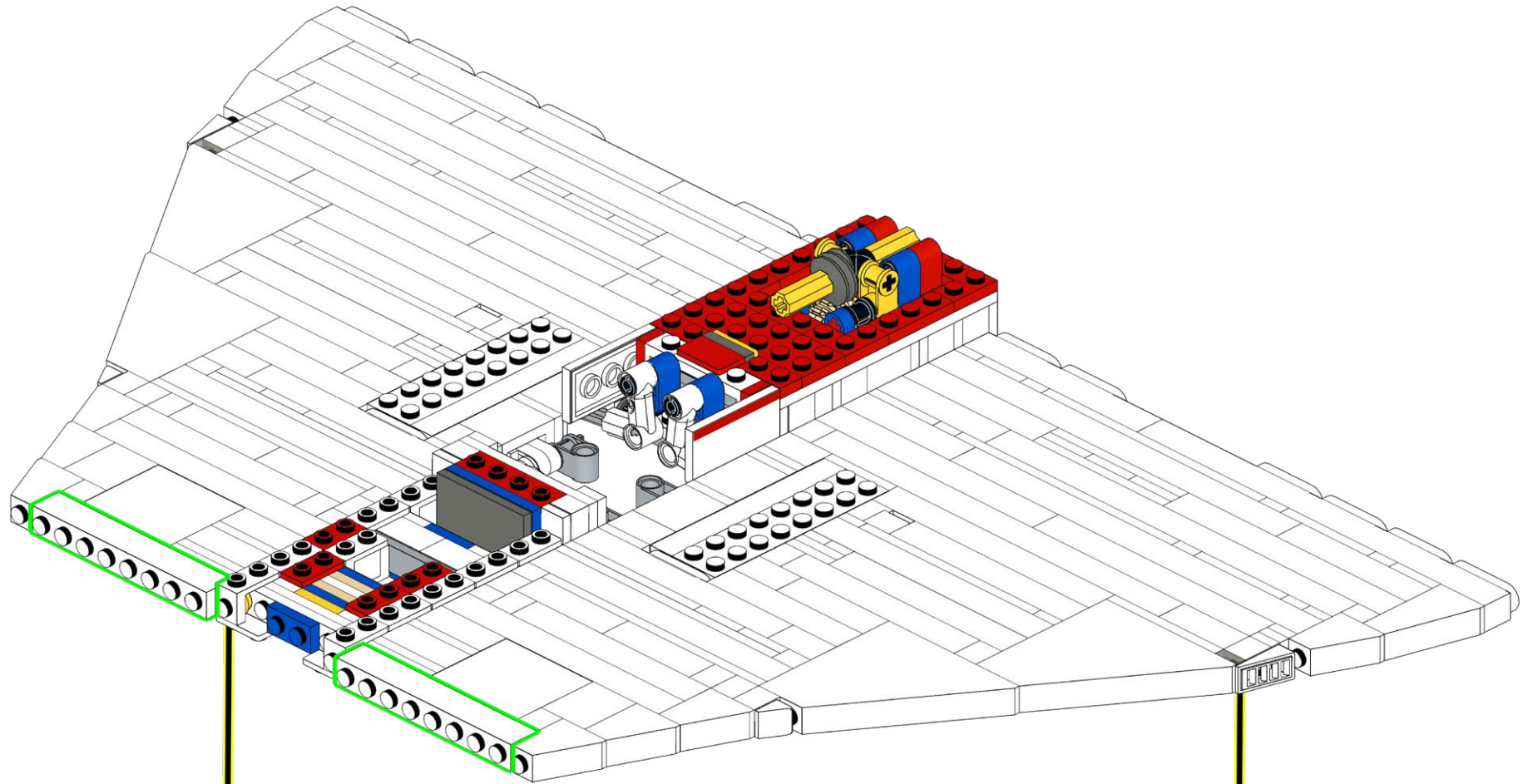

158

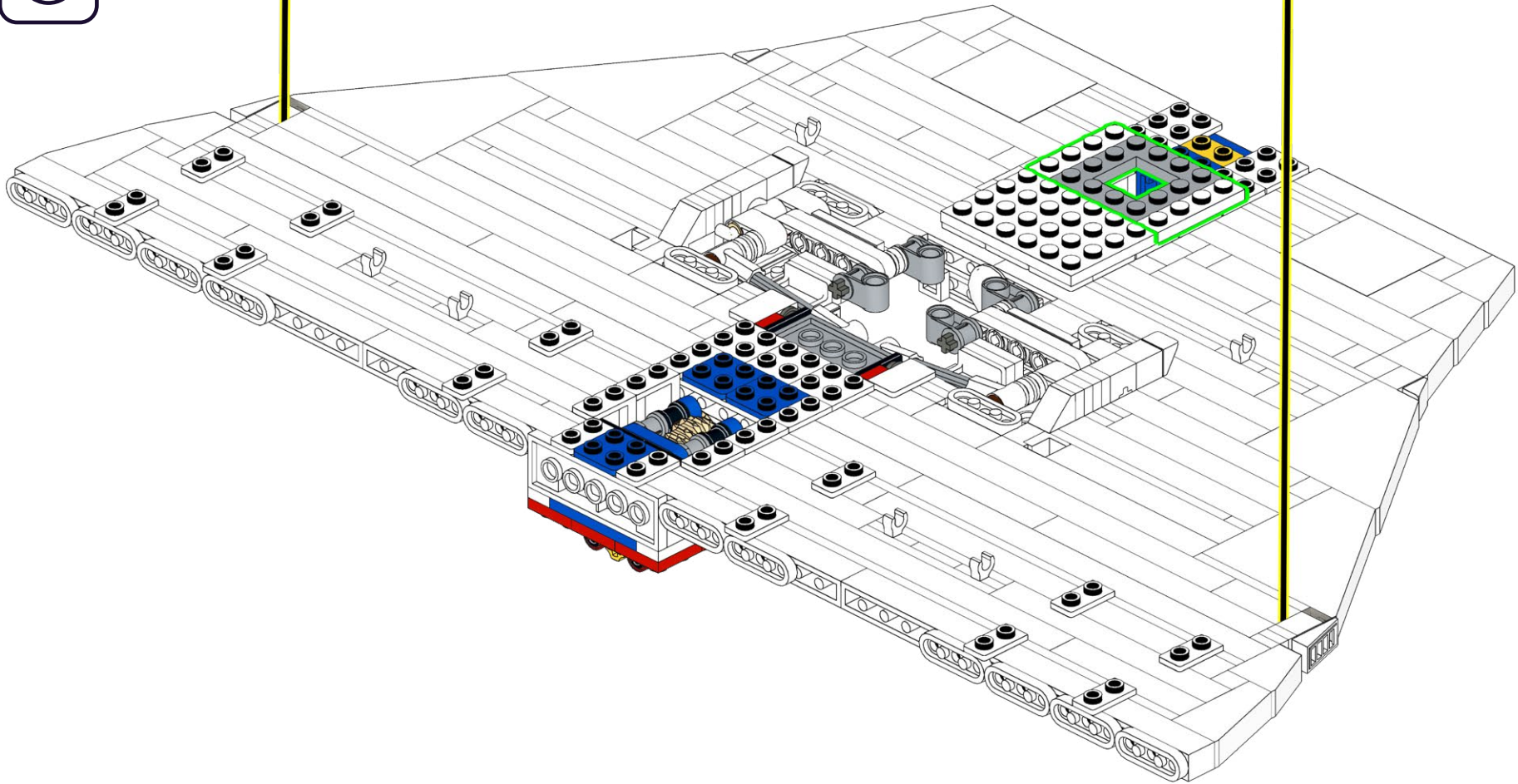
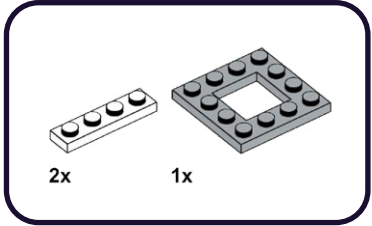

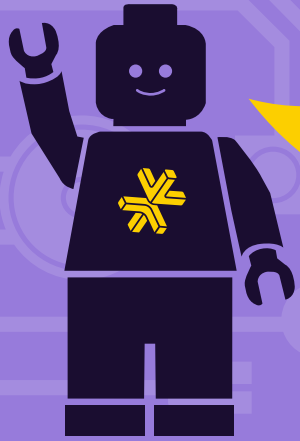
**HOLD UP!**

You might notice some bags aren't in order, as well as left over pieces, but that's ok! We're changing the way you build LEGO!

**ATTENDEZ!**

Vous remarquerez peut-être que certains sacs, ainsi que certaines pièces, ne sont pas dans le bon ordre. Mais pas de panique! Nous changeons simplement la façon avec laquelle vous construisez vos LEGO!

**ASPETTA!**

Potresti notare che alcuni sacchetti non sono in ordine, così come i pezzi avanzati, ma va bene così! Stiamo cambiando il modo in cui costruisci i LEGO!

**HALT!**

Sie werden möglicherweise bemerken, dass einige tüten durcheinander sind und teile übrig bleiben, aber das ist in Ordnung! Wir ändern die art und weise, wie Sie LEGO bauen!

**¡ESPERA!**

Es posible que notes que algunas bolsas están fuera de servicio, así como piezas sobrantes, ¡pero está bien! ¡Estamos cambiando la forma en que construyes LEGO!

**暫停!**

你可能会注意到一些袋子顺序错乱, 以及一些剩余的部件, 但没关系! 我们正在改变你搭建乐高的方式!

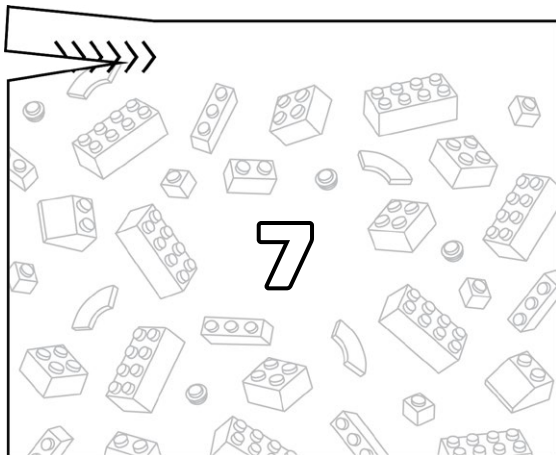
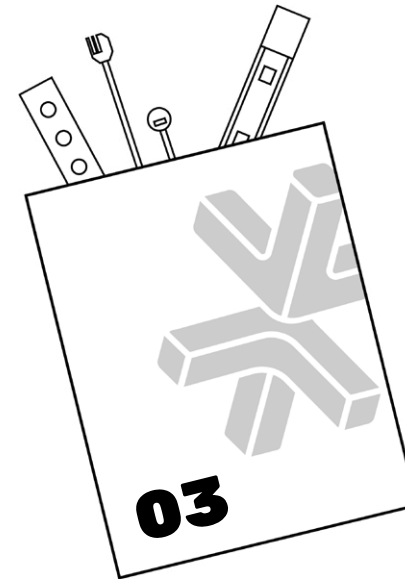
**Open LEGO® Bag 7****Open LMB Bag 03**

**159**

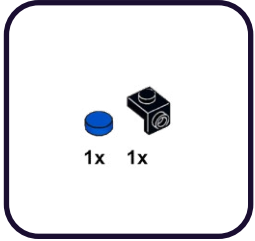

**1**



**160**

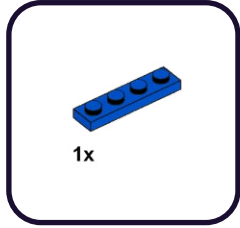

**1**

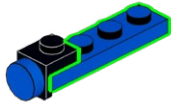

161

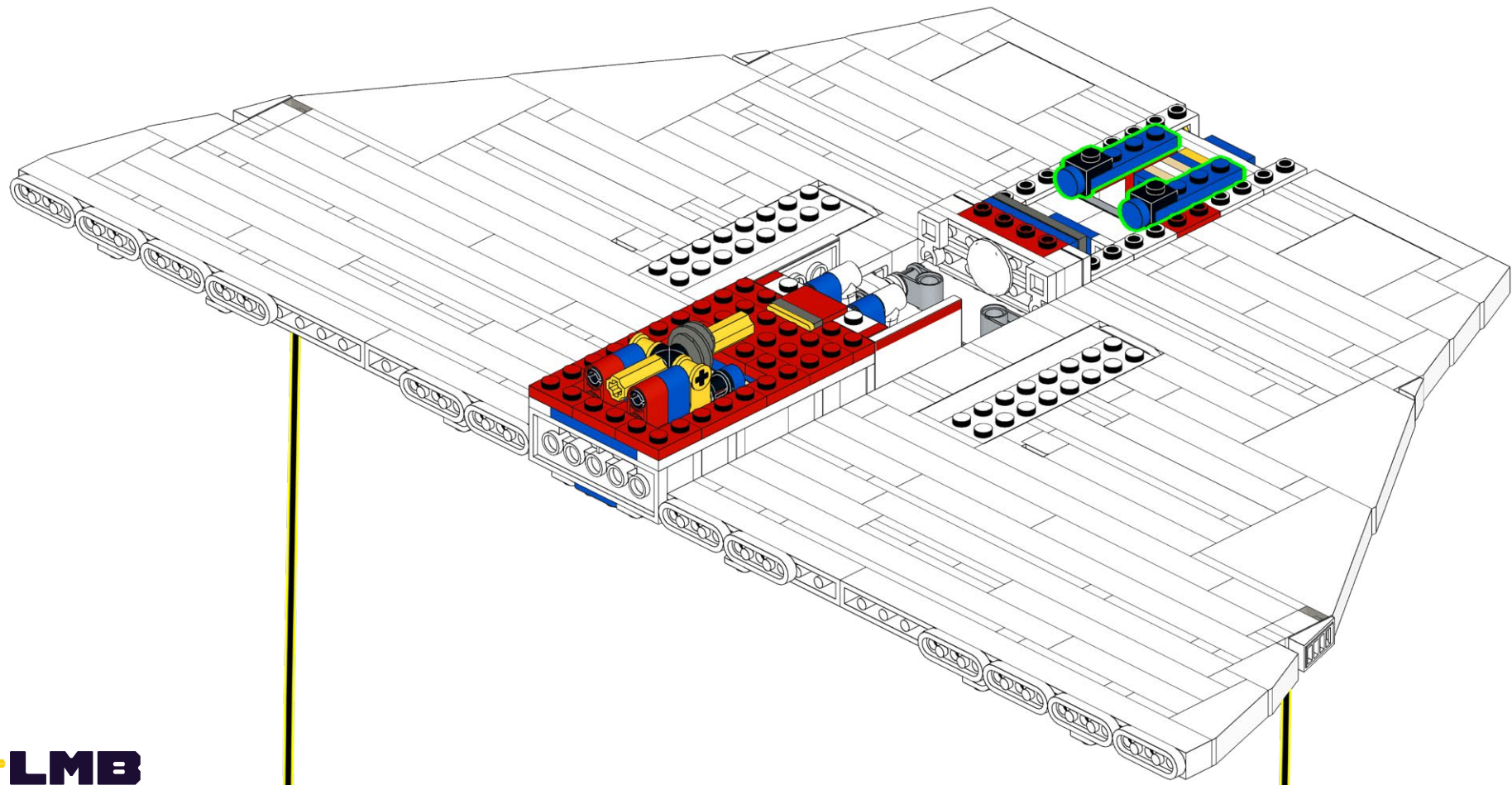

# 162

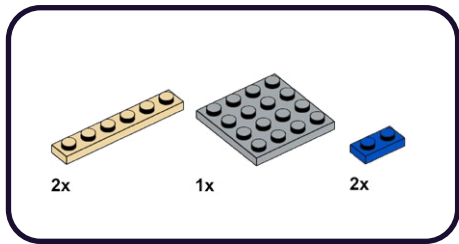

1

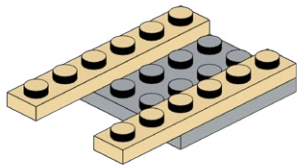

2

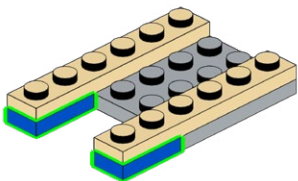

# 163

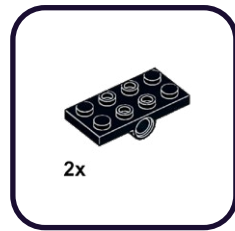

1

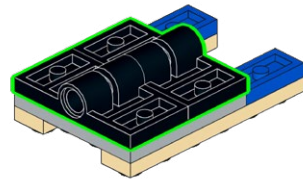



164

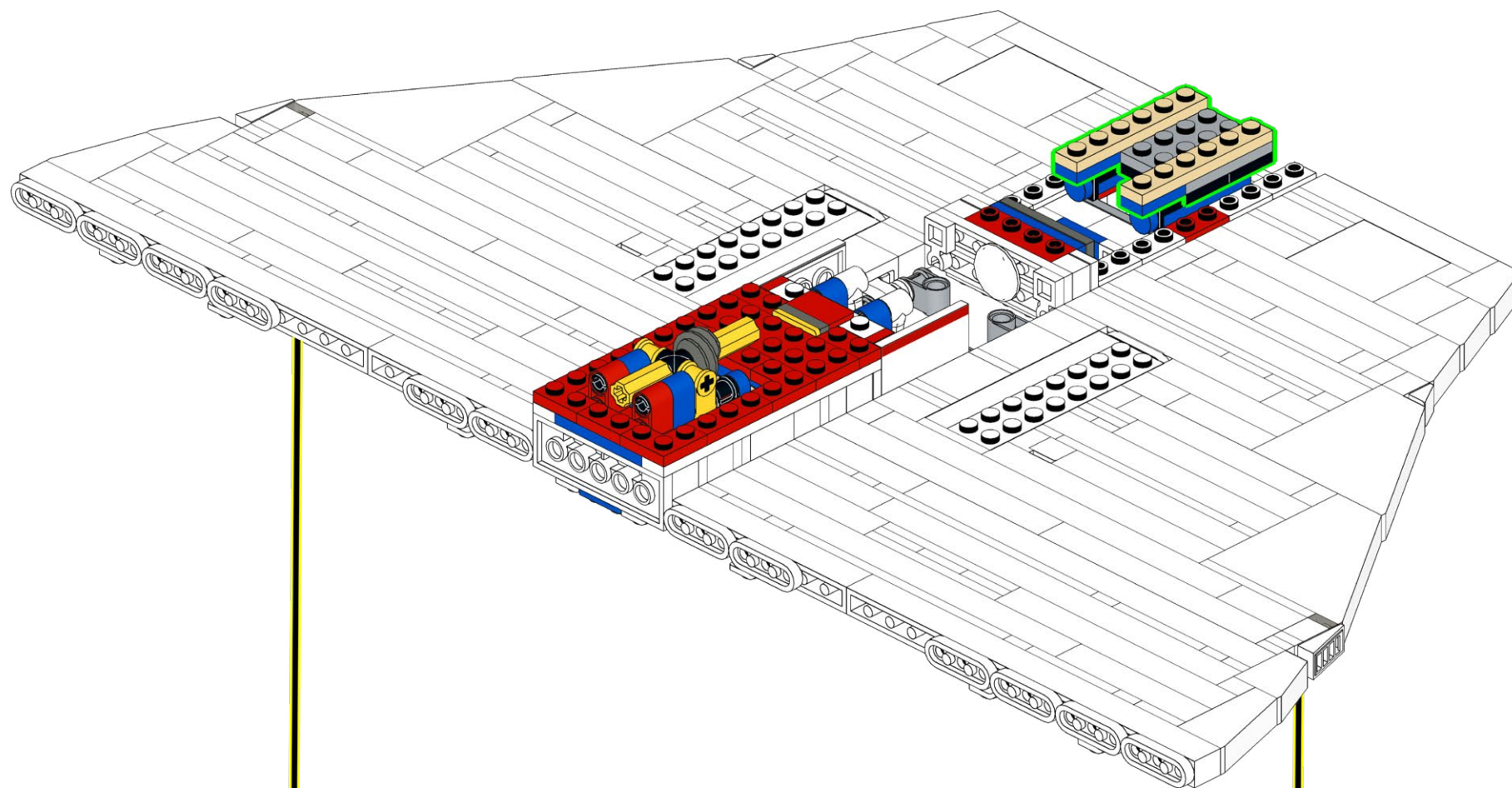

165

2x

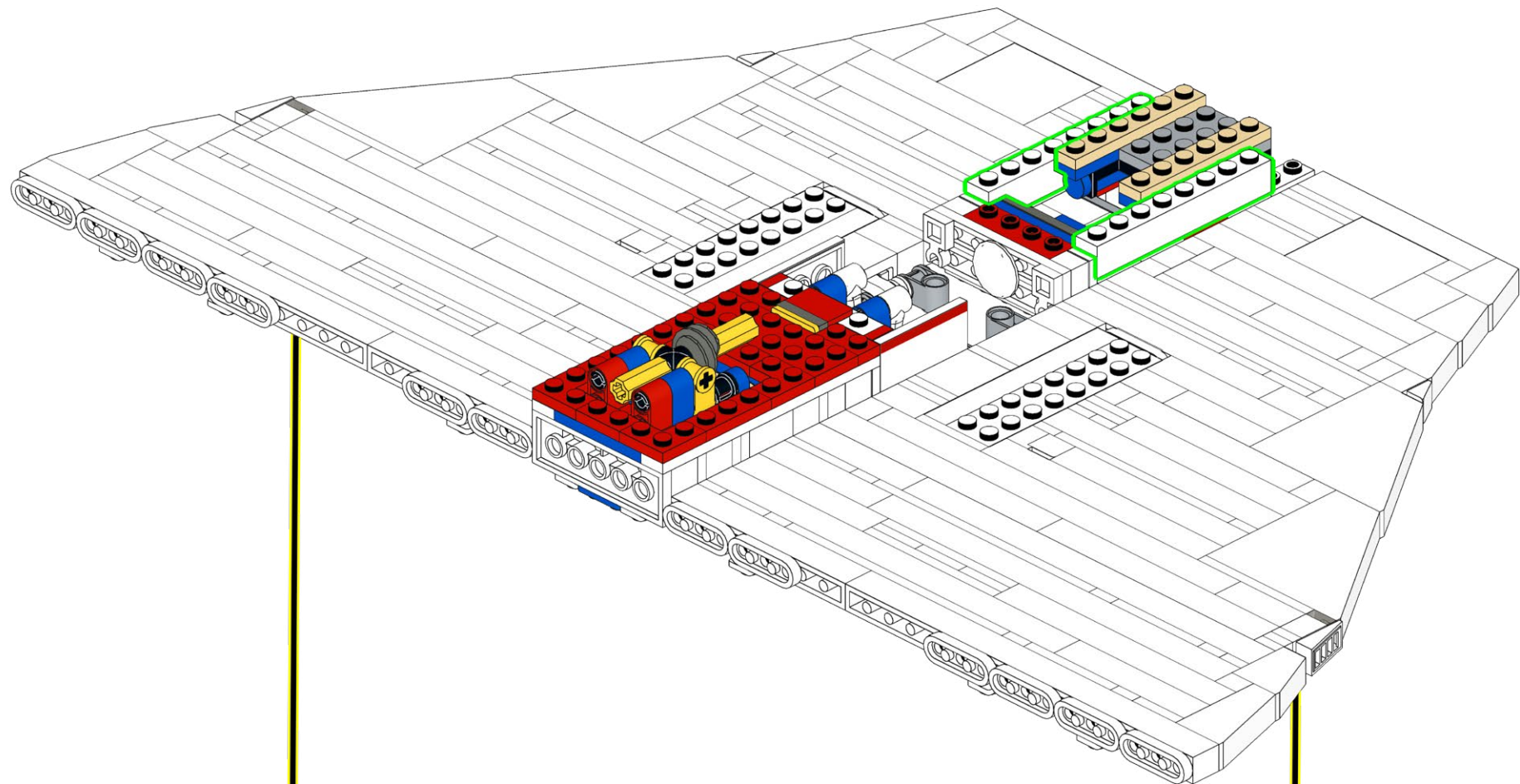

166

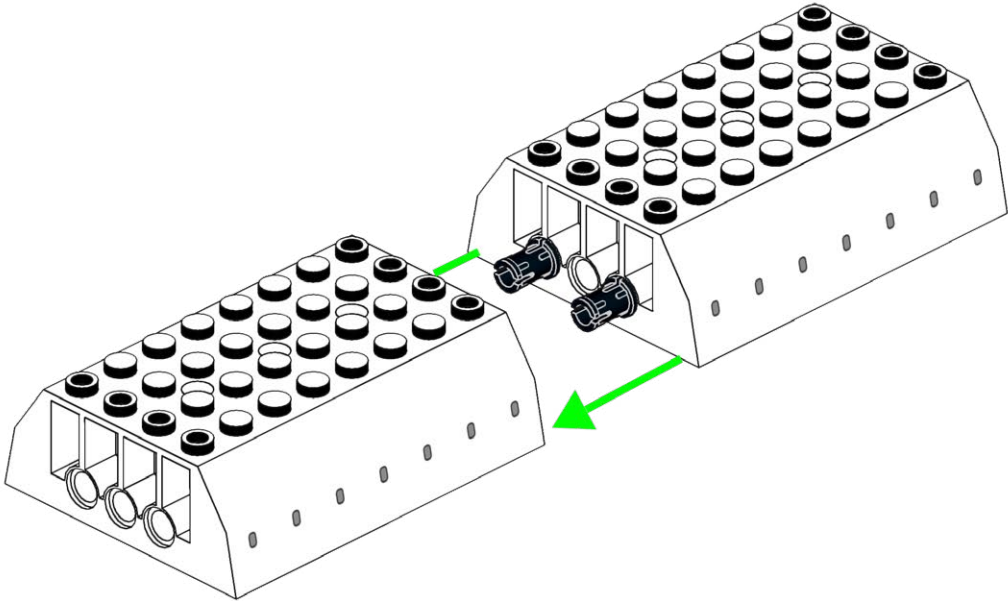
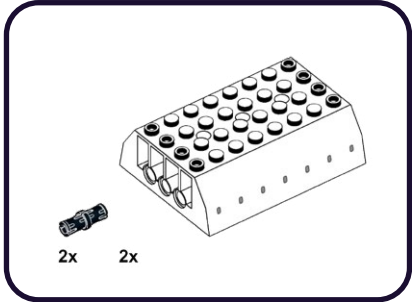

167

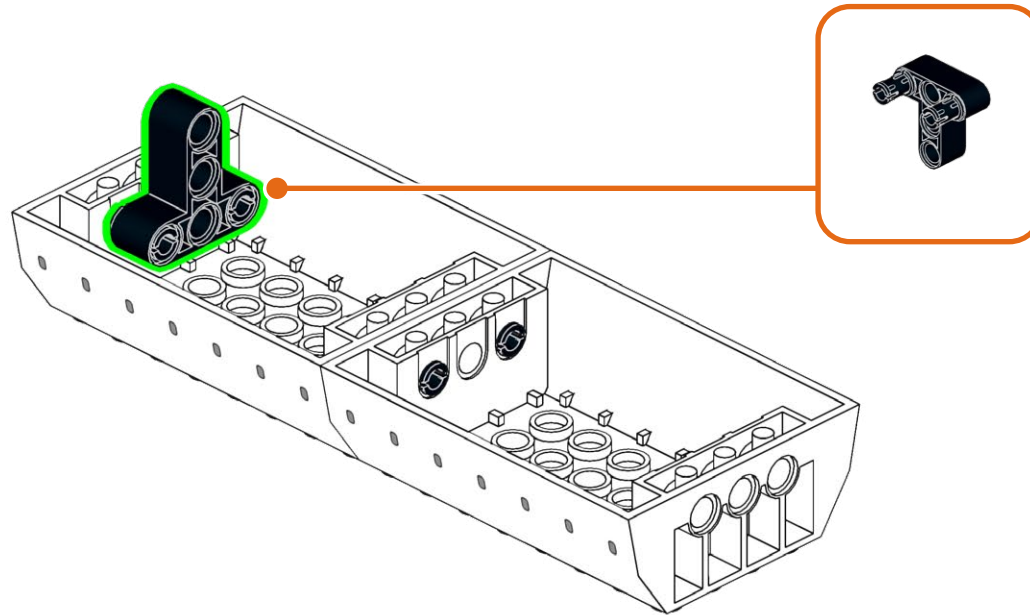
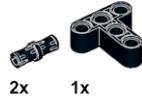

168

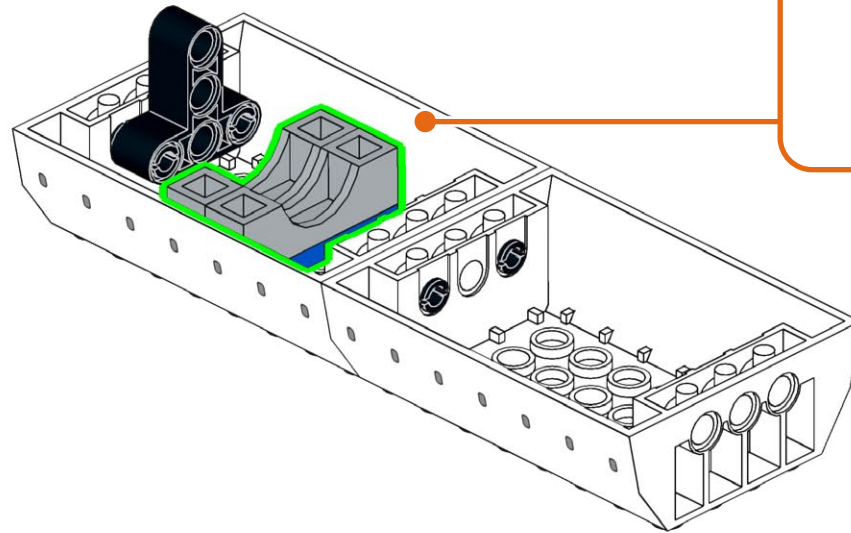
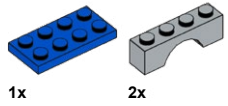

1

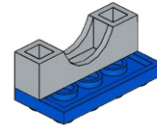

2

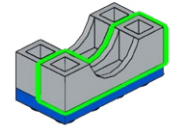

169

2x

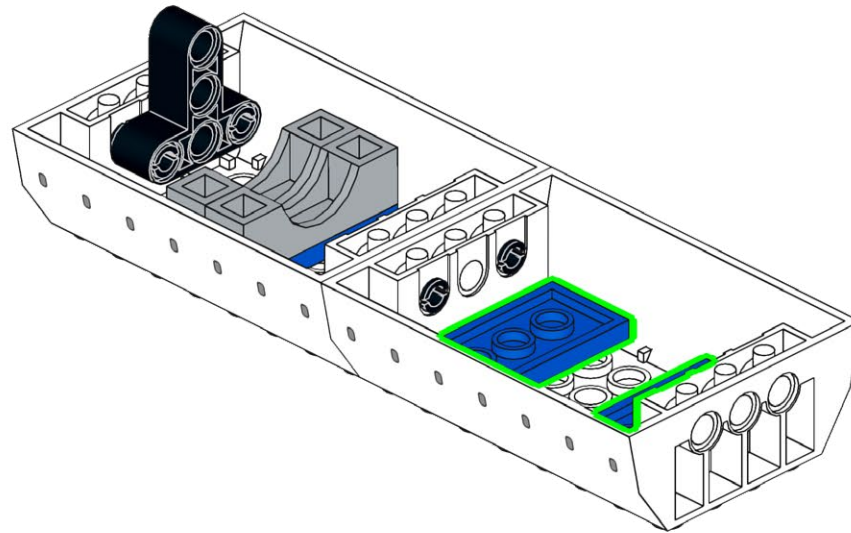

170



2x

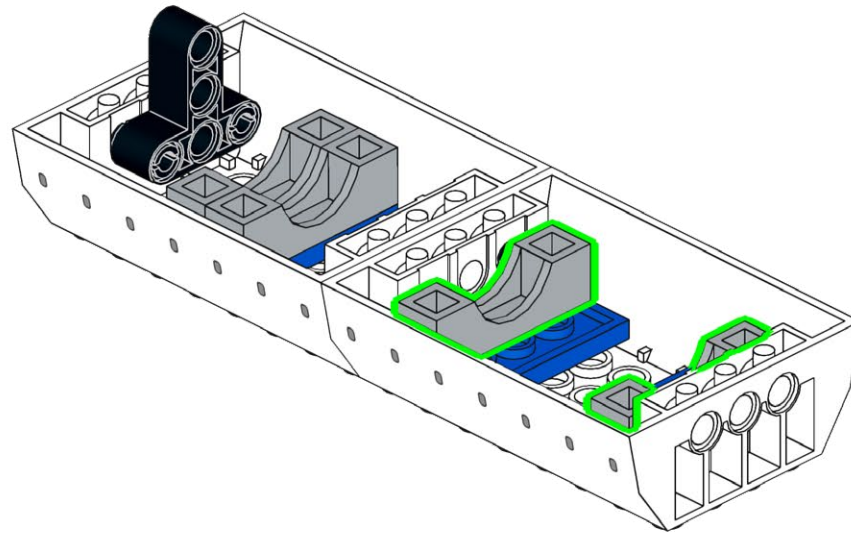

171



1x



1x

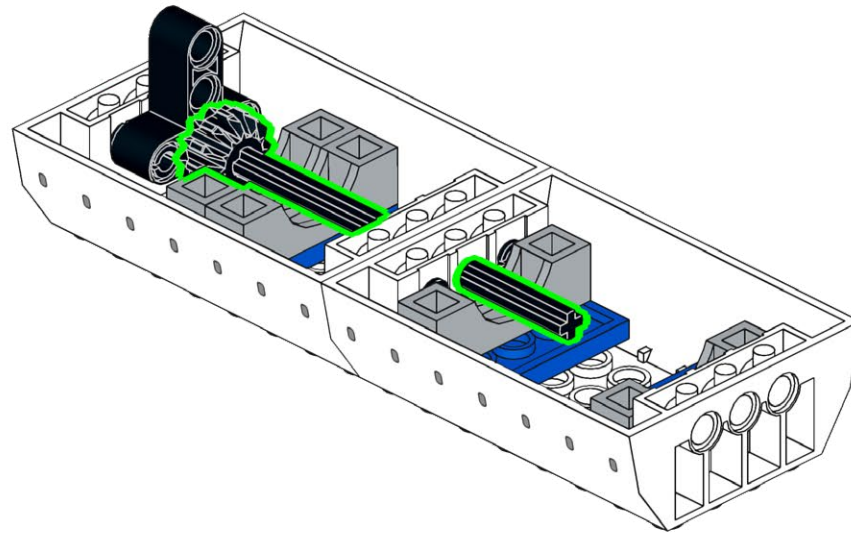



172



1x

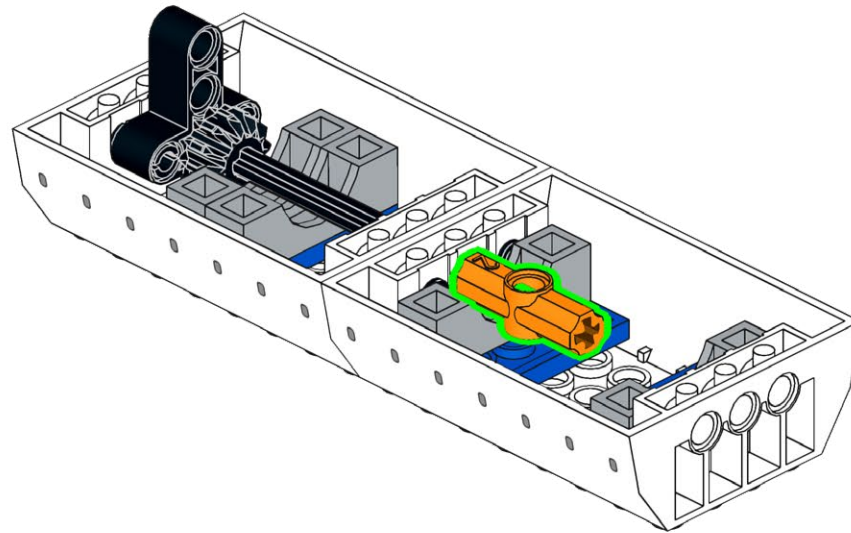

173

1x

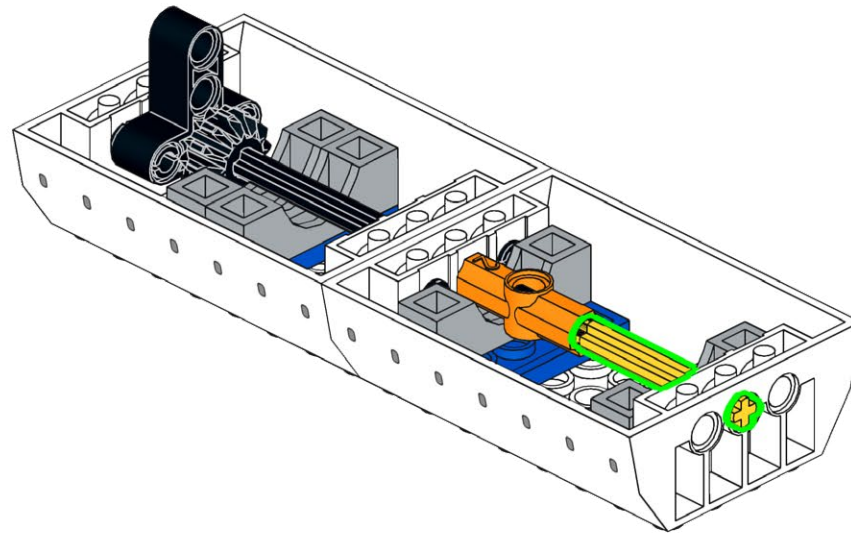

174



2x

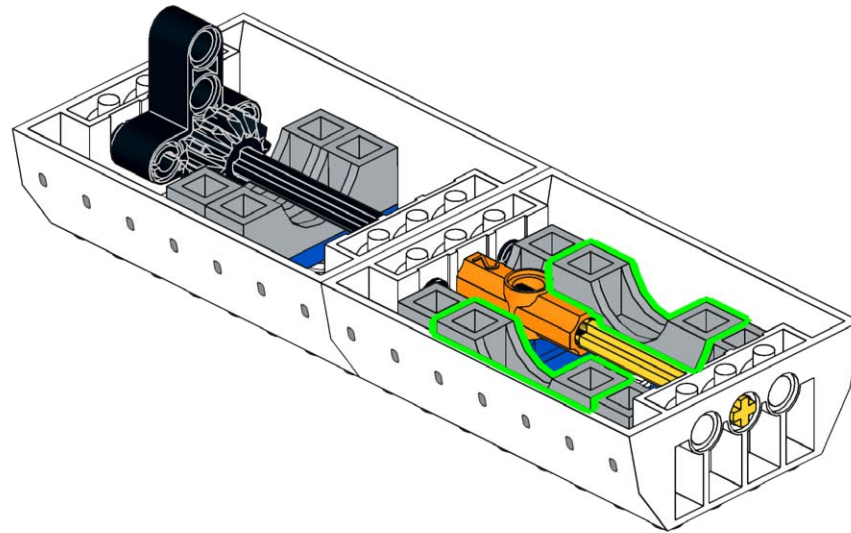

175

6x

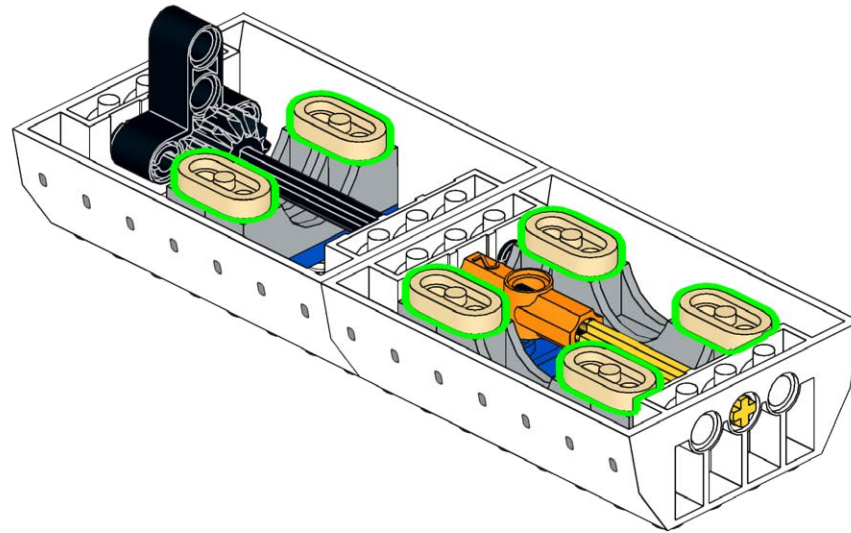

176

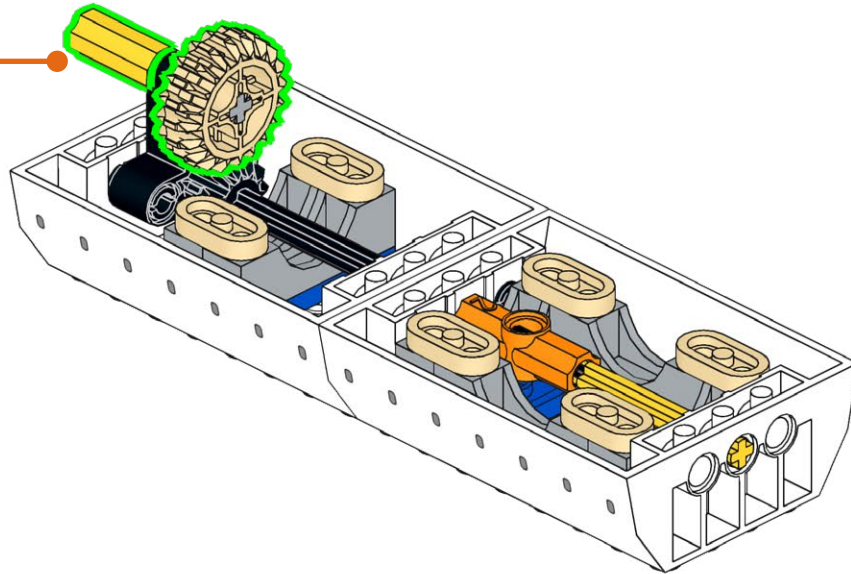
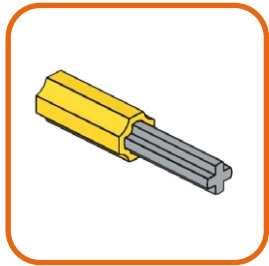
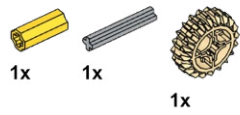

177

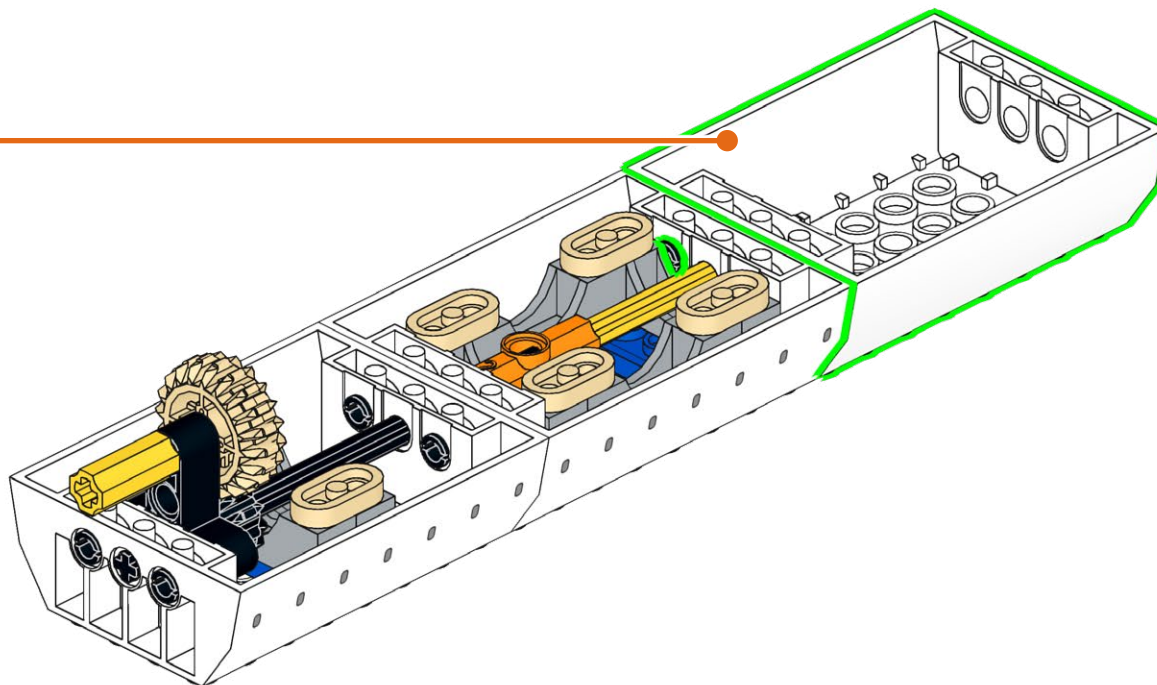
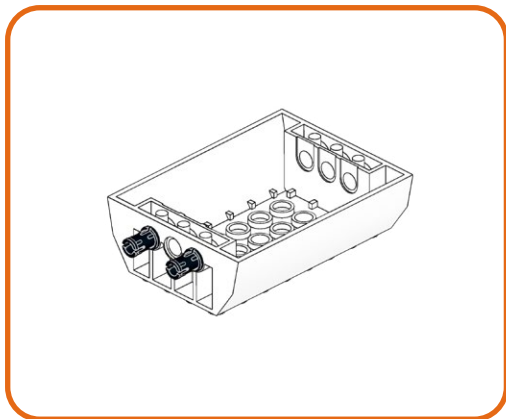
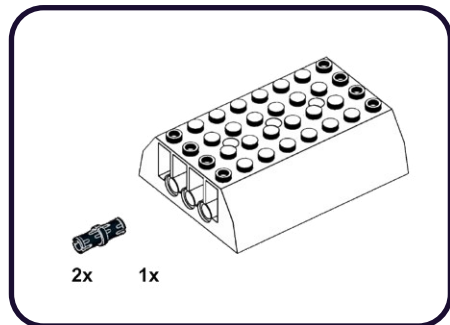

178

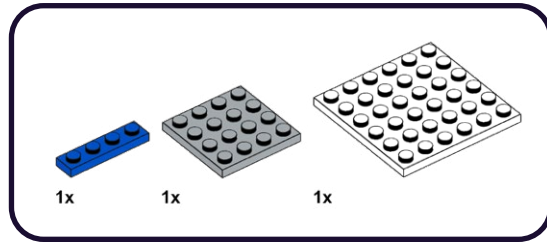

1

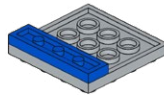

2

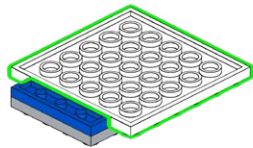

179

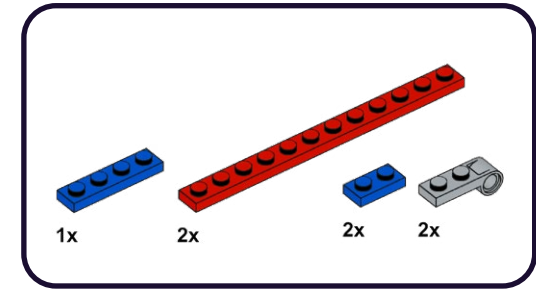

1

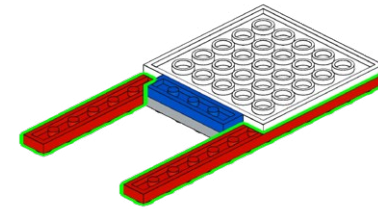

2

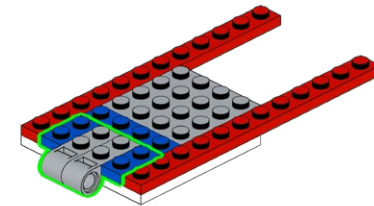

# 180



1

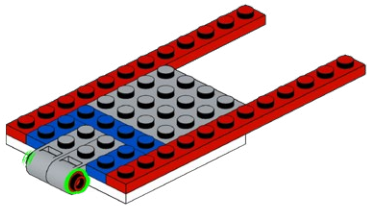

2

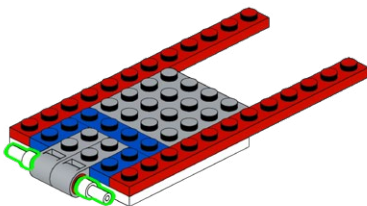

# 181

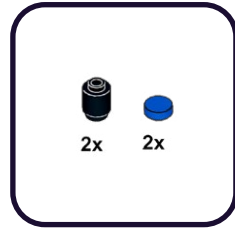

1

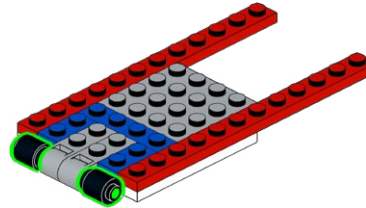

2

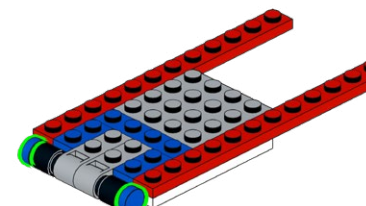



182

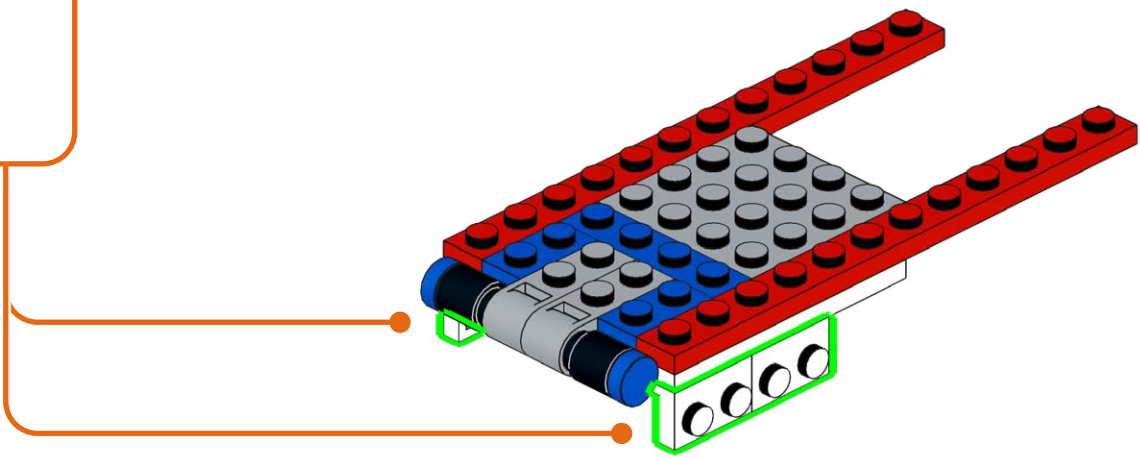
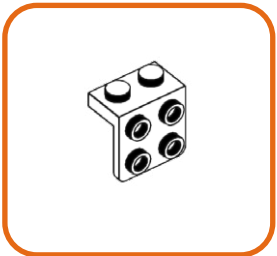
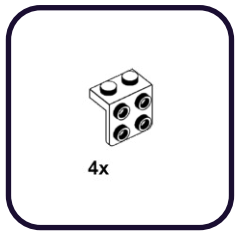

183

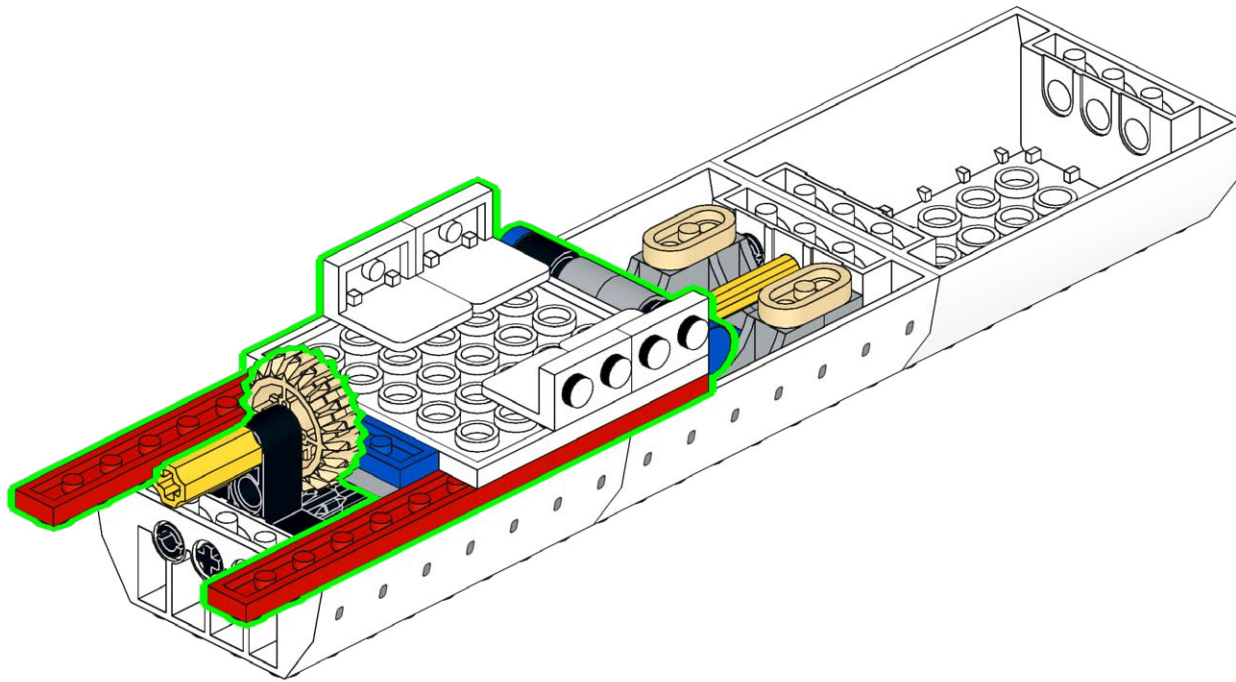

184

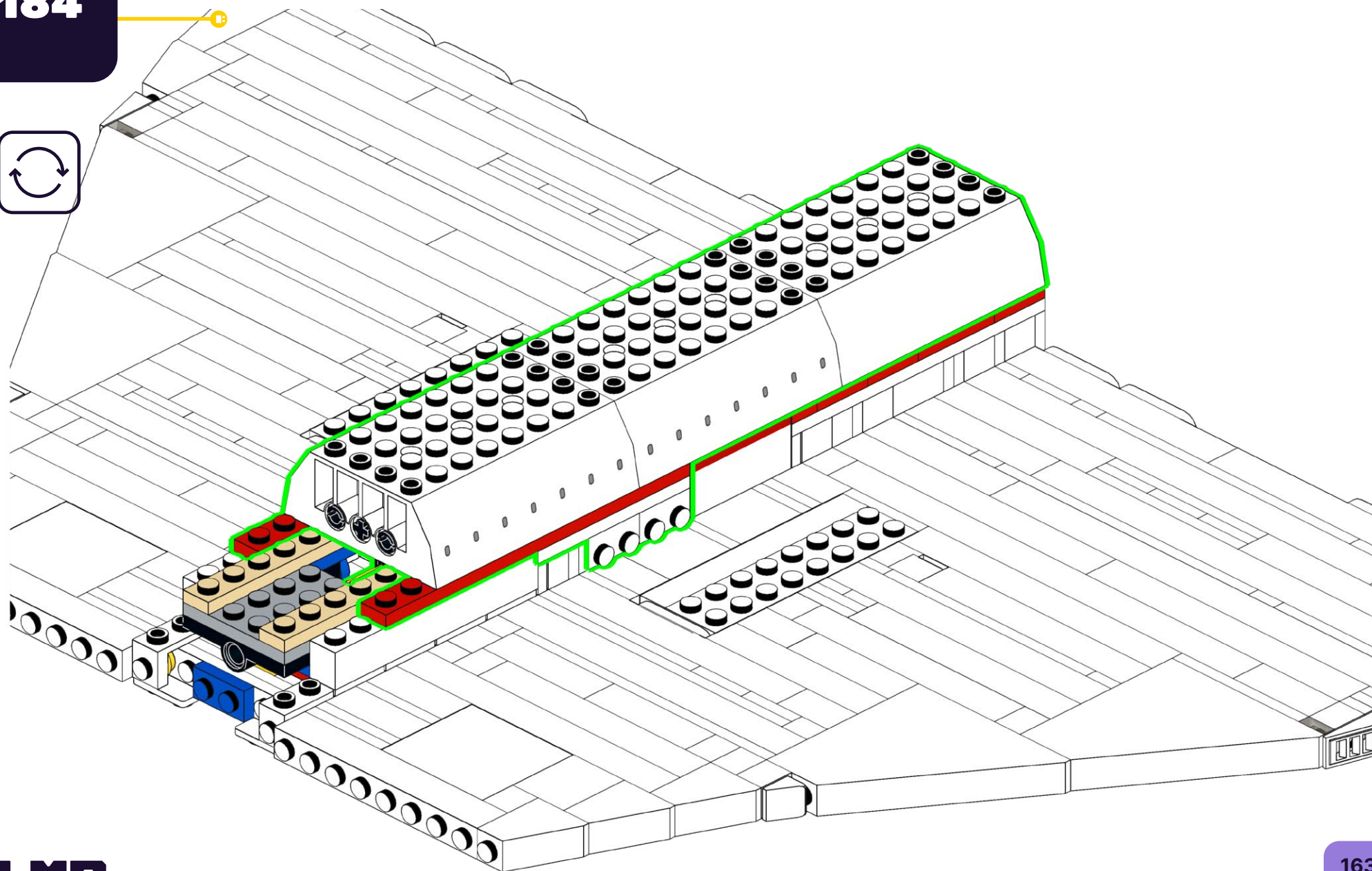

**185**

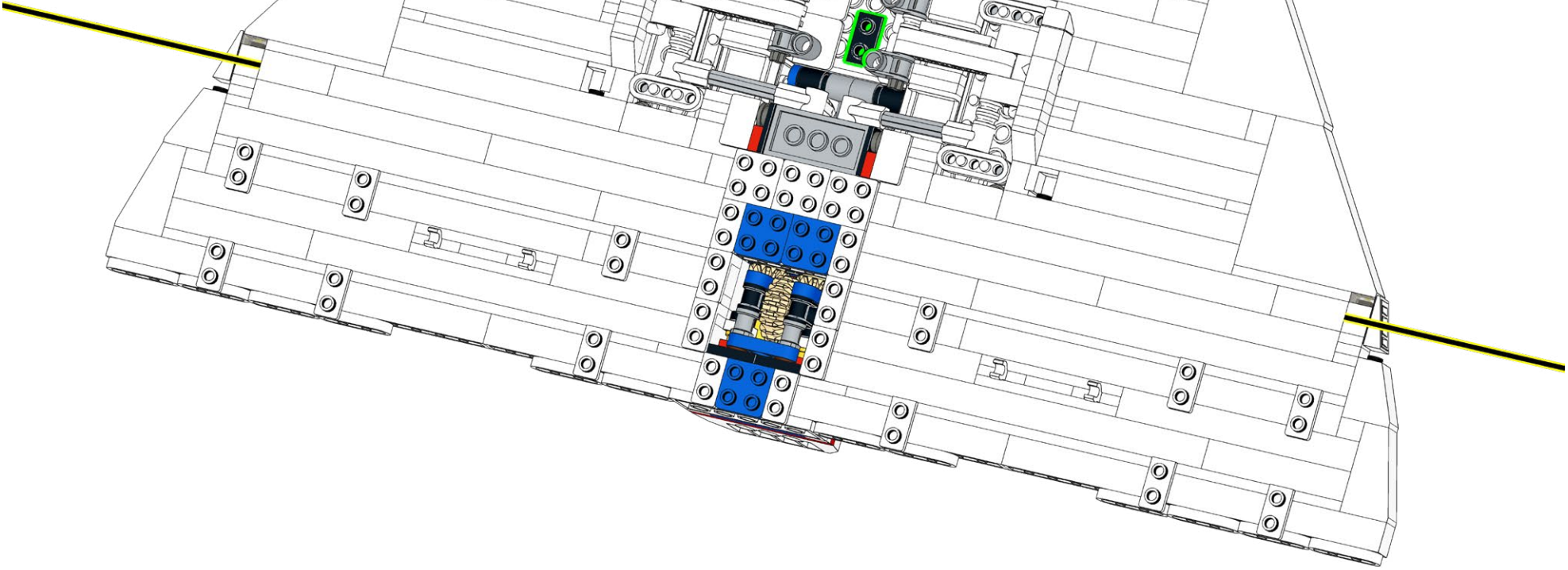
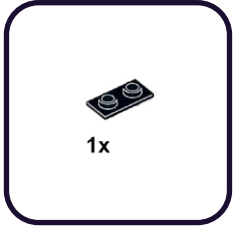

186

1x

1x

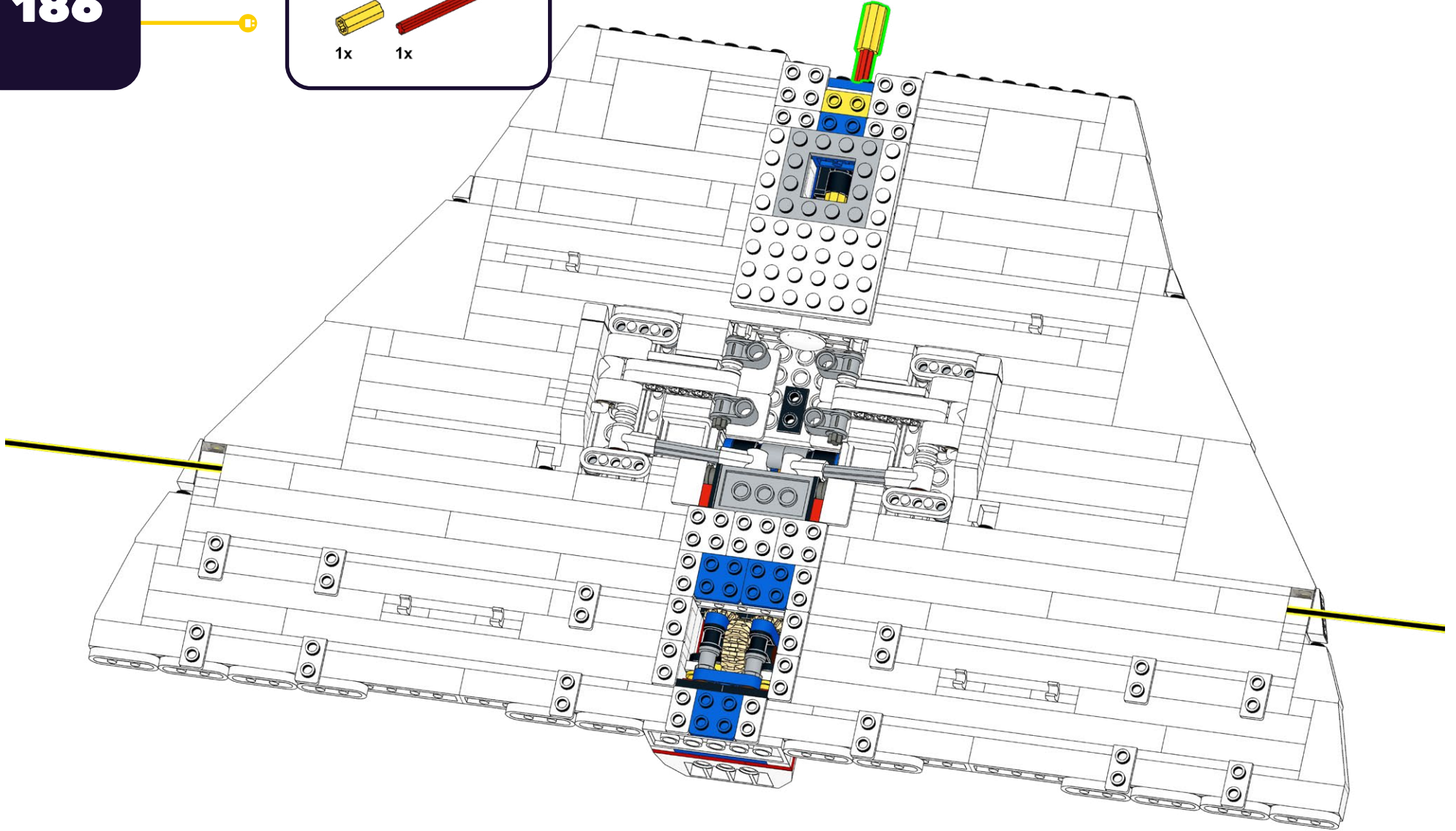

187

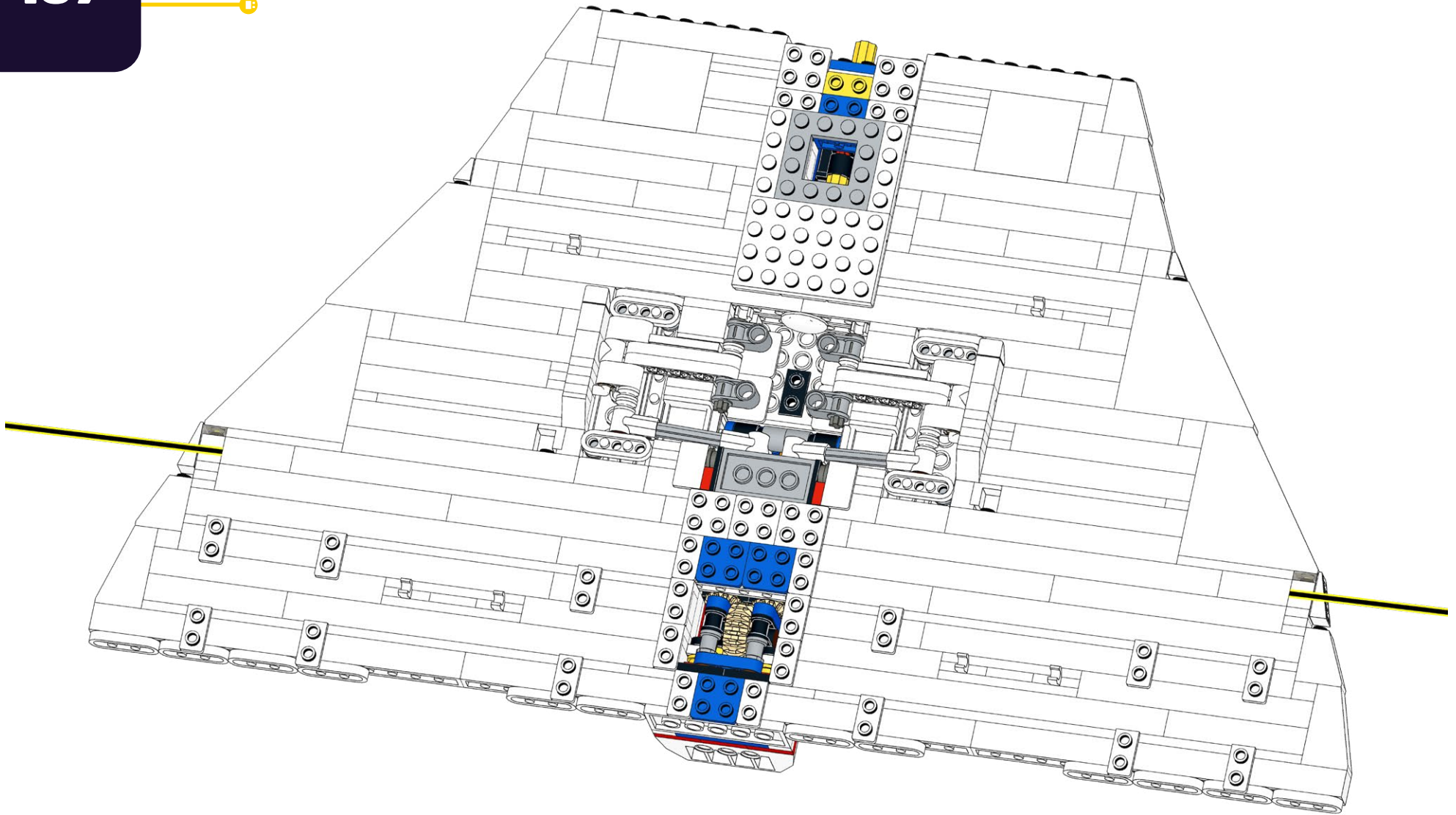

**HOLD UP!**

You might notice some bags aren't in order, as well as left over pieces, but that's ok! We're changing the way you build LEGO!

**ATTENDEZ!**

Vous remarquerez peut-être que certains sacs, ainsi que certaines pièces, ne sont pas dans le bon ordre. Mais pas de panique! Nous changeons simplement la façon avec laquelle vous construisez vos LEGO!

**ASPETTA!**

Potresti notare che alcuni sacchetti non sono in ordine, così come i pezzi avanzati, ma va bene così! Stiamo cambiando il modo in cui costruisci i LEGO!

**HALT!**

Sie werden möglicherweise bemerken, dass einige tüten durcheinander sind und teile übrig bleiben, aber das ist in Ordnung! Wir ändern die art und weise, wie Sie LEGO bauen!

**¡ESPERA!**

Es posible que notes que algunas bolsas están fuera de servicio, así como piezas sobrantes, ¡pero está bien! ¡Estamos cambiando la forma en que construyes LEGO!

**暫停!**

你可能会注意到一些袋子顺序错乱, 以及一些剩余的部件, 但没关系! 我们正在改变你搭建乐高的方式!

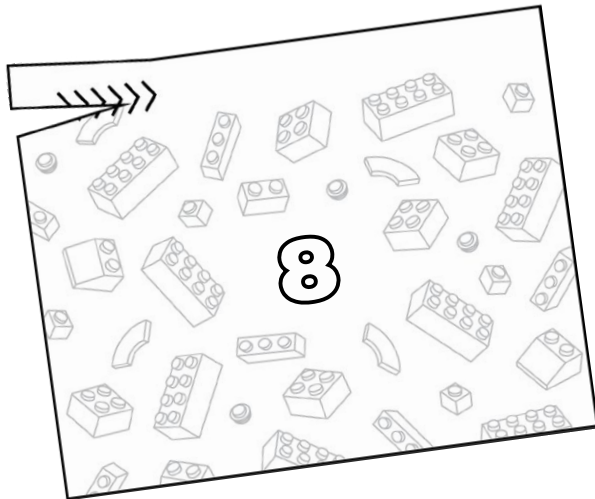
**Open LEGO® Bag 8**

# 188

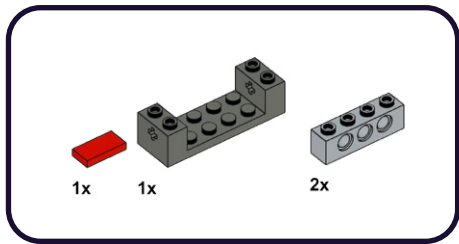

1

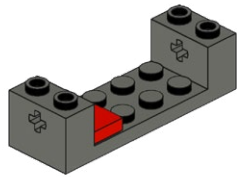

2

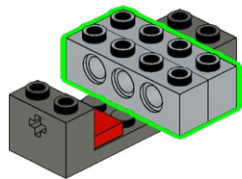

# 189

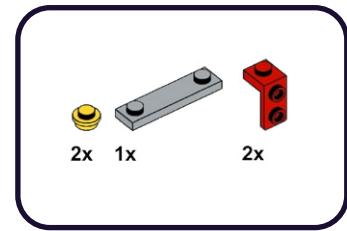

1

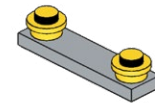

2

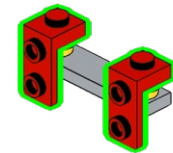



190

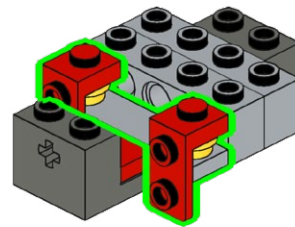

191

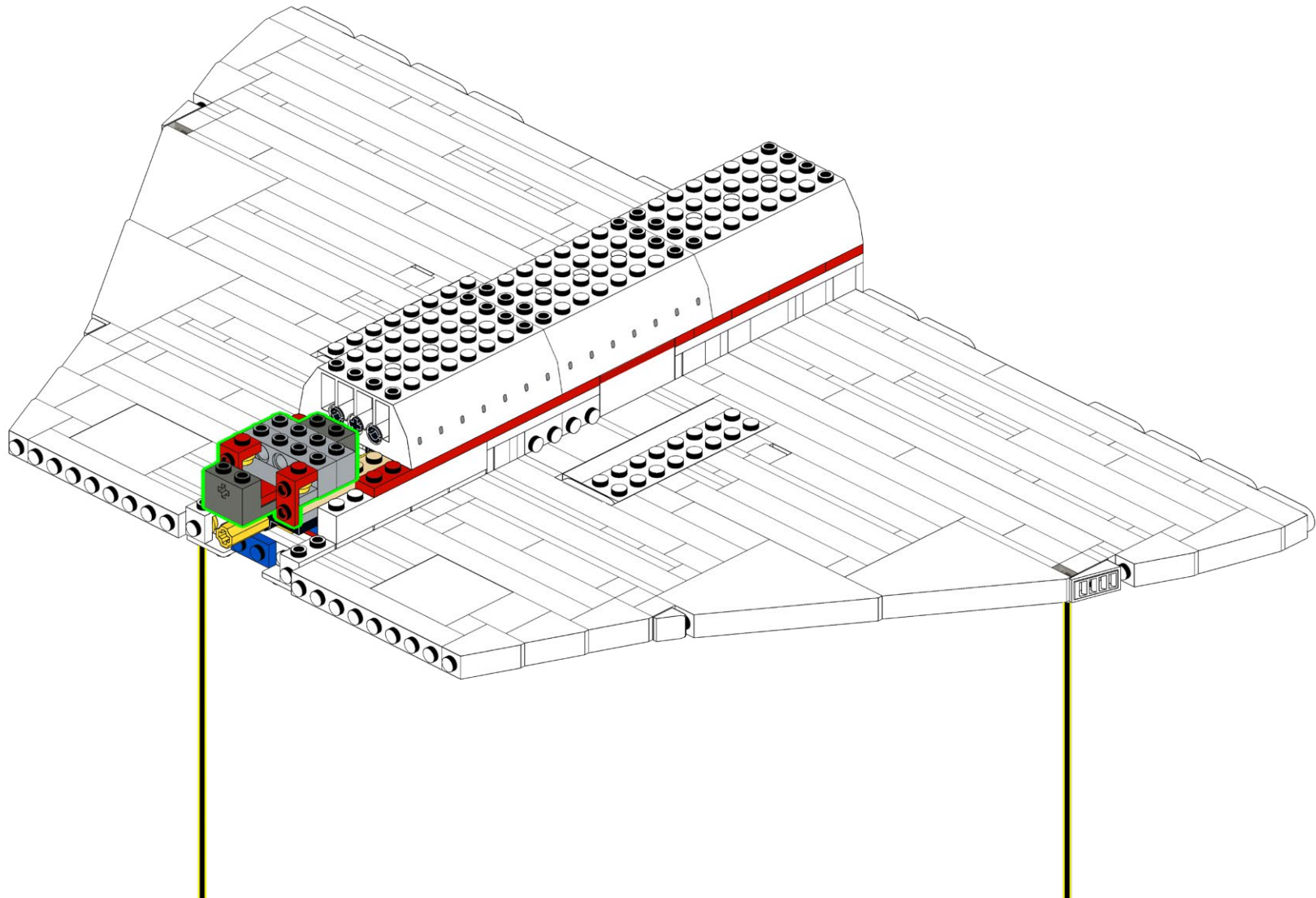

192

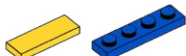

2x

2x

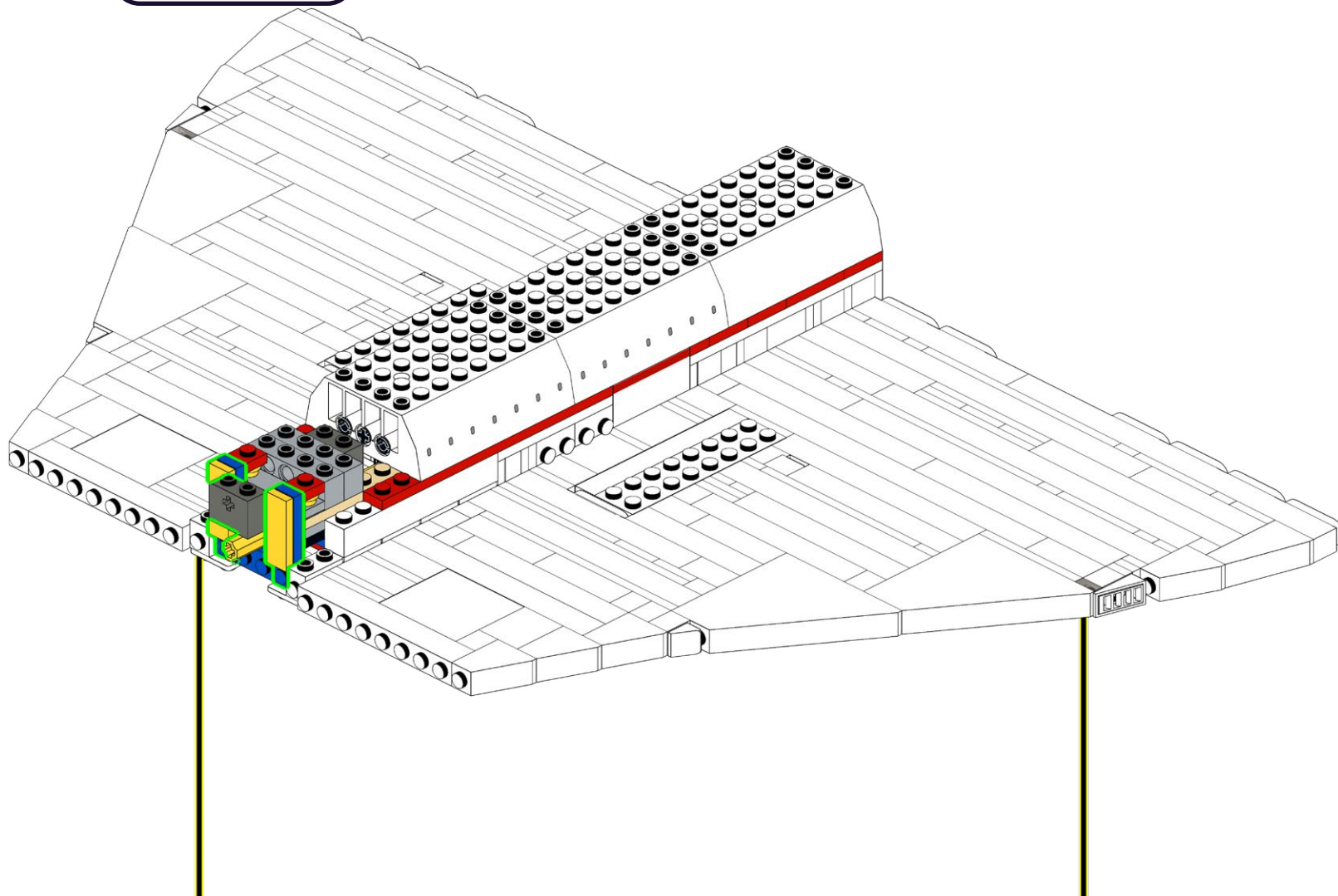

193

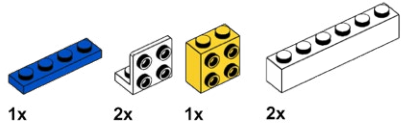

1

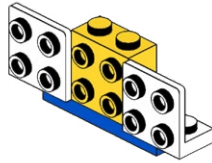

2

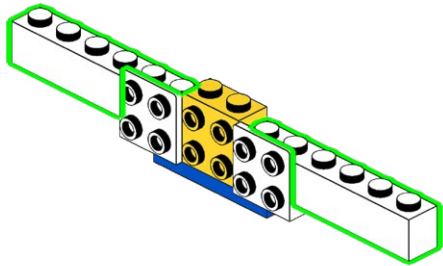

194

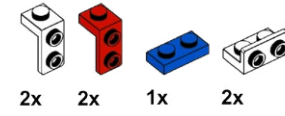

1

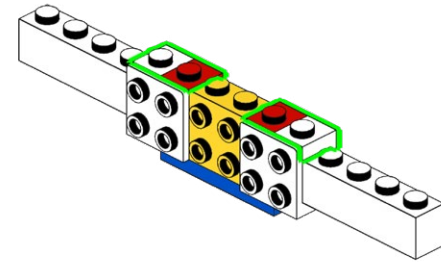

2

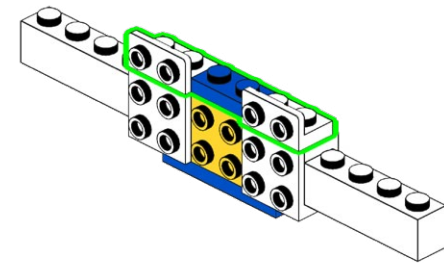

195

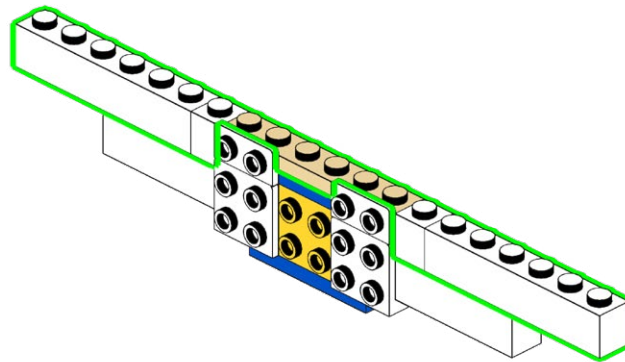
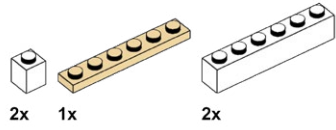

196

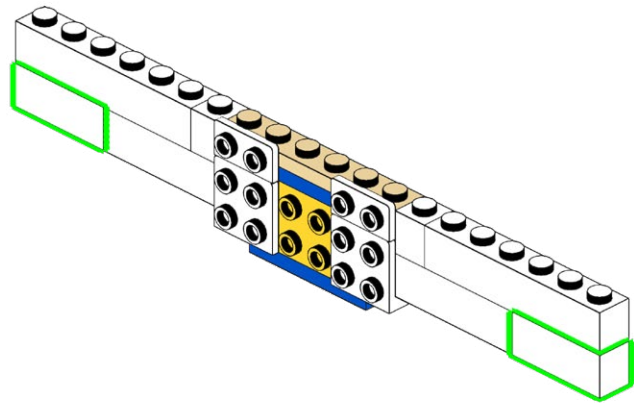
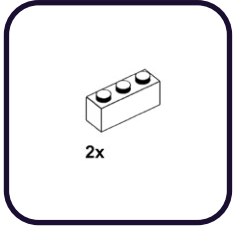

197

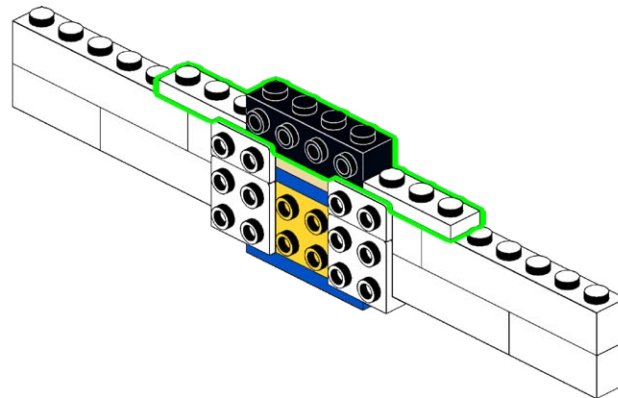
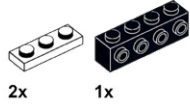

198

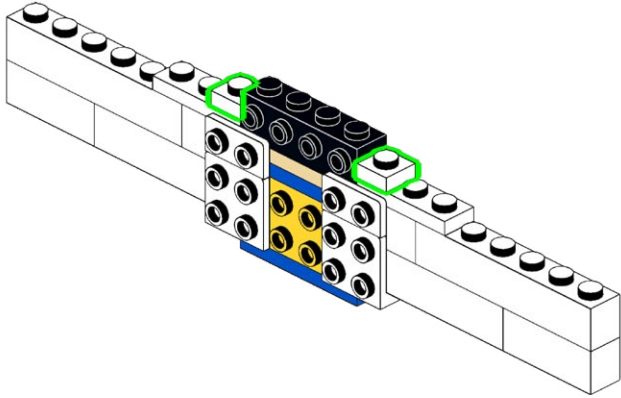
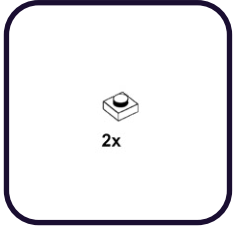



199

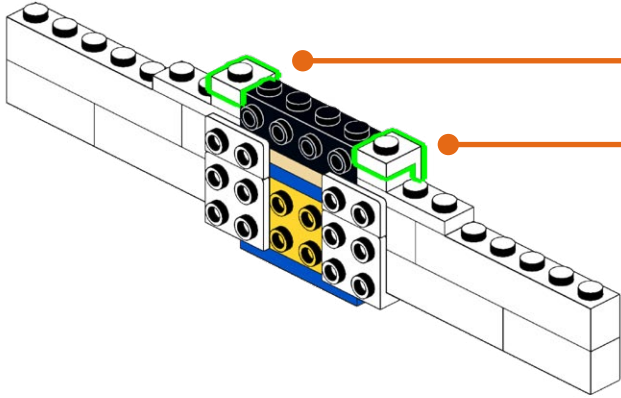
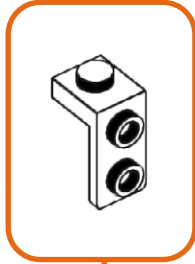
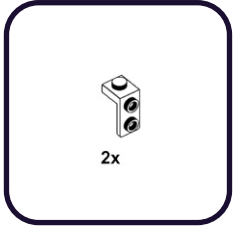

**200**

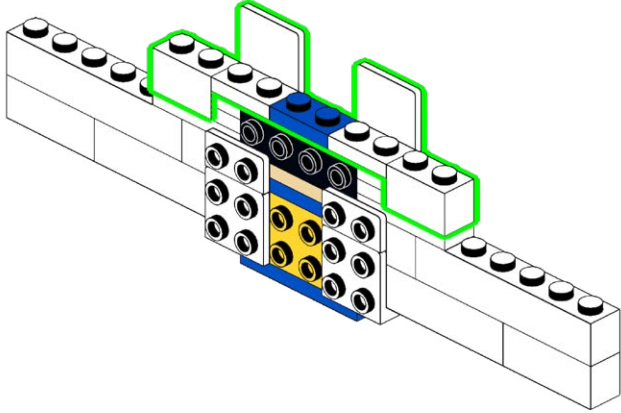
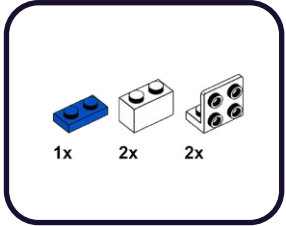

201

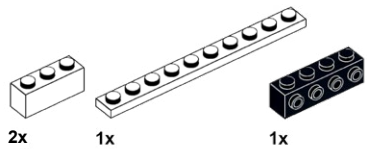

1

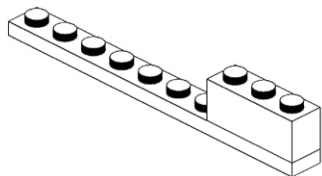

2

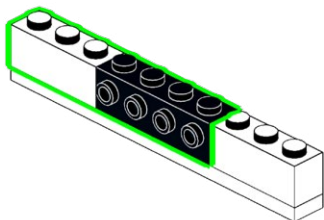

202

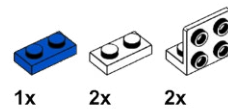

1

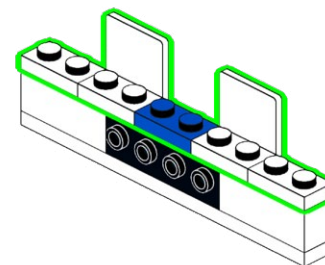

2

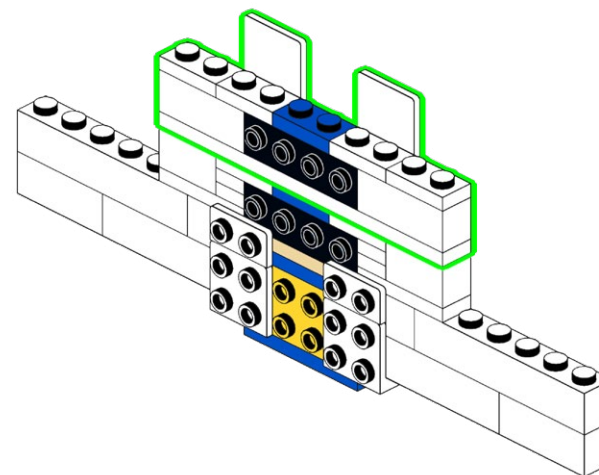

**203**

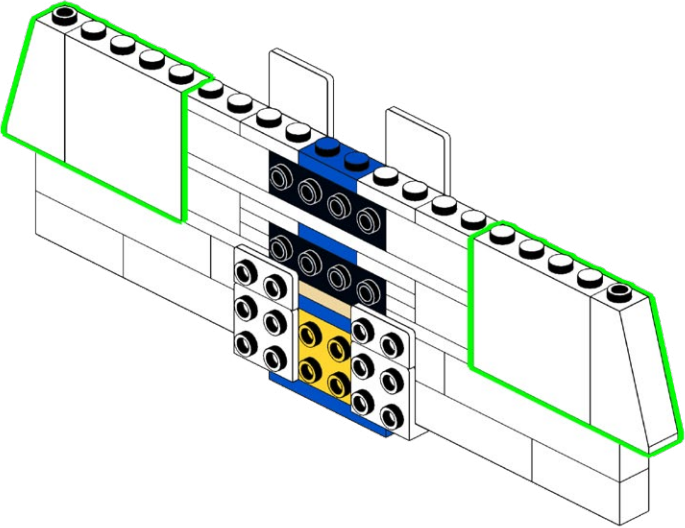
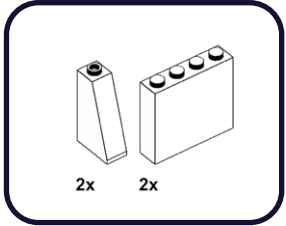

204

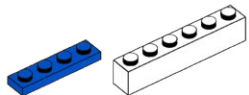

1x

2x

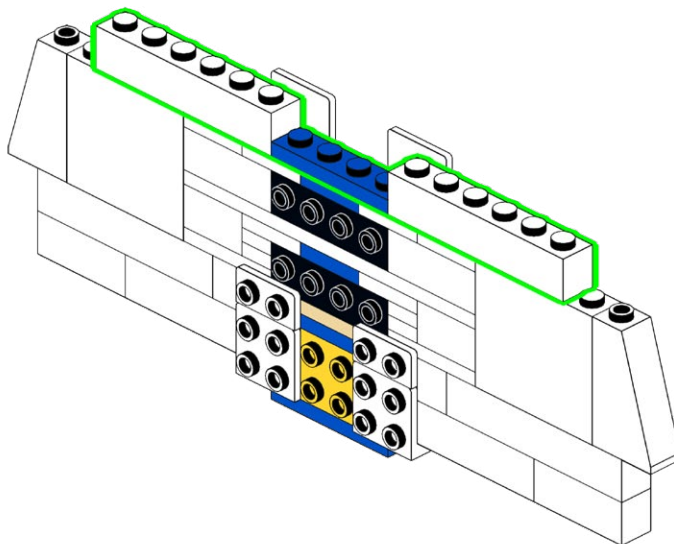

205

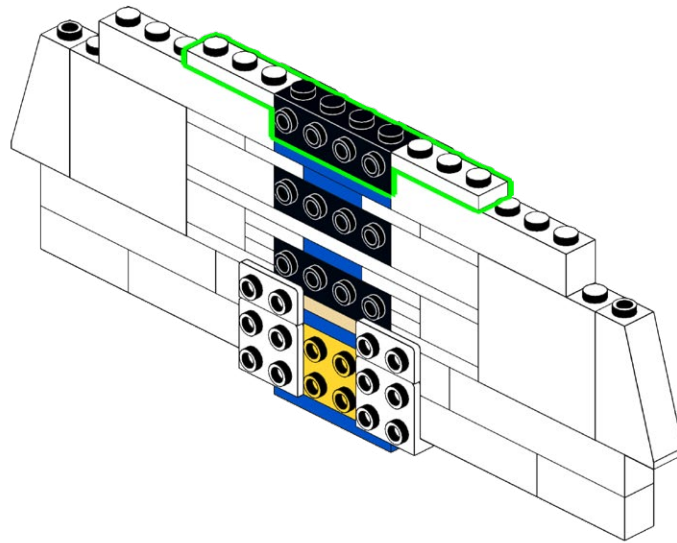
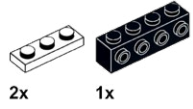

206

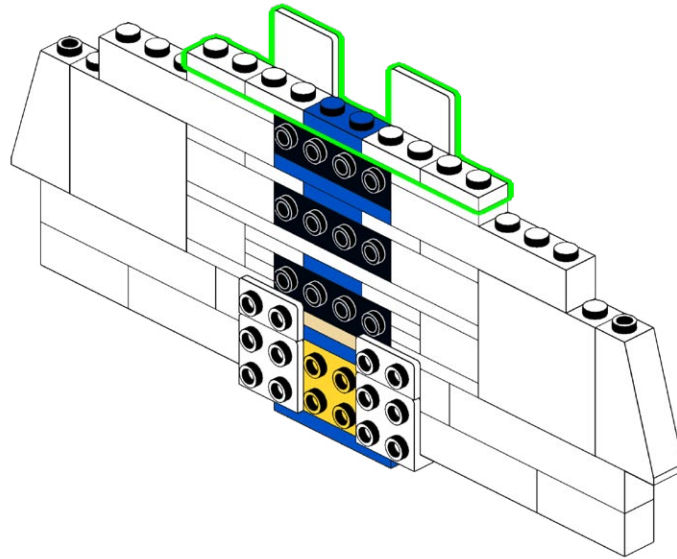
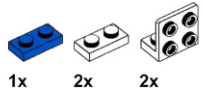

**207**

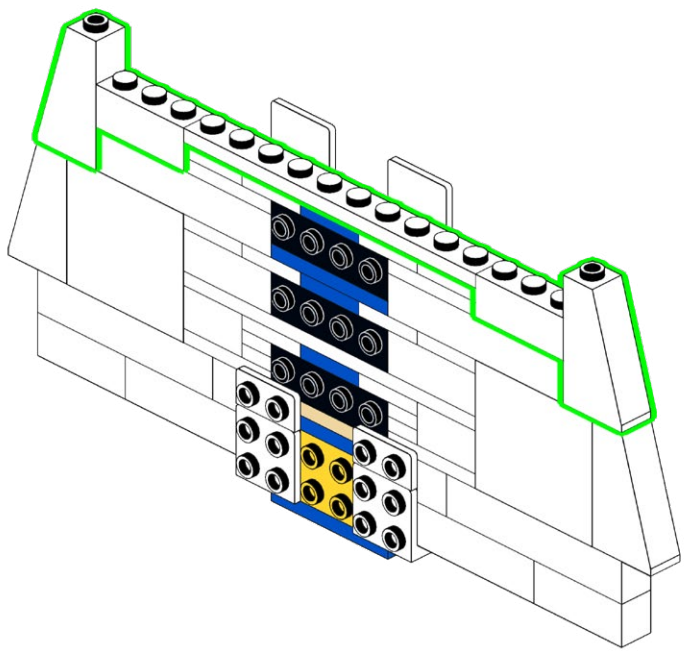
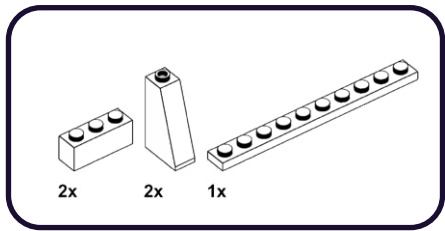



208

2x

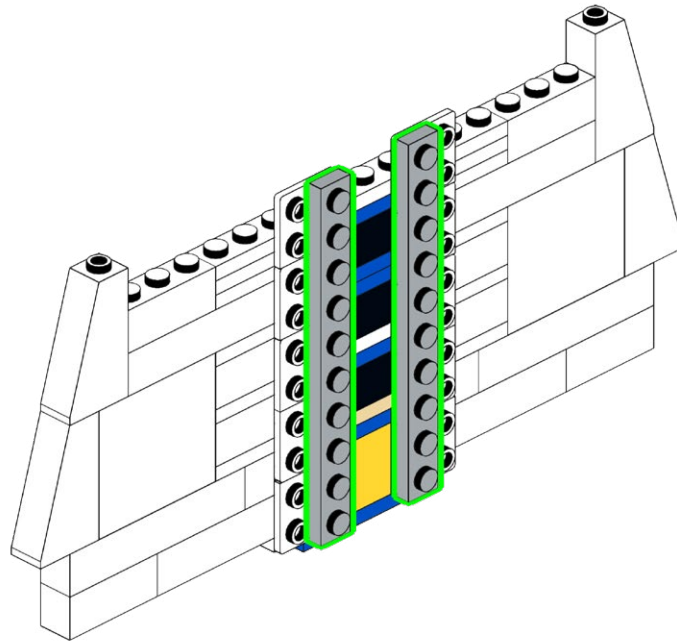

209

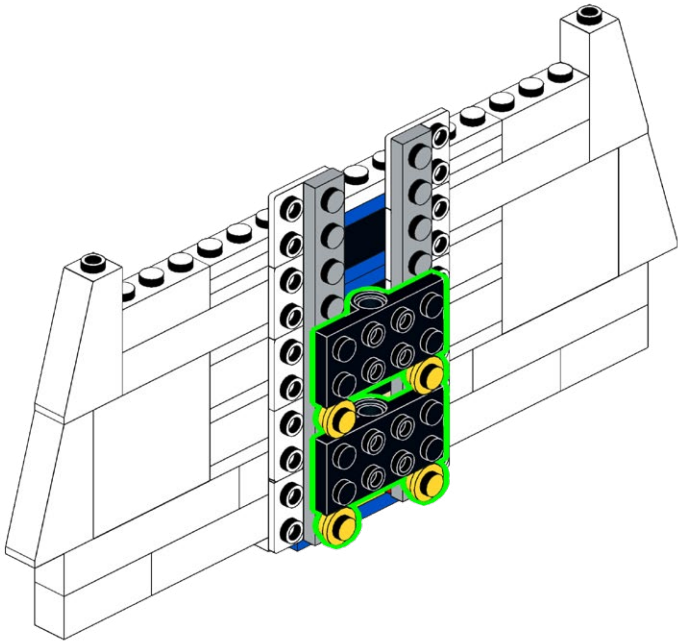

210

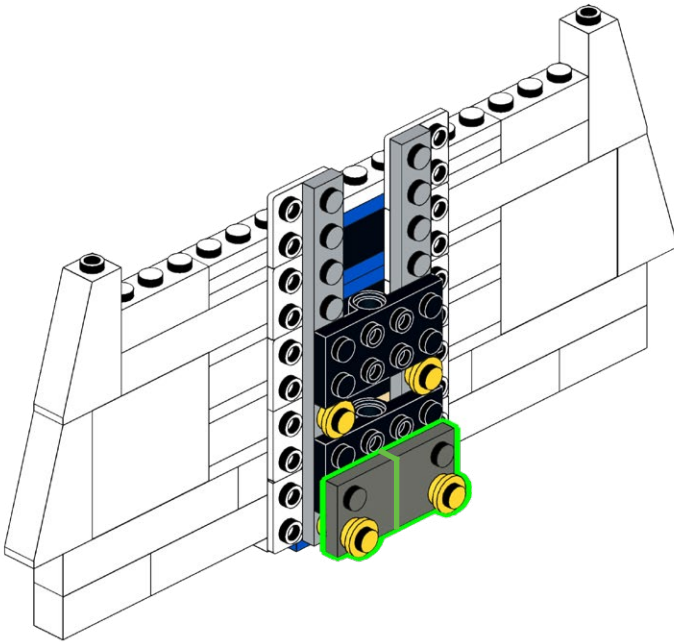
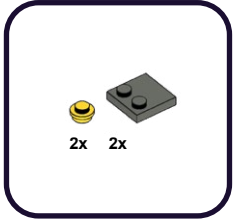

211



2x

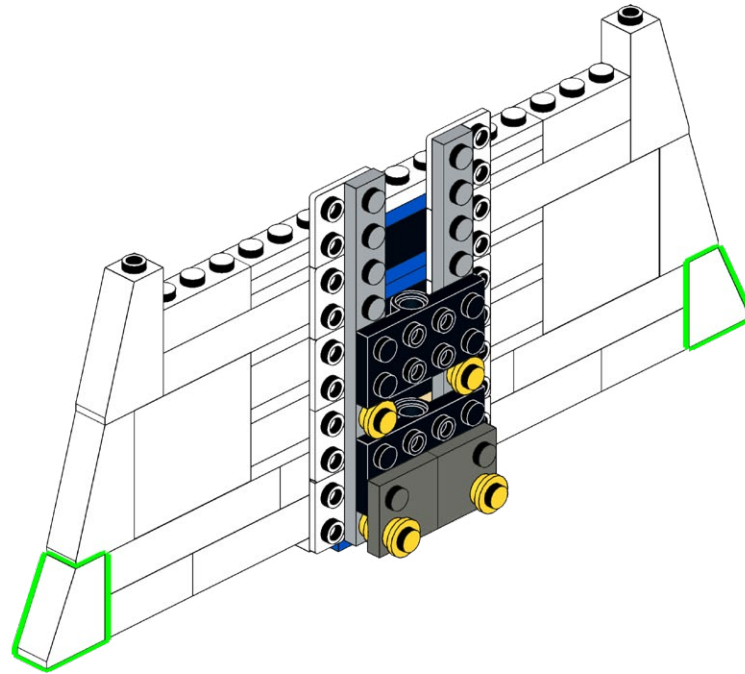

212

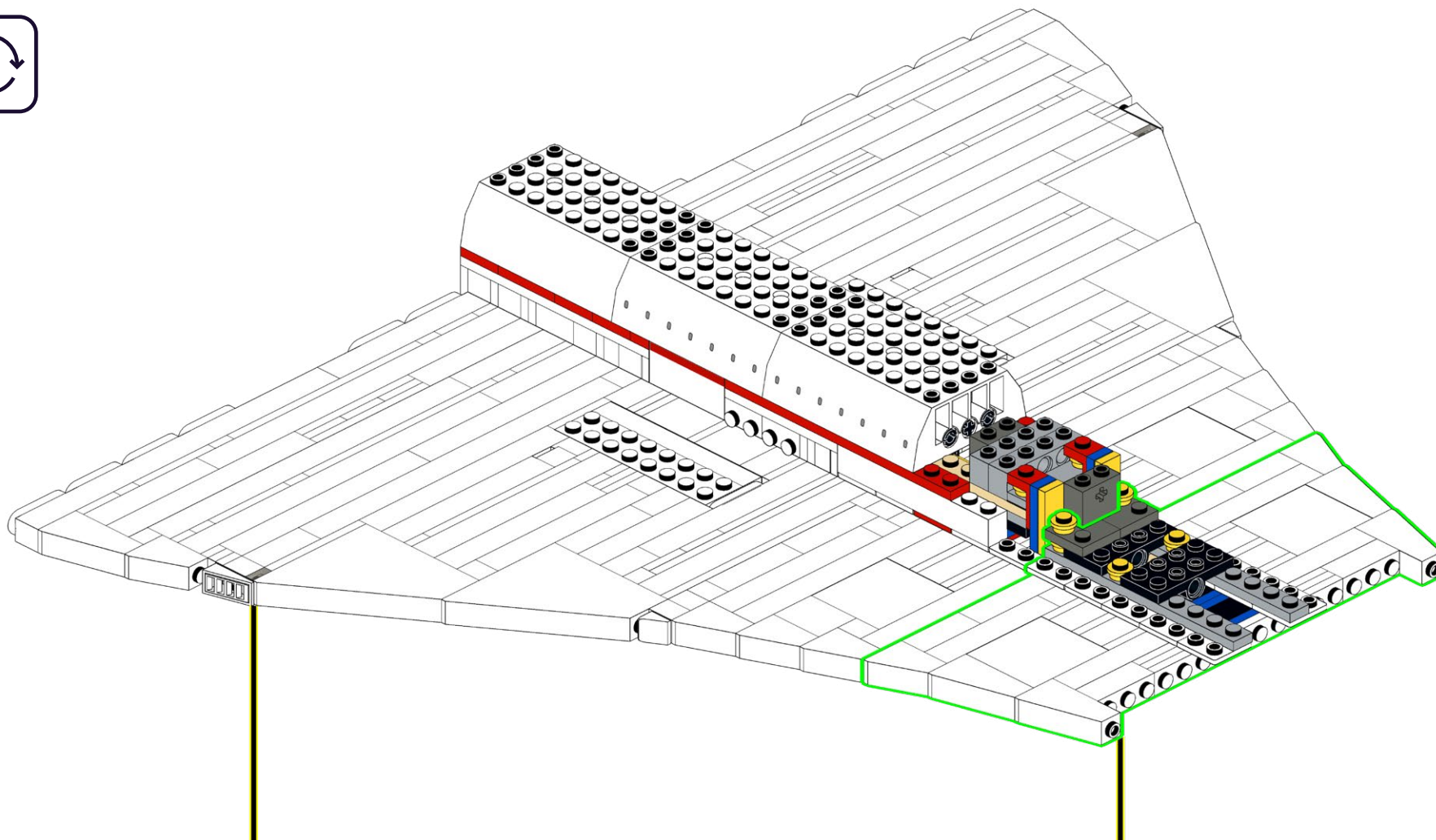

213

1x

2x

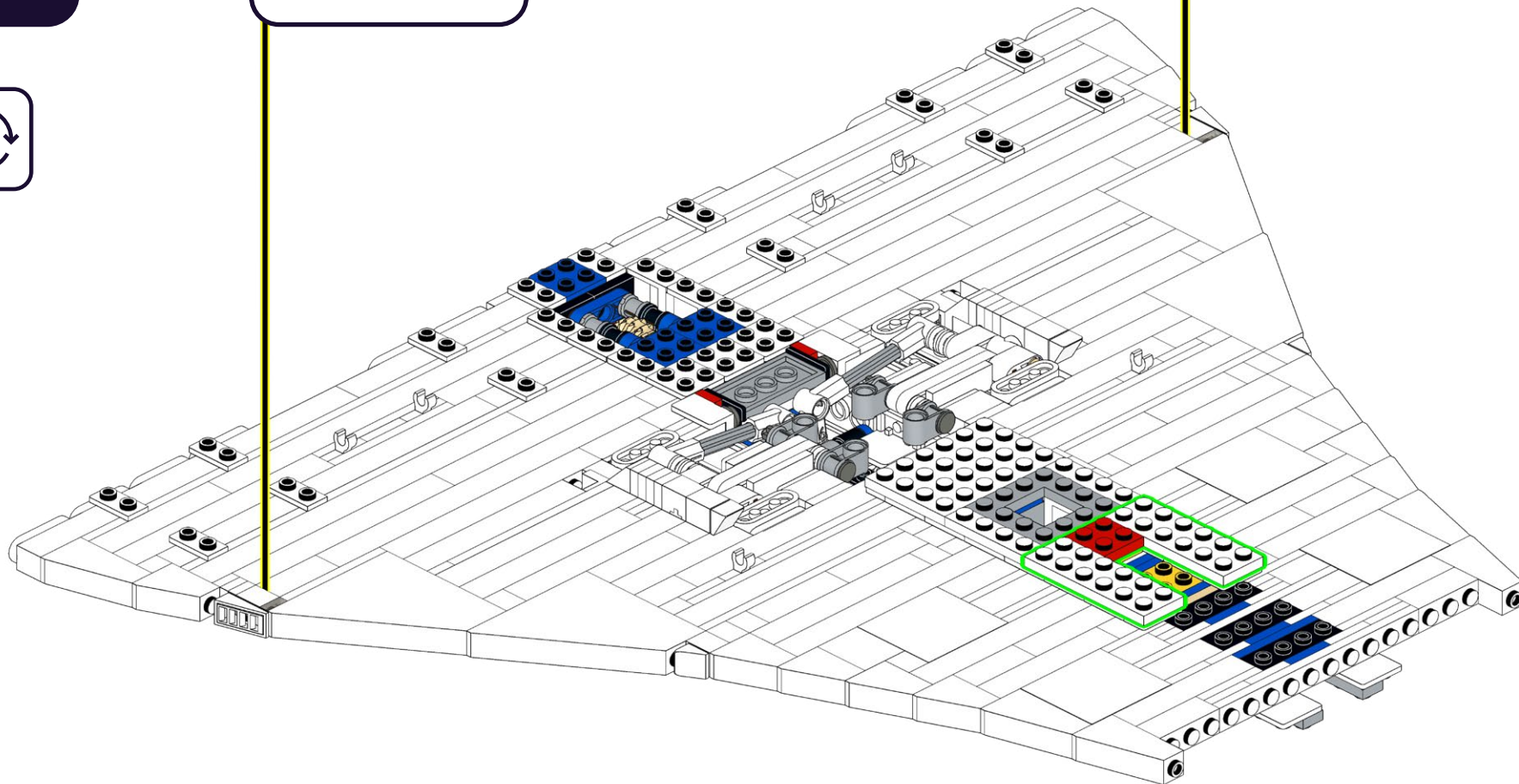

214

1x

1x

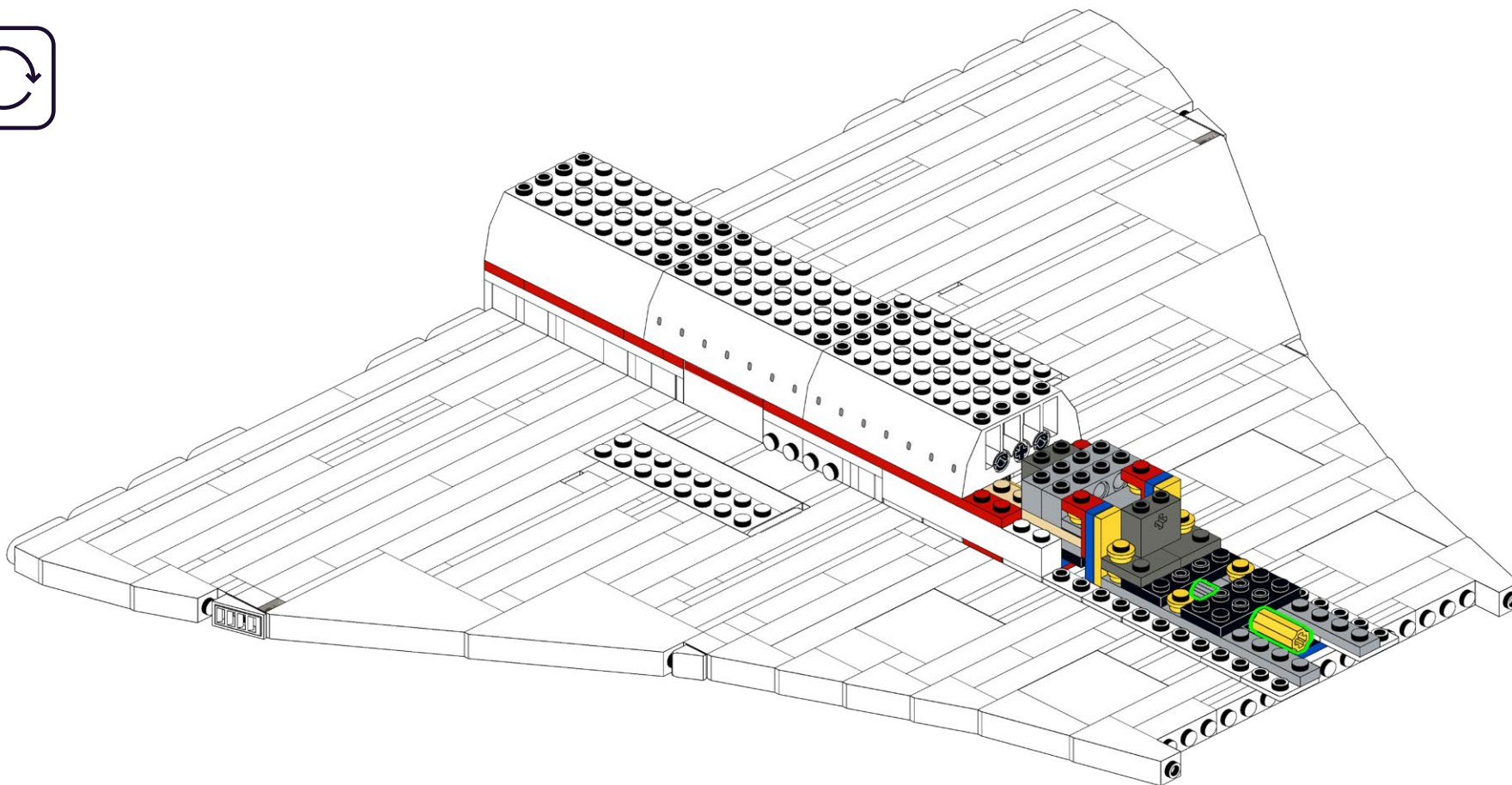

215

2x

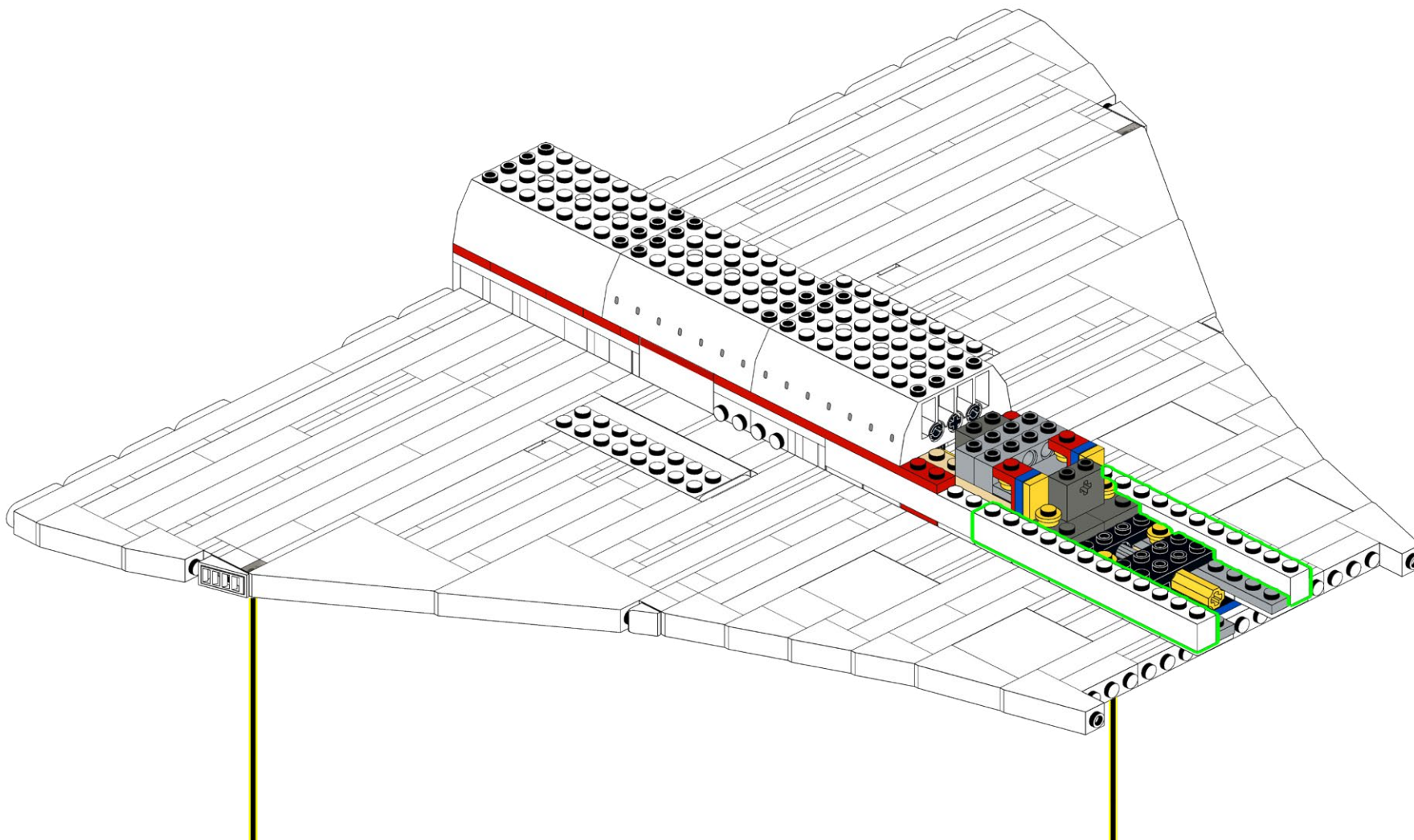



216

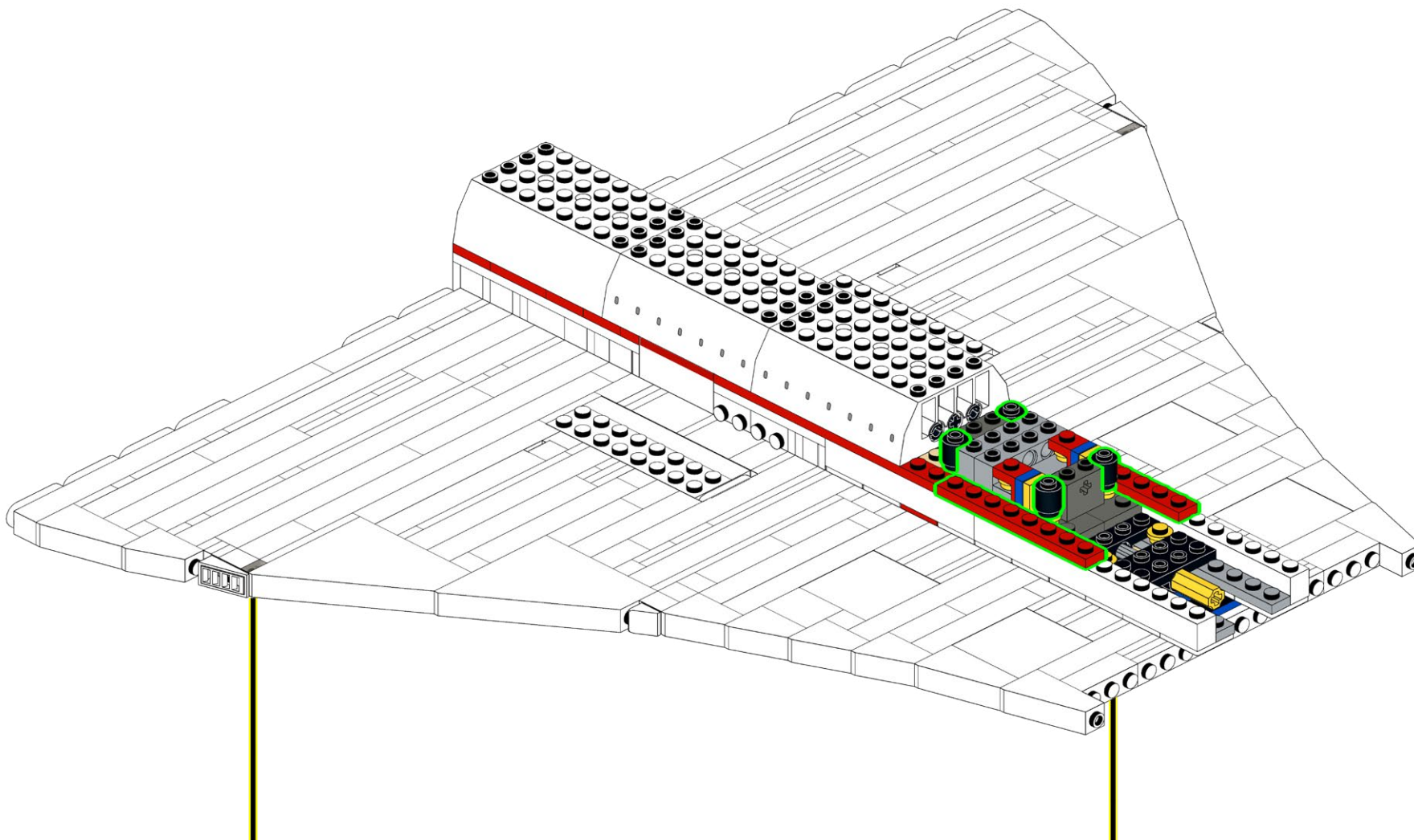
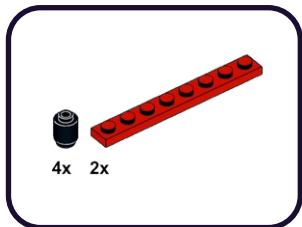

217

1x

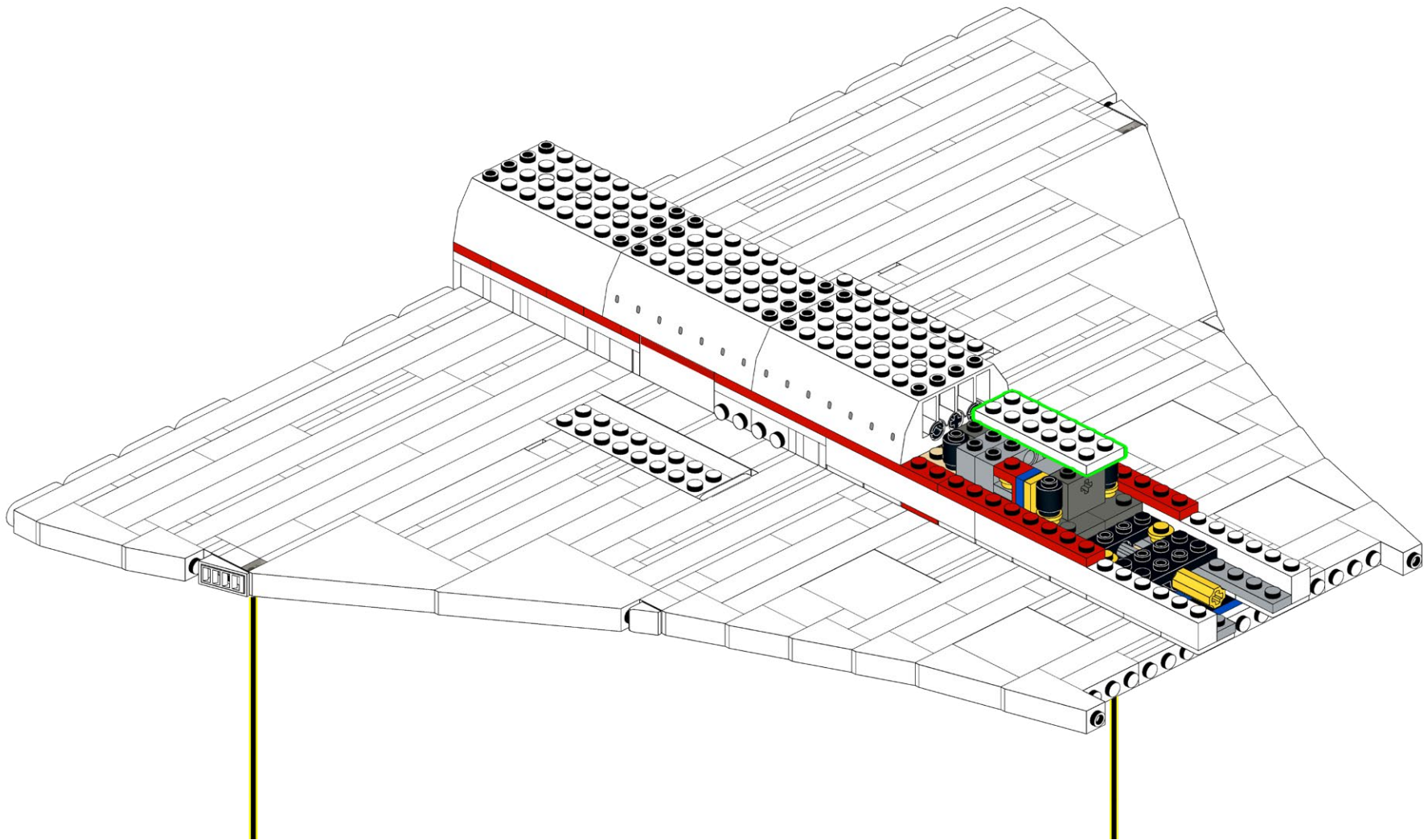

218

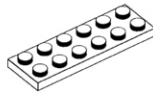

1x

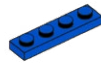

2x

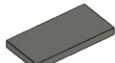

1x

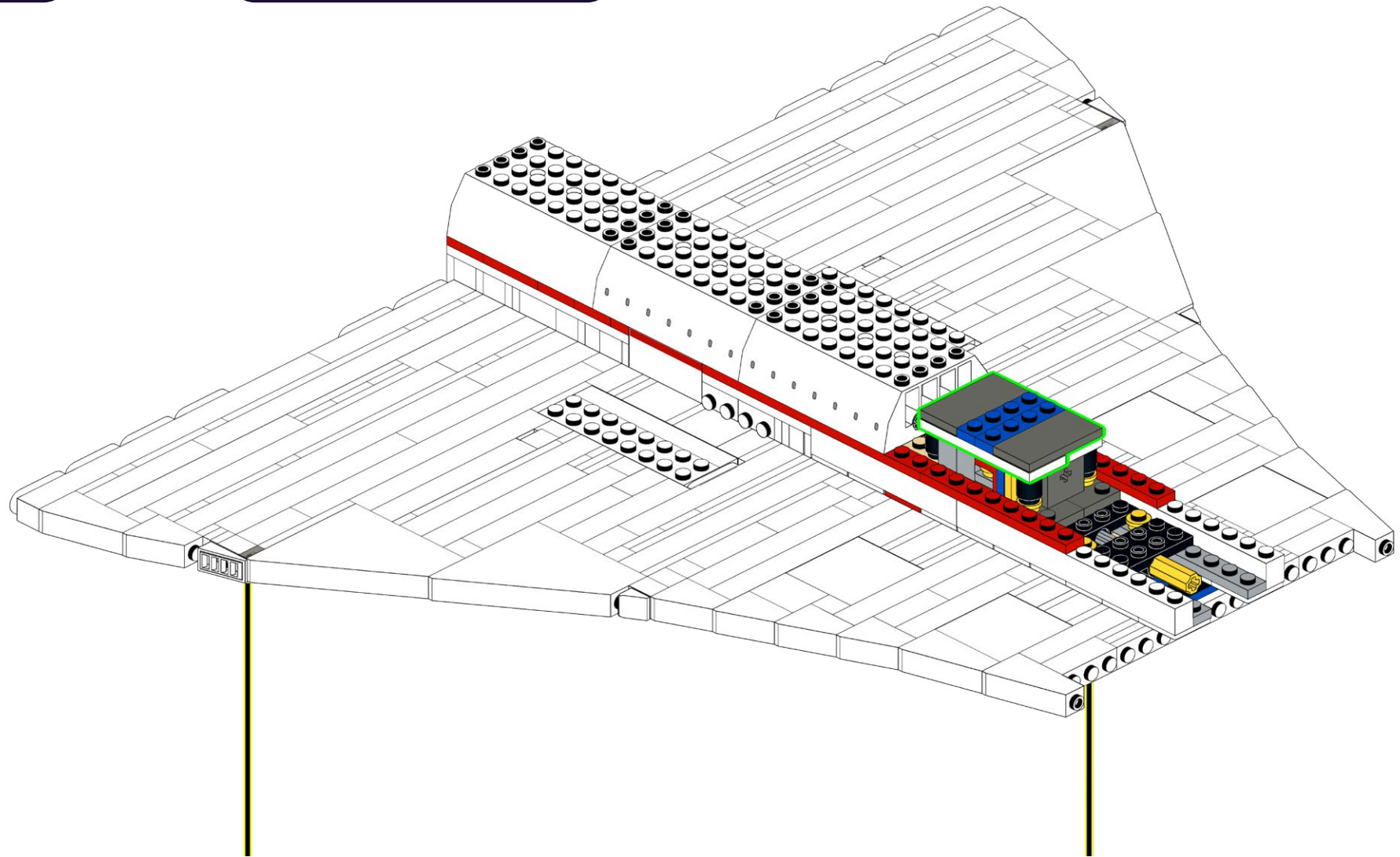

**HOLD UP!**

You might notice some bags aren't in order, as well as left over pieces, but that's ok! We're changing the way you build LEGO!

**ATTENDEZ!**

Vous remarquerez peut-être que certains sacs, ainsi que certaines pièces, ne sont pas dans le bon ordre. Mais pas de panique! Nous changeons simplement la façon avec laquelle vous construisez vos LEGO!

**ASPETTA!**

Potresti notare che alcuni sacchetti non sono in ordine, così come i pezzi avanzati, ma va bene così! Stiamo cambiando il modo in cui costruisci i LEGO!

**HALT!**

Sie werden möglicherweise bemerken, dass einige tüten durcheinander sind und teile übrig bleiben, aber das ist in Ordnung! Wir ändern die art und weise, wie Sie LEGO bauen!

**¡ESPERA!**

Es posible que notes que algunas bolsas están fuera de servicio, así como piezas sobrantes, ¡pero está bien! ¡Estamos cambiando la forma en que construyes LEGO!

**暫停!**

你可能会注意到一些袋子顺序错乱, 以及一些剩余的部件, 但没关系! 我们正在改变你搭建乐高的方式!

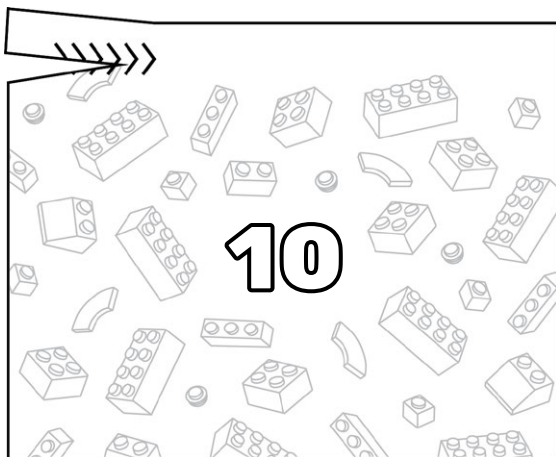
**Open LEGO® Bag 10**

219

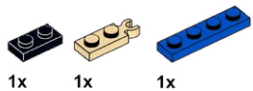

1

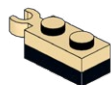

2

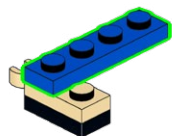

220

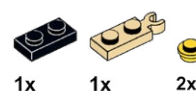

1

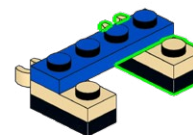

2

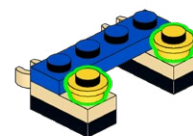

# 221

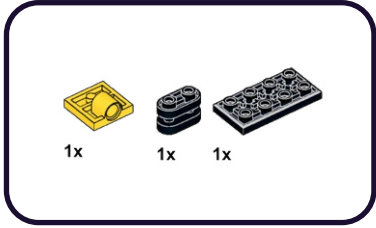

1

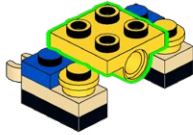

2

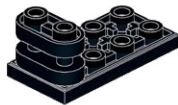

# 222

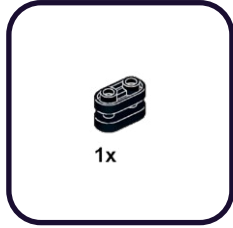

1

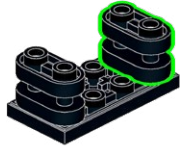

2

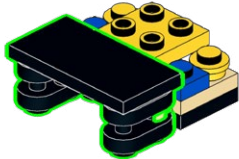

**223**

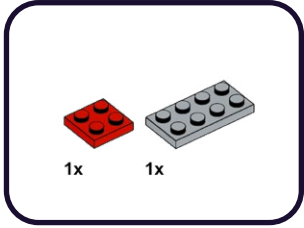

**1**

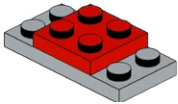

**224**

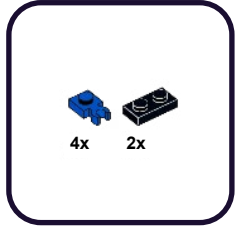

**2**

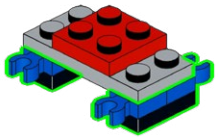
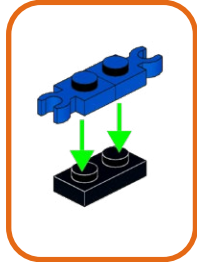

225

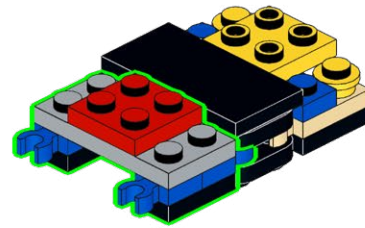



**226**

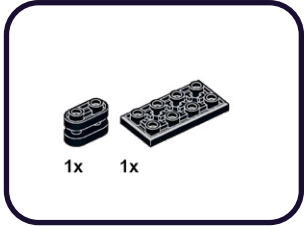

**1**

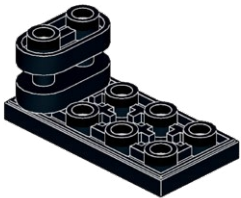

**227**

**2**

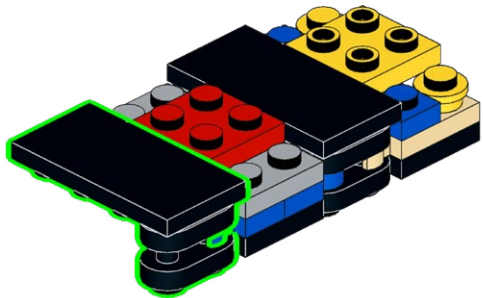

228

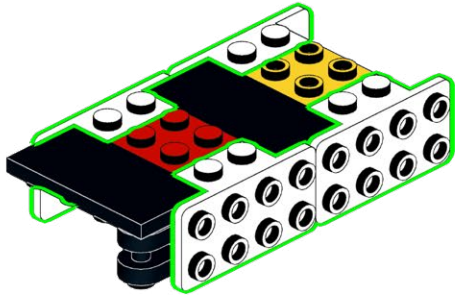
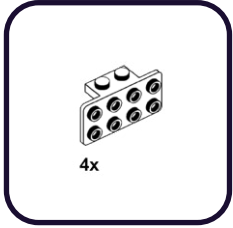

229

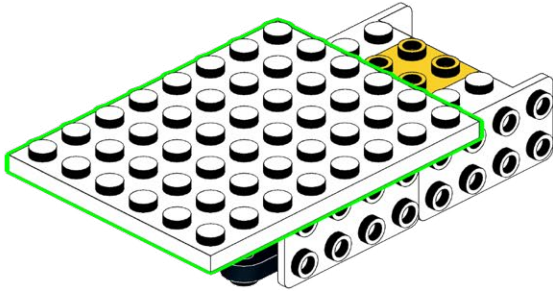
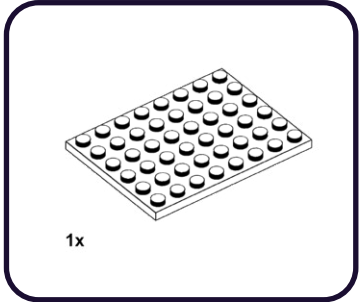

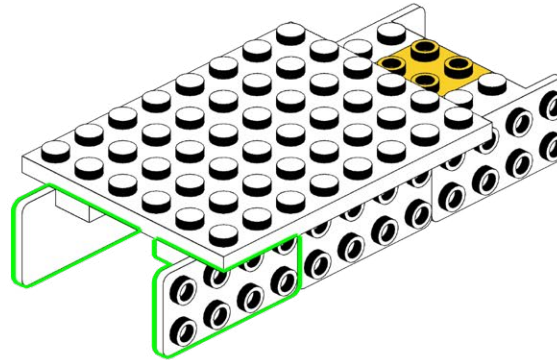
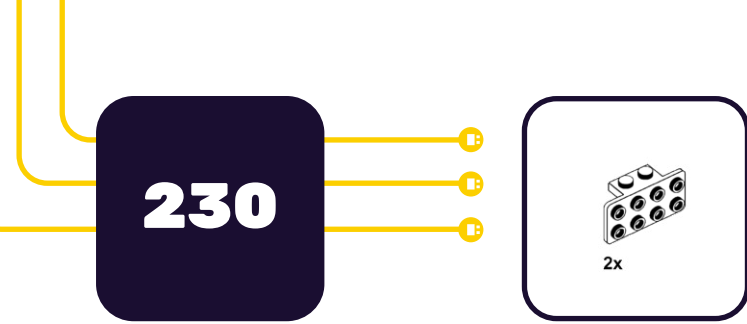

231

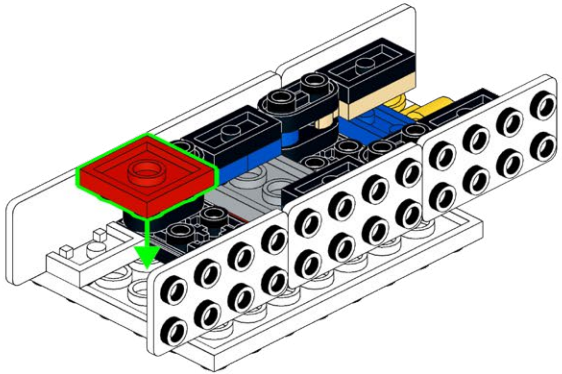
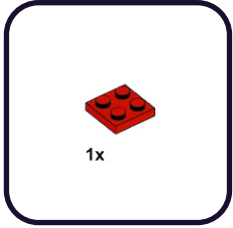

232

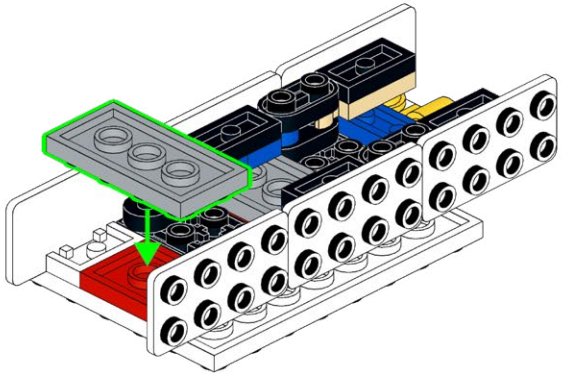
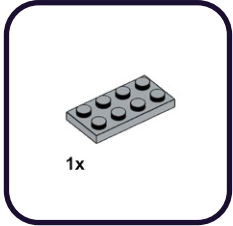

233

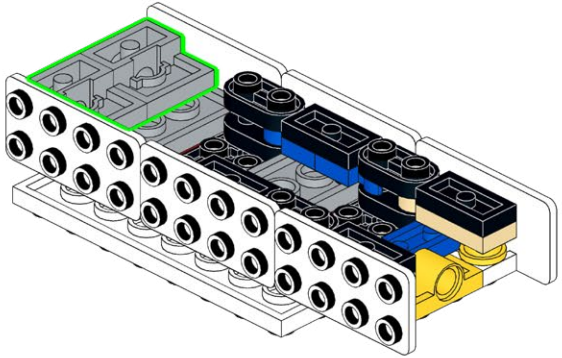
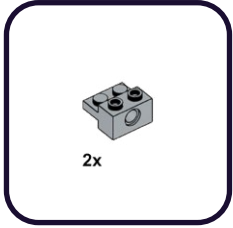

234

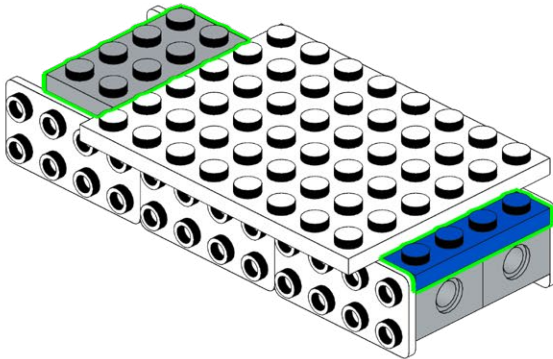
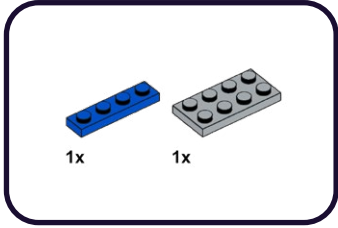



235

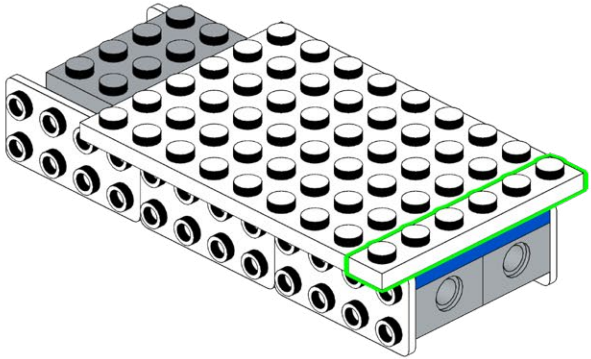
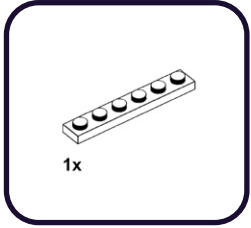

236

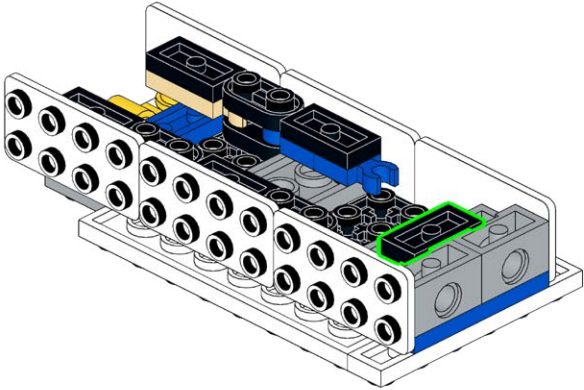
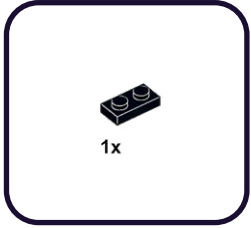

# 237

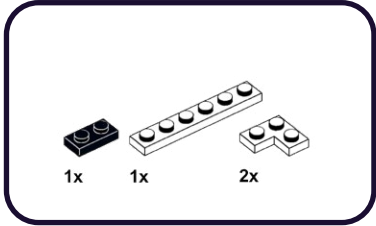

1

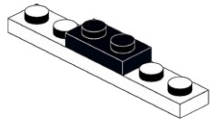

2

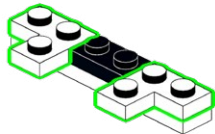

# 238

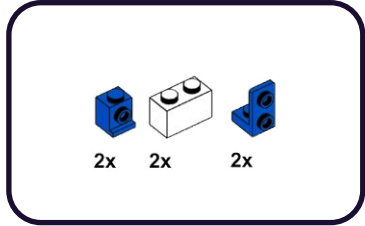

1

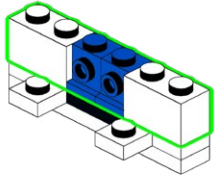

2

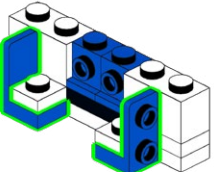

# 239

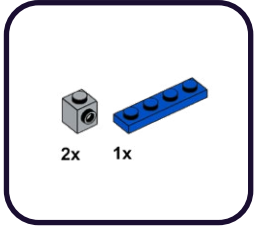

1

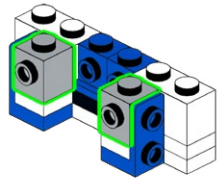

2

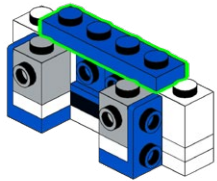

# 240

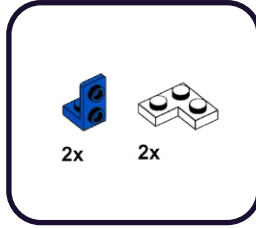

1

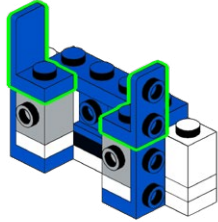

2

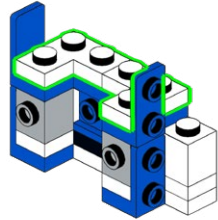

# 241

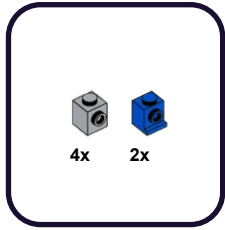

1

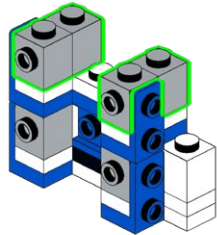

2

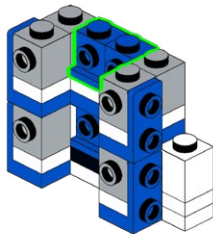

# 242

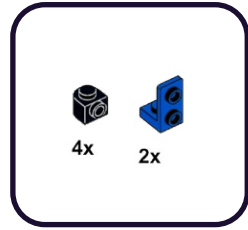

1

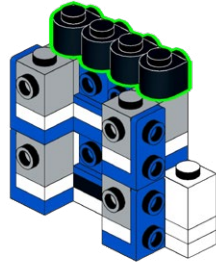

2

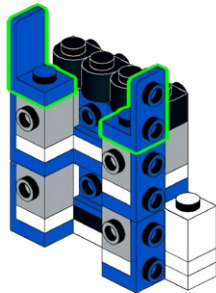

243

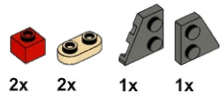

1

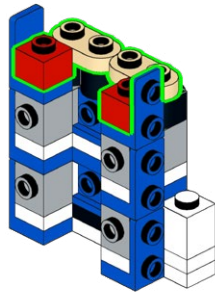

2

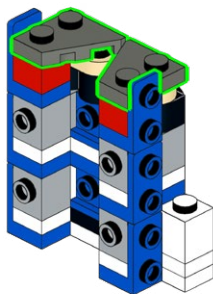

244

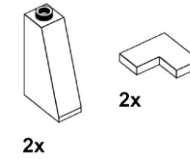

1

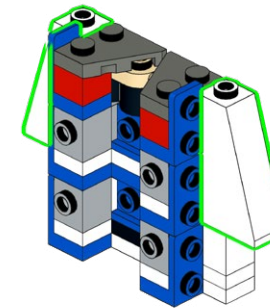

2

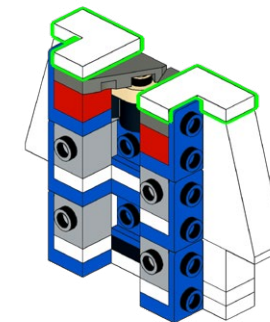

245



1x

246

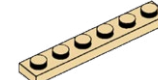

2x

1

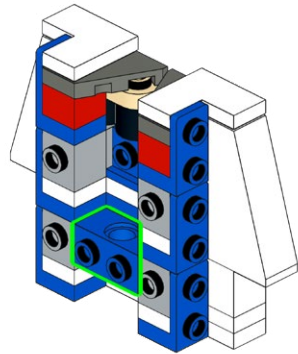

2

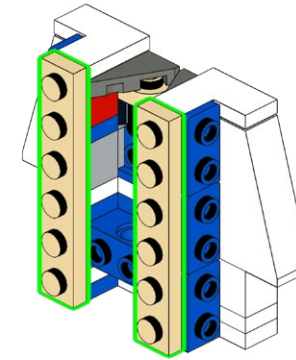

**247**

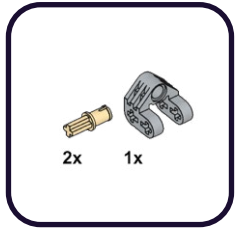

**1**

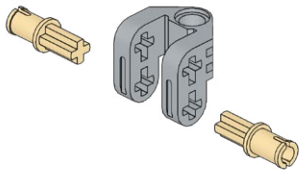

**248**

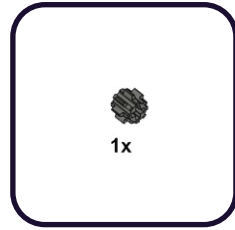

**2**

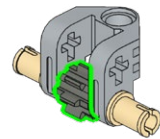



**249**

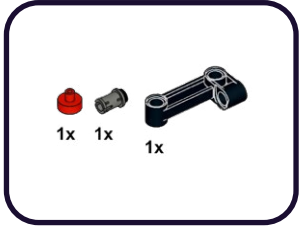

**1**



**2**

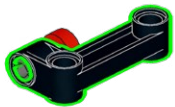

**250**

**1**

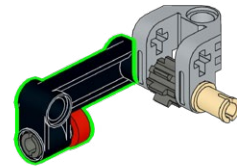

**251**

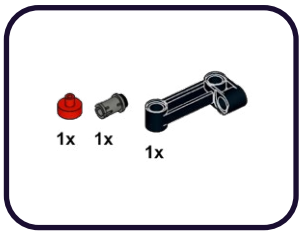

**1**



**2**

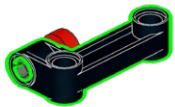

**252**

**1**

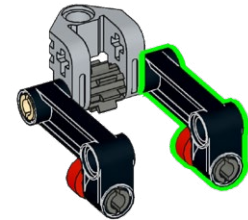

253

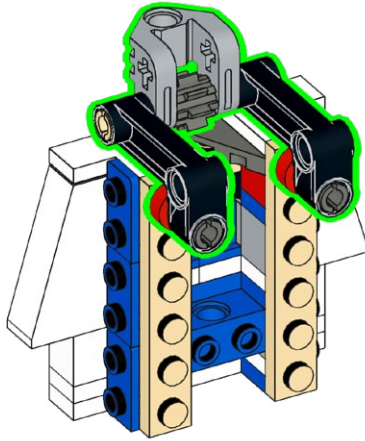
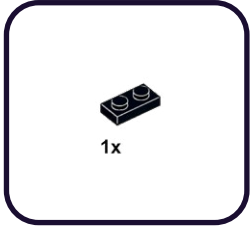

**254**

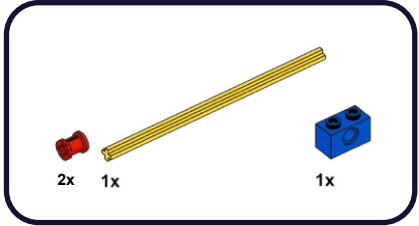

**1**



**2**

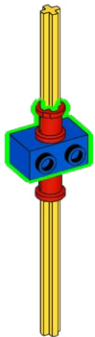

**255**

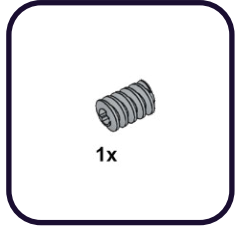

**1**

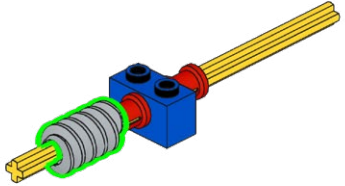

256

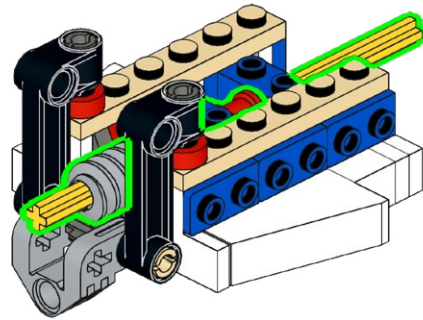

257

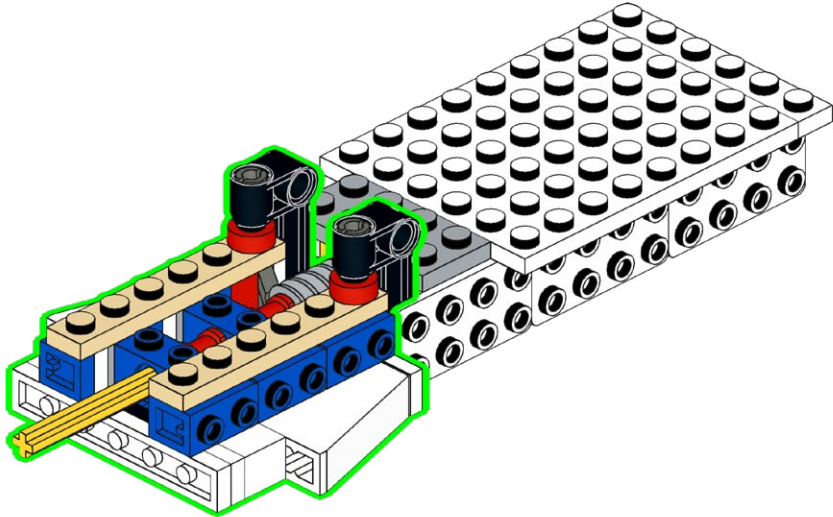

258

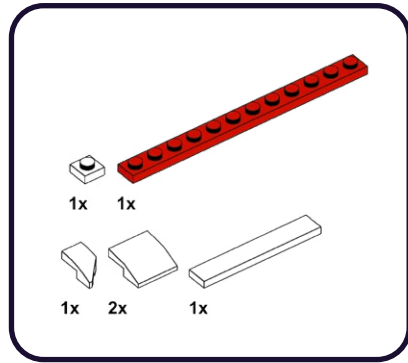

1

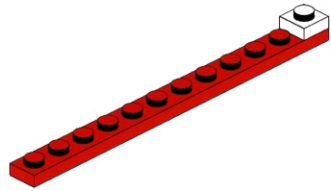

2

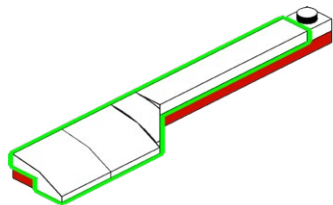

259

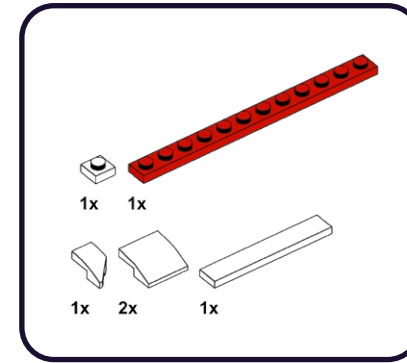

1

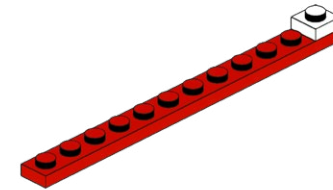

2

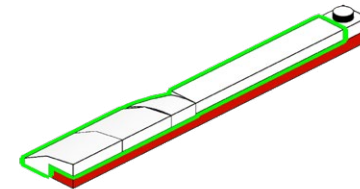

260

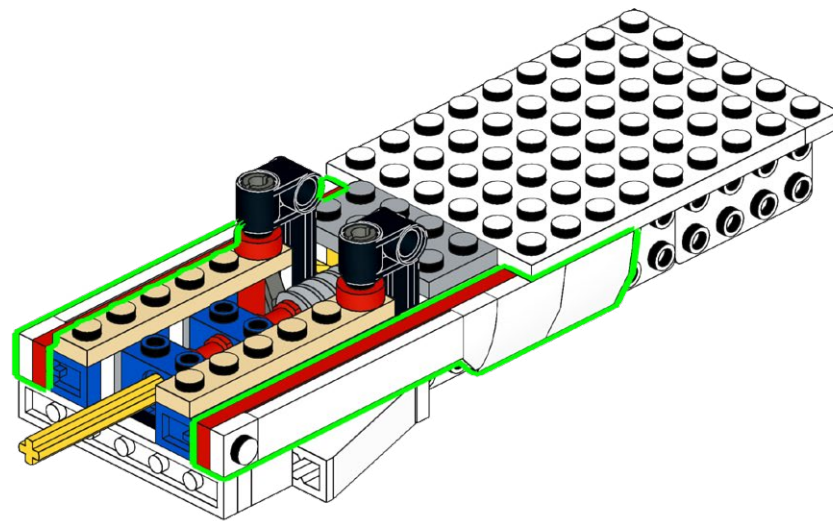



261

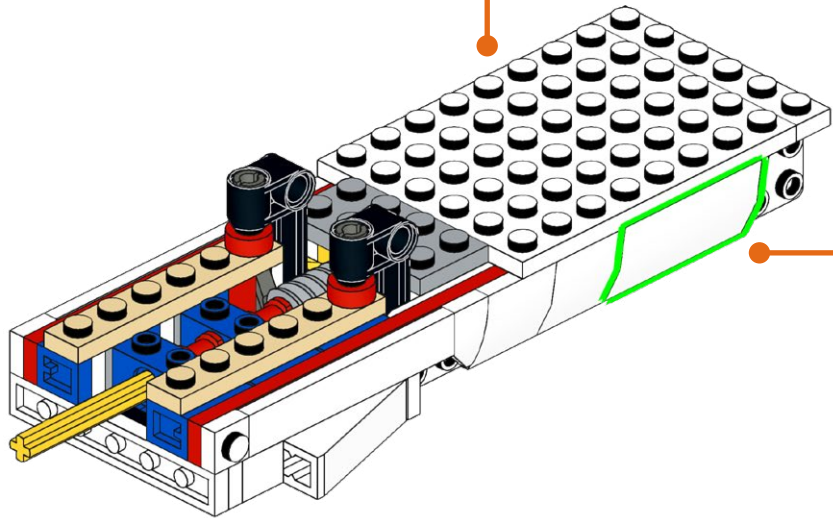
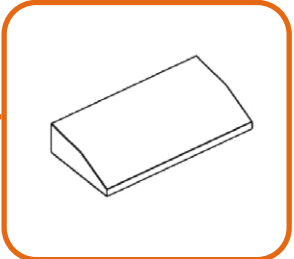
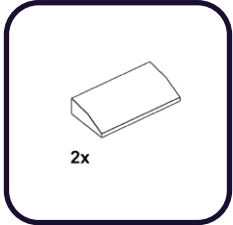

262



2x

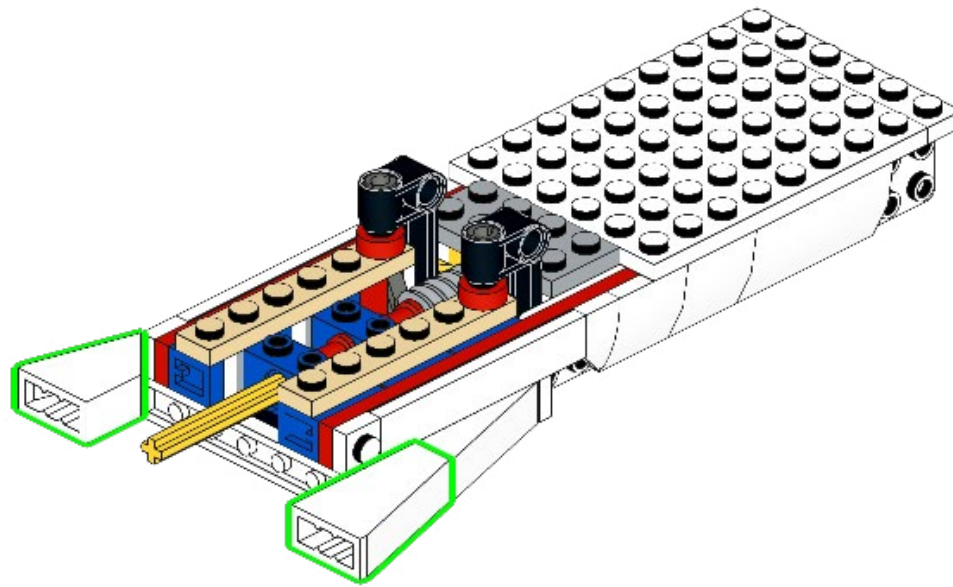

**HOLD UP!**

You might notice some bags aren't in order, as well as left over pieces, but that's ok! We're changing the way you build LEGO!

**ATTENDEZ!**

Vous remarquerez peut-être que certains sacs, ainsi que certaines pièces, ne sont pas dans le bon ordre. Mais pas de panique! Nous changeons simplement la façon avec laquelle vous construisez vos LEGO!

**ASPETTA!**

Potresti notare che alcuni sacchetti non sono in ordine, così come i pezzi avanzati, ma va bene così! Stiamo cambiando il modo in cui costruisci i LEGO!

**HALT!**

Sie werden möglicherweise bemerken, dass einige tüten durcheinander sind und teile übrig bleiben, aber das ist in Ordnung! Wir ändern die art und weise, wie Sie LEGO bauen!

**¡ESPERA!**

Es posible que notes que algunas bolsas están fuera de servicio, así como piezas sobrantes, ¡pero está bien! ¡Estamos cambiando la forma en que construyes LEGO!

**暫停!**

你可能会注意到一些袋子顺序错乱, 以及一些剩余的部件, 但没关系! 我们正在改变你搭建乐高的方式!

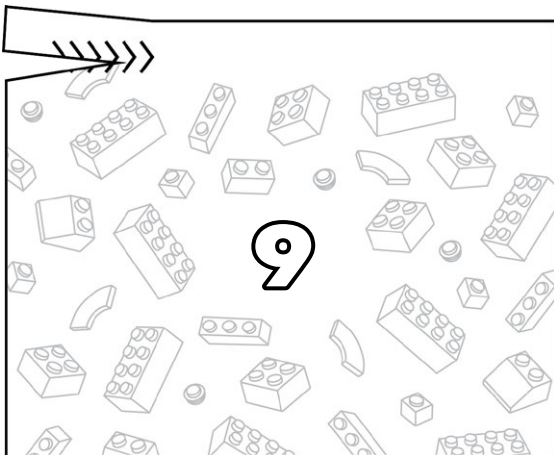
**Open LEGO® Bag 9**

263

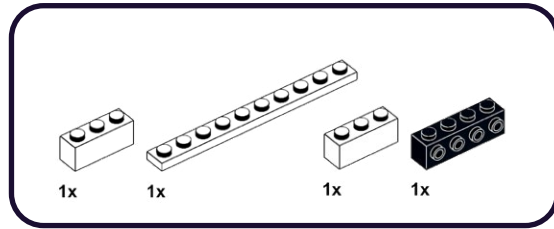

1

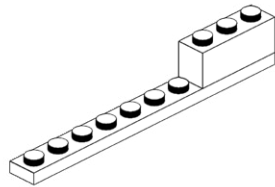

2

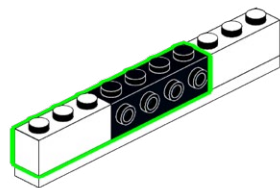

264

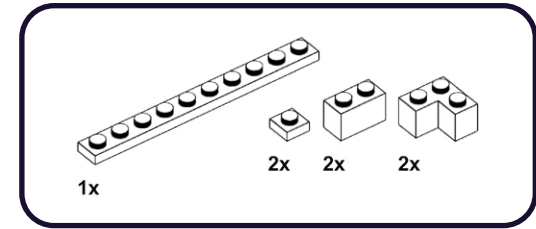

1

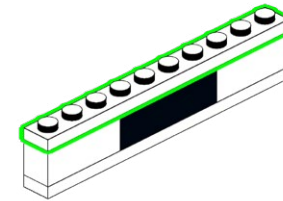

2

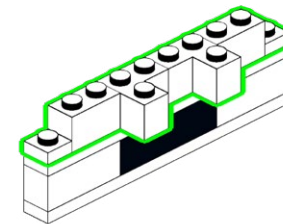

265

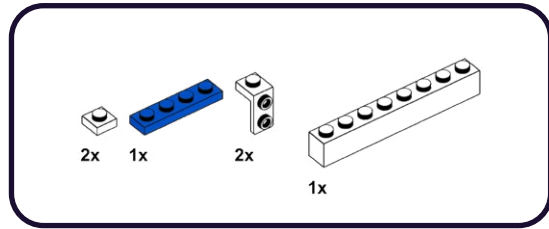

1

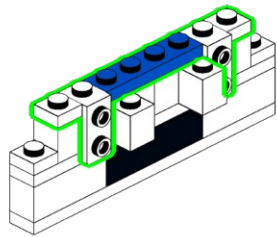

2

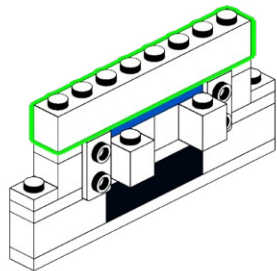

266

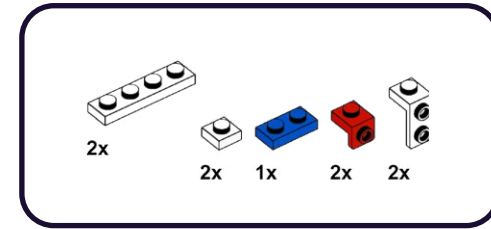

1

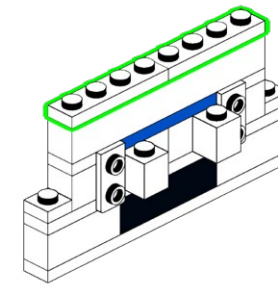

2

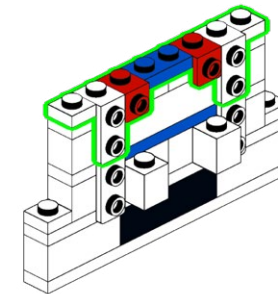

# 267

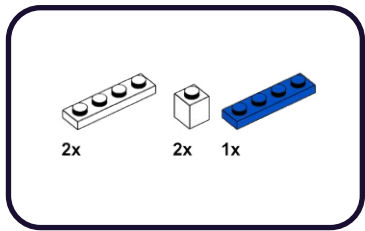

1

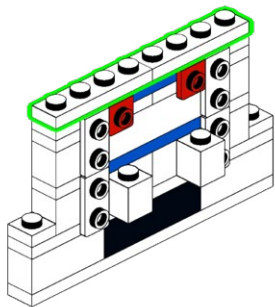

2

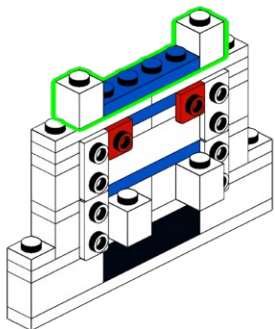

# 268

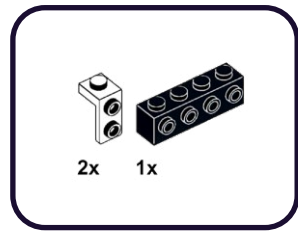

1

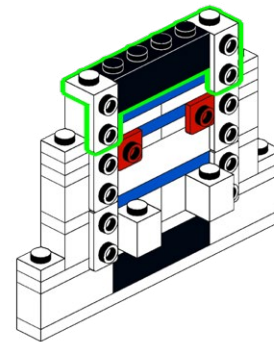

269

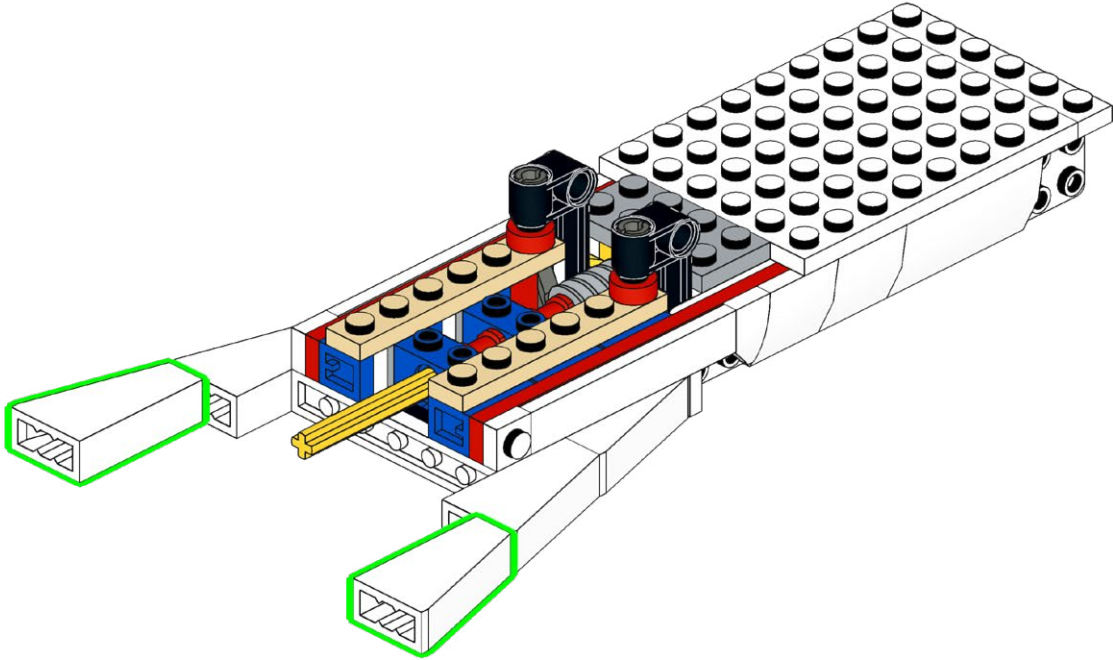
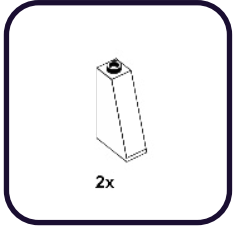

270

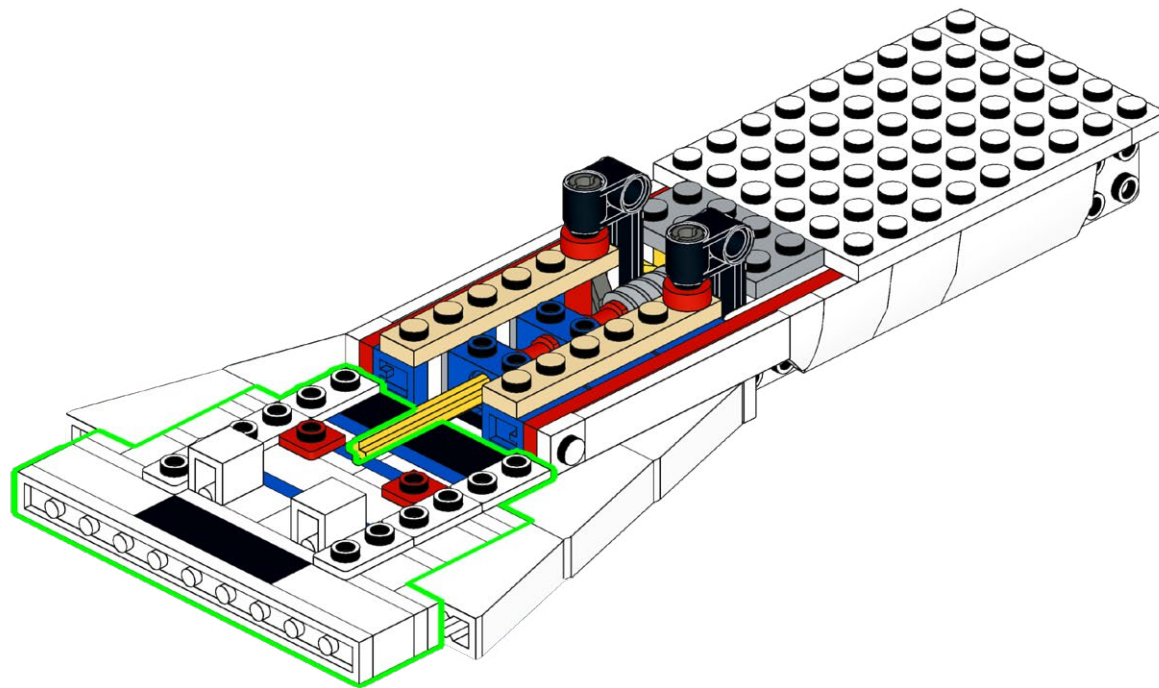



271

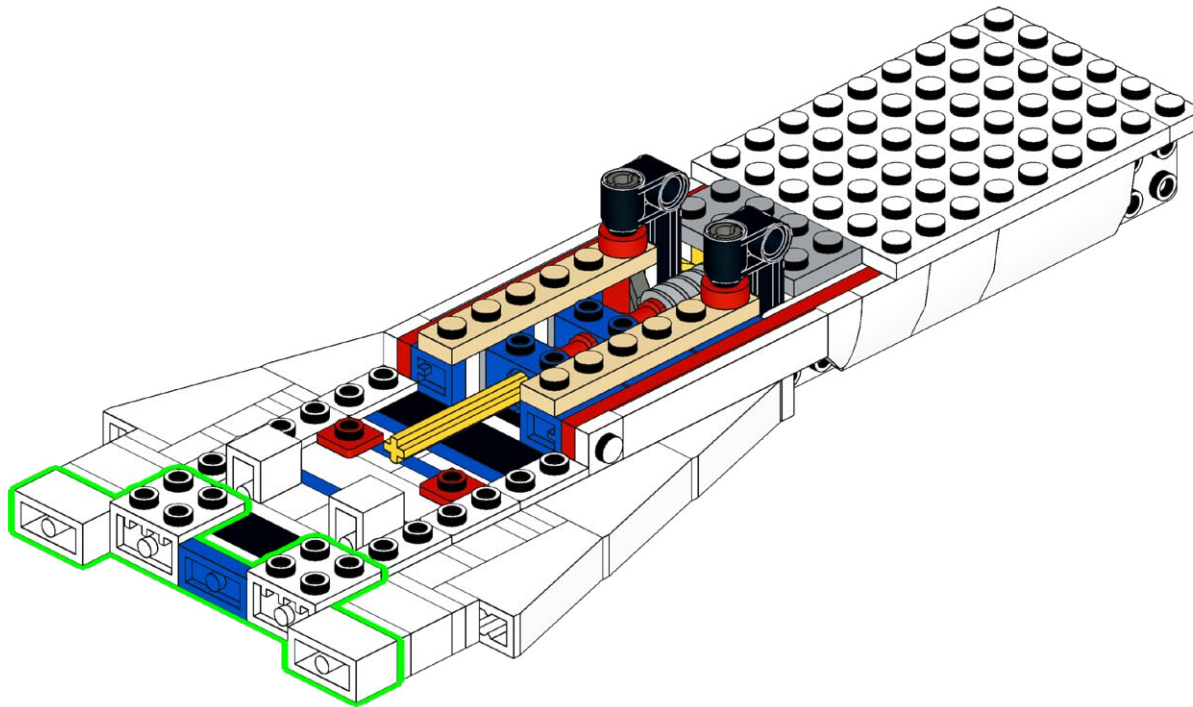
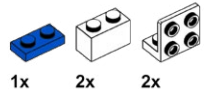

272

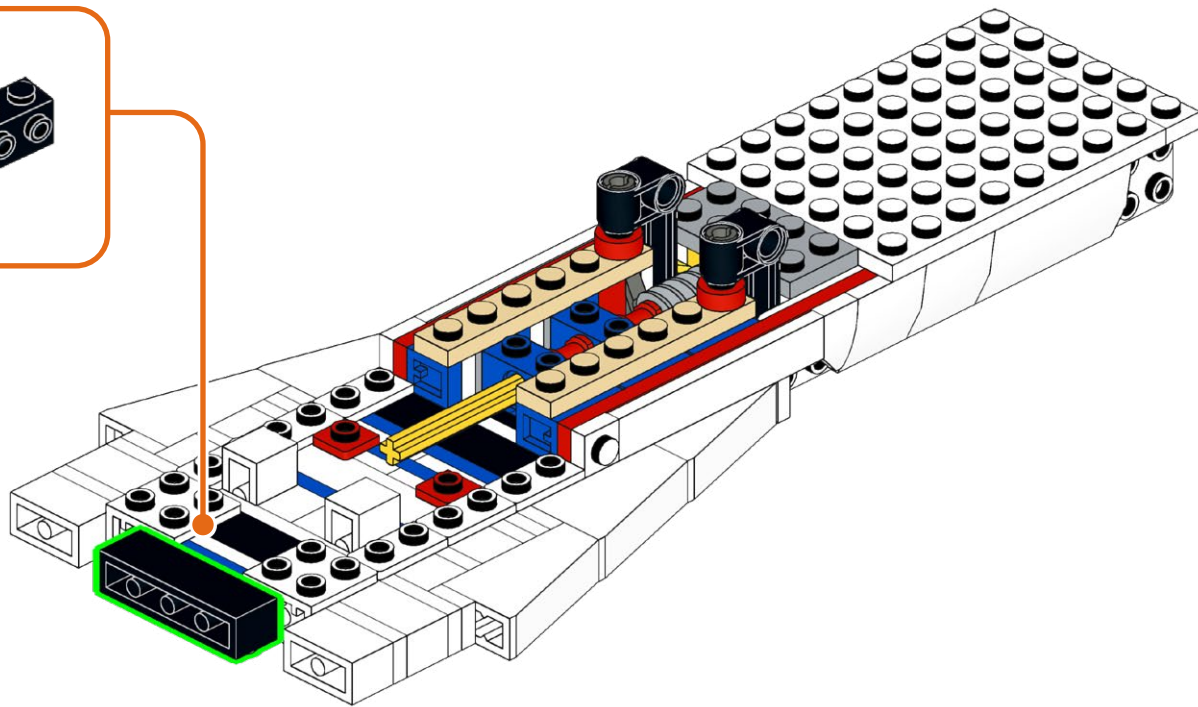
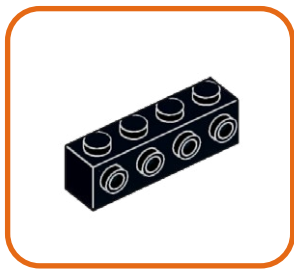
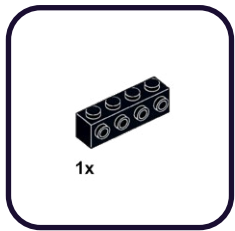

273

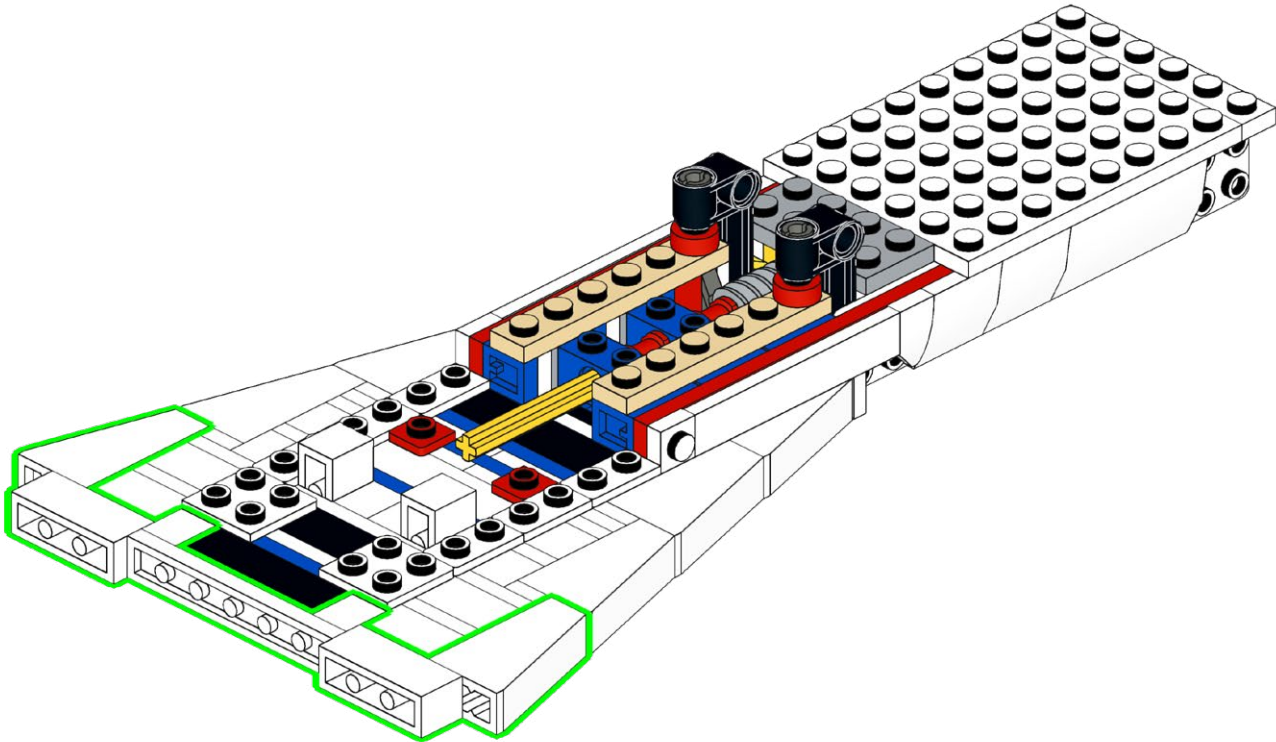
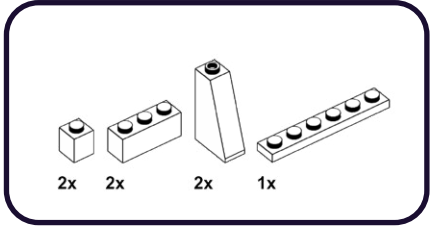

274

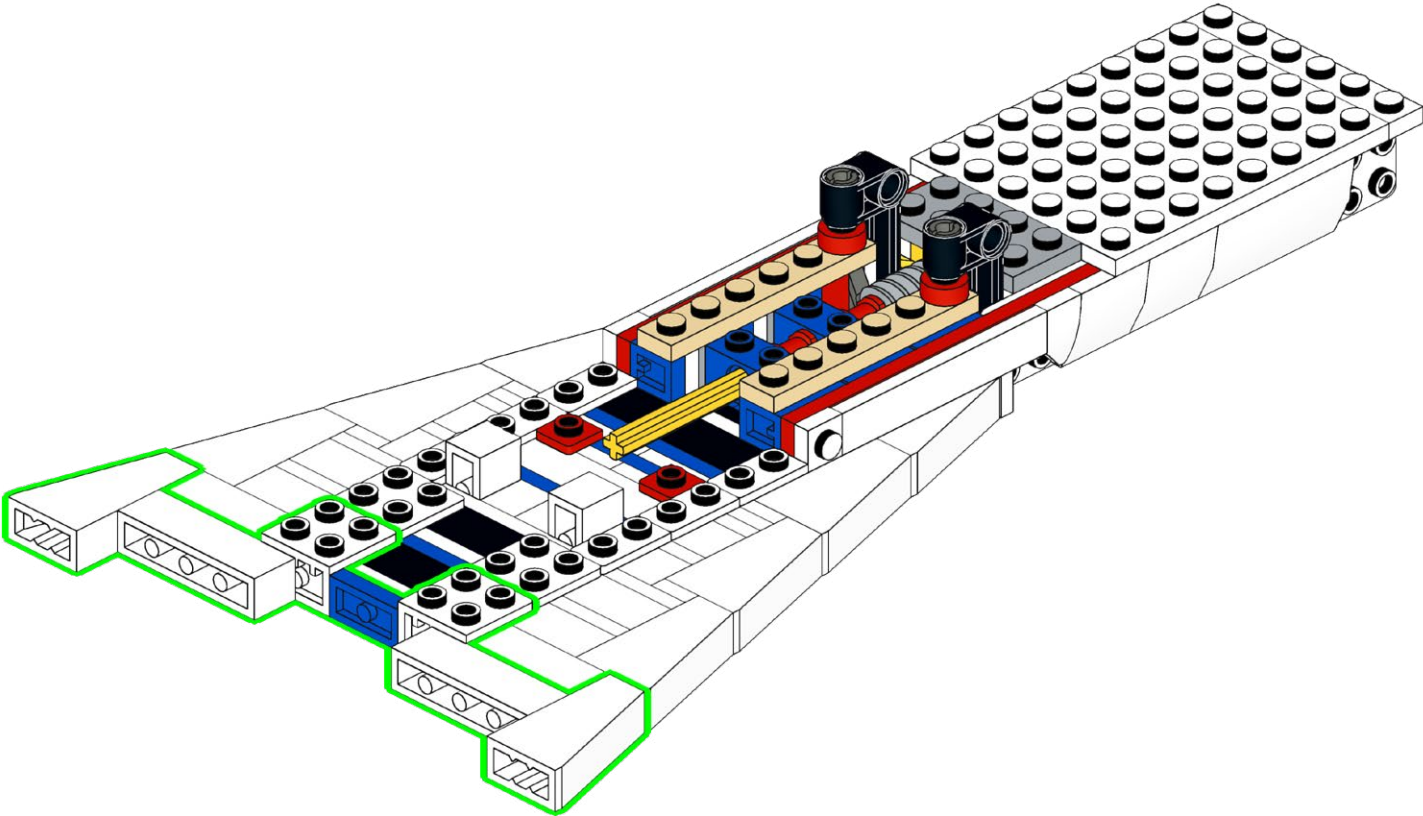
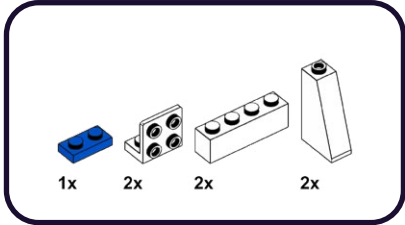

**275**

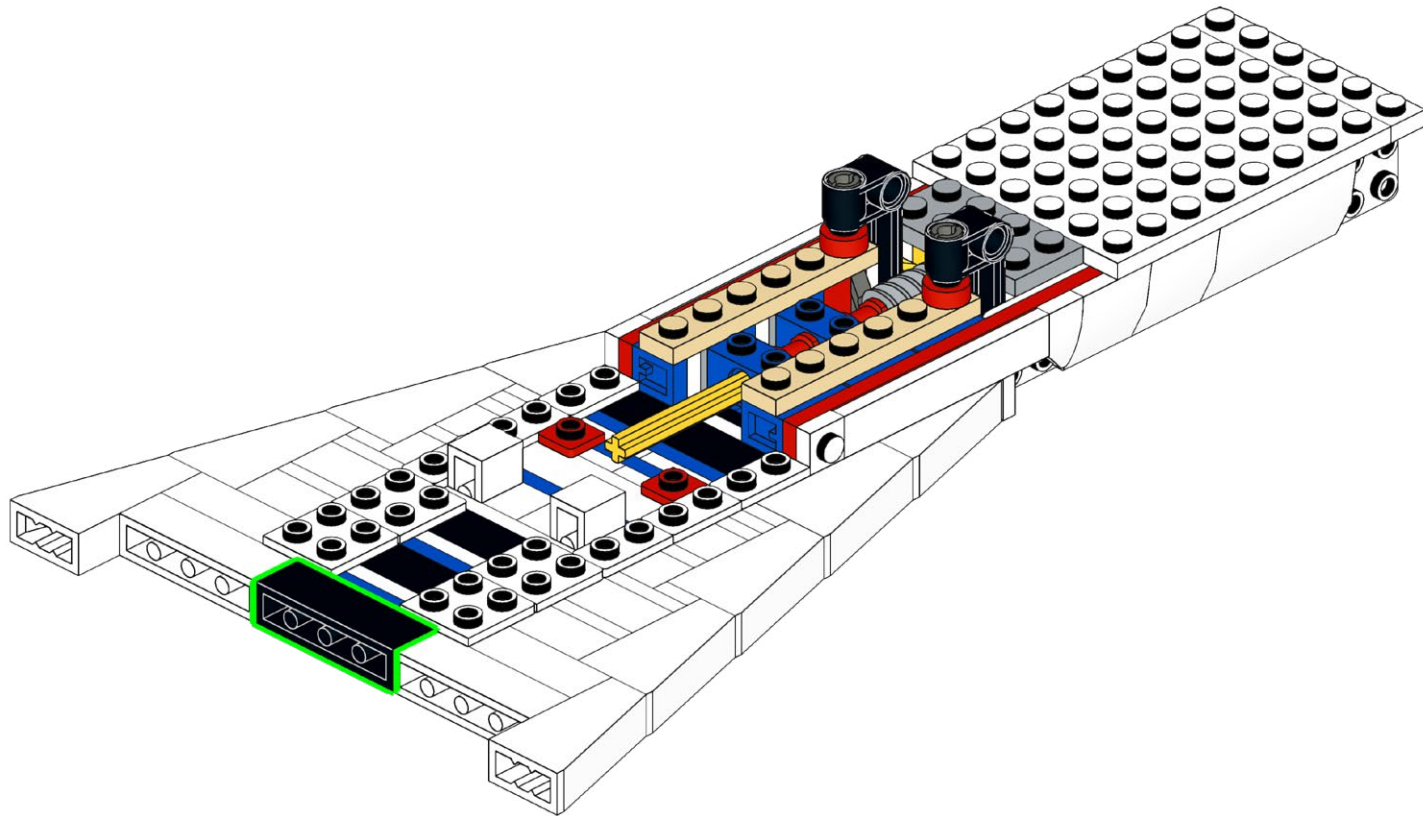
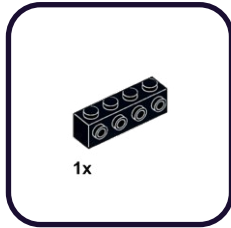

276

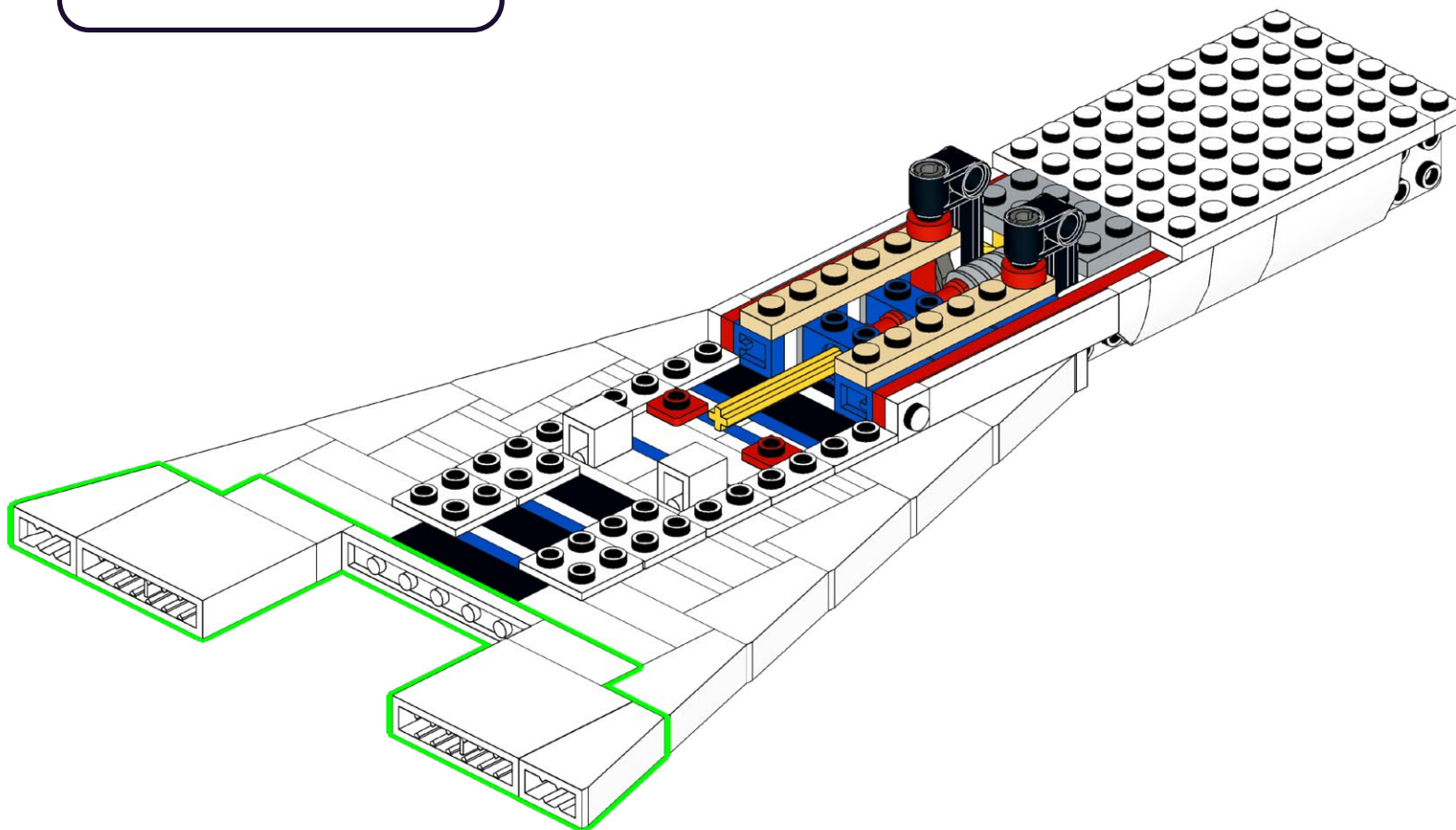
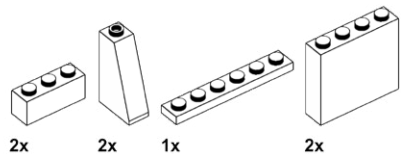

277

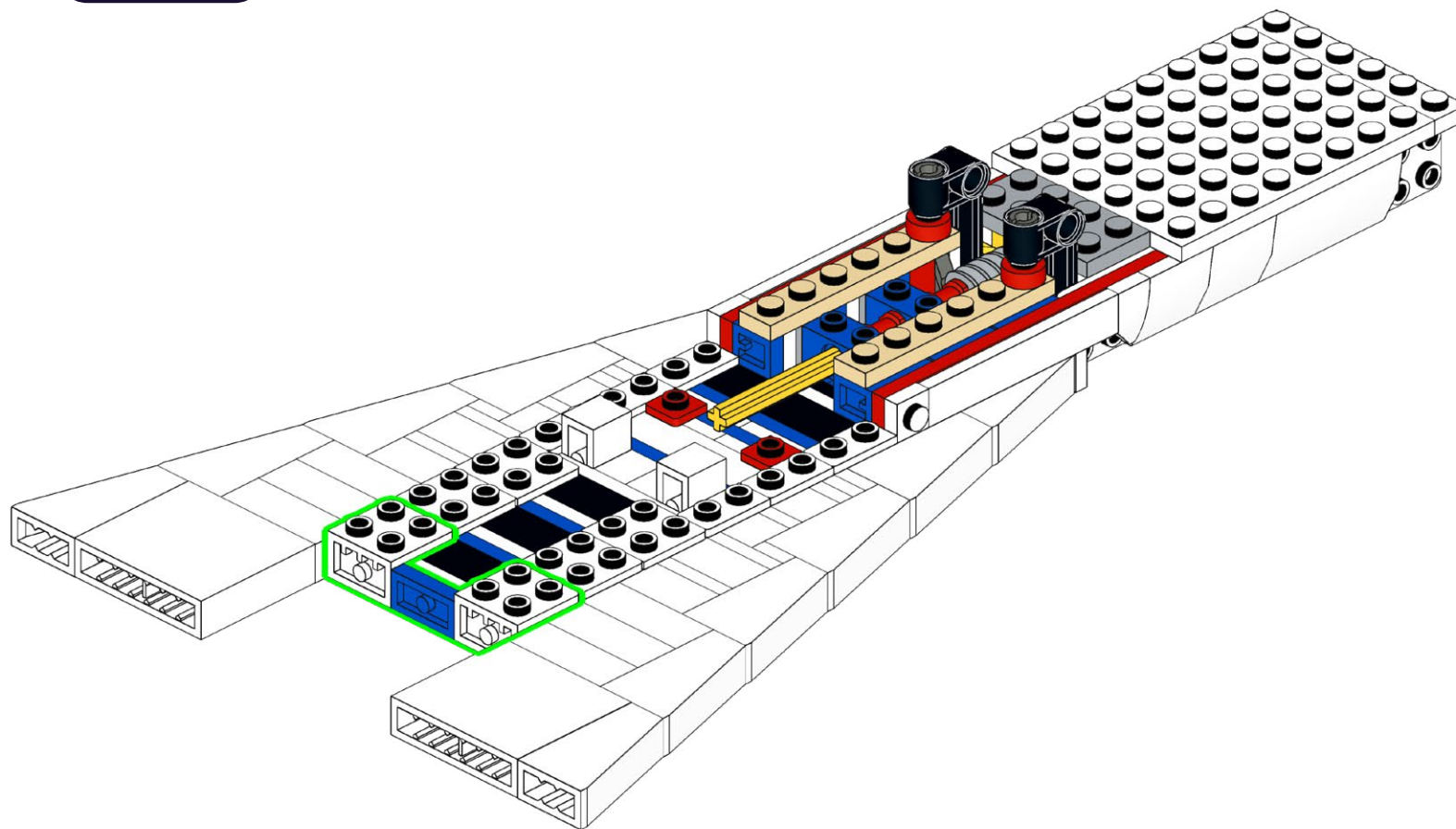
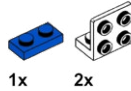

278

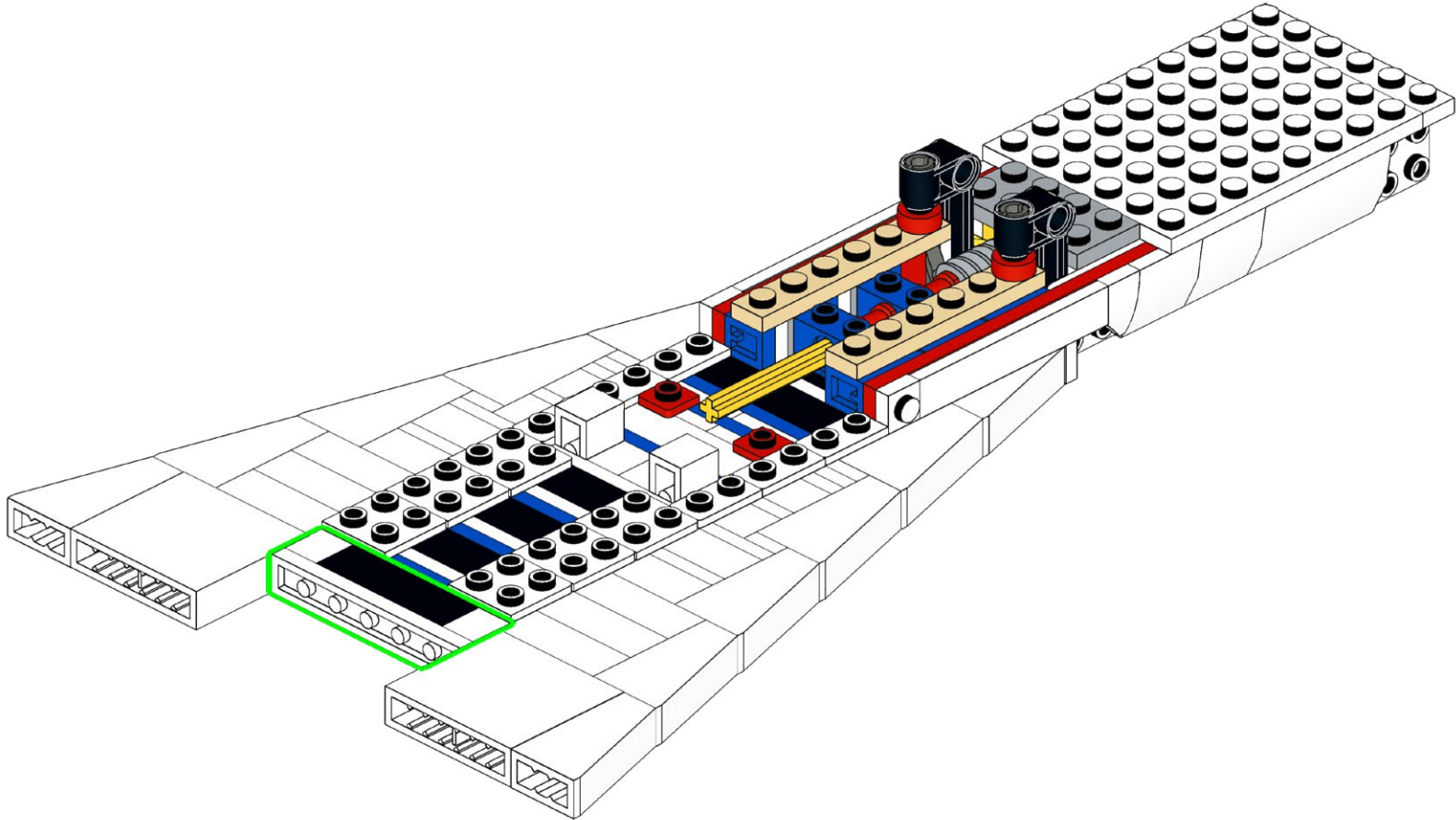
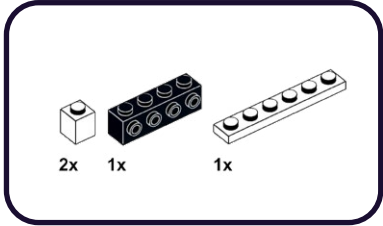



279



1x

2x

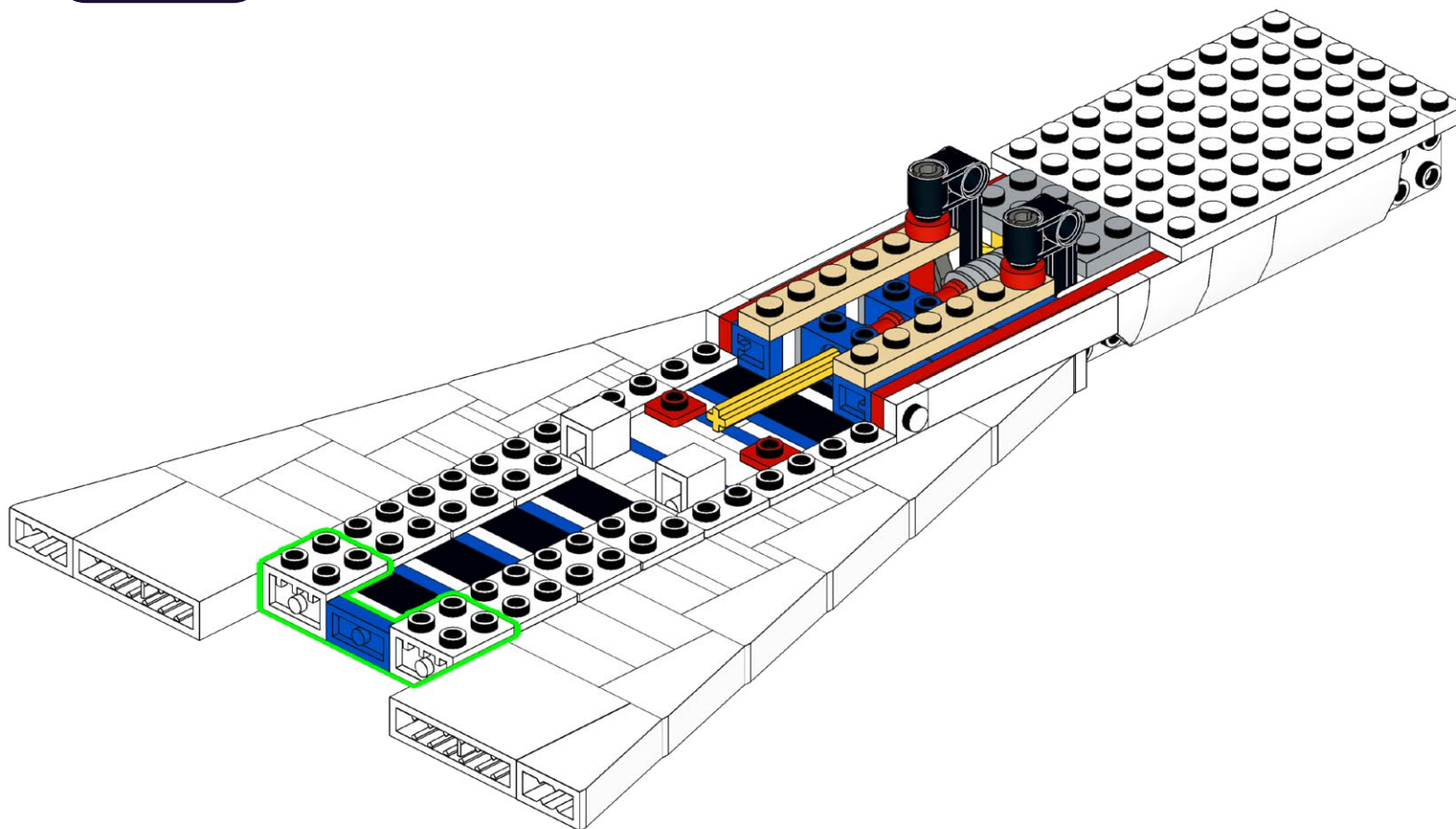

280

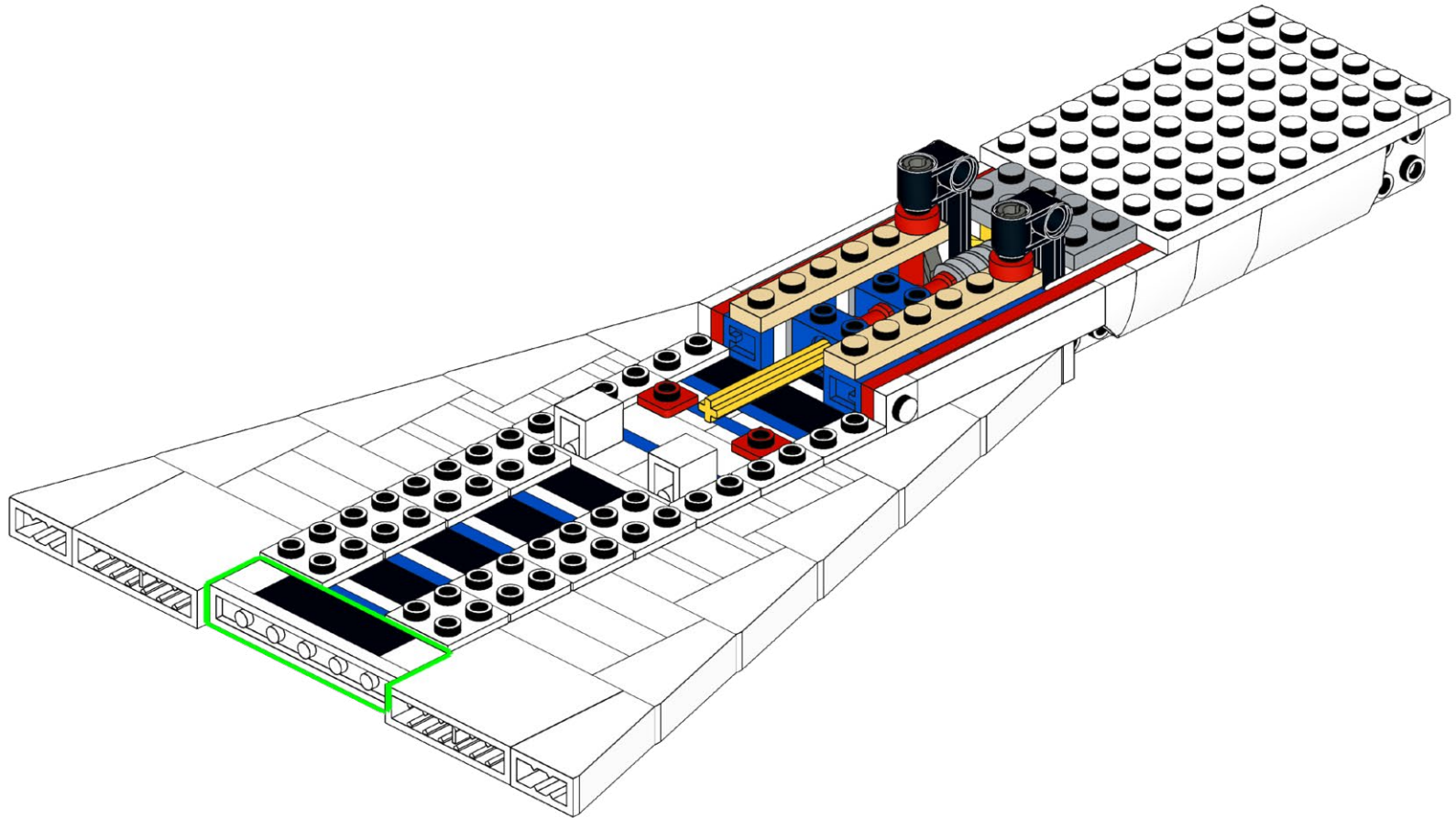
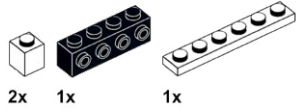

281



1x

2x

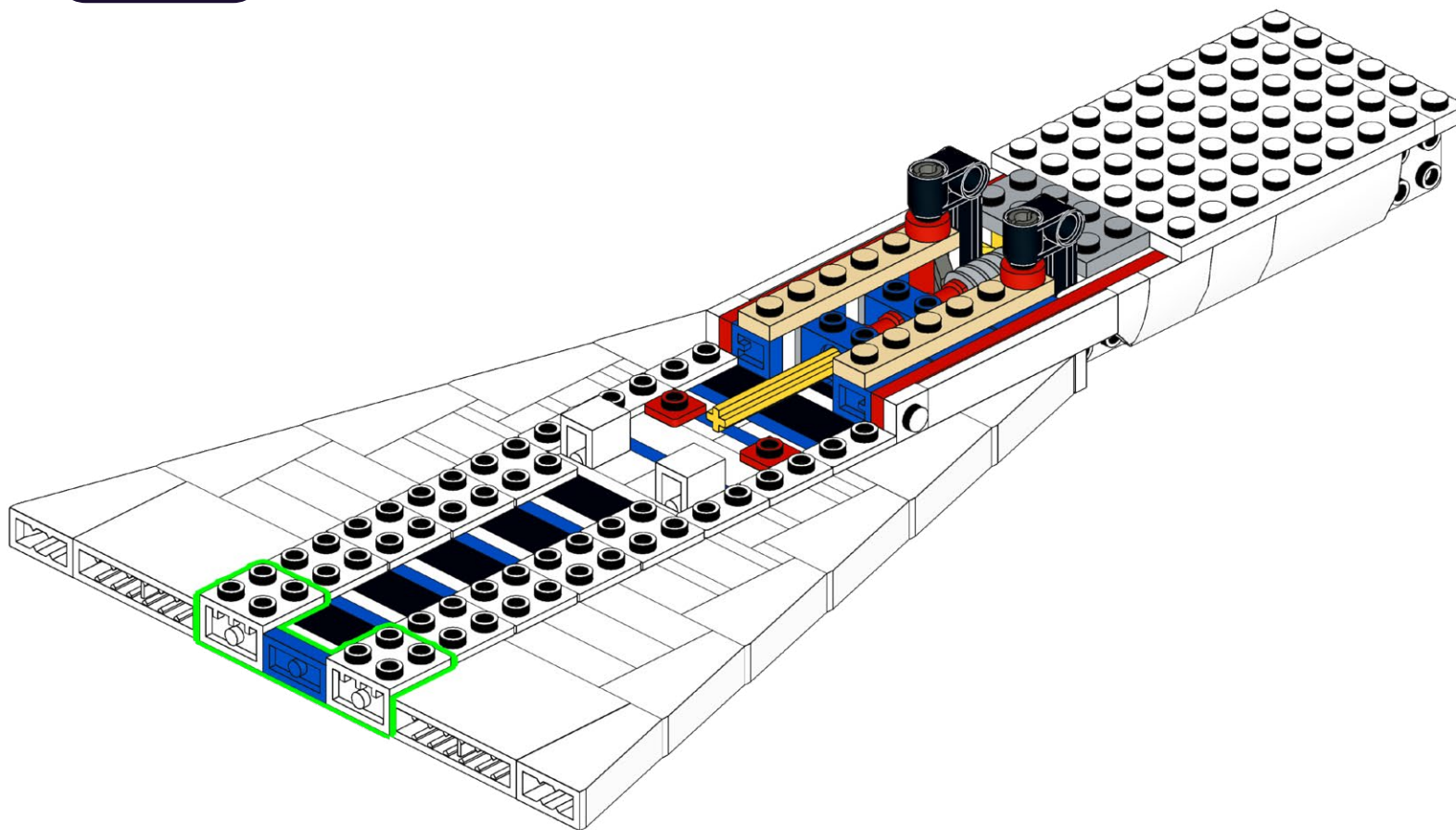

# 282

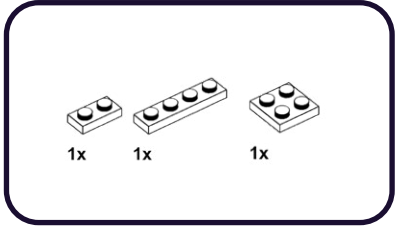

1

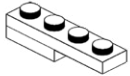

2

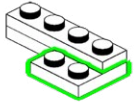

# 283

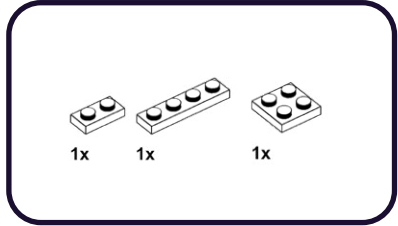

1

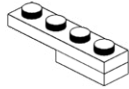

2

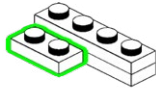

284

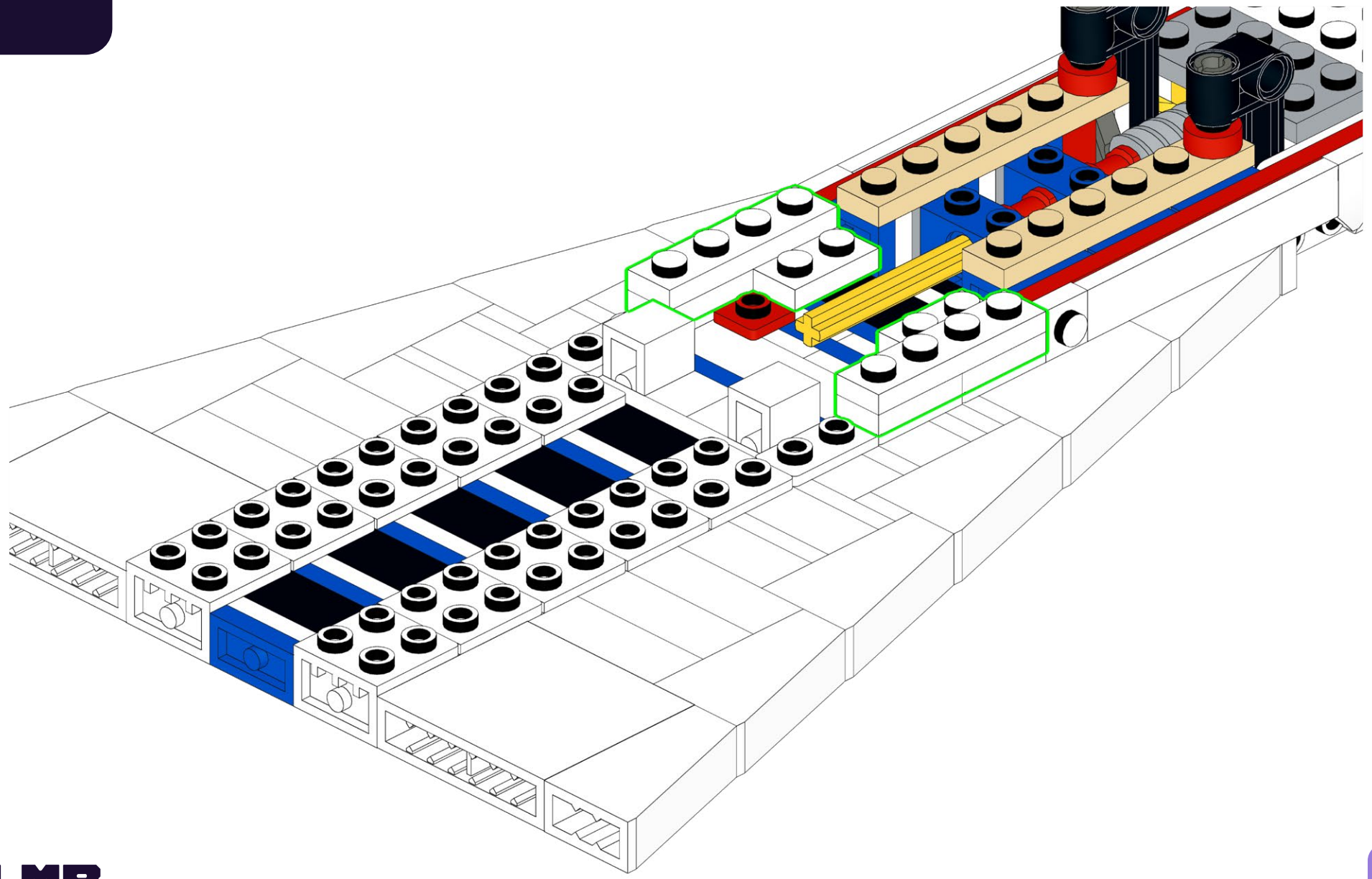

285



1x



1x

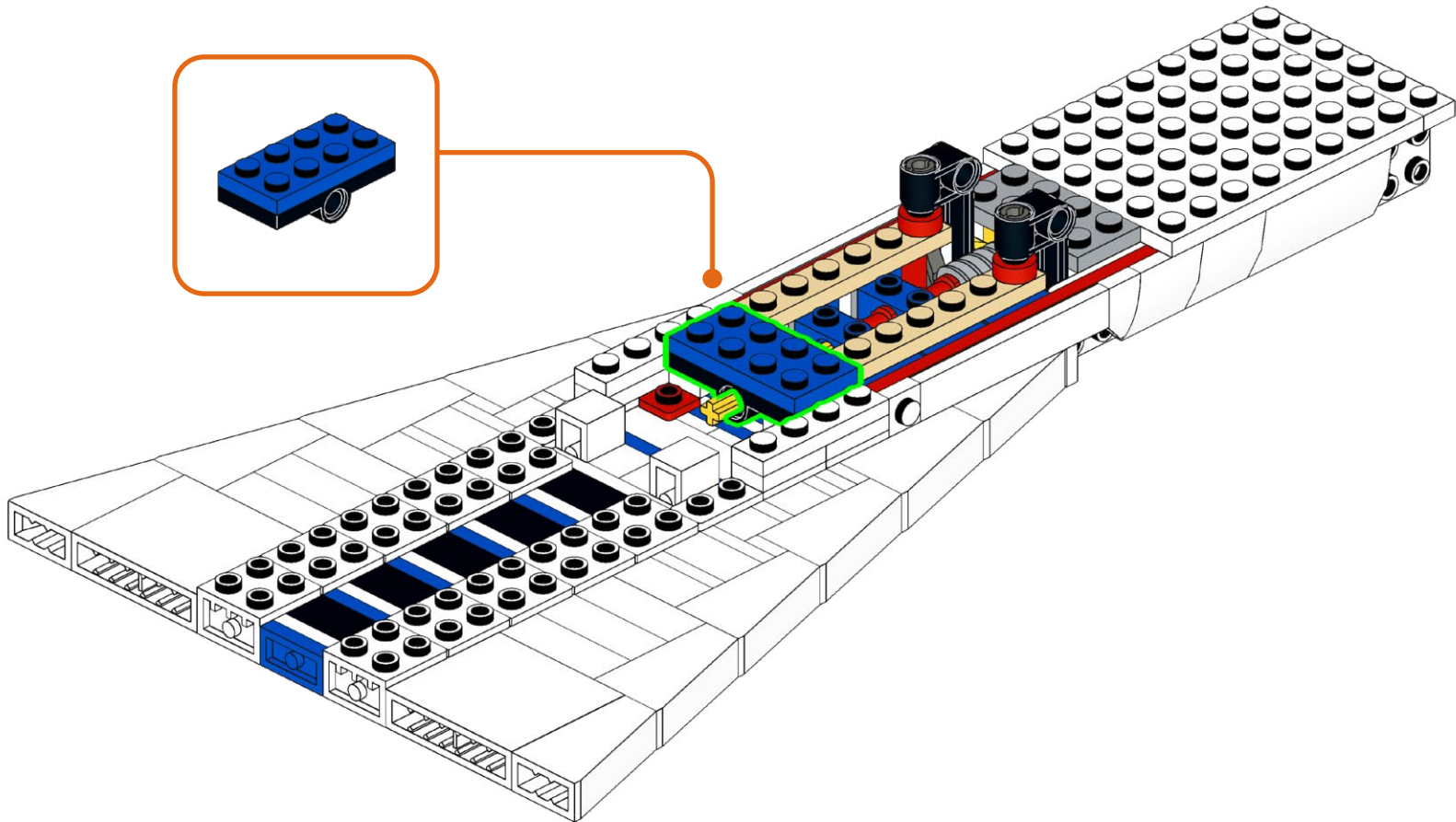
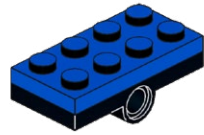

286

1x

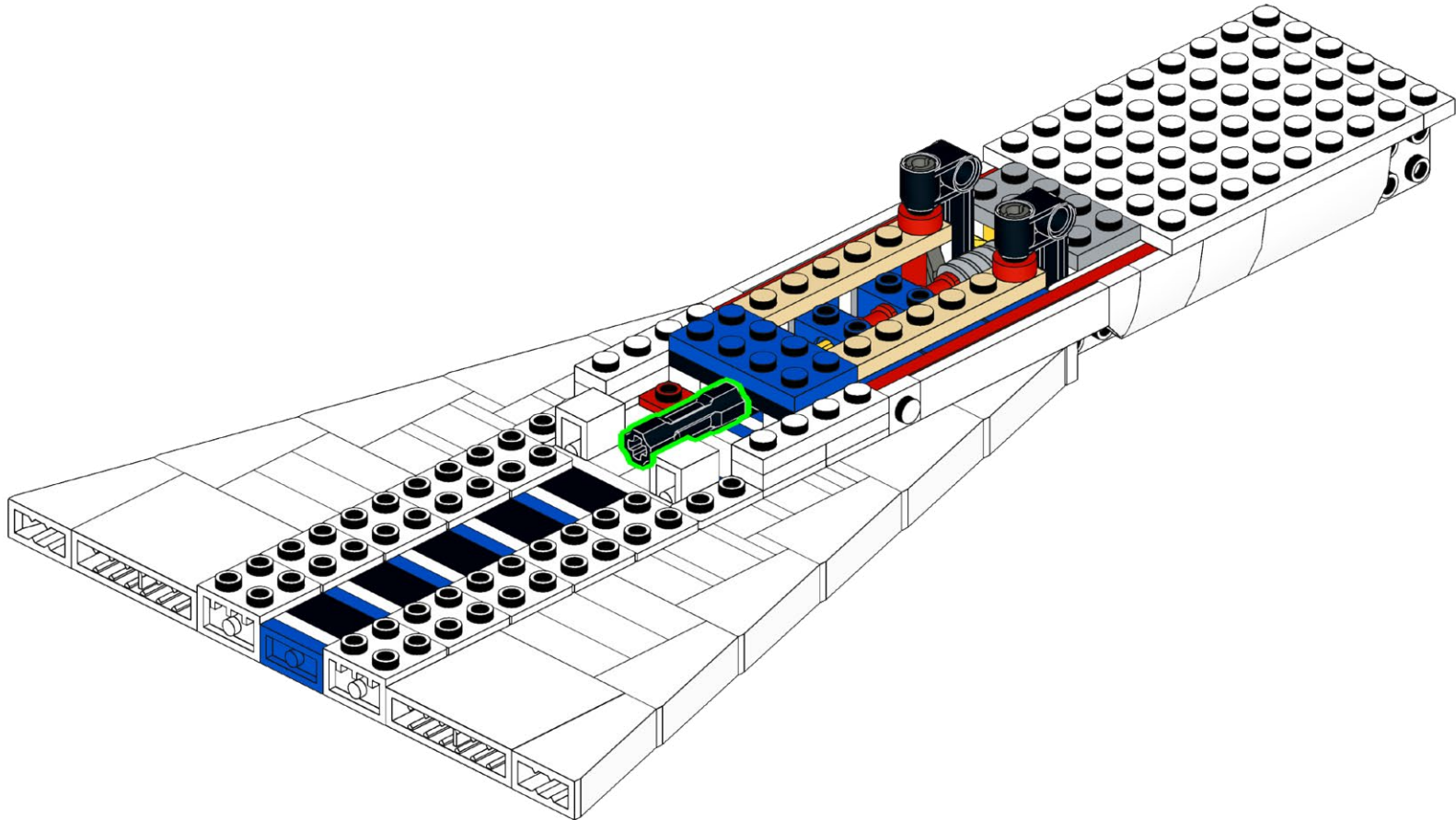

287

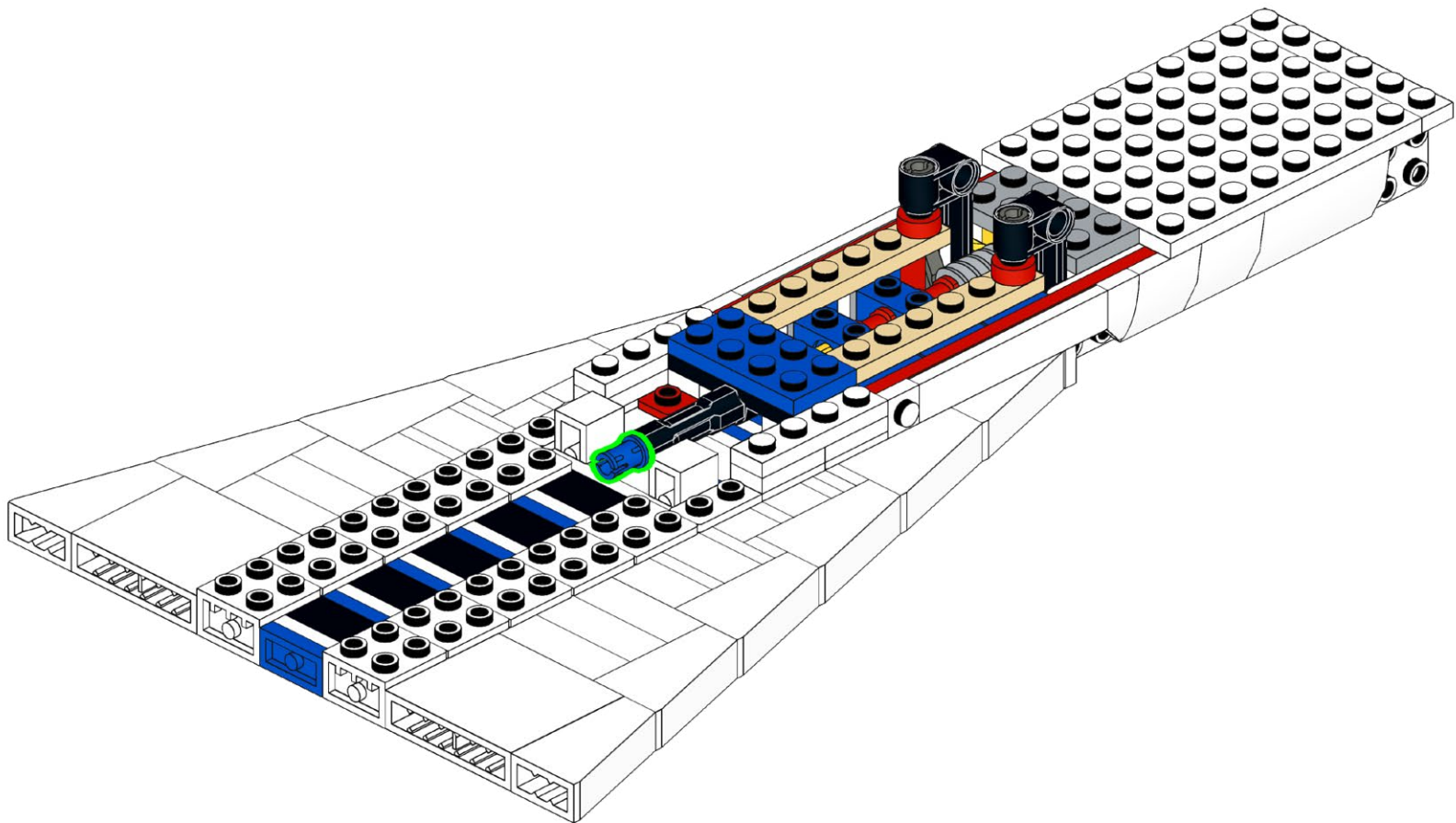
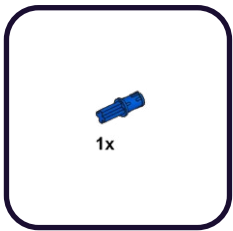



288

1x

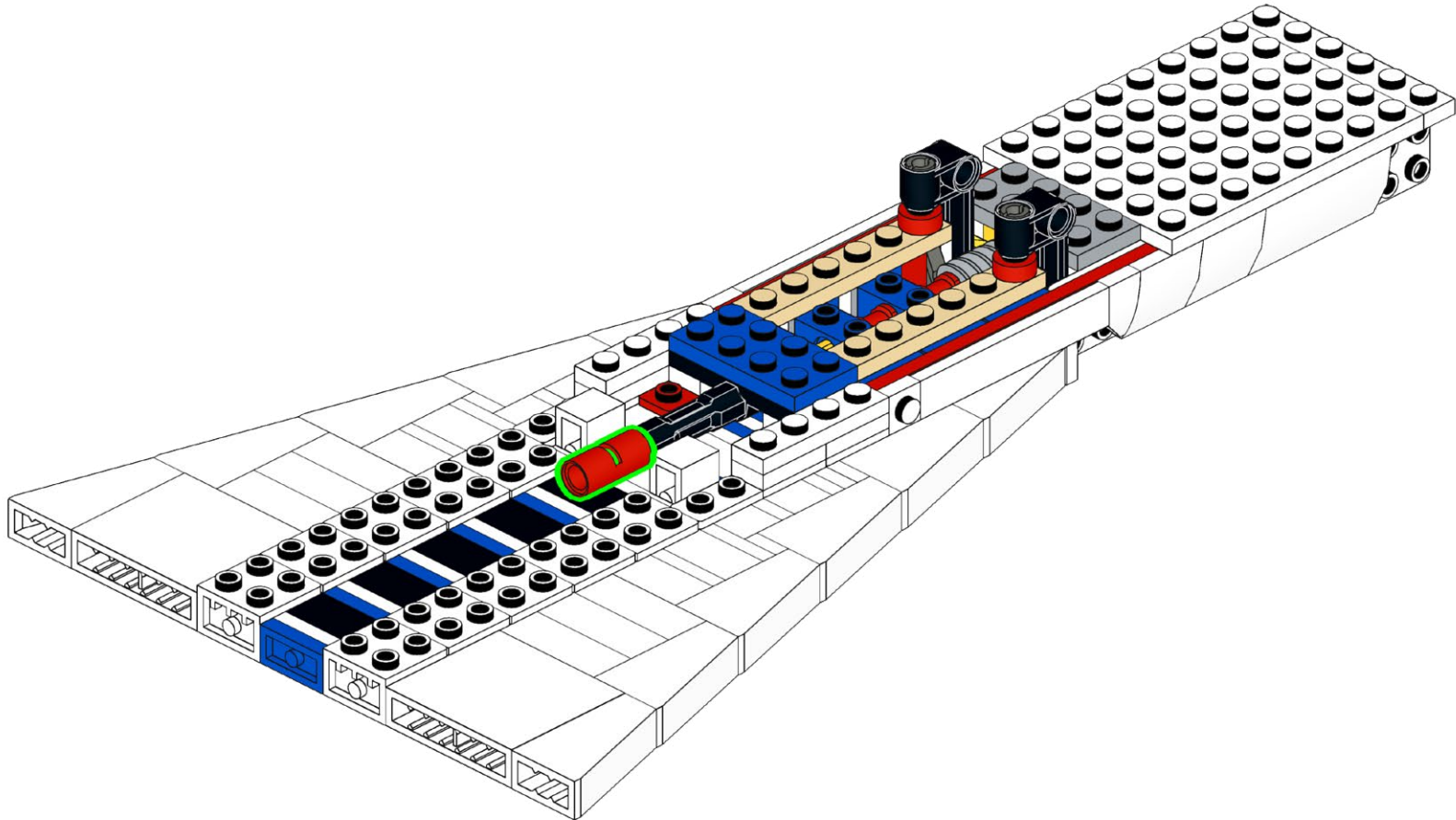

289

1x

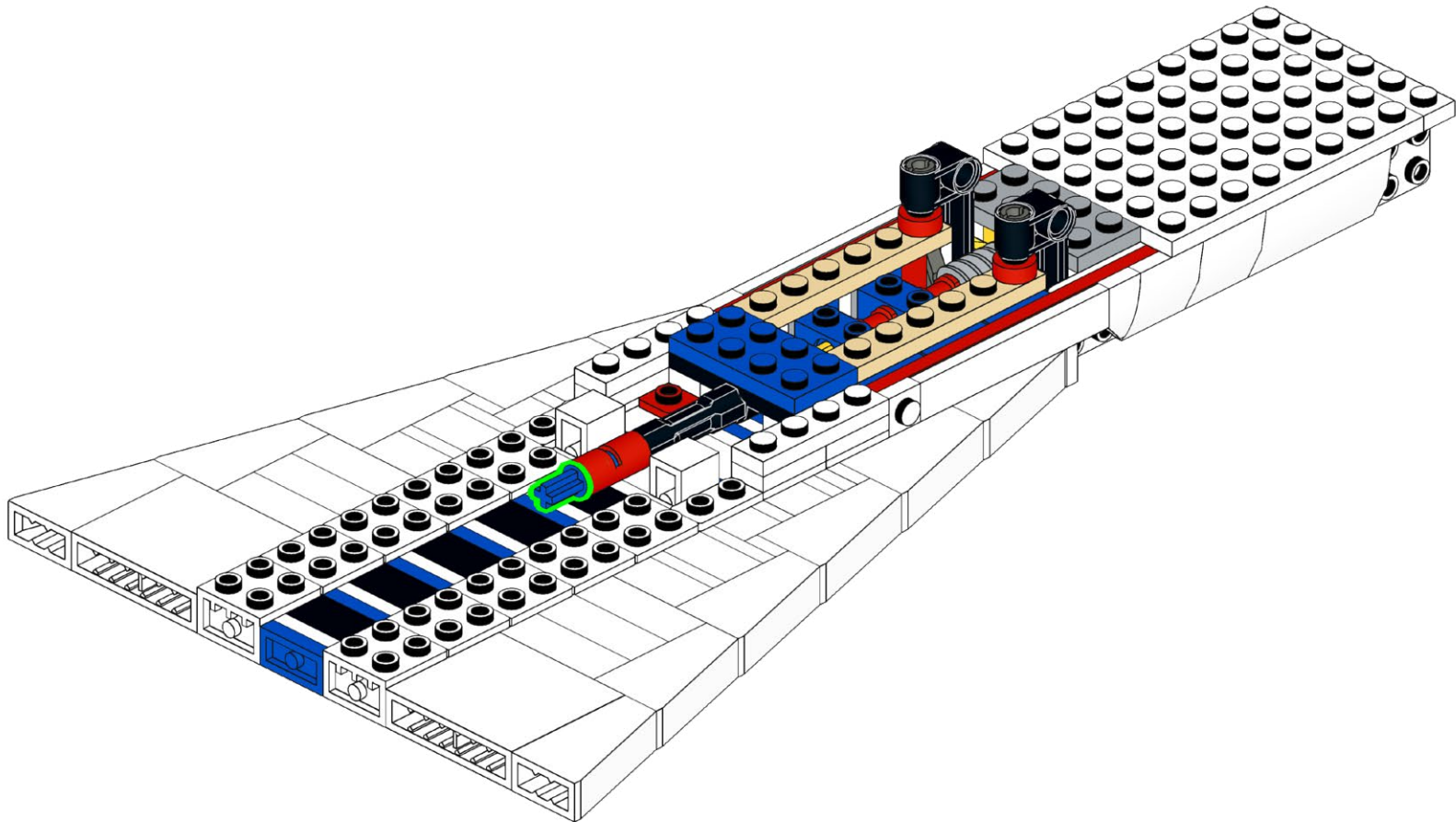

290

1x

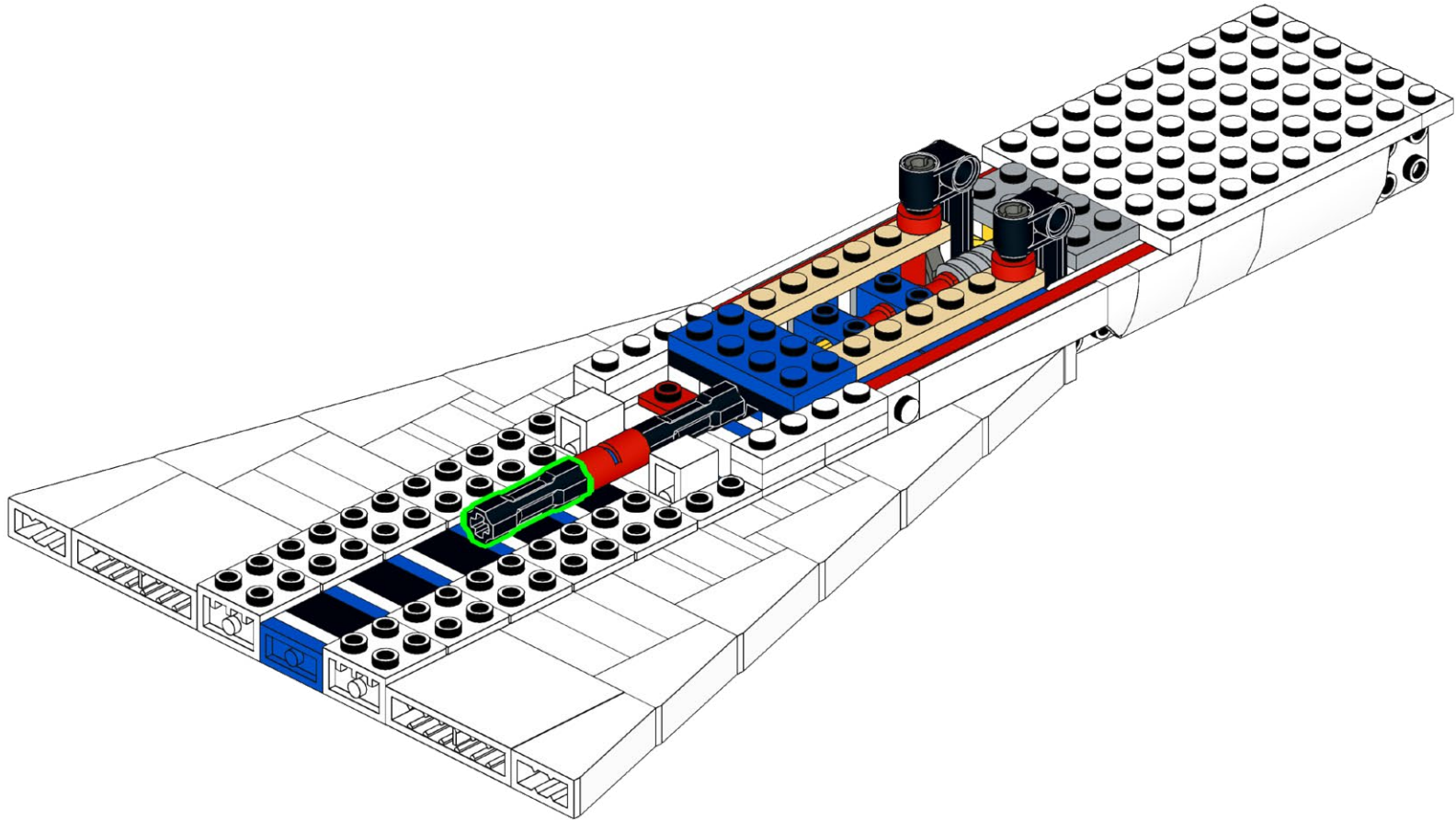

291

2x

2x

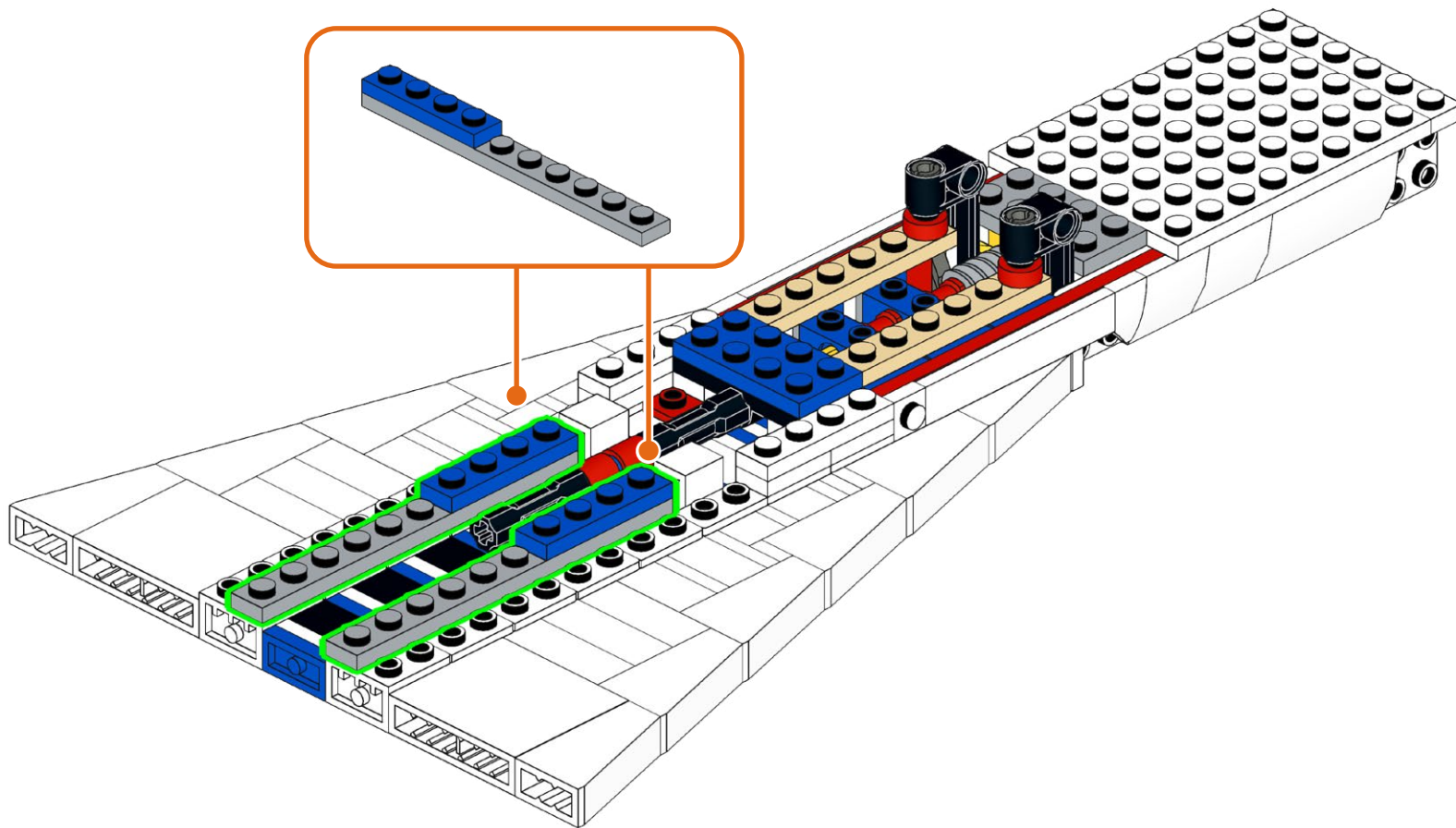

292

1x

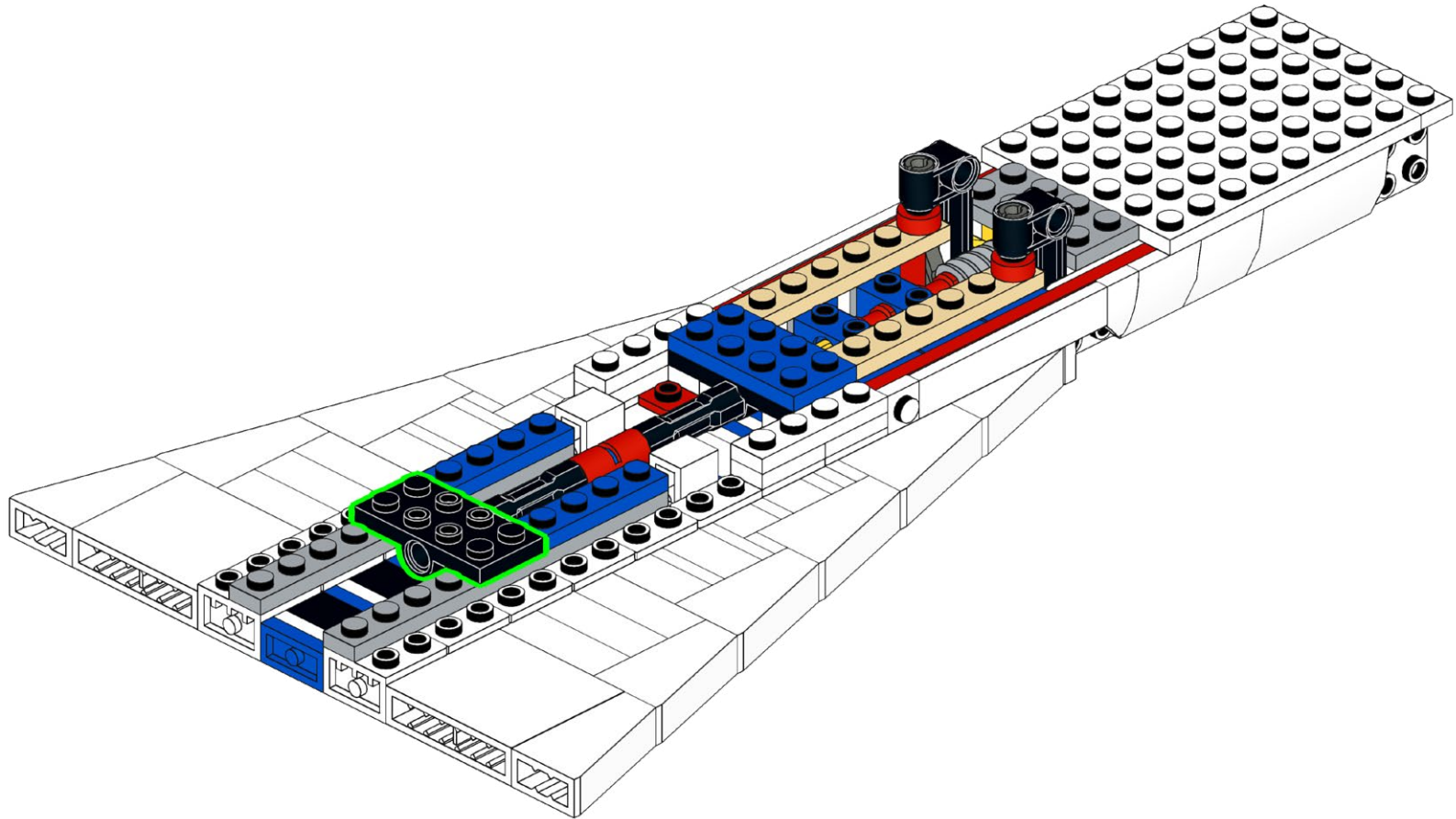

293

1x

2x

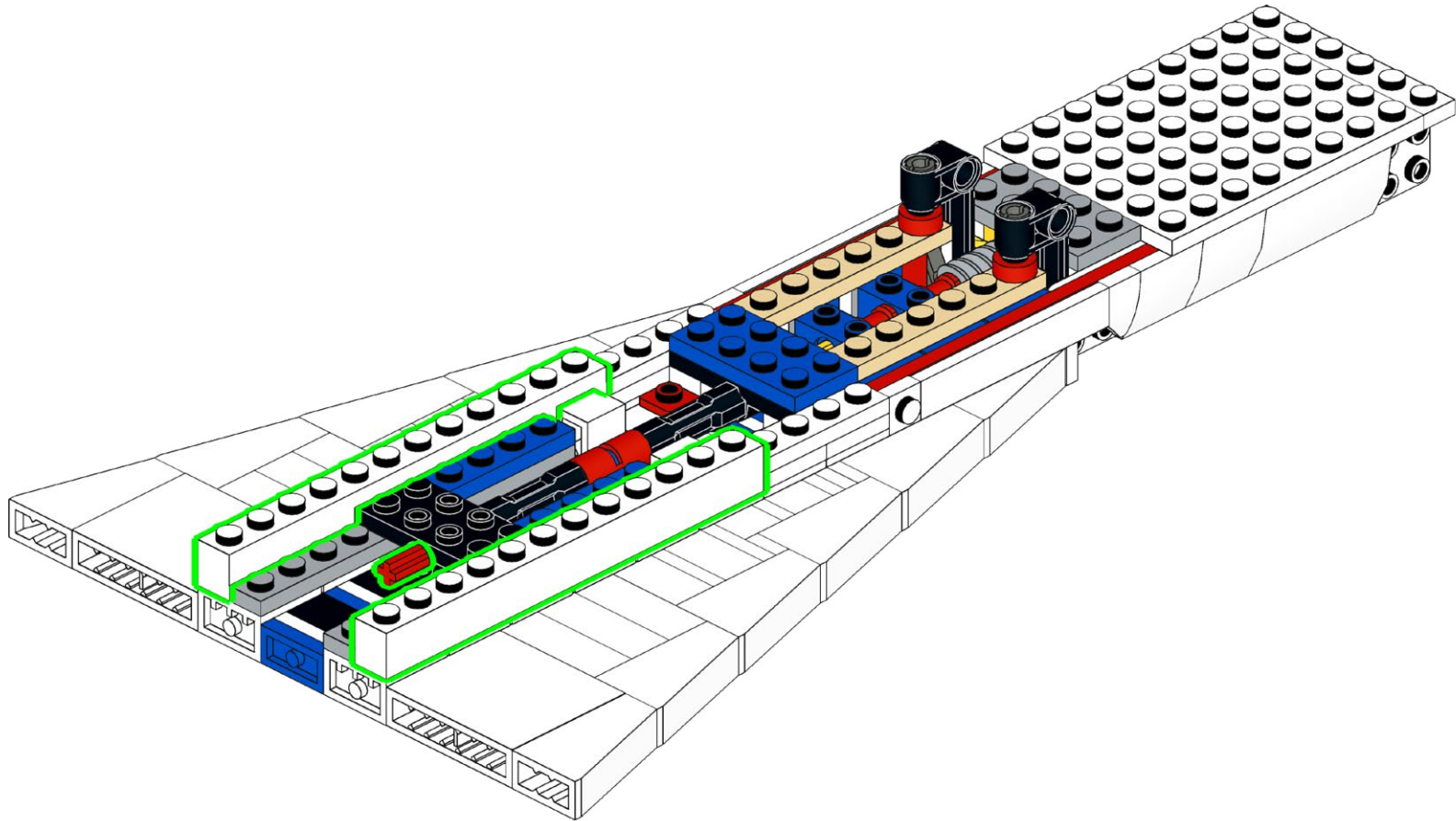

294

1x

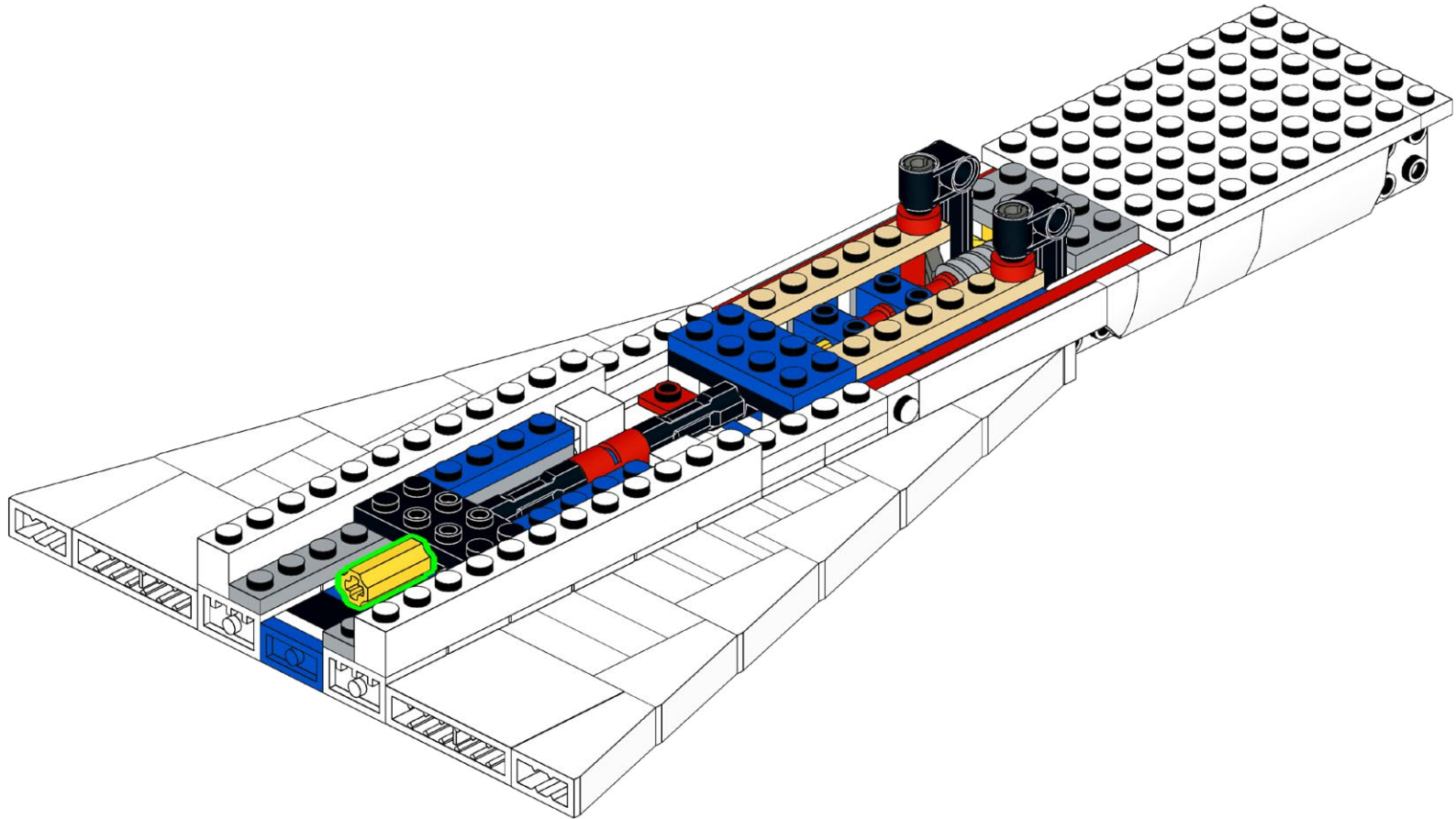

295

1x

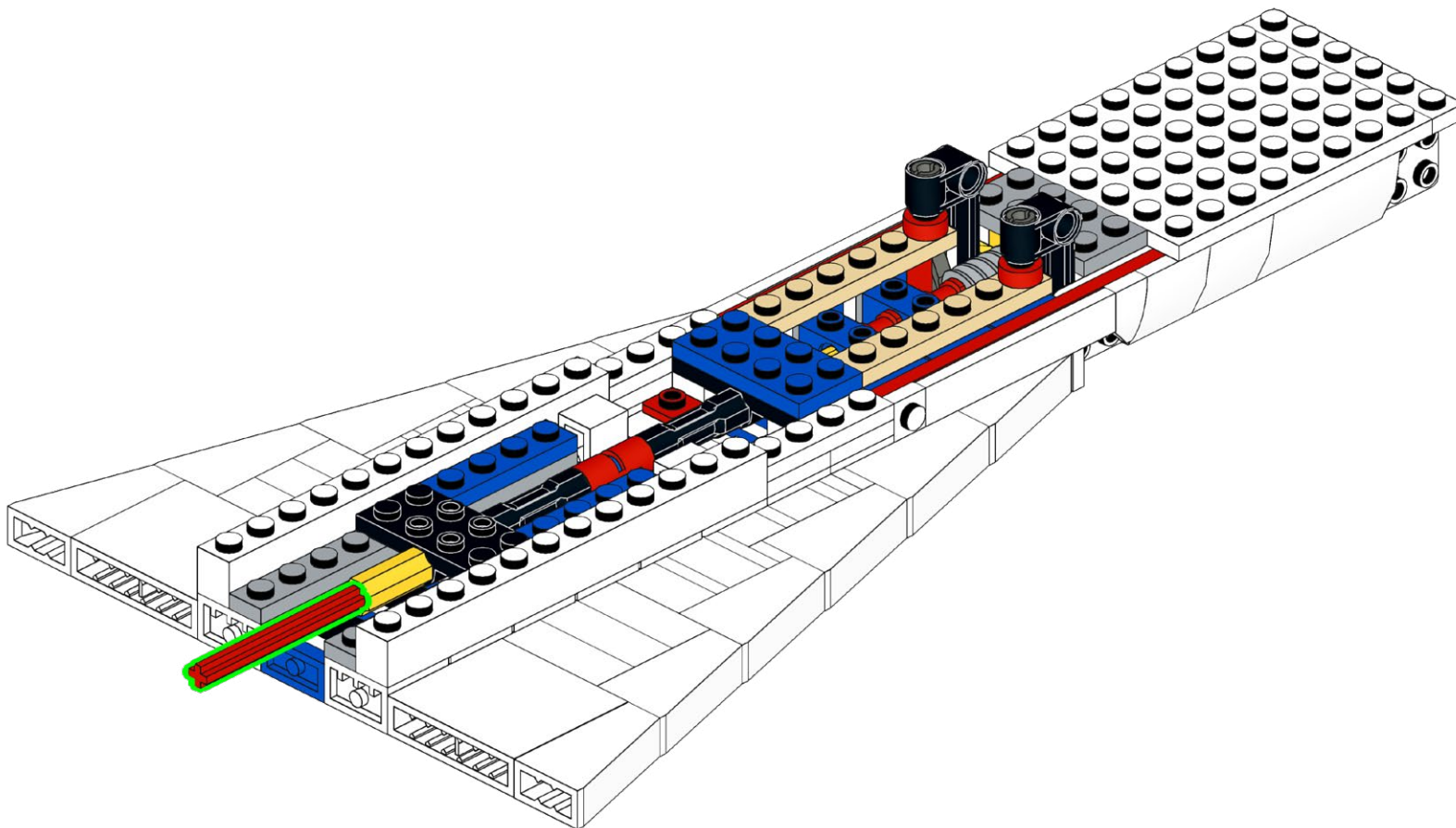



**296**

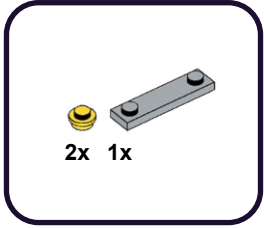

1

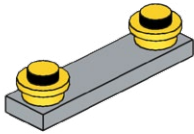

**297**

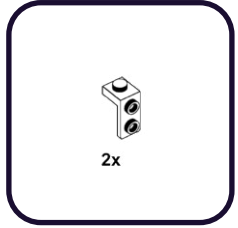

2

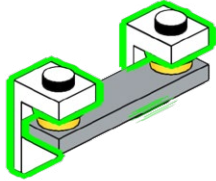

298

1x

1x

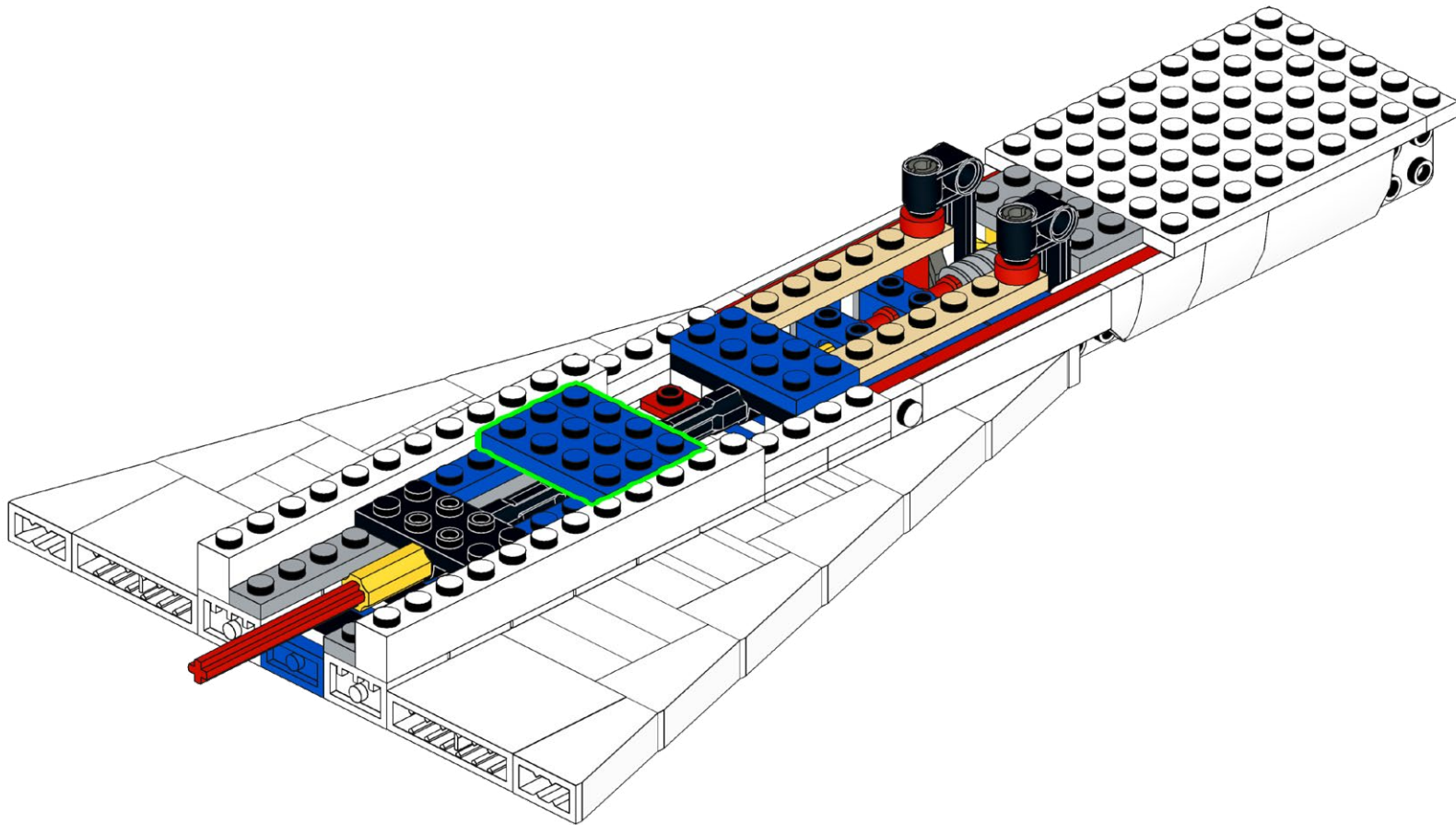

299

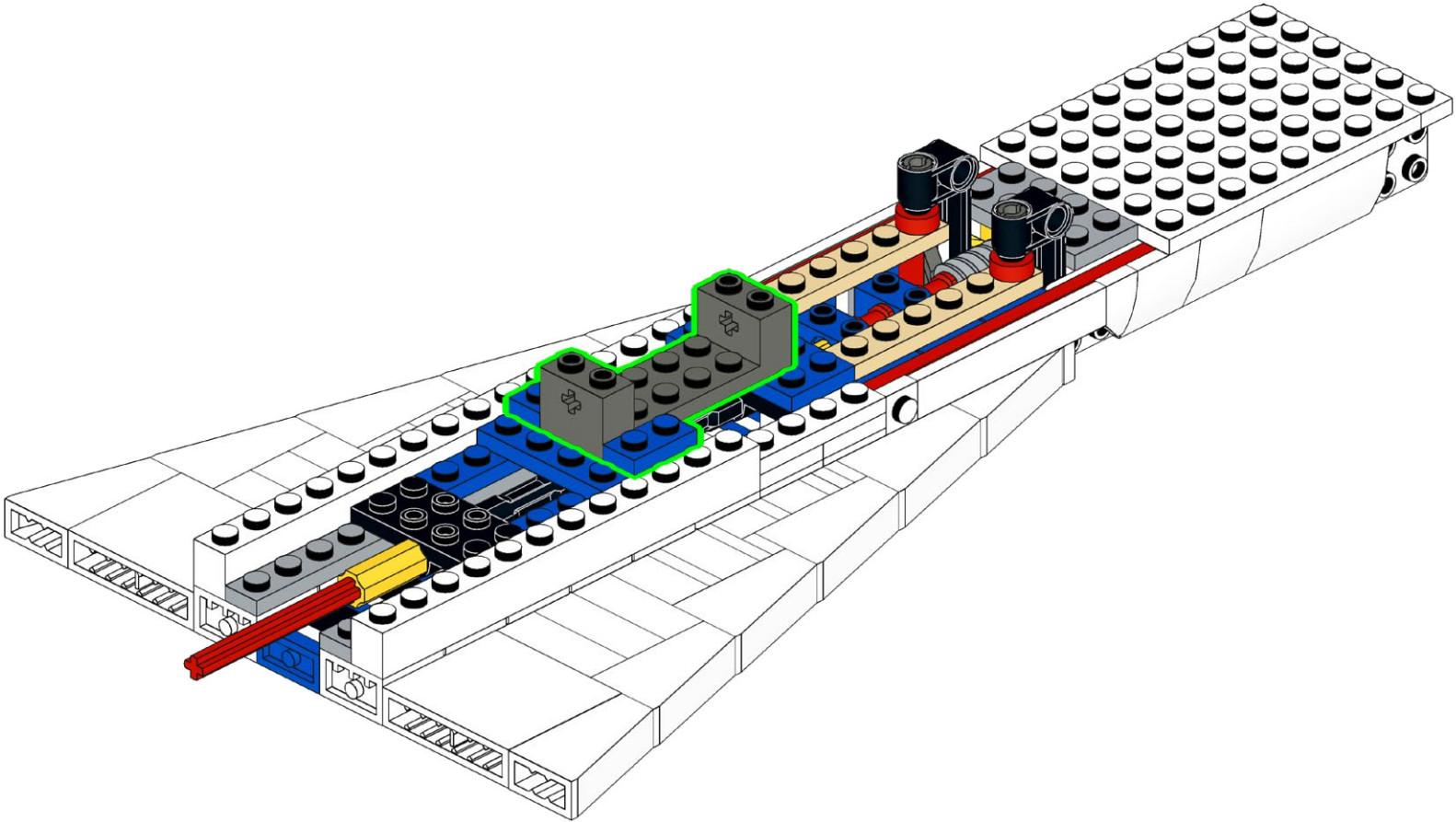
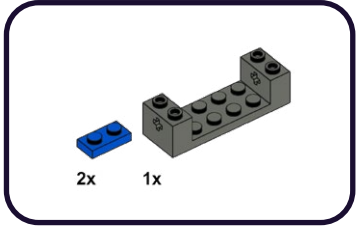

300

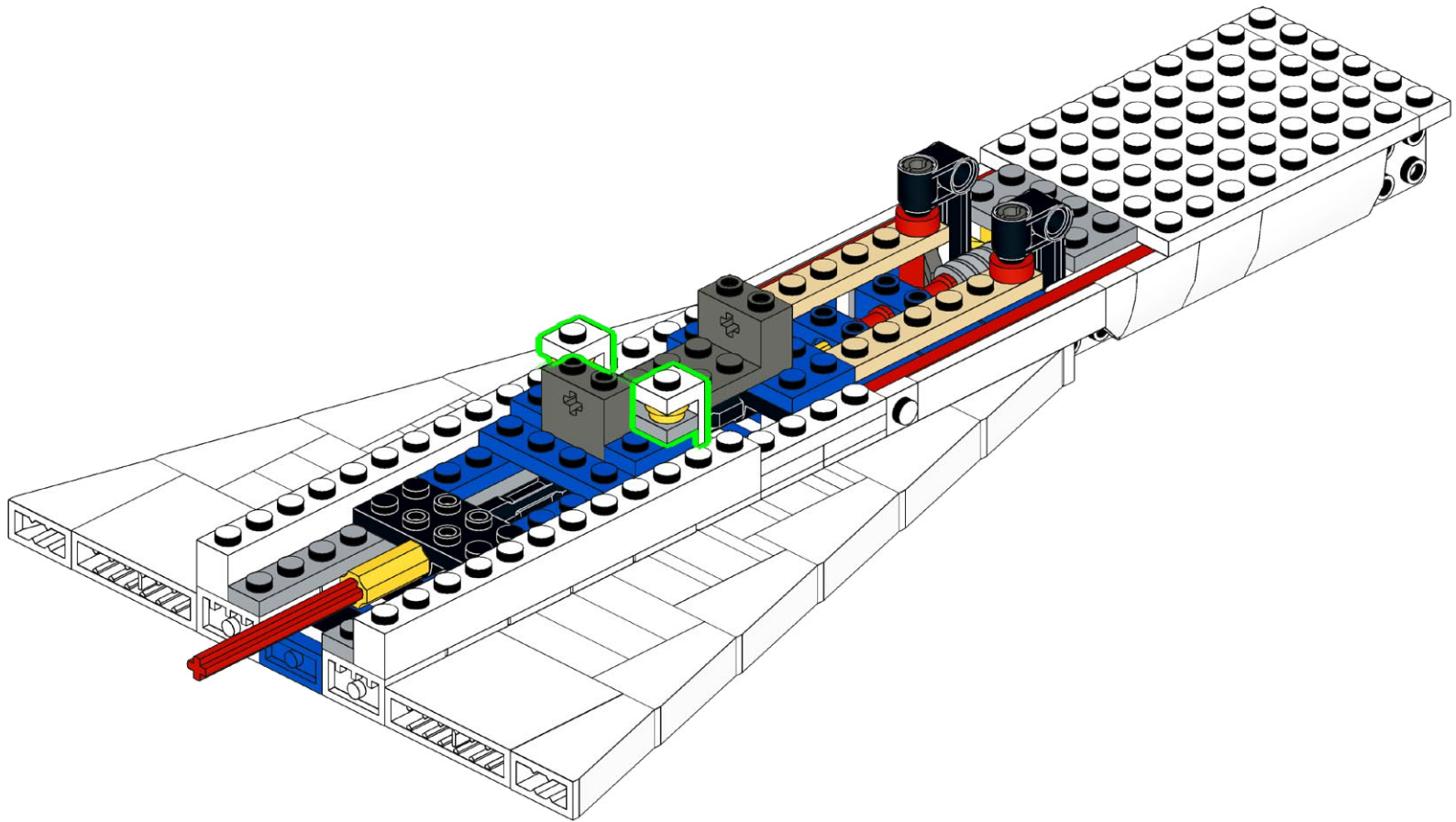

301

2x

2x

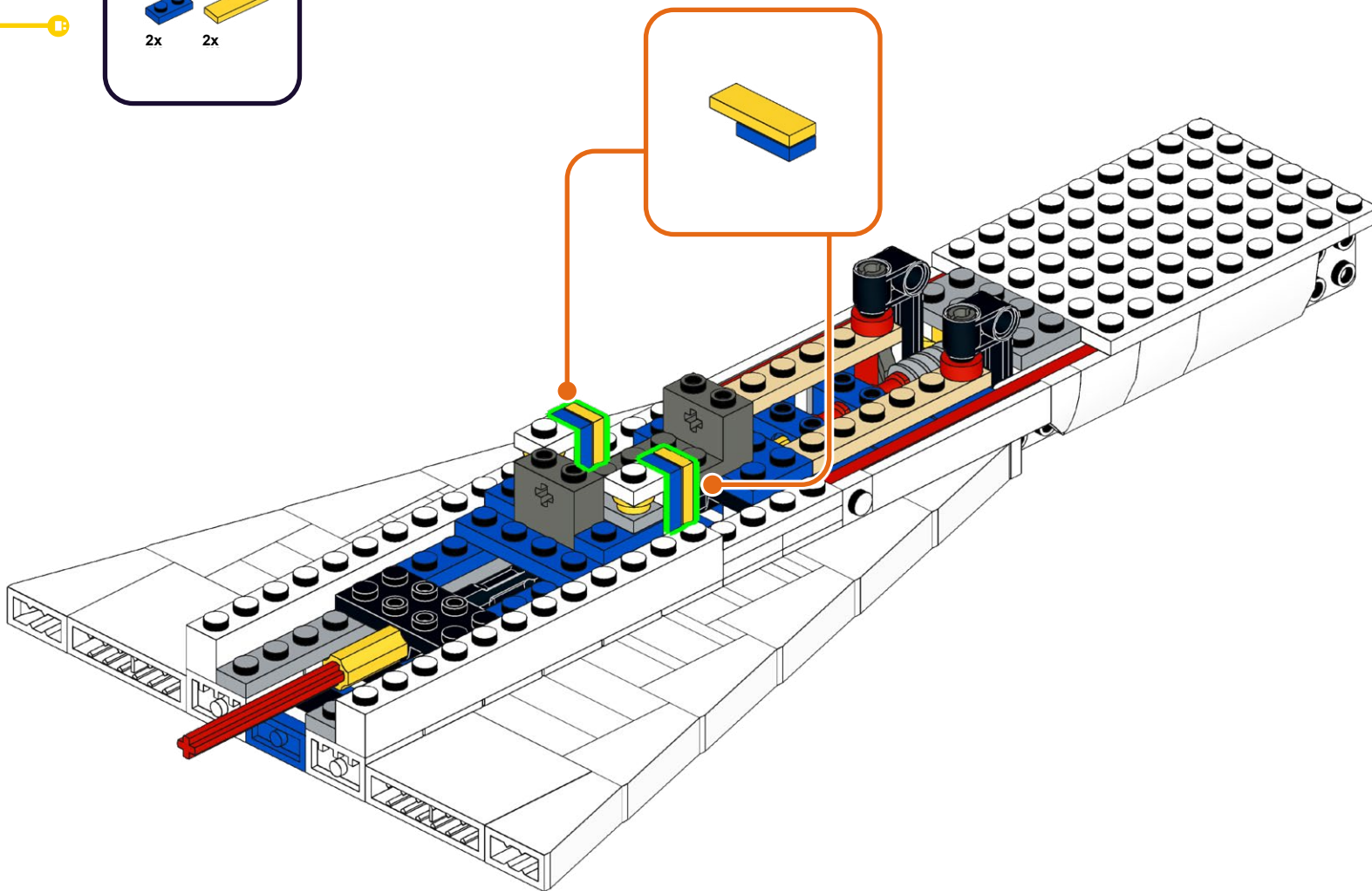

**HOLD UP!**

You might notice some bags aren't in order, as well as left over pieces, but that's ok! We're changing the way you build LEGO!

**ATTENDEZ!**

Vous remarquerez peut-être que certains sacs, ainsi que certaines pièces, ne sont pas dans le bon ordre. Mais pas de panique! Nous changeons simplement la façon avec laquelle vous construisez vos LEGO!

**ASPETTA!**

Potresti notare che alcuni sacchetti non sono in ordine, così come i pezzi avanzati, ma va bene così! Stiamo cambiando il modo in cui costruisci i LEGO!

**HALT!**

Sie werden möglicherweise bemerken, dass einige tüten durcheinander sind und teile übrig bleiben, aber das ist in Ordnung! Wir ändern die art und weise, wie Sie LEGO bauen!

**¡ESPERA!**

Es posible que notes que algunas bolsas están fuera de servicio, así como piezas sobrantes, ¡pero está bien! ¡Estamos cambiando la forma en que construyes LEGO!

**暫停!**

你可能会注意到一些袋子顺序错乱, 以及一些剩余的部件, 但没关系! 我们正在改变你搭建乐高的方式!

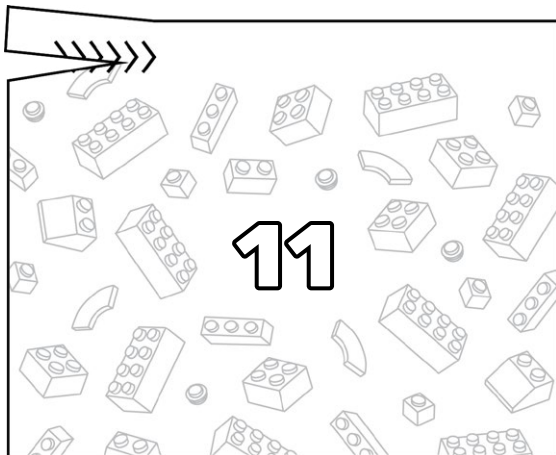
**Open LEGO® Bag 11**

302



2x

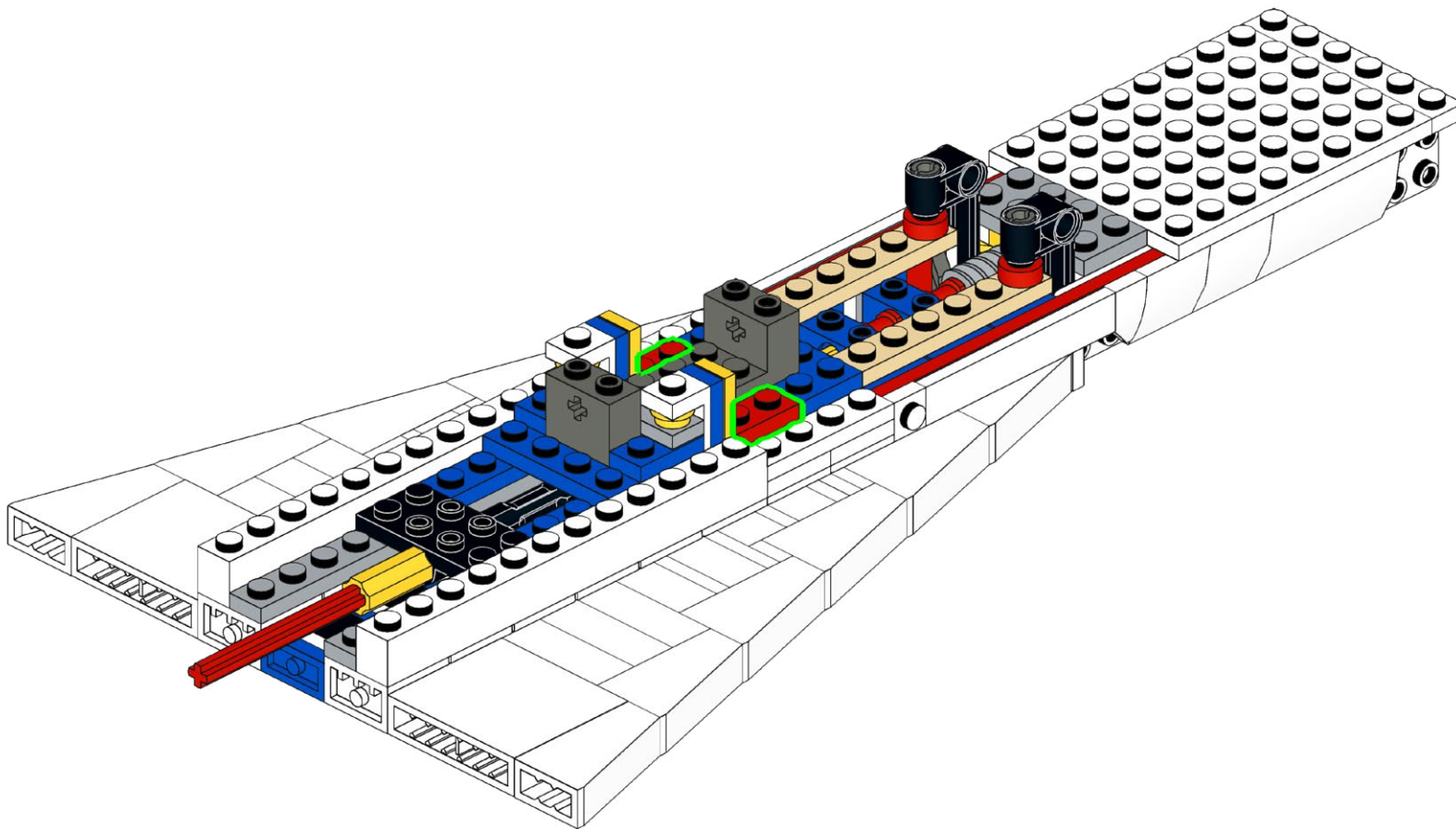

303

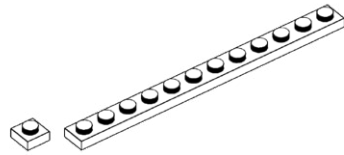

2x 2x

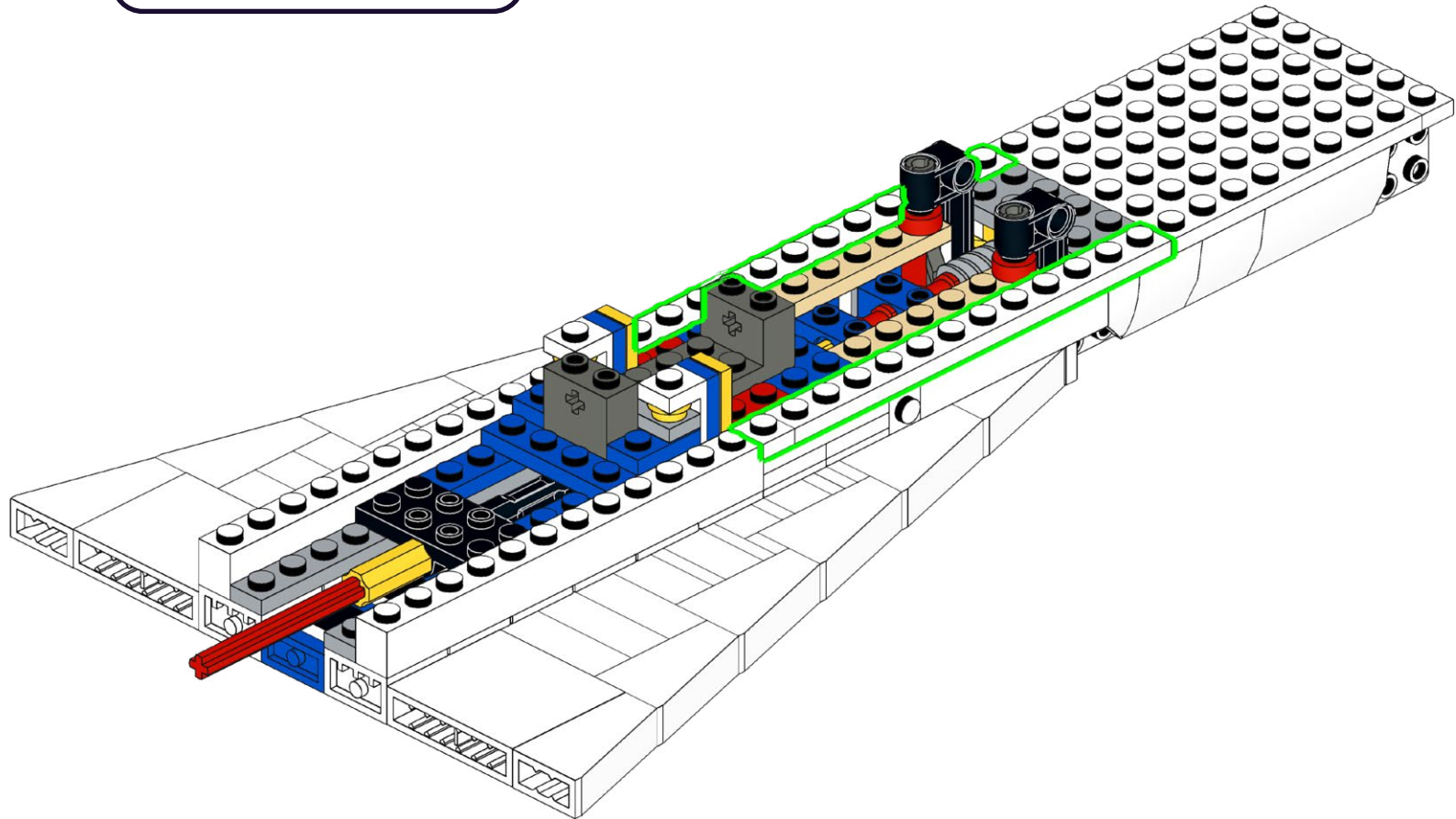



304

3x

2x

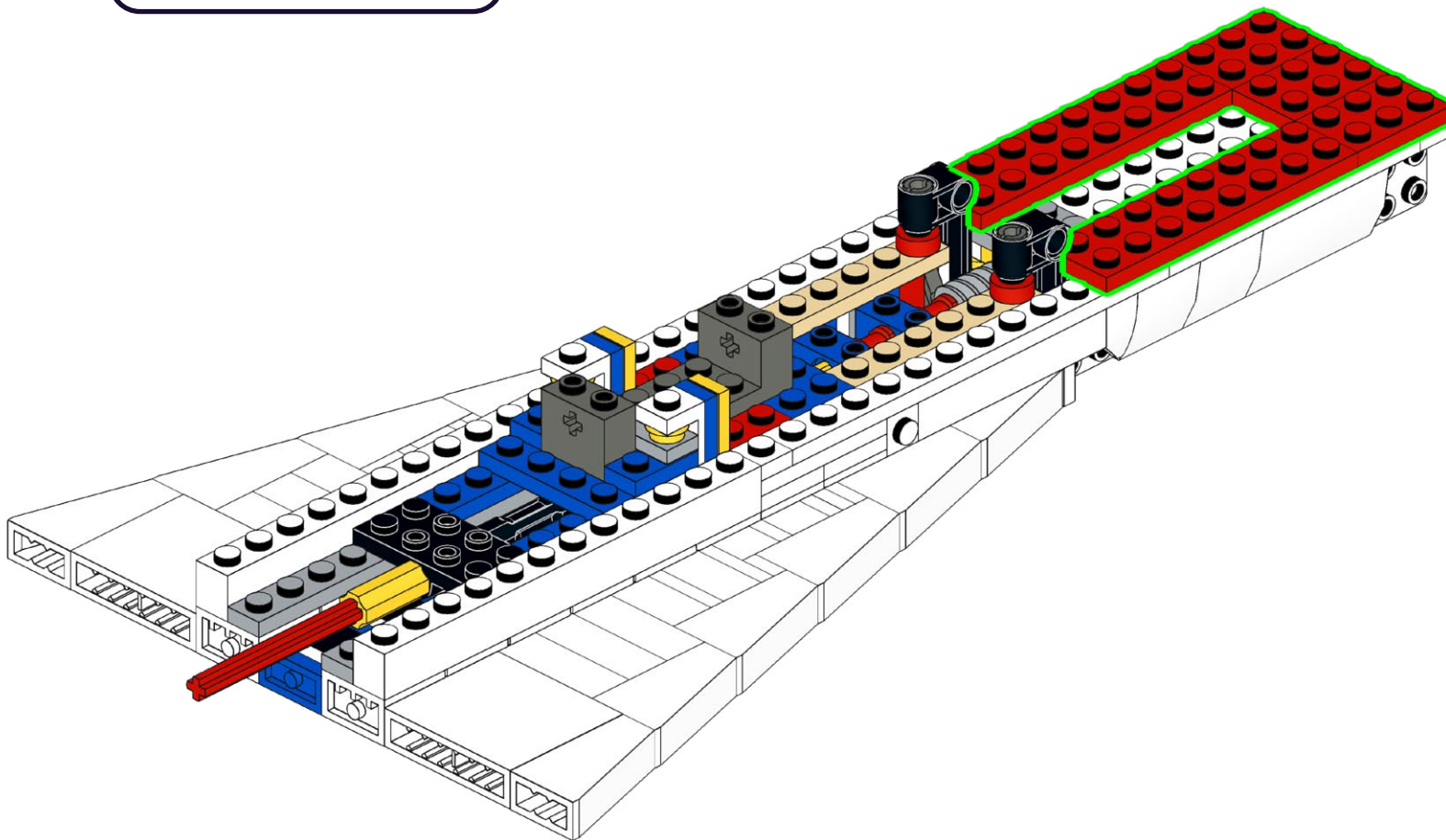

**305**

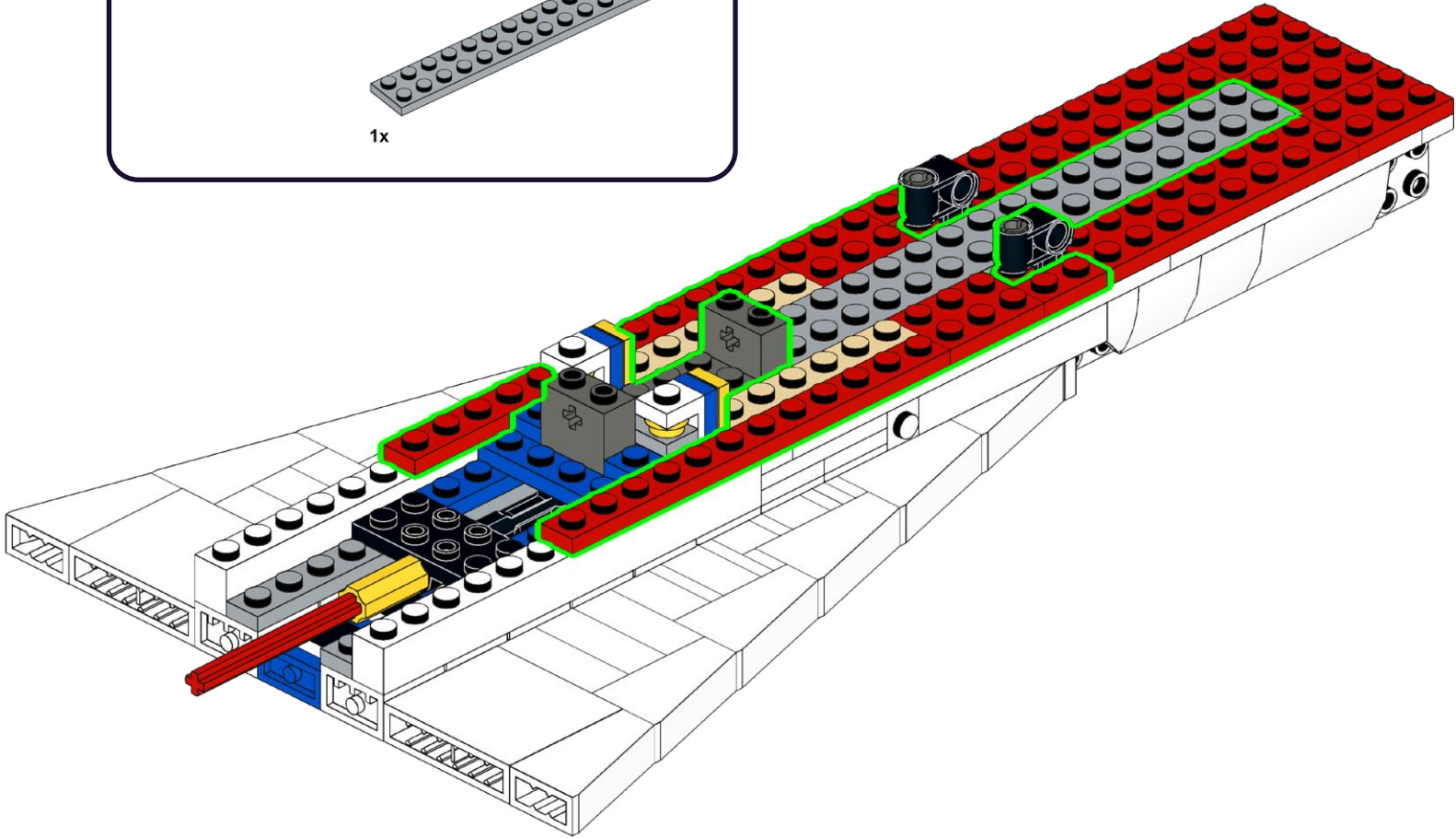
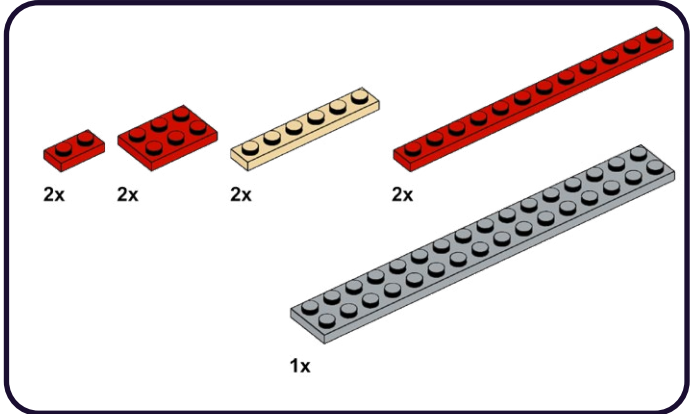

306

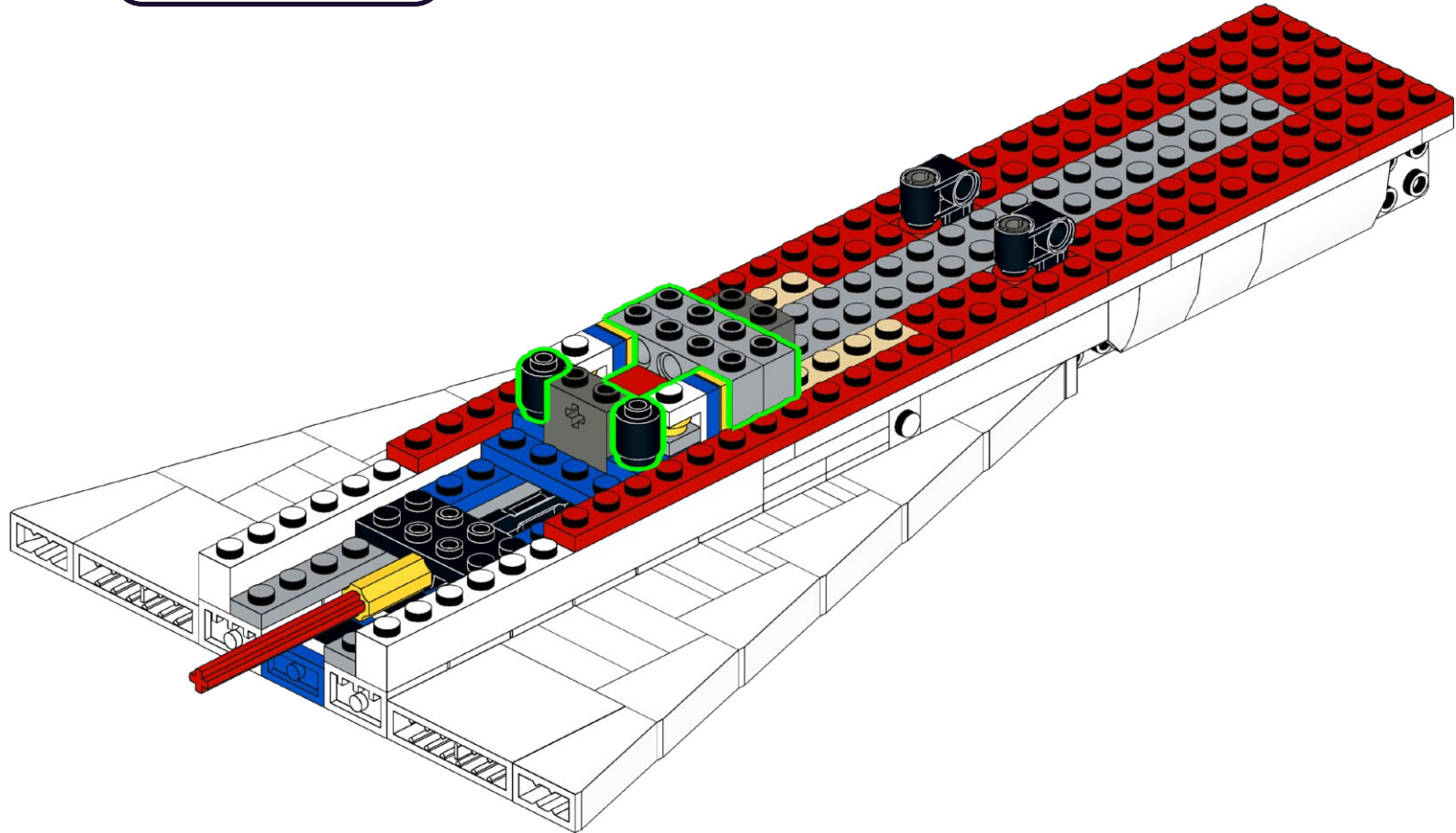
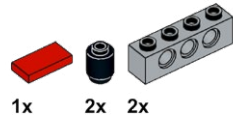

**307**

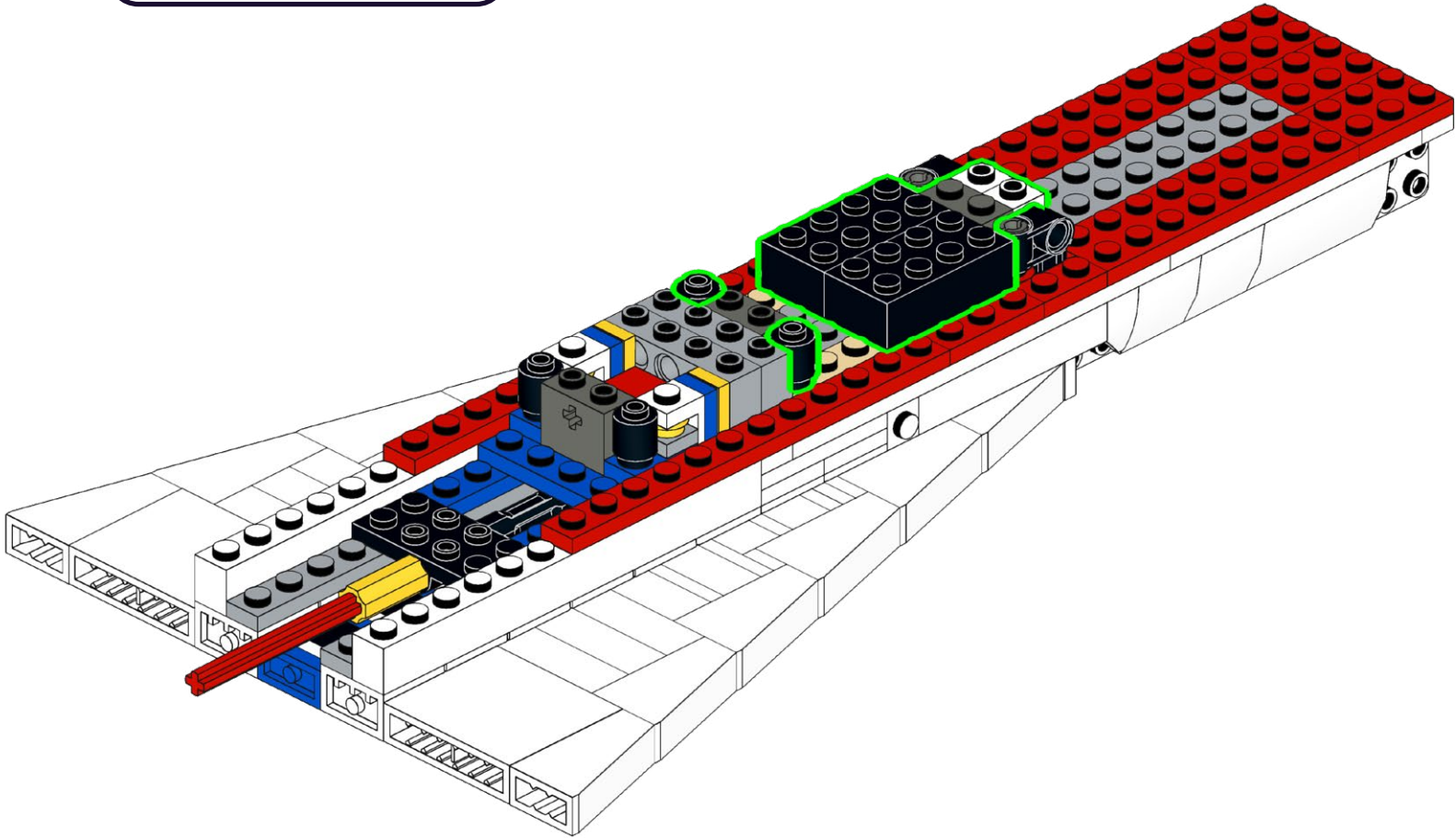
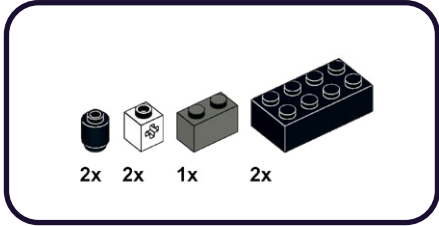

308

1x

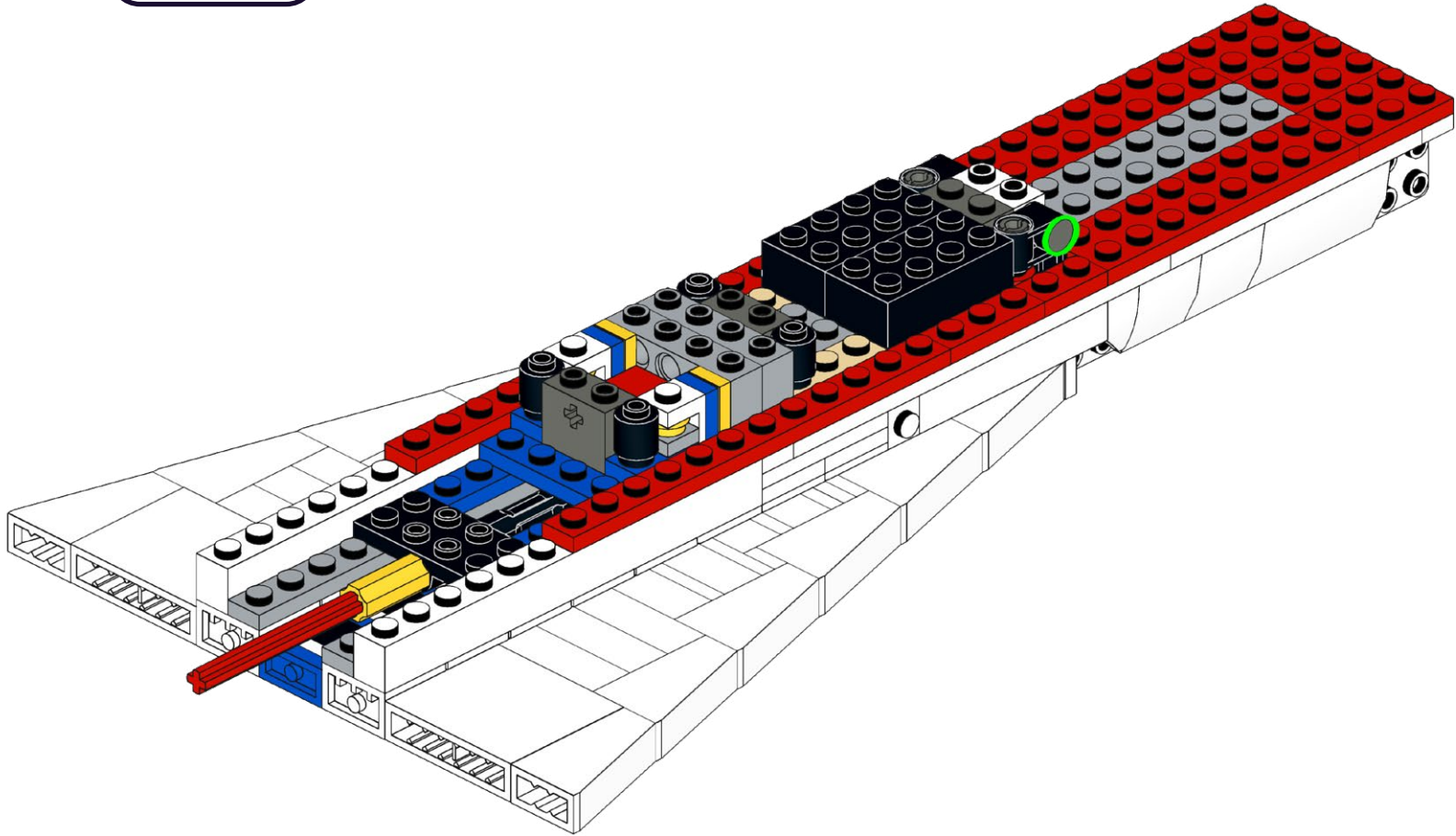

**309**

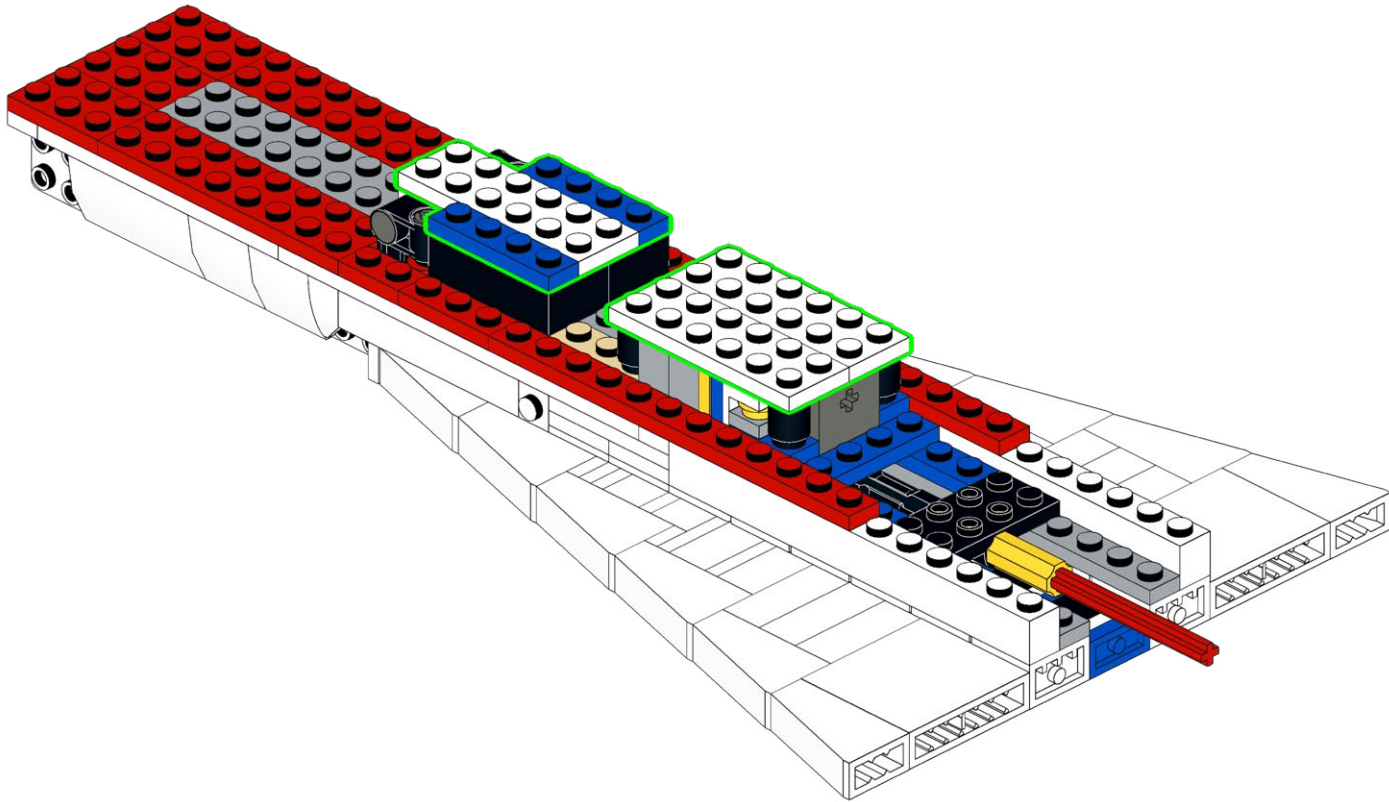
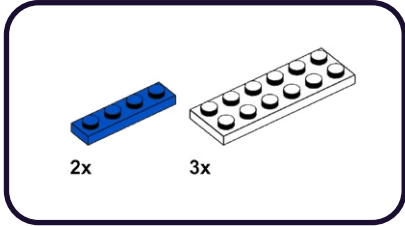

310

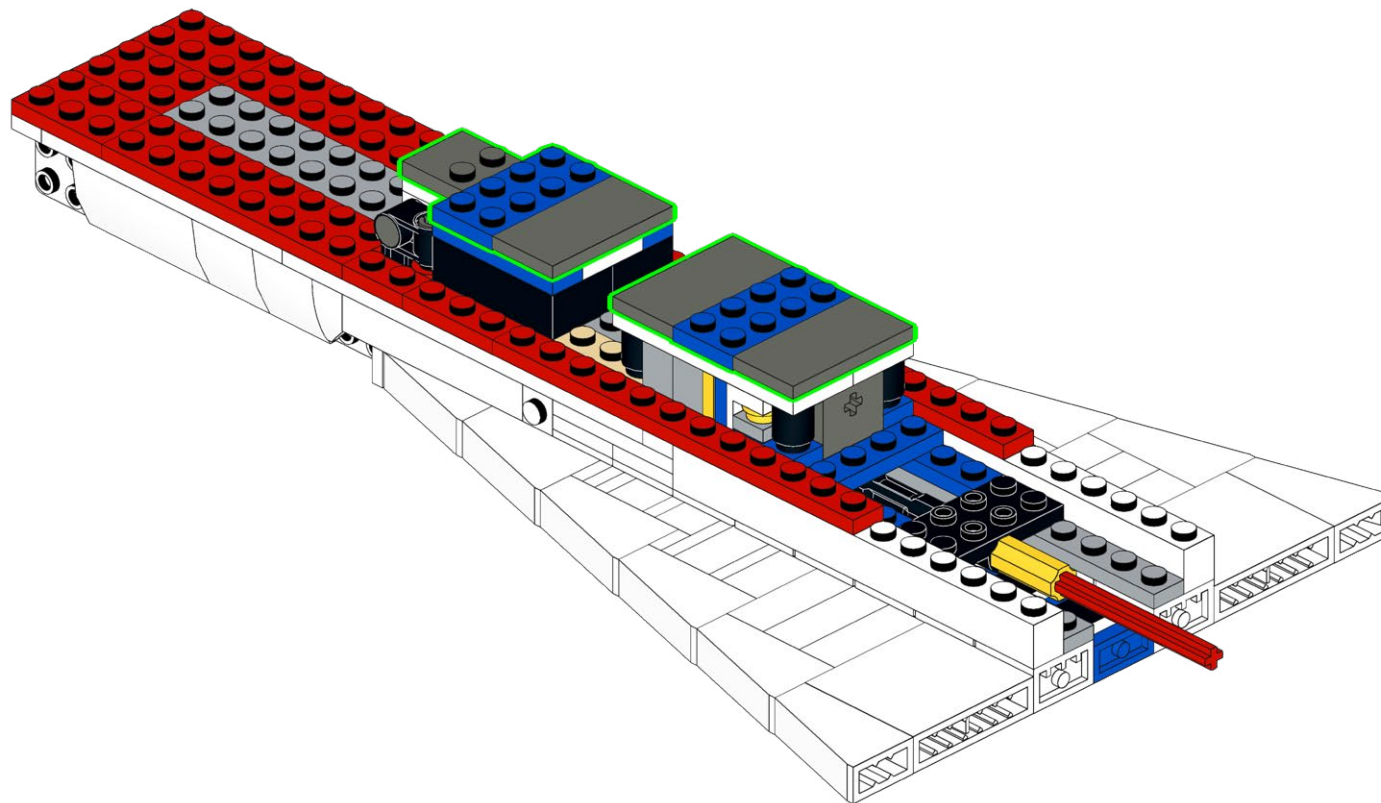
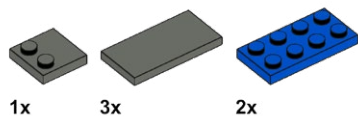

311

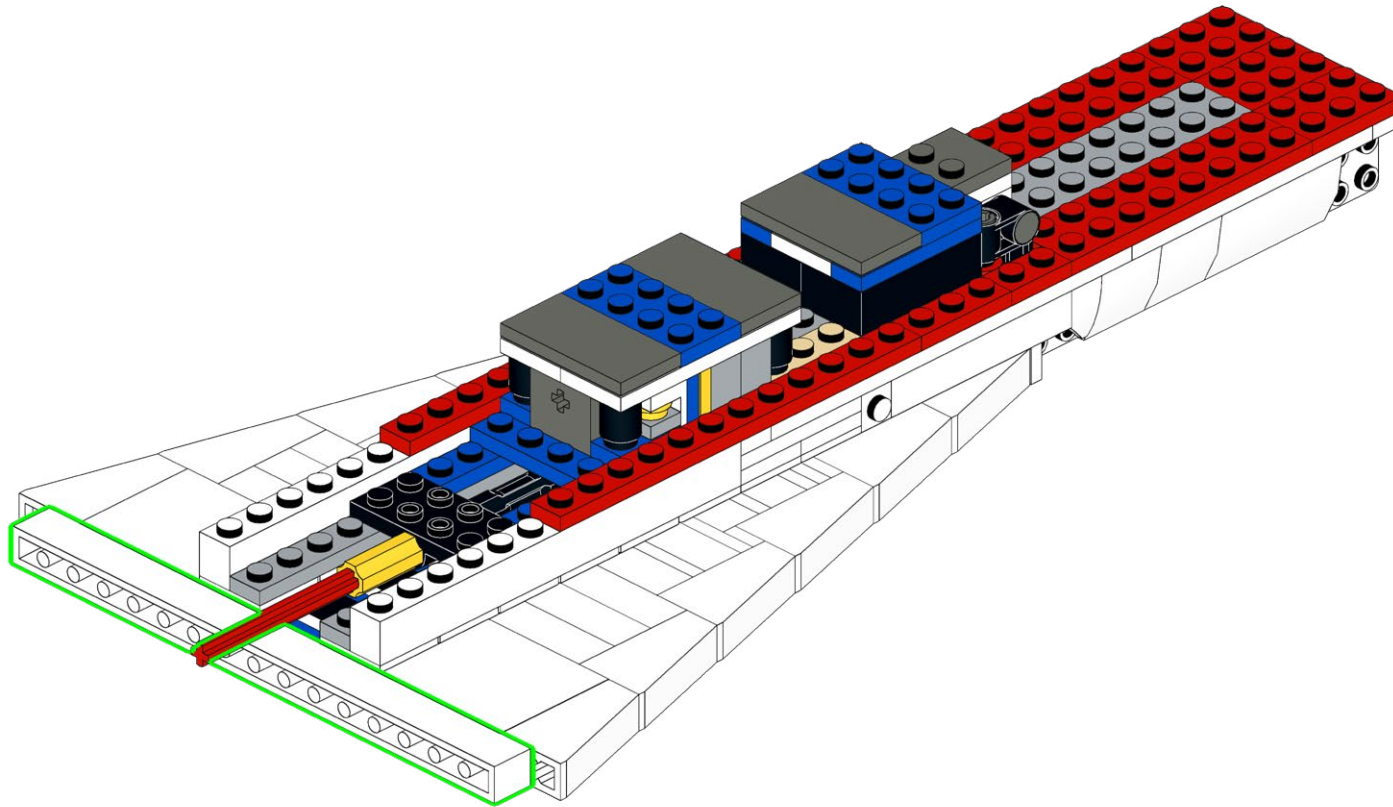
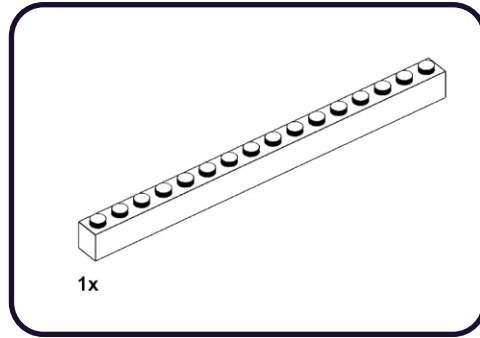



312

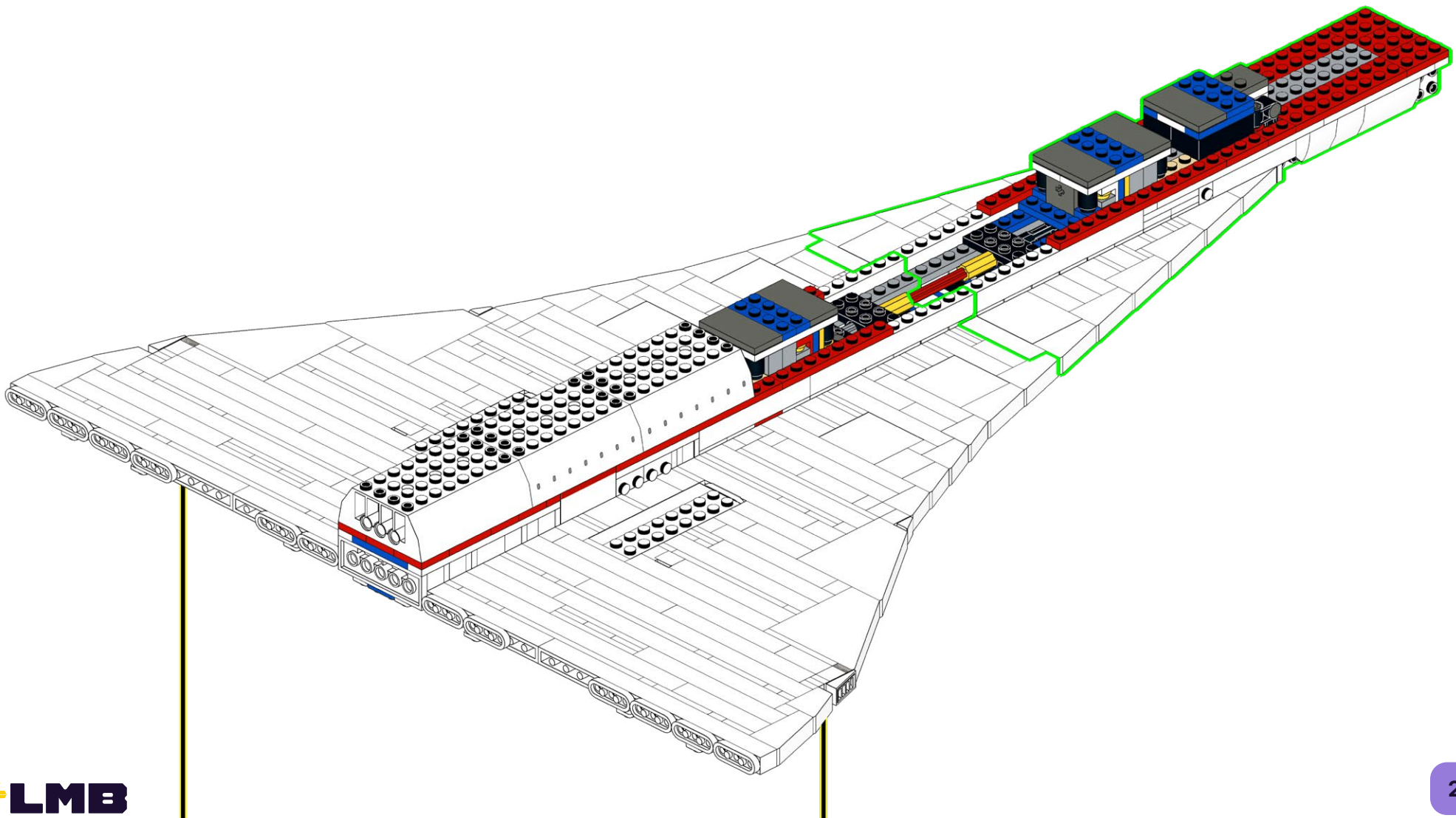

313

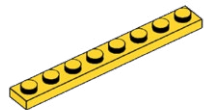

2x

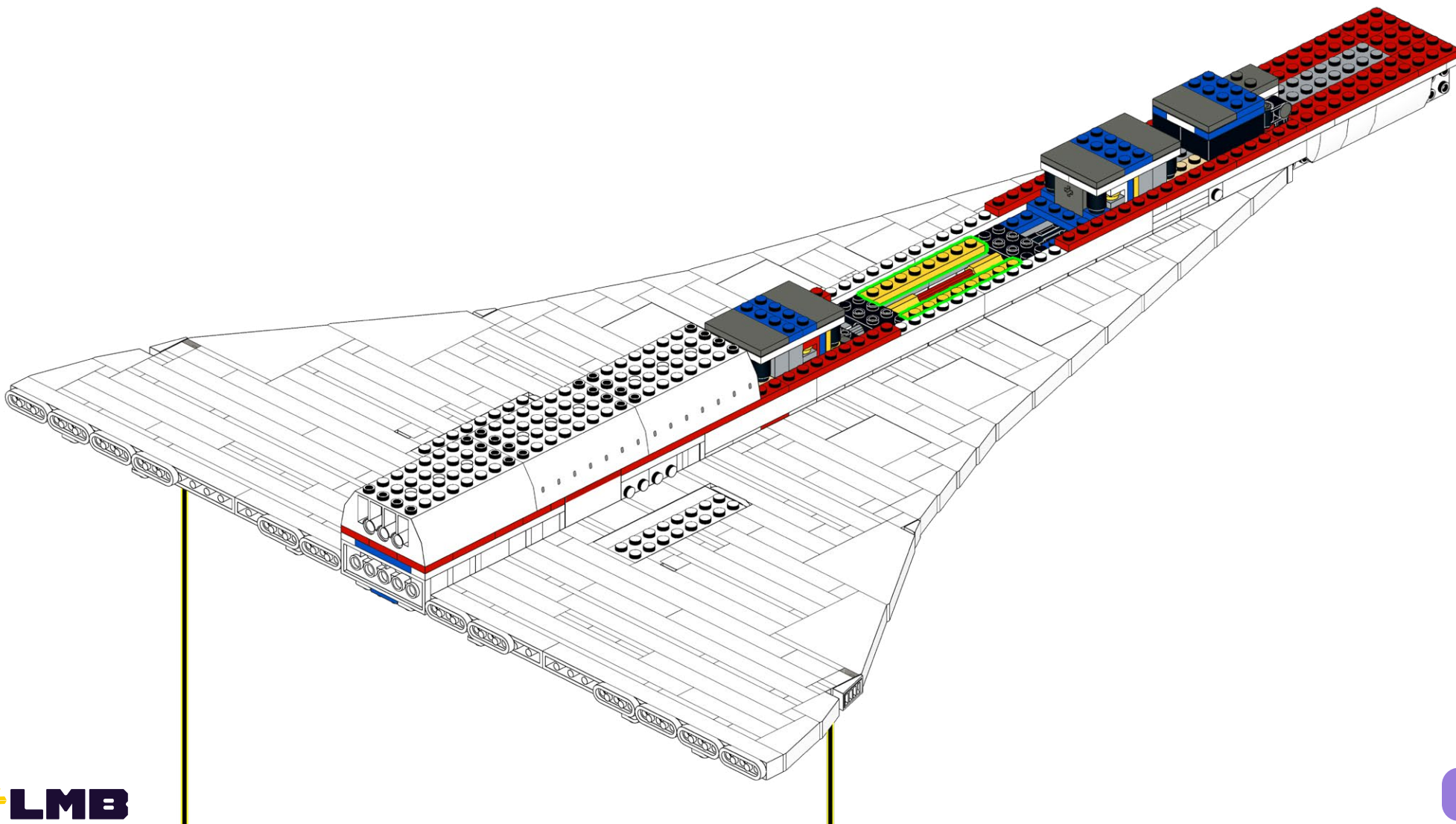

**314**

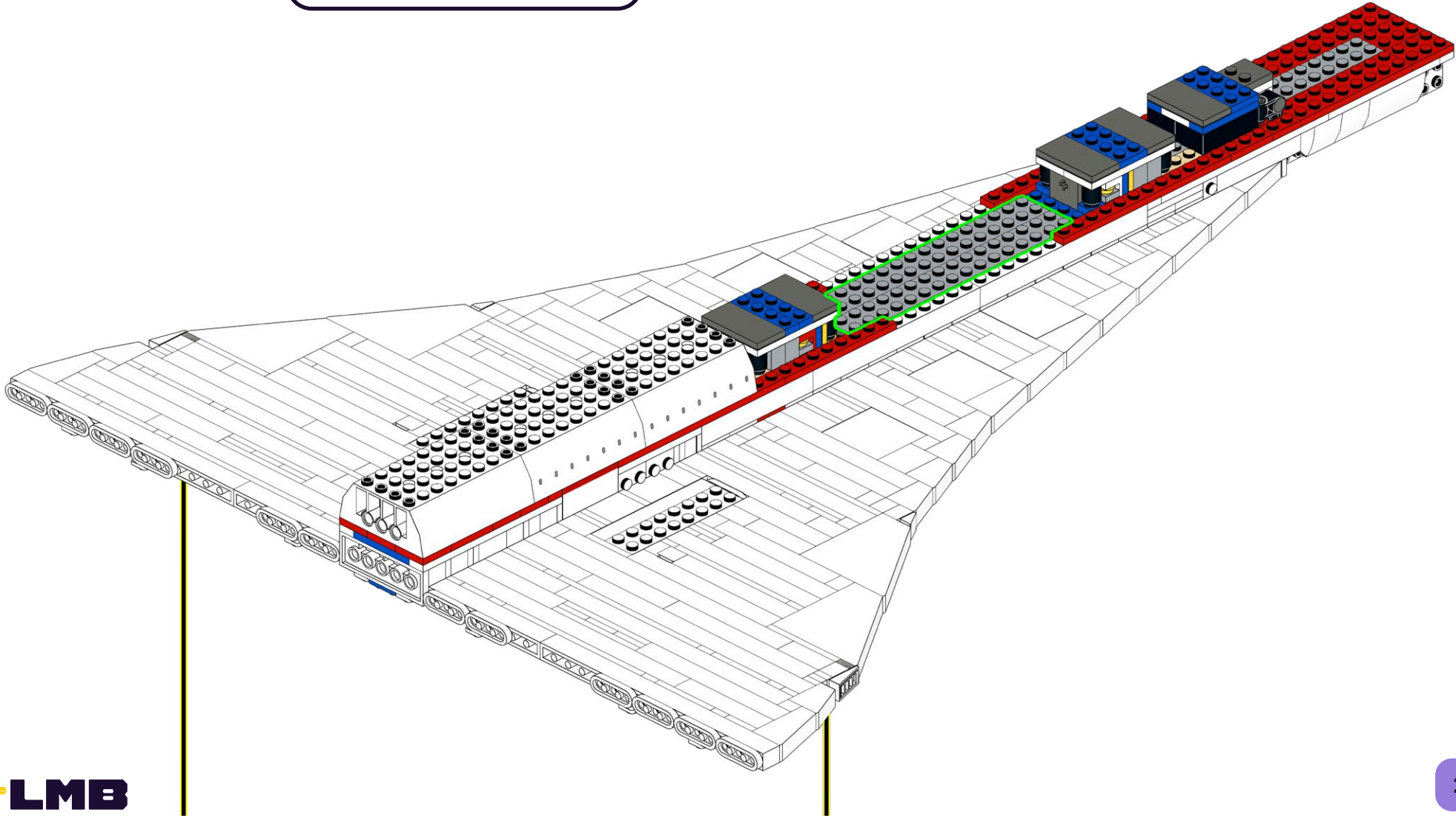
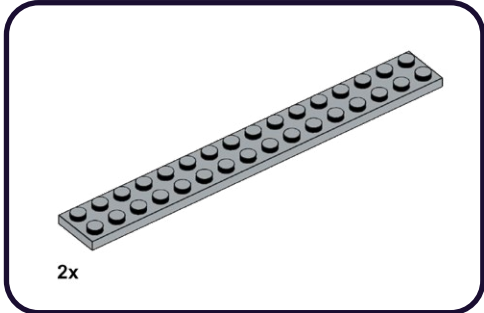

315

2x

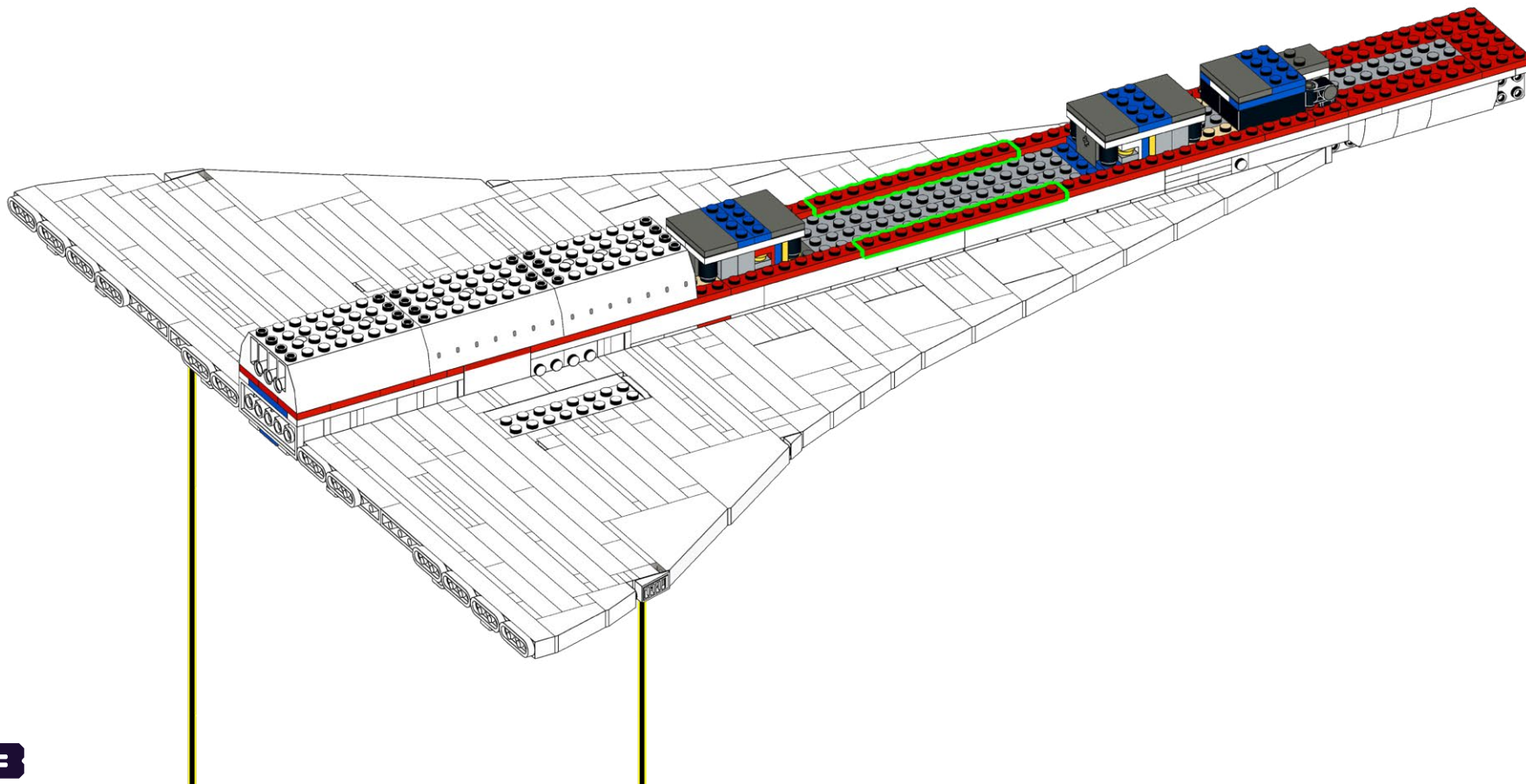

316

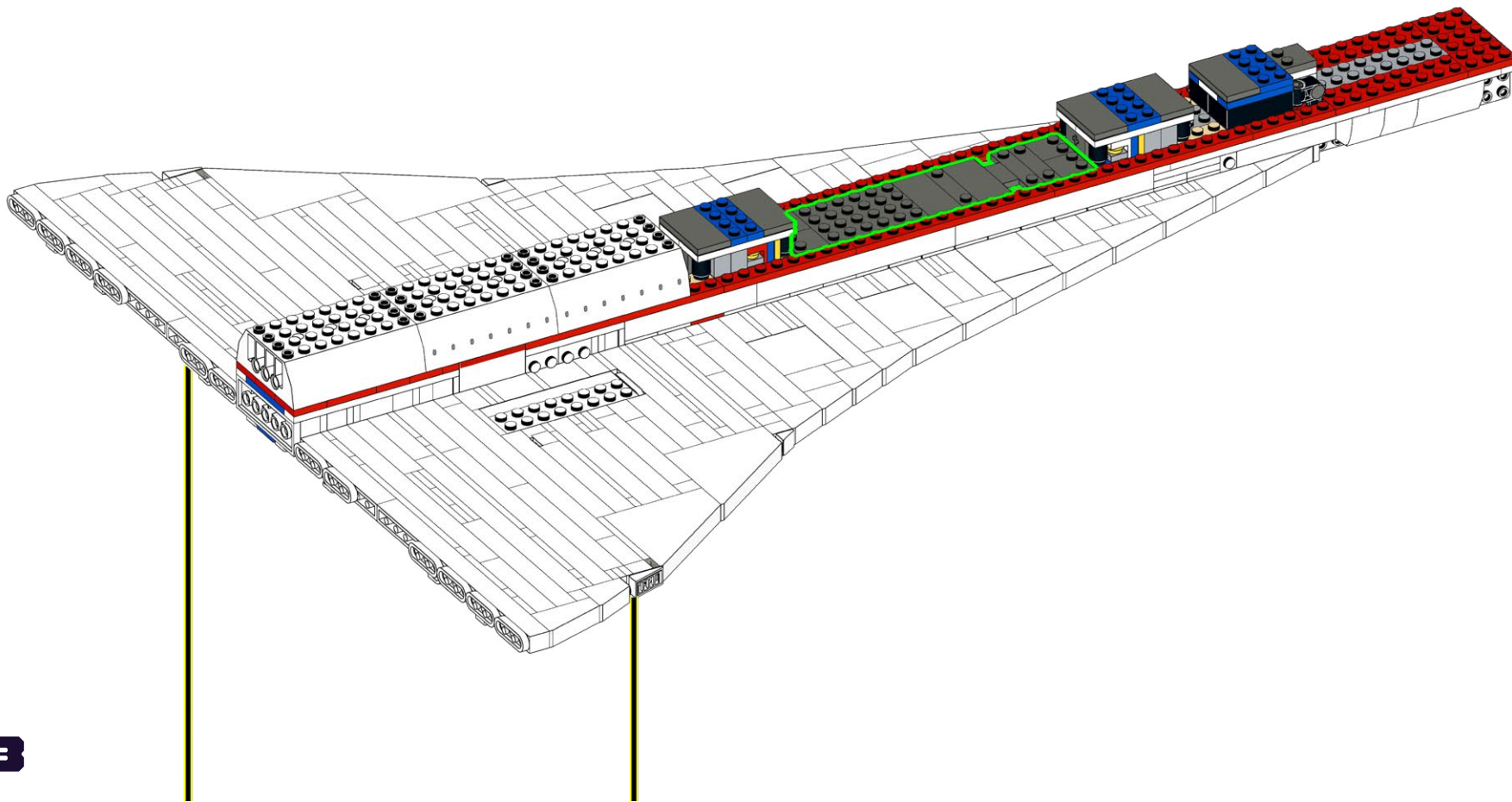
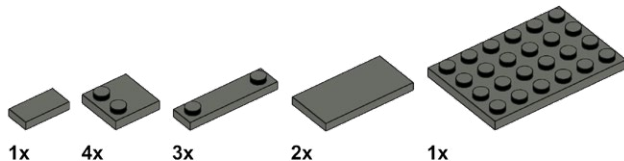

**HOLD UP!**

You might notice some bags aren't in order, as well as left over pieces, but that's ok! We're changing the way you build LEGO!

**ATTENDEZ!**

Vous remarquerez peut-être que certains sacs, ainsi que certaines pièces, ne sont pas dans le bon ordre. Mais pas de panique! Nous changeons simplement la façon avec laquelle vous construisez vos LEGO!

**ASPETTA!**

Potresti notare che alcuni sacchetti non sono in ordine, così come i pezzi avanzati, ma va bene così! Stiamo cambiando il modo in cui costruisci i LEGO!

**HALT!**

Sie werden möglicherweise bemerken, dass einige tüten durcheinander sind und teile übrig bleiben, aber das ist in Ordnung! Wir ändern die art und weise, wie Sie LEGO bauen!

**¡ESPERA!**

Es posible que notes que algunas bolsas están fuera de servicio, así como piezas sobrantes, ¡pero está bien! ¡Estamos cambiando la forma en que construyes LEGO!

**暫停!**

你可能会注意到一些袋子顺序错乱, 以及一些剩余的部件, 但没关系! 我们正在改变你搭建乐高的方式!

**Open LEGO® Bag 12**

317

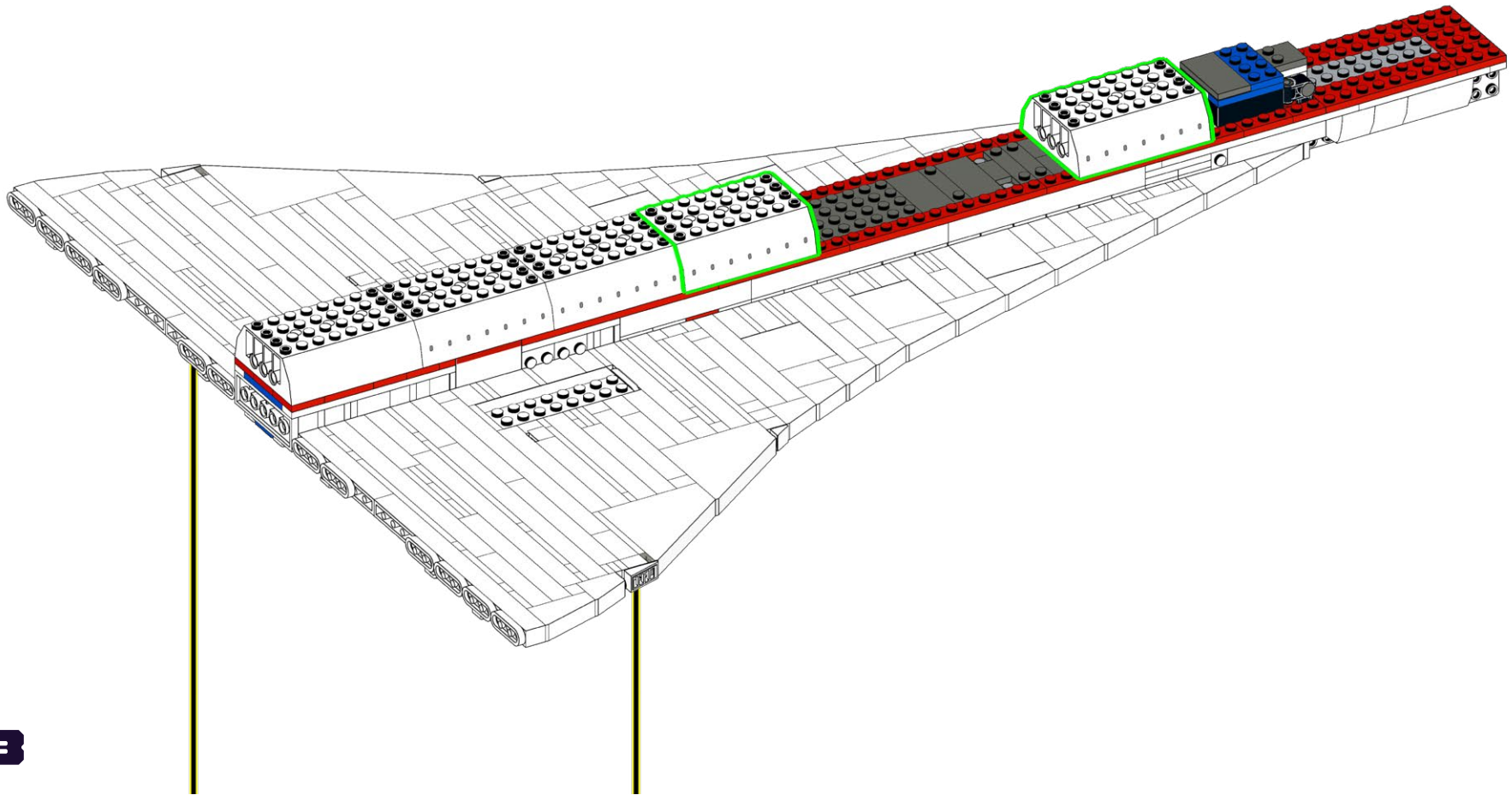
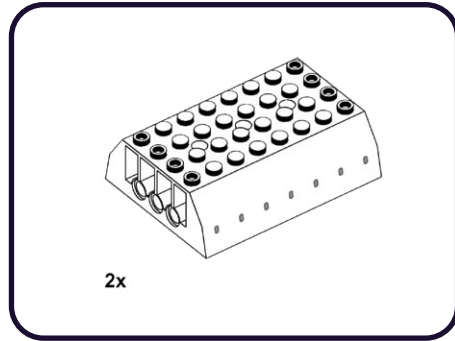

318

1x





319

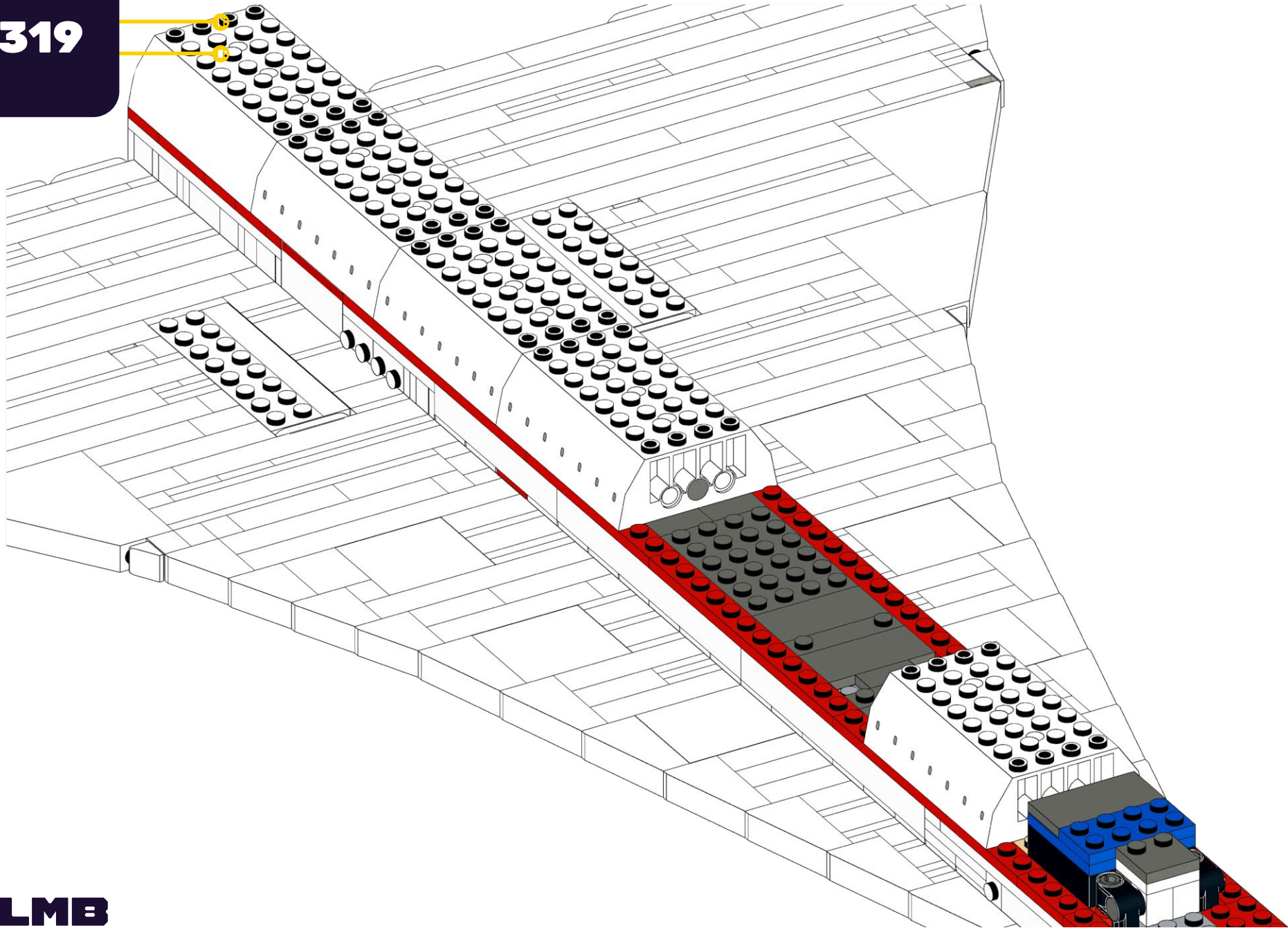

320

1x

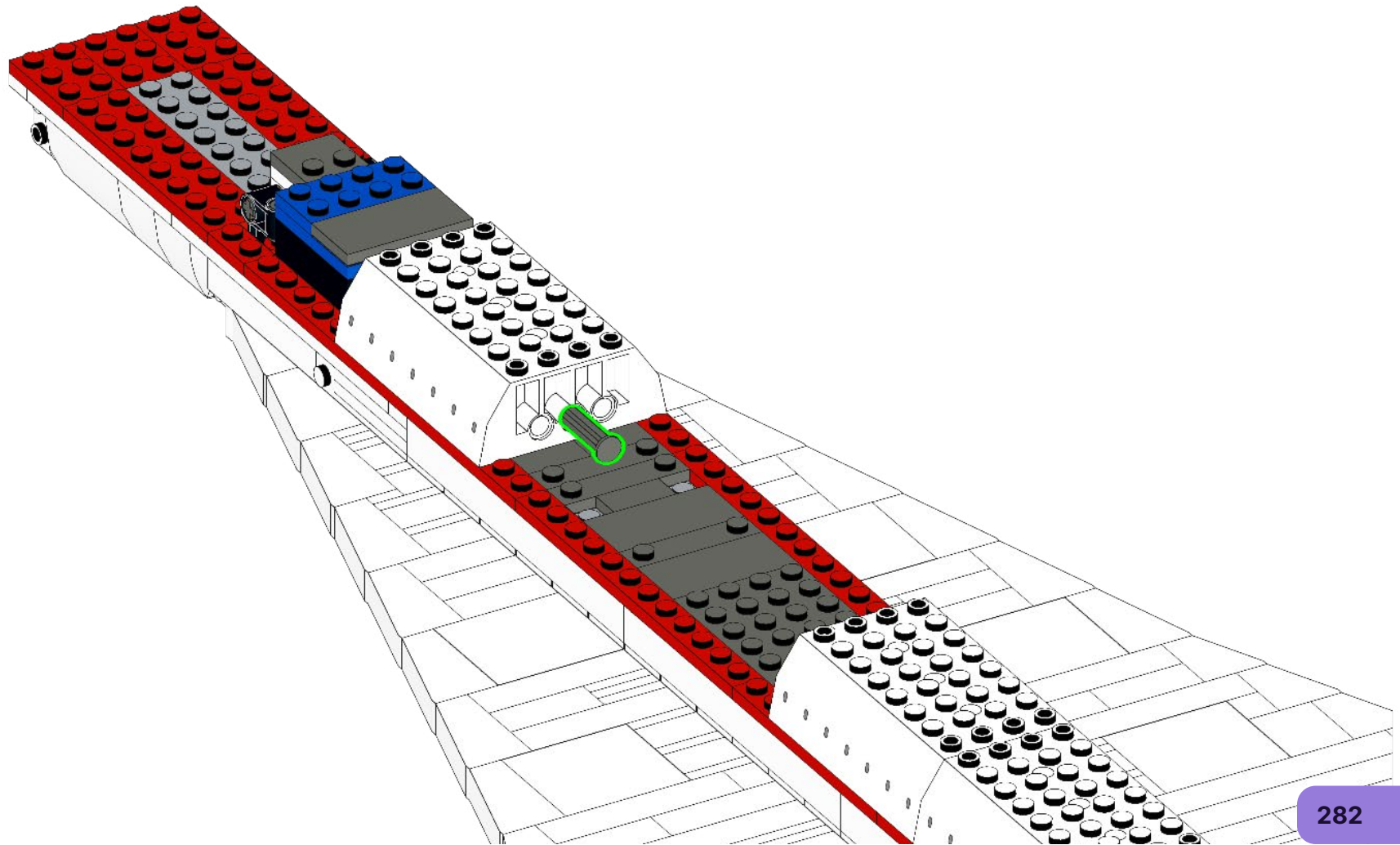

321

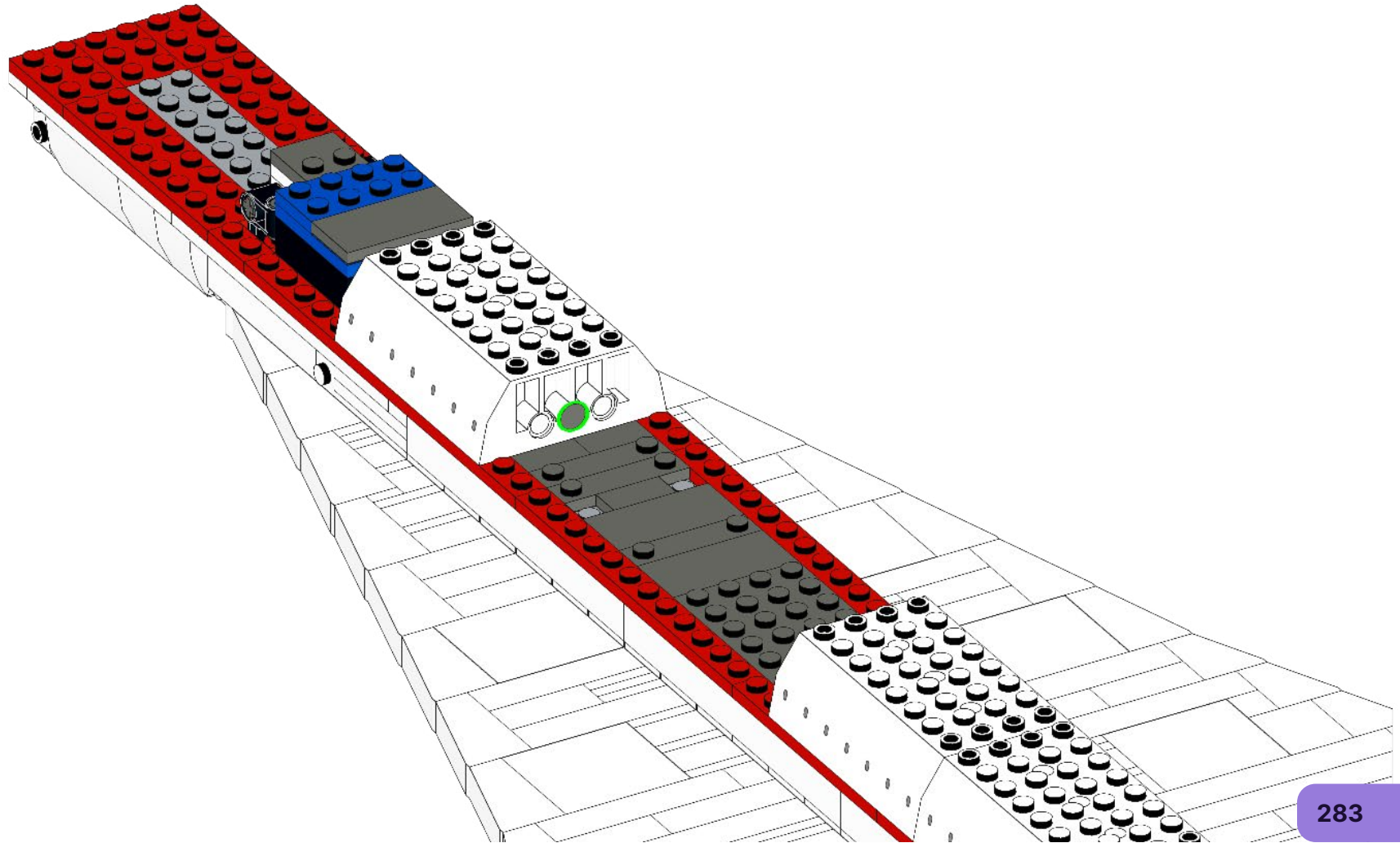

# 322

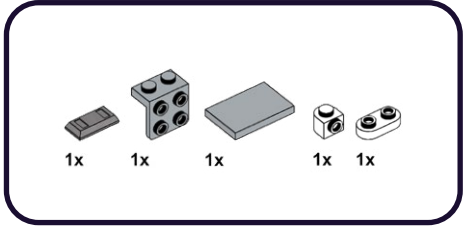

1

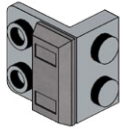

2

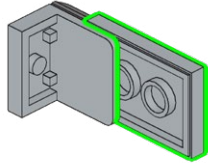

2

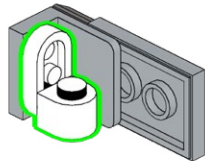

# 323

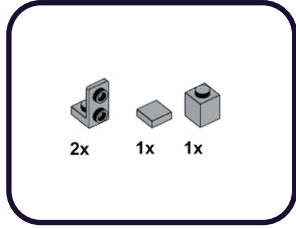

1

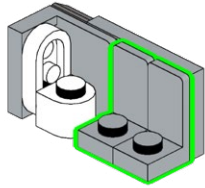

2

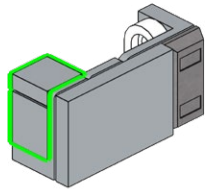

324

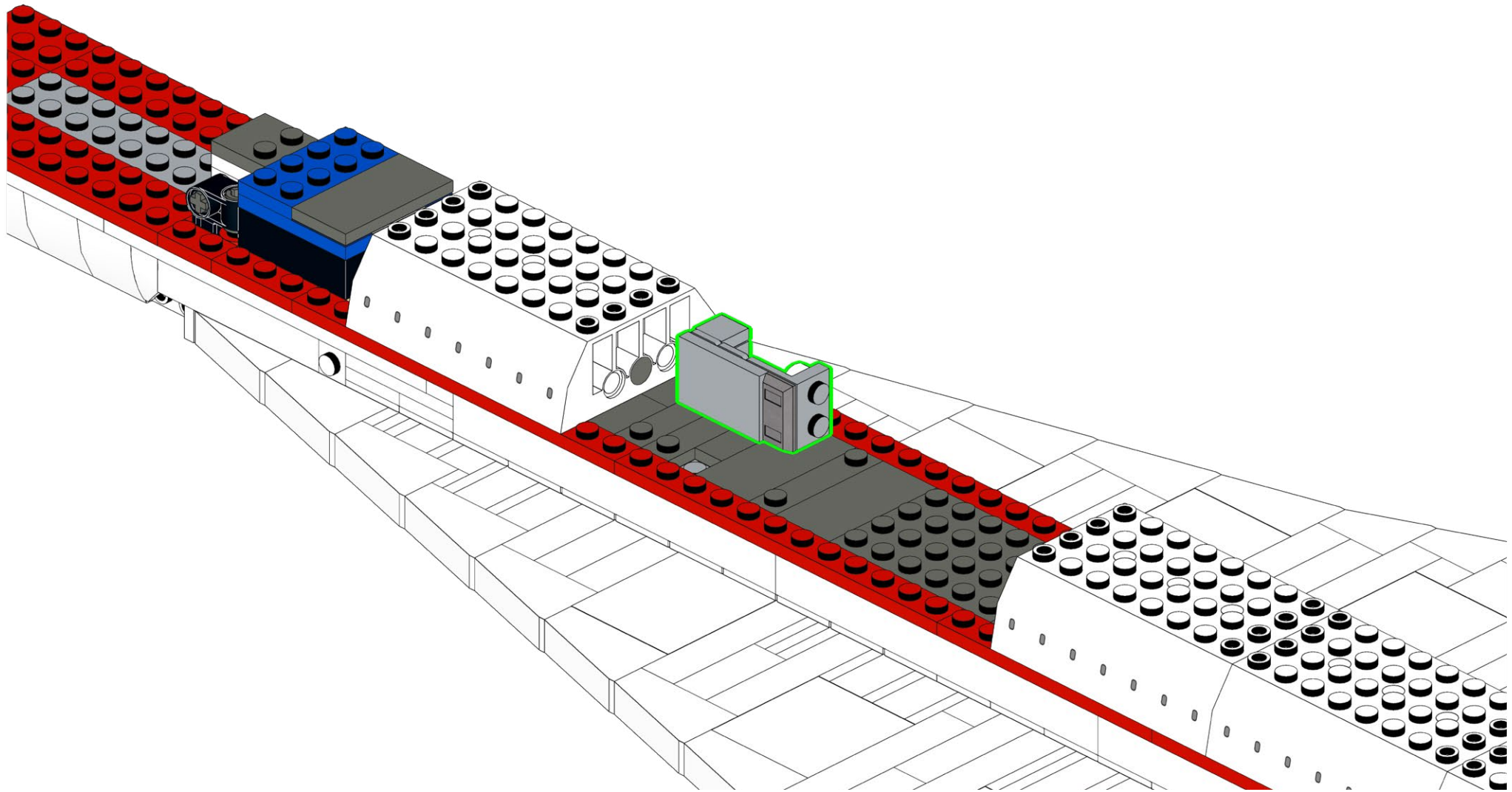

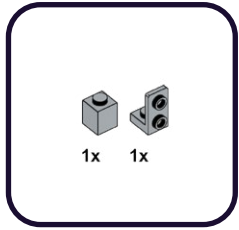

1

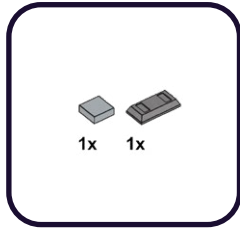
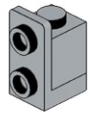

1

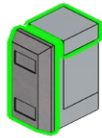

327

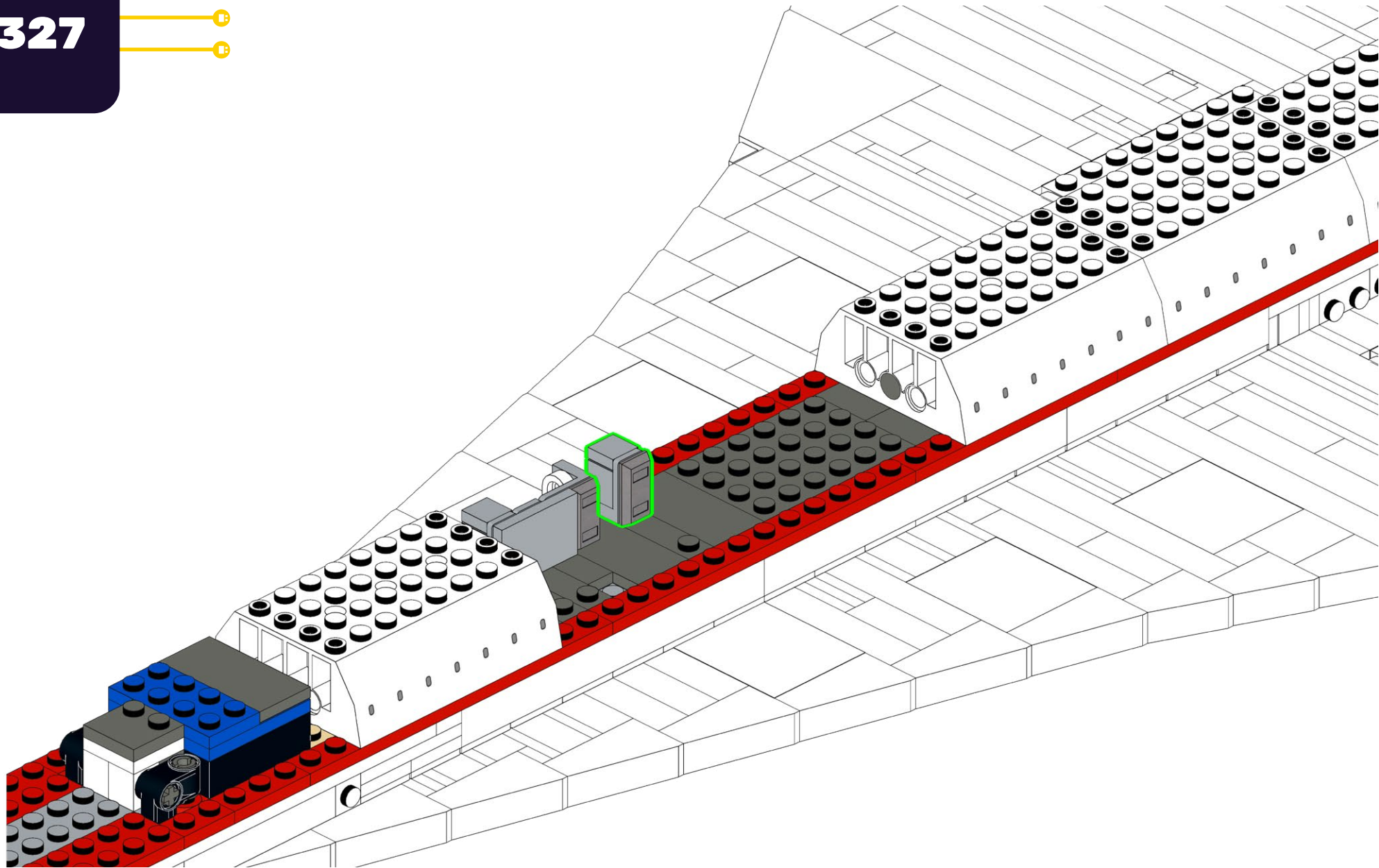

328

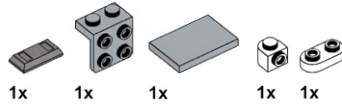

1

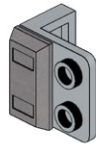

2

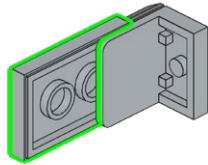

2

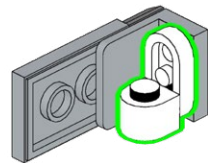

329

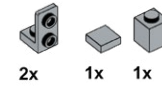

1

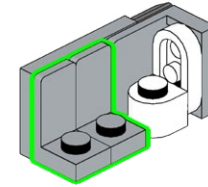

2

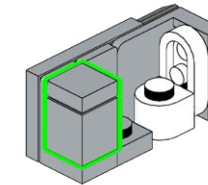



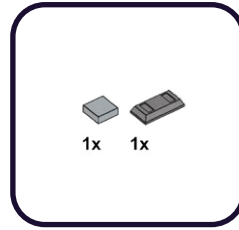
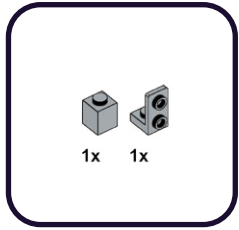

1



1

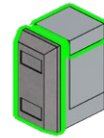

332

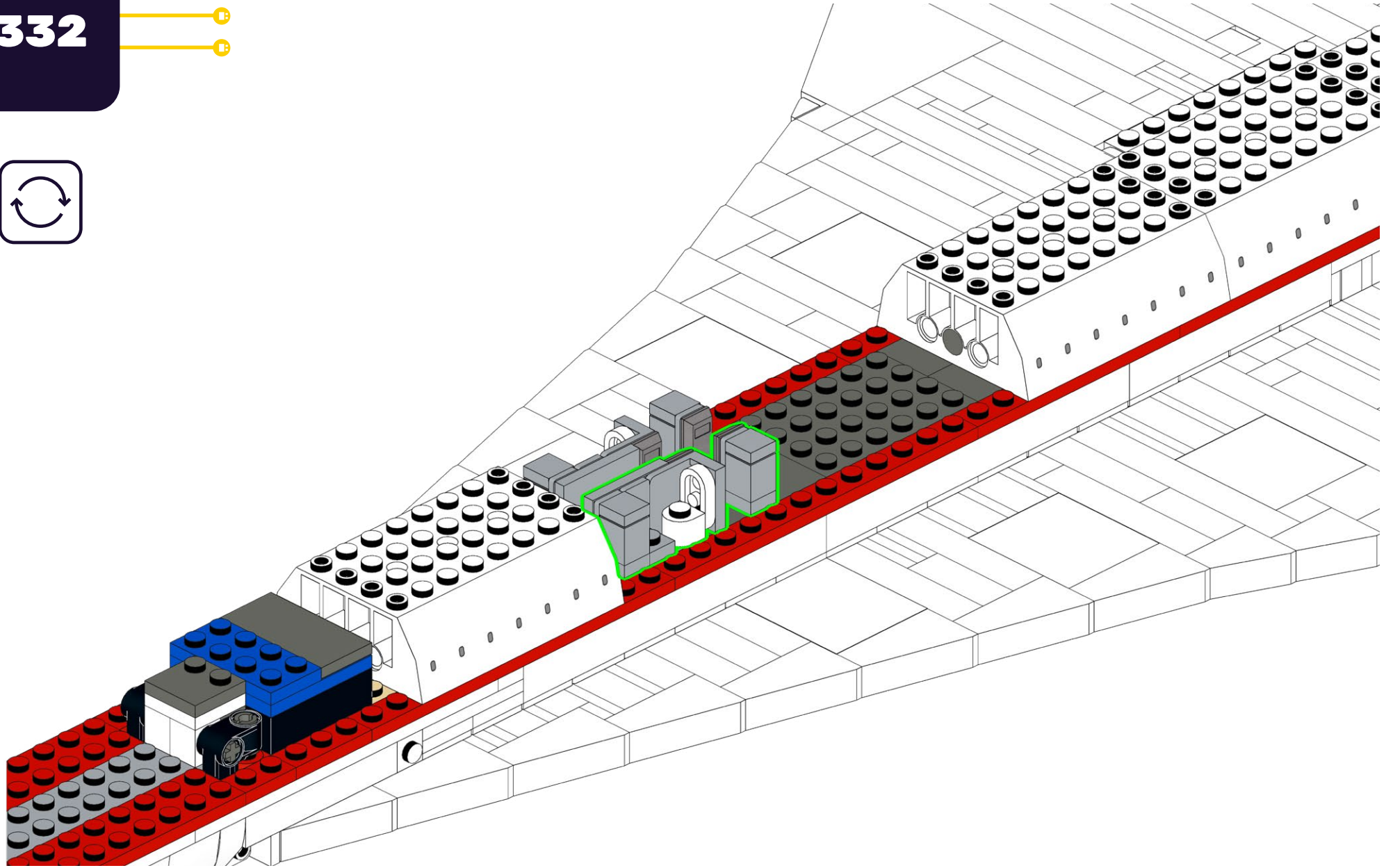

# 333

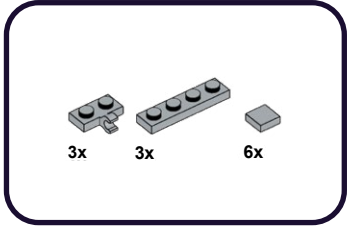

1

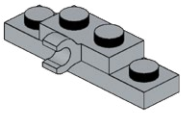

2

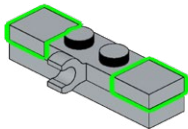

# 334

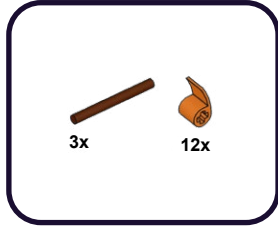

1

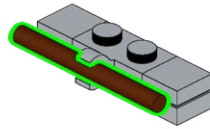

2

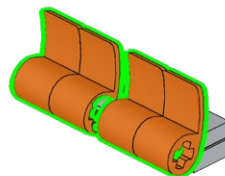

3x

335

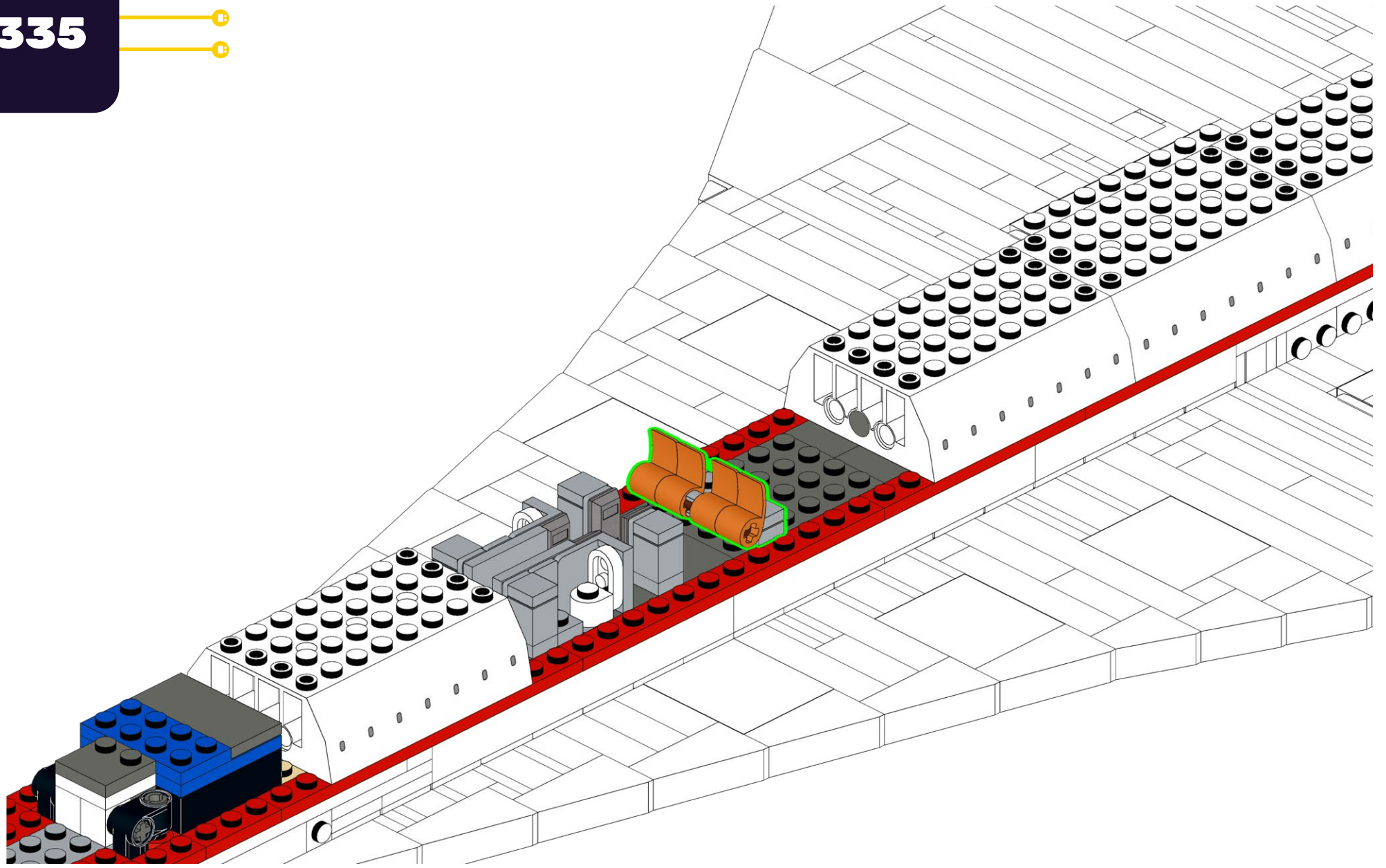

336

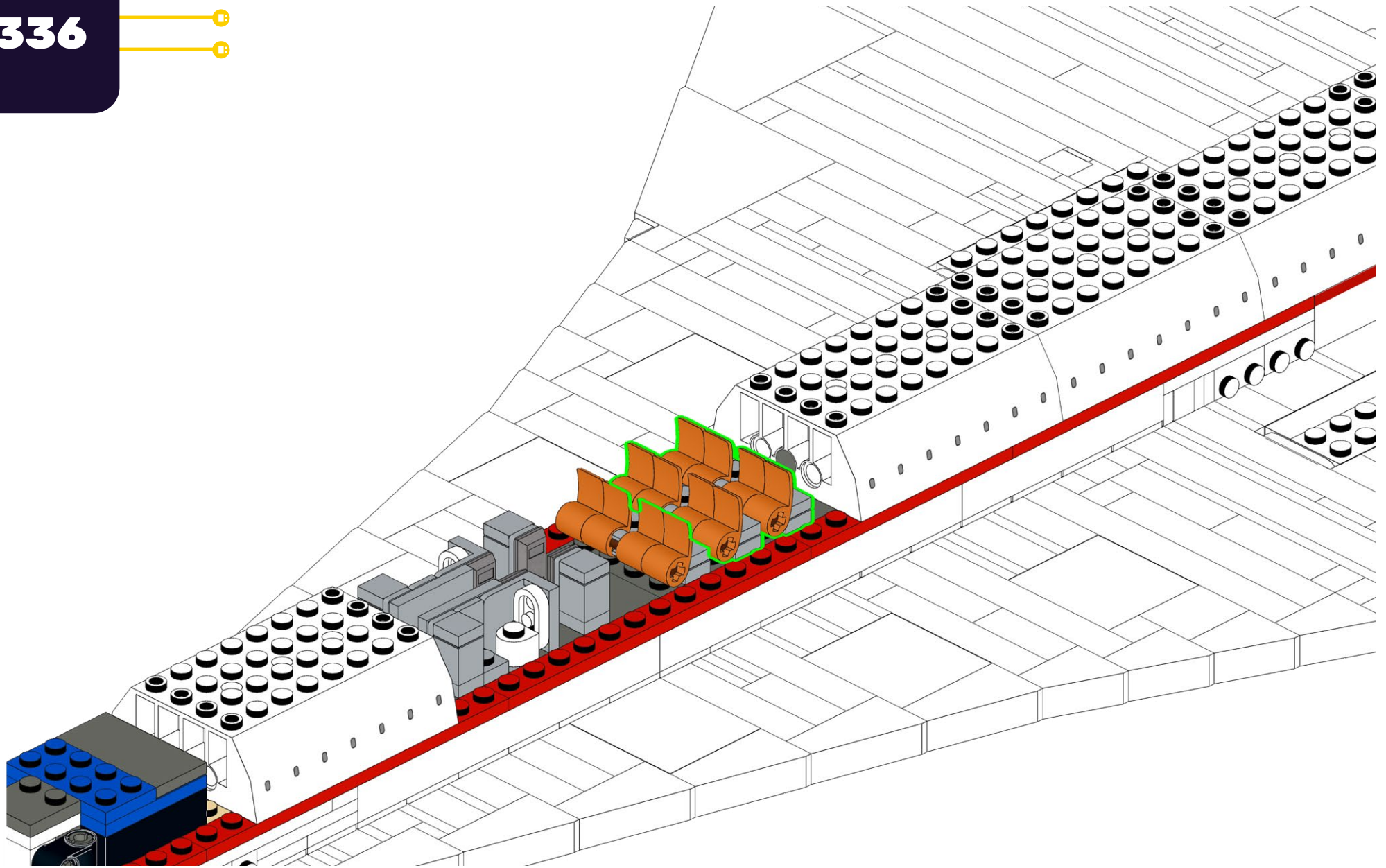

# 337

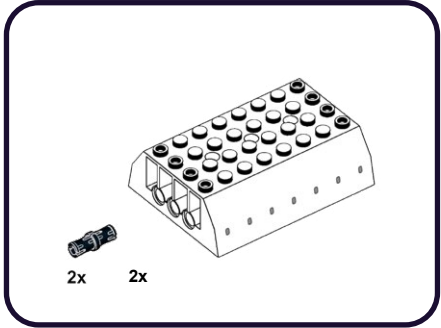

1

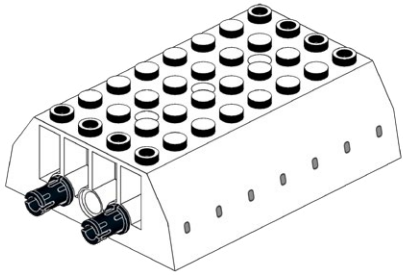

2

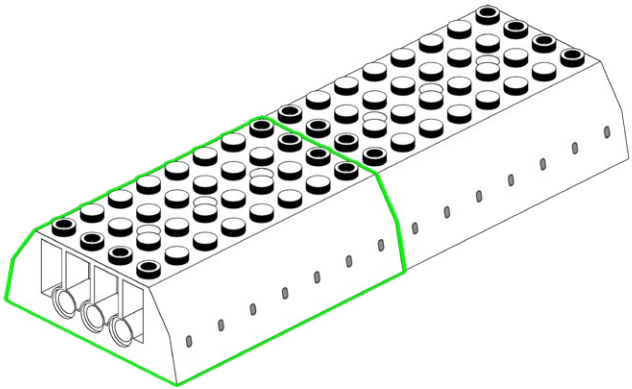

# 338

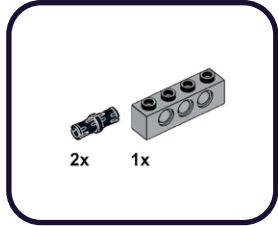

1

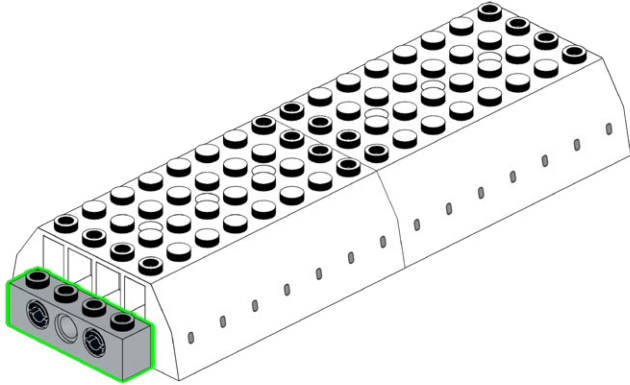

339

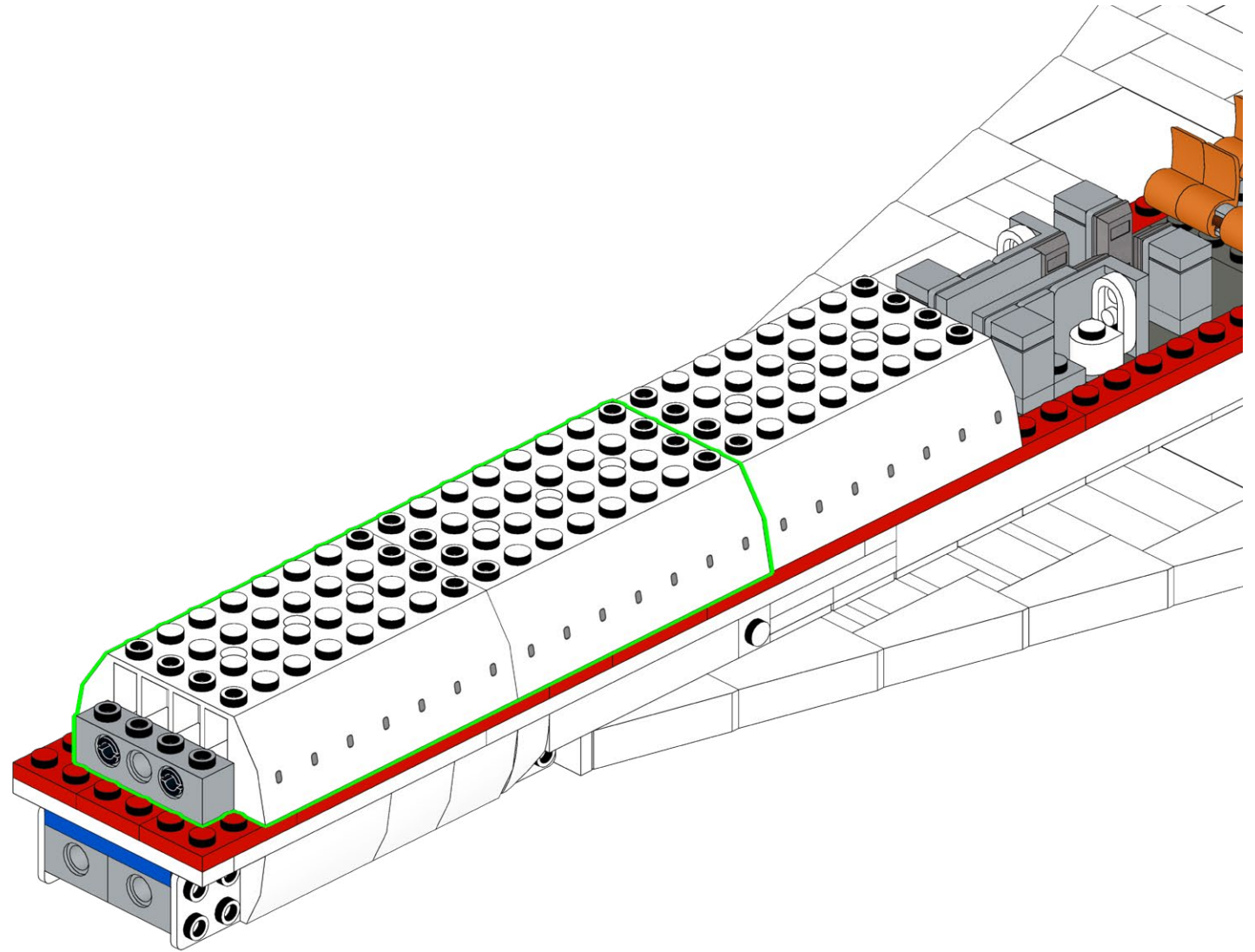

340

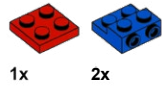

1x

2x

1

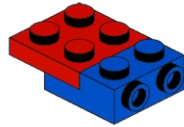

2

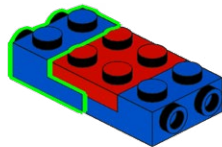

341



1x

1

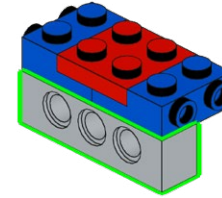



342

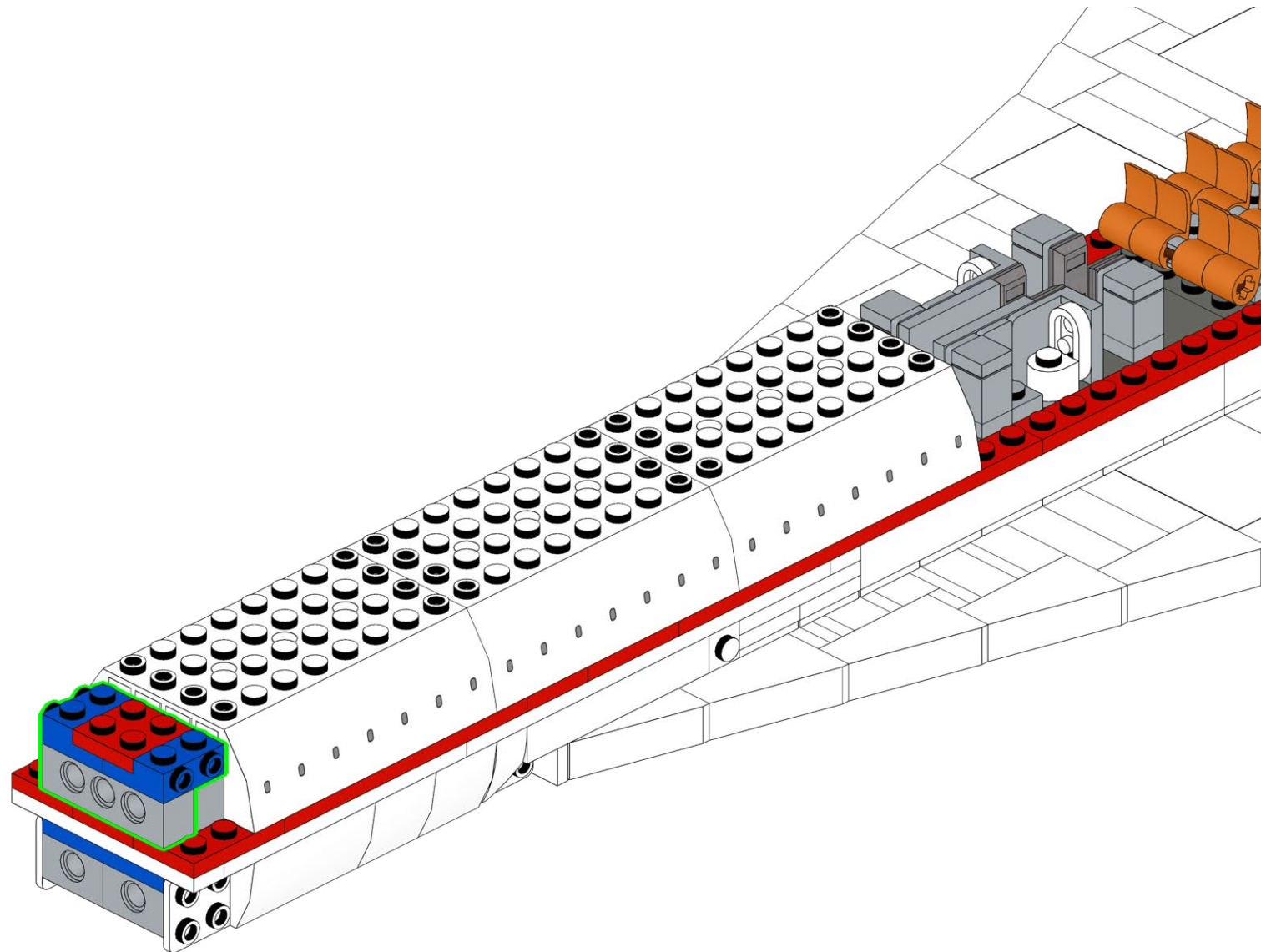

343

2x 6x

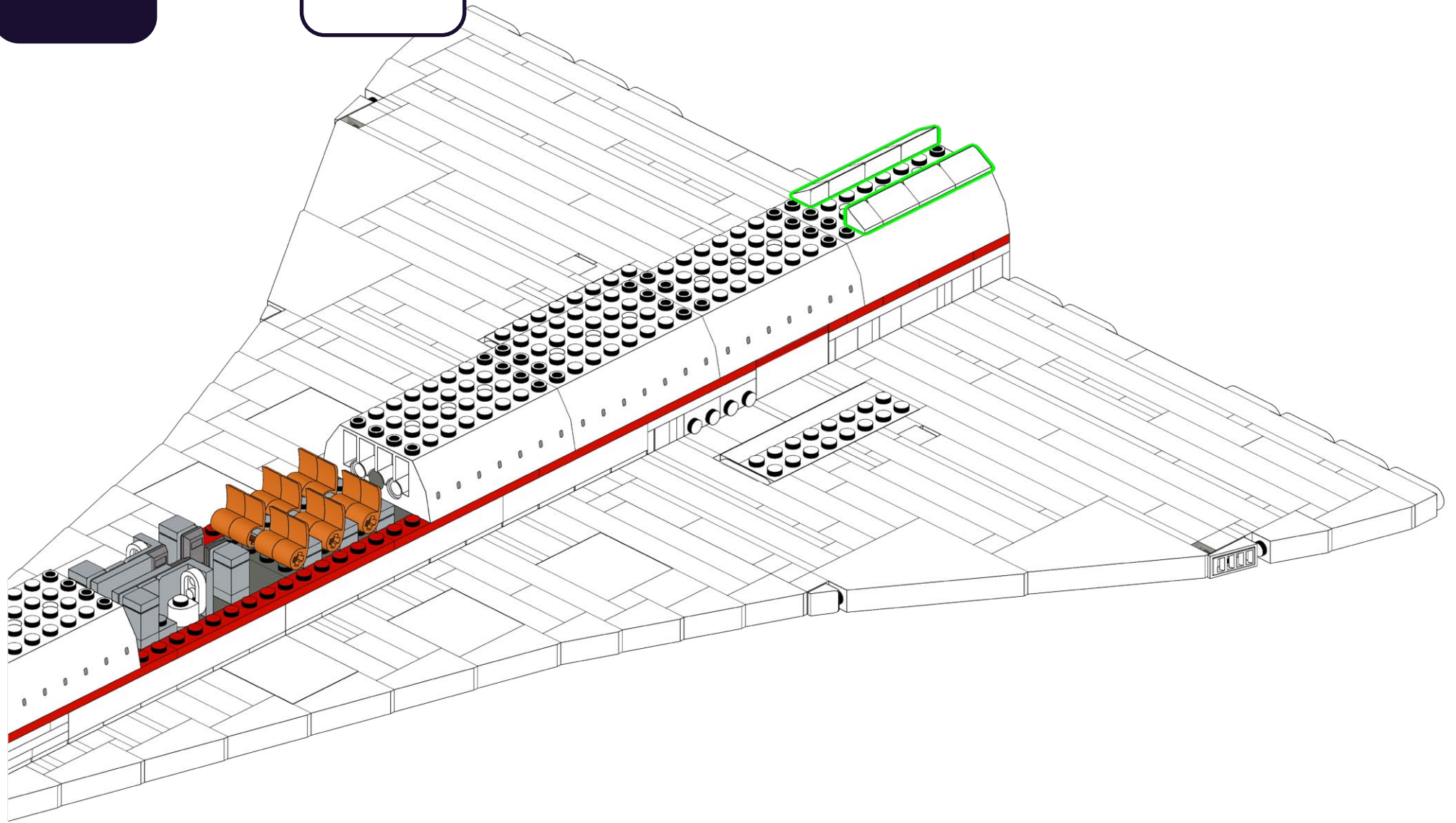

344

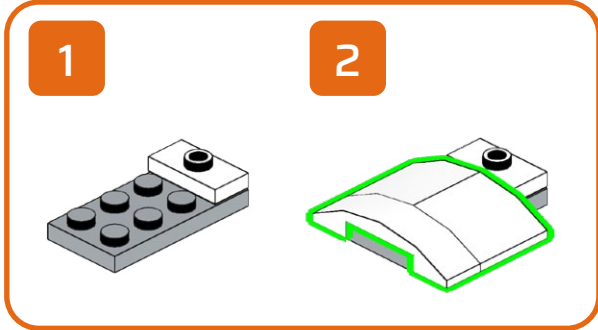
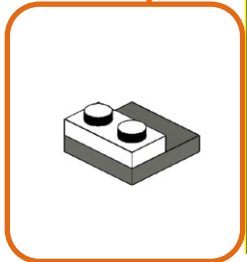
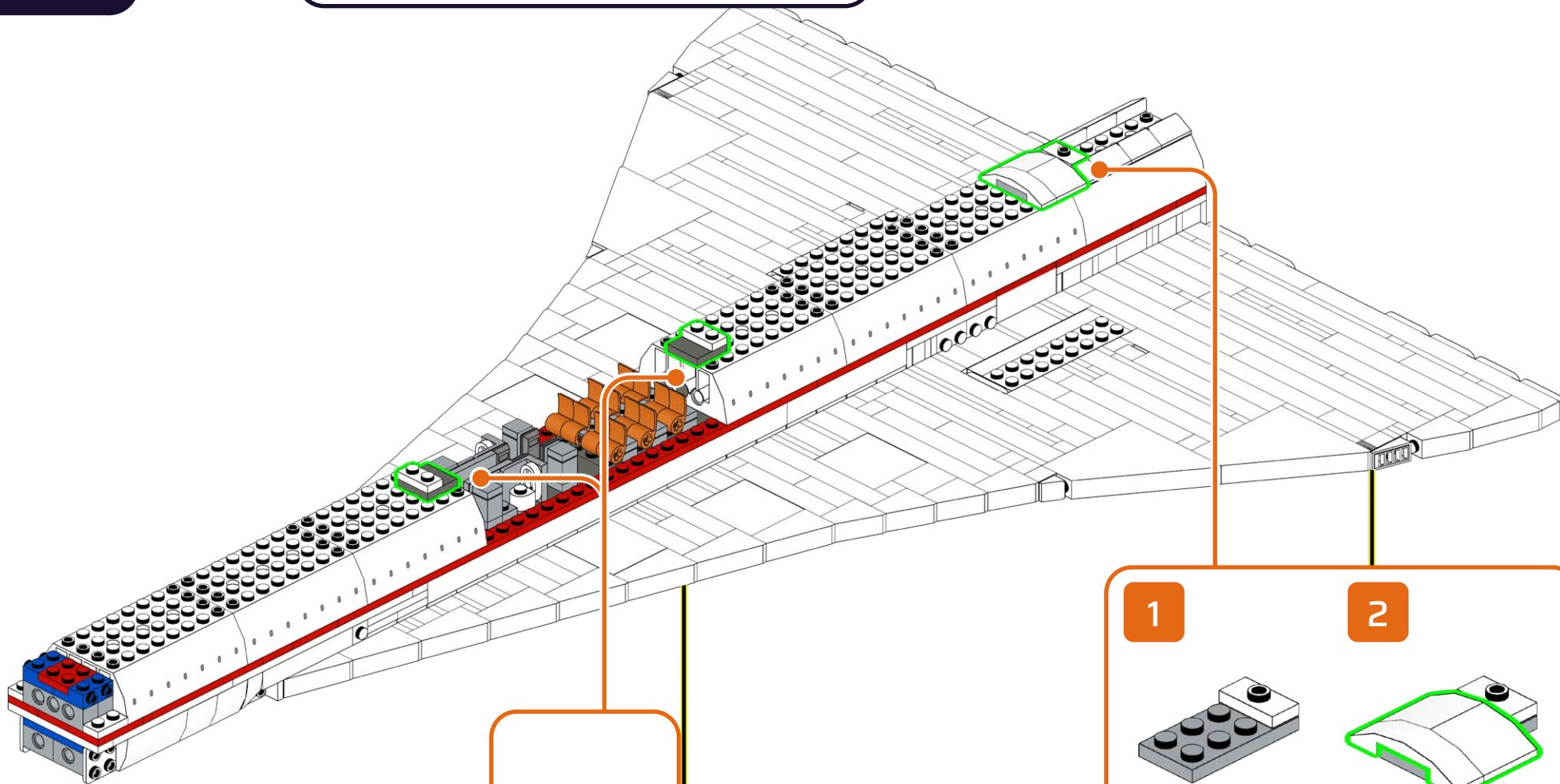
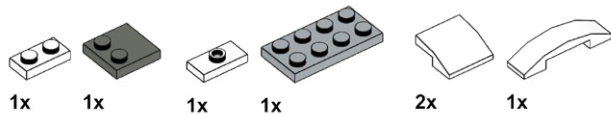

345

4x 20x

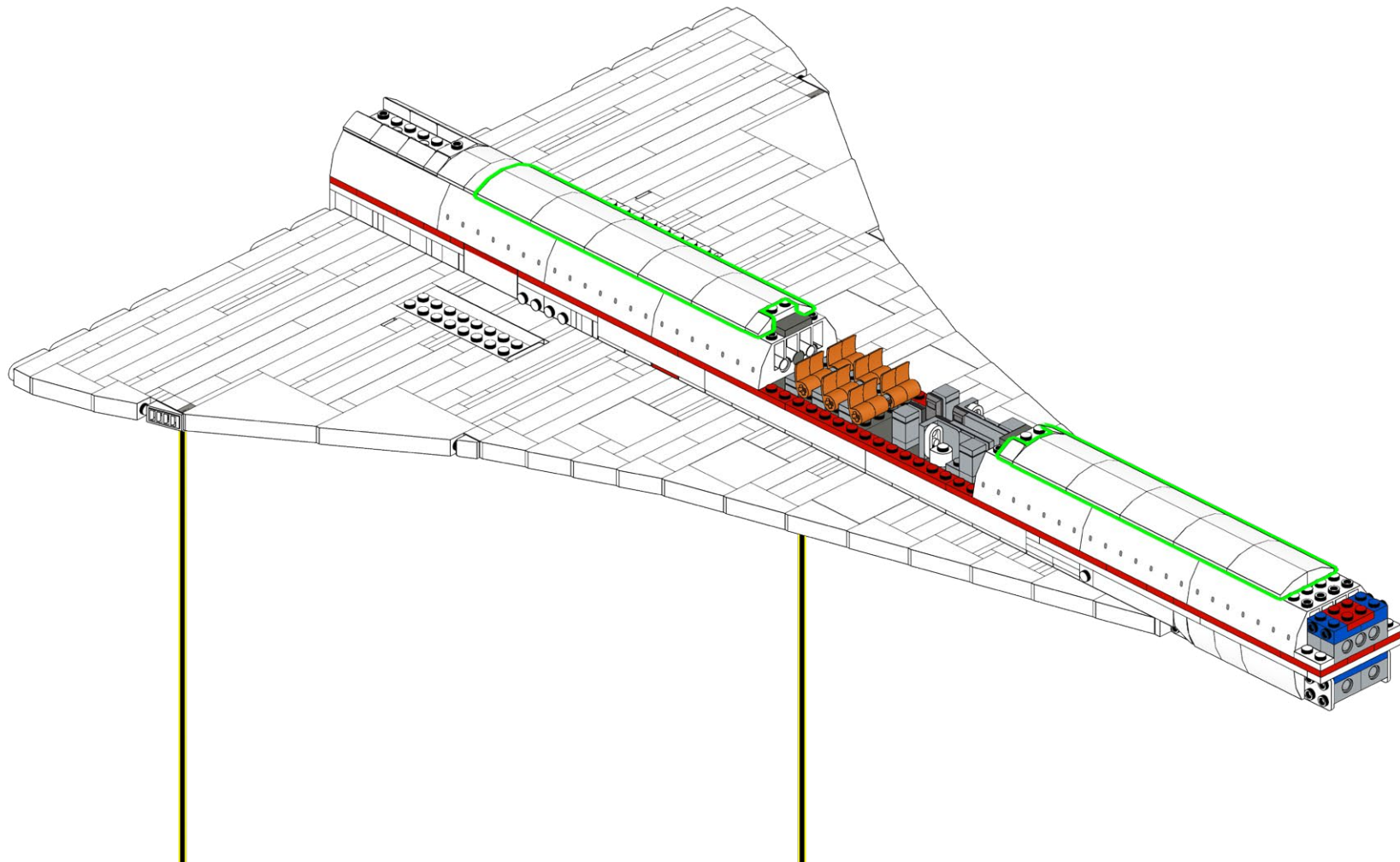

346

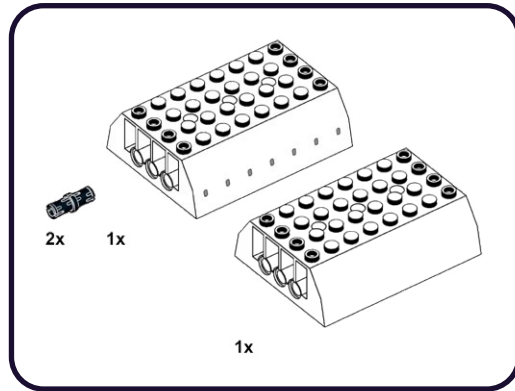

1

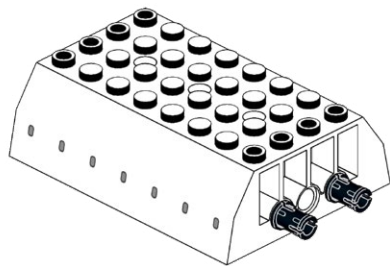

2

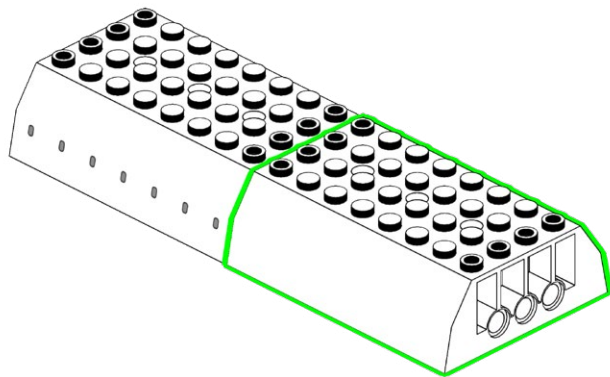

347

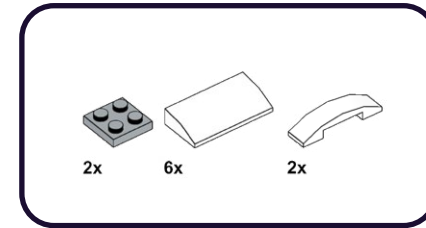

1

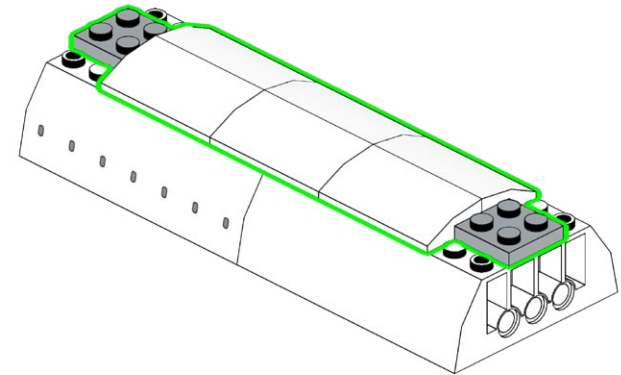

2

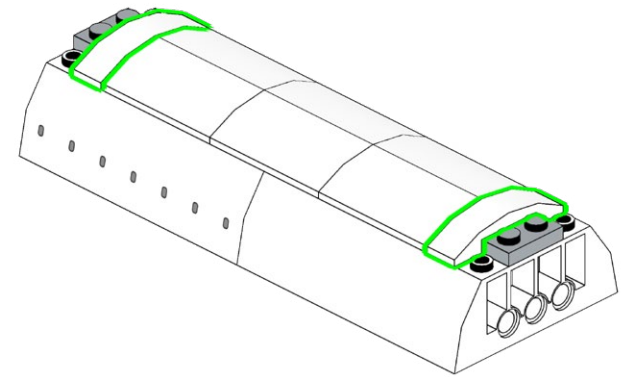

348

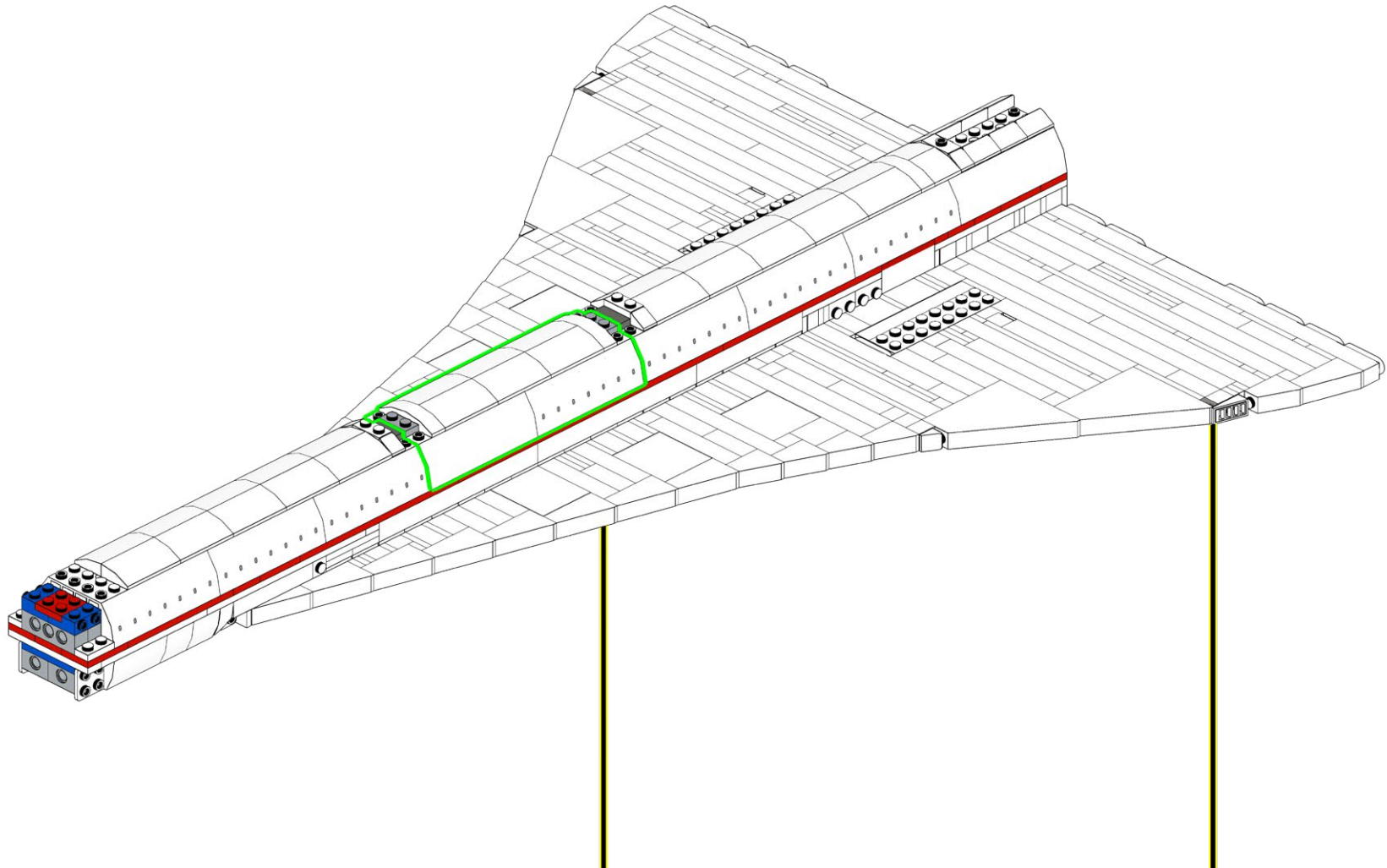

349

4x

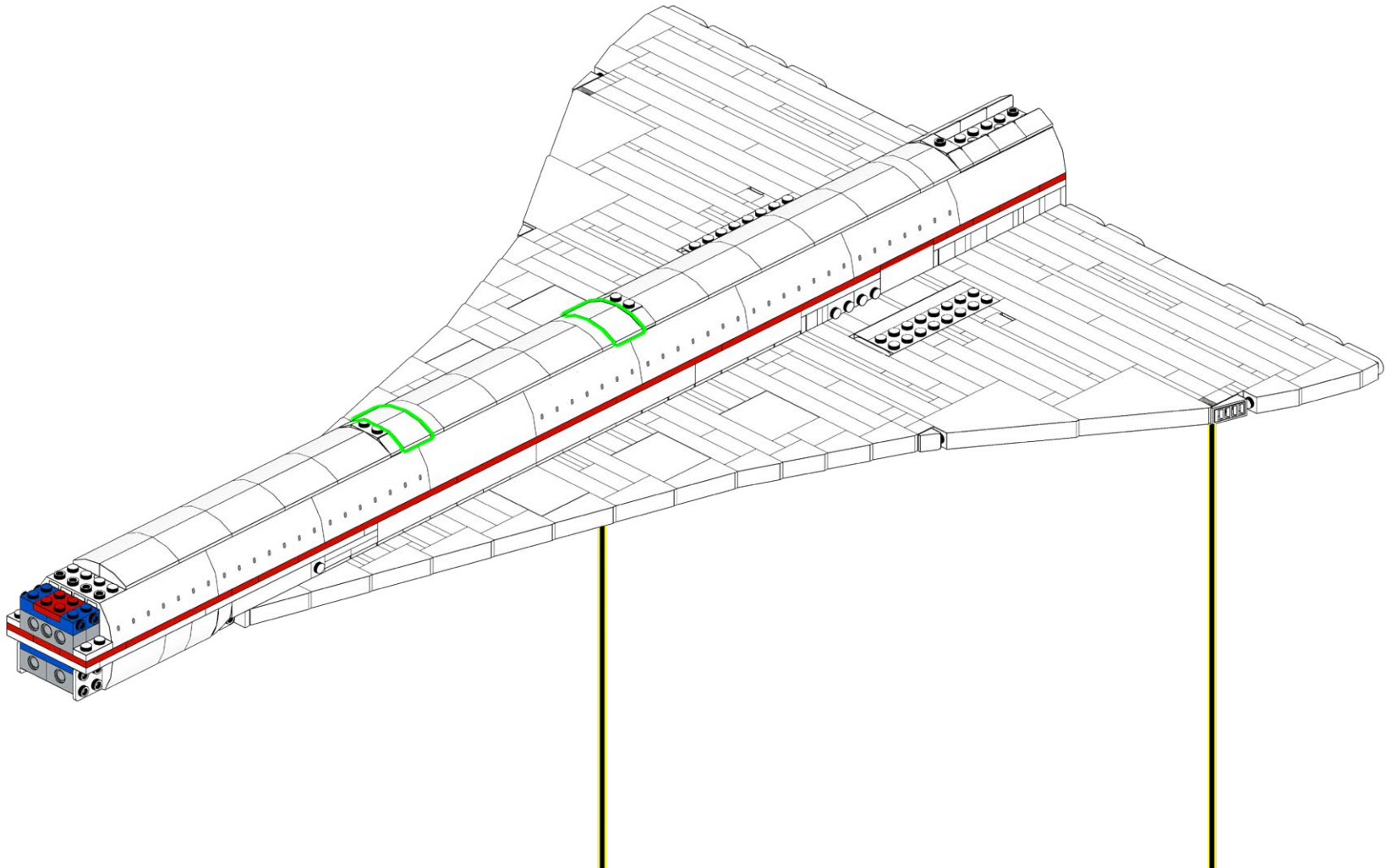

**HOLD UP!**

You might notice some bags aren't in order, as well as left over pieces, but that's ok! We're changing the way you build LEGO!

**ATTENDEZ!**

Vous remarquerez peut-être que certains sacs, ainsi que certaines pièces, ne sont pas dans le bon ordre. Mais pas de panique! Nous changeons simplement la façon avec laquelle vous construisez vos LEGO!

**ASPETTA!**

Potresti notare che alcuni sacchetti non sono in ordine, così come i pezzi avanzati, ma va bene così! Stiamo cambiando il modo in cui costruisci i LEGO!

**HALT!**

Sie werden möglicherweise bemerken, dass einige tüten durcheinander sind und teile übrig bleiben, aber das ist in Ordnung! Wir ändern die art und weise, wie Sie LEGO bauen!

**¡ESPERA!**

Es posible que notes que algunas bolsas están fuera de servicio, así como piezas sobrantes, ¡pero está bien! ¡Estamos cambiando la forma en que construyes LEGO!

**暫停!**

你可能会注意到一些袋子顺序错乱, 以及一些剩余的部件, 但没关系! 我们正在改变你搭建乐高的方式!

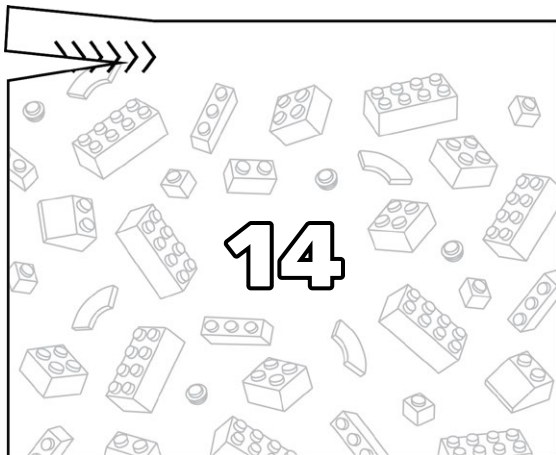
**Open LEGO® Bag 14**



# 350

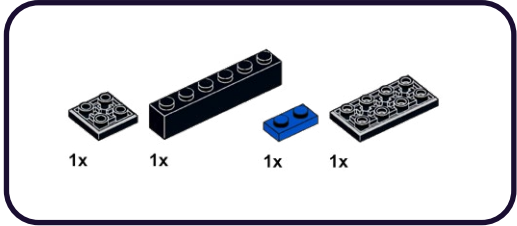

1



2

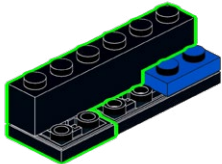

# 351

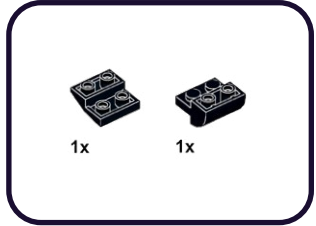

1

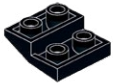

2

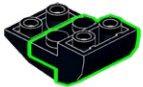

# 352

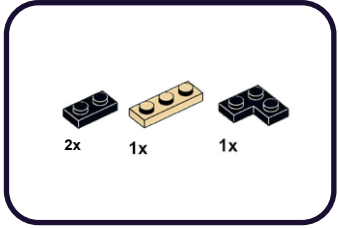

1

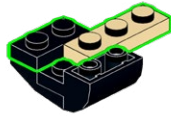

2

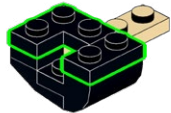

# 353

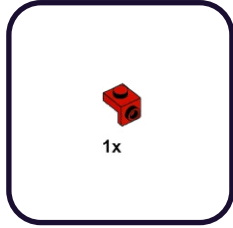

1

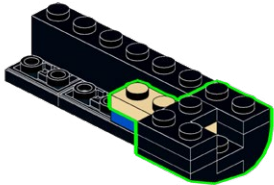

2

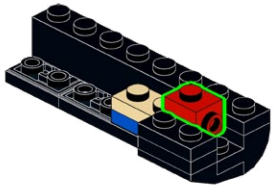

354

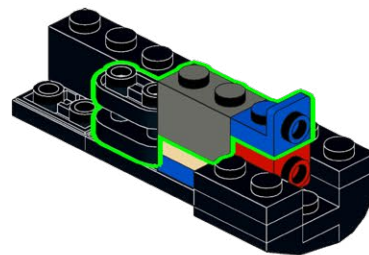

**355**

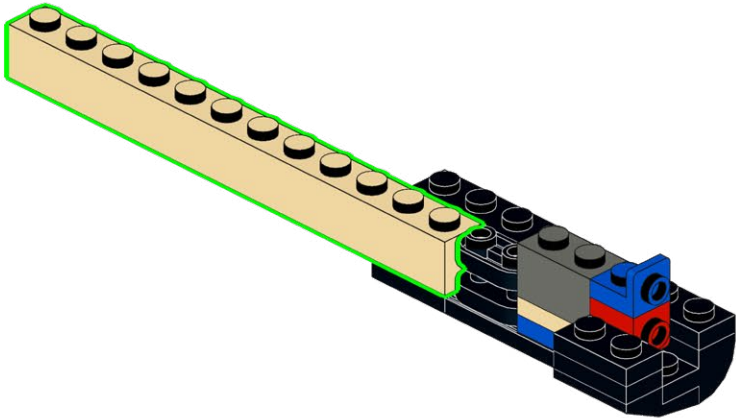
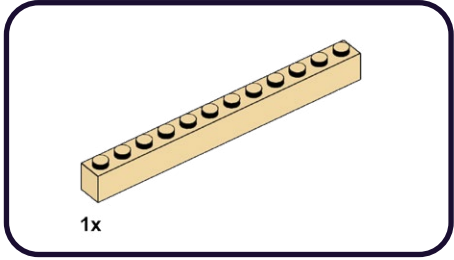

**356**

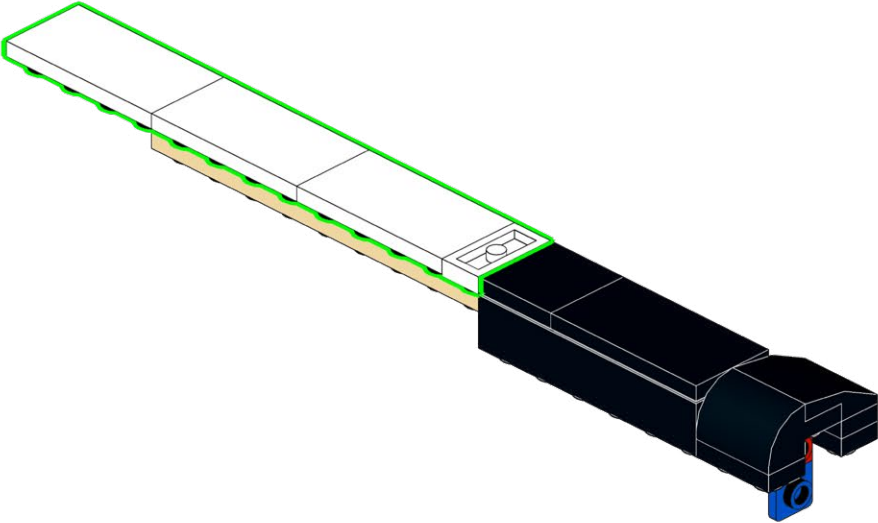
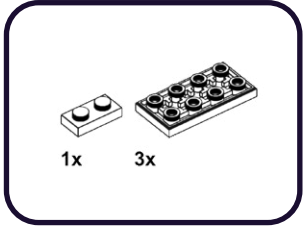

**357**

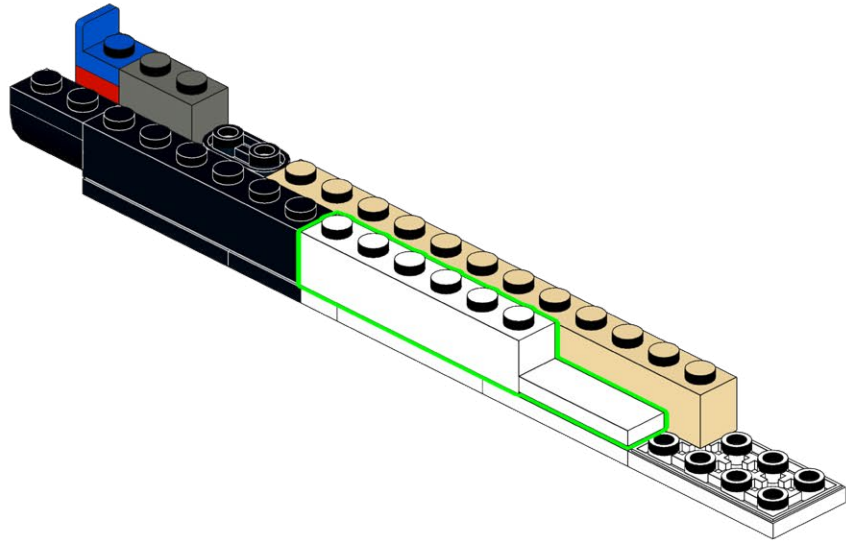
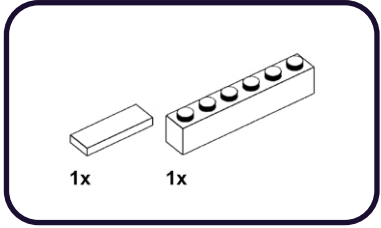

358

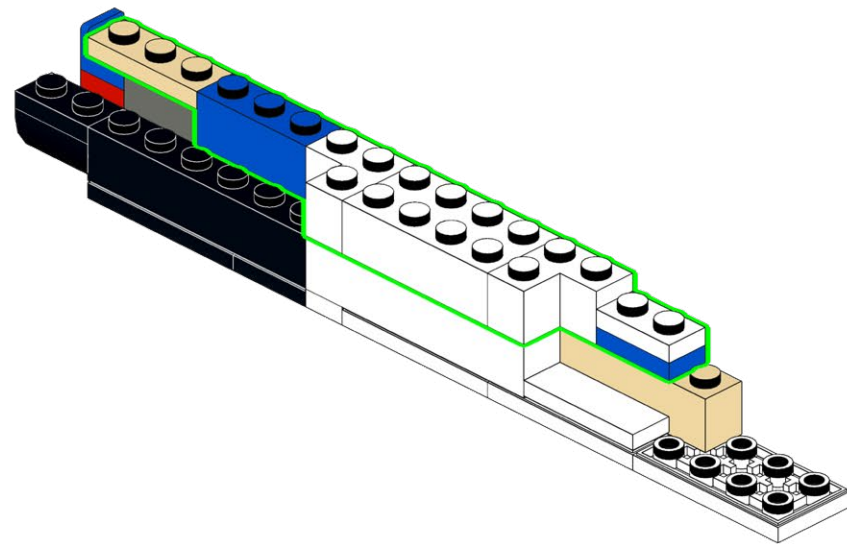
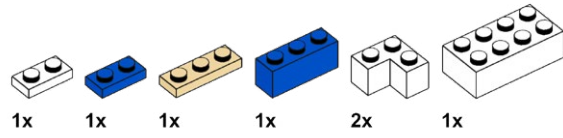

359

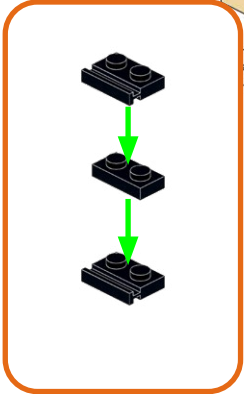
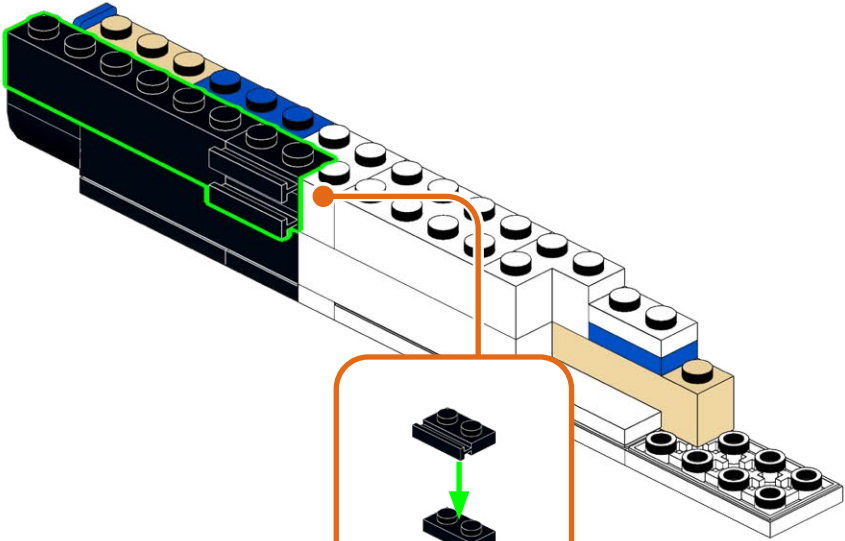
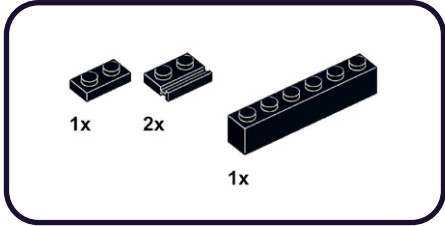



360

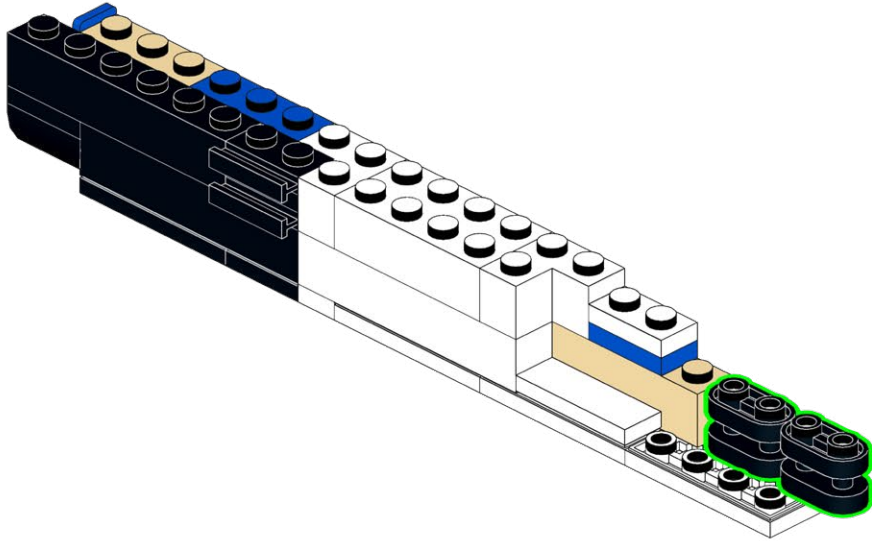

361

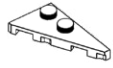

1x

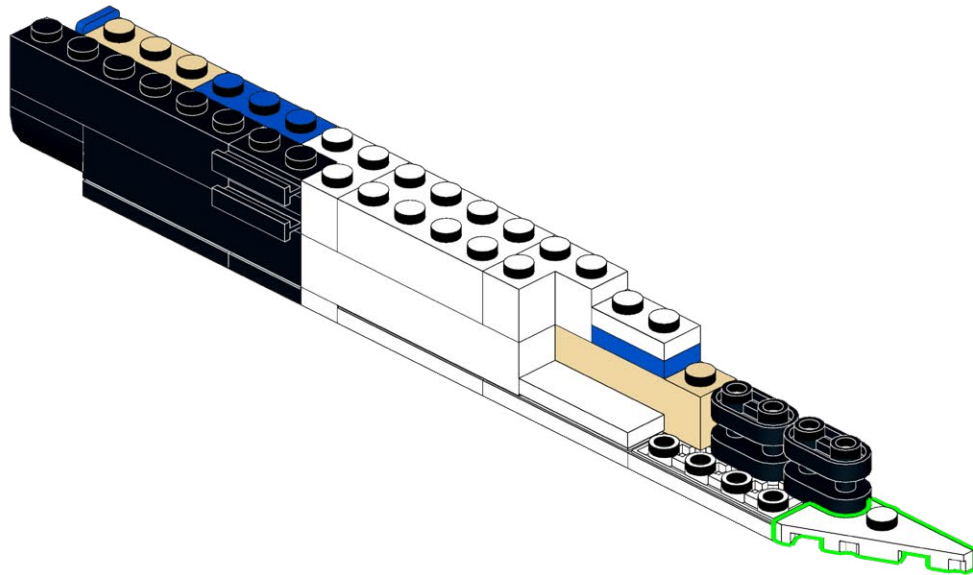

362

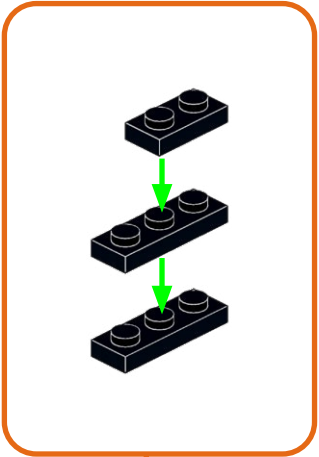
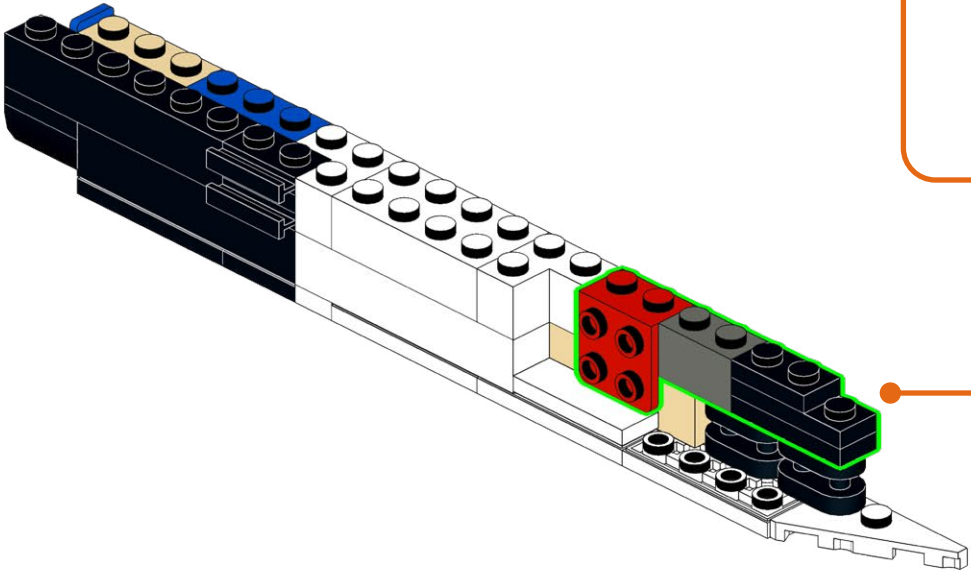
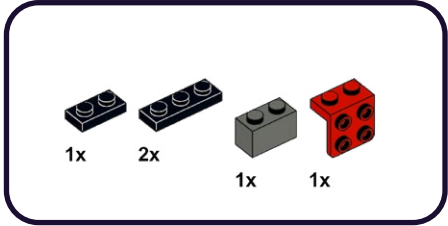

**363**

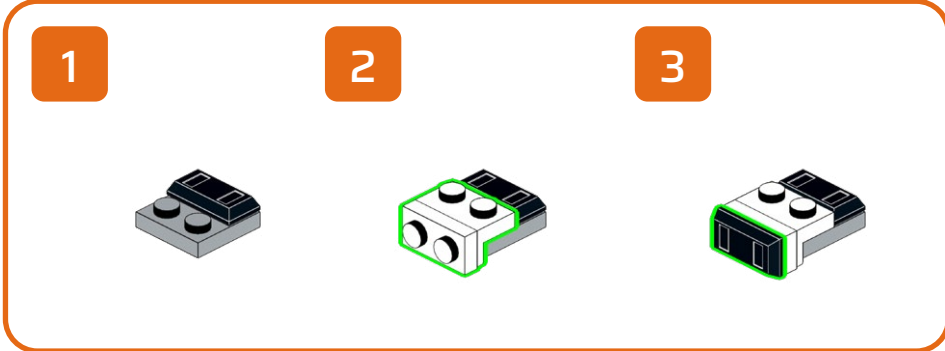
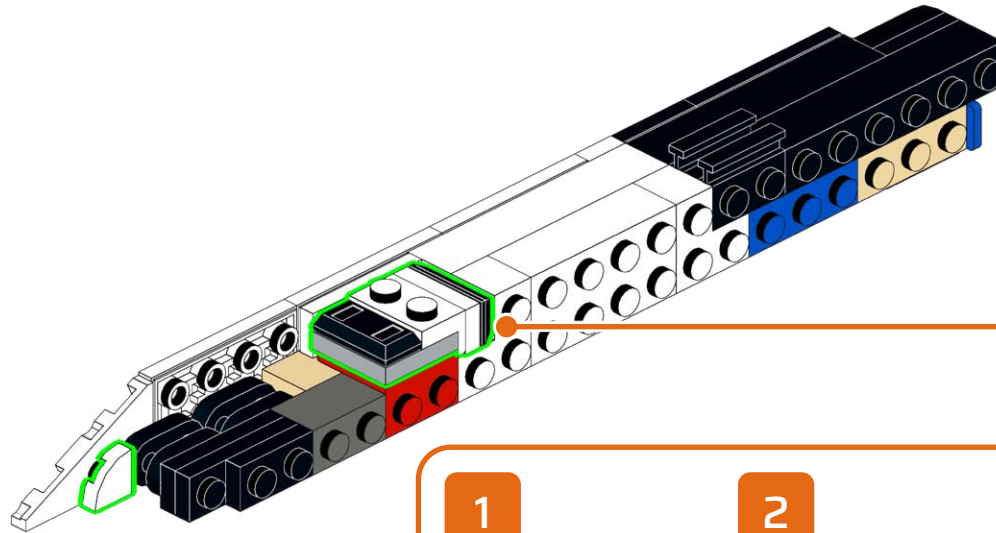
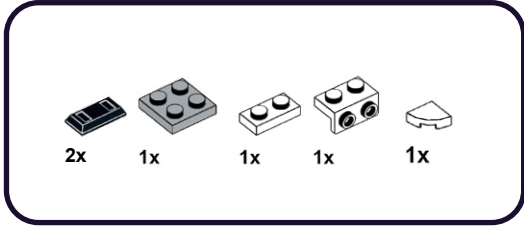

364

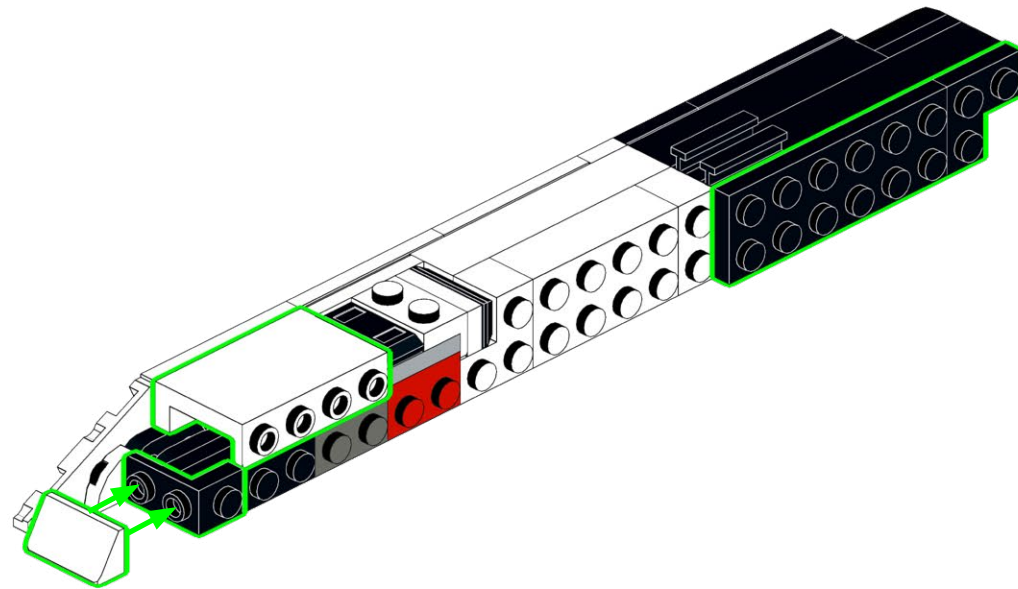
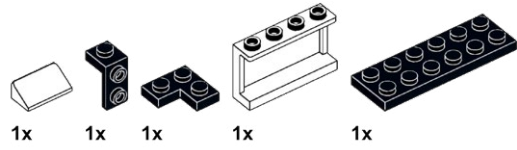

365

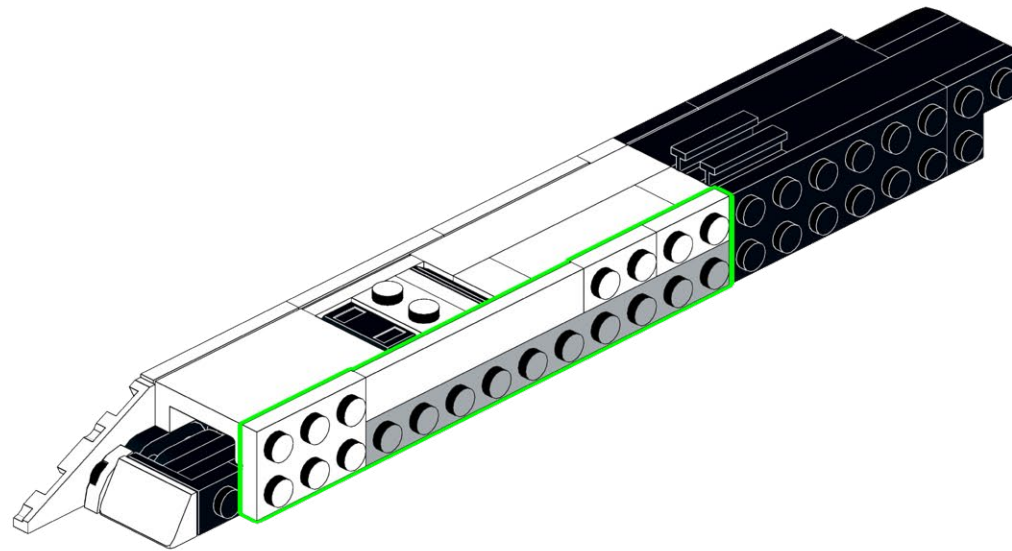
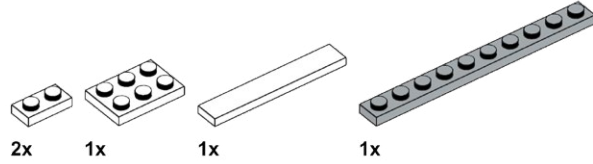

**HOLD UP!**

You might notice some bags aren't in order, as well as left over pieces, but that's ok! We're changing the way you build LEGO!

**ATTENDEZ!**

Vous remarquerez peut-être que certains sacs, ainsi que certaines pièces, ne sont pas dans le bon ordre. Mais pas de panique! Nous changeons simplement la façon avec laquelle vous construisez vos LEGO!

**ASPETTA!**

Potresti notare che alcuni sacchetti non sono in ordine, così come i pezzi avanzati, ma va bene così! Stiamo cambiando il modo in cui costruisci i LEGO!

**HALT!**

Sie werden möglicherweise bemerken, dass einige tüten durcheinander sind und teile übrig bleiben, aber das ist in Ordnung! Wir ändern die art und weise, wie Sie LEGO bauen!

**¡ESPERA!**

Es posible que notes que algunas bolsas están fuera de servicio, así como piezas sobrantes, ¡pero está bien! ¡Estamos cambiando la forma en que construyes LEGO!

**暫停!**

你可能会注意到一些袋子顺序错乱, 以及一些剩余的部件, 但没关系! 我们正在改变你搭建乐高的方式!

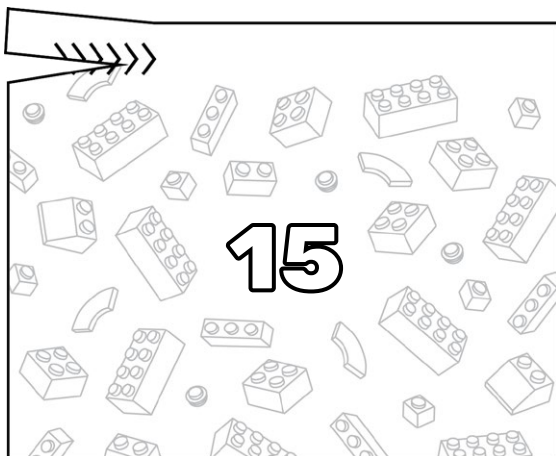
**Open LEGO® Bag 15**

366

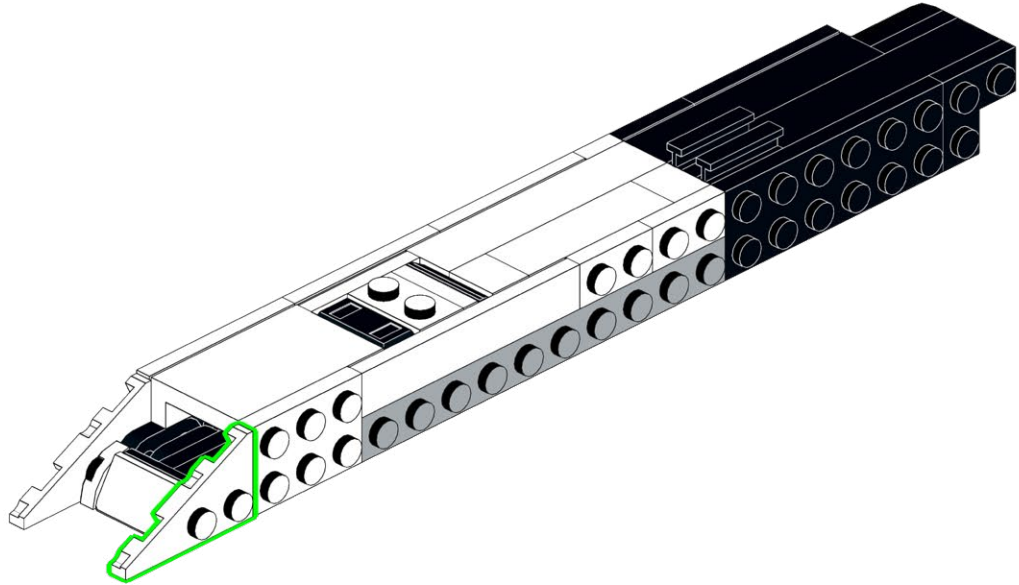
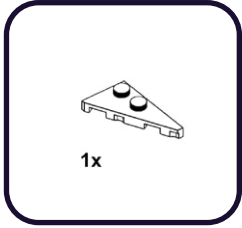



367

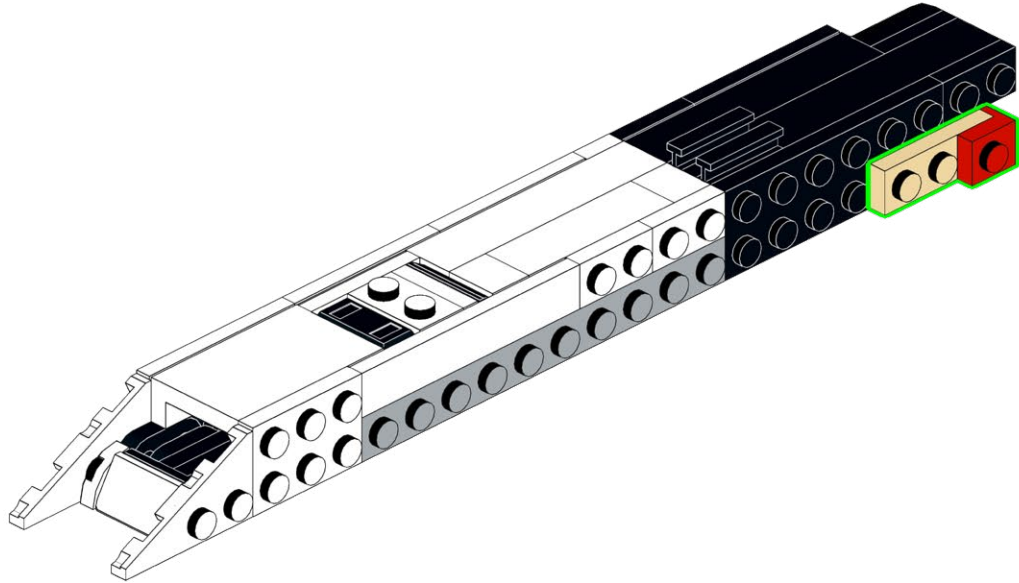
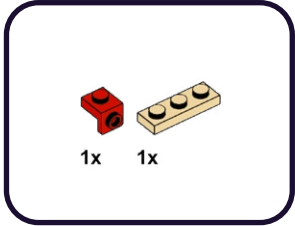

368

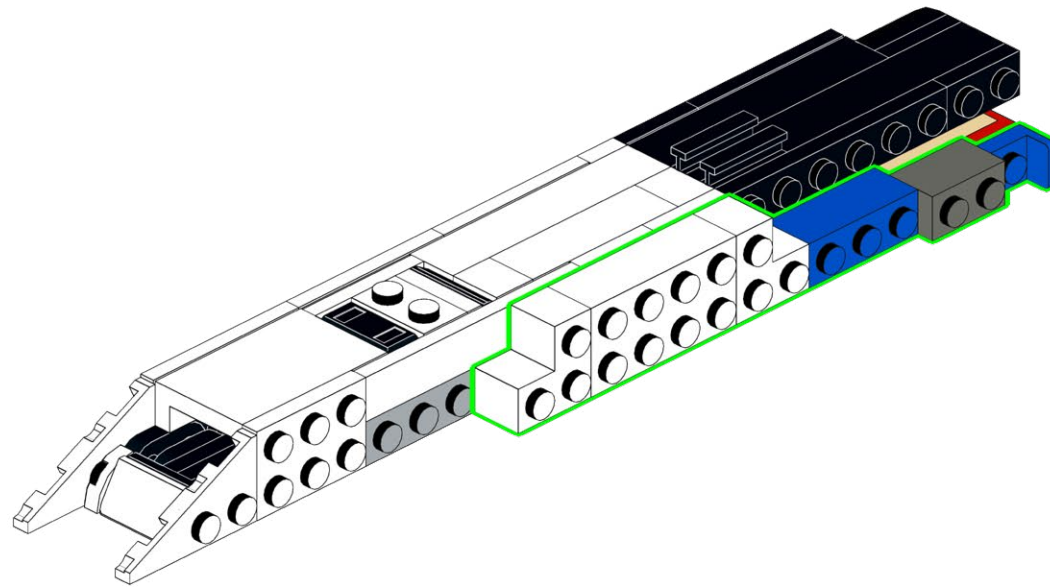
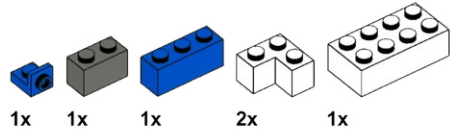

369

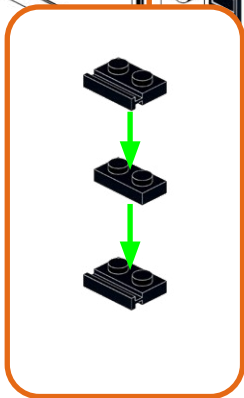
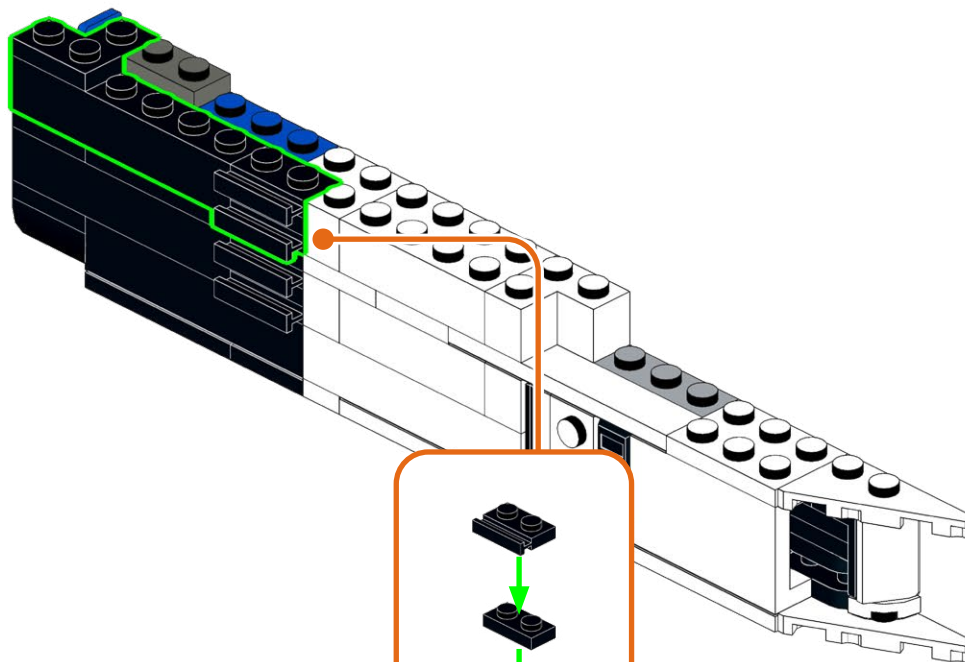
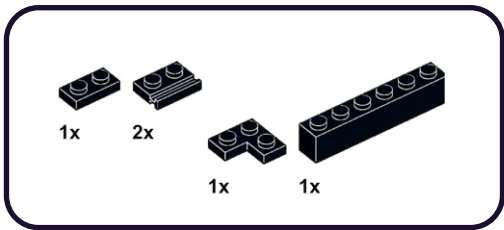

**370**

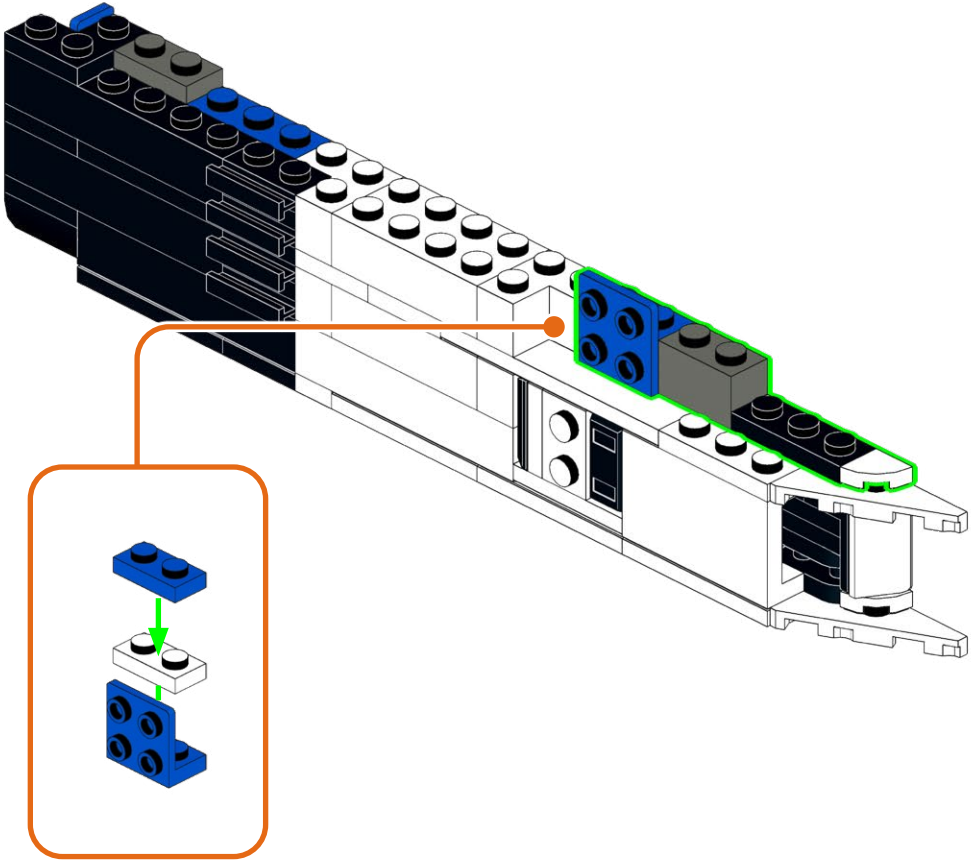
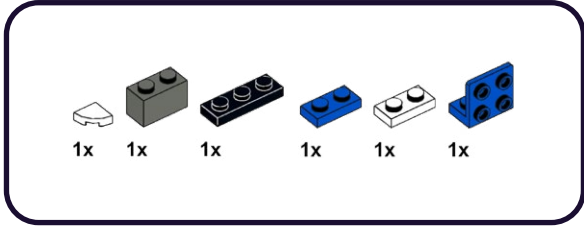

371

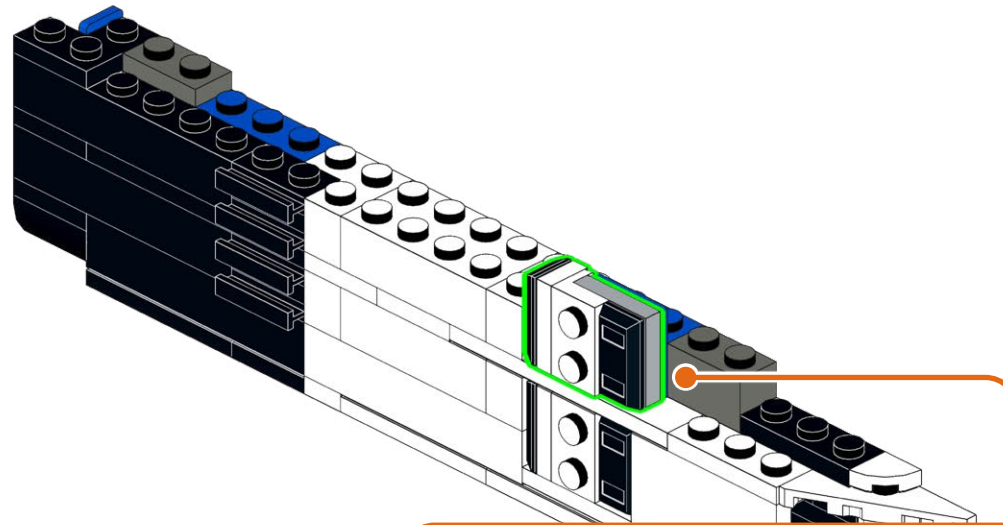
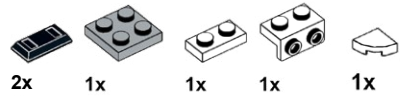

1

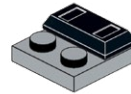

2

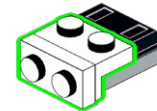

3

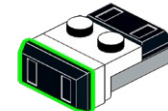

**372**

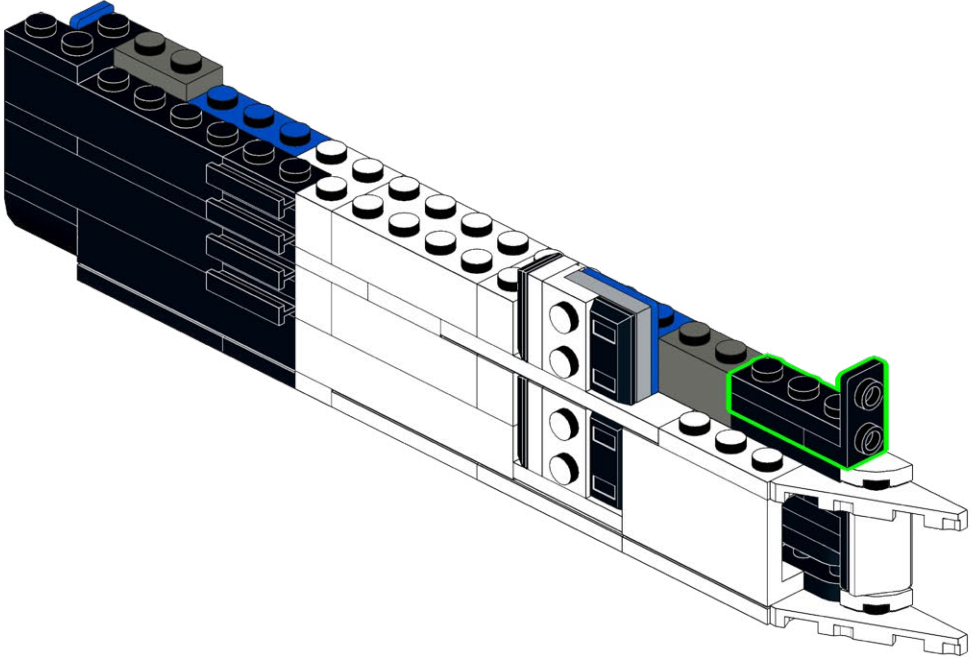
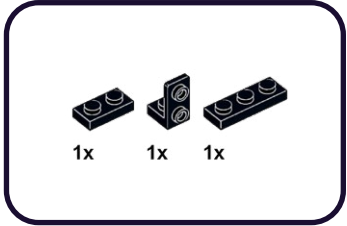

**373**

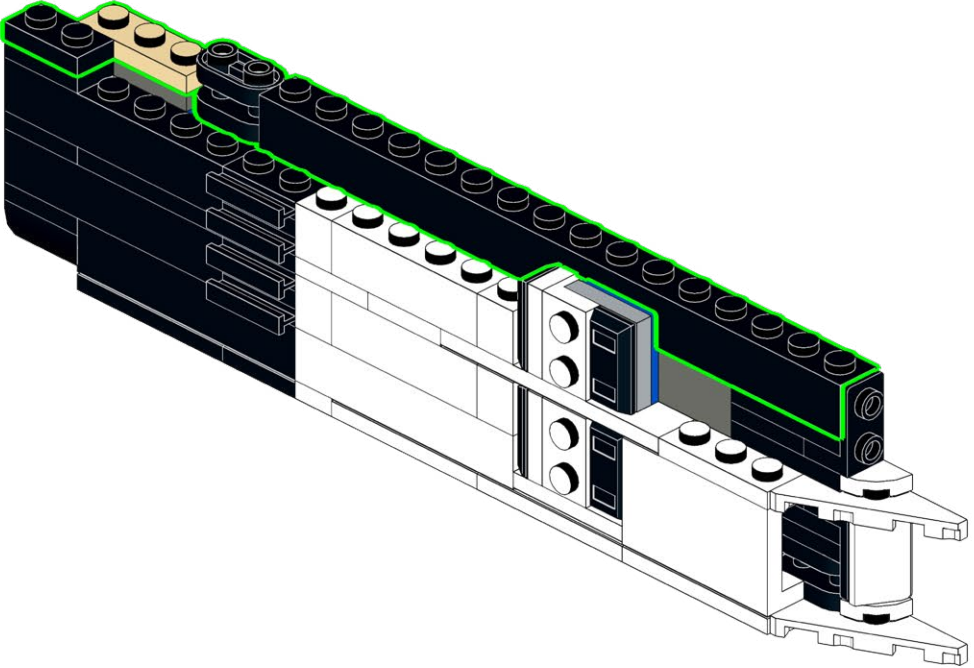
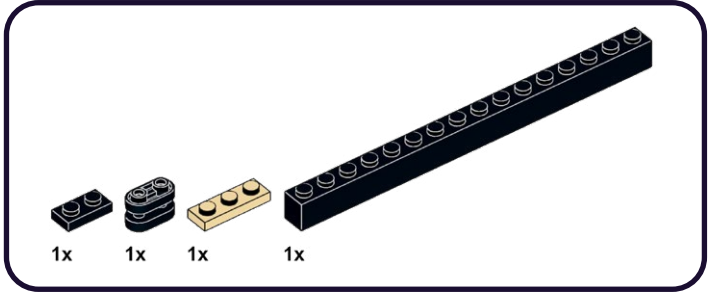

**374**

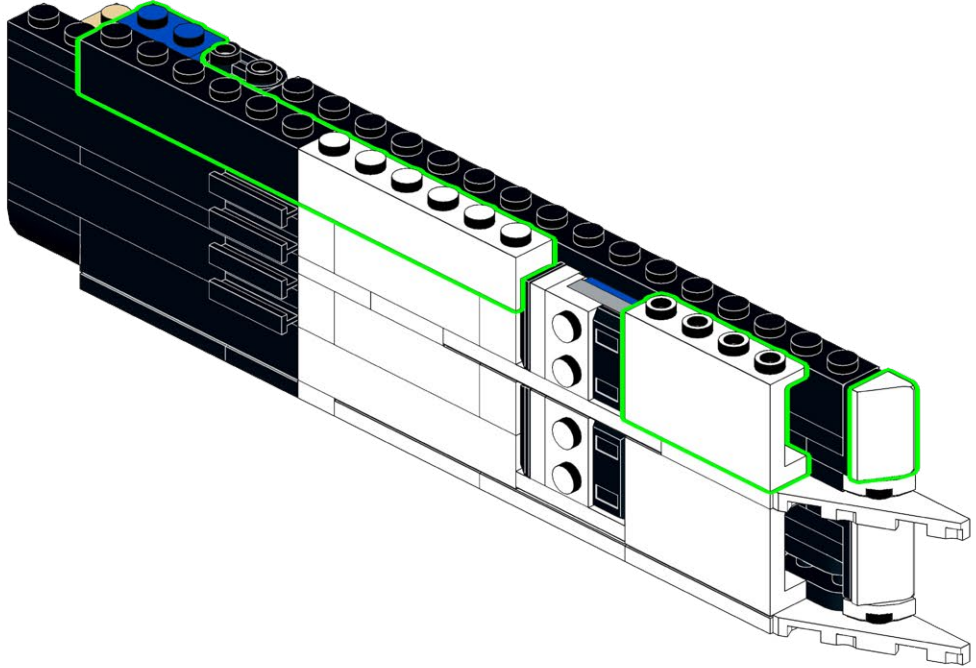
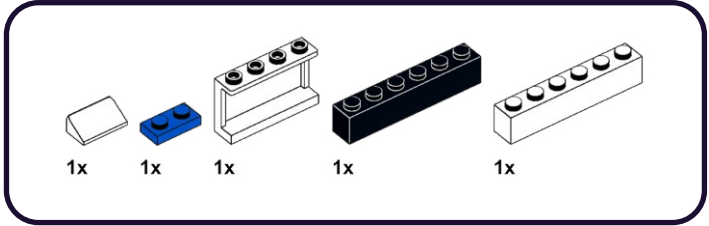



**375**

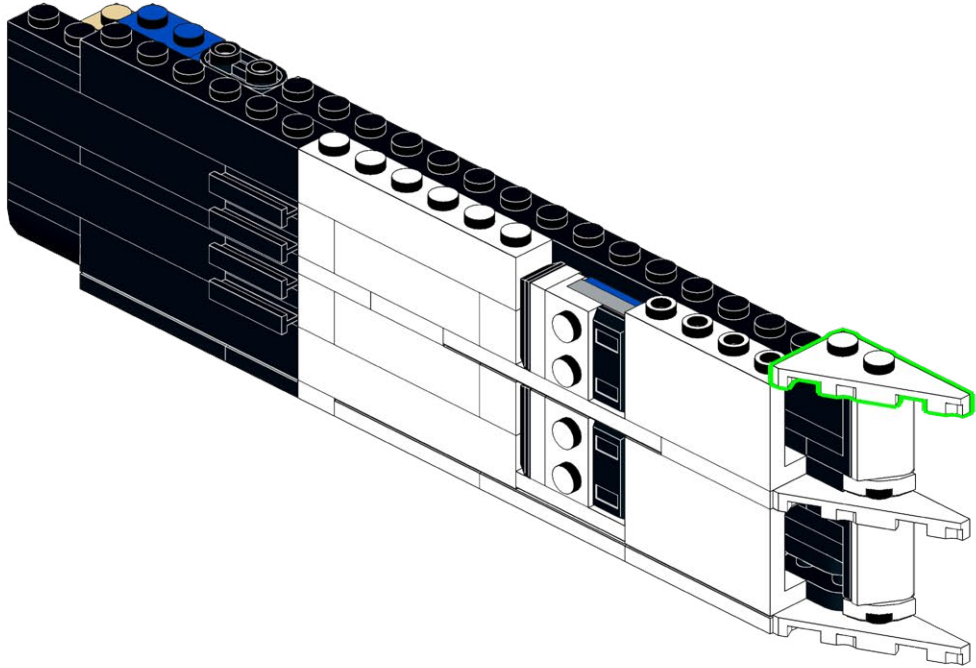
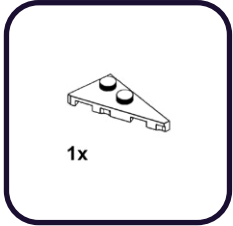

**376**

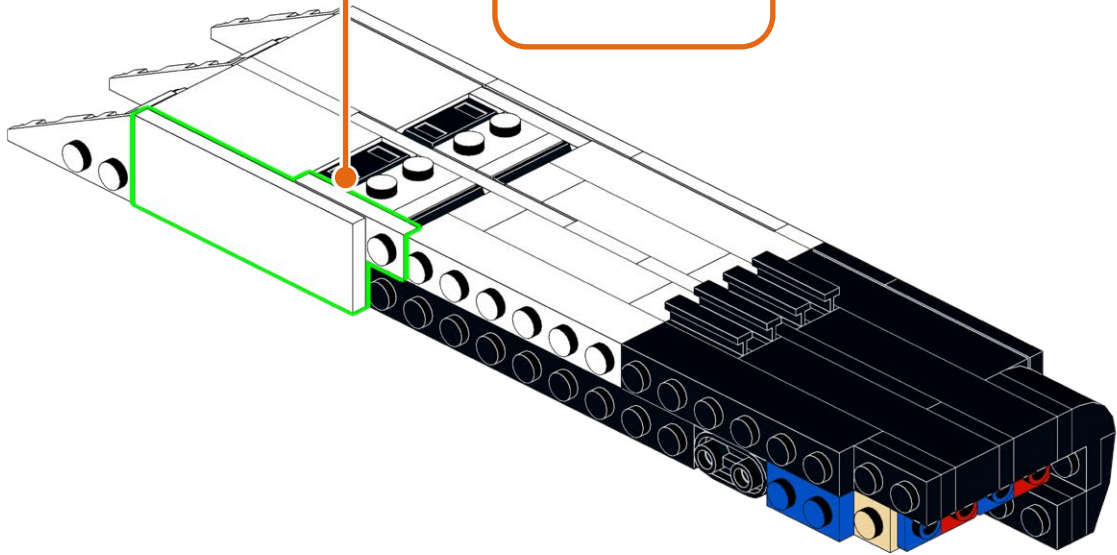
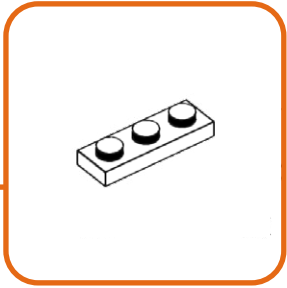
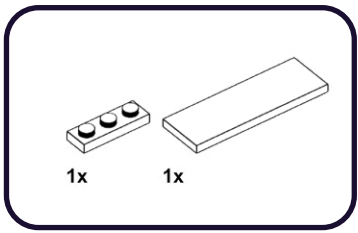

**377**

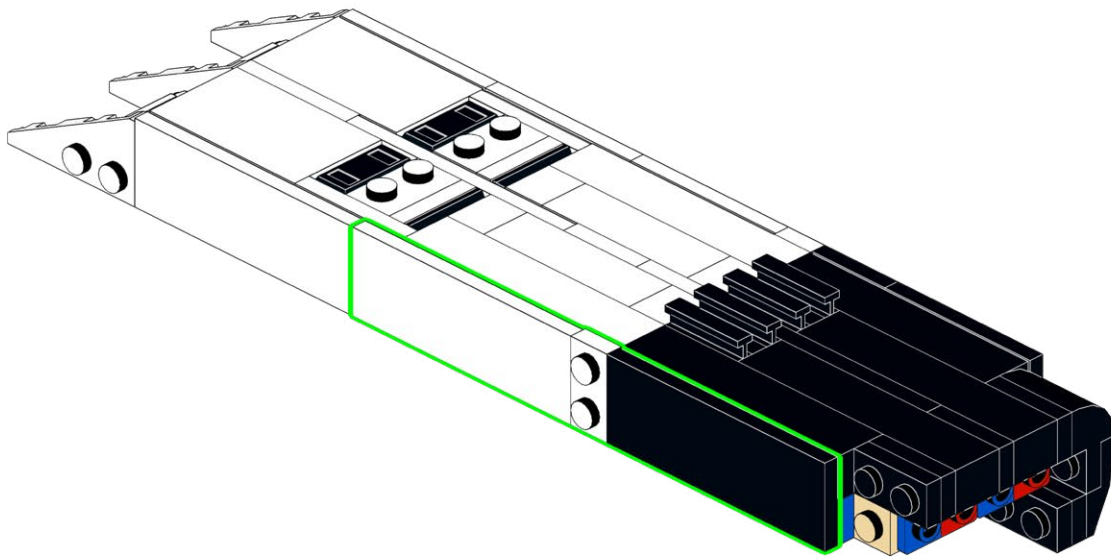
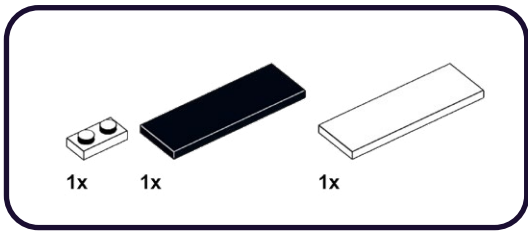

**378**

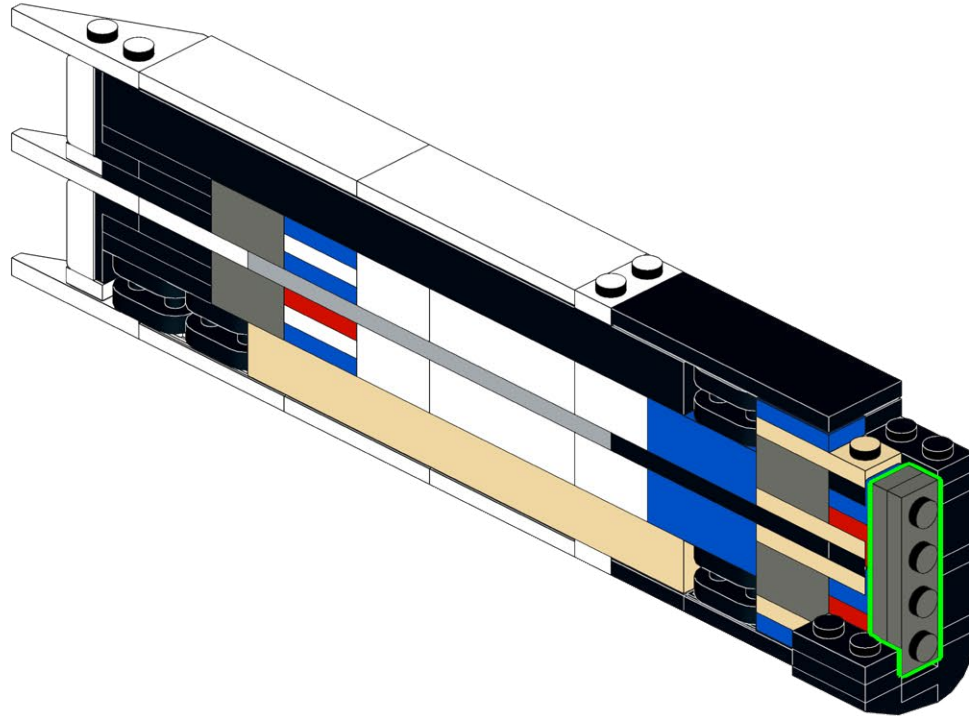
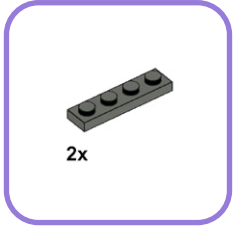

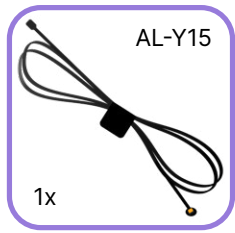

1

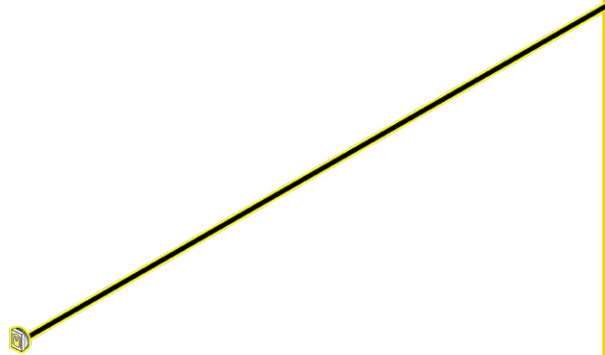

1

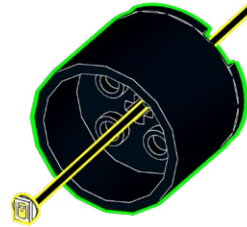

2x

381

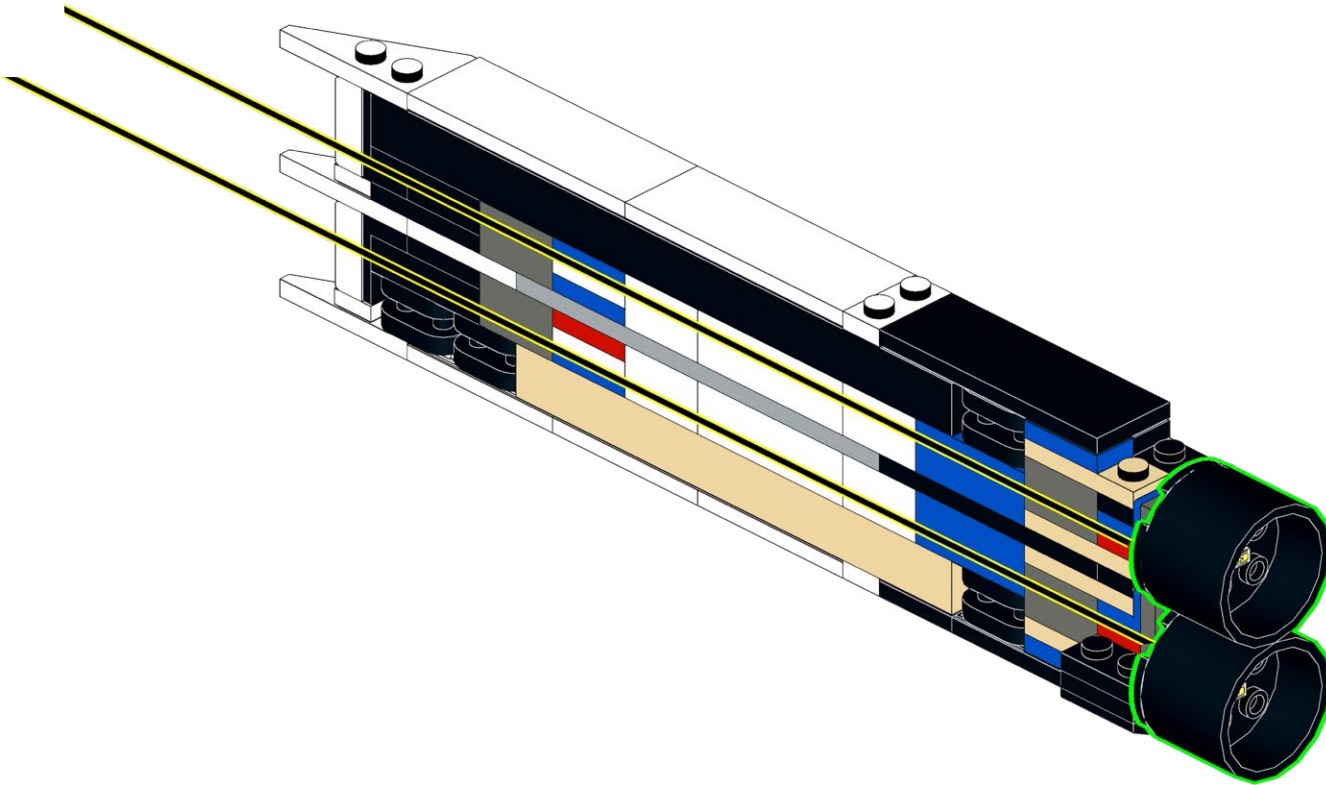

**382**

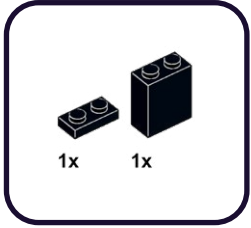

1

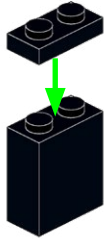

**383**



1



384

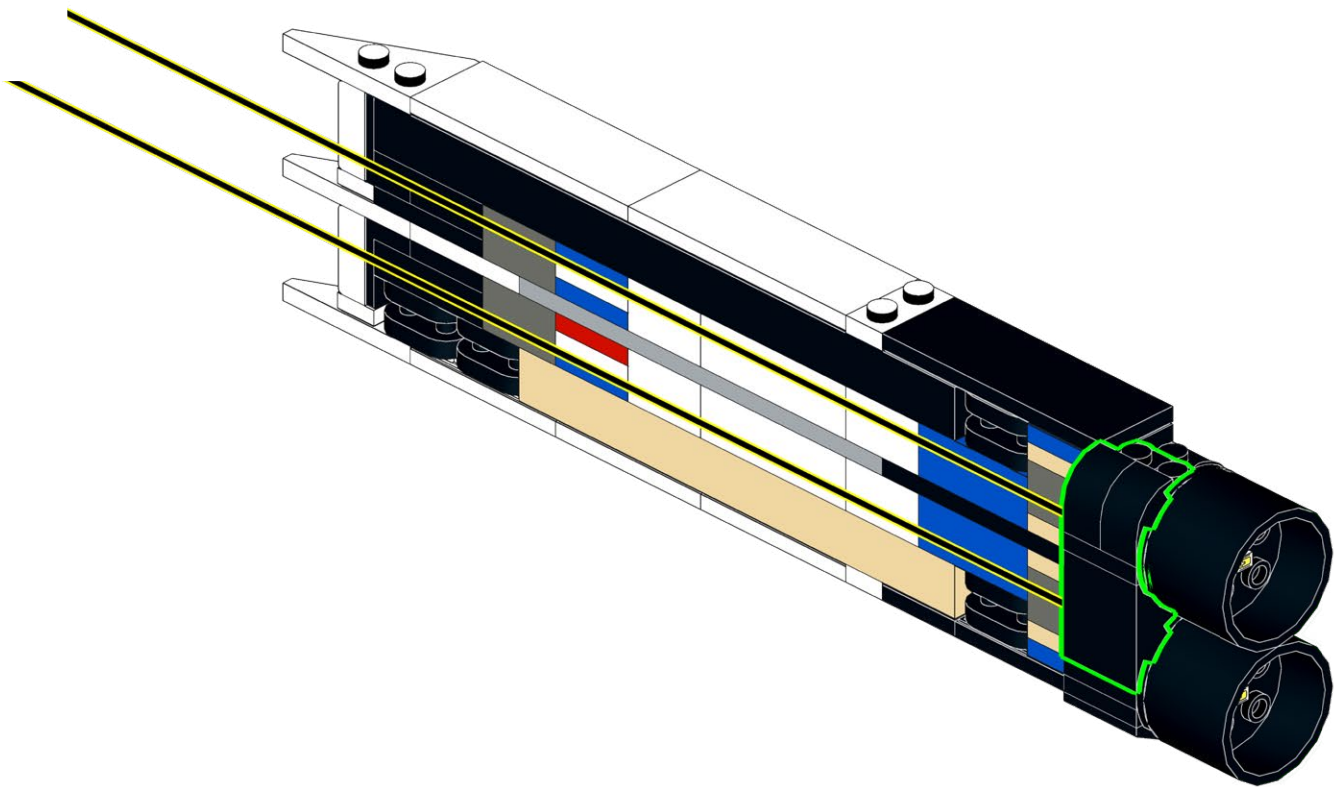
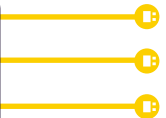



**385**

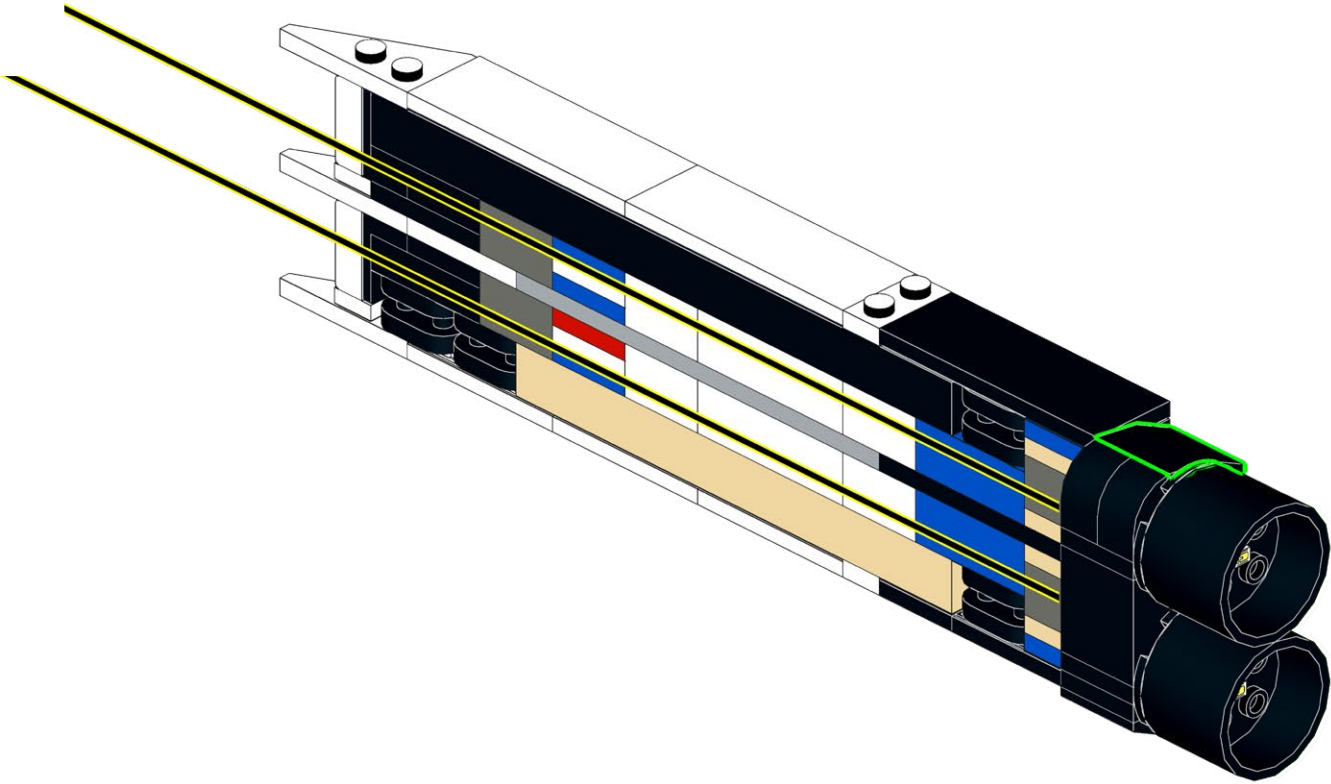
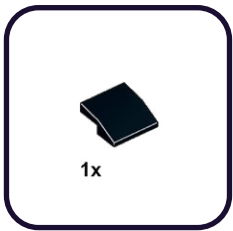

**386**

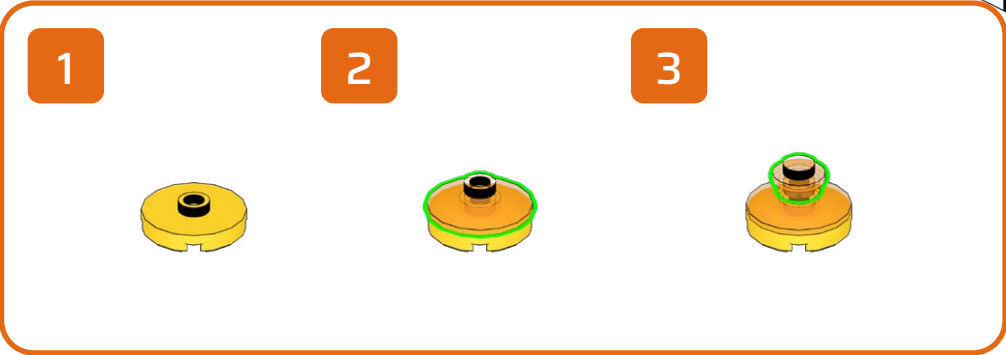
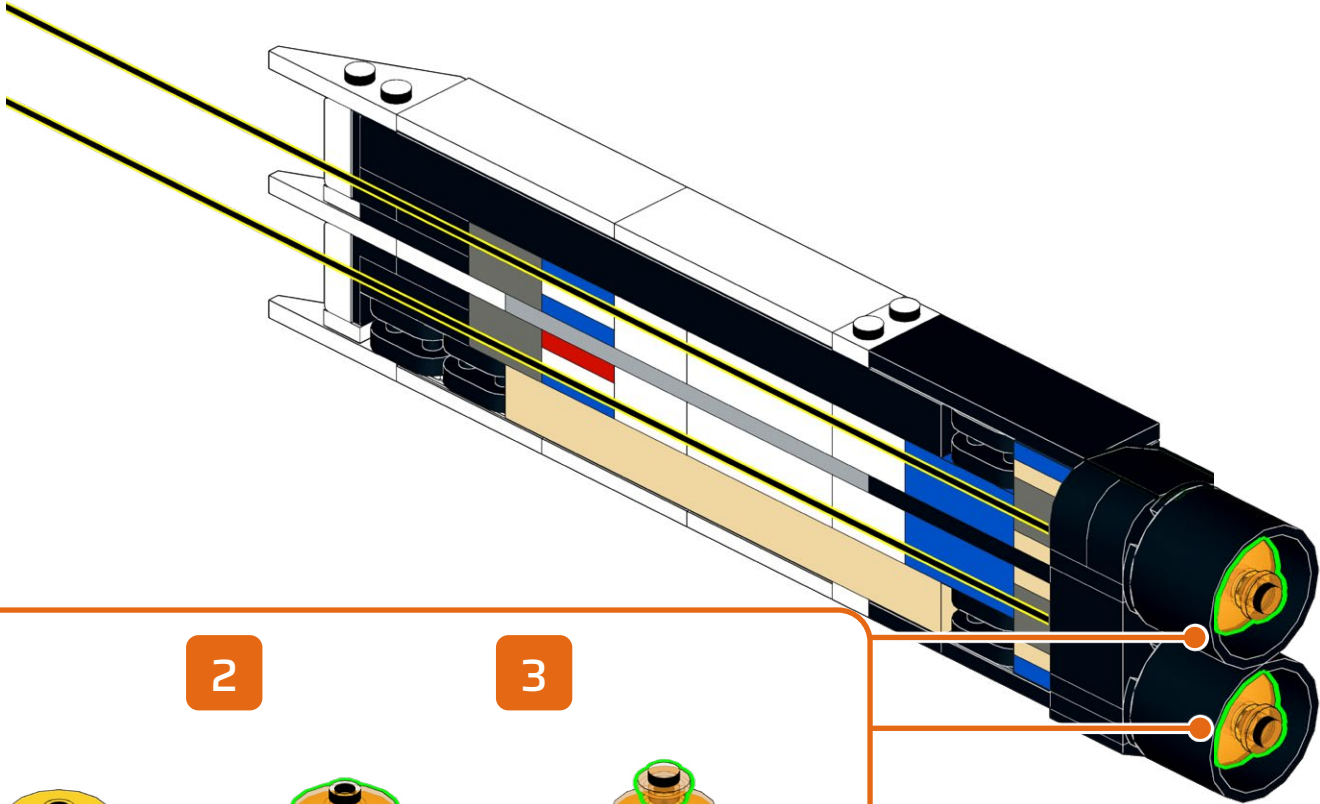
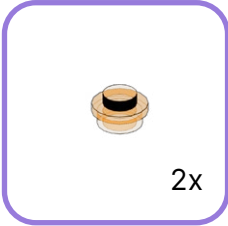
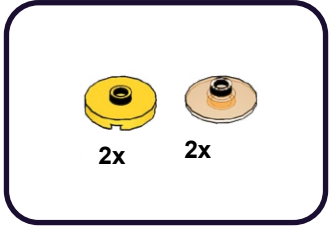

387

To be used later  
A utilizar plus tard  
Da utilizzare dopo  
Zur späteren Verwendung  
Para ser utilizado más tarde  
稍后使用

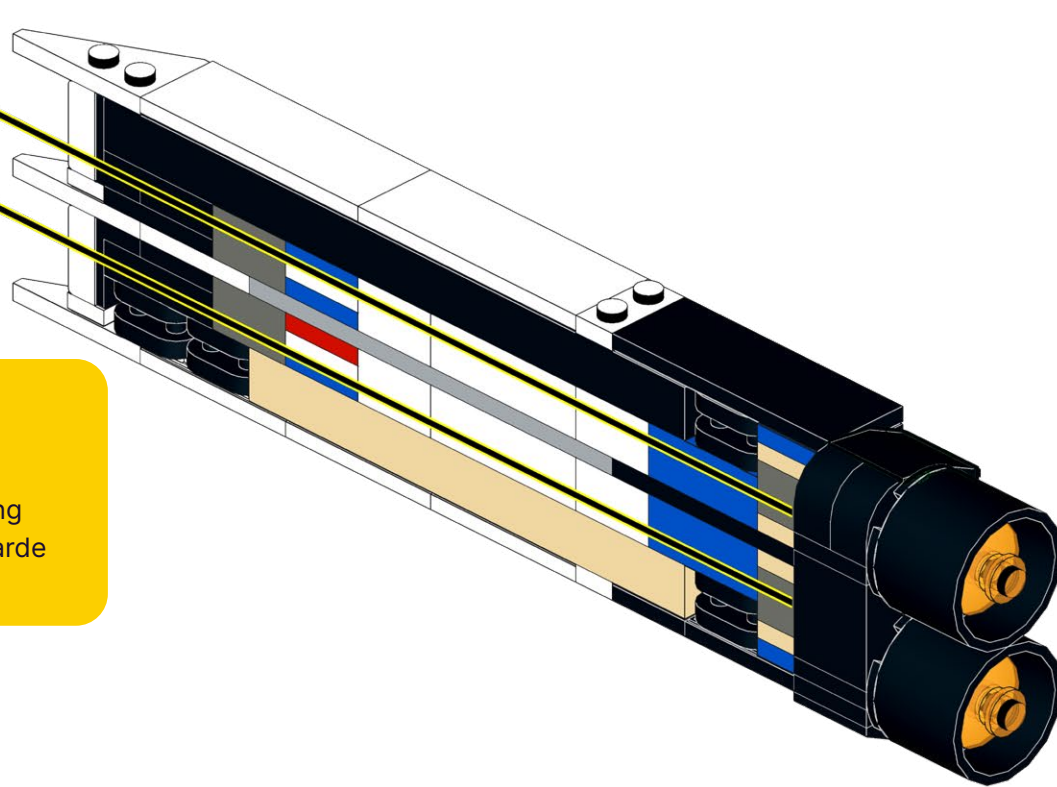
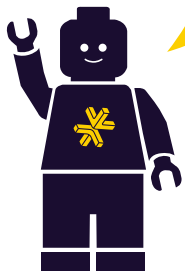

388

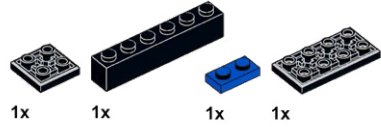

1



2

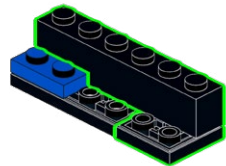

389

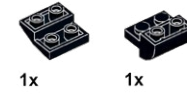

1

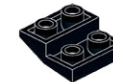

2

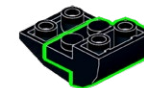

# 390

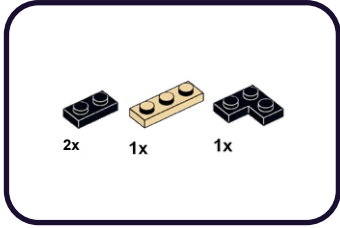

1

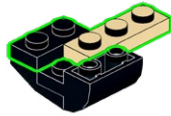

2

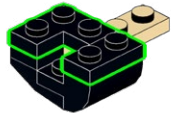

# 391

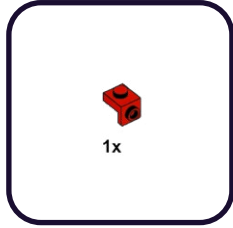

1

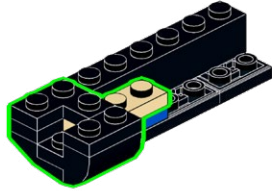

2

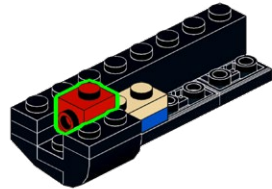

392

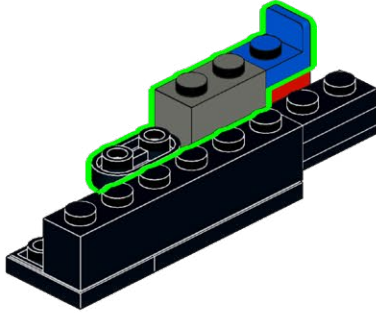
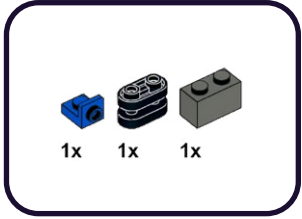

**393**

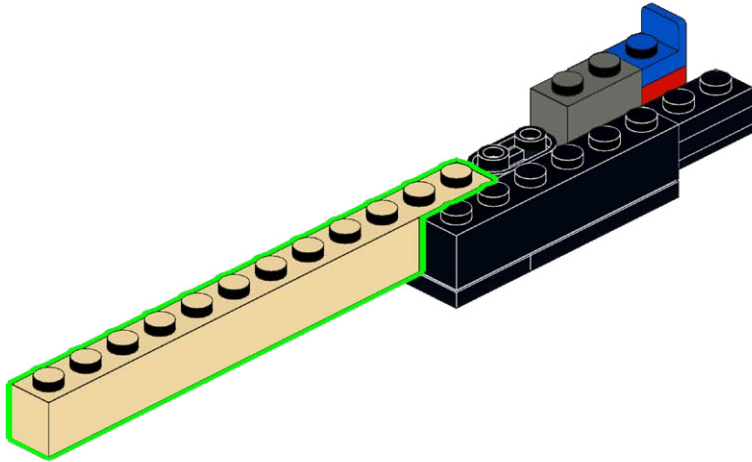
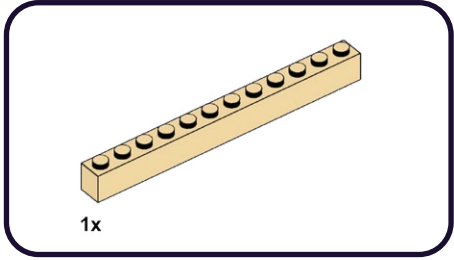

394

1x

3x

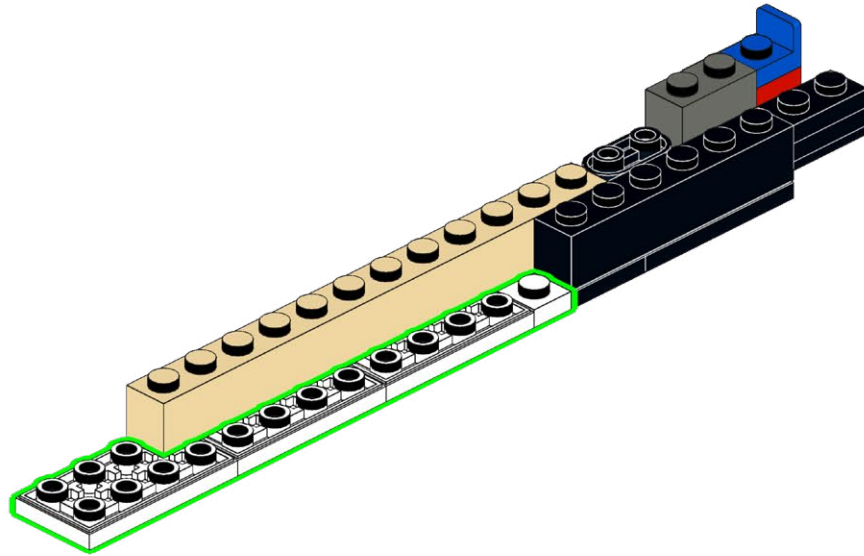
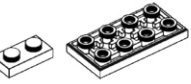



**395**

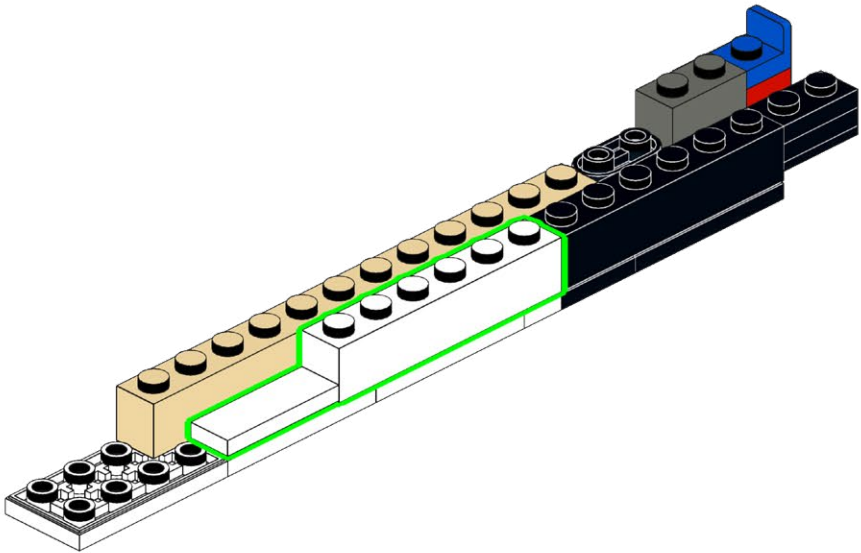
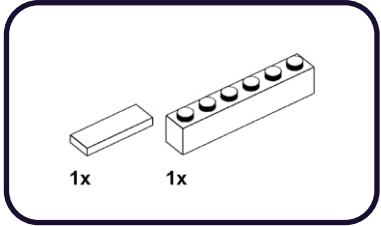

396

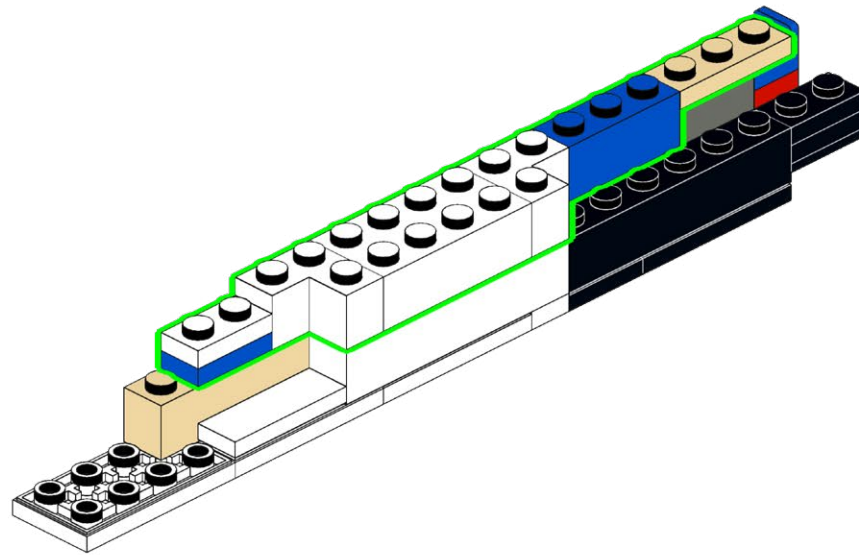
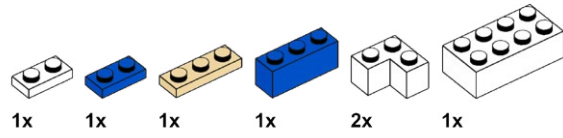

**397**

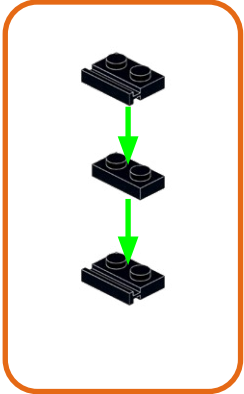
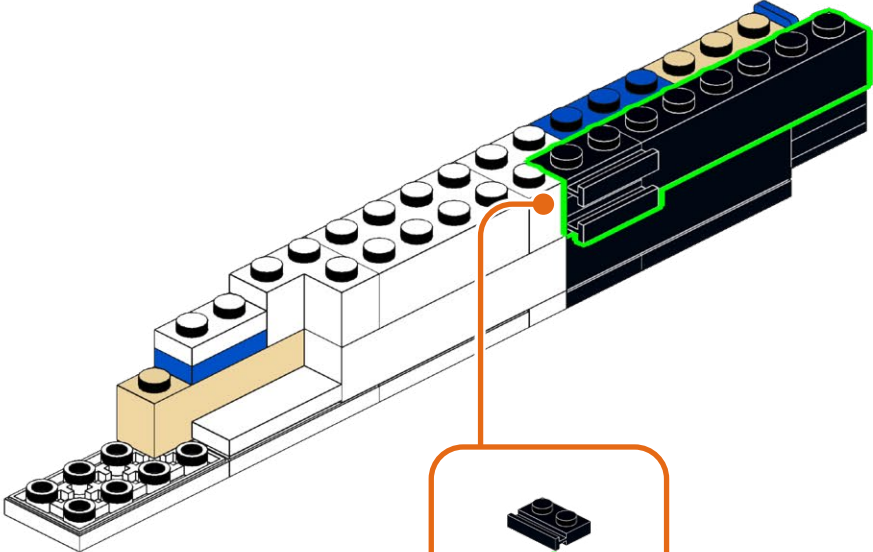
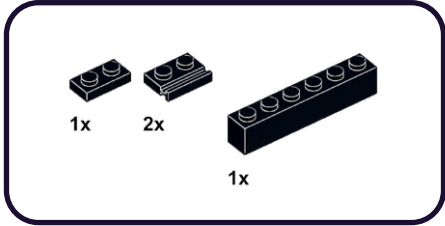

398

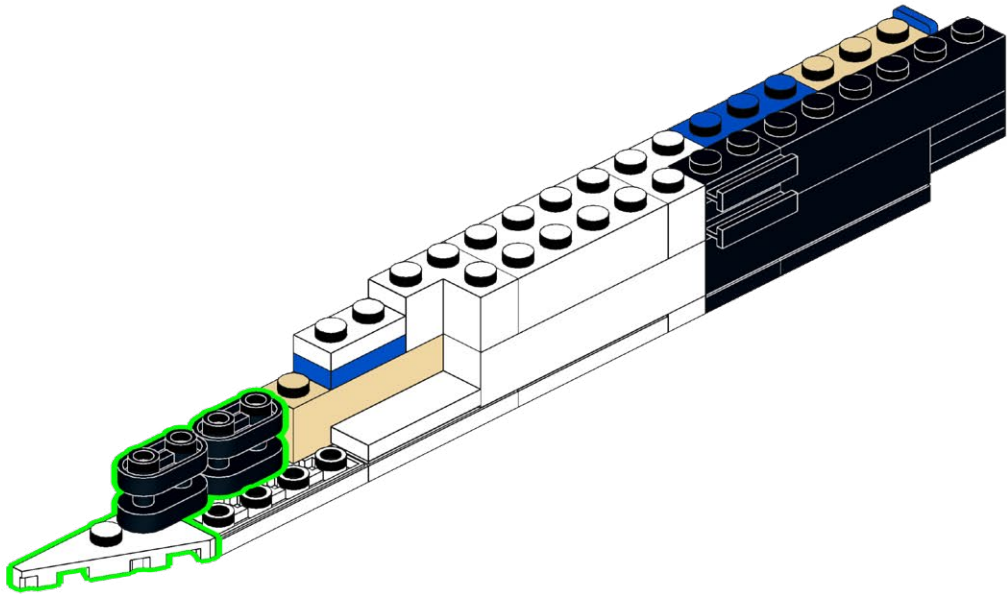
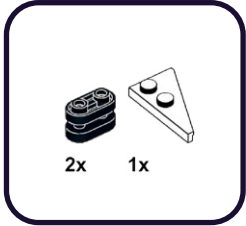

399

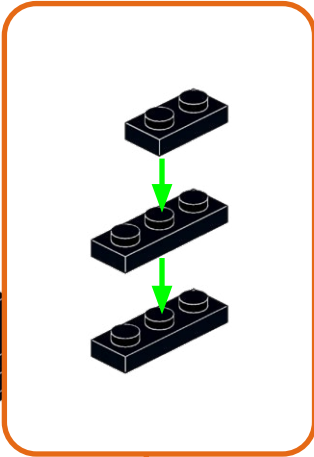
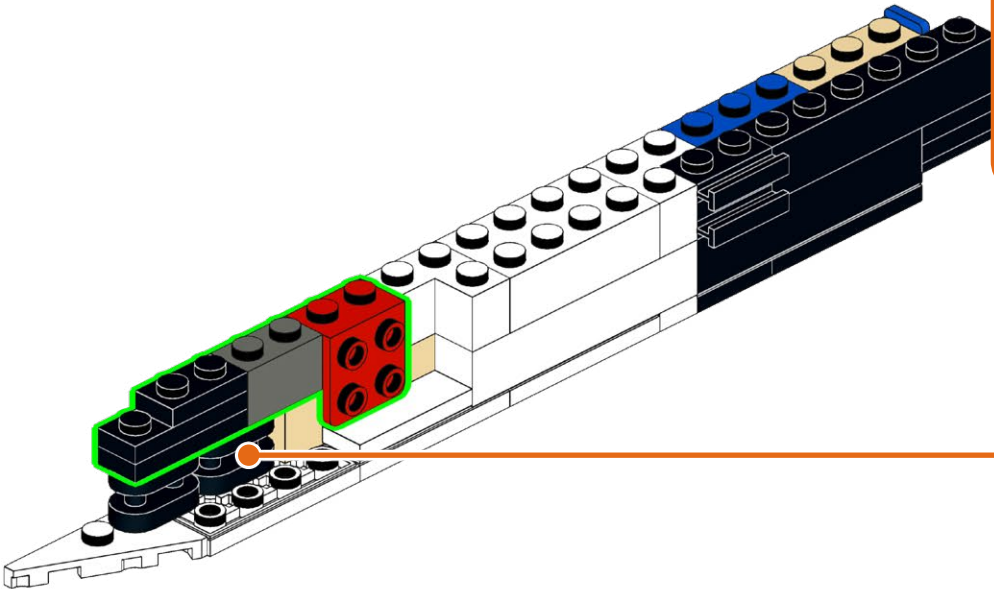
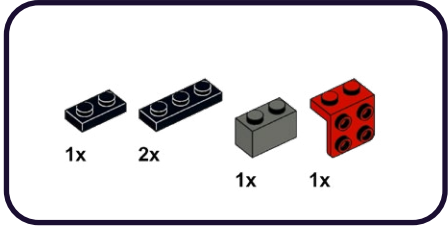

400

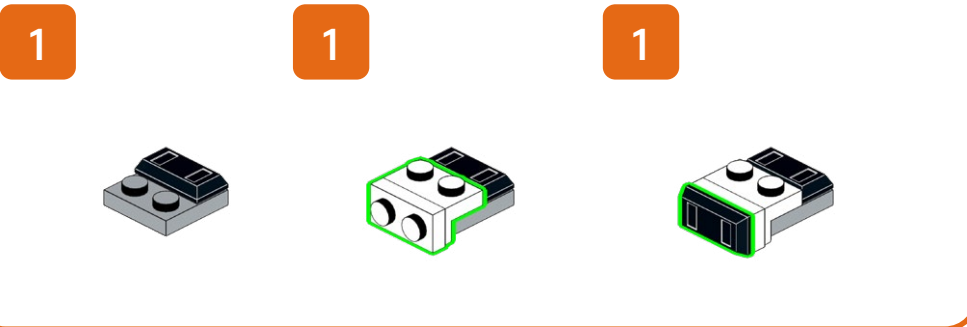
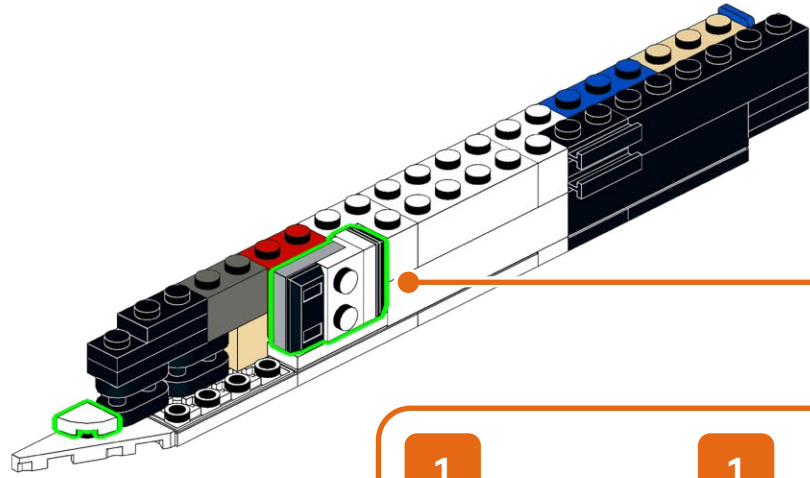
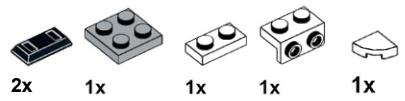

401

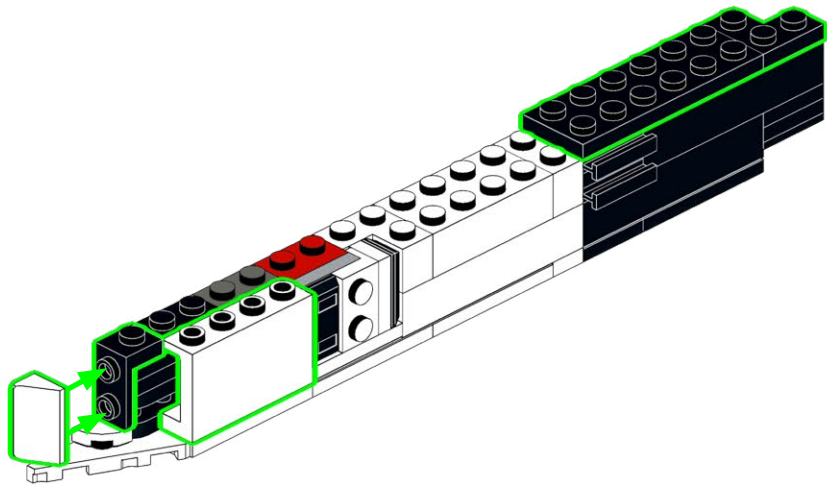
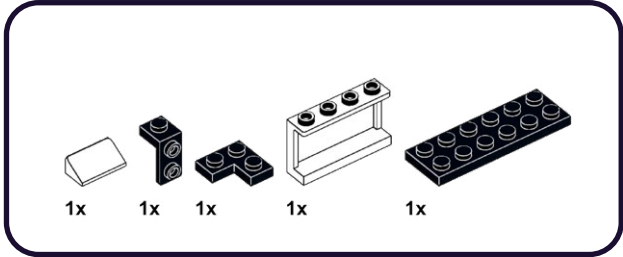

402

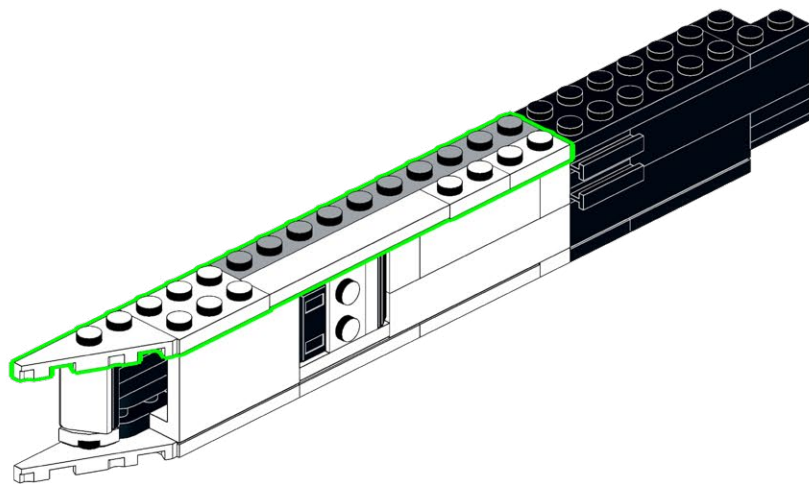
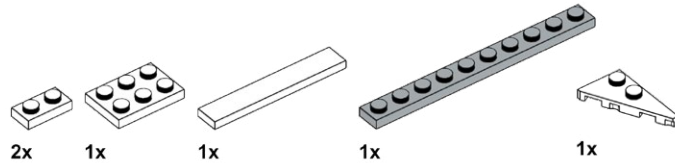



403

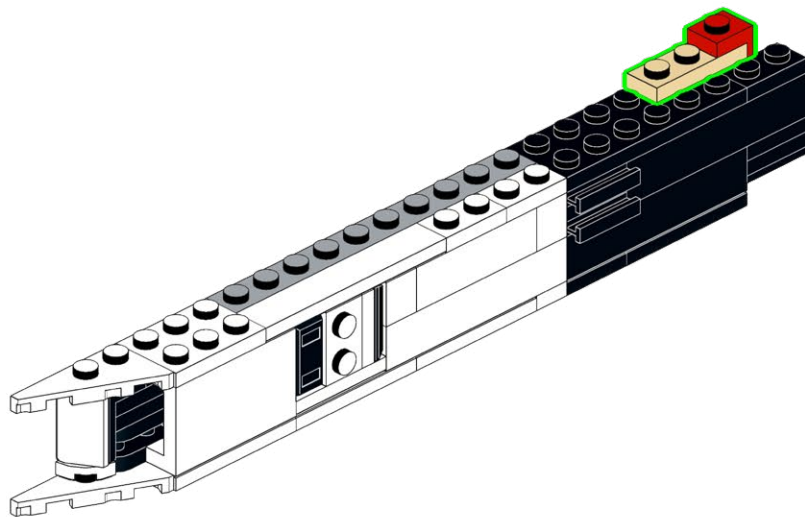
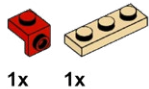

404

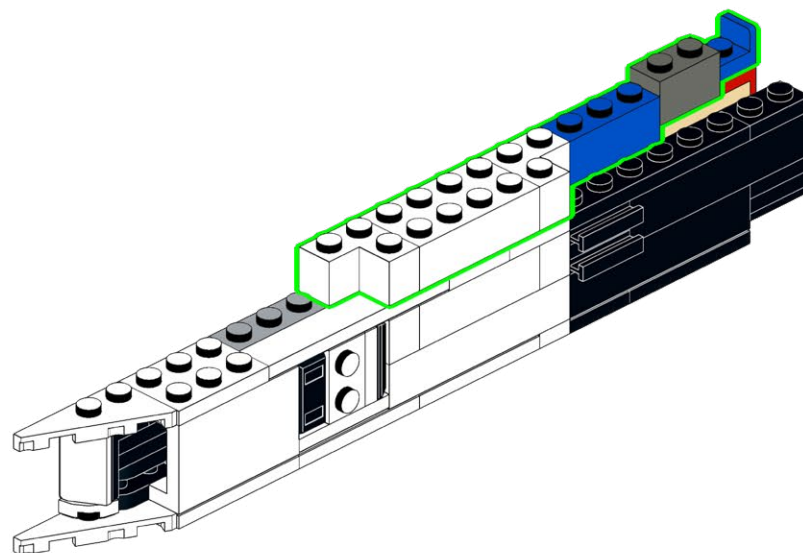
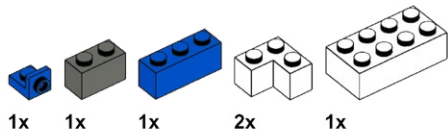

405

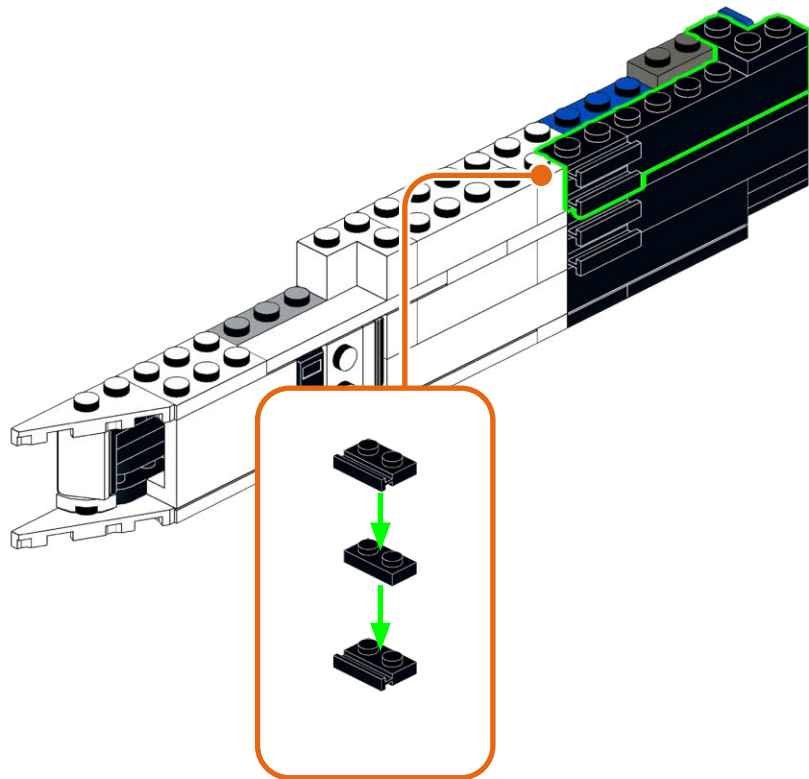
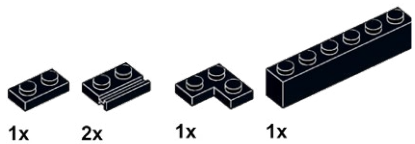

406

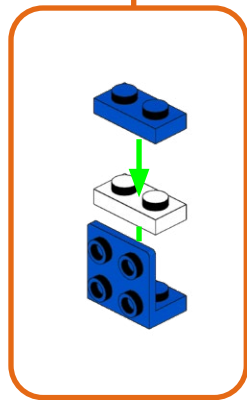
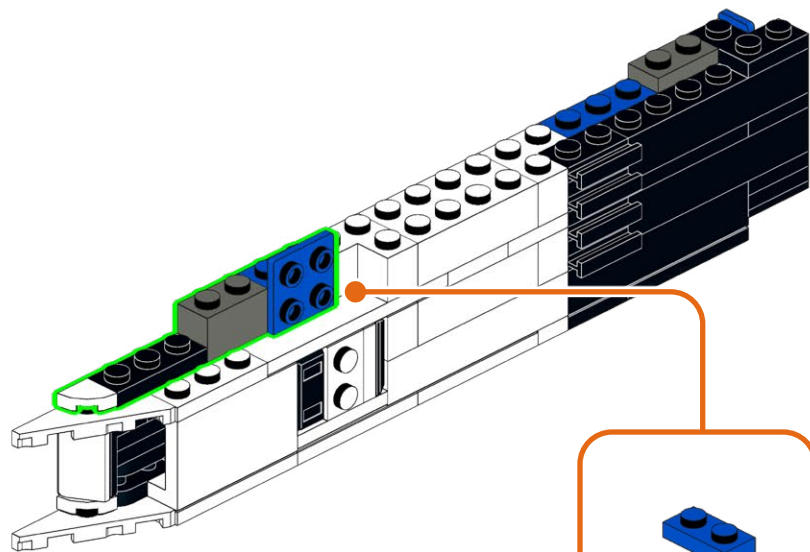
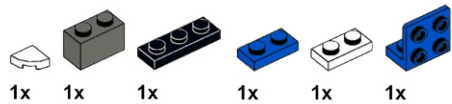

**407**

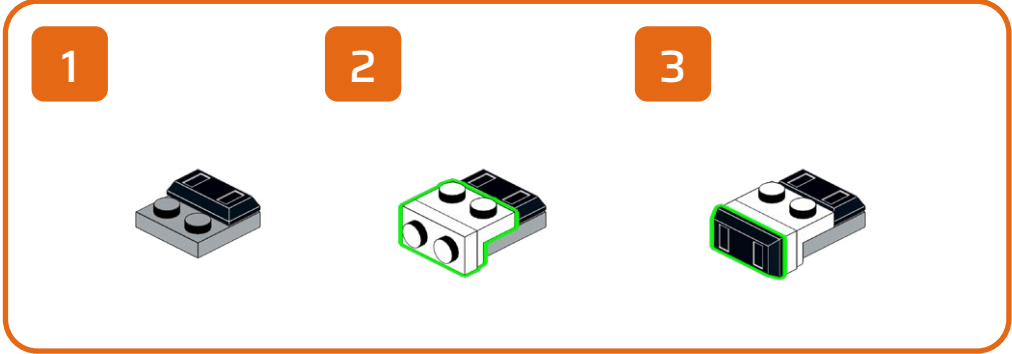
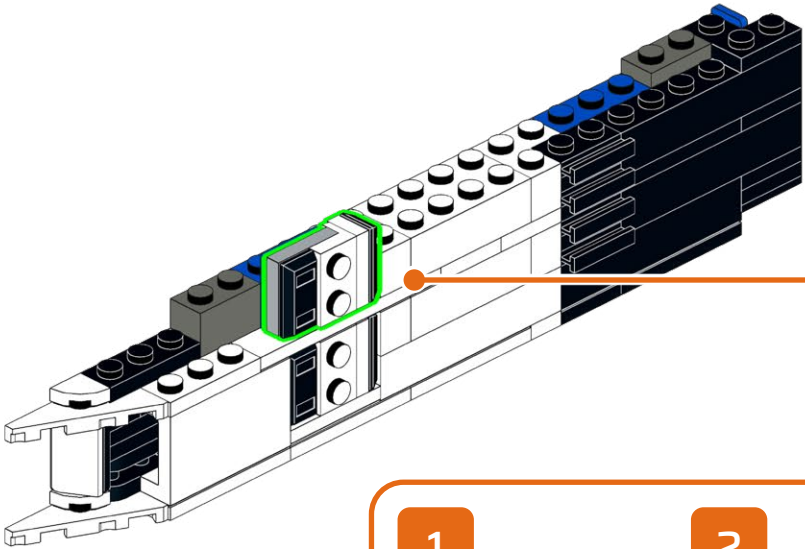
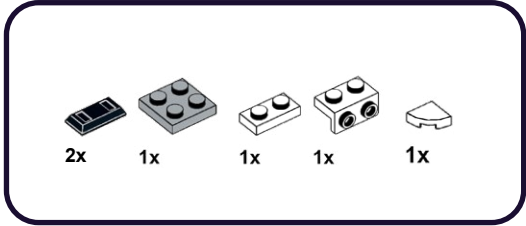

408

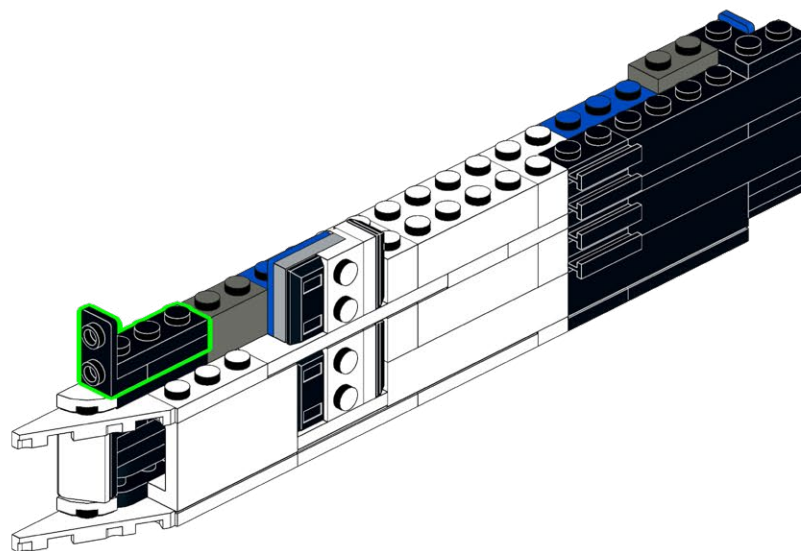
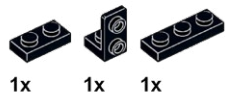

409

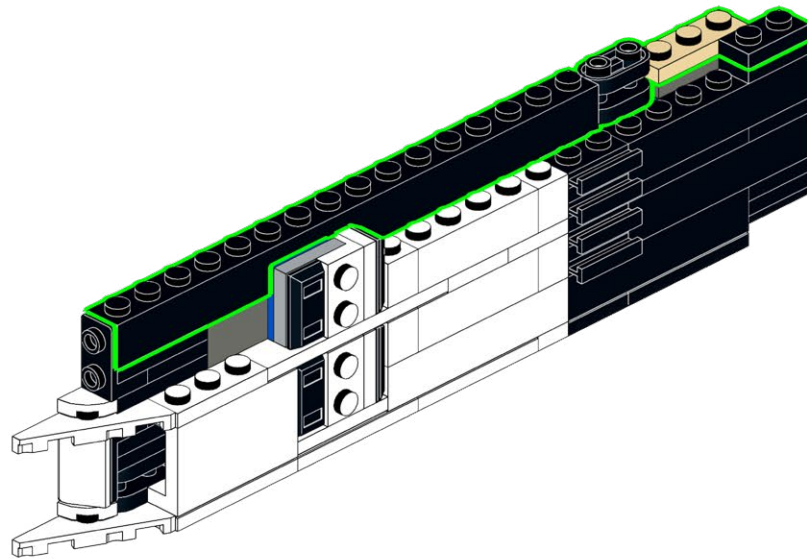
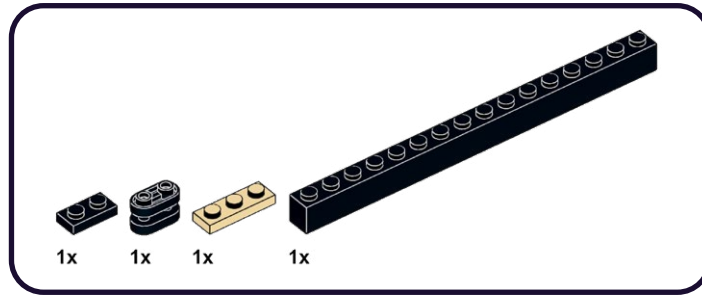

410

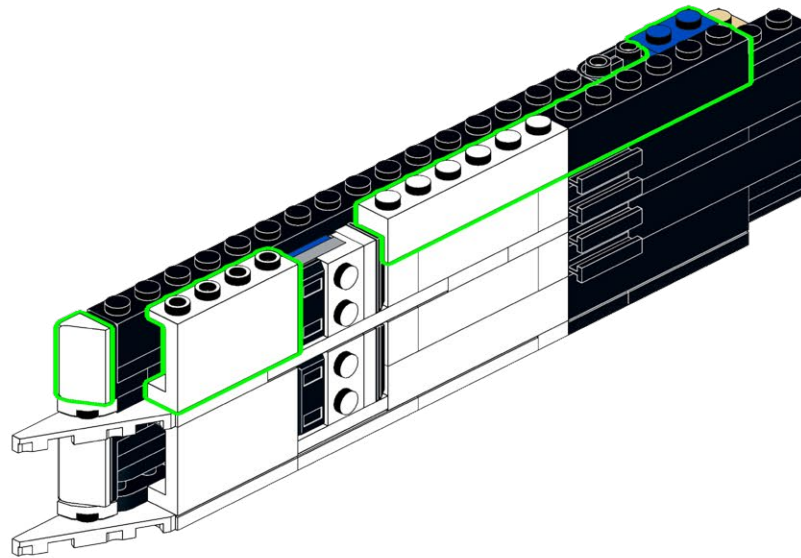
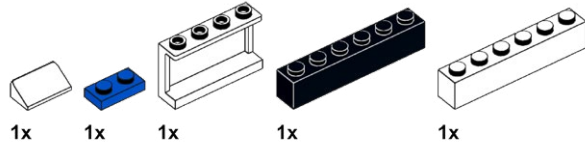



411

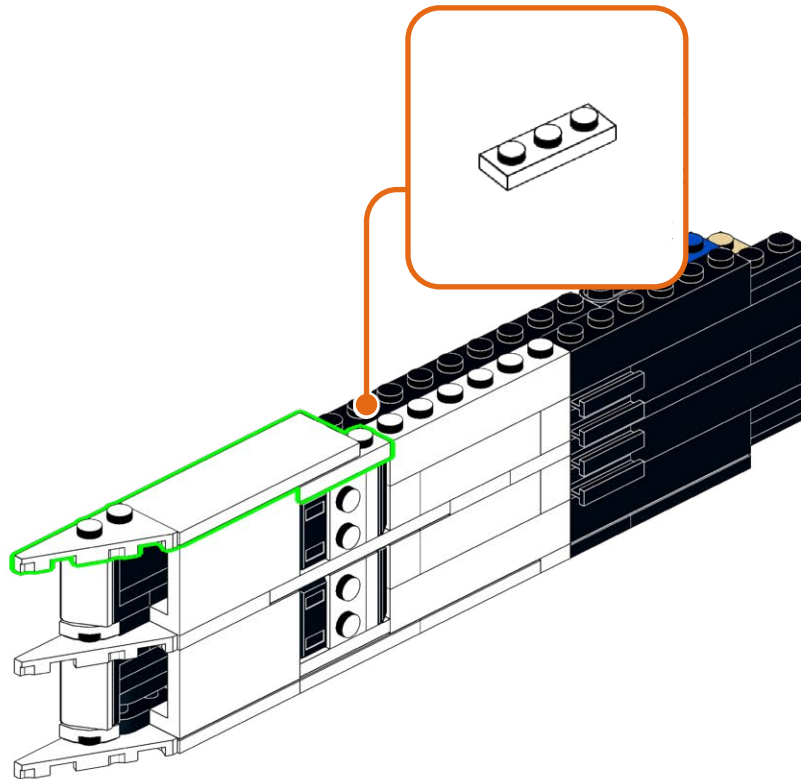
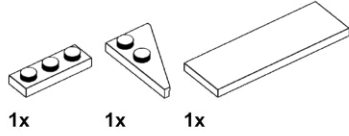

412

1x

1x

1x

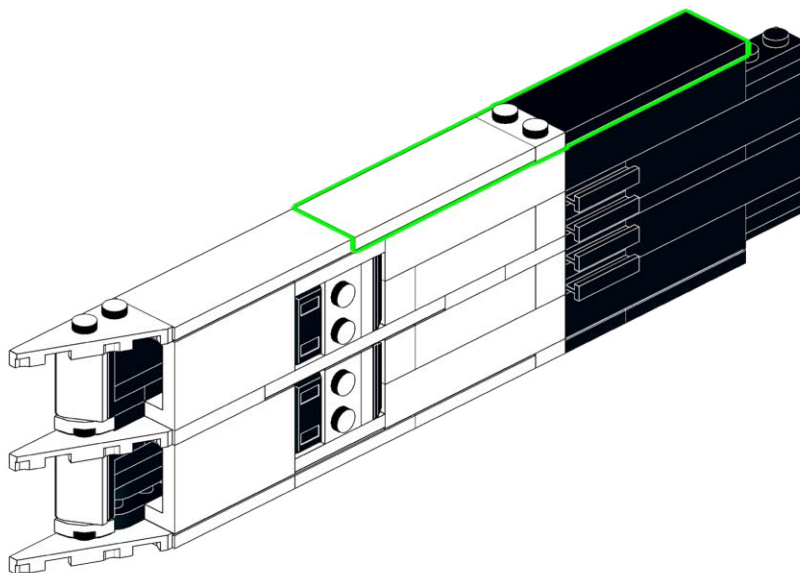

413

2x

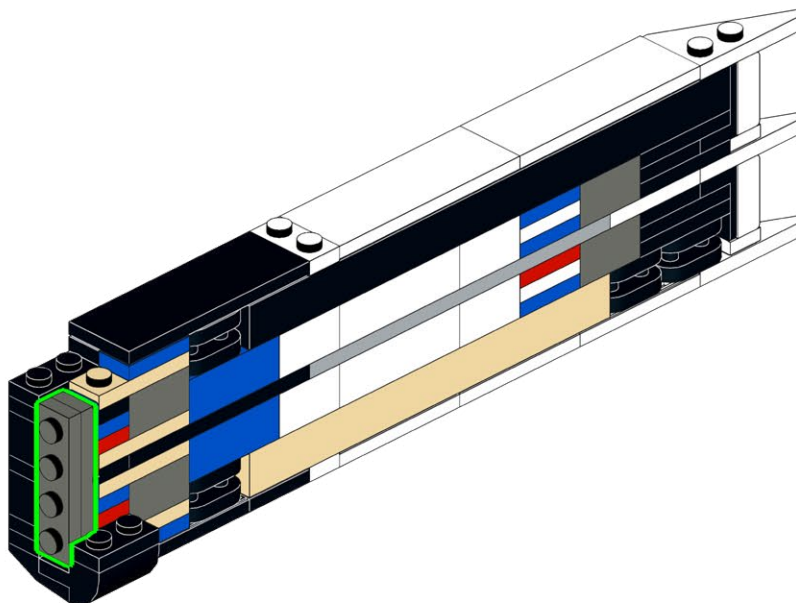
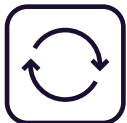

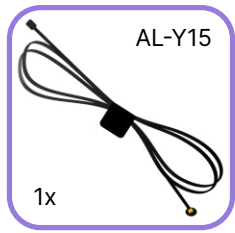

1

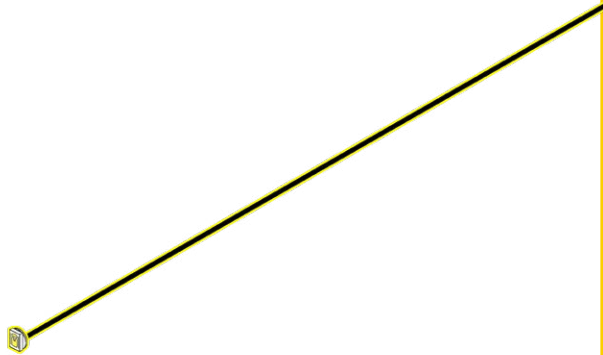

1

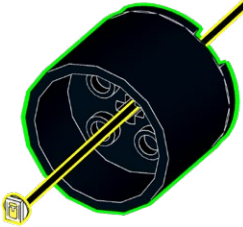

2x

416

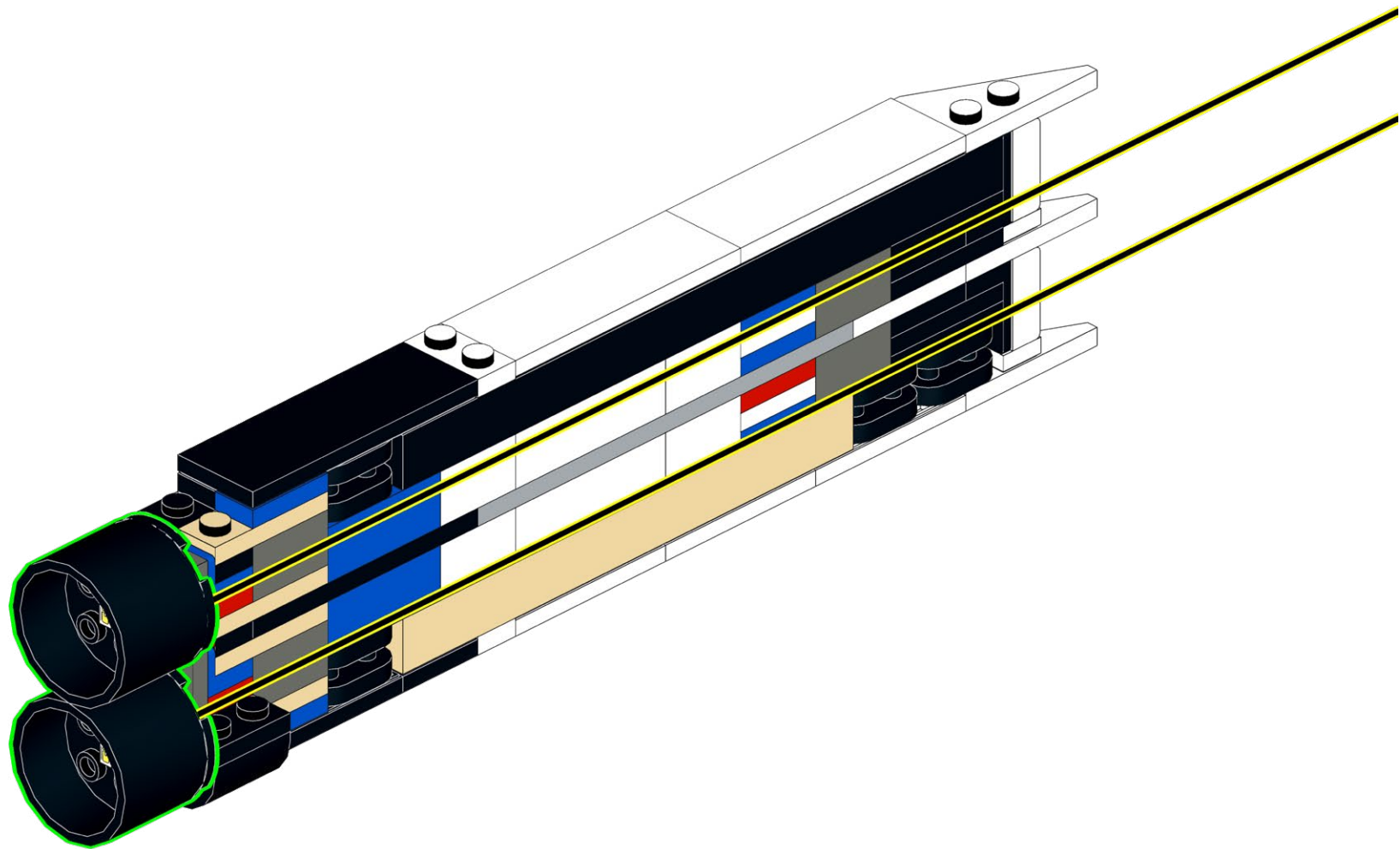

**417**

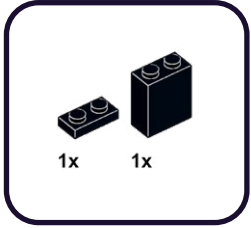

**1**

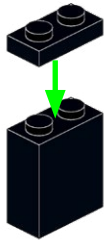

**418**



**1**



419

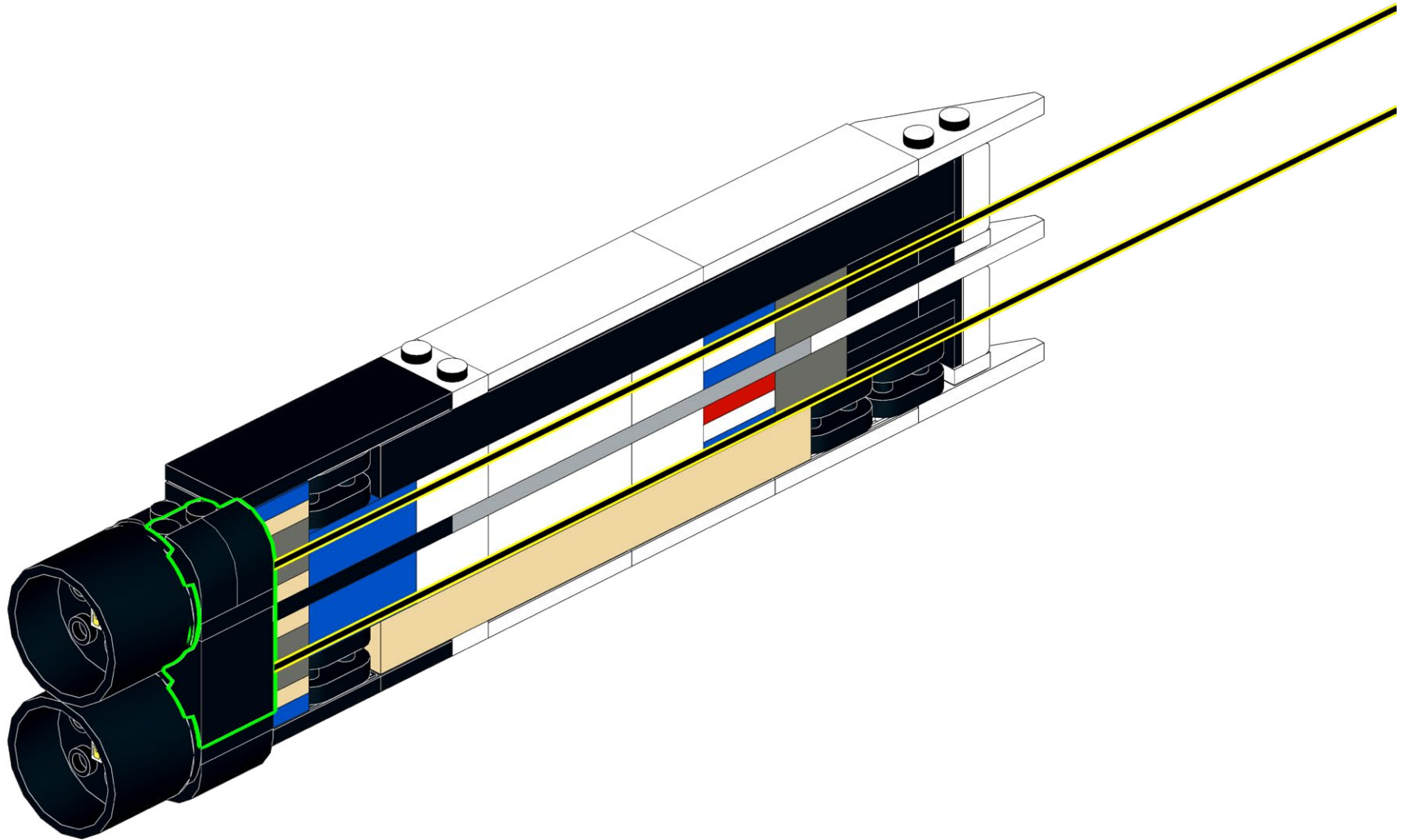

420

1x

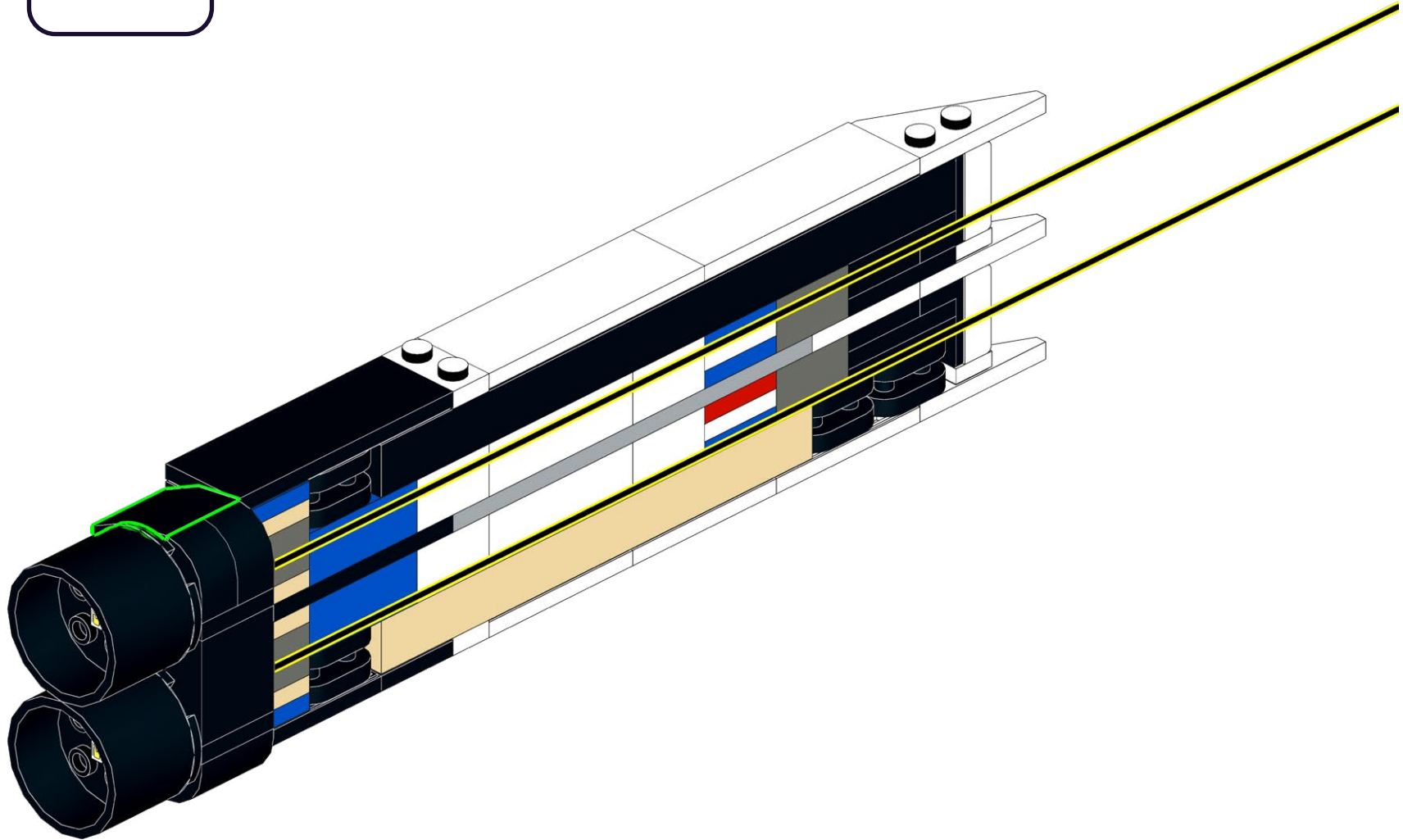



421



2x

2x



2x

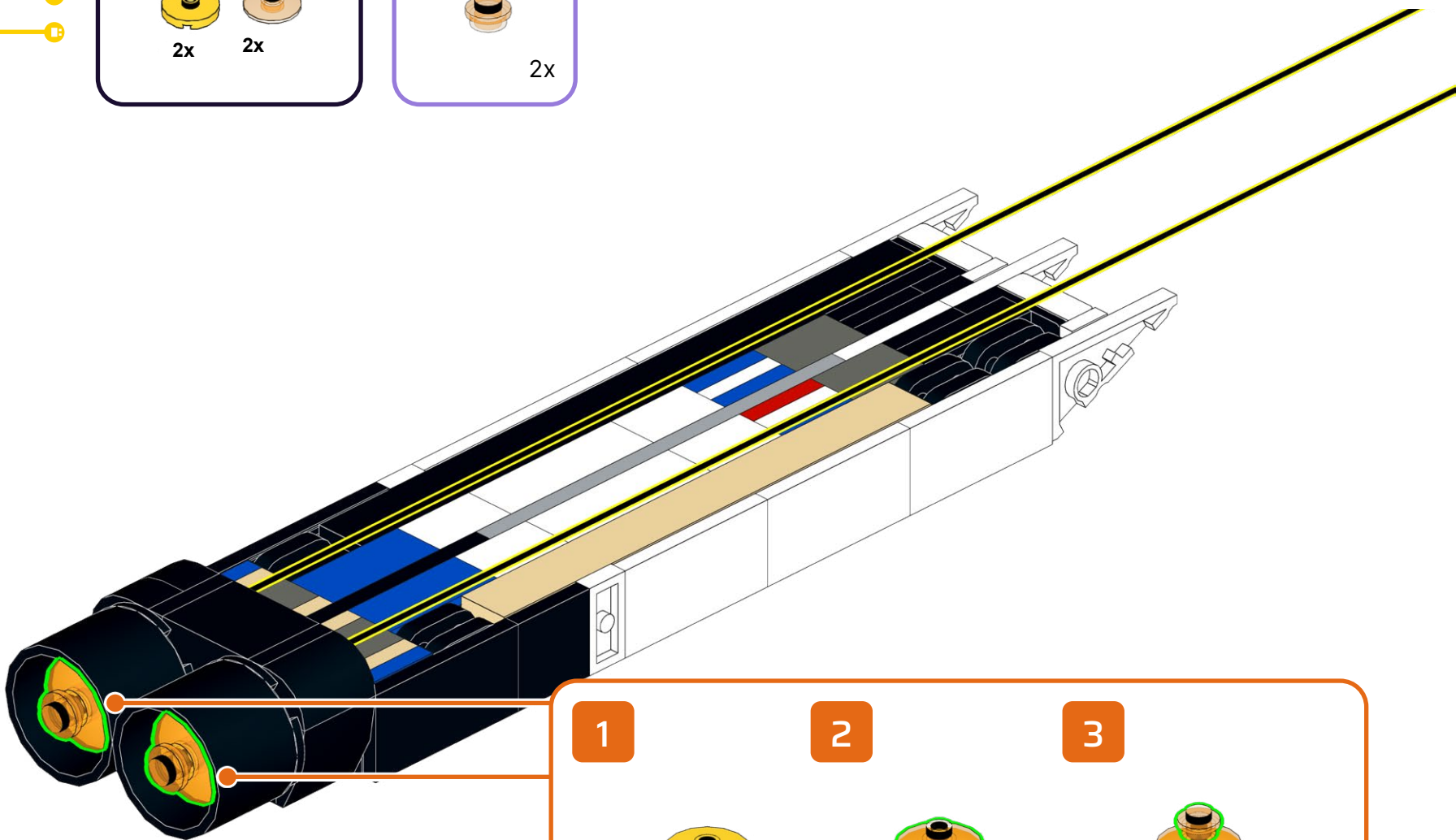
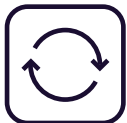

1



2

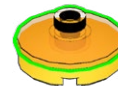

3



422

To be used later  
A utiliser plus tard  
Da utilizzare dopo  
Zur späteren Verwendung  
Para ser utilizado más tarde  
稍后使用

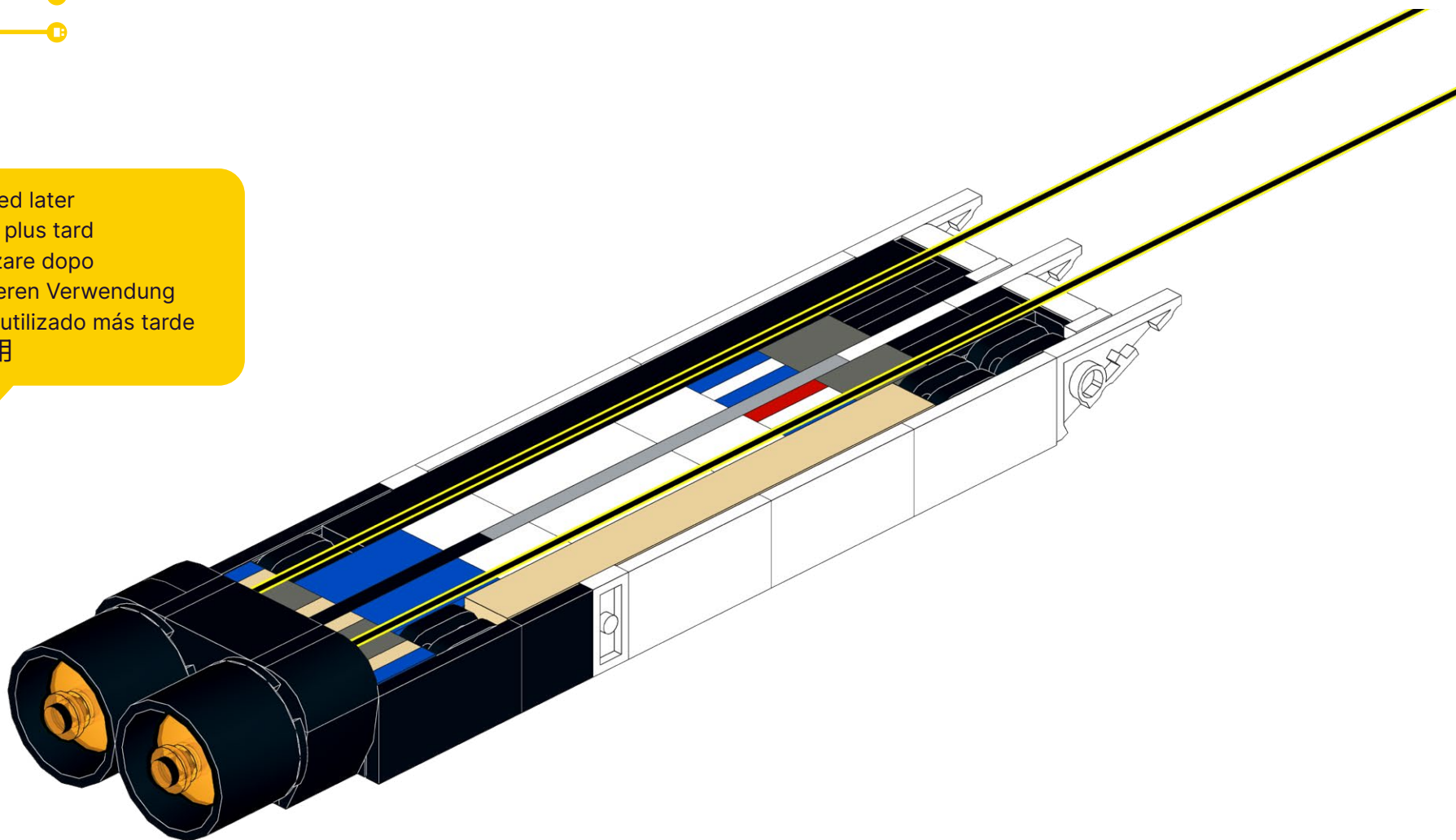

423

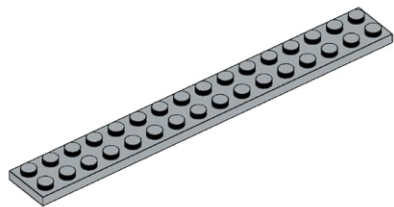

2x

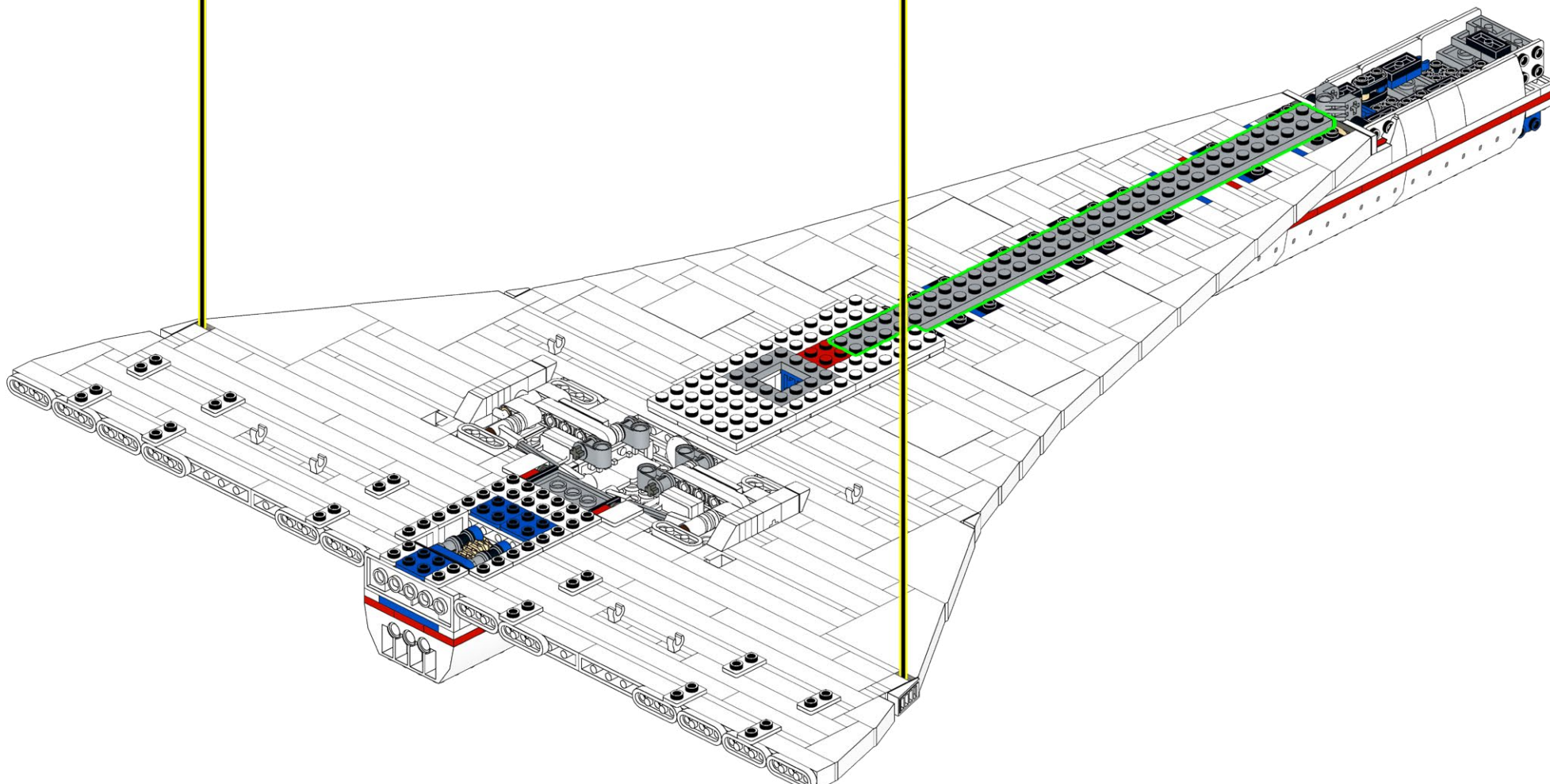

424

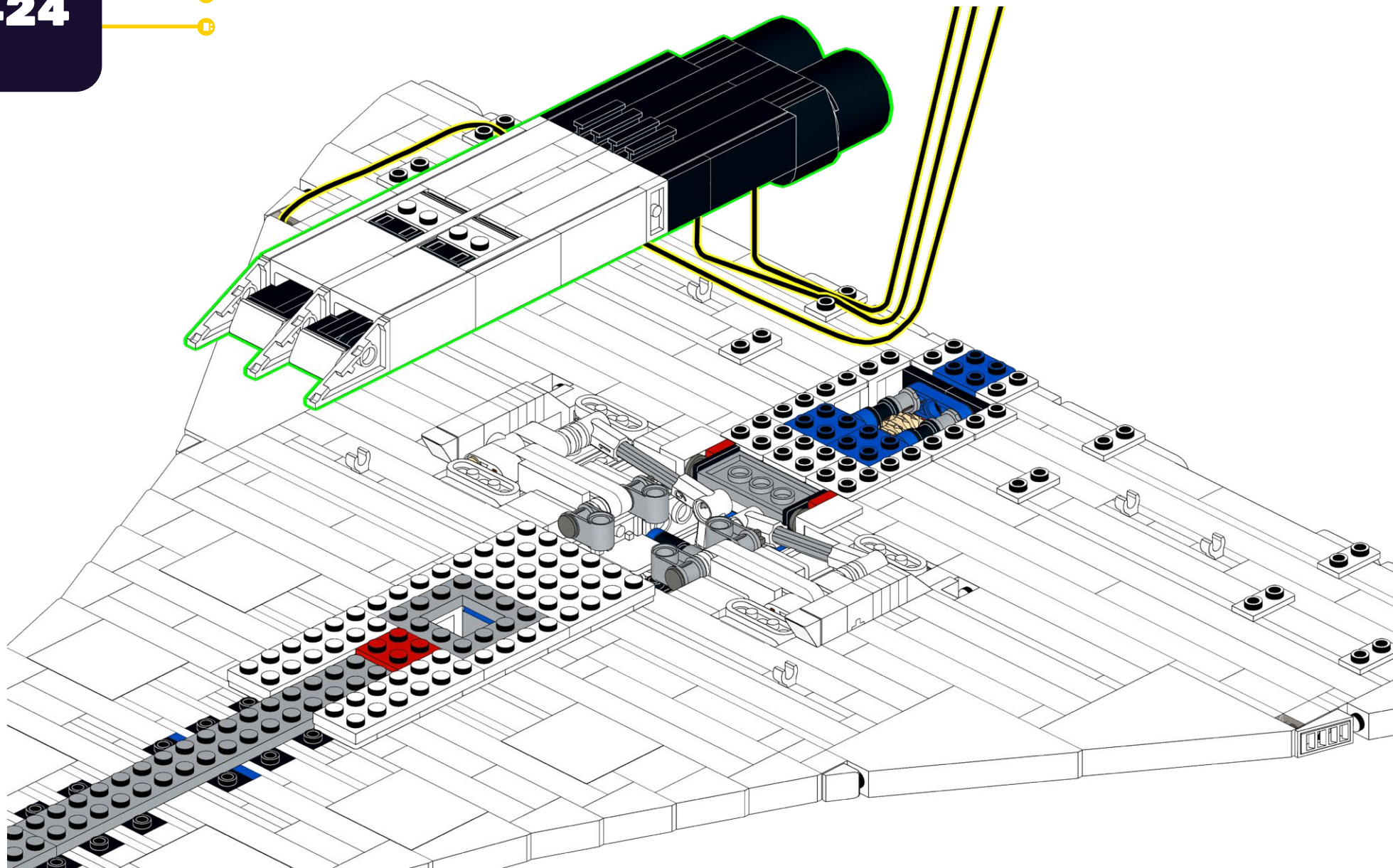

425

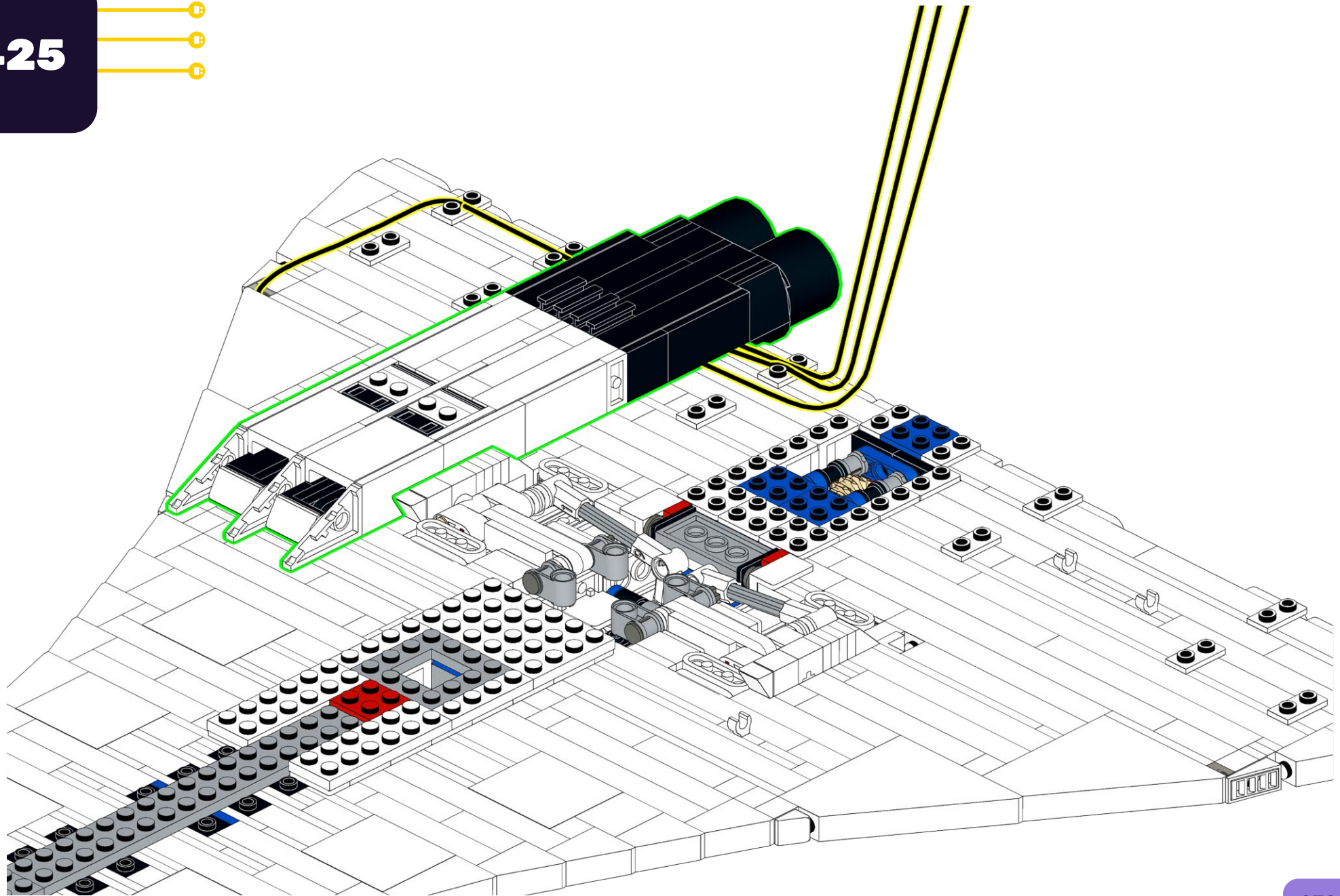

426

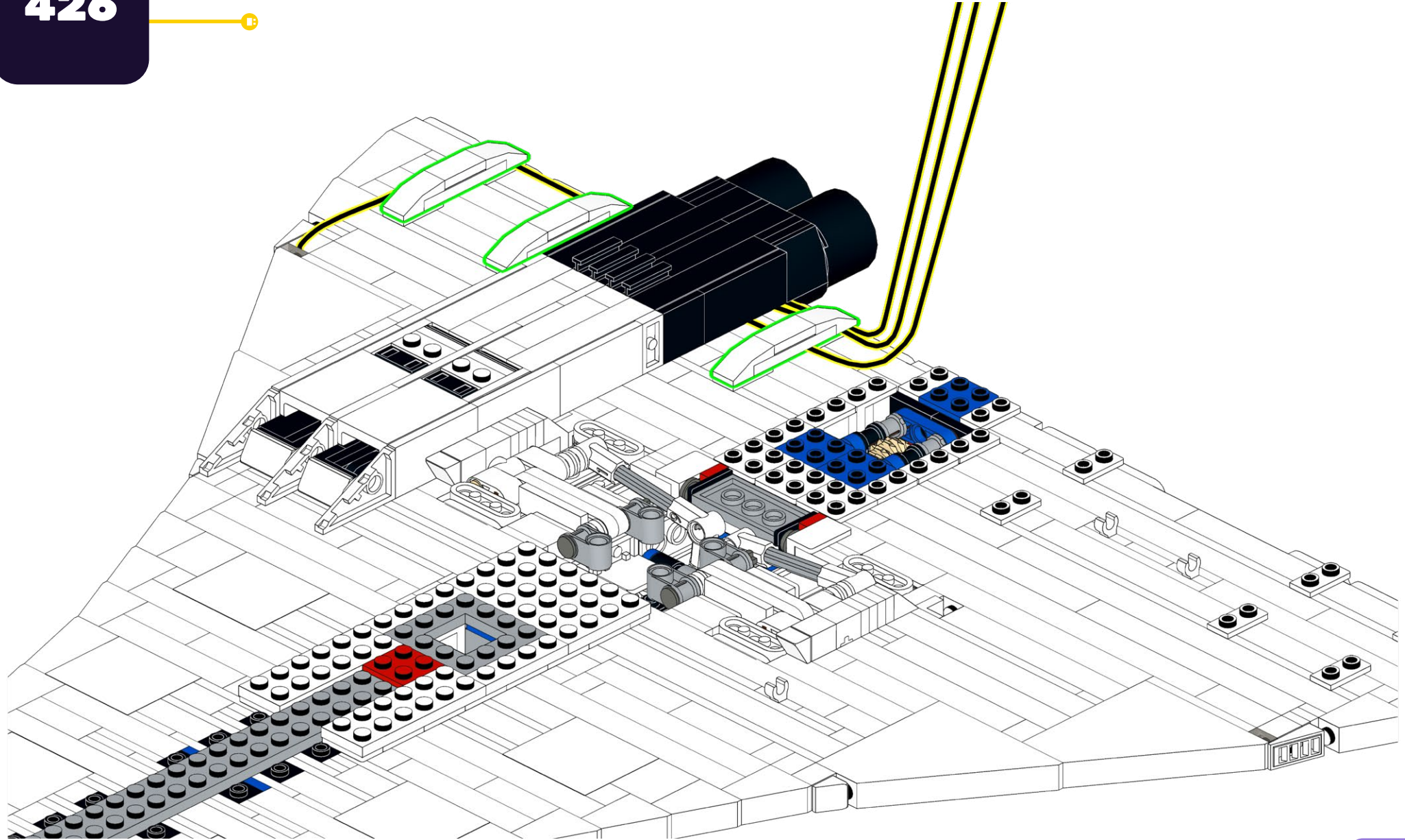

427

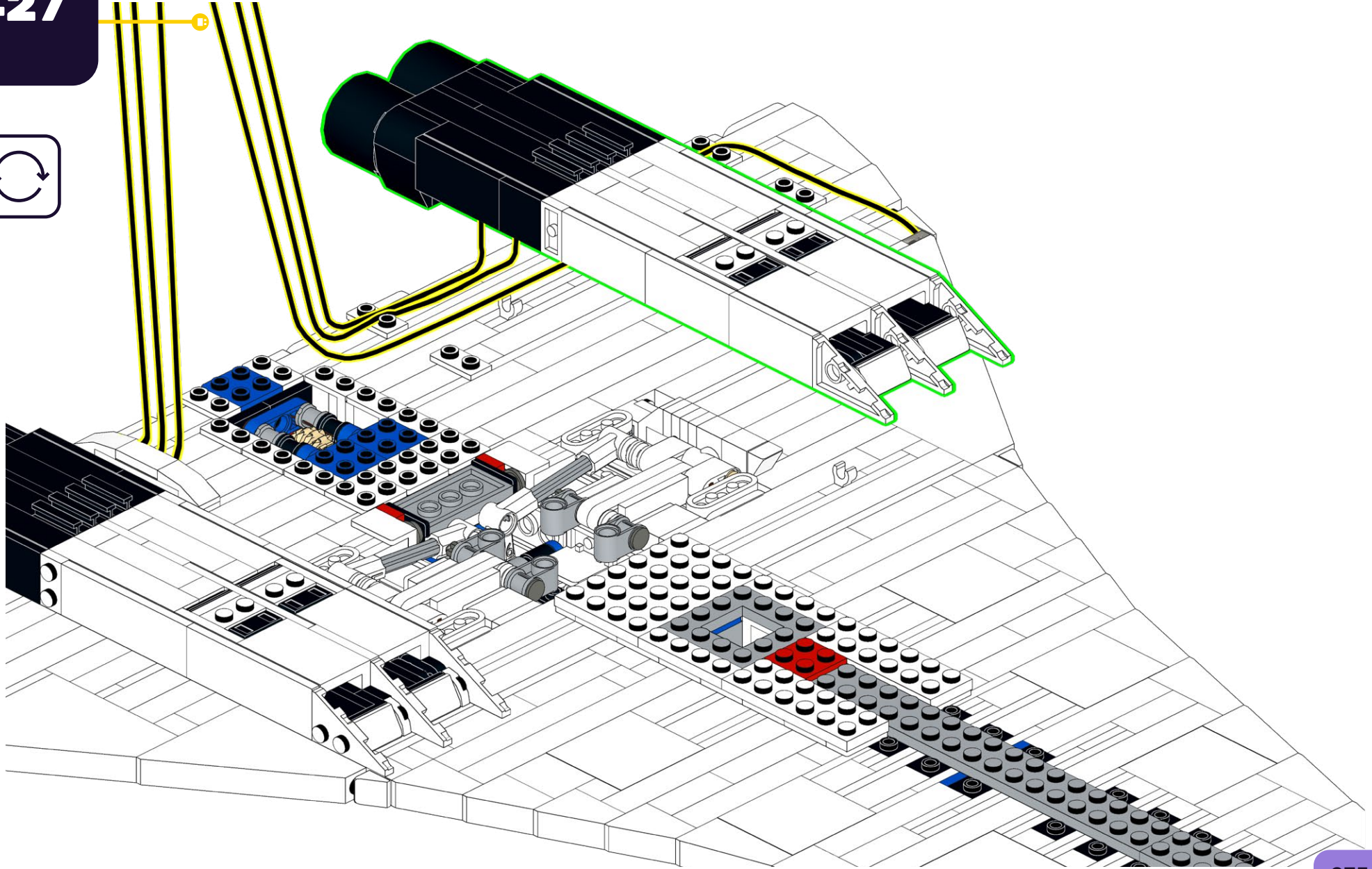

428

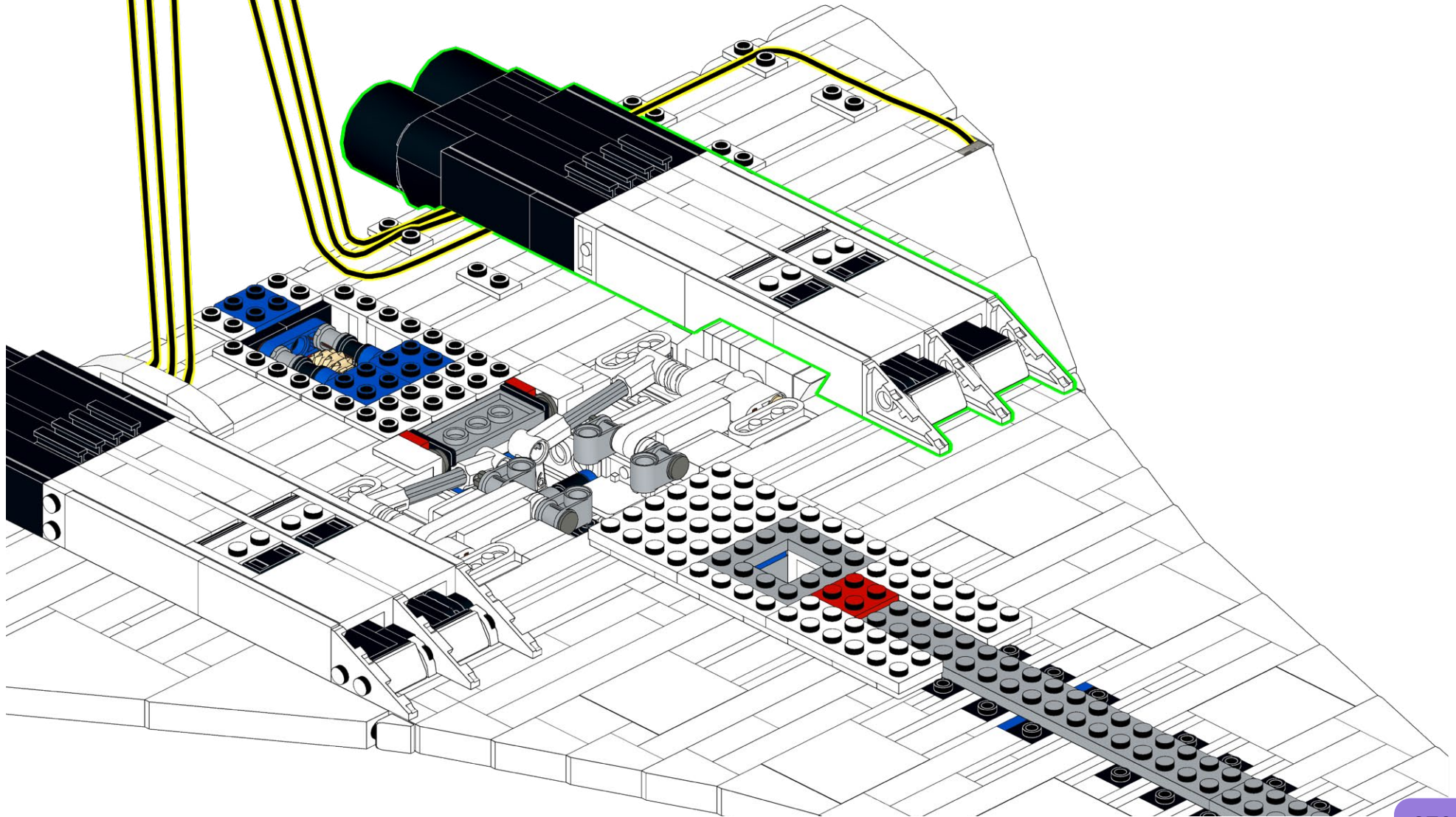



429

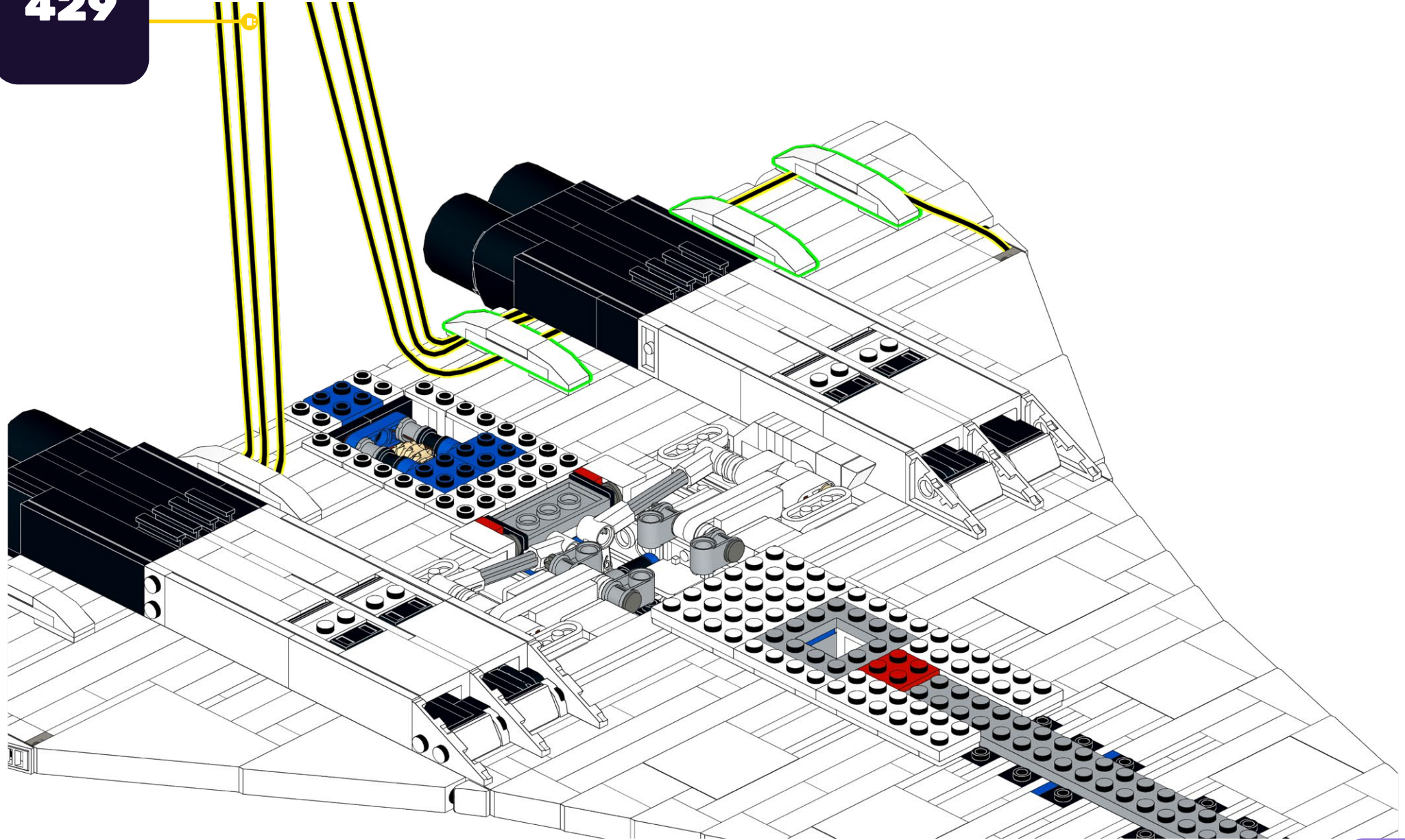

**HOLD UP!**

You might notice some bags aren't in order, as well as left over pieces, but that's ok! We're changing the way you build LEGO!

**ATTENDEZ!**

Vous remarquerez peut-être que certains sacs, ainsi que certaines pièces, ne sont pas dans le bon ordre. Mais pas de panique! Nous changeons simplement la façon avec laquelle vous construisez vos LEGO!

**ASPETTA!**

Potresti notare che alcuni sacchetti non sono in ordine, così come i pezzi avanzati, ma va bene così! Stiamo cambiando il modo in cui costruisci i LEGO!

**HALT!**

Sie werden möglicherweise bemerken, dass einige tüten durcheinander sind und teile übrig bleiben, aber das ist in Ordnung! Wir ändern die art und weise, wie Sie LEGO bauen!

**¡ESPERA!**

Es posible que notes que algunas bolsas están fuera de servicio, así como piezas sobrantes, ¡pero está bien! ¡Estamos cambiando la forma en que construyes LEGO!

**暫停!**

你可能会注意到一些袋子顺序错乱, 以及一些剩余的部件, 但没关系! 我们正在改变你搭建乐高的方式!

**Open LEGO® Bag 16**

**430**

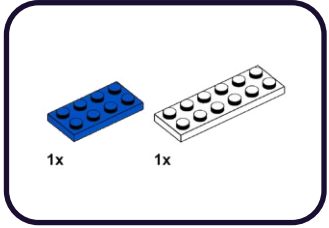

**1**

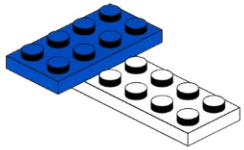

**431**

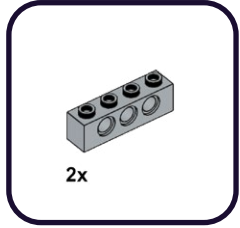

**1**

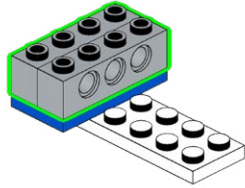

**432**



**433**

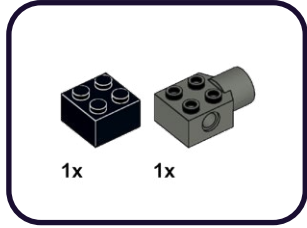

**1**

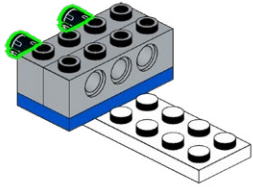

**1**

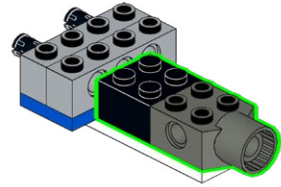

**434**

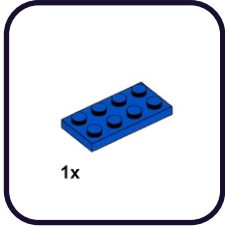

**1**

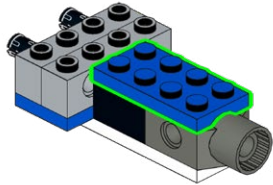

**435**

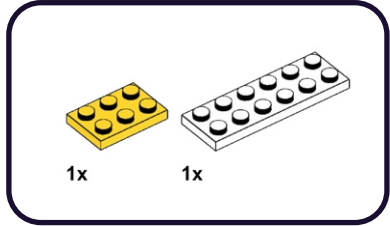

**1**

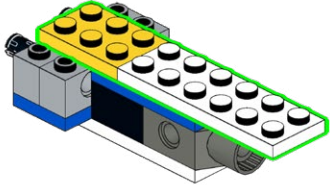

**436**

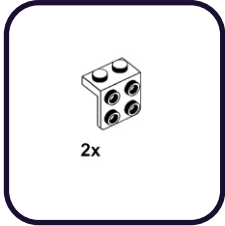

**437**

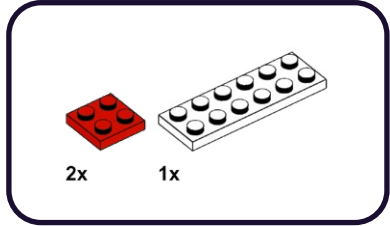

1

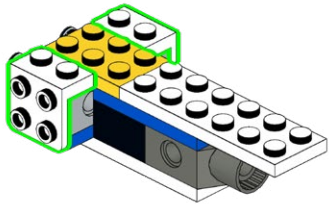

1

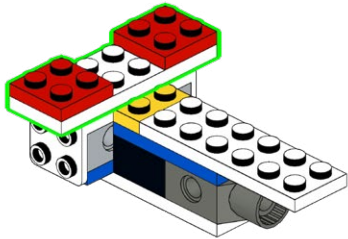

**438**

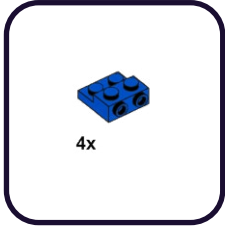

**439**

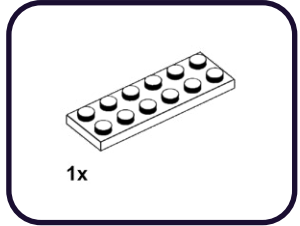

1

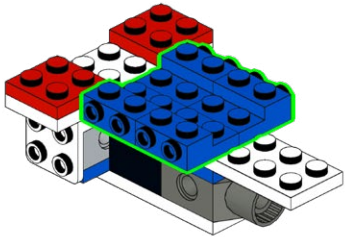

1

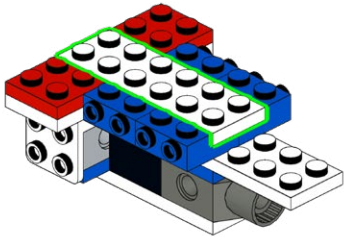

440

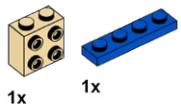

1x

1x

1



2

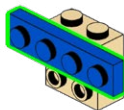

441

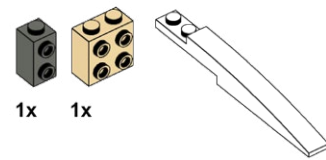

1x

1x

1x

1

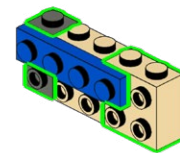

2

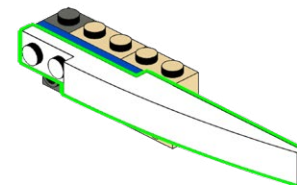



442

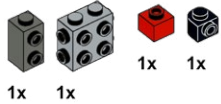

1

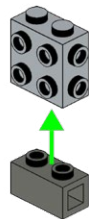

2

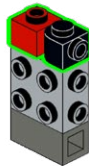

443

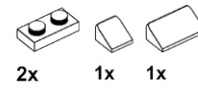

1



2

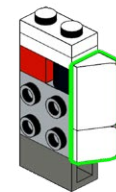

444

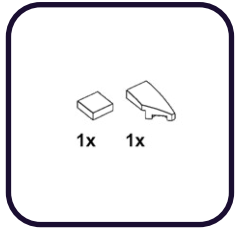

1

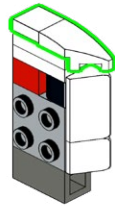

445



1

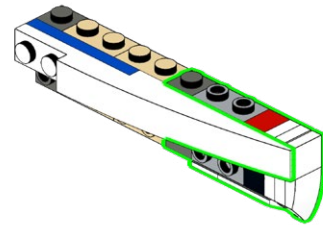

**HOLD UP!**

You might notice some bags aren't in order, as well as left over pieces, but that's ok! We're changing the way you build LEGO!

**ATTENDEZ!**

Vous remarquerez peut-être que certains sacs, ainsi que certaines pièces, ne sont pas dans le bon ordre. Mais pas de panique! Nous changeons simplement la façon avec laquelle vous construisez vos LEGO!

**ASPETTA!**

Potresti notare che alcuni sacchetti non sono in ordine, così come i pezzi avanzati, ma va bene così! Stiamo cambiando il modo in cui costruisci i LEGO!

**HALT!**

Sie werden möglicherweise bemerken, dass einige tüten durcheinander sind und teile übrig bleiben, aber das ist in Ordnung! Wir ändern die art und weise, wie Sie LEGO bauen!

**¡ESPERA!**

Es posible que notes que algunas bolsas están fuera de servicio, así como piezas sobrantes, ¡pero está bien! ¡Estamos cambiando la forma en que construyes LEGO!

**暫停!**

你可能会注意到一些袋子顺序错乱, 以及一些剩余的部件, 但没关系! 我们正在改变你搭建乐高的方式!

**Open LEGO® Bag 17**

446

2x 2x 1x

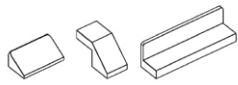

1

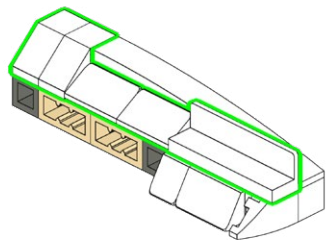

2

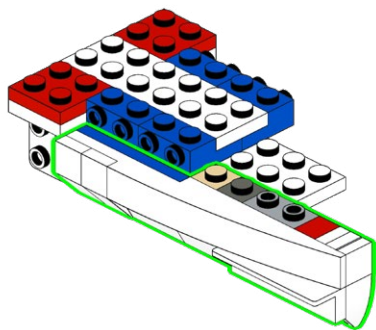

447

1x



1

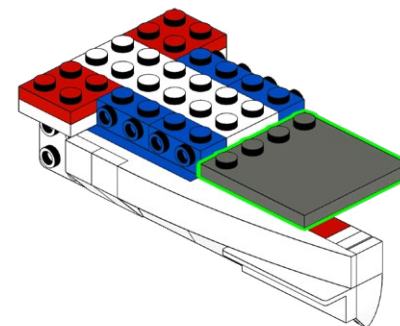

448

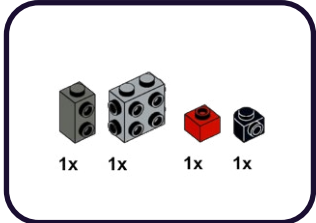

1

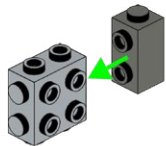

2

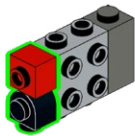

449

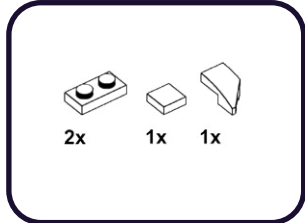

1

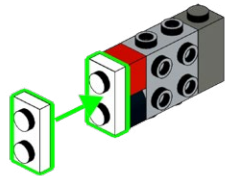

2

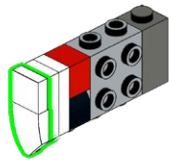

450

1x



1

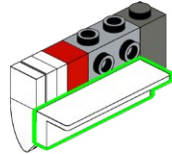

2

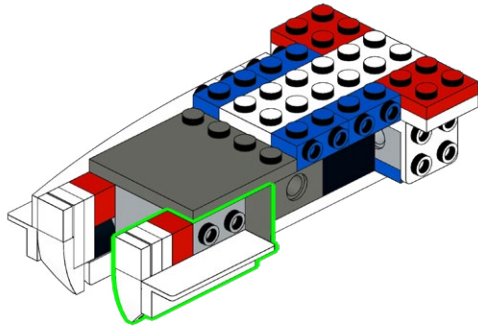

451

1x 2x 2x

1

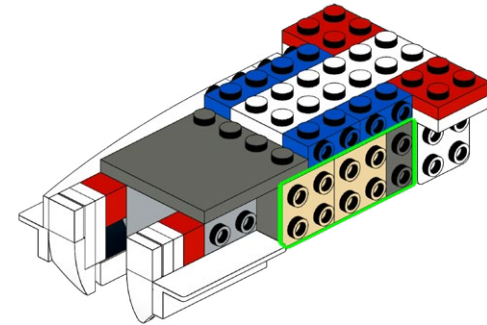

2

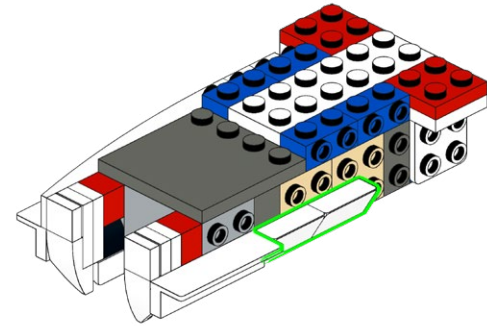

452

1x 1x

453

4x

1

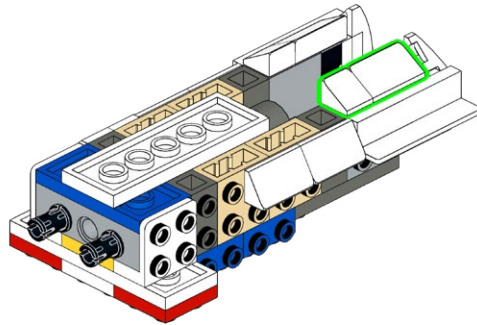

1

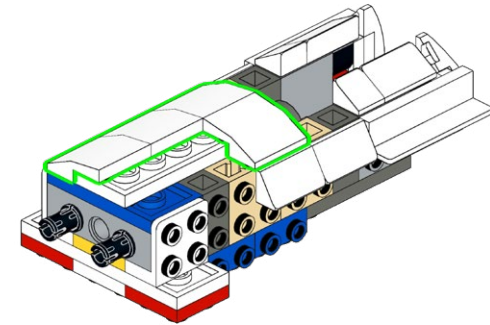

454

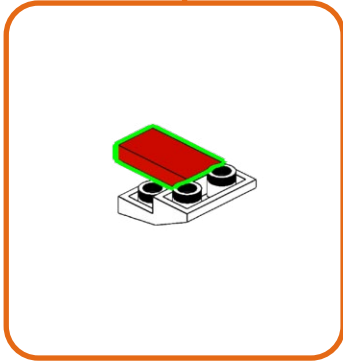
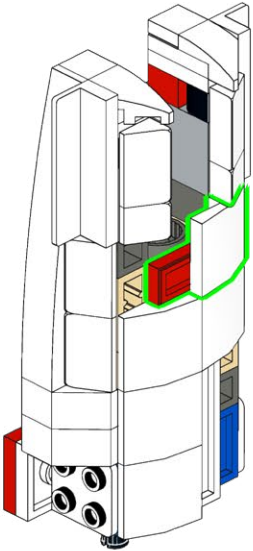
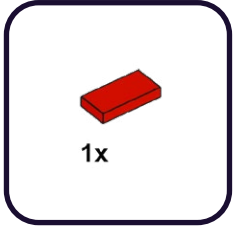



**455**

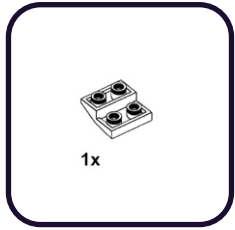

**456**

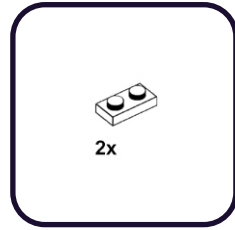

1

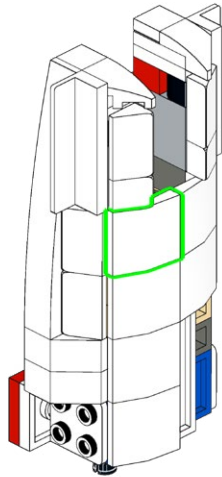

1

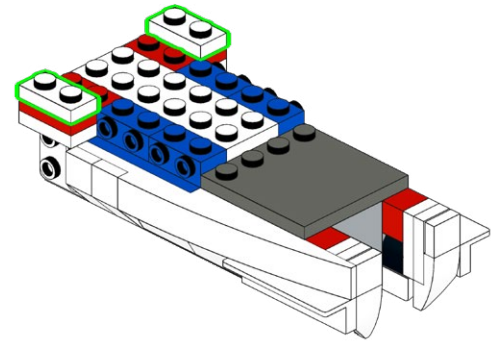

457

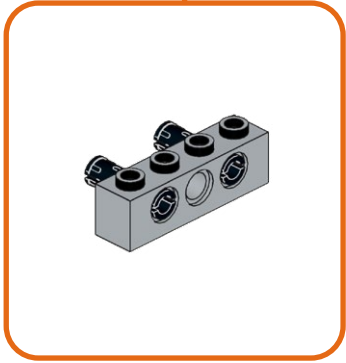
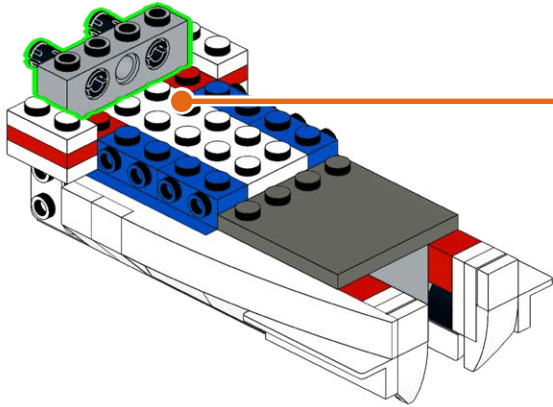
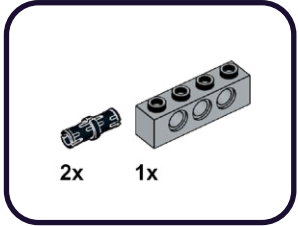

458

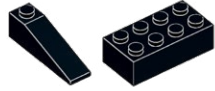

2x

1x

1

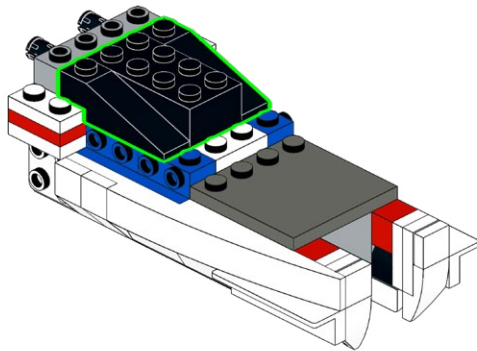

459



2x

1

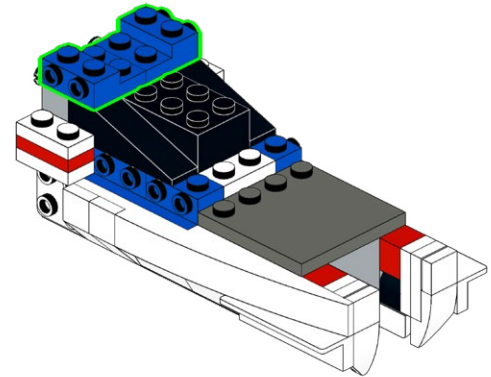

460

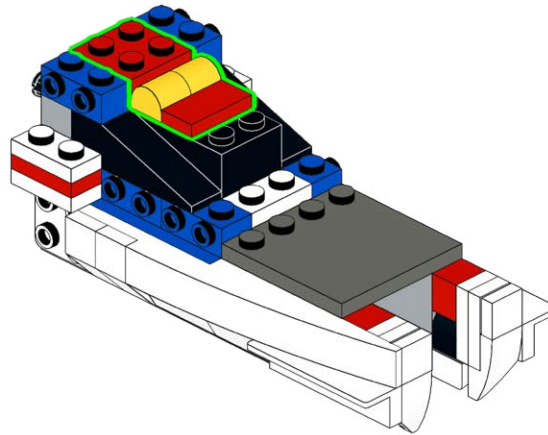
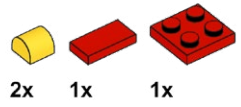

**461**

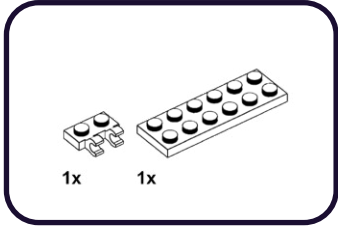

**1**

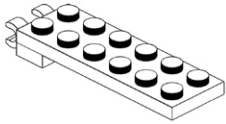

**462**

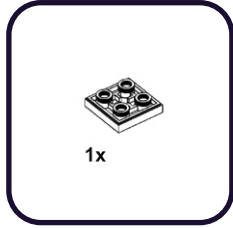

**1**

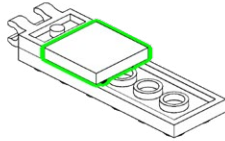

**463**

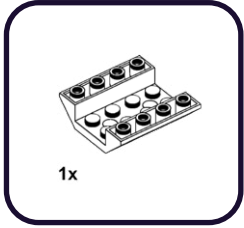

**464**

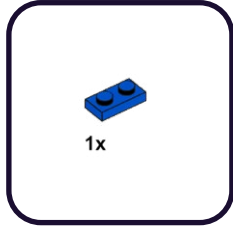

**1**

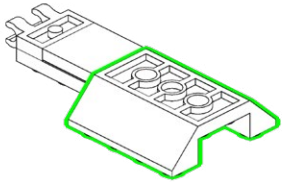

**1**

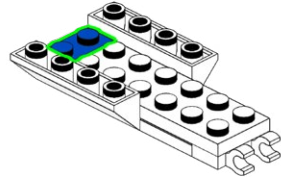

465

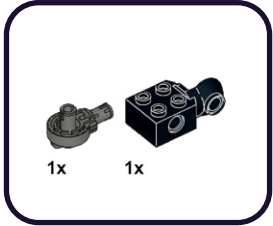

1

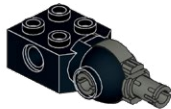

466



1

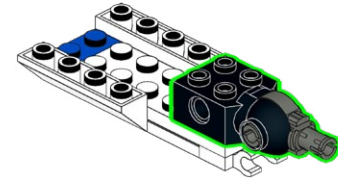

**467**

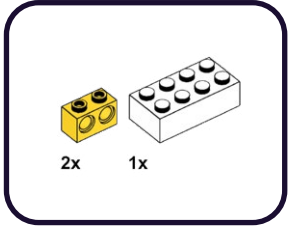

**1**

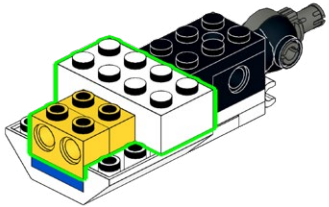

**468**

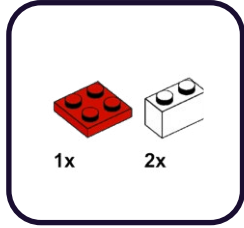

**1**

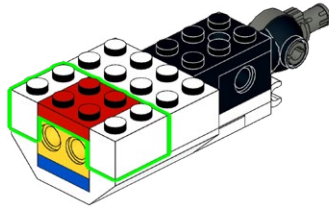



469

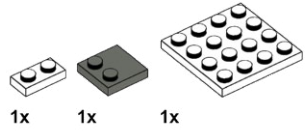

1x 1x 1x

1

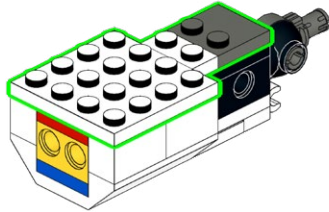

470

1

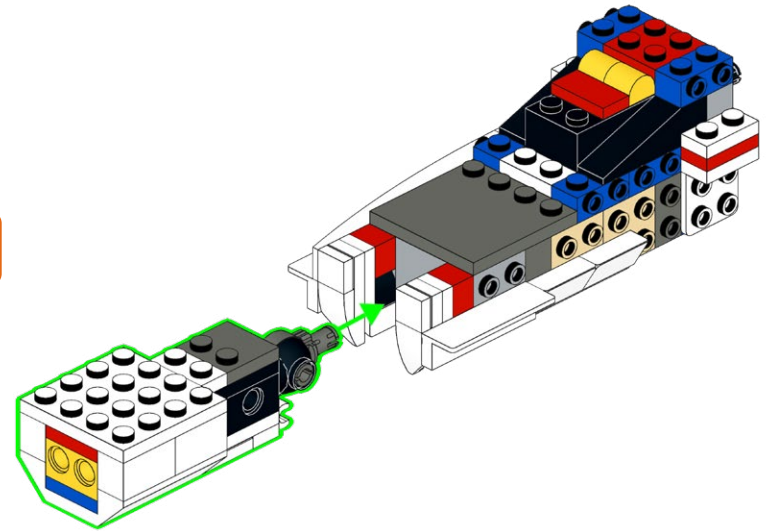

471

1x

1x

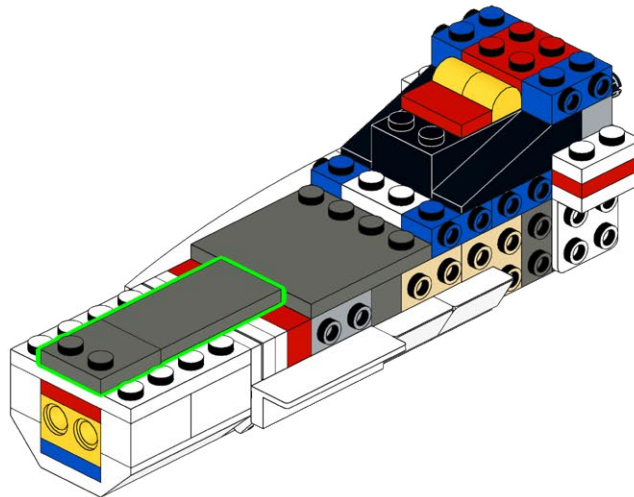

472

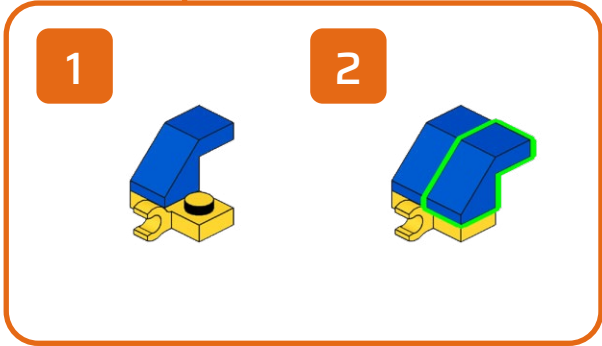
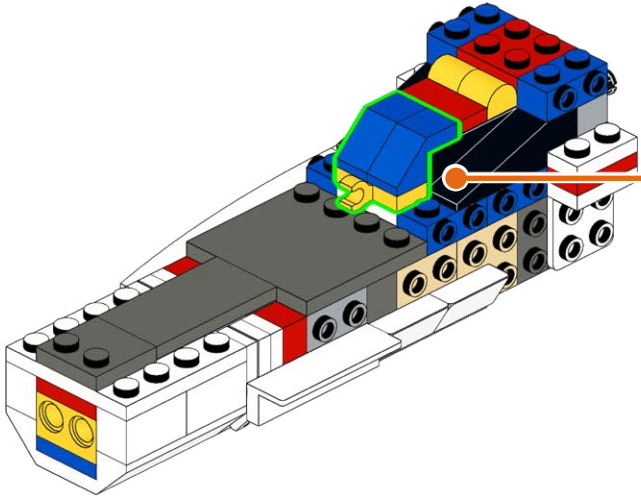
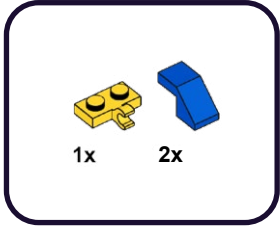

**473**

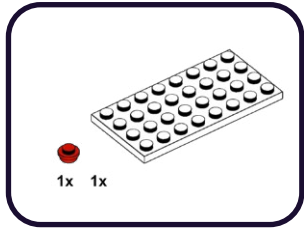

**1**

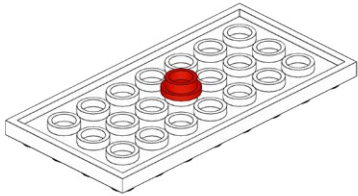

**474**

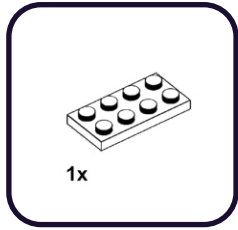

**1**

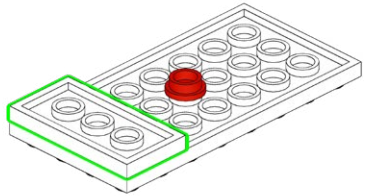

**475**

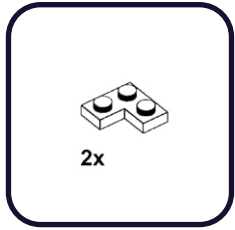

**476**

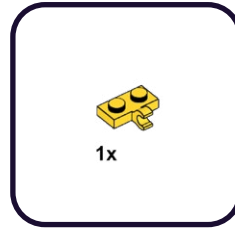

**1**

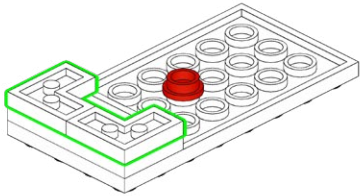

**1**

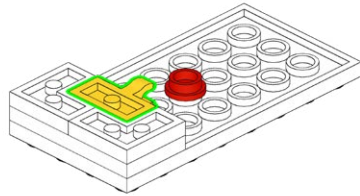

**477**

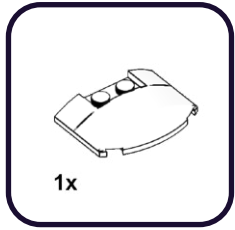

**478**

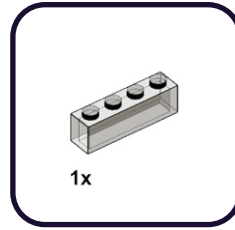

**1**

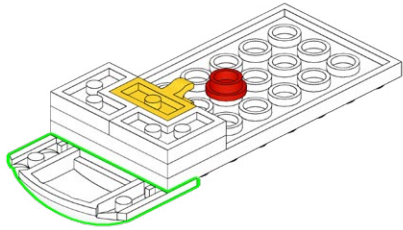

**1**

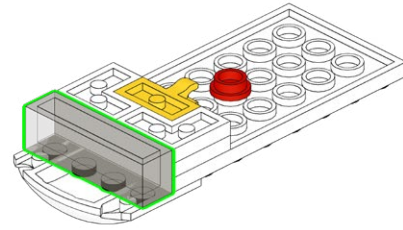

**479**



**480**

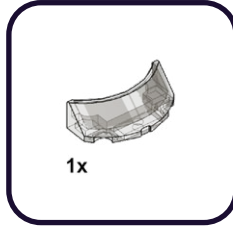

**1**

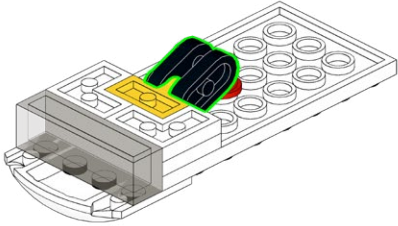

**1**

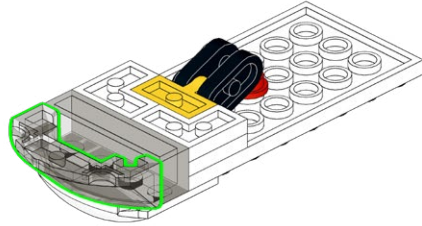

**481**

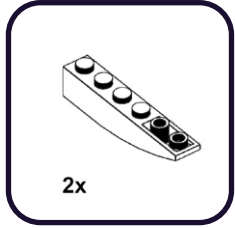

2x



**1**

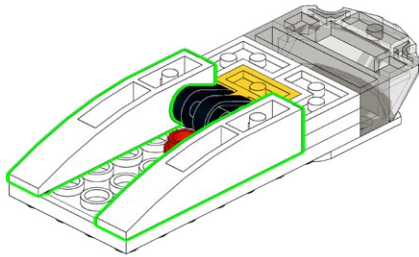

**482**

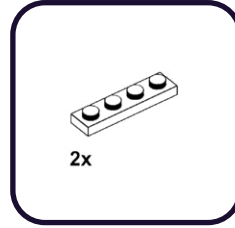

2x

**1**

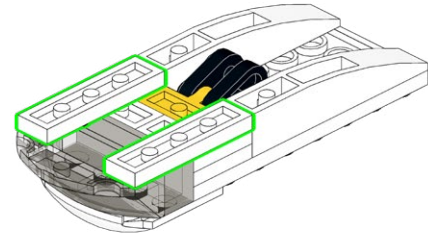



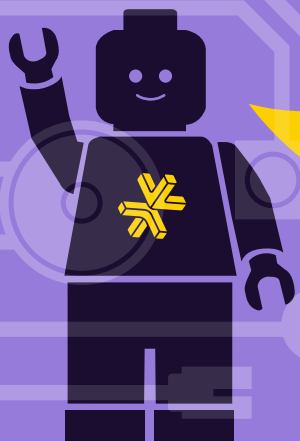

### **HOLD UP!**

You might notice some bags aren't in order, as well as left over pieces, but that's ok! We're changing the way you build LEGO!

### **ATTENDEZ!**

Vous remarquerez peut-être que certains sacs, ainsi que certaines pièces, ne sont pas dans le bon ordre. Mais pas de panique! Nous changeons simplement la façon avec laquelle vous construisez vos LEGO!

### **ASPETTA!**

Potresti notare che alcuni sacchetti non sono in ordine, così come i pezzi avanzati, ma va bene così! Stiamo cambiando il modo in cui costruisci i LEGO!

### **HALT!**

Sie werden möglicherweise bemerken, dass einige tüten durcheinander sind und teile übrig bleiben, aber das ist in Ordnung! Wir ändern die art und weise, wie Sie LEGO bauen!

### **¡ESPERA!**

Es posible que notes que algunas bolsas están fuera de servicio, así como piezas sobrantes, ¡pero está bien! ¡Estamos cambiando la forma en que construyes LEGO!

### **暫停!**

你可能会注意到一些袋子顺序错乱, 以及一些剩余的部件, 但没关系! 我们正在改变你搭建乐高的方式!

Open LMB Bag 01

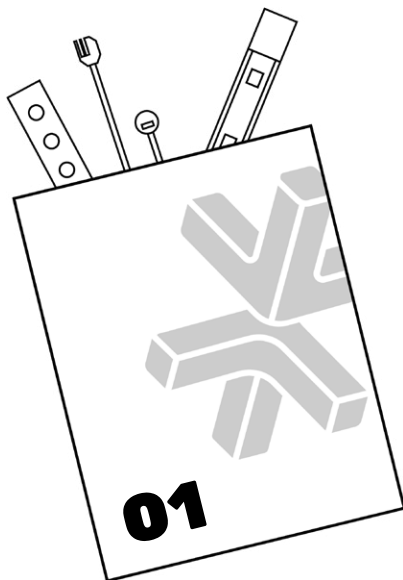

**483**

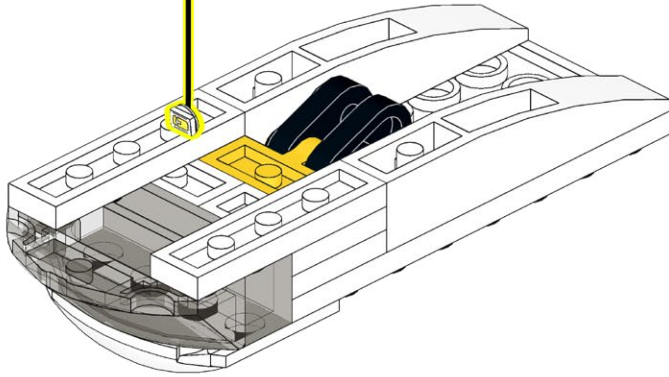
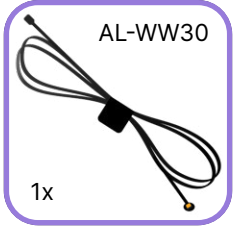

484

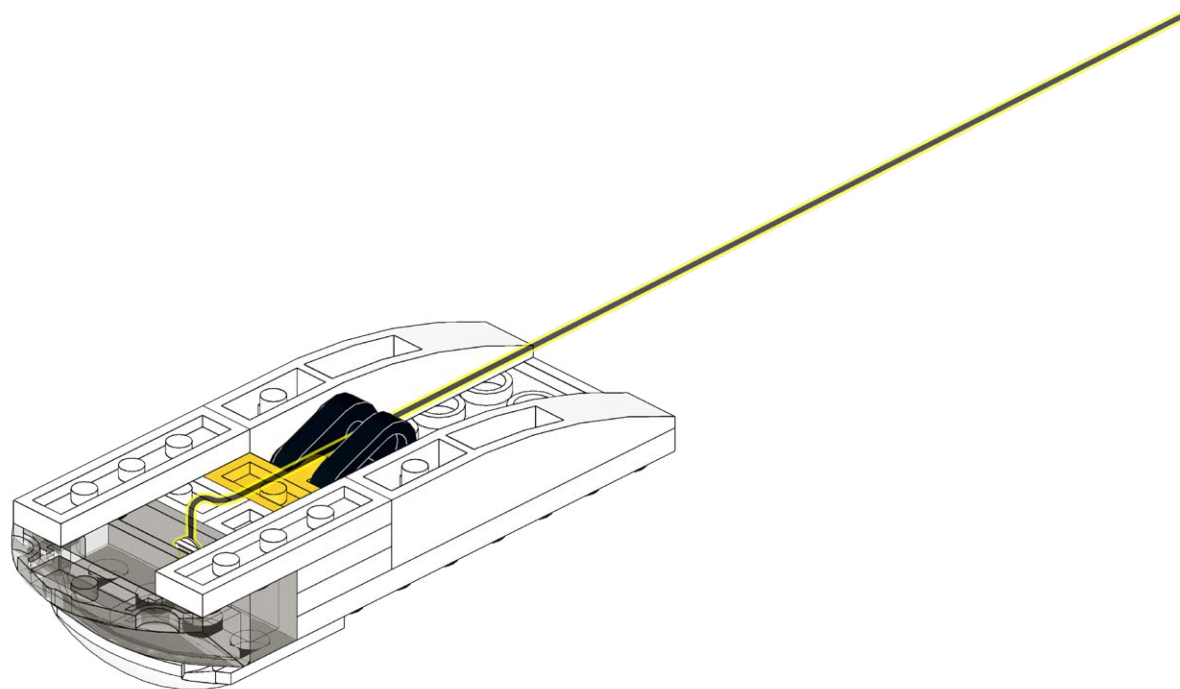

485



1x

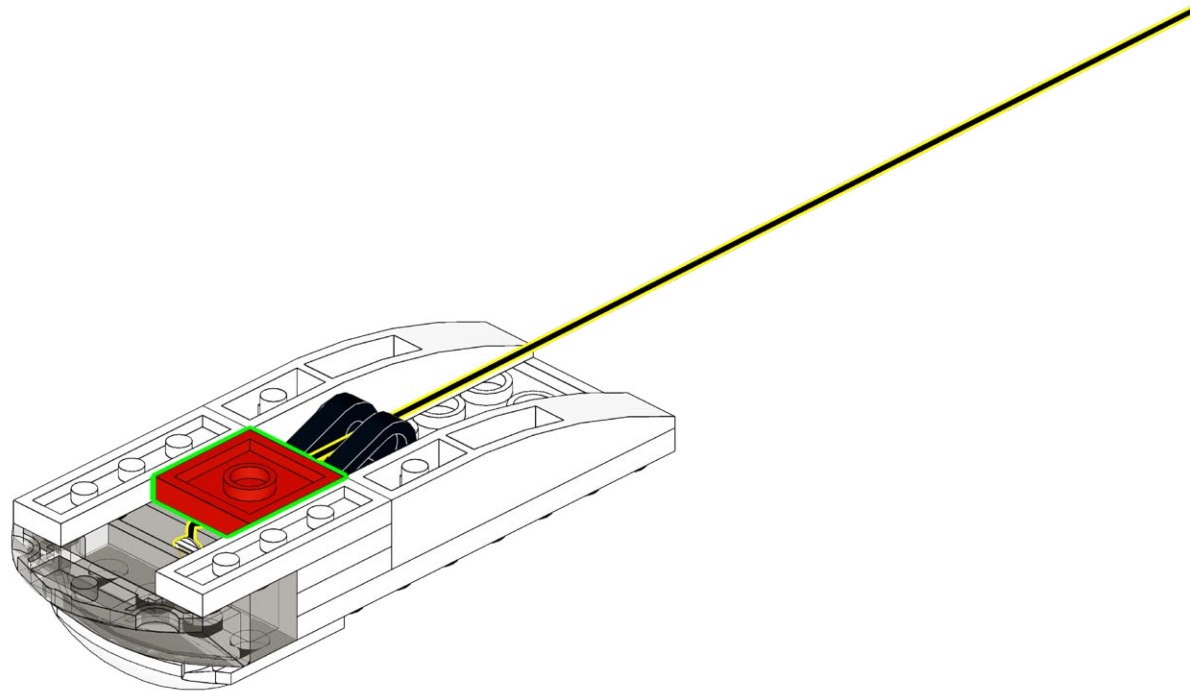

486

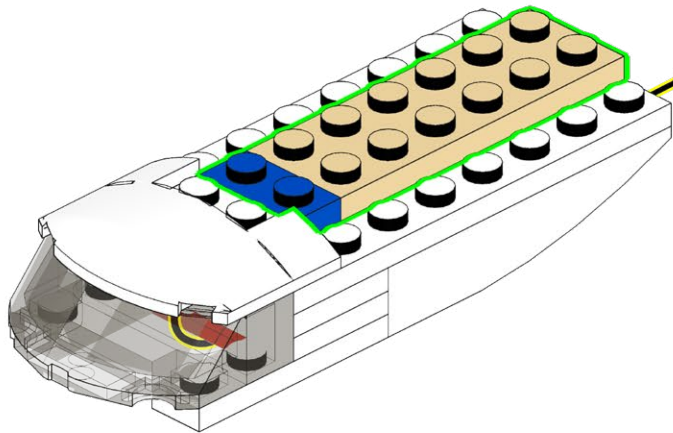
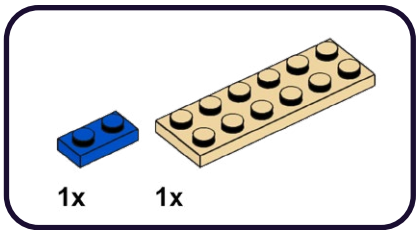

487

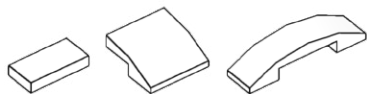

1x

6x

1x

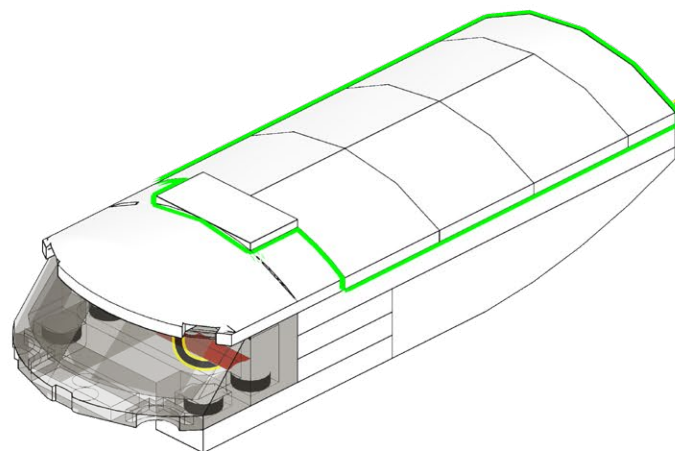

488

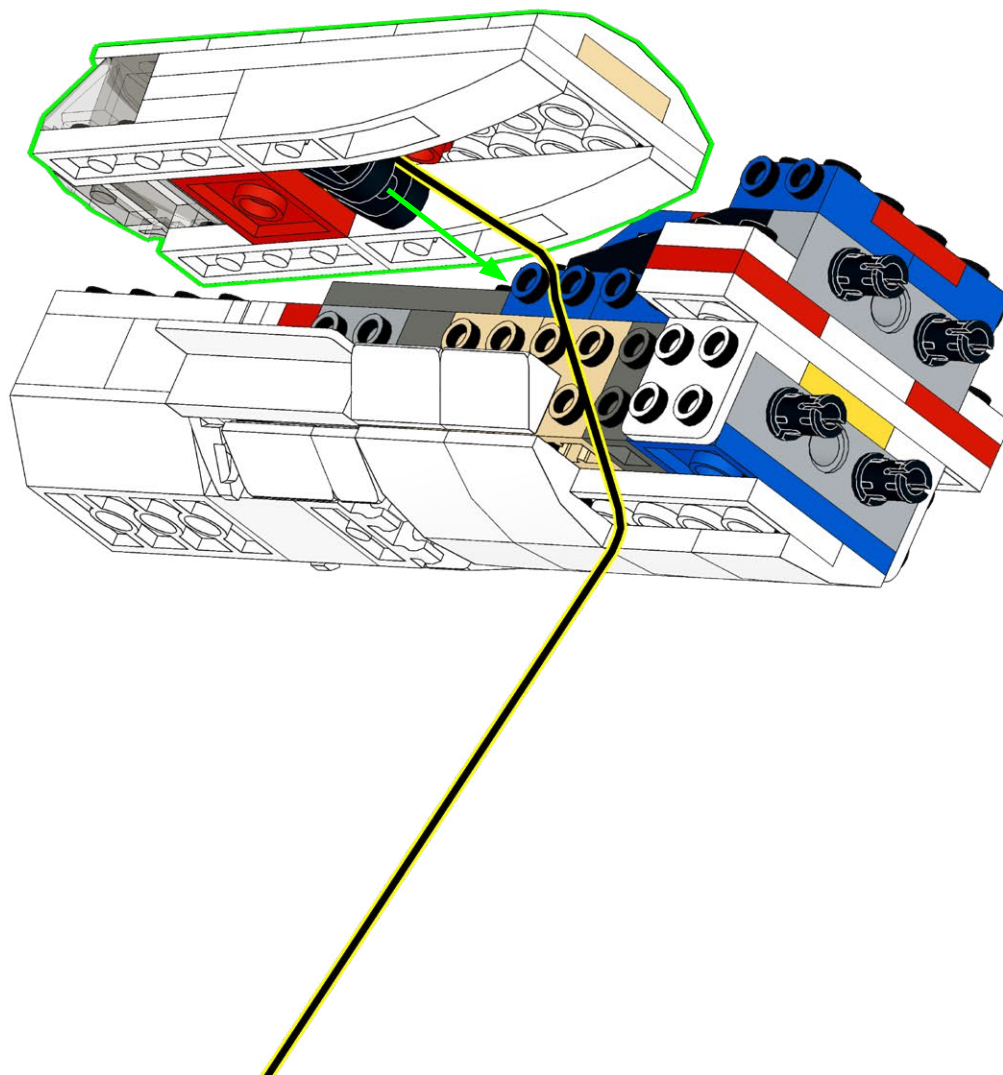

489

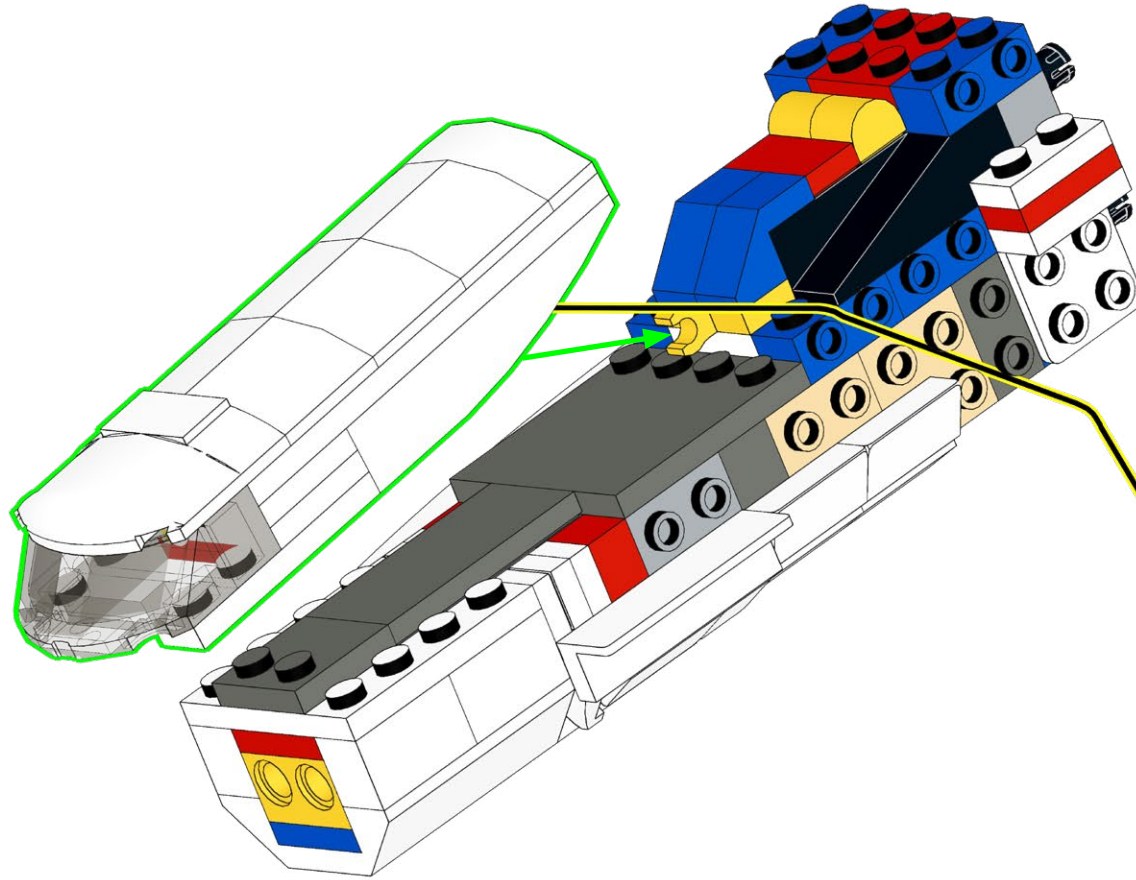



490

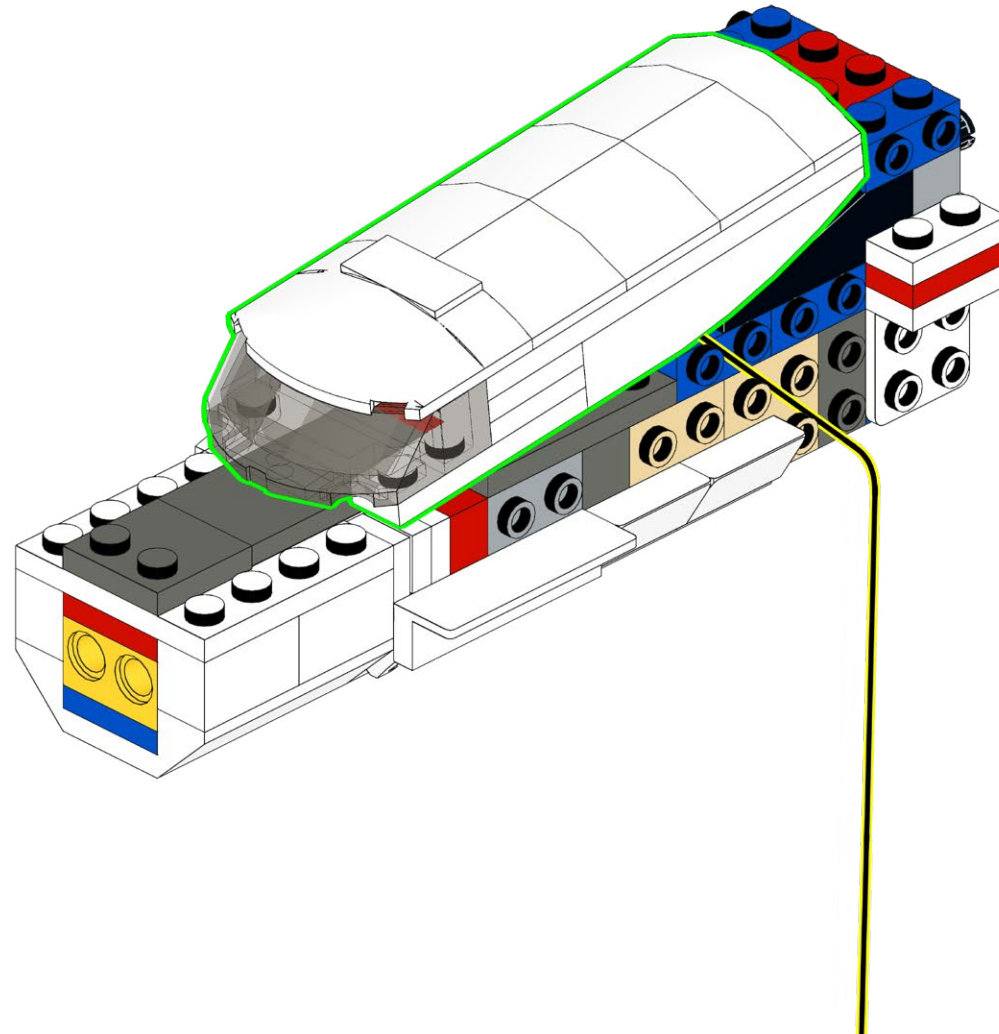

491

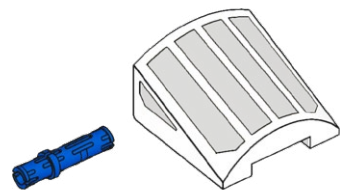

2x

1x

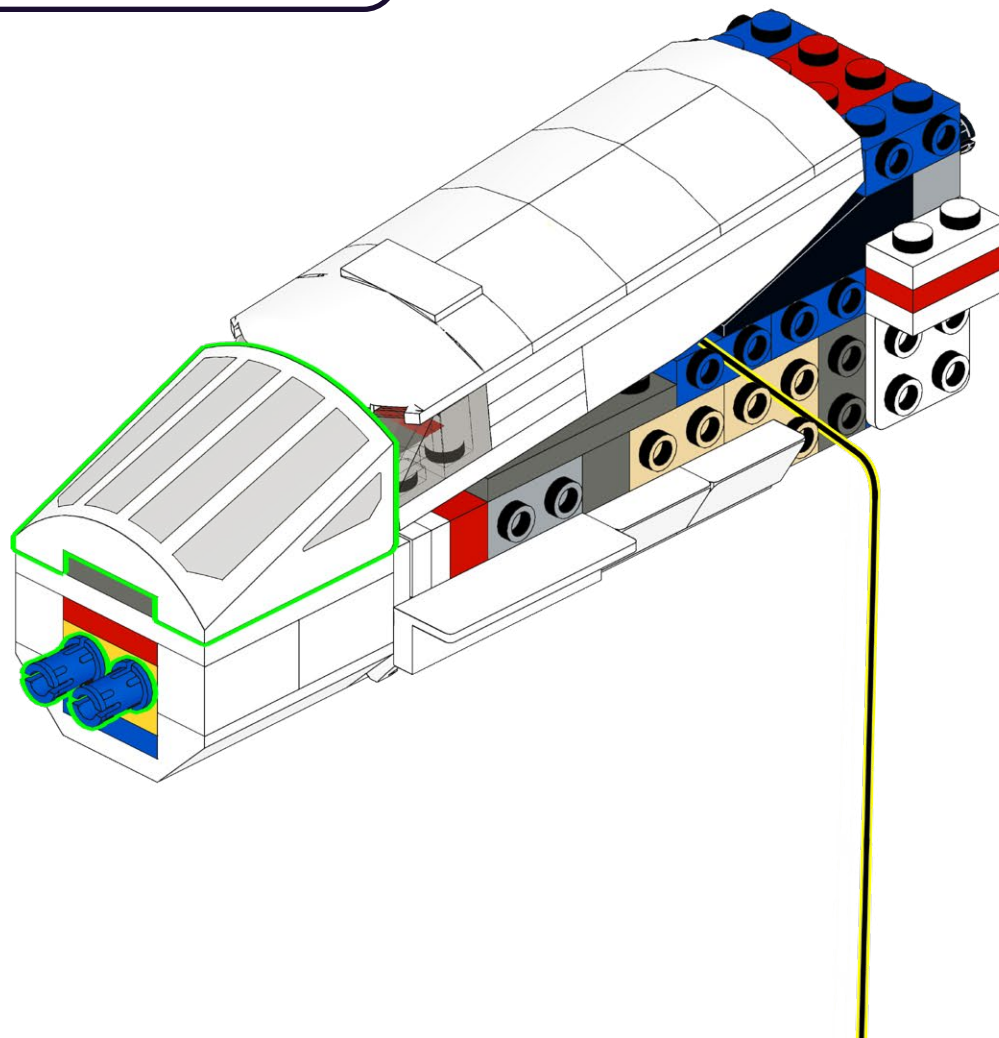

492

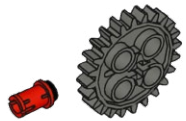

2x

1x

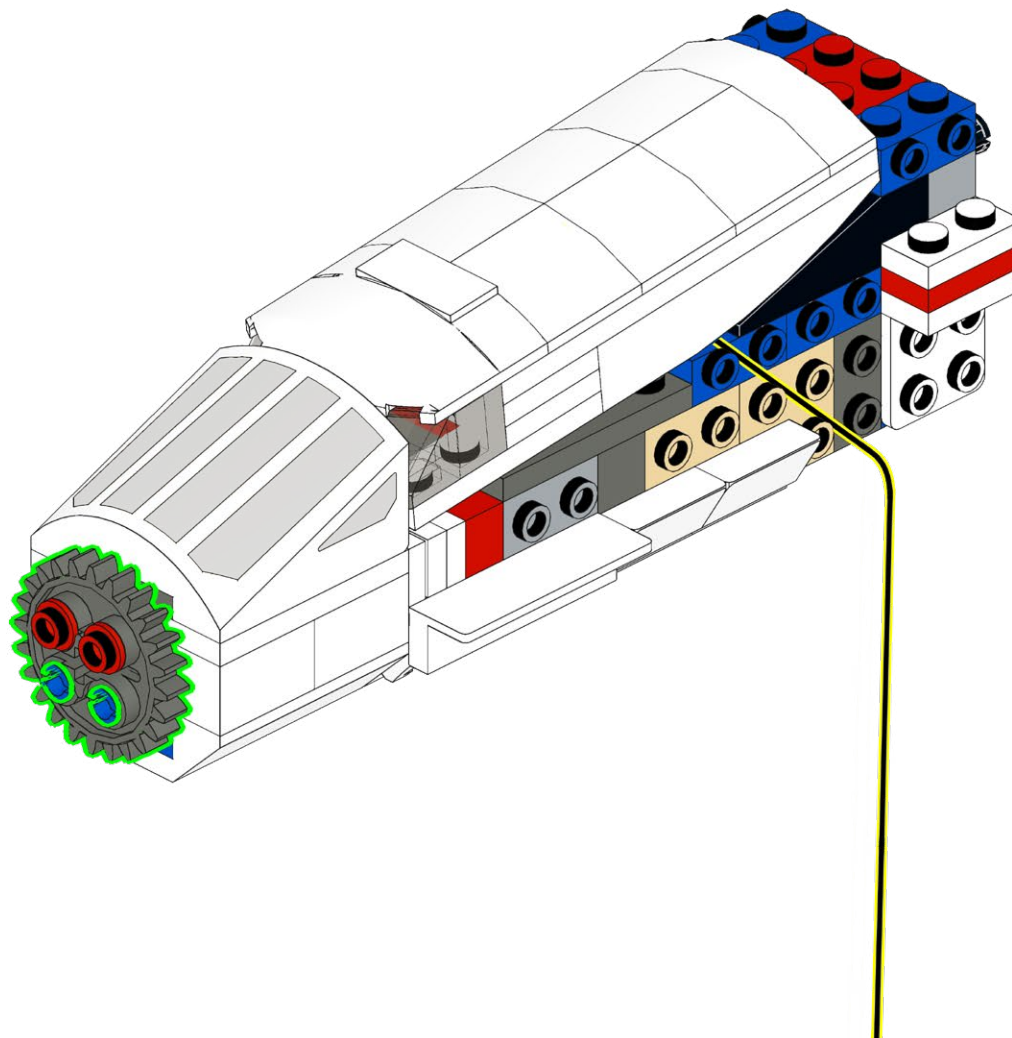

493



1x

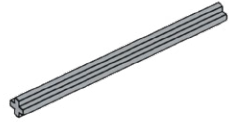

1x

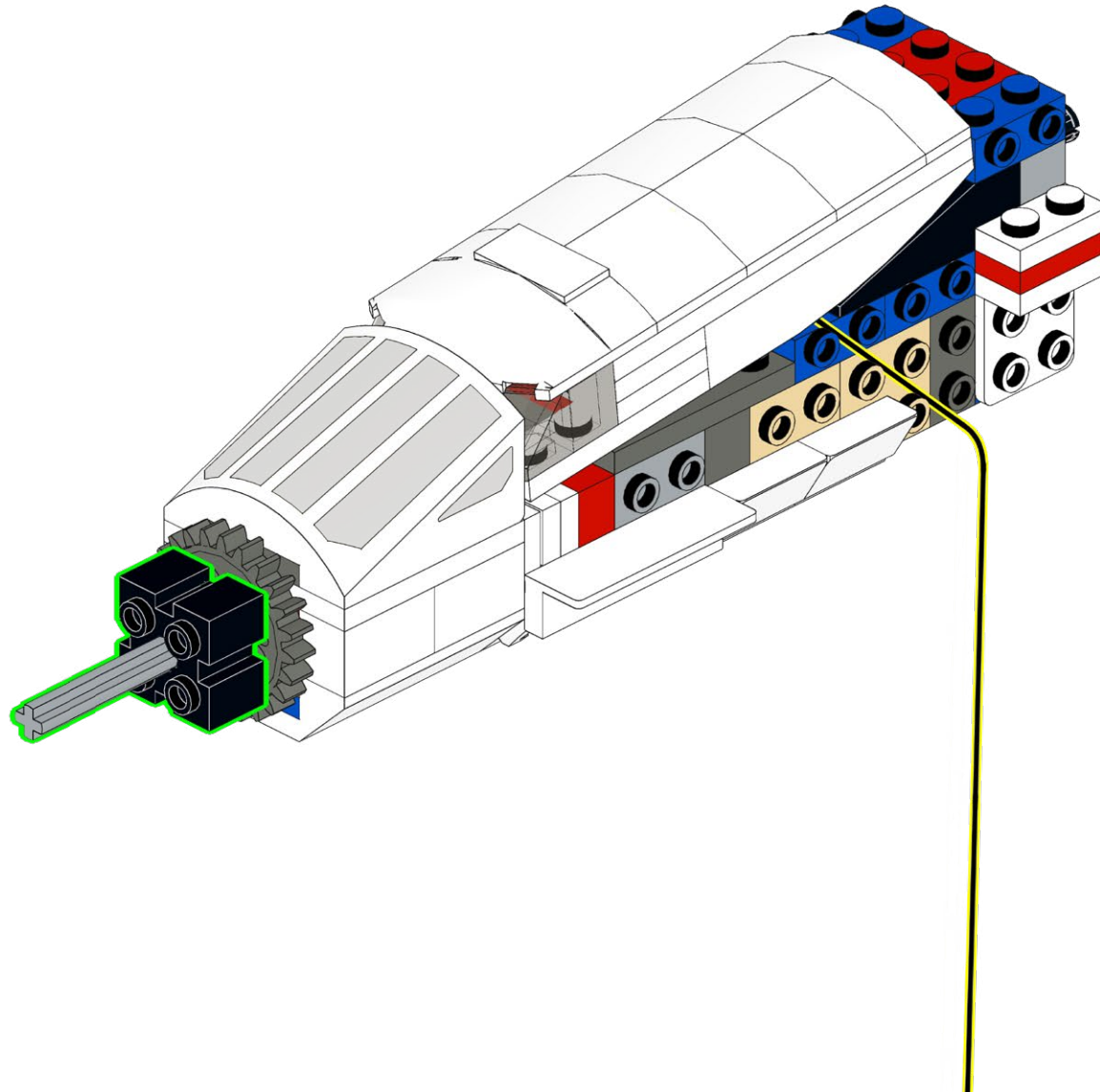

494

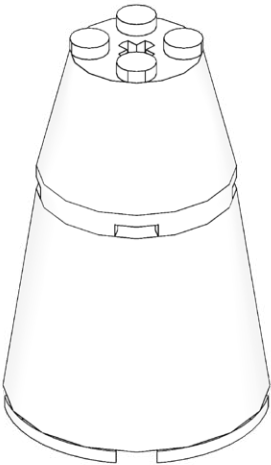
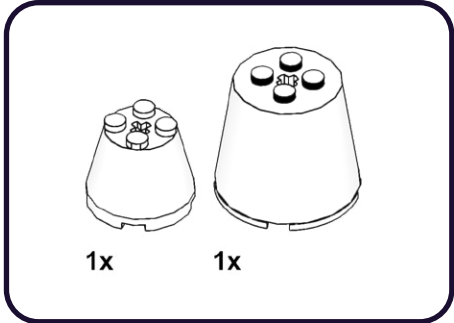

**495**

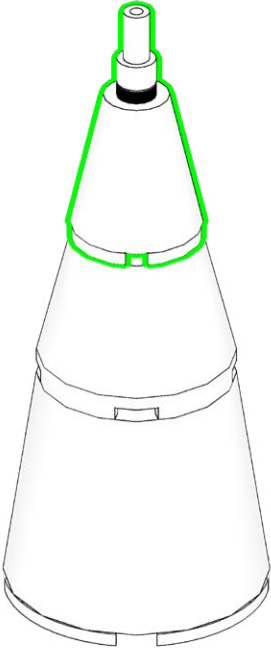
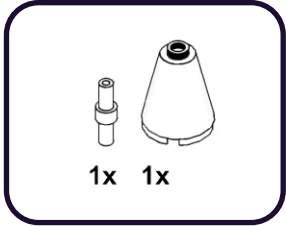

496

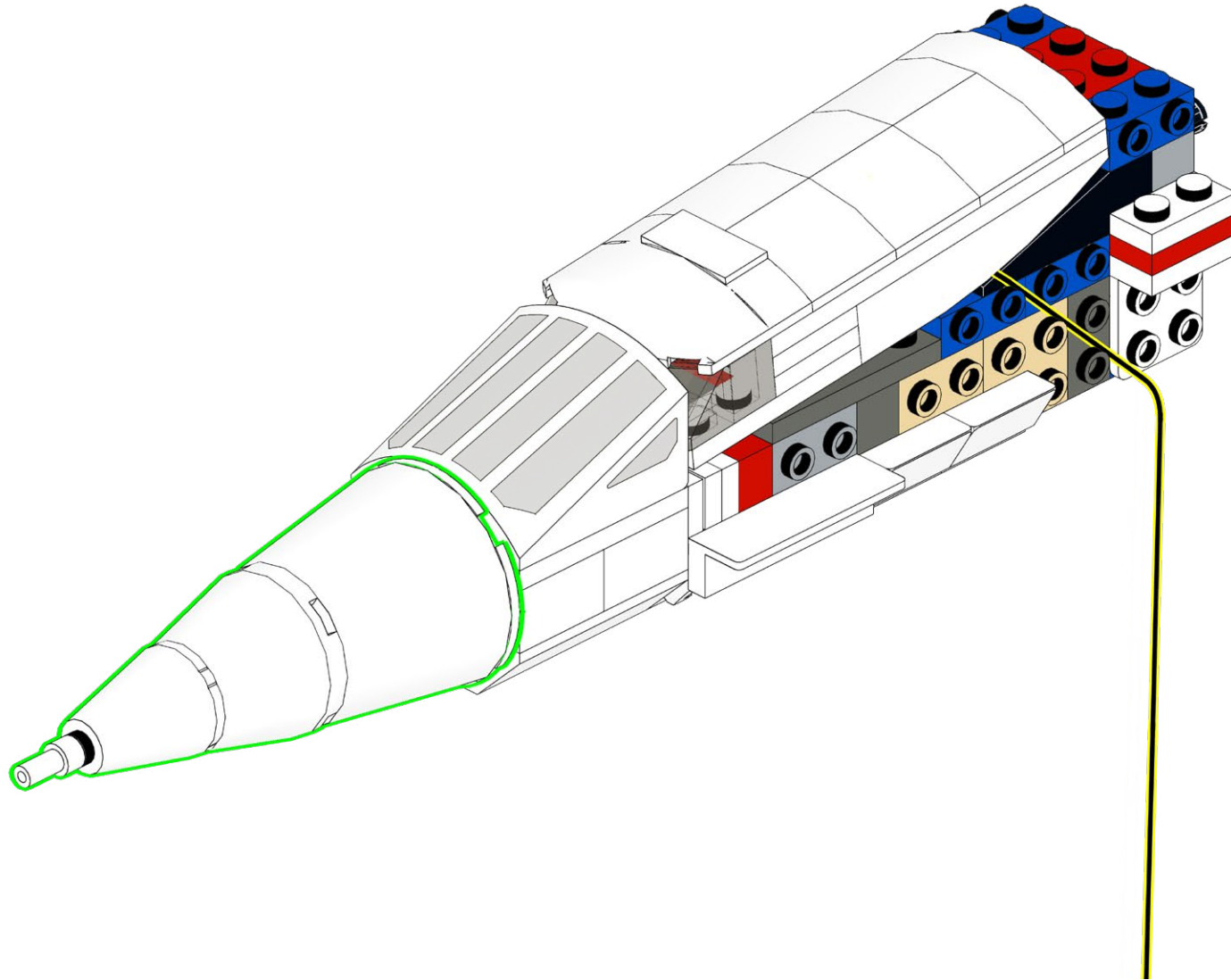

497

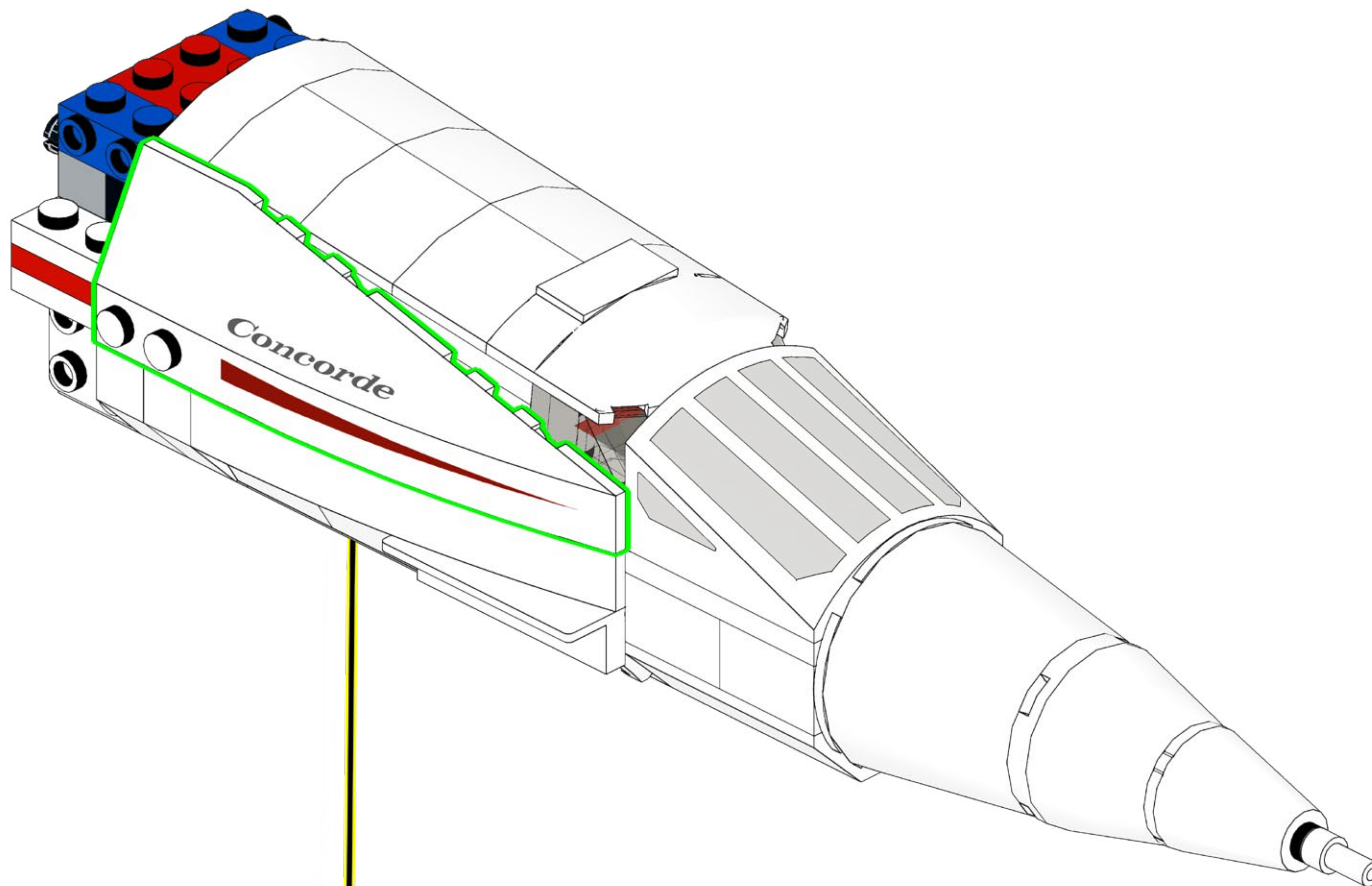
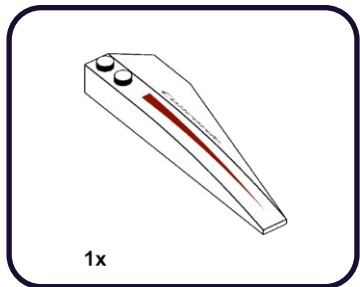



498

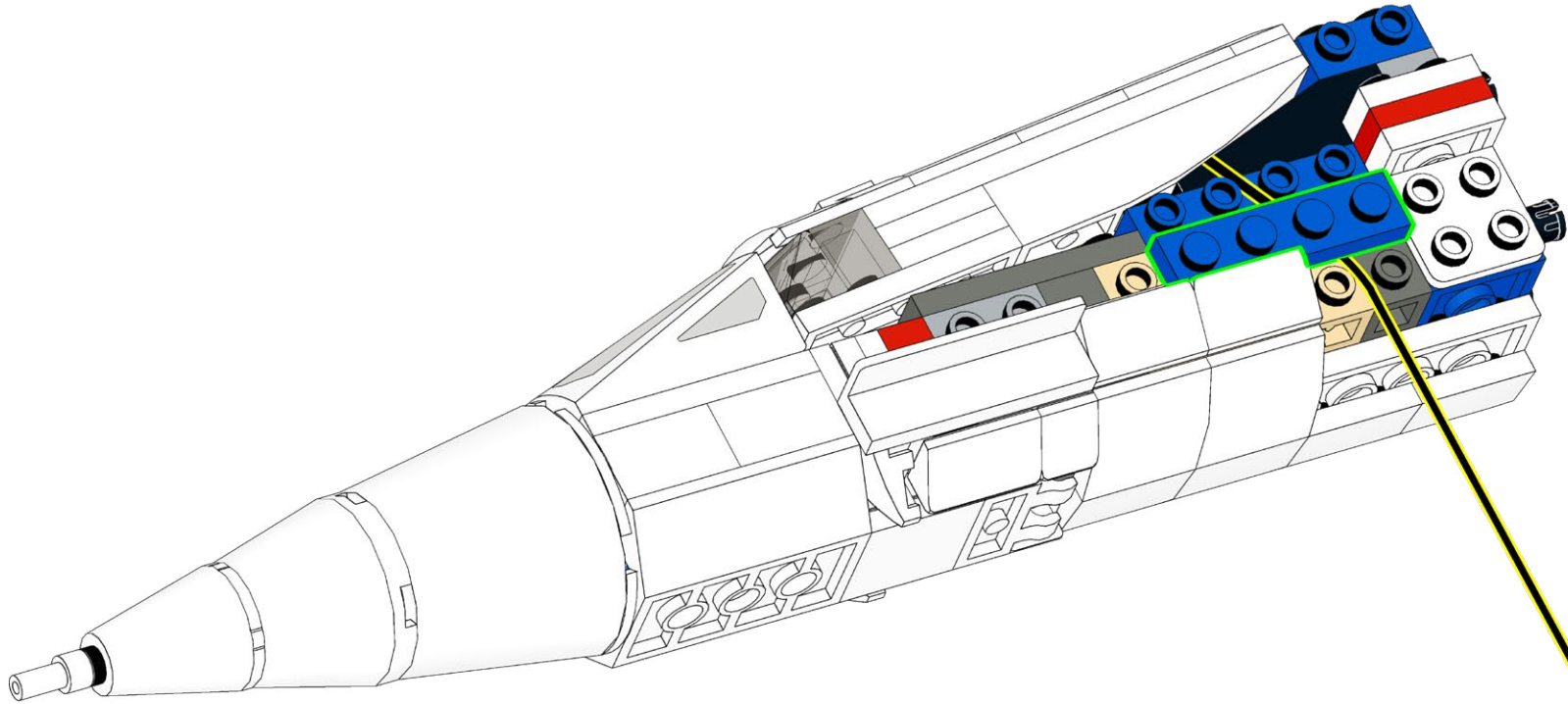
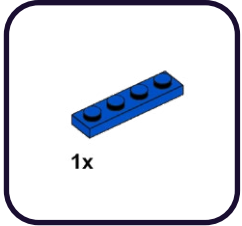

499

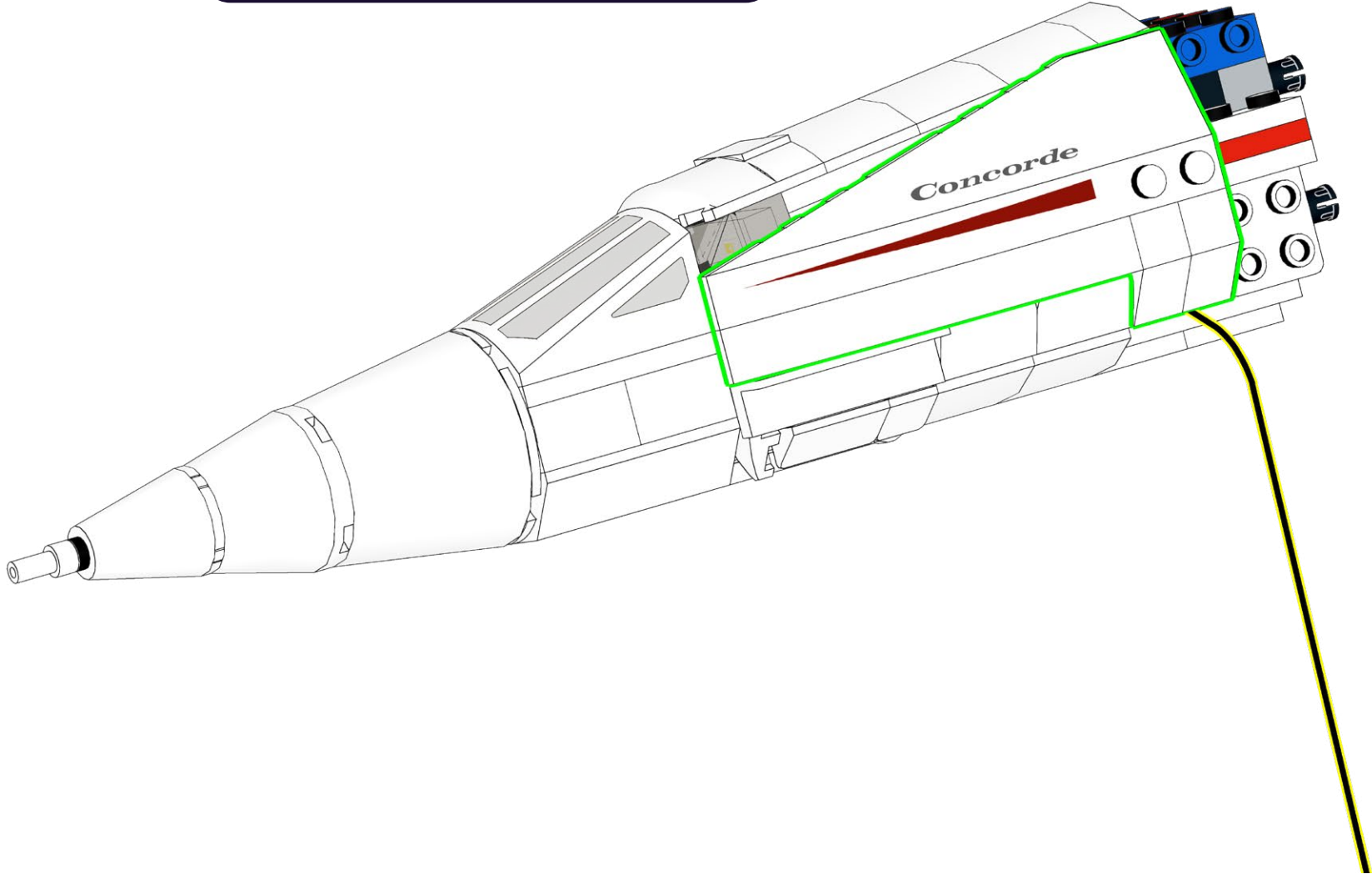
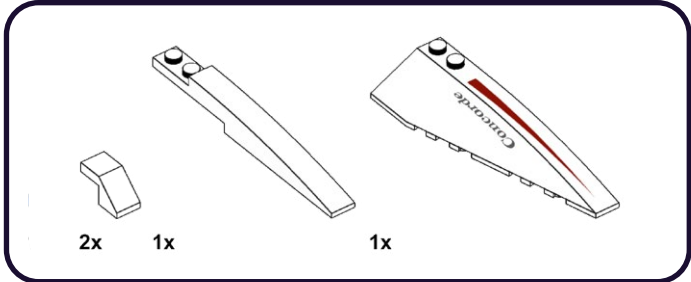

500

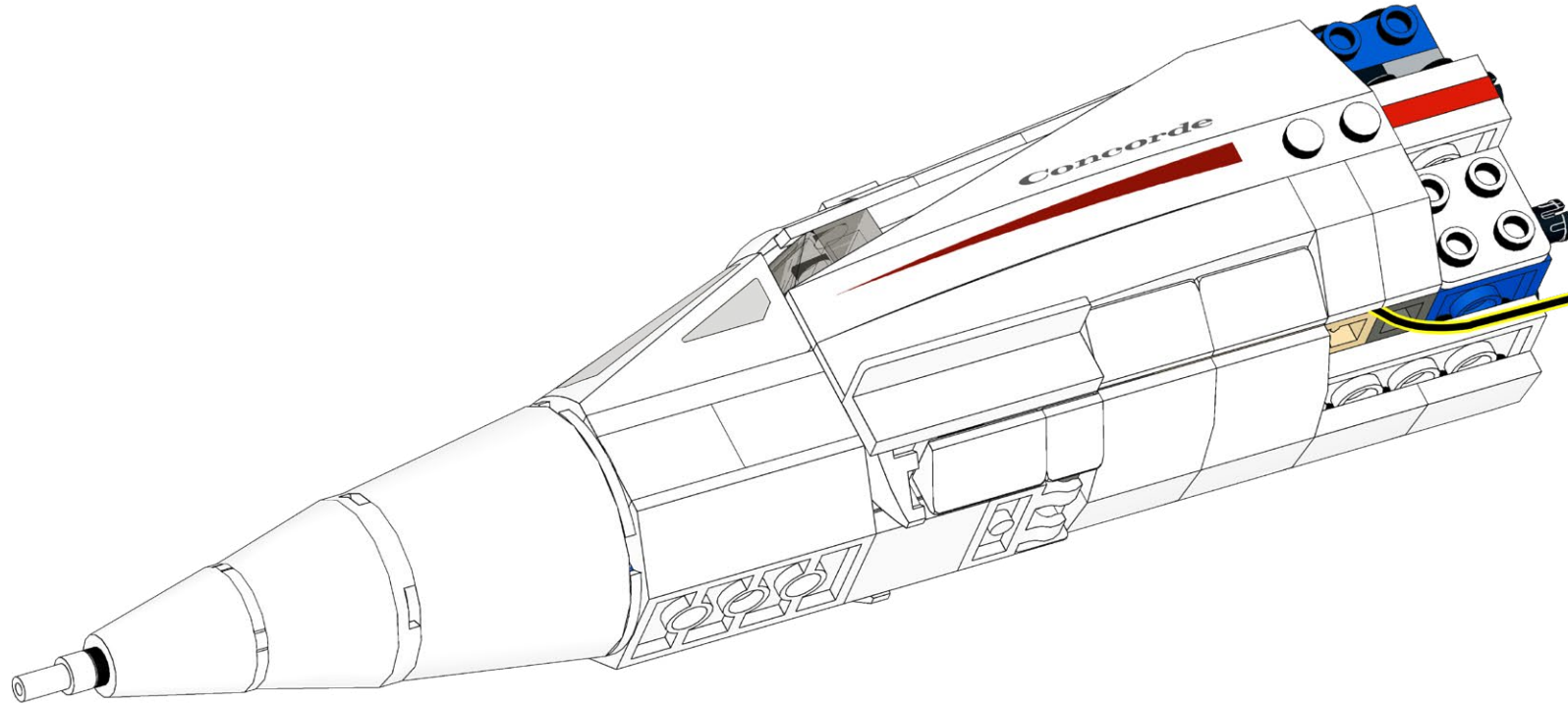

501

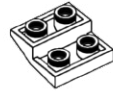

2x

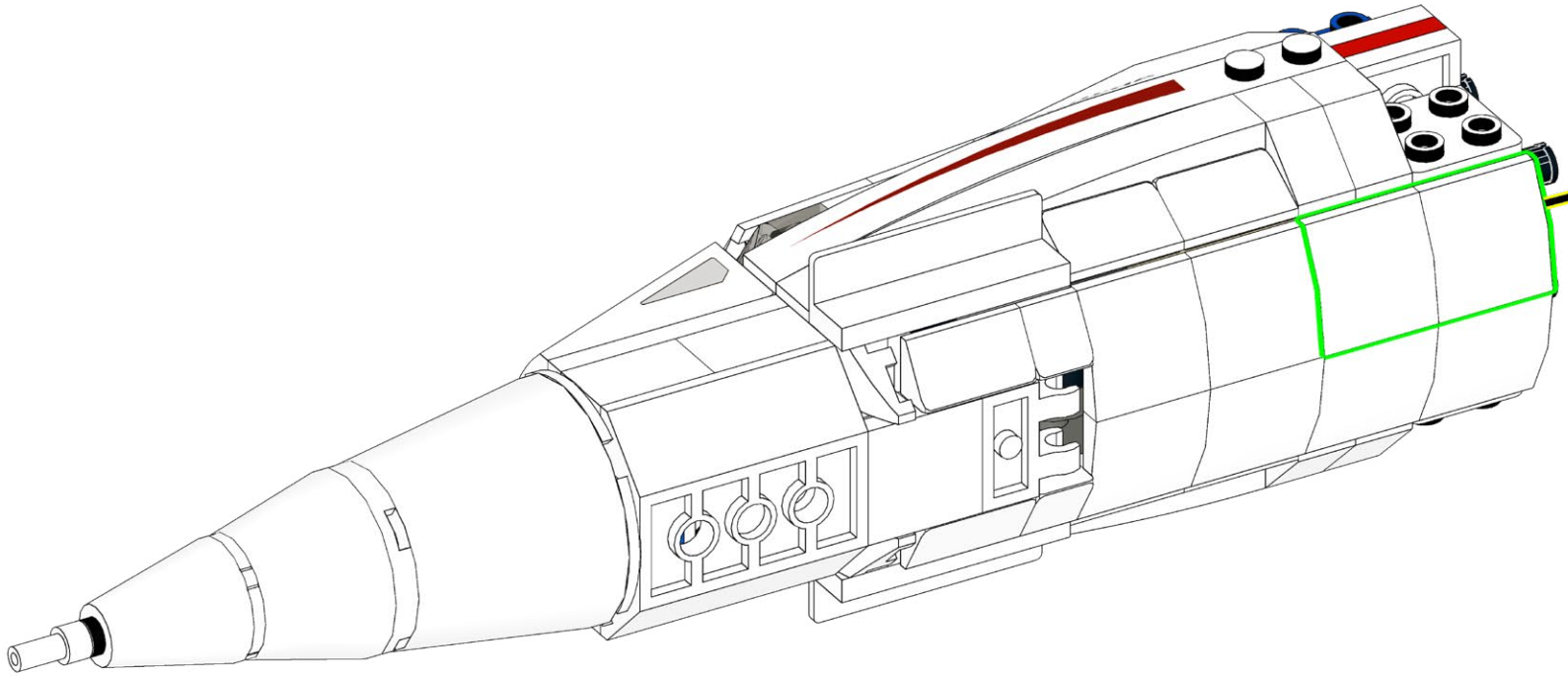

502

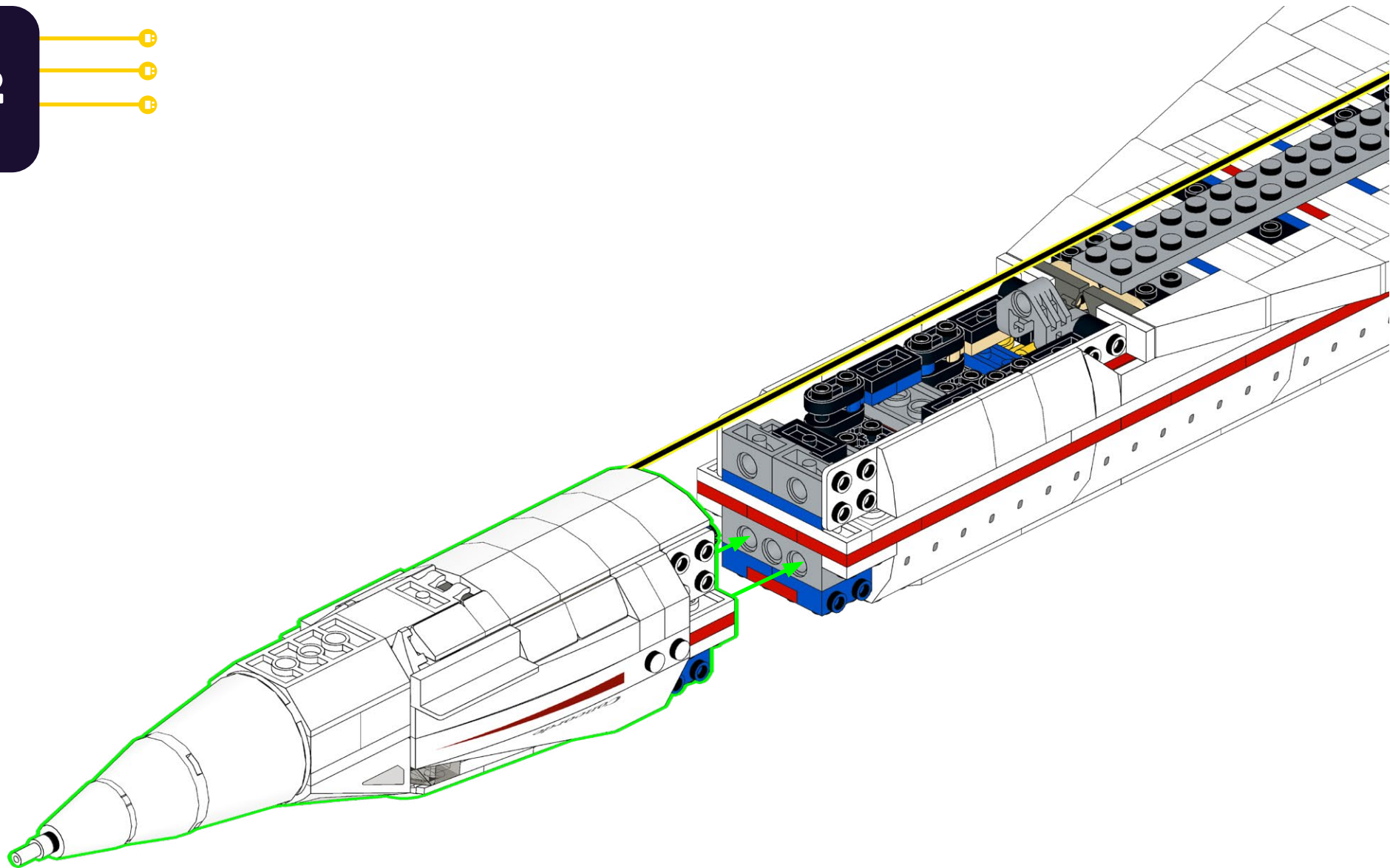

503

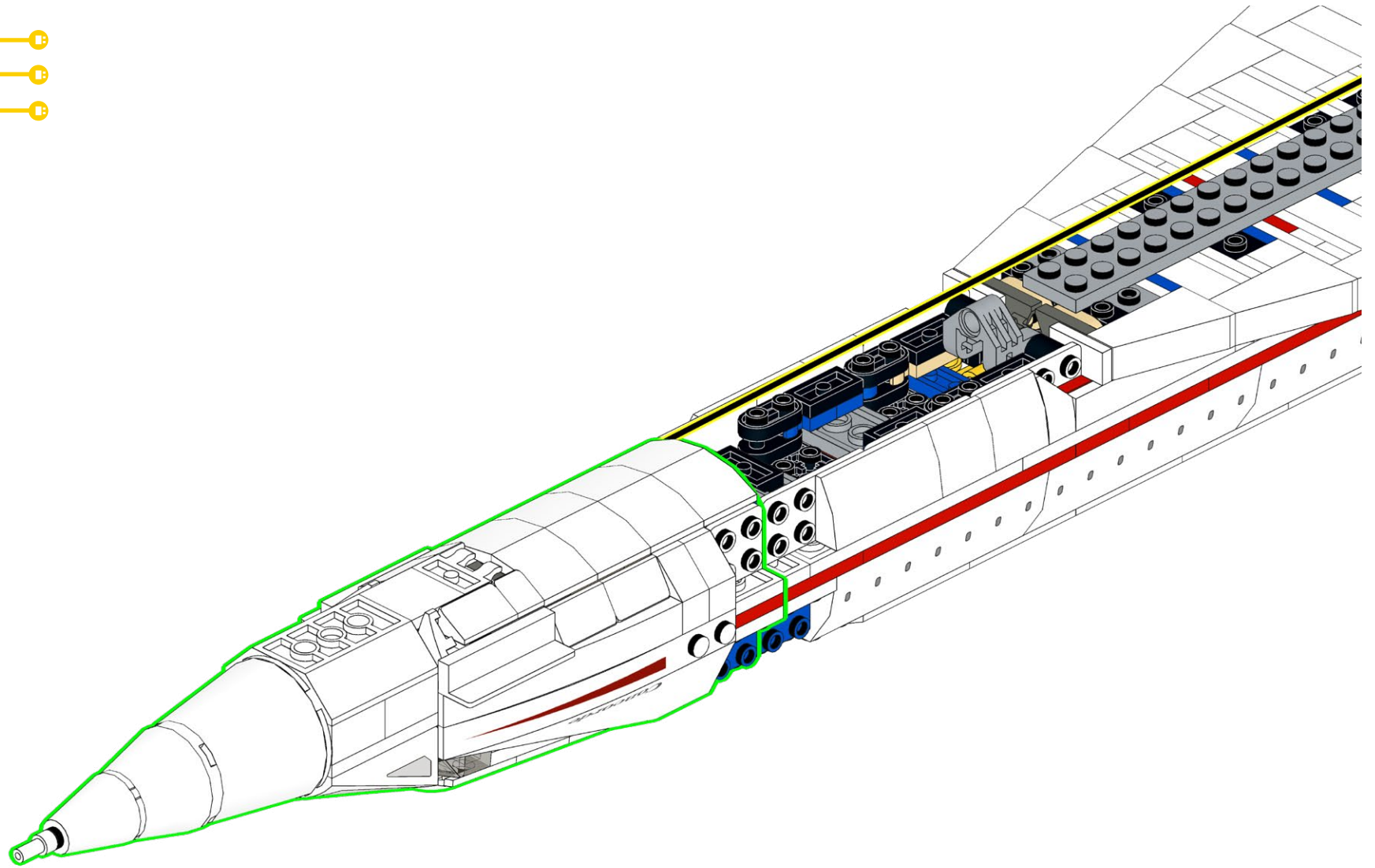

504

AR-WW15

2x

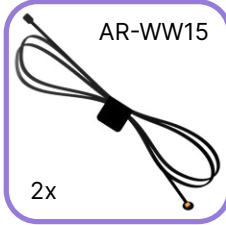

1

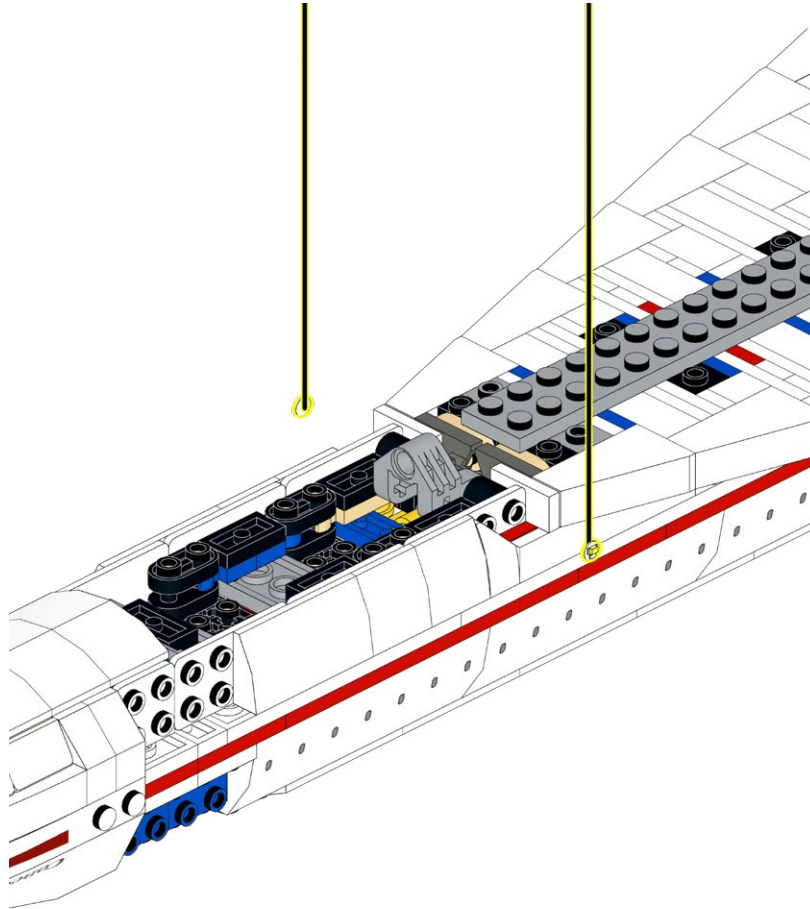

505

2x



1

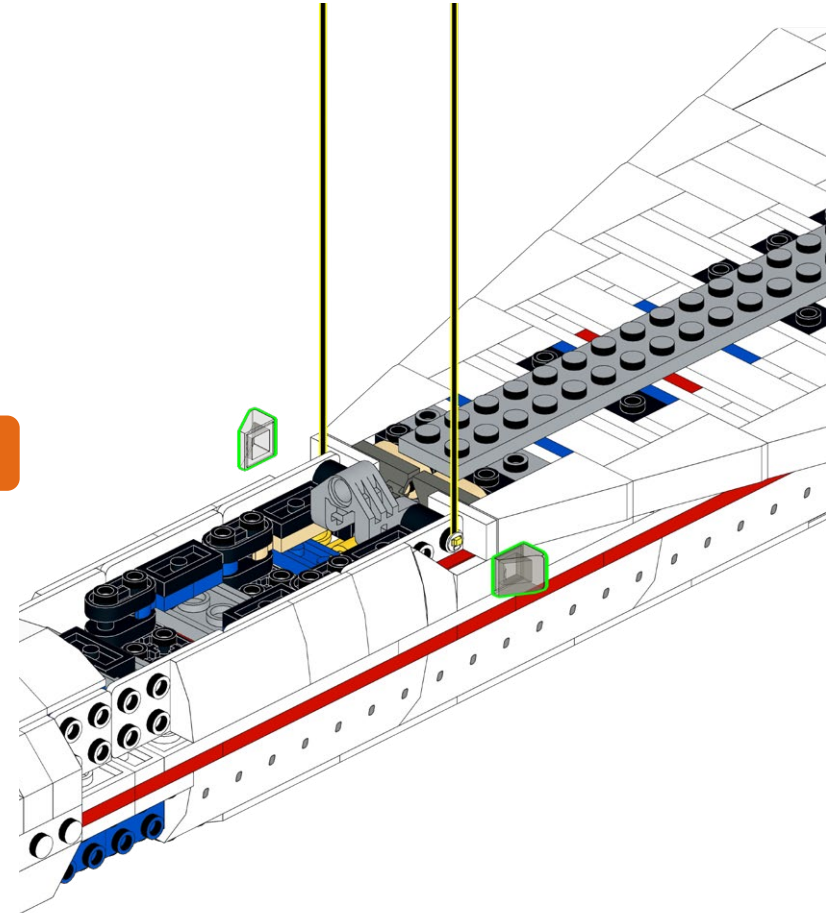

506

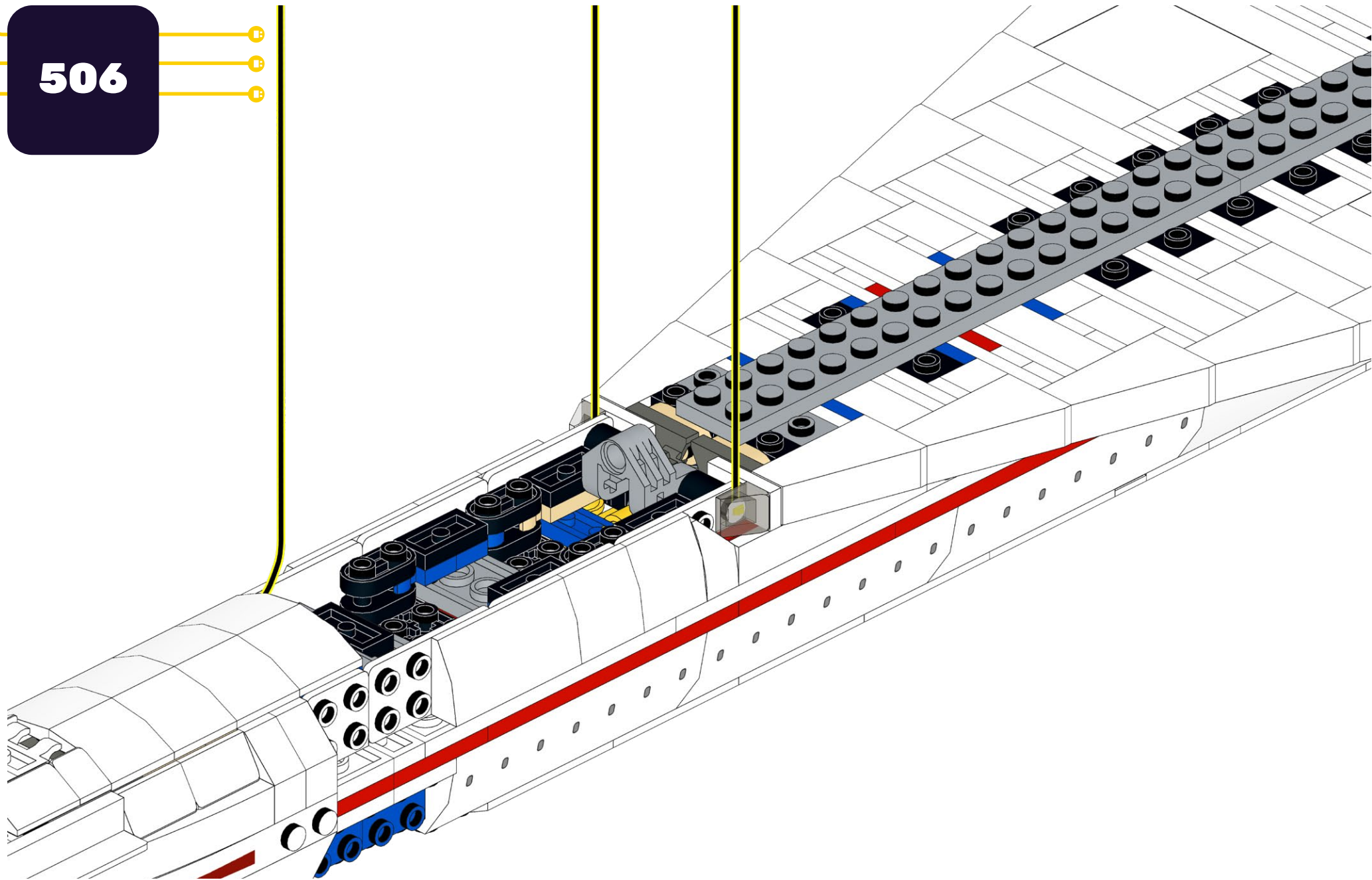



**507**

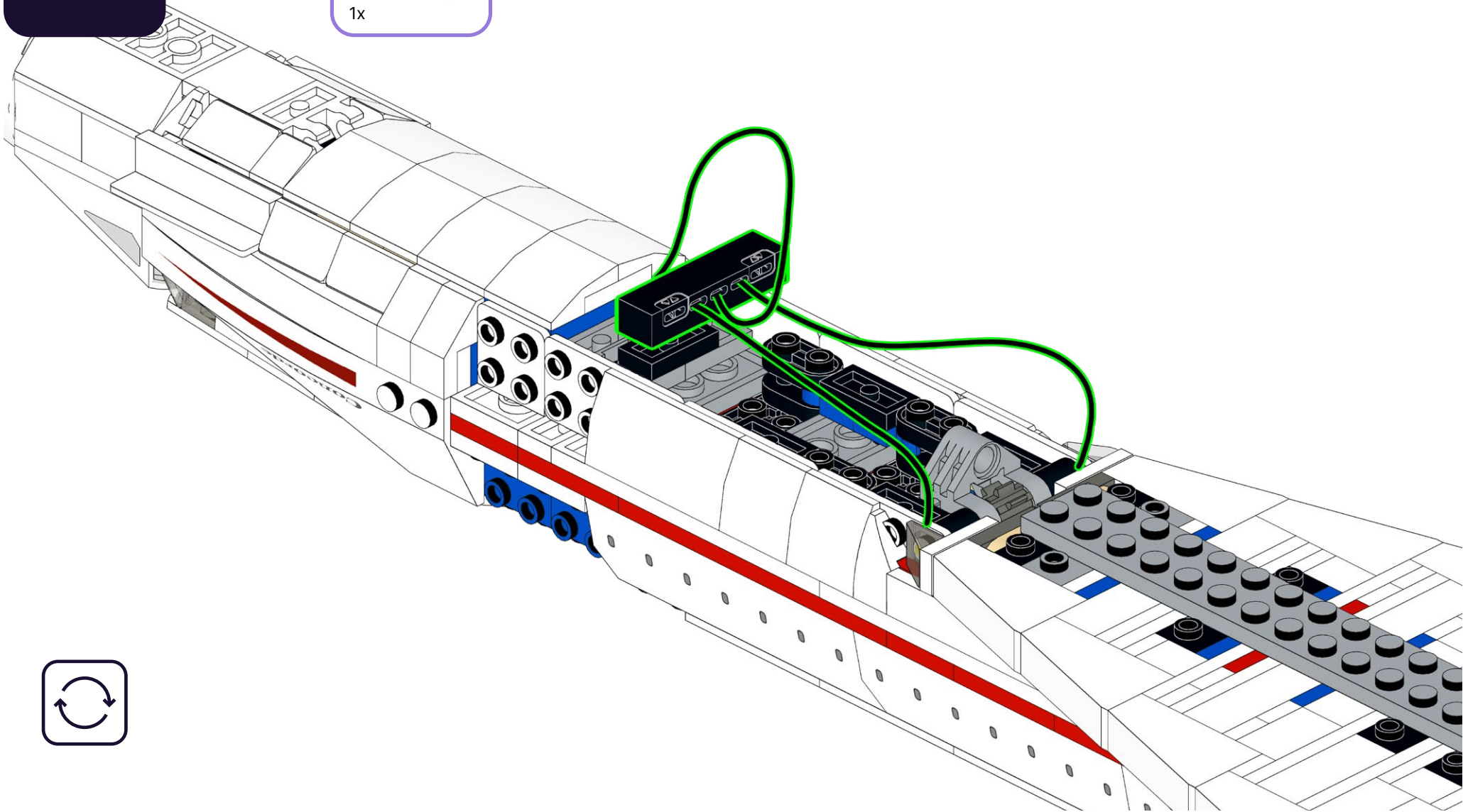
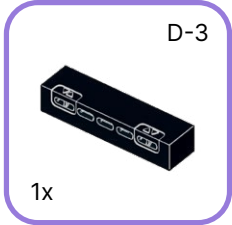

**508**

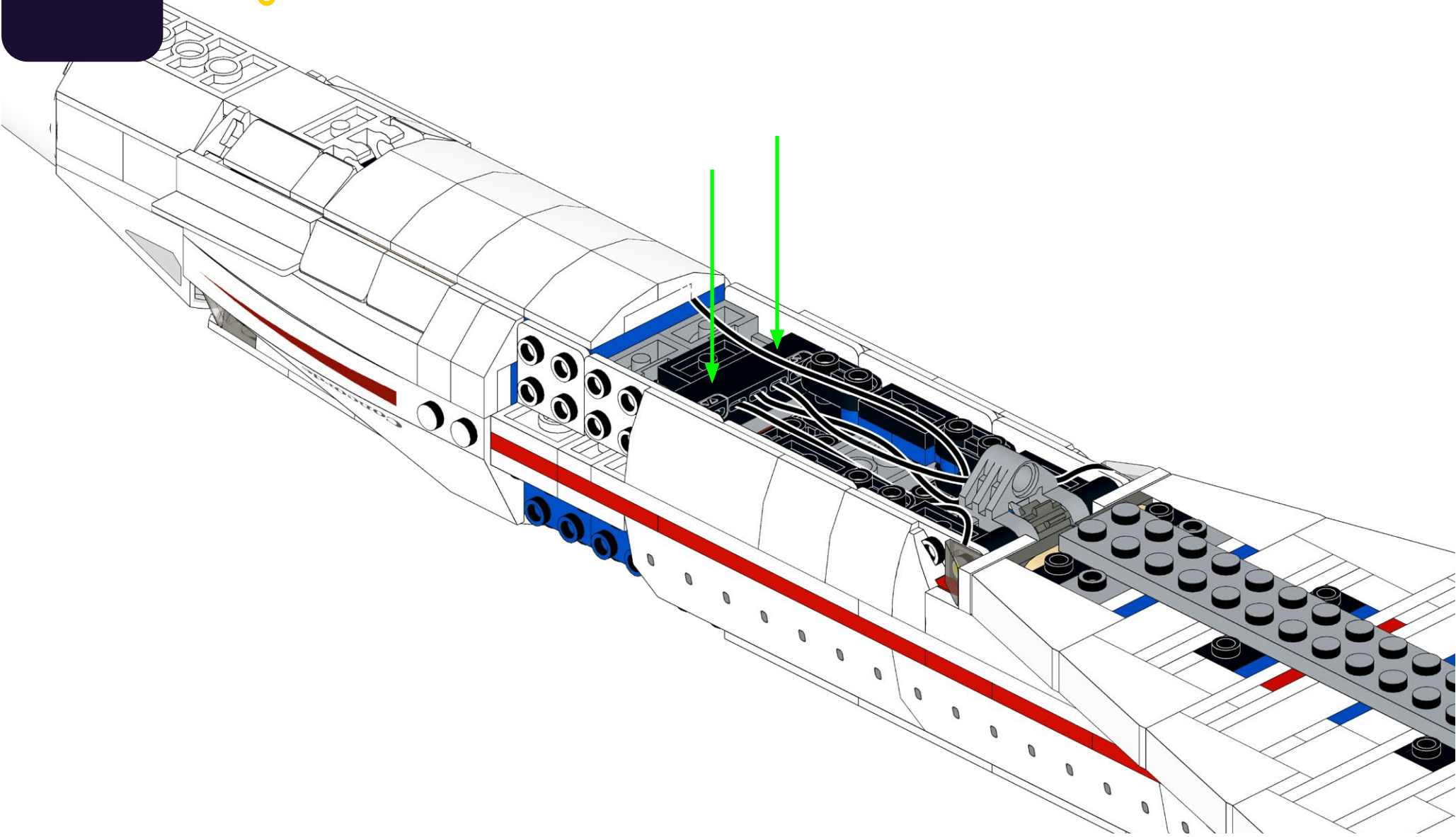

**509**

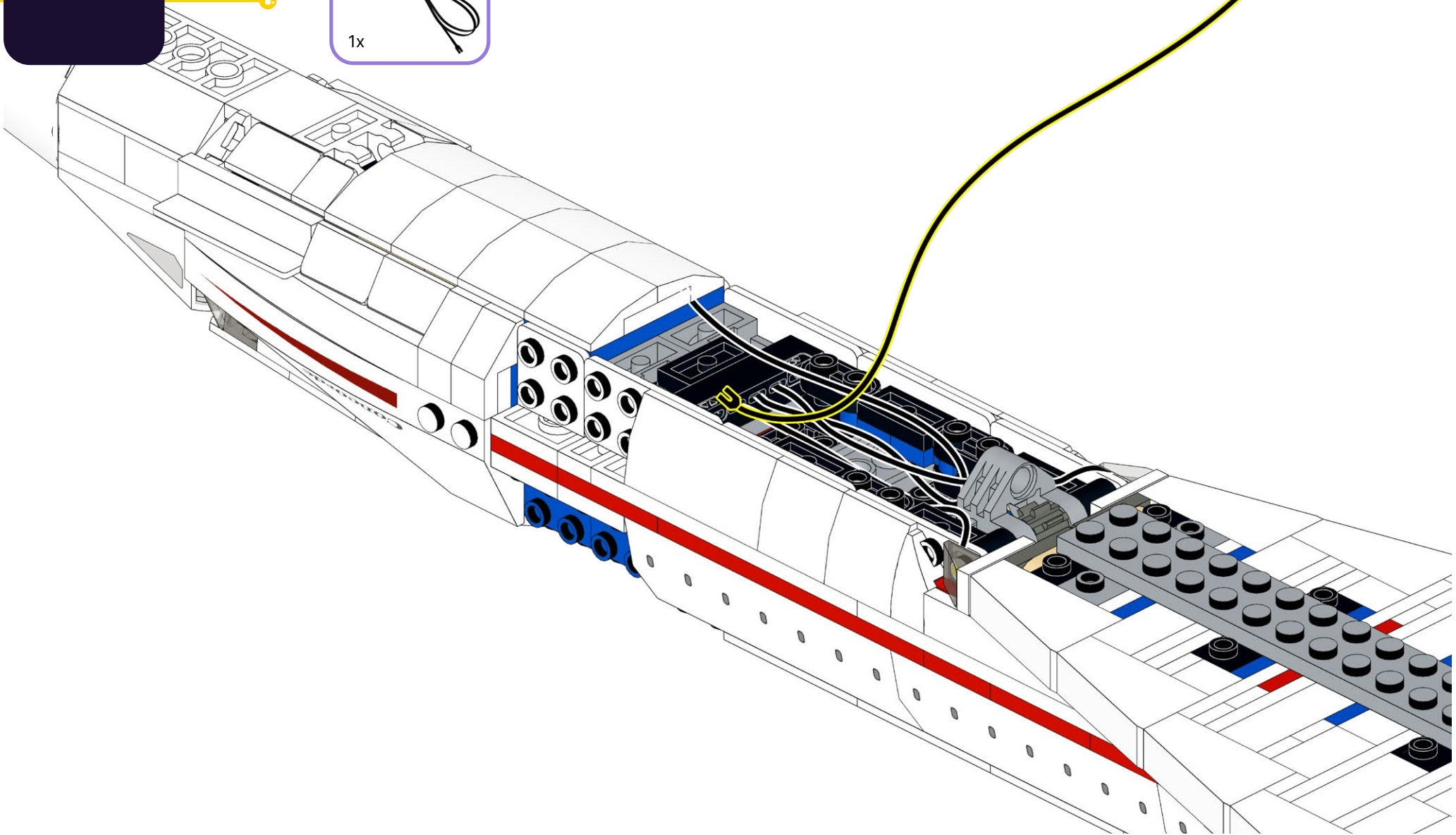
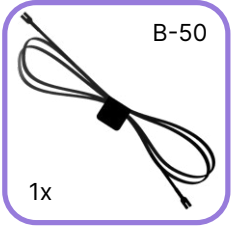

510

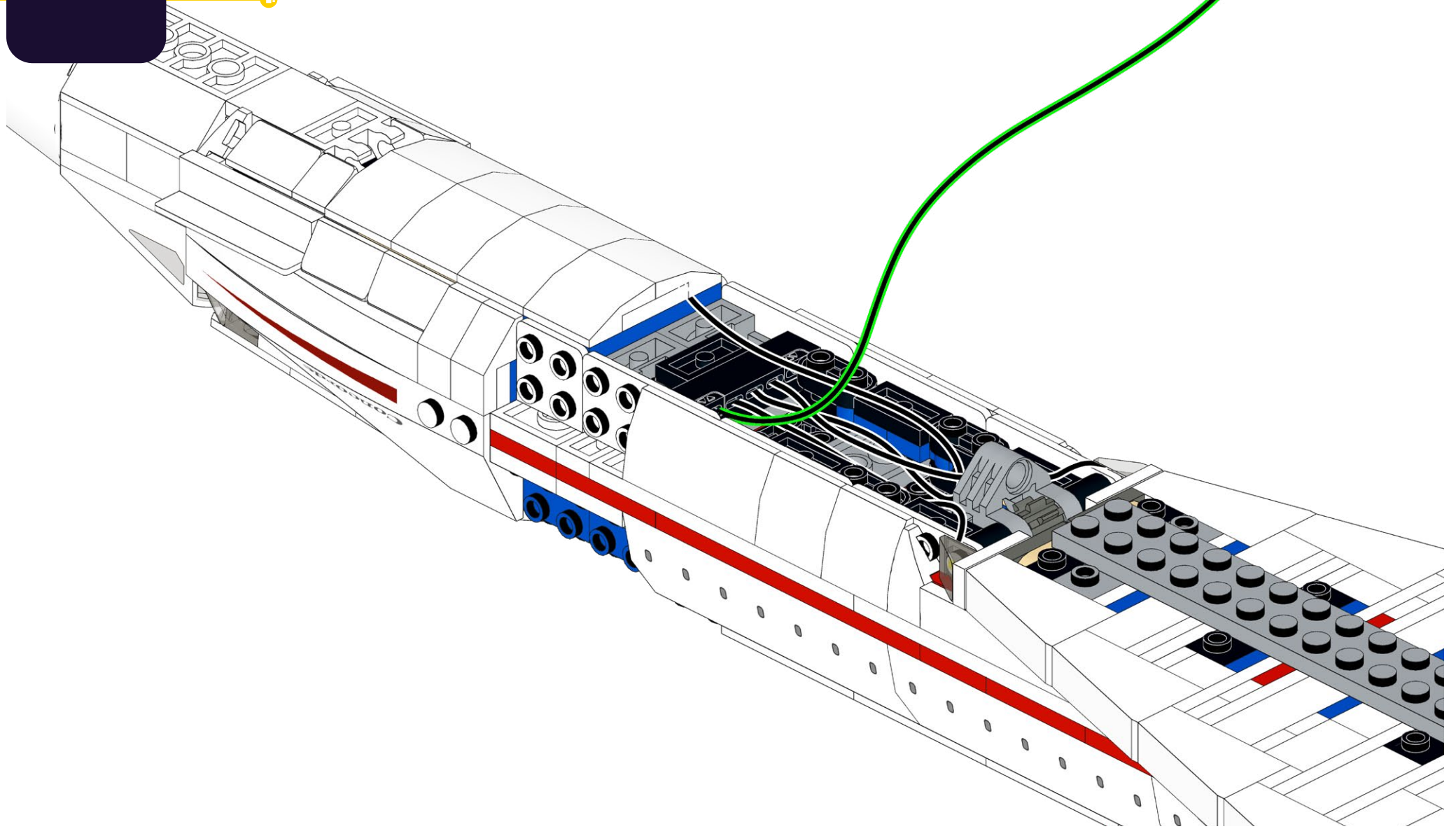

511

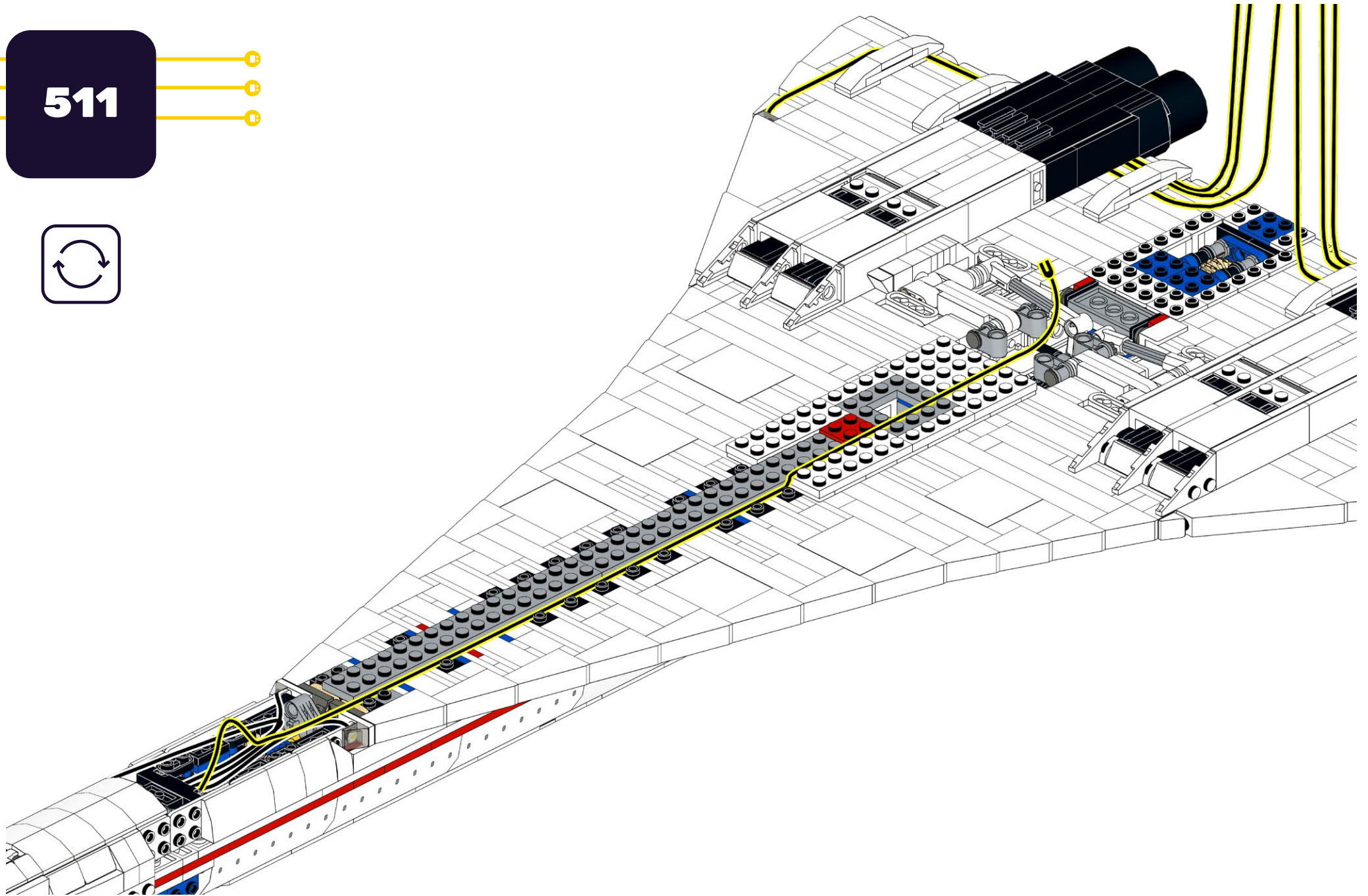

**512**

4x    2x    1x

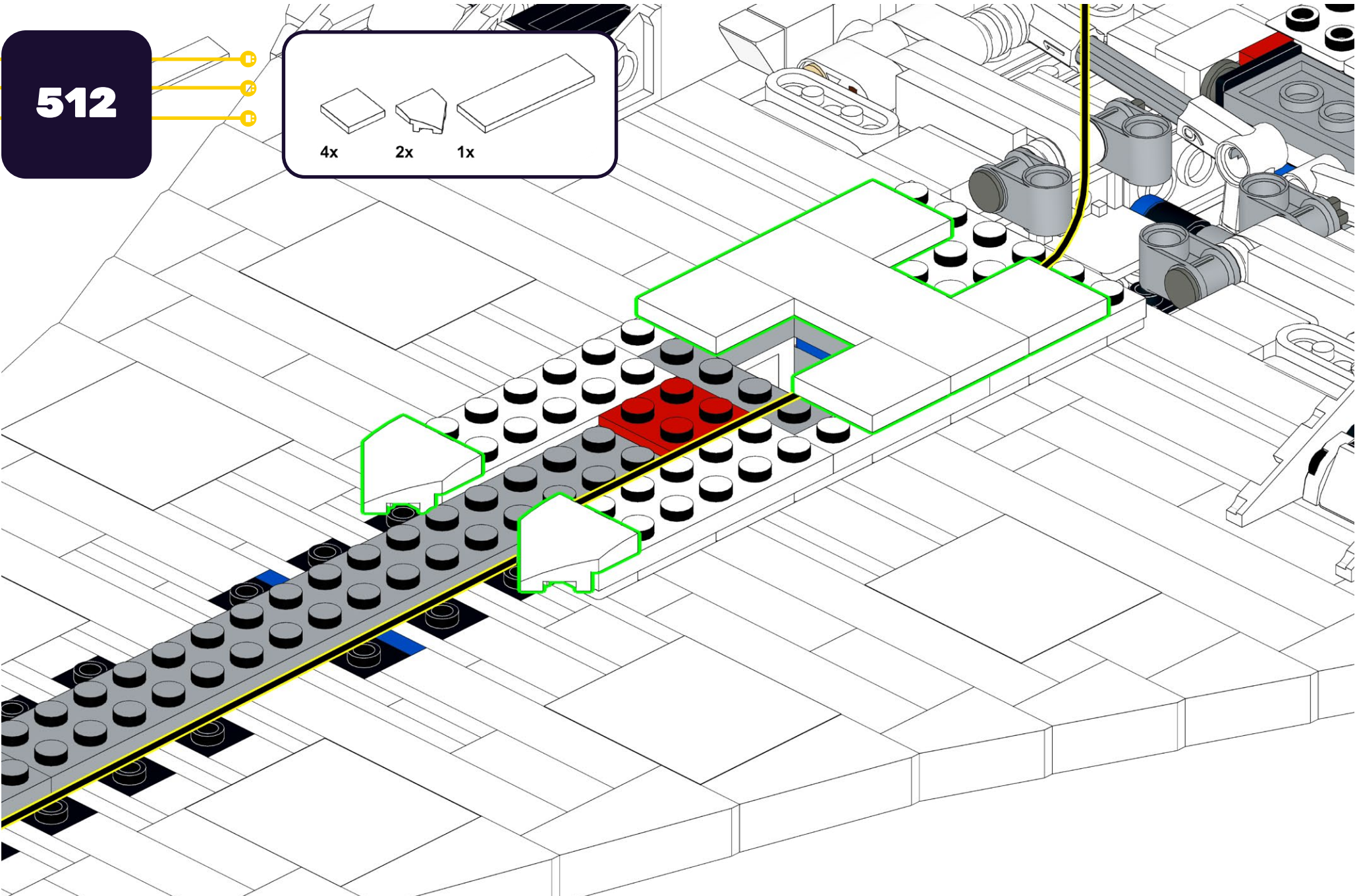

513



1x



2x



26x

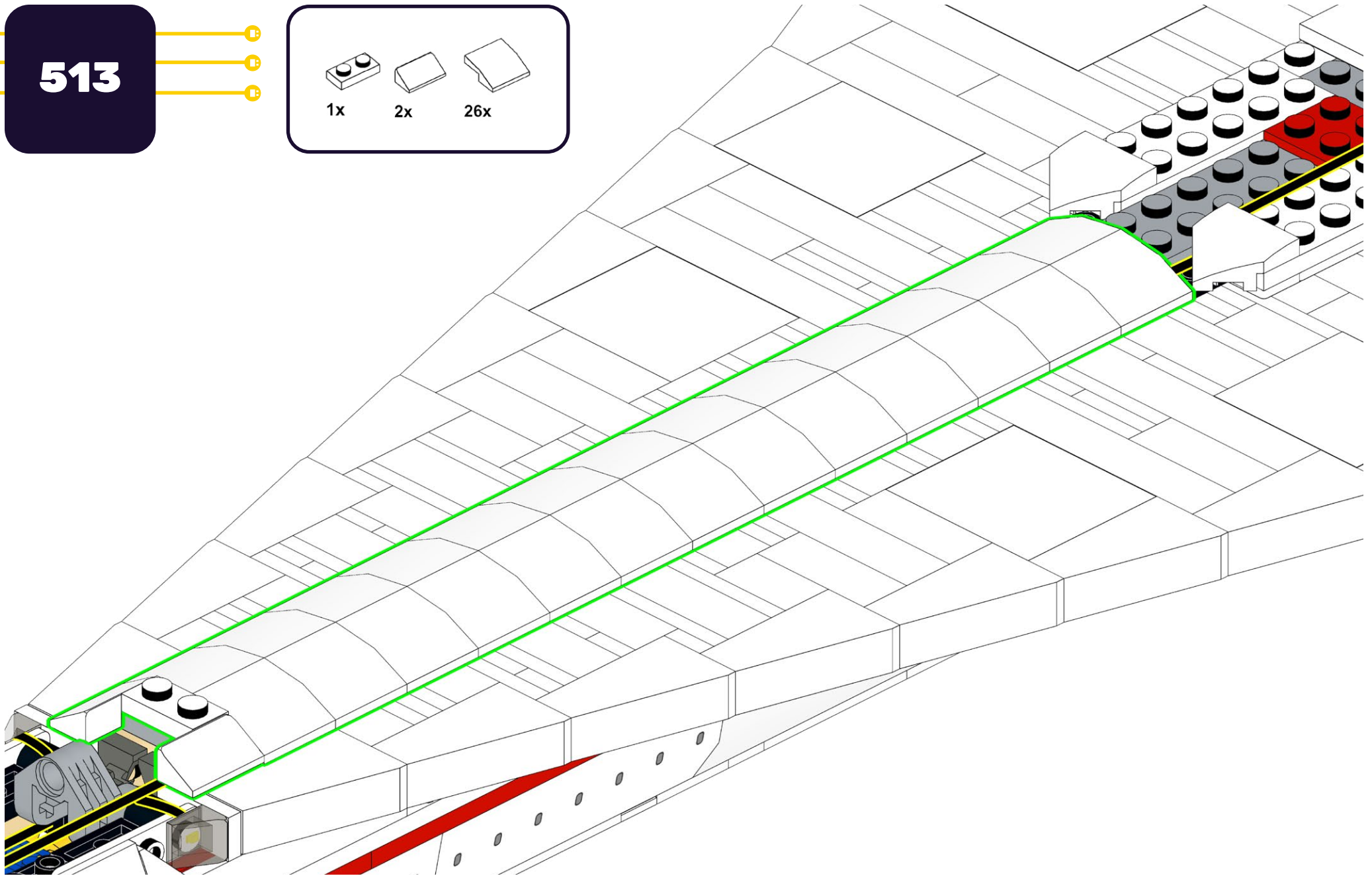

514

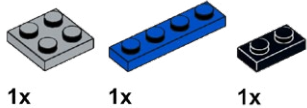

1x

1x

1x

1

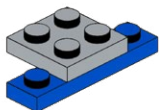

1

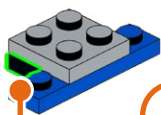

515

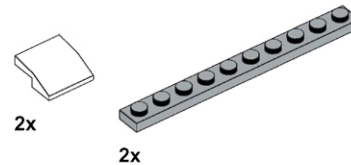

2x

2x

1

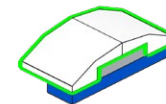

1

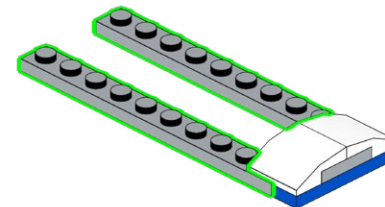



**516**

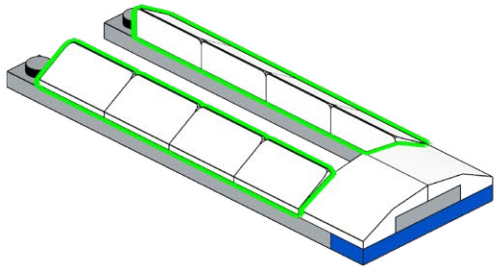
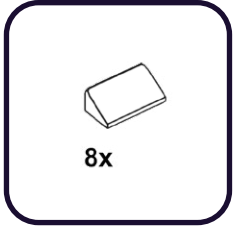

517

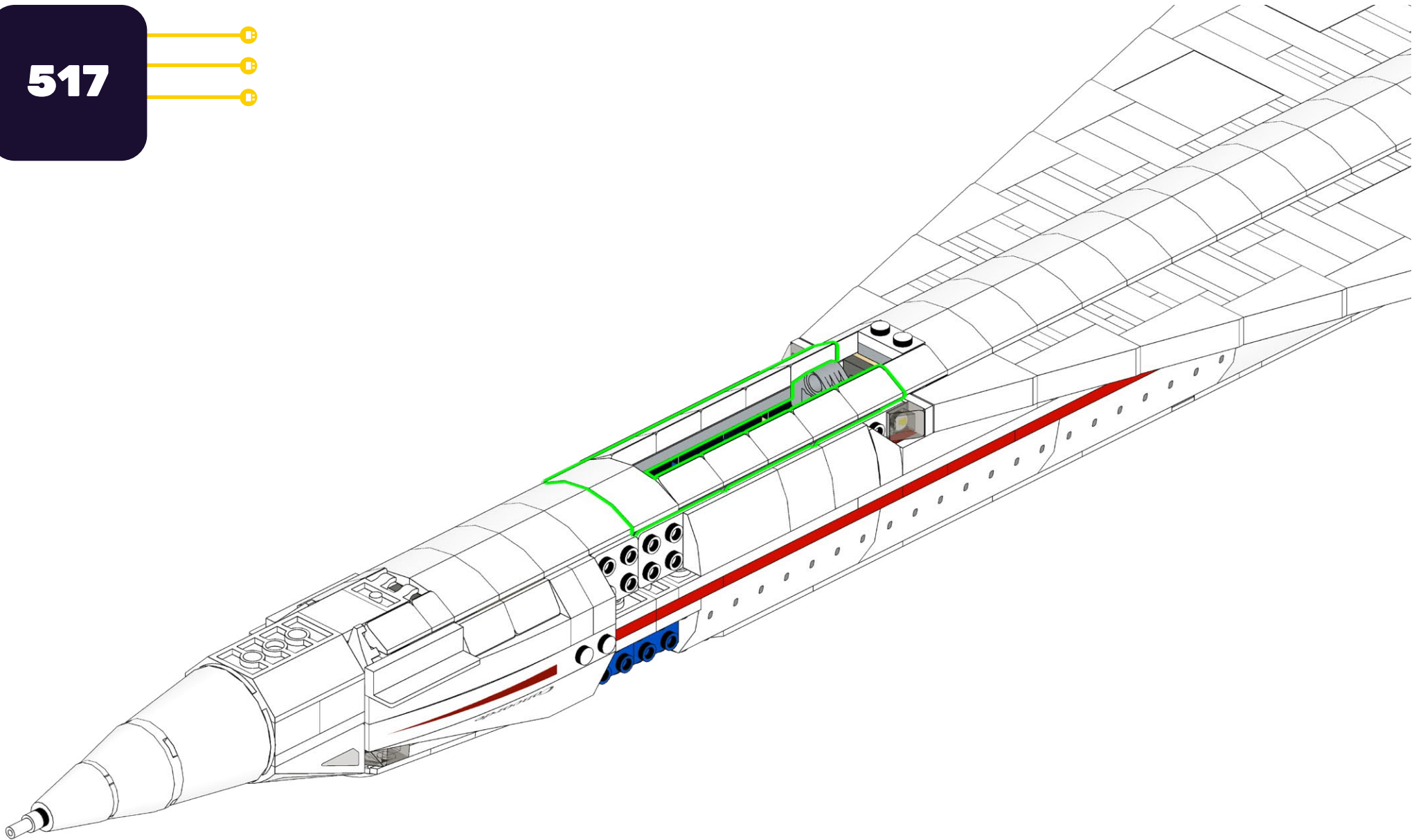

518

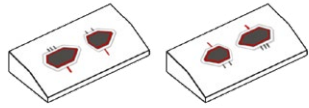

1x

1x

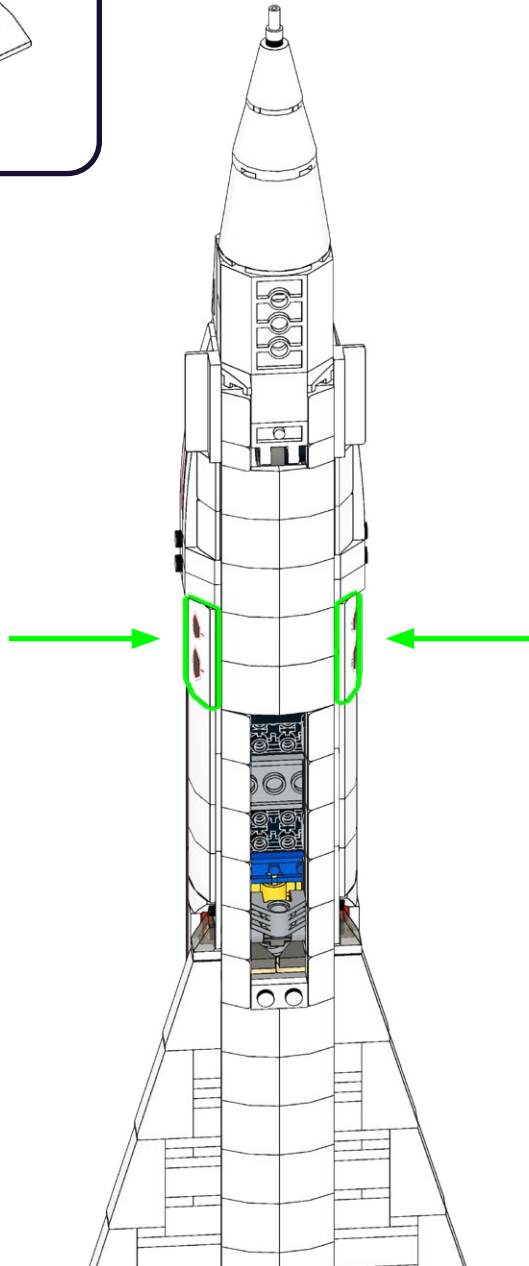

519

2x

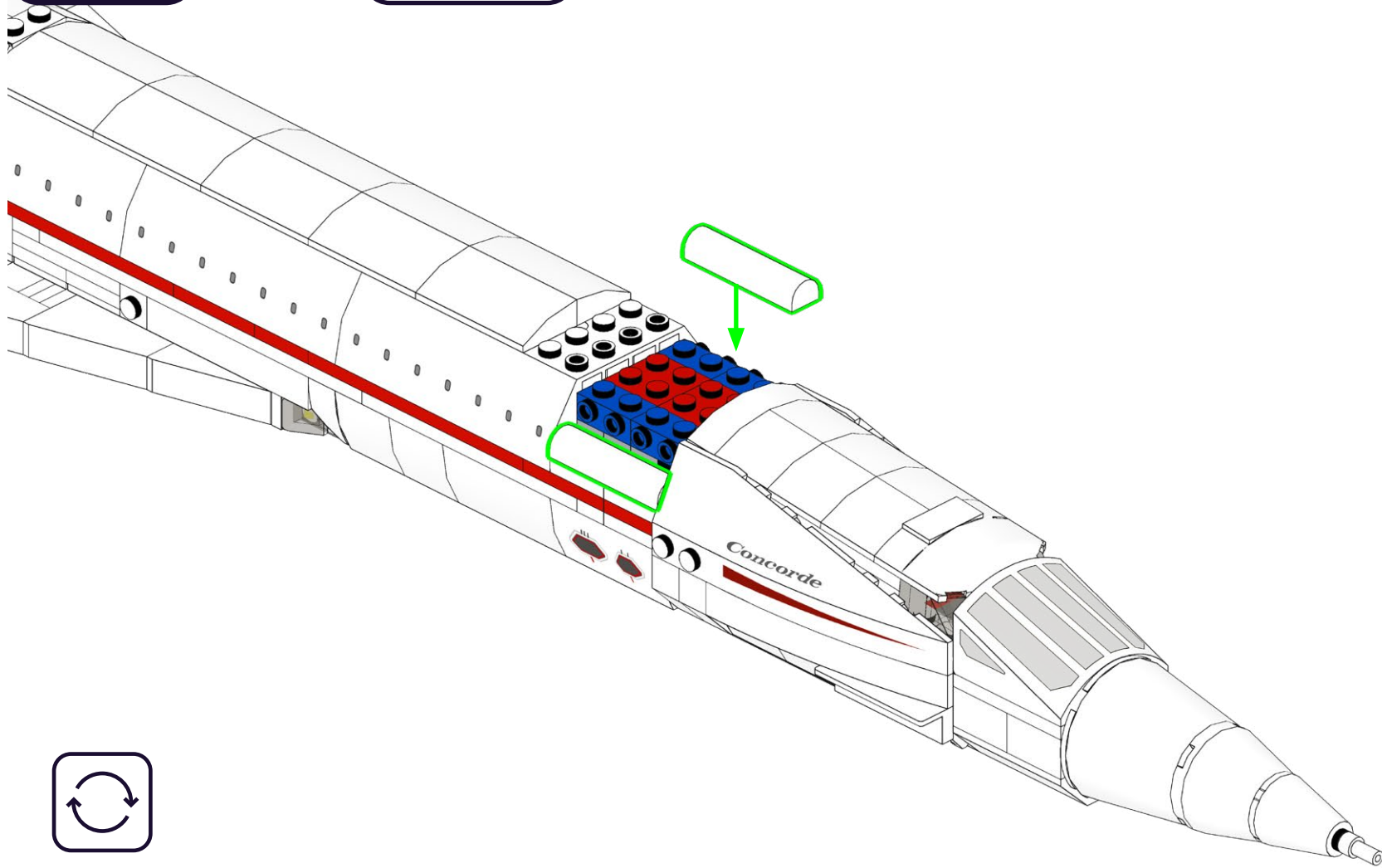

520

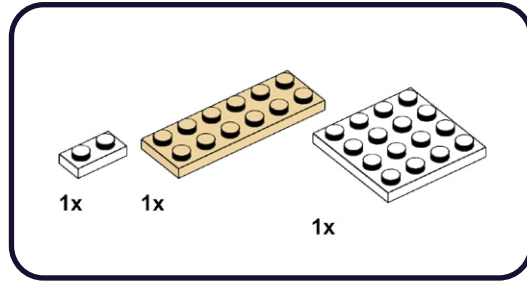

1

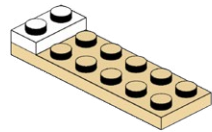

1

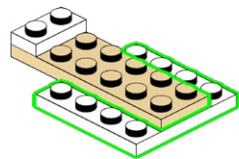

521

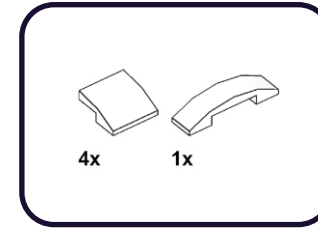

1

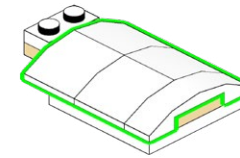

522

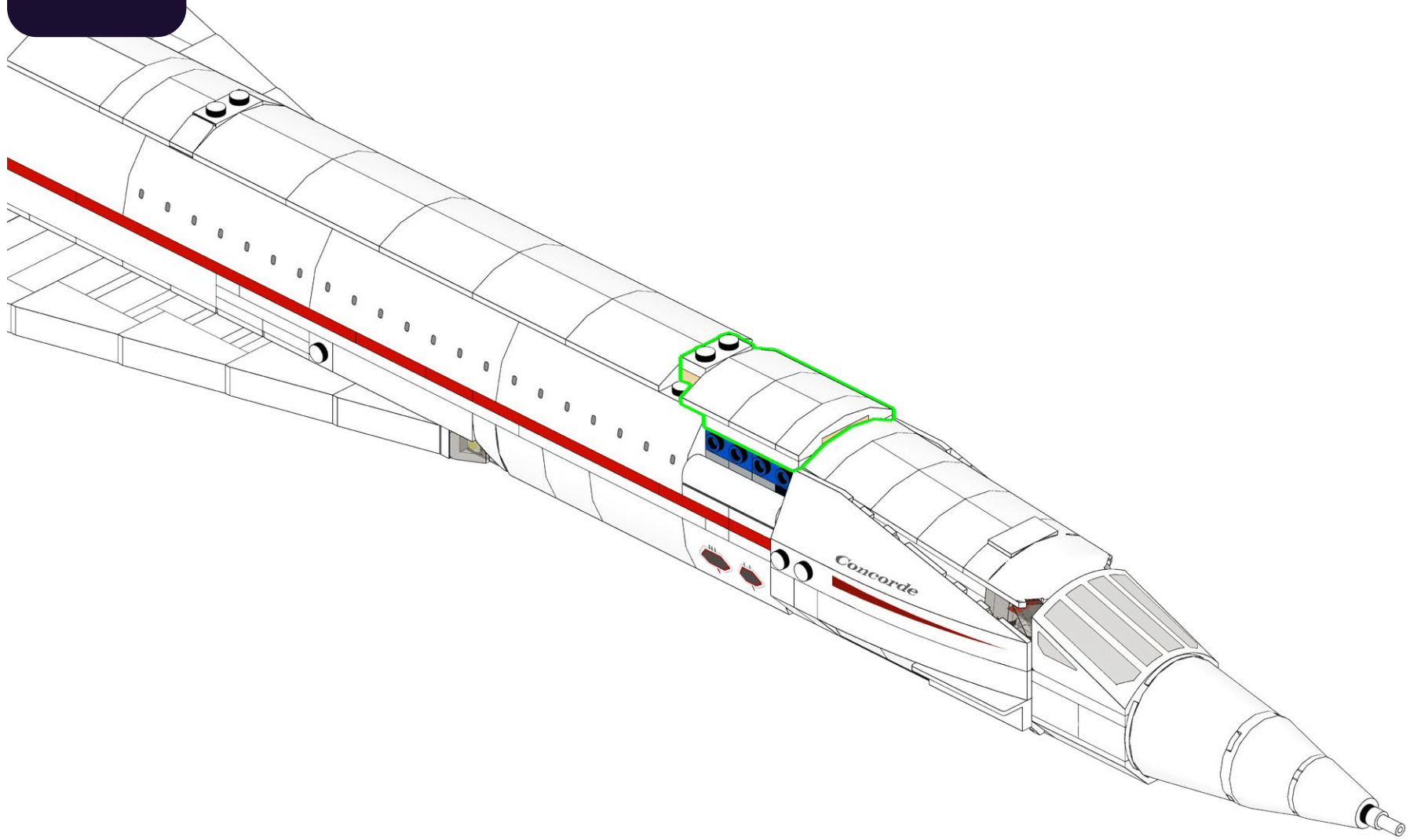

**523**

1x 1x 1x 1x

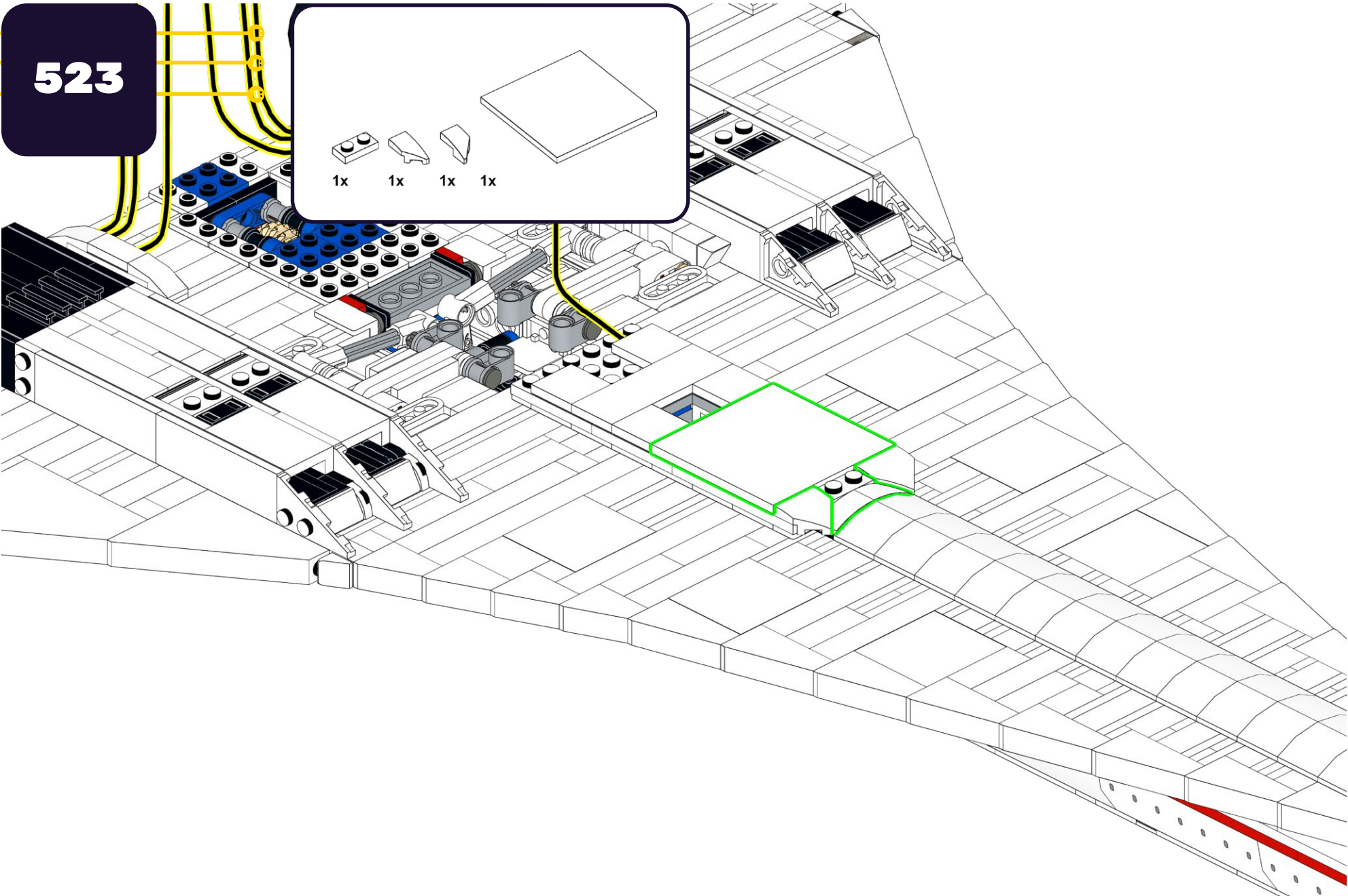

**524**

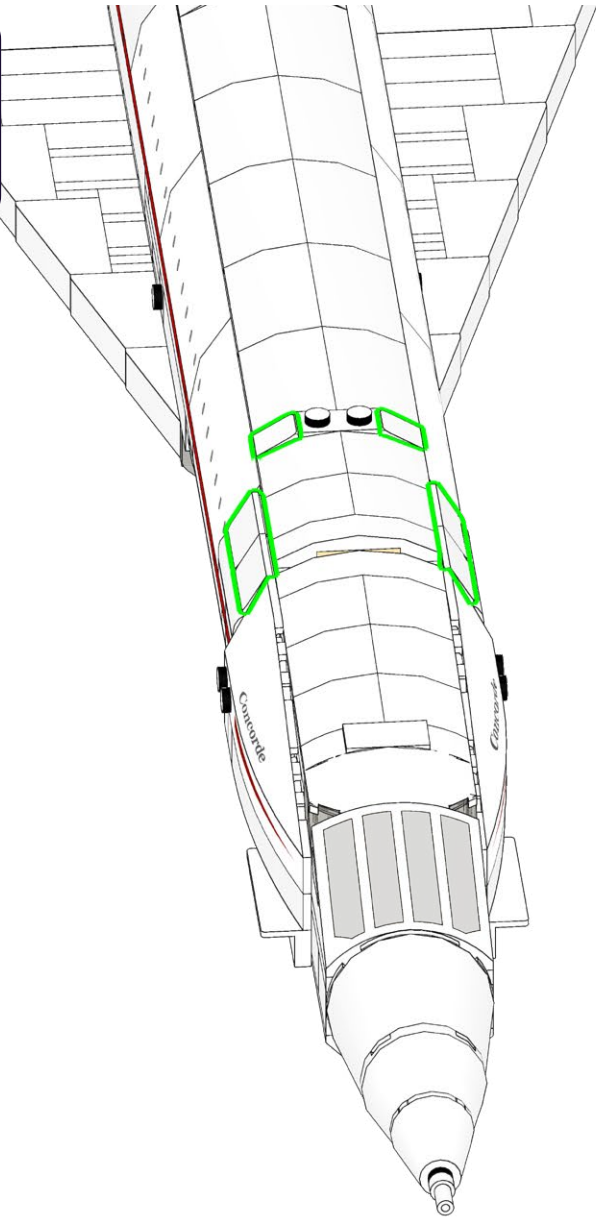
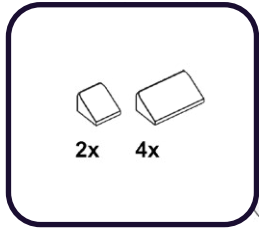



**HOLD UP!**

You might notice some bags aren't in order, as well as left over pieces, but that's ok! We're changing the way you build LEGO!

**ATTENDEZ!**

Vous remarquerez peut-être que certains sacs, ainsi que certaines pièces, ne sont pas dans le bon ordre. Mais pas de panique! Nous changeons simplement la façon avec laquelle vous construisez vos LEGO!

**ASPETTA!**

Potresti notare che alcuni sacchetti non sono in ordine, così come i pezzi avanzati, ma va bene così! Stiamo cambiando il modo in cui costruisci i LEGO!

**HALT!**

Sie werden möglicherweise bemerken, dass einige tüten durcheinander sind und teile übrig bleiben, aber das ist in Ordnung! Wir ändern die art und weise, wie Sie LEGO bauen!

**¡ESPERA!**

Es posible que notes que algunas bolsas están fuera de servicio, así como piezas sobrantes, ¡pero está bien! ¡Estamos cambiando la forma en que construyes LEGO!

**暫停!**

你可能会注意到一些袋子顺序错乱, 以及一些剩余的部件, 但没关系! 我们正在改变你搭建乐高的方式!

Open LEGO® Bag 18 and 19

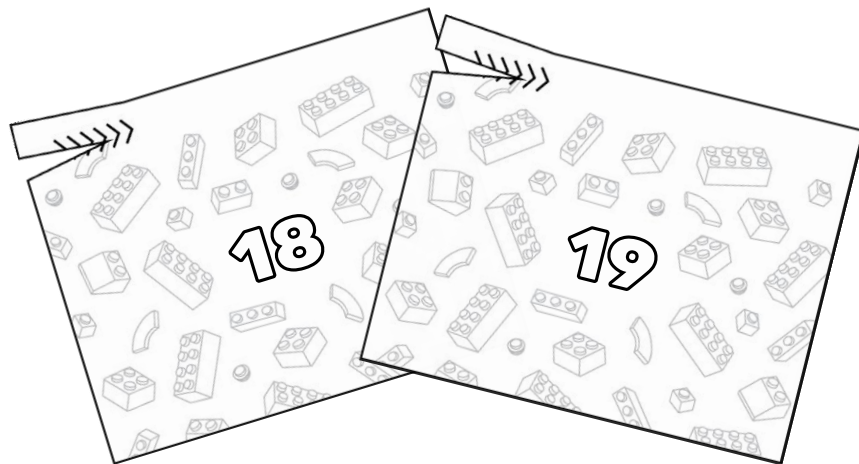

**525**

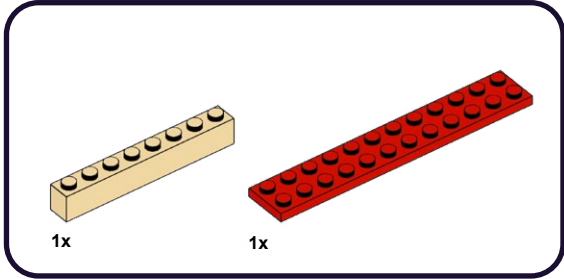

**526**

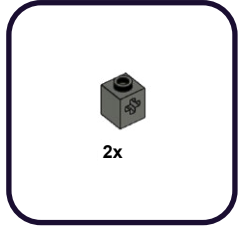

**1**

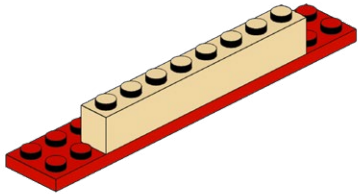

**1**

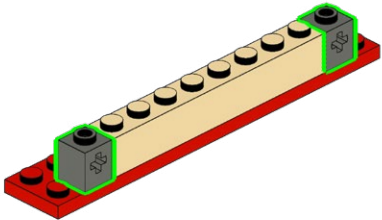

# 527

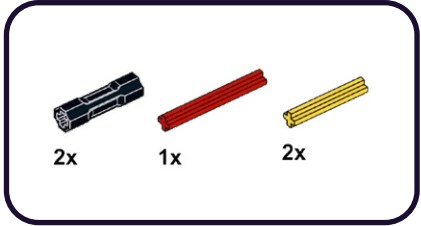

1

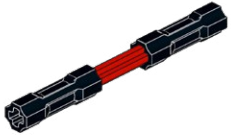

1

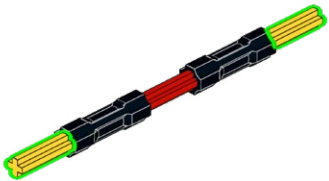

# 528

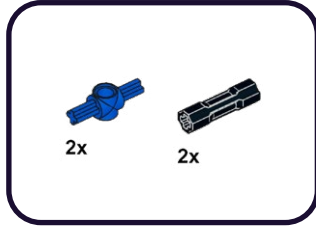

1

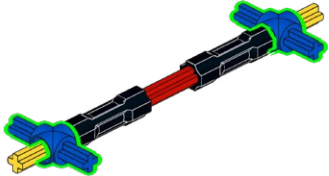

1

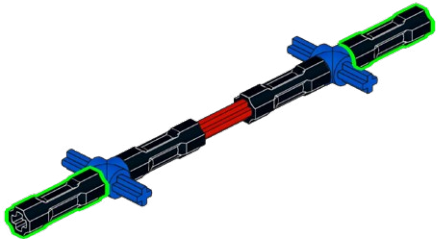

# 529

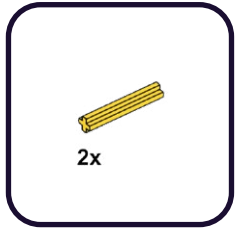

1

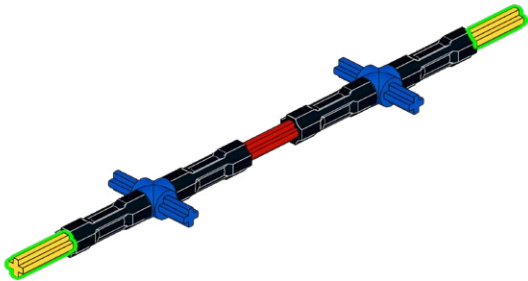

1

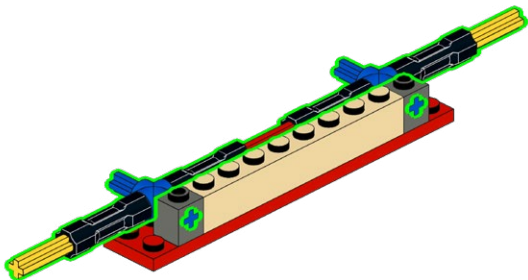

# 530

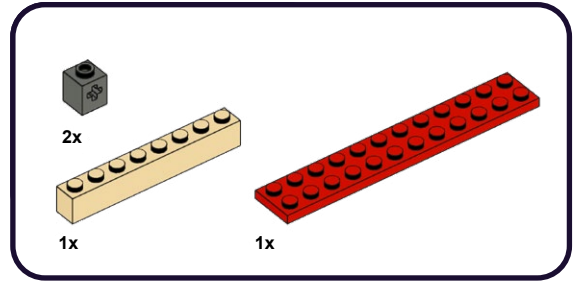

1

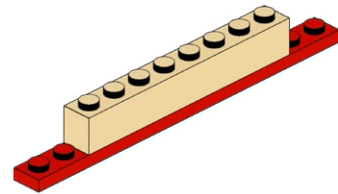

1

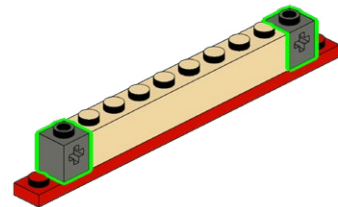

**531**

**532**

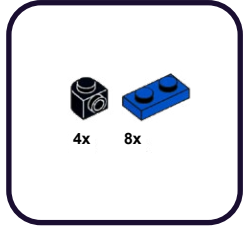

1

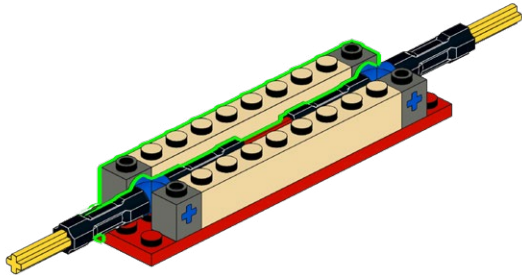

1

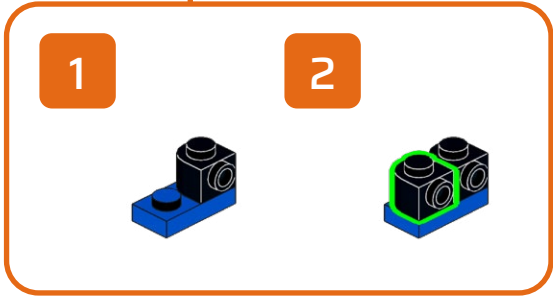
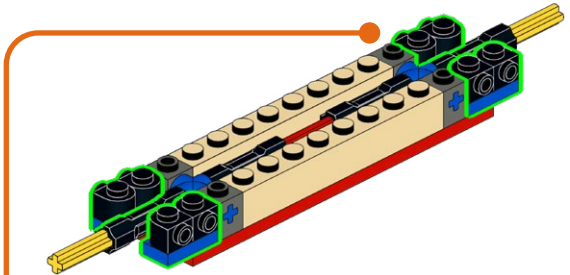

# 533

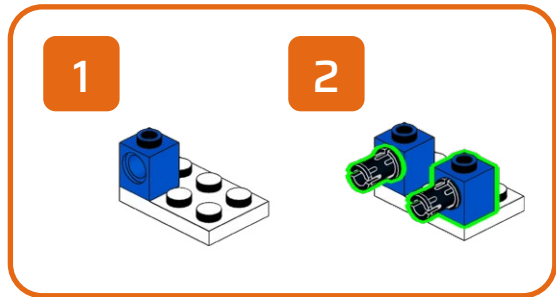
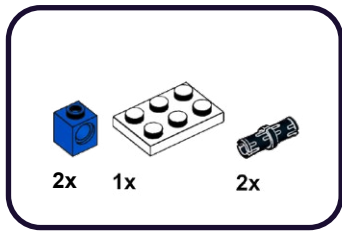

1

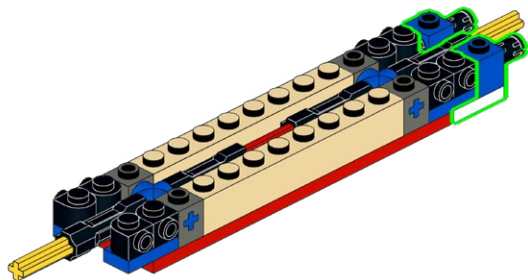

# 534

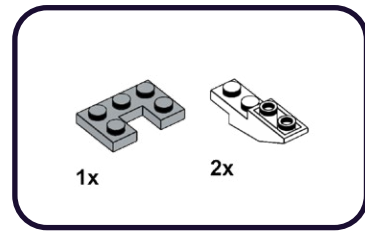

1

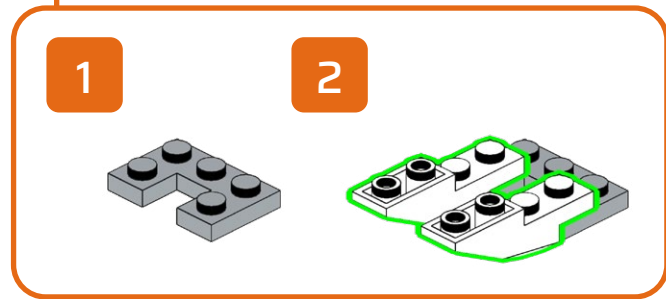

535

2x 4x

536

1x 1x 1x

1

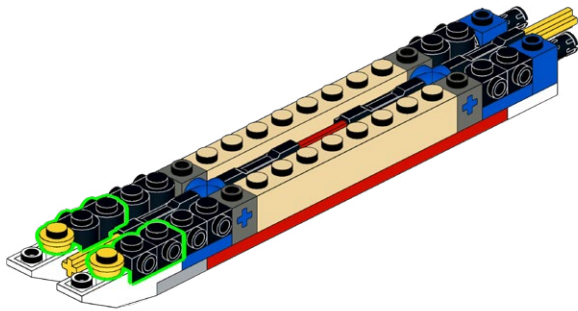

1

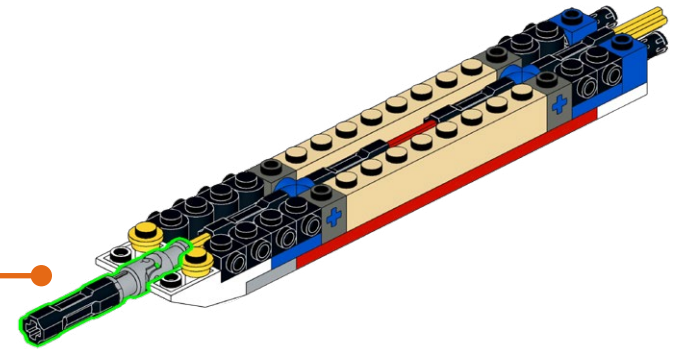

1

2

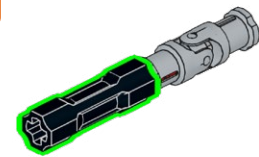
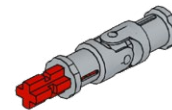

# 537

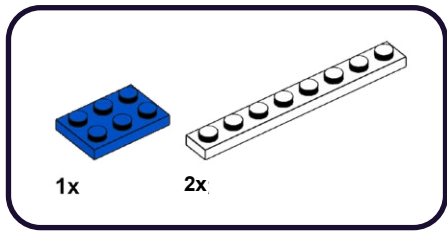

1

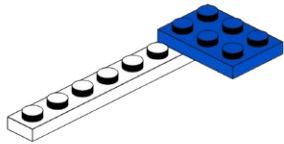

1

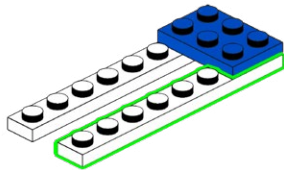

# 538

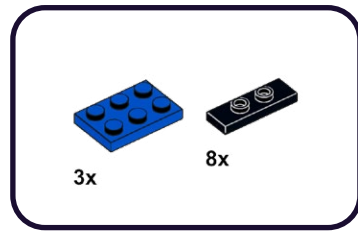

1

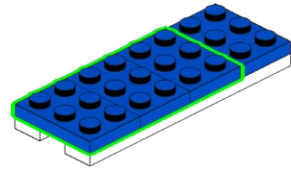

1

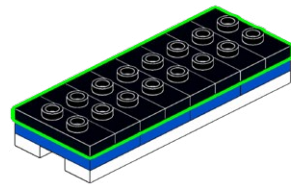



**539**

**1**

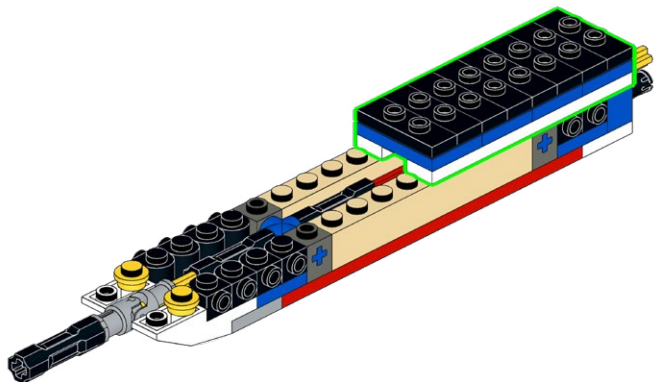

**540**

**1**

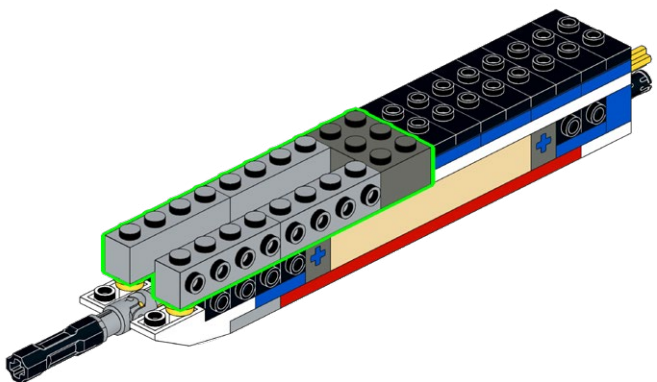
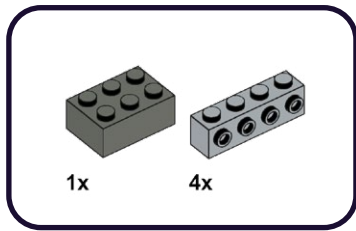

541

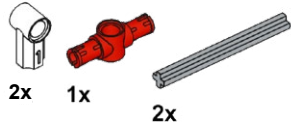

1



2

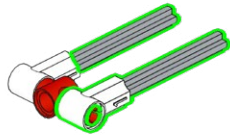

542

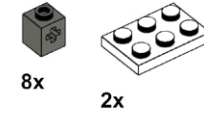

1

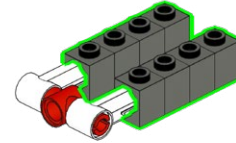

2

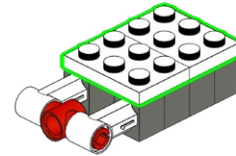

543

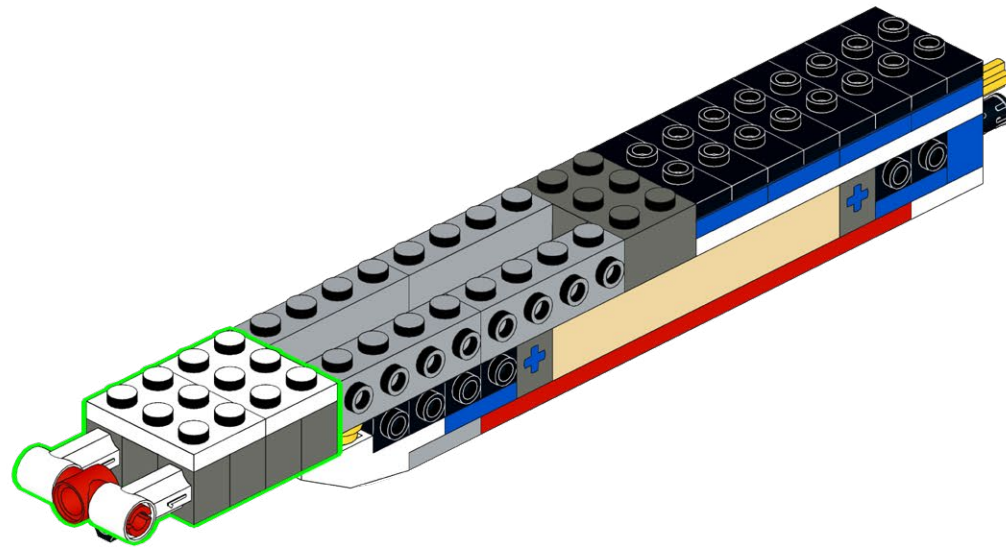

544

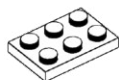

1x



2x

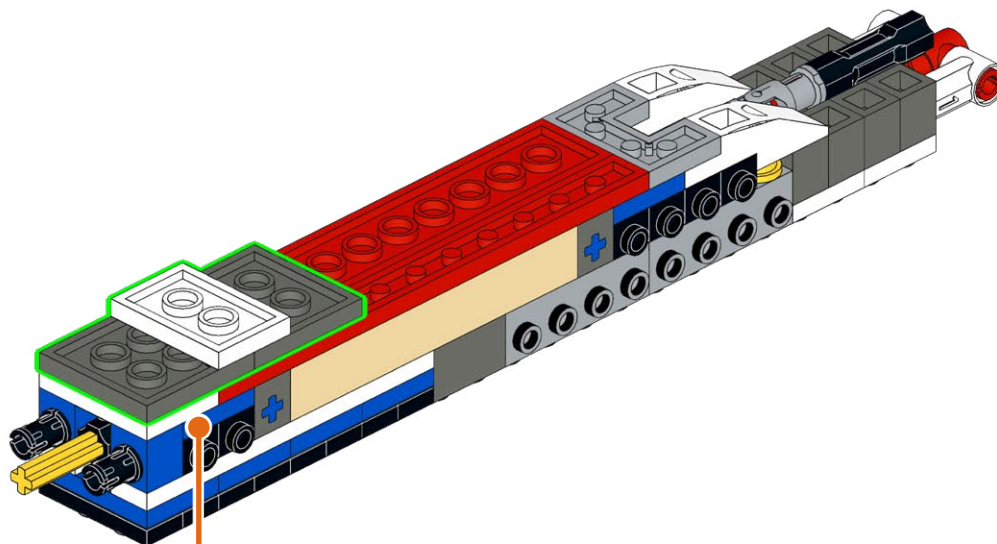

1

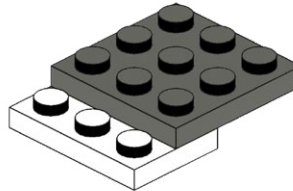

2

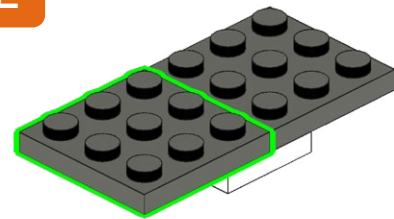

545

1x

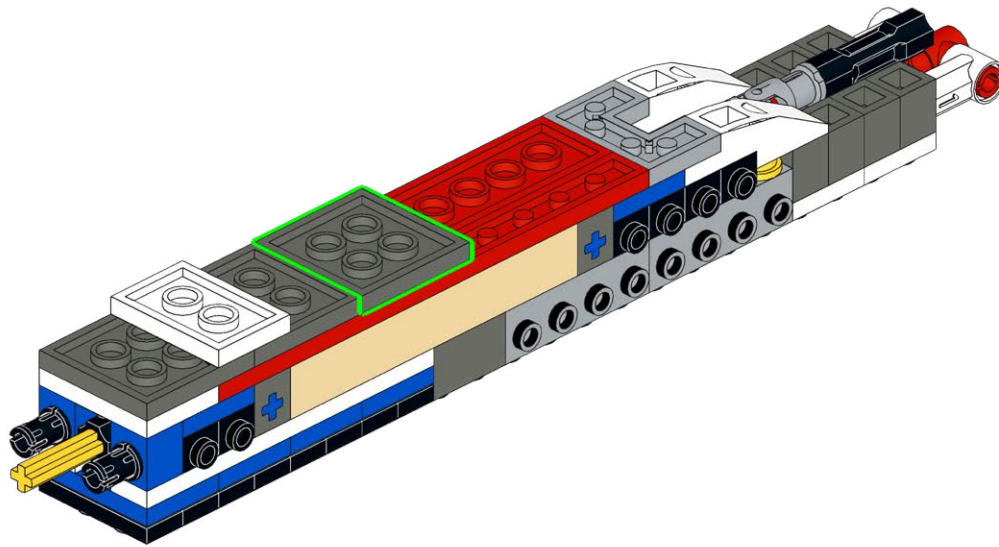

546

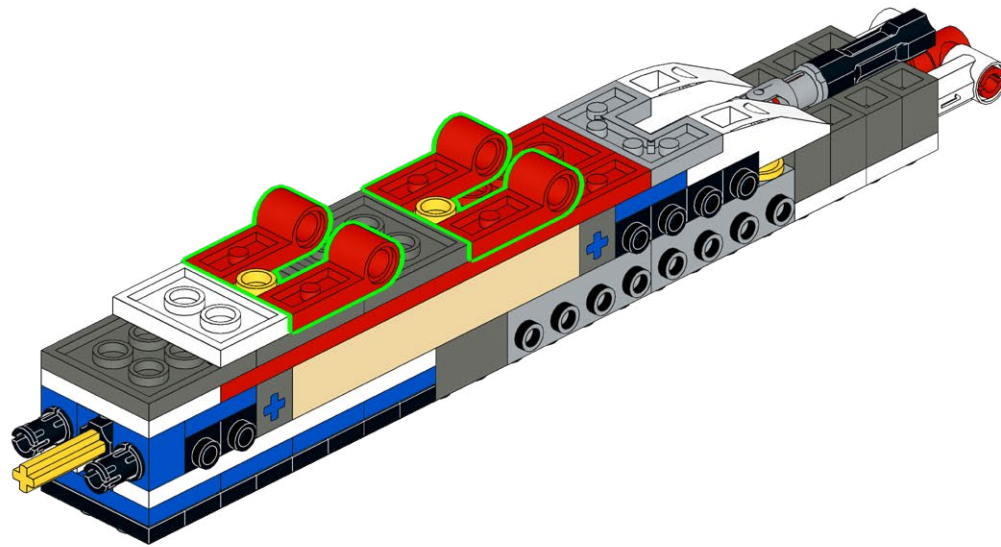
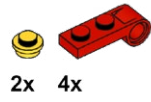

547

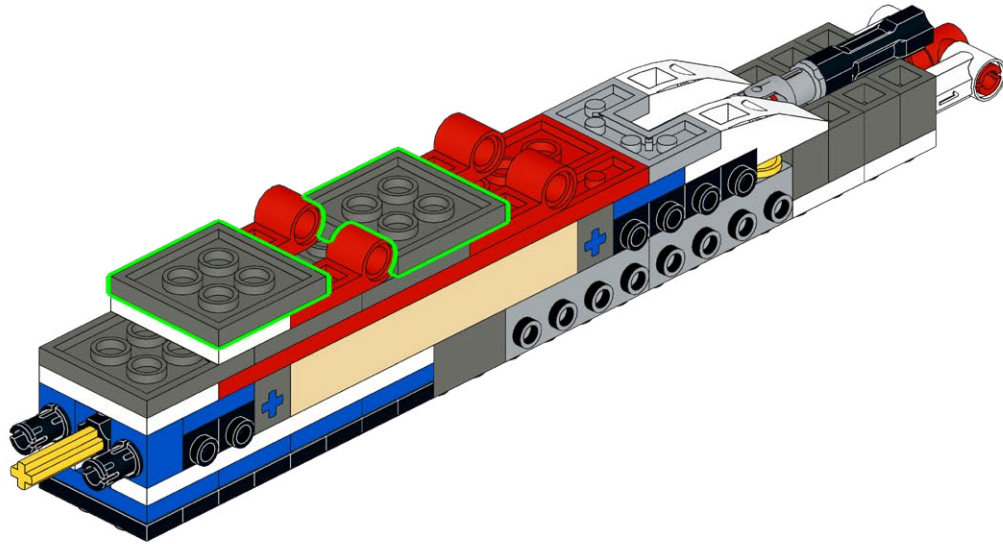
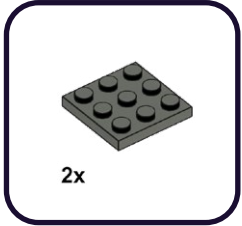

548

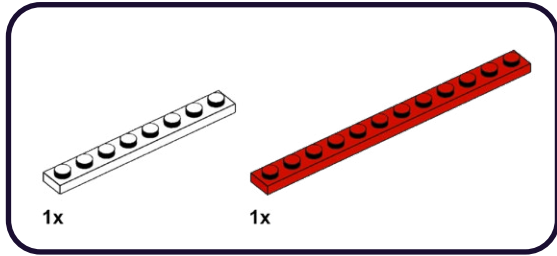

1

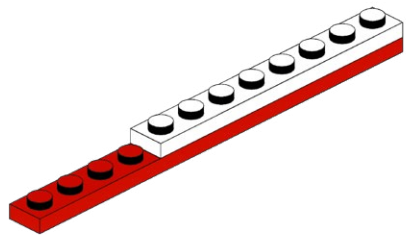

549

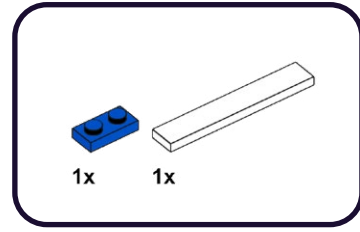

1

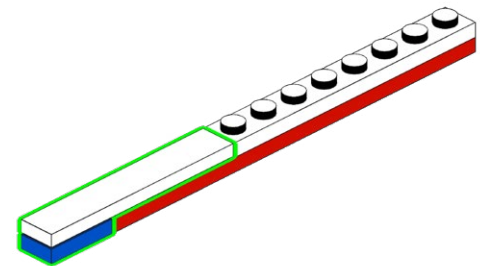



550

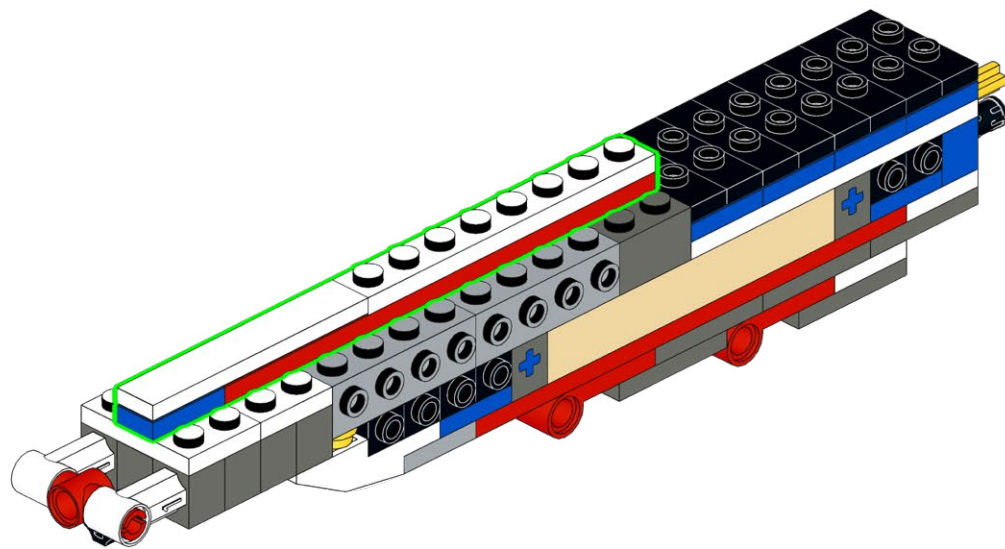

551

4x 12x

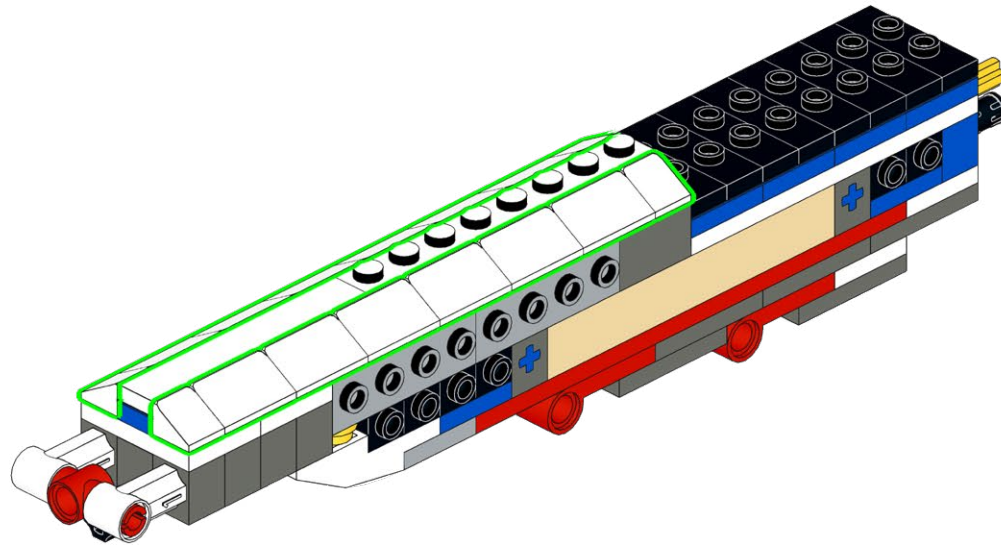

**552**

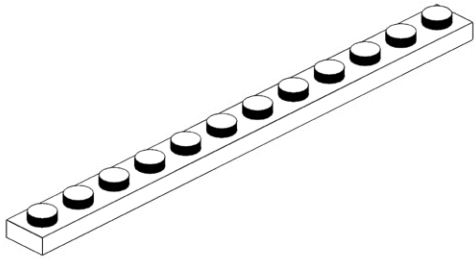
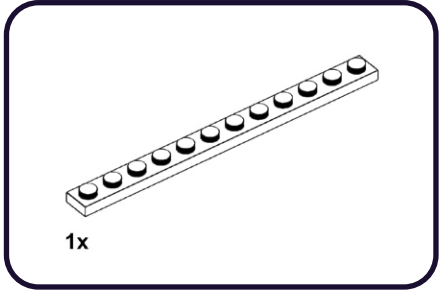

553

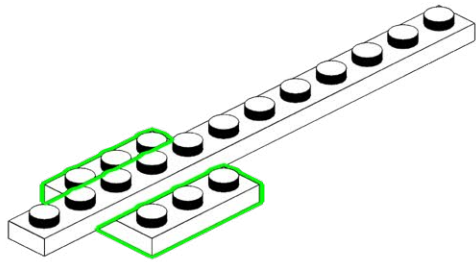
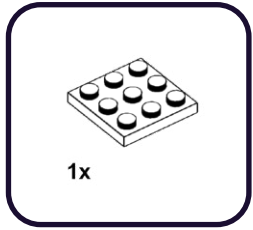

554

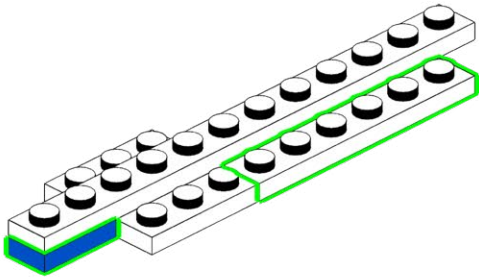
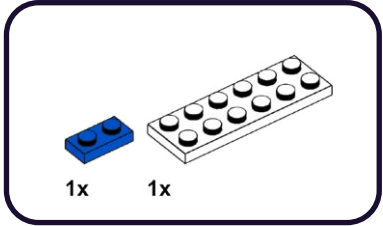

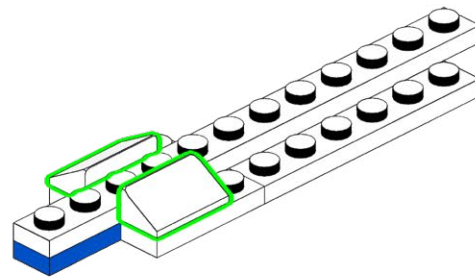

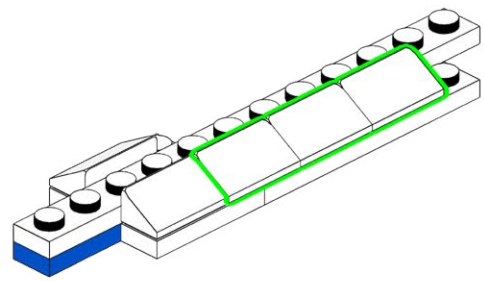
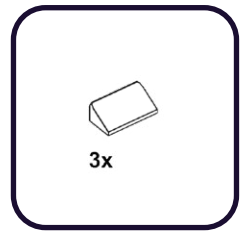
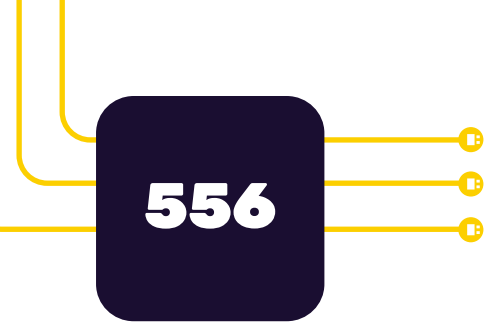

**557**

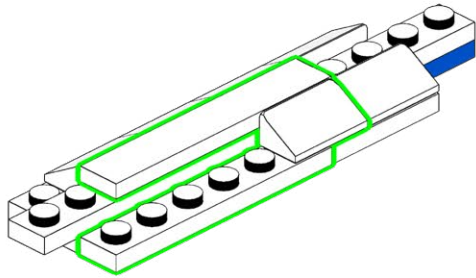
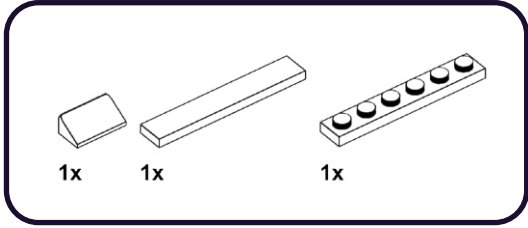
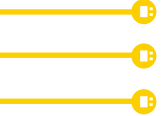



**558**

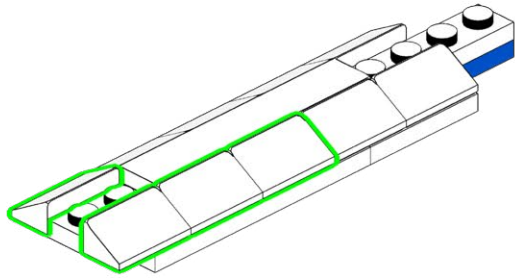
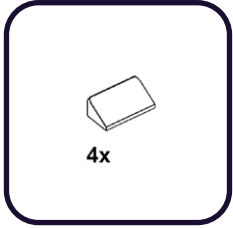

559

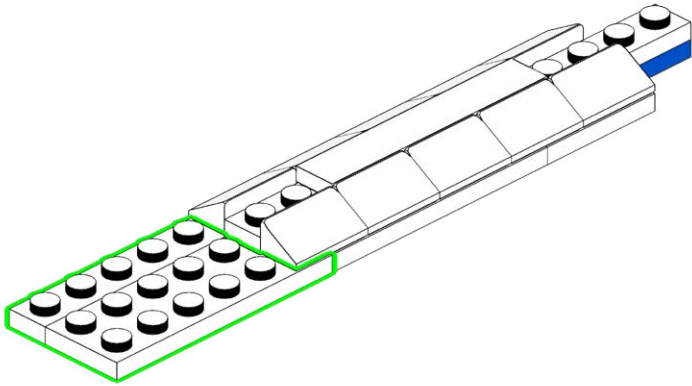
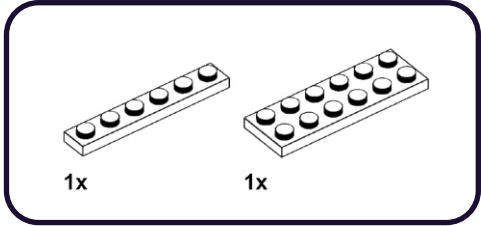

560

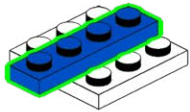
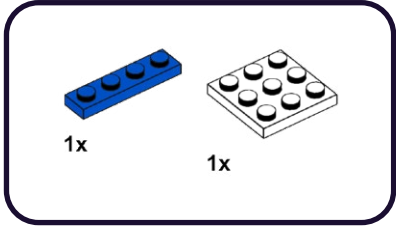

**561**

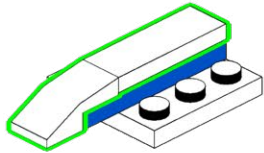
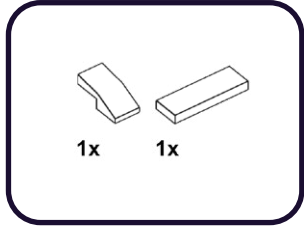

562

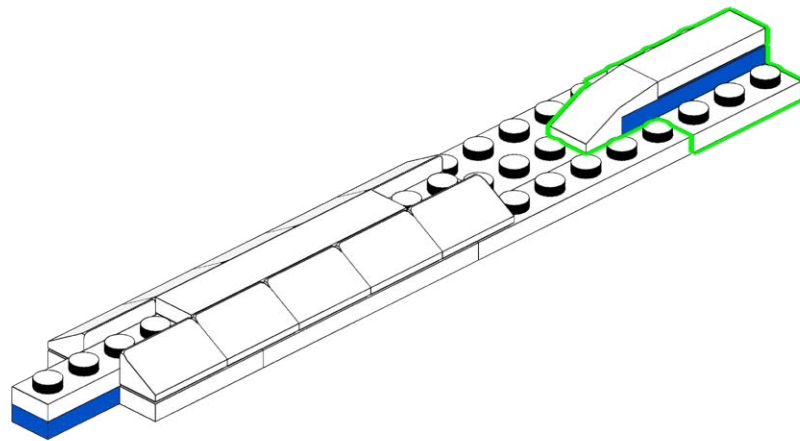

**563**

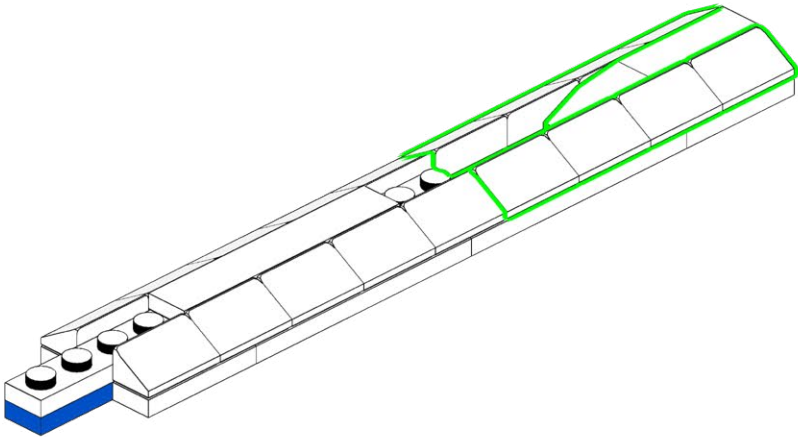
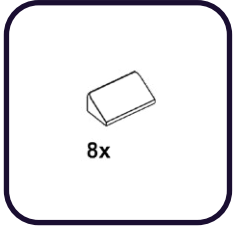

564

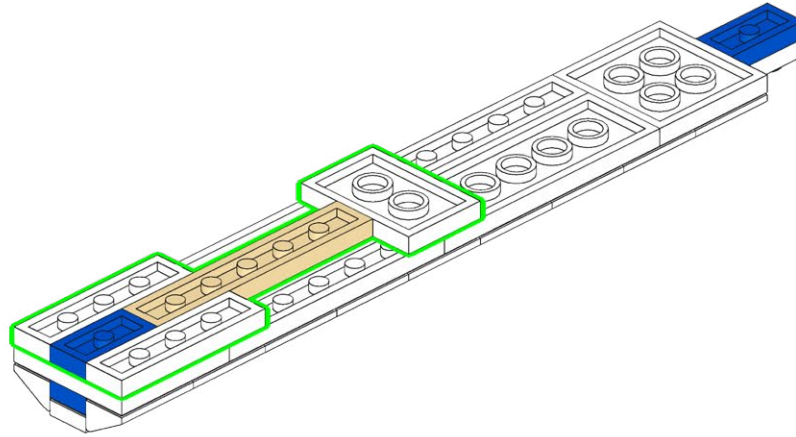
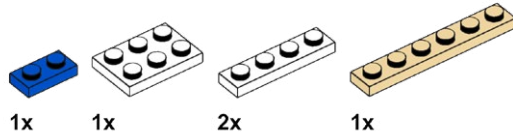

**565**

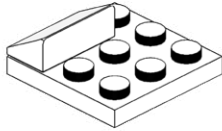
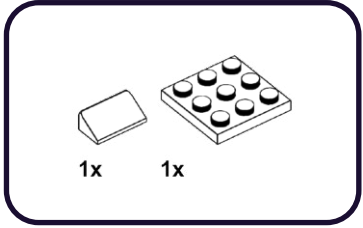



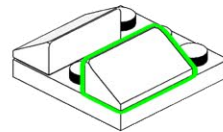

**567**

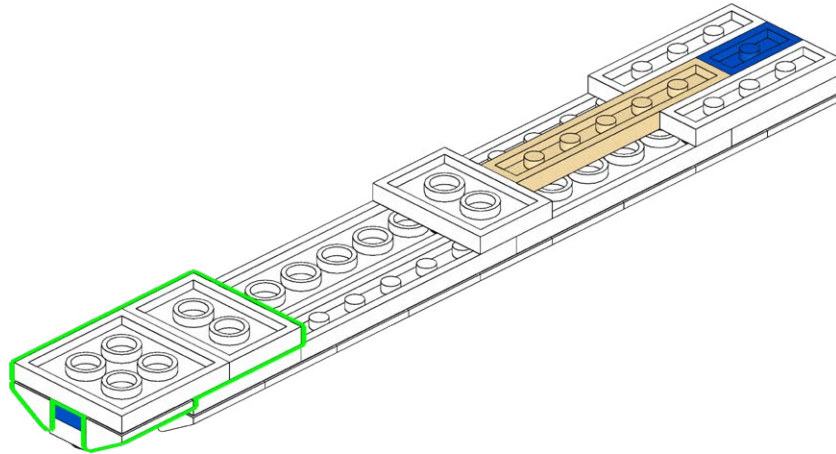
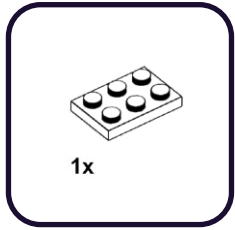

568

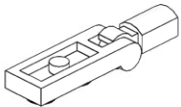
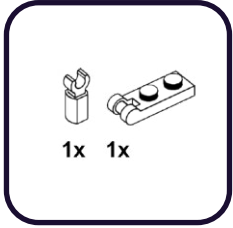

569

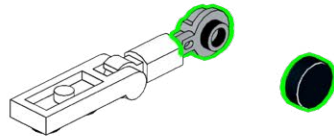
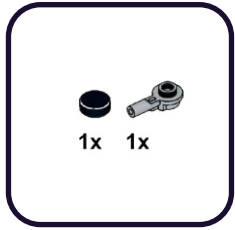

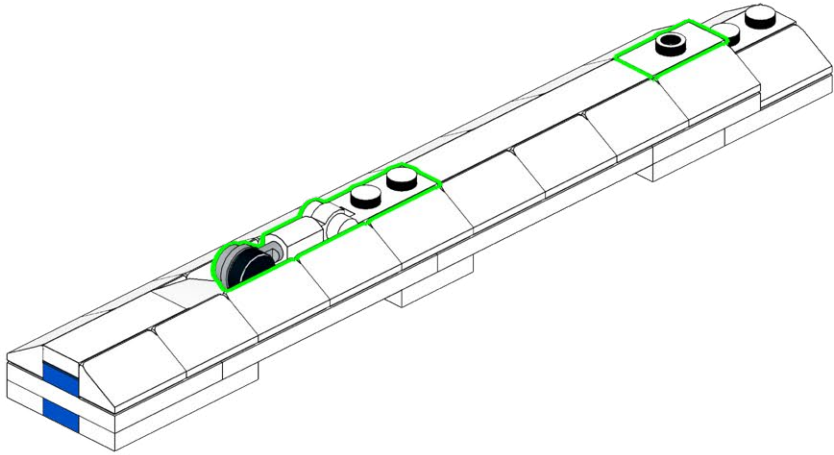
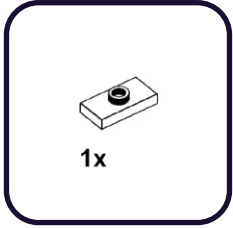

**571**

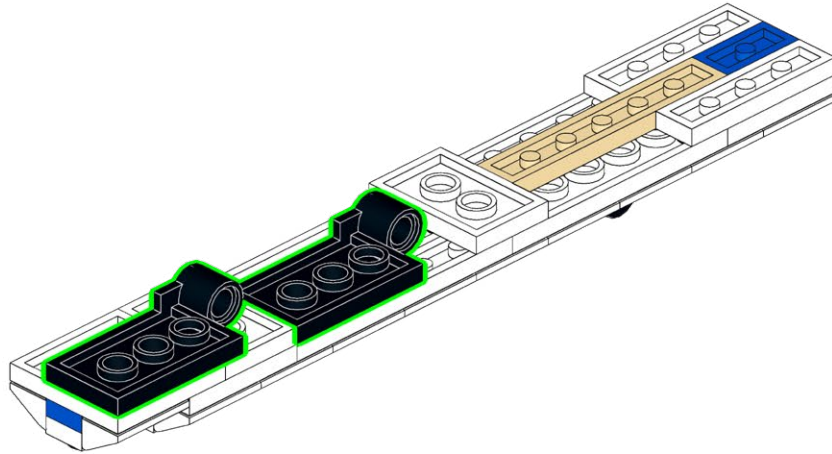

**572**

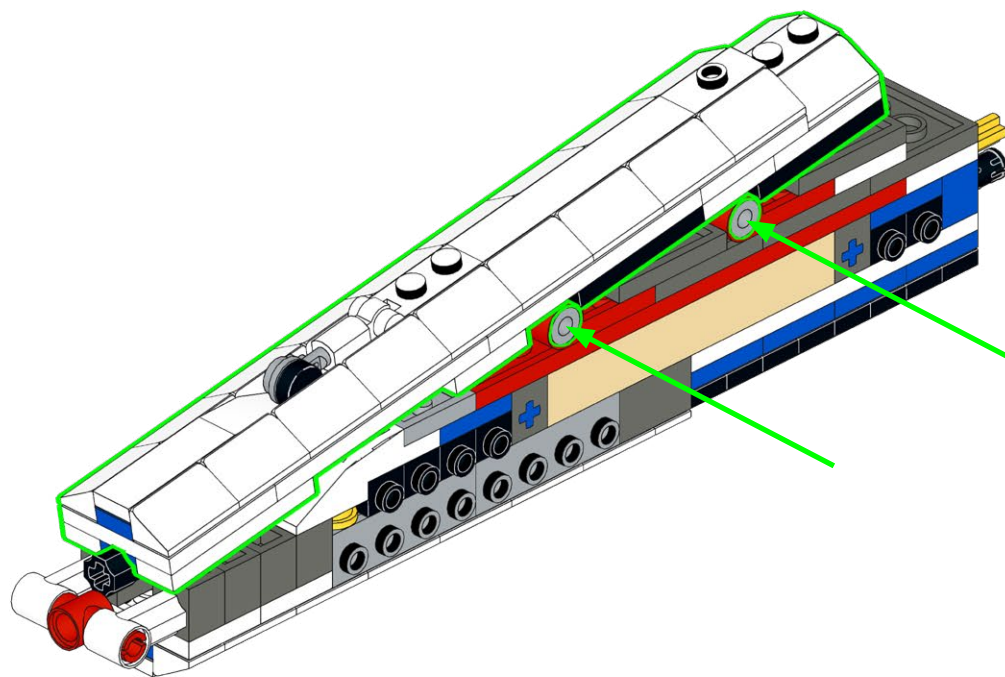
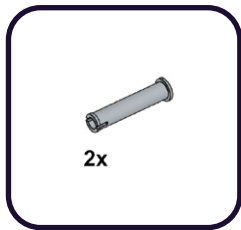

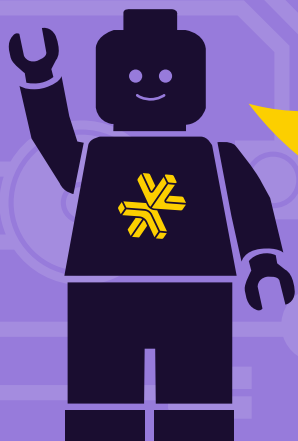
**HOLD UP!**

You might notice some bags aren't in order, as well as left over pieces, but that's ok! We're changing the way you build LEGO!

**ATTENDEZ!**

Vous remarquerez peut-être que certains sacs, ainsi que certaines pièces, ne sont pas dans le bon ordre. Mais pas de panique! Nous changeons simplement la façon avec laquelle vous construisez vos LEGO!

**ASPETTA!**

Potresti notare che alcuni sacchetti non sono in ordine, così come i pezzi avanzati, ma va bene così! Stiamo cambiando il modo in cui costruisci i LEGO!

**HALT!**

Sie werden möglicherweise bemerken, dass einige tüten durcheinander sind und teile übrig bleiben, aber das ist in Ordnung! Wir ändern die art und weise, wie Sie LEGO bauen!

**¡ESPERA!**

Es posible que notes que algunas bolsas están fuera de servicio, así como piezas sobrantes, ¡pero está bien! ¡Estamos cambiando la forma en que construyes LEGO!

**暫停!**

你可能会注意到一些袋子顺序错乱, 以及一些剩余的部件, 但没关系! 我们正在改变你搭建乐高的方式!

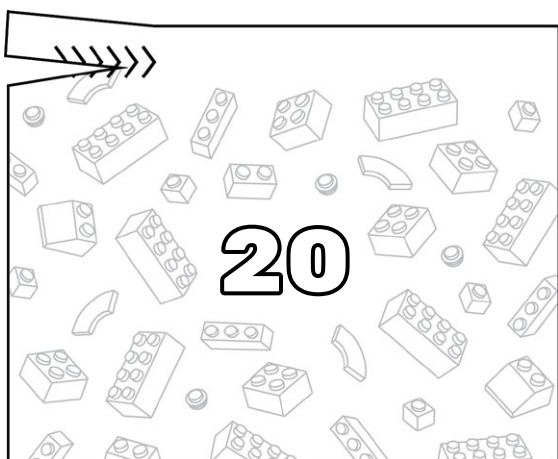
**Open LEGO® Bag 20**



**573**

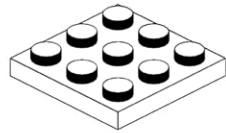
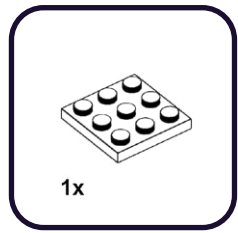

**574**

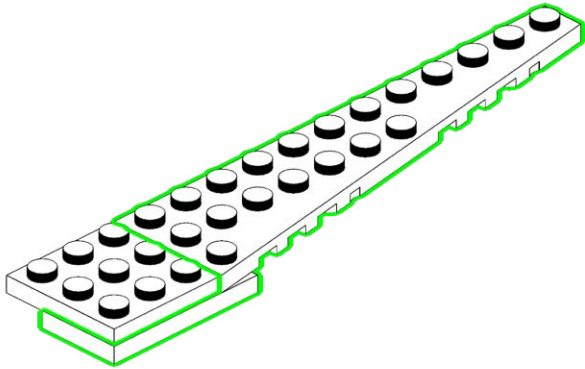
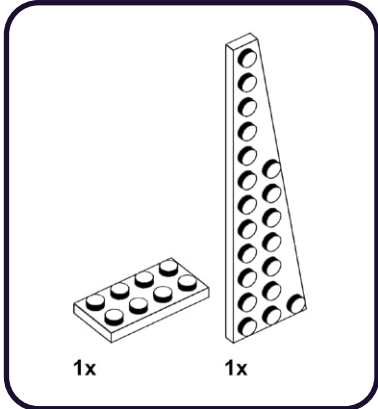

**575**

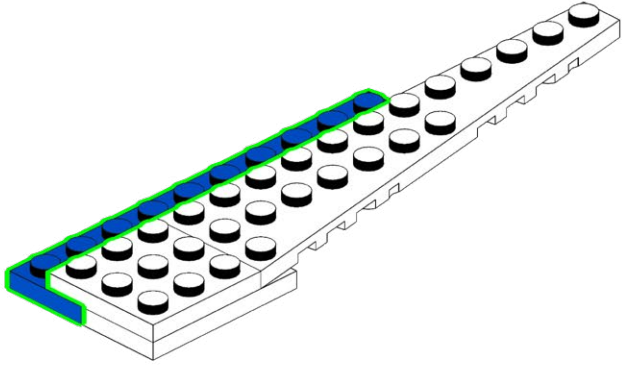
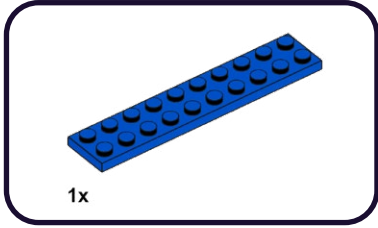

576

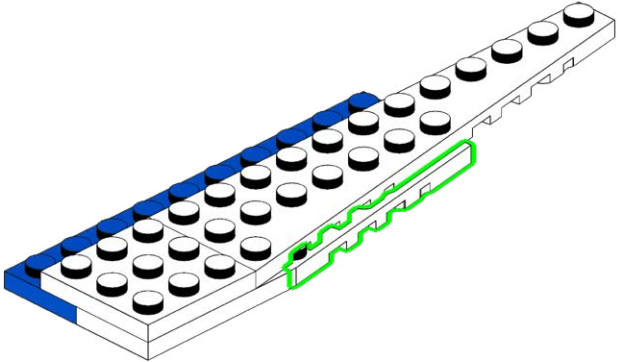
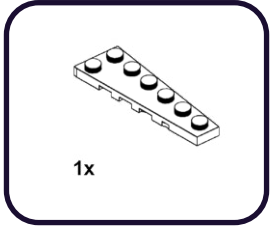

**577**

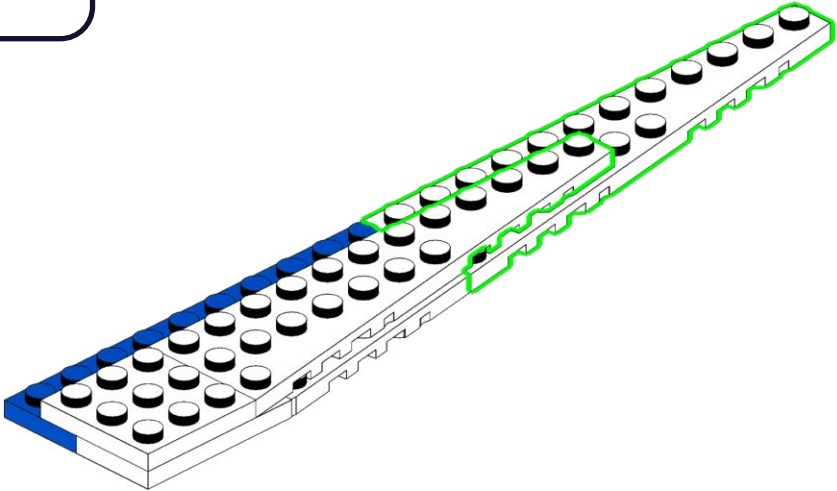
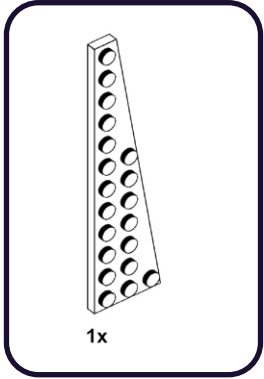

**578**

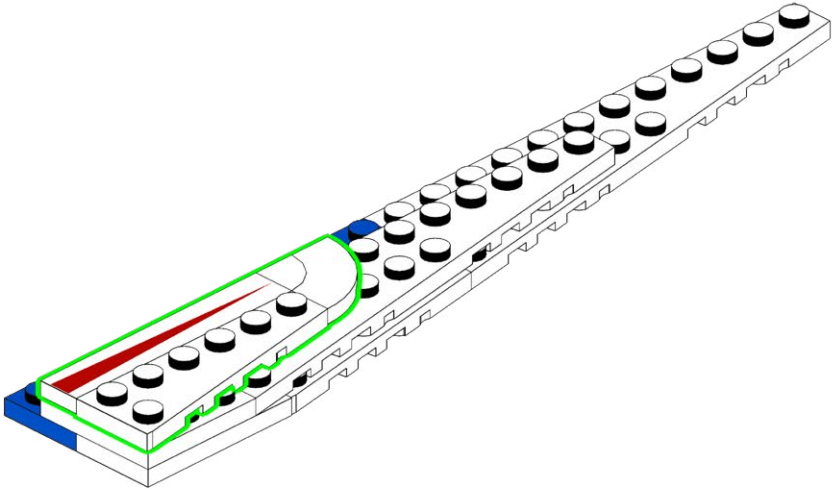
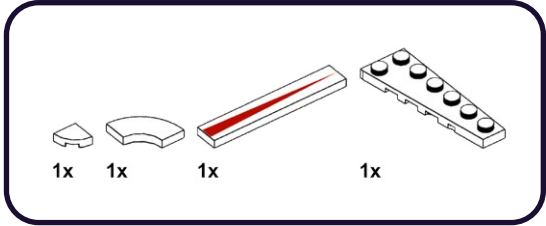

**579**

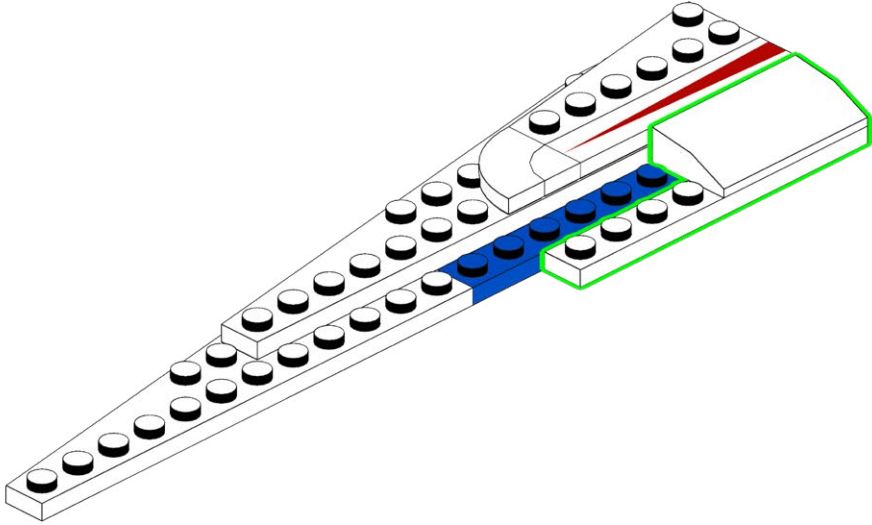
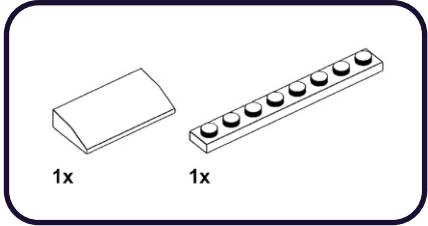

**580**

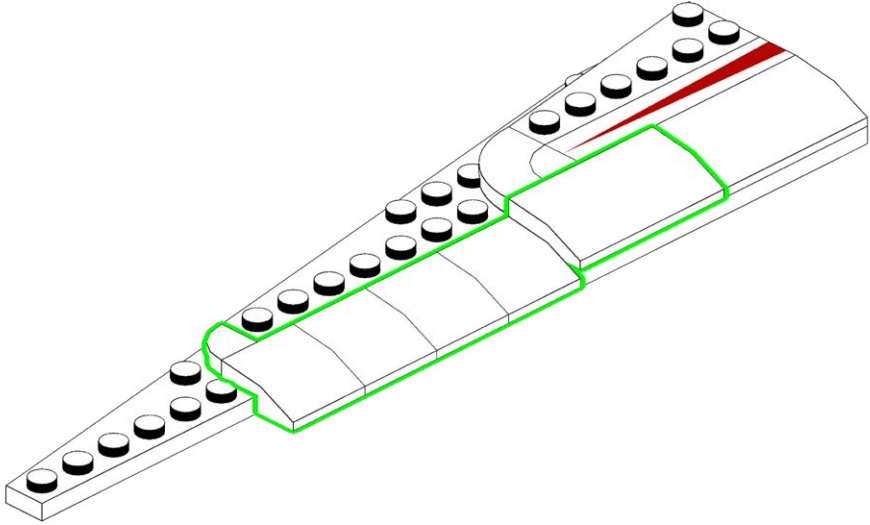
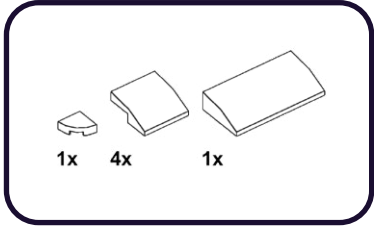



581

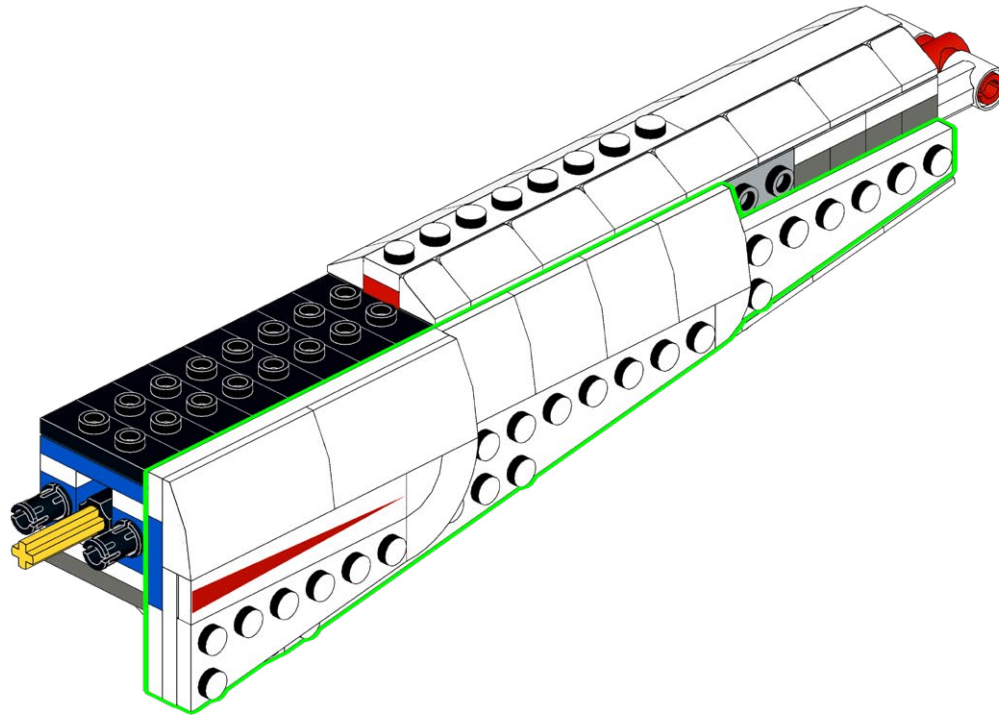

582

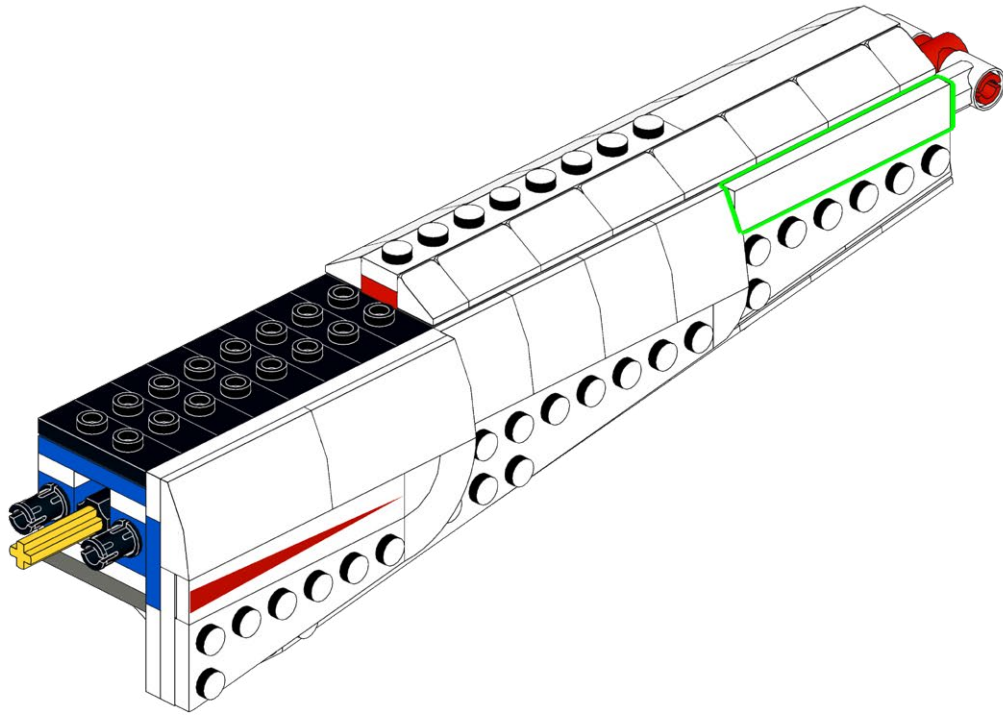
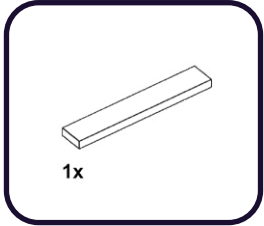

**583**

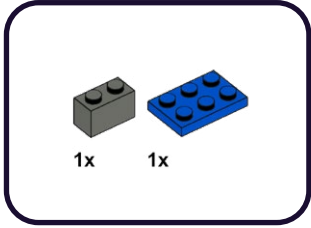

1

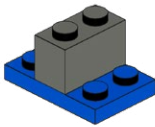

**584**

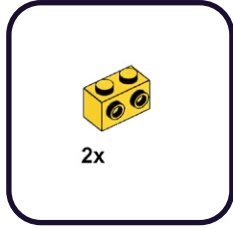

1

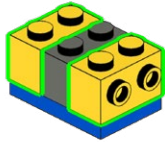

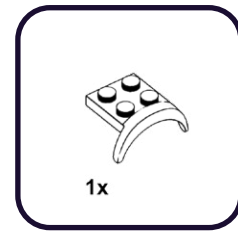
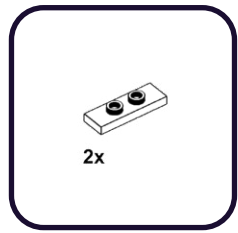

1

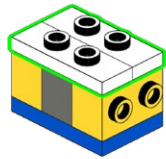

1



587

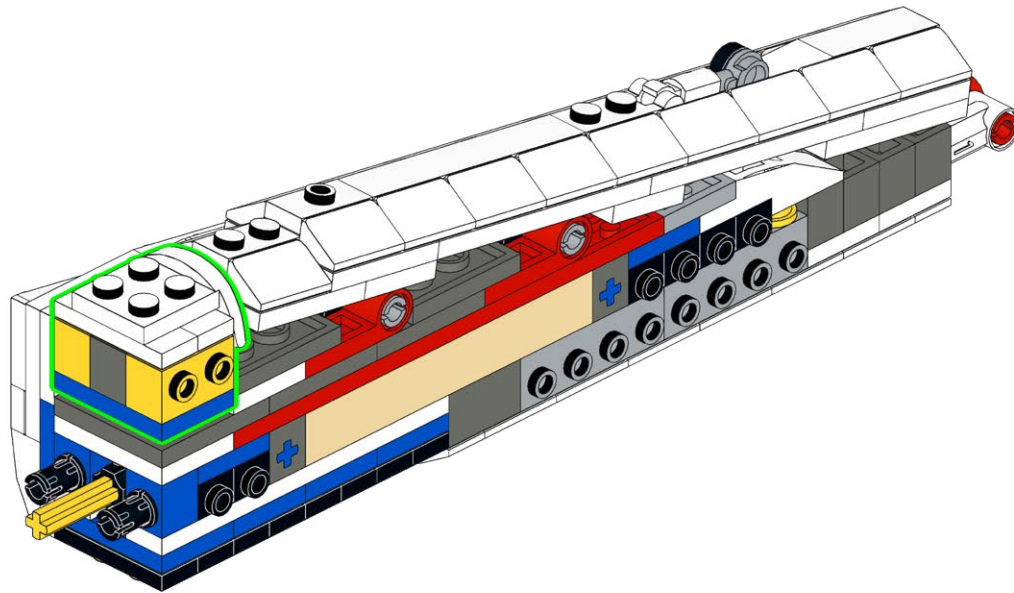

588

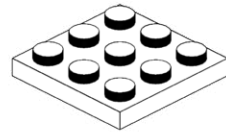
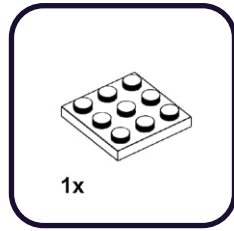

589

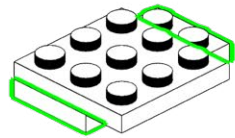
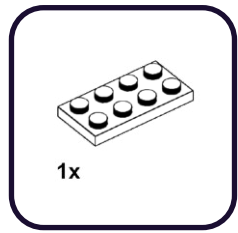

**590**

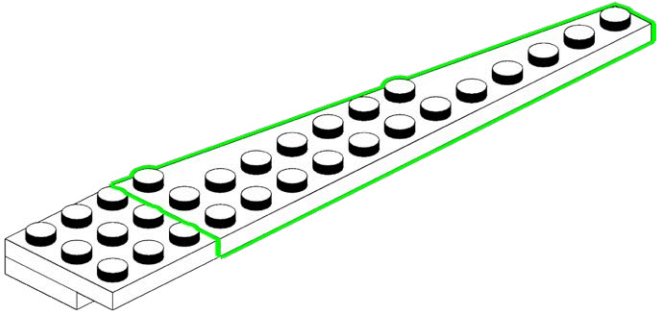
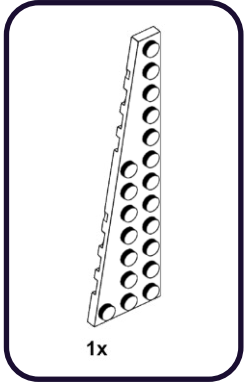



591

1x

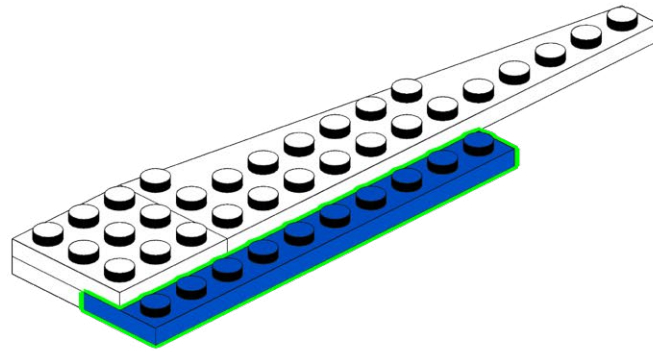



593

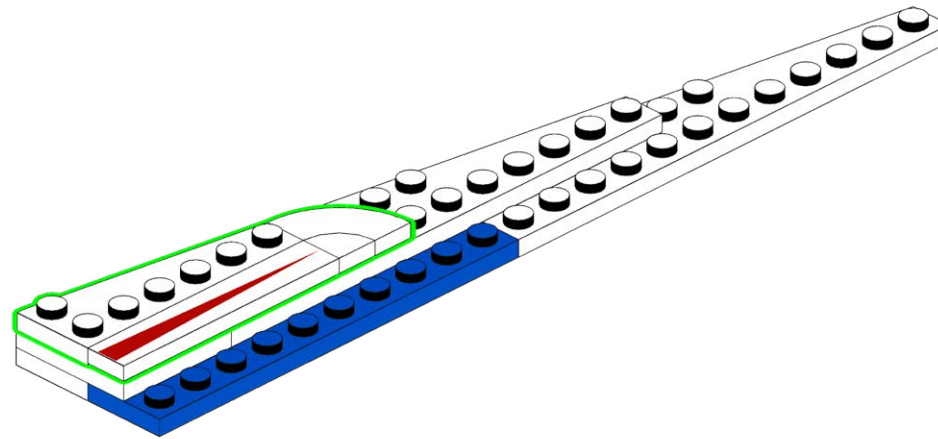
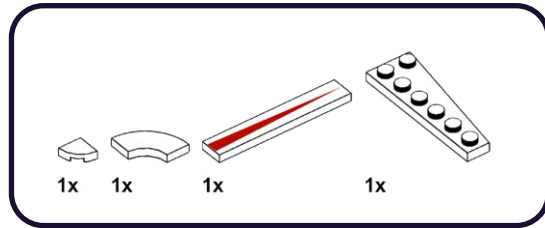

594

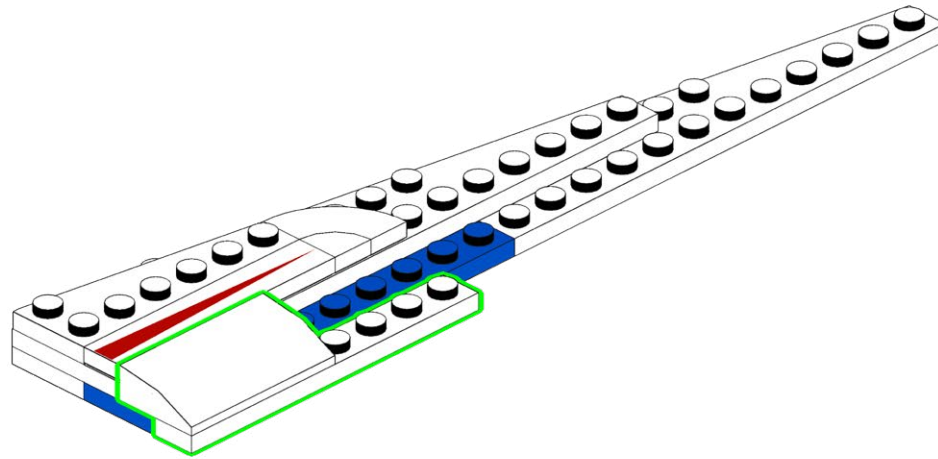
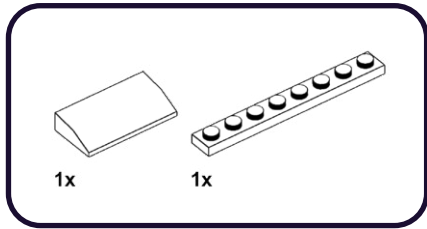

**595**

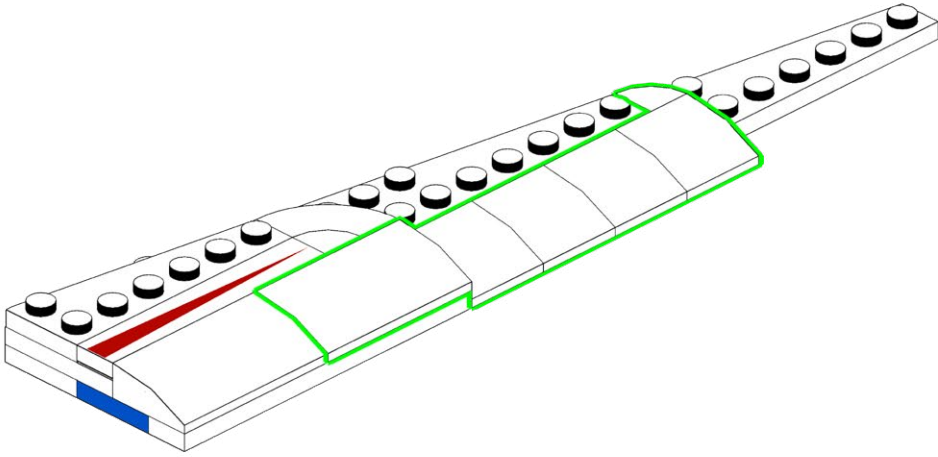
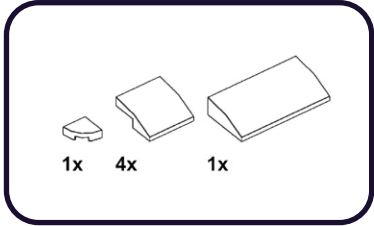

596

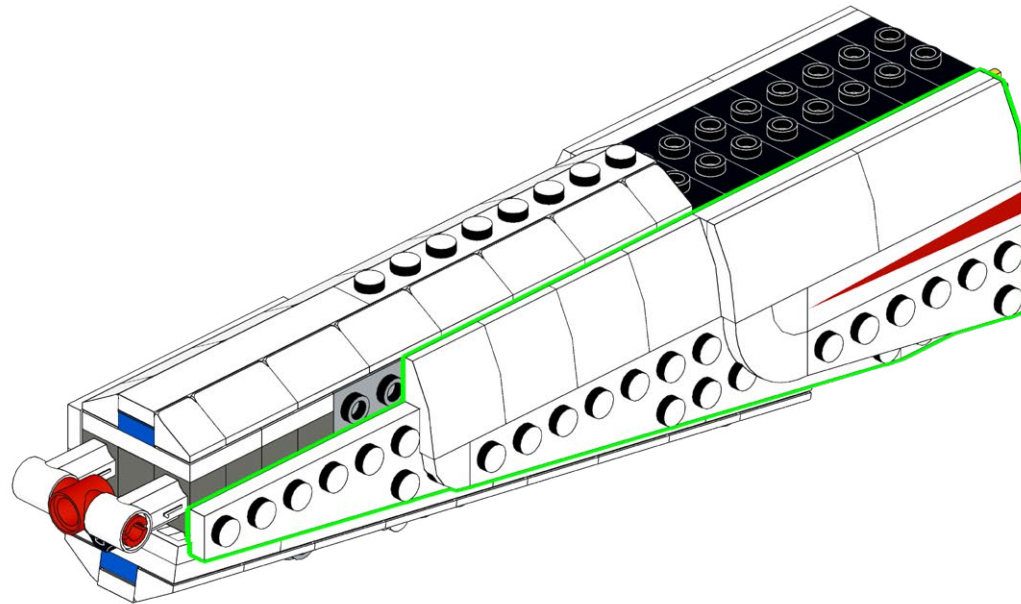

**597**

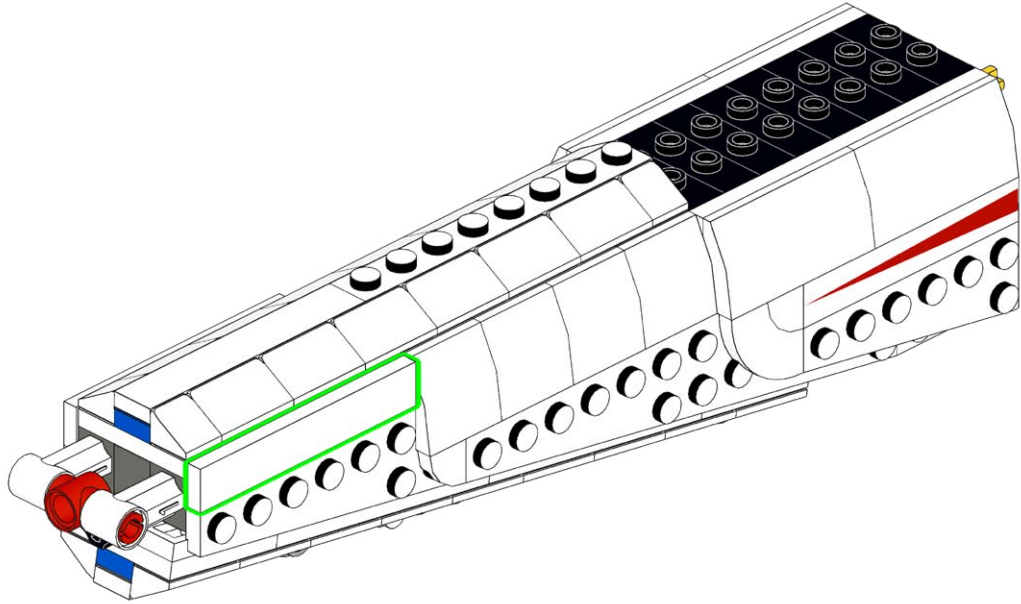
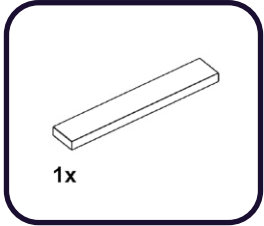

598

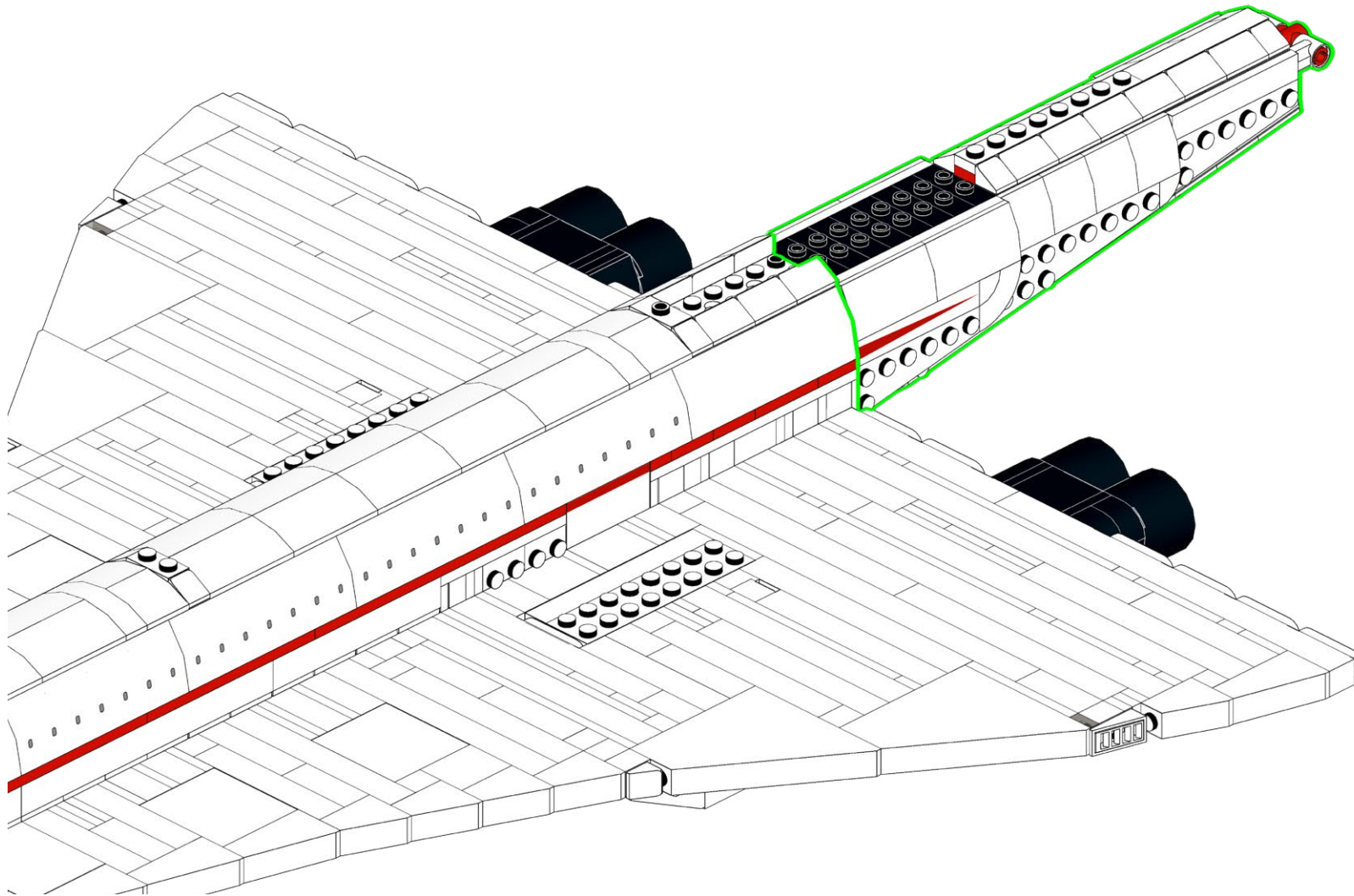



**599**

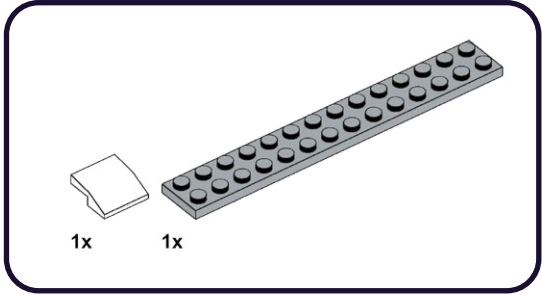

**1**

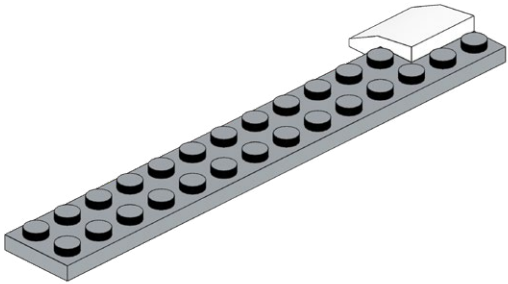

**600**

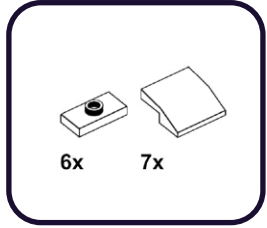

**1**

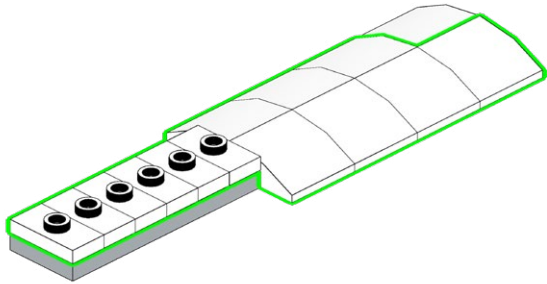

601

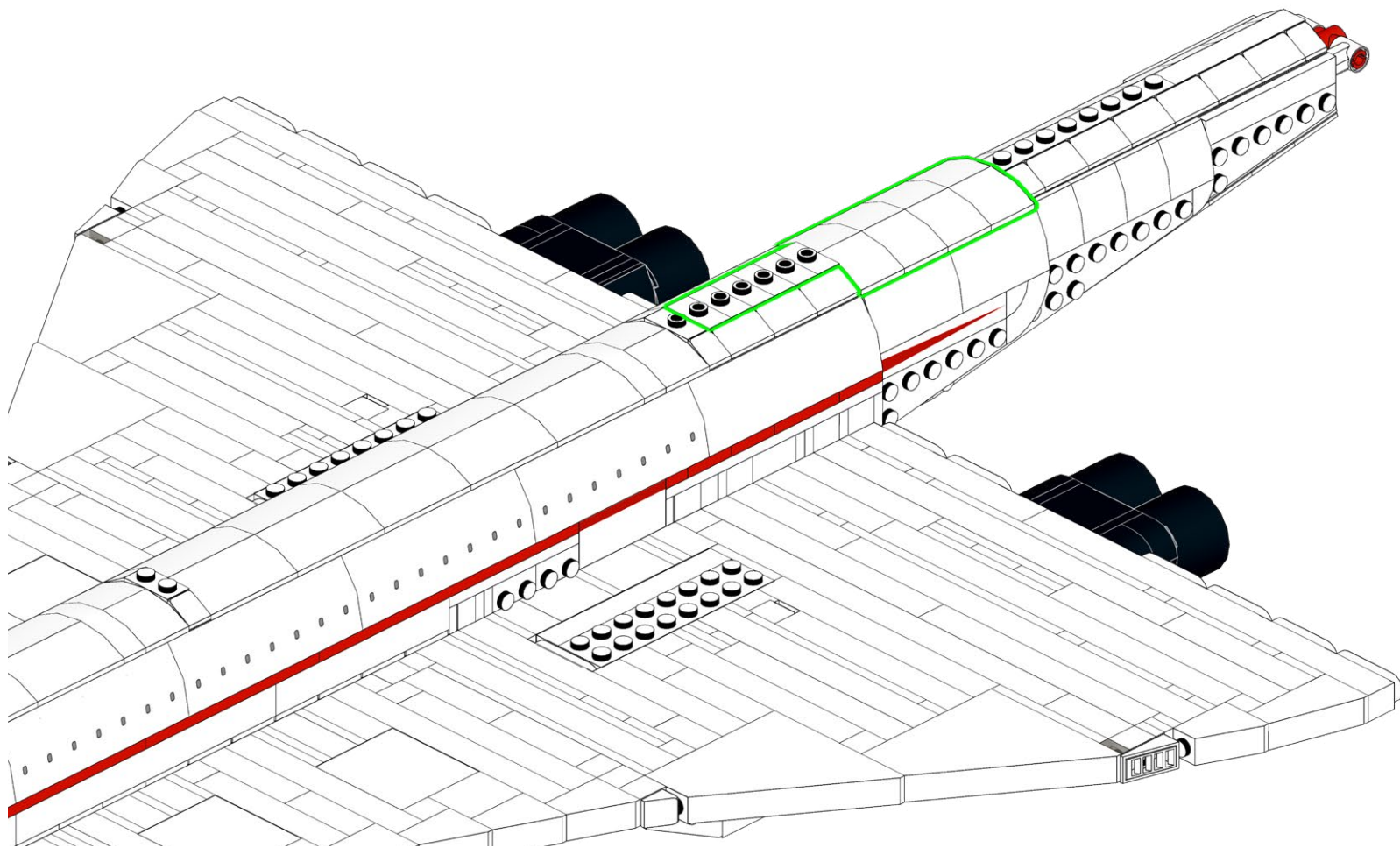

**602**

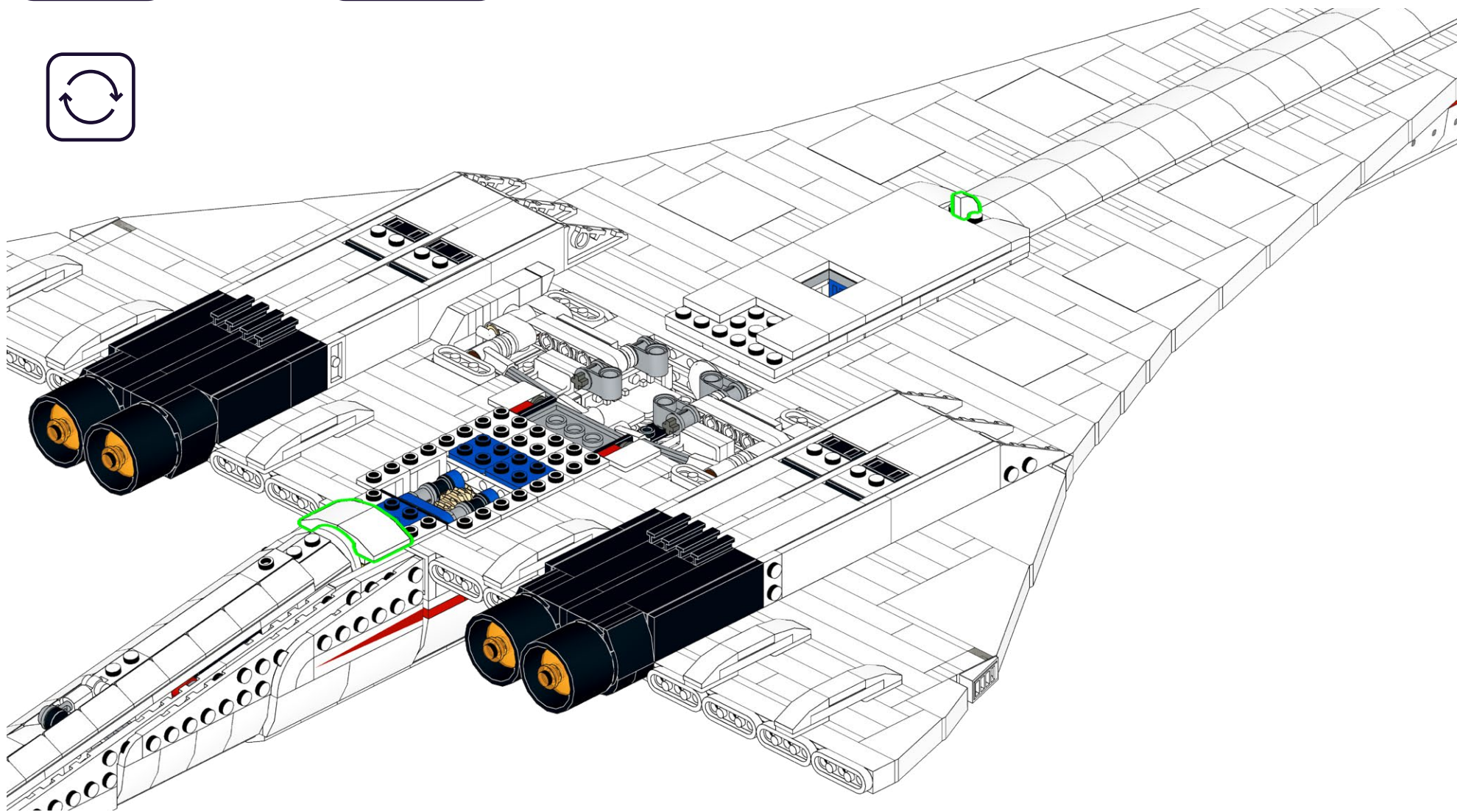
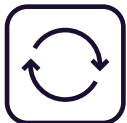
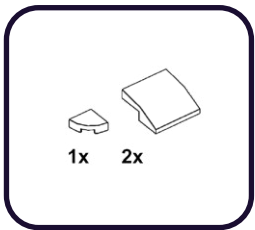

603

1x

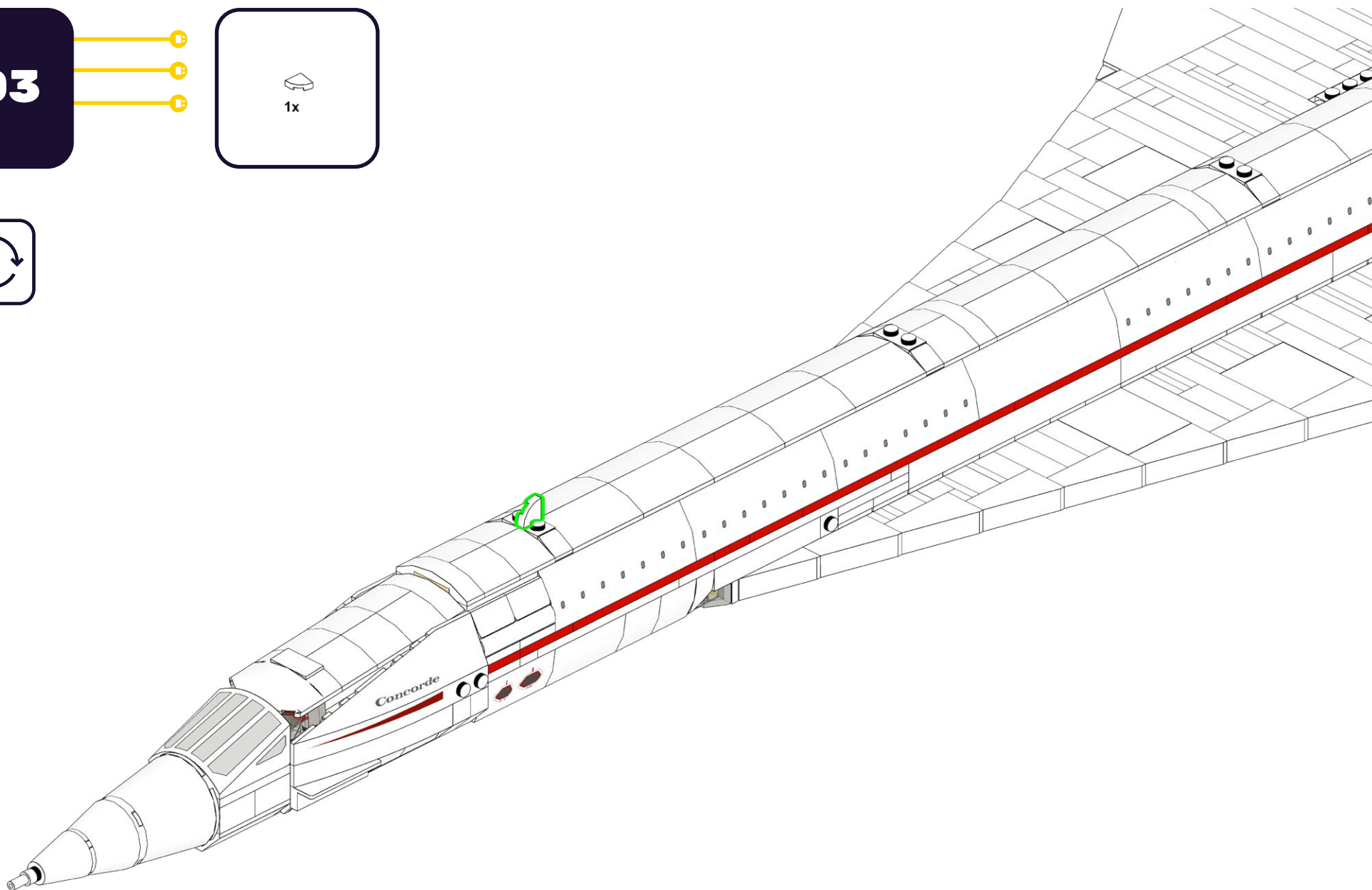

604

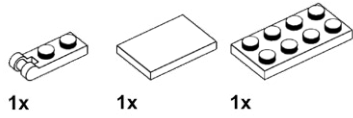

1



2

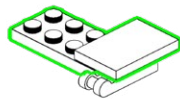

605

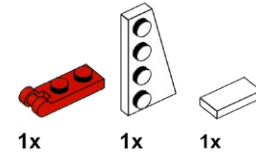

1

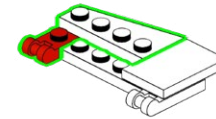

2

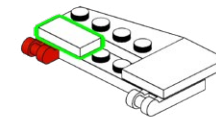

# 606

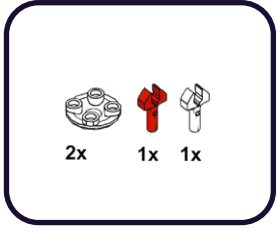

1

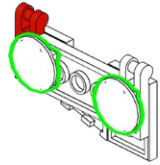

2

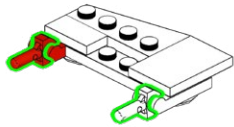

# 607

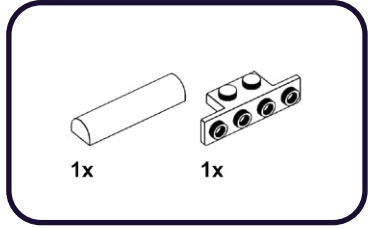

1

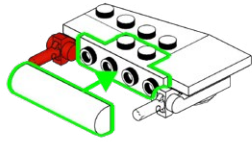

608

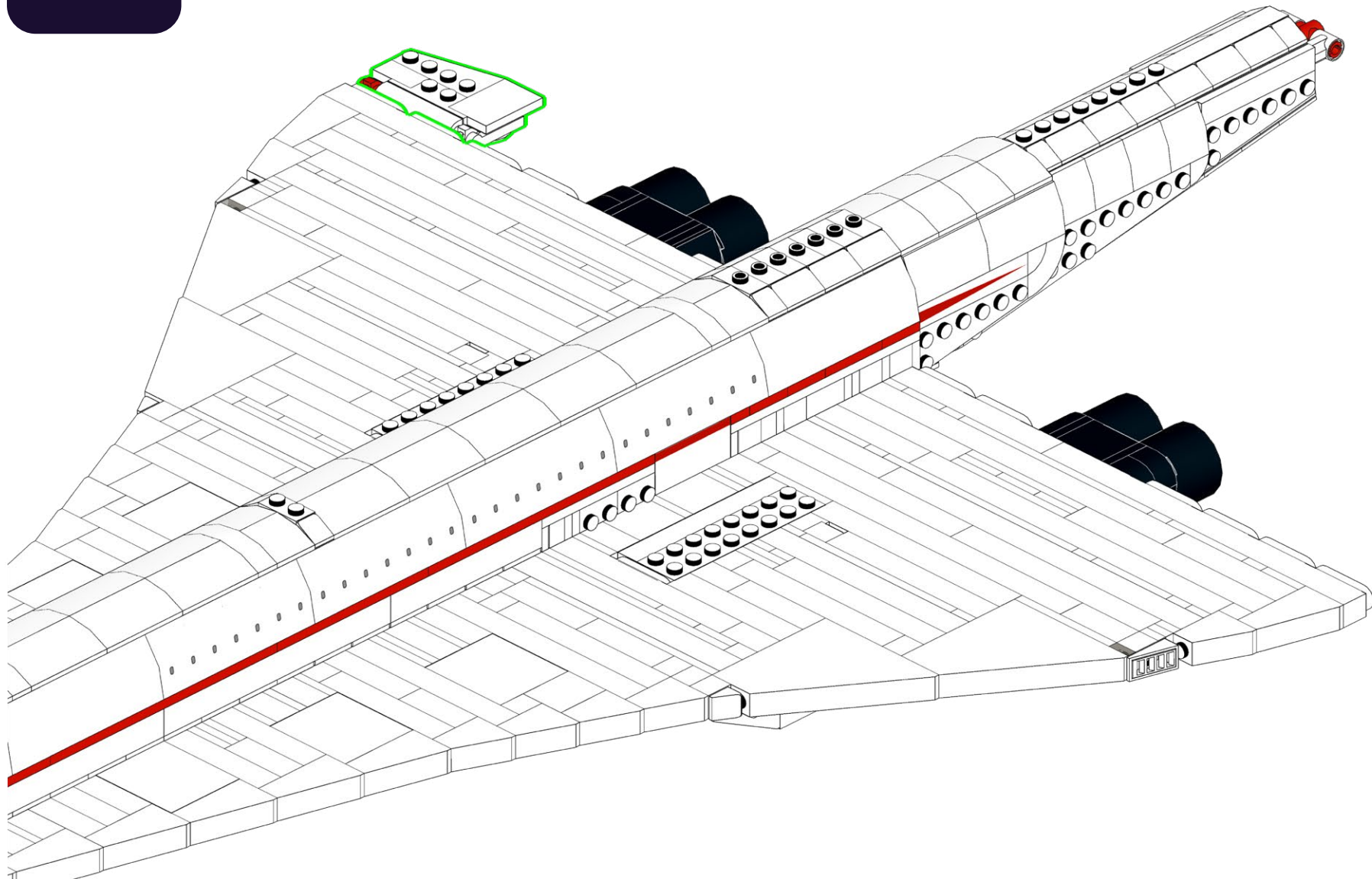

# 609

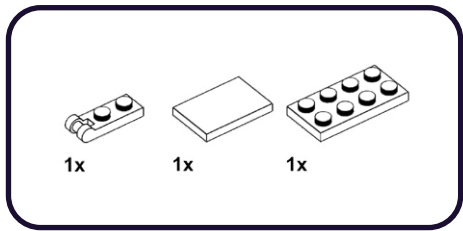

1



2

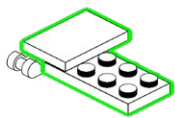

# 610

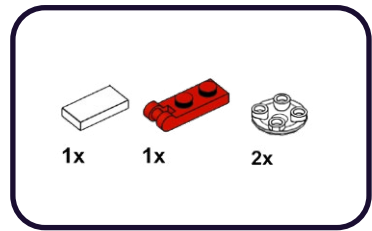

1

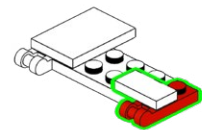

2

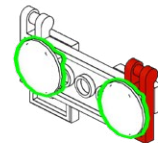



# 611

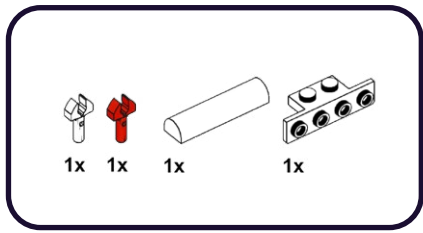

1

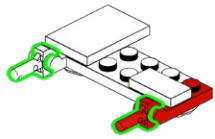

2

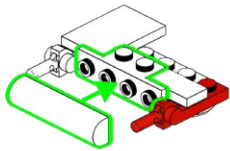

# 612

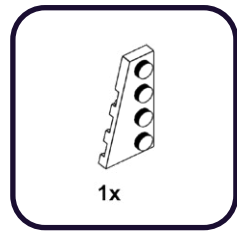

1

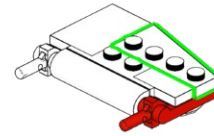

613

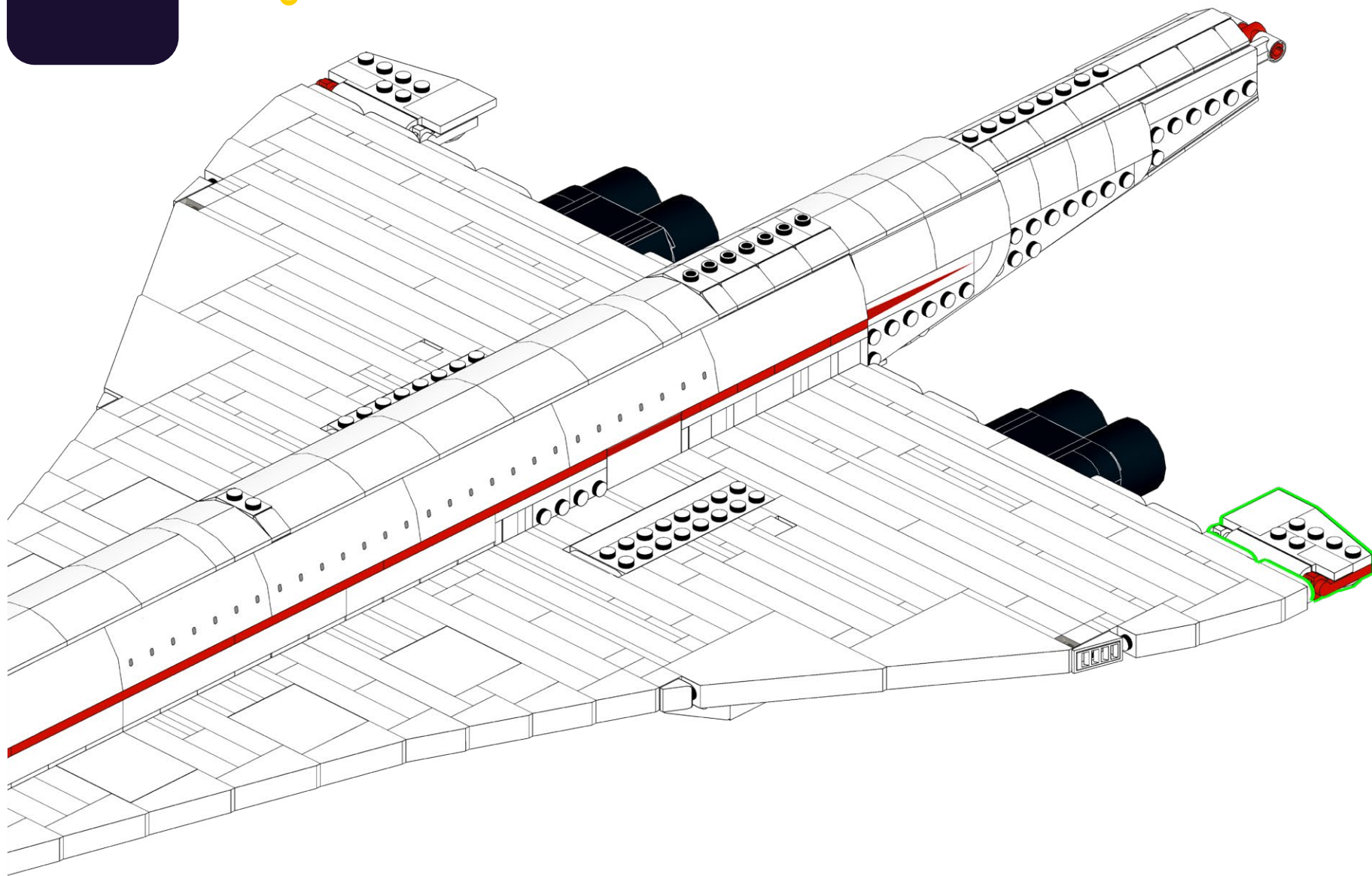

# 614

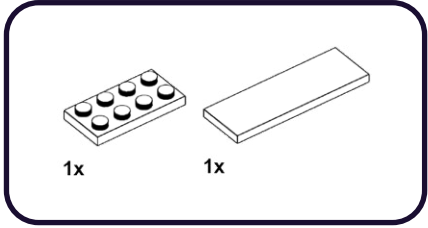

1

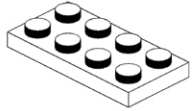

2

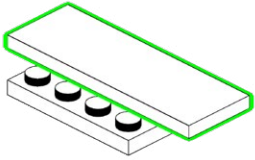

# 615

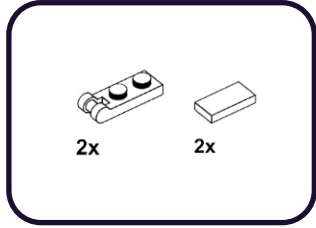

1

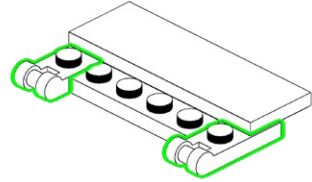

2

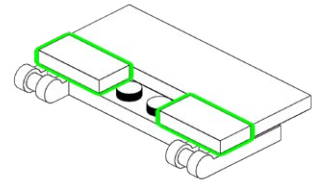

**616**

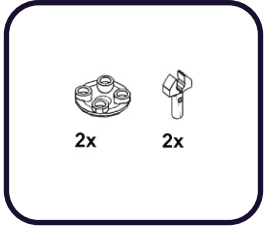

**1**

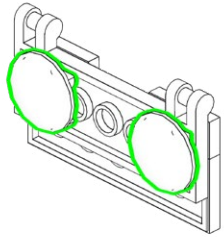

**2**

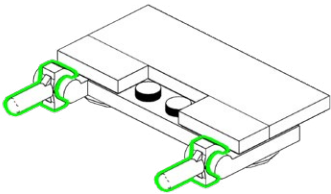

**617**

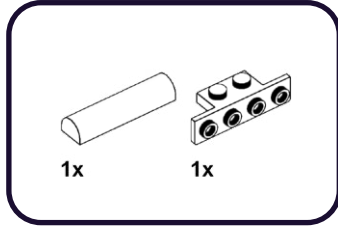

**1**

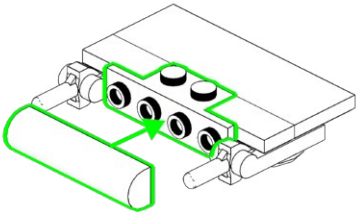

**4x**

618

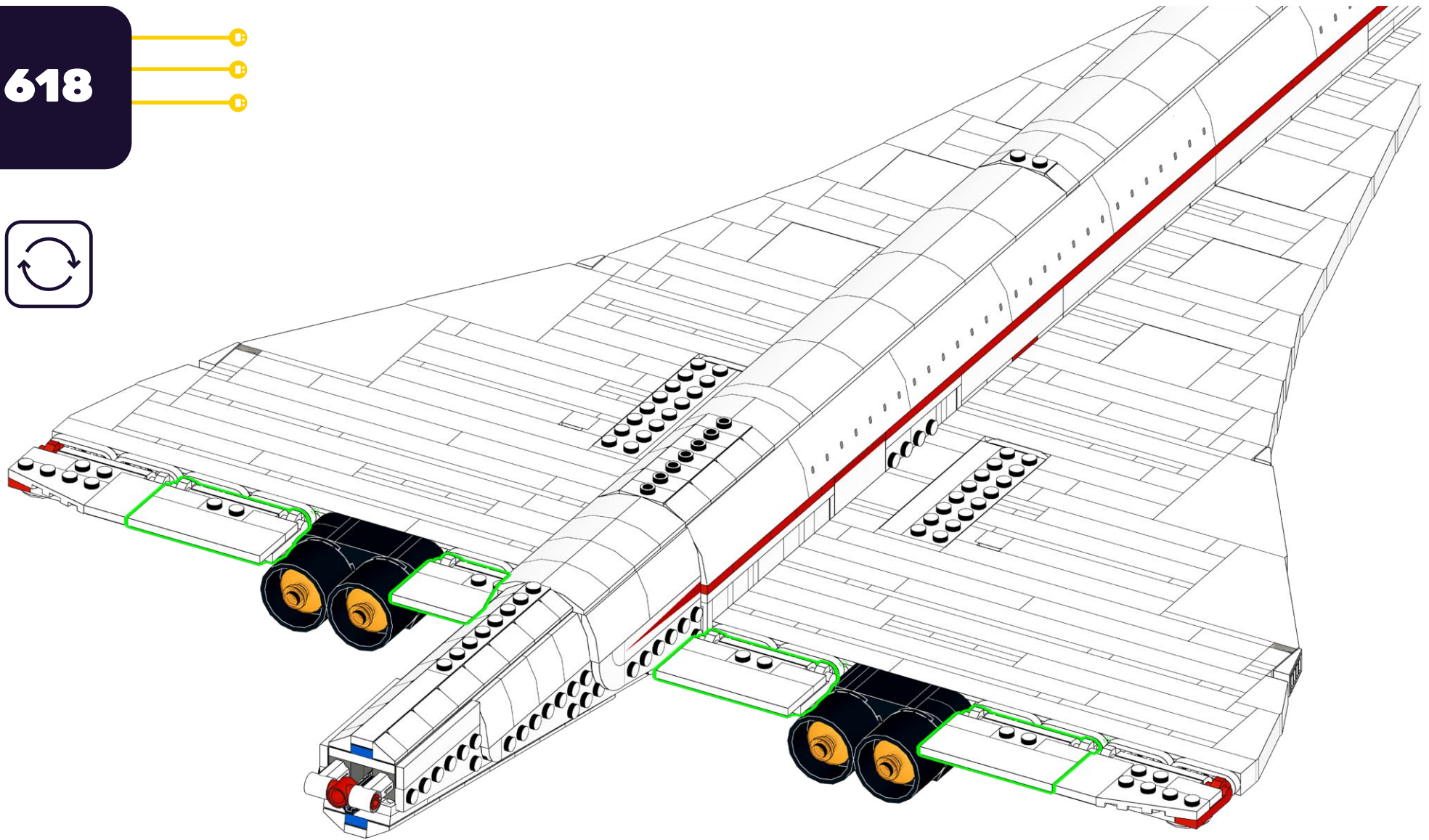

619

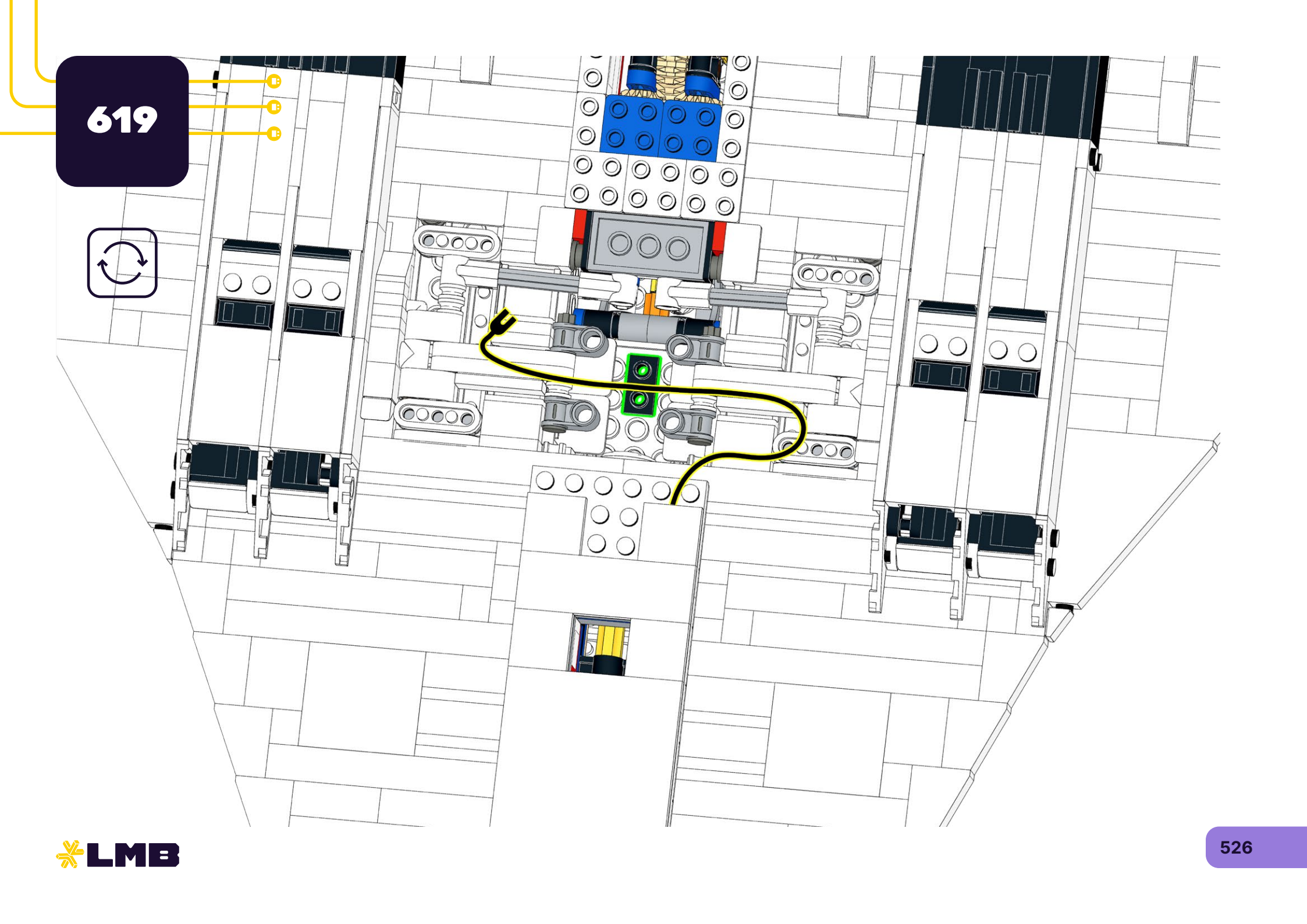
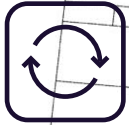

**620**

DS-4  
1x

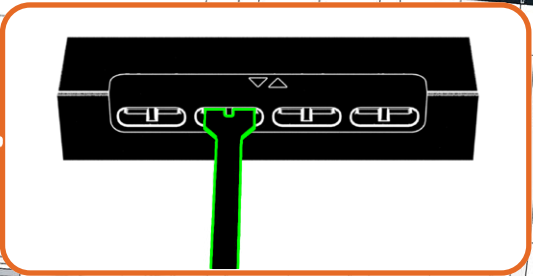

621

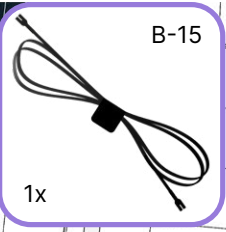



622

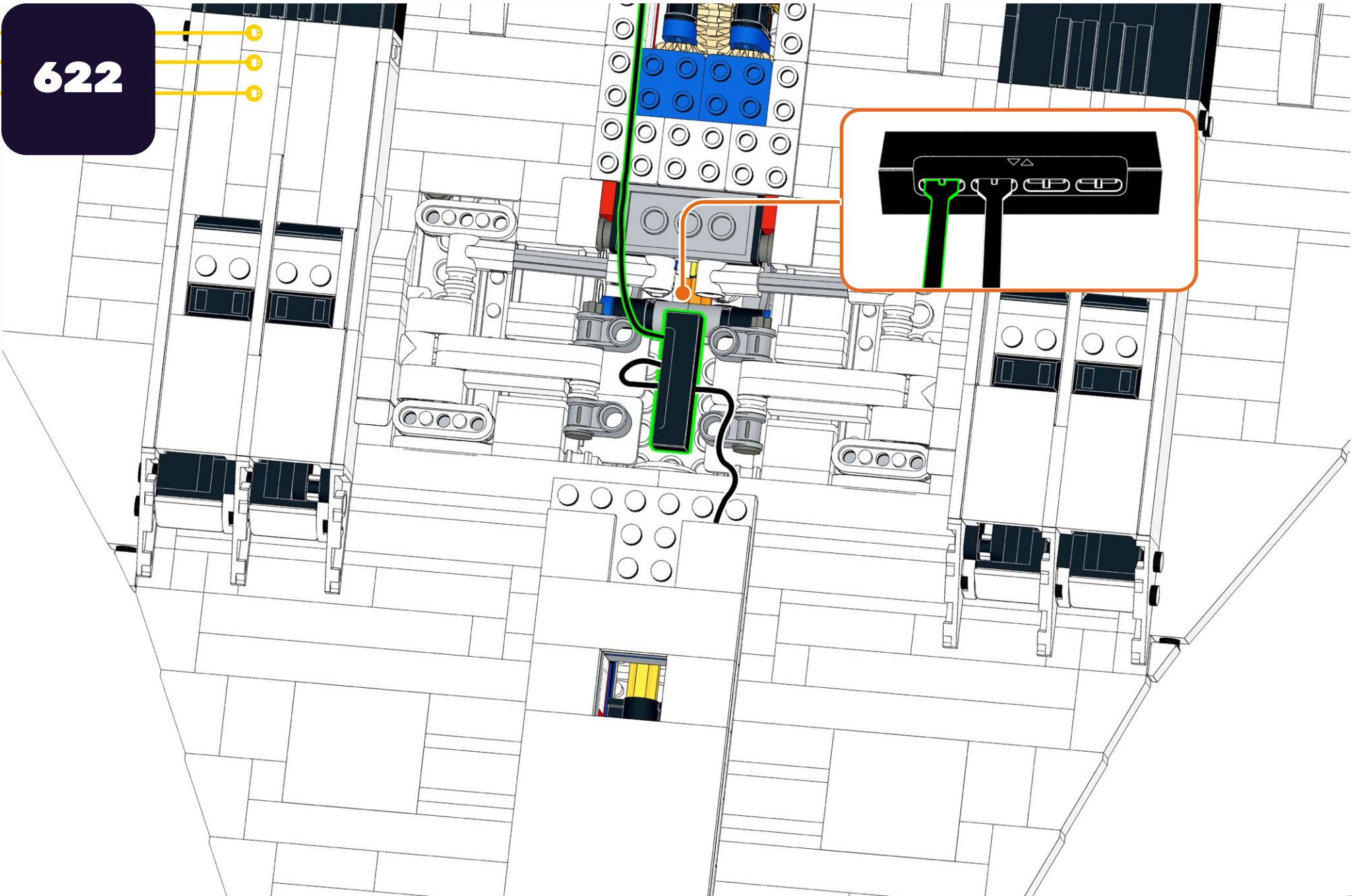

623

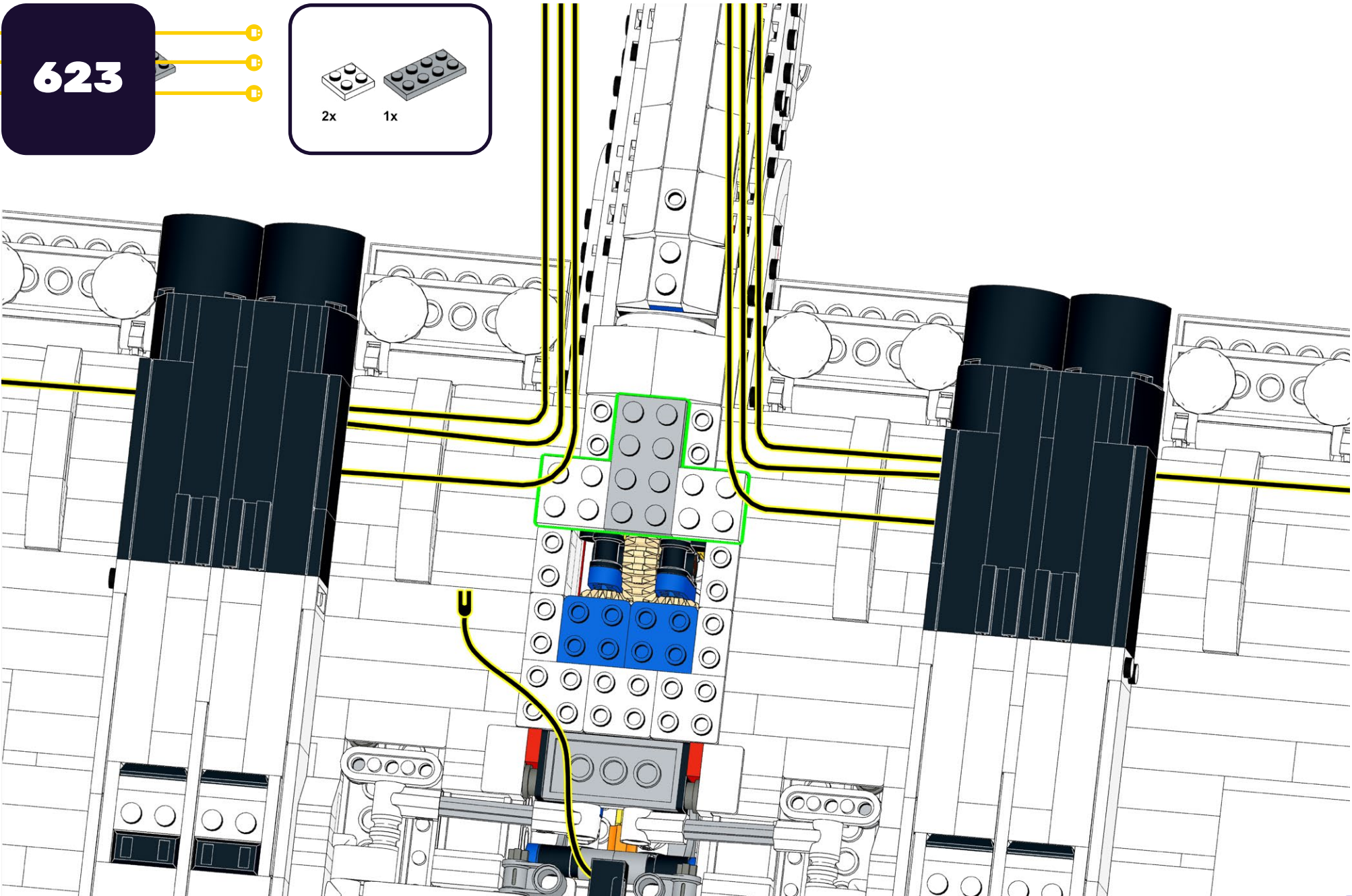
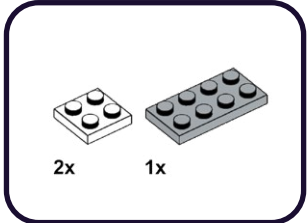

624

D-6

1x

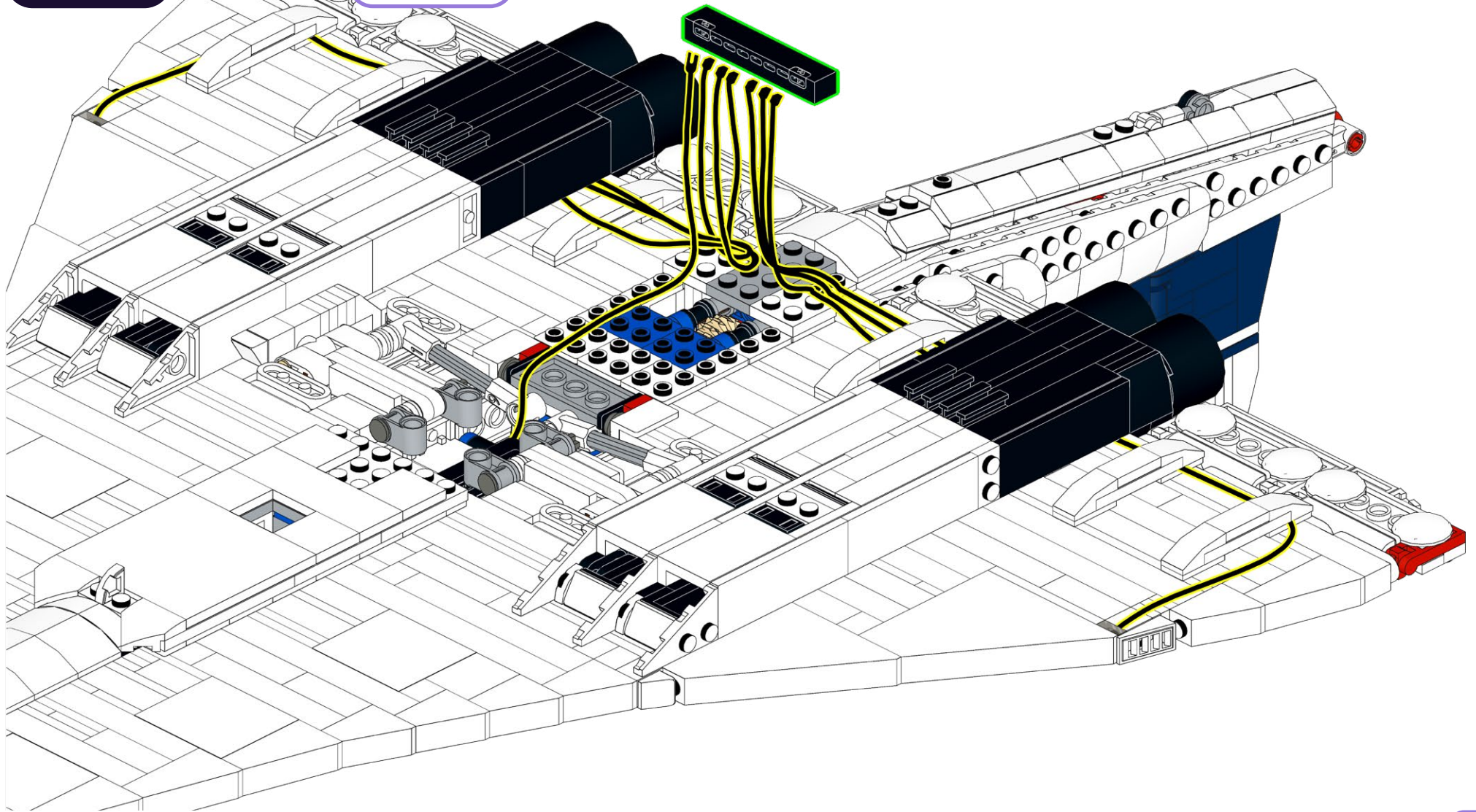

625

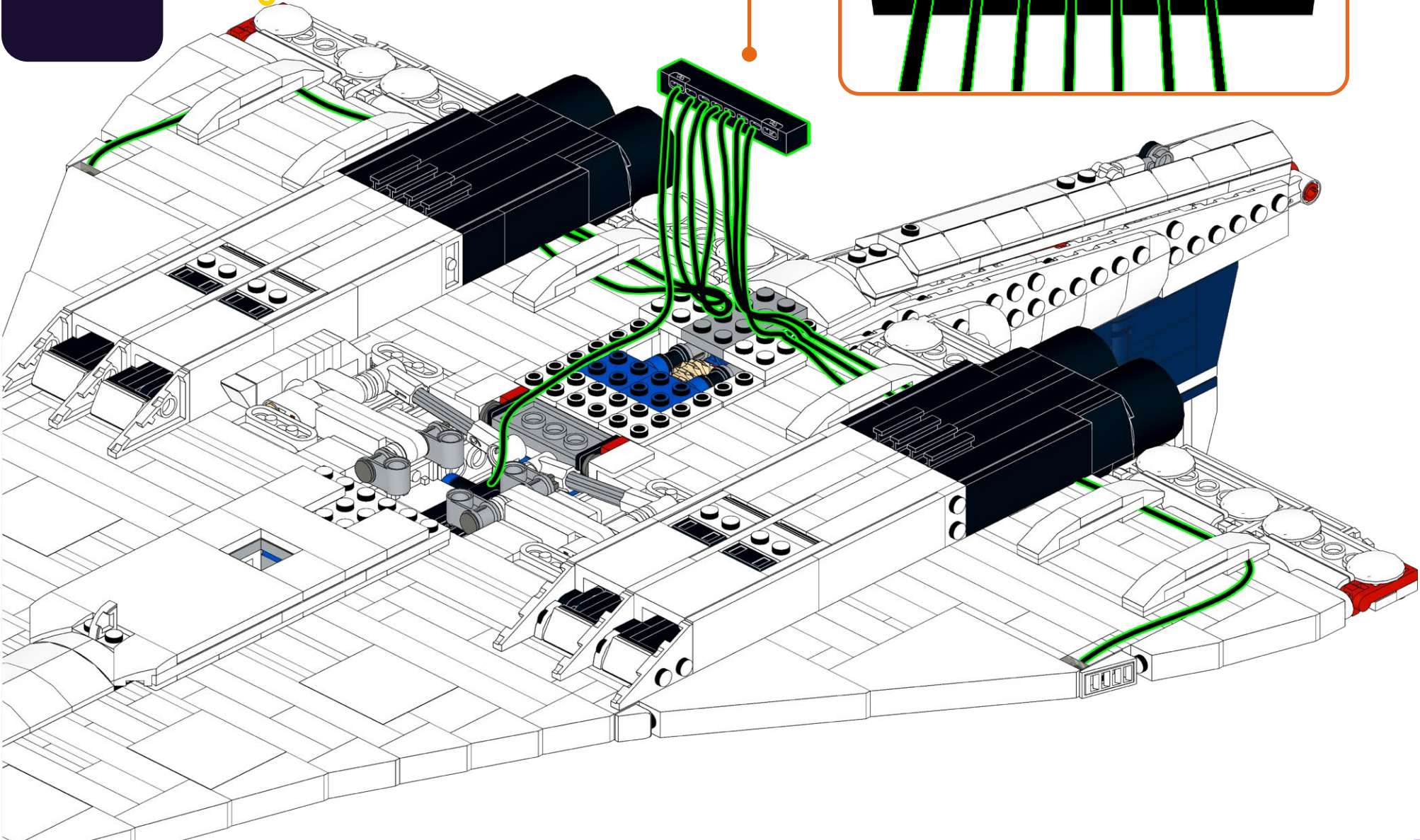

626

2x

1x

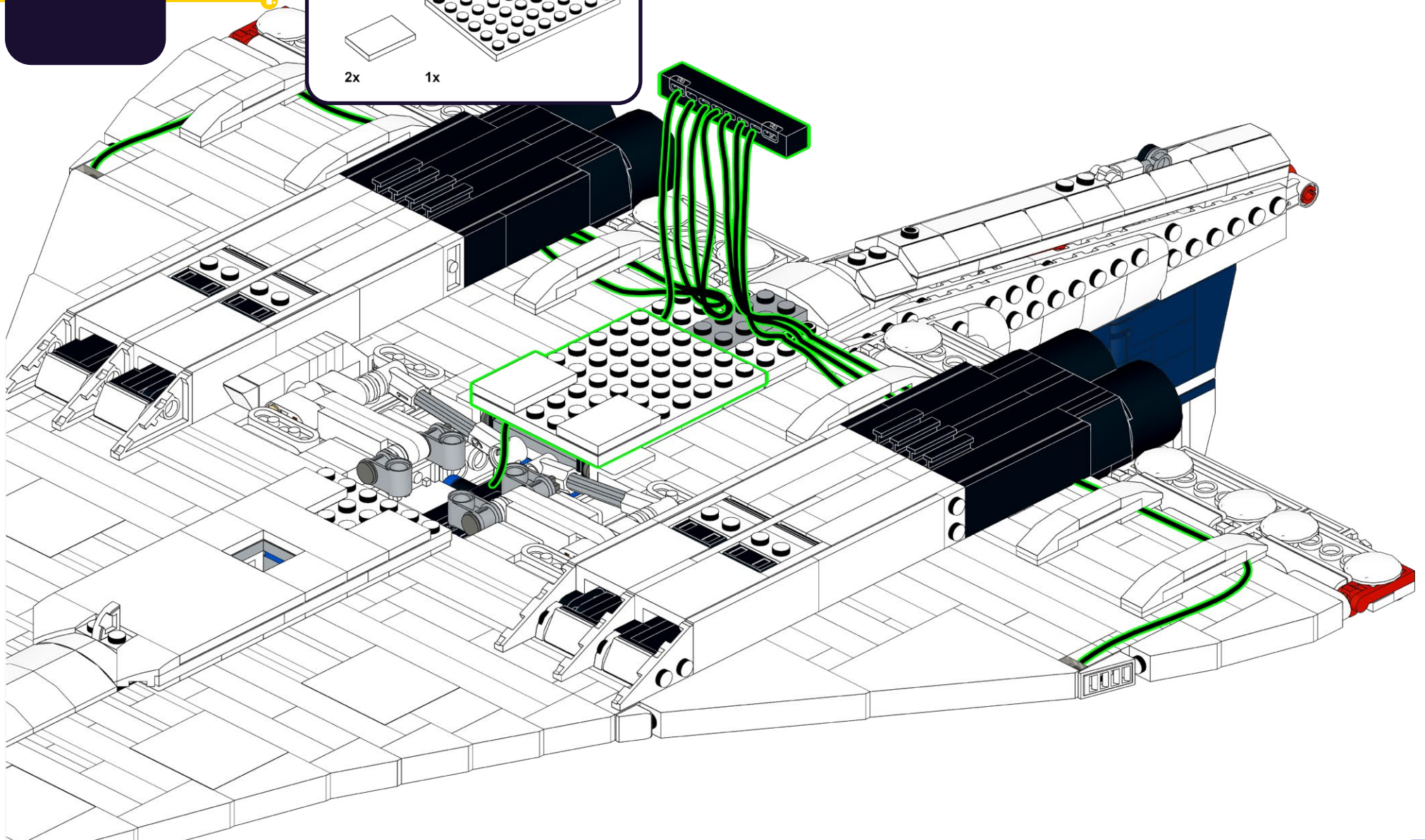

627

1x

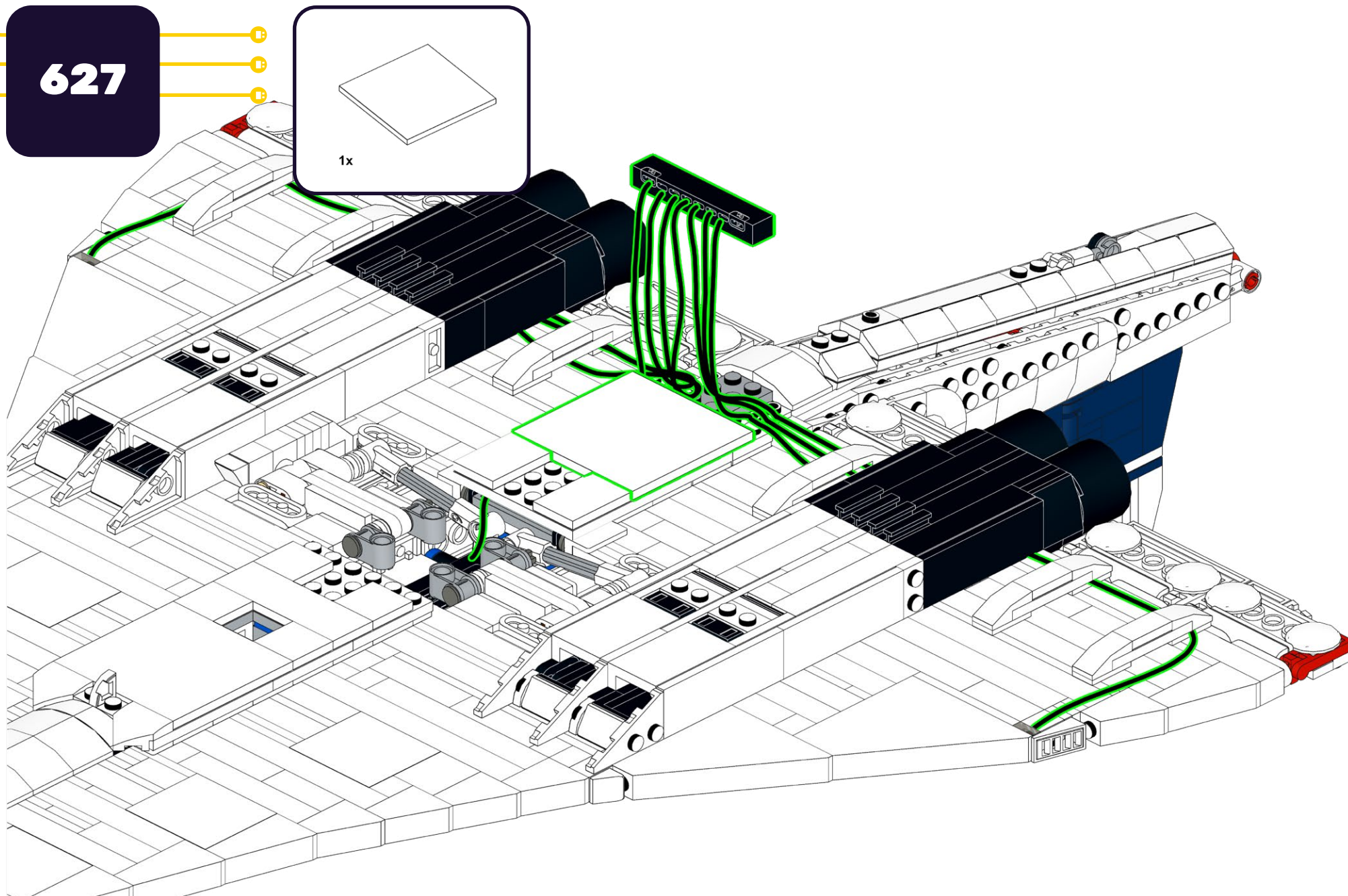

628

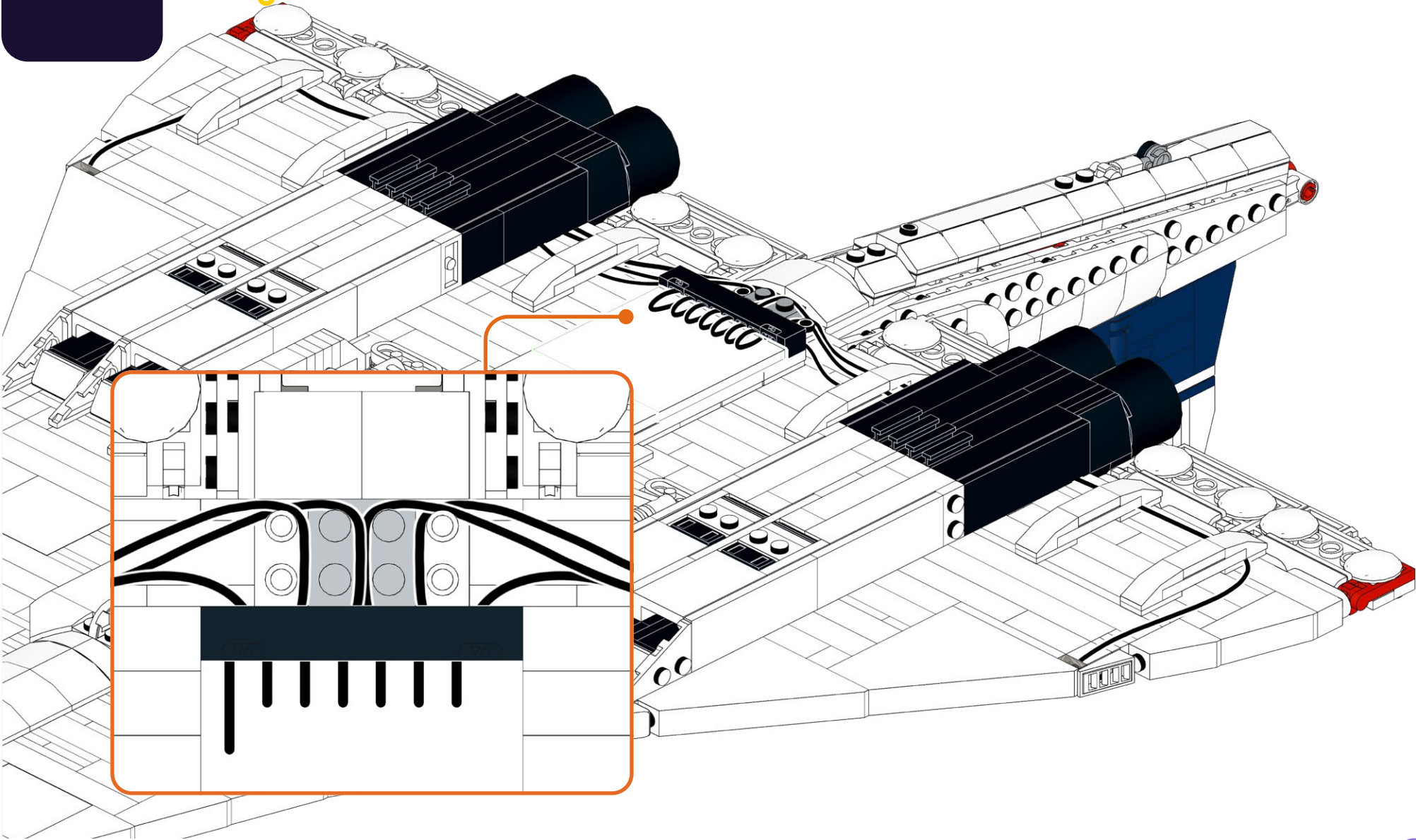

629

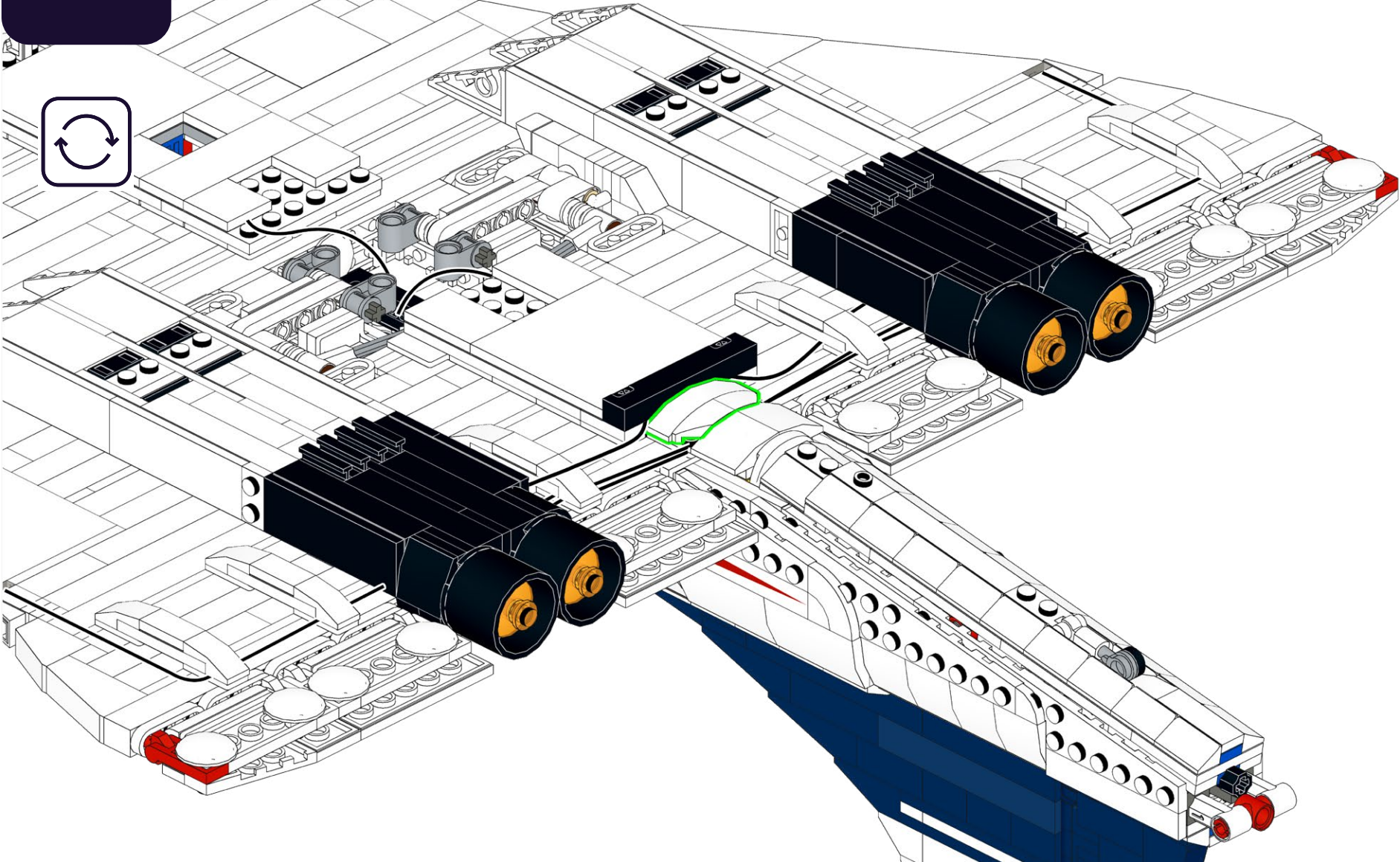



630

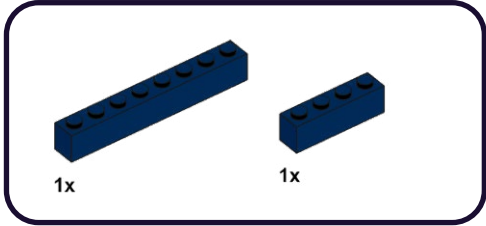

1



2

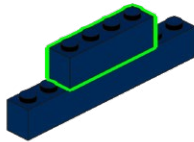

631

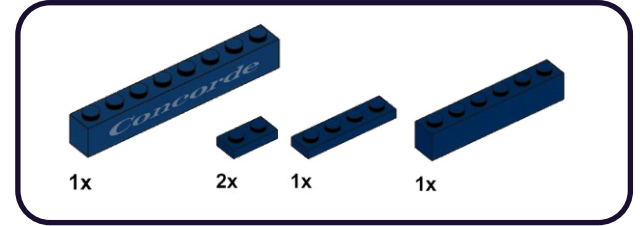

1

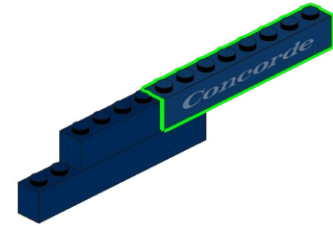

2

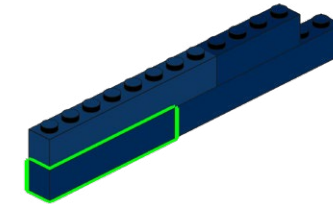

3

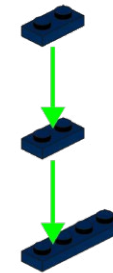

632

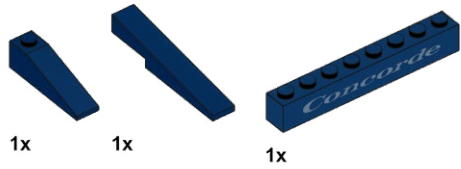

1

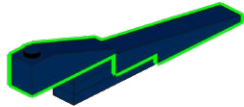

2

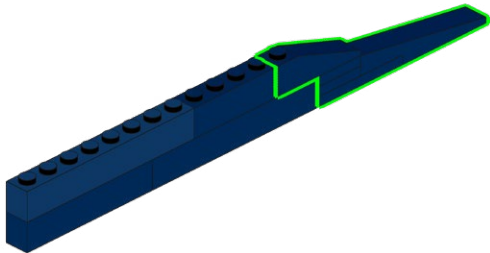

633

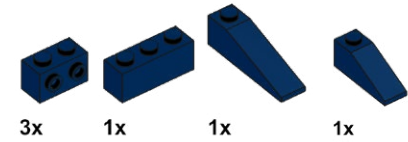

1

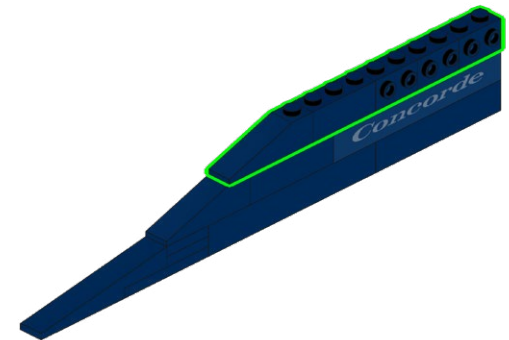

2

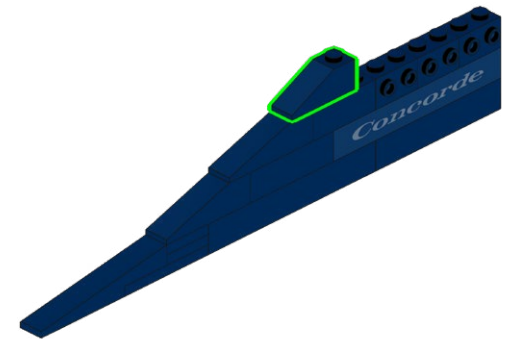

634

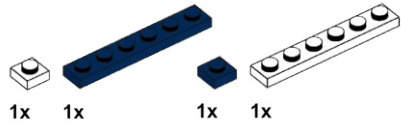

1

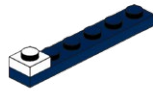

2

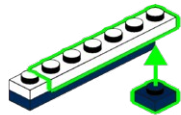

635

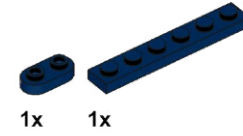

1

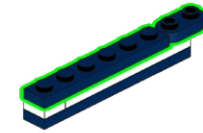

2

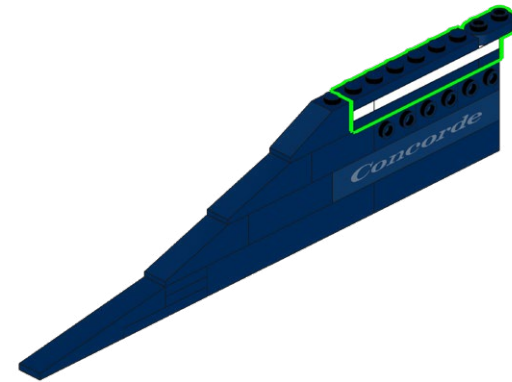

636

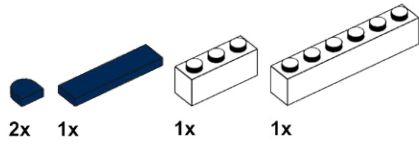

1

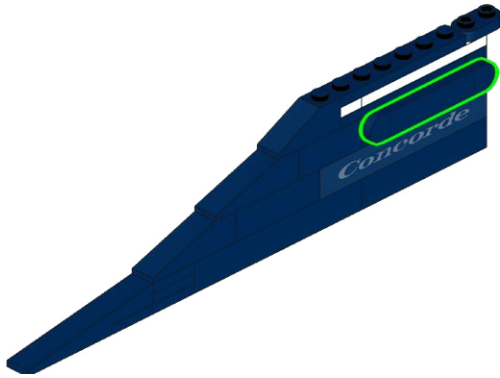

2

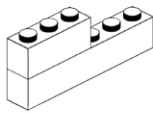

637

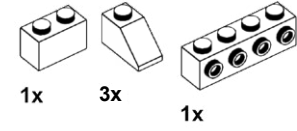

1

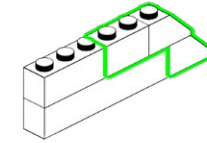

2

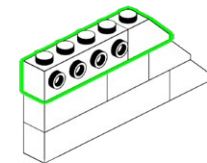

638

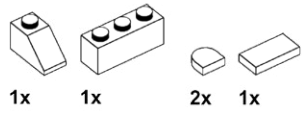

1

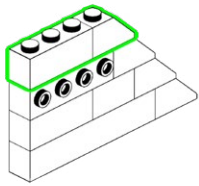

2

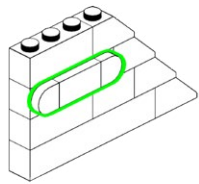

639

1

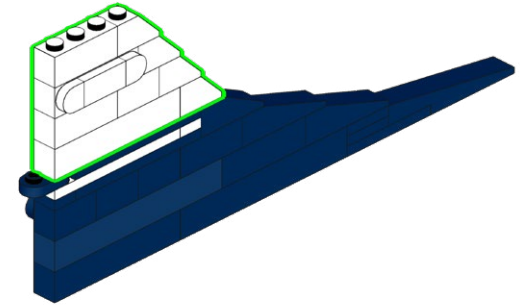

# 640

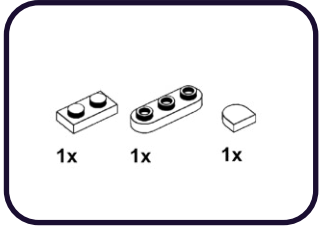

1



2



# 641

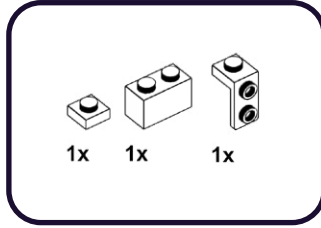

1

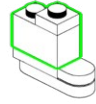

2

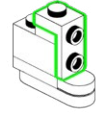

642

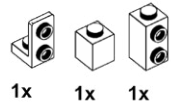

1

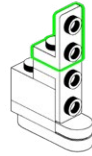

2

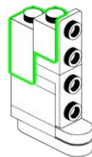

643

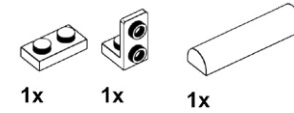

1

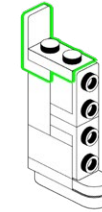

2

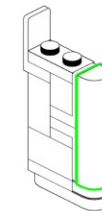

# 644

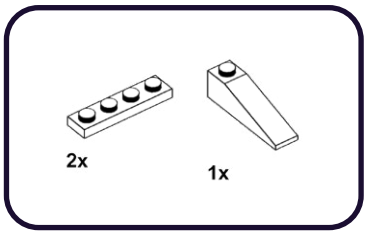

1

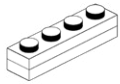

2

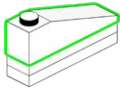

# 645

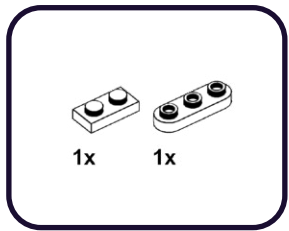

1

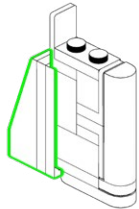

2





**646**

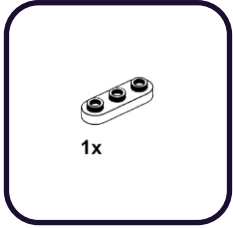

**647**

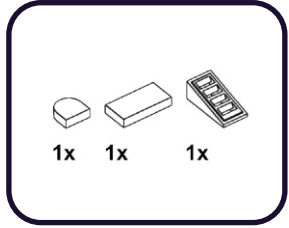

**1**

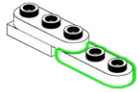

**2**

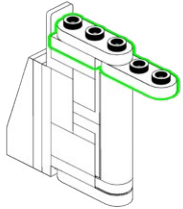

**1**

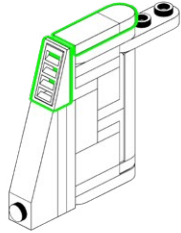

648

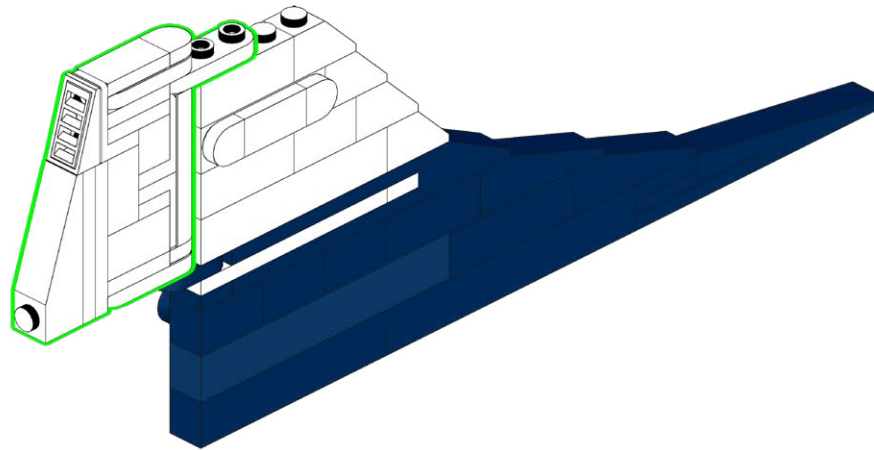

**649**

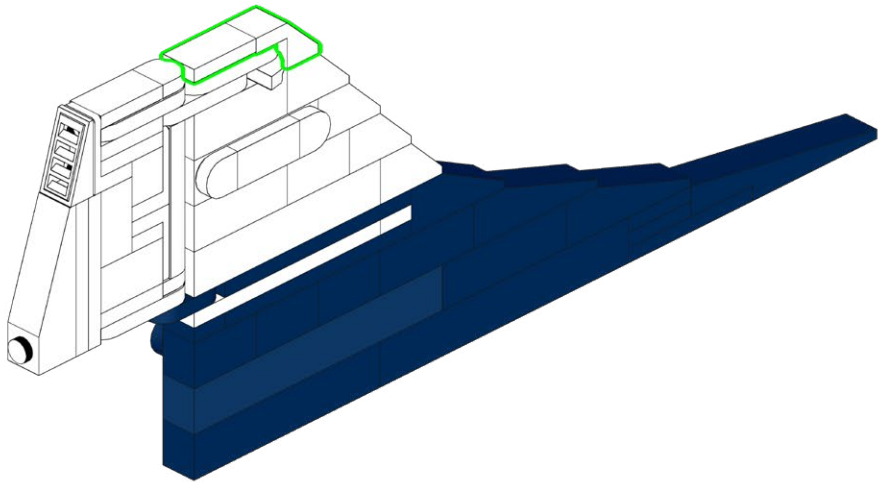
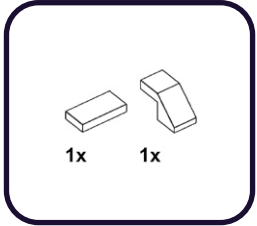

# 650

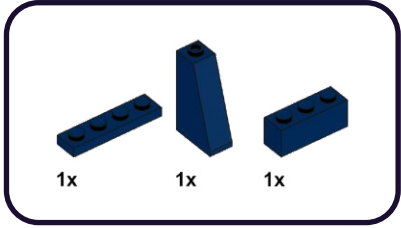

1



2

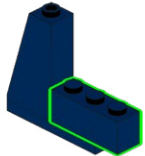

# 651

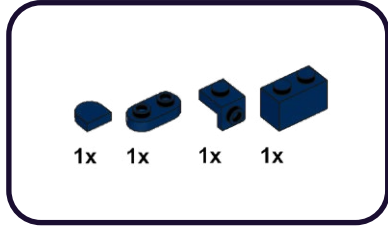

1

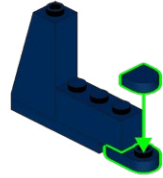

2

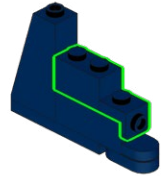

# 652

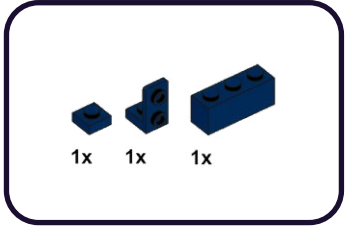

1

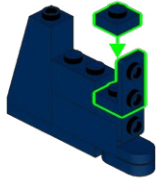

2

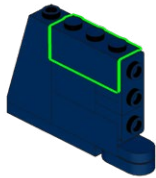

# 653

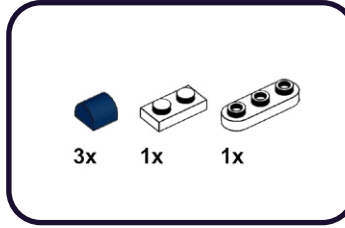

1

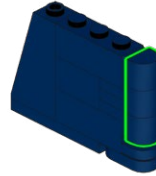

2



654

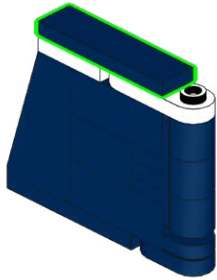
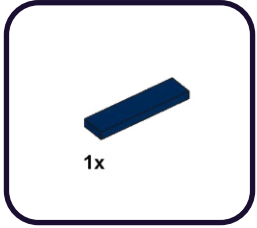

655

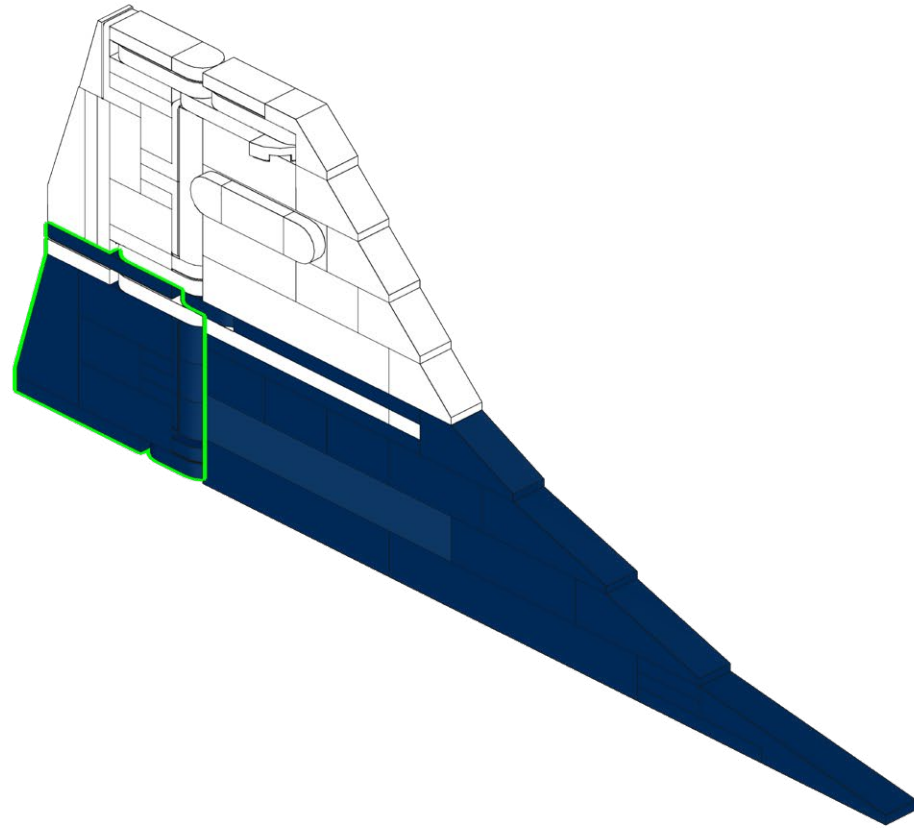

656

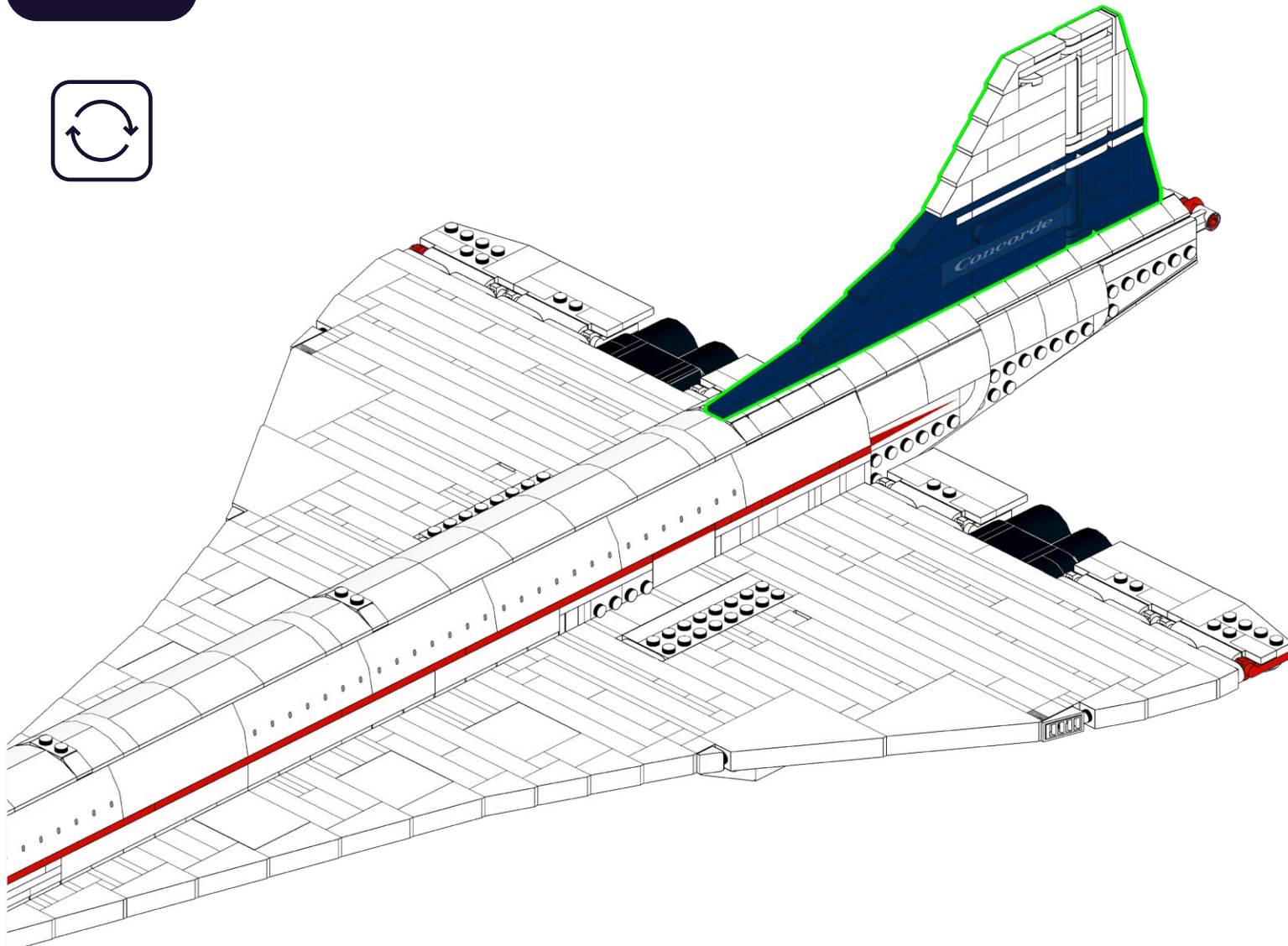



# 657

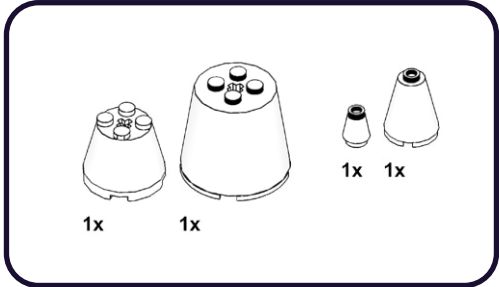

1

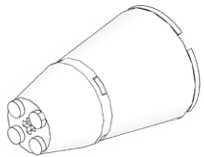

2

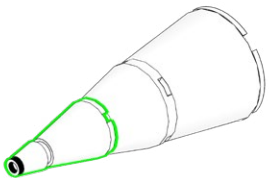

# 658

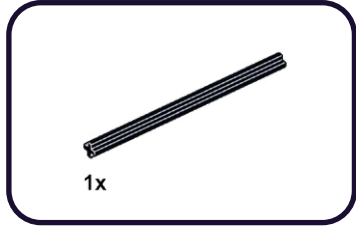

1

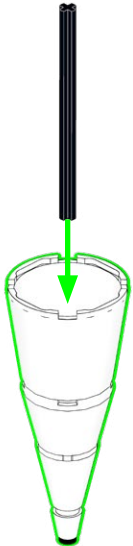

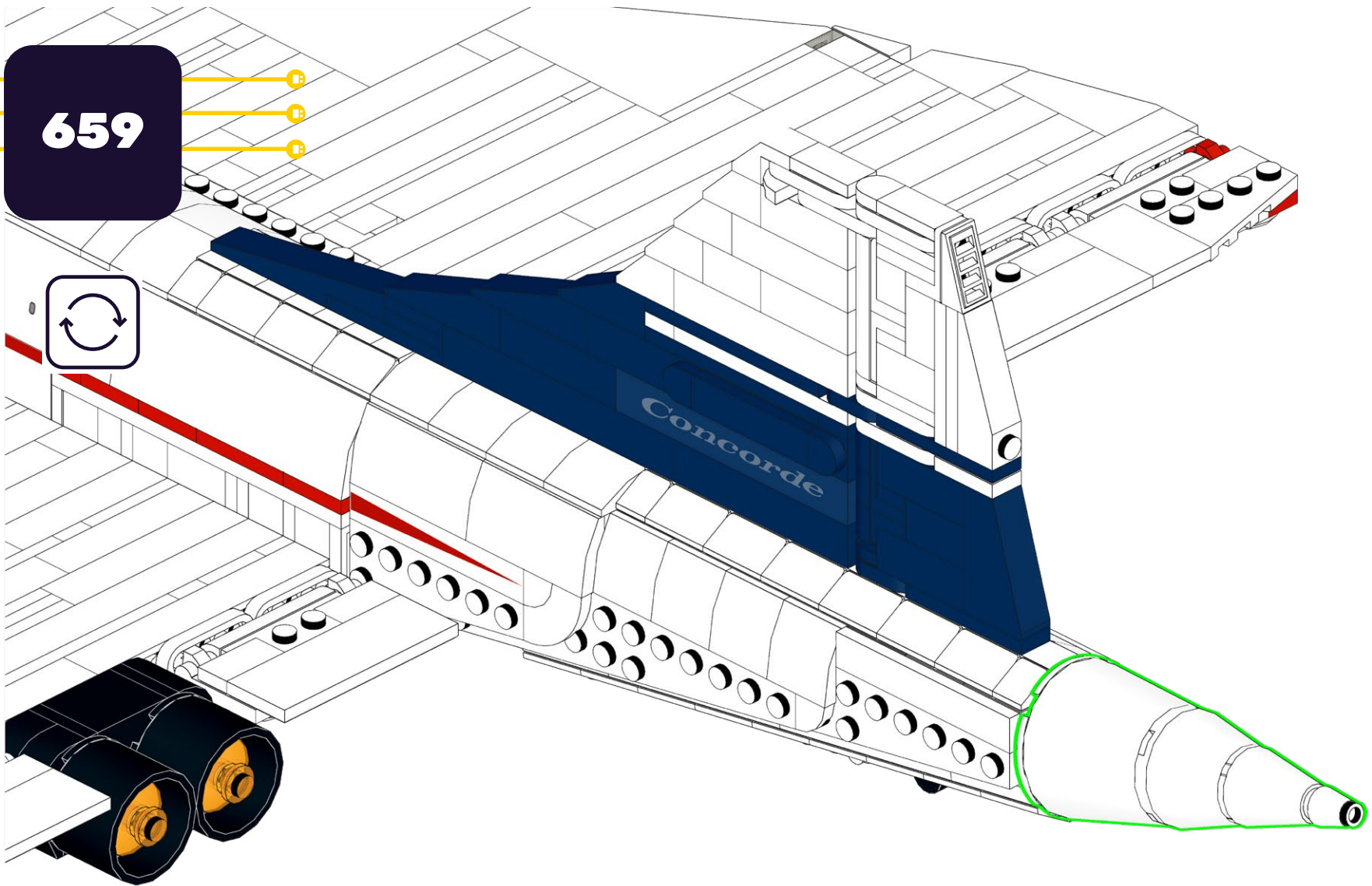

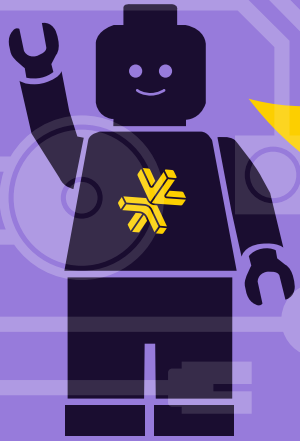
**HOLD UP!**

You might notice some bags aren't in order, as well as left over pieces, but that's ok! We're changing the way you build LEGO!

**ATTENDEZ!**

Vous remarquerez peut-être que certains sacs, ainsi que certaines pièces, ne sont pas dans le bon ordre. Mais pas de panique! Nous changeons simplement la façon avec laquelle vous construisez vos LEGO!

**ASPETTA!**

Potresti notare che alcuni sacchetti non sono in ordine, così come i pezzi avanzati, ma va bene così! Stiamo cambiando il modo in cui costruisci i LEGO!

**HALT!**

Sie werden möglicherweise bemerken, dass einige tüten durcheinander sind und teile übrig bleiben, aber das ist in Ordnung! Wir ändern die art und weise, wie Sie LEGO bauen!

**¡ESPERA!**

Es posible que notes que algunas bolsas están fuera de servicio, así como piezas sobrantes, ¡pero está bien! ¡Estamos cambiando la forma en que construyes LEGO!

**暫停!**

你可能会注意到一些袋子顺序错乱, 以及一些剩余的部件, 但没关系! 我们正在改变你搭建乐高的方式!

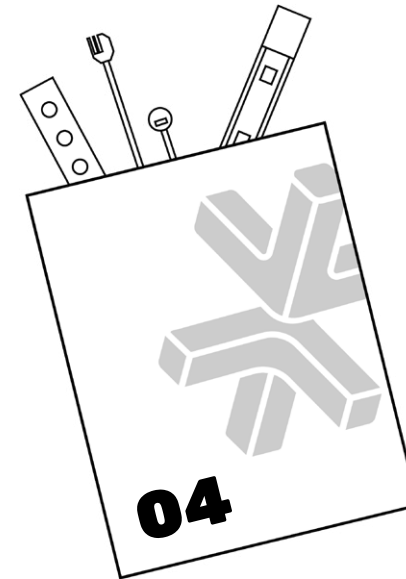
**Open LEGO® Bag 21****Open LMB Bag 04**

660

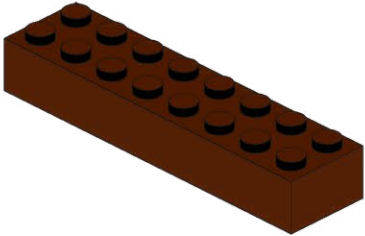
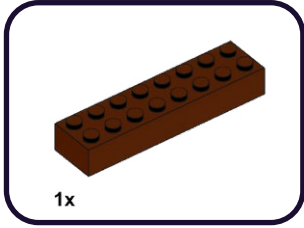

661

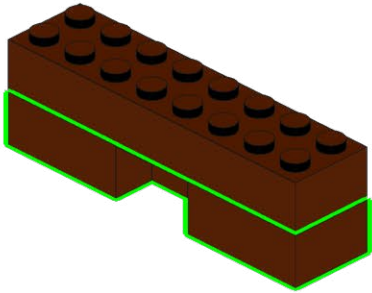
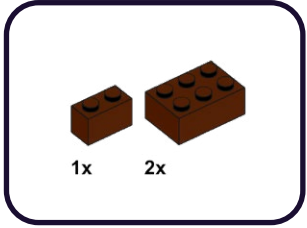

662

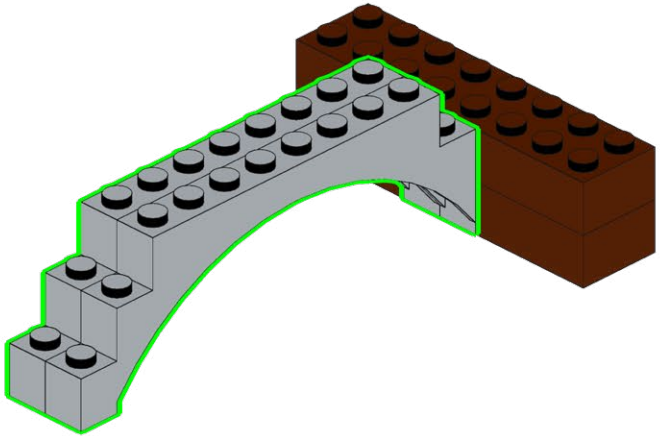
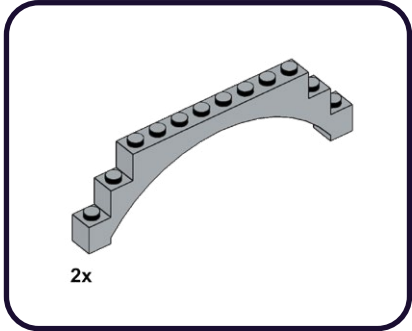

**663**

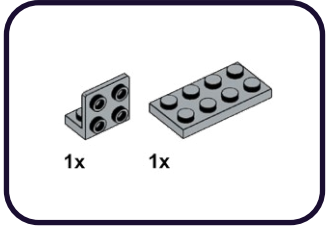

1



2

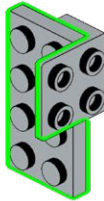

**664**

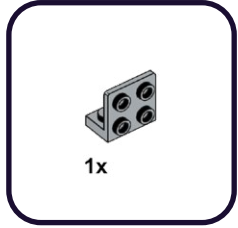

1

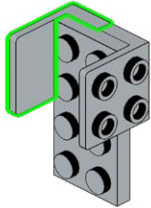

665

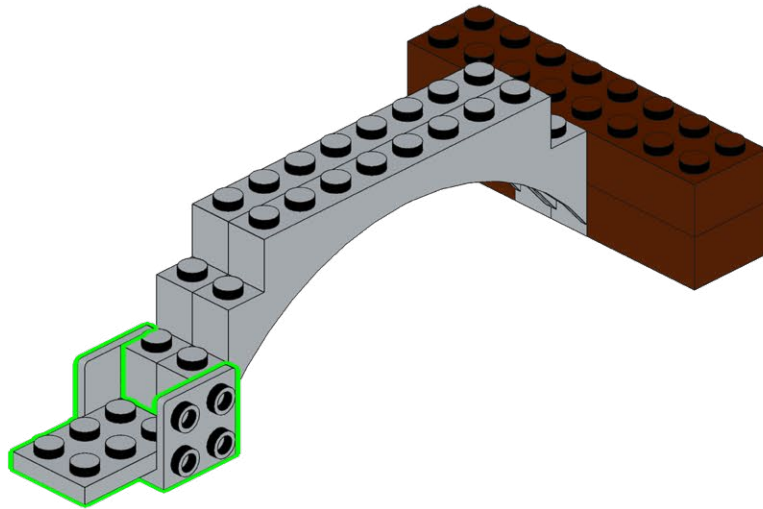



666

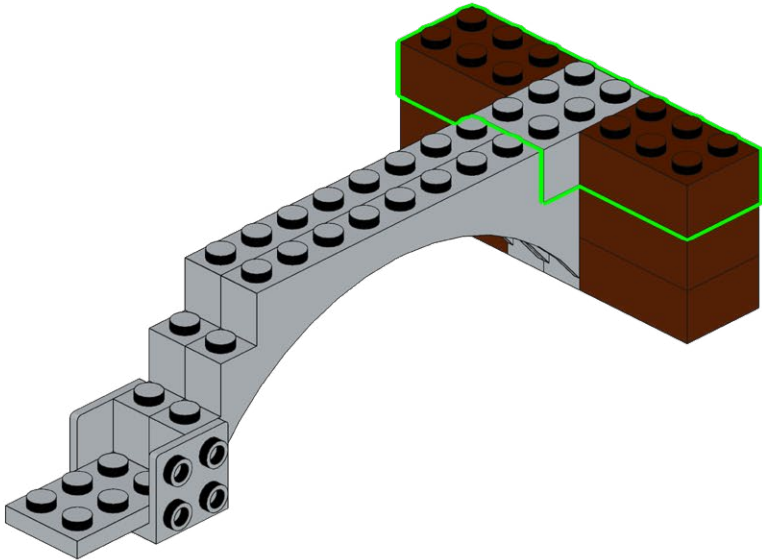
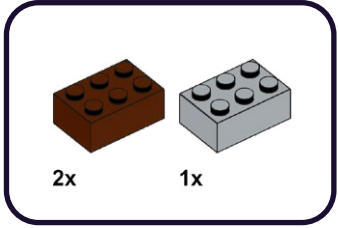

667

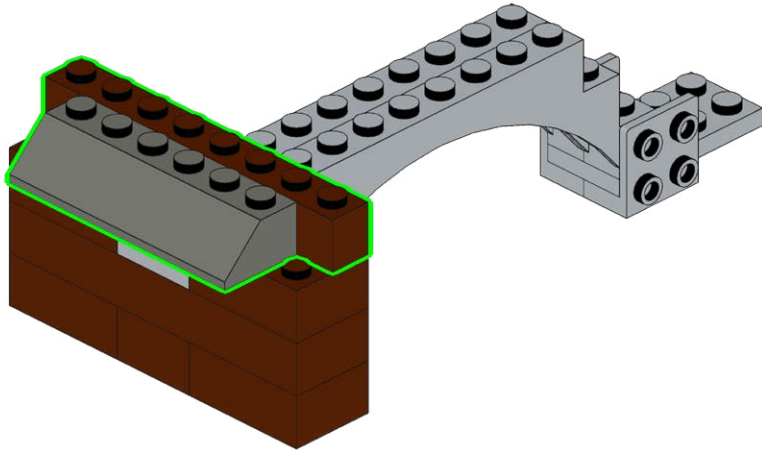
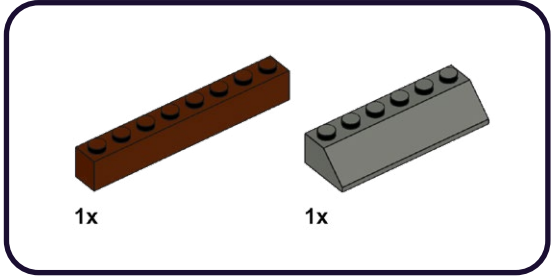
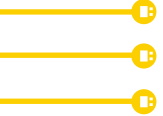

668

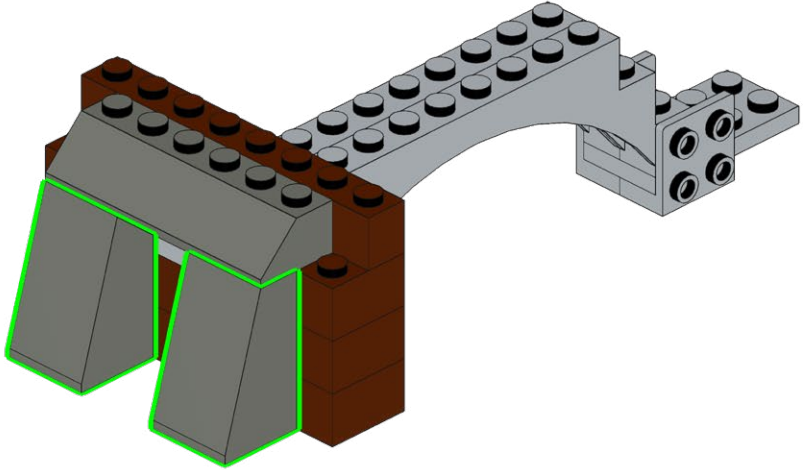
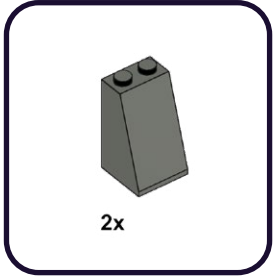

669

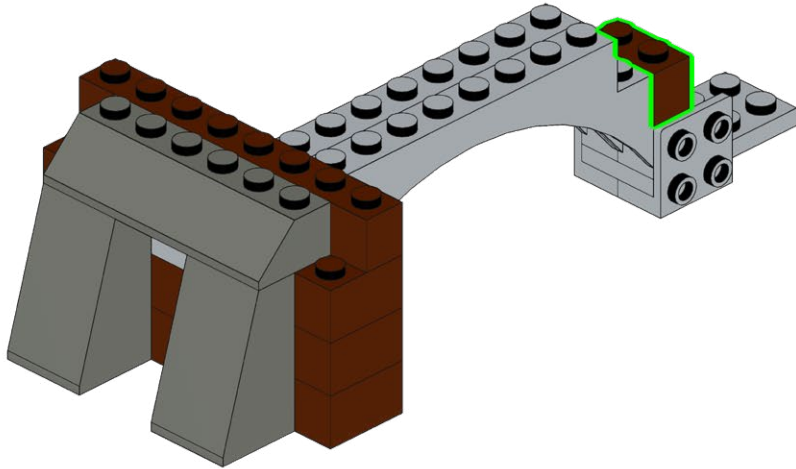
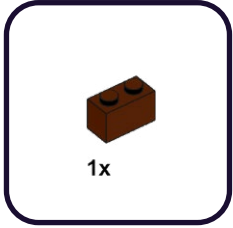

670

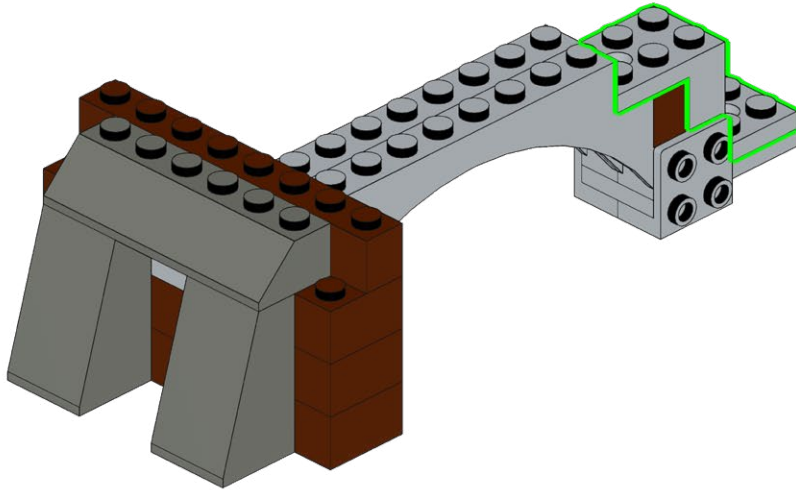
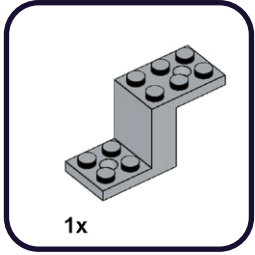

671

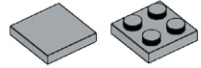

1x

1x

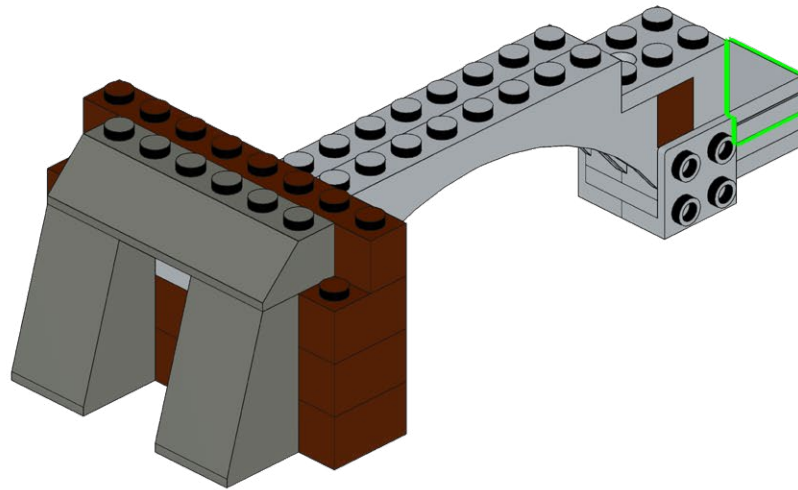
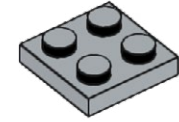

672

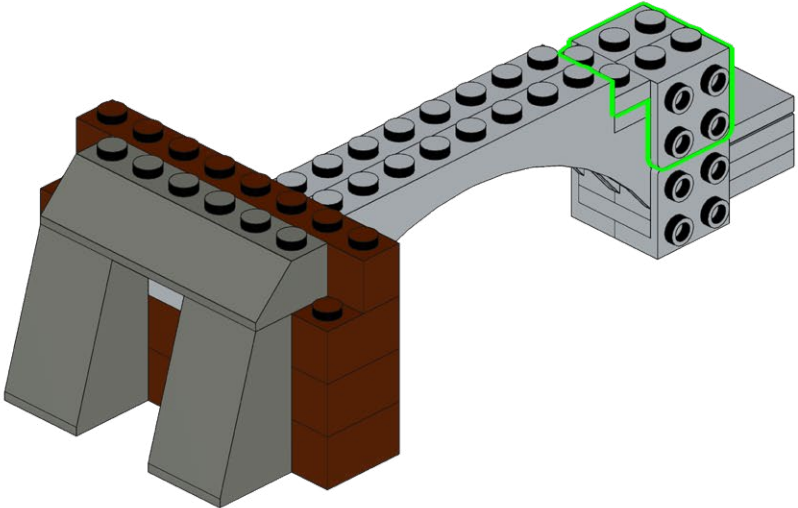
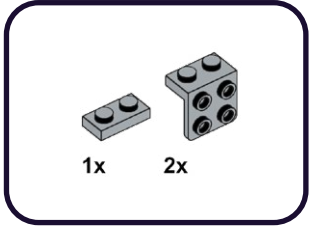

**673**

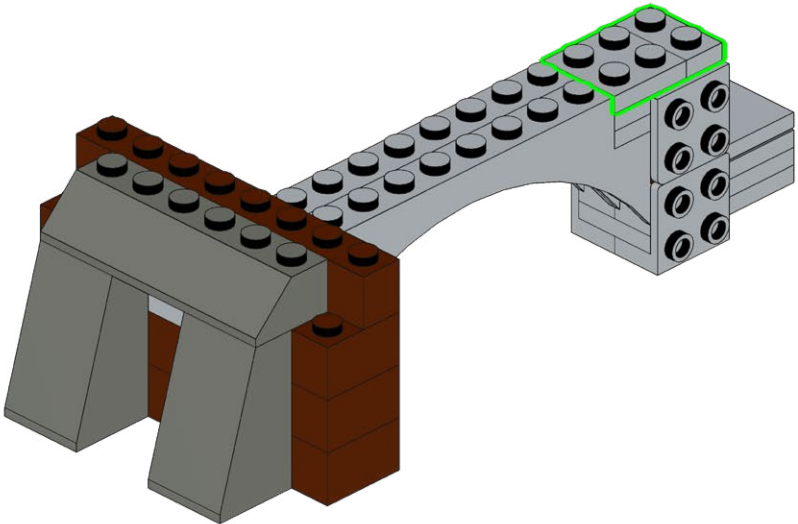
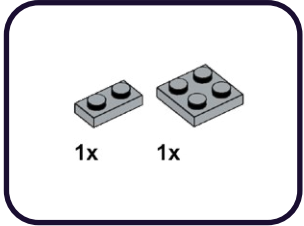



674

2x

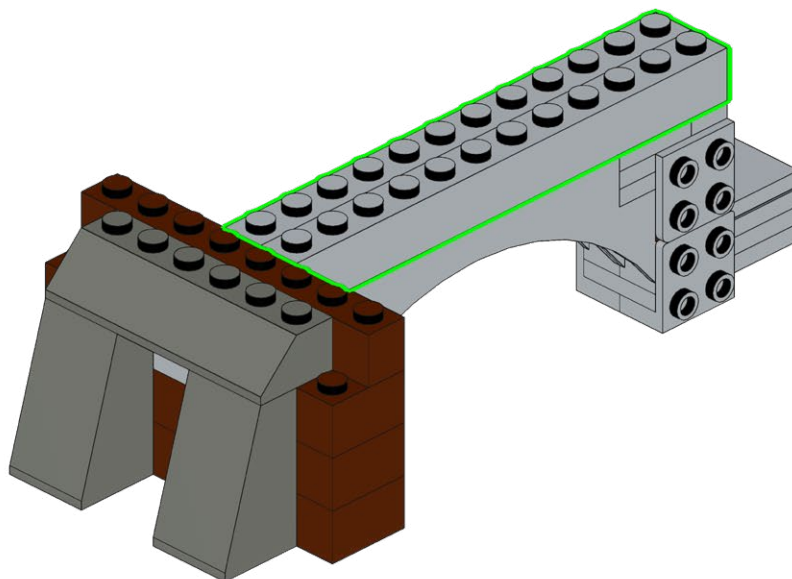

675

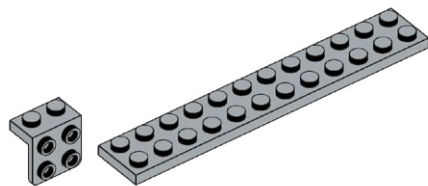

2x

1x

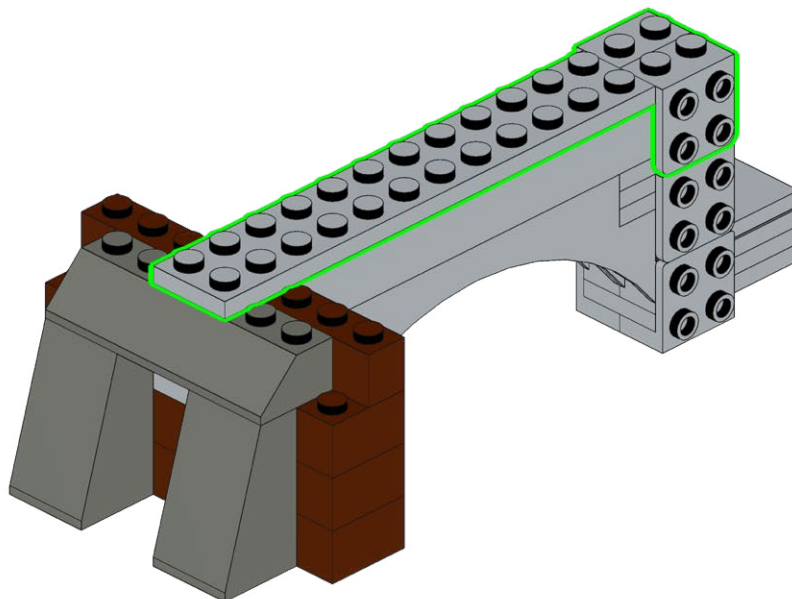

676

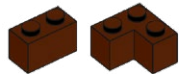

2x

2x

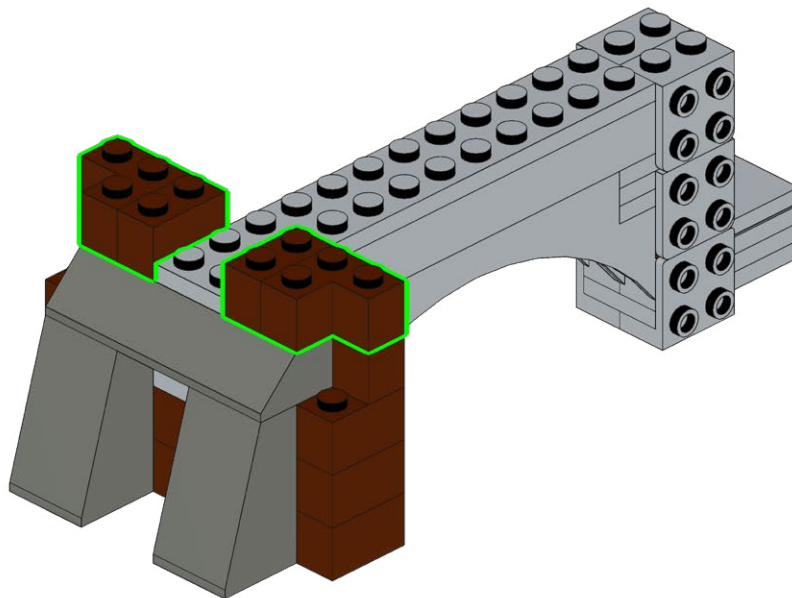

677

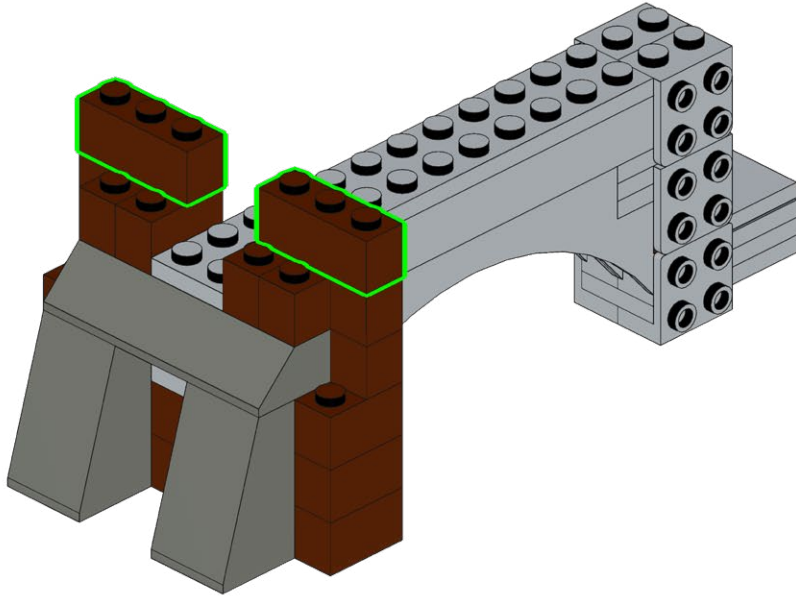
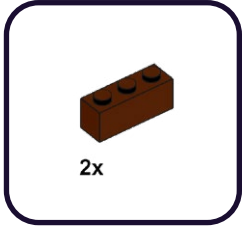

**678**

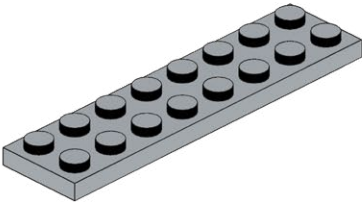
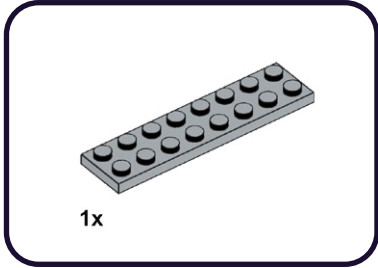

**679**

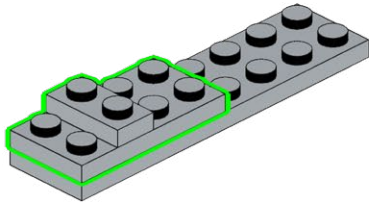
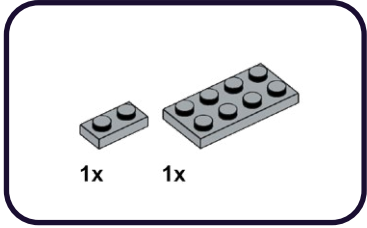

680

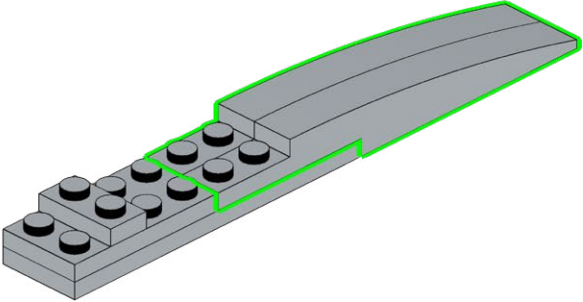
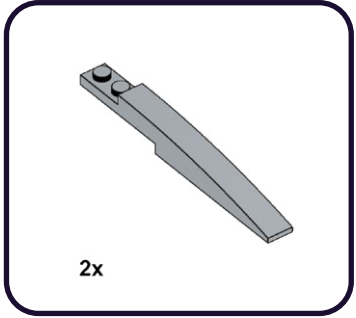

681

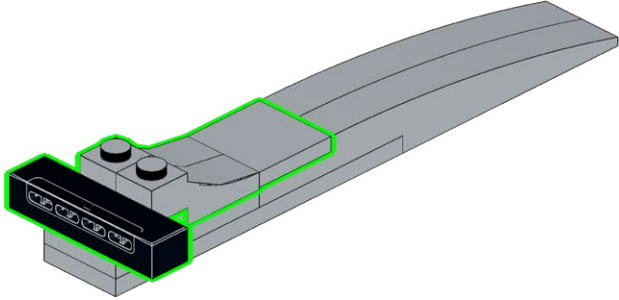
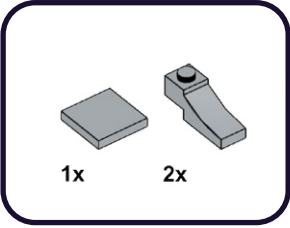



682

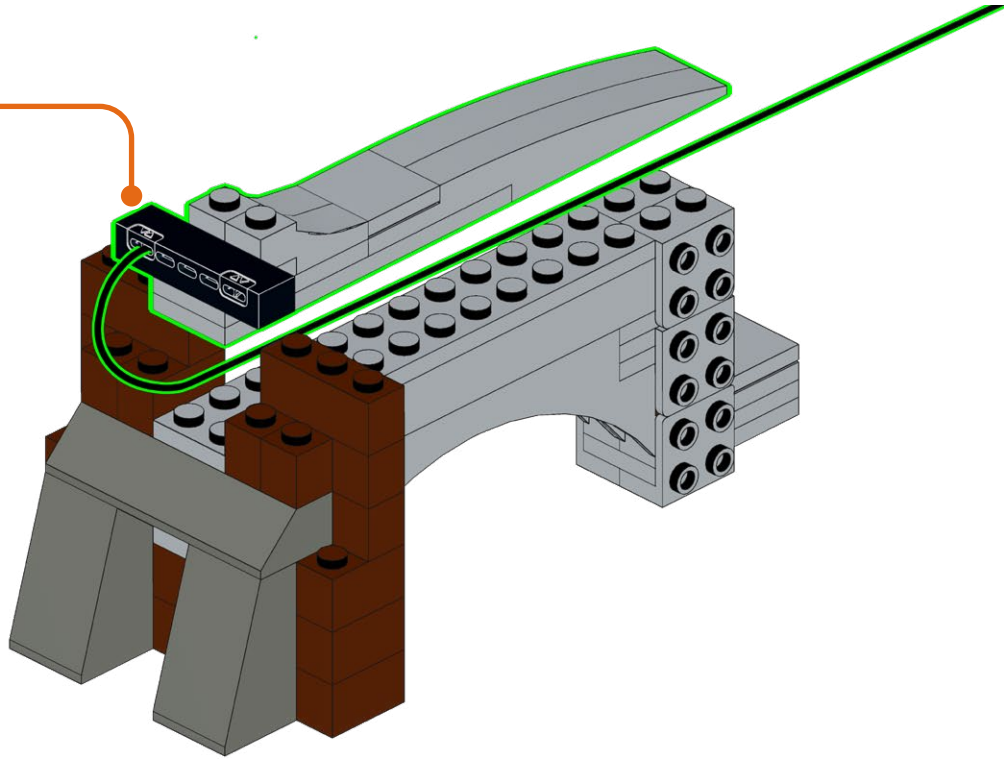
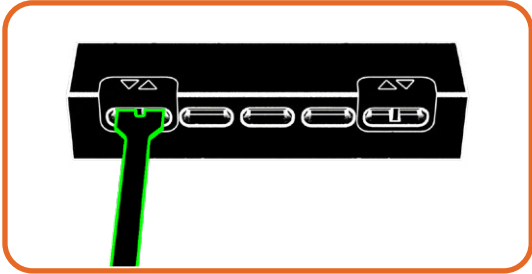
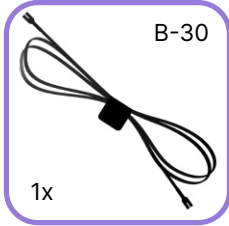

683

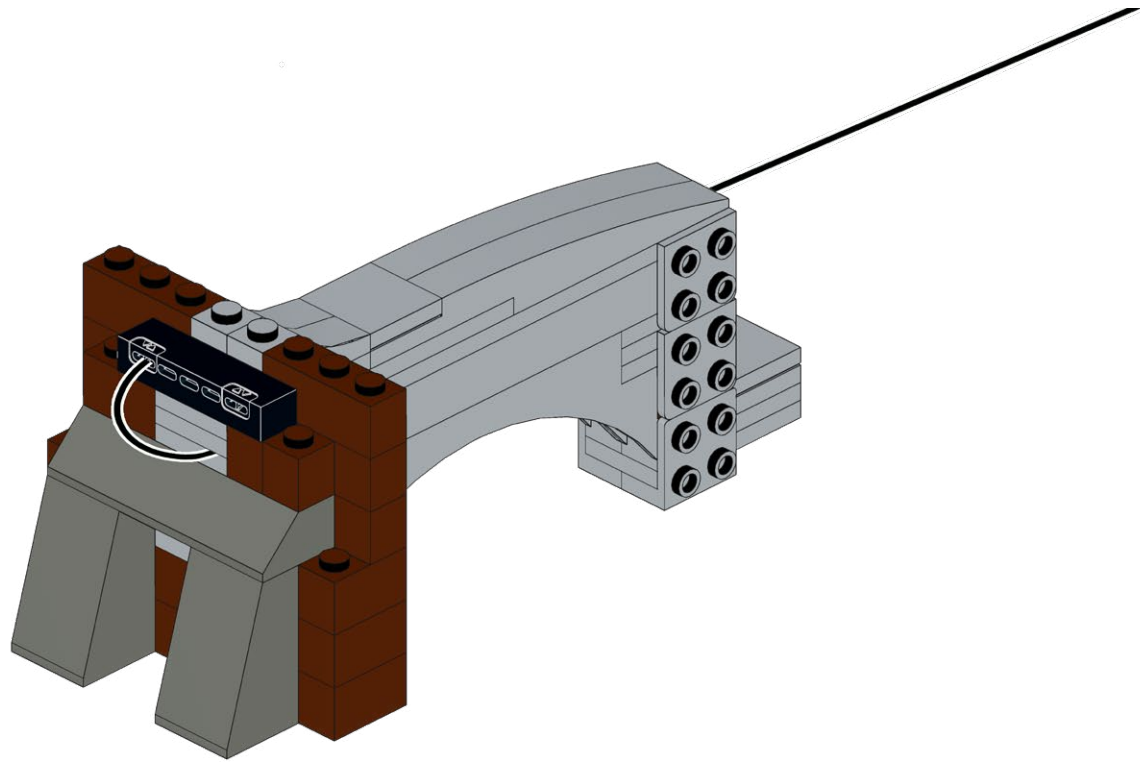

684

2x

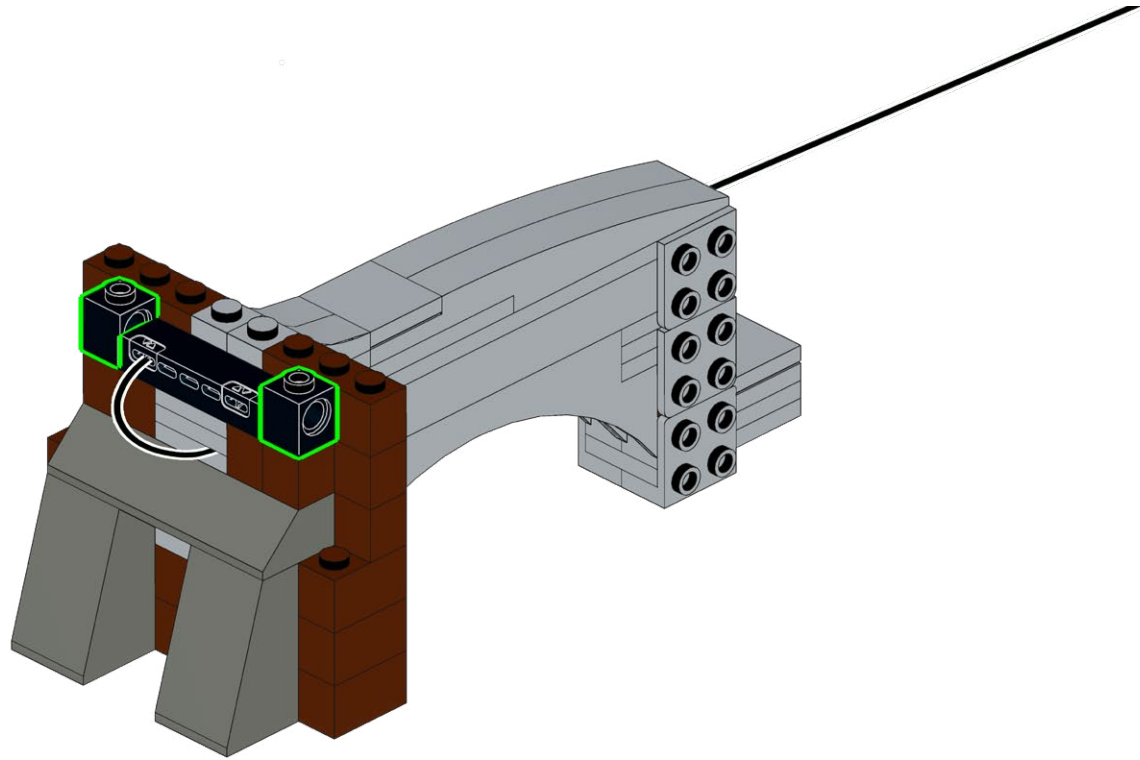

685

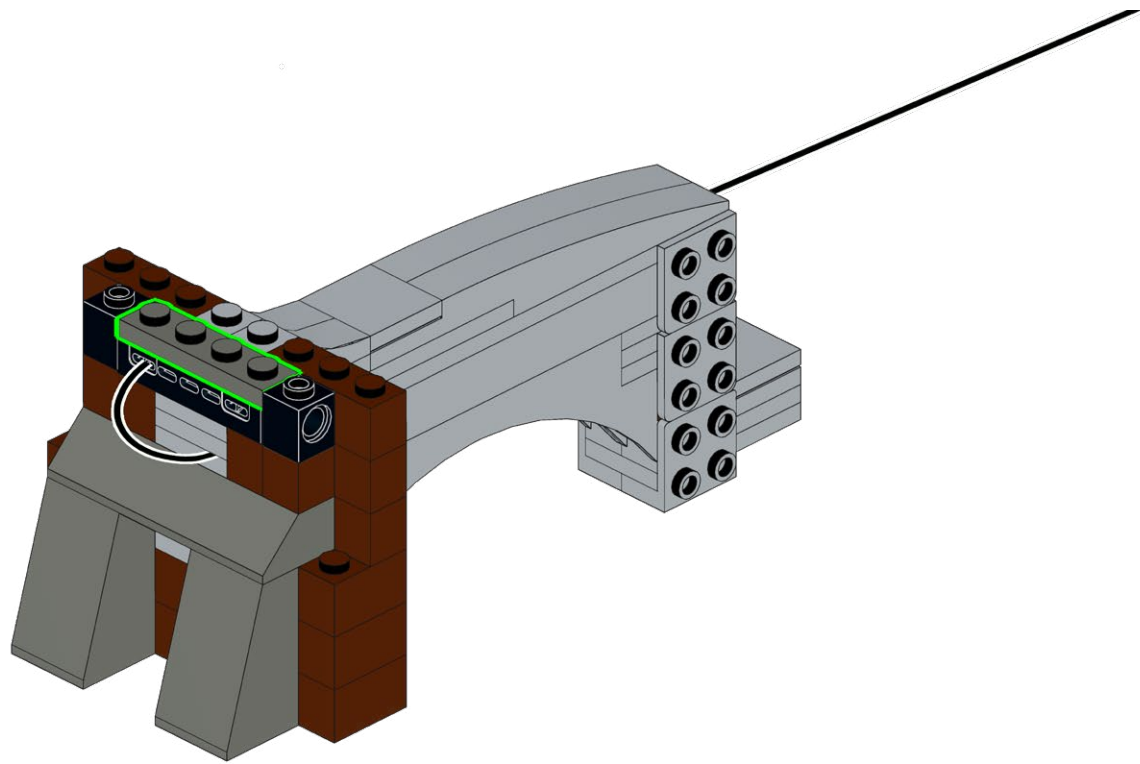
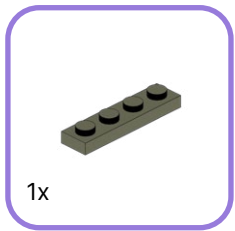

686

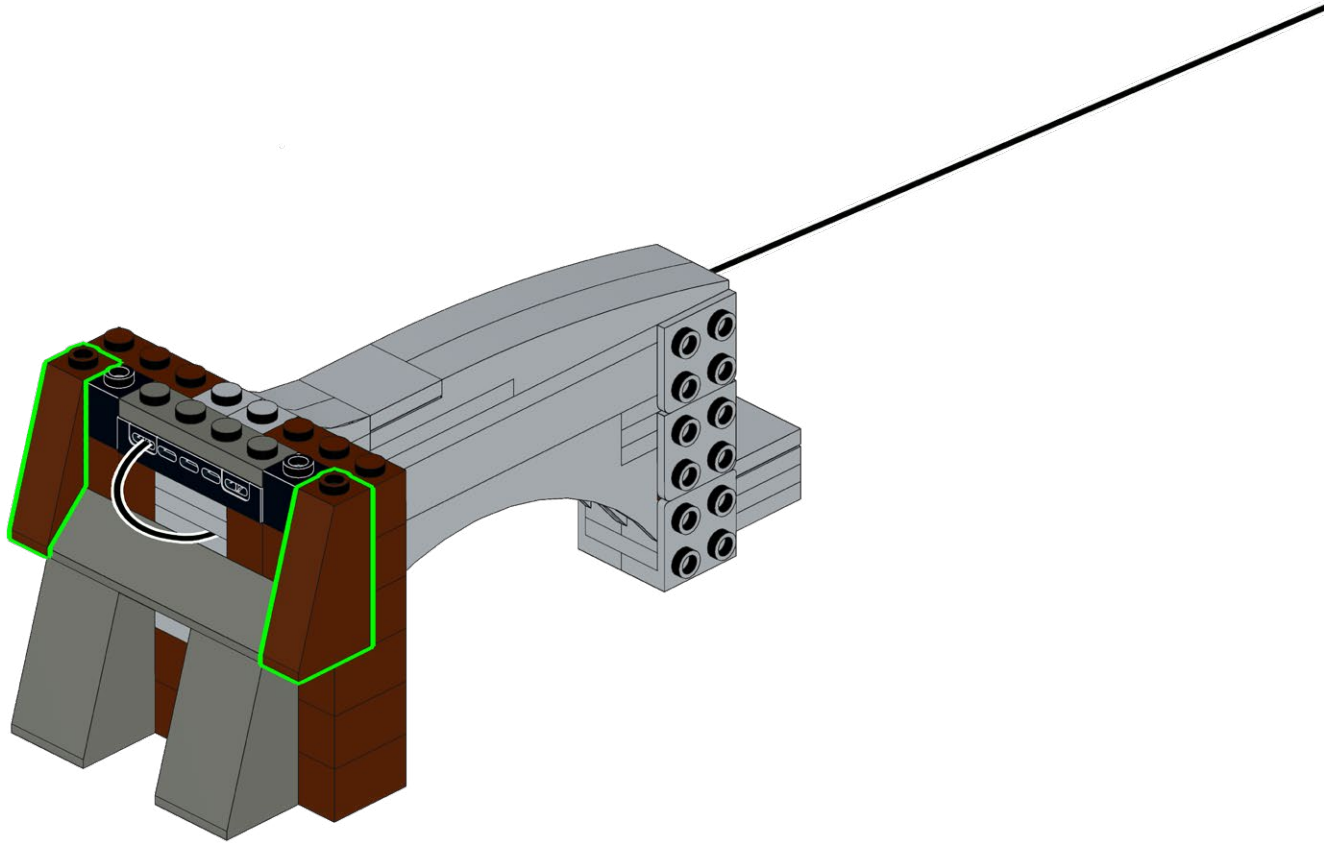
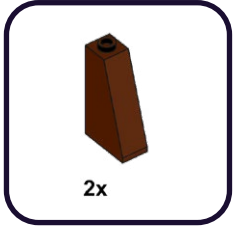

687

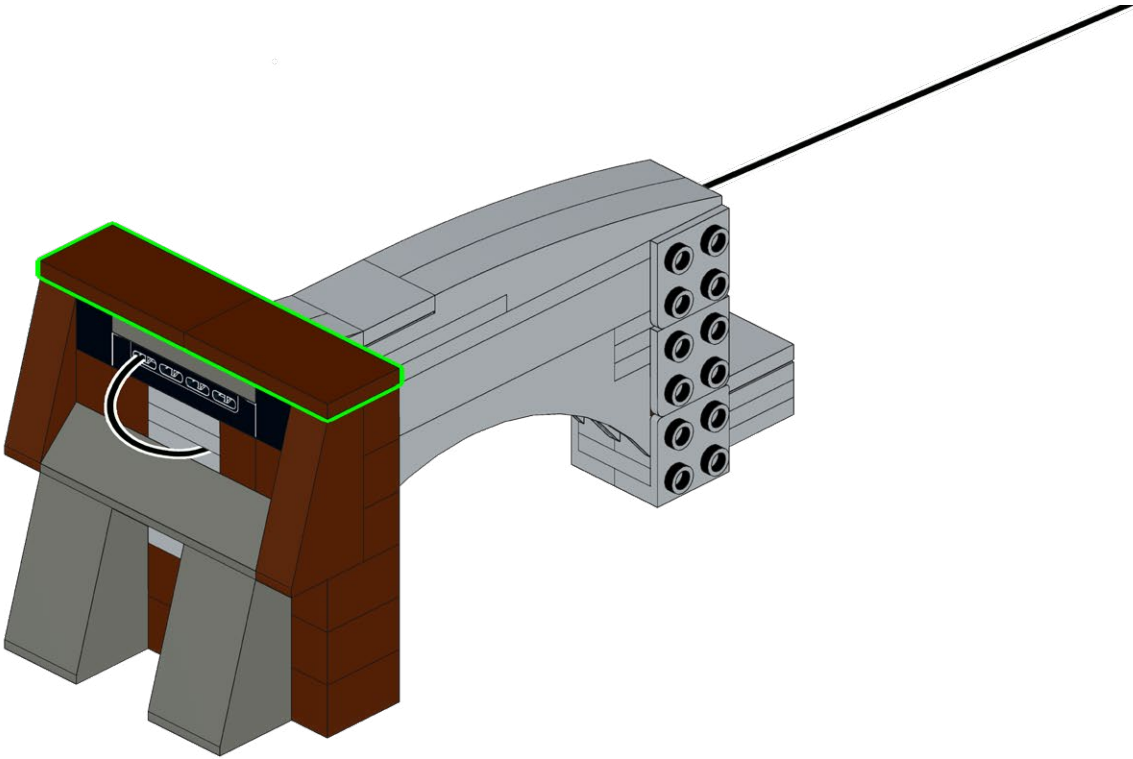
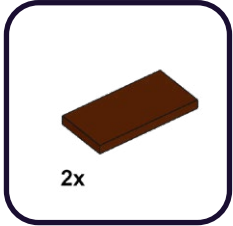

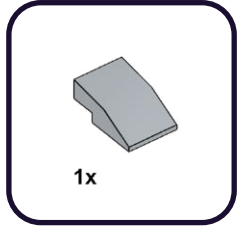
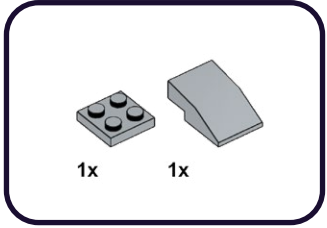

1

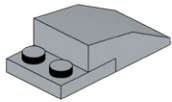

1

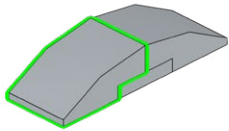

2x

690

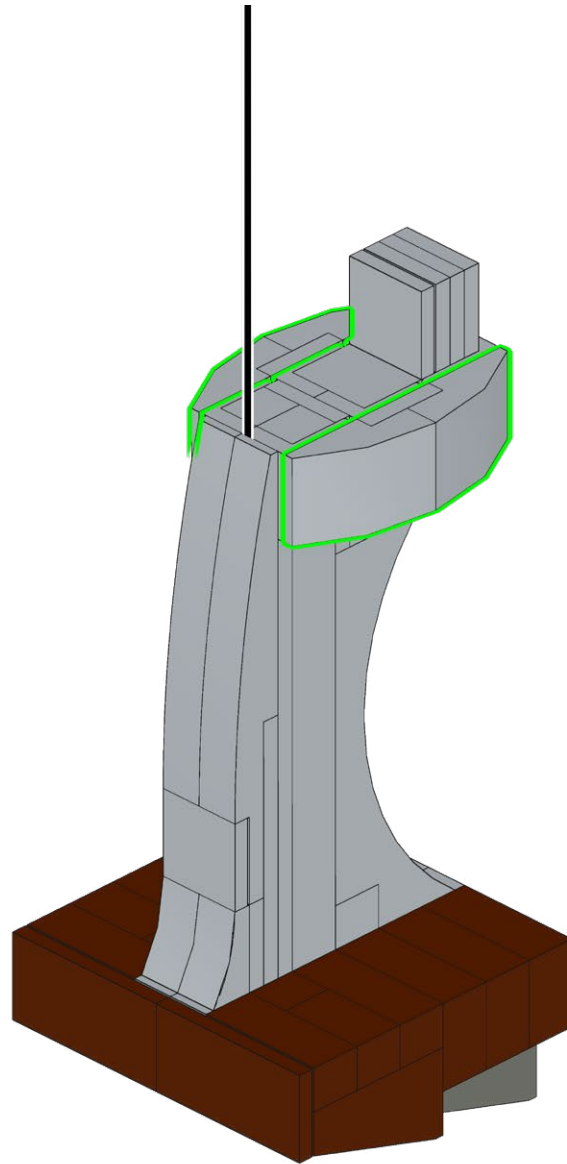



691

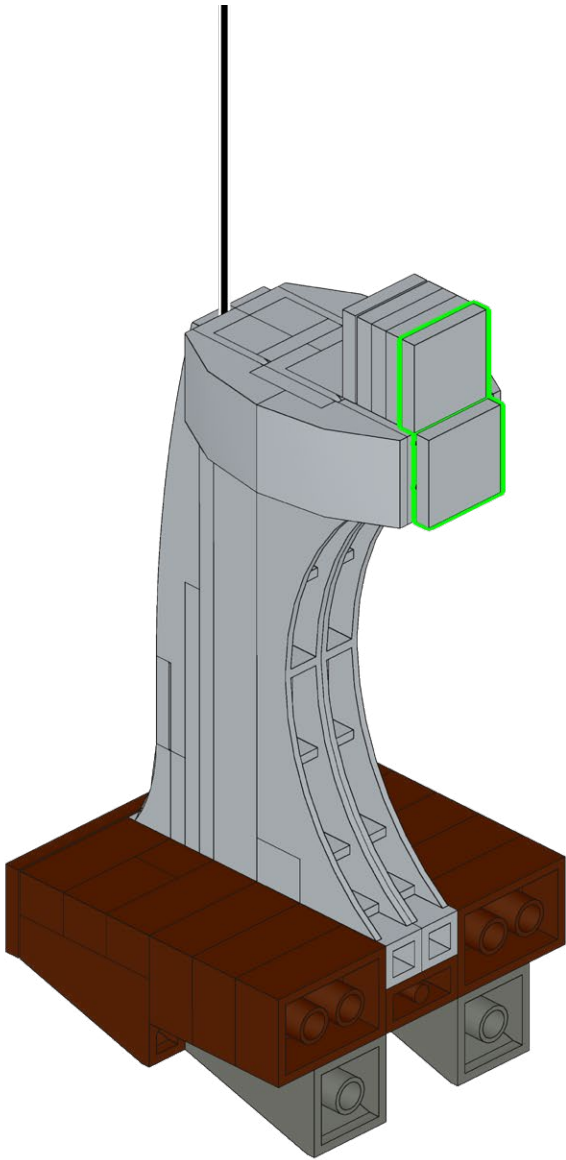
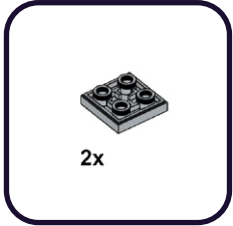

692

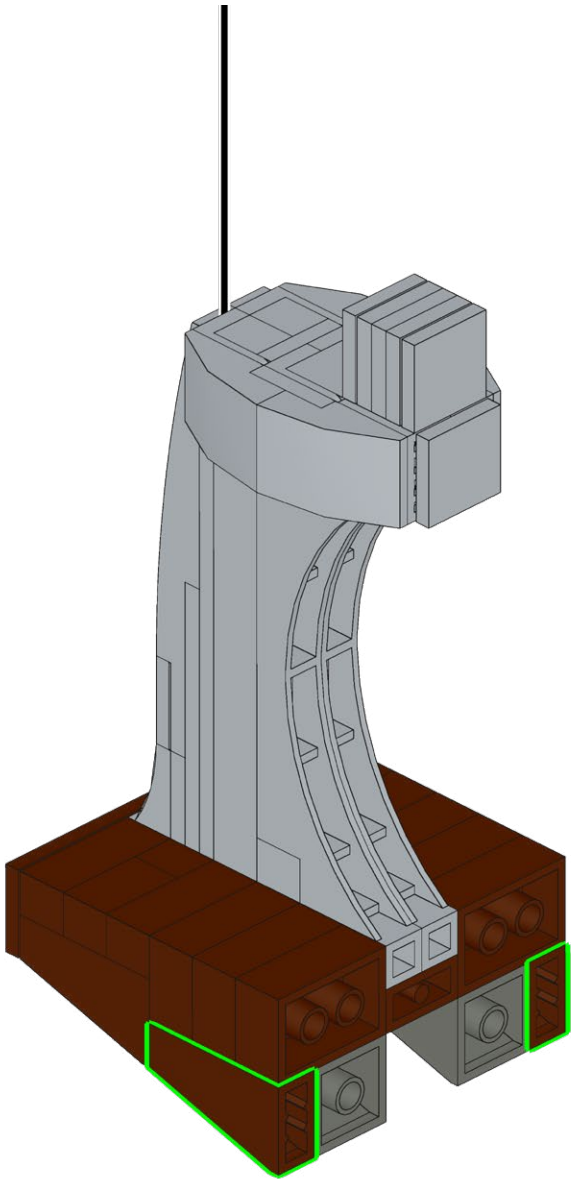
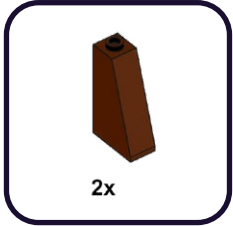

693



694

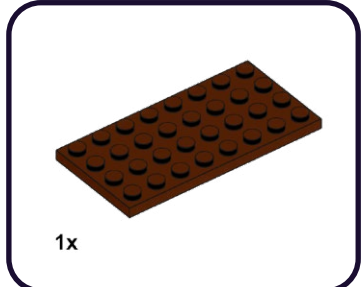

1

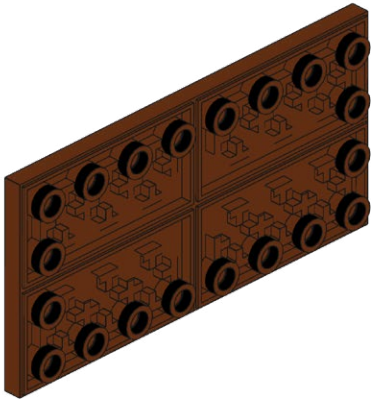

1

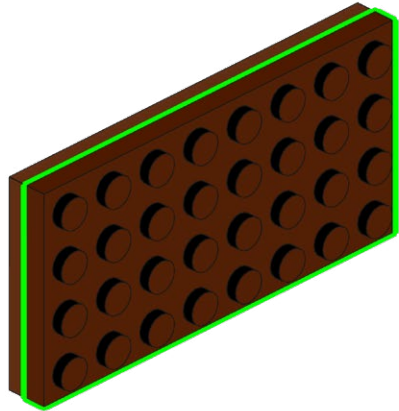

**695**

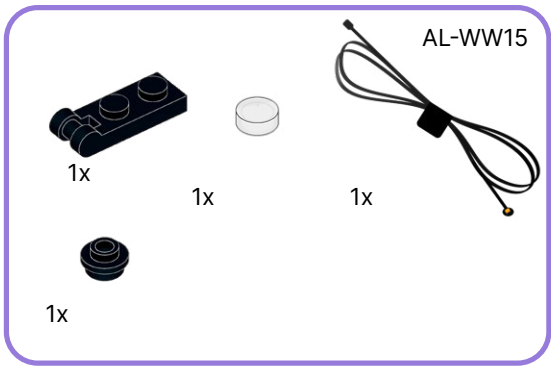

**696**

**1**

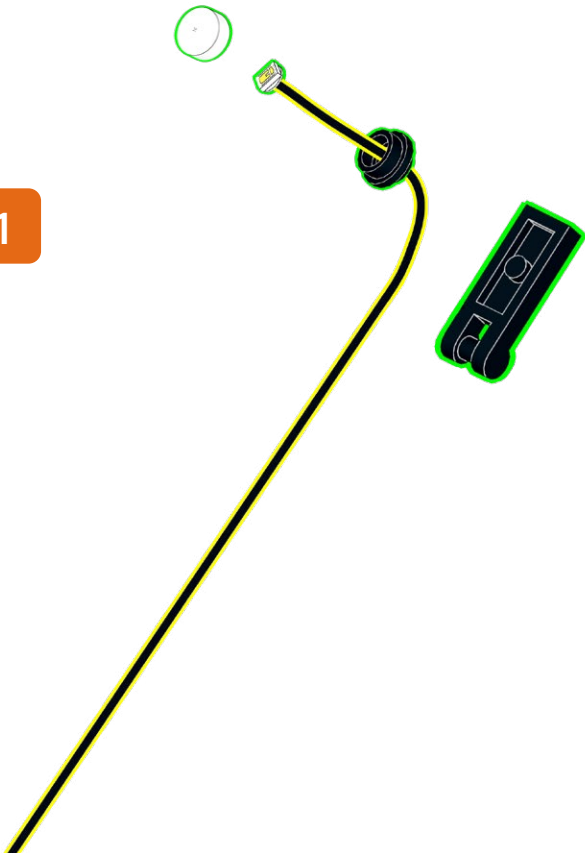

**1**

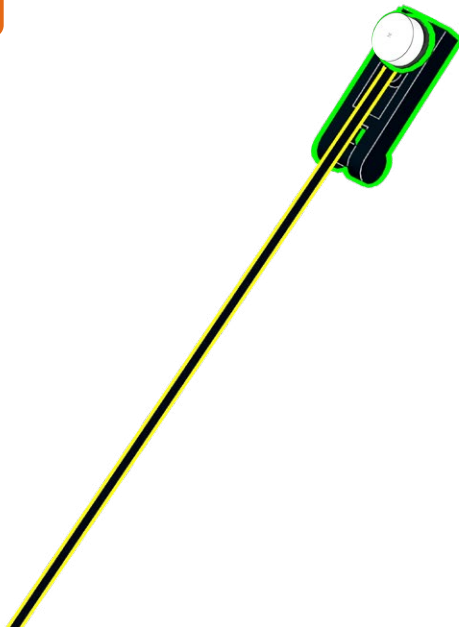

**697**

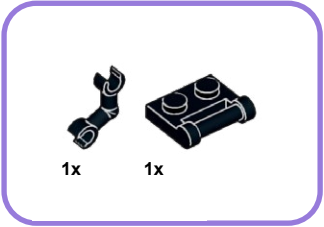

1



**698**

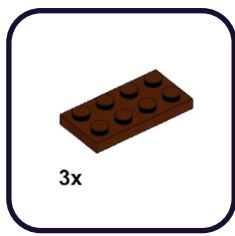

1

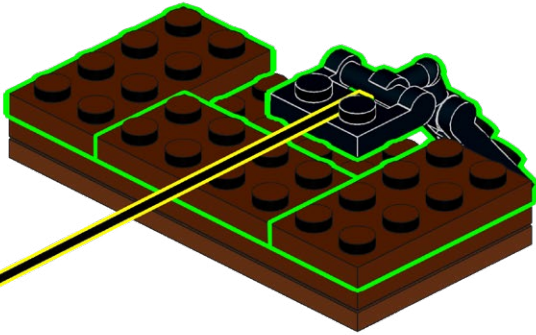

699

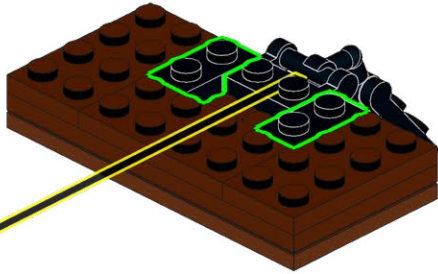
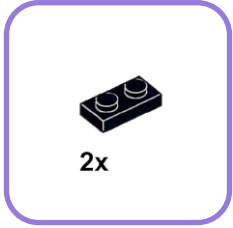



701

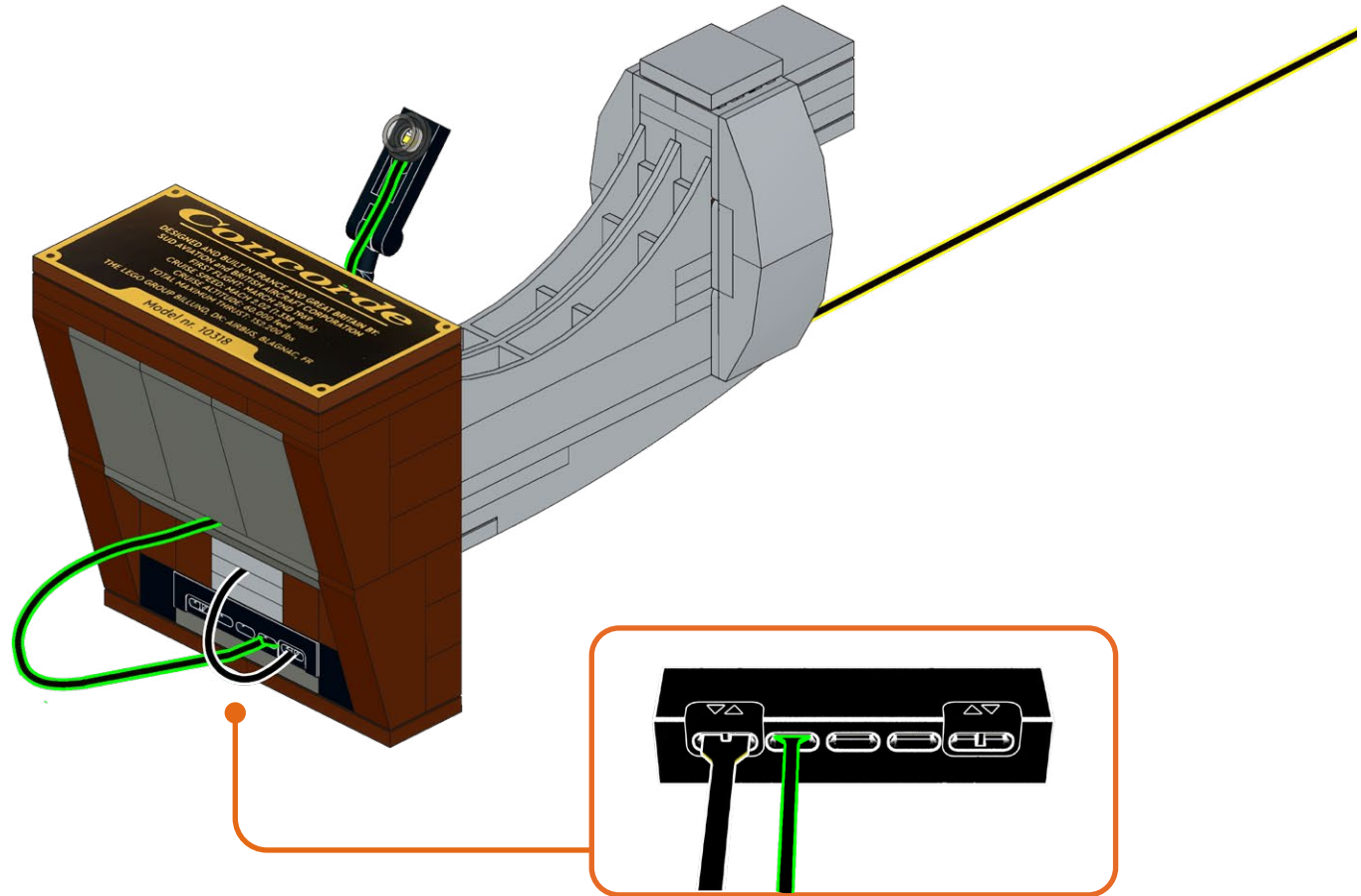



702

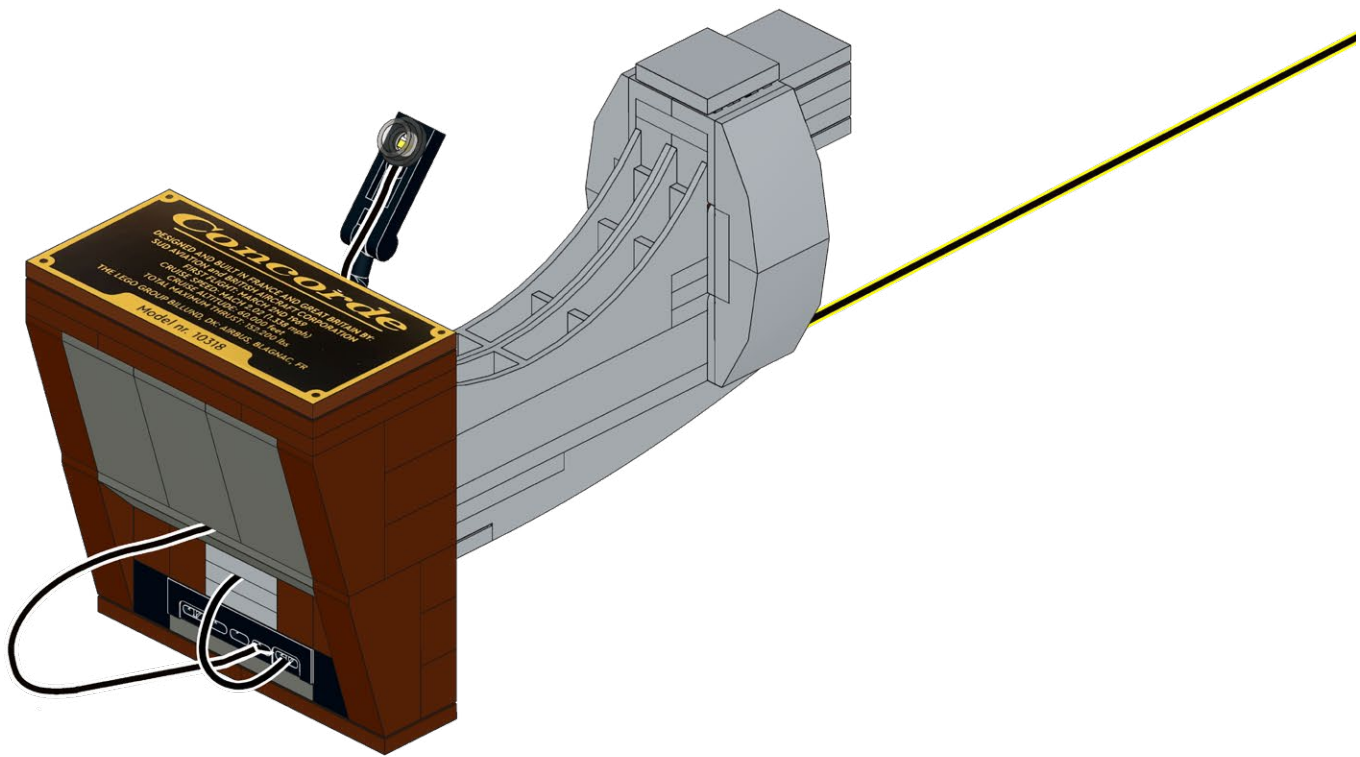
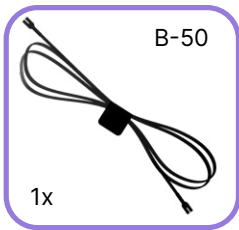

703

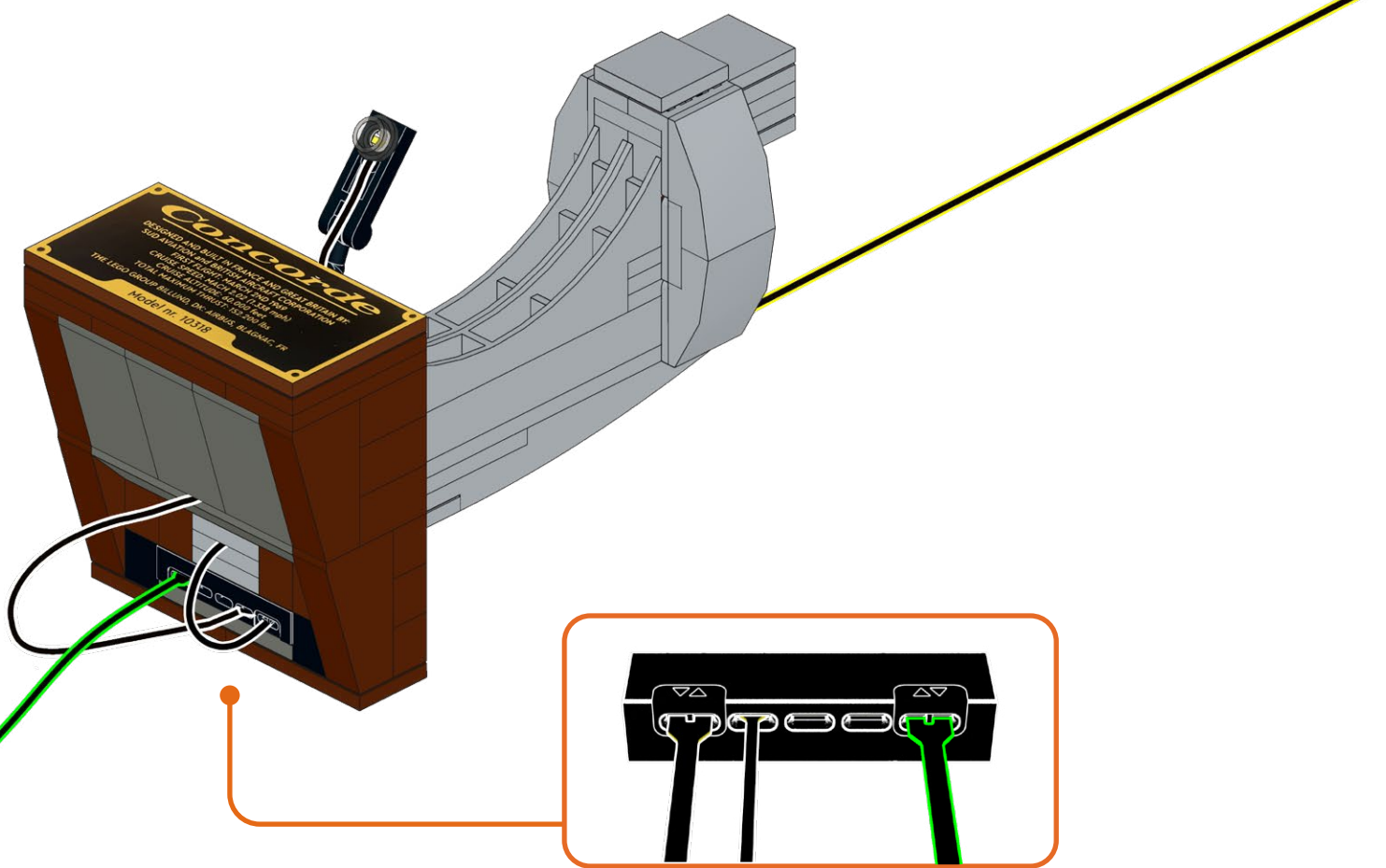

704

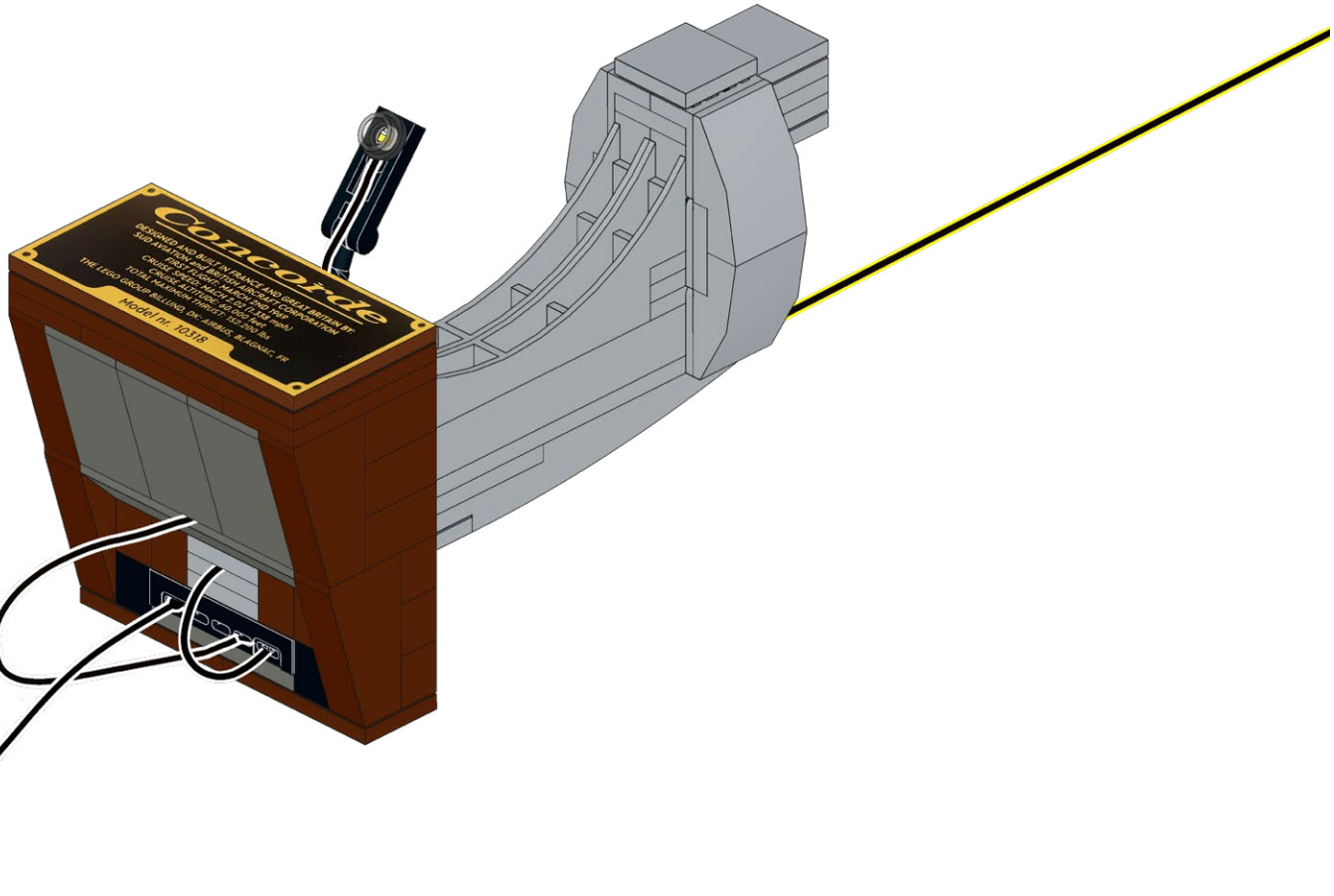

705

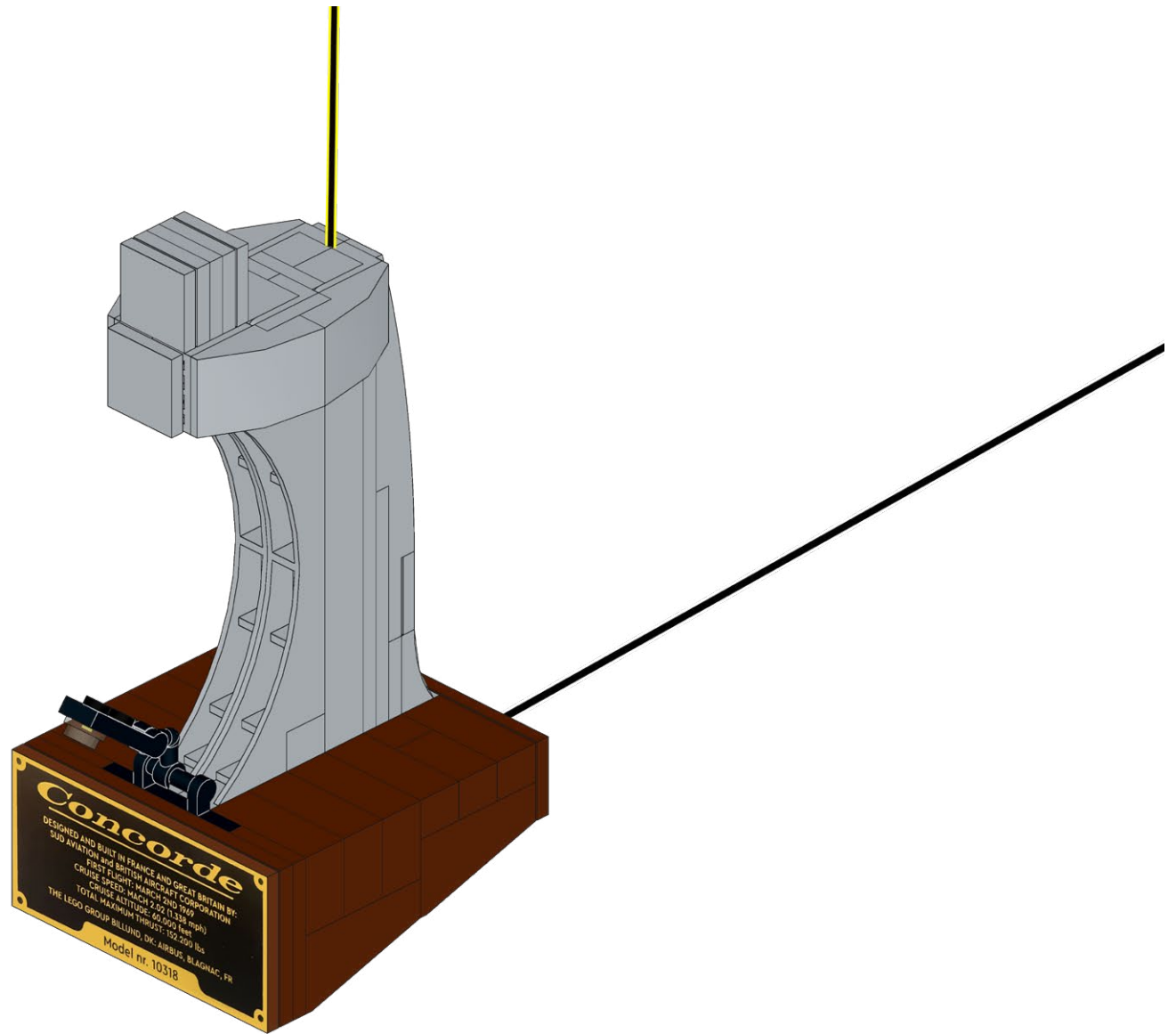

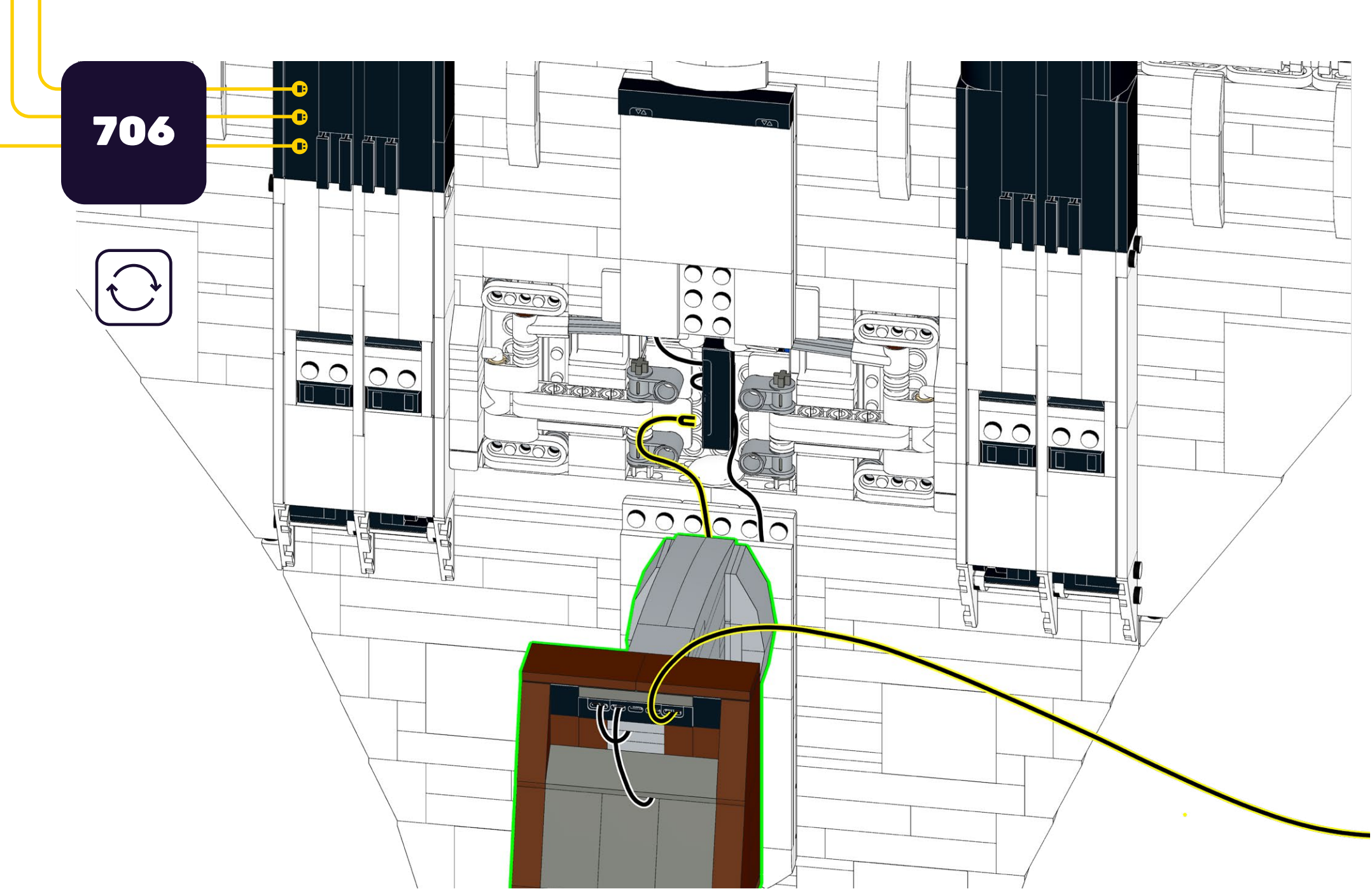

**707**

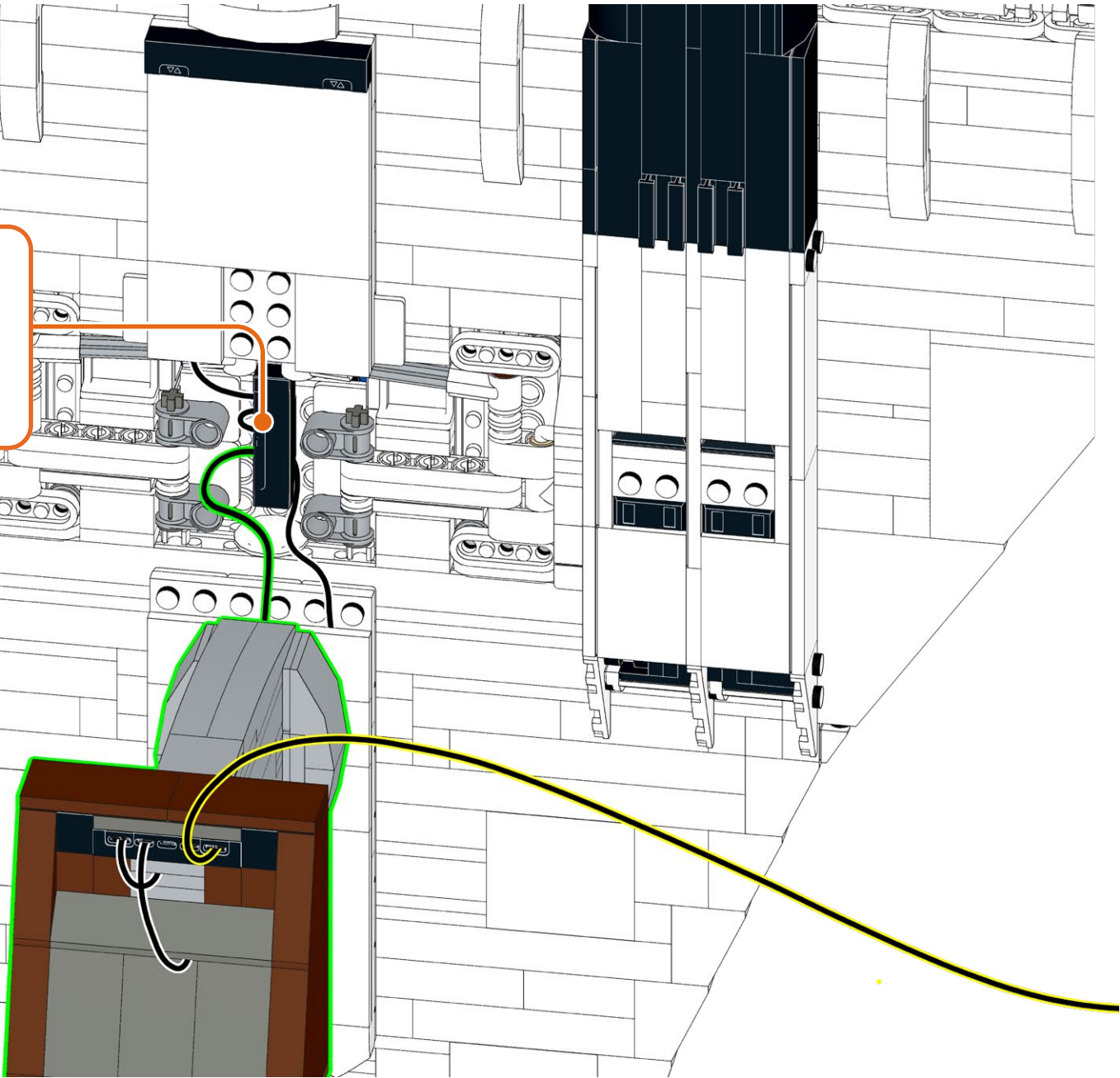
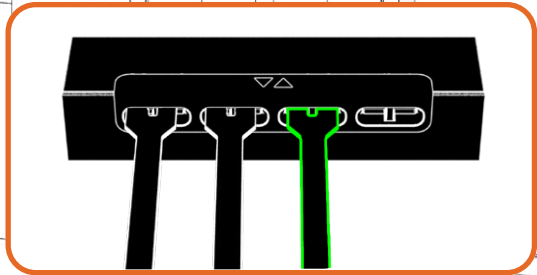

# 708

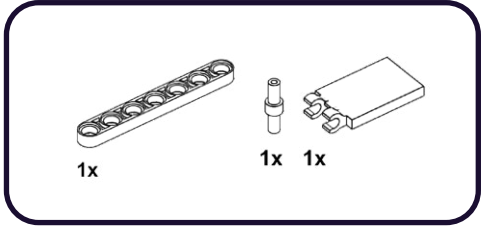

1

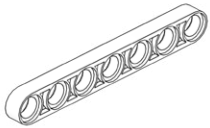

1

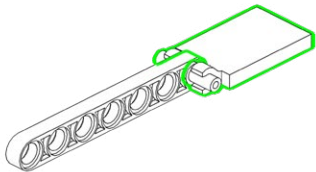

# 709

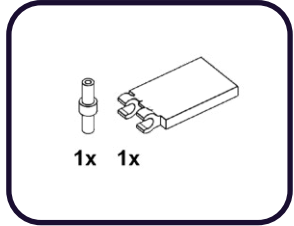

1

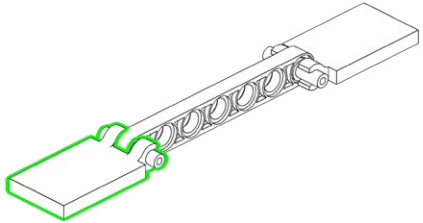

710

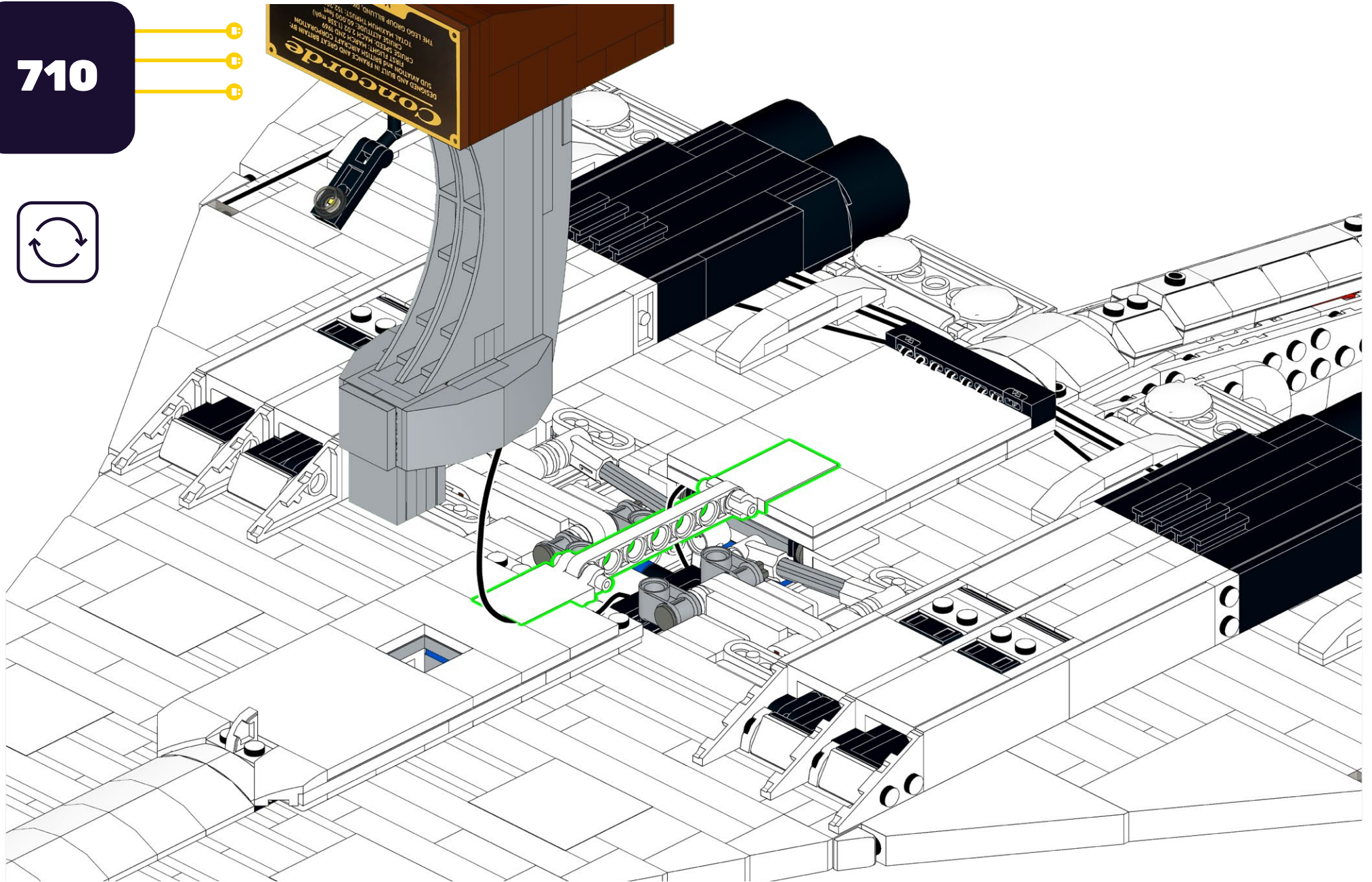



711

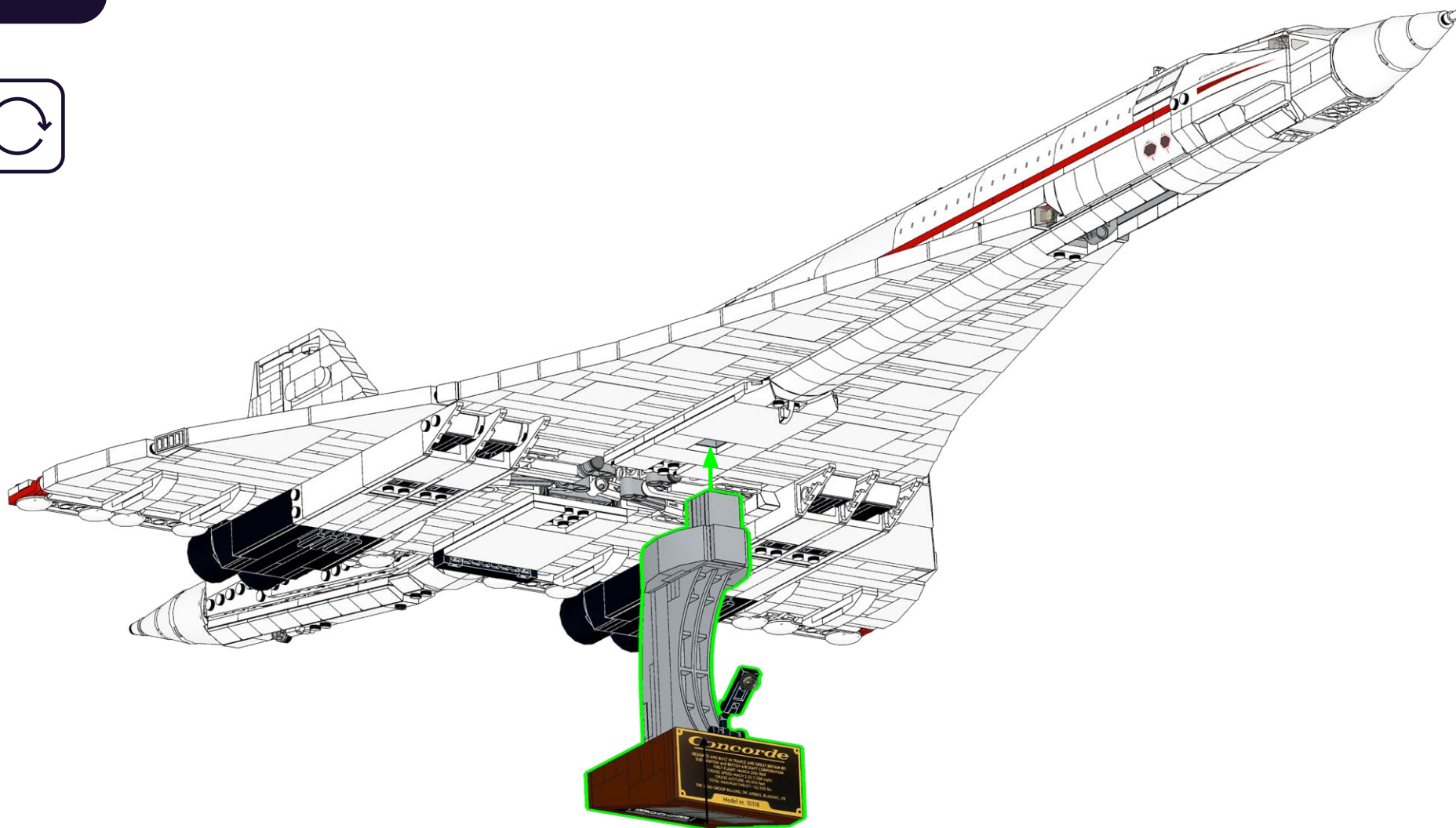

712

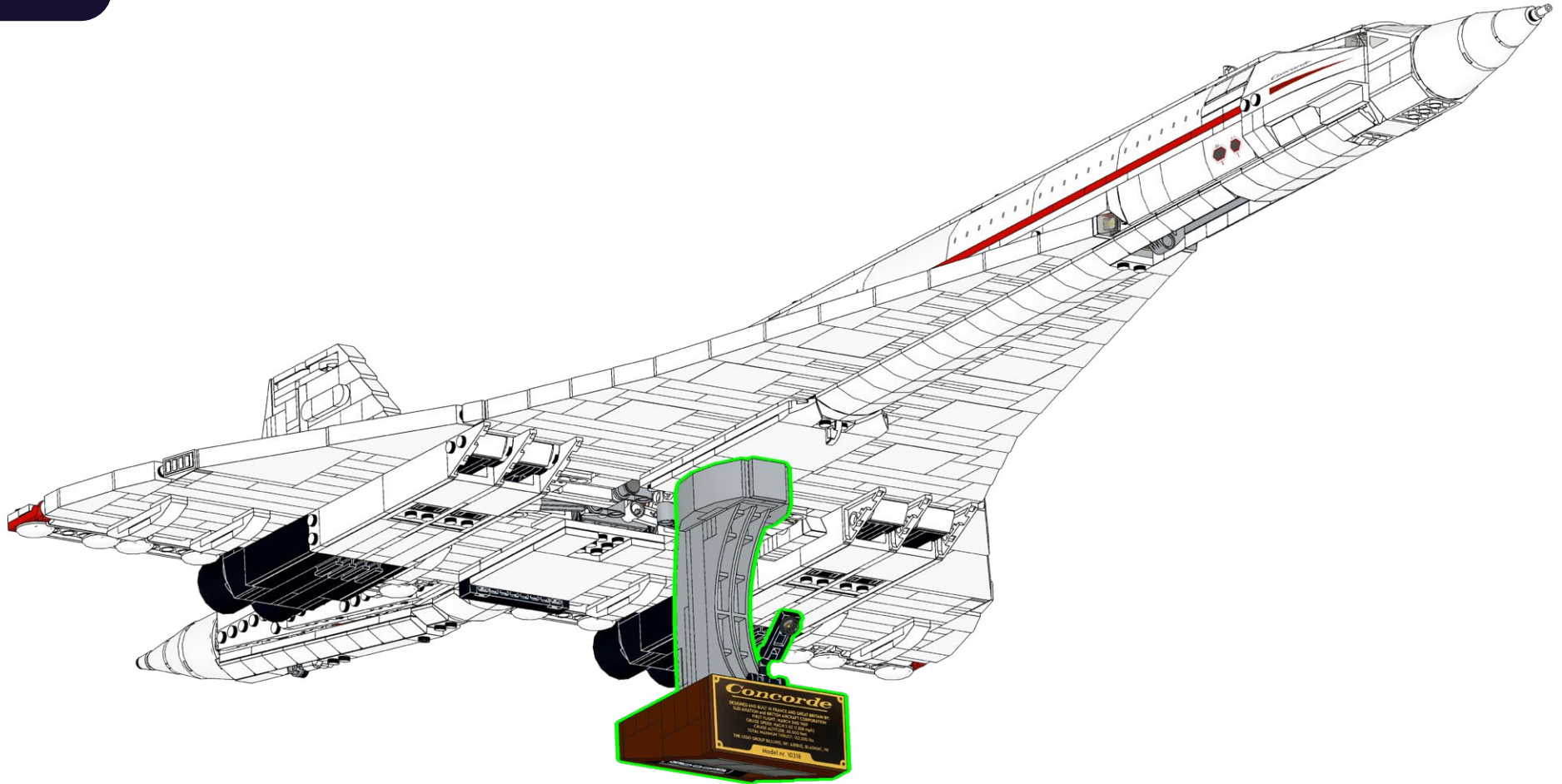

713

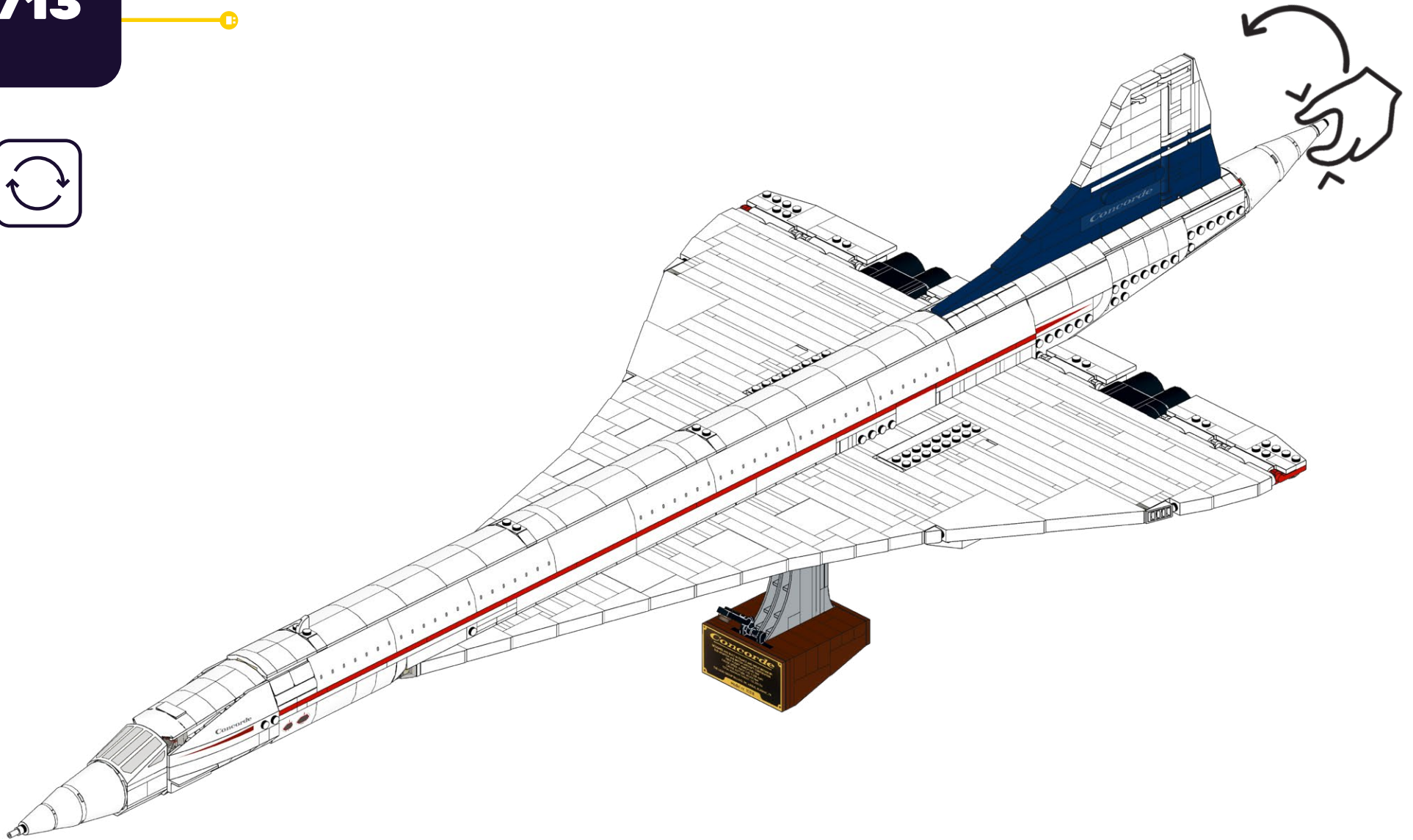

714

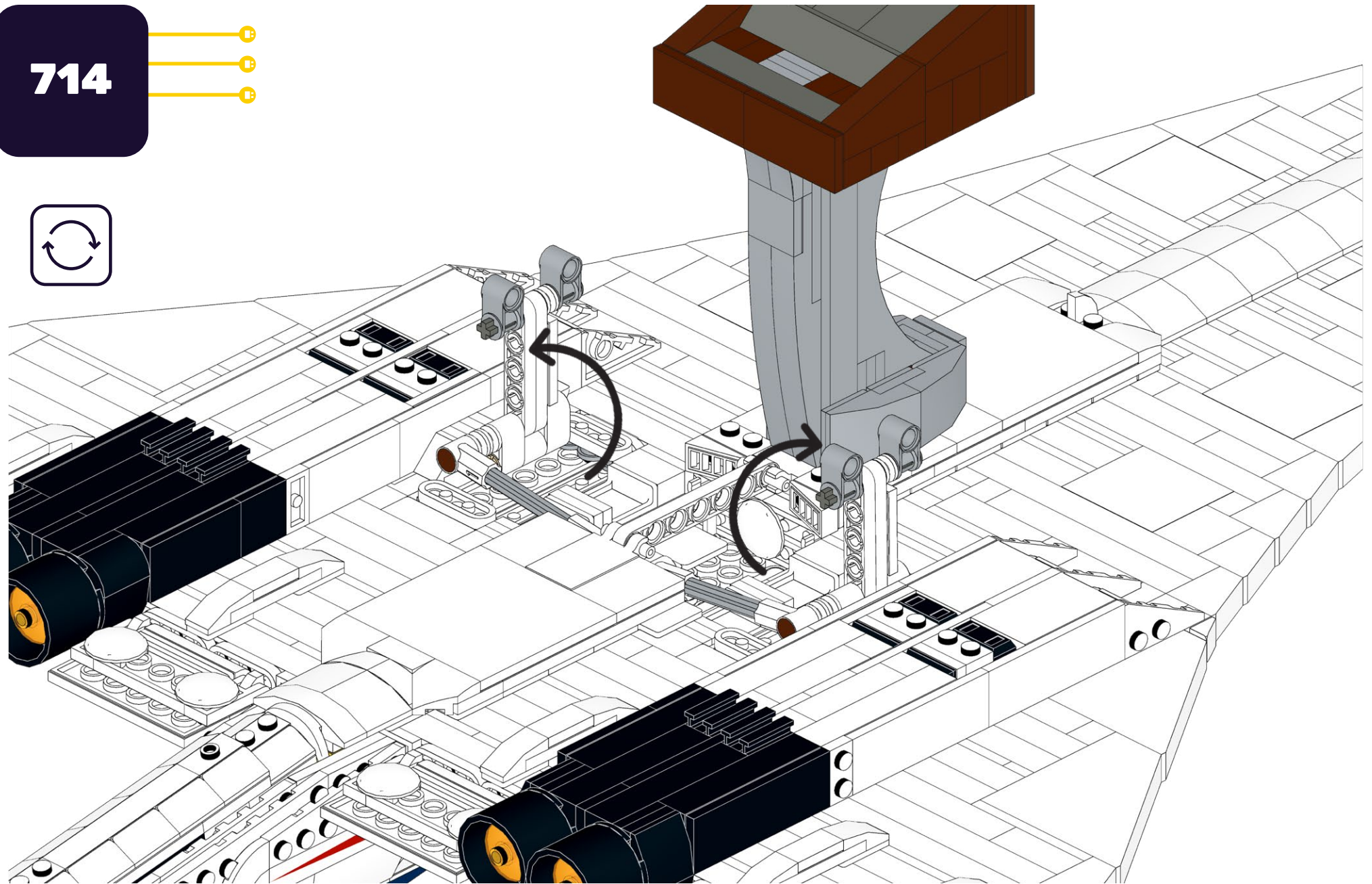

**715**



**1**

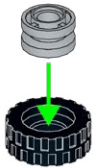

**716**

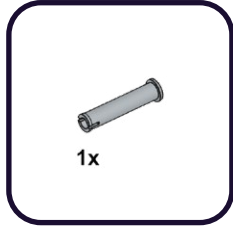

**1**



**4x**

717

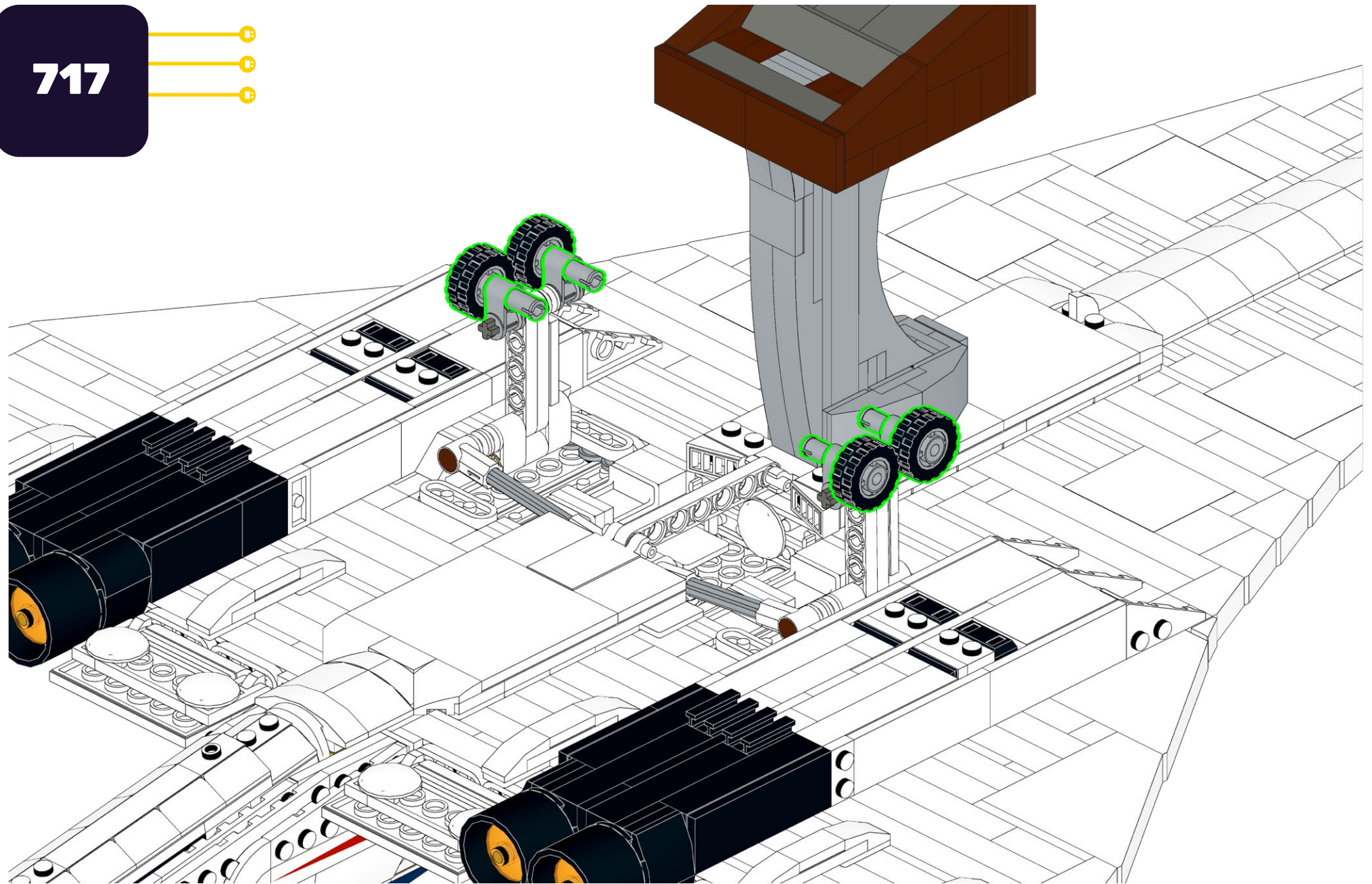

718



4x

4x

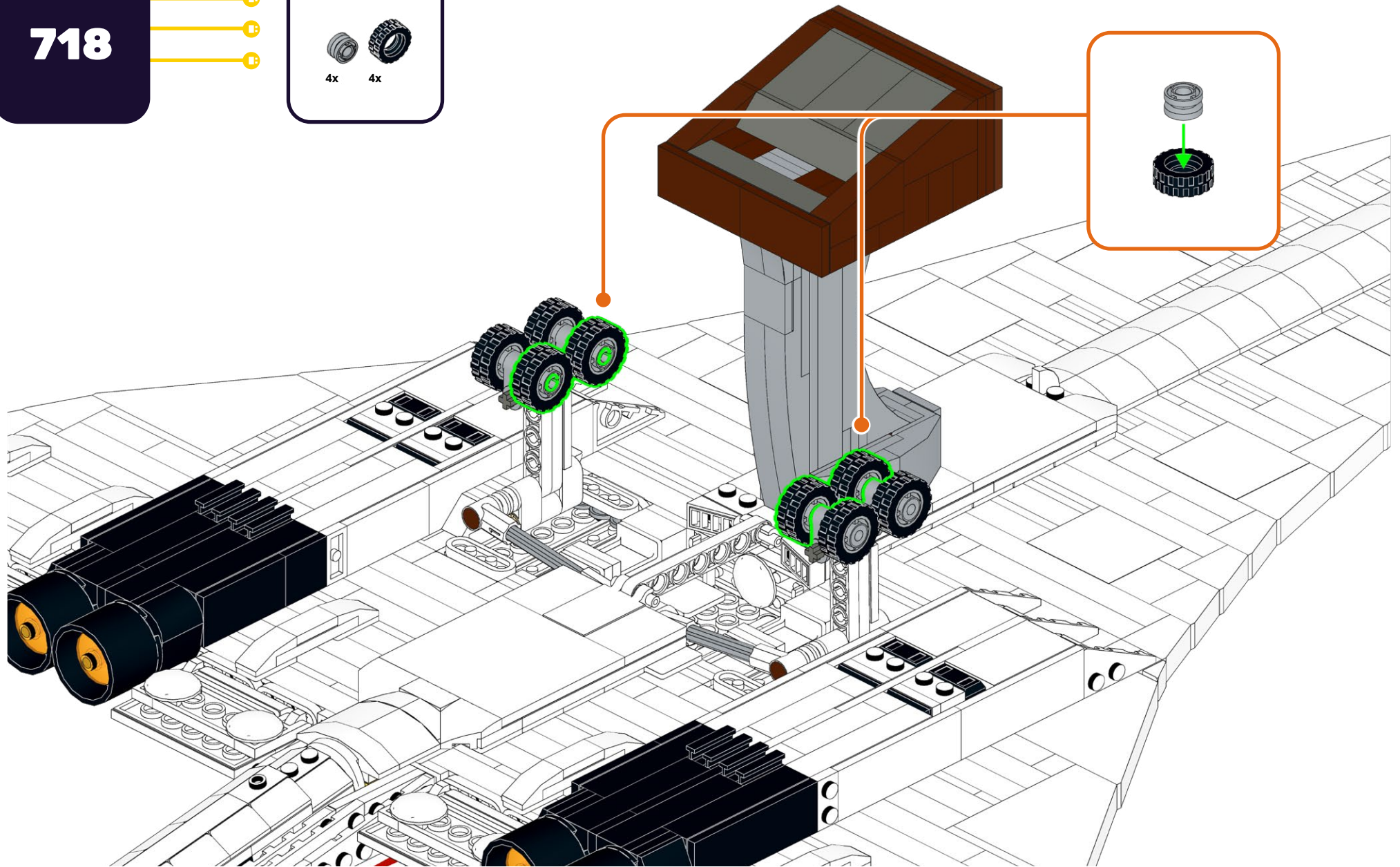
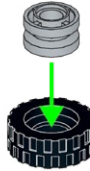

719



1x 1x

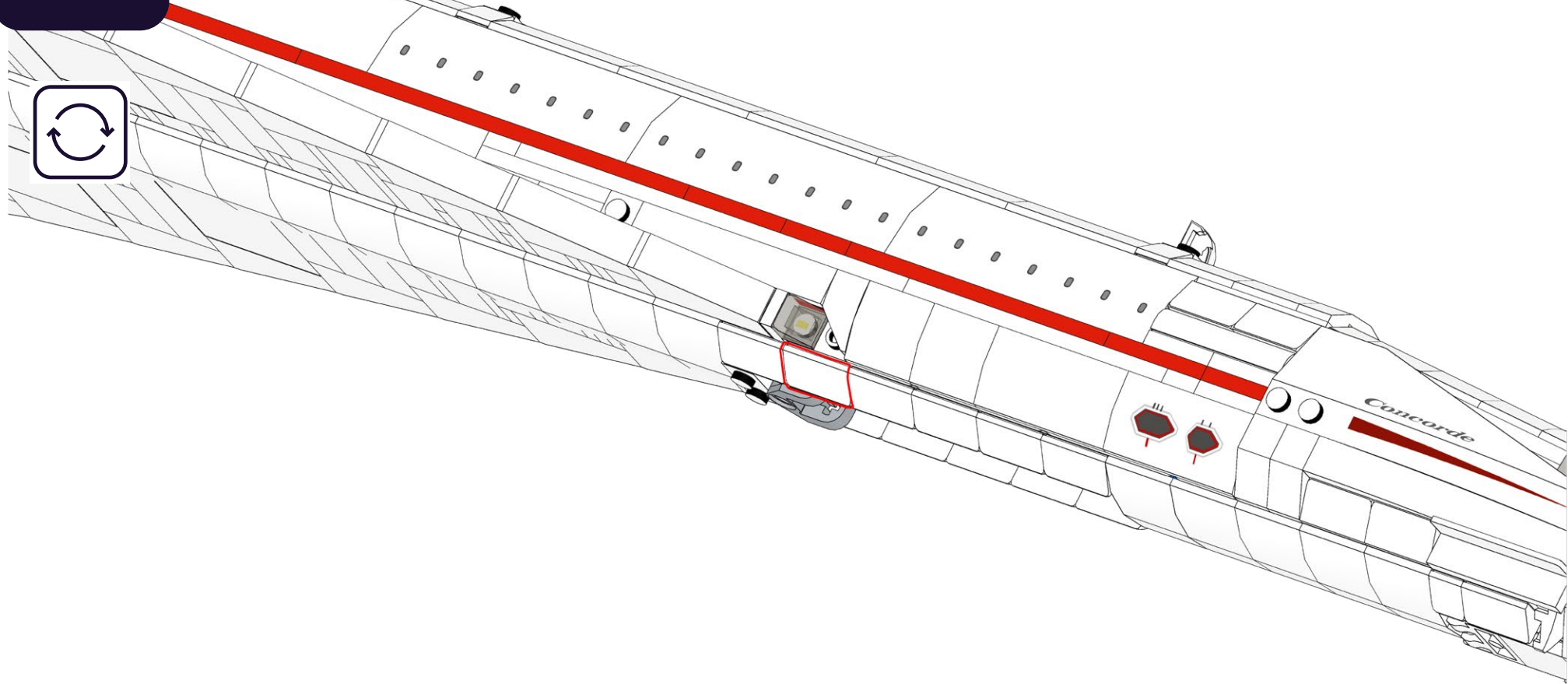



**720**

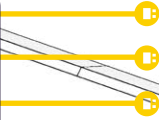

1x 1x

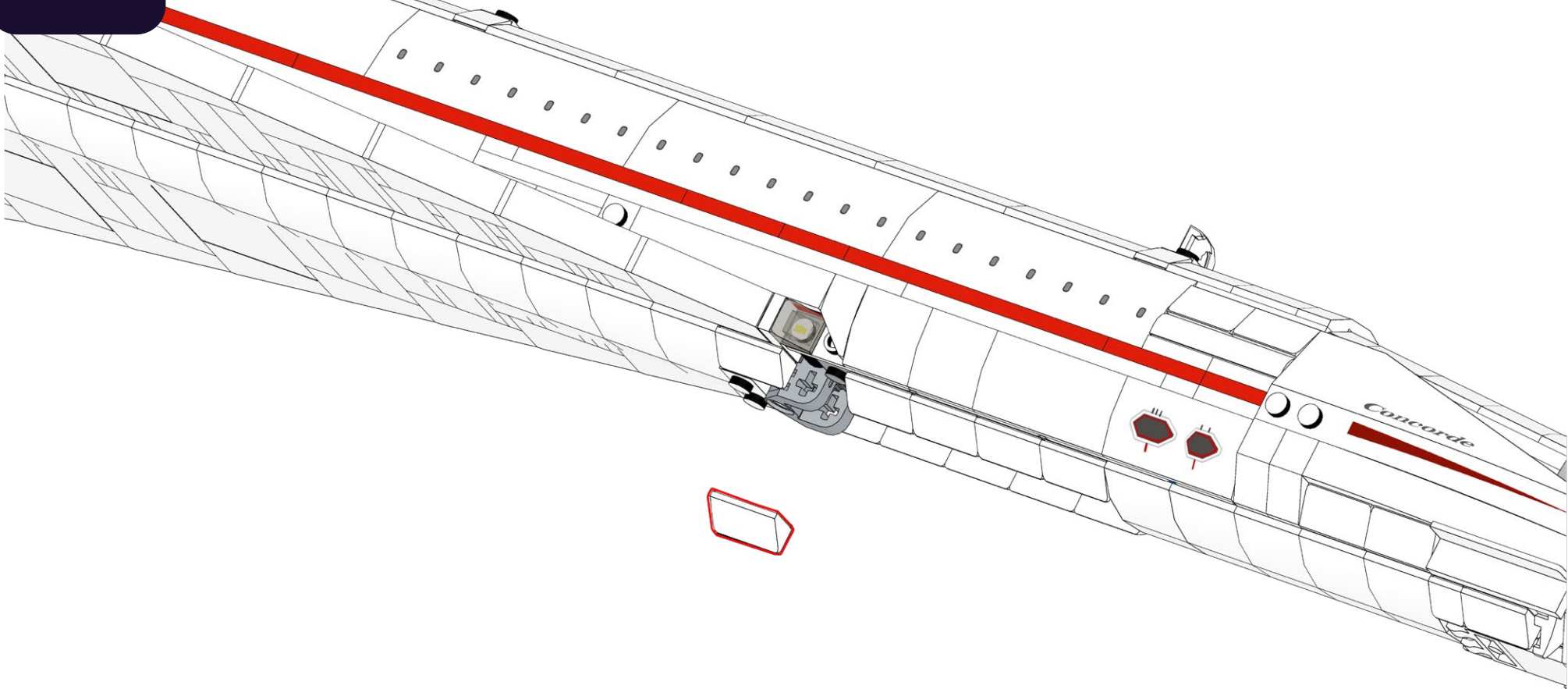

721



# 722

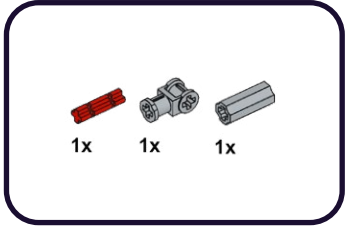

1

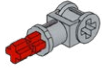

2

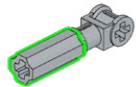

# 723

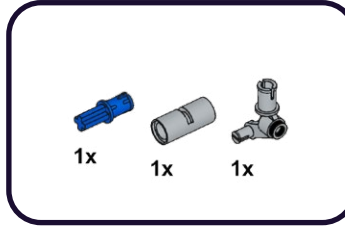

1

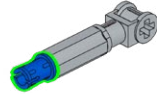

2

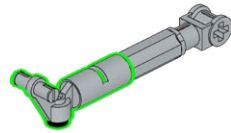



1



1

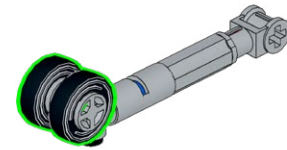

726

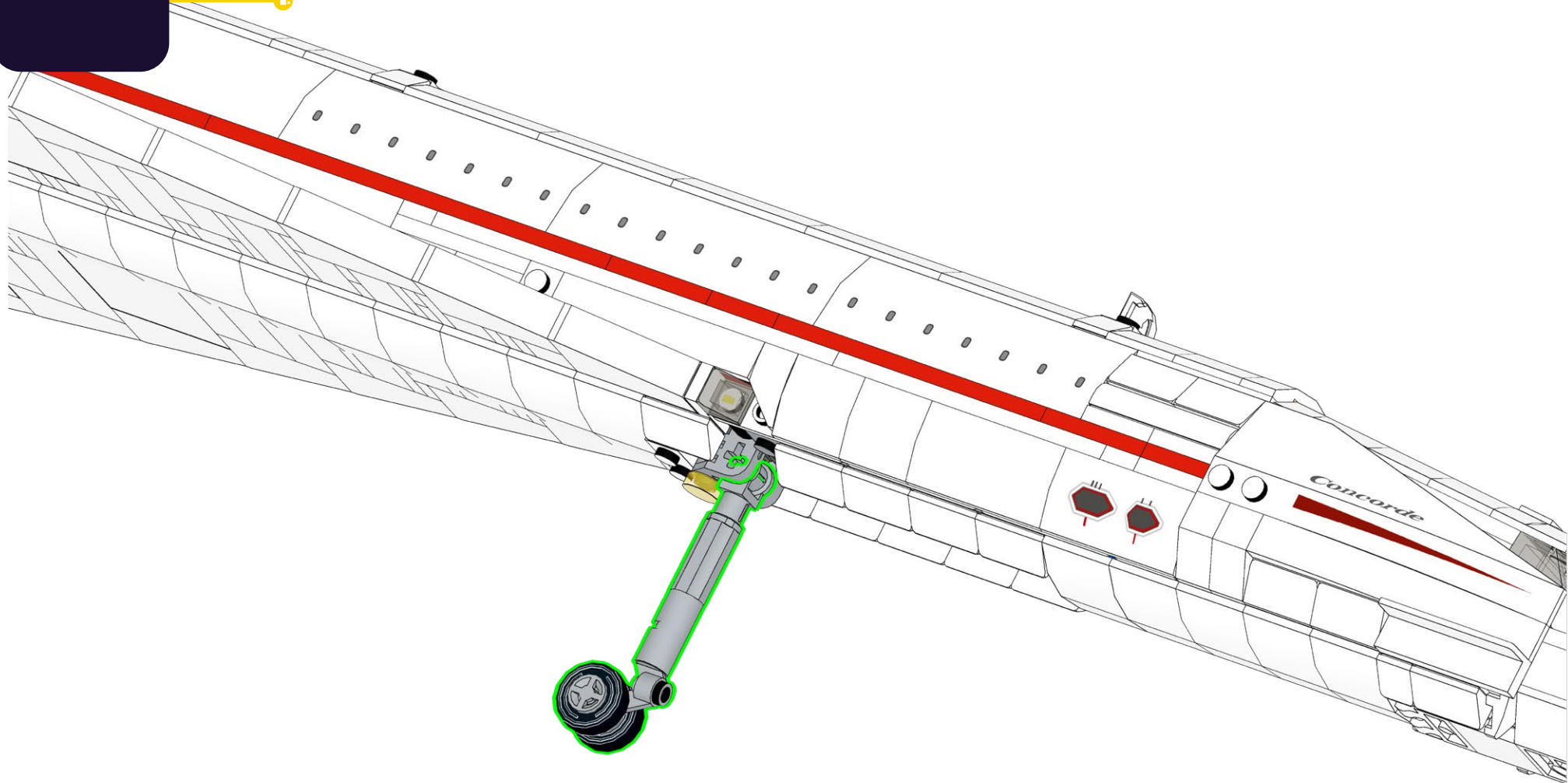

**727**

1x

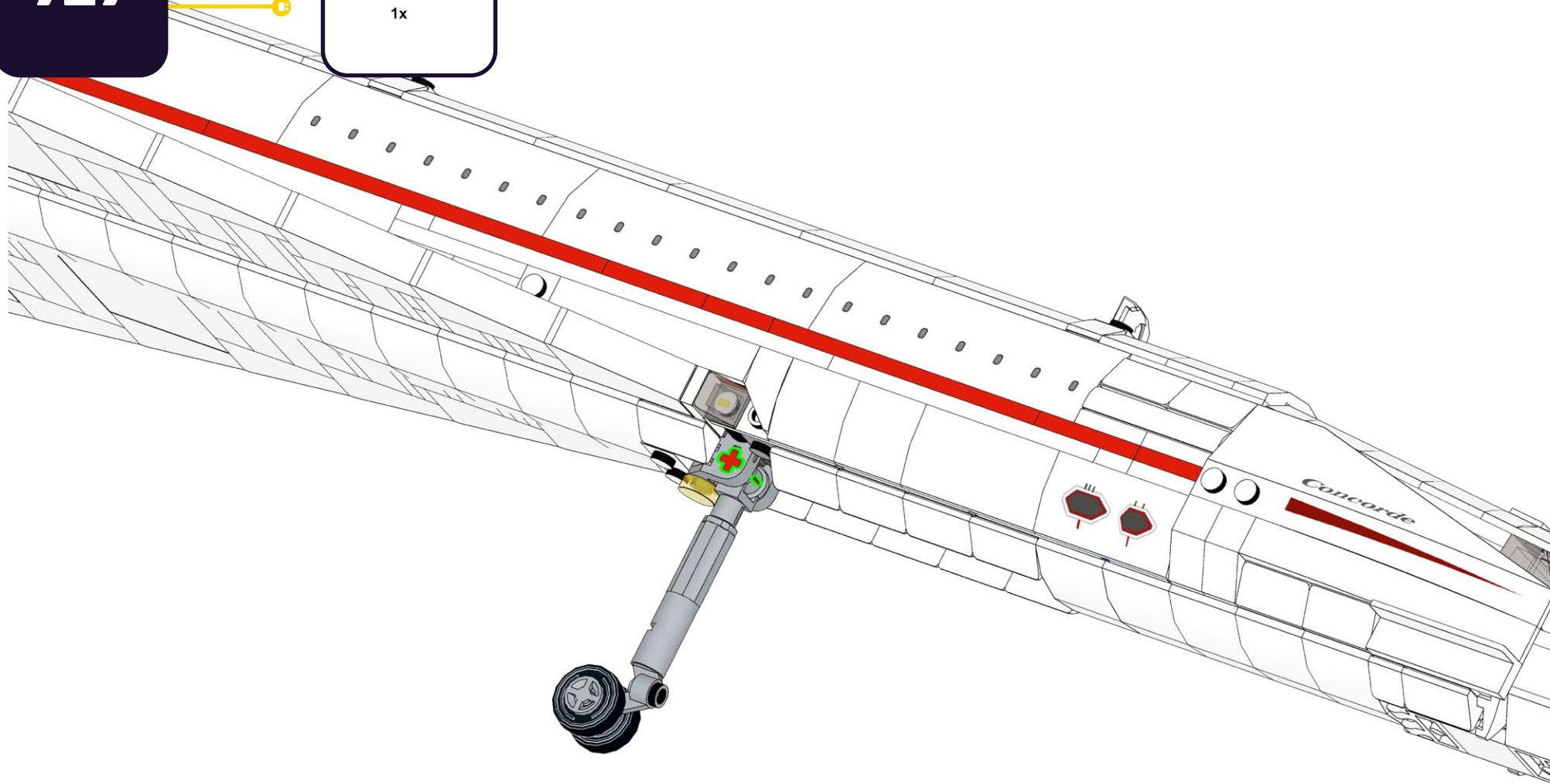

**728**

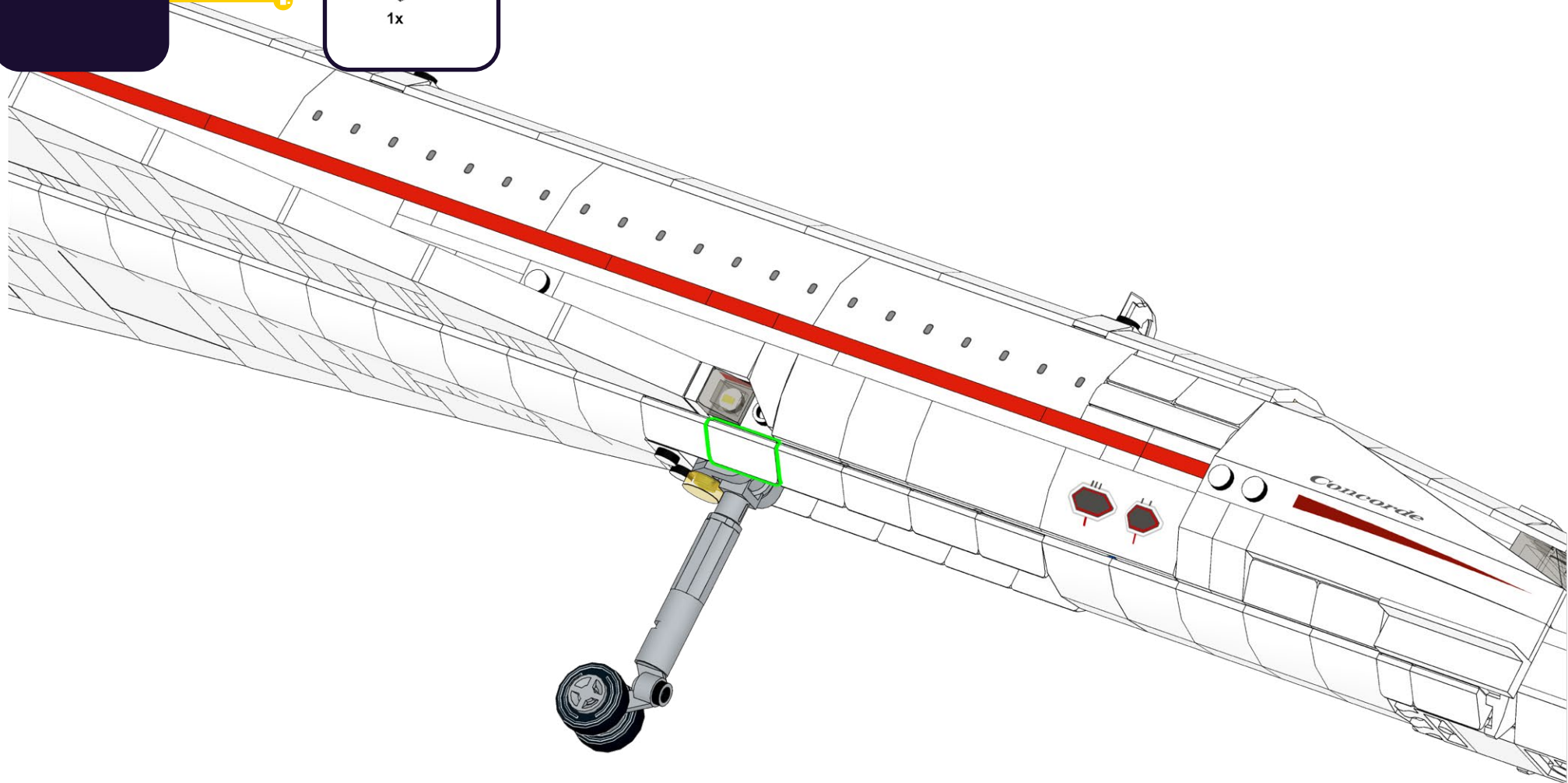
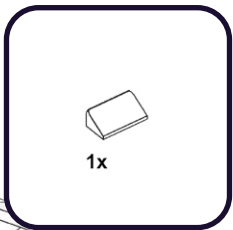

729

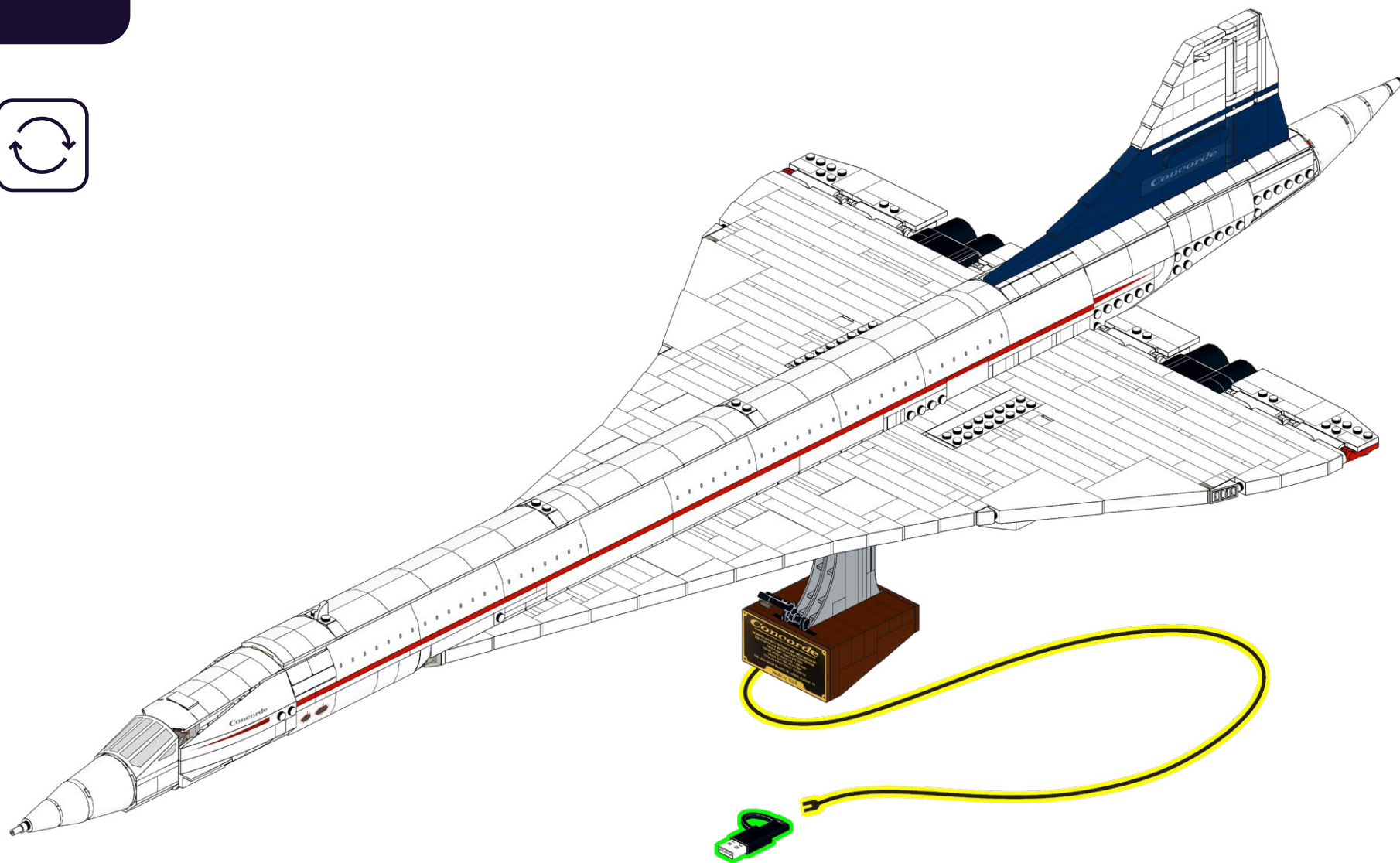
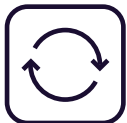



730

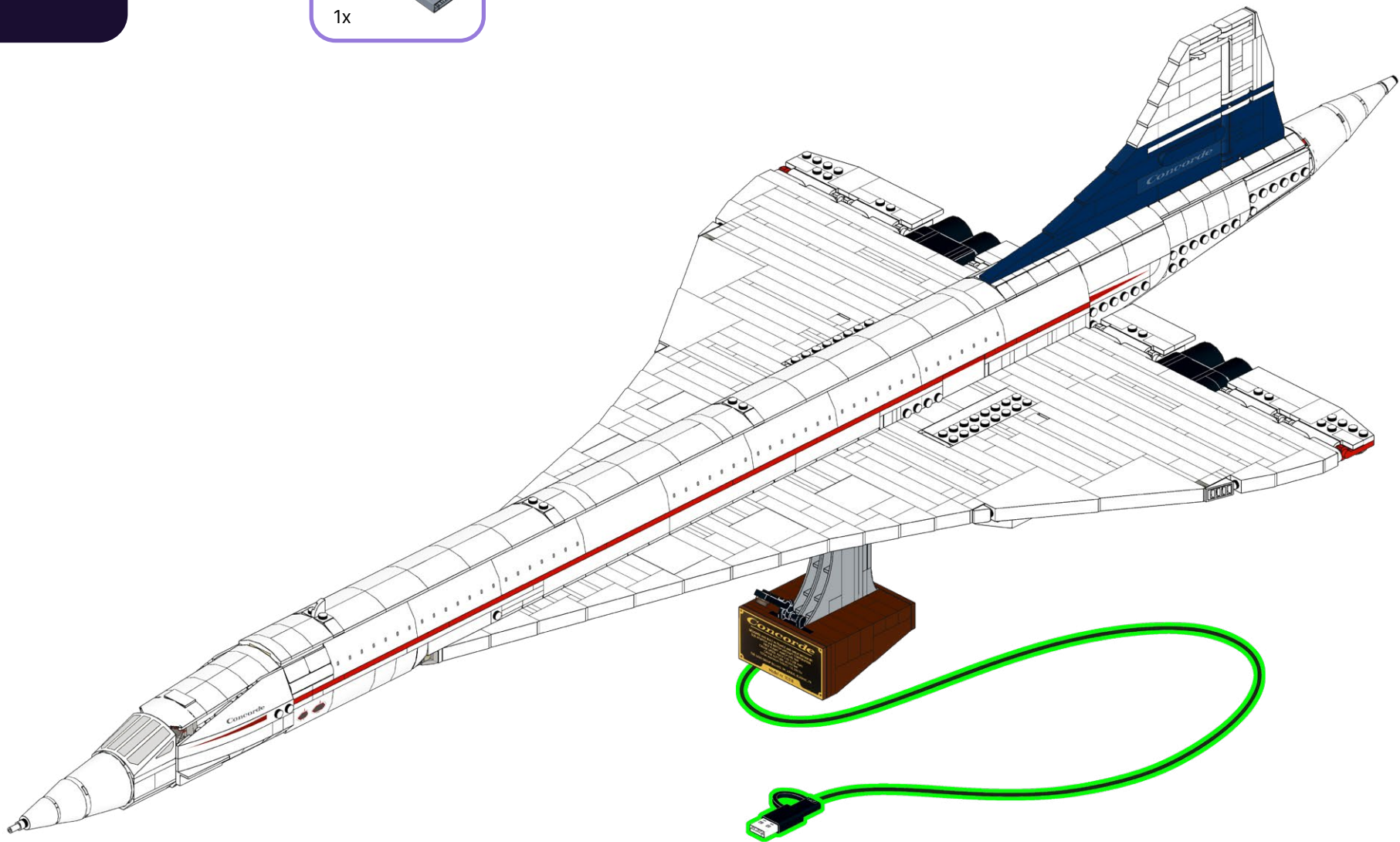

731



# Concorde

DESIGNED AND BUILT IN FRANCE AND GREAT BRITAIN BY:  
SUD AVIATION and BRITISH AIRCRAFT CORPORATION

FIRST FLIGHT: MARCH 2ND 1969

CRUISE SPEED: MACH 2.02 (1.338 mph)

CRUISE ALTITUDE: 60.000 feet

TOTAL MAXIMUM THRUST: 152.200 lbs

THE LEGO GROUP BILLUND, DK; AIRBUS, BLAGNAC, FR

Model nr. 10318

Model nr. 10318

THE LEGO GROUP BILLUND, DK; AIRBUS, BLAGNAC, FR

TOTAL MAXIMUM THRUST: 152.200 lbs

CRUISE ALTITUDE: 60.000 feet

CRUISE SPEED: MACH 2.02 (1.338 mph)

FIRST FLIGHT: MARCH 2ND 1969

SUD AVIATION and BRITISH AIRCRAFT CORPORATION

DESIGNED AND BUILT IN FRANCE AND GREAT BRITAIN BY:

# Concorde

**732**



# FINAL PRODUCT



# PACKAGE CONTENTS



**4x** AL-Y15  
Astro Light Large  
Yellow 15cm



**1x** AL-WW15  
Astro Light Large  
Warm White 15cm



**1x** AL-WW30  
Astro Light Large  
Warm White 30cm



**2x** AR-WW15  
Astro Light Regular  
Warm White 15cm



**1x** AR-G30  
Astro Light Regular  
Green 30cm



**1x** AR-R30  
Astro Light Regular  
Red 30cm



**2x** D-3  
Dock-3



**1x** D-6  
Dock-6



**1x** DS-4  
Dock Split-4



**1x** B-15  
Belt 15cm



**1x** B-30  
Belt 30cm



**2x** B-50  
Belt 50cm

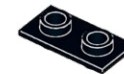

**1x** T-1x2  
Tether 1x2



**1x** AC-C  
Astro Cap Clear



**1x** FLX-C  
Flux Converter

# PACKAGE CONTENTS



**2x** Slope 30 1×1 × 2/3  
Trans-Clear



**2x** Plate 1×1  
Trans Clear

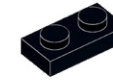

**2x** Plate 1×2  
Black



**1x** Plate, Round 1×1 with  
Open Stud - Black



**2x** Brick 1×1 Modified with  
Stud on side



**2x** Brick 1×1 Technic Hole  
Black

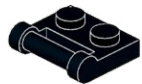

**1x** Plate, Modified 1×2 with  
Bar Handle on End -  
Black



**4x** Plate 1×1  
White



**1x** Plate, Modified 1×2  
with Bar Handle on Side  
Closed Ends - Black



**4x** Plate, Round 1×1 - Trans  
Orange



**1x** Arm Skeleton, Bent with  
Clips (Horizontal Grip) -  
Black

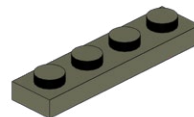

**5x** Plate 1×4 - Dark Grey

# CONTACT US

Click below for customer support, or general inquiries.

Cliquez ci-dessous pour accéder au support client ou aux renseignements généraux.

Clicca qui sotto per l'assistenza clienti o per richieste generali.

Contact Us



Contactez-nous



Contattaci



Klicken sie unten für kundensupport oder allgemeine anfragen.

Haga clic a continuación para atención al cliente o consultas generales.

点击下方获取客户支持或一般咨询。

Kontaktieren sie uns



Contáctanos



联系我们



## TROUBLESHOOTING

If you're stuck, scan the QR code for troubleshooting.

Se sei bloccato, scansiona il codice QR per la risoluzione dei problemi.

Wenn Sie nicht weiterkommen, scannen Sie den QR-Code zur Fehlerbehebung.

Si vous êtes bloqué, scannez le code QR pour le dépannage

Si está atascado, escanee el código QR para solucionar el problema.

如果遇到问题, 请扫描二维码进行故障排除

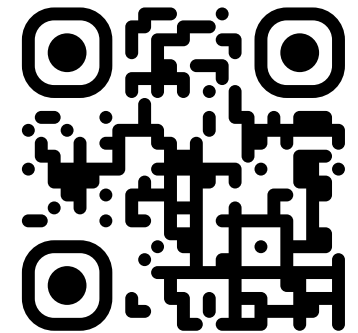



# LIGHTMYBRICKS

[lightmybricks.com](https://lightmybricks.com)



LEGO® is a trademark of the LEGO Group of companies, which does not sponsor, authorize or endorse this product. All LEGO® sets featured in images are sold separately. This is not a LEGO® product. The LEGO Group is not liable for any loss, injury or damage arising from the use or misuse of this product. ©2024 Light My Bricks Pty Ltd. All rights reserved. [www.lightmybricks.com](https://www.lightmybricks.com)

Our components are designed and packaged in Australia by Light My Bricks Pty Ltd. Components are manufactured in China. 3fl bldg C, Shuanghuan Quanxin Technology Information Industry Park Baolong Street, Longgang District, Shenzhen, China. Imported in Australia by Light My Bricks Pty Ltd, 5/26 Rushdale St, Knoxfield, VIC, 3180, Australia.

WARNING: CHOKING HAZARD - Small parts. Not for children under 3 years.

AVERTISSEMENT : RISQUE D'ÉTOUFFEMENT - Petites pièces. Ne convient pas aux enfants de moins de 3 ans.

ATTENZIONE: PERICOLO DI SOFFOCAMENTO - Piccole parti. Non adatto a bambini di età inferiore a 3 anni.

WARNUNG: ERSTICKUNGSGEFAHR - Kleine Teile. Nicht für Kinder unter 3 Jahren geeignet.

ADVERTENCIA: PELIGRO DE ASFIXIA - Piezas pequeñas. No son apto para niños menores de 3 años.

警告：窒息危险 - 小零件。不适合3岁以下儿童。