



LIGHT KIT INSTALLATION GUIDE

JAZZ CLUB

FOR LEGO
SET
#10326



CONTENTS



03

Getting Started

- 04** Legend
- 05** Component Handling
- 06** Blueprint

08

Instructions

- 25** LMB Bag 01
- 88** LMB Bag 02
- 203** LMB Bag 03
- 259** LMB Bag 04
- 333** LMB Bag 05

362

Final Product

- 363** Package Contents
- 365** Contact & Troubleshooting

GETTING STARTED



Bold, beautiful and bright, Light My Bricks elevates your favourite LEGO set from knick-knack to statement piece. Create a talking point at home or in the office that speaks to your passions with Light My Bricks. To learn more, click below.

[Learn More](#)



Audacieux, beau et lumineux, Light My Bricks élève votre ensemble LEGO préféré du statut de bibelot à celui de pièce maîtresse. Que ce soit à la maison ou au bureau, partagez votre passion des LEGO avec Light My Bricks. Cliquez ci-dessous pour en savoir plus.

[En savoir plus](#)



Audace, bello e luminoso, Light My Bricks eleva il tuo set LEGO preferito da soprammobile a pezzo di tendenza. Crea un punto di discussione a casa o in ufficio che parli alle tue passioni con Light My Bricks. Per saperne di più, clicca qui sotto.

[Ulteriori Informazioni](#)



Mutig, schön und hell – Light My Bricks verwandelt Ihr Lieblings-LEGO-Set von einem schnickschnack in ein statement-stück. Schaffen sie einen gesprächspunkt zu hause oder im büro, der Ihre leidenschaften widerspiegelt, mit Light My Bricks. Um mehr zu erfahren, klicken sie unten.

[Mehr erfahren](#)



Audaz, hermoso y brillante, Light My Bricks eleva tu set LEGO favorito de una chuchería a una pieza llamativa. Crea un tema de conversación en casa o en la oficina que hable de tus pasiones con Light My Bricks. Para obtener más información, haga clic a continuación.

[Más información](#)



大胆、美丽而明亮，Light My Bricks 将你喜爱的乐高套装从小摆件提升为引人注目的装饰品。在家或办公室打造一个能表达你激情的话题，了解更多，请点击下方。

[了解更多](#)



LEGEND

Rotate Set



Retournez L'ensemble
Ruota Set
Set Drehen
Rotar Conjunto
旋转套件

Add Part



Ajoutez une Pièce
Aggiungi Parte
Teil Hinzufügen
Agregar Pieza
添加零件

Click



Cliquez
Clic
Klicken
Clic
点击

Pinch/Fold



Pincez/Pliez
Pizzicare/Piegare
Kneifen/Falten
Pellizcar/Doblar
折叠

Pull Cable



Tirez le Cable
Tirare il Cavo
Kabel Ziehen
Tirar del Cable
拉动电缆

Repeat Step



Répétez
Ripetere
Wiederholen
Repetir
重复

Sticker



Autocollant
Adesivo
Aufkleber
Pegatina
贴纸

Power On Test



Test de mise sous tension
Test di Potenza
Stromtest
Prueba de Energía
电源测试

Disconnect Power



Débranchez L'alimentation
Scollegare L'alimentazione
Strom Trennen
Desconectar la Energía
断开电源

Troubleshoot



Dépanner
Risolvere
Fehlerbehebung
Solución de Problemas
故障排除

COMPONENT HANDLING

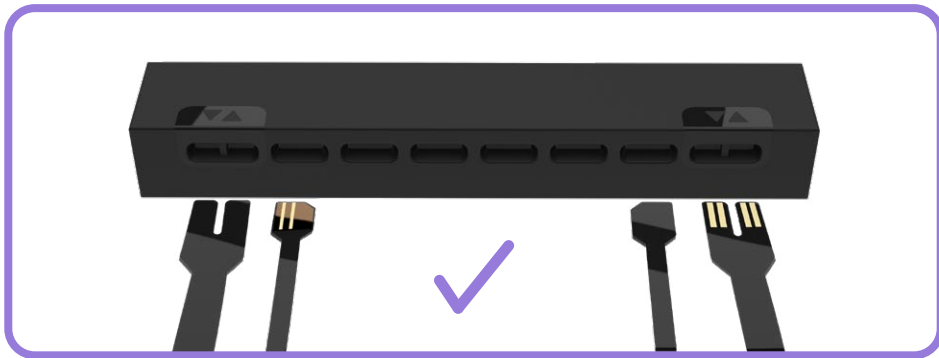
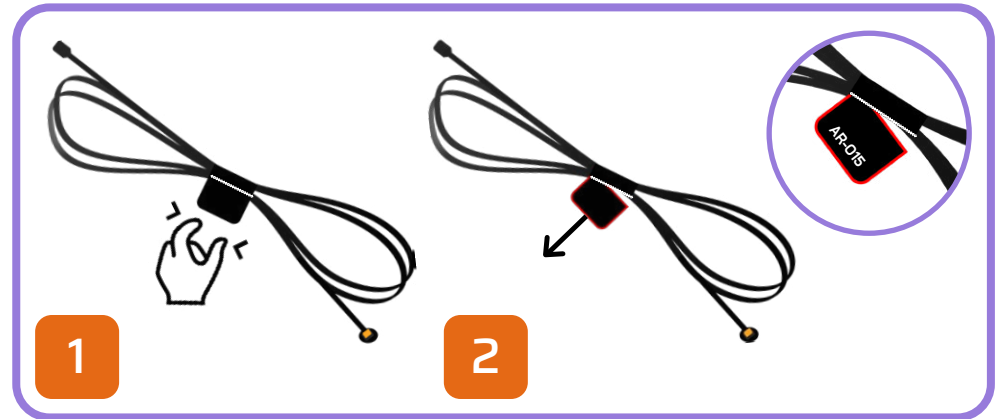
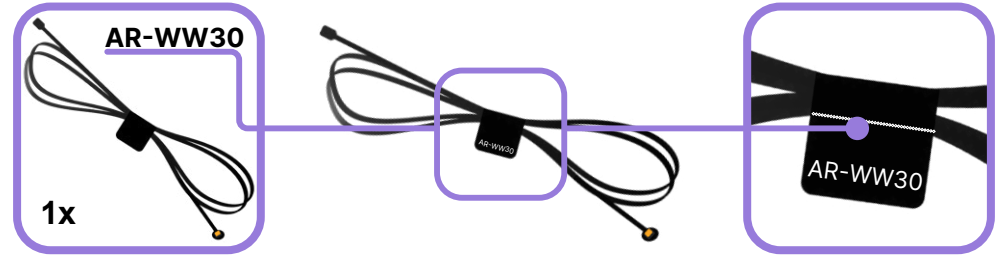
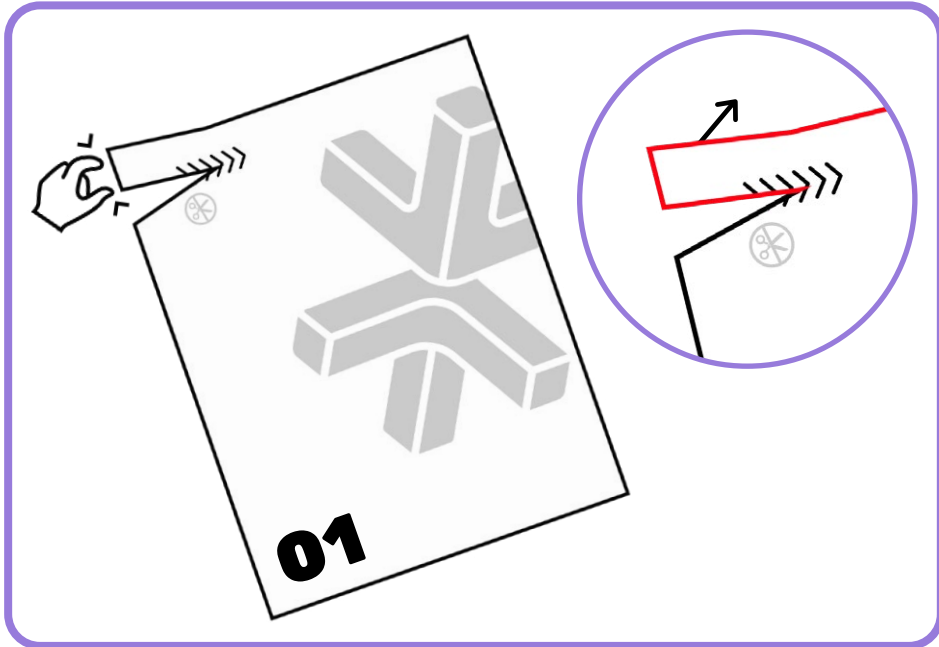

BLUEPRINT

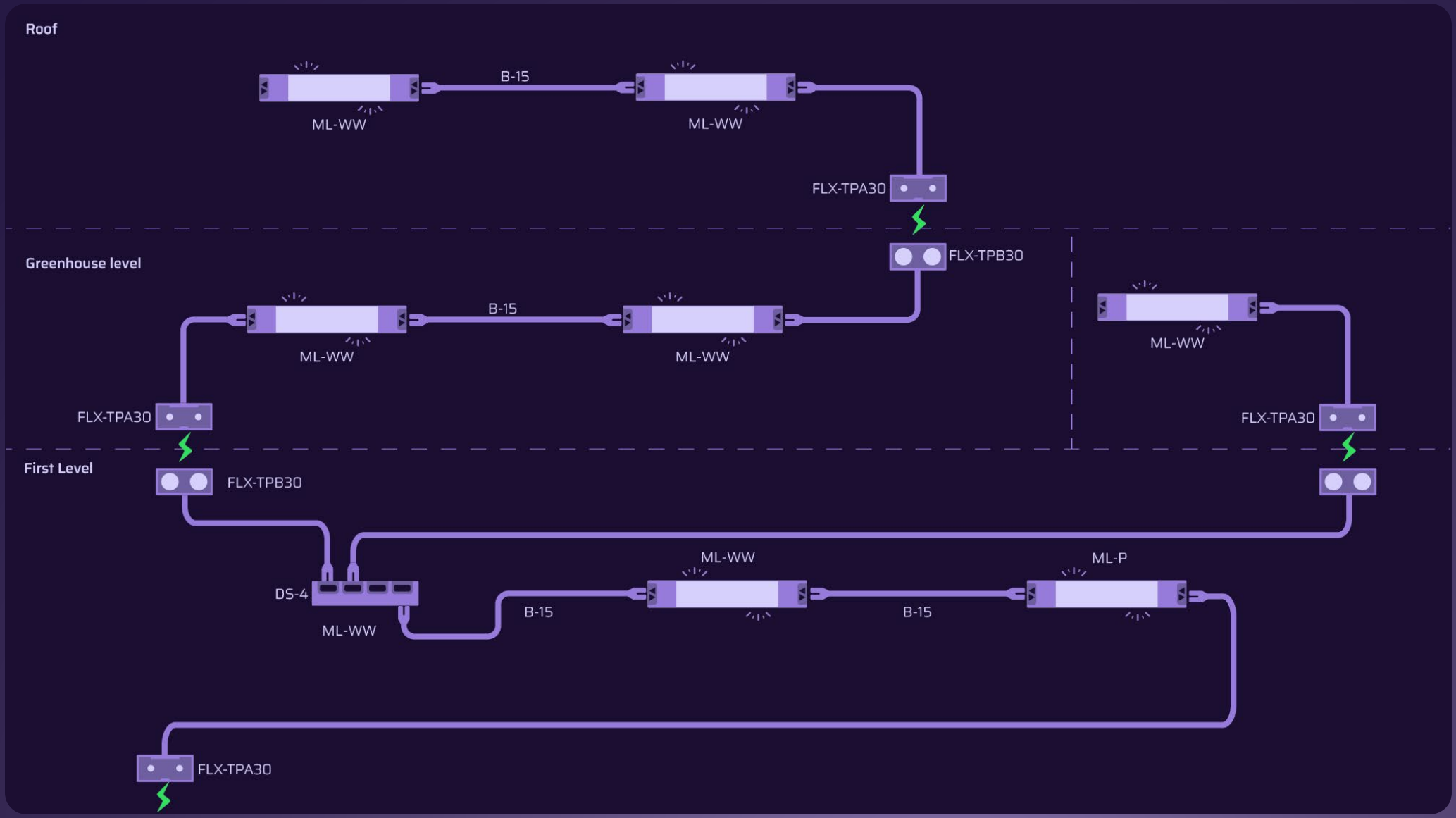

BLUEPRINT

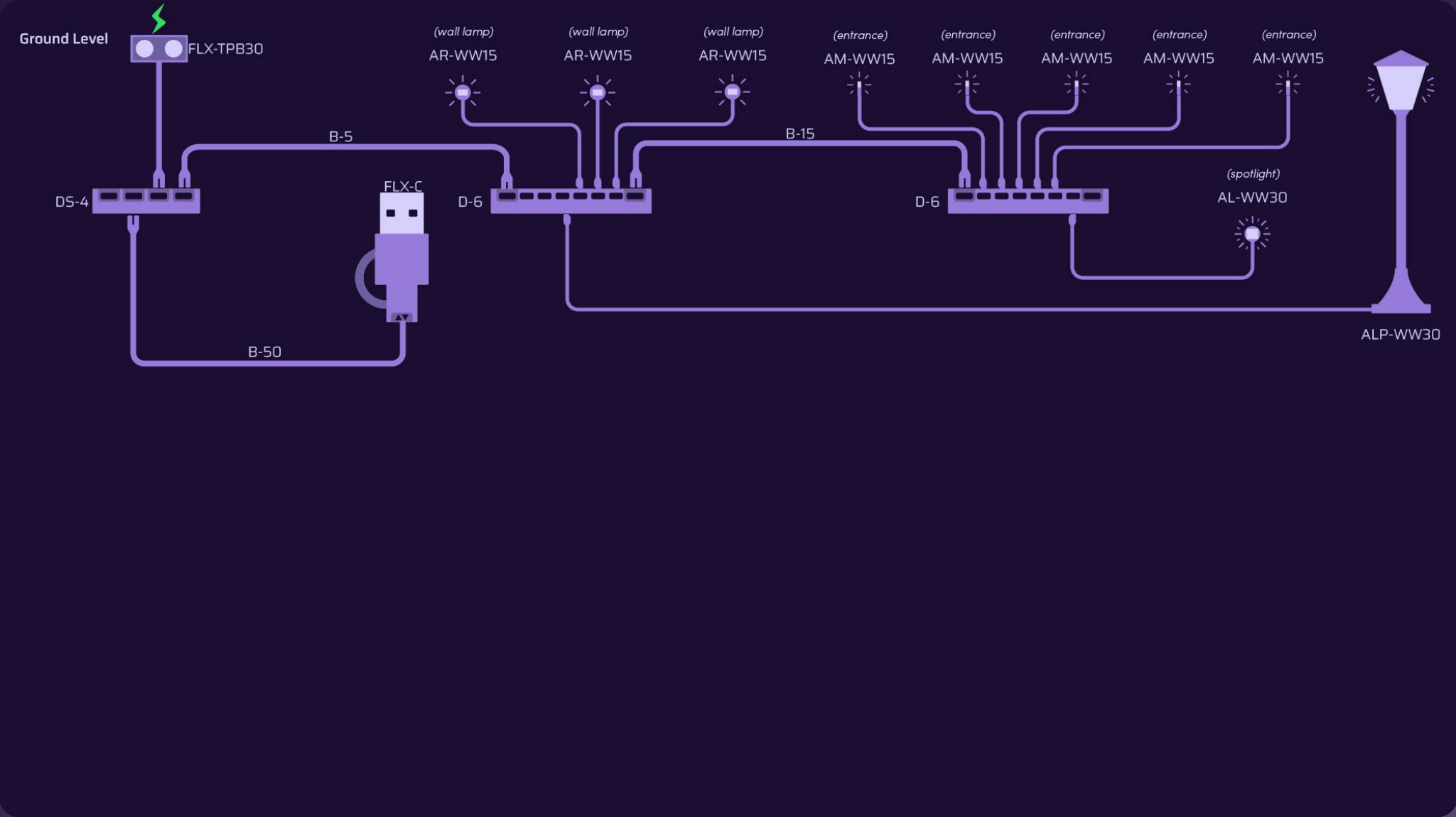

1



2

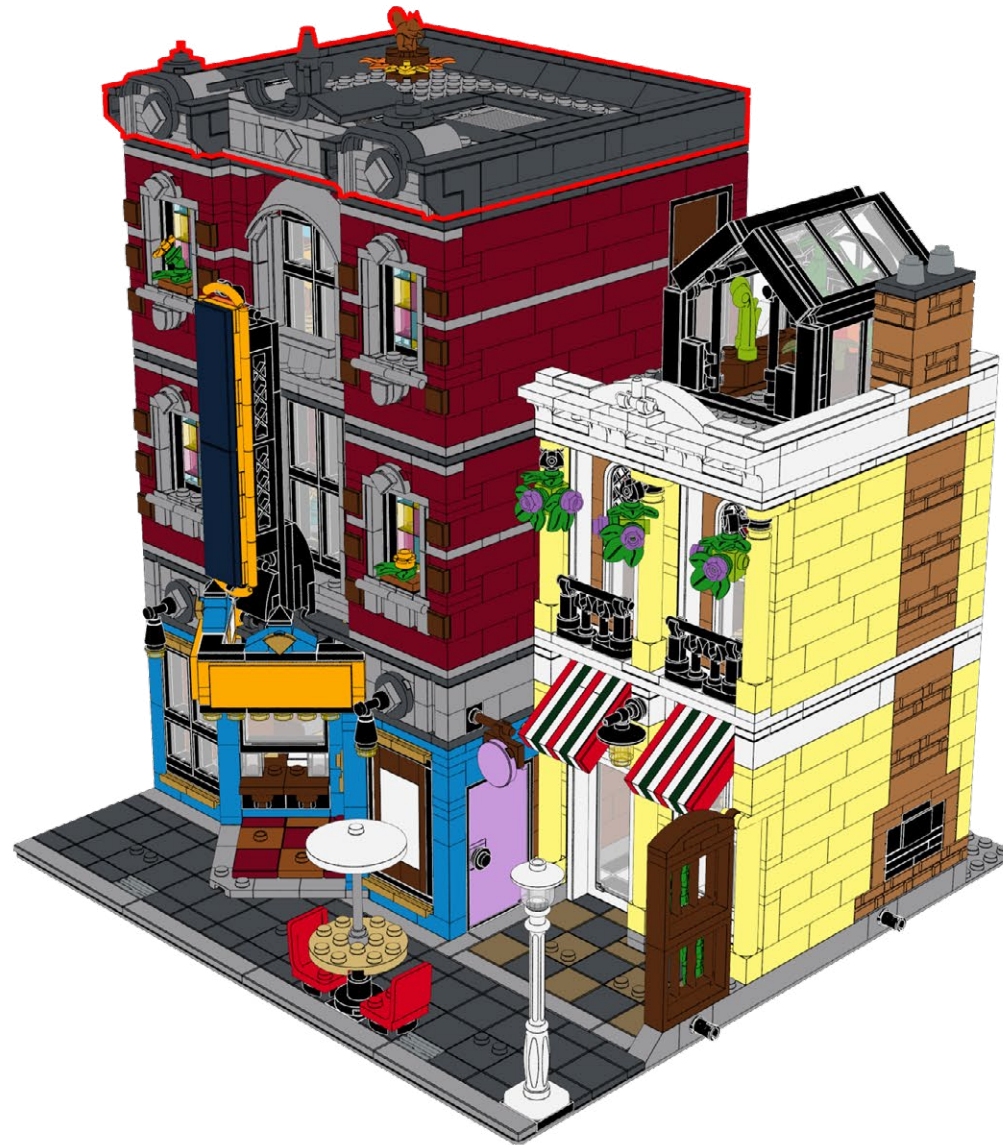

3



4



5



6



7

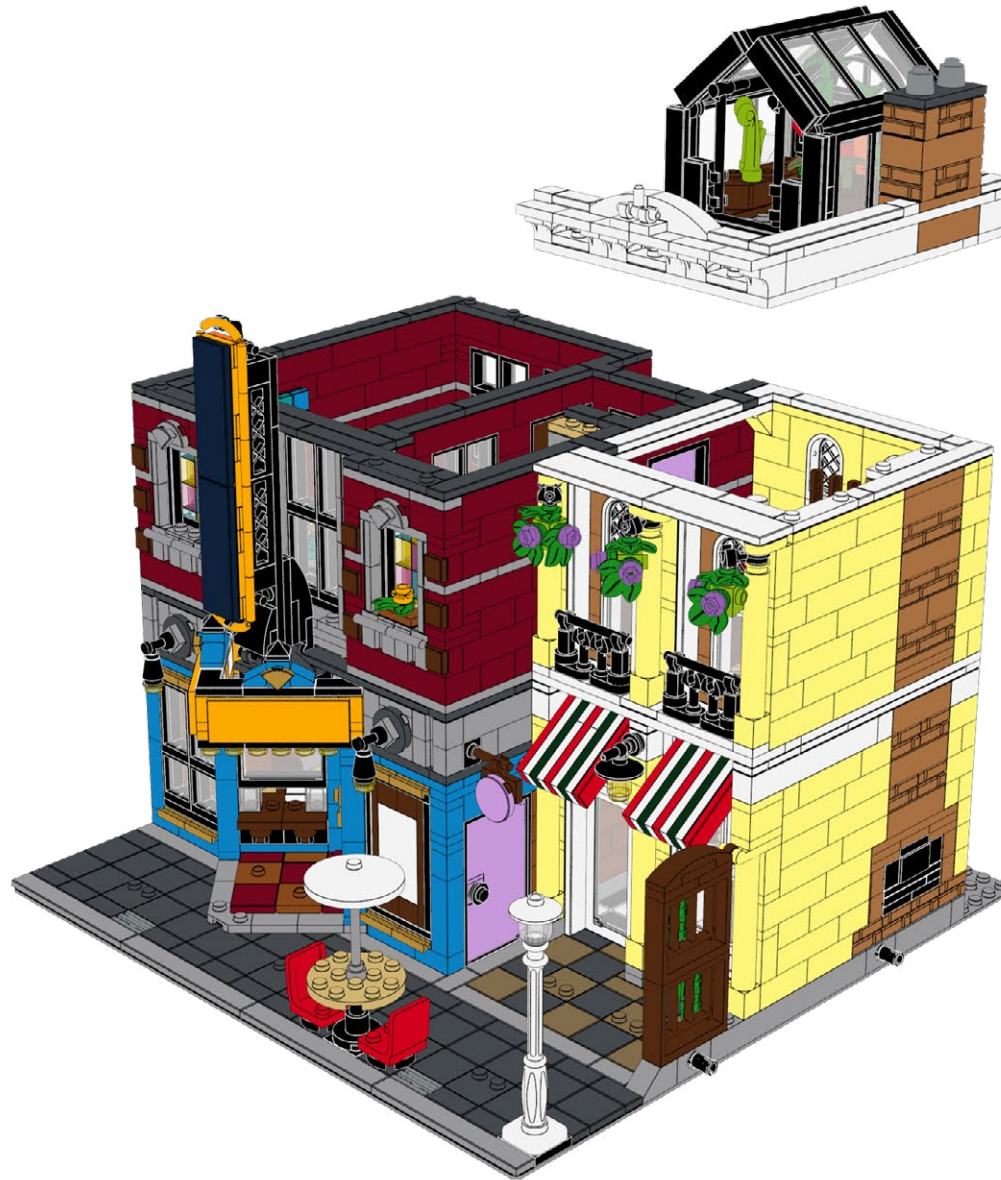

8



9



10



11



12



13

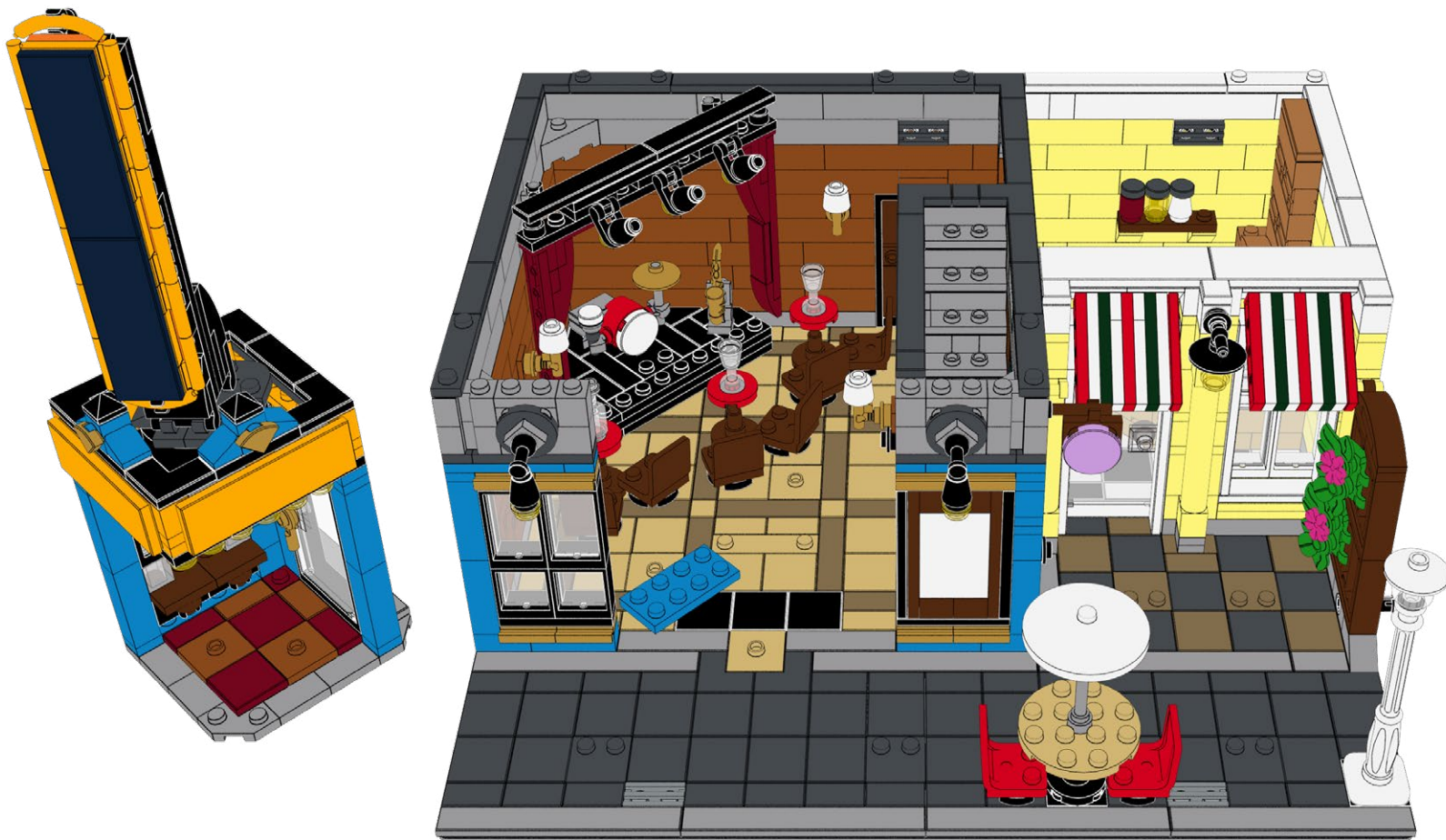

14

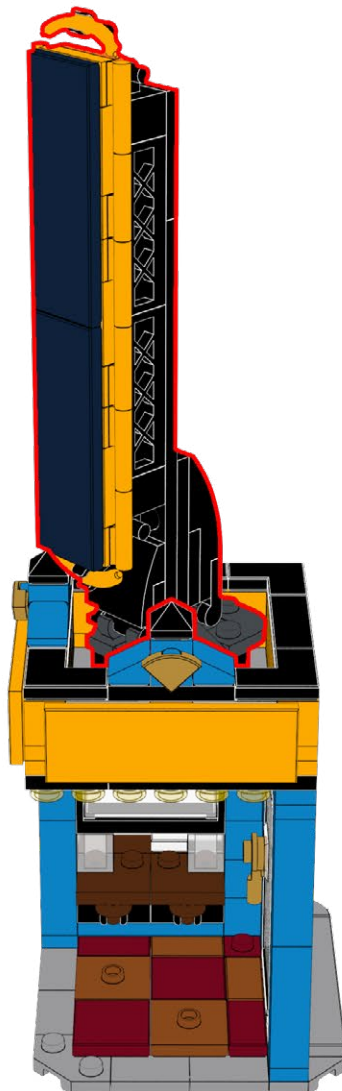

15

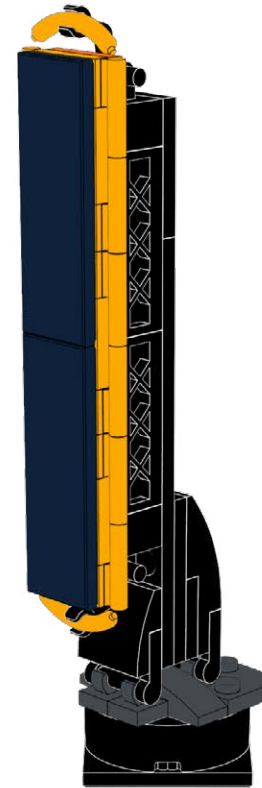

16



17

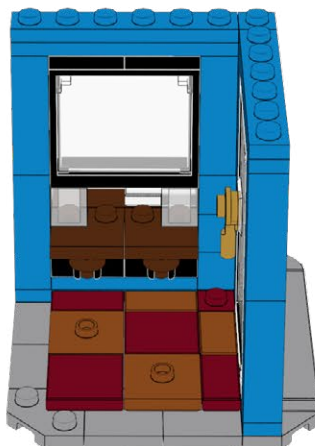
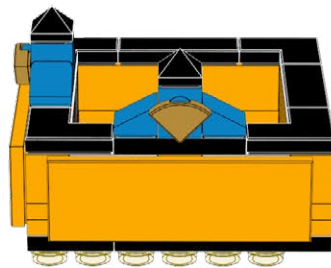

**HOLD UP!**

You might notice some bags aren't in order, as well as left over pieces, but that's ok! We're changing the way you build LEGO!

ATTENDEZ!

Vous remarquerez peut-être que certains sacs, ainsi que certaines pièces, ne sont pas dans le bon ordre. Mais pas de panique! Nous changeons simplement la façon avec laquelle vous construisez vos LEGO!

ASPETTA!

Potresti notare che alcuni sacchetti non sono in ordine, così come i pezzi avanzati, ma va bene così! Stiamo cambiando il modo in cui costruisci i LEGO!

HALT!

Sie werden möglicherweise bemerken, dass einige tüten durcheinander sind und teile übrig bleiben, aber das ist in Ordnung! Wir ändern die art und weise, wie Sie LEGO bauen!

¡ESPERA!

Es posible que notes que algunas bolsas están fuera de servicio, así como piezas sobrantes, ¡pero está bien! ¡Estamos cambiando la forma en que construyes LEGO!

暫停!

你可能会注意到一些袋子顺序错乱, 以及一些剩余的部件, 但没关系! 我们正在改变你搭建乐高的方式!

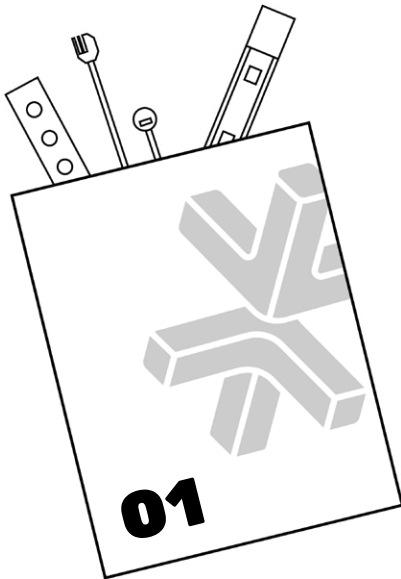
Open LMB Bag 01

18

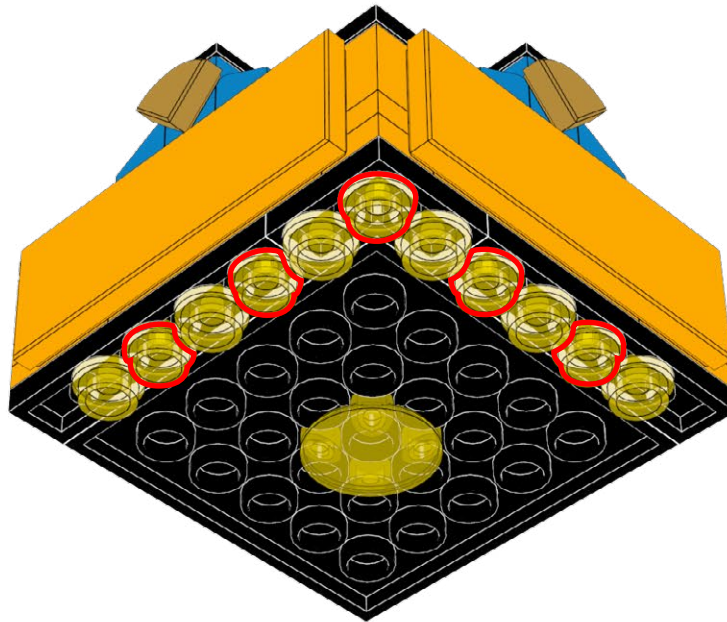

19

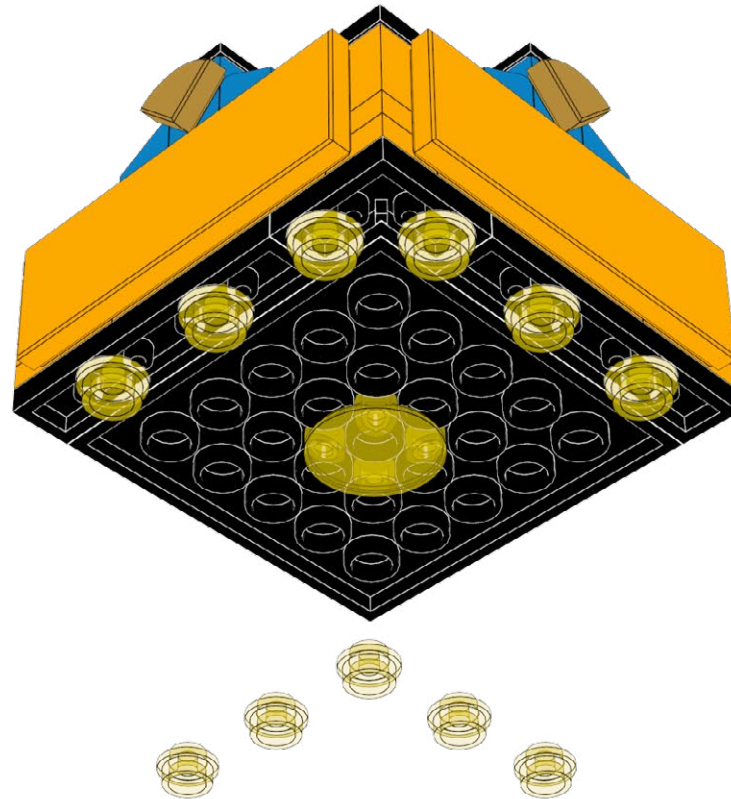

20

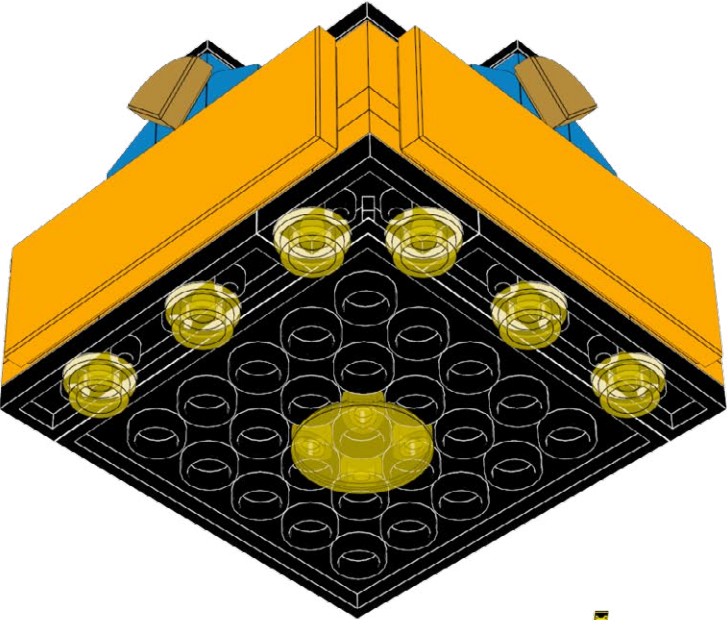
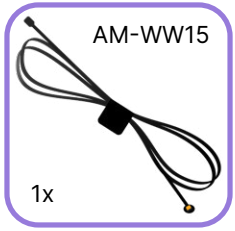

21

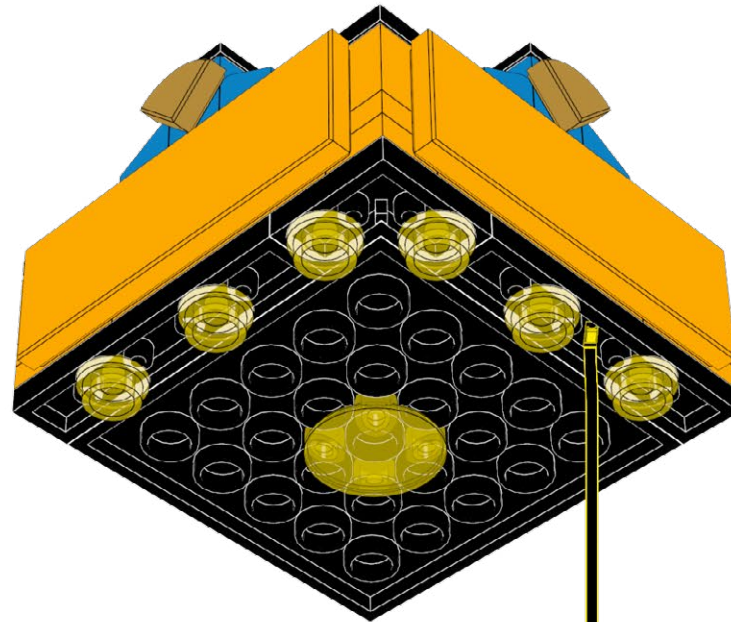

22

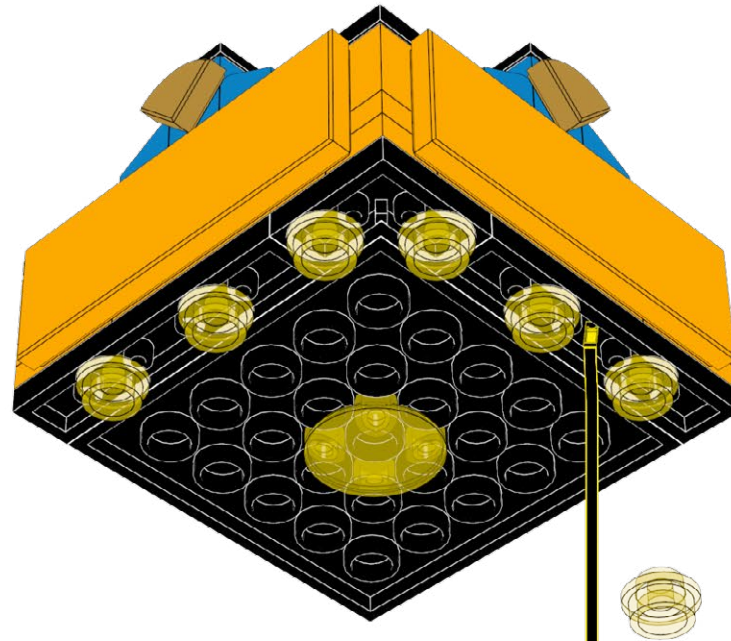

23

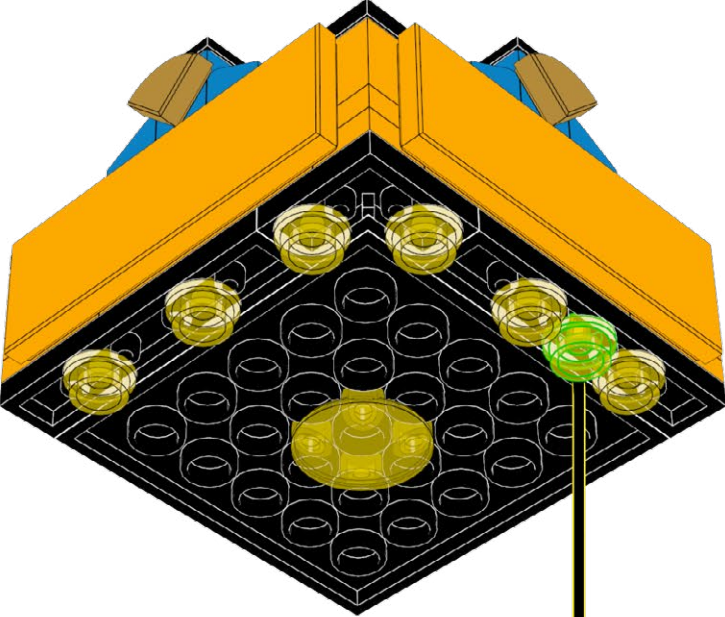

24

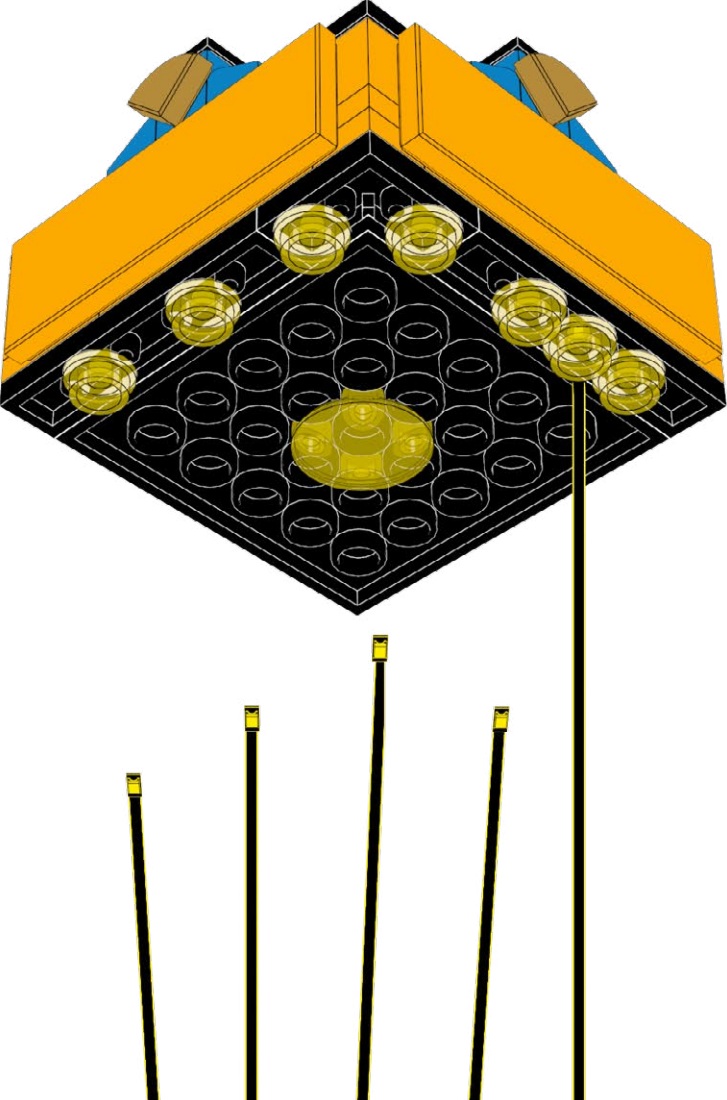
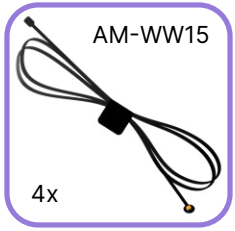

25

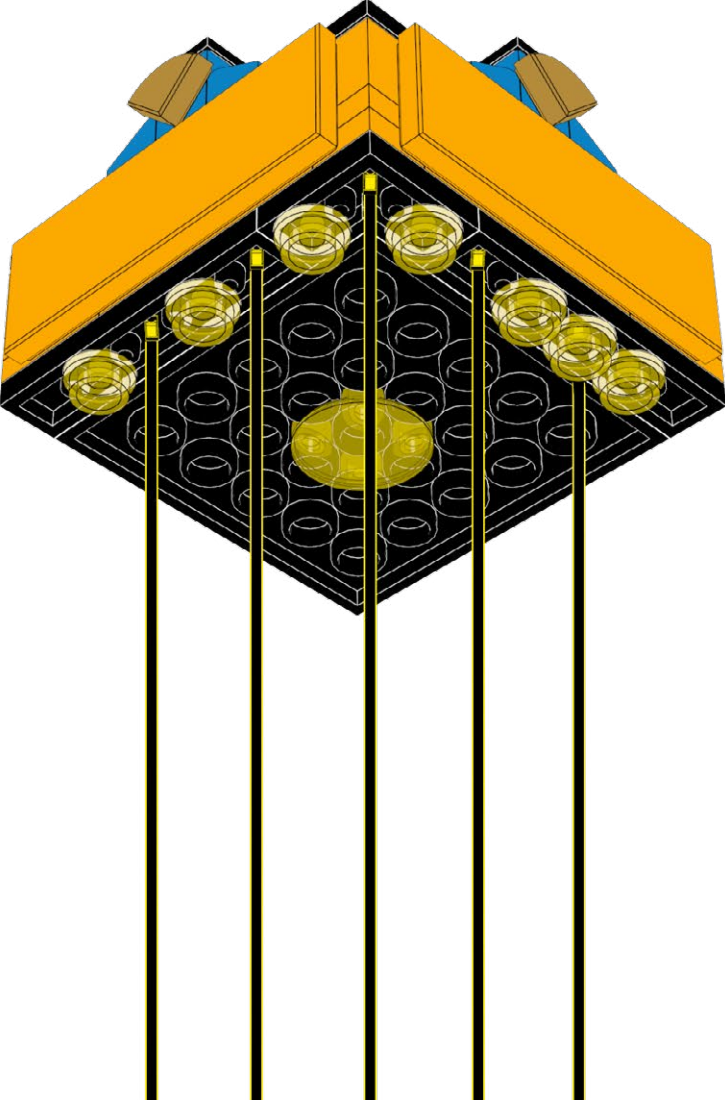

26

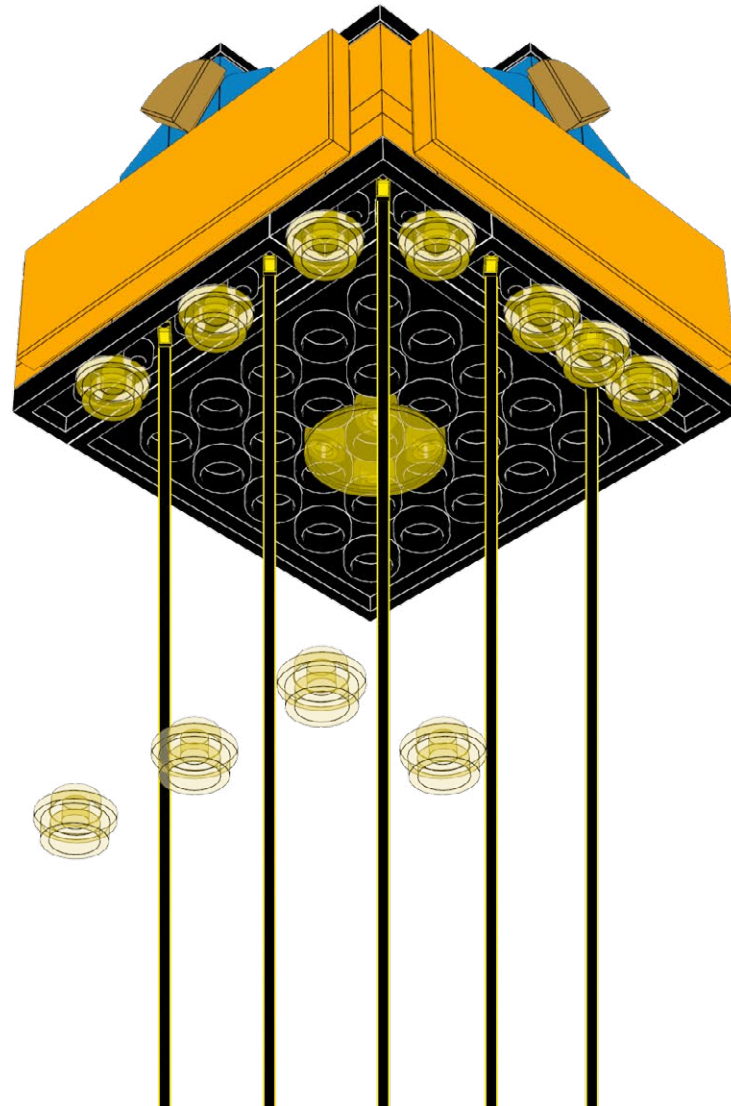

27

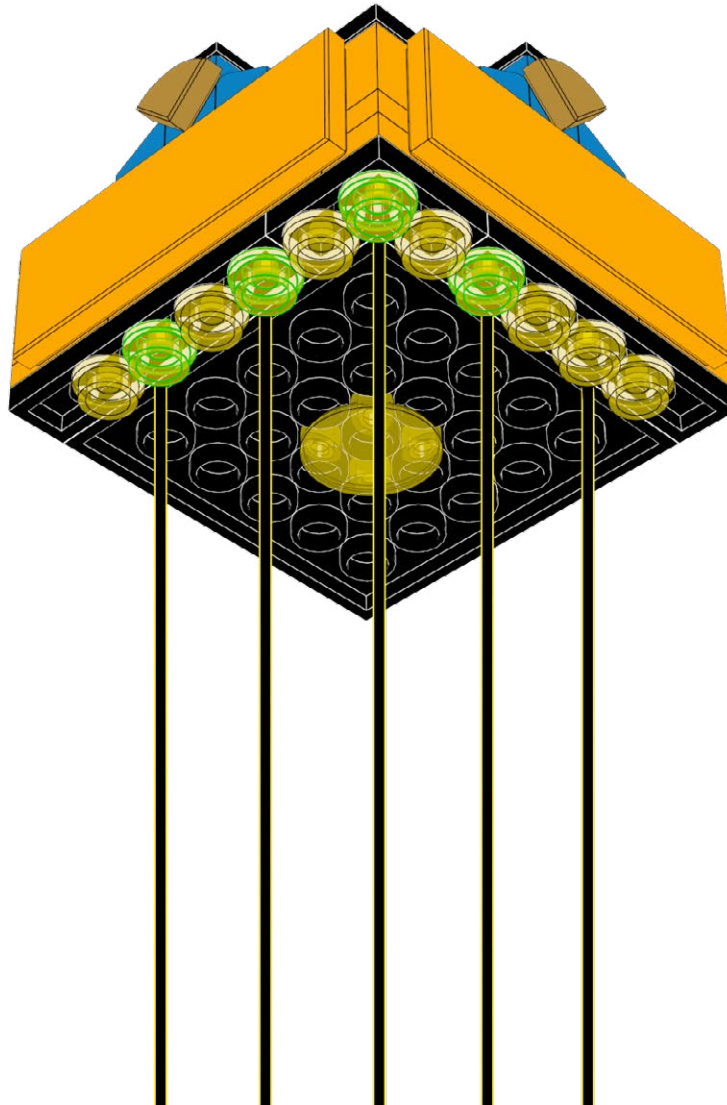

28

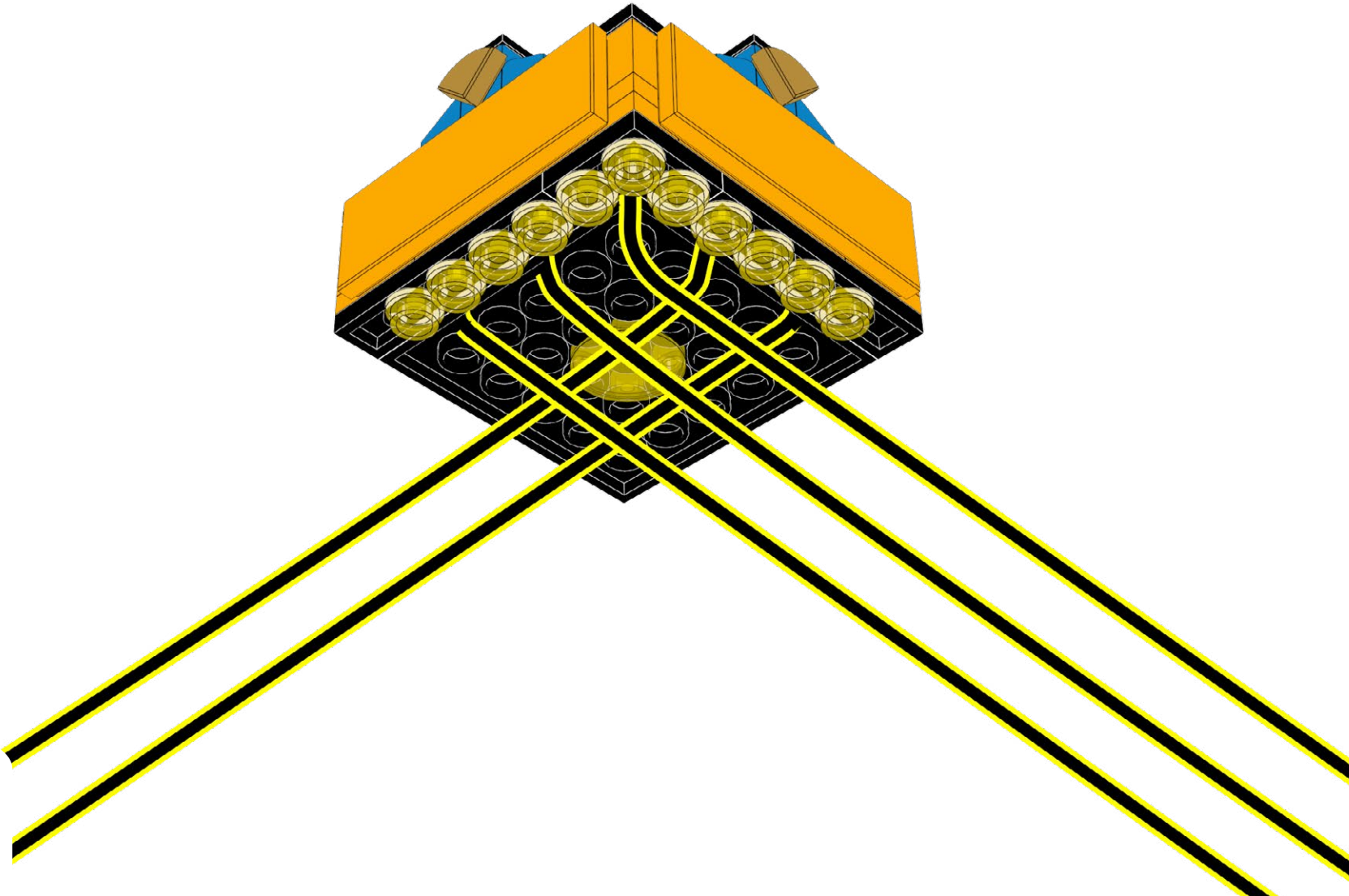
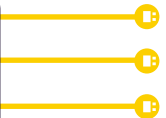

29

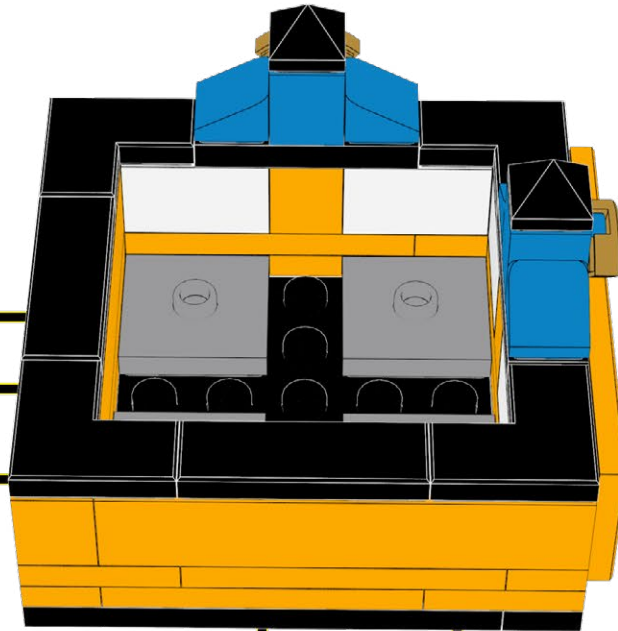

30

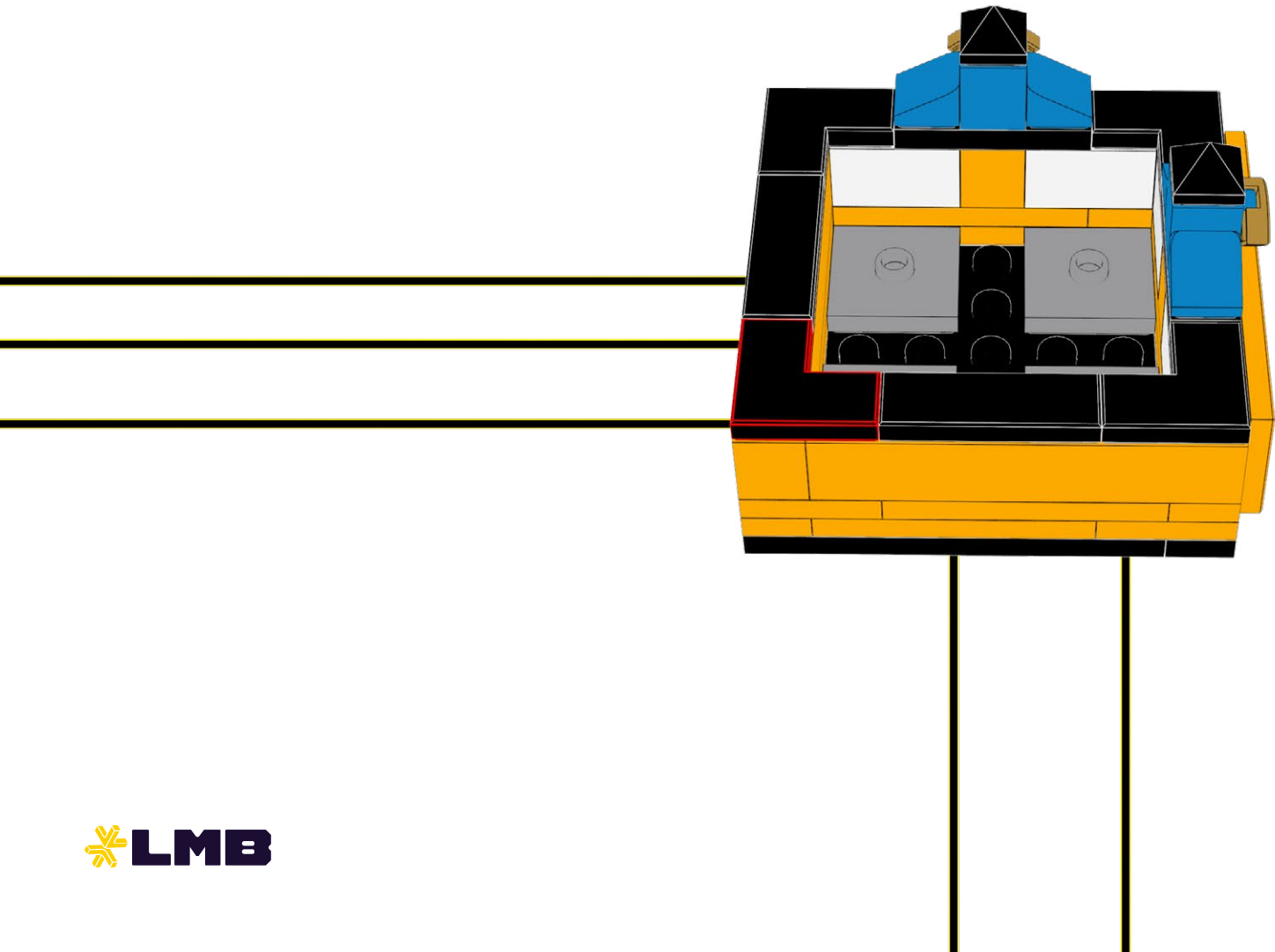

31

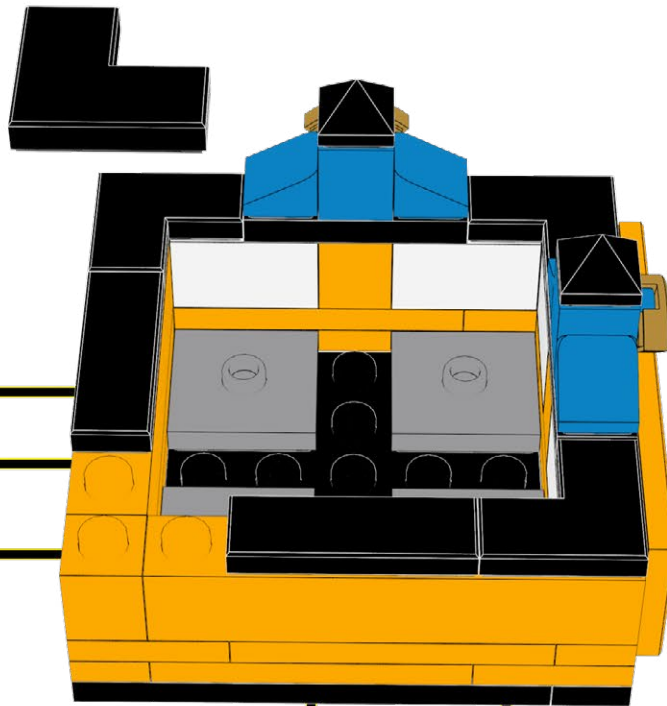

32

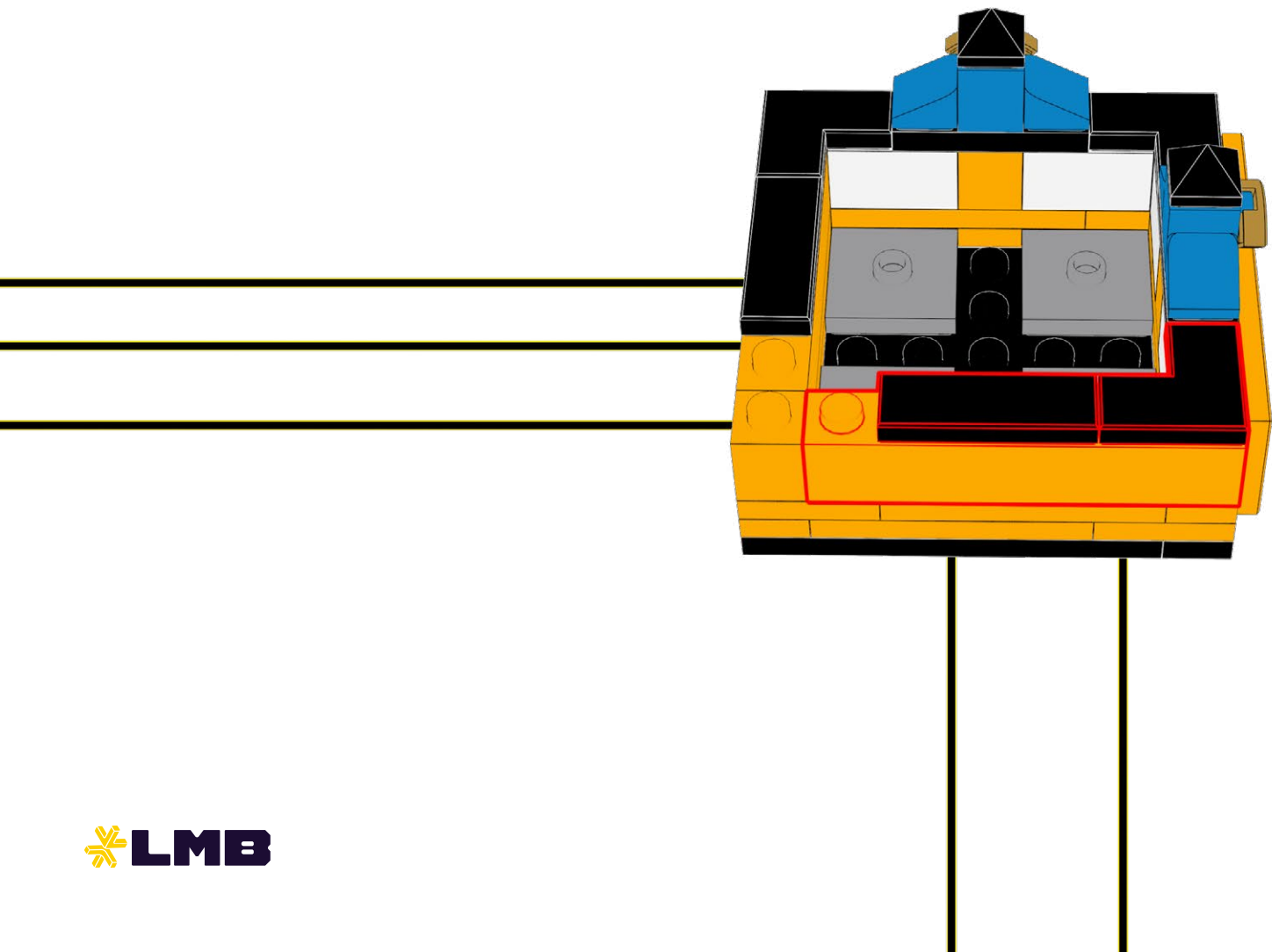

33

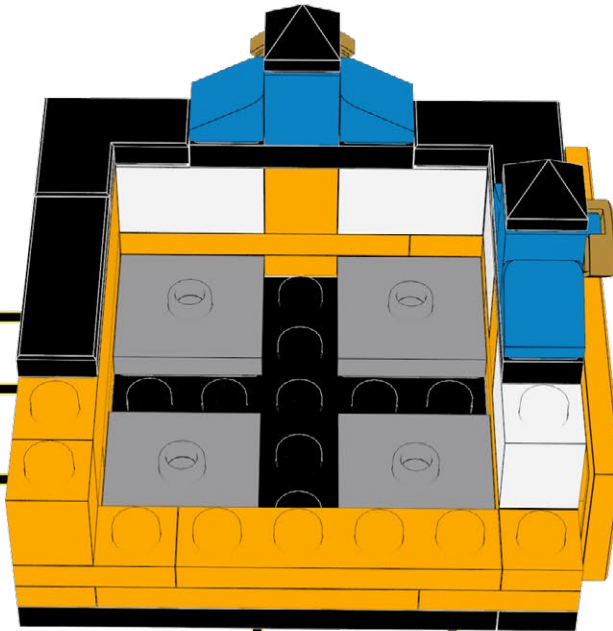
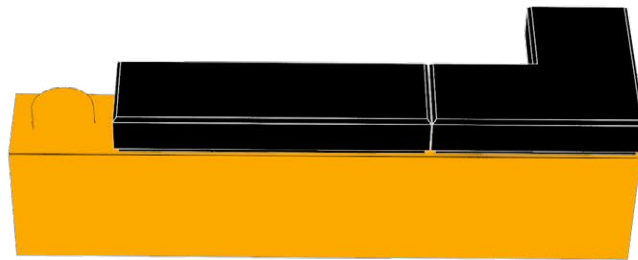

34

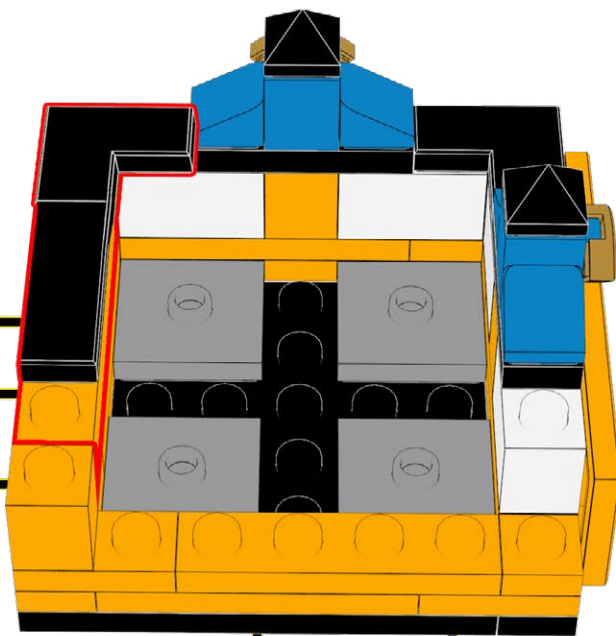

35

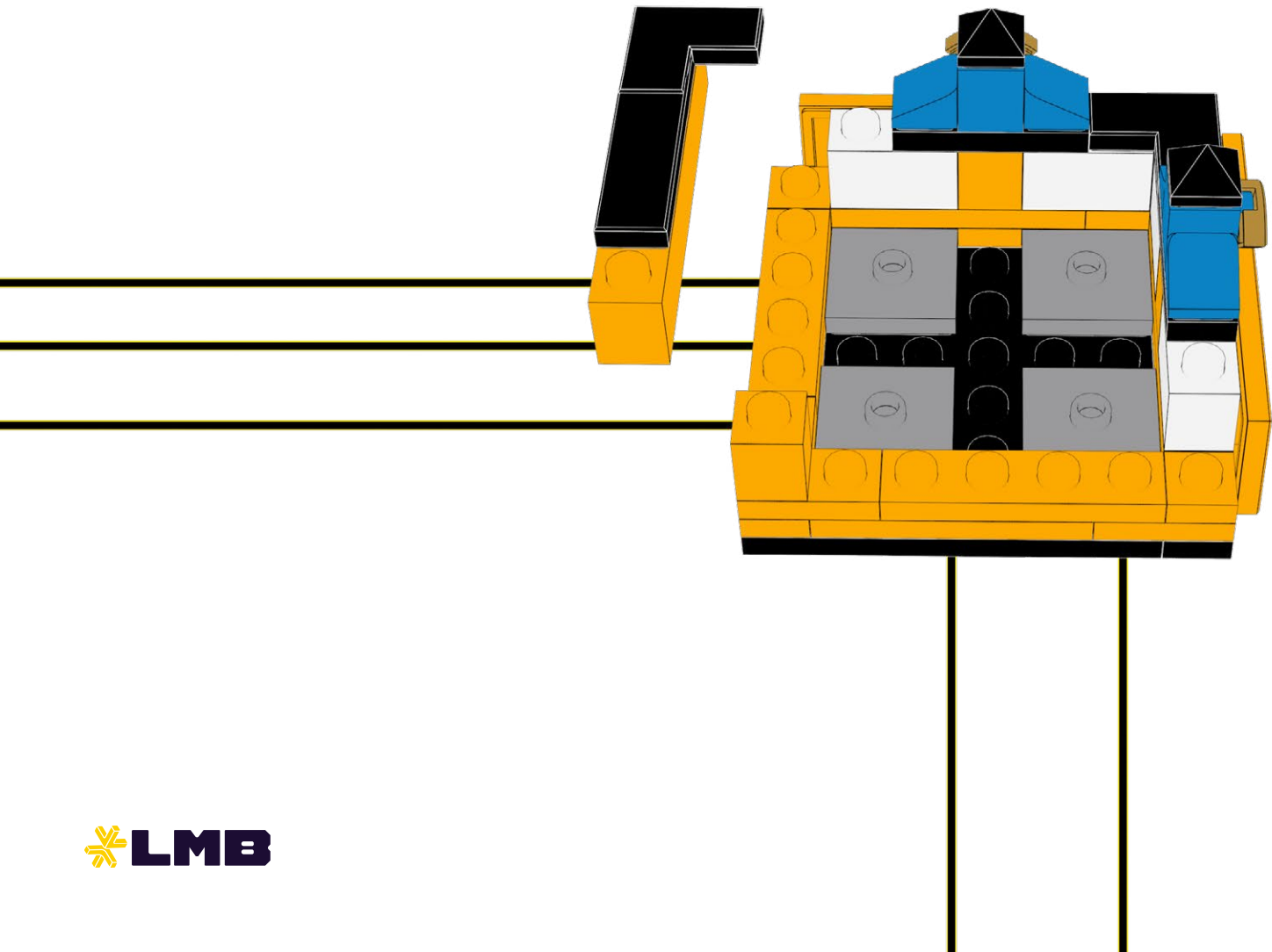

36

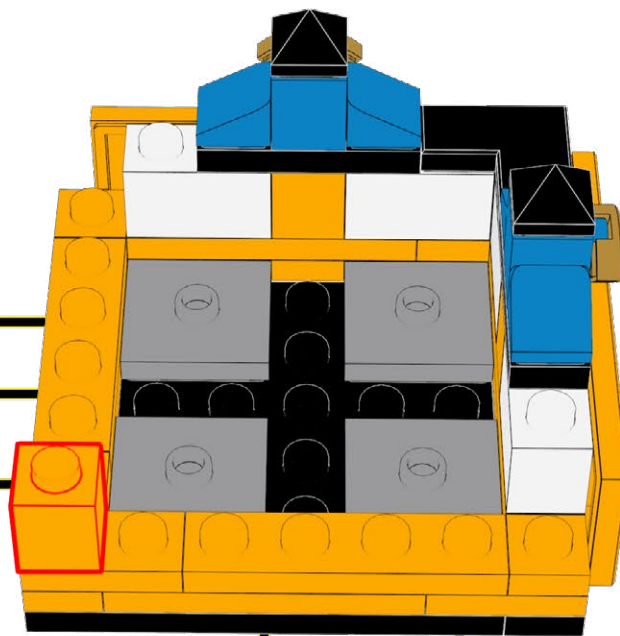

37

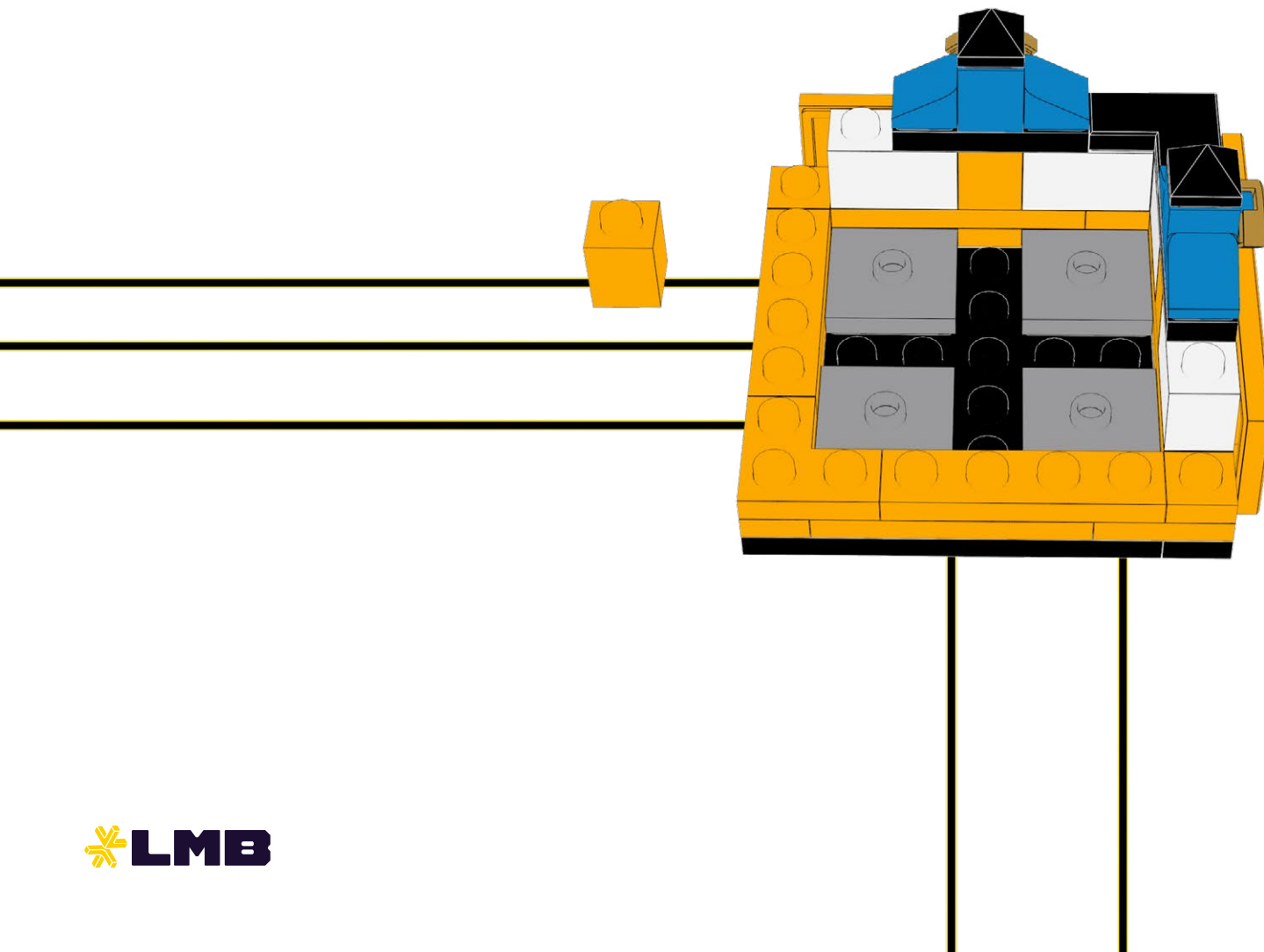

38

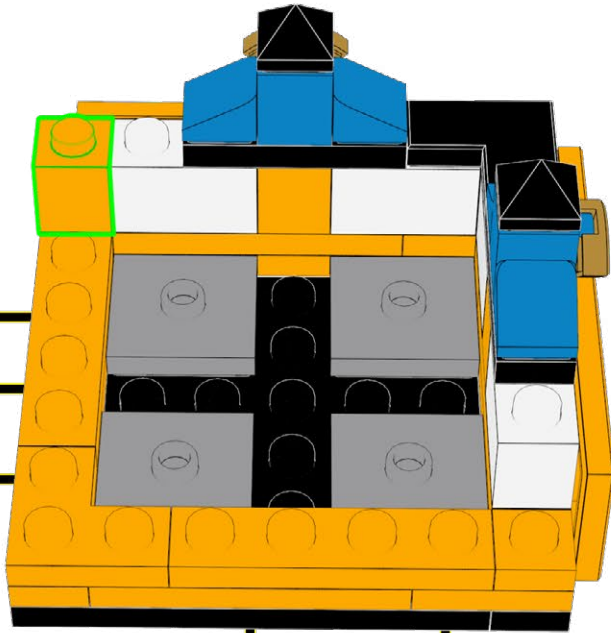

39

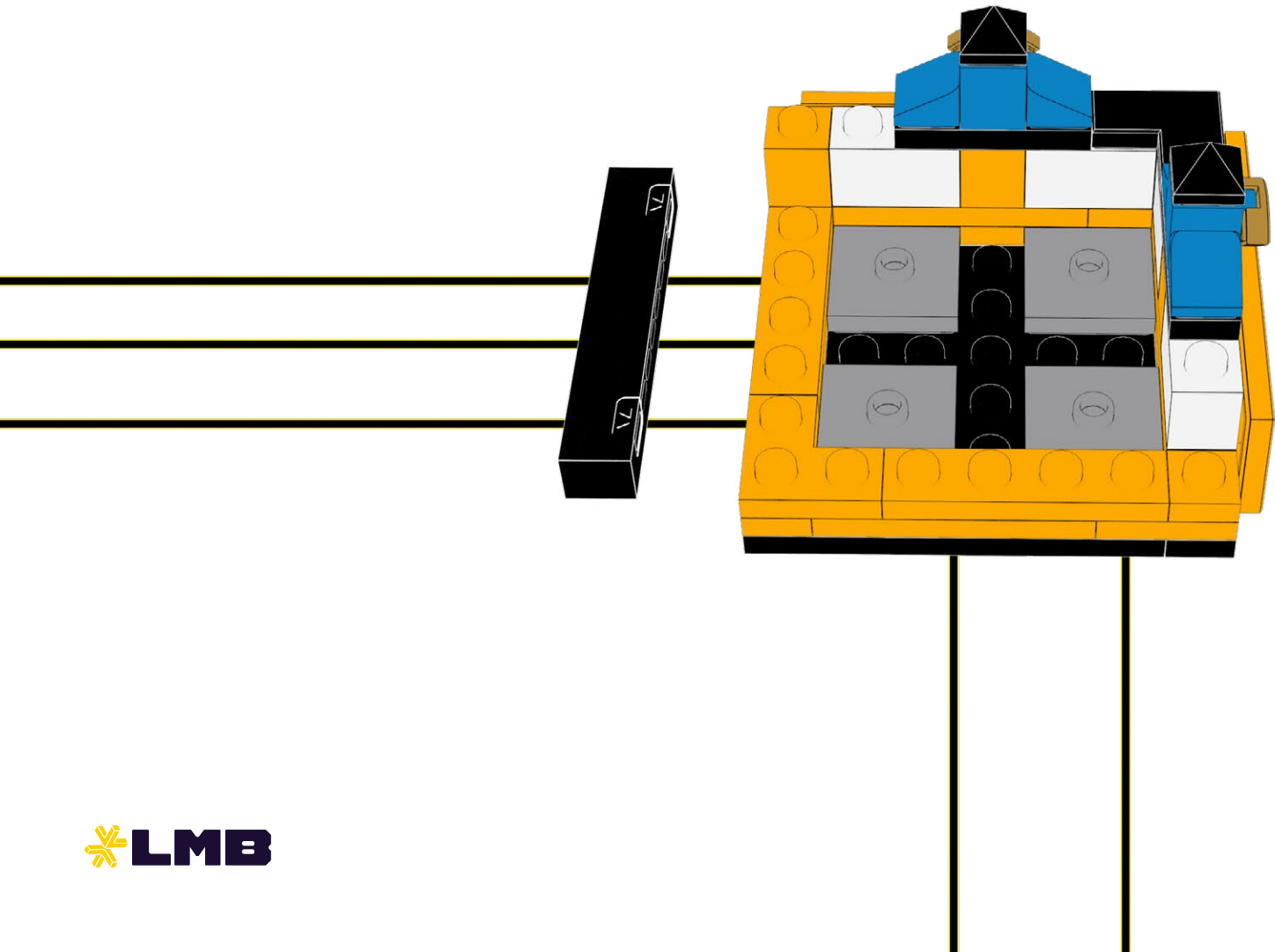
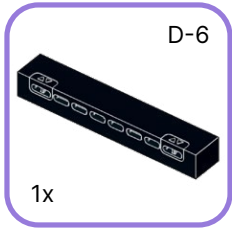

40

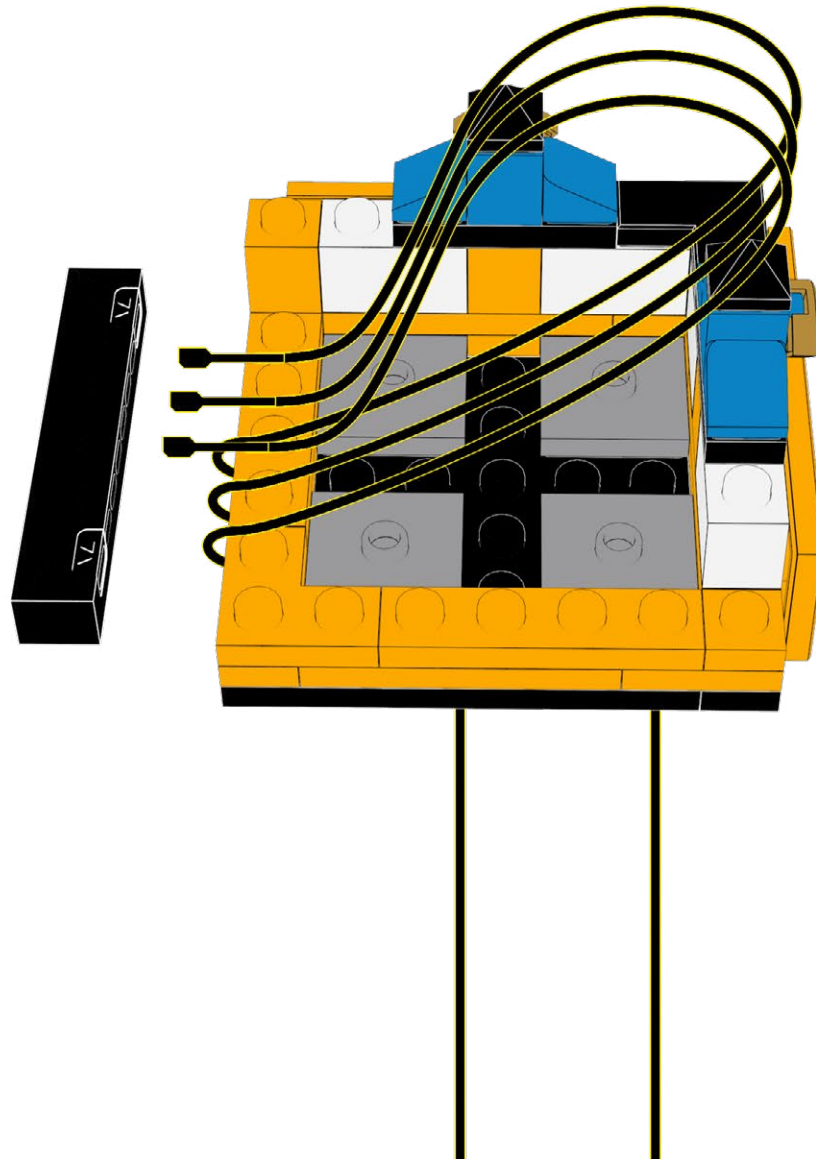

41

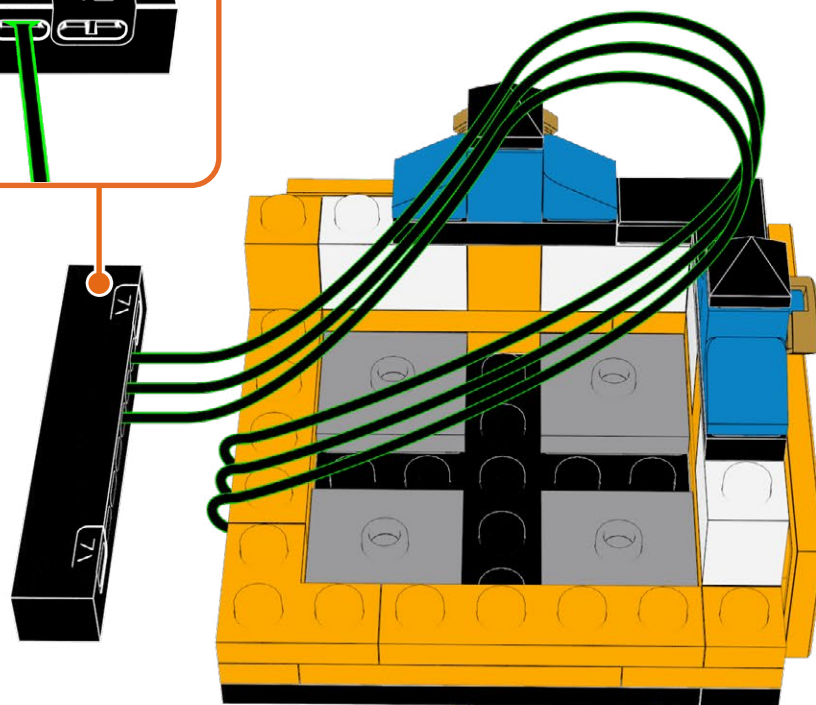
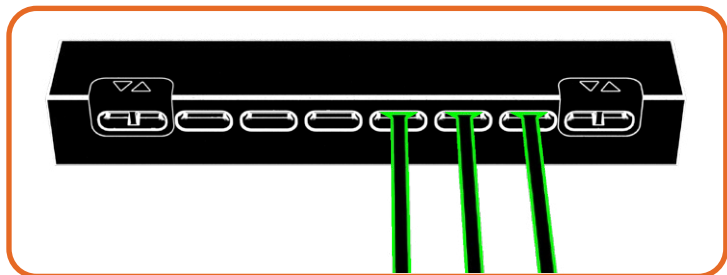

42

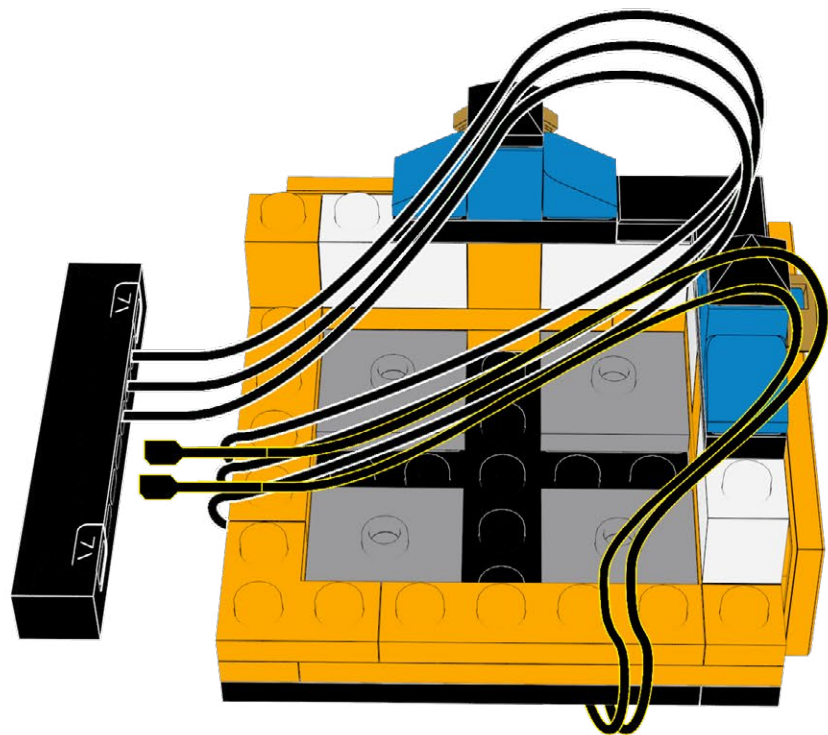

43

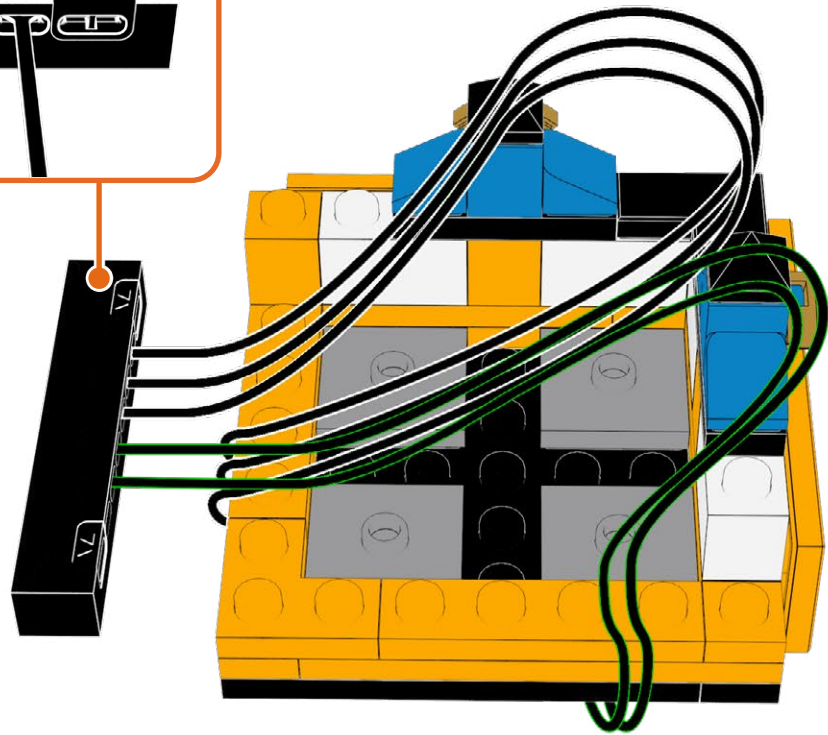
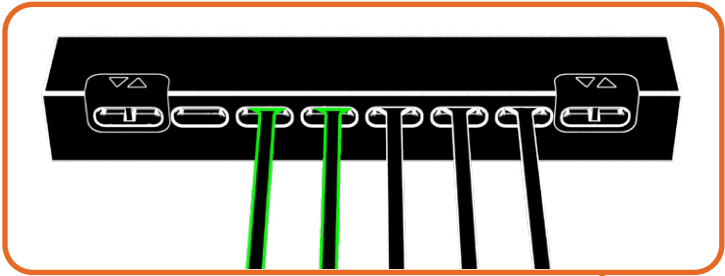

44

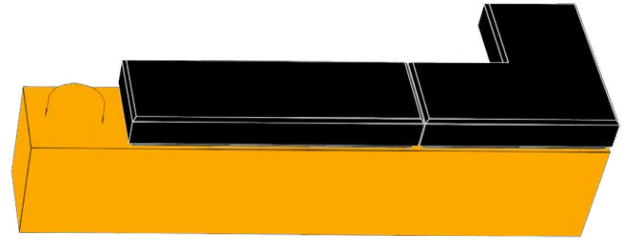
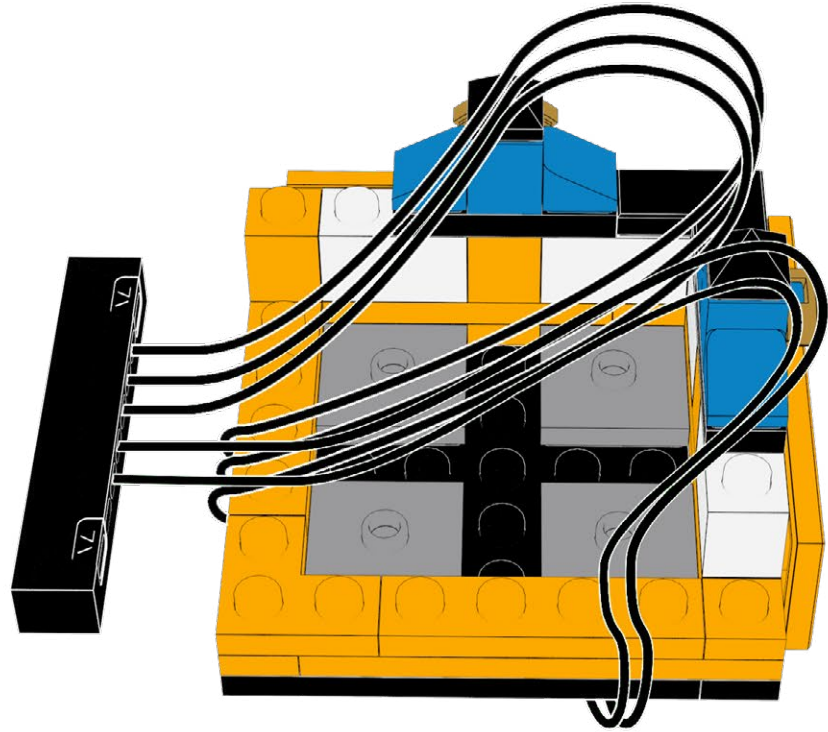

45

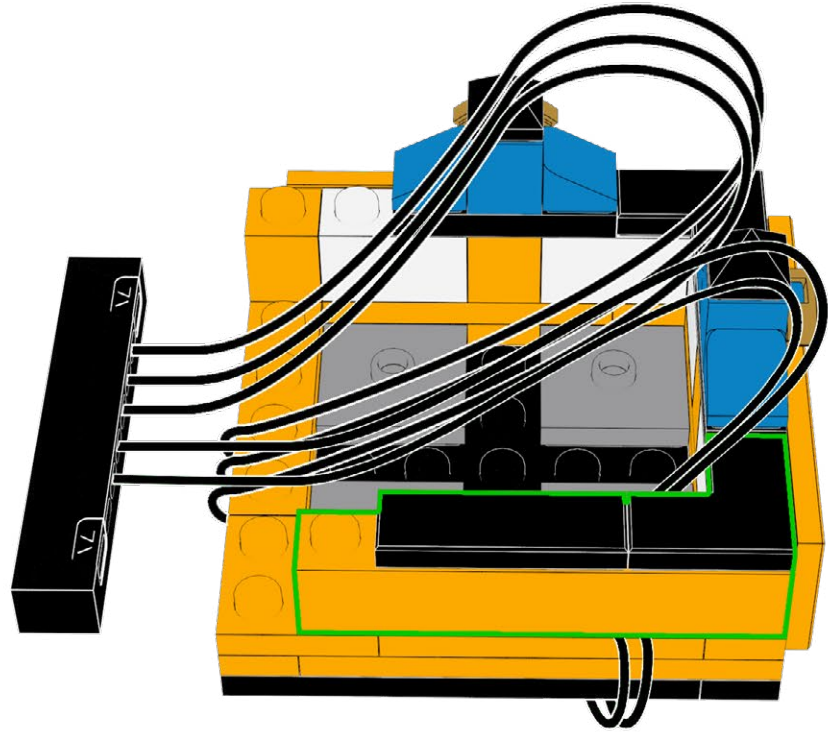

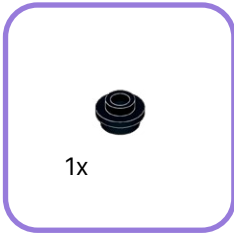
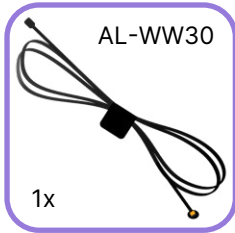

1

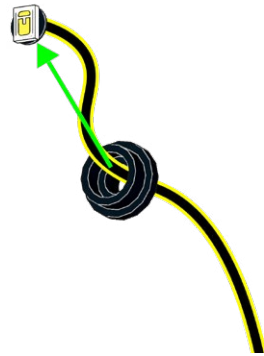

2

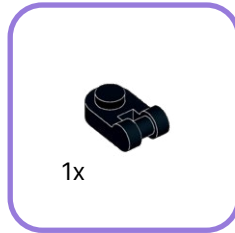

1

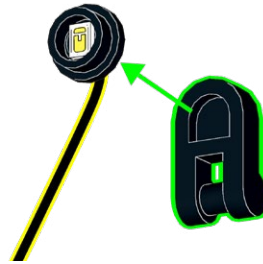

2



3

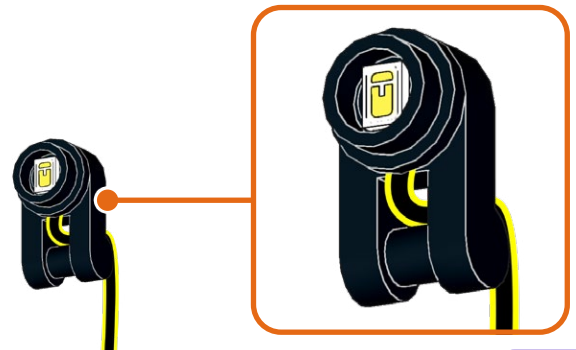

48

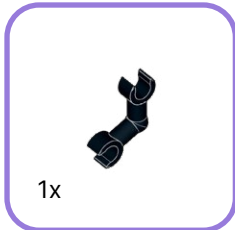

1

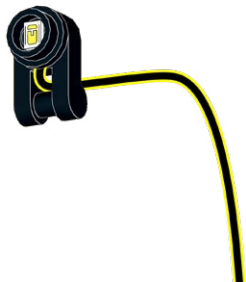

2

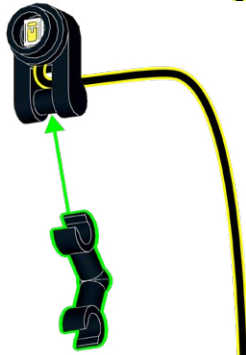

3

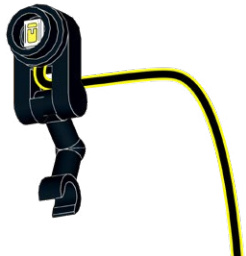

49

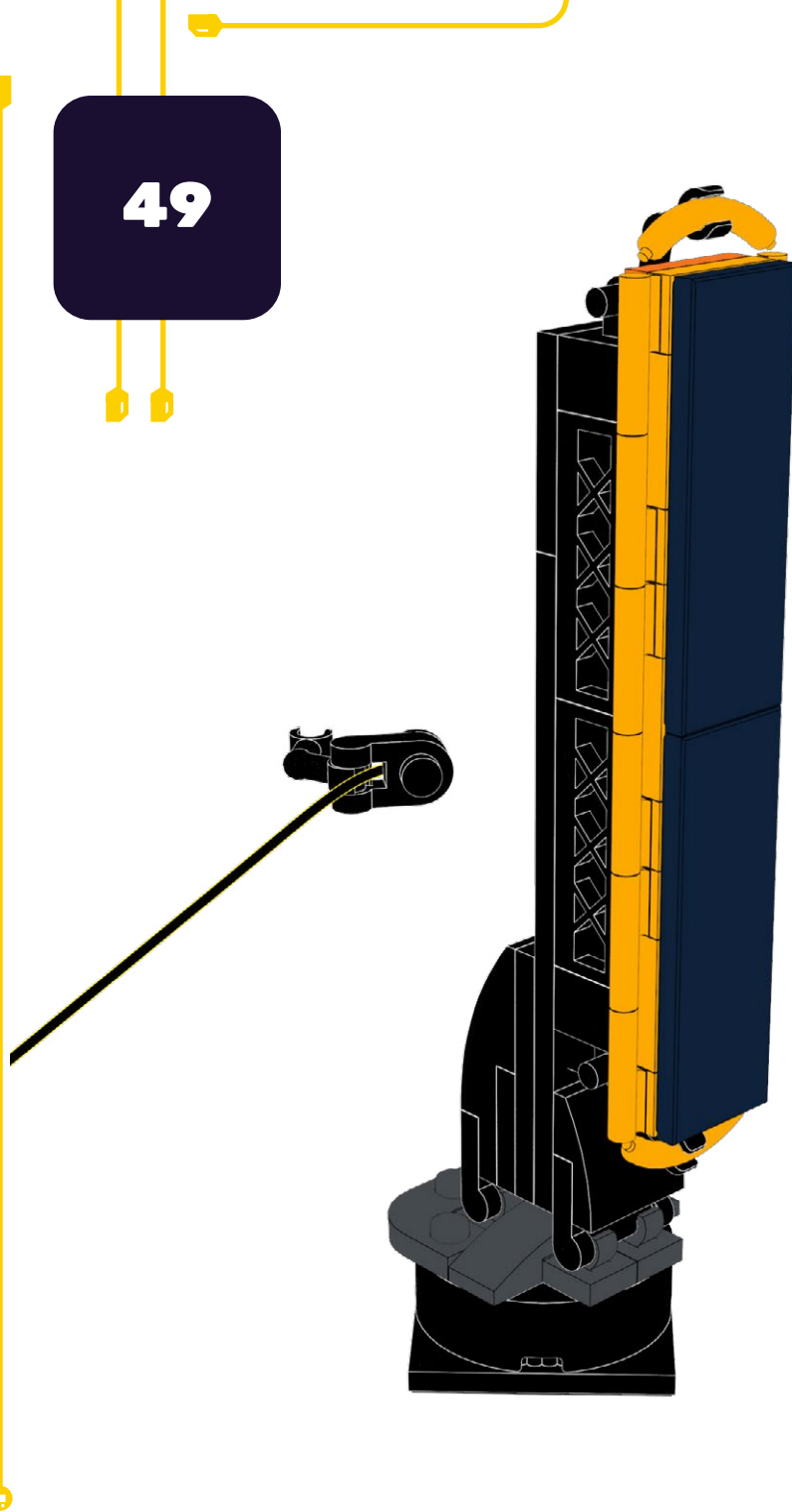

50

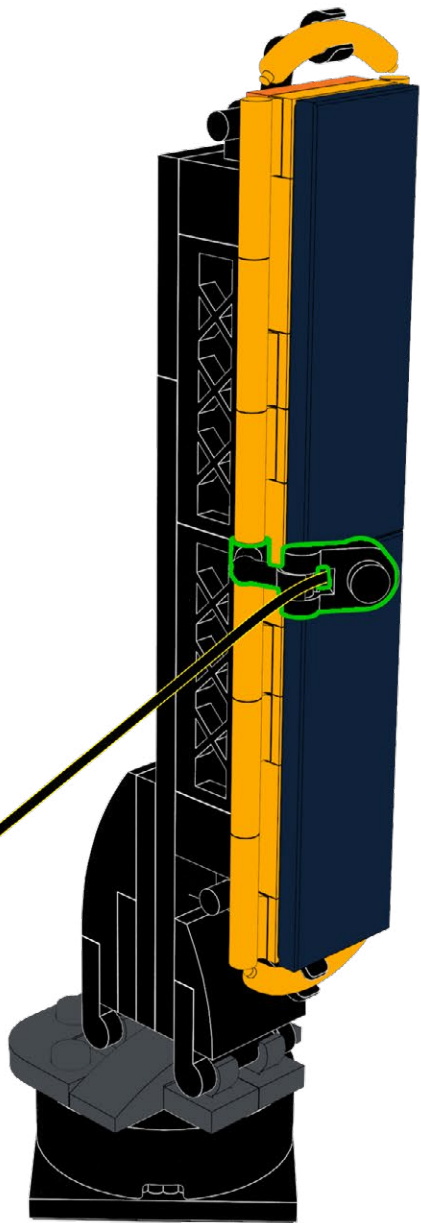
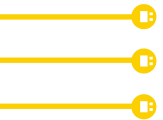

51

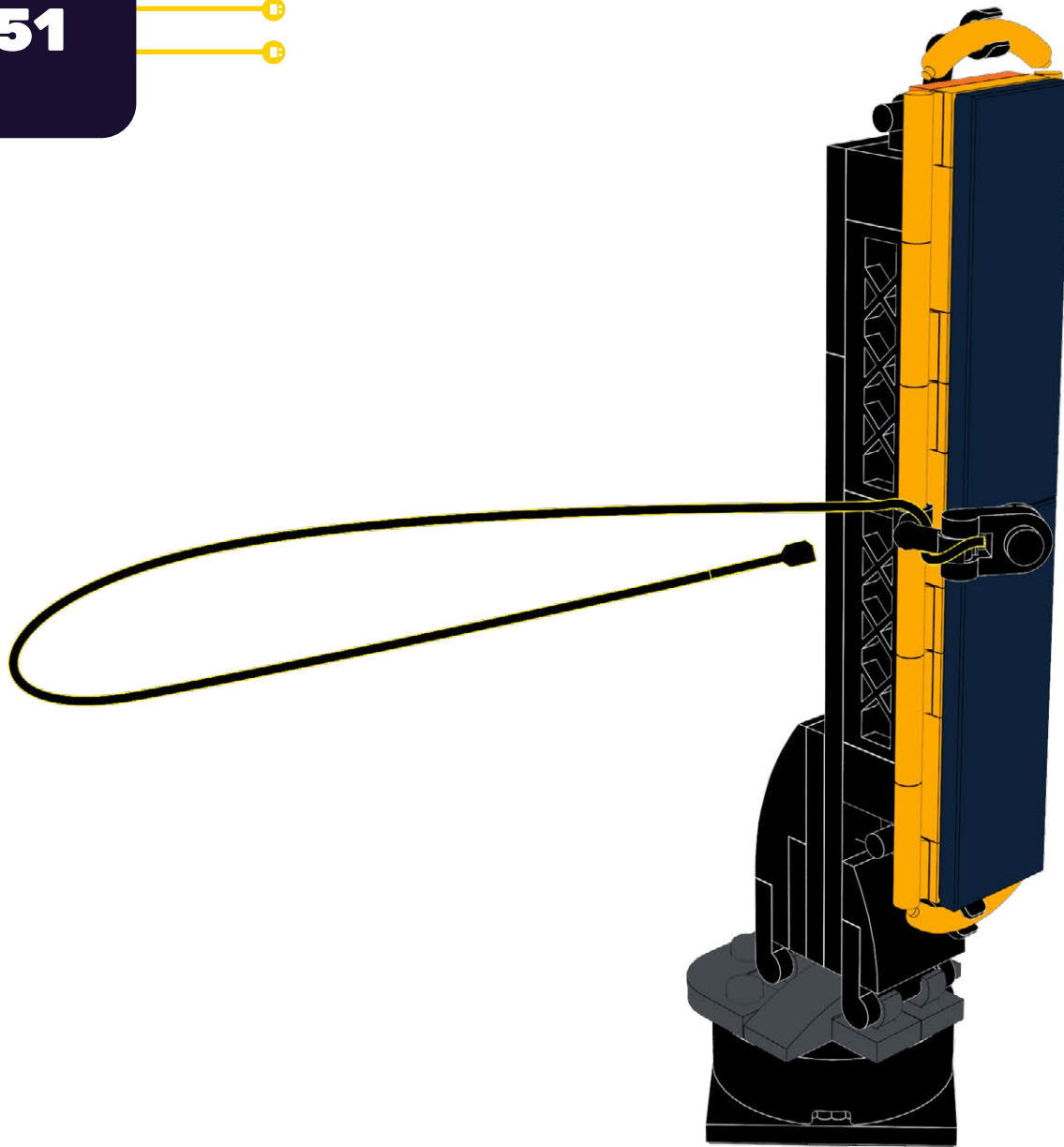

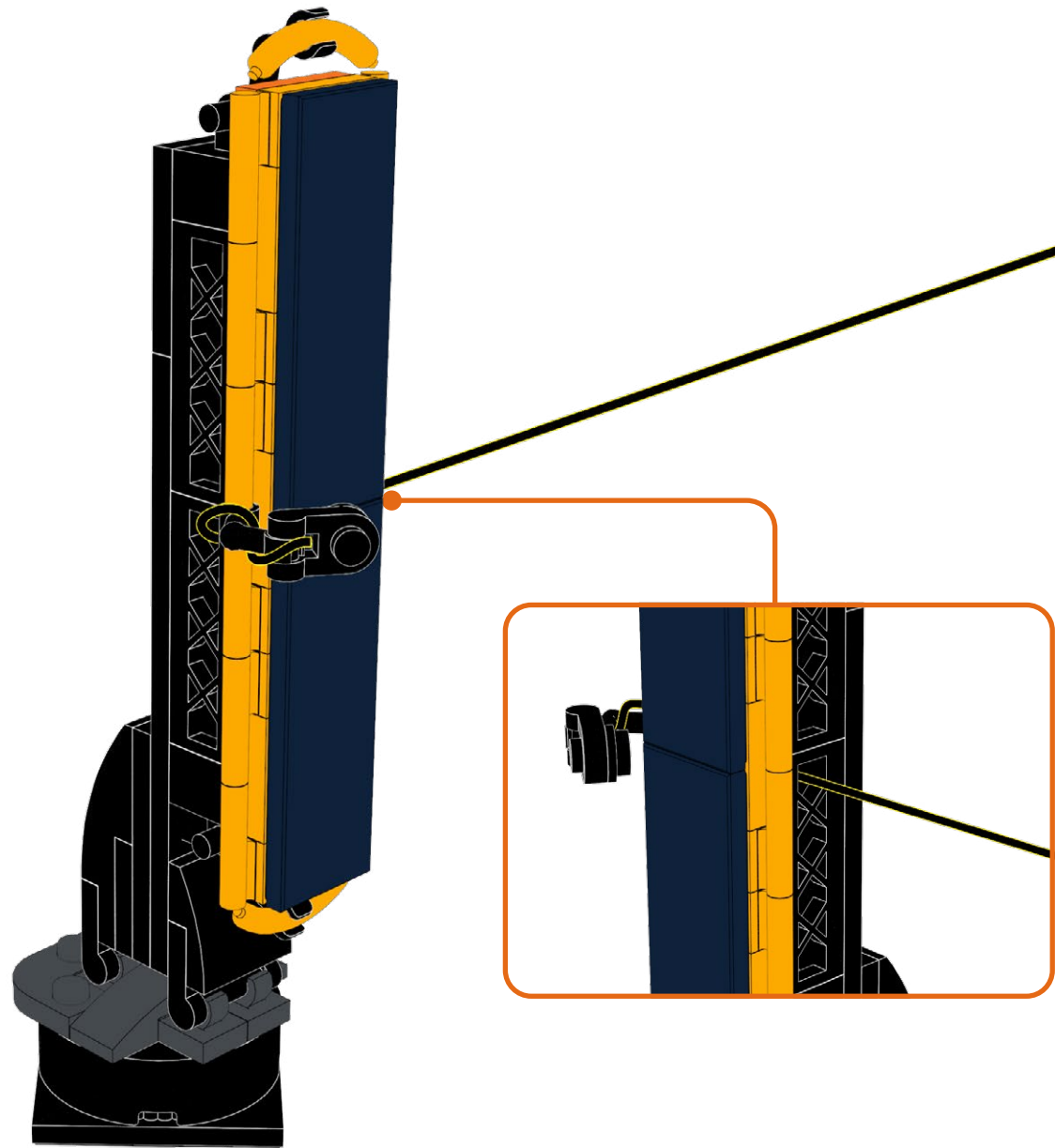

53

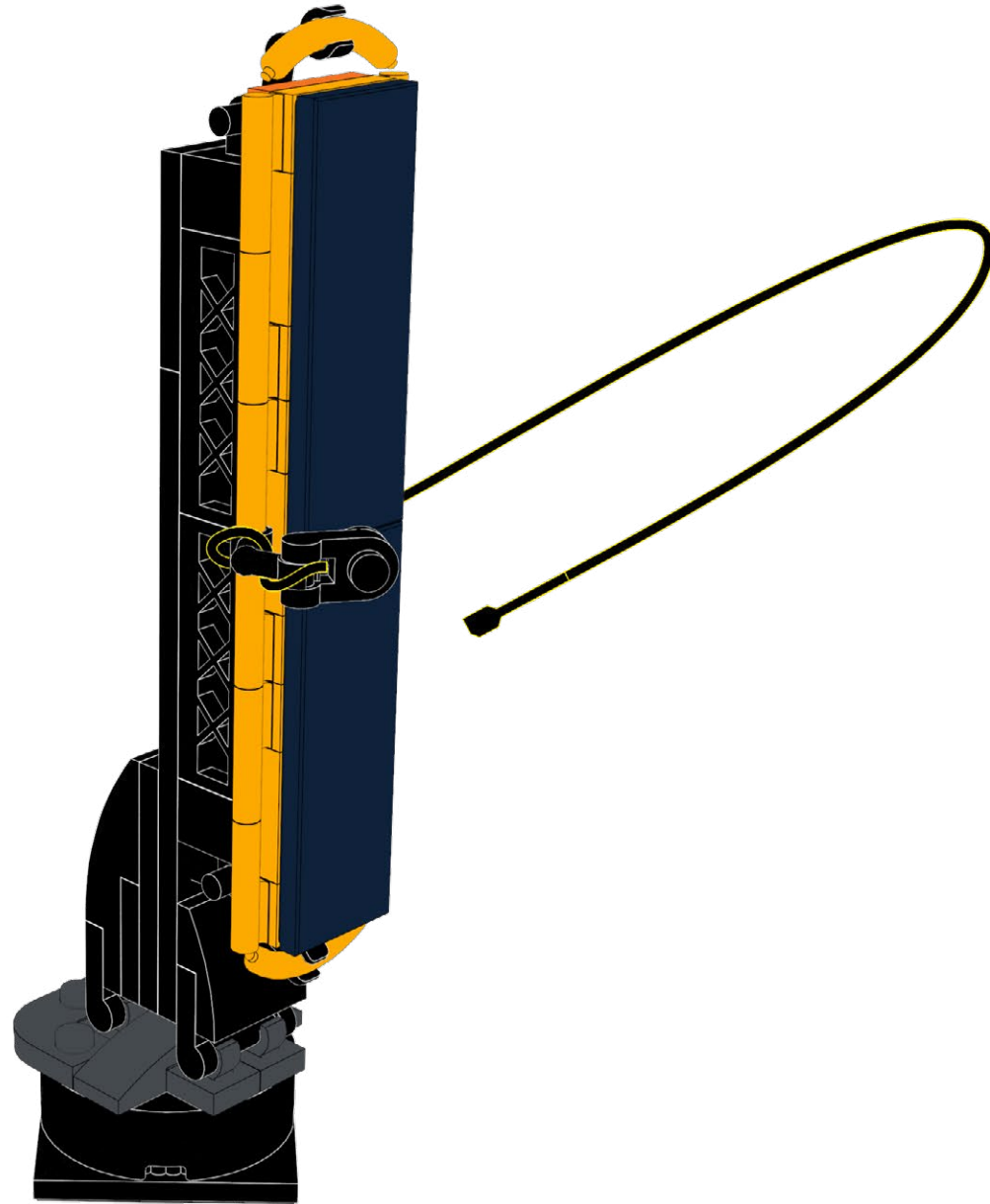

54

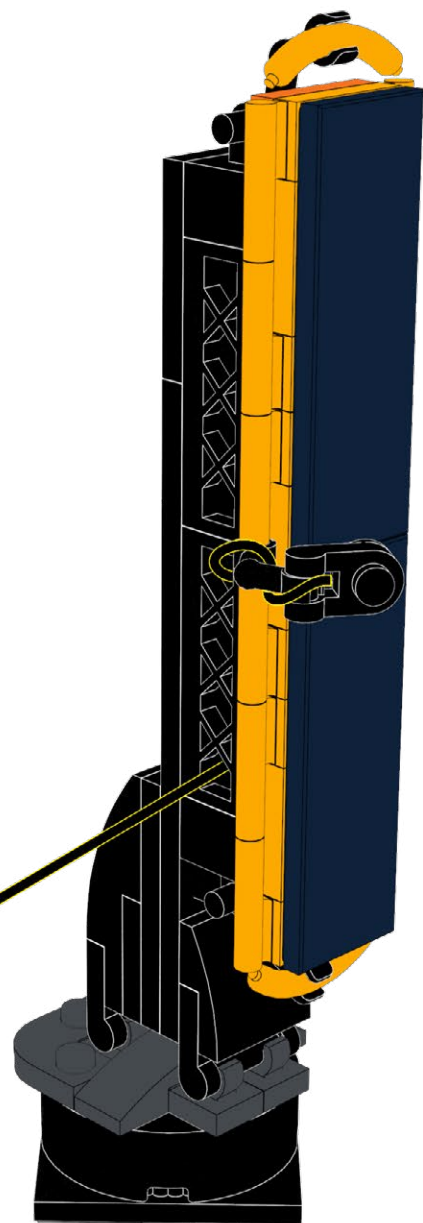

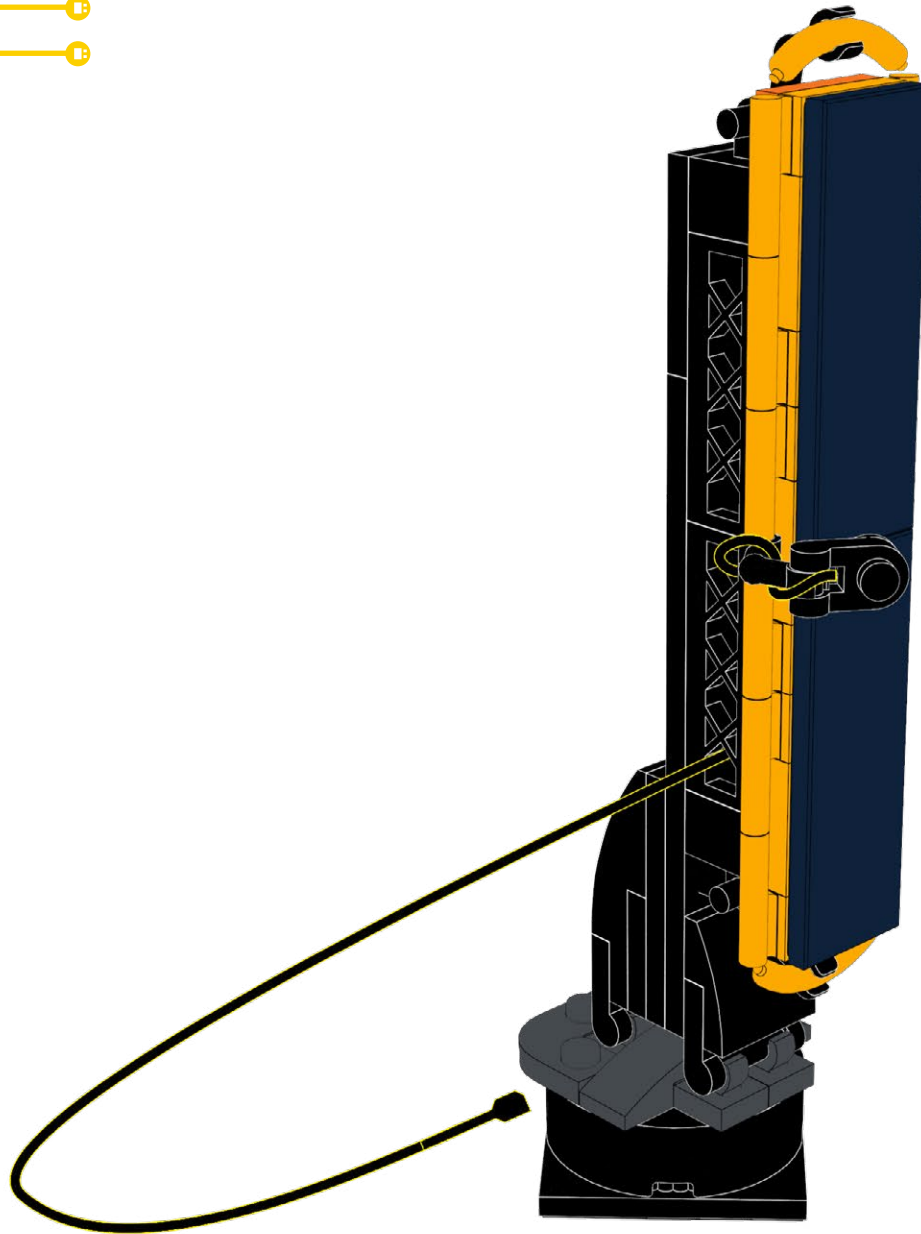
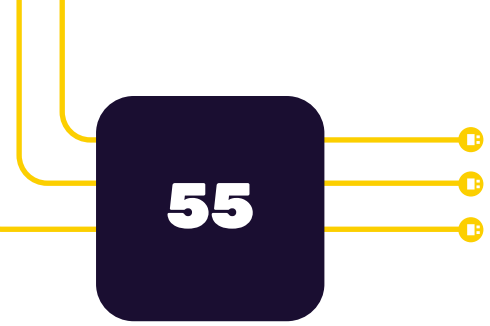

56

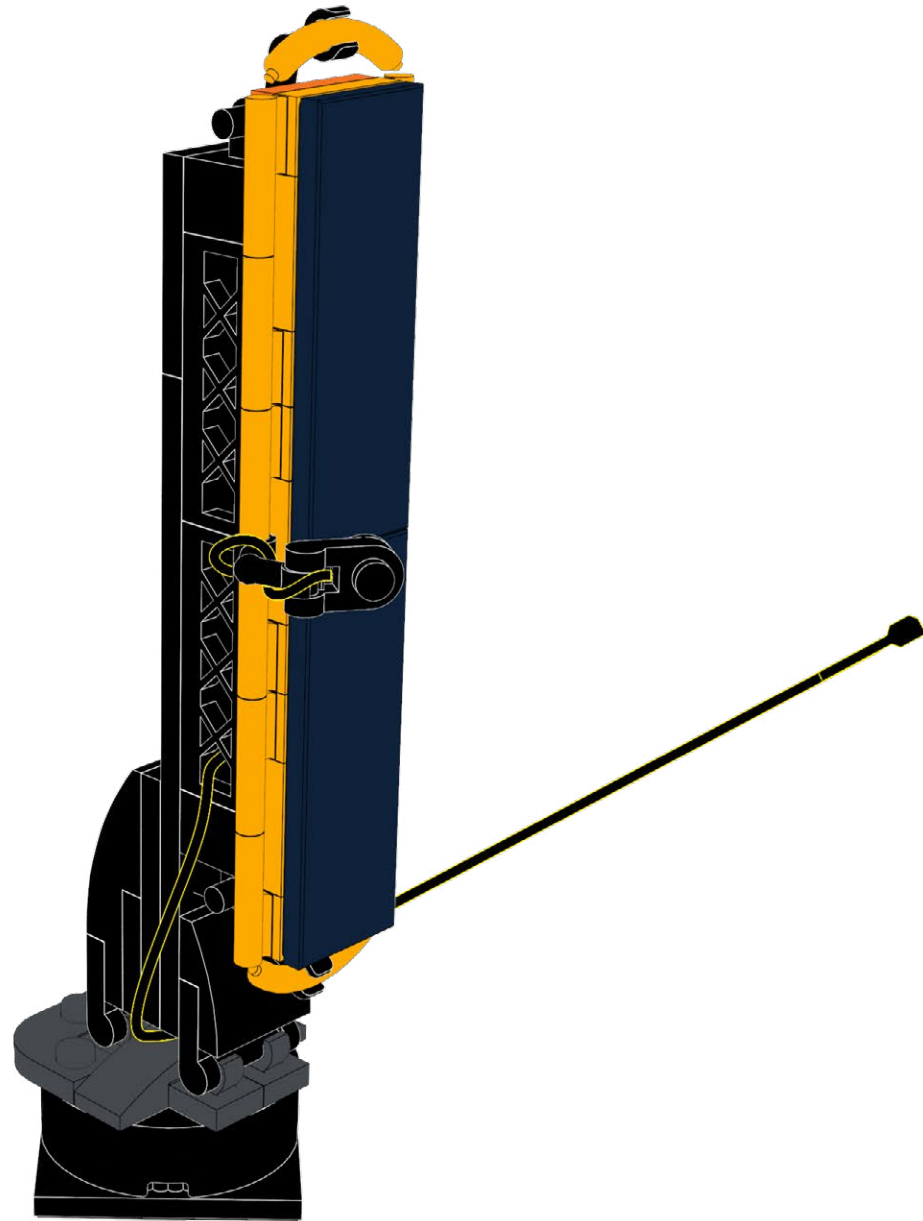

57

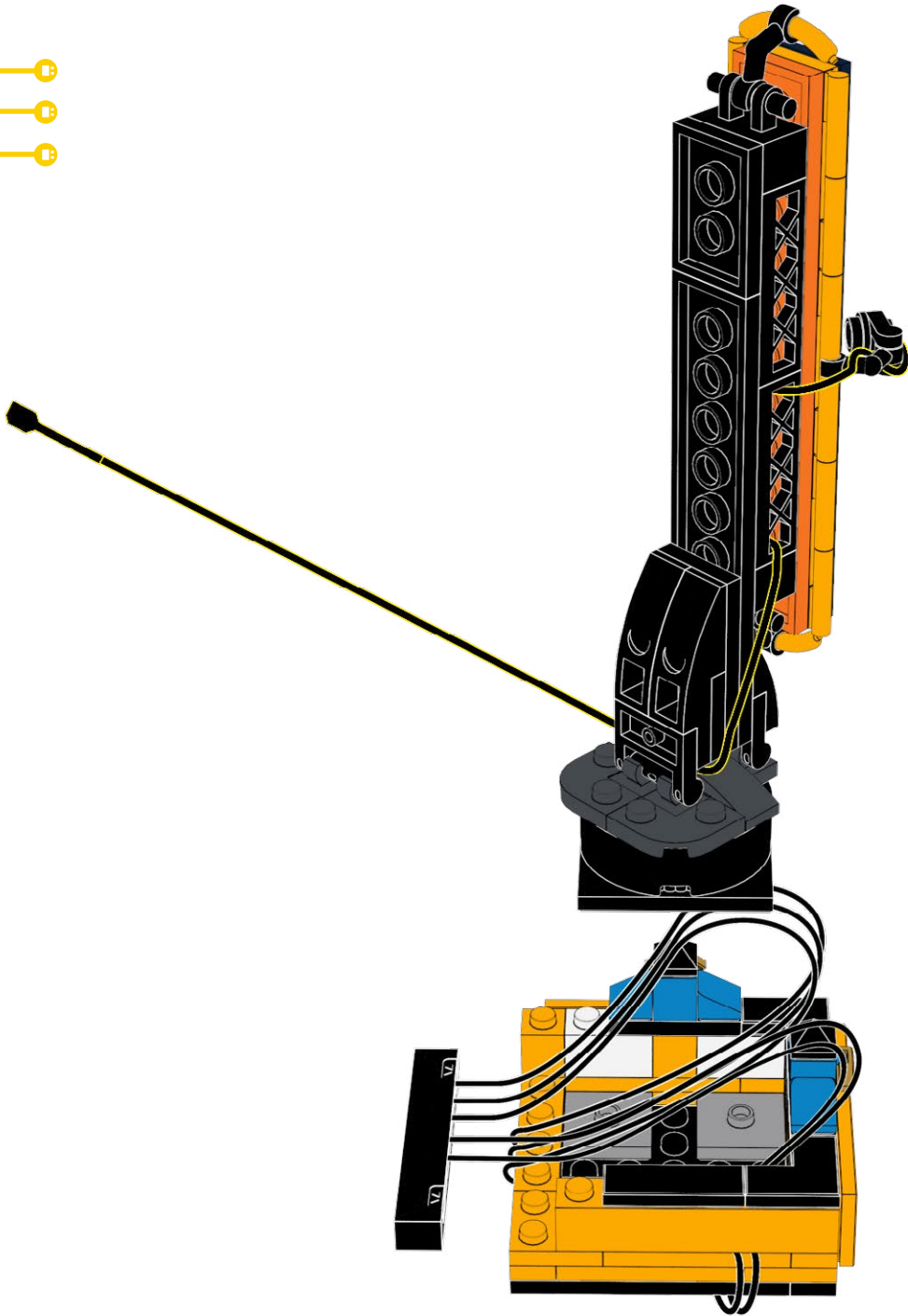

58

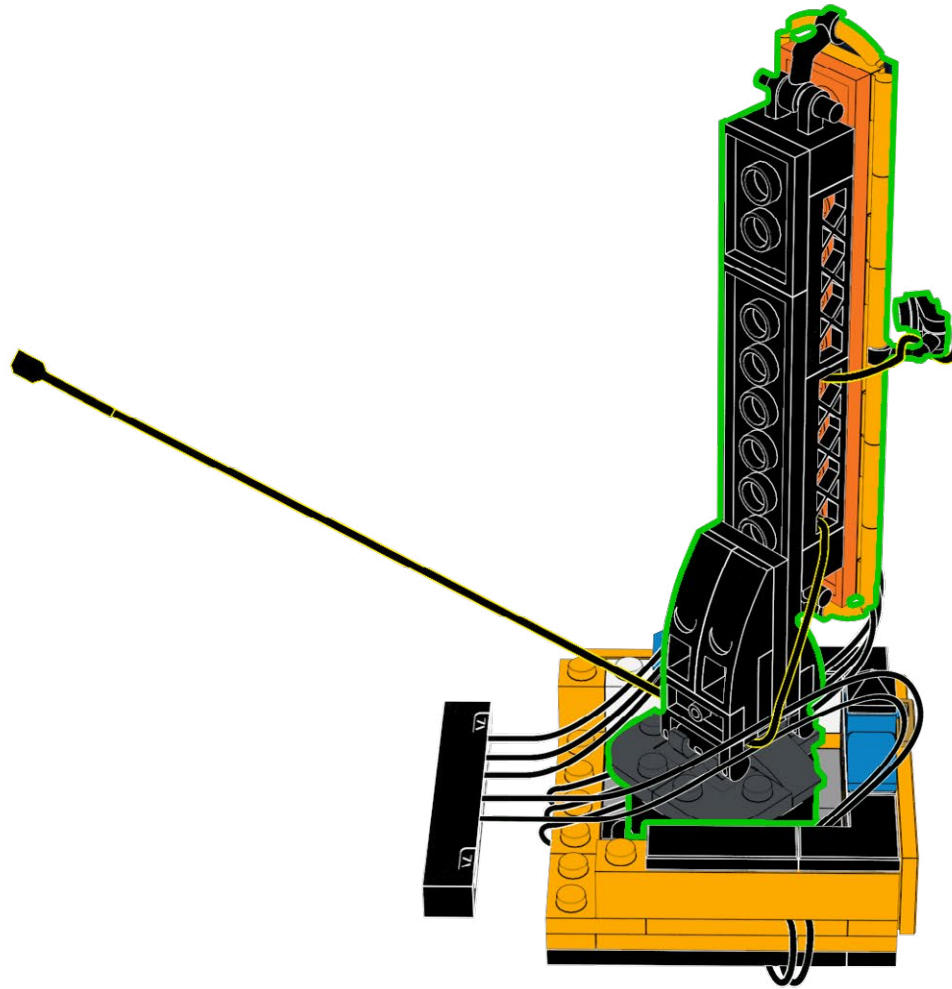
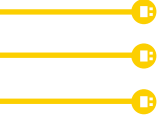

59

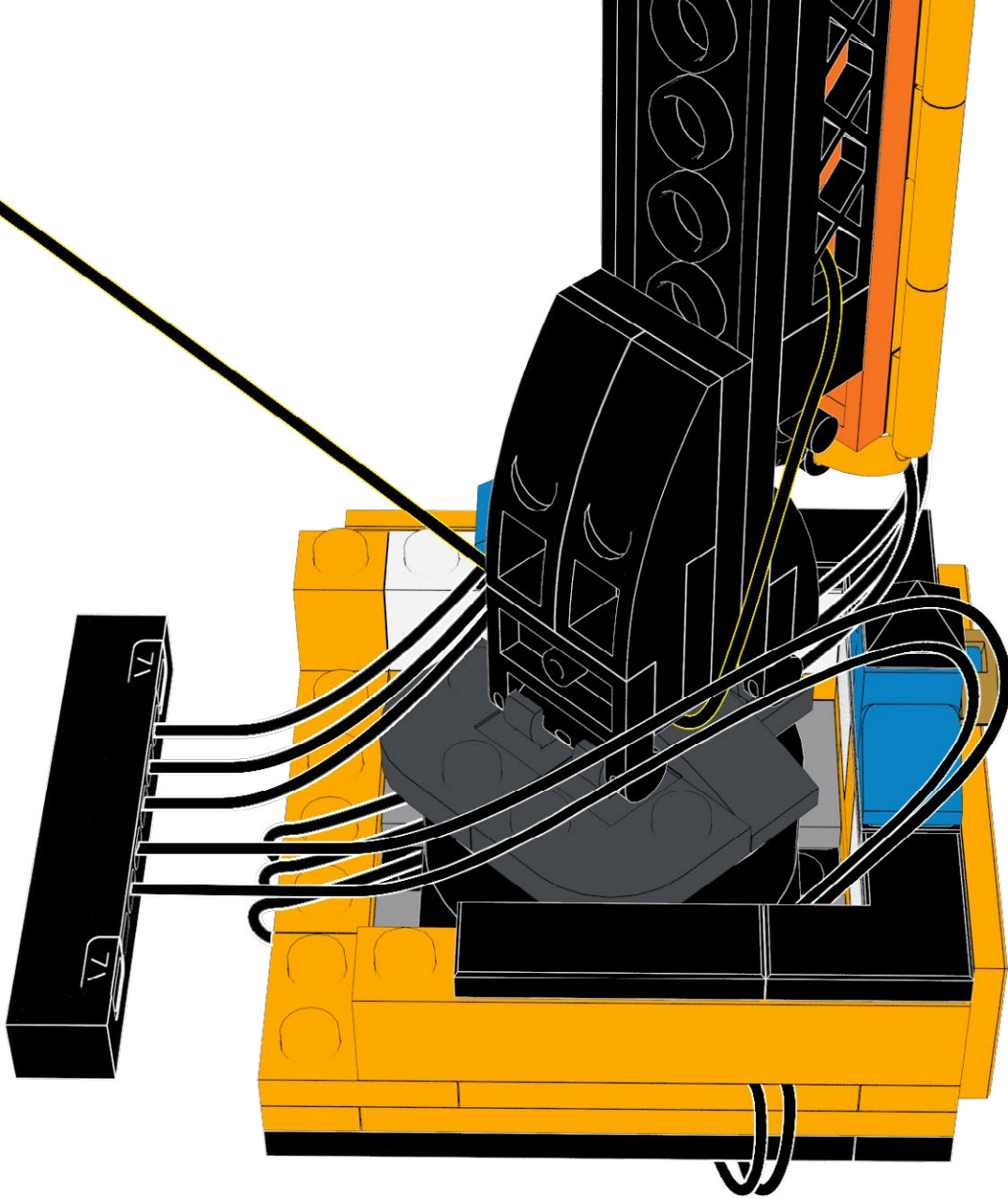

60

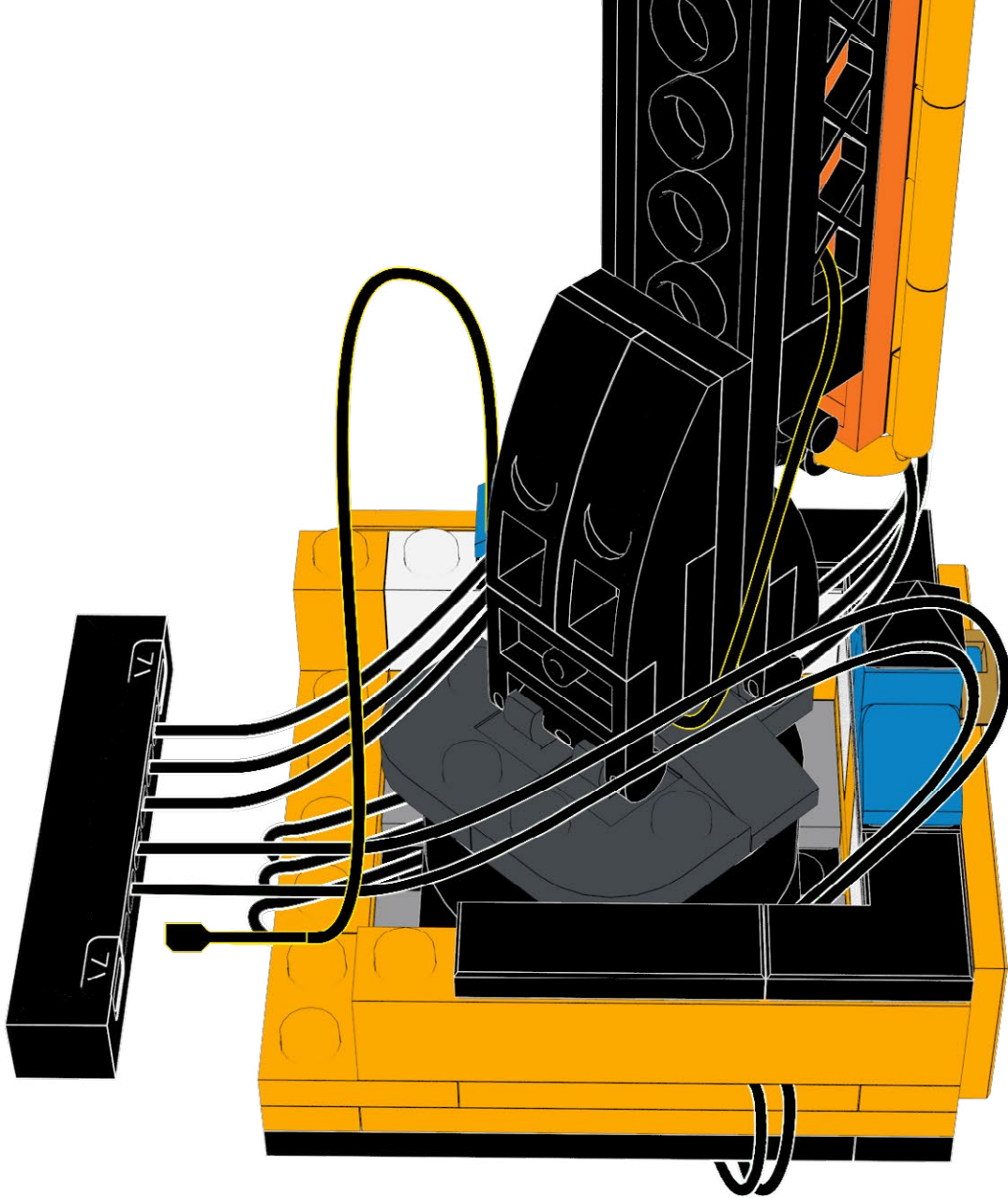

61

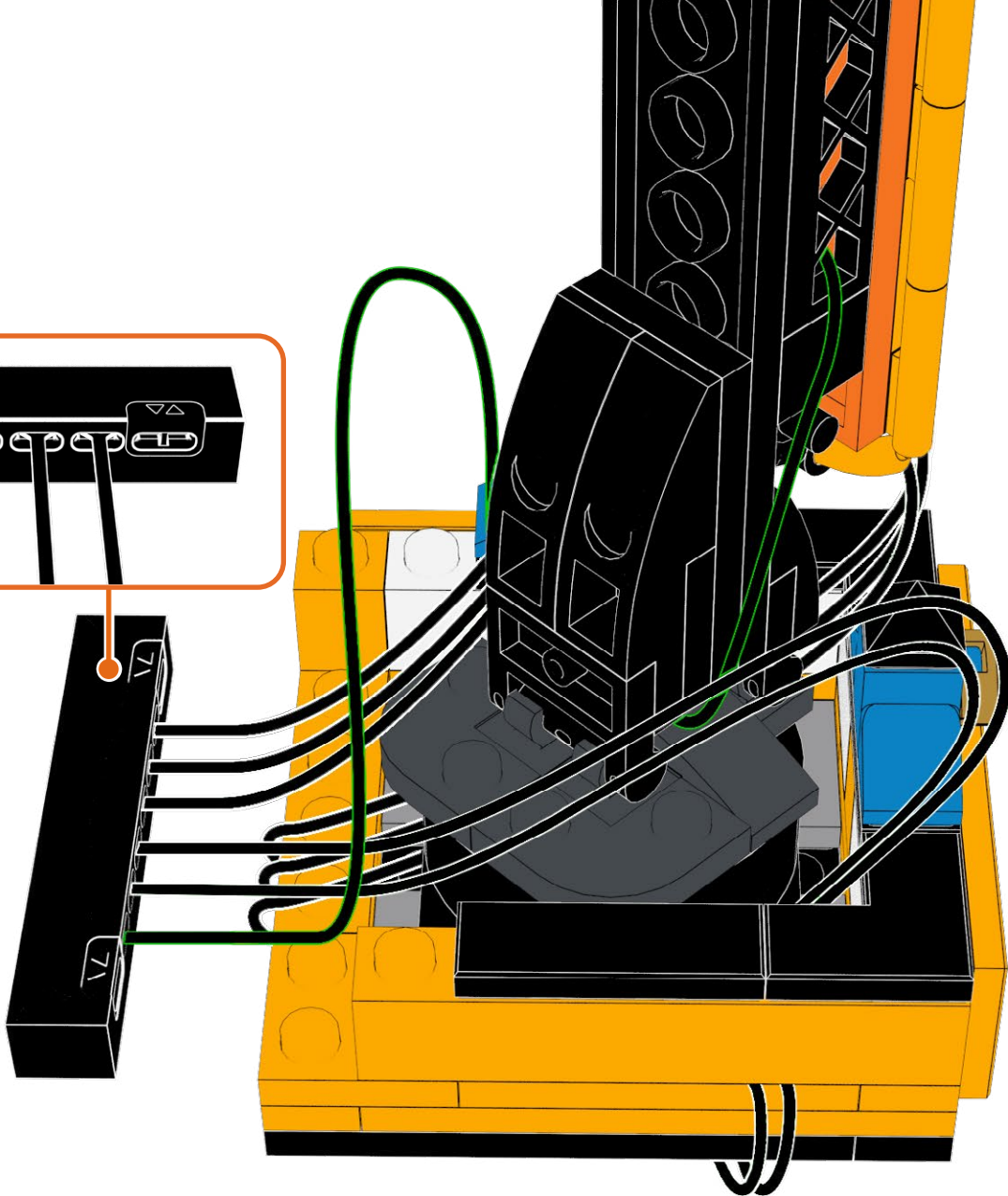
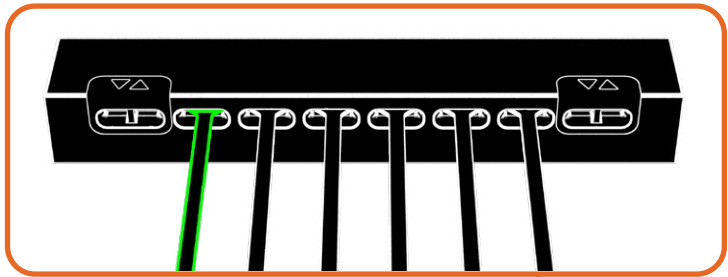

62

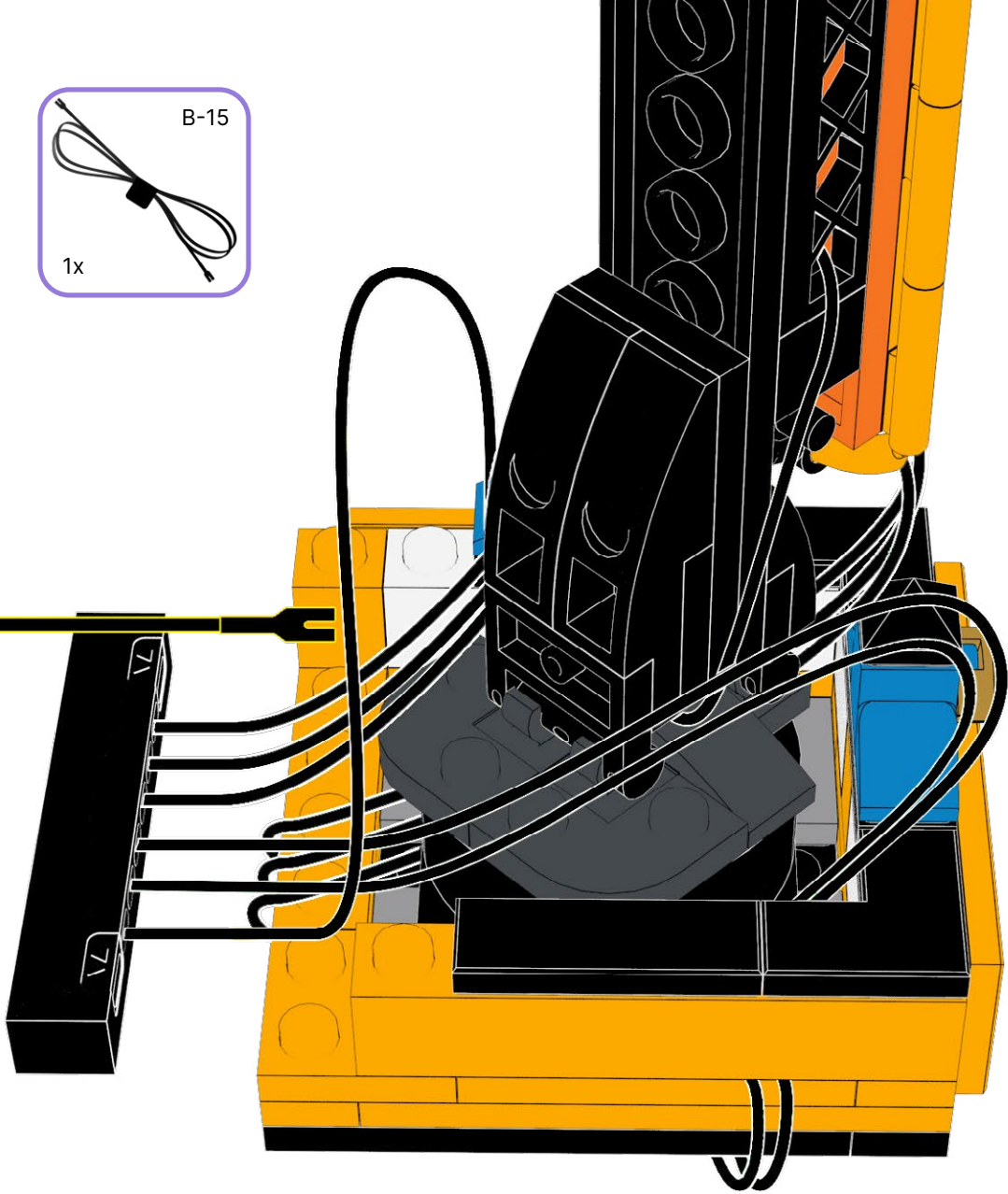
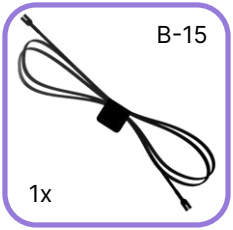

63

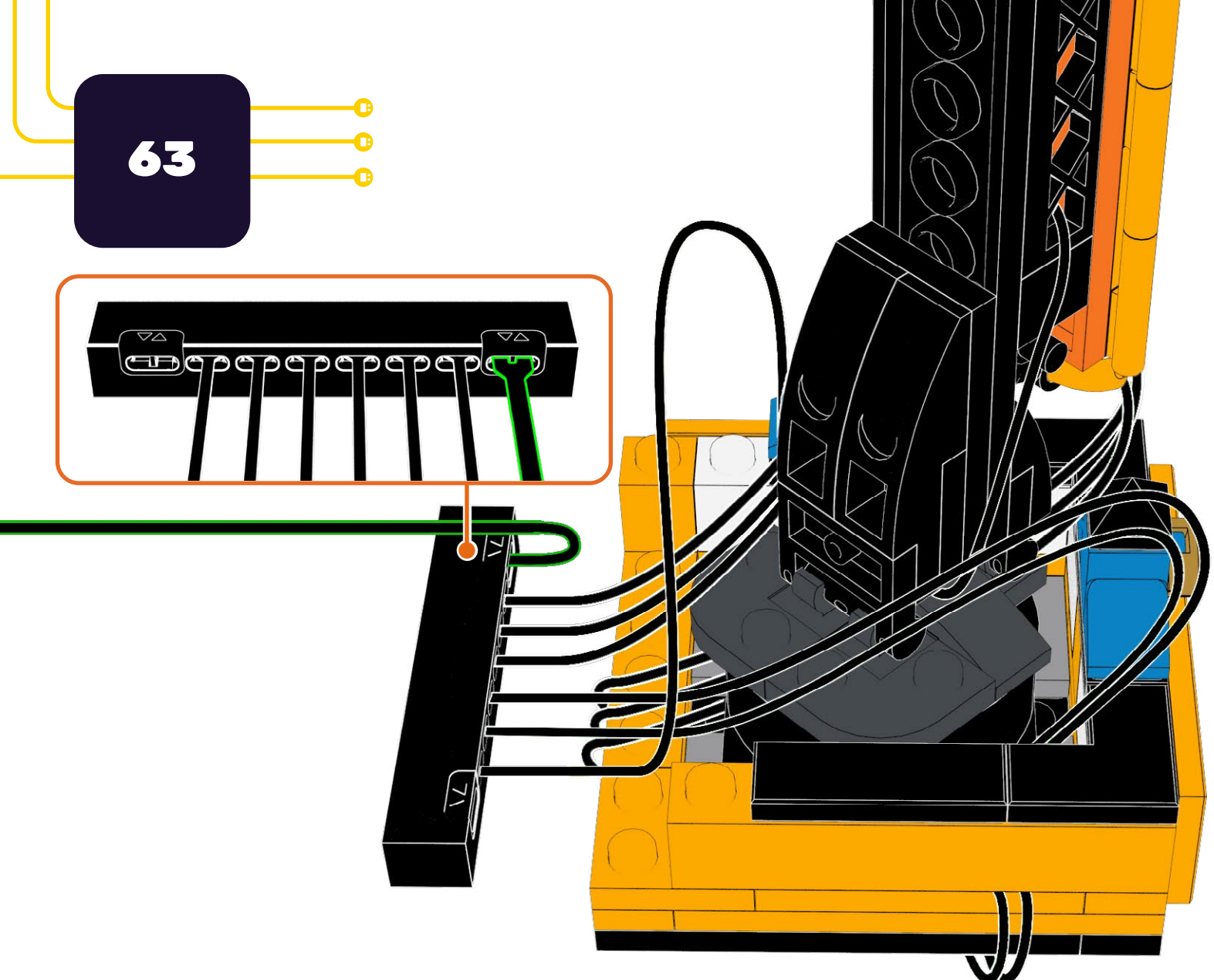
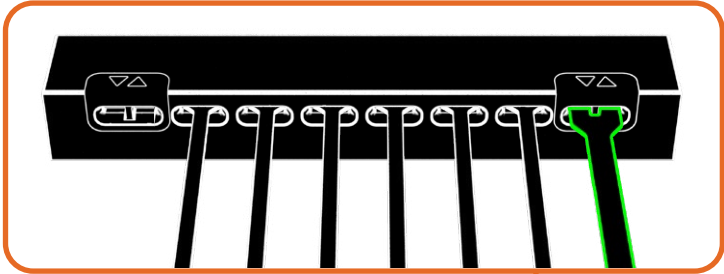

64

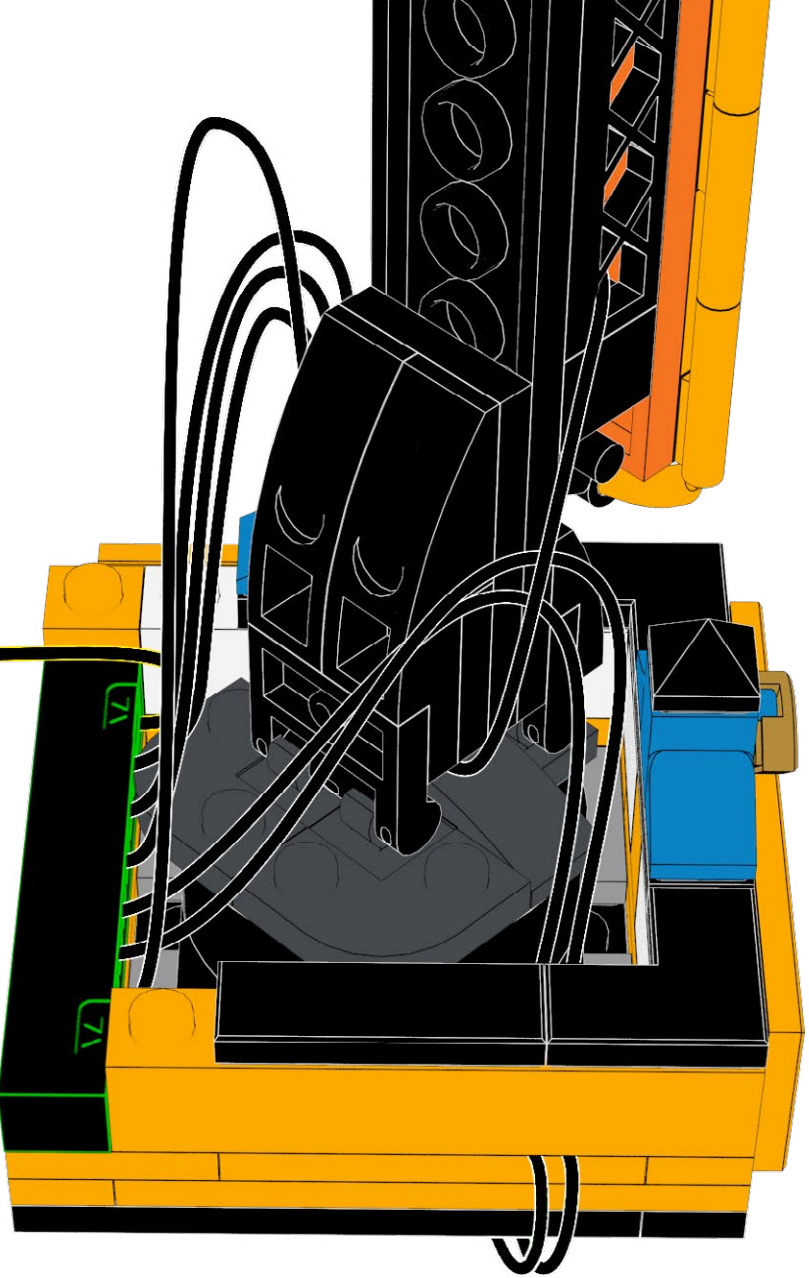

65

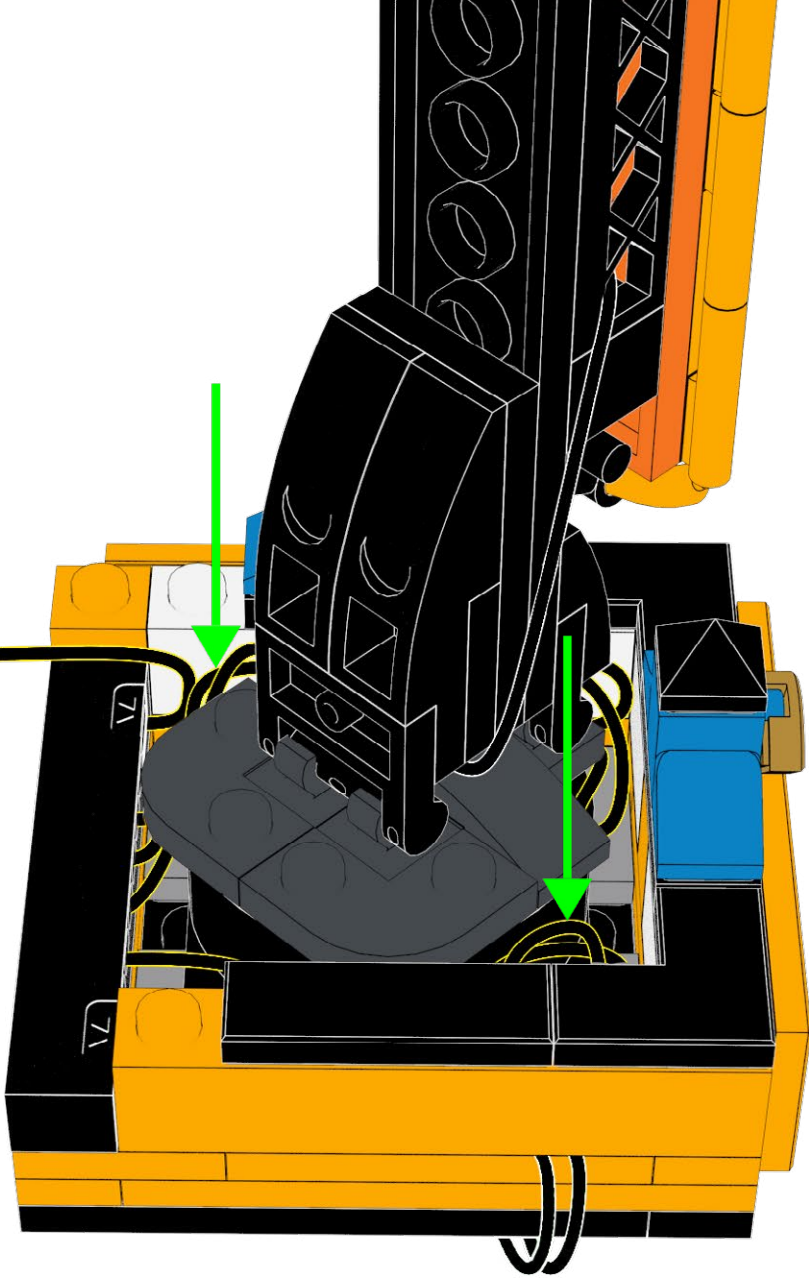

66

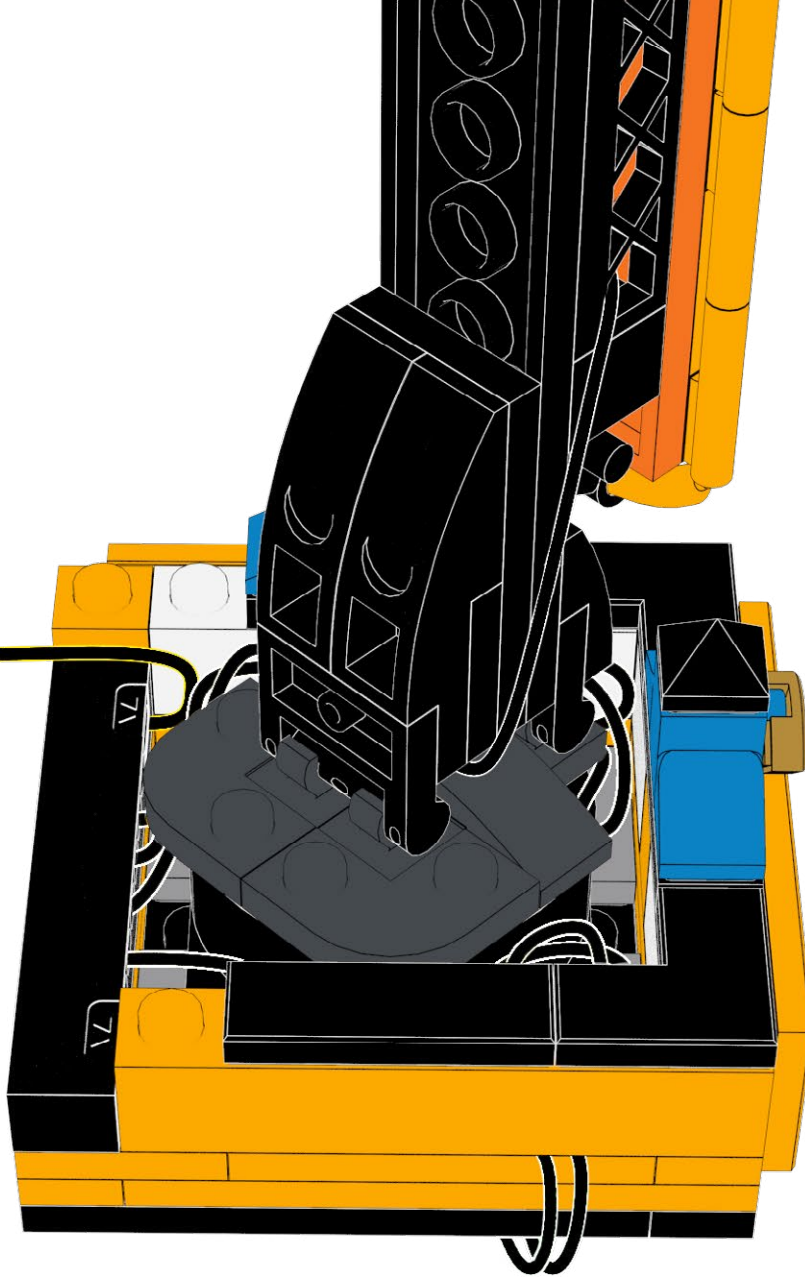

67

1x

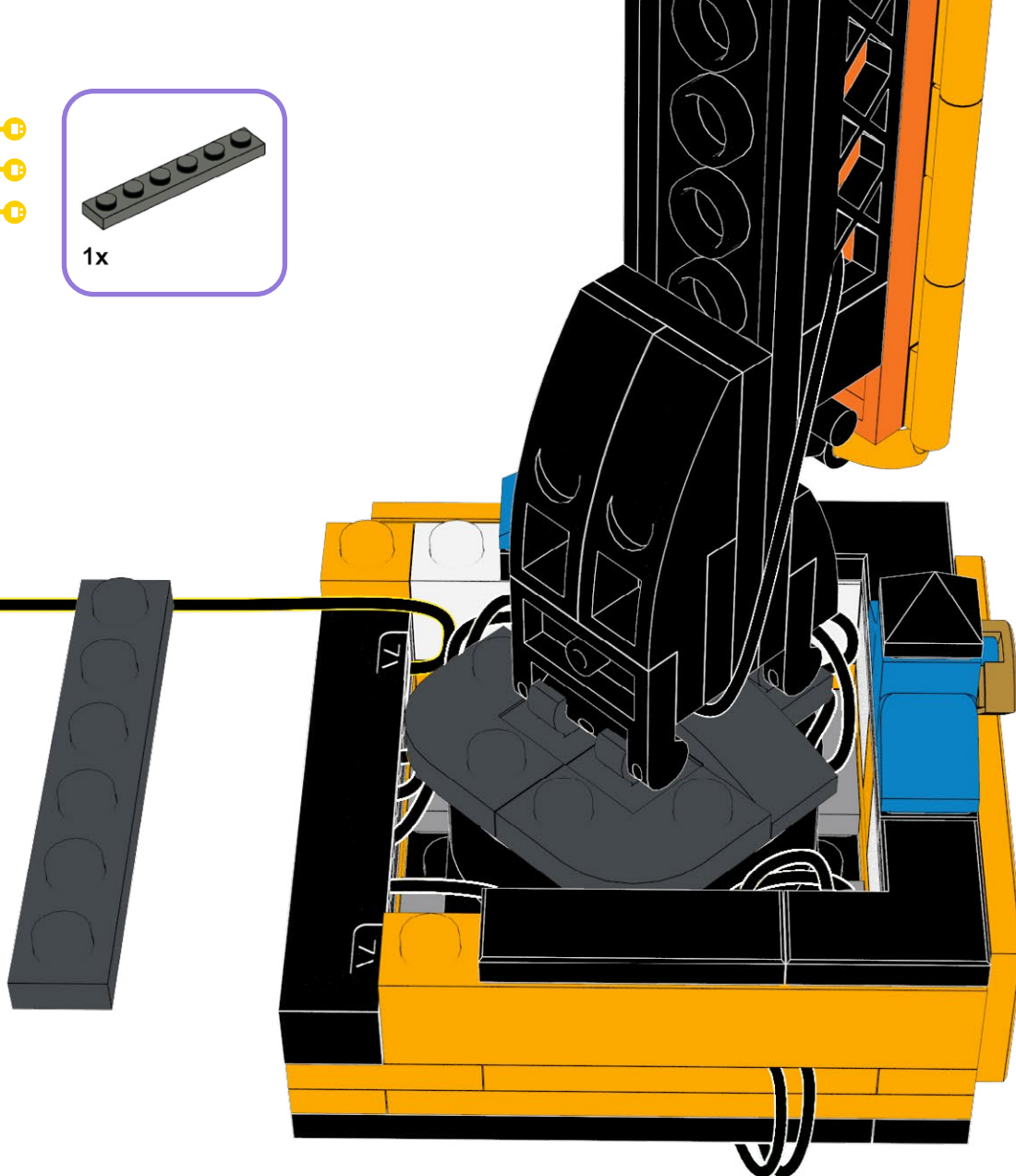

68

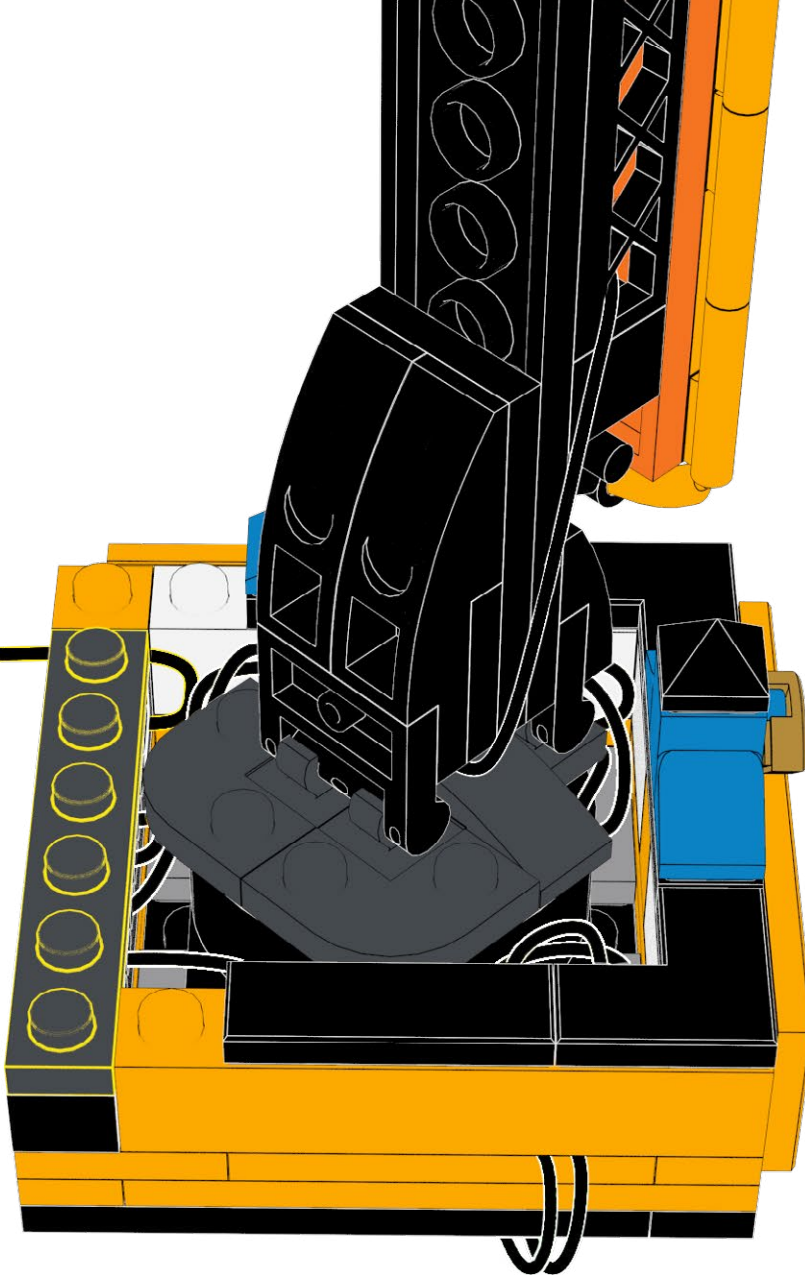

69

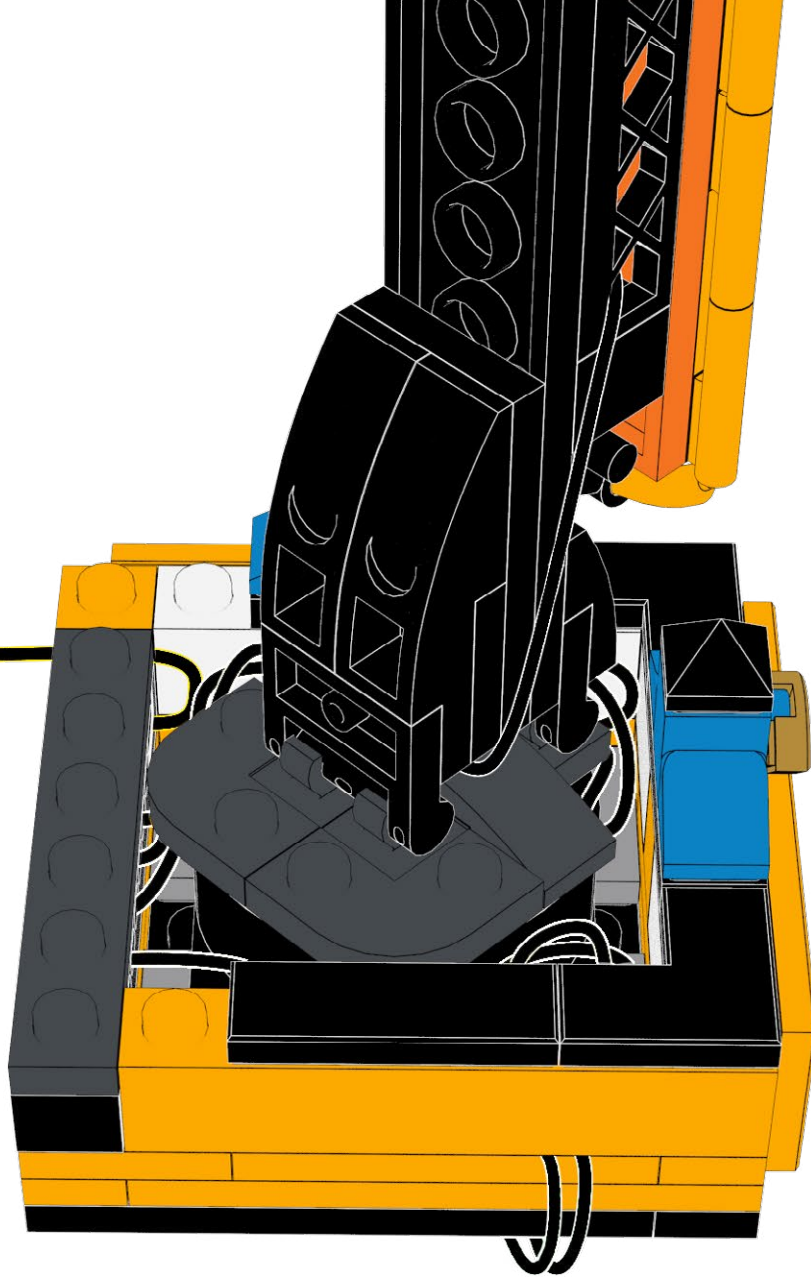
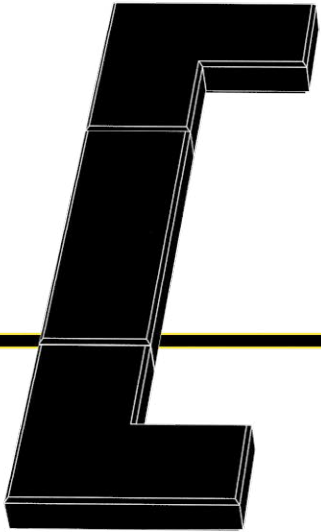

70

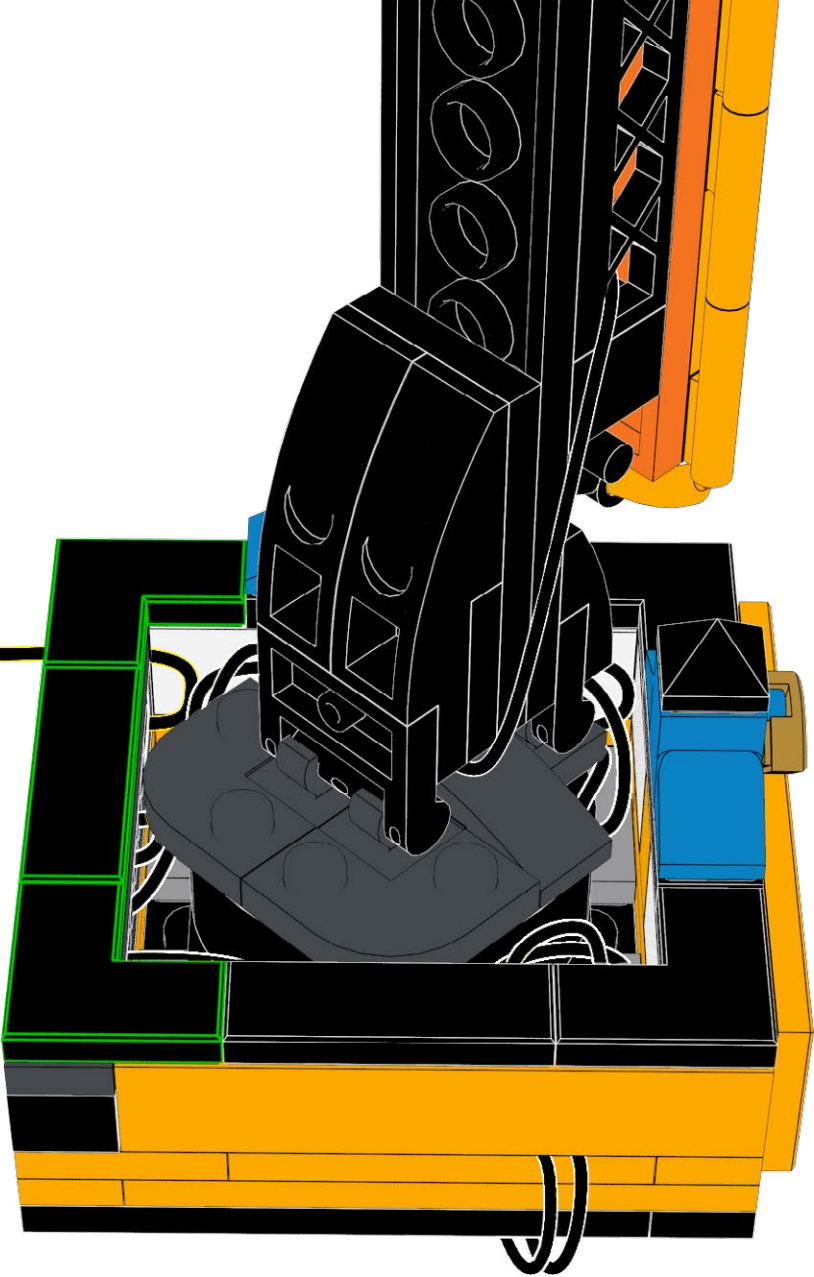

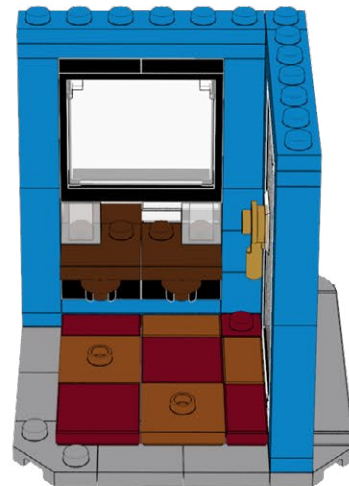
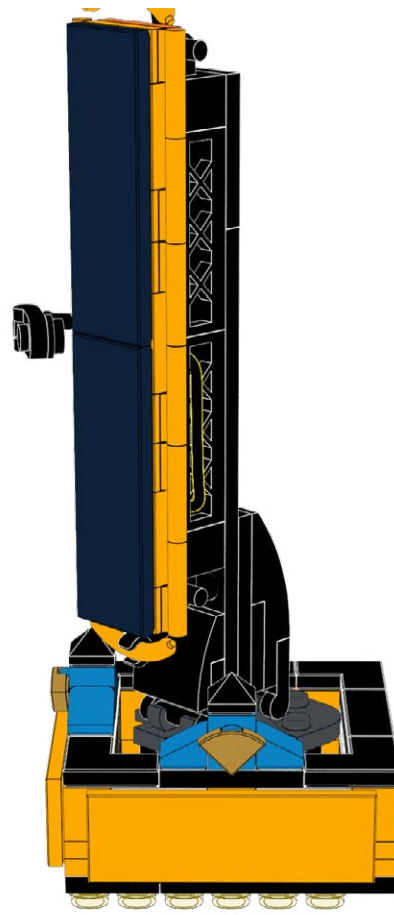
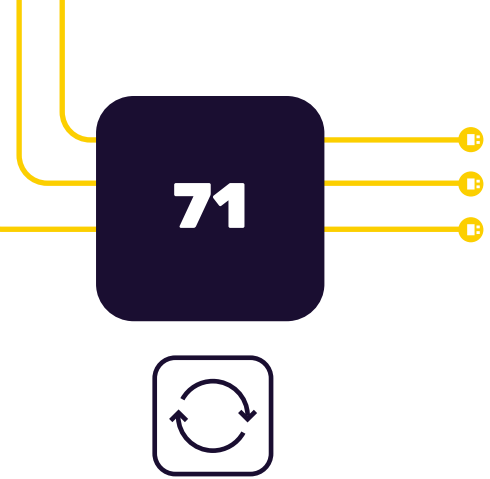

72

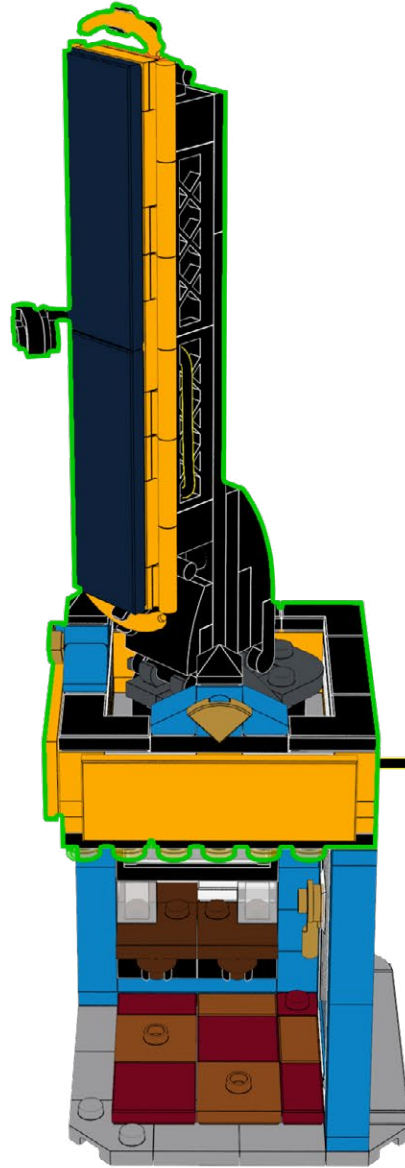

73



74



75

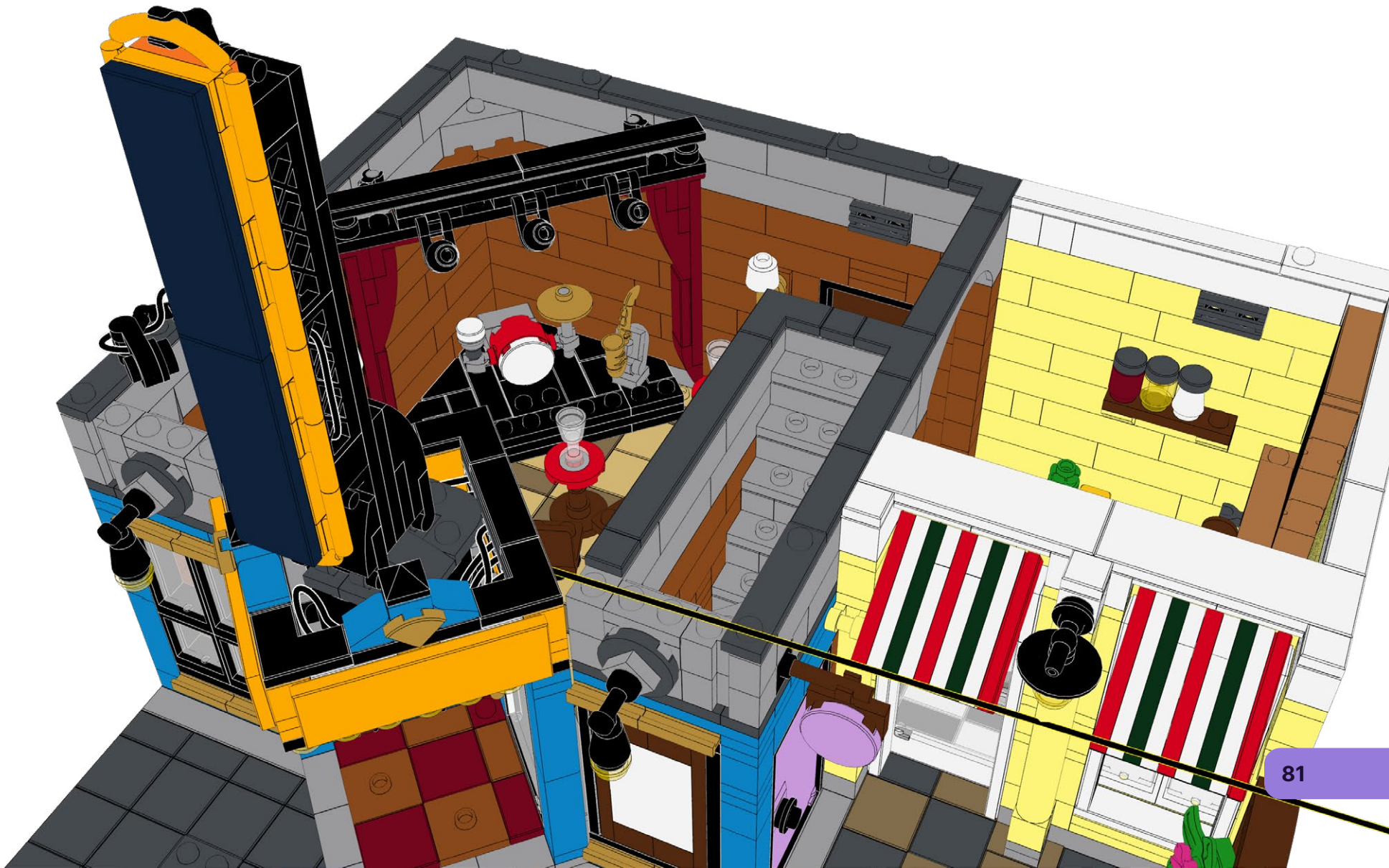

76



77

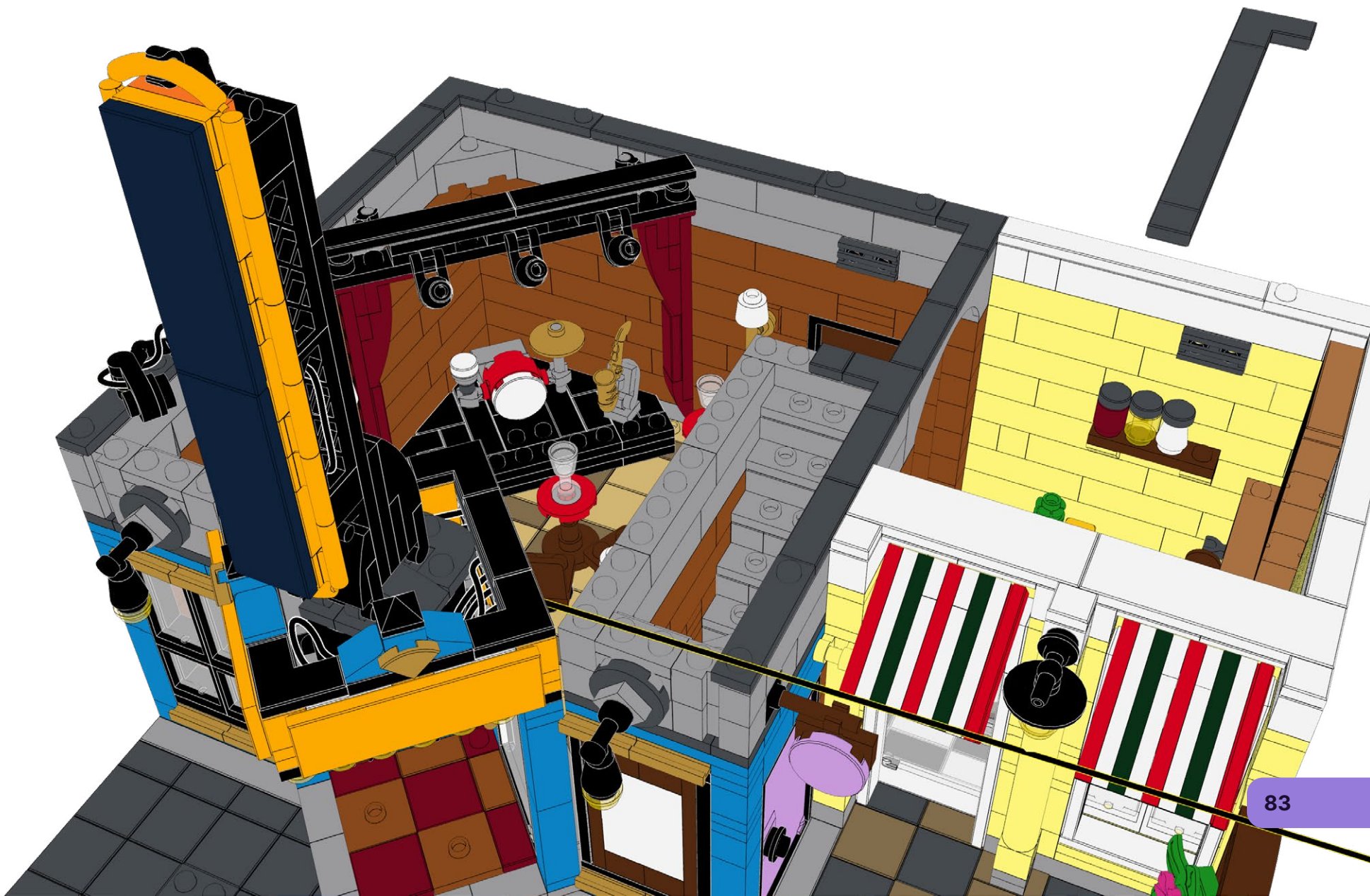



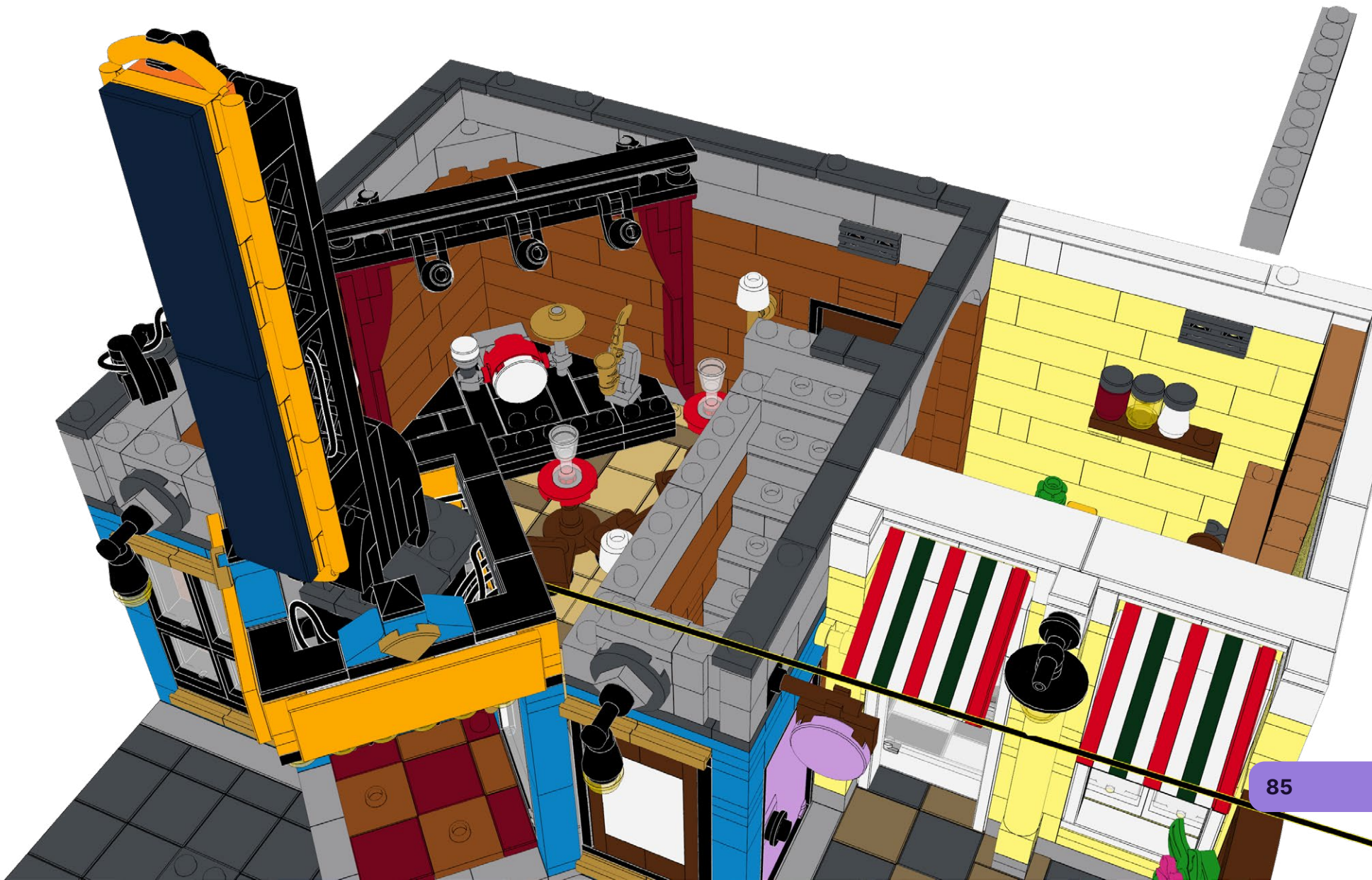



81

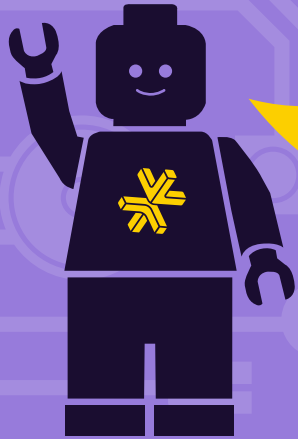

**HOLD UP!**

You might notice some bags aren't in order, as well as left over pieces, but that's ok! We're changing the way you build LEGO!

ATTENDEZ!

Vous remarquerez peut-être que certains sacs, ainsi que certaines pièces, ne sont pas dans le bon ordre. Mais pas de panique! Nous changeons simplement la façon avec laquelle vous construisez vos LEGO!

ASPETTA!

Potresti notare che alcuni sacchetti non sono in ordine, così come i pezzi avanzati, ma va bene così! Stiamo cambiando il modo in cui costruisci i LEGO!

HALT!

Sie werden möglicherweise bemerken, dass einige tüten durcheinander sind und teile übrig bleiben, aber das ist in Ordnung! Wir ändern die art und weise, wie Sie LEGO bauen!

¡ESPERA!

Es posible que notes que algunas bolsas están fuera de servicio, así como piezas sobrantes, ¡pero está bien! ¡Estamos cambiando la forma en que construyes LEGO!

暫停!

你可能会注意到一些袋子顺序错乱, 以及一些剩余的部件, 但没关系! 我们正在改变你搭建乐高的方式!

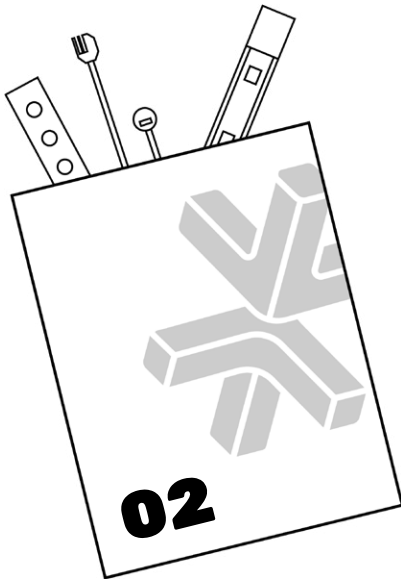
Open LMB Bag 02

82

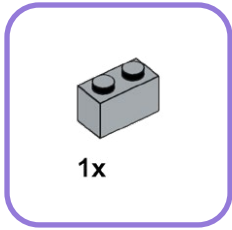



84



2x



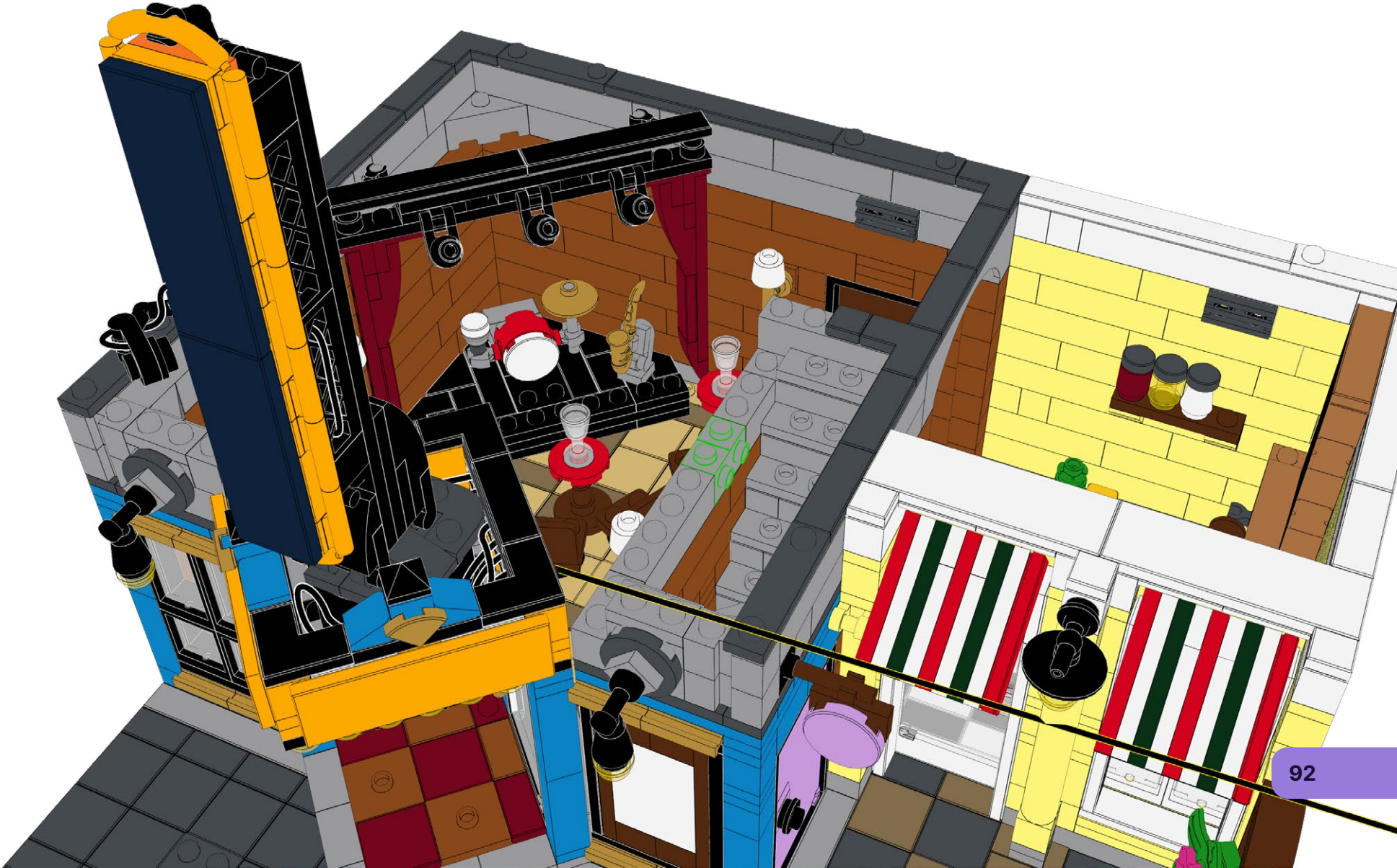



87

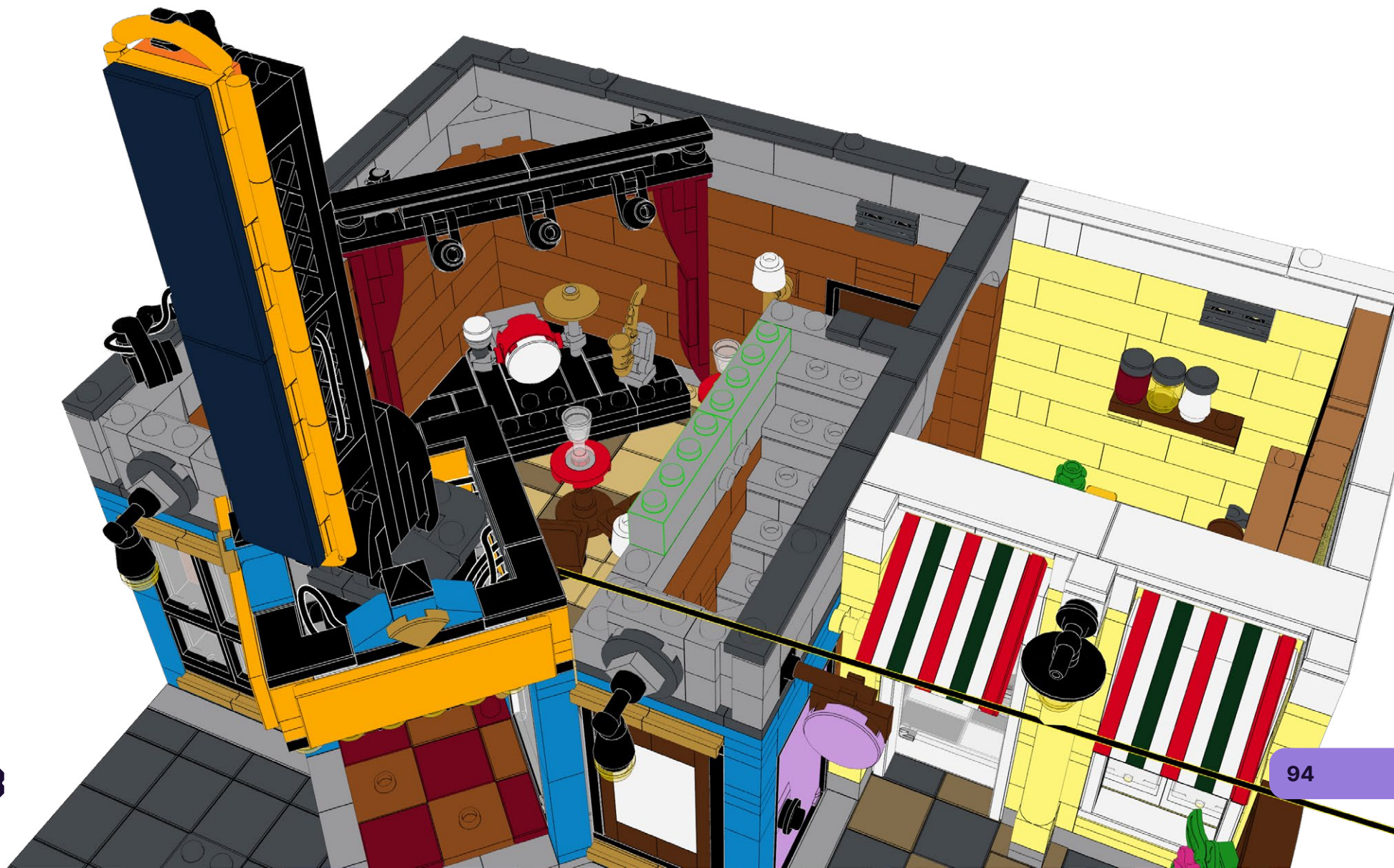

88



89

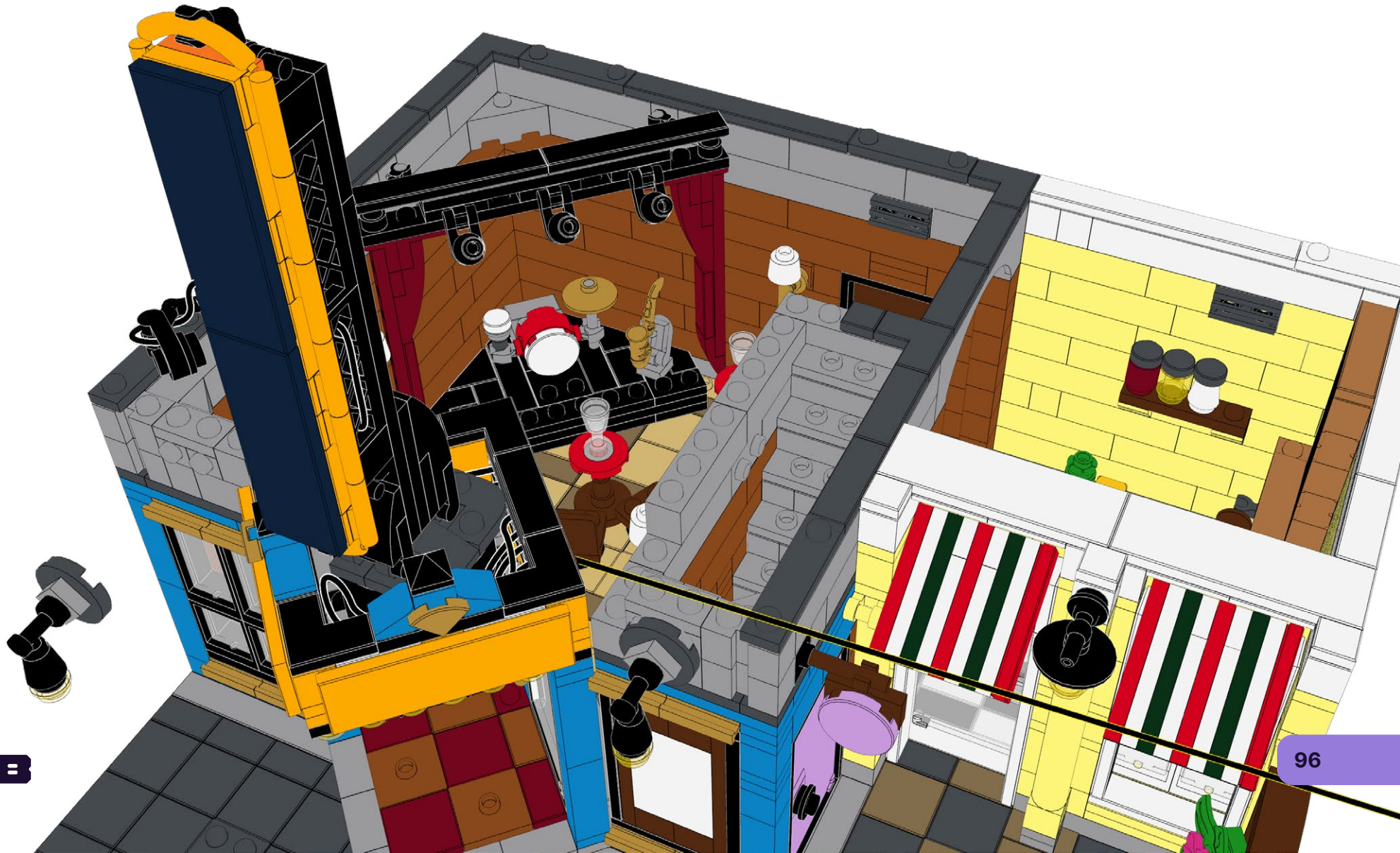

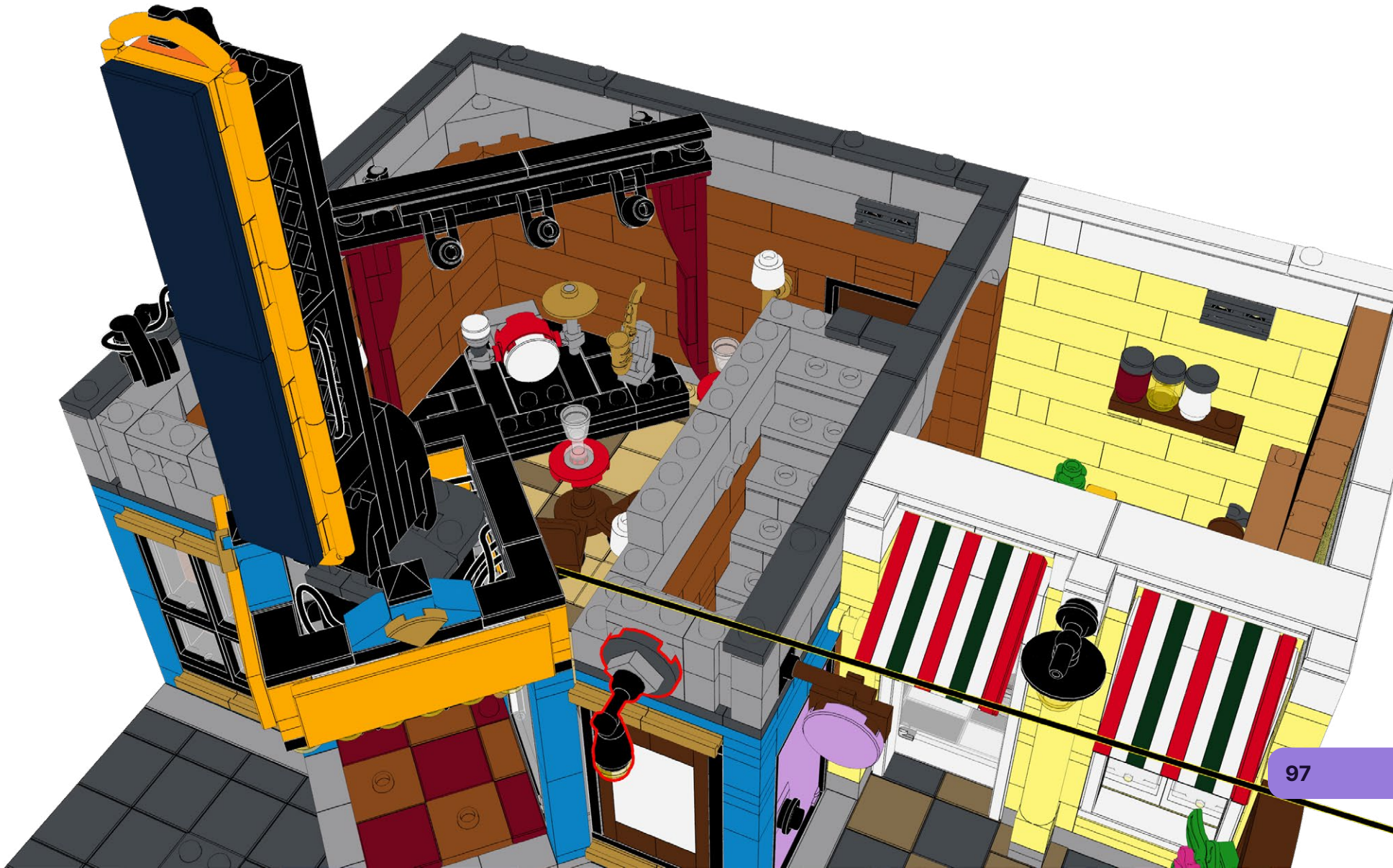

91





1

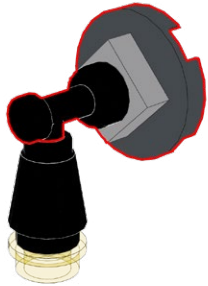

2

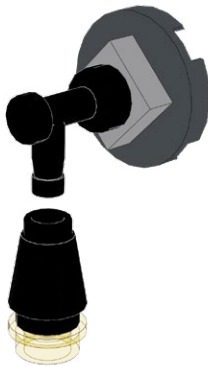

1



2



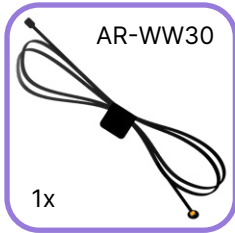

1

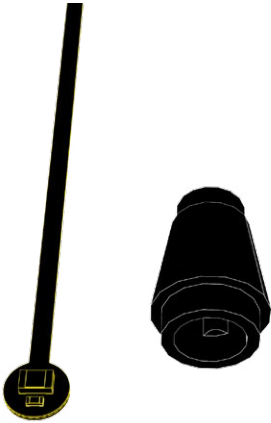

2



1



2





1

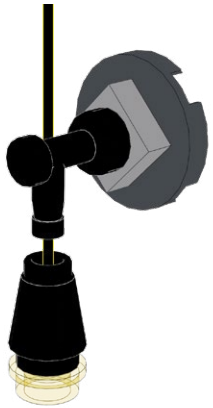

2

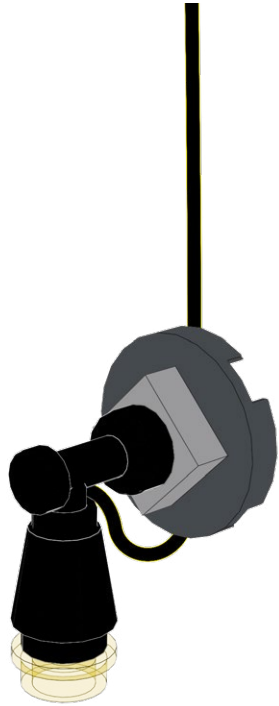
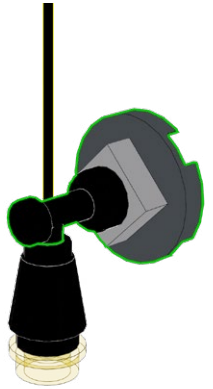



99



100

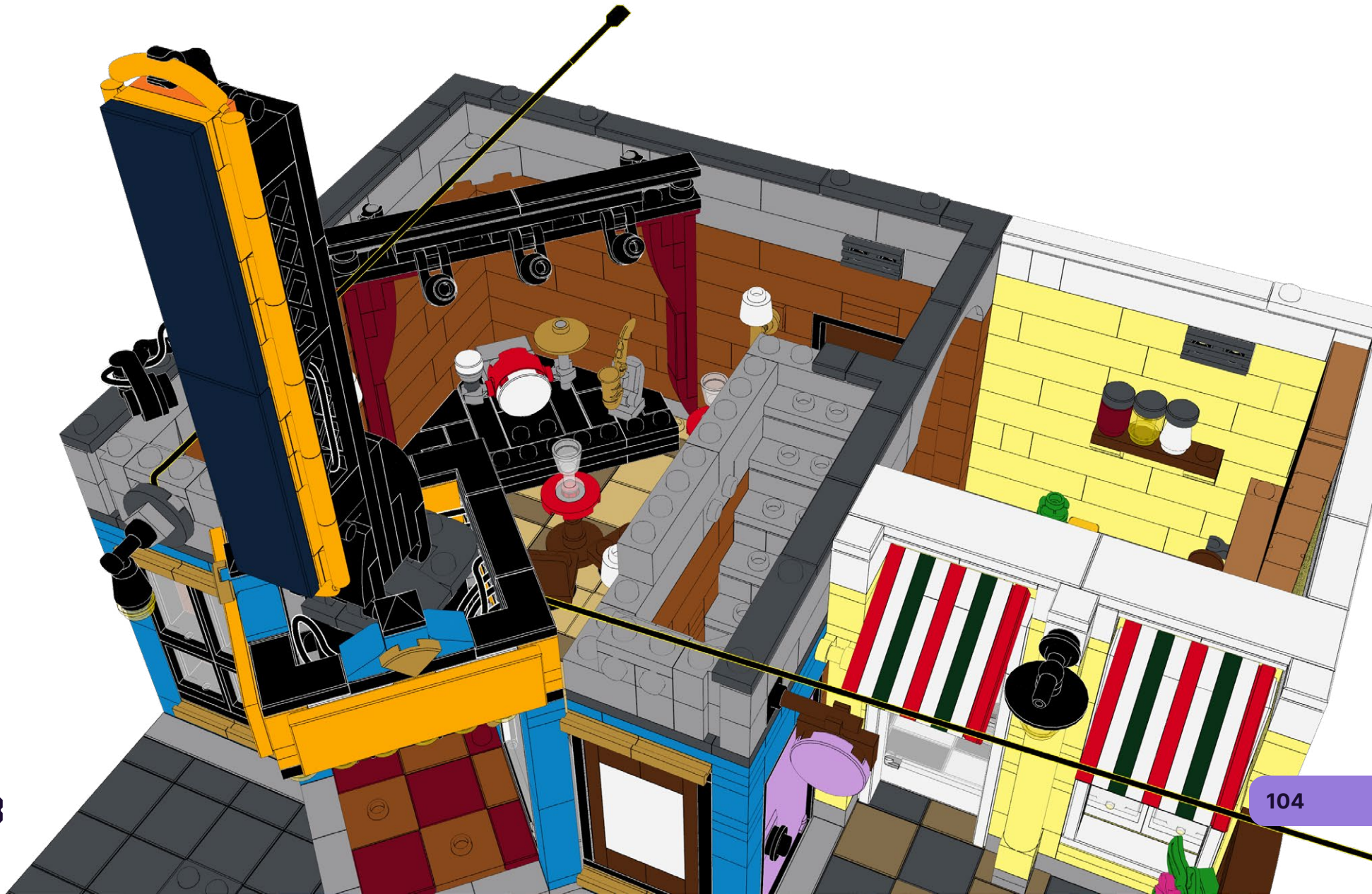

101

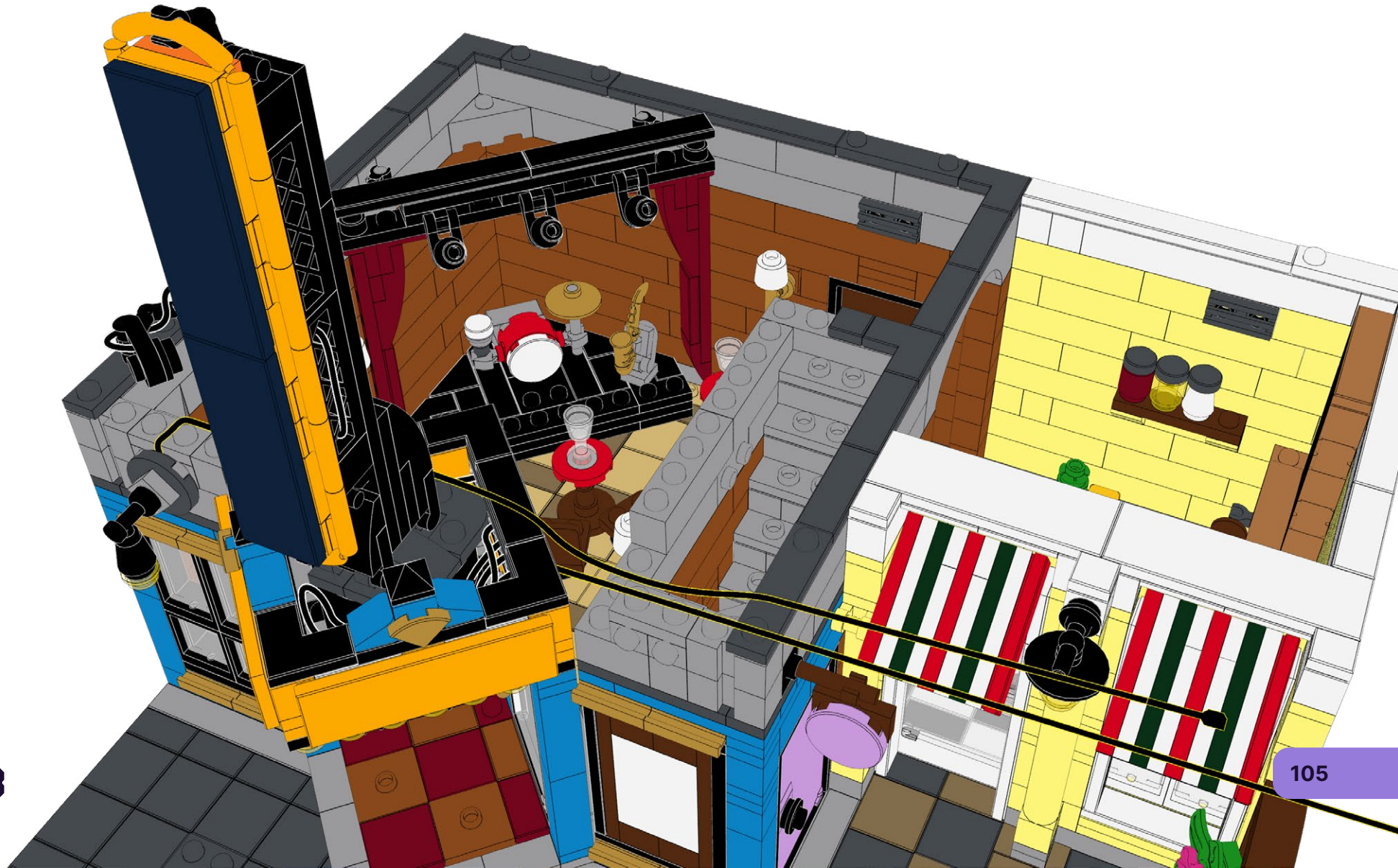

102



103



104

1

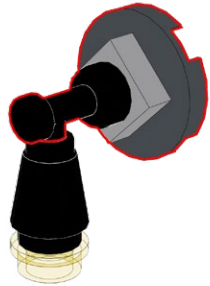

2

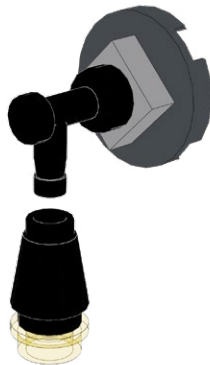

105

1



2



106

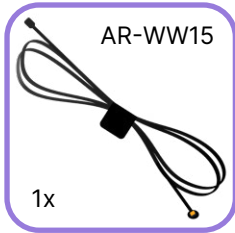

1

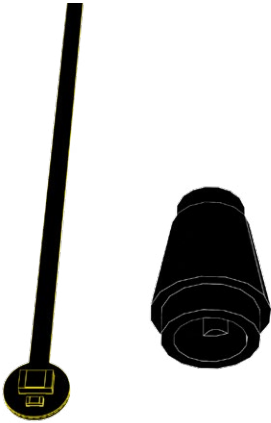

2



107

1



2



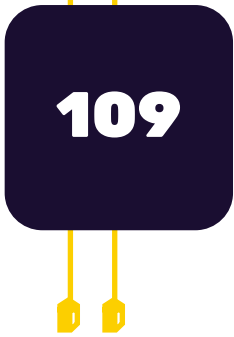
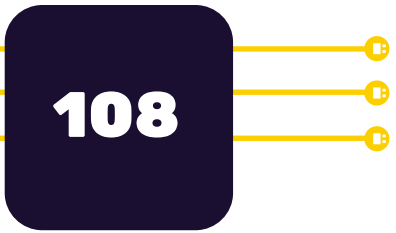

1

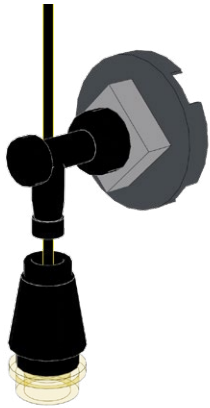

2

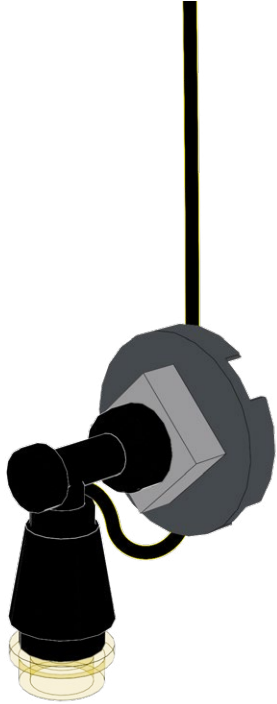
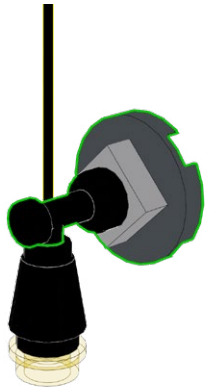

110

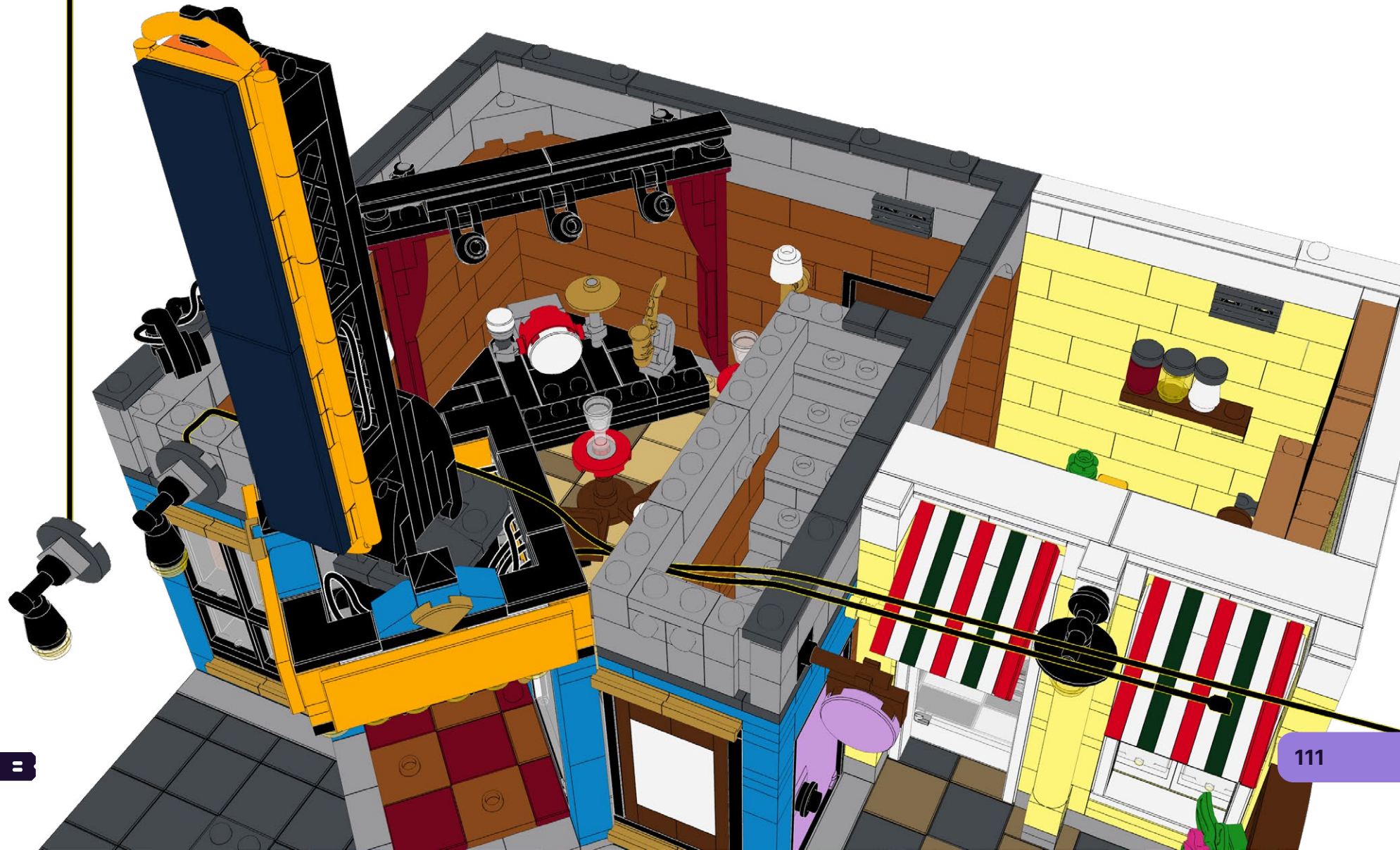

111

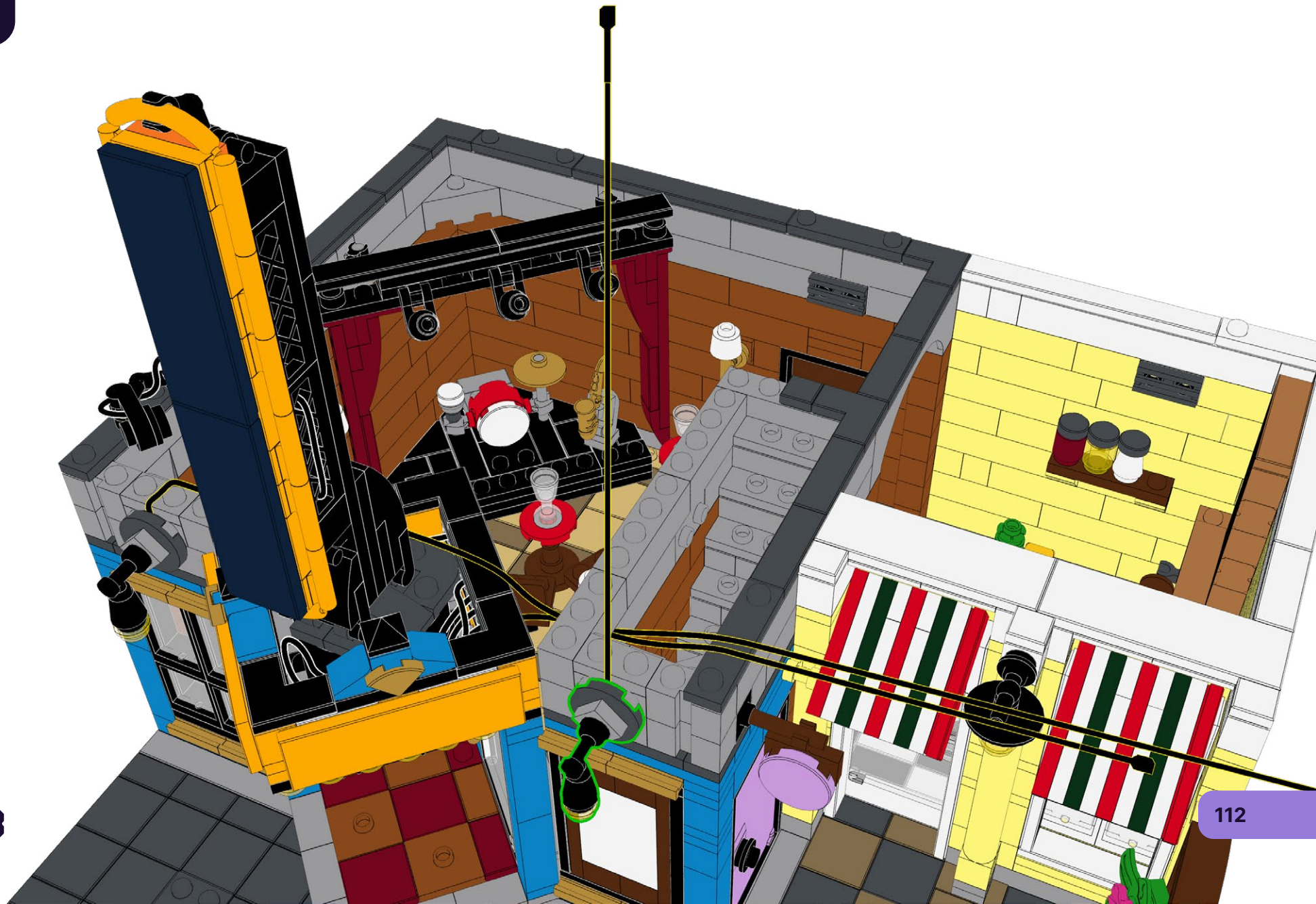

112

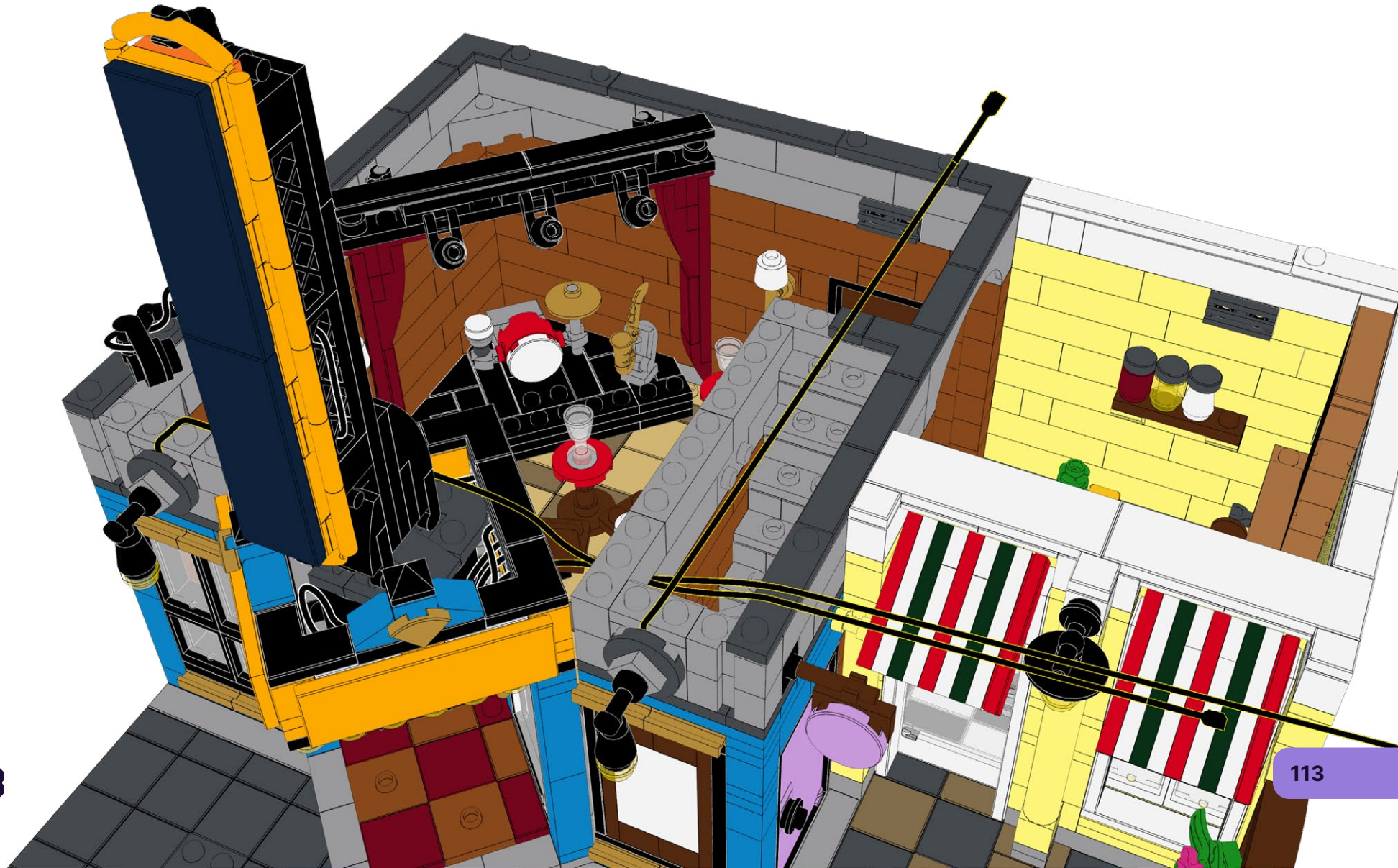

113



114



115



116

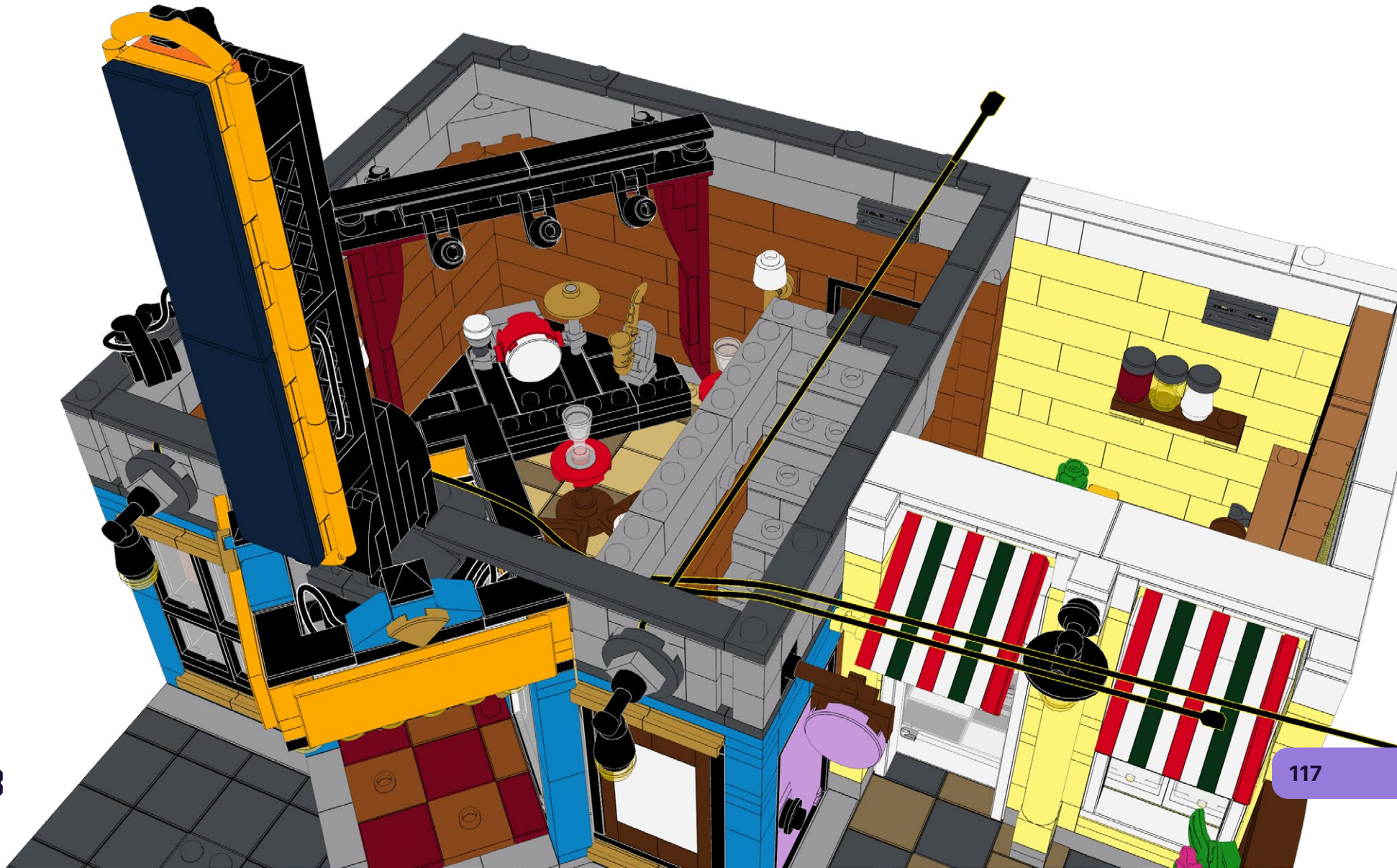

117

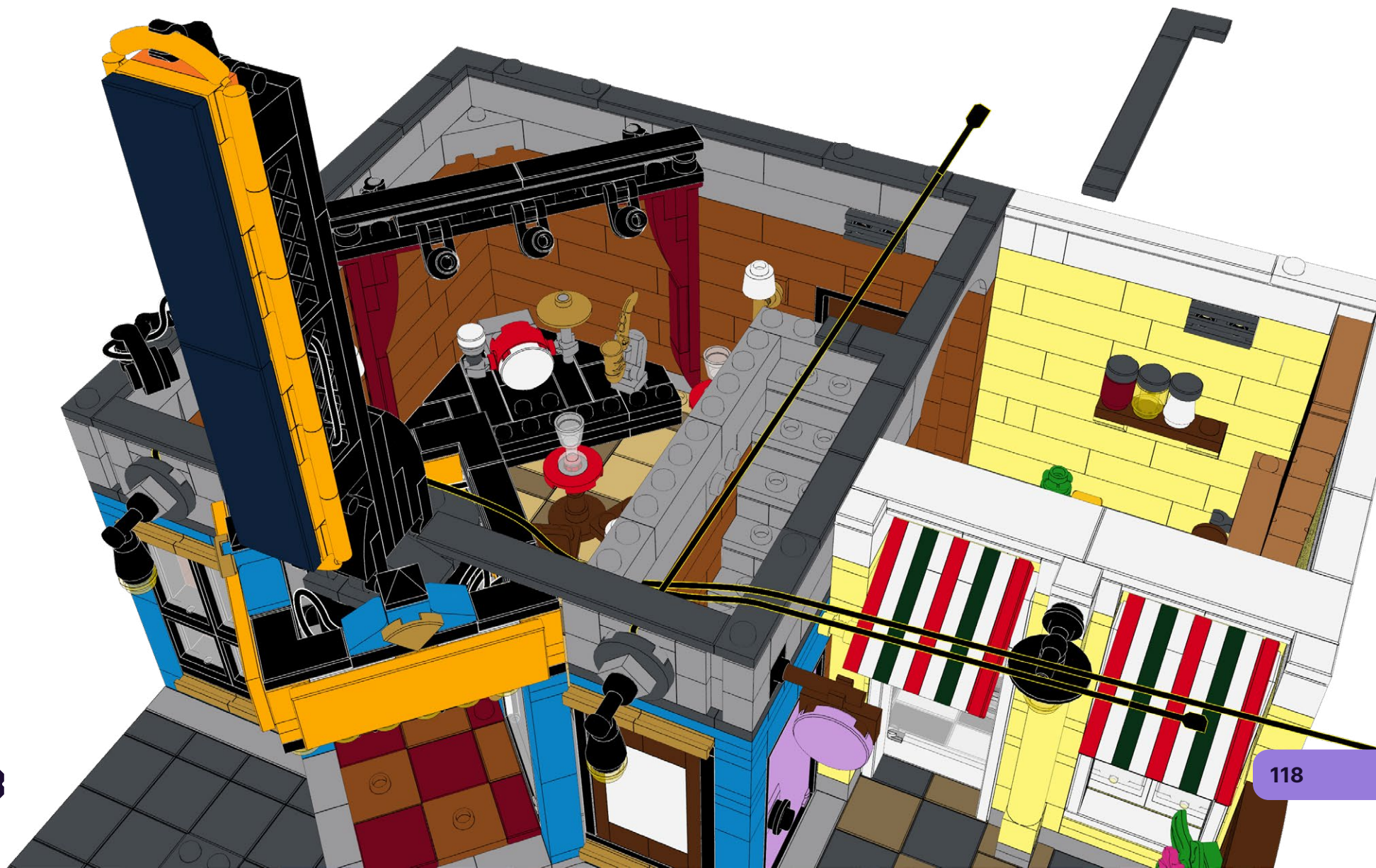

118

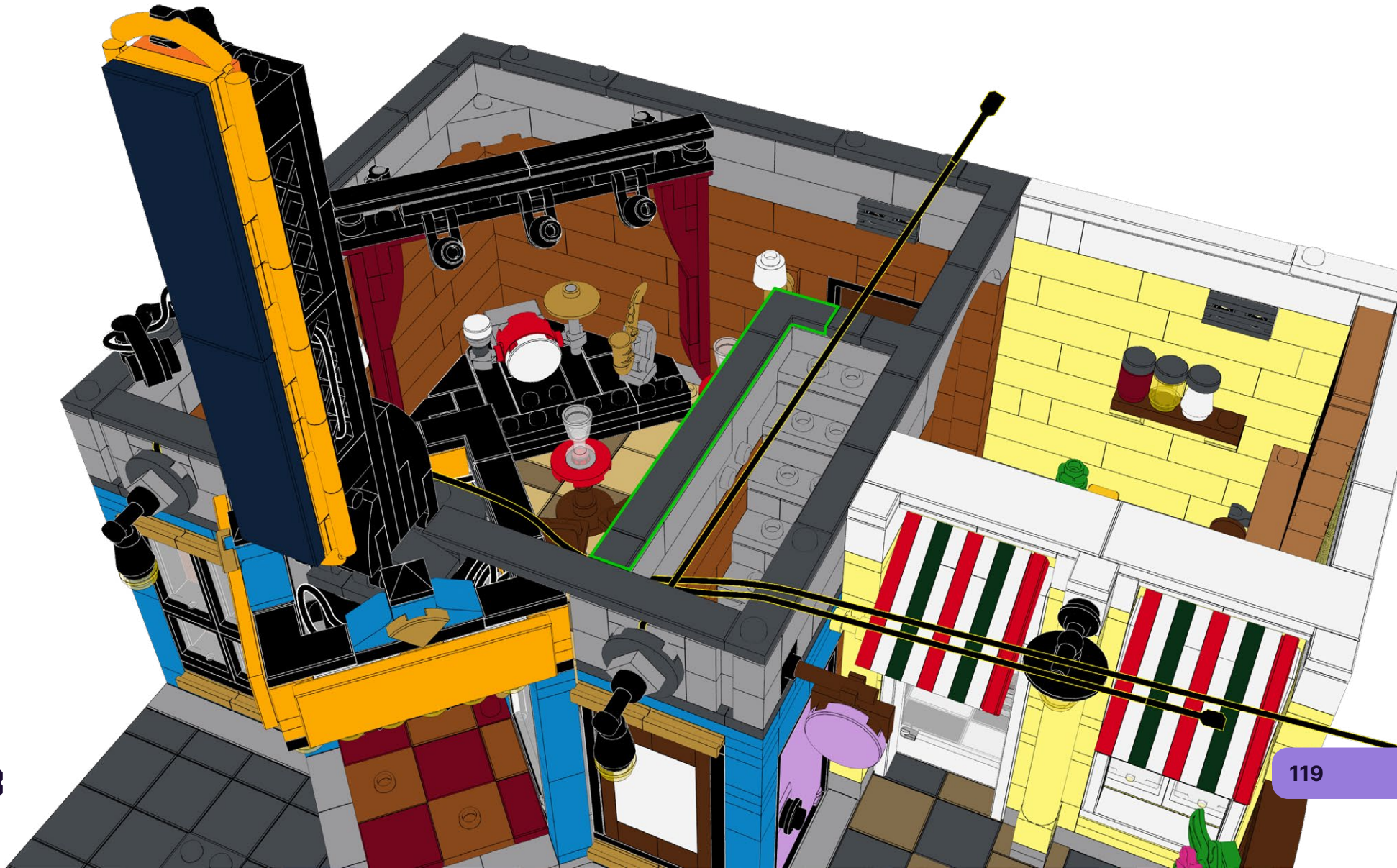

119

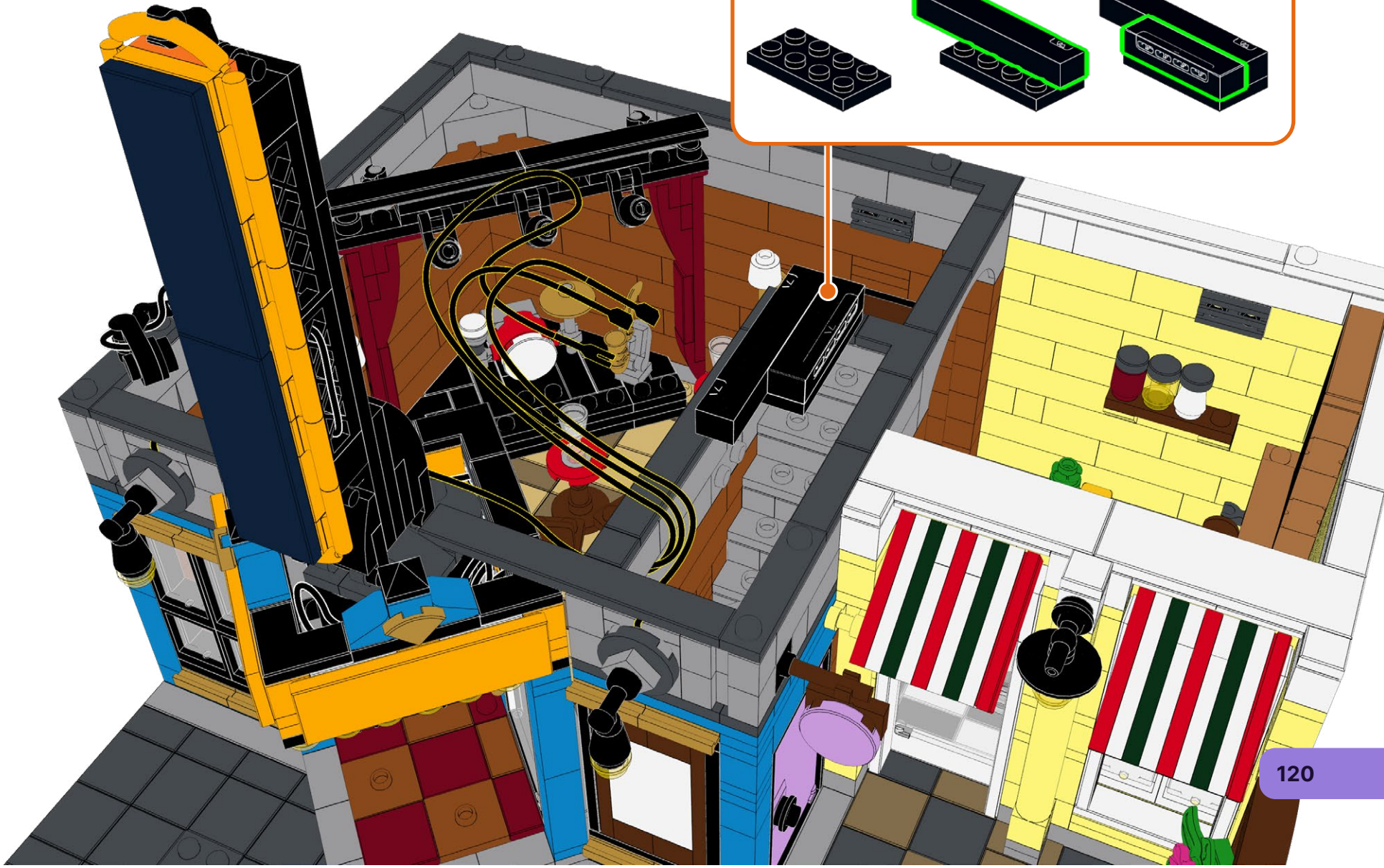
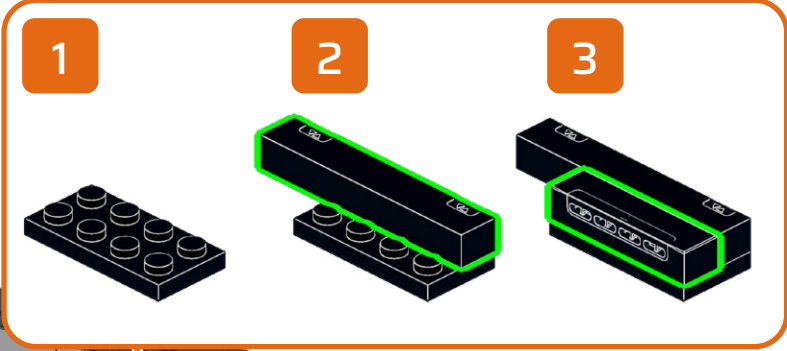
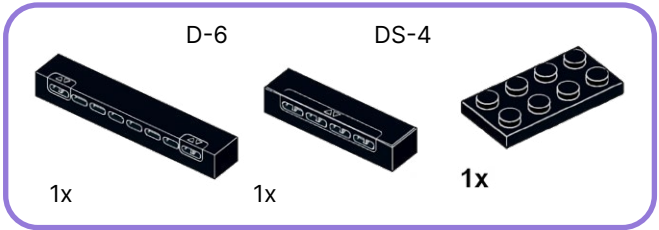

120

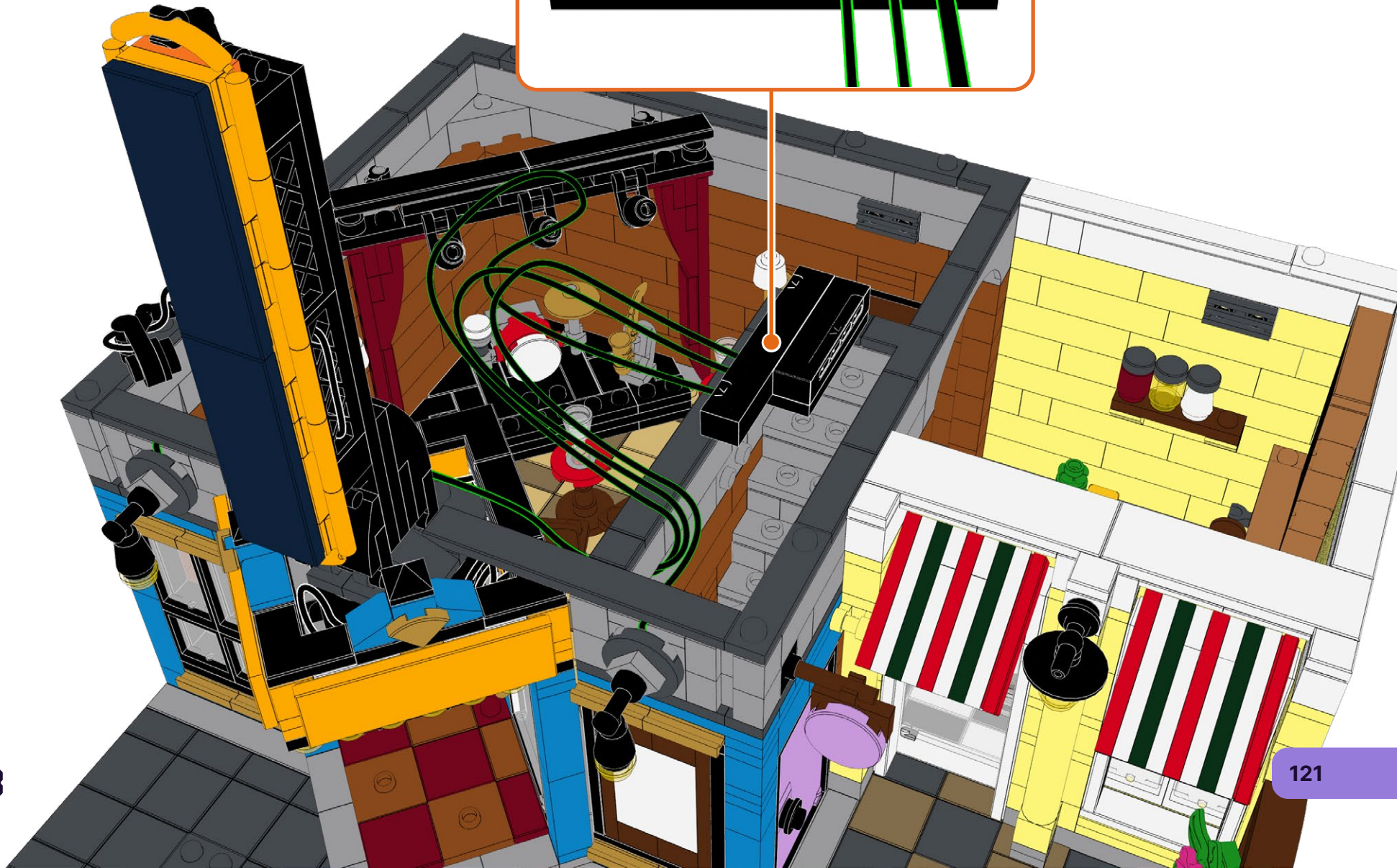
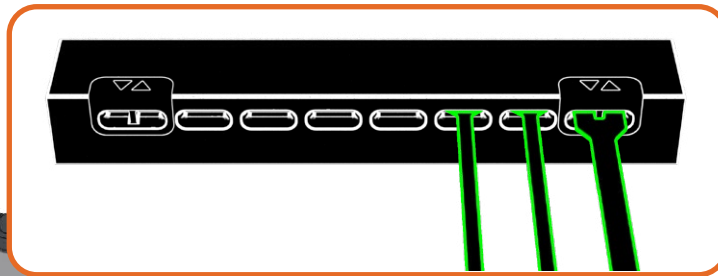

121

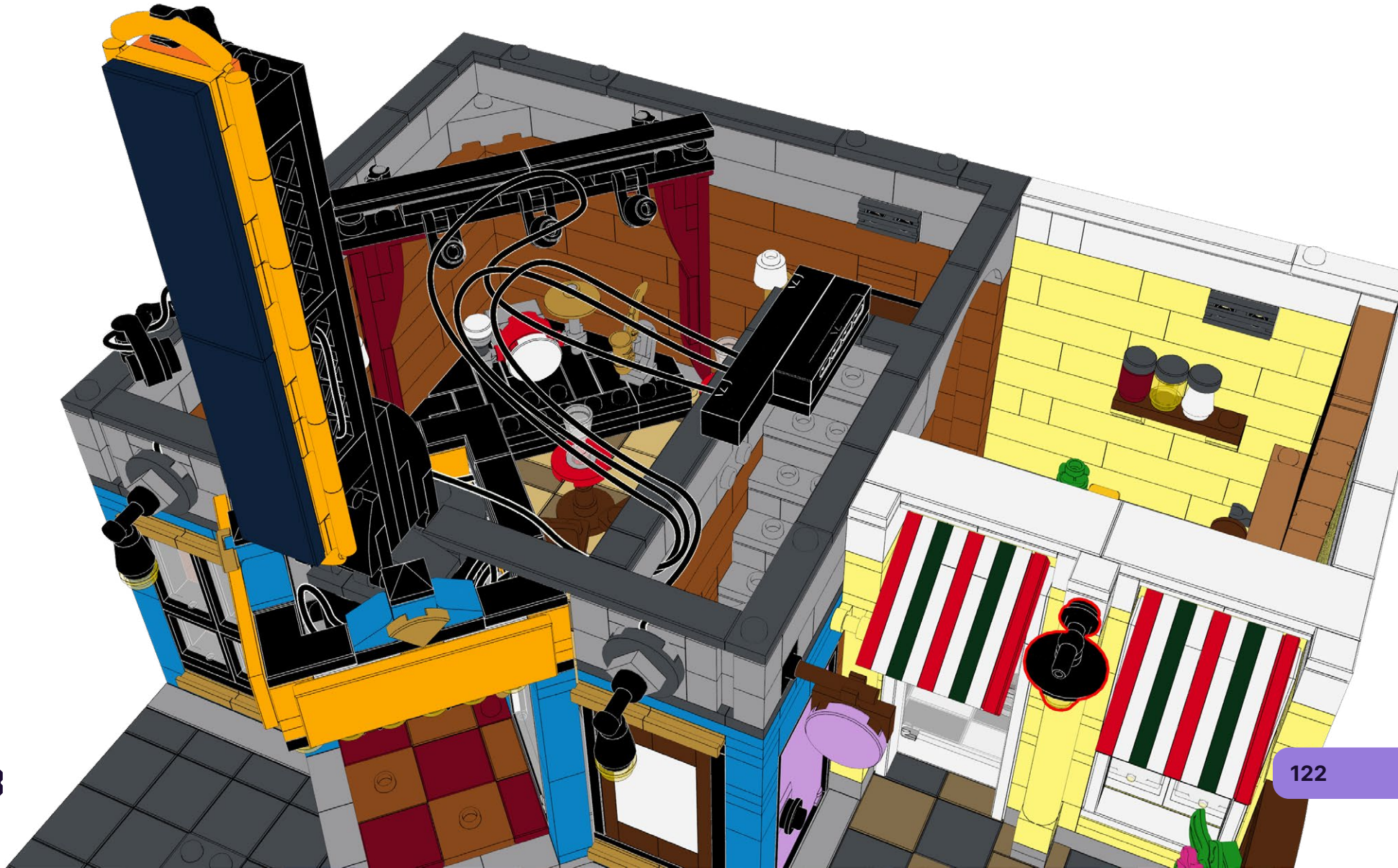



1



2



1



2

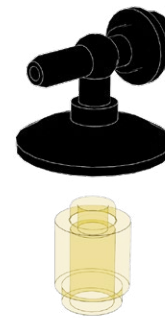

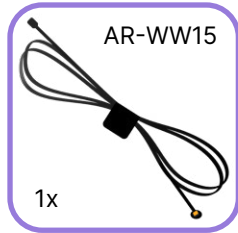

1



2

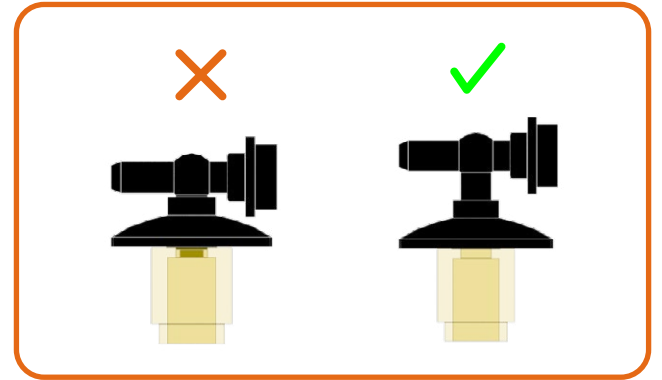
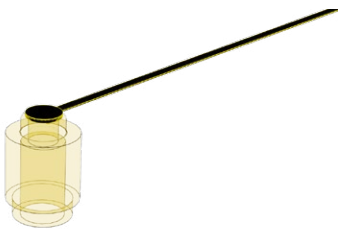

1

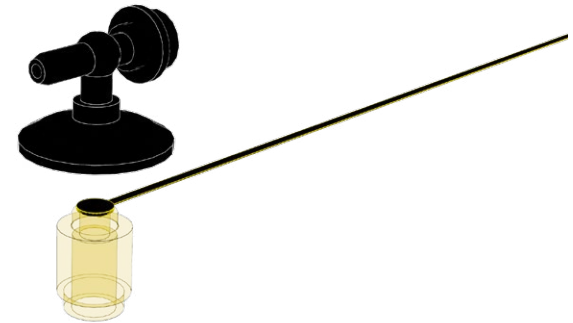

2



128

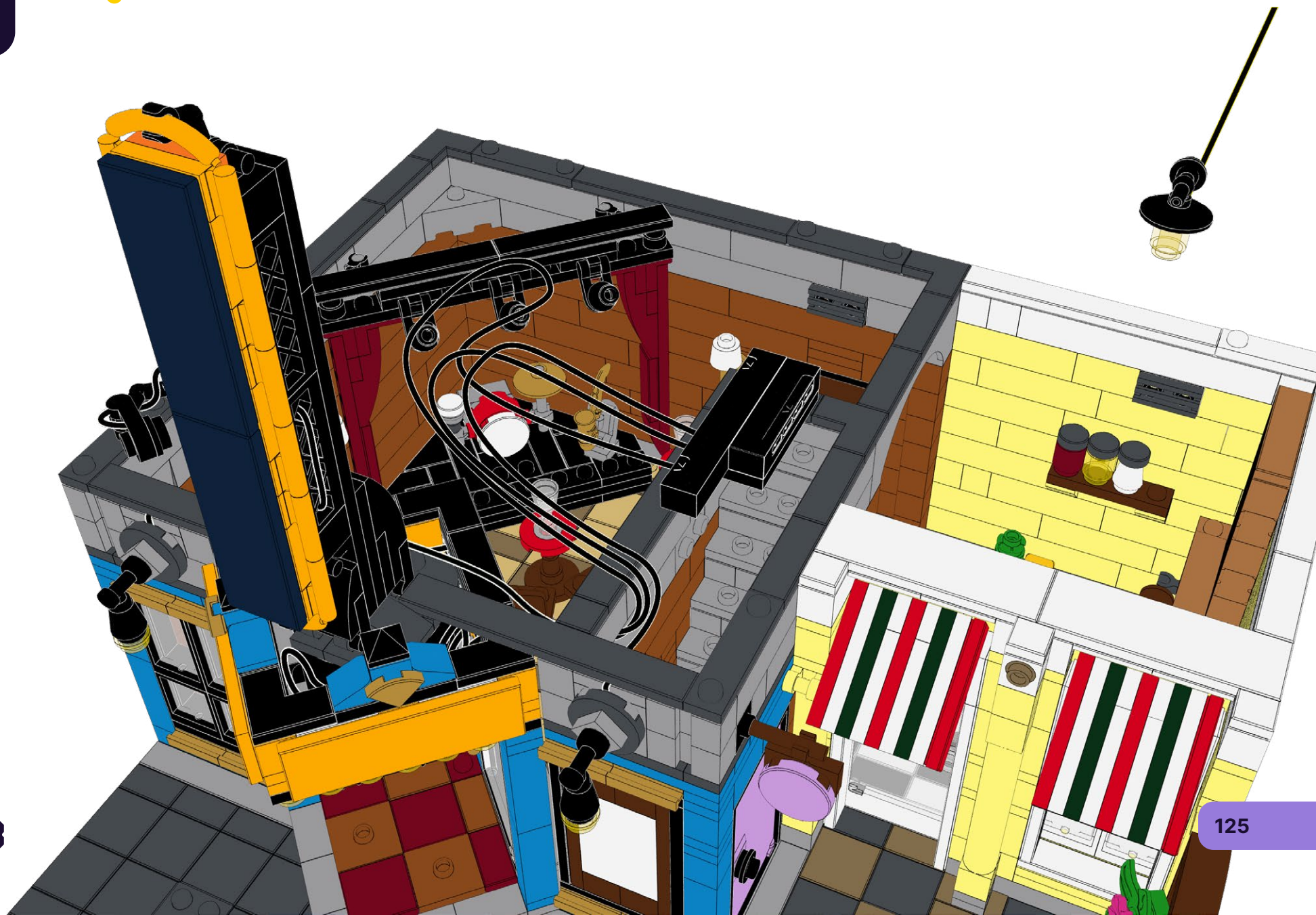

129

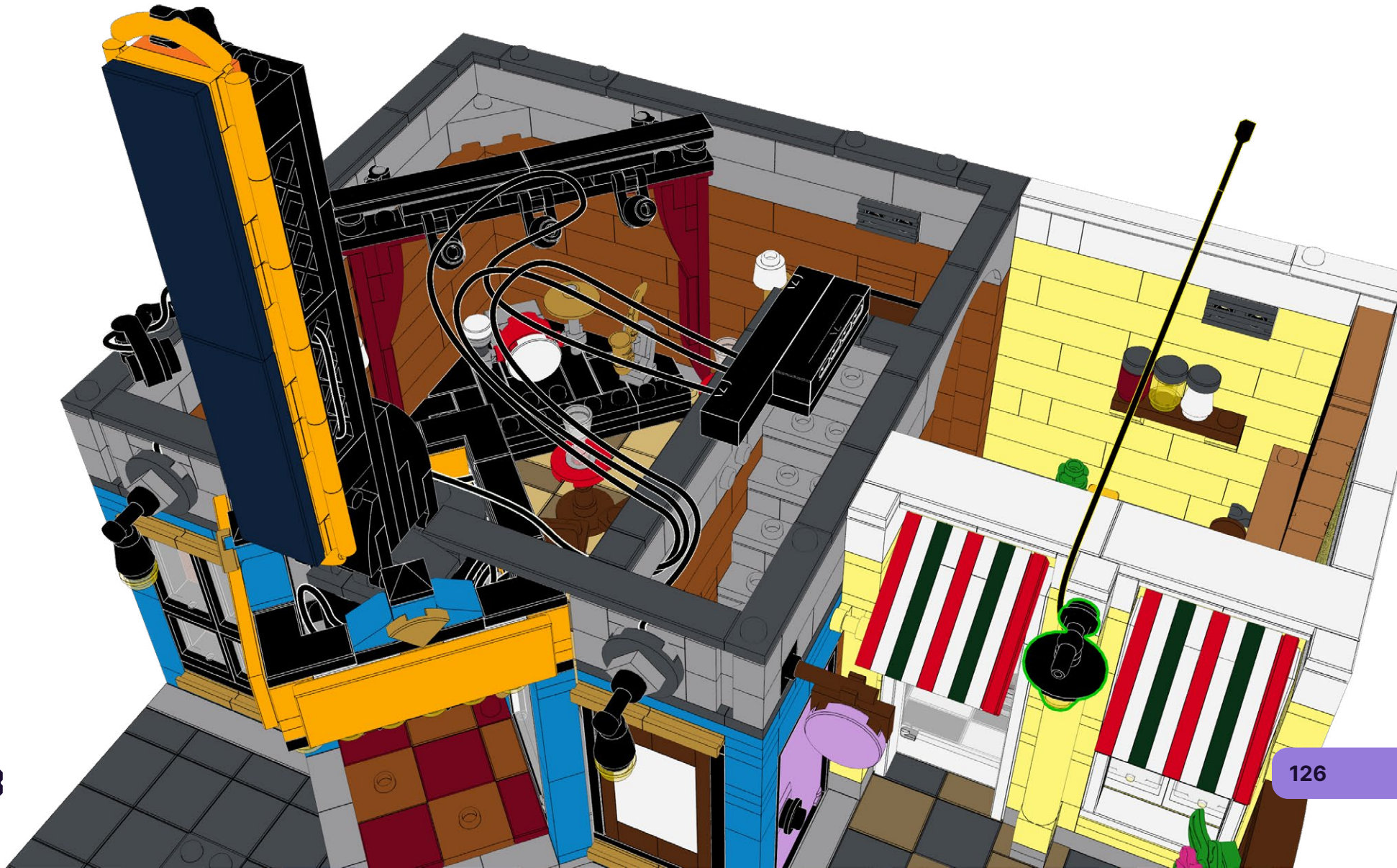

130

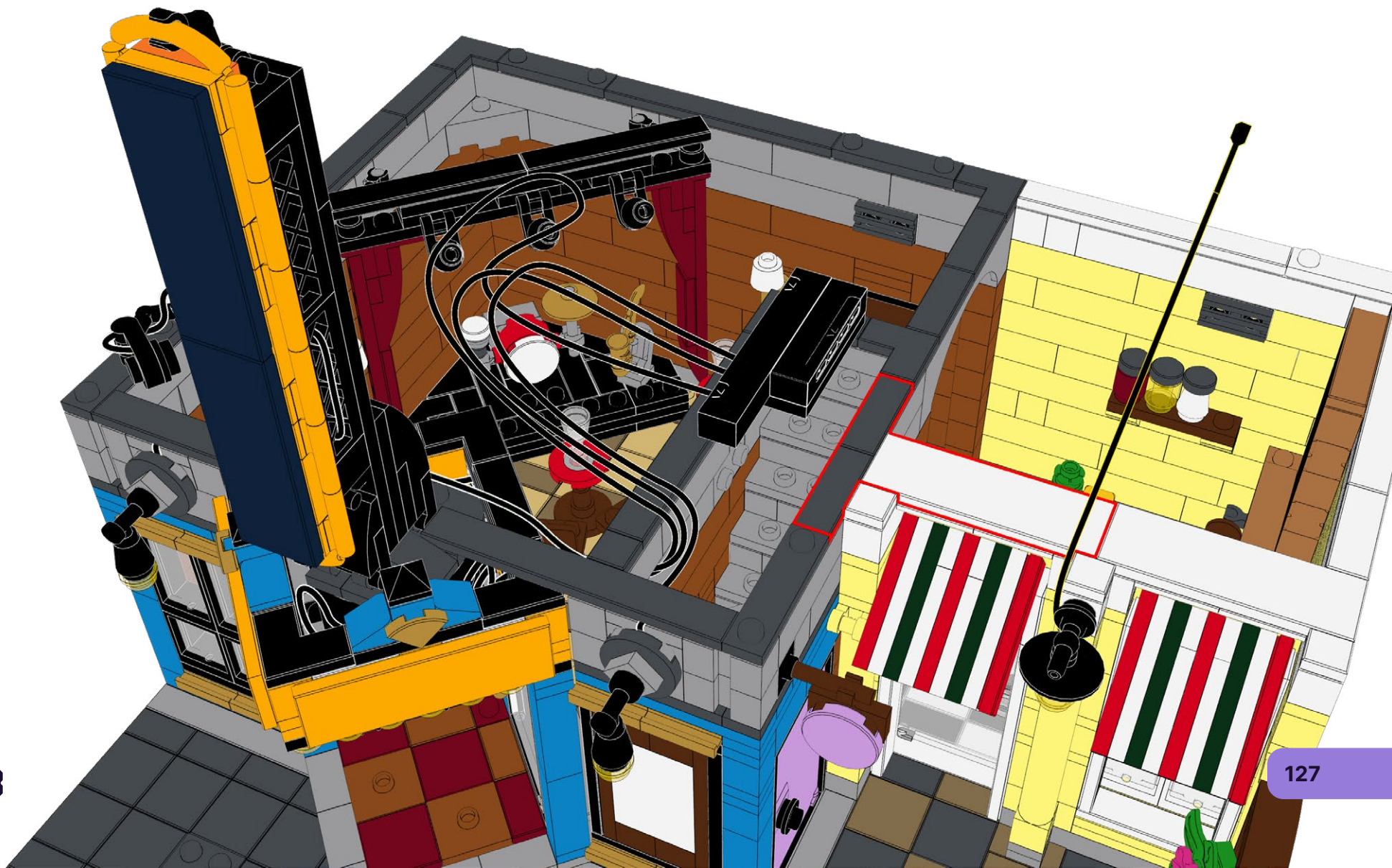

131

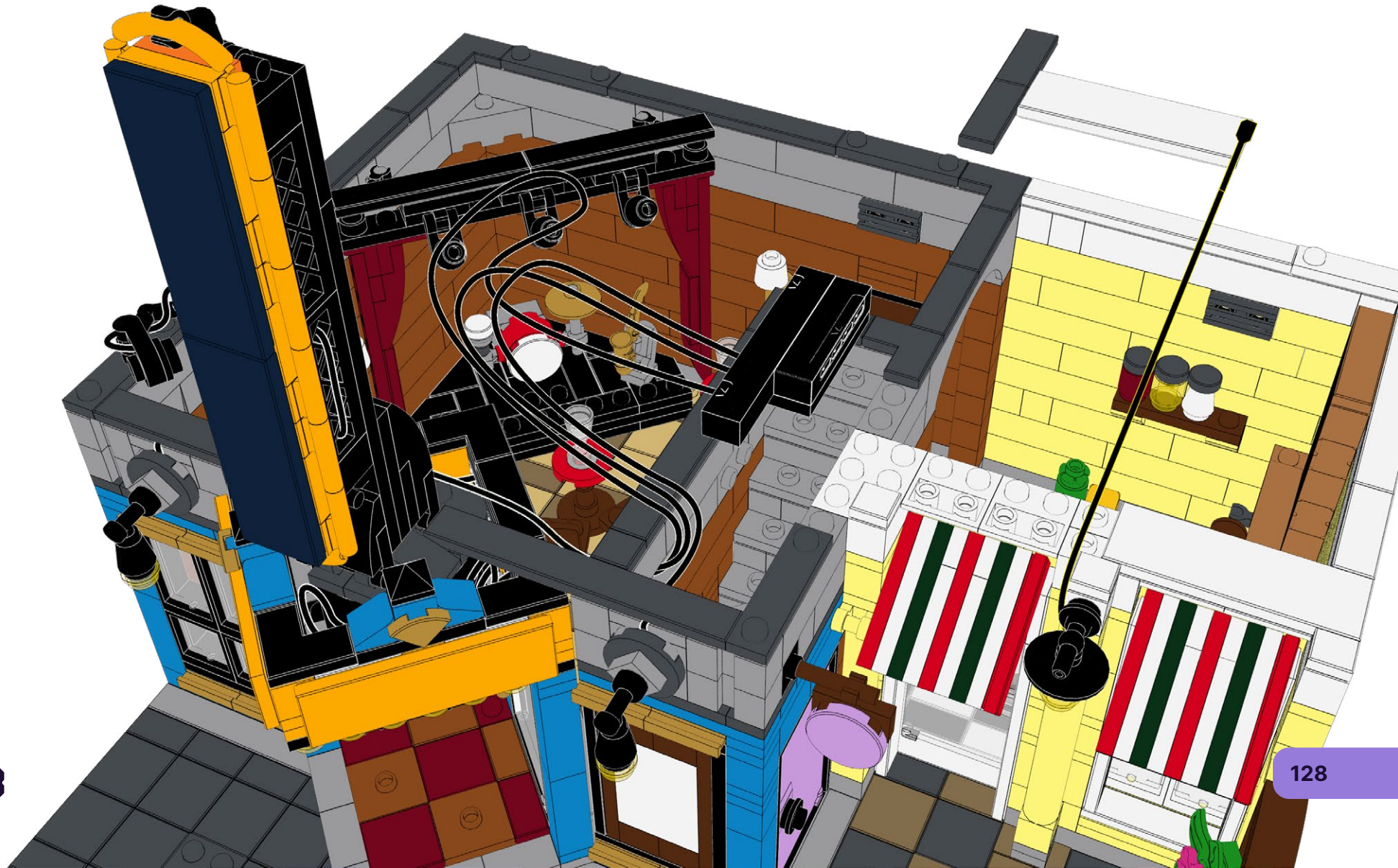

132

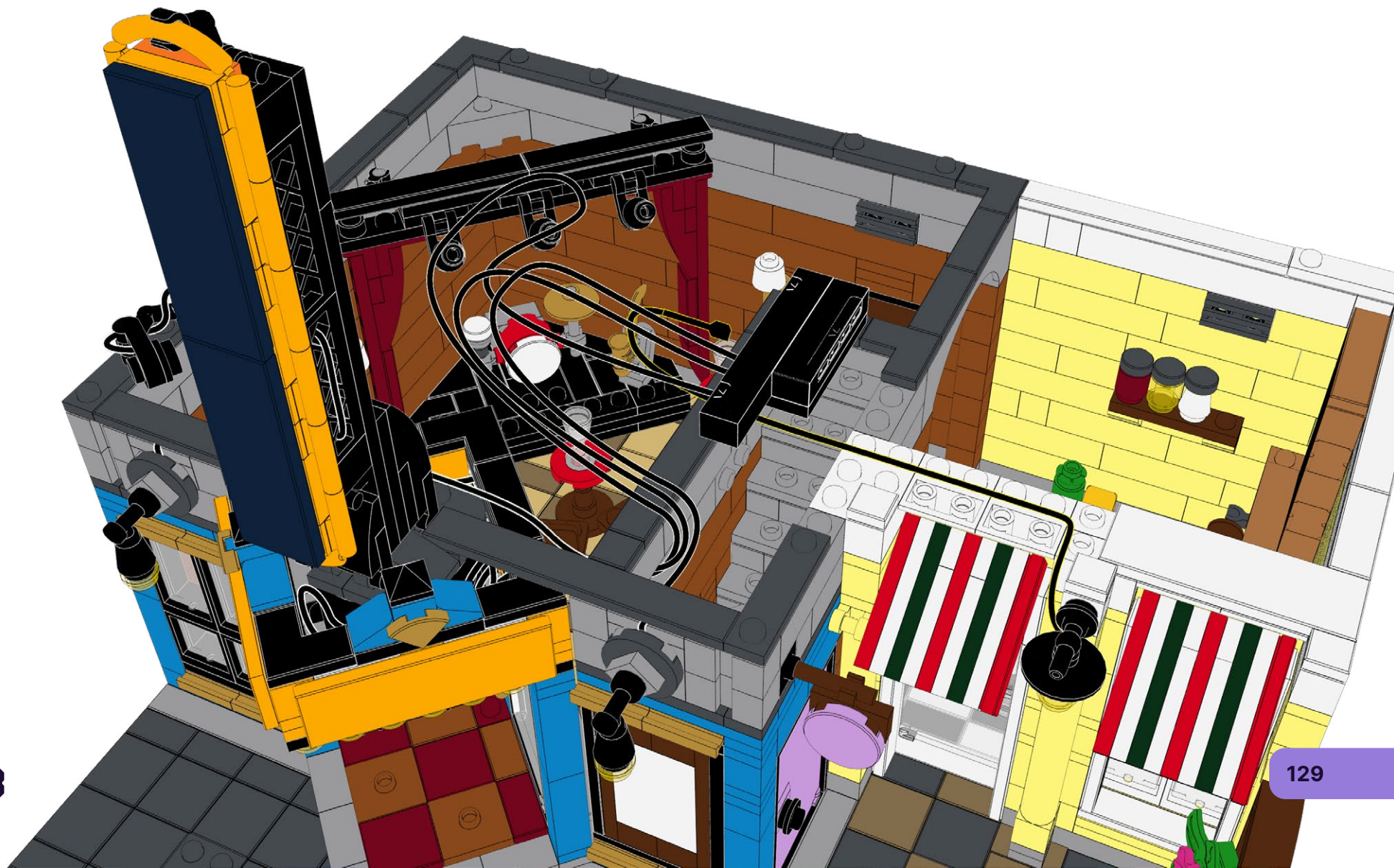

133

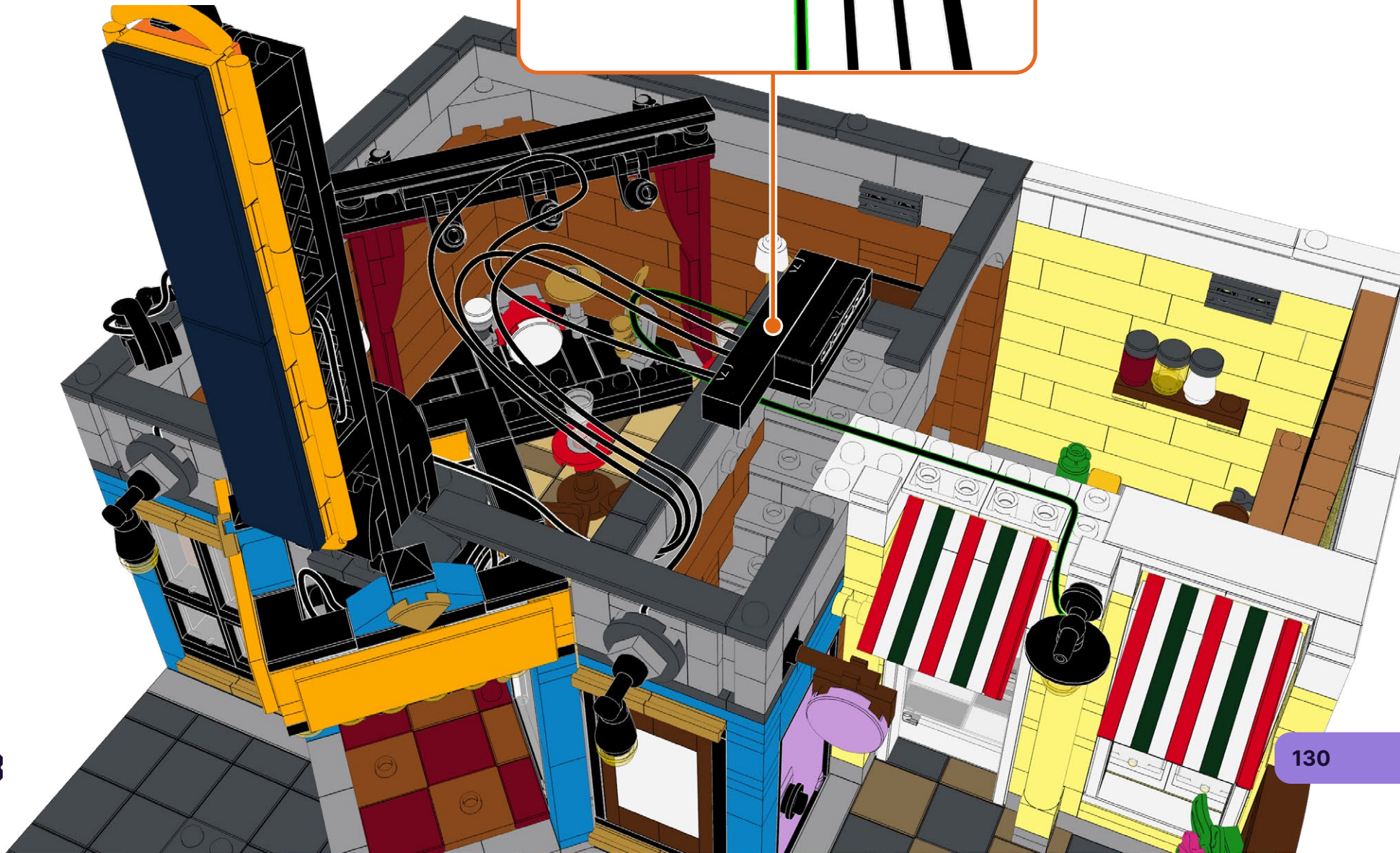
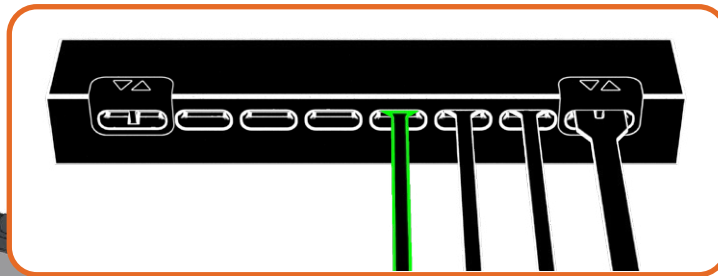

134

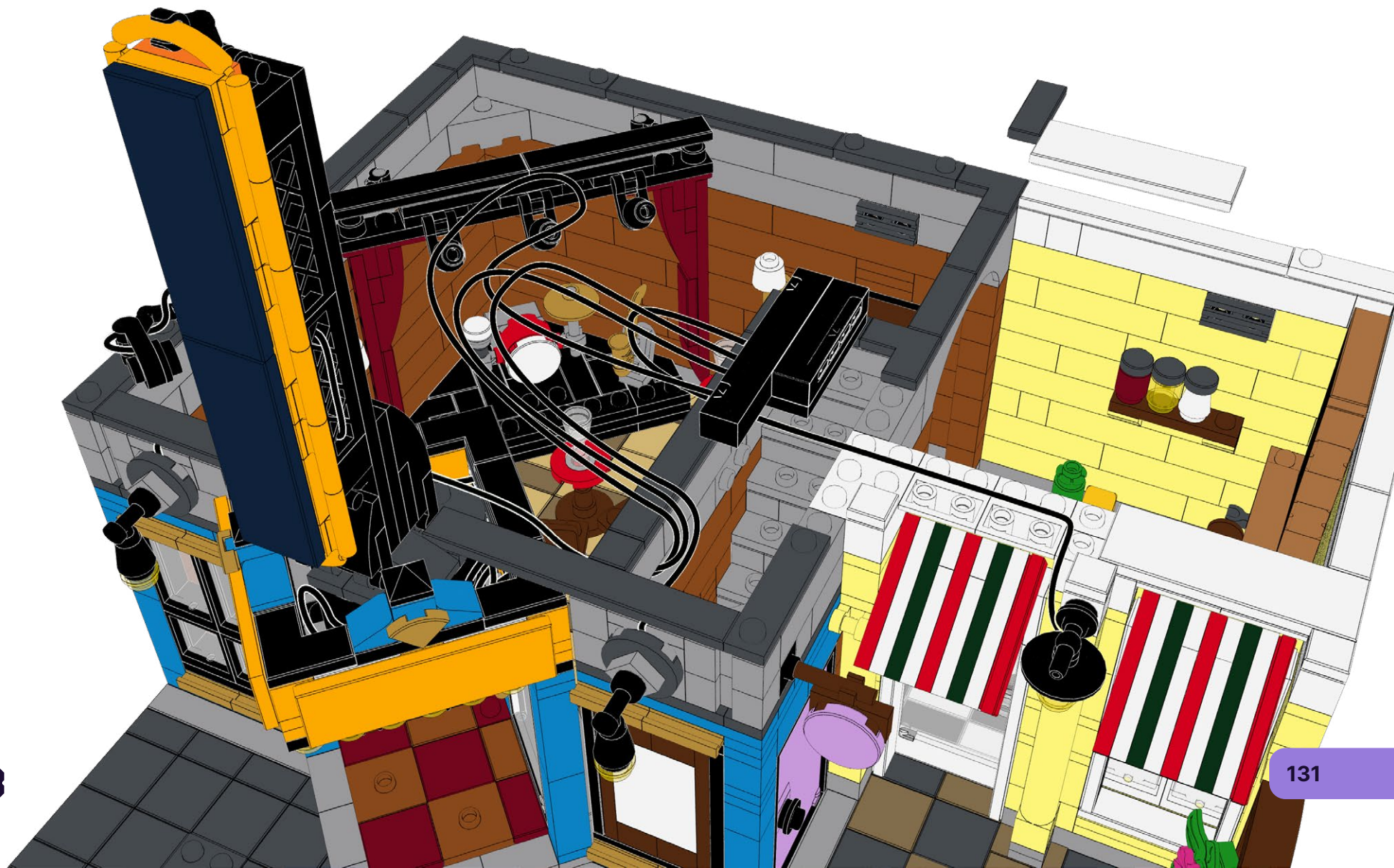

135

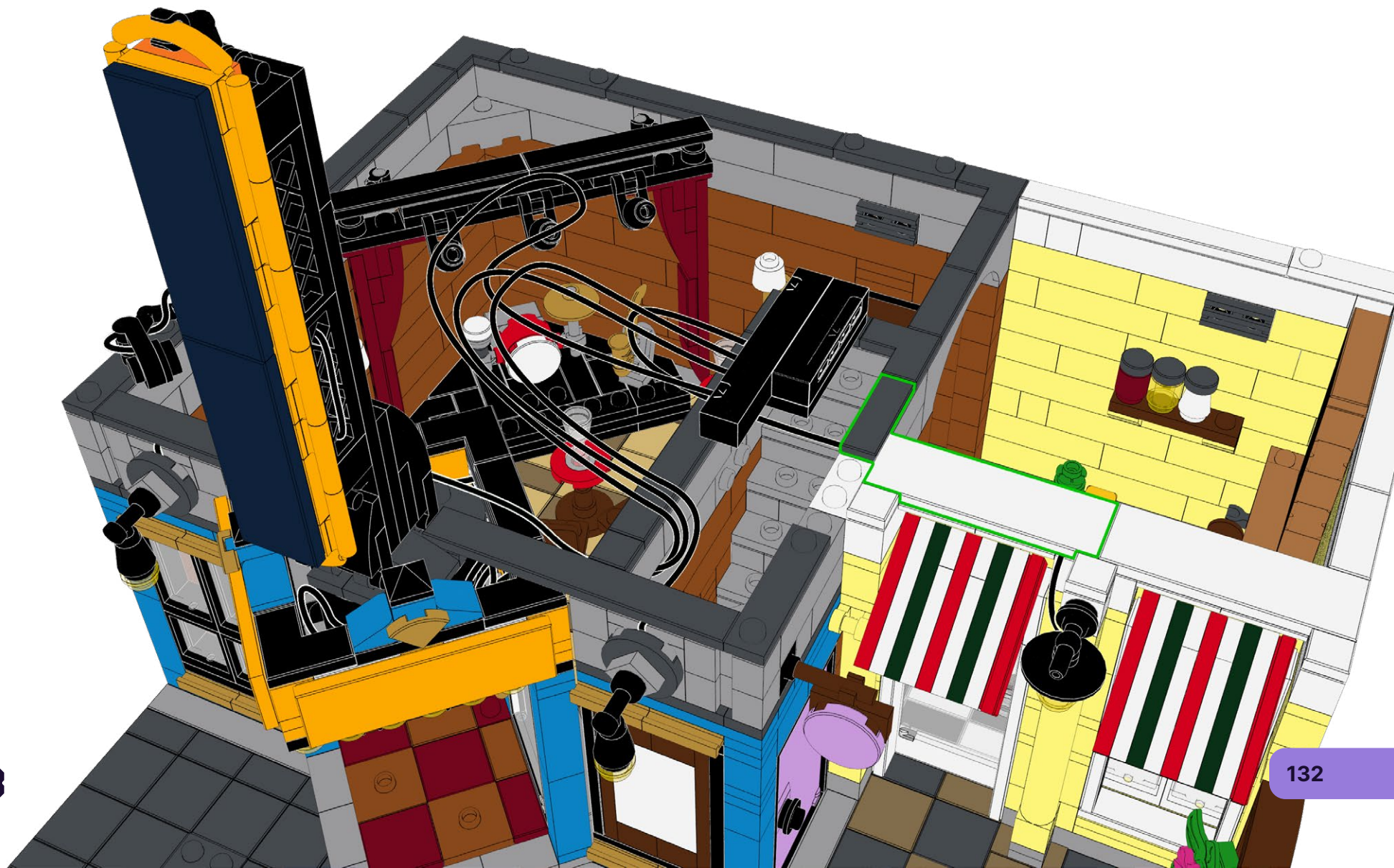

136

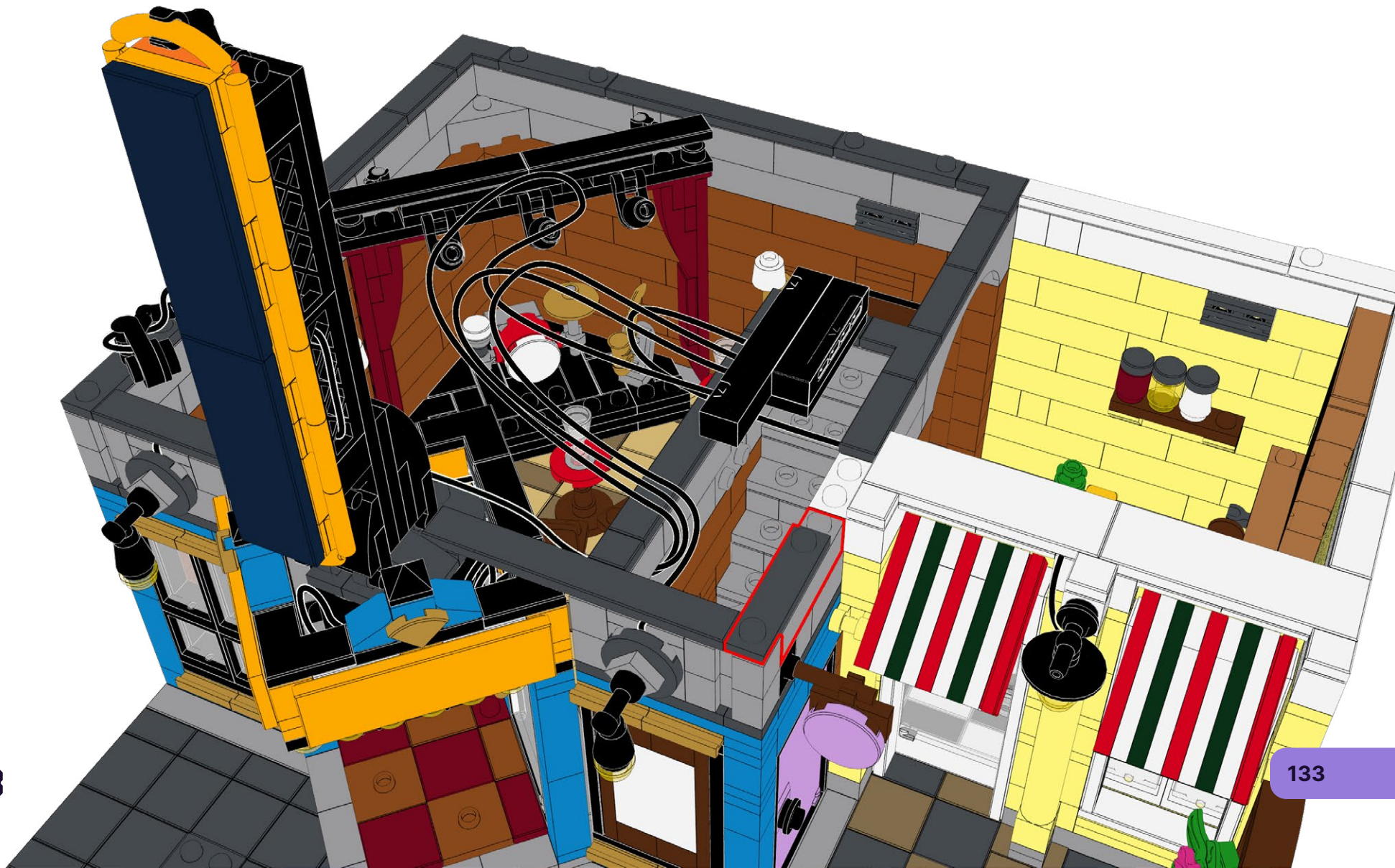

137

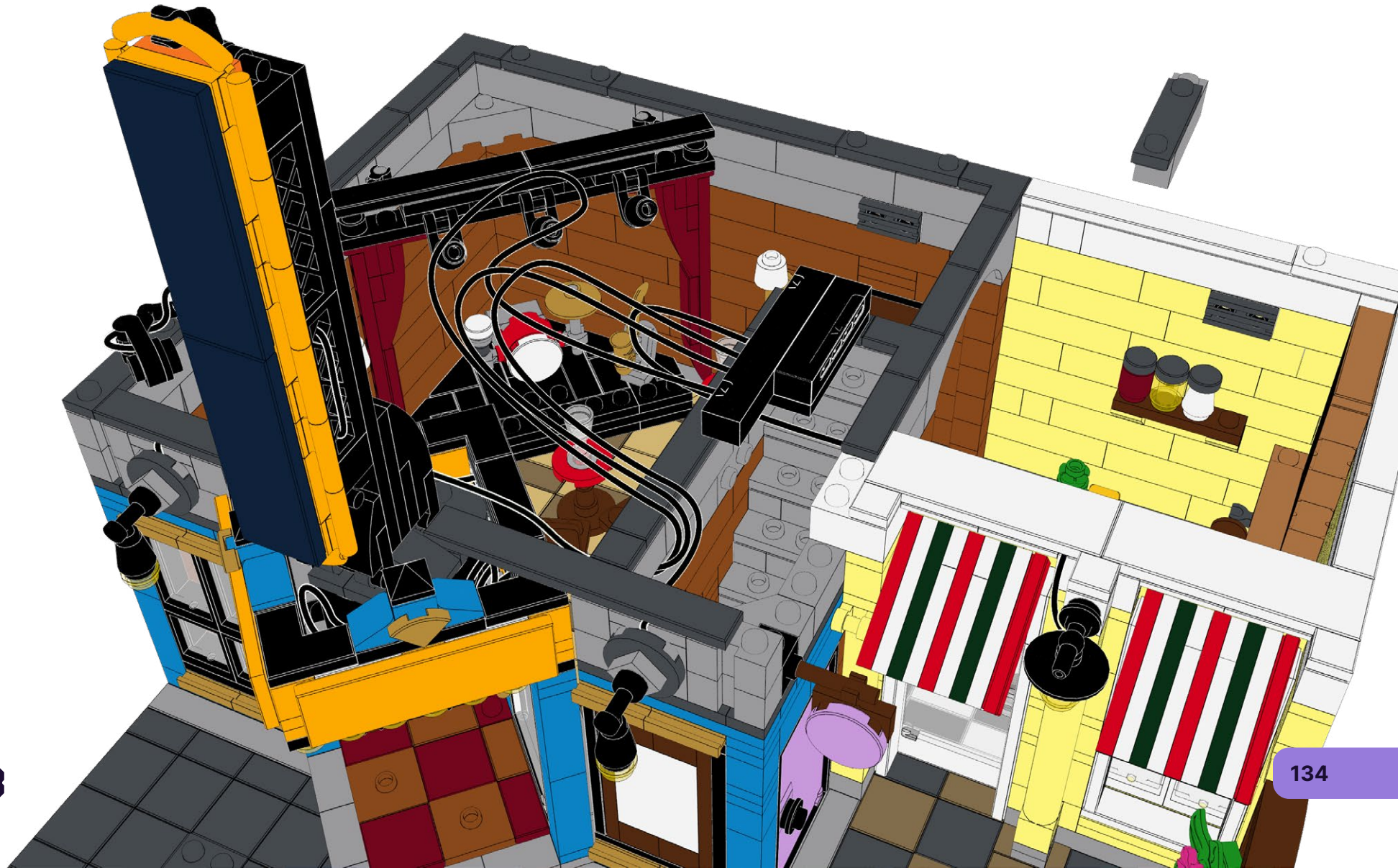

138

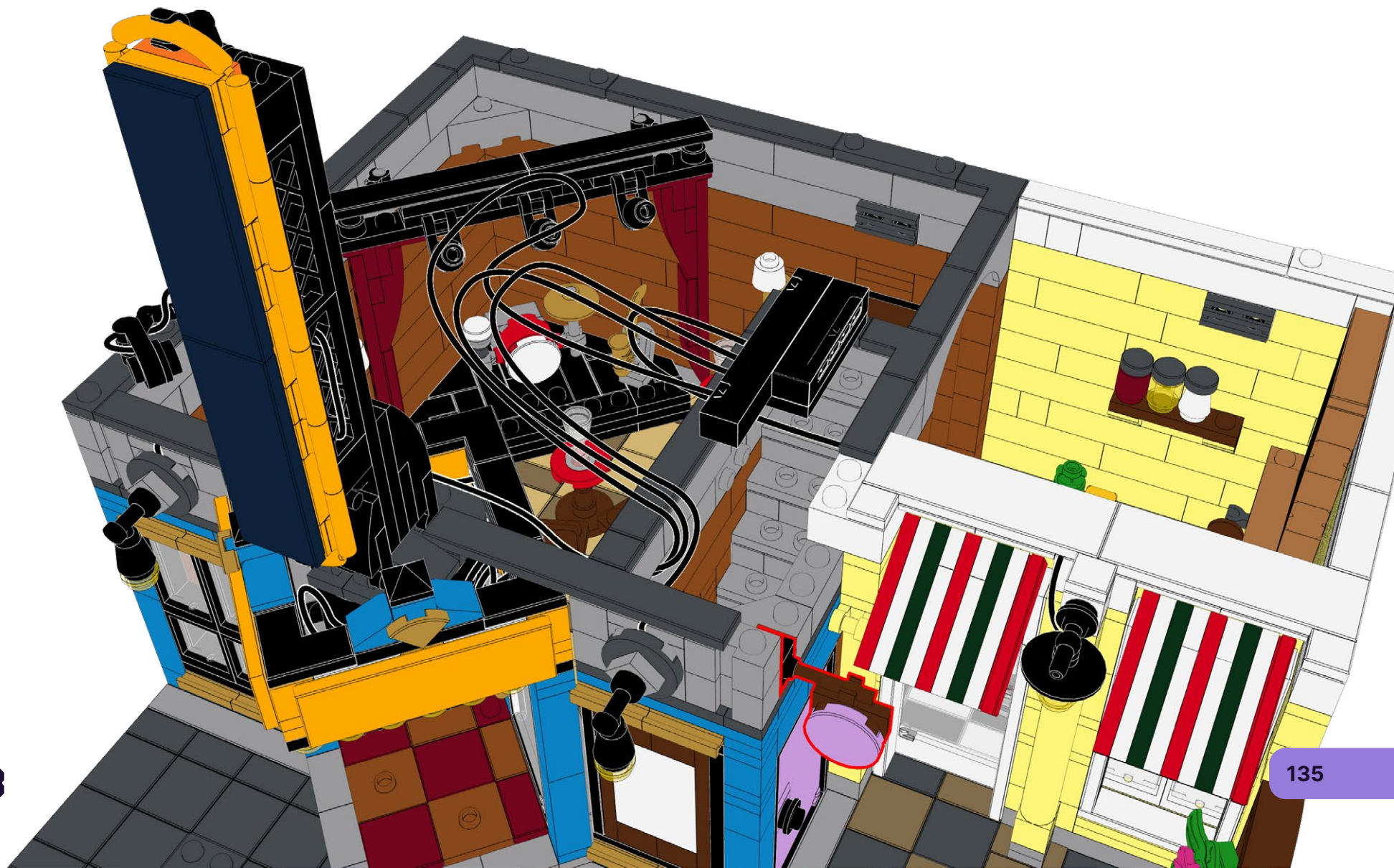

139

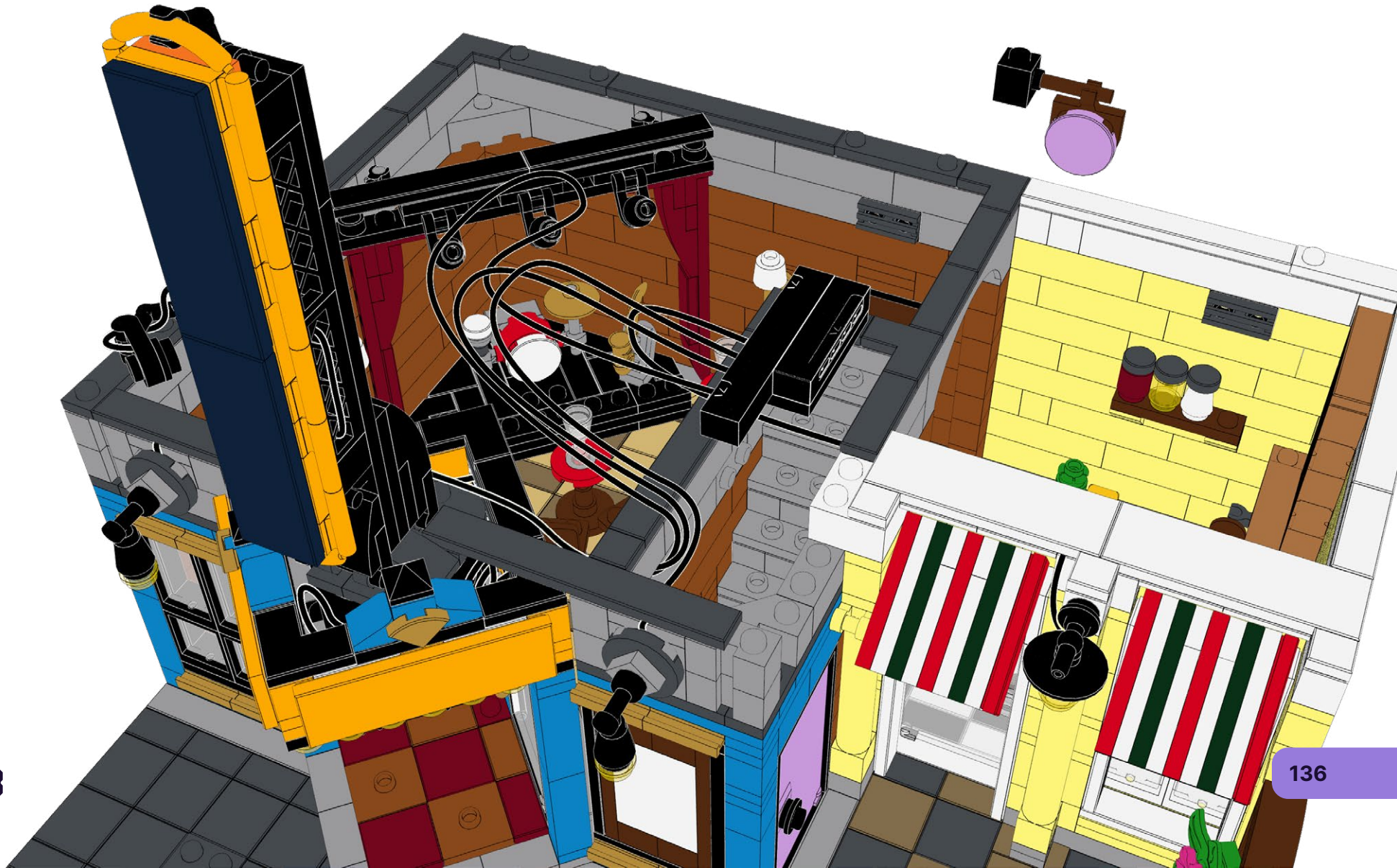

141



1x

1

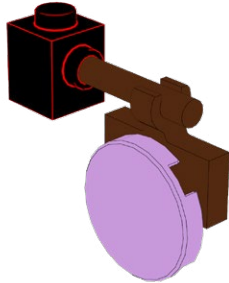

2

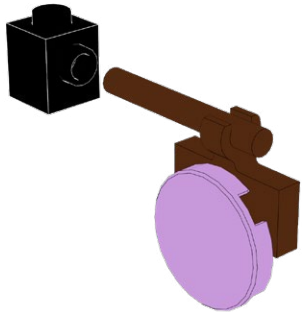

142

1

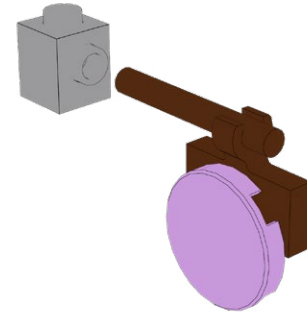

2

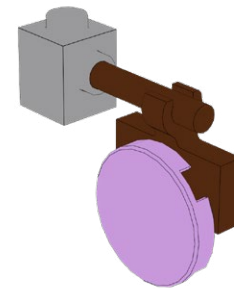

143

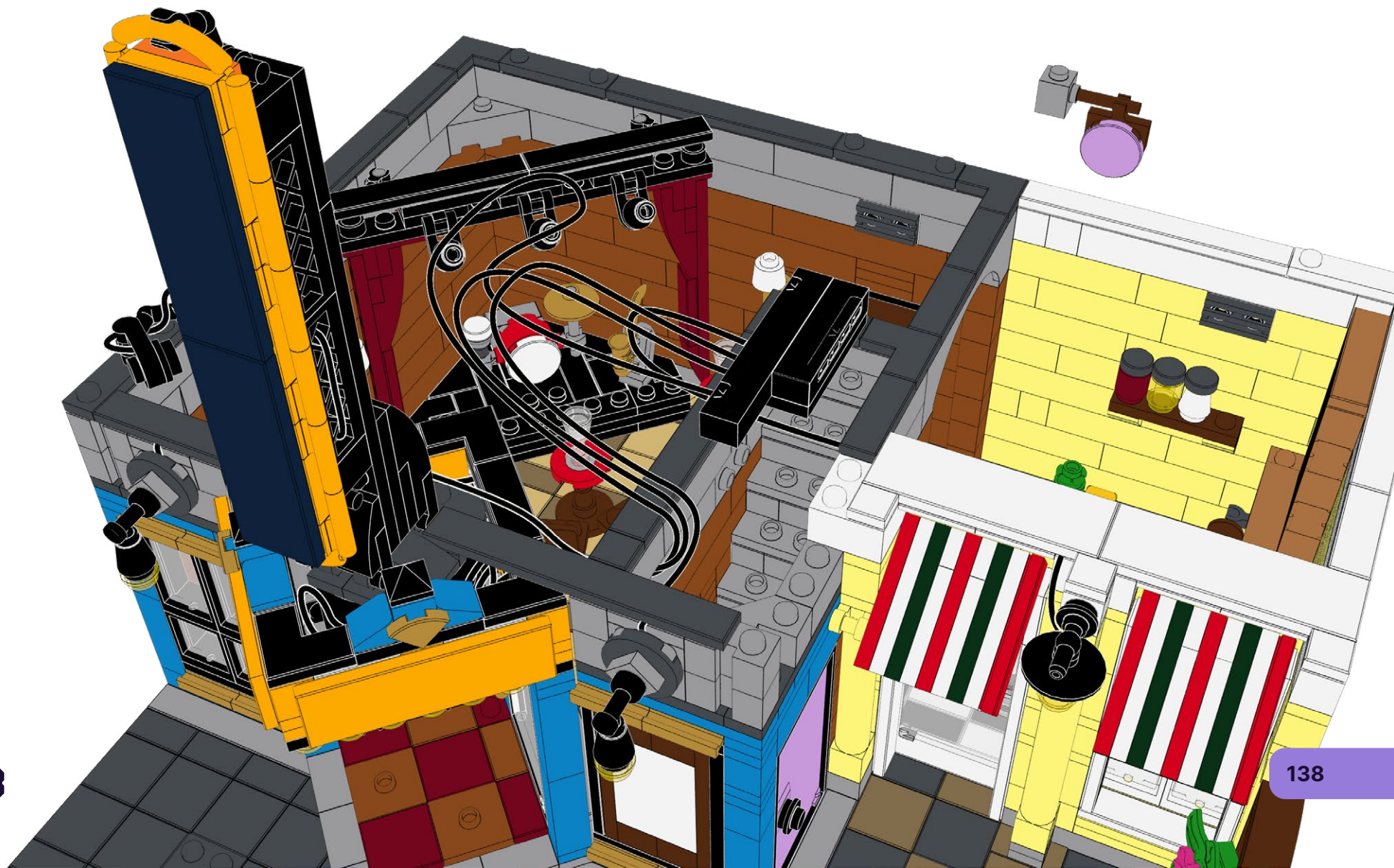

144

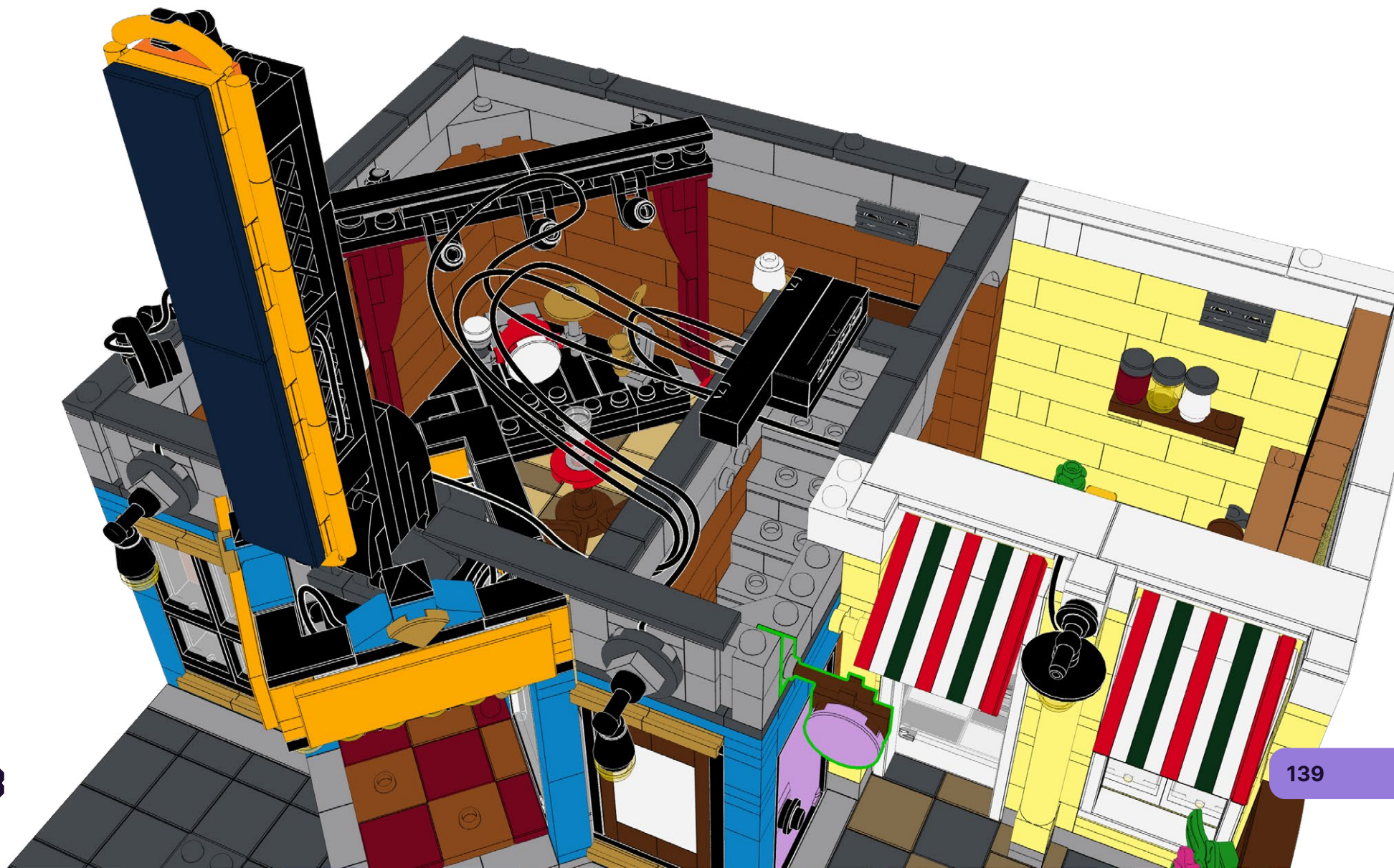

145

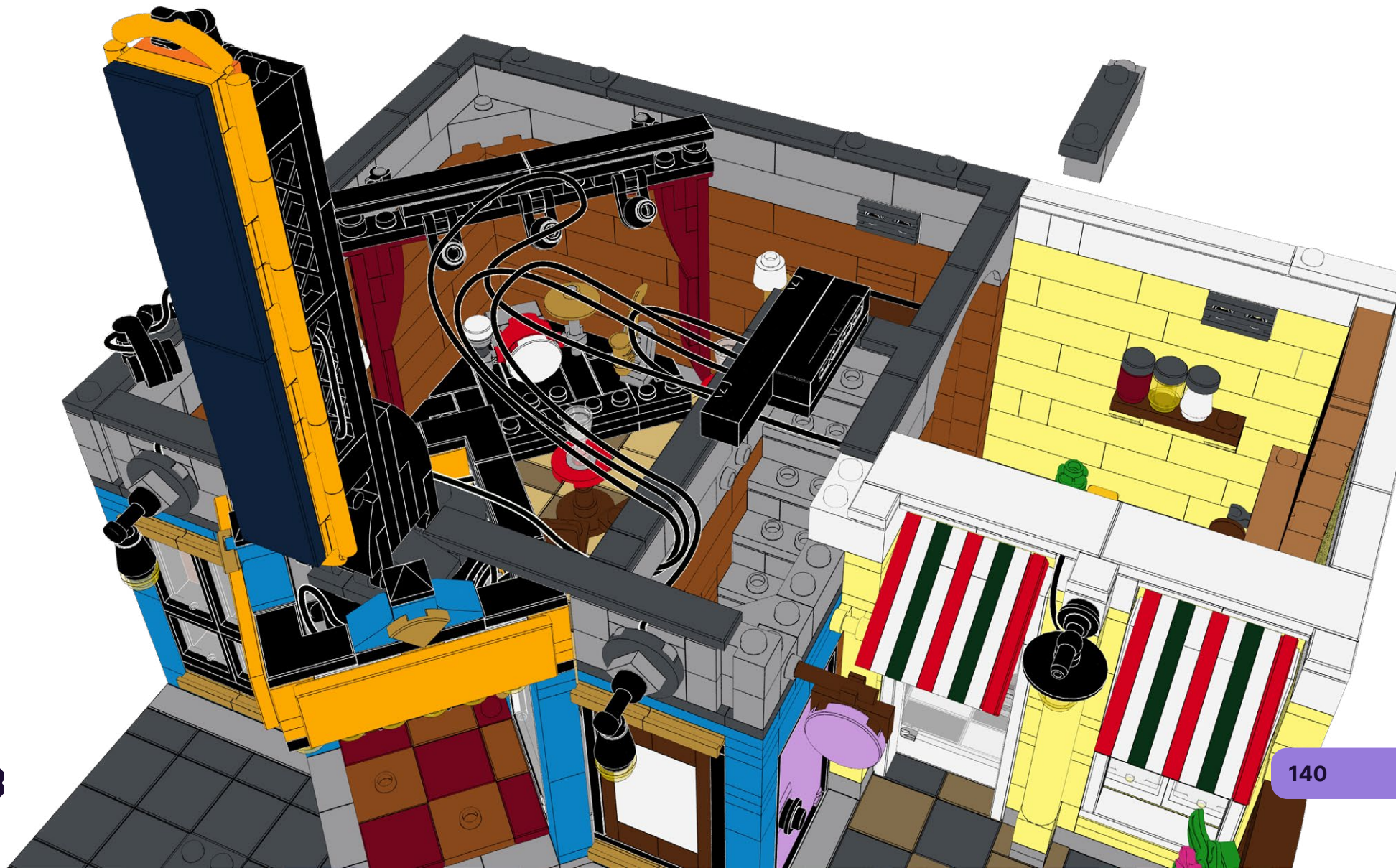

146

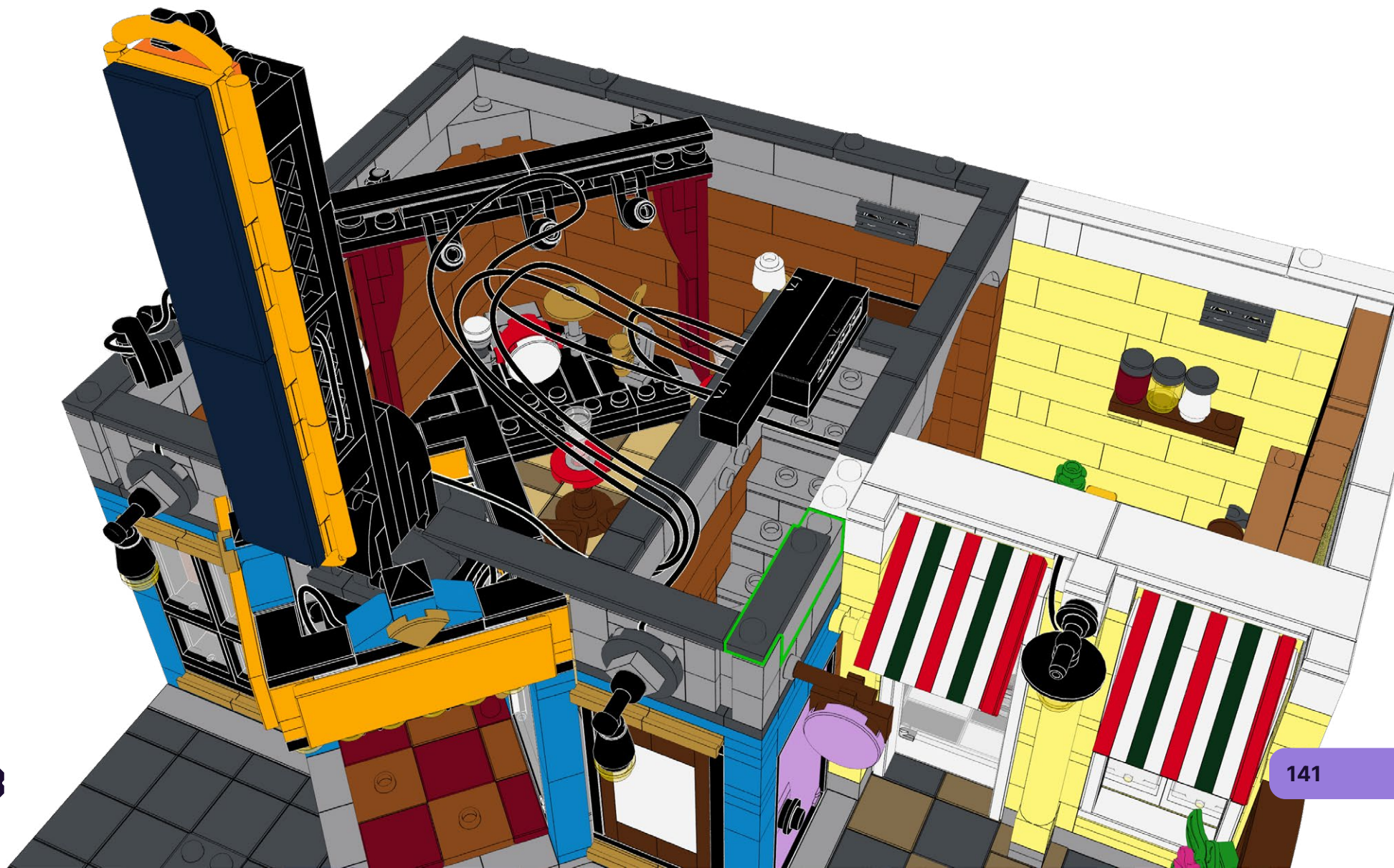

147

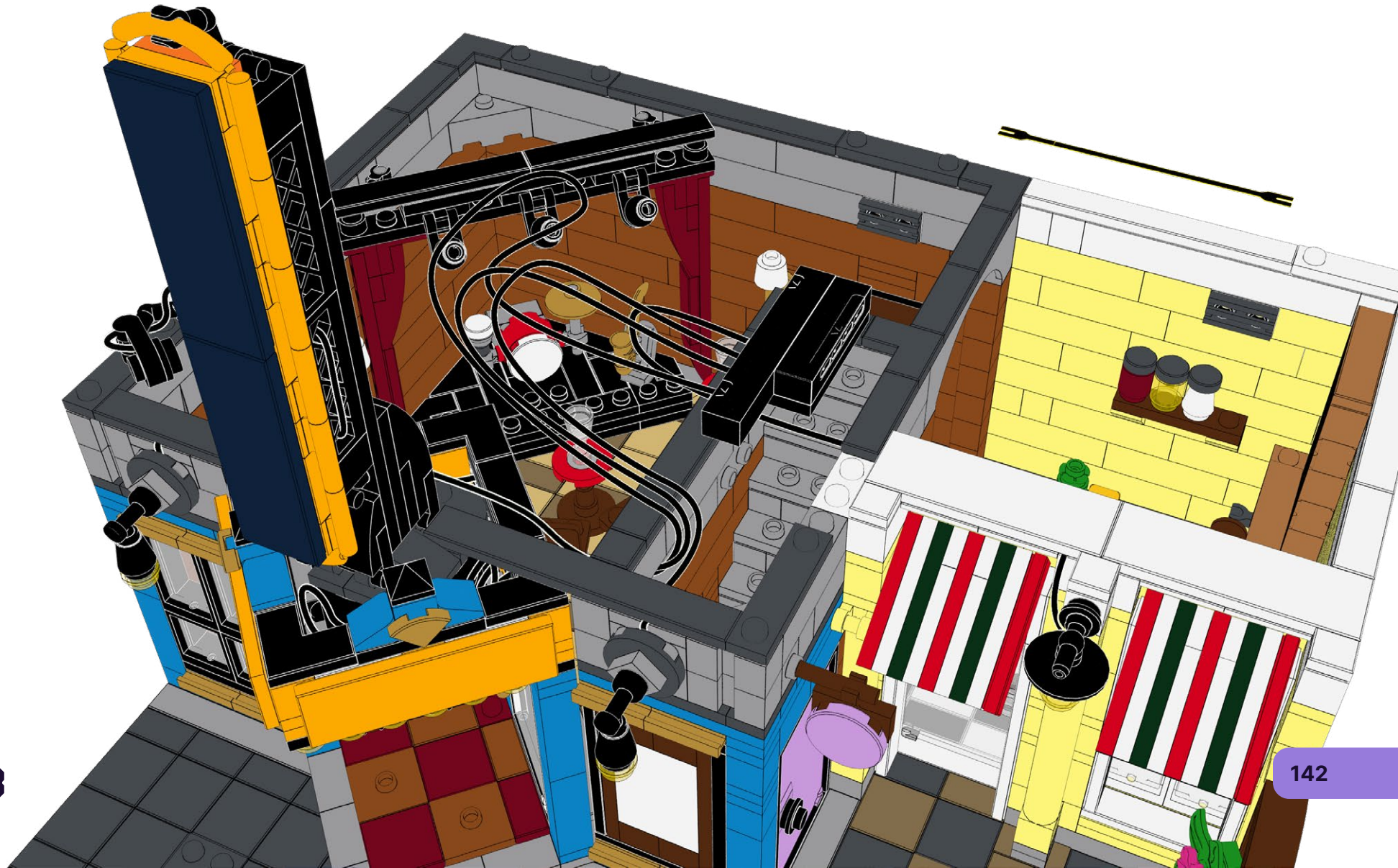
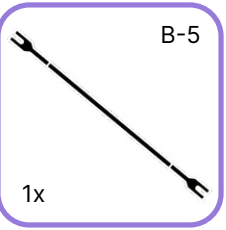

148

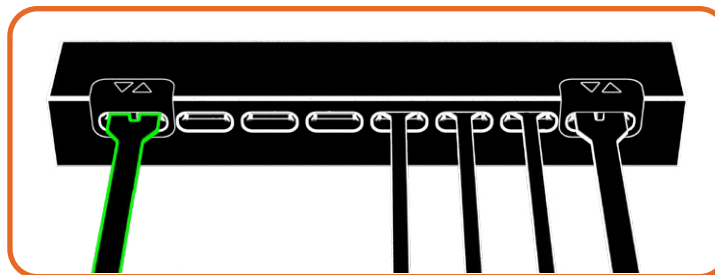

149

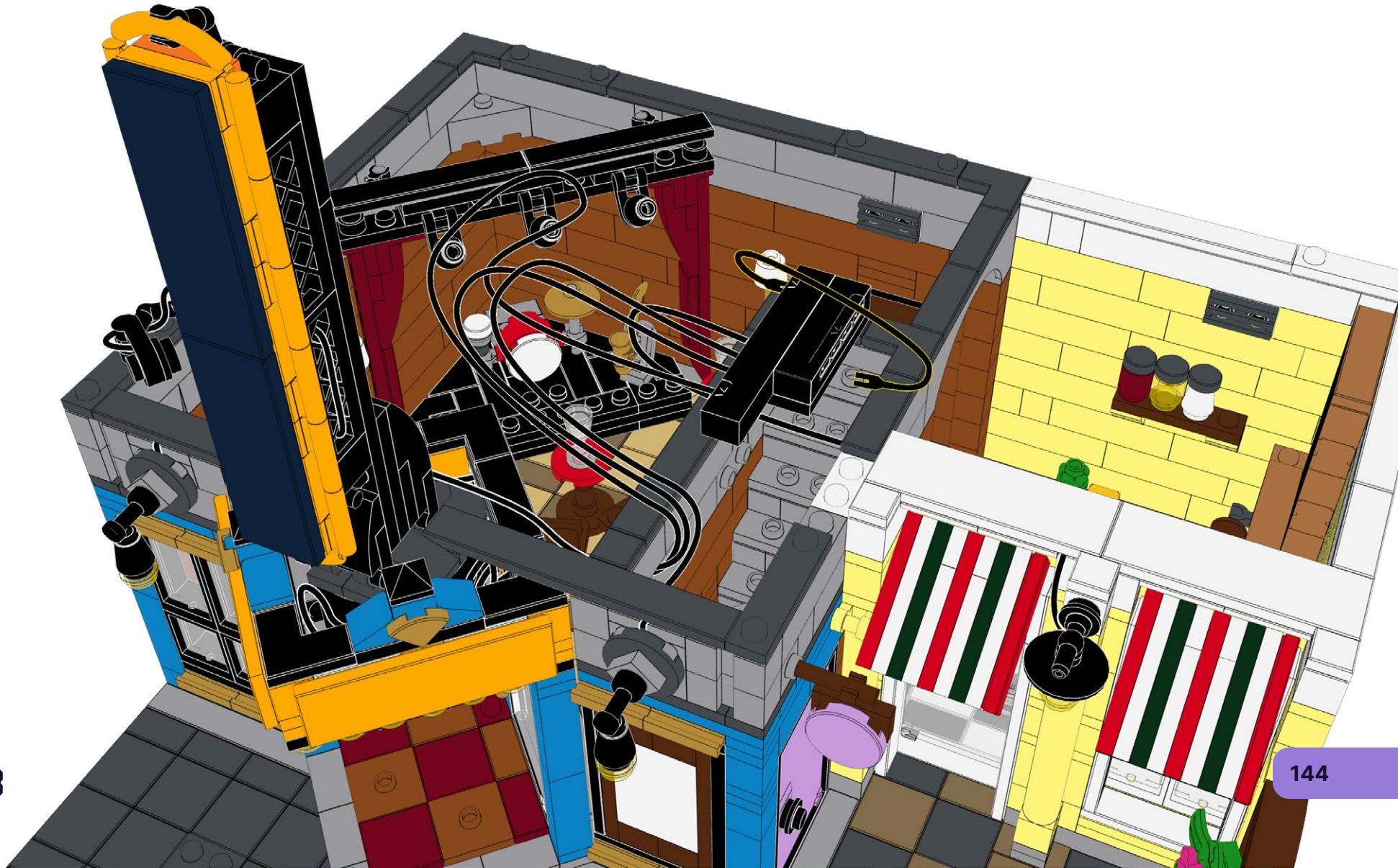

150

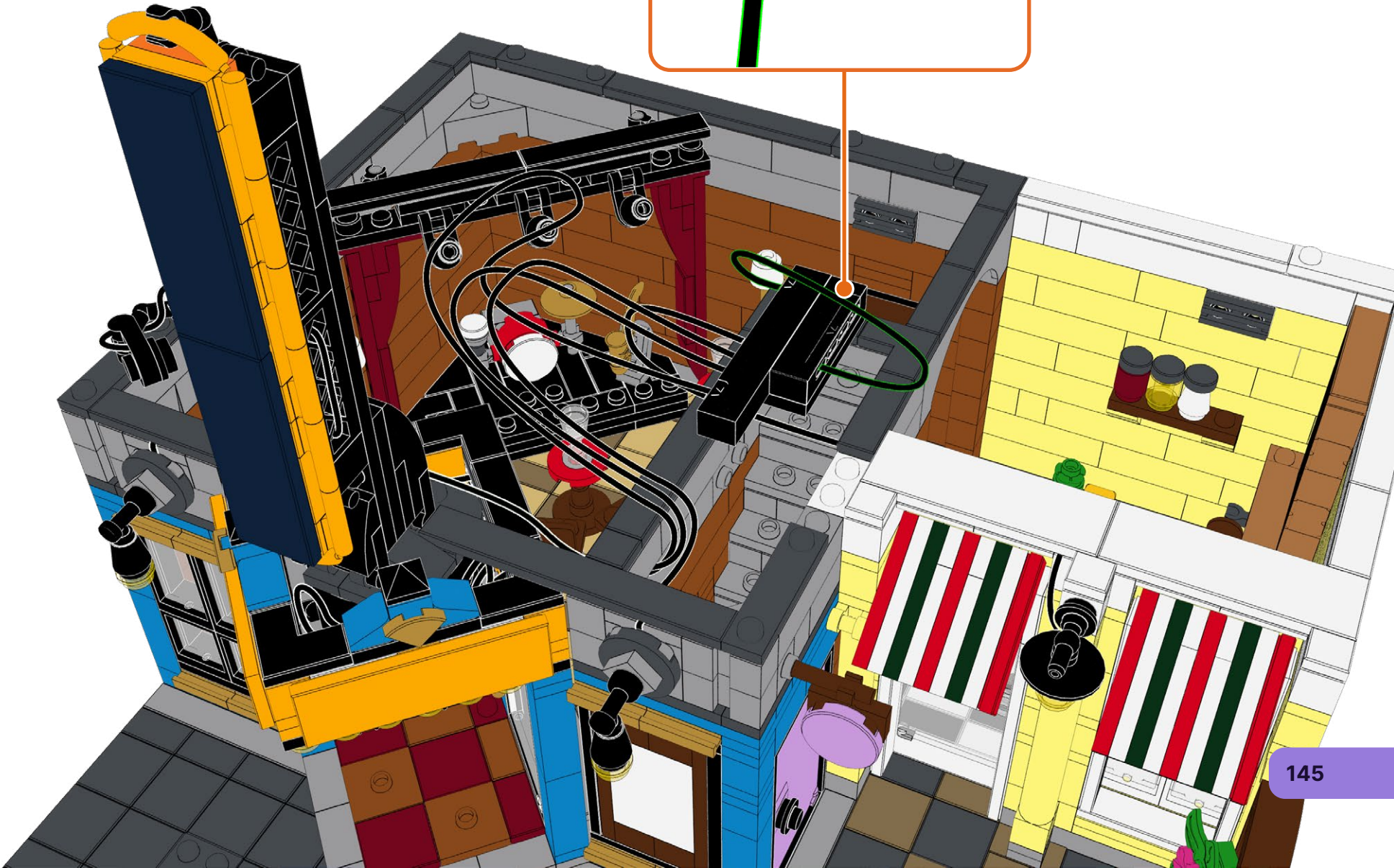
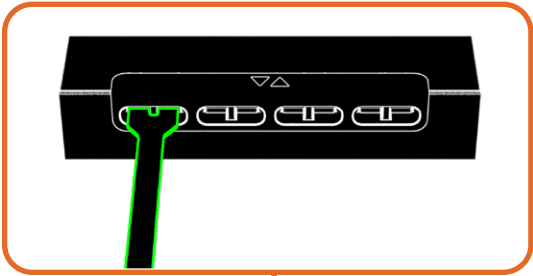

151

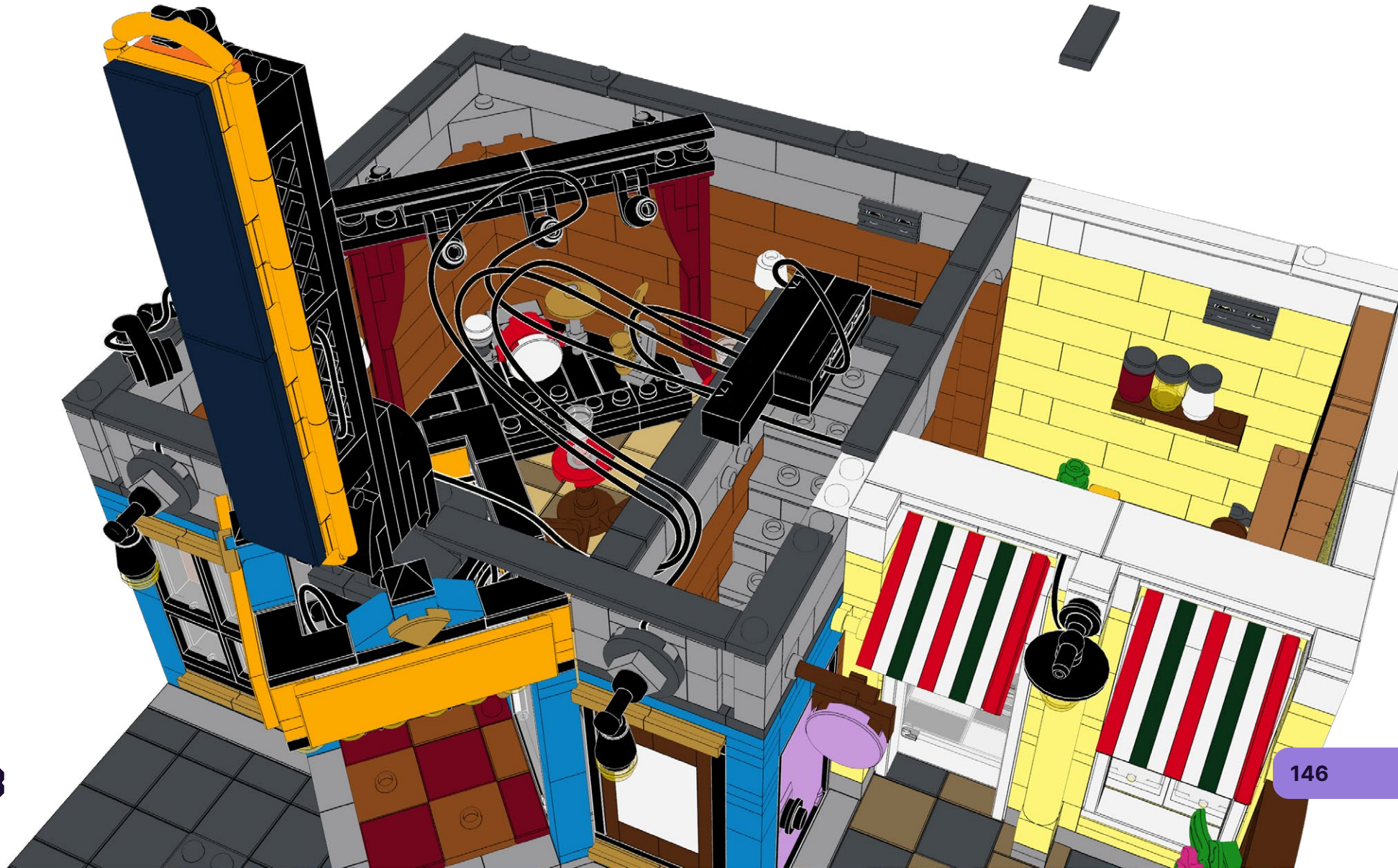

152

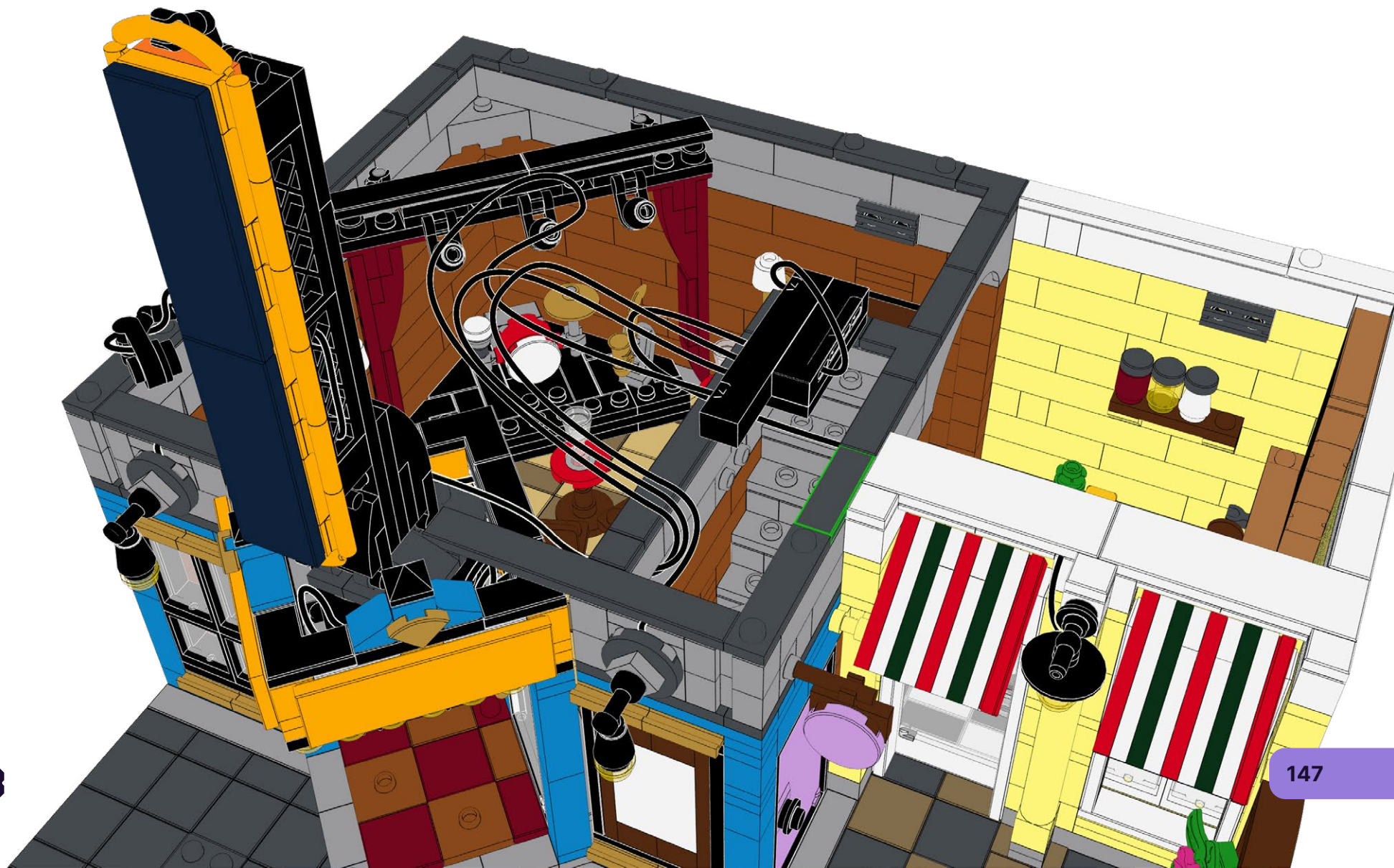

153



154



155



156



157



158



159



160



161

ALP-W30

1x



162

Astro Lamp Cap

1x

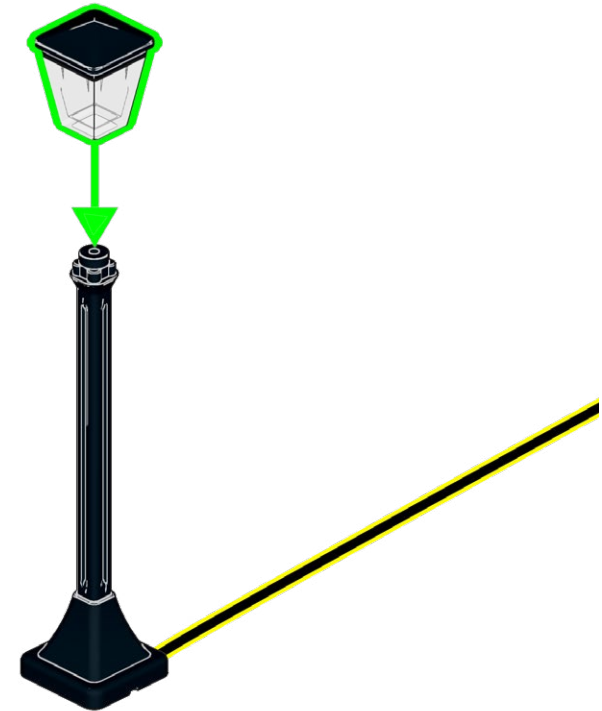
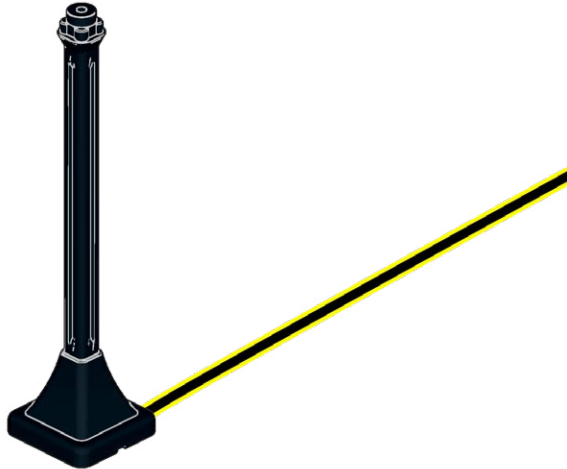

163



164

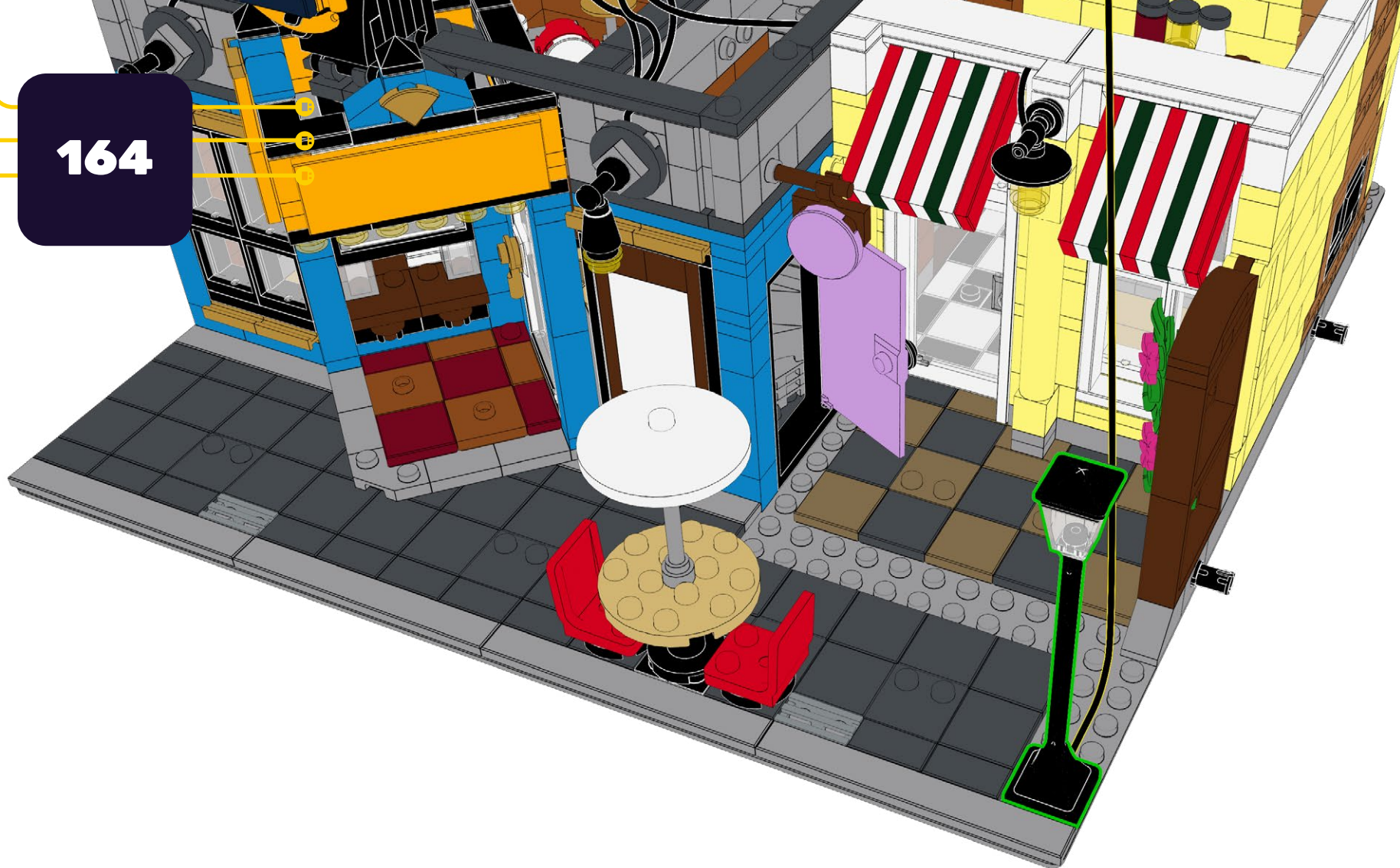

165



166



167



168



169



170



171



172



173



174



175

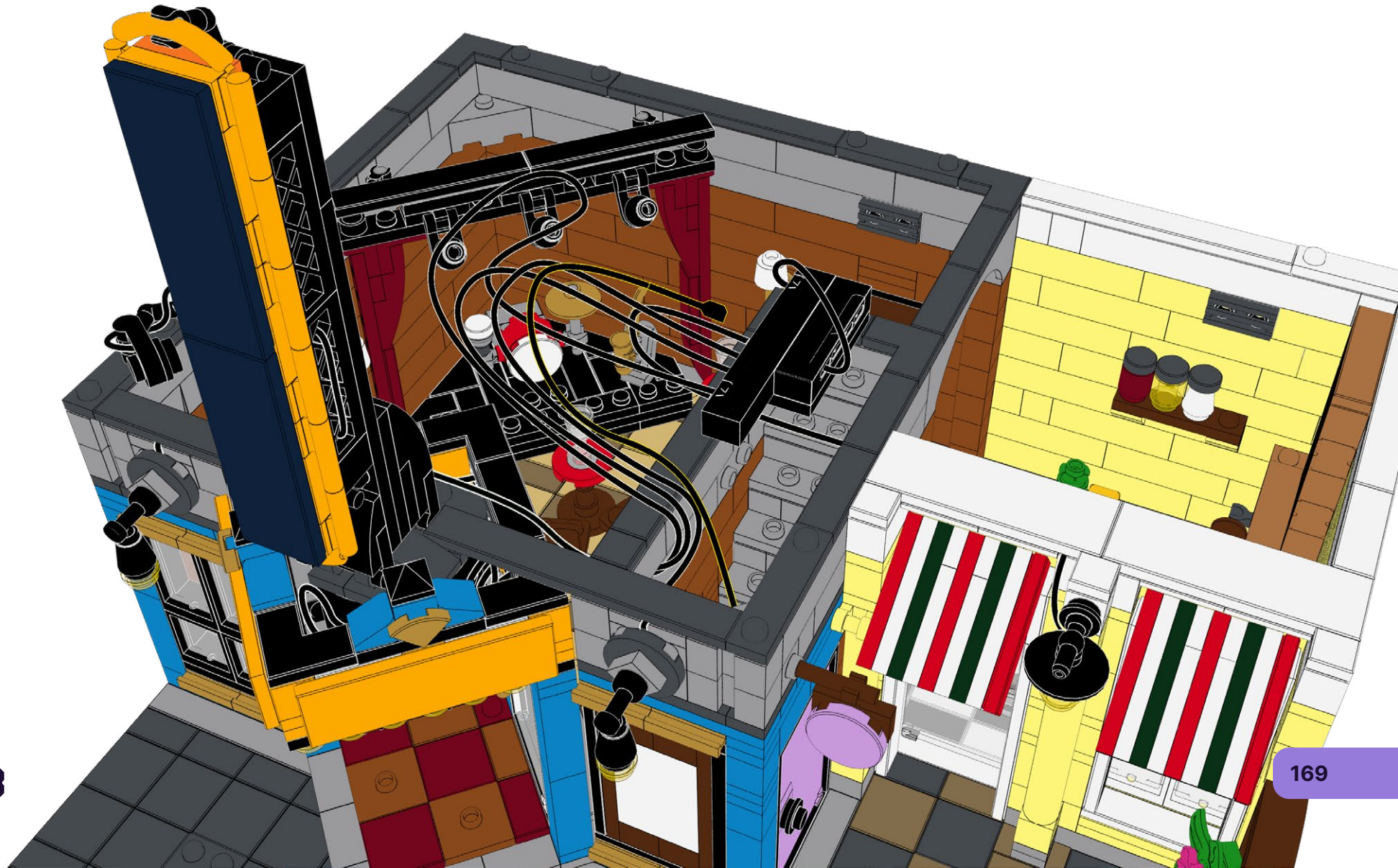

176

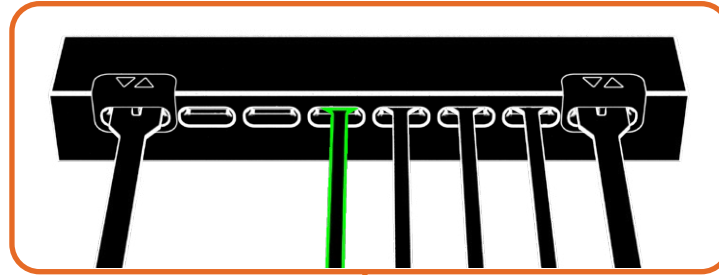

177

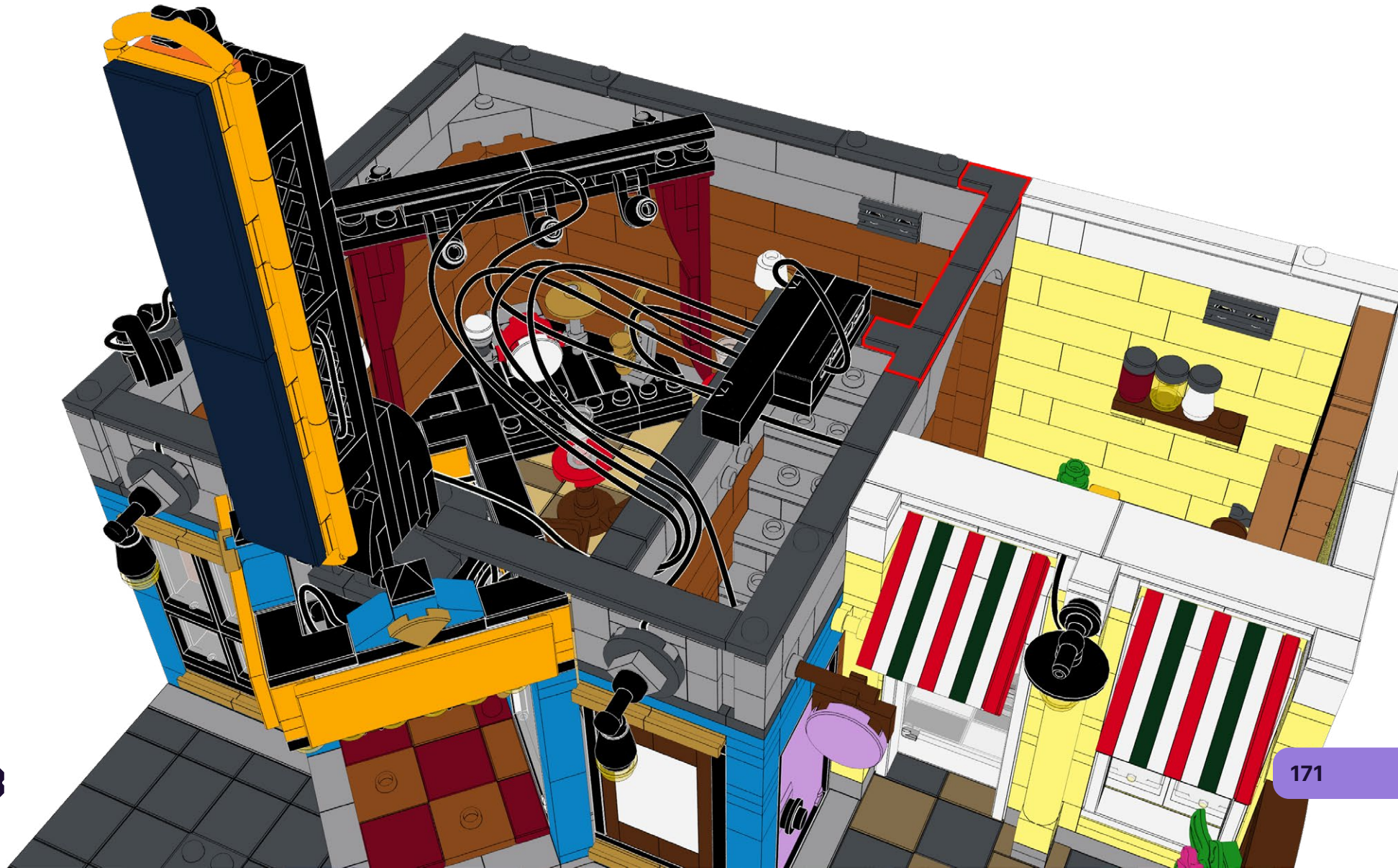

178

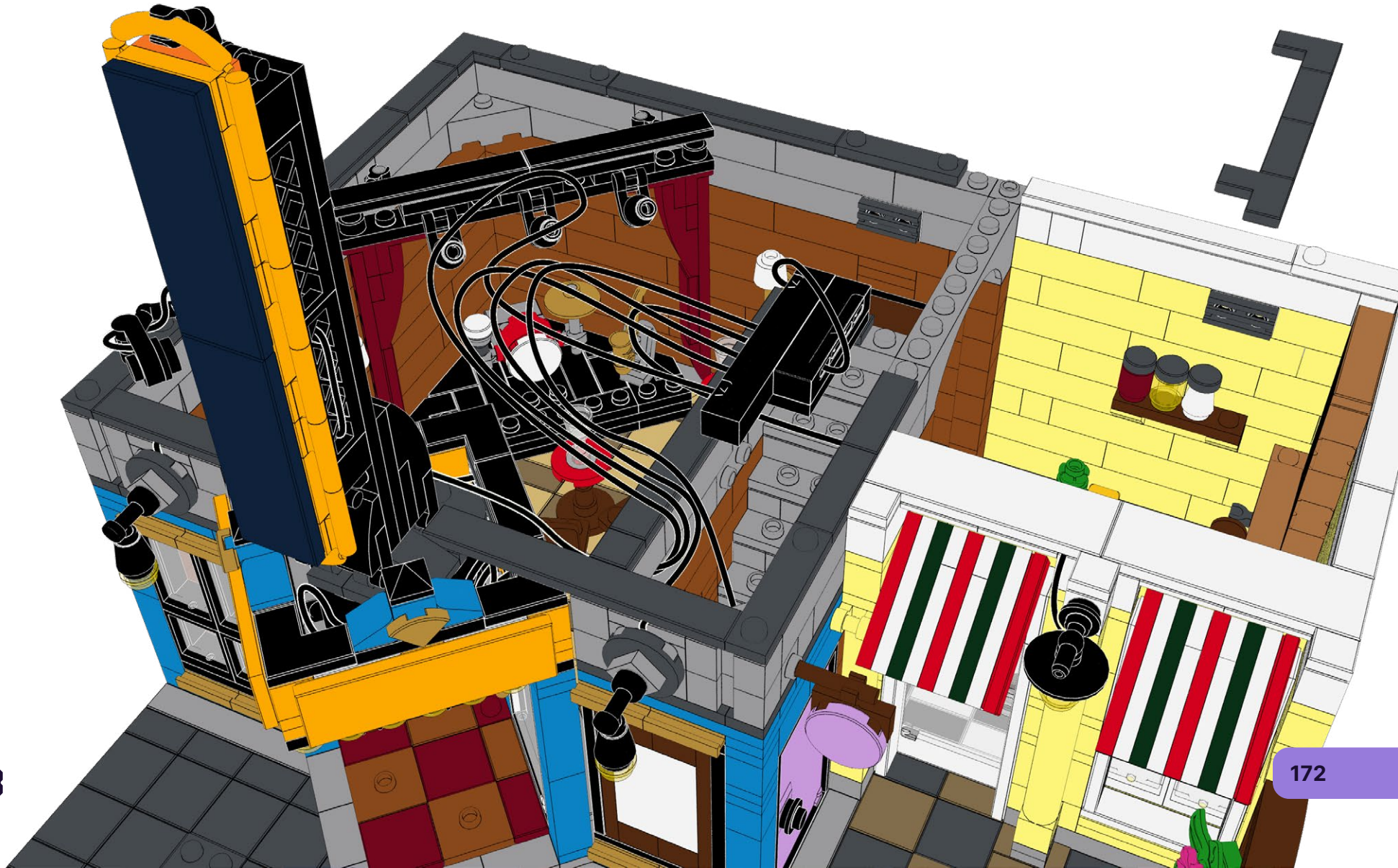

179

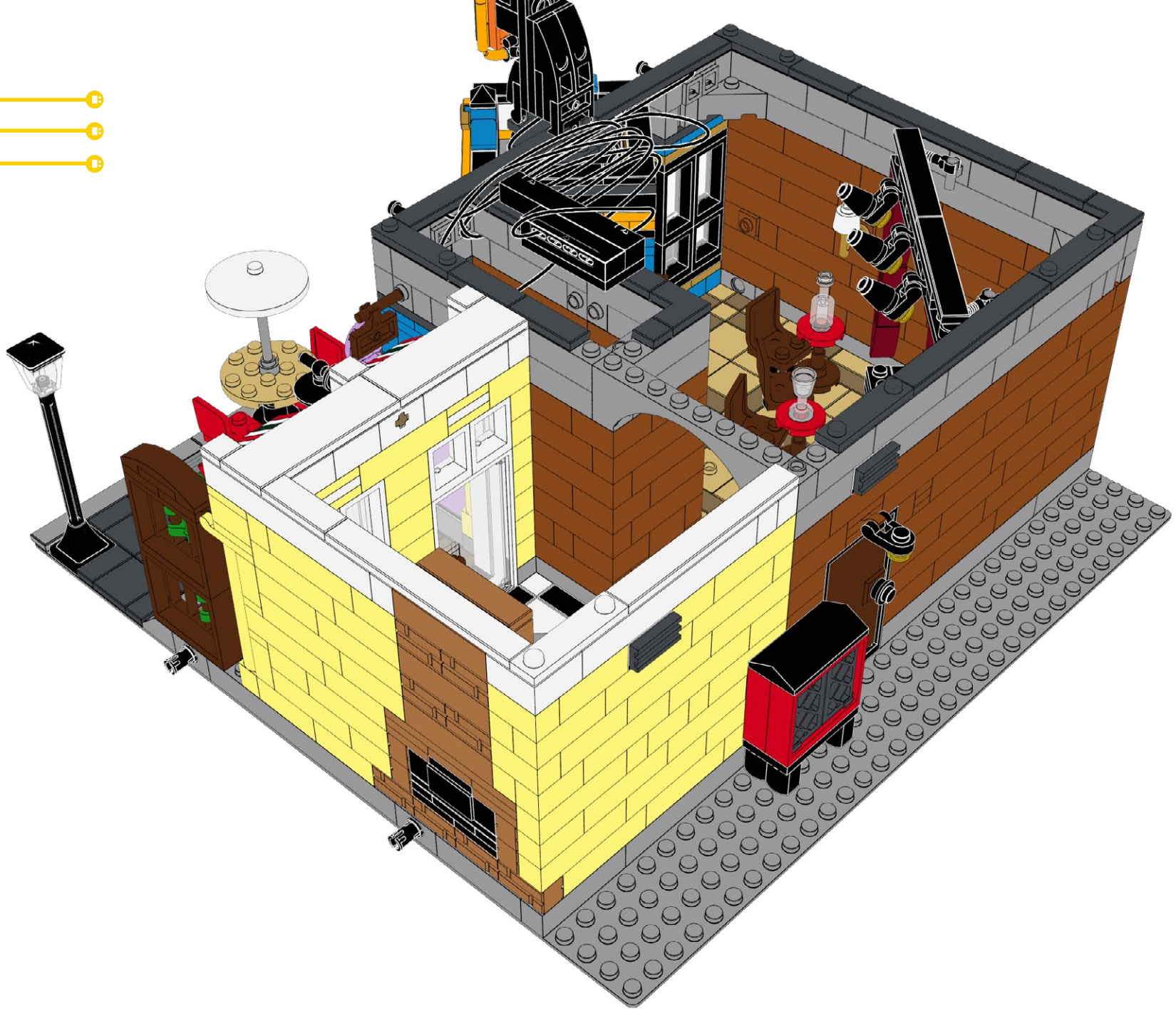

180

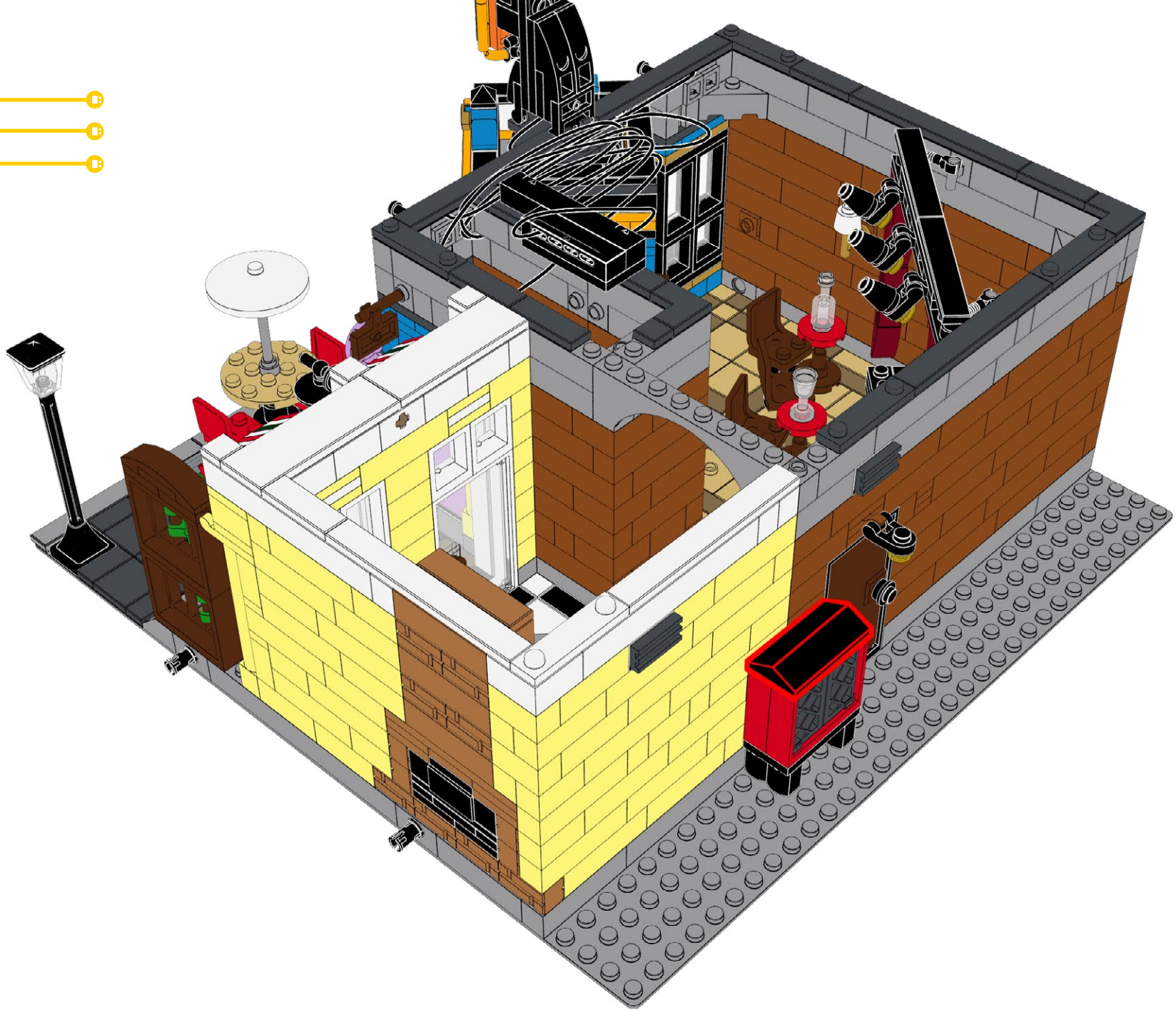

181

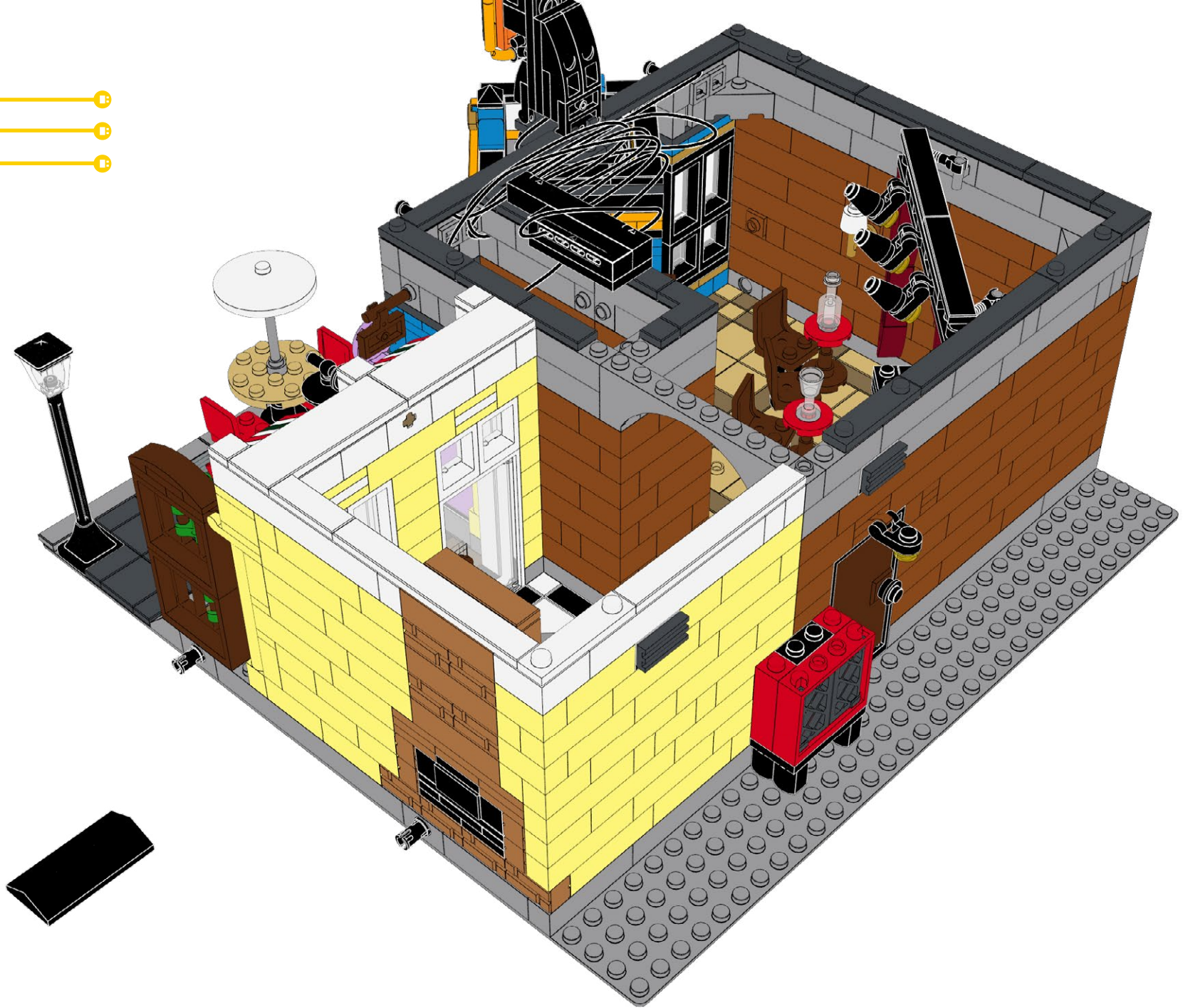

182

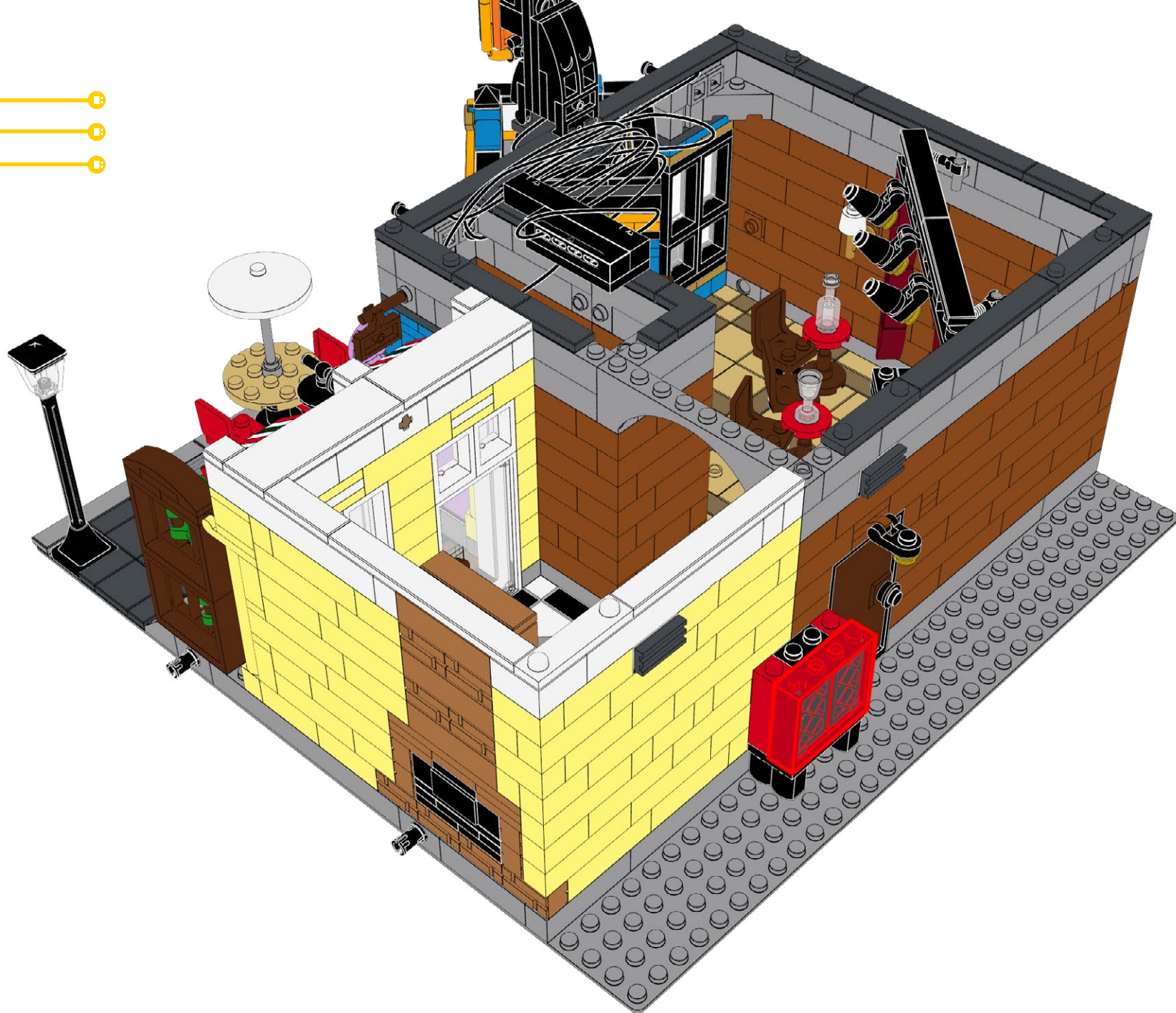

183

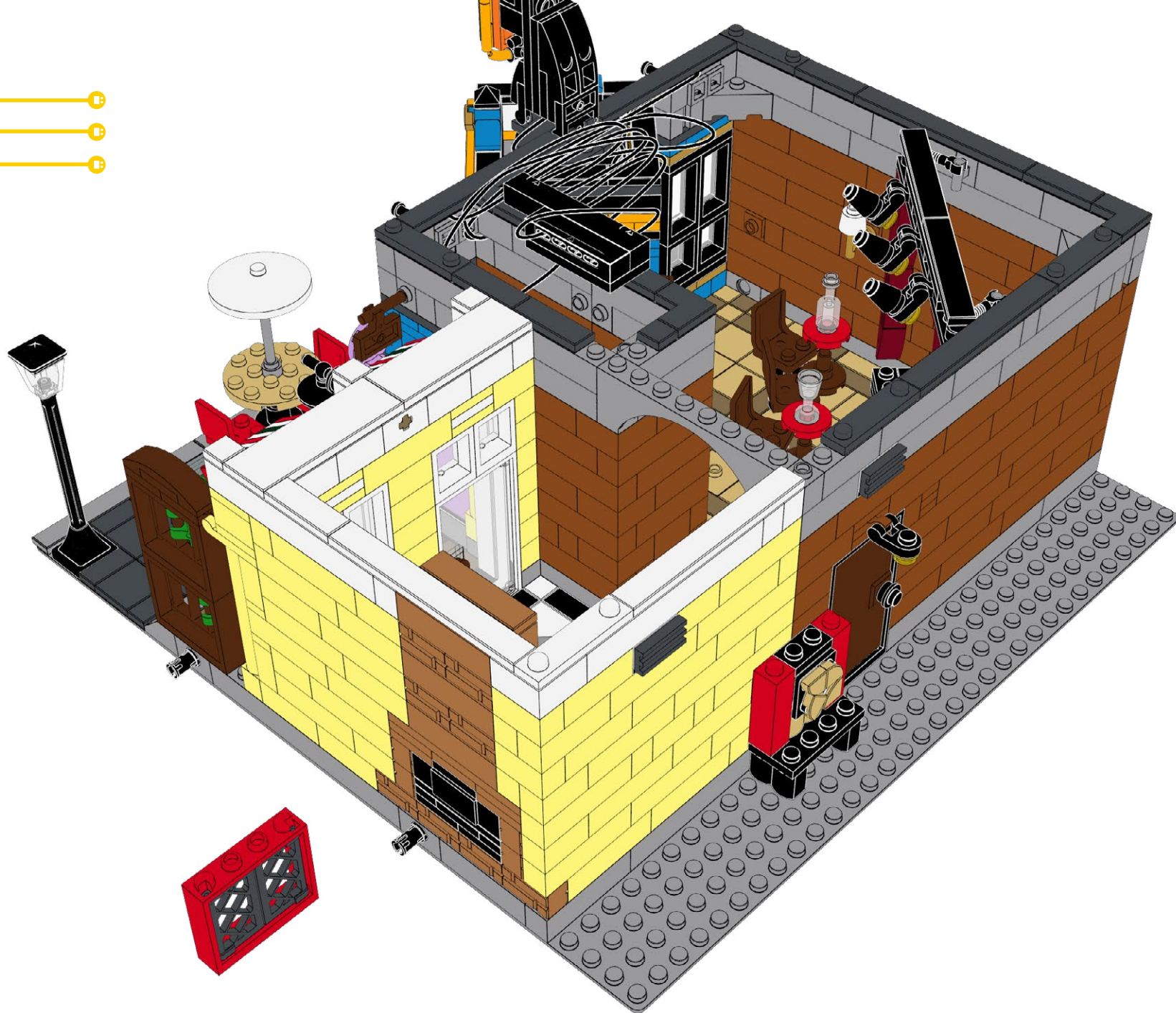

184

FLX-C

1x



B-50

1x

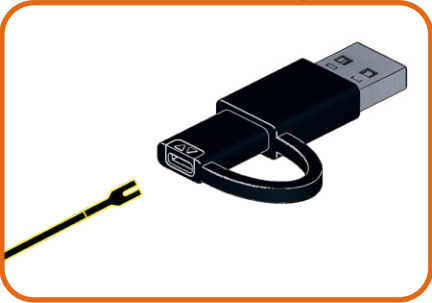
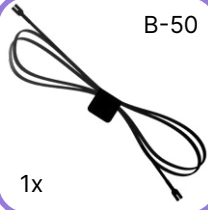

185

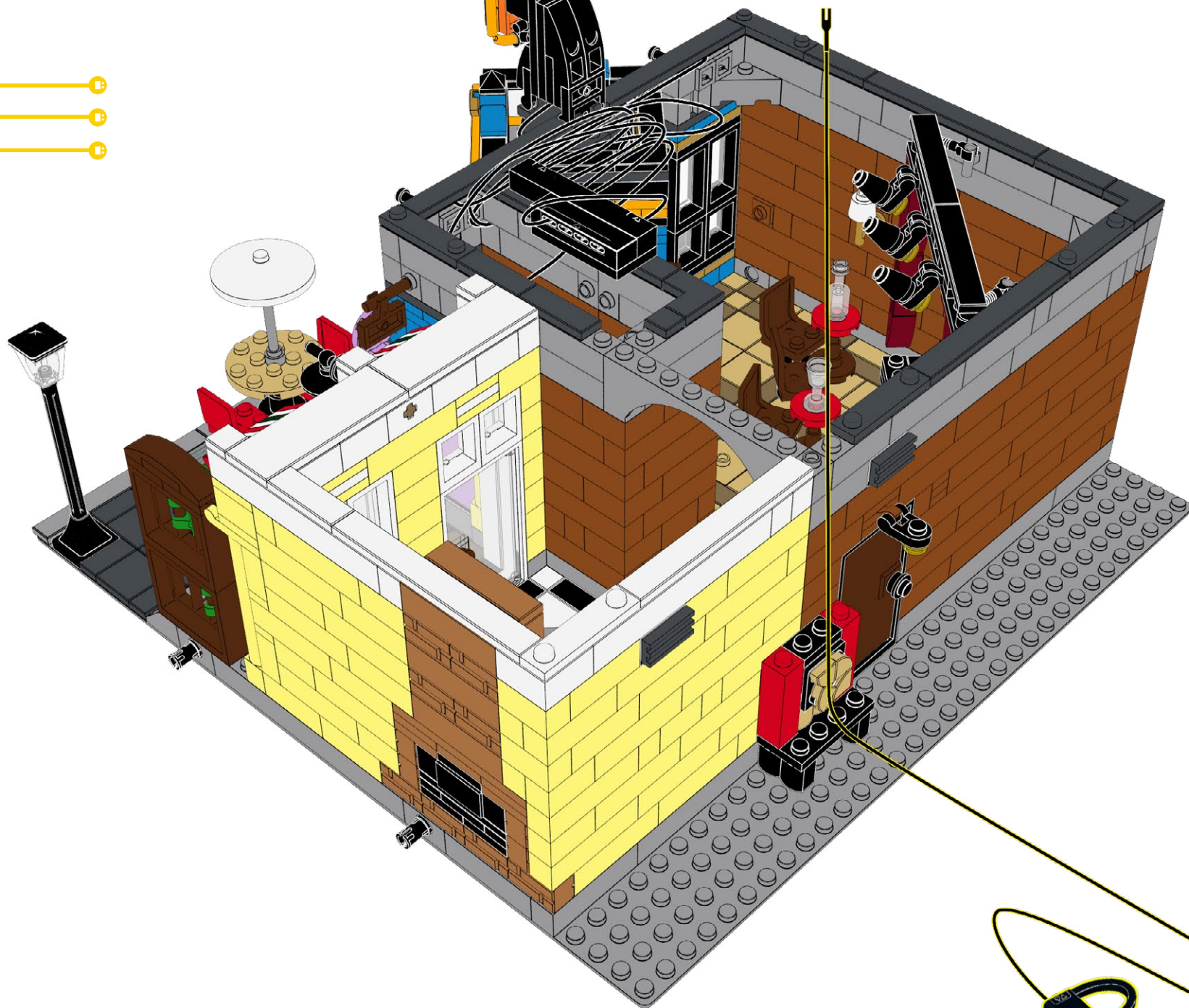

186

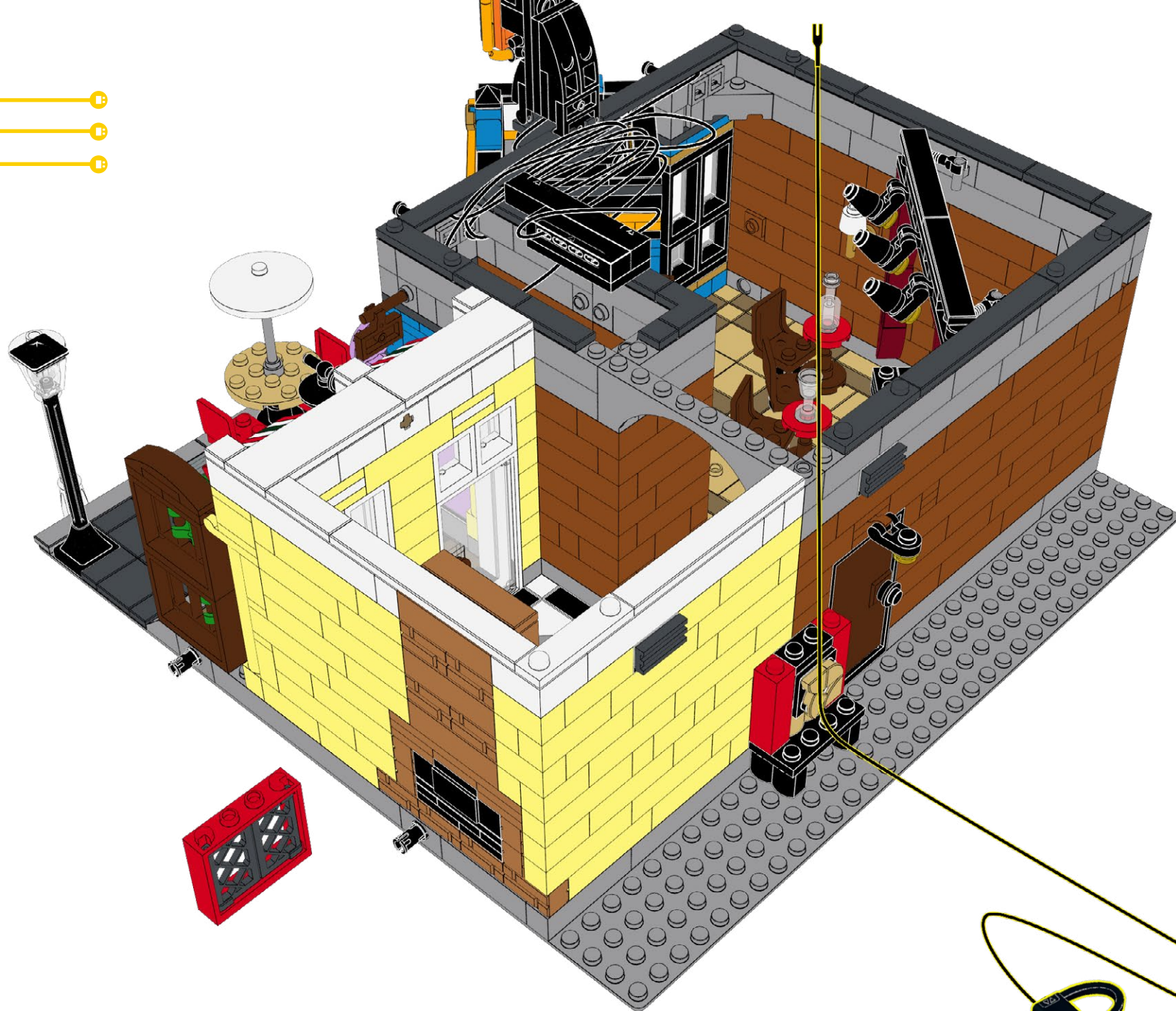

187

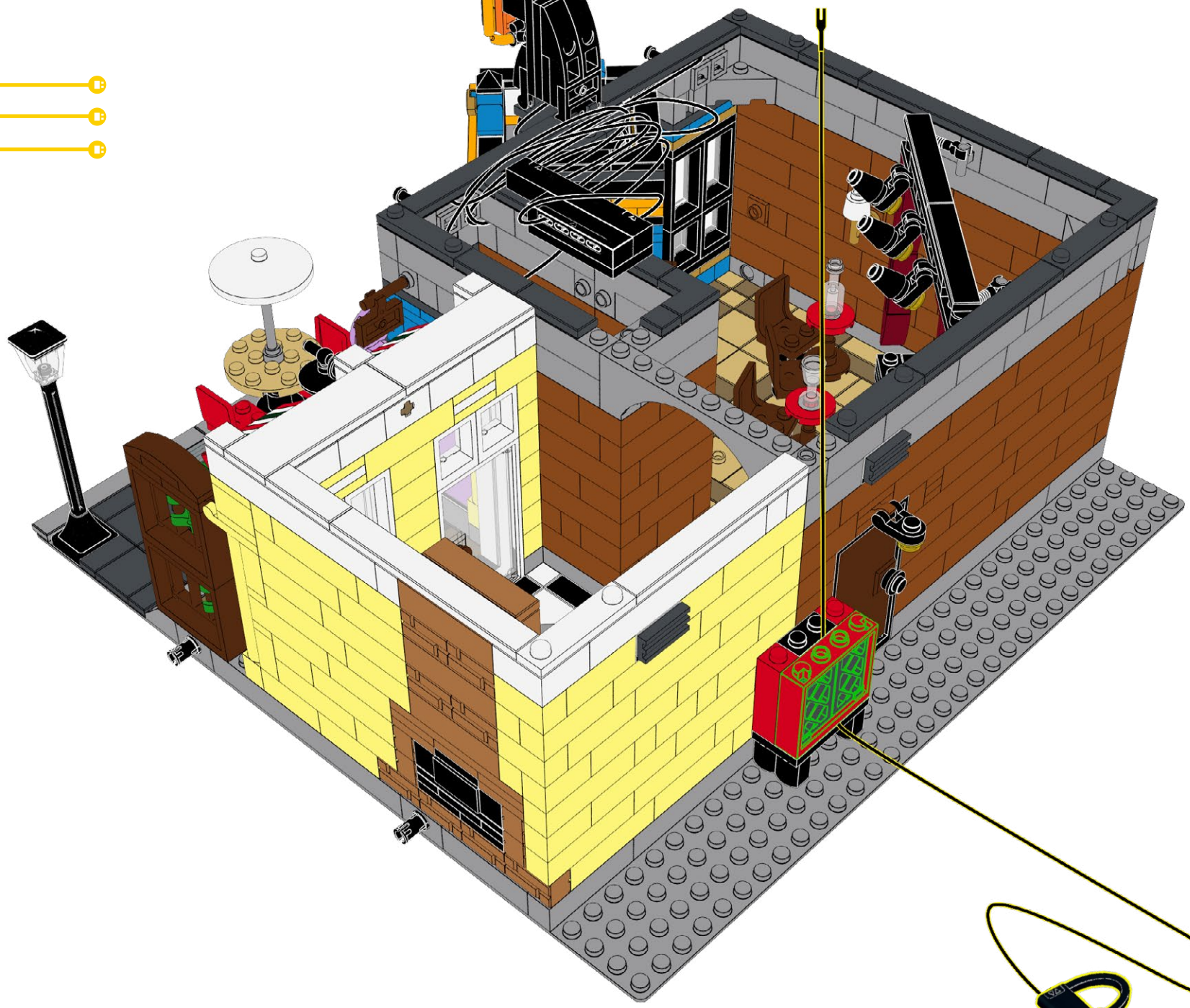

188

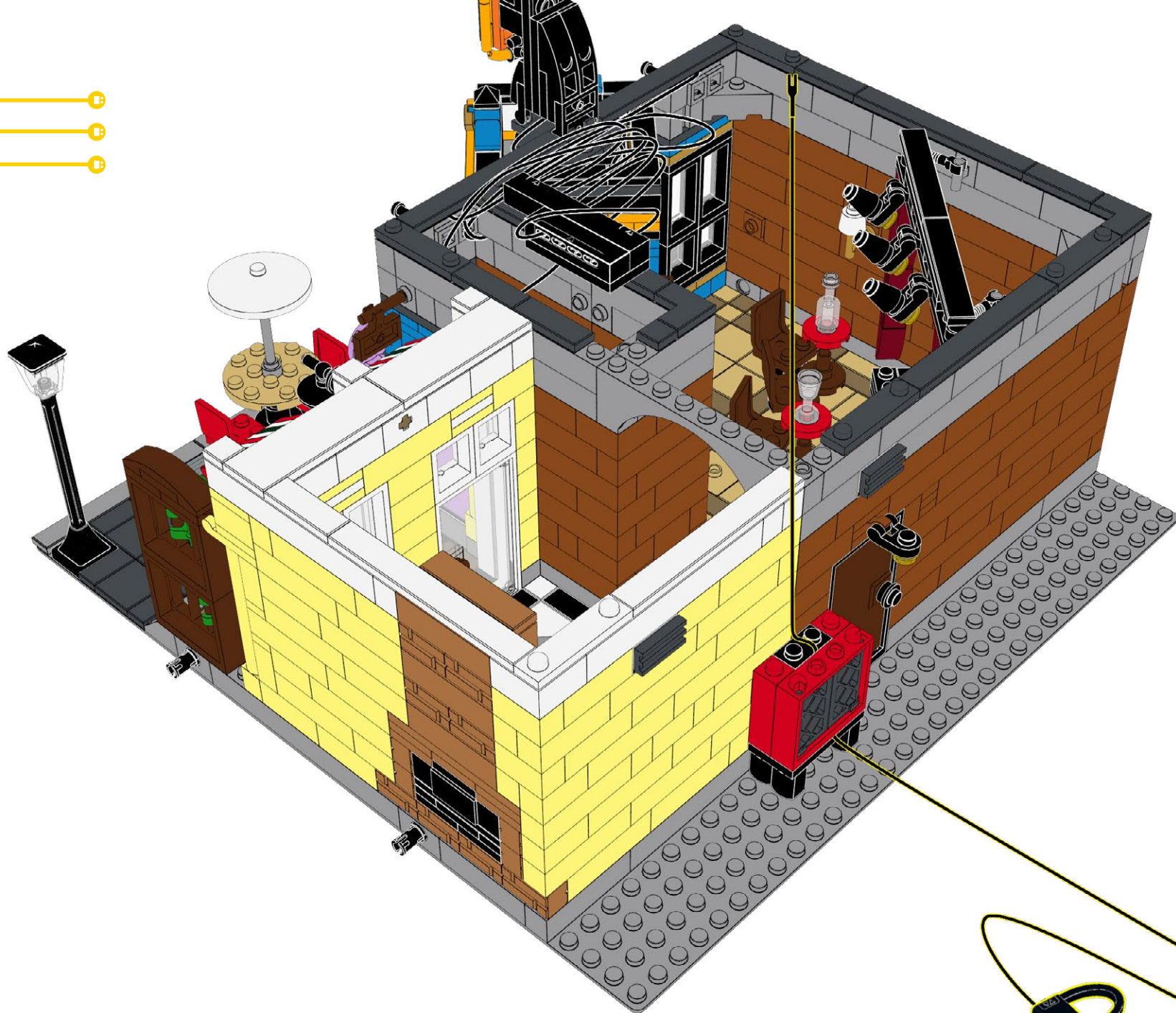

189

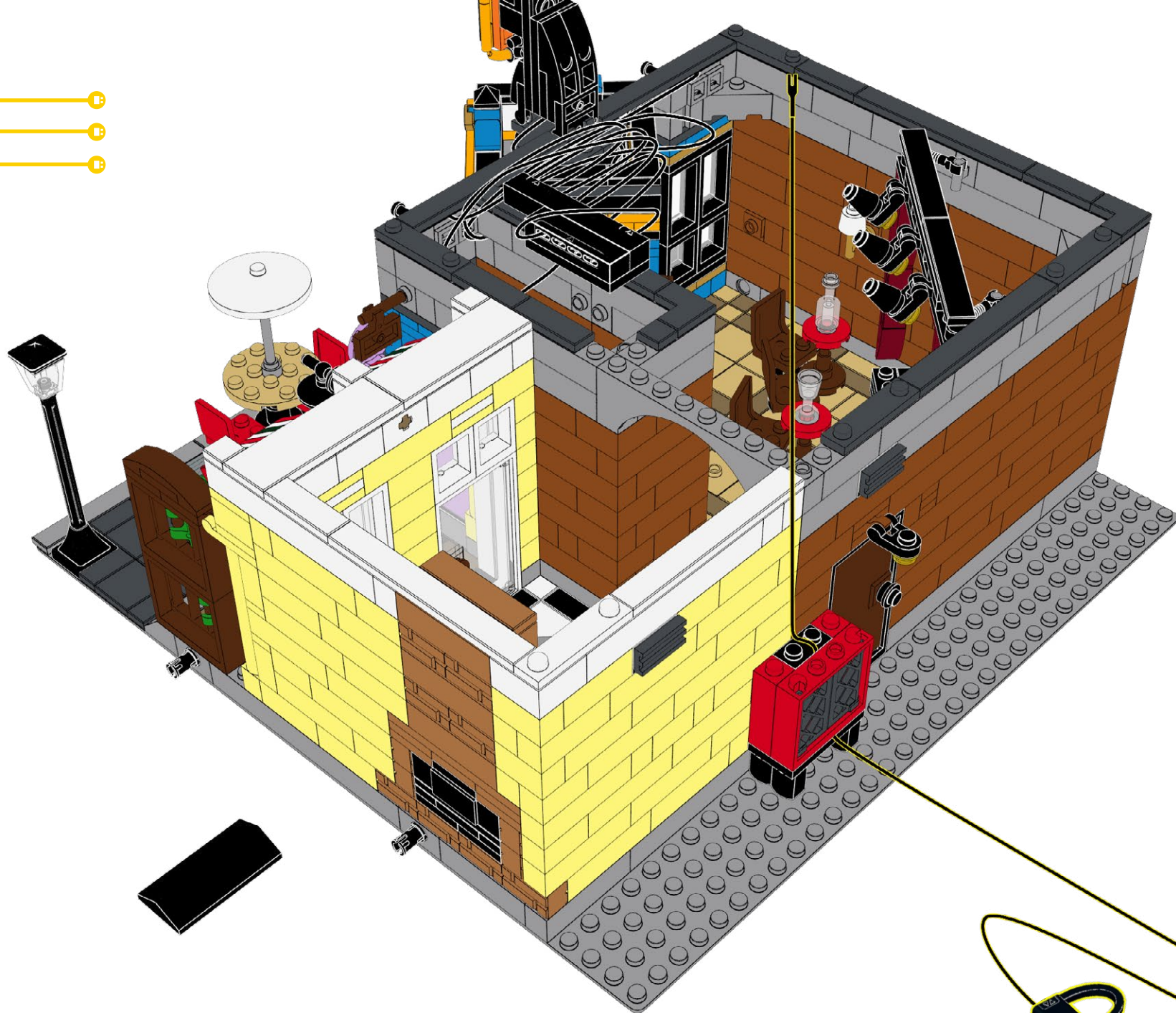

190

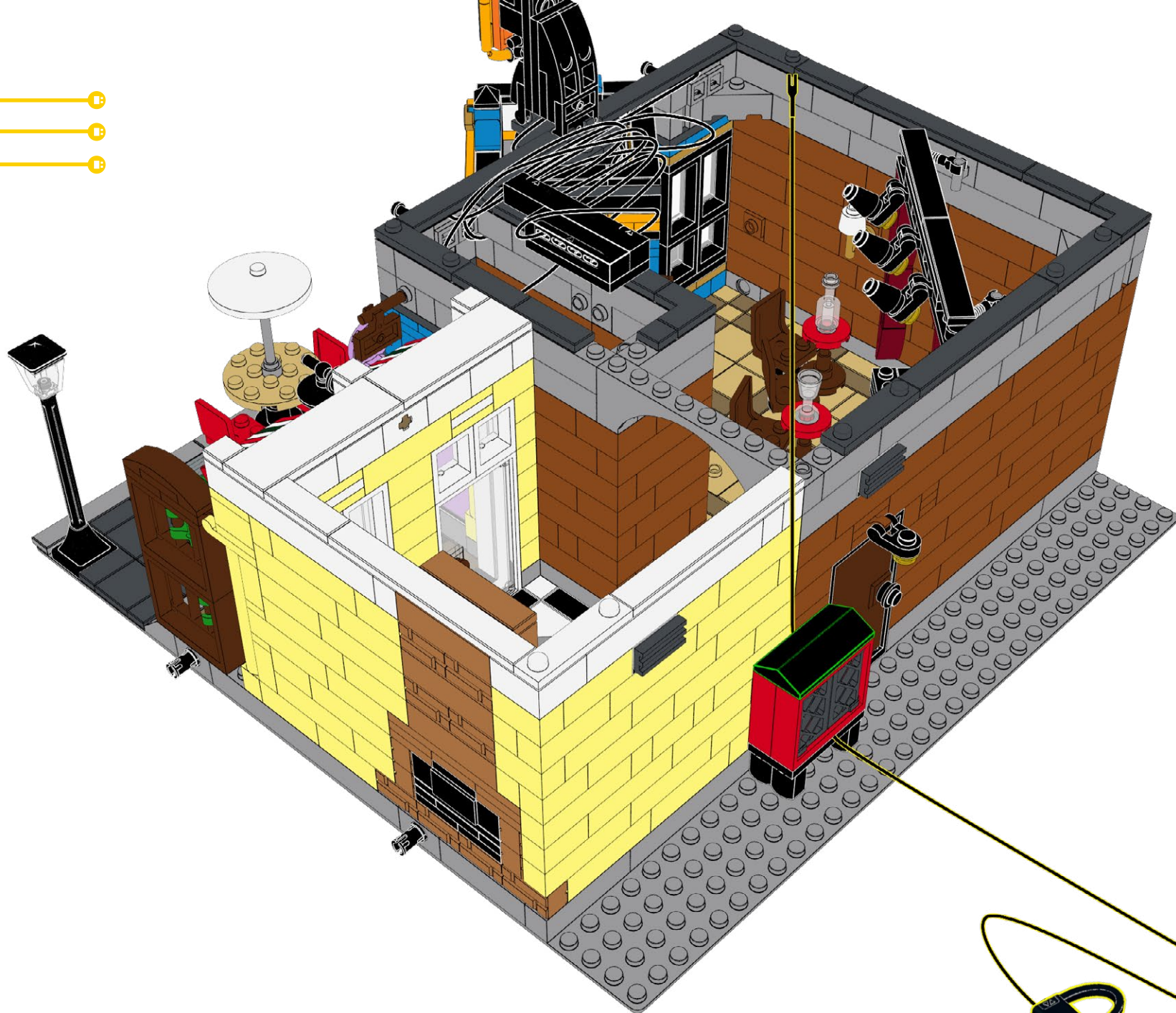

191

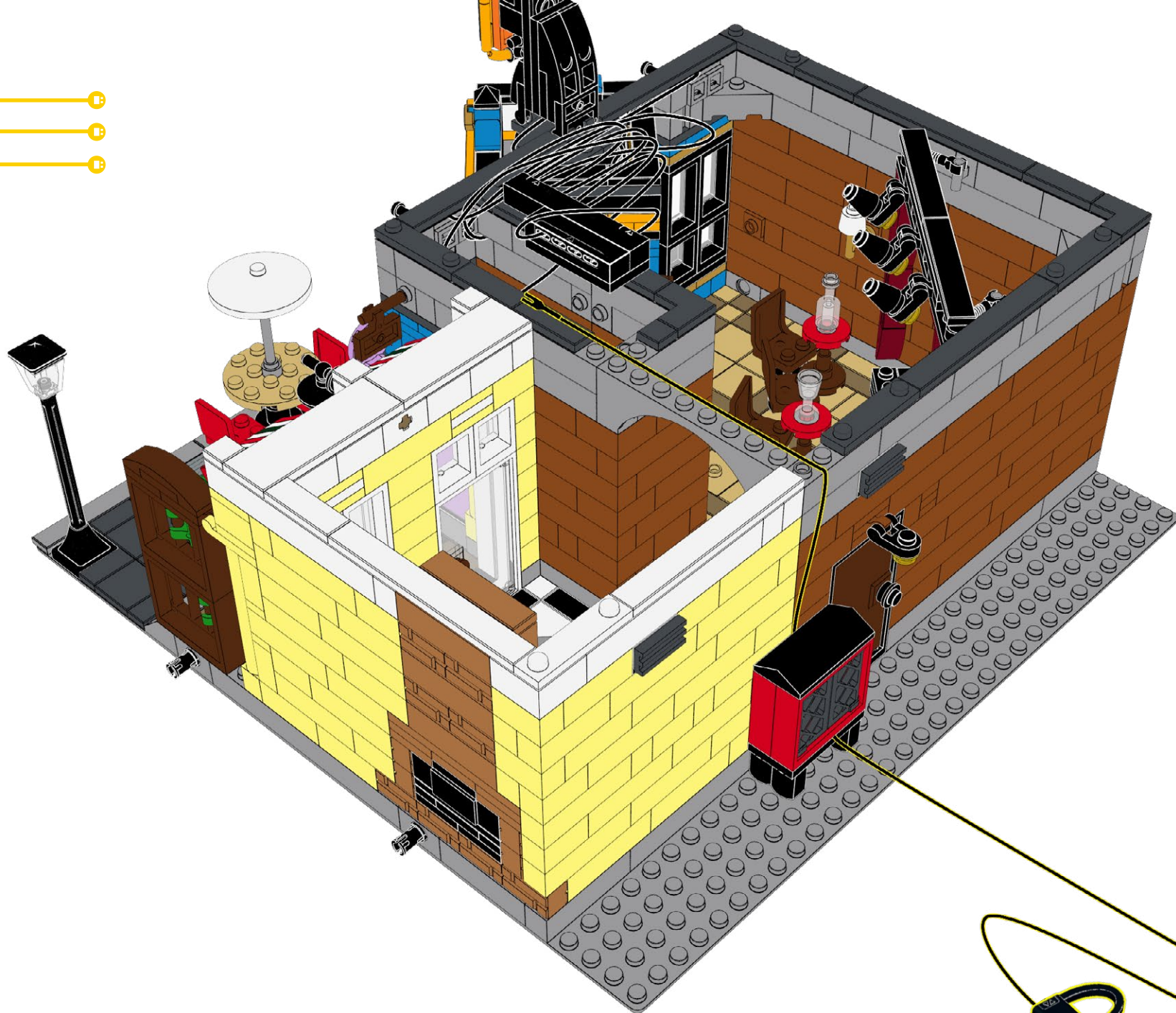

192

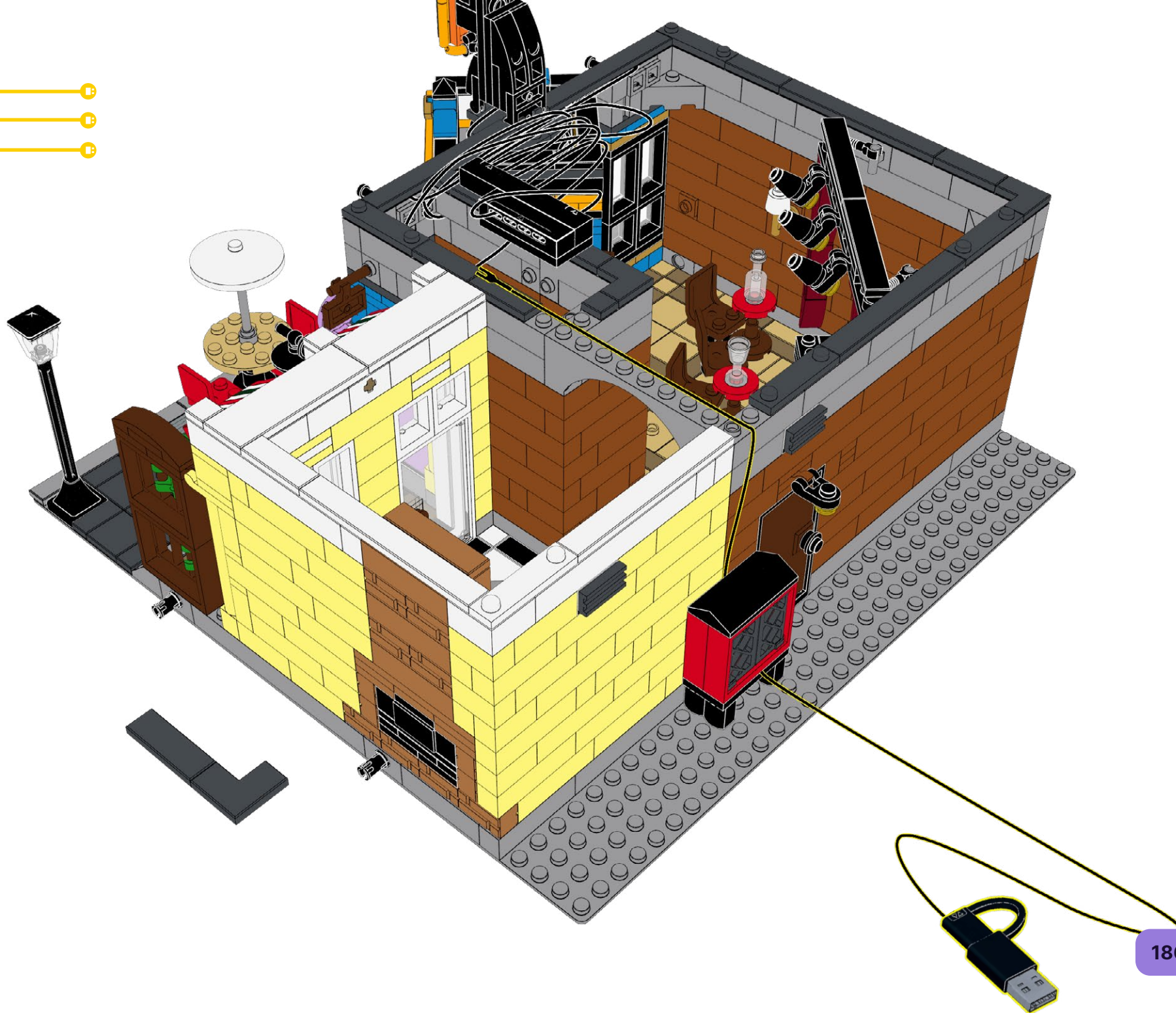

193

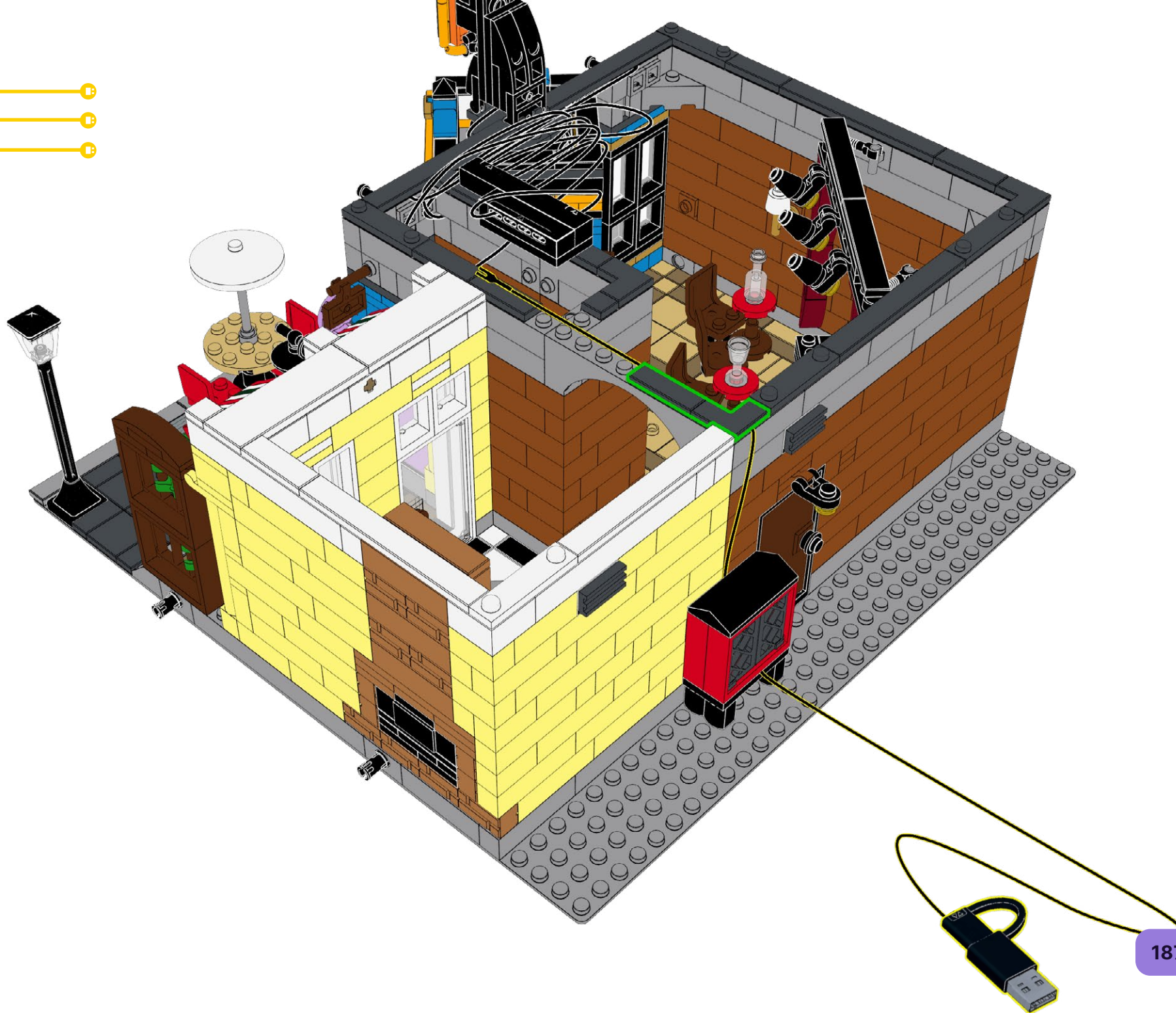

194

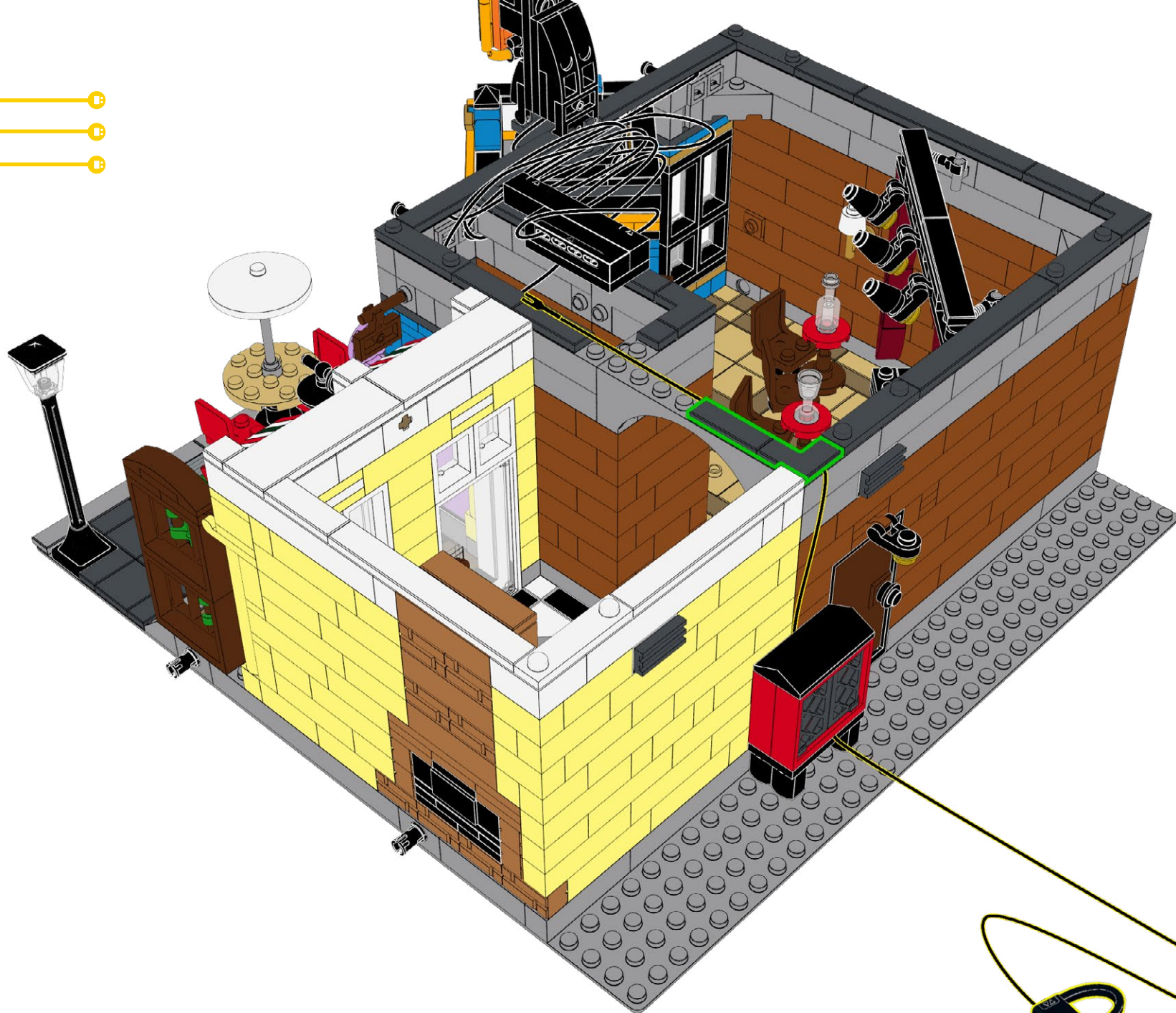

195

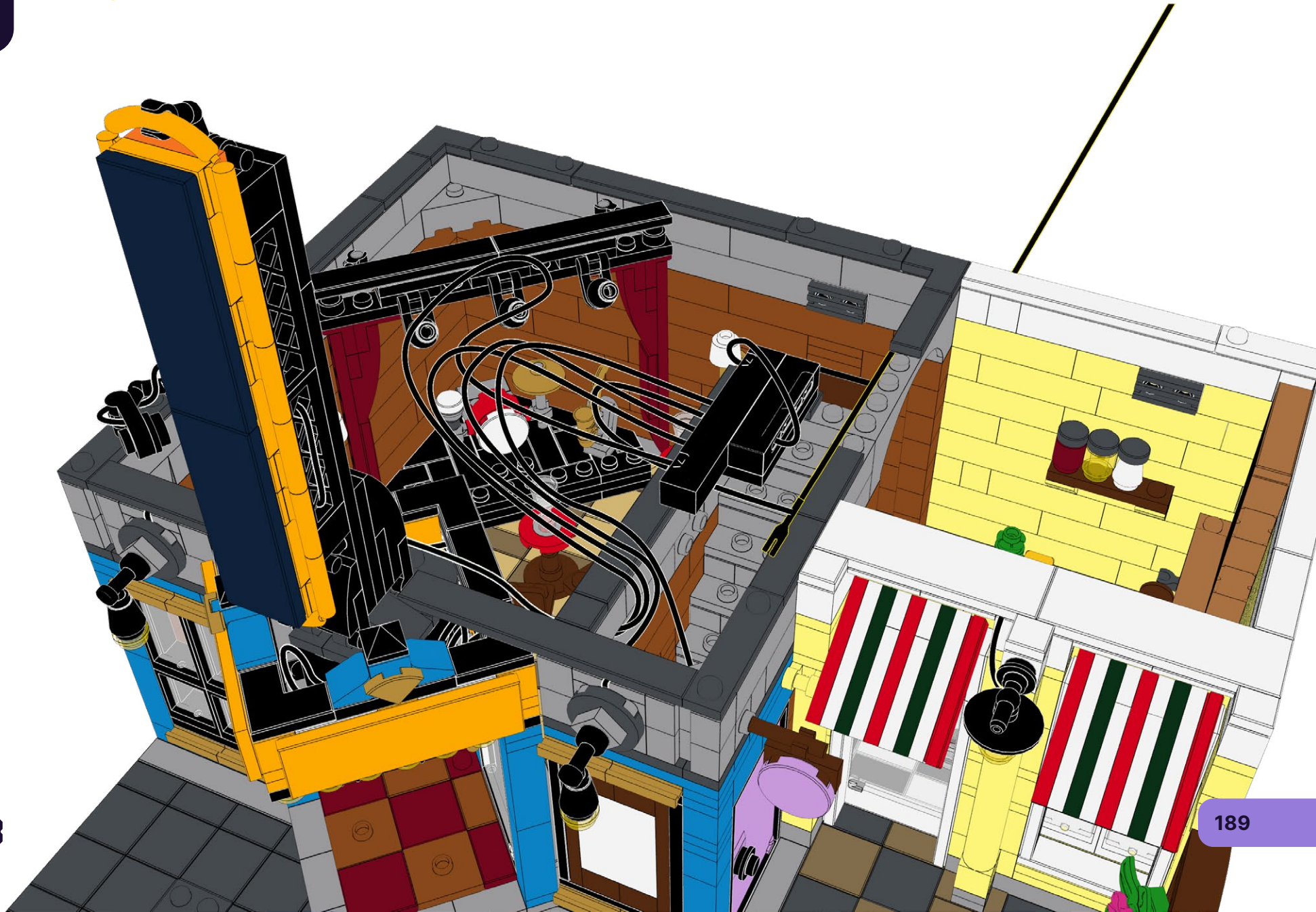

196

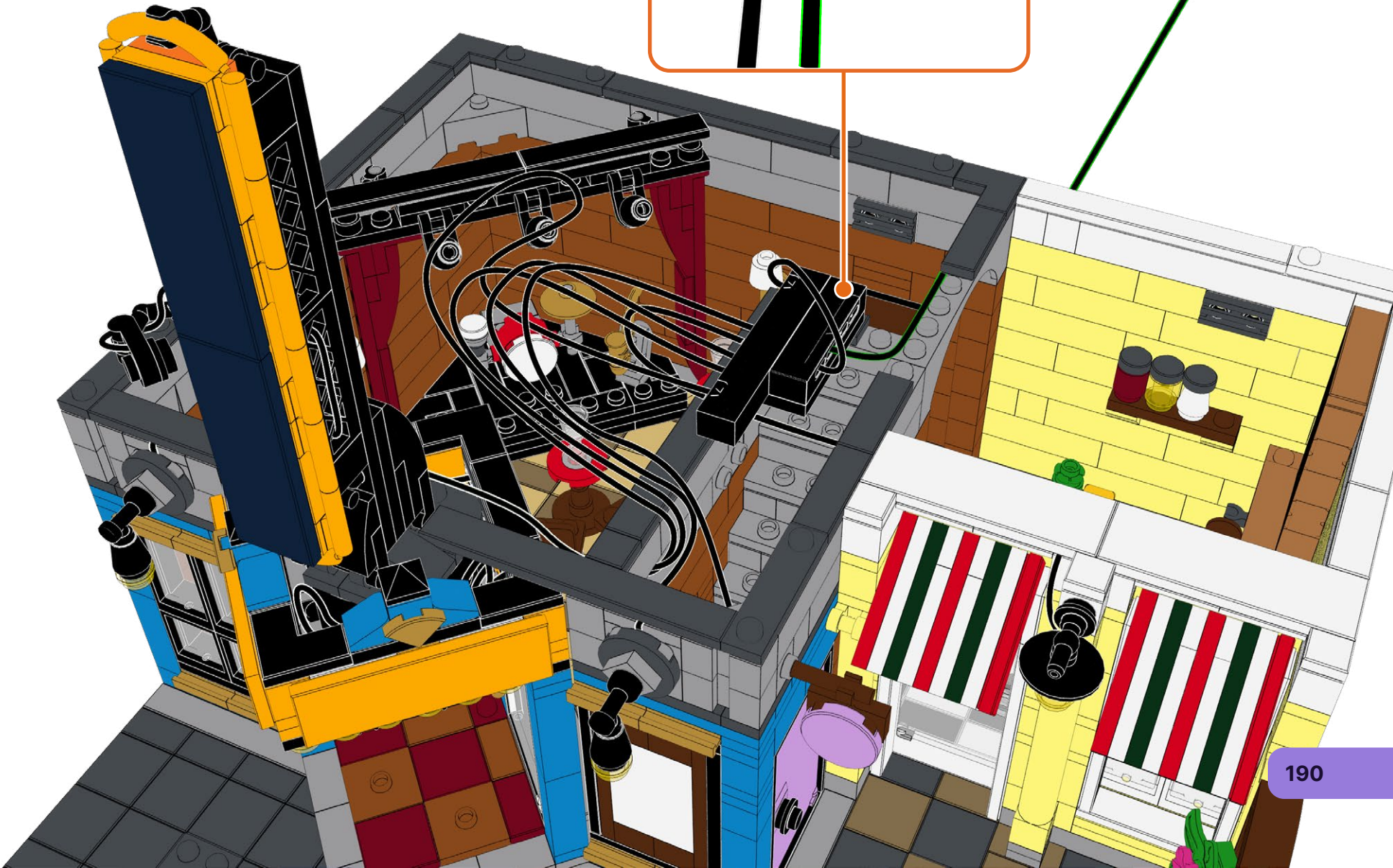
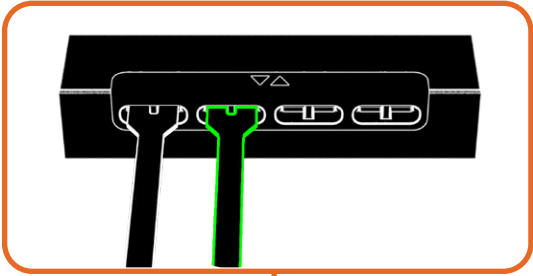

197

FLX-TPB30

1x

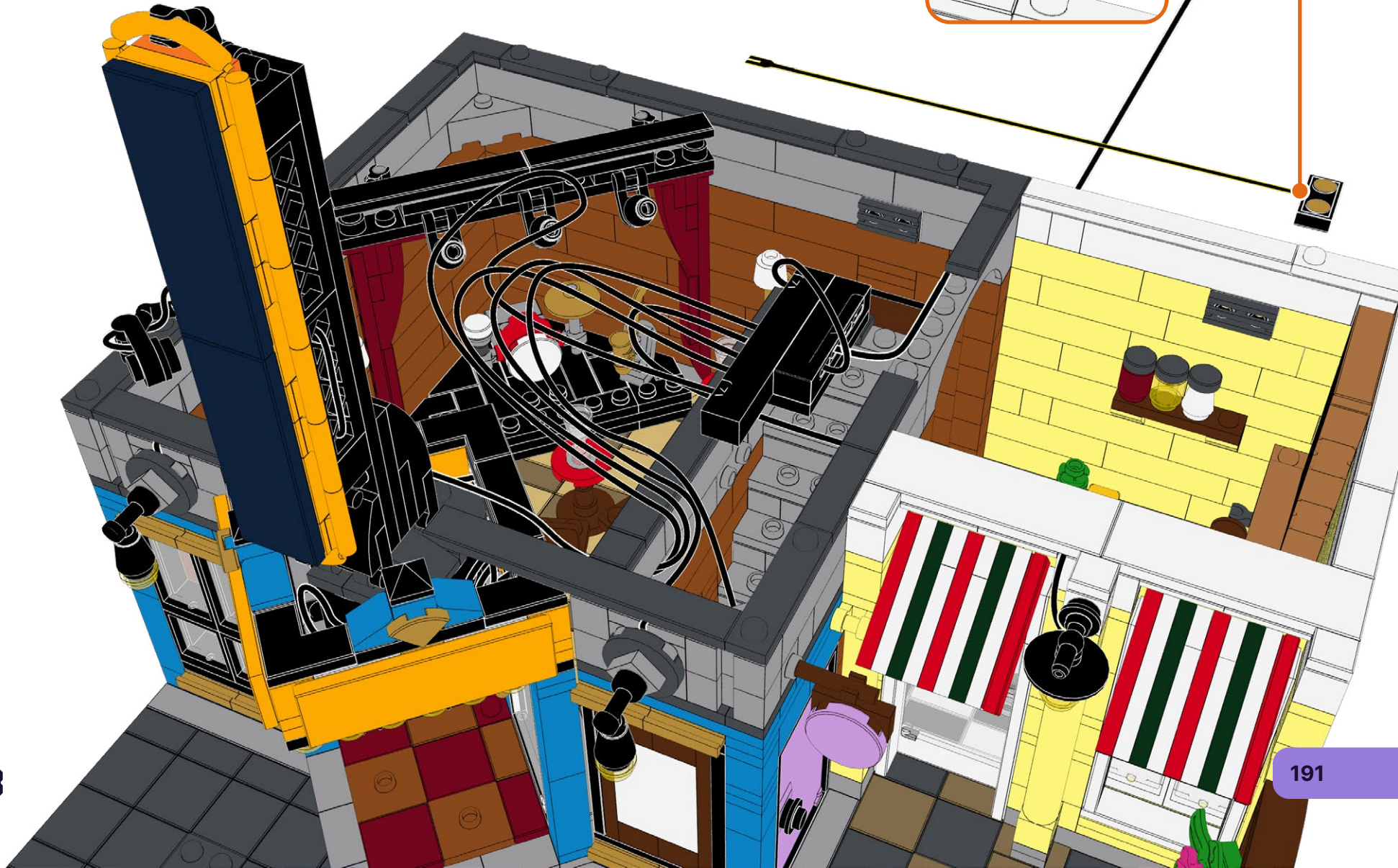
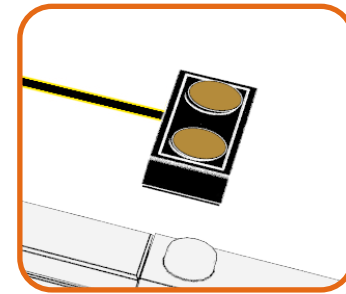

198

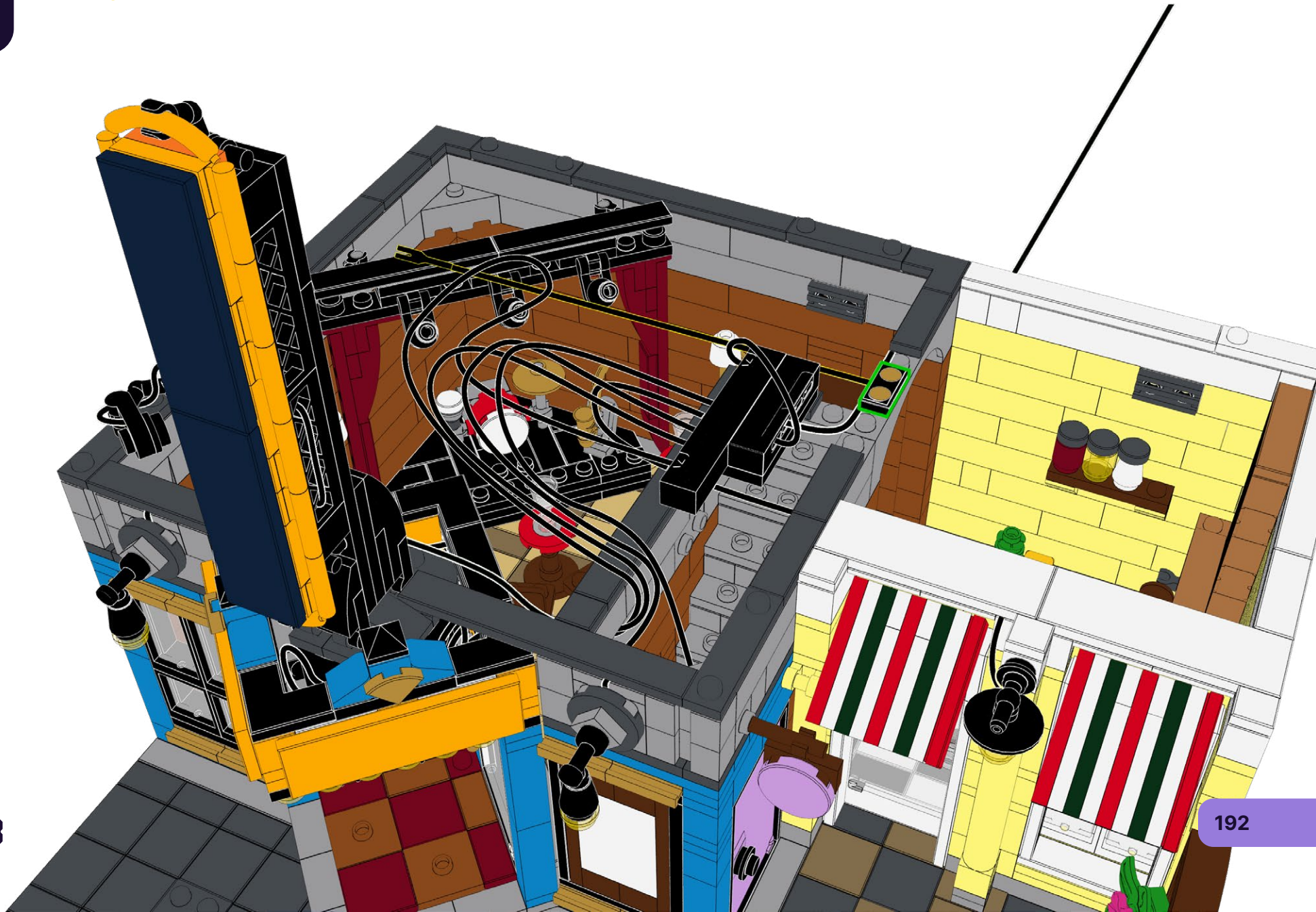

199

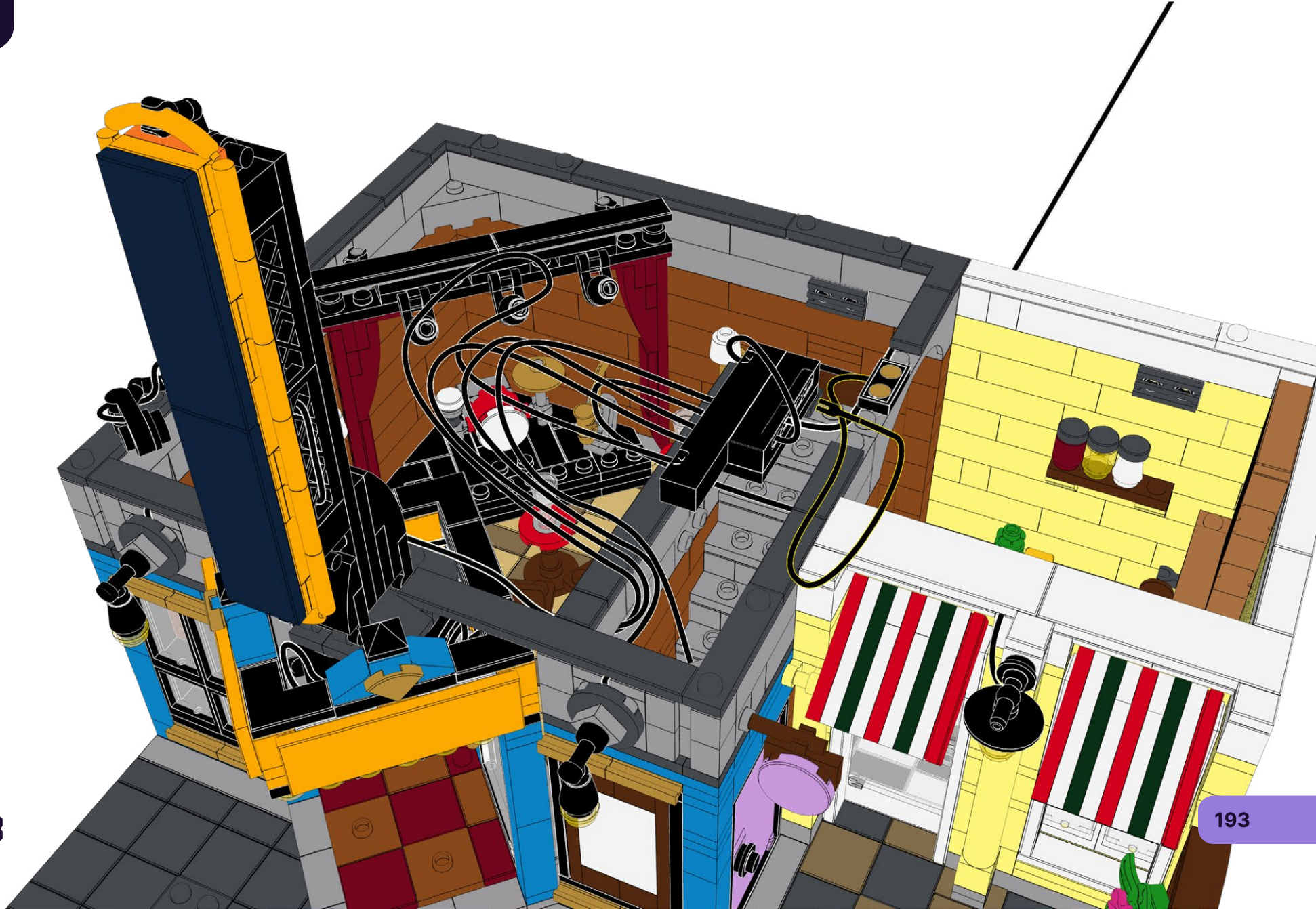

200

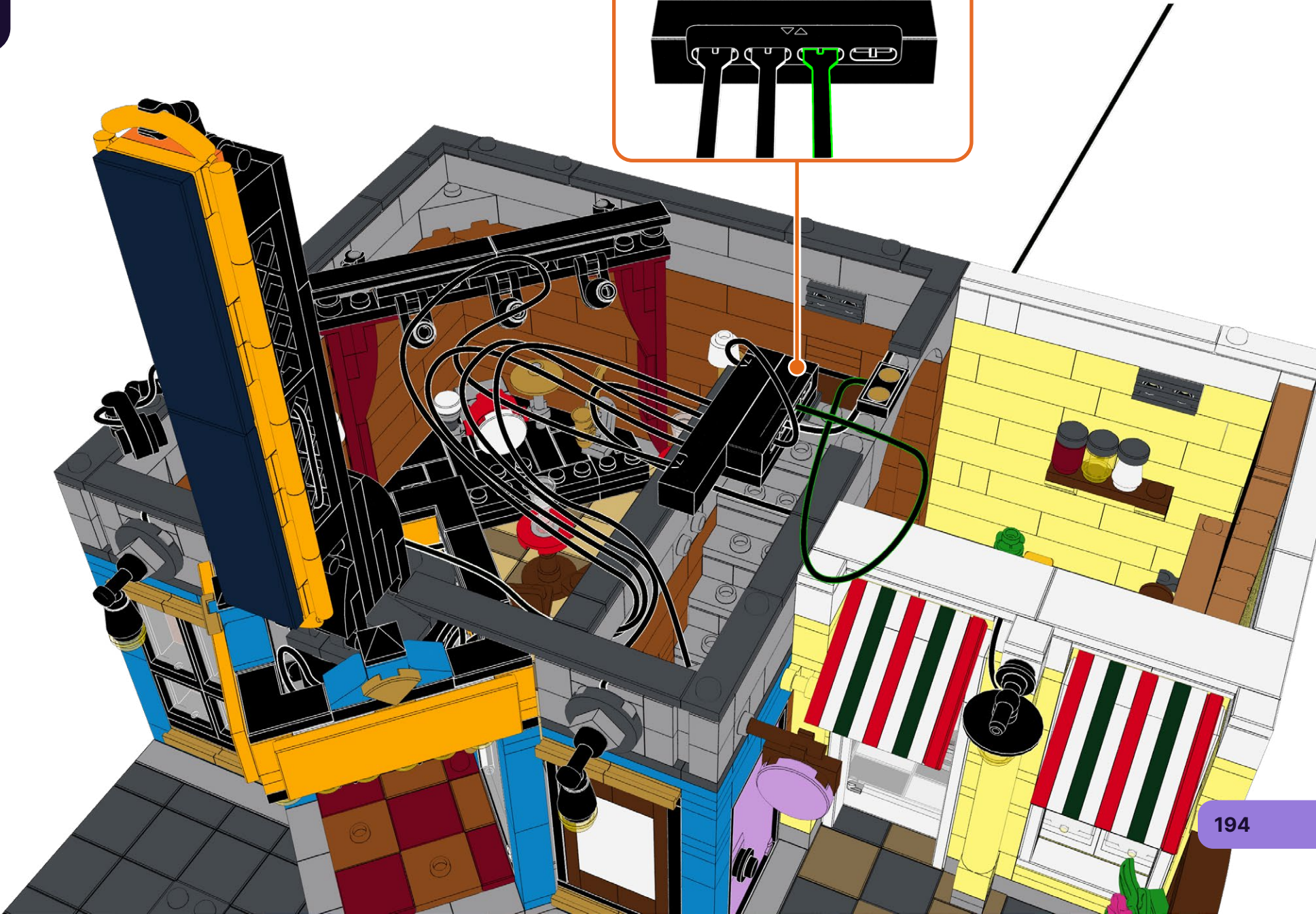
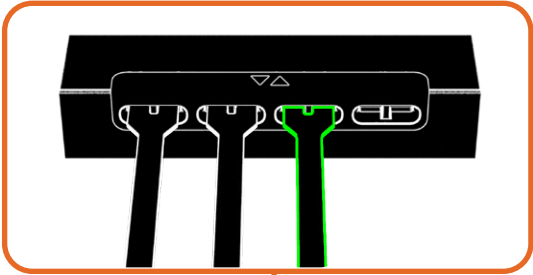

201

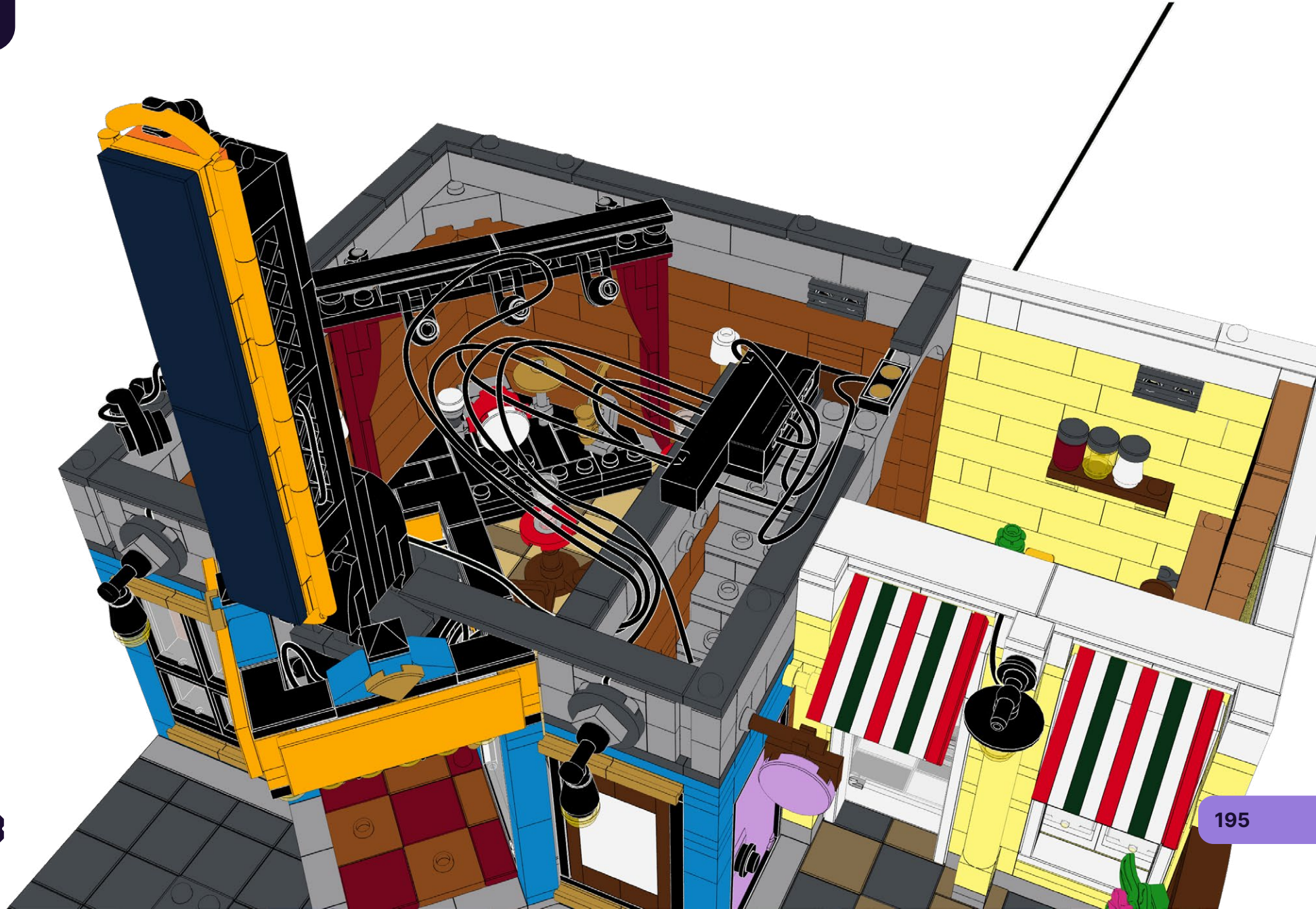

202

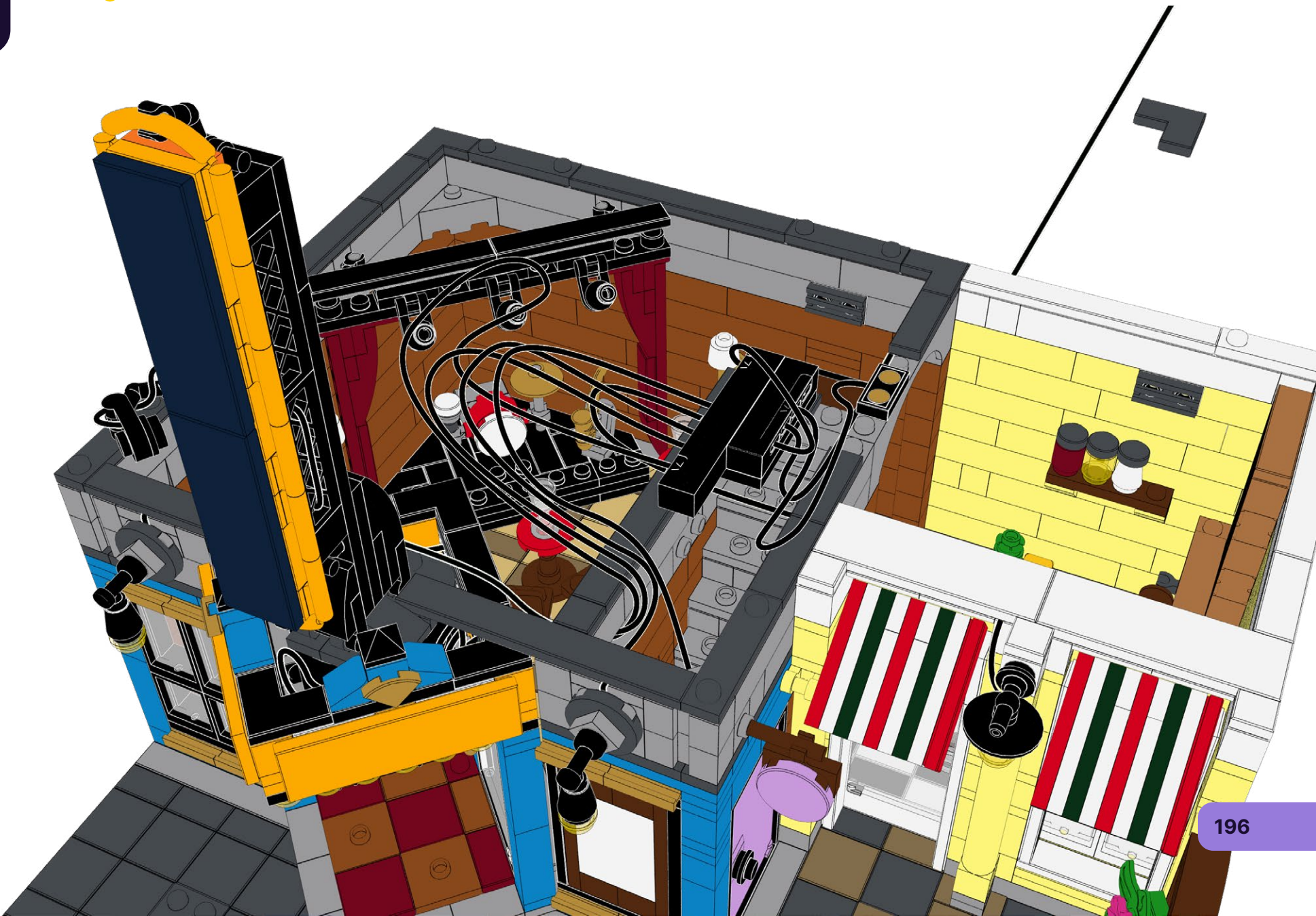

203

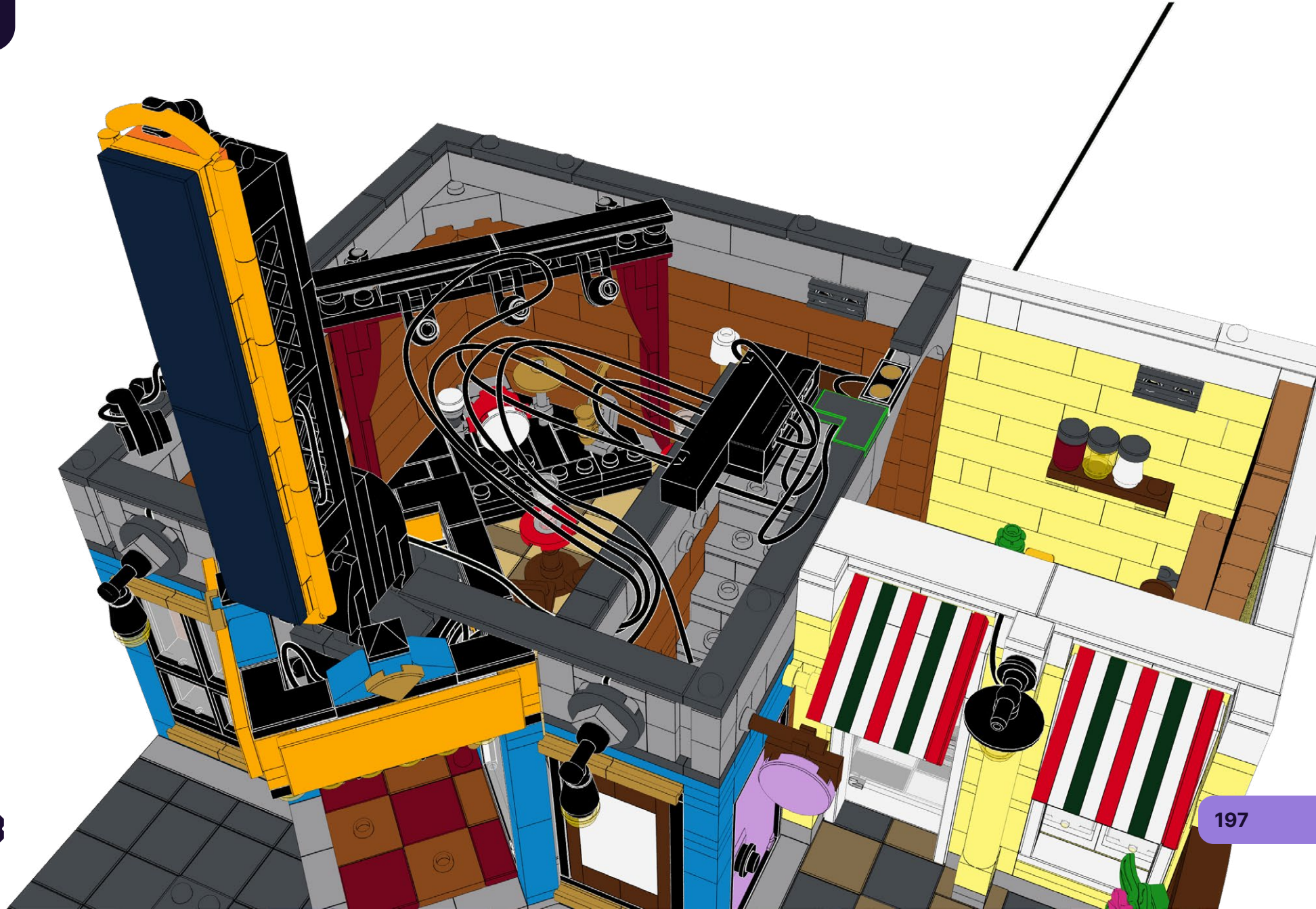

204

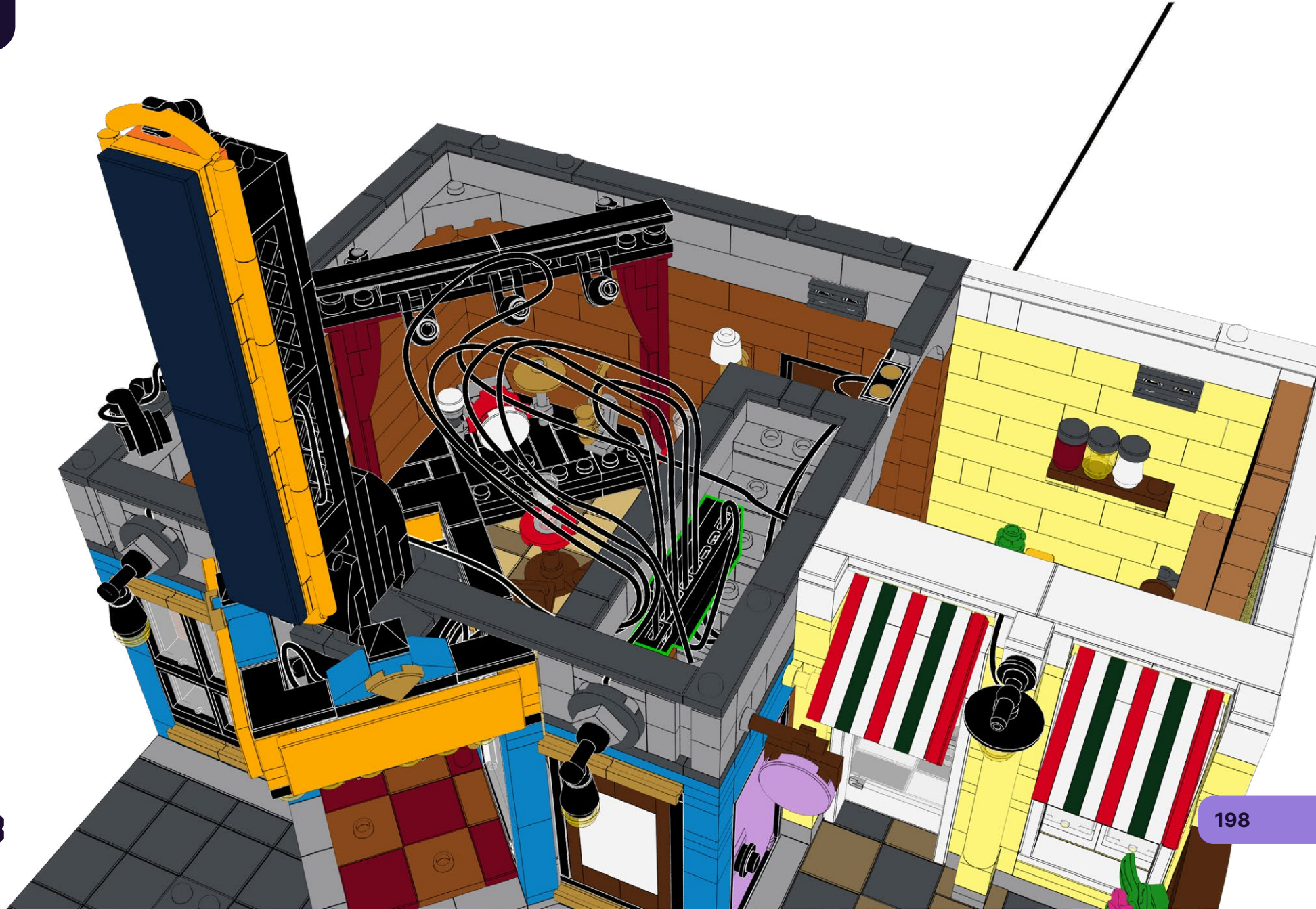

205



206

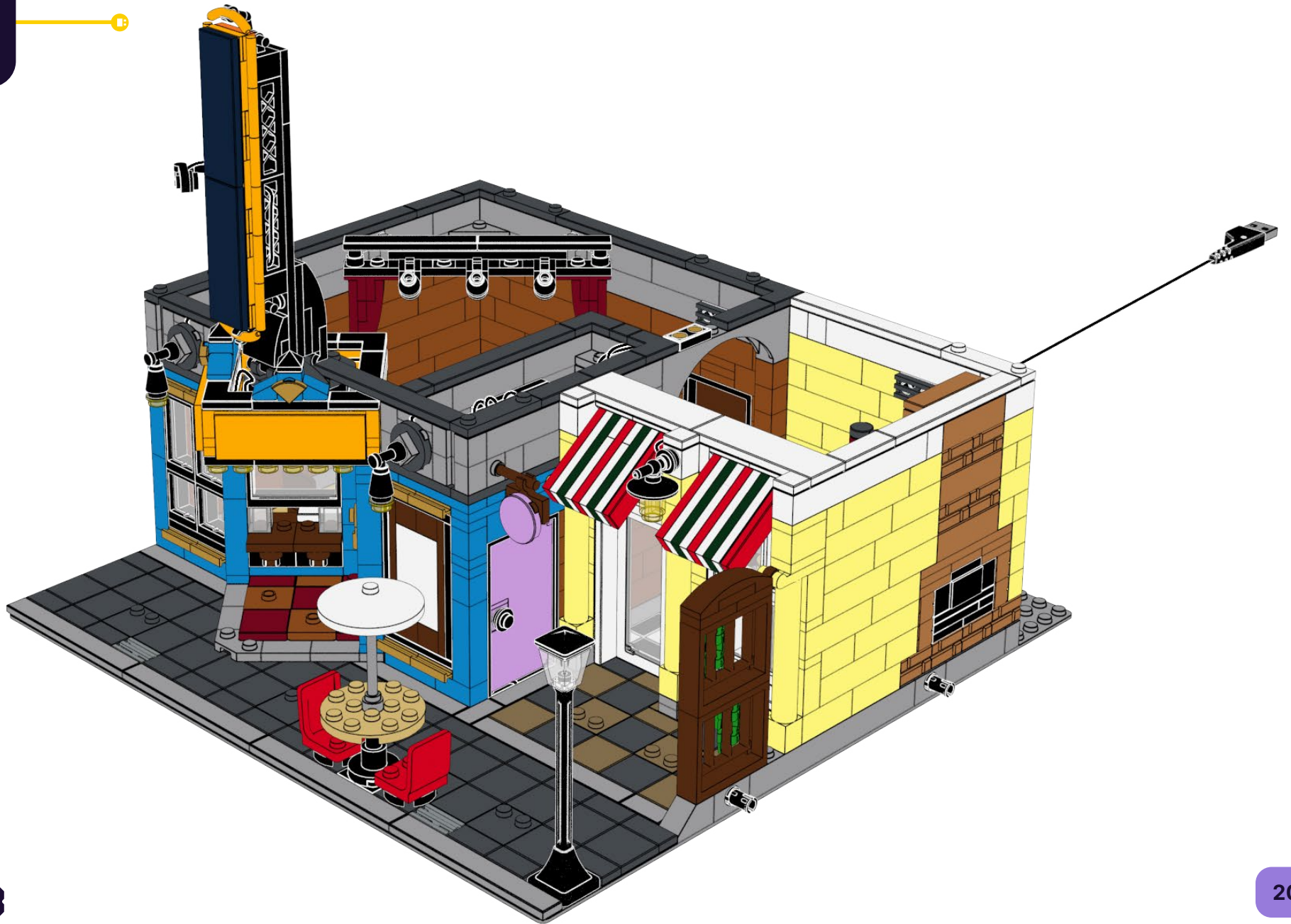

207



Power on Test
Test de mise sous tension
Test di Potenza
Stromtest
Prueba de Energía
电源测试



208



**HOLD UP!**

You might notice some bags aren't in order, as well as left over pieces, but that's ok! We're changing the way you build LEGO!

ATTENDEZ!

Vous remarquerez peut-être que certains sacs, ainsi que certaines pièces, ne sont pas dans le bon ordre. Mais pas de panique! Nous changeons simplement la façon avec laquelle vous construisez vos LEGO!

ASPETTA!

Potresti notare che alcuni sacchetti non sono in ordine, così come i pezzi avanzati, ma va bene così! Stiamo cambiando il modo in cui costruisci i LEGO!

HALT!

Sie werden möglicherweise bemerken, dass einige tüten durcheinander sind und teile übrig bleiben, aber das ist in Ordnung! Wir ändern die art und weise, wie Sie LEGO bauen!

¡ESPERA!

Es posible que notes que algunas bolsas están fuera de servicio, así como piezas sobrantes, ¡pero está bien! ¡Estamos cambiando la forma en que construyes LEGO!

暫停!

你可能会注意到一些袋子顺序错乱, 以及一些剩余的部件, 但没关系! 我们正在改变你搭建乐高的方式!

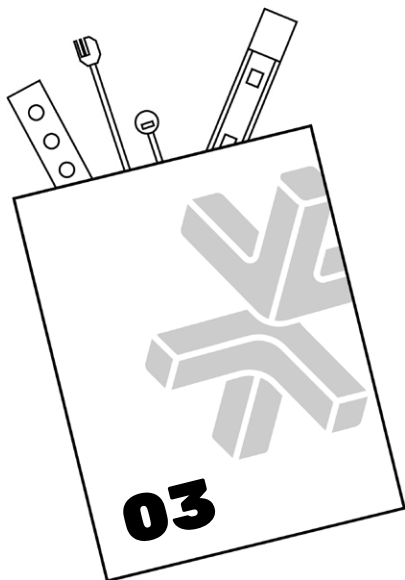
Open LMB Bag 03

209

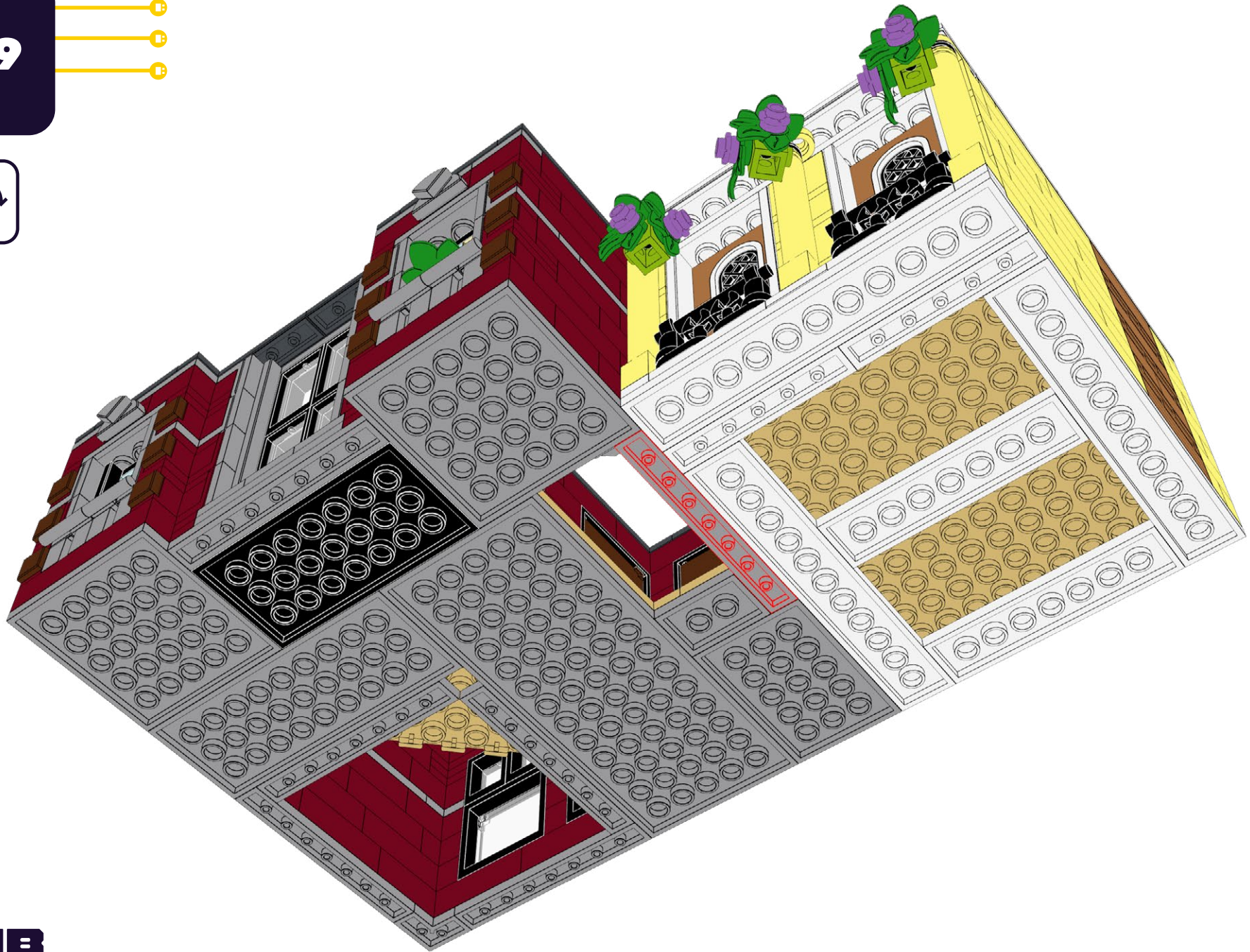

210

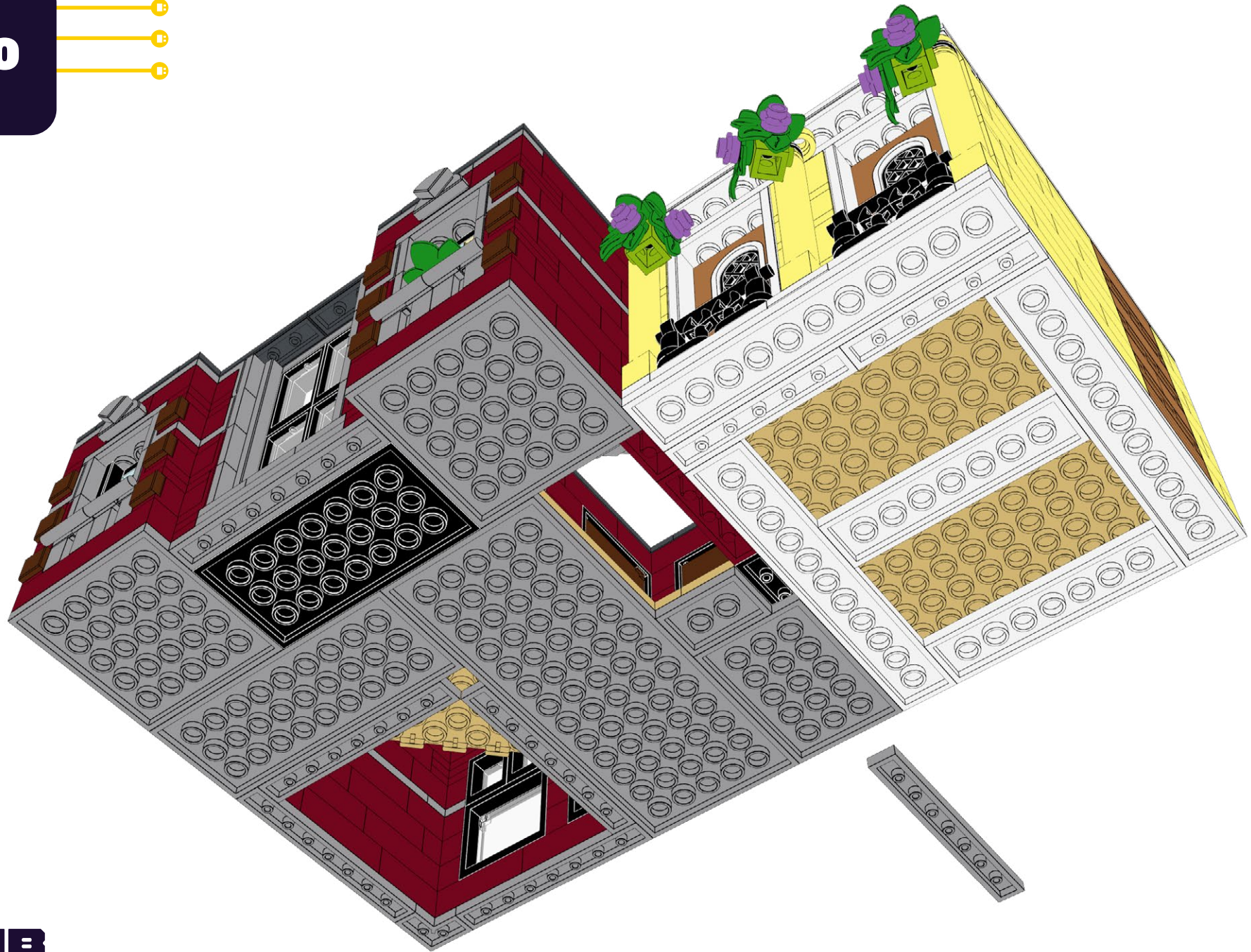

211

FLX-TPA15

1x

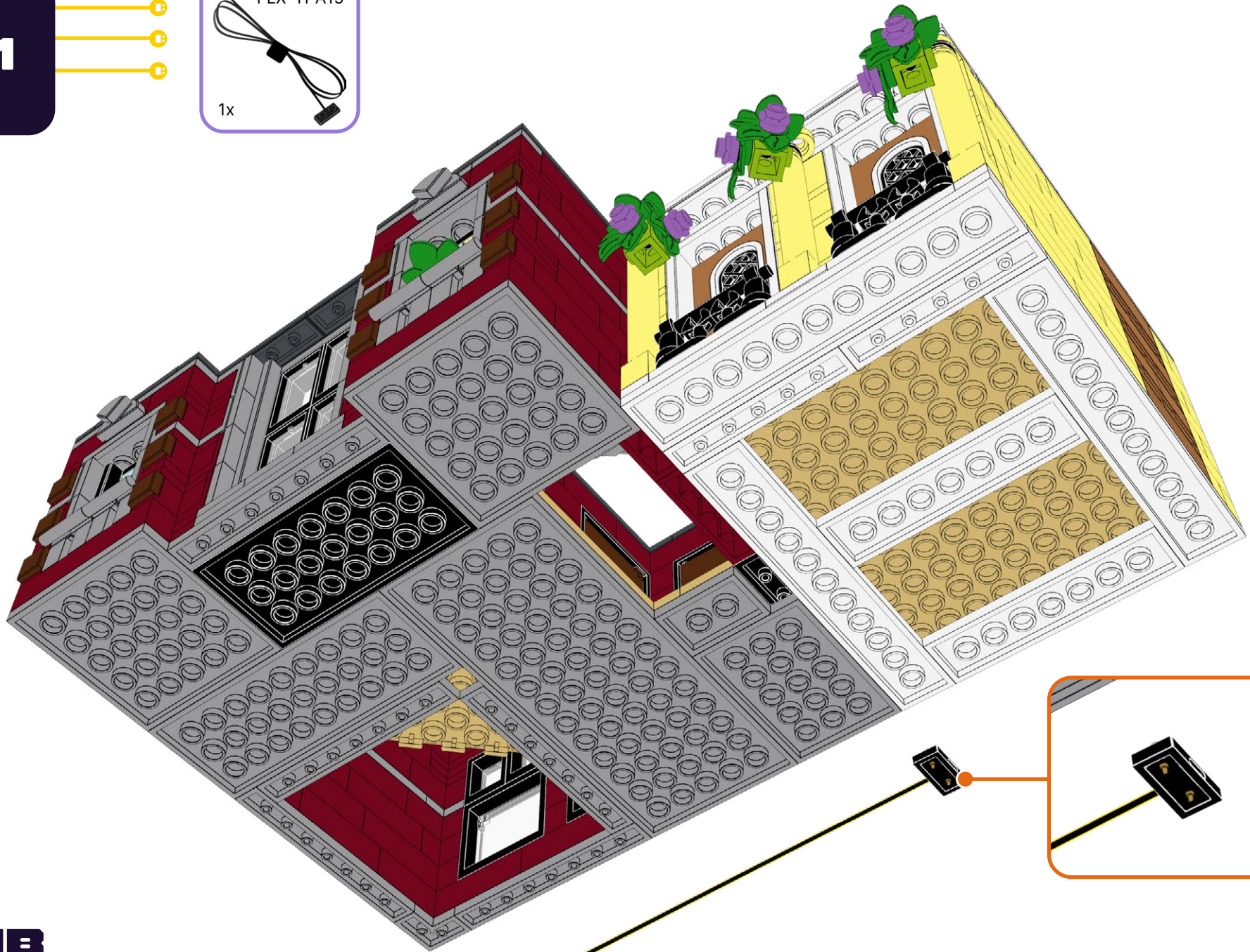

212

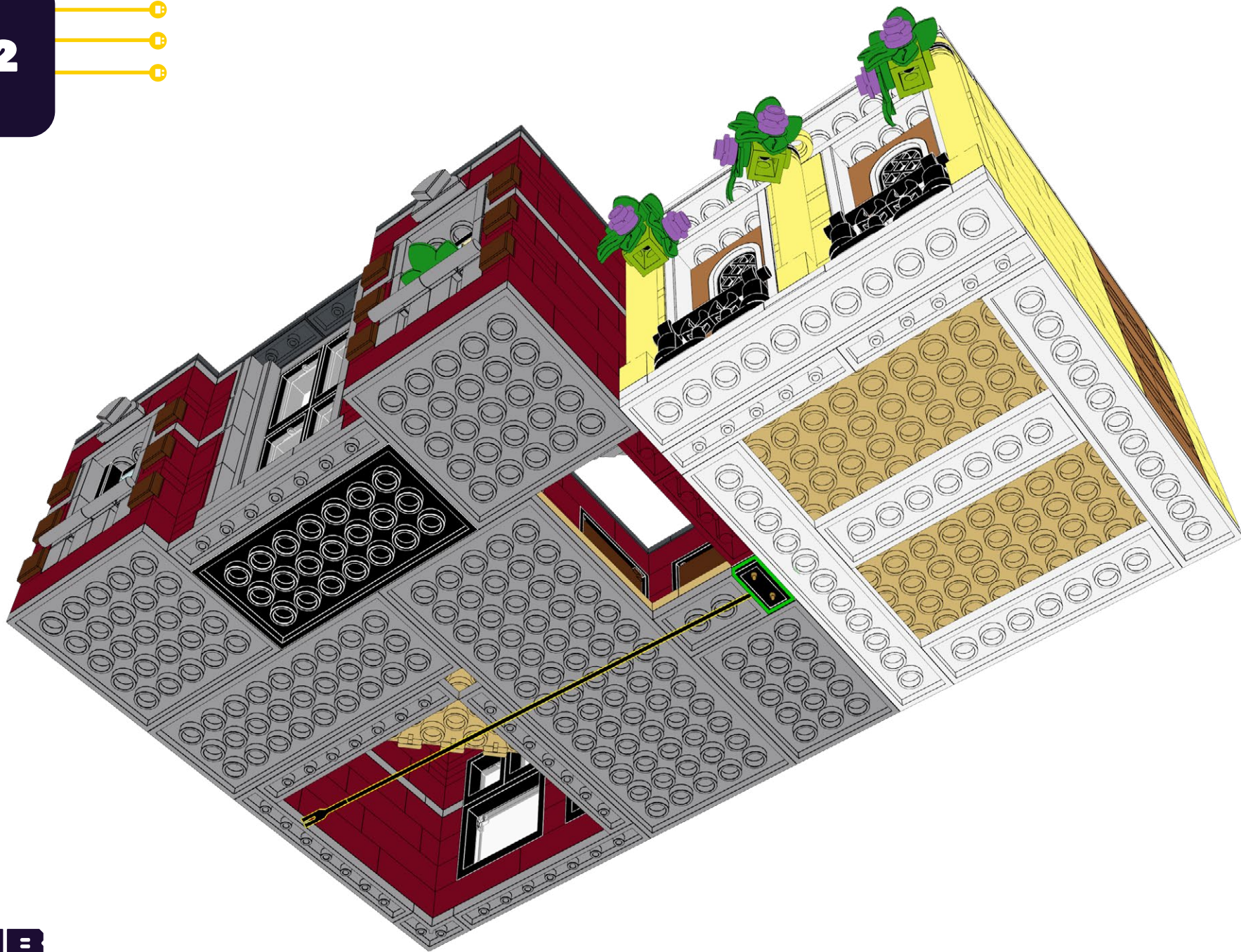

213

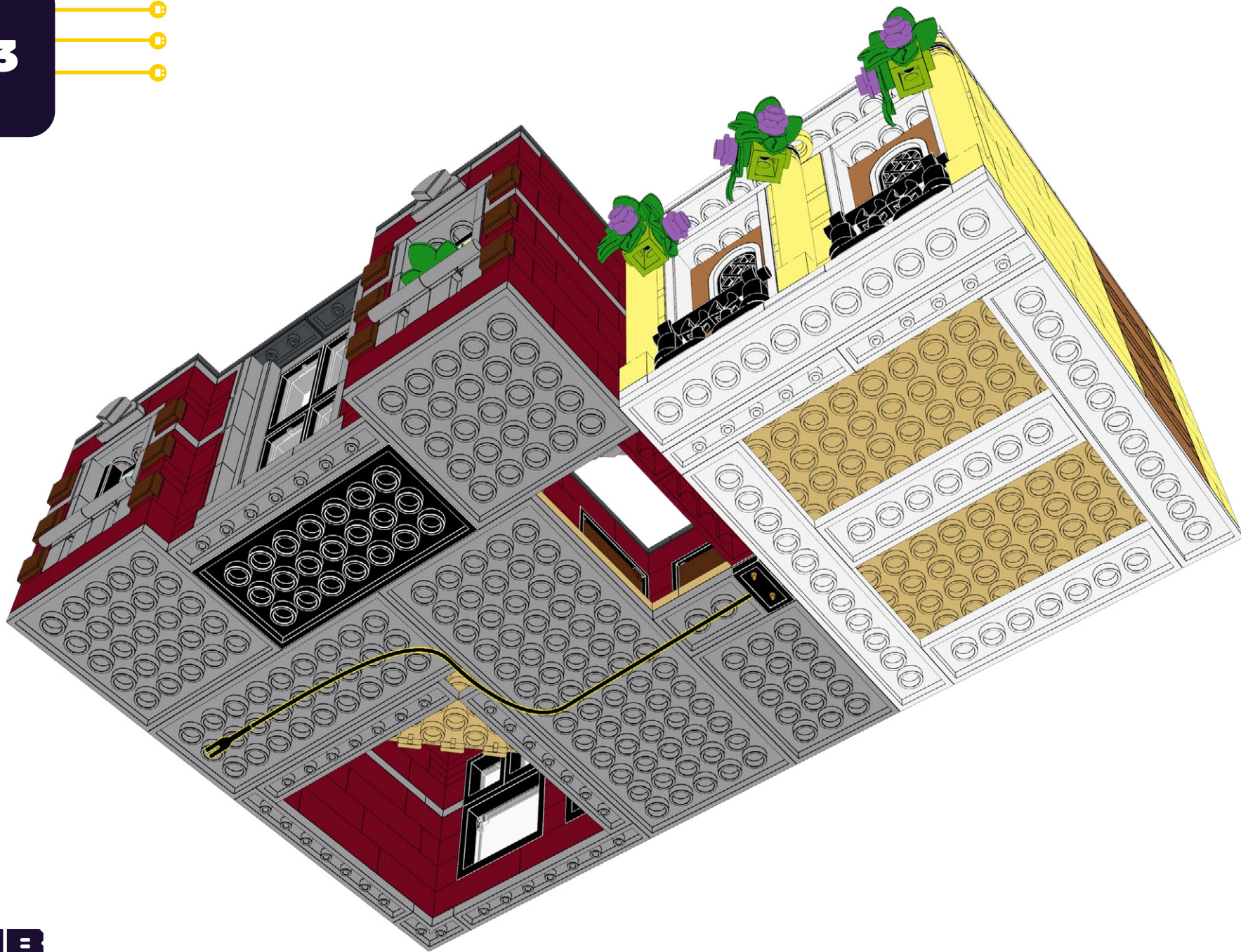

214

T-1x6



1x

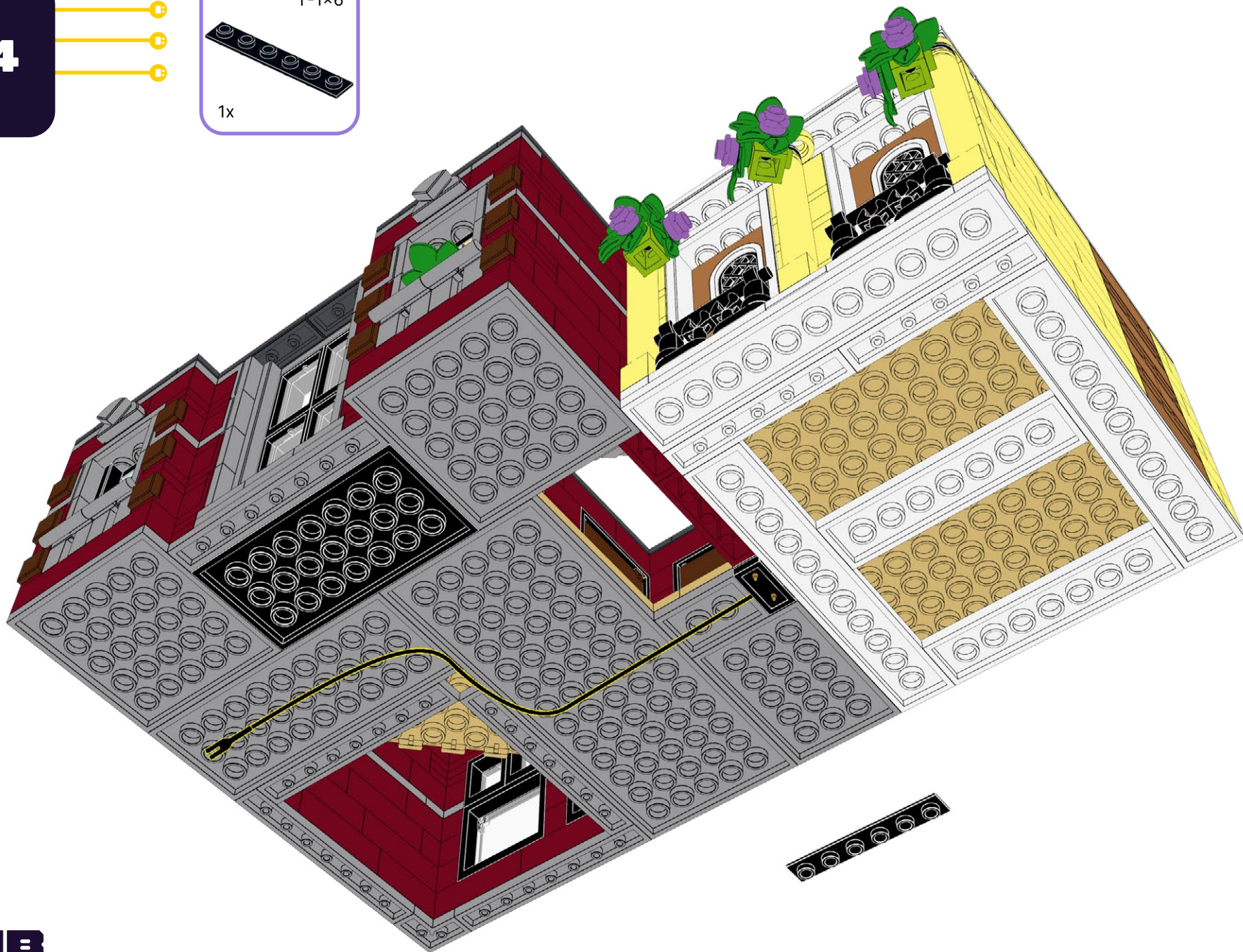

215

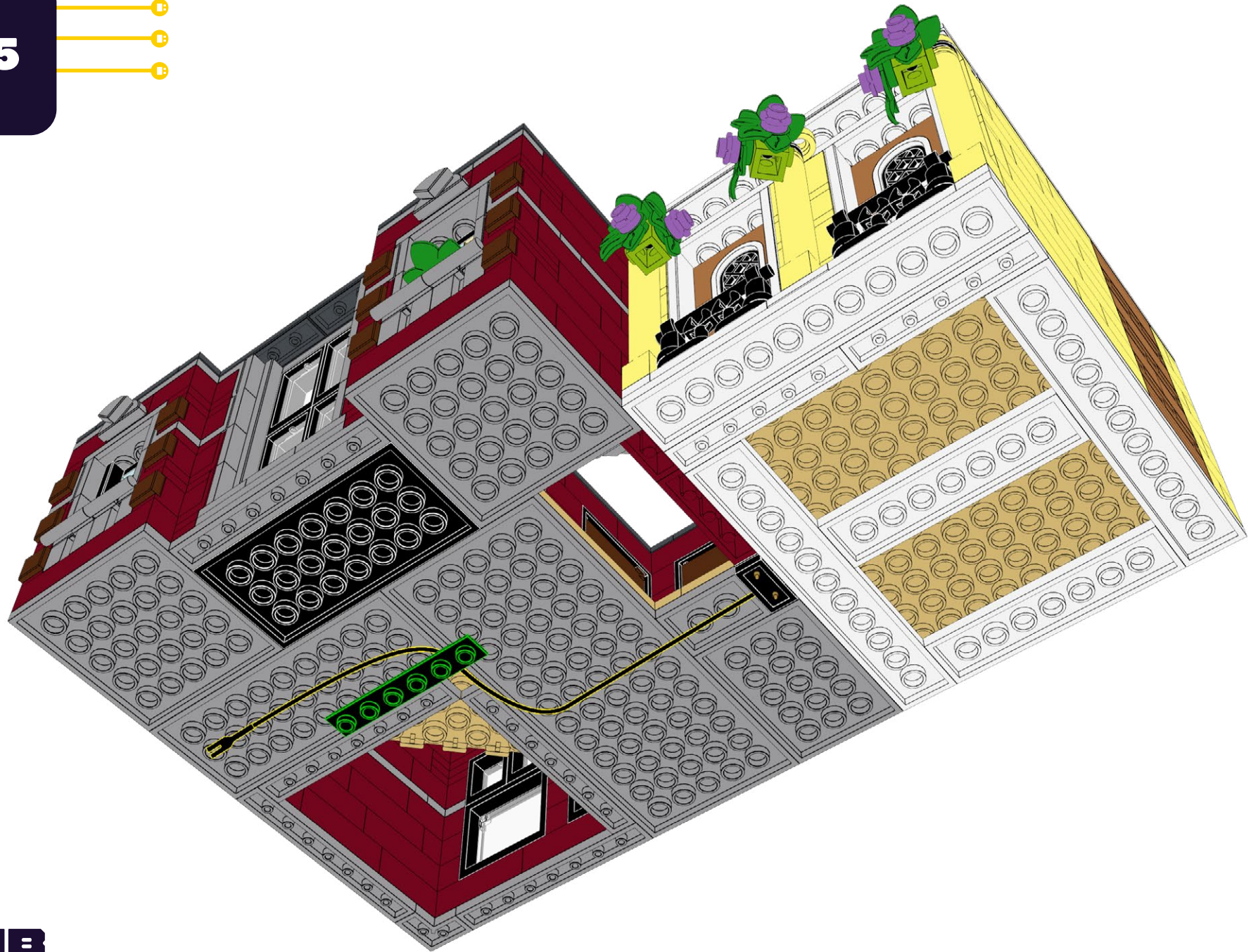

216

ML-P



1x

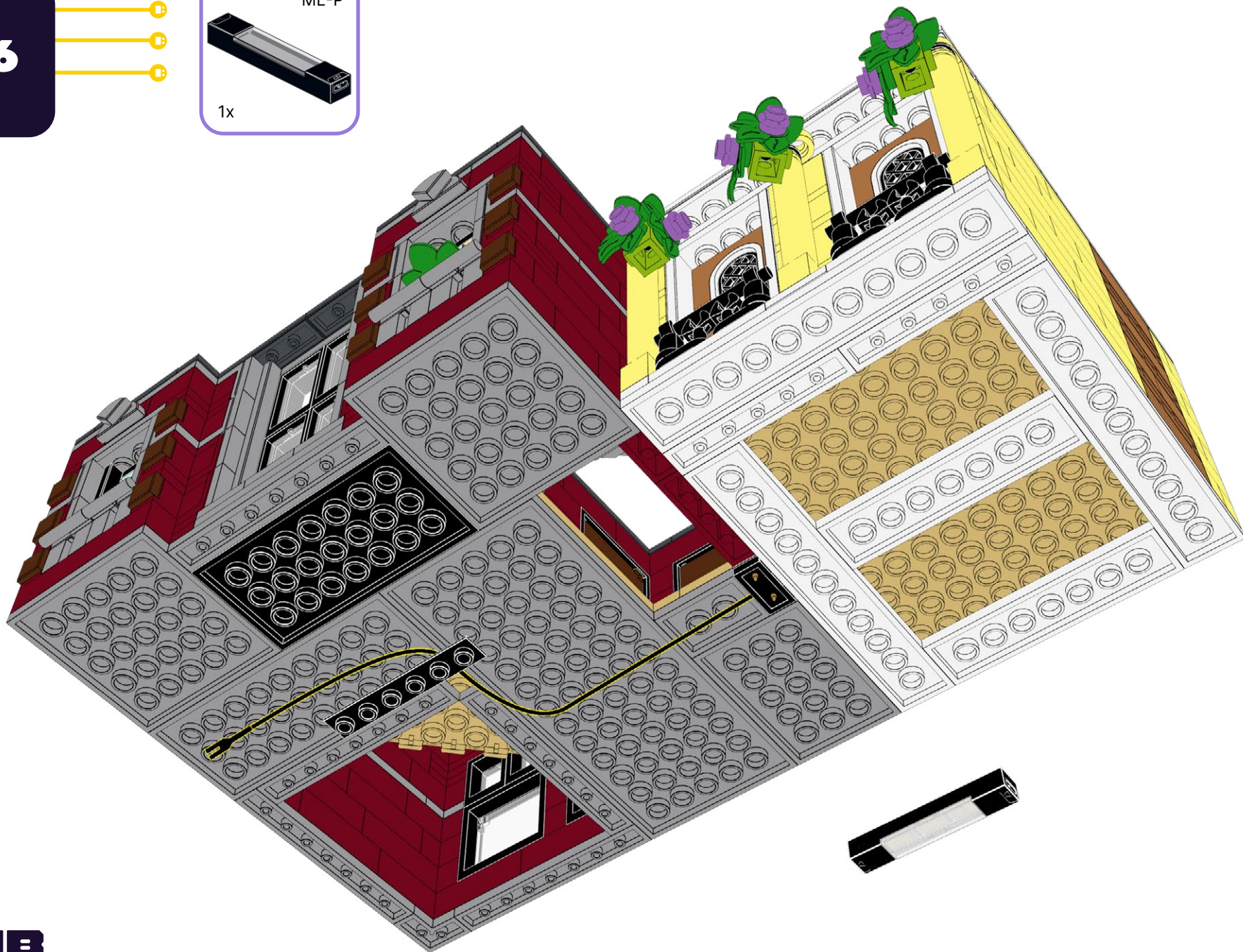

217

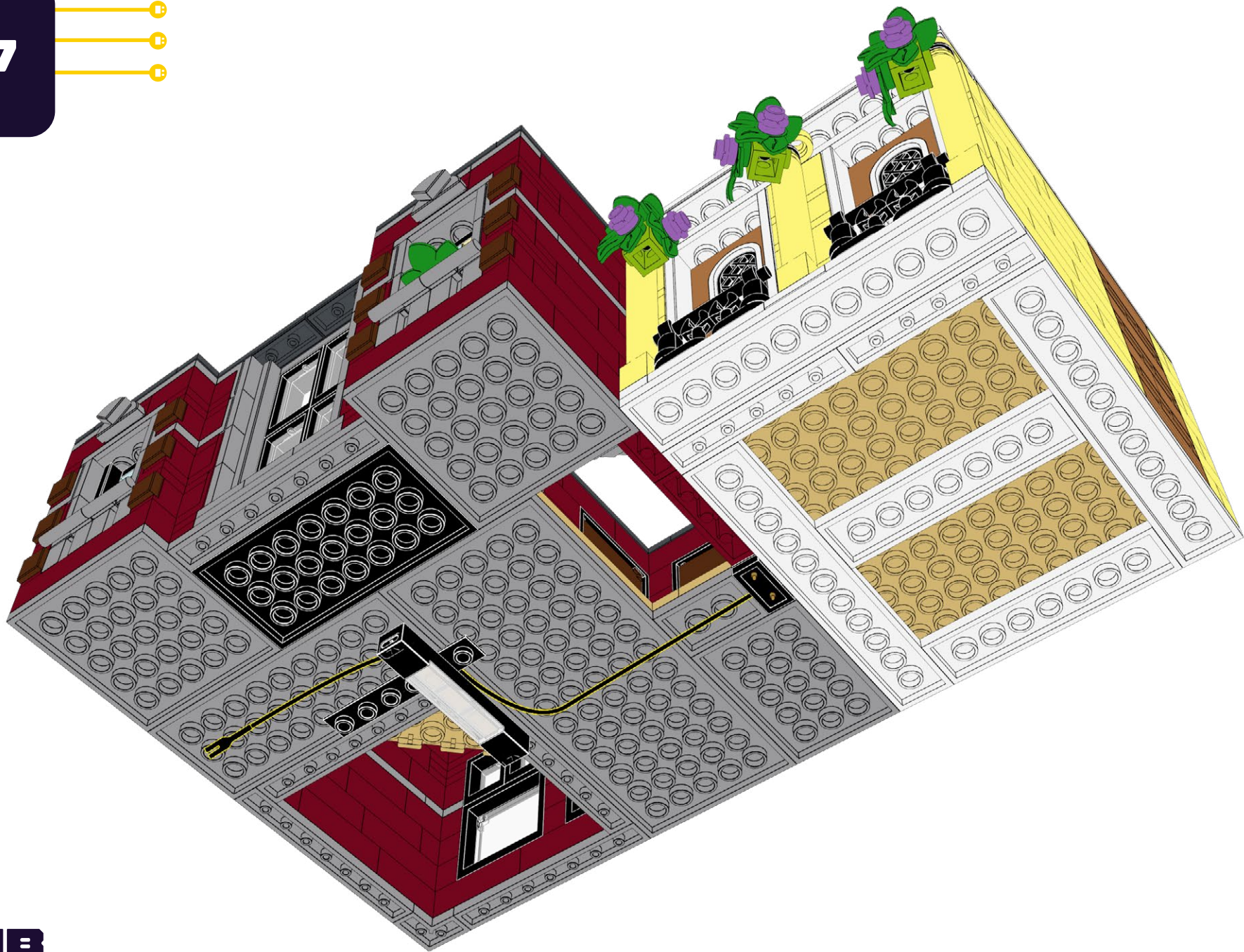

218

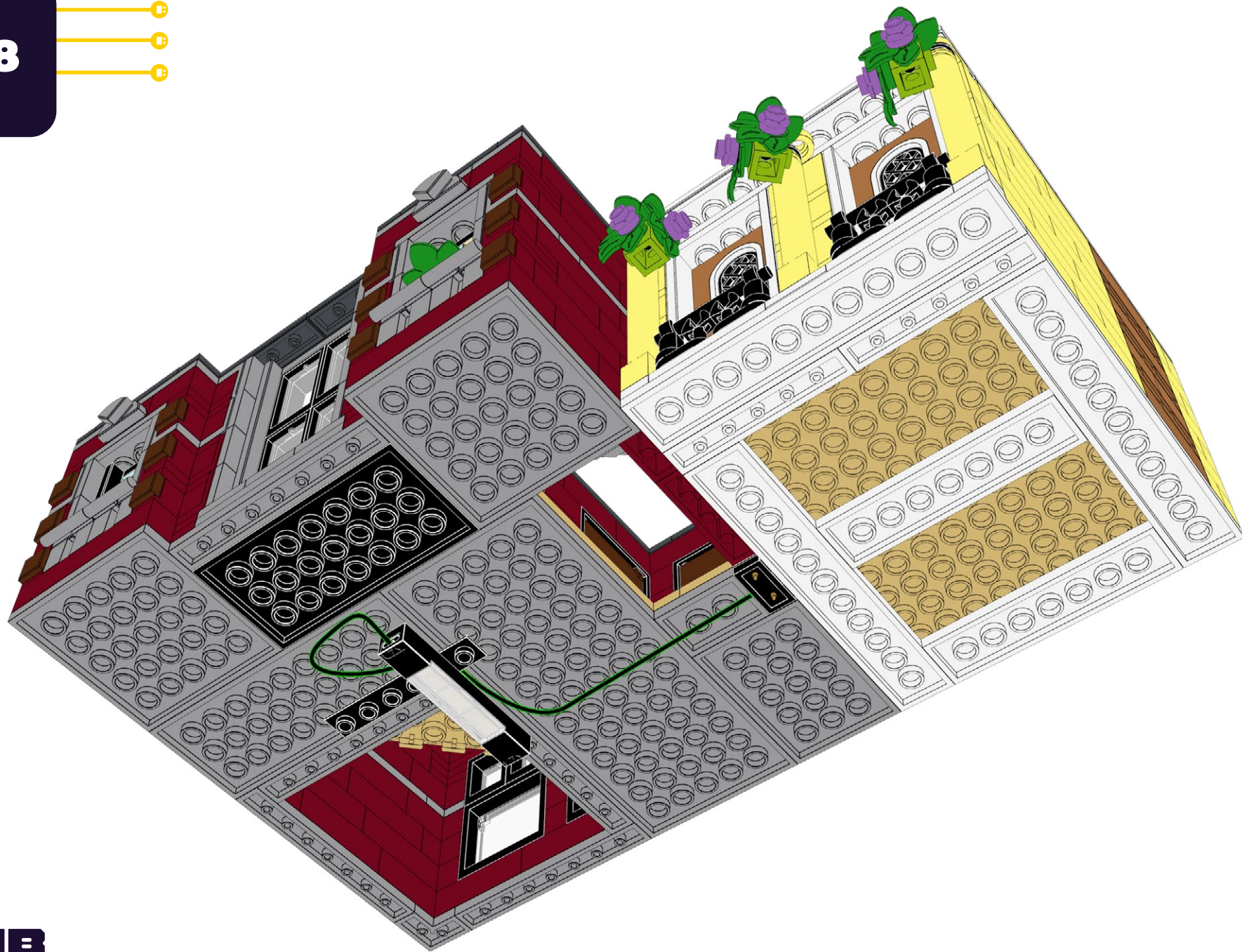

219

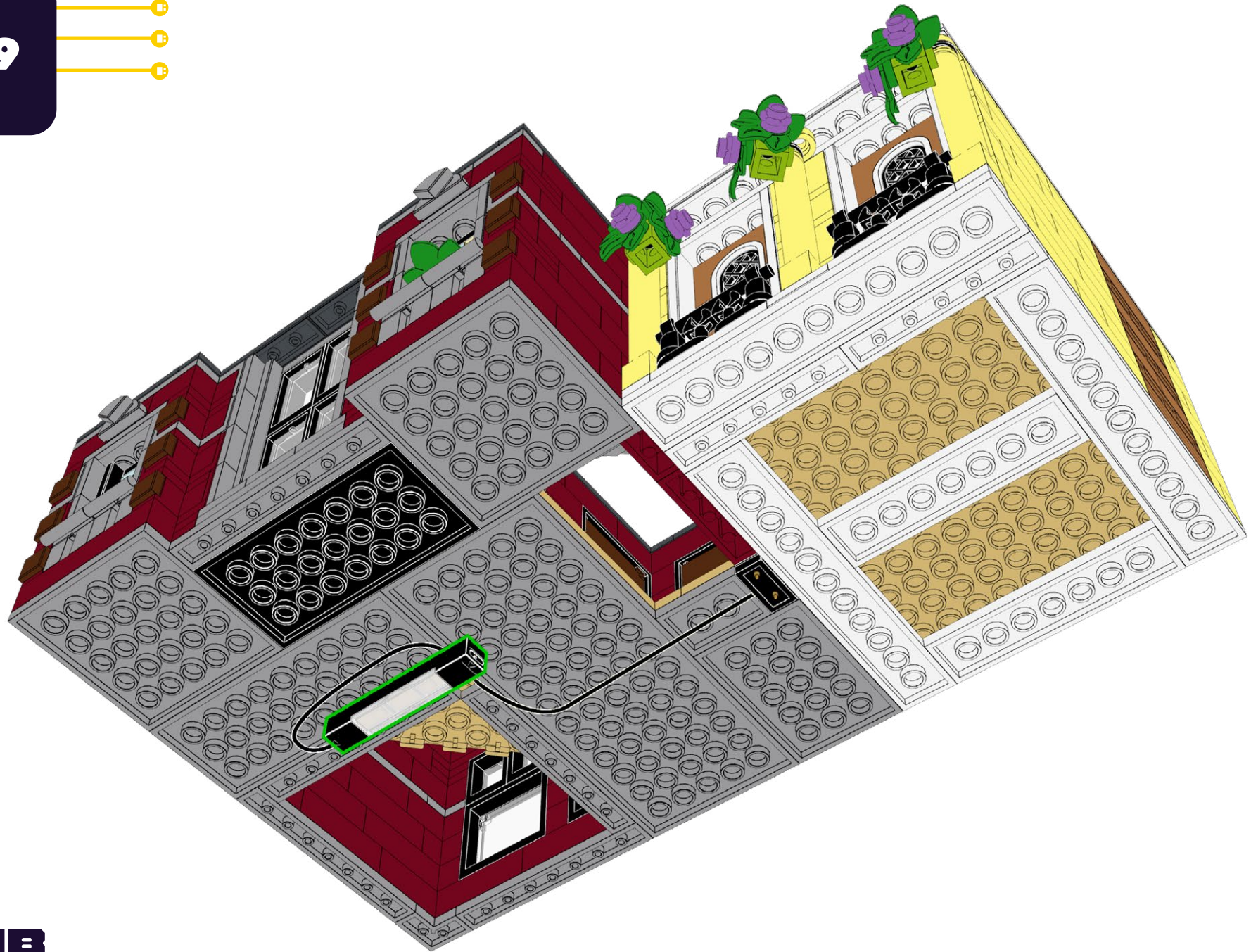

220

T-1x6



1x

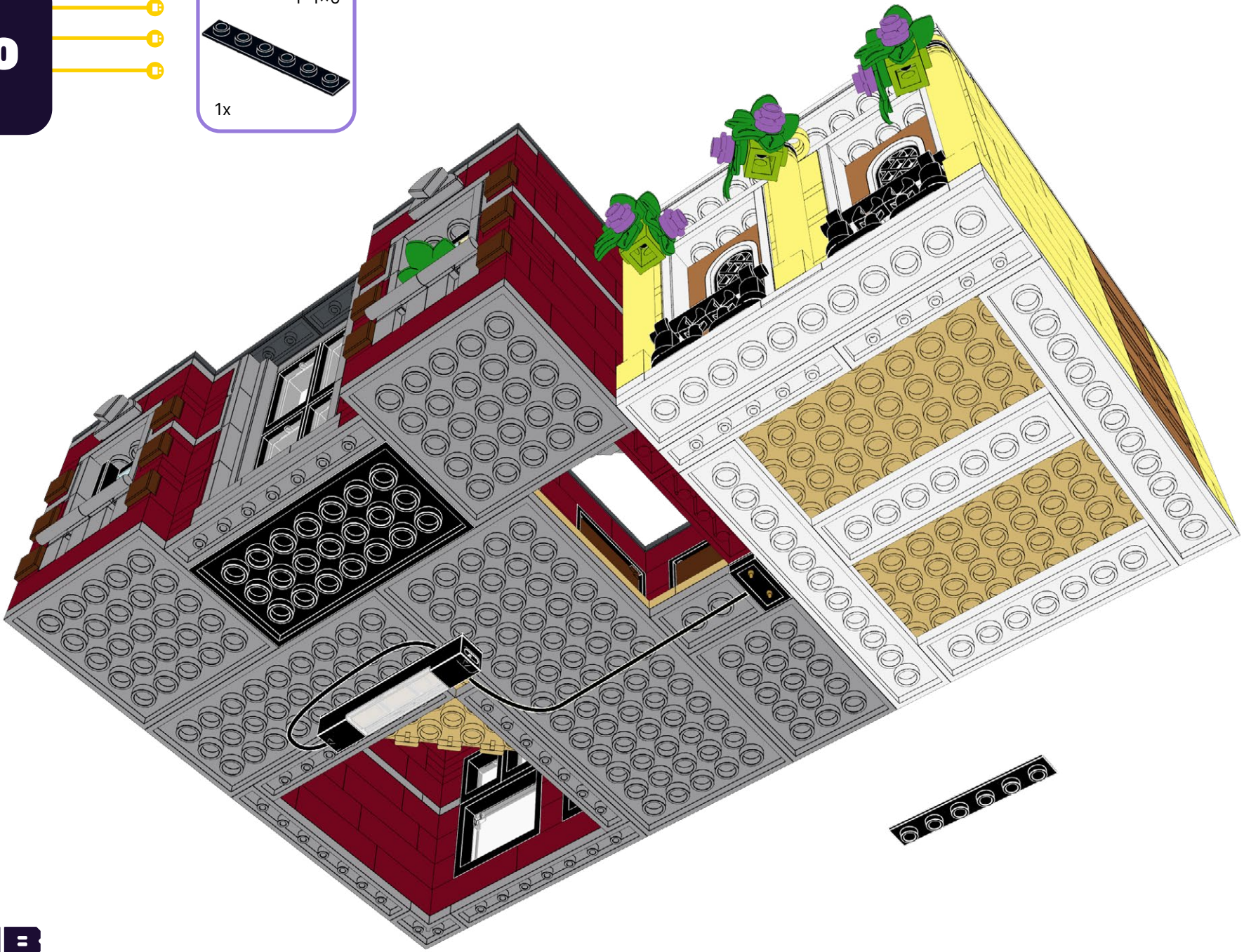

221



222

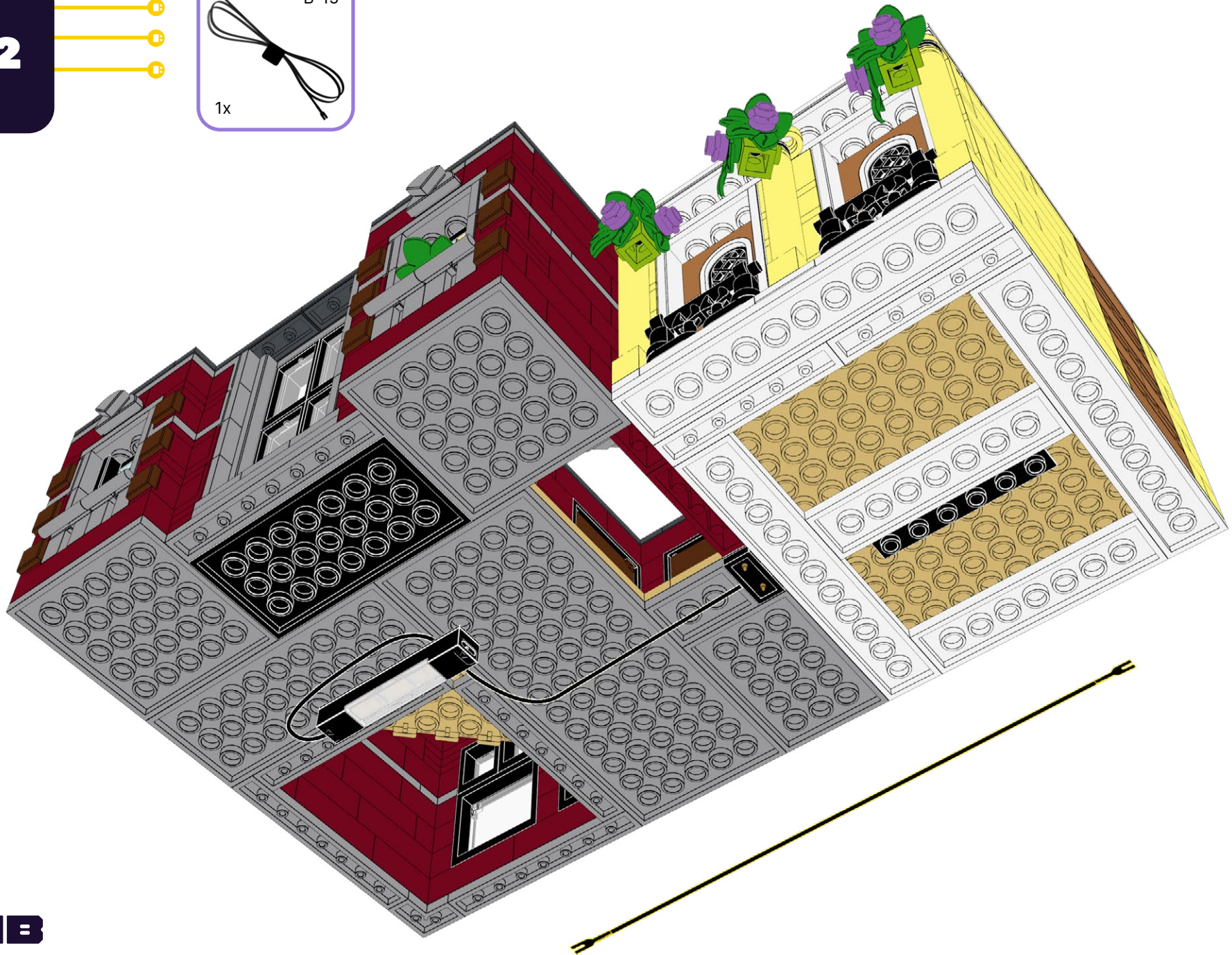
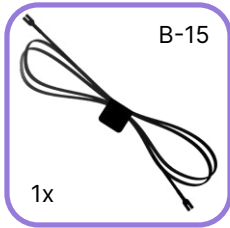

223

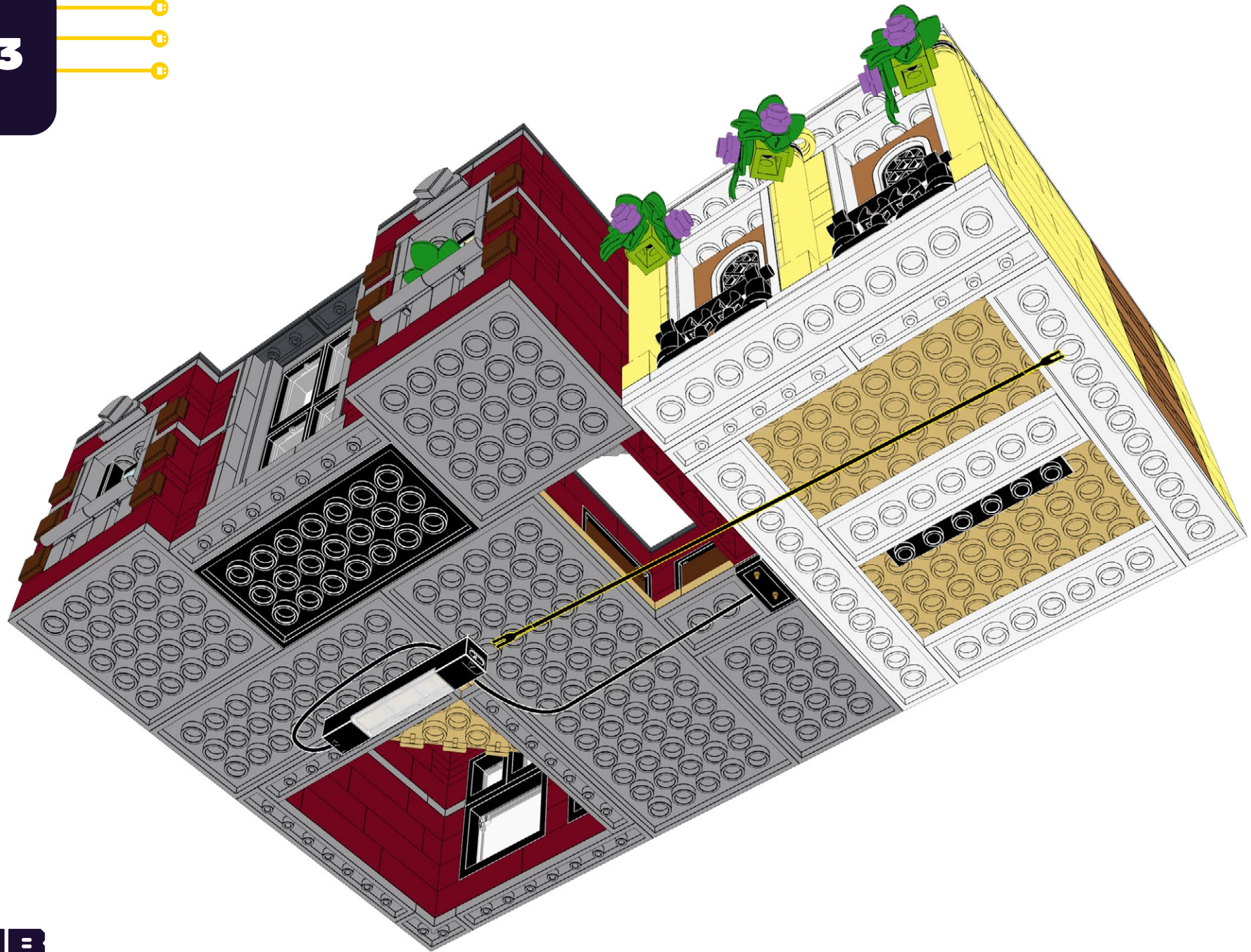

224

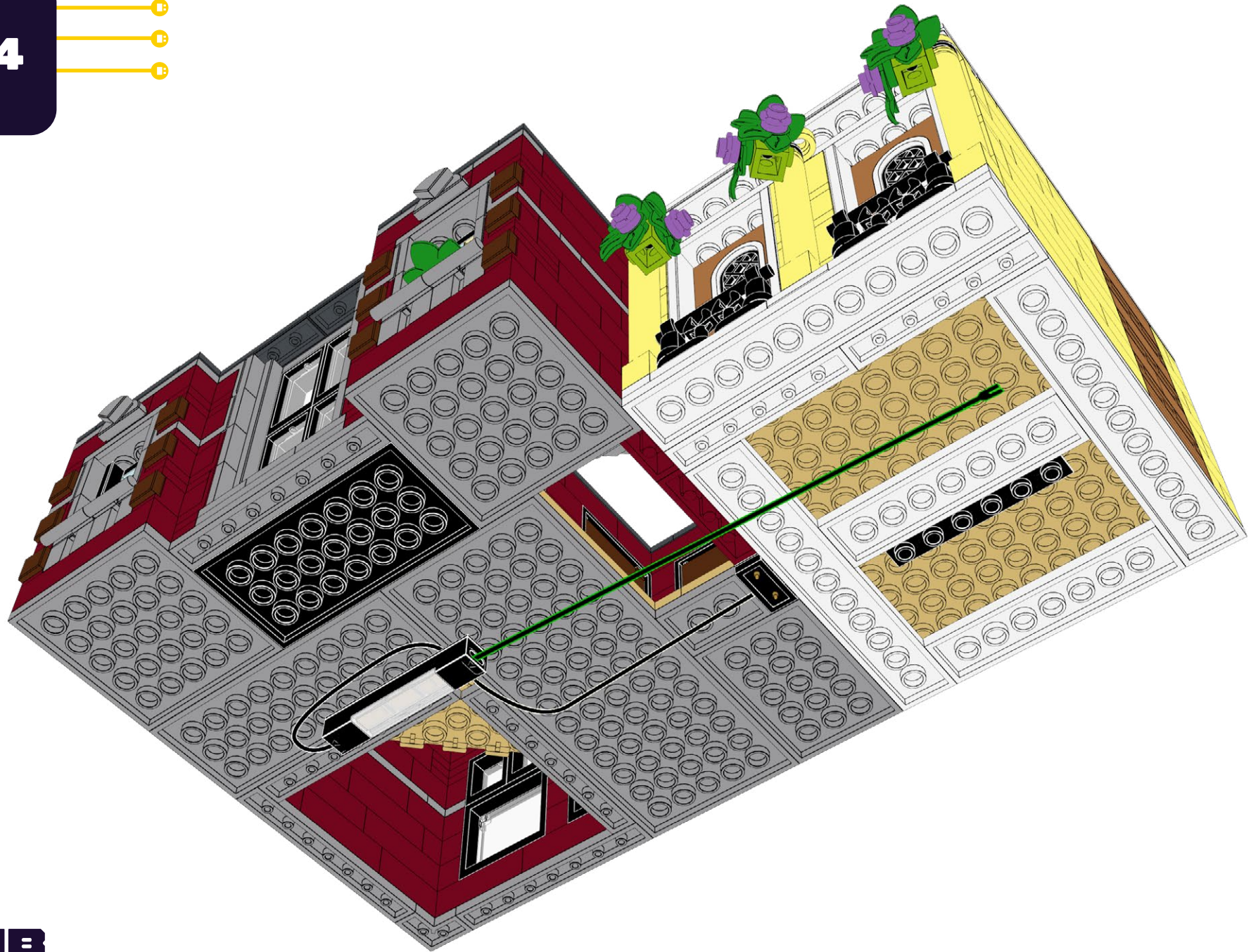

225

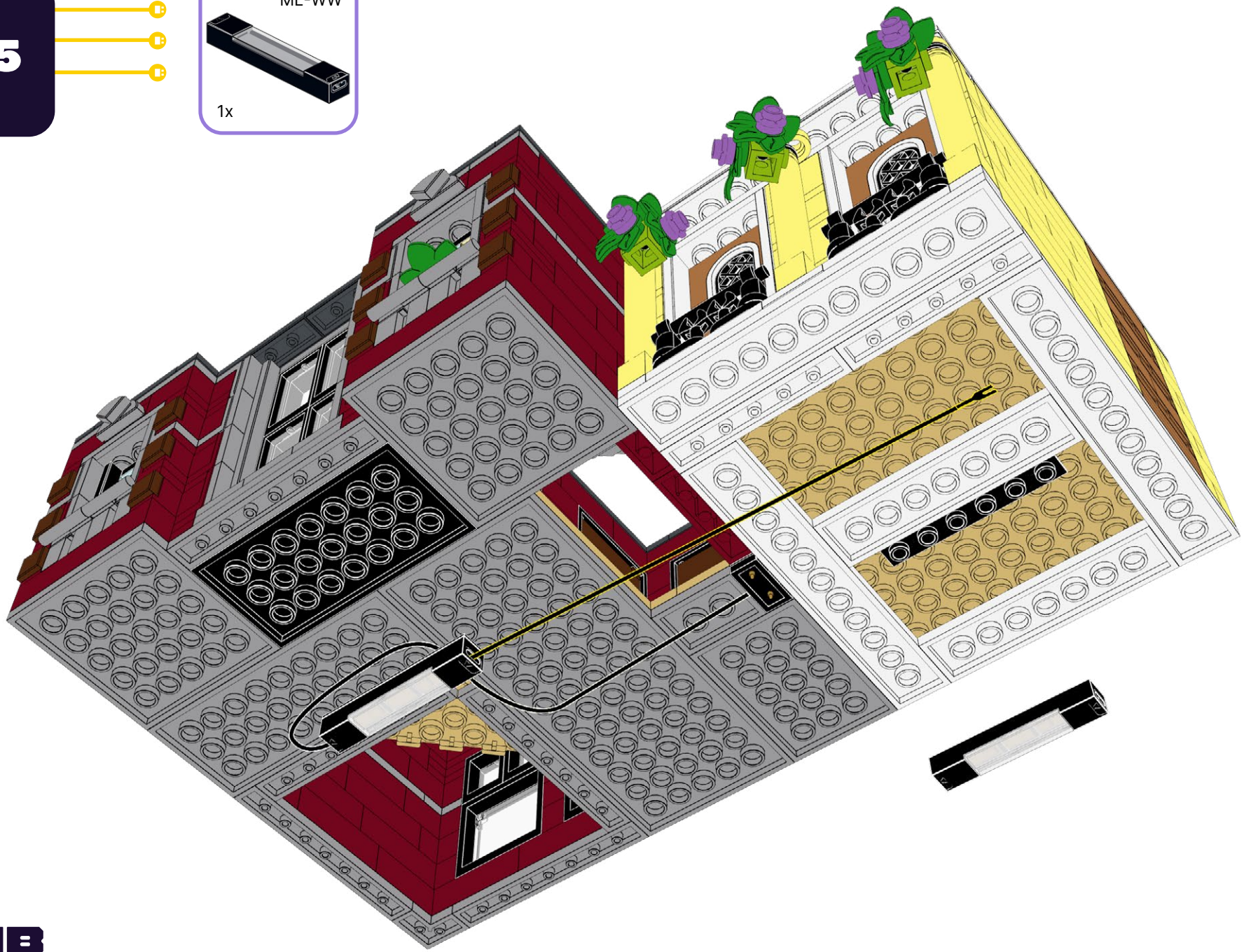
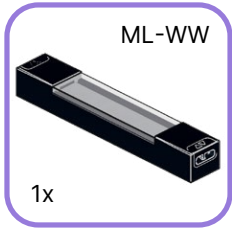

226

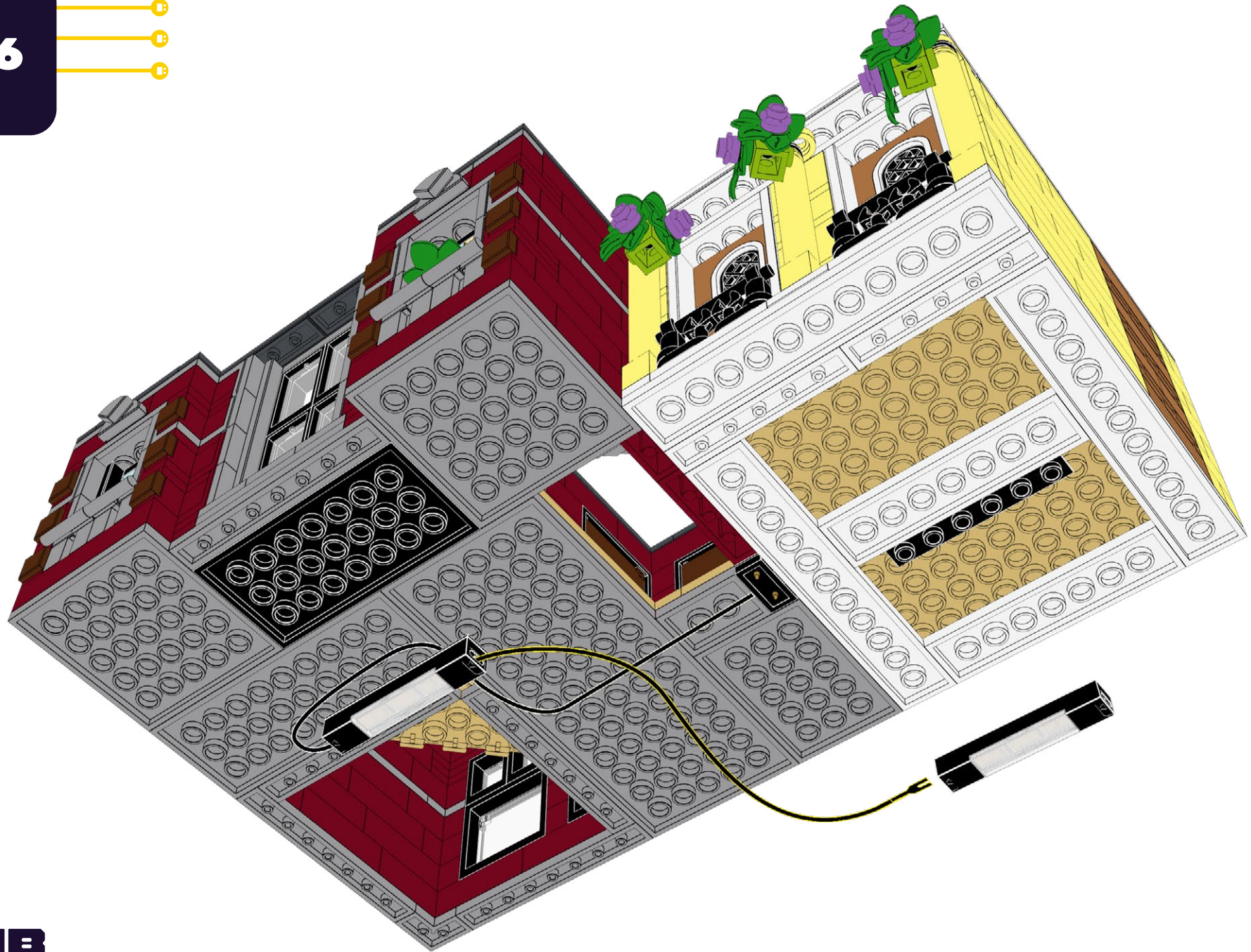

227

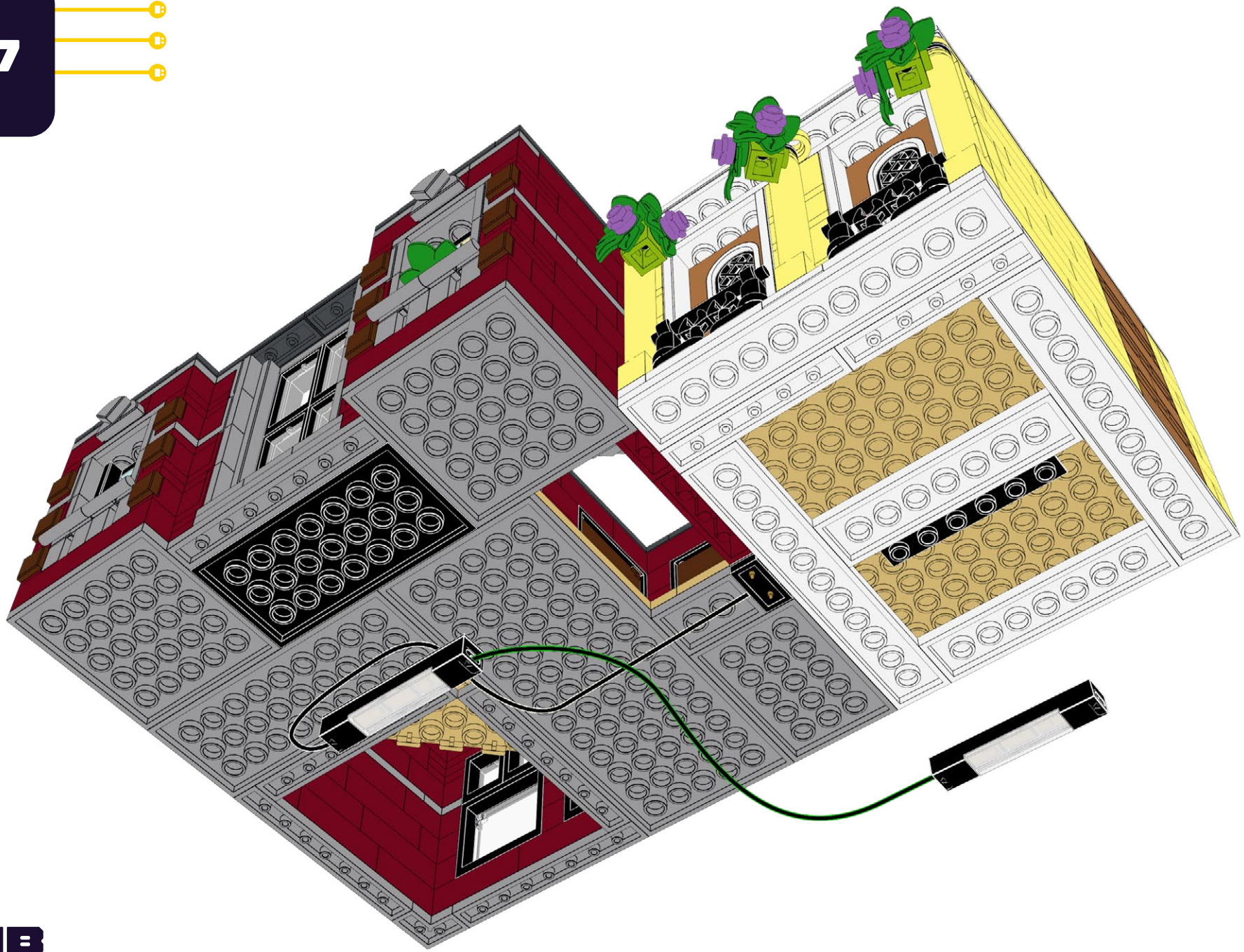

228



229

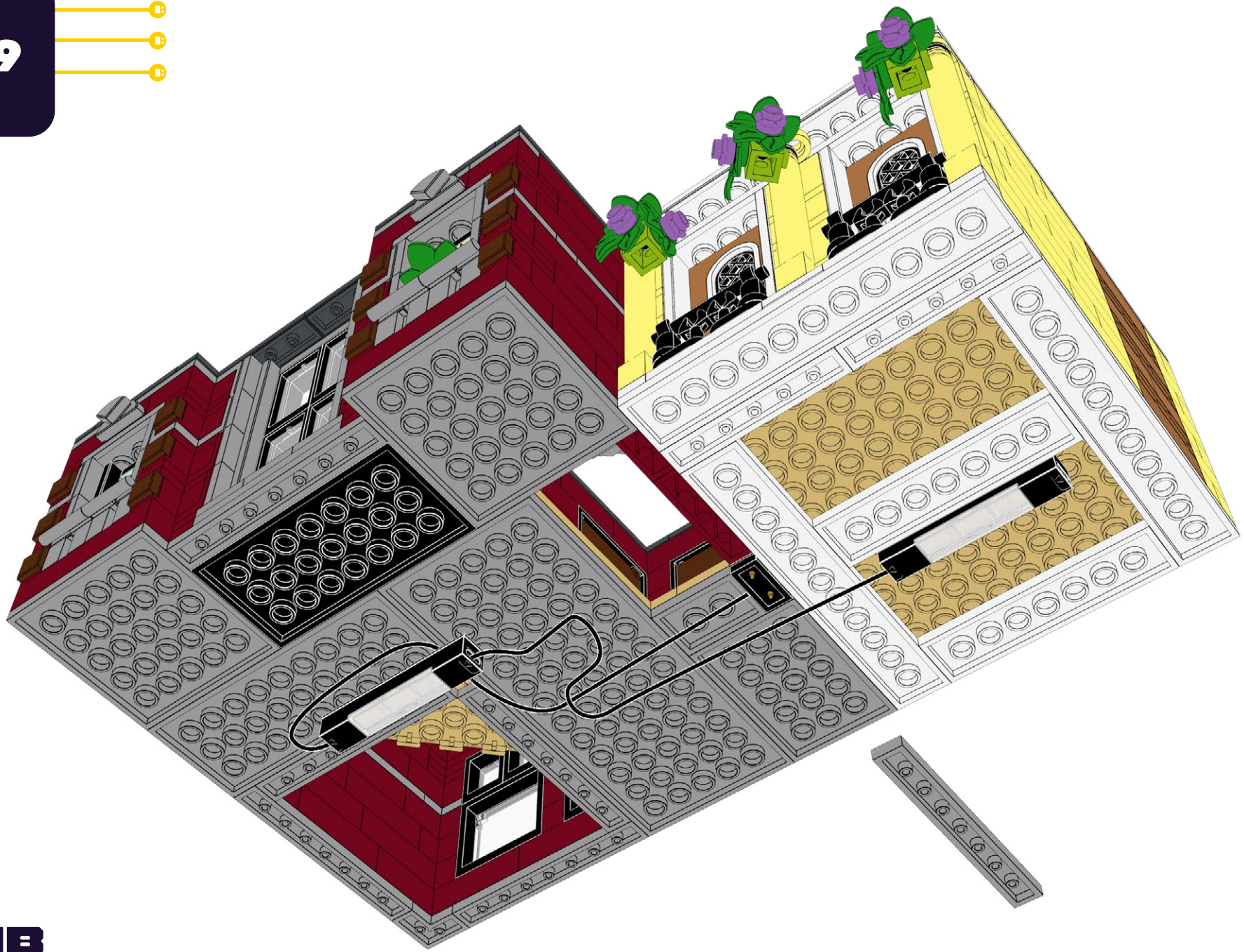

230



231

T-1x4



1x

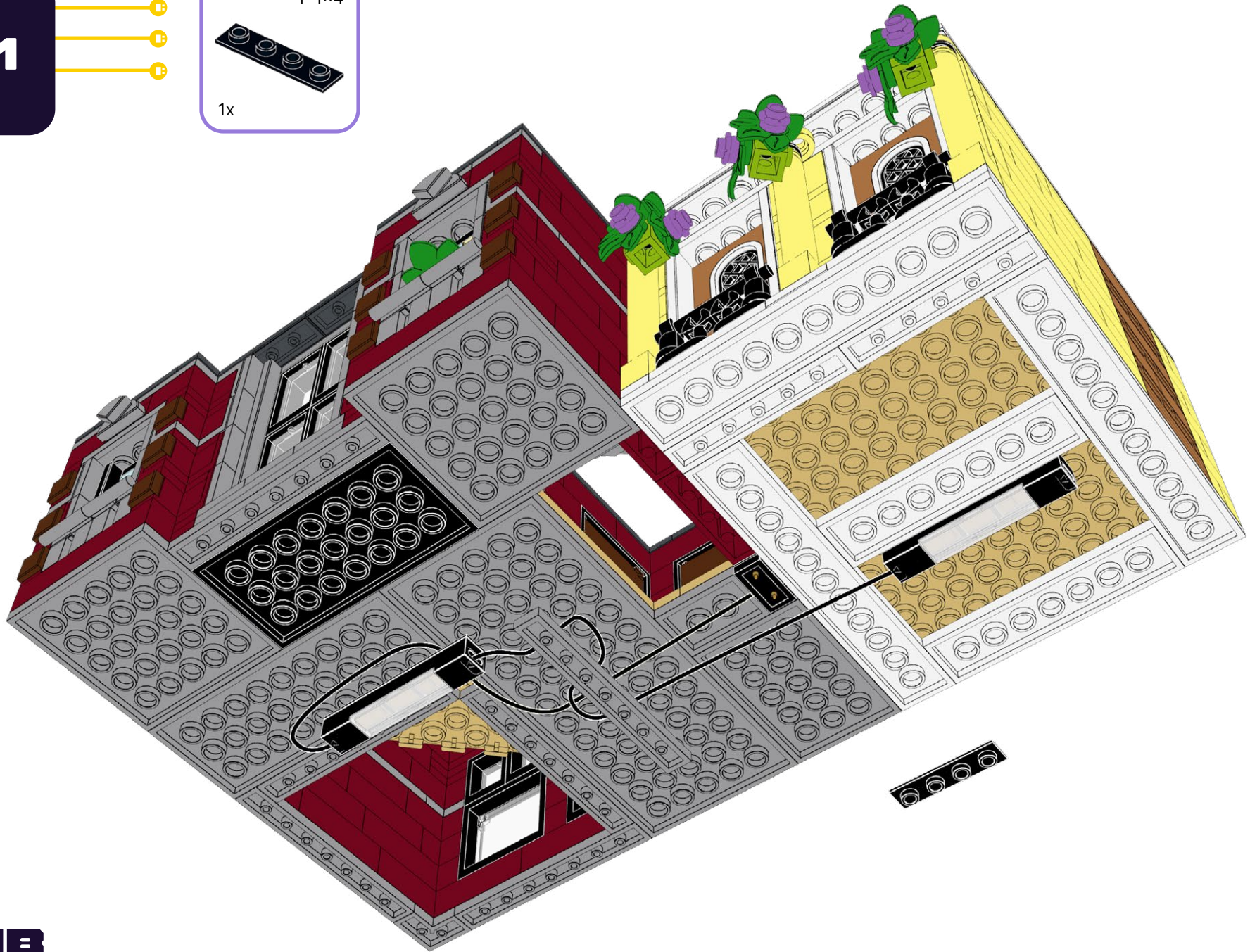

232



233

DS-4



1x

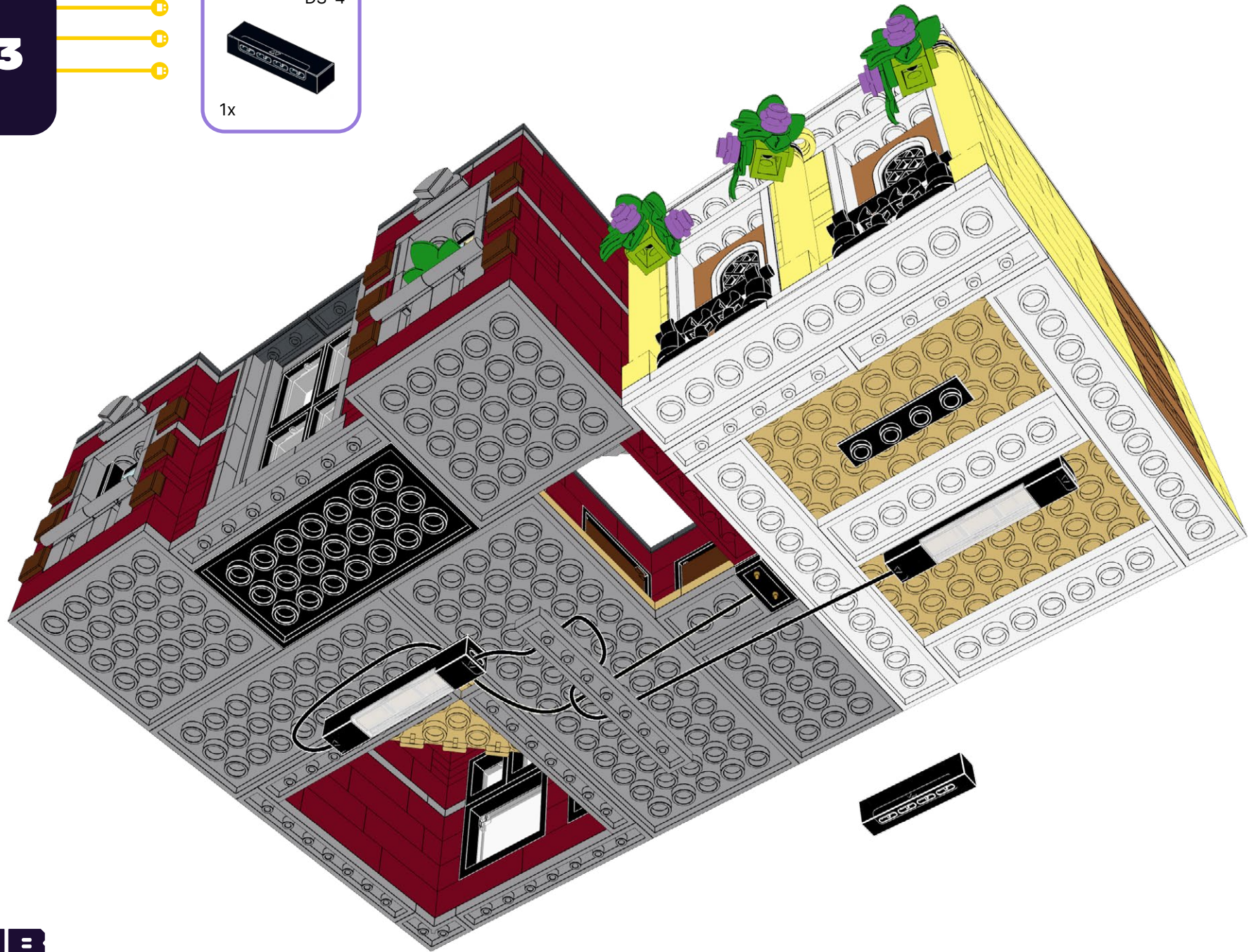

234



235

B-5

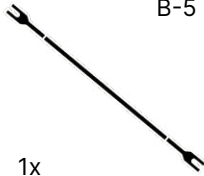

1x

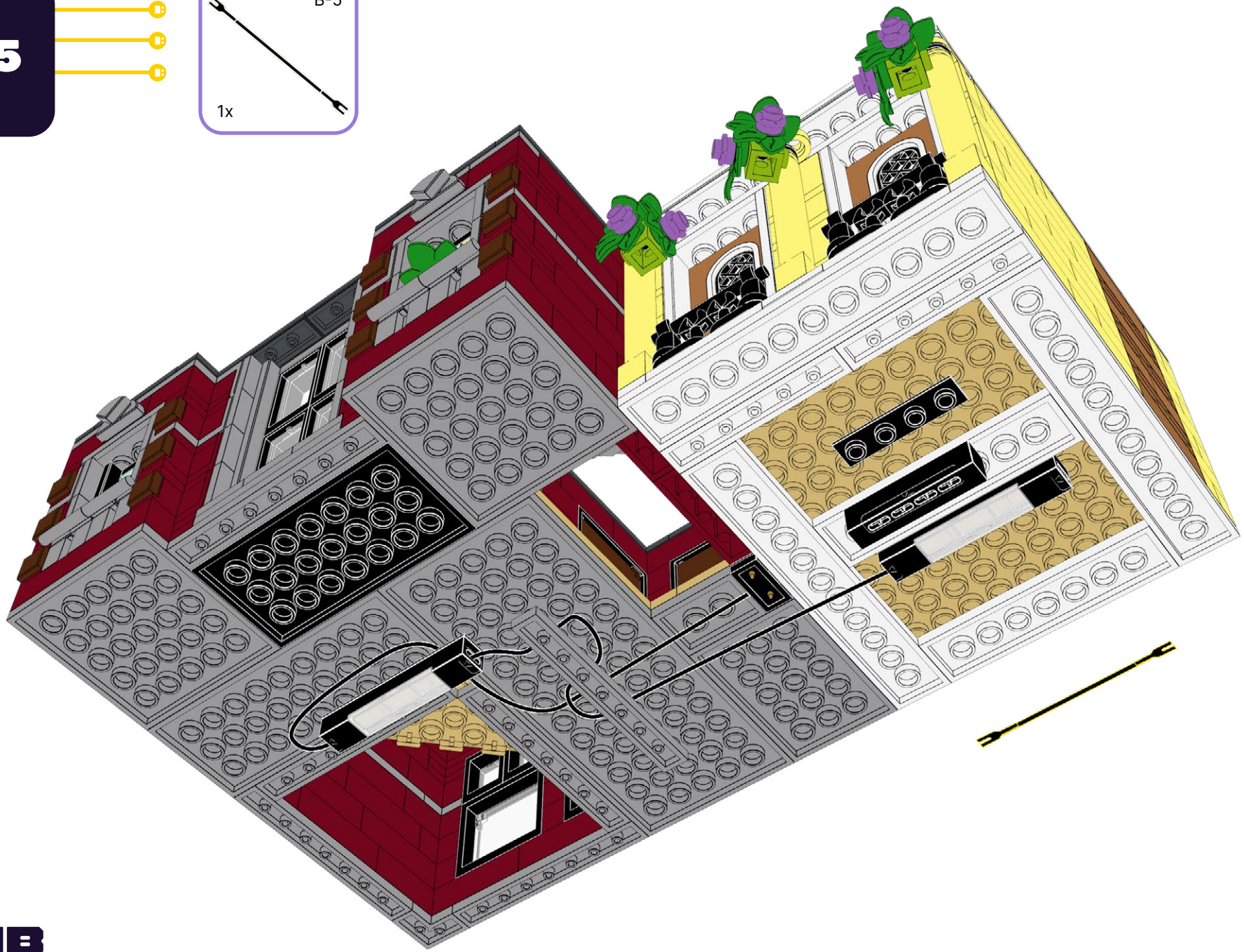

236



237



238

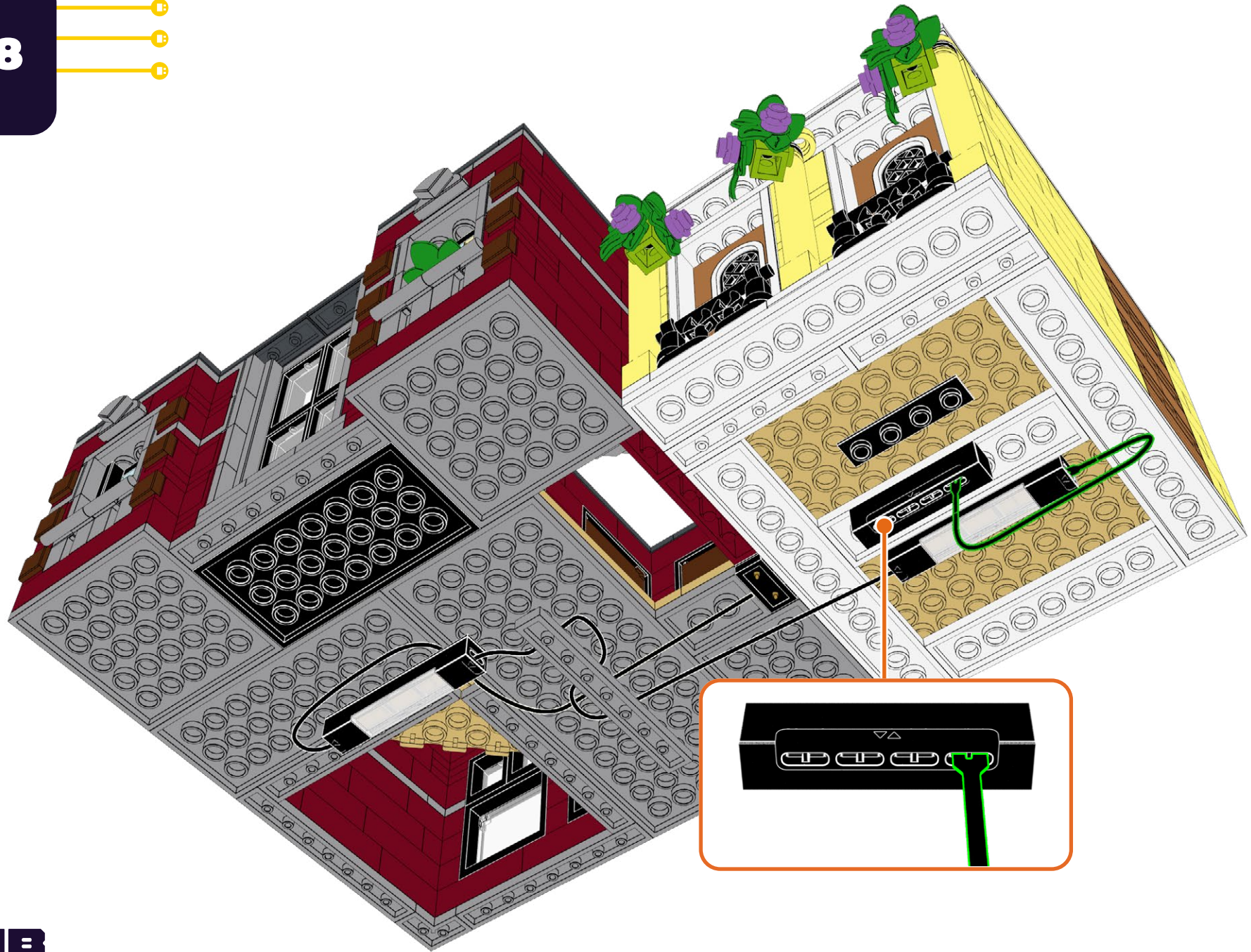

239

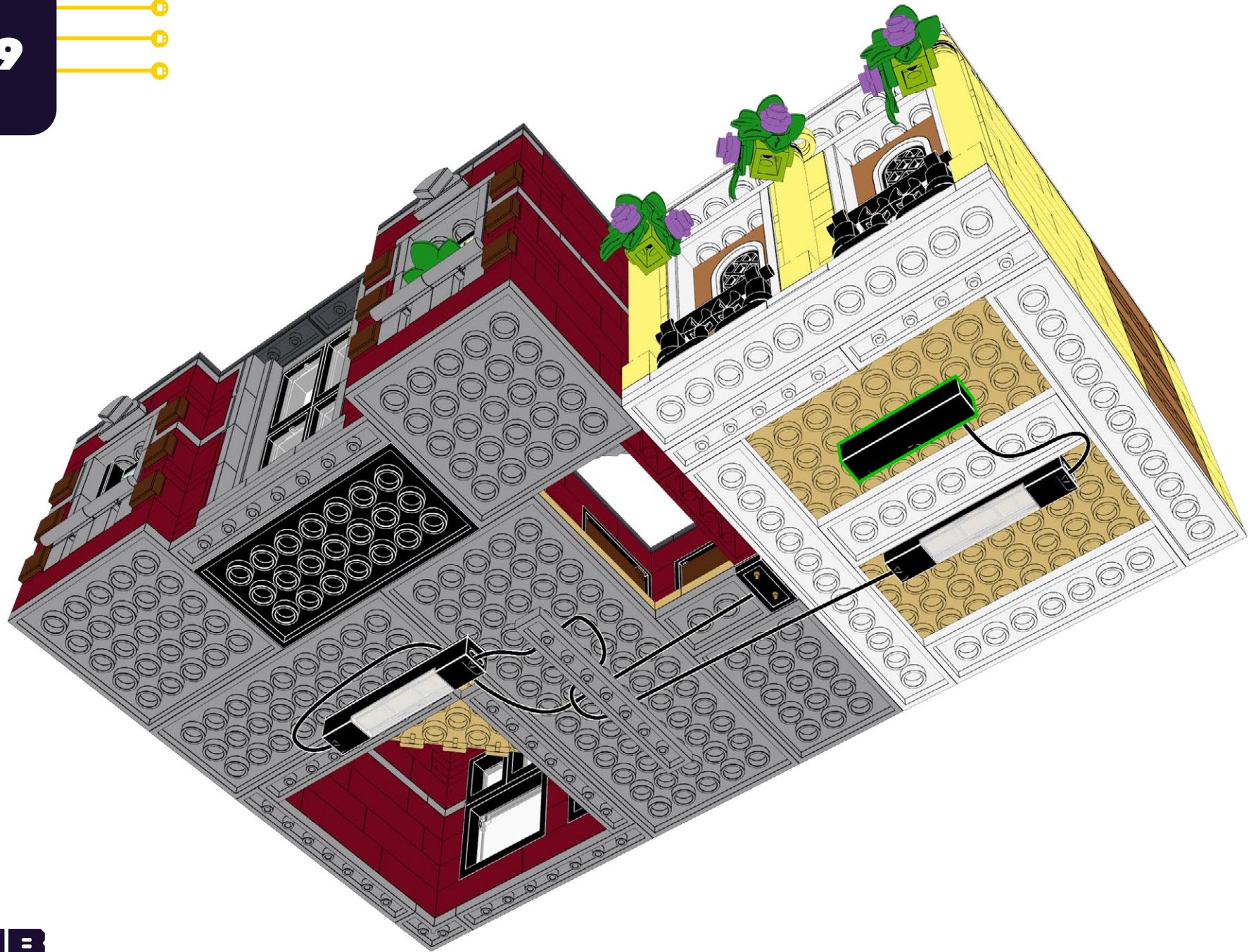

240



241



242



243



244



245

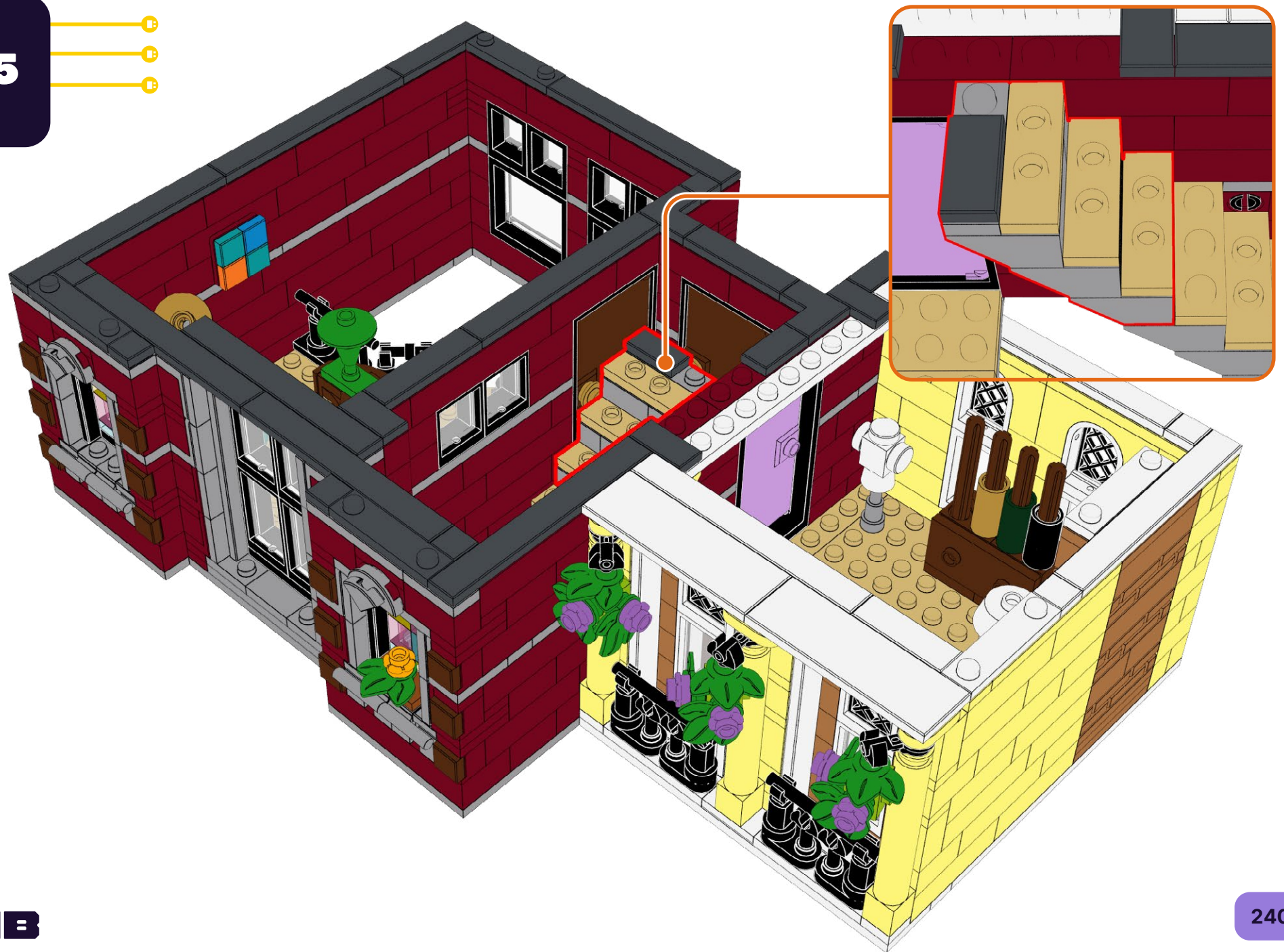

246



247

FLX-TPB30

1x

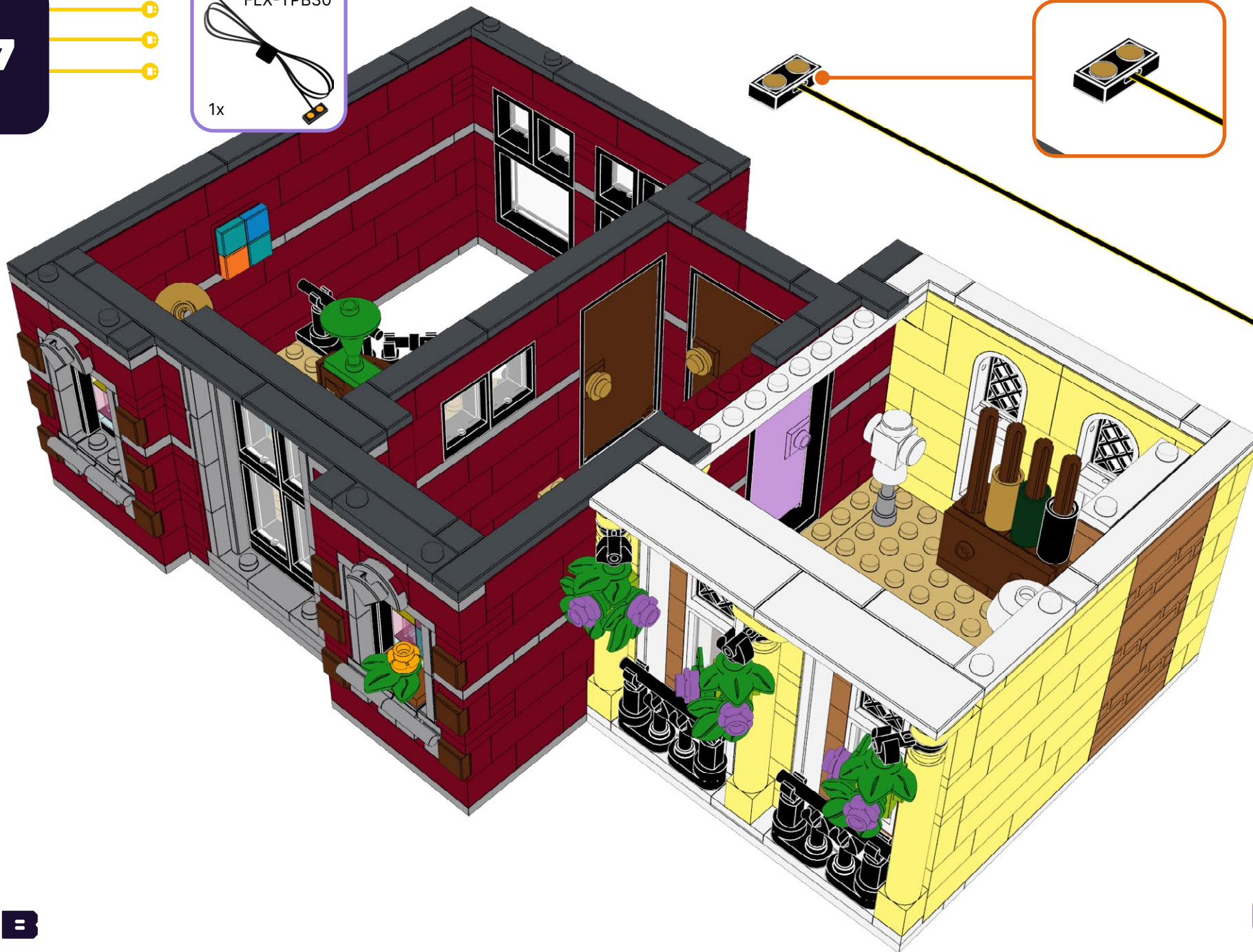
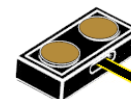
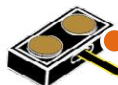

248



249



250

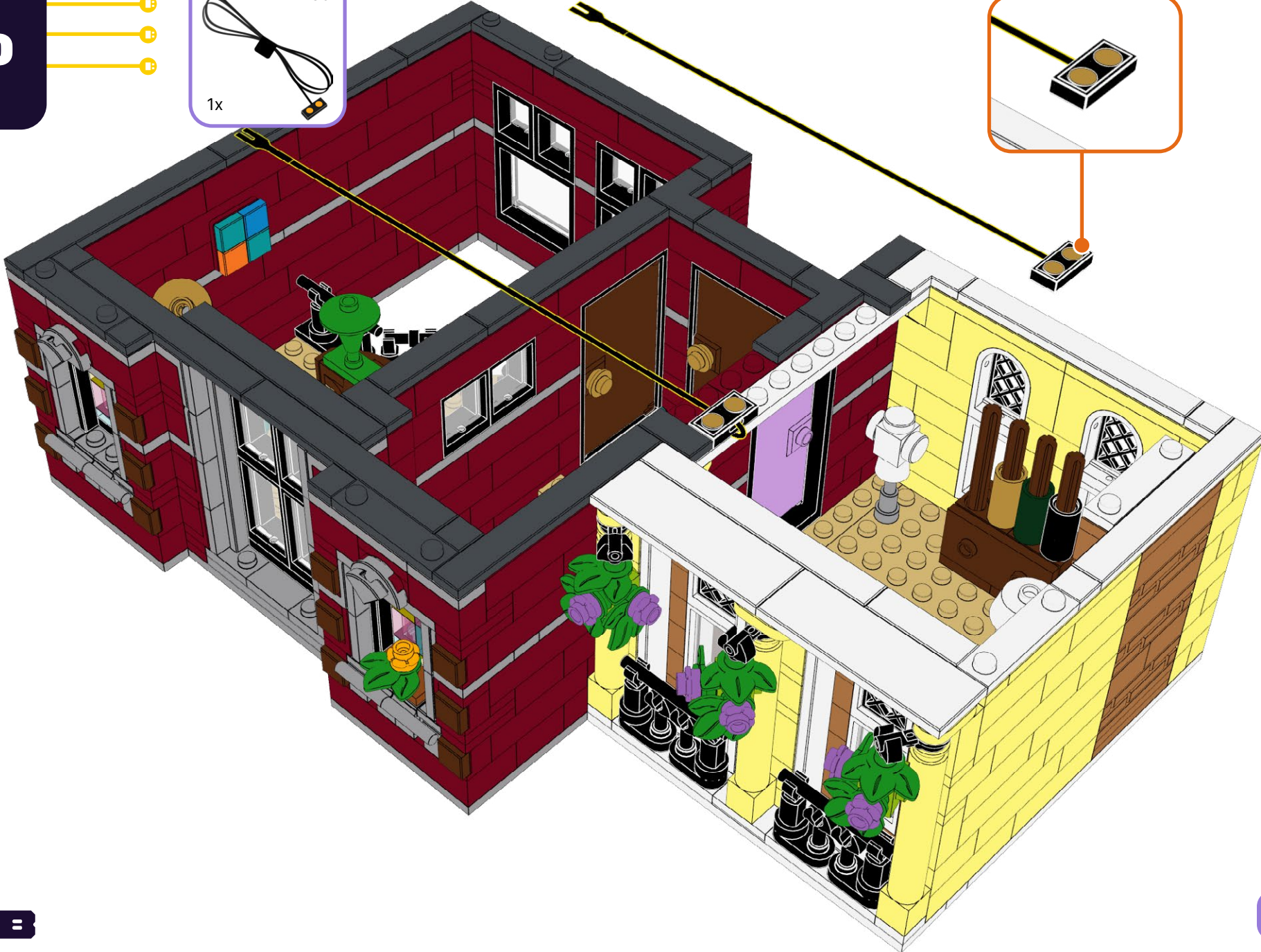
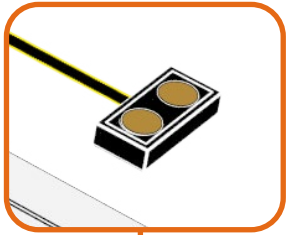

251

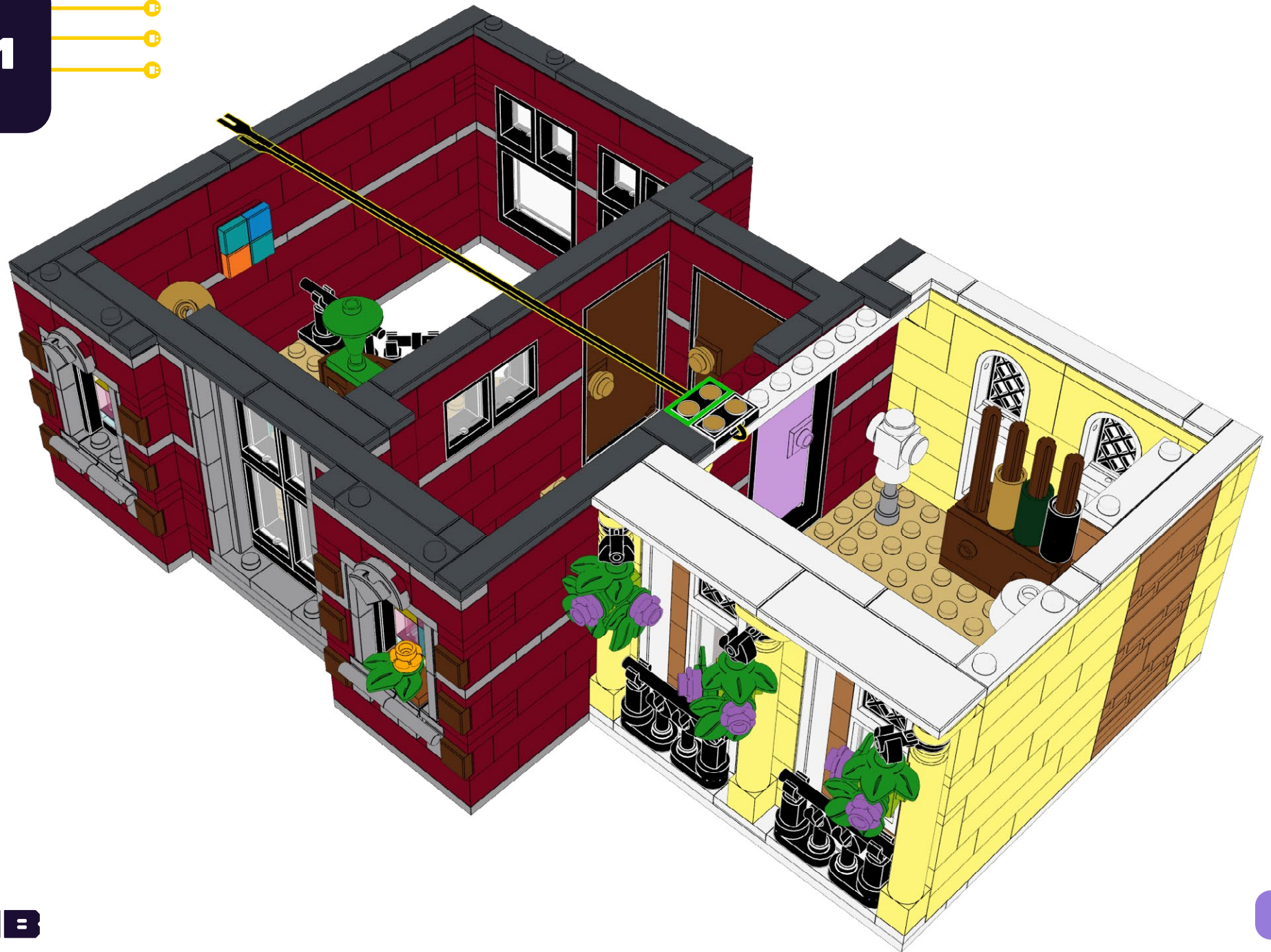

252



253



254



255



256

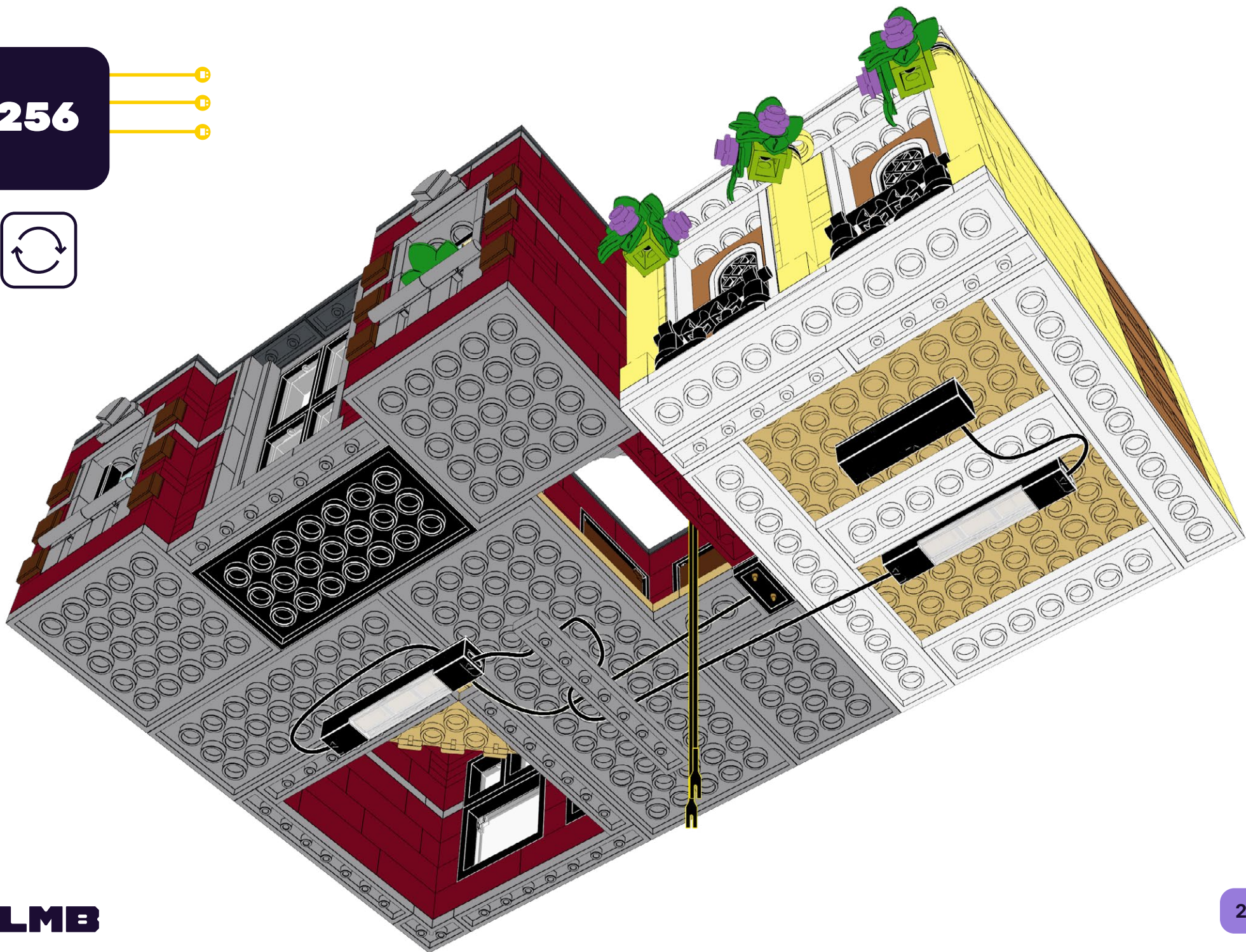

257

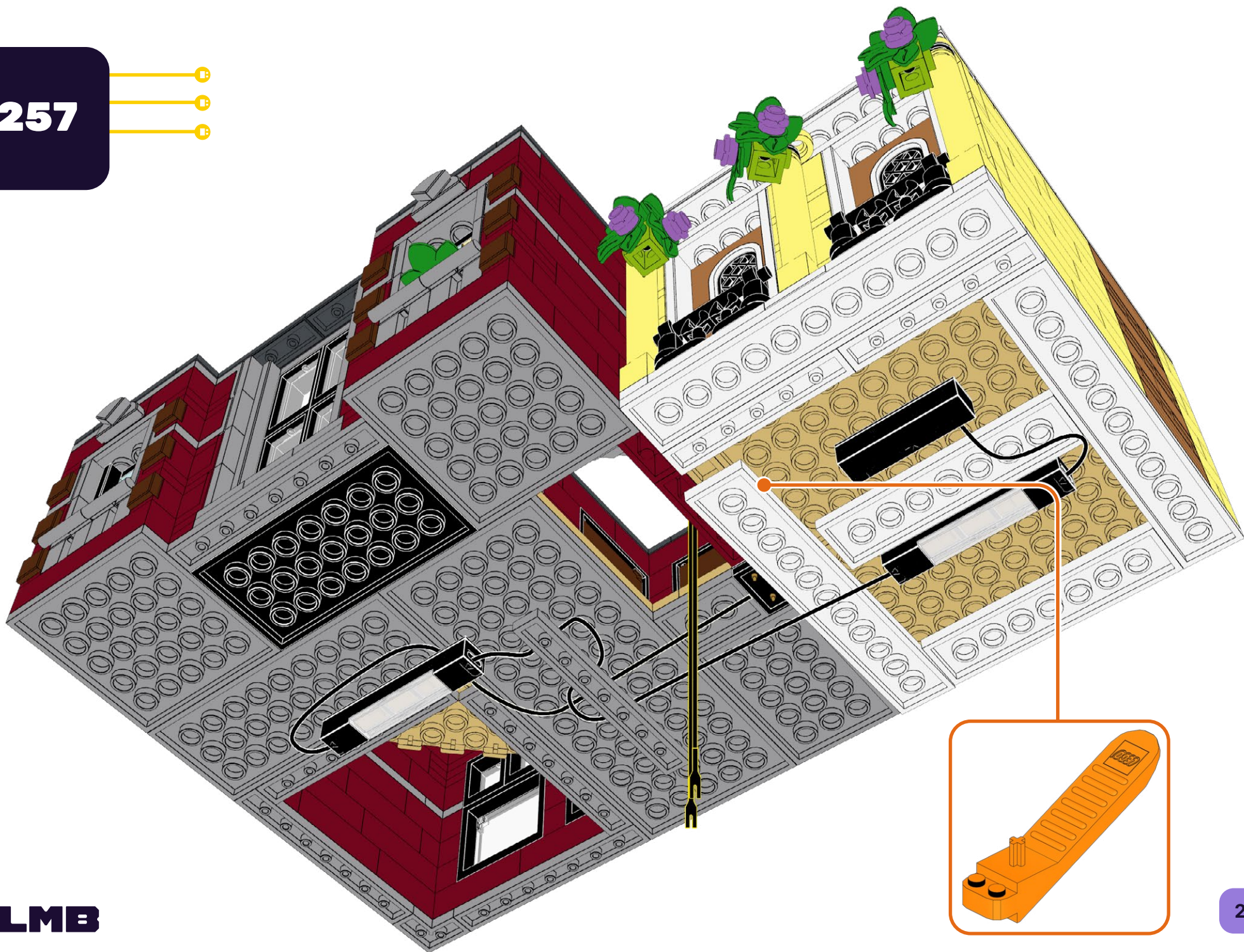

258

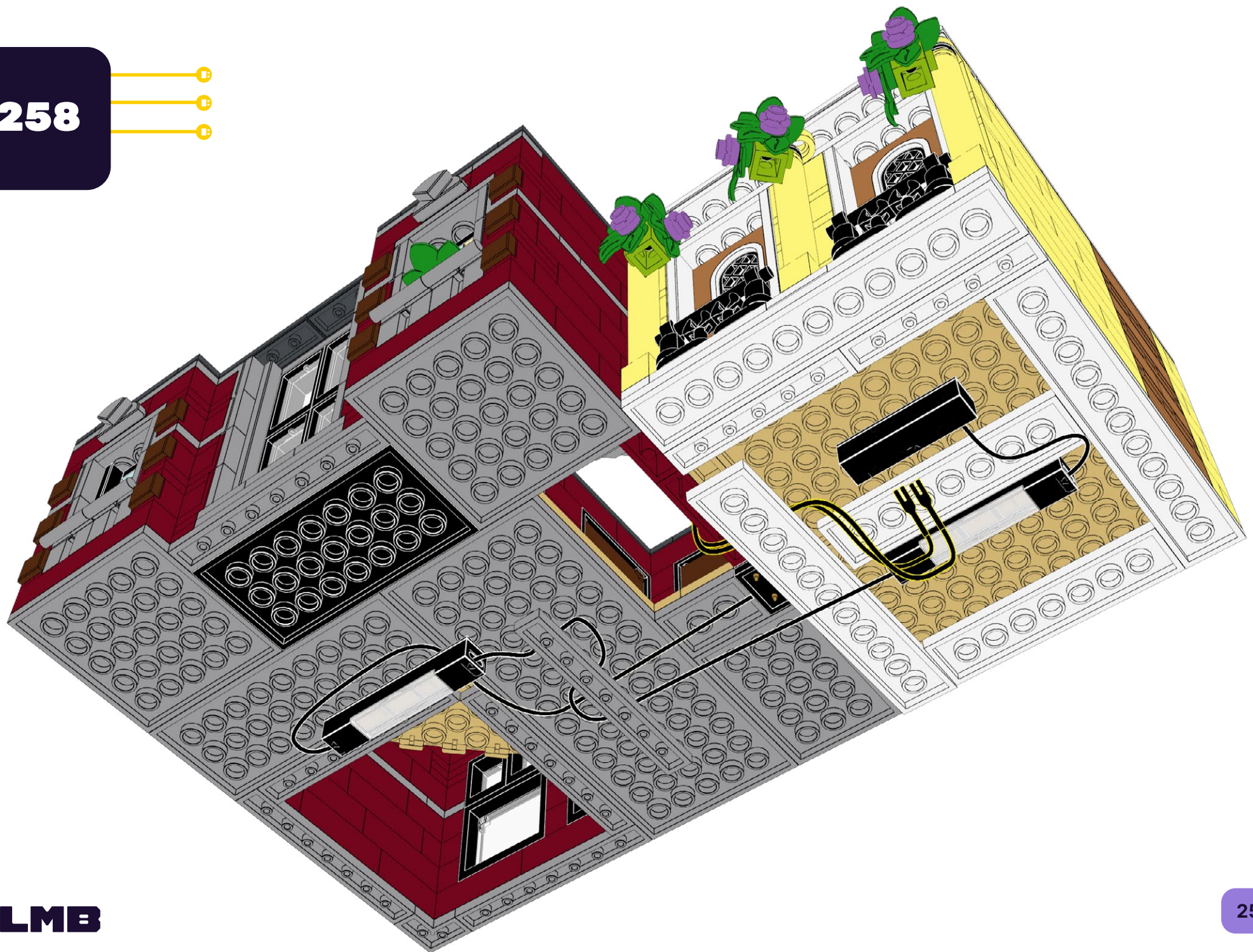

259

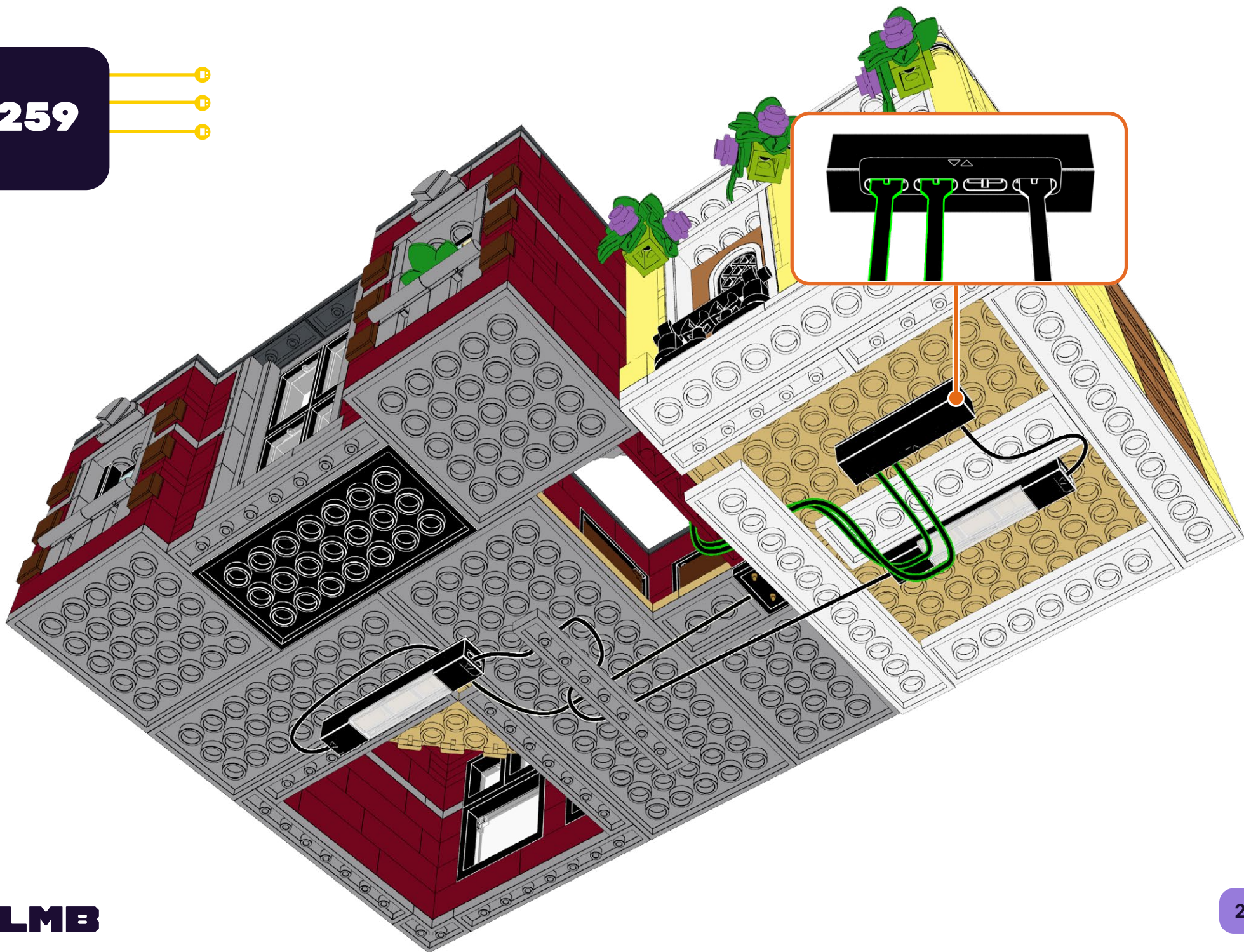

260

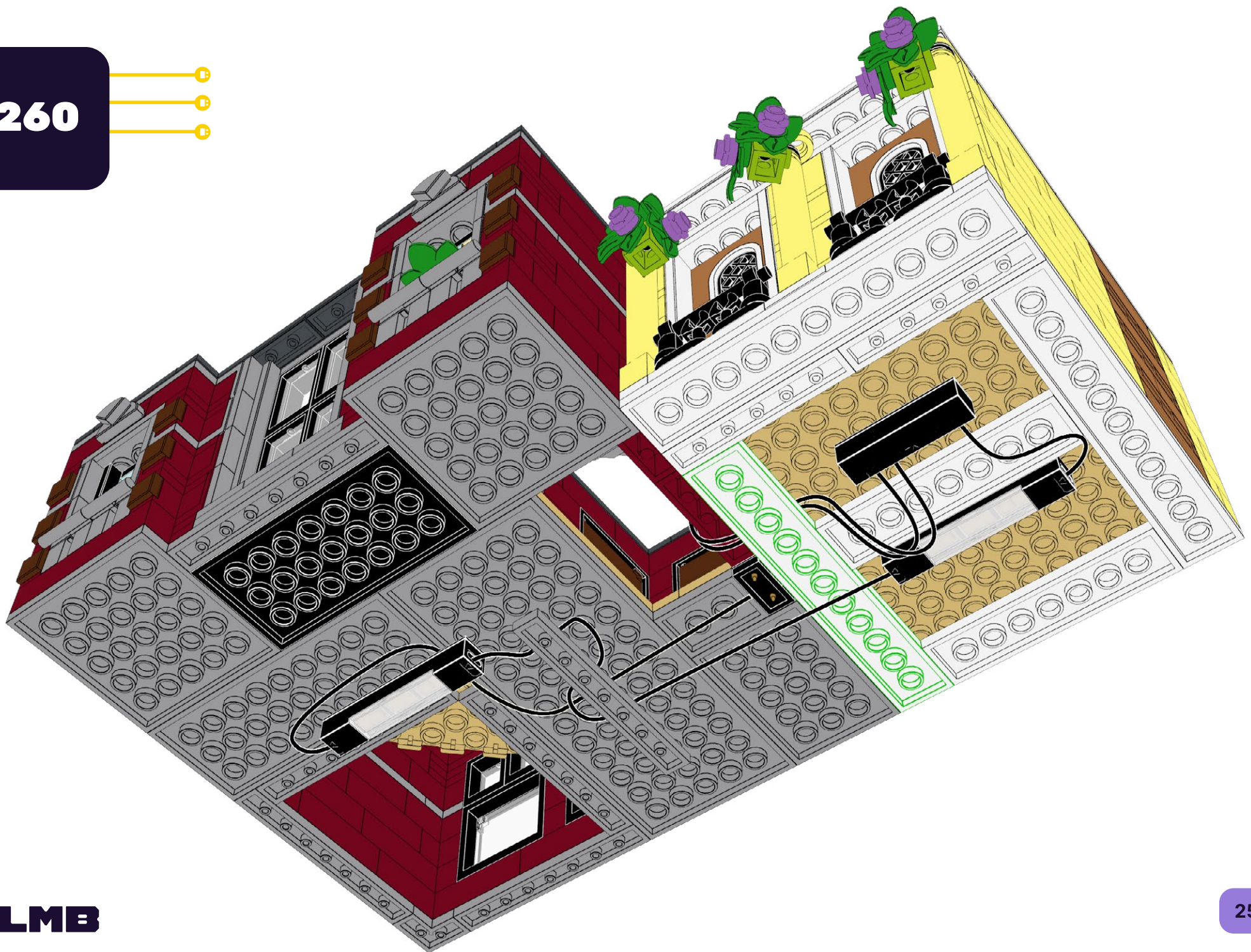

261



262



263



Power on Test
Test de mise sous tension
Test di Potenza
Stromtest
Prueba de Energía
电源测试



**HOLD UP!**

You might notice some bags aren't in order, as well as left over pieces, but that's ok! We're changing the way you build LEGO!

ATTENDEZ!

Vous remarquerez peut-être que certains sacs, ainsi que certaines pièces, ne sont pas dans le bon ordre. Mais pas de panique! Nous changeons simplement la façon avec laquelle vous construisez vos LEGO!

ASPETTA!

Potresti notare che alcuni sacchetti non sono in ordine, così come i pezzi avanzati, ma va bene così! Stiamo cambiando il modo in cui costruisci i LEGO!

HALT!

Sie werden möglicherweise bemerken, dass einige tüten durcheinander sind und teile übrig bleiben, aber das ist in Ordnung! Wir ändern die art und weise, wie Sie LEGO bauen!

¡ESPERA!

Es posible que notes que algunas bolsas están fuera de servicio, así como piezas sobrantes, ¡pero está bien! ¡Estamos cambiando la forma en que construyes LEGO!

暫停!

你可能会注意到一些袋子顺序错乱, 以及一些剩余的部件, 但没关系! 我们正在改变你搭建乐高的方式!

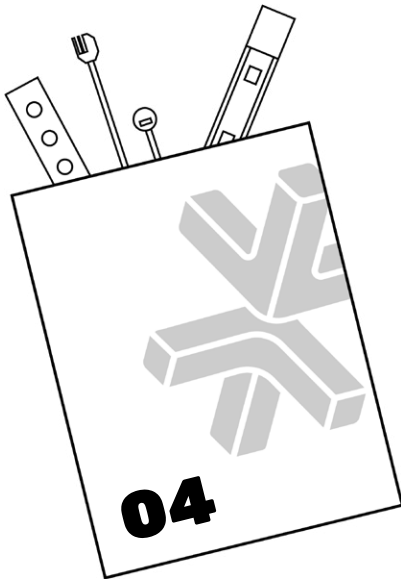
Open LMB Bag 04

264

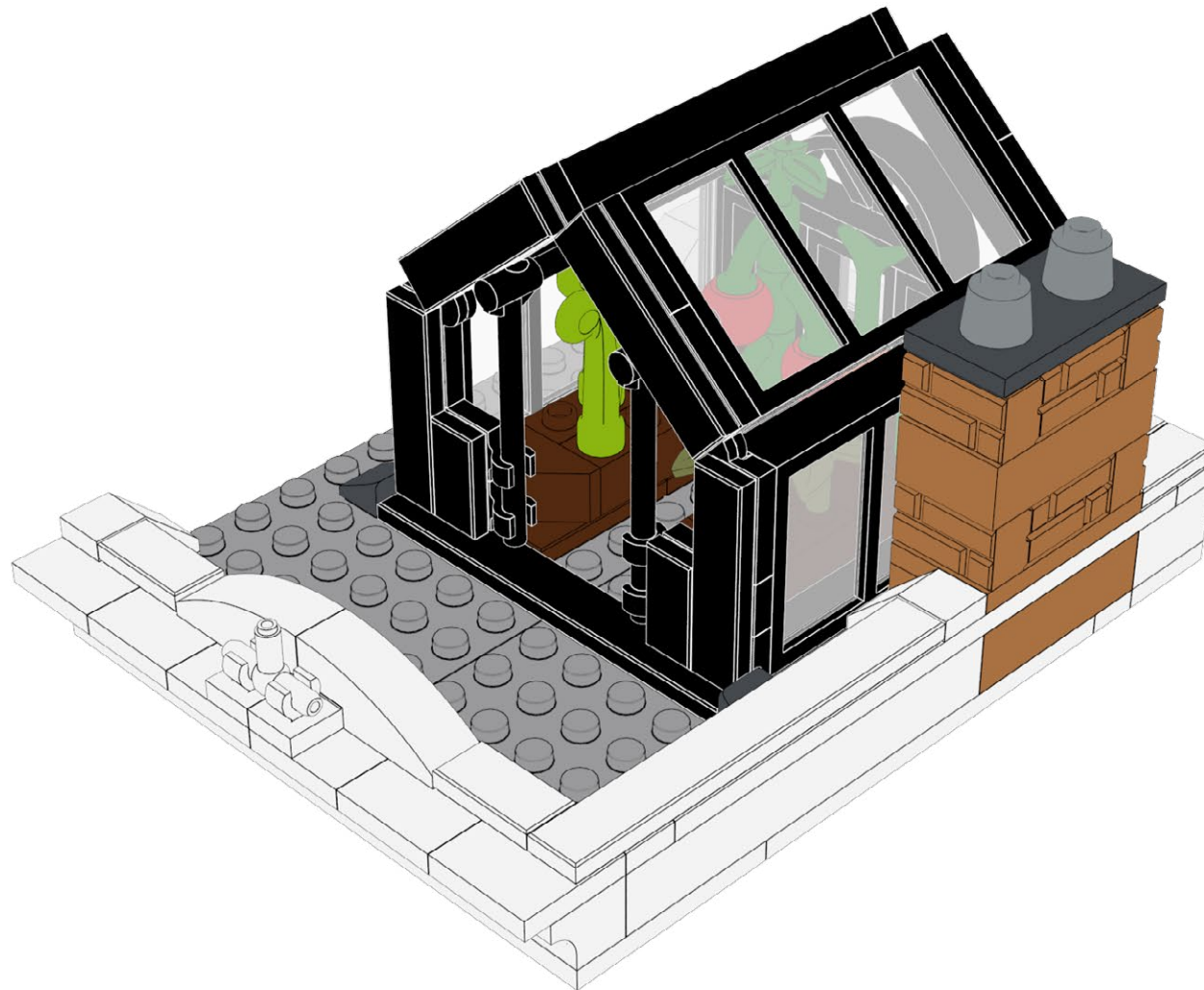

265

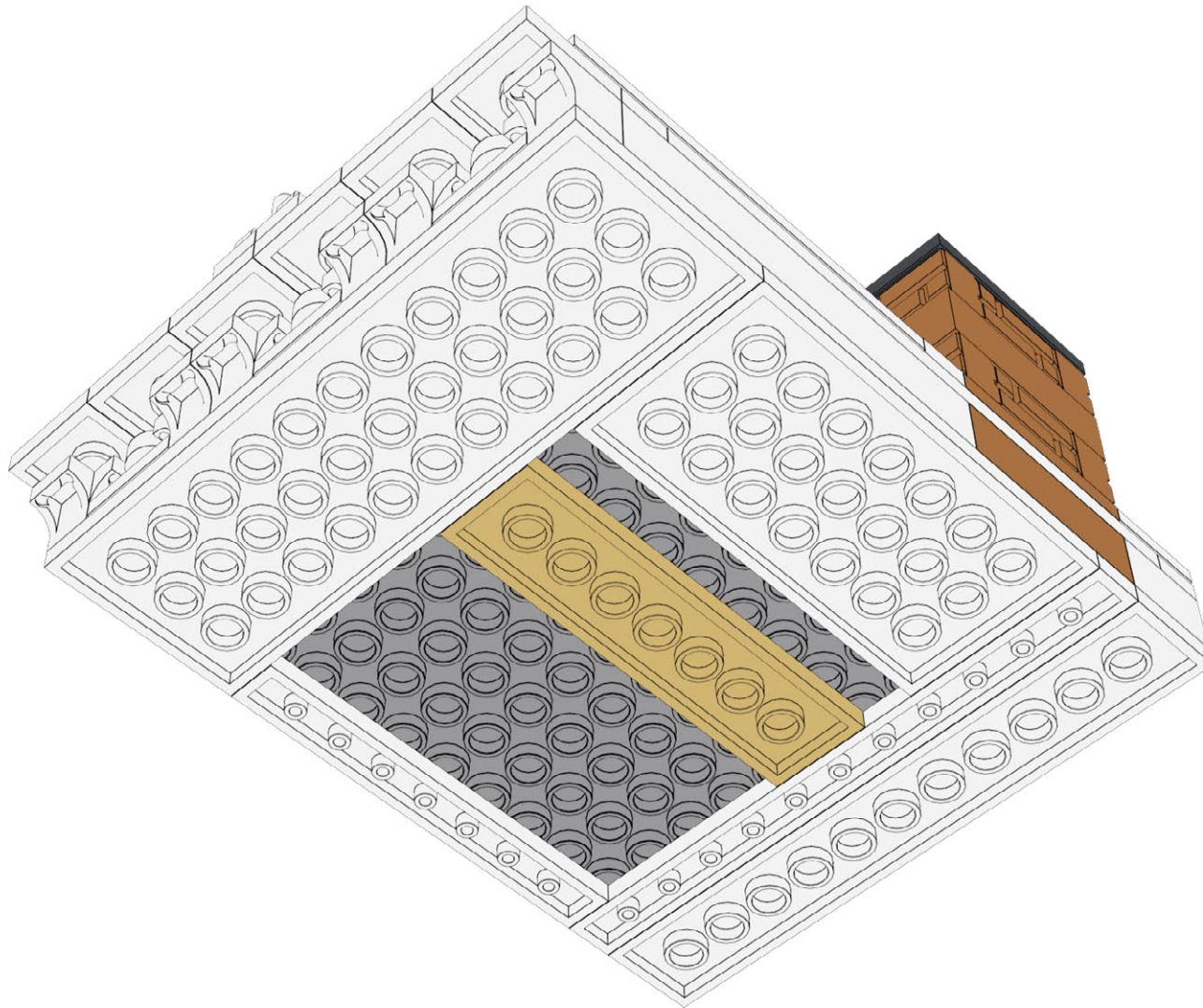

266

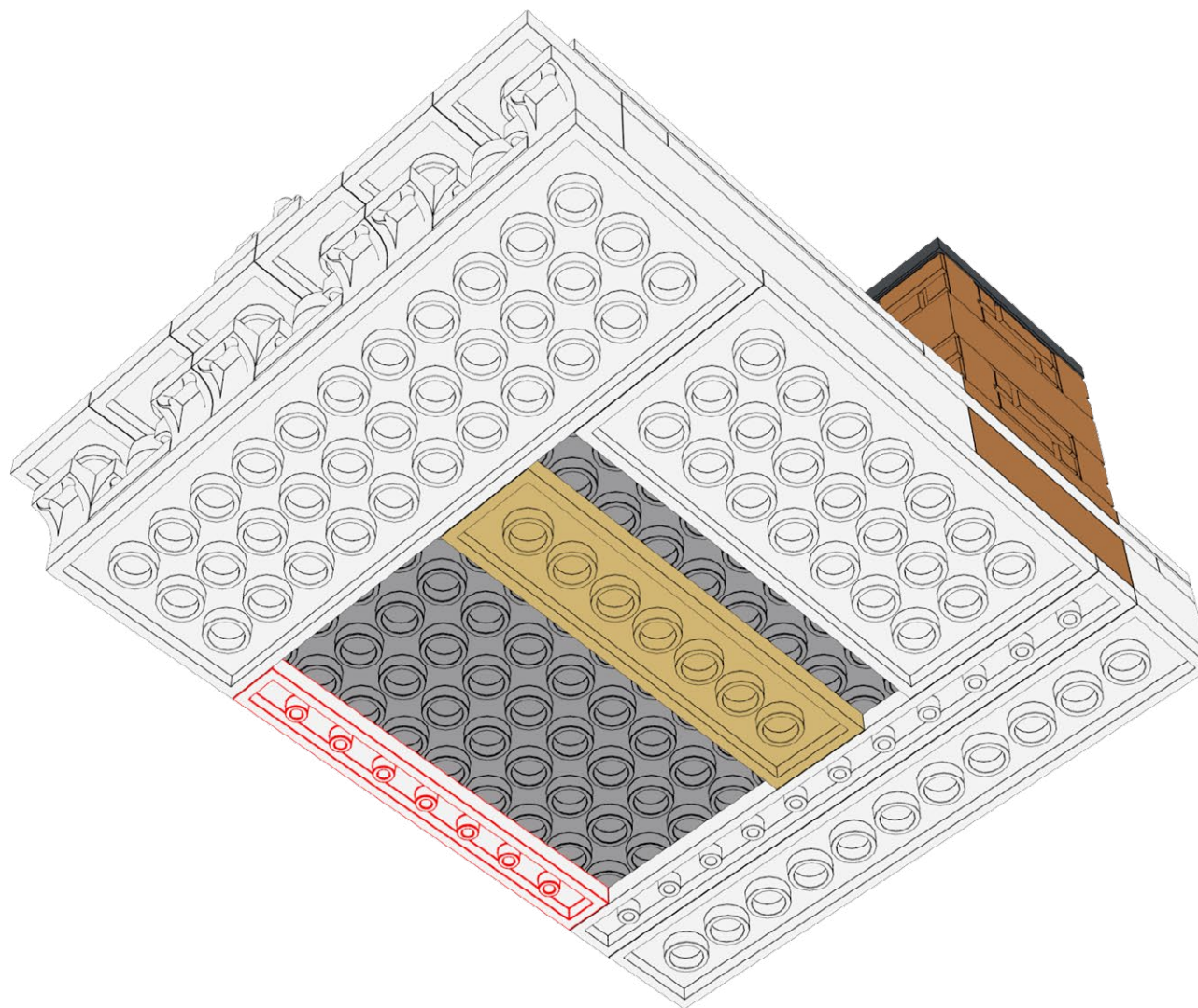

267

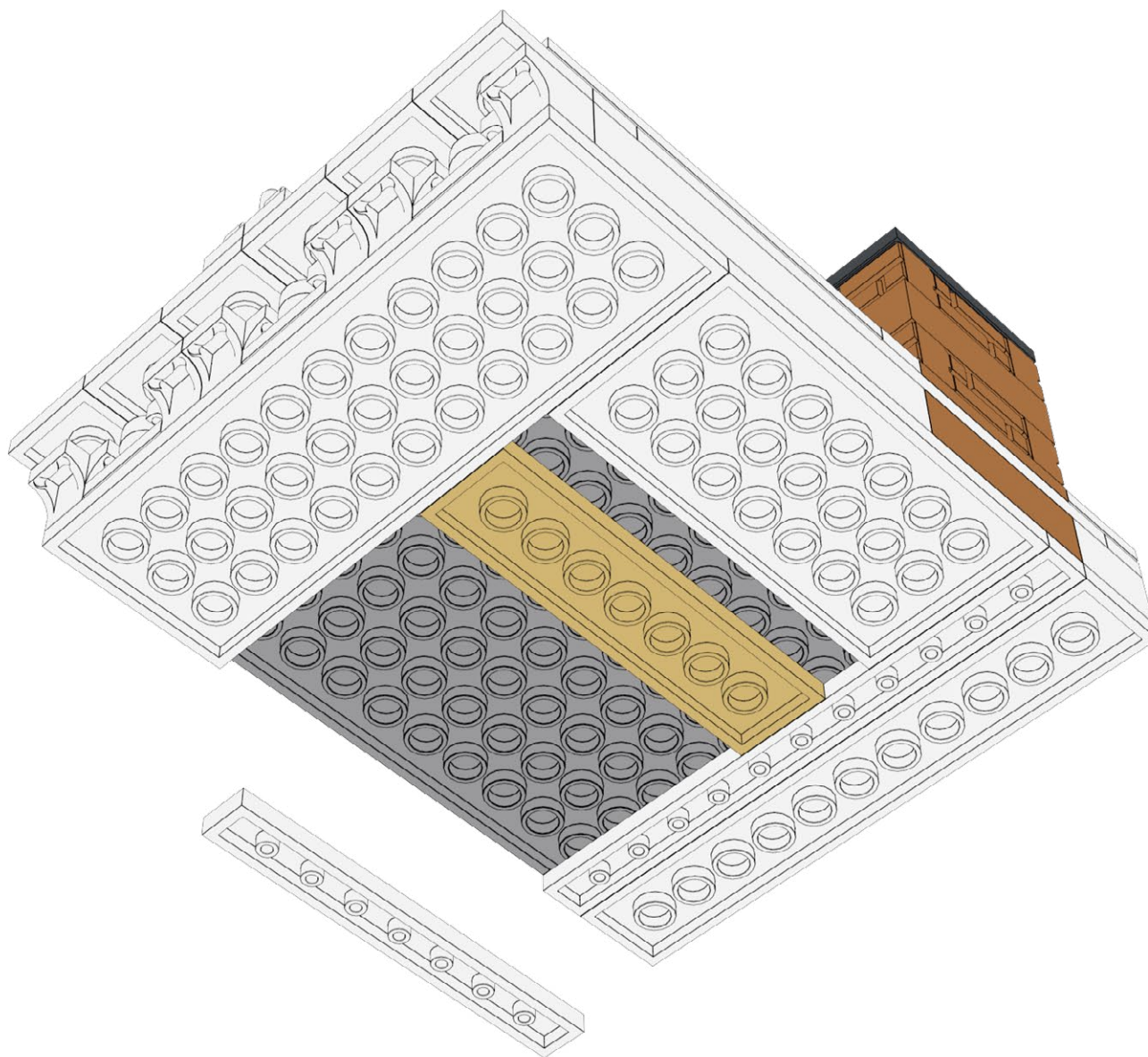

268

FLX-TPA30

1x

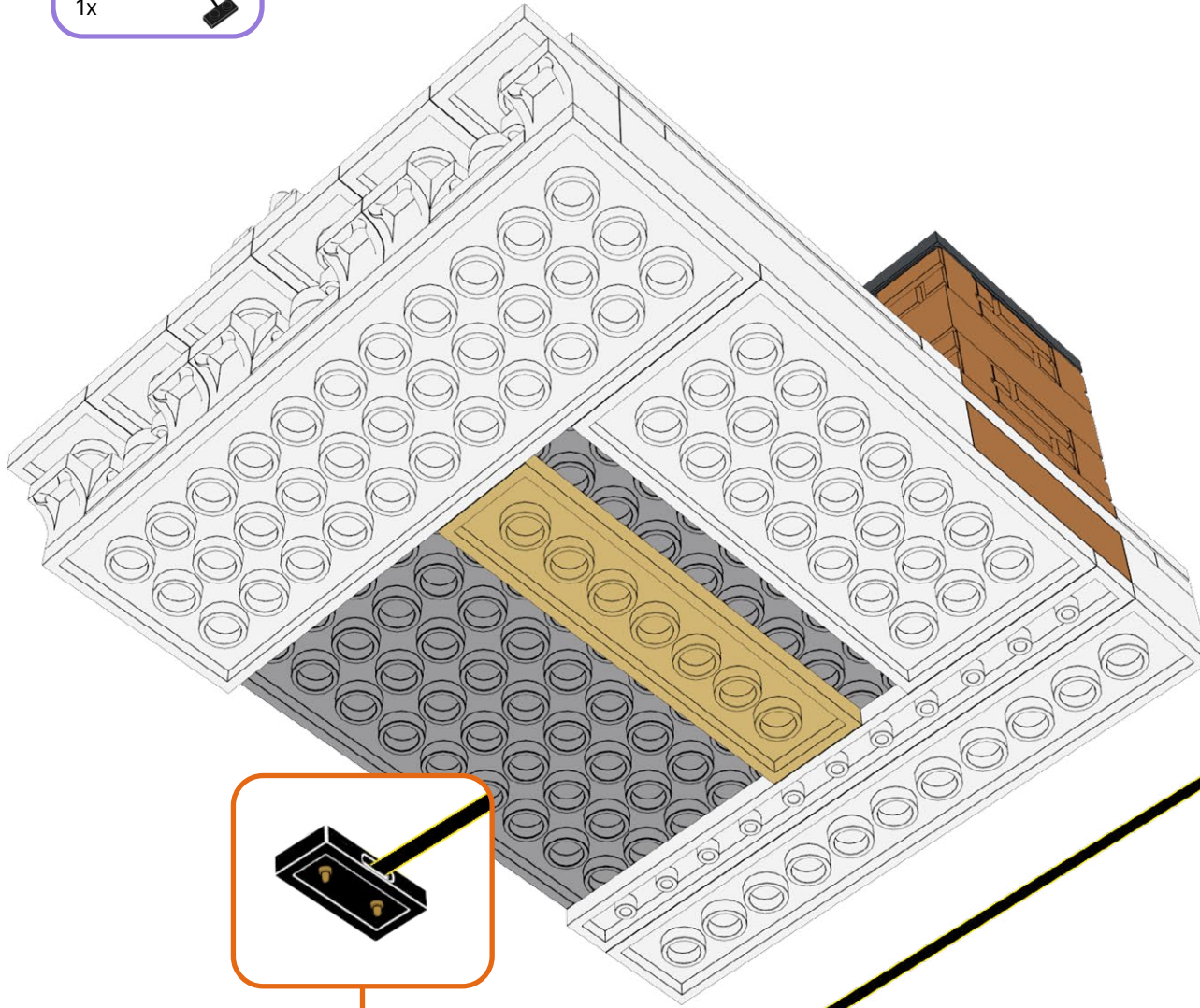

269

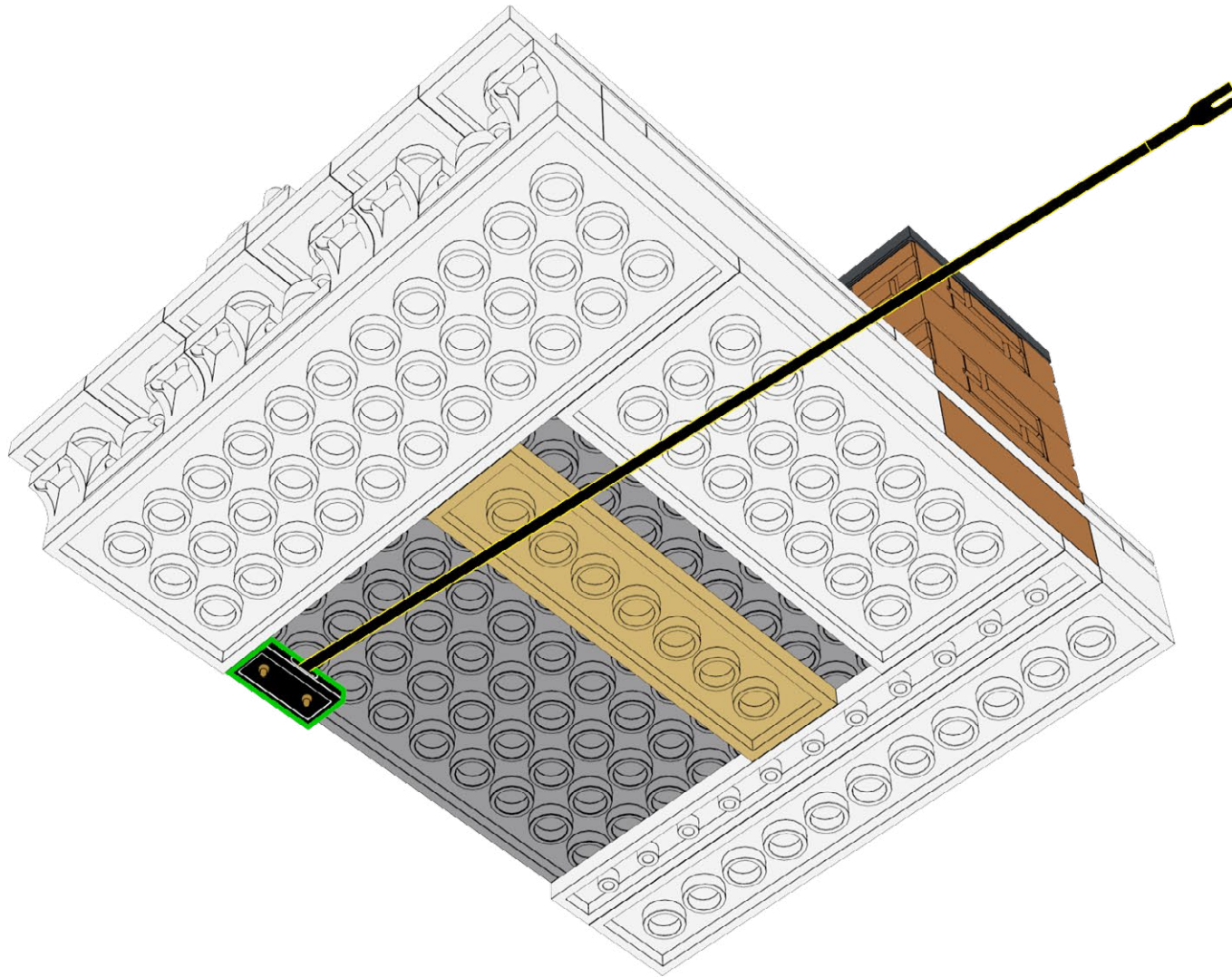

270

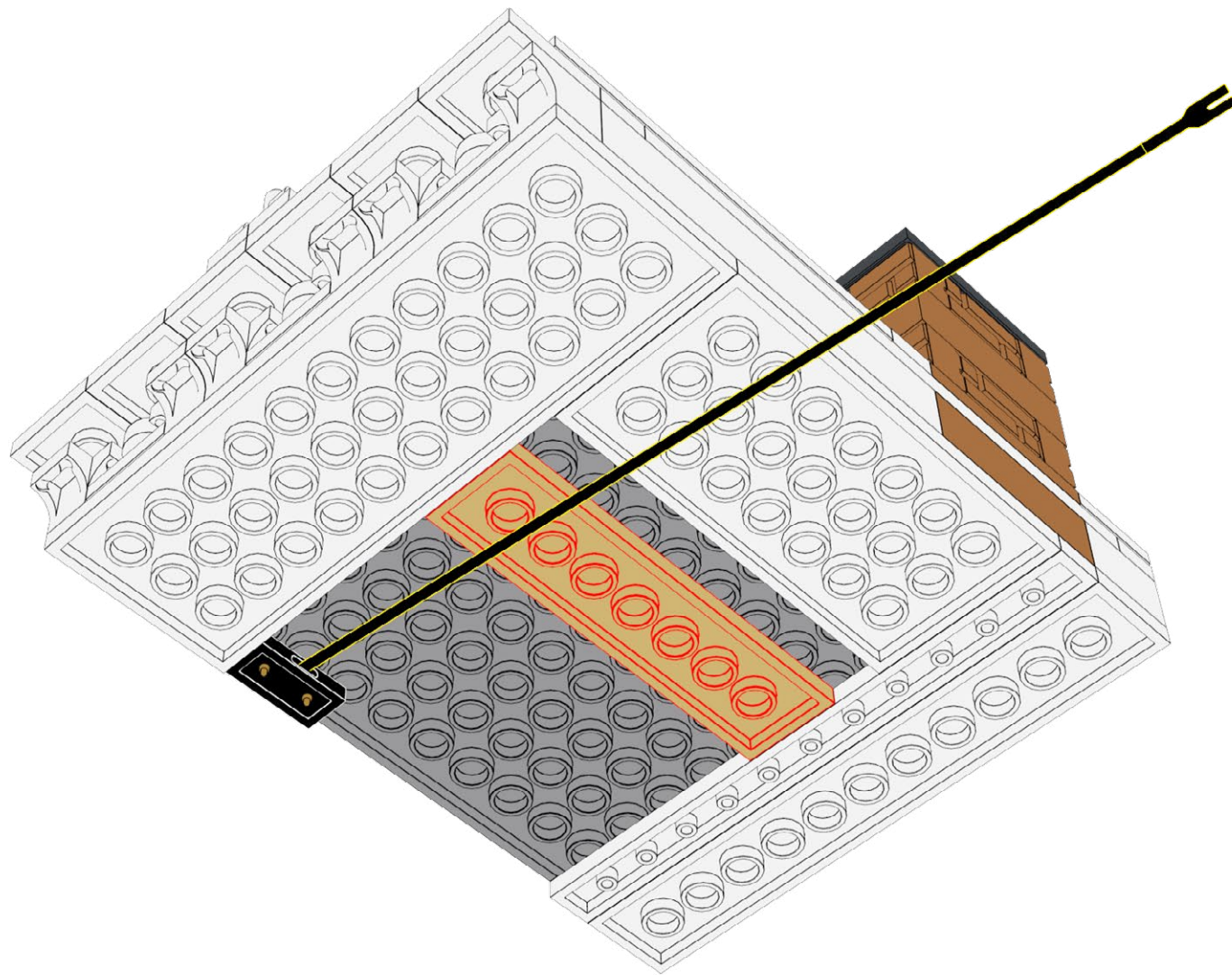

271

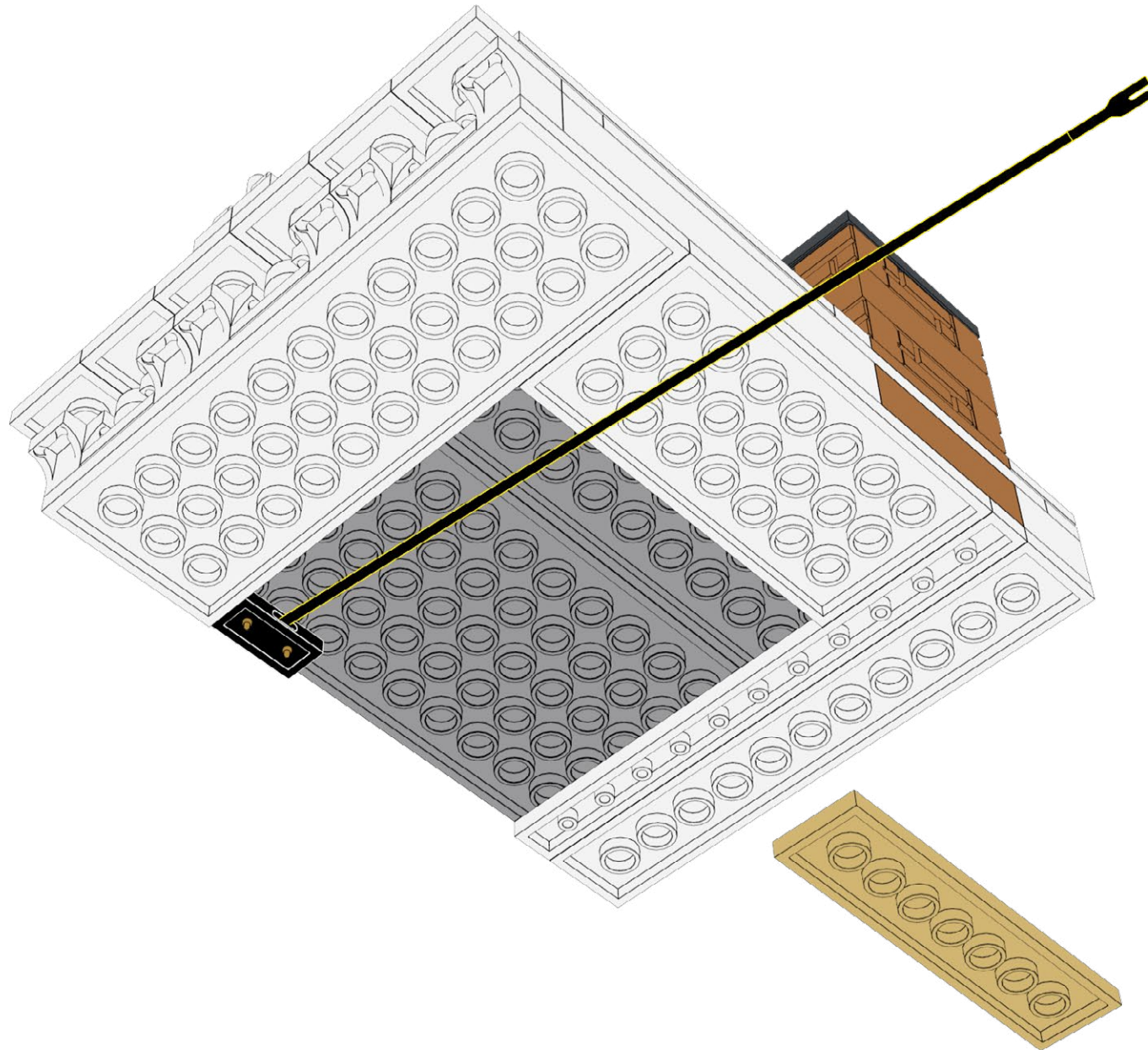

272

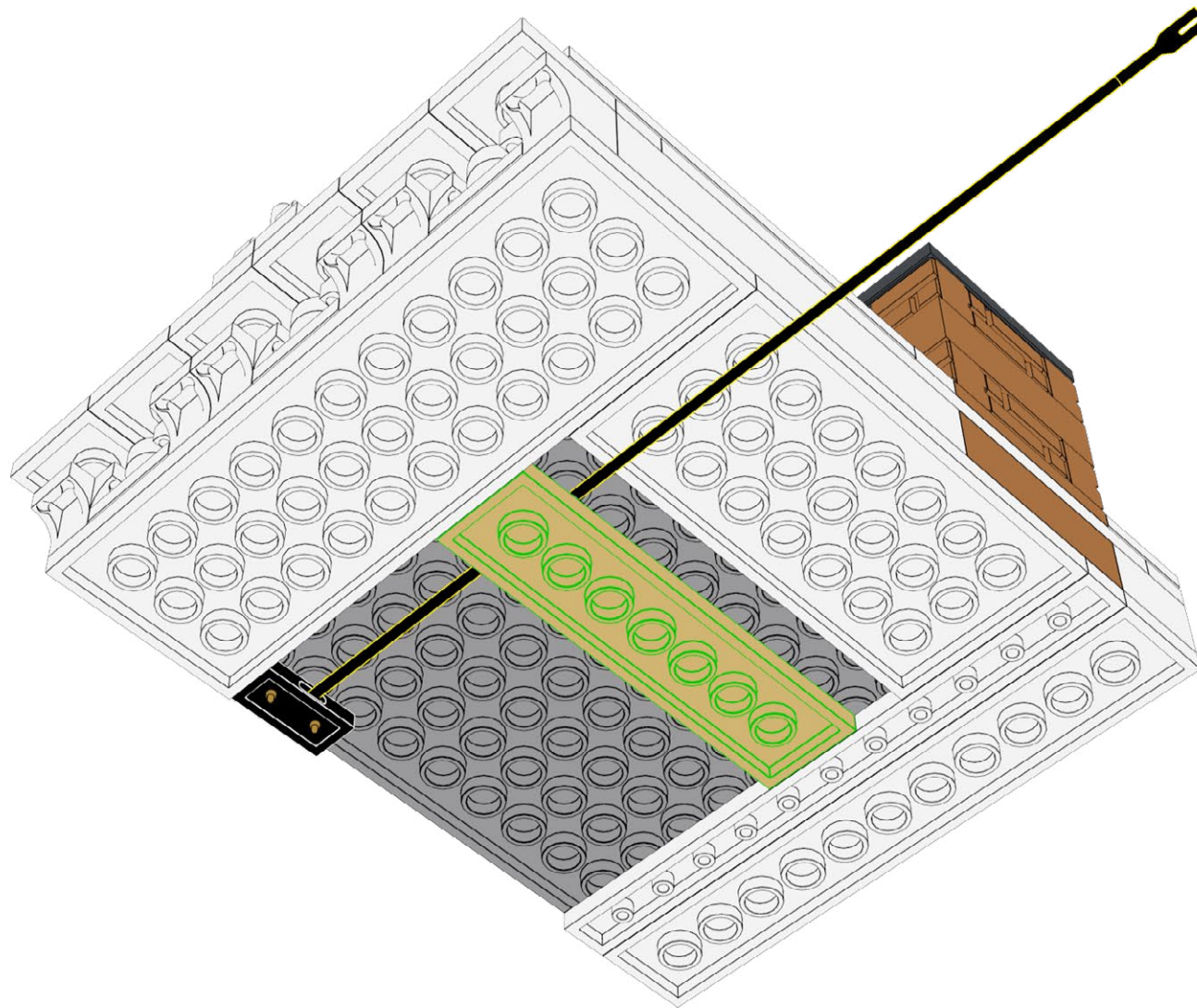

273

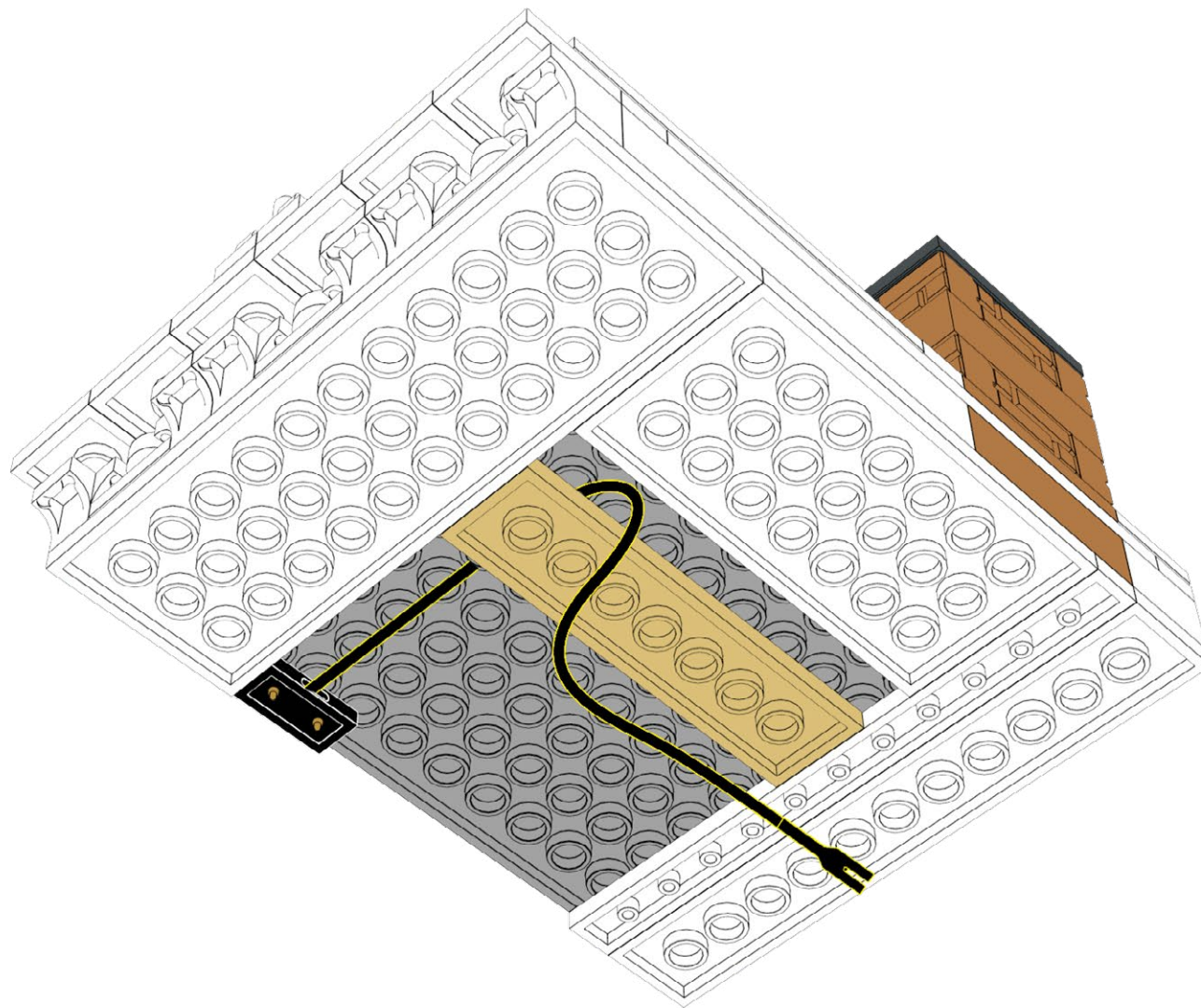

274

T-1x6
1x

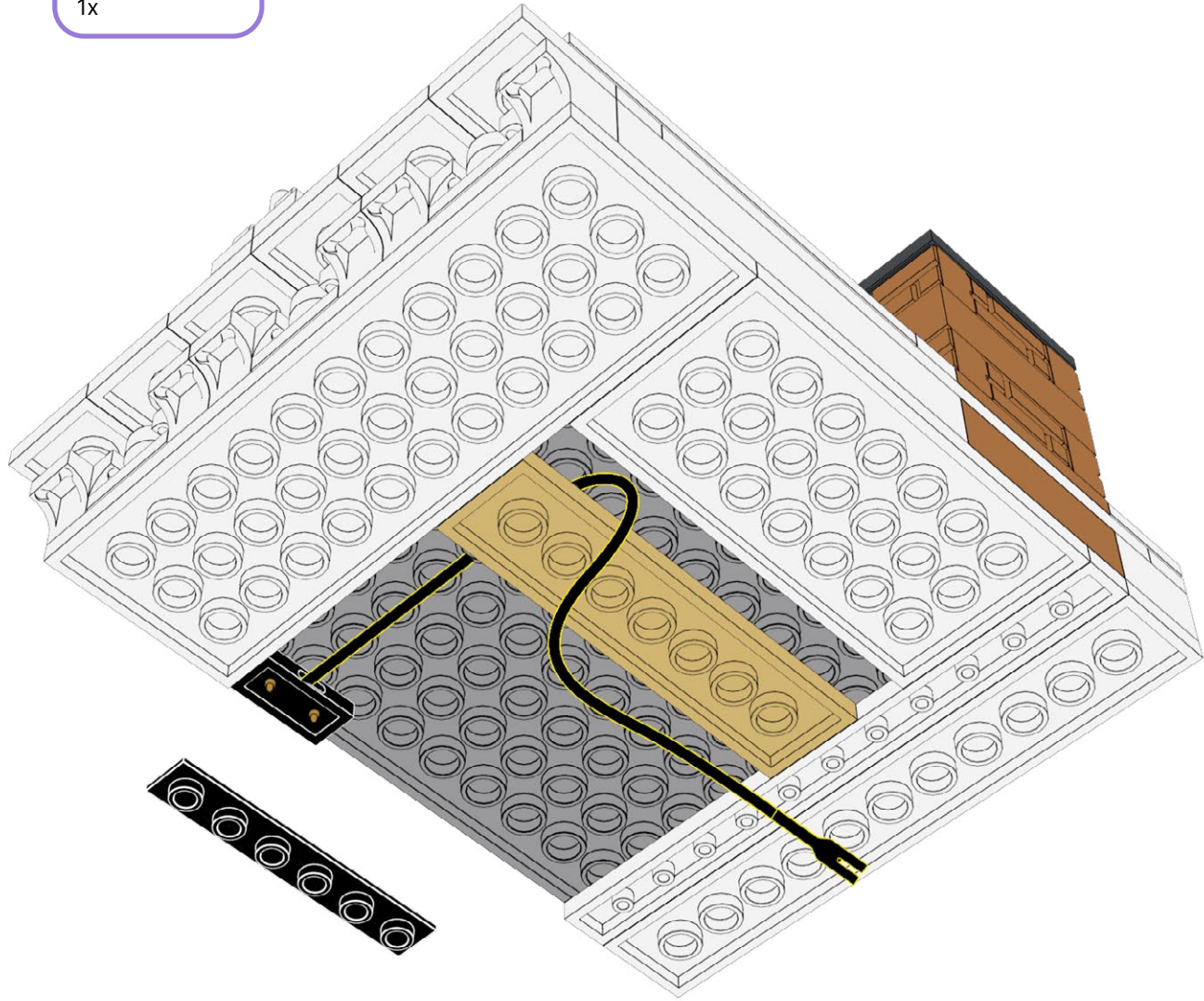

275

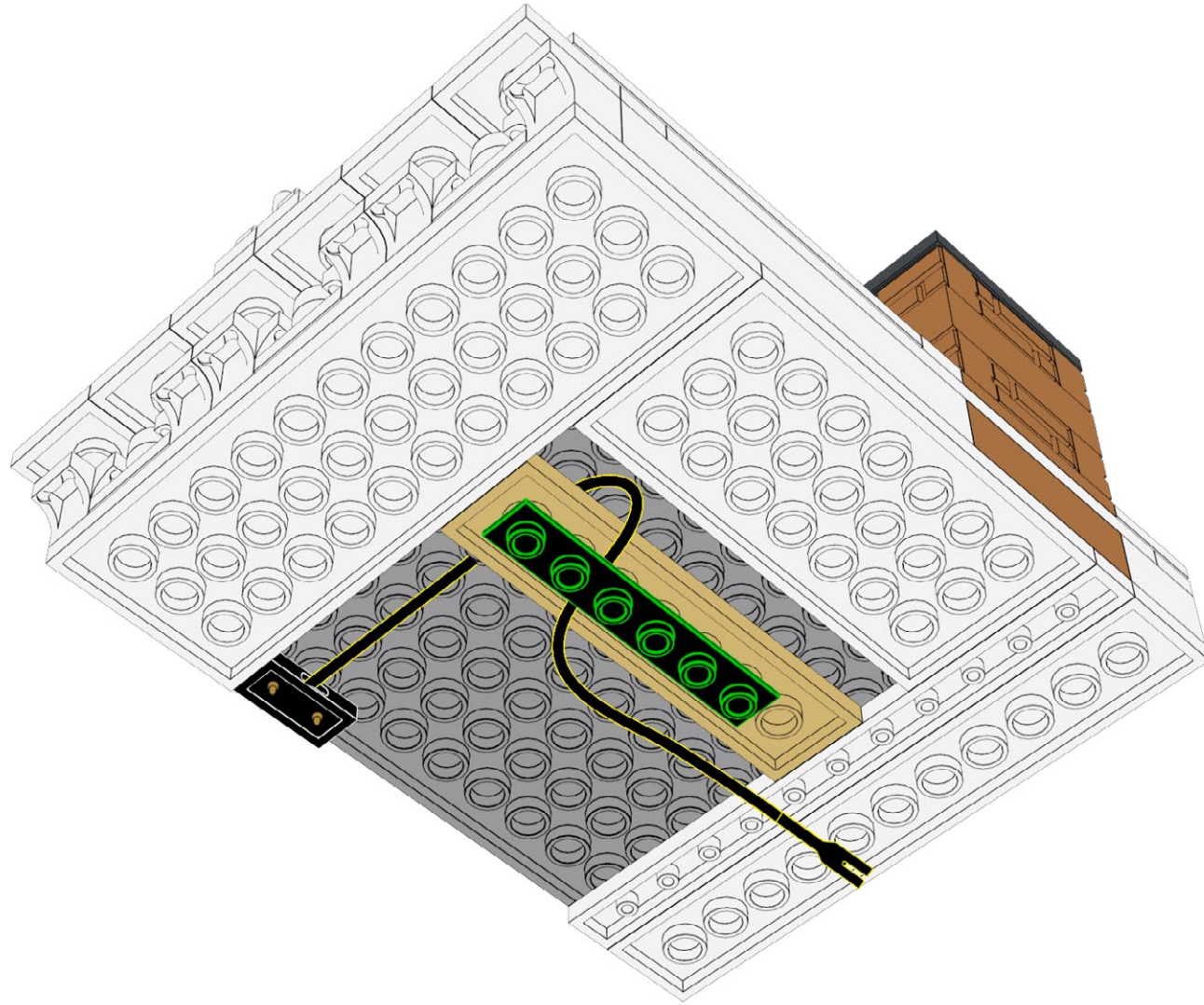

276

ML-WW

1x

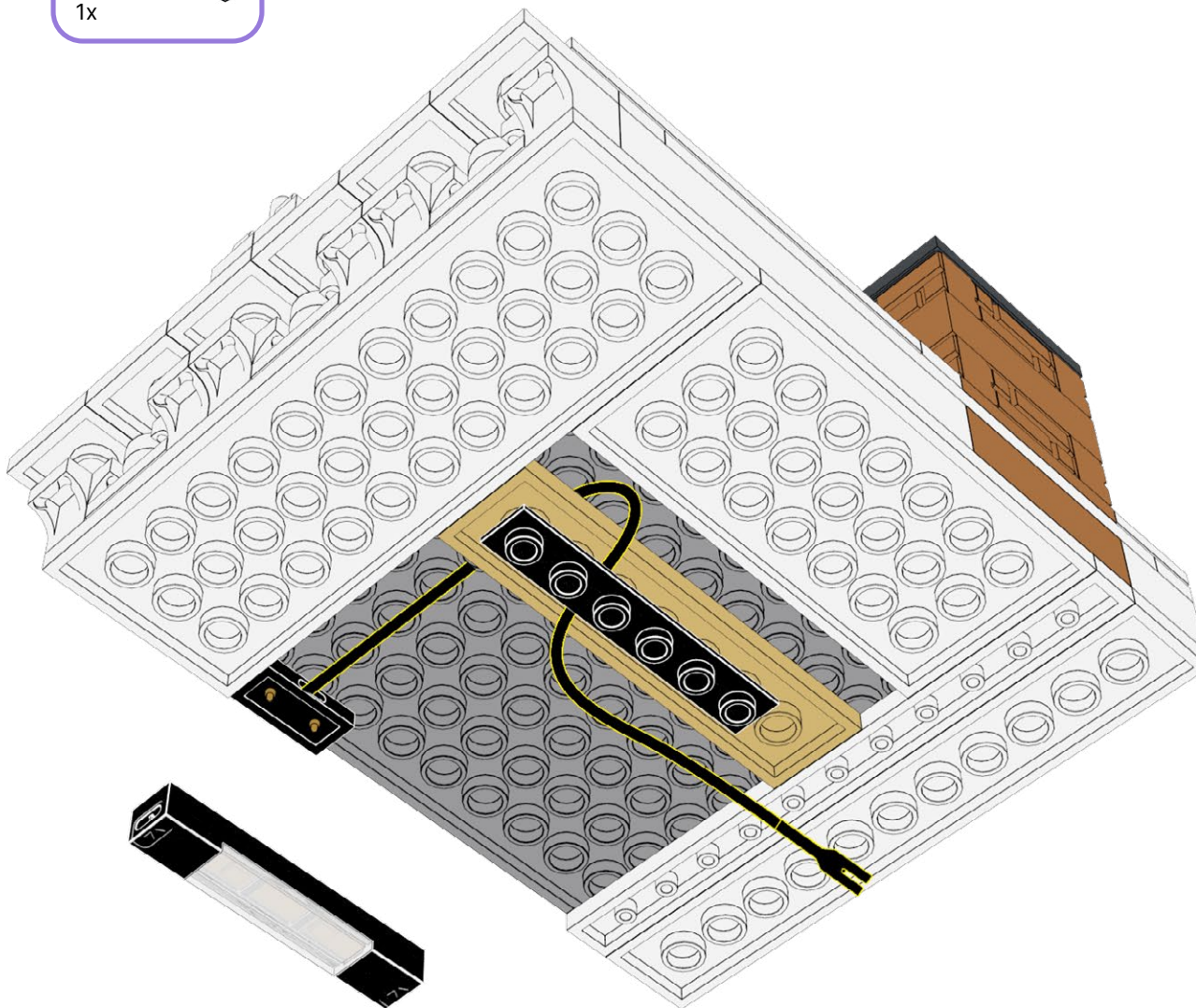

277

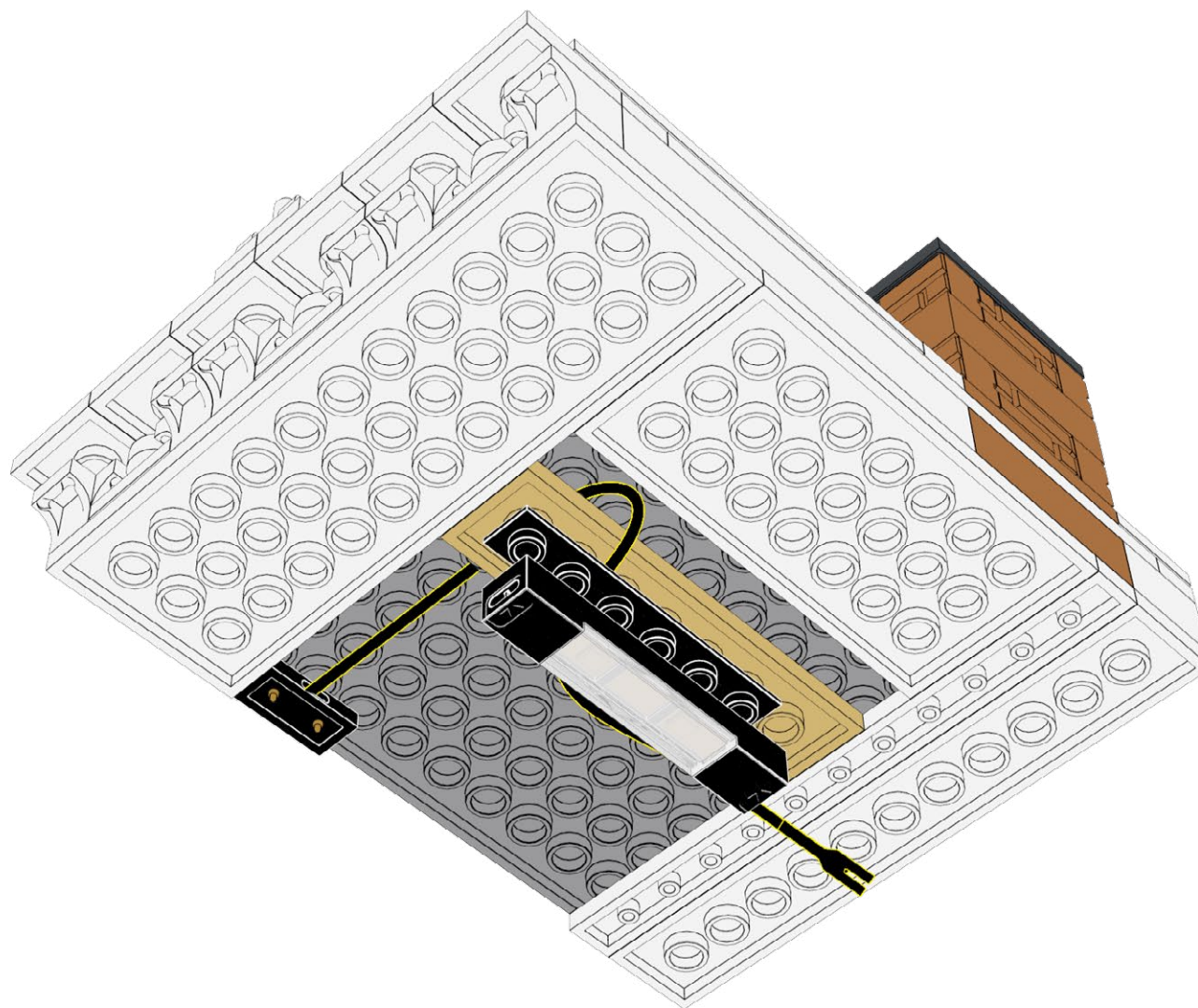

278

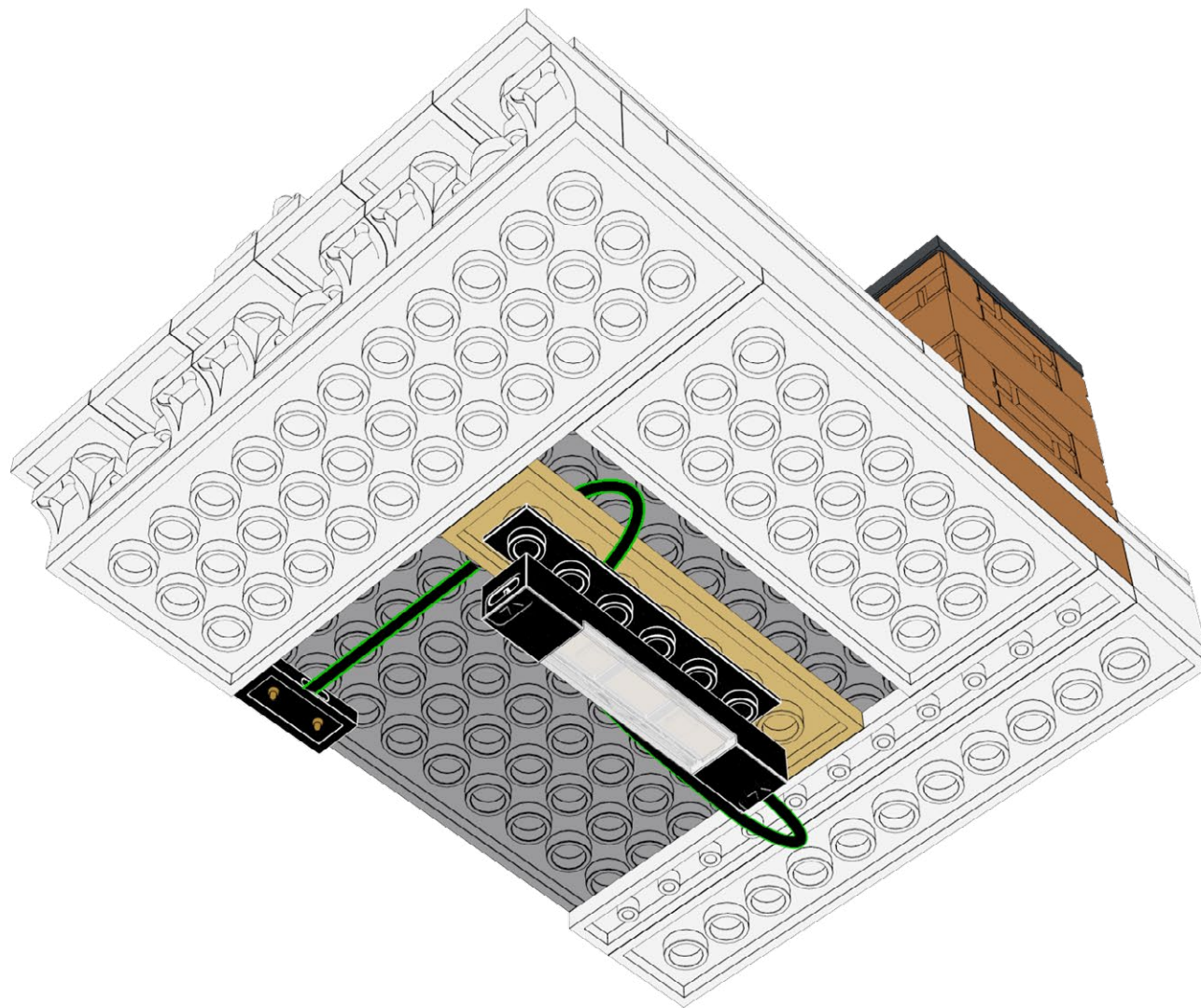

279

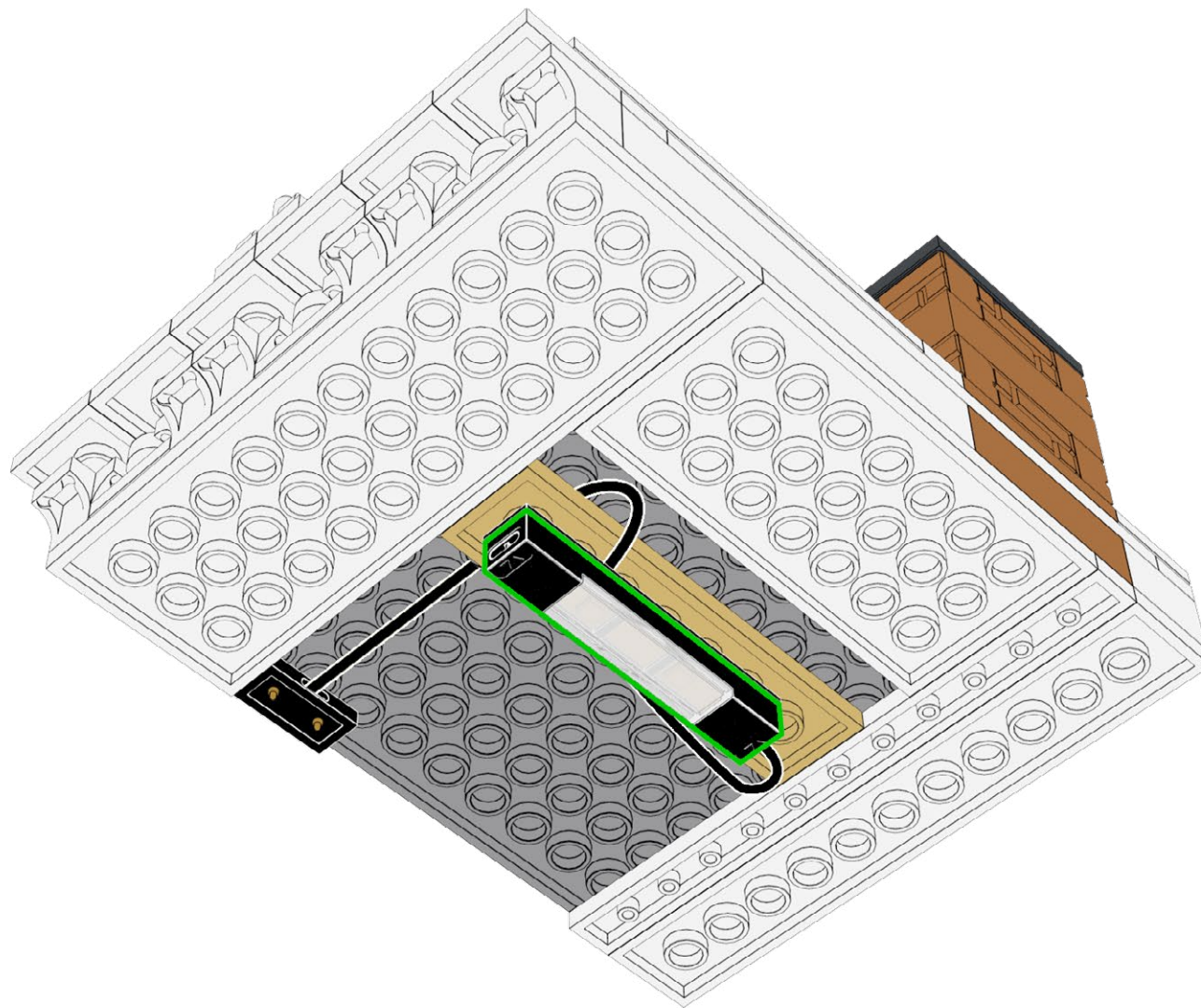

280

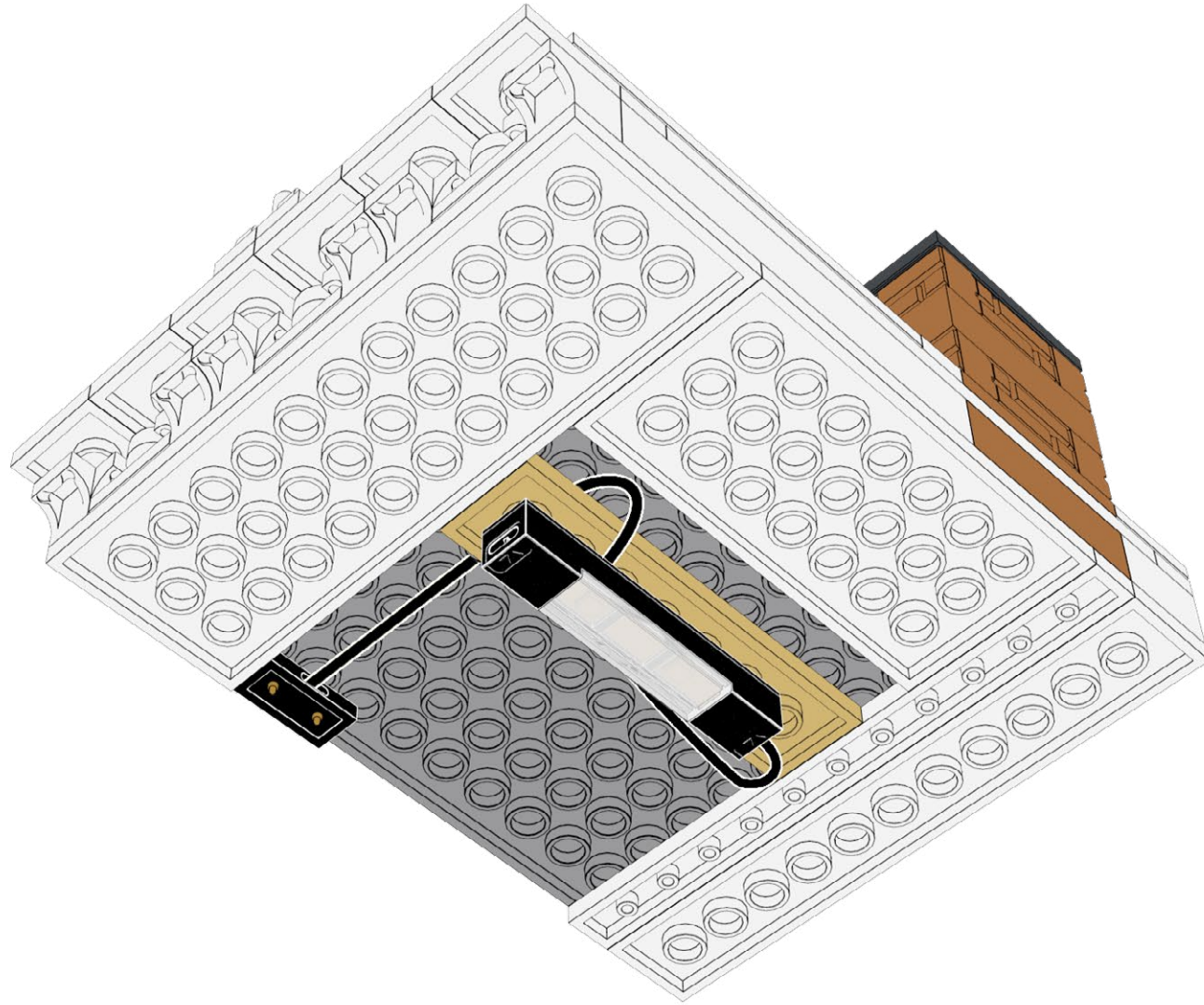

281



282

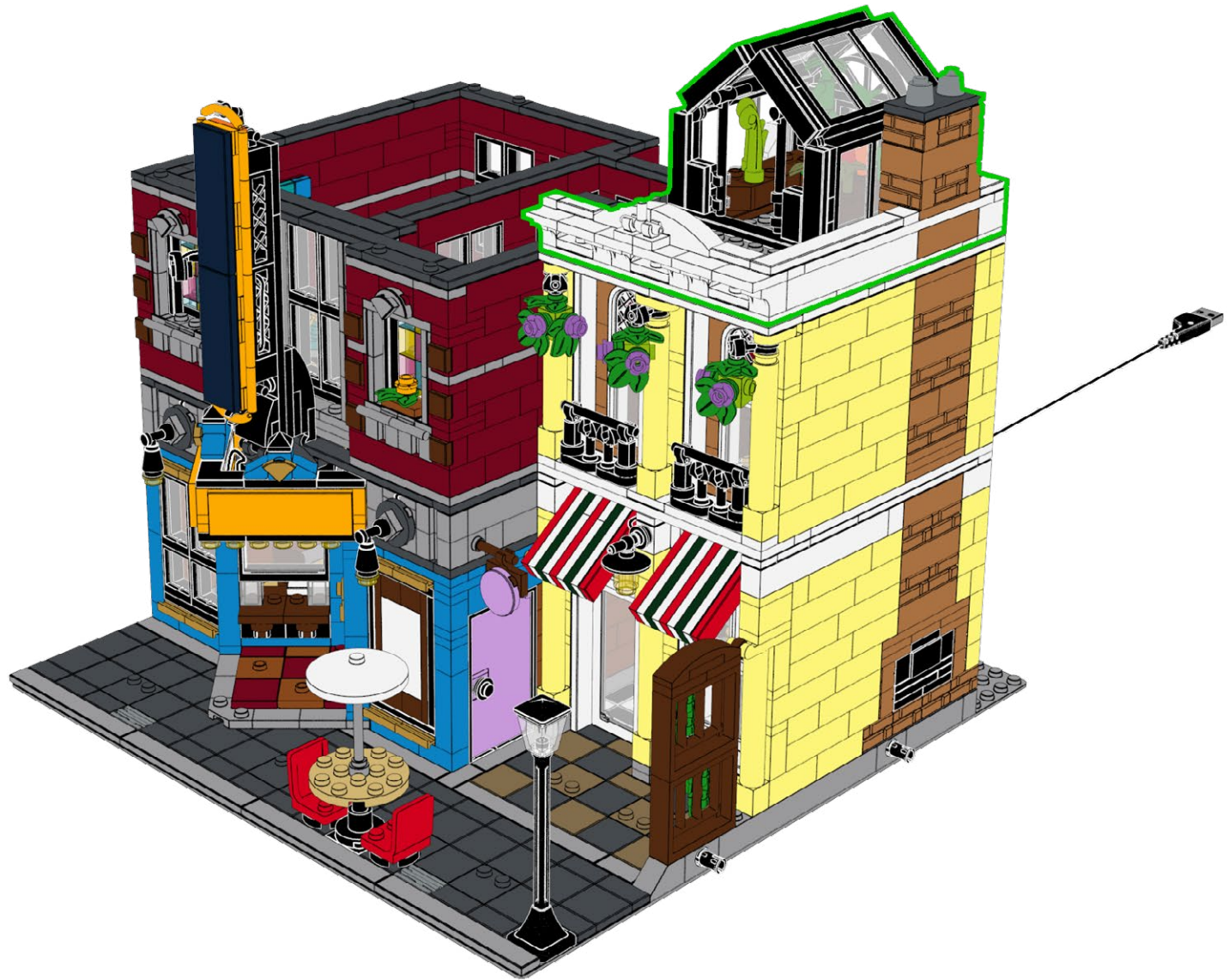

283



Power on Test
Test de mise sous tension
Test di Potenza
Stromtest
Prueba de Energía
电源测试



284



285



286



287



288



289

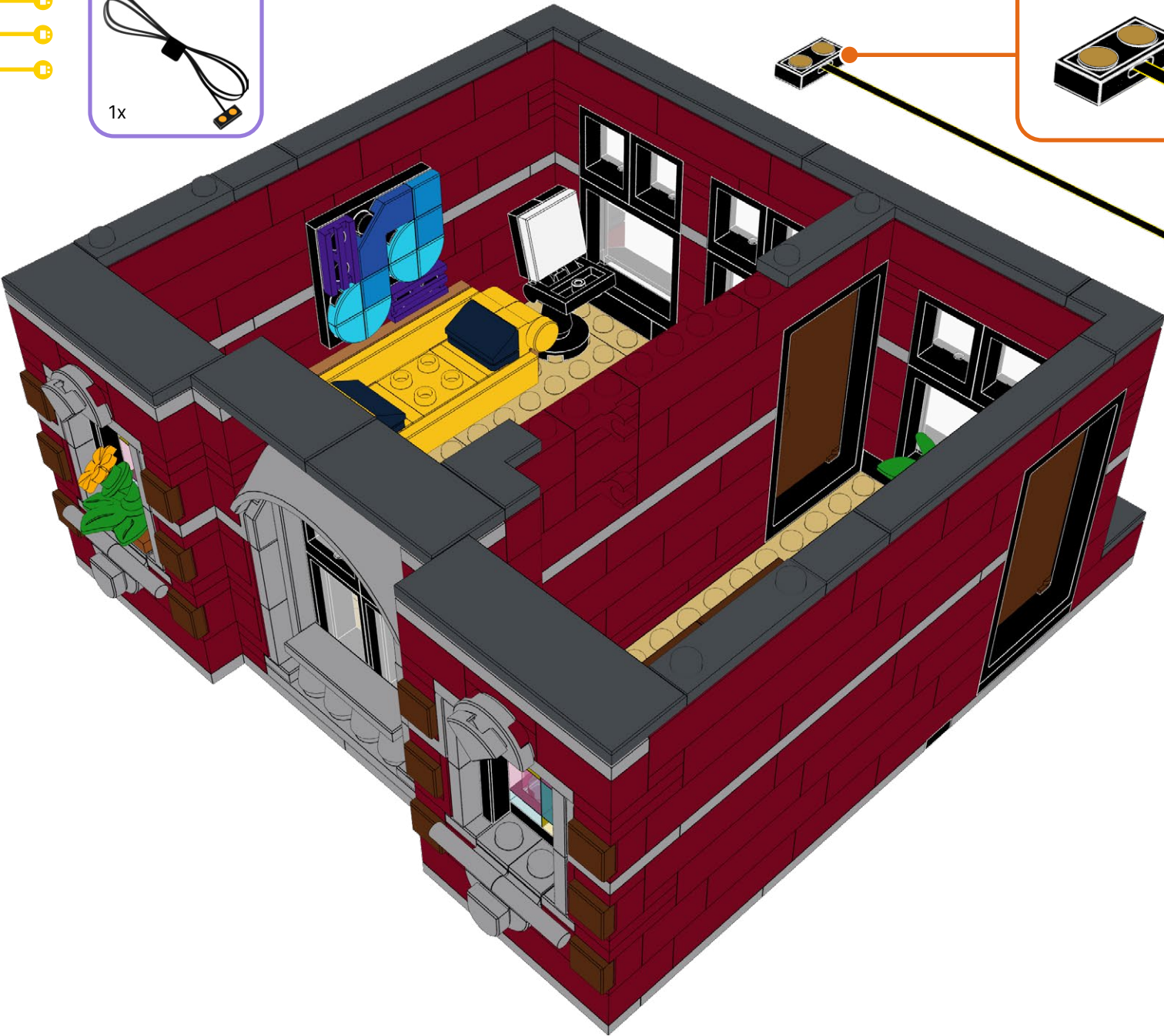
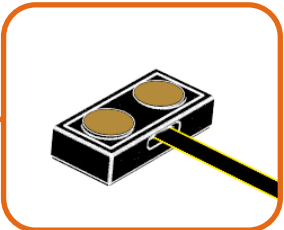
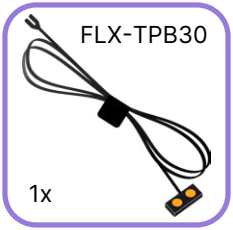

290



291

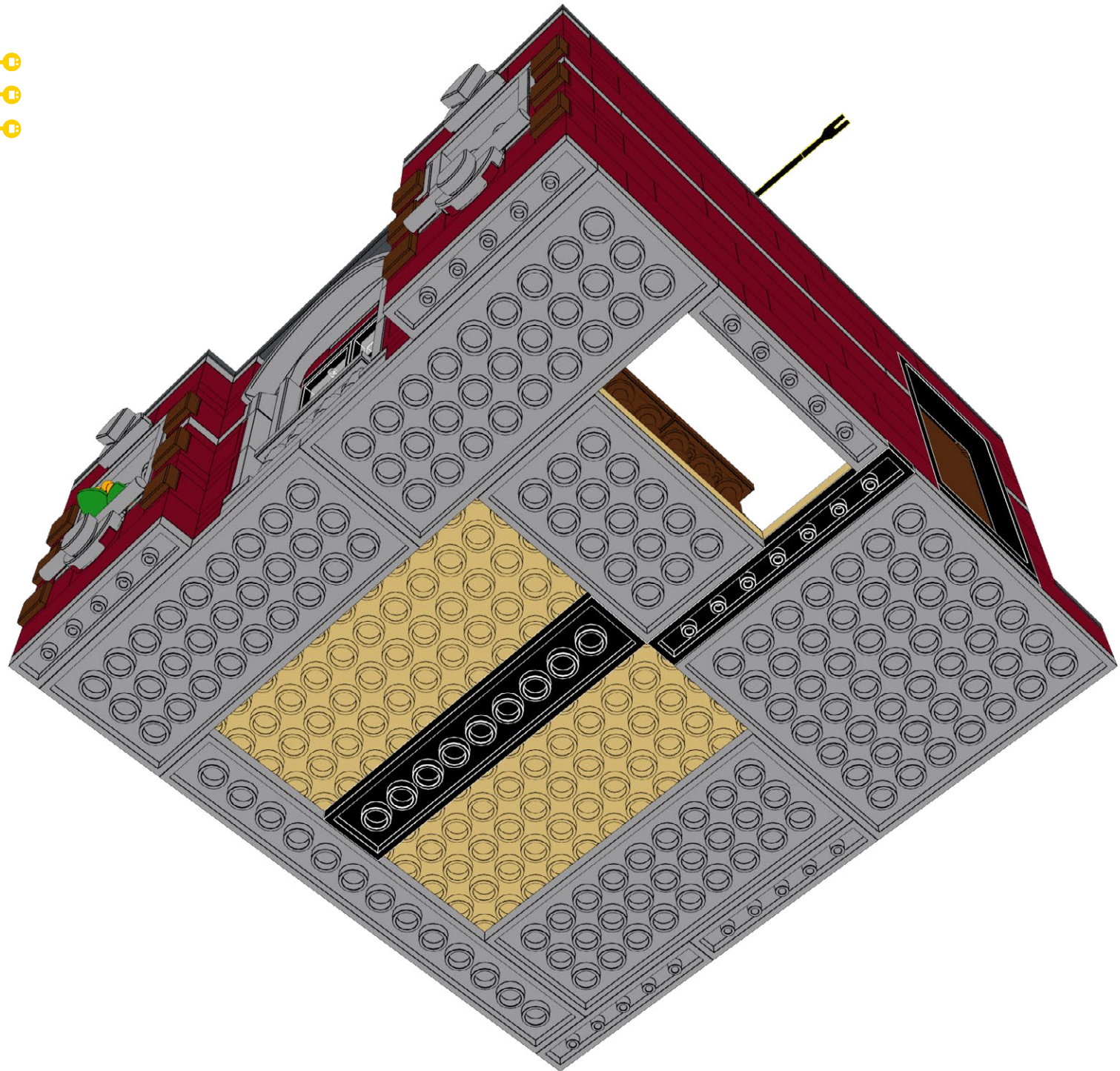

292

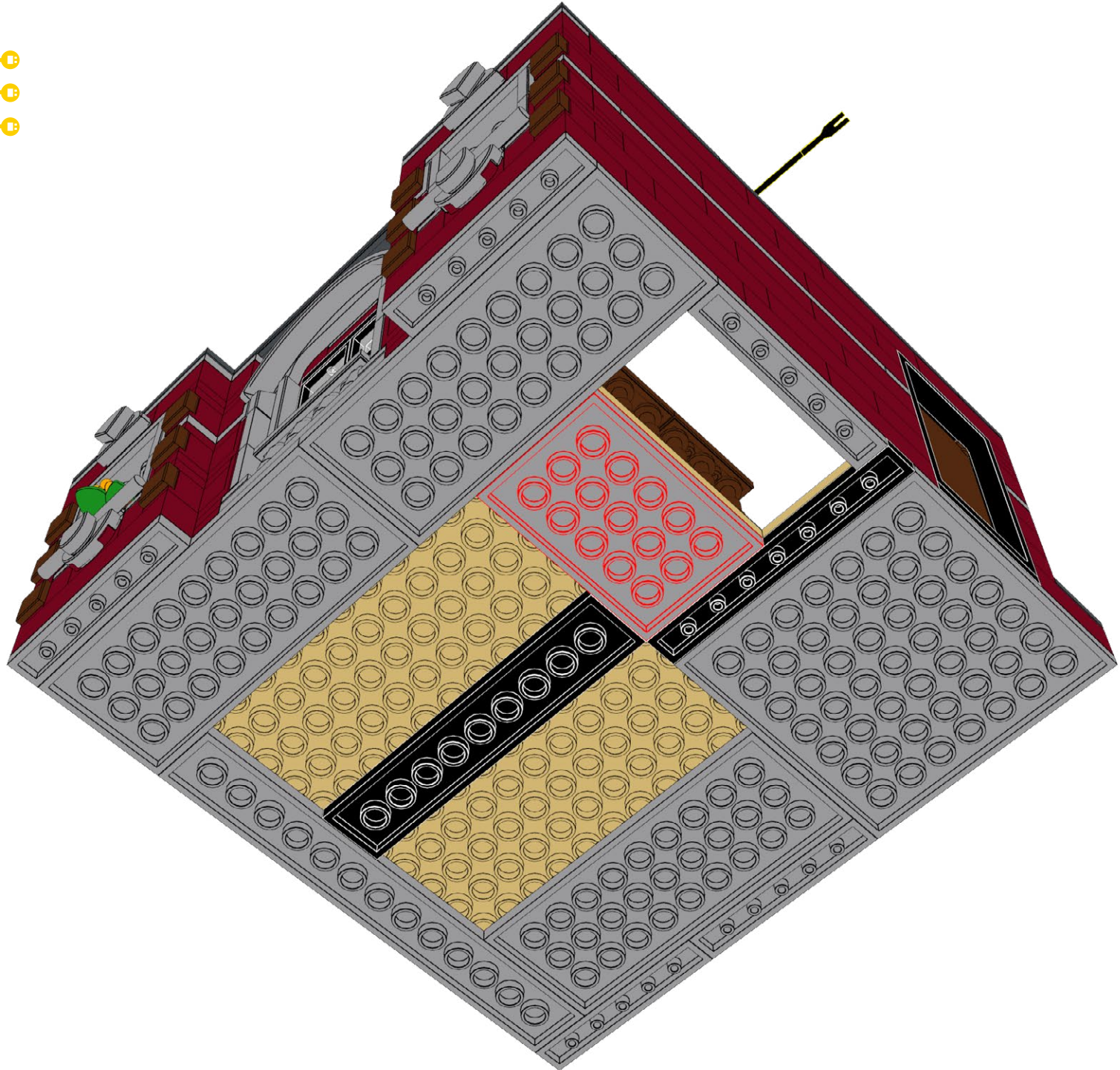

293

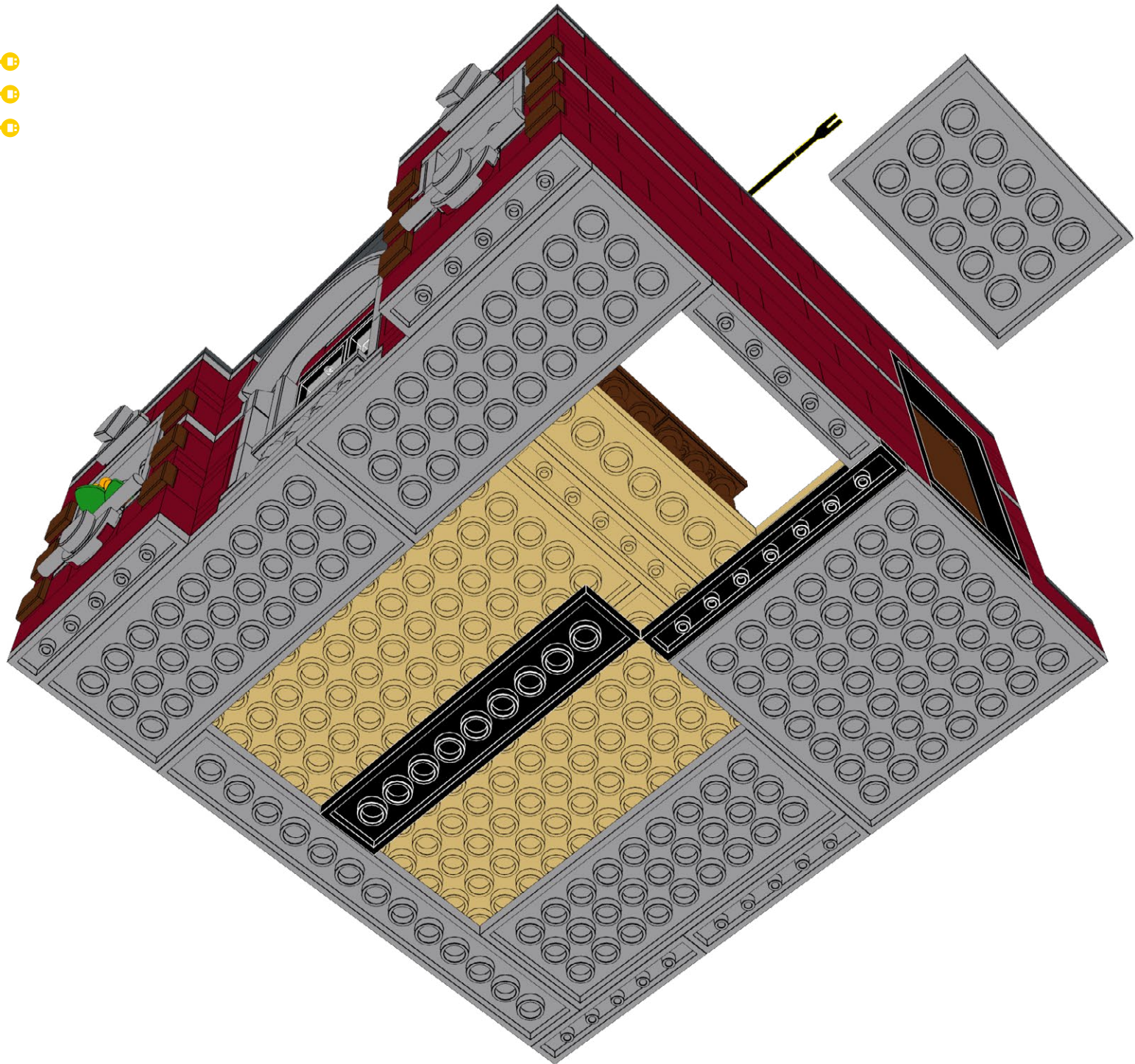

294



295



296



297

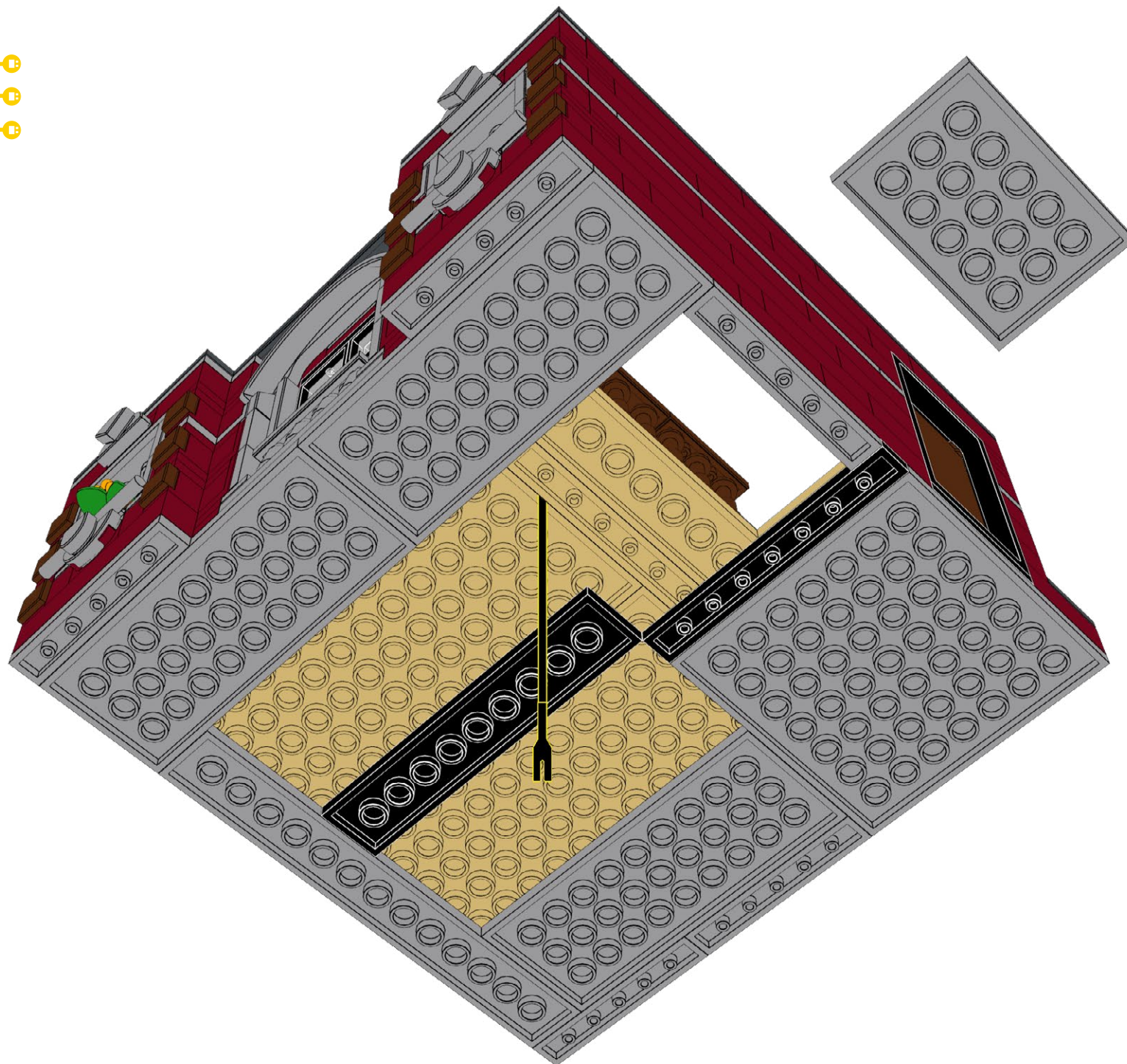

298

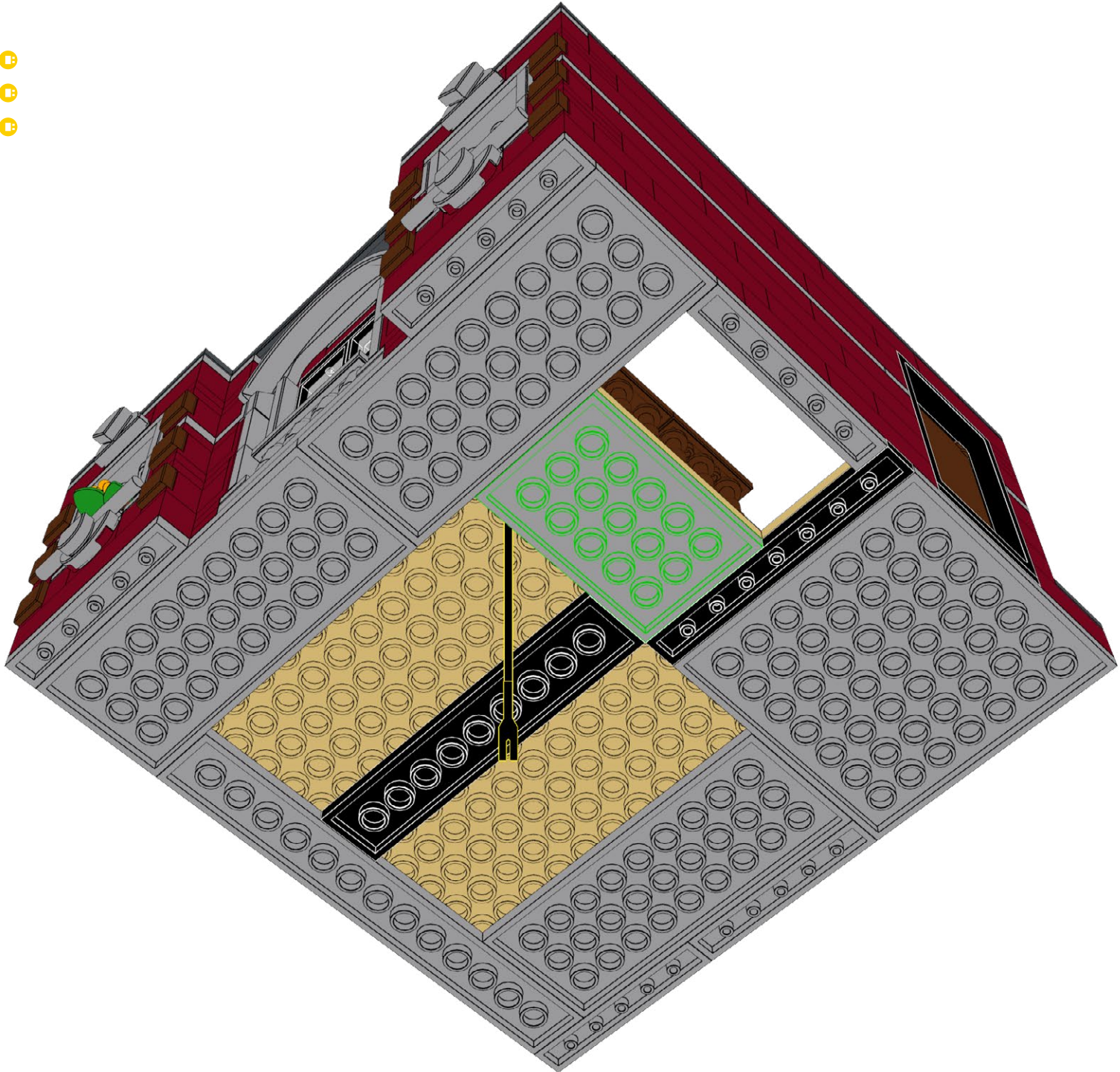

299



300



301



T-1x6
1x

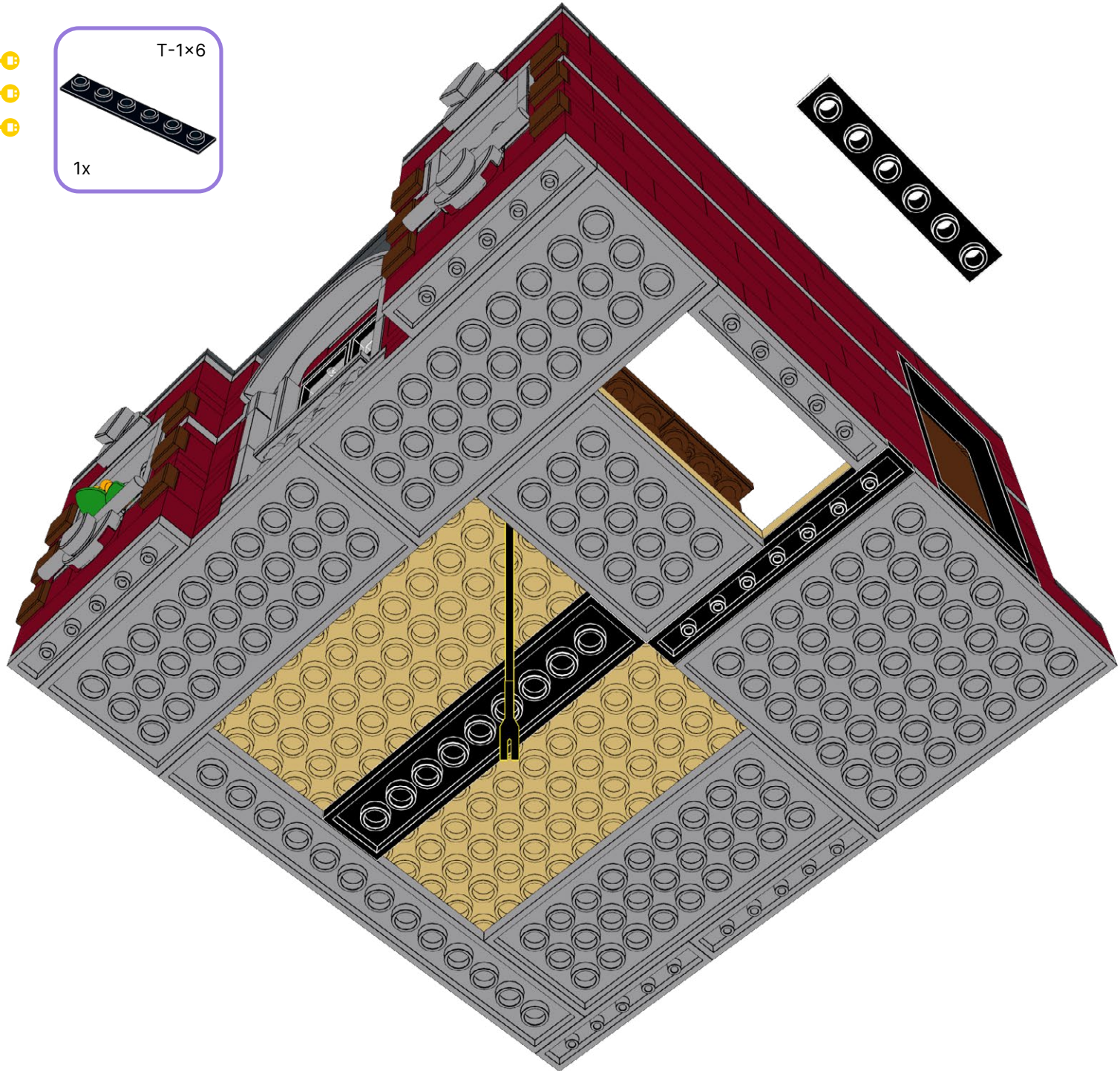

302

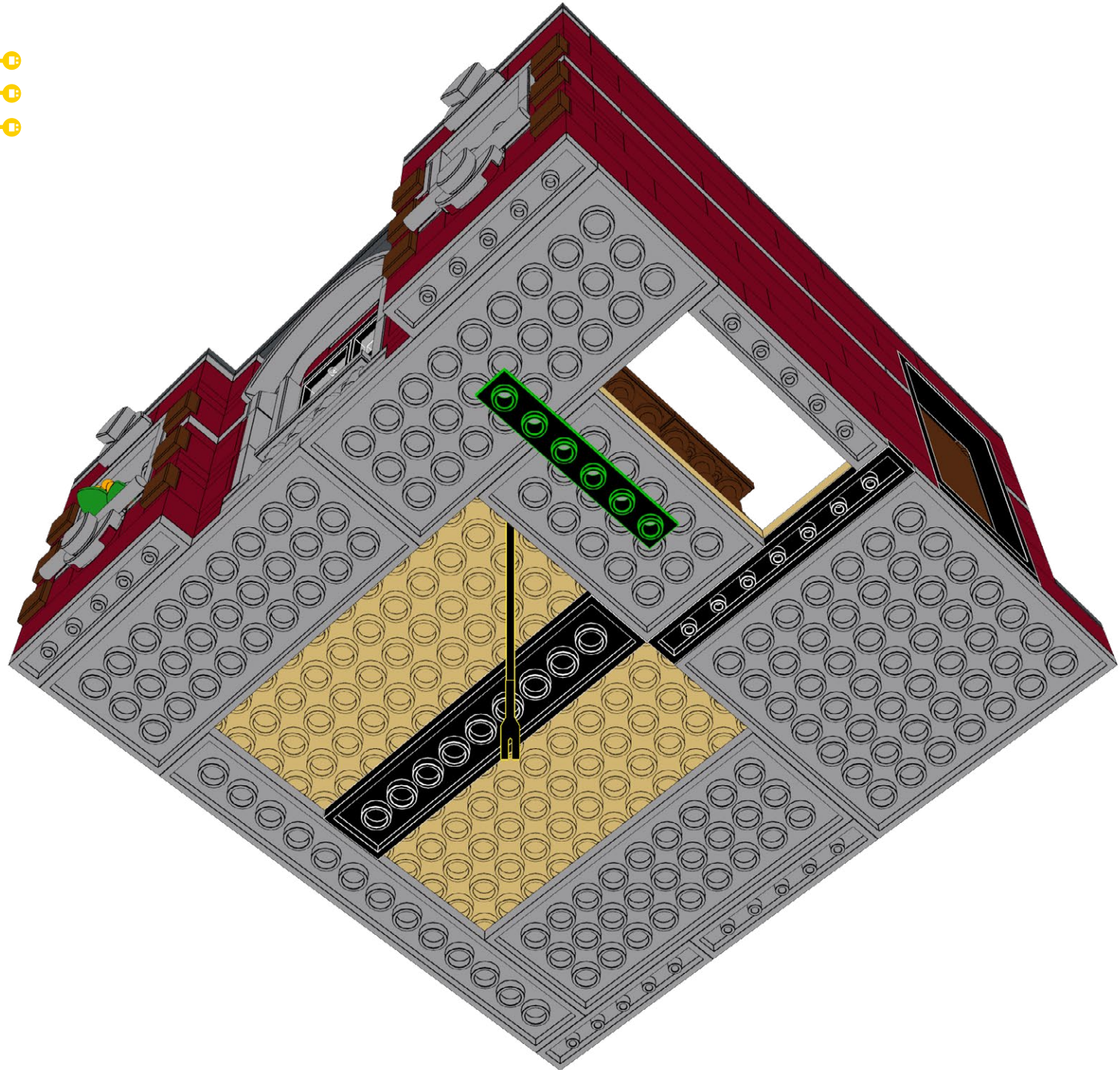

303

ML-WW

1x

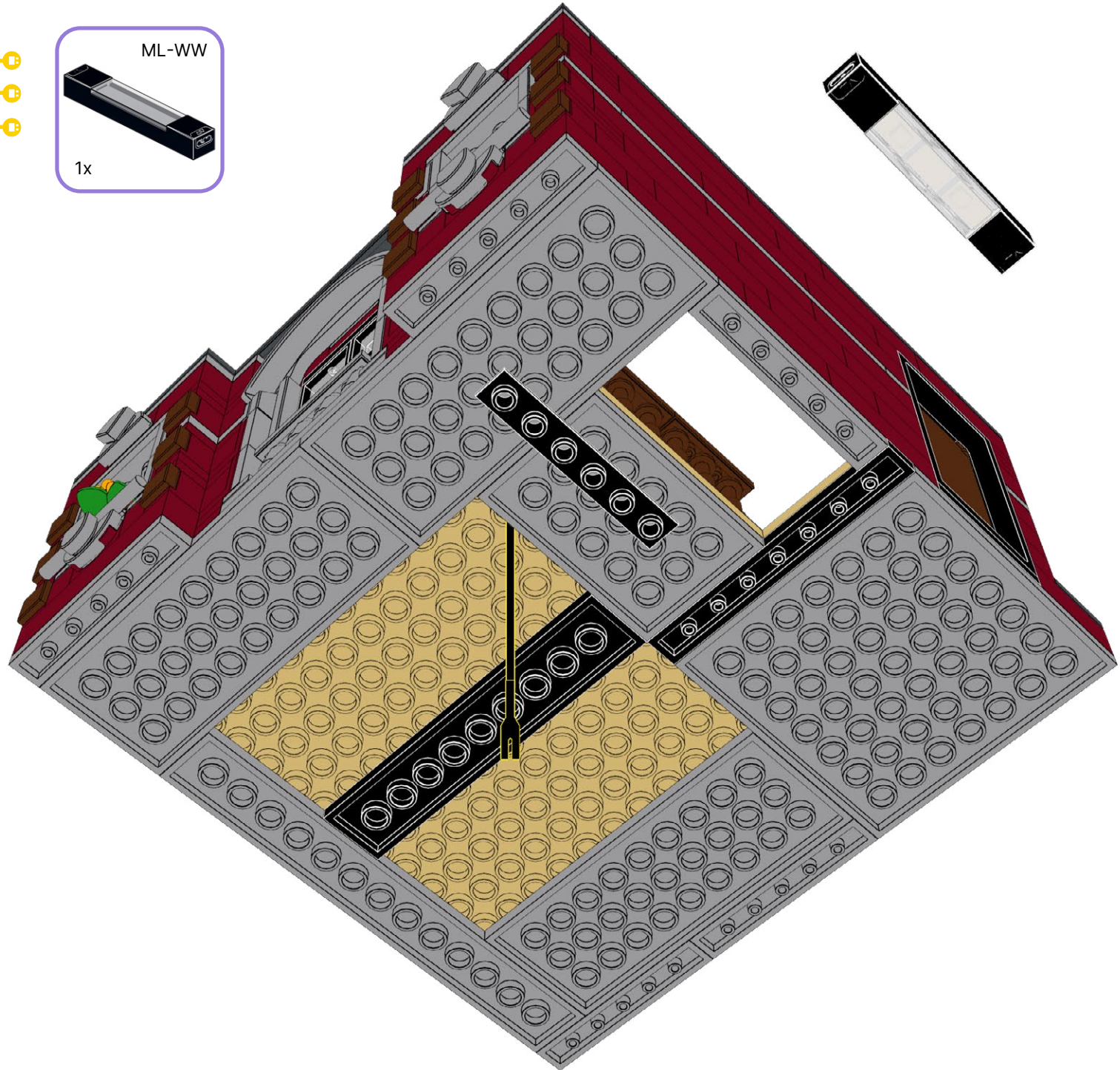

304

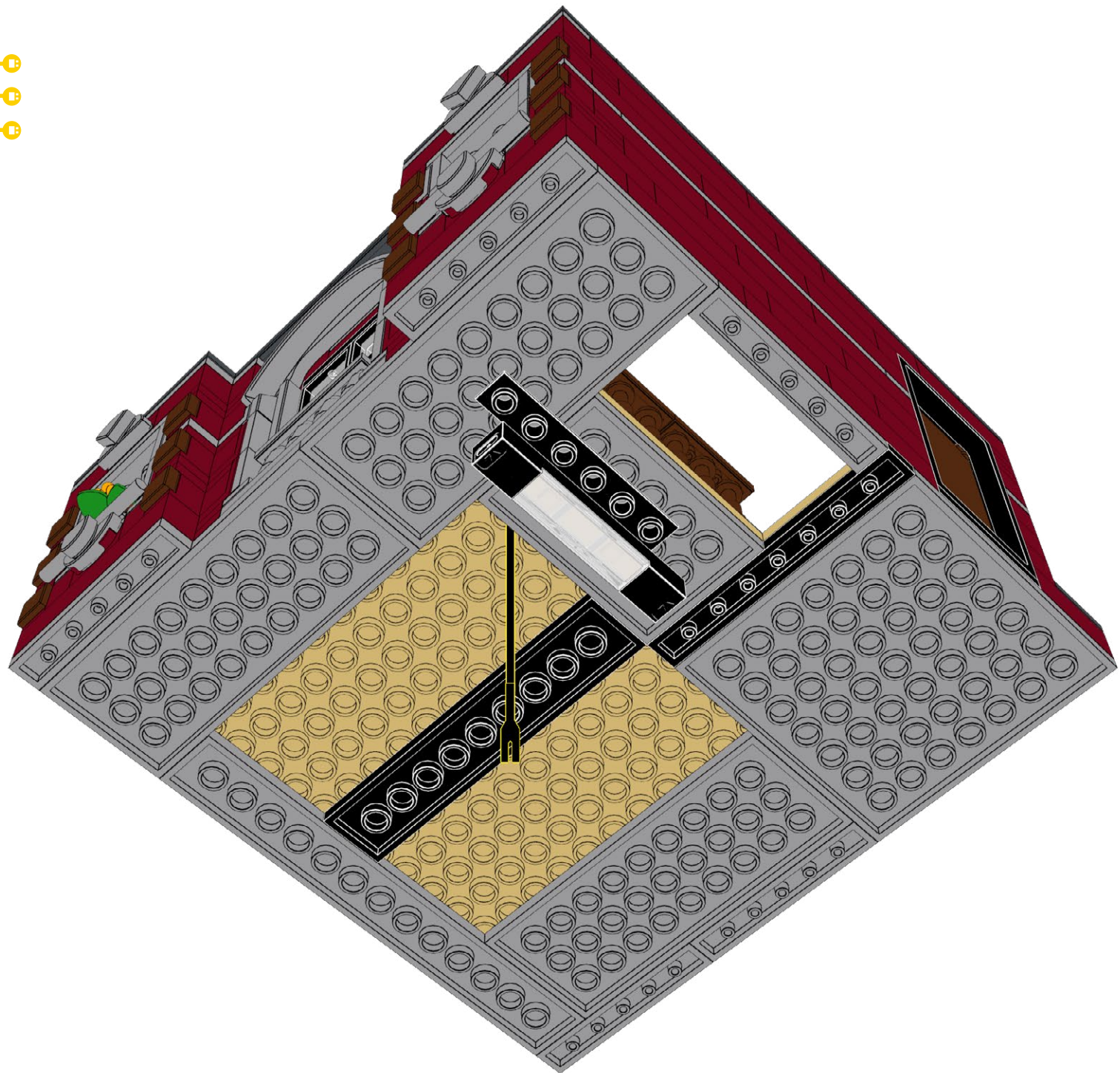

305

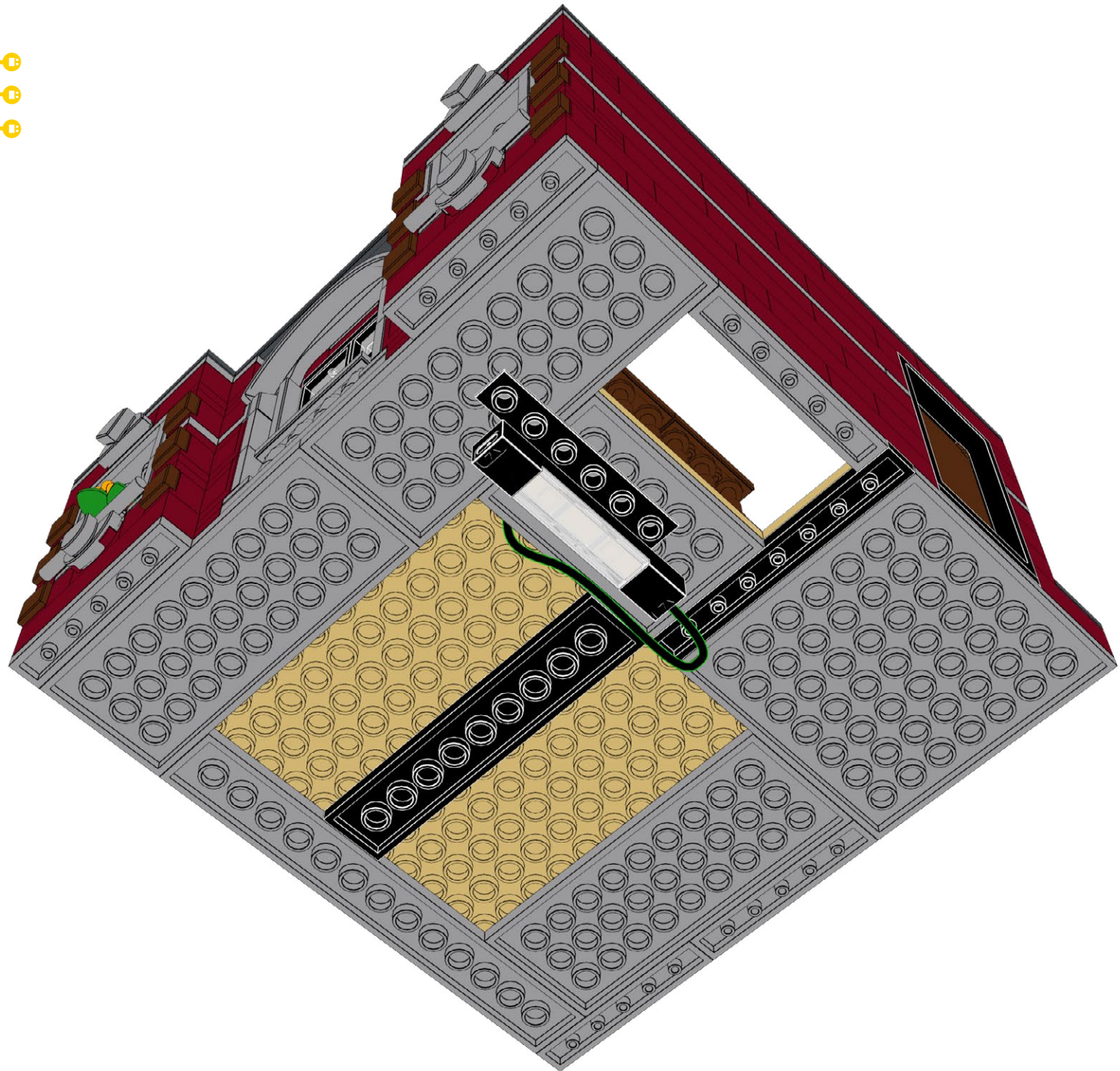

306

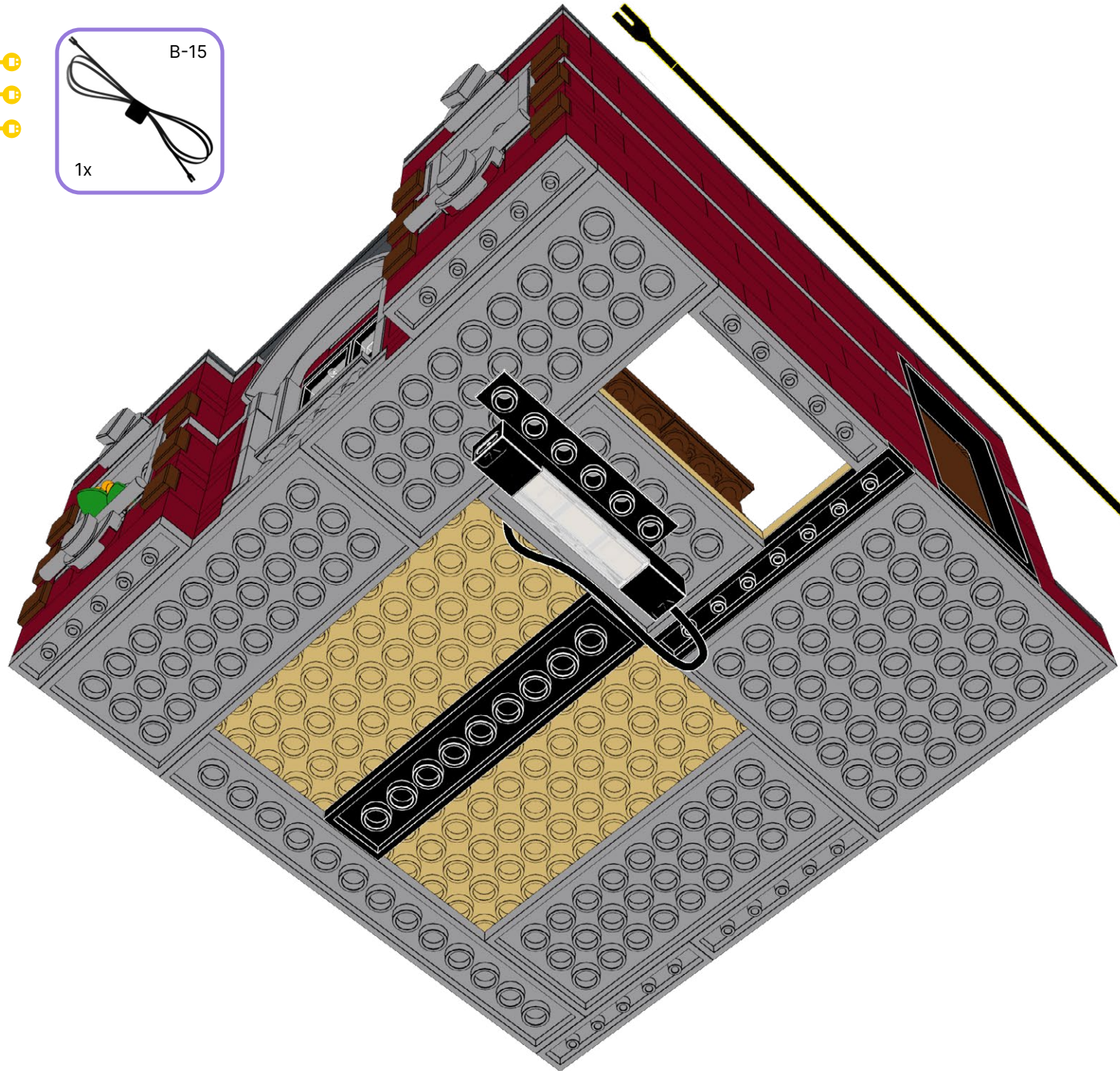
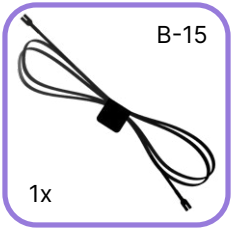

307

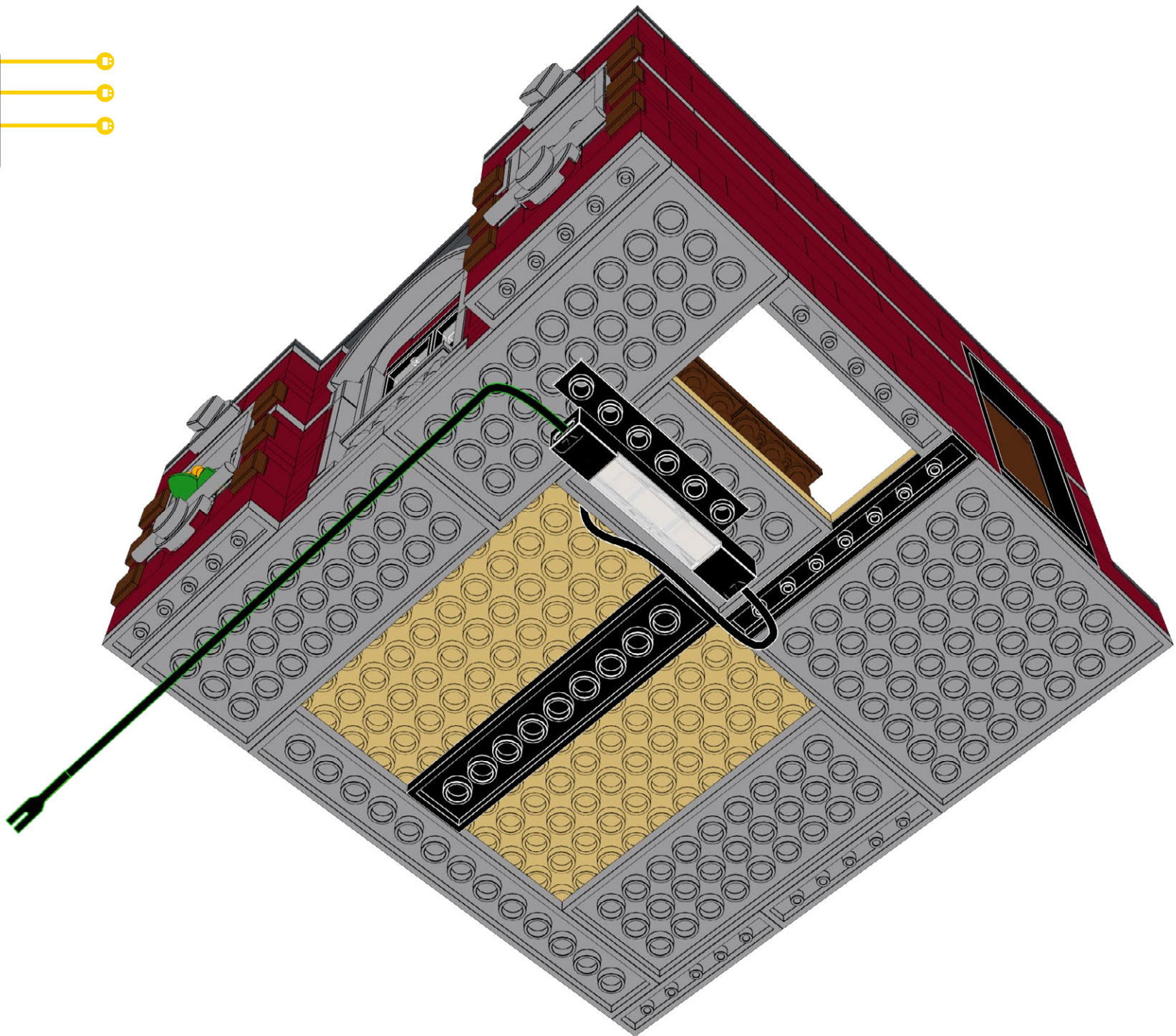

308

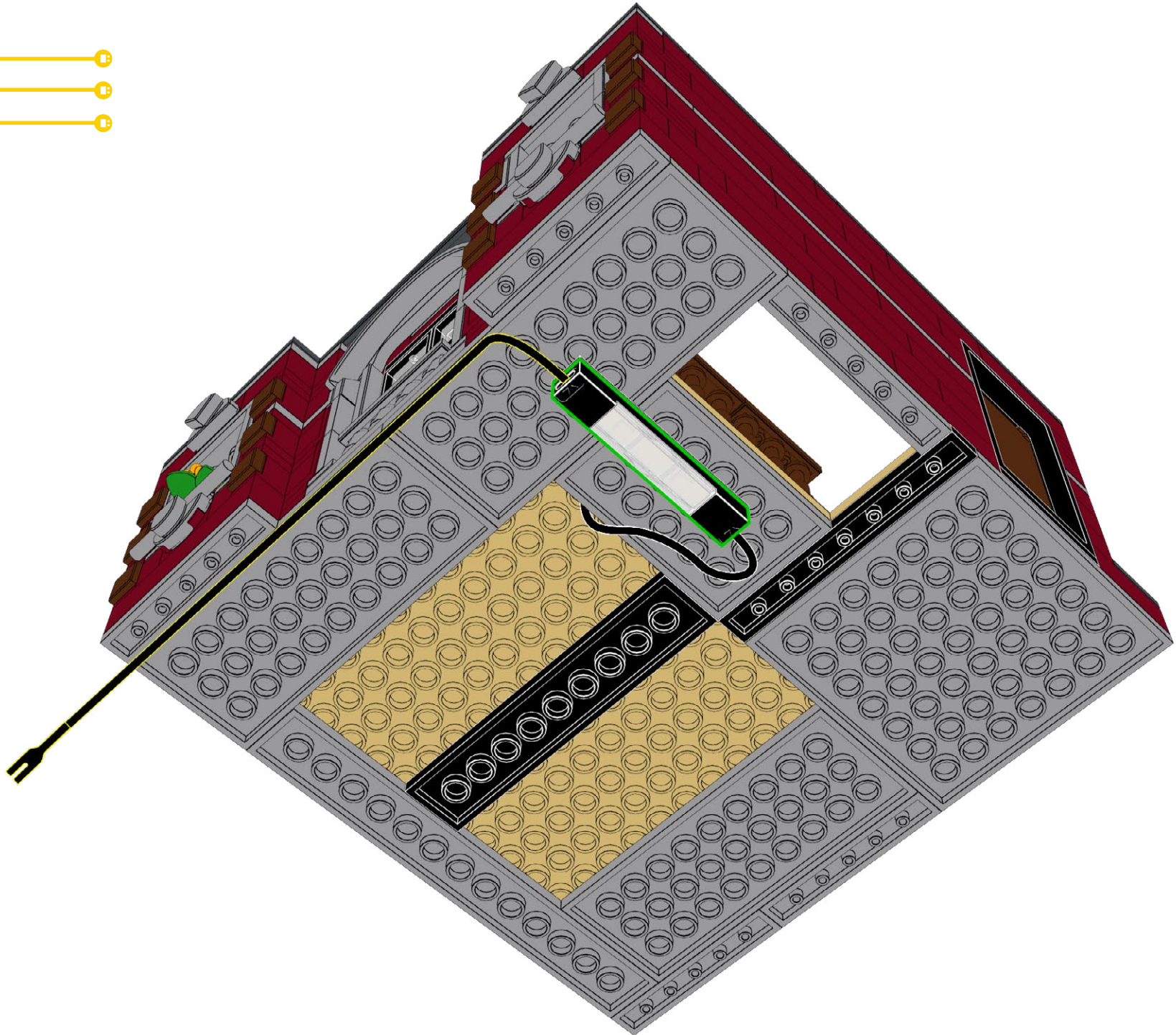

309

T-1x6
1x

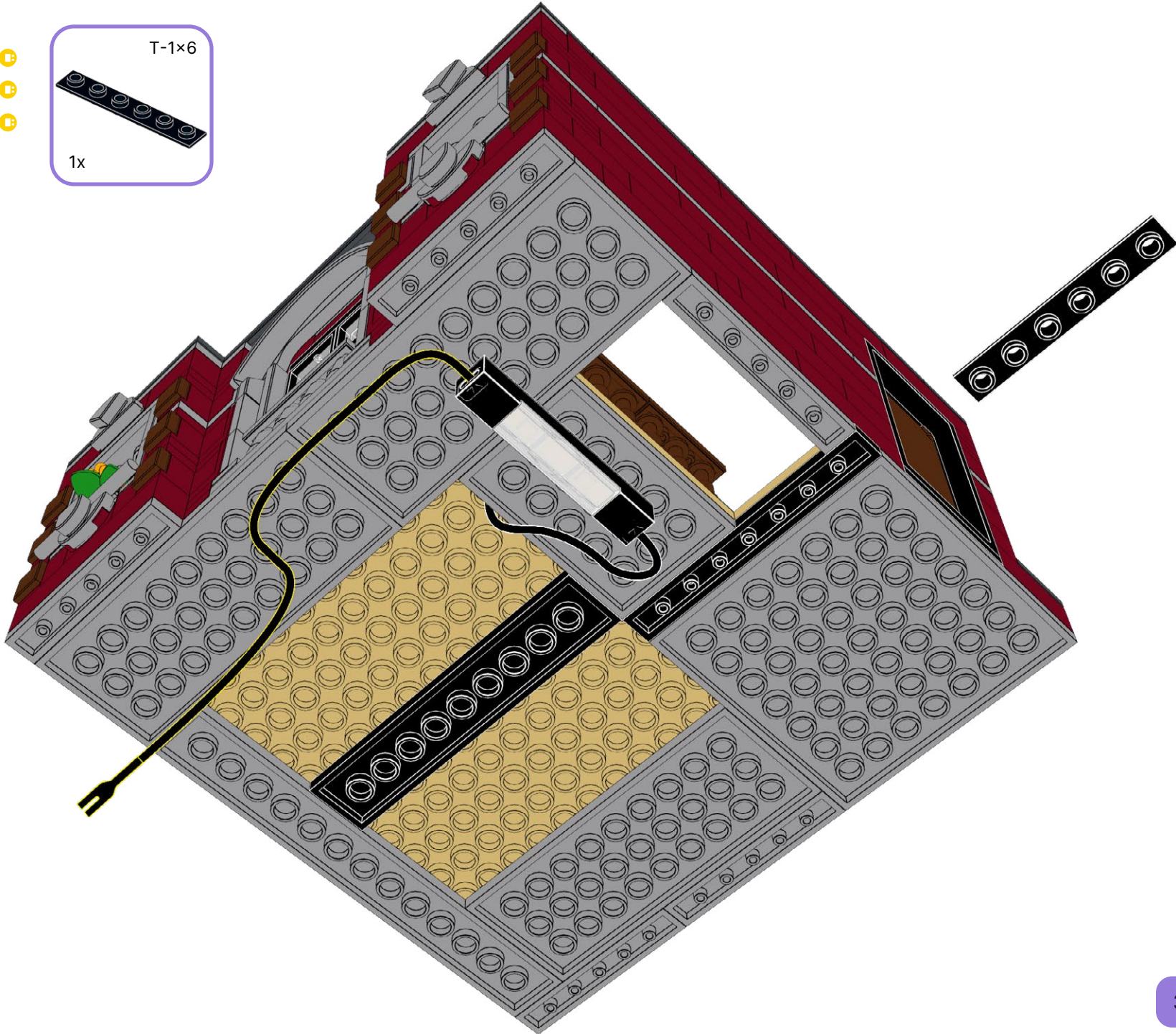

310

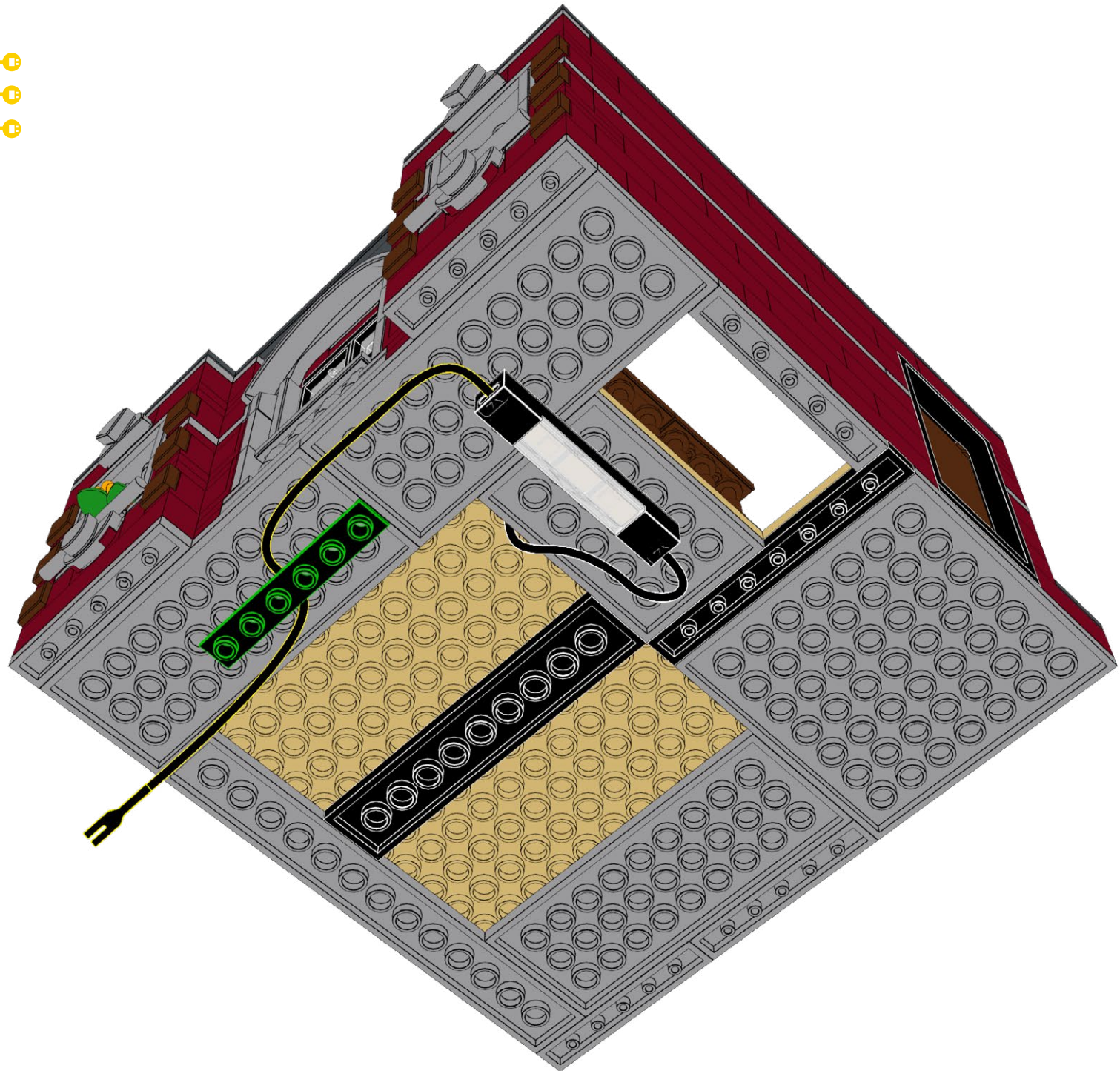

311

ML-WW



1x

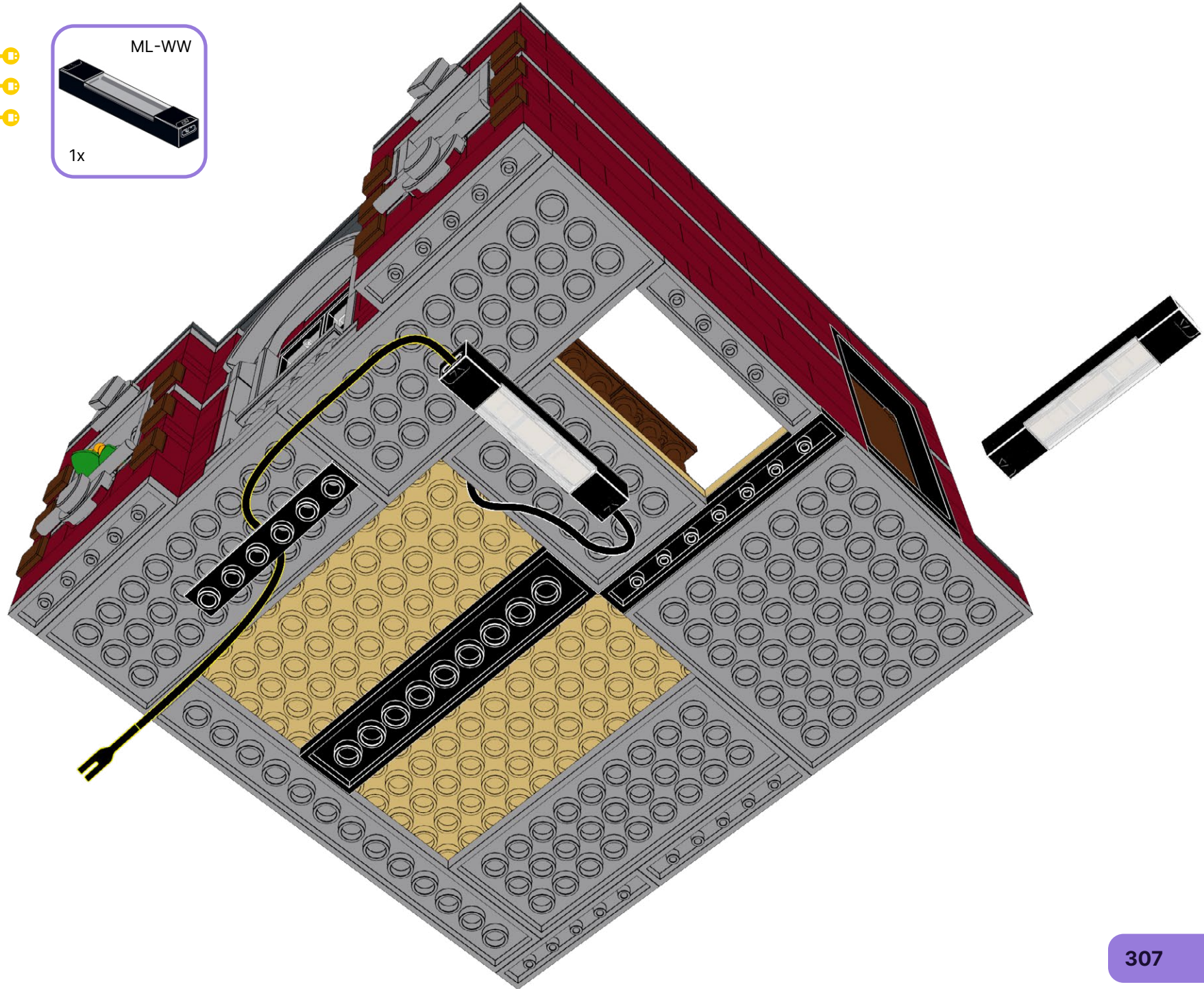

312

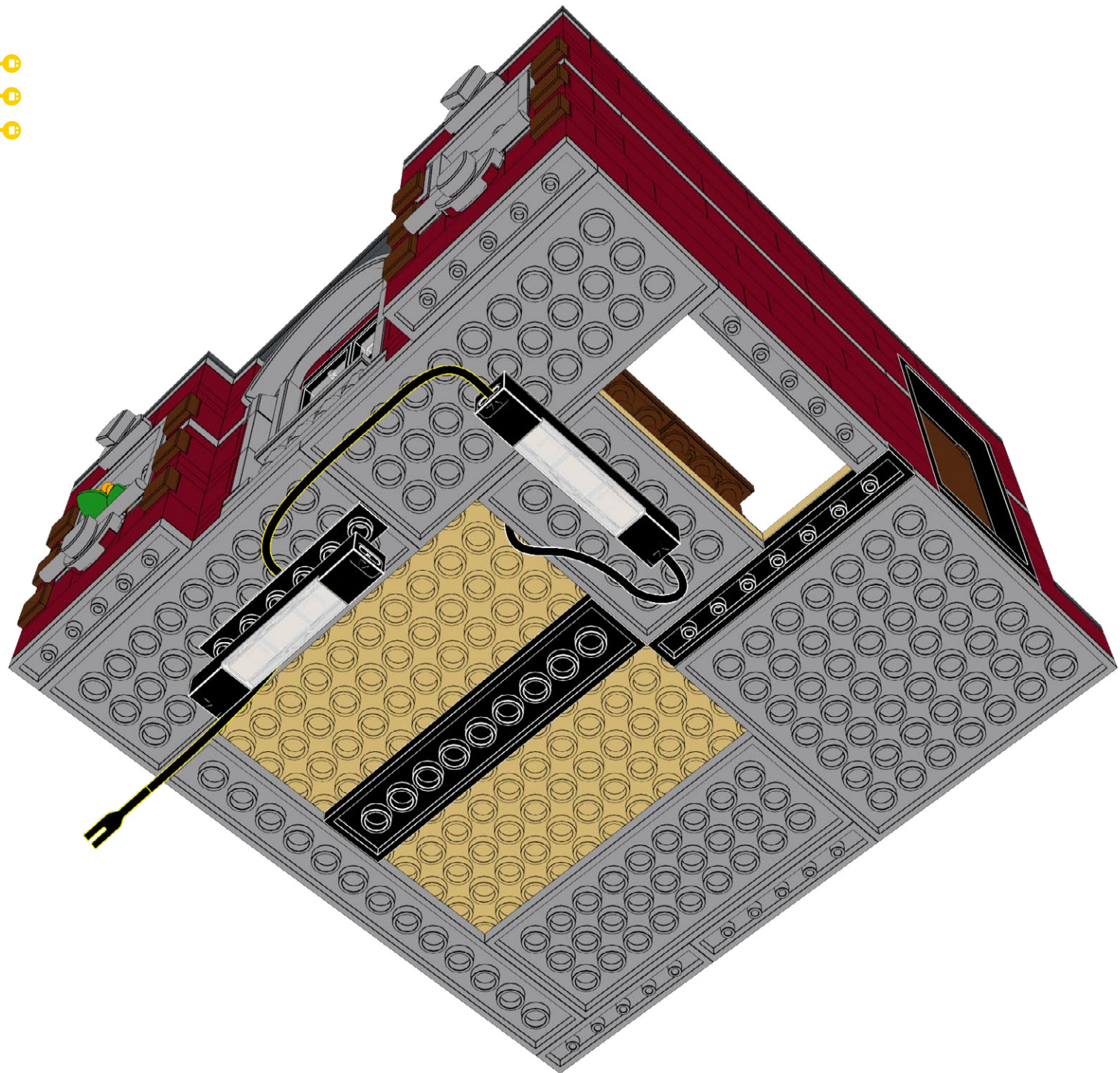

313

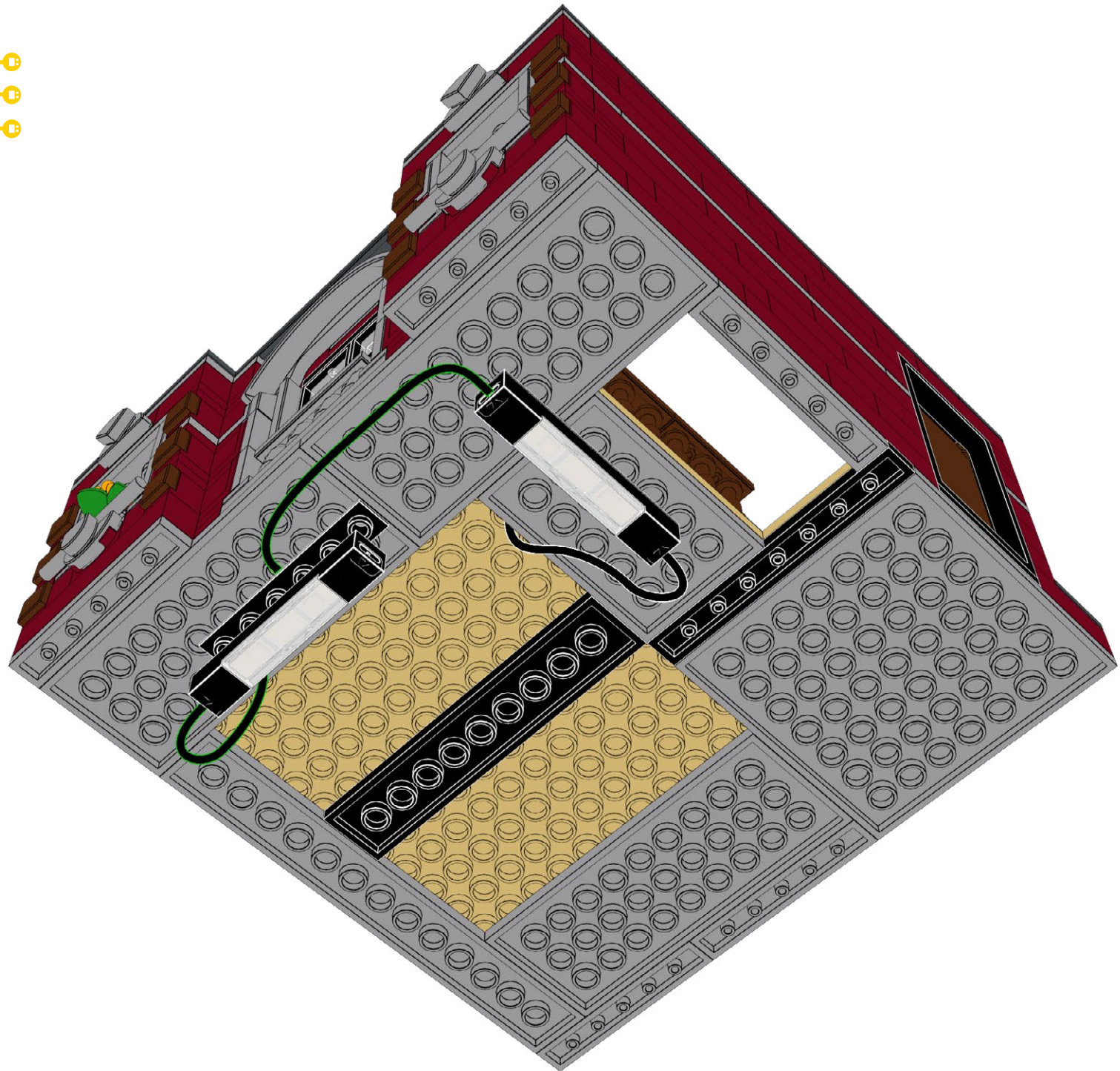

314

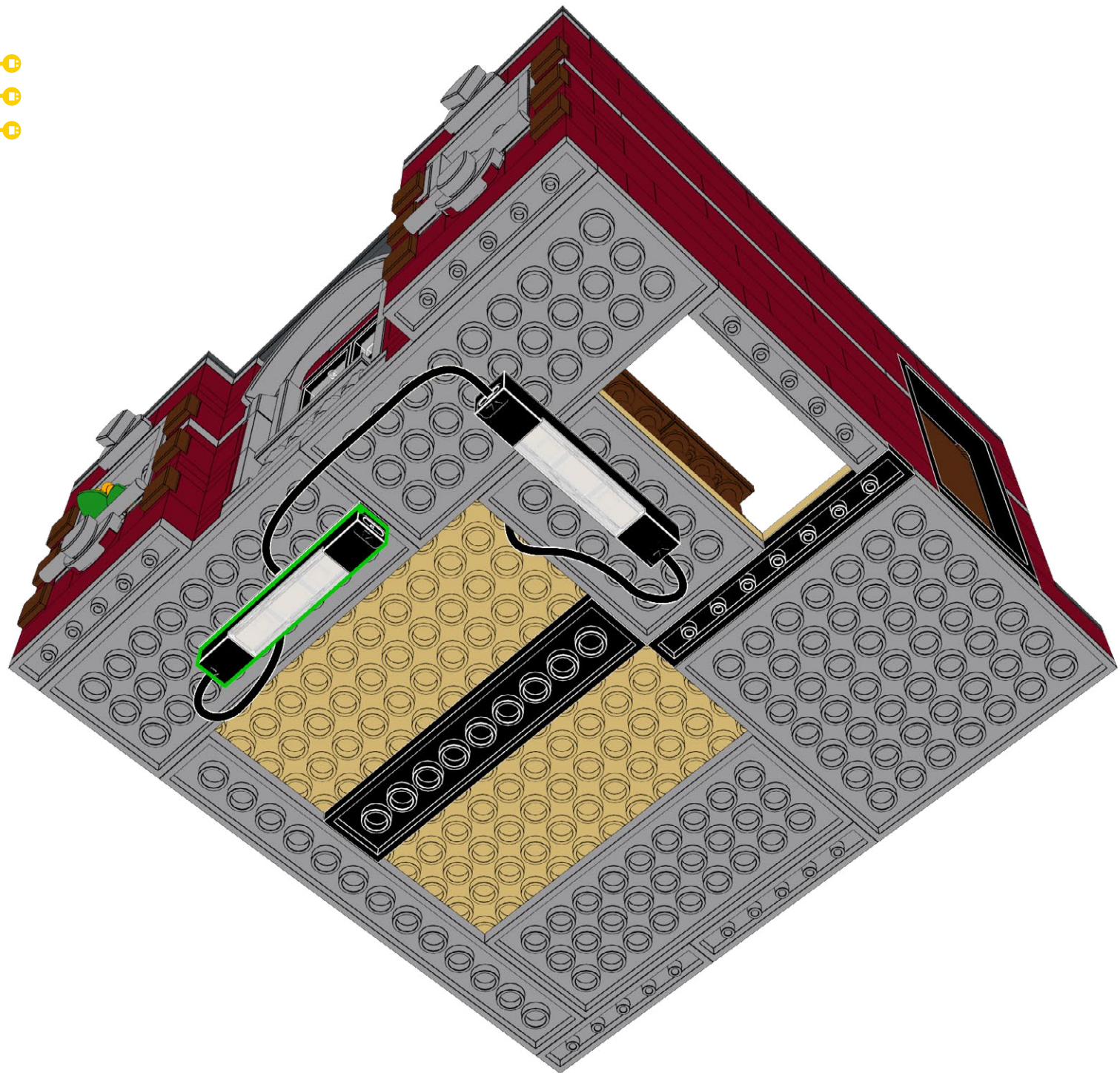

315

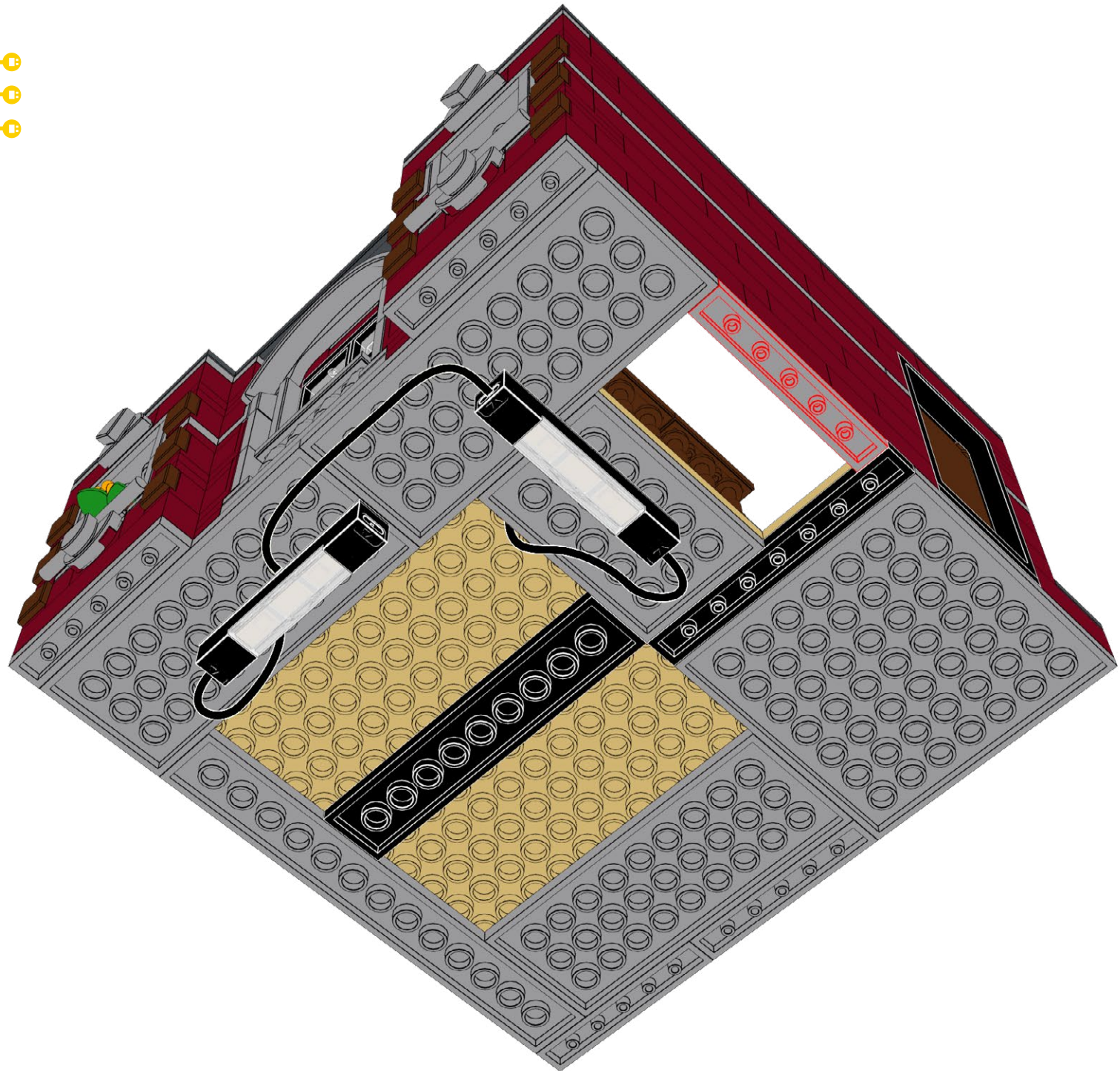

316

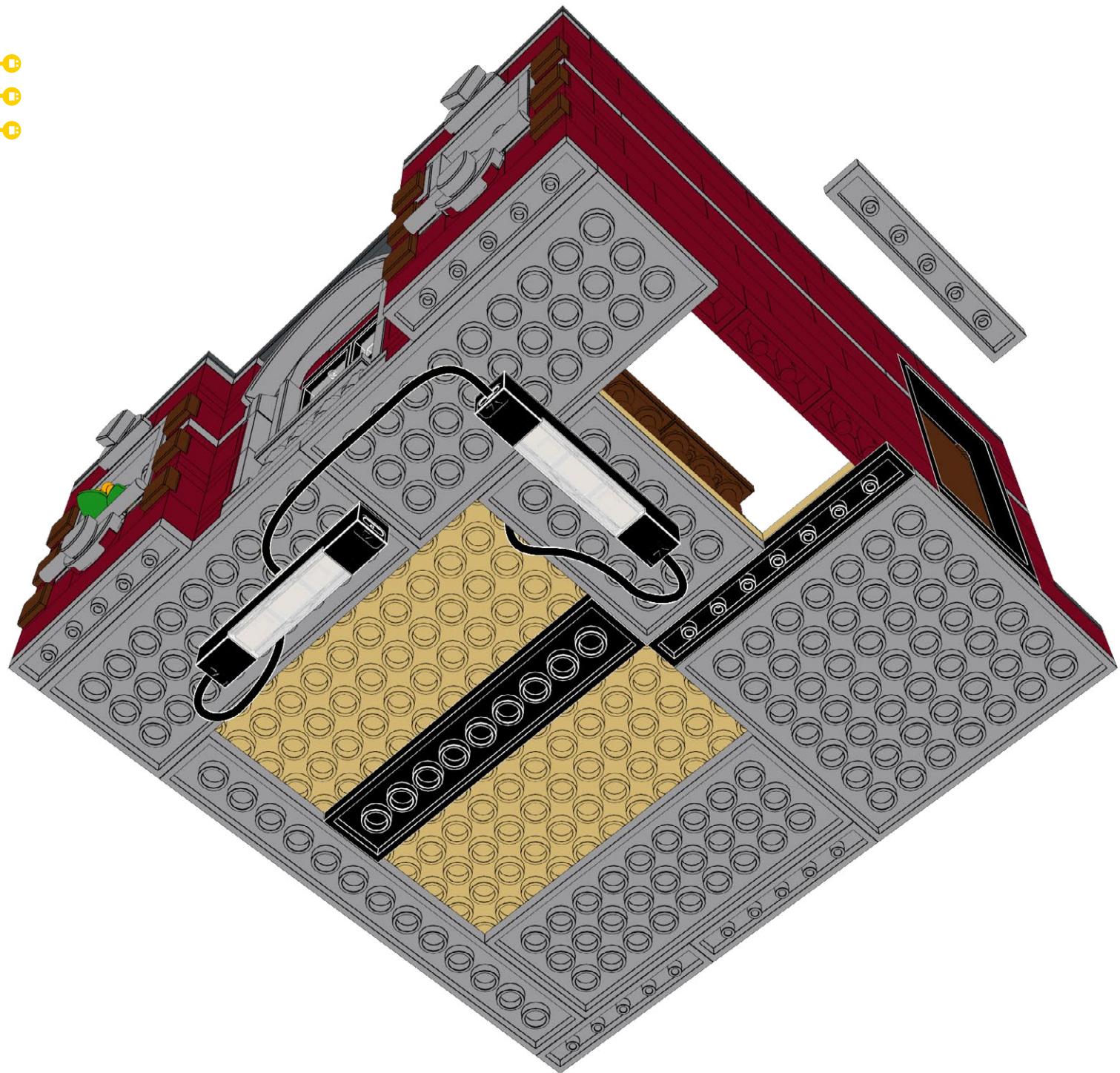

317

FLX-TPA30

1x

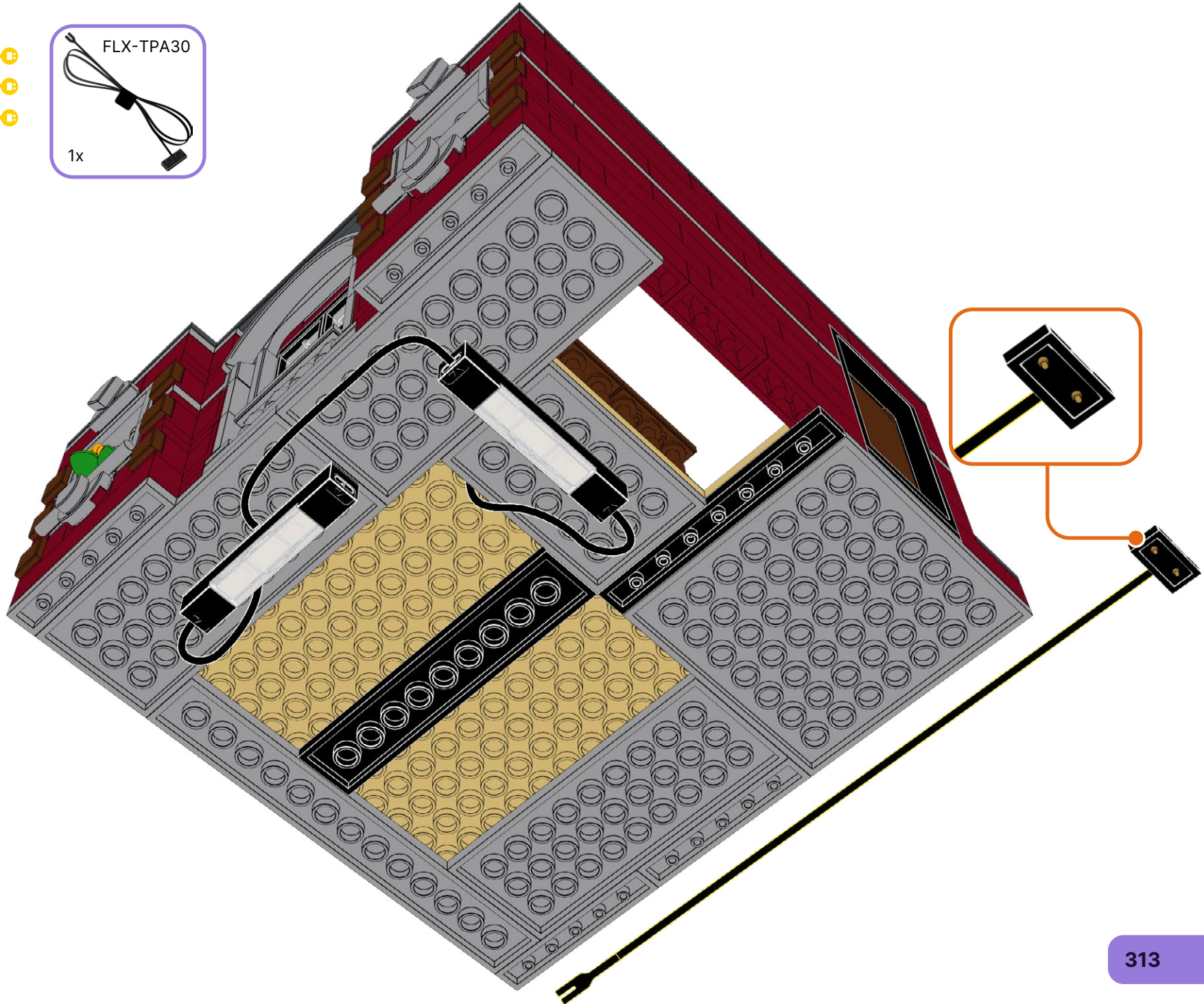

318

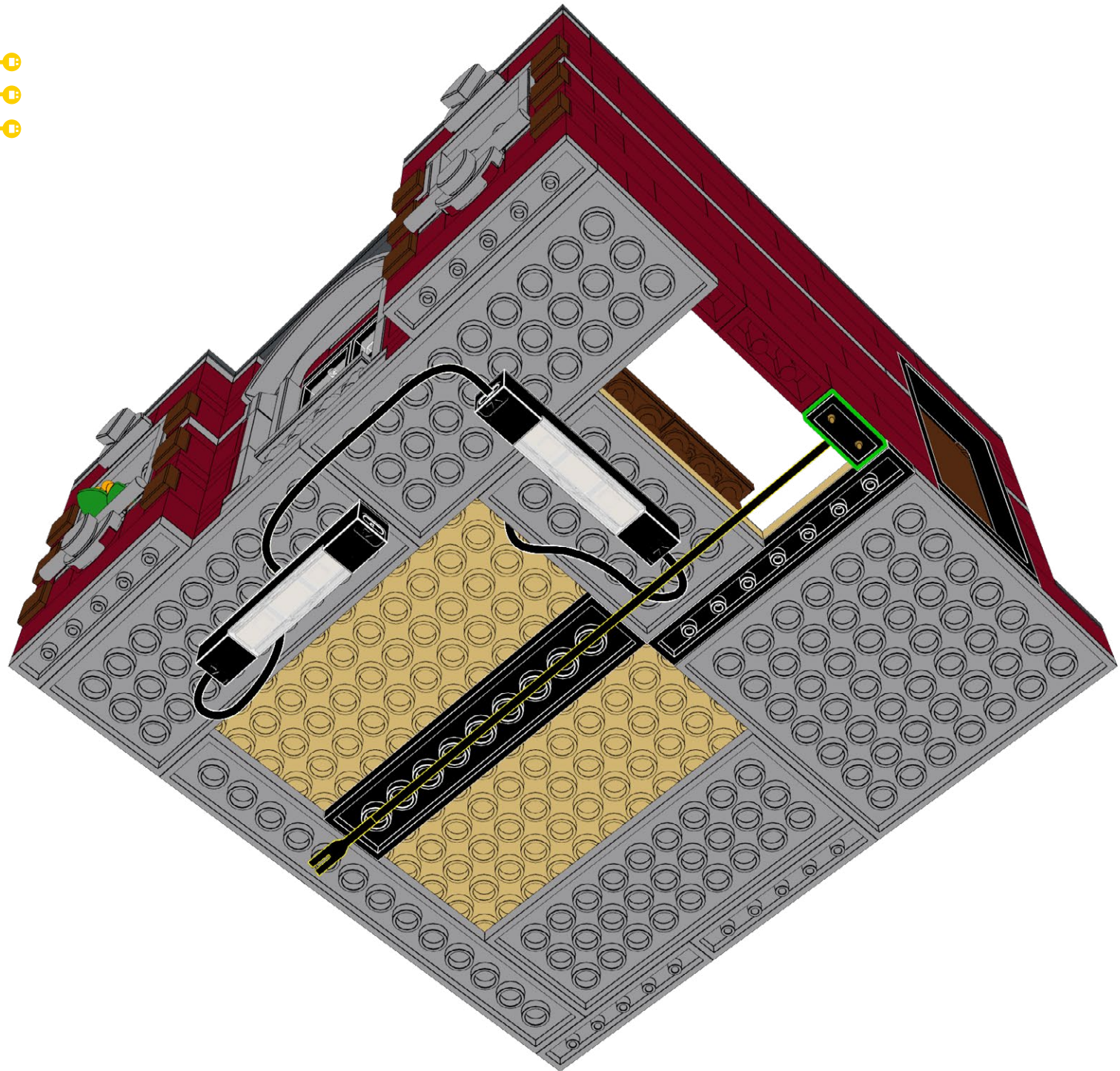

319

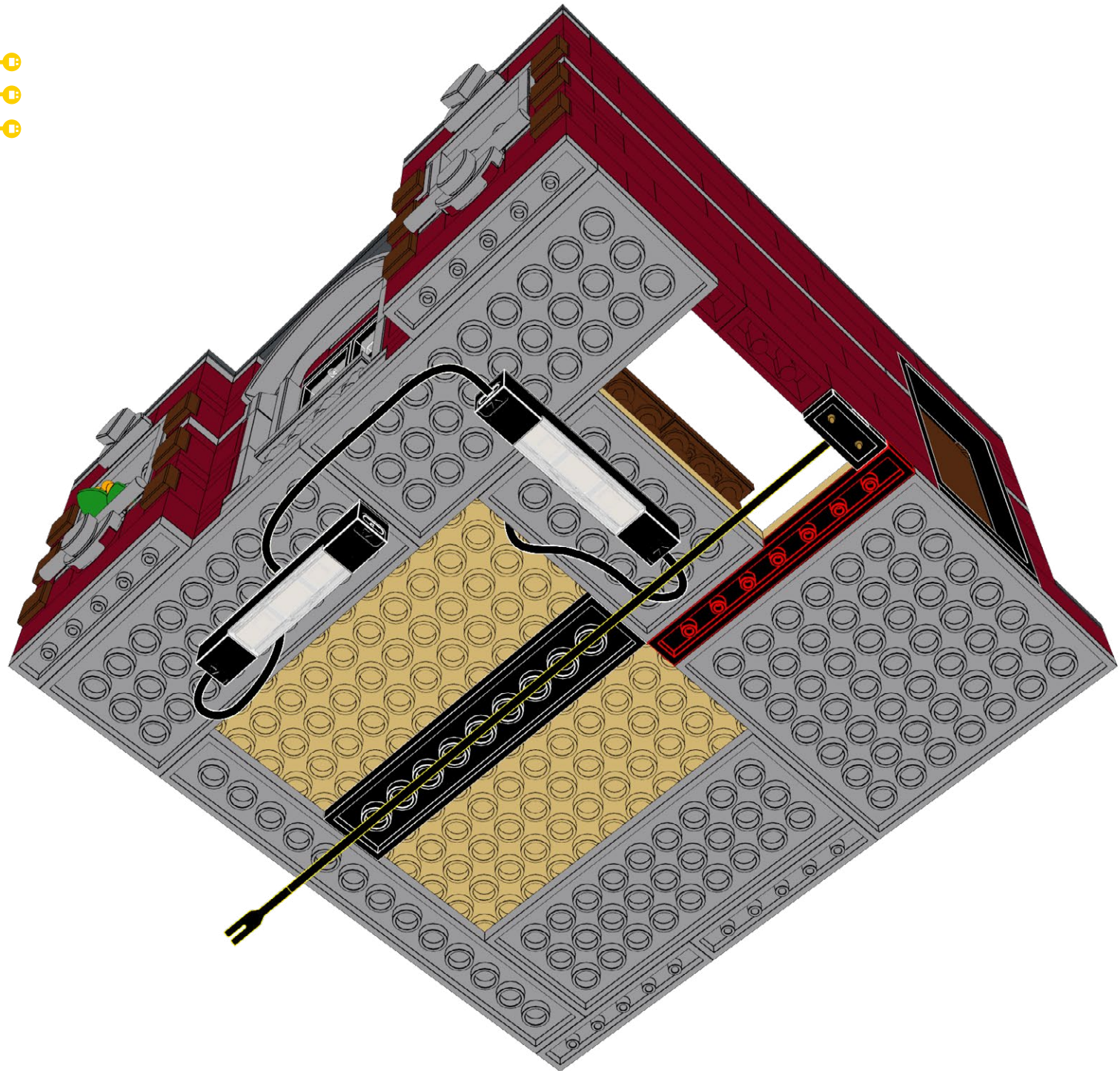

320

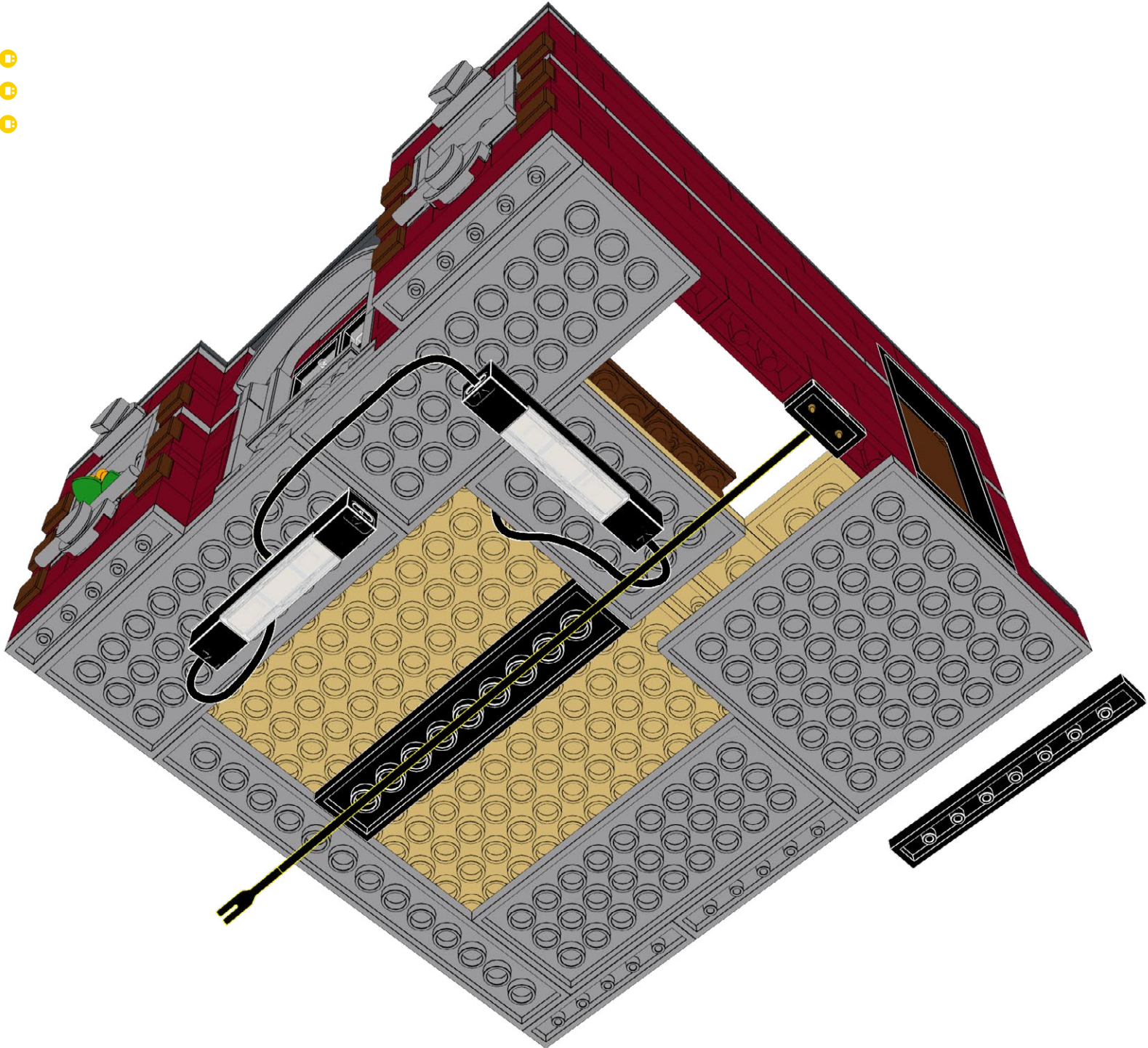

321

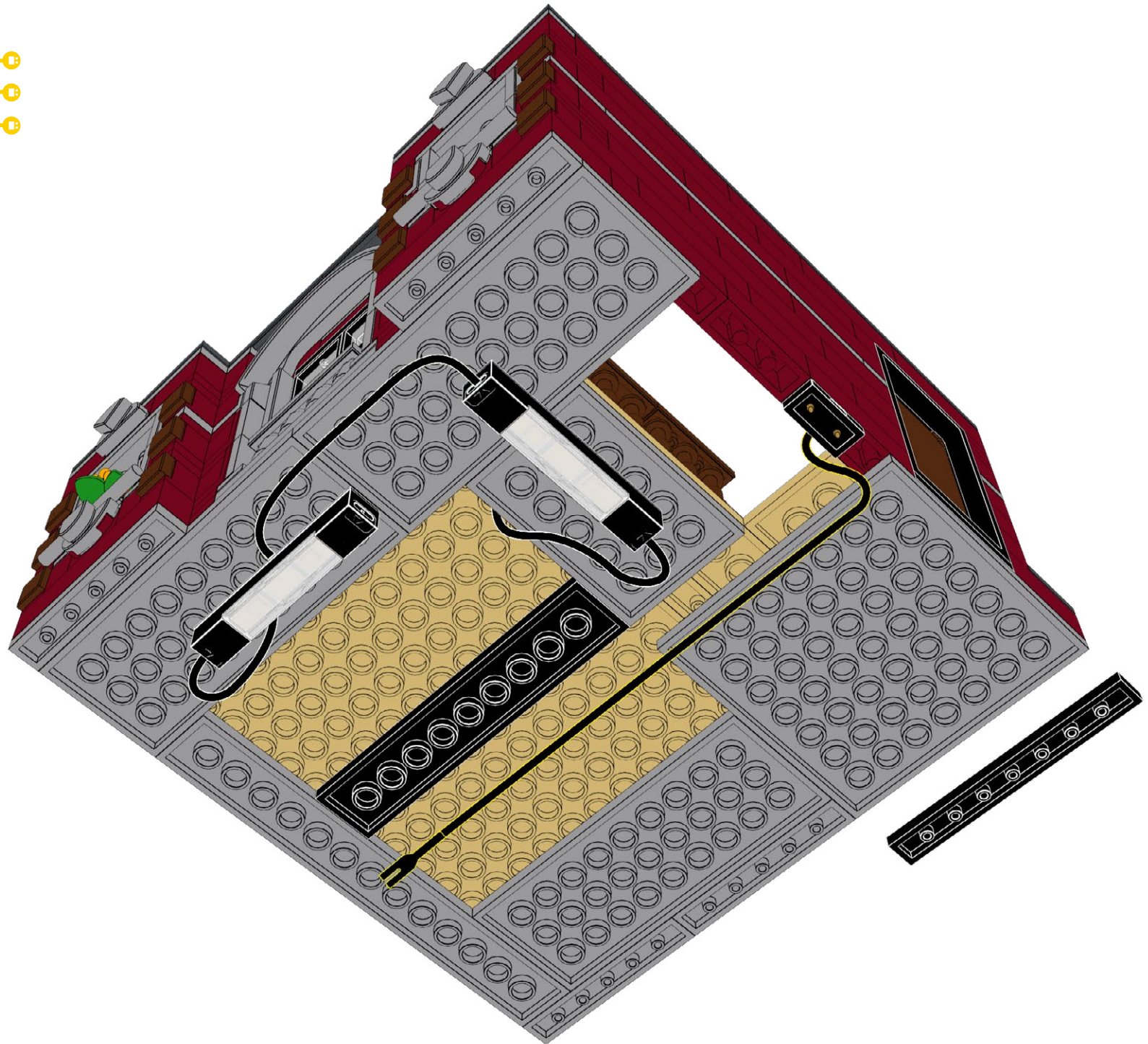

322

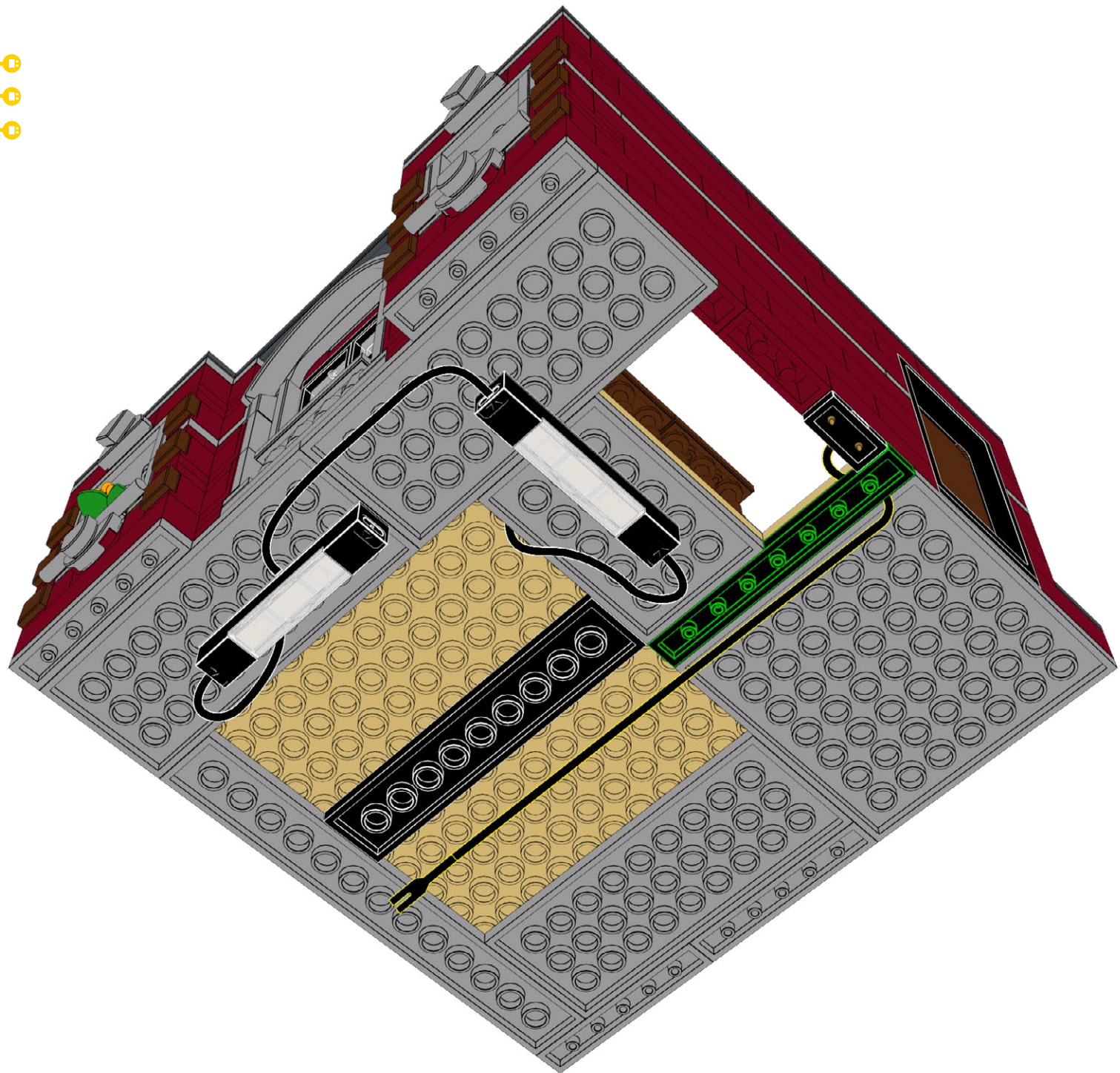

323

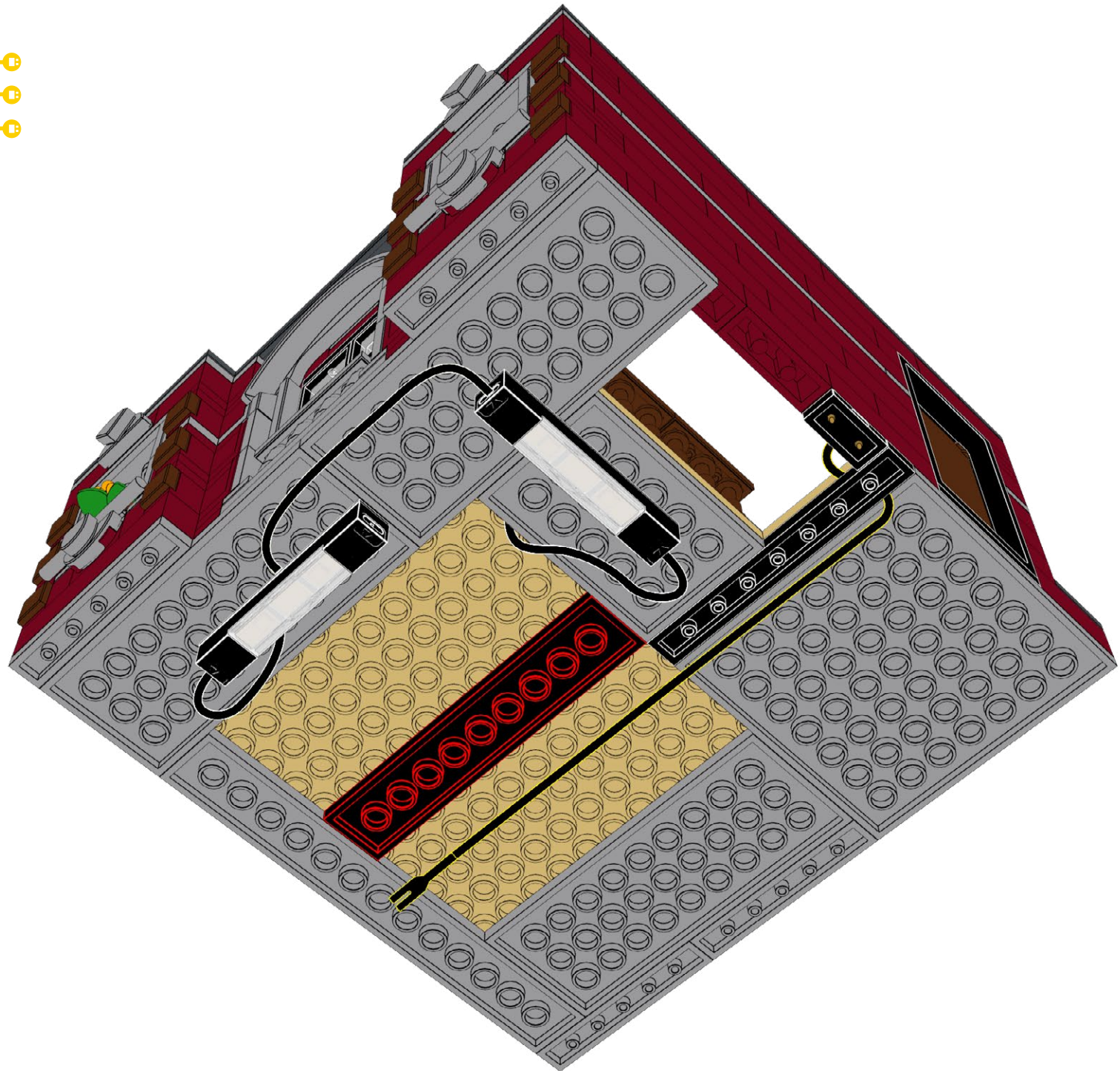

324

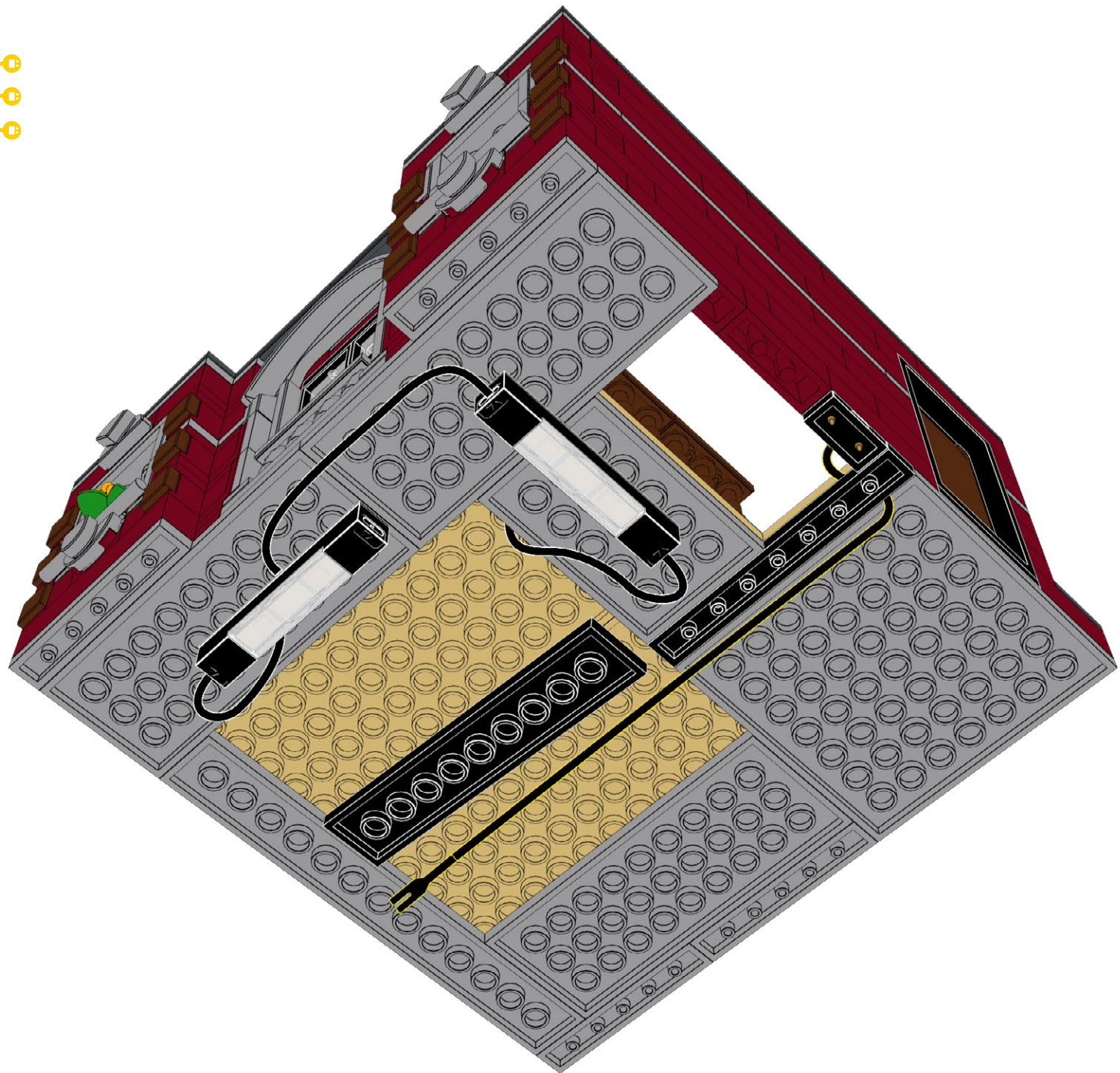

325

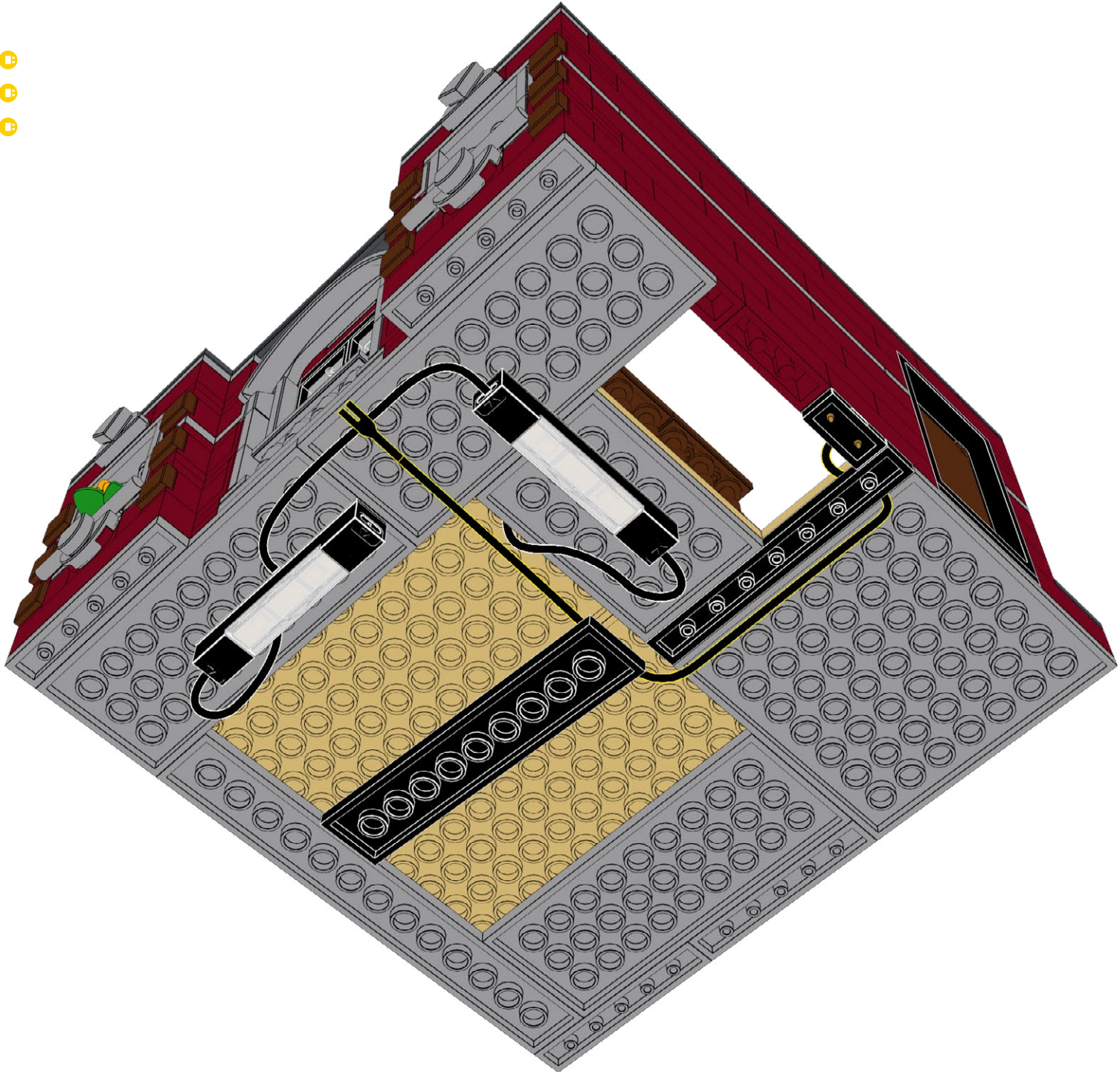

326

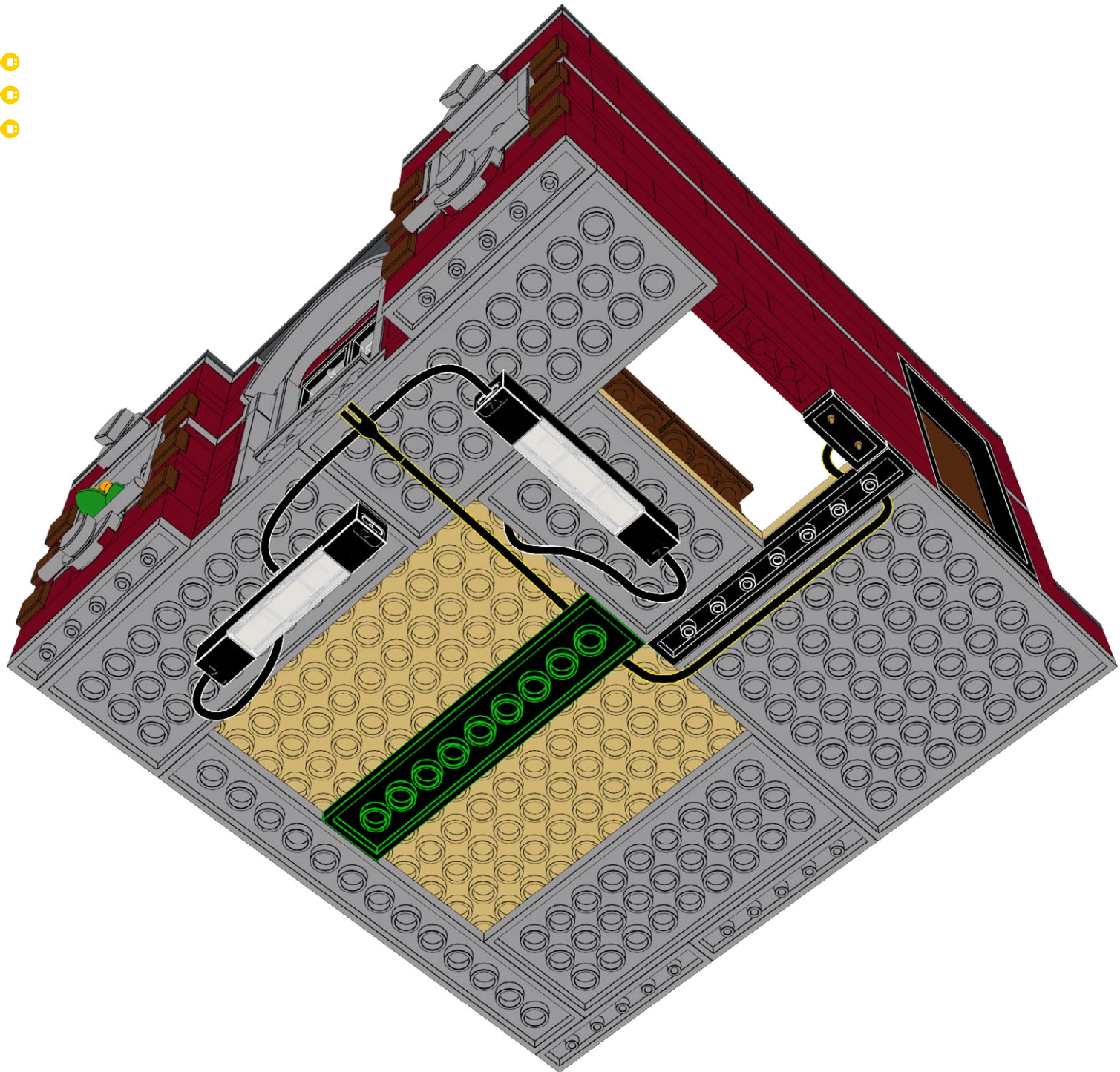

327

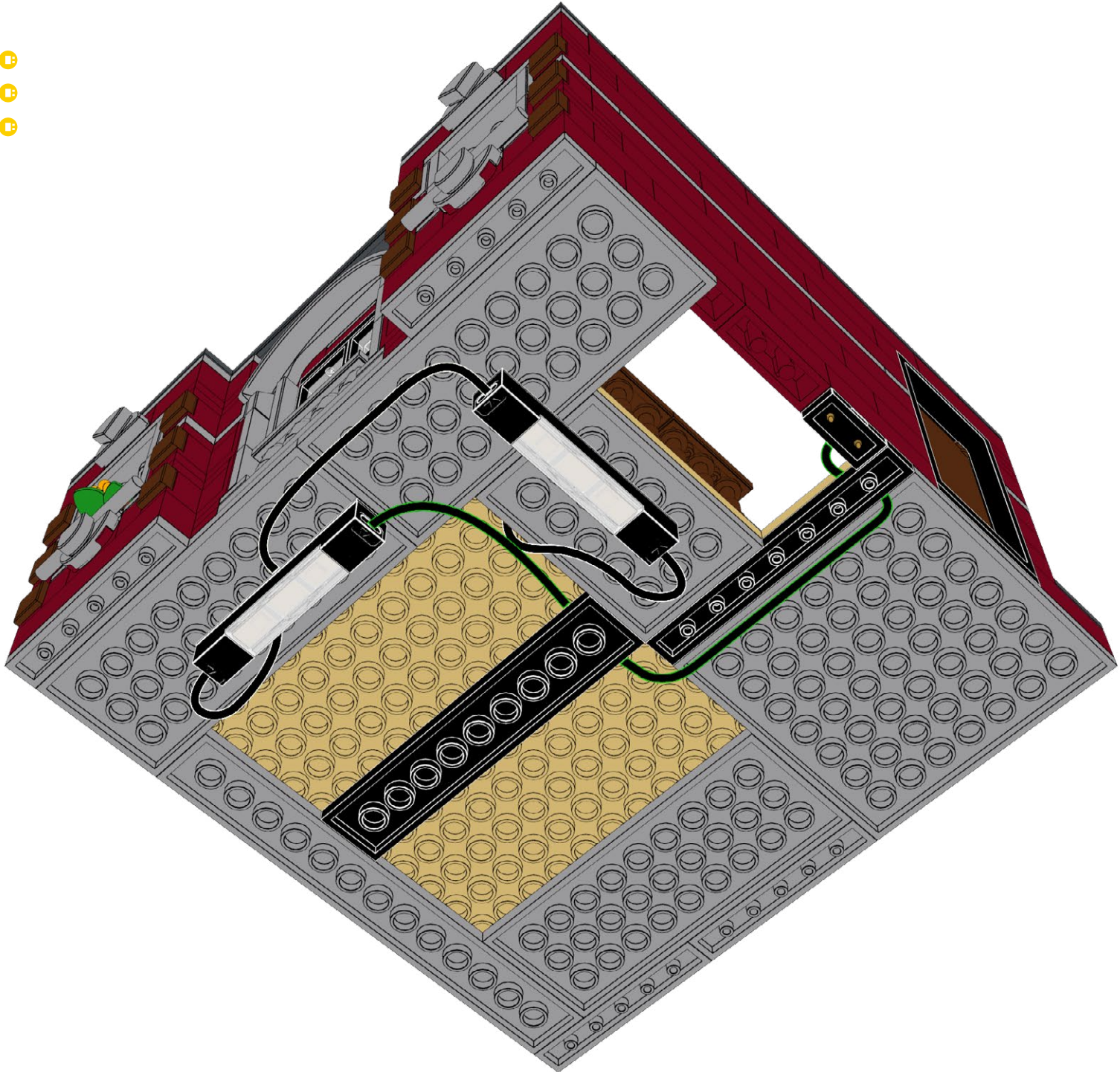

328



329

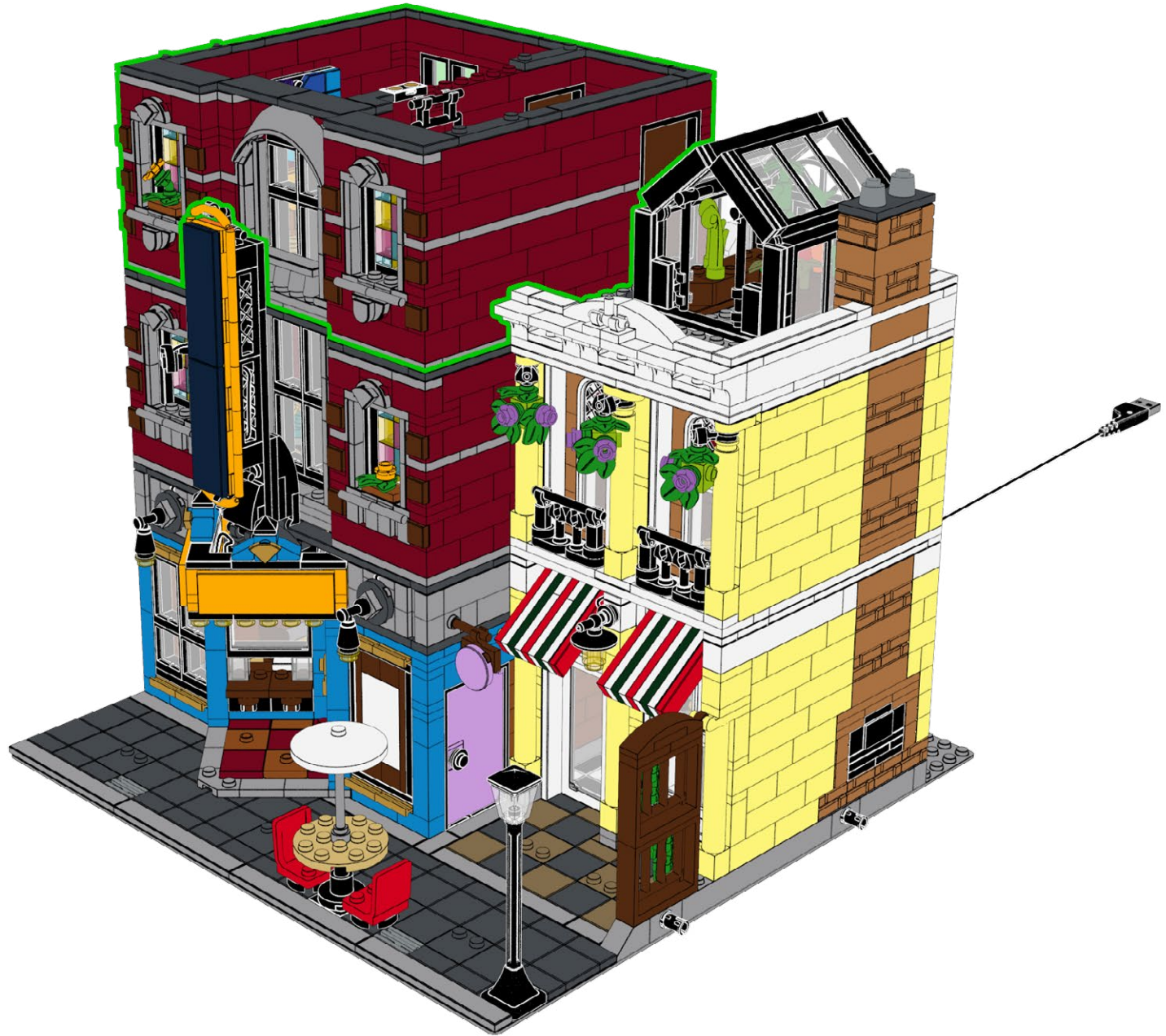

330



Power on Test
Test de mise sous tension
Test di Potenza
Stromtest
Prueba de Energía
电源测试



331

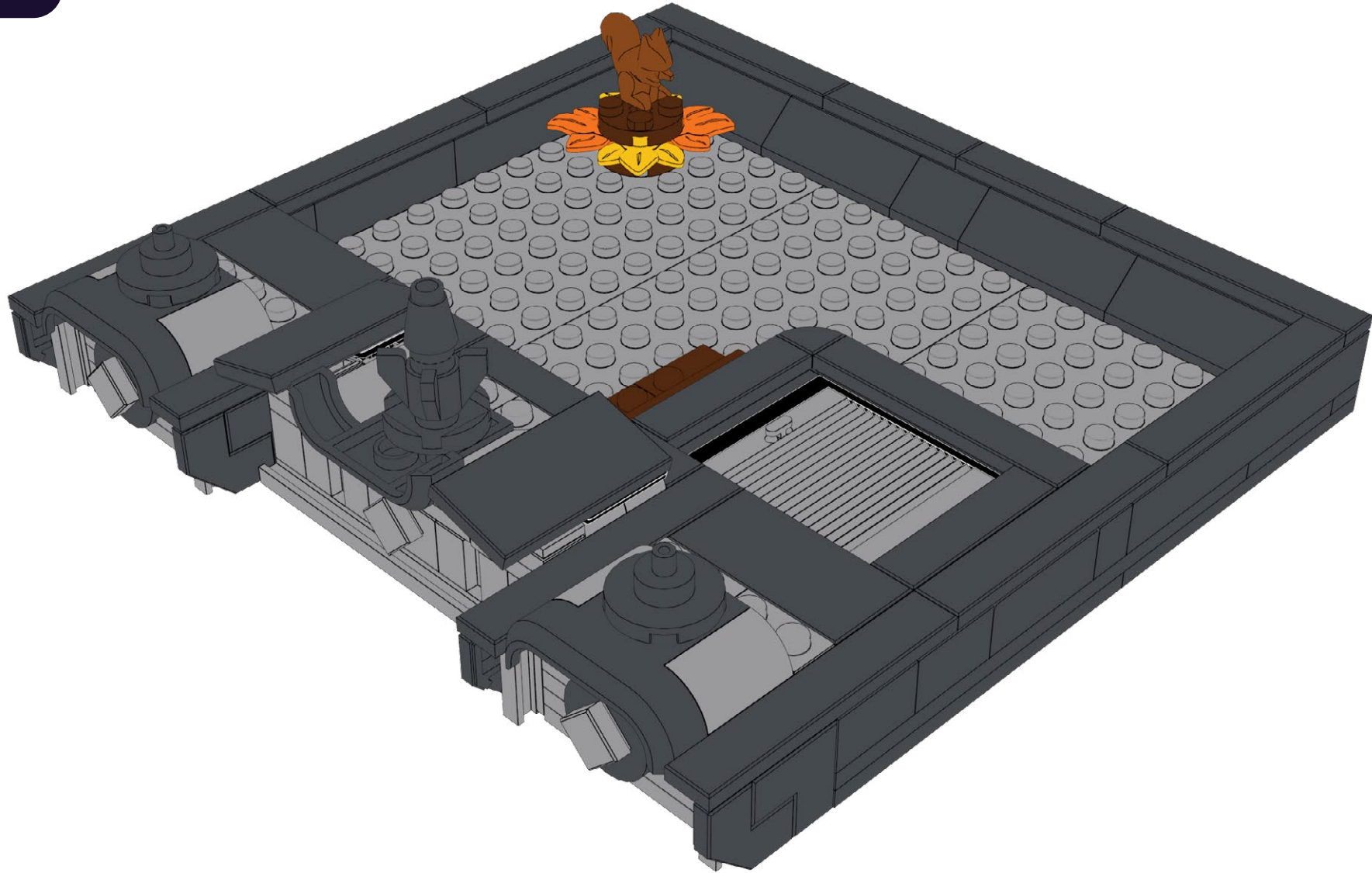

332

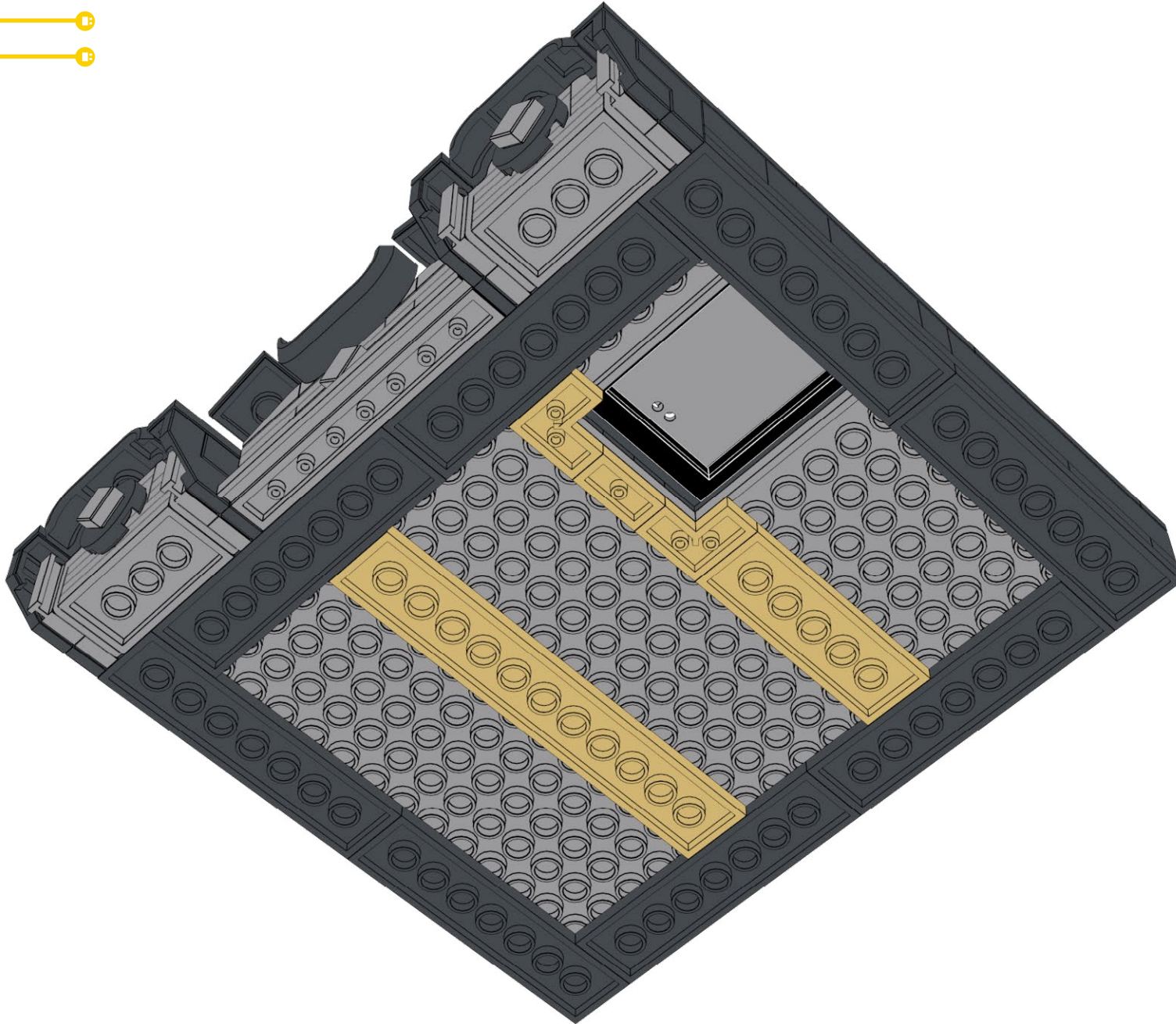

333

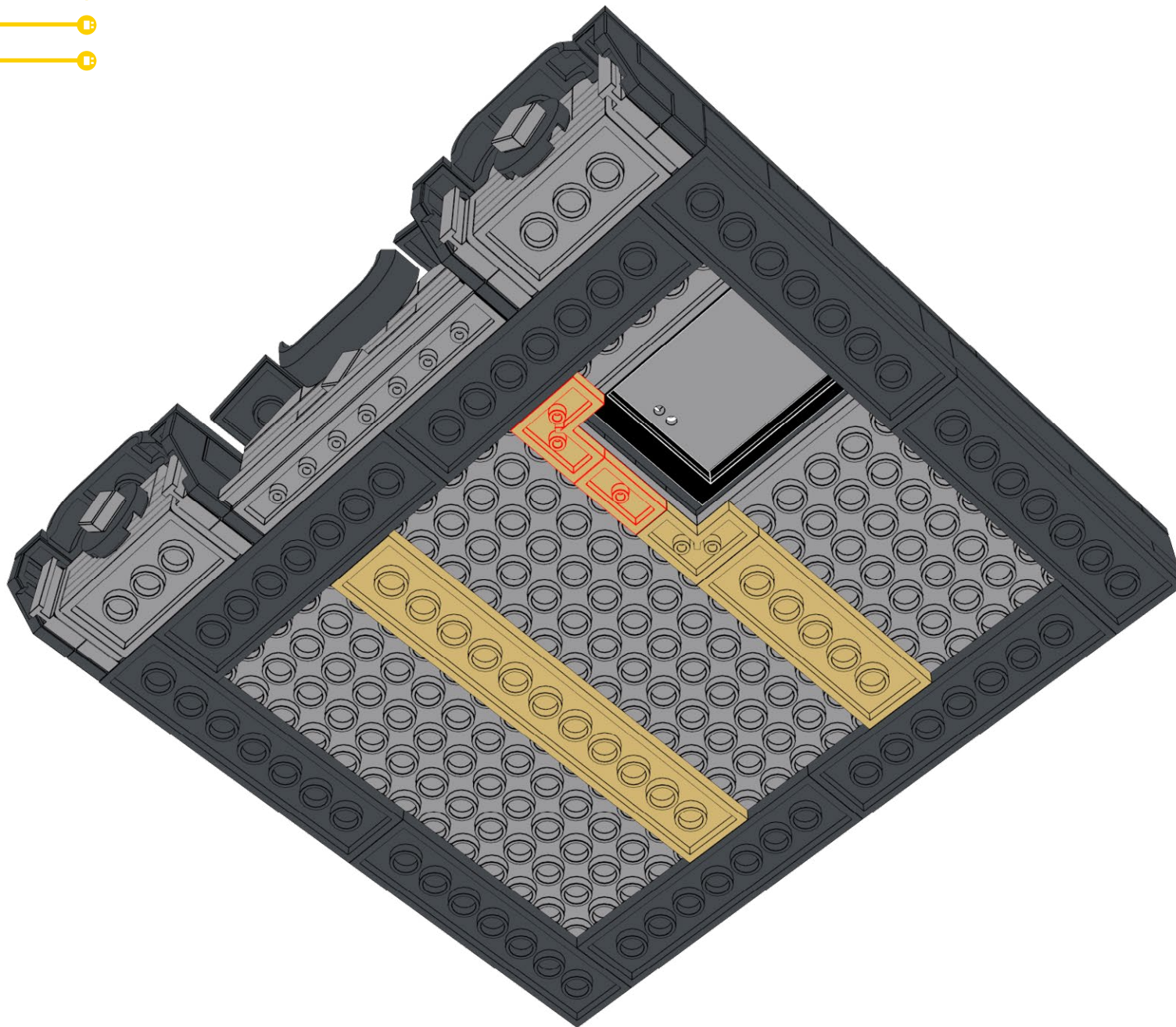

334

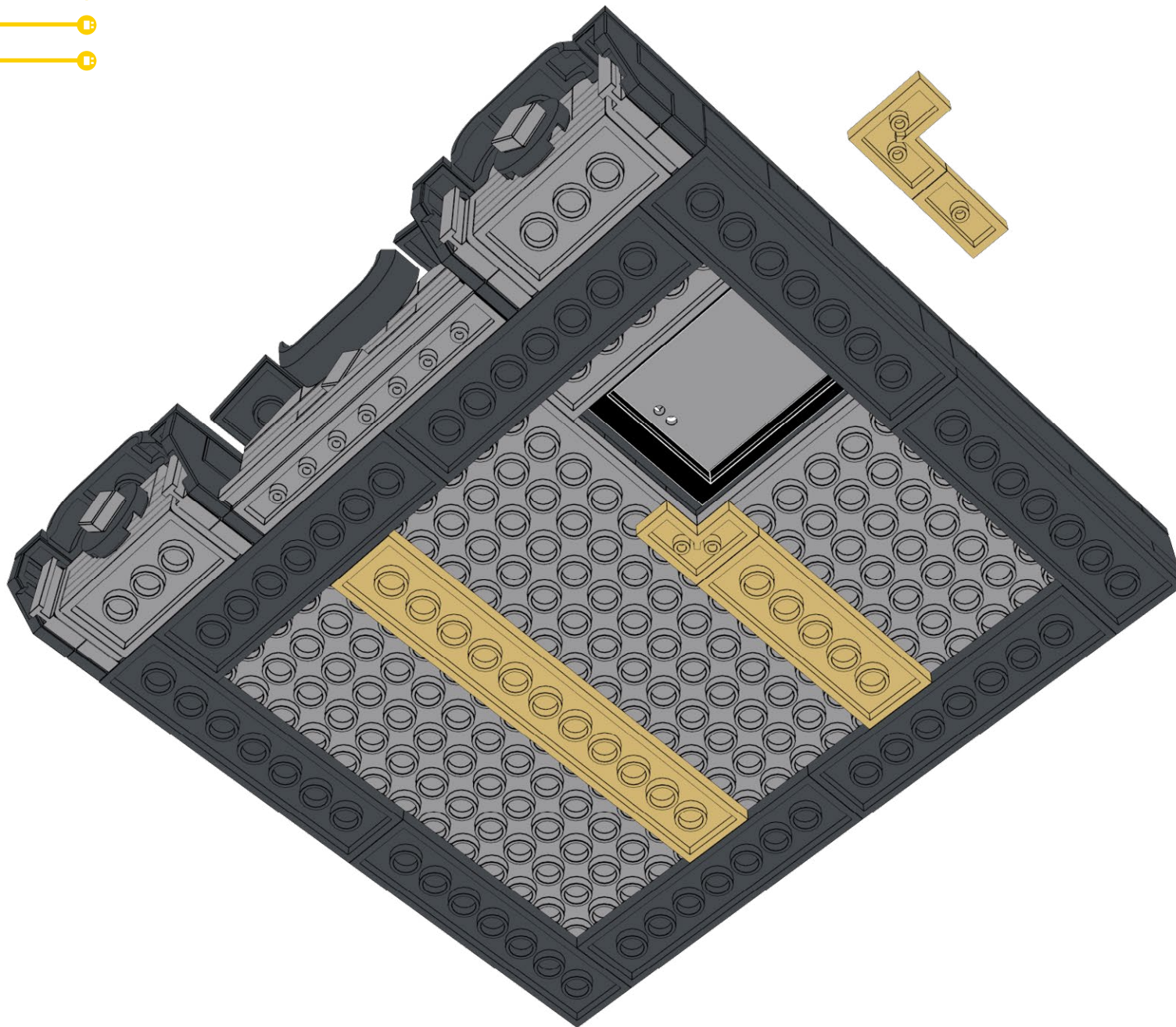

335

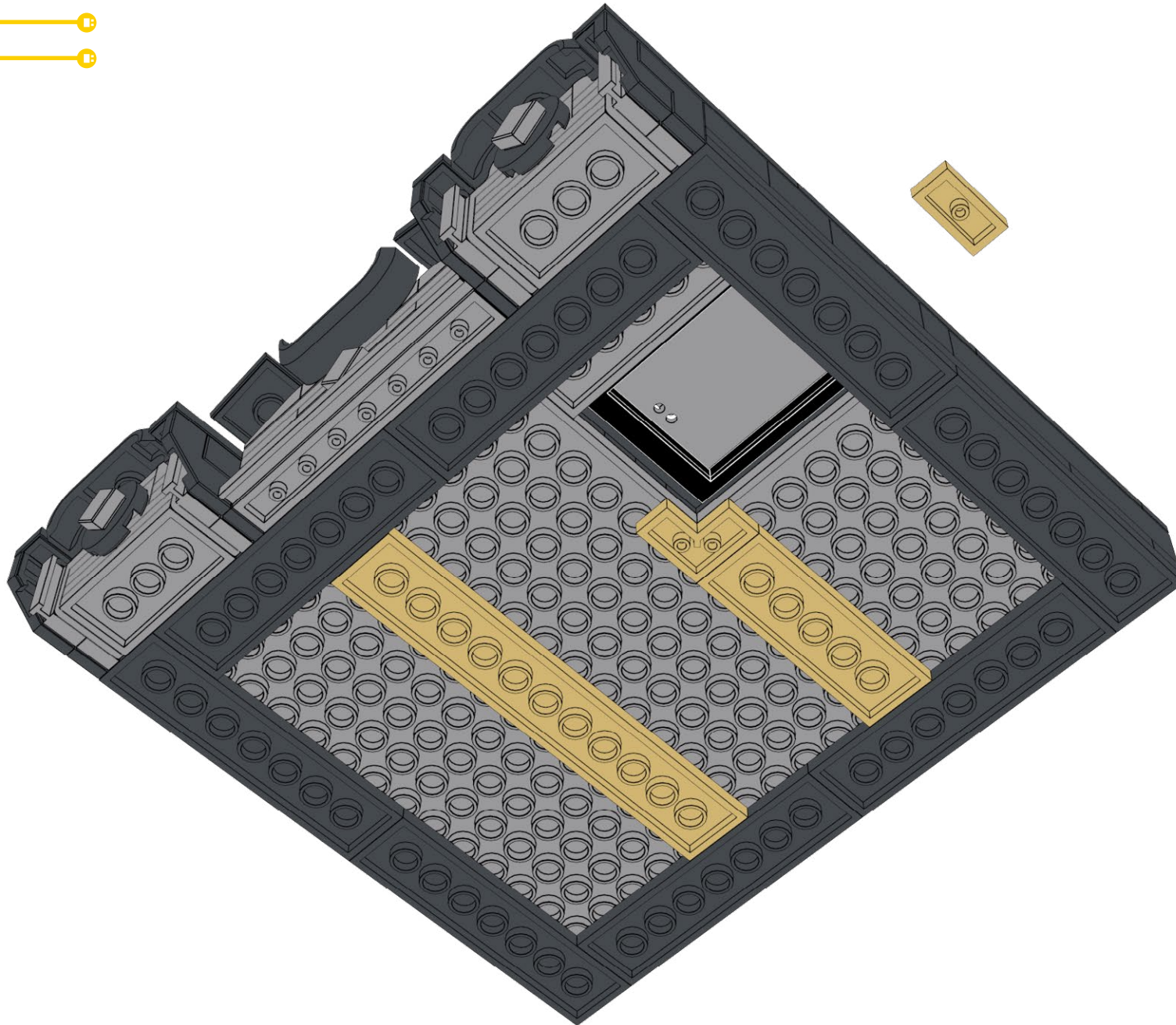

336

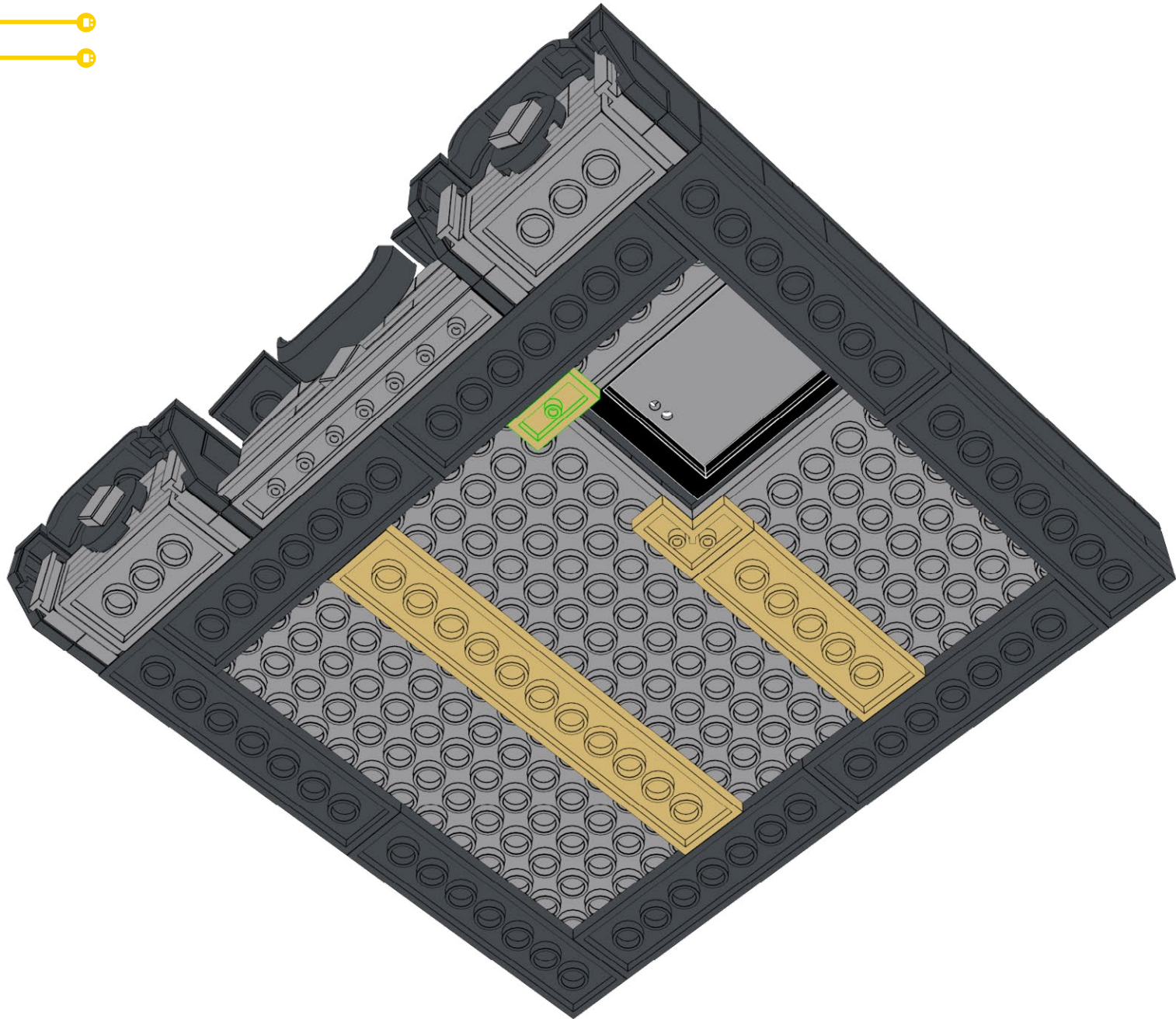

**HOLD UP!**

You might notice some bags aren't in order, as well as left over pieces, but that's ok! We're changing the way you build LEGO!

ATTENDEZ!

Vous remarquerez peut-être que certains sacs, ainsi que certaines pièces, ne sont pas dans le bon ordre. Mais pas de panique! Nous changeons simplement la façon avec laquelle vous construisez vos LEGO!

ASPETTA!

Potresti notare che alcuni sacchetti non sono in ordine, così come i pezzi avanzati, ma va bene così! Stiamo cambiando il modo in cui costruisci i LEGO!

HALT!

Sie werden möglicherweise bemerken, dass einige tüten durcheinander sind und teile übrig bleiben, aber das ist in Ordnung! Wir ändern die art und weise, wie Sie LEGO bauen!

¡ESPERA!

Es posible que notes que algunas bolsas están fuera de servicio, así como piezas sobrantes, ¡pero está bien! ¡Estamos cambiando la forma en que construyes LEGO!

暫停!

你可能会注意到一些袋子顺序错乱, 以及一些剩余的部件, 但没关系! 我们正在改变你搭建乐高的方式!

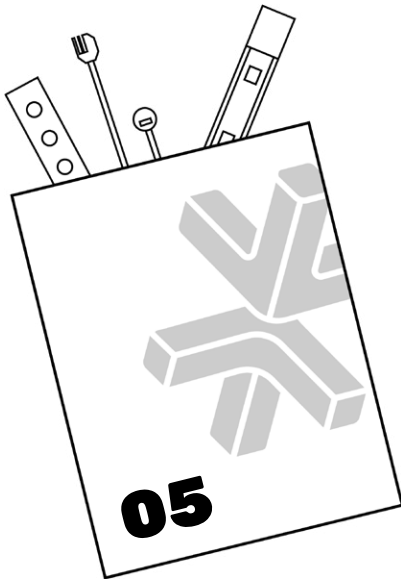
Open LMB Bag 05

337

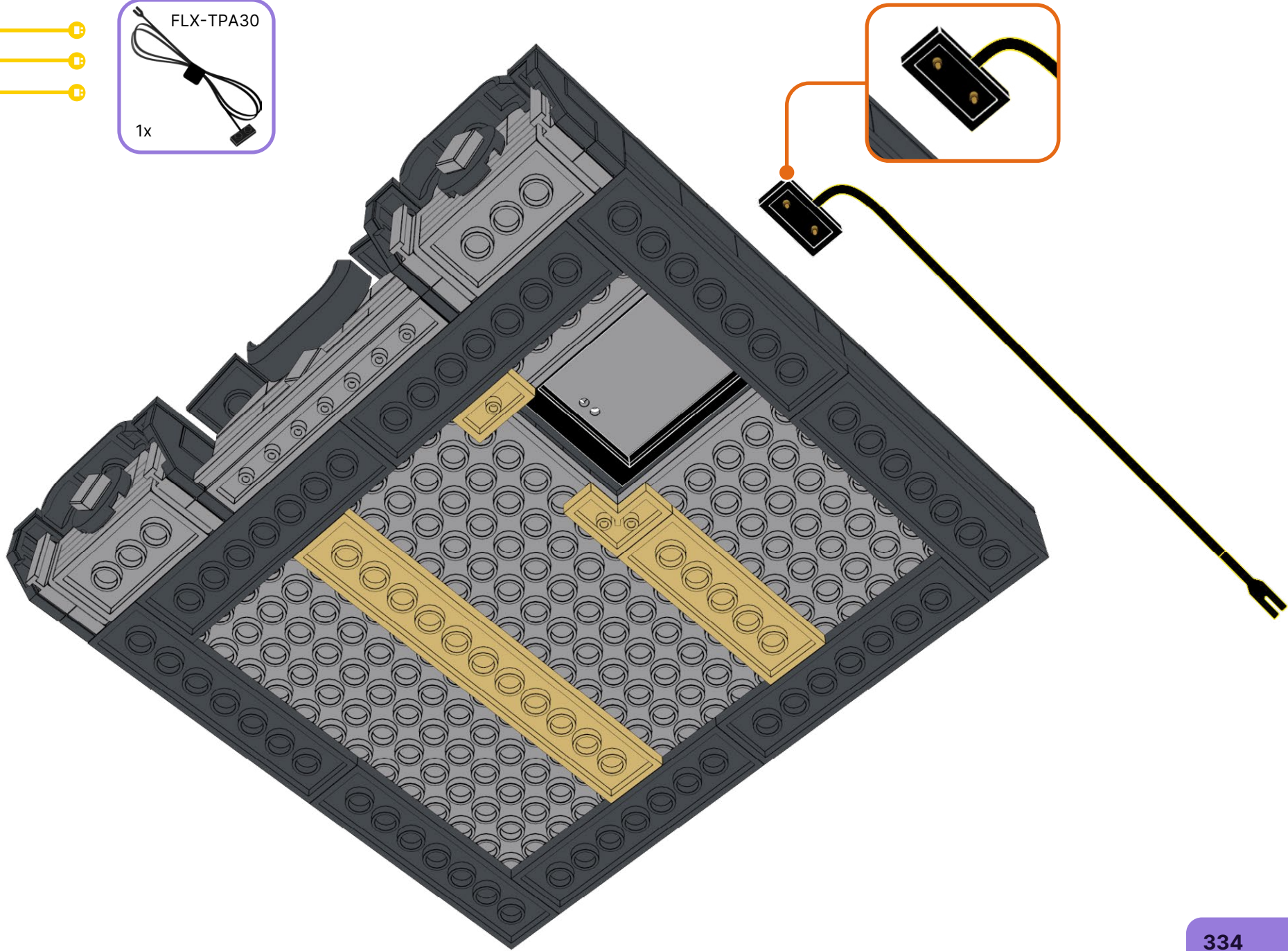

338

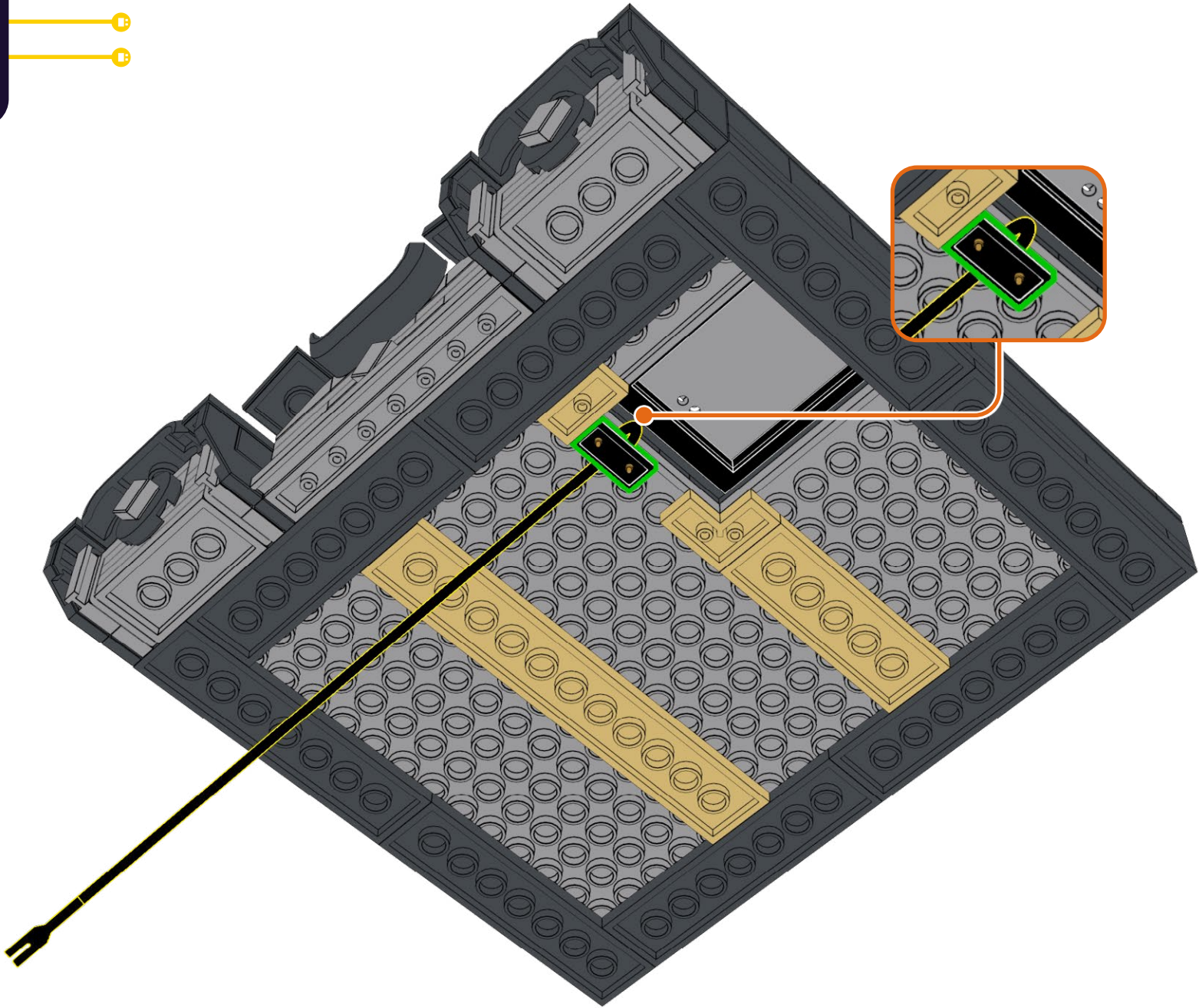
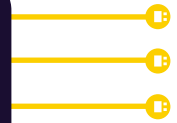

339

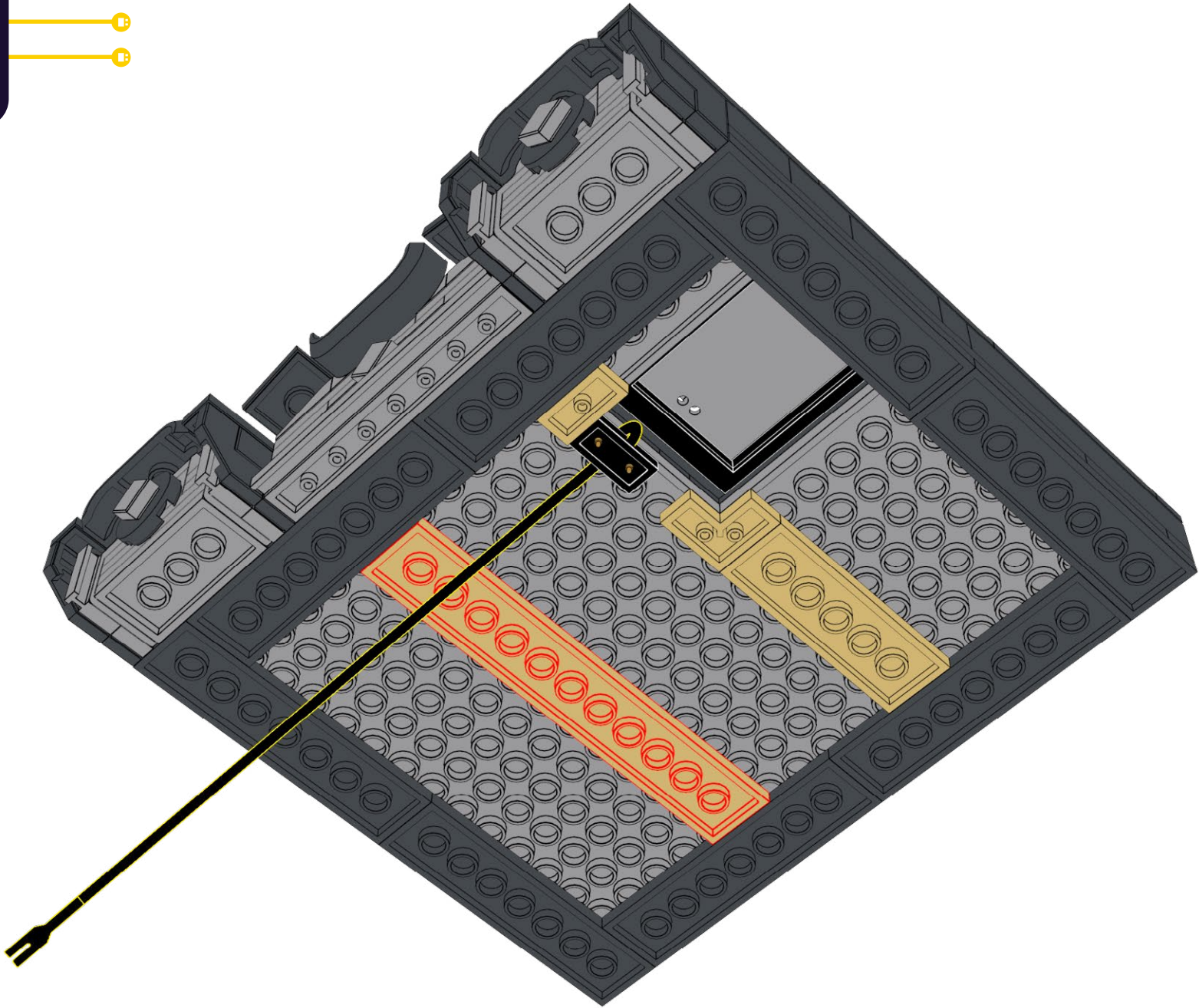
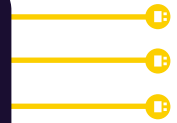

340

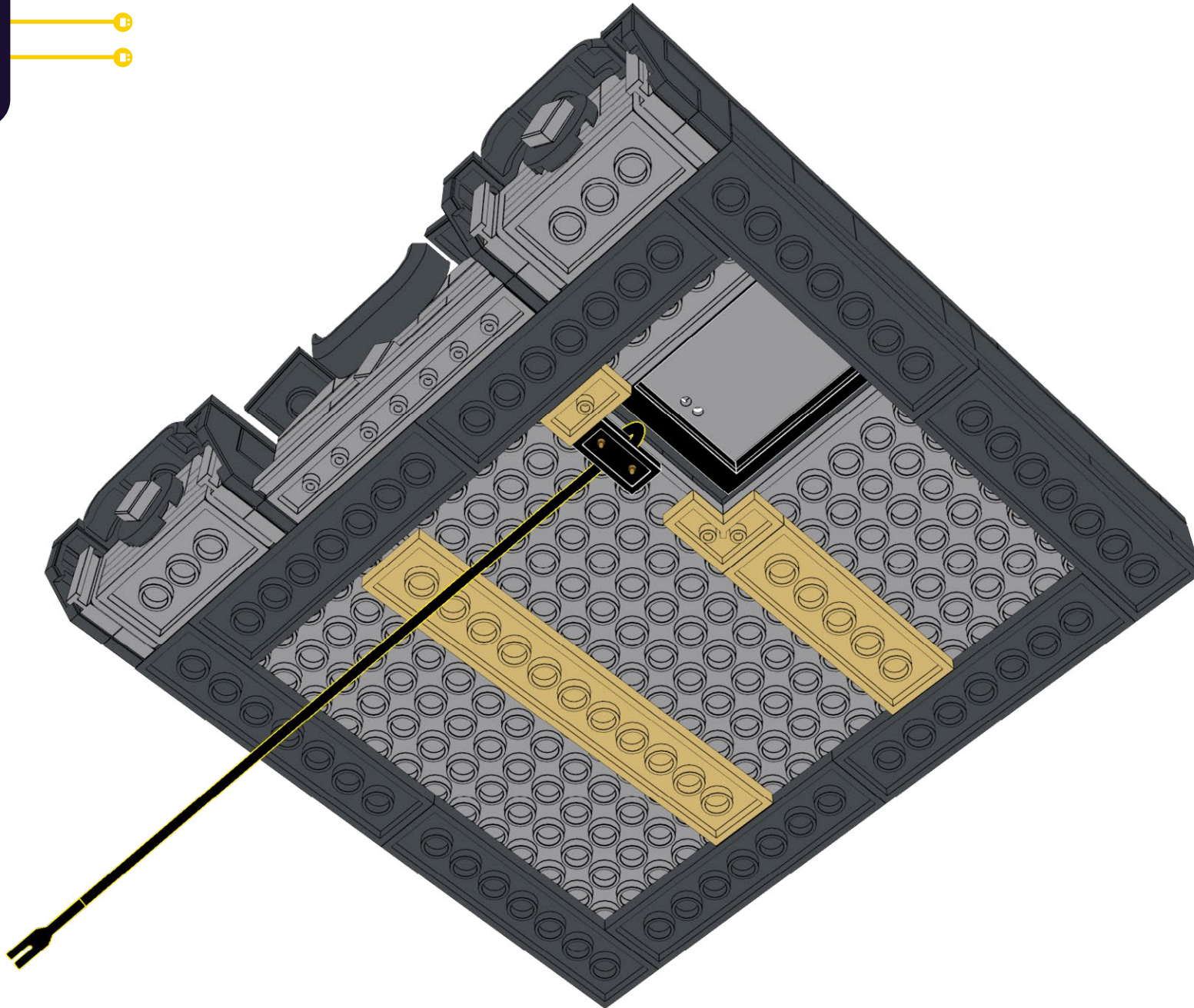

341

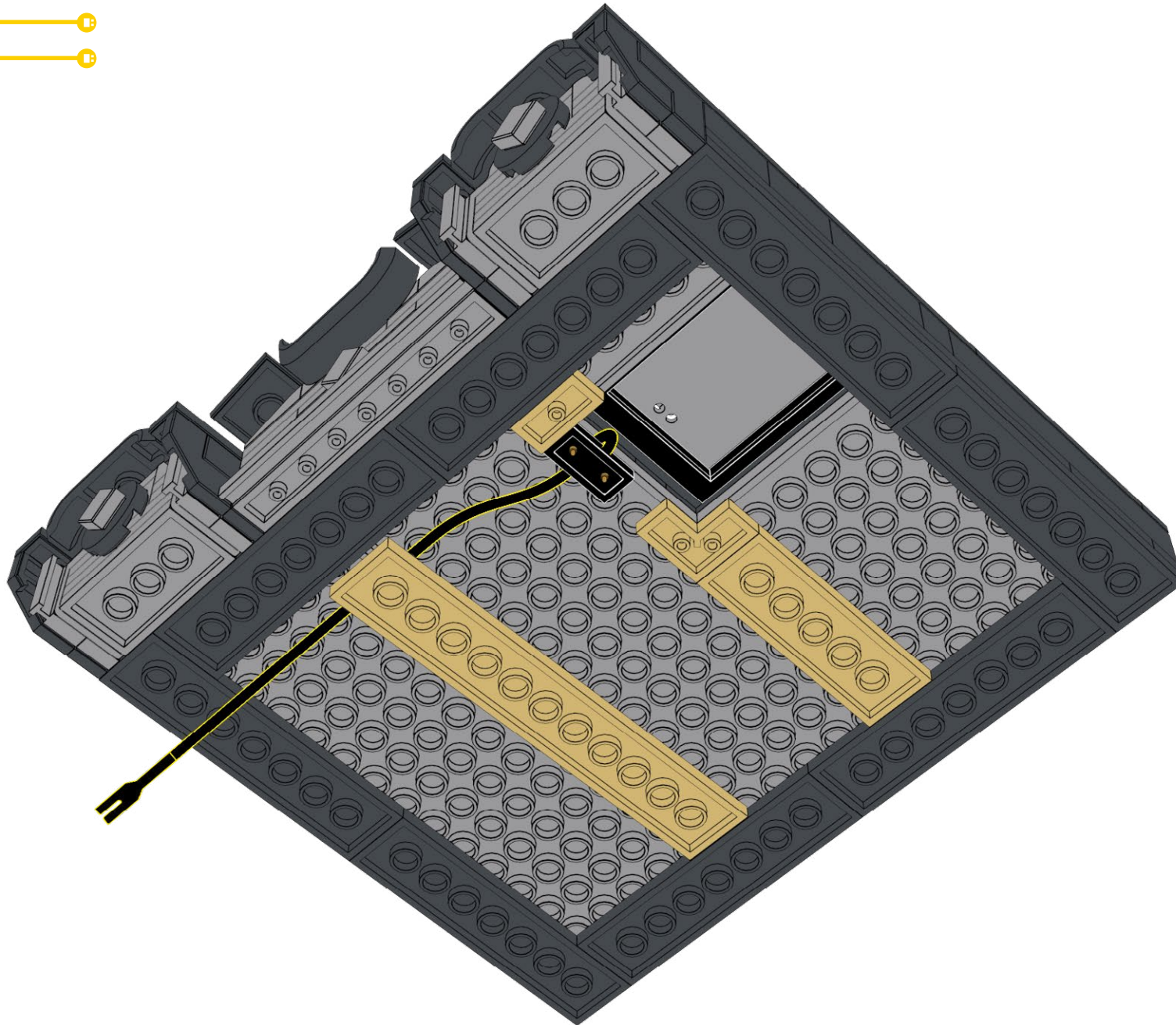

342

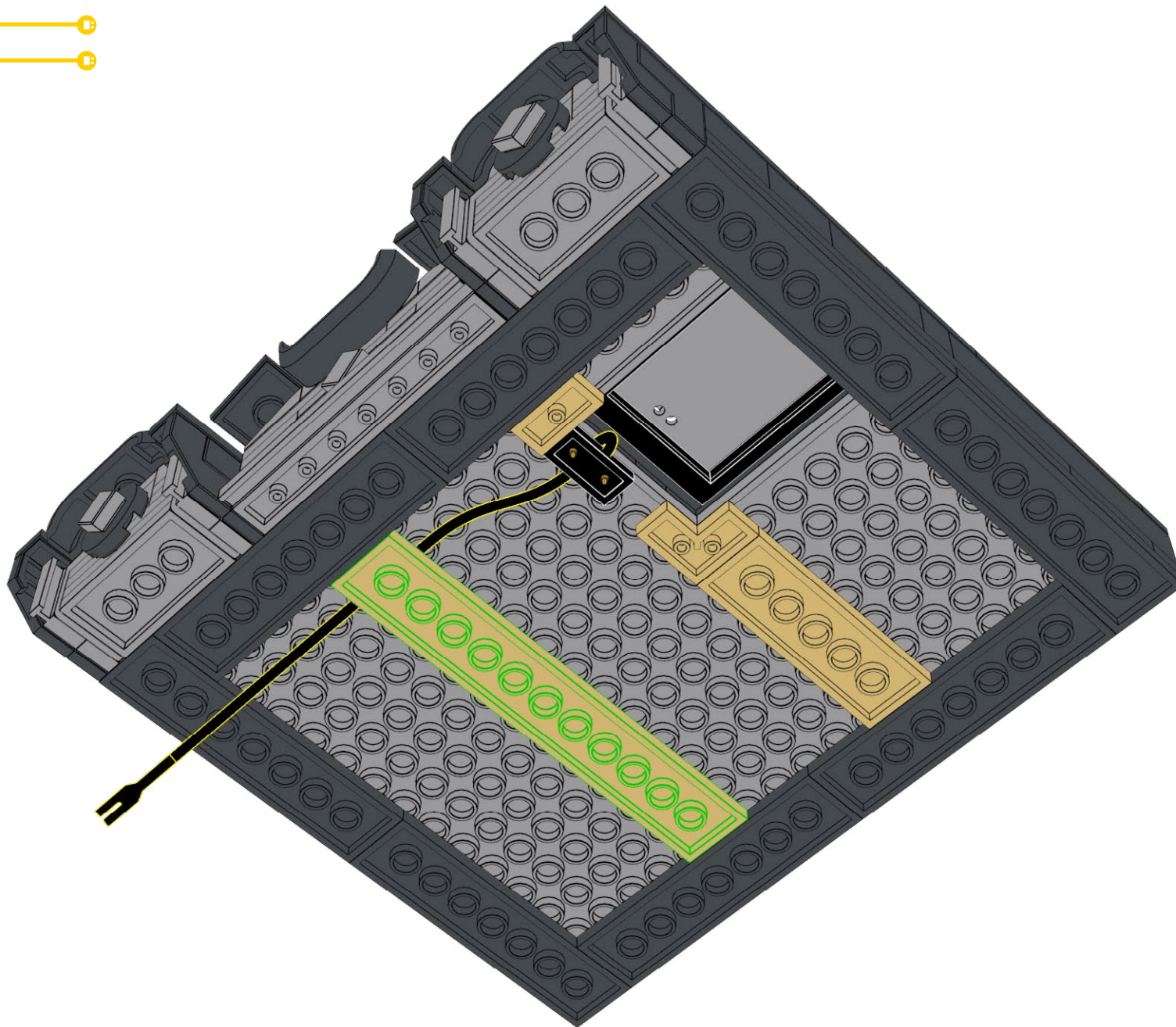

343

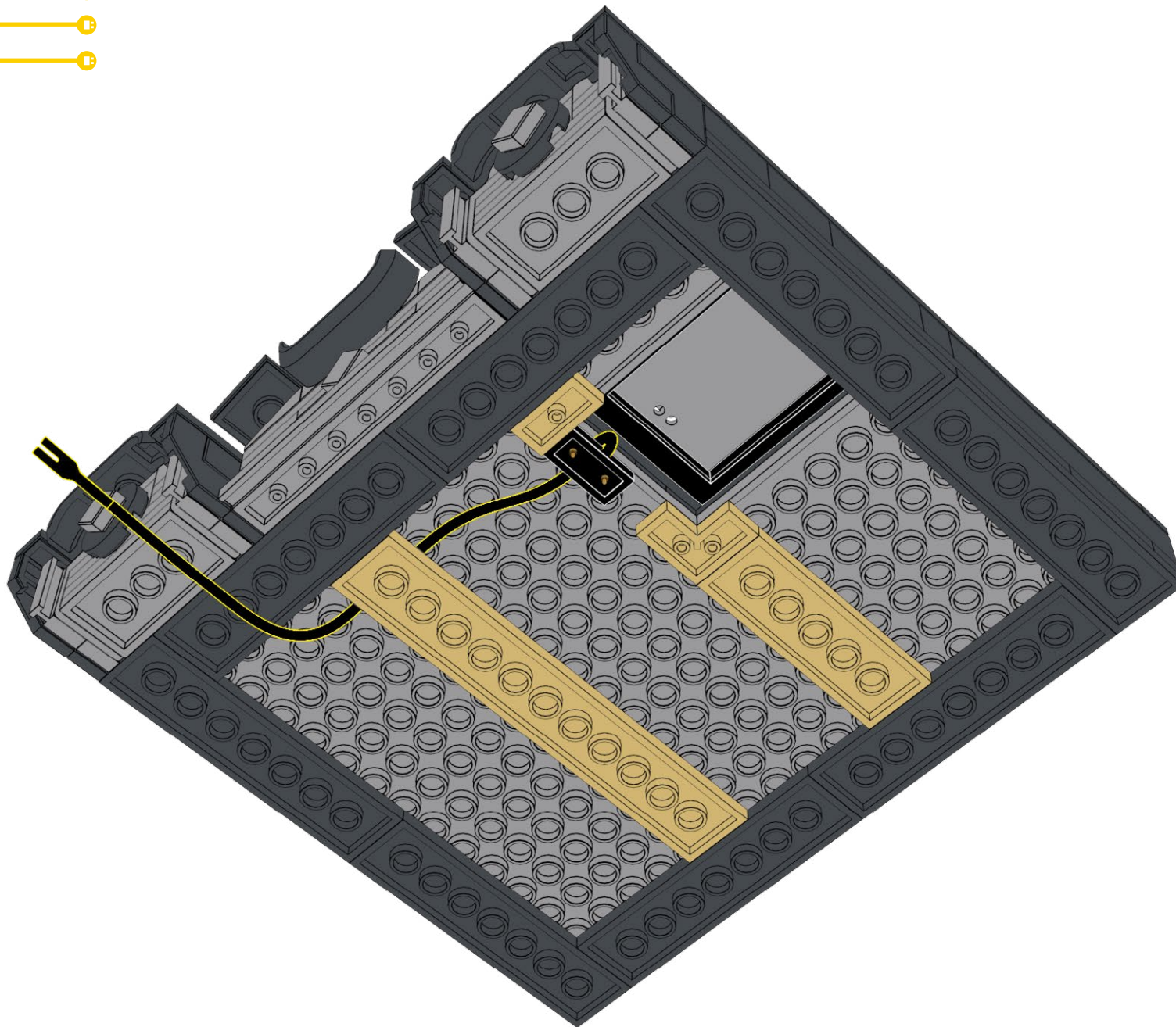

344

T-1x6

1x

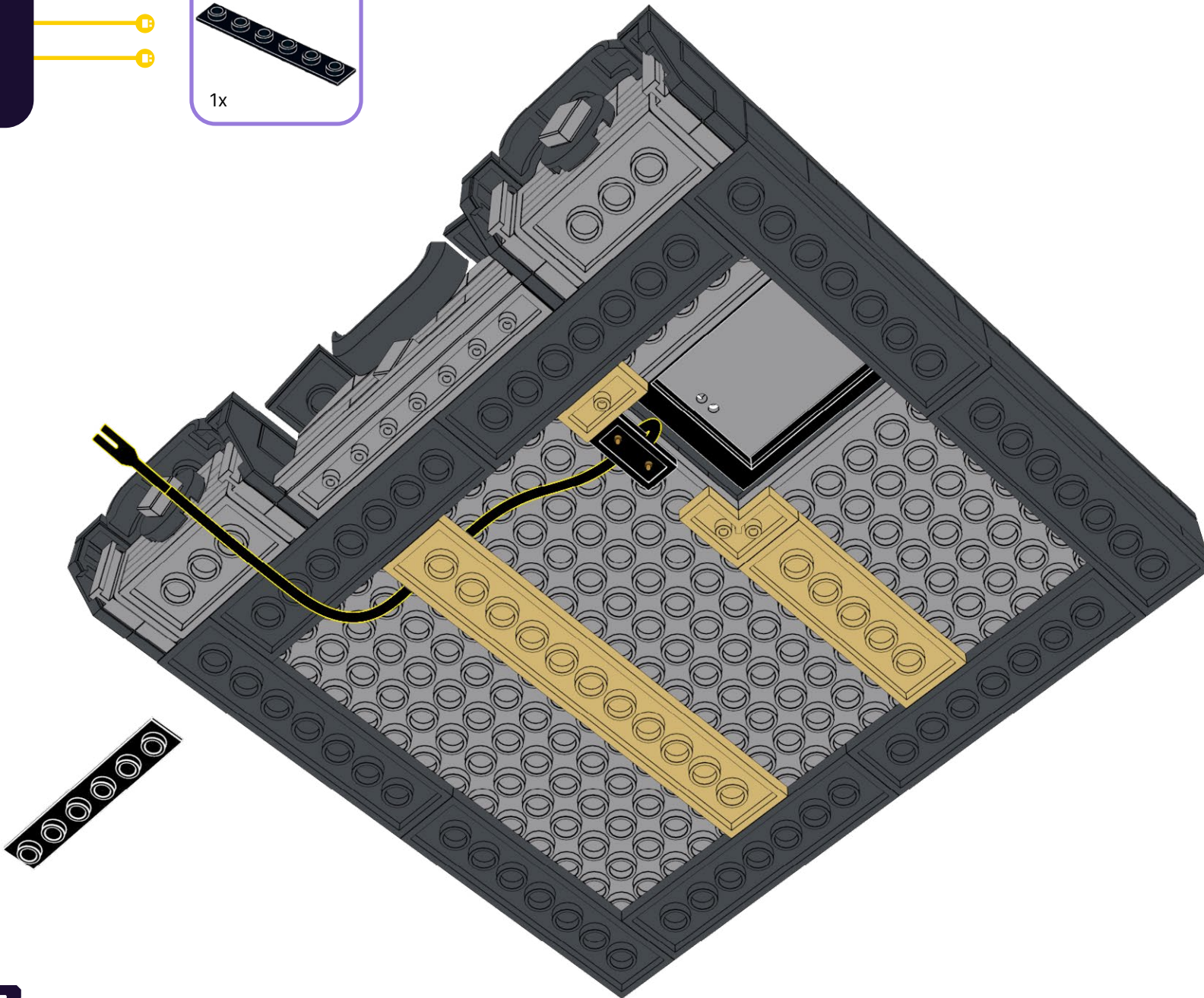

345

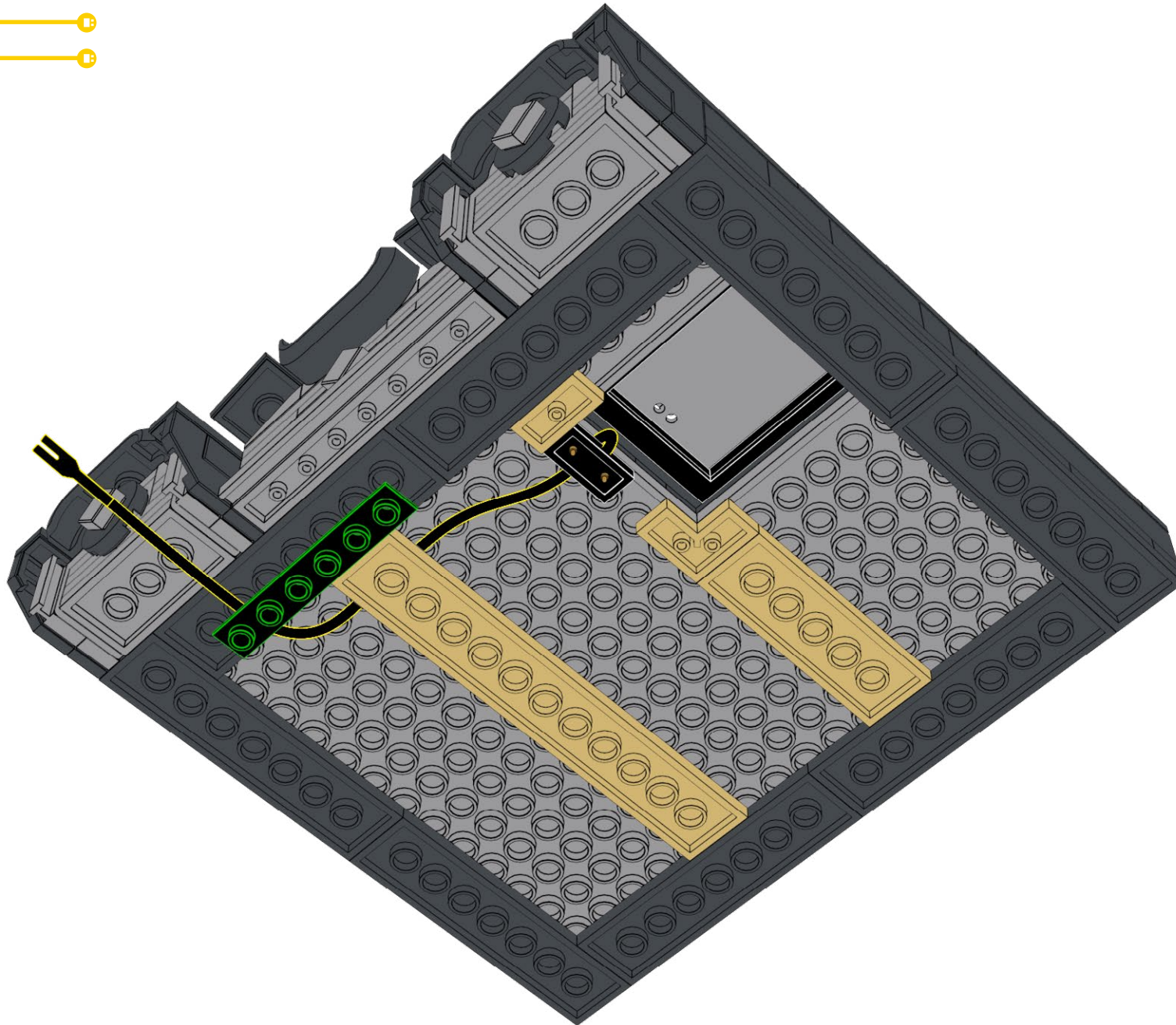

346

ML-WW

1x

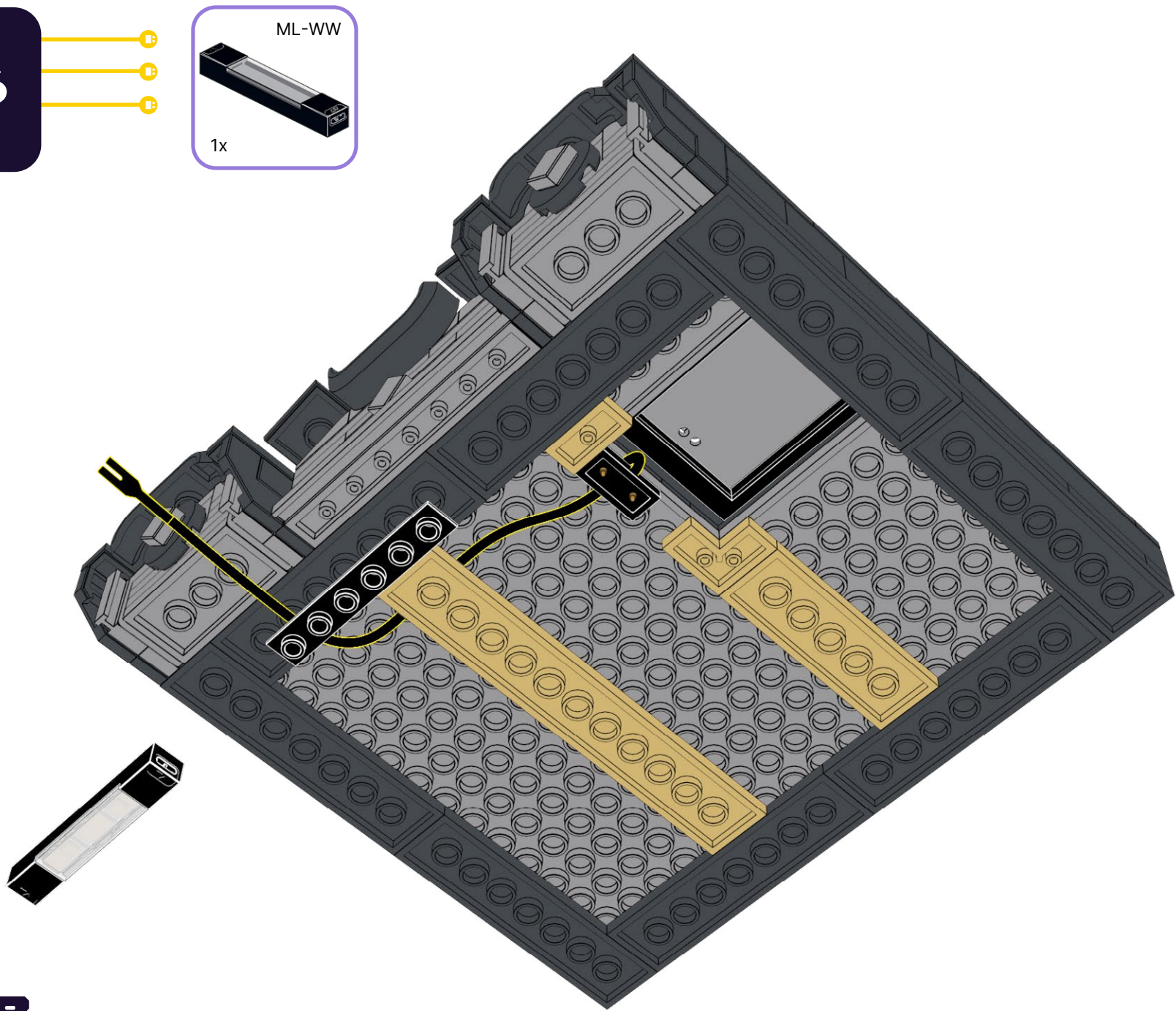

347

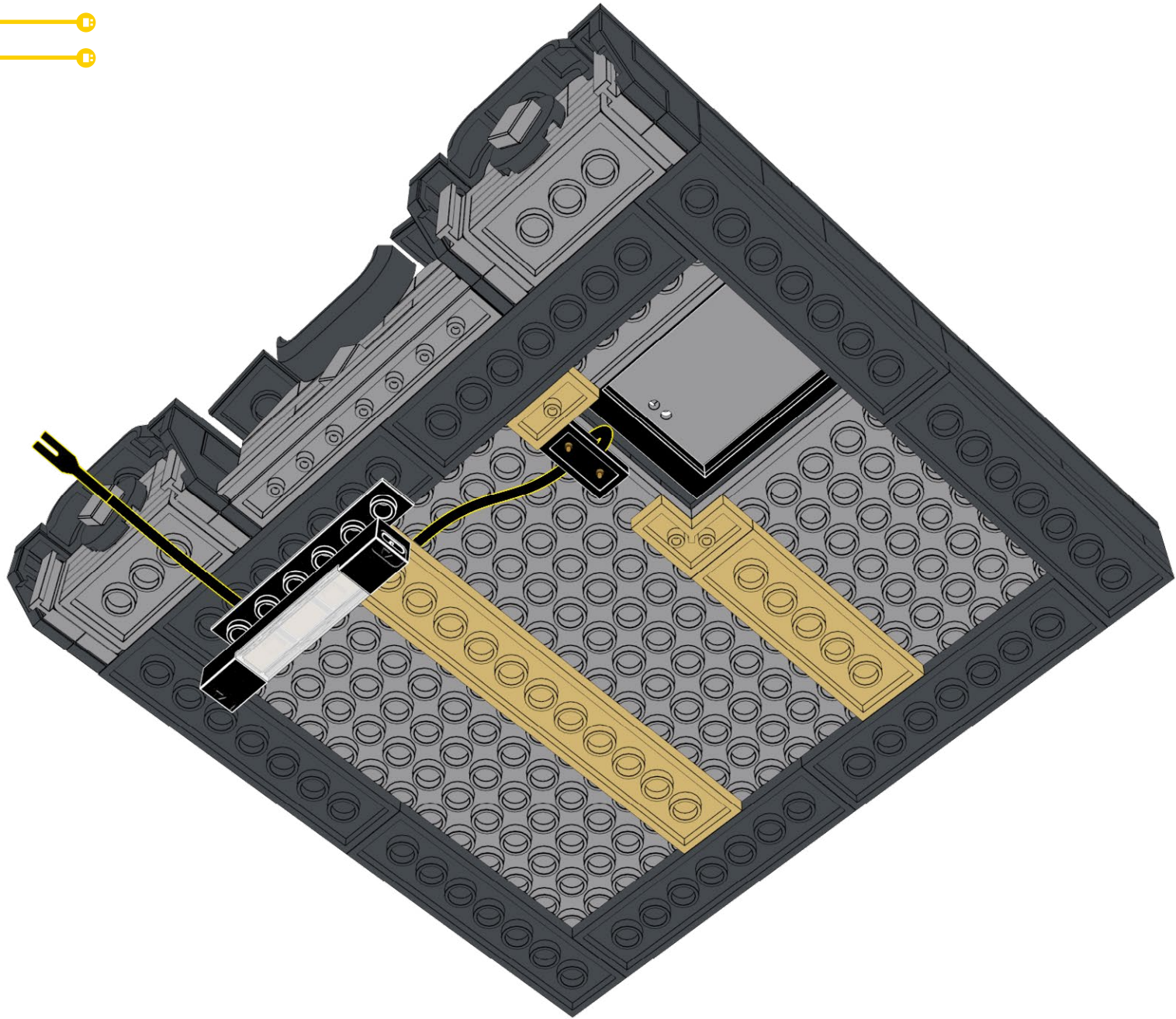

348

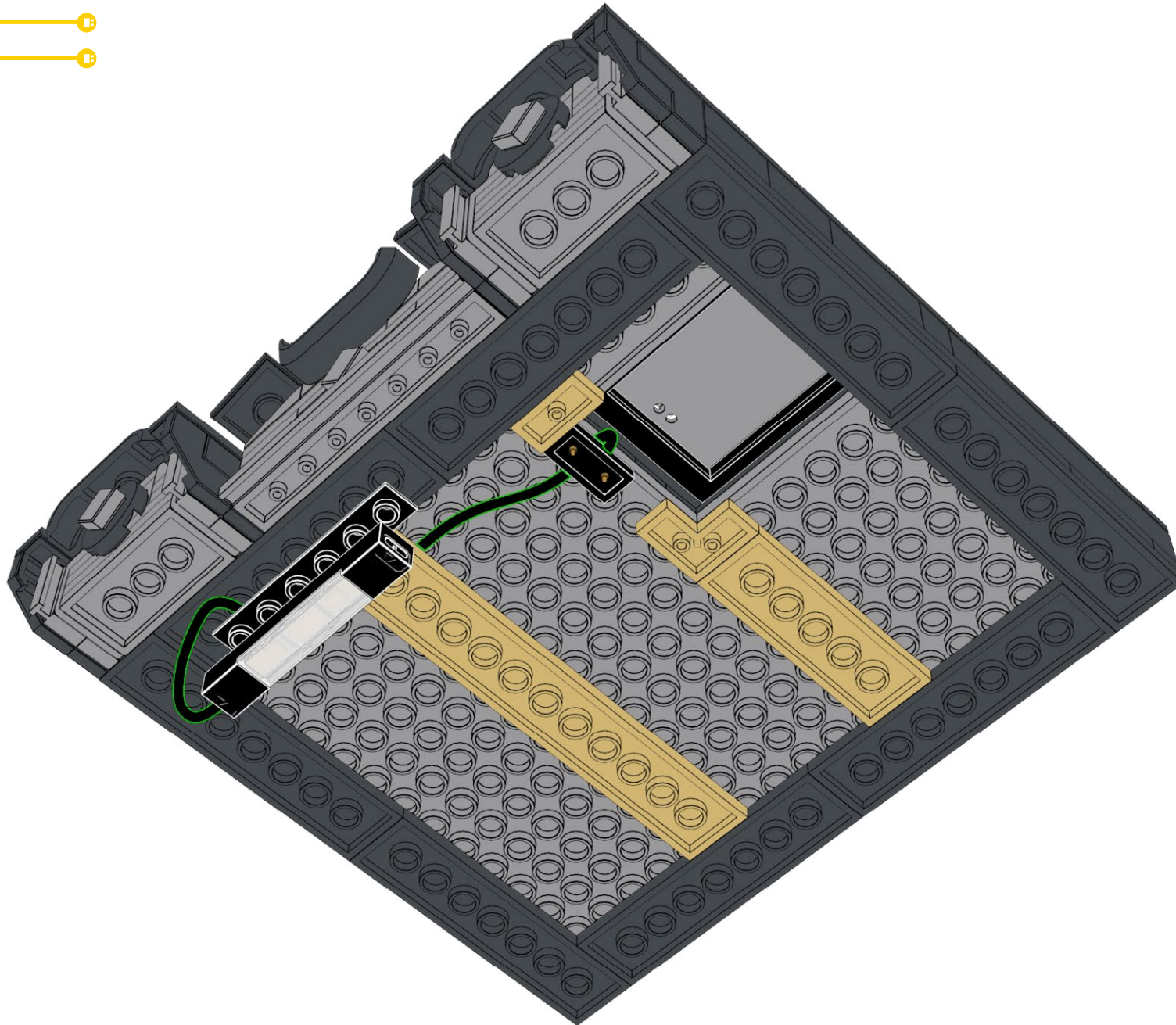

349

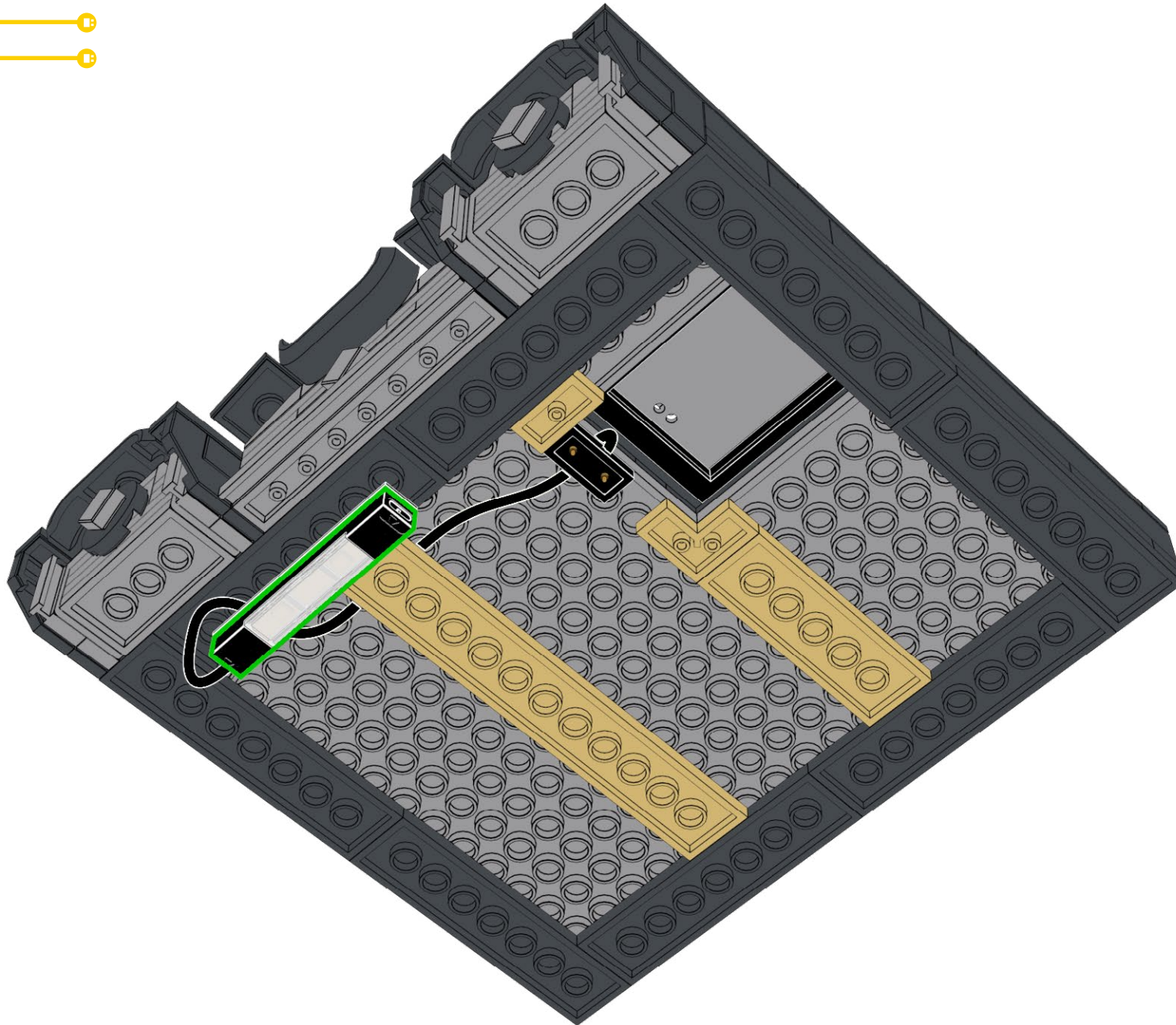

350

T-1x6
1x

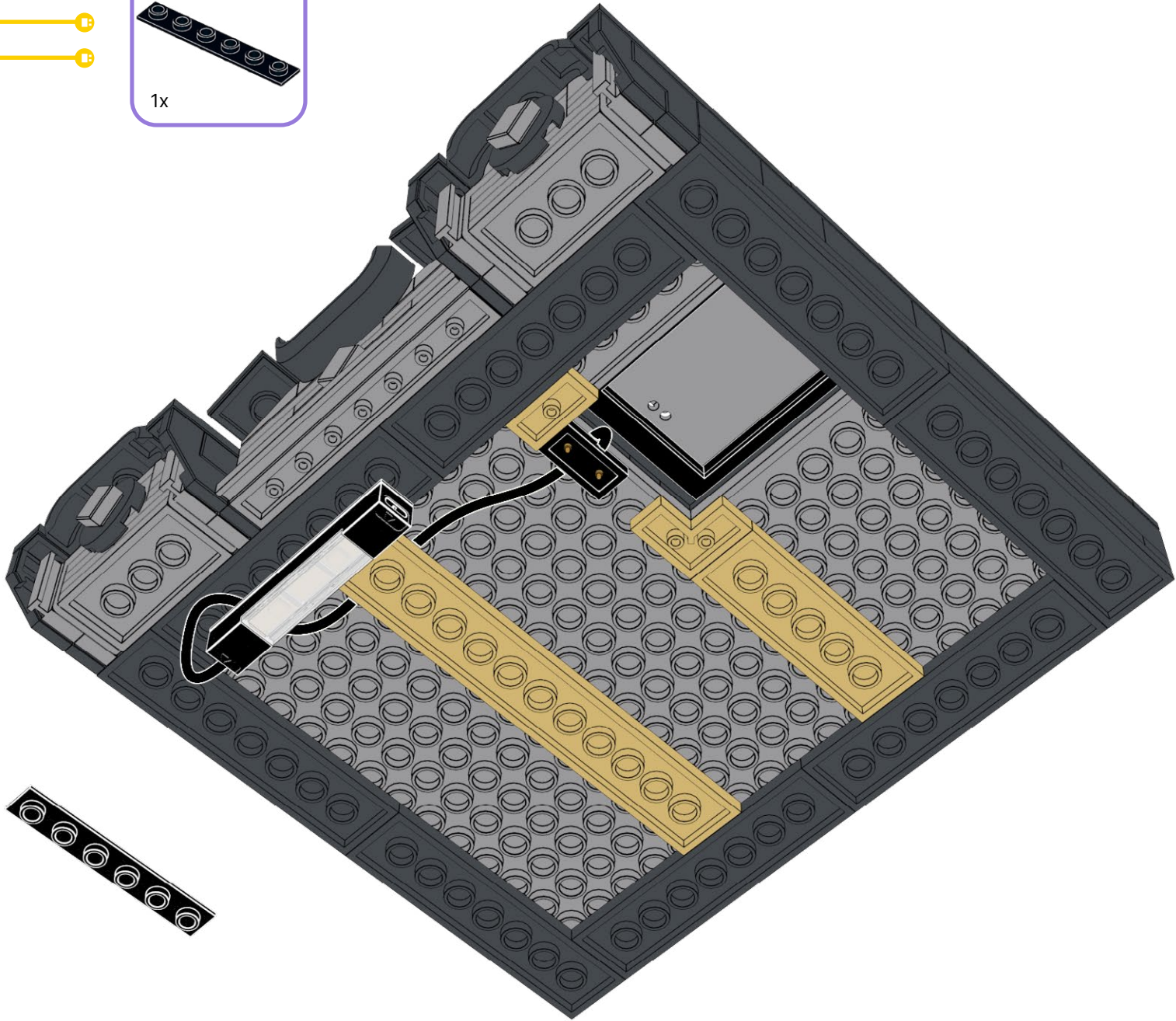

351

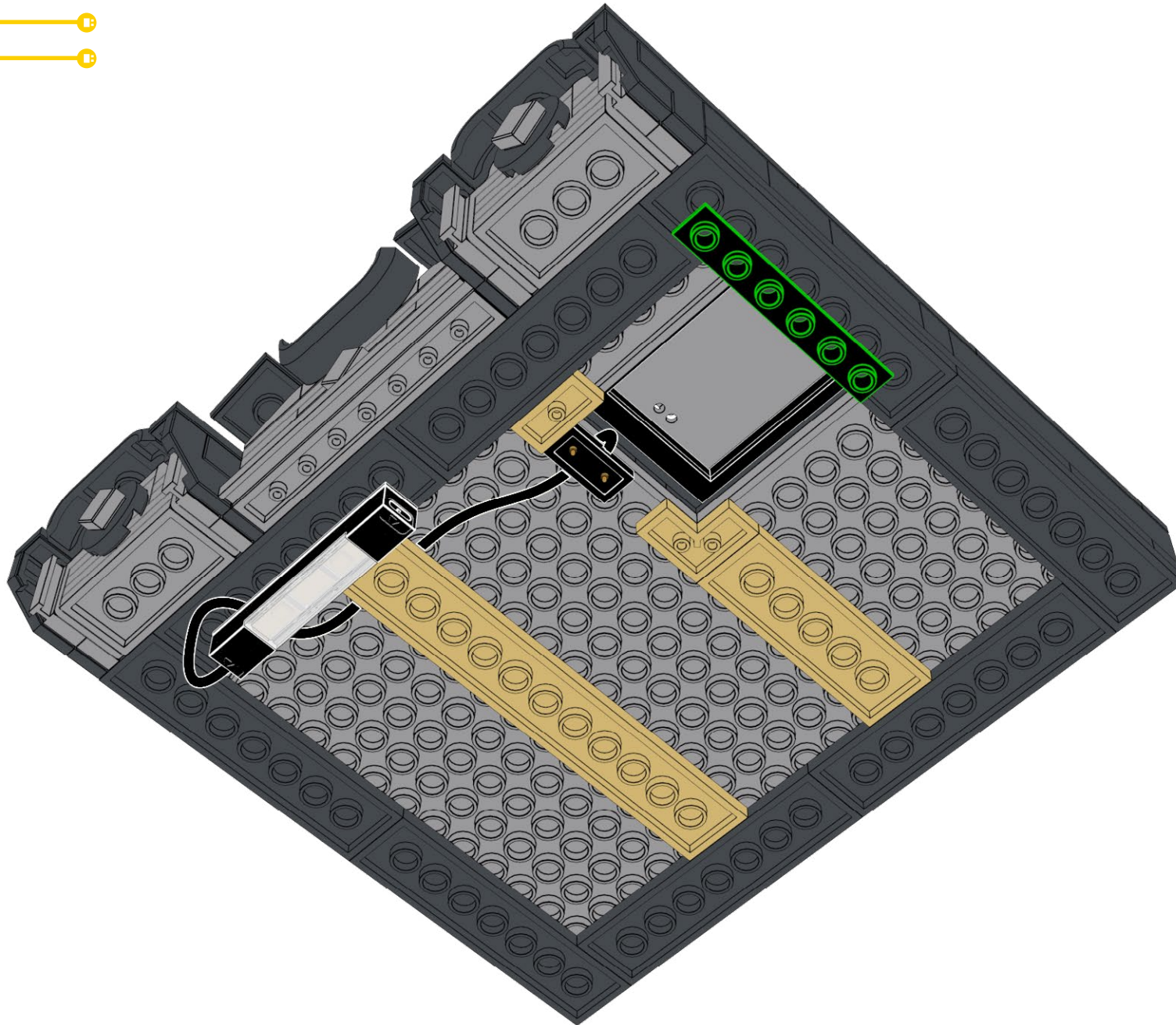

352

ML-WW



1x

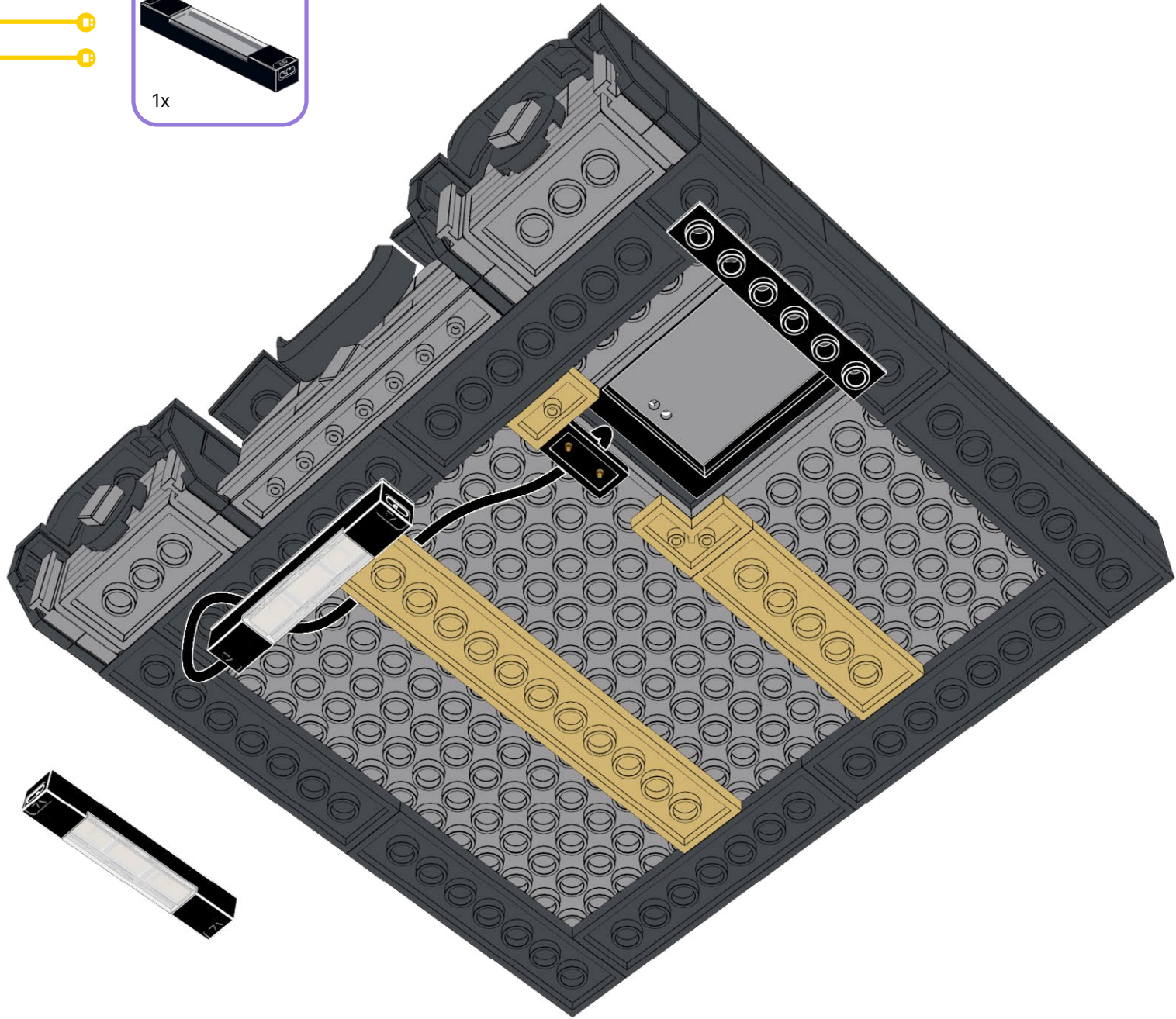

353

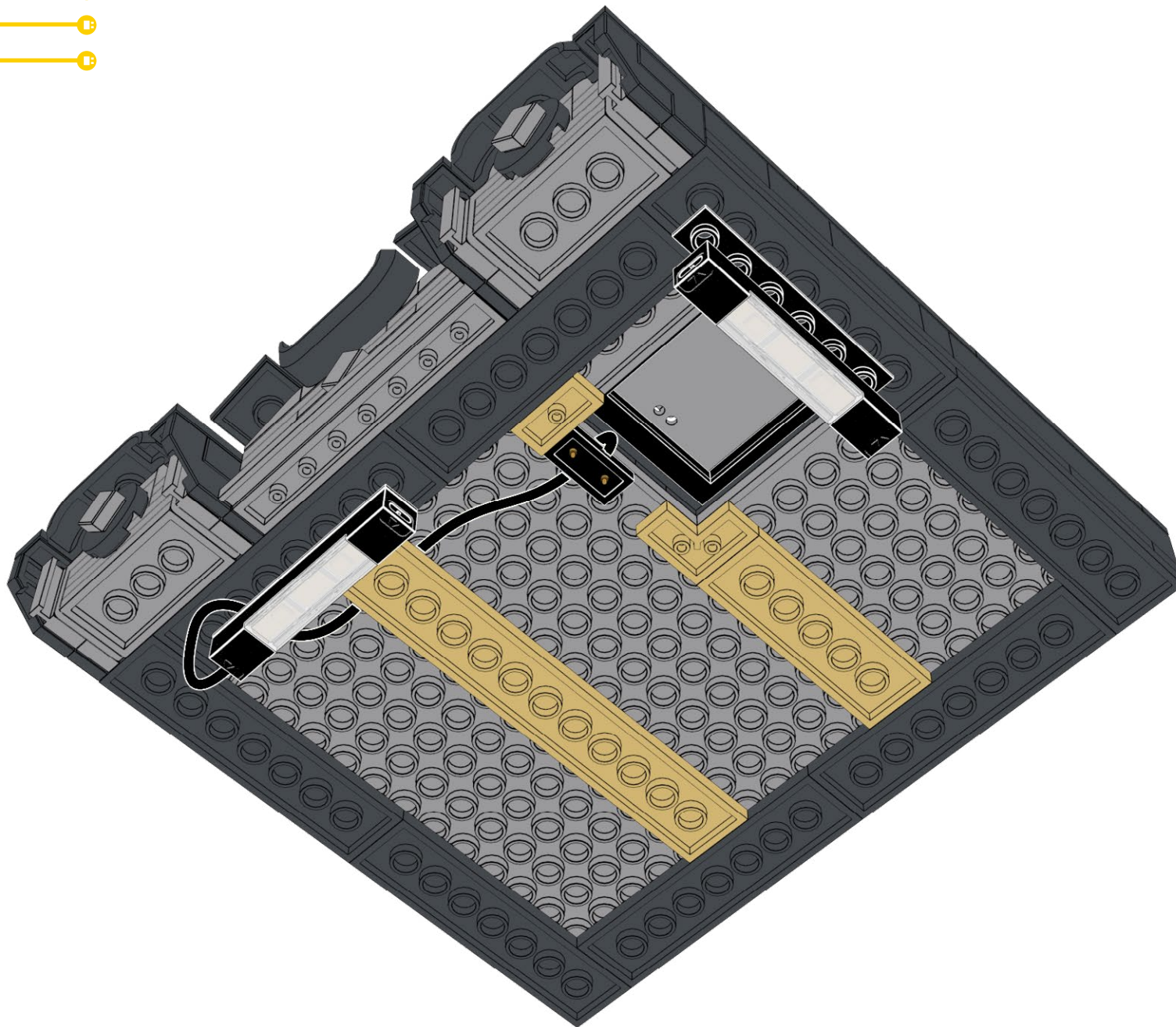

354

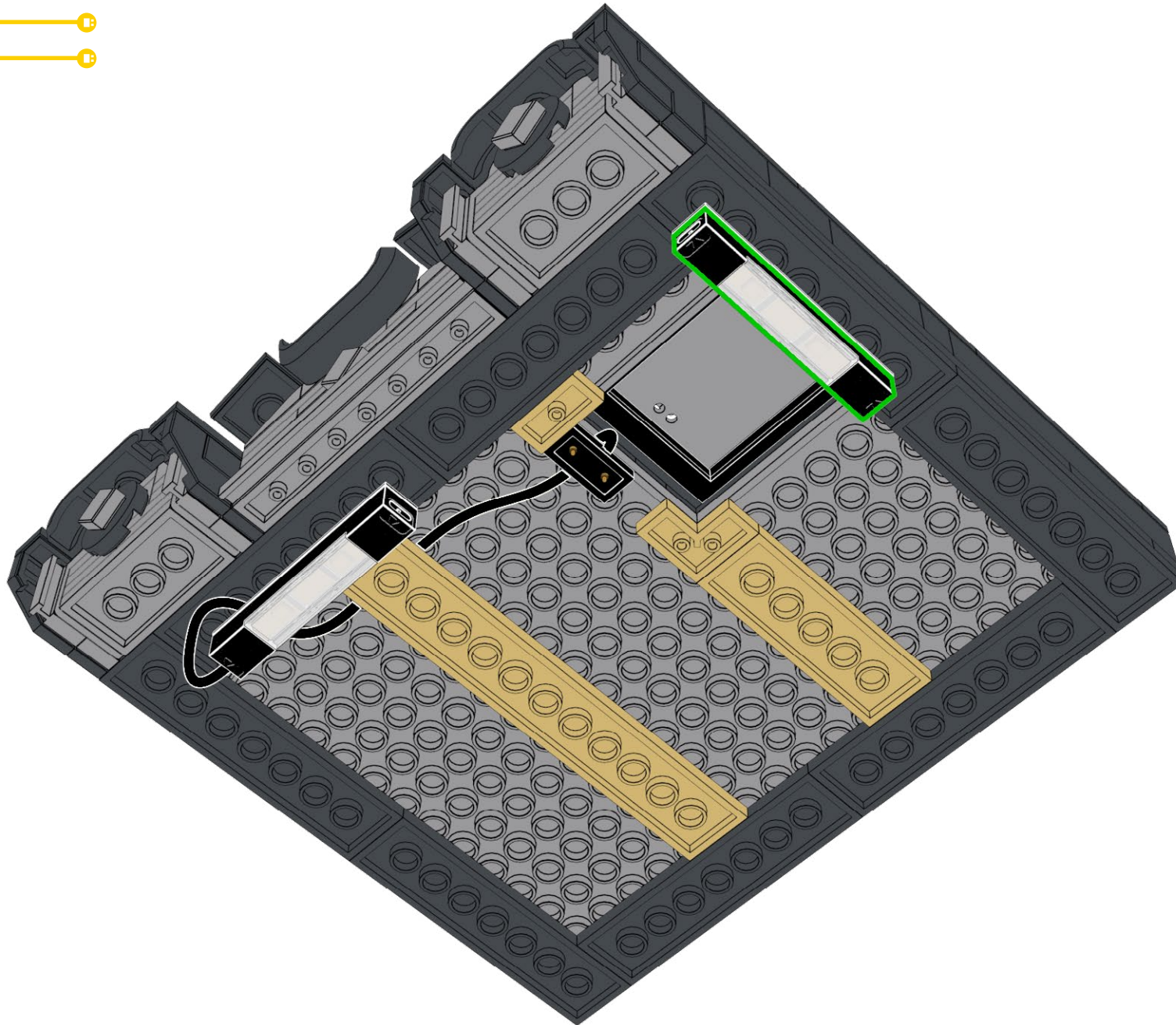

356

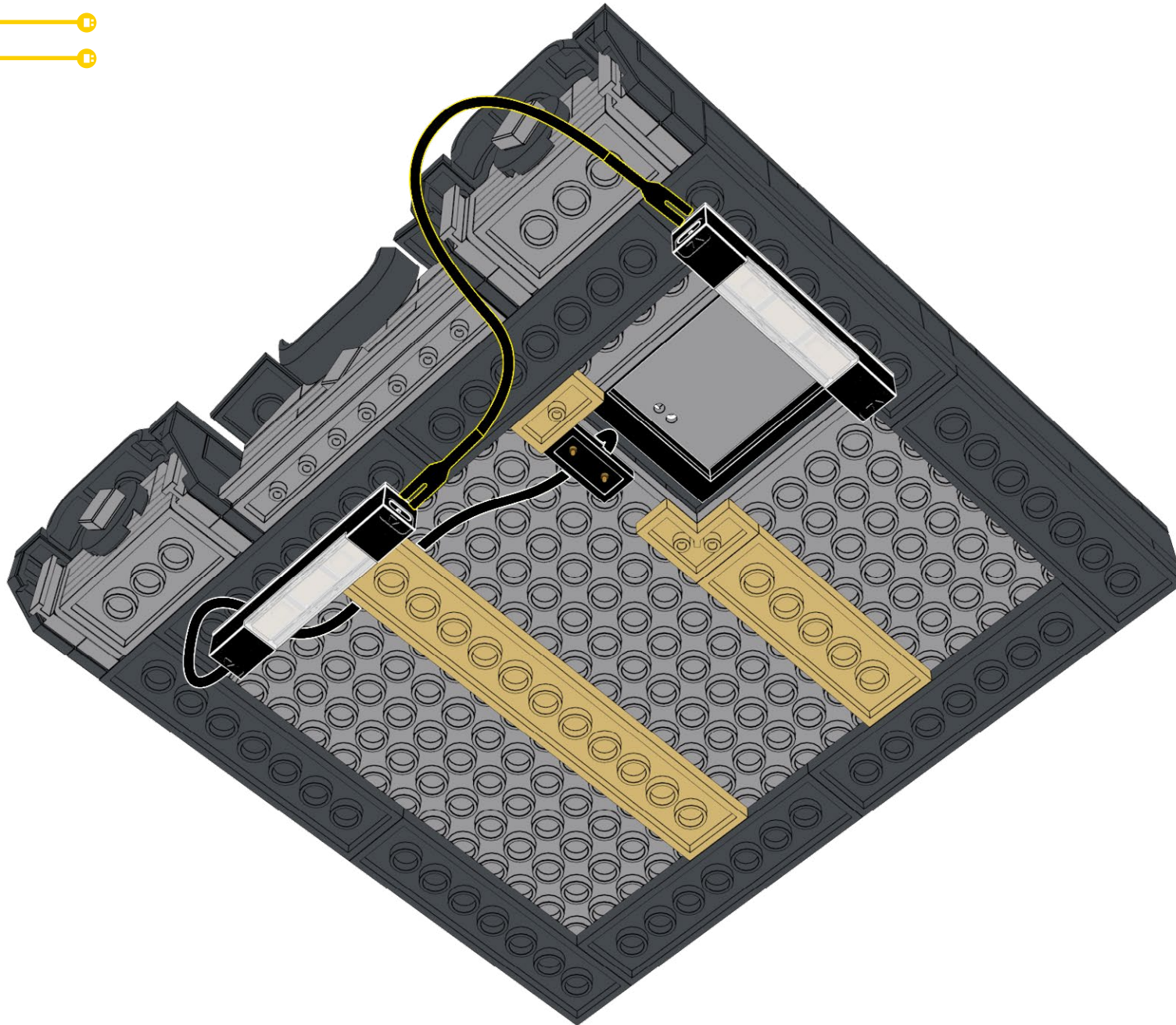

357

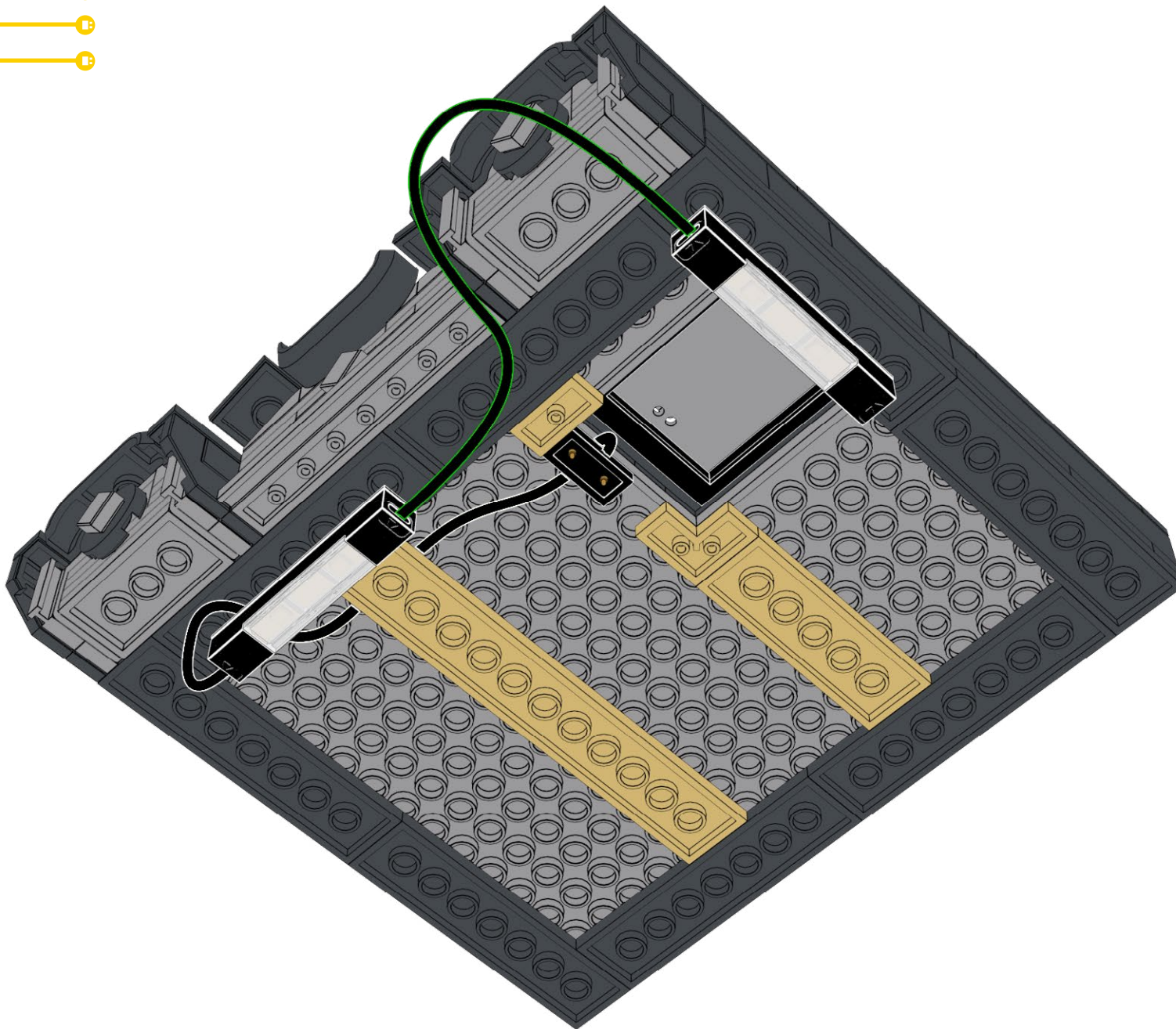

358

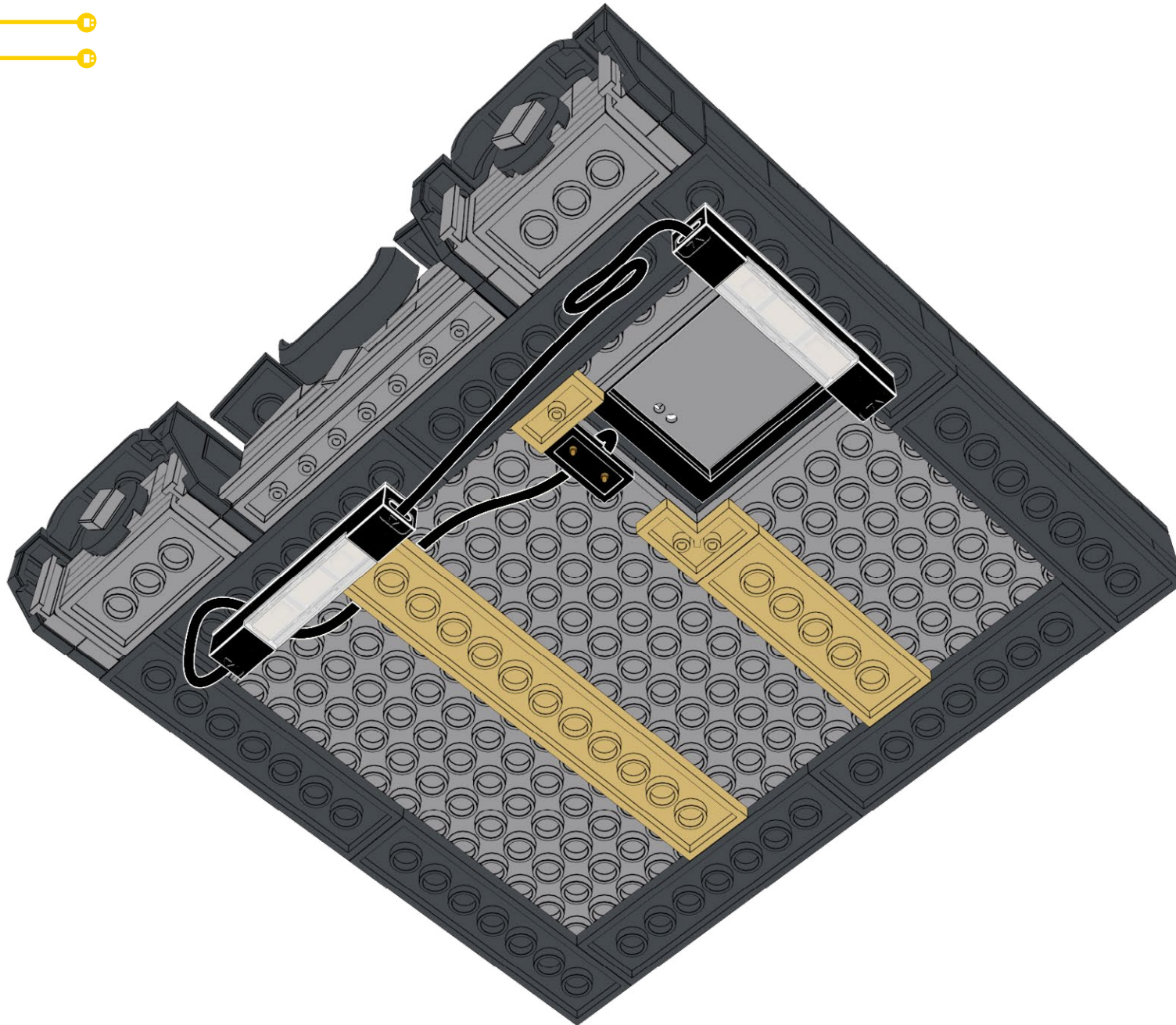

359

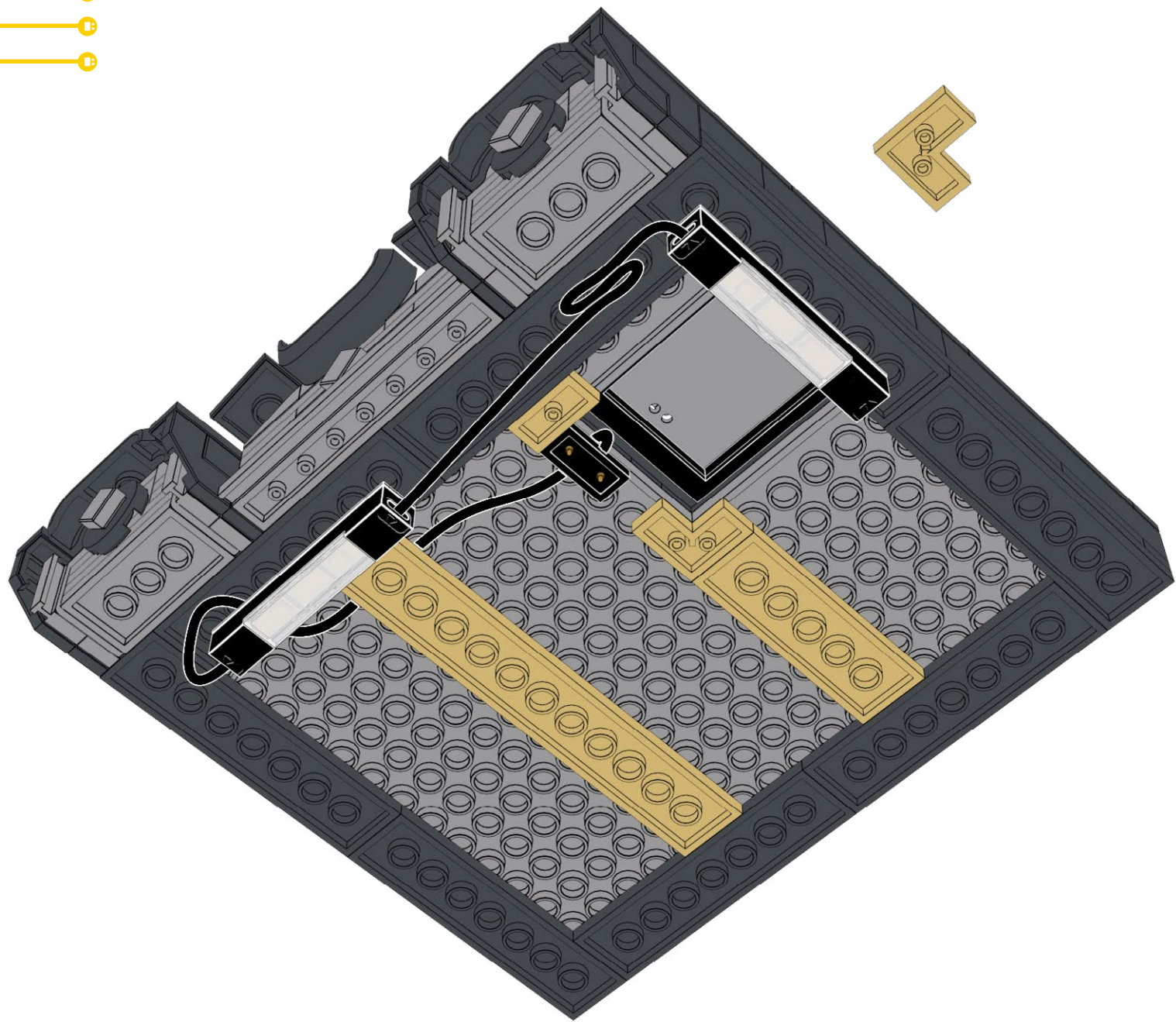

360

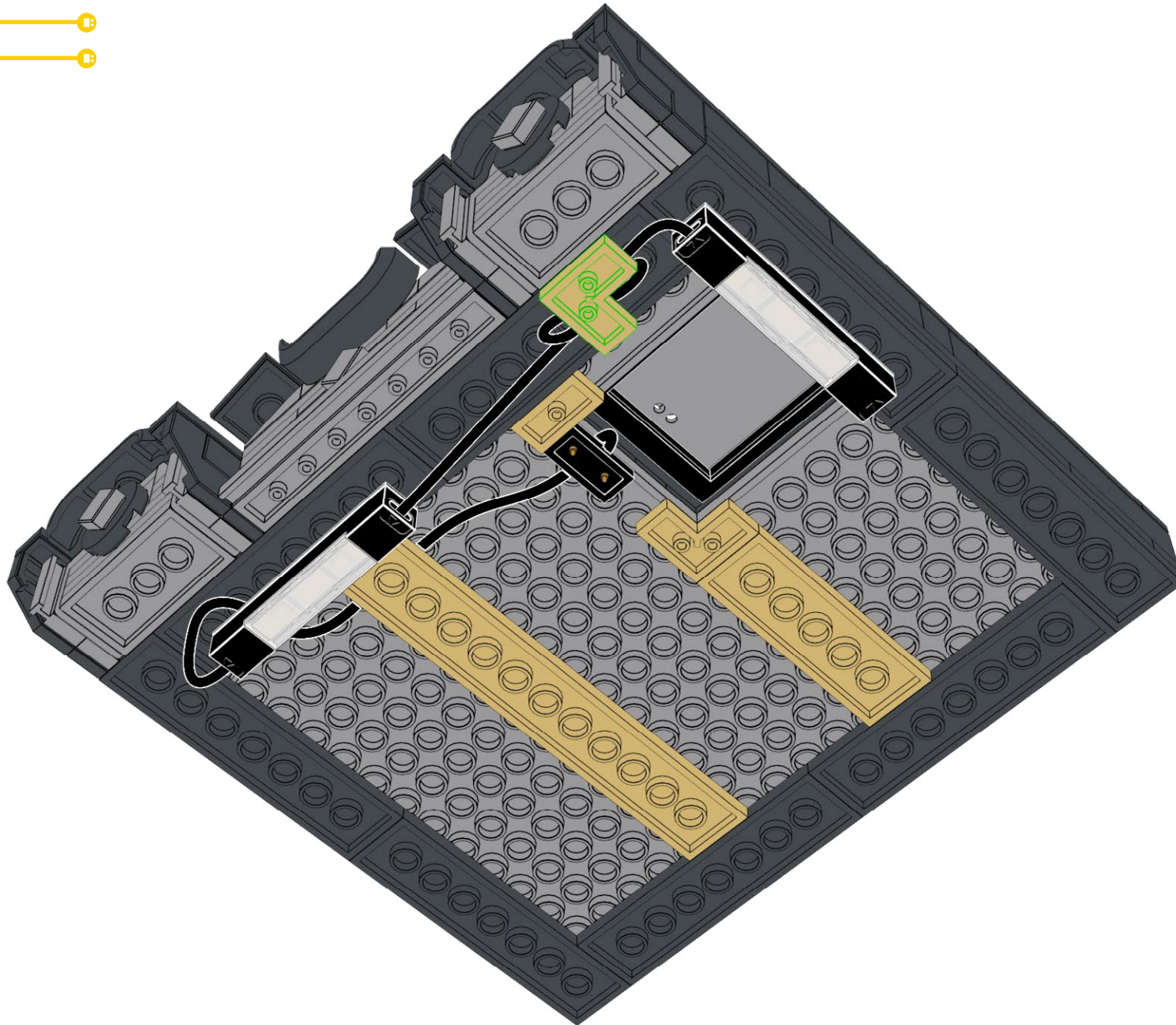

361

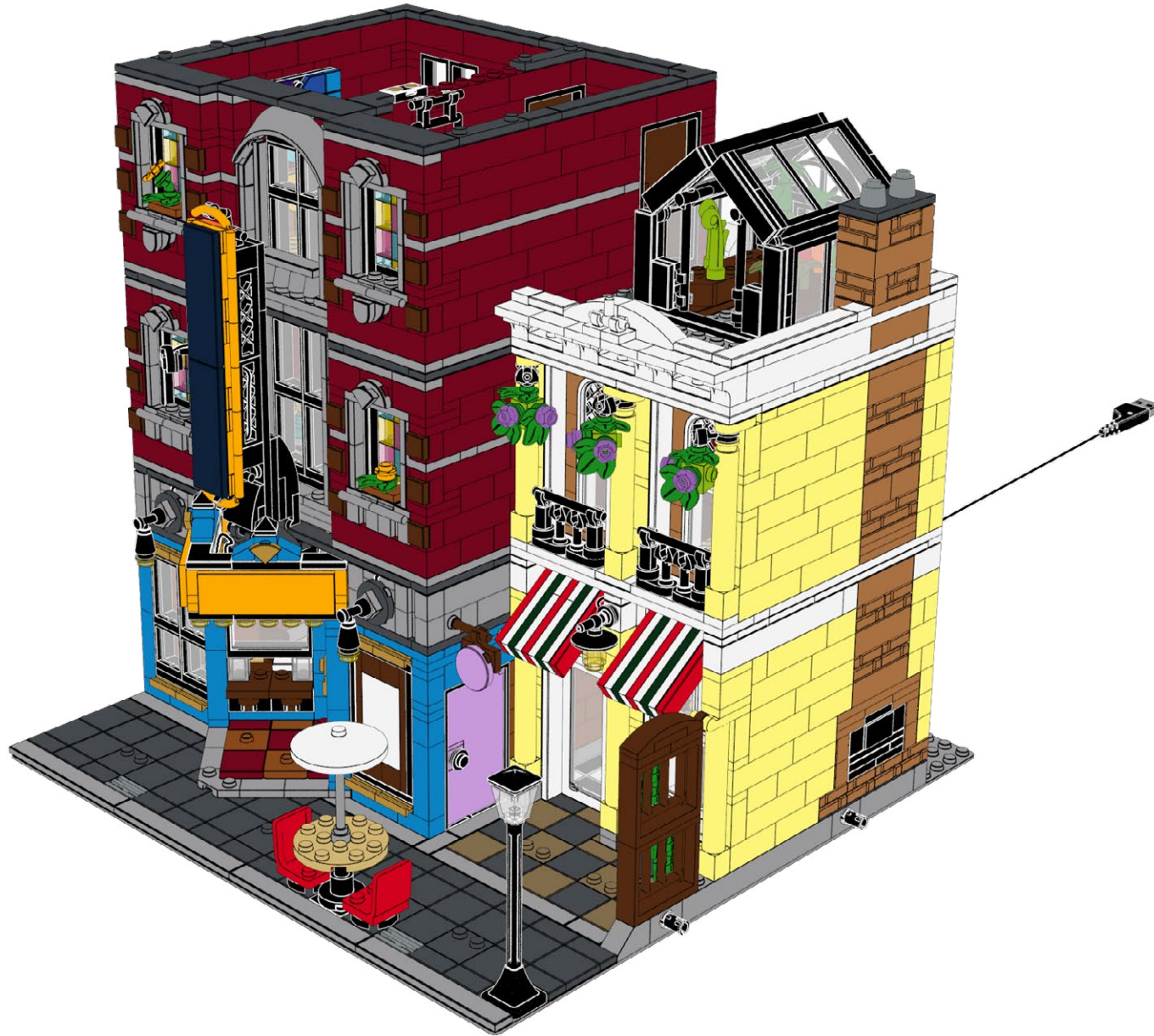

362

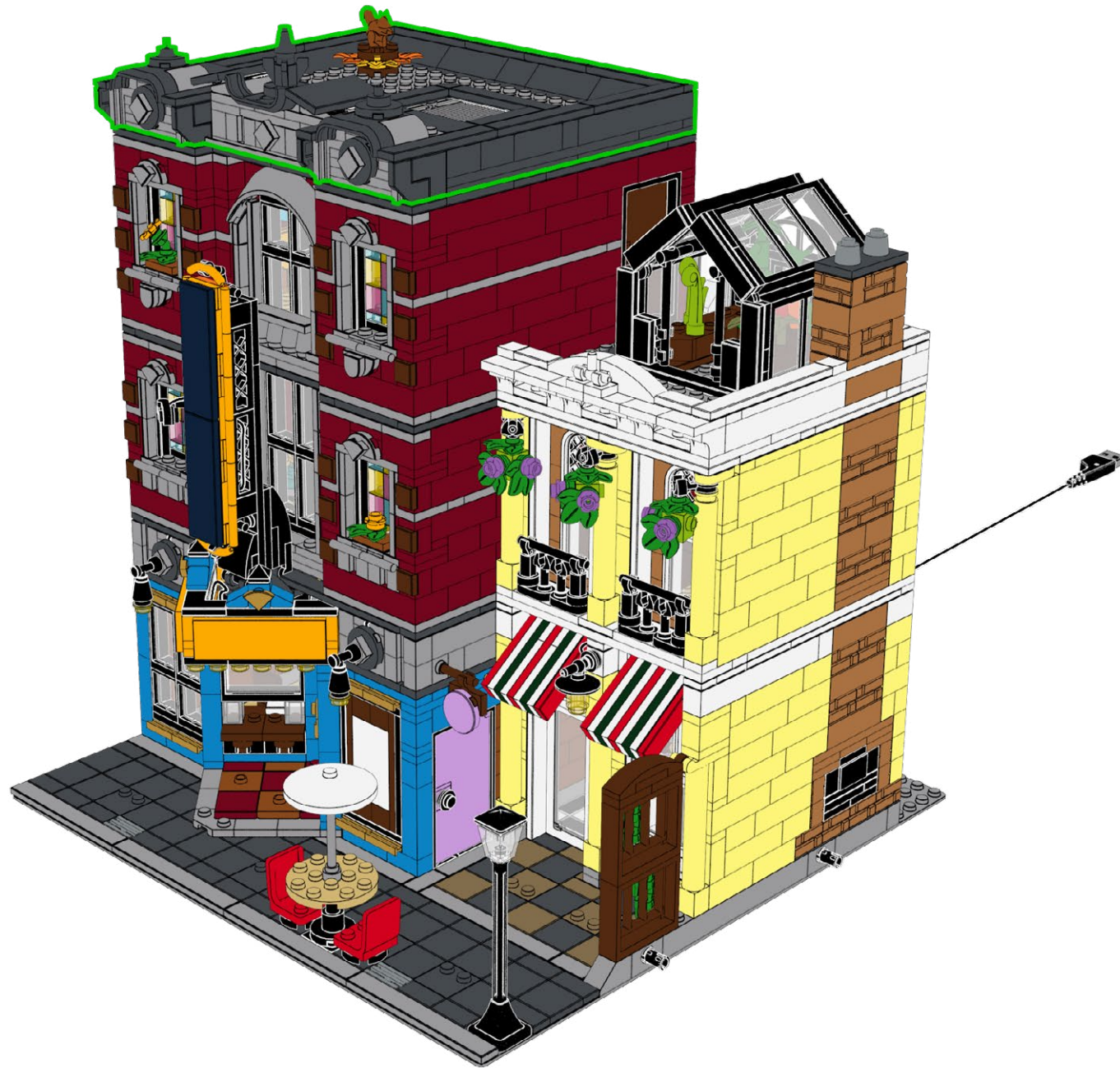

363



364



LIVE MUSIC ALL NIGHT
and magic show

FINAL PRODUCT



PACKAGE CONTENTS



2x AR-WW15
Astro Light Regular
Warm White 15cm



4x FLX-TPB30
Flux Touch Plate B
30cm



1x ALP-30
Astro Lamp Post
30cm



1x AR-WW30
Astro Light Regular
Warm White 30cm



4x FLX-TPA30
Flux Touch Plate A
30cm

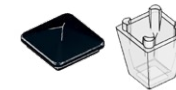

1x Astro Lamp Cap



1x AL-WW30
Astro Light Large
Warm White 30cm



2x B-5
Belt 5cm



1x ML-P
Metero Light
Pink



5x AM-WW15
Astro Light Micro
Warm White 15cm



4x B-15
Belt 15cm



7x T-1x6
Tether 1x6



6x ML-WW
Metero Light
Warm White



1x B-50
Belt 50cm



1x T-1x4

PACKAGE CONTENTS



1x Plate, Round 1x1 with
Open Stud - Black



1x Plate, Round 1x1
with Bar Handle
Black



1x Plate 1x6
Dark Bluish Grey



1x

1x Arm Skeleton, Bent with
Clips (Horizontal Grip) -
Black



1x Plate 2x4
Black



1x FLX-C
Flux Converter



3x Brick, Modified 1x1
with Stud on Side
Light Bluish Grey



1x Brick 1x2
Light Bluish Grey

CONTACT US

Click below for customer support, or general inquiries.

Cliquez ci-dessous pour accéder au support client ou aux renseignements généraux.

Clicca qui sotto per l'assistenza clienti o per richieste generali.

Contact Us



Contactez-nous



Contattaci



Klicken sie unten für kundensupport oder allgemeine anfragen.

Haga clic a continuación para atención al cliente o consultas generales.

点击下方获取客户支持或一般咨询。

Kontaktieren sie uns



Contáctanos



联系我们



TROUBLESHOOTING

If you're stuck, scan the QR code for troubleshooting.

Se sei bloccato, scansiona il codice QR per la risoluzione dei problemi.

Wenn Sie nicht weiterkommen, scannen Sie den QR-Code zur Fehlerbehebung.

Si vous êtes bloqué, scannez le code QR pour le dépannage

Si está atascado, escanee el código QR para solucionar el problema.

如果遇到问题, 请扫描二维码进行故障排除

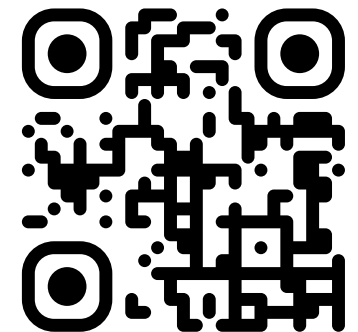



LIGHT MY BRICKS

lightmybricks.com



LEGO® is a trademark of the LEGO Group of companies, which does not sponsor, authorize or endorse this product. All LEGO® sets featured in images are sold separately. This is not a LEGO® product. The LEGO Group is not liable for any loss, injury or damage arising from the use or misuse of this product. ©2024 Light My Bricks Pty Ltd. All rights reserved. www.lightmybricks.com

Our components are designed and packaged in Australia by Light My Bricks Pty Ltd. Components are manufactured in China. 3fl bldg C, Shuanghuan Quanxin Technology Information Industry Park Baolong Street, Longgang District, Shenzhen, China. Imported in Australia by Light My Bricks Pty Ltd, 5/26 Rushdale St, Knoxfield, VIC, 3180, Australia.

WARNING: CHOKING HAZARD - Small parts. Not for children under 3 years.

AVERTISSEMENT : RISQUE D'ÉTOUFFEMENT - Petites pièces. Ne convient pas aux enfants de moins de 3 ans.

ATTENZIONE: PERICOLO DI SOFFOCAMENTO - Piccole parti. Non adatto a bambini di età inferiore a 3 anni.

WARNUNG: ERSTICKUNGSGEFAHR - Kleine Teile. Nicht für Kinder unter 3 Jahren geeignet.

ADVERTENCIA: PELIGRO DE ASFIXIA - Piezas pequeñas. No son apto para niños menores de 3 años.

警告：窒息危險 - 小零件。不适合3岁以下儿童。