

LIGHT KIT INSTALLATION GUIDE

PORSCHE 911

FOR LEGO
SET
#10295

CONTENTS



03

Getting Started

- 04 Legend
- 05 Component Handling
- 06 Blueprint

07

Instructions

- 07 LEGO Bag 1
- 45 LEGO Bag 2
- 116 LEGO Bag 3 - LMB Bag 02
- 161 LEGO Bag 4 - LMB Bag 01
- 196 LEGO Bag 5
- 275 LEGO Bag 6
- 327 LEGO Bag 7
- 396 Turbo:
 - LEGO Bag 8
 - LEGO Bag 9
- 485 Targa:
 - LEGO Bag 8
 - LEGO Bag 10

551

Final Product

- 552 Package Contents
- 553 Contact & Troubleshooting

GETTING STARTED



Bold, beautiful and bright, Light My Bricks elevates your favourite LEGO set from knick-knack to statement piece. Create a talking point at home or in the office that speaks to your passions with Light My Bricks. To learn more, click below.

[Learn More](#)



Audacieux, beau et lumineux, Light My Bricks élève votre ensemble LEGO préféré du statut de bibelot à celui de pièce maîtresse. Que ce soit à la maison ou au bureau, partagez votre passion des LEGO avec Light My Bricks. Cliquez ci-dessous pour en savoir plus.

[En savoir plus](#)



Audace, bello e luminoso, Light My Bricks eleva il tuo set LEGO preferito da soprammobile a pezzo di tendenza. Crea un punto di discussione a casa o in ufficio che parli alle tue passioni con Light My Bricks. Per saperne di più, clicca qui sotto.

[Ulteriori Informazioni](#)



Mutig, schön und hell – Light My Bricks verwandelt Ihr Lieblings-LEGO-Set von einem schnickschnack in ein statement-stück. Schaffen sie einen gesprächspunkt zu hause oder im büro, der Ihre leidenschaften widerspiegelt, mit Light My Bricks. Um mehr zu erfahren, klicken sie unten.

[Mehr erfahren](#)



Audaz, hermoso y brillante, Light My Bricks eleva tu set LEGO favorito de una chuchería a una pieza llamativa. Crea un tema de conversación en casa o en la oficina que hable de tus pasiones con Light My Bricks. Para obtener más información, haga clic a continuación.

[Más información](#)



大胆、美丽而明亮，Light My Bricks 将你喜爱的乐高套装从小摆件提升为引人注目的装饰品。在家或办公室打造一个能表达你激情的话题，了解更多，请点击下方。

[了解更多](#)



LEGEND

Rotate Set



Retournez L'ensemble
Ruota Set
Set Drehen
Rotar Conjunto
旋转套件

Add Part



Ajoutez une Pièce
Aggiungi Parte
Teil Hinzufügen
Agregar Pieza
添加零件

Click



Cliquez
Clic
Klicken
Clic
点击

Pinch/Fold



Pincez/Pliez
Pizzicare/Piegare
Kneifen/Falten
Pellizcar/Doblar
折叠

Pull Cable



Tirez le Cable
Tirare il Cavo
Kabel Ziehen
Tirar del Cable
拉动电缆

Repeat Step



Répétez
Ripetere
Wiederholen
Repetir
重复

Sticker



Autocollant
Adesivo
Aufkleber
Pegatina
贴纸

Power On Test



Test de mise sous tension
Test di Potenza
Stromtest
Prueba de Energía
电源测试

Disconnect Power



Débranchez L'alimentation
Scollegare L'alimentazione
Strom Trennen
Desconectar la Energía
断开电源

Troubleshoot



Dépanner
Risolvere
Fehlerbehebung
Solución de Problemas
故障排除

COMPONENT HANDLING

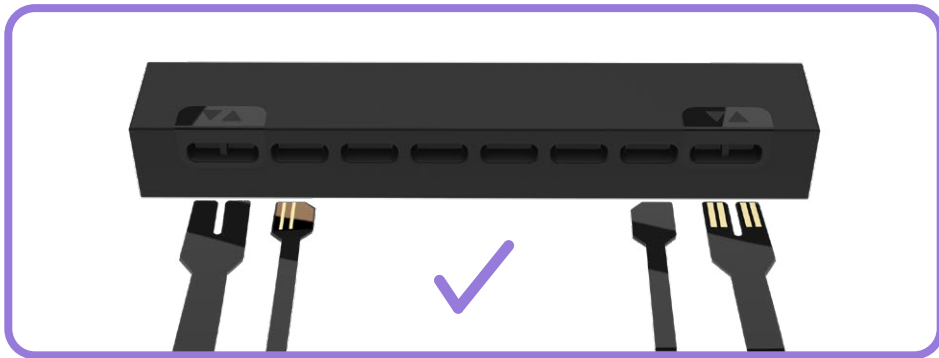
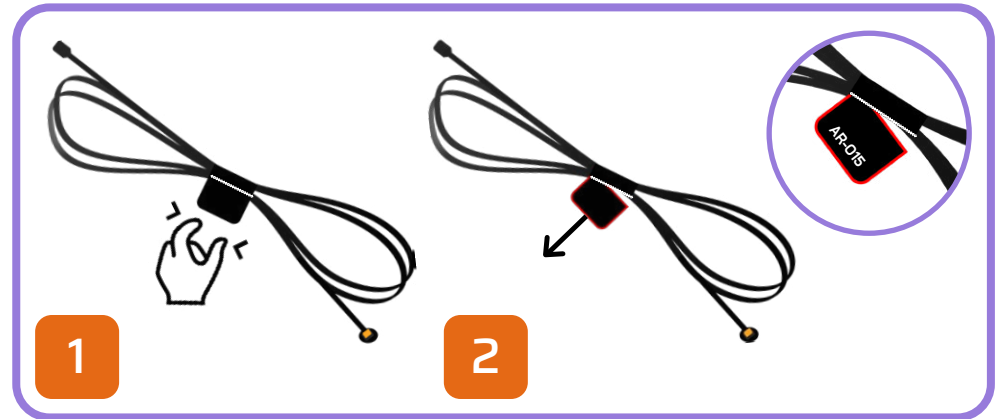
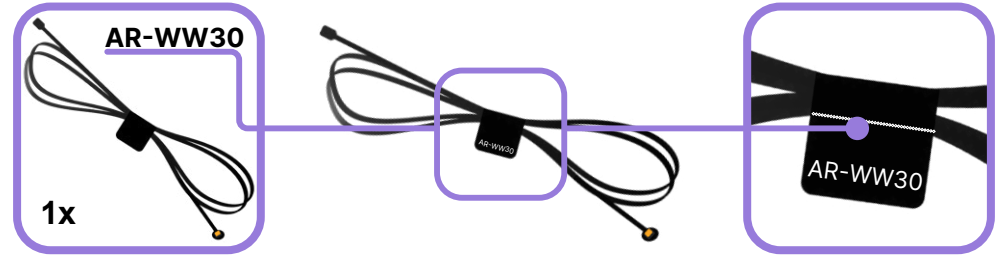
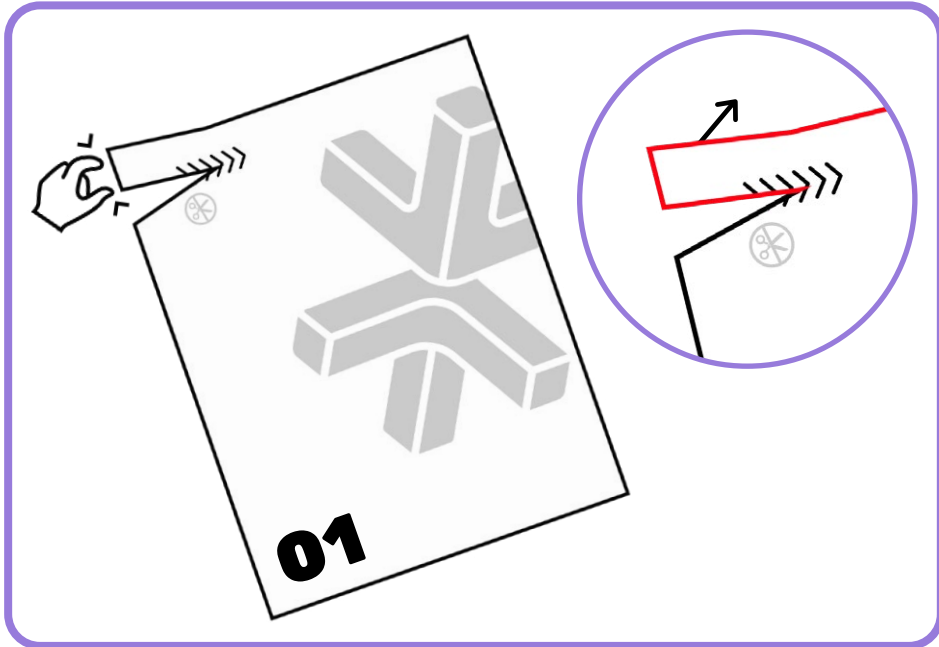

BLUEPRINT

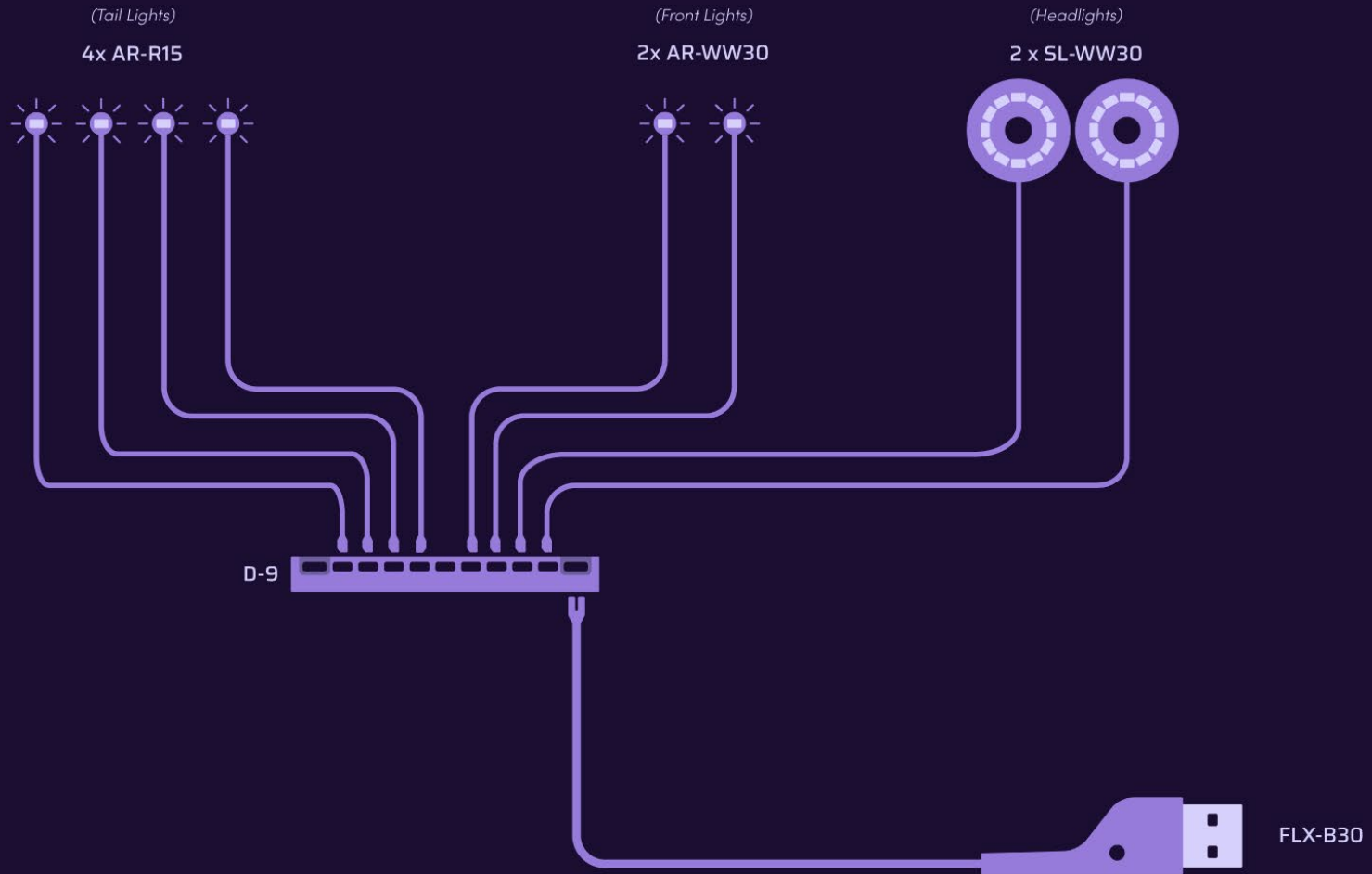

**HOLD UP!**

You might notice some bags aren't in order, as well as left over pieces, but that's ok! We're changing the way you build LEGO!

ATTENDEZ!

Vous remarquerez peut-être que certains sacs, ainsi que certaines pièces, ne sont pas dans le bon ordre. Mais pas de panique! Nous changeons simplement la façon avec laquelle vous construisez vos LEGO!

ASPETTA!

Potresti notare che alcuni sacchetti non sono in ordine, così come i pezzi avanzati, ma va bene così! Stiamo cambiando il modo in cui costruisci i LEGO!

HALT!

Sie werden möglicherweise bemerken, dass einige tüten durcheinander sind und teile übrig bleiben, aber das ist in Ordnung! Wir ändern die art und weise, wie Sie LEGO bauen!

¡ESPERA!

Es posible que notes que algunas bolsas están fuera de servicio, así como piezas sobrantes, ¡pero está bien! ¡Estamos cambiando la forma en que construyes LEGO!

暫停!

你可能会注意到一些袋子顺序错乱, 以及一些剩余的部件, 但没关系! 我们正在改变你搭建乐高的方式!

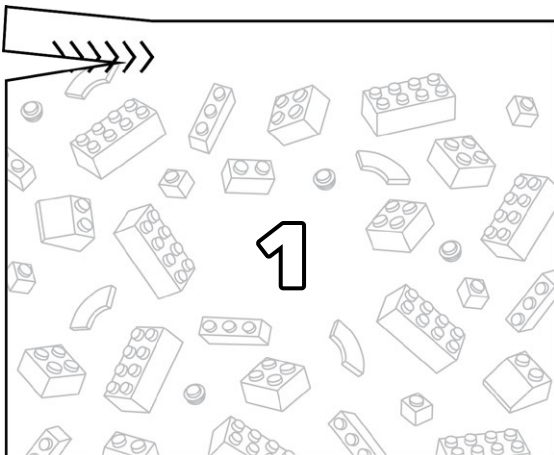
Open LEGO® Bag 1

1

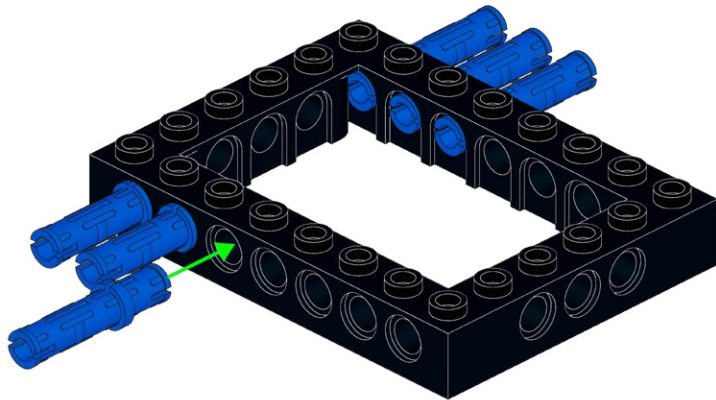
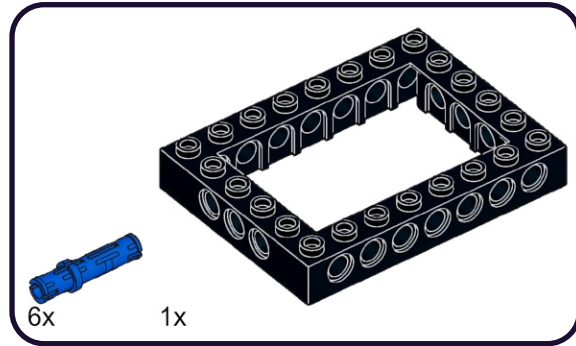

2

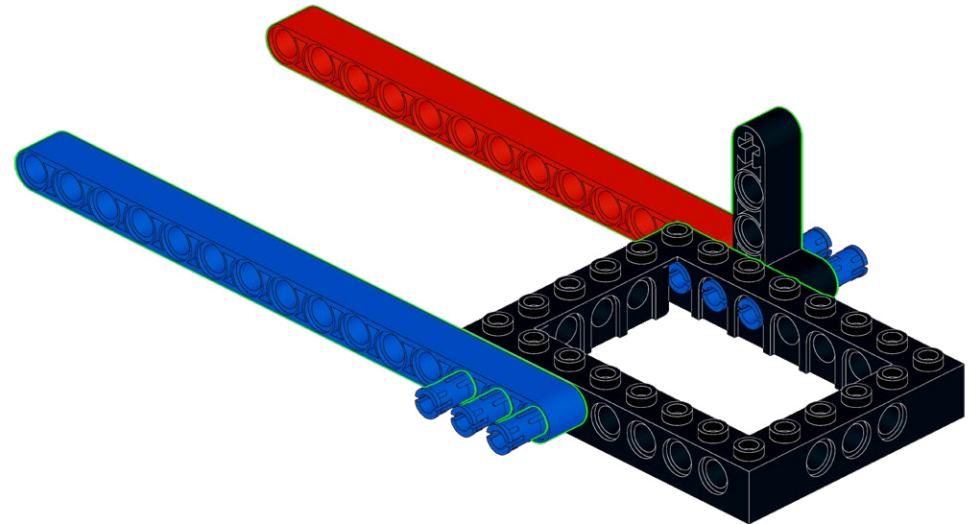
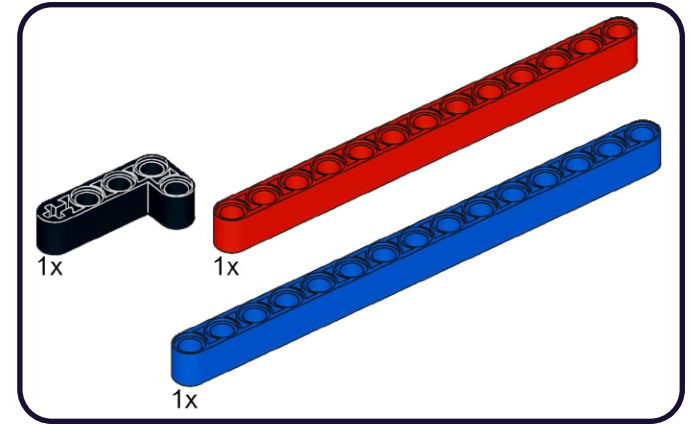

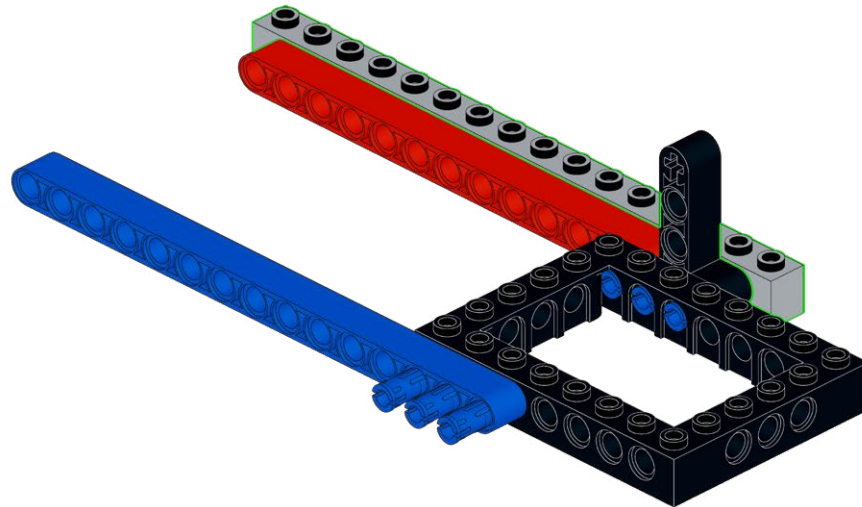
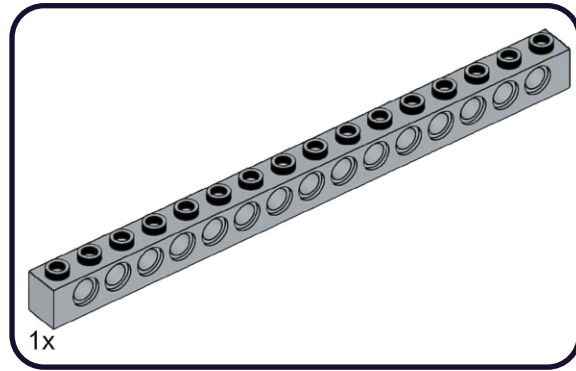

4

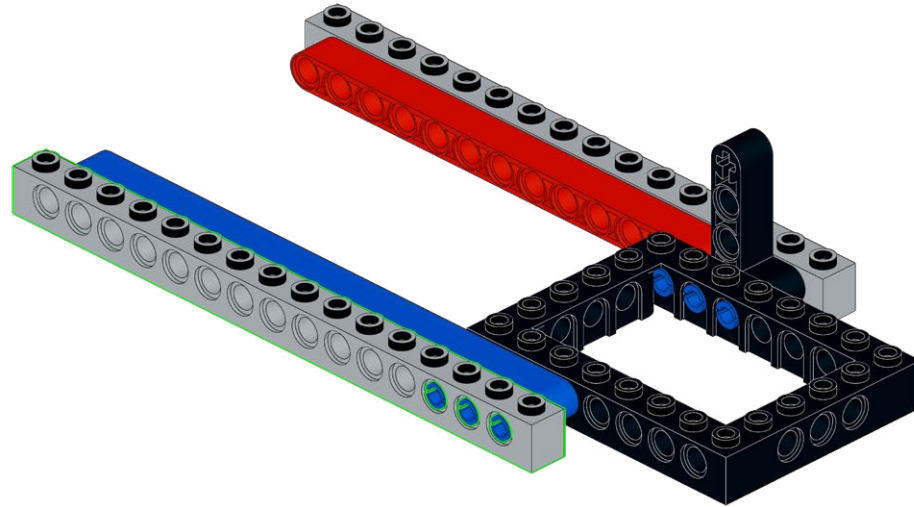
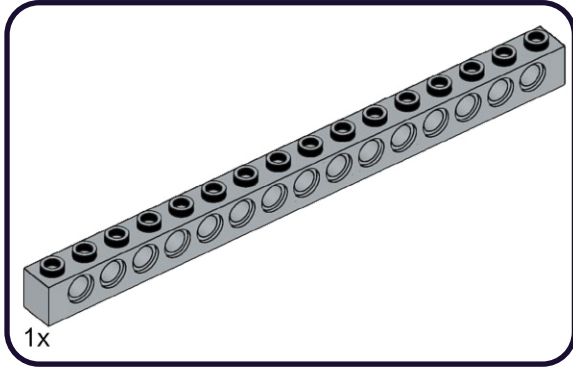

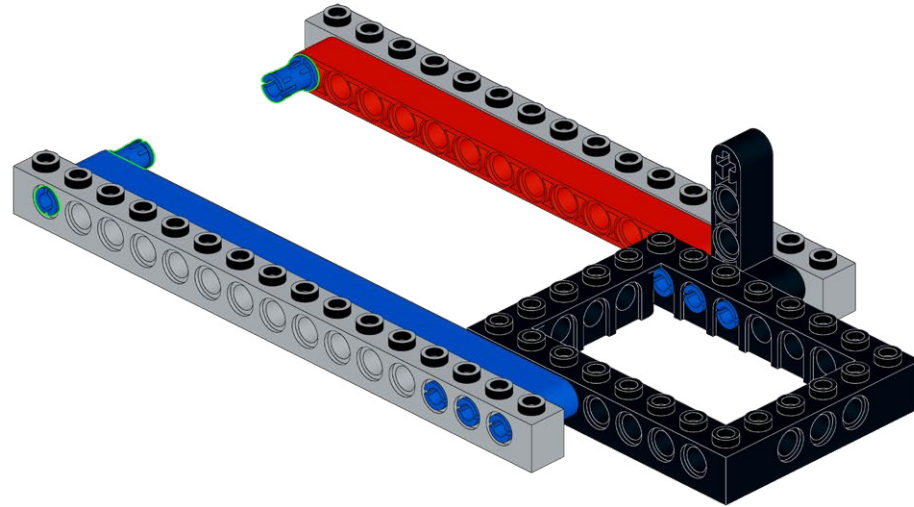
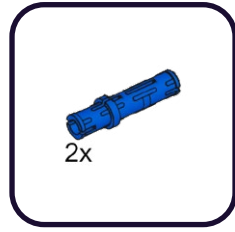

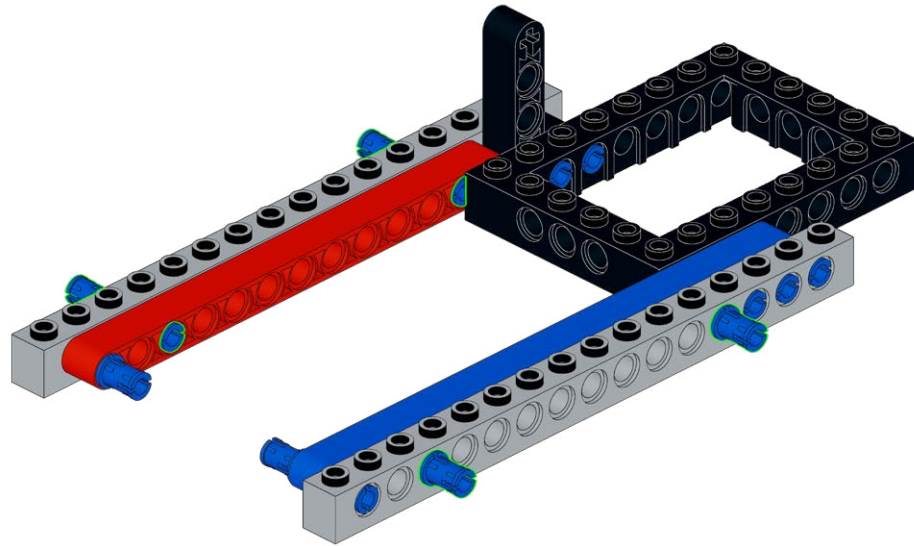
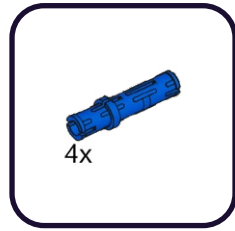
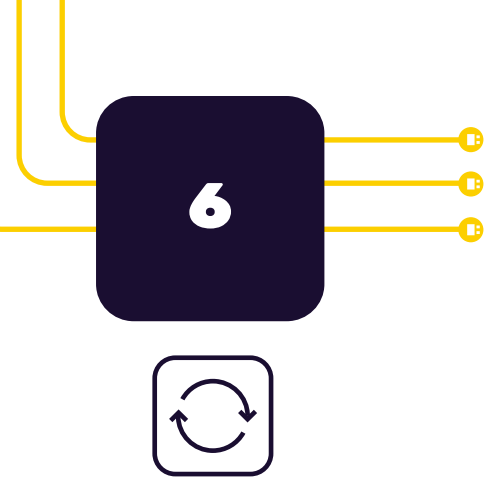

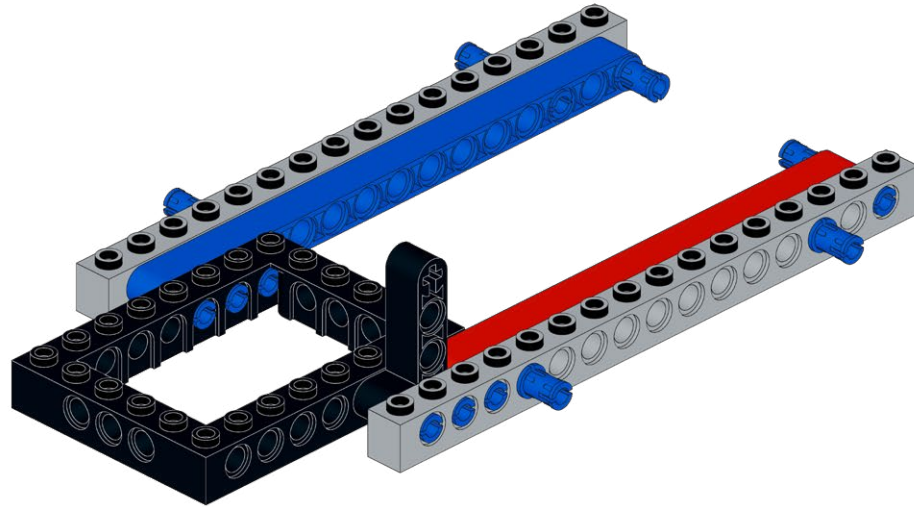

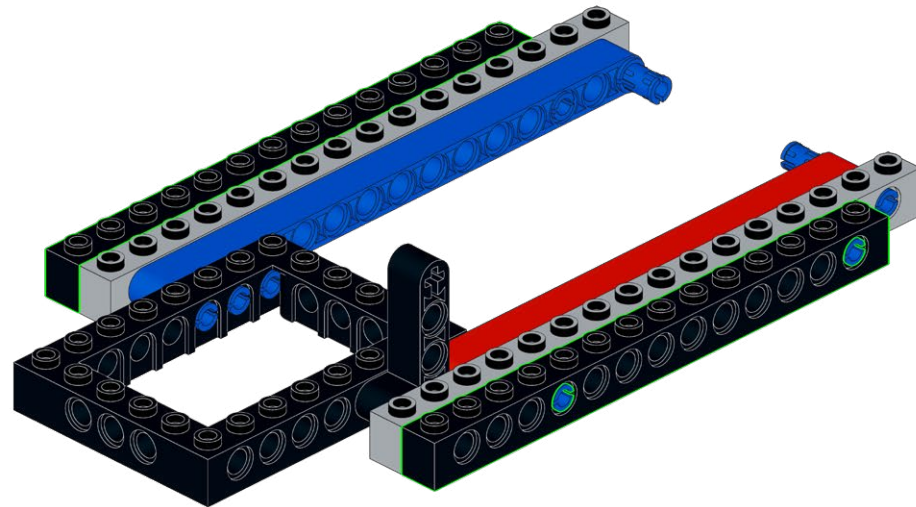
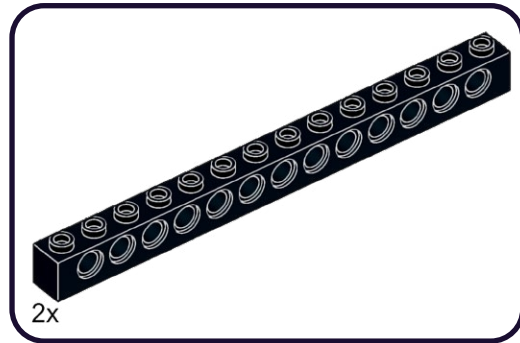
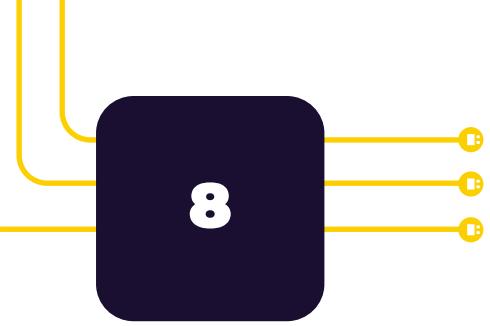

9

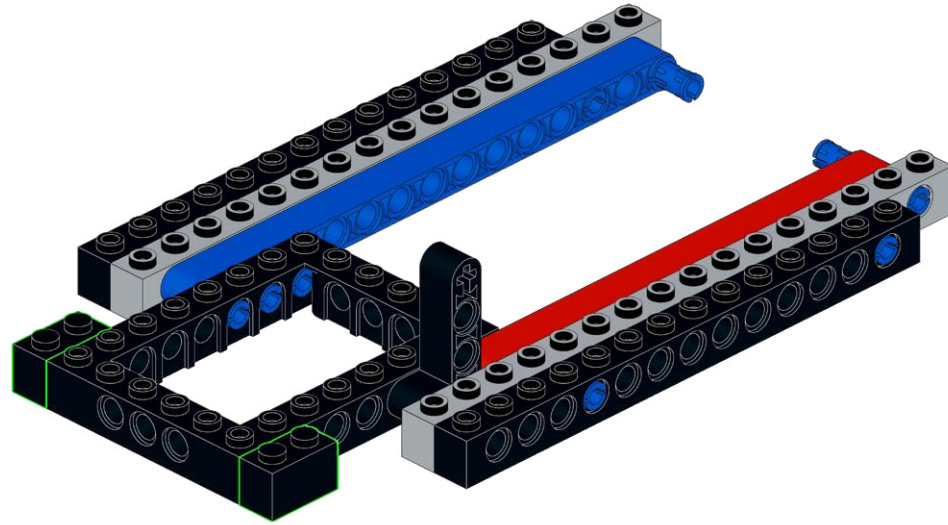
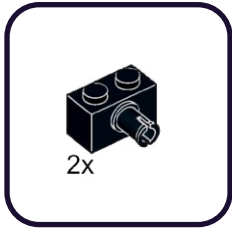

10

2x

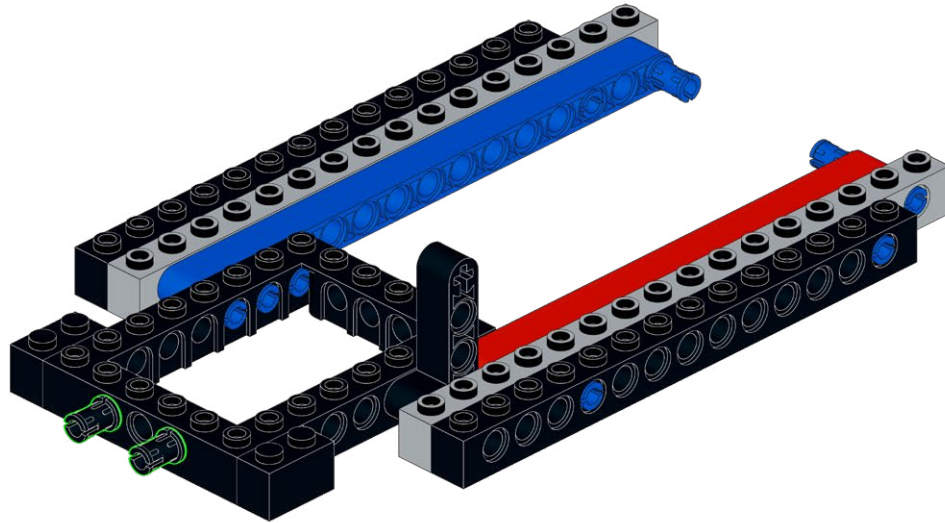

11

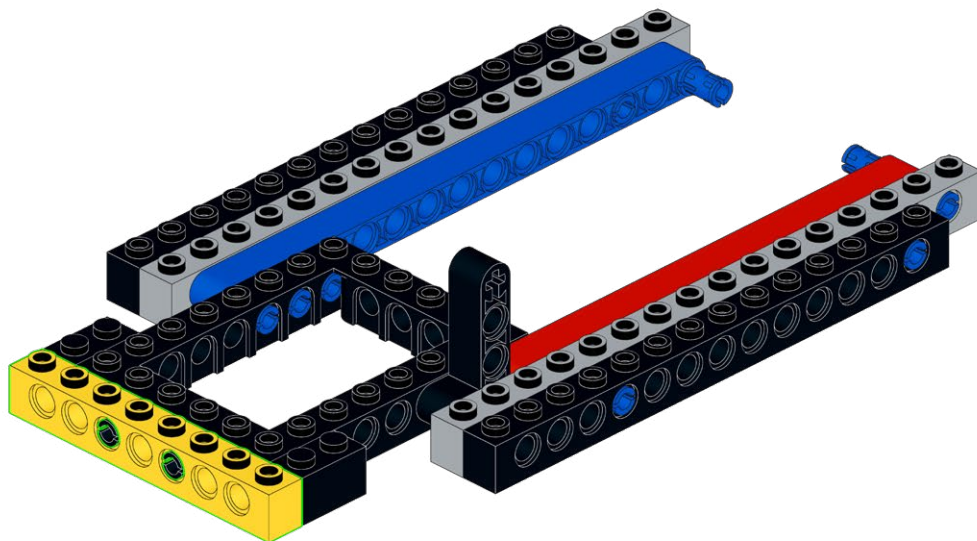
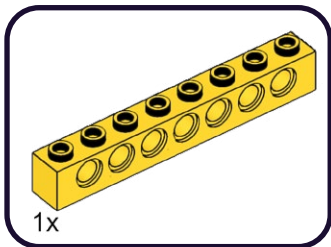

12

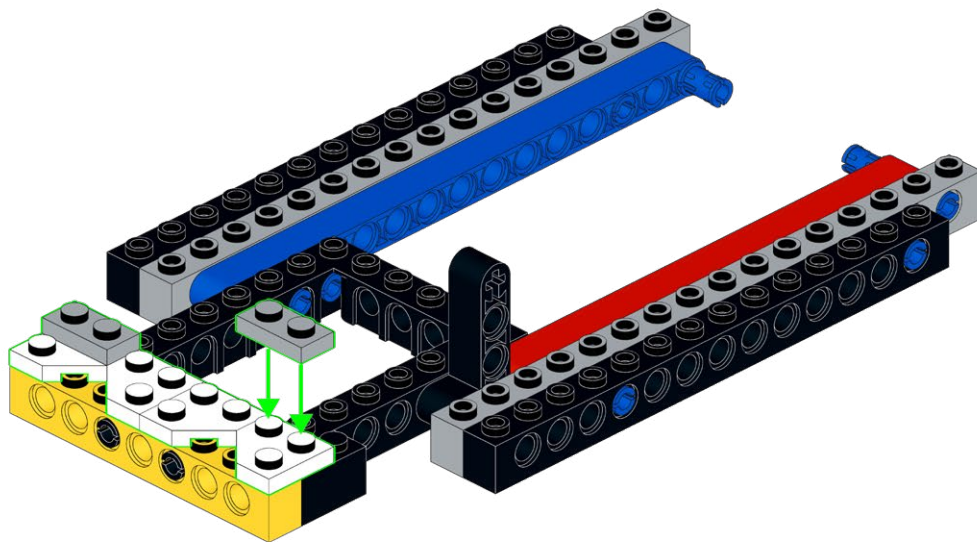
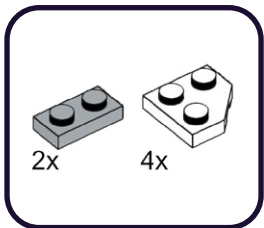

13

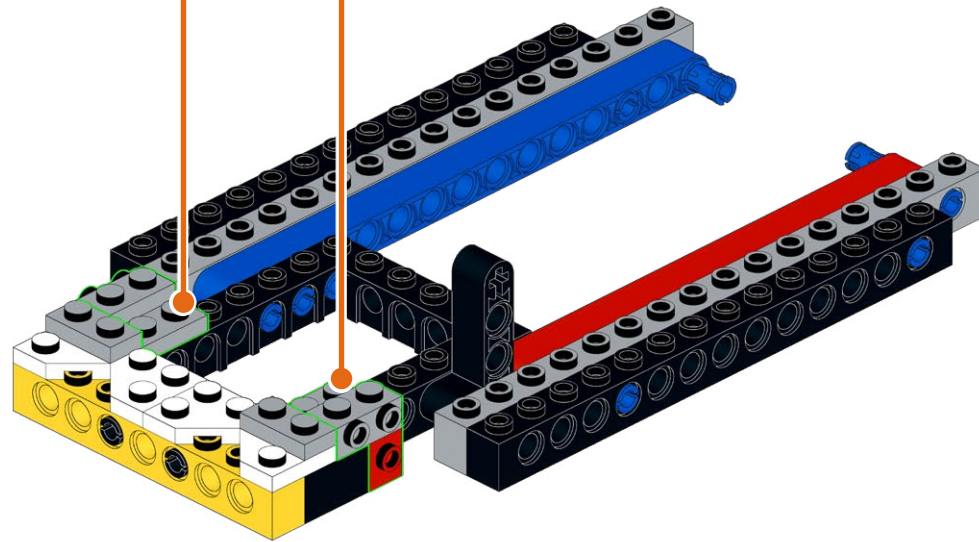
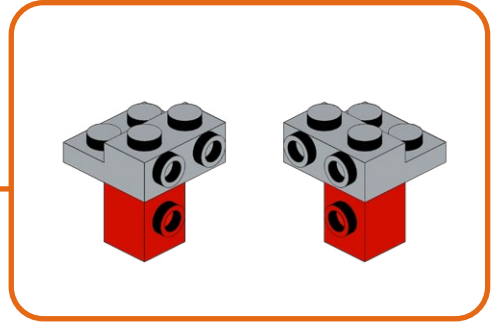
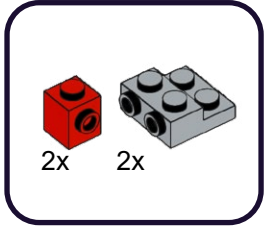

14

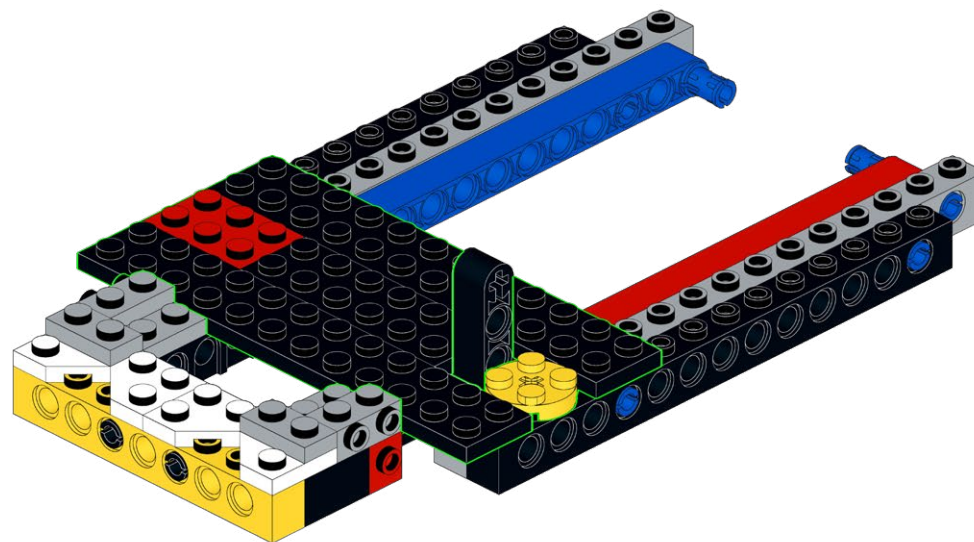
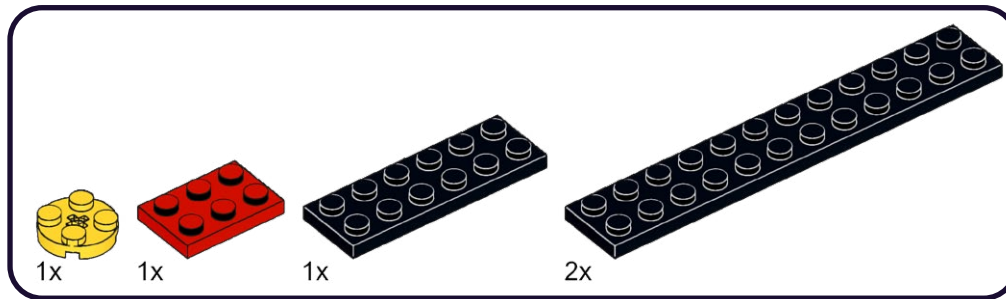

15

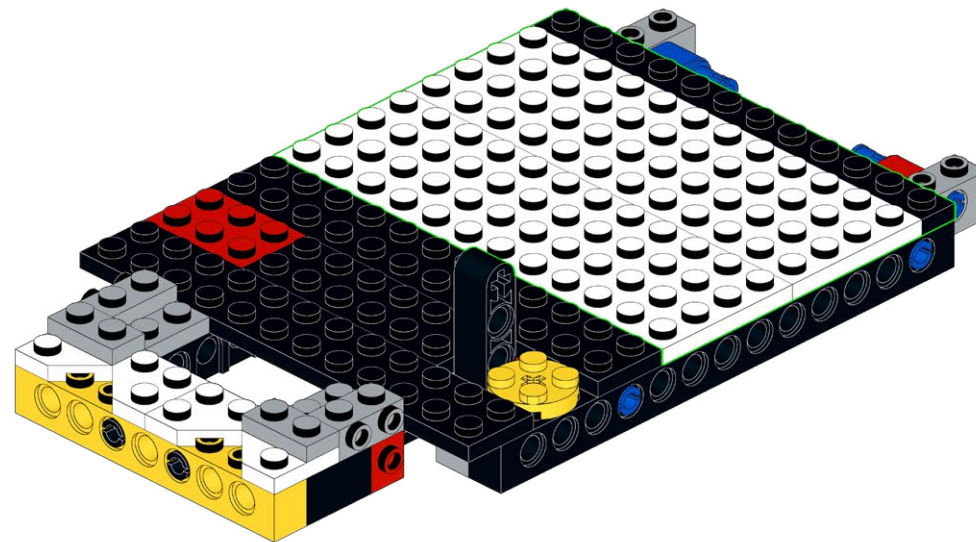
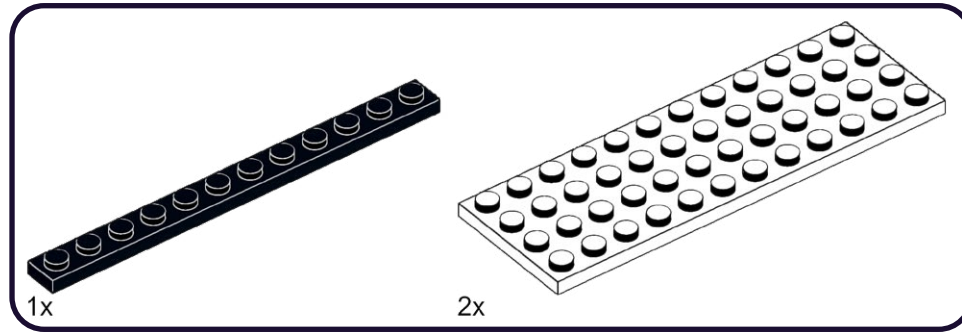

16

2x

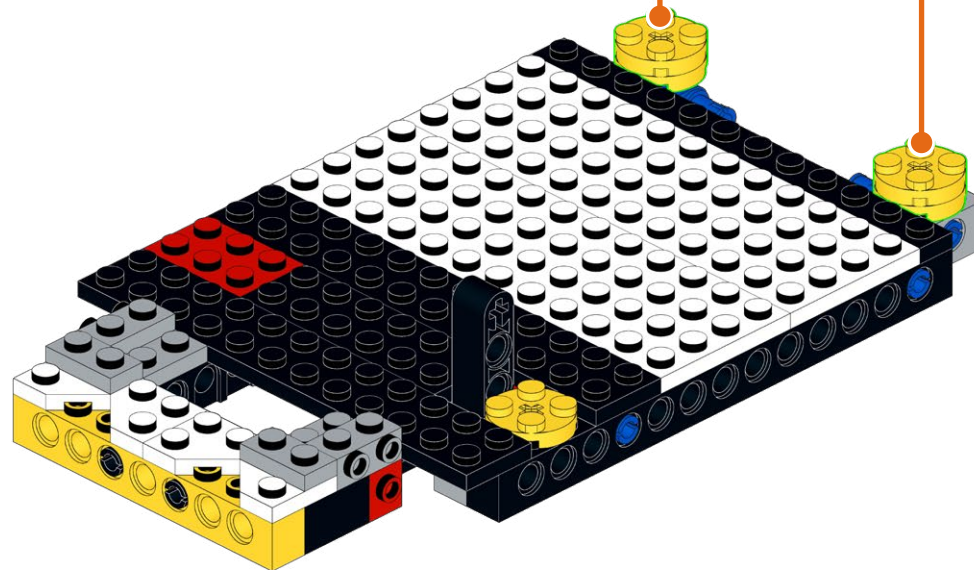

17

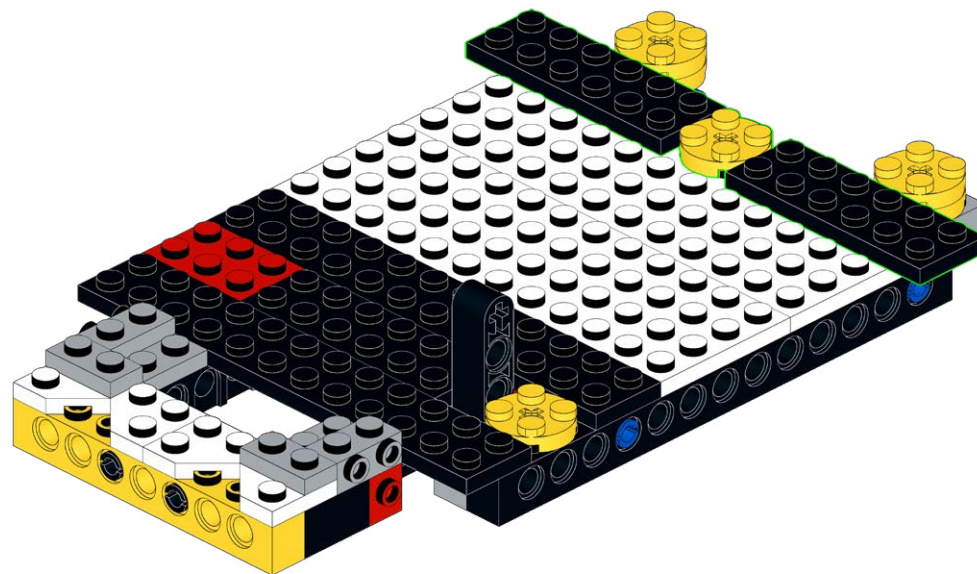
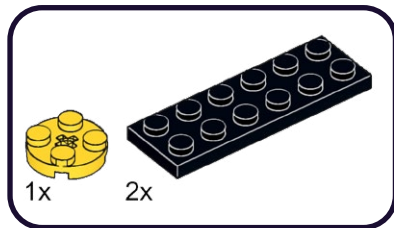

18

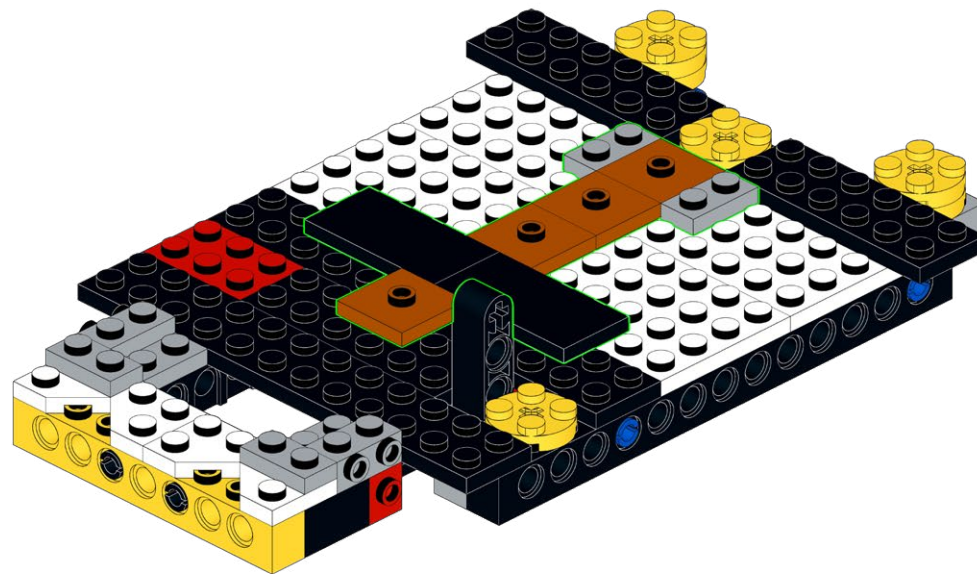
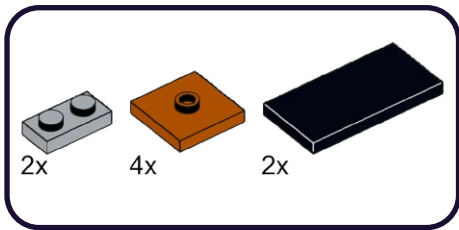

19

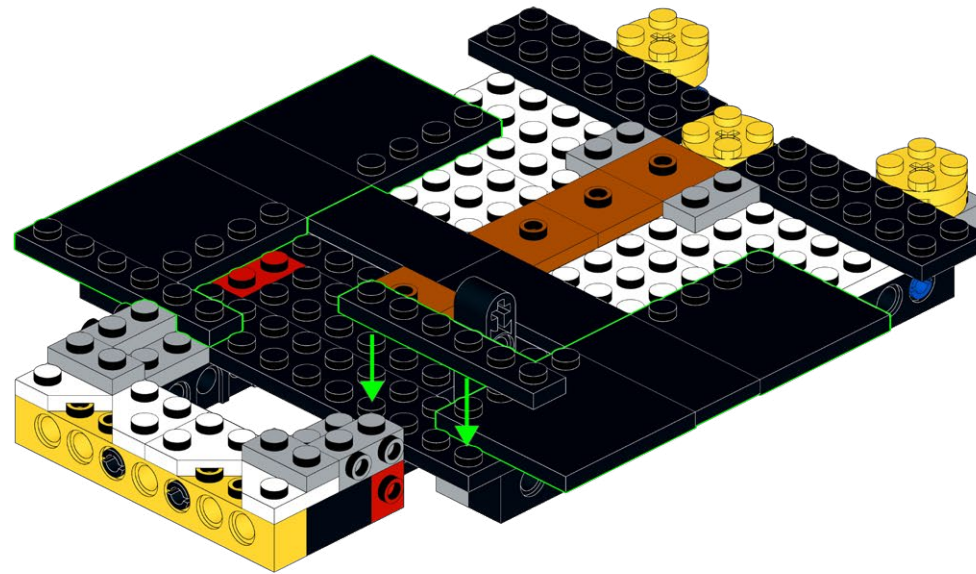
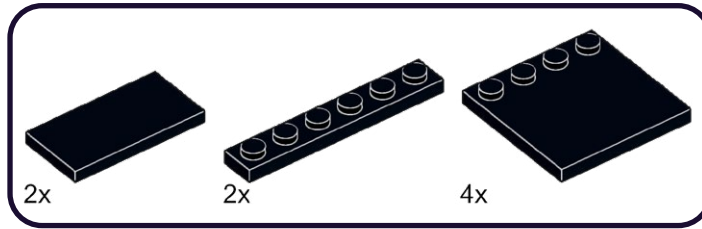

20

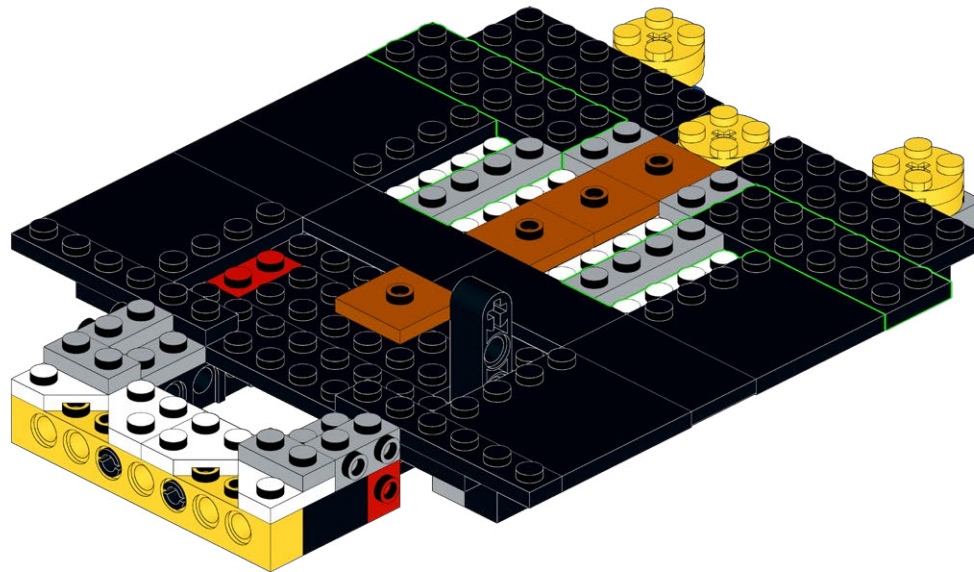
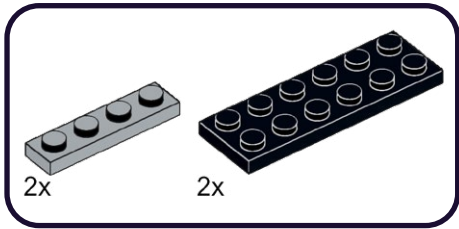

21

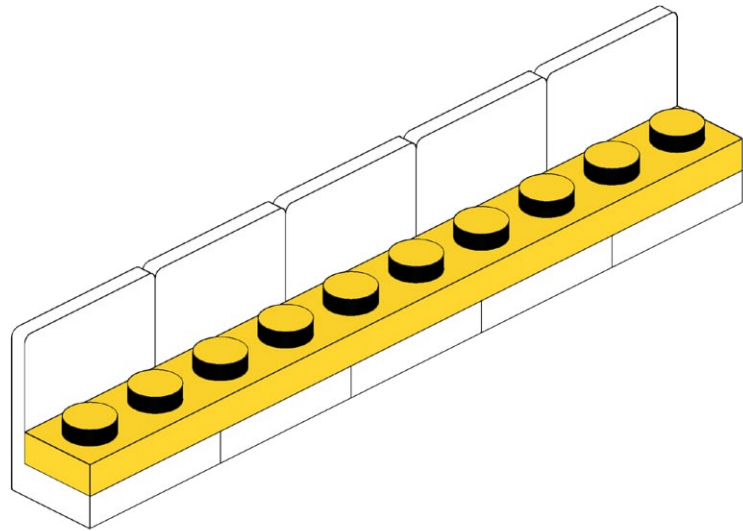
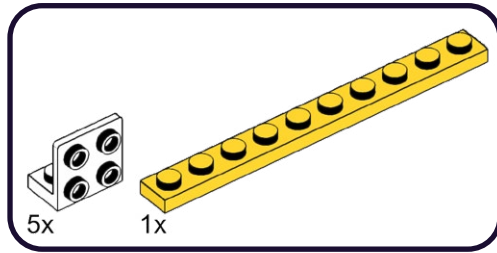

22

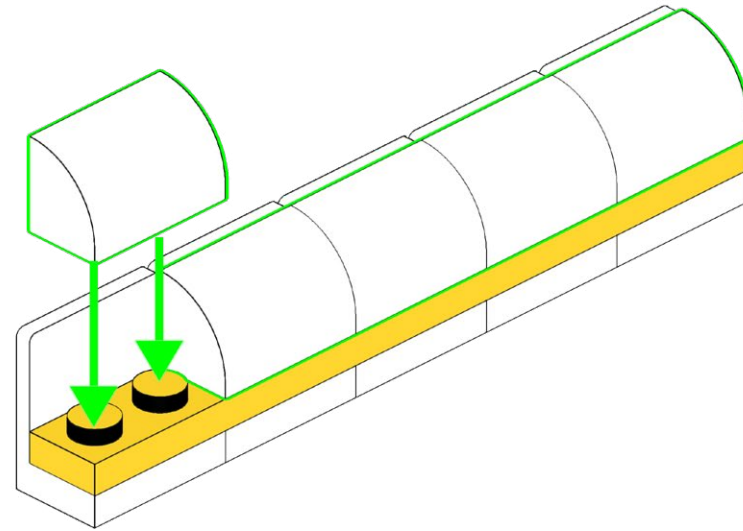
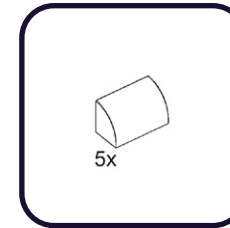

2x

23

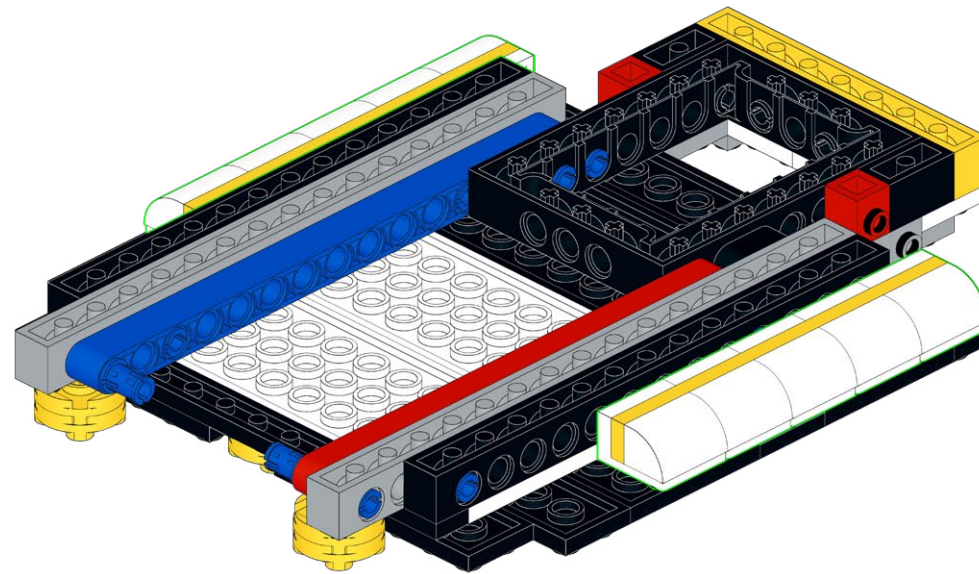

24

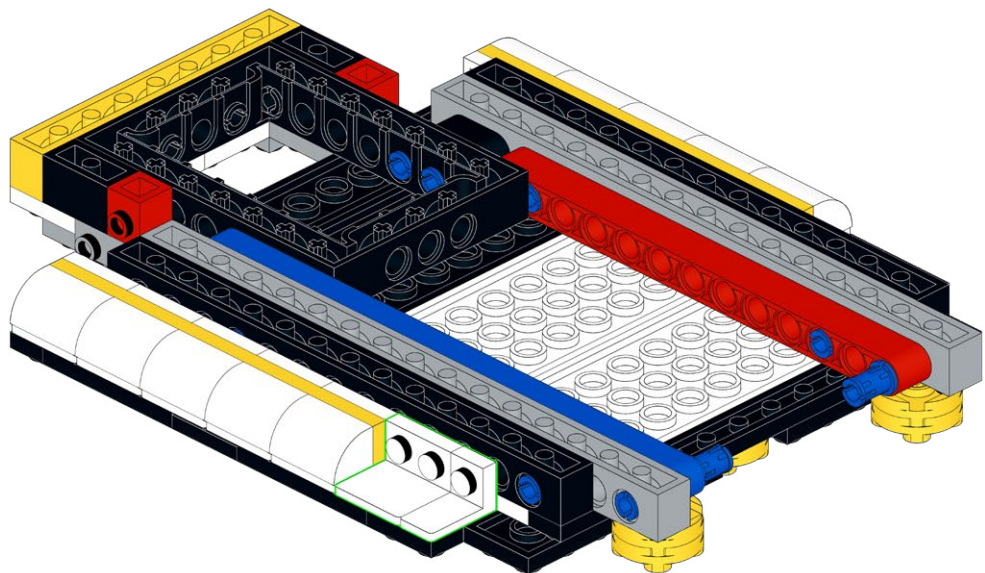
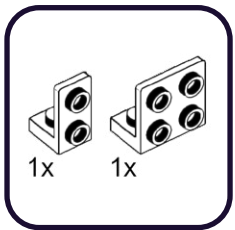
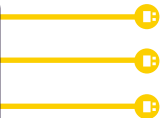

25

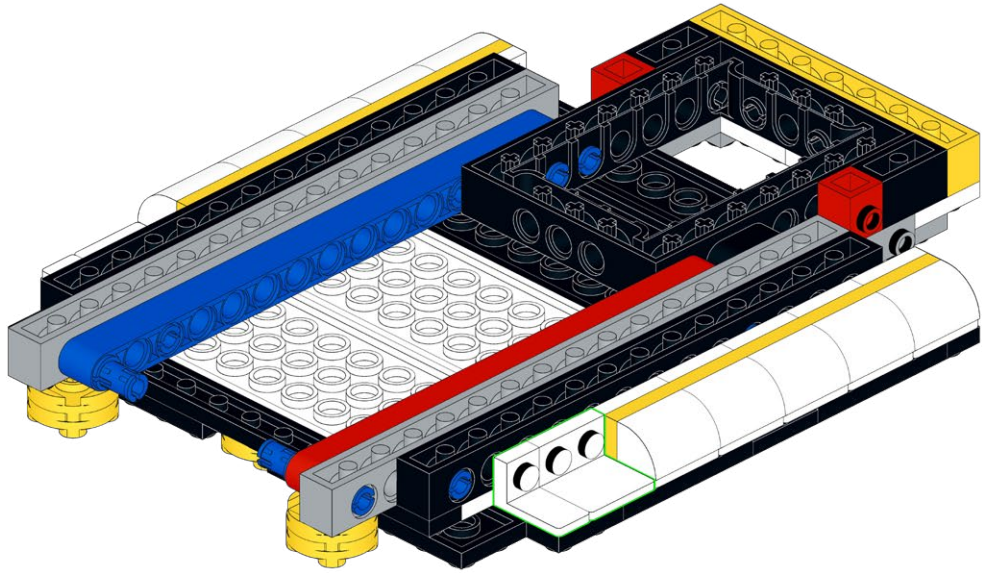
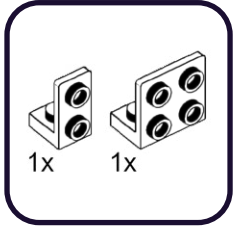
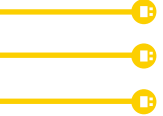

26

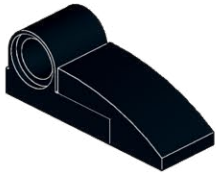
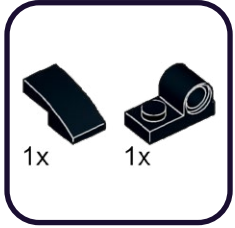

27

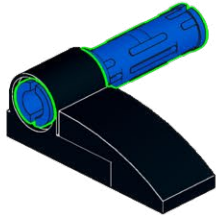
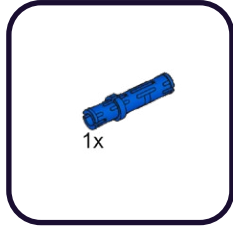

28

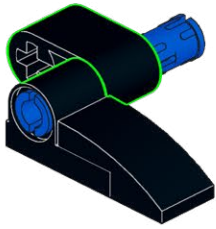
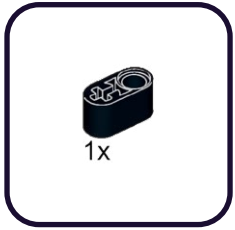

29

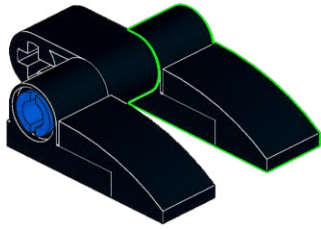
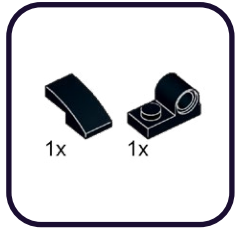

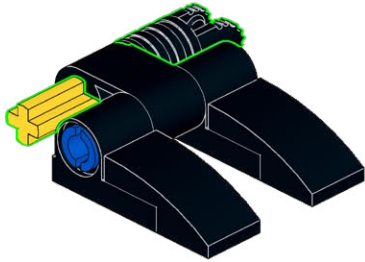
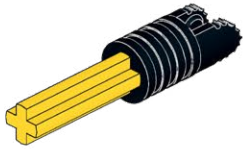
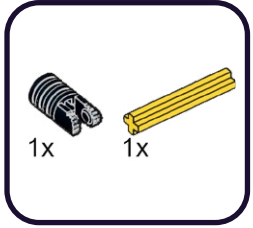

32

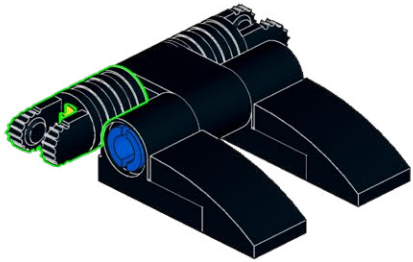

33

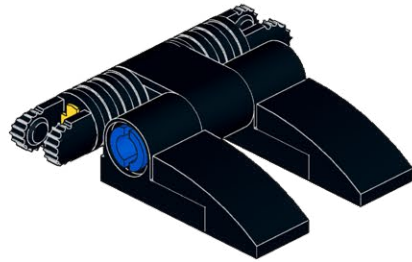

2x

34

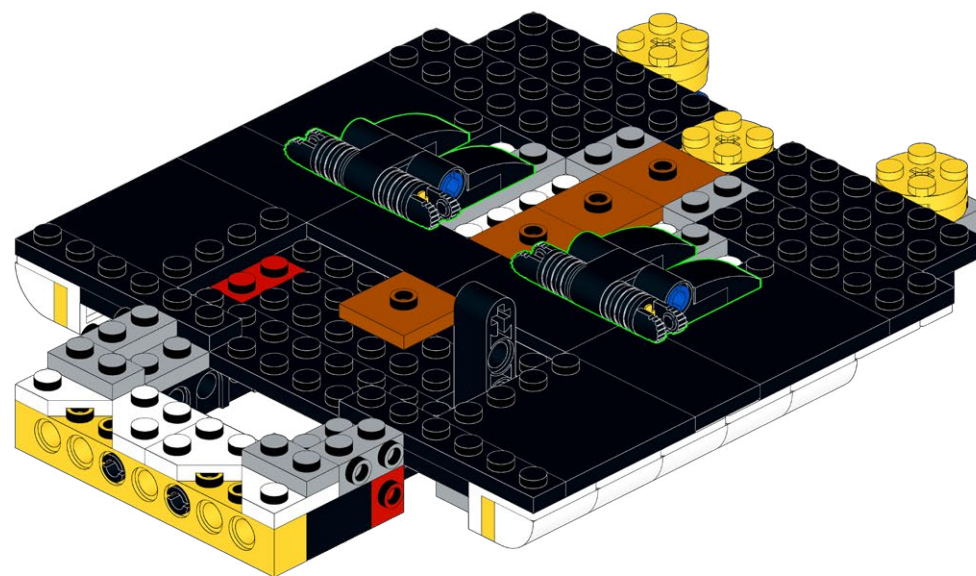

35

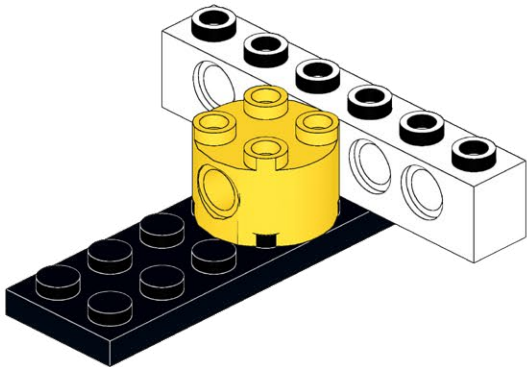
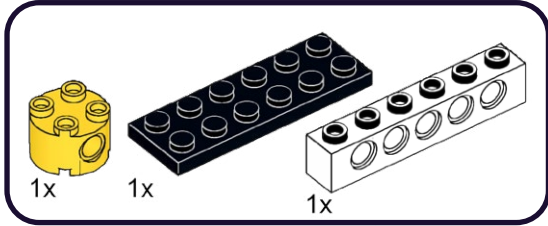

36

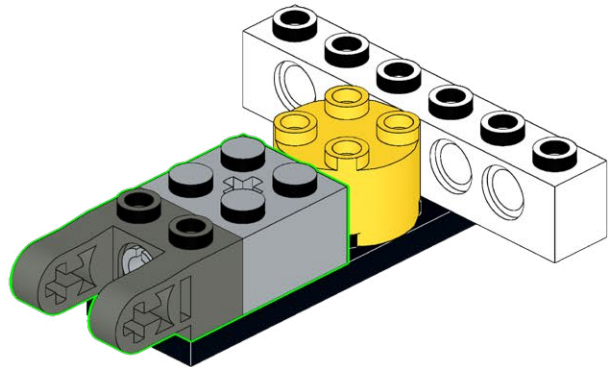
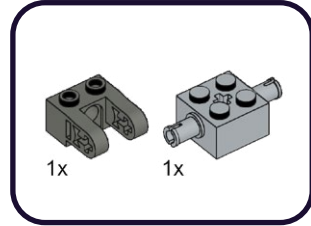

37

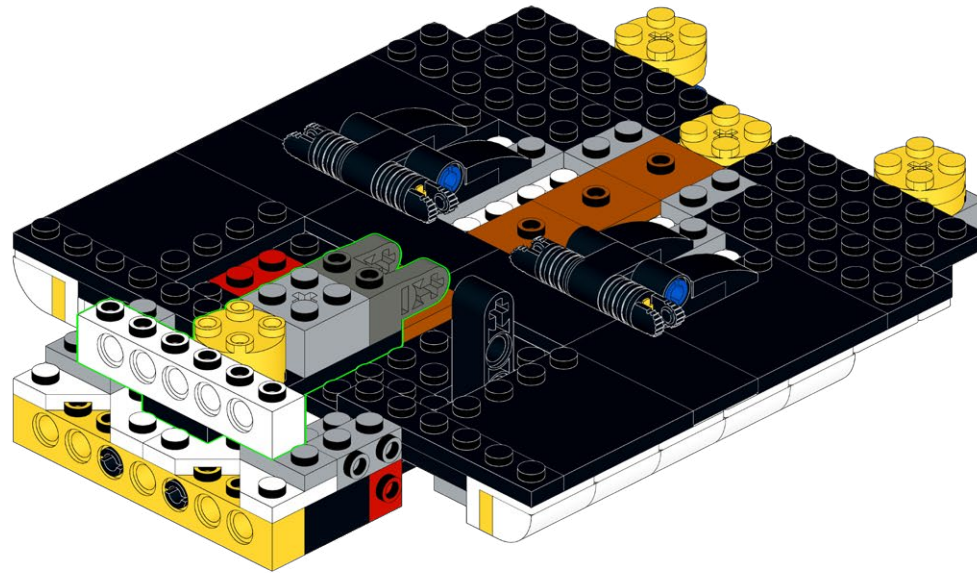

38

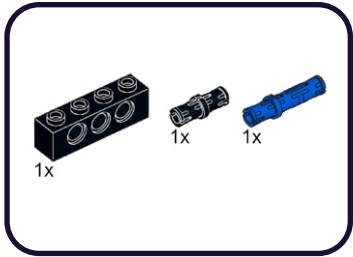

1

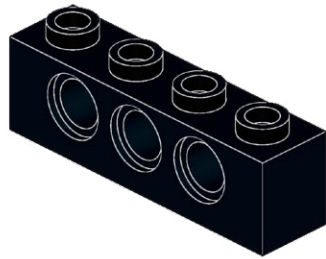

2

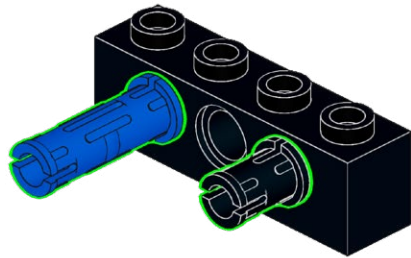

39

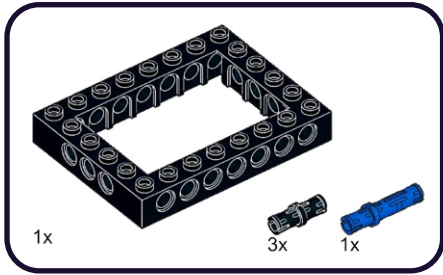

1

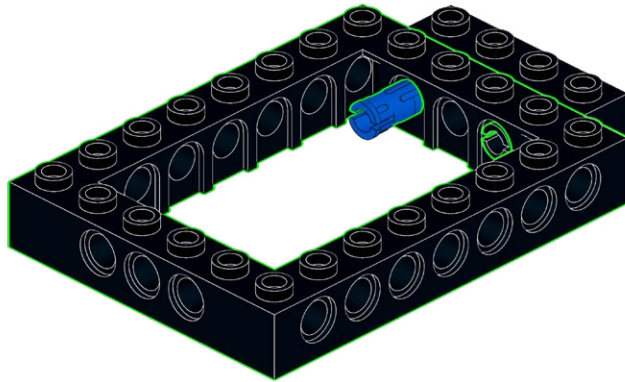

2

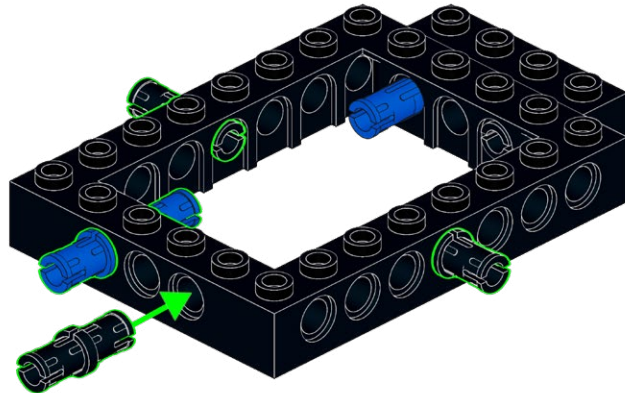

40

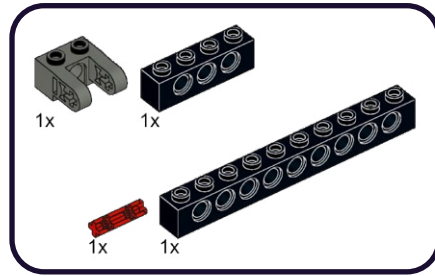

1

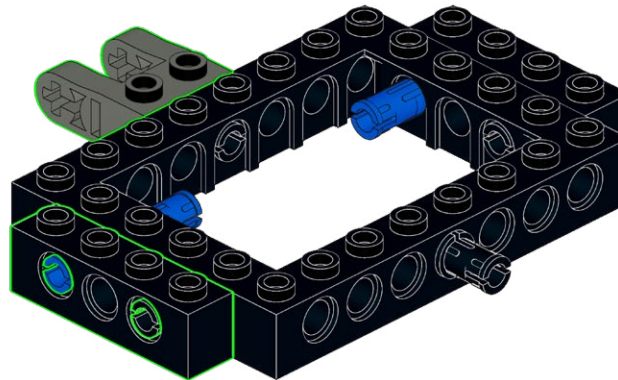

2

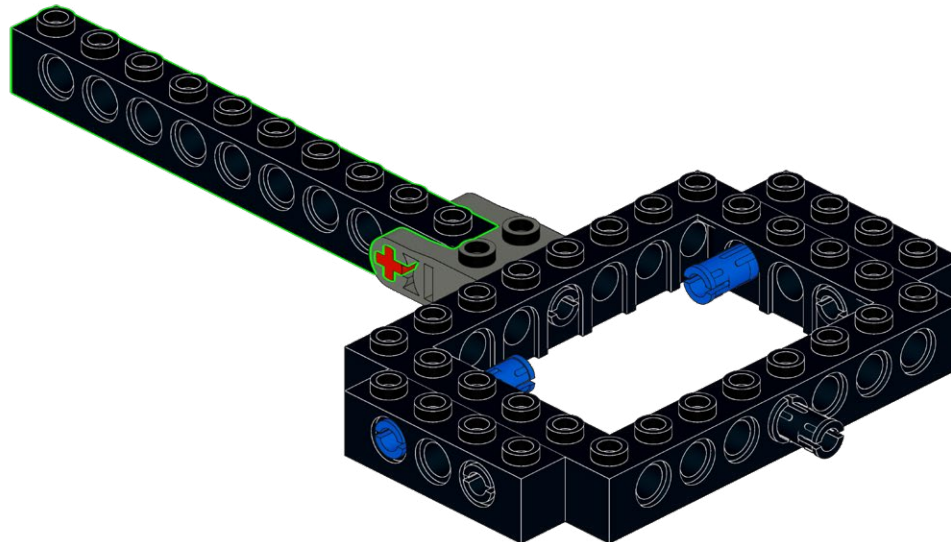

41

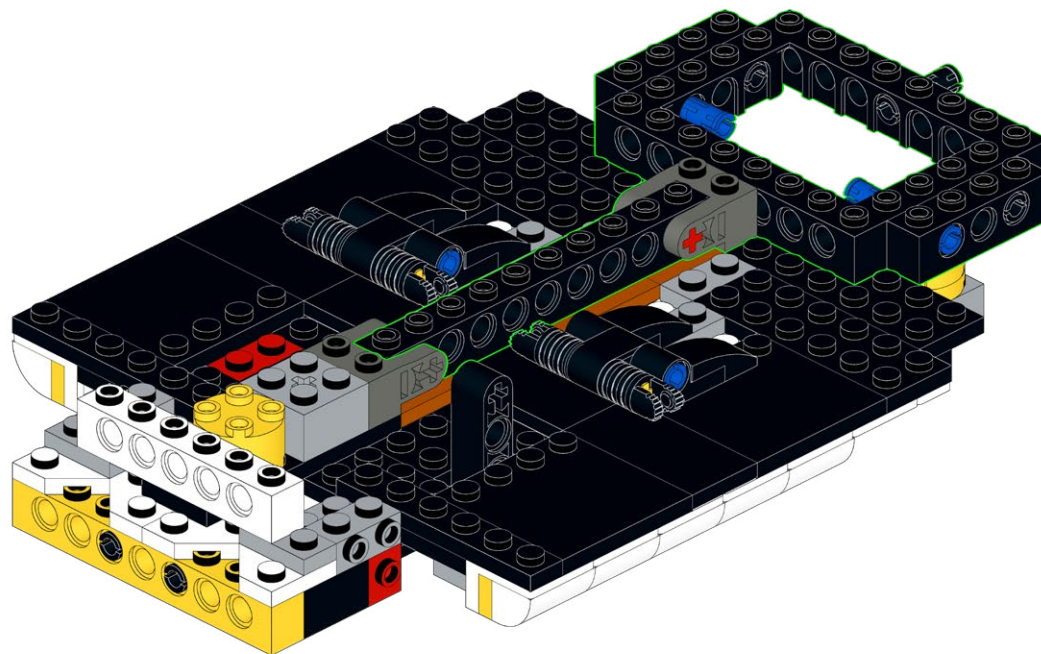

42

1x

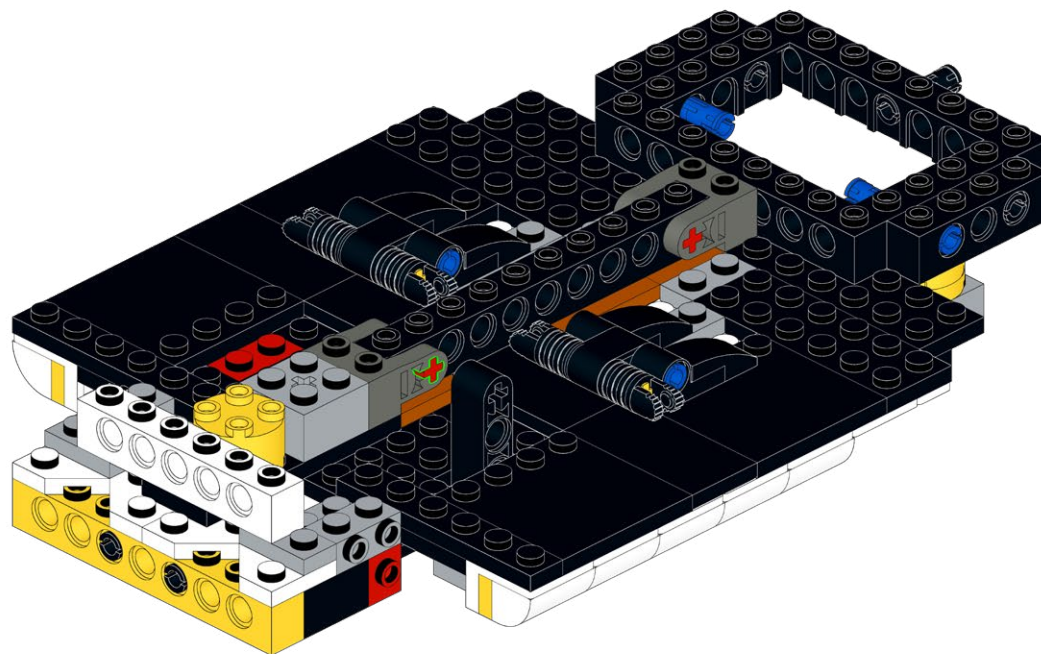

43

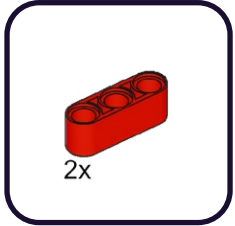

2x

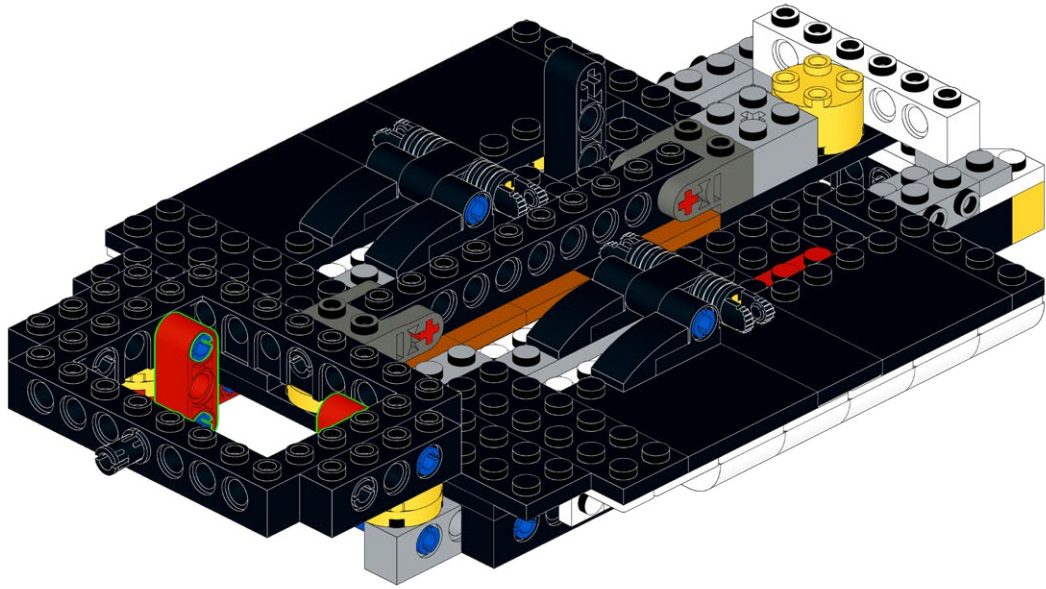

44

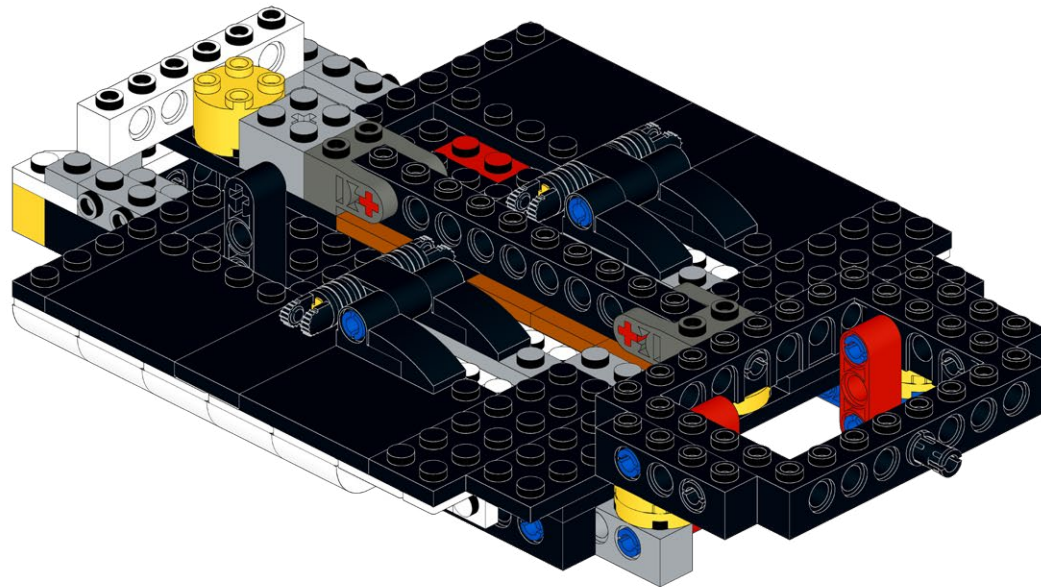

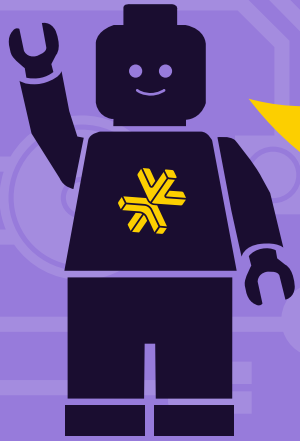
**HOLD UP!**

You might notice some bags aren't in order, as well as left over pieces, but that's ok! We're changing the way you build LEGO!

ATTENDEZ!

Vous remarquerez peut-être que certains sacs, ainsi que certaines pièces, ne sont pas dans le bon ordre. Mais pas de panique! Nous changeons simplement la façon avec laquelle vous construisez vos LEGO!

ASPETTA!

Potresti notare che alcuni sacchetti non sono in ordine, così come i pezzi avanzati, ma va bene così! Stiamo cambiando il modo in cui costruisci i LEGO!

HALT!

Sie werden möglicherweise bemerken, dass einige tüten durcheinander sind und teile übrig bleiben, aber das ist in Ordnung! Wir ändern die art und weise, wie Sie LEGO bauen!

¡ESPERA!

Es posible que notes que algunas bolsas están fuera de servicio, así como piezas sobrantes, ¡pero está bien! ¡Estamos cambiando la forma en que construyes LEGO!

暫停!

你可能会注意到一些袋子顺序错乱, 以及一些剩余的部件, 但没关系! 我们正在改变你搭建乐高的方式!

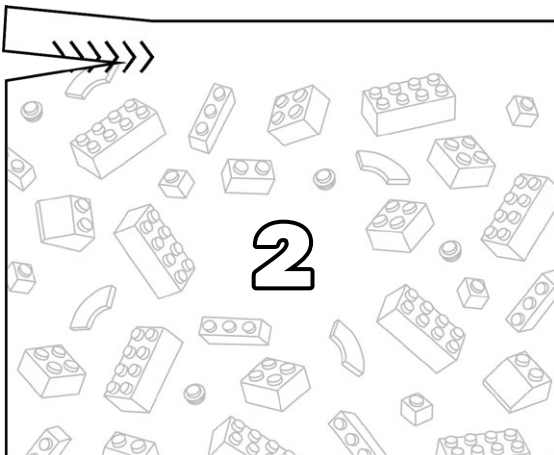
Open LEGO® Bag 1

45

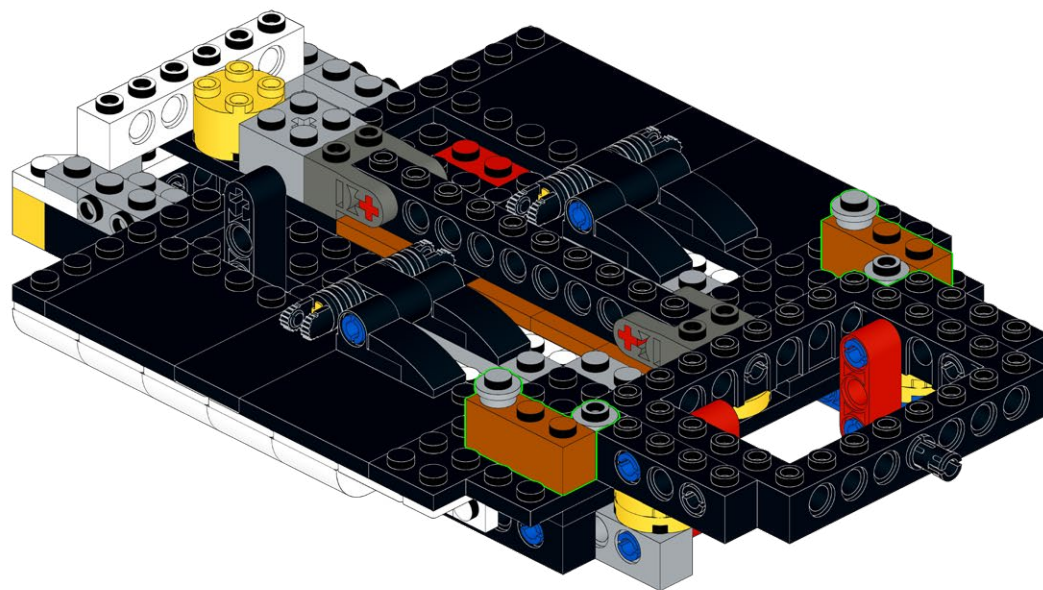
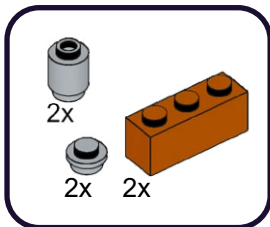

46

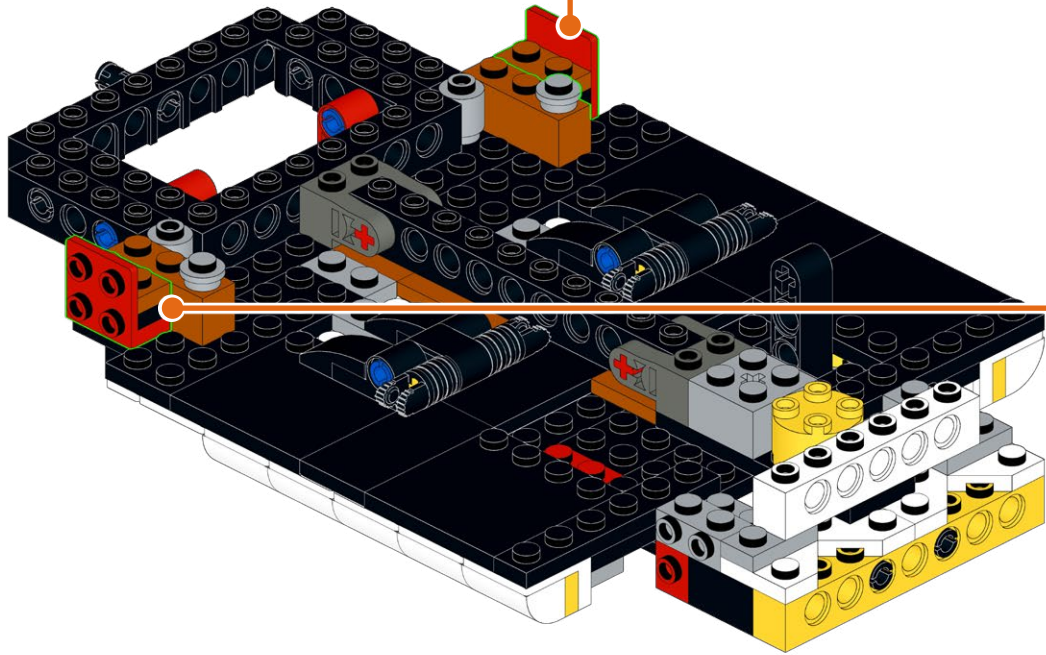
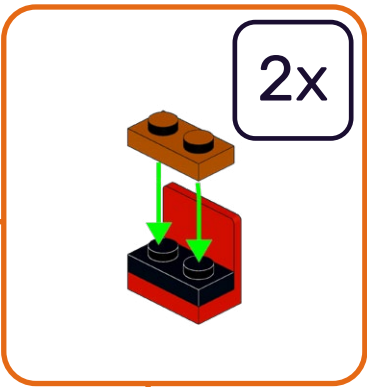
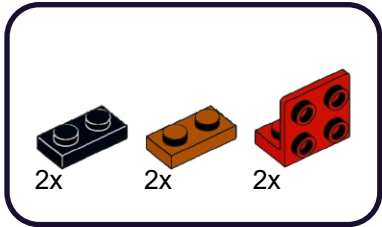

47

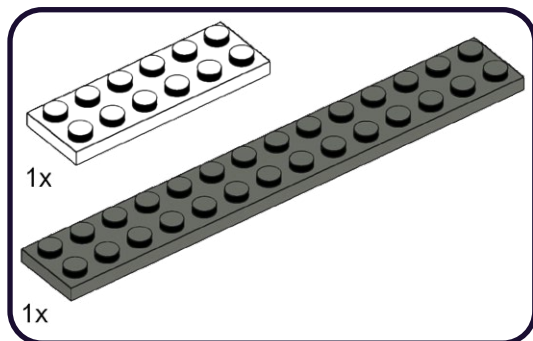

1

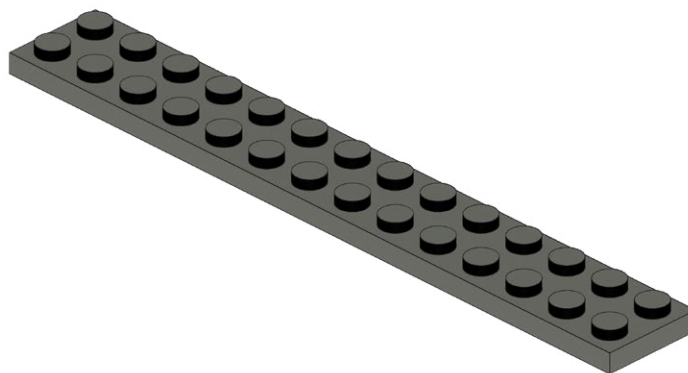

2

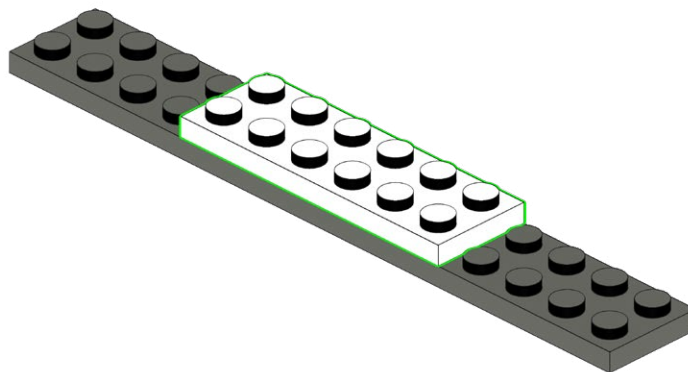

48

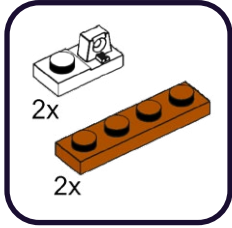

1

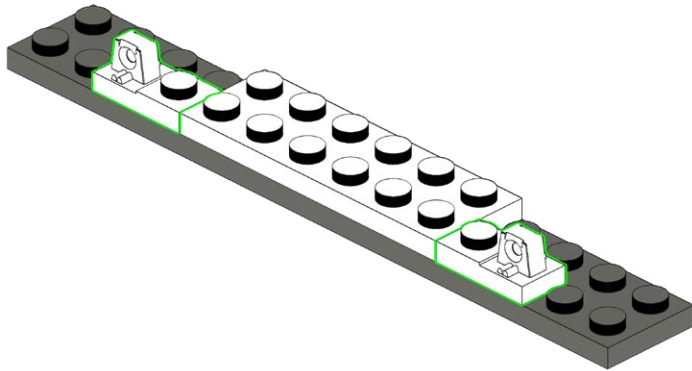

2

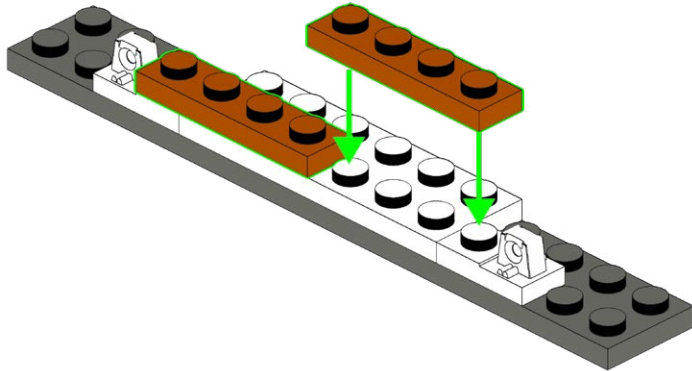

49

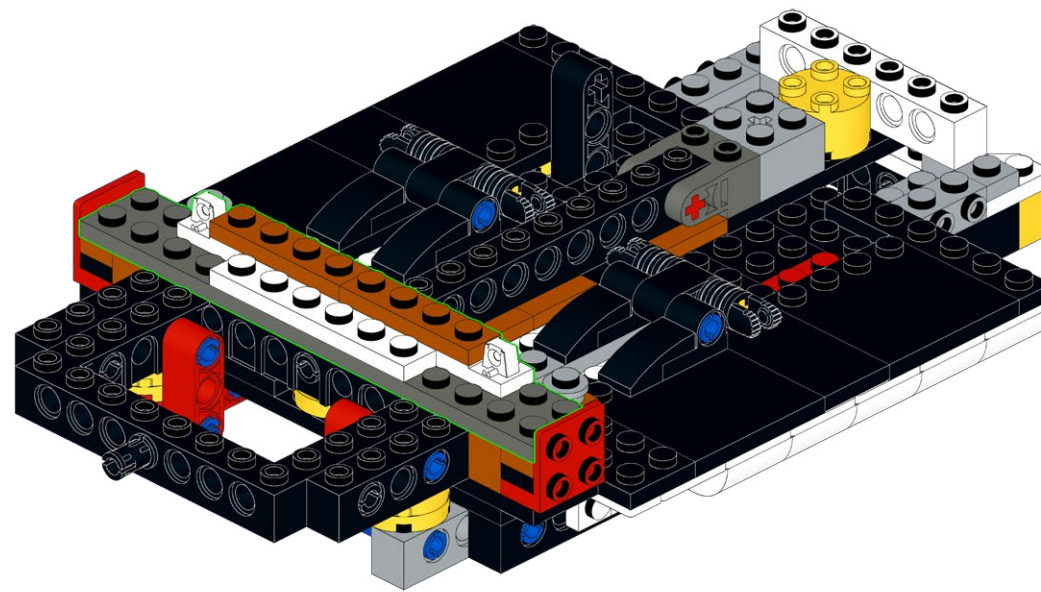

50

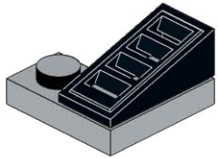
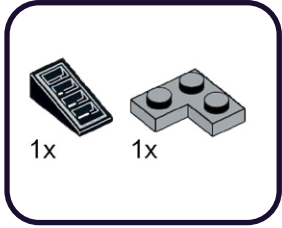

51

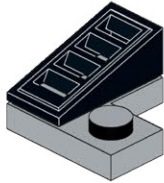
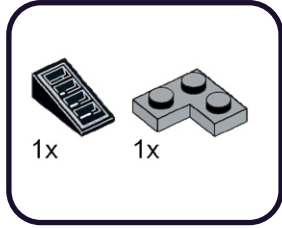

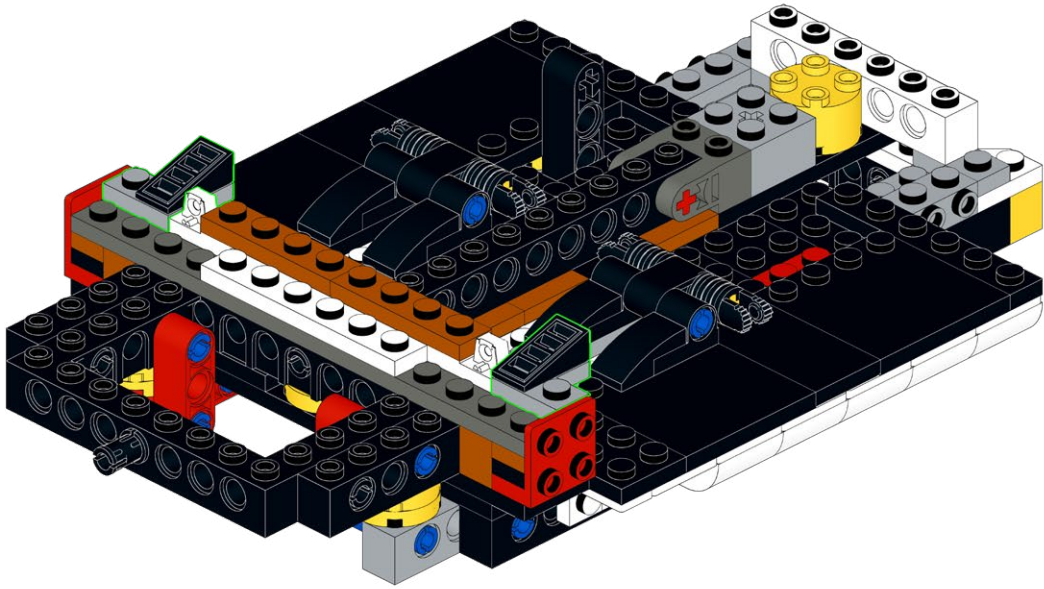

53

2x

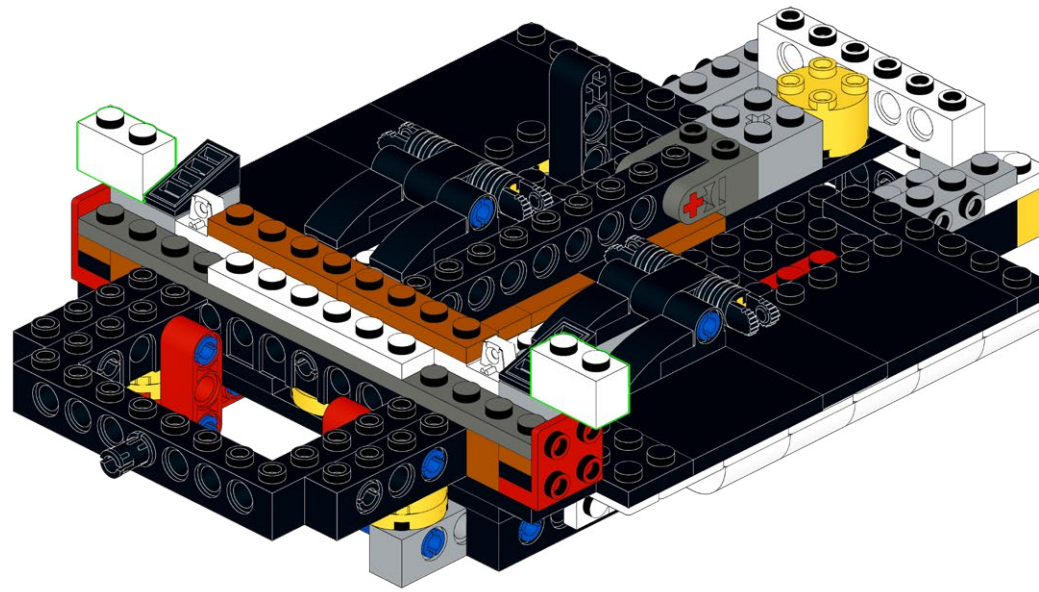

54

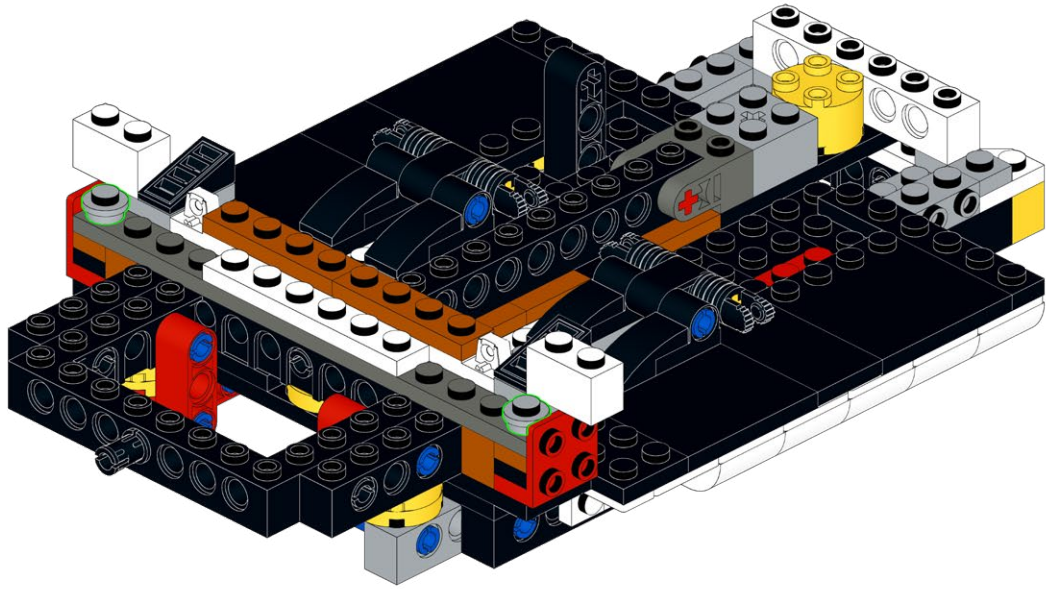
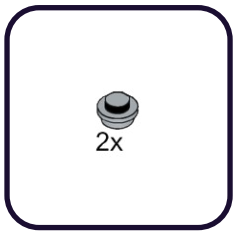

55

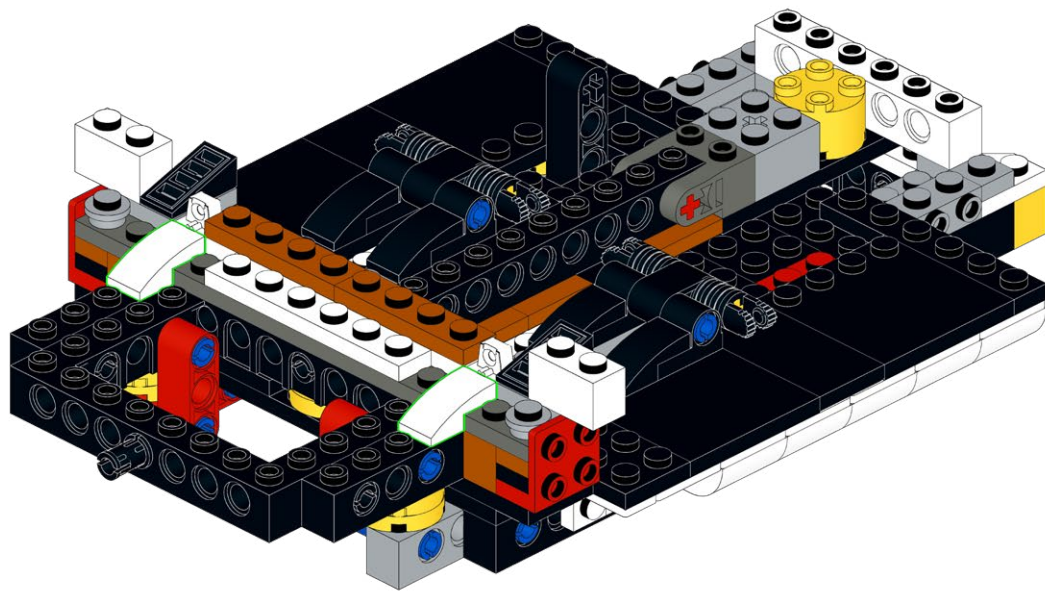
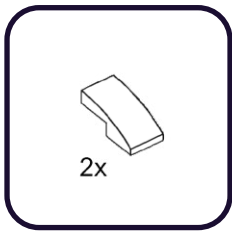

56

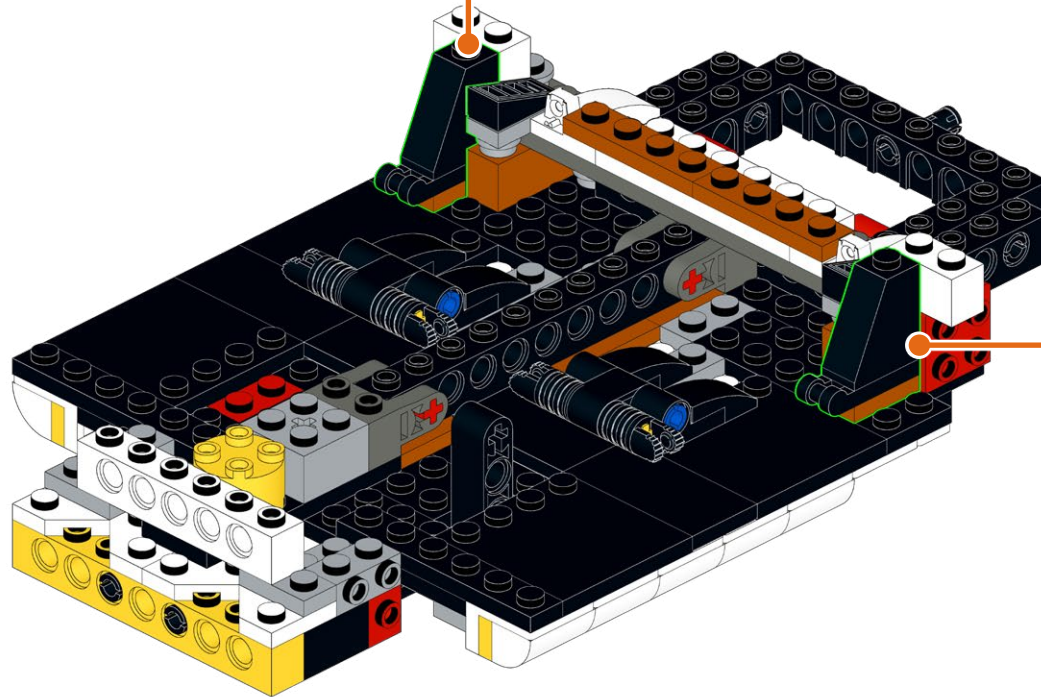
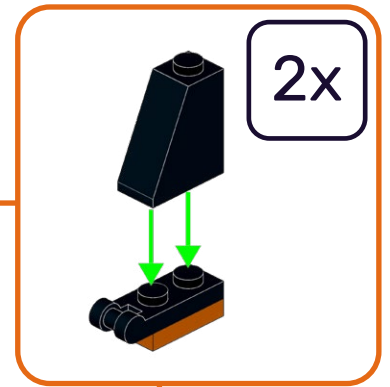
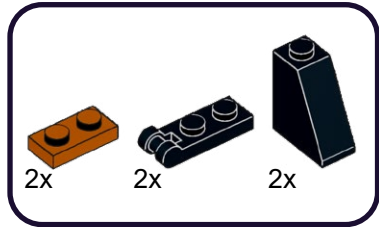

57

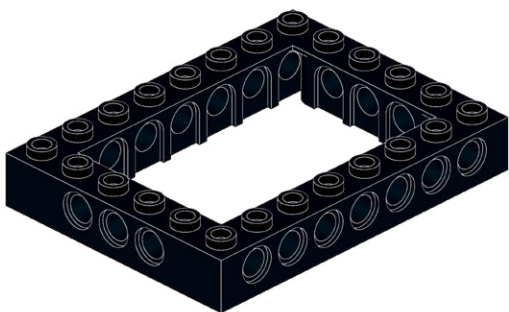
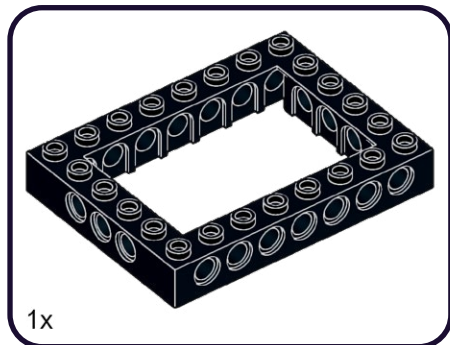

58

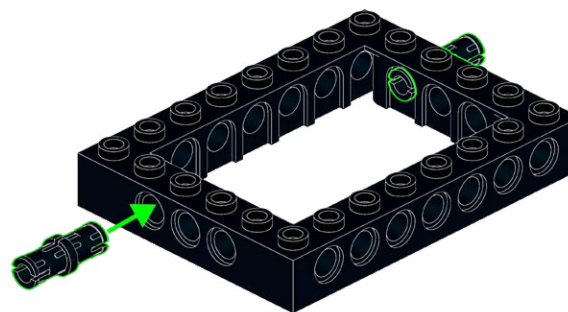

59

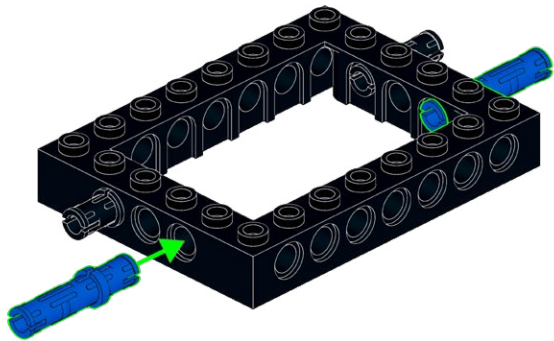
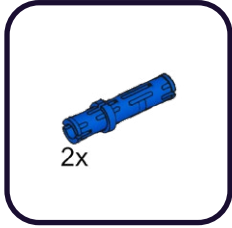

60

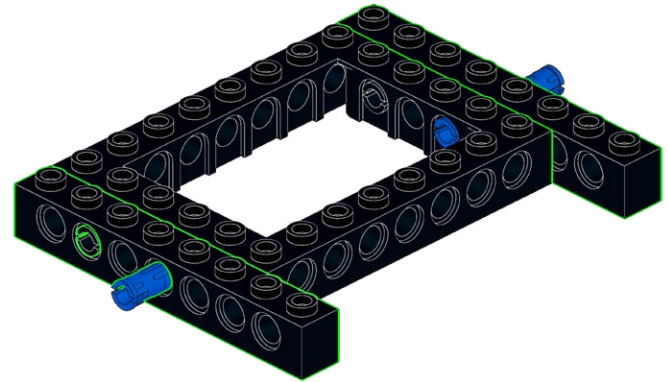
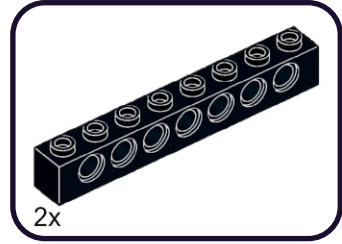

61

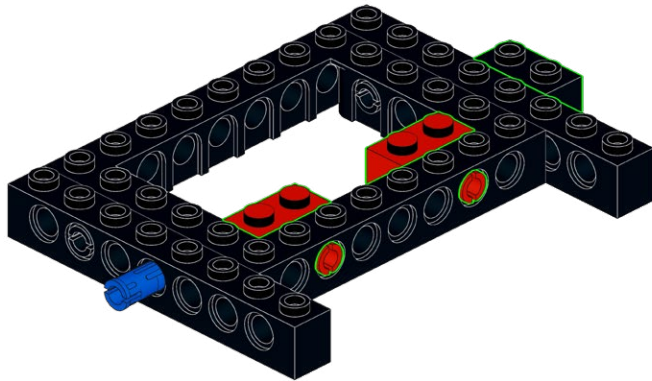
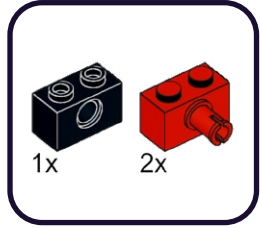

62

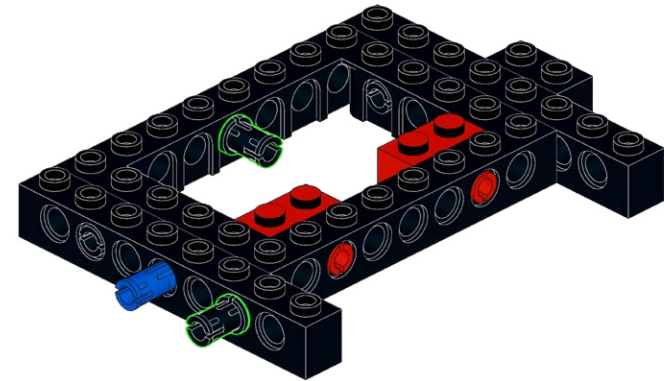

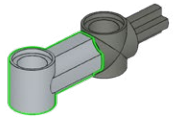
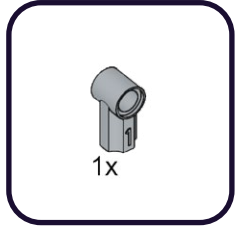
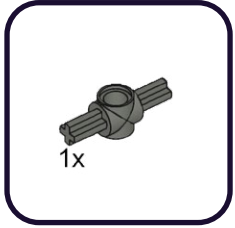

65

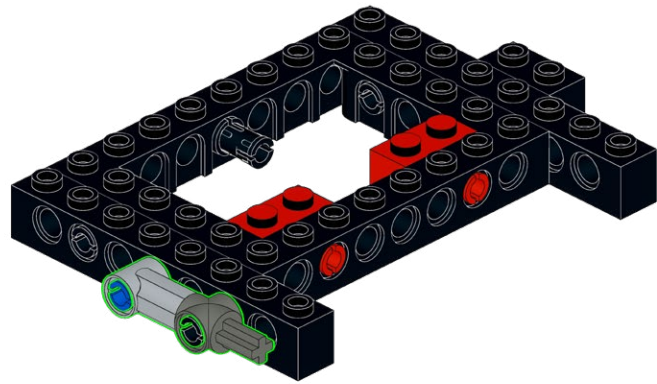

66

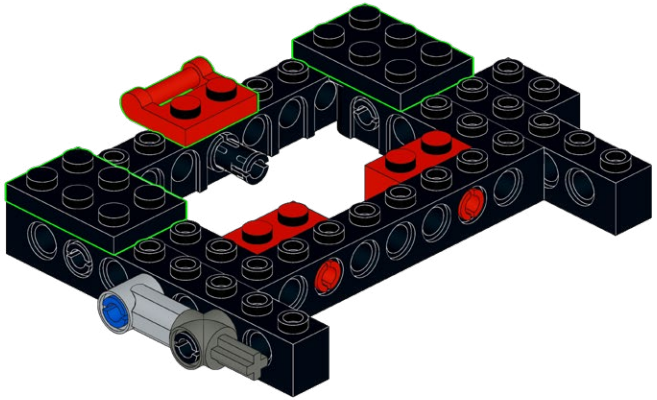
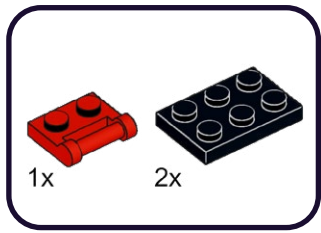

67

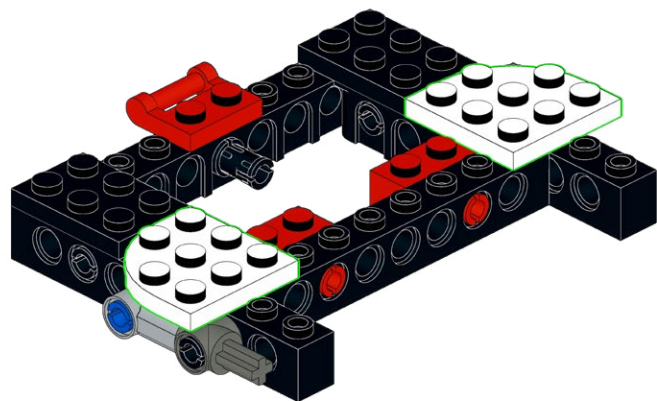
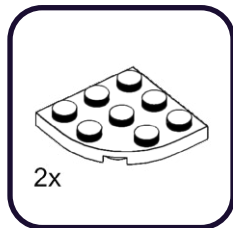

68

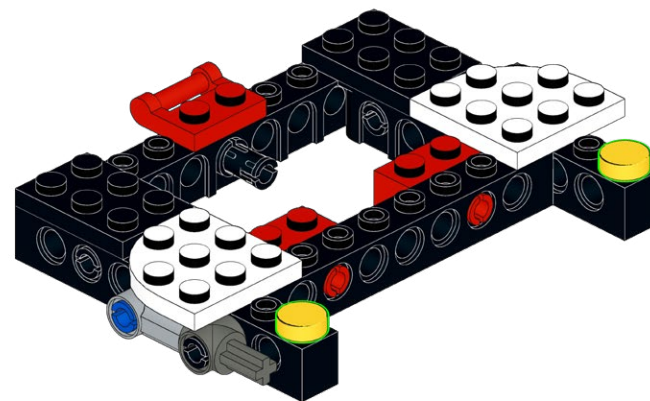
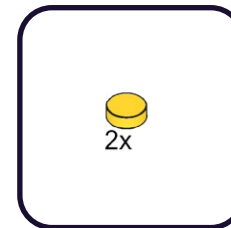

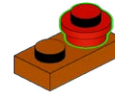
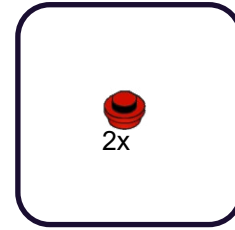
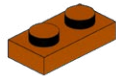
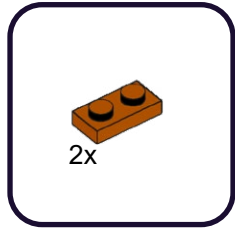

71

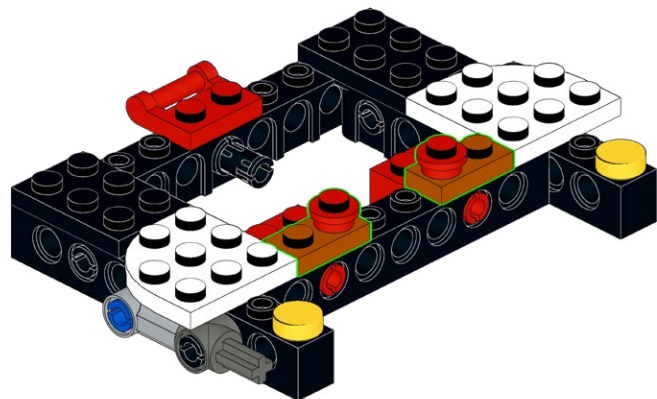

72

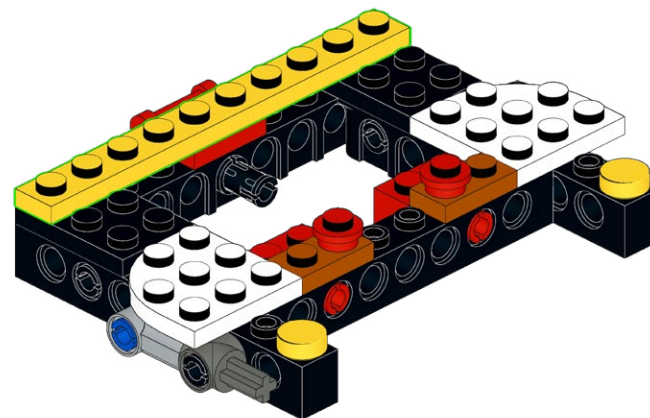
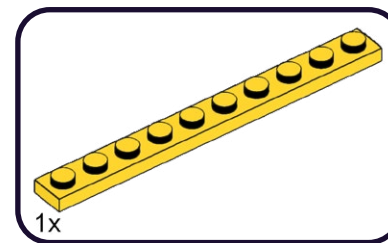

73

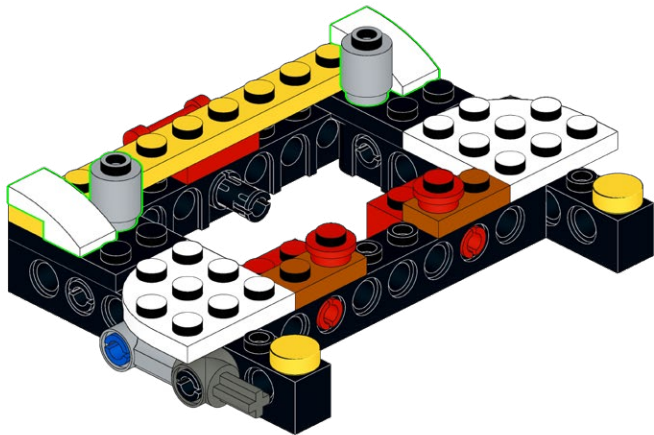
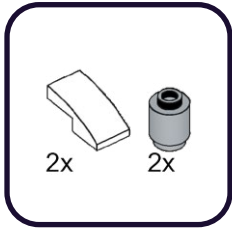

74

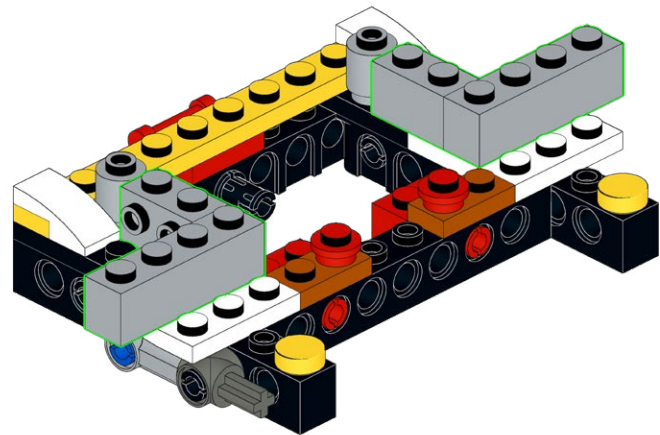
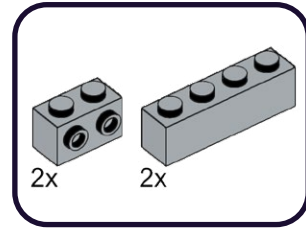

75

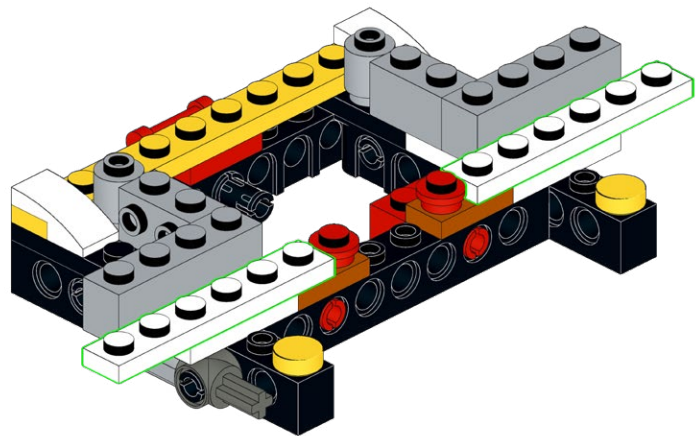
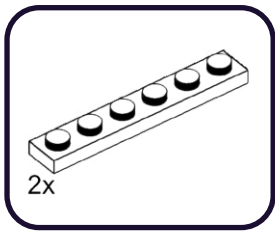

76

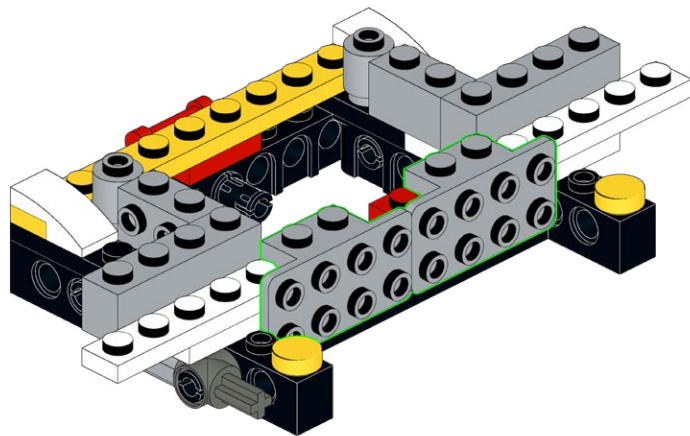
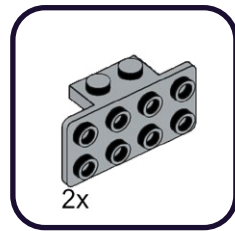

77

2x

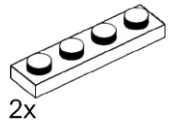

2x

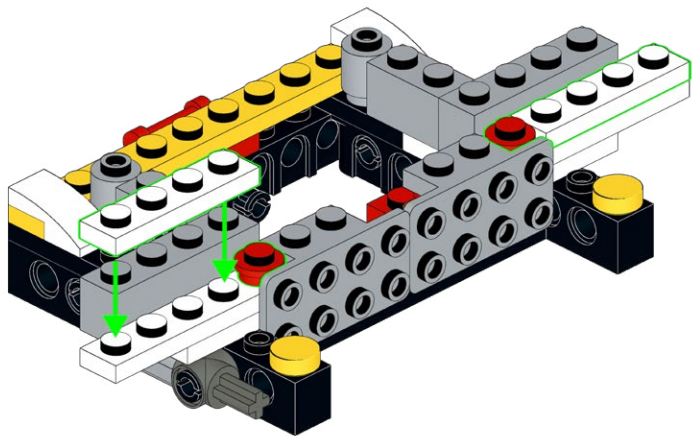

78

2x

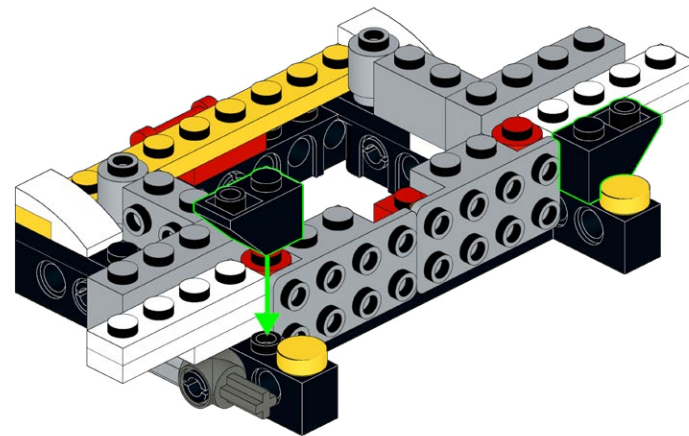

79

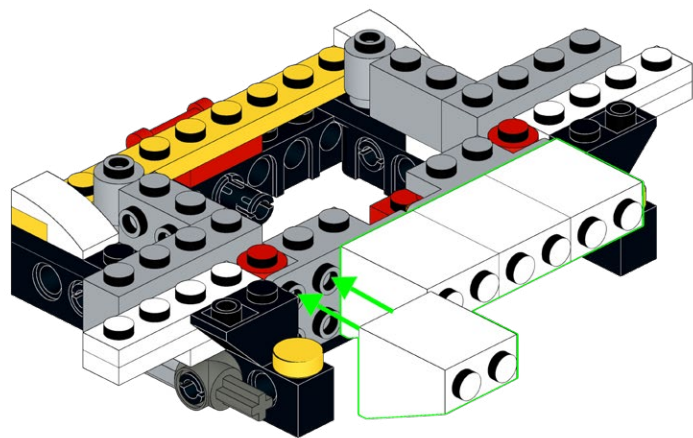
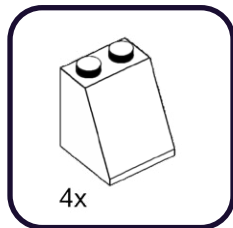

80

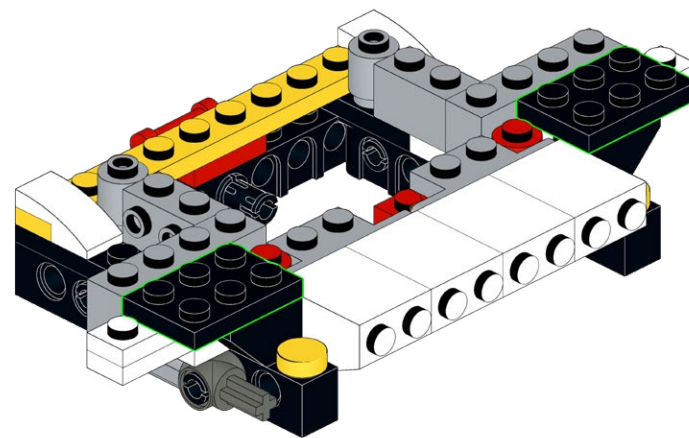
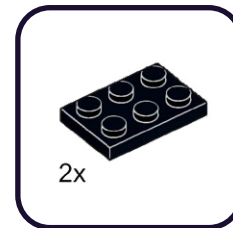

81



2x

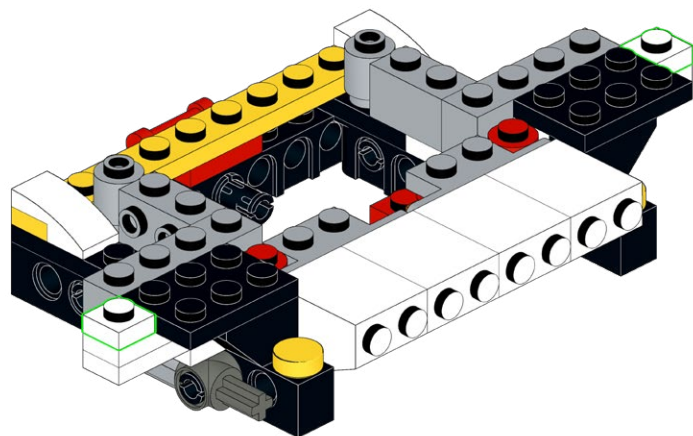

82



2x

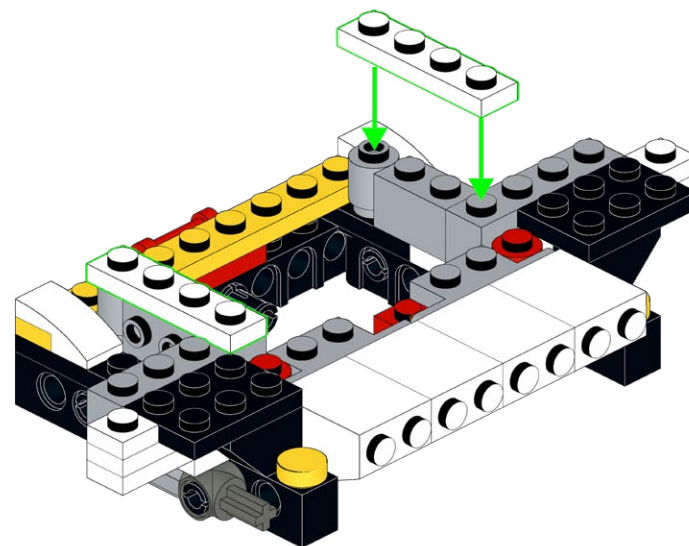

83

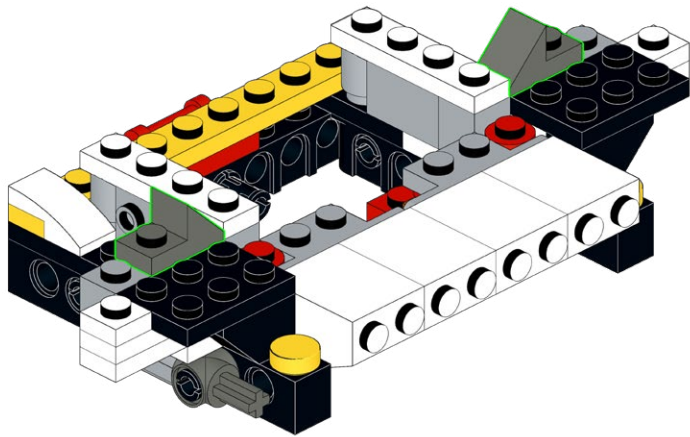
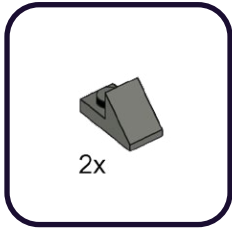

84

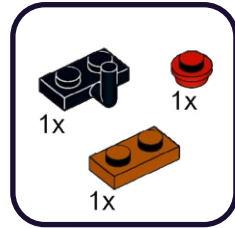

1

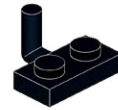

2

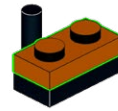

3

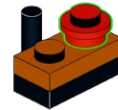

85

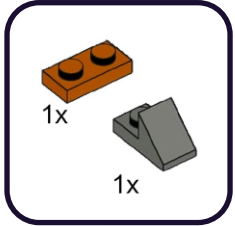

1

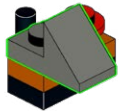

2

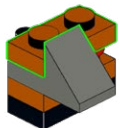

86

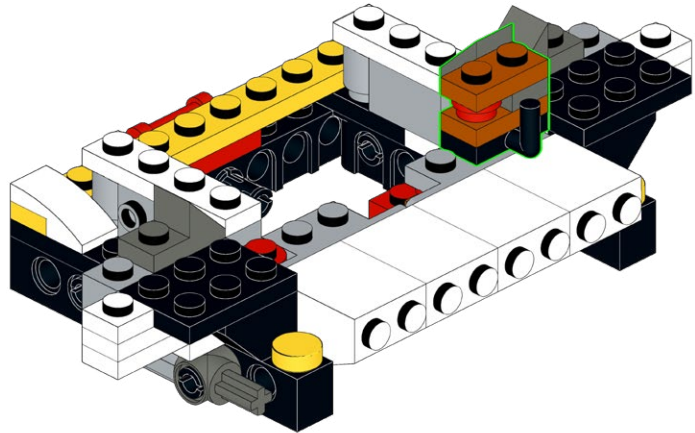

87

4x

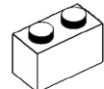

88

2x

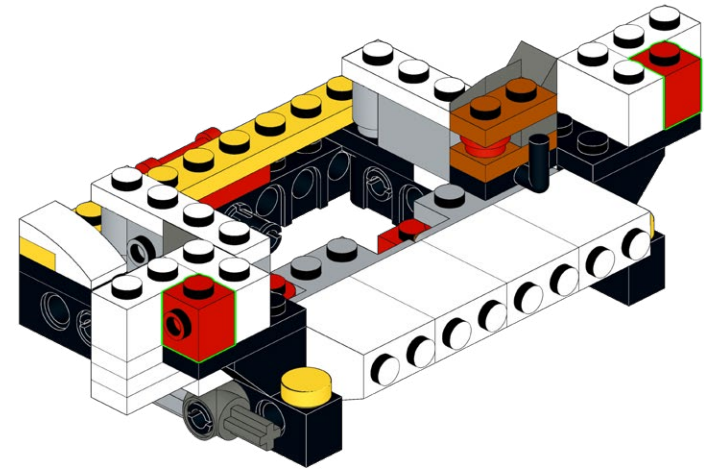
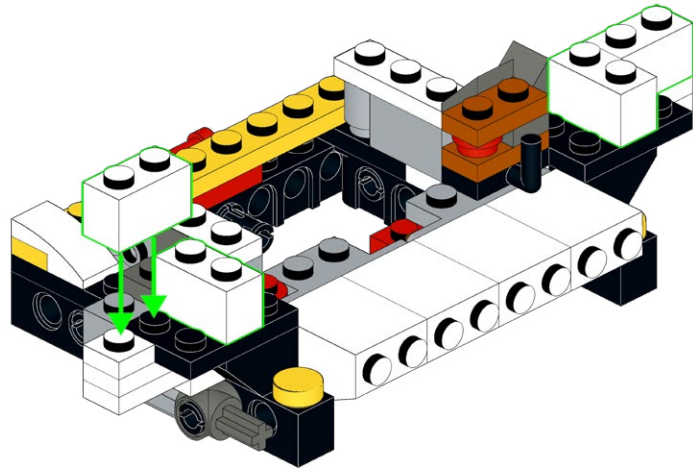

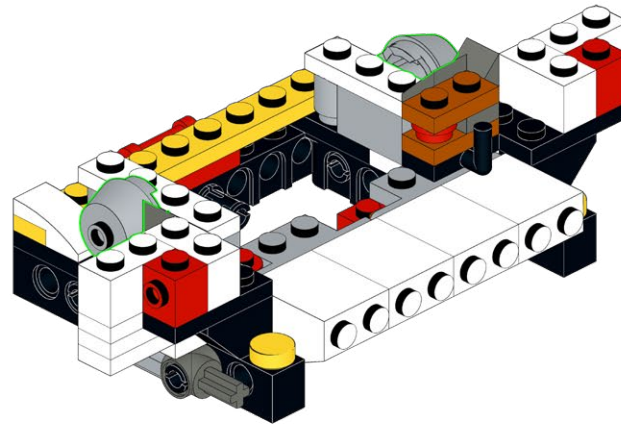

90

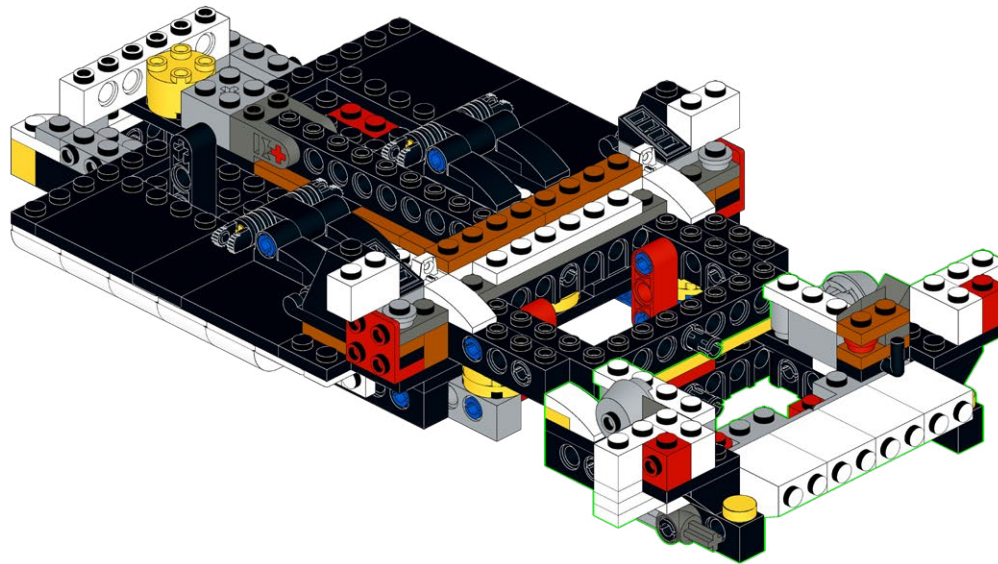

91

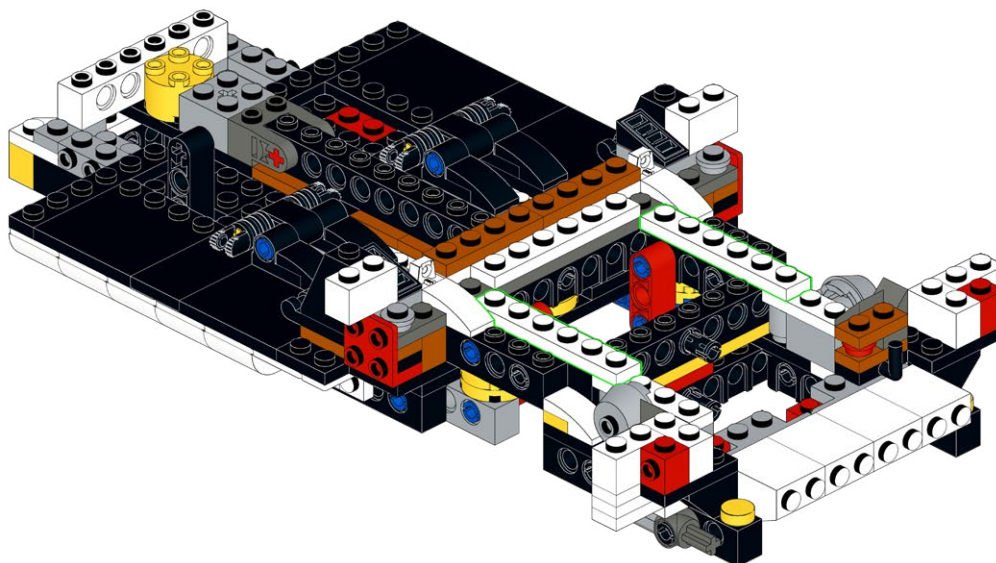
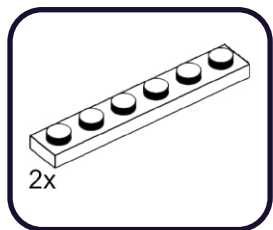

92

2x 1x

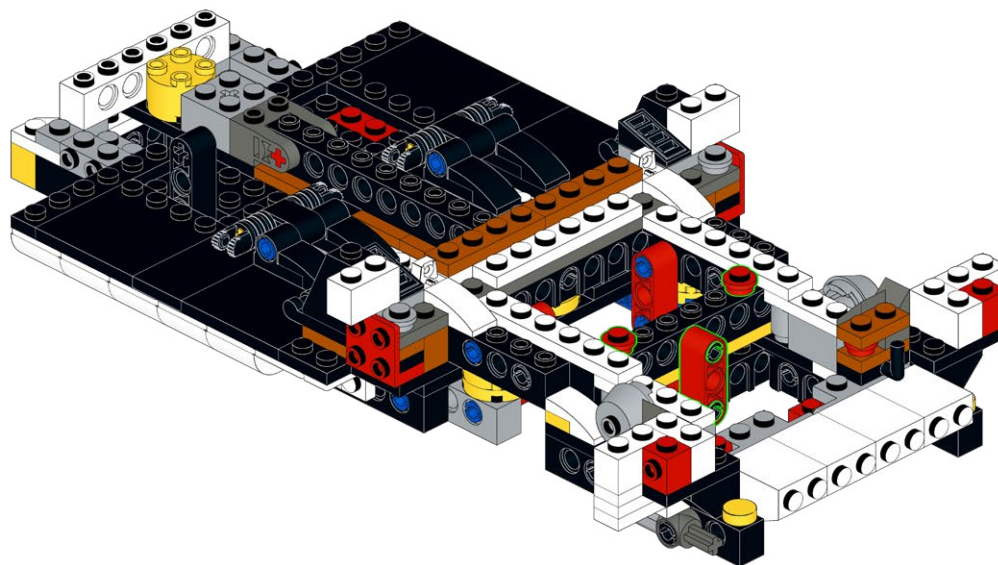
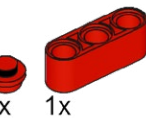

93

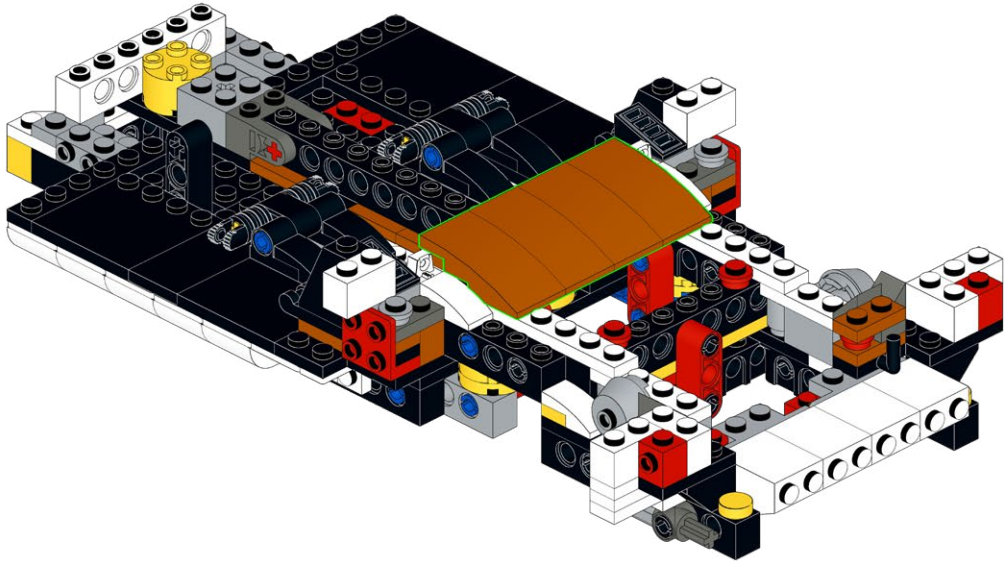
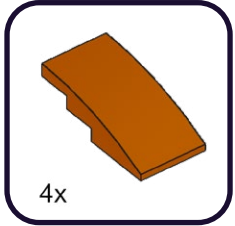

94

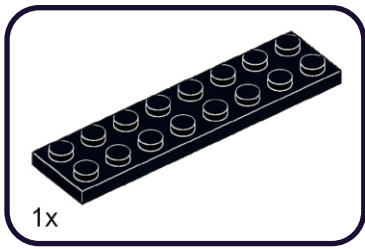

95

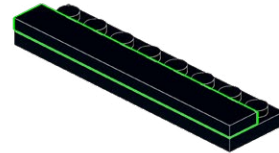
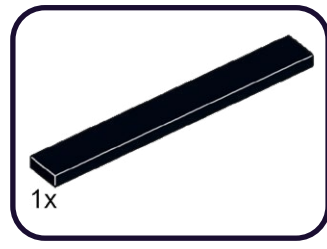

96

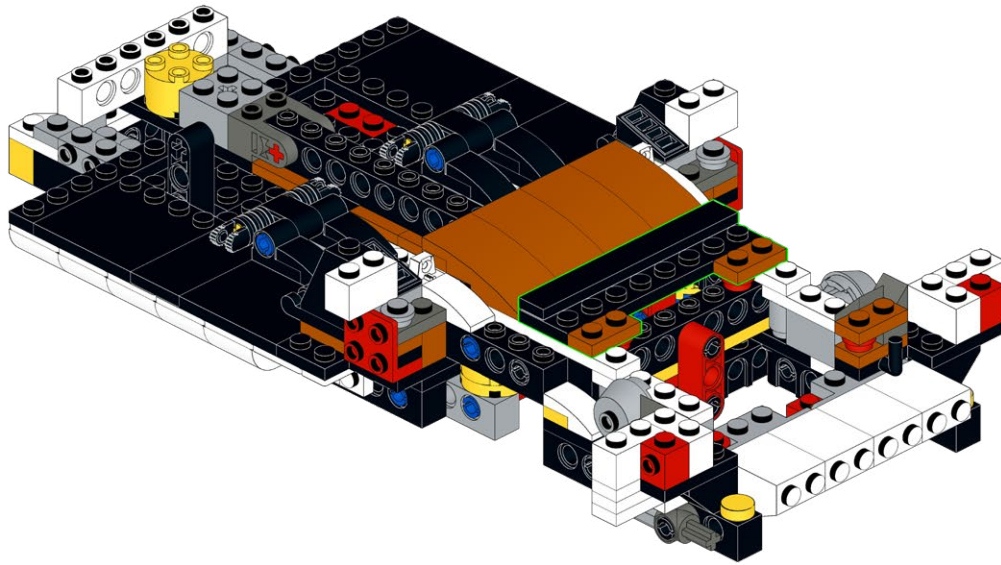
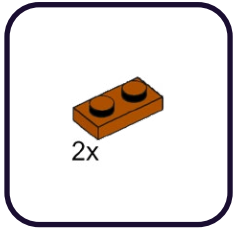

97

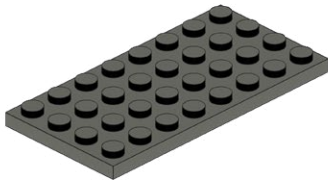
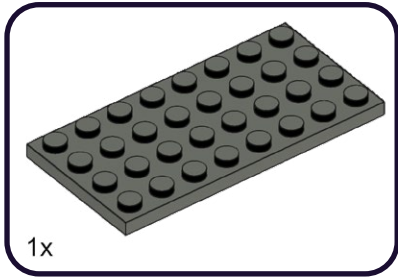

98

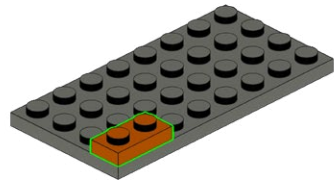
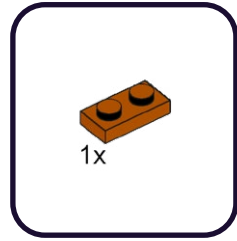

99

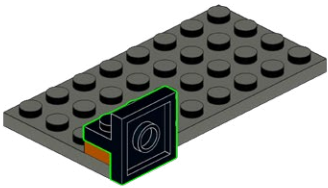
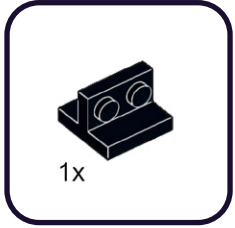

100

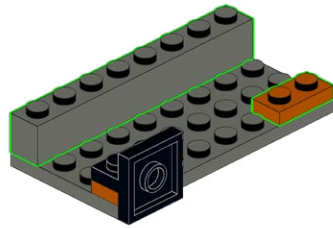
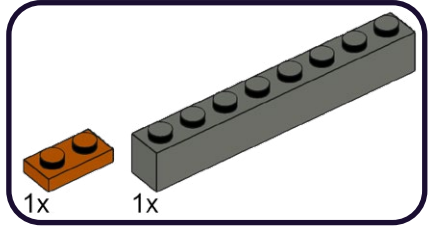

101

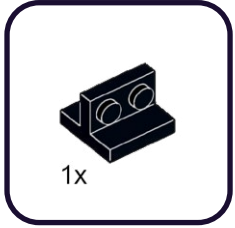

102

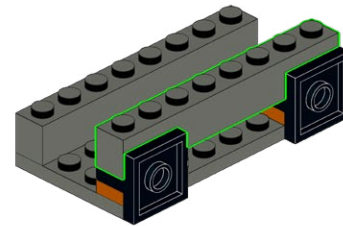
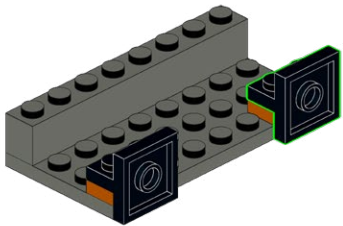
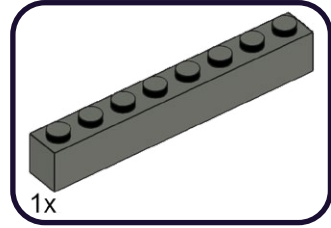

103

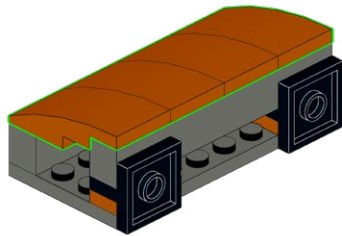
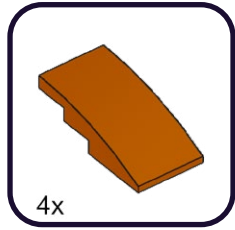

104

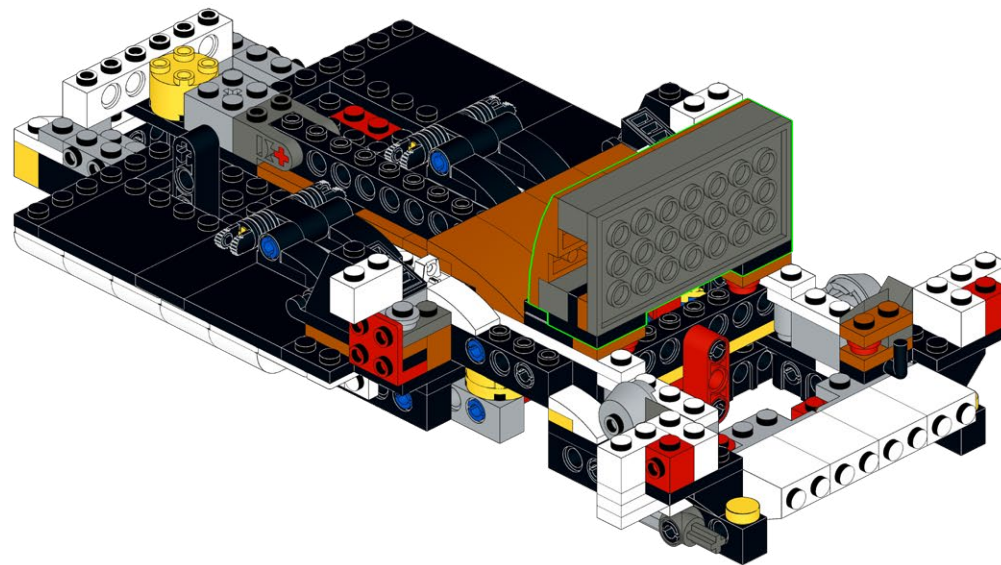

105

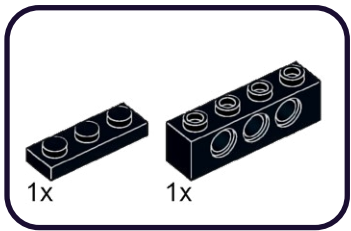

106

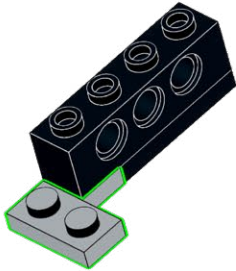
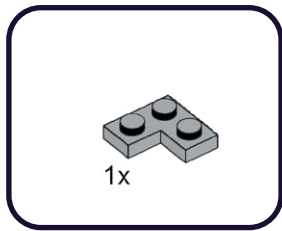

107



1x

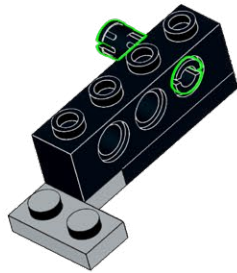

108

1x

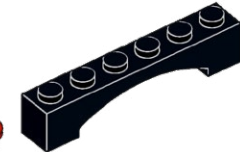

1x

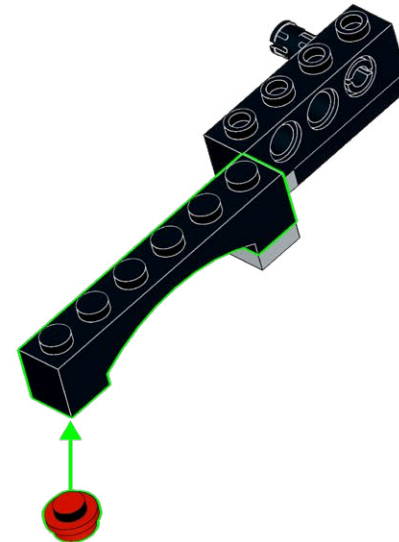

109

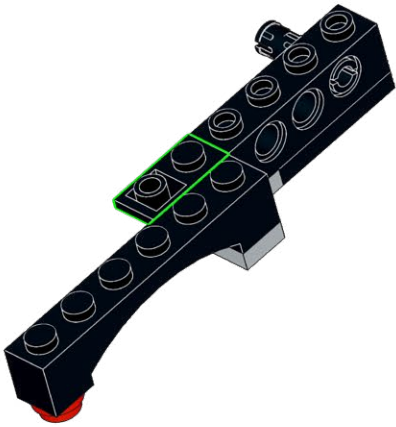
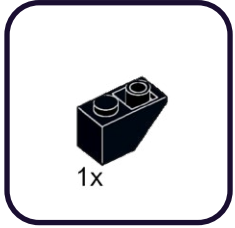

110

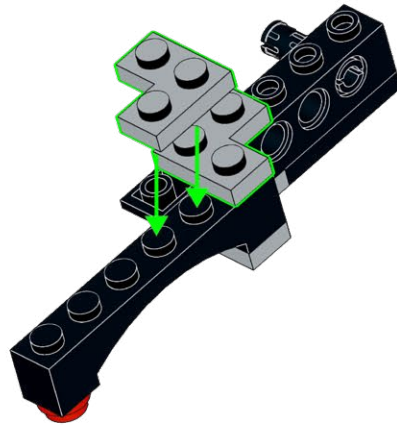
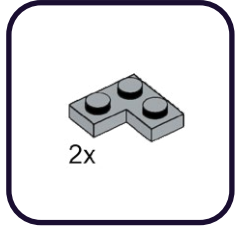

111

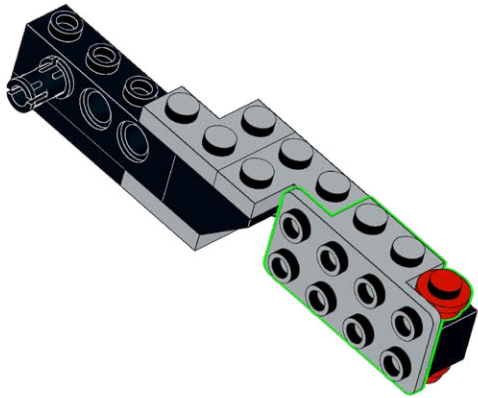
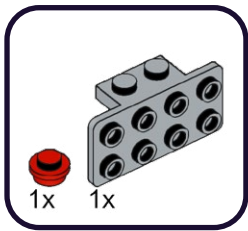

112

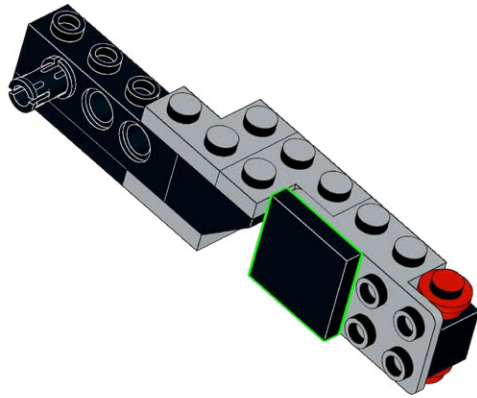
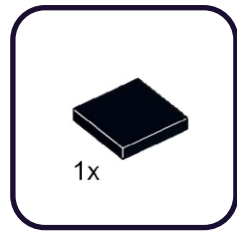

113

2x

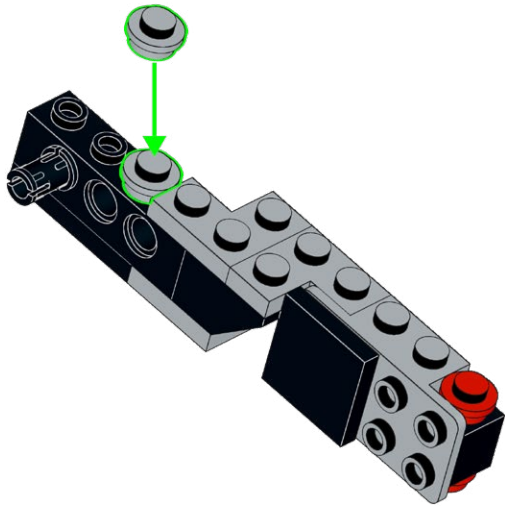

114

1x

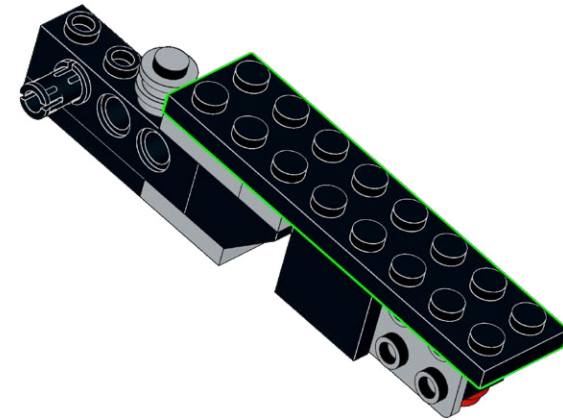
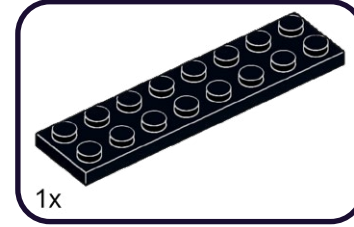

115

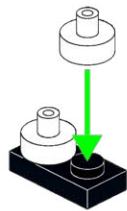
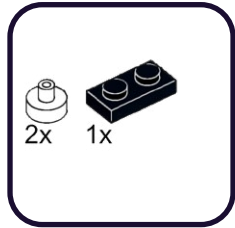

116

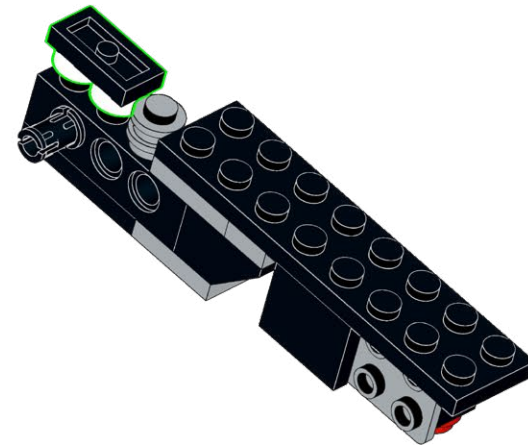

117

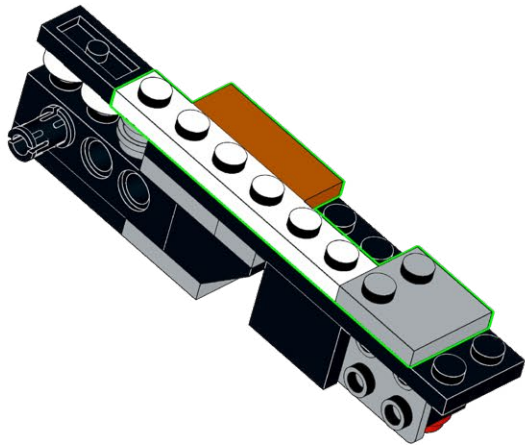
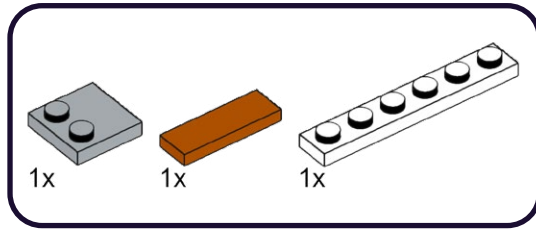

118

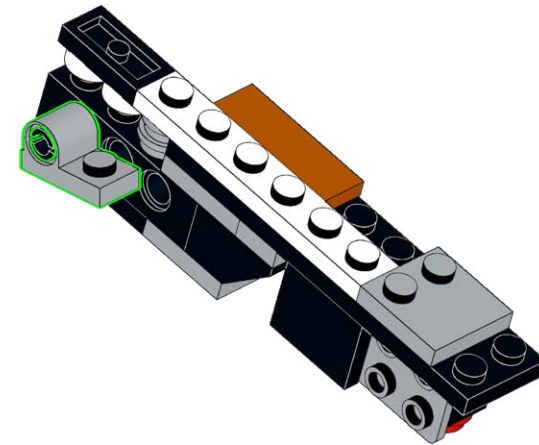
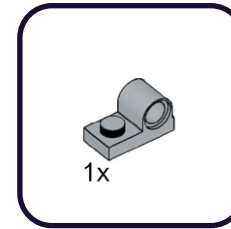

119

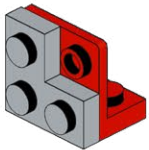
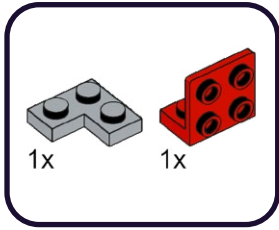

120

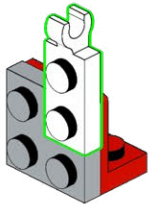
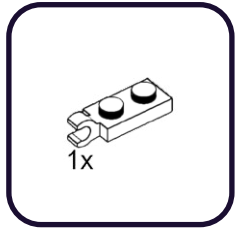

121

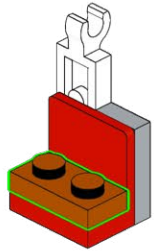
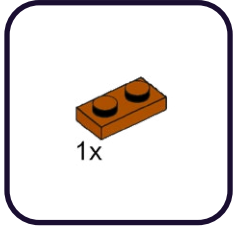

122

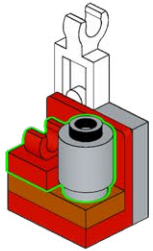
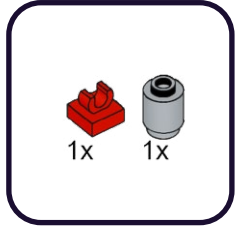

123

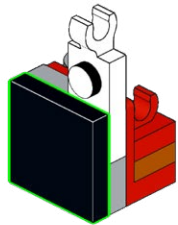
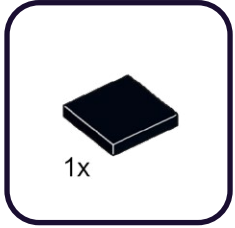

124

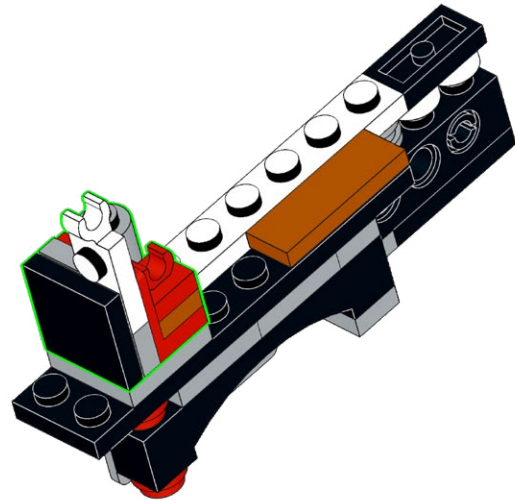

125

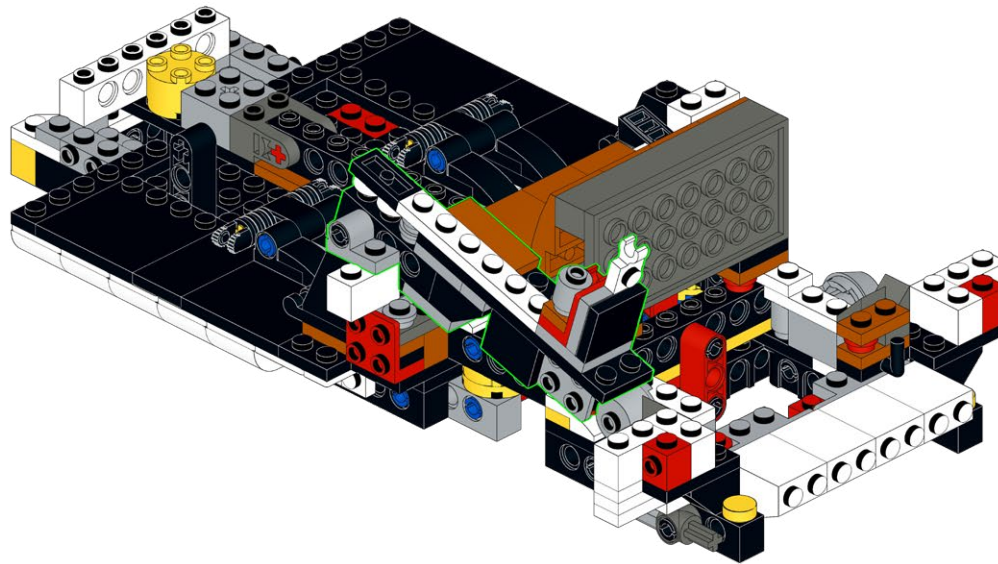

126

1x

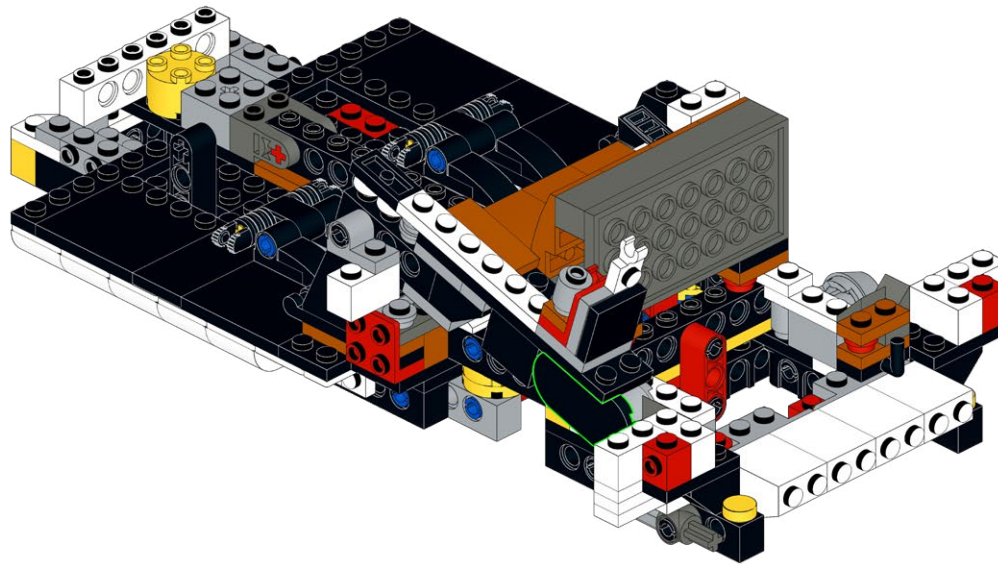

127

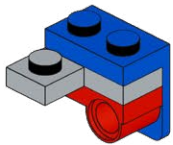
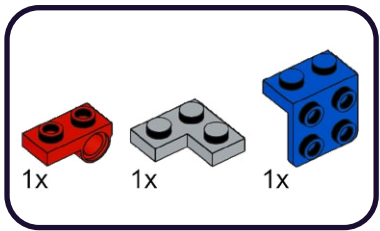

128

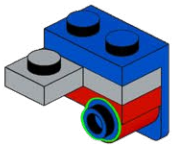
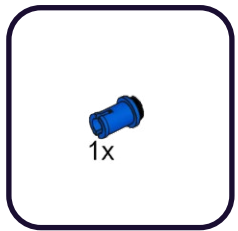

129

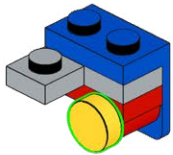
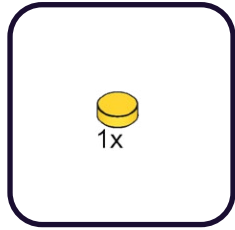

130

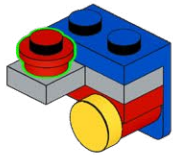
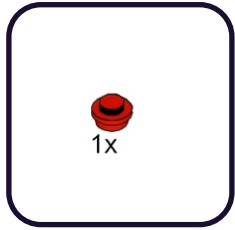

131

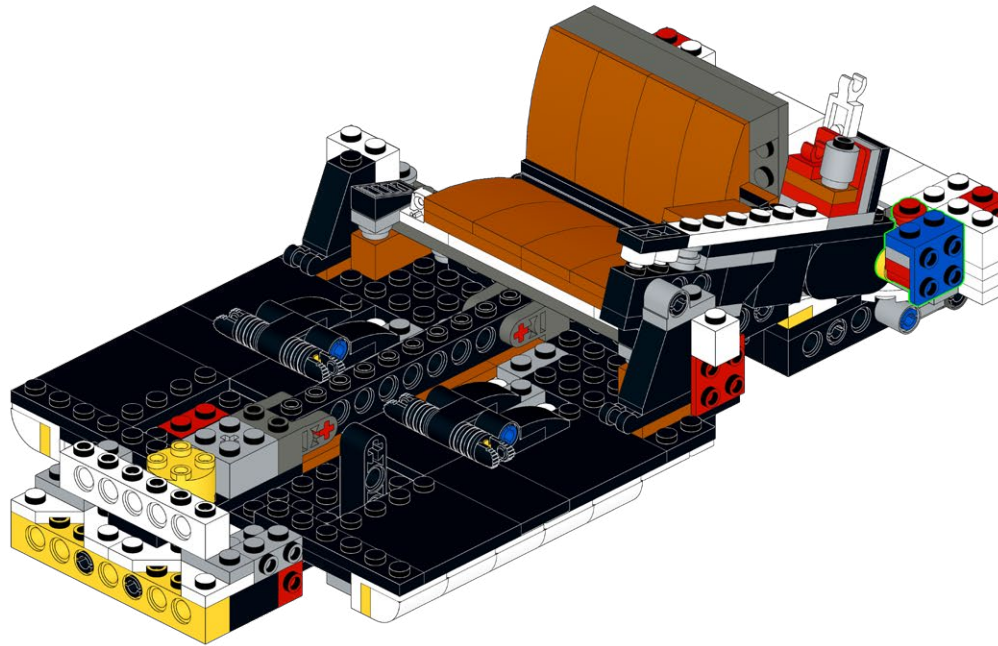

132

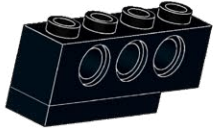
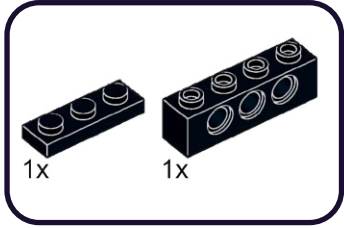

133

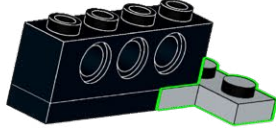
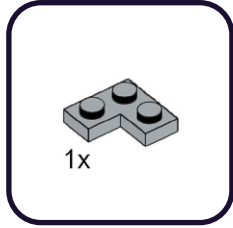

134

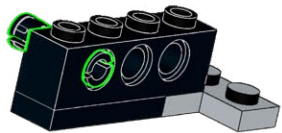

135

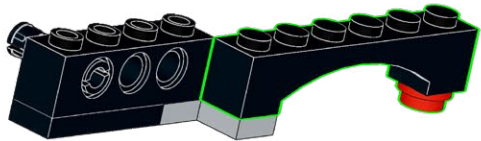
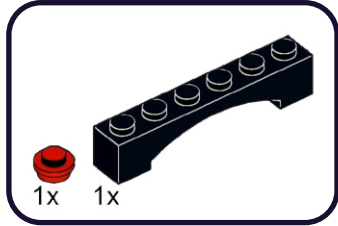

136

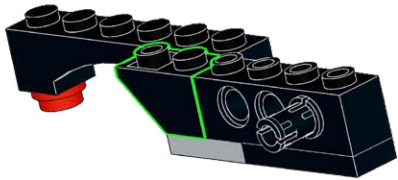
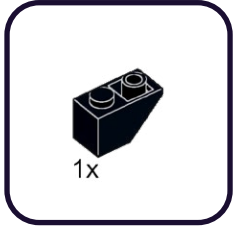

137

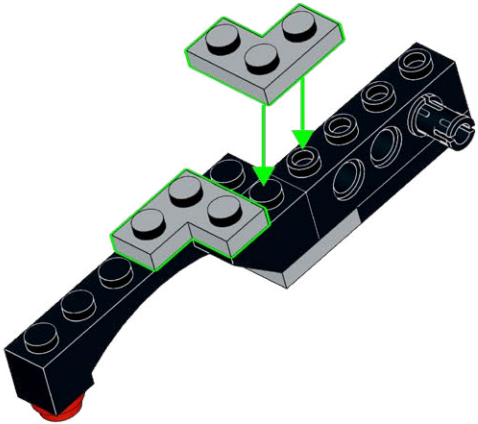
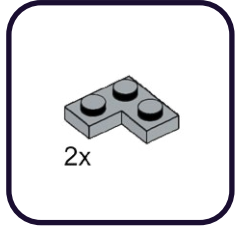

138

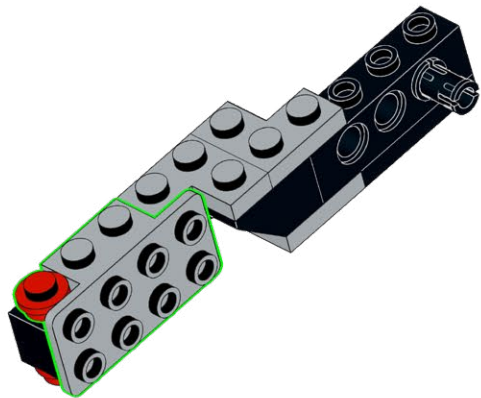
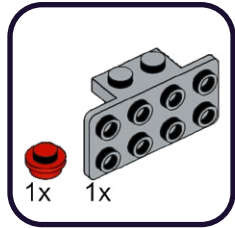

139

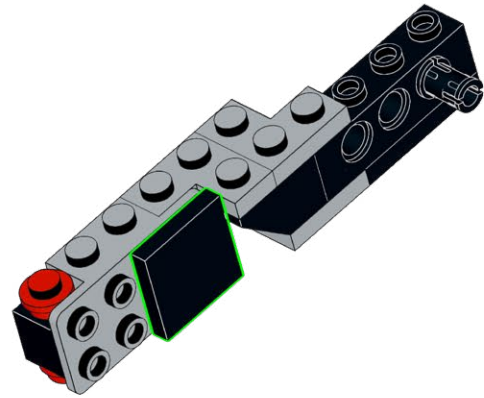
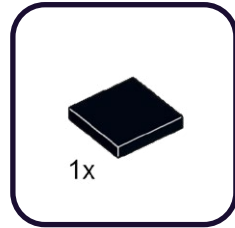

140

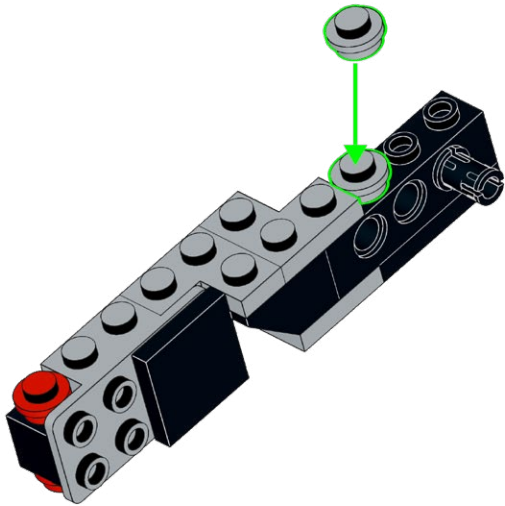
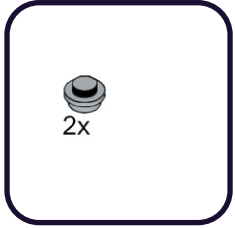

141

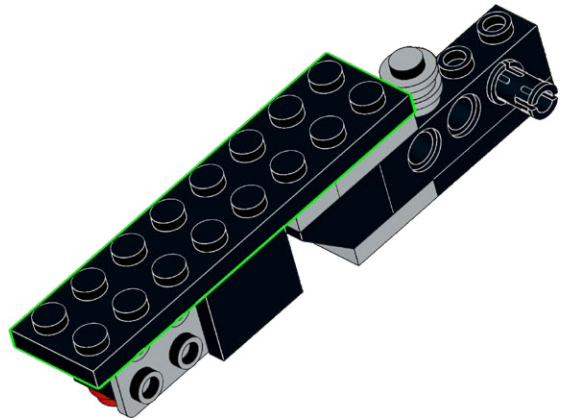
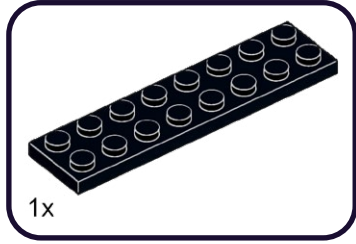

142

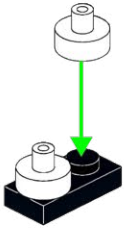
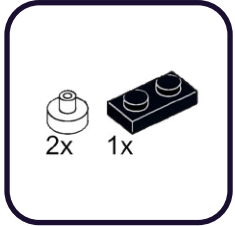

143

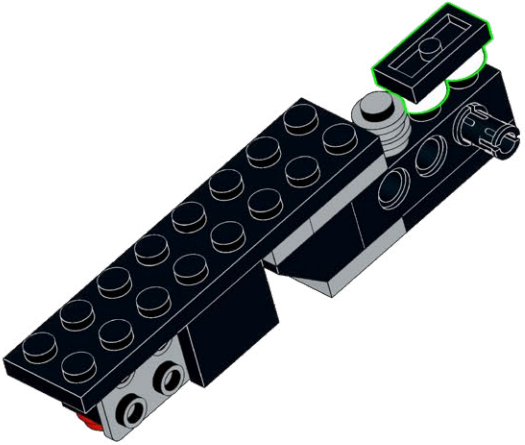

144

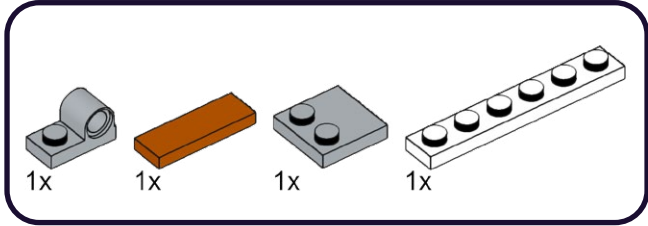

145

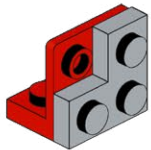
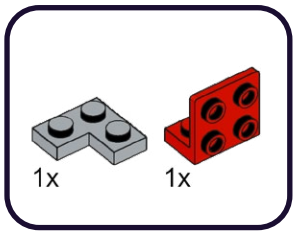

146

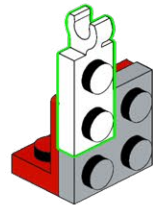
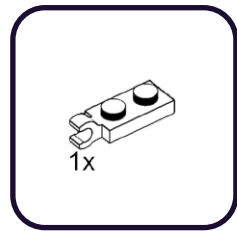

147

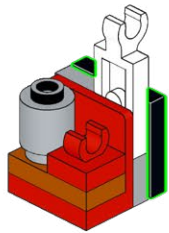
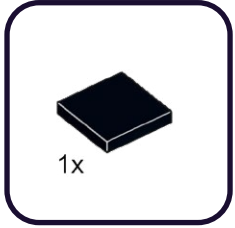

148

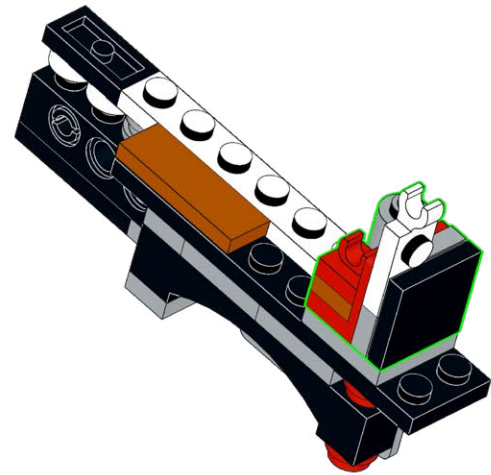

149

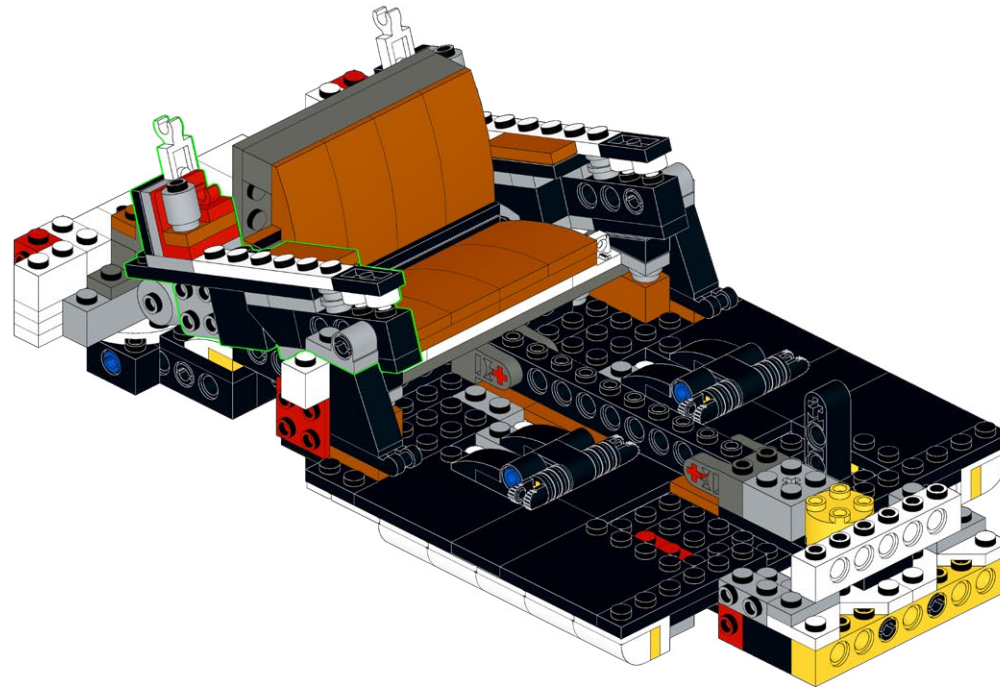

150

1x

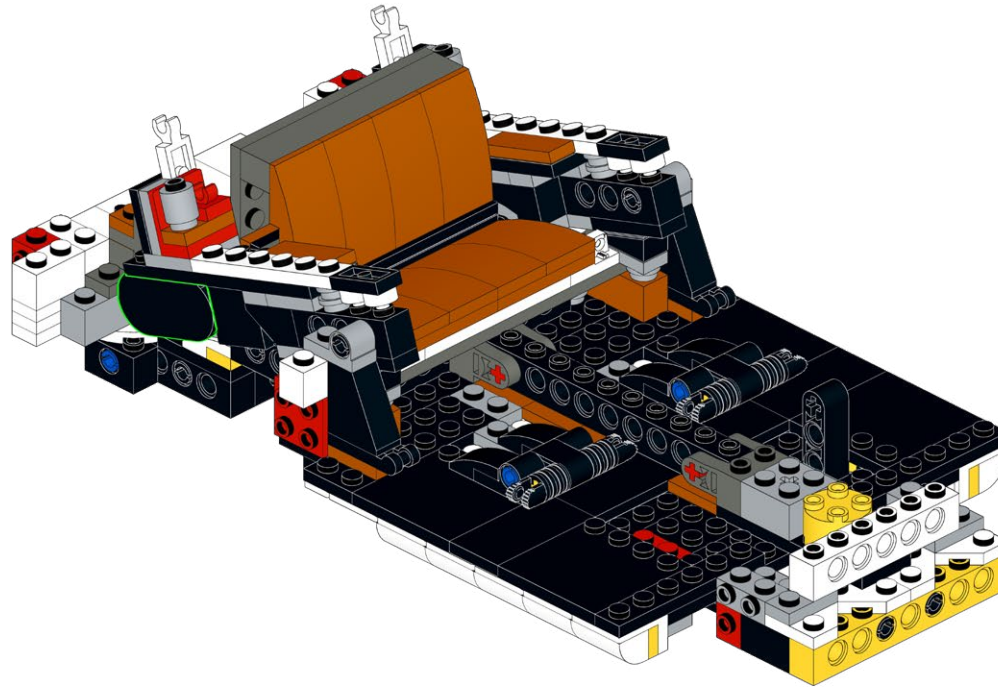

151

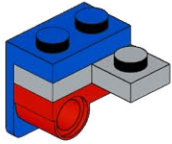
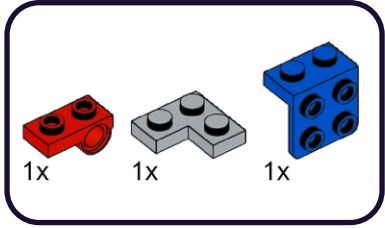

152

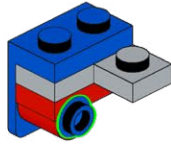
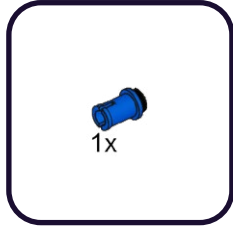

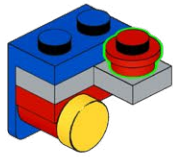
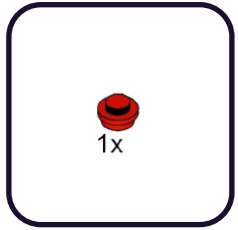
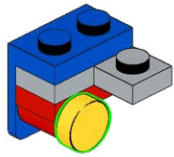
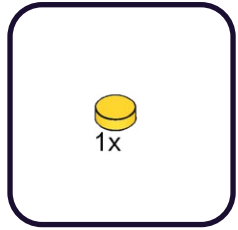

155

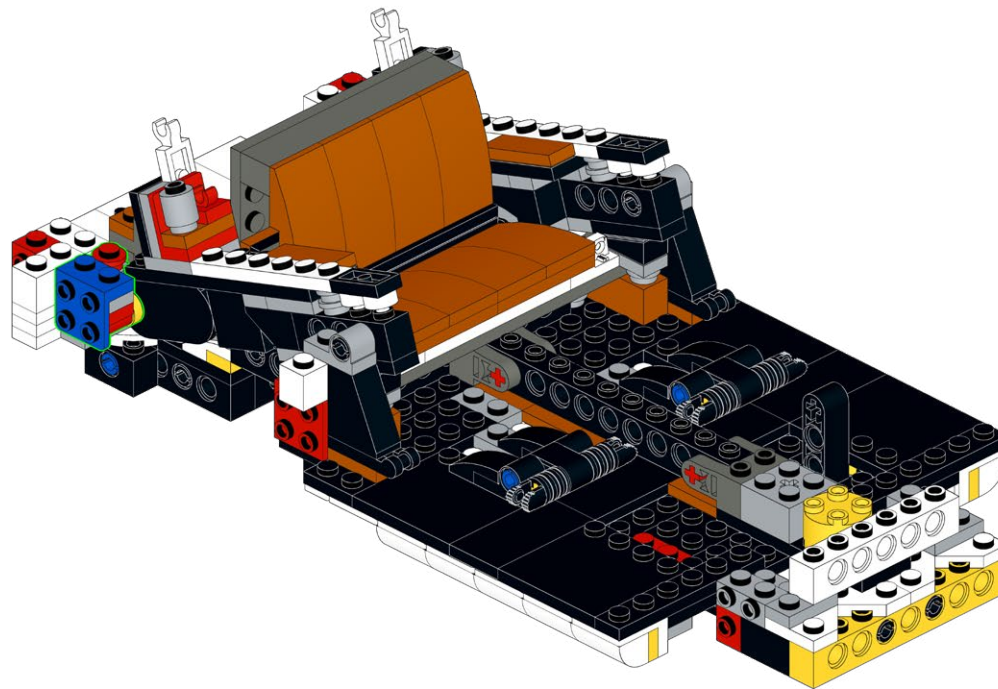

156

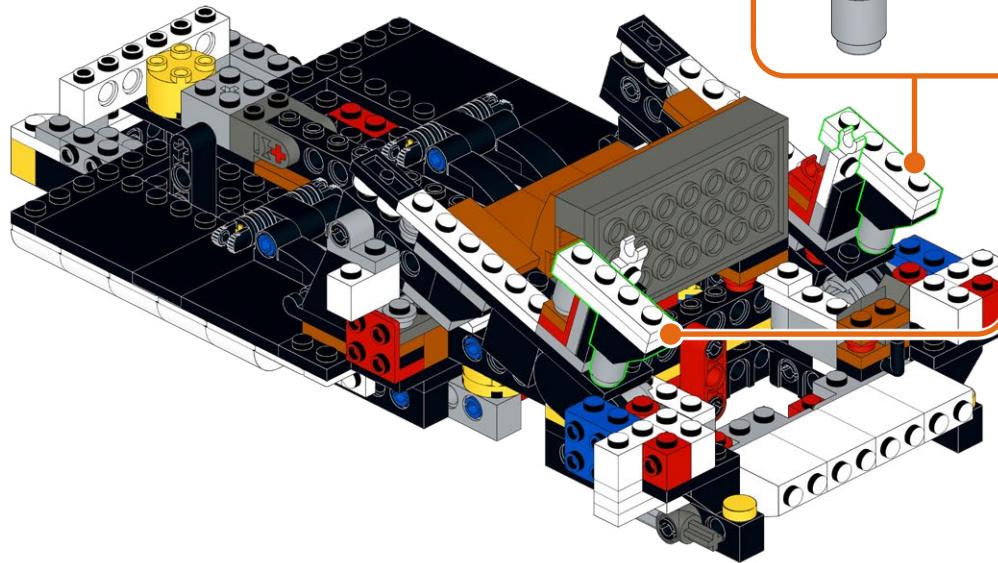
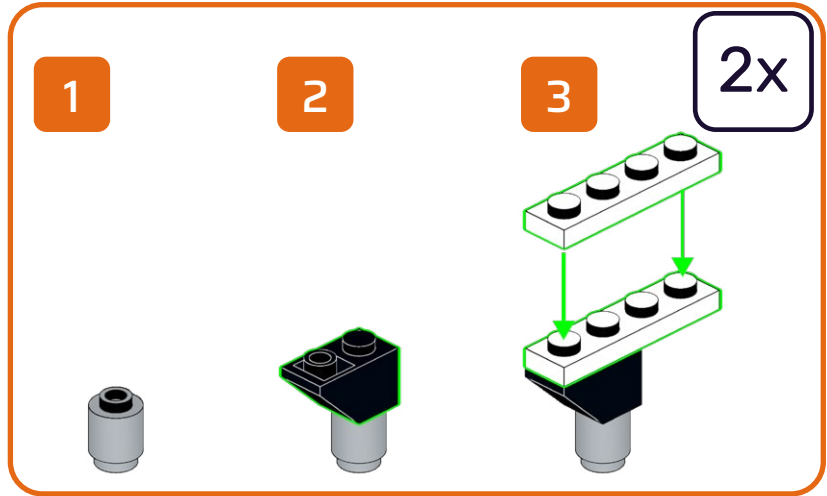
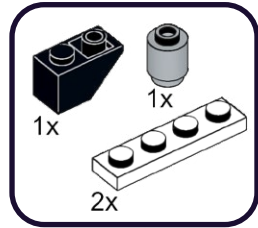

157

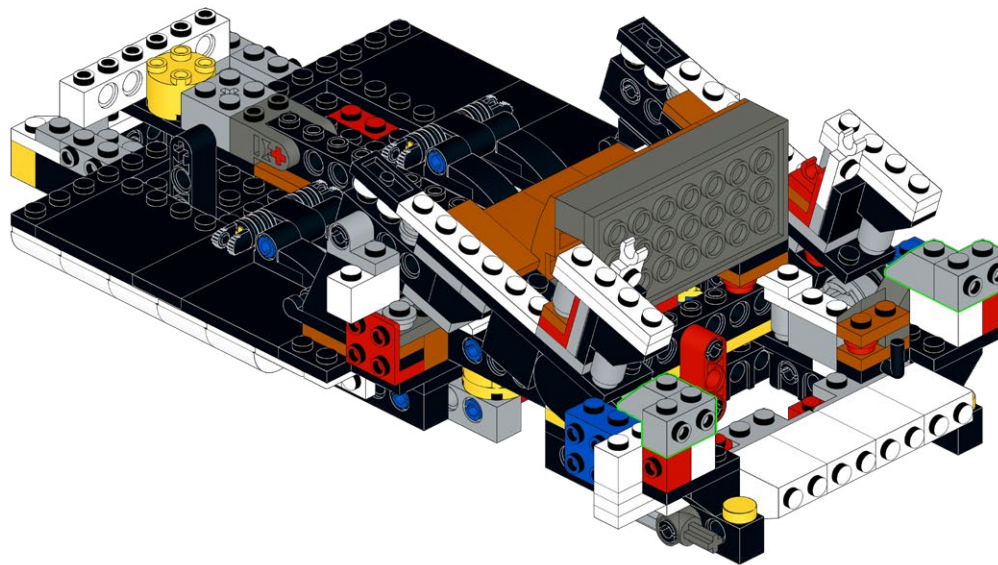
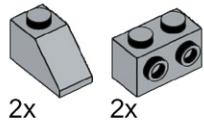



HOLD UP!

You might notice some bags aren't in order, as well as left over pieces, but that's ok! We're changing the way you build LEGO!

ATTENDEZ!

Vous remarquerez peut-être que certains sacs, ainsi que certaines pièces, ne sont pas dans le bon ordre. Mais pas de panique! Nous changeons simplement la façon avec laquelle vous construisez vos LEGO!

ASPETTA!

Potresti notare che alcuni sacchetti non sono in ordine, così come i pezzi avanzati, ma va bene così! Stiamo cambiando il modo in cui costruisci i LEGO!

HALT!

Sie werden möglicherweise bemerken, dass einige tüten durcheinander sind und teile übrig bleiben, aber das ist in Ordnung! Wir ändern die art und weise, wie Sie LEGO bauen!

¡ESPERA!

Es posible que notes que algunas bolsas están fuera de servicio, así como piezas sobrantes, ¡pero está bien! ¡Estamos cambiando la forma en que construyes LEGO!

暫停!

你可能会注意到一些袋子顺序错乱, 以及一些剩余的部件, 但没关系! 我们正在改变你搭建乐高的方式!

Open LEGO® Bag 1

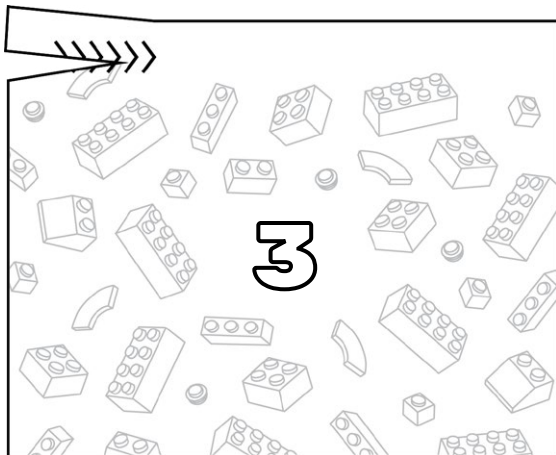

Open LMB Bag 01

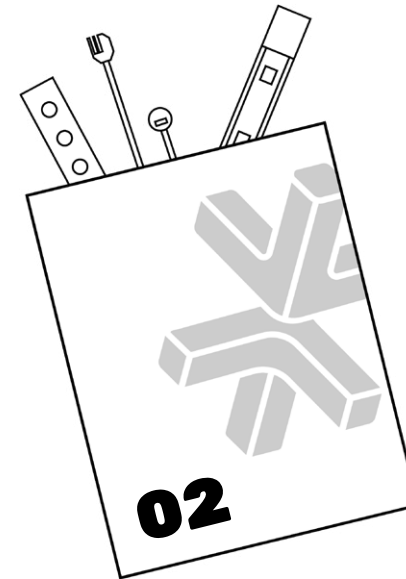

158

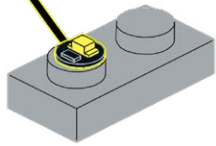
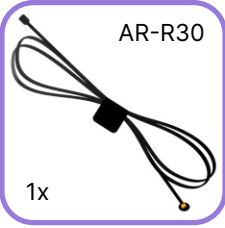
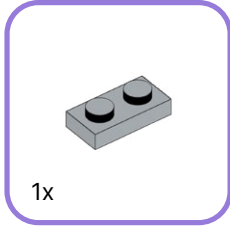

159

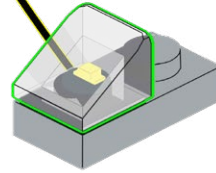
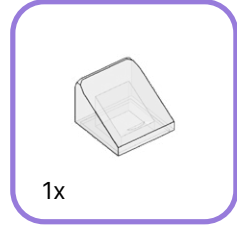

160

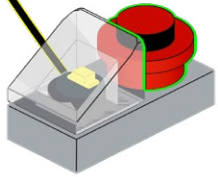
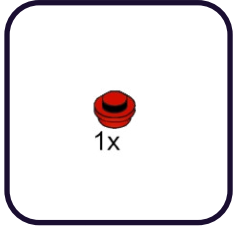

161

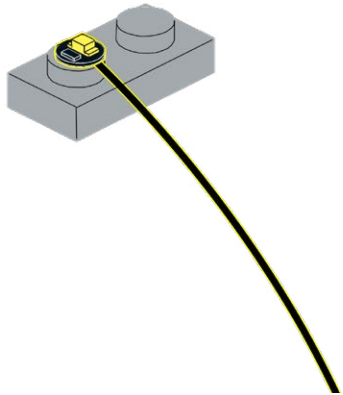
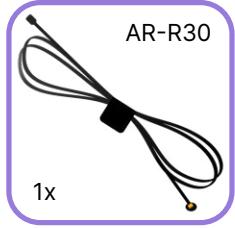
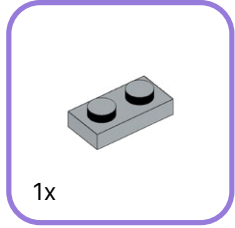

162

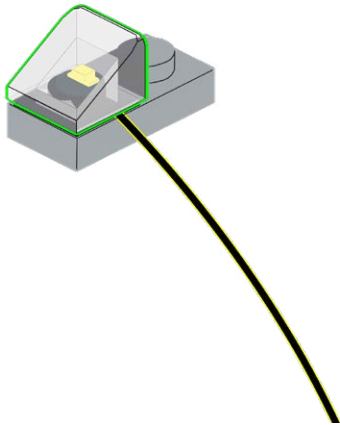
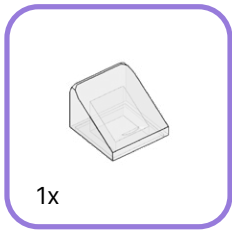

163

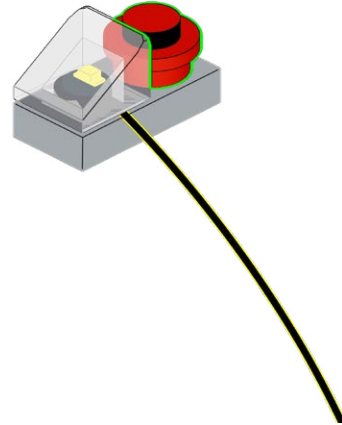
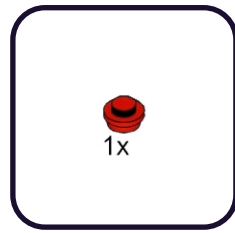

164

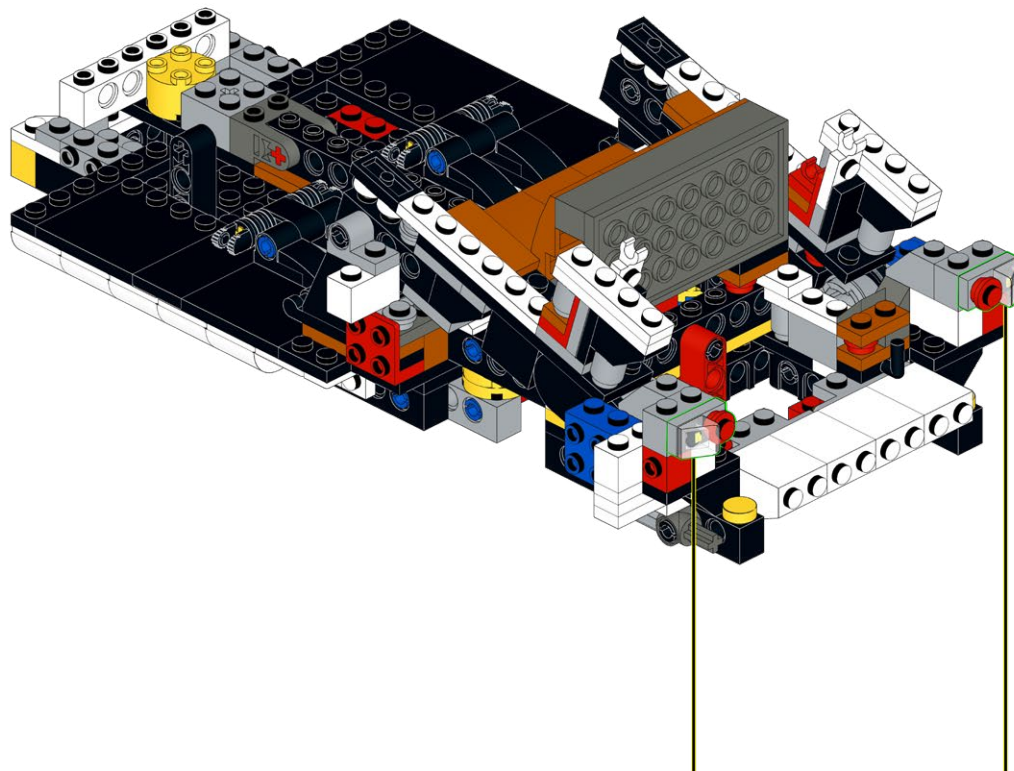

165

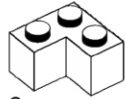

2x

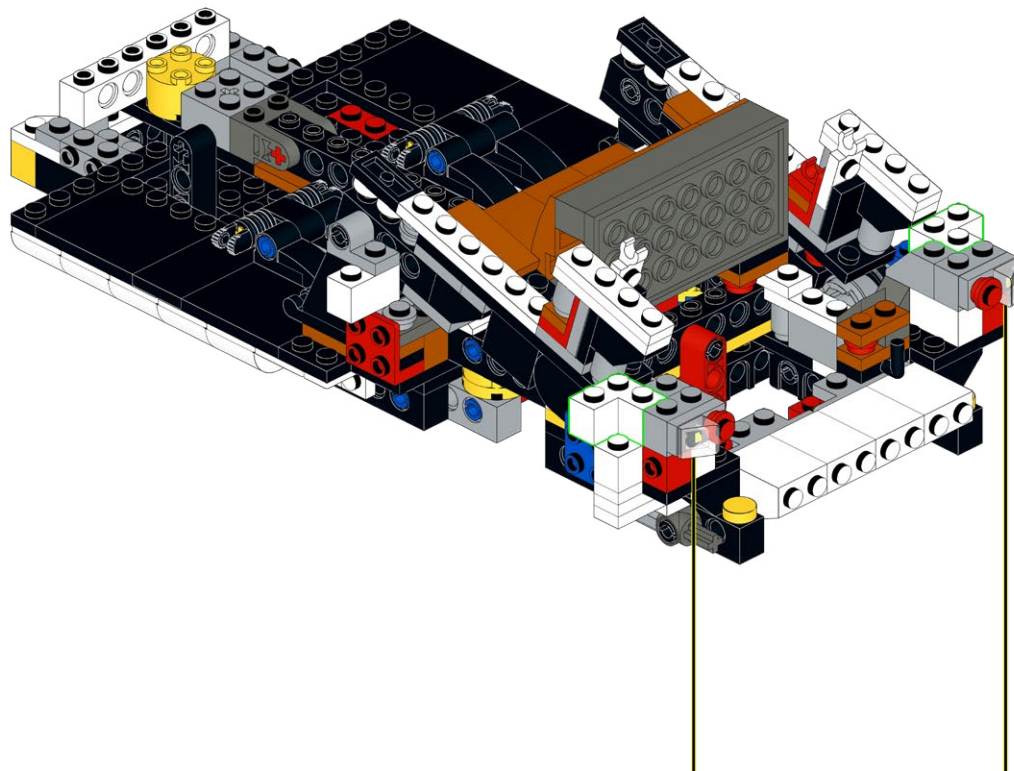

166

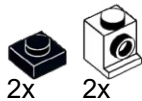

2x

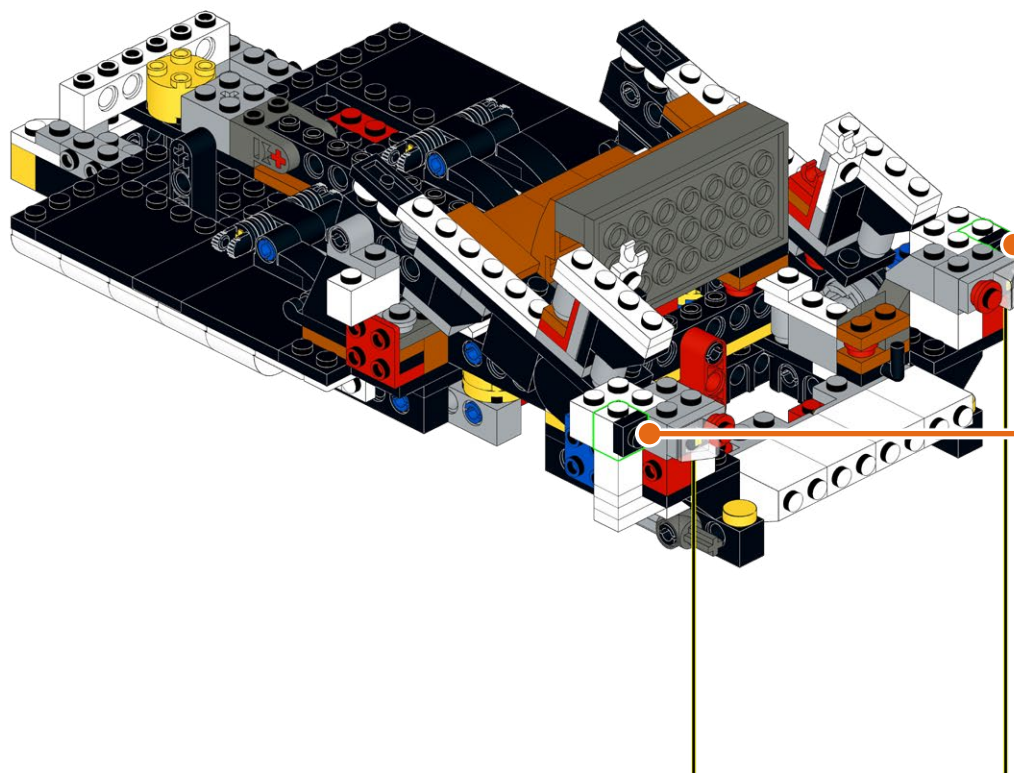
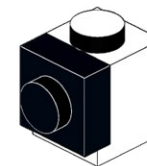

167

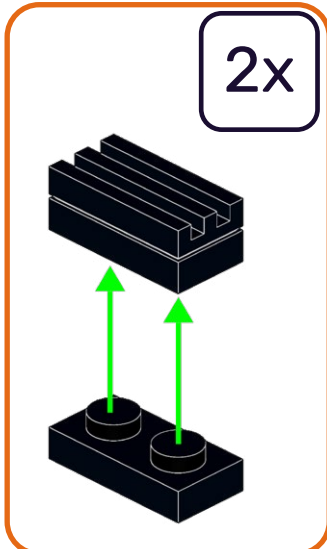
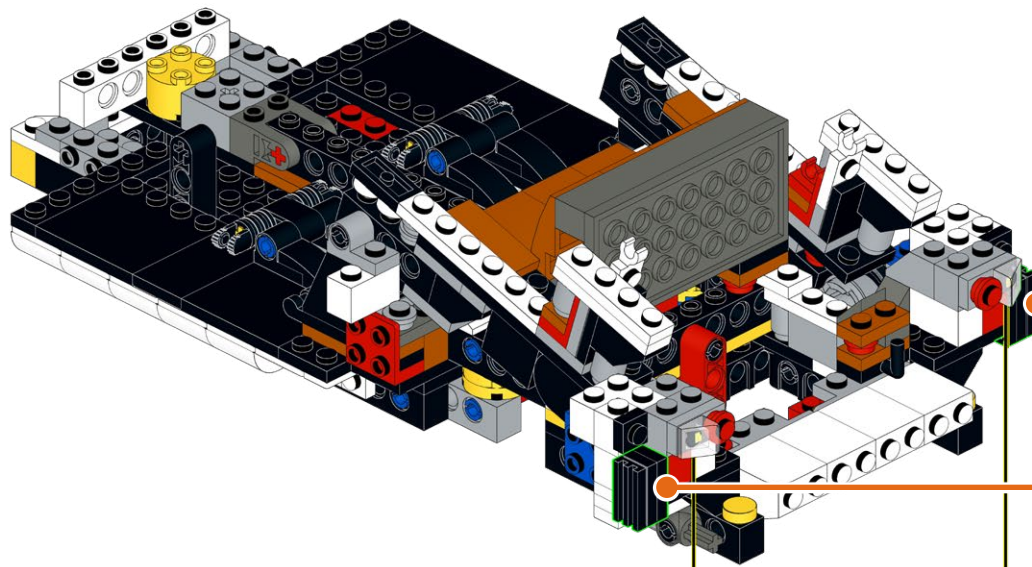
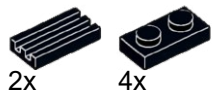

168

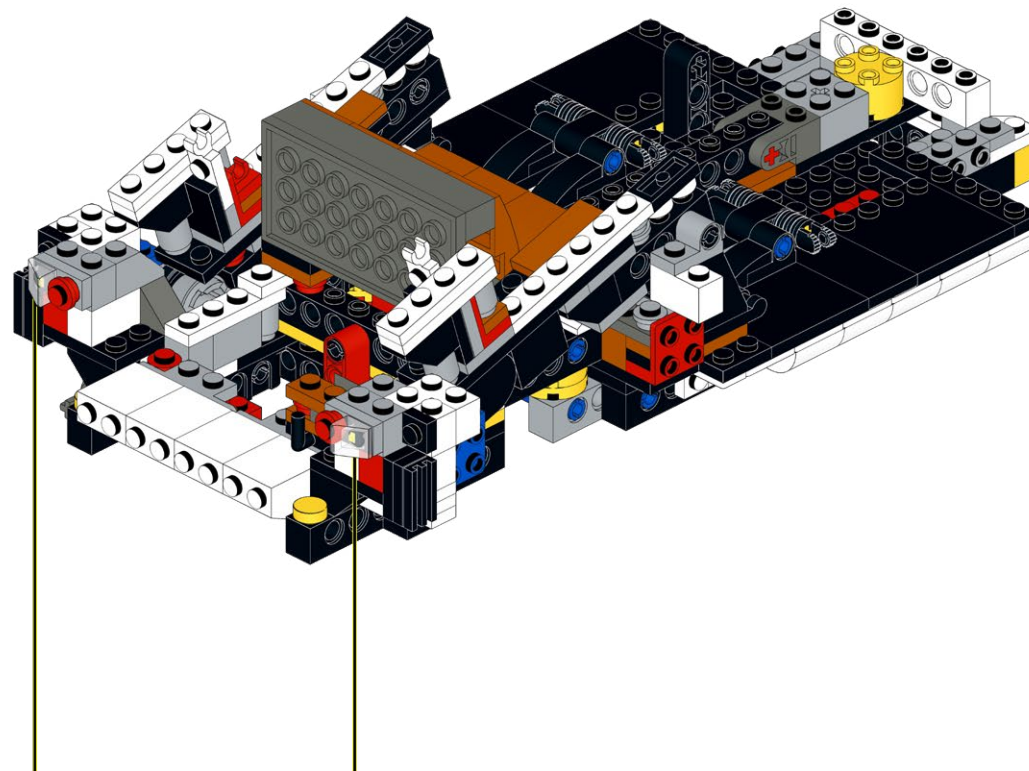

169

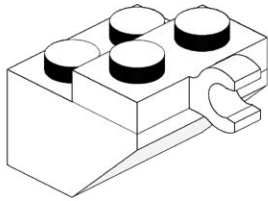
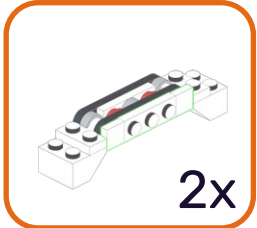
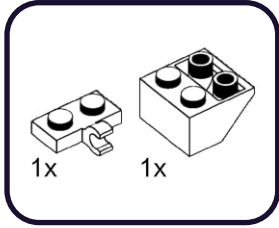

170

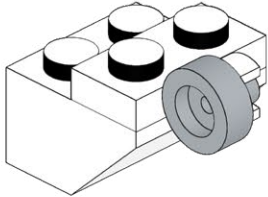
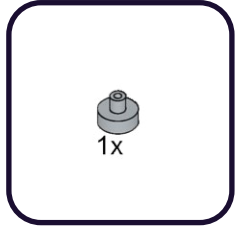

171

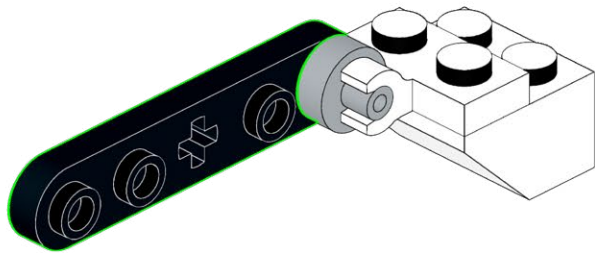
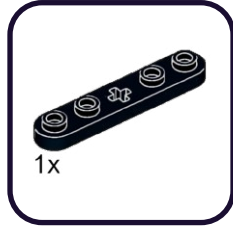

172

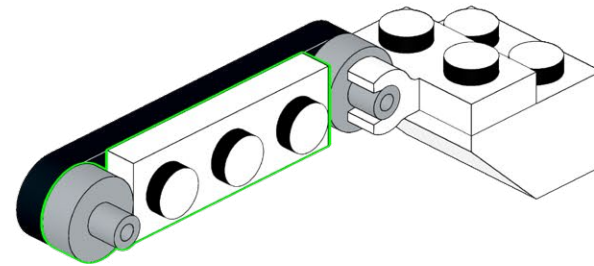
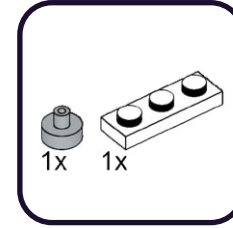

173

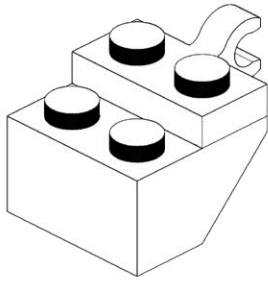
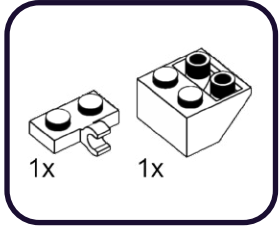

174

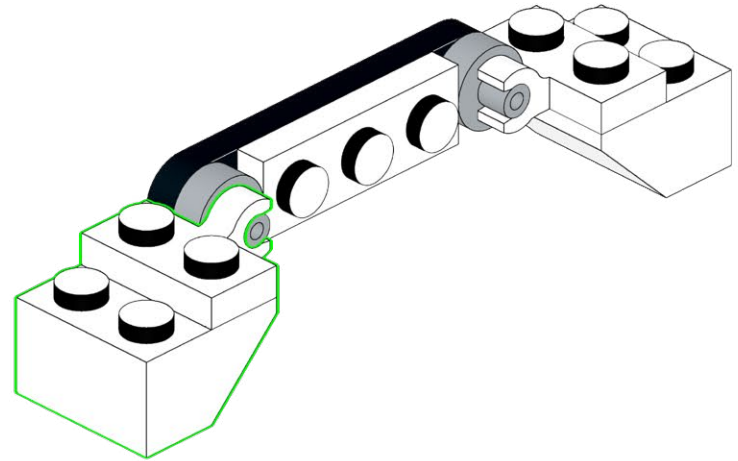

175

2x 1x

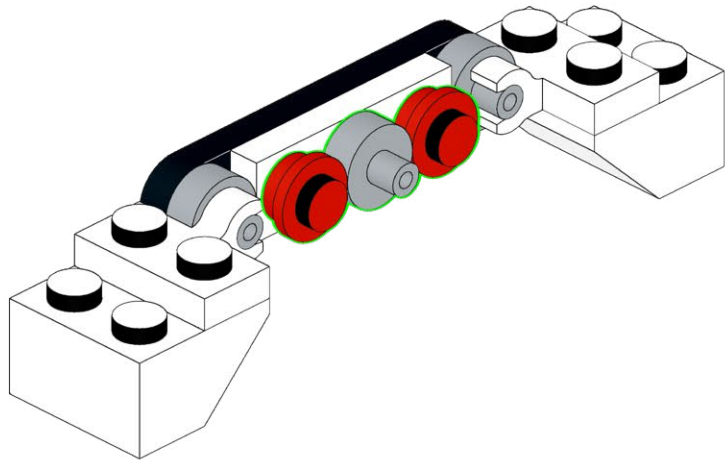

176

1x

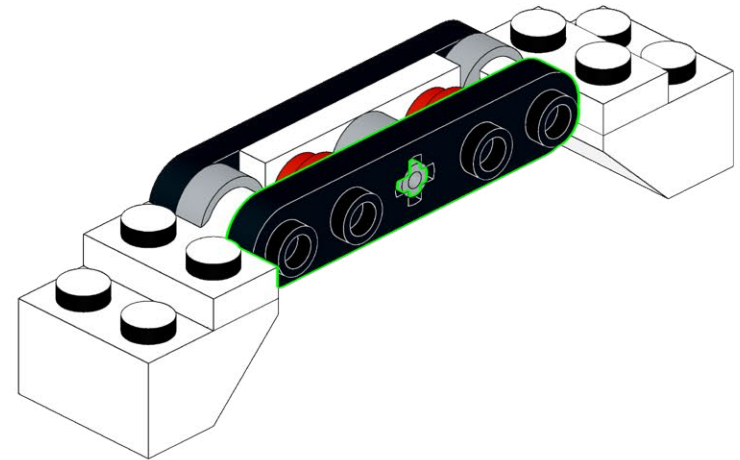

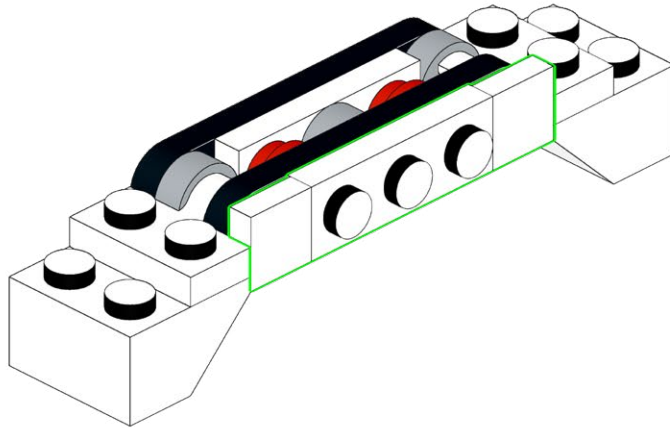
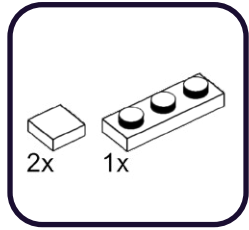

2x

178

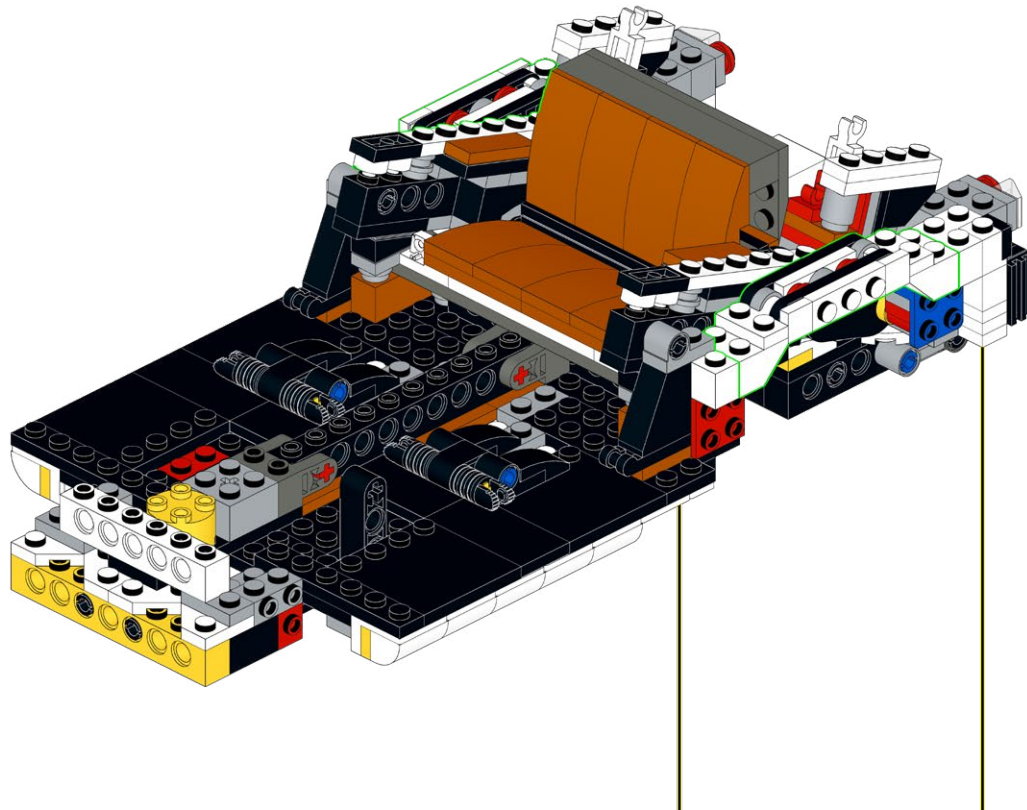

179

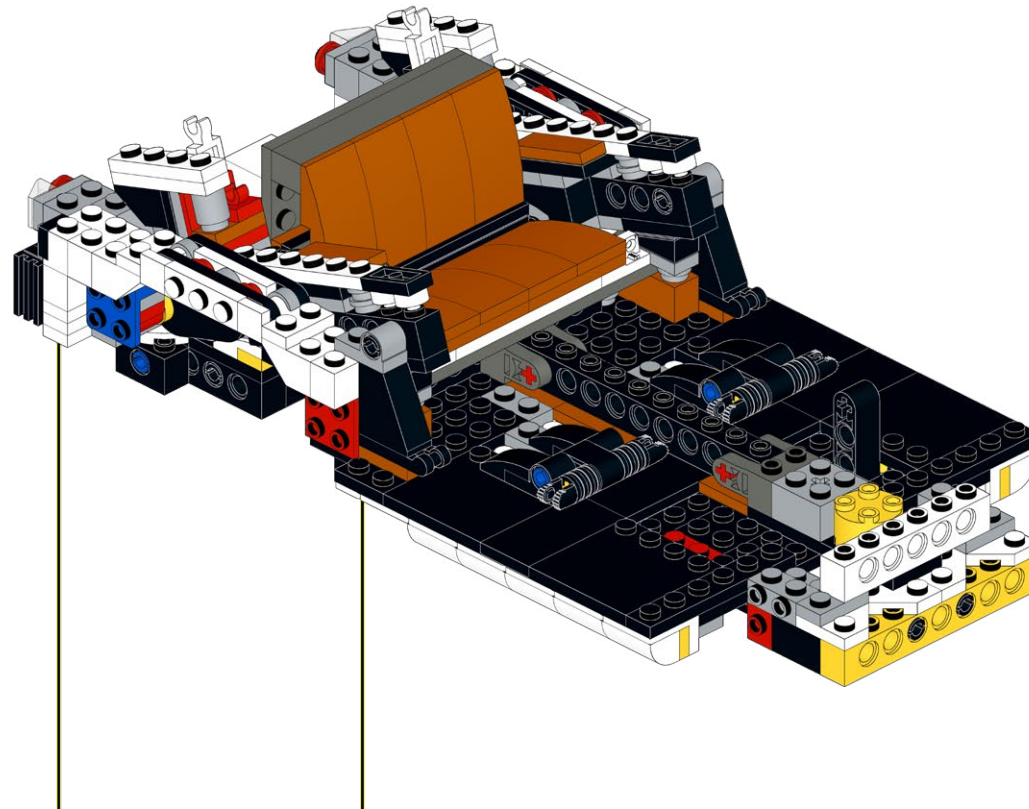

180

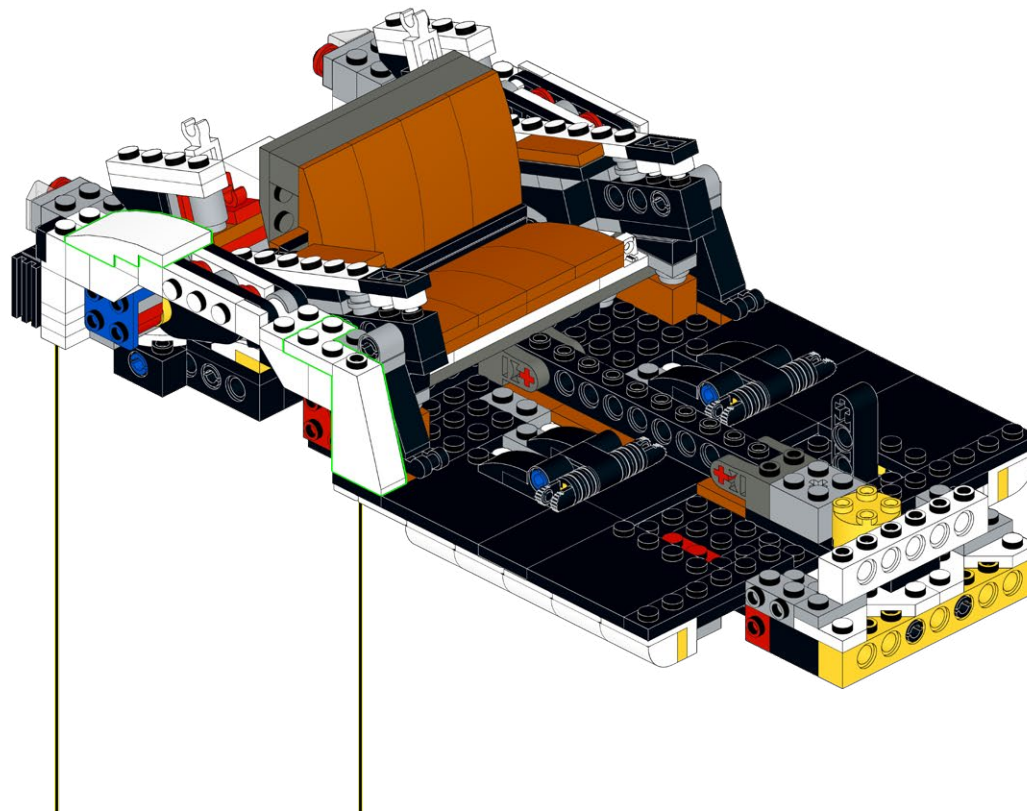
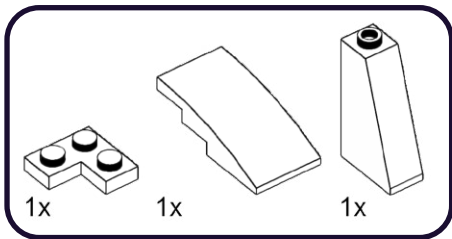

181

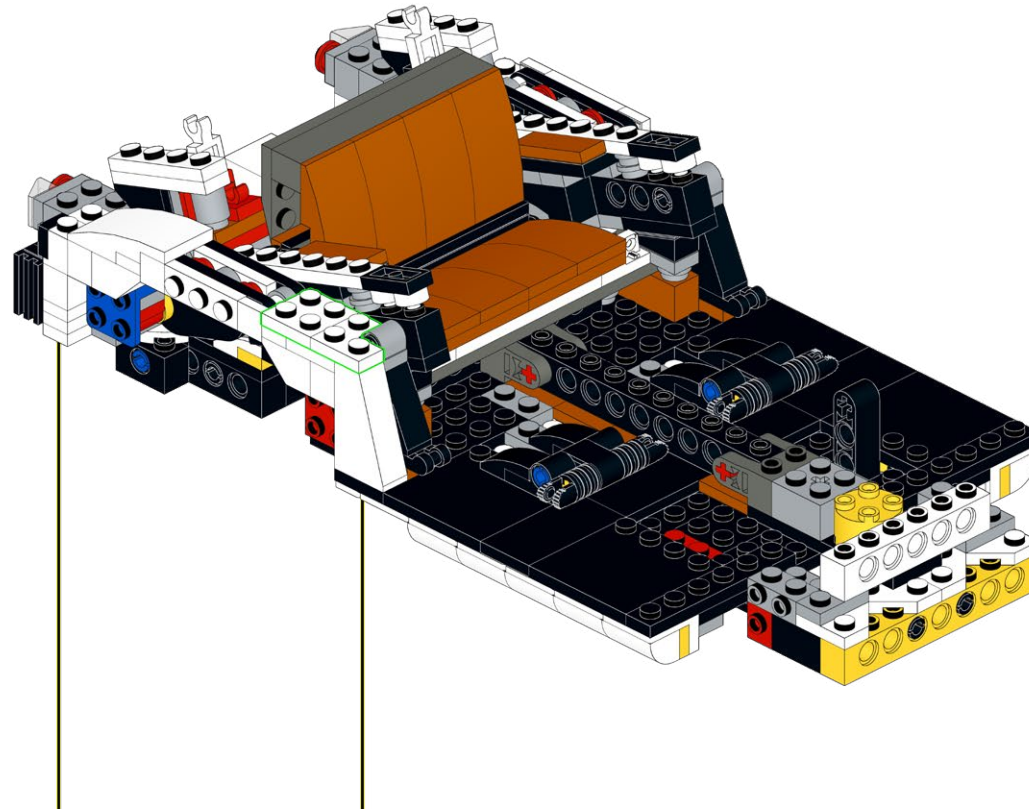
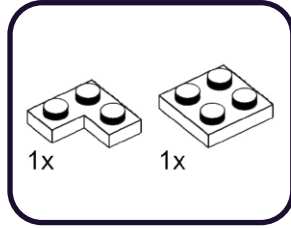

182

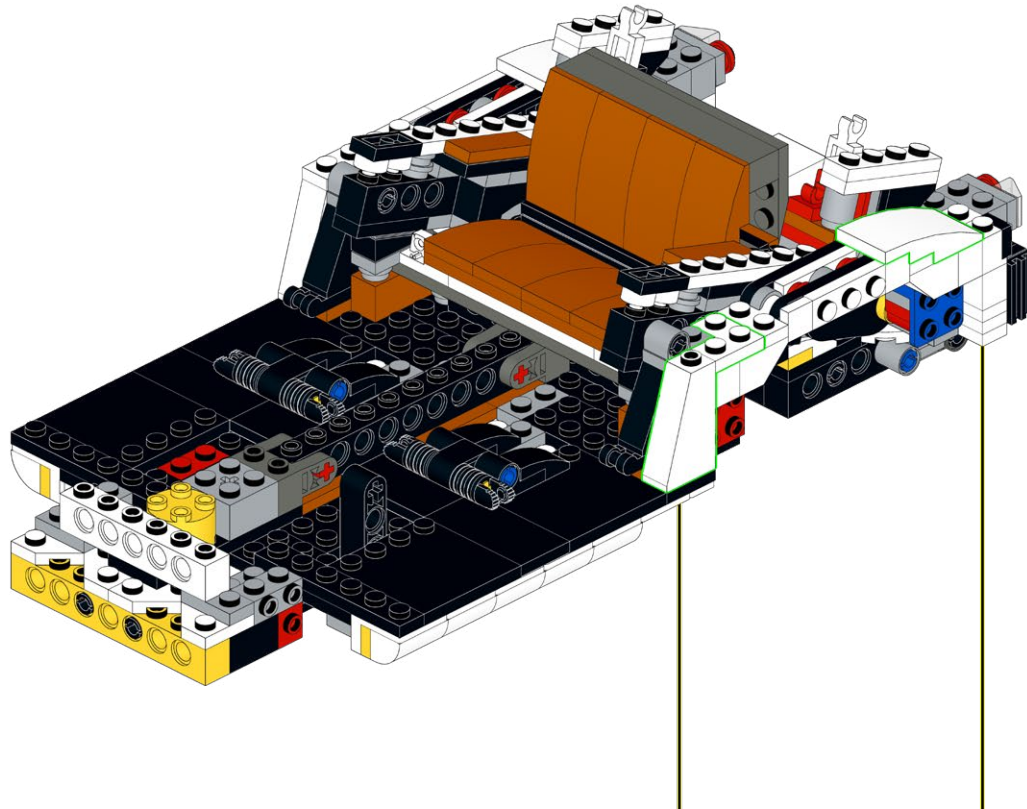
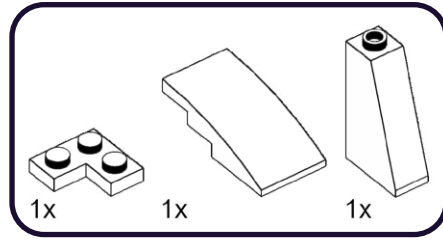

183

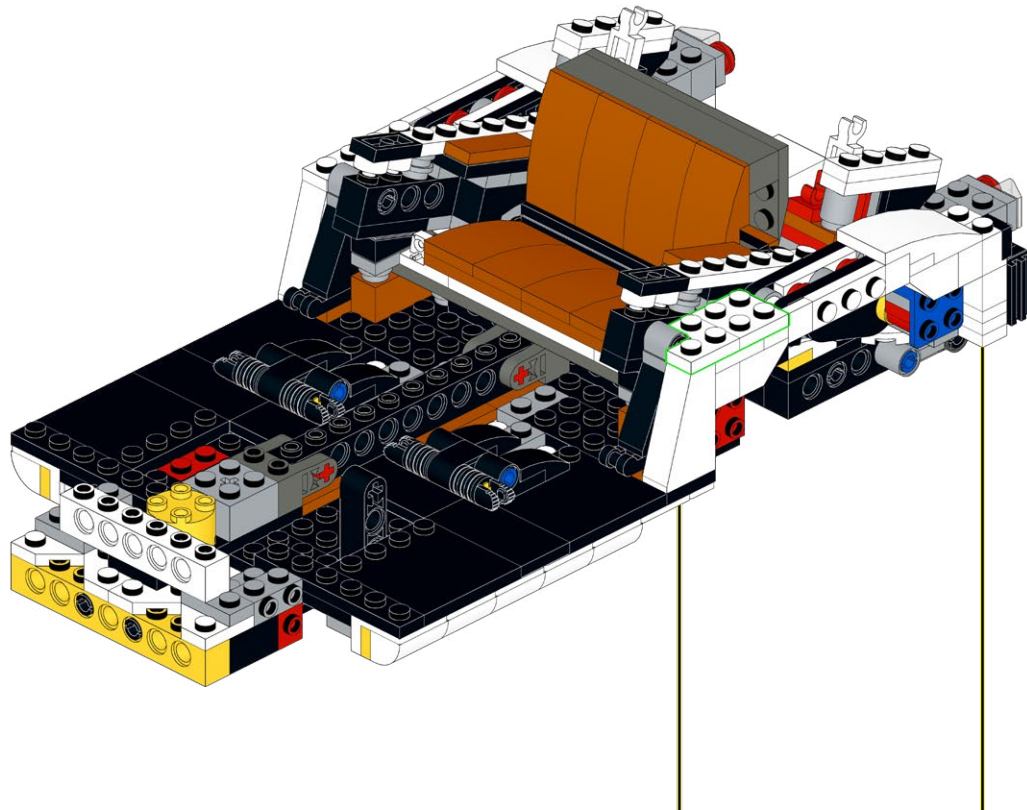
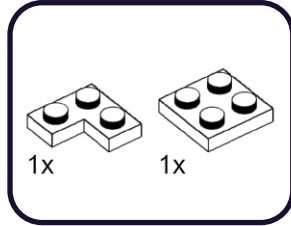

184

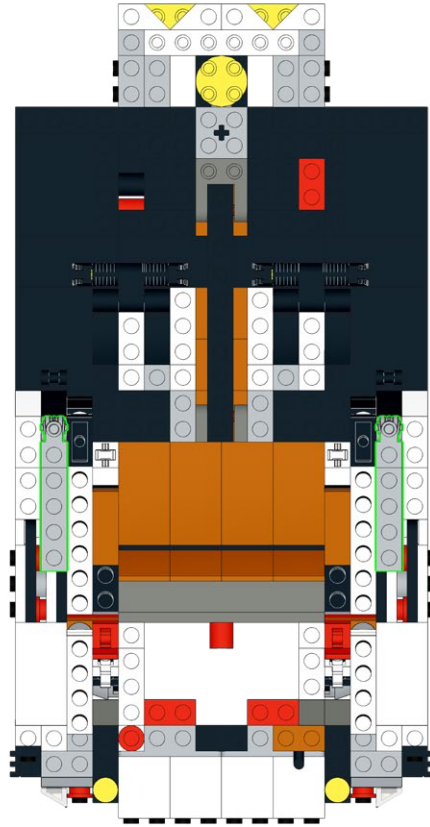
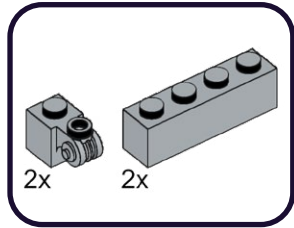
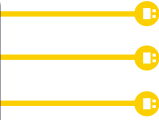

185

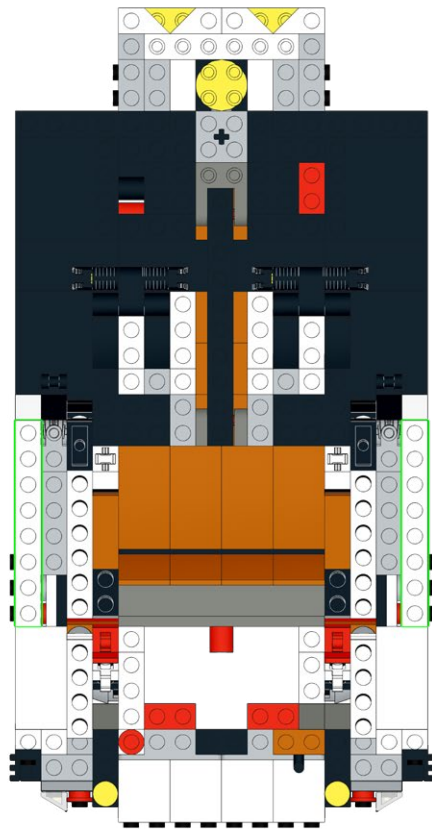
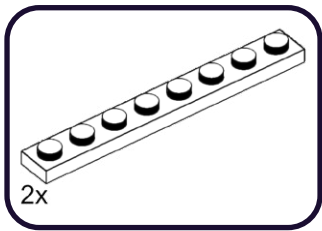

186

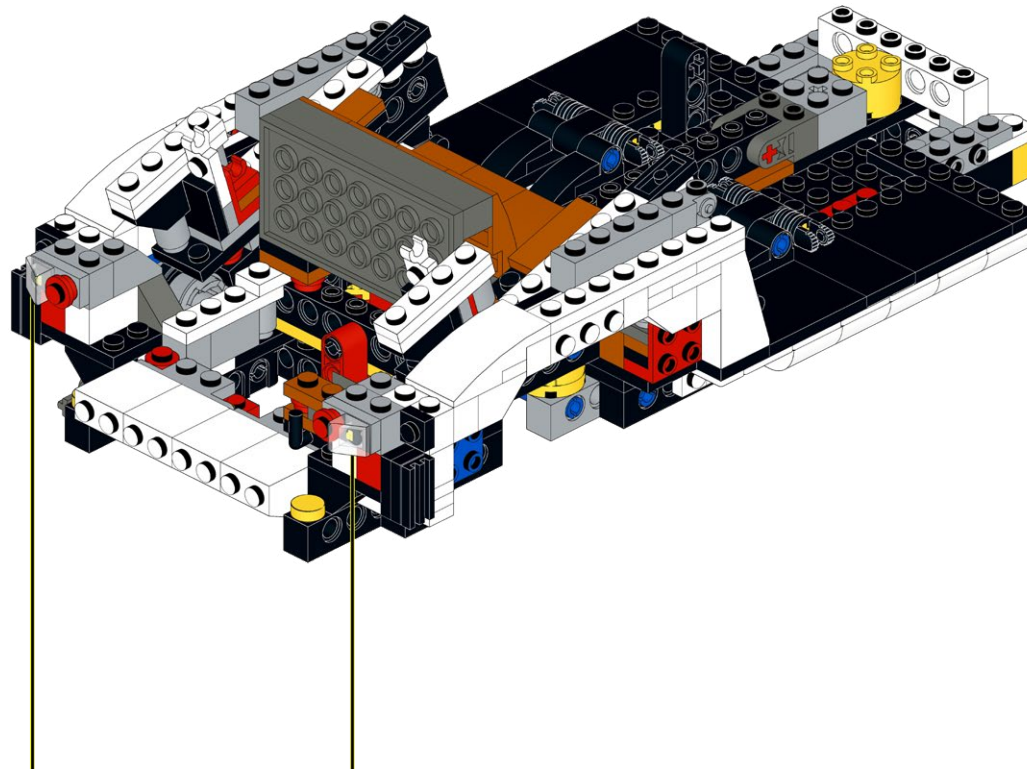

187

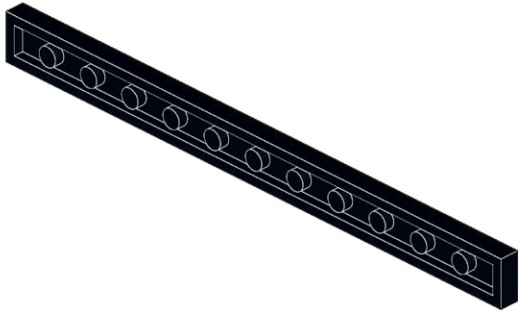
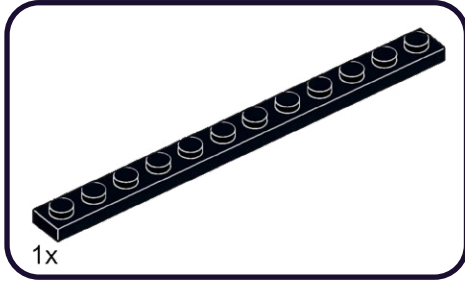

188

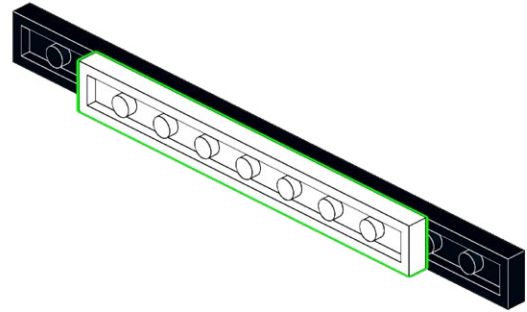
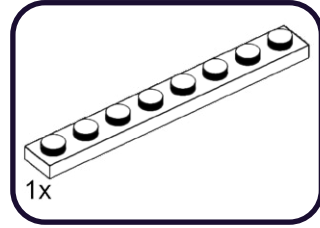

189

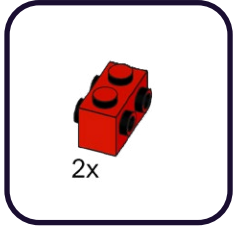

190

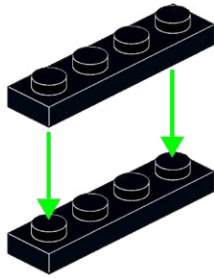
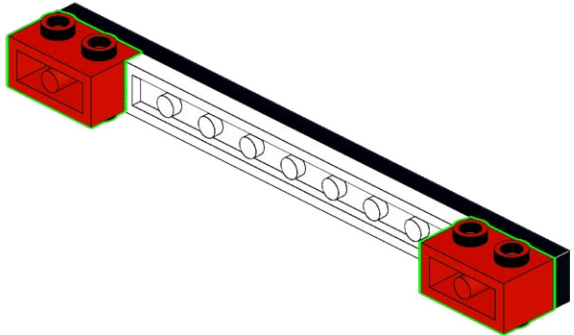
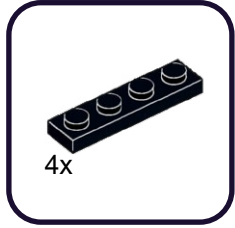

2x

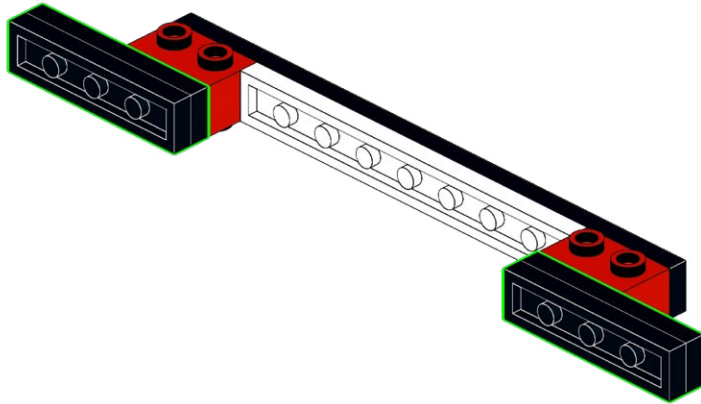
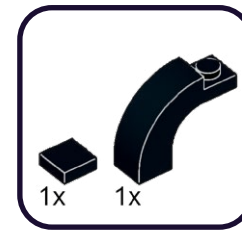
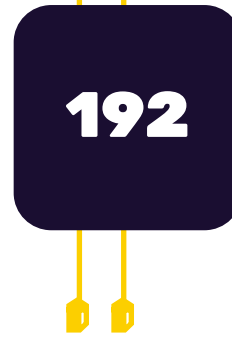

193

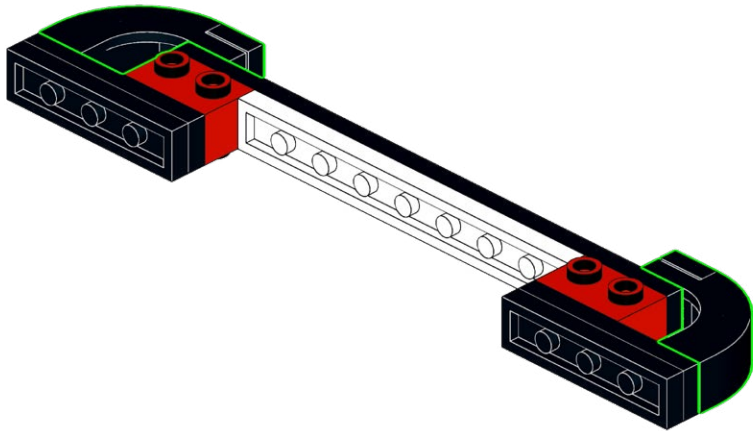

194

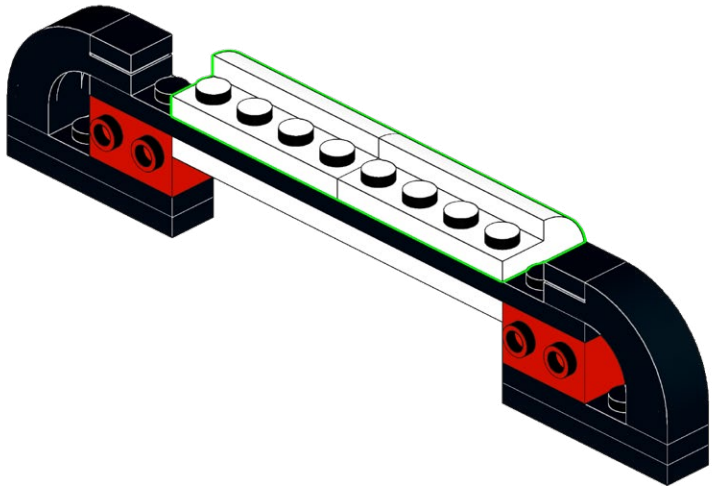
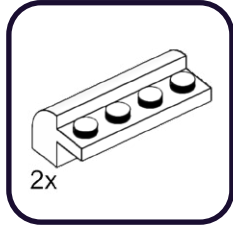

195

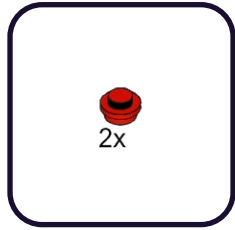

196

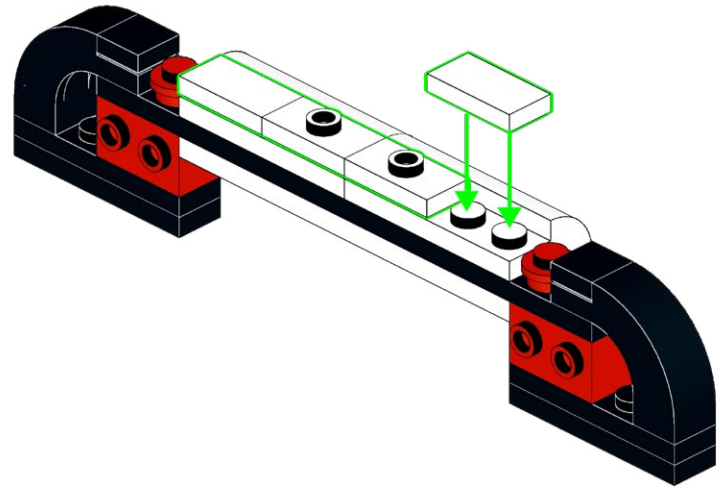
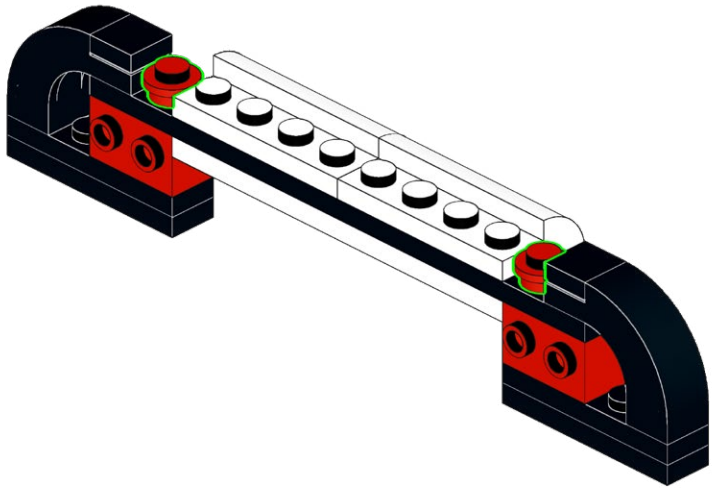
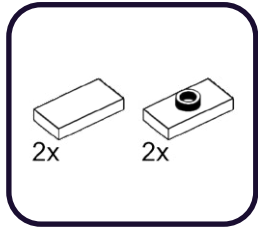

197



2x

198



2x

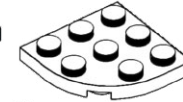

2x

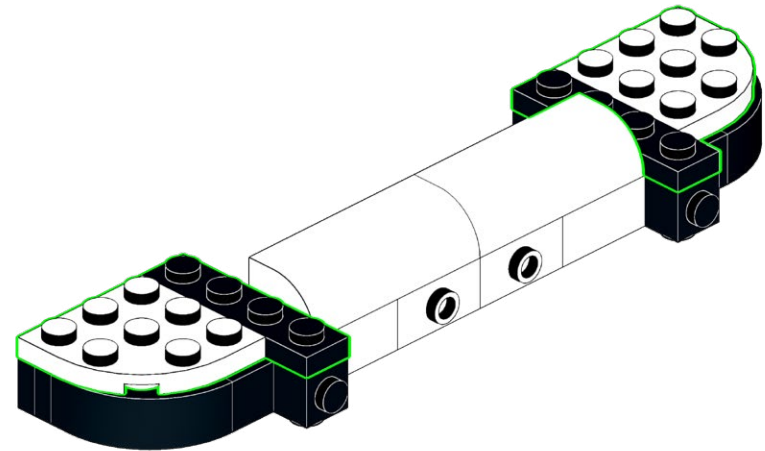
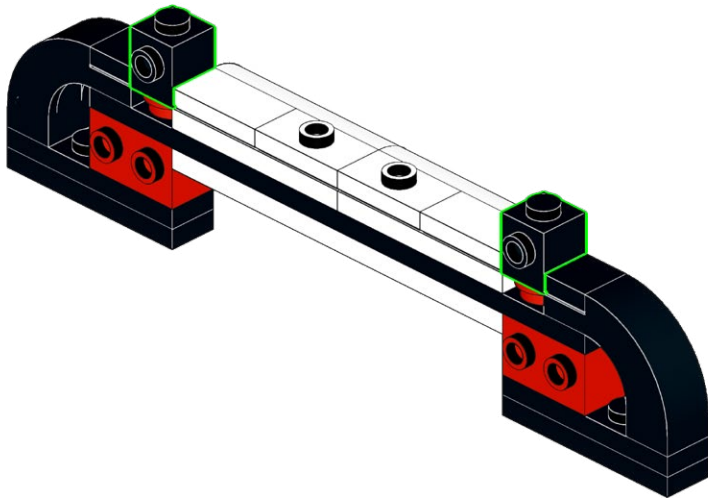
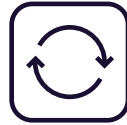

199

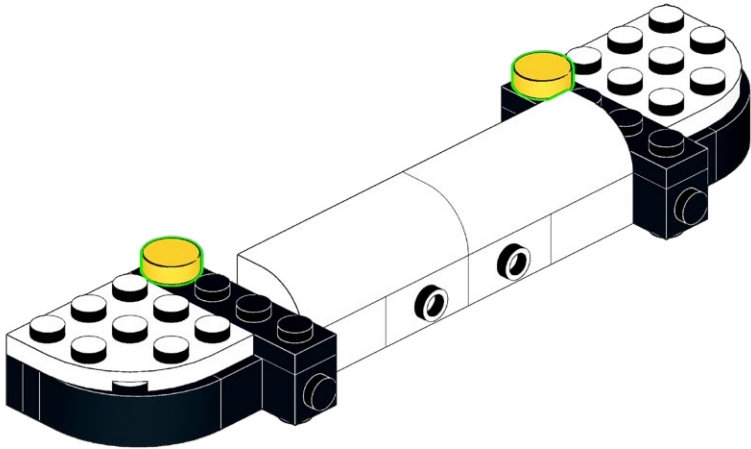
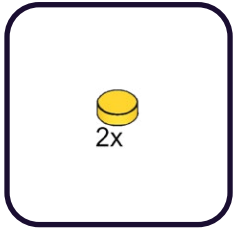

200

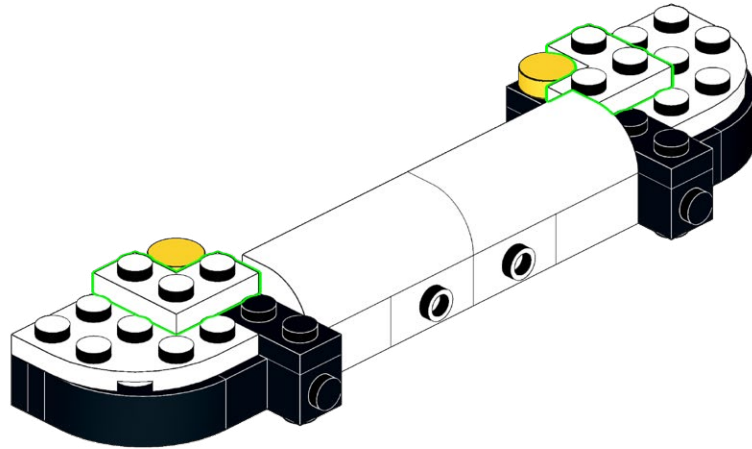
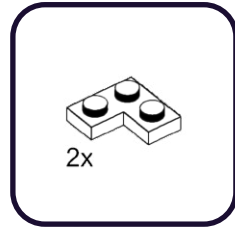

201



202

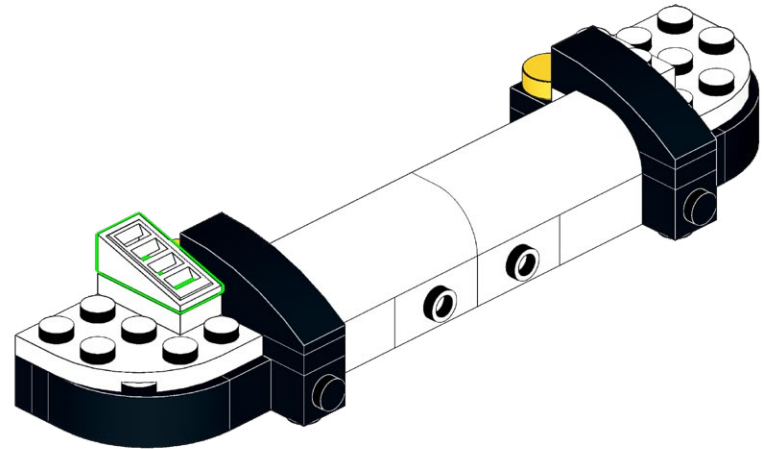
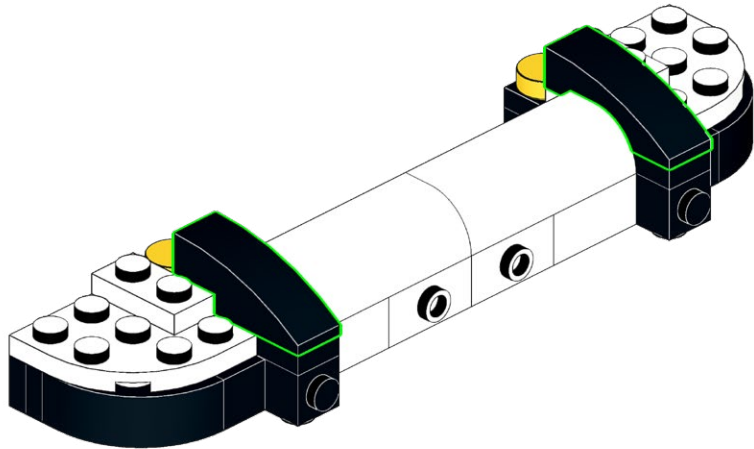
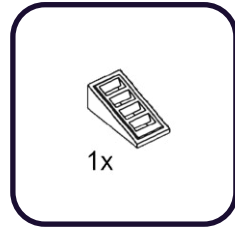

203

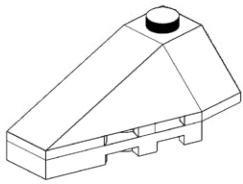
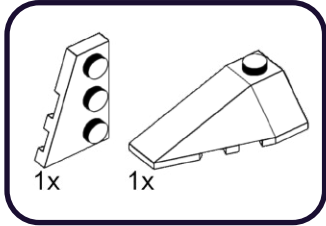

204

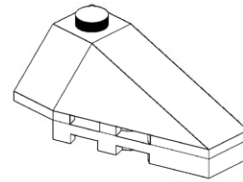
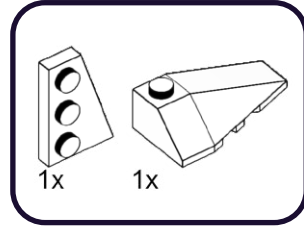

205

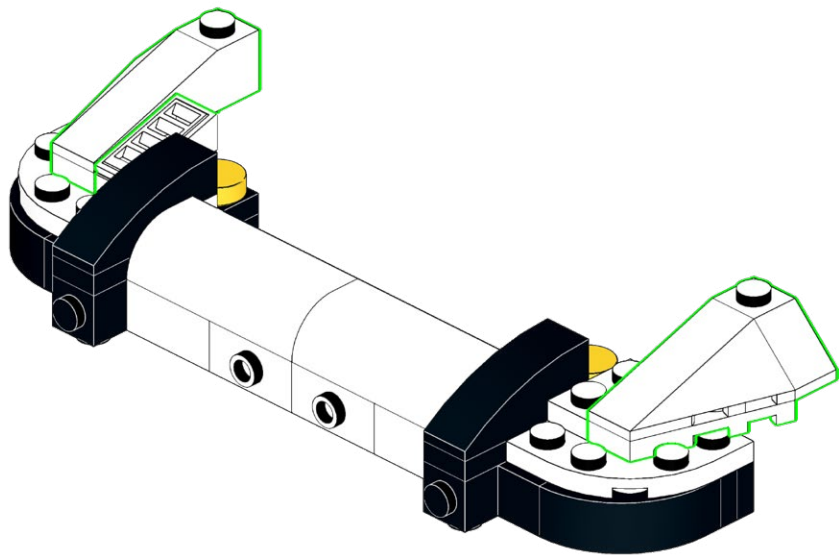

206

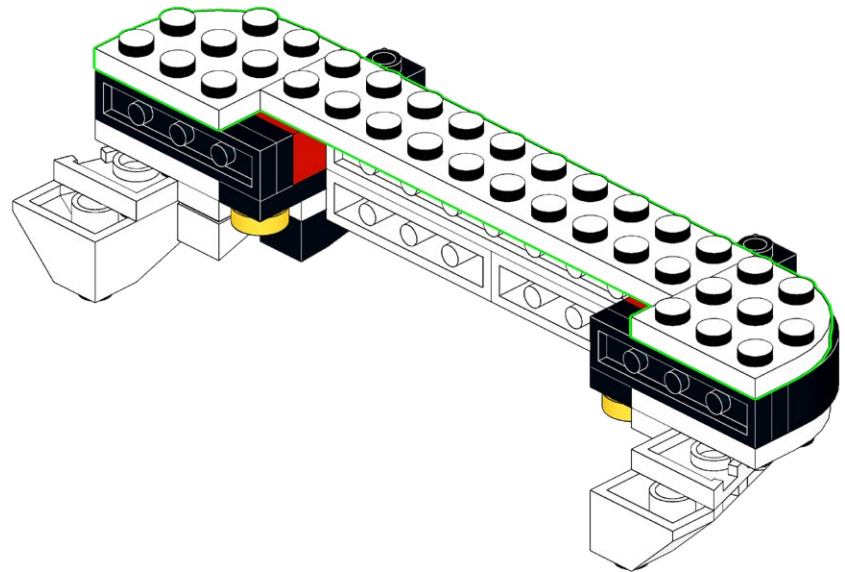
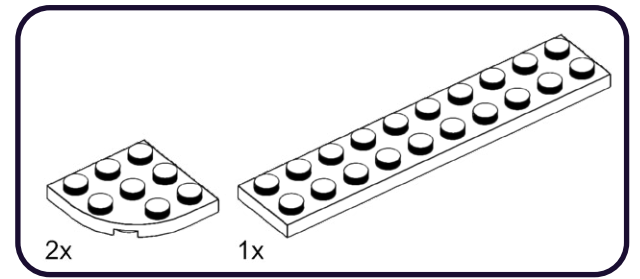
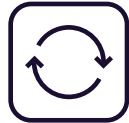

207

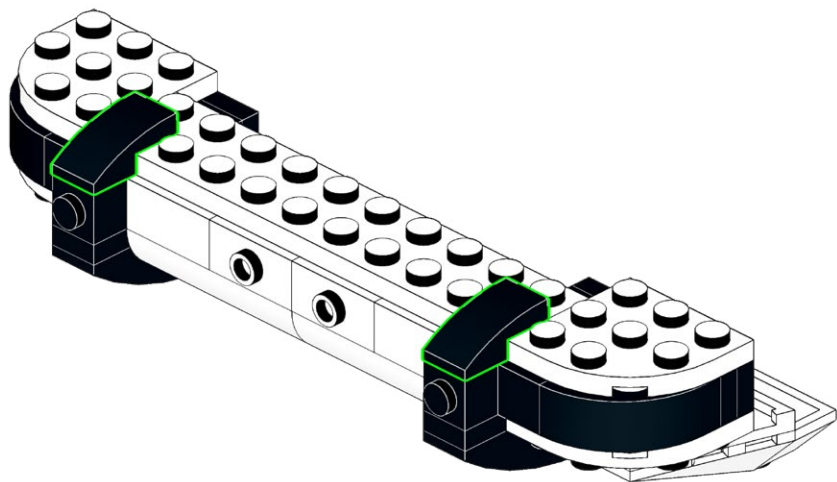

208

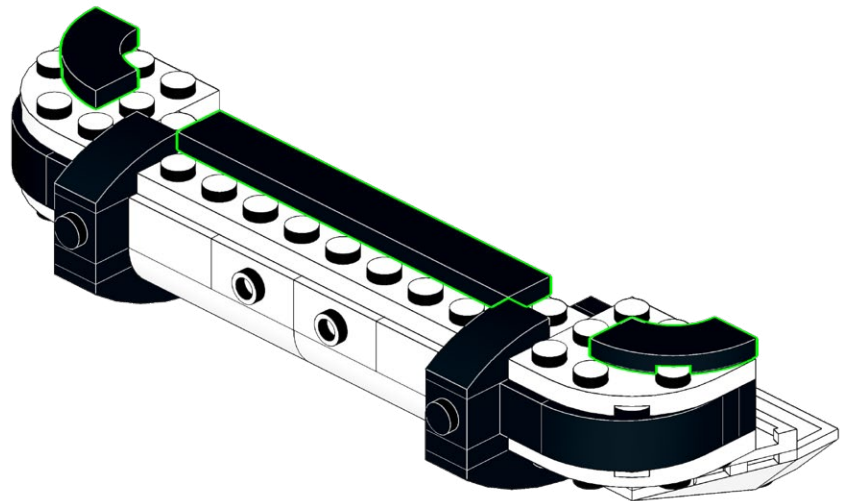
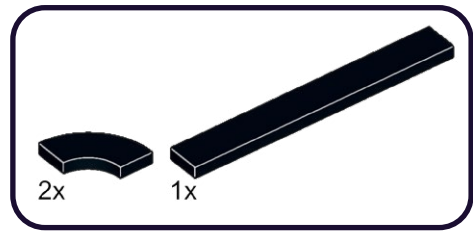

209

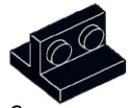

2x

210

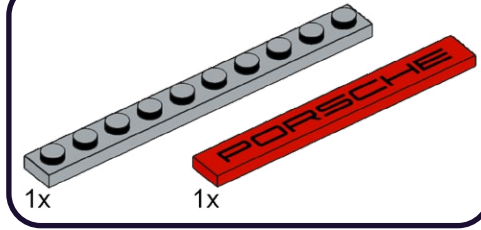

1x

1x

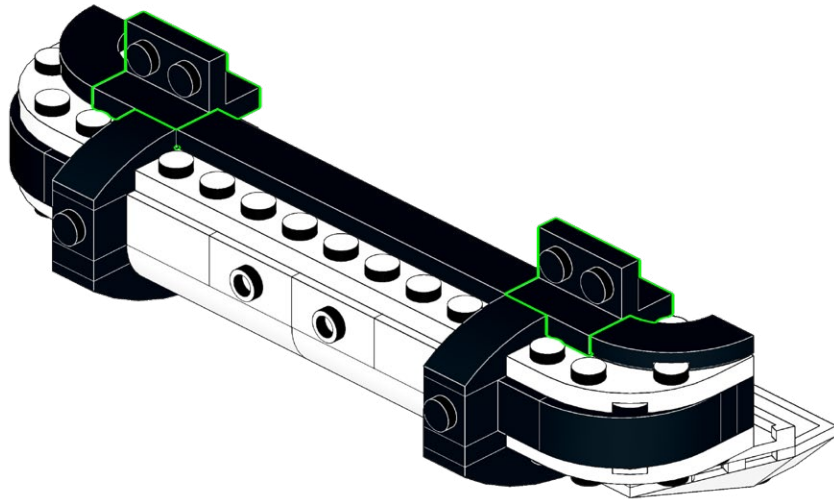

211

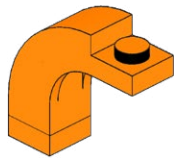
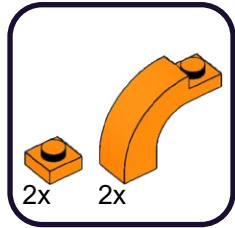

2x

212

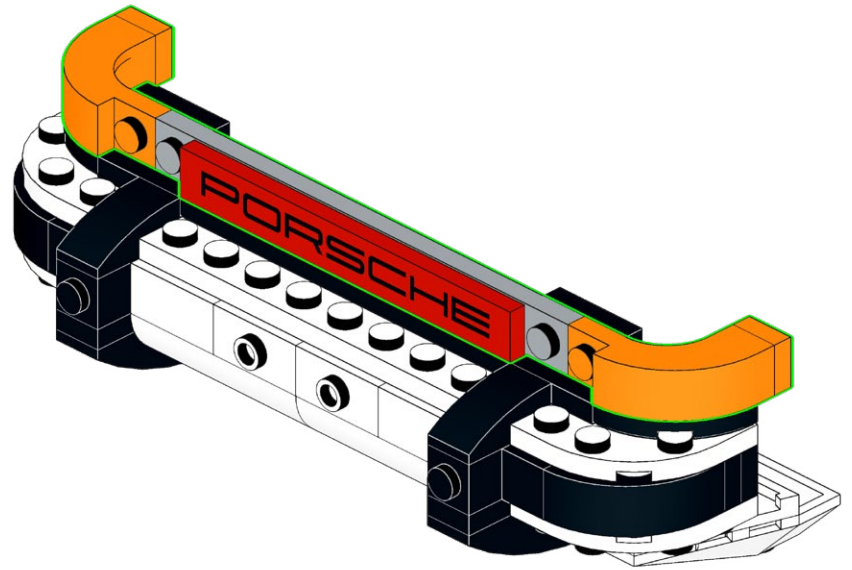

213

AR-R30

2x

214

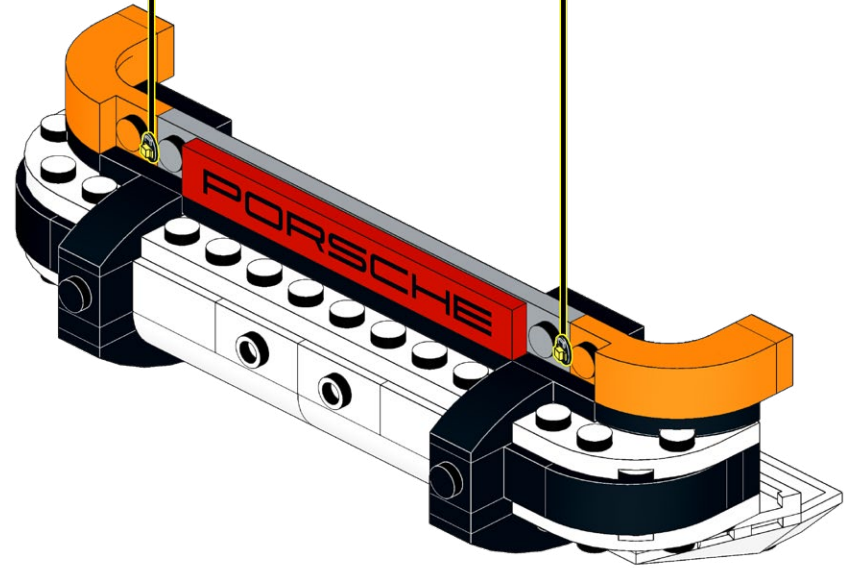
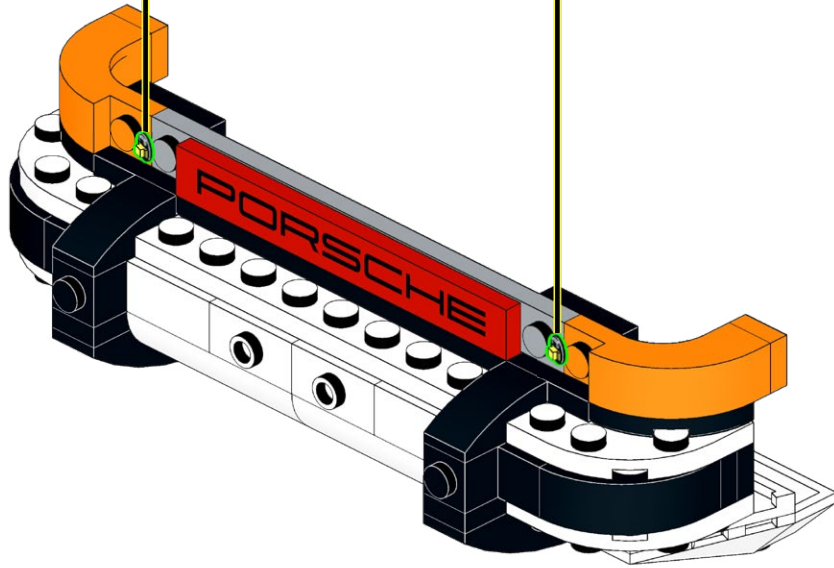

215

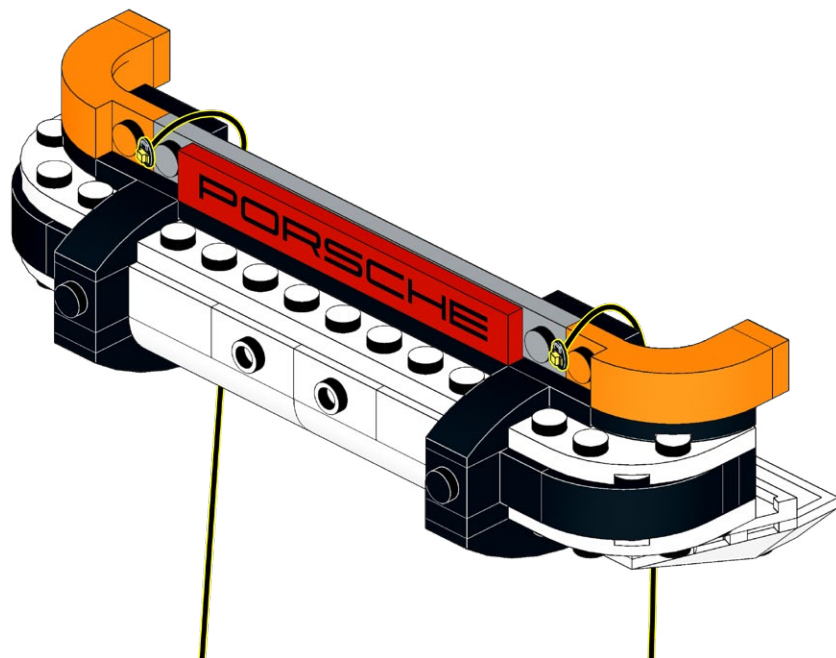

216

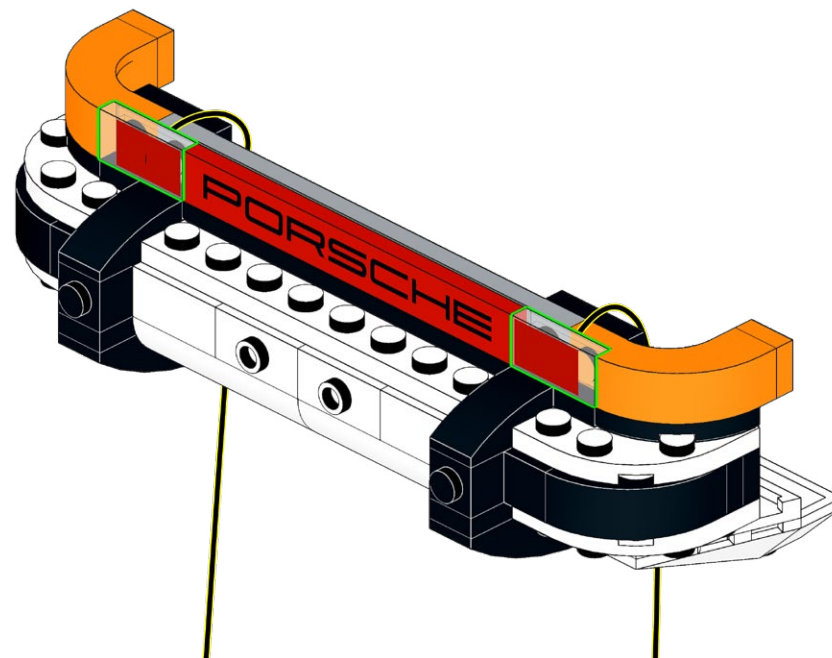
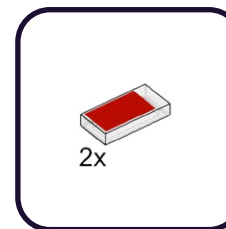

217

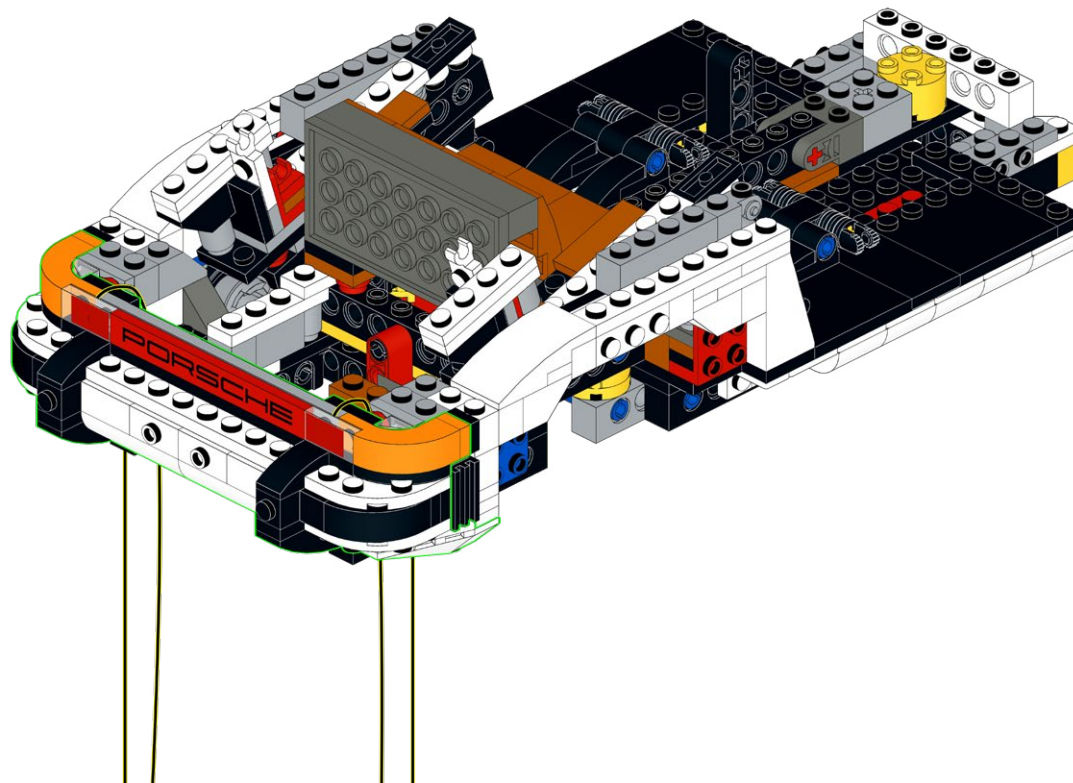

218

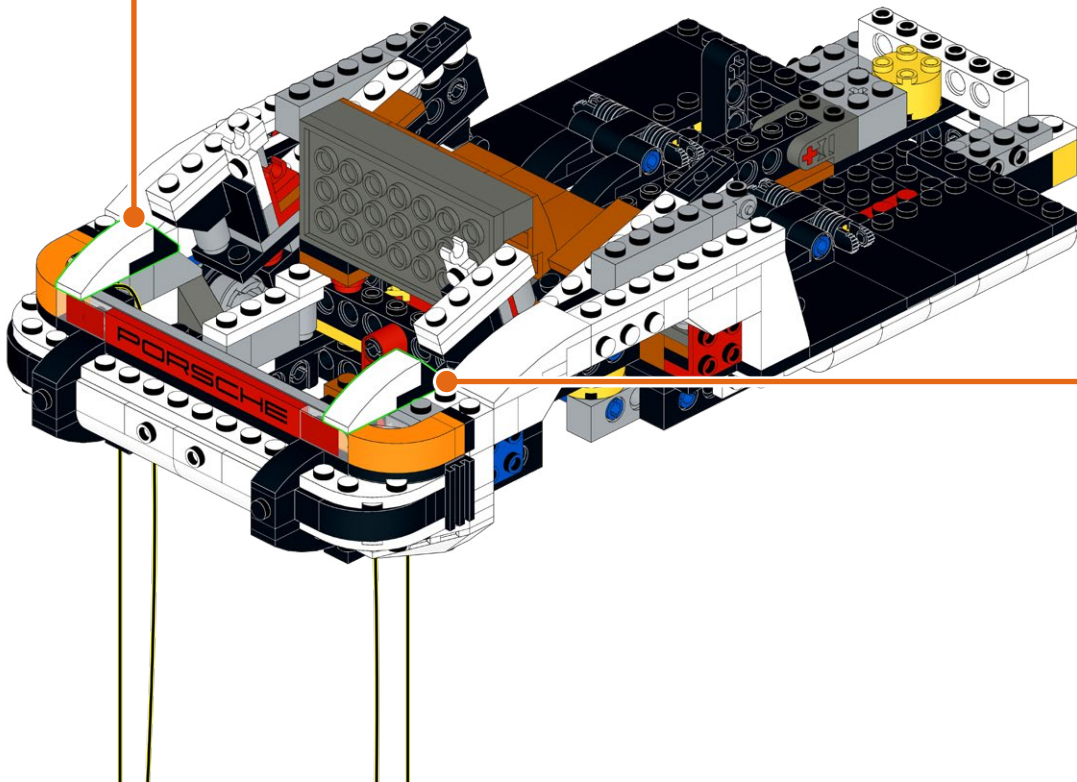
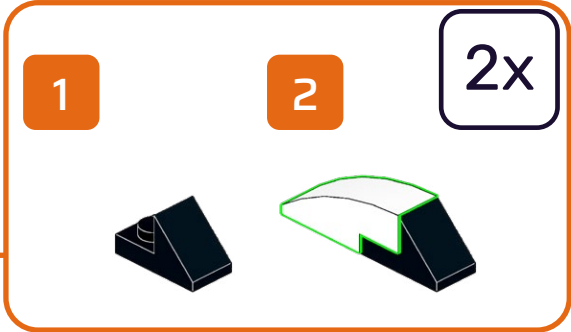
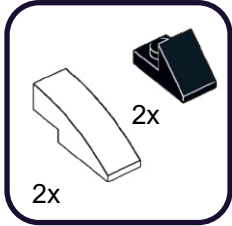

219

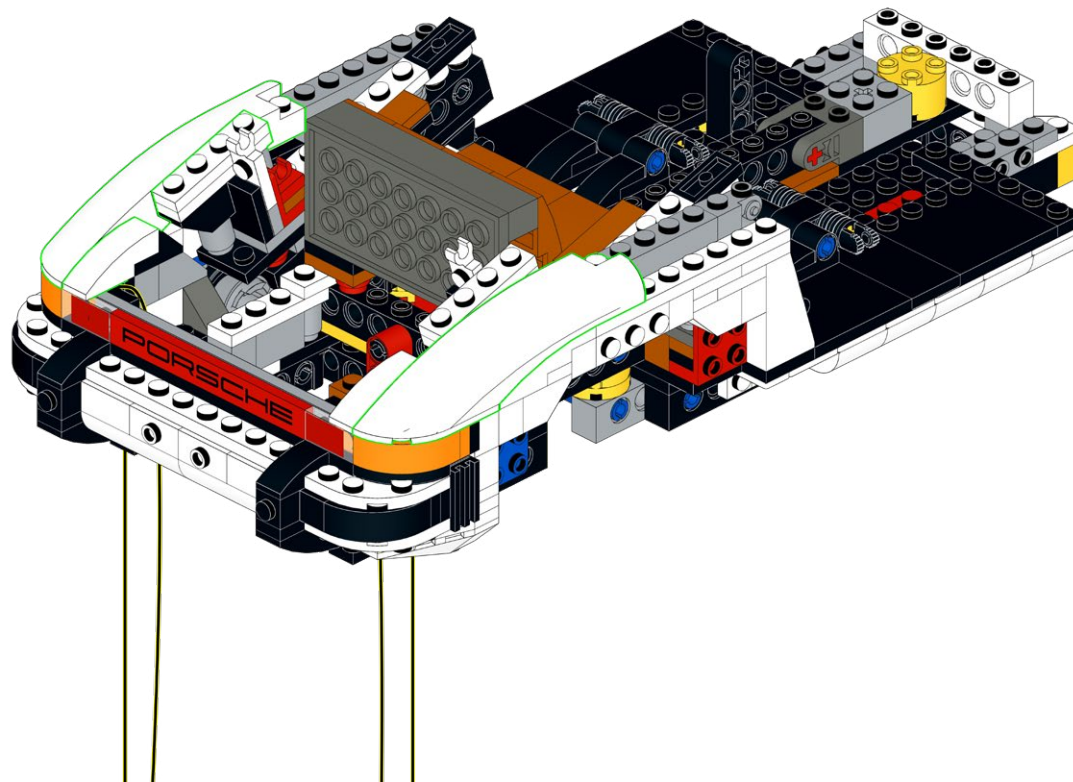
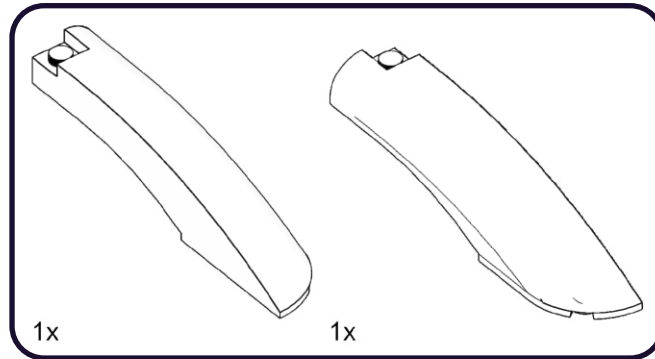

220

3x

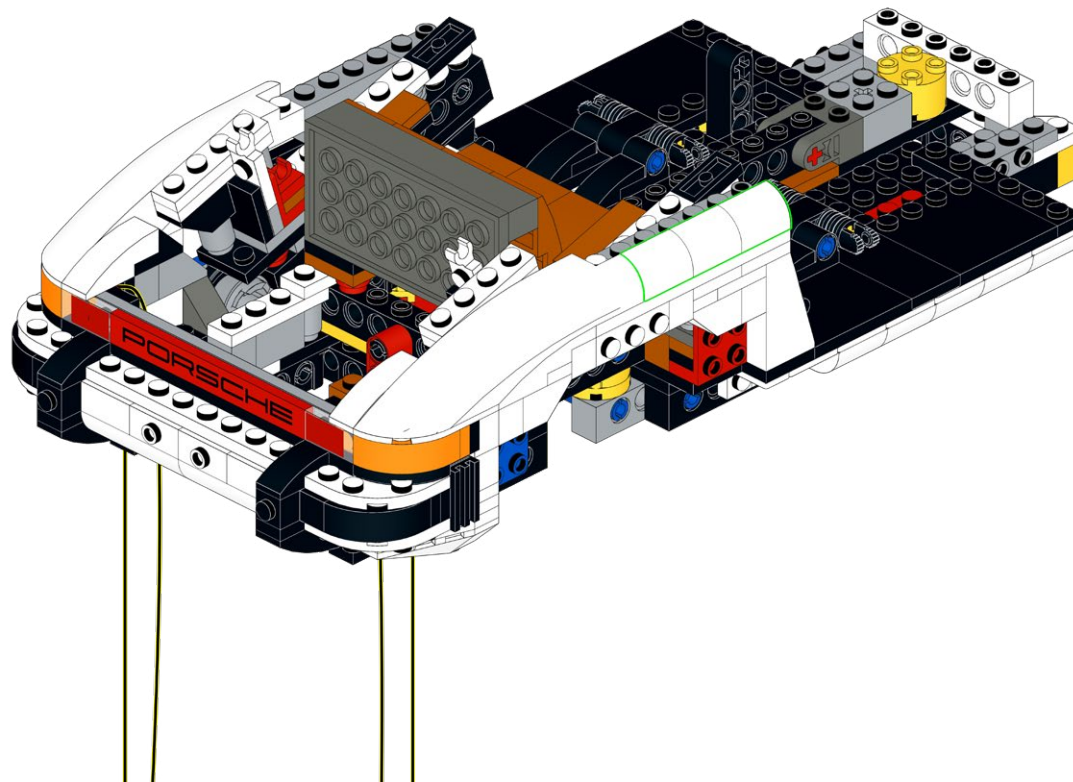

221

3x

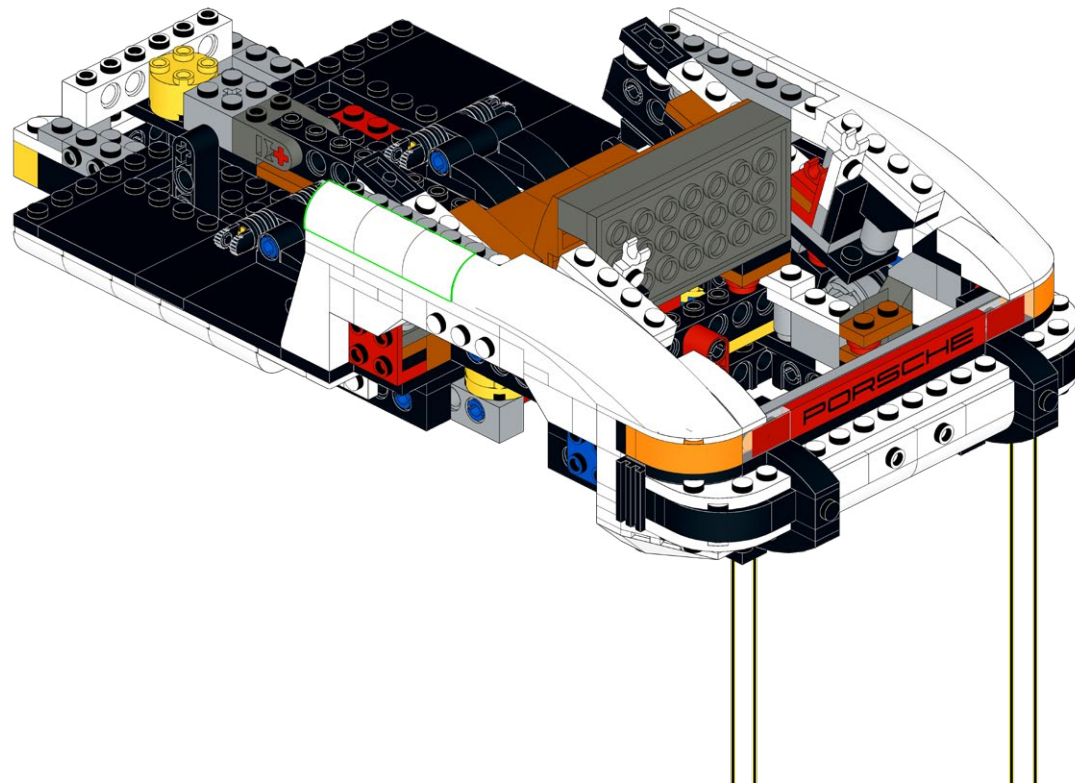

222

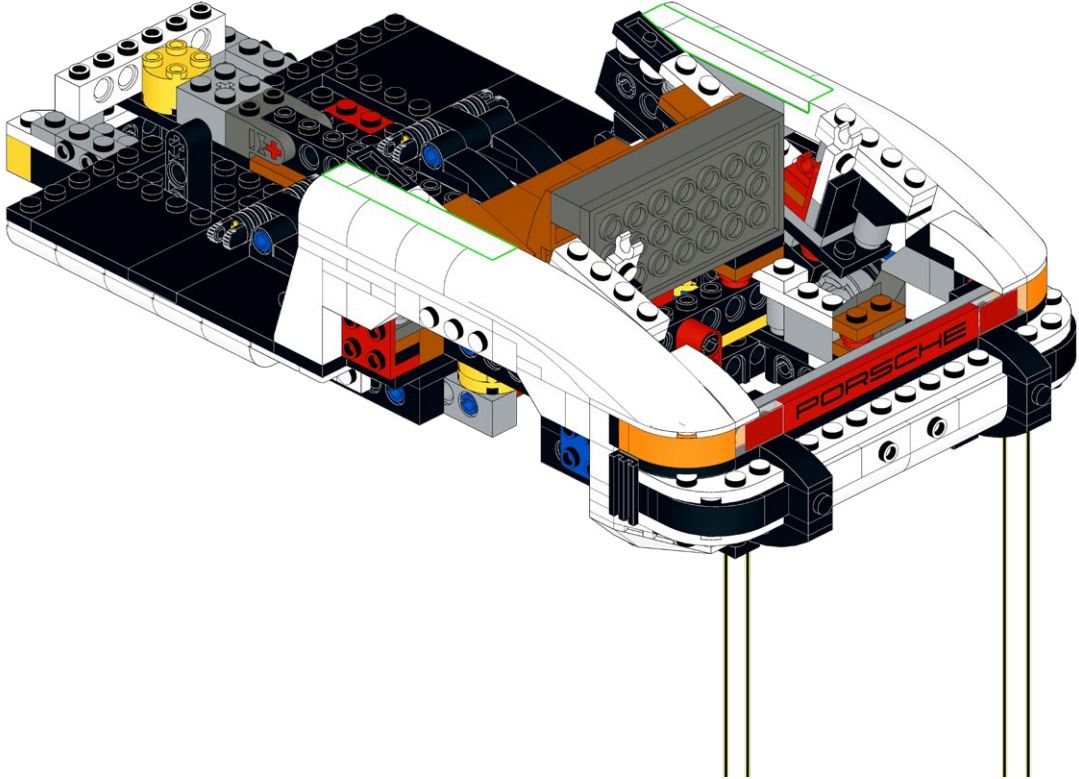
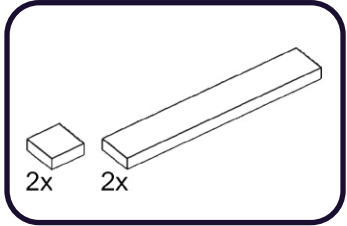

223

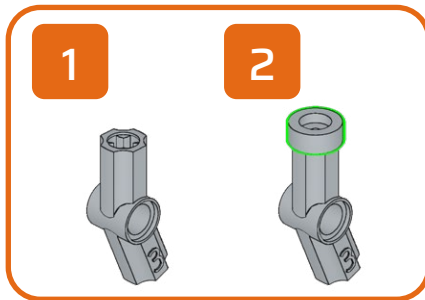
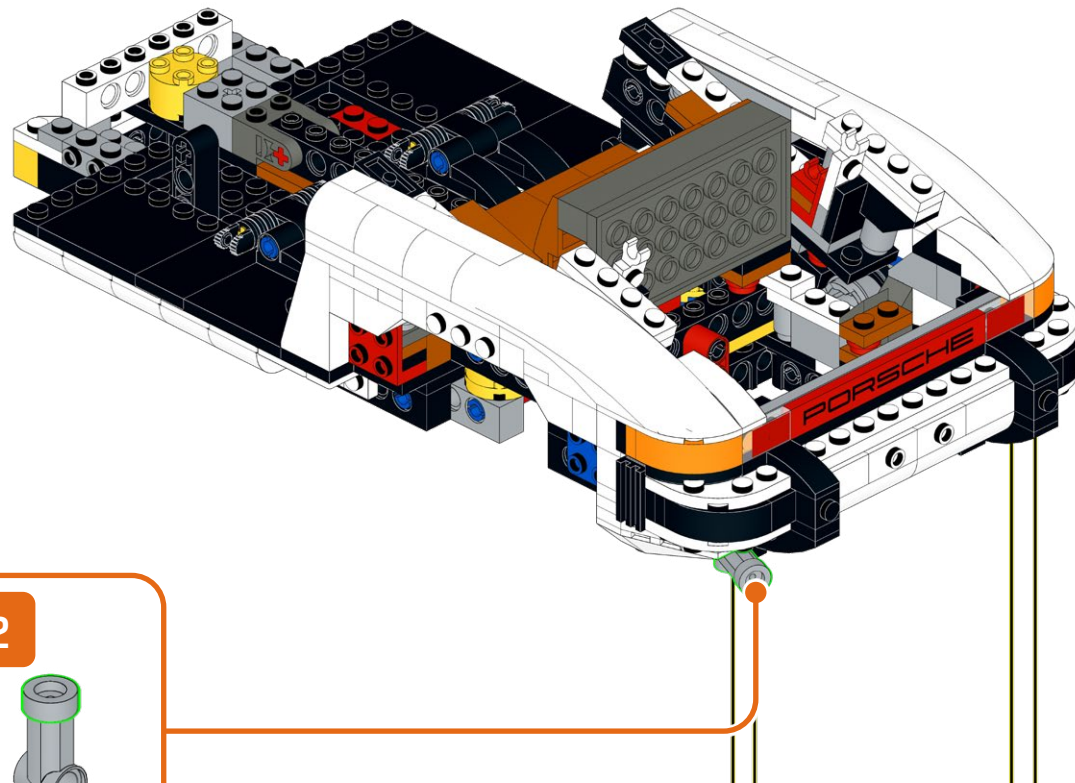
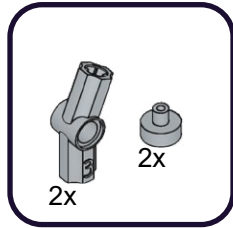



HOLD UP!

You might notice some bags aren't in order, as well as left over pieces, but that's ok! We're changing the way you build LEGO!

ATTENDEZ!

Vous remarquerez peut-être que certains sacs, ainsi que certaines pièces, ne sont pas dans le bon ordre. Mais pas de panique! Nous changeons simplement la façon avec laquelle vous construisez vos LEGO!

ASPETTA!

Potresti notare che alcuni sacchetti non sono in ordine, così come i pezzi avanzati, ma va bene così! Stiamo cambiando il modo in cui costruisci i LEGO!

HALT!

Sie werden möglicherweise bemerken, dass einige tüten durcheinander sind und teile übrig bleiben, aber das ist in Ordnung! Wir ändern die art und weise, wie Sie LEGO bauen!

¡ESPERA!

Es posible que notes que algunas bolsas están fuera de servicio, así como piezas sobrantes, ¡pero está bien! ¡Estamos cambiando la forma en que construyes LEGO!

暫停!

你可能会注意到一些袋子顺序错乱, 以及一些剩余的部件, 但没关系! 我们正在改变你搭建乐高的方式!

Open LEGO® Bag 1

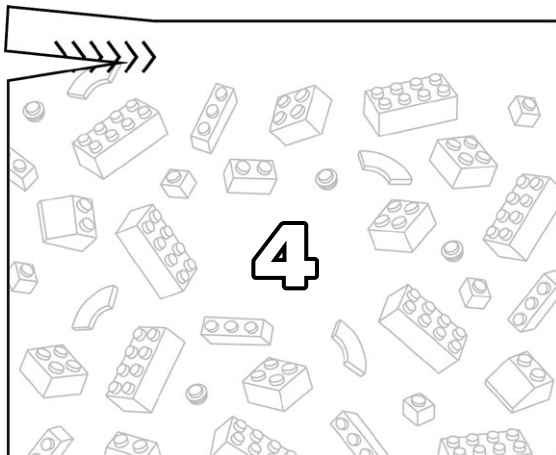

Open LMB Bag 01

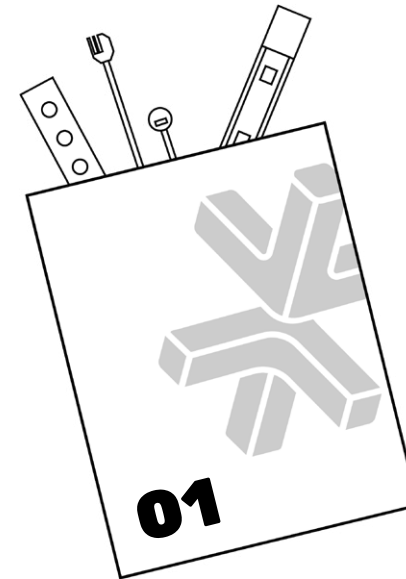

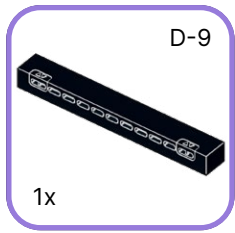
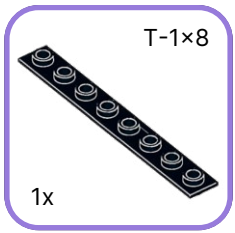

226

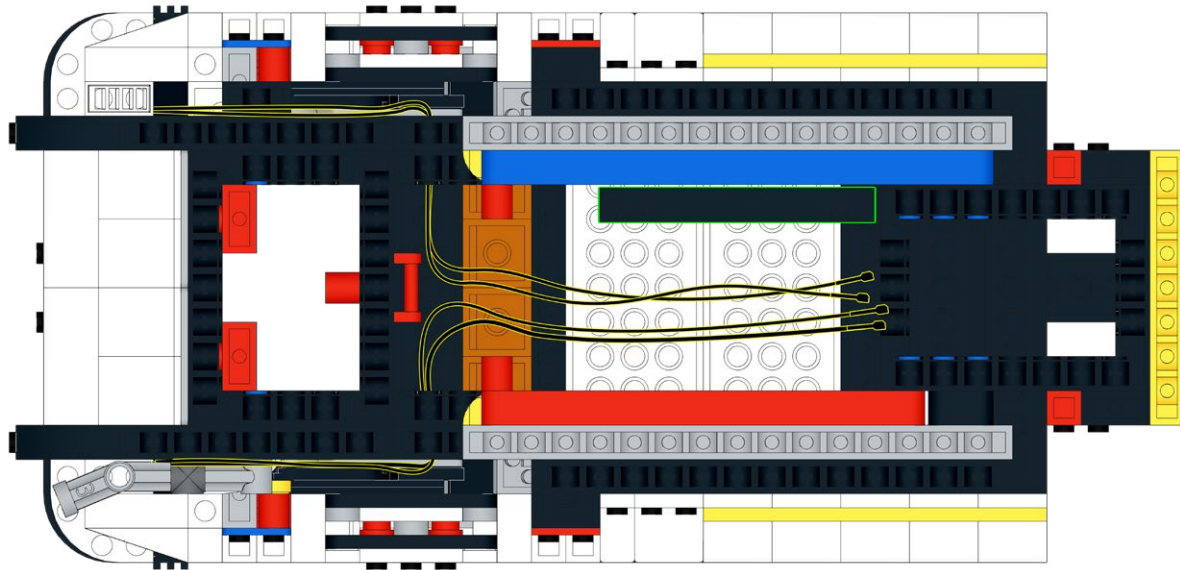

227

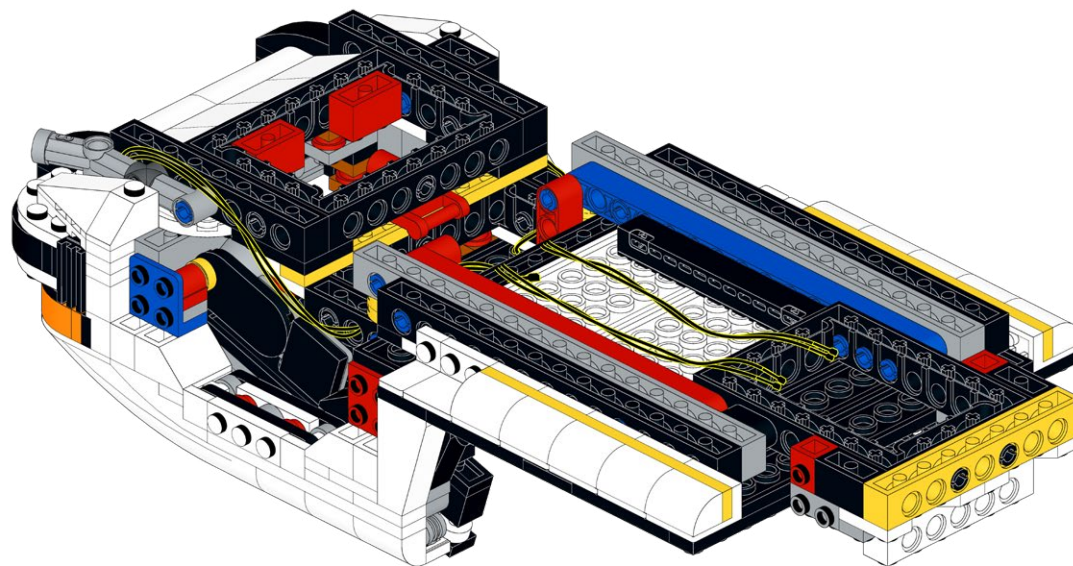

228

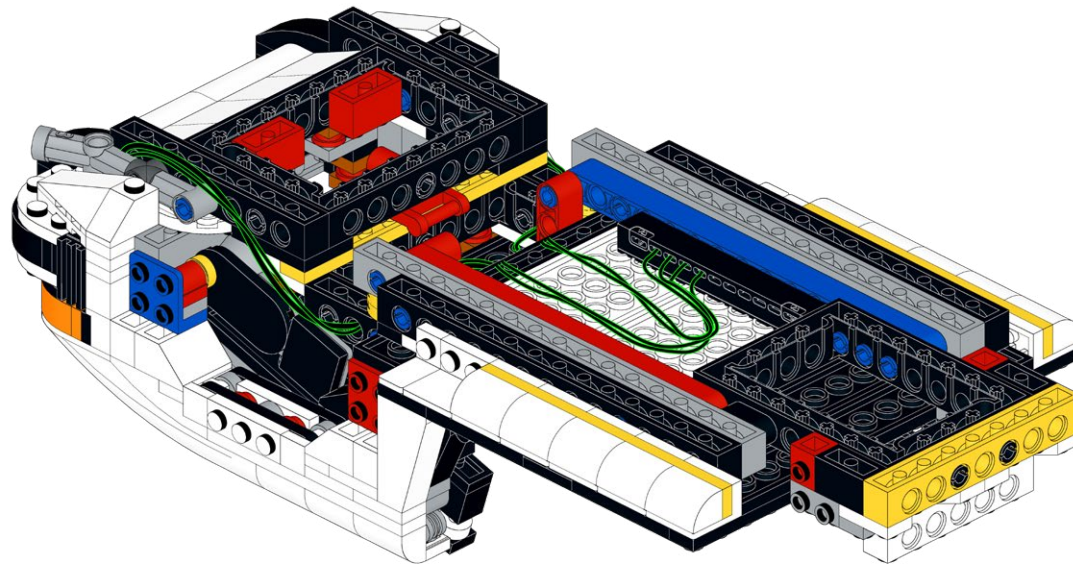

229

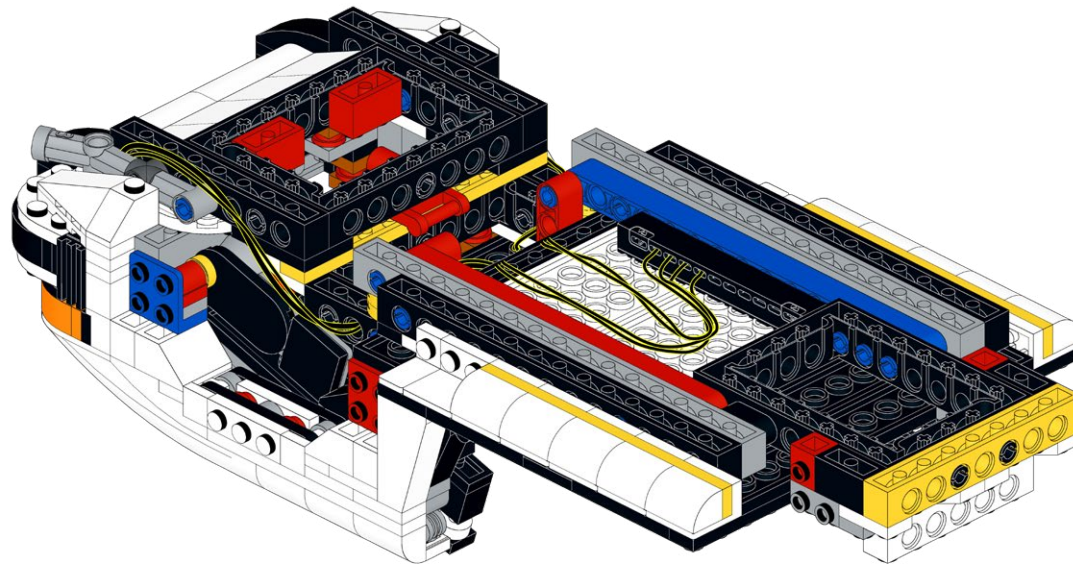

230

FLX-C

1x

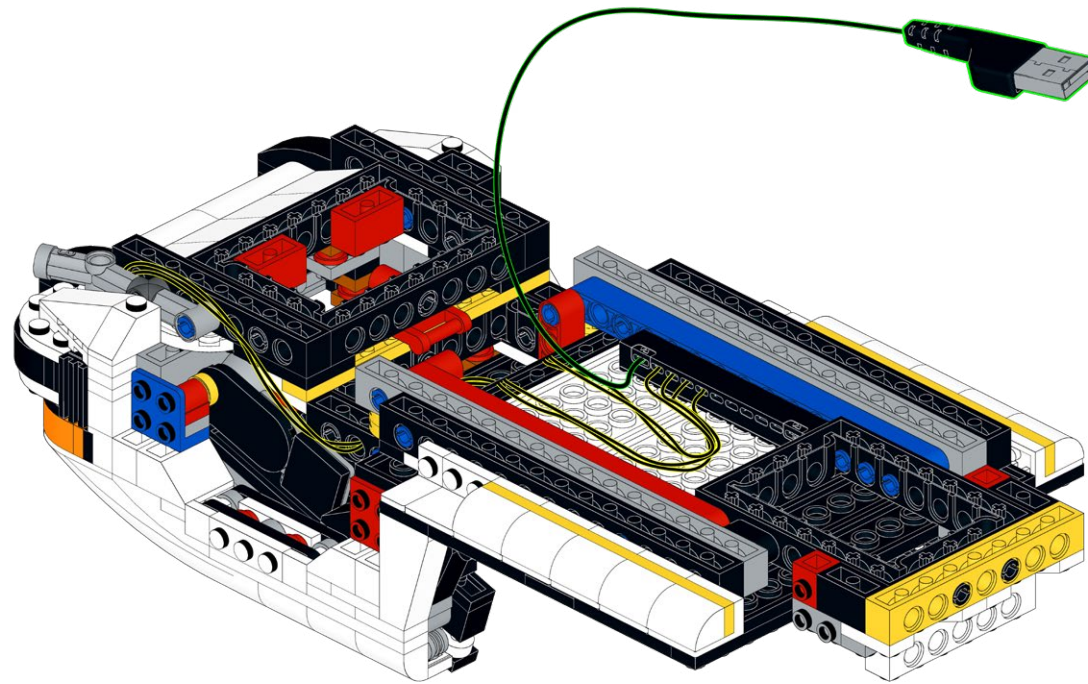

231

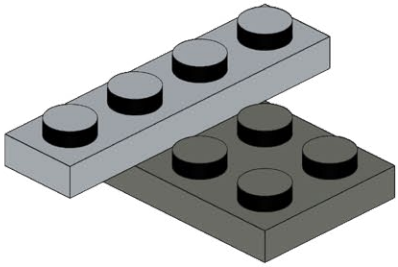
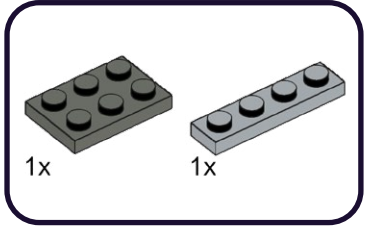

232

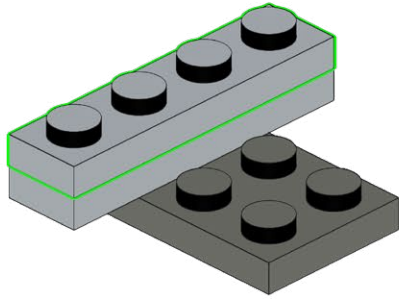
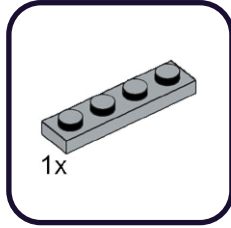

233

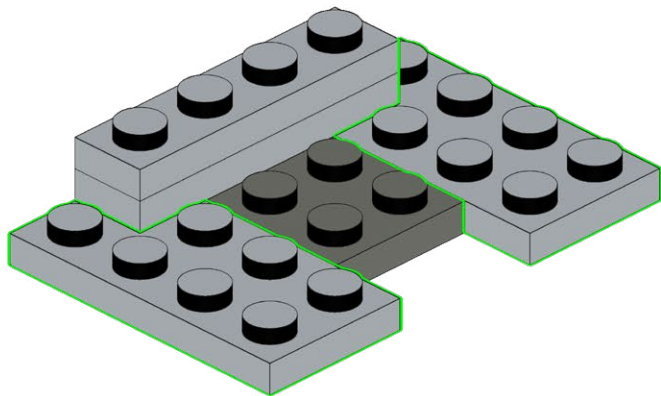
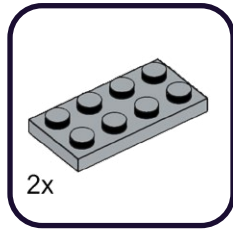

234

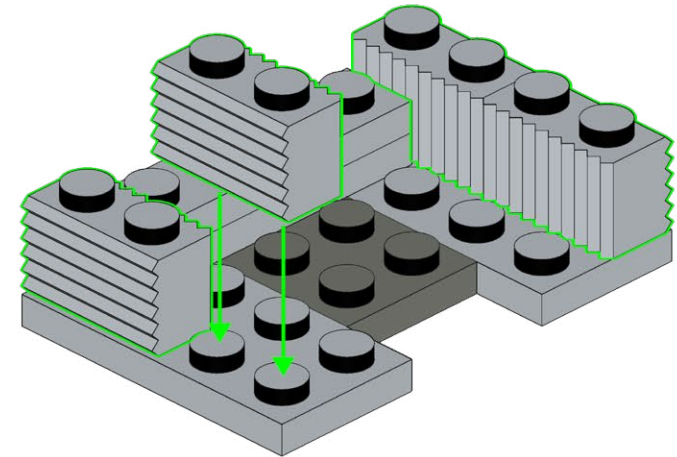
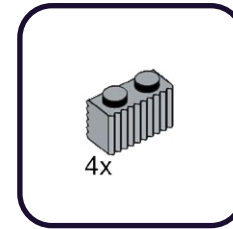

235

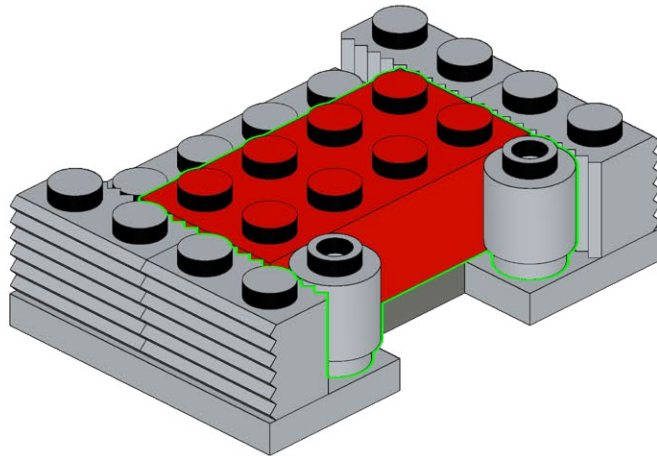
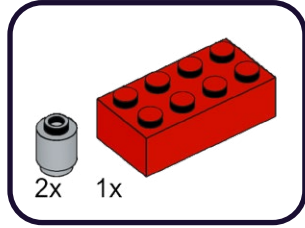

236

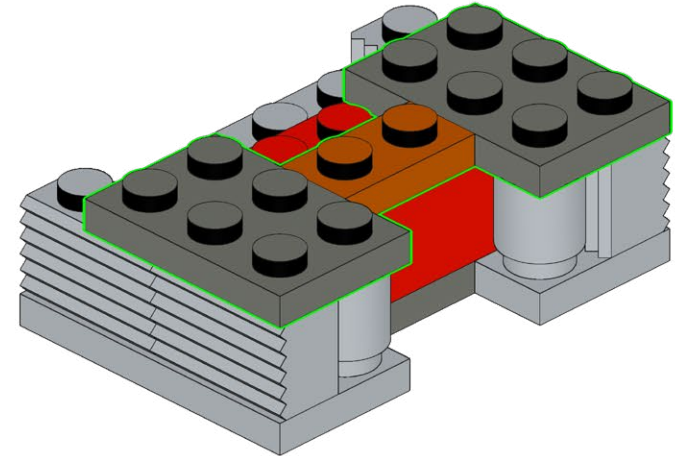
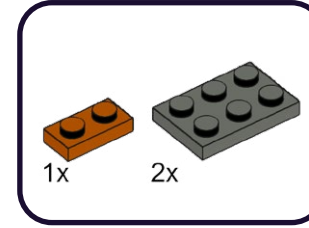

237

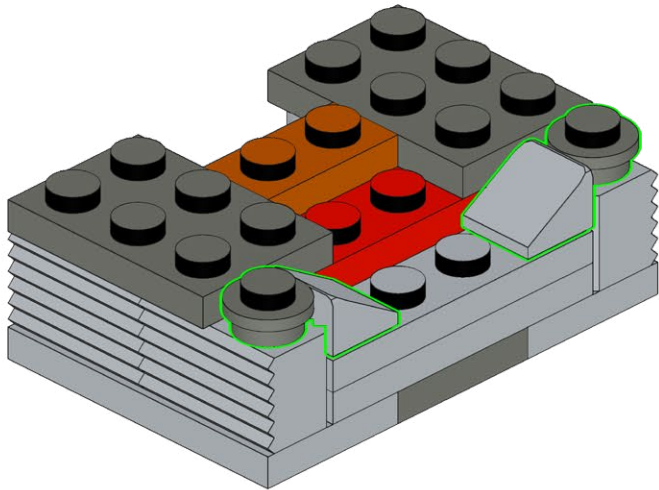
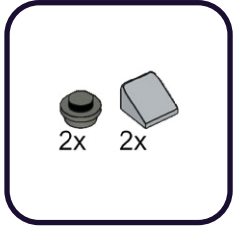

238

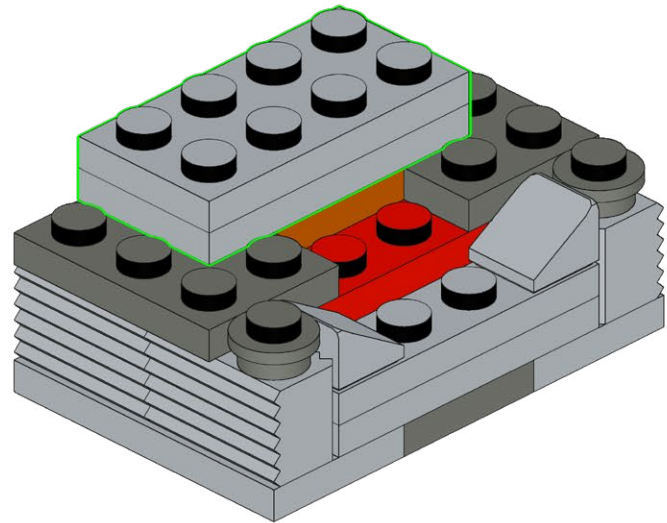
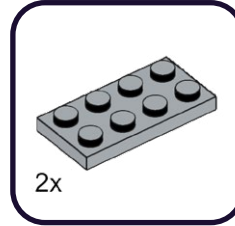

239

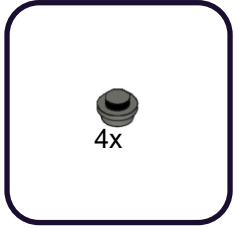

2x

240

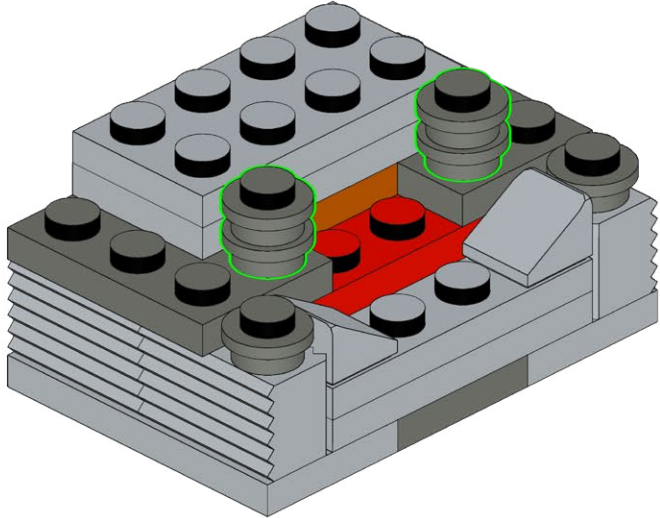

241

1x

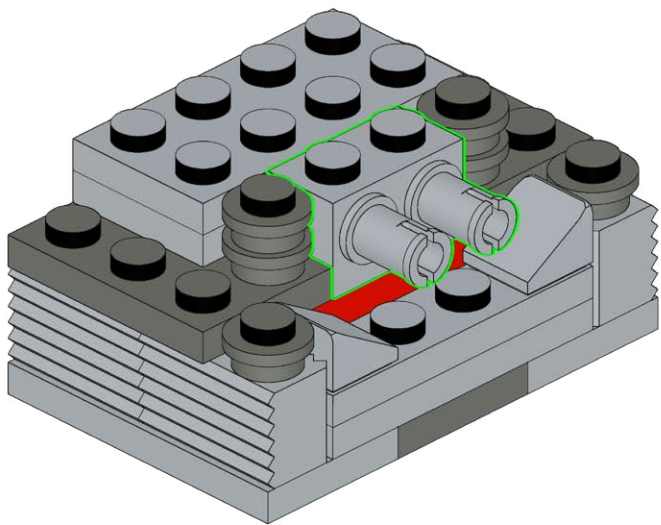
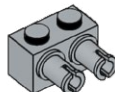

242

4x

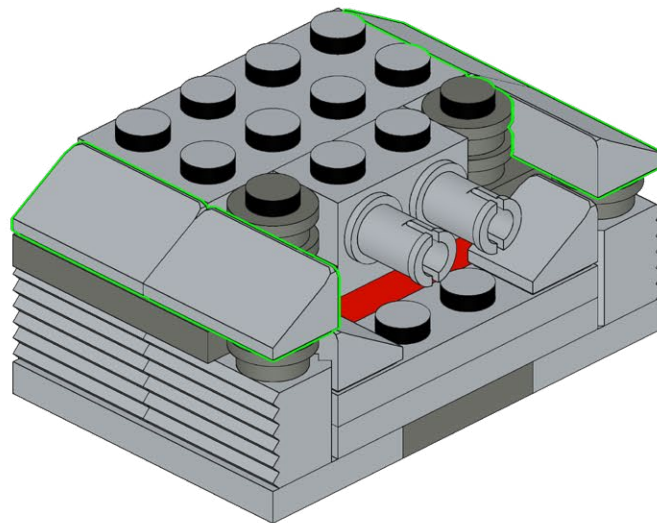

243

2x

1x

244

1x

1x

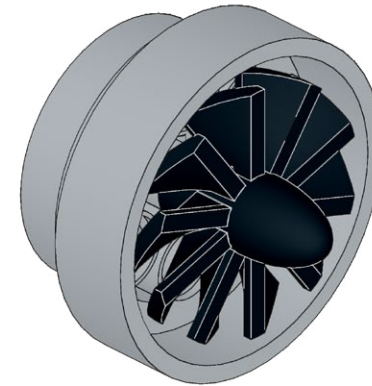
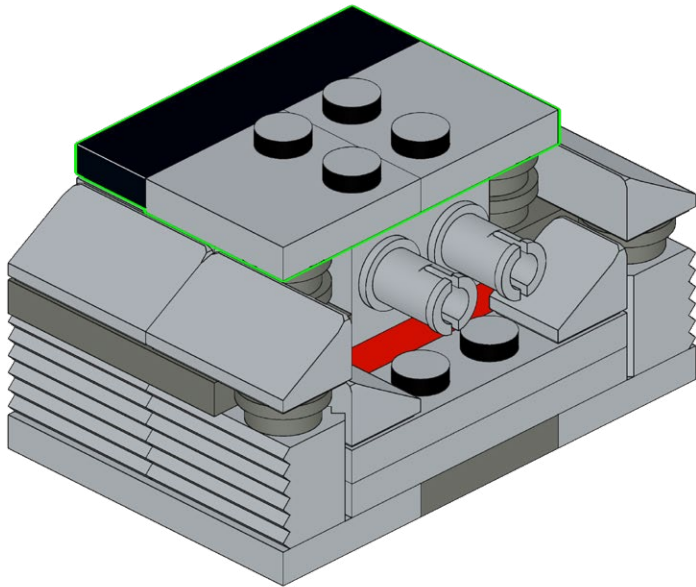

245

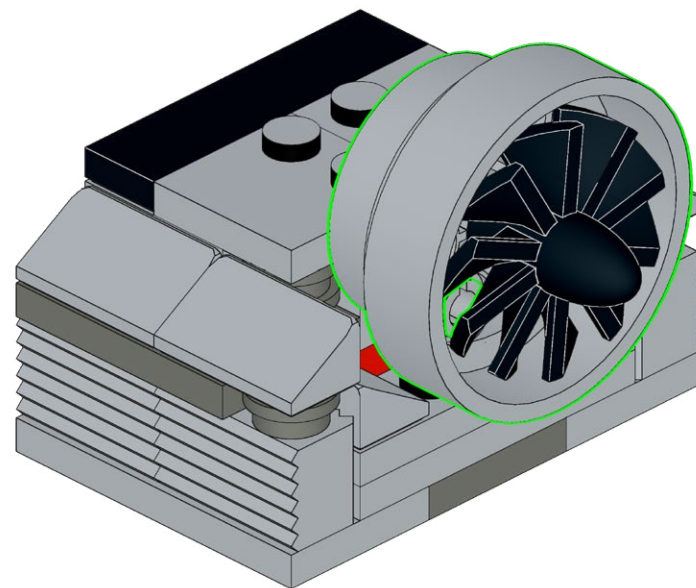

246

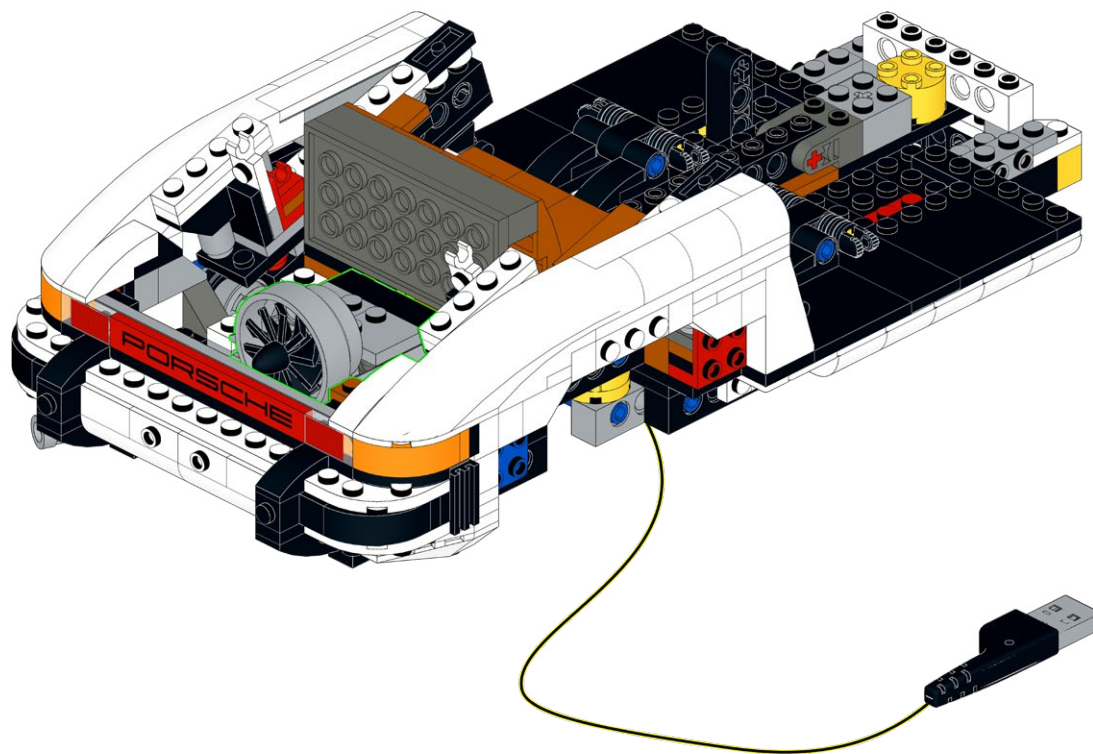

247

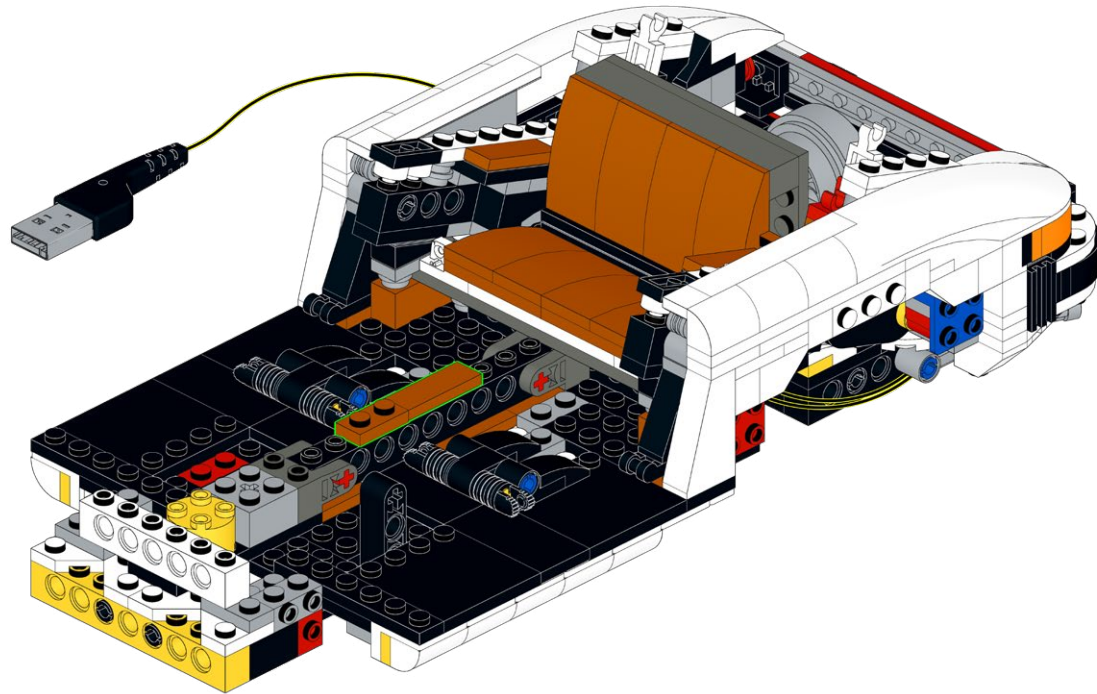
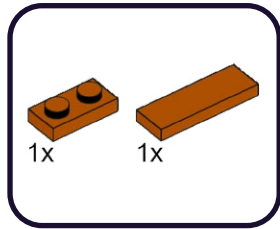

248

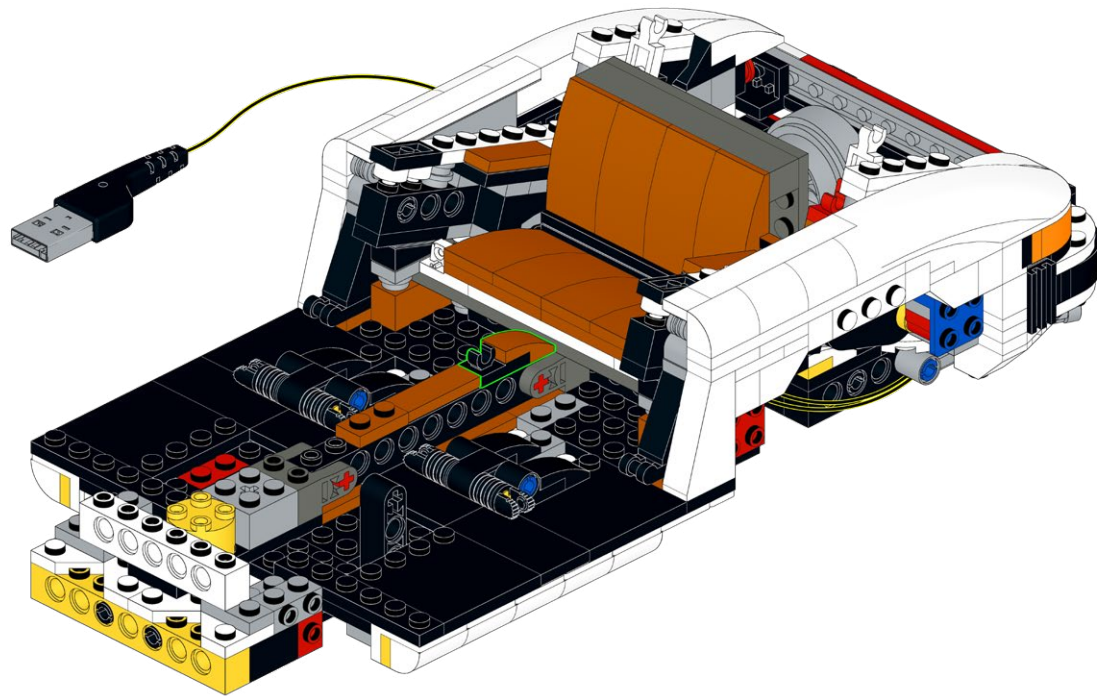
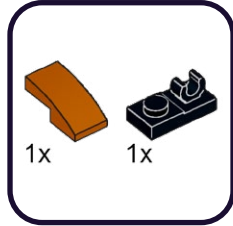

249

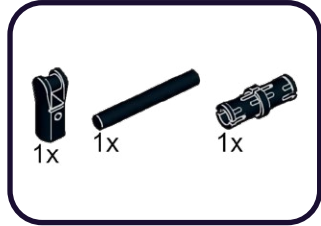

1

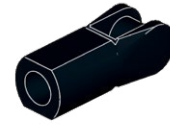

2

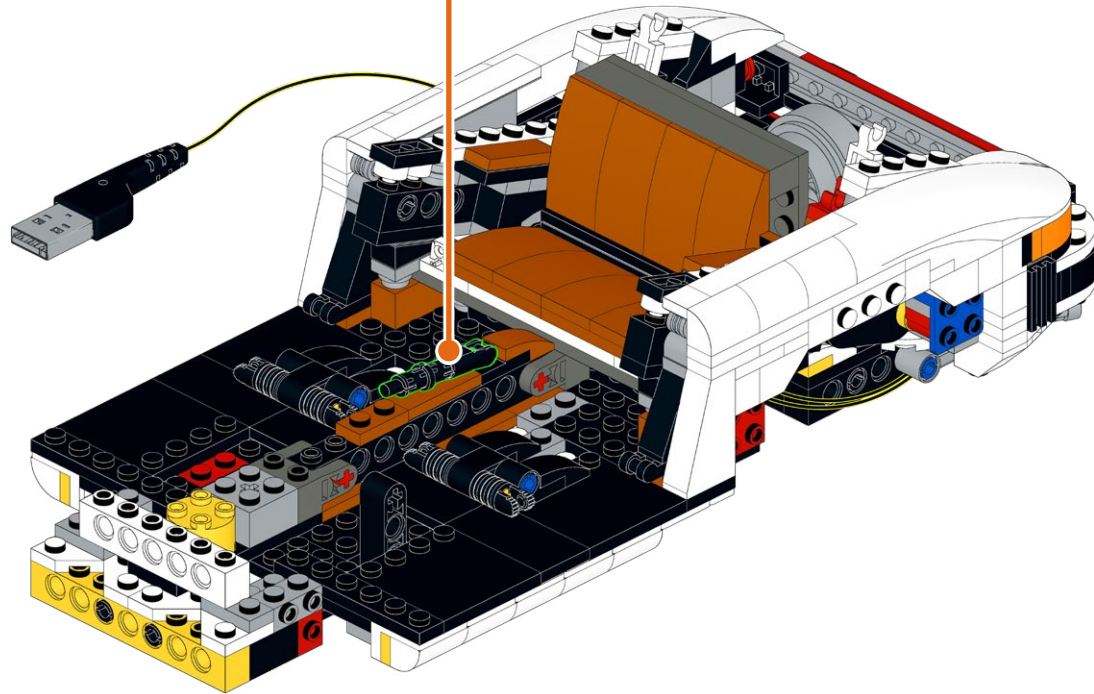
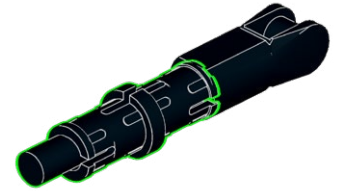

250

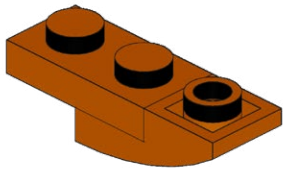
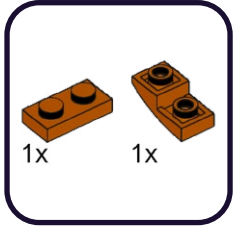

251

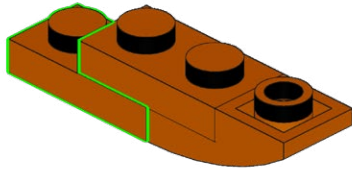
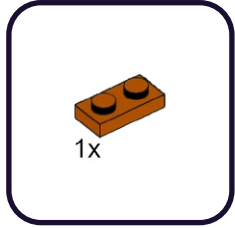

252

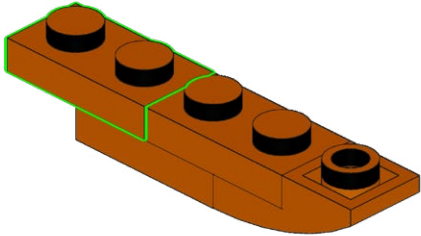
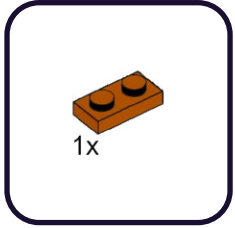

253

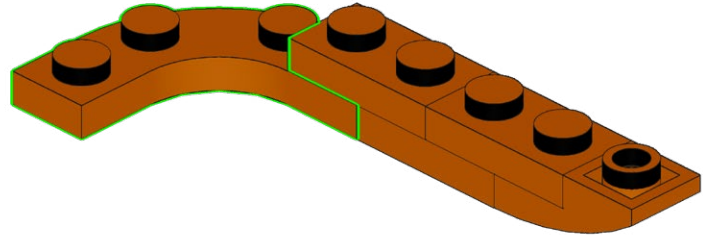
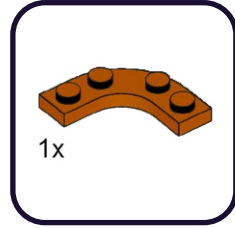

254

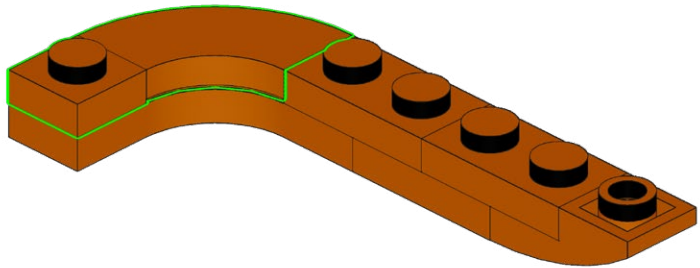
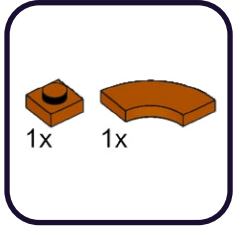

255

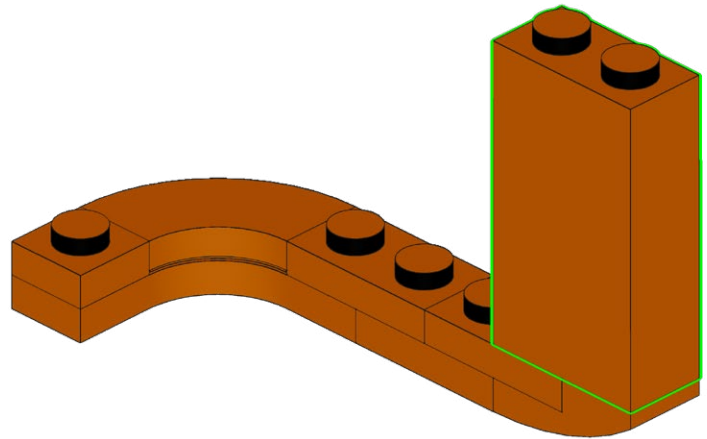
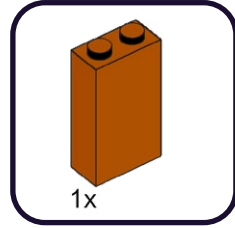

256

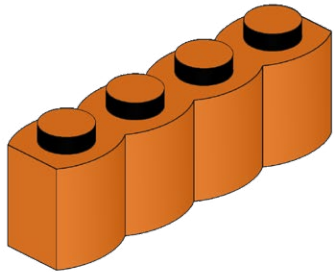
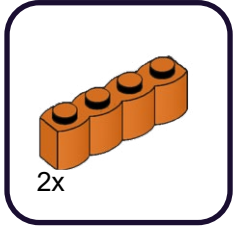

257

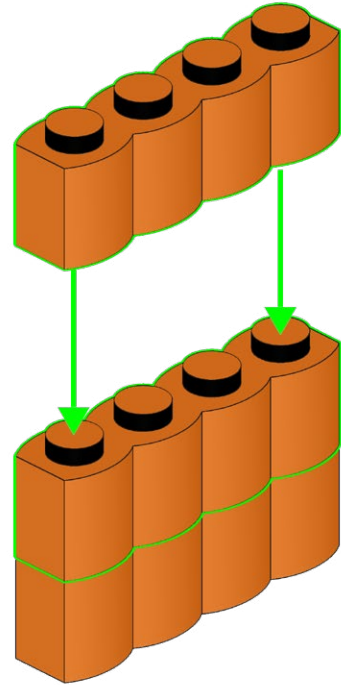
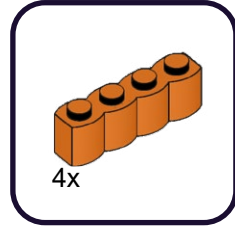

2x

258

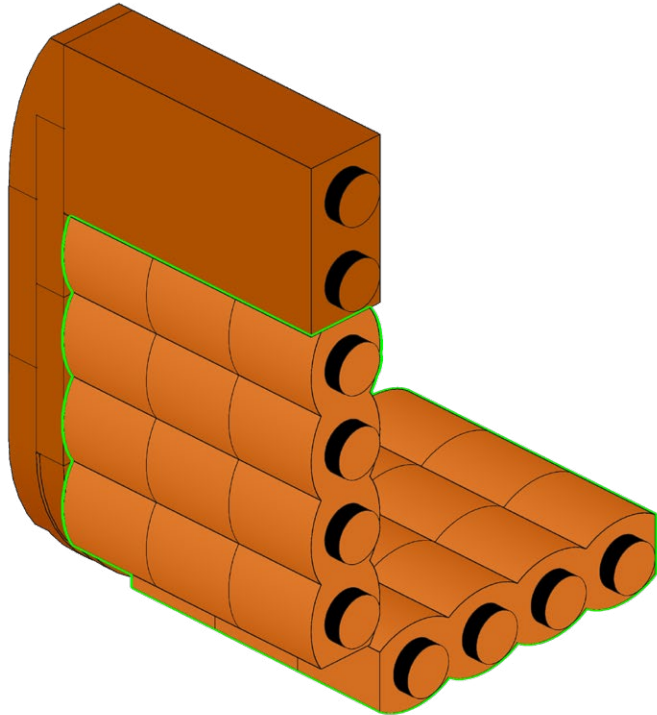
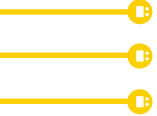

259

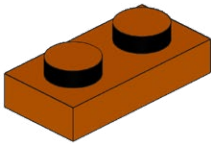
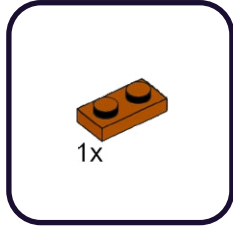

260

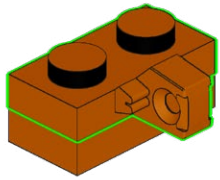
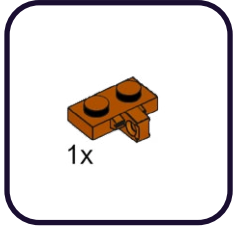

261

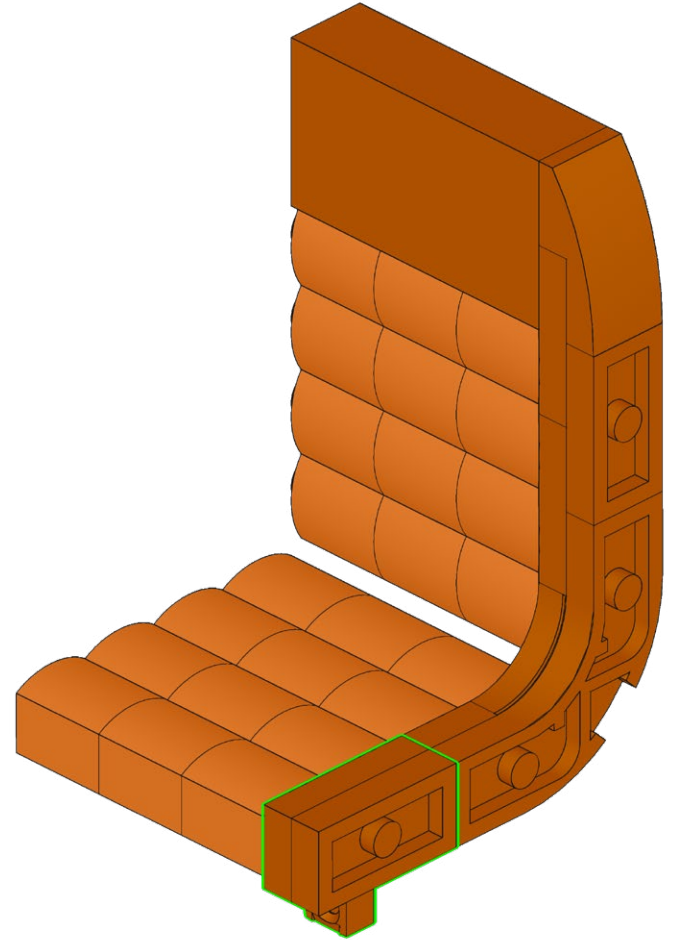
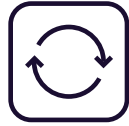

262

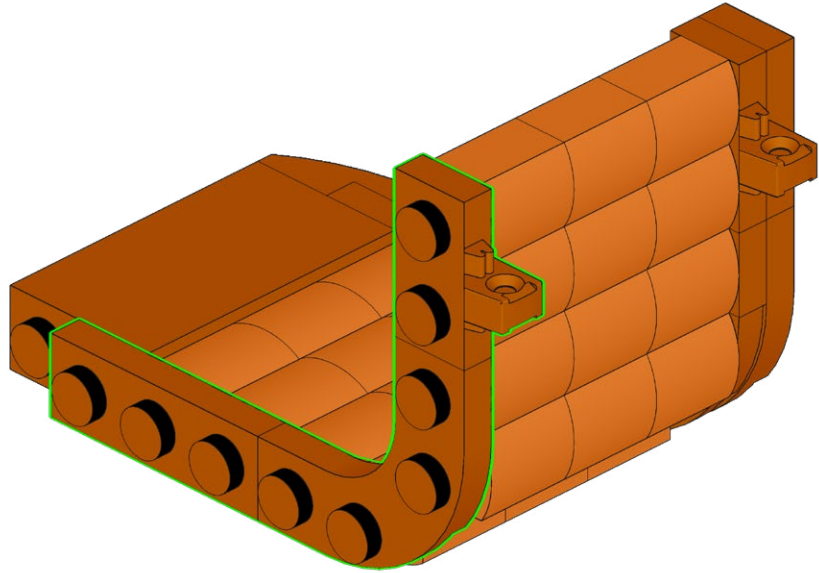
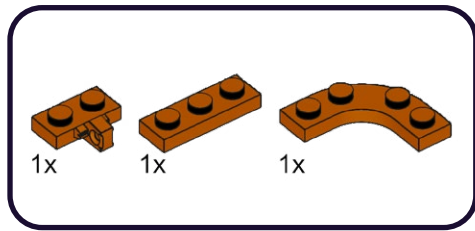

263

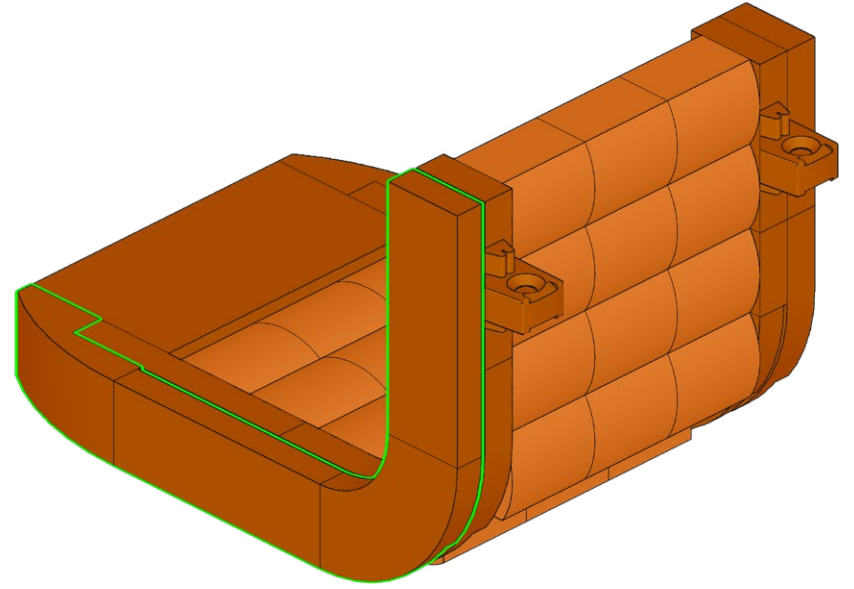
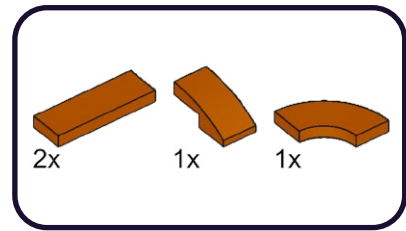

264

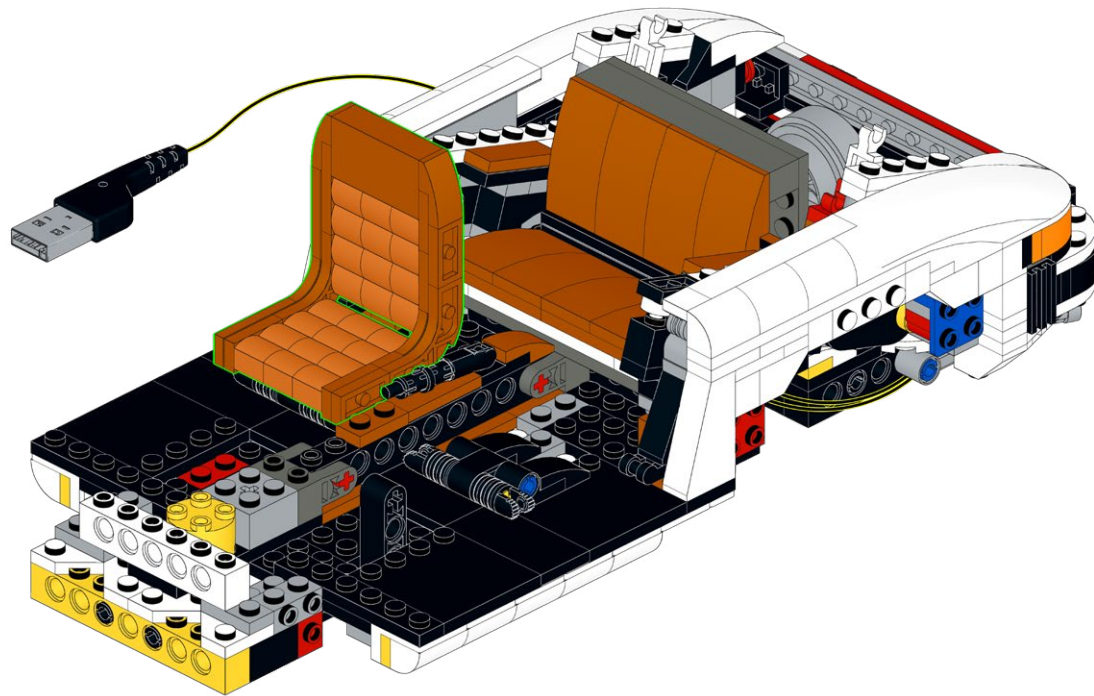

265

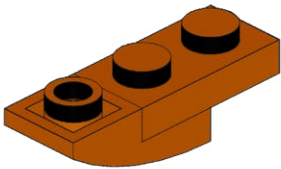
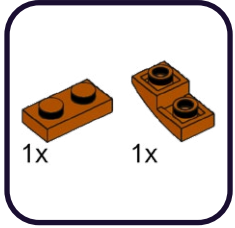

266

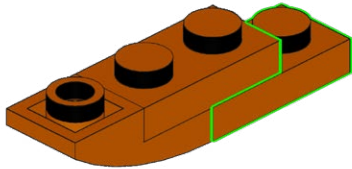
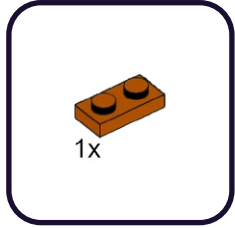

267

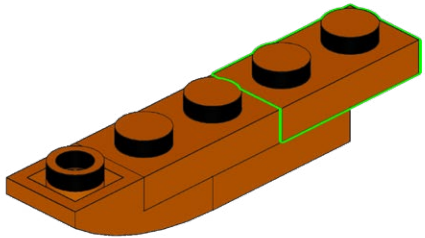
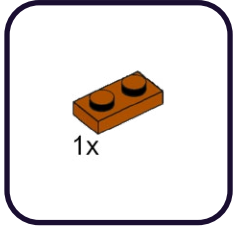

268

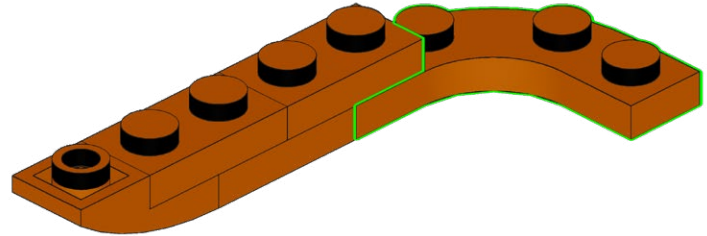
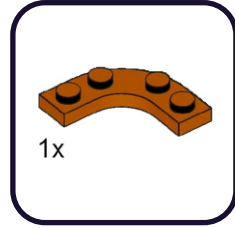

269

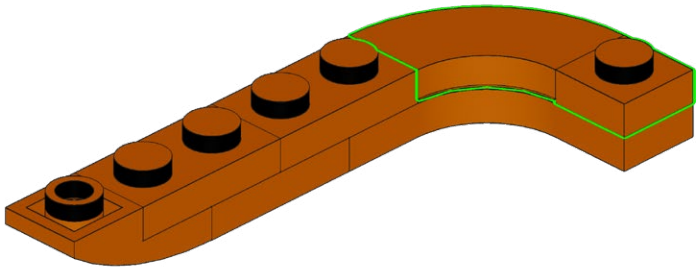
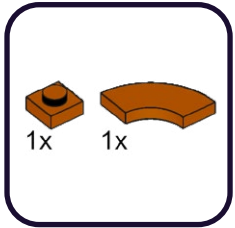

270

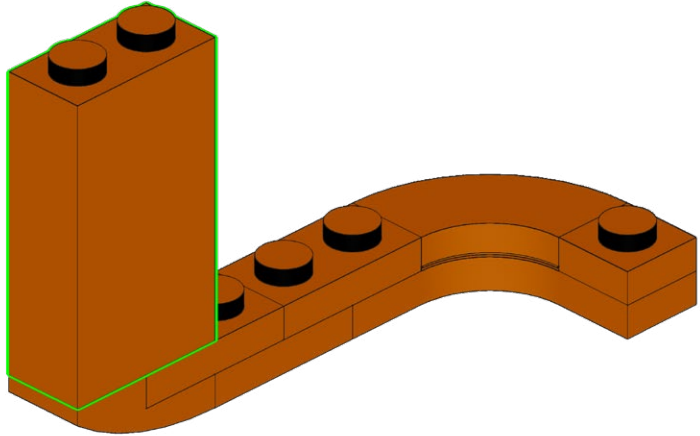
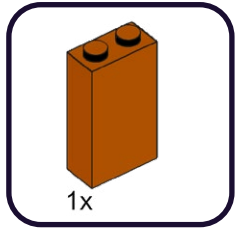

271

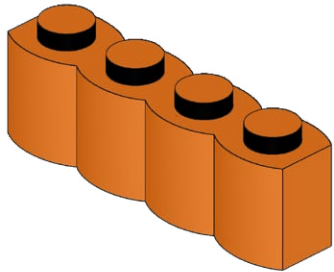
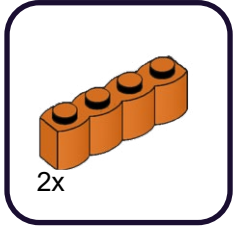

272

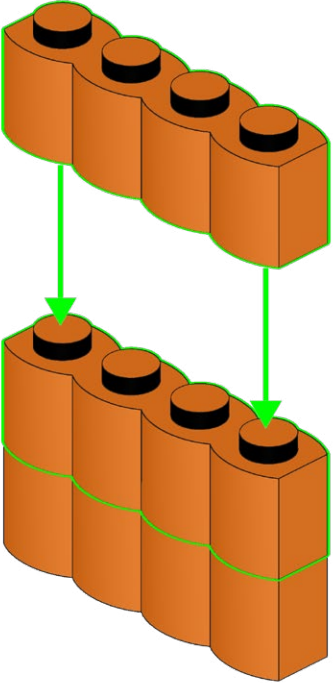
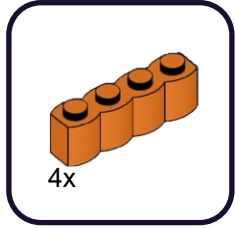

2x

273

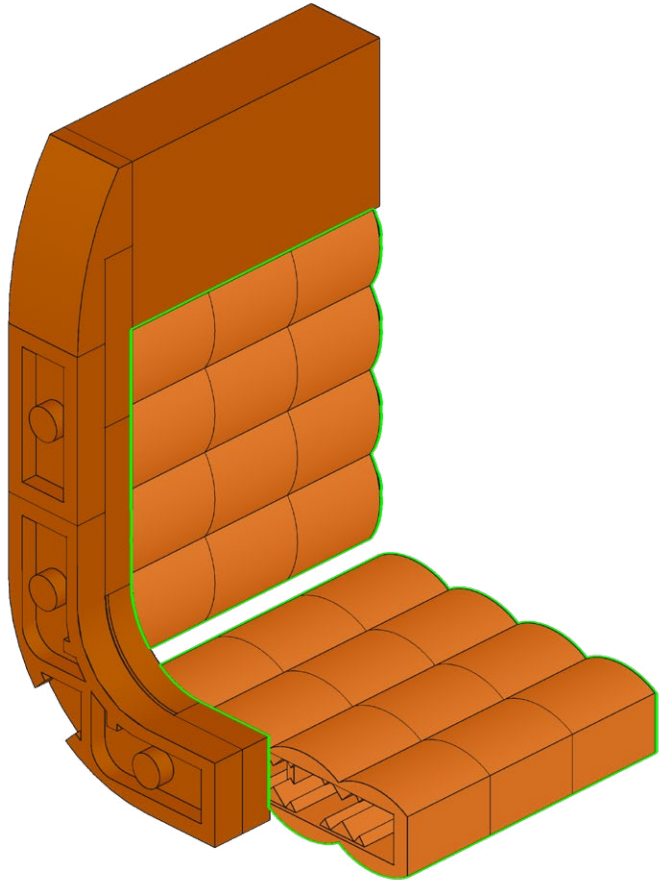
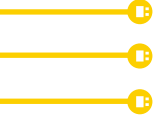

274

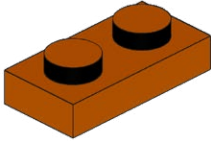
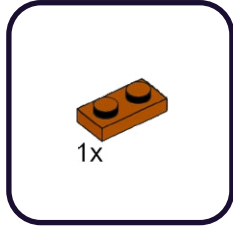

275

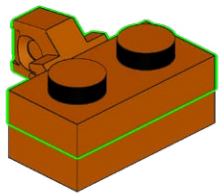
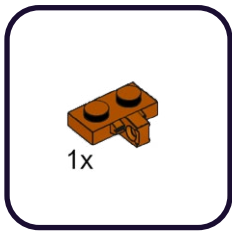

276

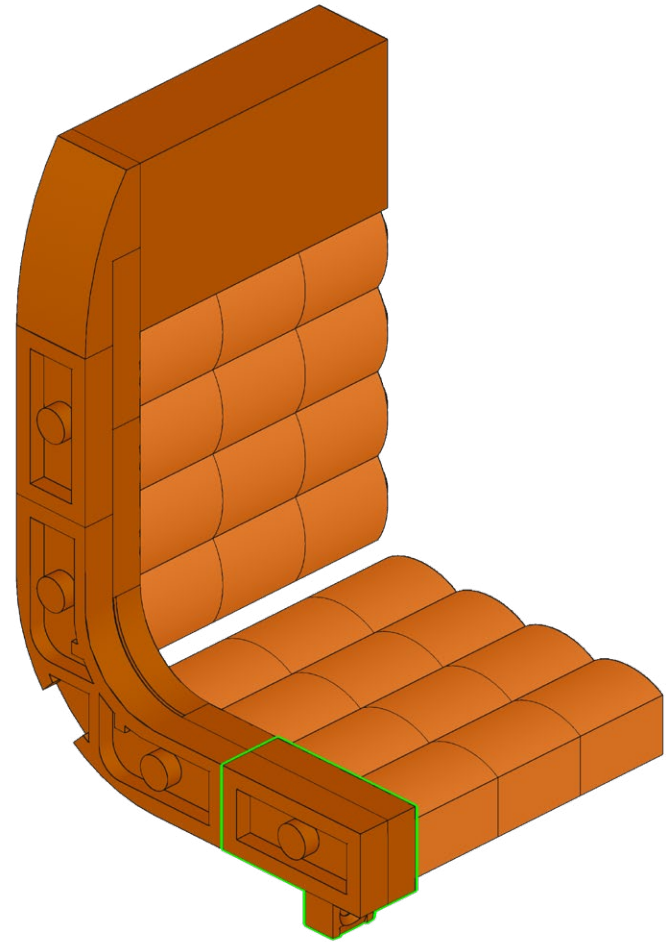

277

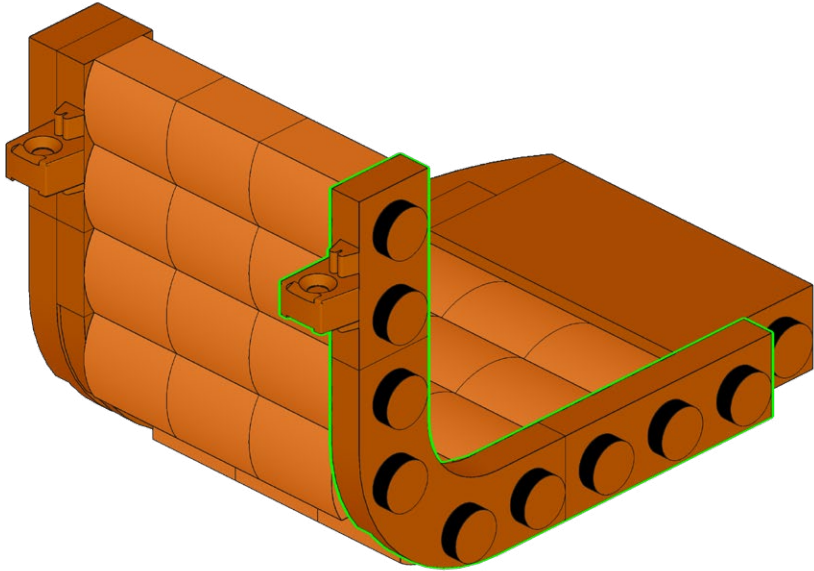
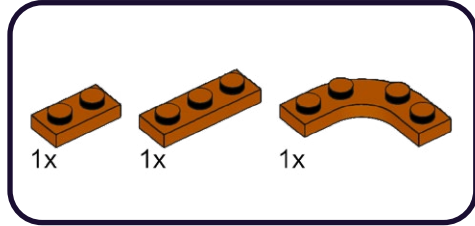

278

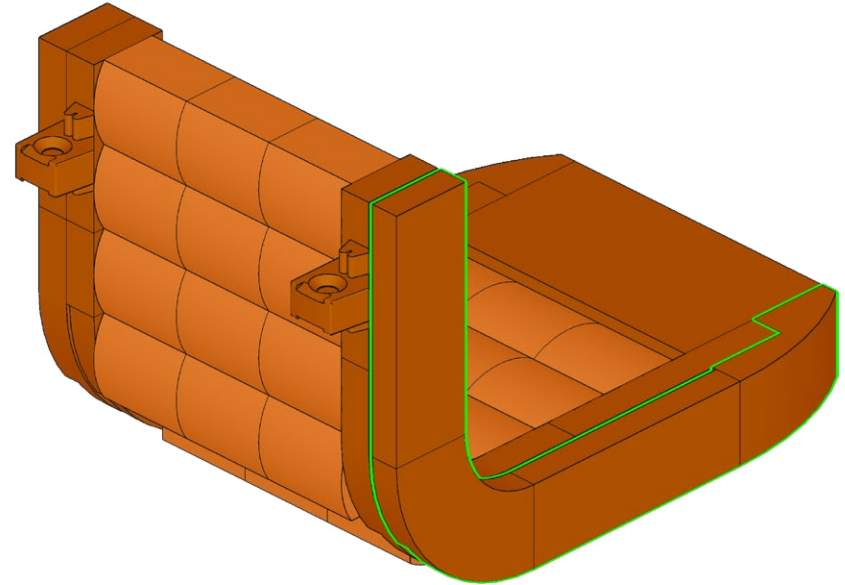
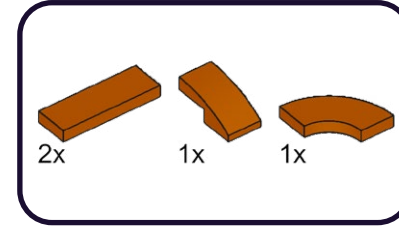

279

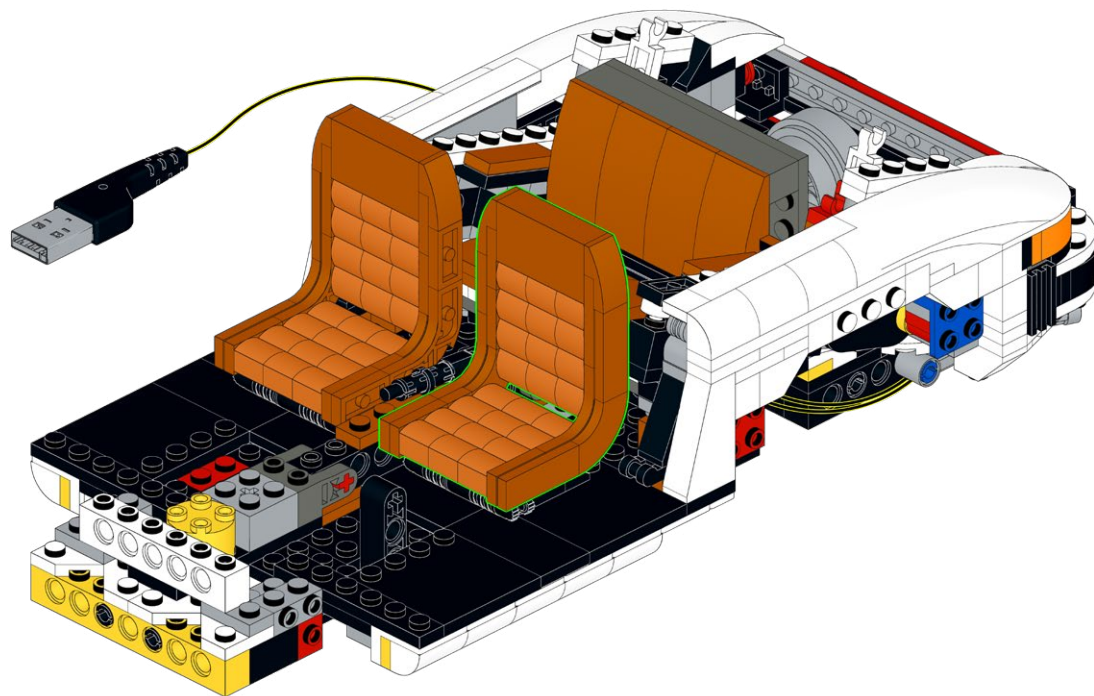

**HOLD UP!**

You might notice some bags aren't in order, as well as left over pieces, but that's ok! We're changing the way you build LEGO!

ATTENDEZ!

Vous remarquerez peut-être que certains sacs, ainsi que certaines pièces, ne sont pas dans le bon ordre. Mais pas de panique! Nous changeons simplement la façon avec laquelle vous construisez vos LEGO!

ASPETTA!

Potresti notare che alcuni sacchetti non sono in ordine, così come i pezzi avanzati, ma va bene così! Stiamo cambiando il modo in cui costruisci i LEGO!

HALT!

Sie werden möglicherweise bemerken, dass einige tüten durcheinander sind und teile übrig bleiben, aber das ist in Ordnung! Wir ändern die art und weise, wie Sie LEGO bauen!

¡ESPERA!

Es posible que notes que algunas bolsas están fuera de servicio, así como piezas sobrantes, ¡pero está bien! ¡Estamos cambiando la forma en que construyes LEGO!

暫停!

你可能会注意到一些袋子顺序错乱, 以及一些剩余的部件, 但没关系! 我们正在改变你搭建乐高的方式!

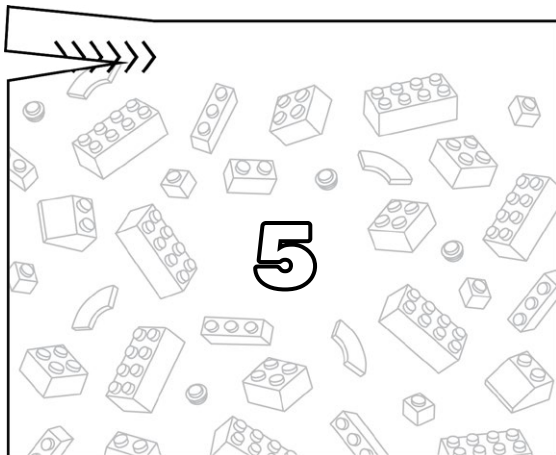
Open LEGO® Bag 1

280

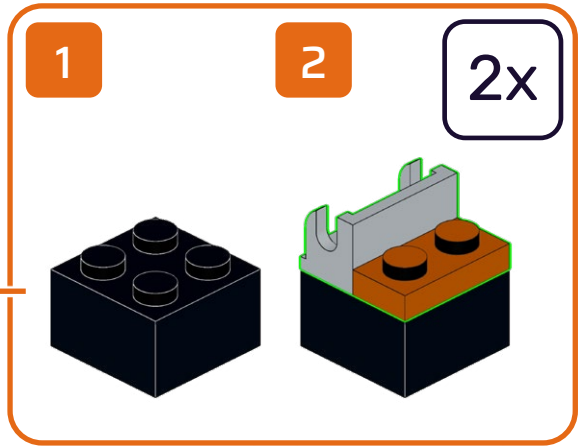
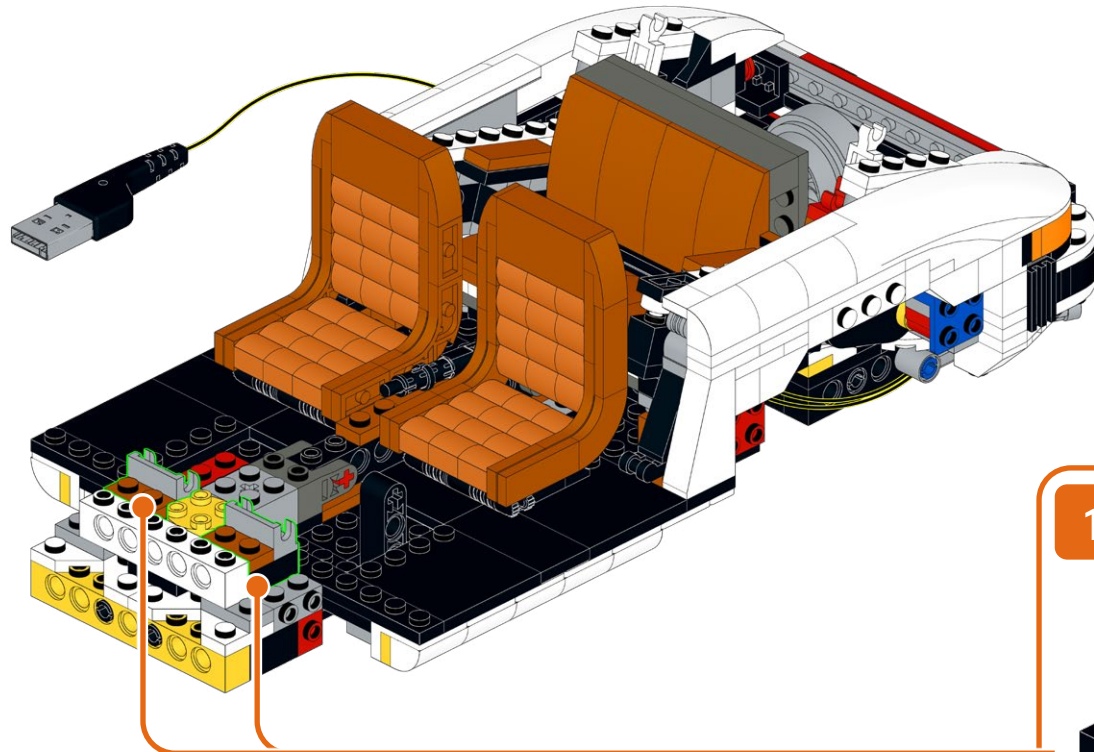
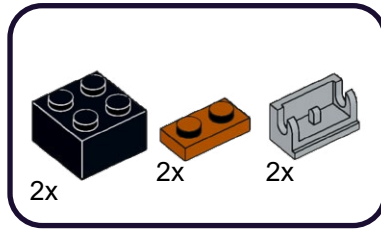

281

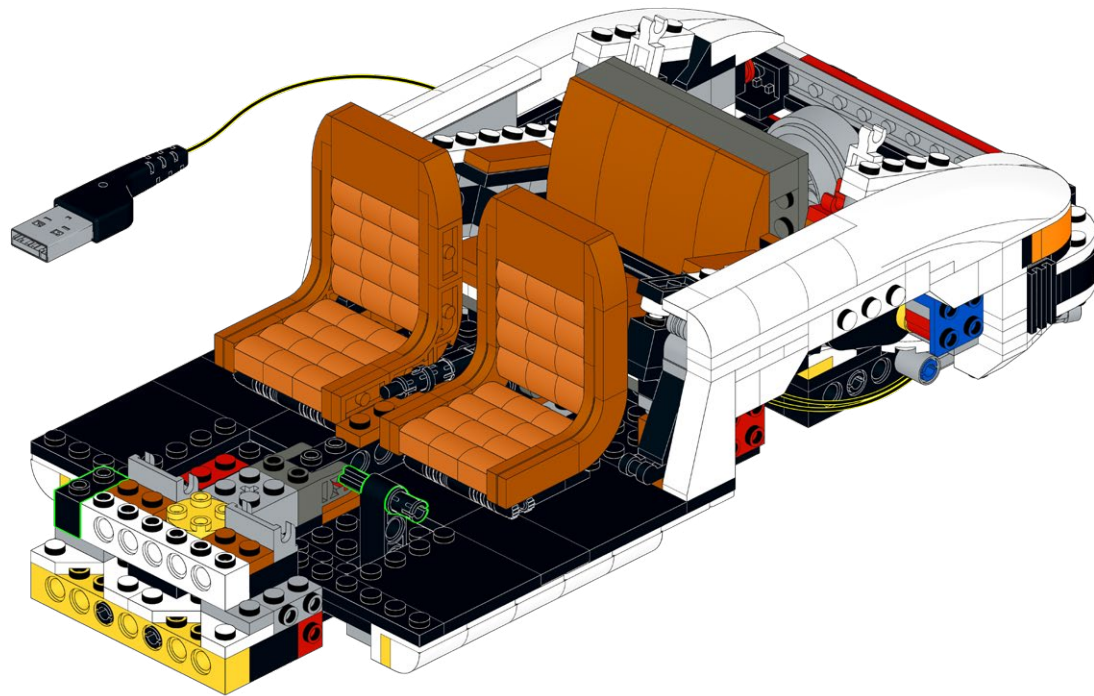
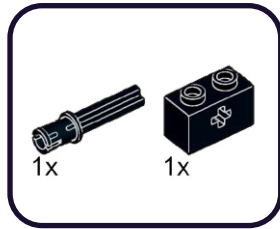

282

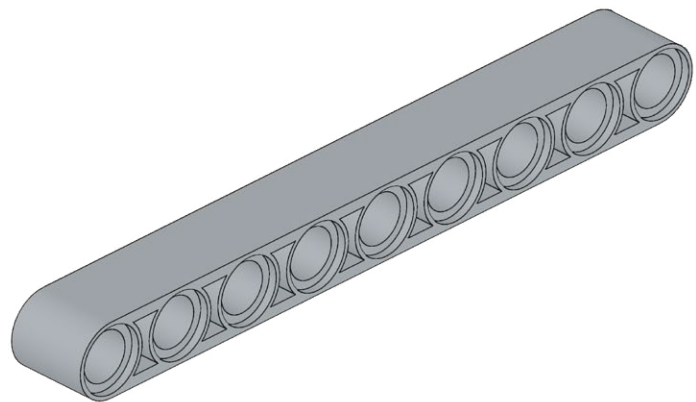
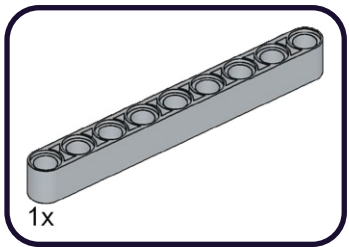

283

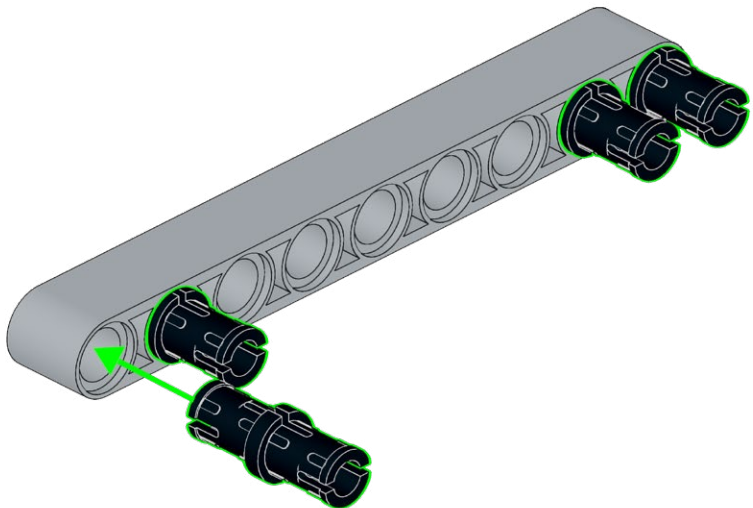

284

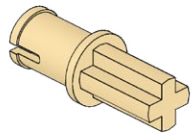
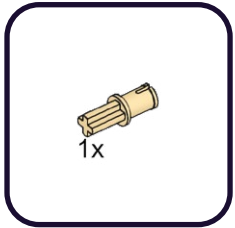

285

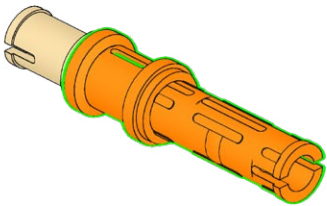
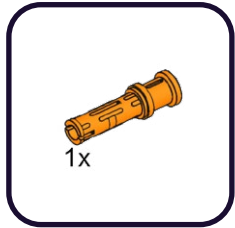

286

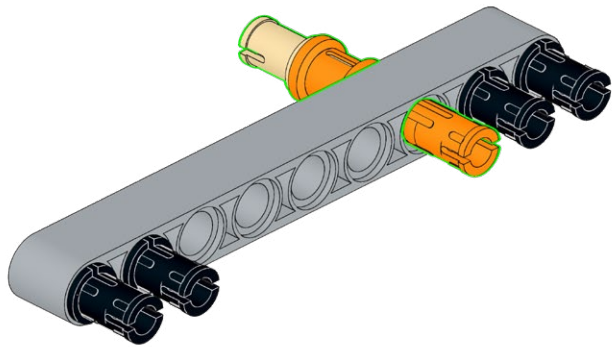

287

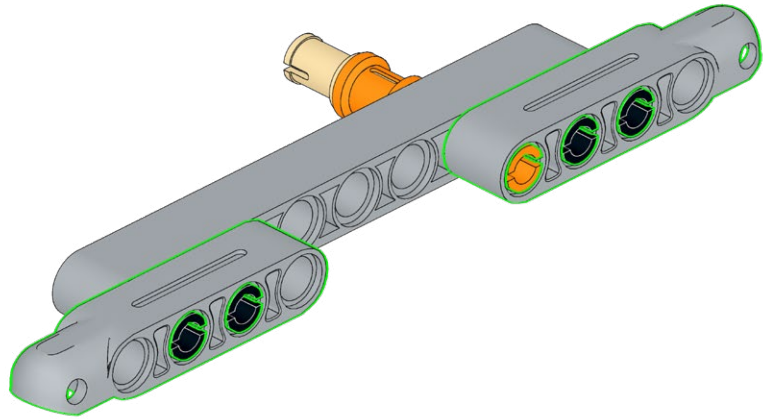
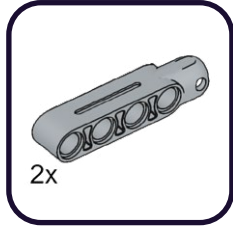

288

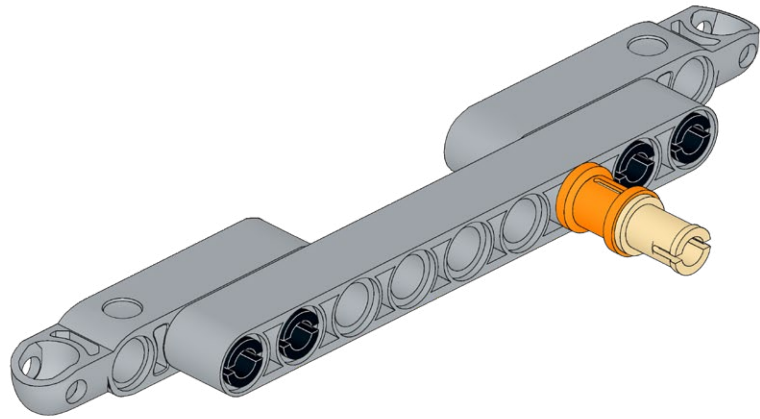

289

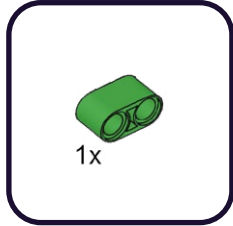

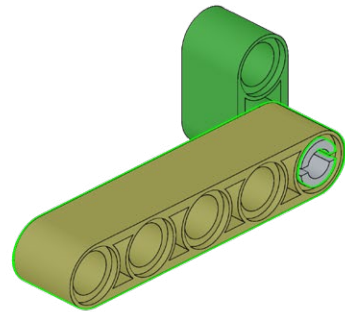
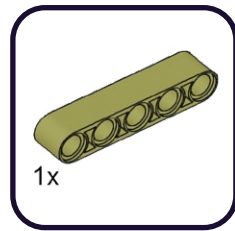
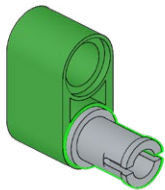
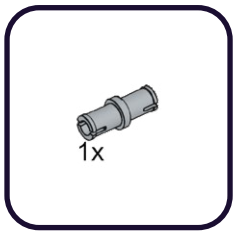

292

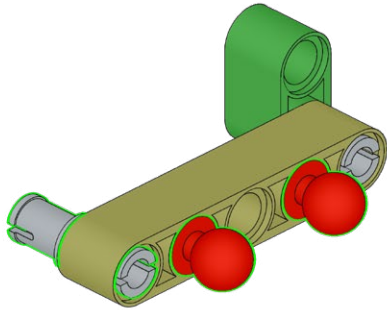
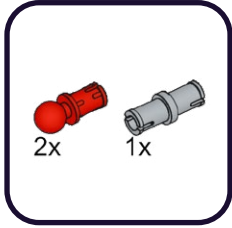

293

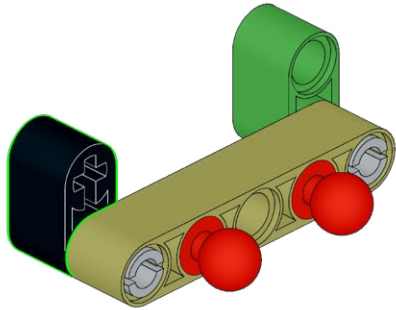
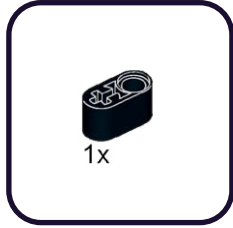

294

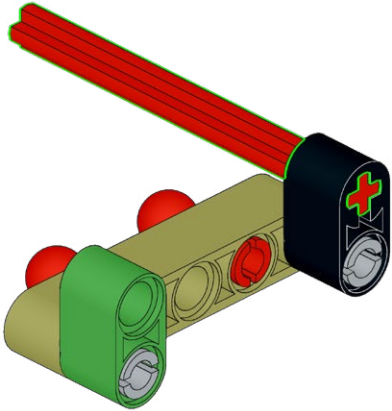
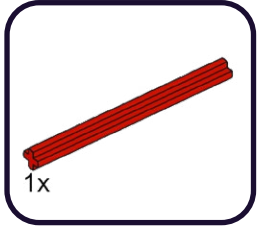

295

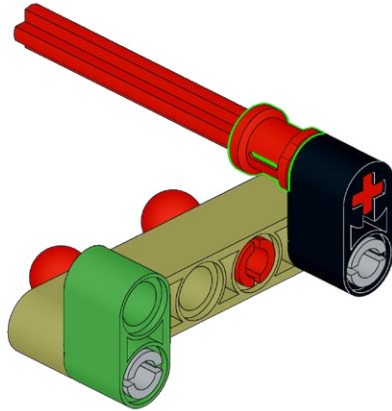
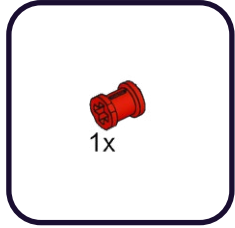

296

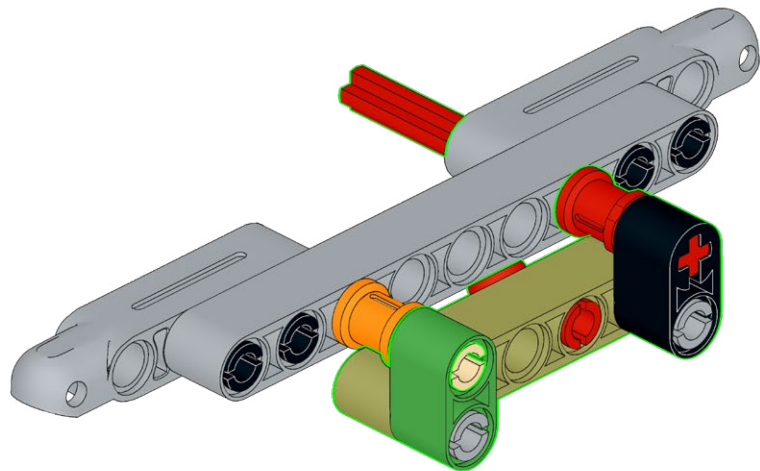

297

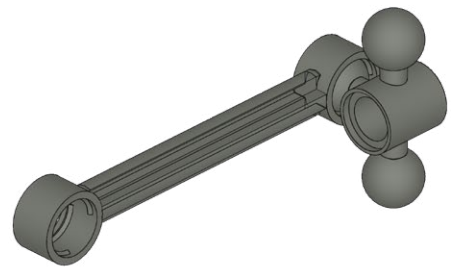
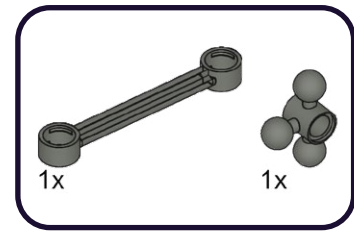

298

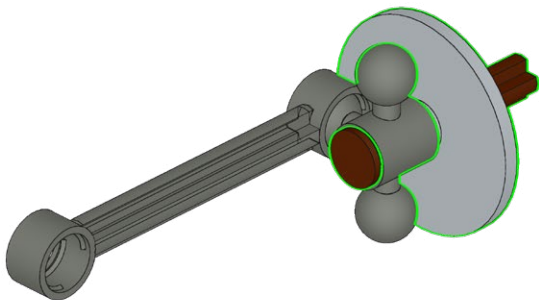
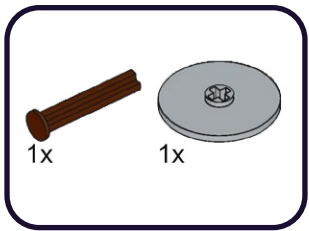

299

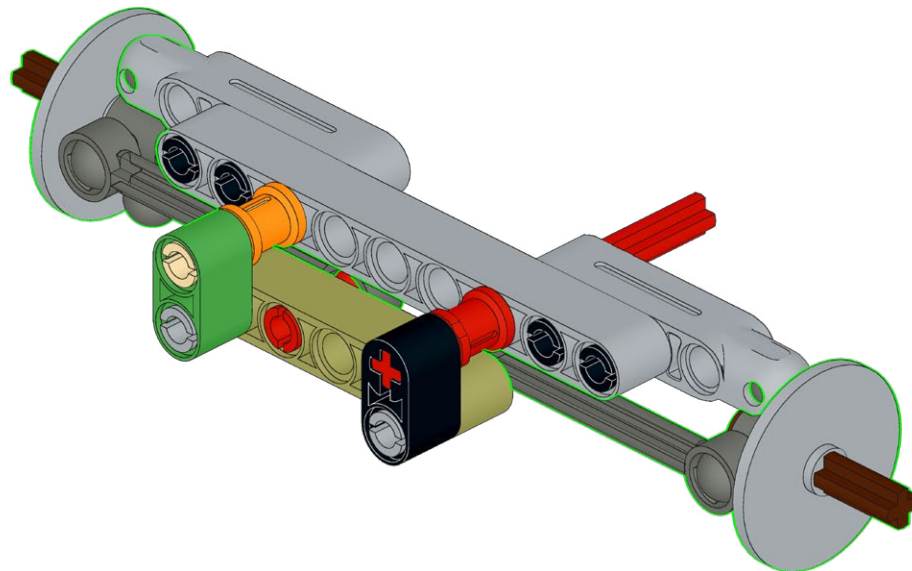

300

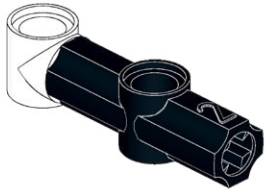
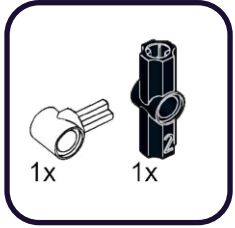

301

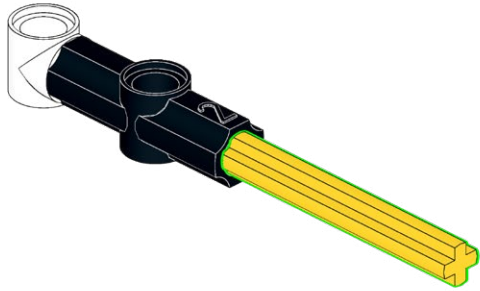
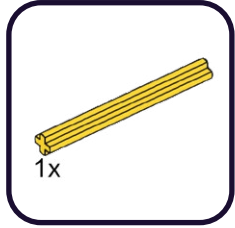

302

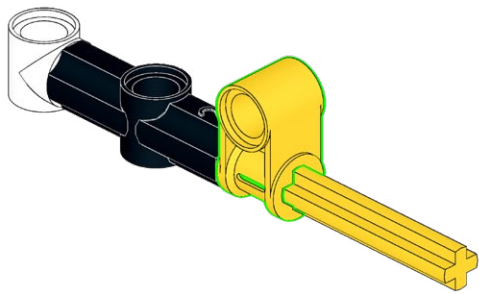
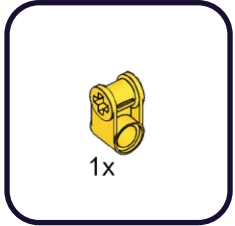

303

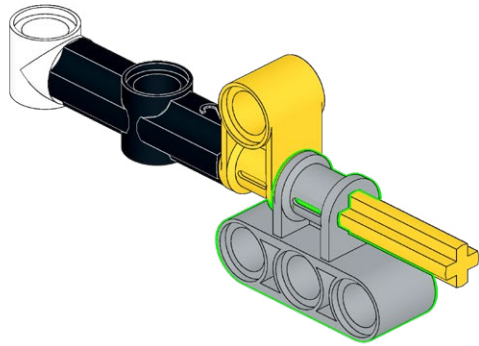
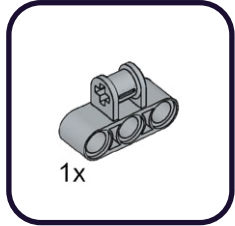

304

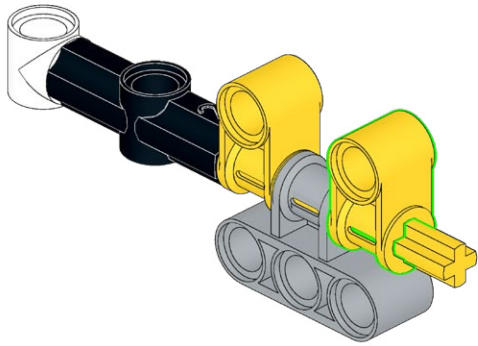
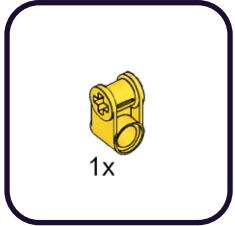

305

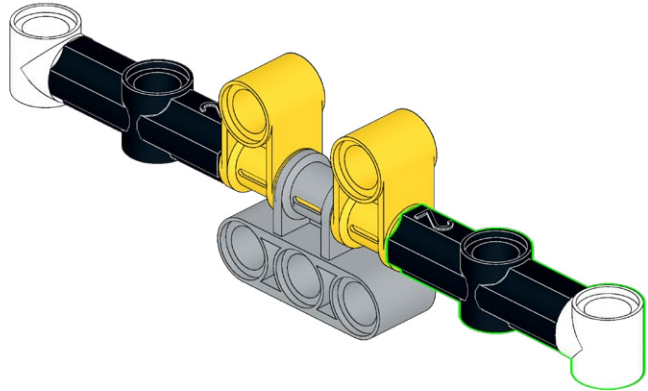
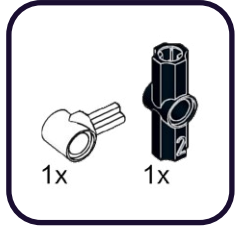

306

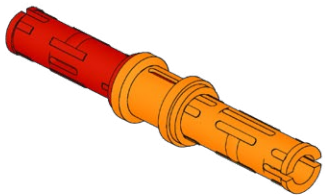
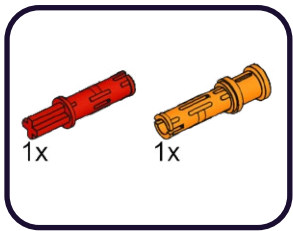

307

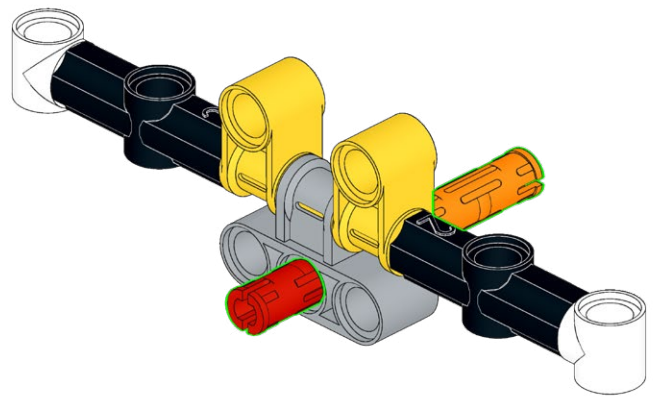

308

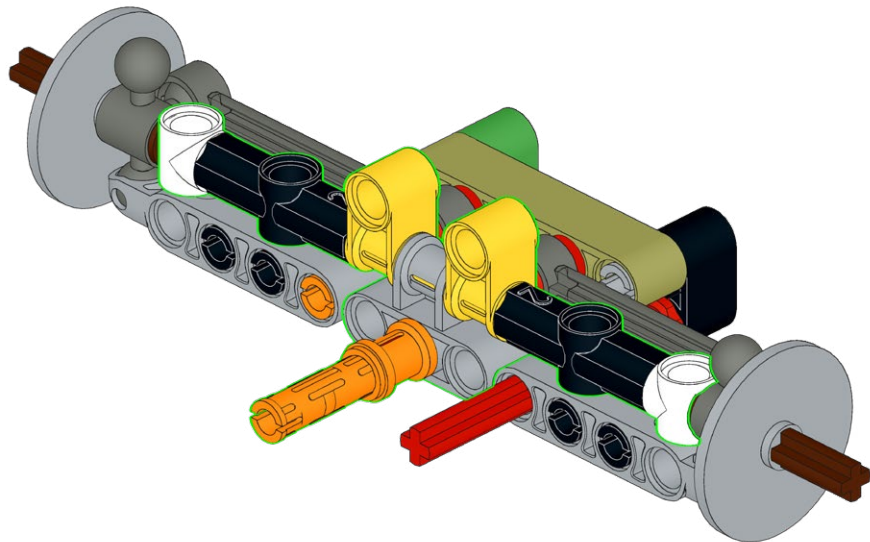

309

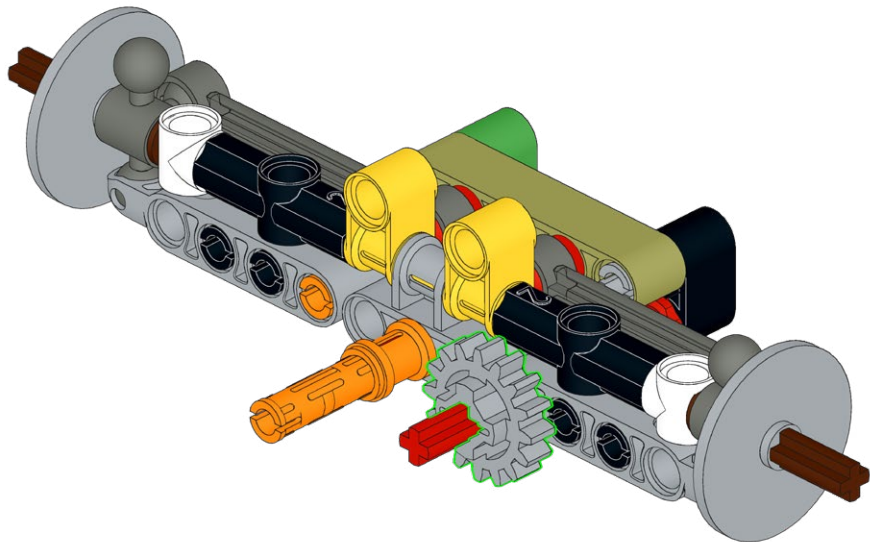
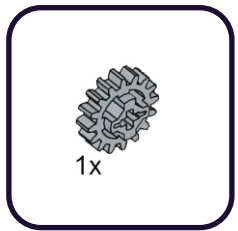

310

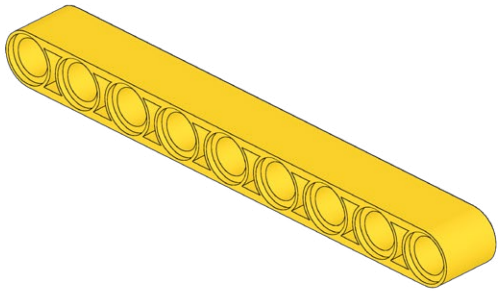
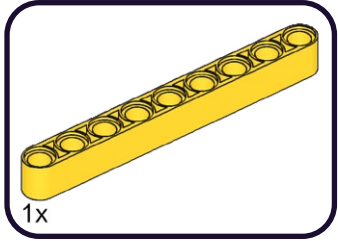

311

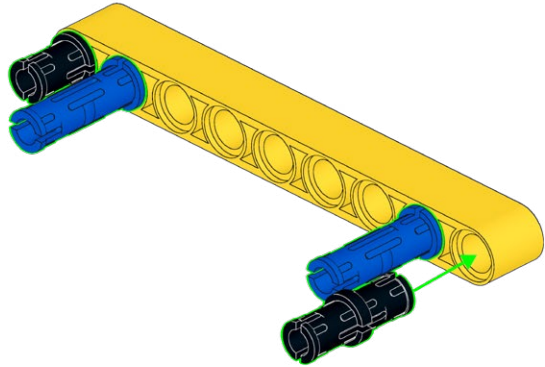
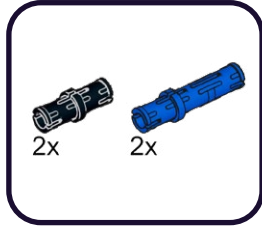

312

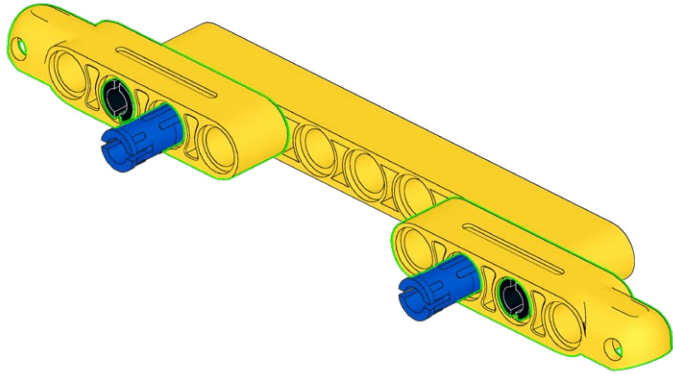
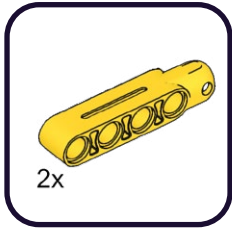

313

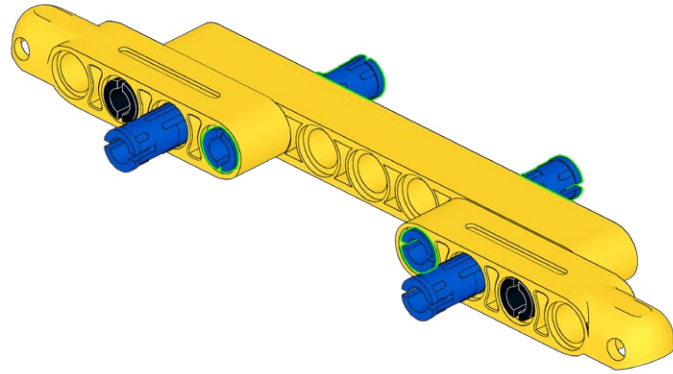
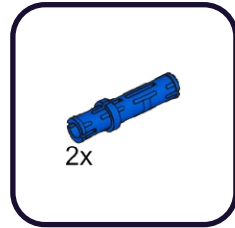

314

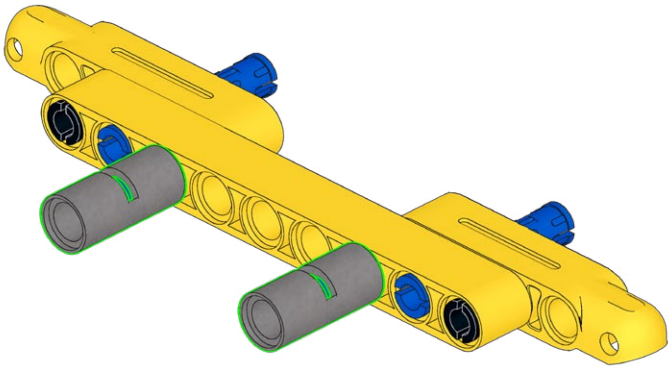
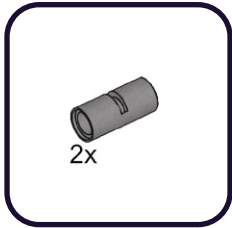

315

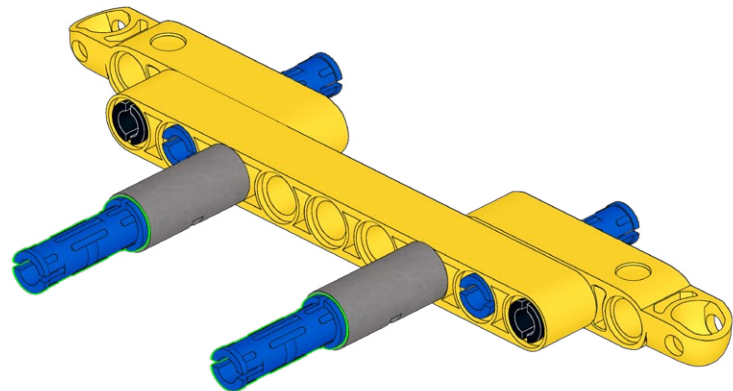
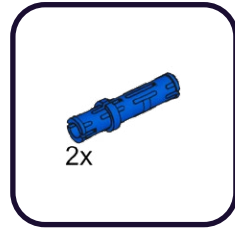

316

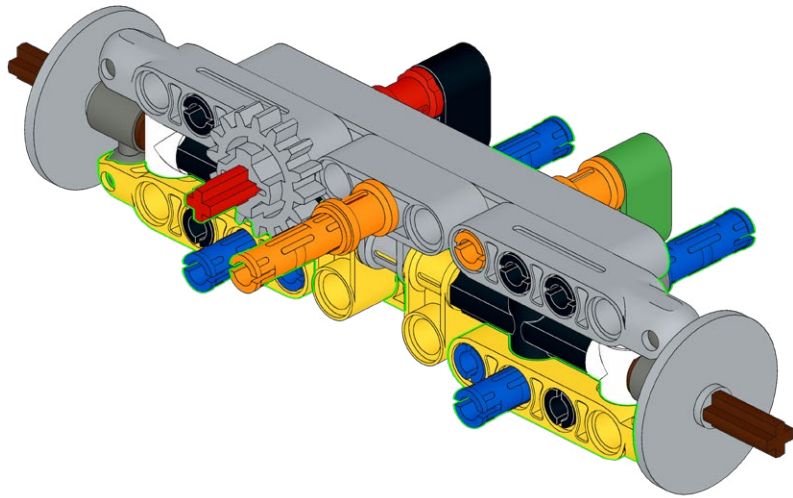

317

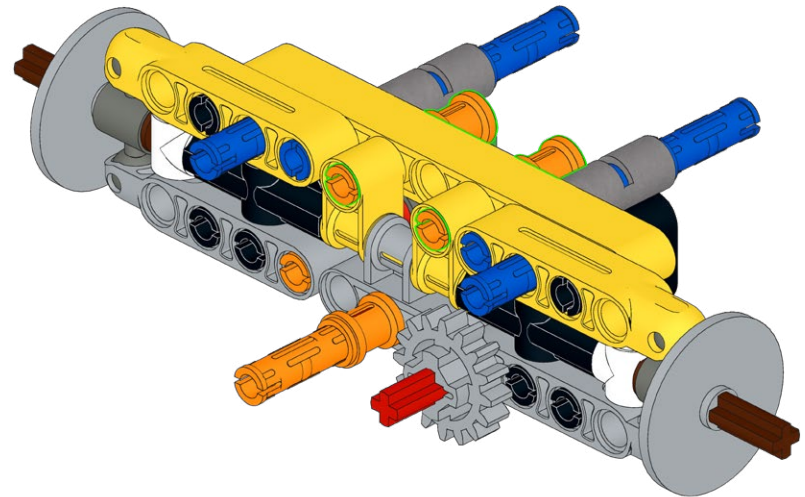
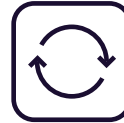
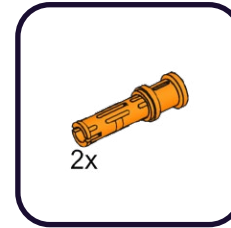

318

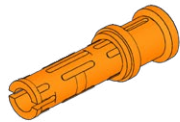
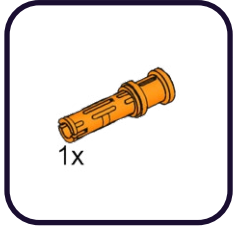

319

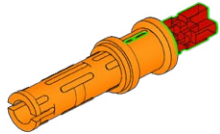
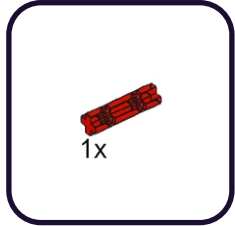

320

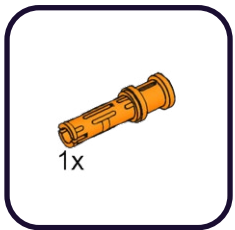

2x

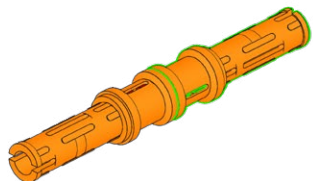

321

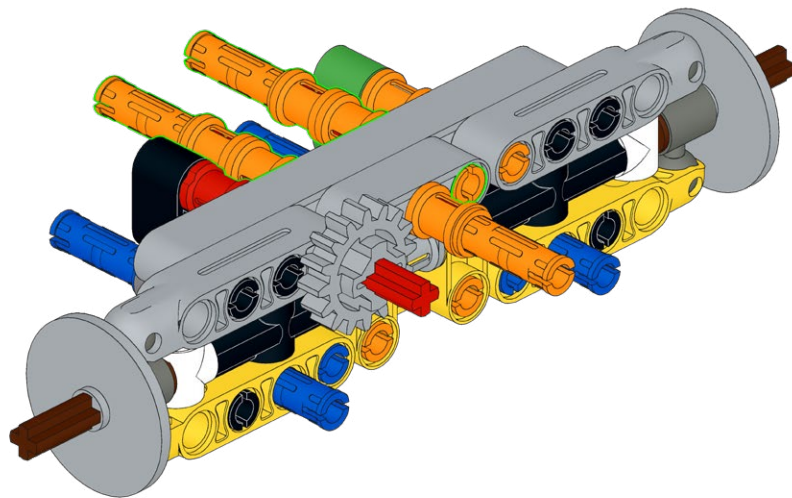
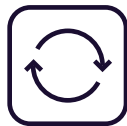

322

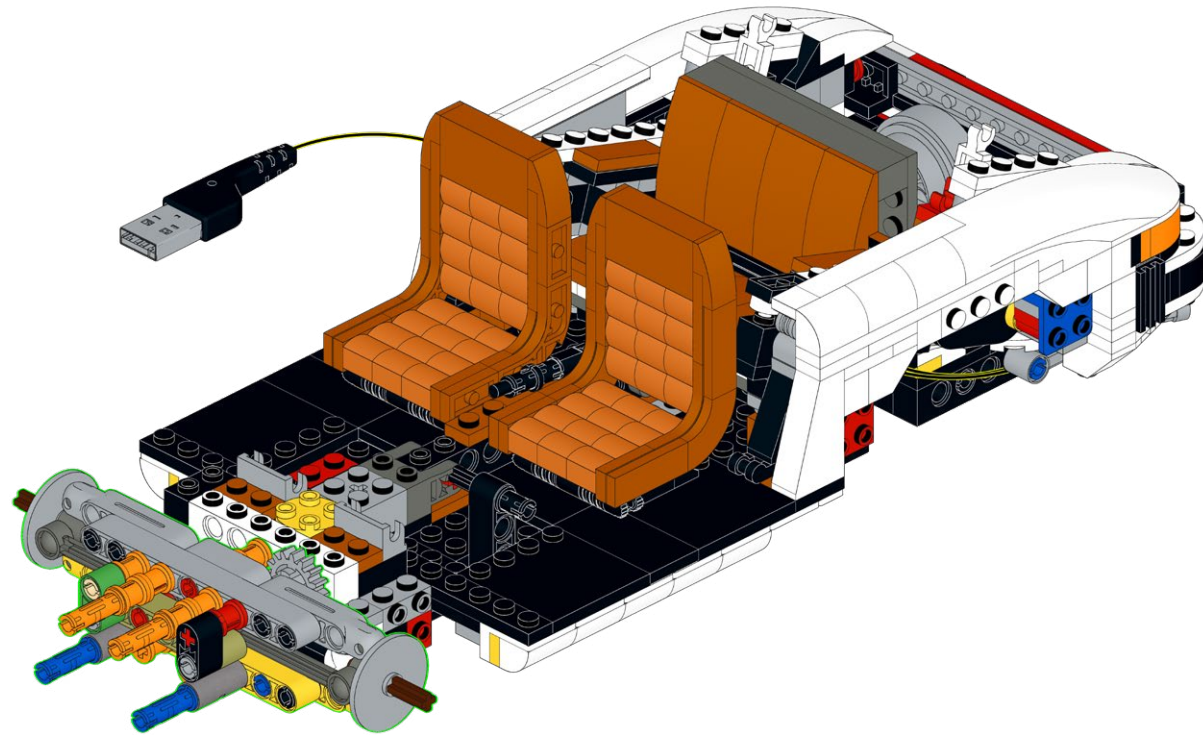

323

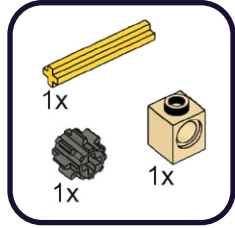

1

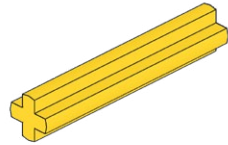

2

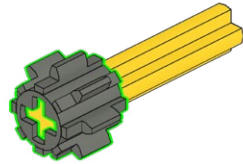

3

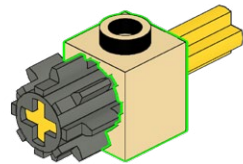

324

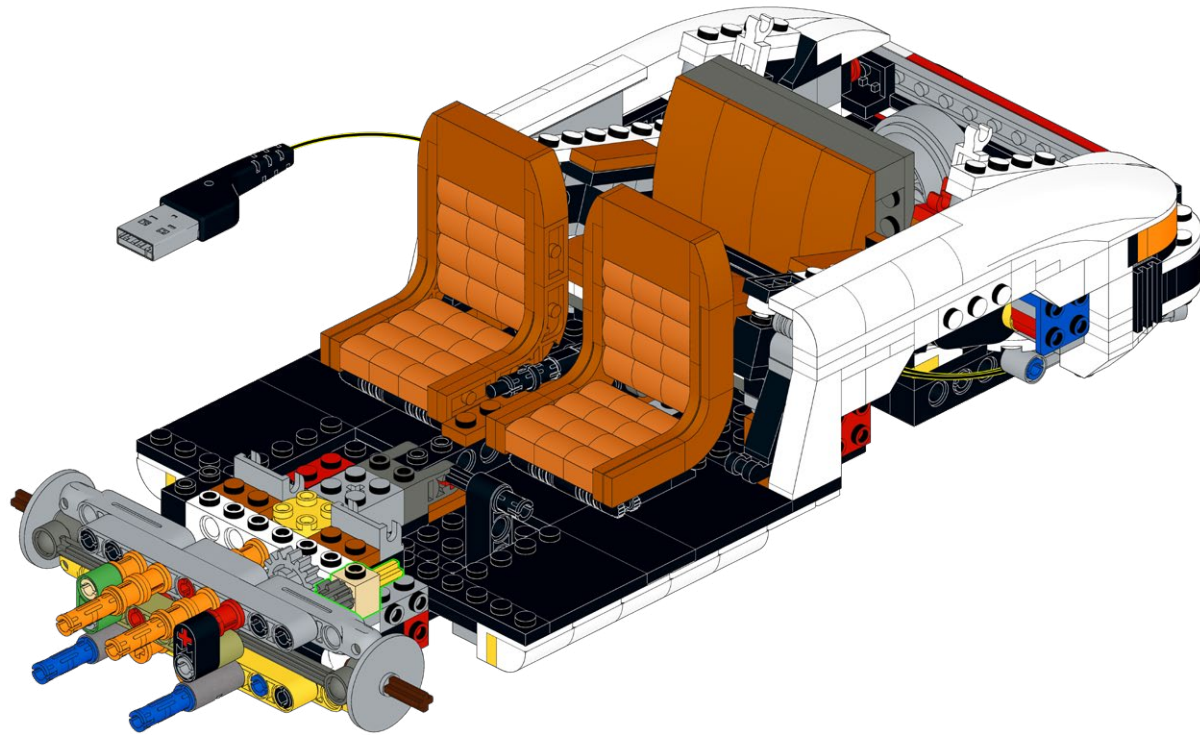

325

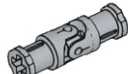

1x

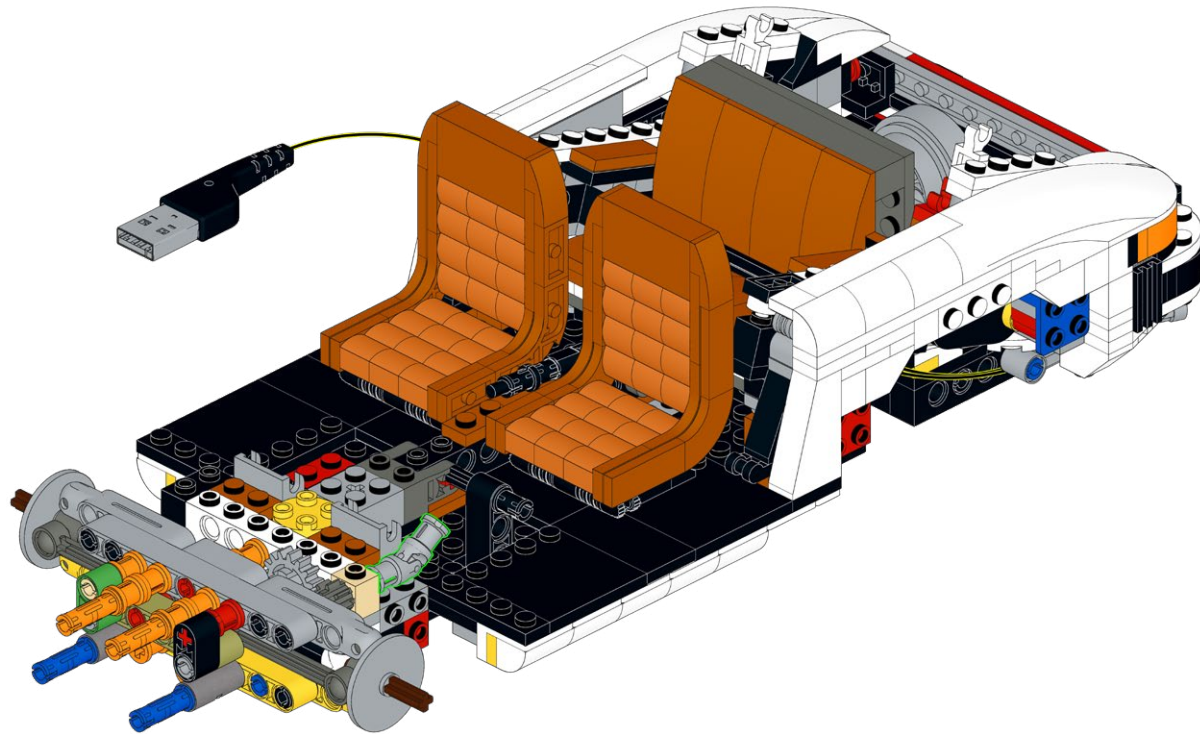

326

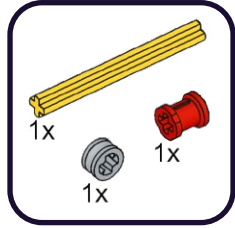

1

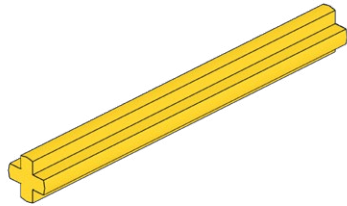

2

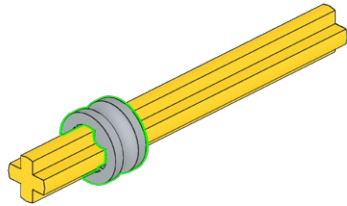

3

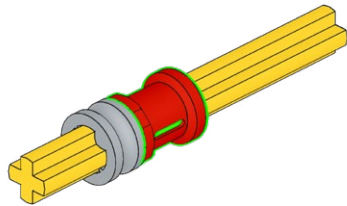

327

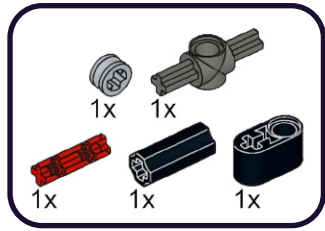

1

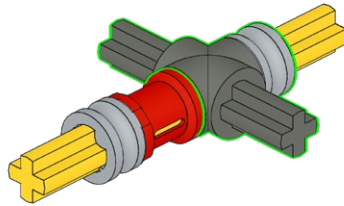

2

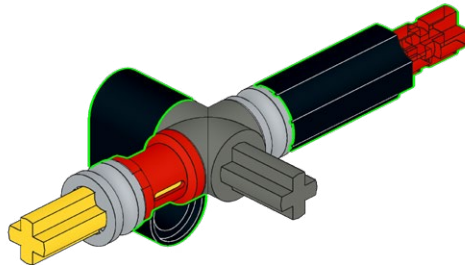

328

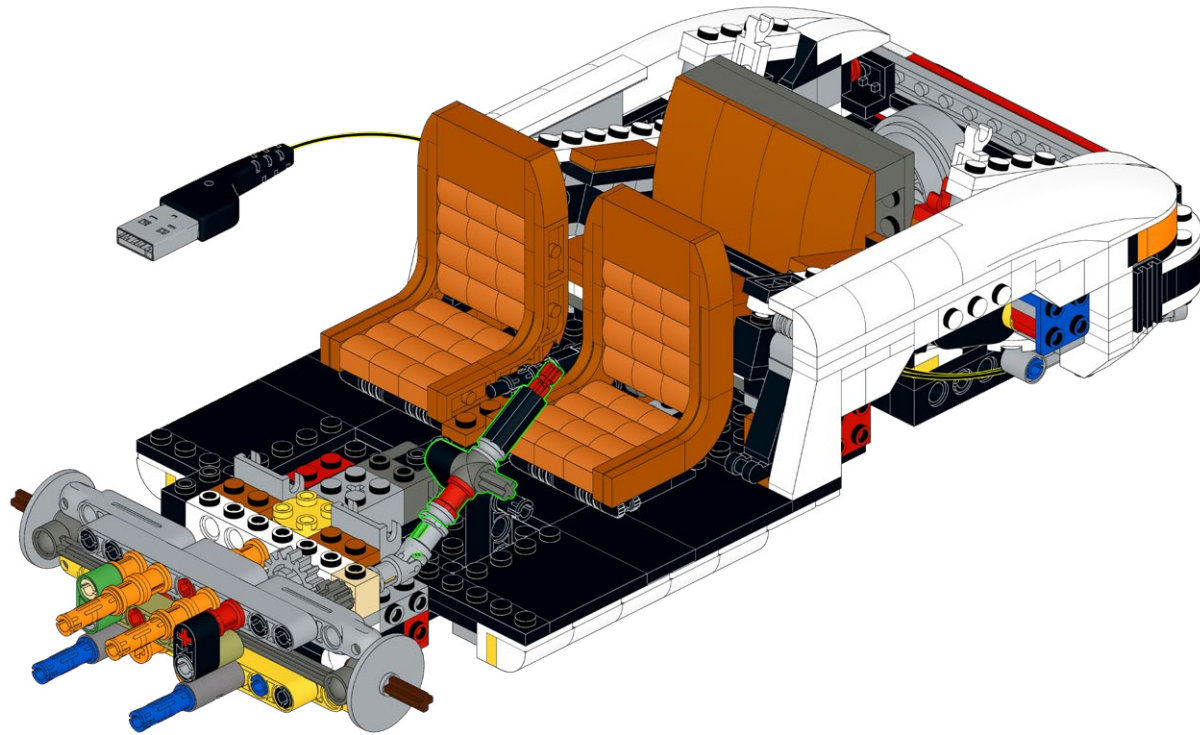

329

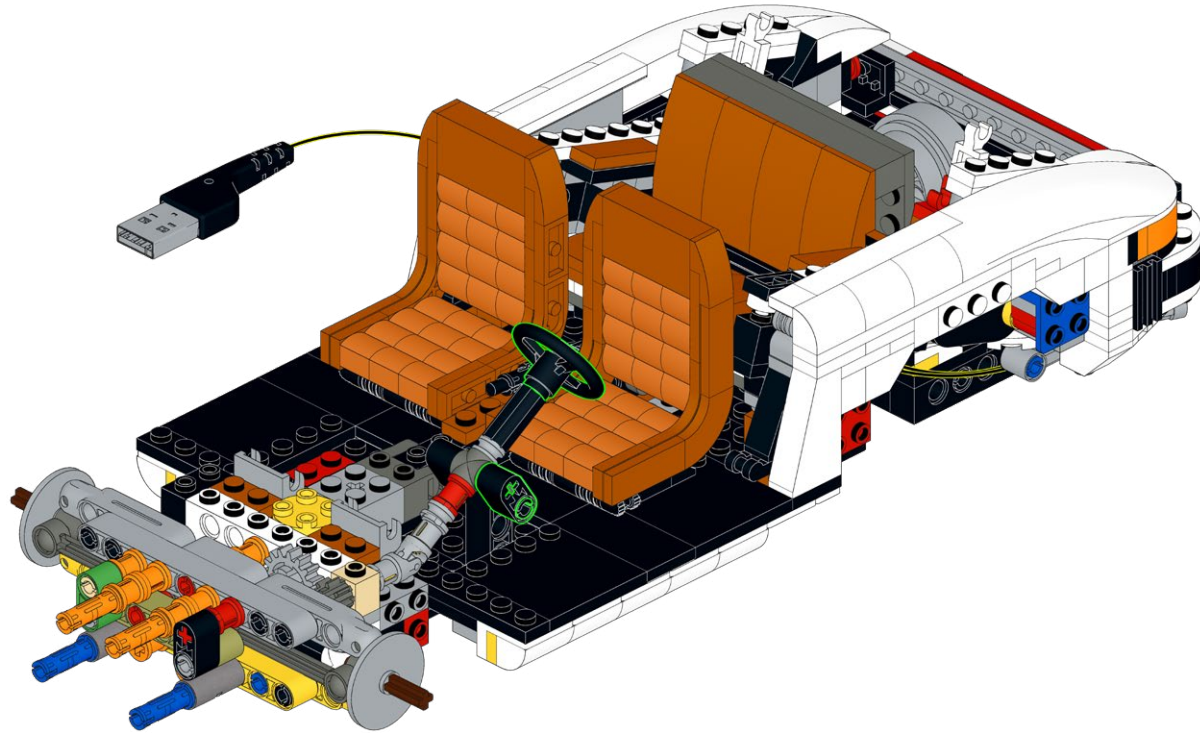
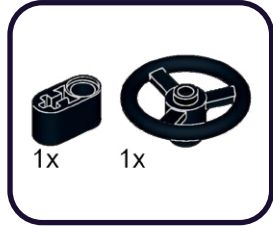

330

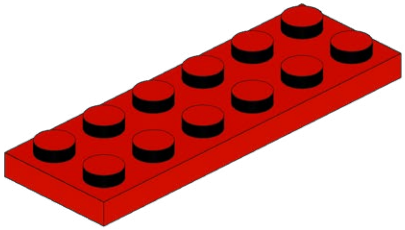
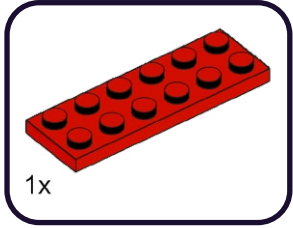

331

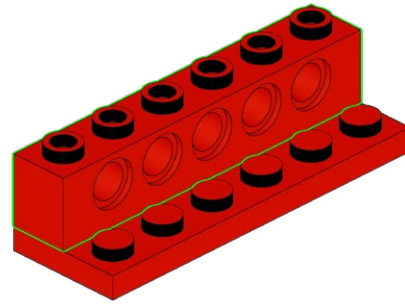
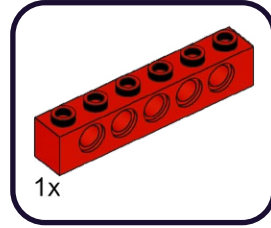

332

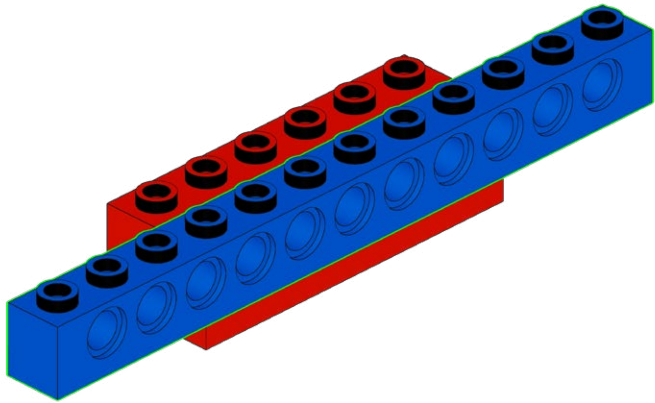
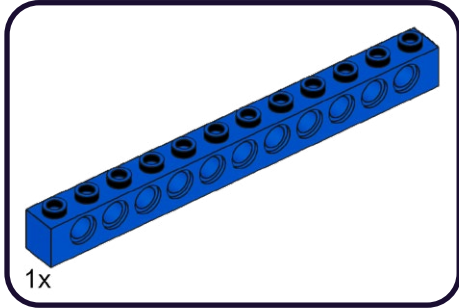

333

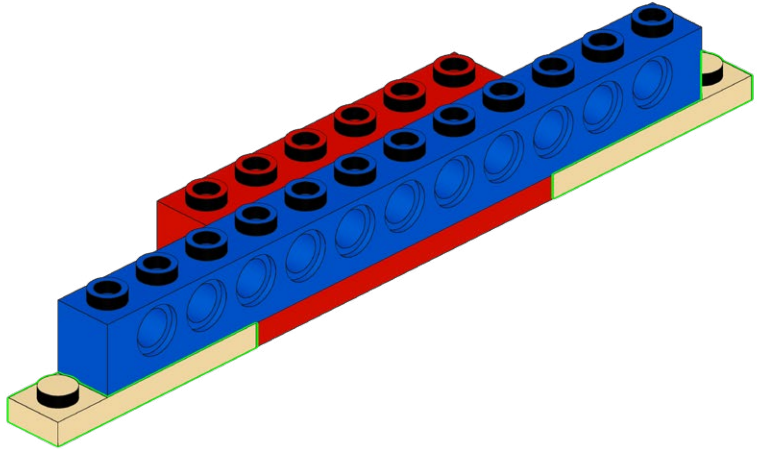
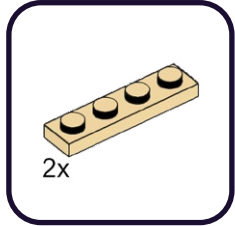

334



2x

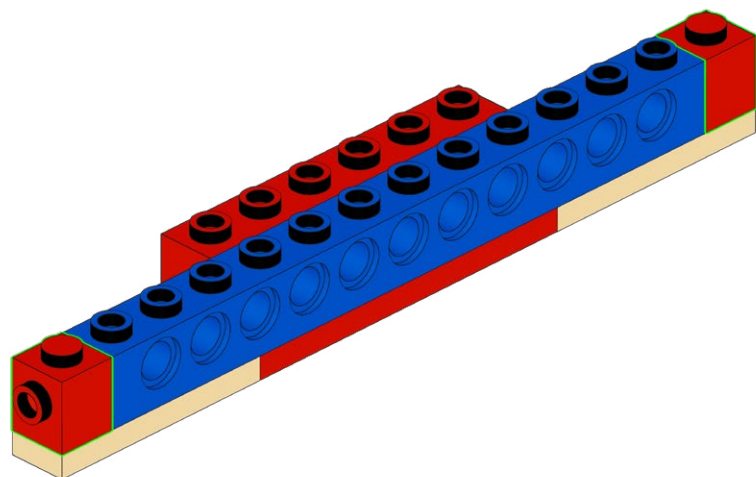

335



4x

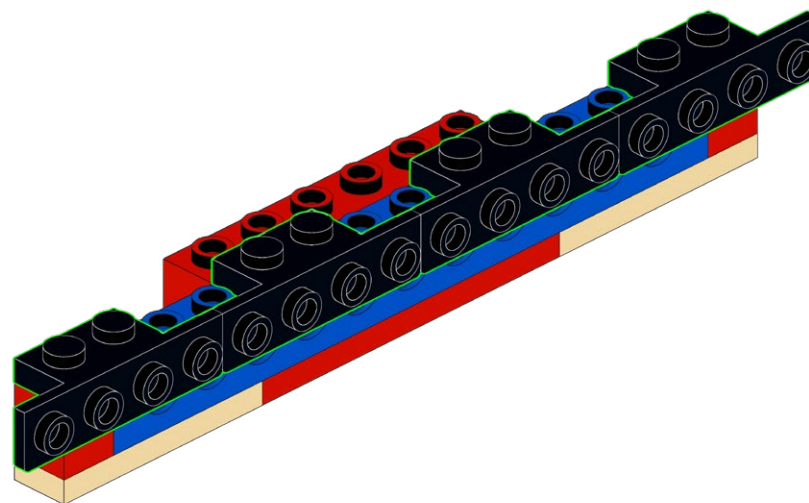

336

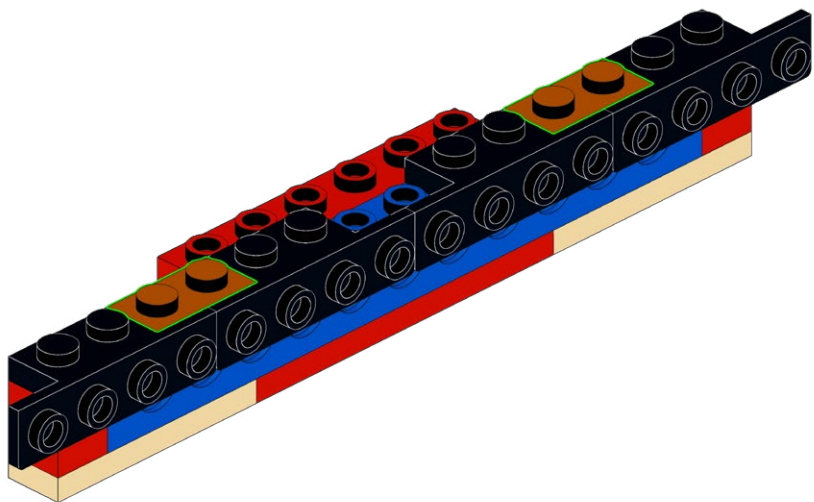
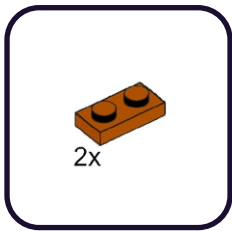

337

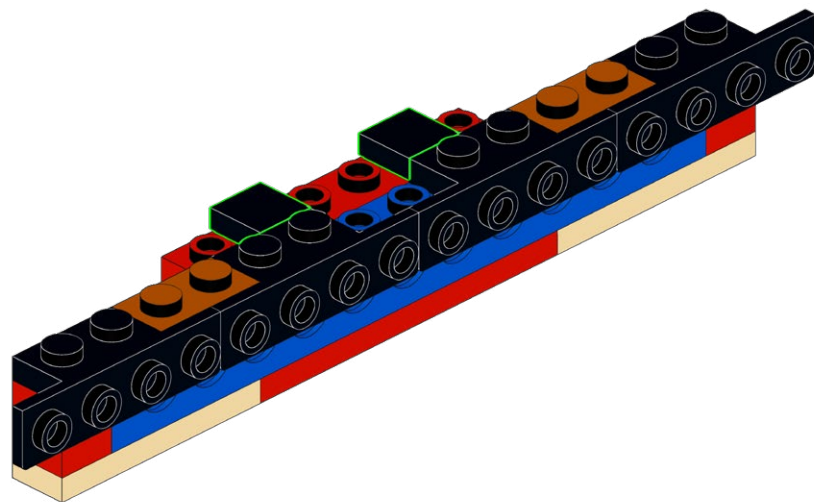
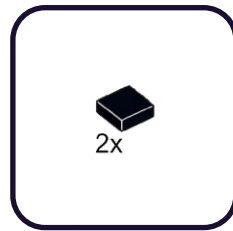

338

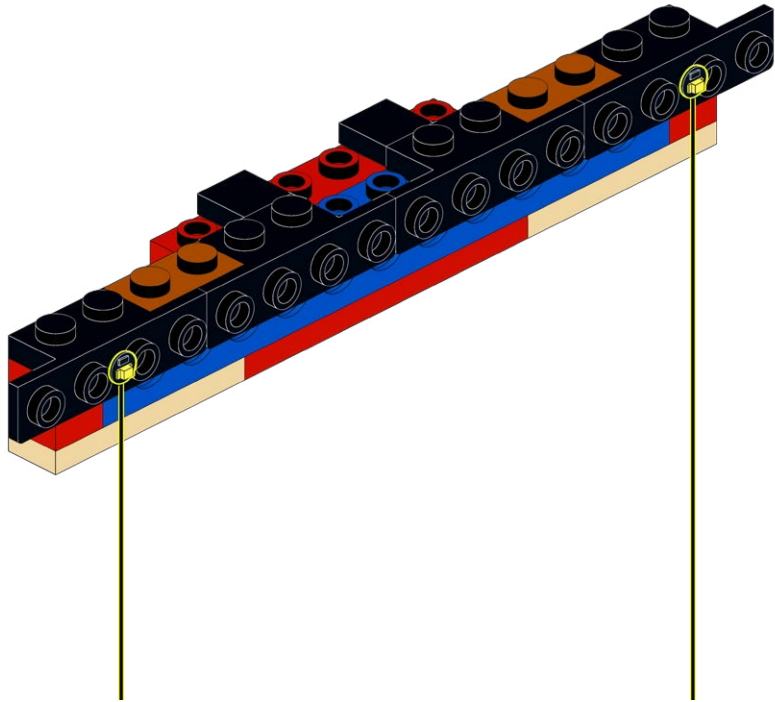
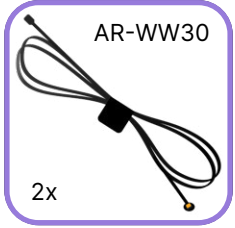

339

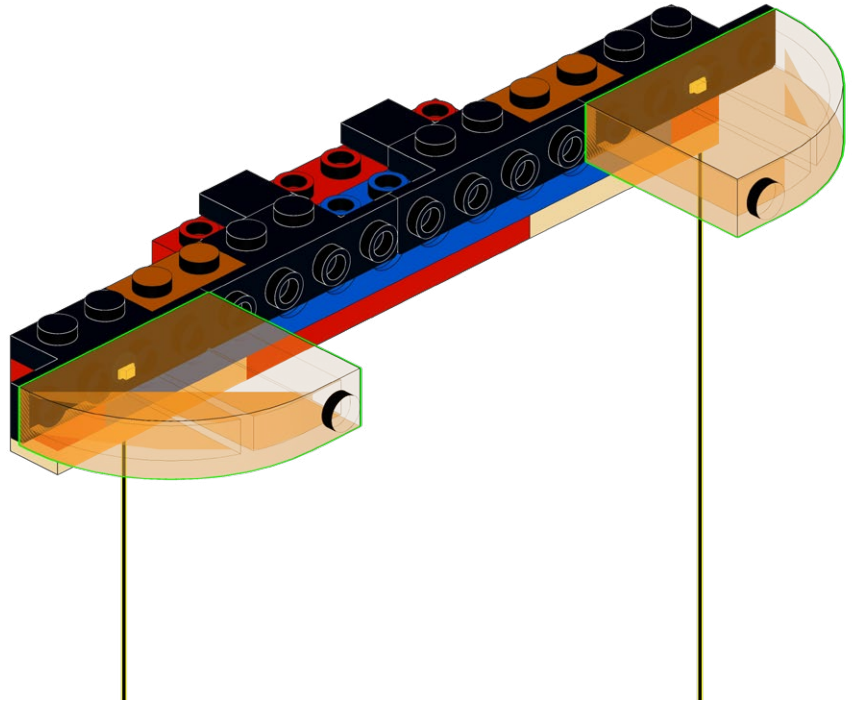
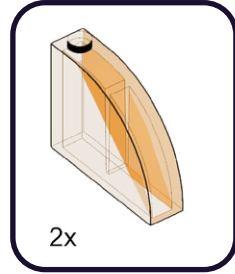

340

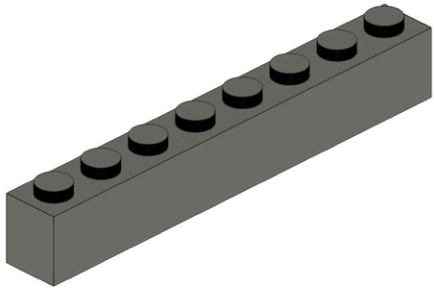
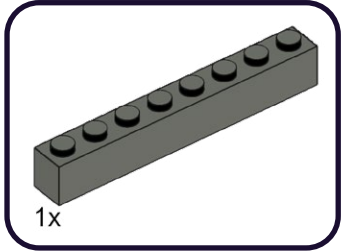

341

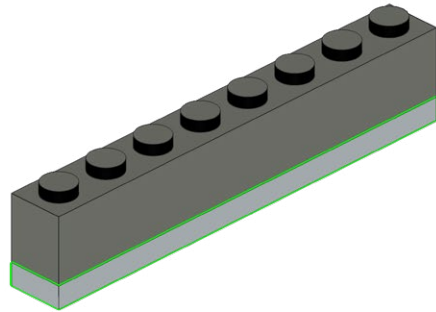
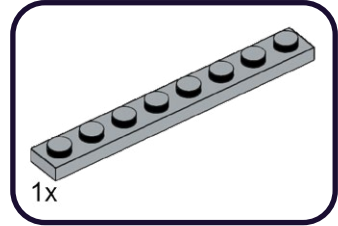

342

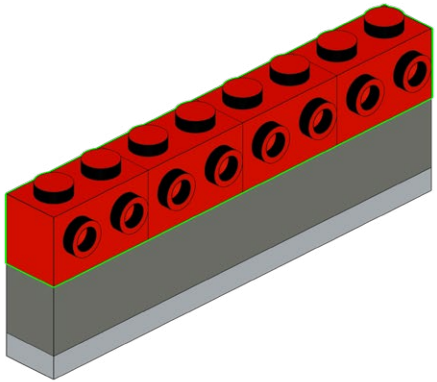
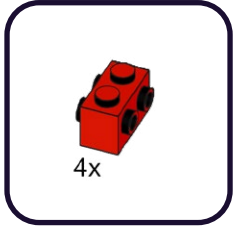

343

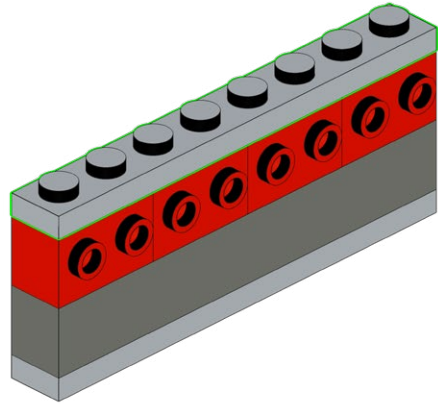
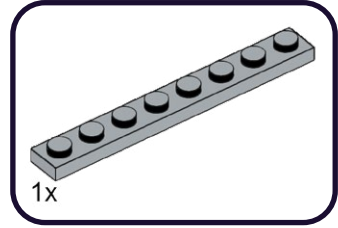

344

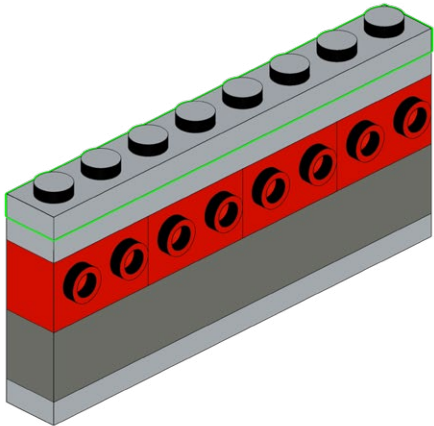
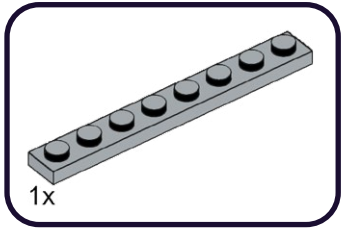

345

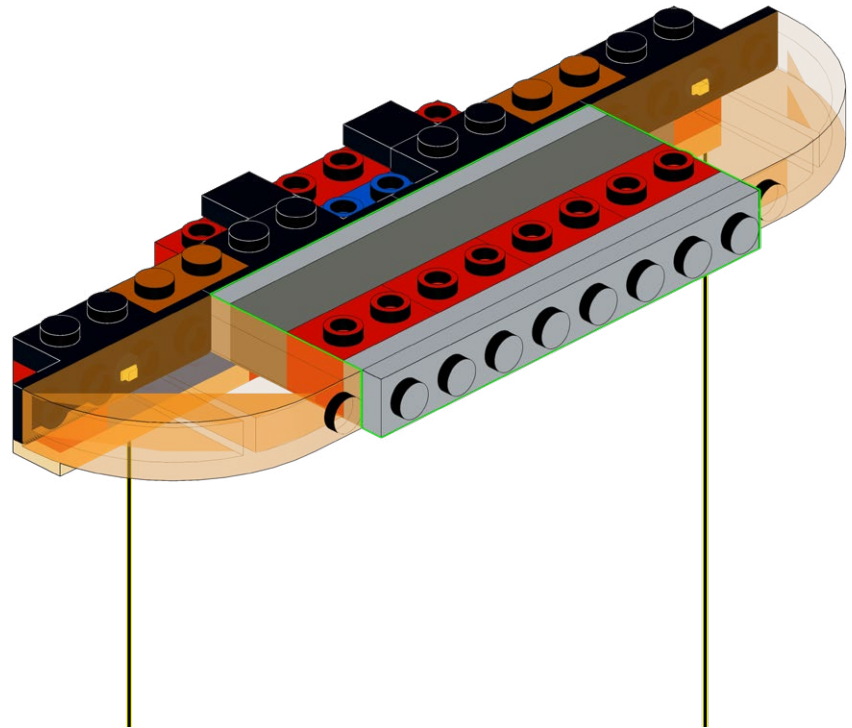

346

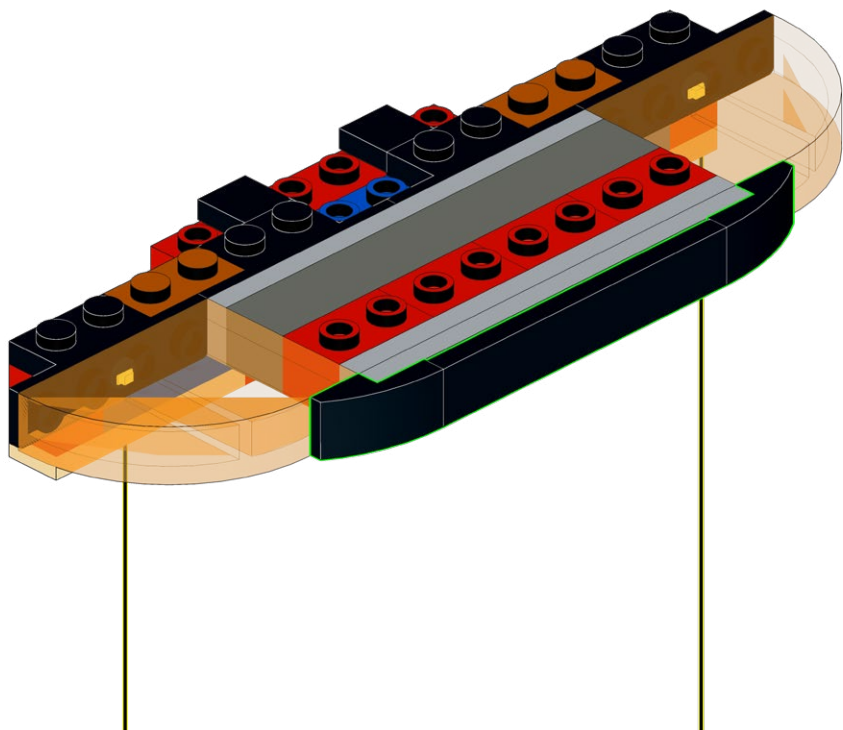
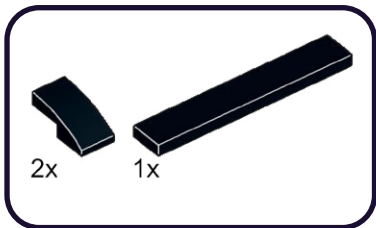

347

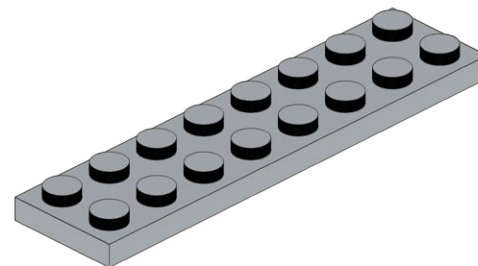
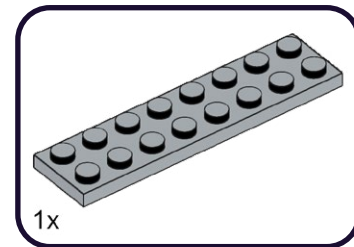

348

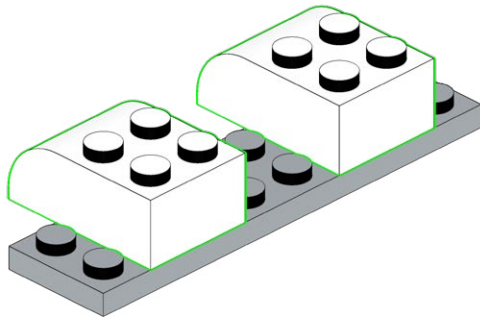
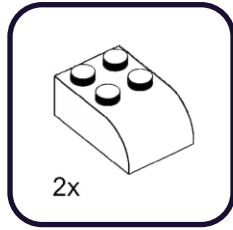

349

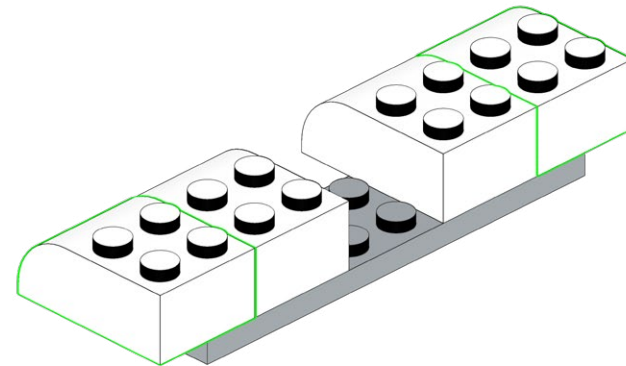
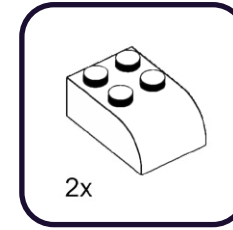

350

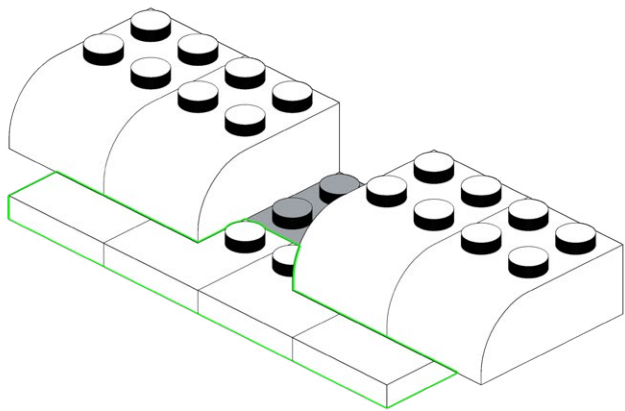
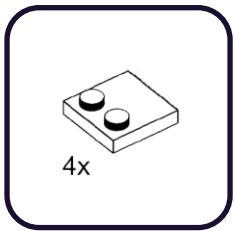

351

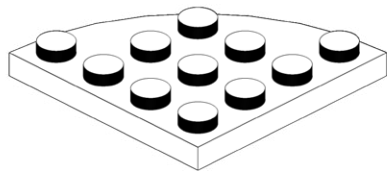
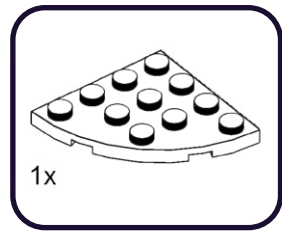

352

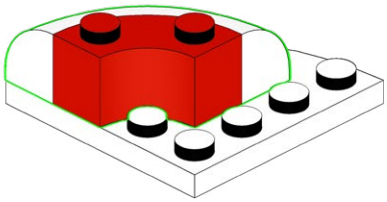
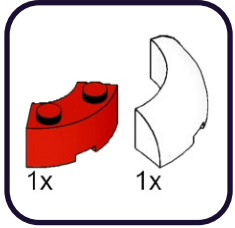

353

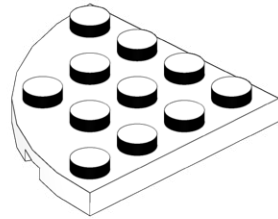
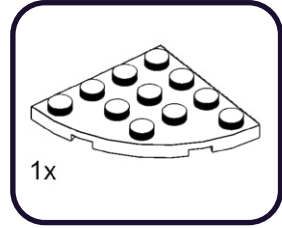

354

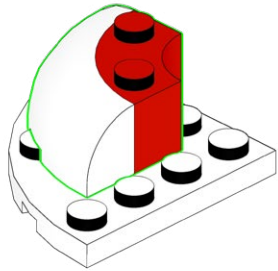
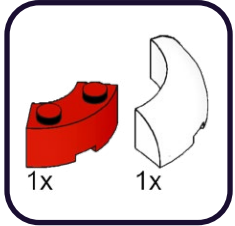

355

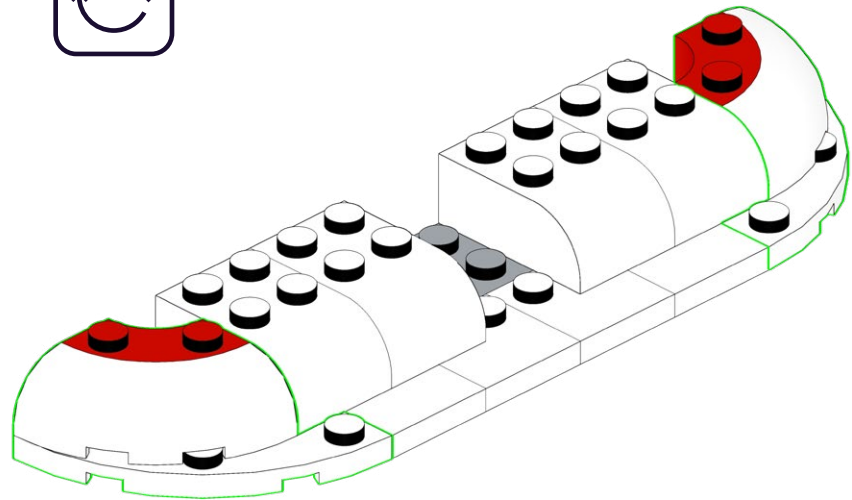
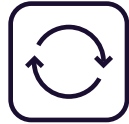

356

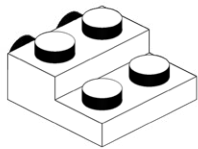
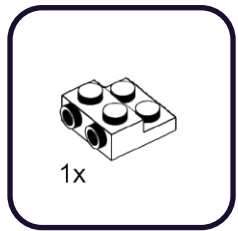

357

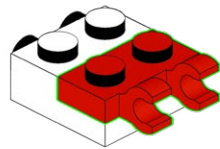
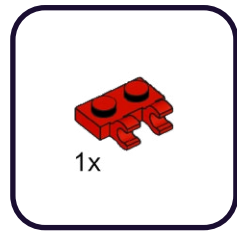

358

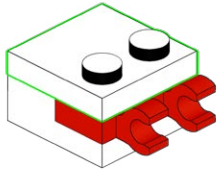
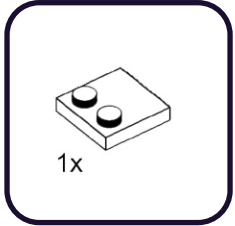

359

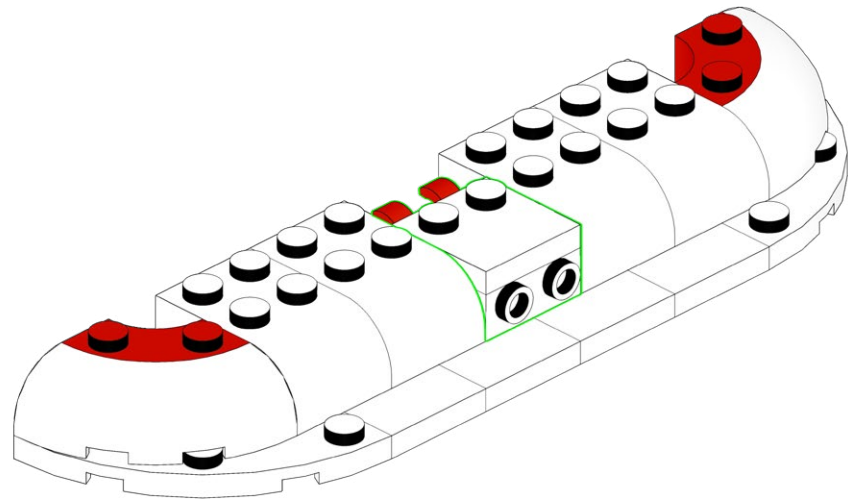

360

2x

361

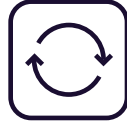

362

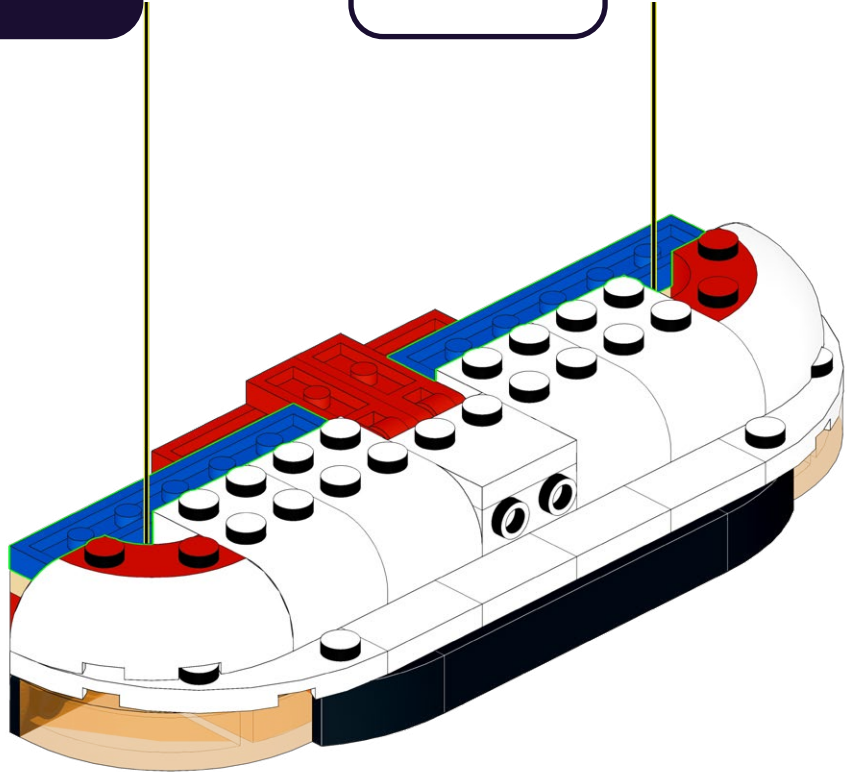
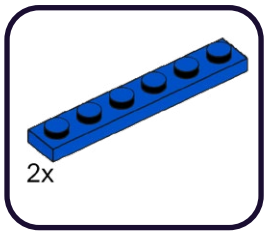

363

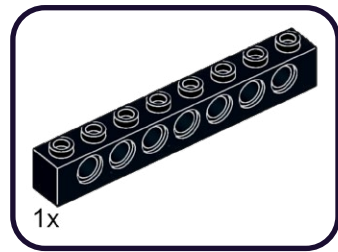

364

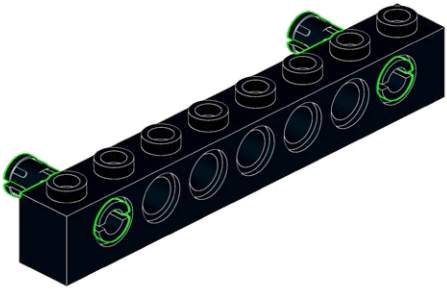

365

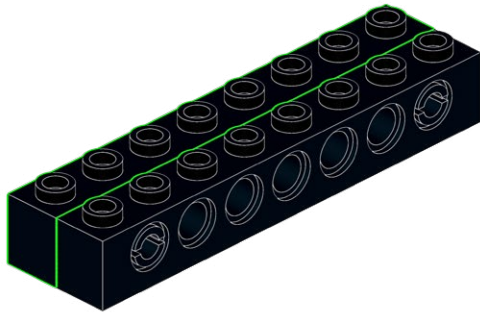
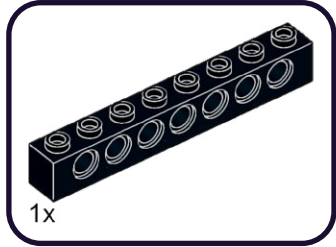

366

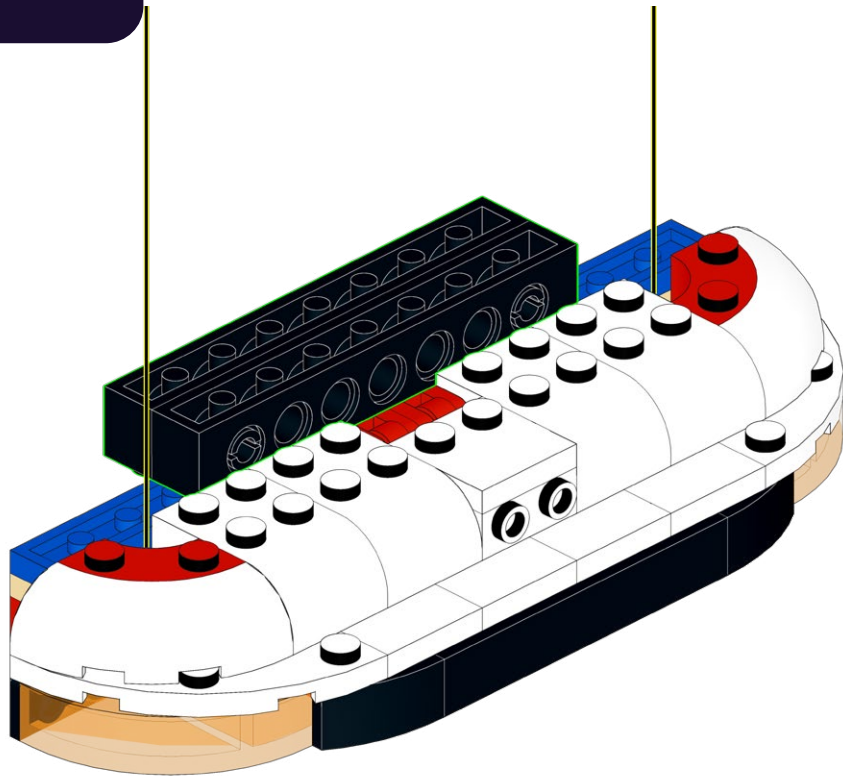

367

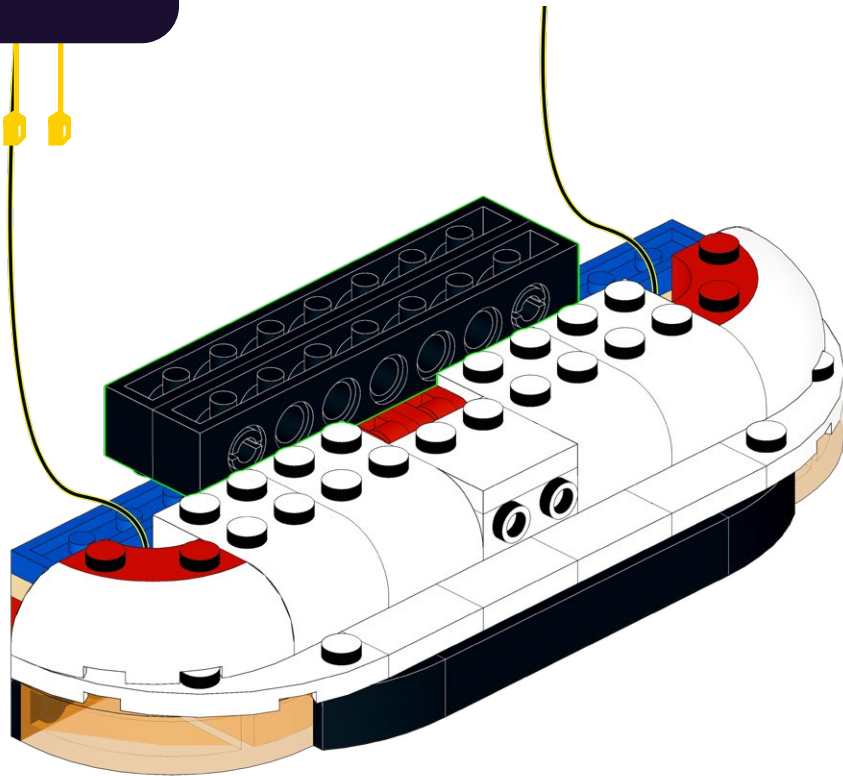

368

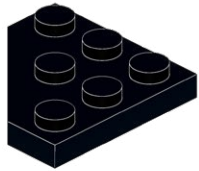

369

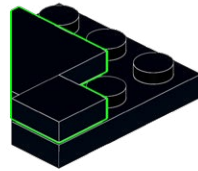
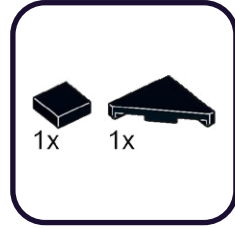

370

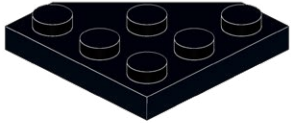

371

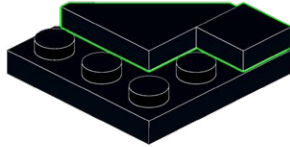
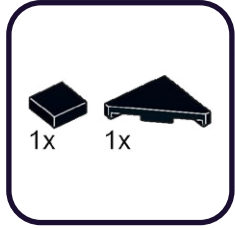

372

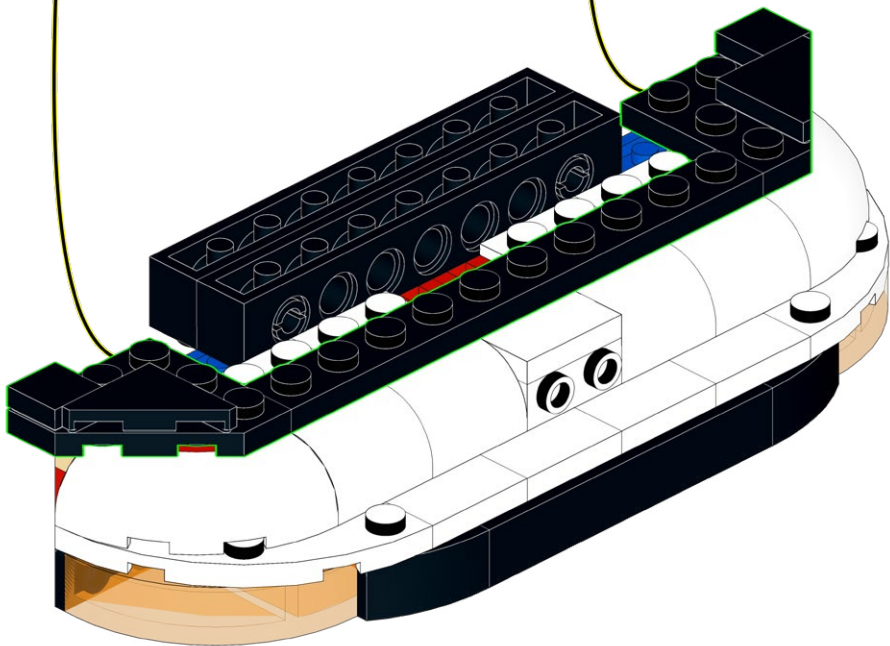
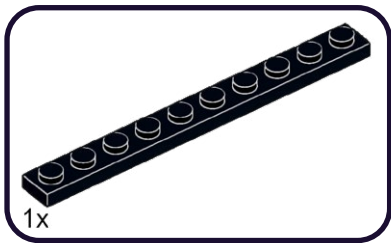

373

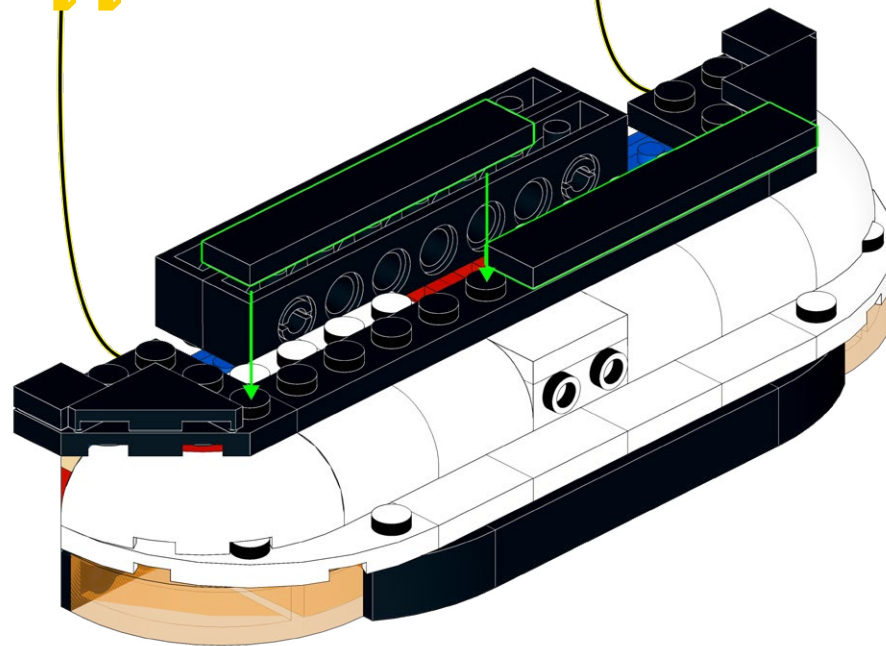
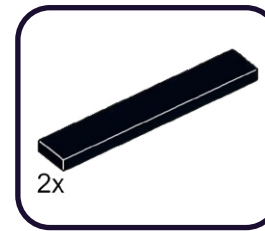

374

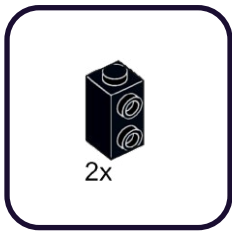

375

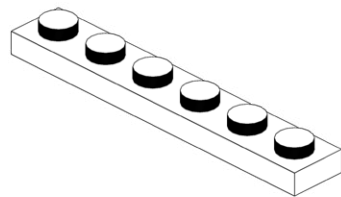
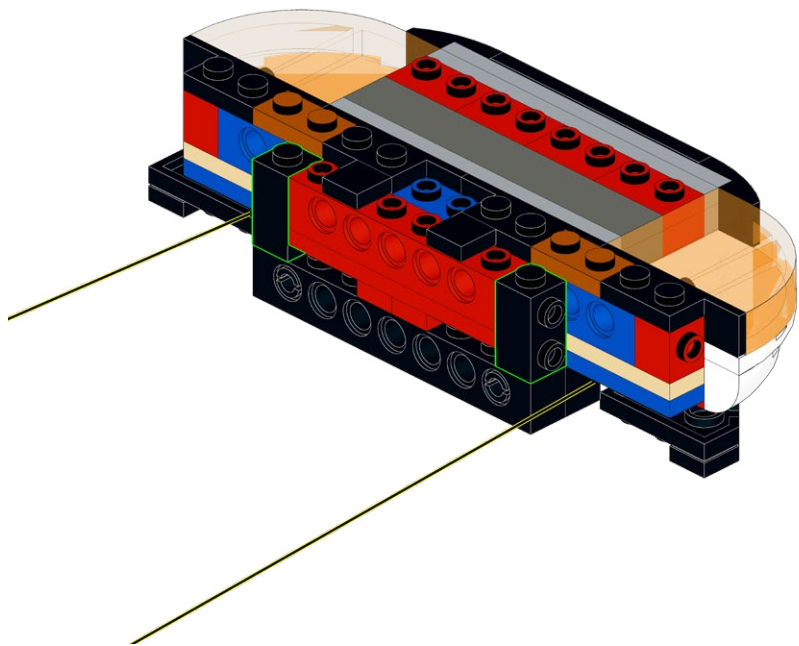
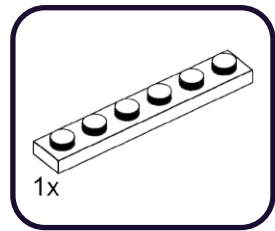

376

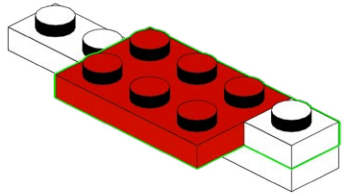
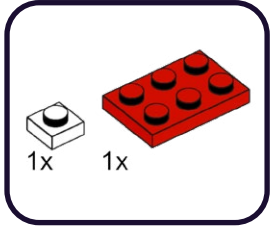

377

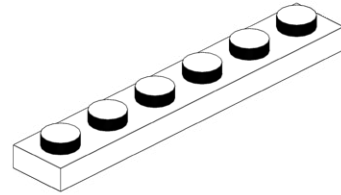
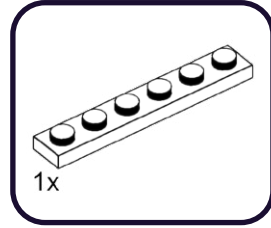

378

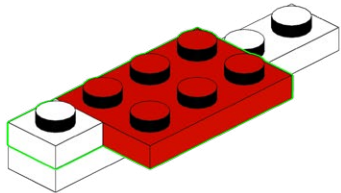
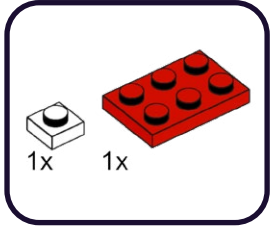

379

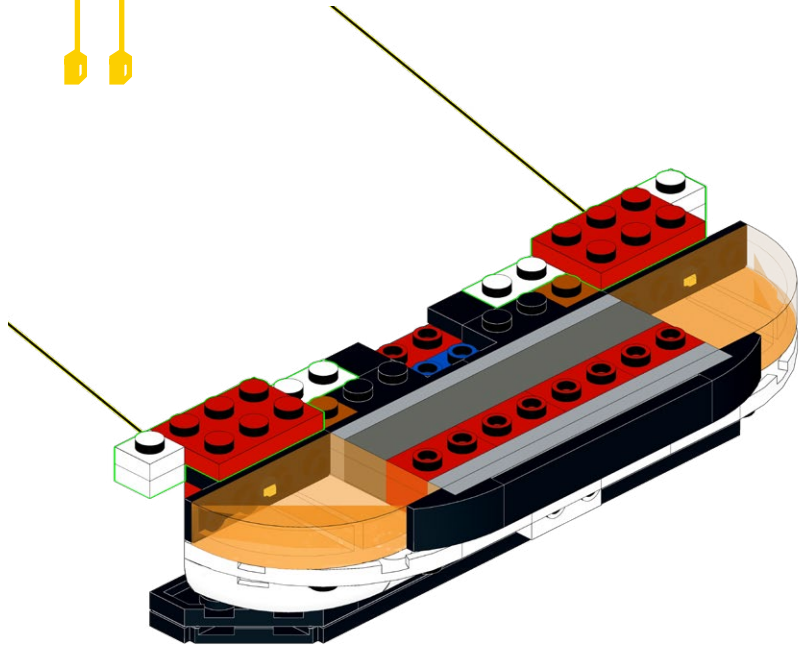

380

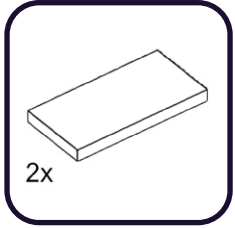

381

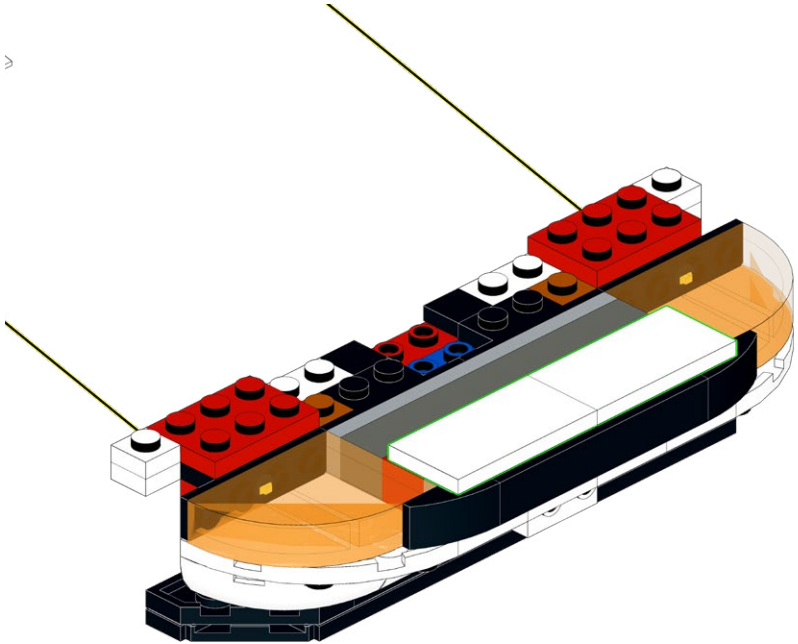
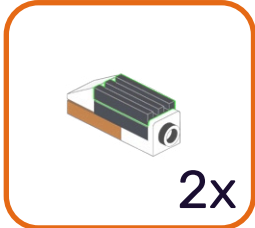
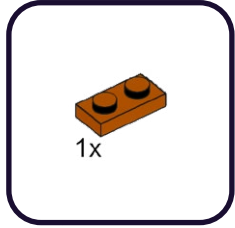

382

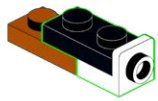
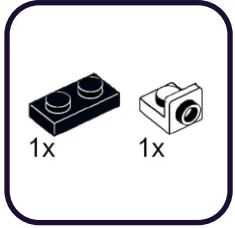

383

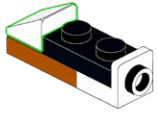
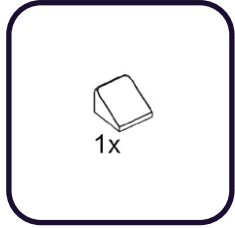

384

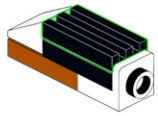
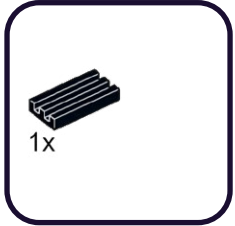

2x

385

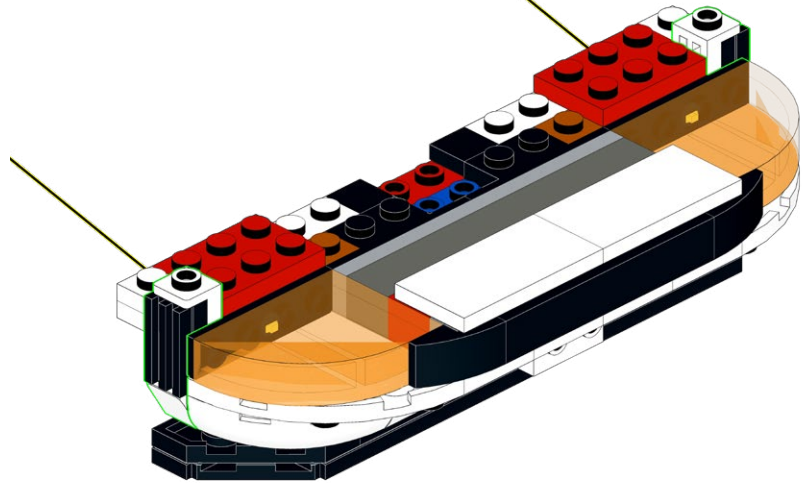

386

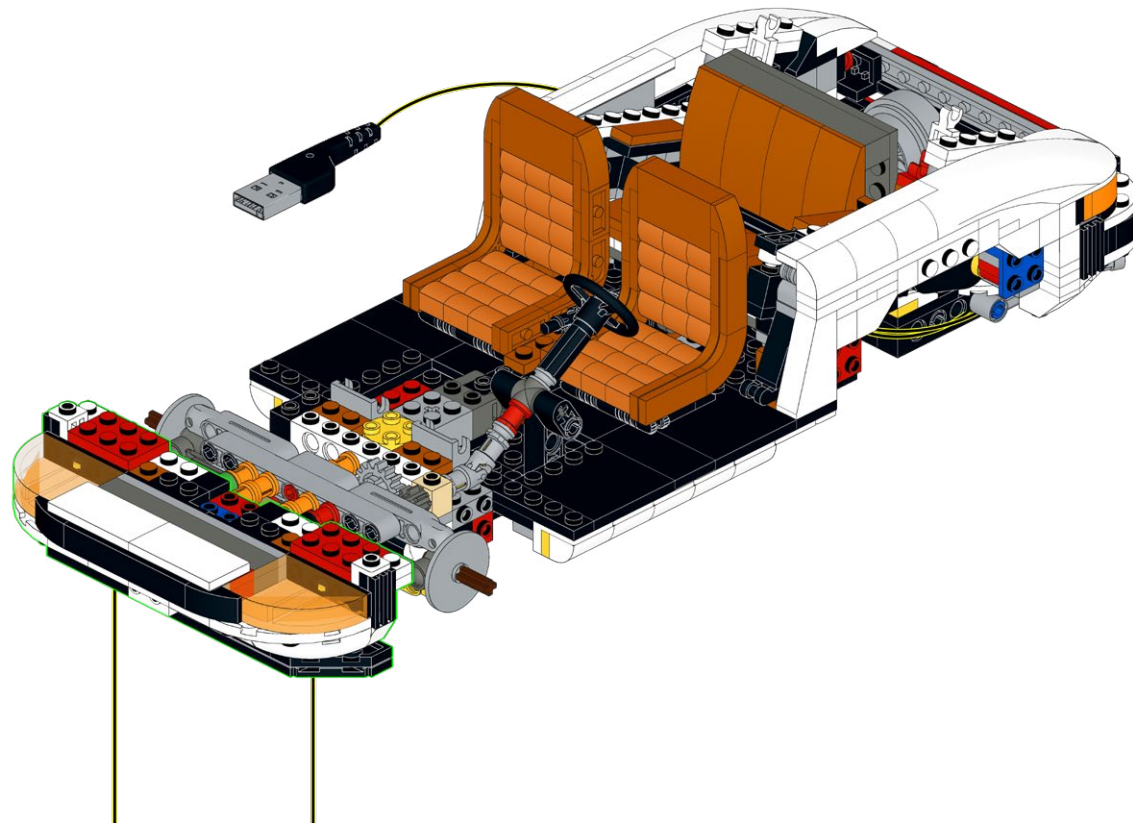

387

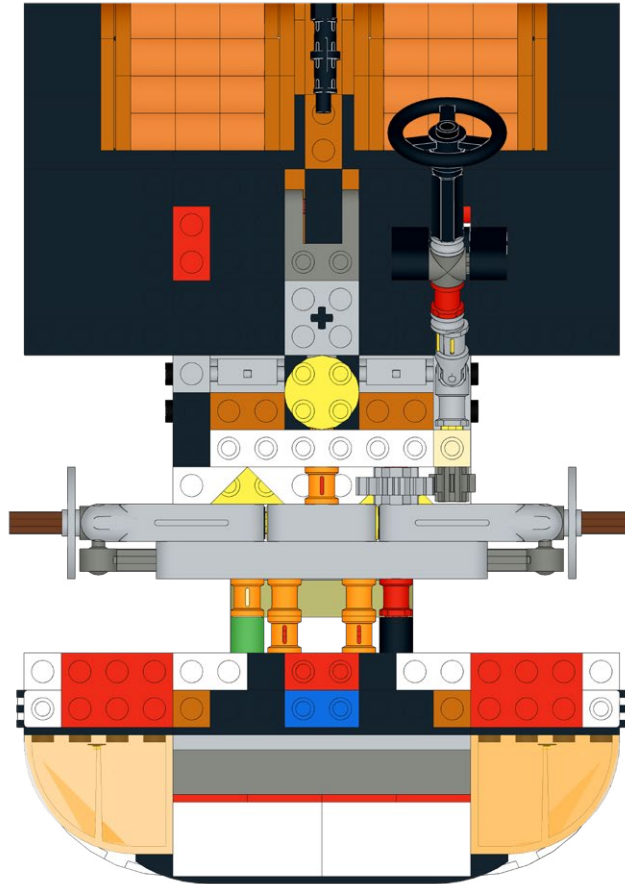

388

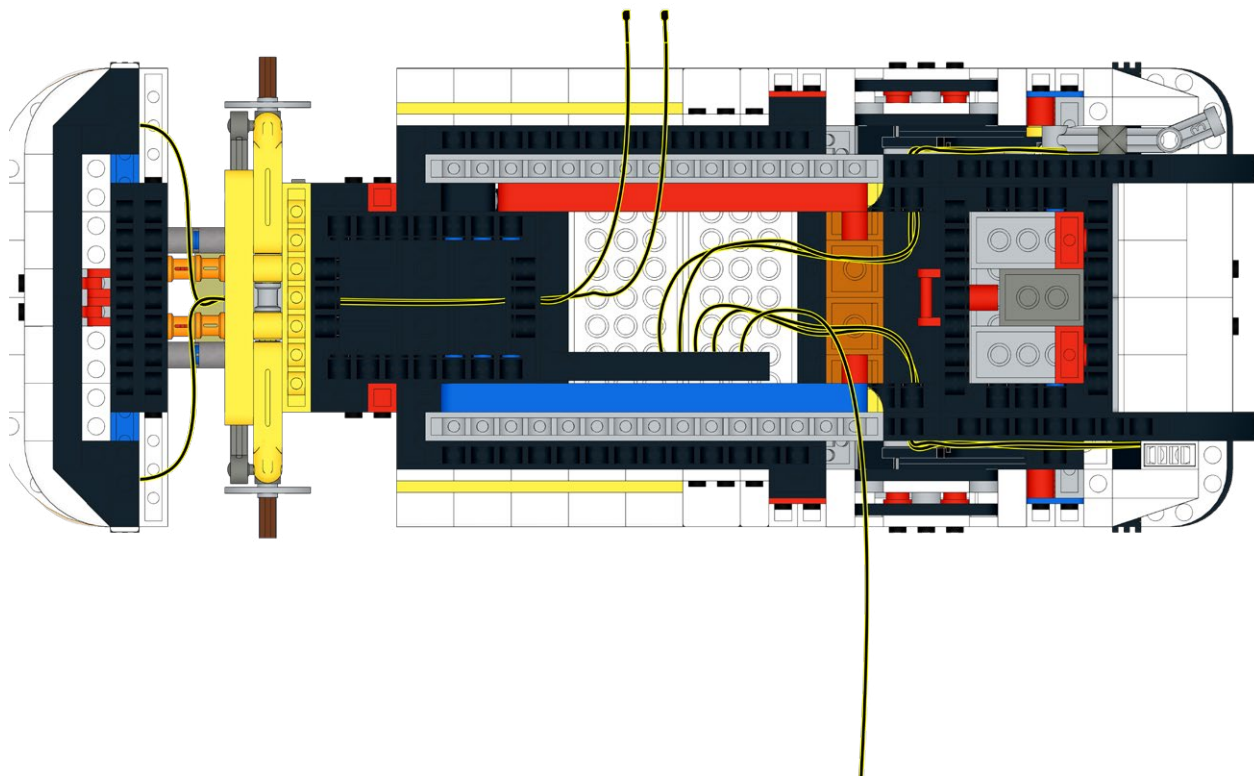

389

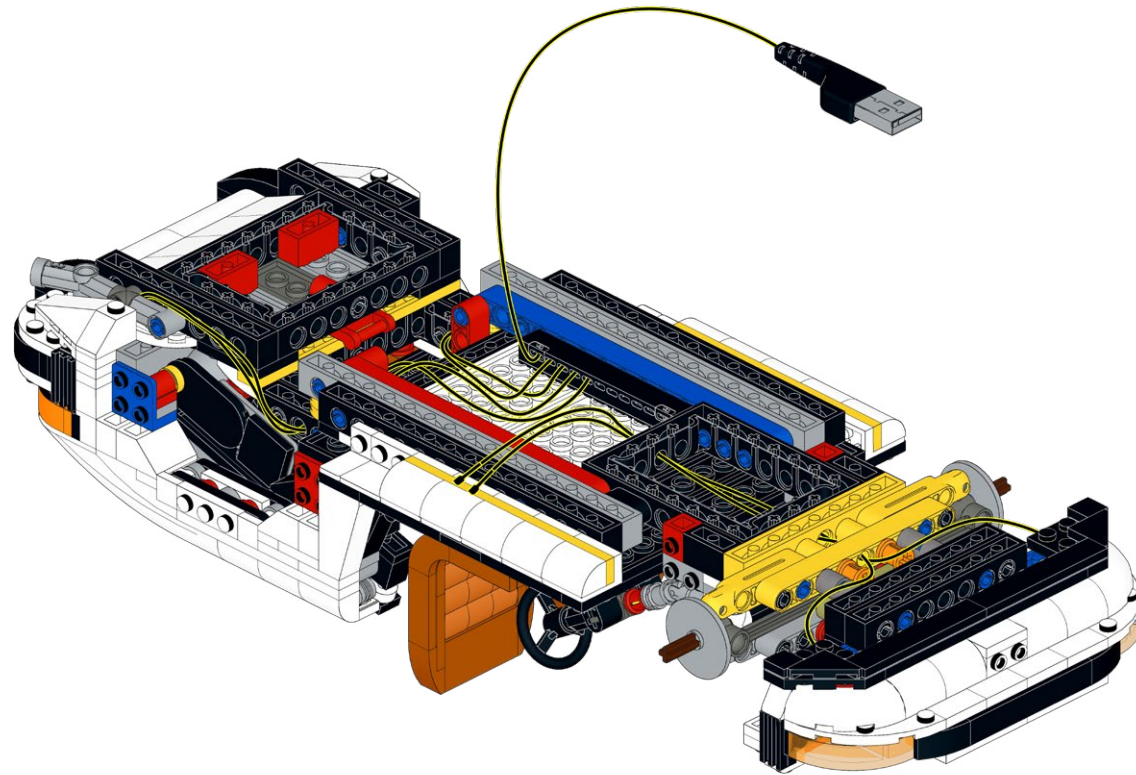

390

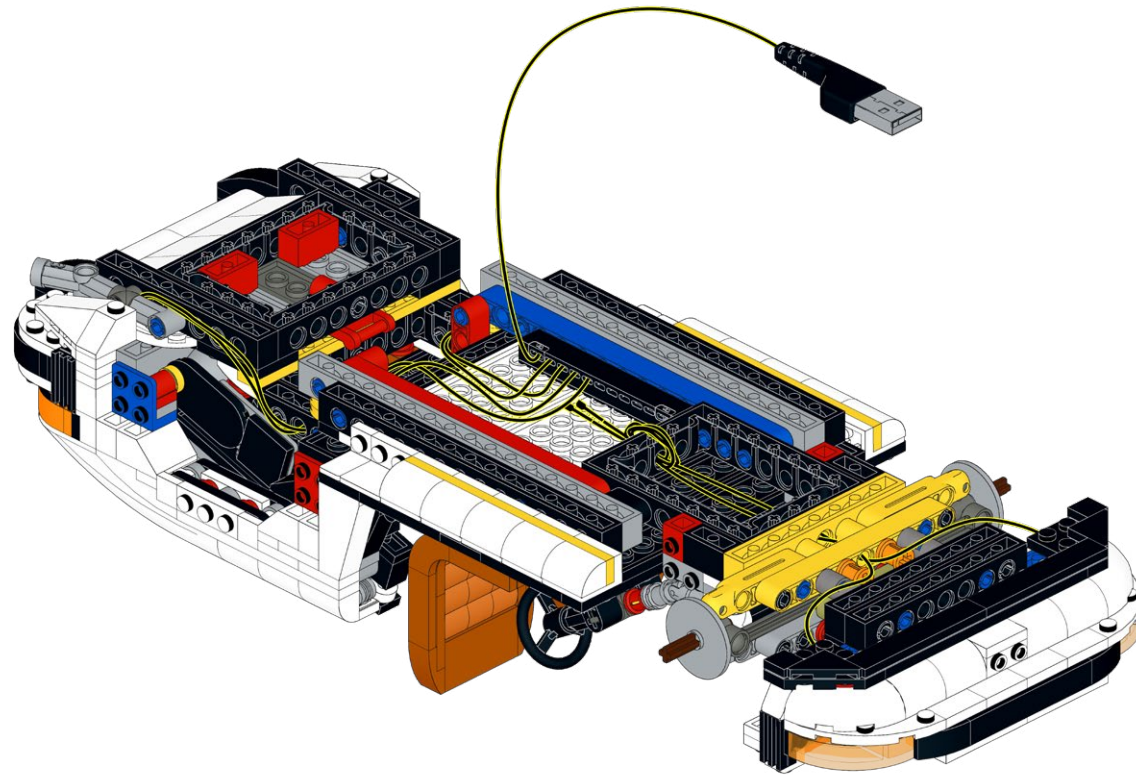

391

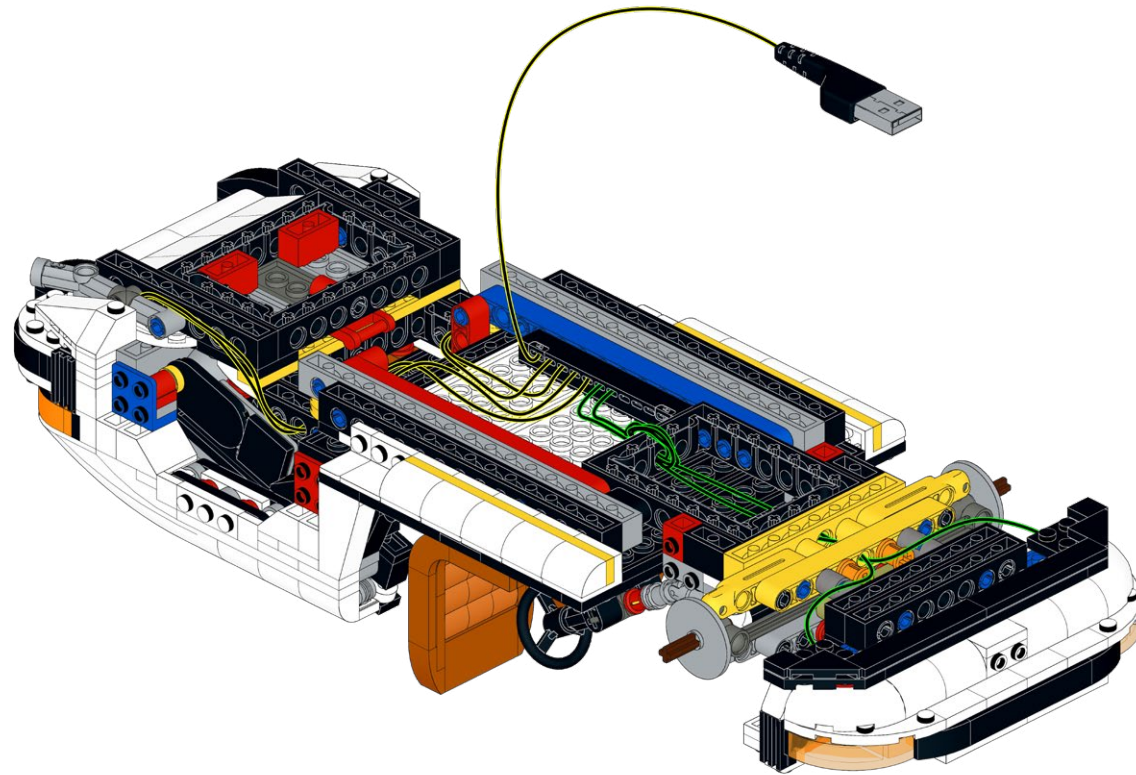

392

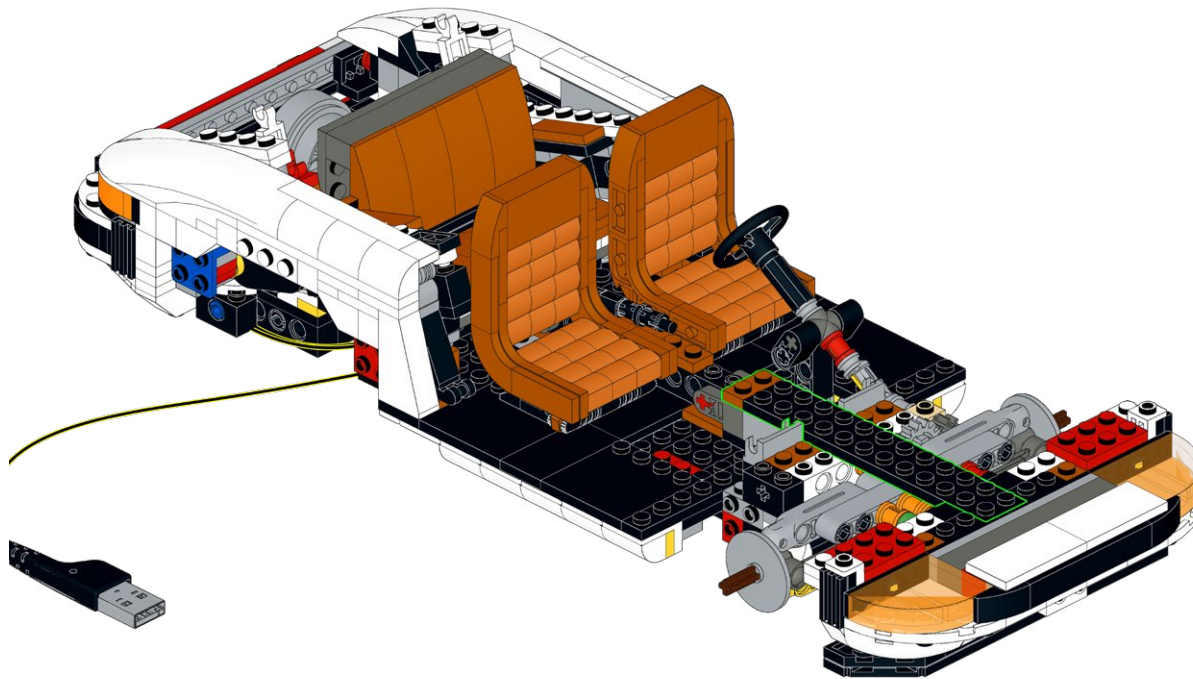
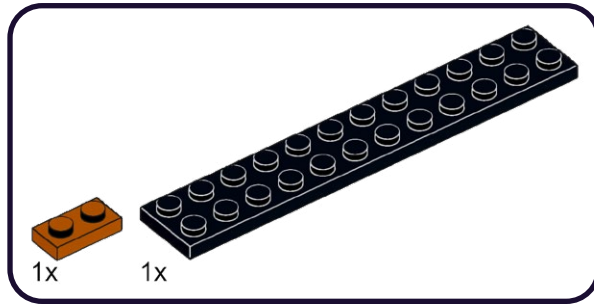

393

2x

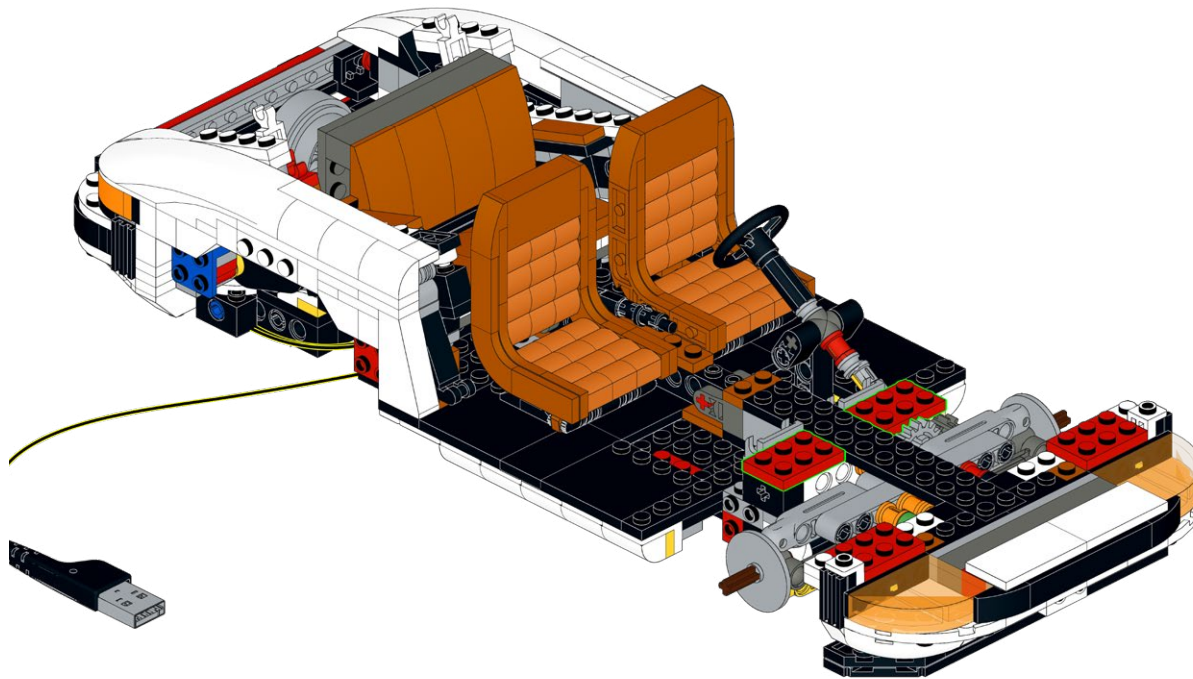

394

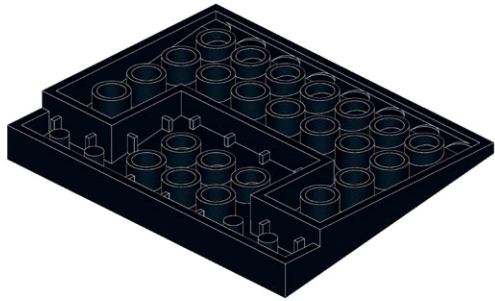
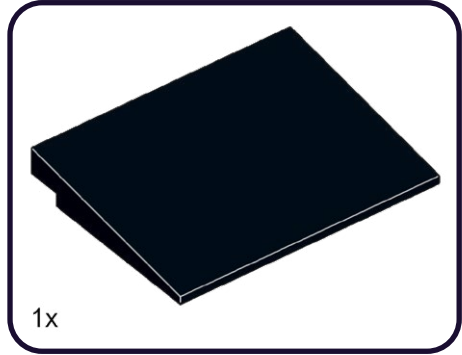

395

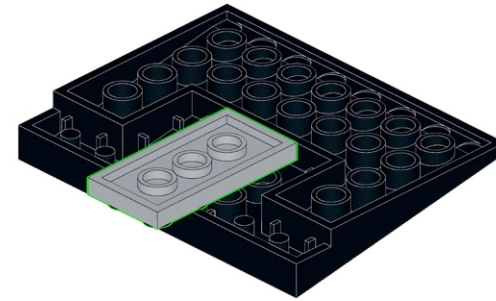
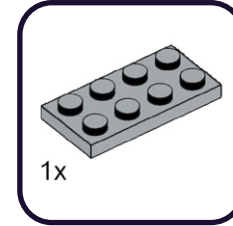

396

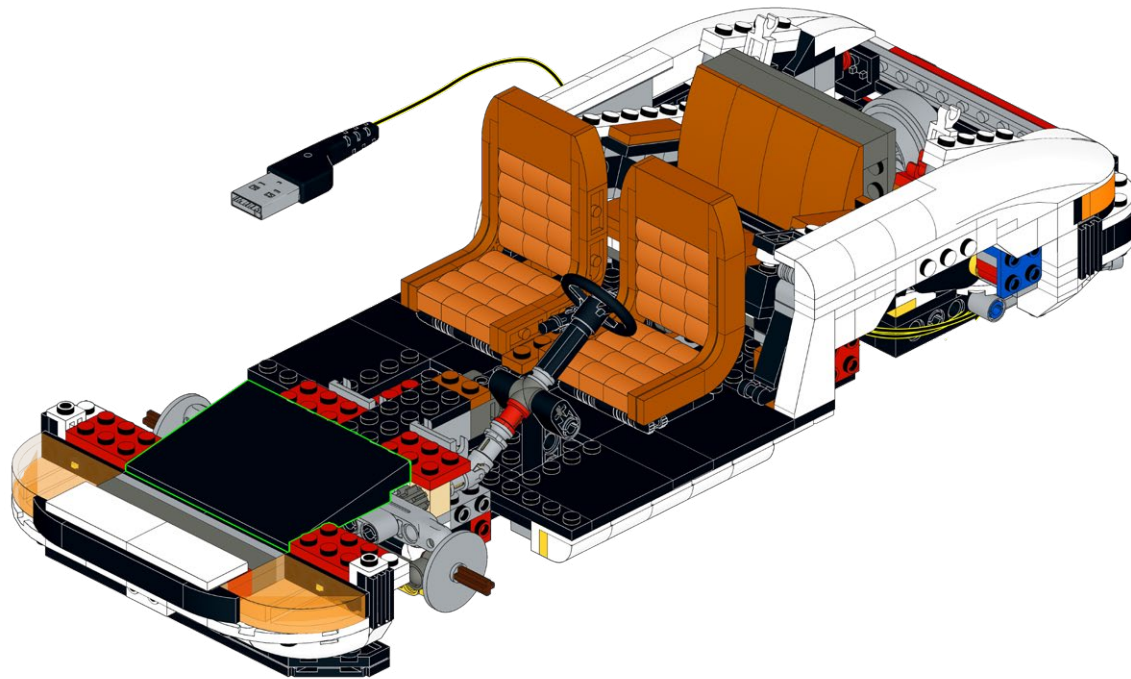

397

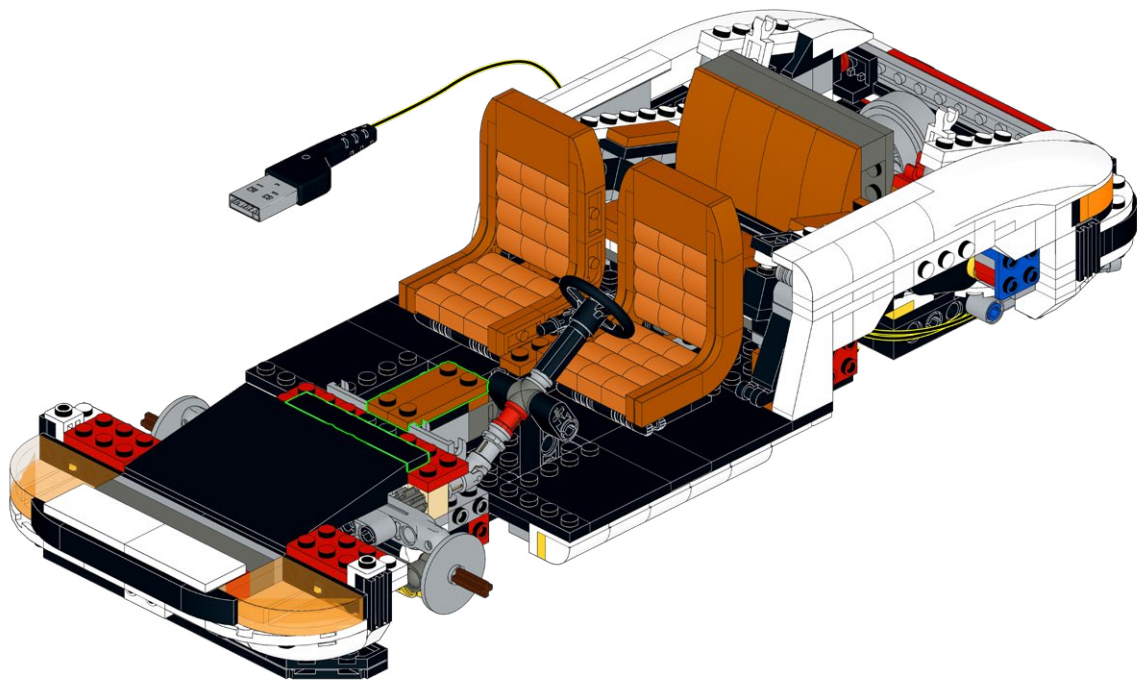
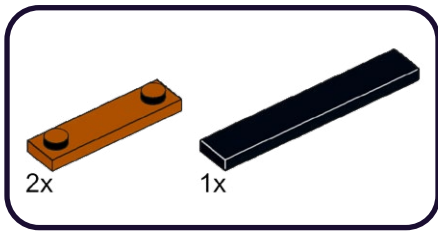

398

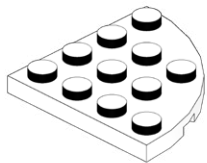
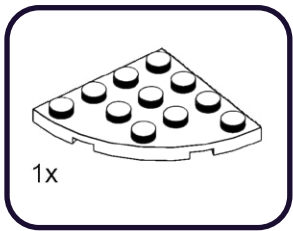

399

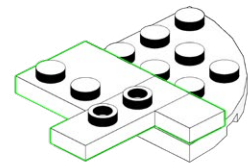
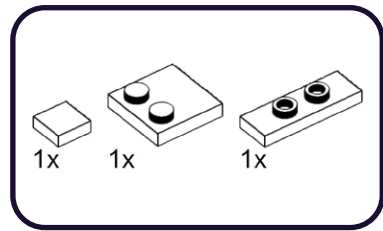

400

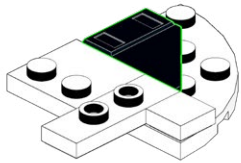

401

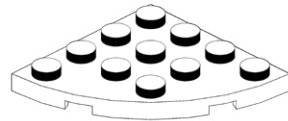
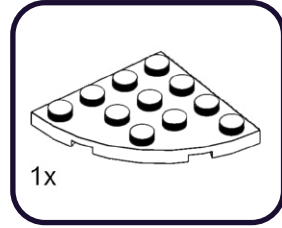

402

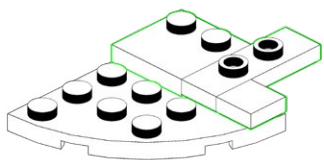
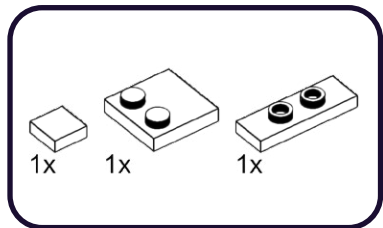

403

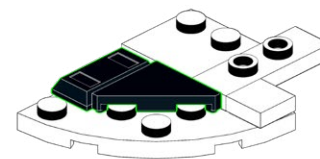
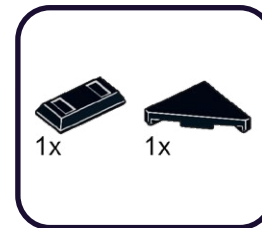

404



2x

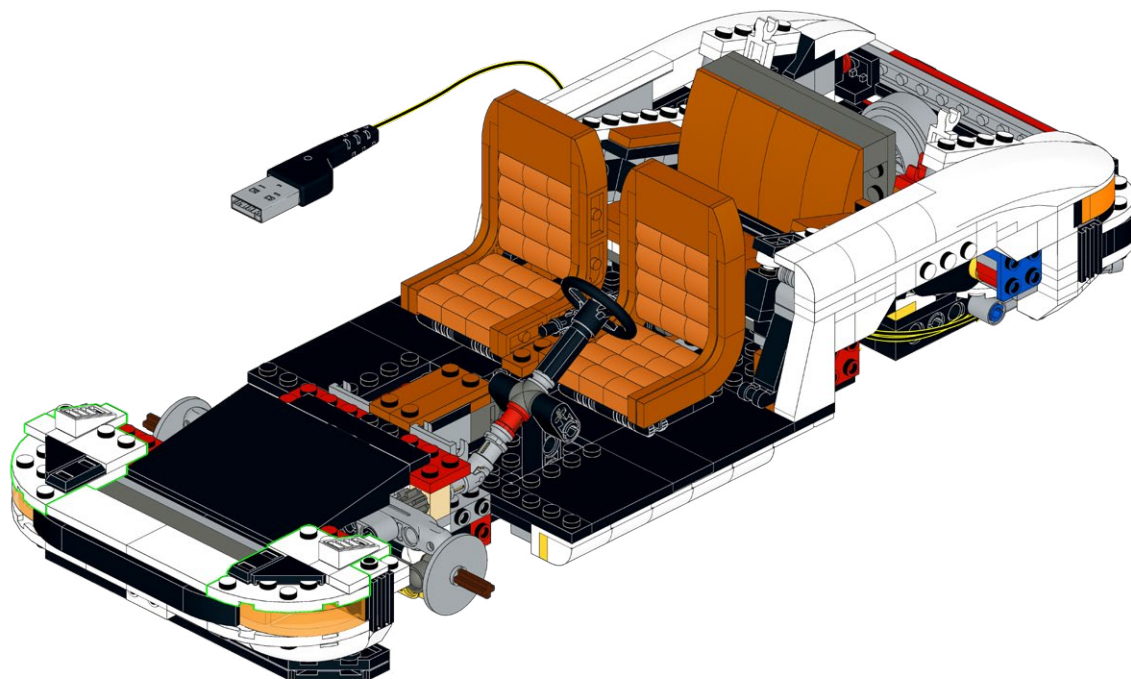

405

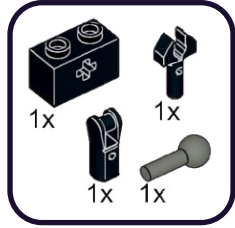

1



2

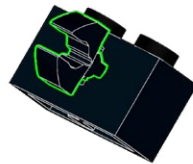

3

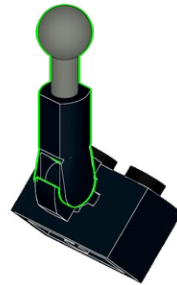

406

1x

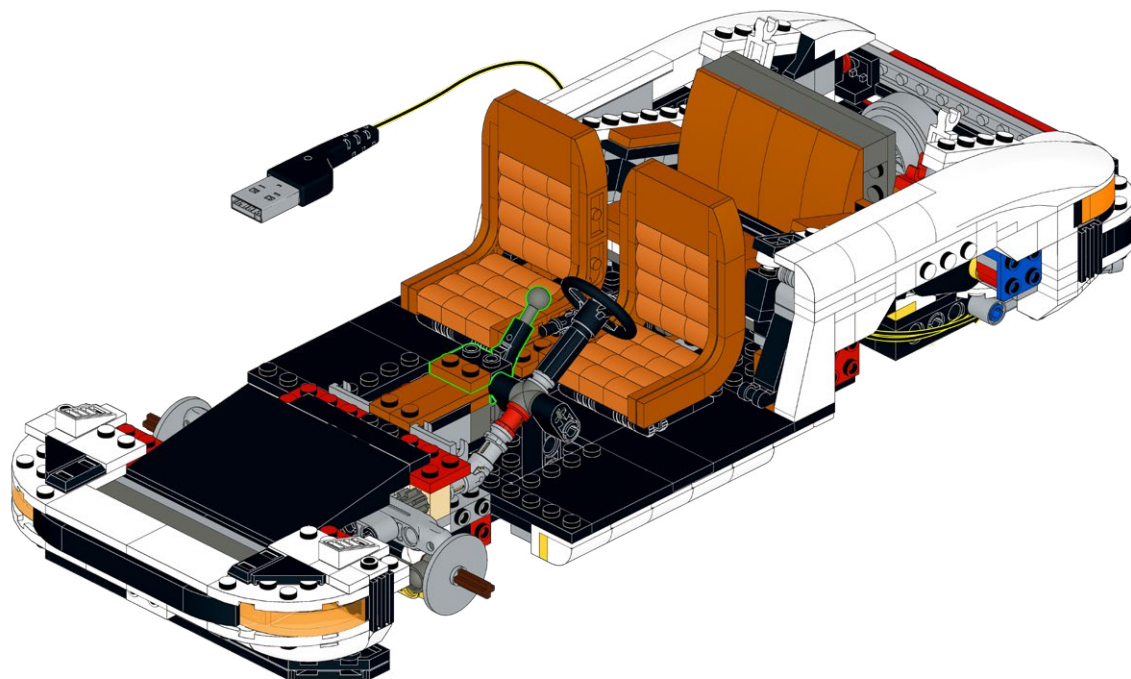

407

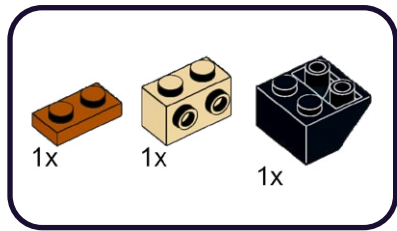

1

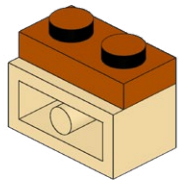

2

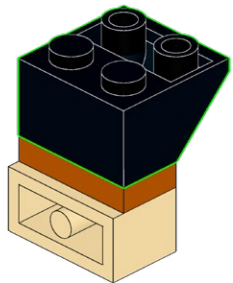

408

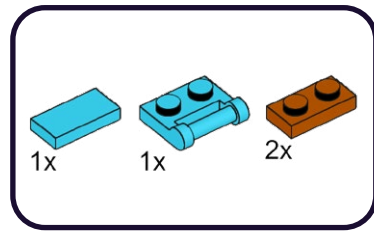

1

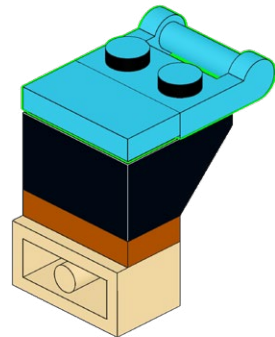

2

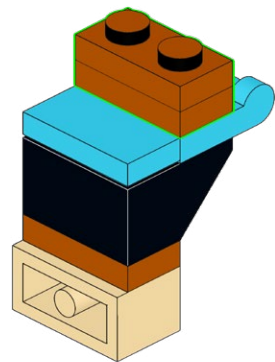

409

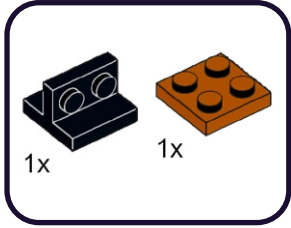

1

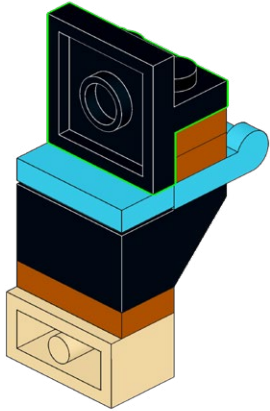

2

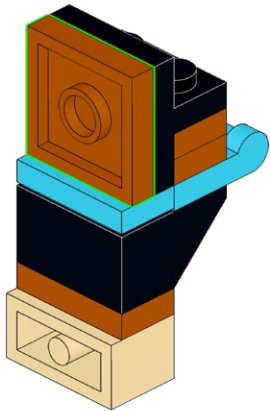

410



1

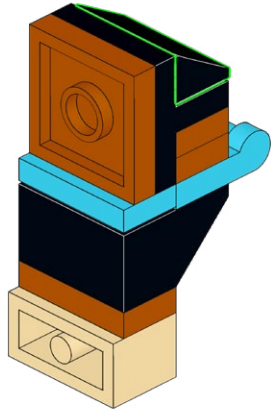

411

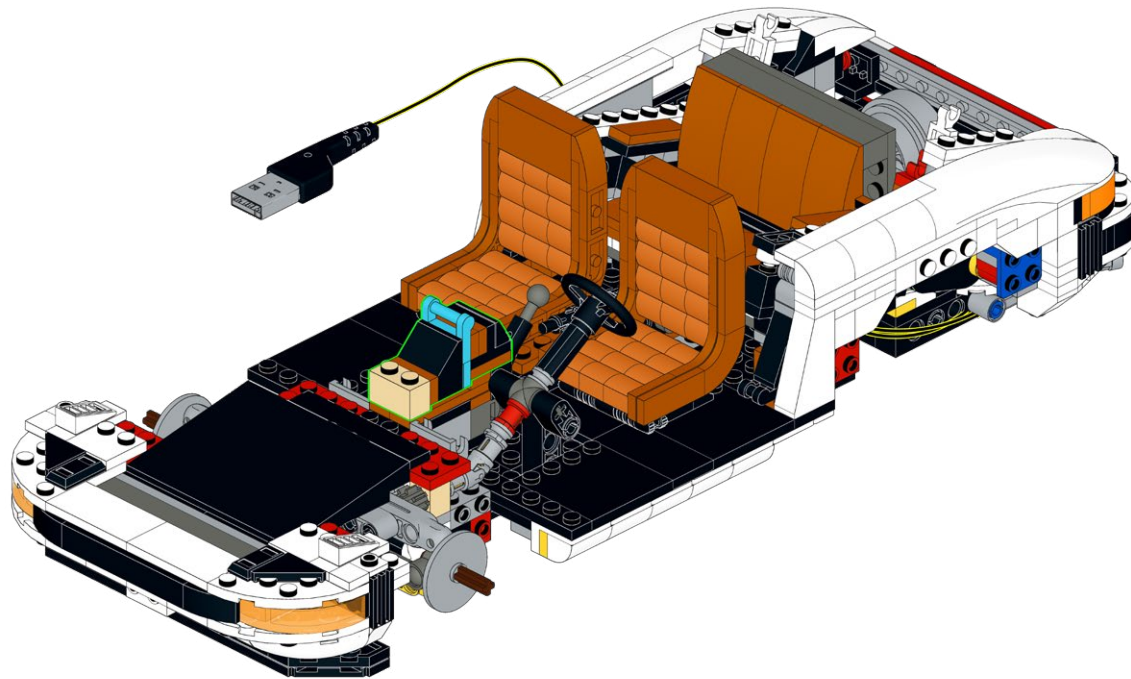



HOLD UP!

You might notice some bags aren't in order, as well as left over pieces, but that's ok! We're changing the way you build LEGO!

ATTENDEZ!

Vous remarquerez peut-être que certains sacs, ainsi que certaines pièces, ne sont pas dans le bon ordre. Mais pas de panique! Nous changeons simplement la façon avec laquelle vous construisez vos LEGO!

ASPETTA!

Potresti notare che alcuni sacchetti non sono in ordine, così come i pezzi avanzati, ma va bene così! Stiamo cambiando il modo in cui costruisci i LEGO!

HALT!

Sie werden möglicherweise bemerken, dass einige tüten durcheinander sind und teile übrig bleiben, aber das ist in Ordnung! Wir ändern die art und weise, wie Sie LEGO bauen!

¡ESPERA!

Es posible que notes que algunas bolsas están fuera de servicio, así como piezas sobrantes, ¡pero está bien! ¡Estamos cambiando la forma en que construyes LEGO!

暫停!

你可能会注意到一些袋子顺序错乱, 以及一些剩余的部件, 但没关系! 我们正在改变你搭建乐高的方式!

Open LEGO® Bag 1

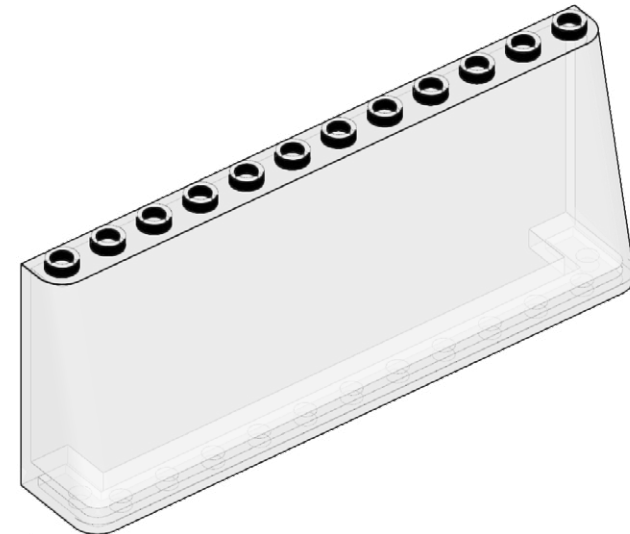
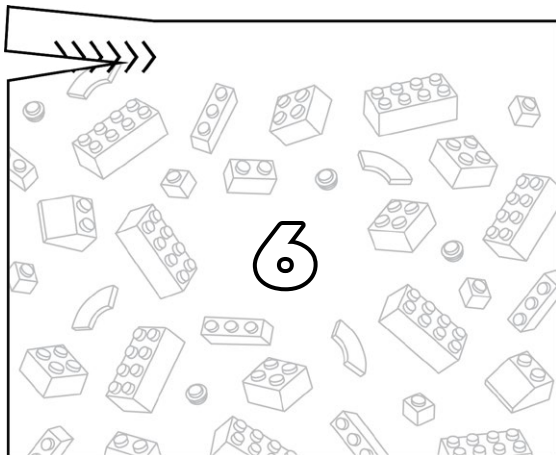

1x

412

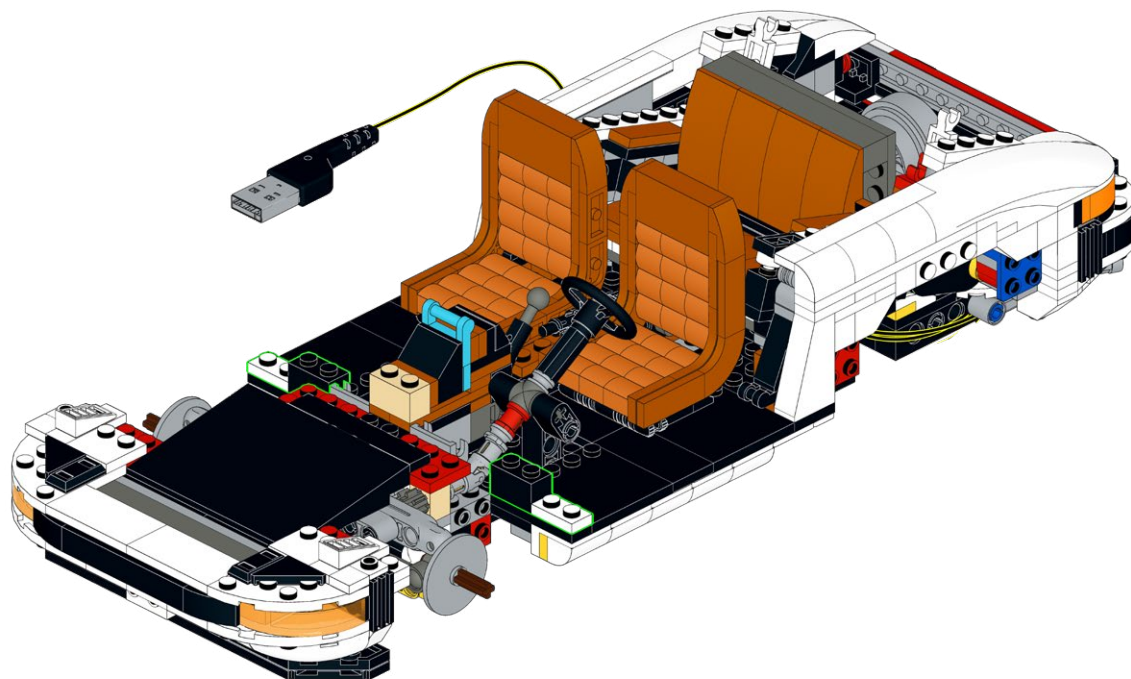
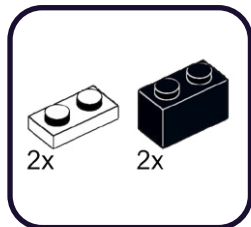

413

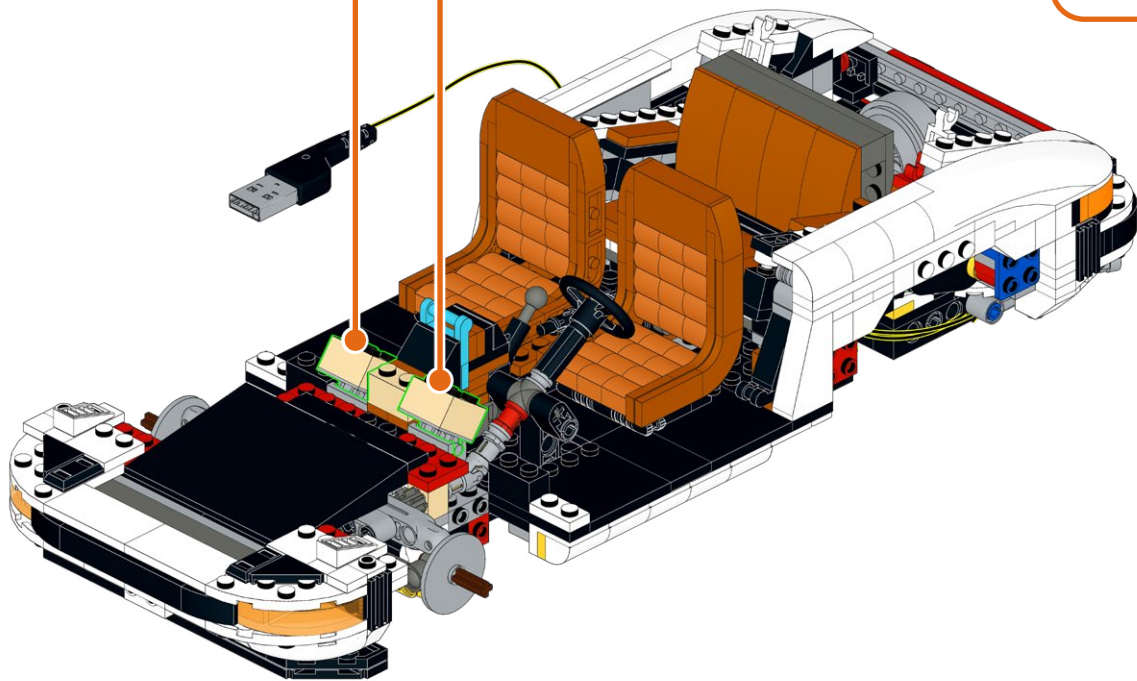
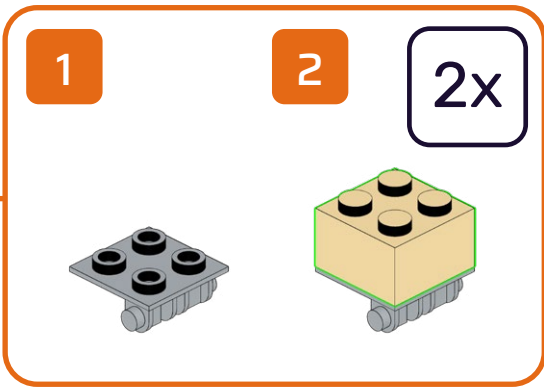
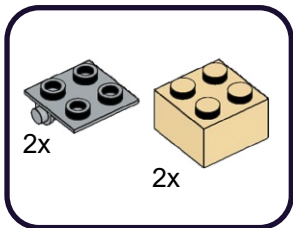

414

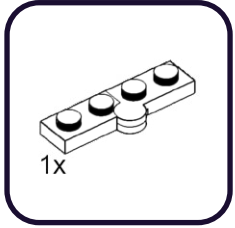

415

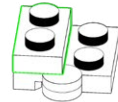
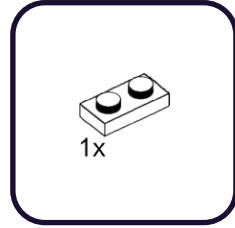

416

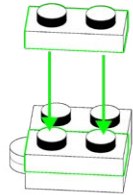
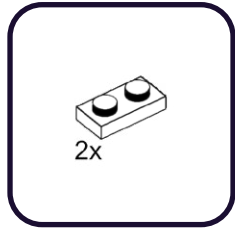

417

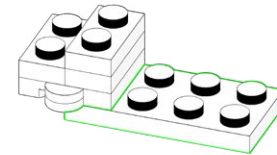
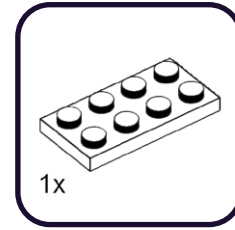
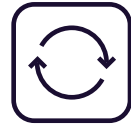

418

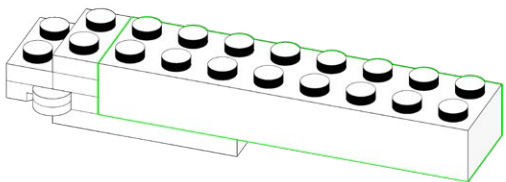
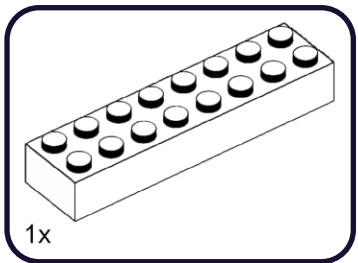

419

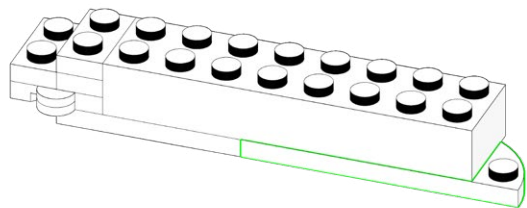
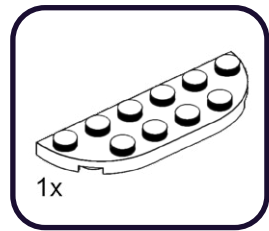

420

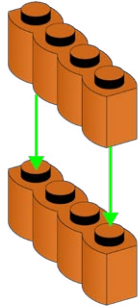
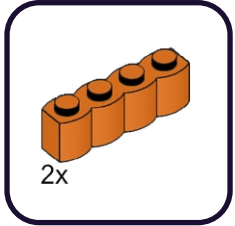

421

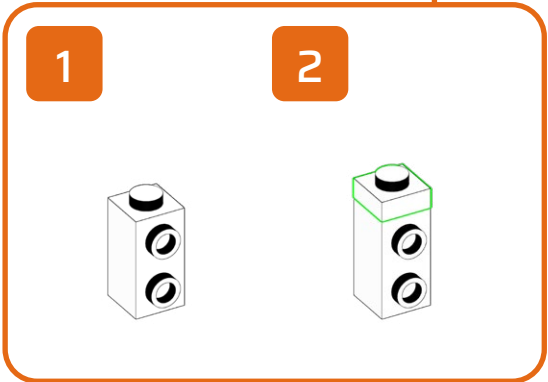
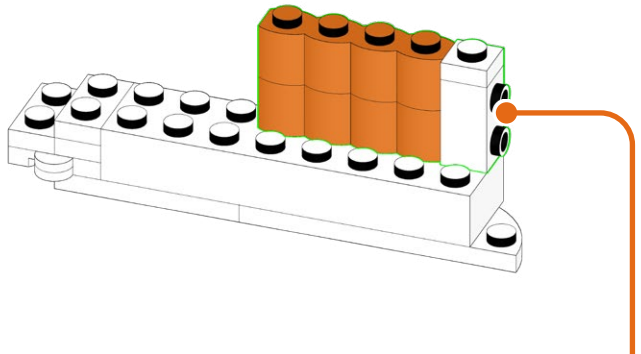
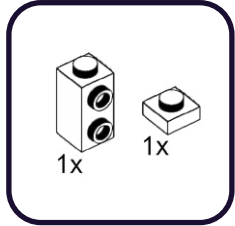

422

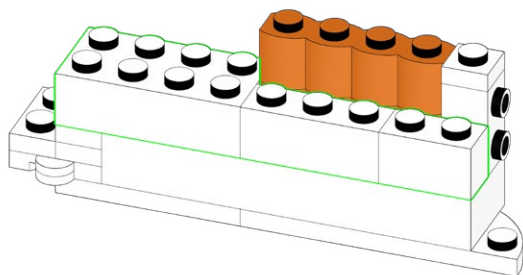
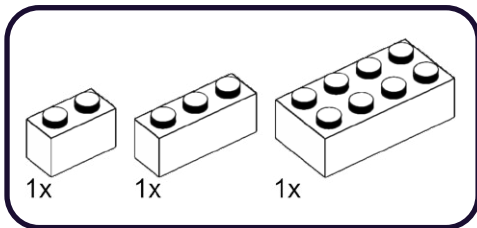

423

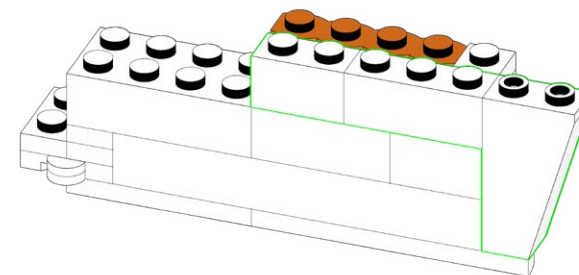
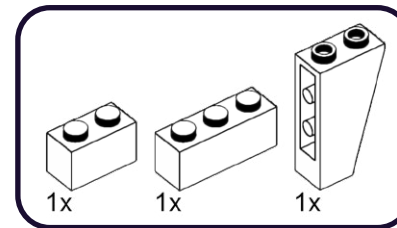

424

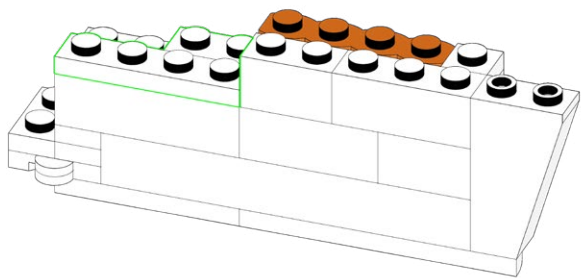
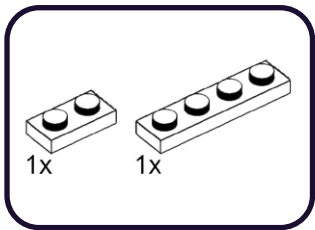

425

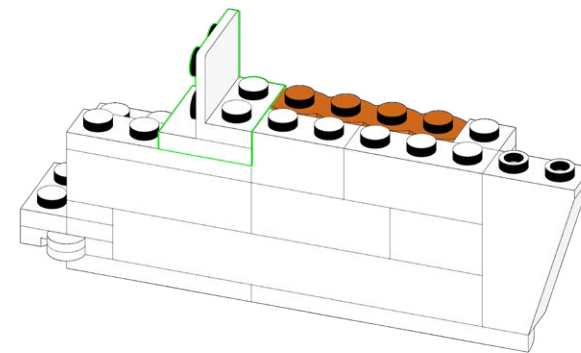
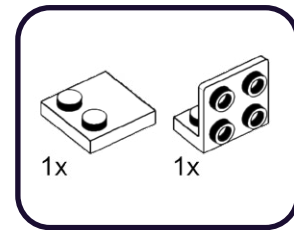

426

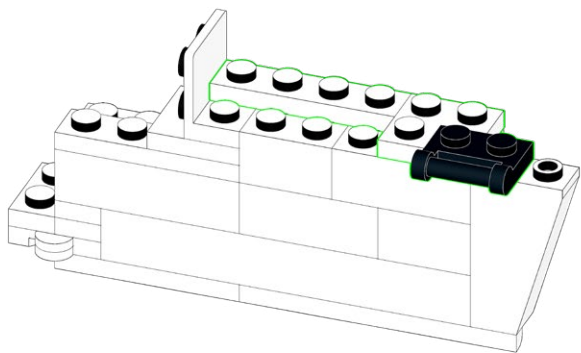
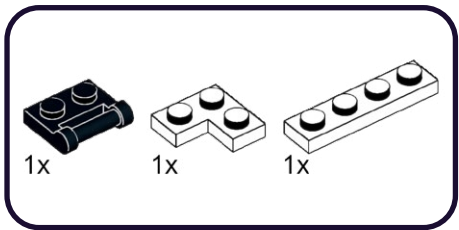

427

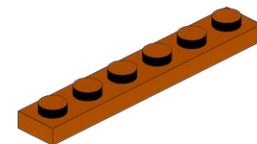
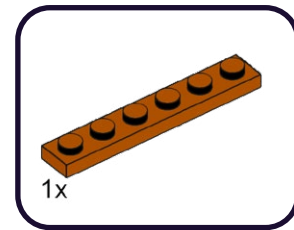

428

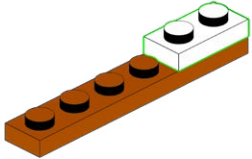
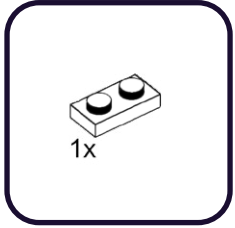

429

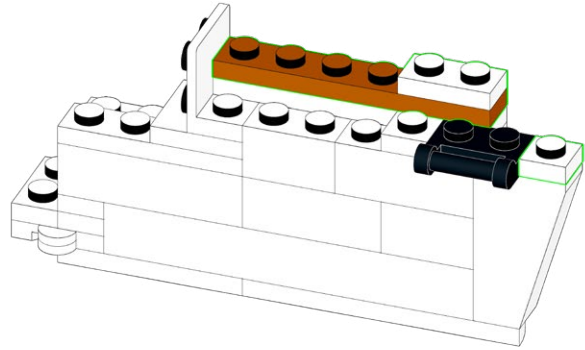
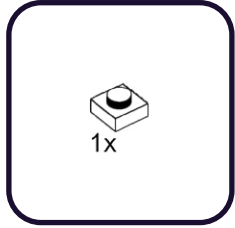

430

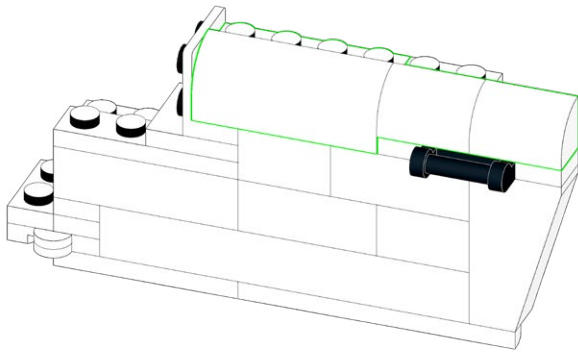
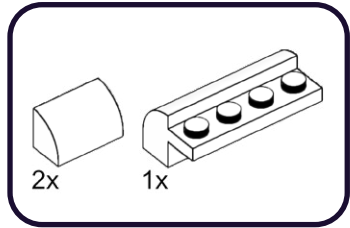

431

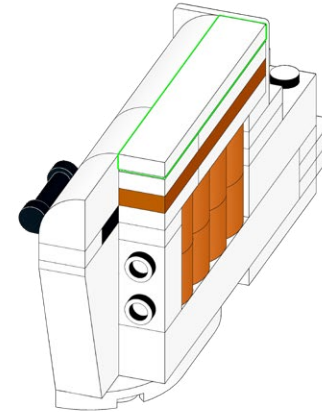
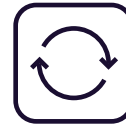
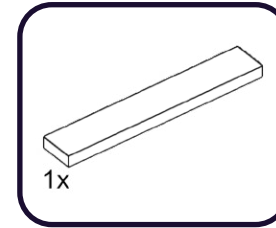

432

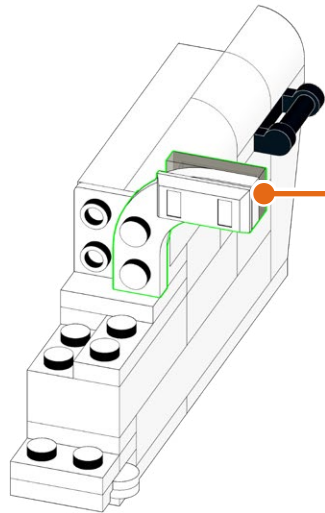
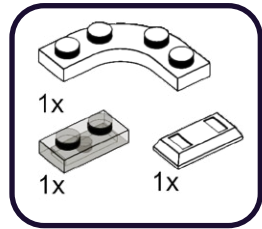

1

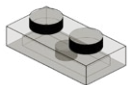

2

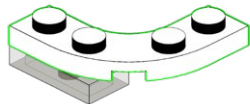

3

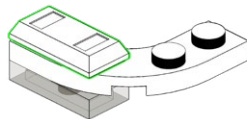

433

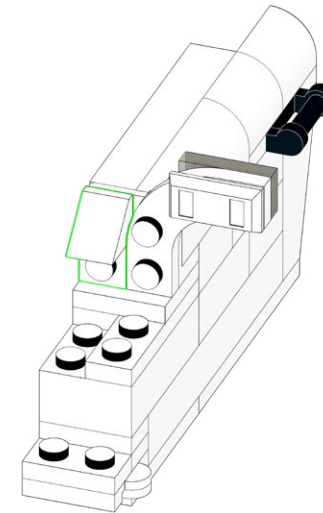
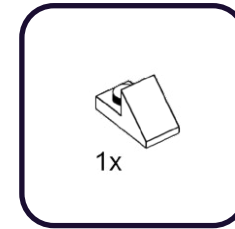

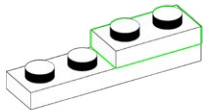
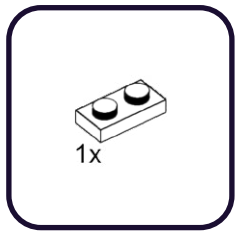
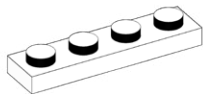
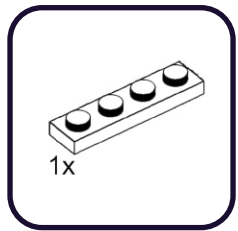

436

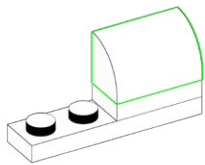
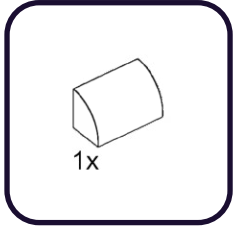

437

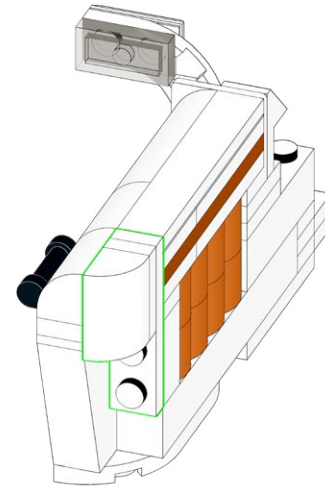

438

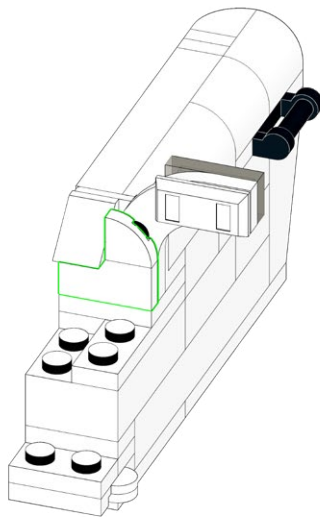
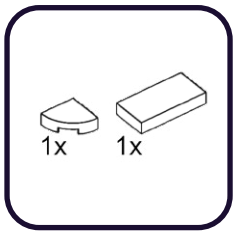

439

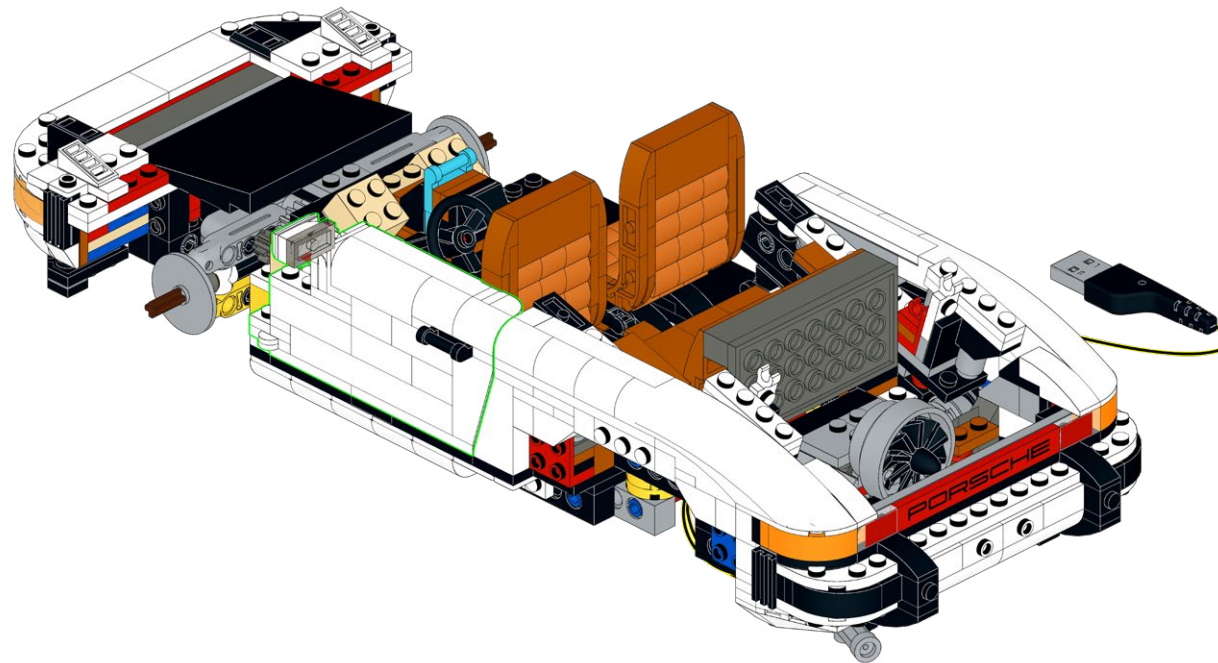

440

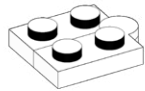
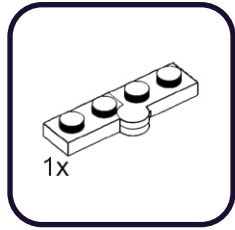

441

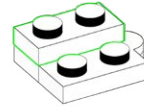
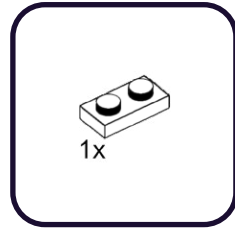

442

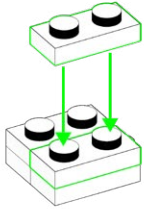
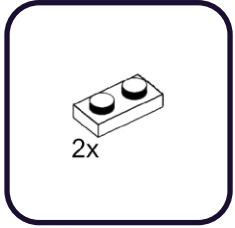

443

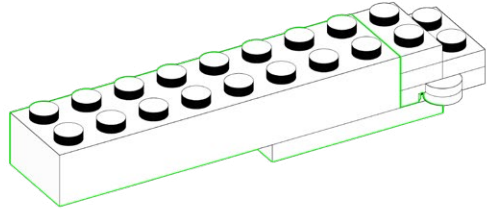
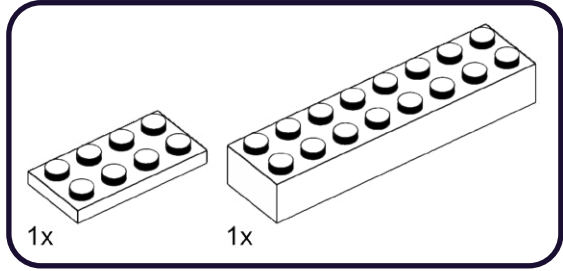

444

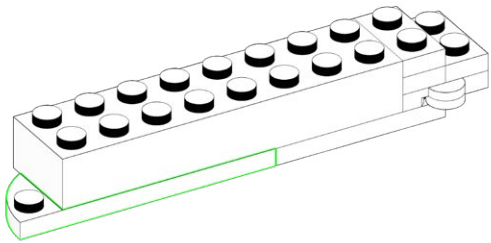
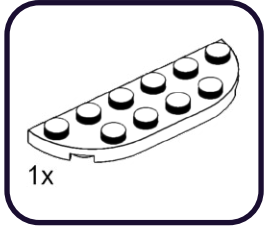

445

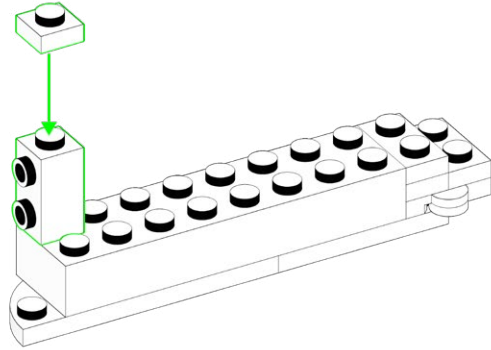
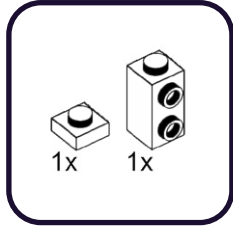

446

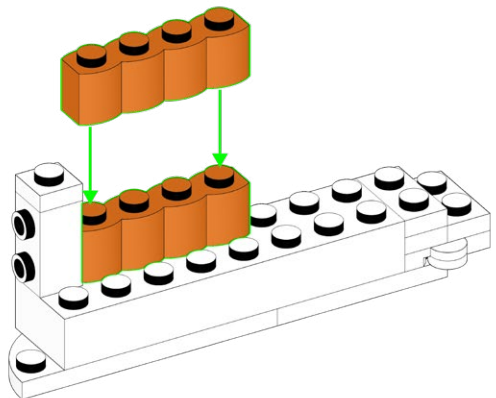
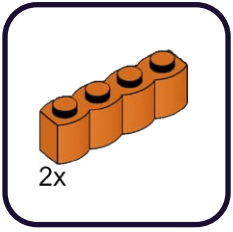

447

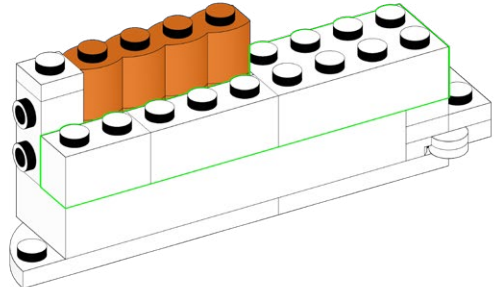
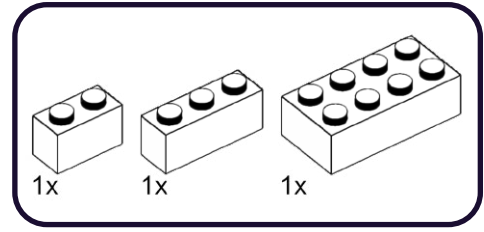

448

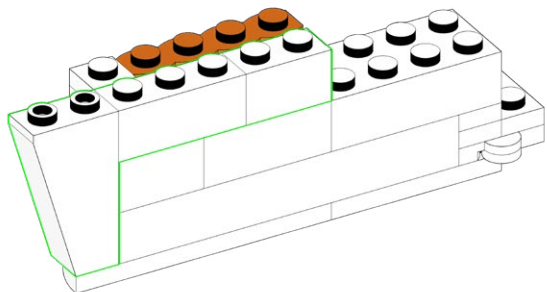
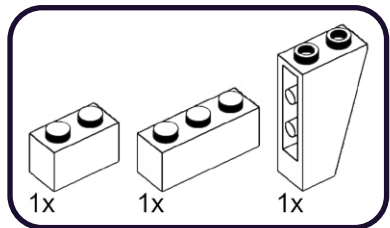

449

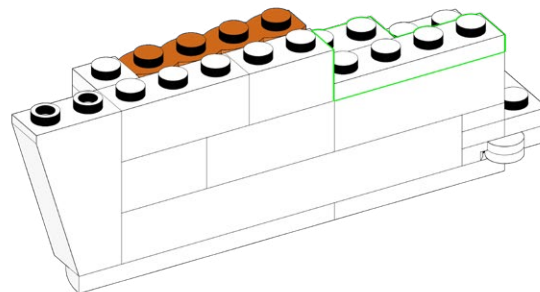
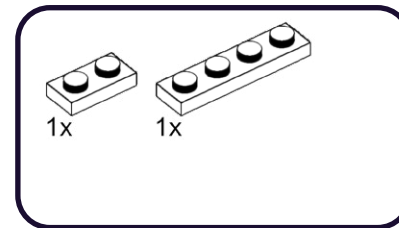

450

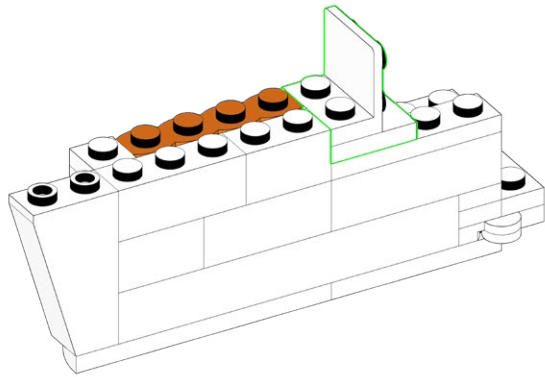
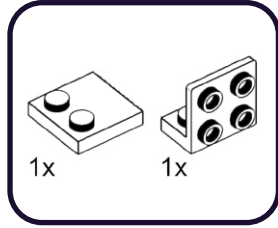

451

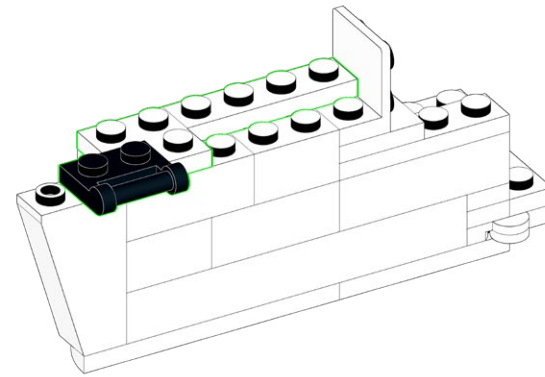
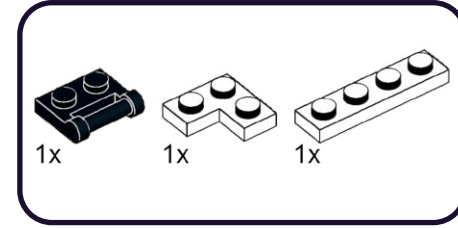

452

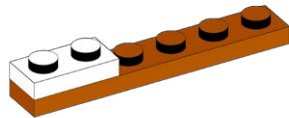
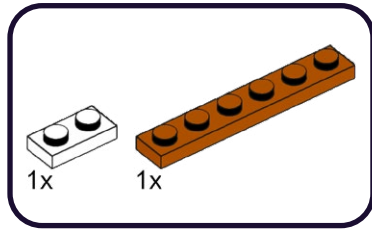

453

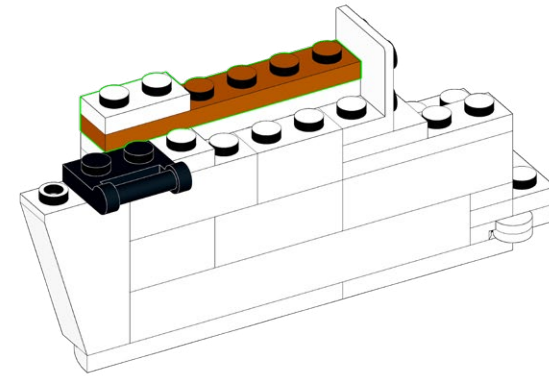

454

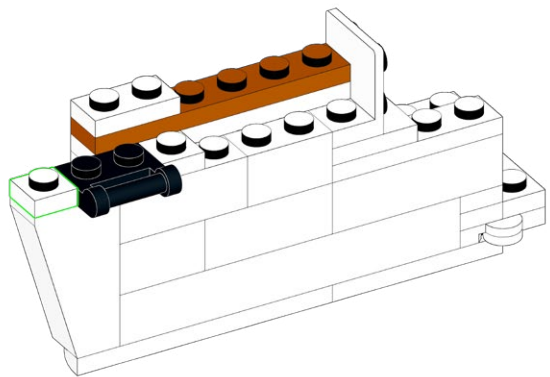
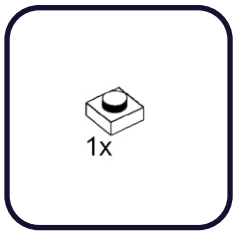

455

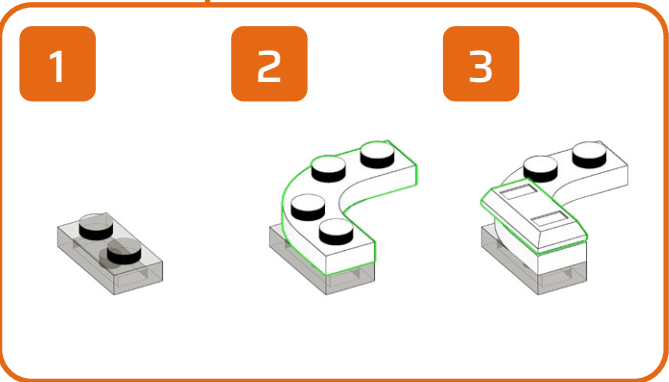
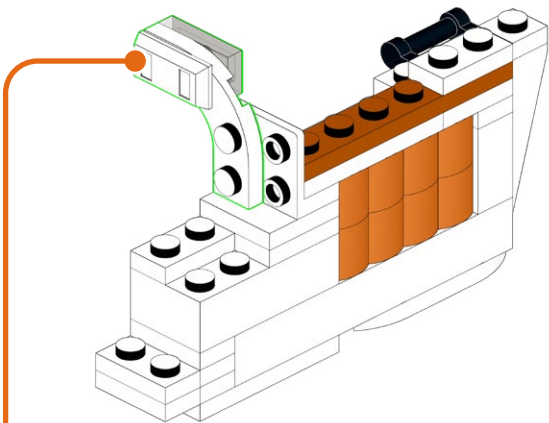
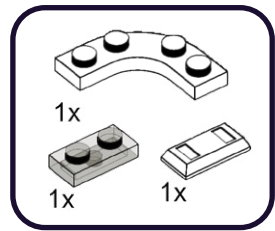

456



1x

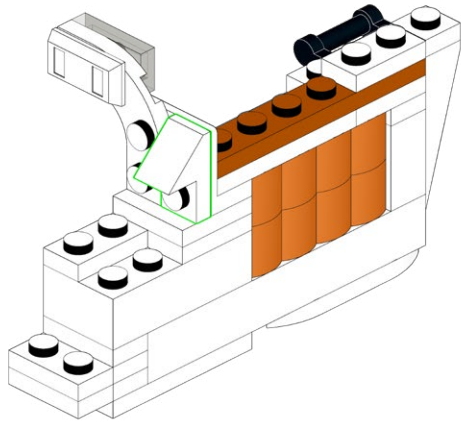

457

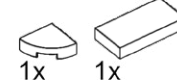

1x

1x

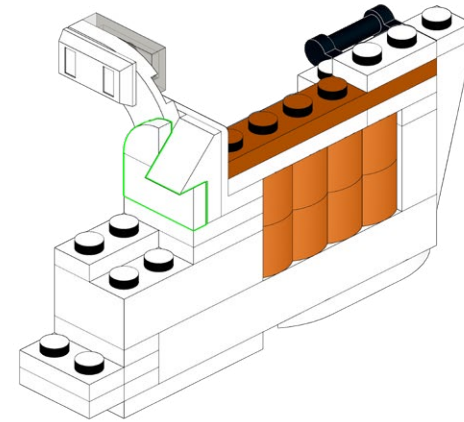

458

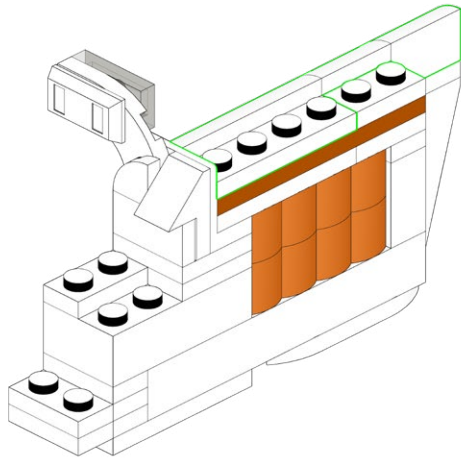
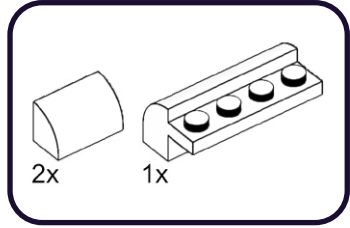

459

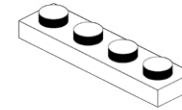
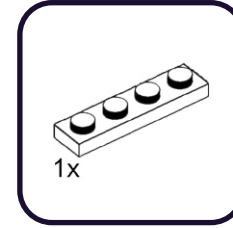

460

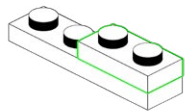
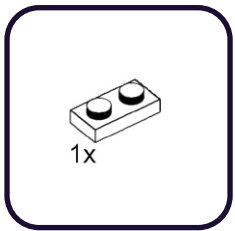

461

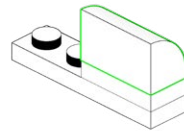
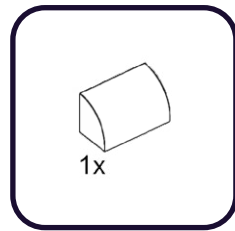

462

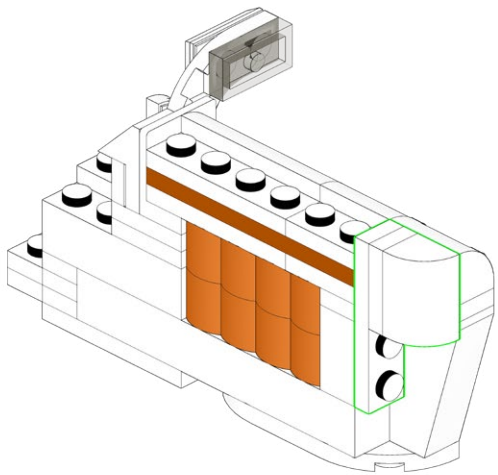

463

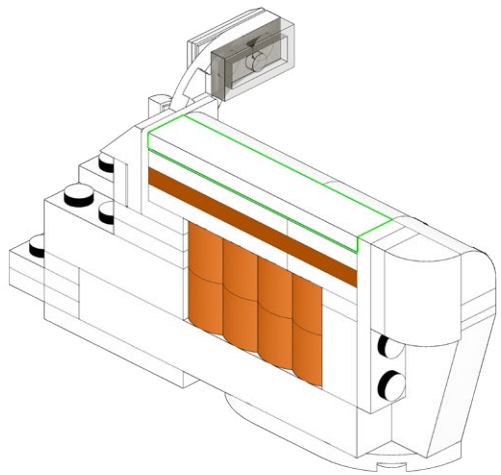
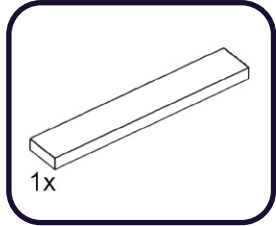

464

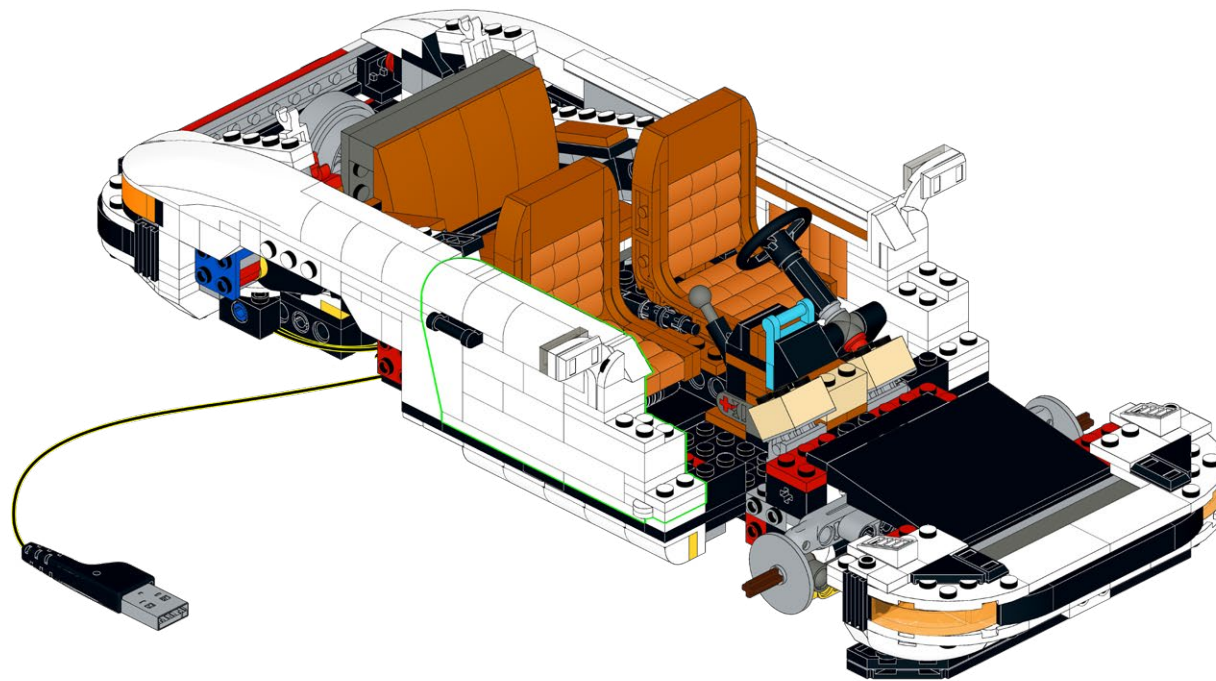

465

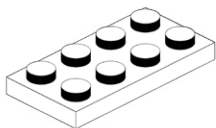
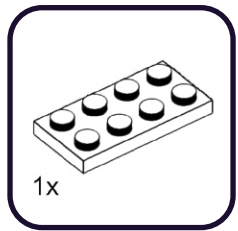

466

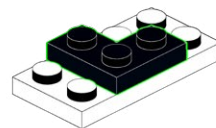
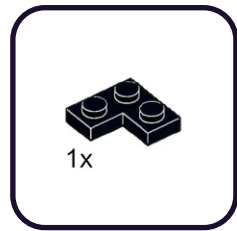

467

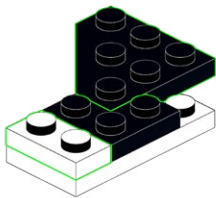
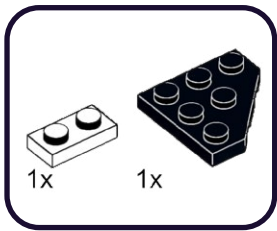

468

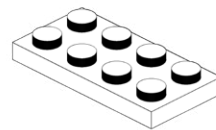
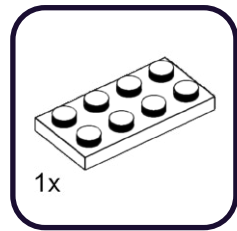

469

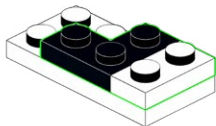
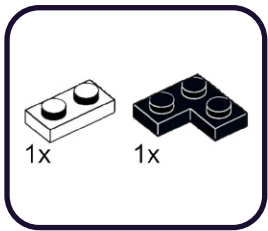

470

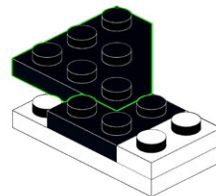
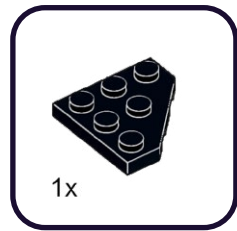

471

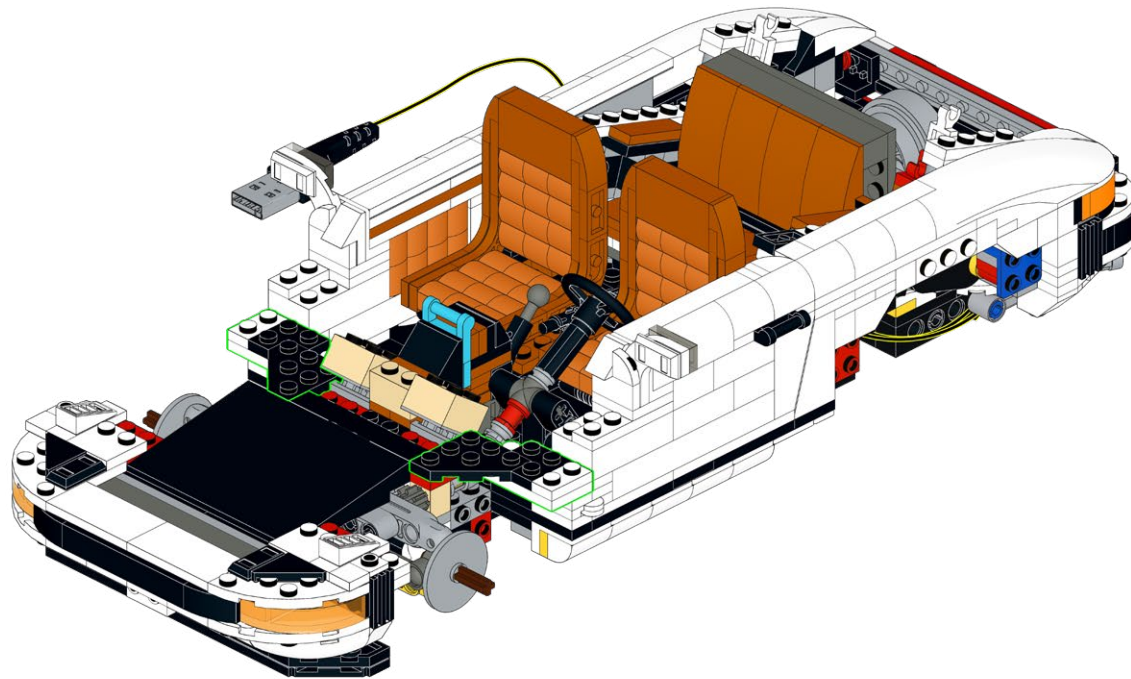

472

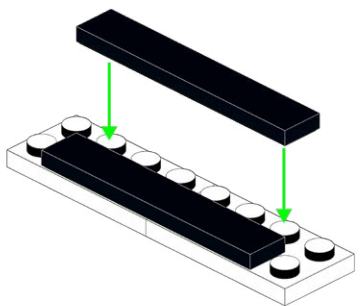
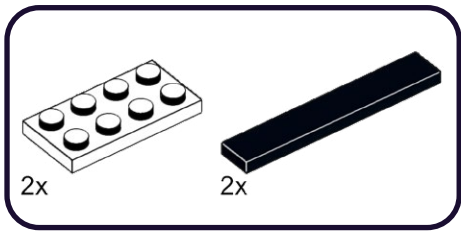

473

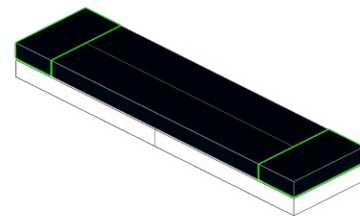
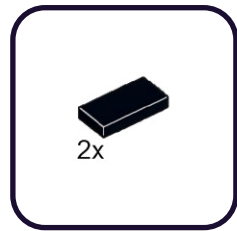

474

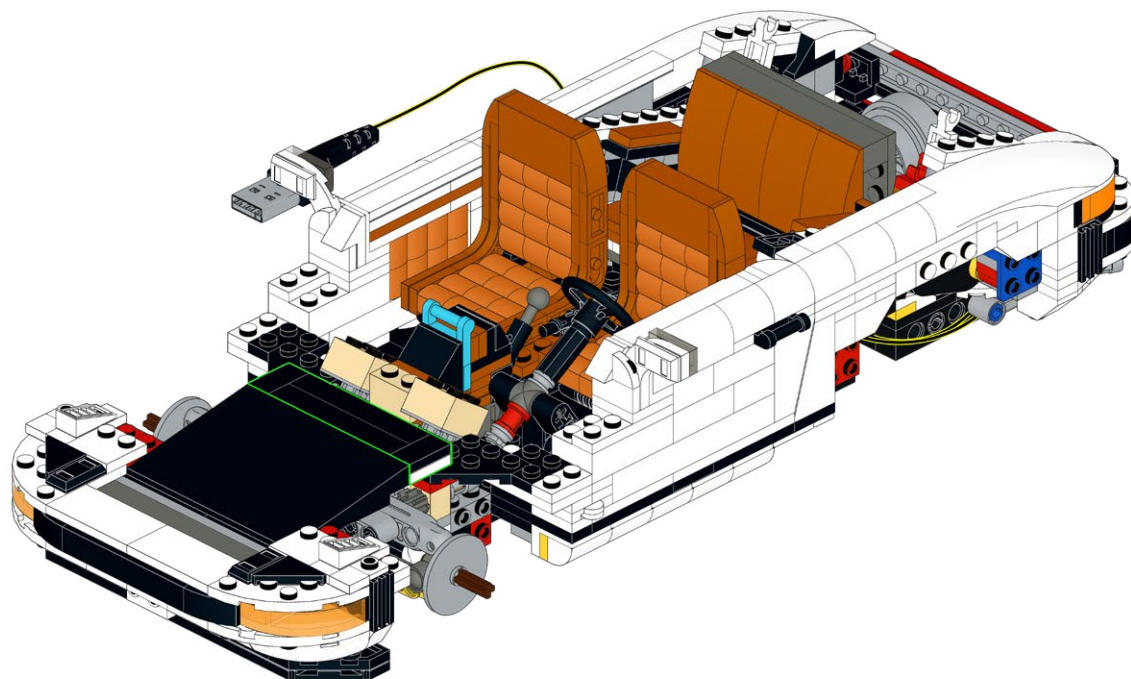

475

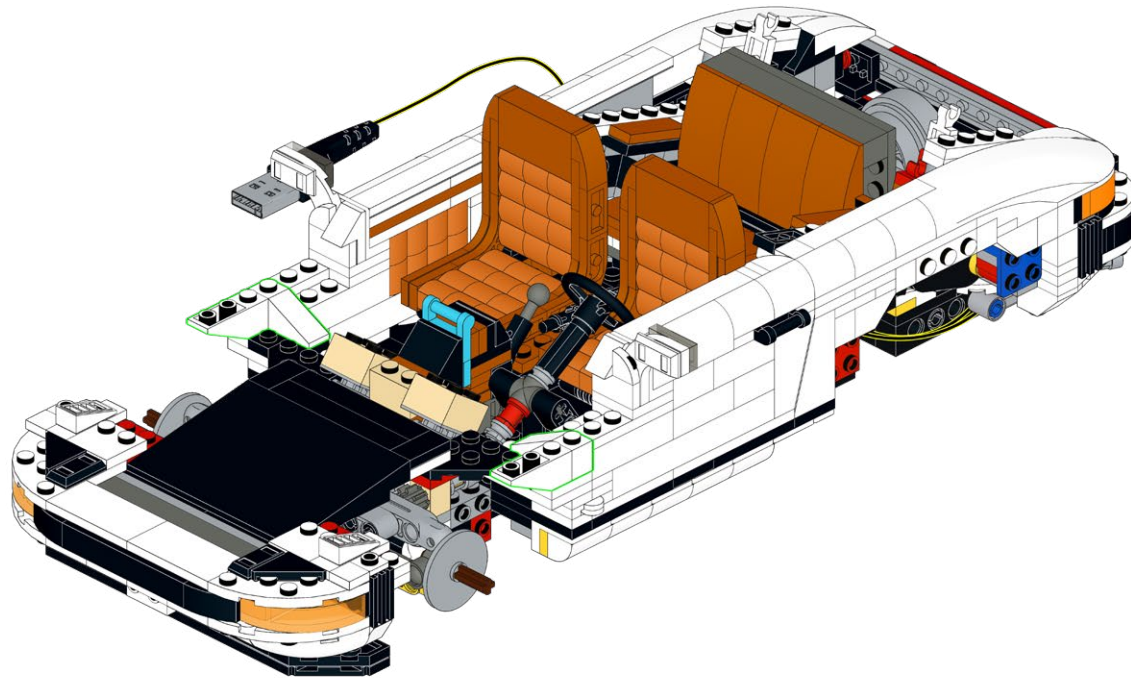
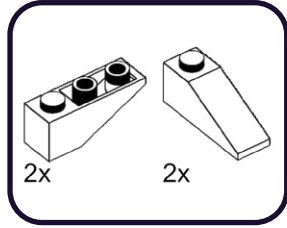

476

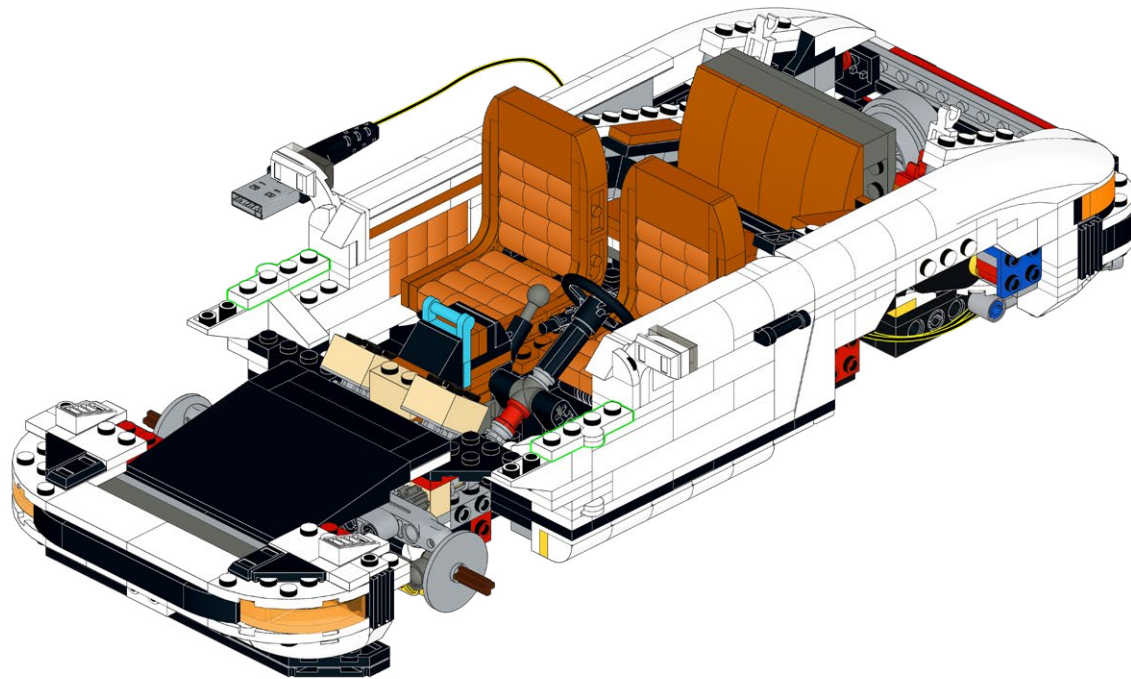
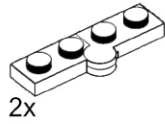

477

4x

2x

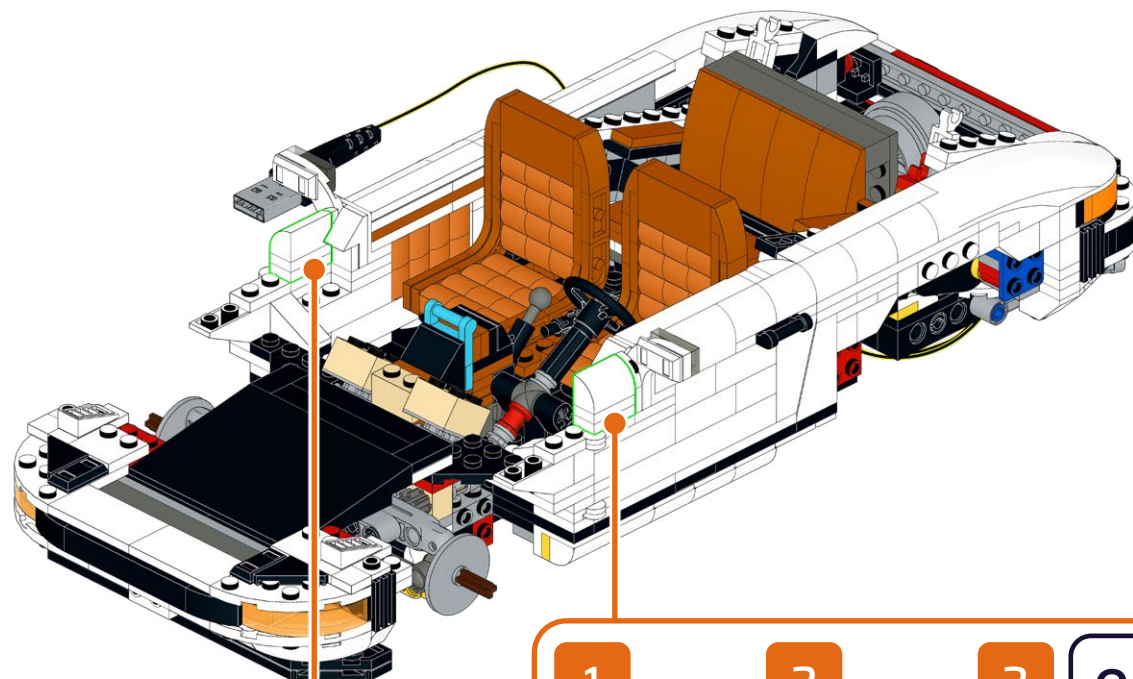

1

2

3

2x

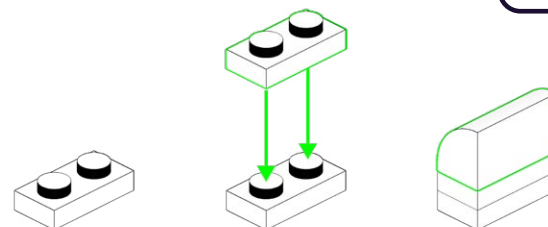

478

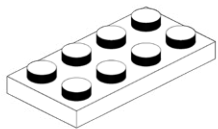
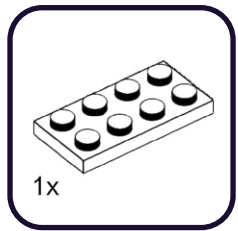

479

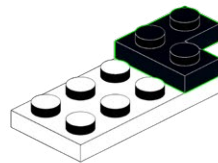
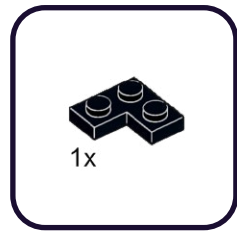

480

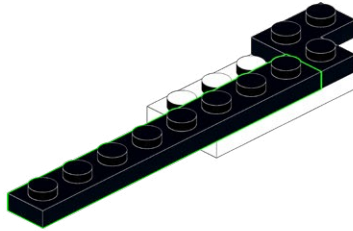
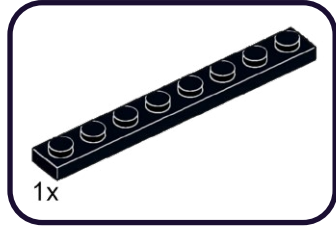

481

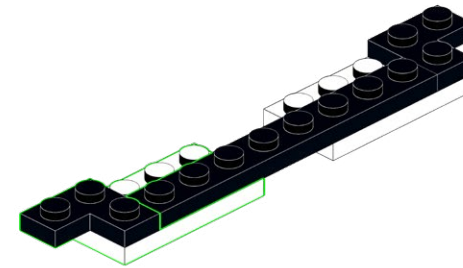
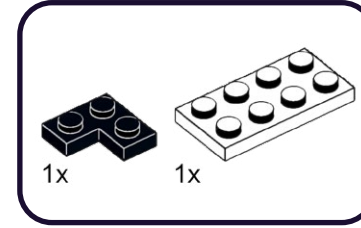

482

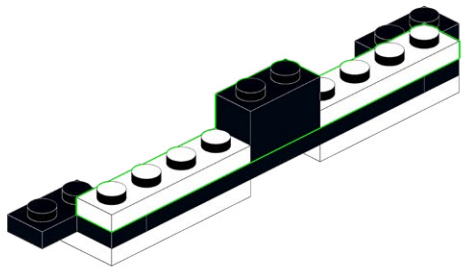
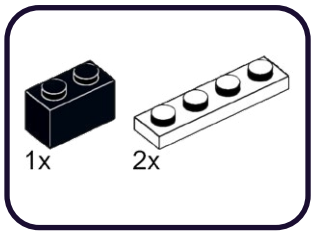

483

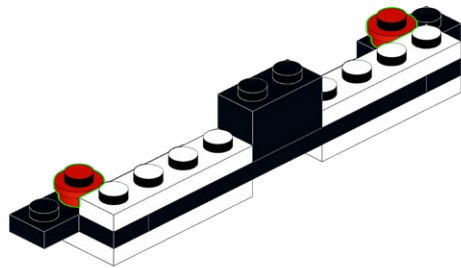
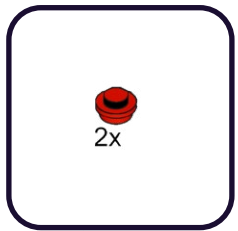

484

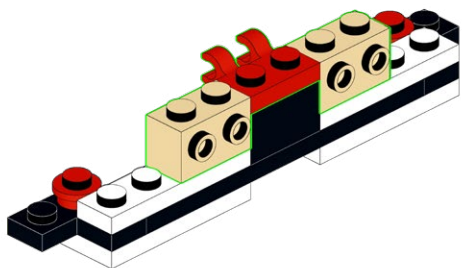
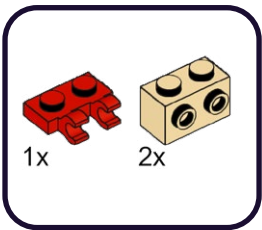

485

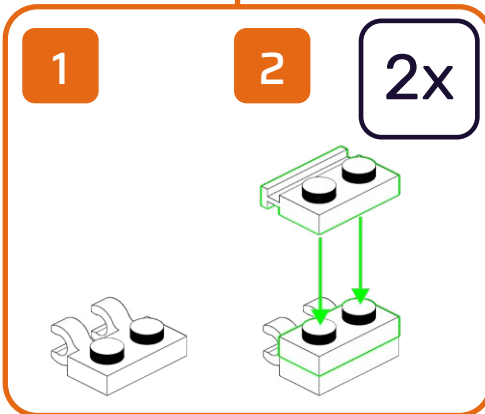
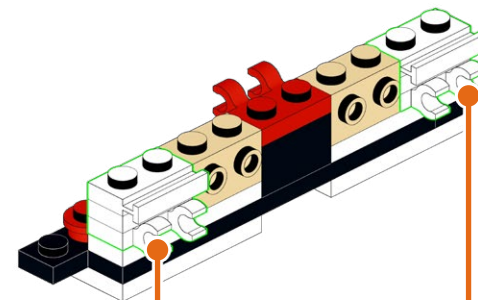
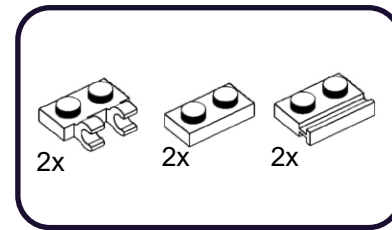

486

2x

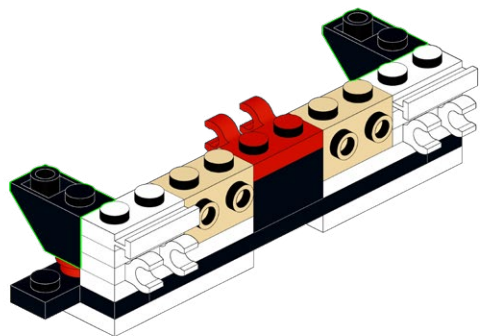
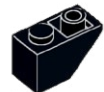

487

2x

1x

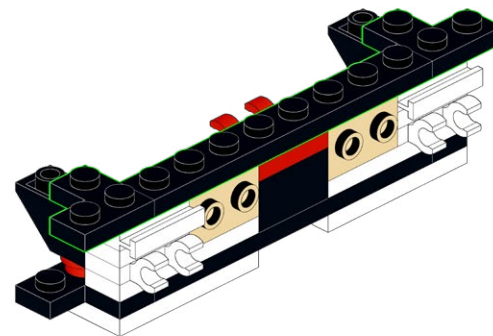
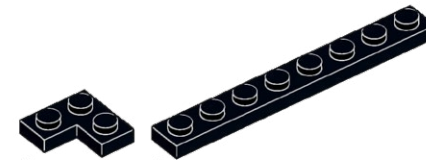

488



2x

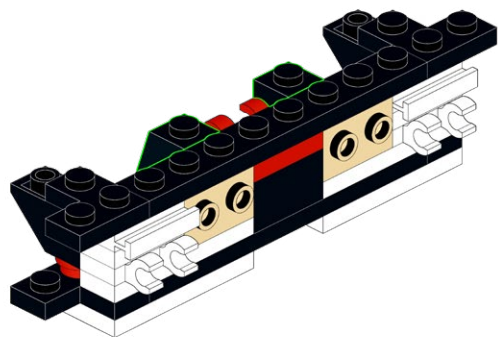

489



2x

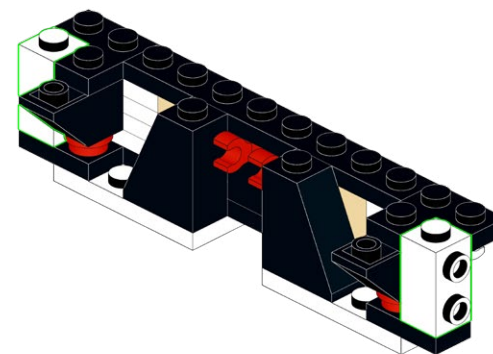
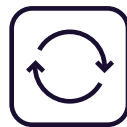

490

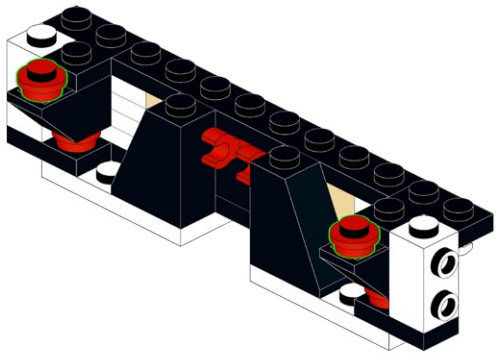
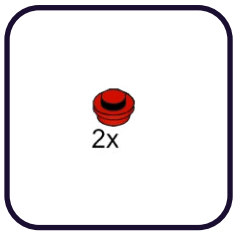

491

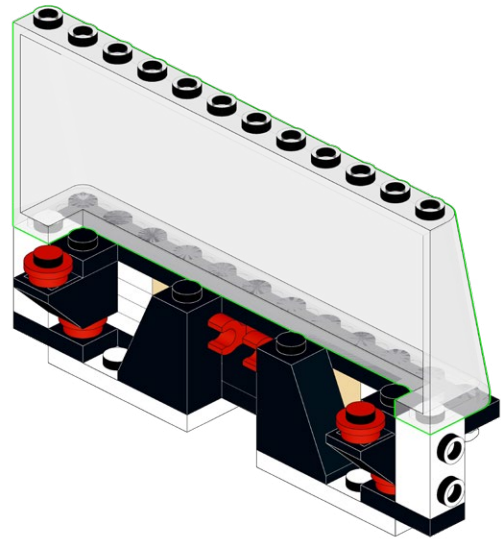
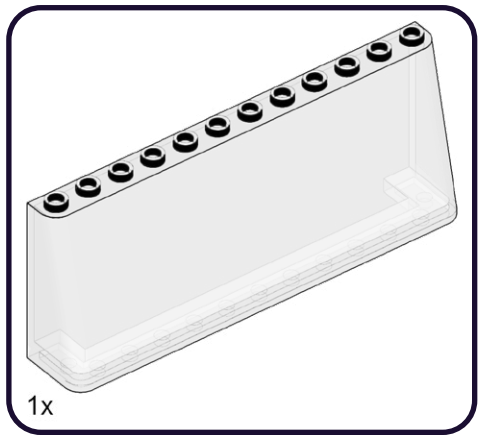

492

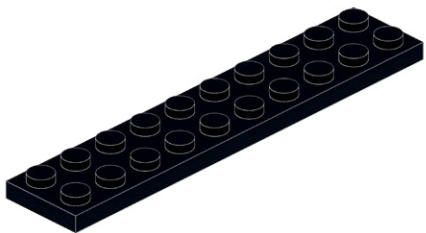
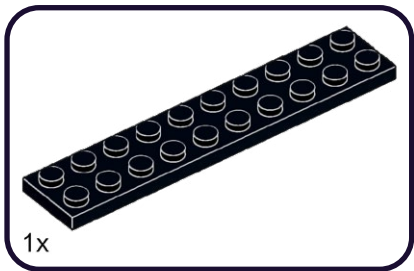

493

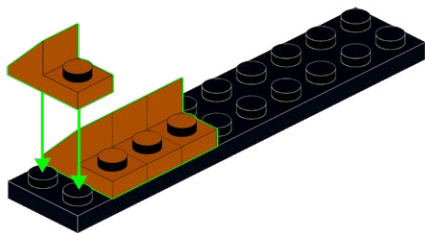
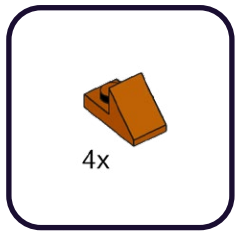

494

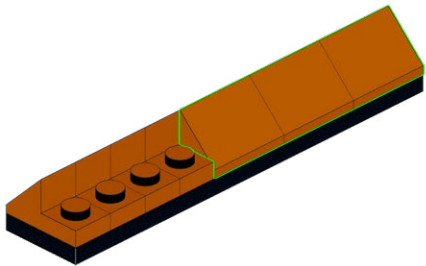
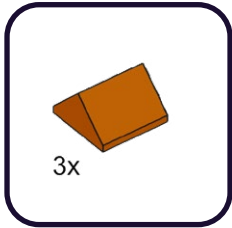

495

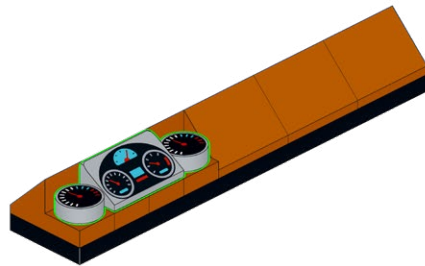
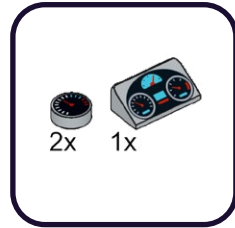

496

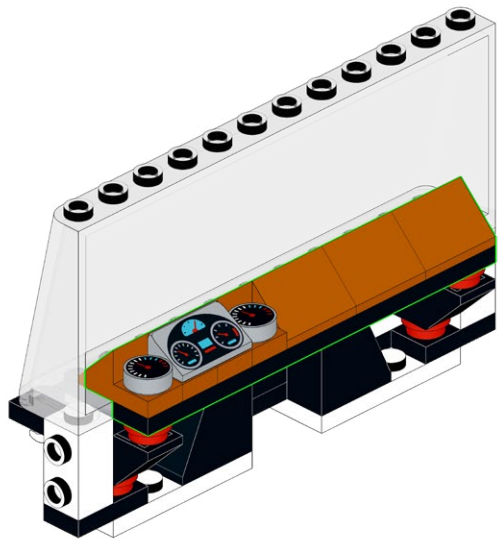

497

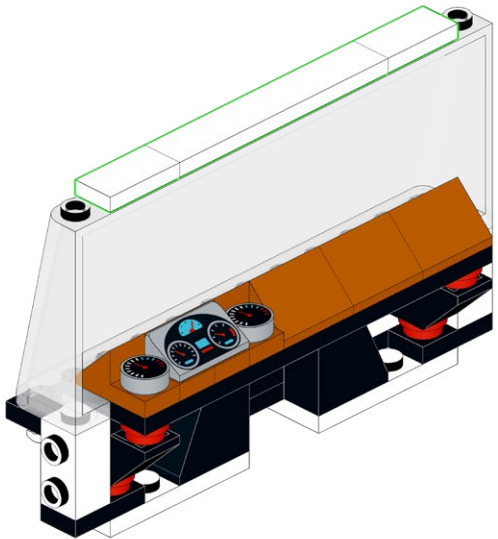
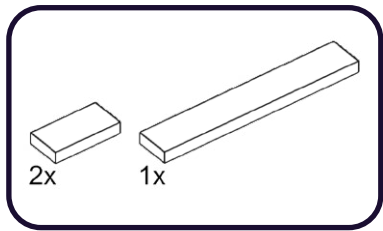

498

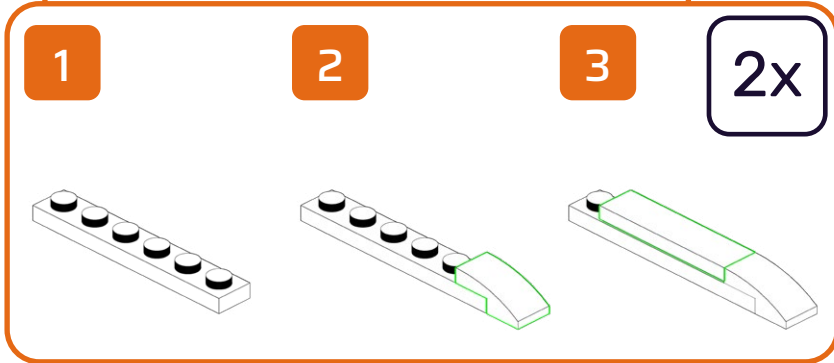
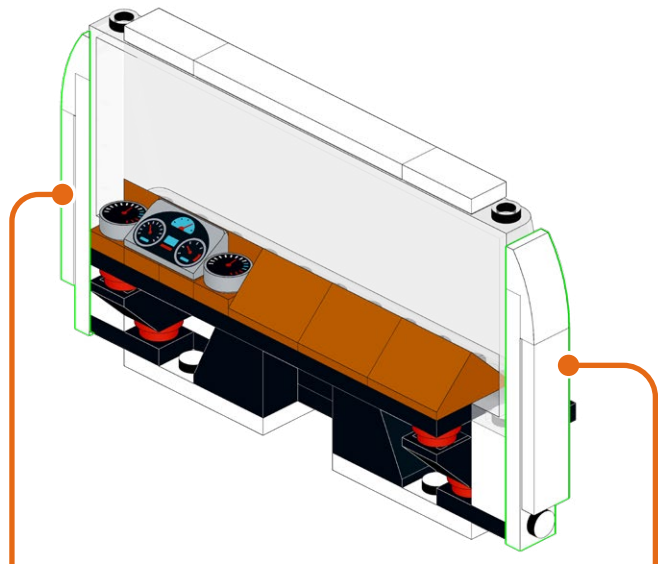
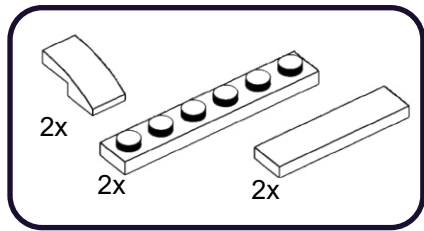

499

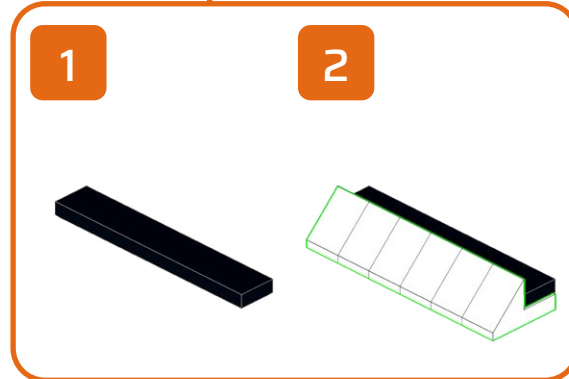
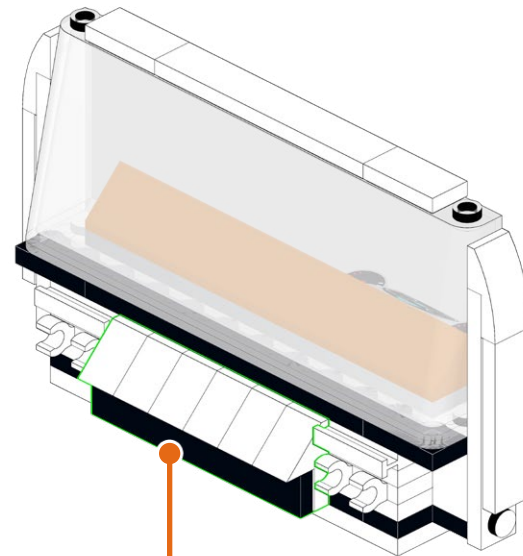
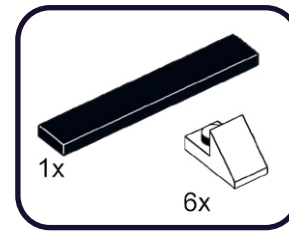

500

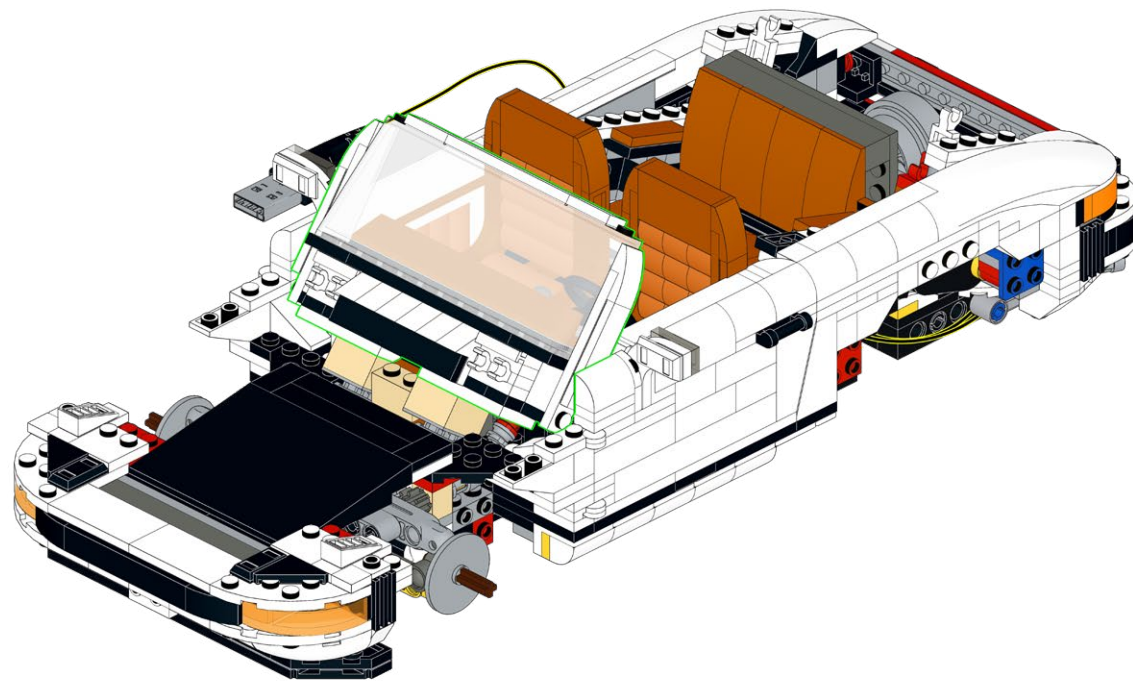

**HOLD UP!**

You might notice some bags aren't in order, as well as left over pieces, but that's ok! We're changing the way you build LEGO!

ATTENDEZ!

Vous remarquerez peut-être que certains sacs, ainsi que certaines pièces, ne sont pas dans le bon ordre. Mais pas de panique! Nous changeons simplement la façon avec laquelle vous construisez vos LEGO!

ASPETTA!

Potresti notare che alcuni sacchetti non sono in ordine, così come i pezzi avanzati, ma va bene così! Stiamo cambiando il modo in cui costruisci i LEGO!

HALT!

Sie werden möglicherweise bemerken, dass einige tüten durcheinander sind und teile übrig bleiben, aber das ist in Ordnung! Wir ändern die art und weise, wie Sie LEGO bauen!

¡ESPERA!

Es posible que notes que algunas bolsas están fuera de servicio, así como piezas sobrantes, ¡pero está bien! ¡Estamos cambiando la forma en que construyes LEGO!

暫停!

你可能会注意到一些袋子顺序错乱, 以及一些剩余的部件, 但没关系! 我们正在改变你搭建乐高的方式!

Open LEGO® Bag 1

501

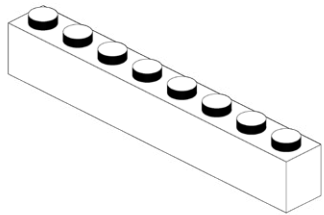
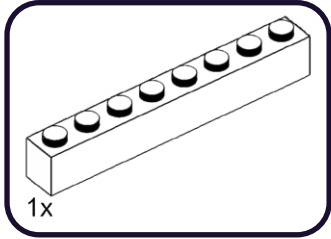

502

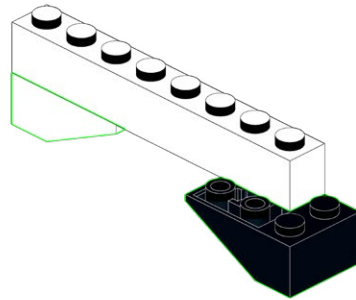
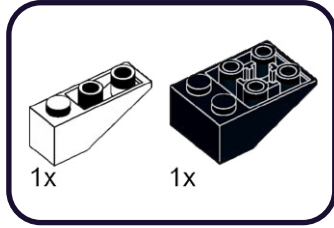

503

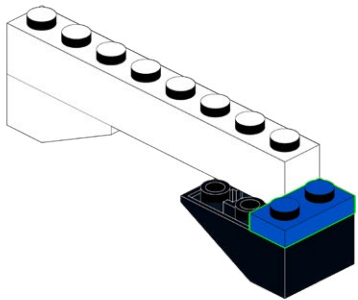
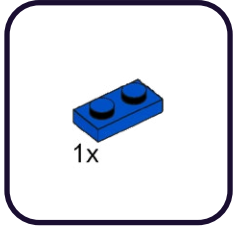

504

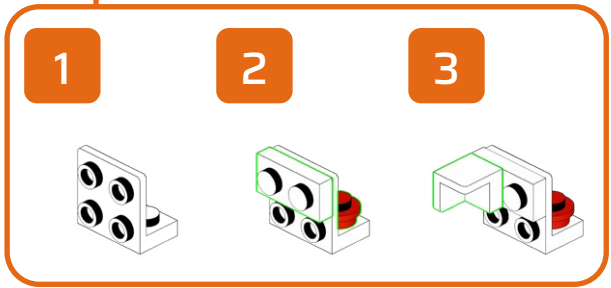
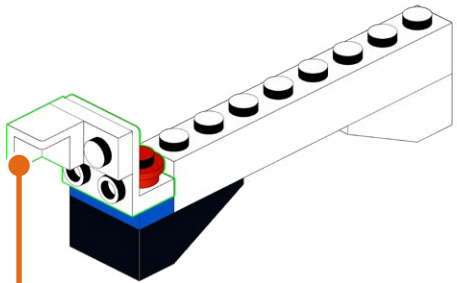
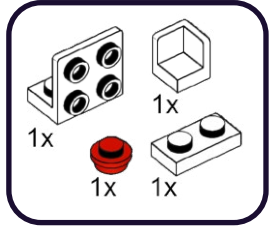

505

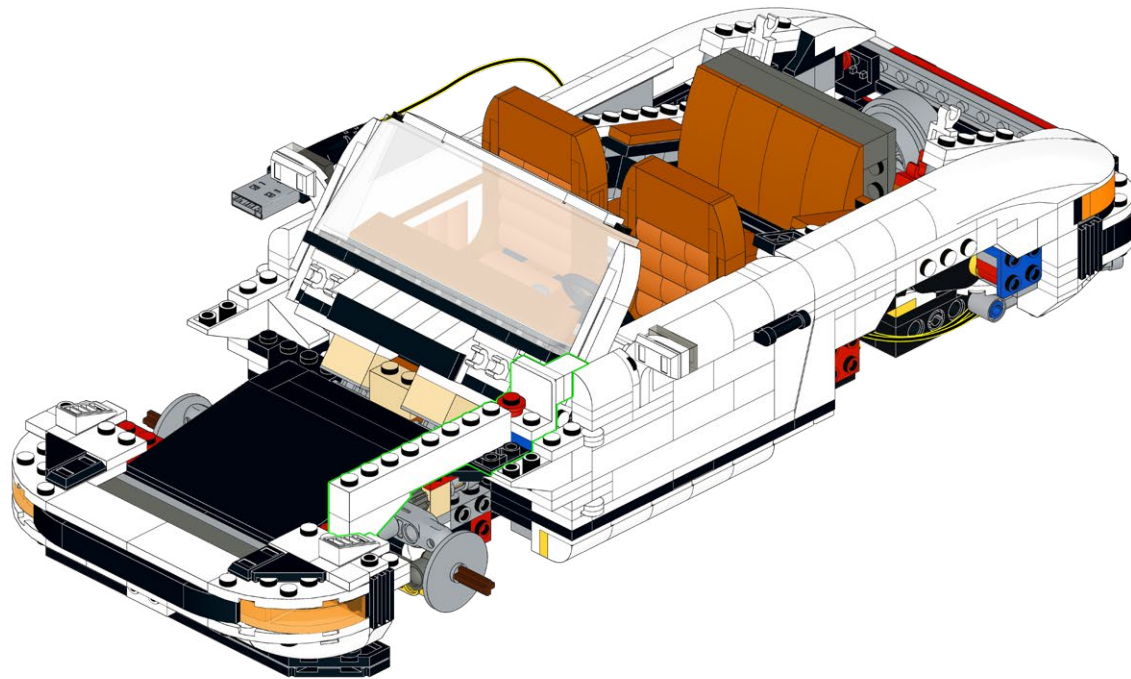

506

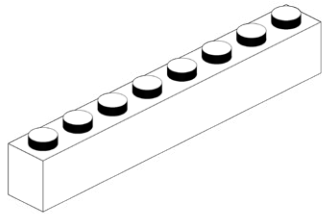
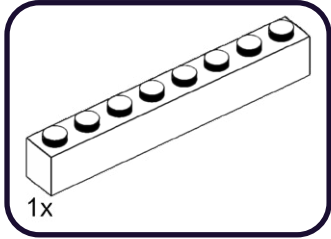

507

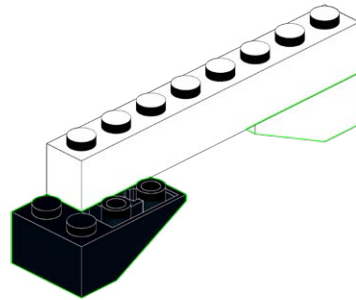
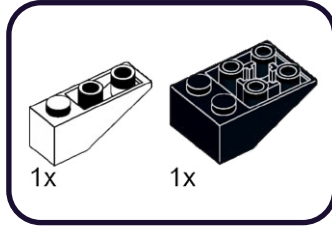

508

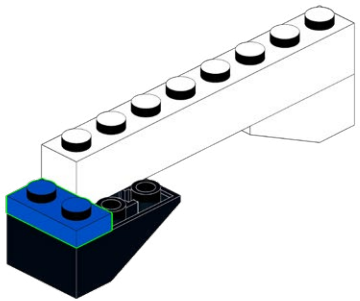
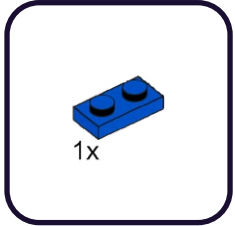

509

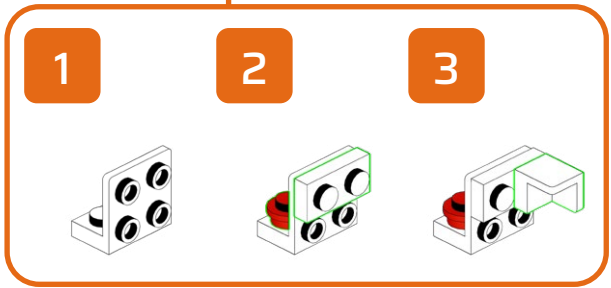
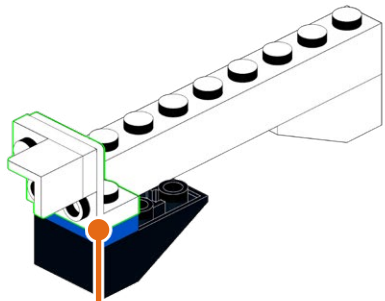
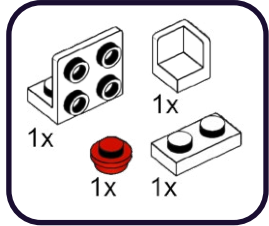

510

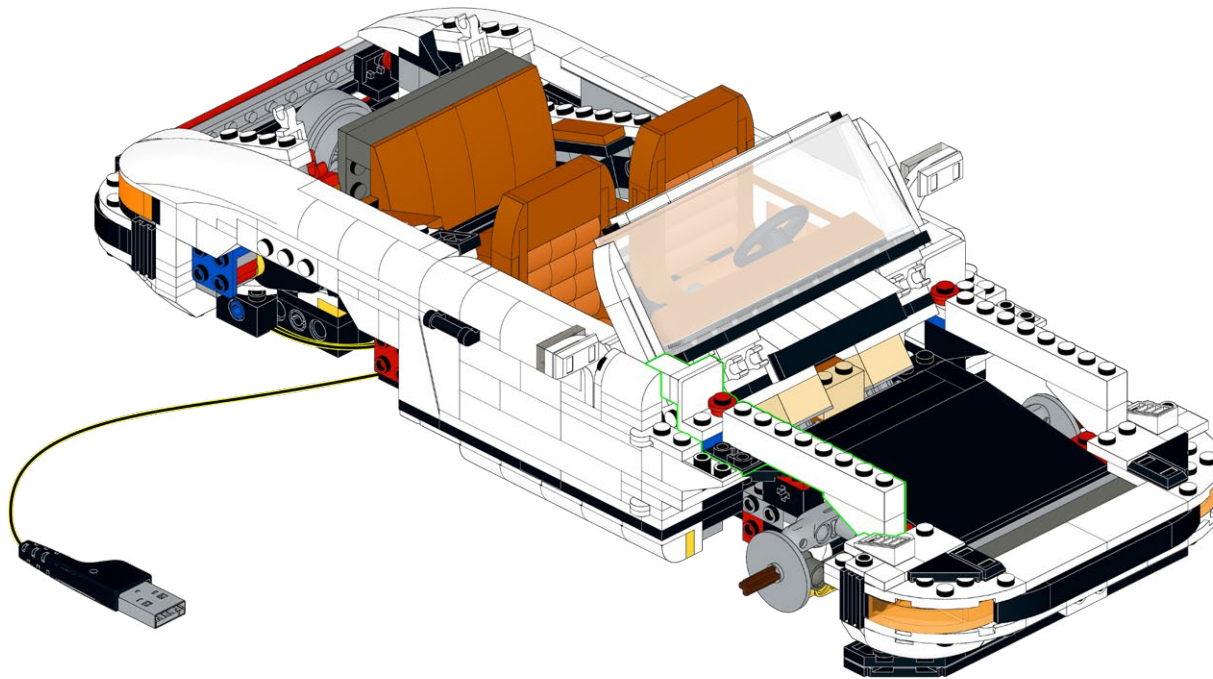

511

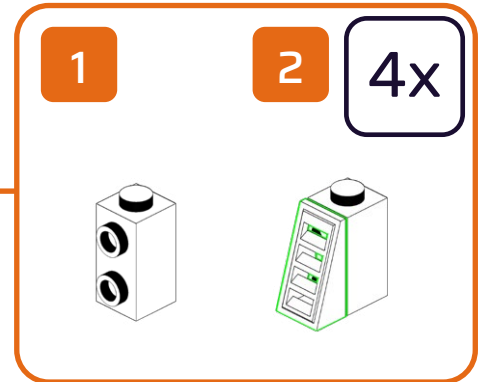
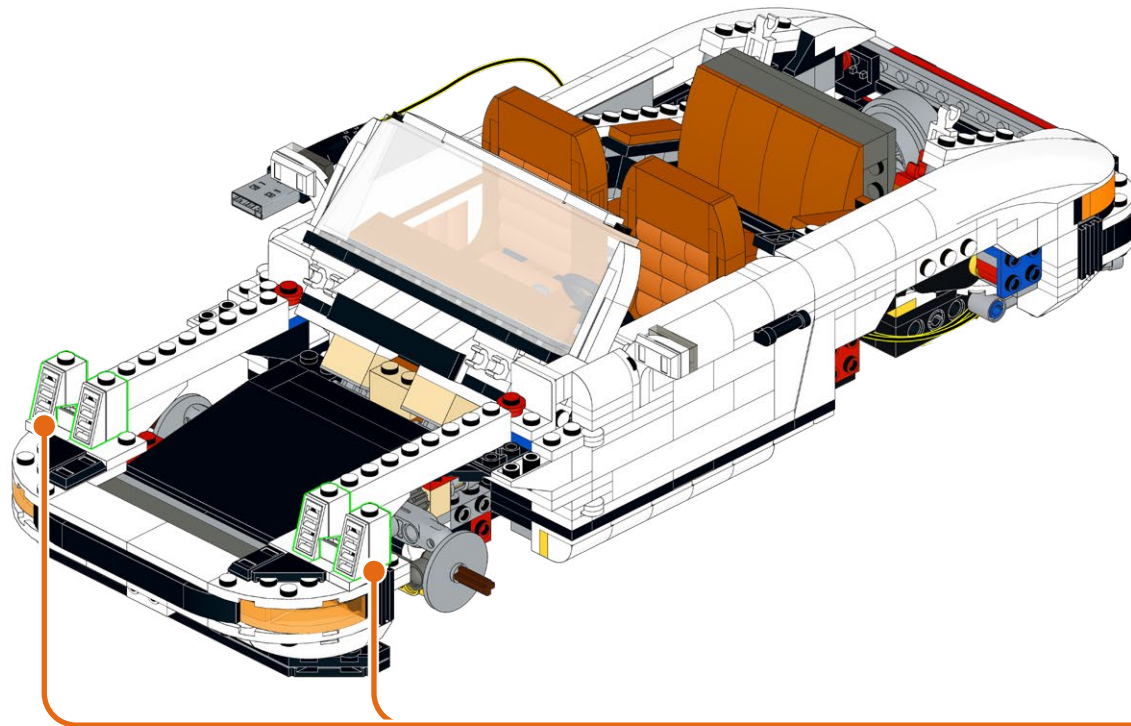
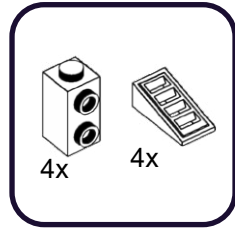

512

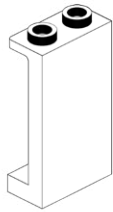
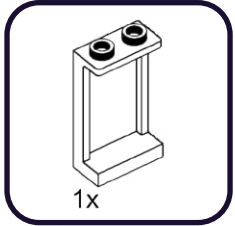

513

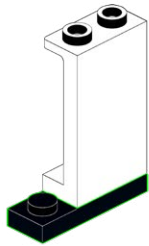
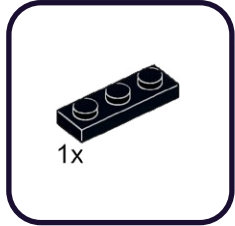

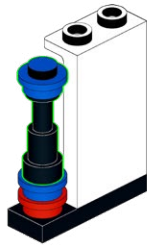
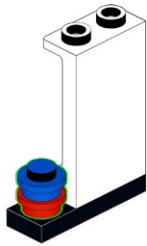
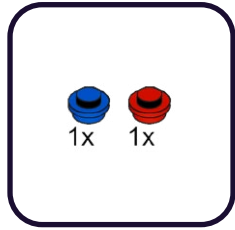

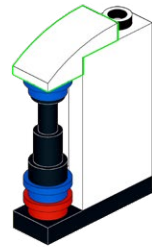
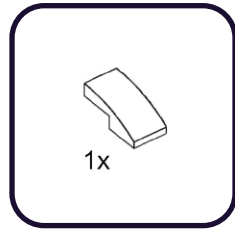
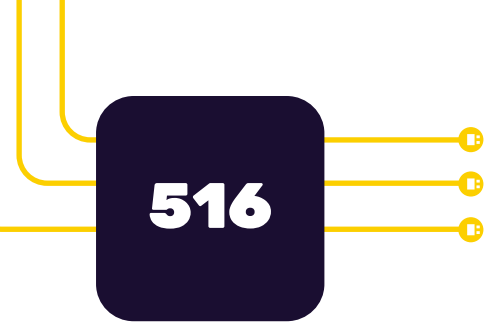

517

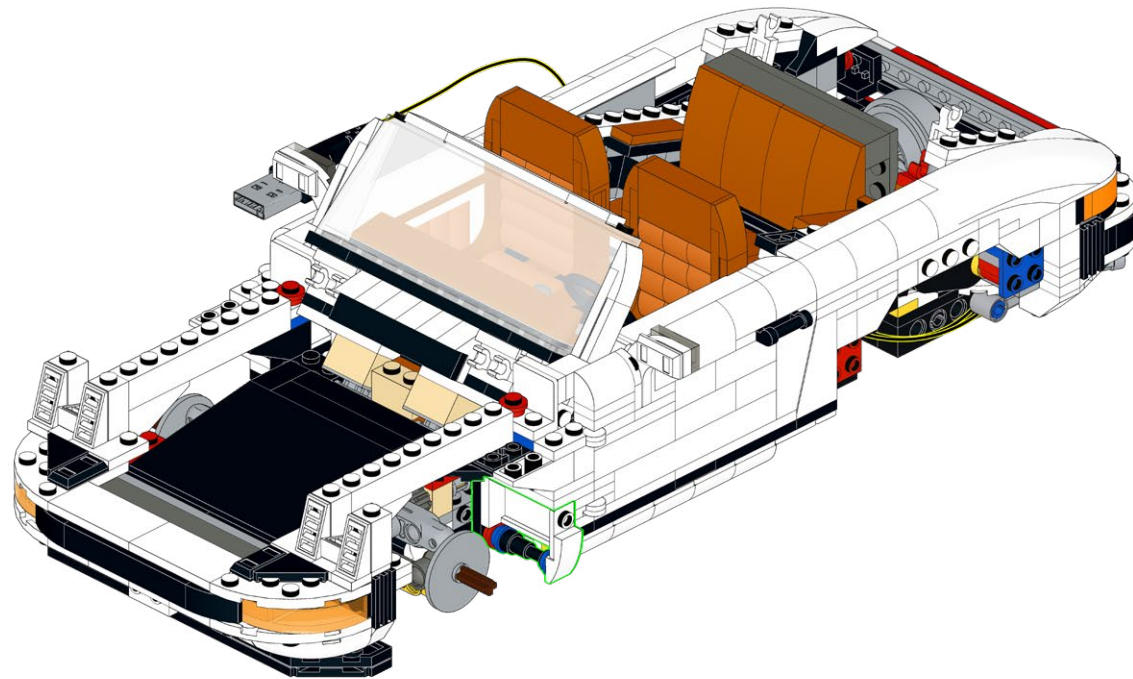

518

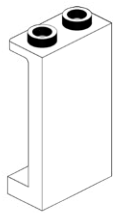
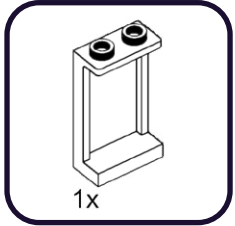

519

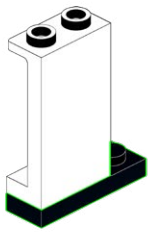
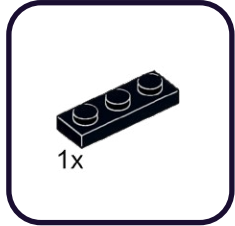

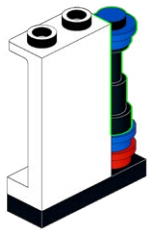
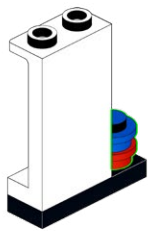
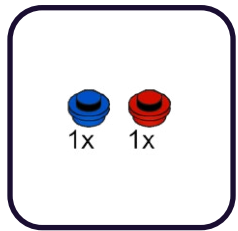

522

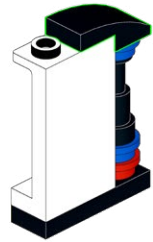

523

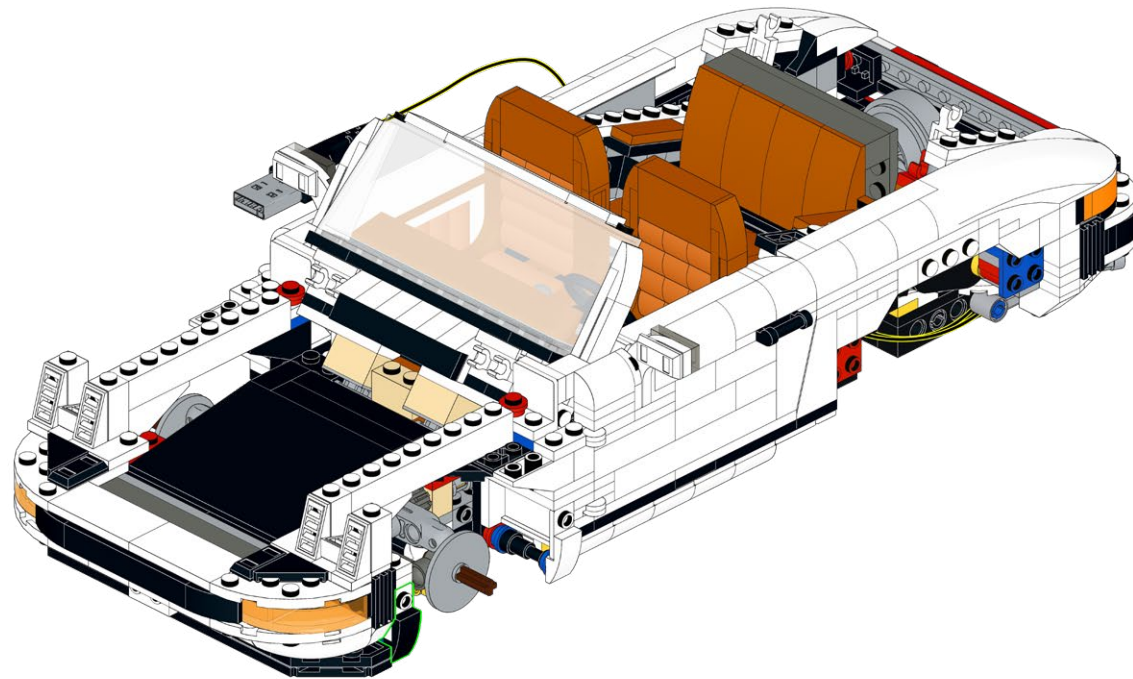

524

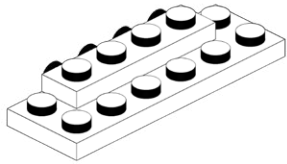
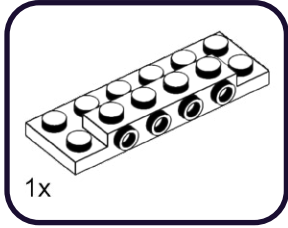

525

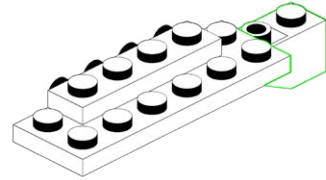
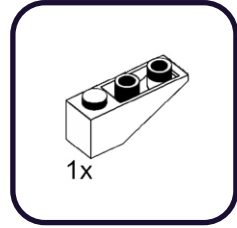

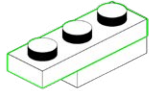
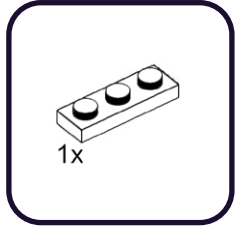
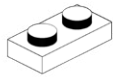
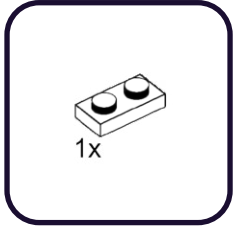

528

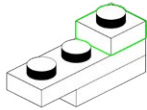
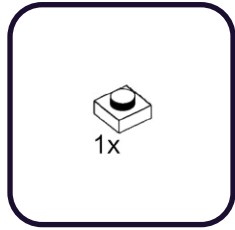

529

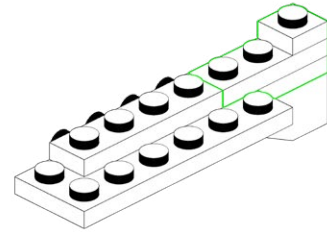

530

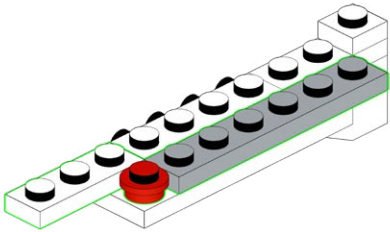
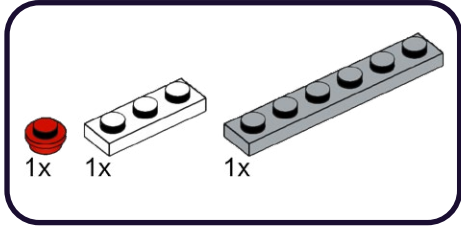

531

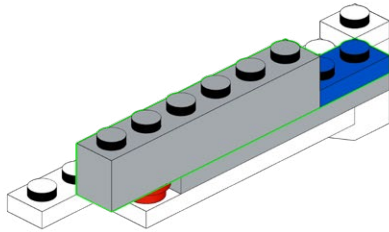
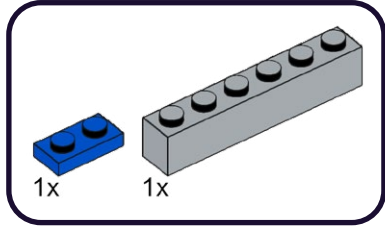

532

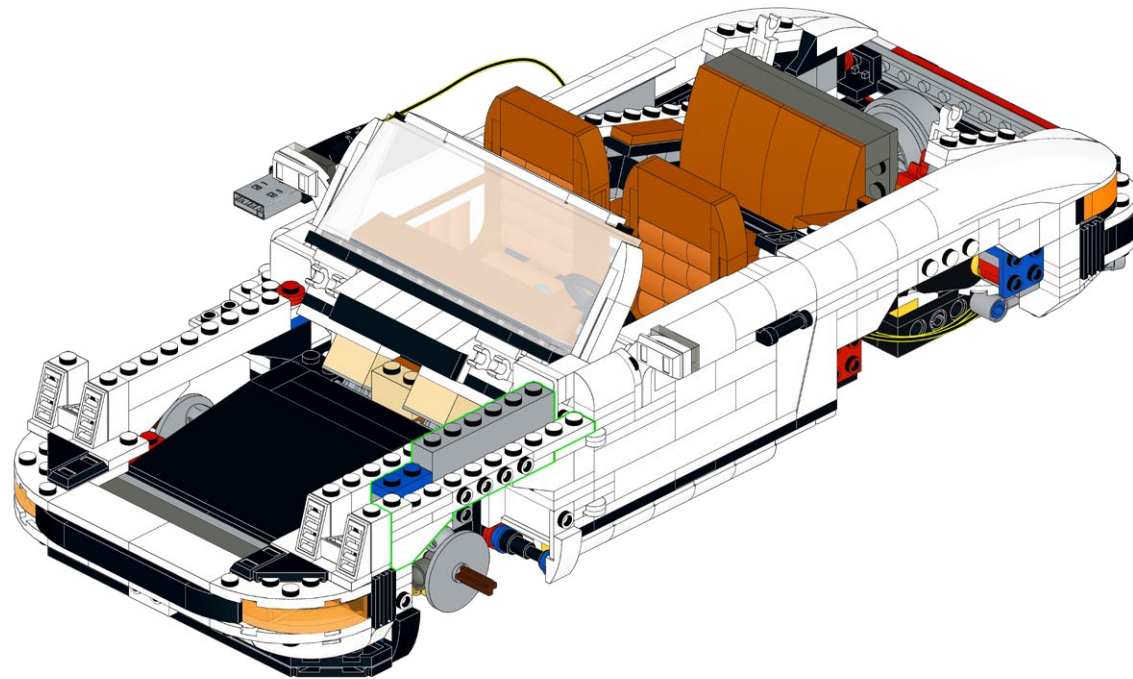

533

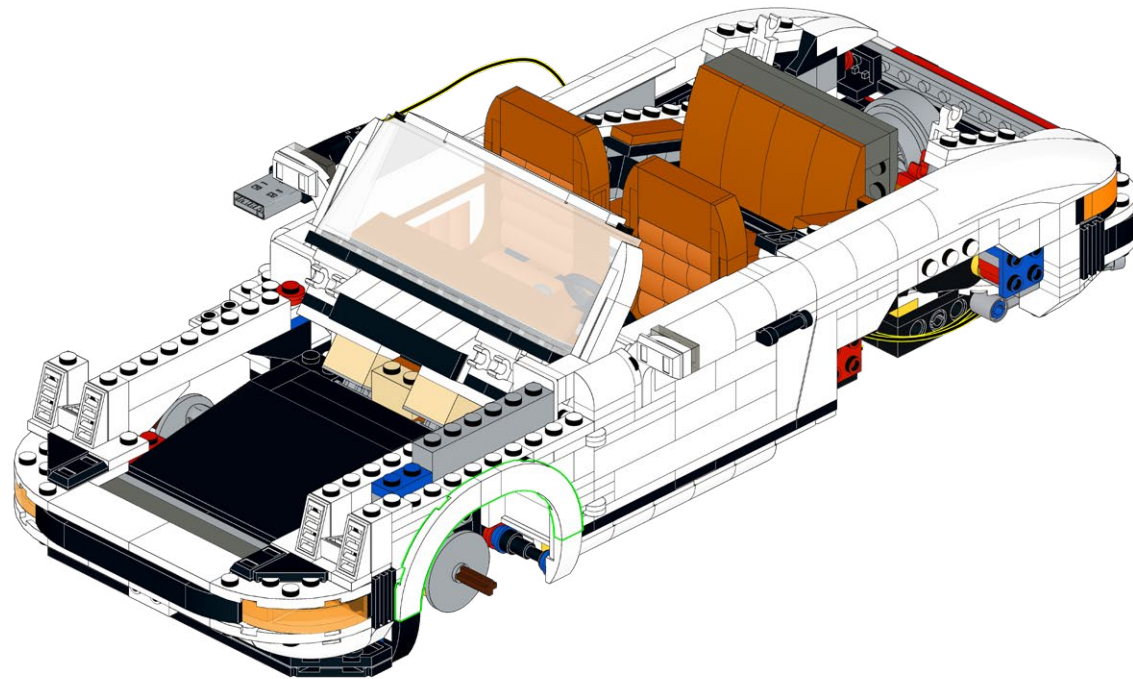
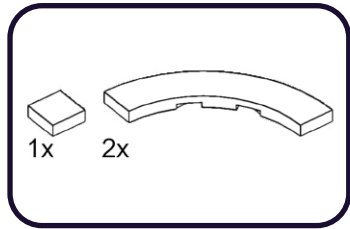

534

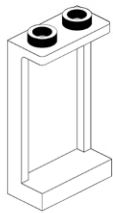
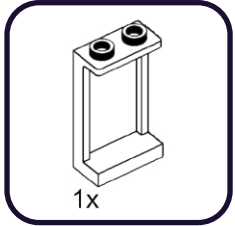

535

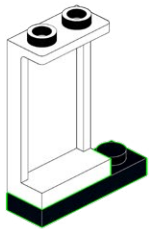
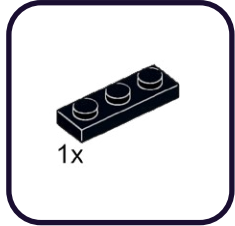

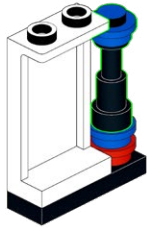
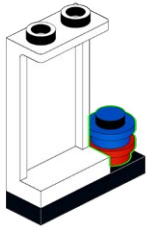
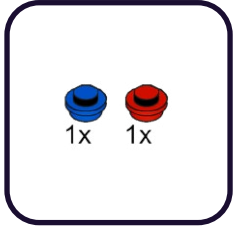

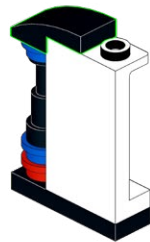
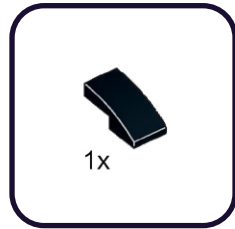
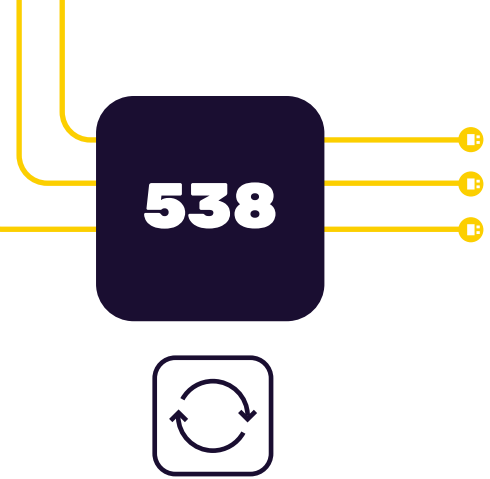

539

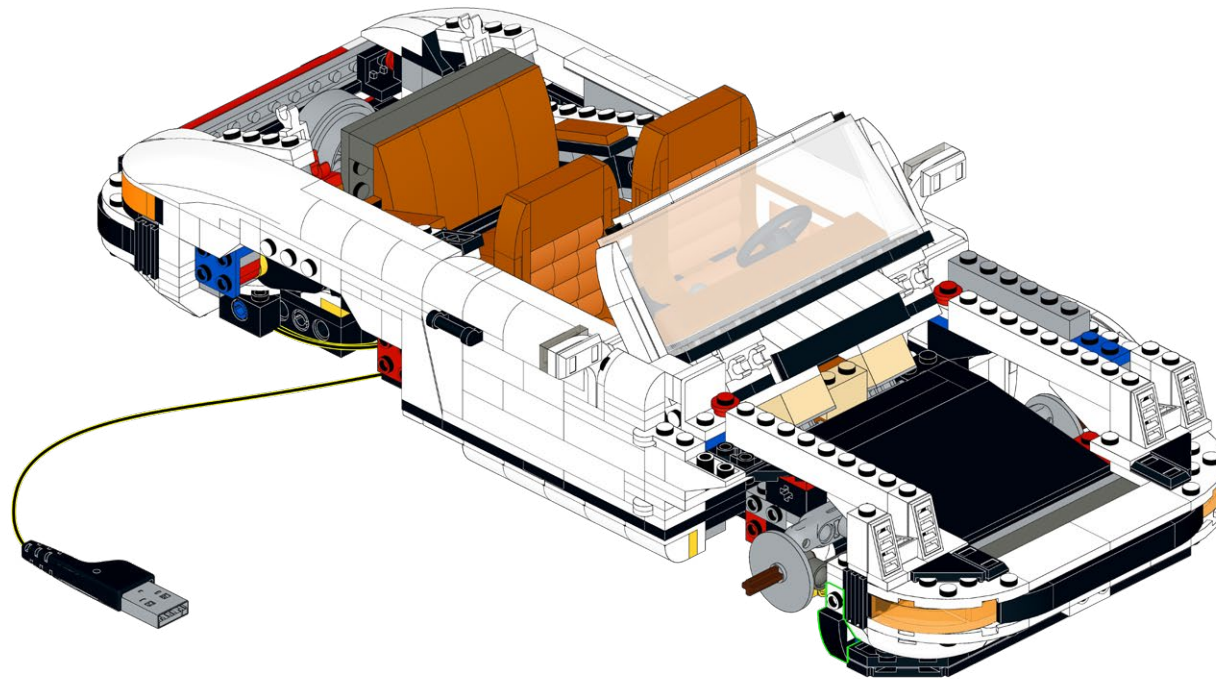

540

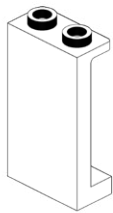
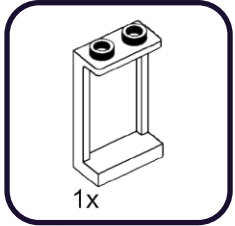

541

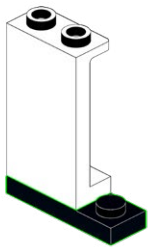
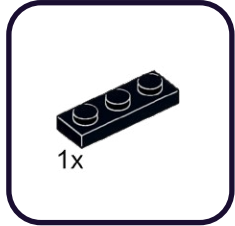

542

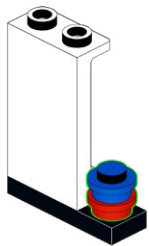
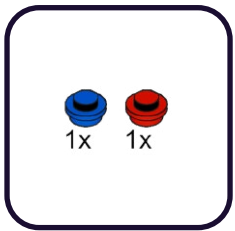

543

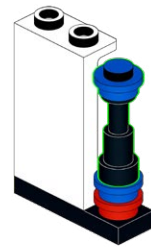

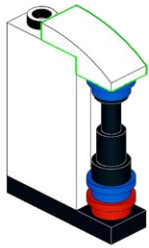
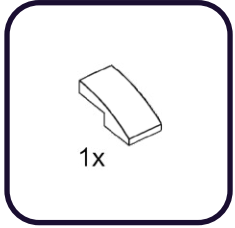
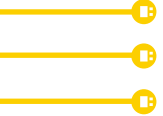

545

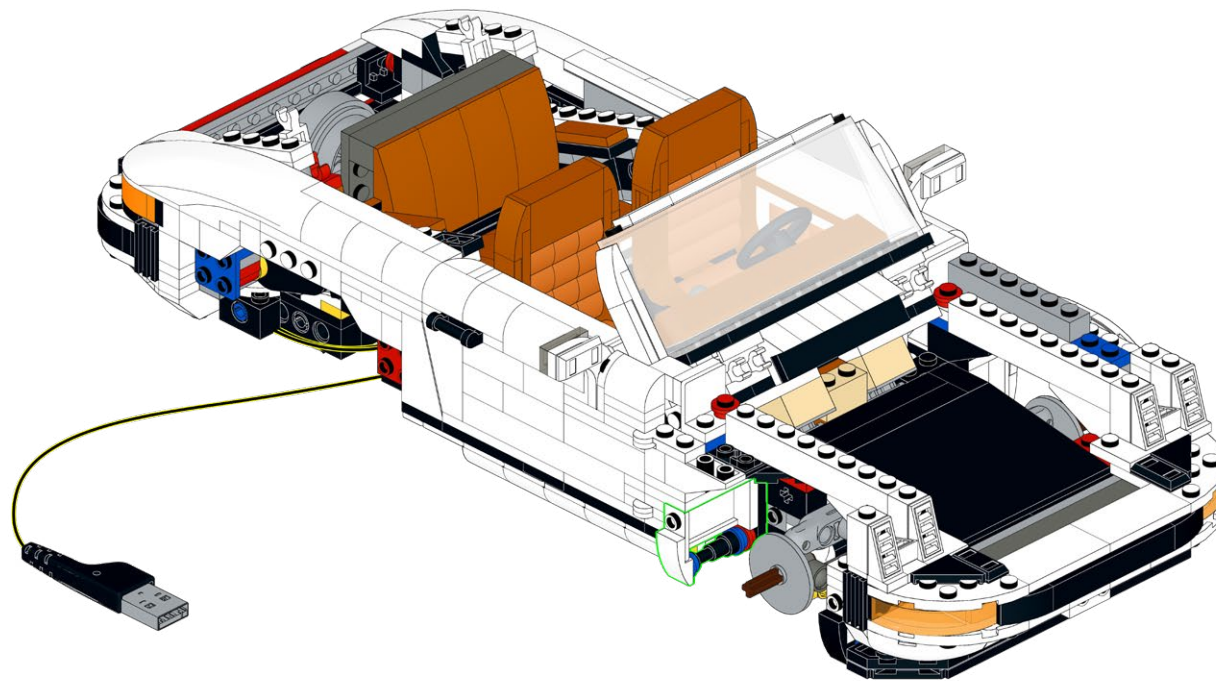

546

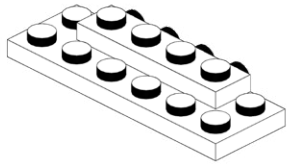
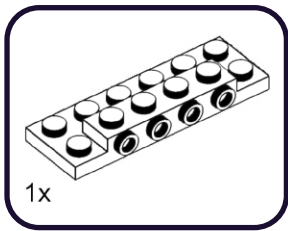

547

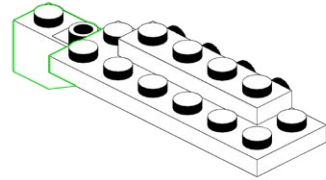
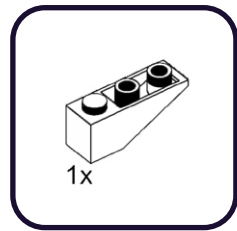

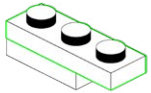
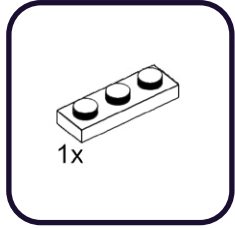
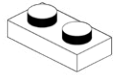
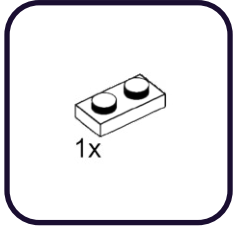

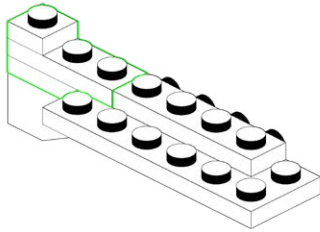
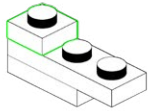
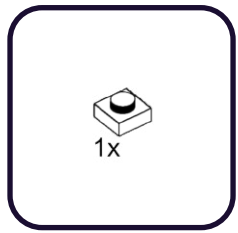

552

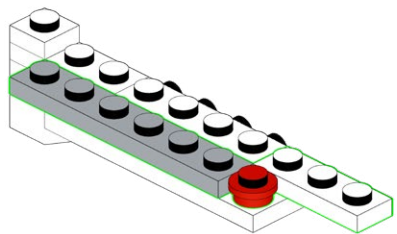
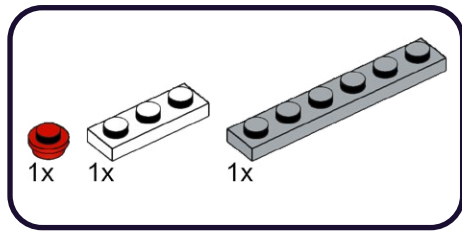

553

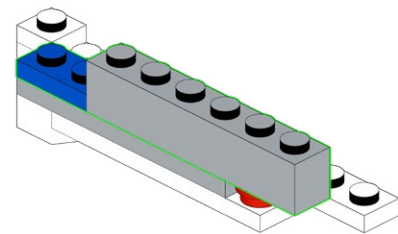
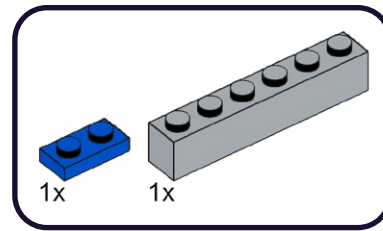

554

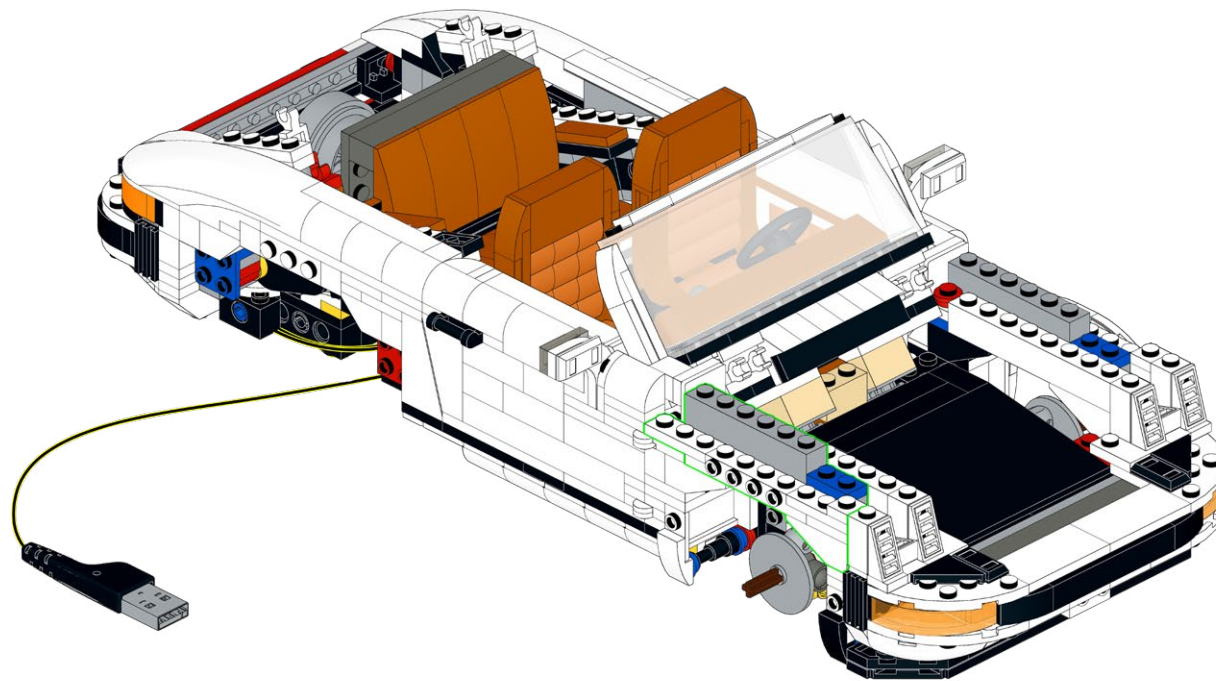

555

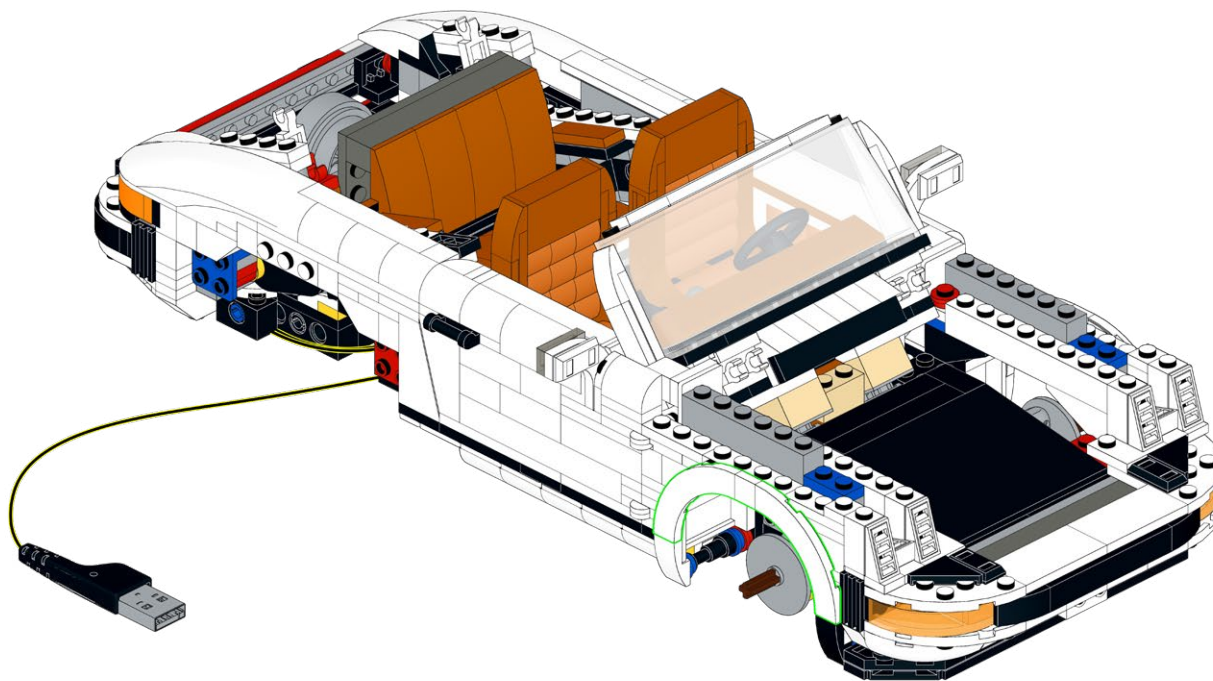
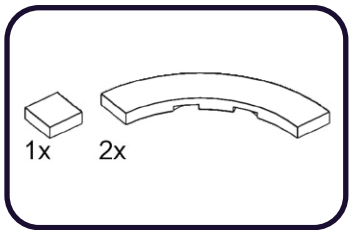

556



557

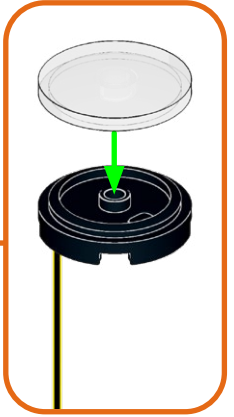
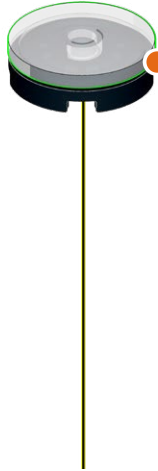

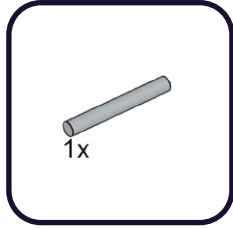

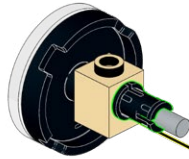
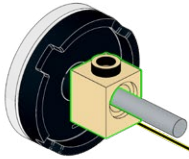
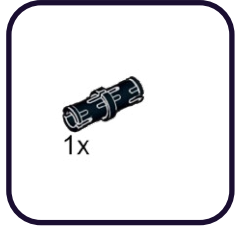
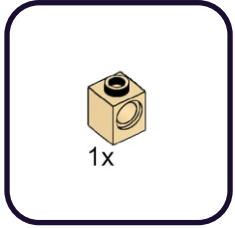

562

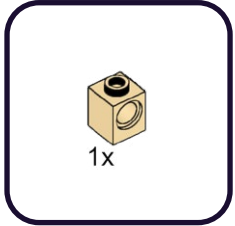

563

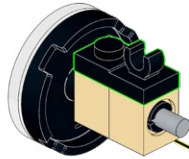
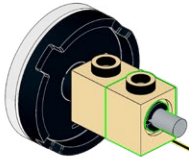
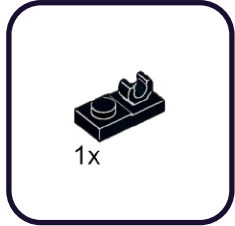

564

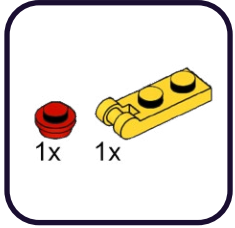

565

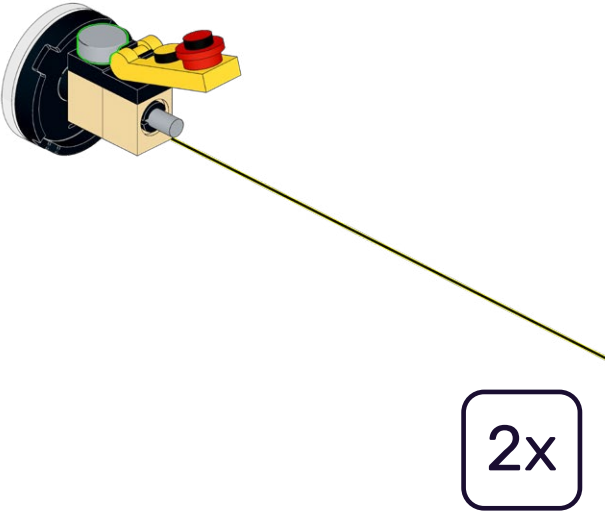
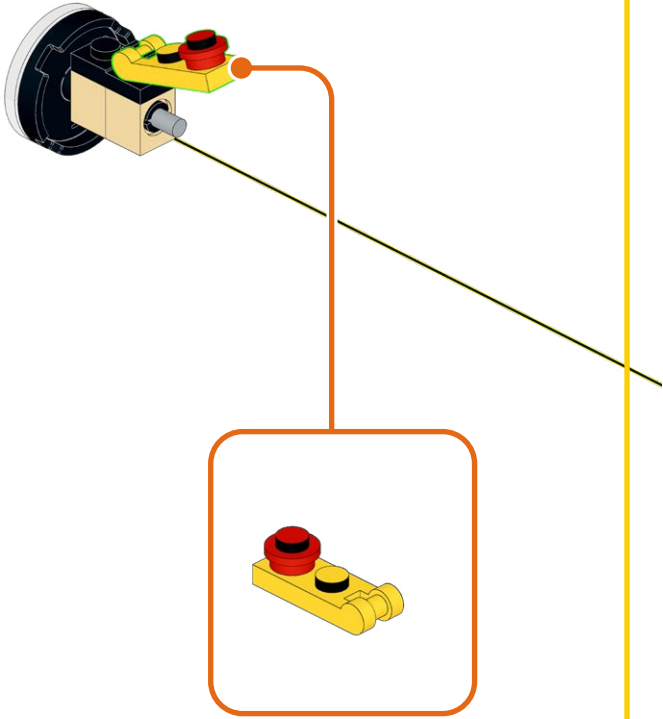
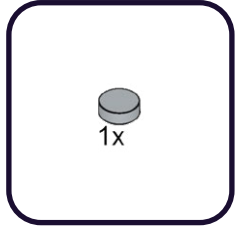

566

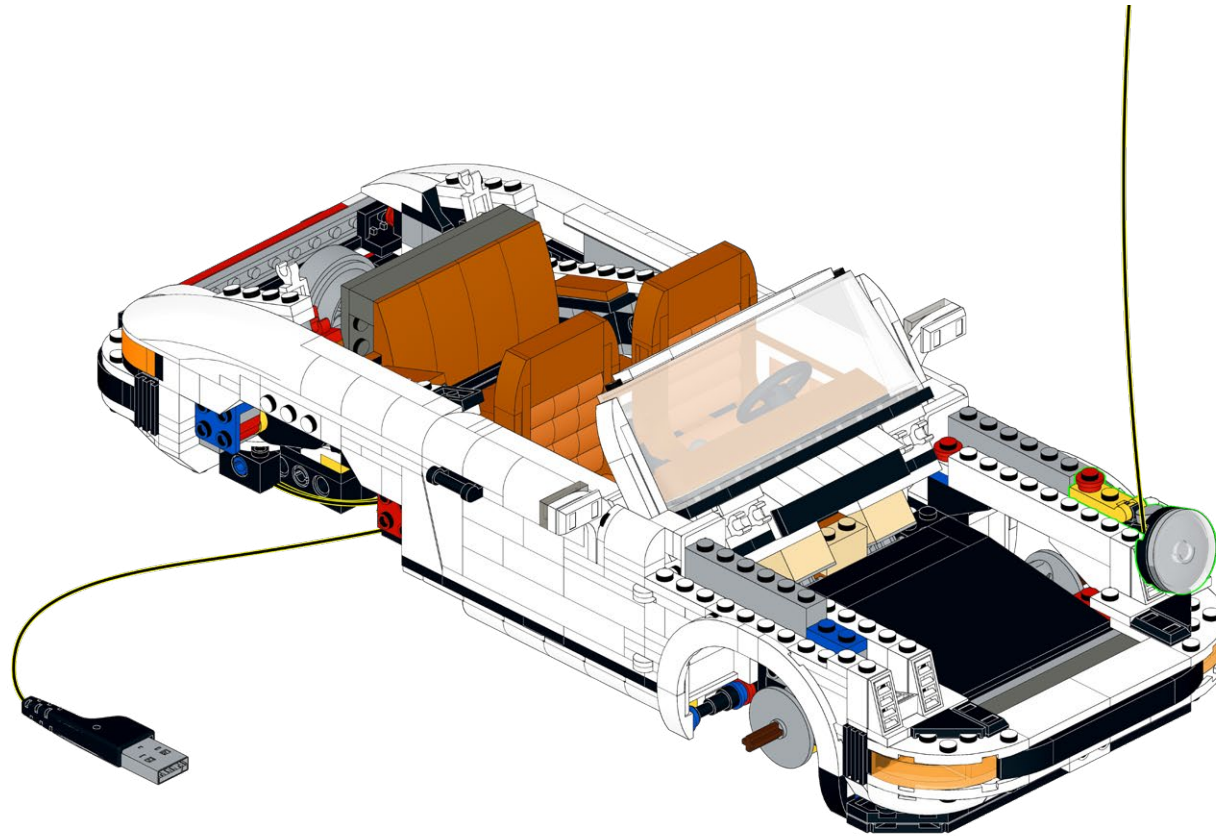

567

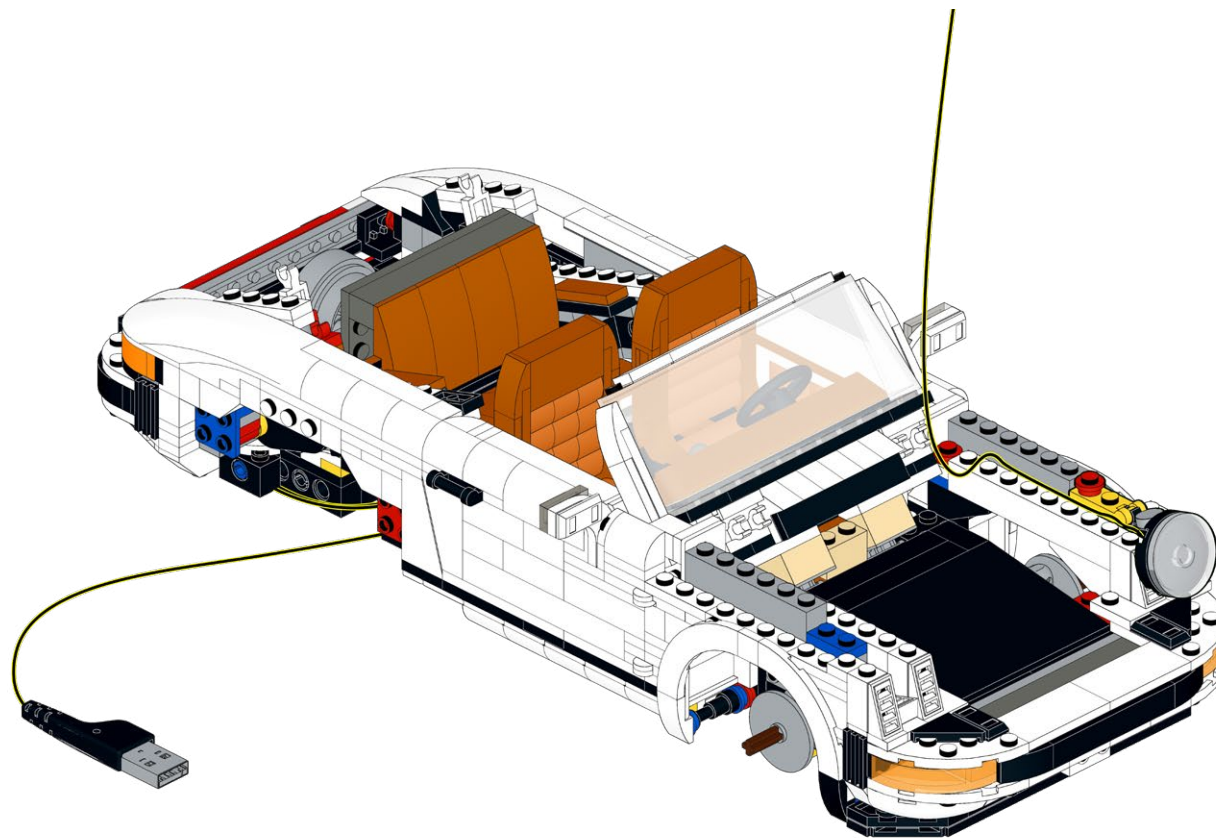

568

5x

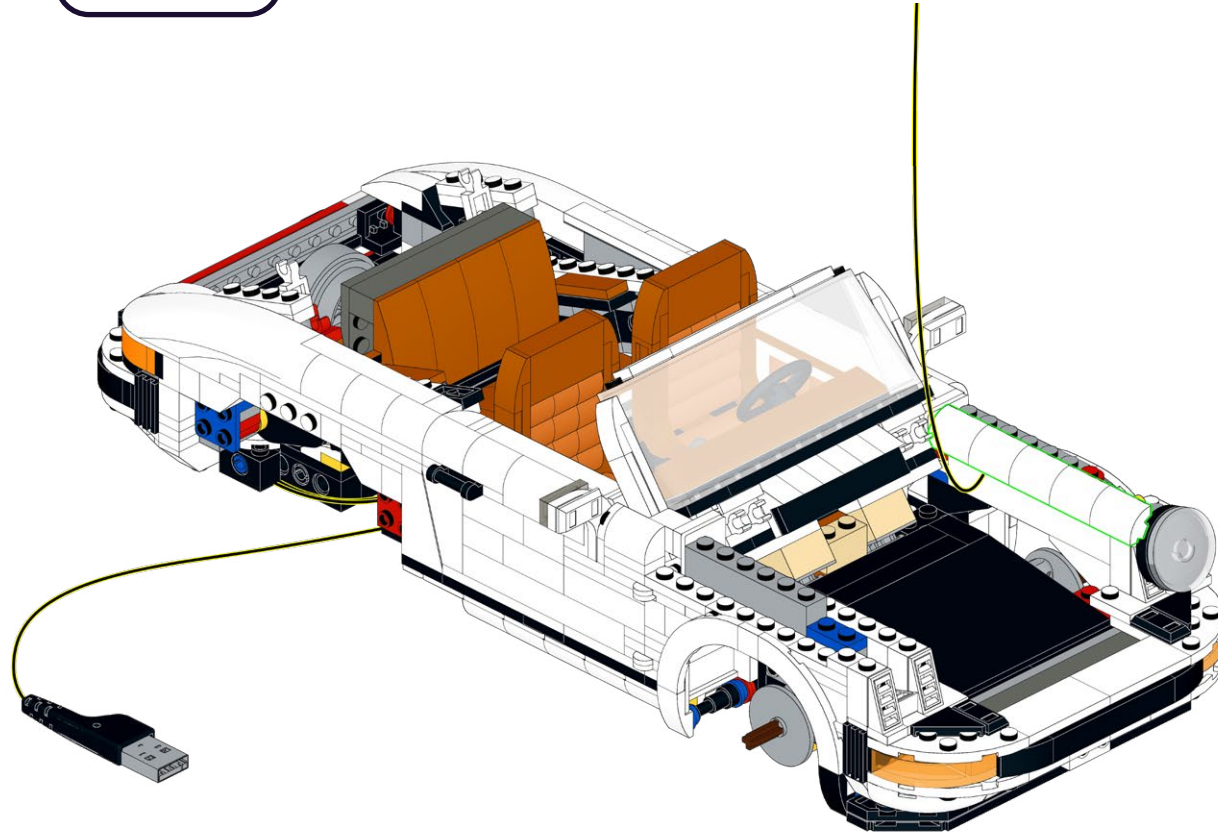

569

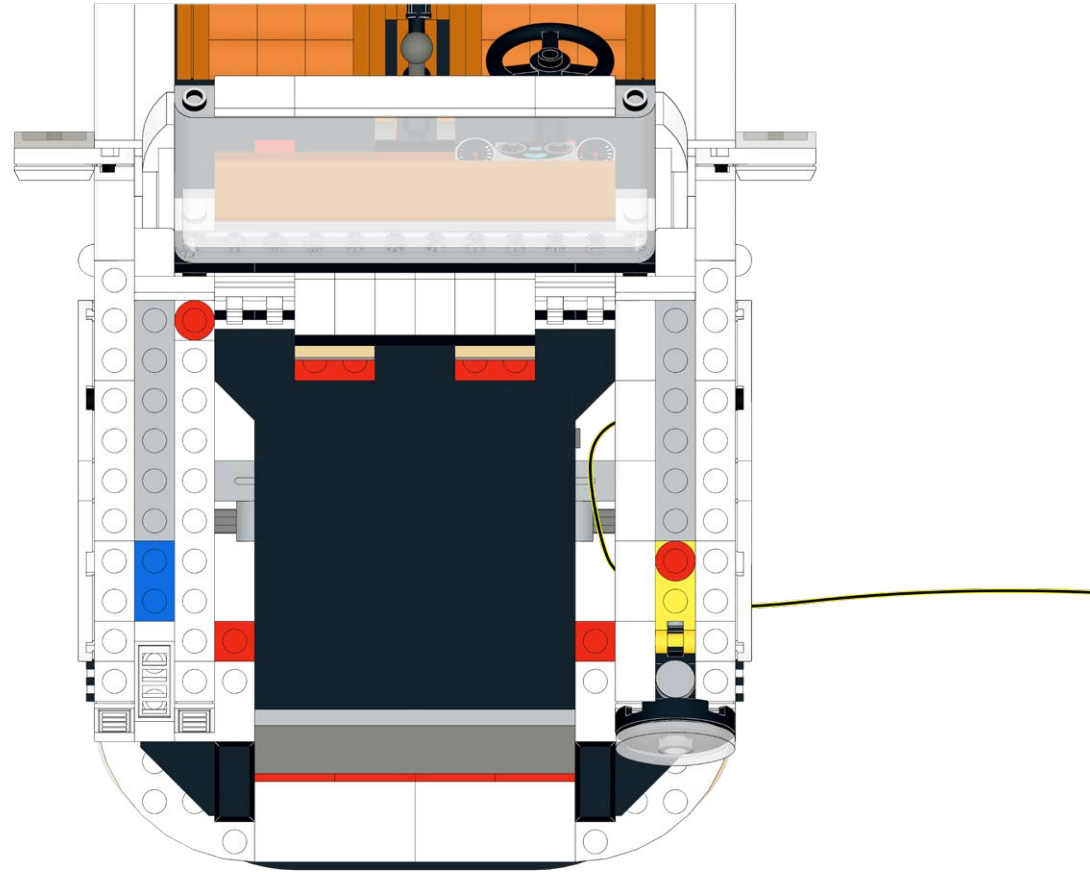

570

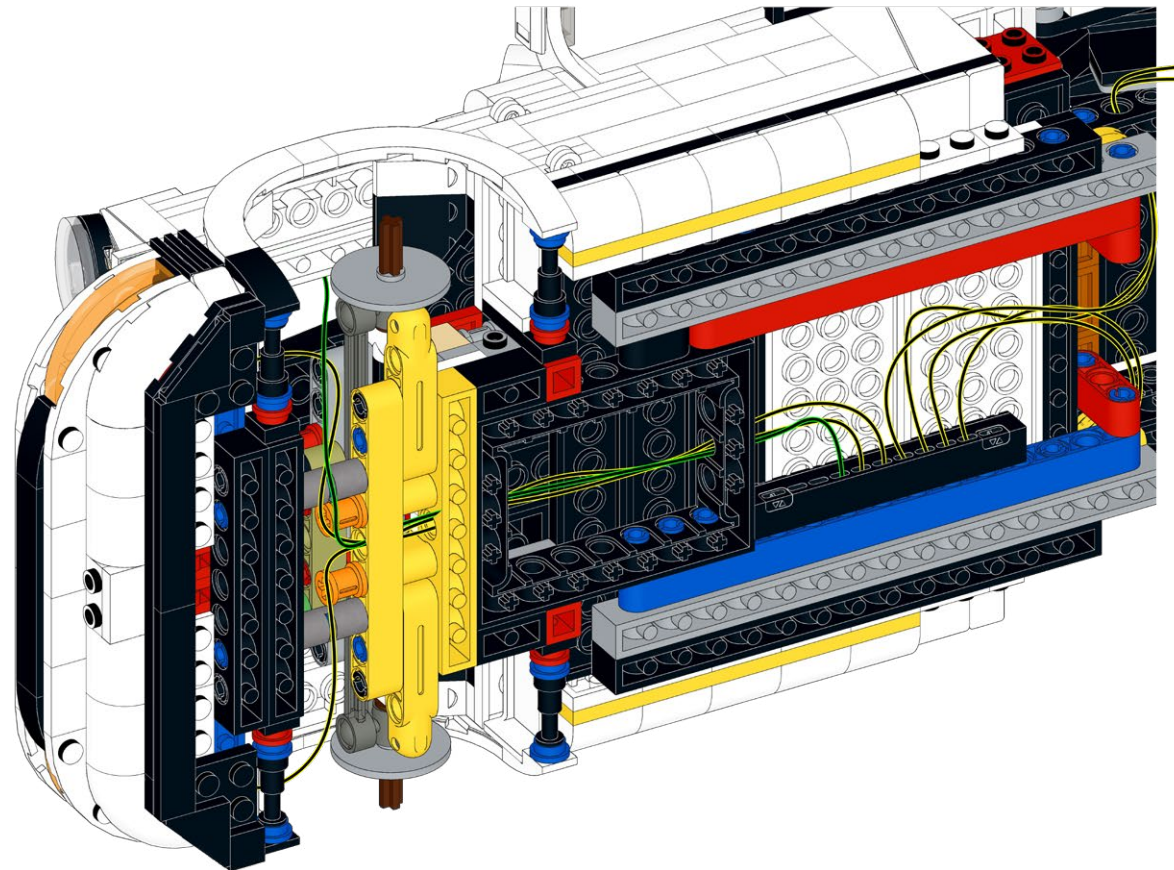

571

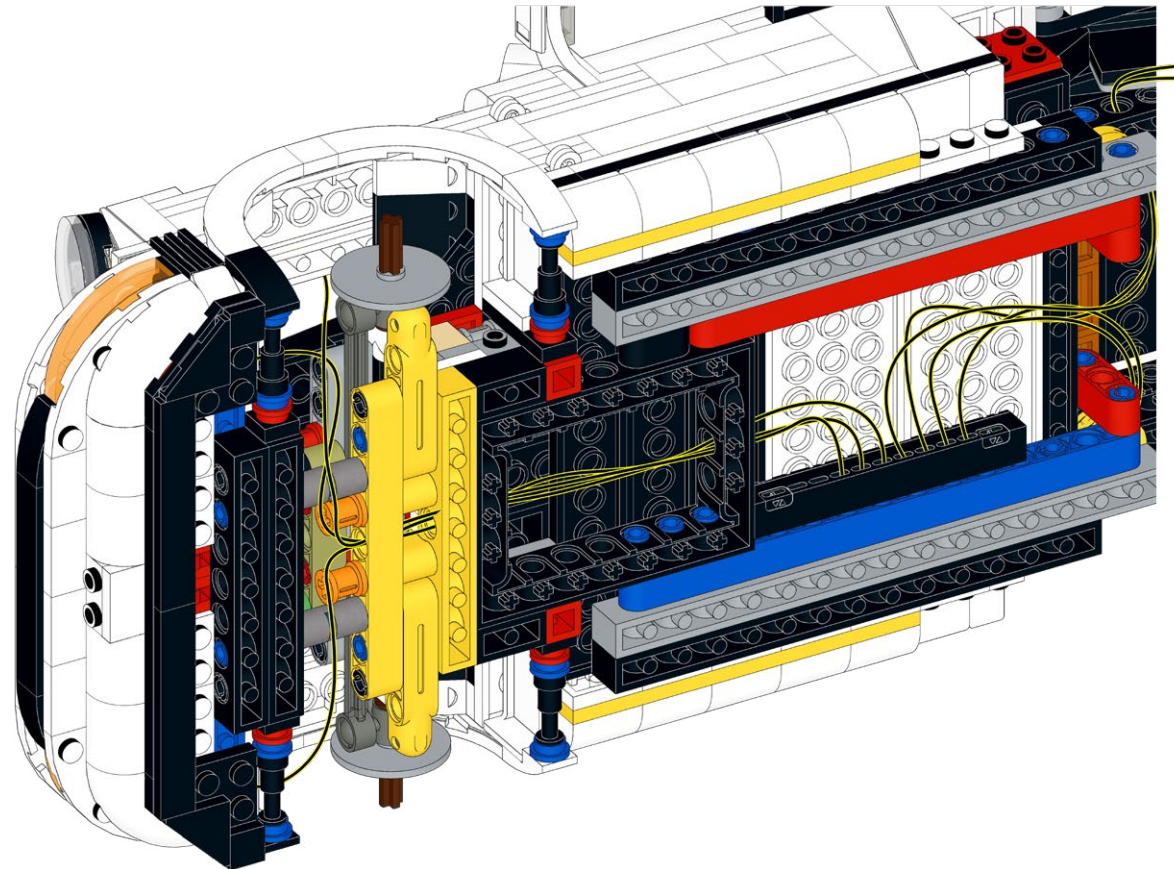

572

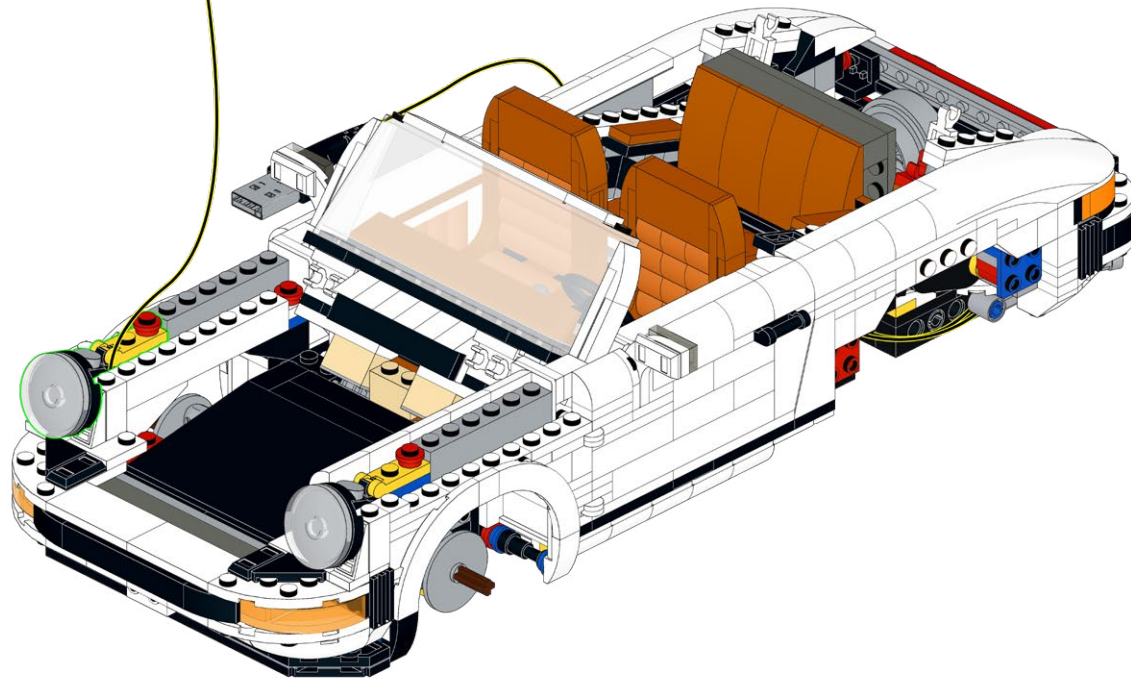

573

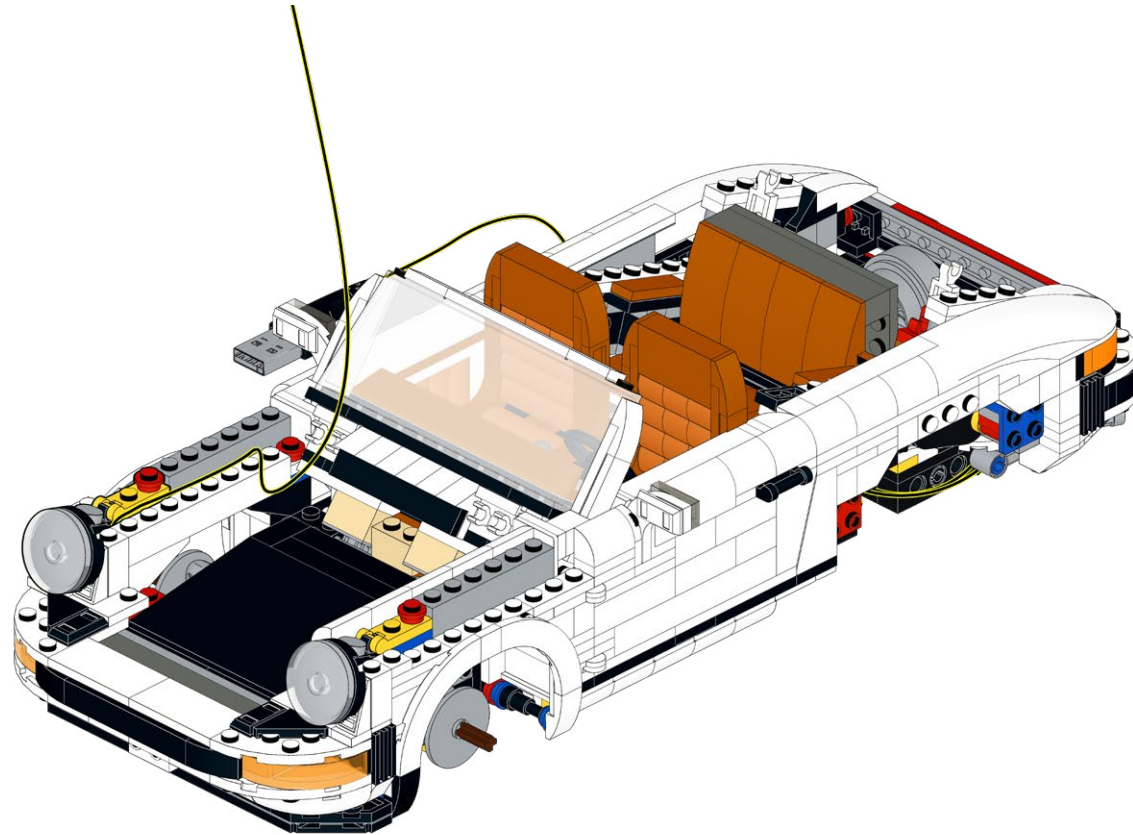

574

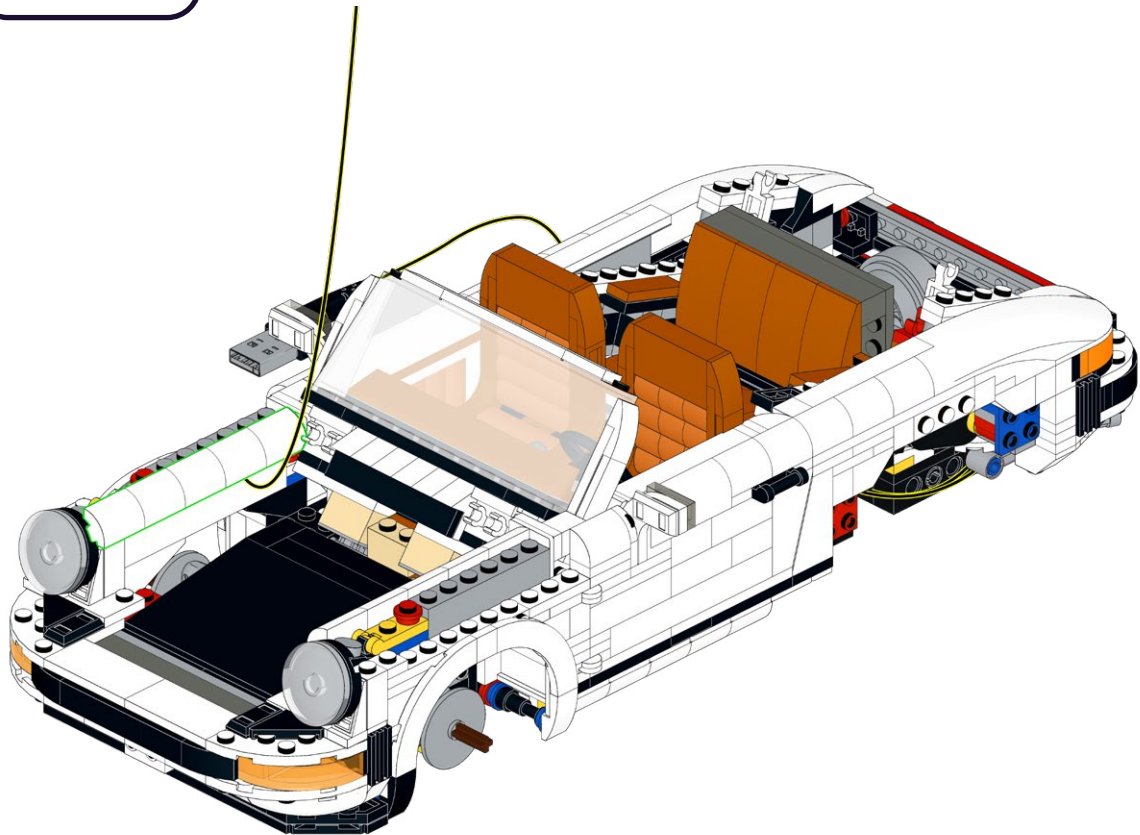
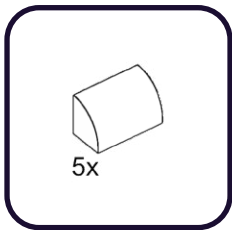

575

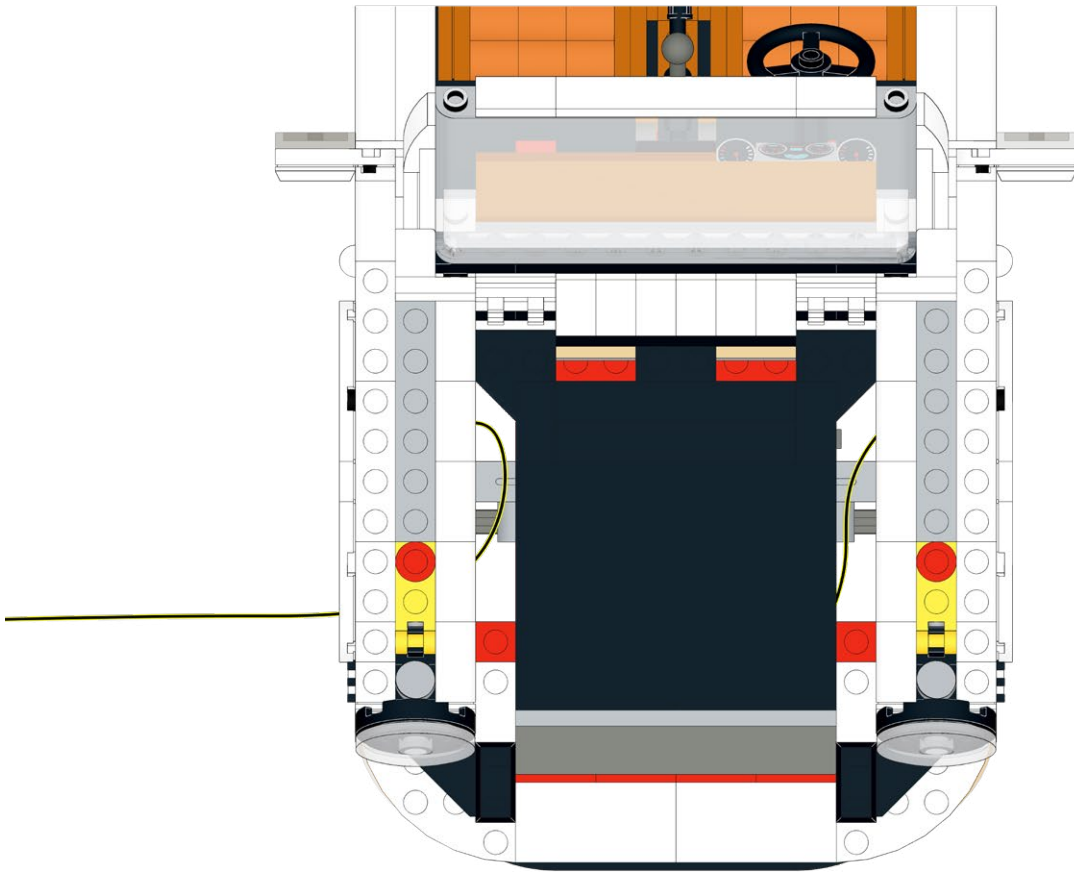

576

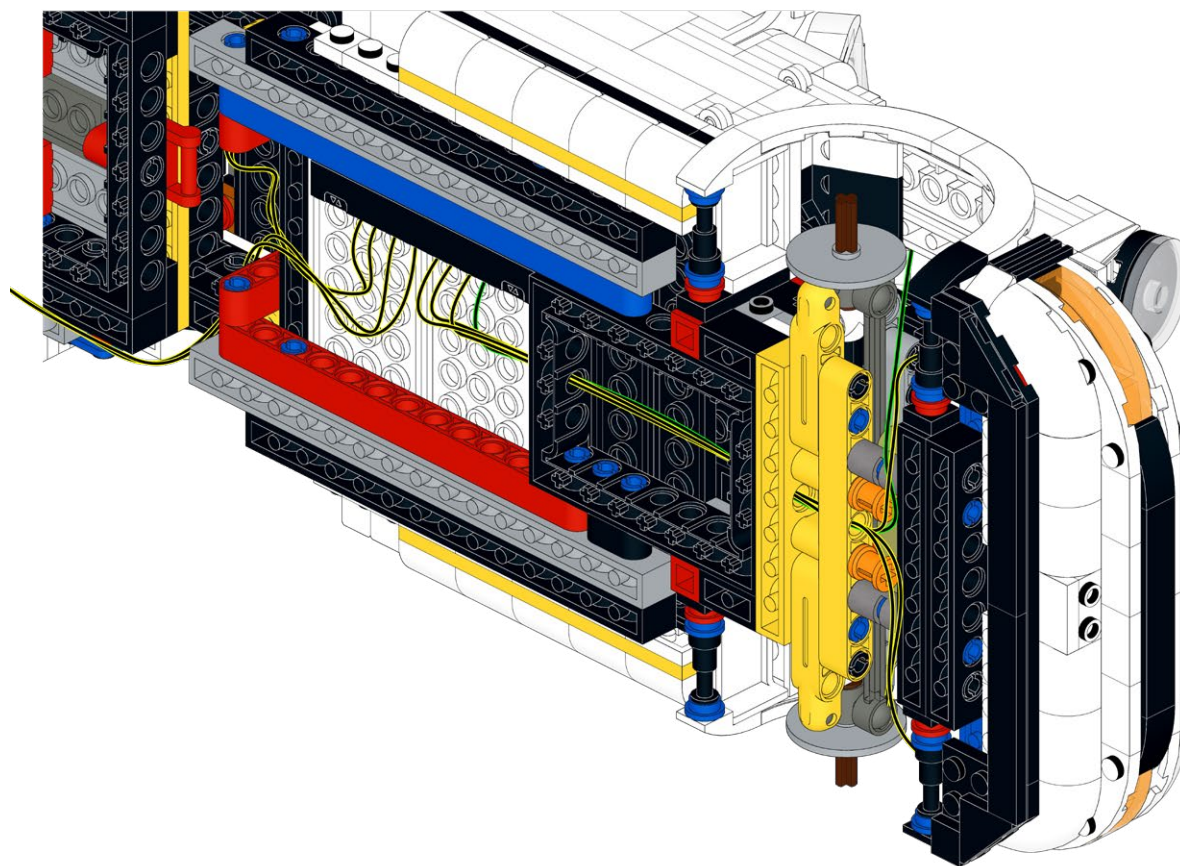

577

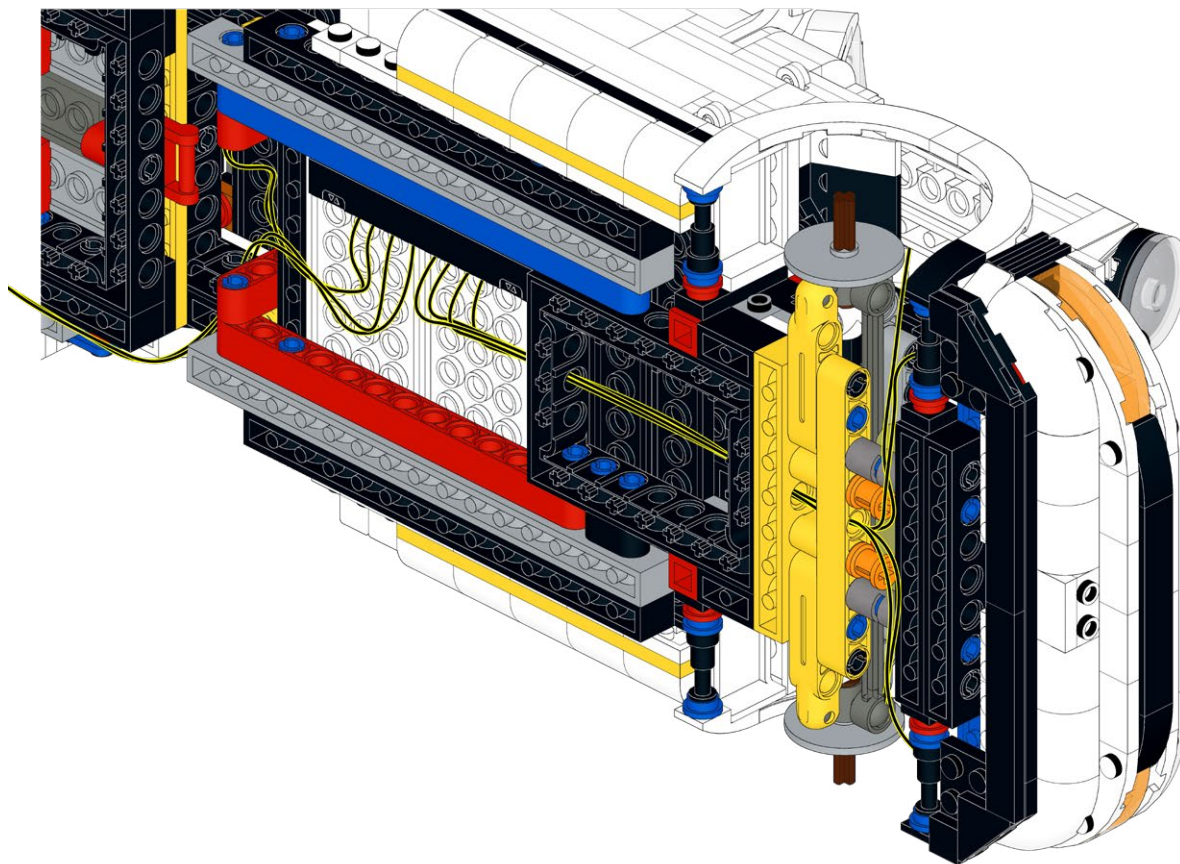

578

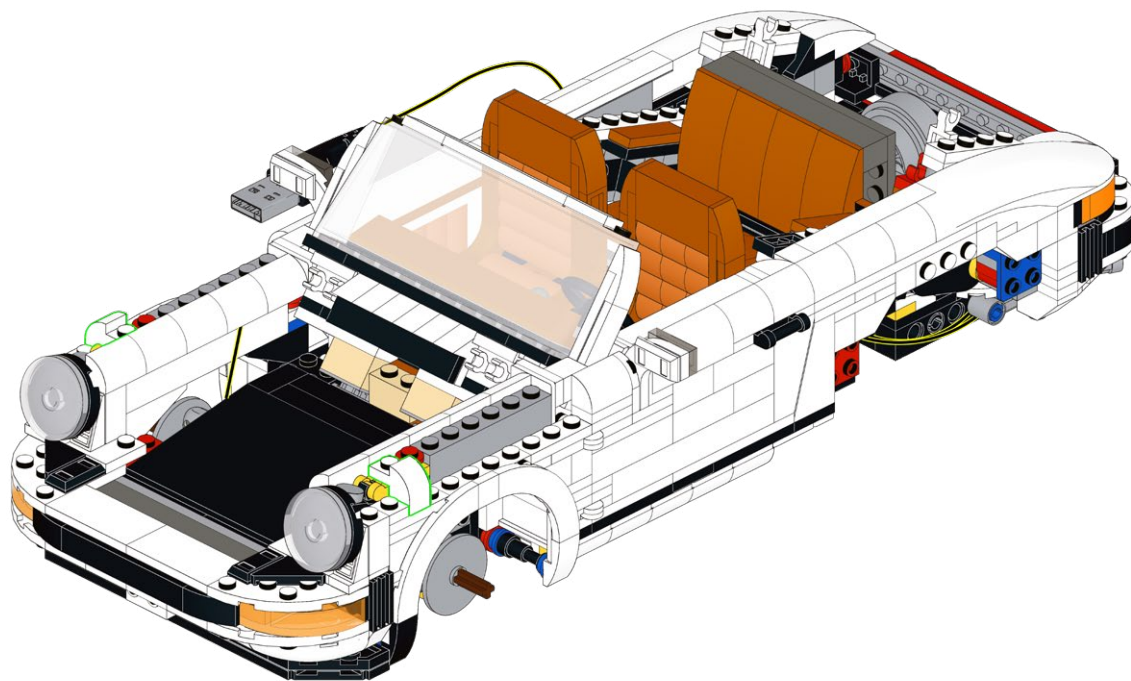
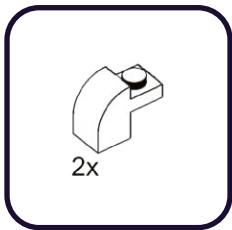

579

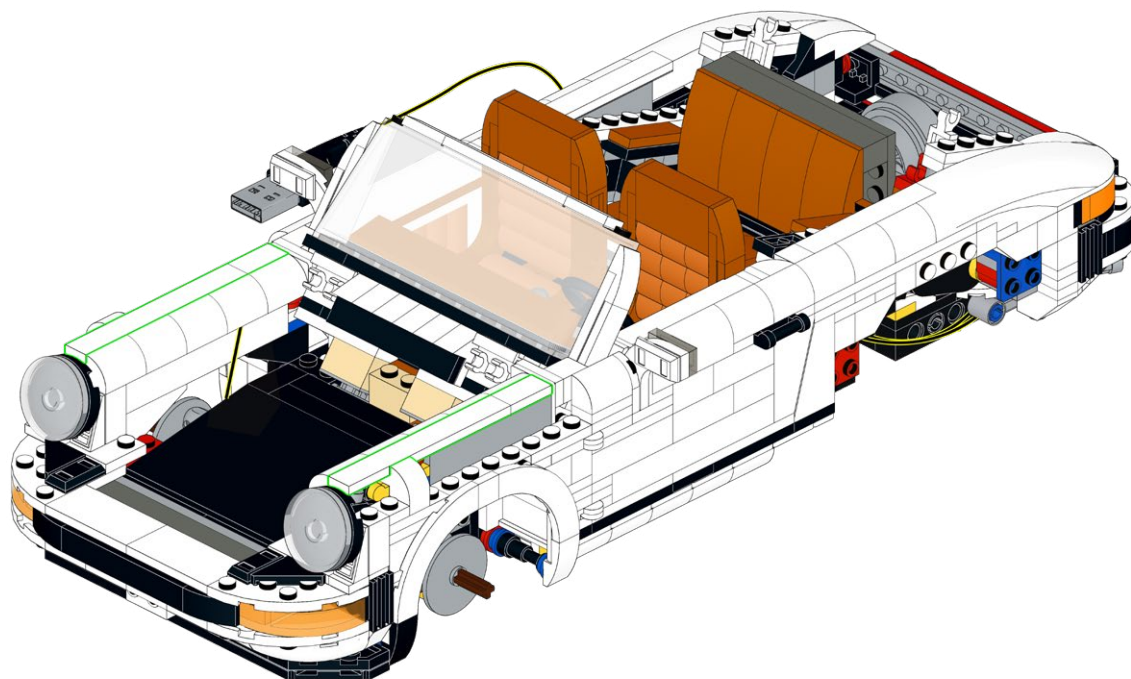
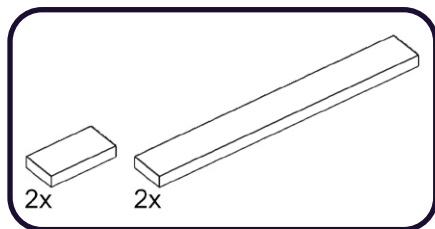

580

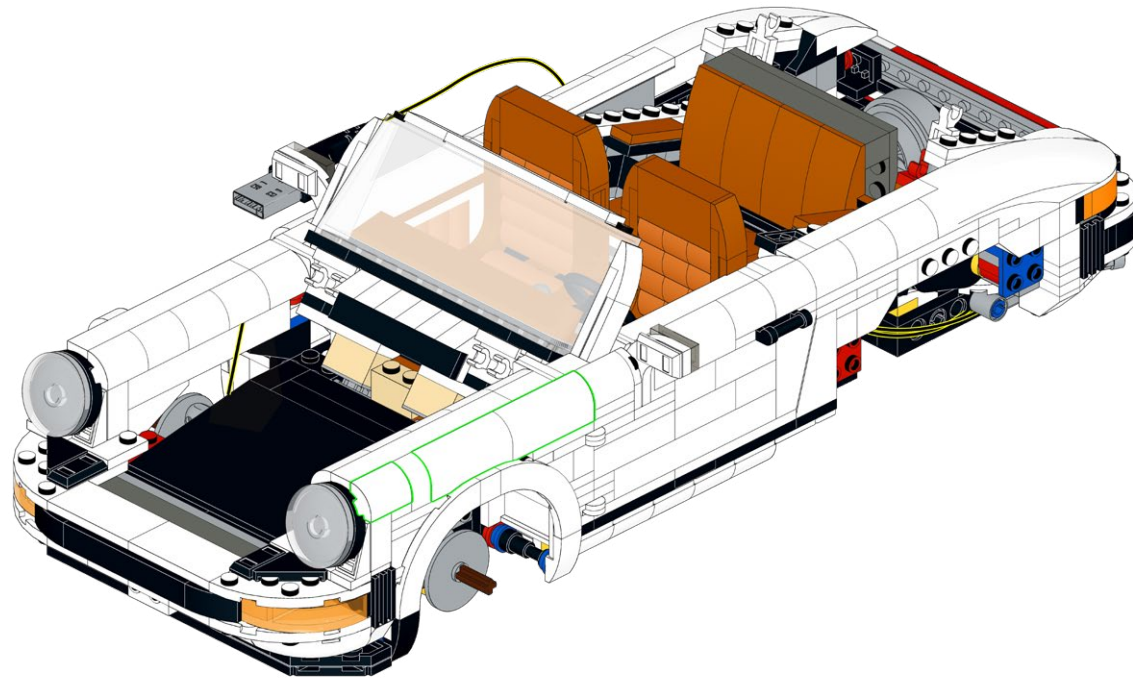
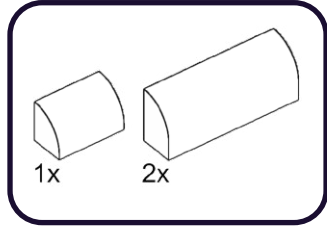

581

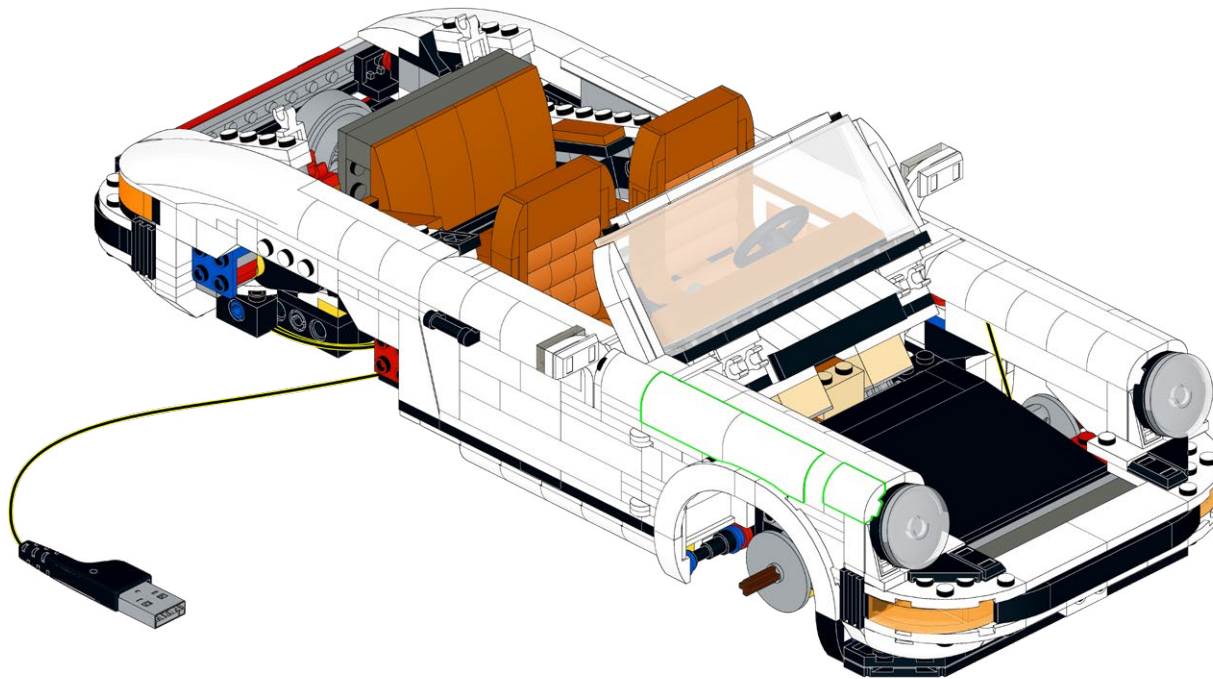
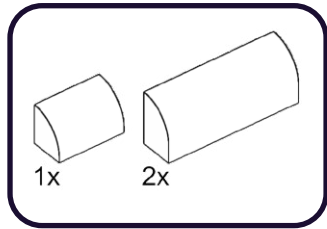

582

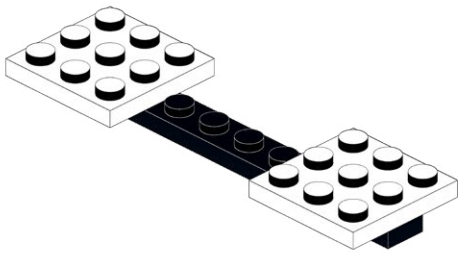
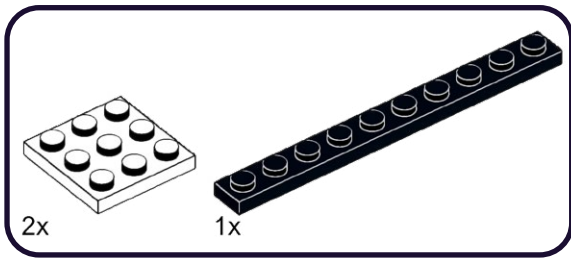

583

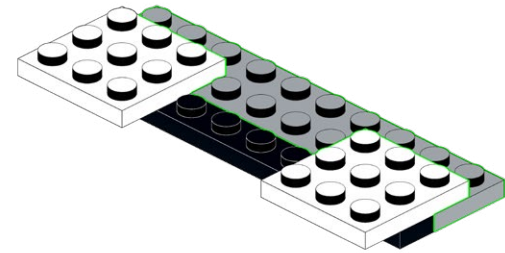
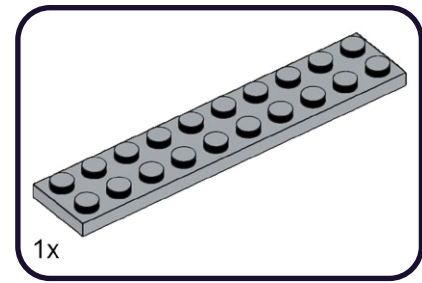

584

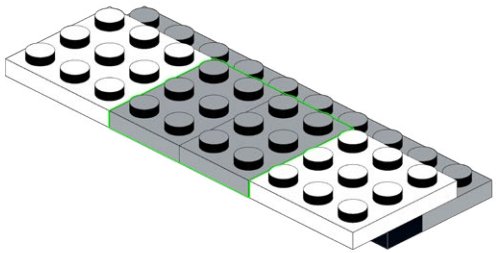
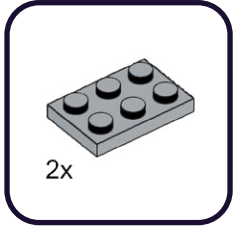

585

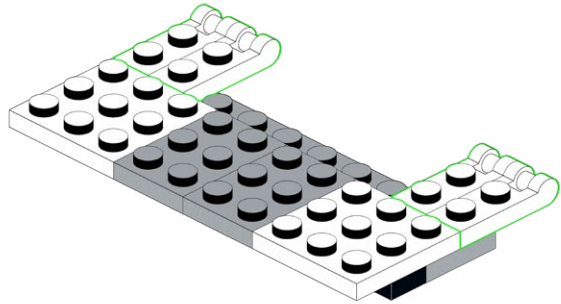
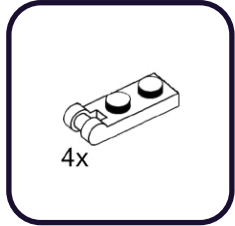

586

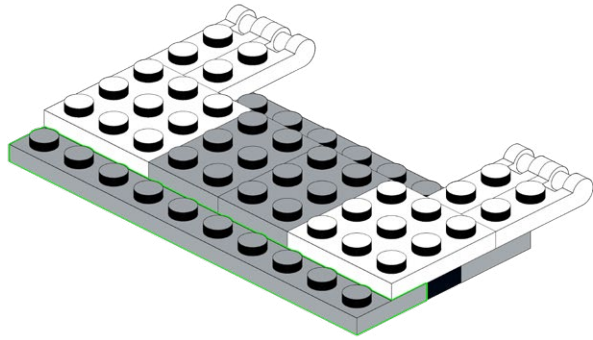
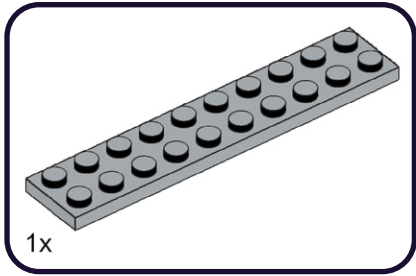

587

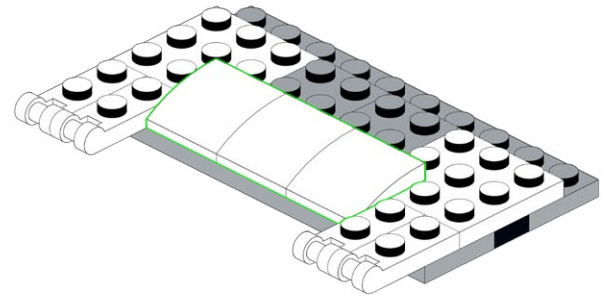
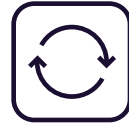
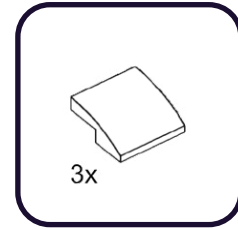

588

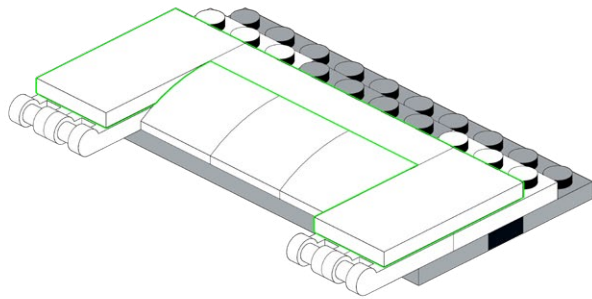
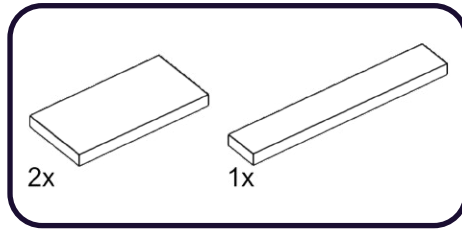

589

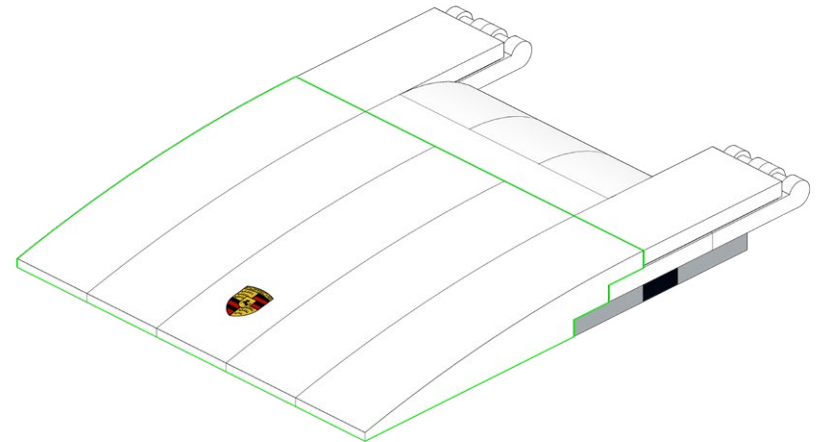
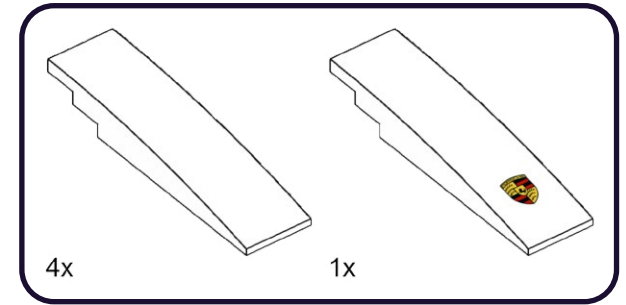

590

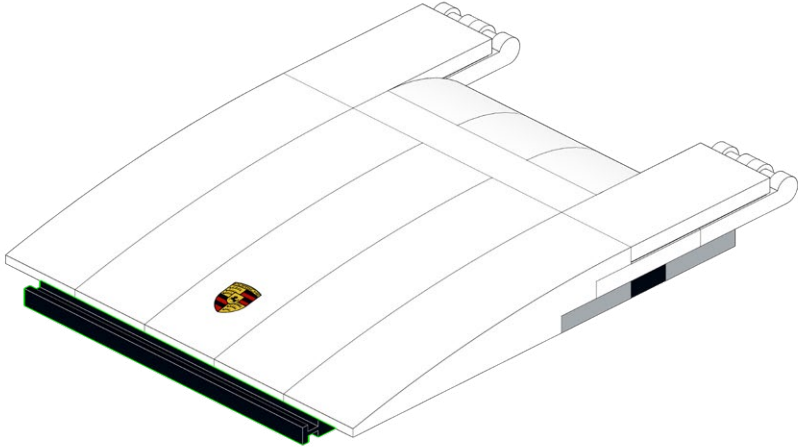
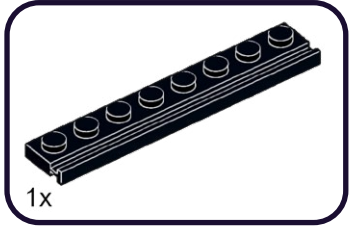

591

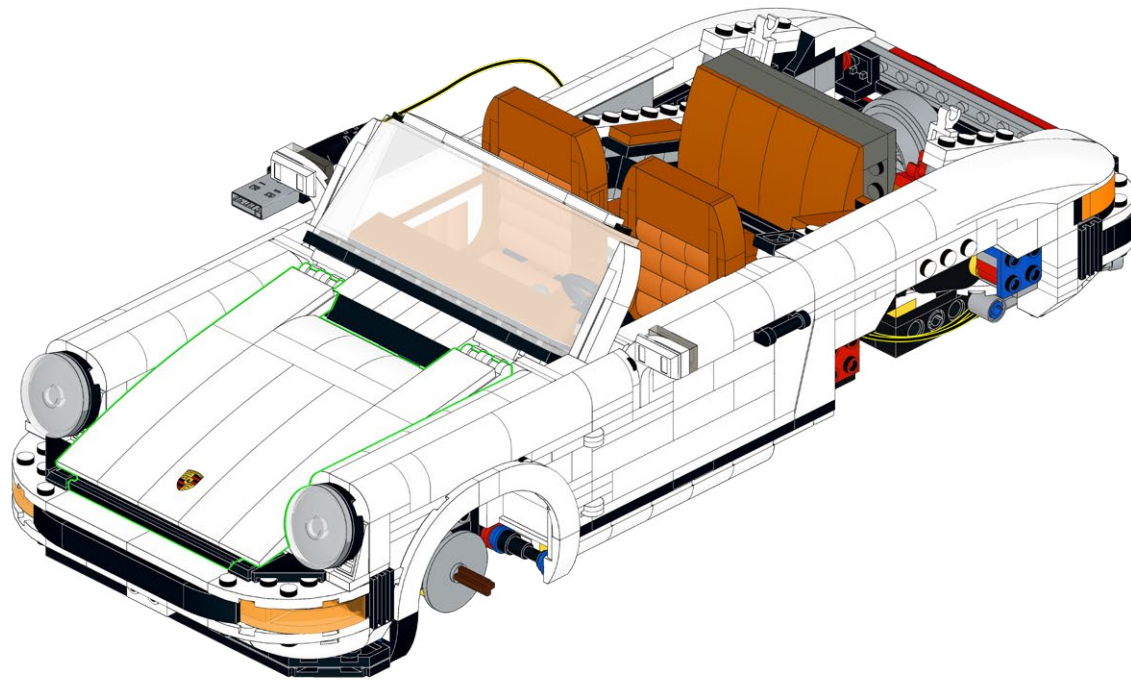

592

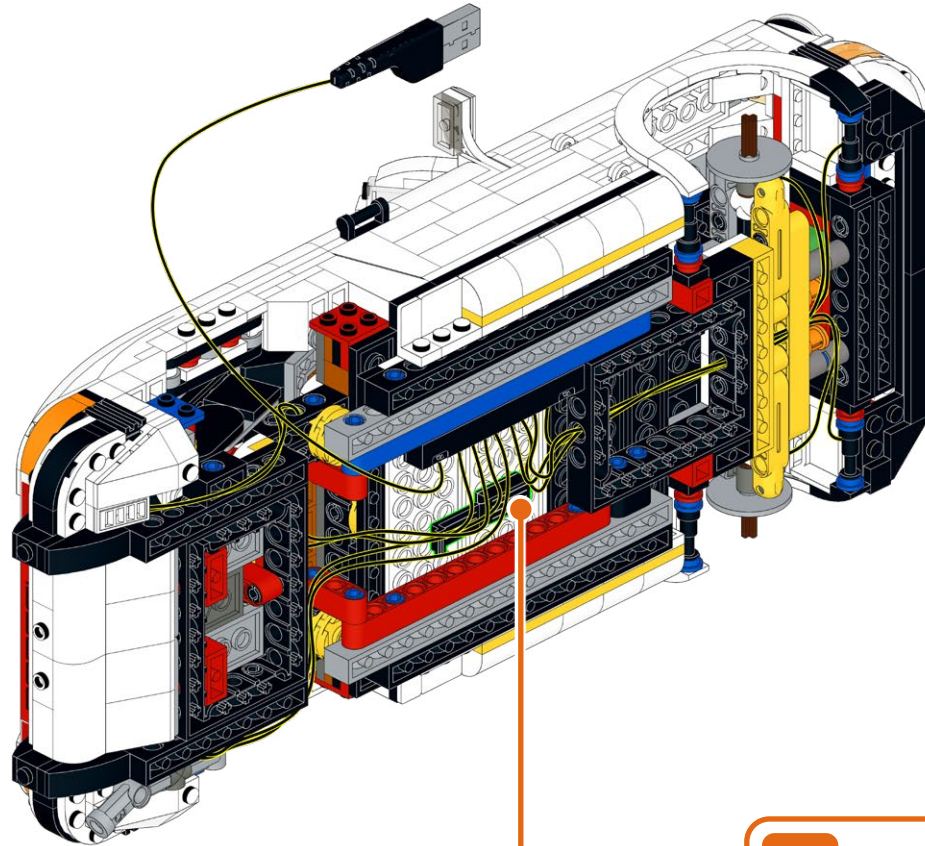
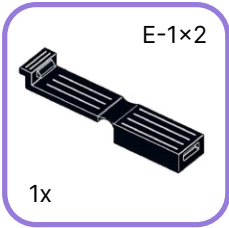
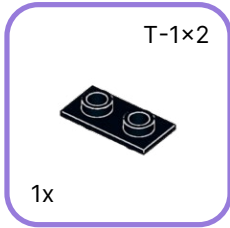

593

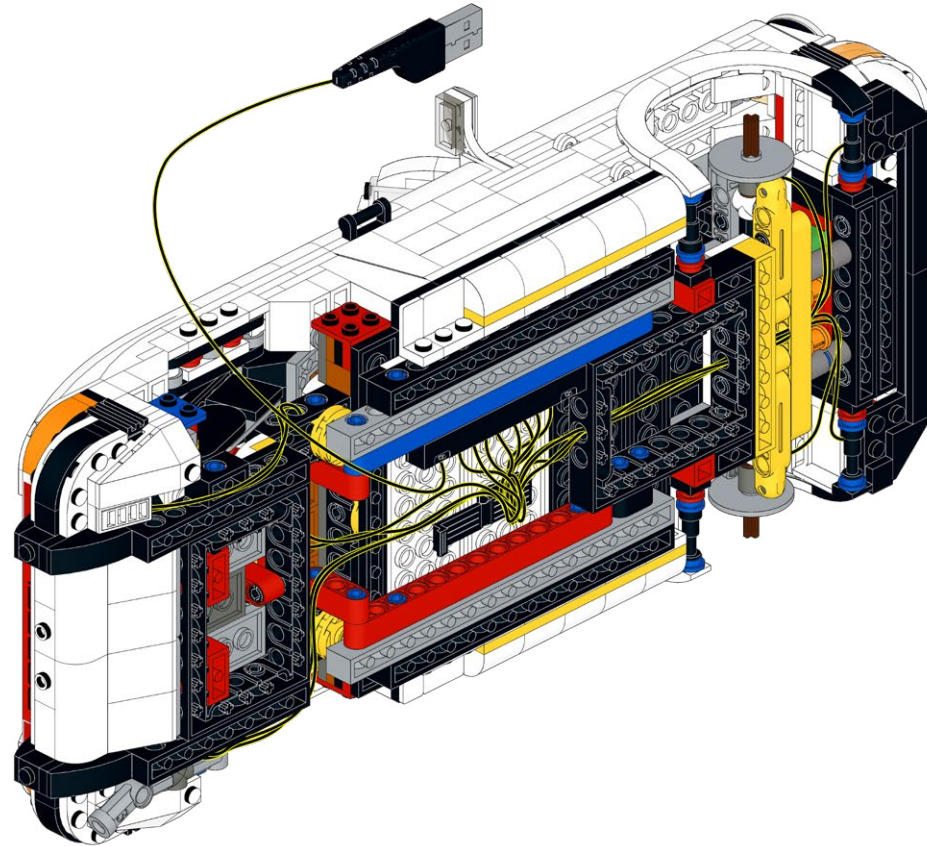

594

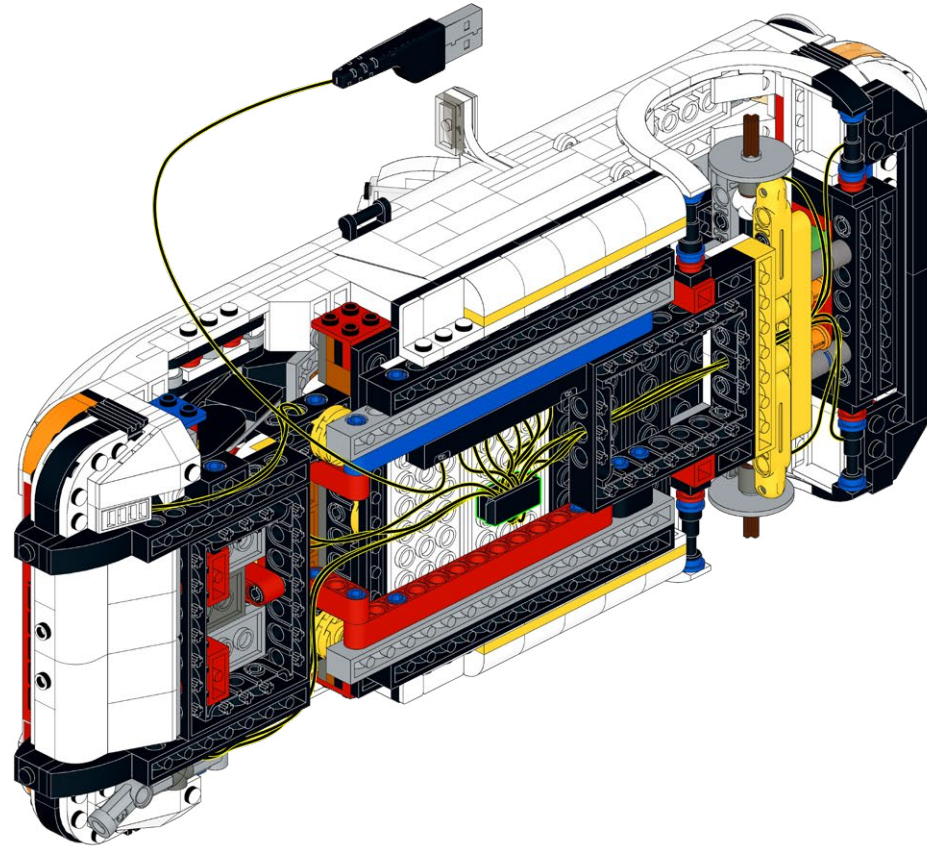

595

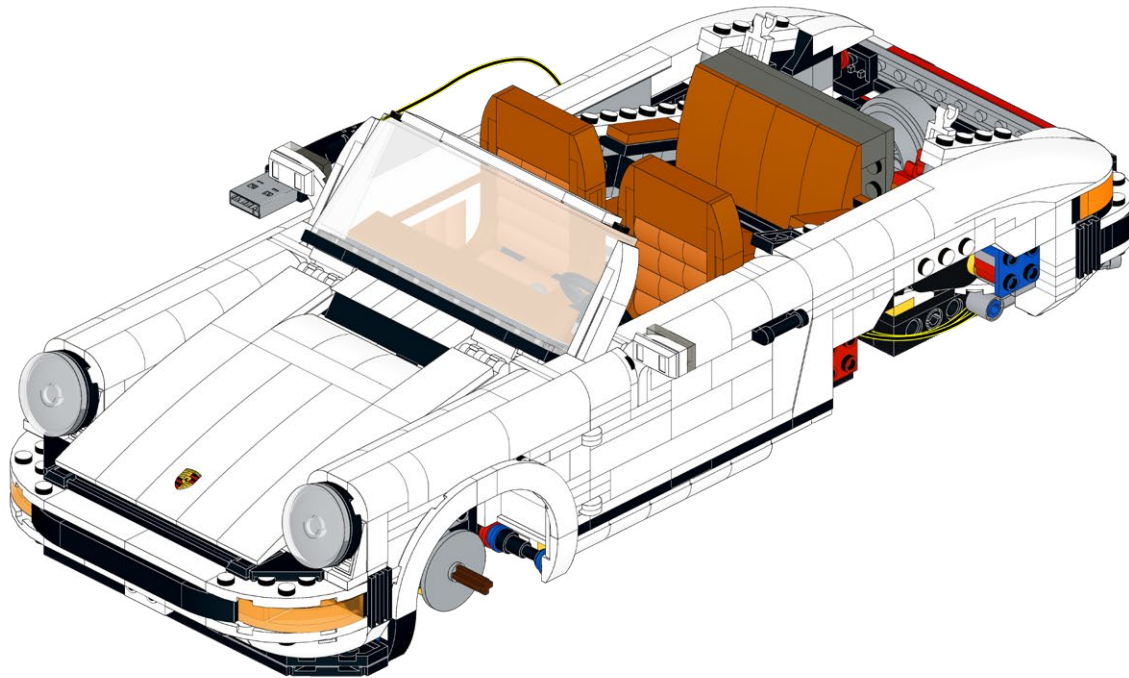



HOLD UP!

You might notice some bags aren't in order, as well as left over pieces, but that's ok! We're changing the way you build LEGO!

ATTENDEZ!

Vous remarquerez peut-être que certains sacs, ainsi que certaines pièces, ne sont pas dans le bon ordre. Mais pas de panique! Nous changeons simplement la façon avec laquelle vous construisez vos LEGO!

ASPETTA!

Potresti notare che alcuni sacchetti non sono in ordine, così come i pezzi avanzati, ma va bene così! Stiamo cambiando il modo in cui costruisci i LEGO!

HALT!

Sie werden möglicherweise bemerken, dass einige tüten durcheinander sind und teile übrig bleiben, aber das ist in Ordnung! Wir ändern die art und weise, wie Sie LEGO bauen!

¡ESPERA!

Es posible que notes que algunas bolsas están fuera de servicio, así como piezas sobrantes, ¡pero está bien! ¡Estamos cambiando la forma en que construyes LEGO!

暫停!

你可能会注意到一些袋子顺序错乱, 以及一些剩余的部件, 但没关系! 我们正在改变你搭建乐高的方式!

Choose your favourite

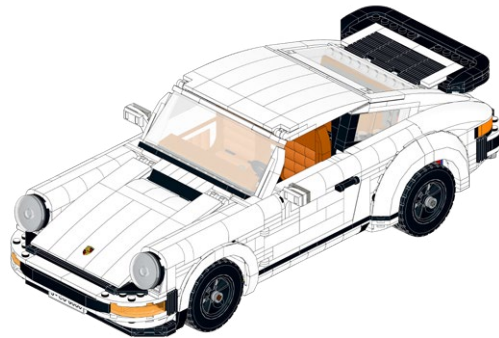

Page 395

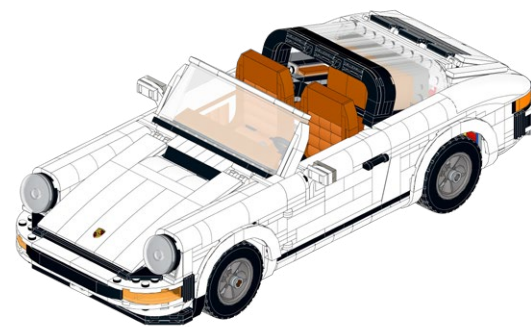

Page 486

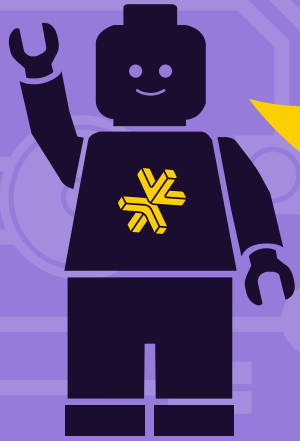
**HOLD UP!**

You might notice some bags aren't in order, as well as left over pieces, but that's ok! We're changing the way you build LEGO!

ATTENDEZ!

Vous remarquerez peut-être que certains sacs, ainsi que certaines pièces, ne sont pas dans le bon ordre. Mais pas de panique! Nous changeons simplement la façon avec laquelle vous construisez vos LEGO!

ASPETTA!

Potresti notare che alcuni sacchetti non sono in ordine, così come i pezzi avanzati, ma va bene così! Stiamo cambiando il modo in cui costruisci i LEGO!

HALT!

Sie werden möglicherweise bemerken, dass einige tüten durcheinander sind und teile übrig bleiben, aber das ist in Ordnung! Wir ändern die art und weise, wie Sie LEGO bauen!

¡ESPERA!

Es posible que notes que algunas bolsas están fuera de servicio, así como piezas sobrantes, ¡pero está bien! ¡Estamos cambiando la forma en que construyes LEGO!

暫停!

你可能会注意到一些袋子顺序错乱, 以及一些剩余的部件, 但没关系! 我们正在改变你搭建乐高的方式!

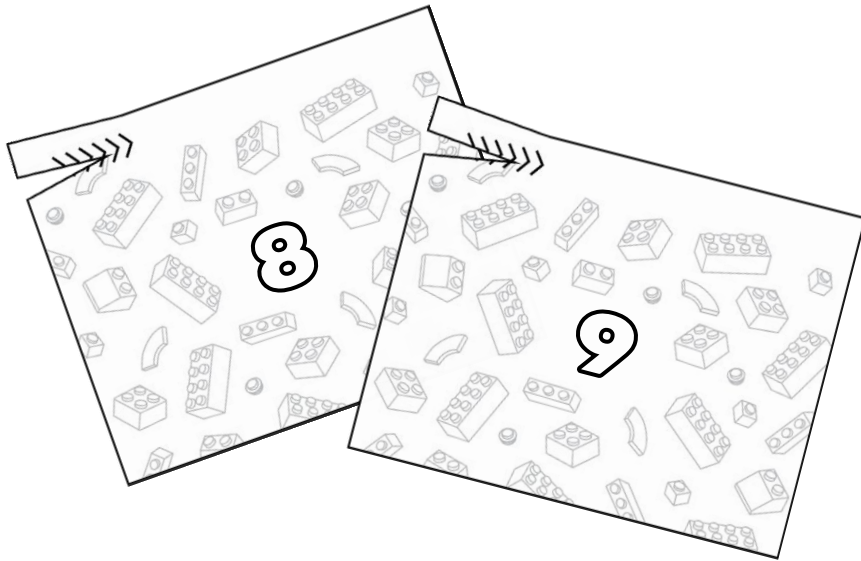
Open LEGO® Bags 8 & 9

596

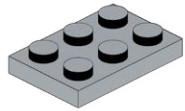
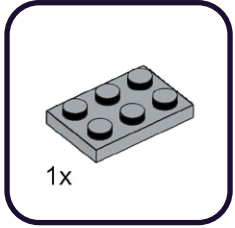

597

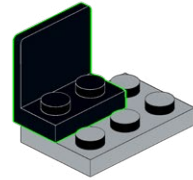
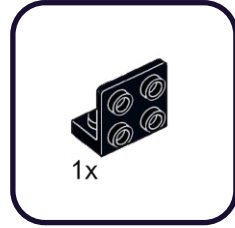

598

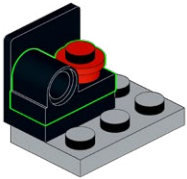

599

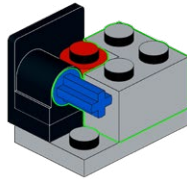
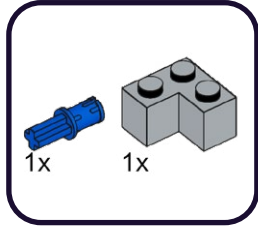

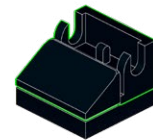
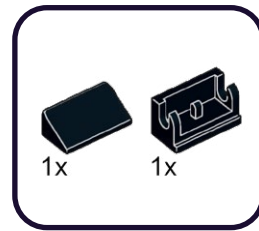
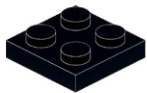
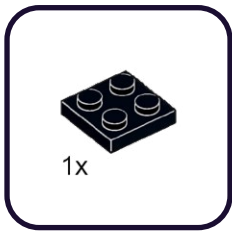

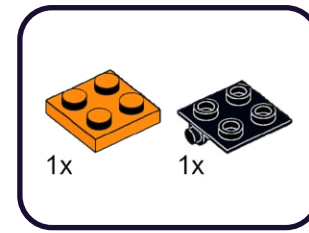
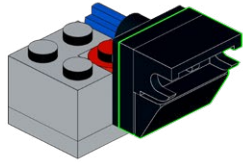

604

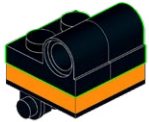
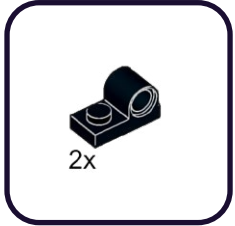

605

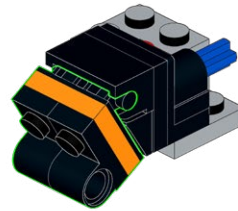
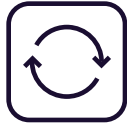

606

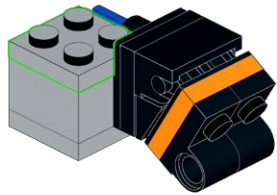
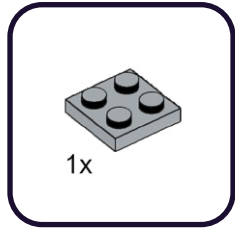

607

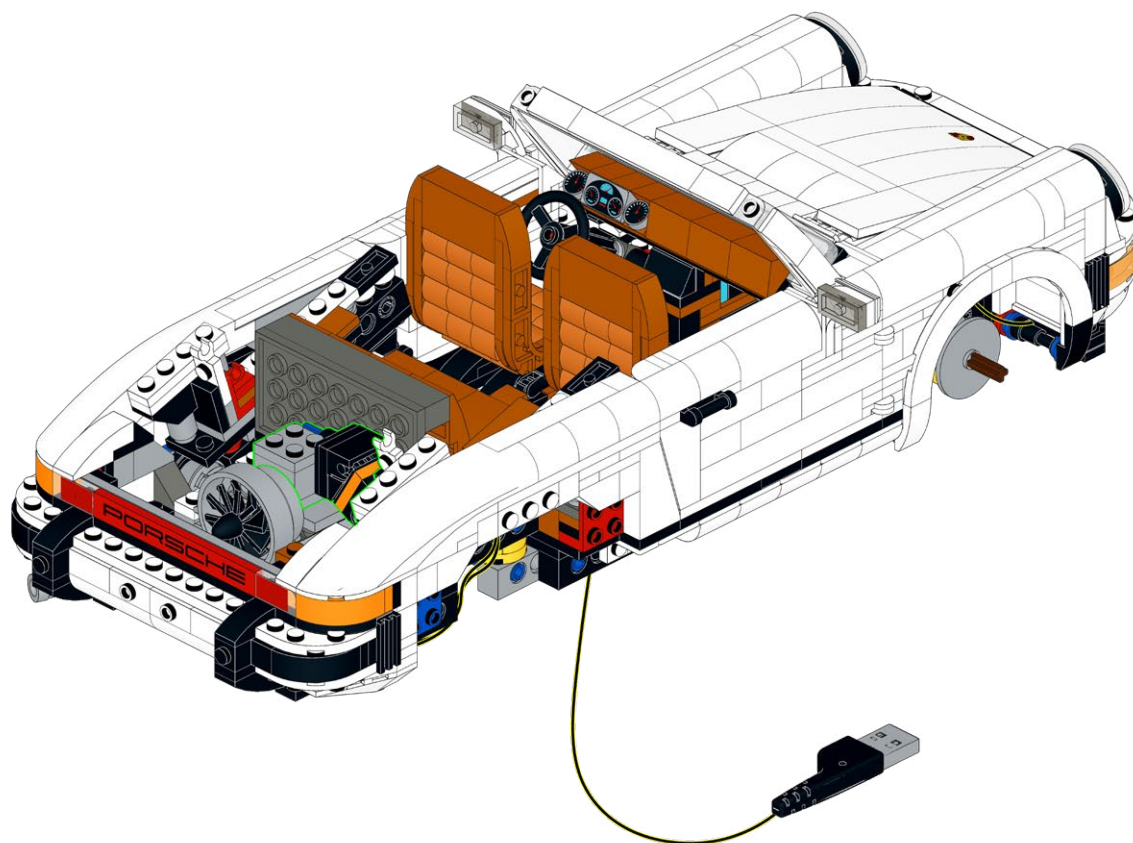

608

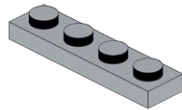
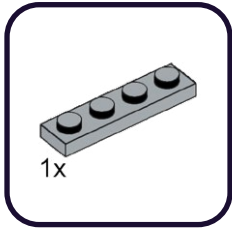

609

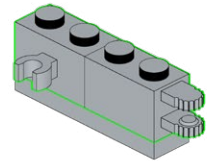
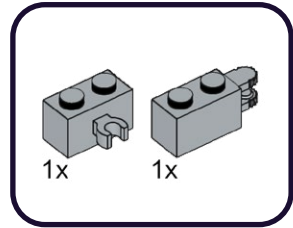

610

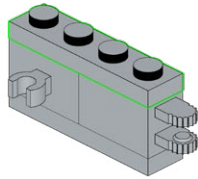
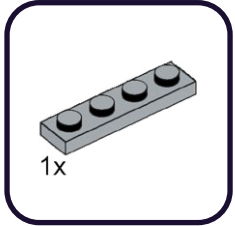

611

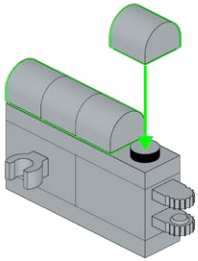
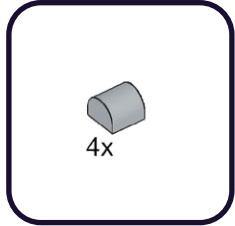

612



613

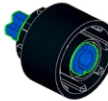
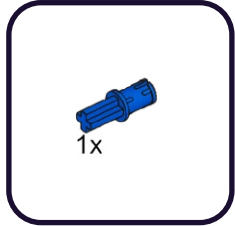

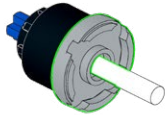
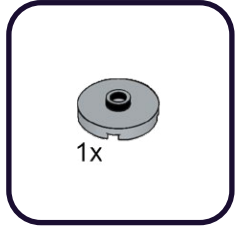
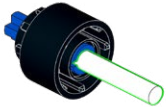
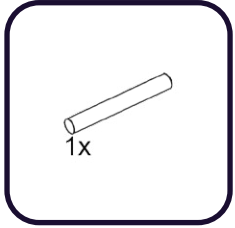

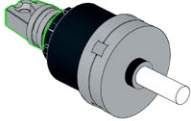
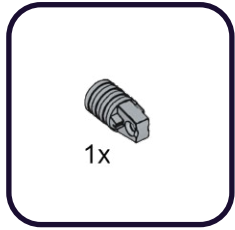
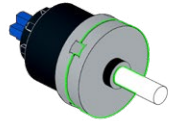
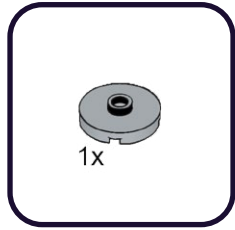

618

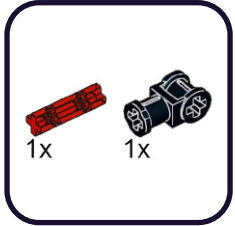

619



620

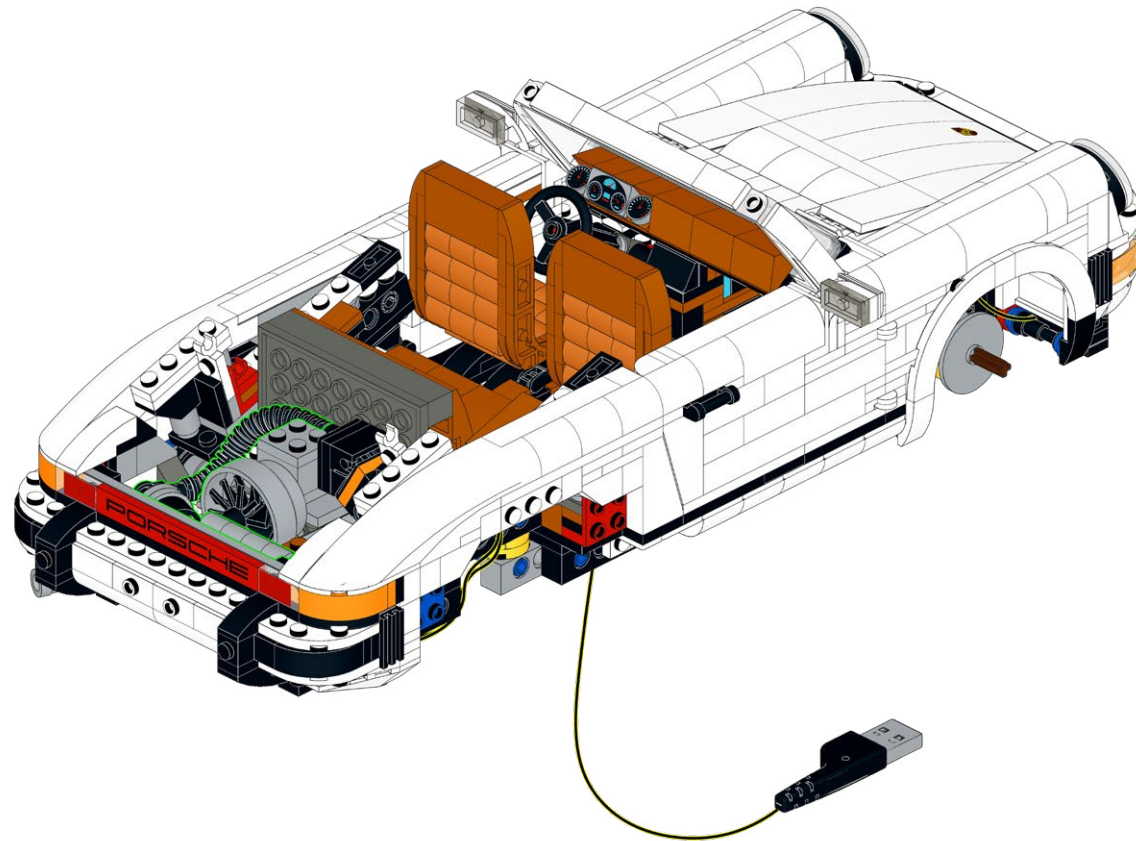

621

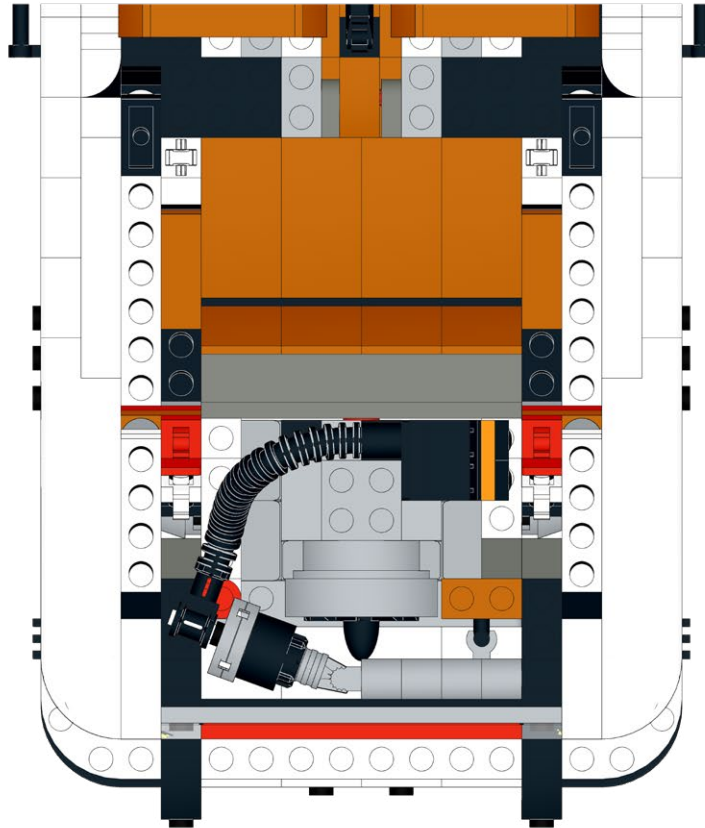

622

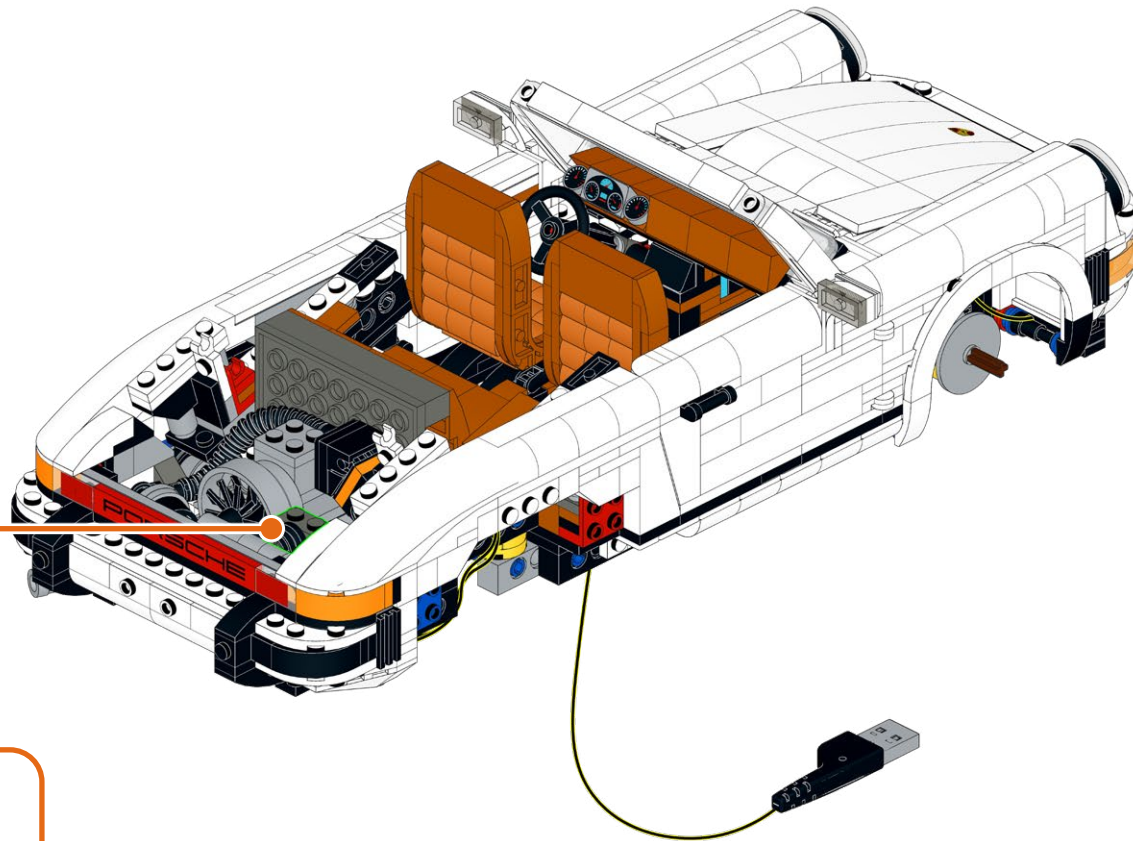

623

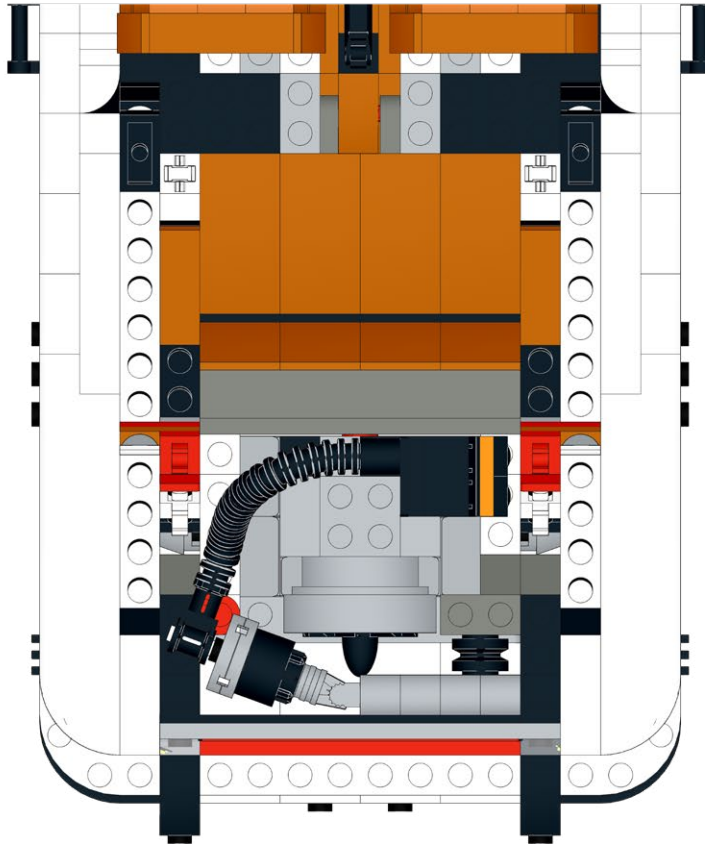

624

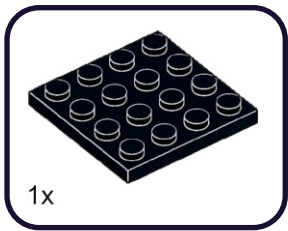

625

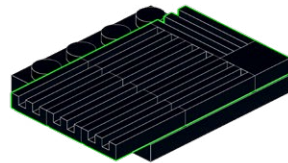
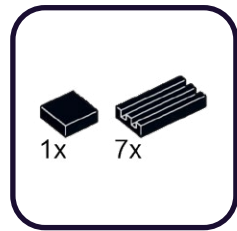

626

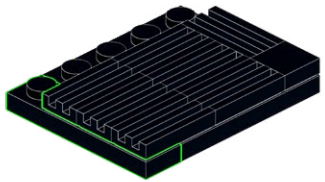
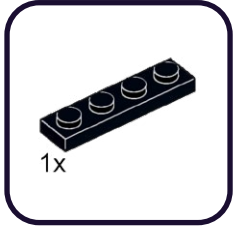

627

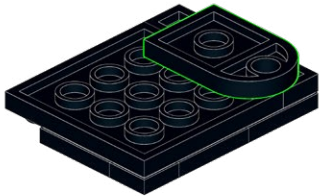

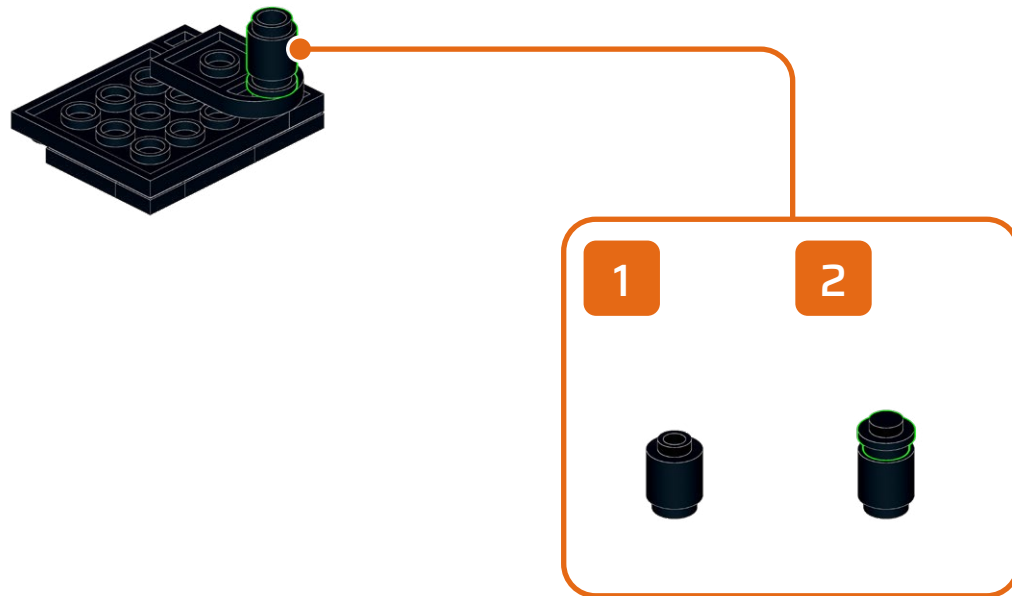

629

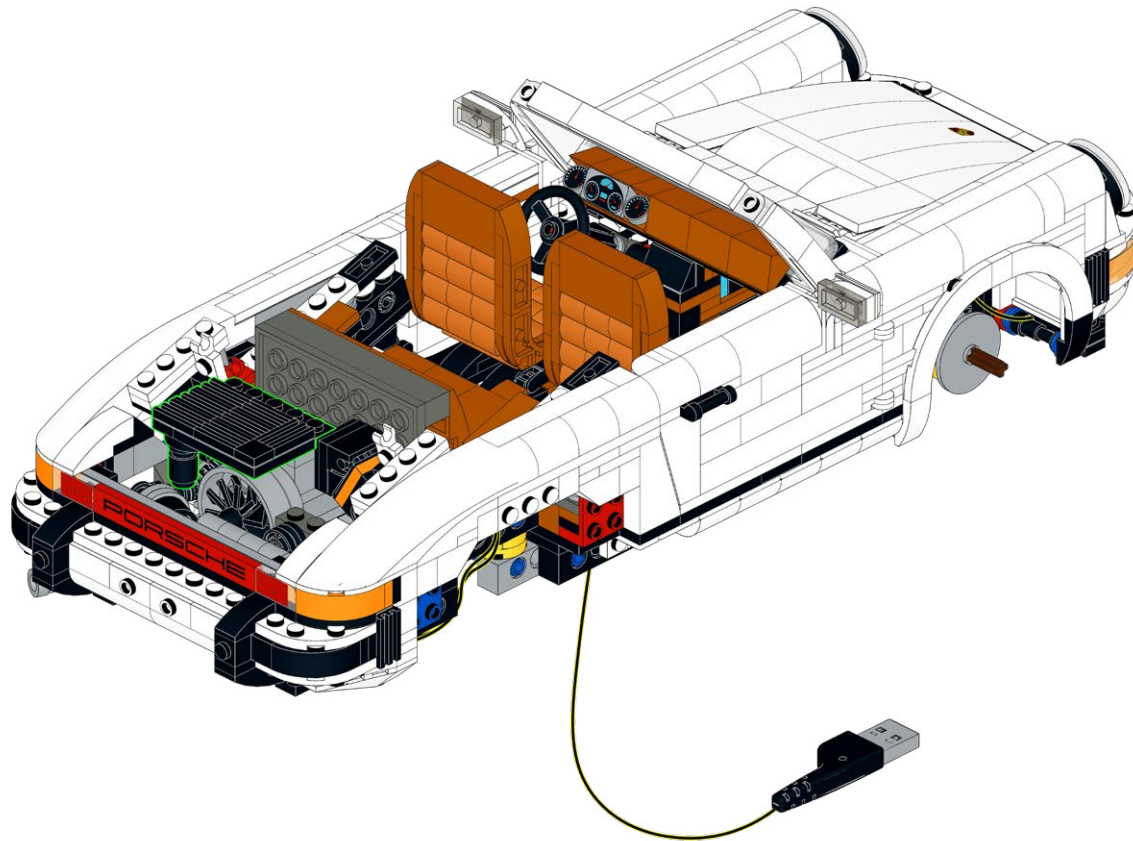

630

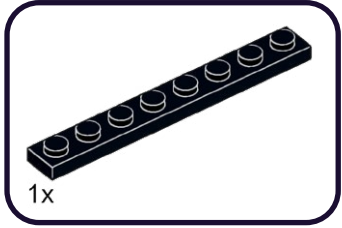

631

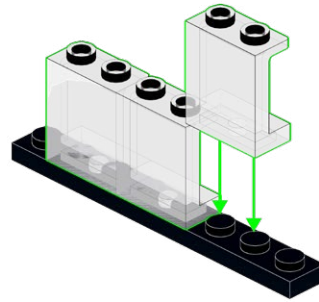
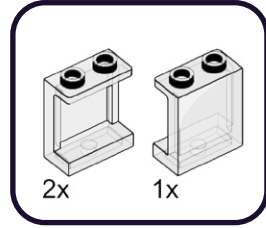

632

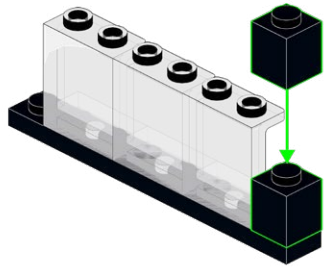
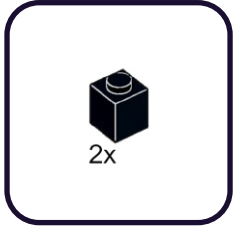

633

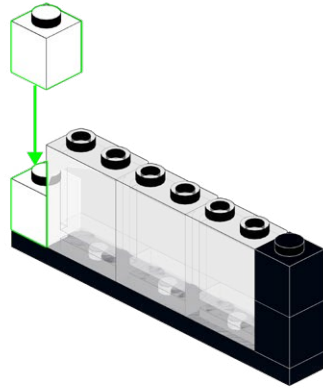
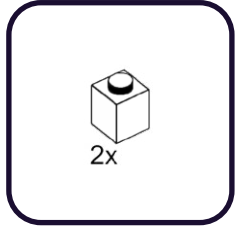

634

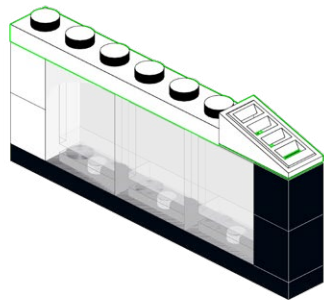
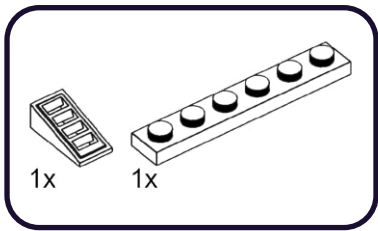

635

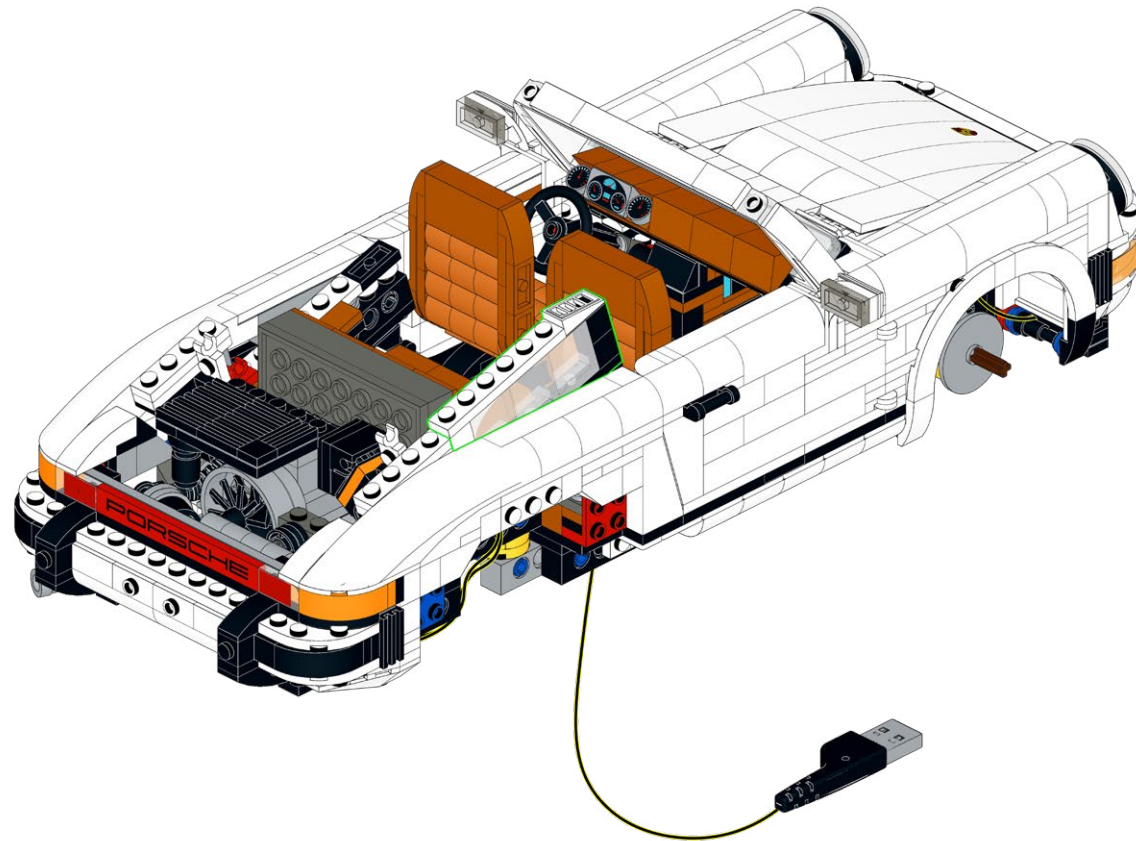

636

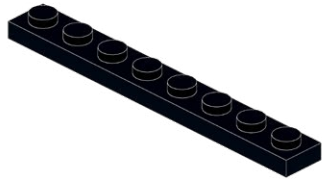
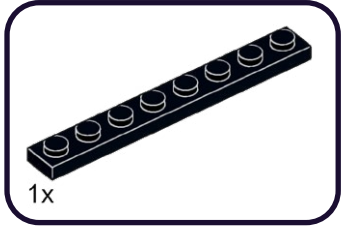

637

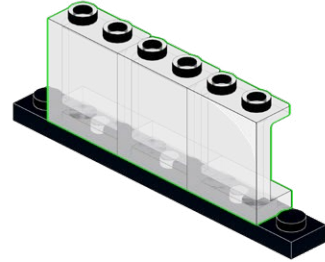
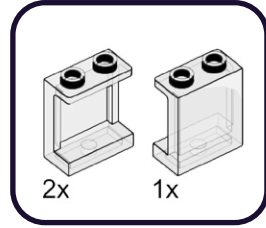

638

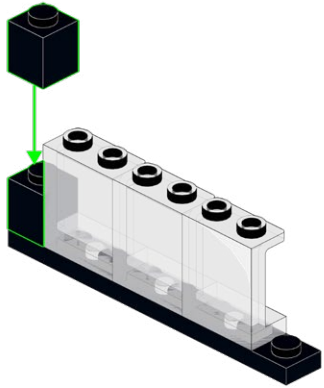
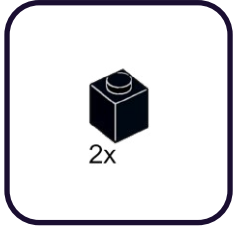

639

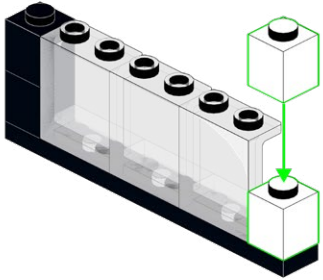
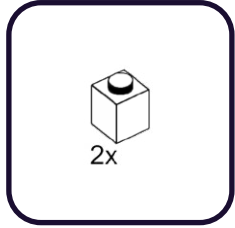

640

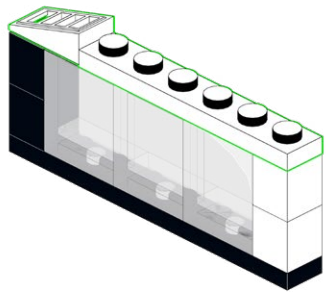
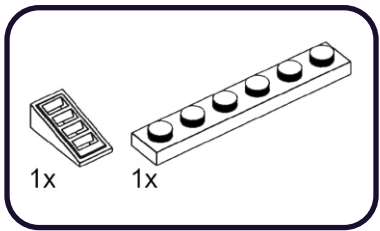

641

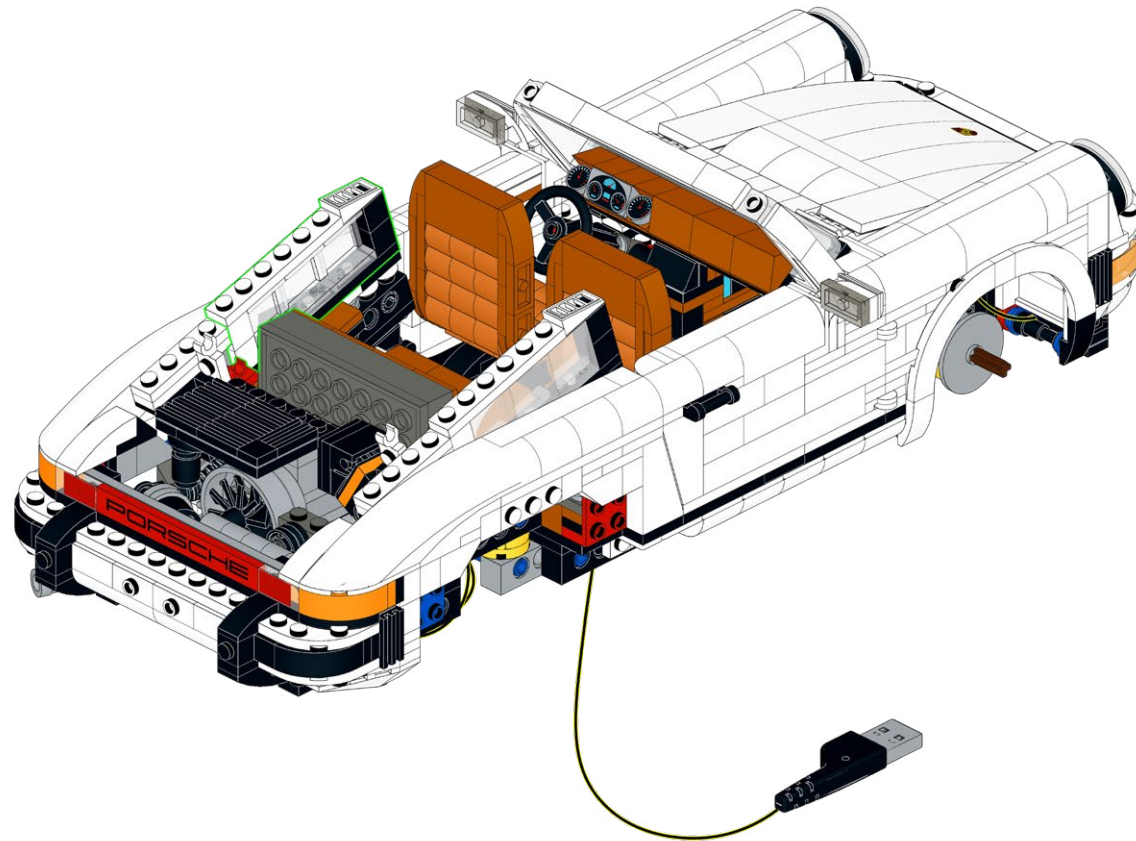

642

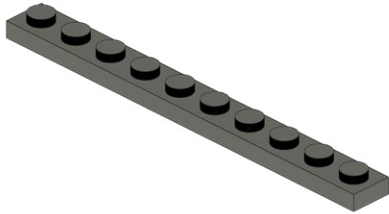
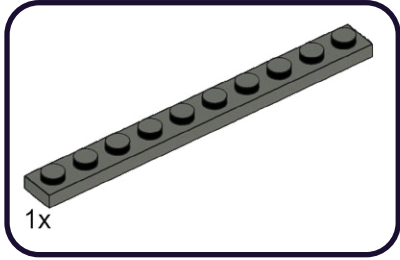

643

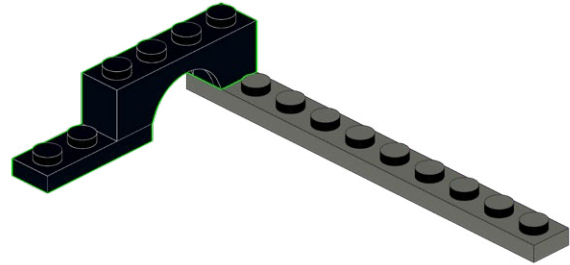
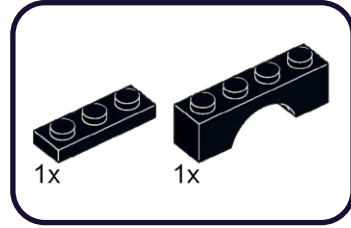

644

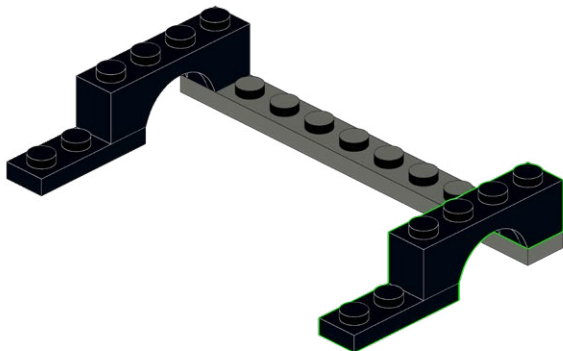
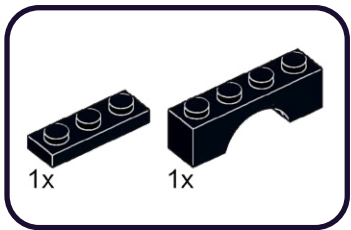

645

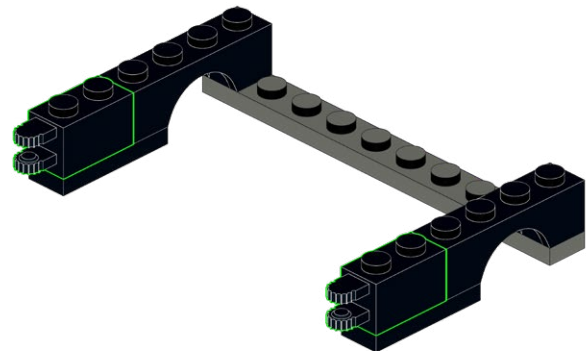
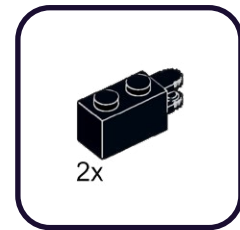

646

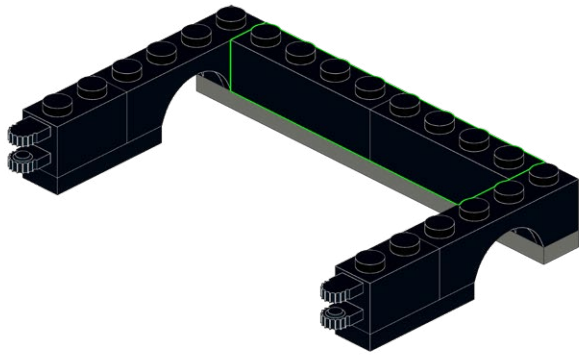
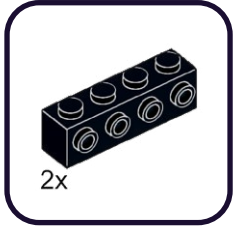

647

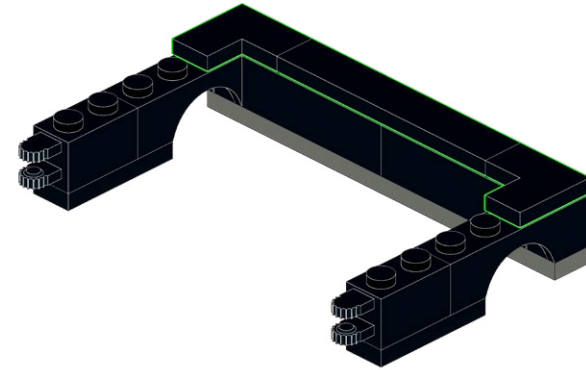
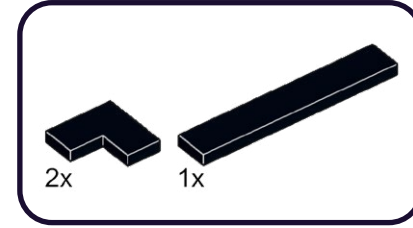

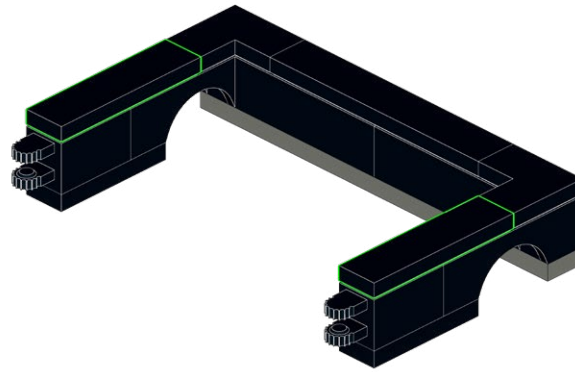
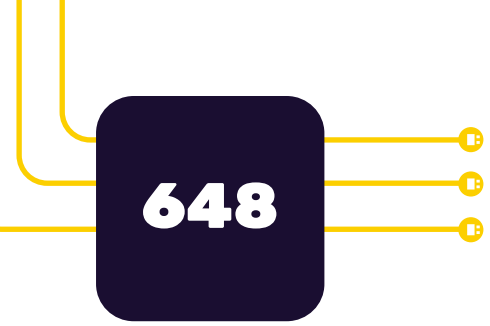

649

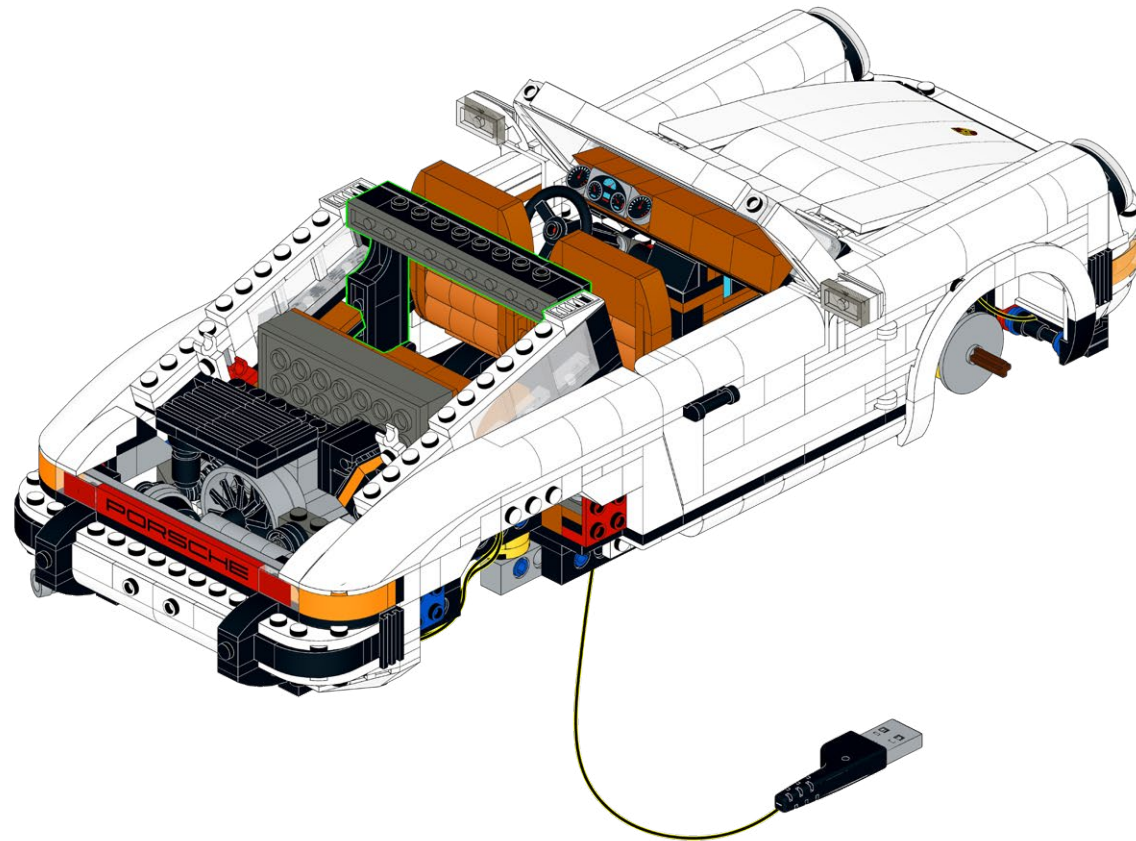

650

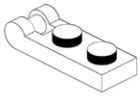
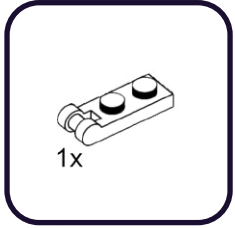

651

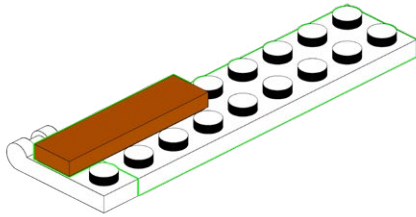
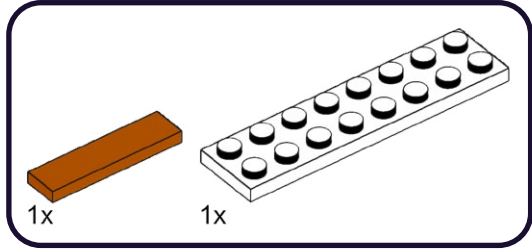

652

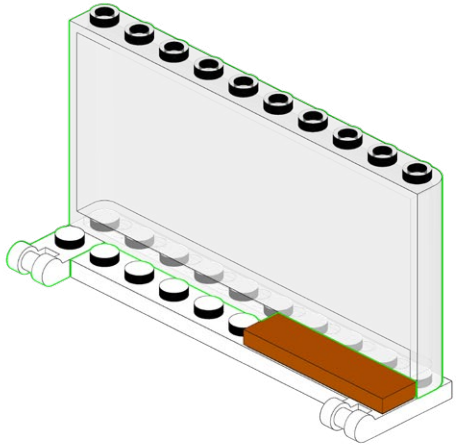
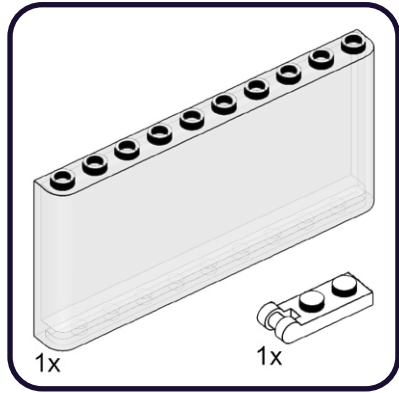

653

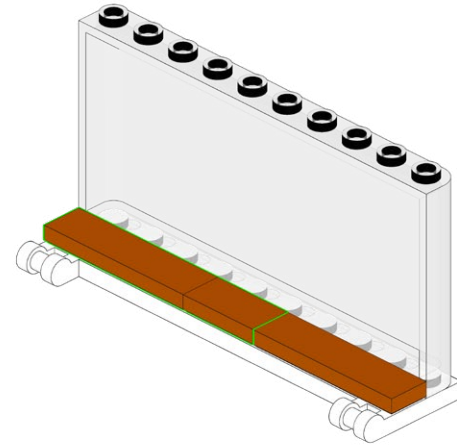
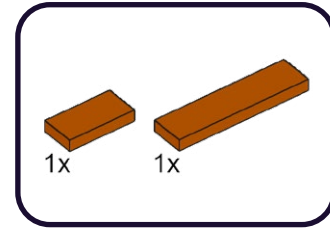

654

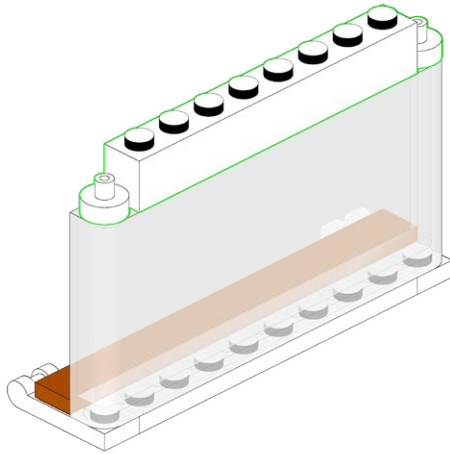
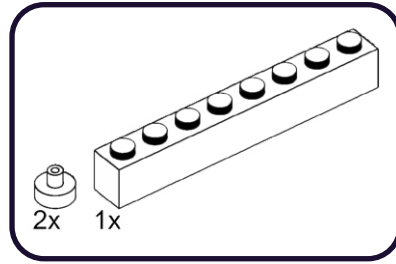

655

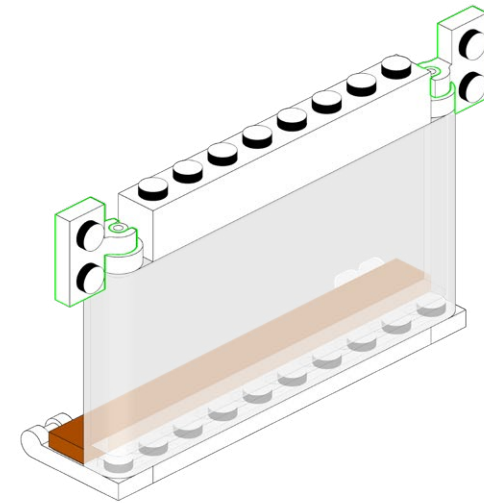
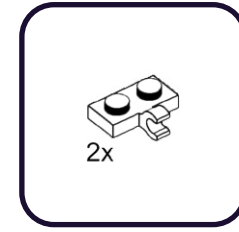

656

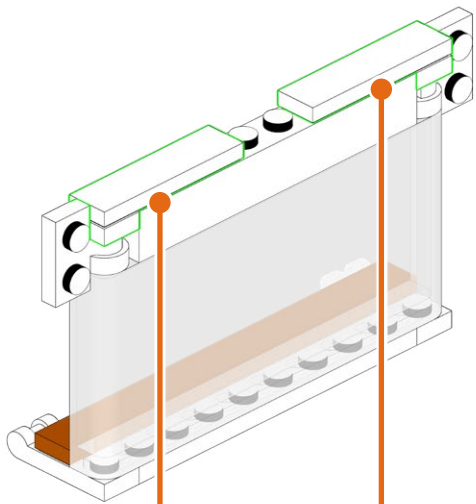
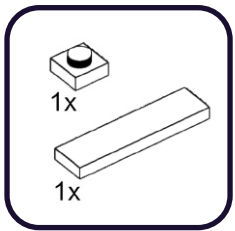

657

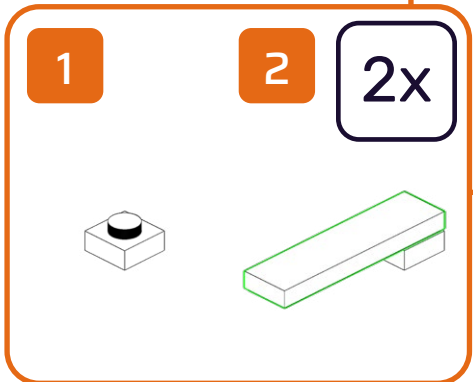
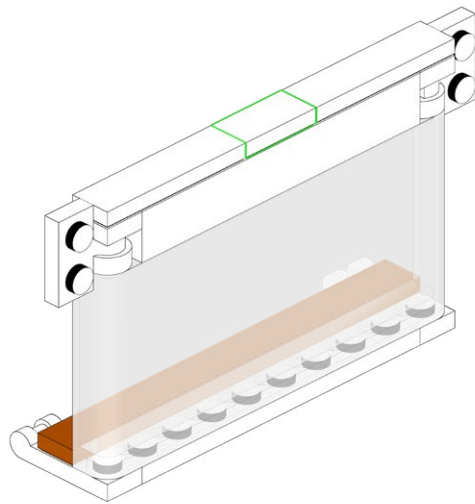
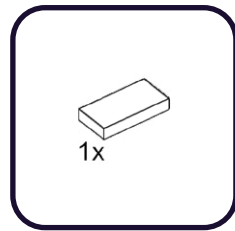

658

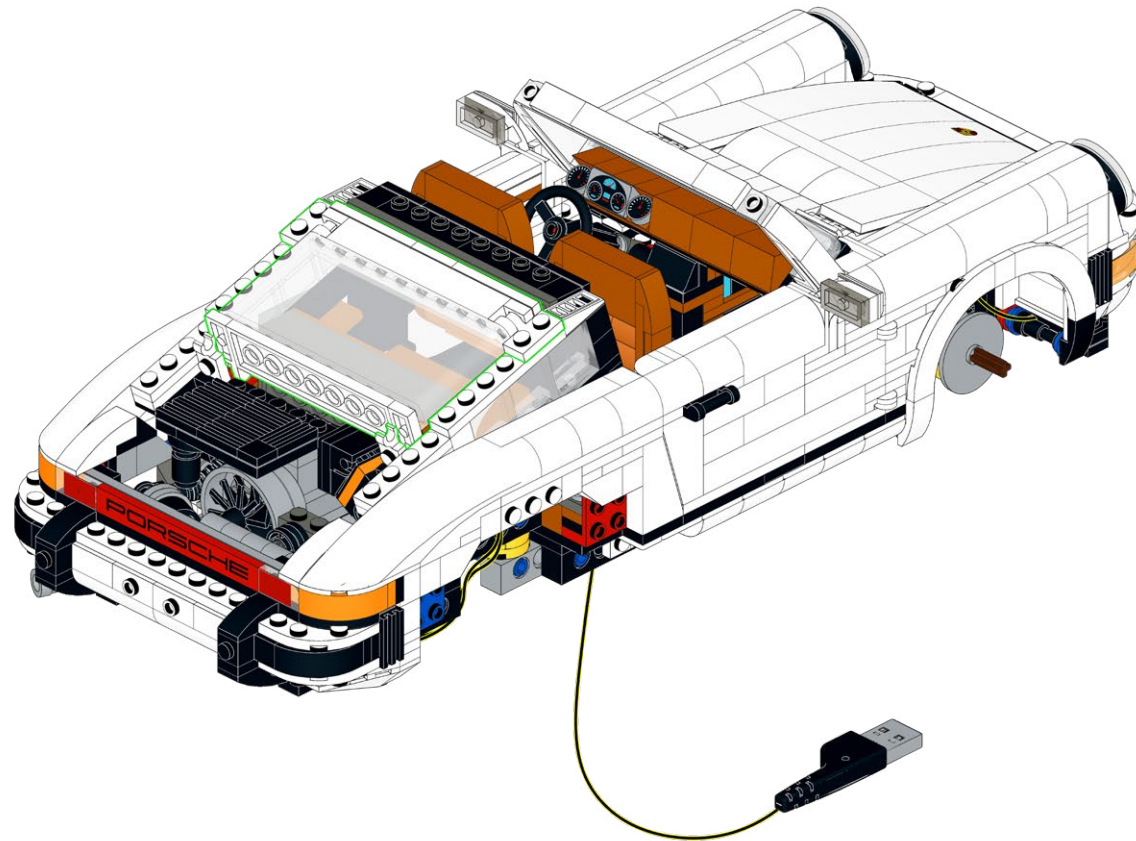

659

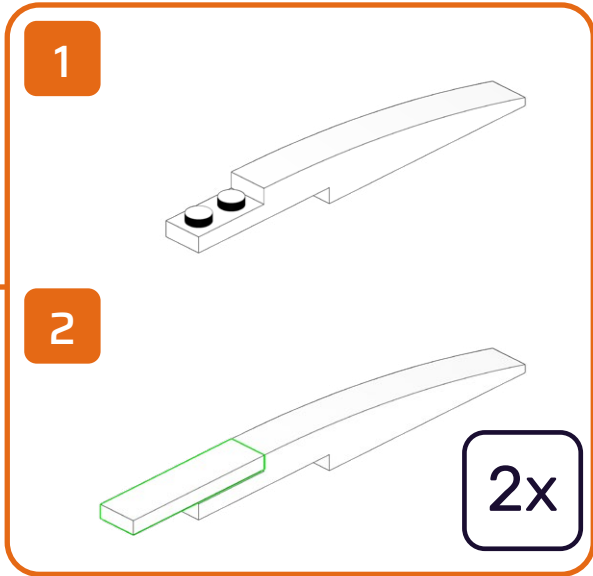
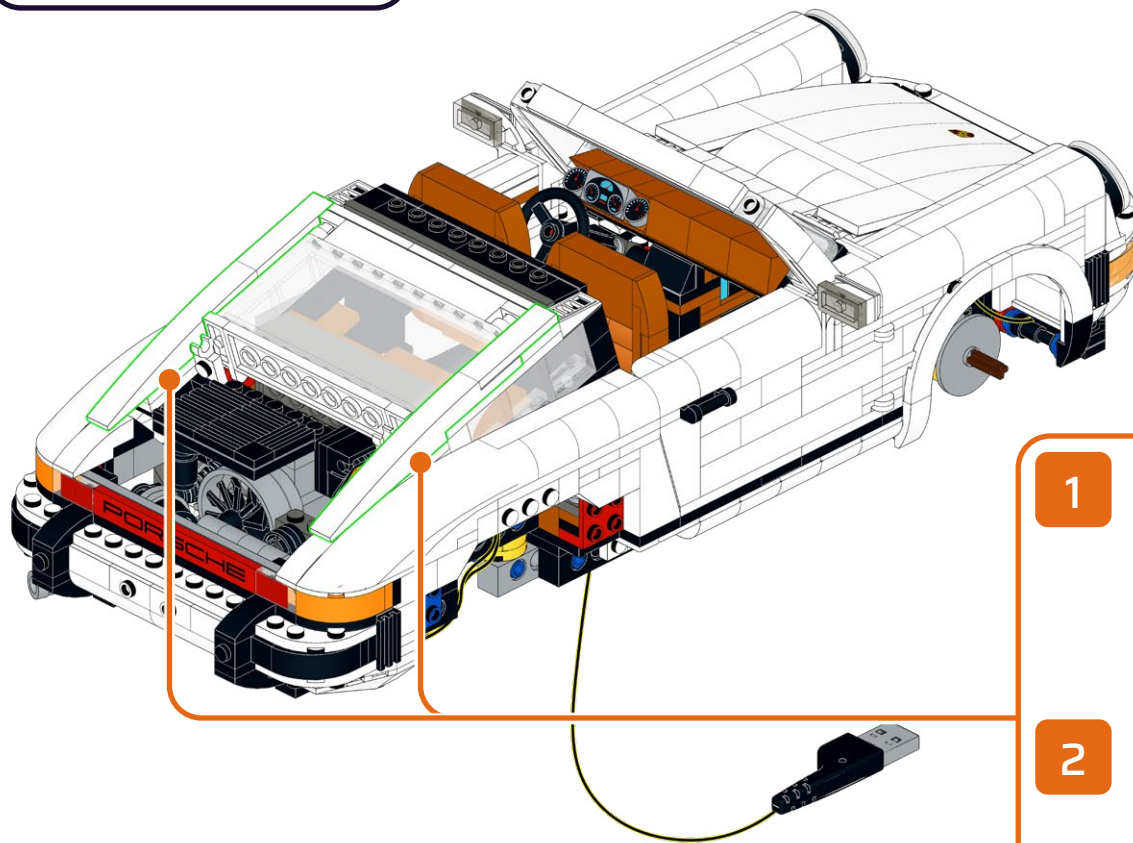
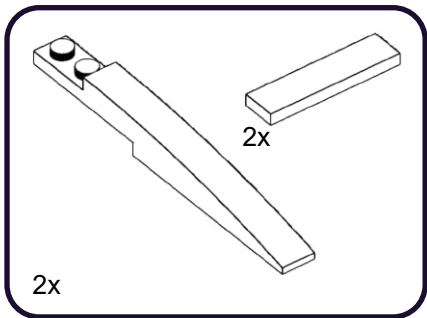

660

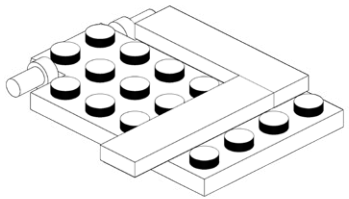
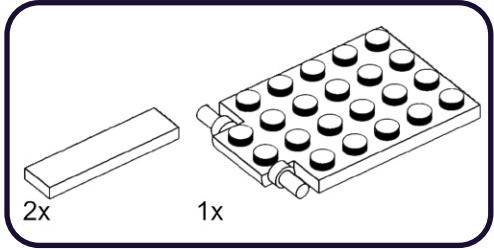

661

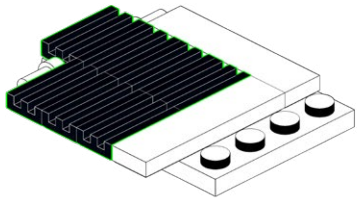
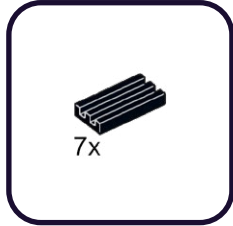

662

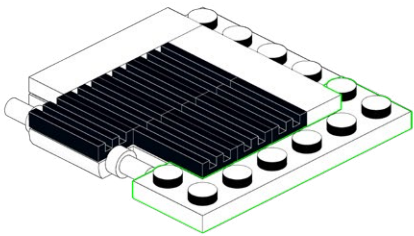
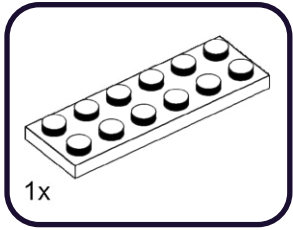

663

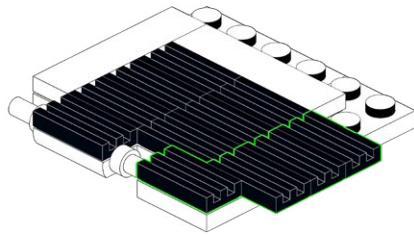
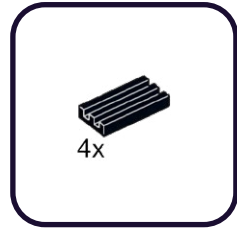

664

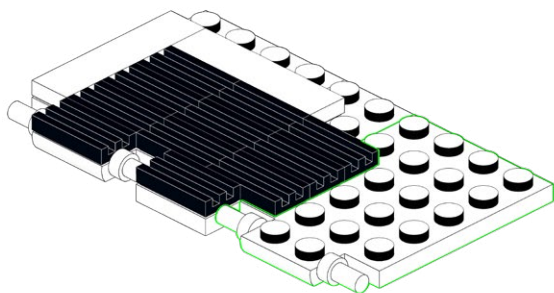
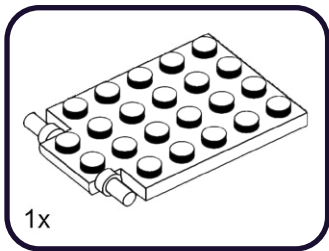

665

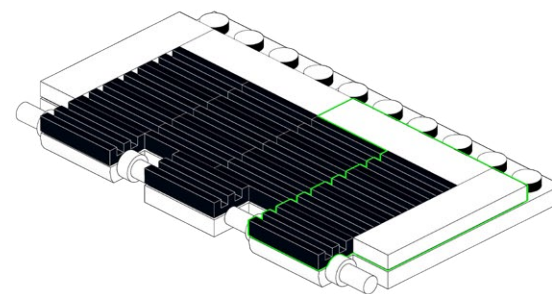
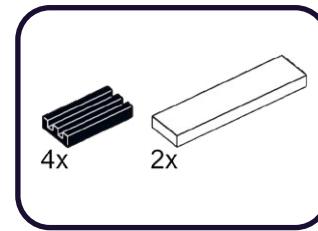

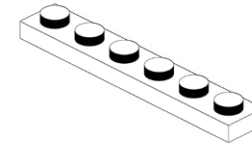
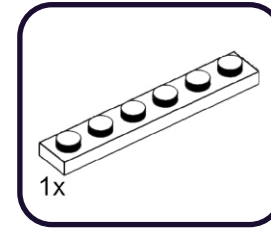
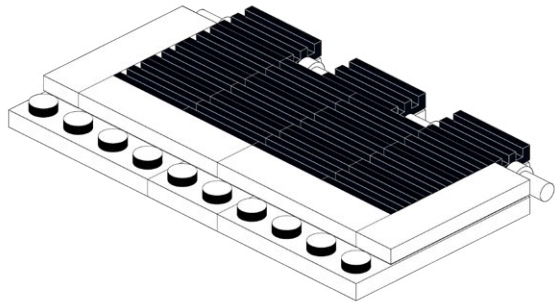

668

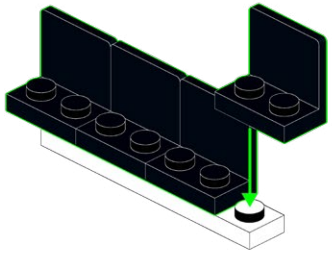
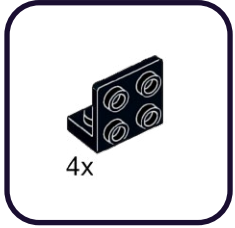

669

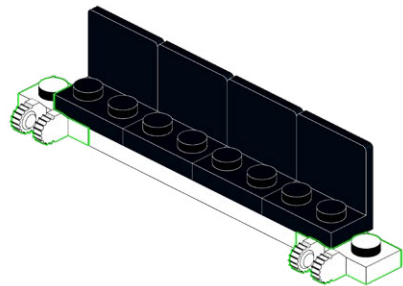
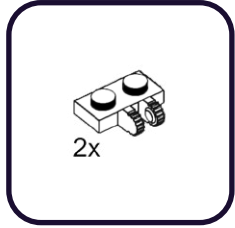

670

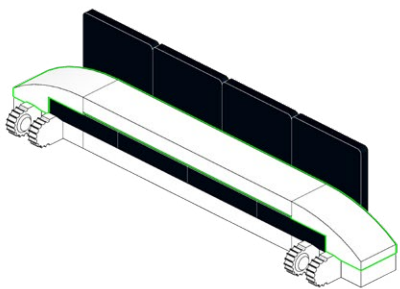
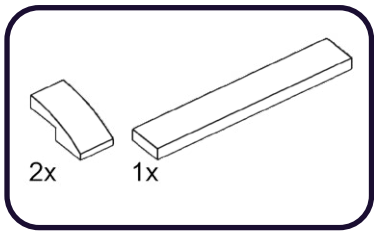

671

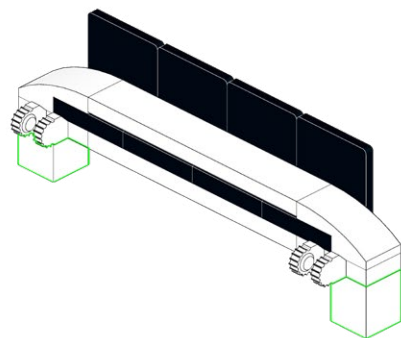
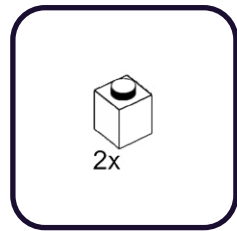

672

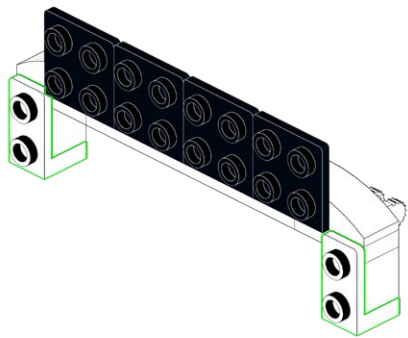
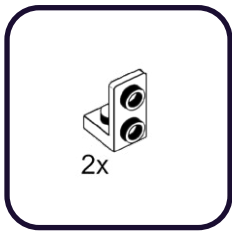

673

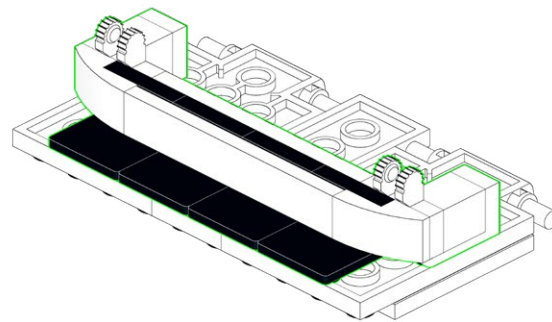
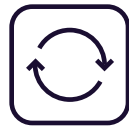

674

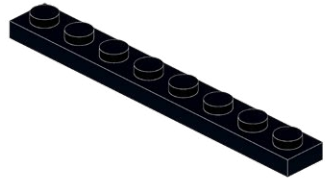
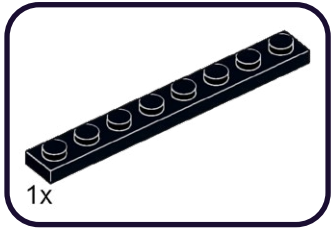

675

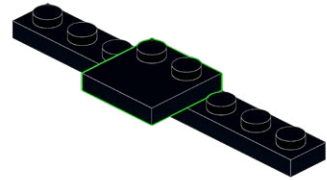
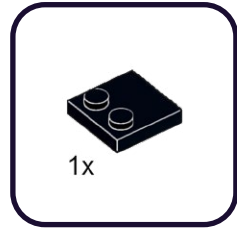

676

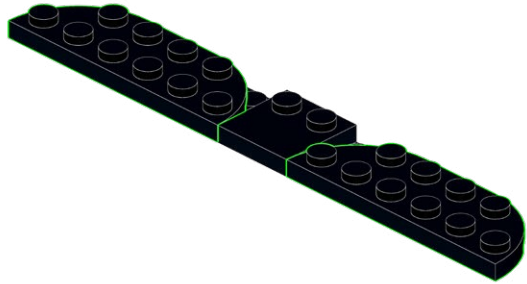

677

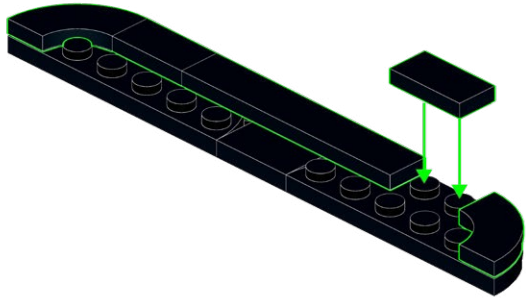
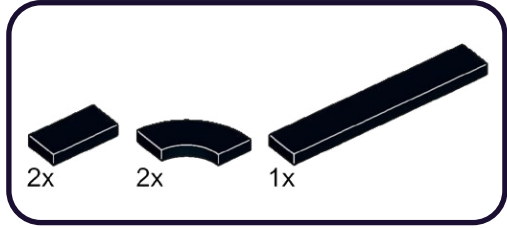

678

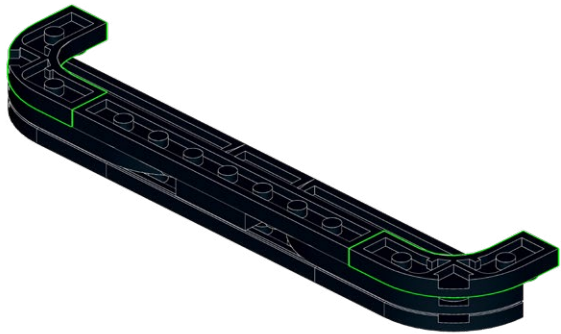
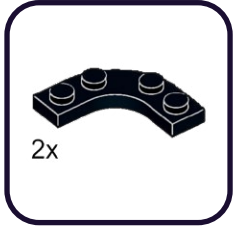

679

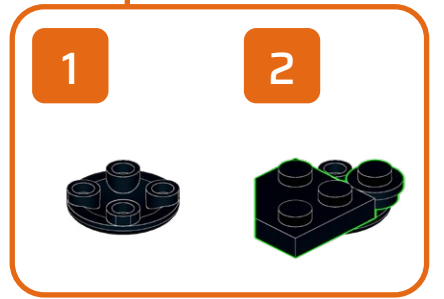
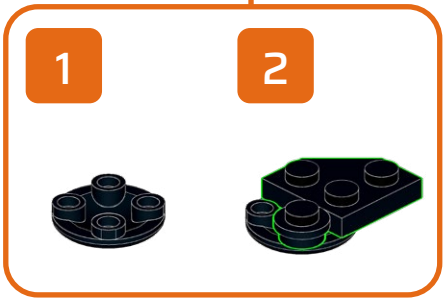
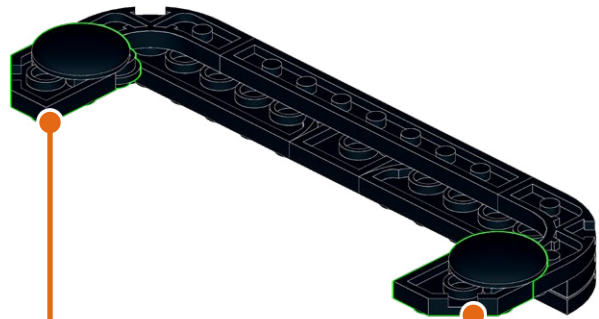
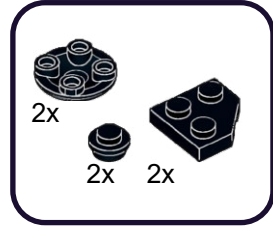

680

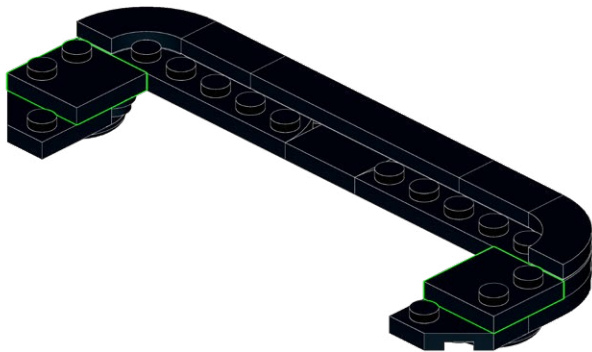
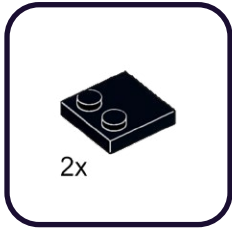

681

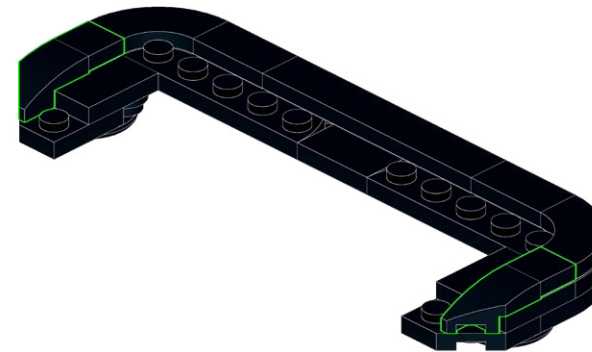
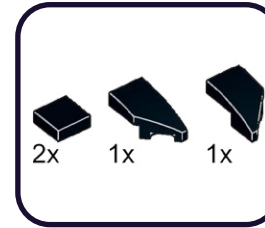

682

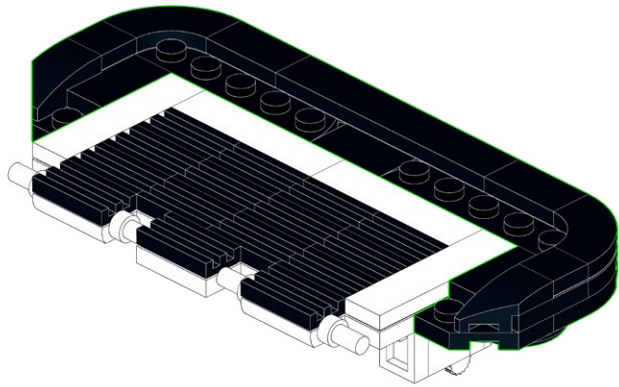

683

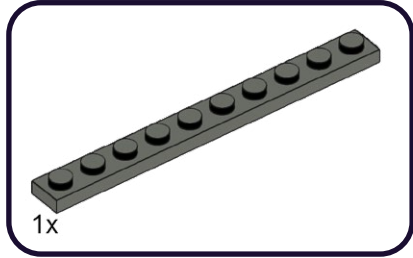

684

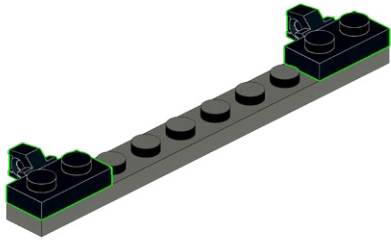
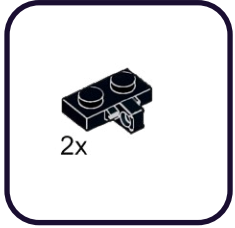

685

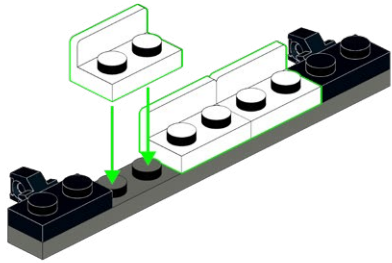
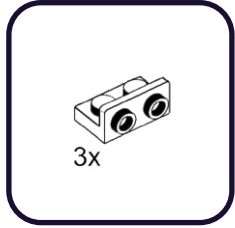

686

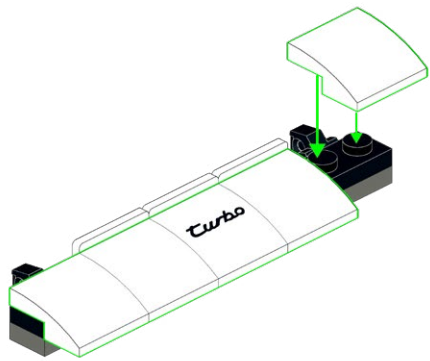
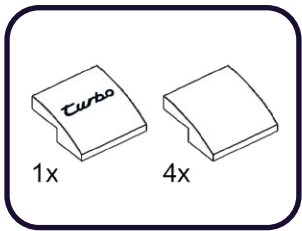

687

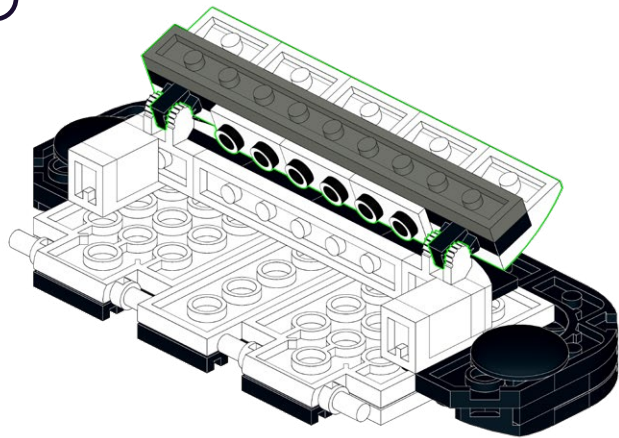
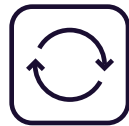

688

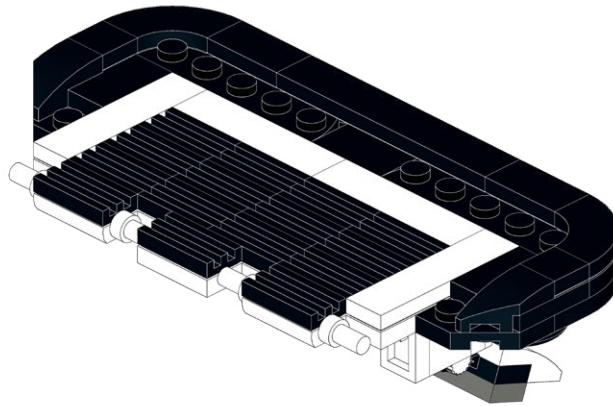

689

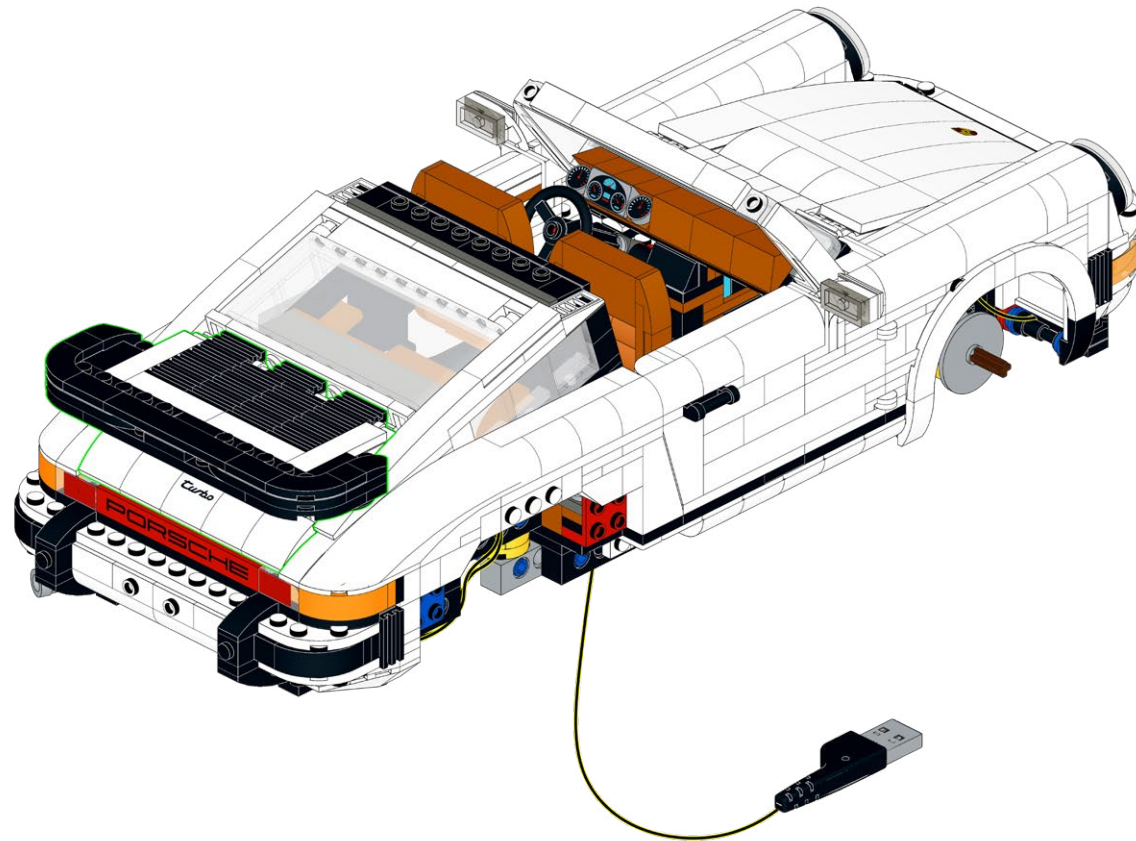

690

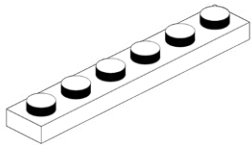
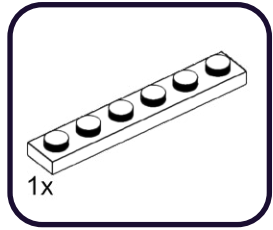

691

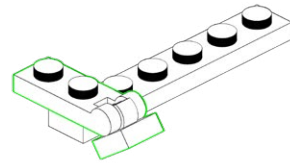
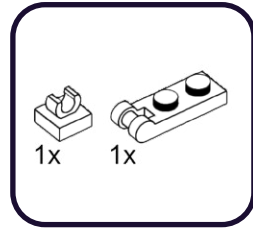

692

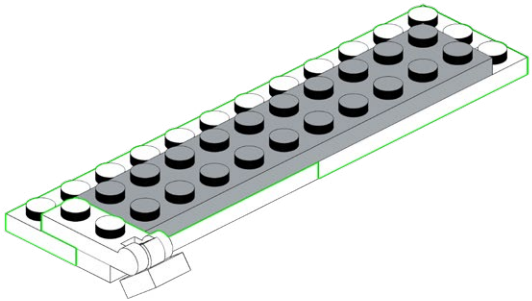
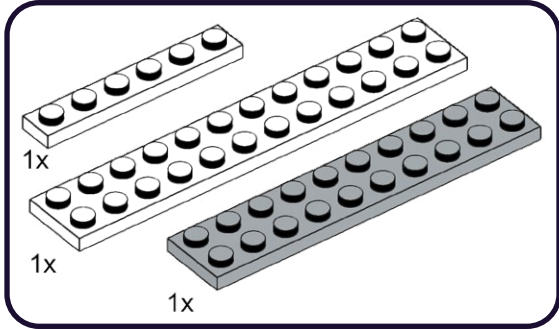

693

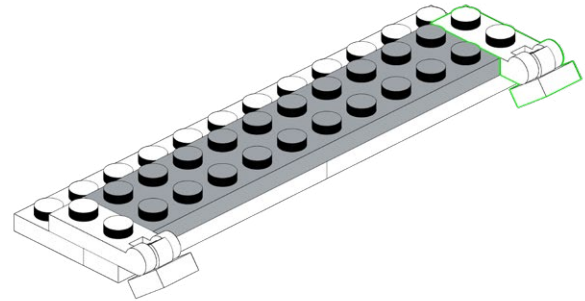
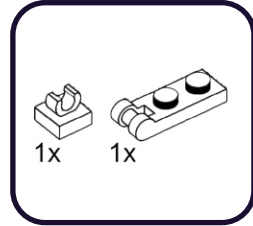

694

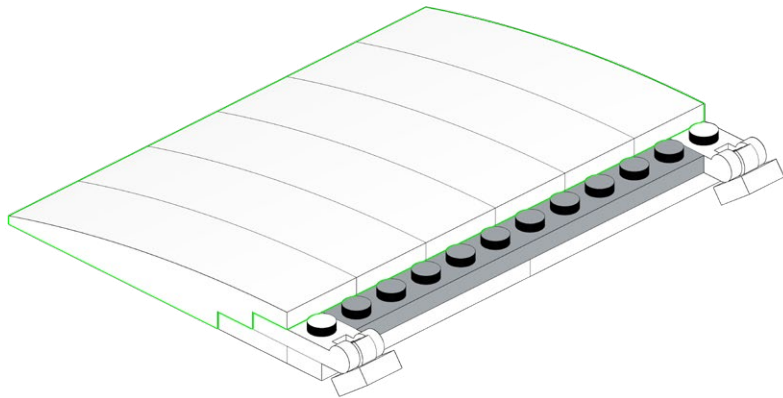
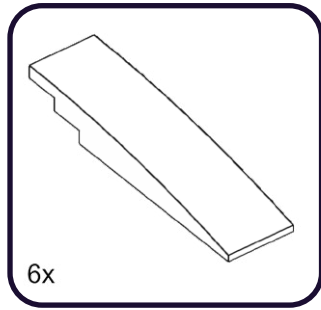

695

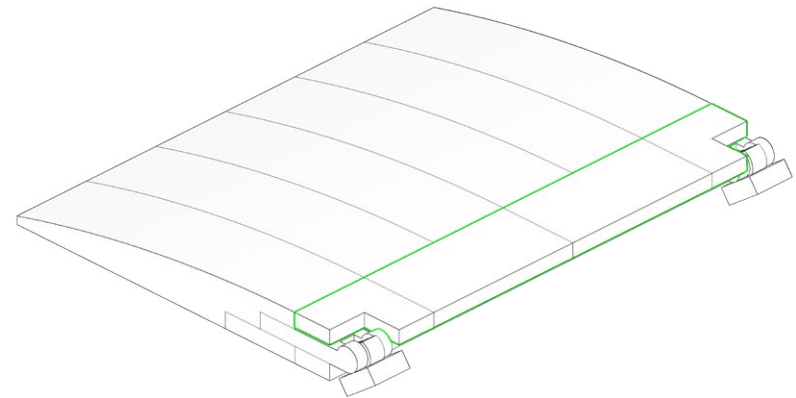
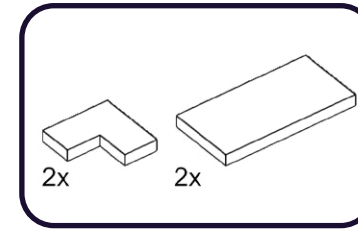

696

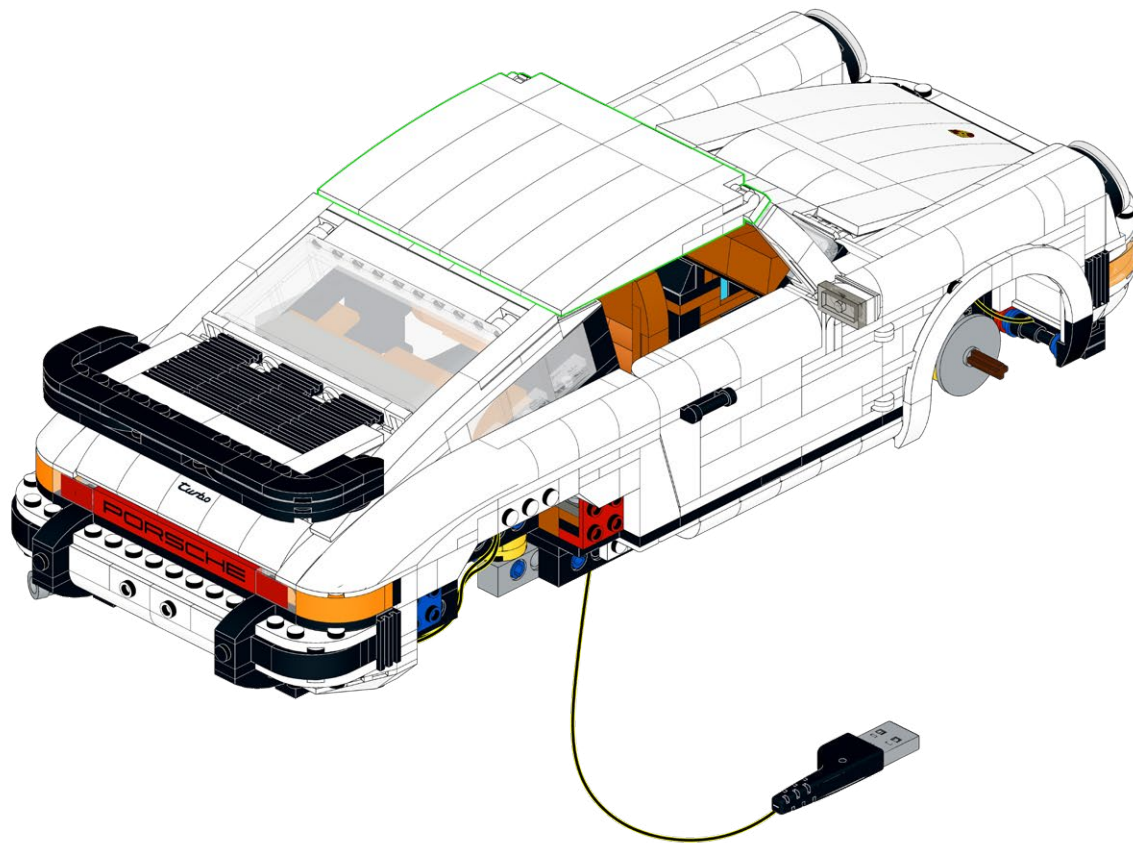

697

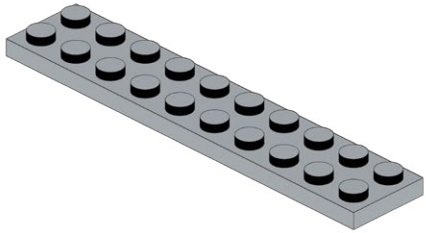
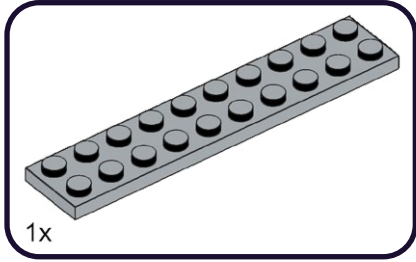

698

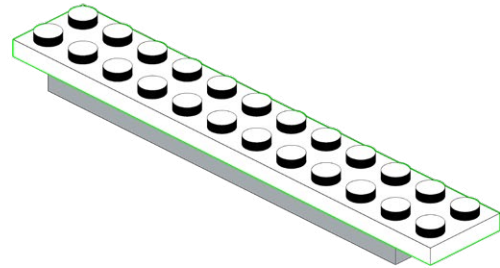
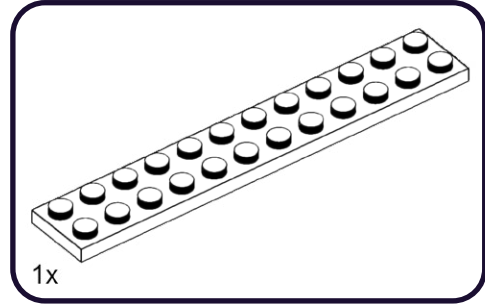

699

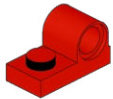
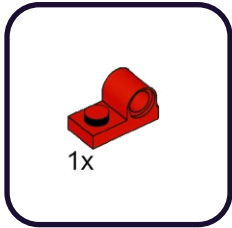

700

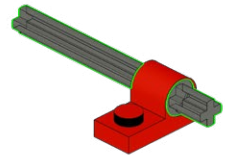
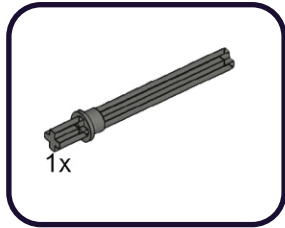

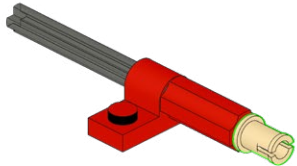
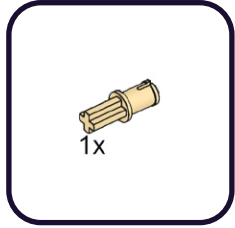
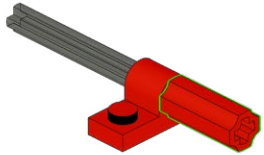
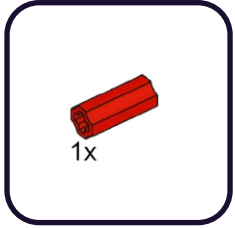

703

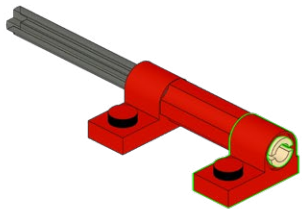
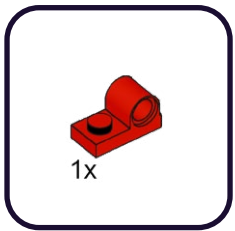

704

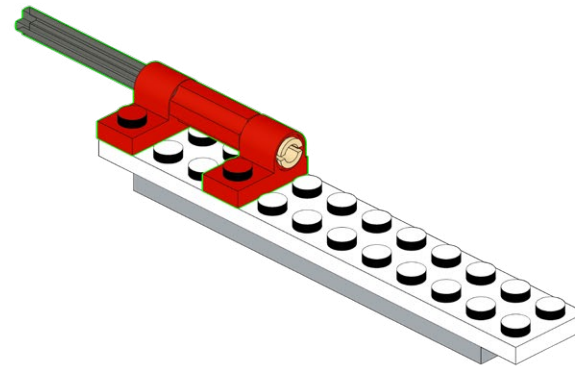

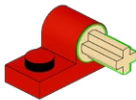
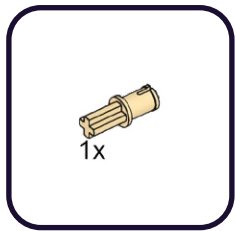
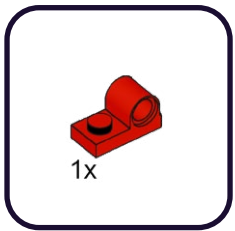

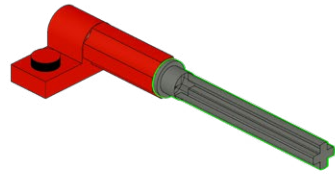
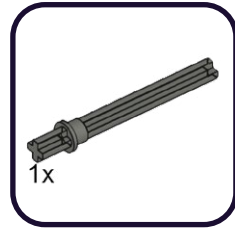
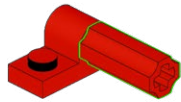
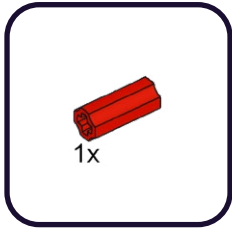

709

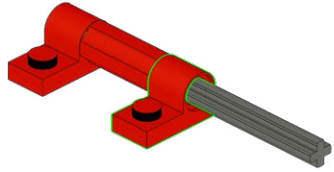
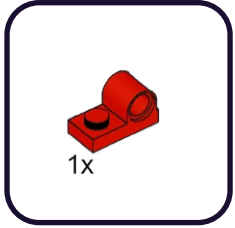

710

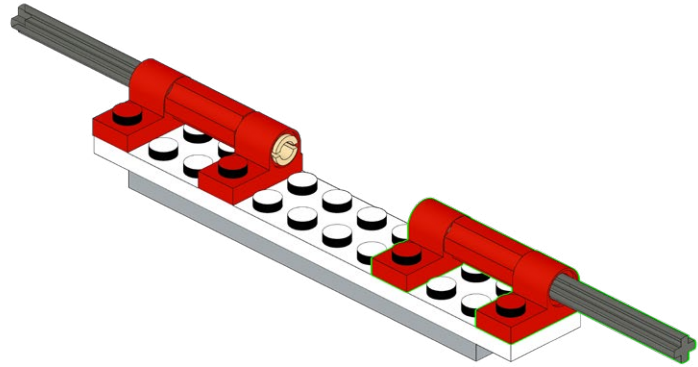

711

5x



712

2x

1x

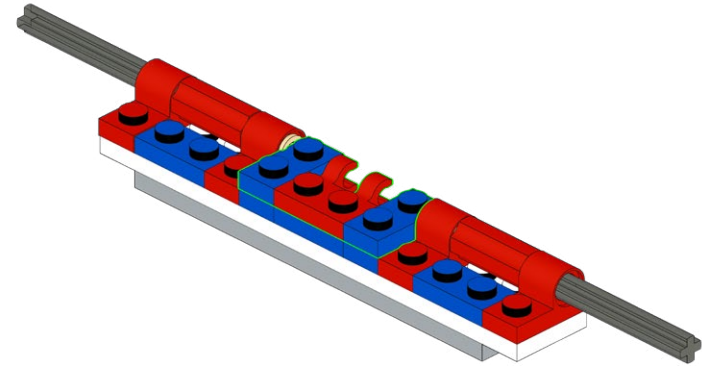
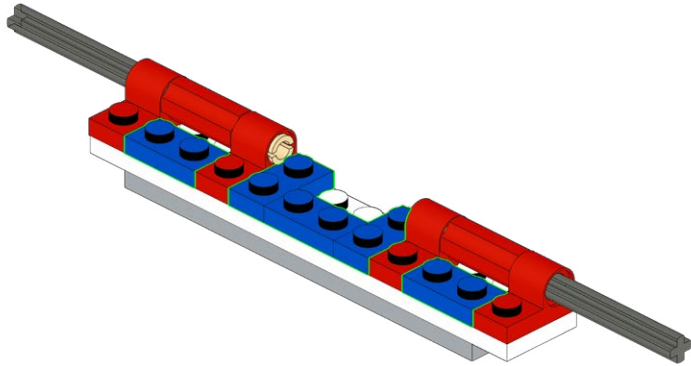
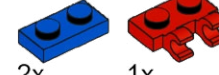

713

2x

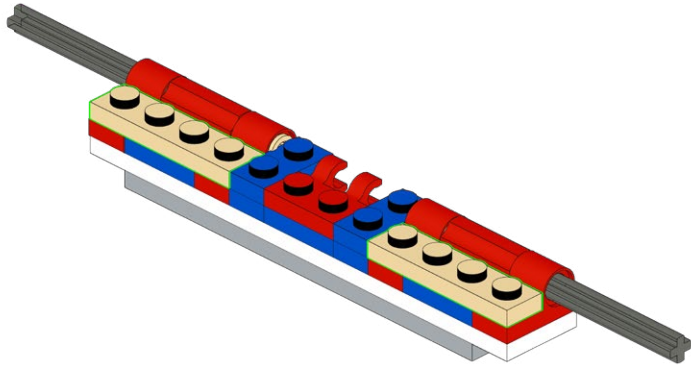
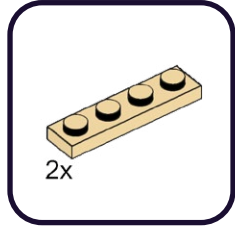

714

2x

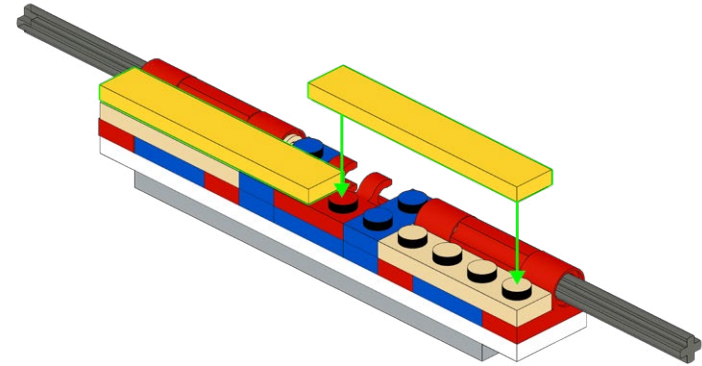
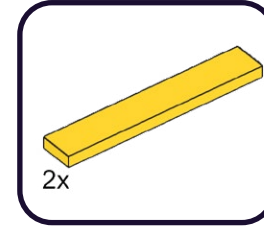

715

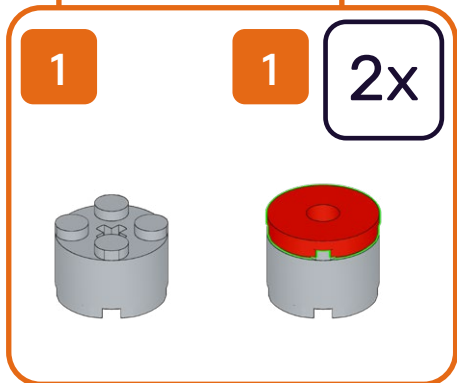
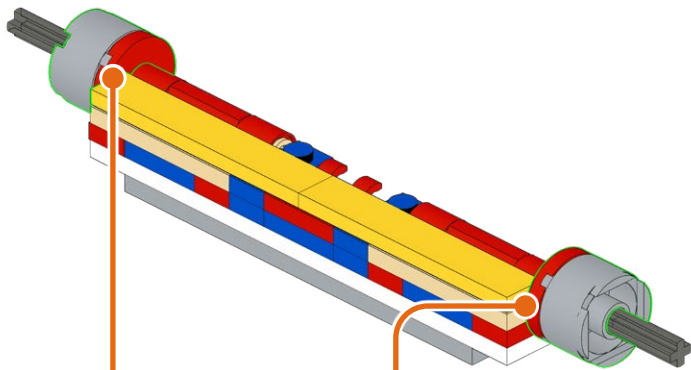
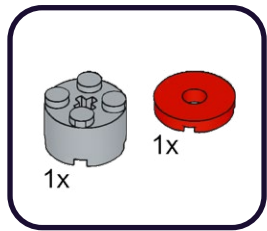

716

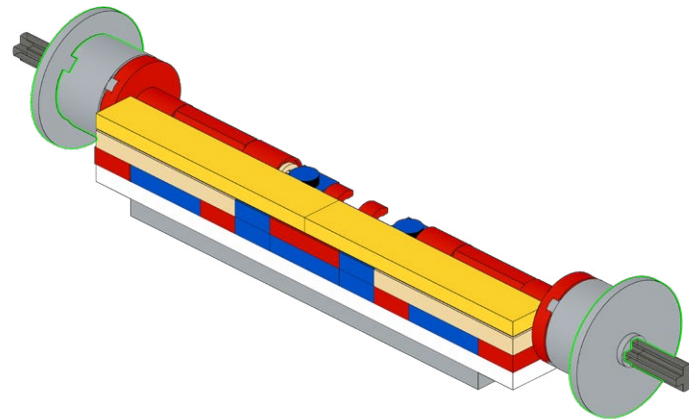
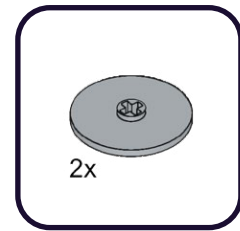

717

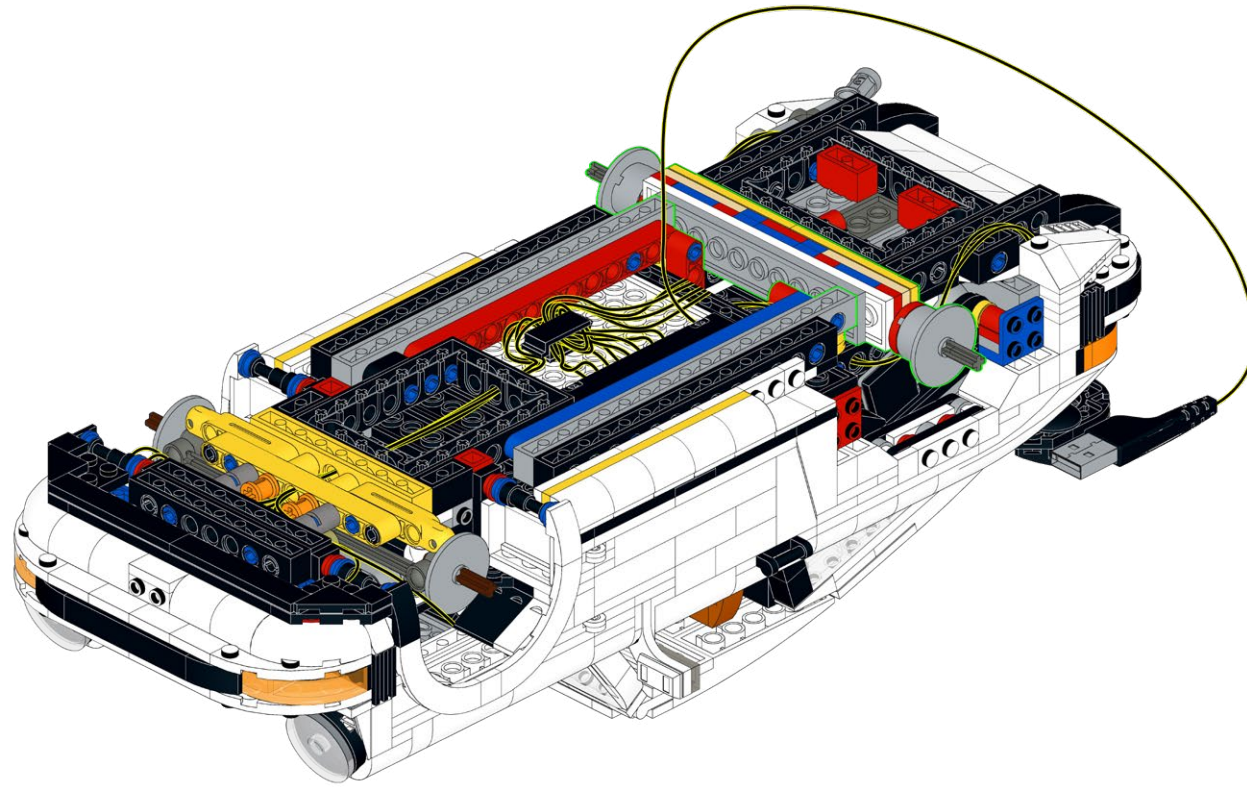

718

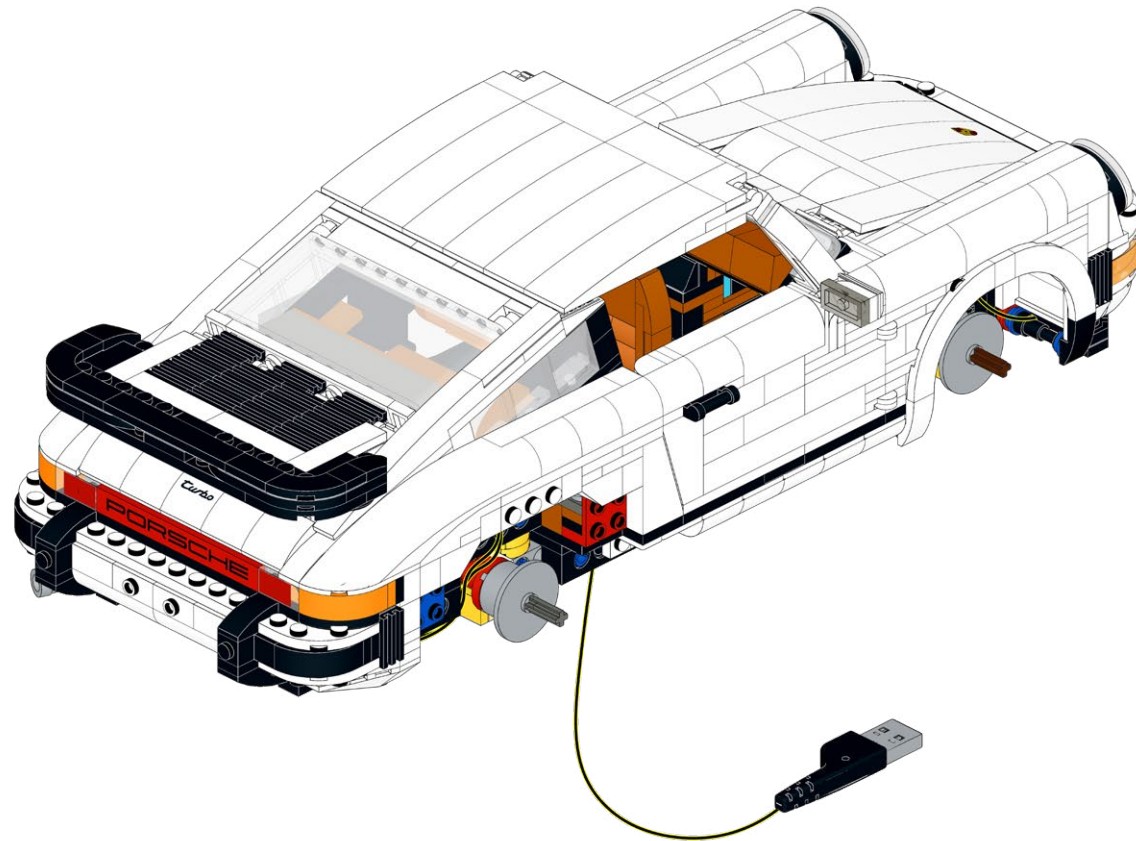

719

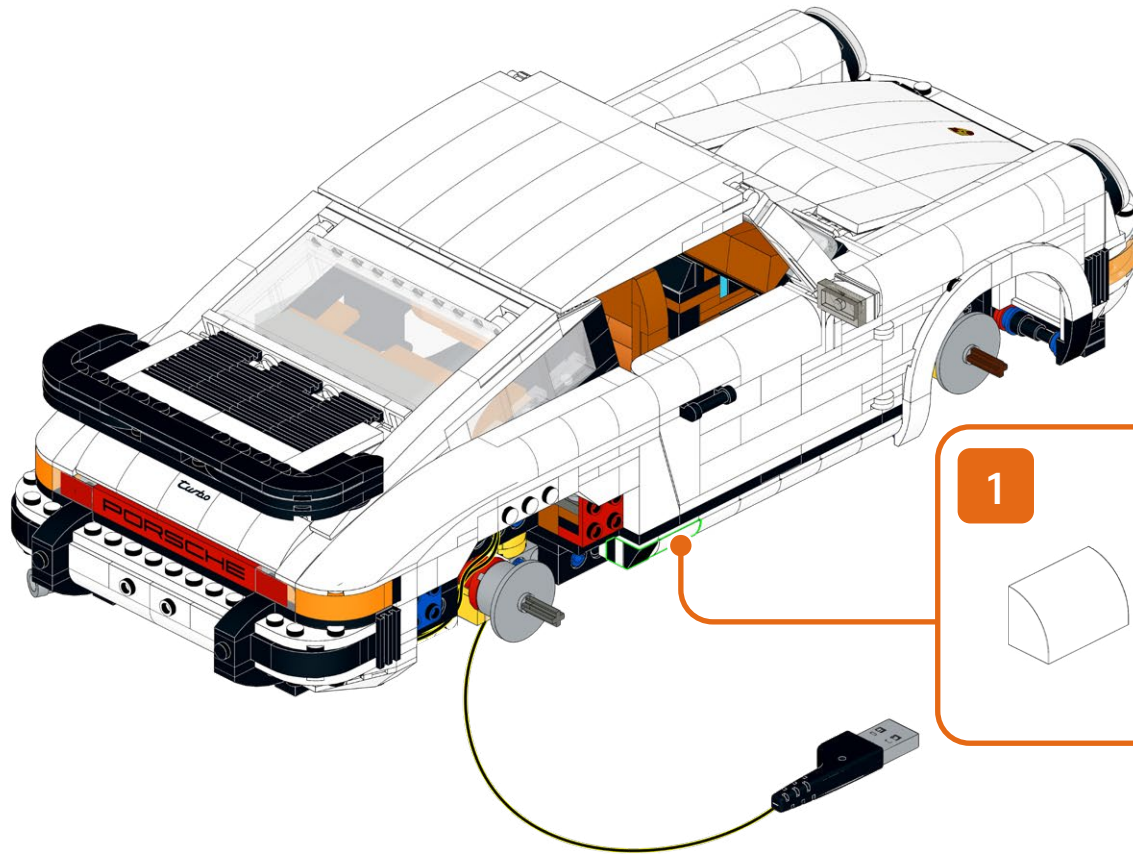
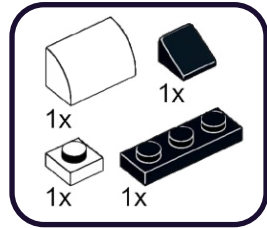

720

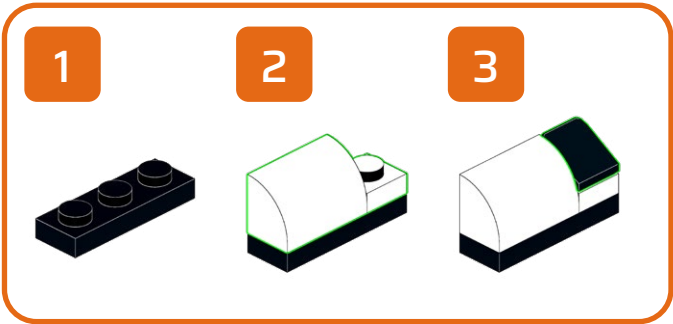
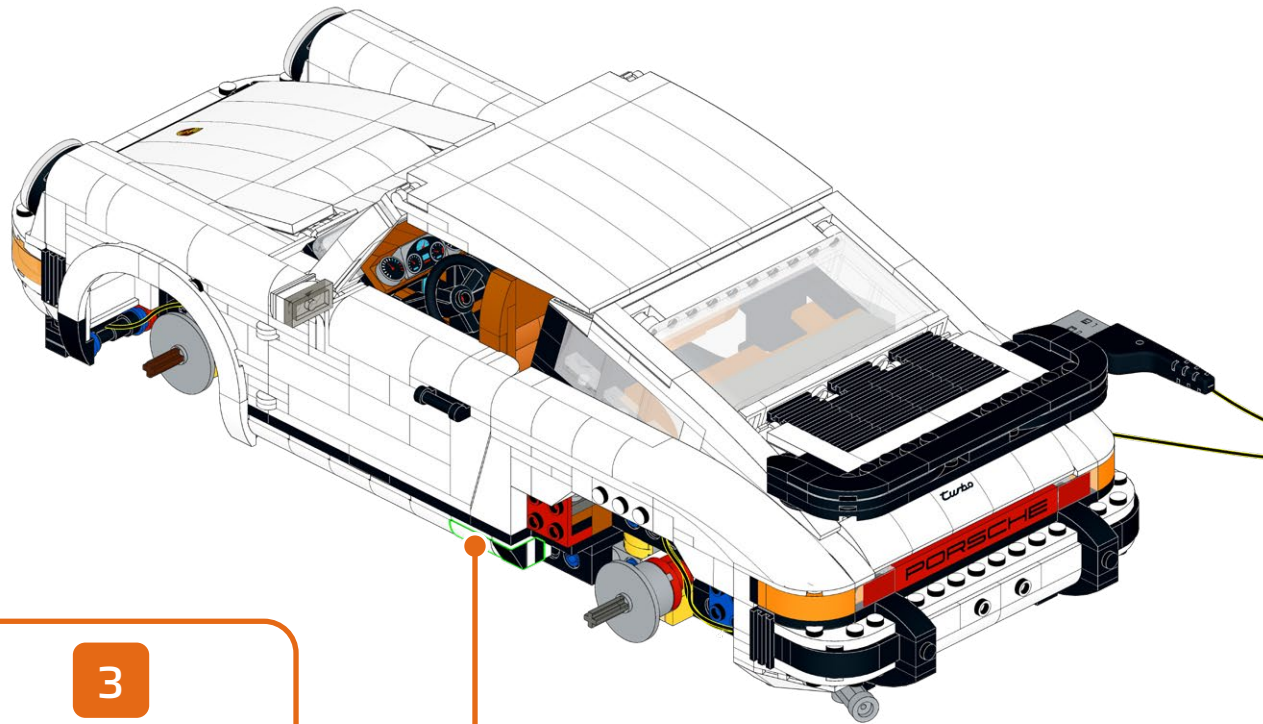
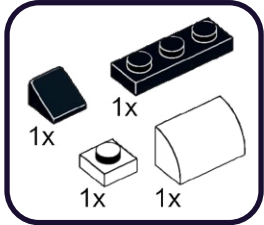

721

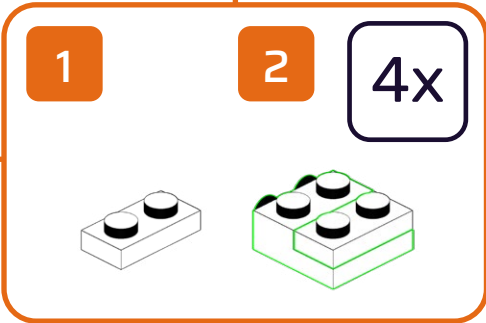
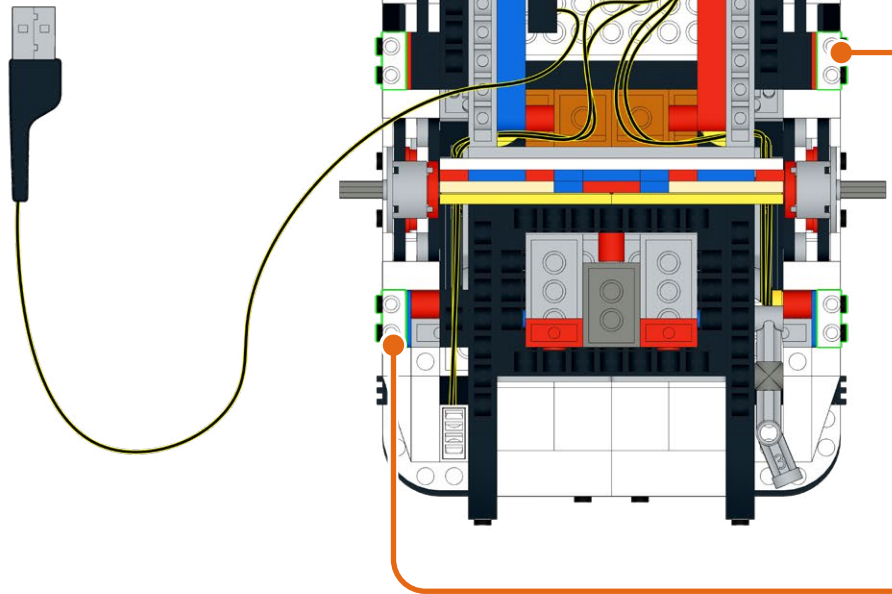
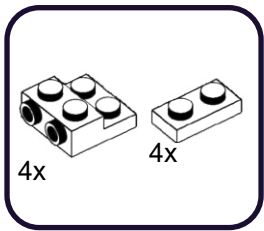

722

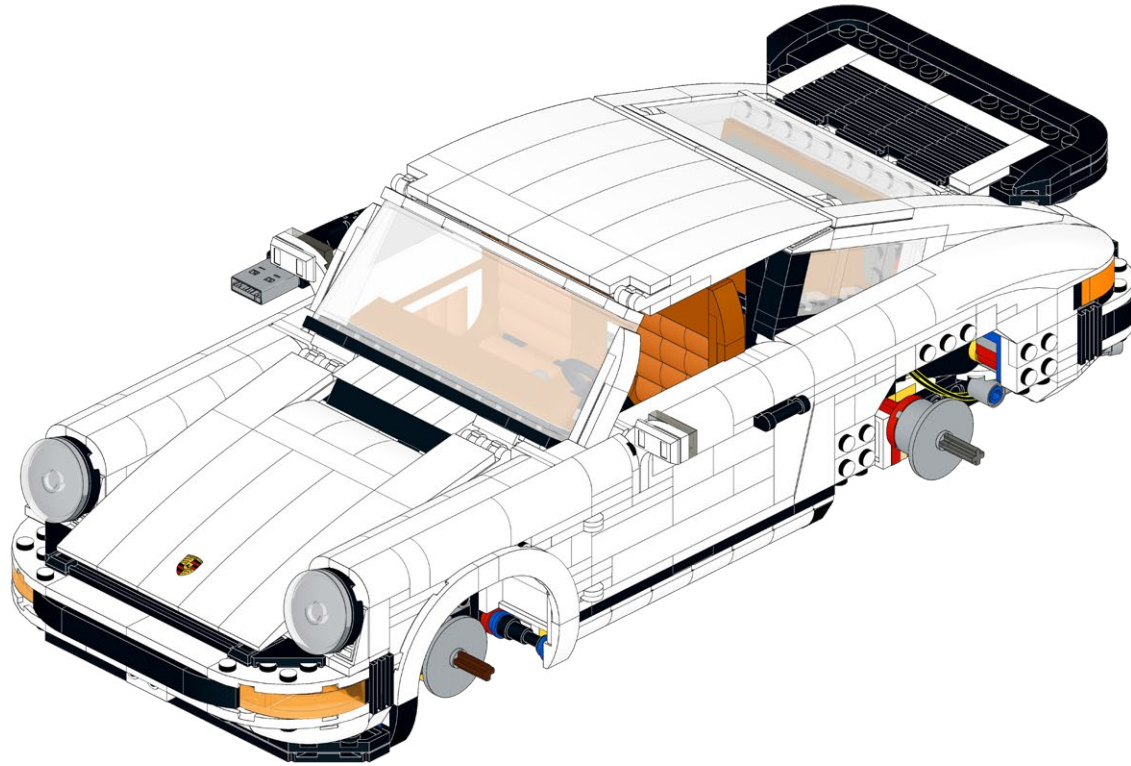

723

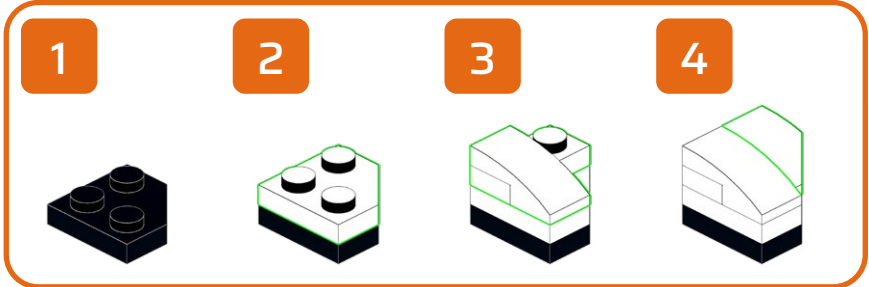
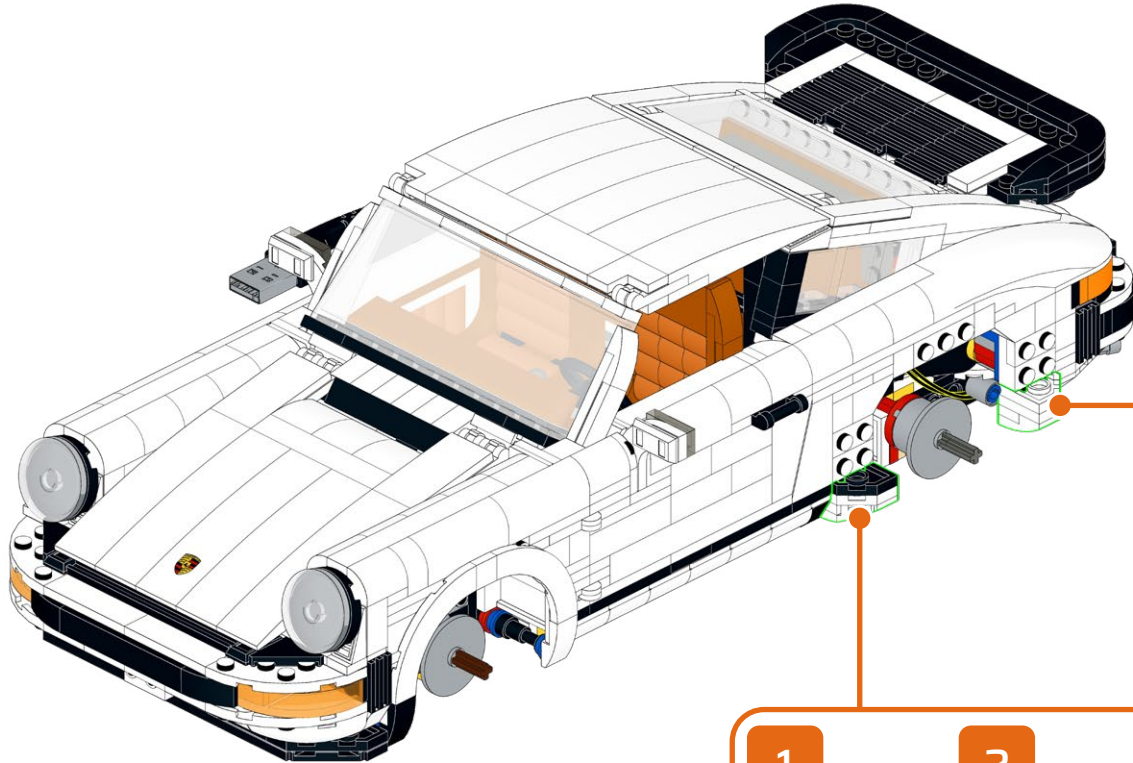
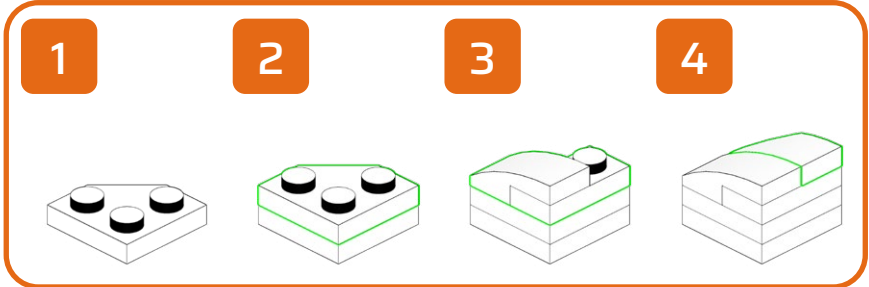
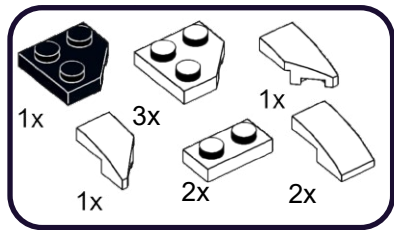

724

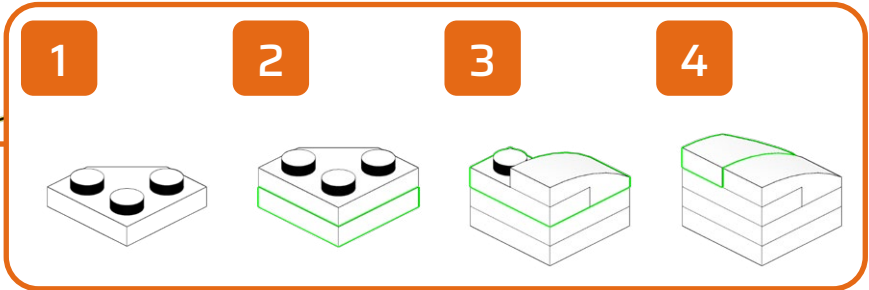
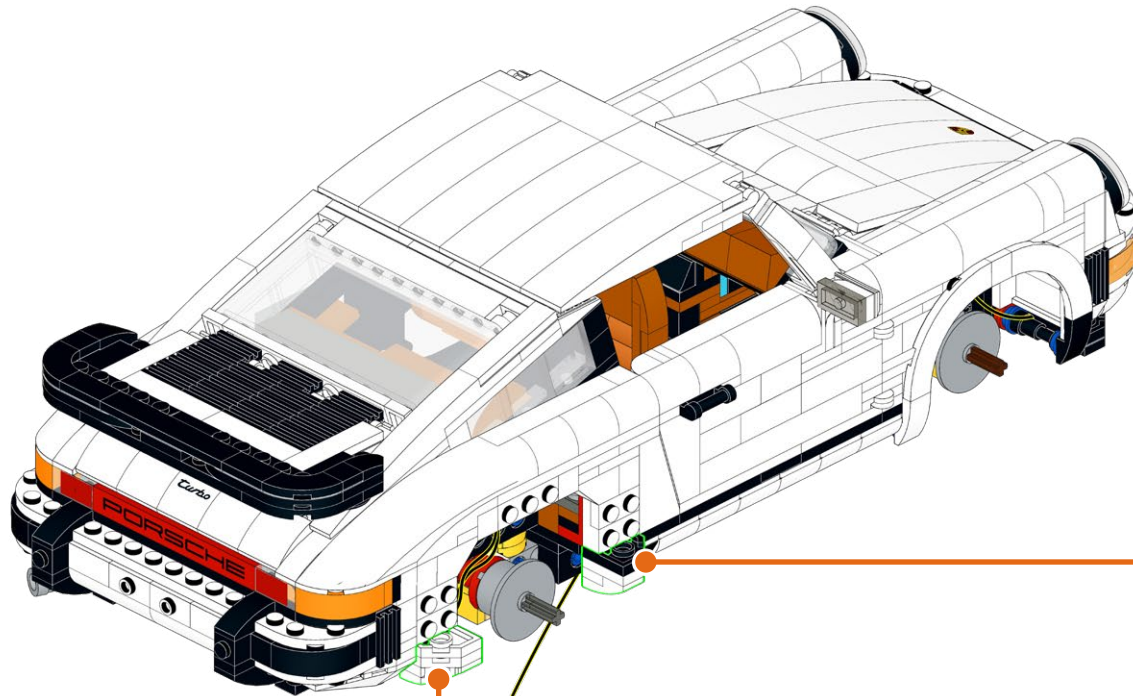
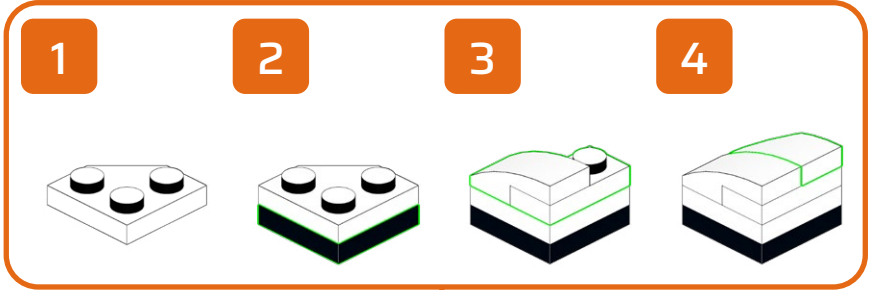
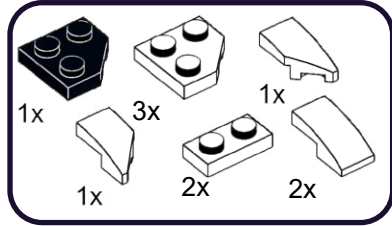

725

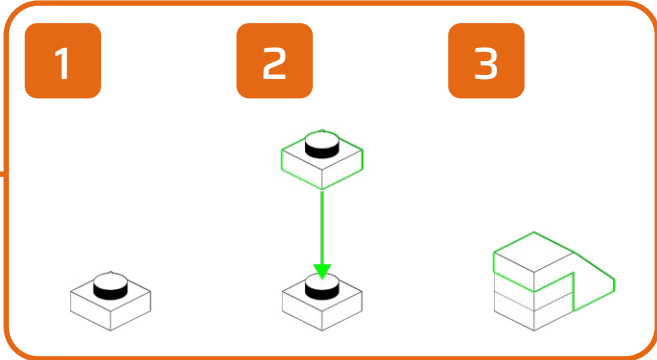
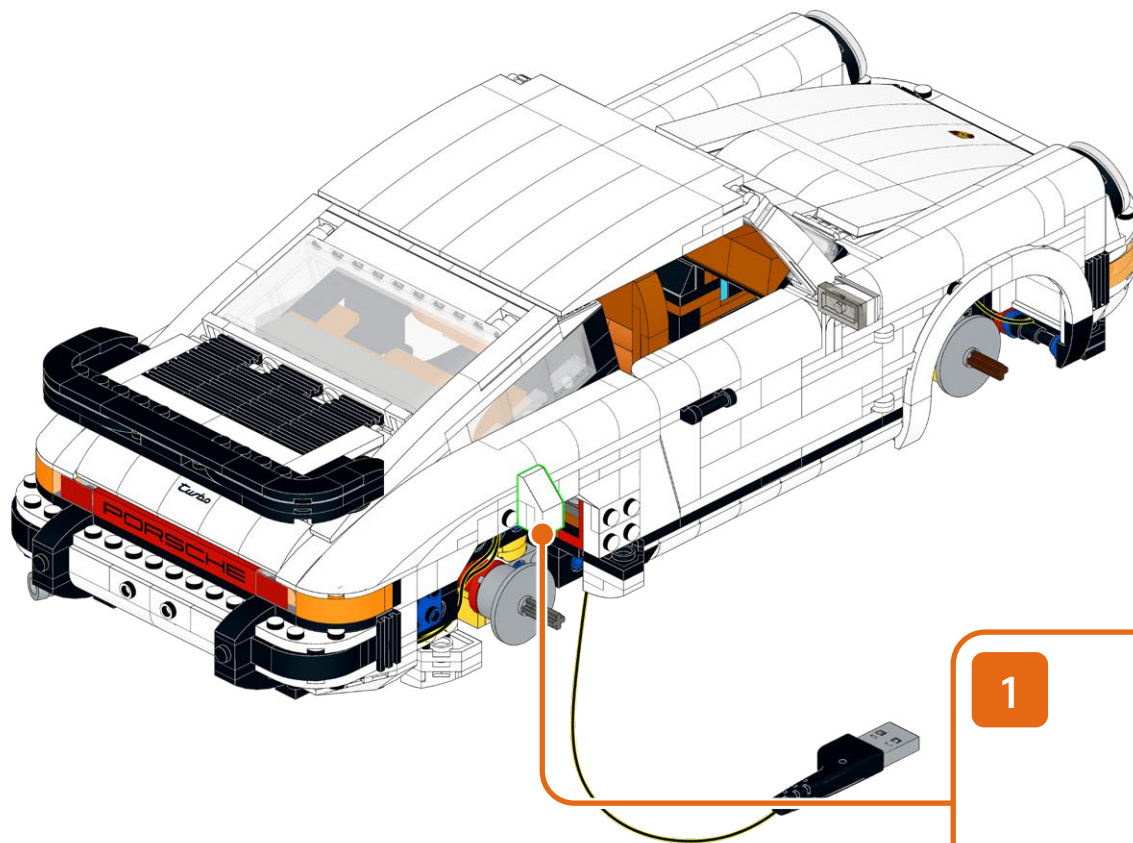
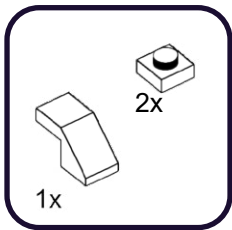

726

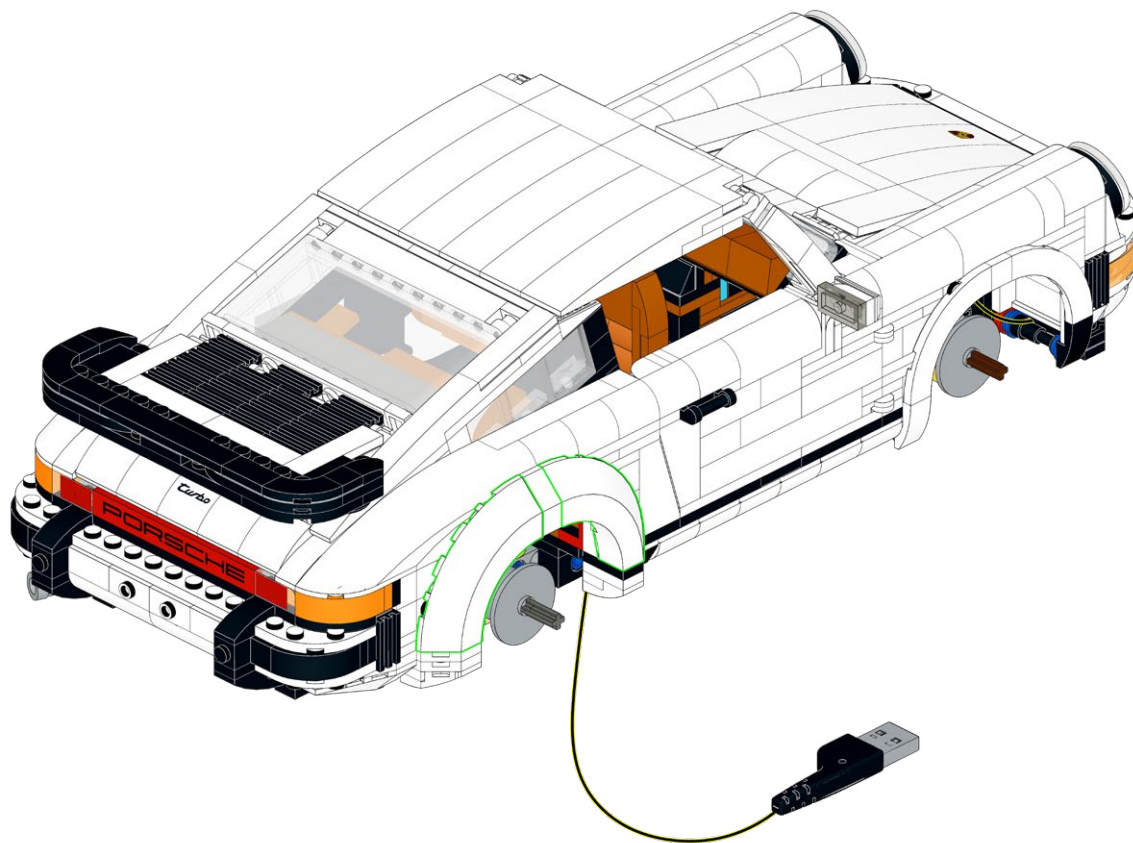
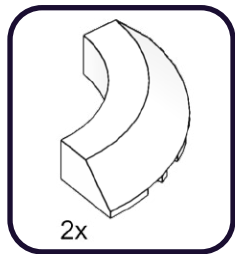

727

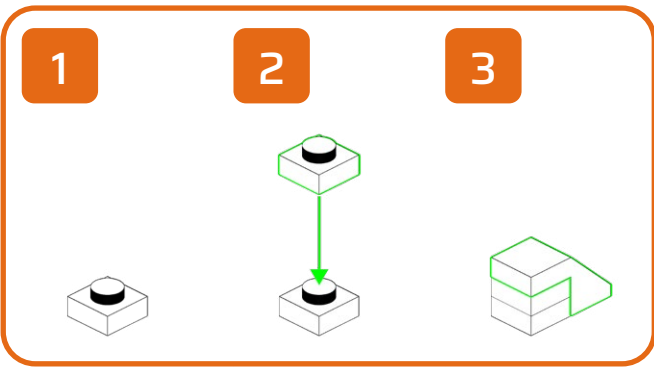
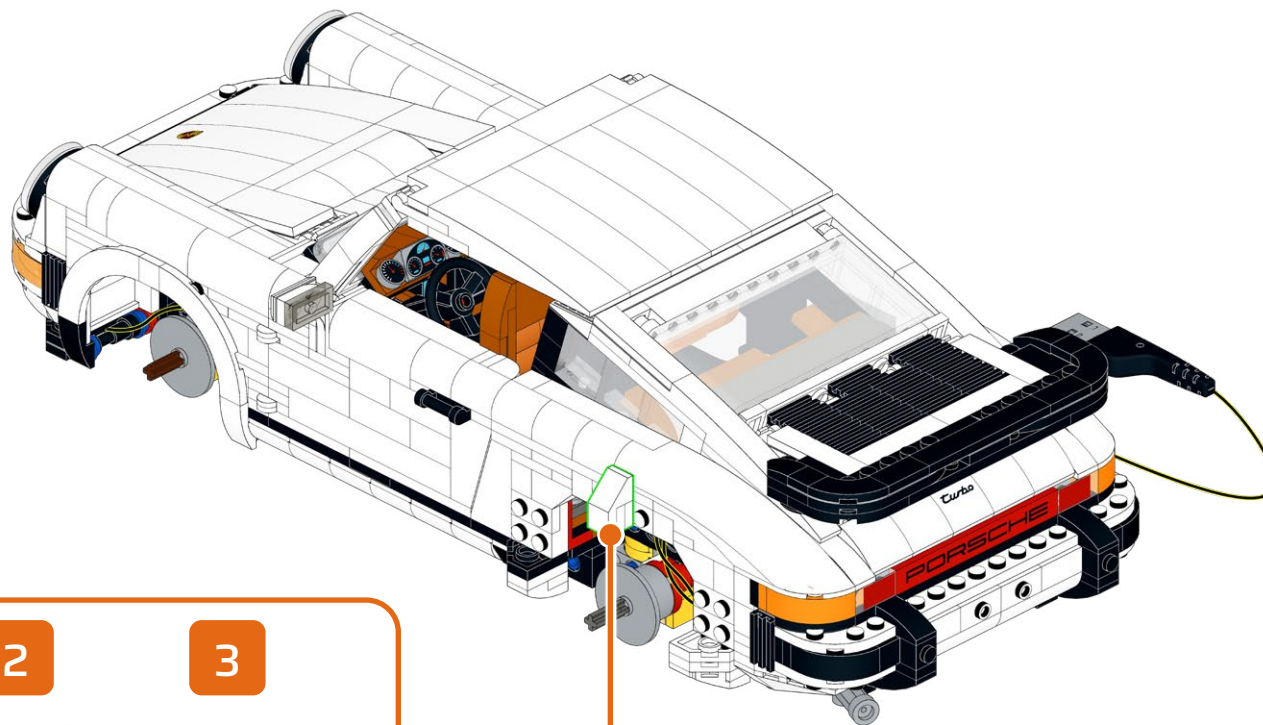
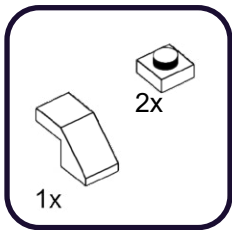
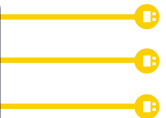

728

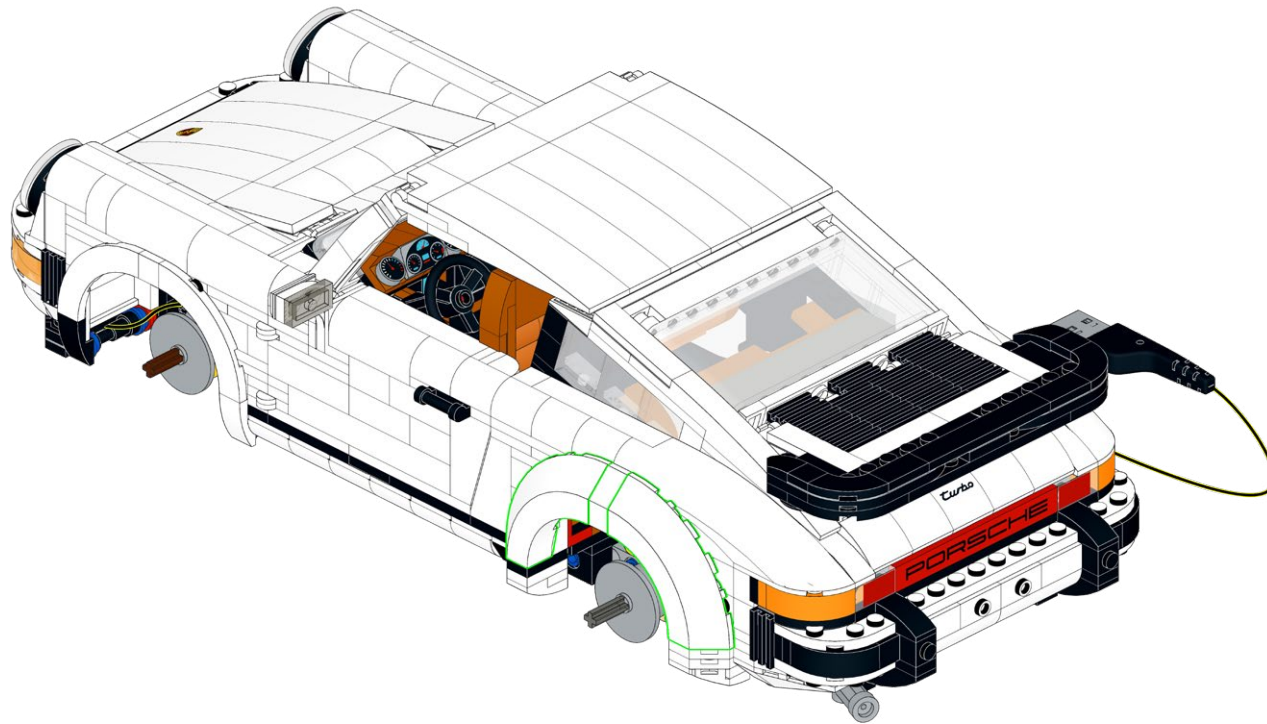
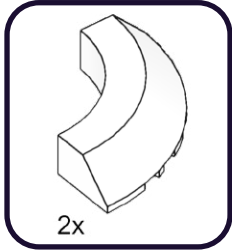

729

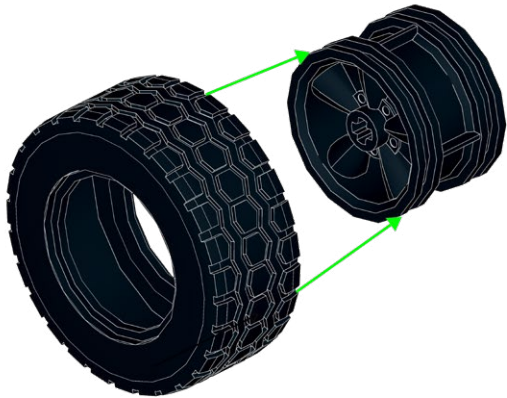

730



2x

731

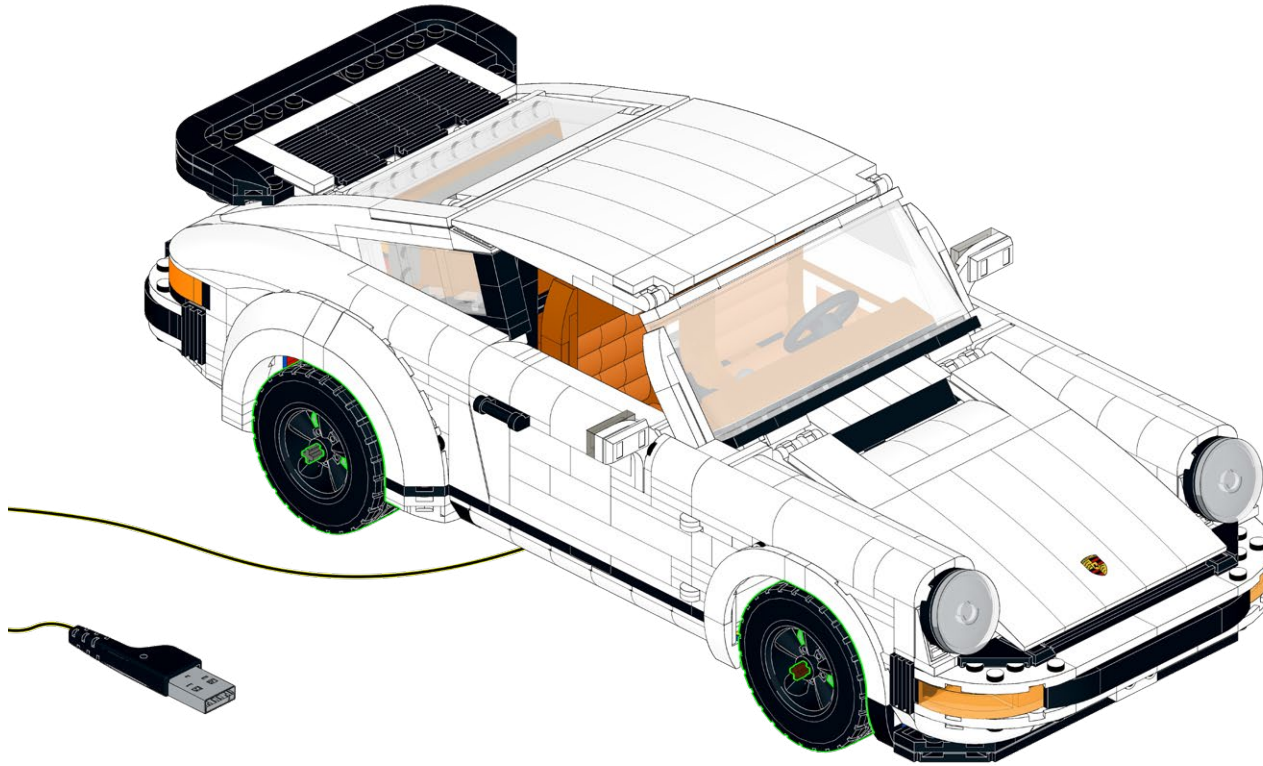

732

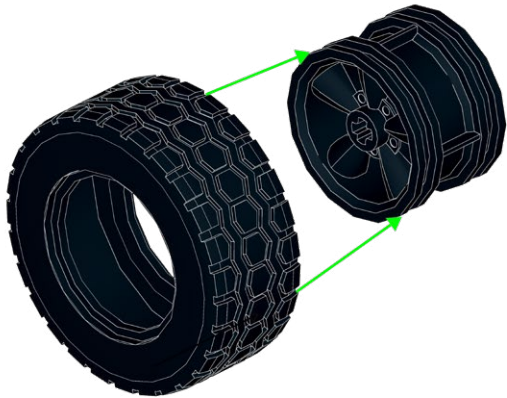

733



2x

734

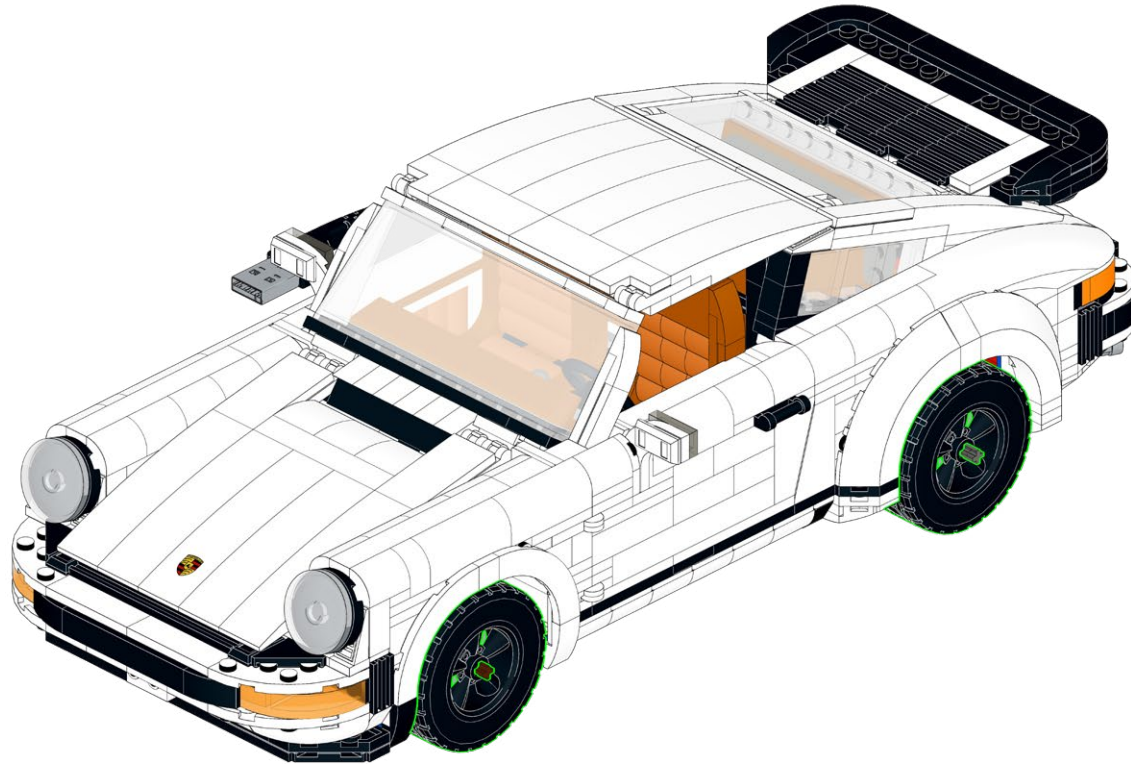

735

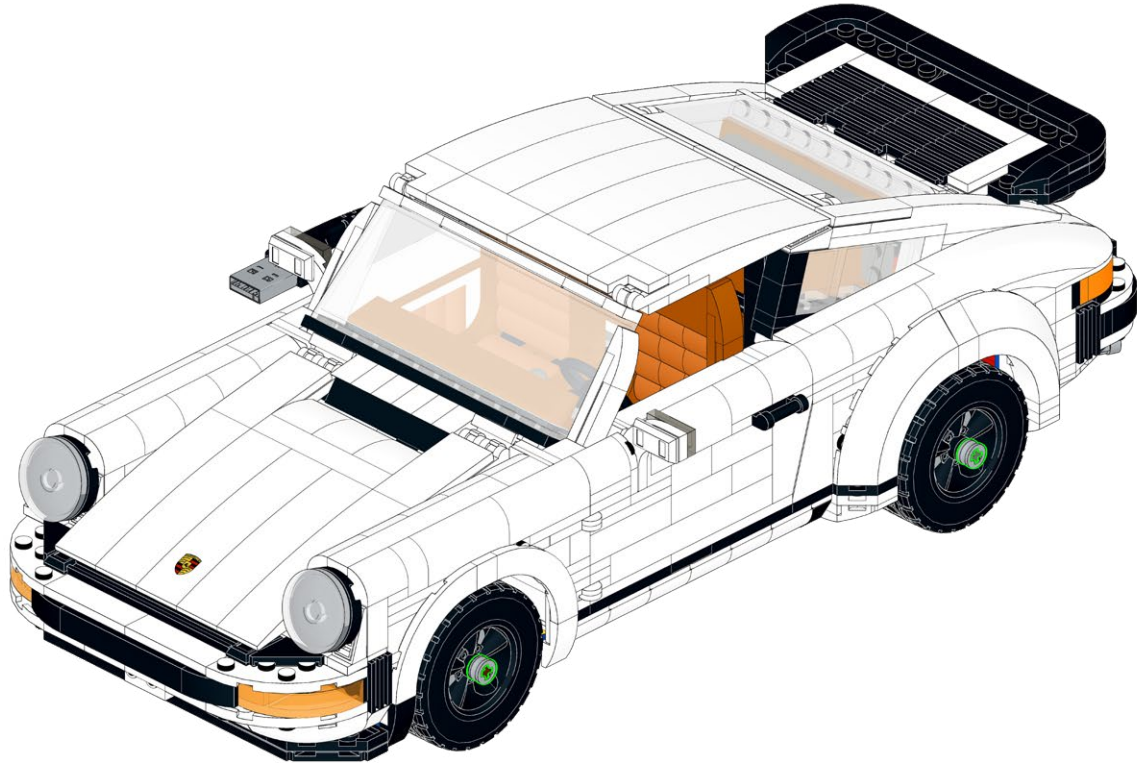

736

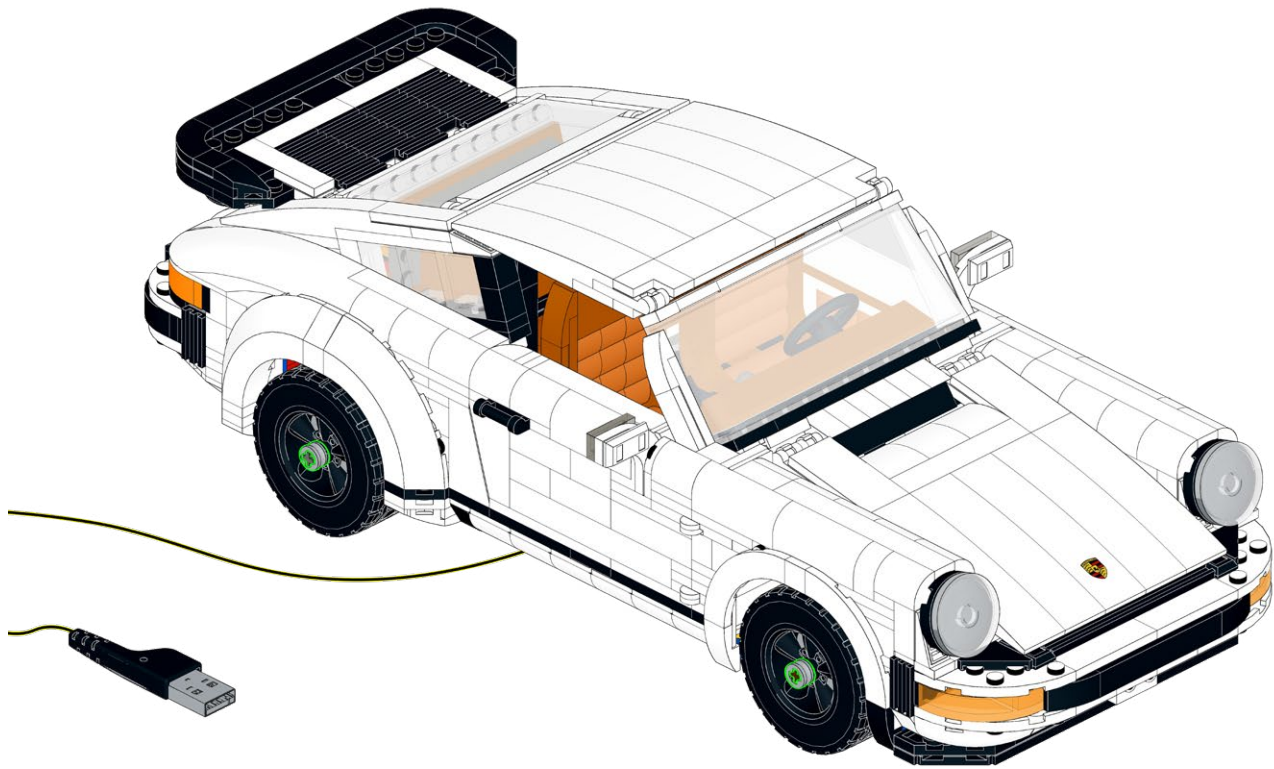

737

S - CU 6000

1x



1x

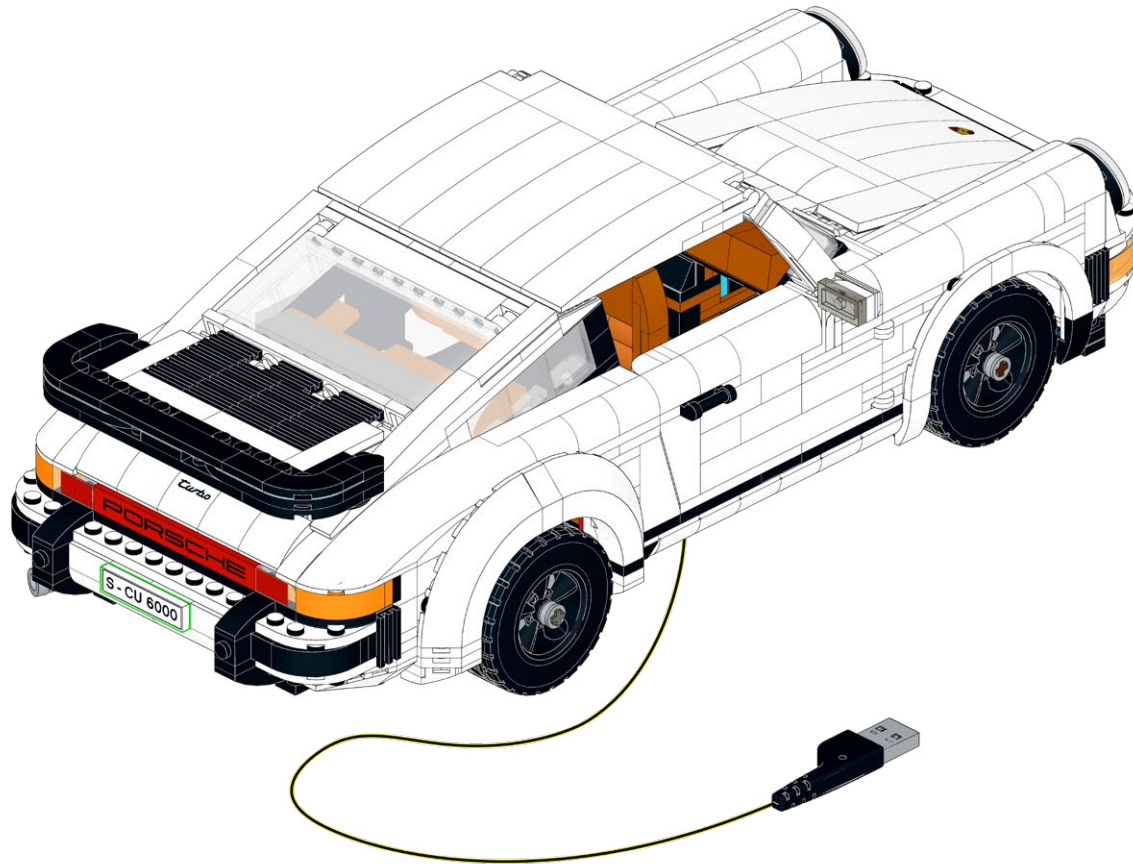

738

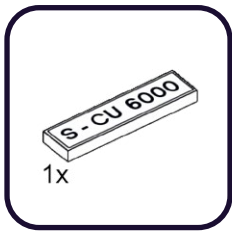

1x

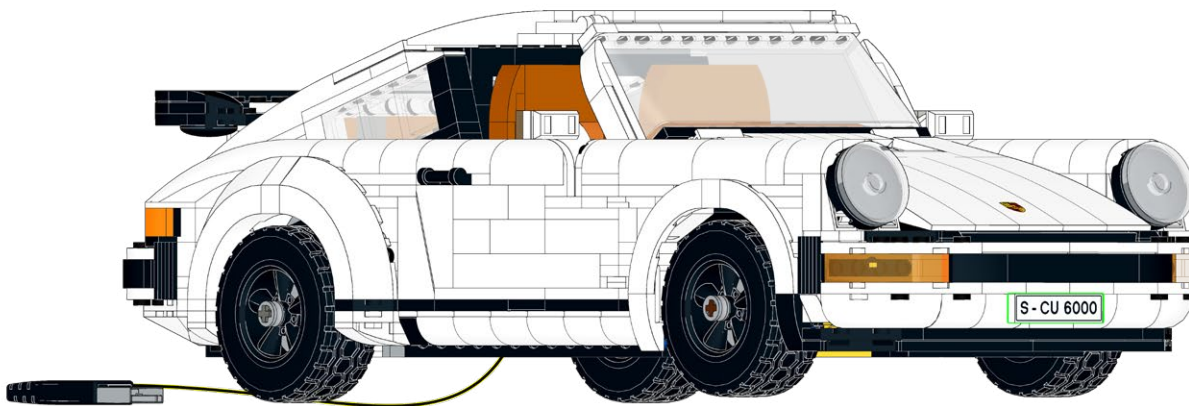

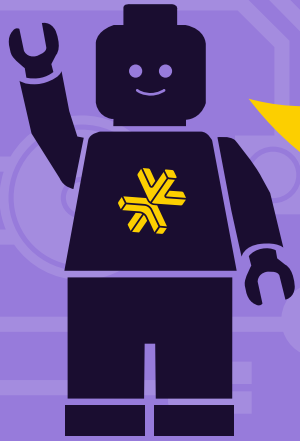

HOLD UP!

You might notice some bags aren't in order, as well as left over pieces, but that's ok! We're changing the way you build LEGO!

ATTENDEZ!

Vous remarquerez peut-être que certains sacs, ainsi que certaines pièces, ne sont pas dans le bon ordre. Mais pas de panique! Nous changeons simplement la façon avec laquelle vous construisez vos LEGO!

ASPETTA!

Potresti notare che alcuni sacchetti non sono in ordine, così come i pezzi avanzati, ma va bene così! Stiamo cambiando il modo in cui costruisci i LEGO!

HALT!

Sie werden möglicherweise bemerken, dass einige tüten durcheinander sind und teile übrig bleiben, aber das ist in Ordnung! Wir ändern die art und weise, wie Sie LEGO bauen!

¡ESPERA!

Es posible que notes que algunas bolsas están fuera de servicio, así como piezas sobrantes, ¡pero está bien! ¡Estamos cambiando la forma en que construyes LEGO!

暫停!

你可能会注意到一些袋子顺序错乱, 以及一些剩余的部件, 但没关系! 我们正在改变你搭建乐高的方式!

Open LEGO® Bags 8 & 10

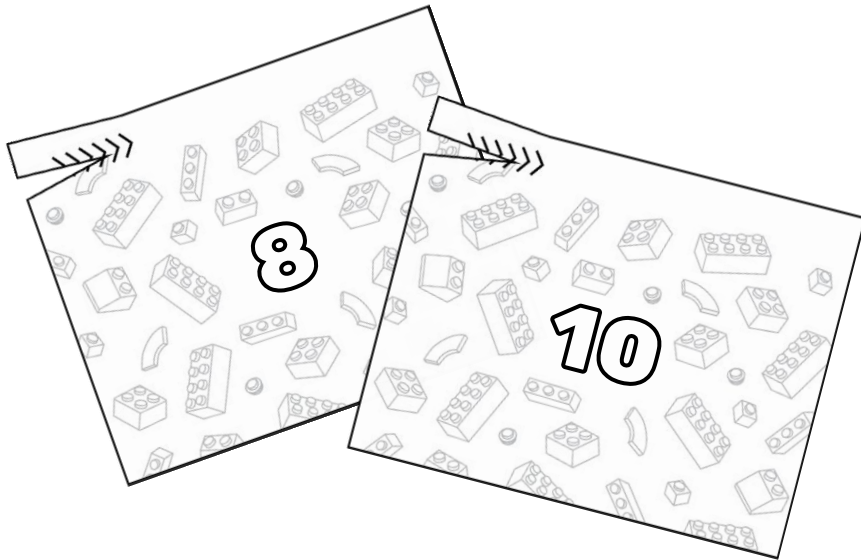

739

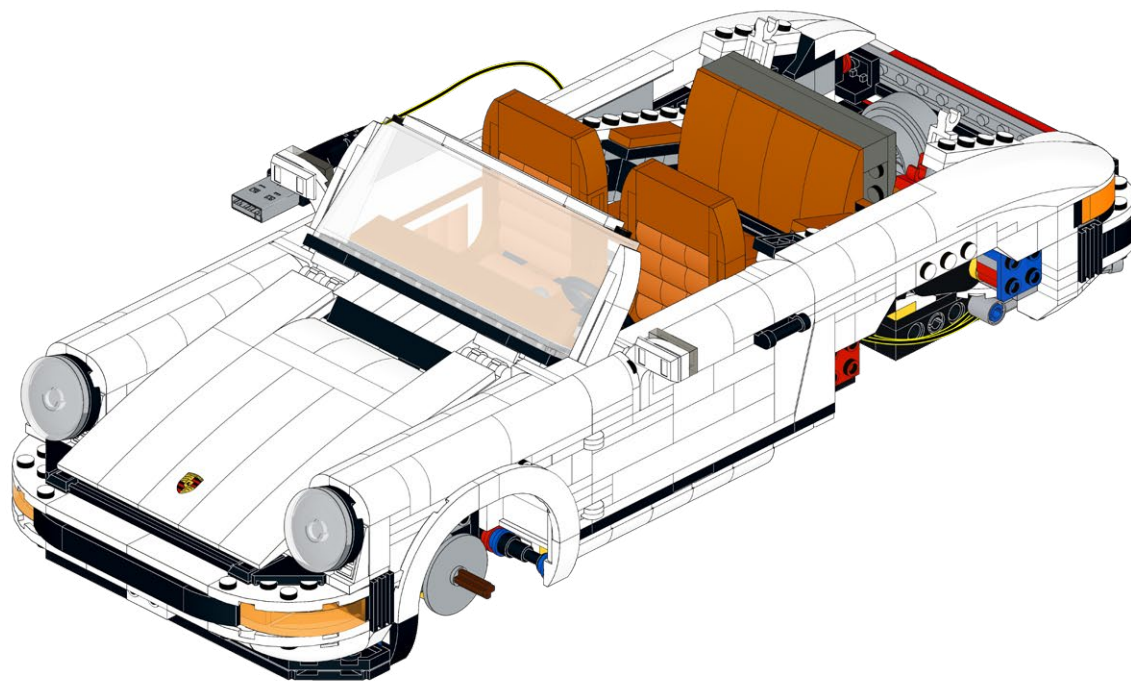

740

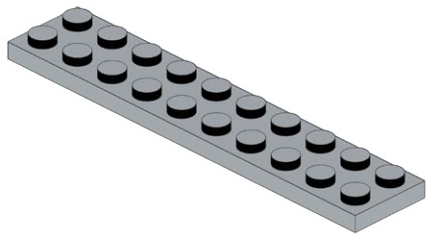
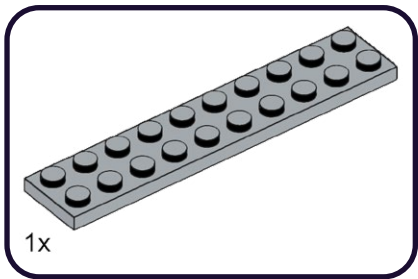

741

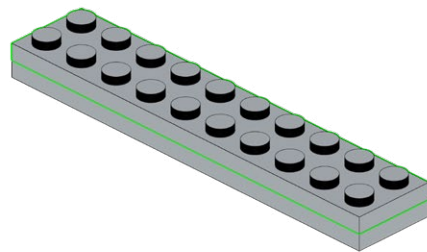
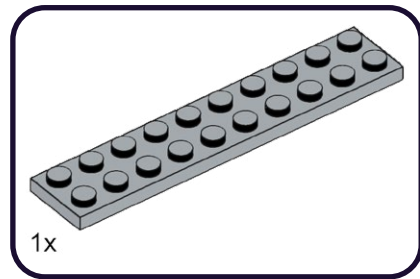

742

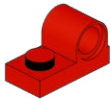
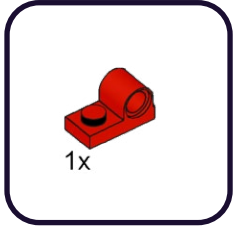

743

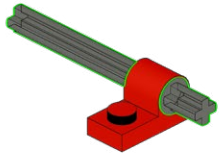
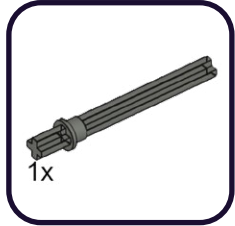

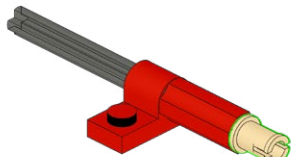
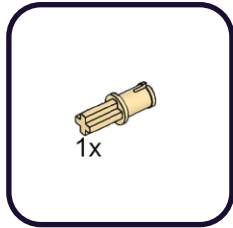
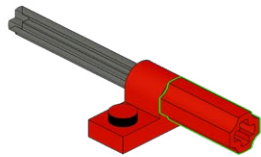
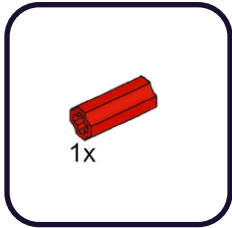

746

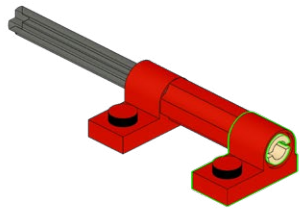
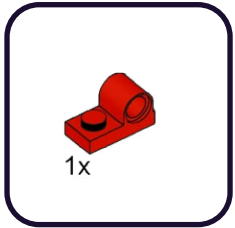

747

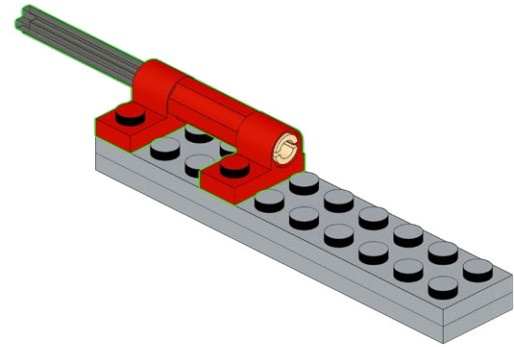

748

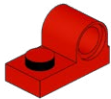
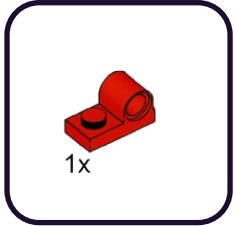

749

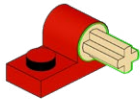
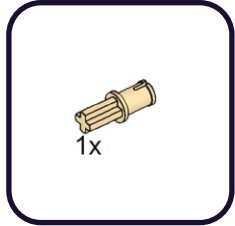

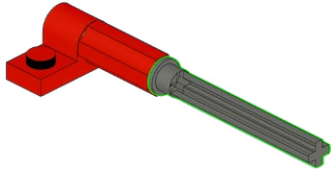
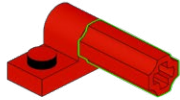
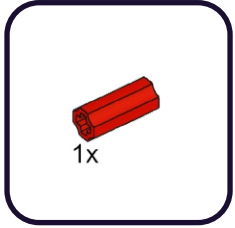

752

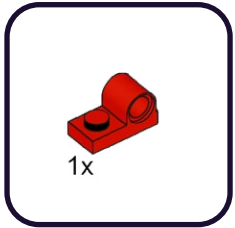

753

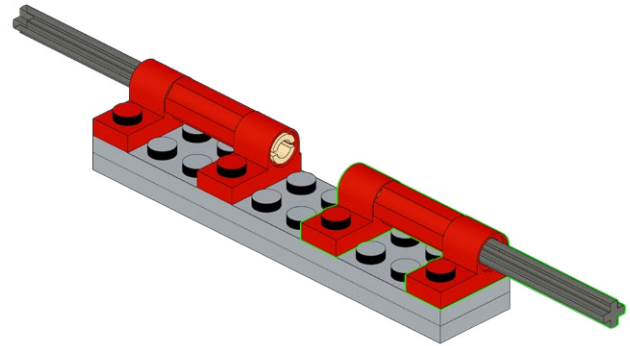
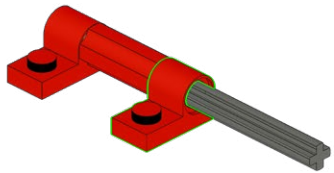

754

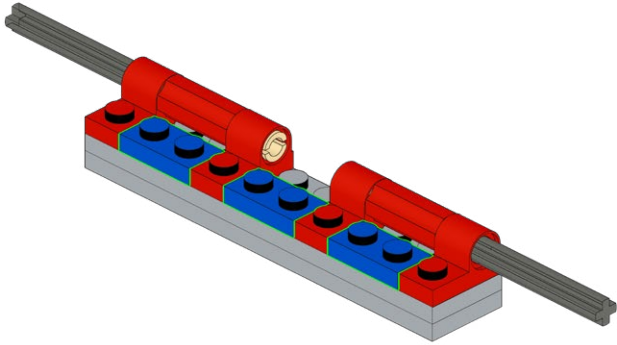
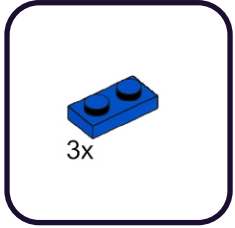

755

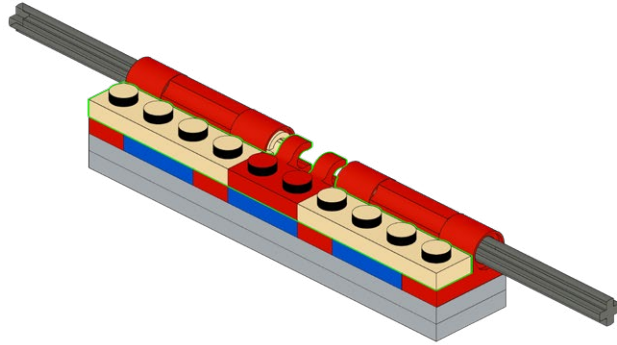
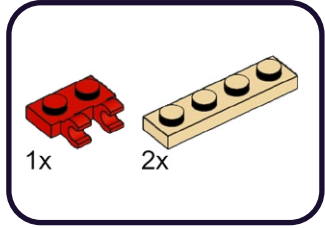

756

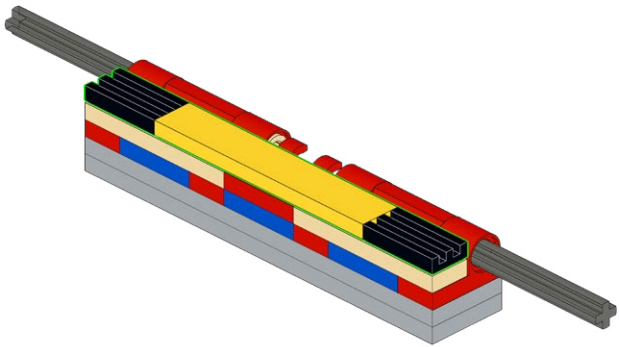
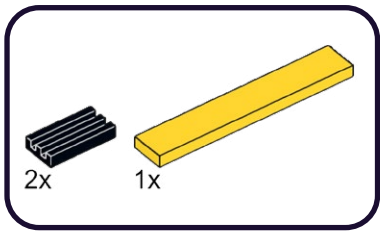

757

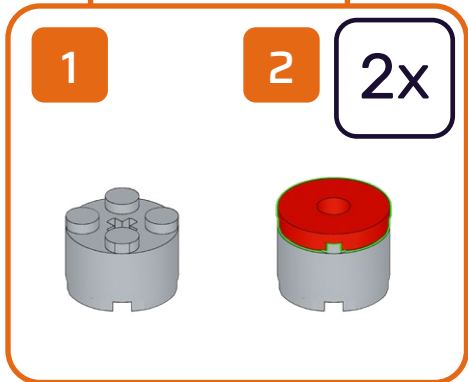
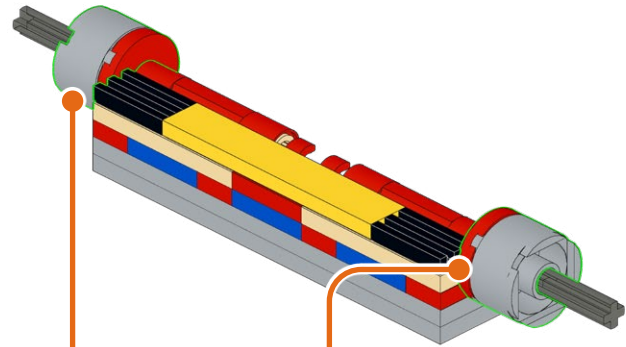
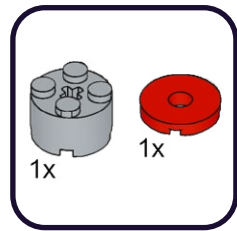

758

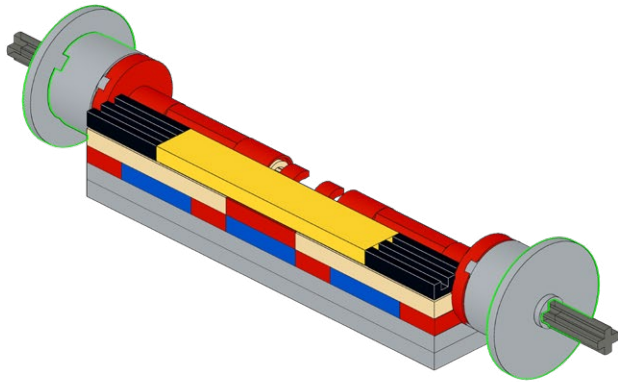
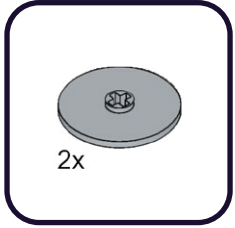

759

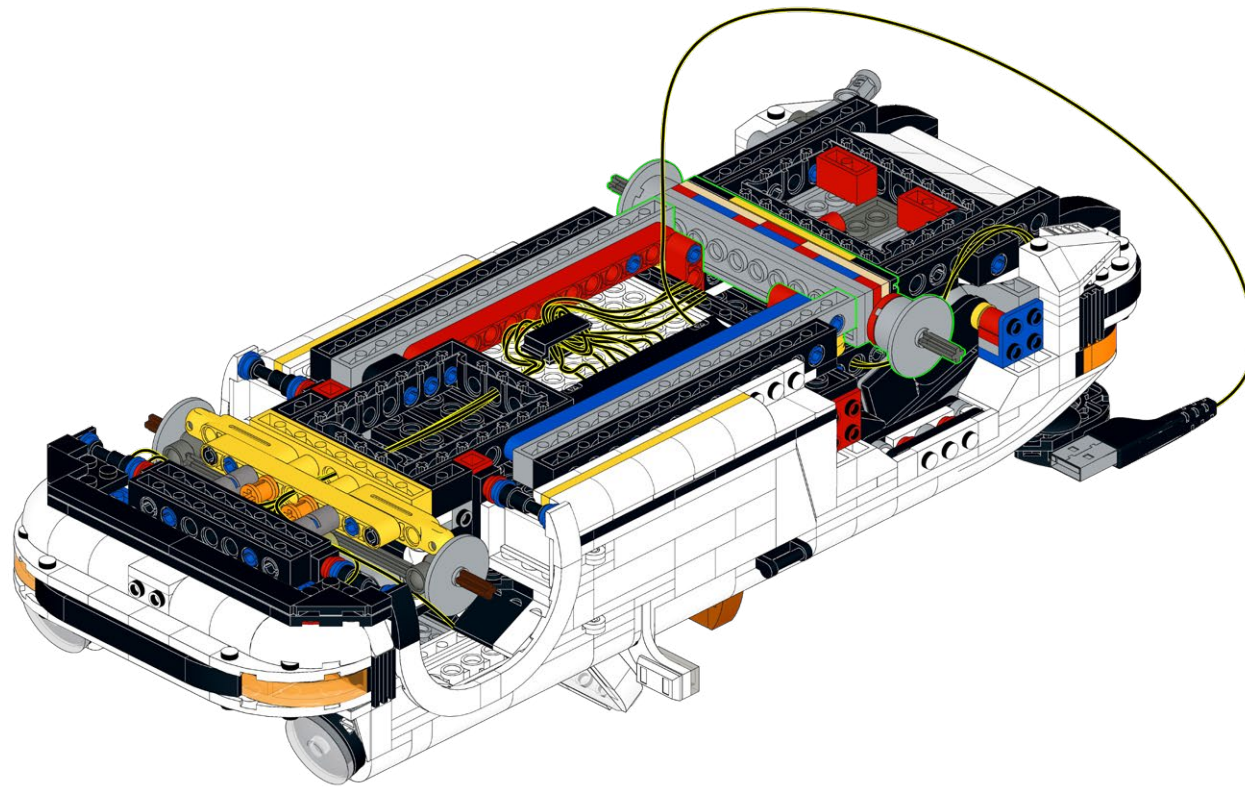

760

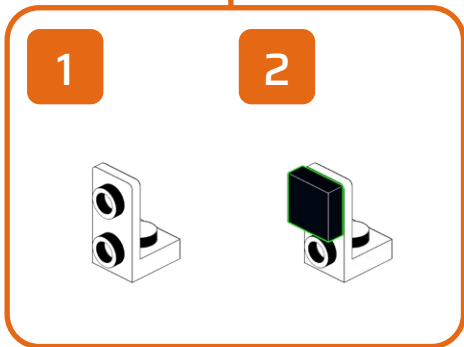
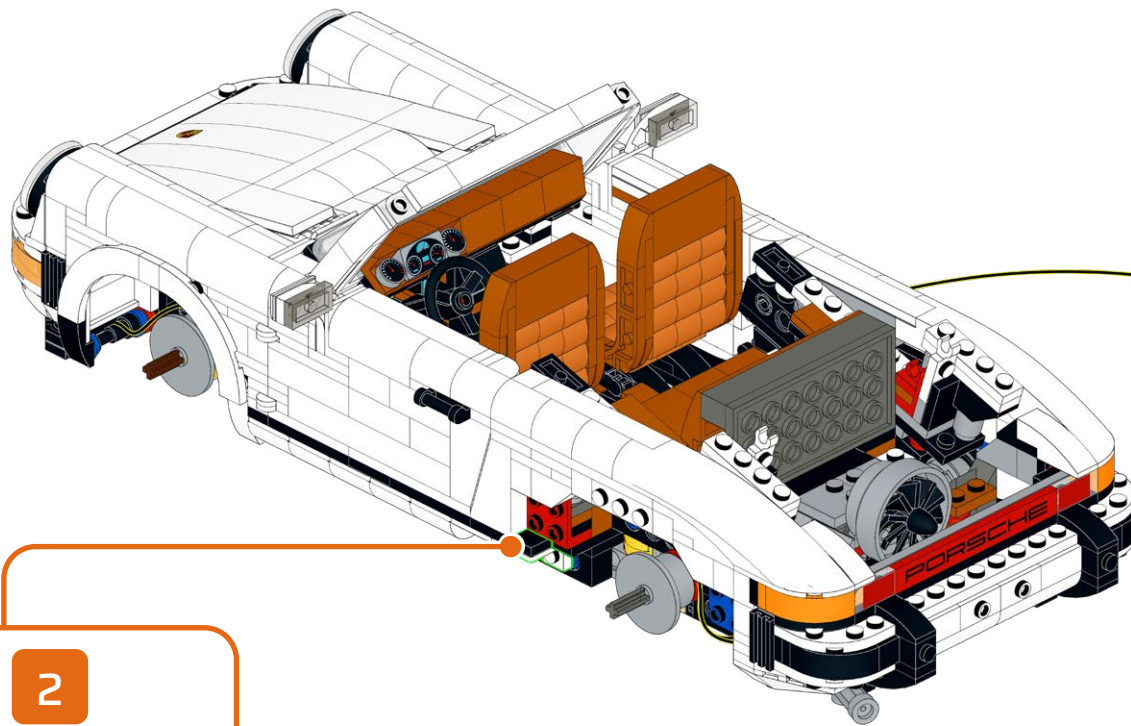
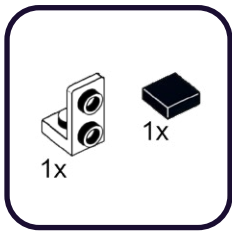

761

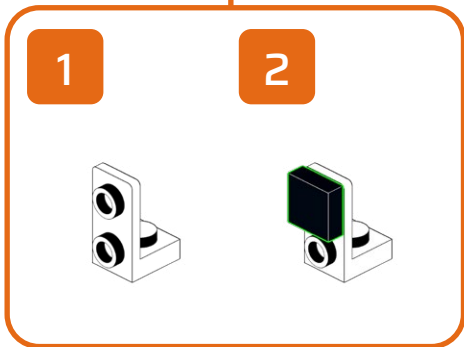
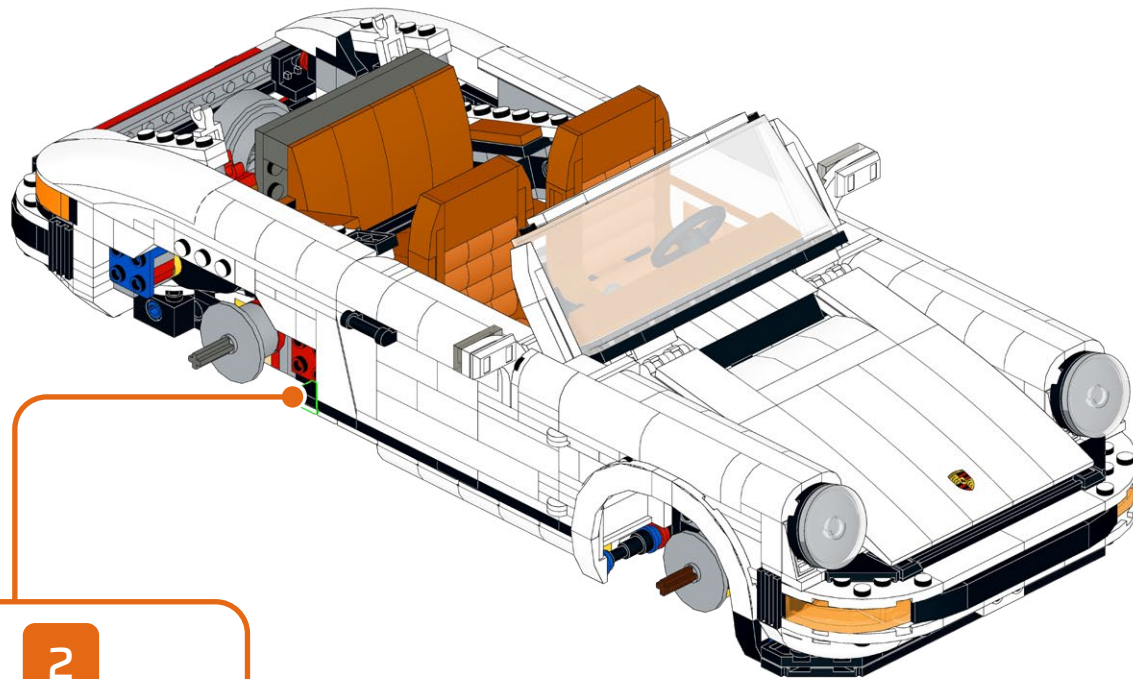
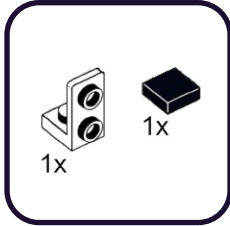

762

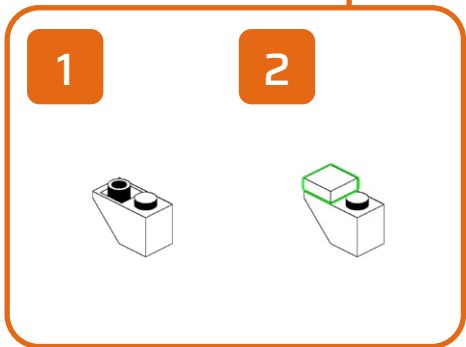
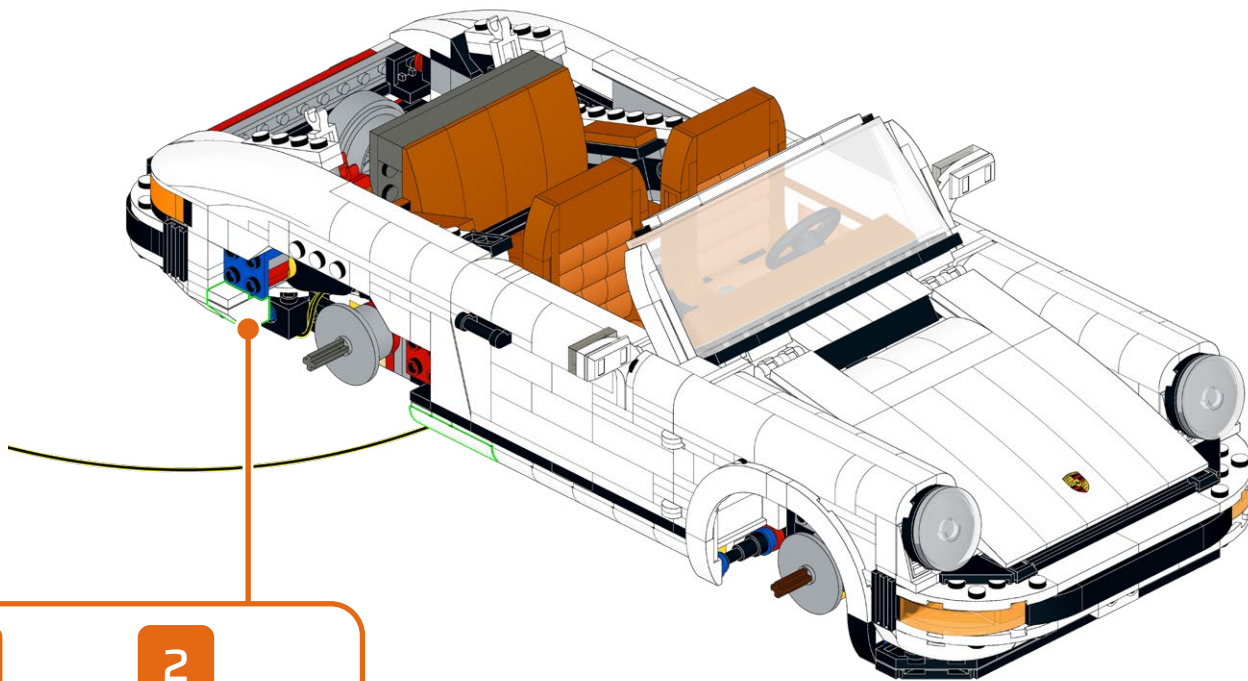
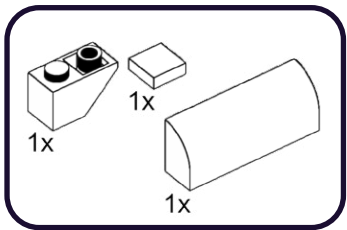

763

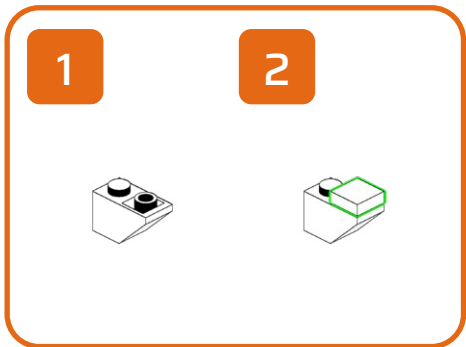
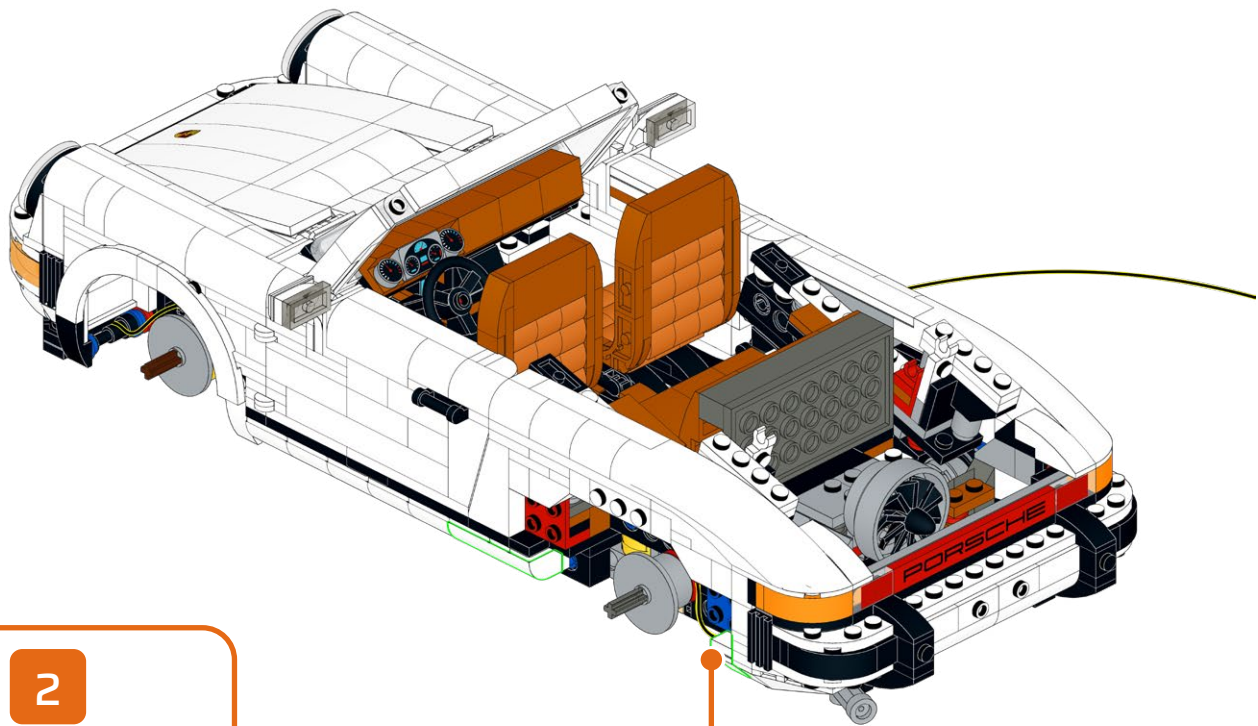
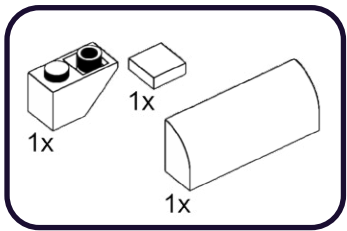

764

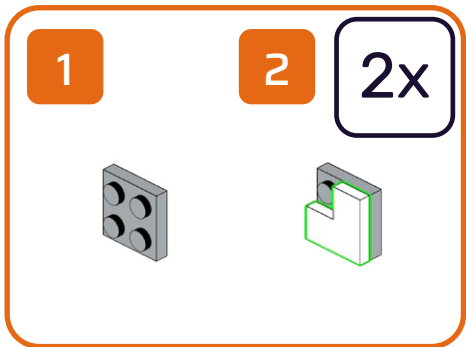
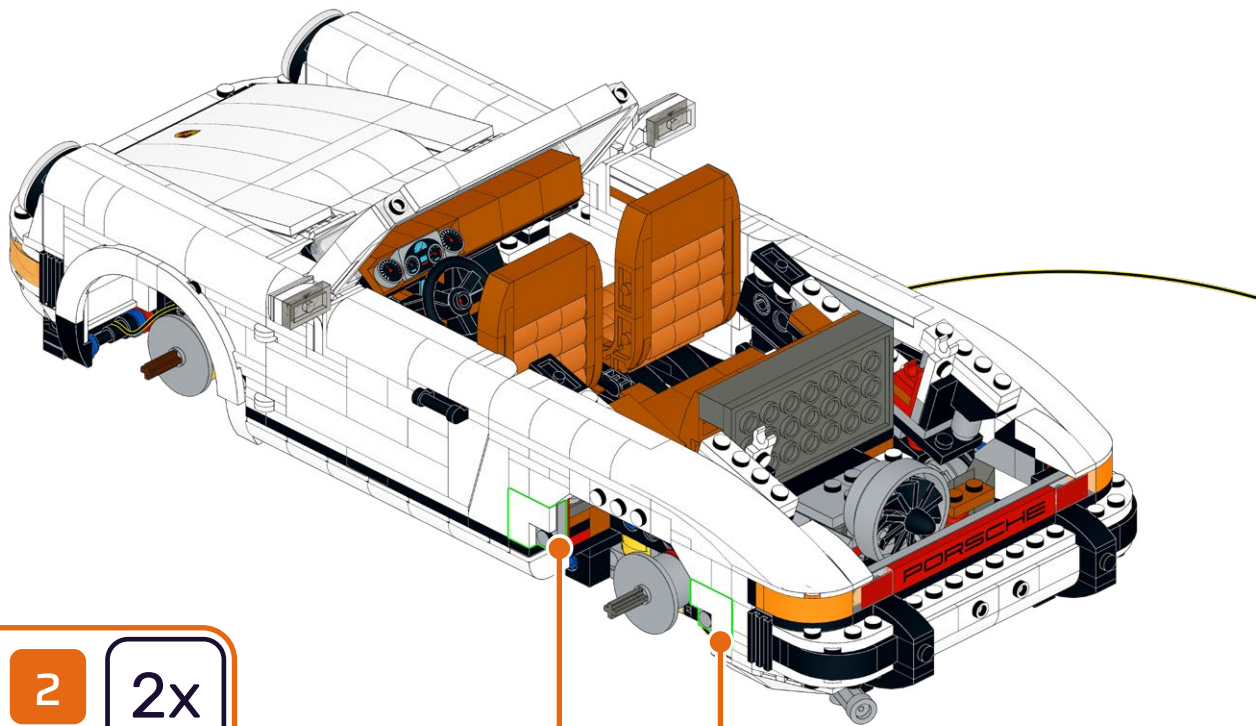
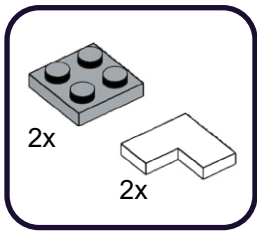

765

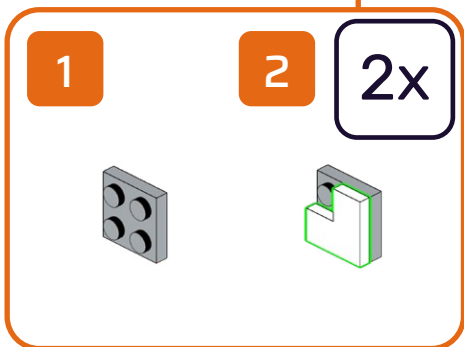
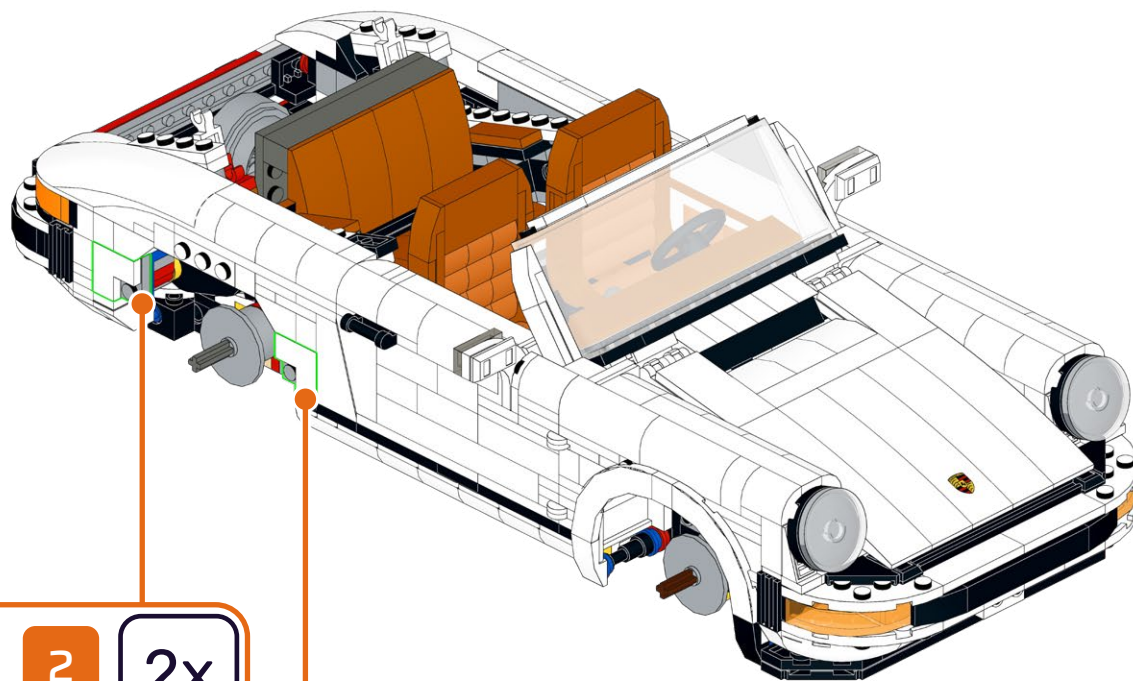
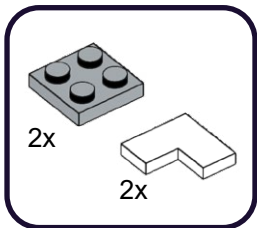

766

2x

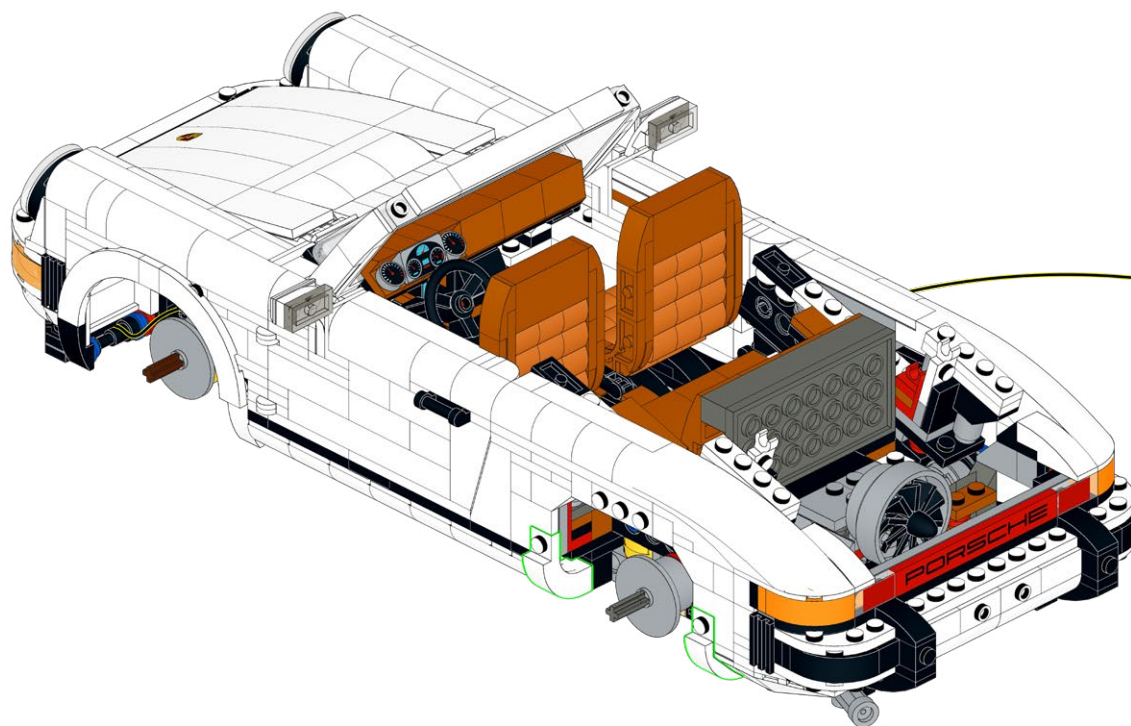

767

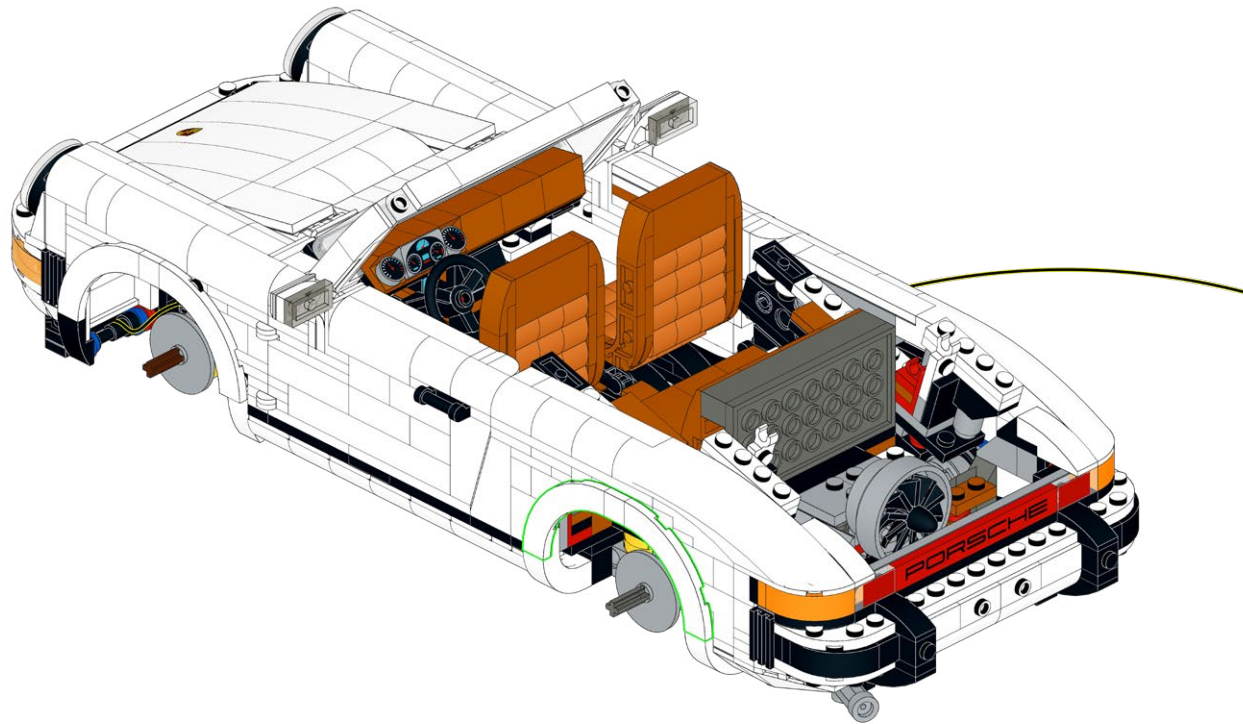
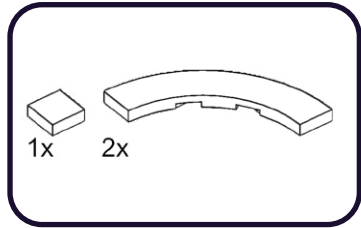

768

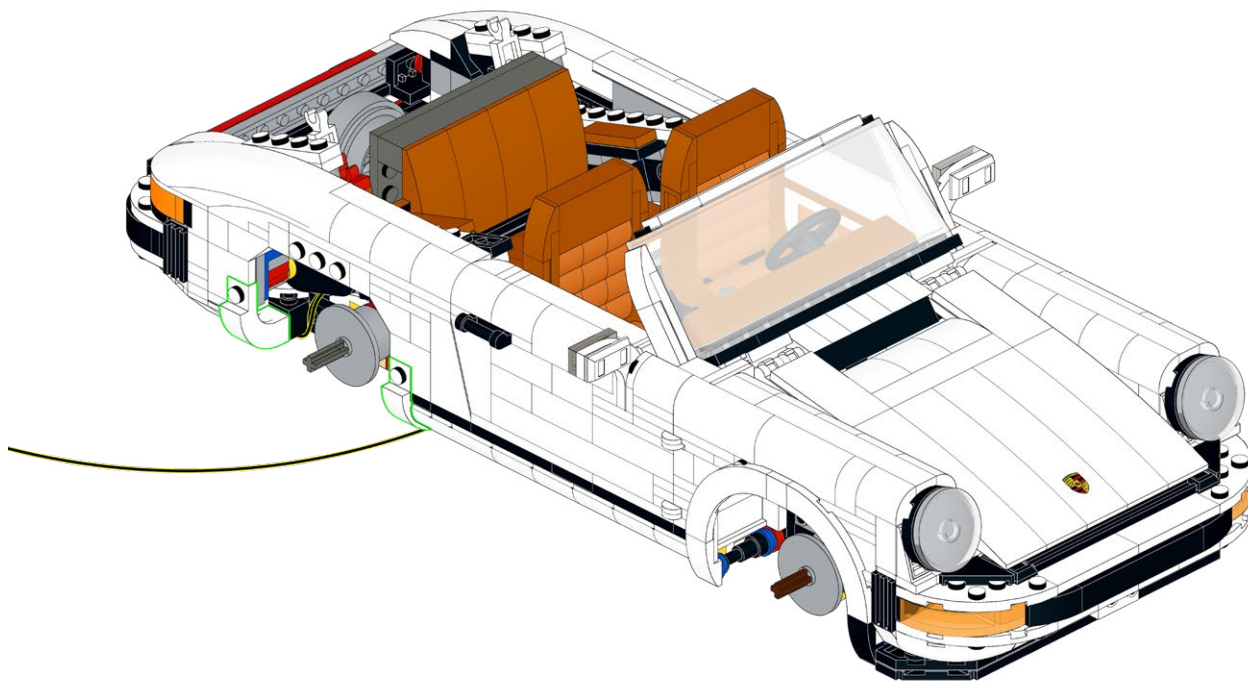
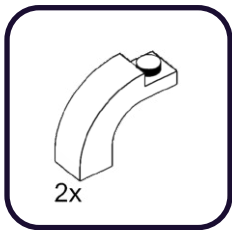

769

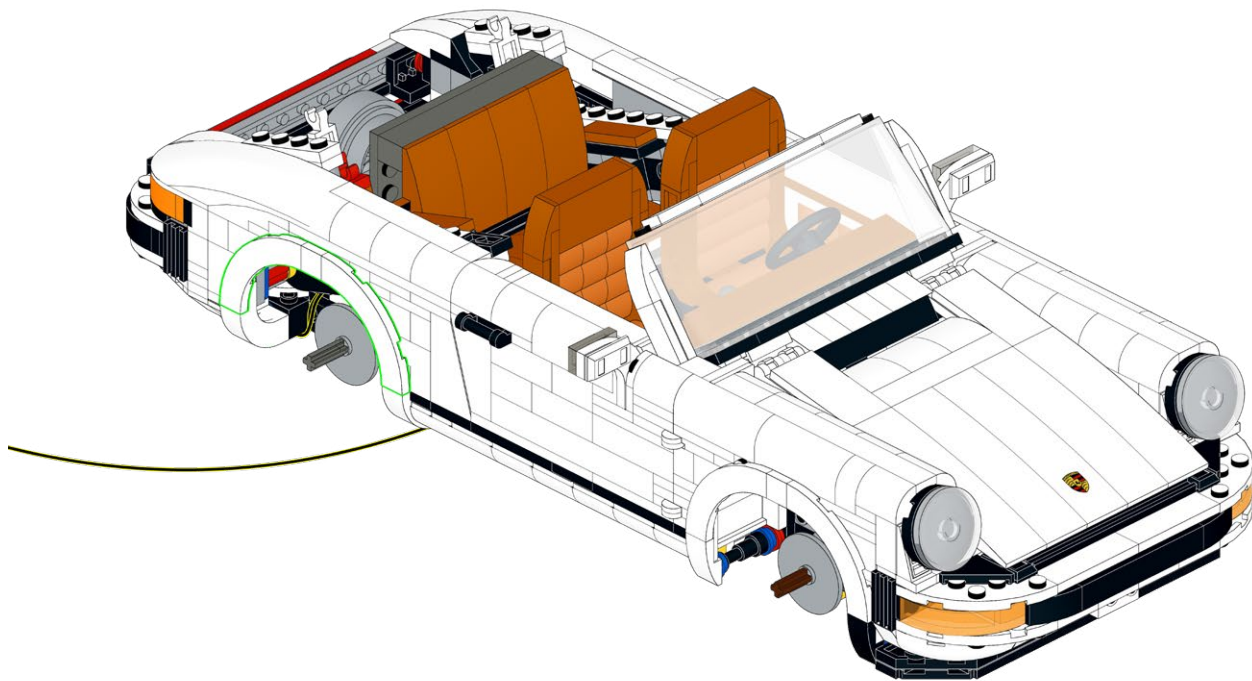
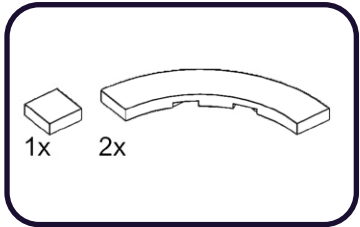

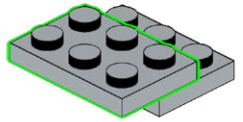
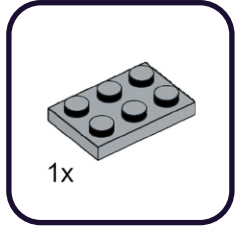
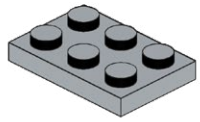
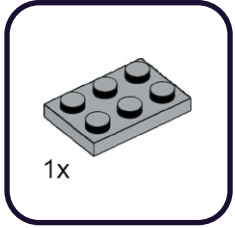

772

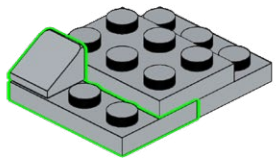
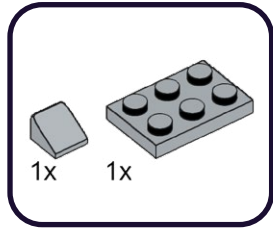

773

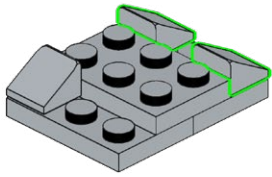
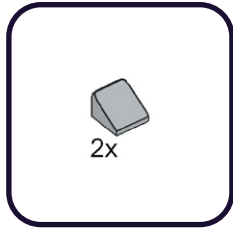

774

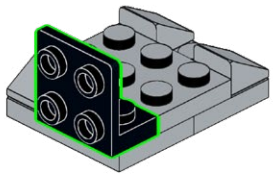
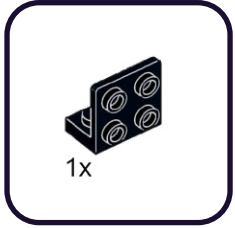

775

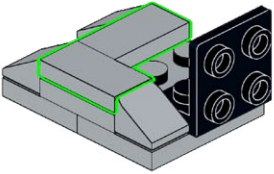
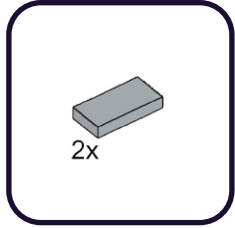

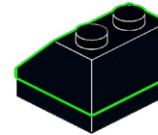
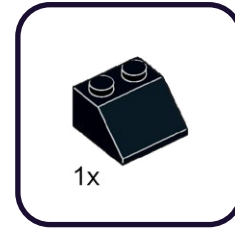
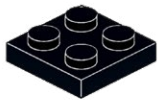
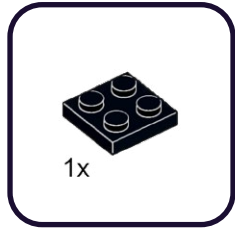

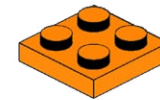
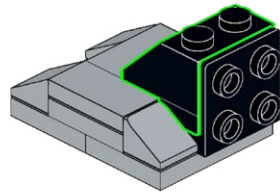
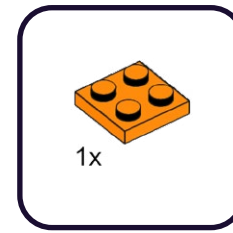
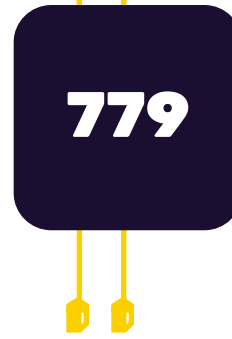

780

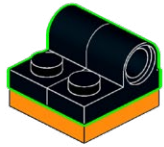

781

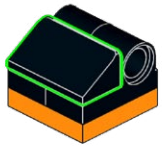

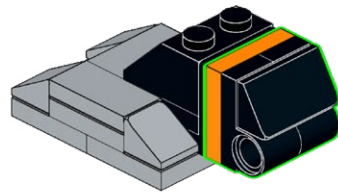

783

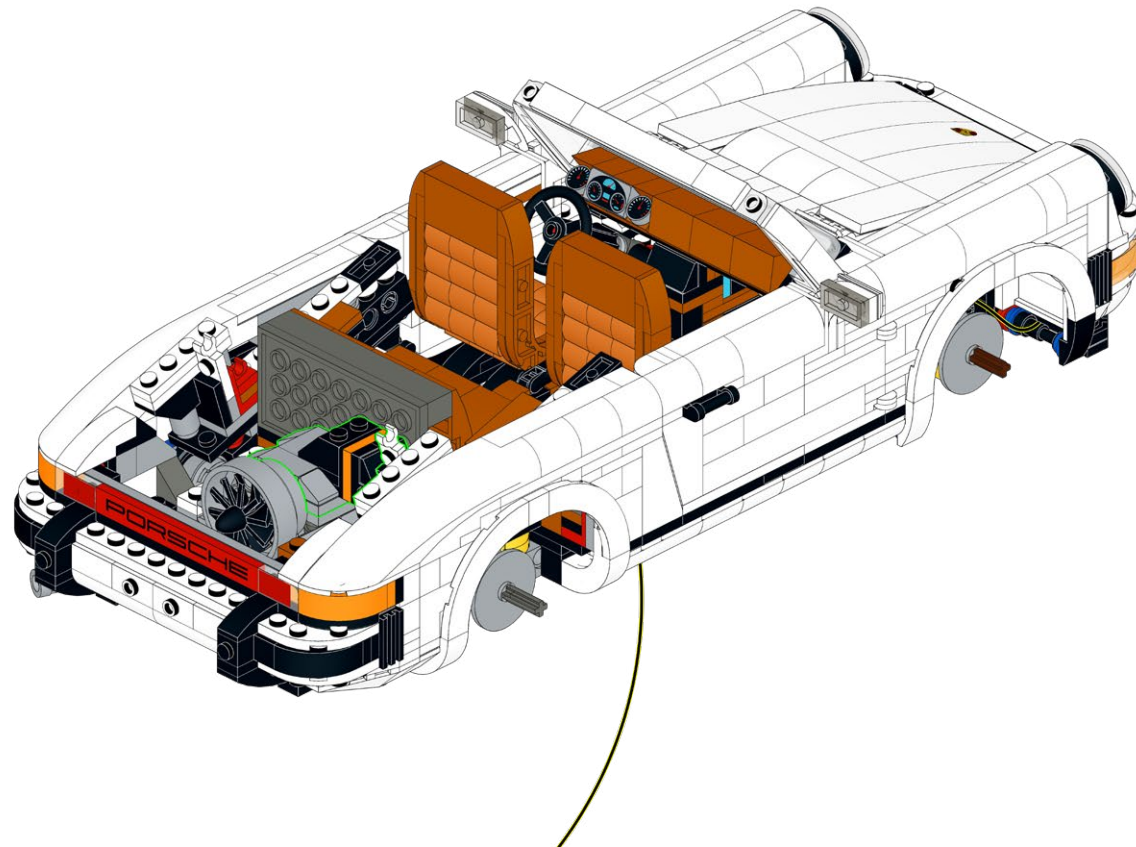

784

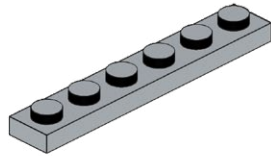
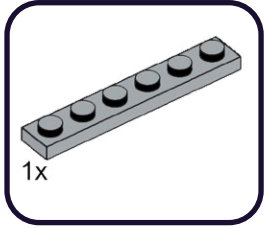

785

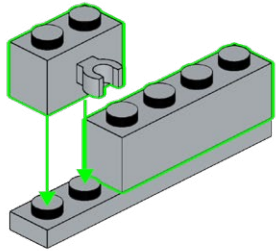
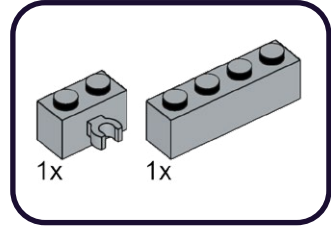

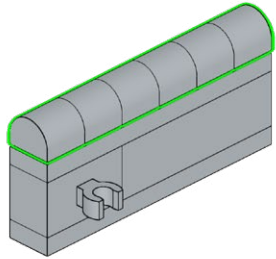
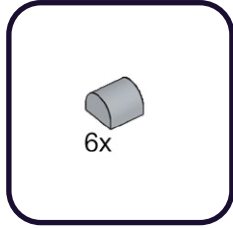
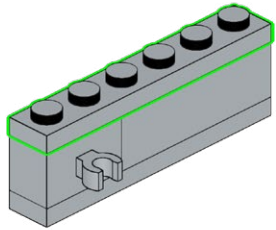
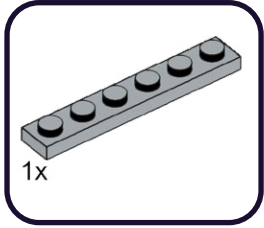

788

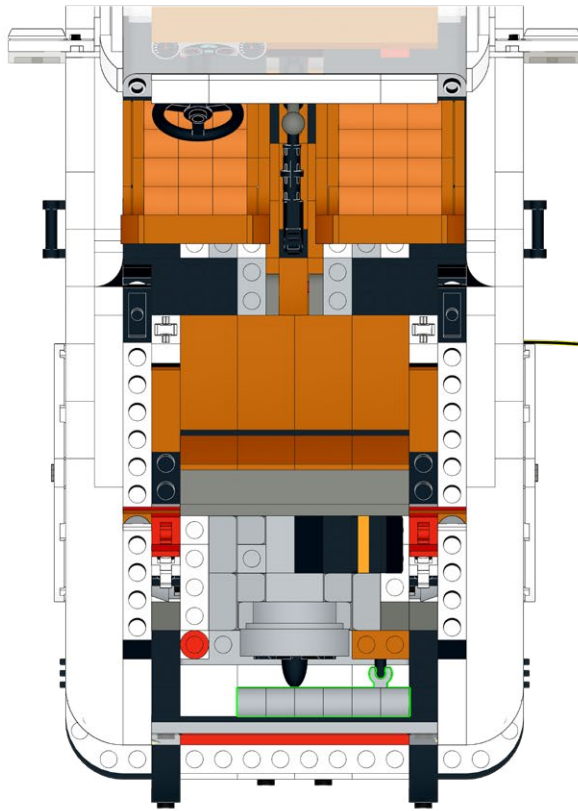

789

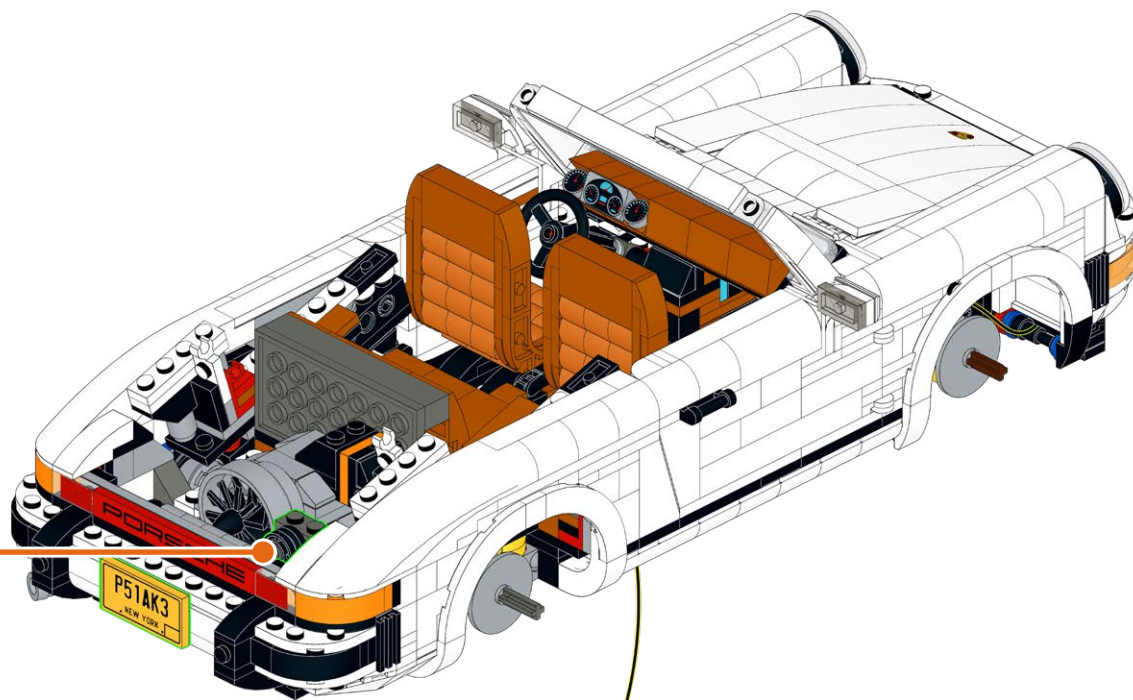
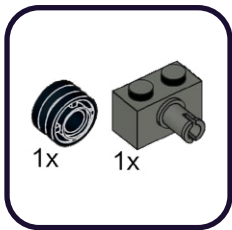

790

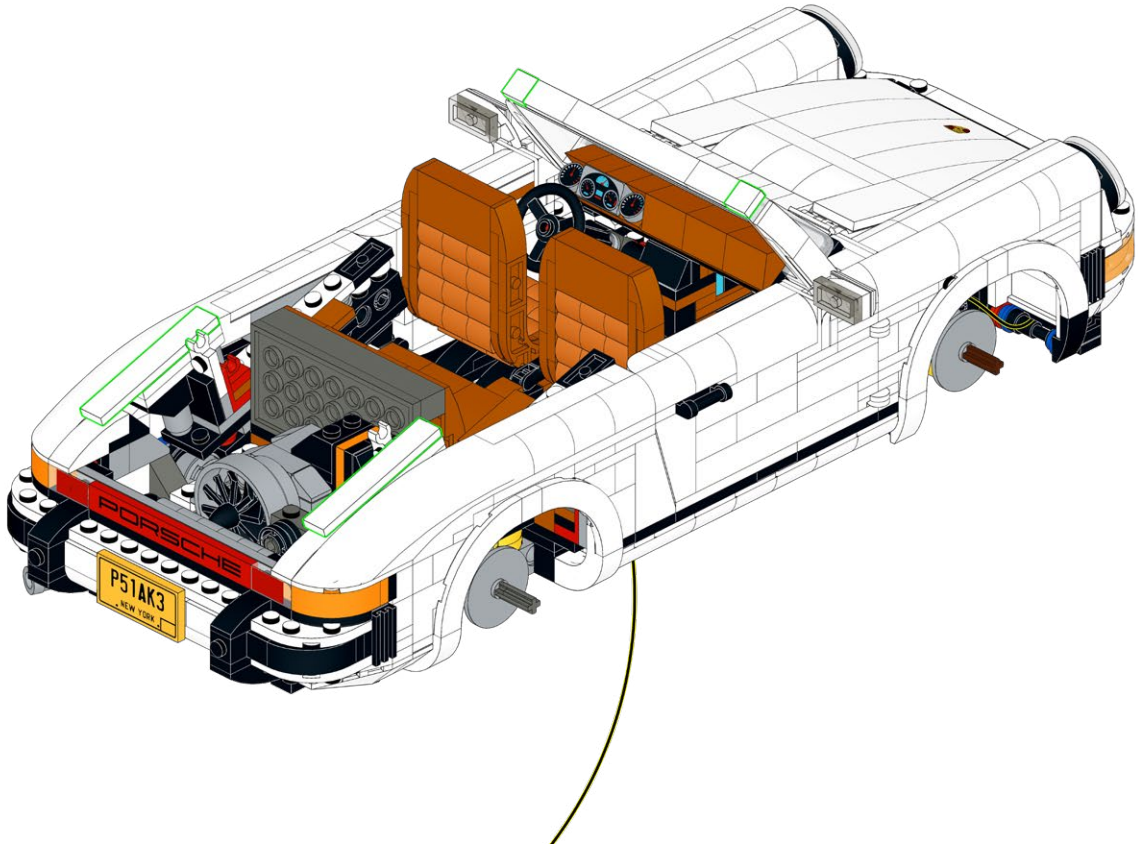
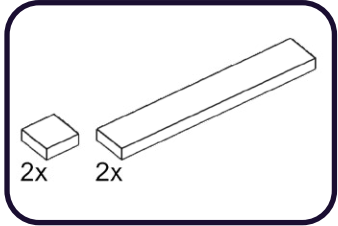

791

6x

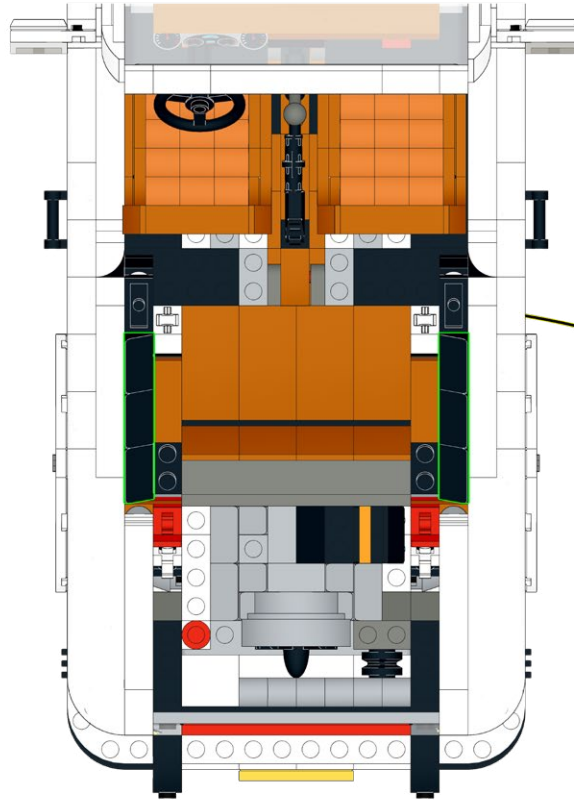

792

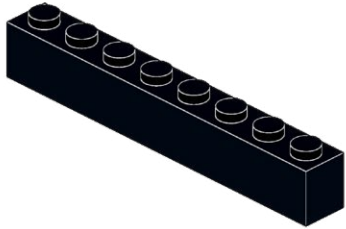
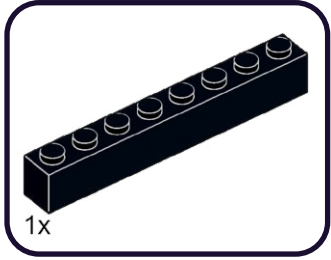

793

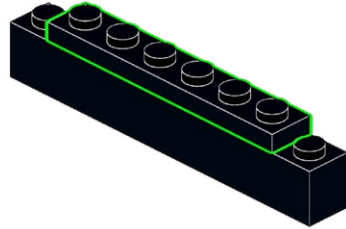
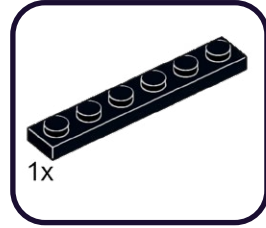

794

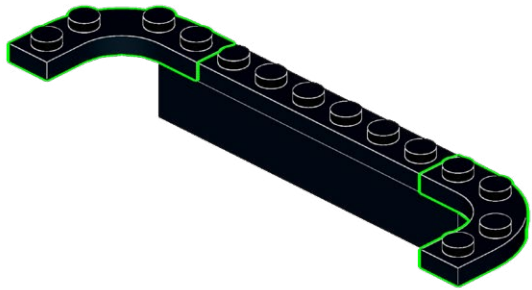
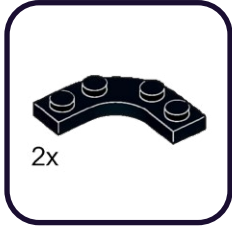

795

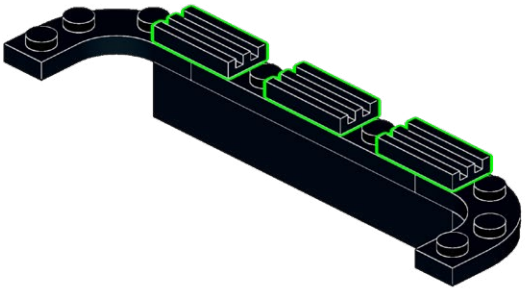
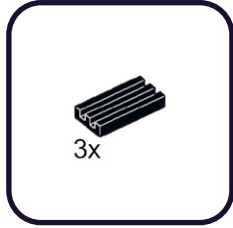

796

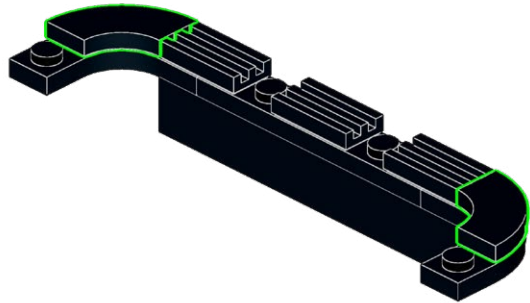
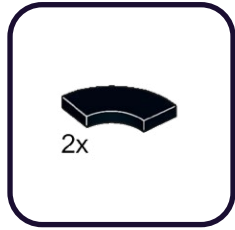

797

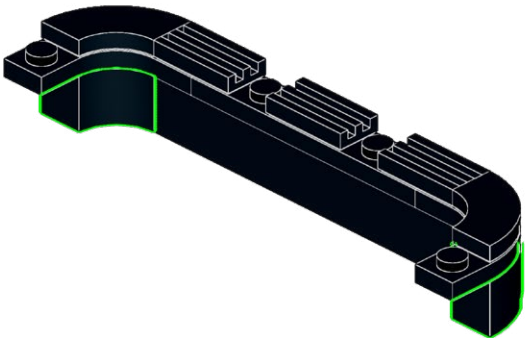

798

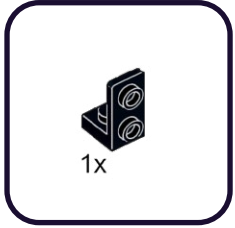

799

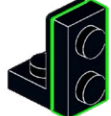
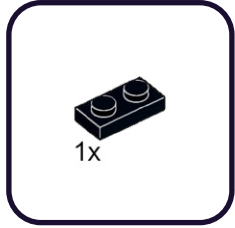

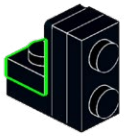
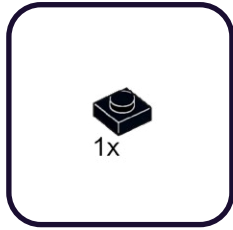
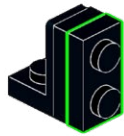
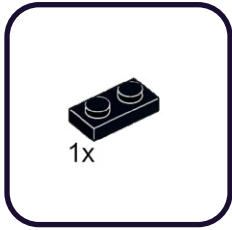

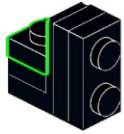
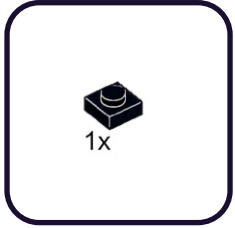

2x

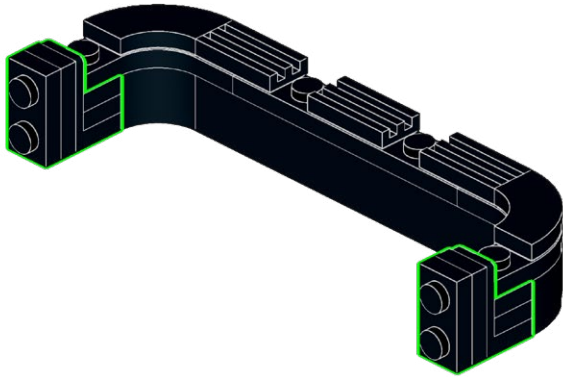

804

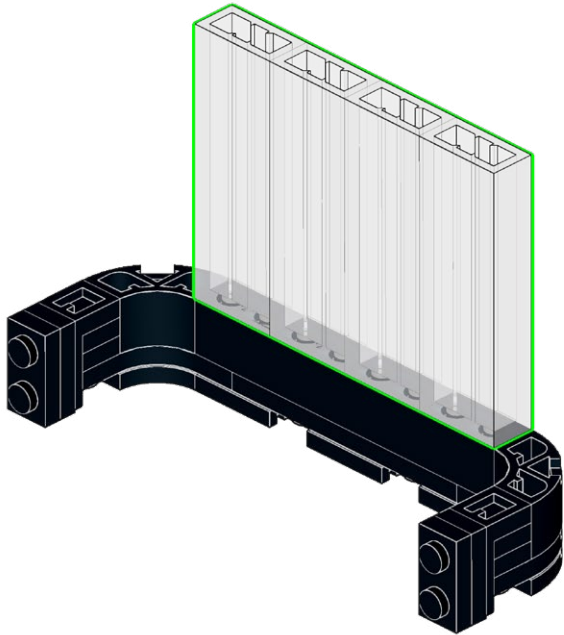
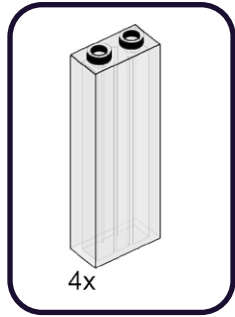

805

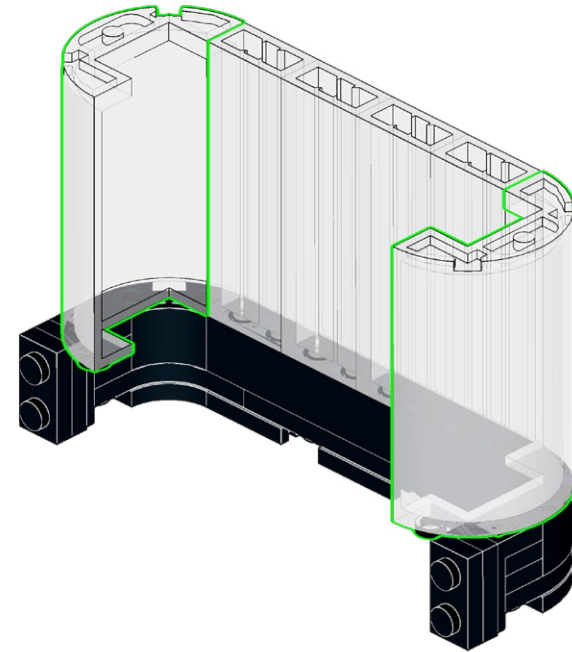

806

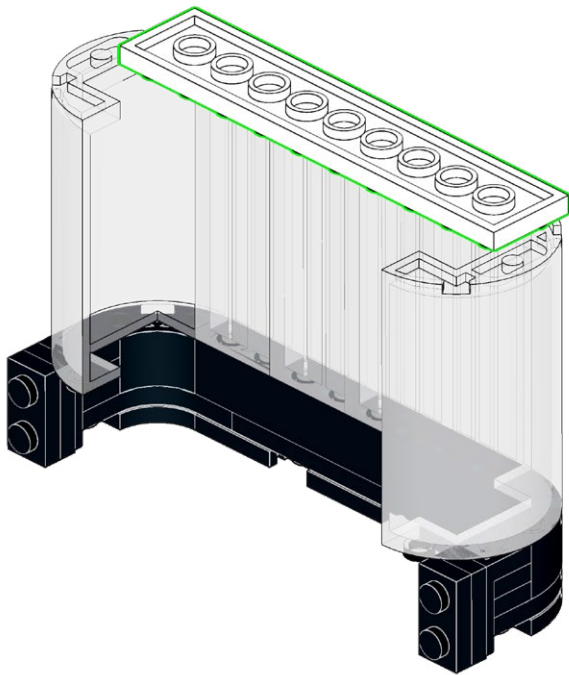
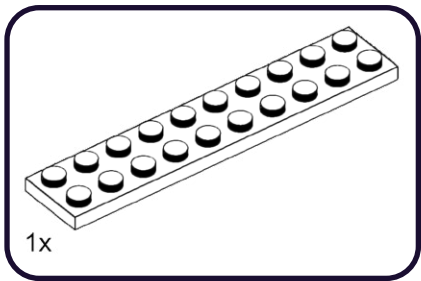

807

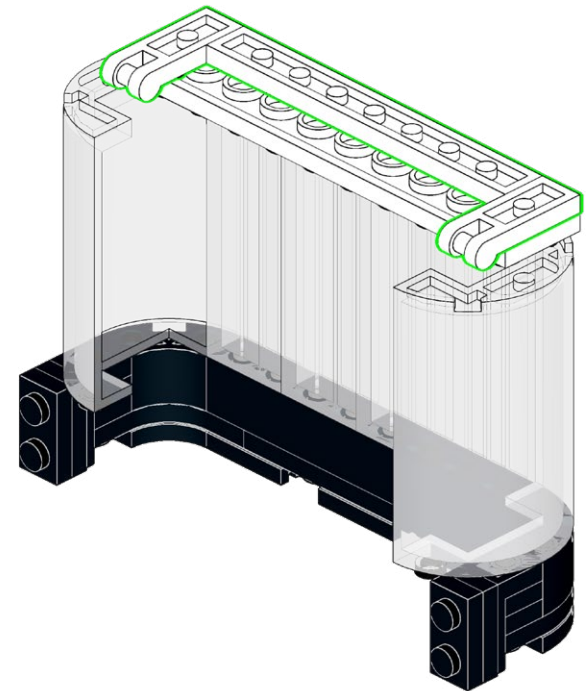
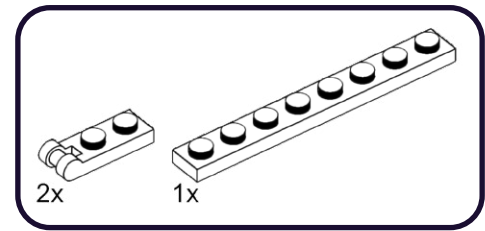

808

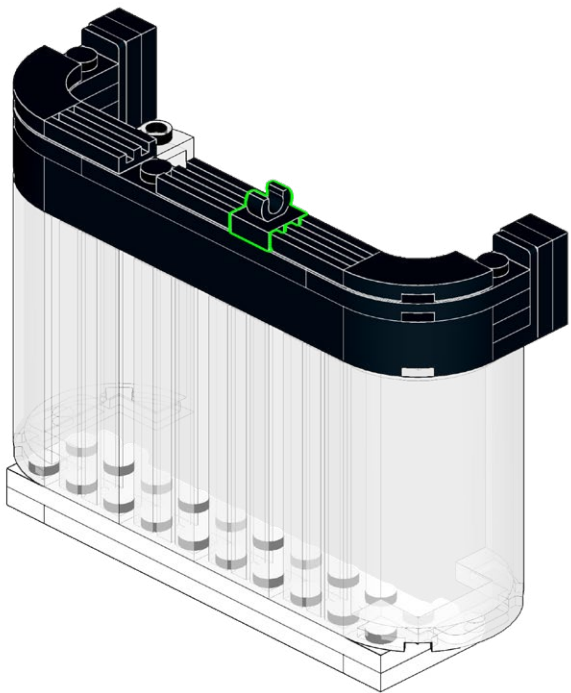
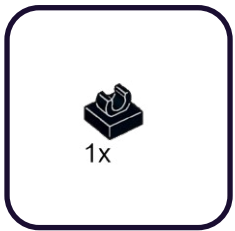

809

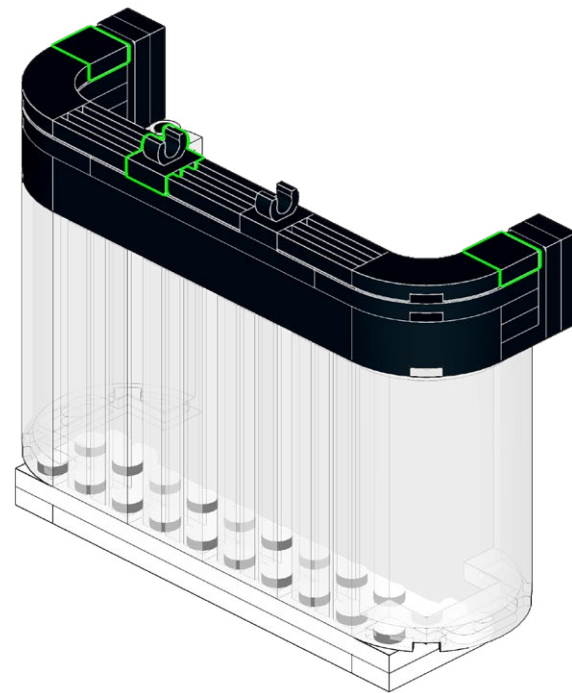
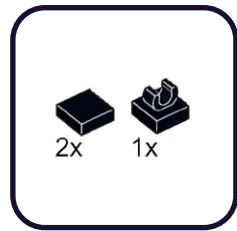

810

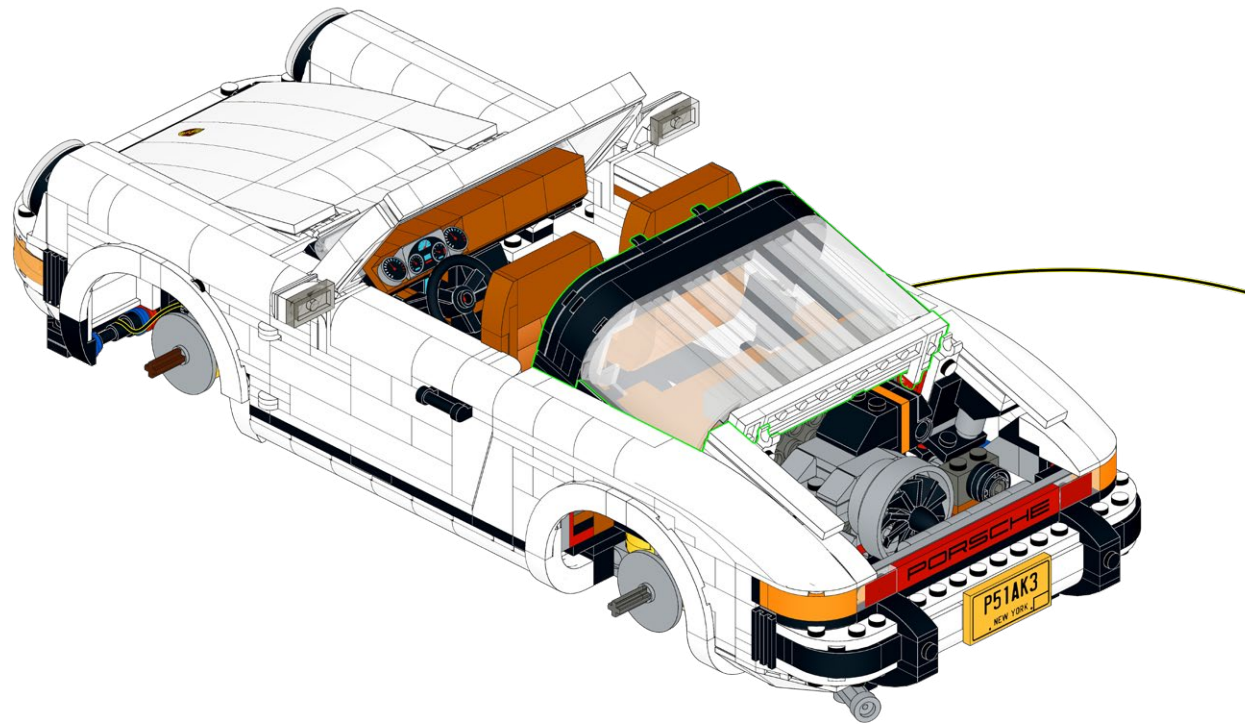

811

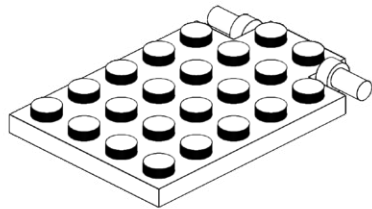
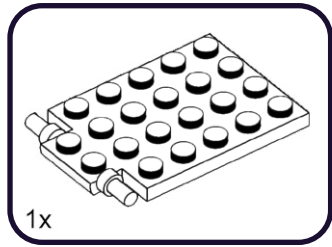

812

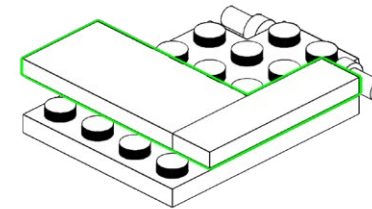
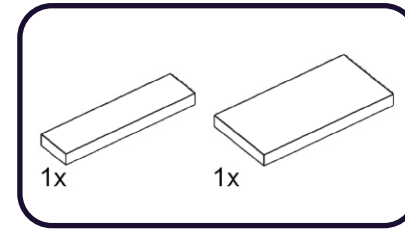

813

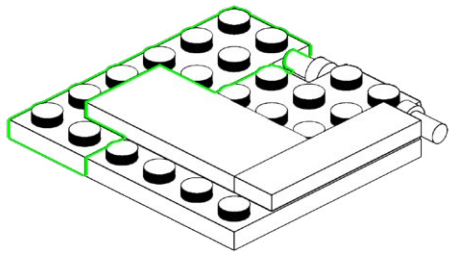
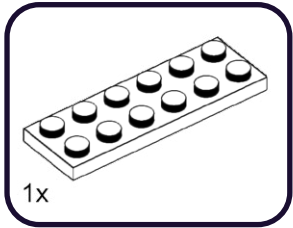

814

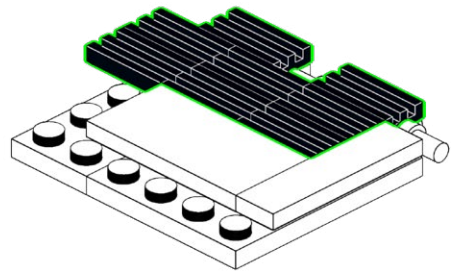
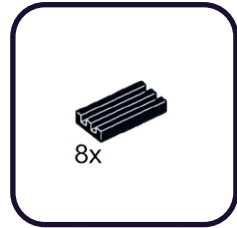

815

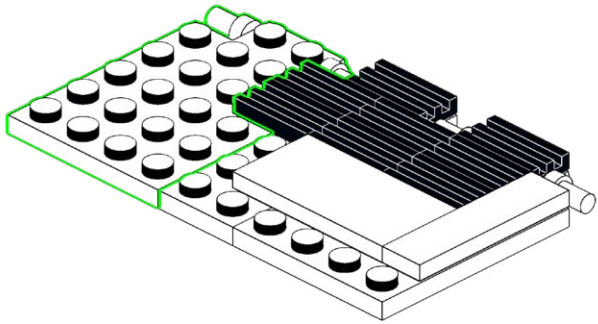
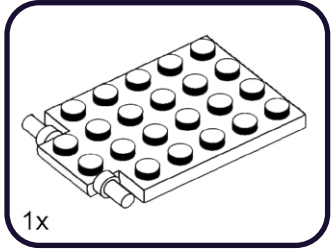

816

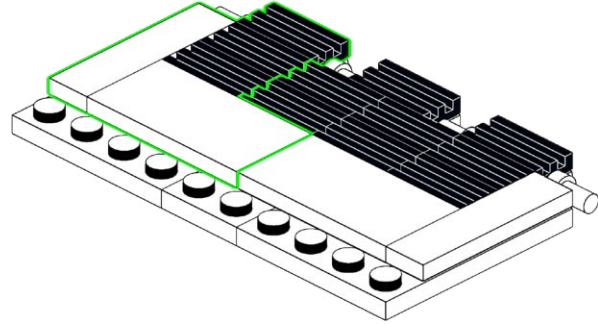
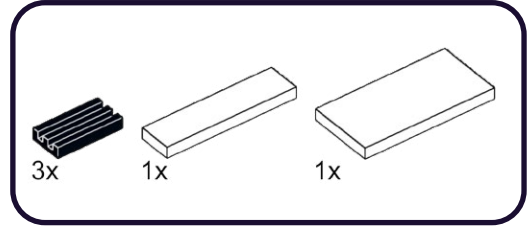

817

2x

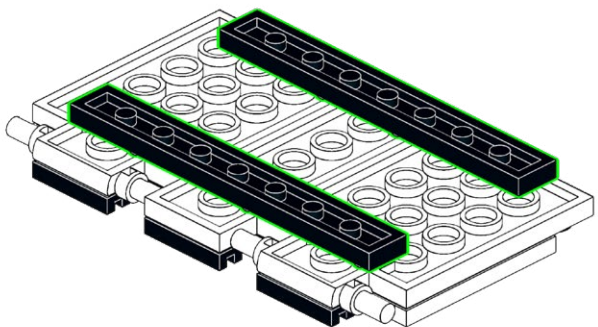

818

1x

4x

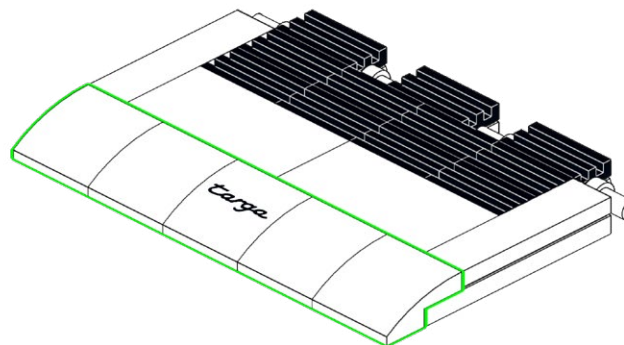
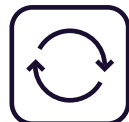

819

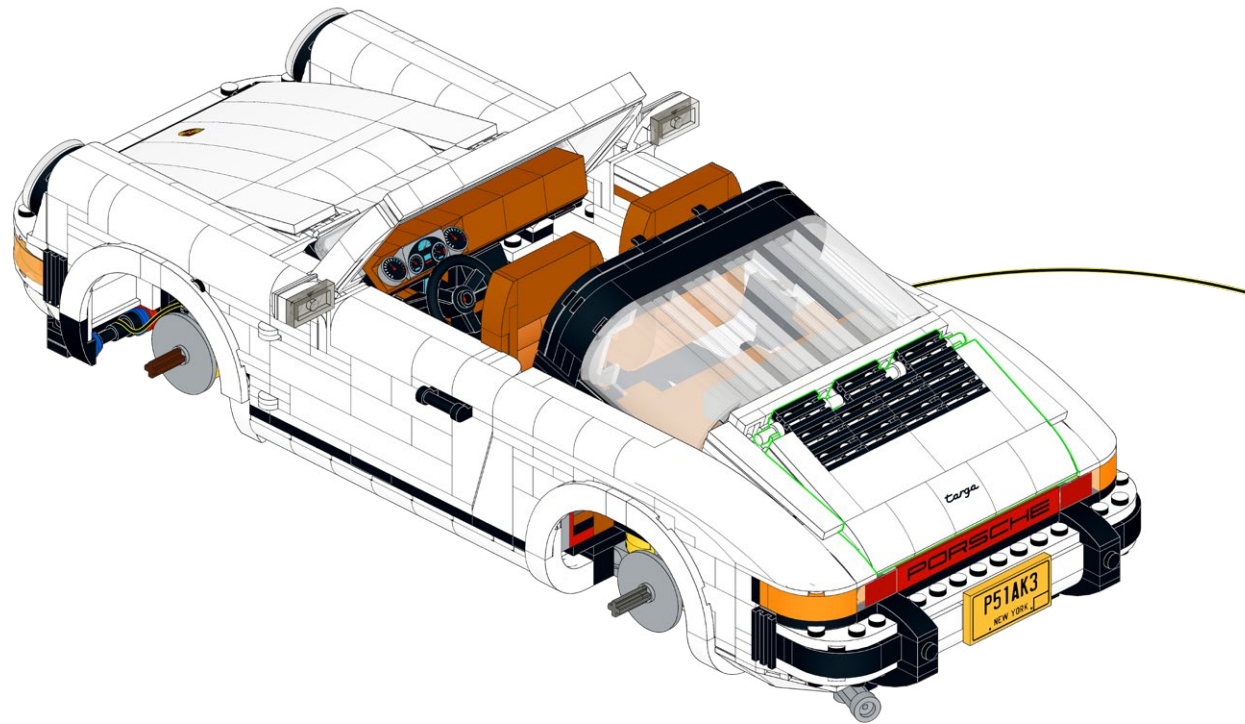

820

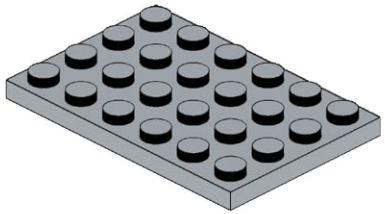
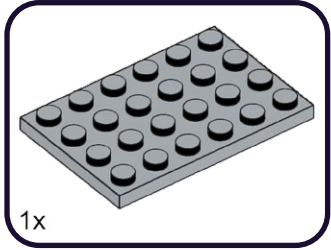

821

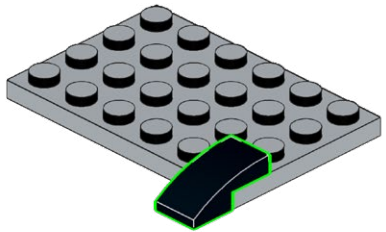
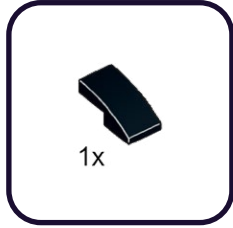

822

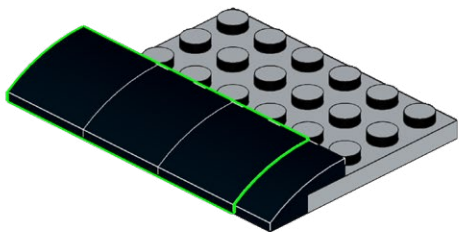

823

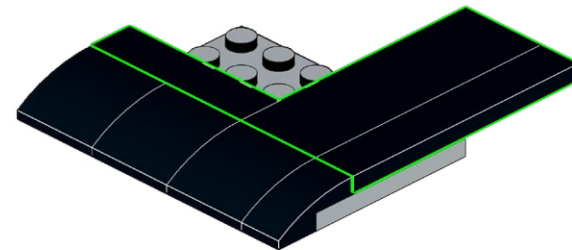
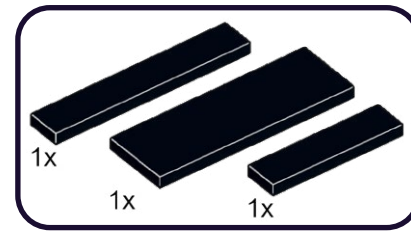

824

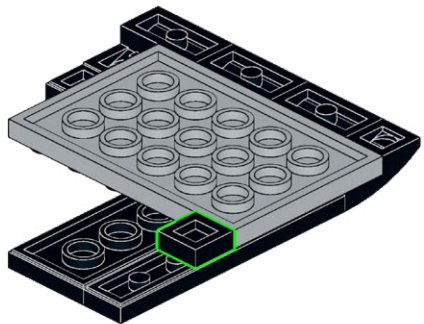
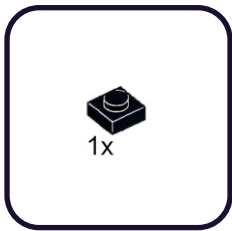

825

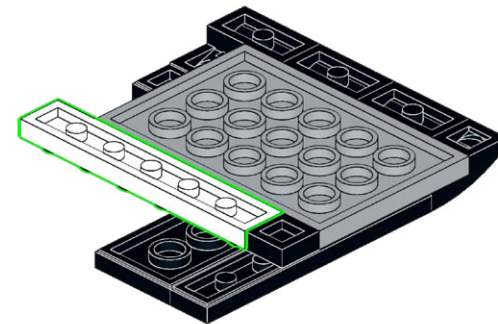
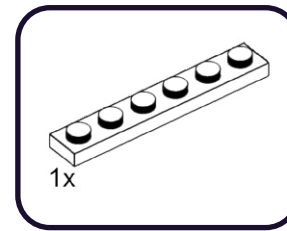

826

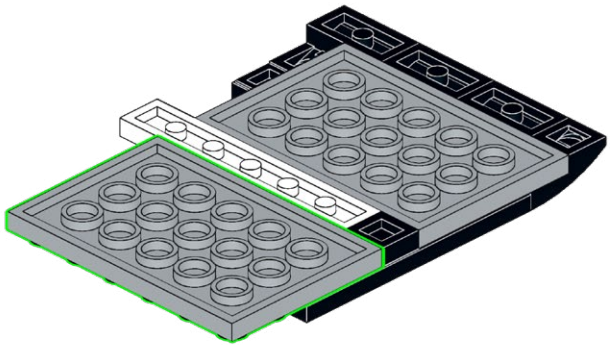
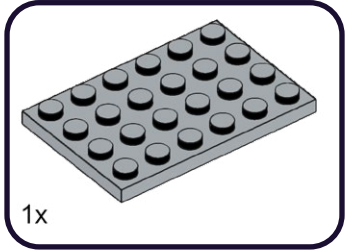

827

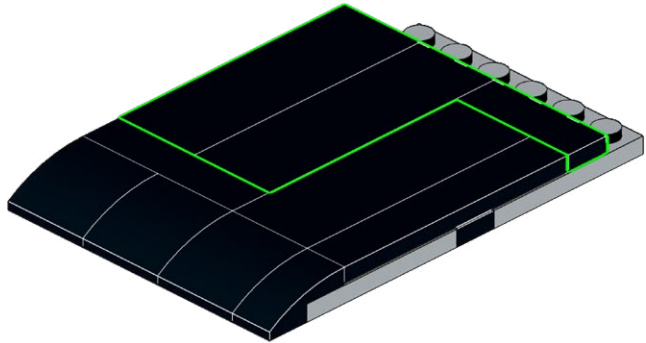
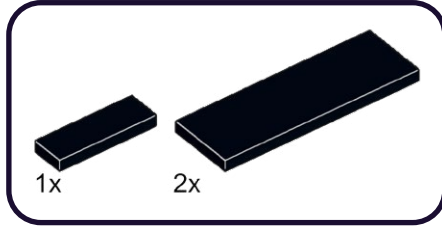

828

1x

3x

829

4x

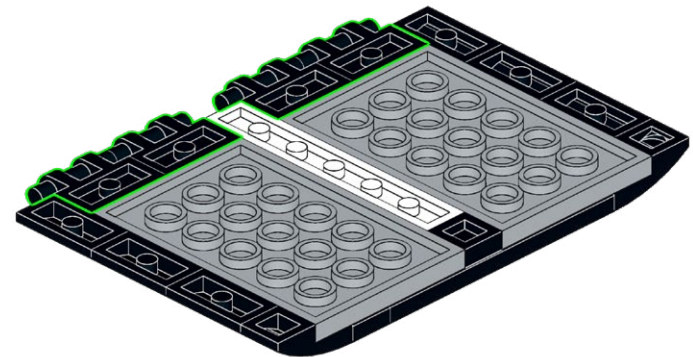
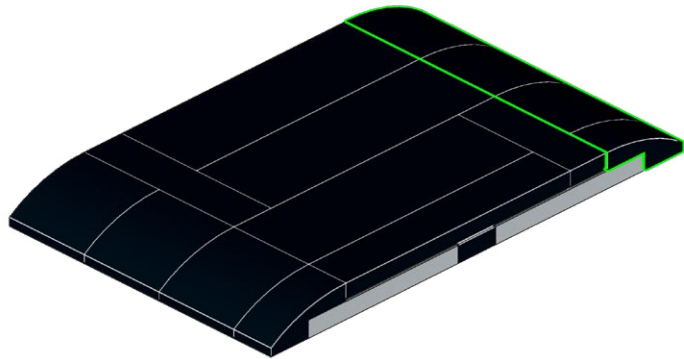

830

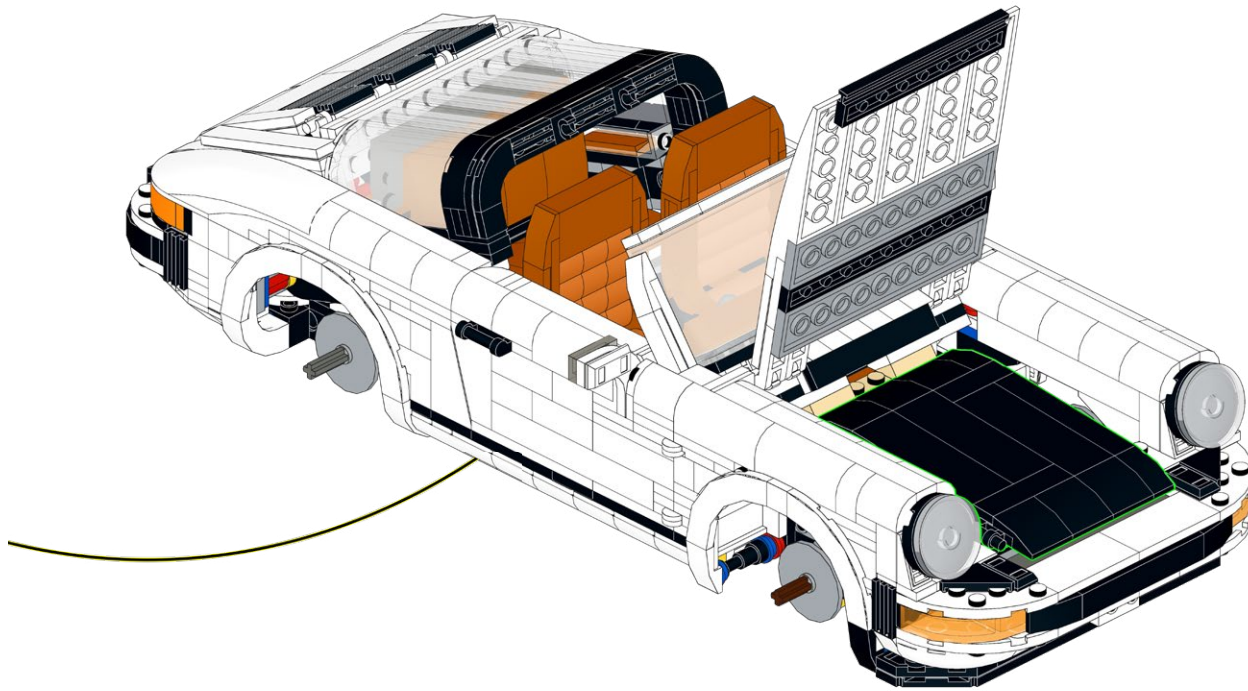

831

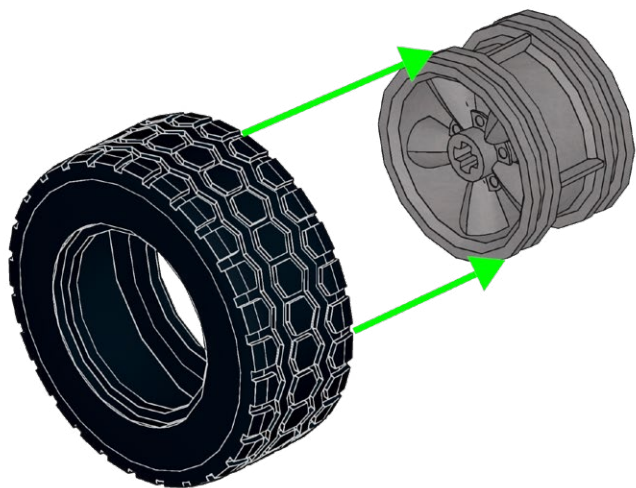
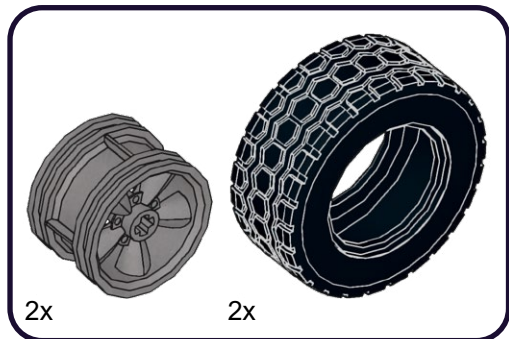

832



2x

833

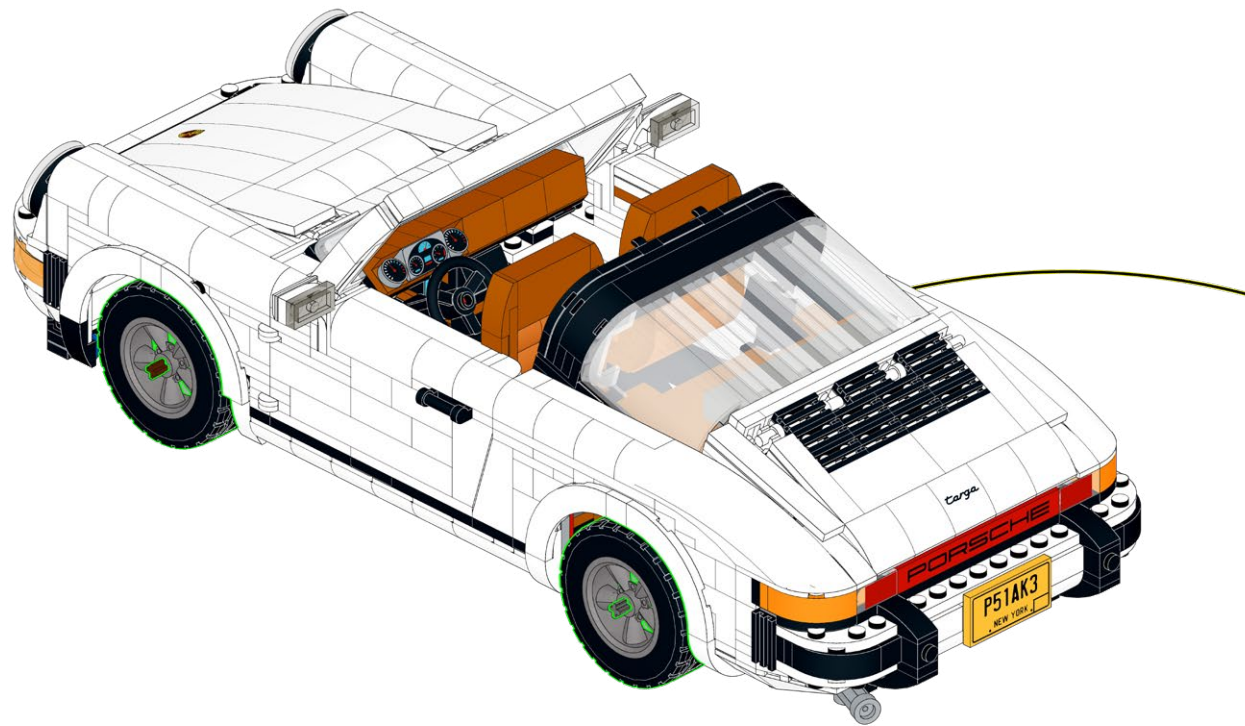

834



2x

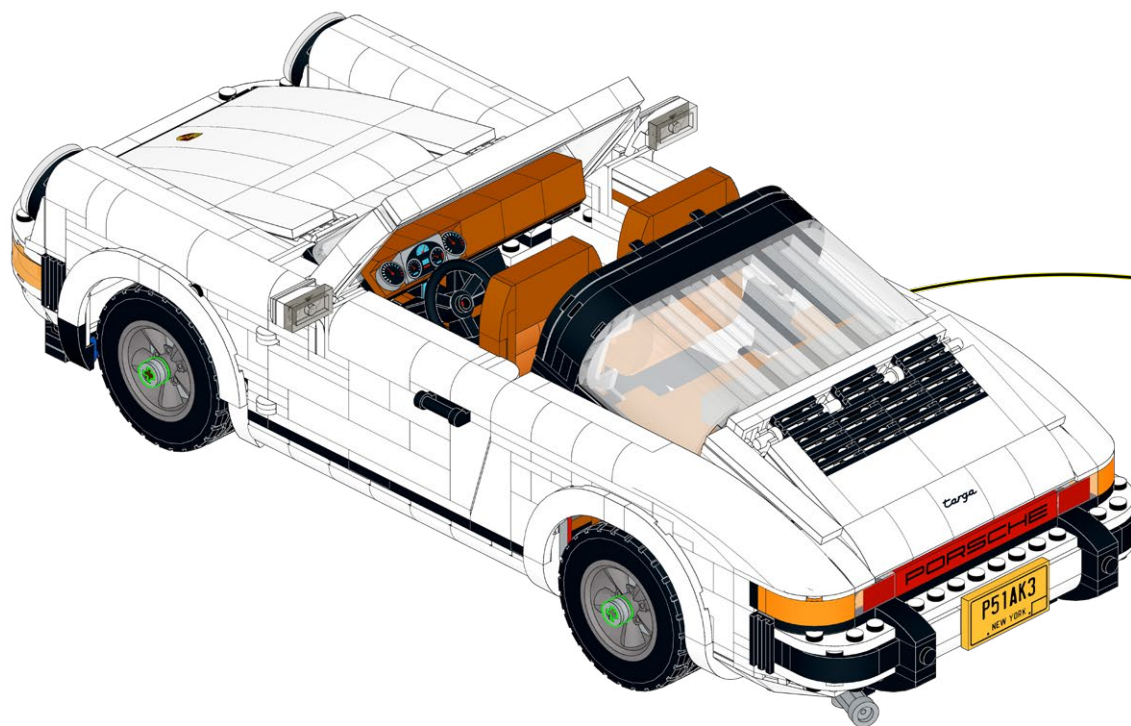

835

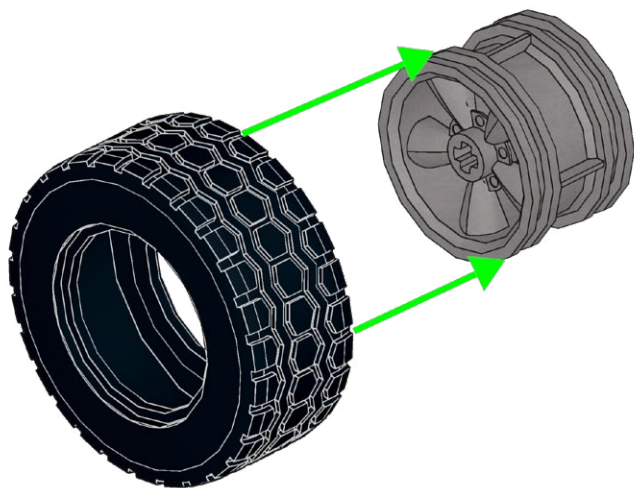
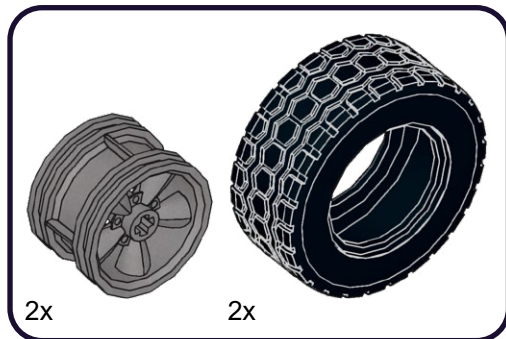

836



2x

837

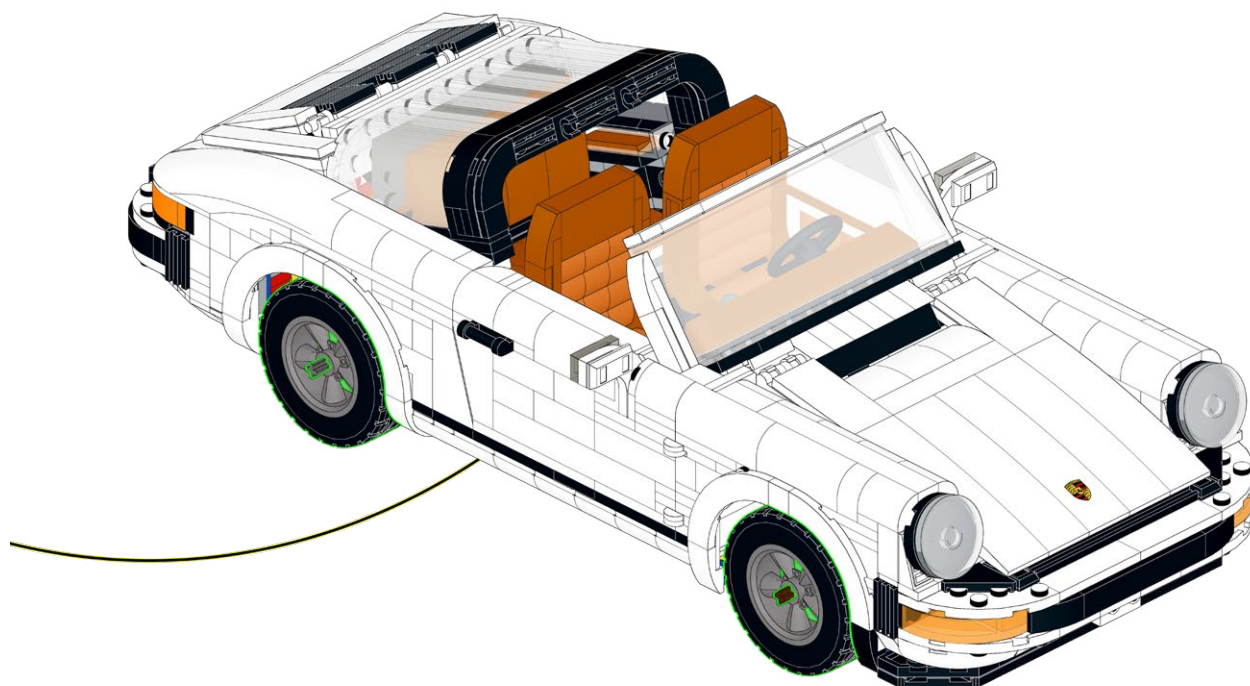

838



2x

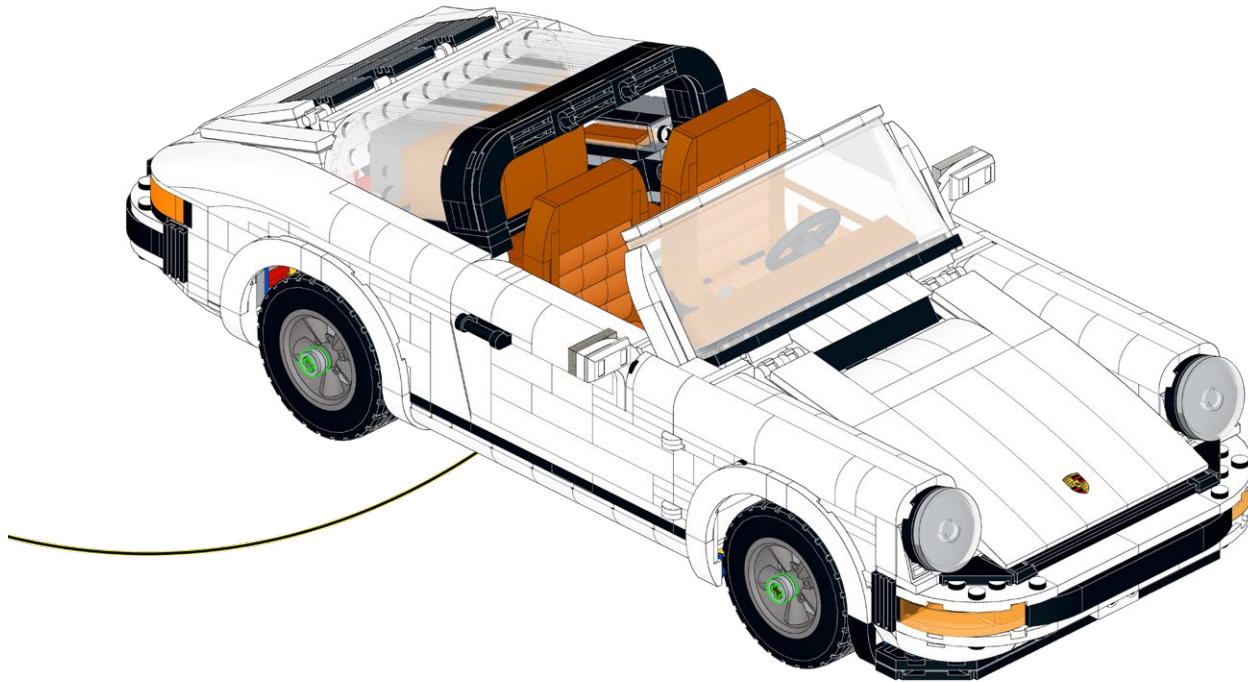

839



Power on Test
Test de mise sous tension
Test di Potenza
Stromtest
Prueba de Energía
电源测试



840



PORSCHE

CU 6000

FINAL PRODUCT



PACKAGE CONTENTS



2x SL-WW30
Solar Light
Warm White 30cm



1x 9 Dock



2x Solar Cap
Frosted Clear



2x AR-WW30
Astro Regular
Warm White 30cm



1x Tether - 1x2

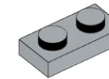

2x Plate 1x2
Light Bluish Grey



4x AR-R30
Astro Regular
Red 30cm



1x Tether - 1x8

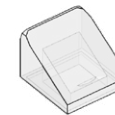

2x Slope 30 1x1 x 2/3
Trans Clear



1x FLX-B30
Flux Belt
30 cm



1x Eclipse

CONTACT US

Click below for customer support, or general inquiries.

Cliquez ci-dessous pour accéder au support client ou aux renseignements généraux.

Clicca qui sotto per l'assistenza clienti o per richieste generali.

Contact Us



Contactez-nous



Contattaci



Klicken sie unten für kundensupport oder allgemeine anfragen.

Haga clic a continuación para atención al cliente o consultas generales.

点击下方获取客户支持或一般咨询。

Kontaktieren sie uns



Contáctanos



联系我们



TROUBLESHOOTING

If you're stuck, scan the QR code for troubleshooting.

Se sei bloccato, scansiona il codice QR per la risoluzione dei problemi.

Wenn Sie nicht weiterkommen, scannen Sie den QR-Code zur Fehlerbehebung.

Si vous êtes bloqué, scannez le code QR pour le dépannage

Si está atascado, escanee el código QR para solucionar el problema.

如果遇到问题, 请扫描二维码进行故障排除

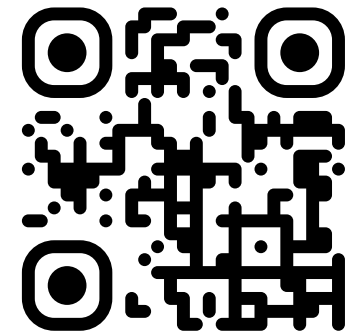



LIGHTMYBRICKS

lightmybricks.com



LEGO® is a trademark of the LEGO Group of companies, which does not sponsor, authorize or endorse this product. All LEGO® sets featured in images are sold separately. This is not a LEGO® product. The LEGO Group is not liable for any loss, injury or damage arising from the use or misuse of this product. ©2024 Light My Bricks Pty Ltd. All rights reserved. www.lightmybricks.com

Our components are designed and packaged in Australia by Light My Bricks Pty Ltd. Components are manufactured in China. 3fl bldg C, Shuanghuan Quanxin Technology Information Industry Park Baolong Street, Longgang District, Shenzhen, China. Imported in Australia by Light My Bricks Pty Ltd, 5/26 Rushdale St, Knoxfield, VIC, 3180, Australia.

WARNING: CHOKING HAZARD - Small parts. Not for children under 3 years.

AVERTISSEMENT : RISQUE D'ÉTOUFFEMENT - Petites pièces. Ne convient pas aux enfants de moins de 3 ans.

ATTENZIONE: PERICOLO DI SOFFOCAMENTO - Piccole parti. Non adatto a bambini di età inferiore a 3 anni.

WARNUNG: ERSTICKUNGSGEFAHR - Kleine Teile. Nicht für Kinder unter 3 Jahren geeignet.

ADVERTENCIA: PELIGRO DE ASFIXIA - Piezas pequeñas. No son apto para niños menores de 3 años.

警告：窒息危险 - 小零件。不适合3岁以下儿童。