

LIGHT KIT INSTALLATION GUIDE

TITANIC (PART 3)

FOR LEGO
SET
#10294

CONTENTS



03

Getting Started

- 04 Legend
- 05 Component Handling
- 06 Blueprint

07

Instructions

- 08 LEGO Bag 4
- 24 **LMB Bag 06**
- 64 LEGO Bag 5
- 99 LEGO Bag 6
- 122 LEGO Bag 7 - **LMB Bag 07**
- 151 LEGO Bag 8
- 175 LEGO Bag 9
- 210 LEGO Bag 10
- 236 LEGO Bag 11
- 253 LEGO Bag 12

280

Final Product

- 281 Package Contents
- 283 Contact & Troubleshooting

GETTING STARTED



Bold, beautiful and bright, Light My Bricks elevates your favourite LEGO set from knick-knack to statement piece. Create a talking point at home or in the office that speaks to your passions with Light My Bricks. To learn more, click below.

[Learn More](#)



Audacieux, beau et lumineux, Light My Bricks élève votre ensemble LEGO préféré du statut de bibelot à celui de pièce maîtresse. Que ce soit à la maison ou au bureau, partagez votre passion des LEGO avec Light My Bricks. Cliquez ci-dessous pour en savoir plus.

[En savoir plus](#)



Audace, bello e luminoso, Light My Bricks eleva il tuo set LEGO preferito da soprammobile a pezzo di tendenza. Crea un punto di discussione a casa o in ufficio che parli alle tue passioni con Light My Bricks. Per saperne di più, clicca qui sotto.

[Ulteriori Informazioni](#)



Mutig, schön und hell – Light My Bricks verwandelt Ihr Lieblings-LEGO-Set von einem schnickschnack in ein statement-stück. Schaffen sie einen gesprächspunkt zu hause oder im büro, der Ihre leidenschaften widerspiegelt, mit Light My Bricks. Um mehr zu erfahren, klicken sie unten.

[Mehr erfahren](#)



Audaz, hermoso y brillante, Light My Bricks eleva tu set LEGO favorito de una chuchería a una pieza llamativa. Crea un tema de conversación en casa o en la oficina que hable de tus pasiones con Light My Bricks. Para obtener más información, haga clic a continuación.

[Más información](#)



大胆、美丽而明亮，Light My Bricks 将你喜爱的乐高套装从小摆件提升为引人注目的装饰品。在家或办公室打造一个能表达你激情的话题，了解更多，请点击下方。

[了解更多](#)



LEGEND

Rotate Set



Retournez L'ensemble
Ruota Set
Set Drehen
Rotar Conjunto
旋转套件

Add Part



Ajoutez une Pièce
Aggiungi Parte
Teil Hinzufügen
Agregar Pieza
添加零件

Click



Cliquez
Clic
Klicken
Clic
点击

Pinch/Fold



Pincez/Pliez
Pizzicare/Piegare
Kneifen/Falten
Pellizcar/Doblar
折叠

Pull Cable



Tirez le Cable
Tirare il Cavo
Kabel Ziehen
Tirar del Cable
拉动电缆

Repeat Step



Répétez
Ripetere
Wiederholen
Repetir
重复

Sticker



Autocollant
Adesivo
Aufkleber
Pegatina
贴纸

Power On Test



Test de mise sous tension
Test di Potenza
Stromtest
Prueba de Energía
电源测试

Disconnect Power



Débranchez L'alimentation
Scollegare L'alimentazione
Strom Trennen
Desconectar la Energía
断开电源

Troubleshoot



Dépanner
Risolvere
Fehlerbehebung
Solución de Problemas
故障排除

COMPONENT HANDLING

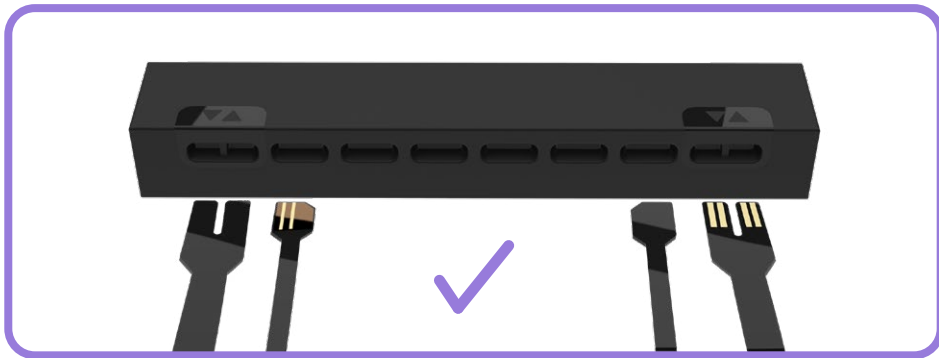
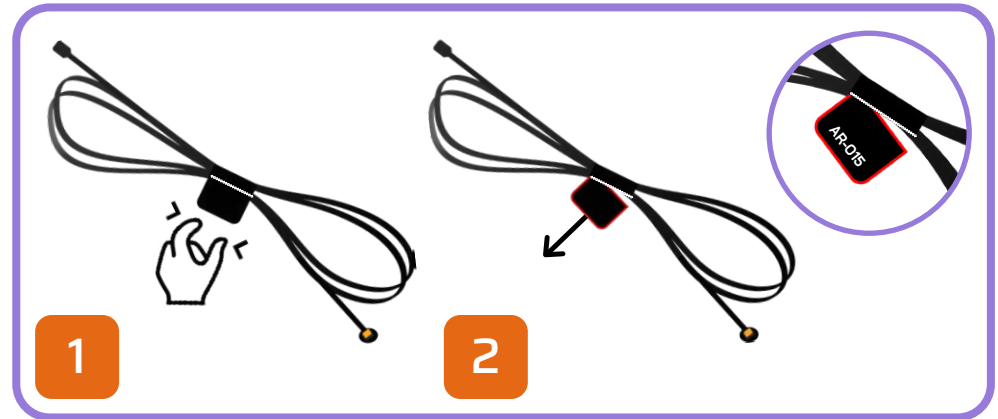
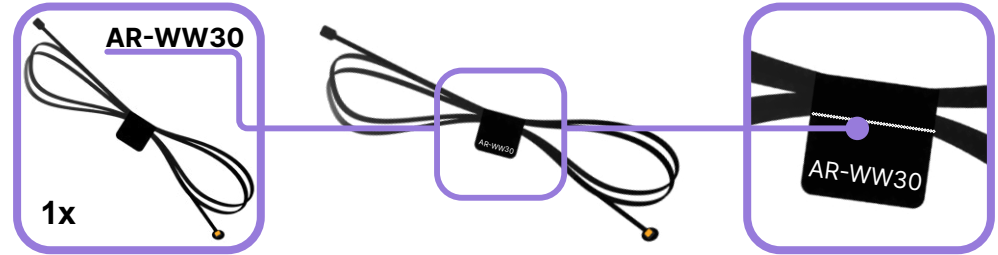
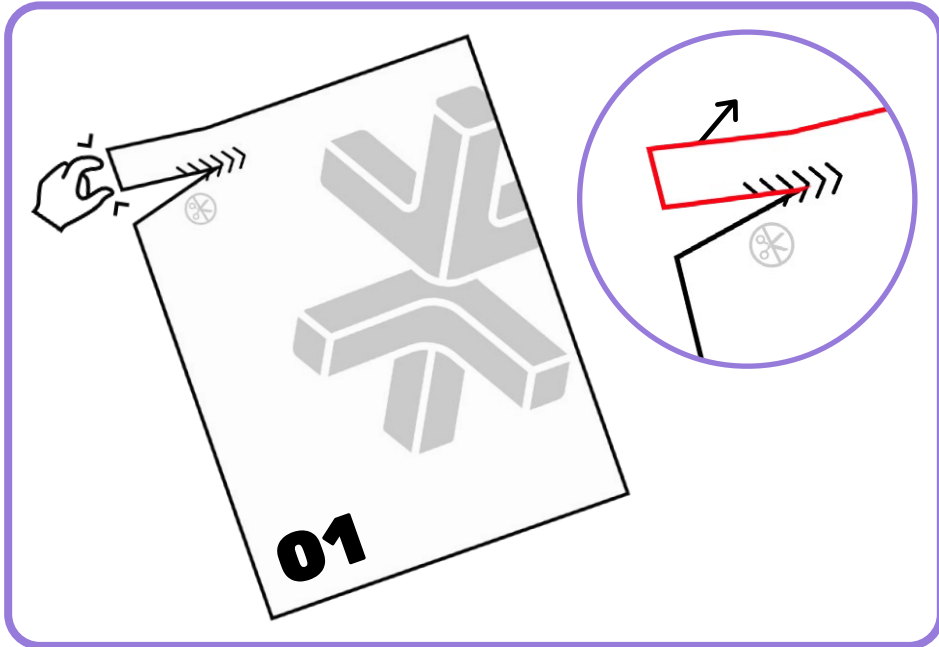

BLUEPRINT



1

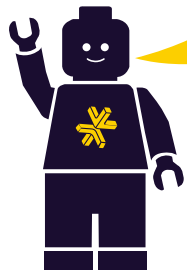

Use LEGO Book 1, up to page 74
Terminer le Livre LEGO® 1
Completa il Libro LEGO® 1
SchlieÙe LEGO® Buch 1 ab
Termina el Libro 1 de LEGO®
完成乐高®第 1 册

P74

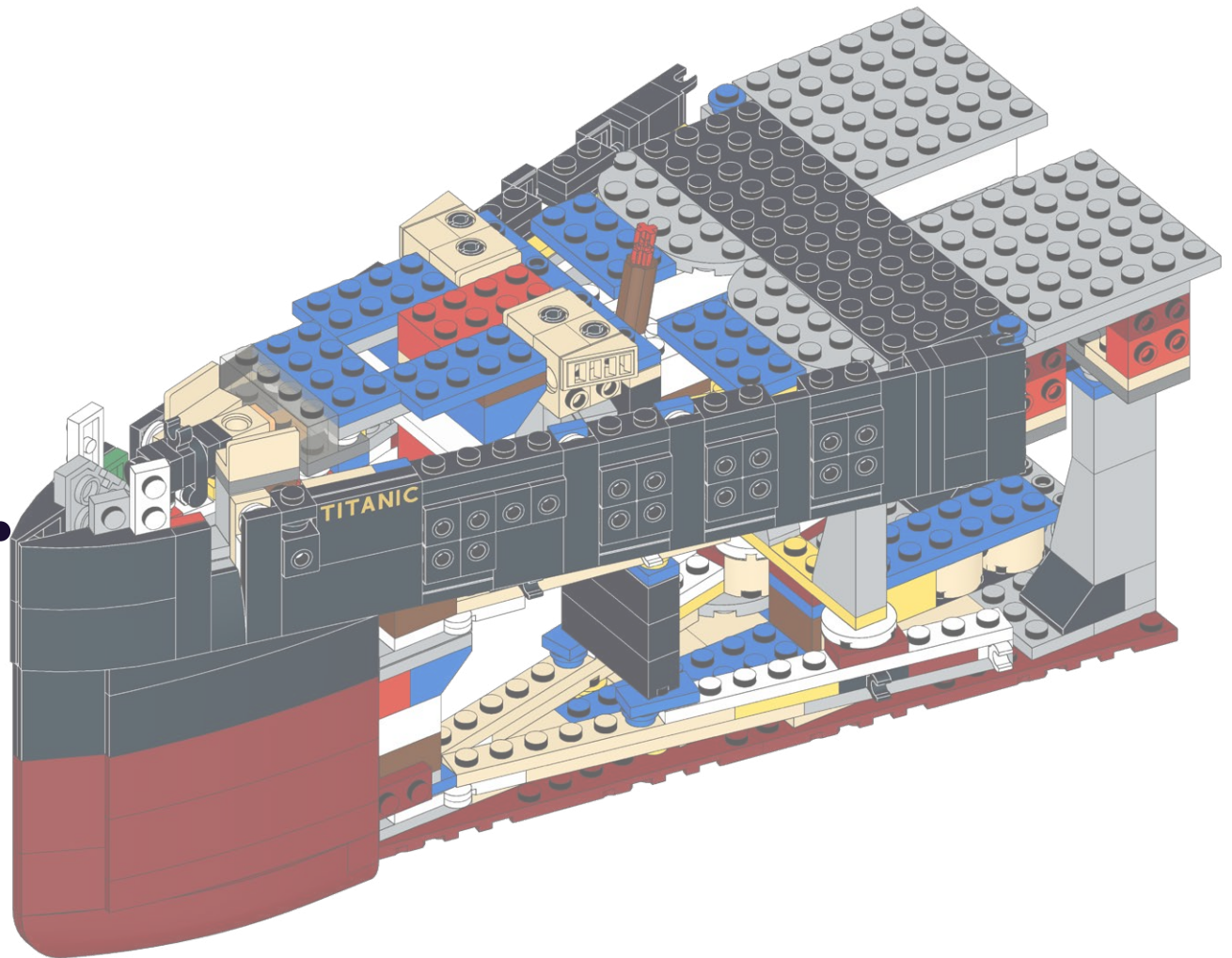

**HOLD UP!**

You might notice some bags aren't in order, as well as left over pieces, but that's ok! We're changing the way you build LEGO!

ATTENDEZ!

Vous remarquerez peut-être que certains sacs, ainsi que certaines pièces, ne sont pas dans le bon ordre. Mais pas de panique! Nous changeons simplement la façon avec laquelle vous construisez vos LEGO!

ASPETTA!

Potresti notare che alcuni sacchetti non sono in ordine, così come i pezzi avanzati, ma va bene così! Stiamo cambiando il modo in cui costruisci i LEGO!

HALT!

Sie werden möglicherweise bemerken, dass einige tüten durcheinander sind und teile übrig bleiben, aber das ist in Ordnung! Wir ändern die art und weise, wie Sie LEGO bauen!

¡ESPERA!

Es posible que notes que algunas bolsas están fuera de servicio, así como piezas sobrantes, ¡pero está bien! ¡Estamos cambiando la forma en que construyes LEGO!

暫停!

你可能会注意到一些袋子顺序错乱, 以及一些剩余的部件, 但没关系! 我们正在改变你搭建乐高的方式!

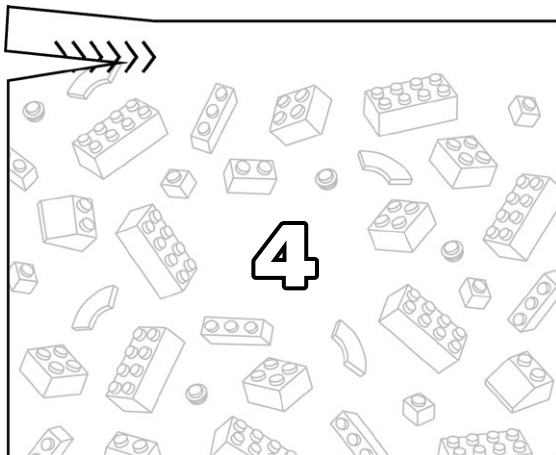
Open LEGO® Bag 4

2

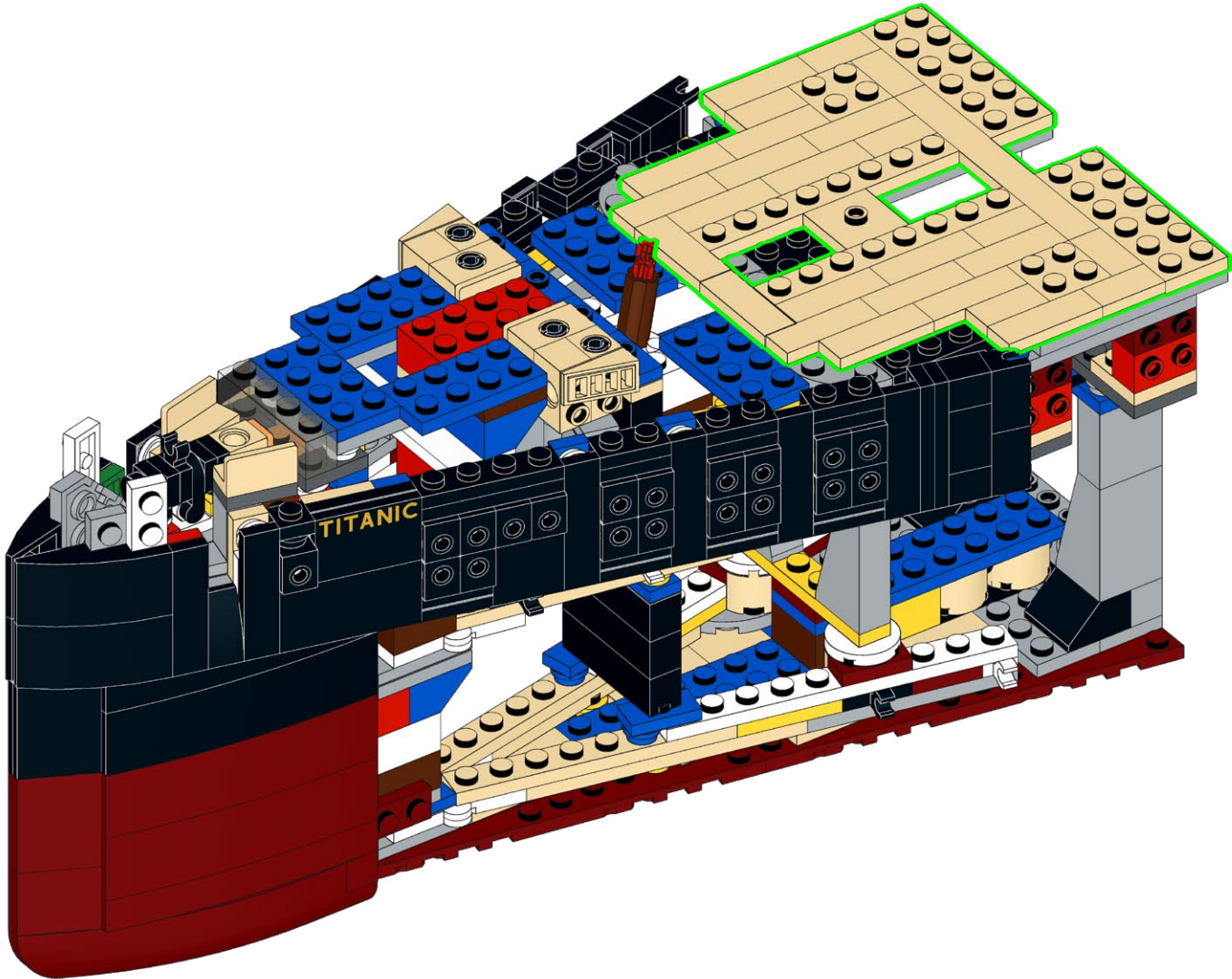
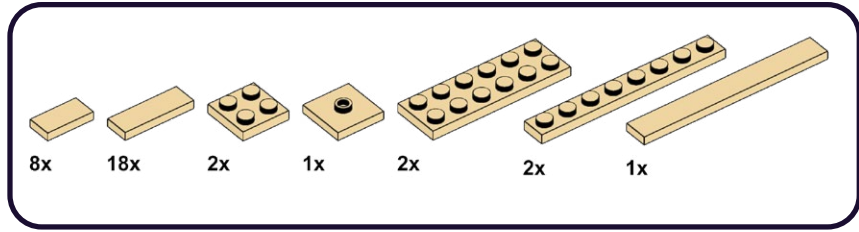

3

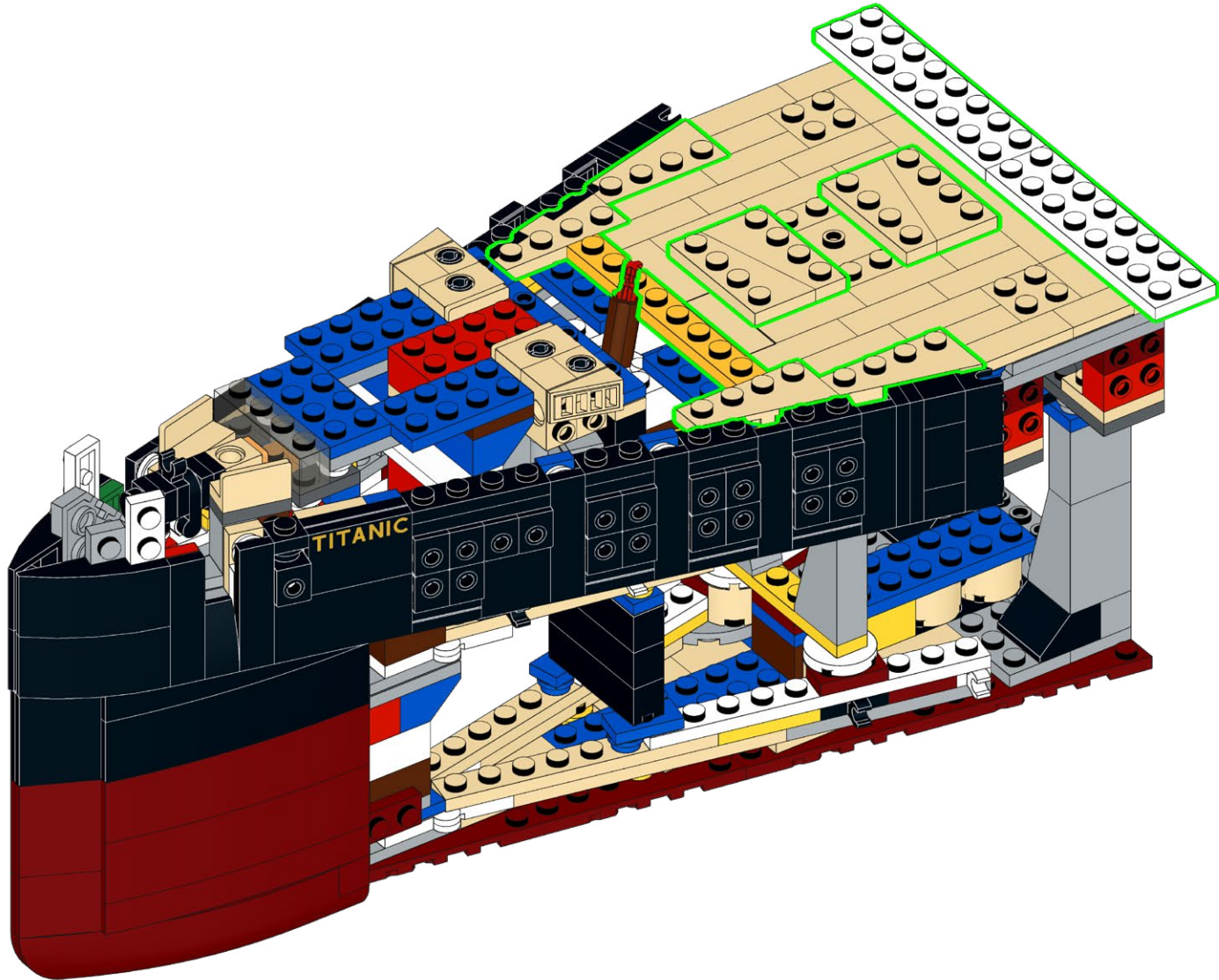
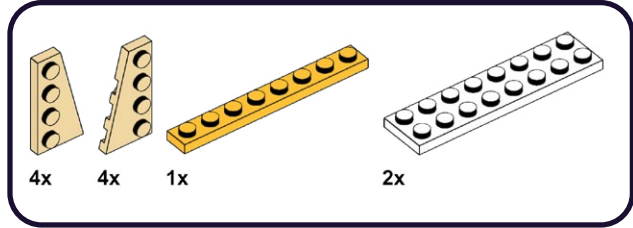

4

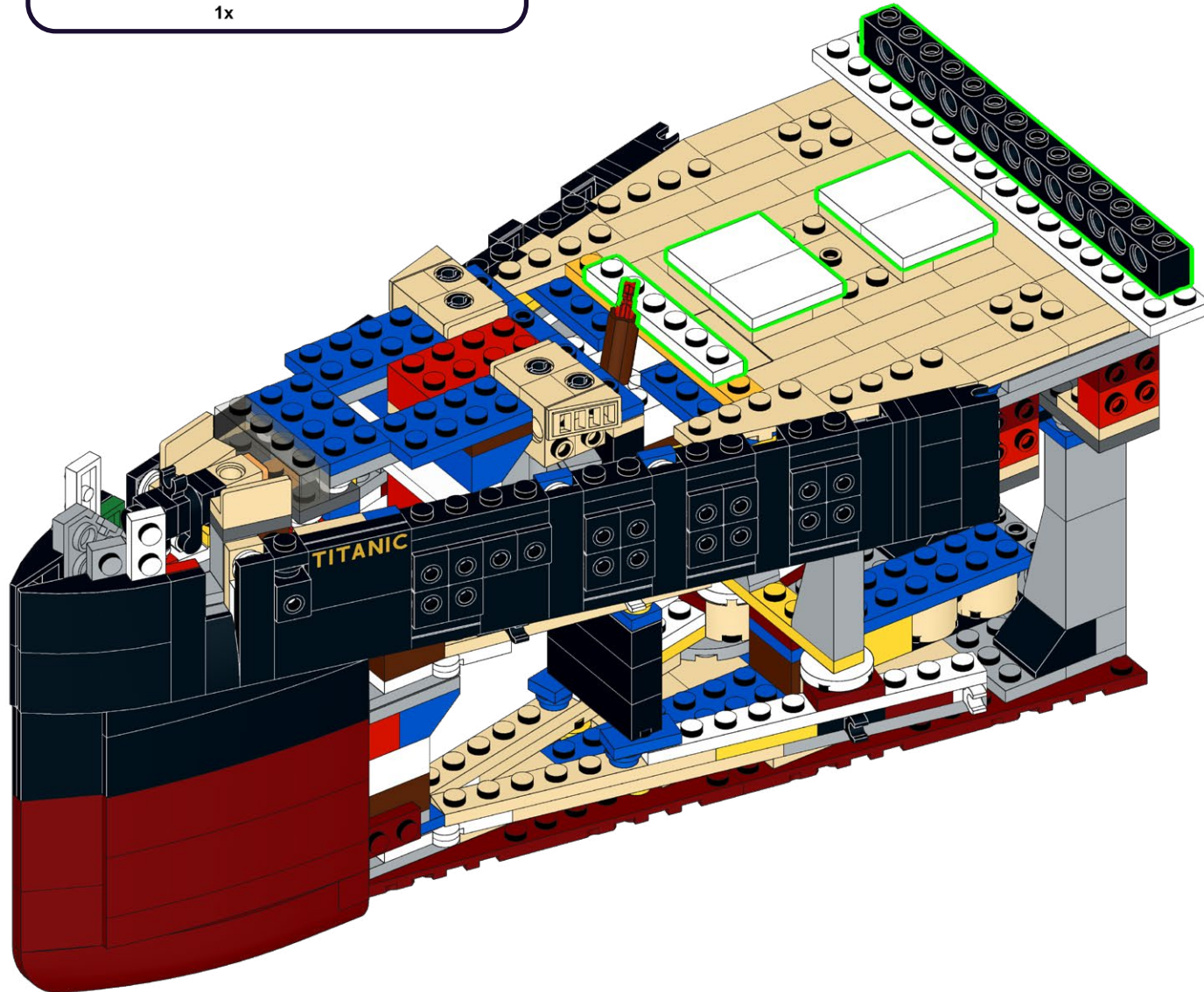
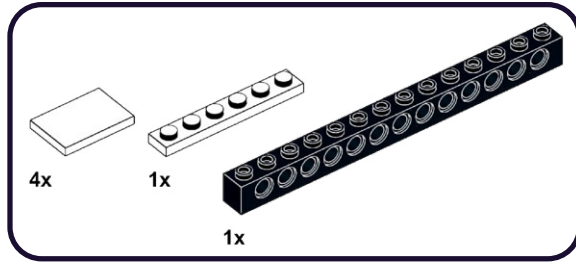

5

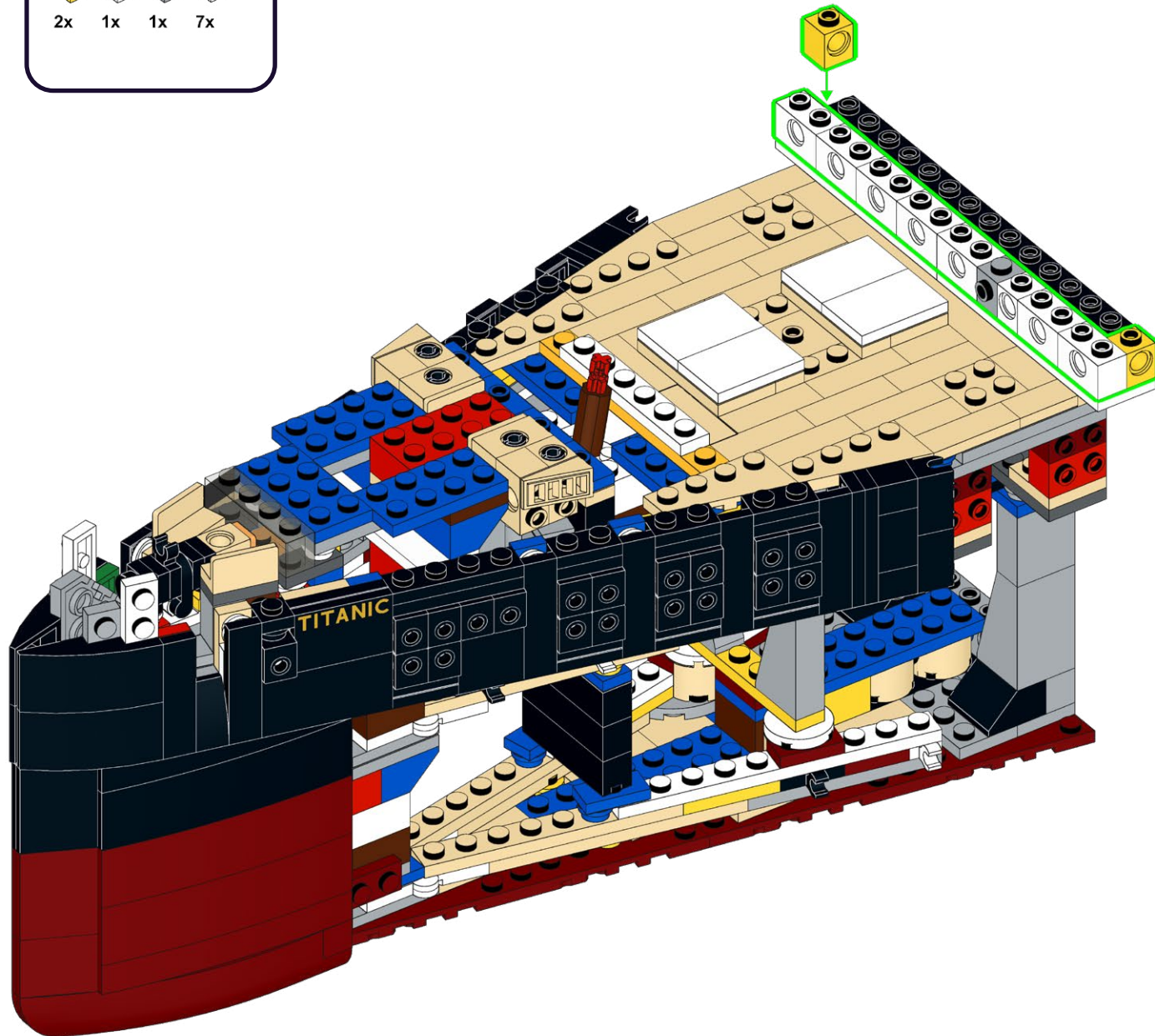
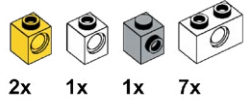

6

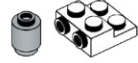

2x 2x

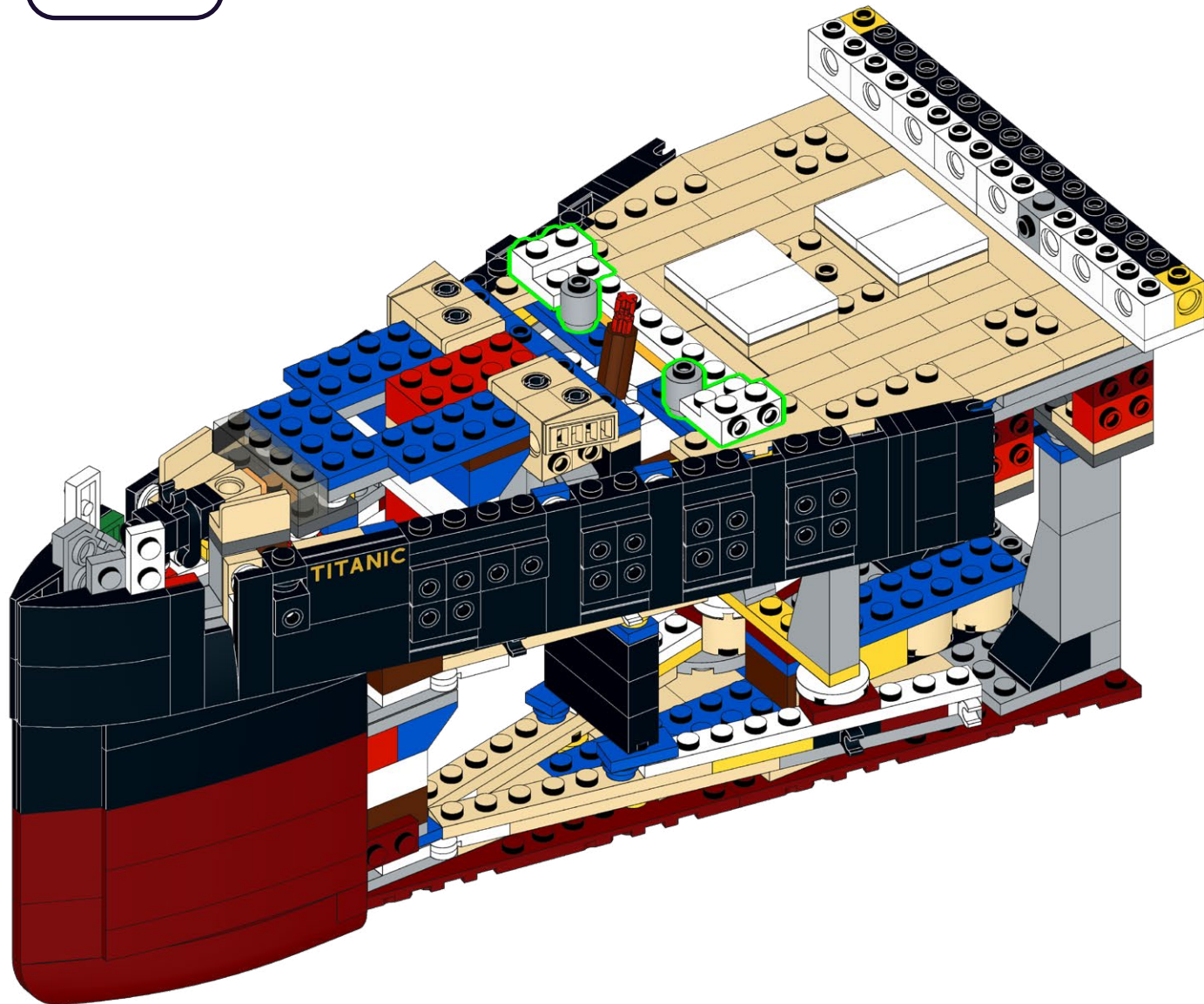

7

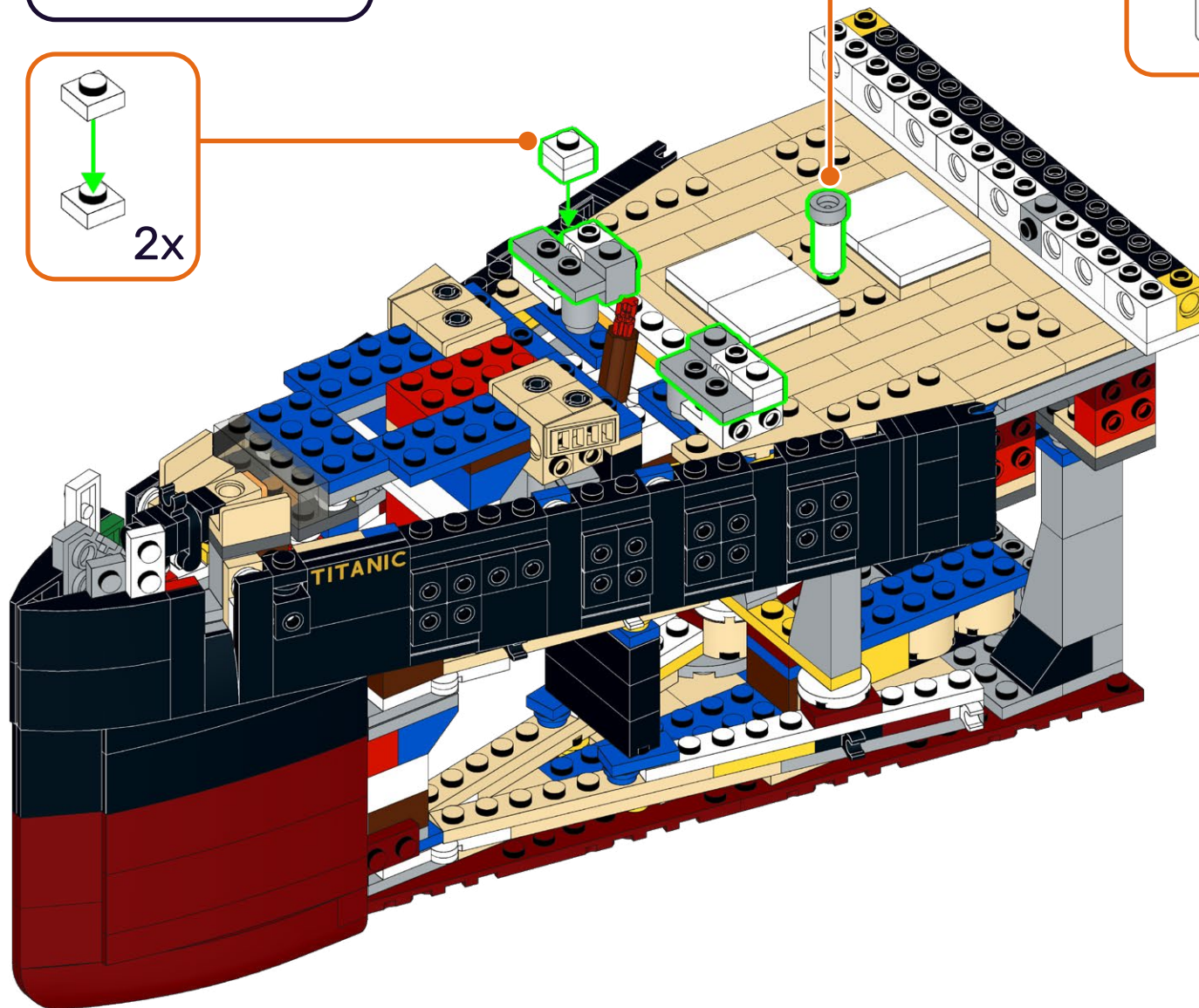
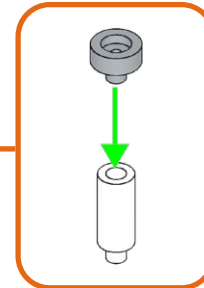
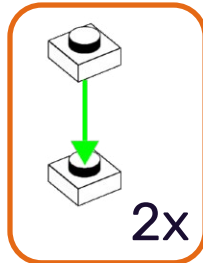
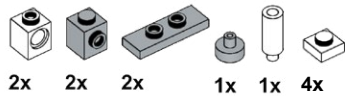

8

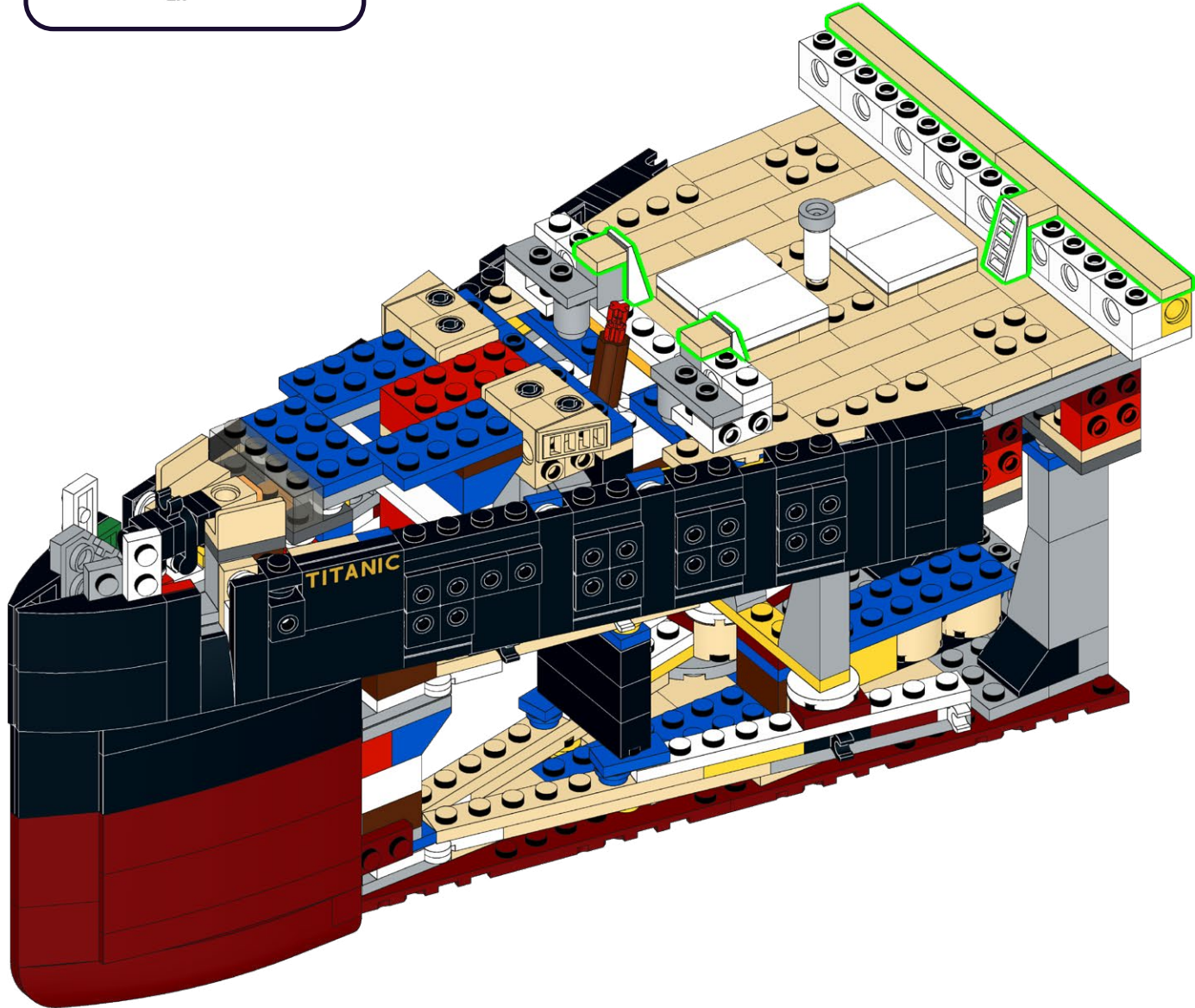
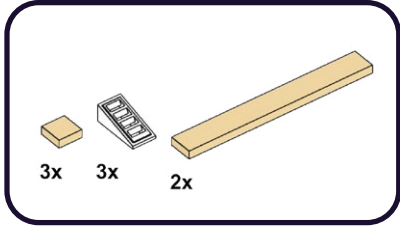

9

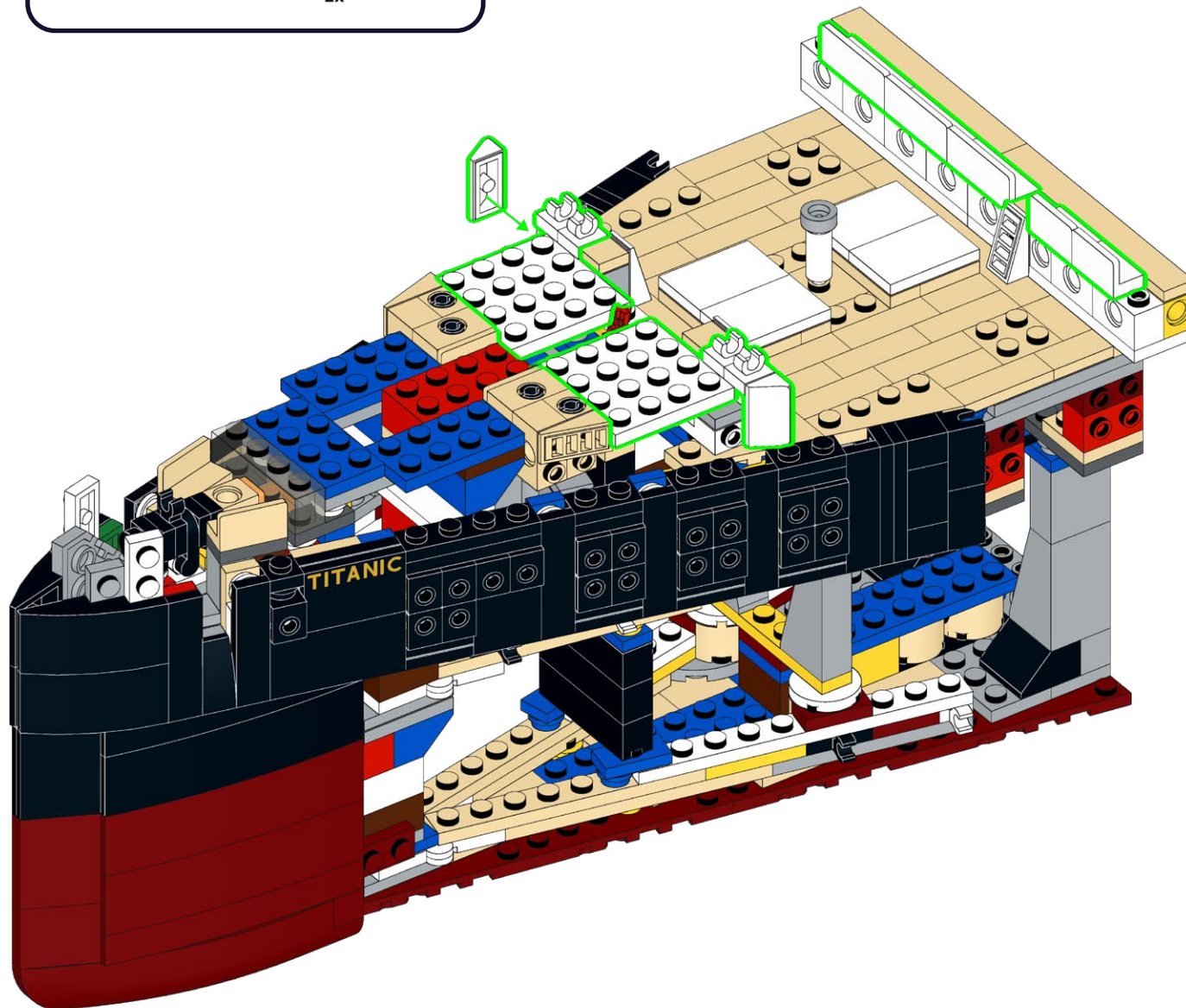
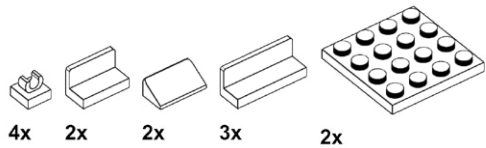

10

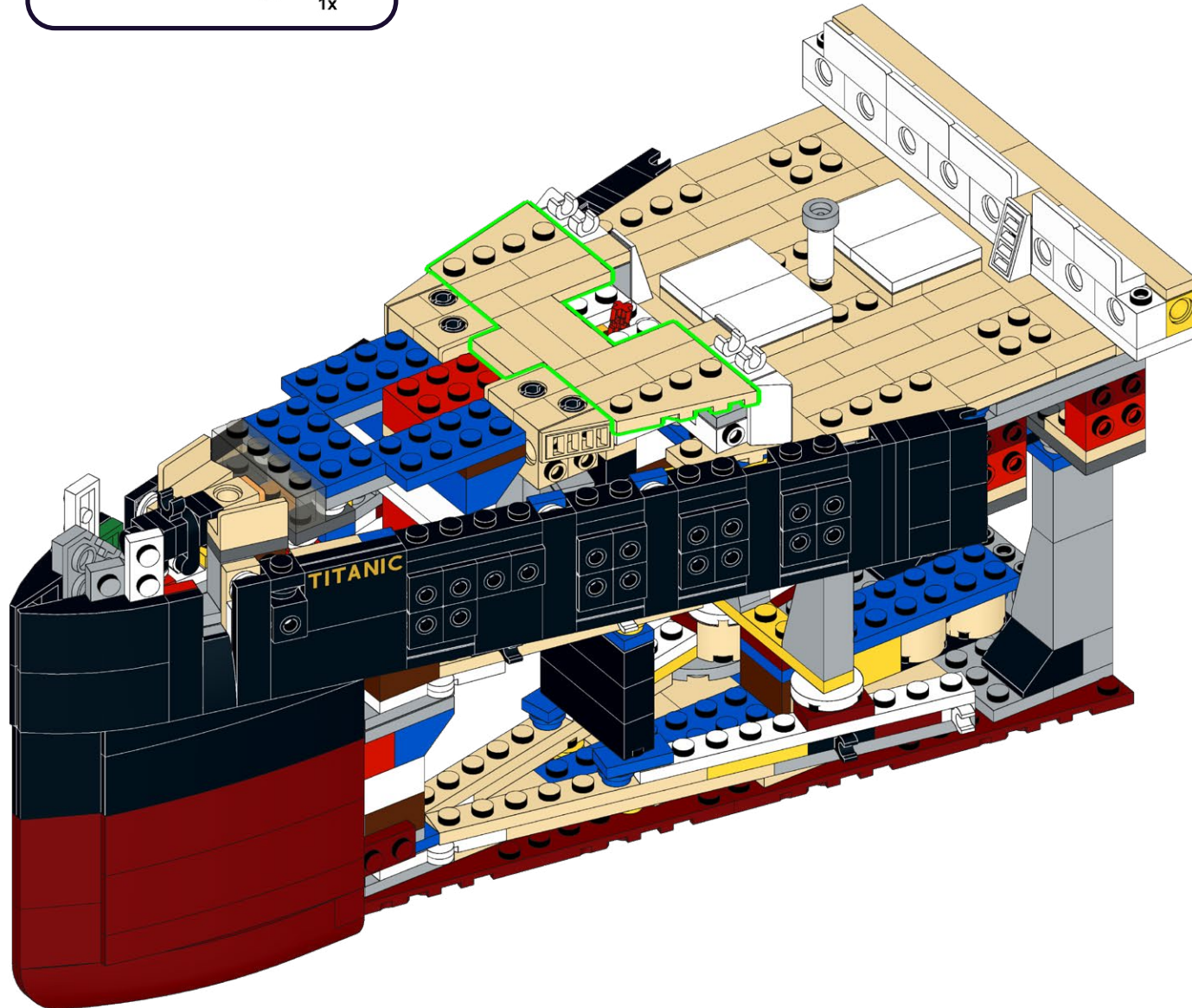
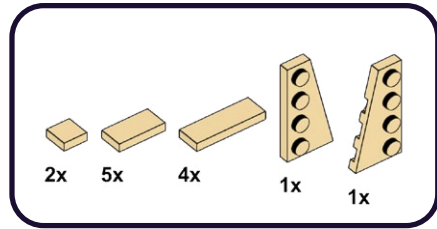

11

1x

1x

2x

1

2

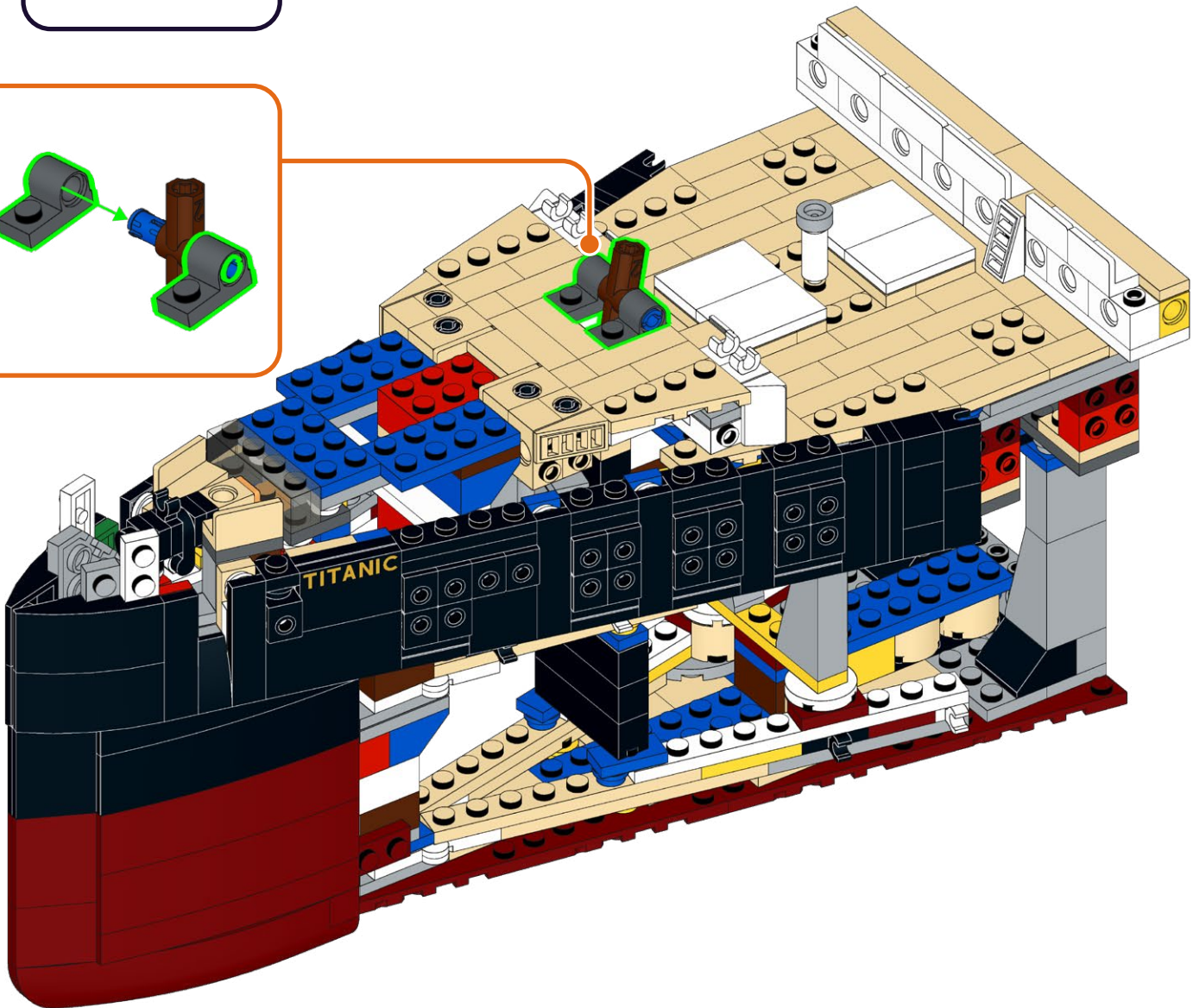
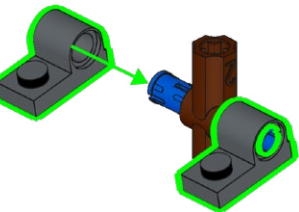

12

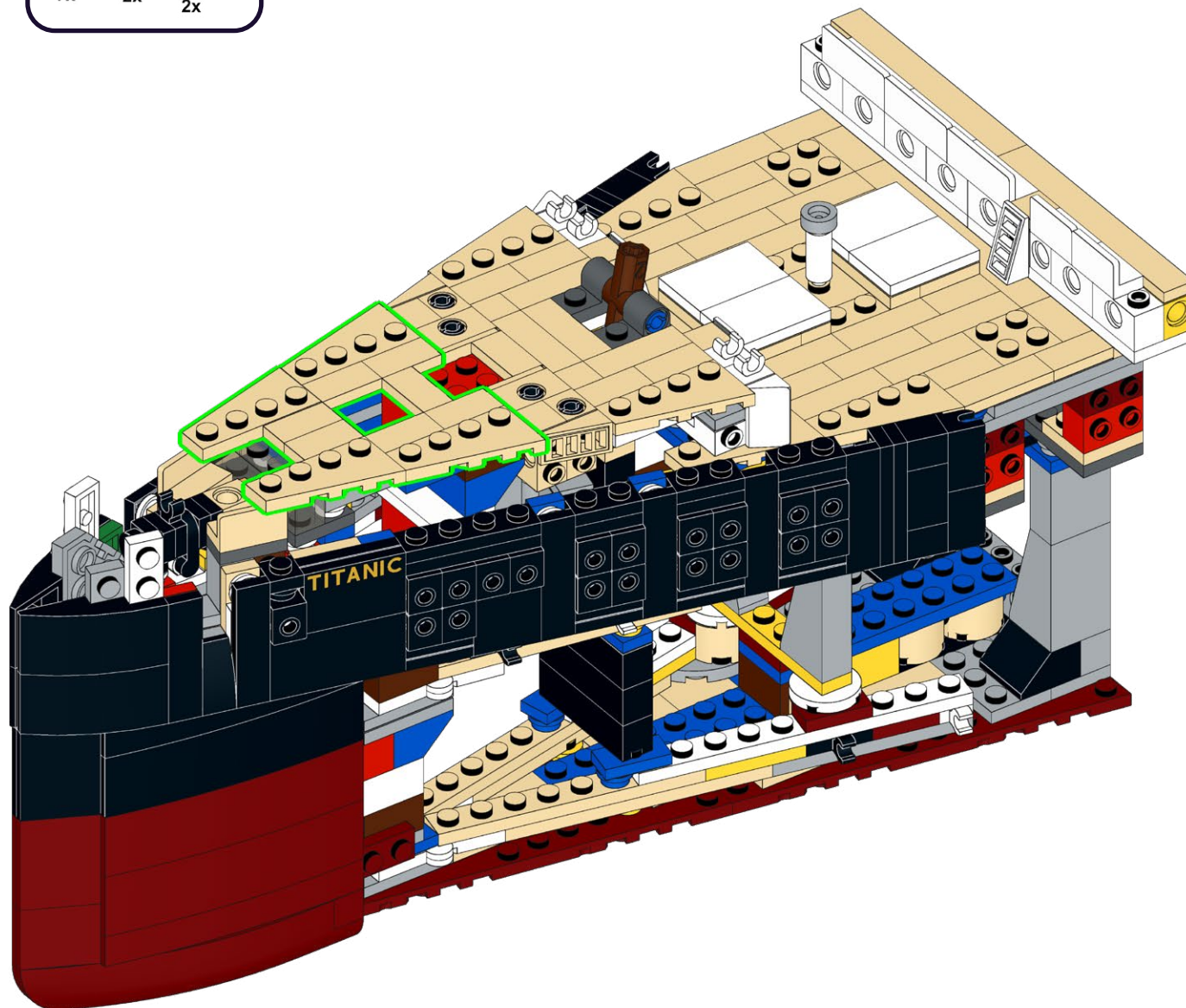
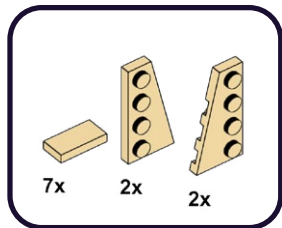

13

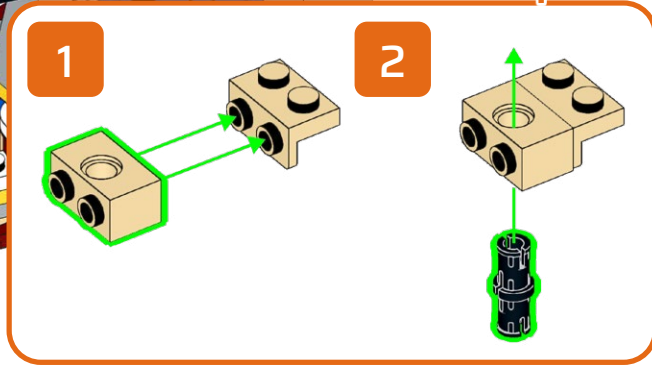
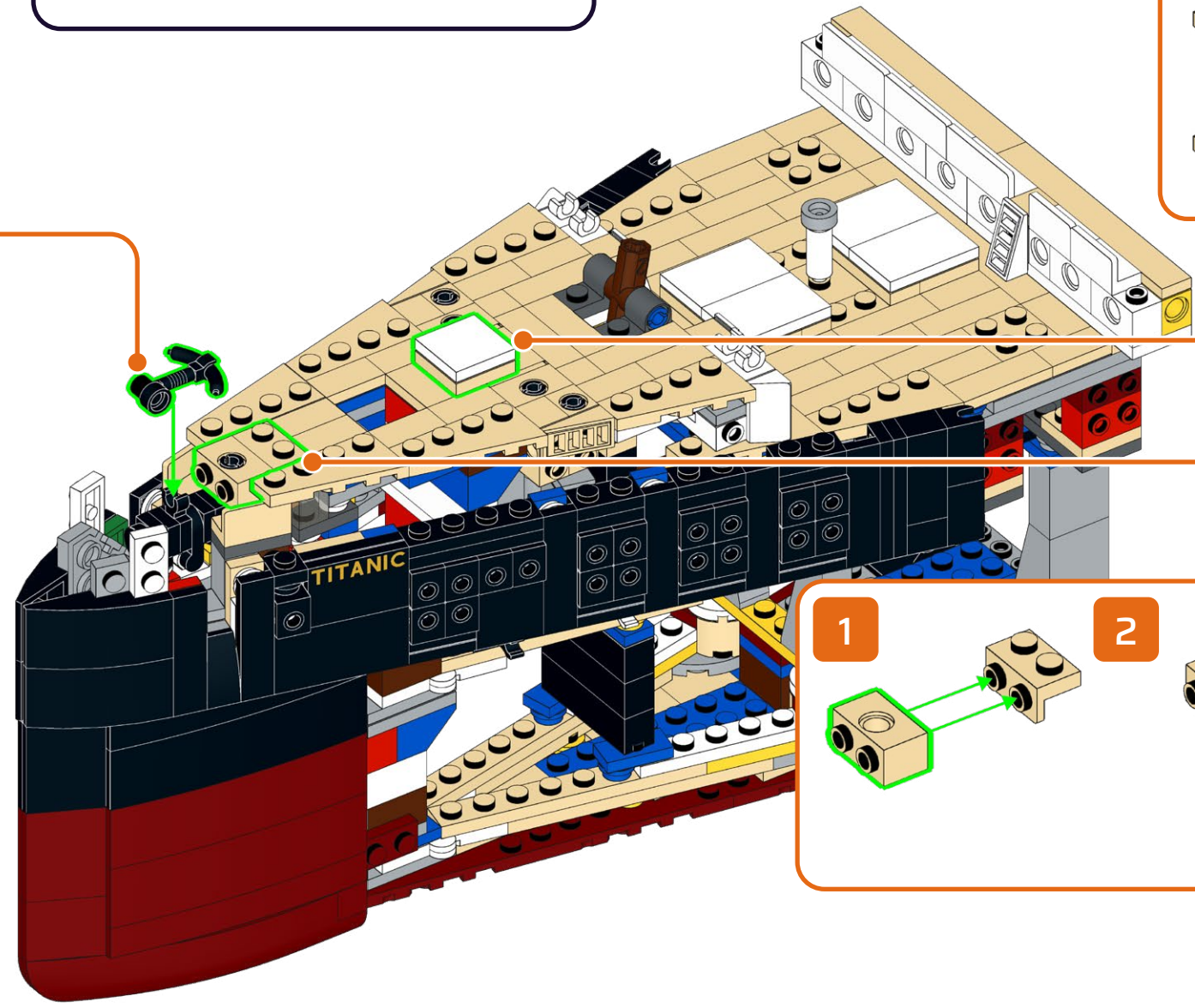
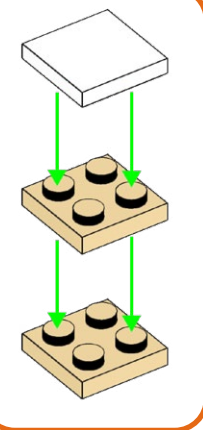
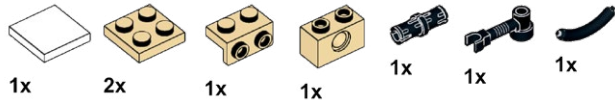

14

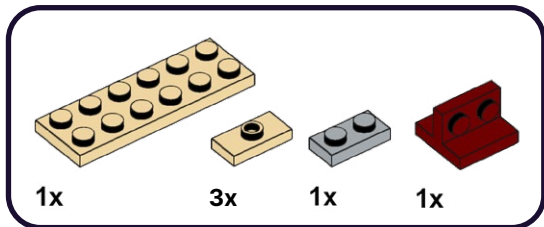

1

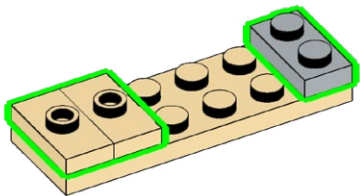

2

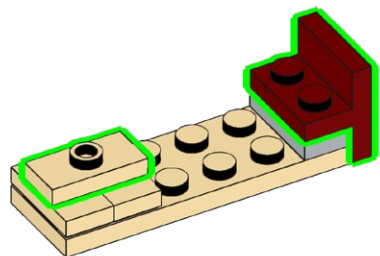

15

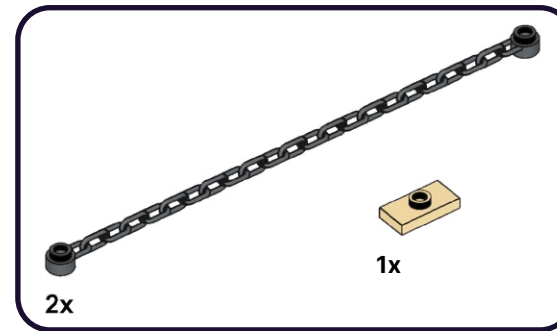

1

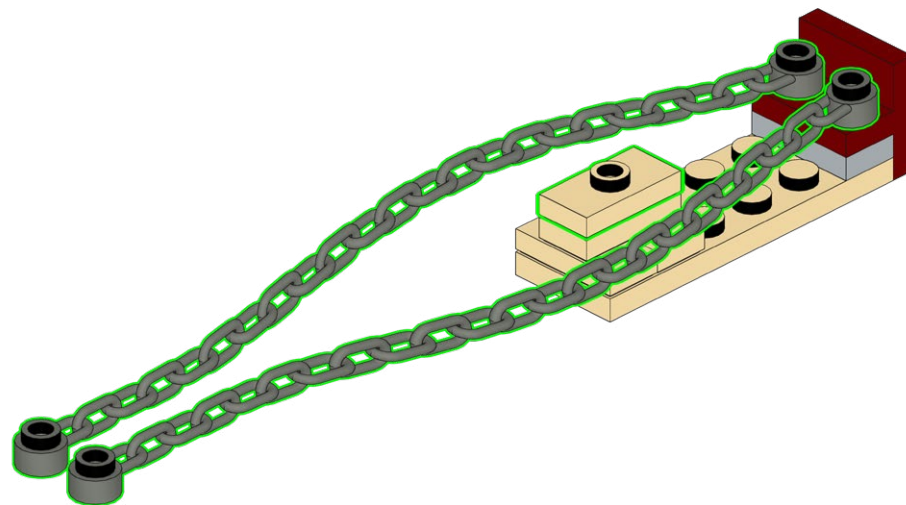

16

1x

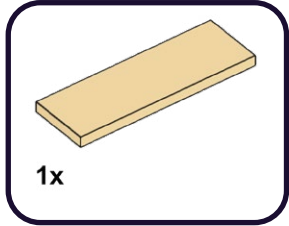

1

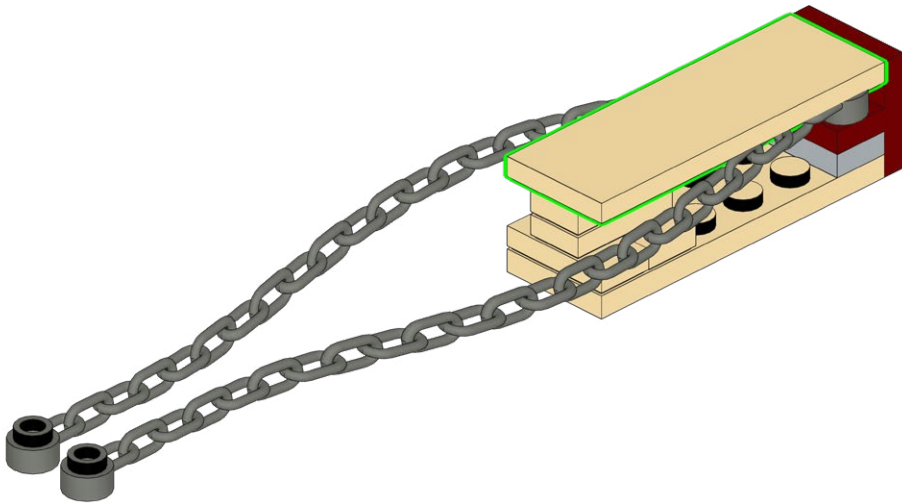

17

2x

2x

2x

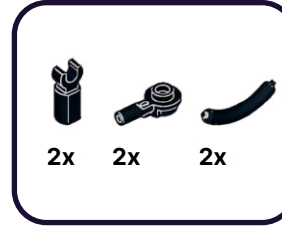

1

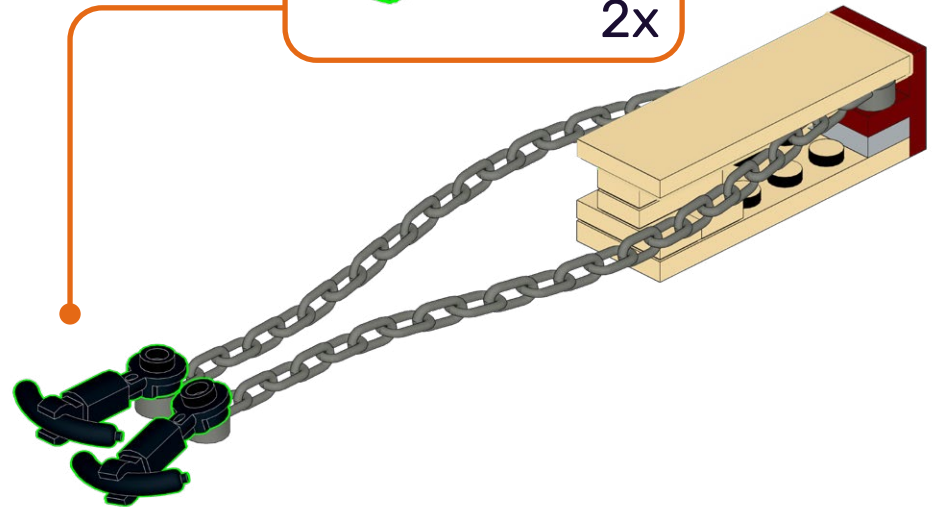
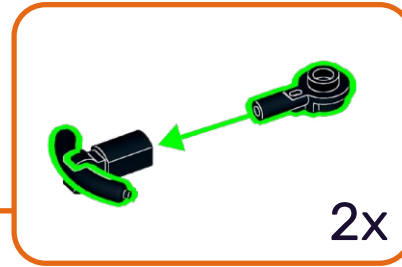

18

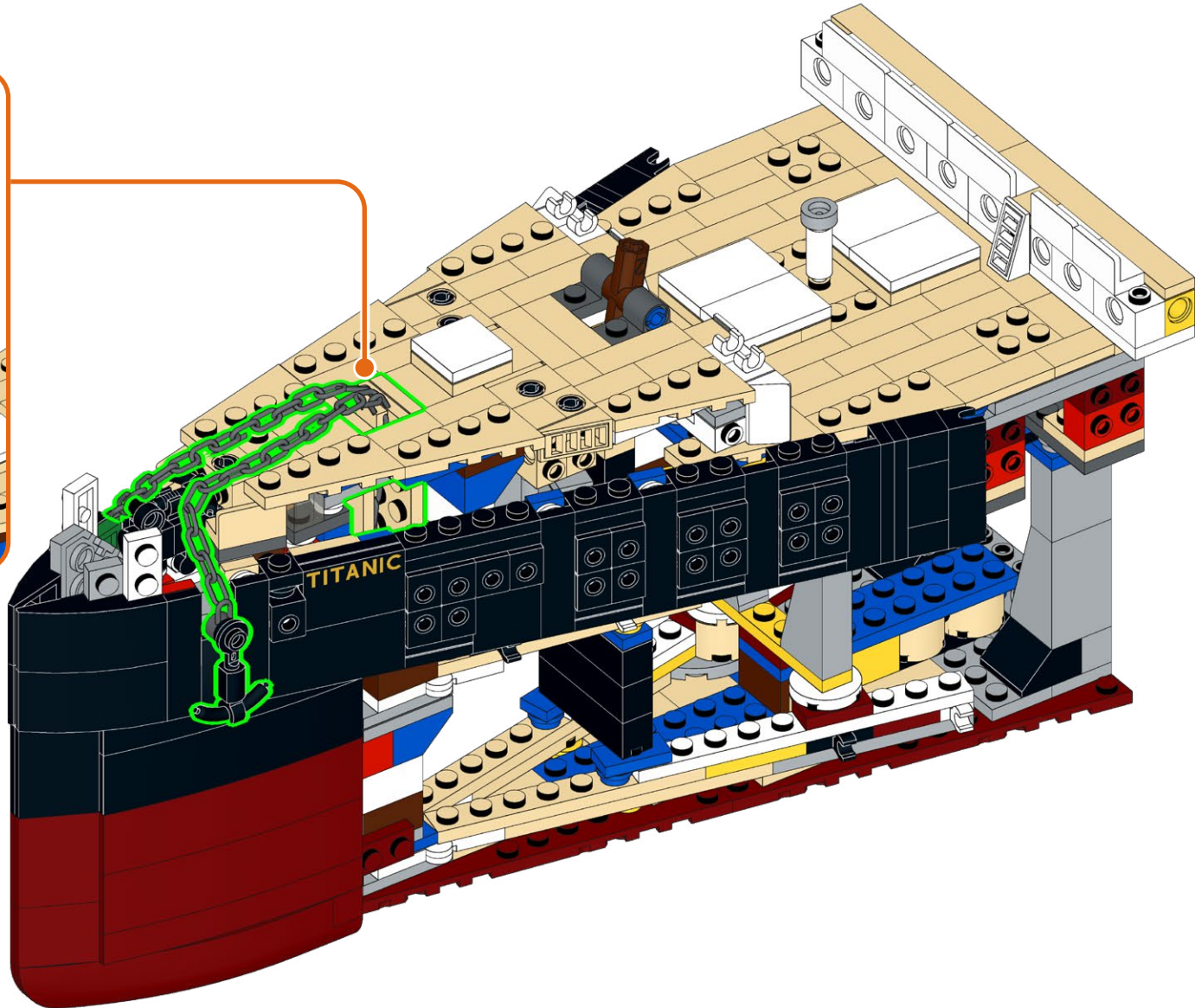
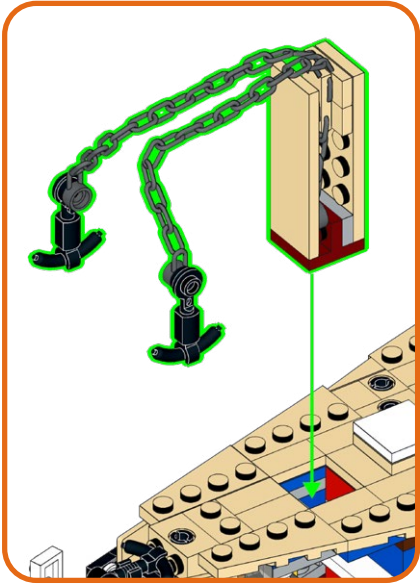

**HOLD UP!**

You might notice some bags aren't in order, as well as left over pieces, but that's ok! We're changing the way you build LEGO!

ATTENDEZ!

Vous remarquerez peut-être que certains sacs, ainsi que certaines pièces, ne sont pas dans le bon ordre. Mais pas de panique! Nous changeons simplement la façon avec laquelle vous construisez vos LEGO!

ASPETTA!

Potresti notare che alcuni sacchetti non sono in ordine, così come i pezzi avanzati, ma va bene così! Stiamo cambiando il modo in cui costruisci i LEGO!

HALT!

Sie werden möglicherweise bemerken, dass einige tüten durcheinander sind und teile übrig bleiben, aber das ist in Ordnung! Wir ändern die art und weise, wie Sie LEGO bauen!

¡ESPERA!

Es posible que notes que algunas bolsas están fuera de servicio, así como piezas sobrantes, ¡pero está bien! ¡Estamos cambiando la forma en que construyes LEGO!

暫停!

你可能会注意到一些袋子顺序错乱, 以及一些剩余的部件, 但没关系! 我们正在改变你搭建乐高的方式!

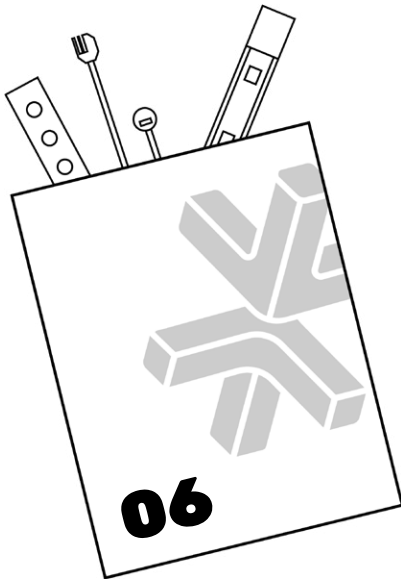
Open LMB Bag 06

19

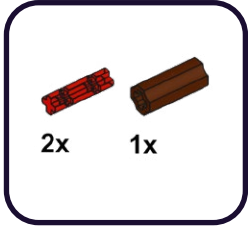

1

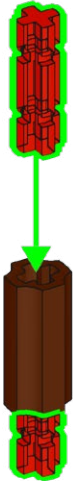

20

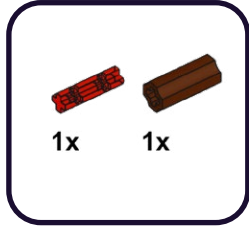

1



21

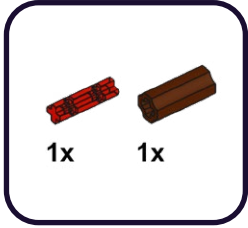

1



22

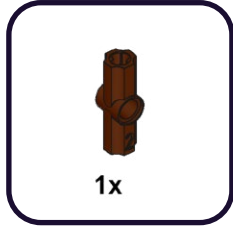

1



23

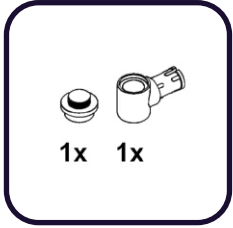

1

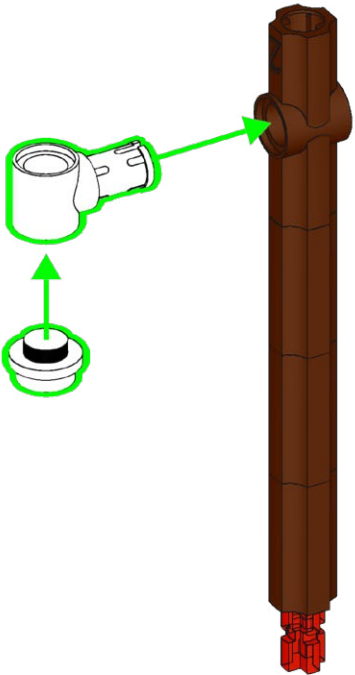

24

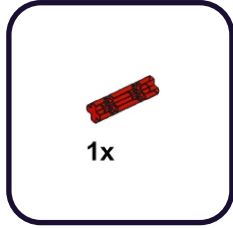

1

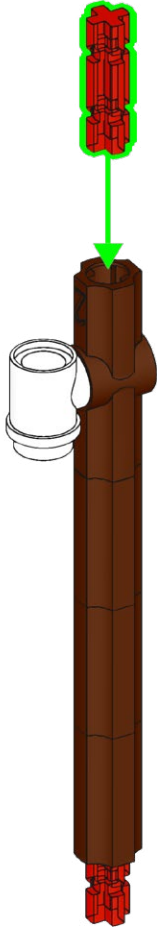

25

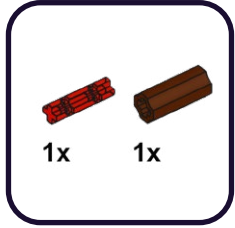

1



26

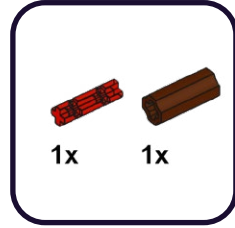

1



27

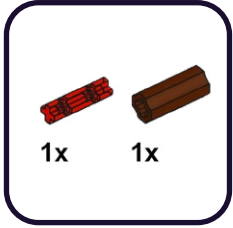

1

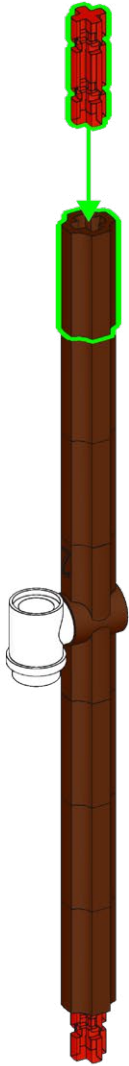

28

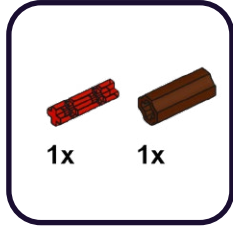

1

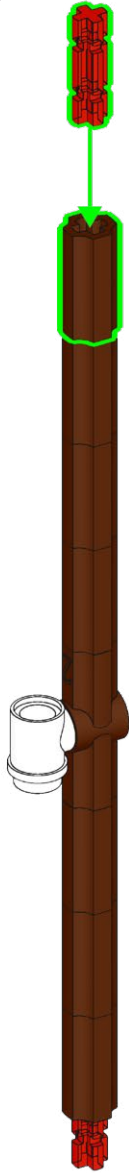

29

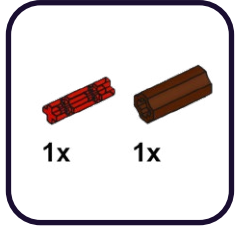

1

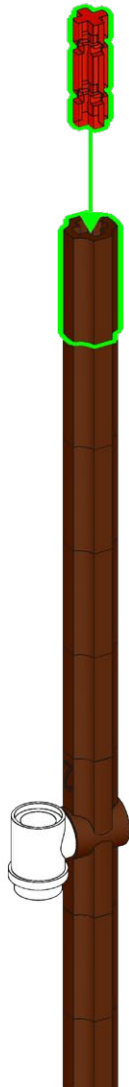

30

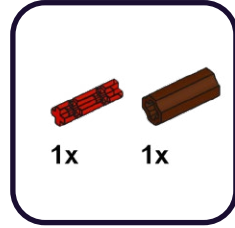

1

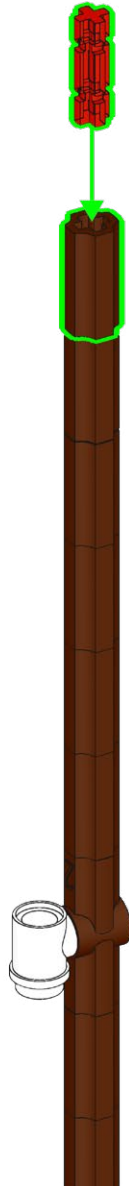

31

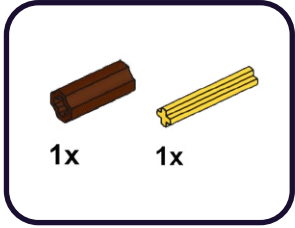

1

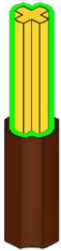

32

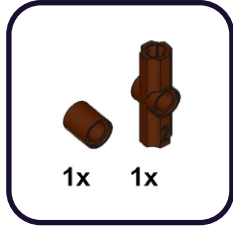

1

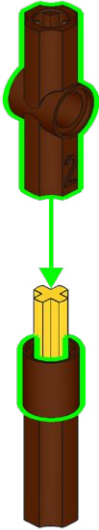

33

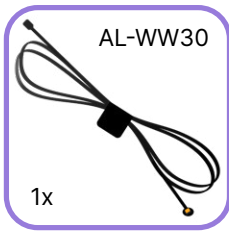

1

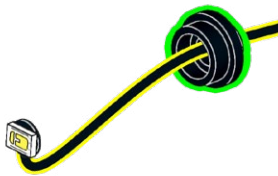

2



3



34

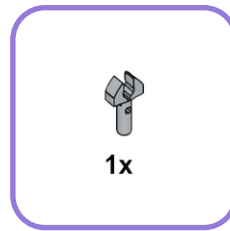

1

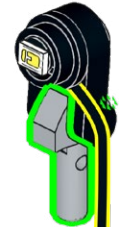

2





1

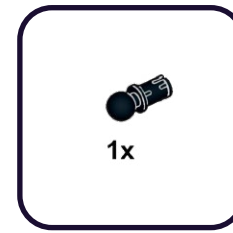
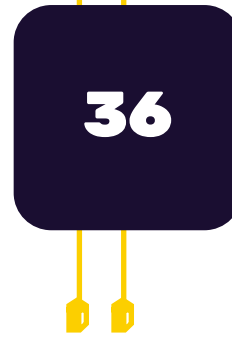
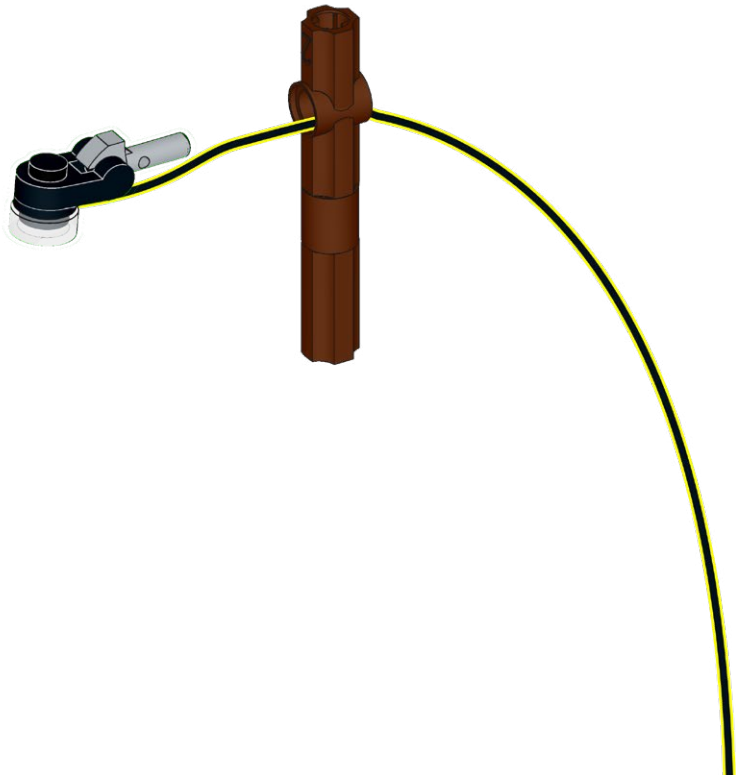

1

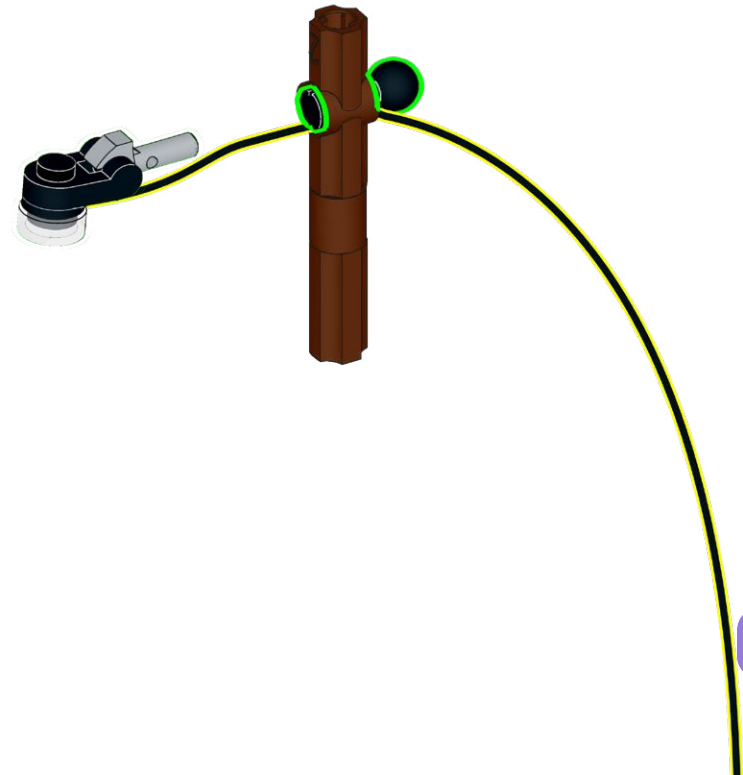



1

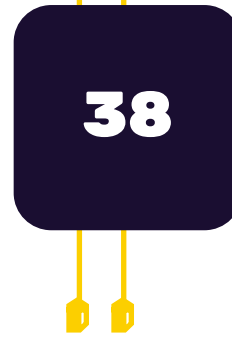
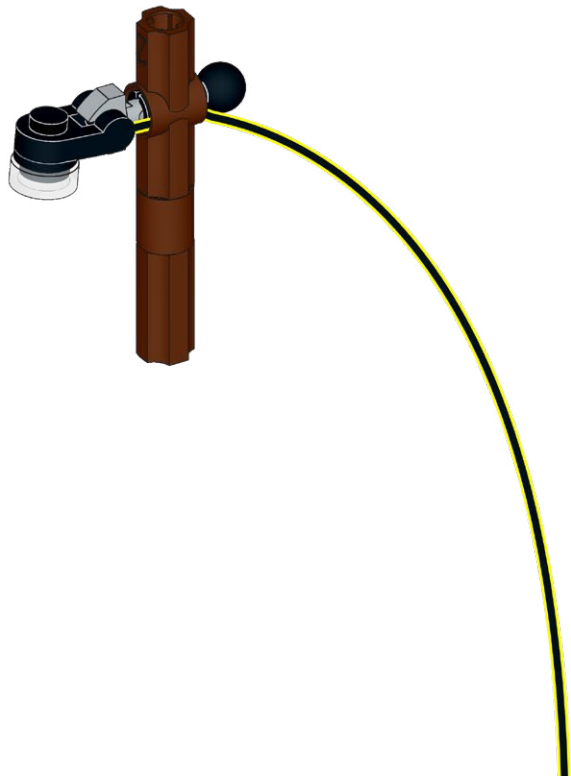

1

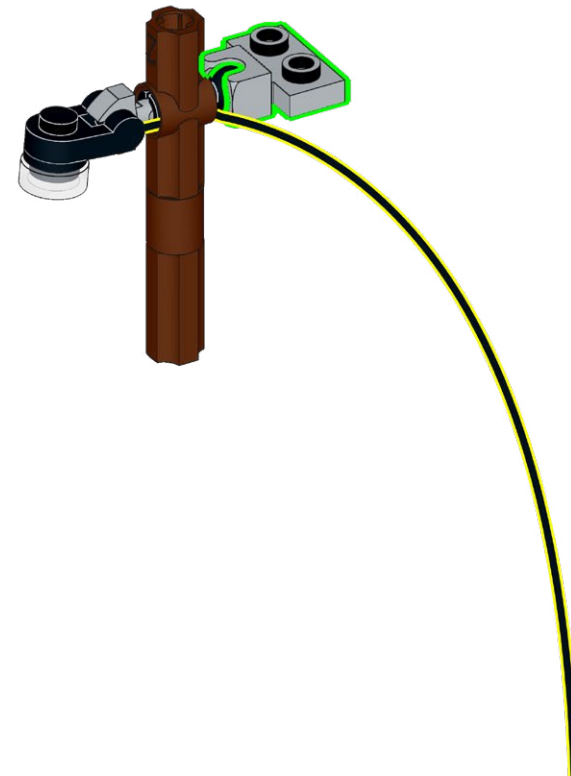
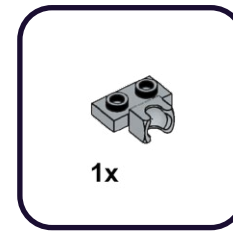

39

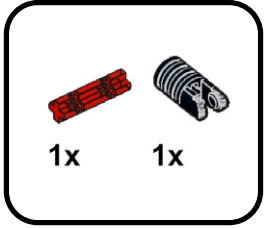

1

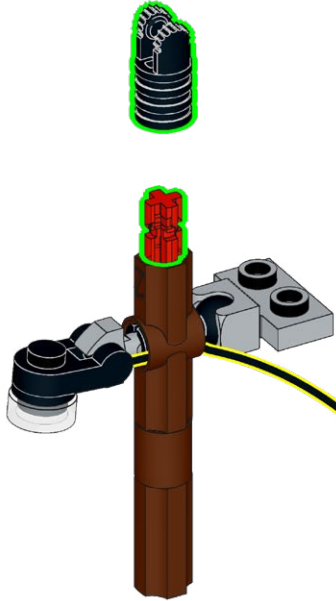

40

1

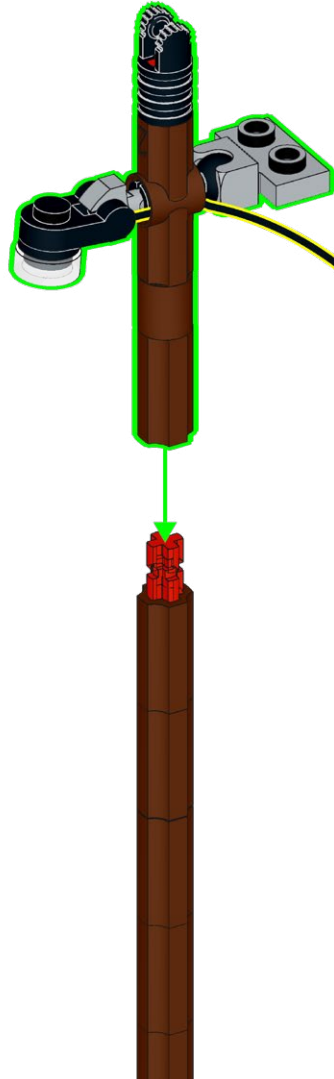

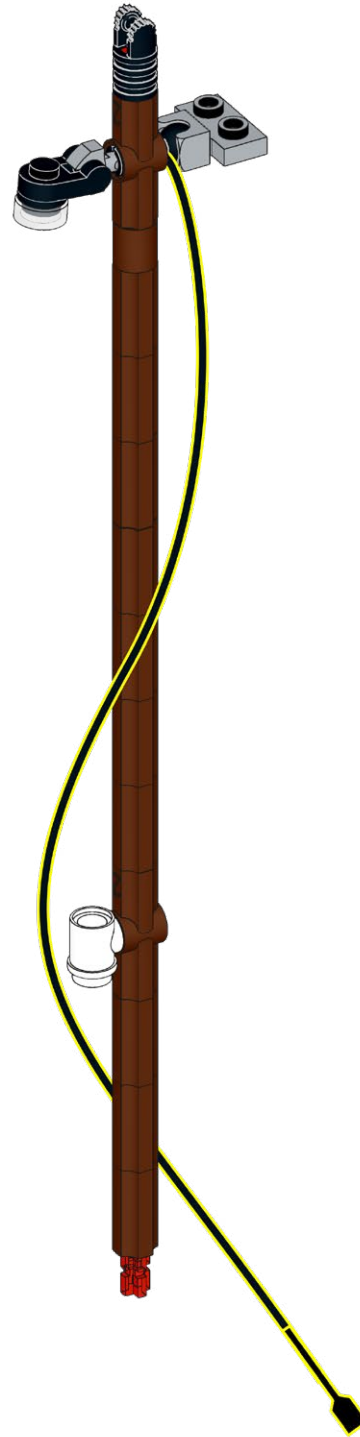

42

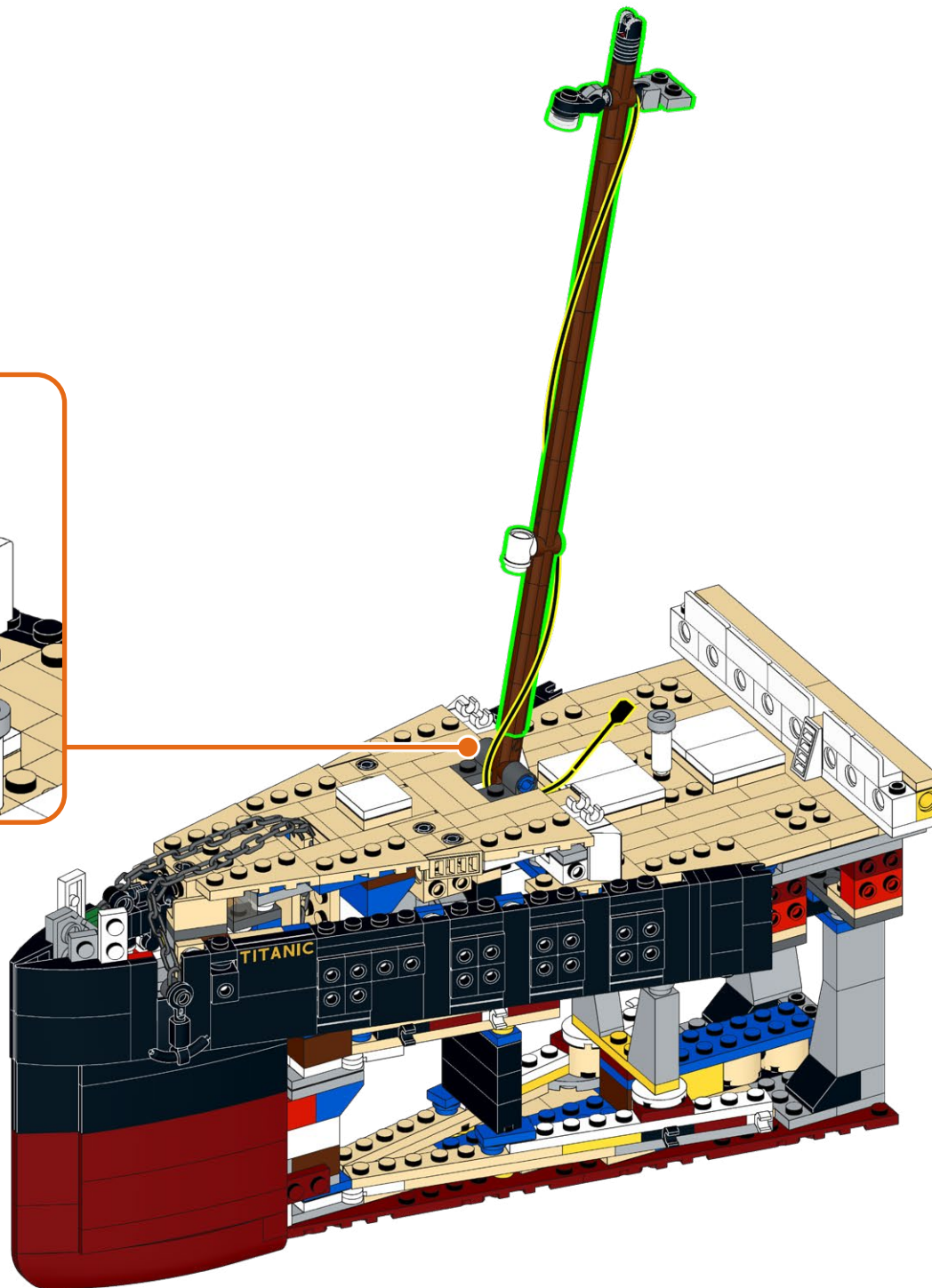
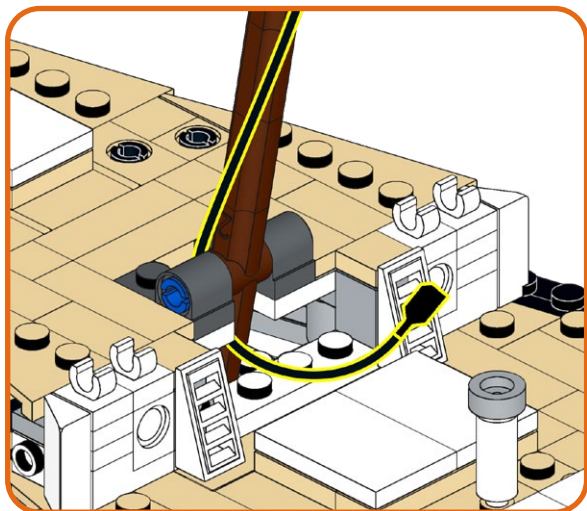

43

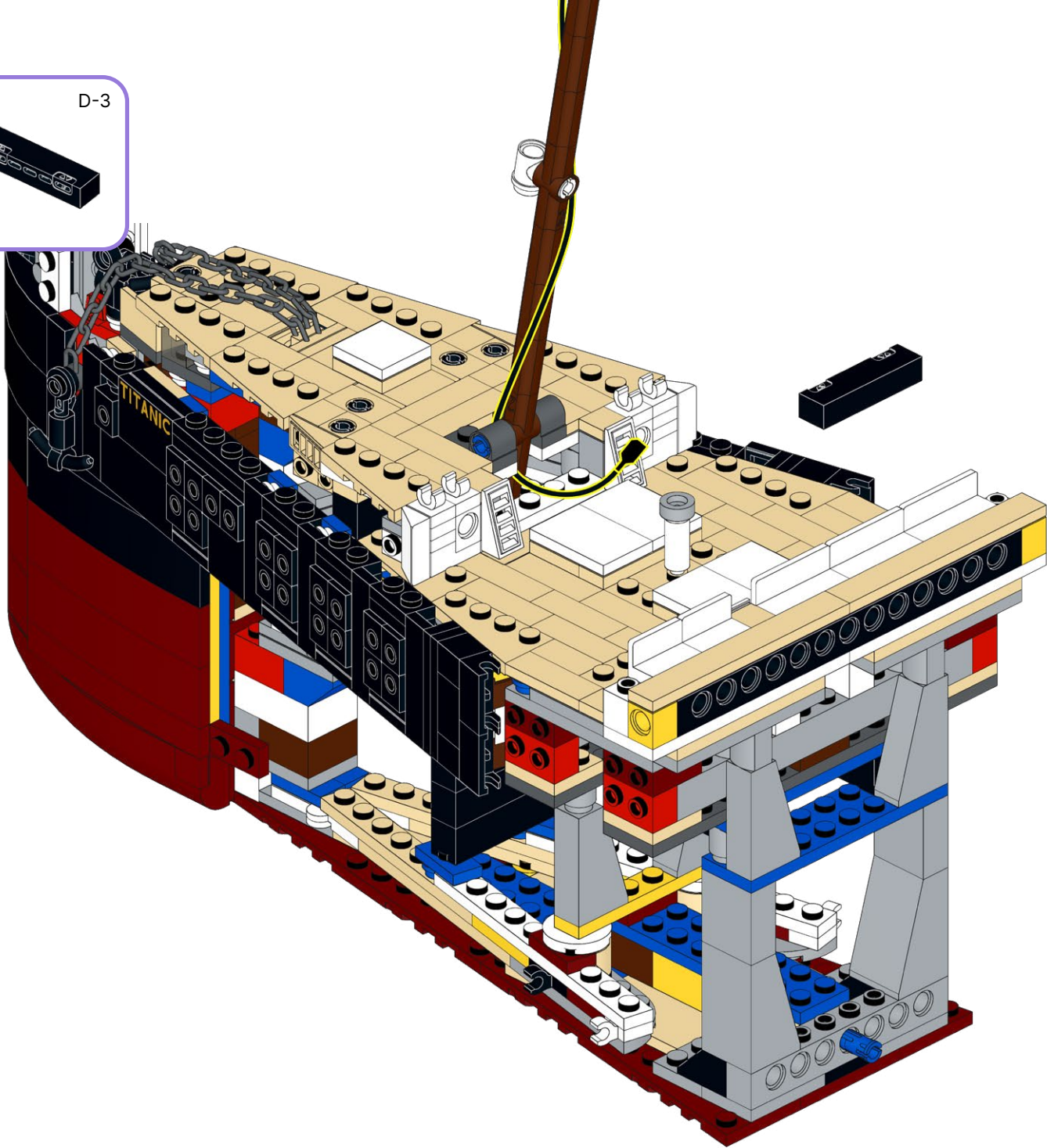
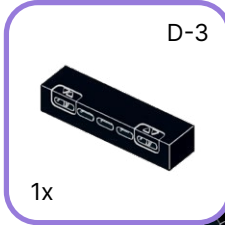

44

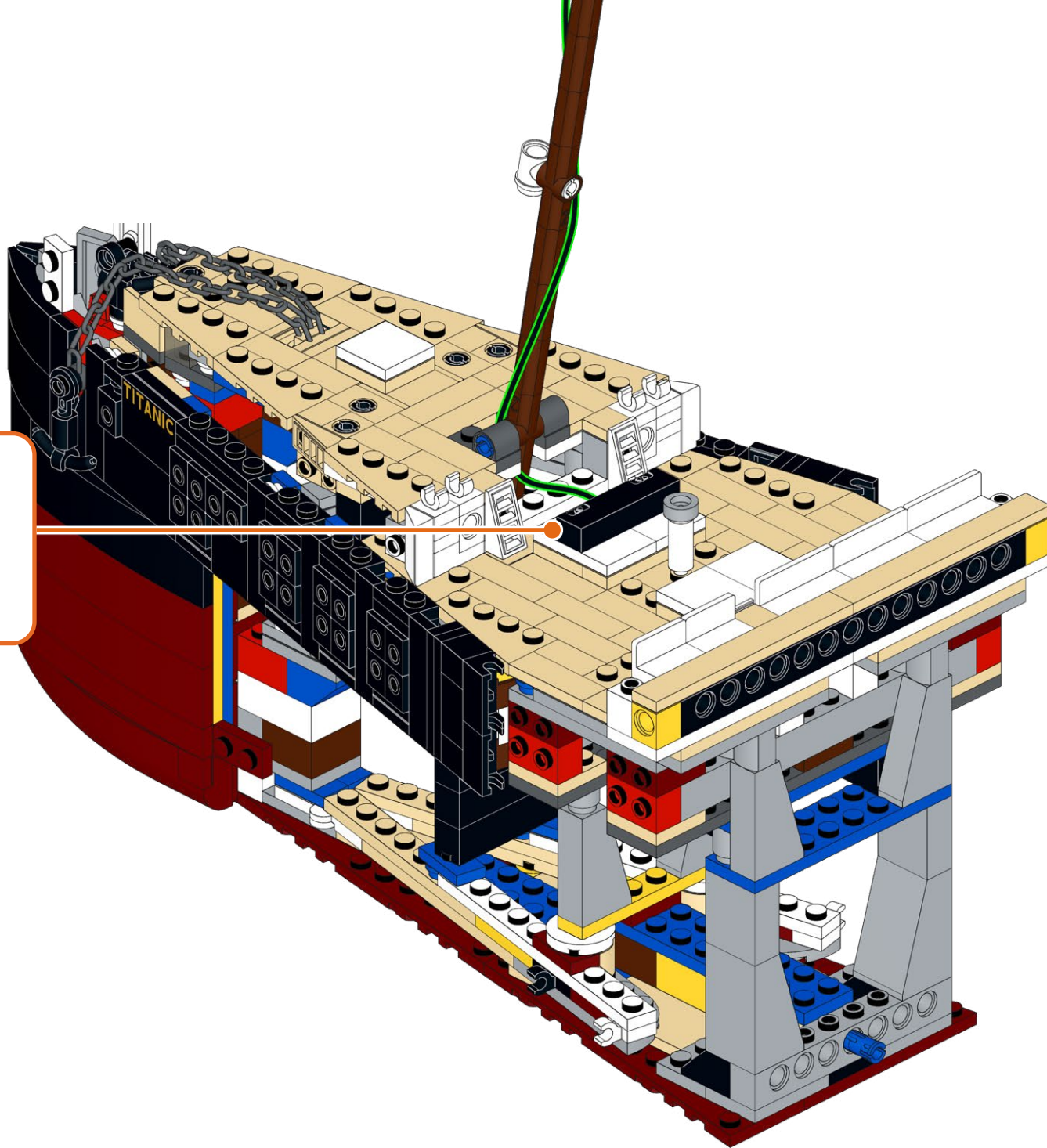
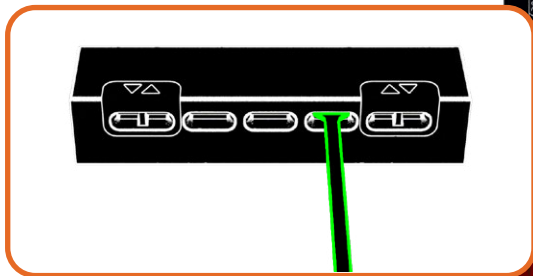

45

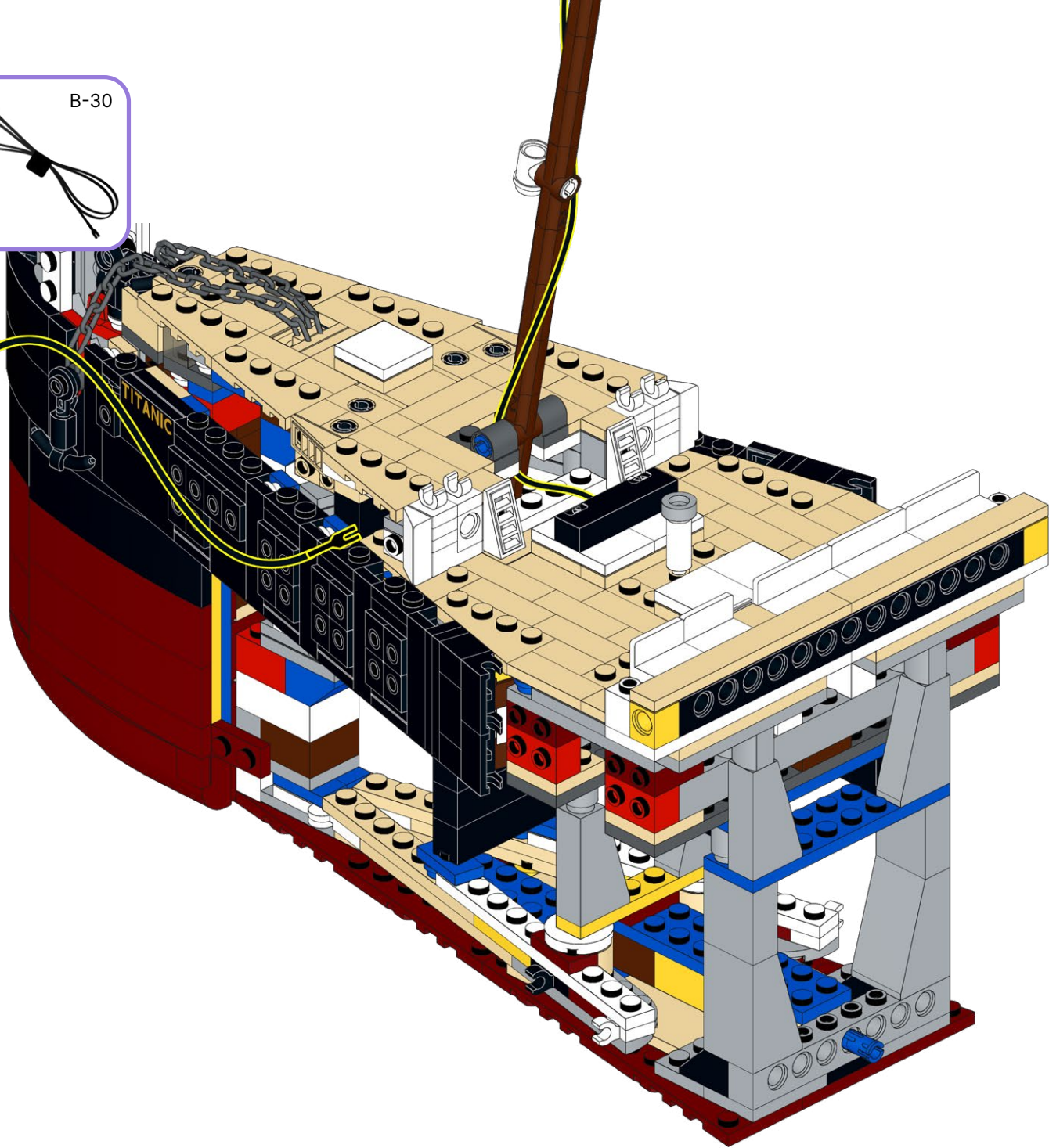
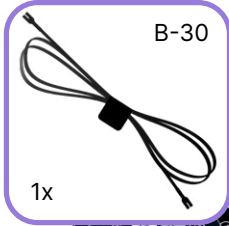

46

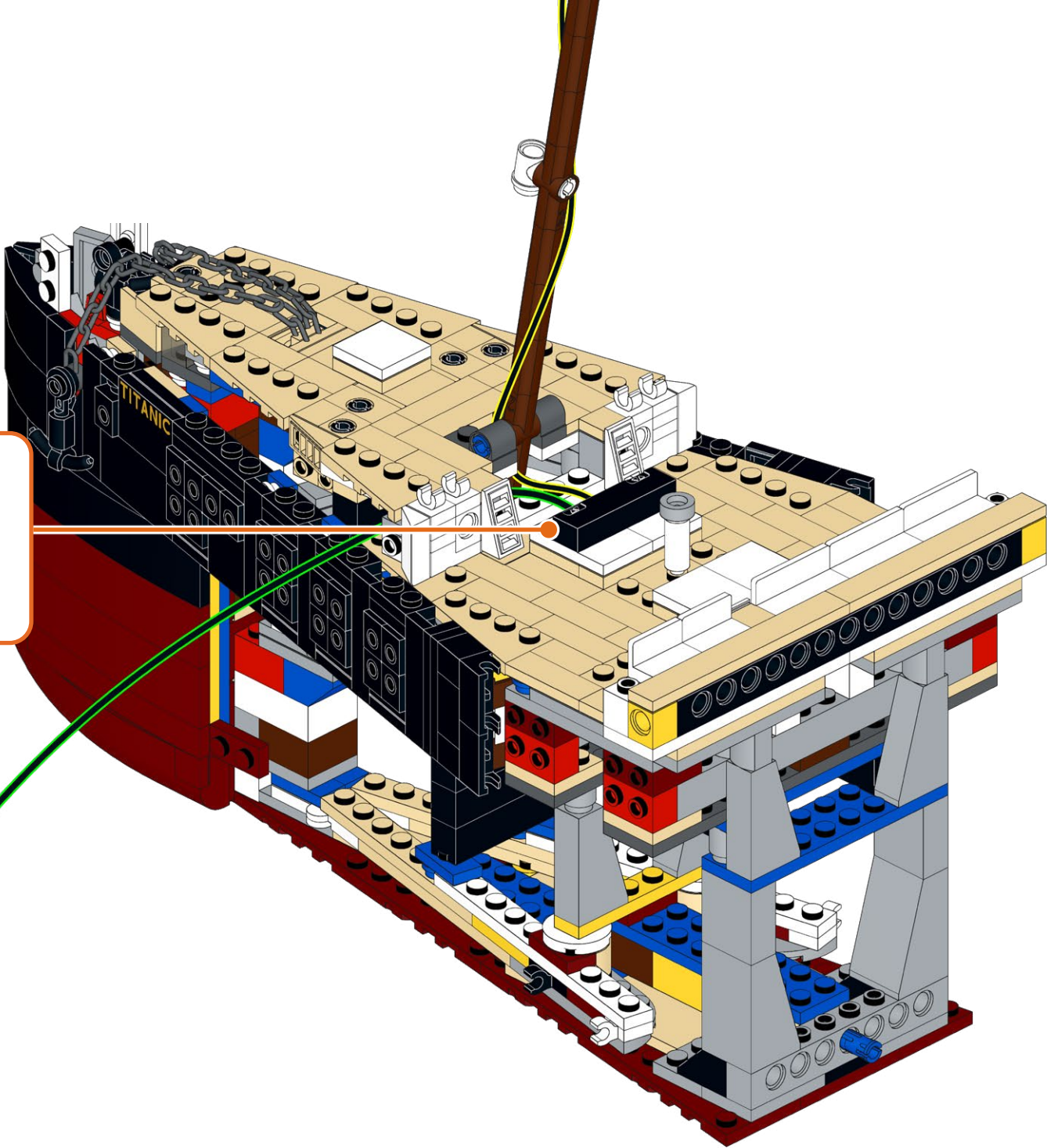
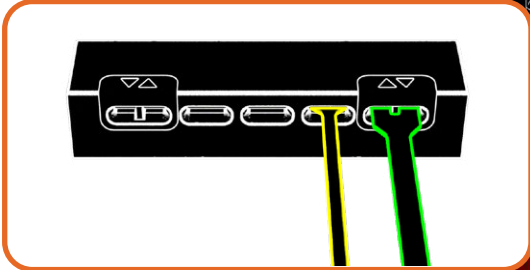

47

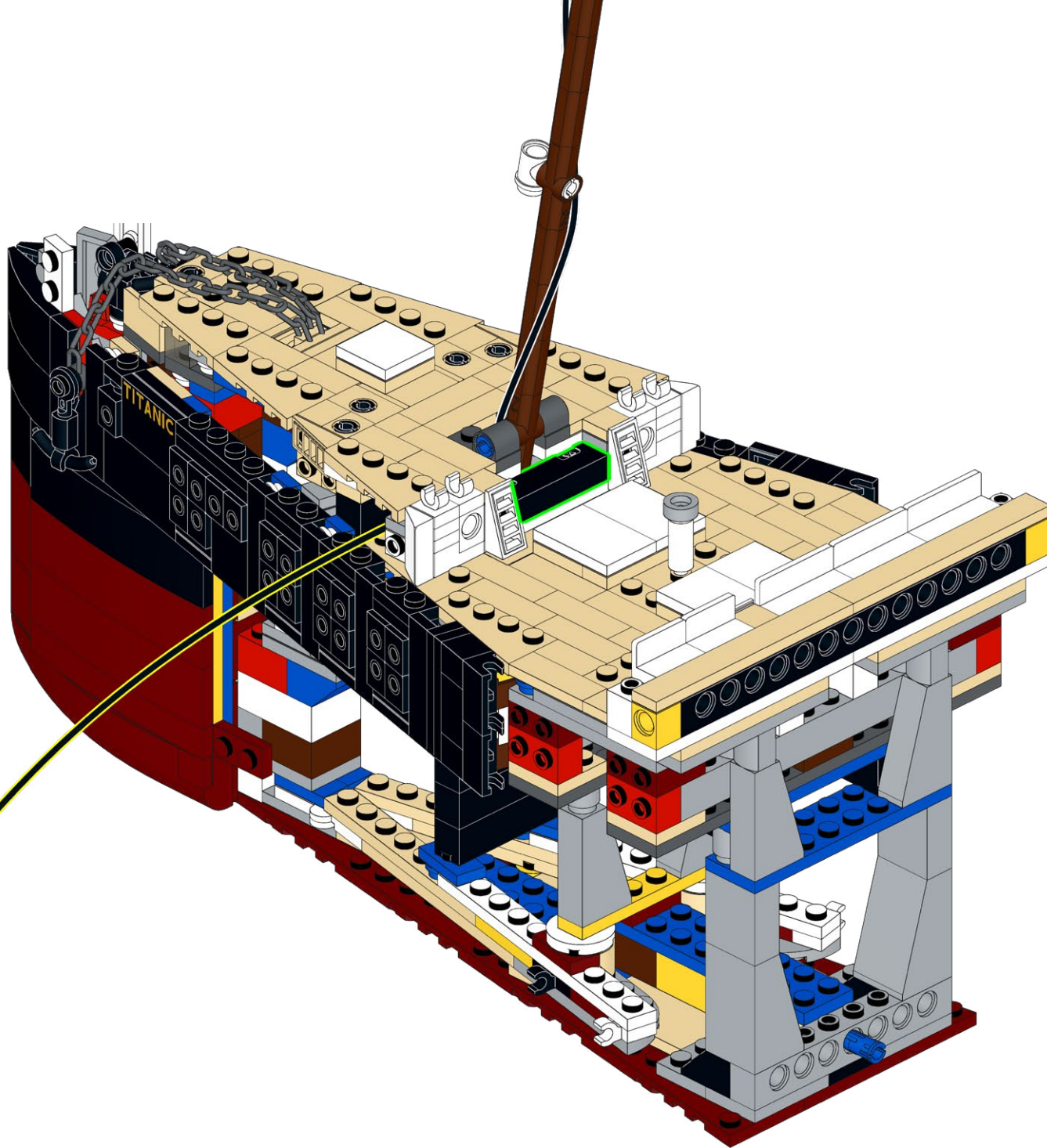

48

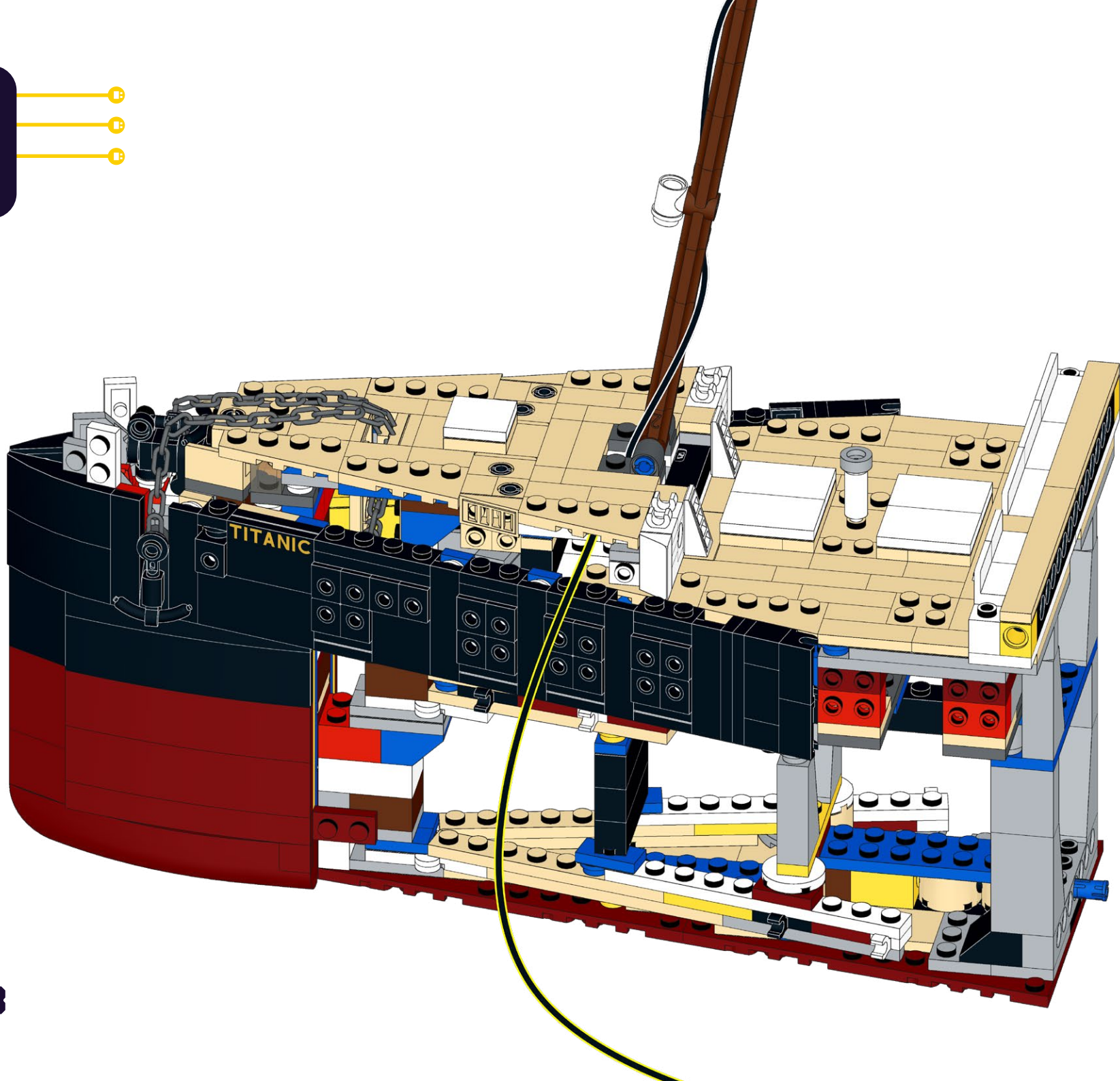

49

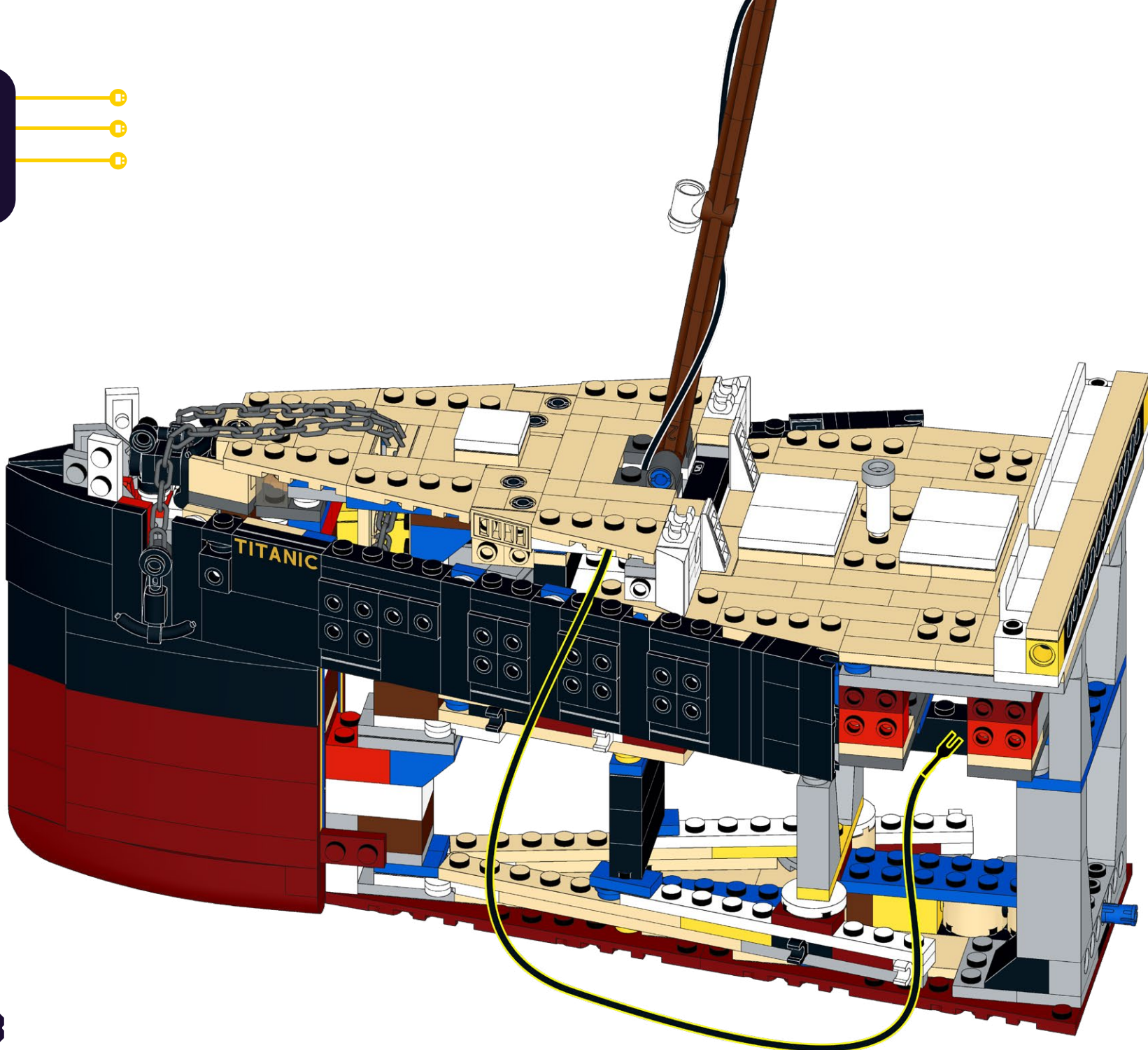

50

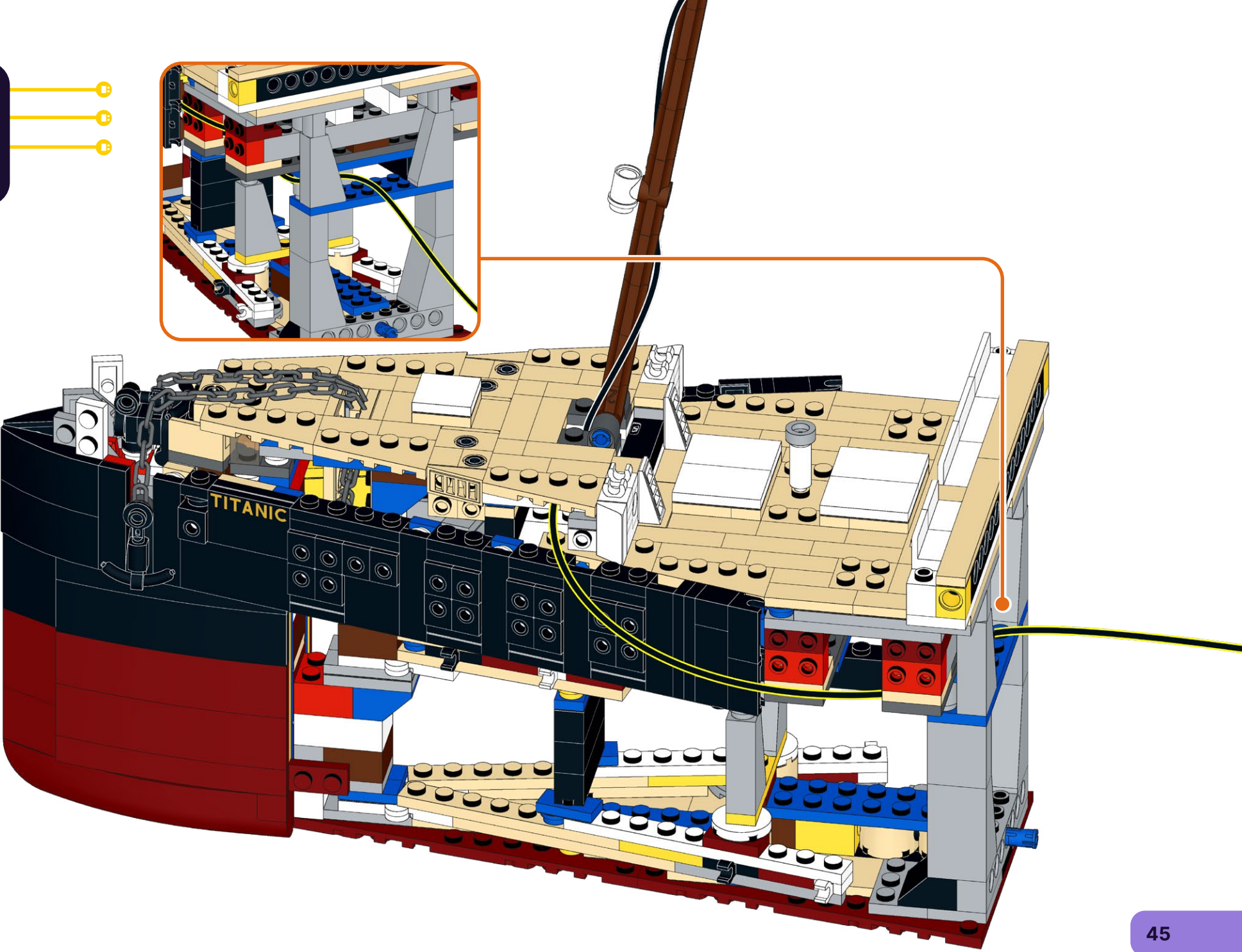
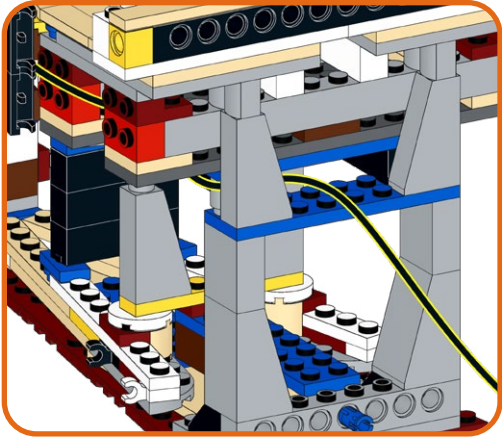

51

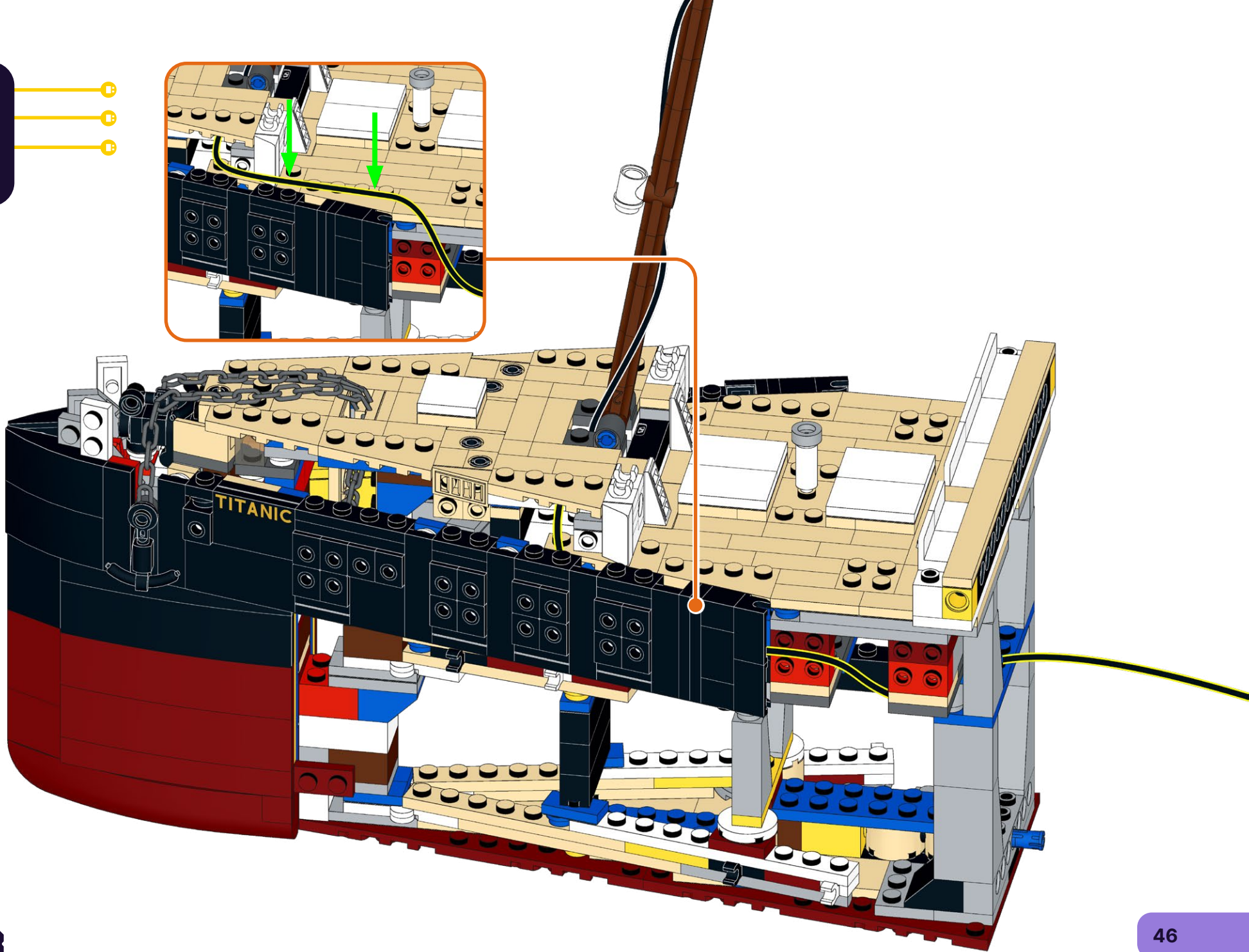
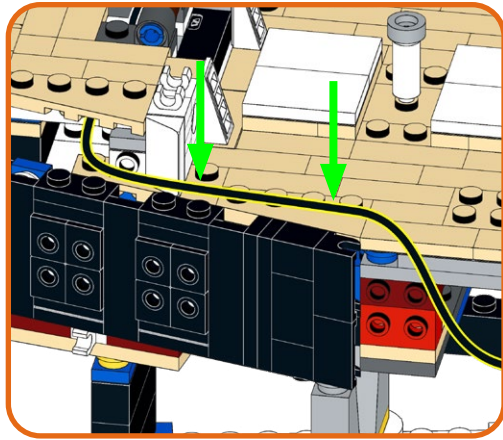

52

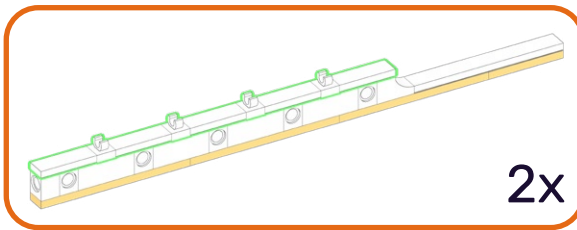
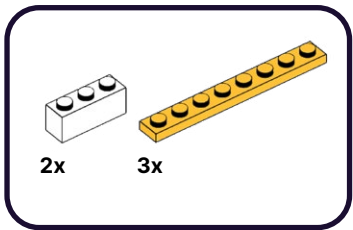

1

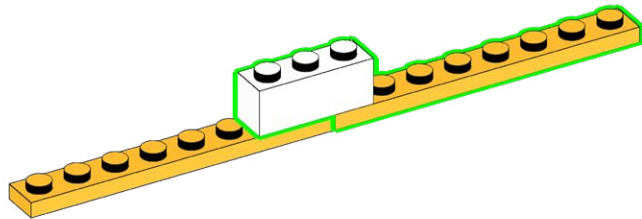

2

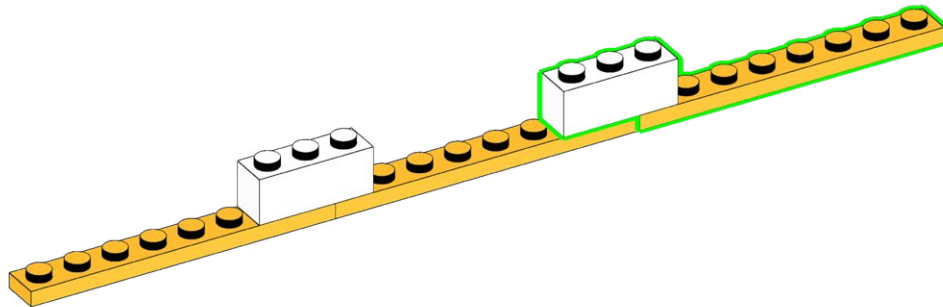

53

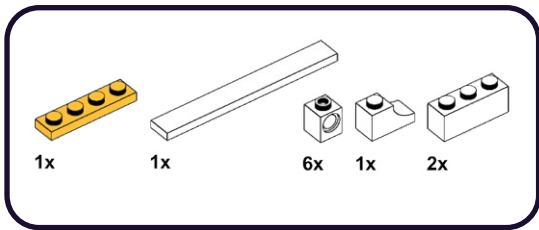

1

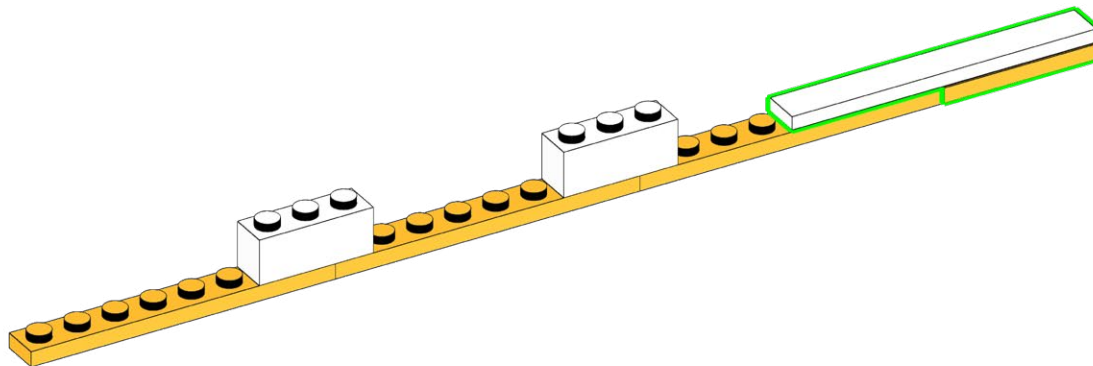

2

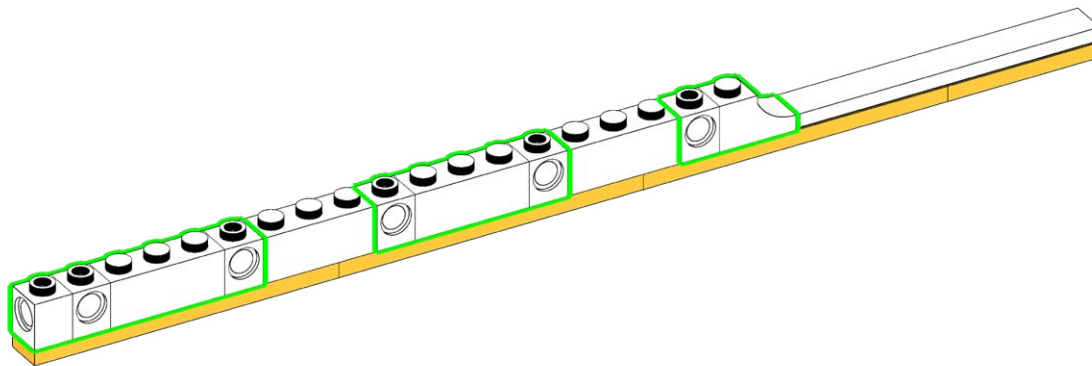

54

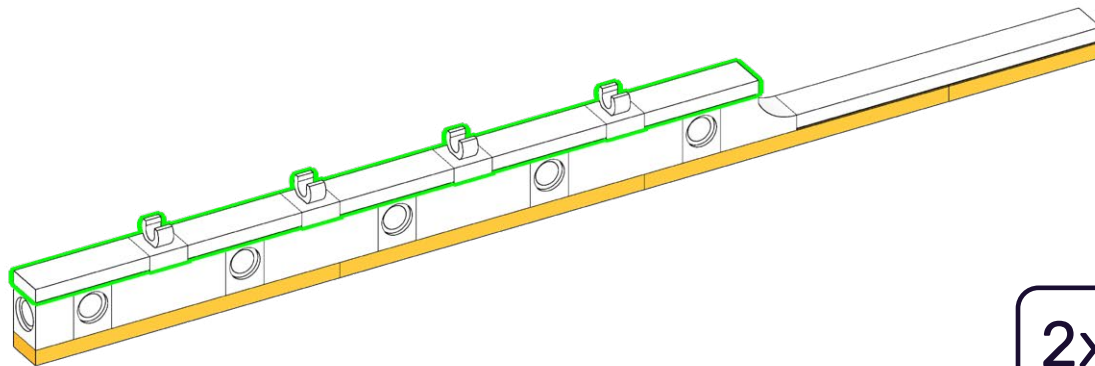
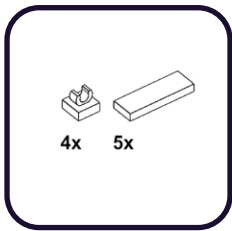

2x

55

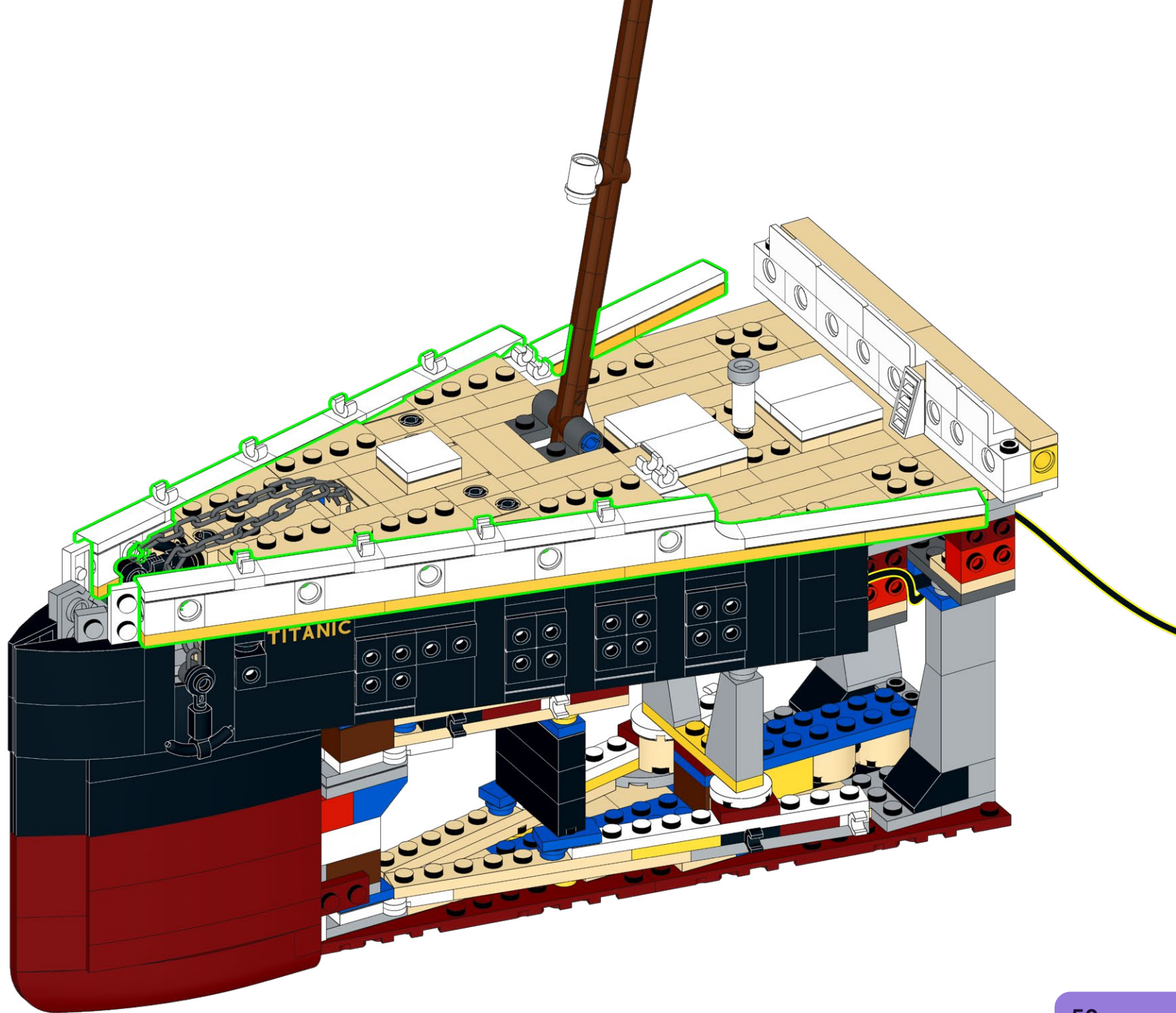

56

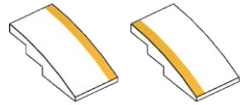

1x

1x

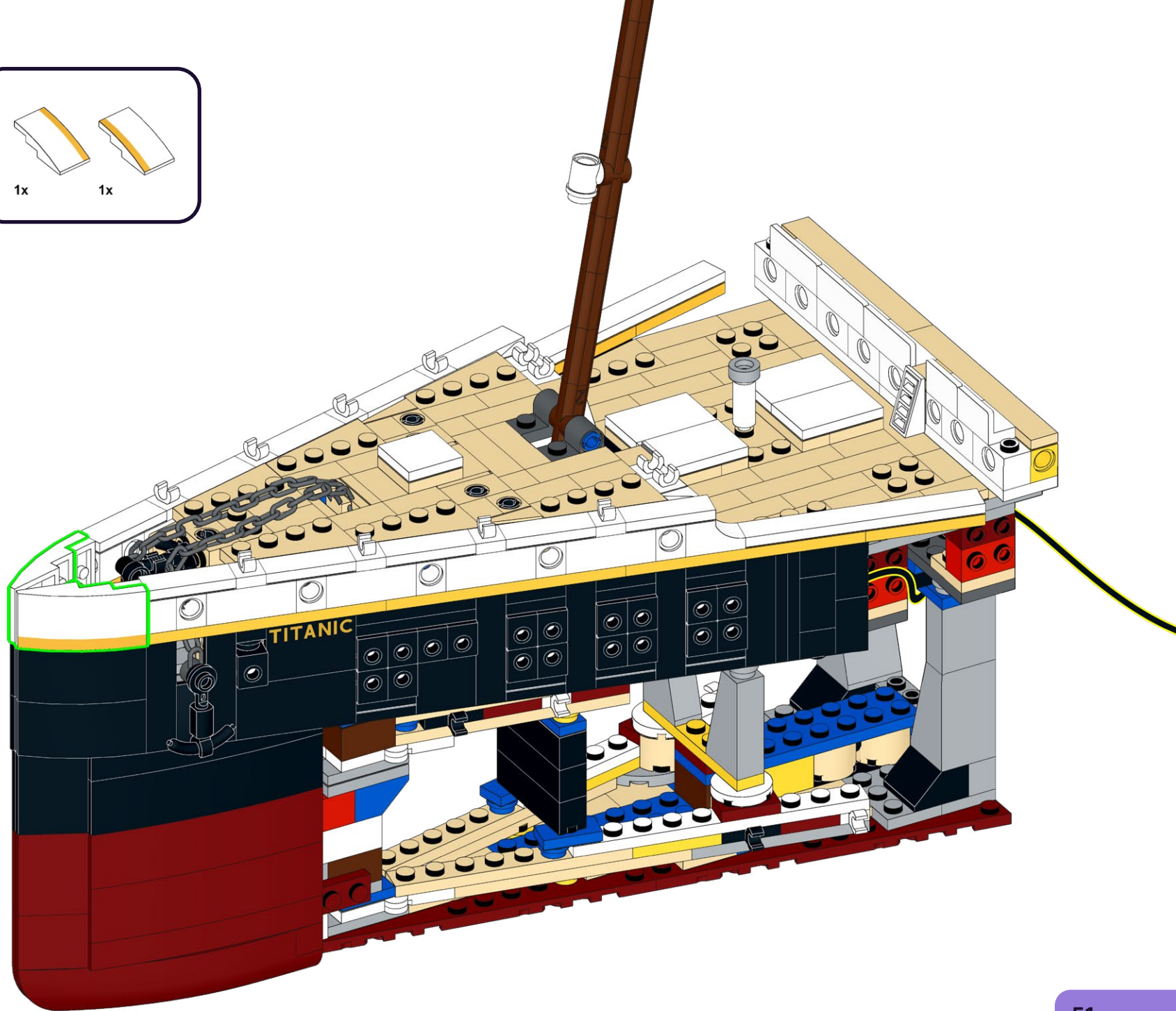

57

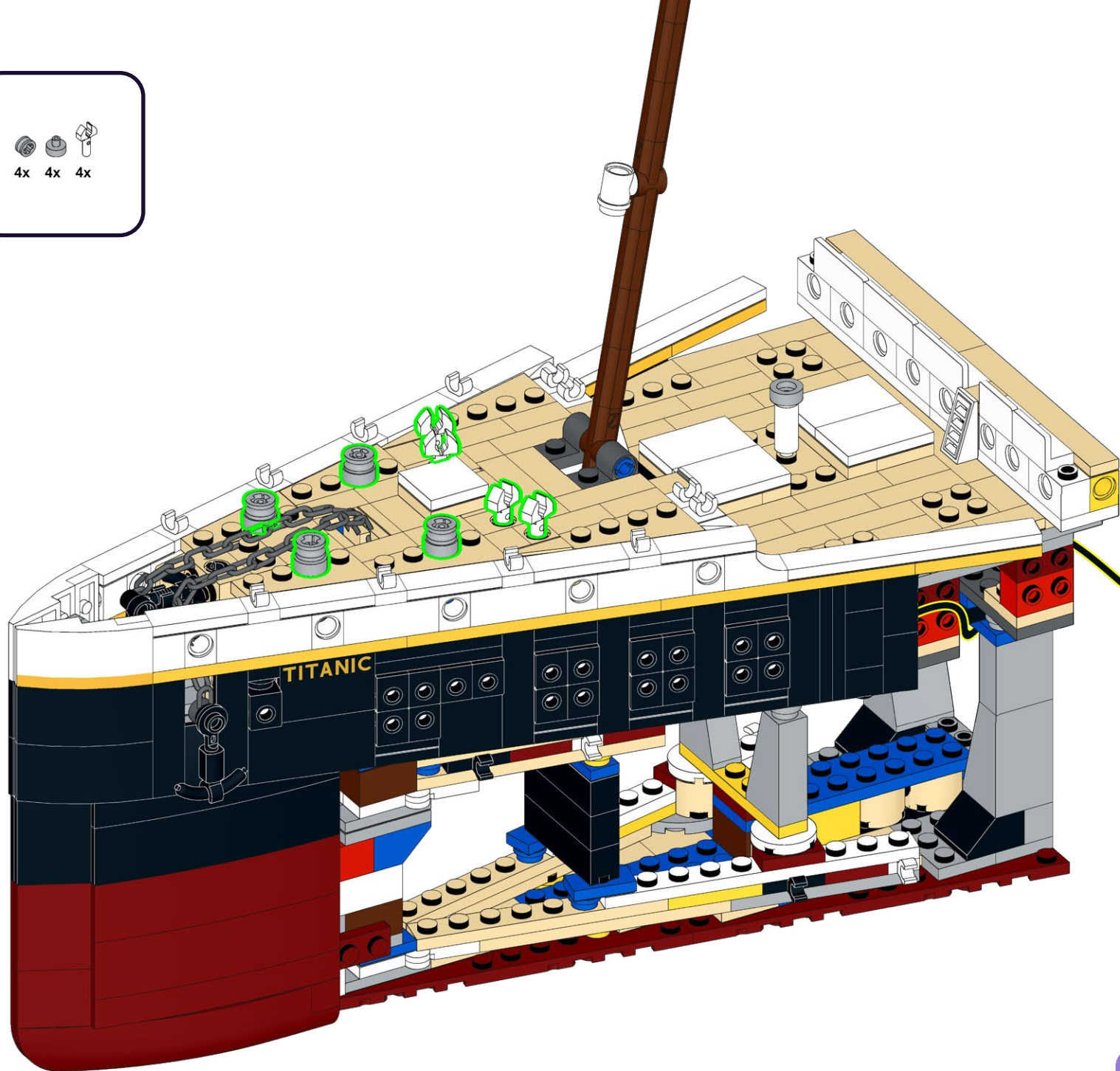

58

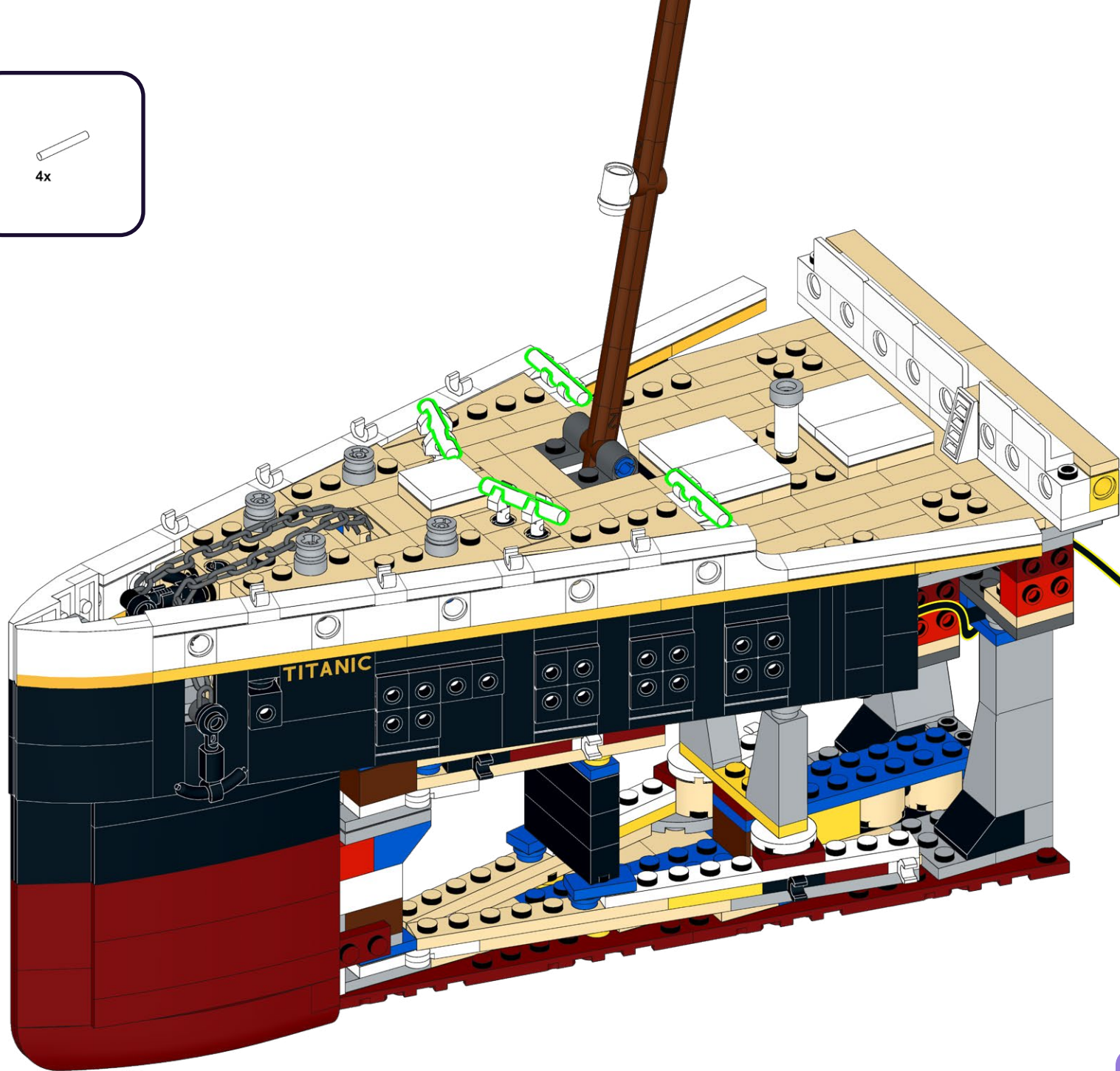
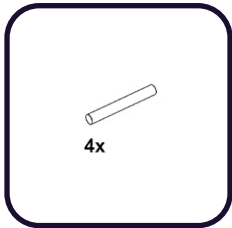

59

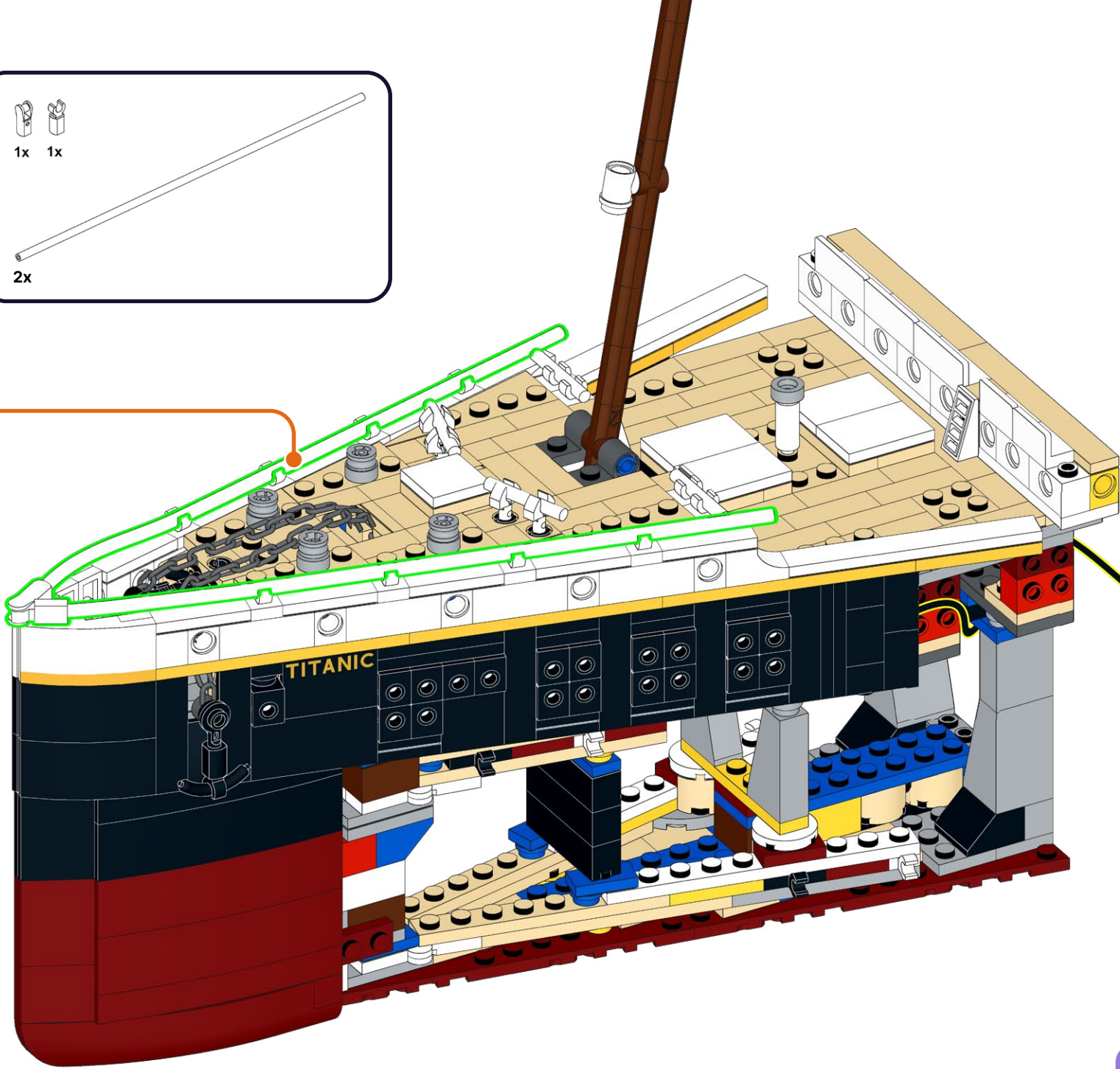
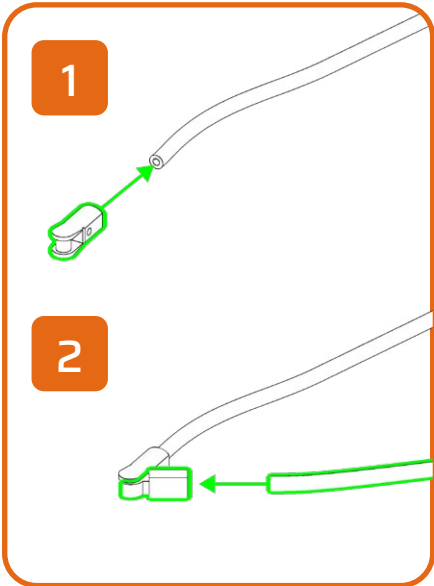
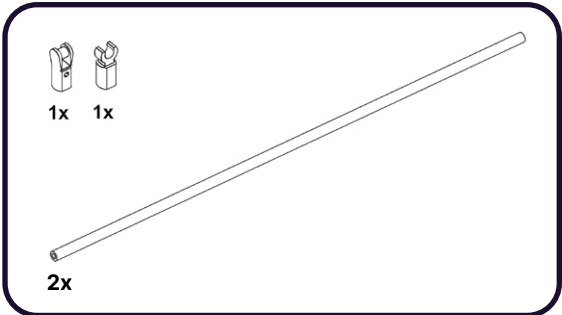

60

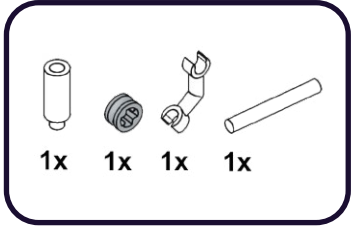

1

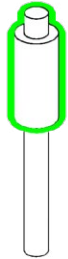

2

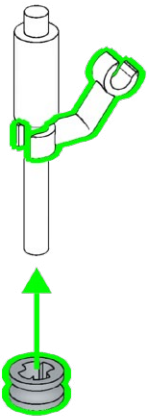

61

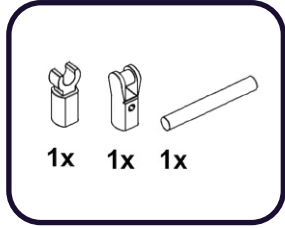

1

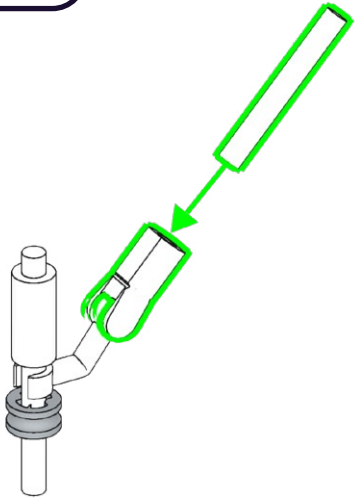

2

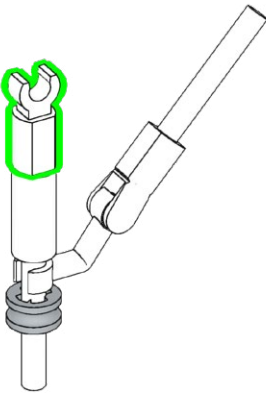

62

1x 1x 1x

1

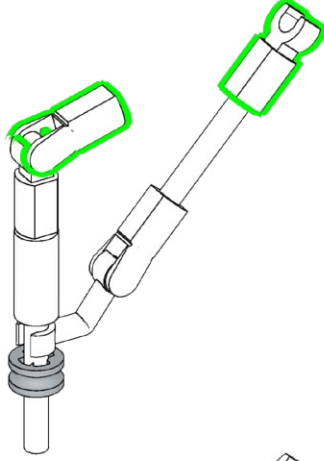

2

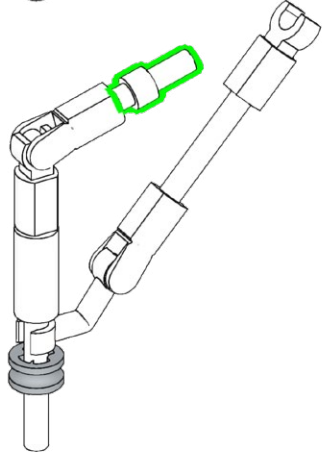

63

1x 1x 1x

1

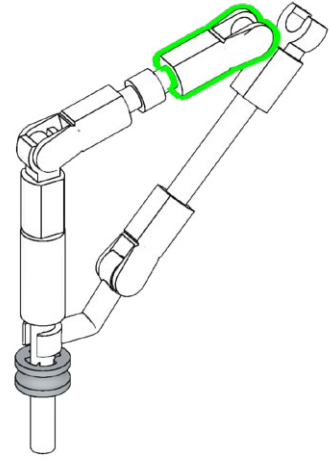

2

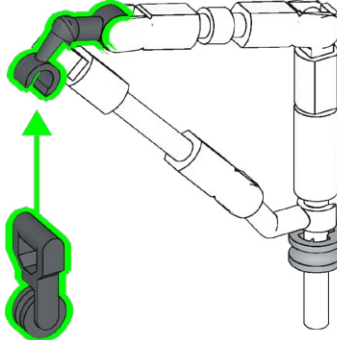

64

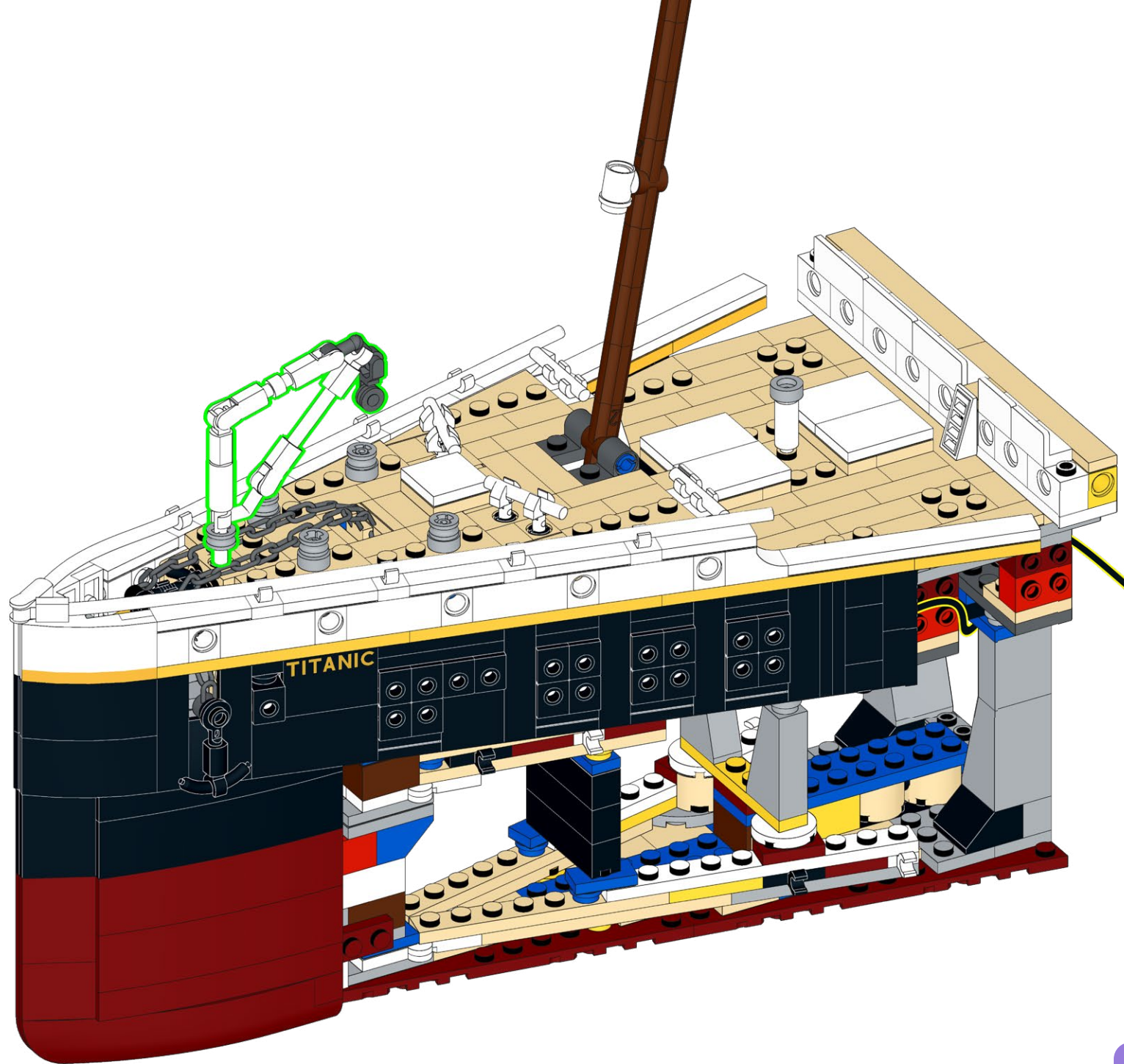

65

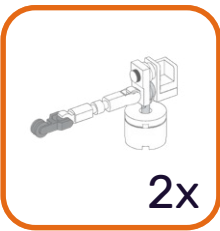
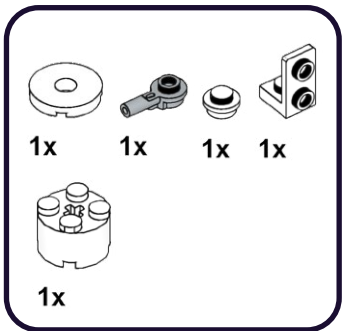

1

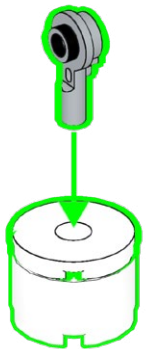

2

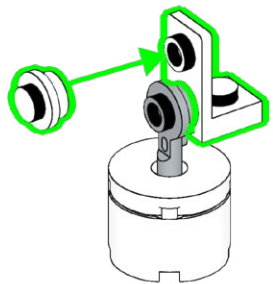

66

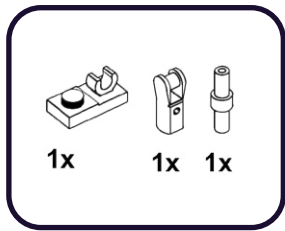

1

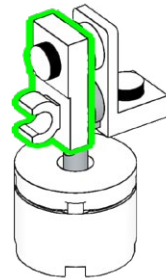

2

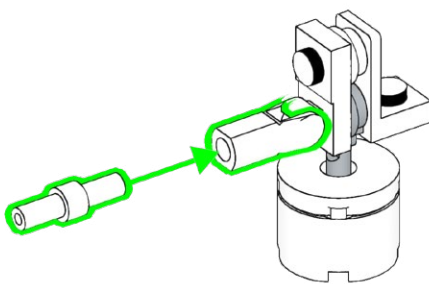

67

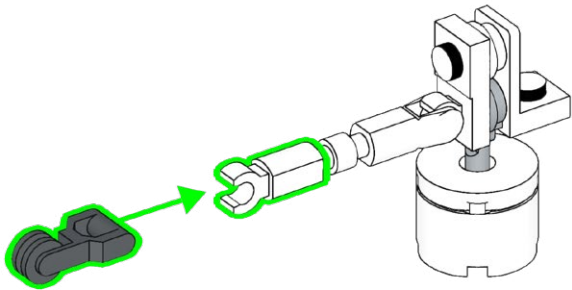
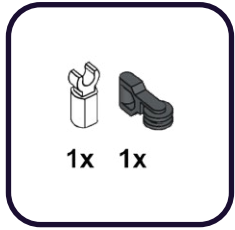

68

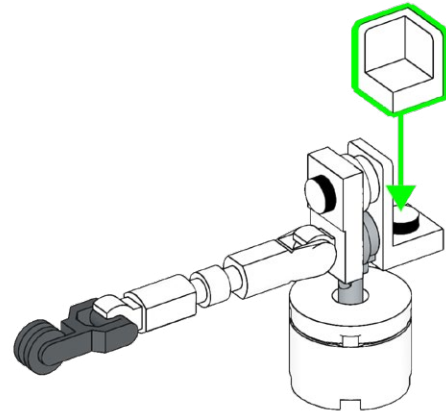
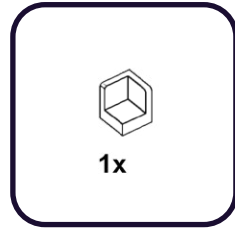

2x

69

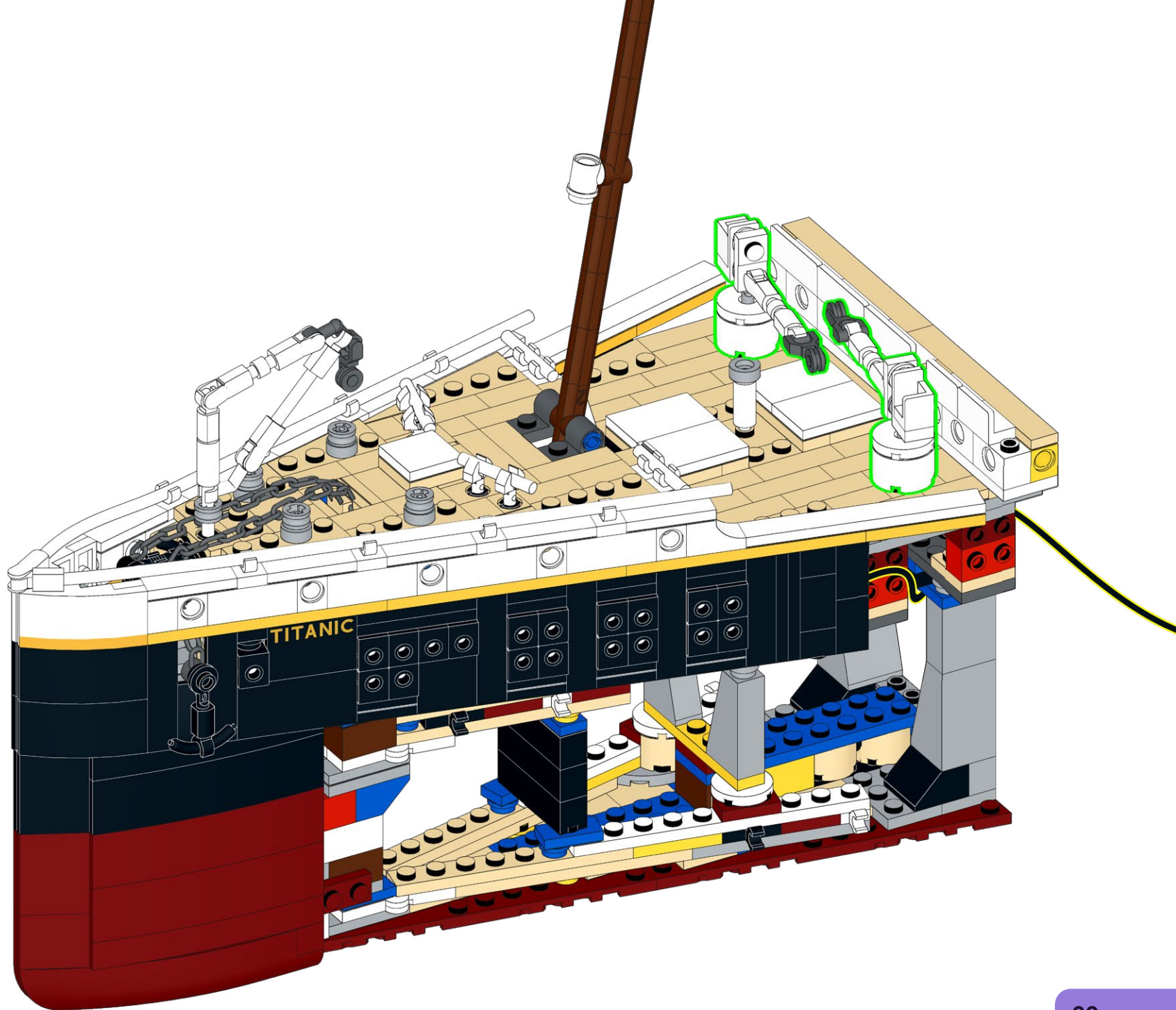

70

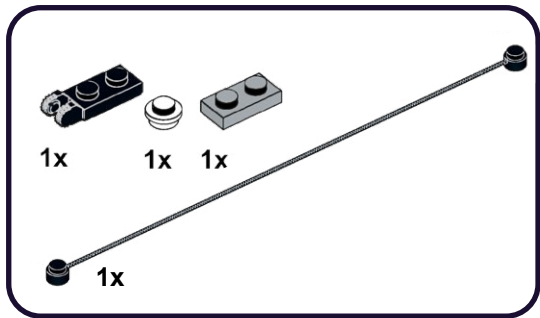

1

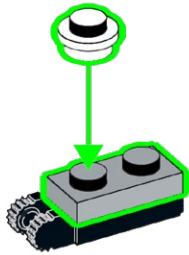

2

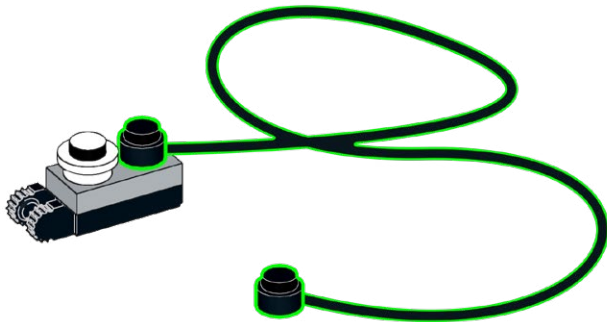

71

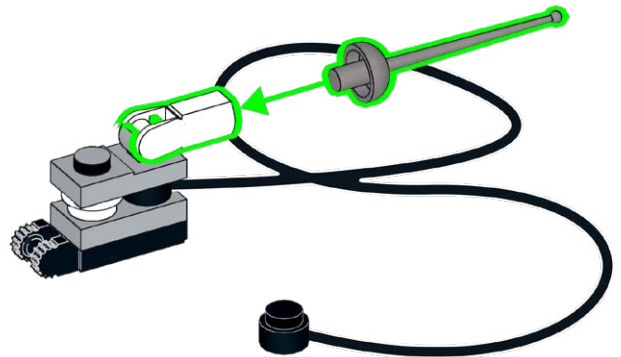
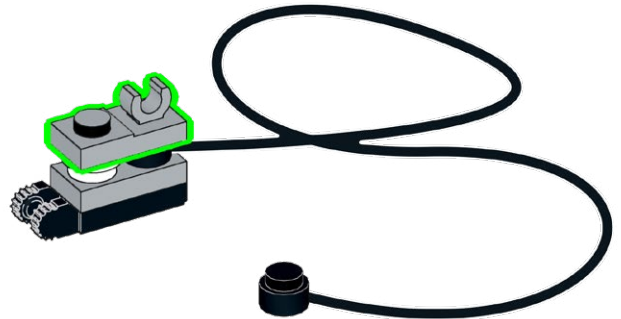
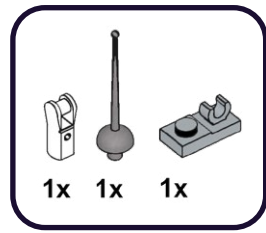

72

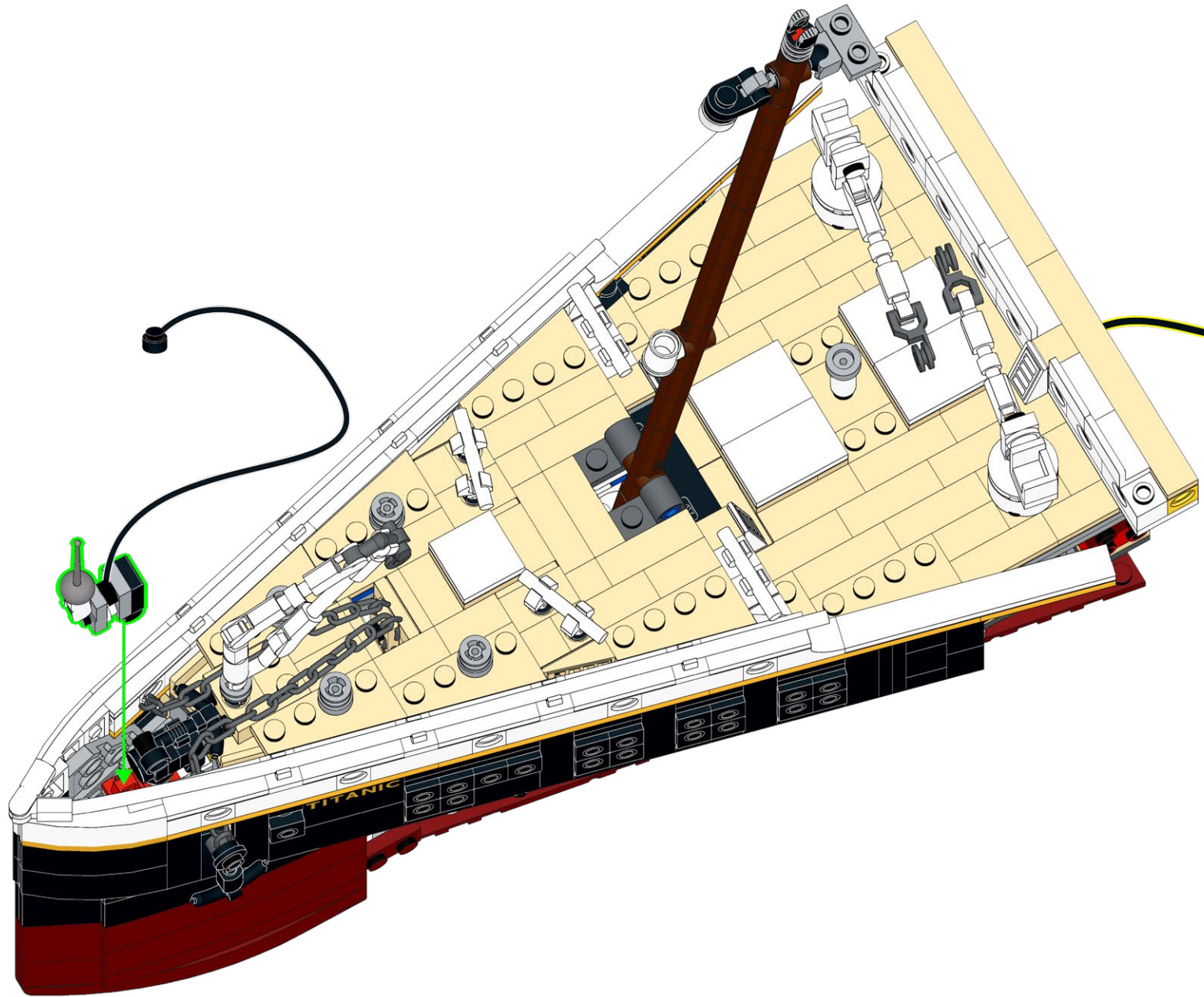

73

1x

1x

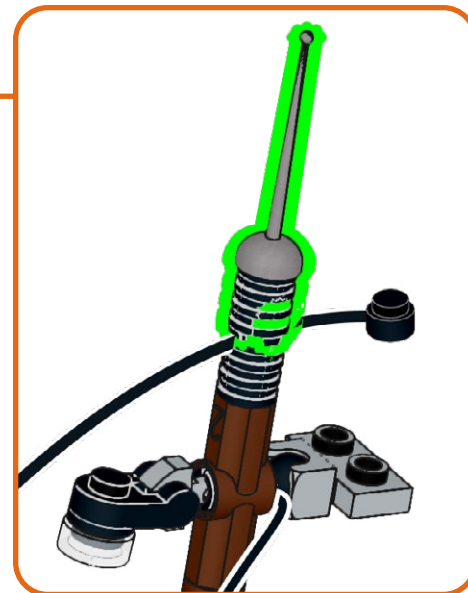
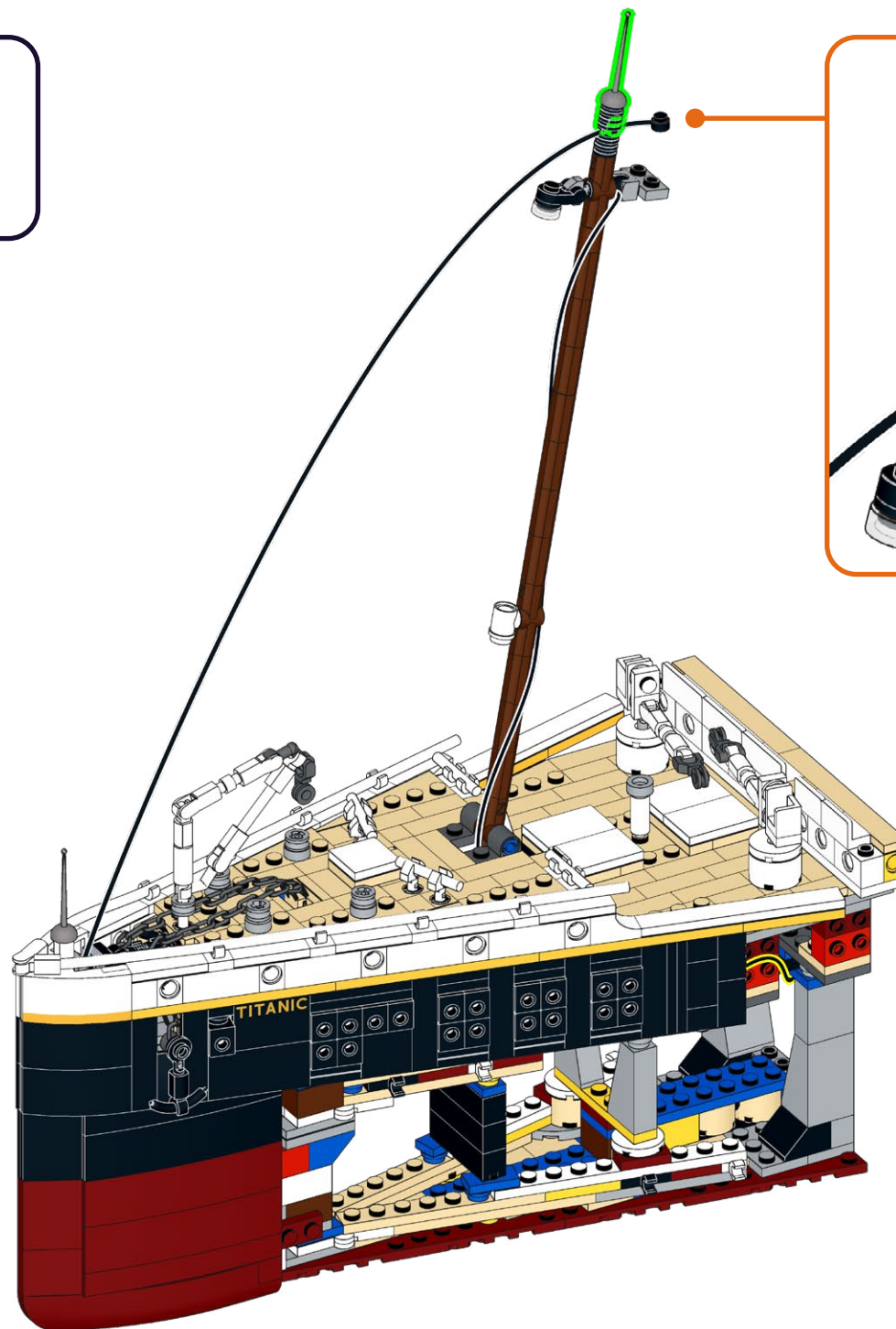
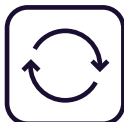

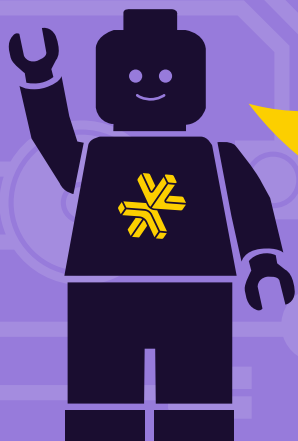
**HOLD UP!**

You might notice some bags aren't in order, as well as left over pieces, but that's ok! We're changing the way you build LEGO!

ATTENDEZ!

Vous remarquerez peut-être que certains sacs, ainsi que certaines pièces, ne sont pas dans le bon ordre. Mais pas de panique! Nous changeons simplement la façon avec laquelle vous construisez vos LEGO!

ASPETTA!

Potresti notare che alcuni sacchetti non sono in ordine, così come i pezzi avanzati, ma va bene così! Stiamo cambiando il modo in cui costruisci i LEGO!

HALT!

Sie werden möglicherweise bemerken, dass einige tüten durcheinander sind und teile übrig bleiben, aber das ist in Ordnung! Wir ändern die art und weise, wie Sie LEGO bauen!

¡ESPERA!

Es posible que notes que algunas bolsas están fuera de servicio, así como piezas sobrantes, ¡pero está bien! ¡Estamos cambiando la forma en que construyes LEGO!

暫停!

你可能会注意到一些袋子顺序错乱, 以及一些剩余的部件, 但没关系! 我们正在改变你搭建乐高的方式!

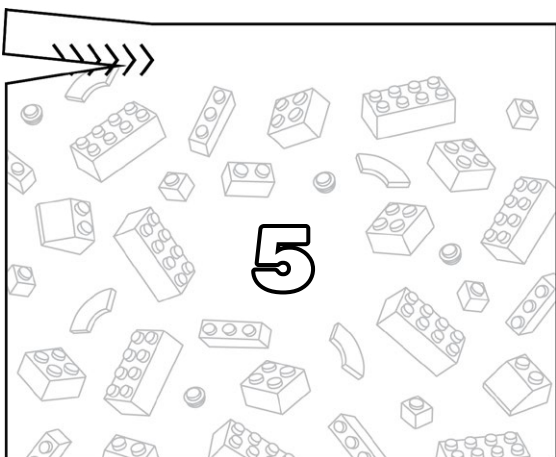
Open LEGO® Bag 5

74

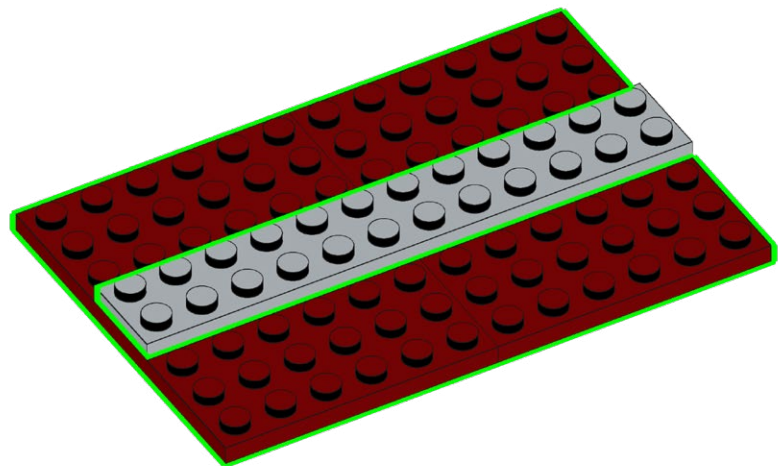
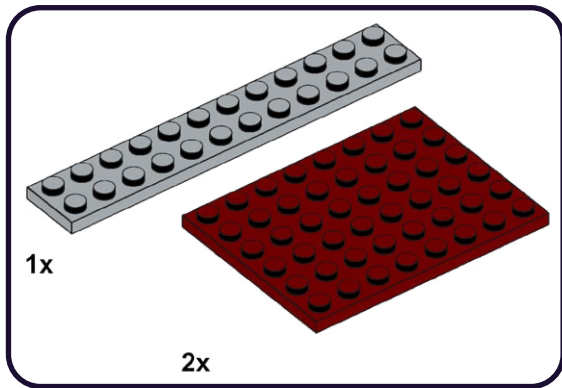

75

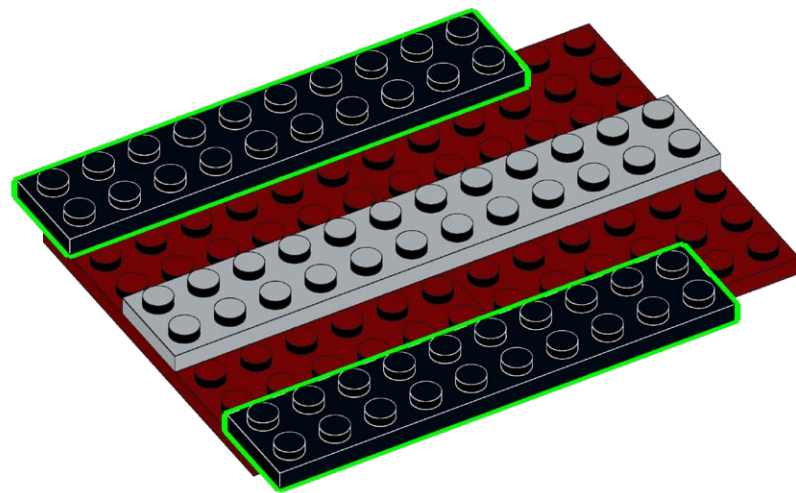
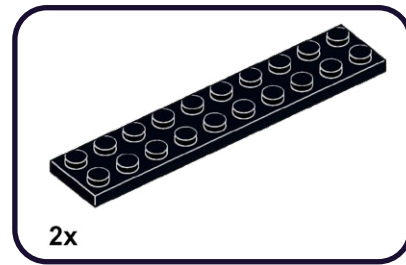

76

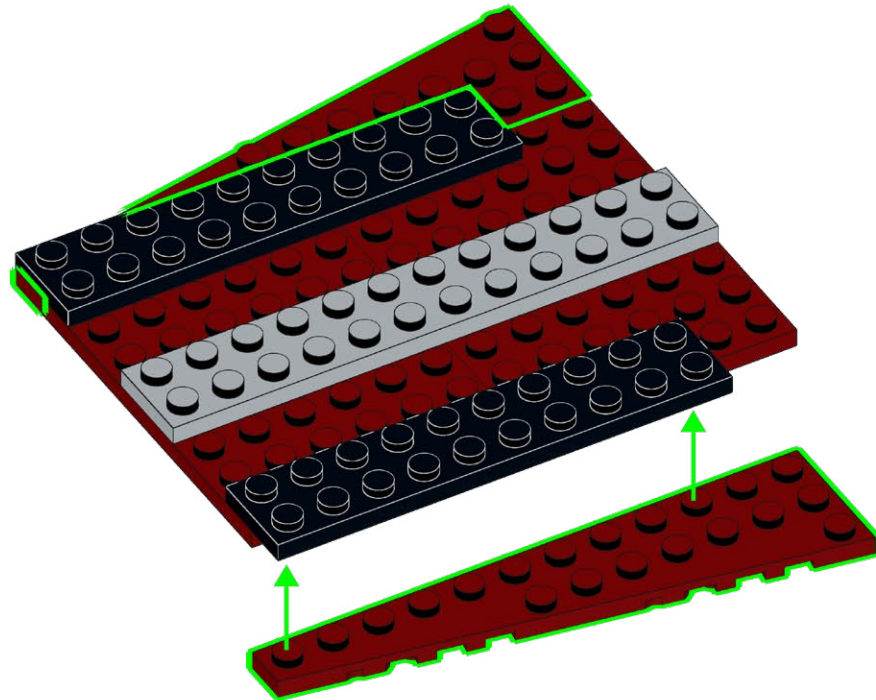
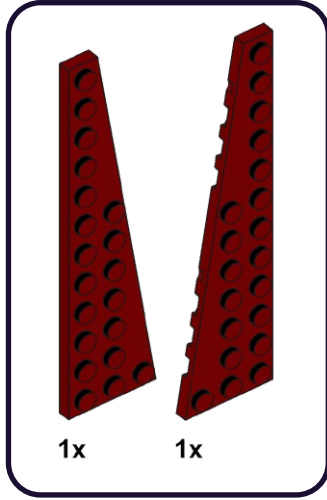

77

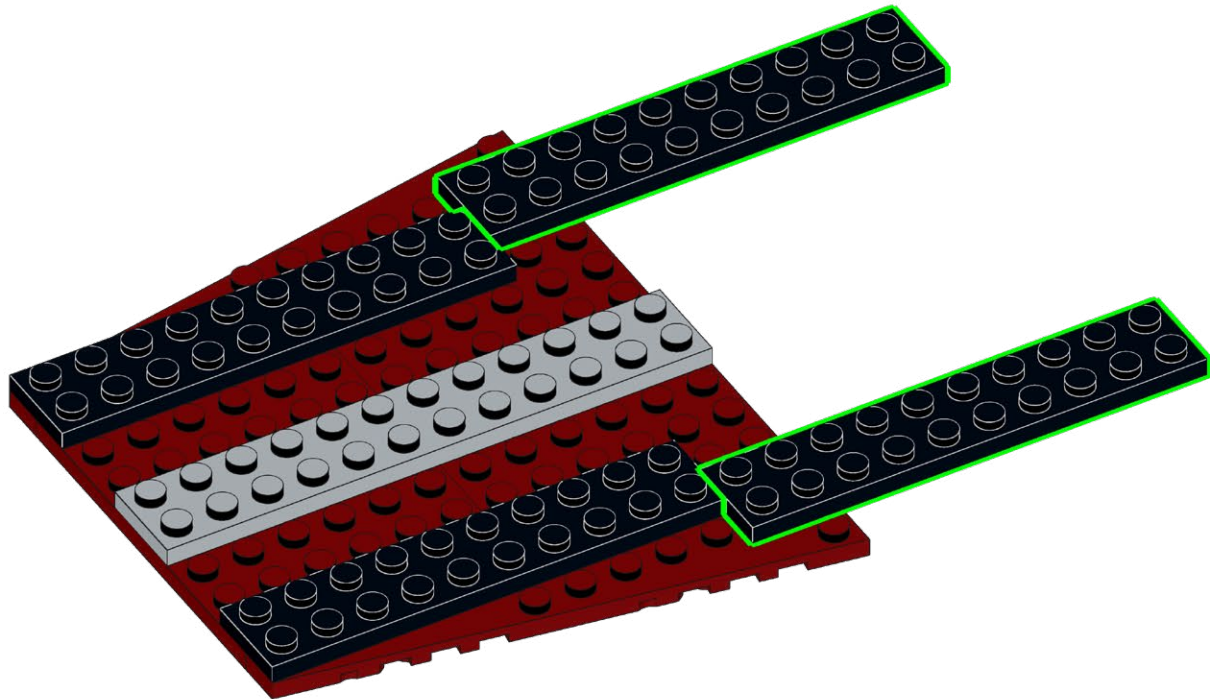
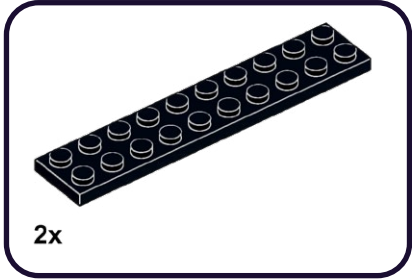

78

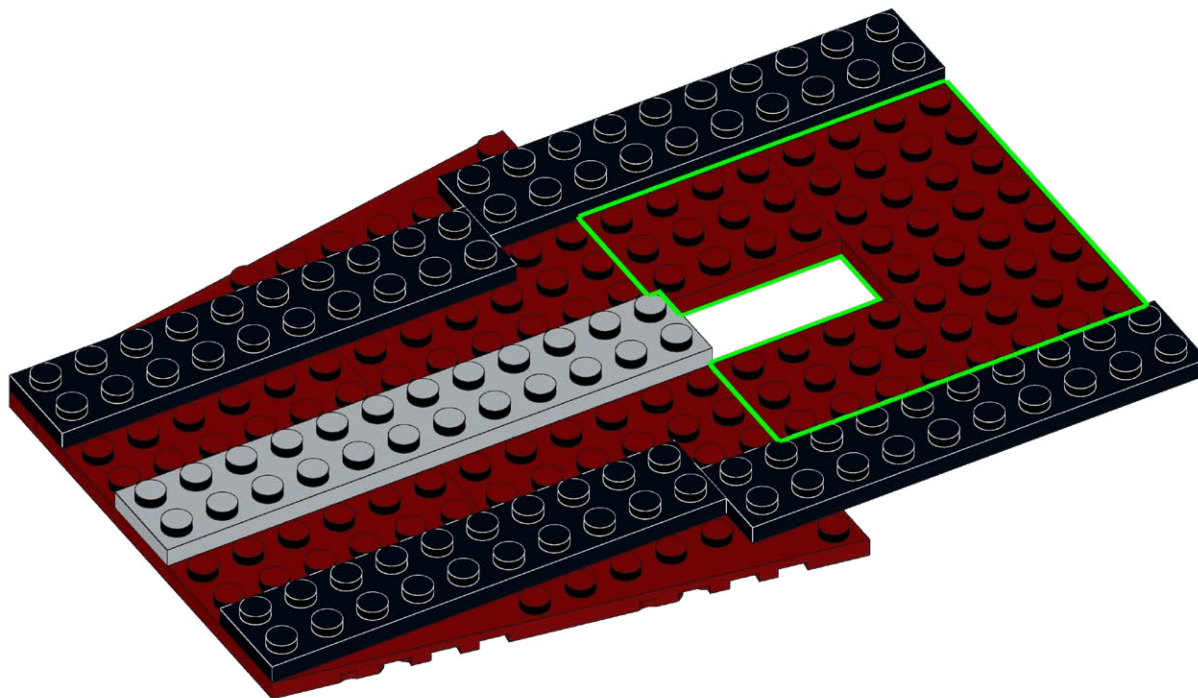
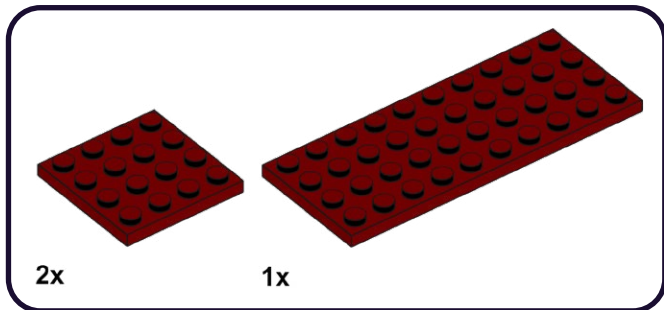

79

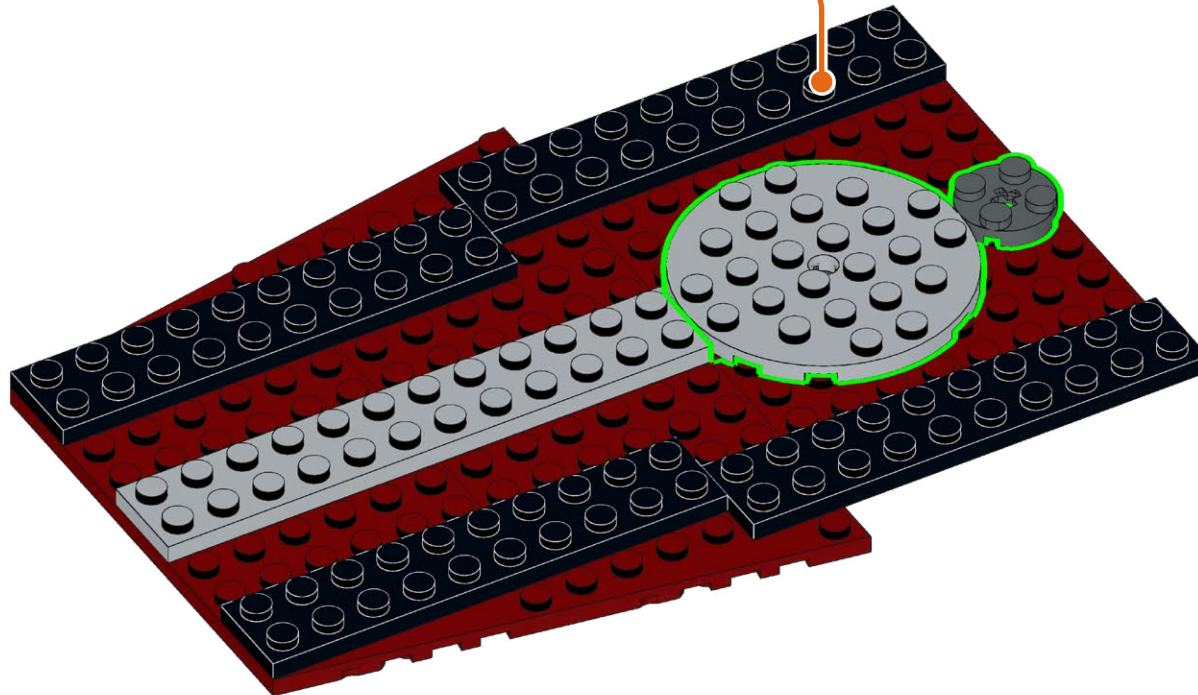
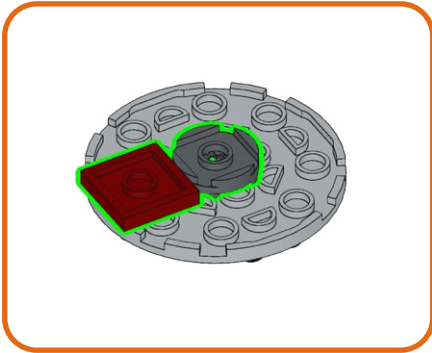
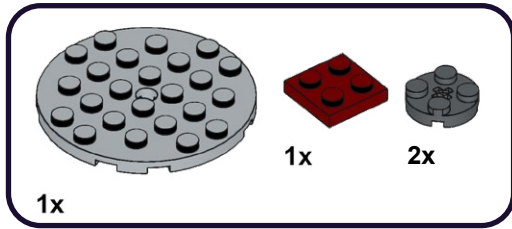

80

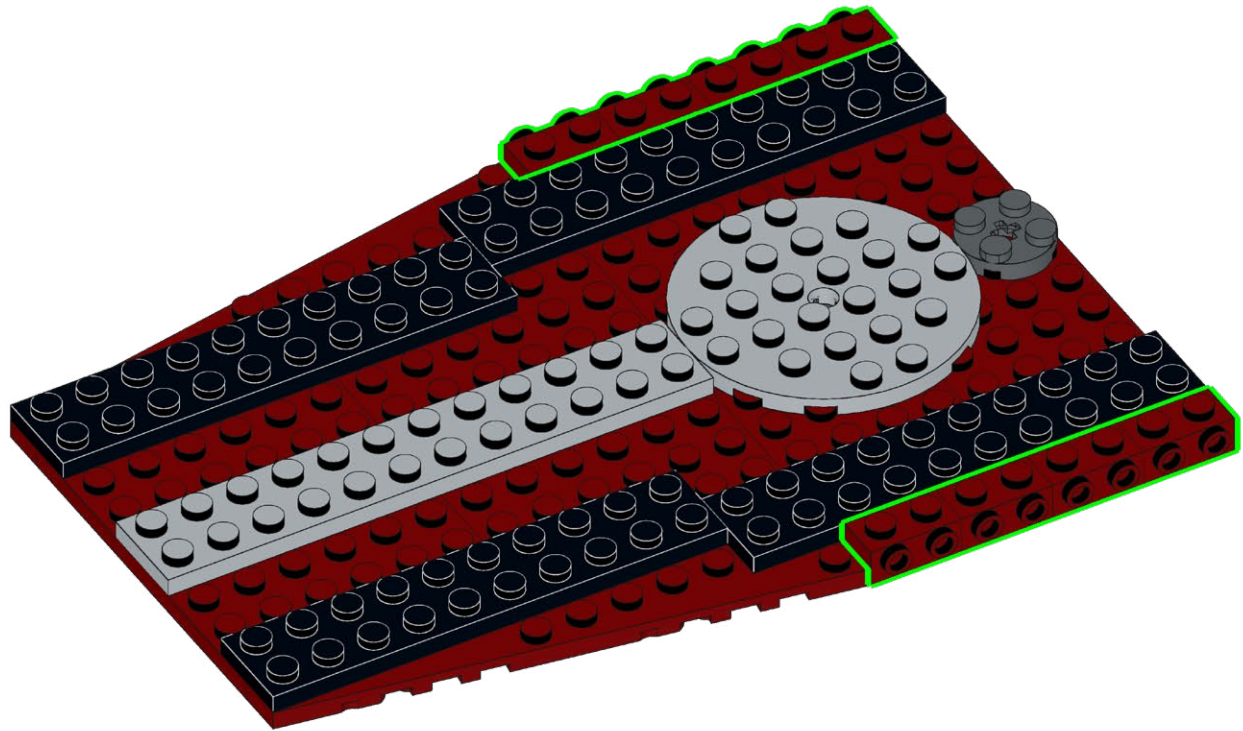
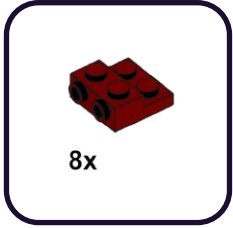

81

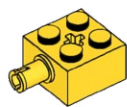

1x

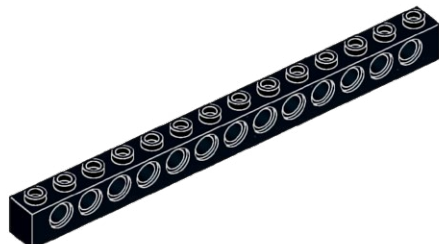

1x

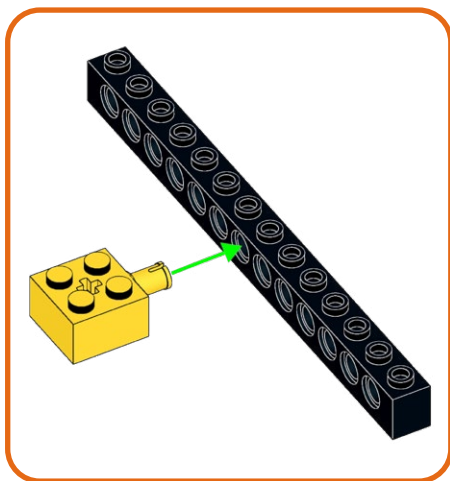
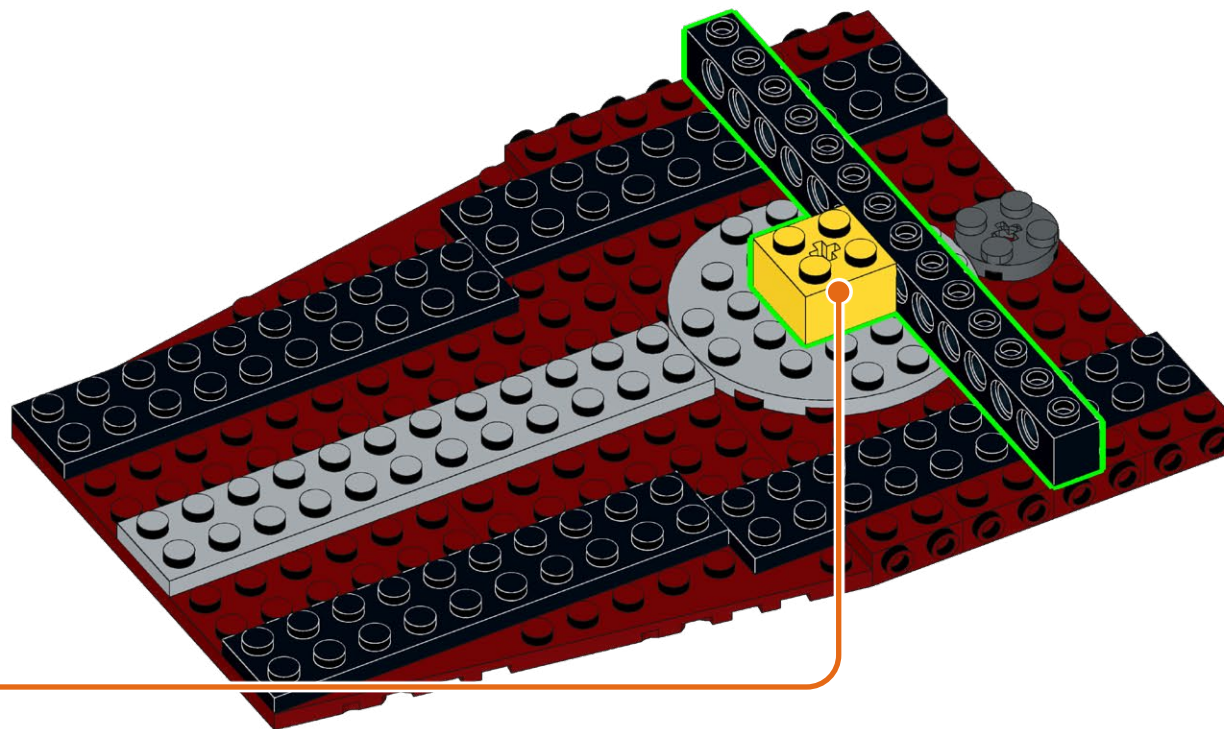

82

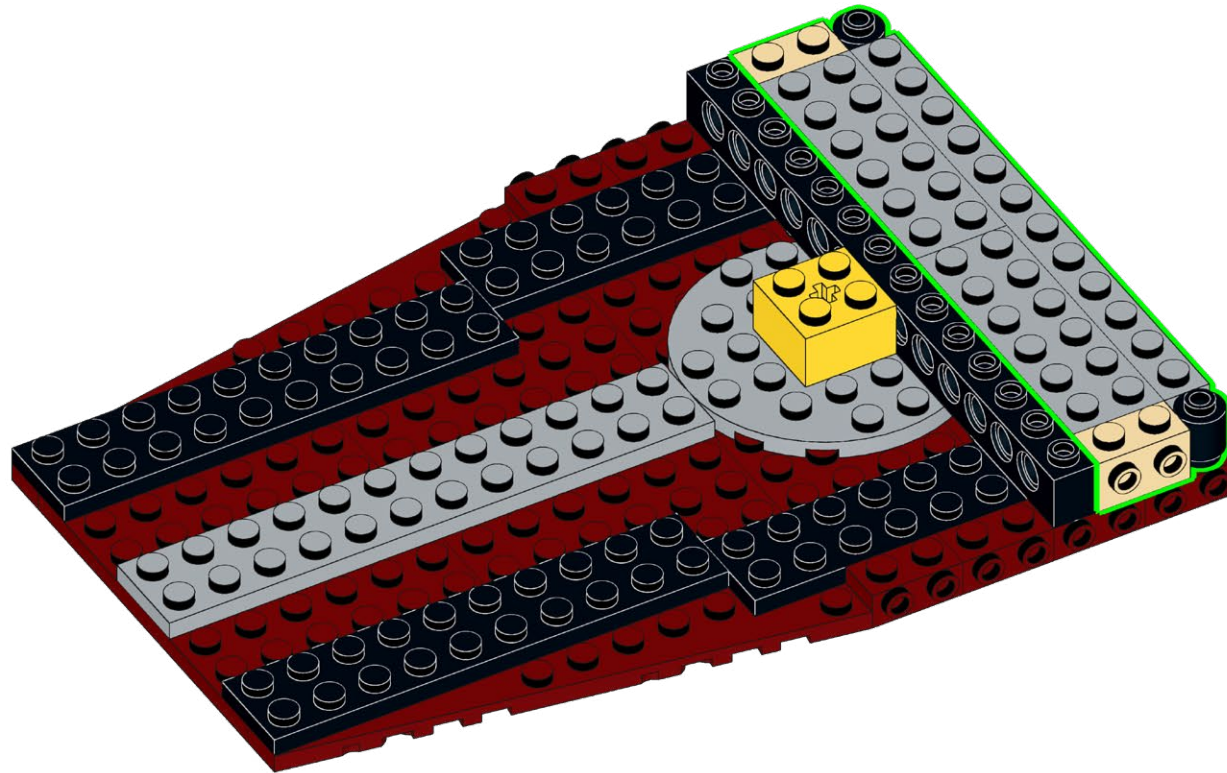
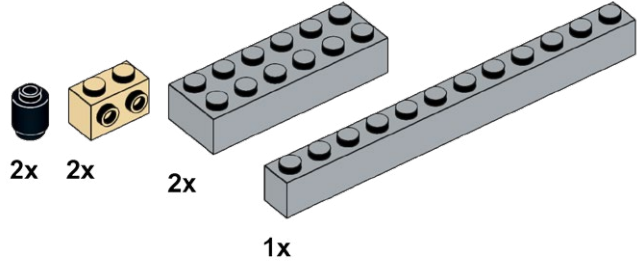

83

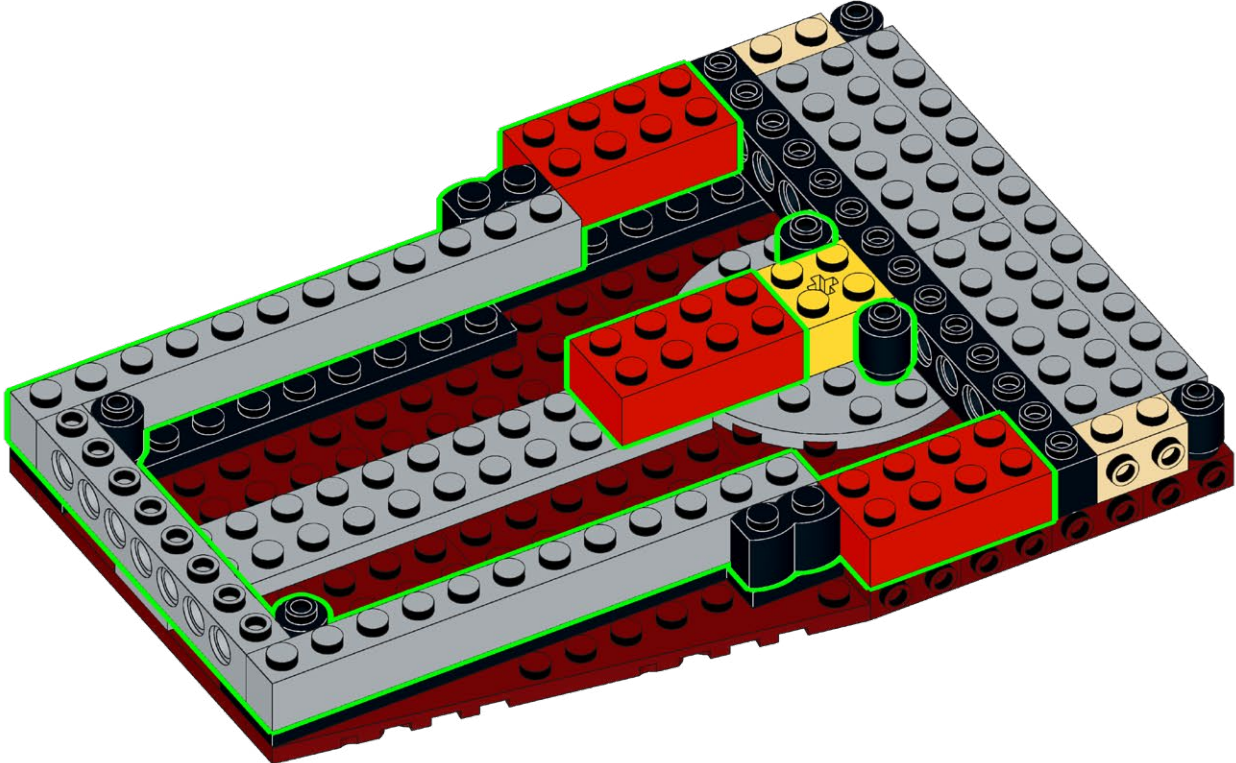
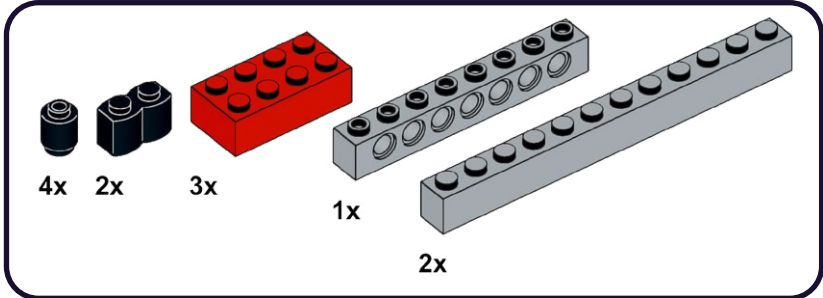

84

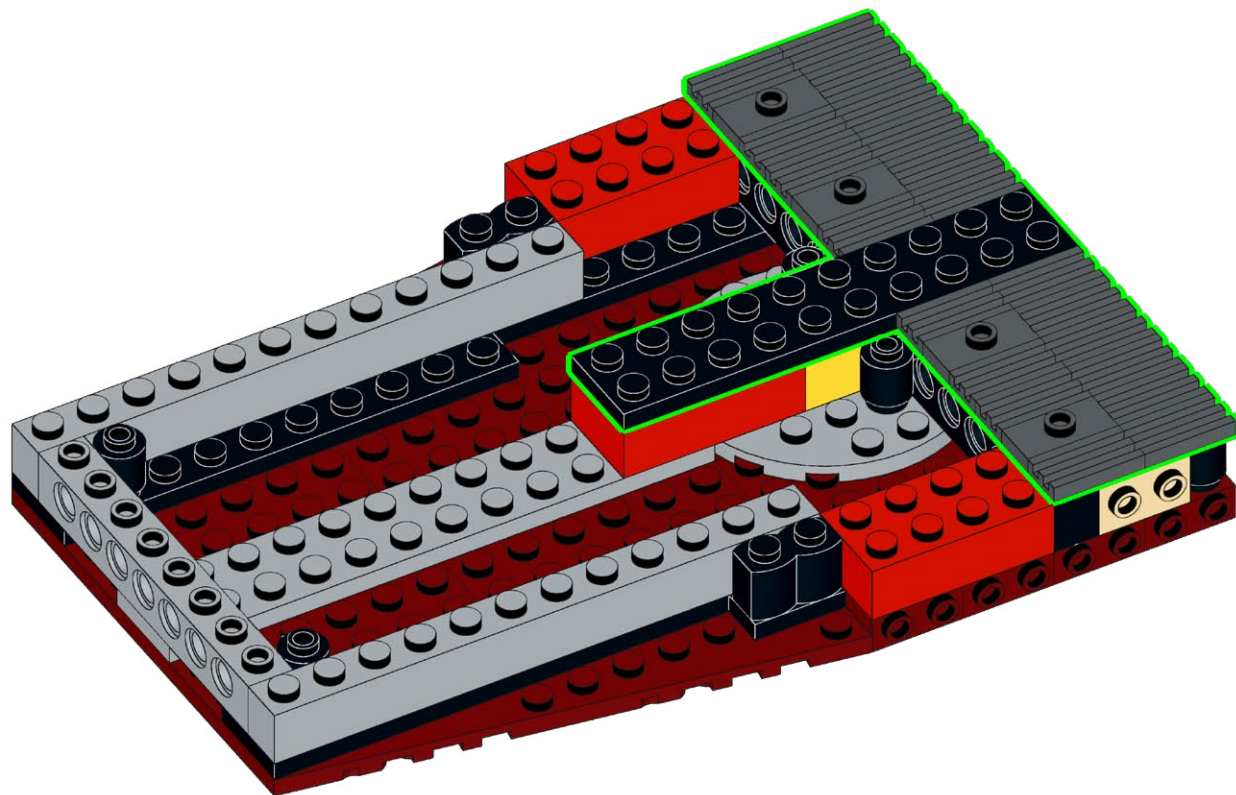
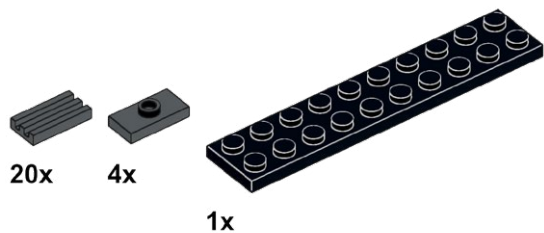

85

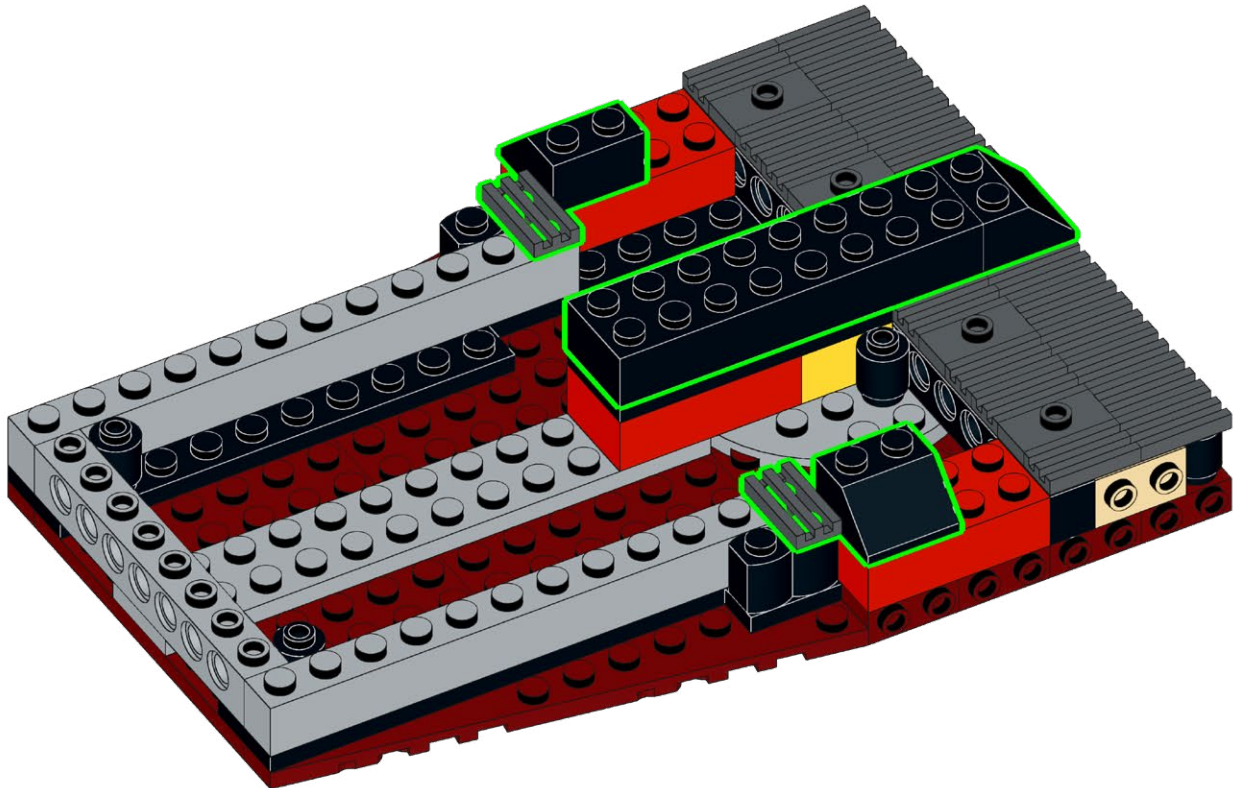
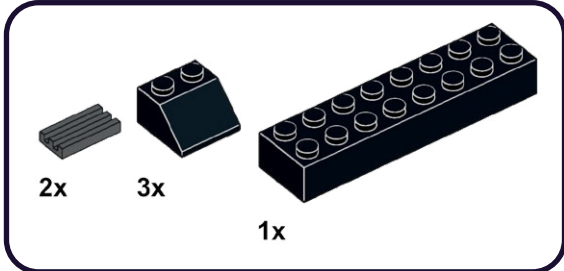

86

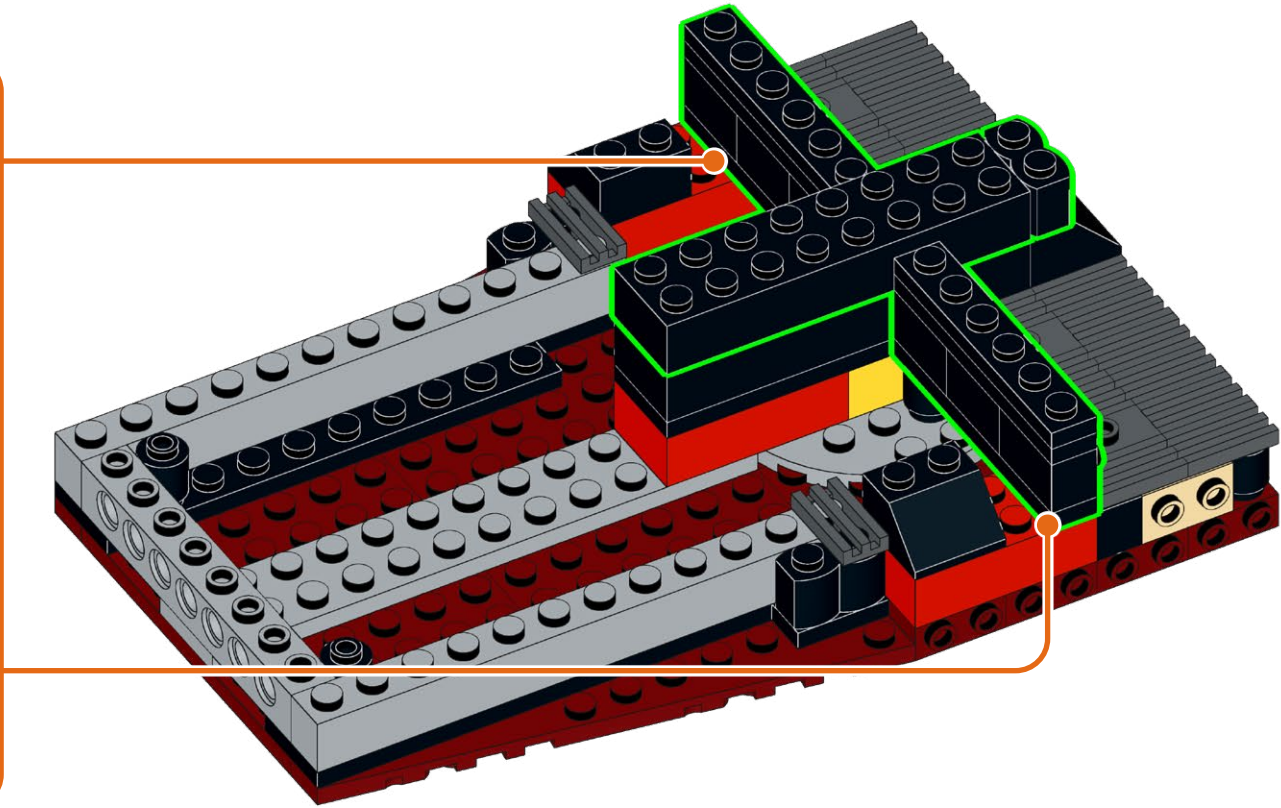
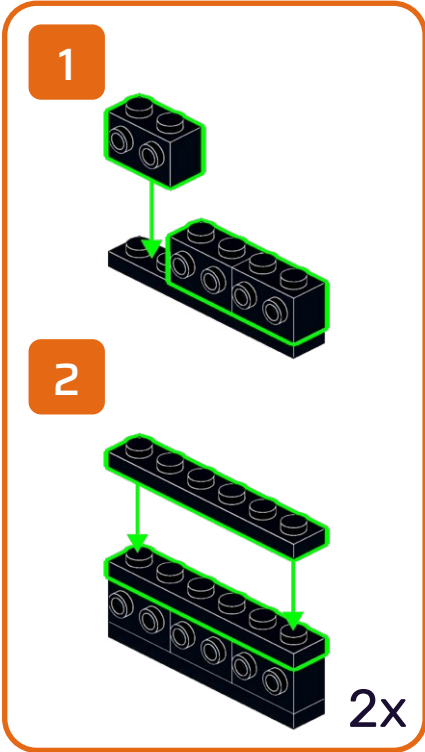
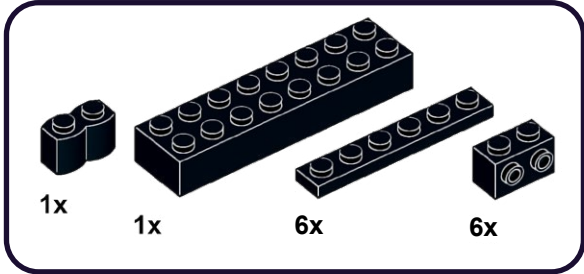

87

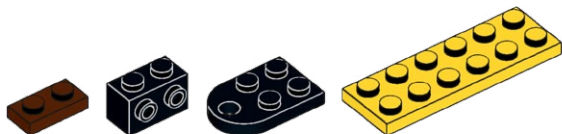

1x

6x

1x

1x

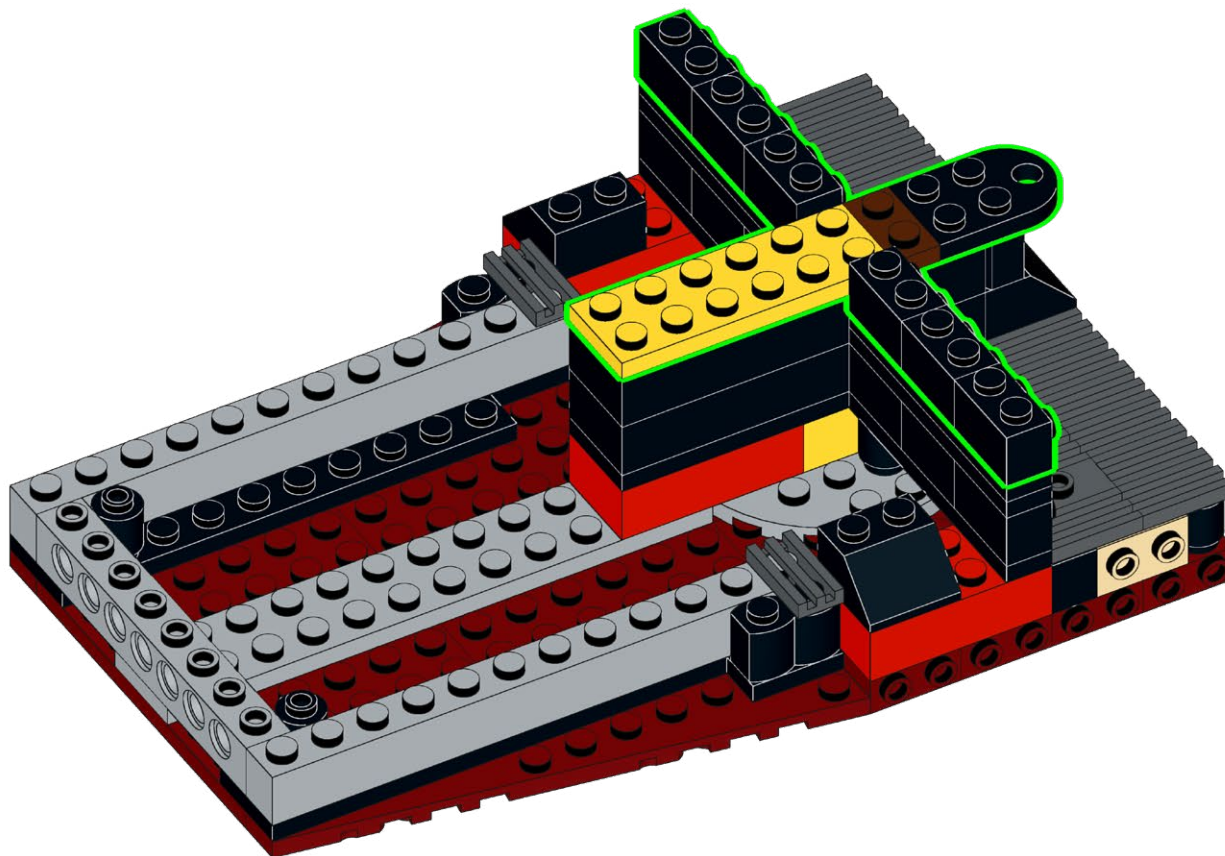

88

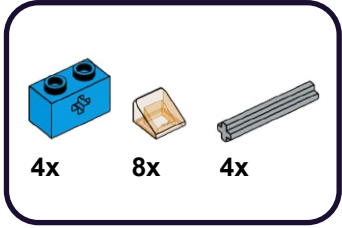

1

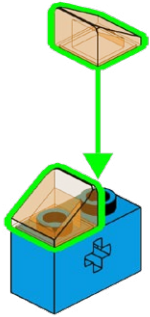

2

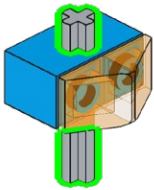

89

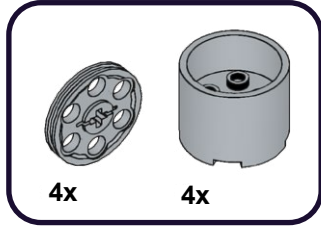

1

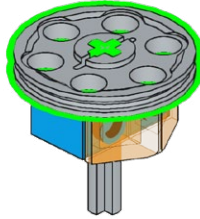

2

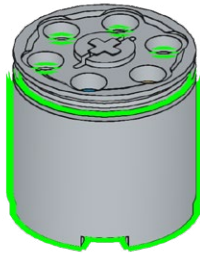

4x

90

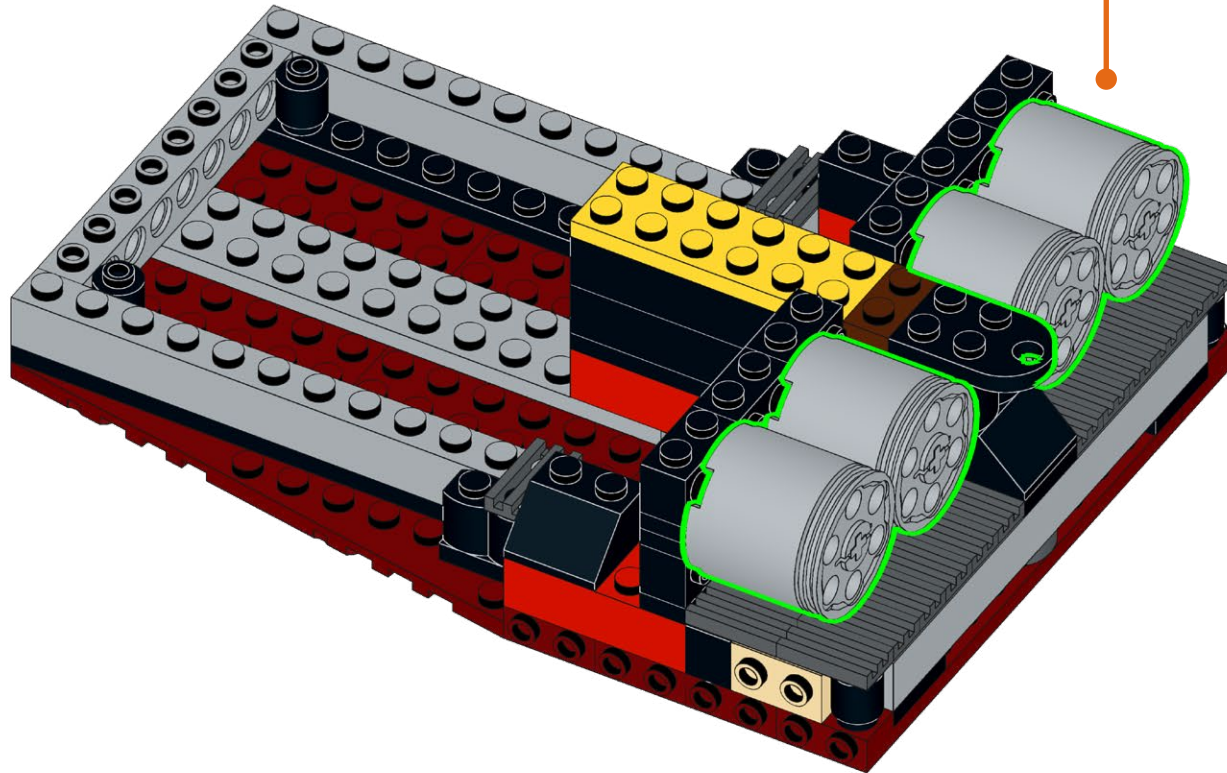
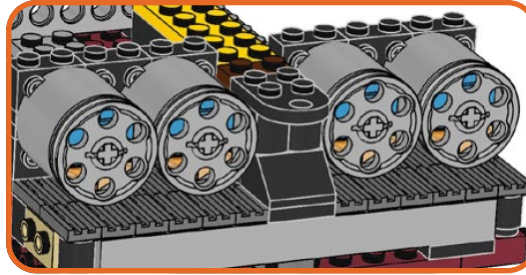

91

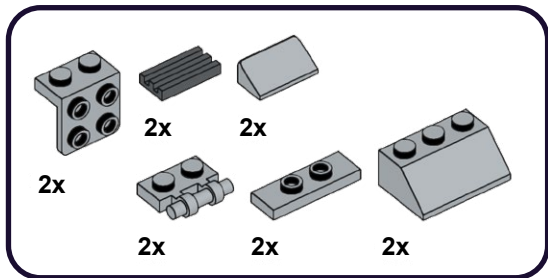

1

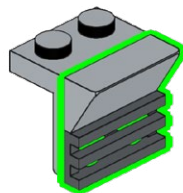

2

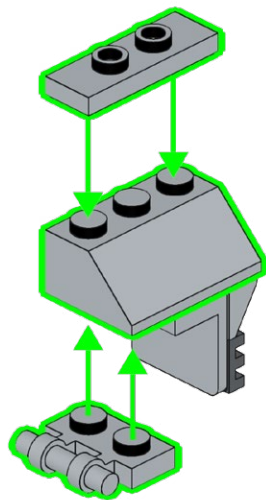

92

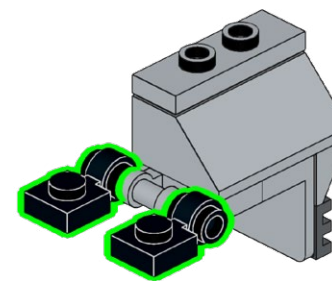
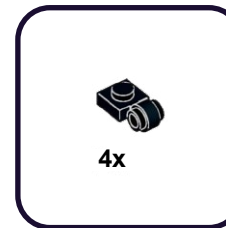

2x

93

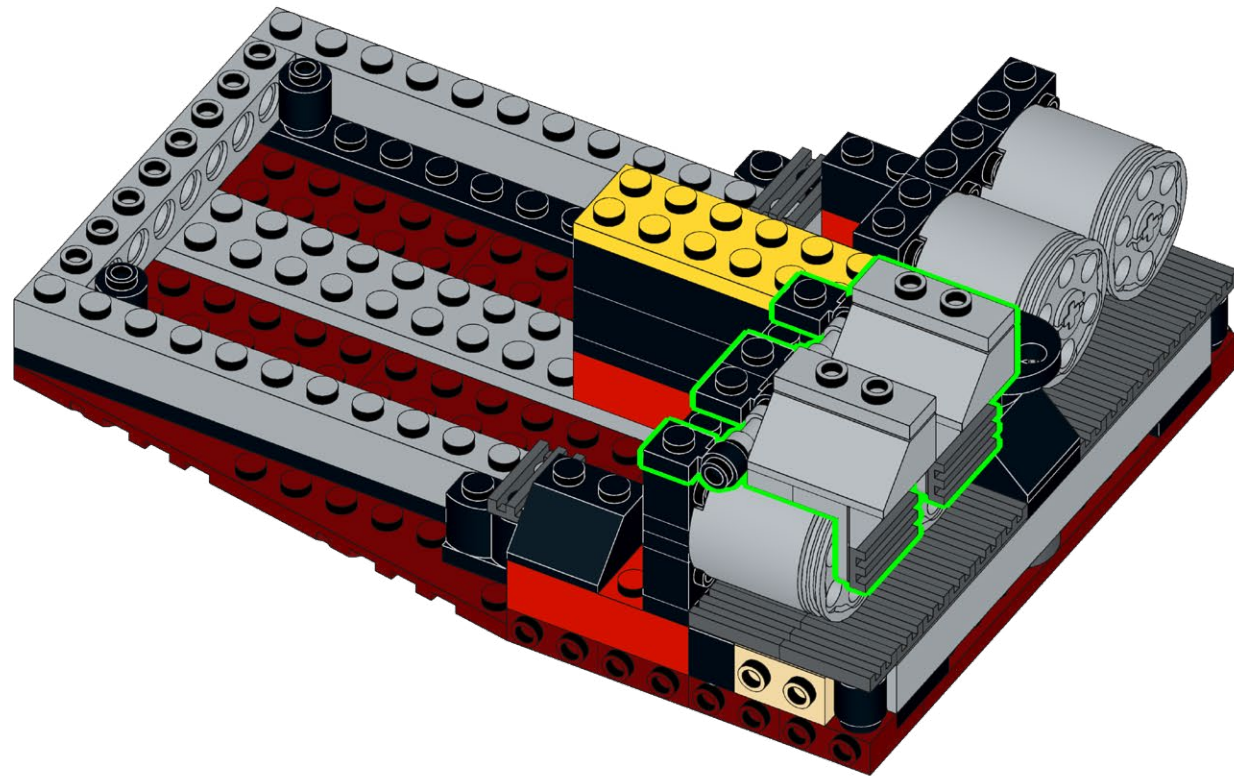

94

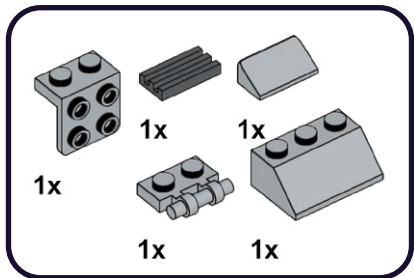

1

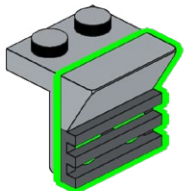

2

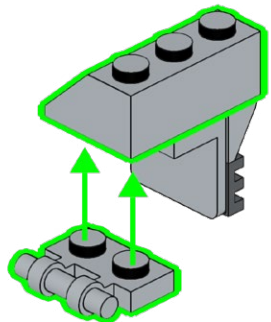

95

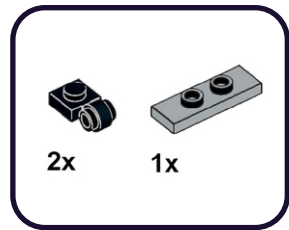

1

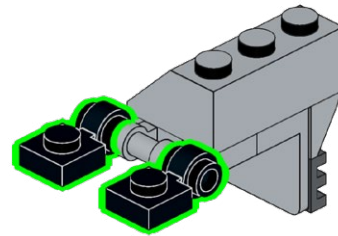

2

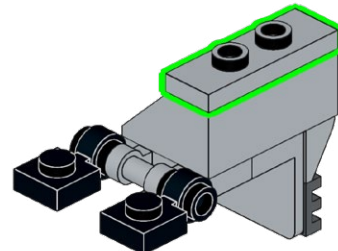

96

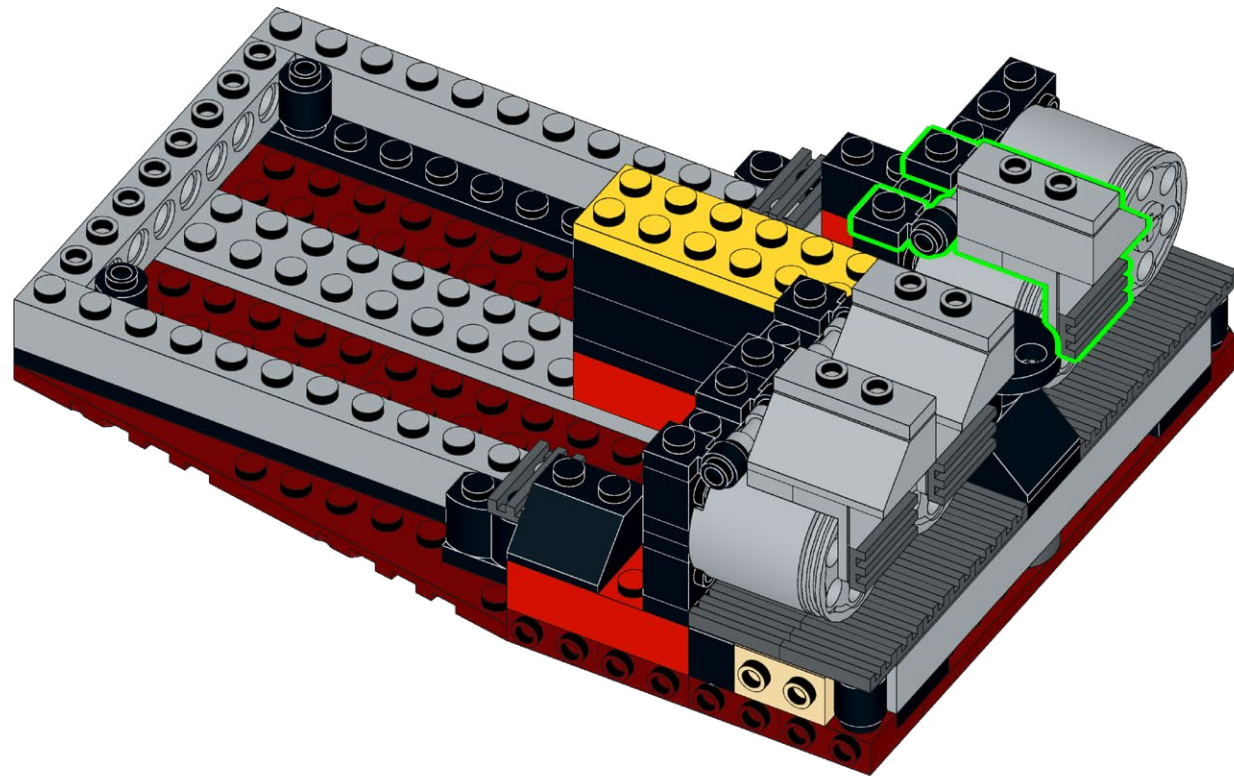

97

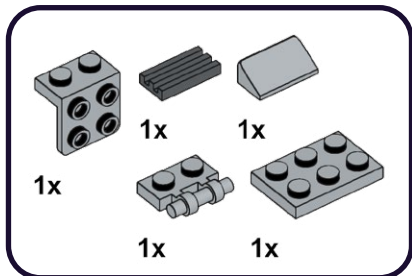

1

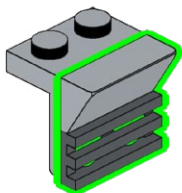

2

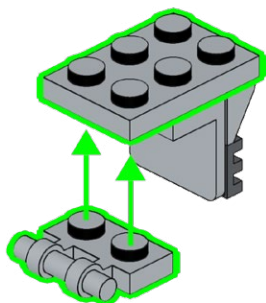

98

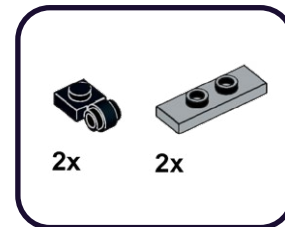

1

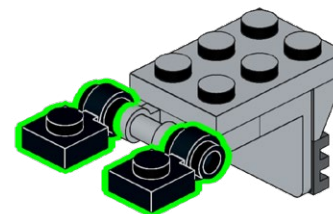

2

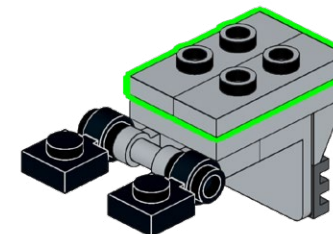

99

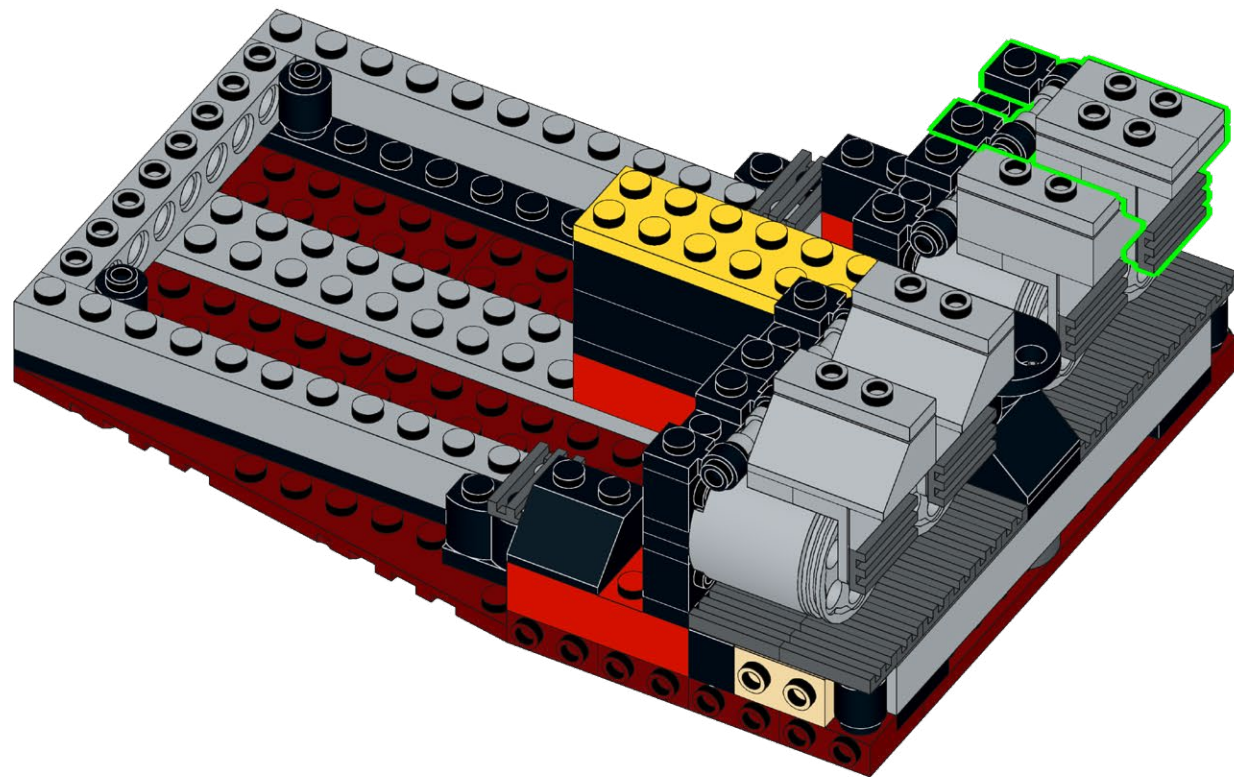

100

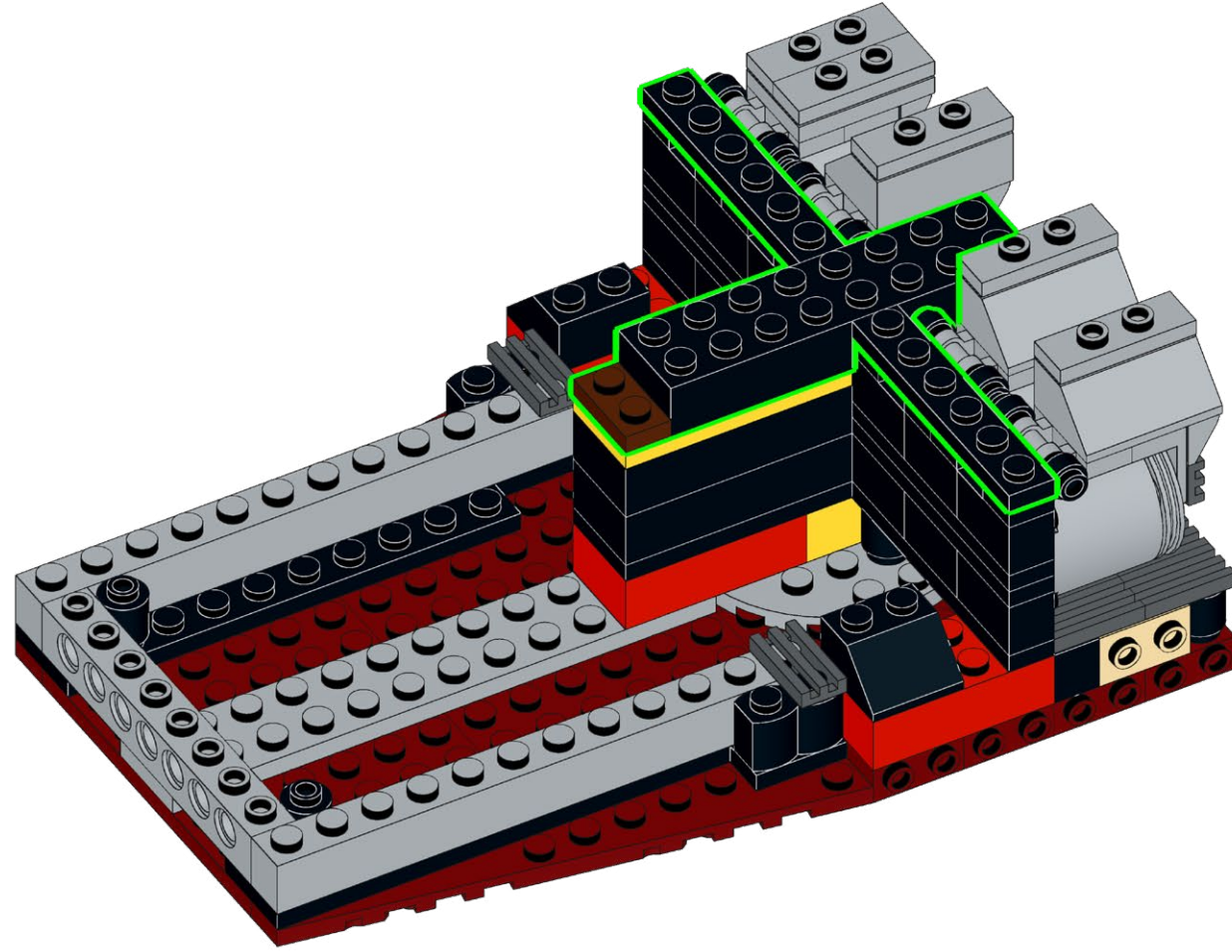
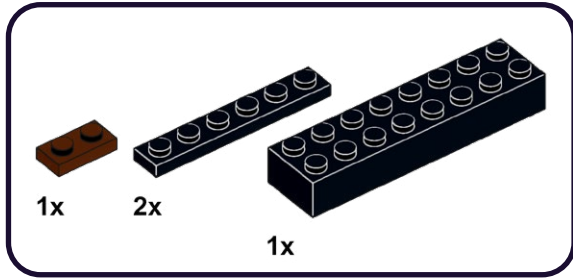

101

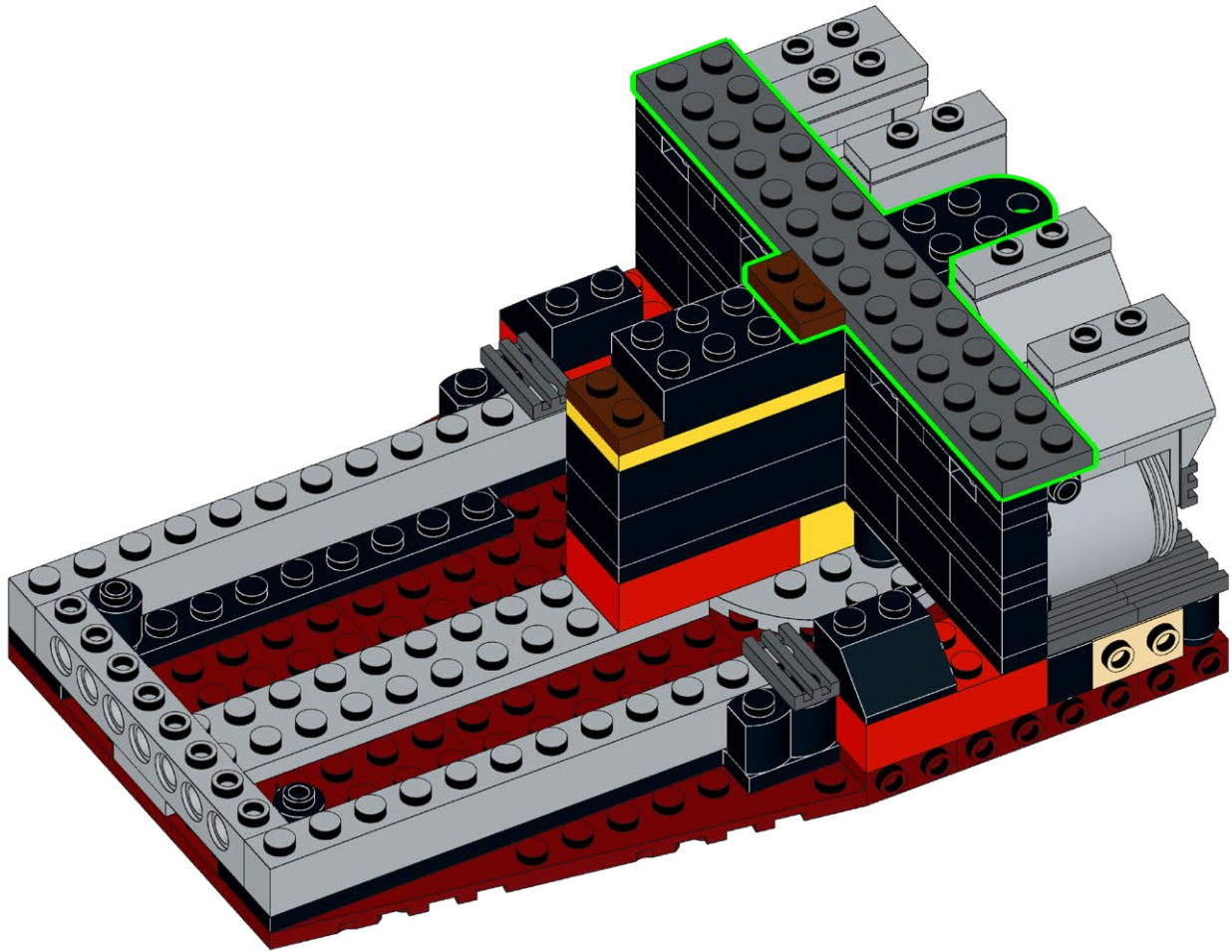
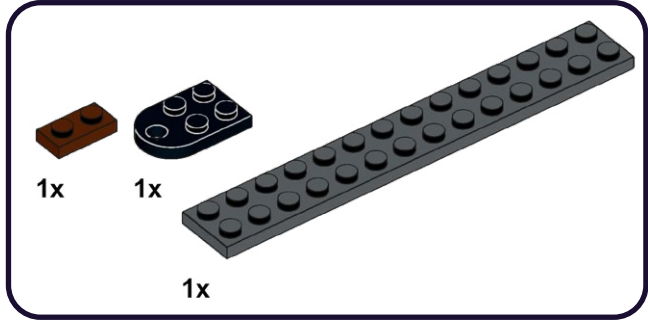

102

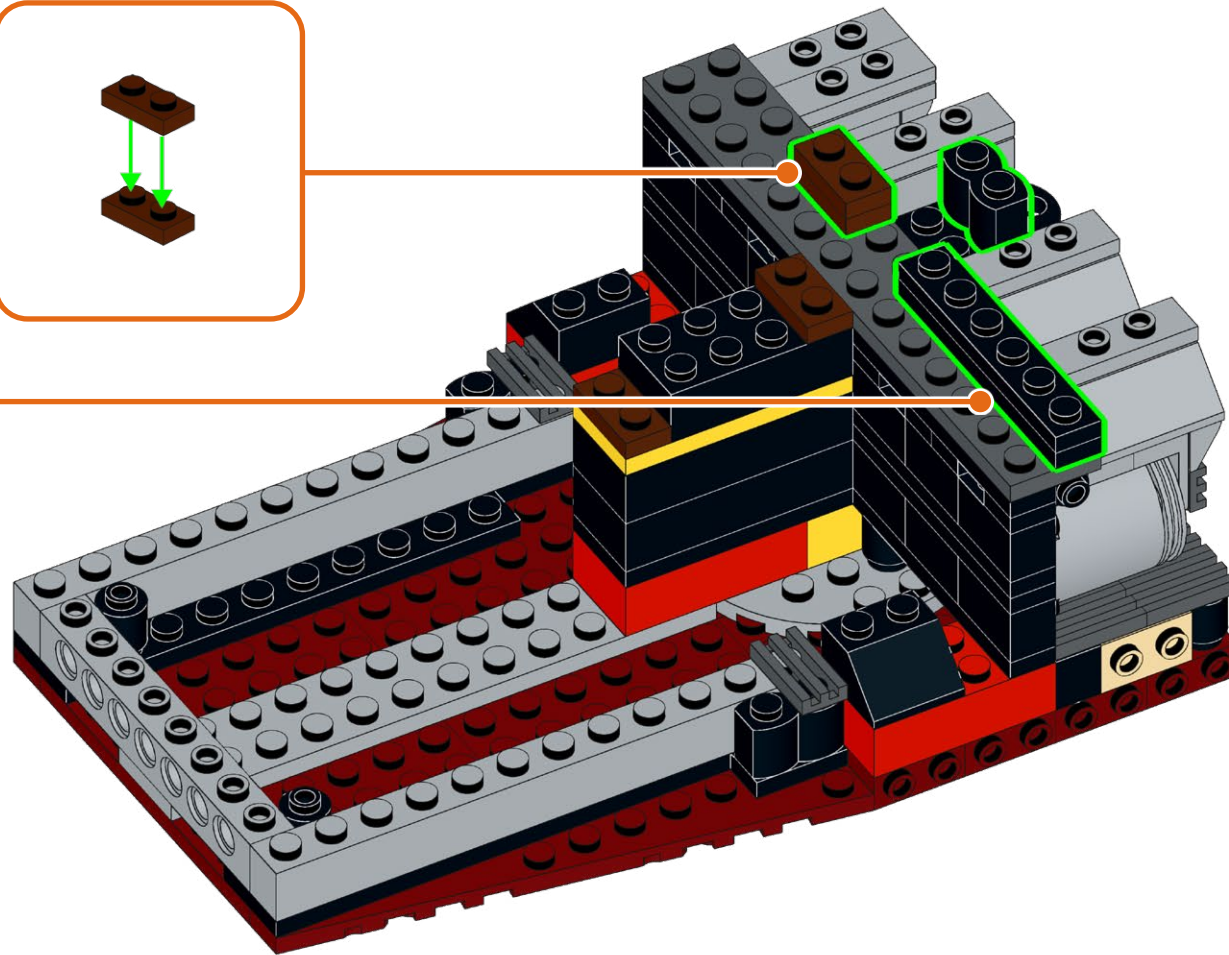
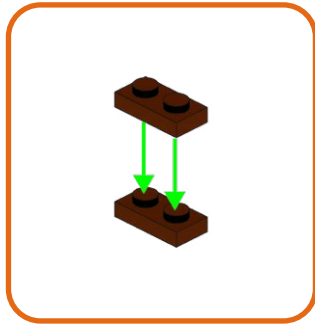
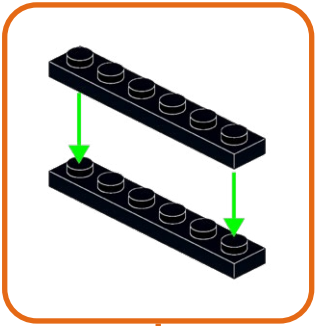
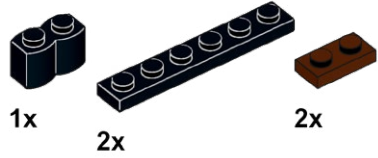

103

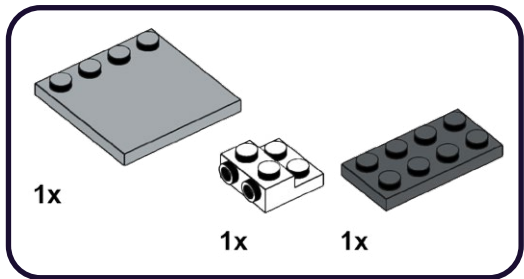

1

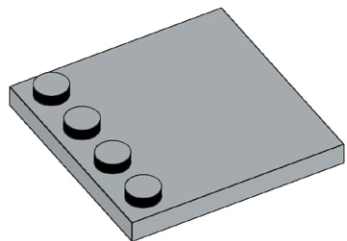

2

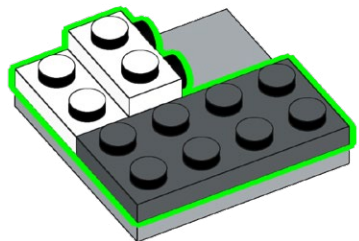

104

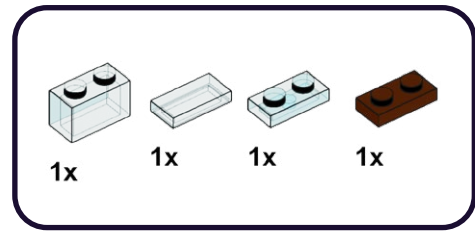

1

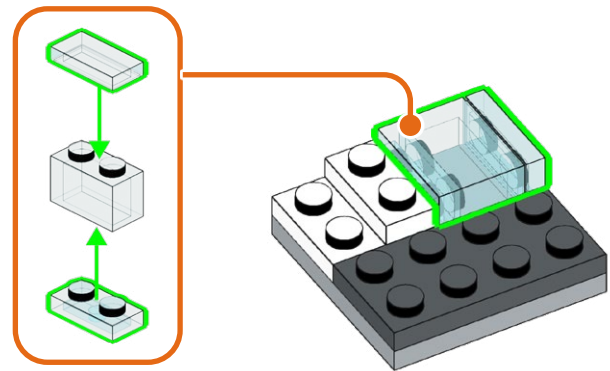

2

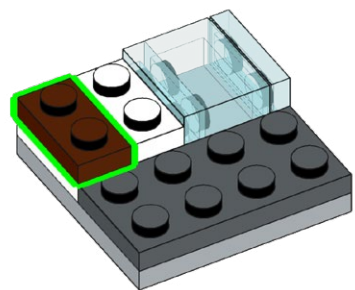

105

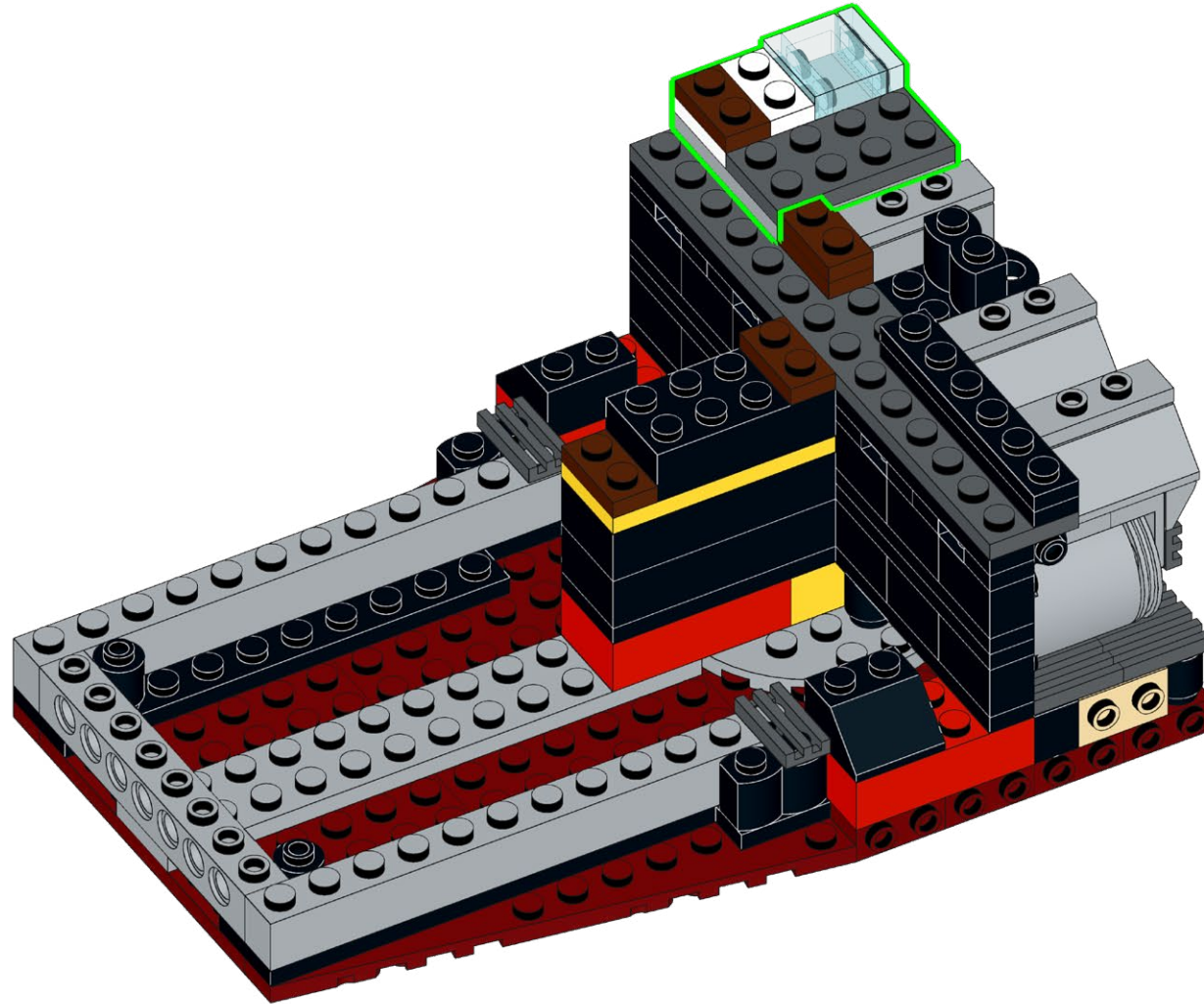

106

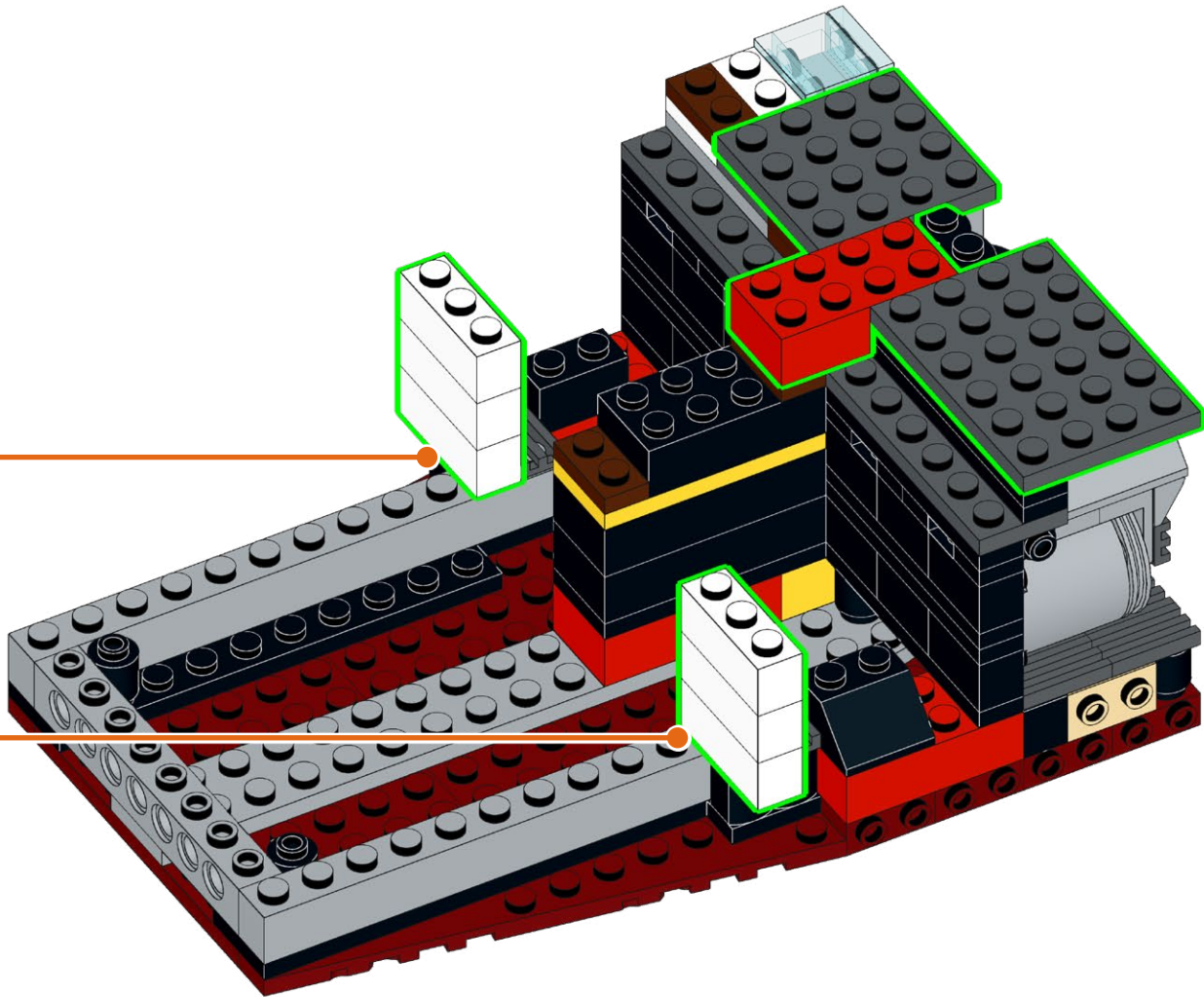
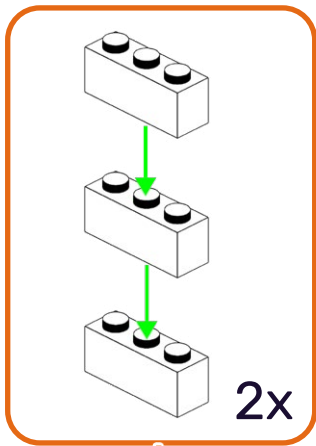
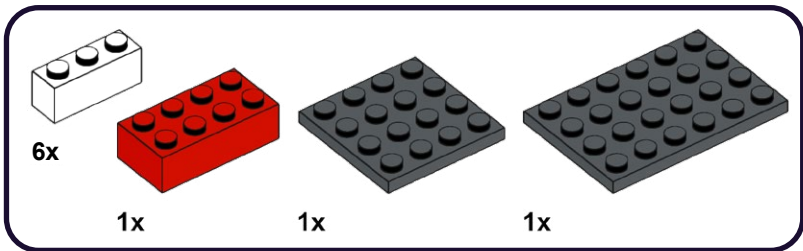

107

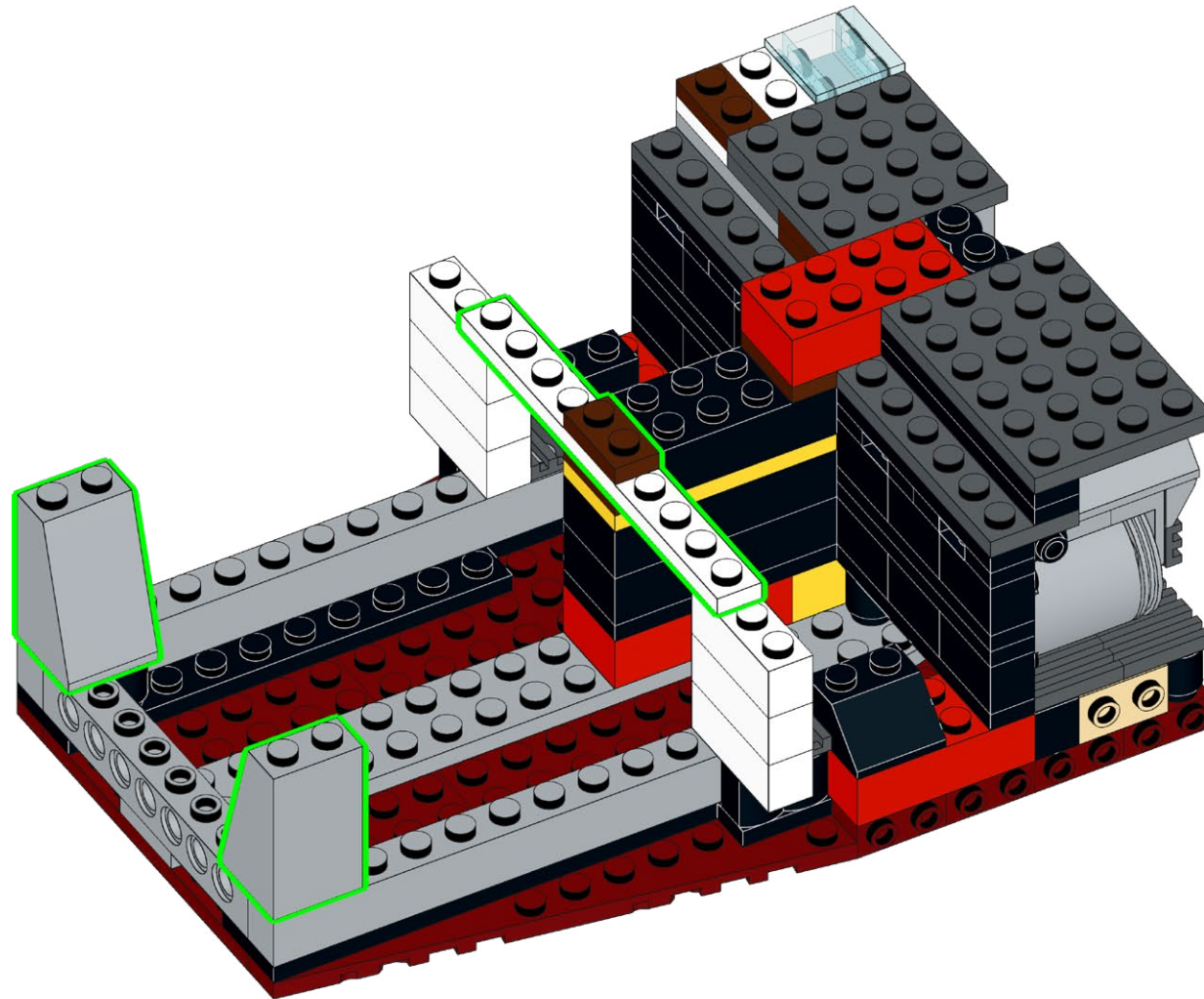
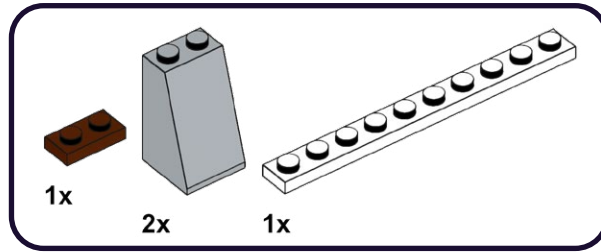

108

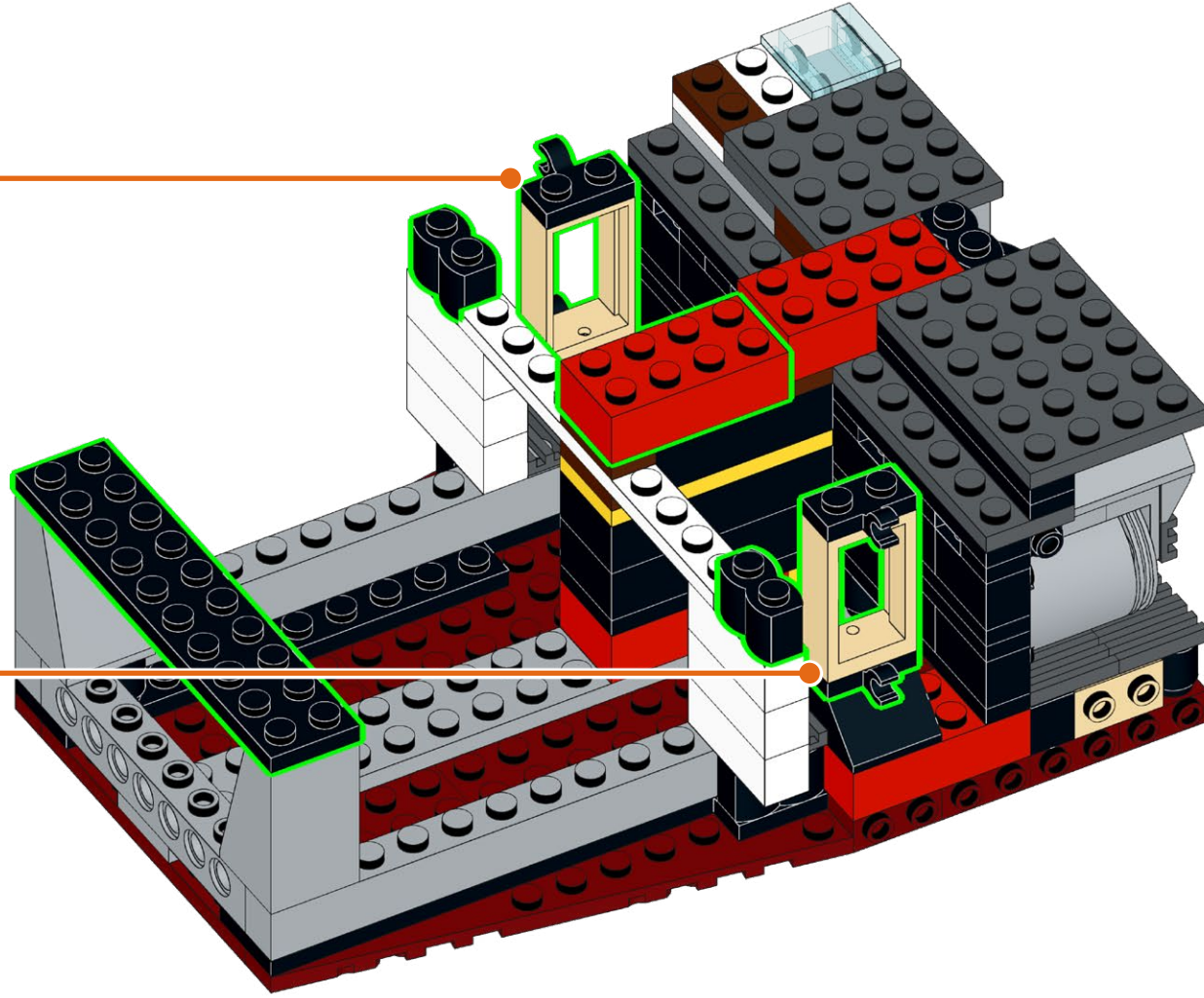
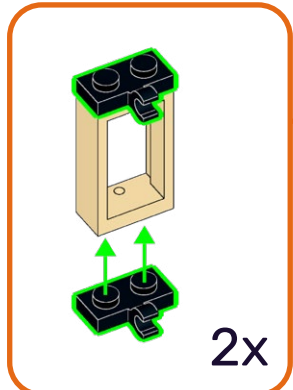
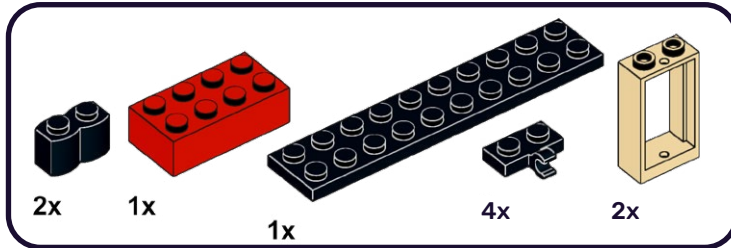

109

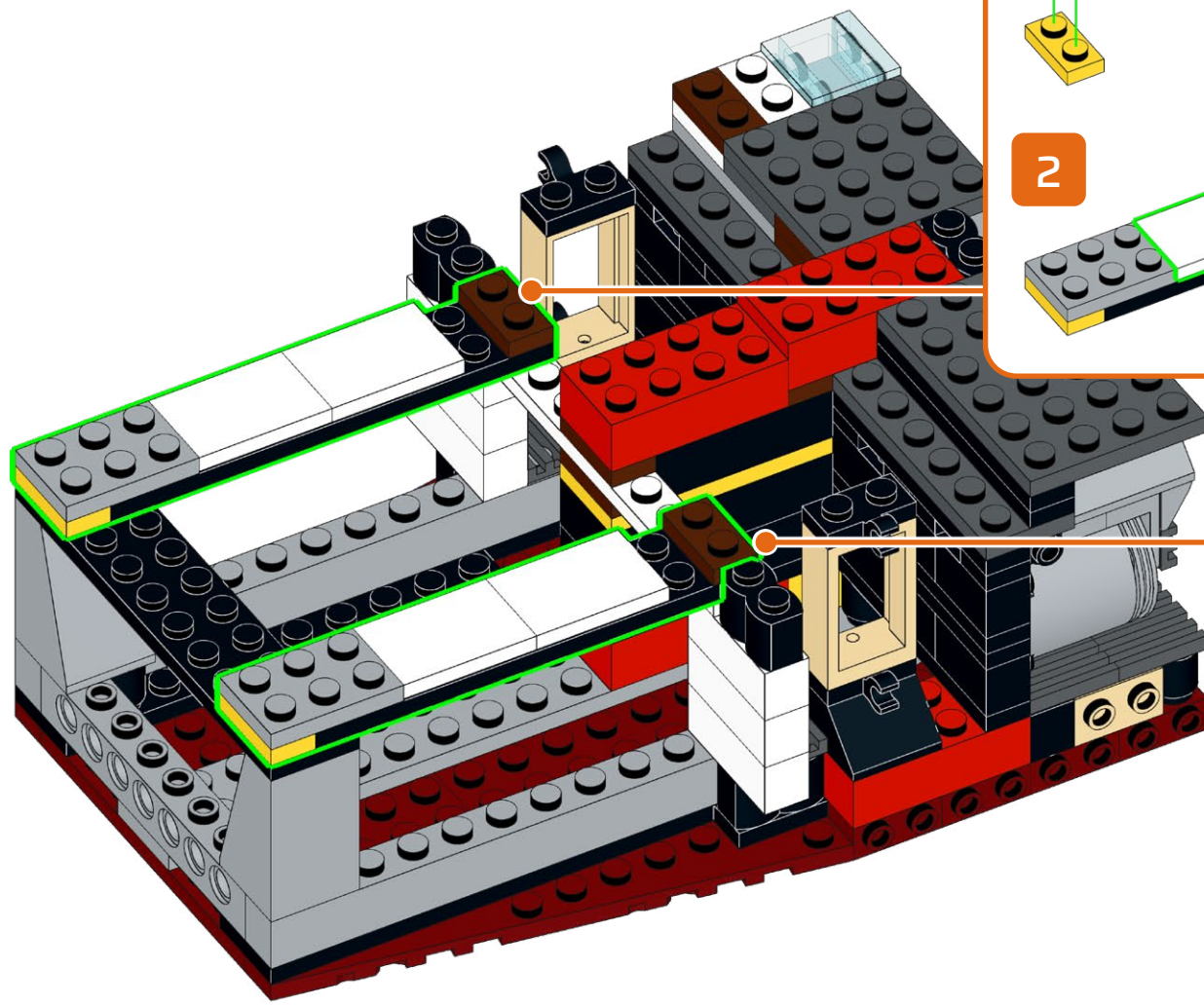
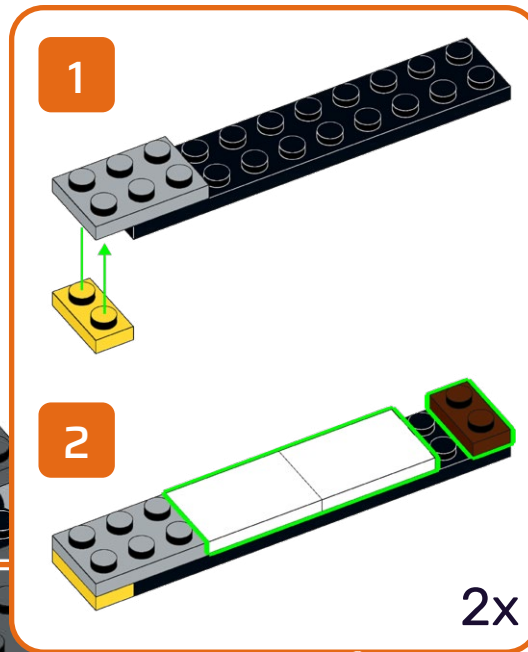
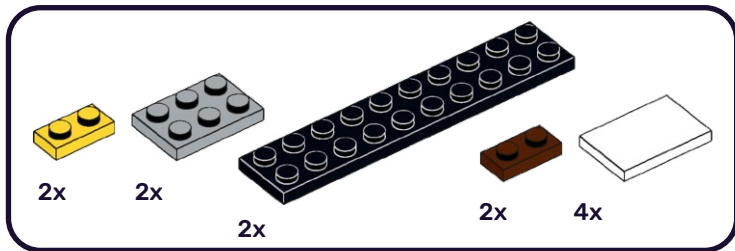

110

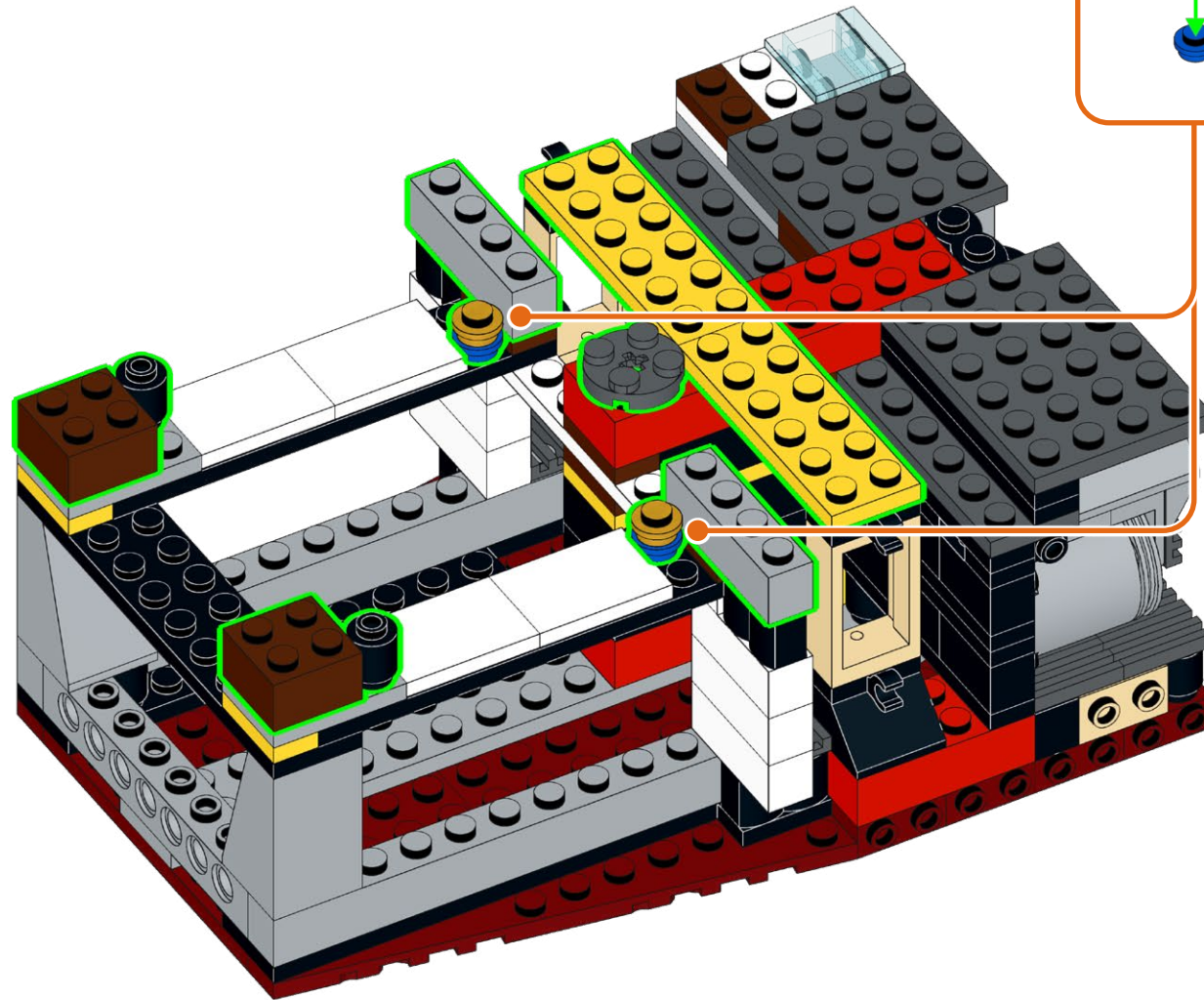
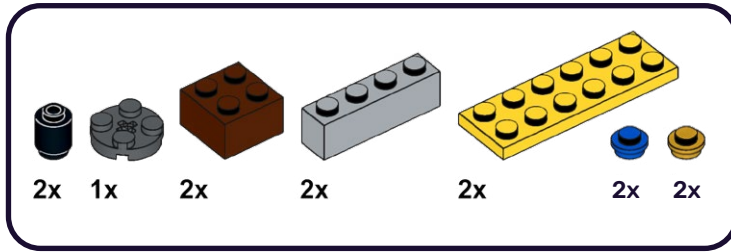

2x

111

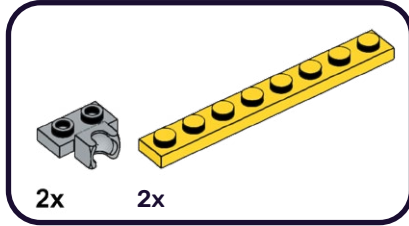

1

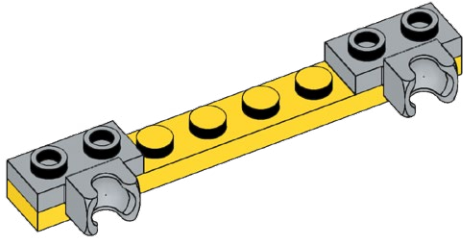

2

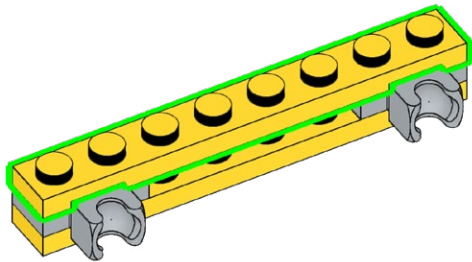

112

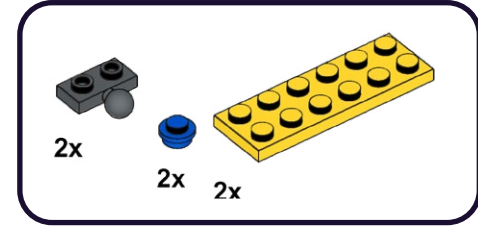

1

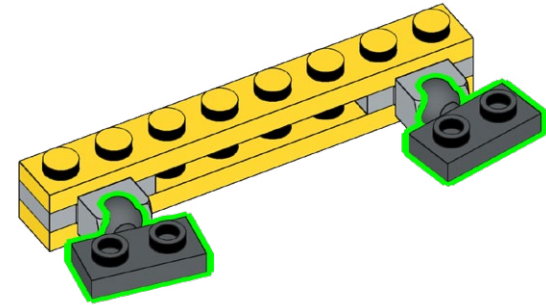

2

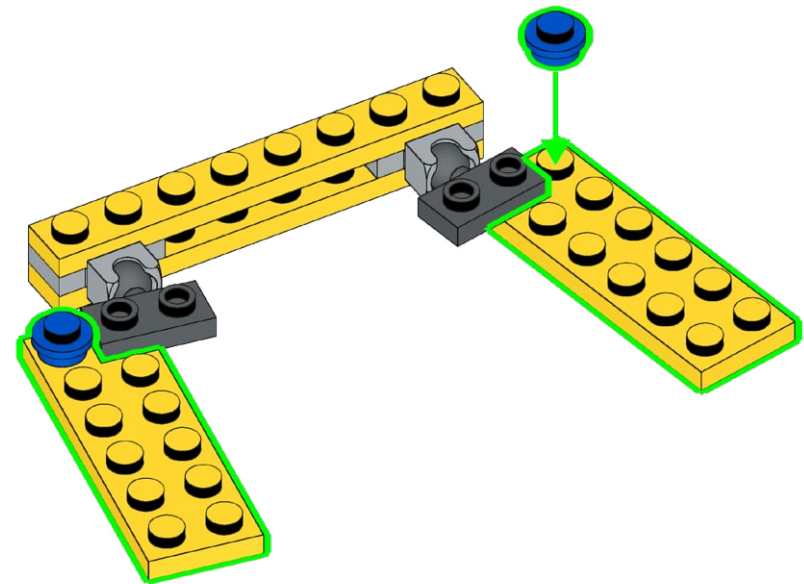

113

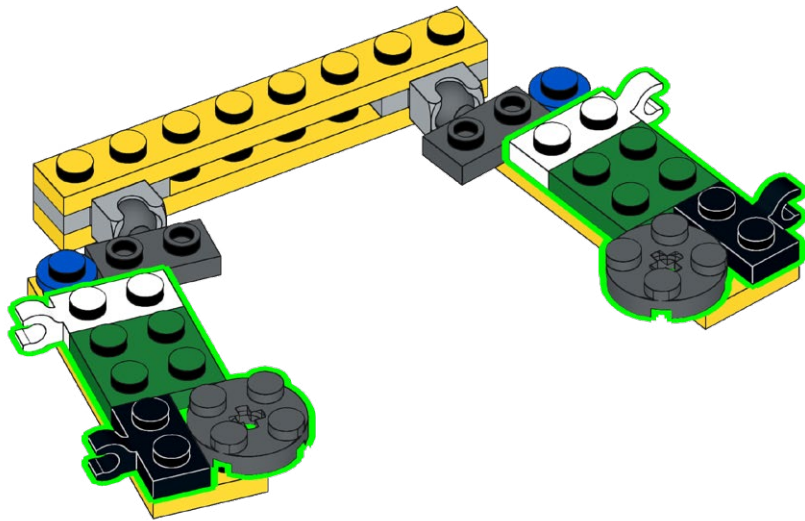
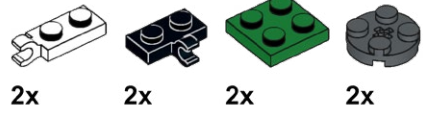

114

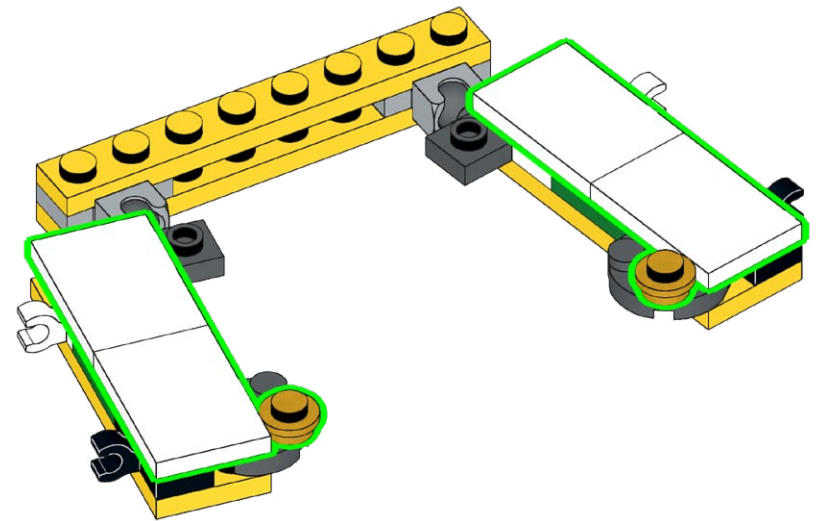
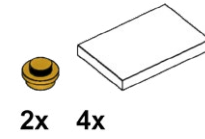

115

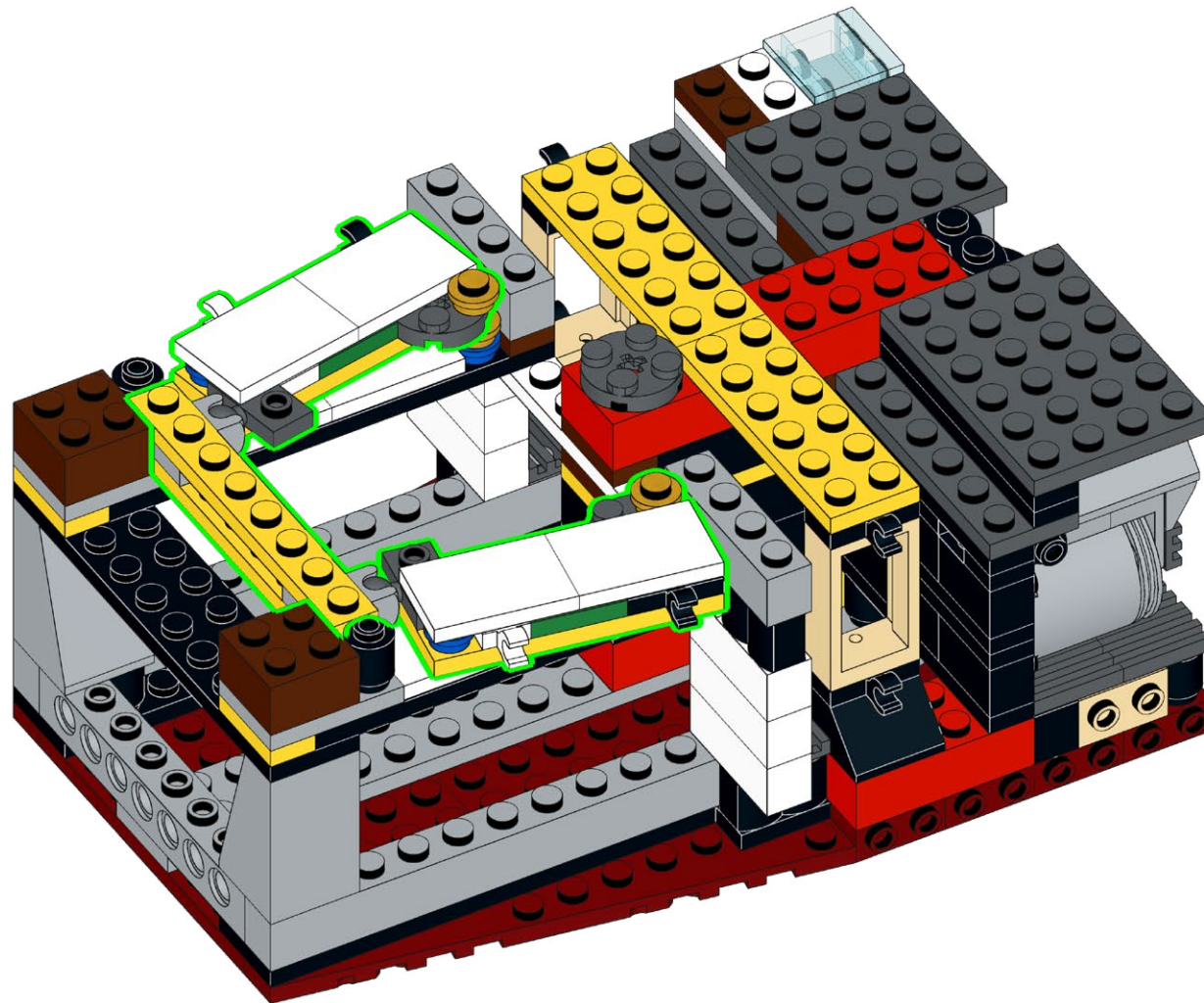

**HOLD UP!**

You might notice some bags aren't in order, as well as left over pieces, but that's ok! We're changing the way you build LEGO!

ATTENDEZ!

Vous remarquerez peut-être que certains sacs, ainsi que certaines pièces, ne sont pas dans le bon ordre. Mais pas de panique! Nous changeons simplement la façon avec laquelle vous construisez vos LEGO!

ASPETTA!

Potresti notare che alcuni sacchetti non sono in ordine, così come i pezzi avanzati, ma va bene così! Stiamo cambiando il modo in cui costruisci i LEGO!

HALT!

Sie werden möglicherweise bemerken, dass einige tüten durcheinander sind und teile übrig bleiben, aber das ist in Ordnung! Wir ändern die art und weise, wie Sie LEGO bauen!

¡ESPERA!

Es posible que notes que algunas bolsas están fuera de servicio, así como piezas sobrantes, ¡pero está bien! ¡Estamos cambiando la forma en que construyes LEGO!

暫停!

你可能会注意到一些袋子顺序错乱, 以及一些剩余的部件, 但没关系! 我们正在改变你搭建乐高的方式!

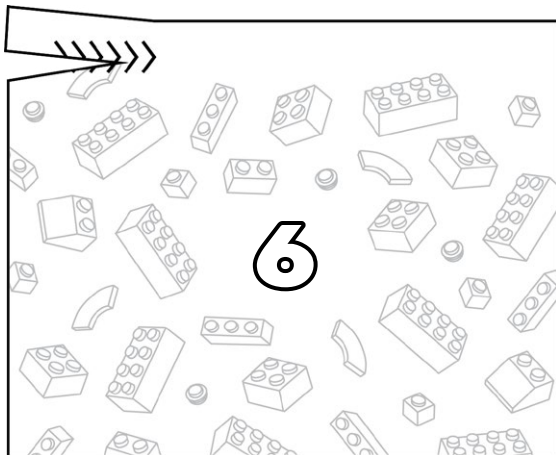
Open LEGO® Bag 6

116

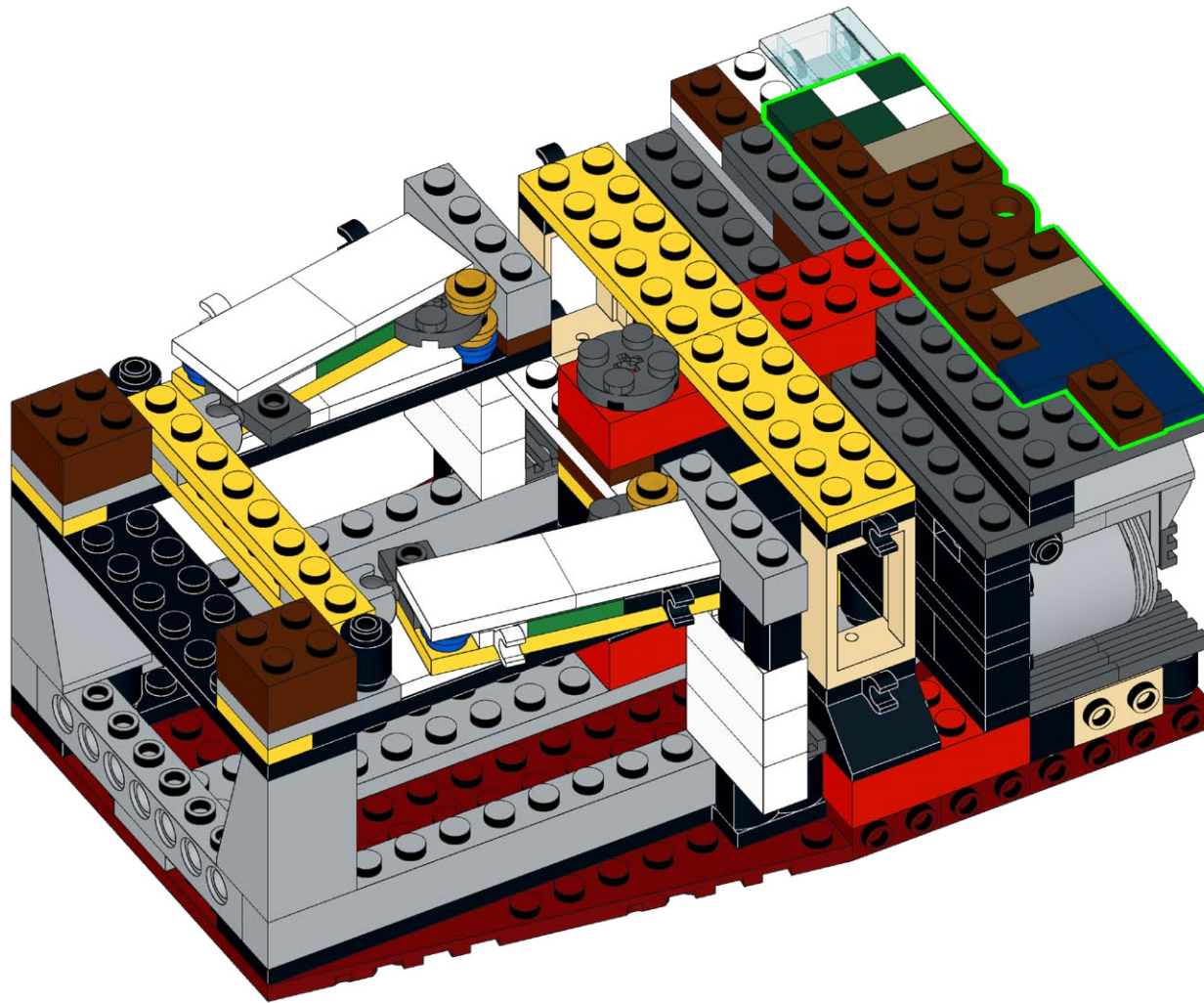
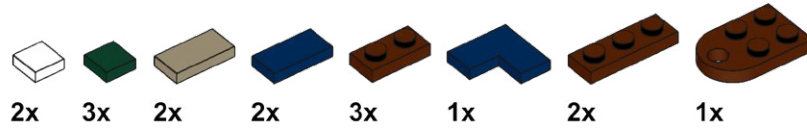

117

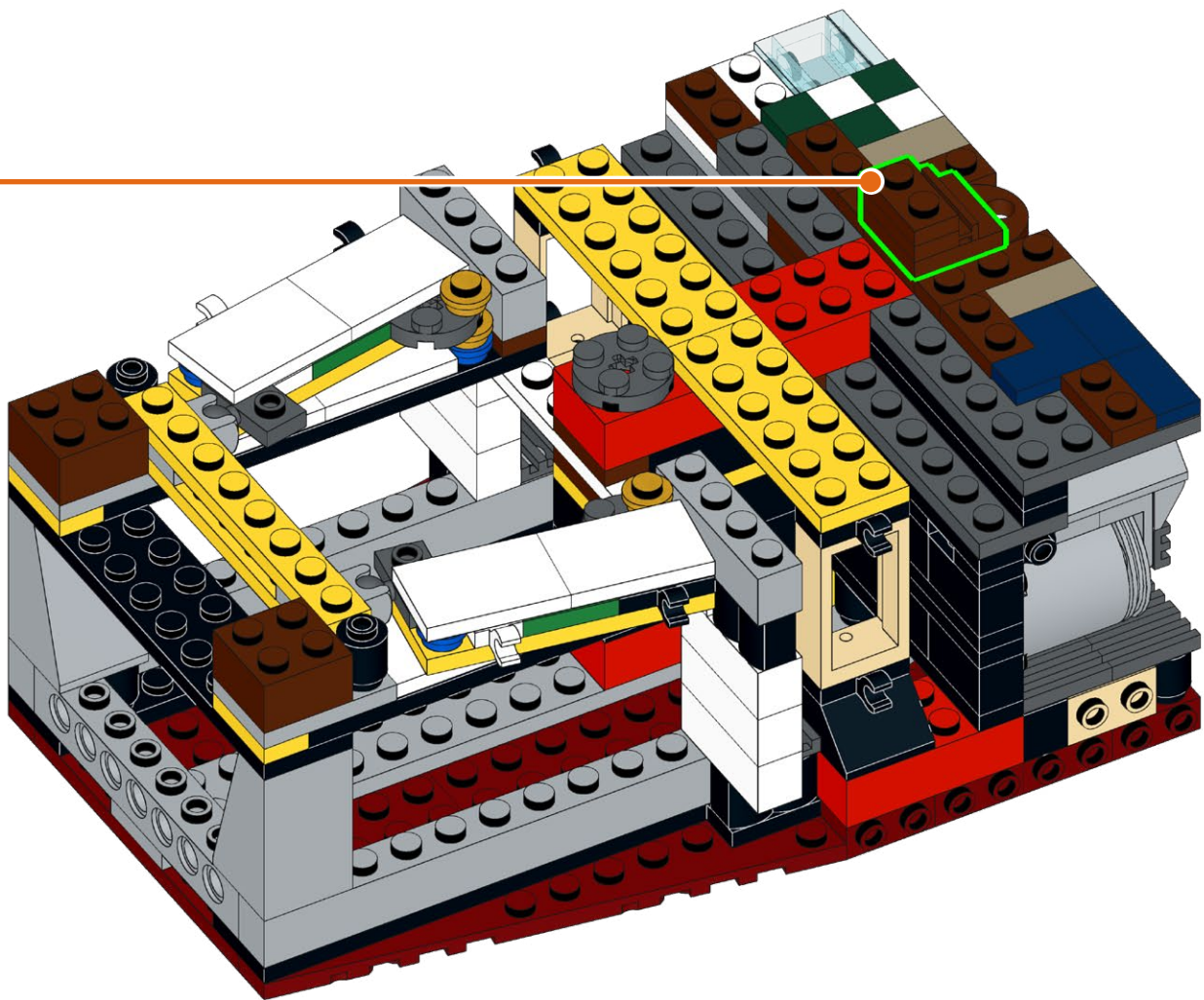
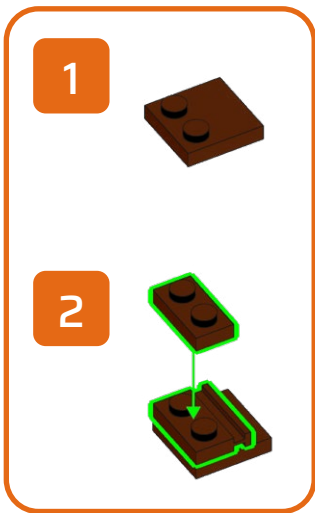
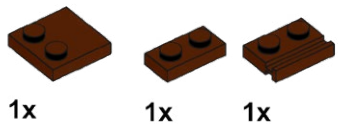

118

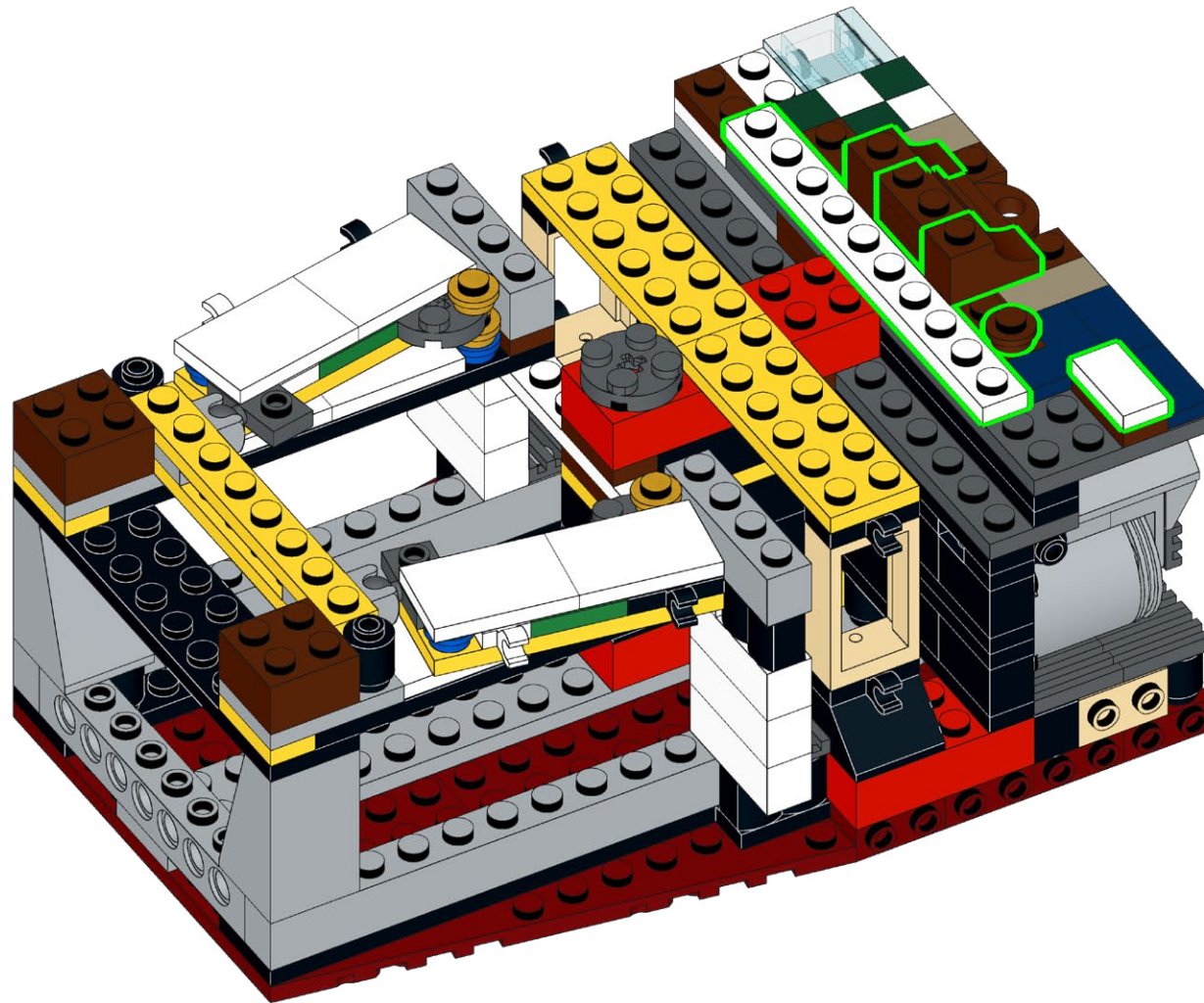
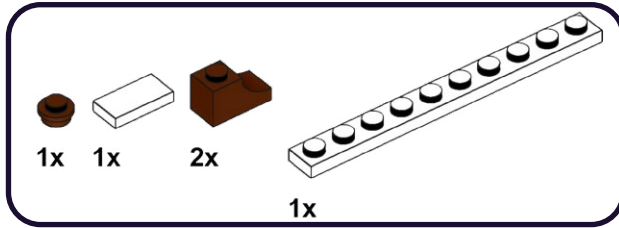

119

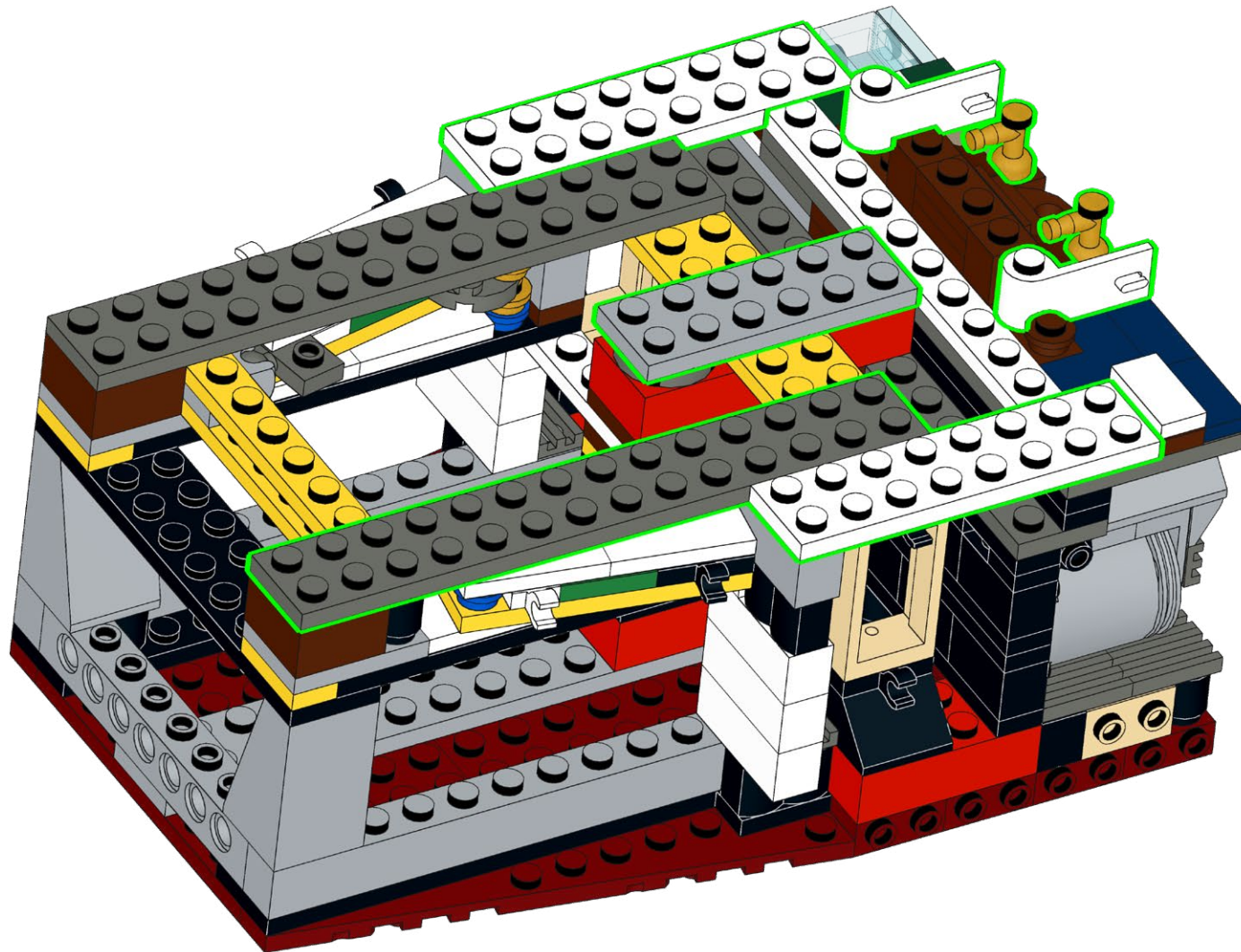
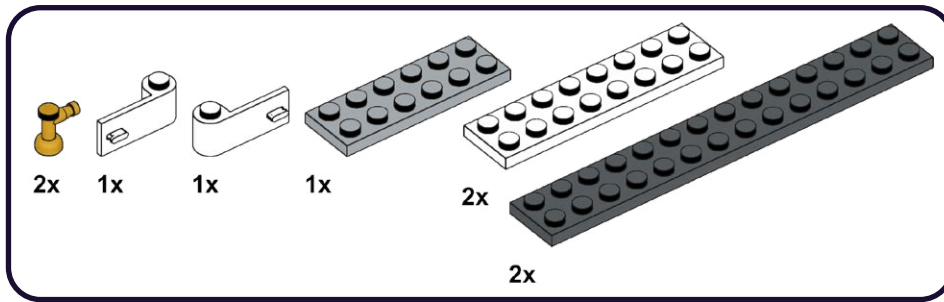

120

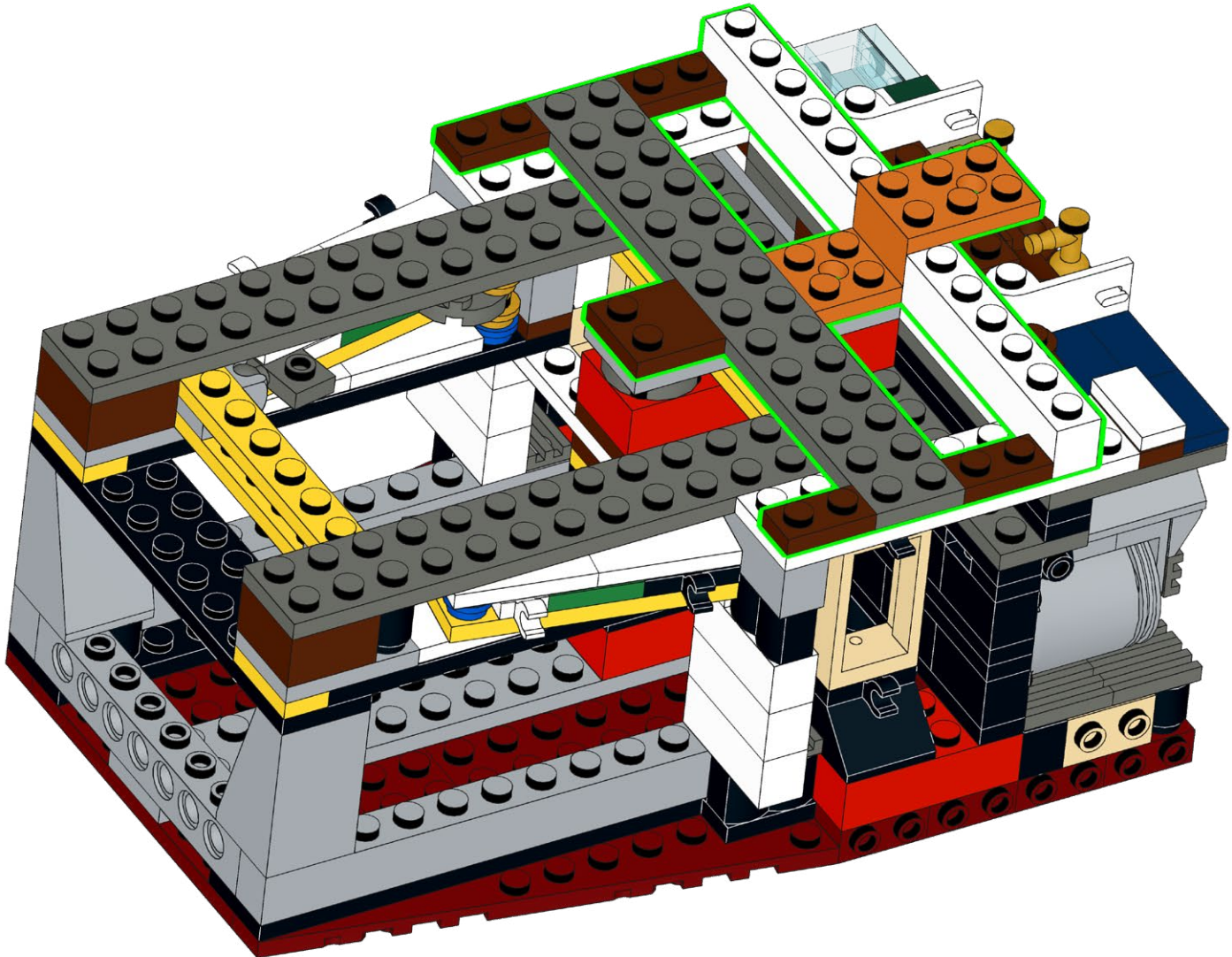
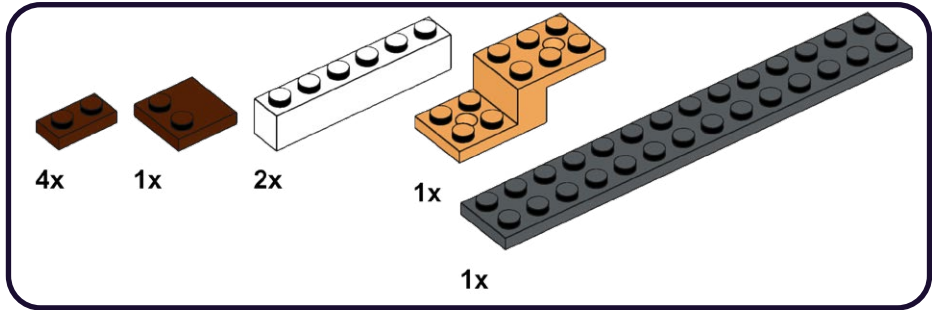

121

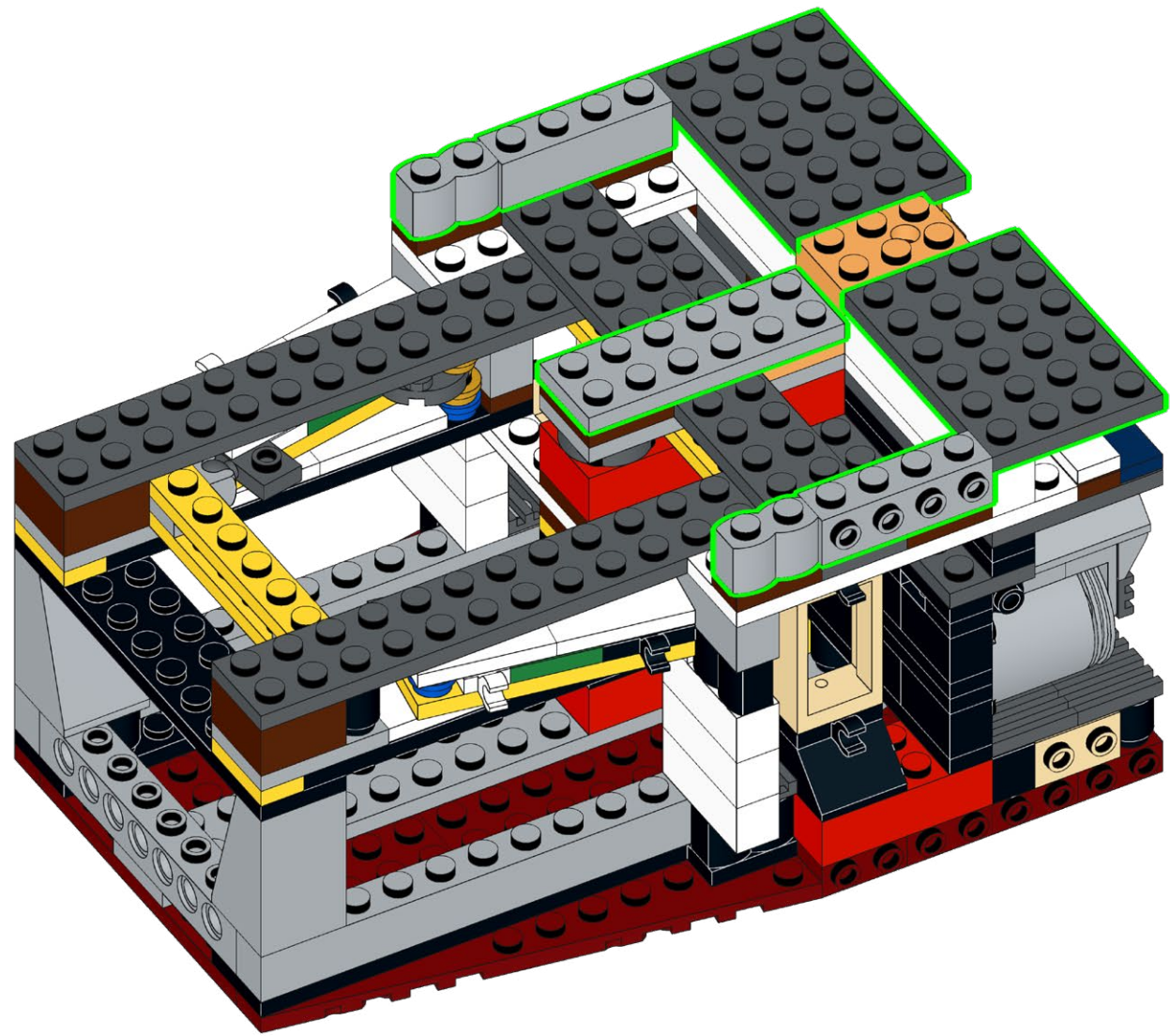
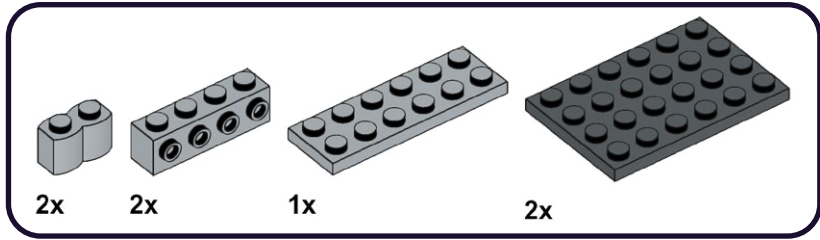

122

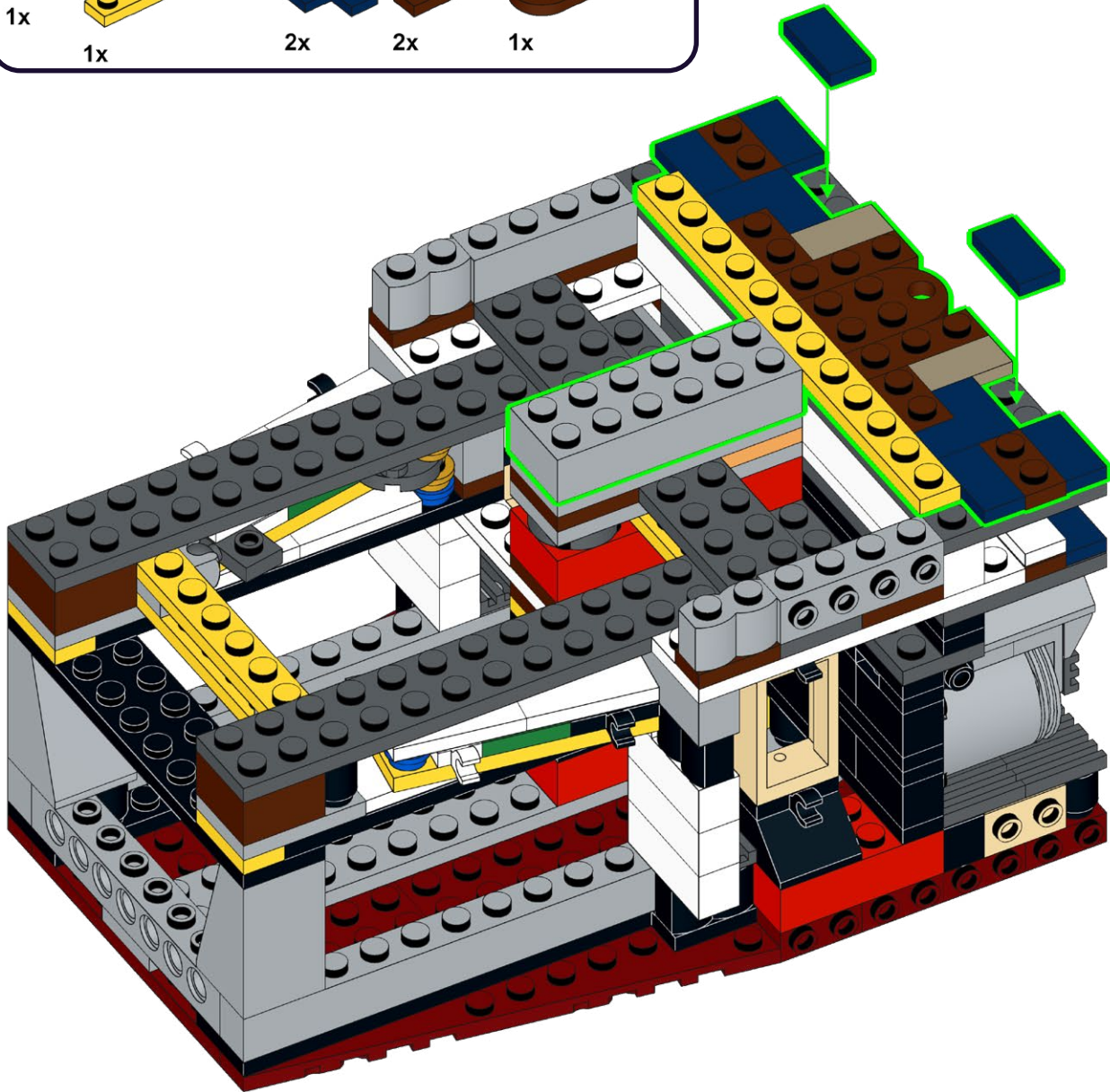
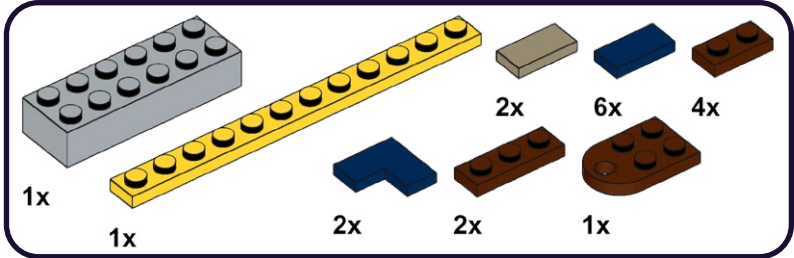

123

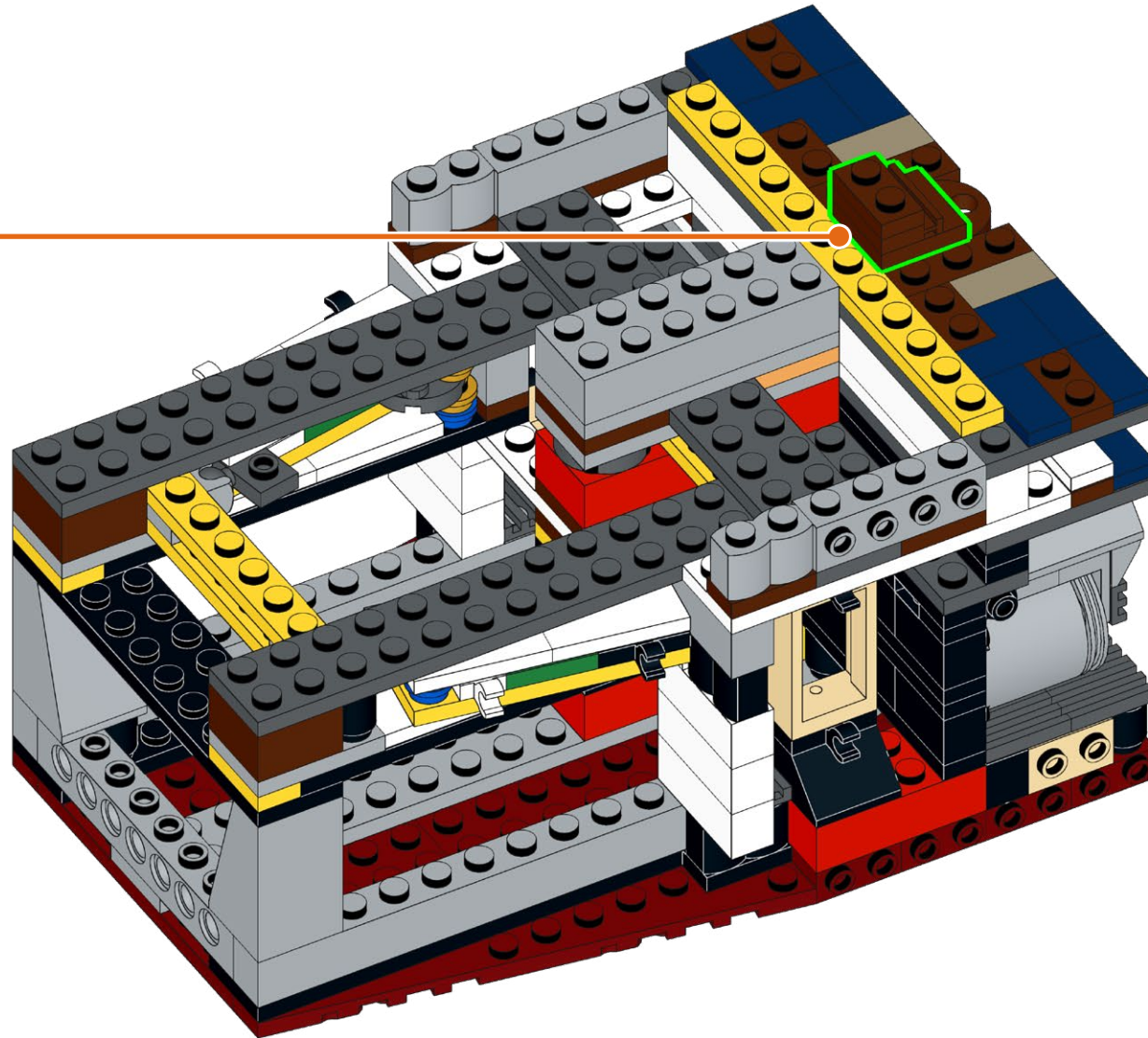
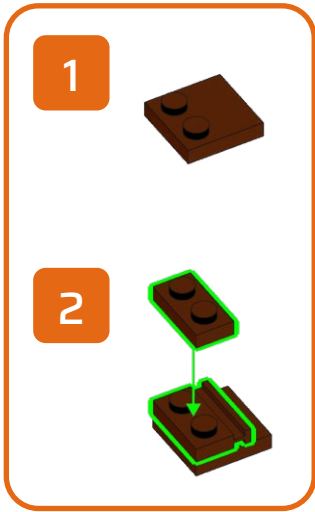
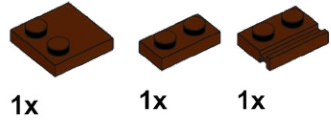

124

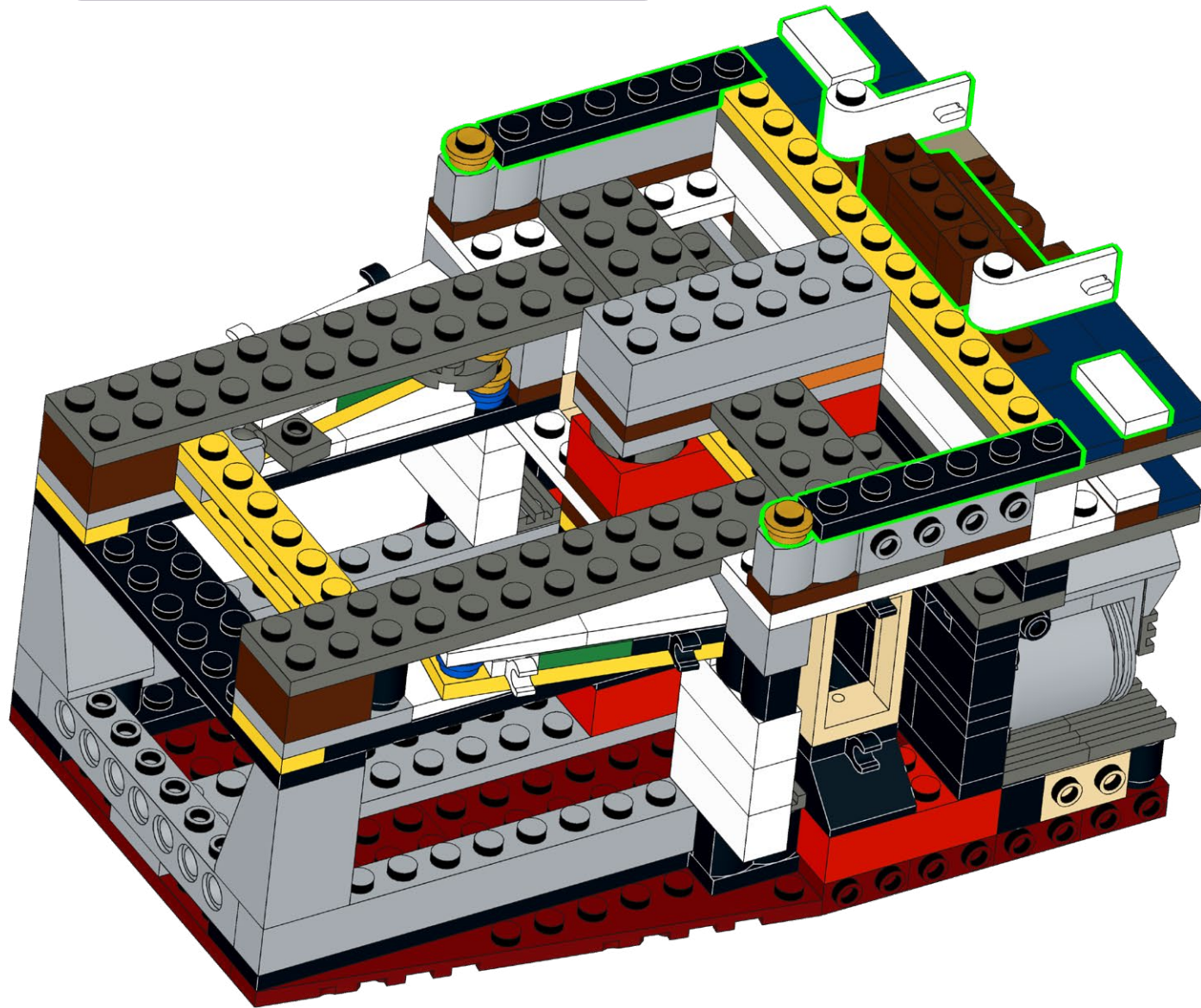
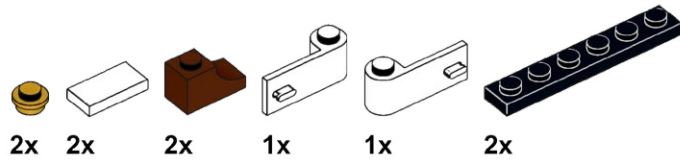

125

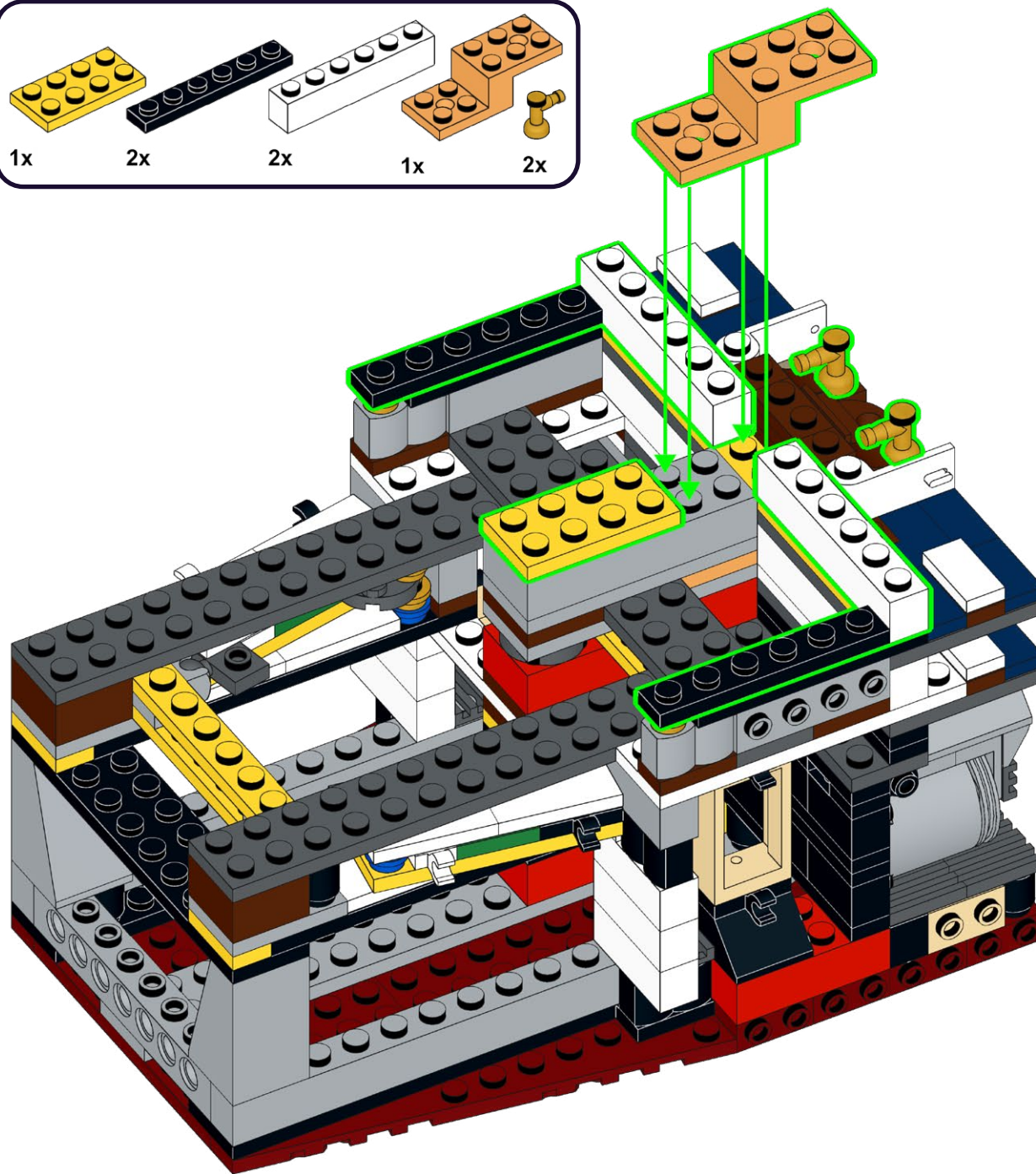
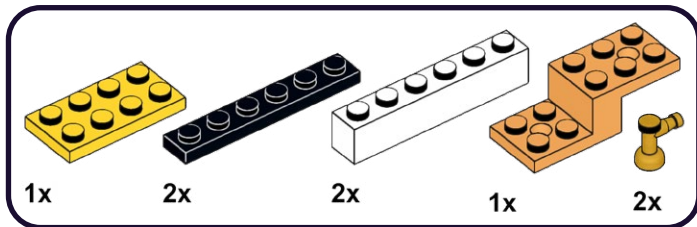

126

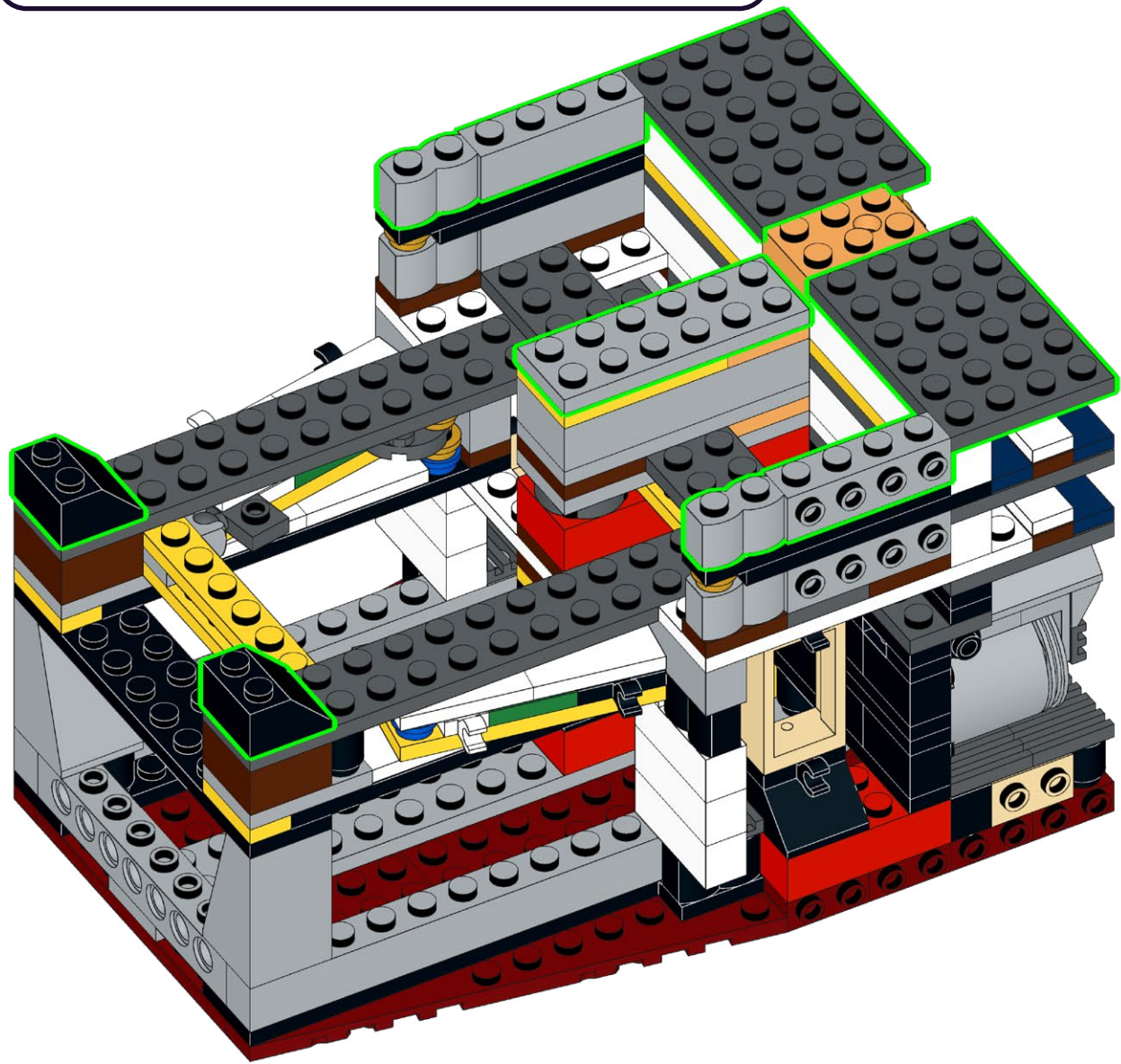
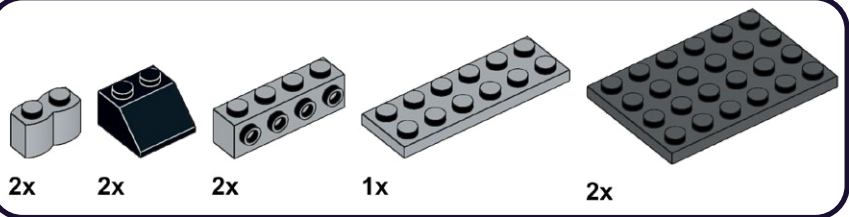

127

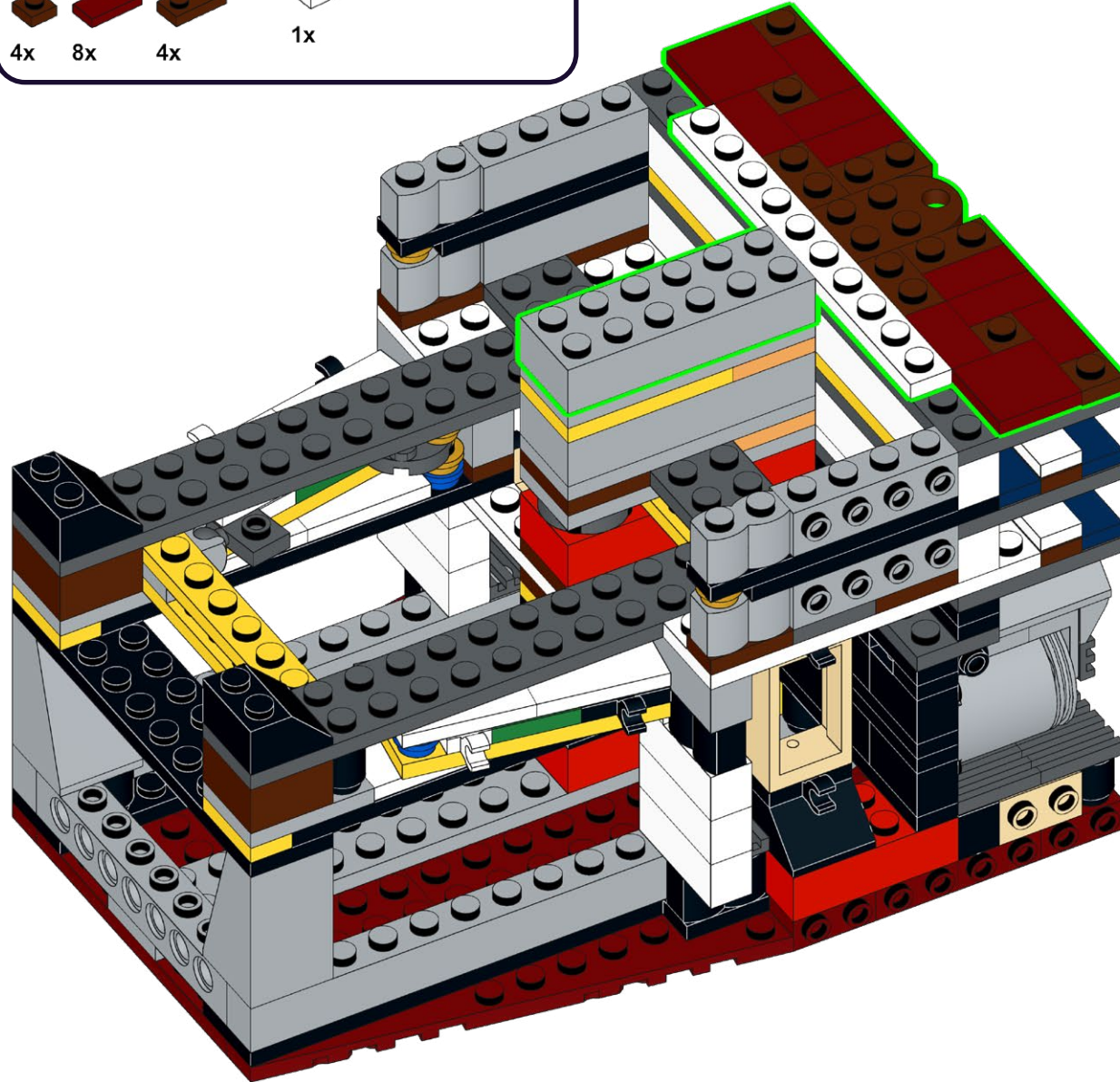
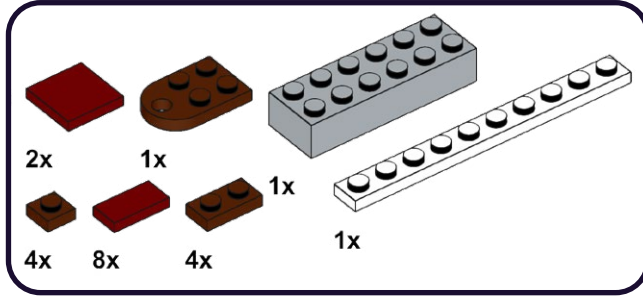

128

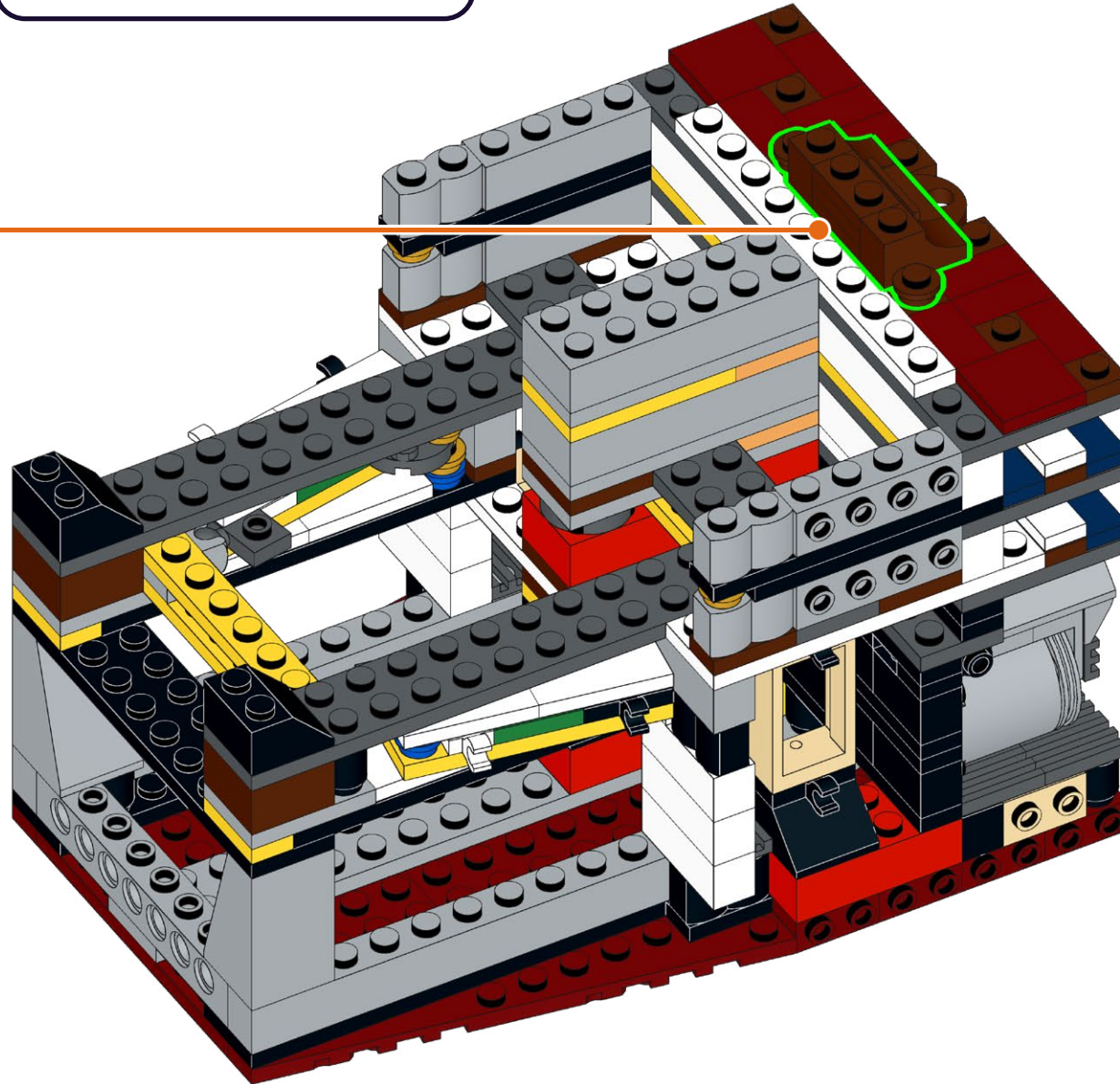
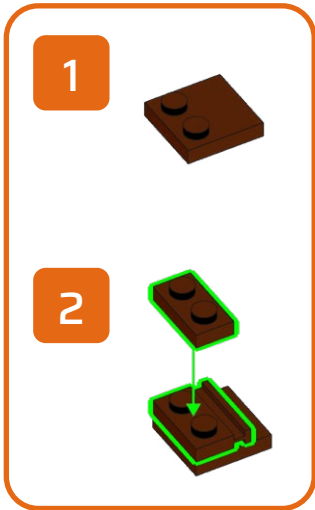
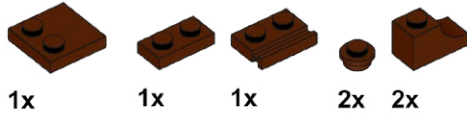

129

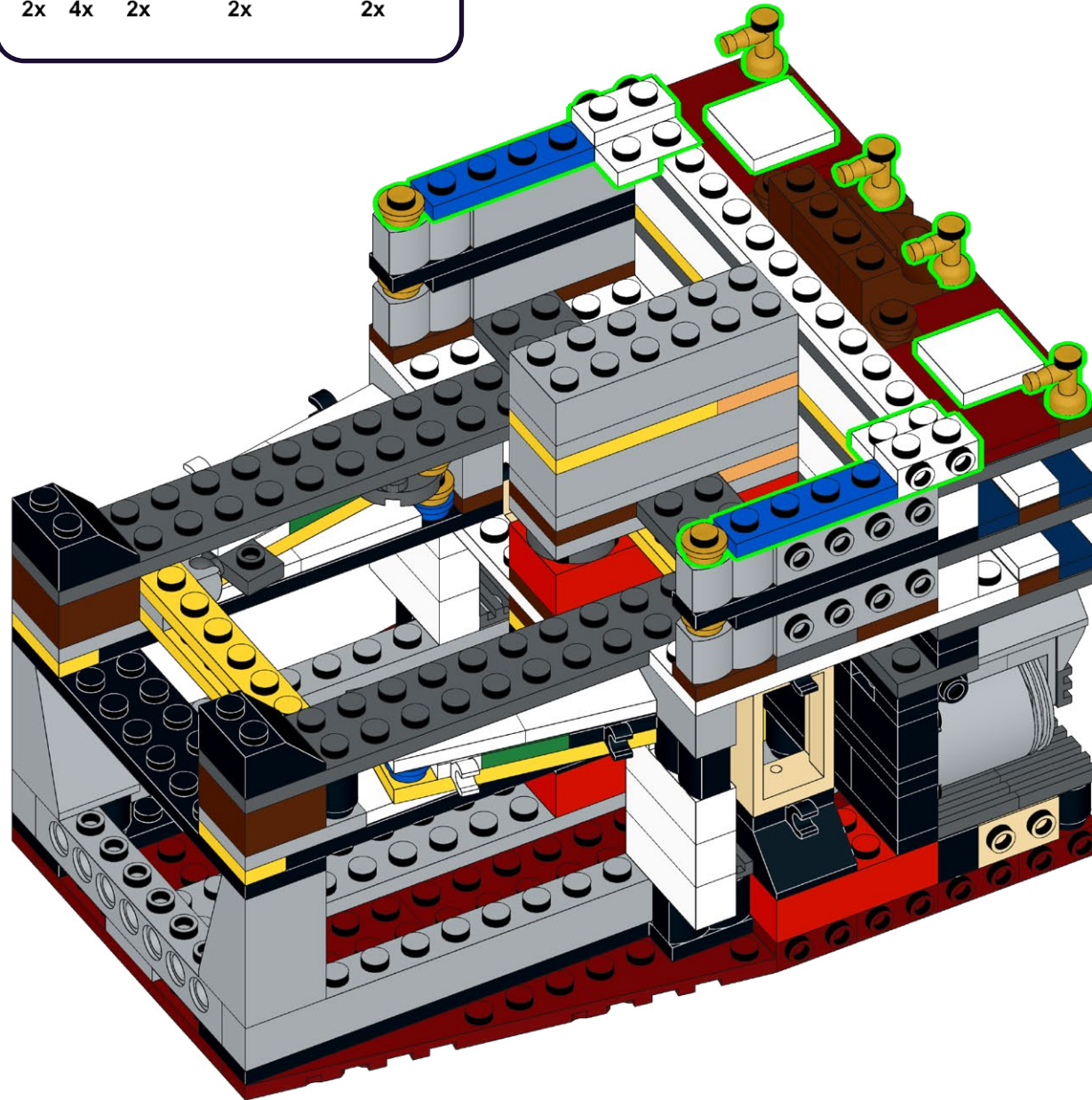
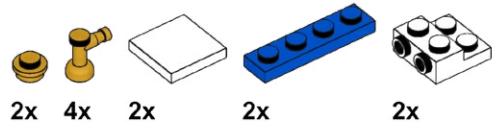

130

6x 4x

2x

2x

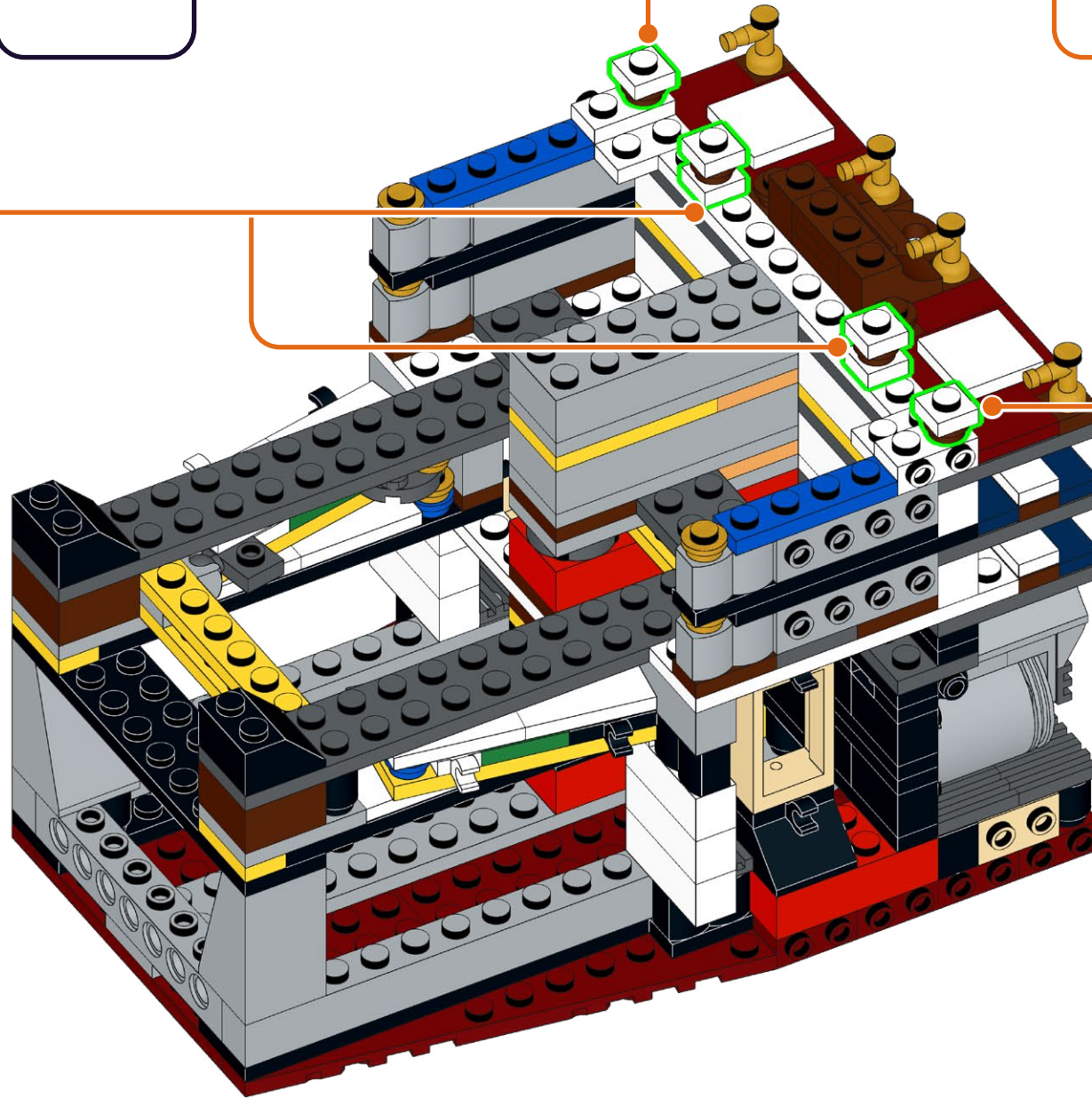

131

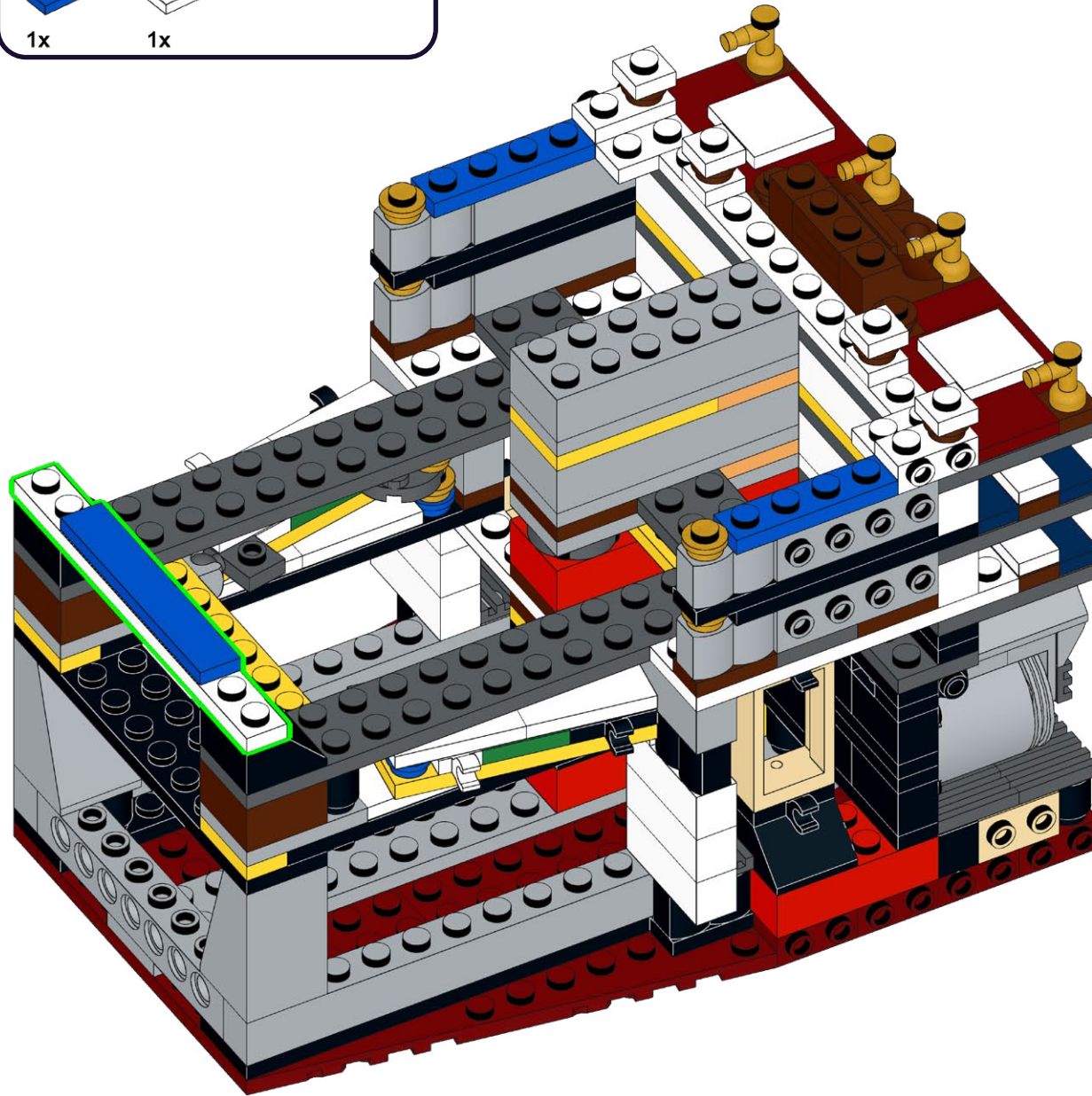
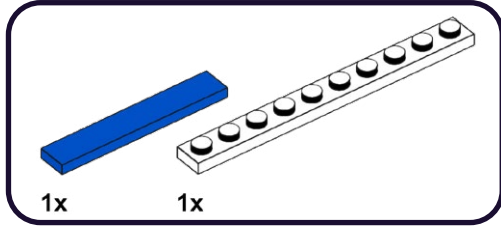

132



4x

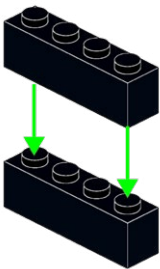

2x

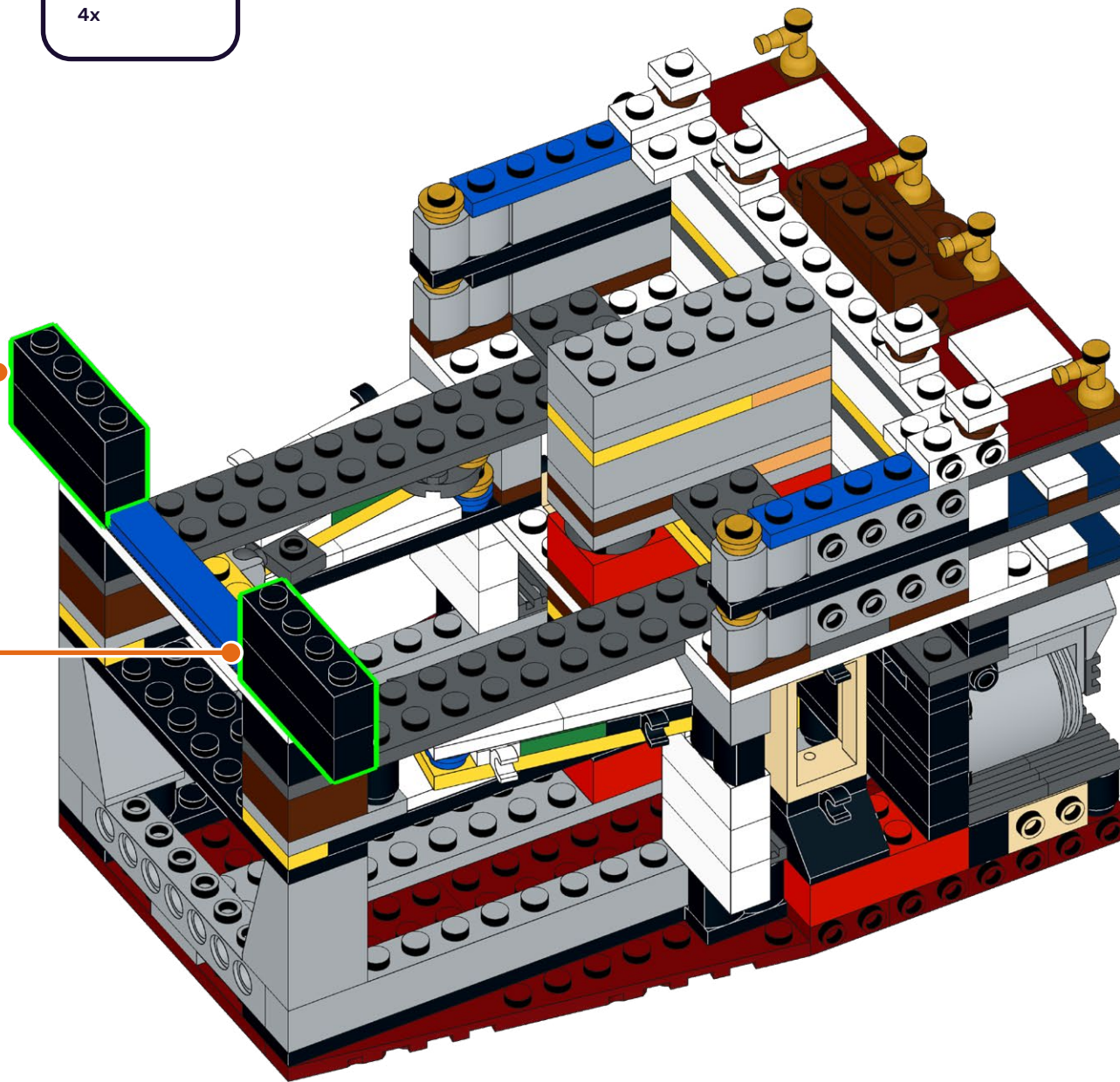

133

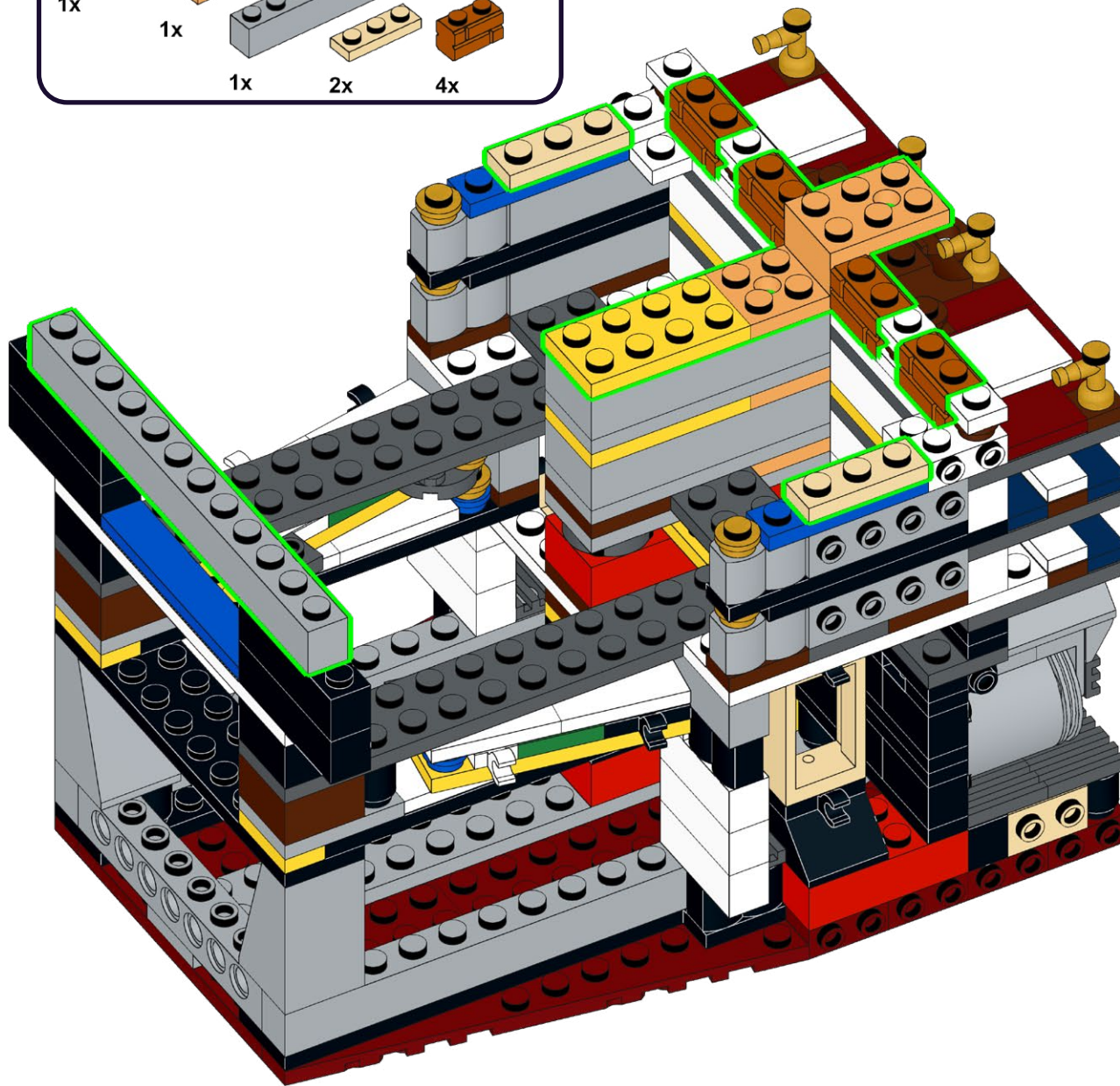
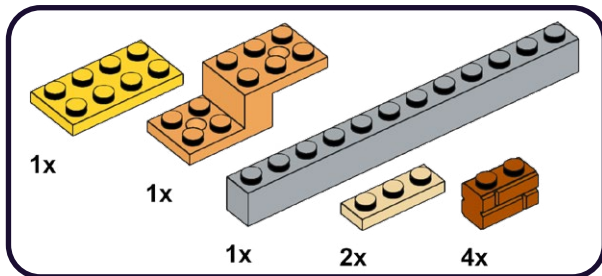

134

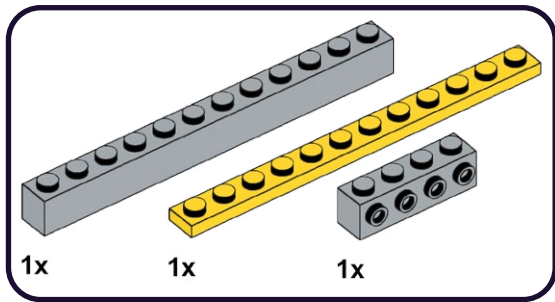

1

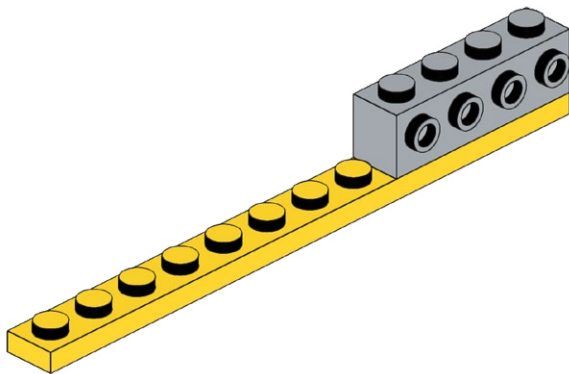

2

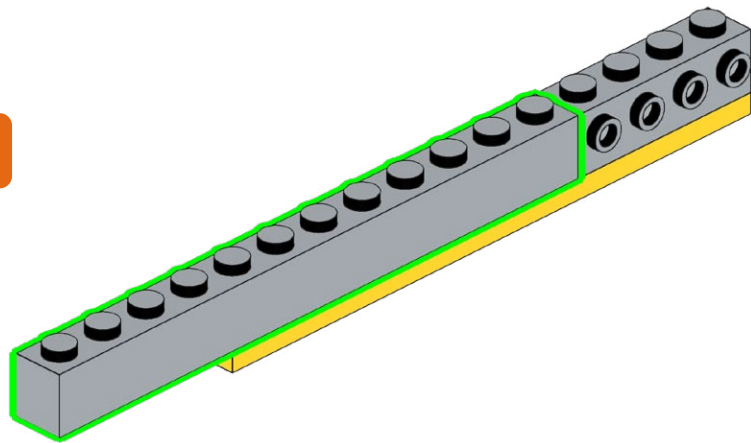

135

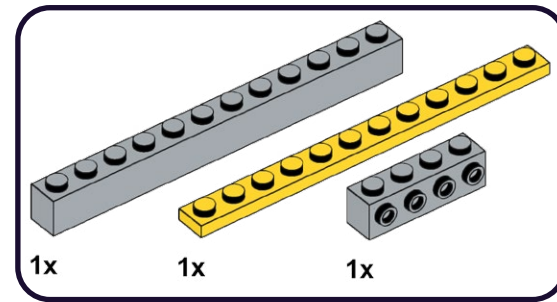

1

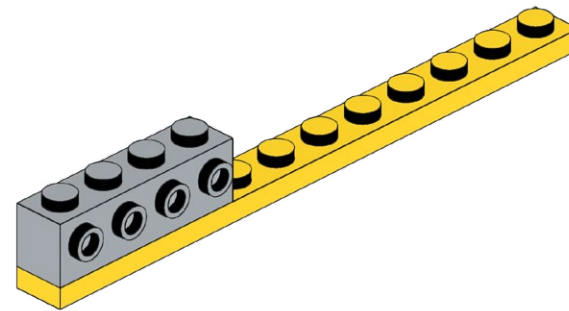

2

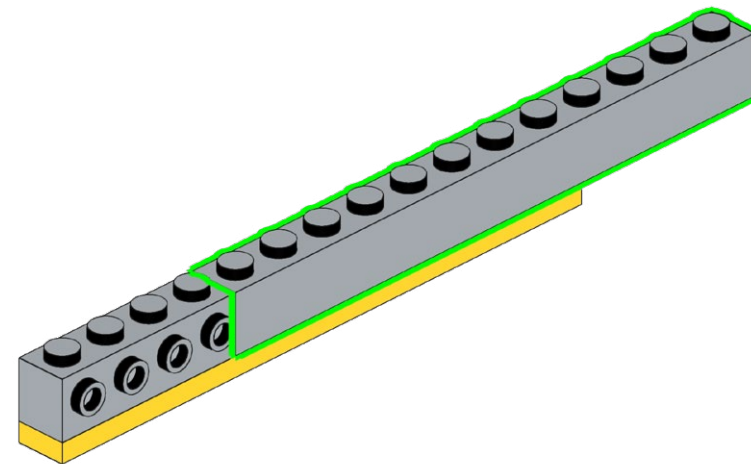

136

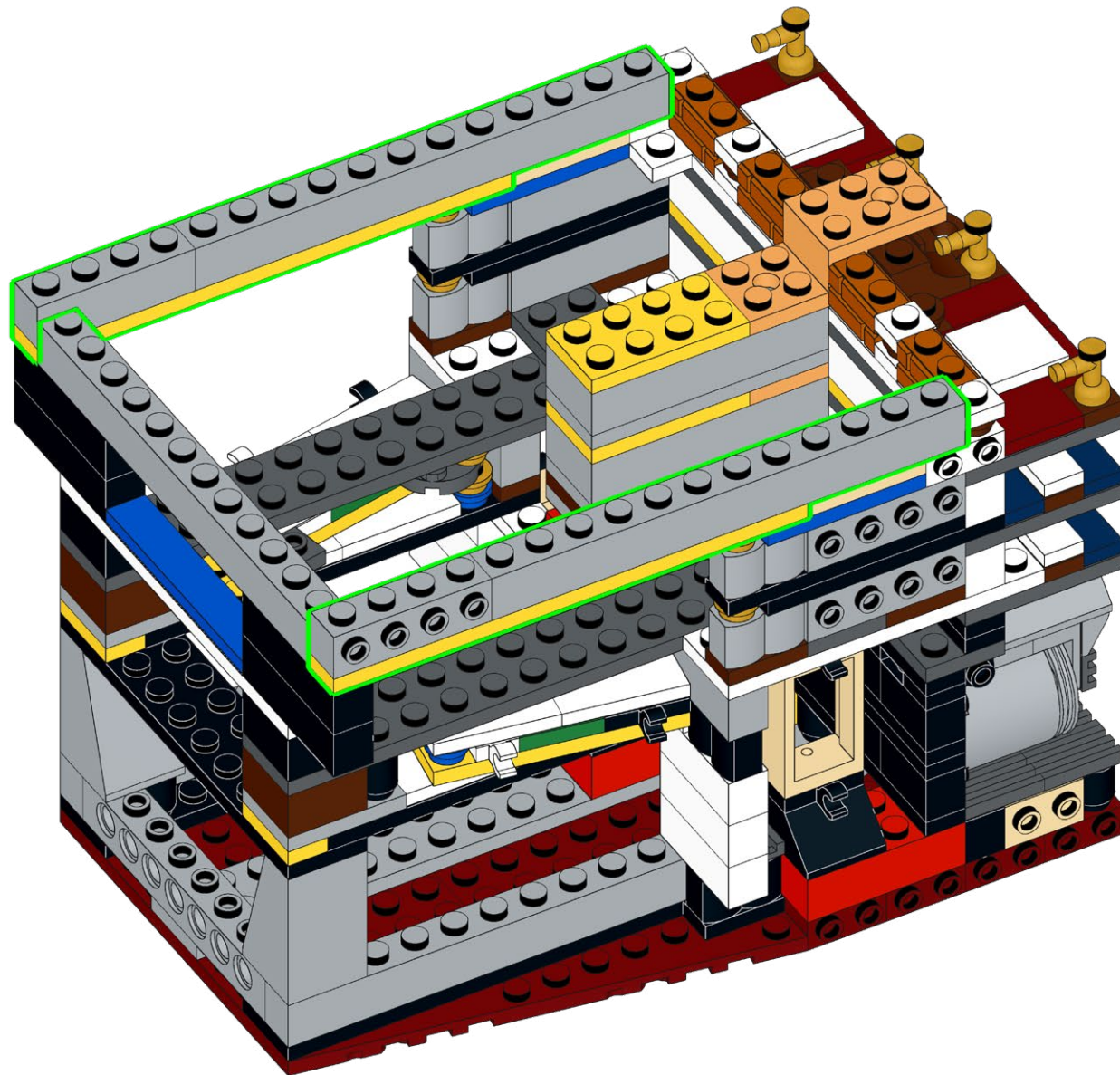

137

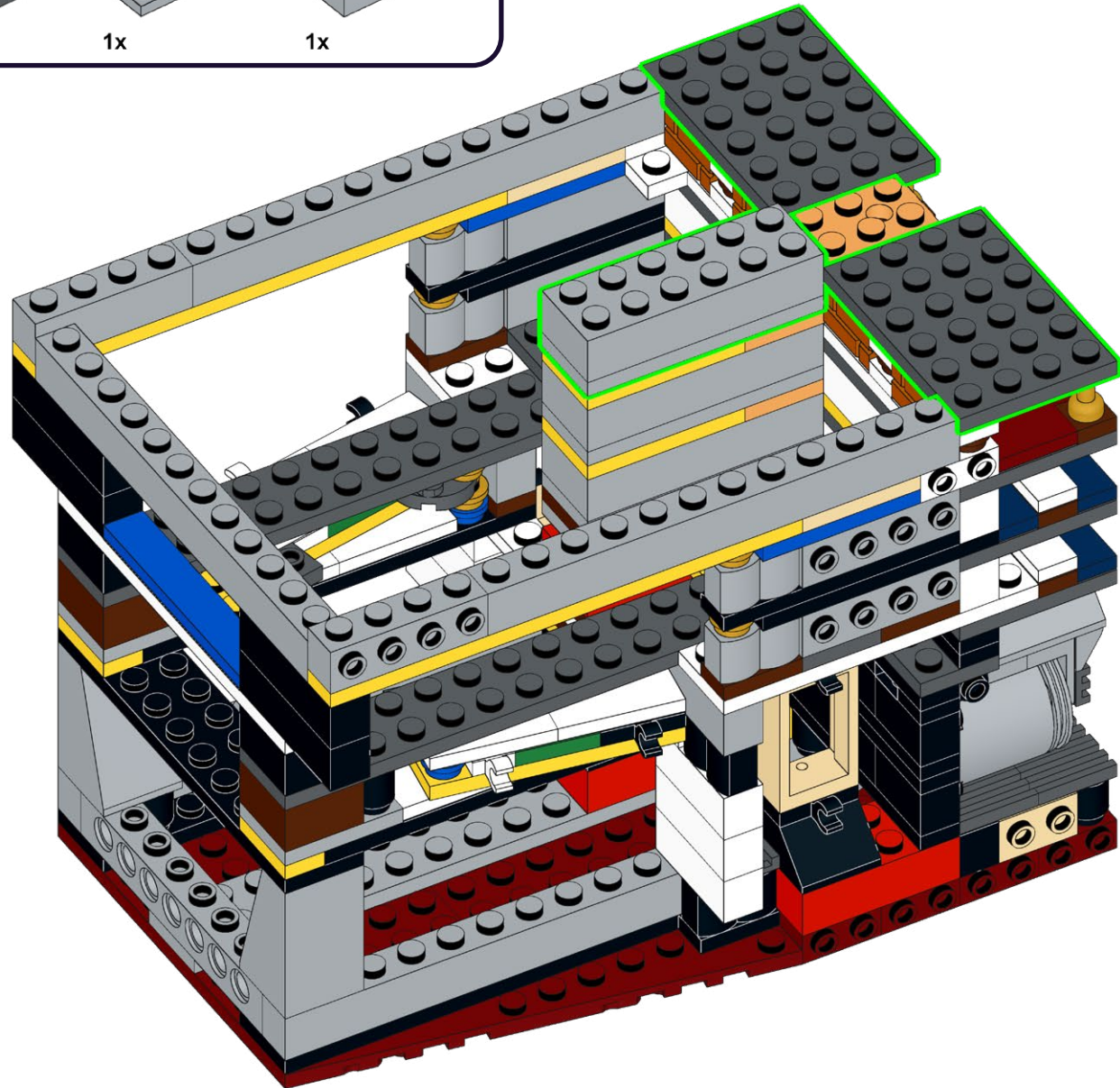
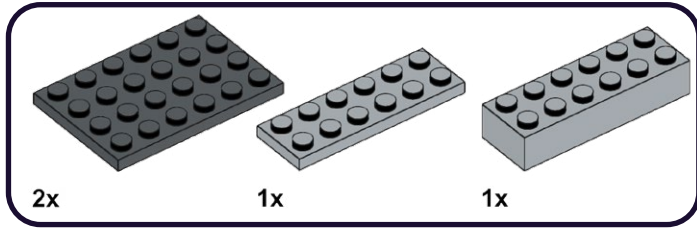

138

2x

2x

2x



HOLD UP!

You might notice some bags aren't in order, as well as left over pieces, but that's ok! We're changing the way you build LEGO!

ATTENDEZ!

Vous remarquerez peut-être que certains sacs, ainsi que certaines pièces, ne sont pas dans le bon ordre. Mais pas de panique! Nous changeons simplement la façon avec laquelle vous construisez vos LEGO!

ASPETTA!

Potresti notare che alcuni sacchetti non sono in ordine, così come i pezzi avanzati, ma va bene così! Stiamo cambiando il modo in cui costruisci i LEGO!

HALT!

Sie werden möglicherweise bemerken, dass einige tüten durcheinander sind und teile übrig bleiben, aber das ist in Ordnung! Wir ändern die art und weise, wie Sie LEGO bauen!

¡ESPERA!

Es posible que notes que algunas bolsas están fuera de servicio, así como piezas sobrantes, ¡pero está bien! ¡Estamos cambiando la forma en que construyes LEGO!

暫停!

你可能会注意到一些袋子顺序错乱, 以及一些剩余的部件, 但没关系! 我们正在改变你搭建乐高的方式!

Open LEGO® Bag 7

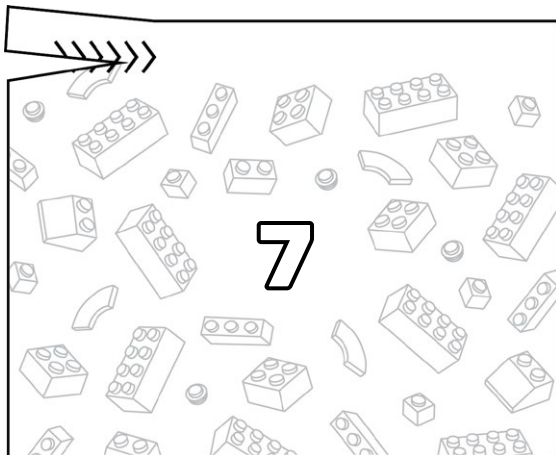

Open LMB Bag 07

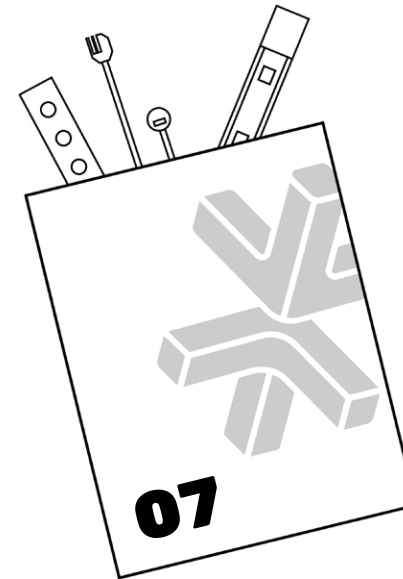

139

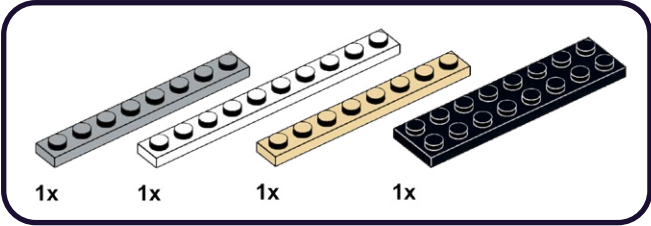

1

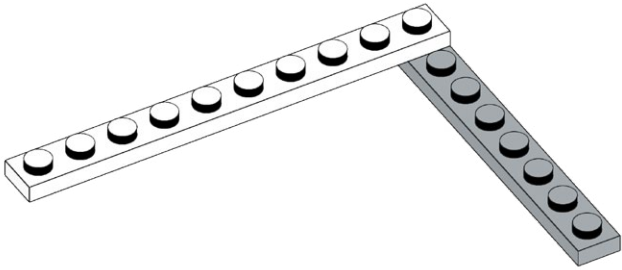

2

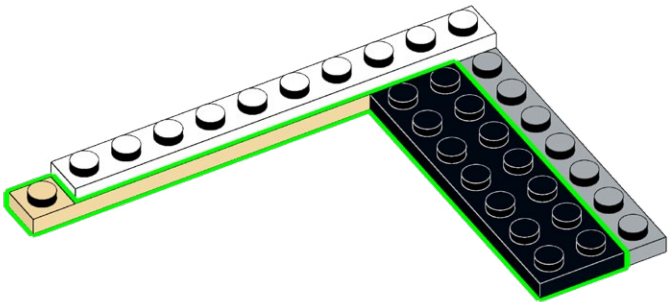

140

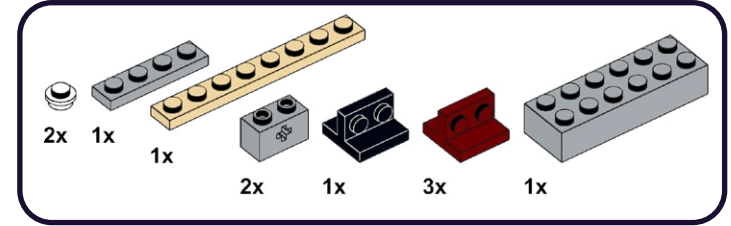

1

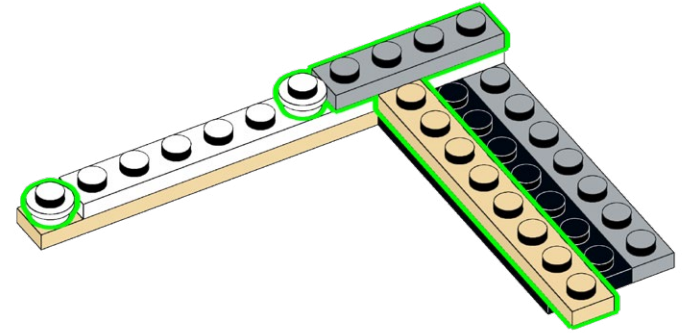

2

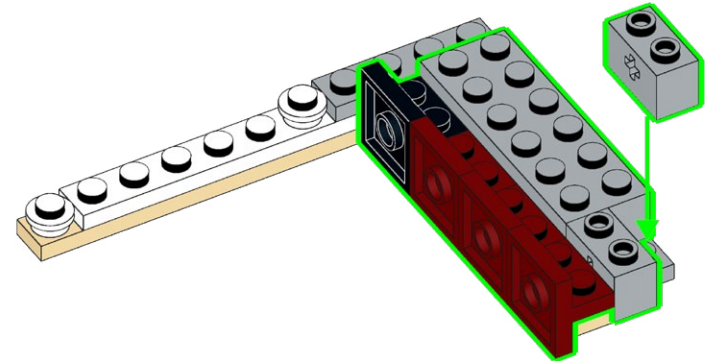

141

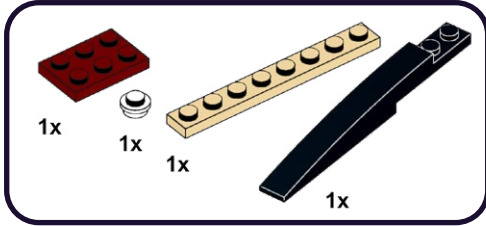

1

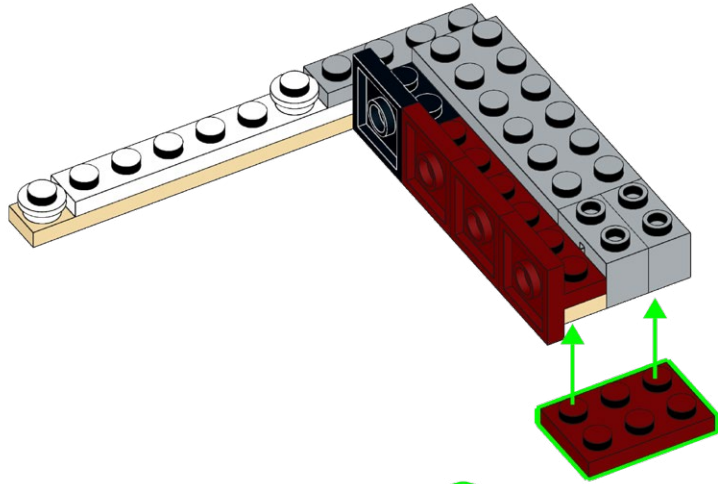

2

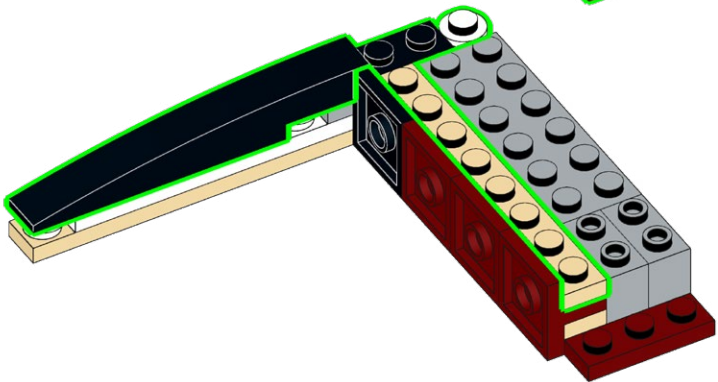

142

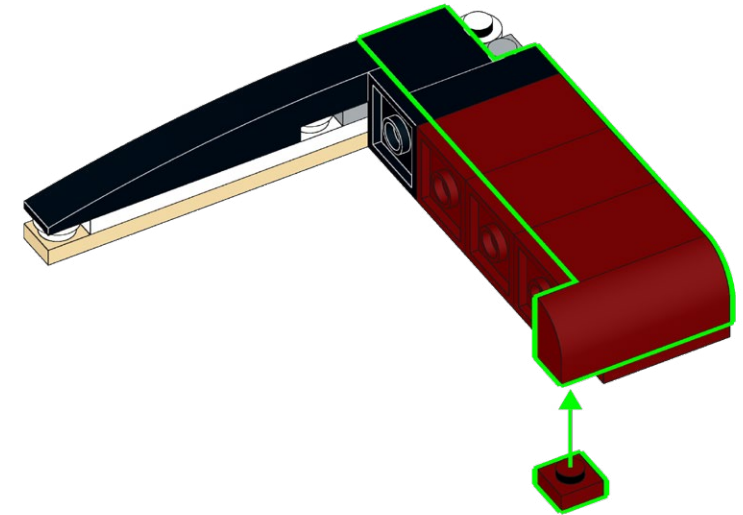
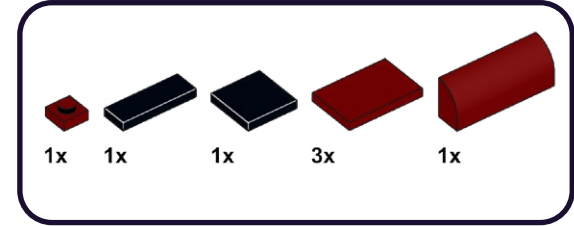

143

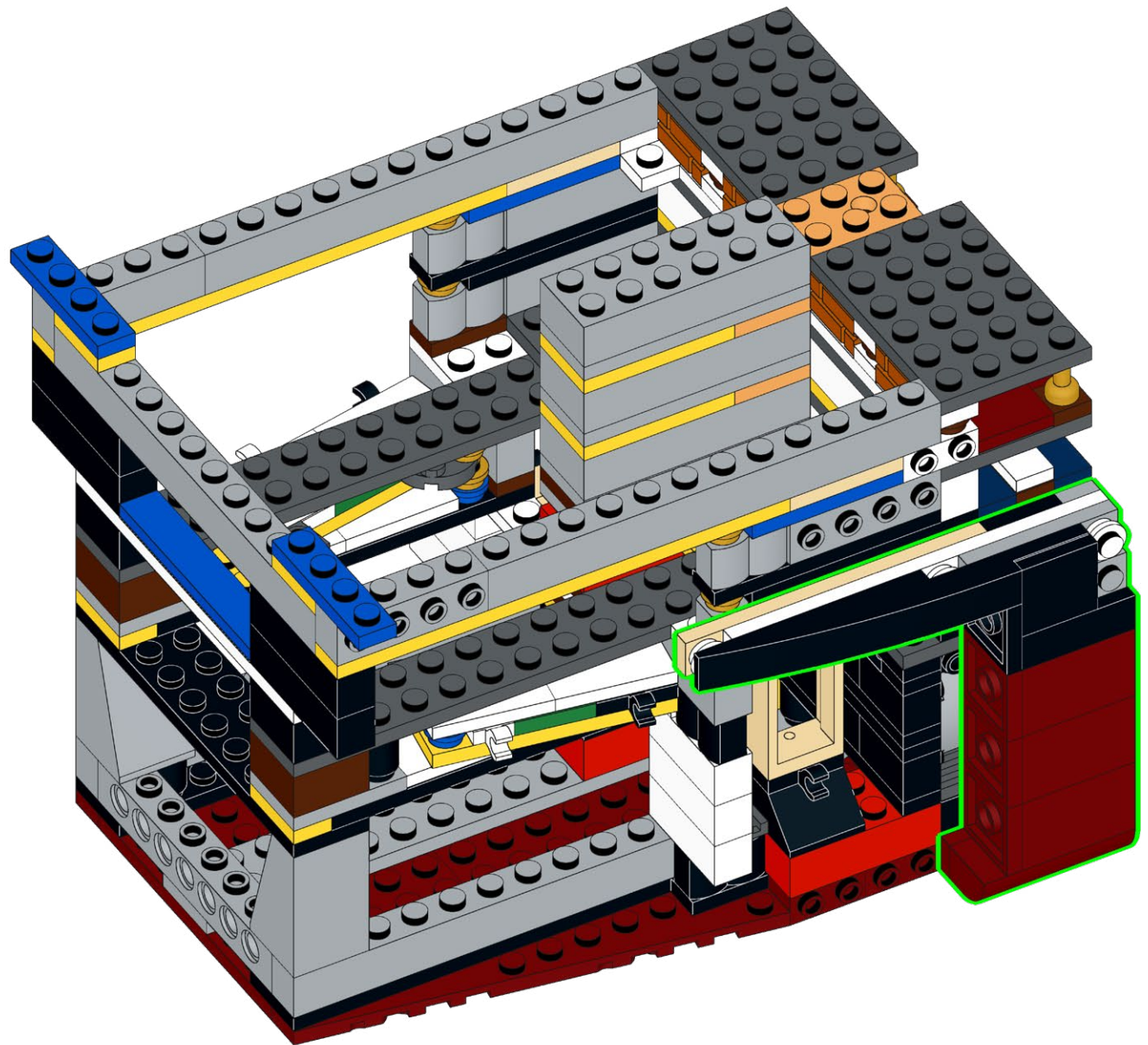

144

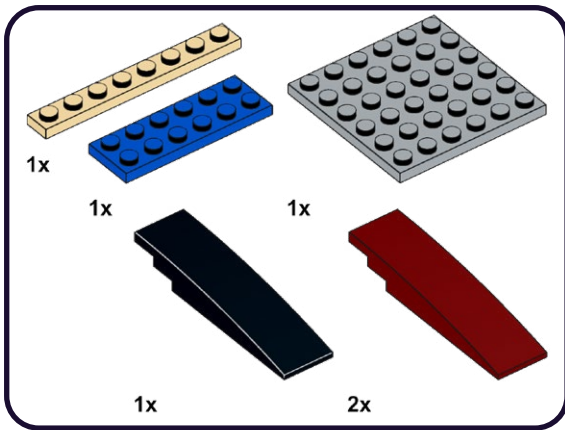

1

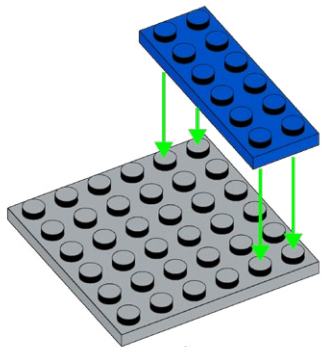

2

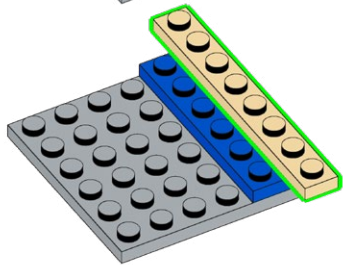

3

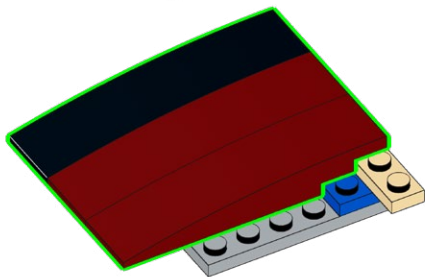

145

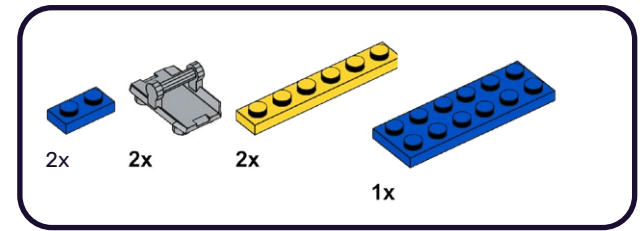

1

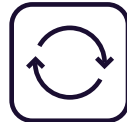
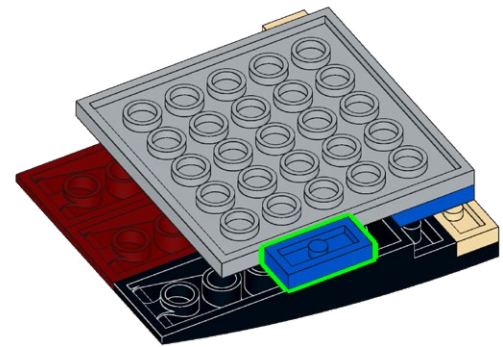

2

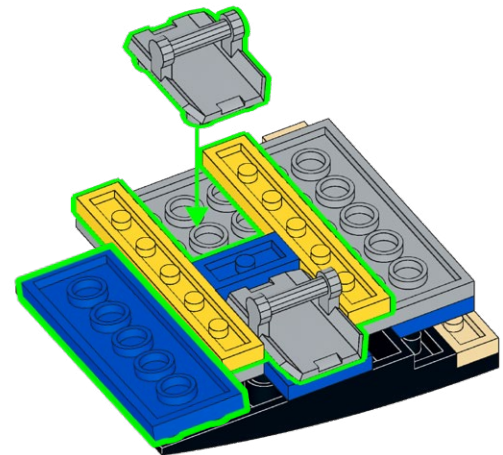

146

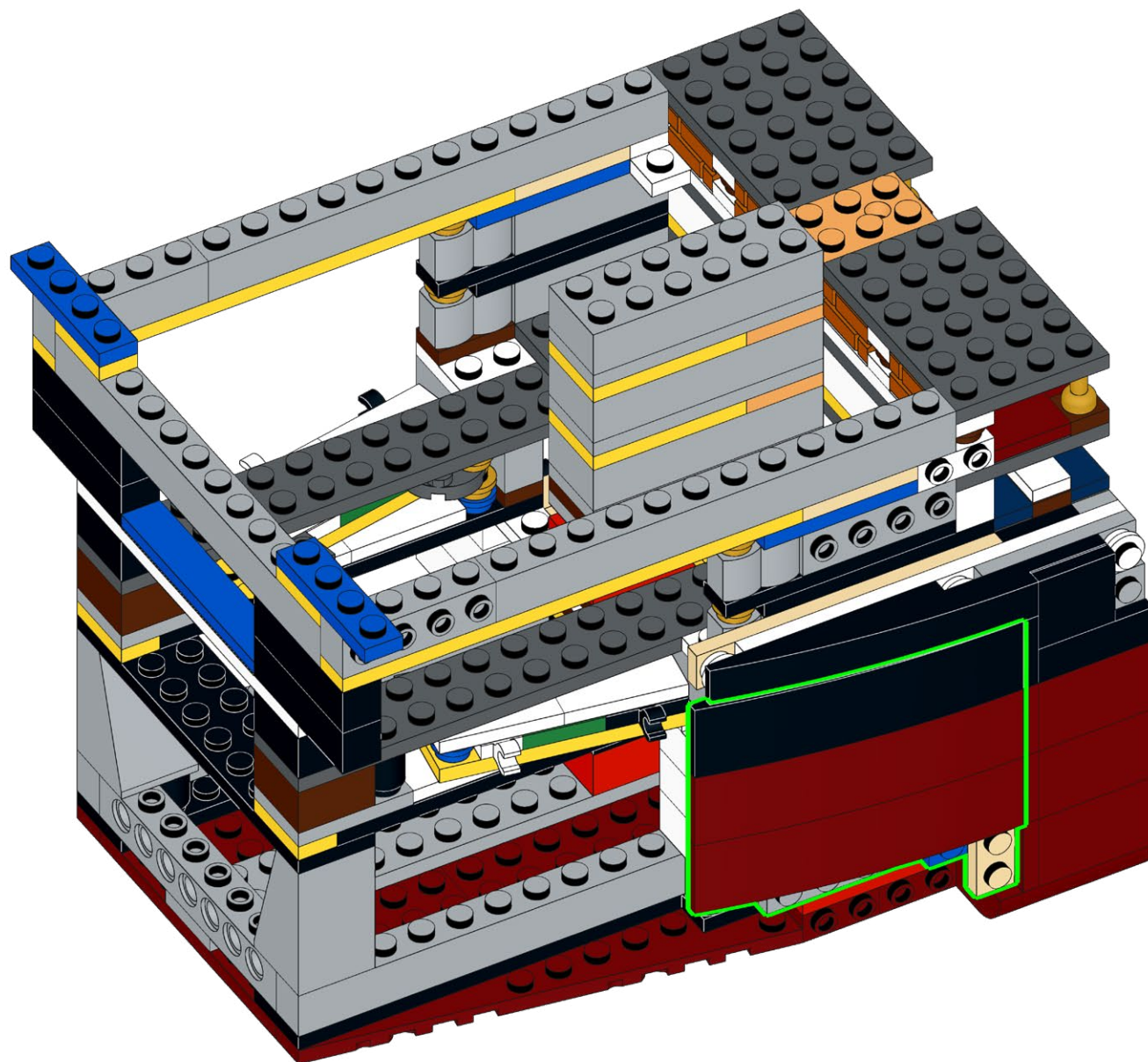

147

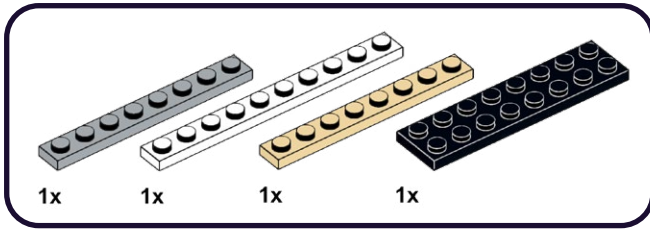

1

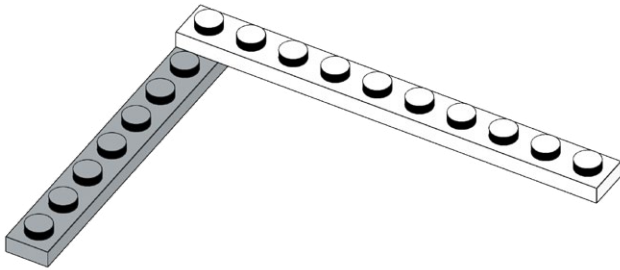

2

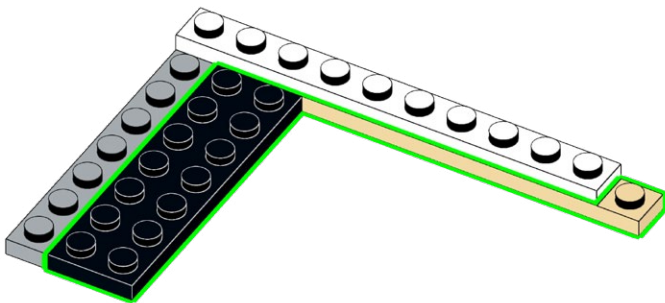

148

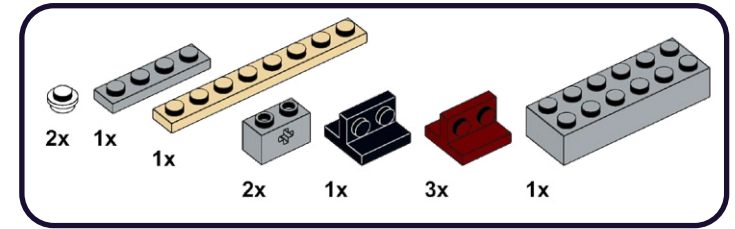

1

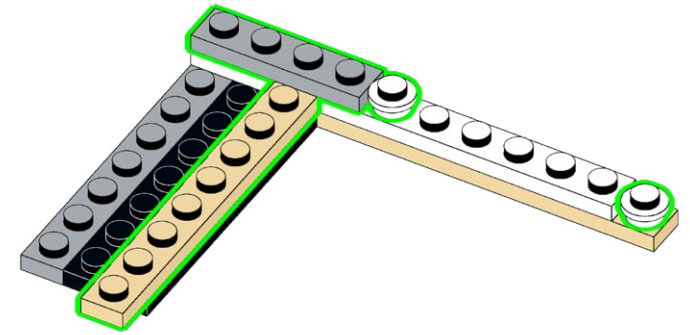

2

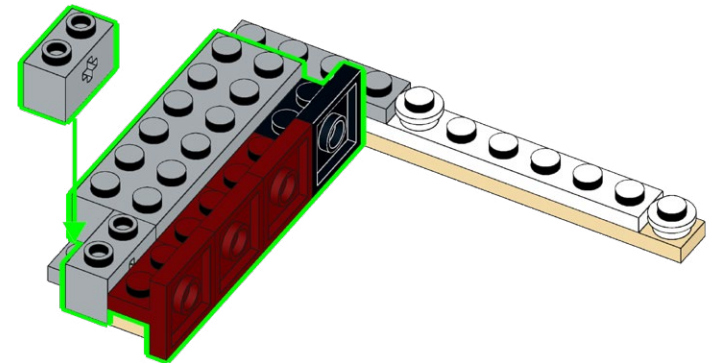

149

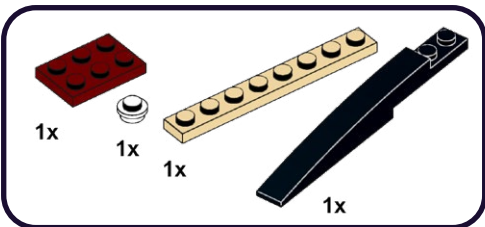

1

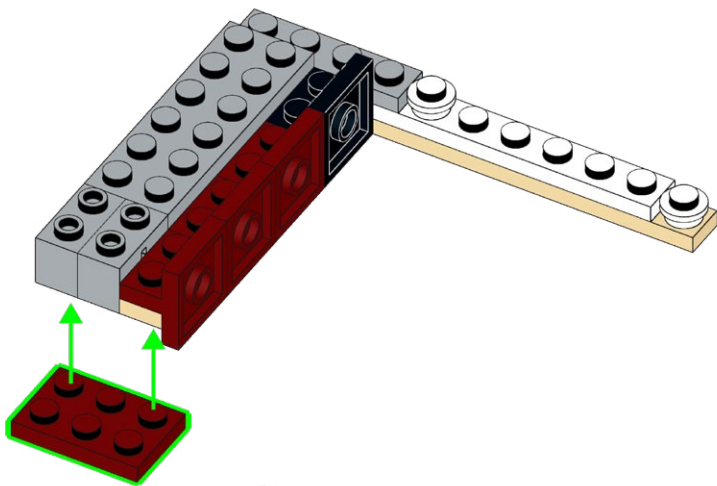

2

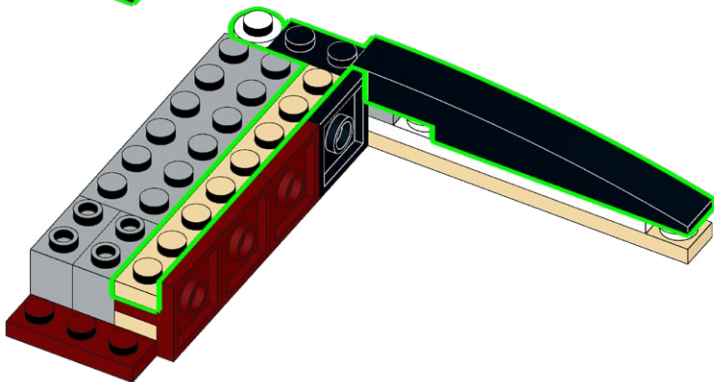

150

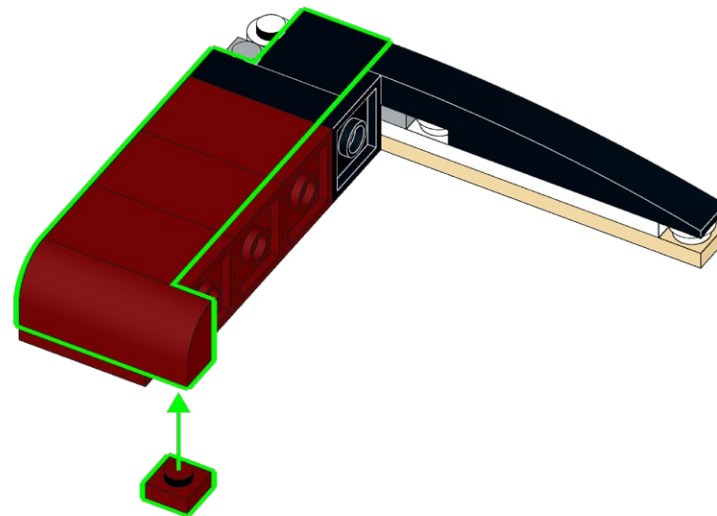
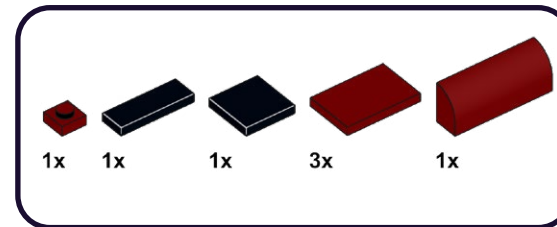

151

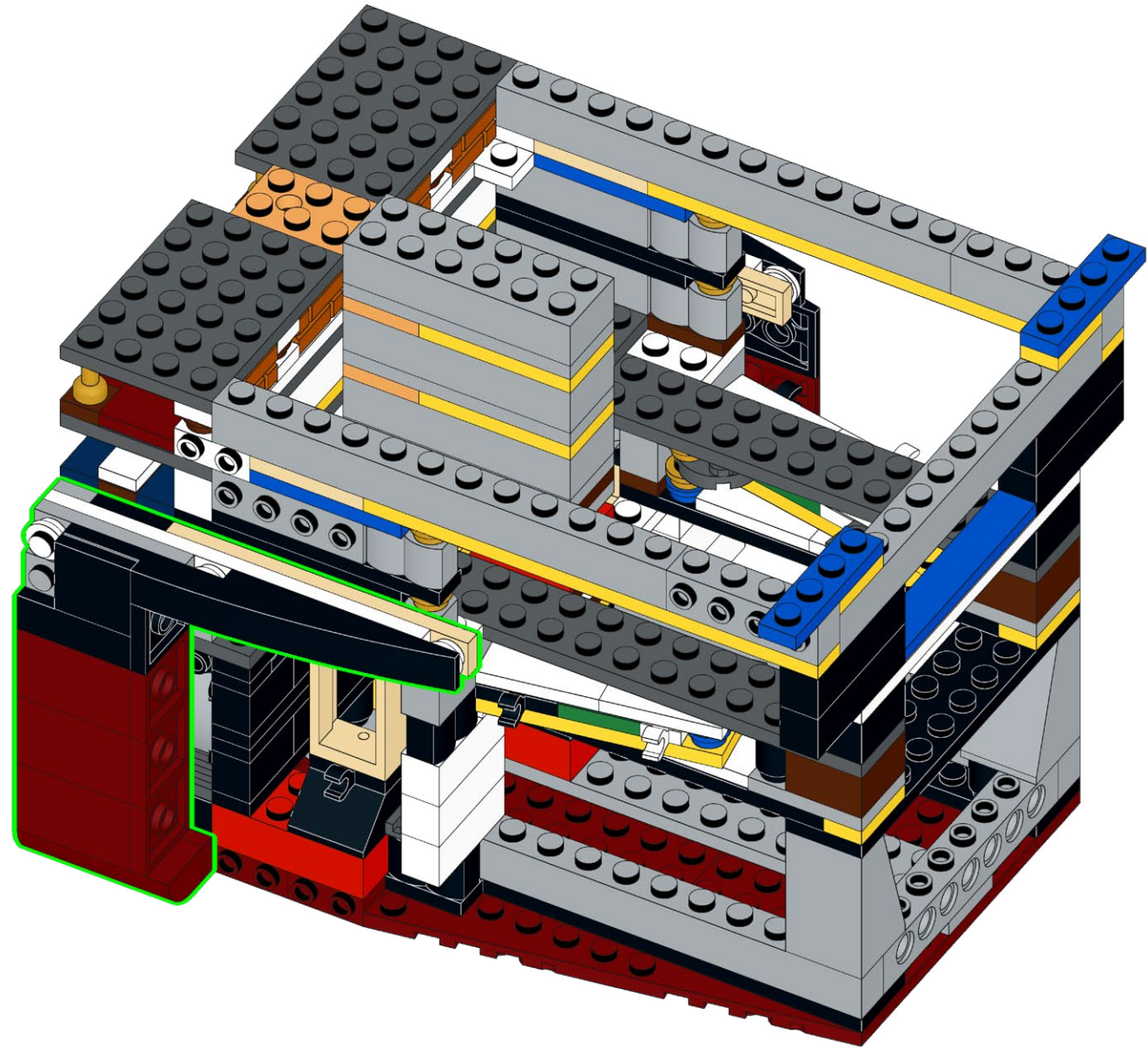

152

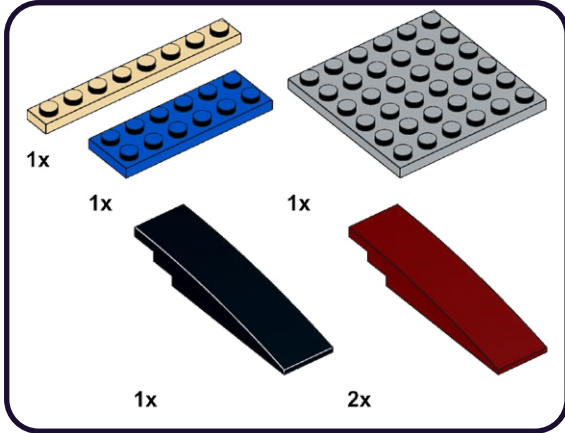

1

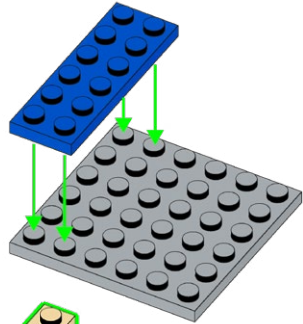

2

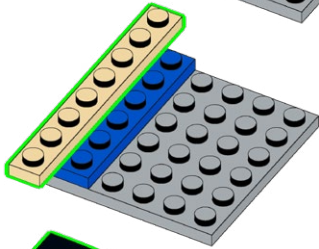

3

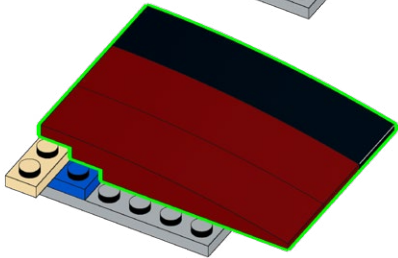

153

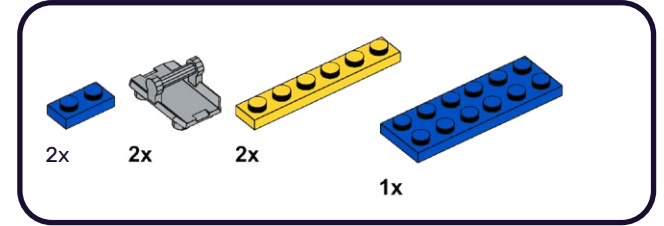

1

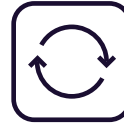
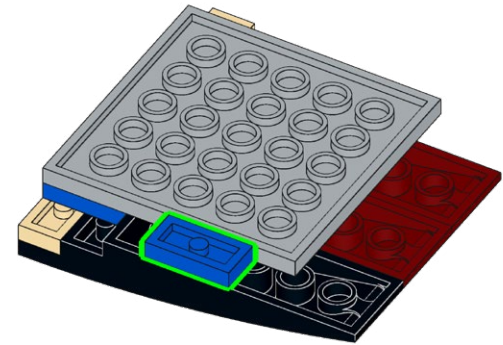

2

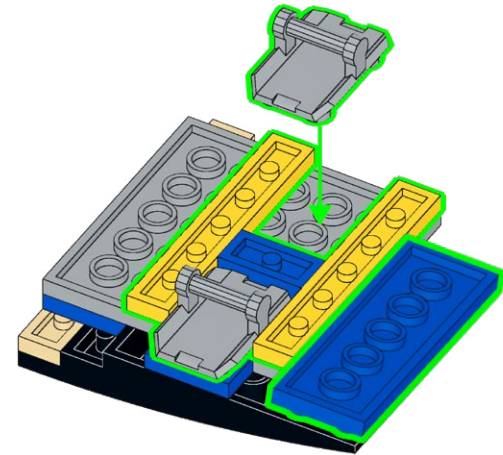

154

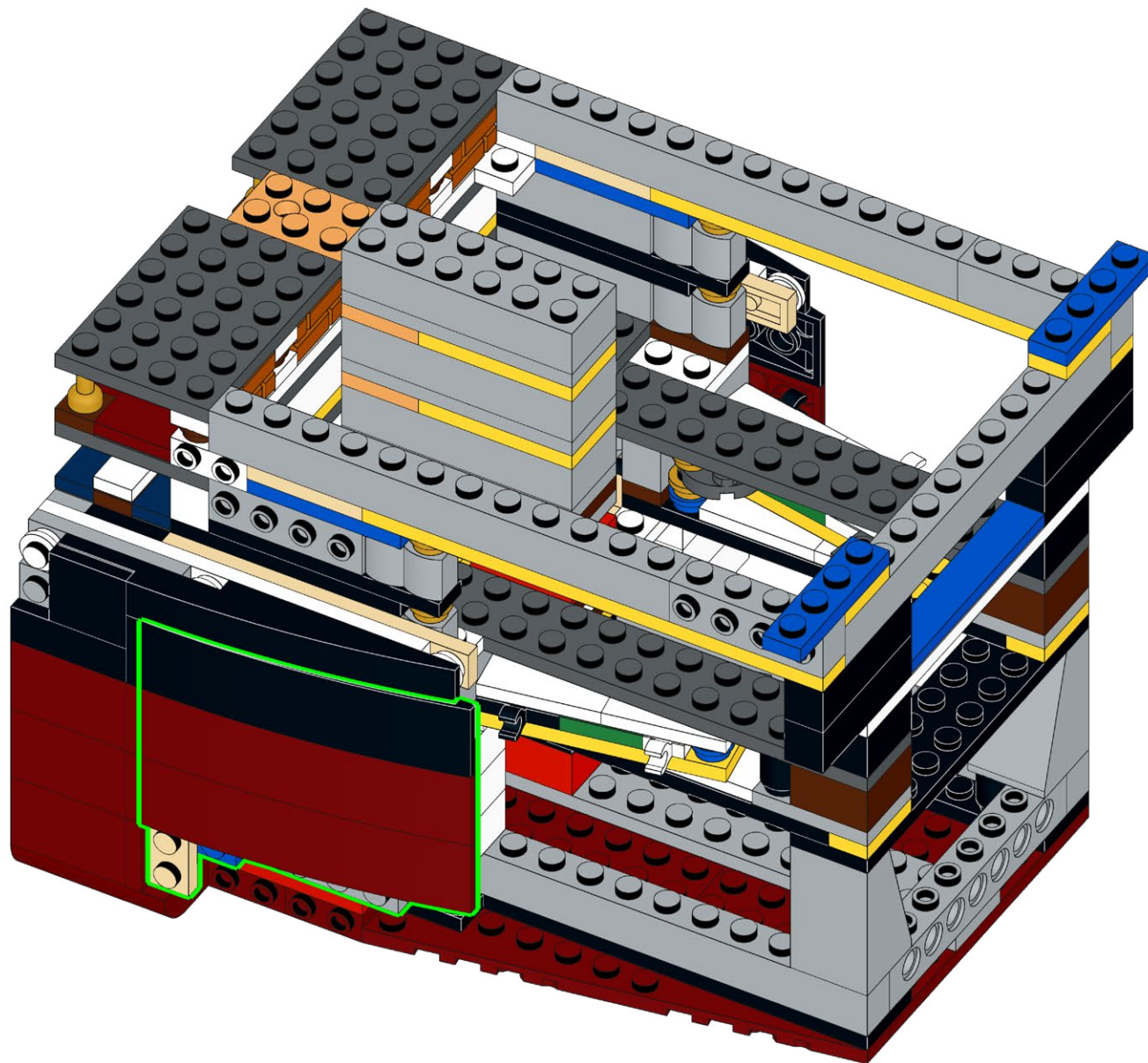

155

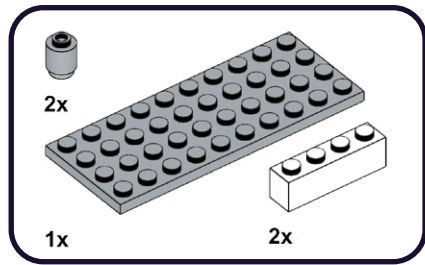

1

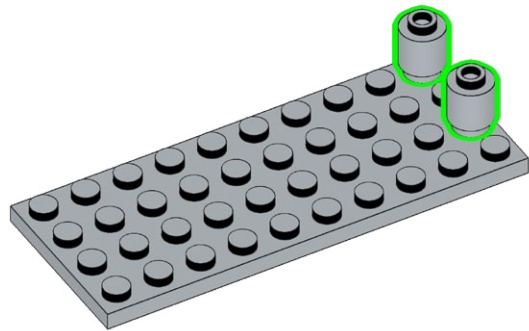

2

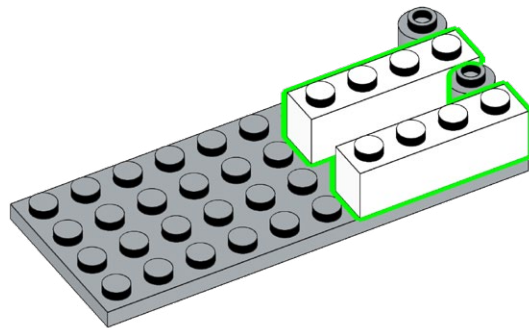

156

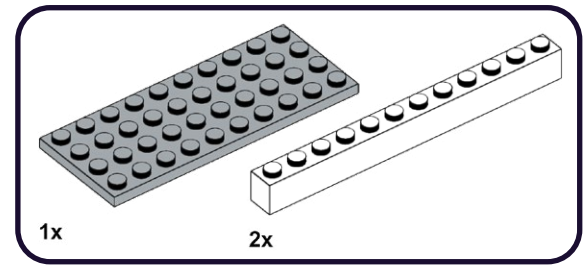

1

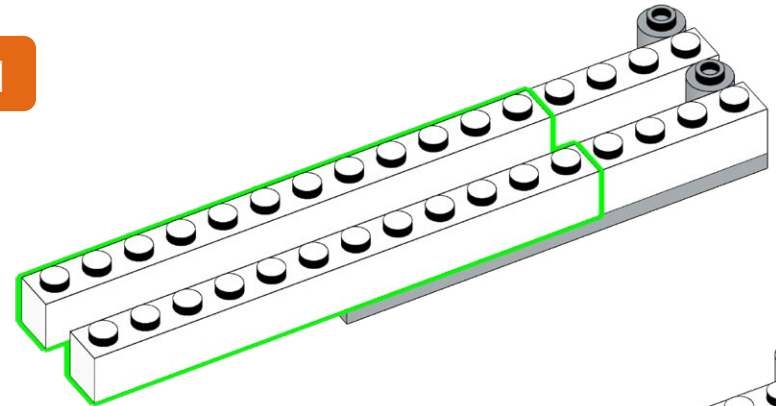

2

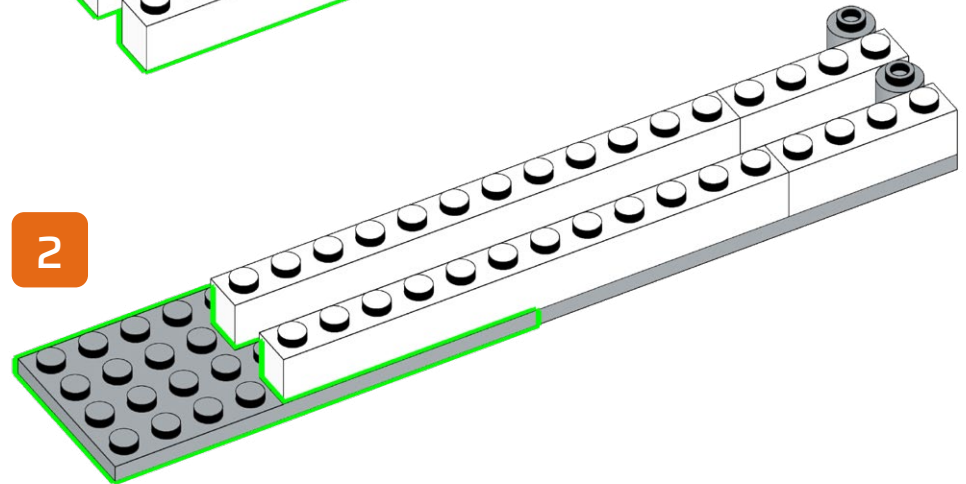

157

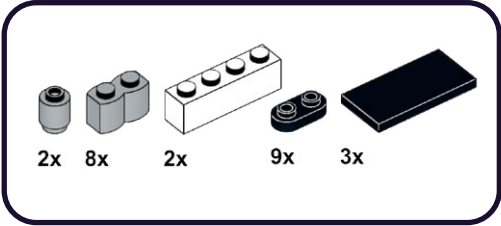

1

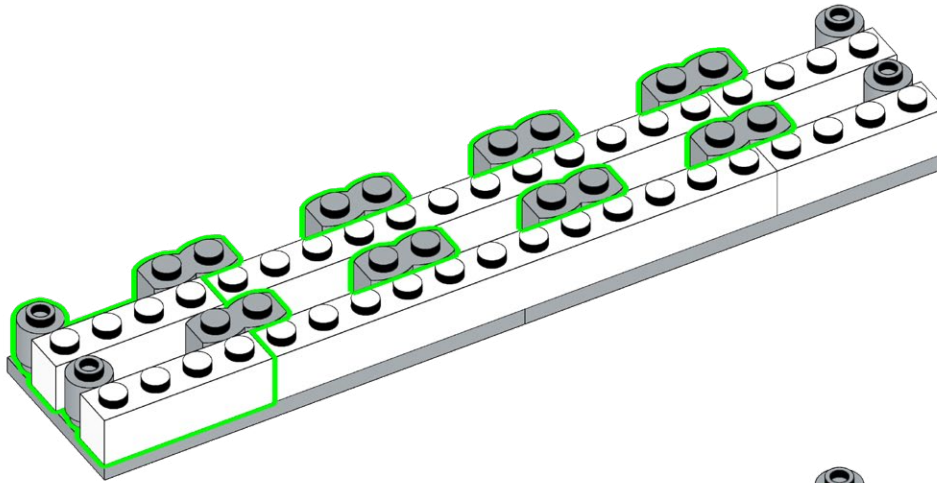

2

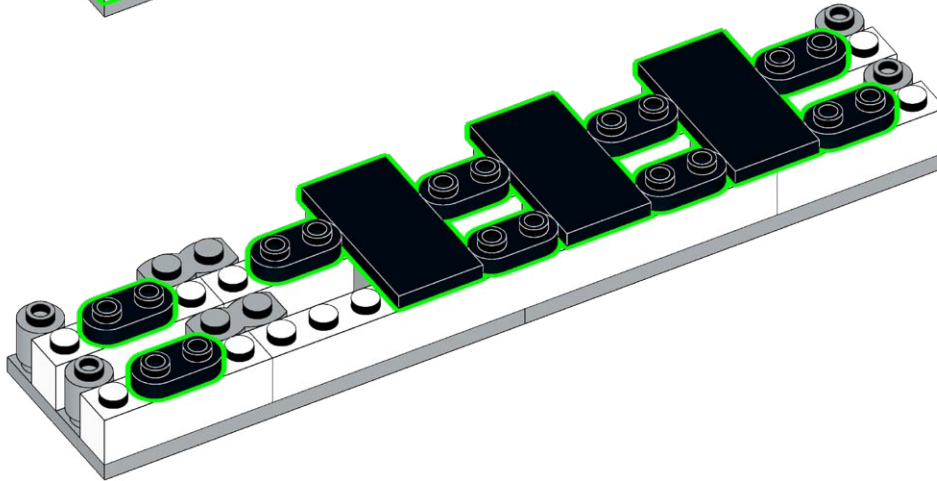

158

4x

18x

10x

1

4x

2

1

2

5x

159

AM-WW30

1x

1x

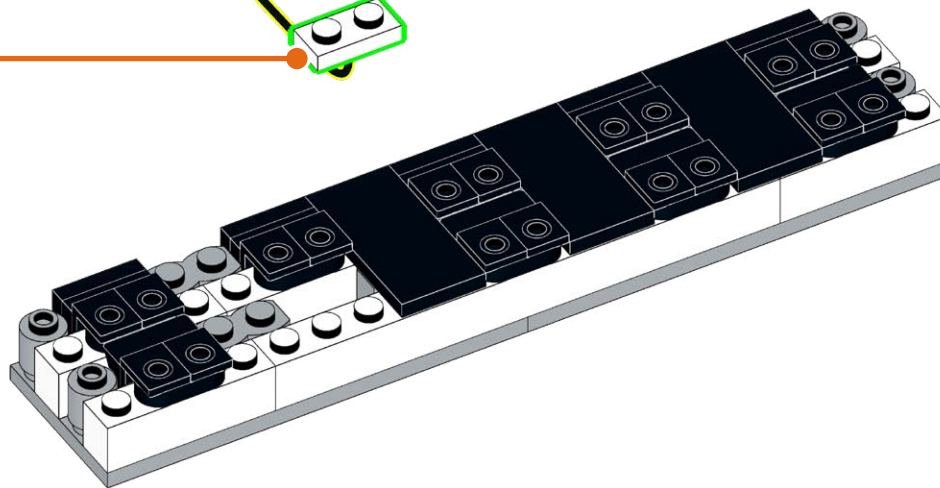
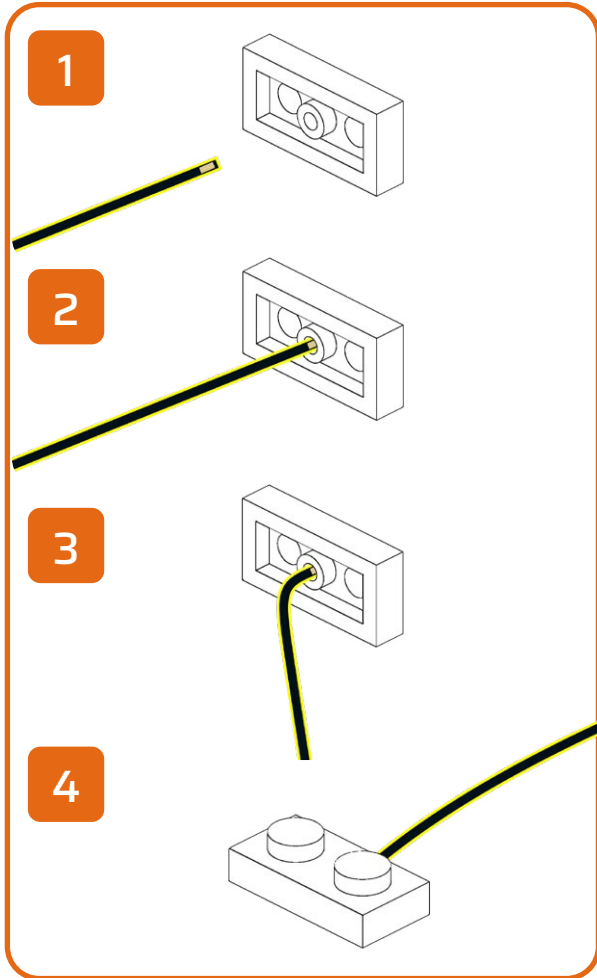

160

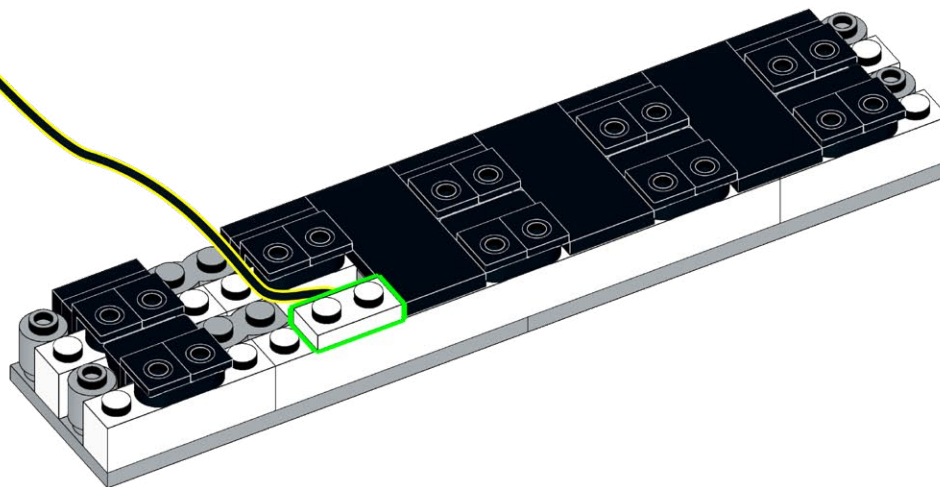

161

1x

2x

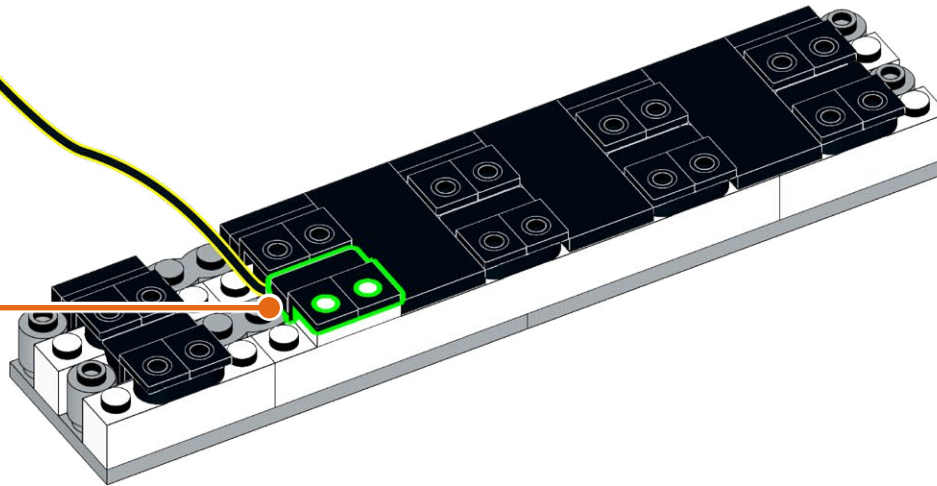
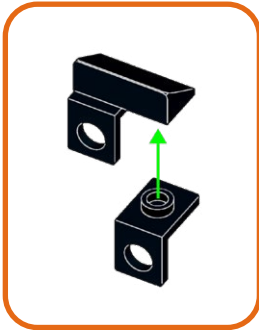

162

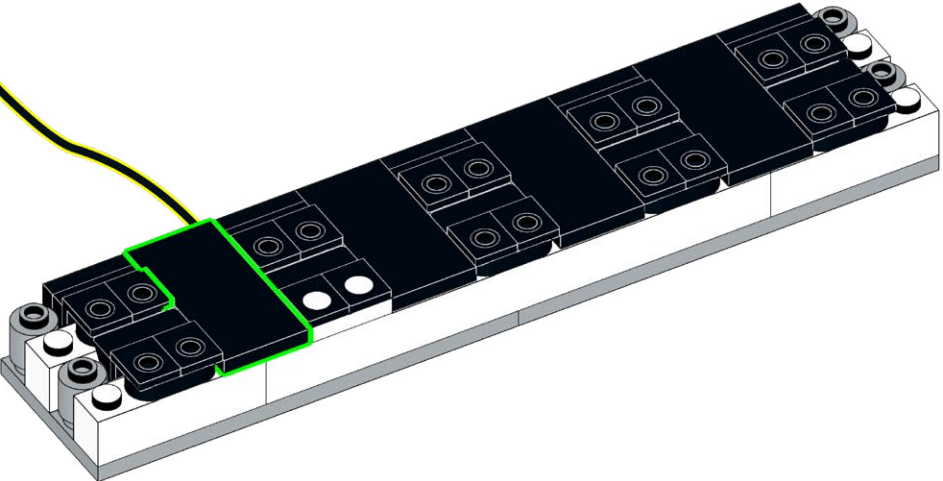
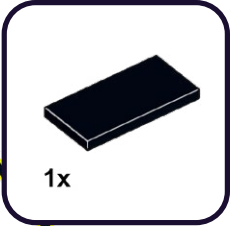

163

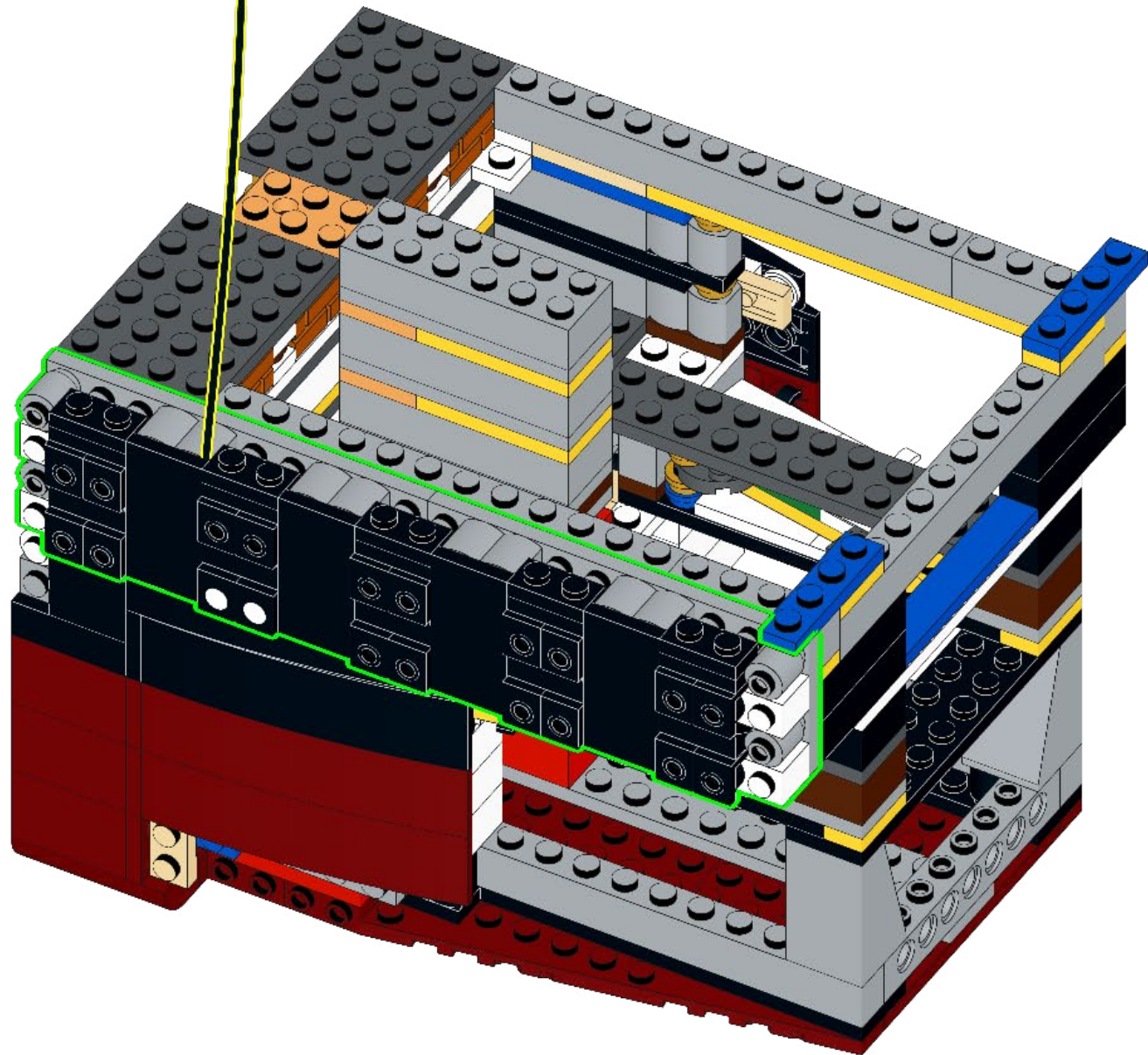

164

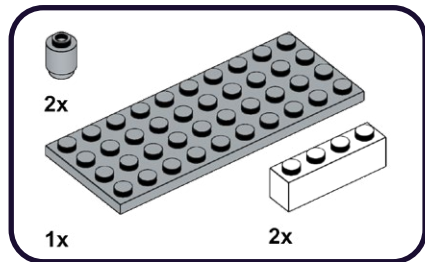

1

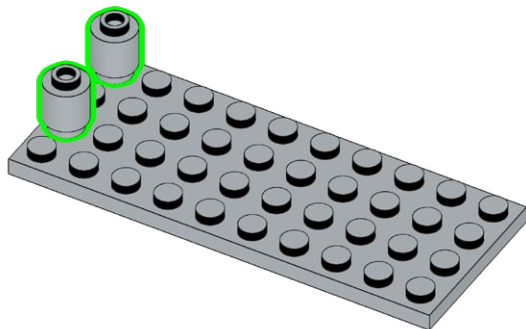

2

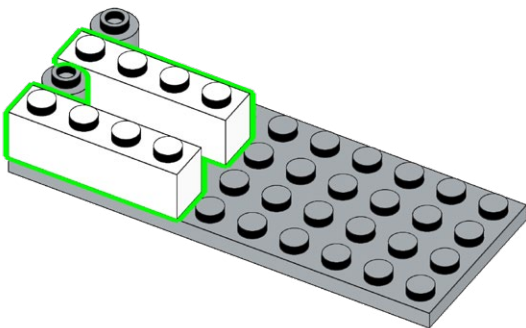

165

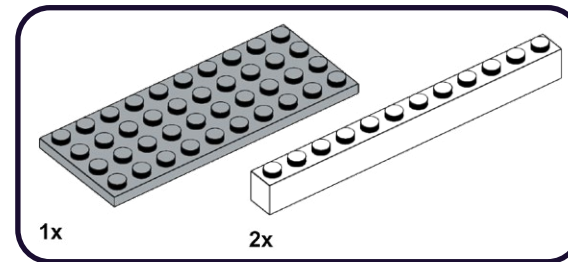

1

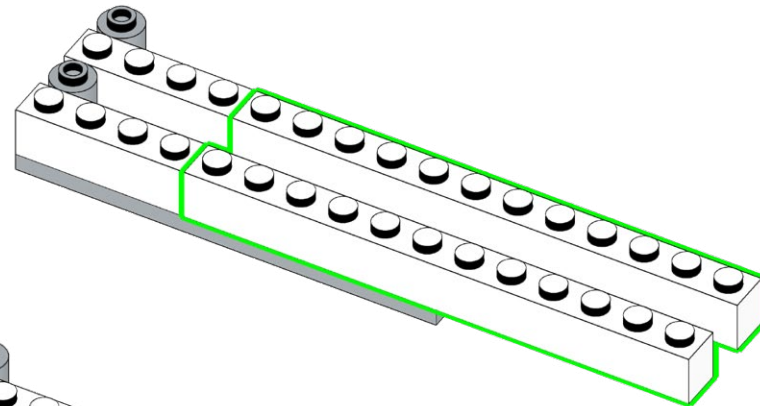

2

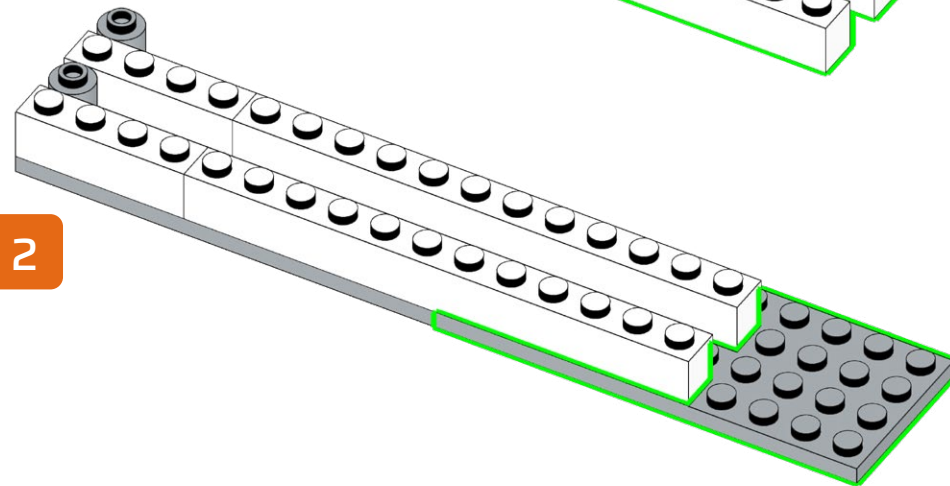

166

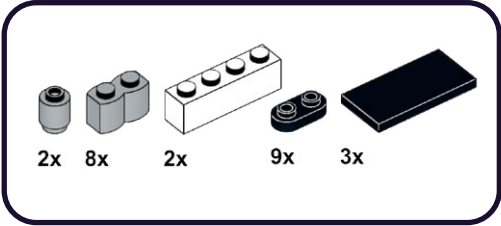

1

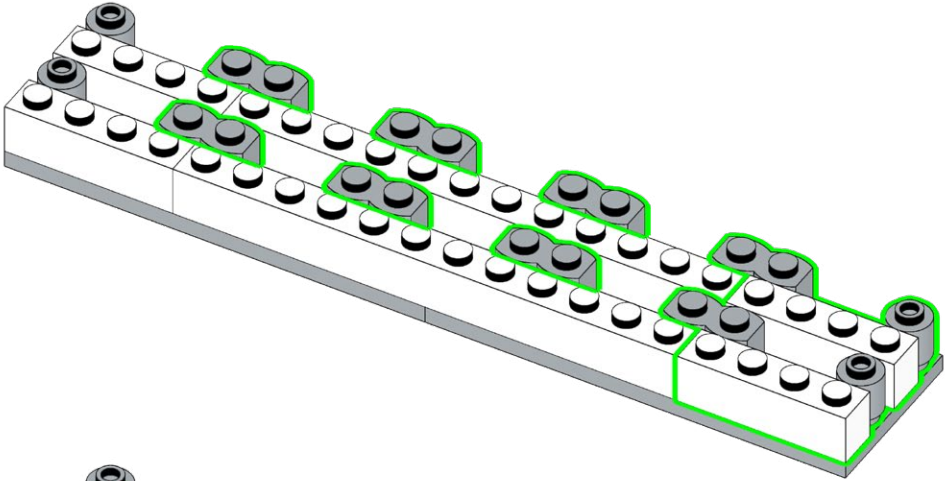

2

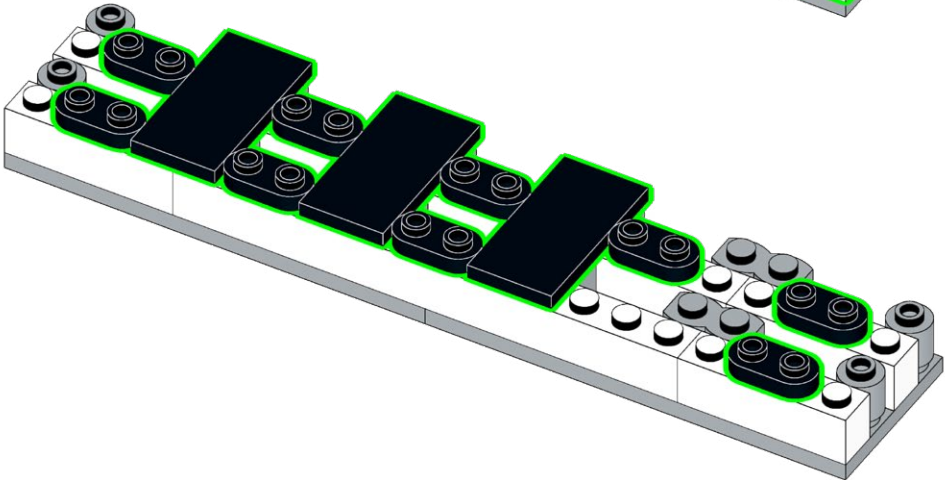

167

4x

18x

10x

1

4x

2

1

2

5x

168

AM-WW30

1x

1x

1

2

3

4

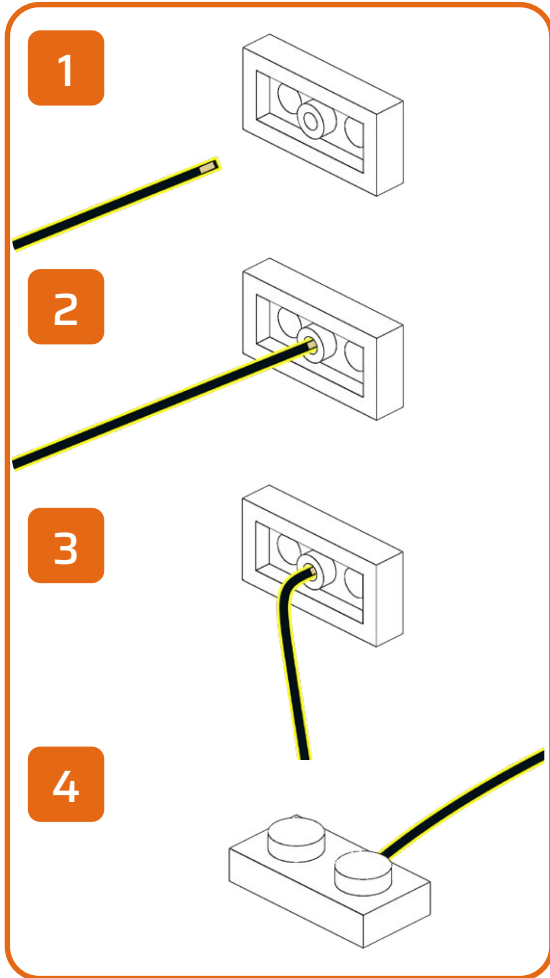
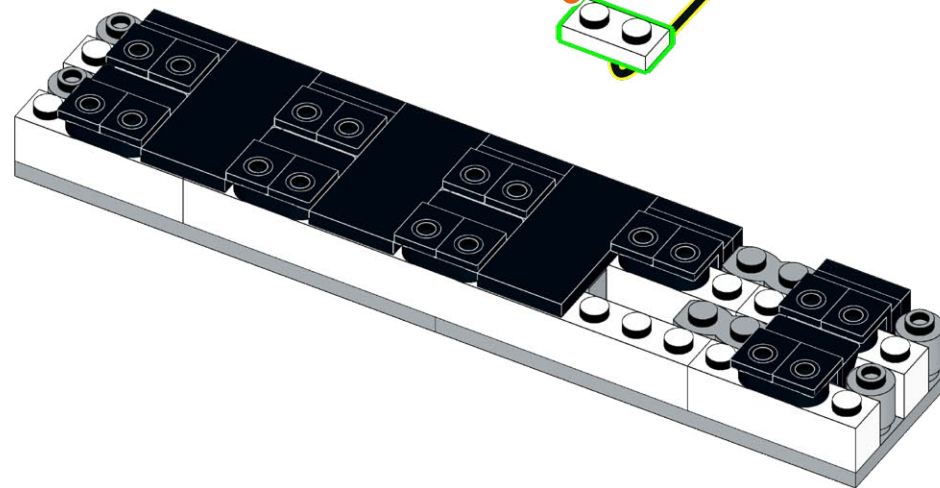

169

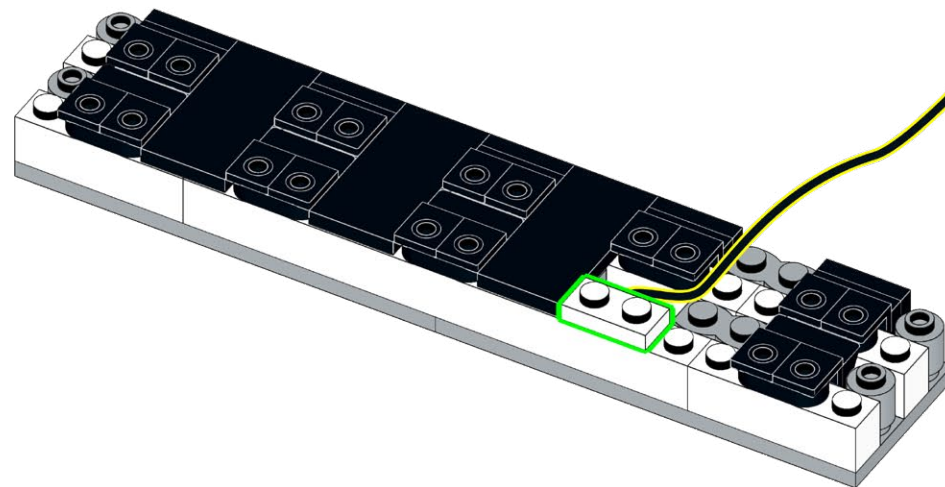

170

1x

2x

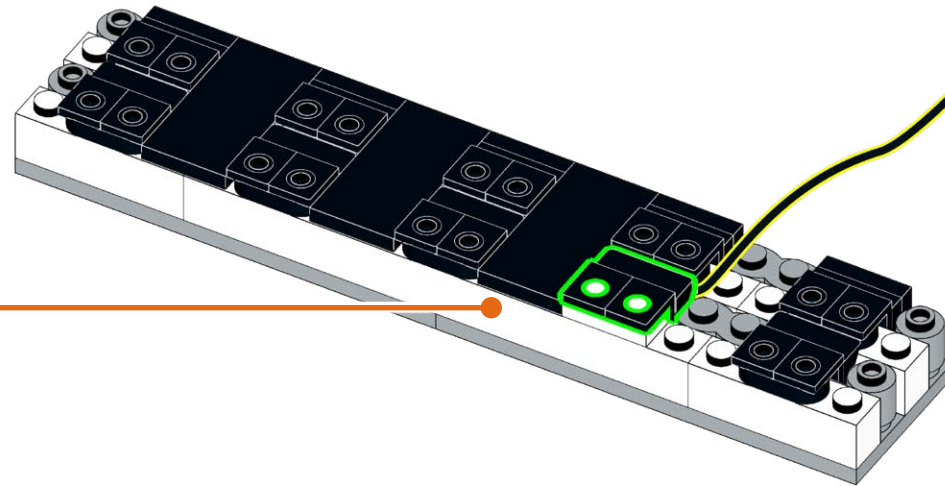
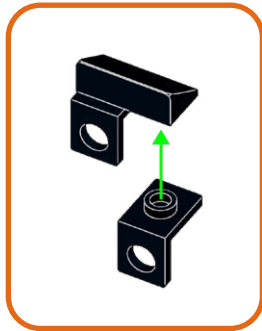

171

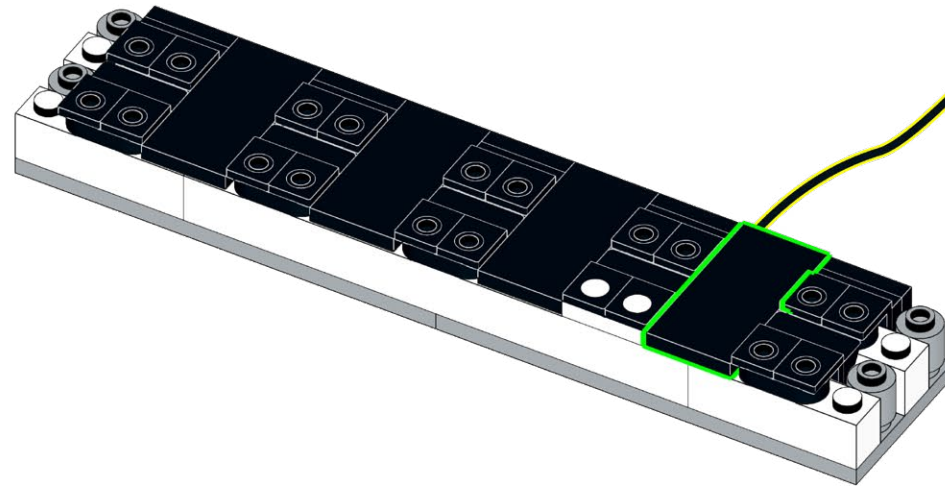
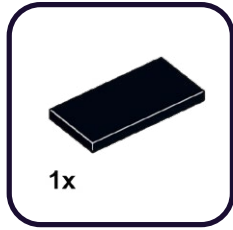

172

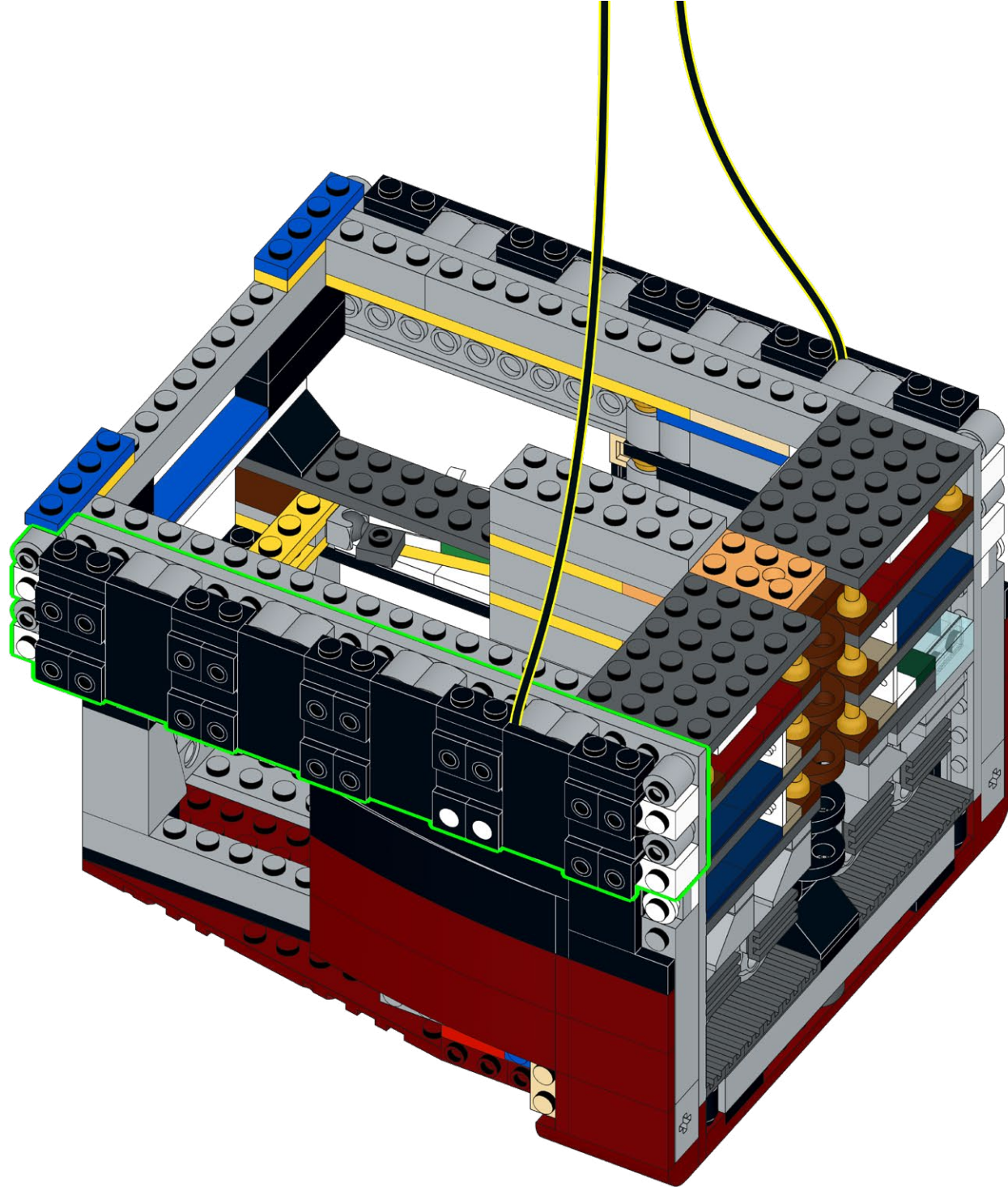

173

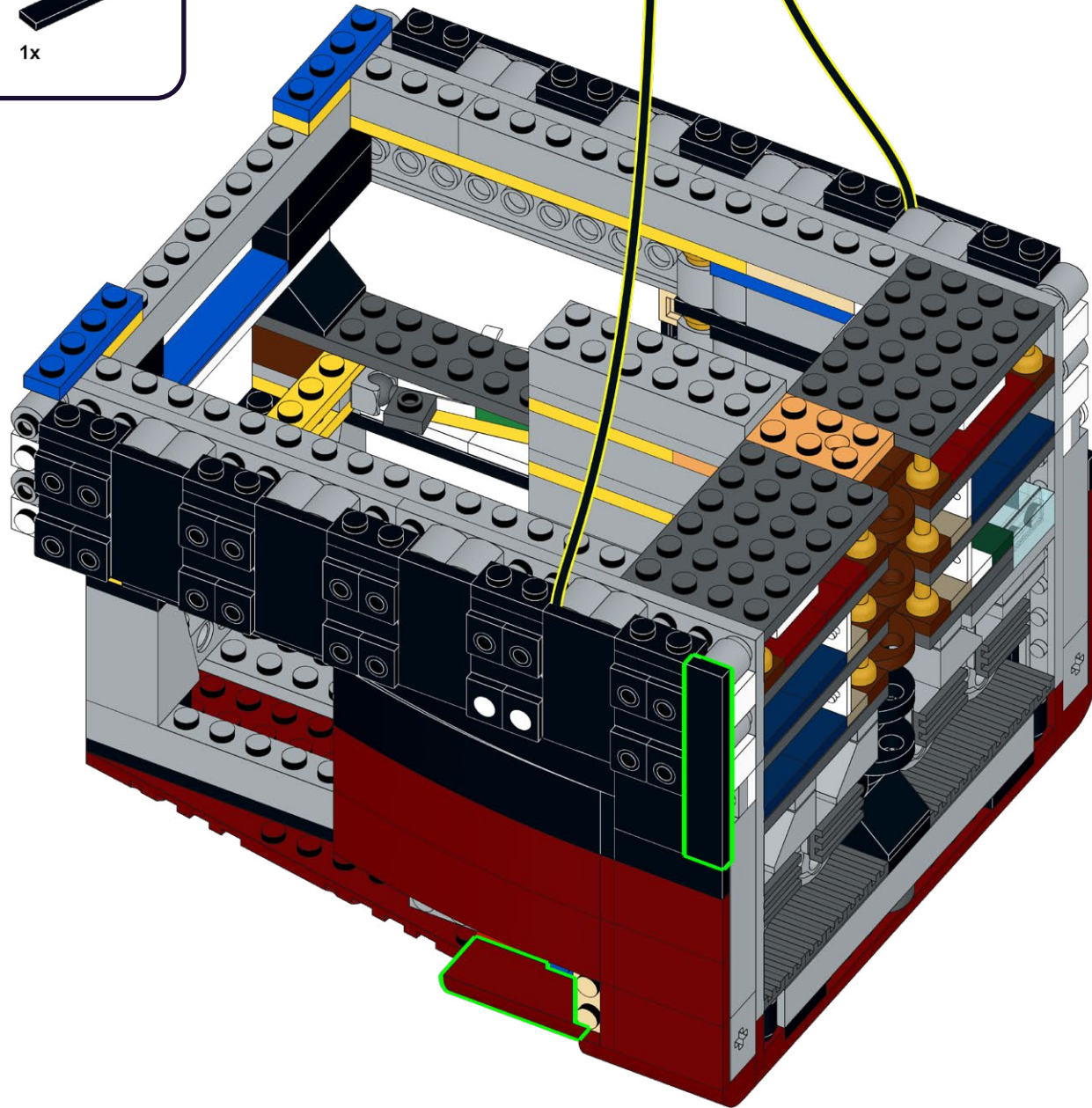
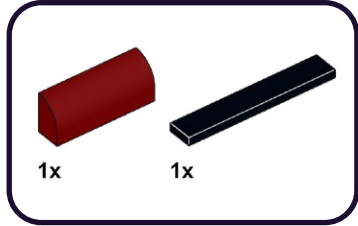

174

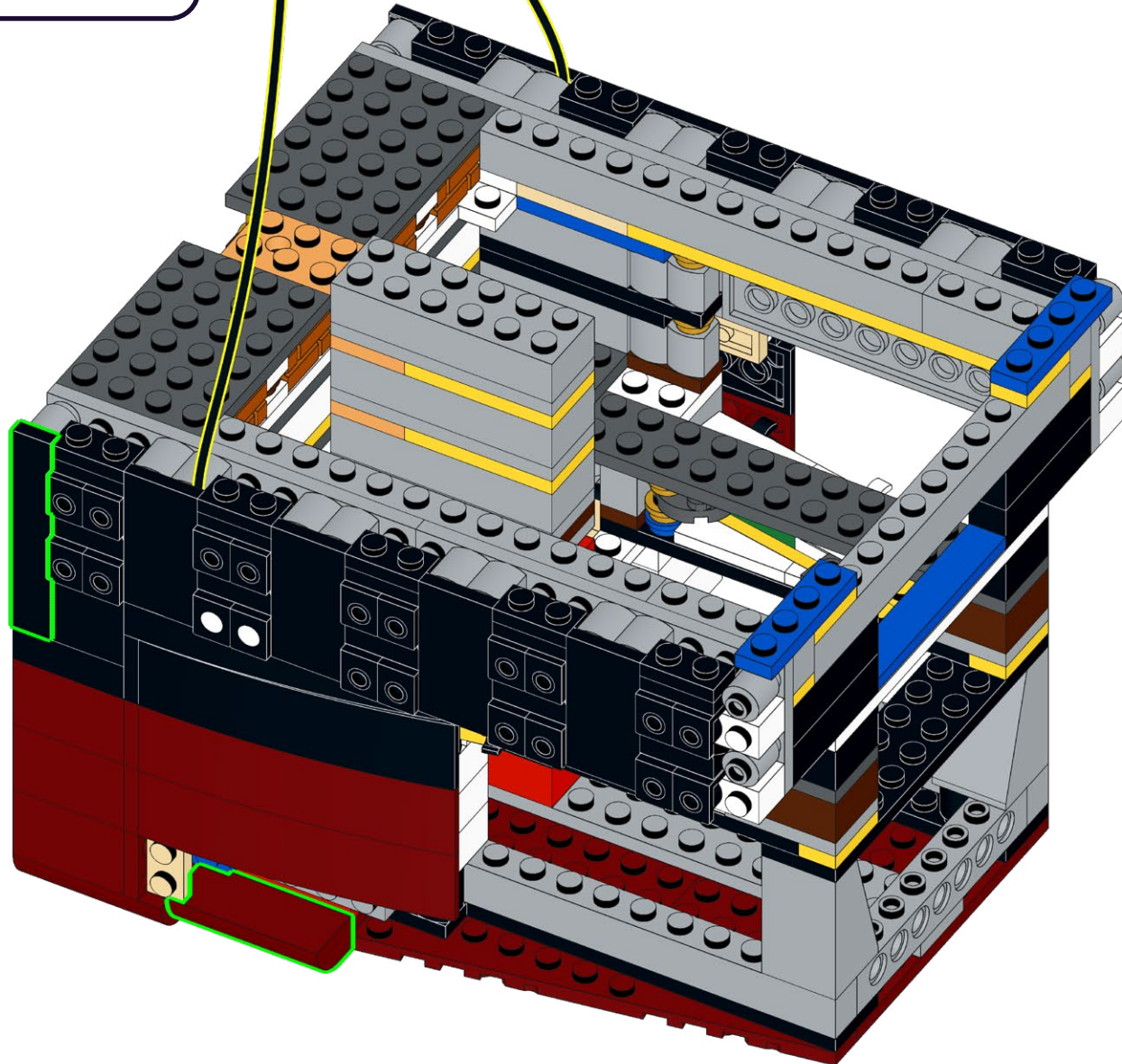
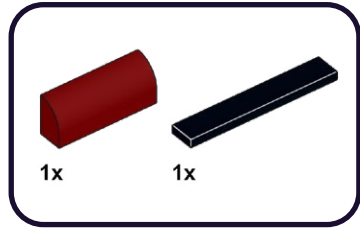

**HOLD UP!**

You might notice some bags aren't in order, as well as left over pieces, but that's ok! We're changing the way you build LEGO!

ATTENDEZ!

Vous remarquerez peut-être que certains sacs, ainsi que certaines pièces, ne sont pas dans le bon ordre. Mais pas de panique! Nous changeons simplement la façon avec laquelle vous construisez vos LEGO!

ASPETTA!

Potresti notare che alcuni sacchetti non sono in ordine, così come i pezzi avanzati, ma va bene così! Stiamo cambiando il modo in cui costruisci i LEGO!

HALT!

Sie werden möglicherweise bemerken, dass einige tüten durcheinander sind und teile übrig bleiben, aber das ist in Ordnung! Wir ändern die art und weise, wie Sie LEGO bauen!

¡ESPERA!

Es posible que notes que algunas bolsas están fuera de servicio, así como piezas sobrantes, ¡pero está bien! ¡Estamos cambiando la forma en que construyes LEGO!

暫停!

你可能会注意到一些袋子顺序错乱, 以及一些剩余的部件, 但没关系! 我们正在改变你搭建乐高的方式!

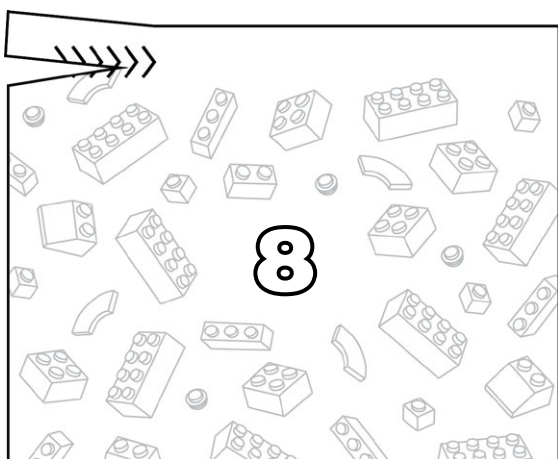
Open LEGO® Bag 8

175

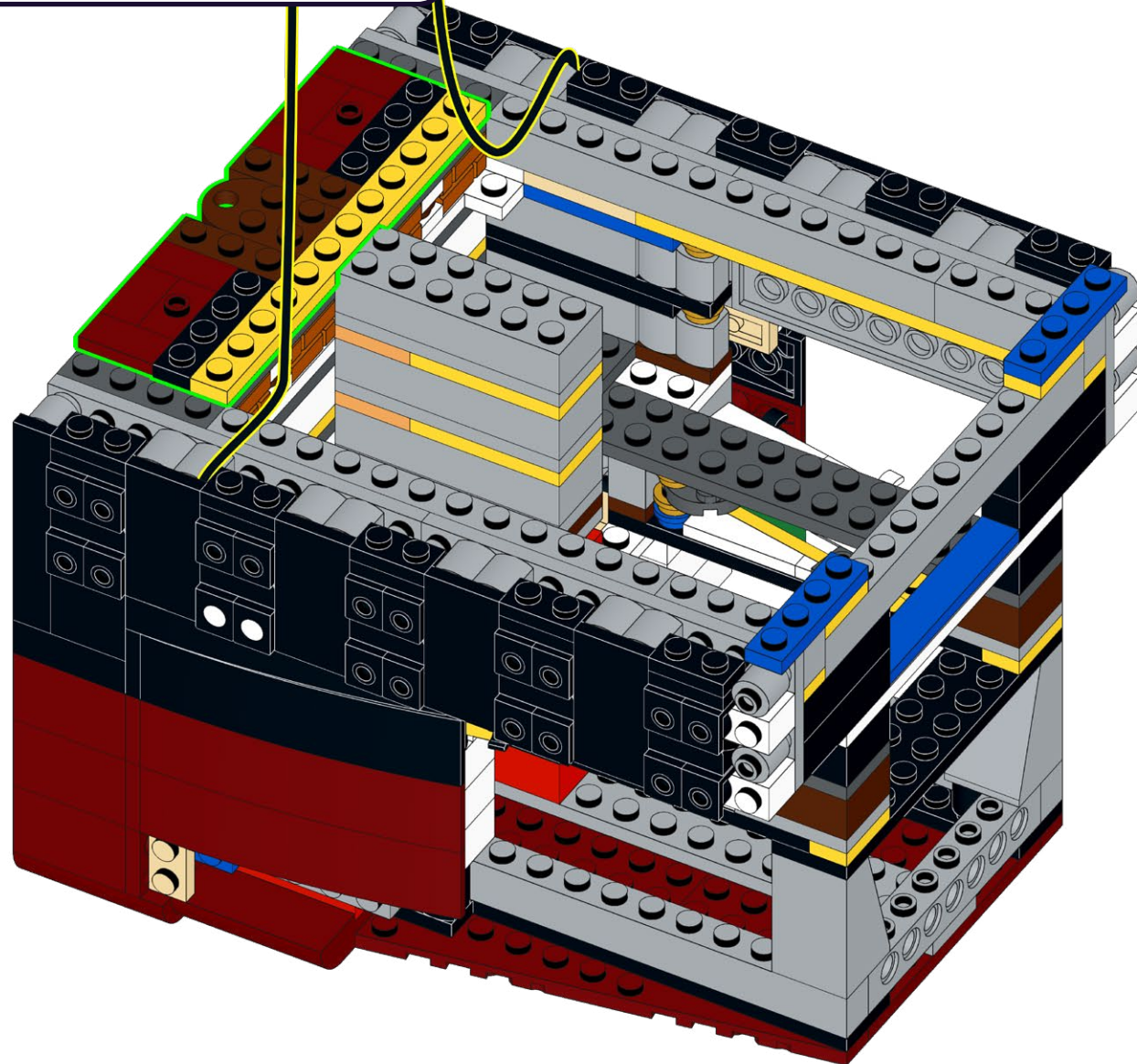
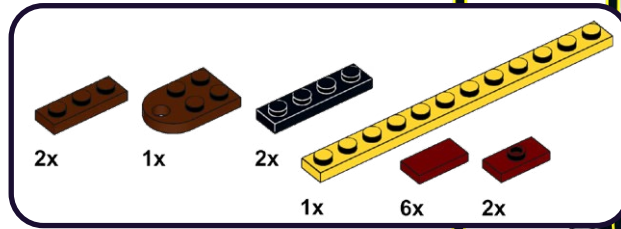

176

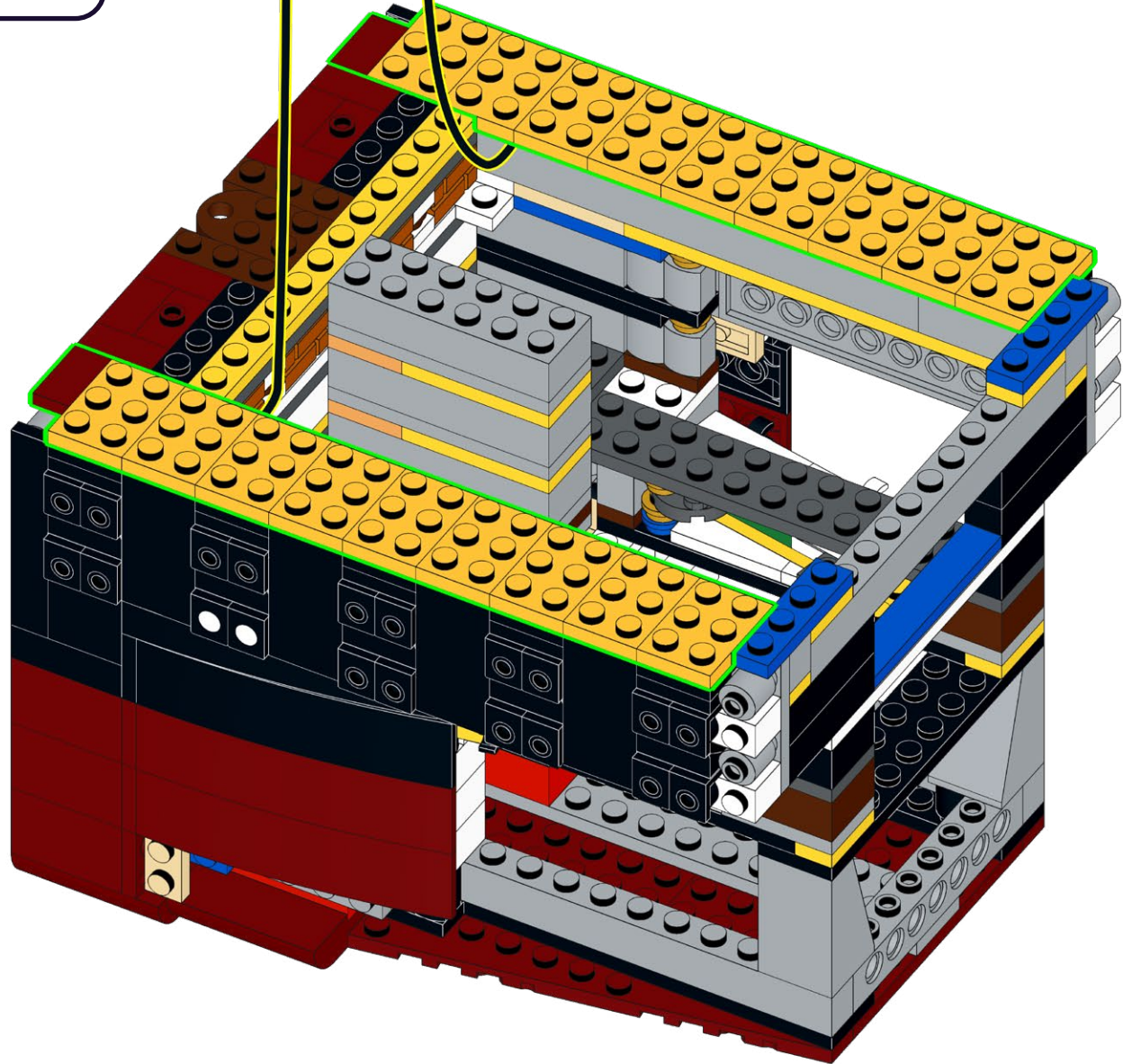
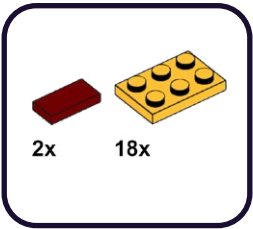

177

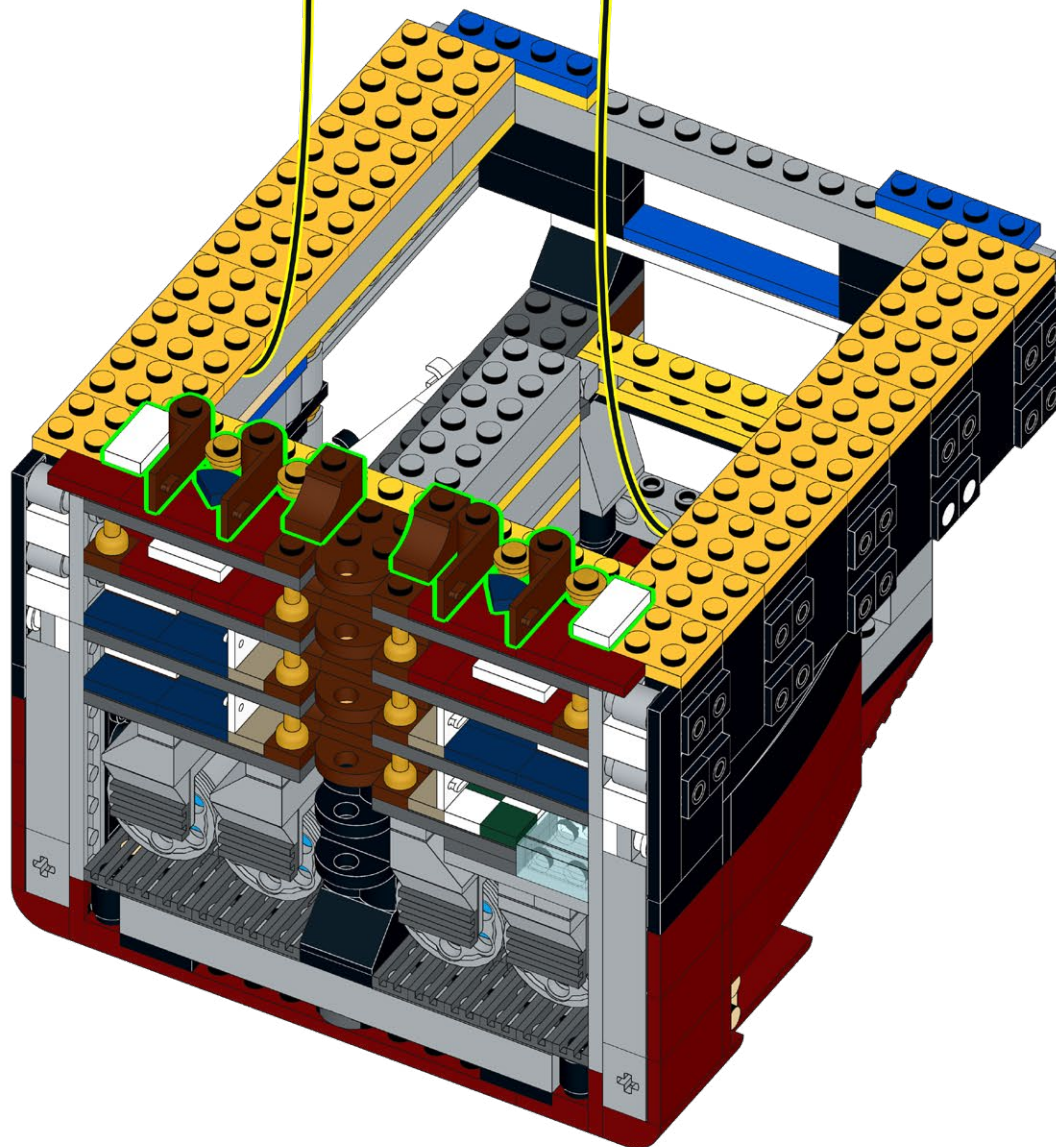
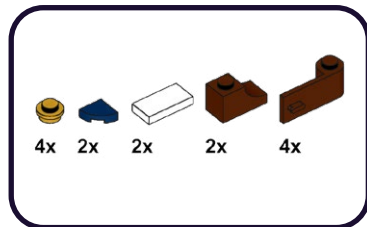

178

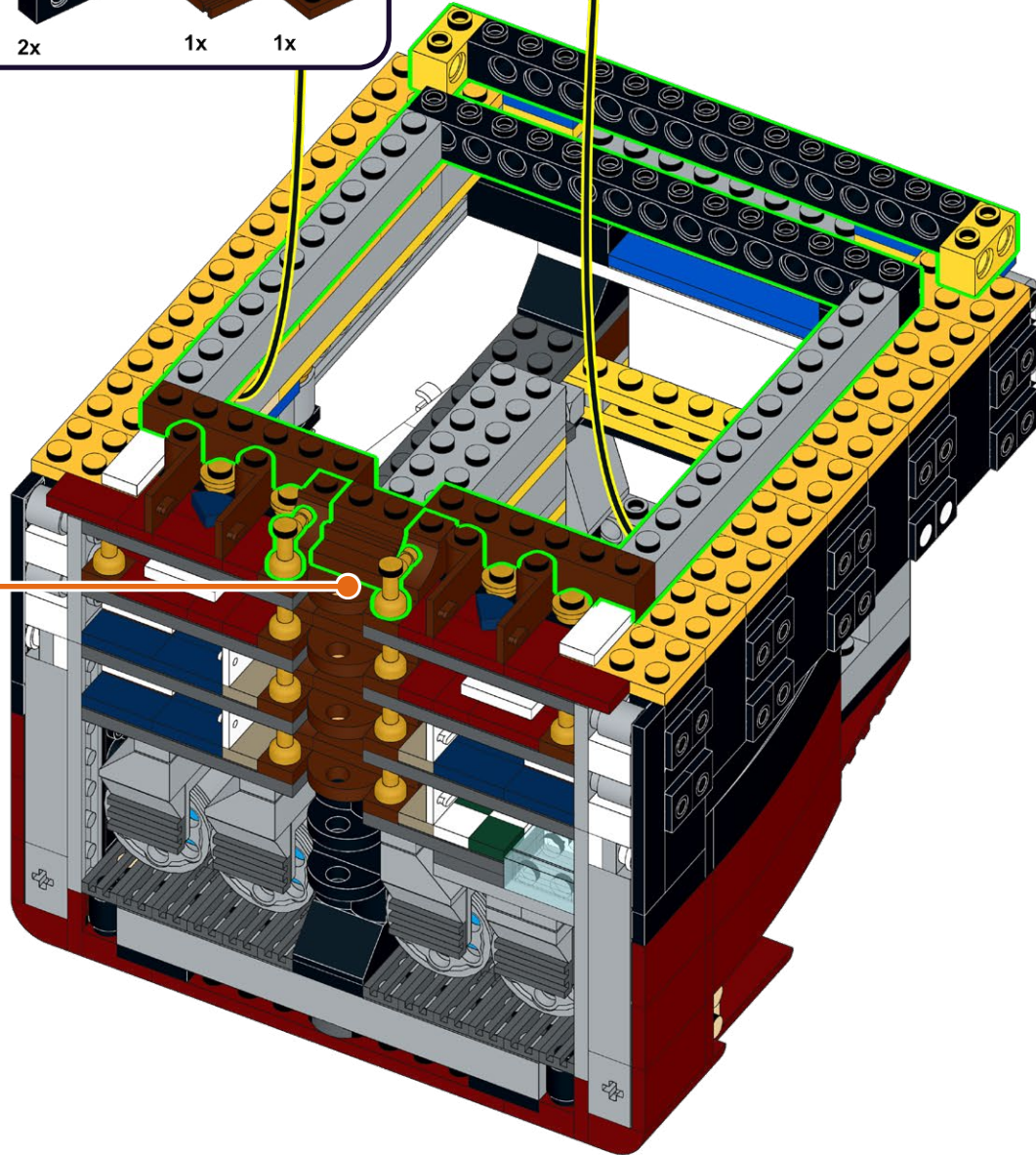
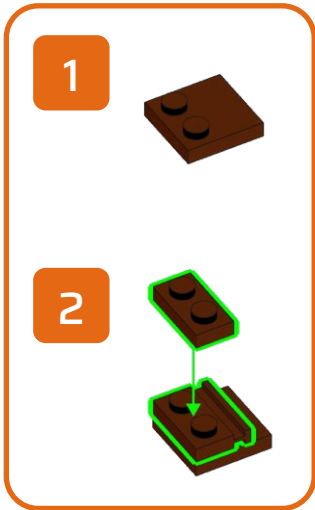
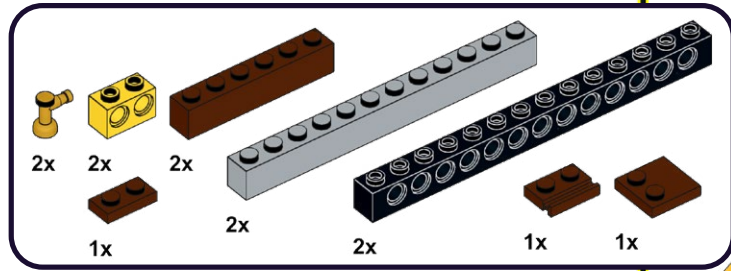

179

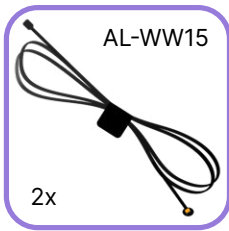

180

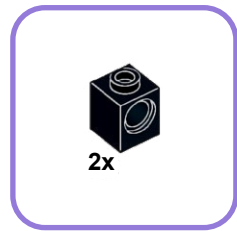

1



2

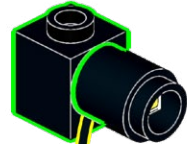

2x

181

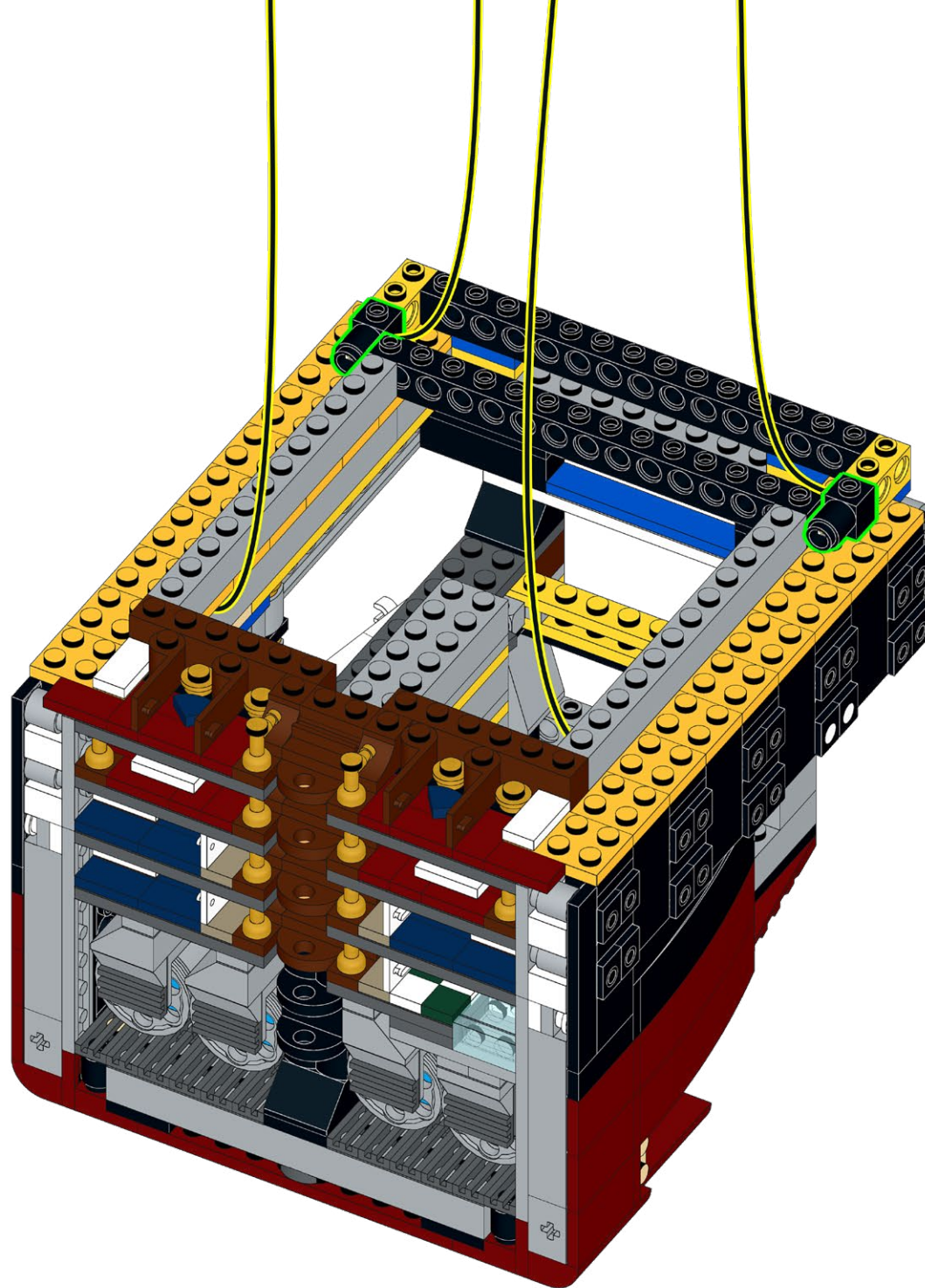

182

2x

2x

2x

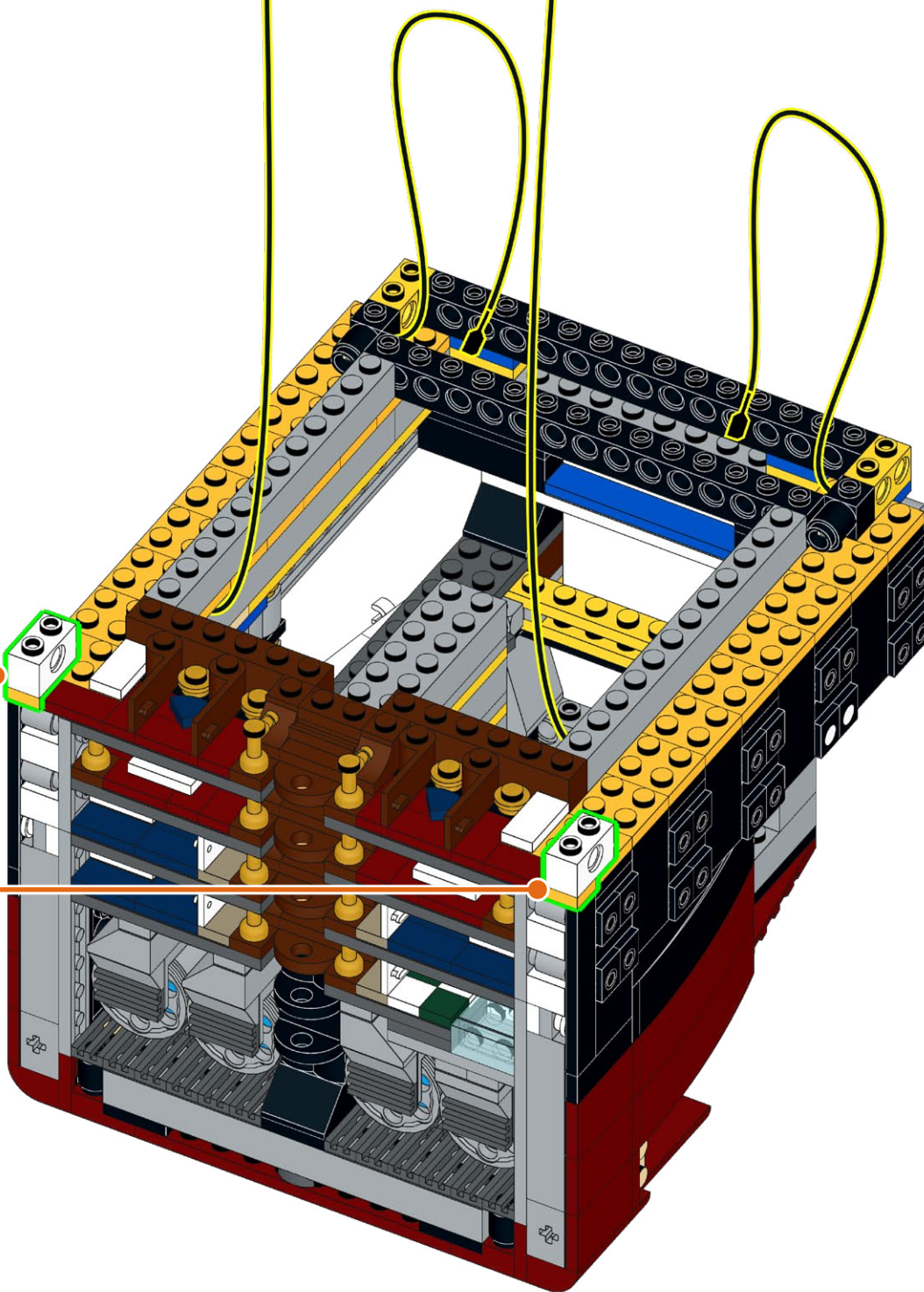

183



14x

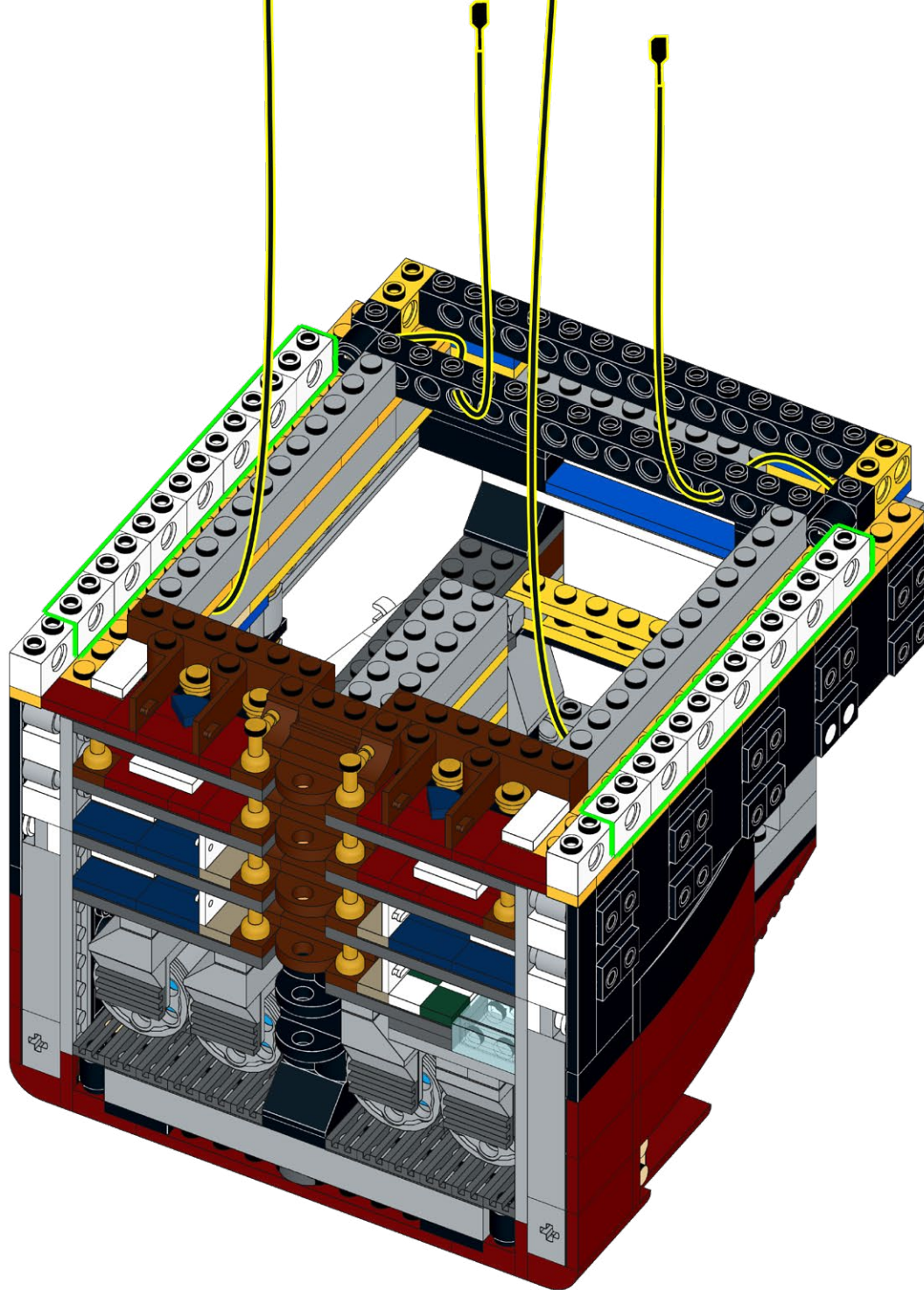

184

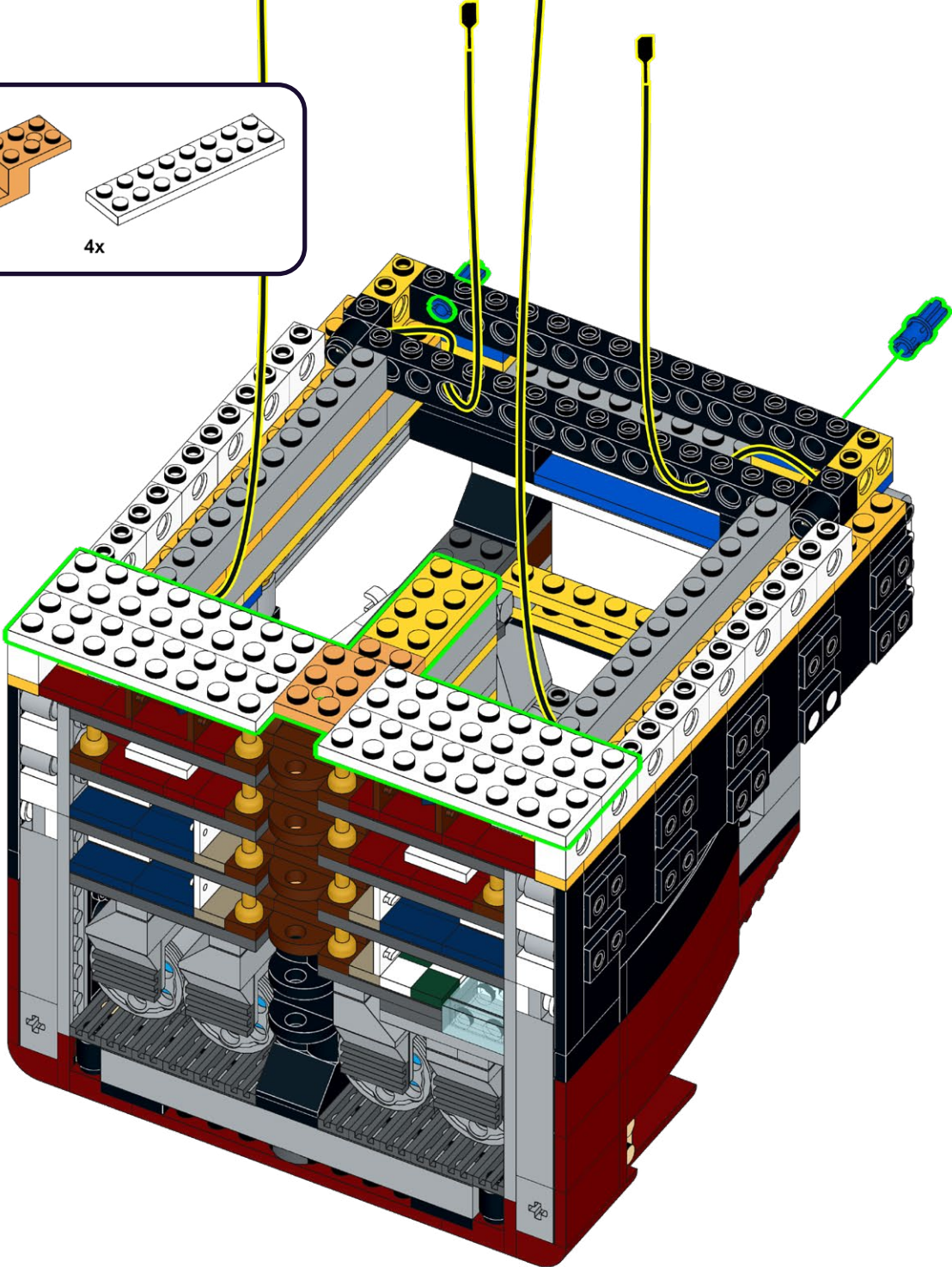
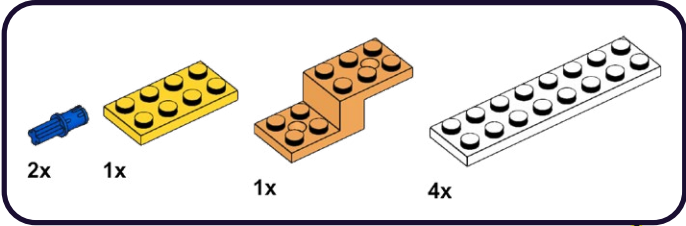

185

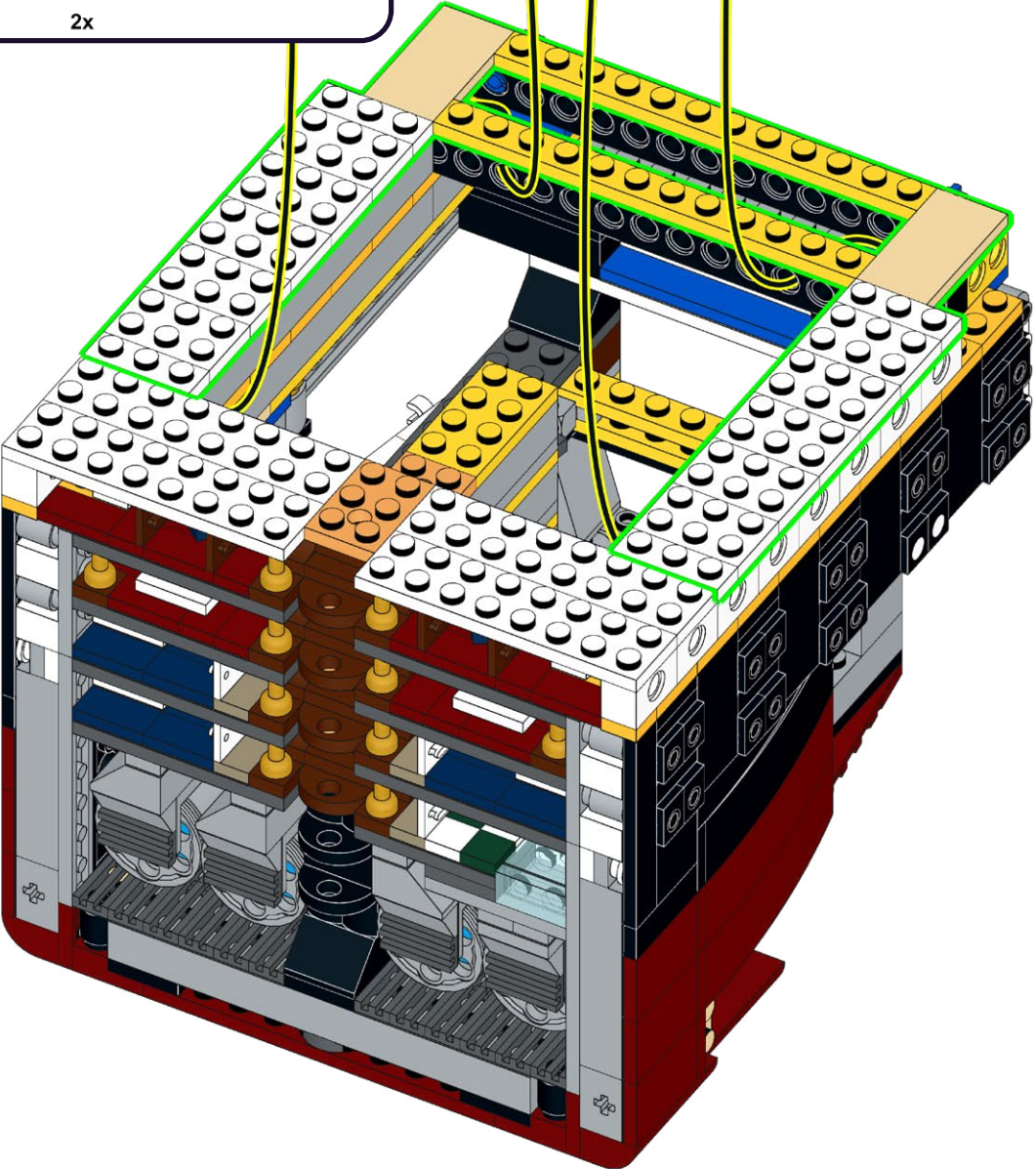
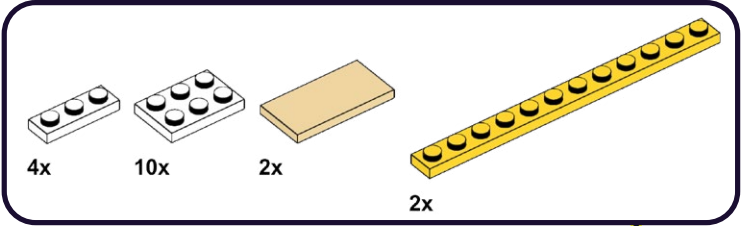

186

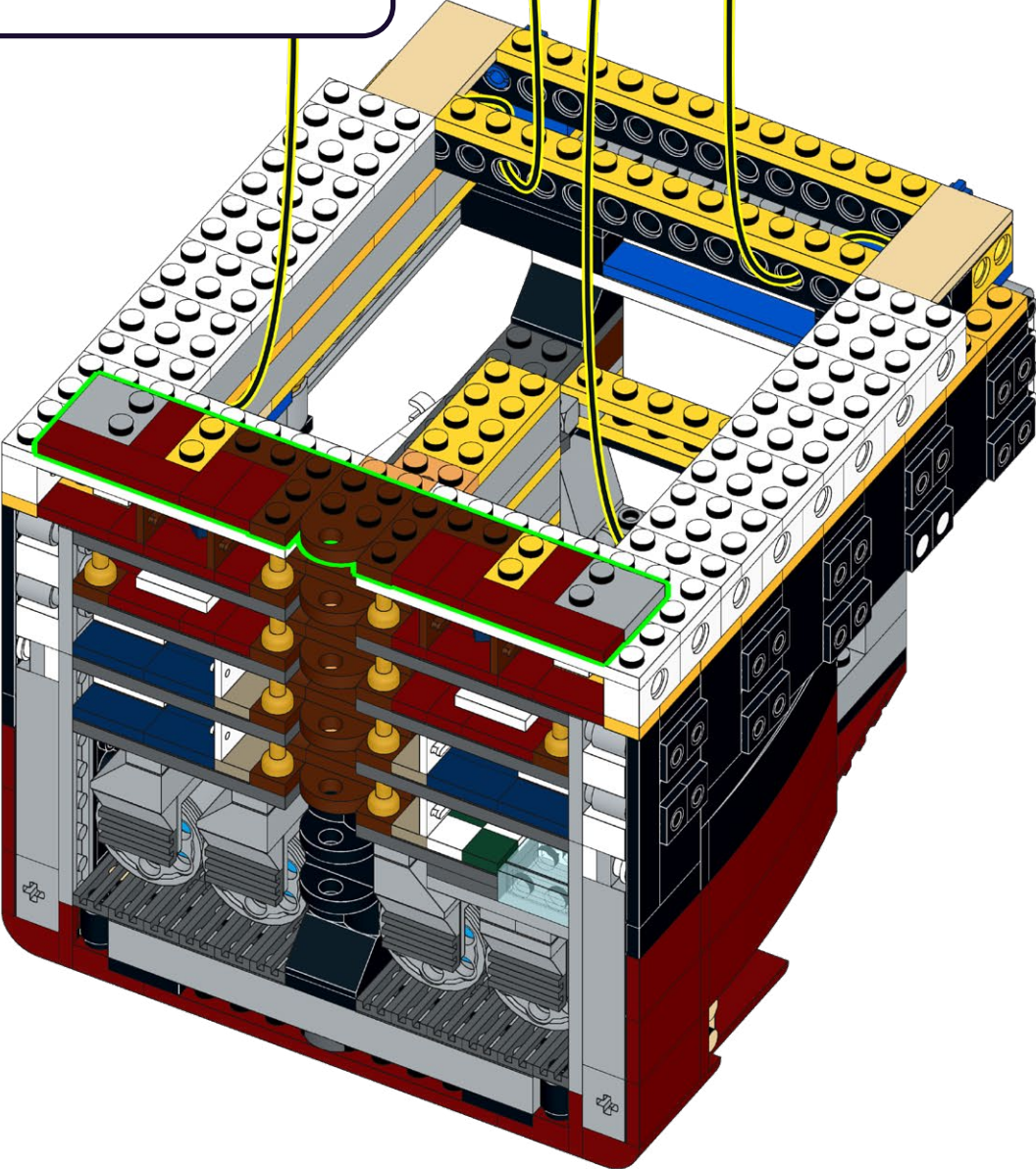
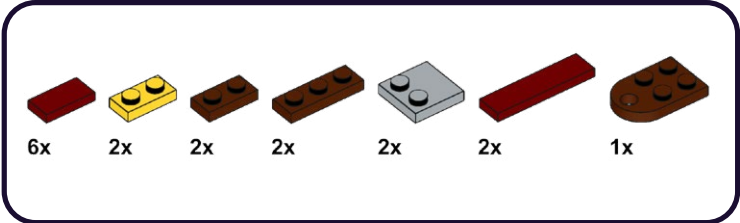

187

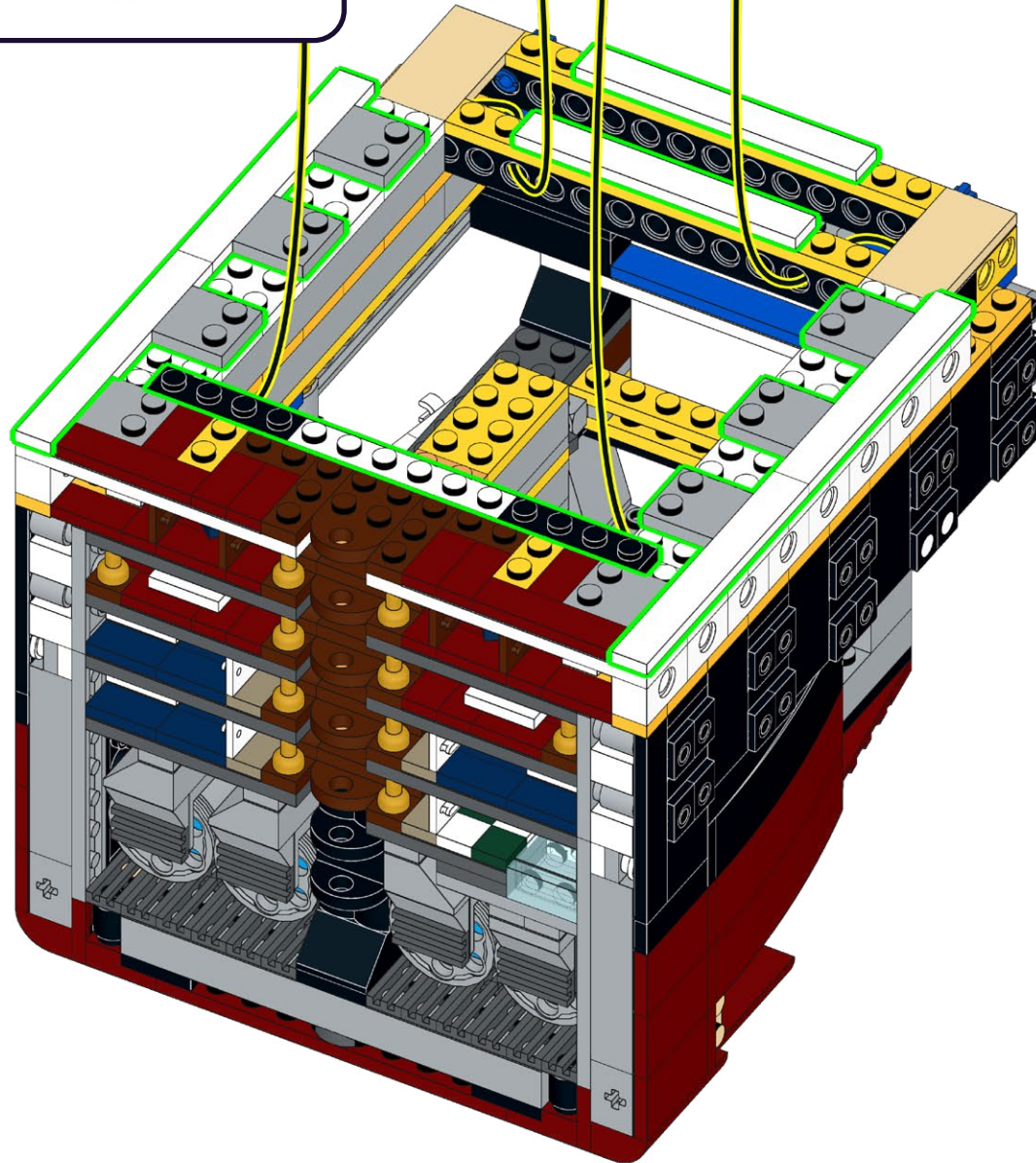
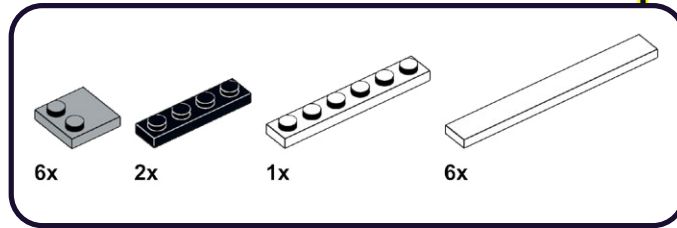

188

- 1x Yellow 1x2 Technic Brick
- 1x Brown 1x2 Technic Brick
- 2x Brown 1x1 Technic Pin
- 2x White 1x1 Technic Pin
- 2x Grey 1x1 Technic Pin
- 1x Brown 1x2 Technic Brick
- 1x Brown 1x3 Technic Brick
- 2x Brown 1x2 Technic Brick
- 2x Grey 1x2 Technic Brick
- 2x Yellow 1x2 Technic Brick
- 2x Blue 1x2 Technic Brick
- 2x Tan 1x6 Technic Brick

- 1 Brown 1x2 Technic Brick
- 2 Brown 1x2 Technic Bricks

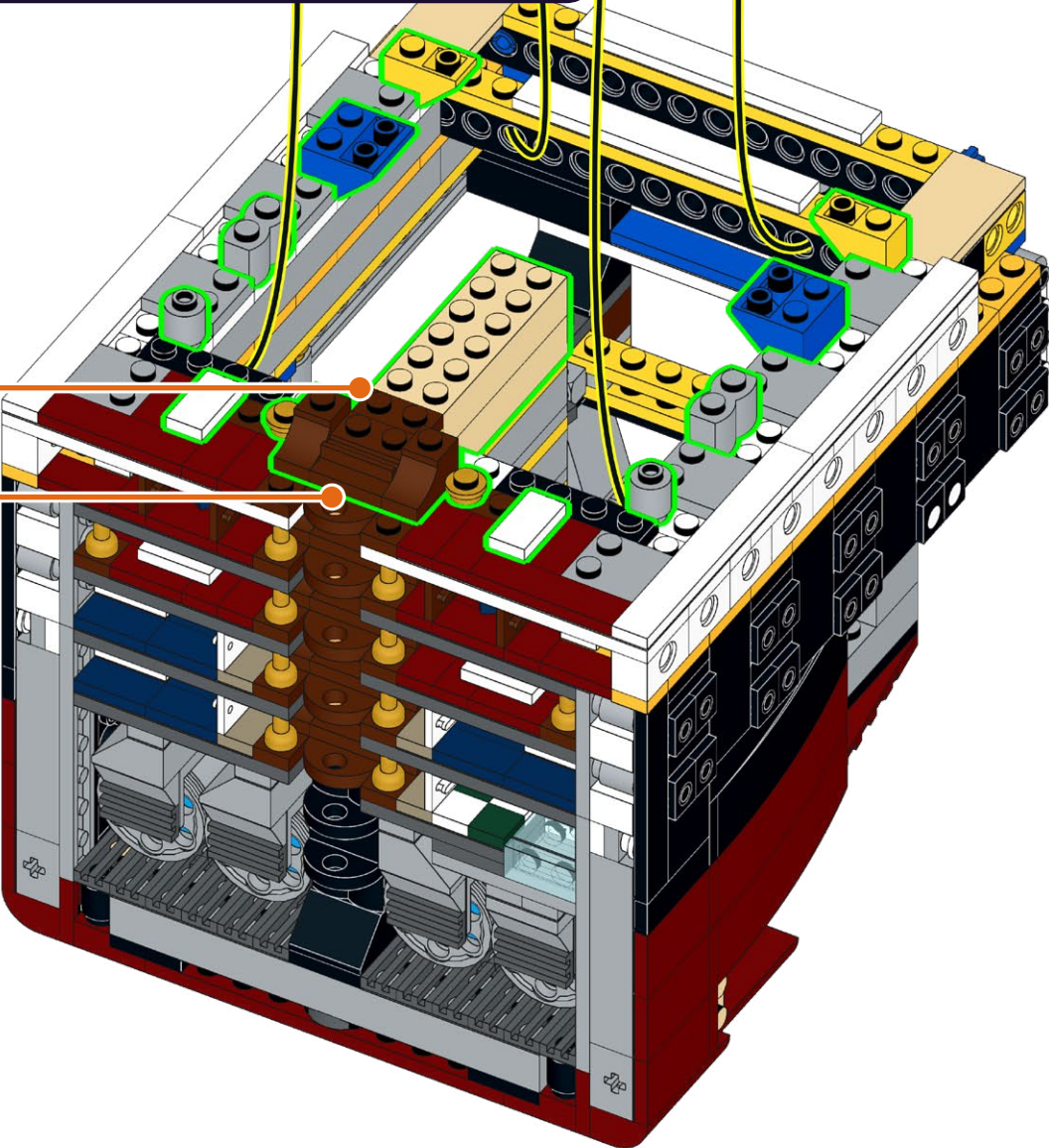
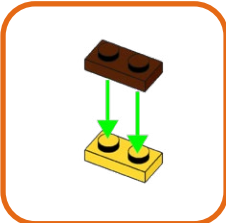

189

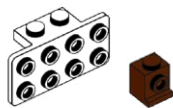

8x

16x

1

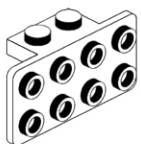

2

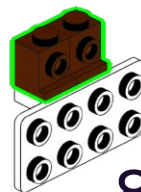

8x

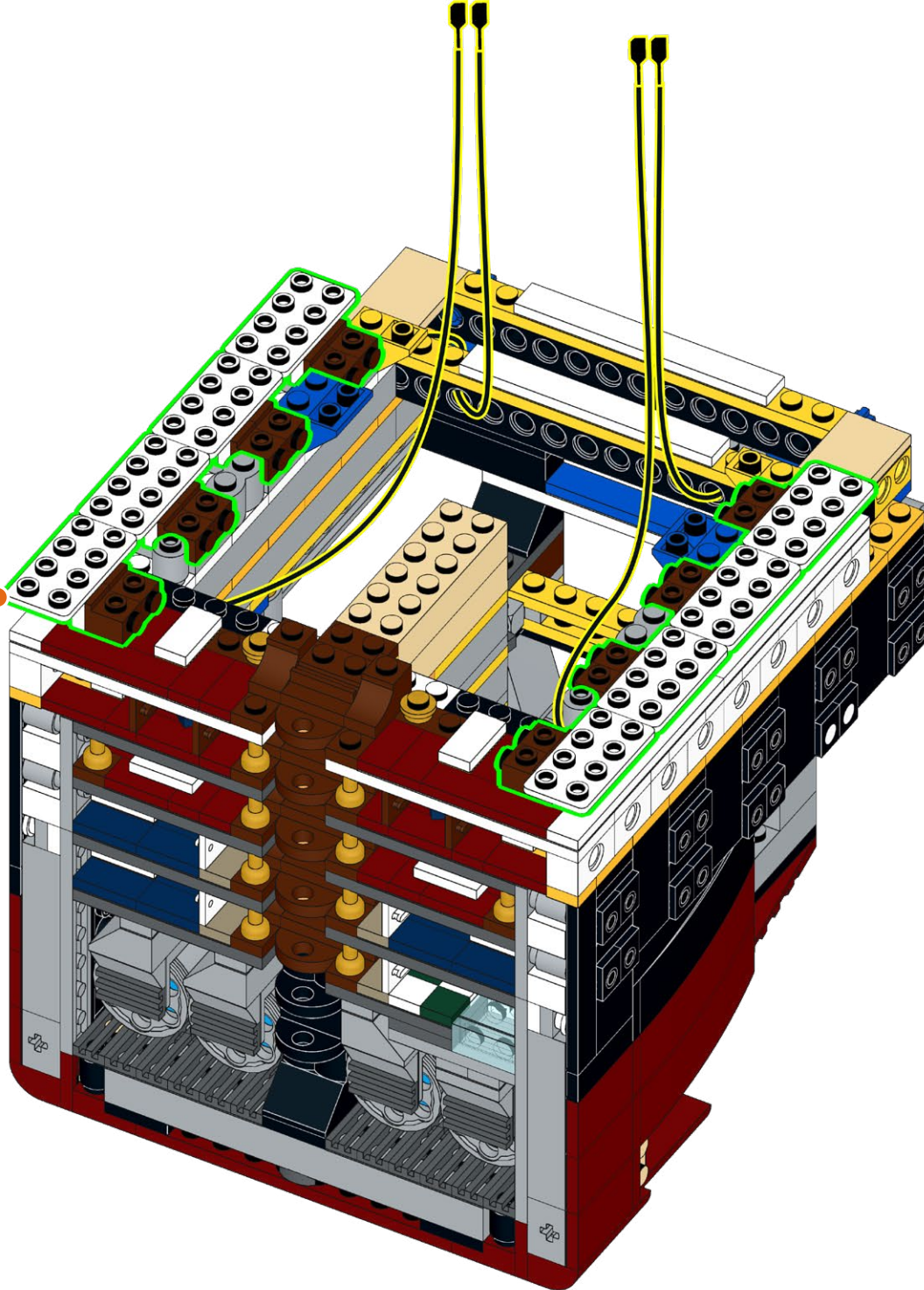

190

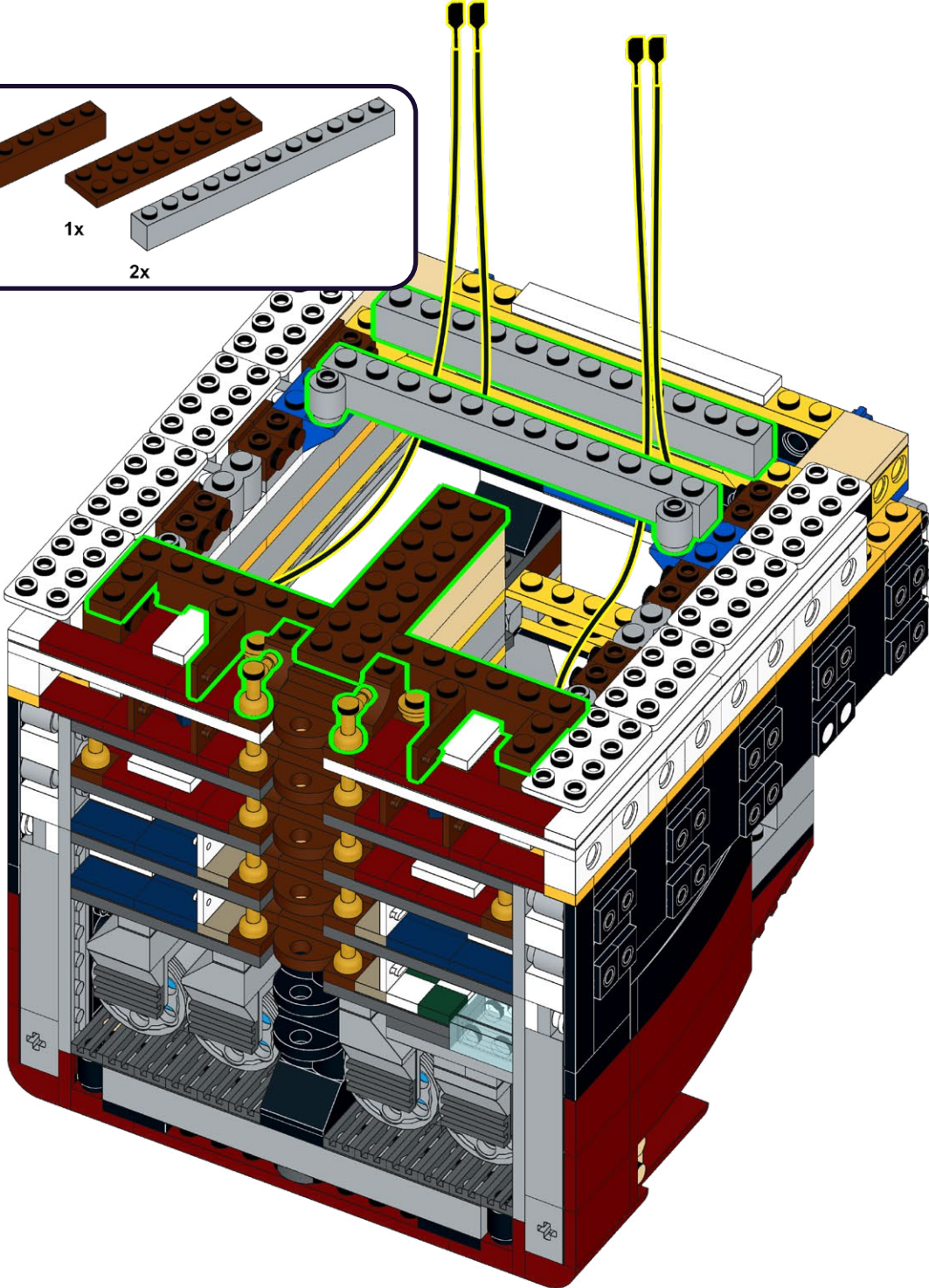
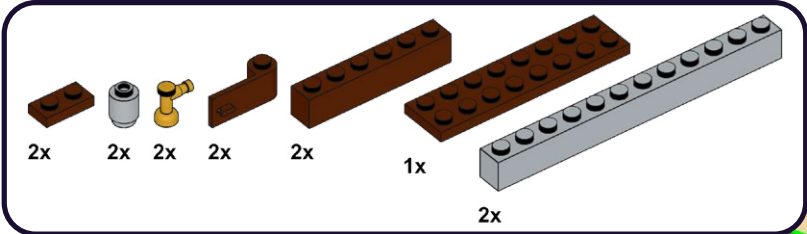

191

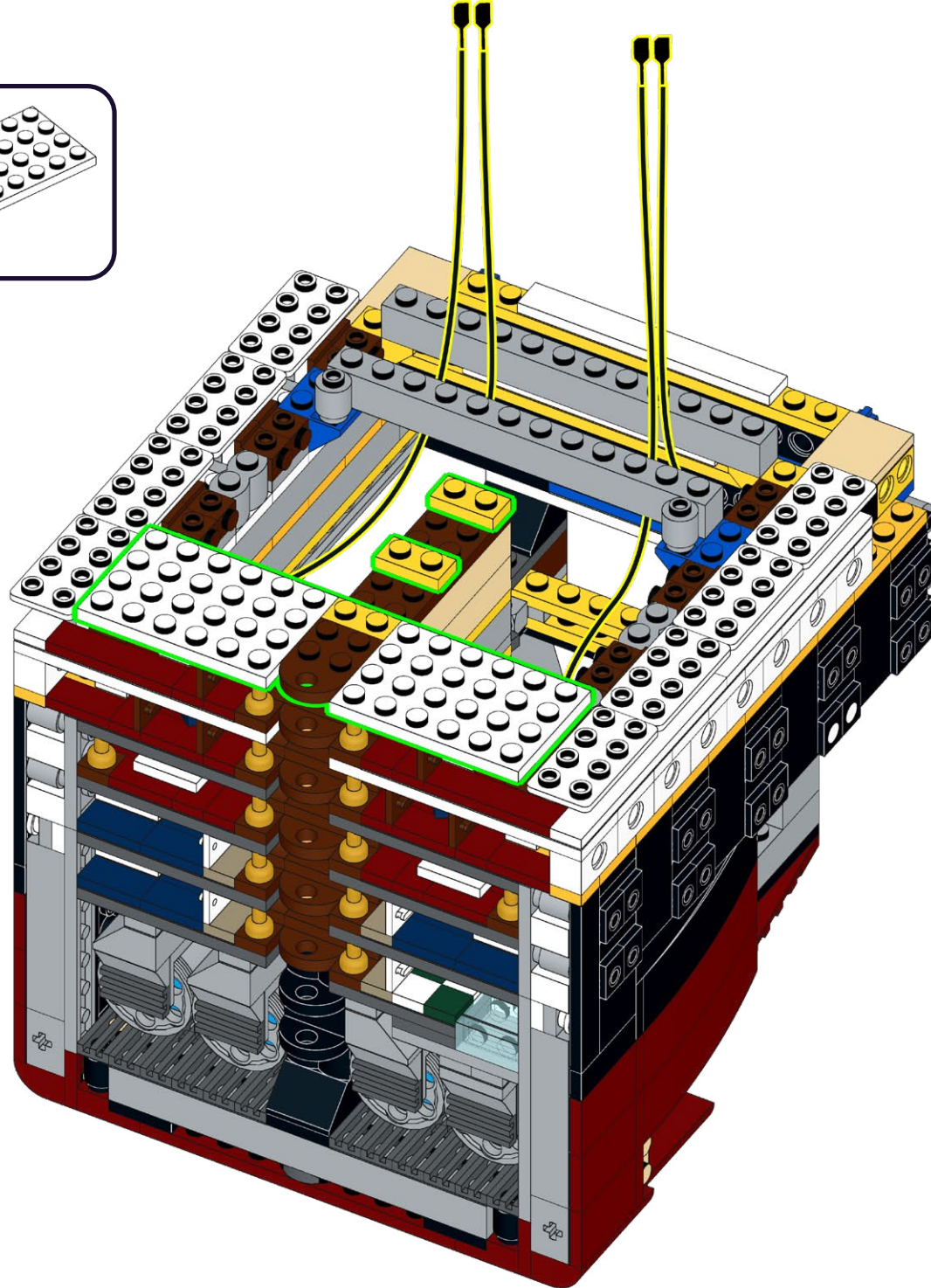
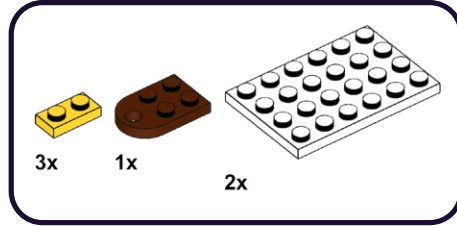

192

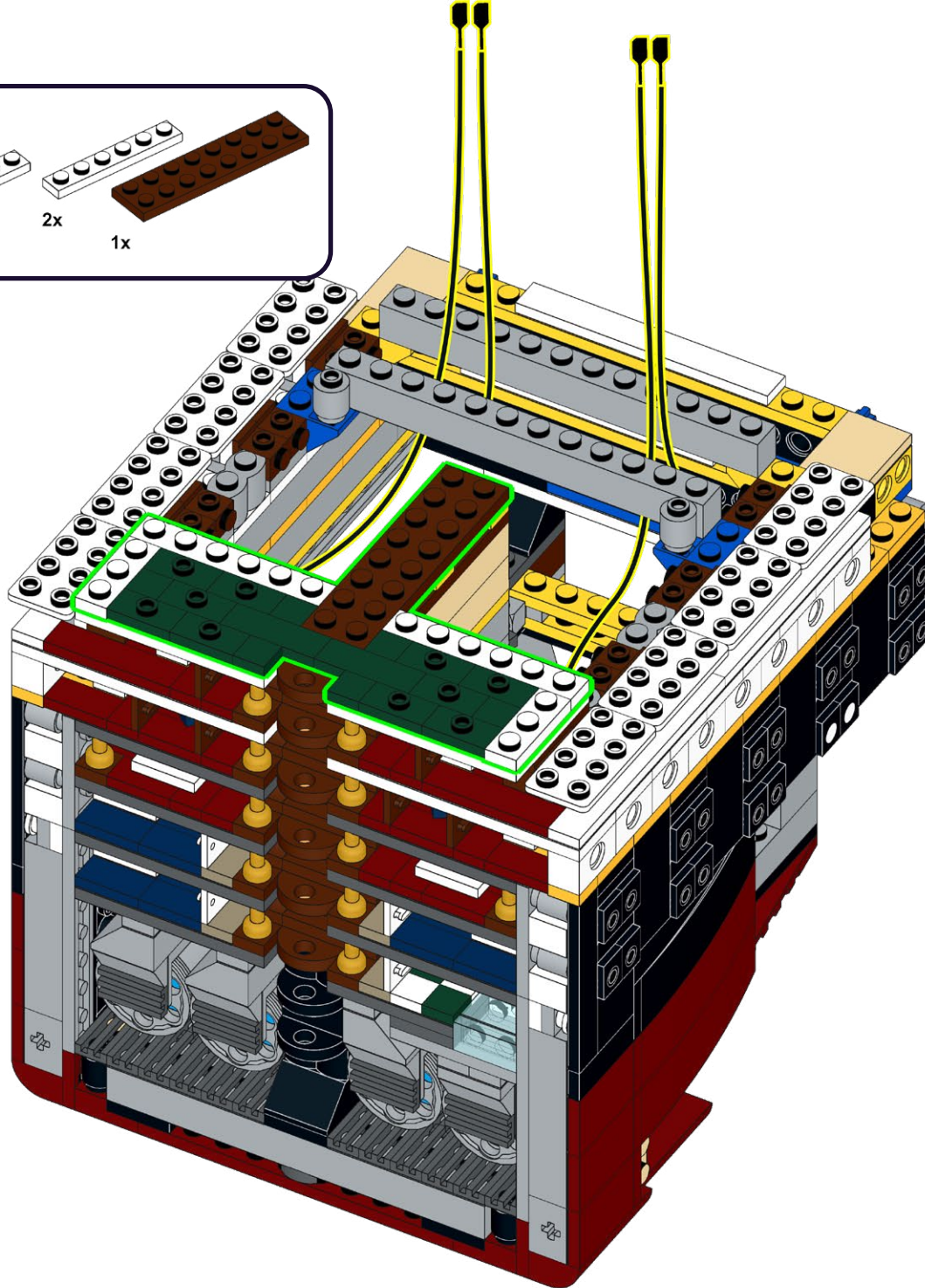
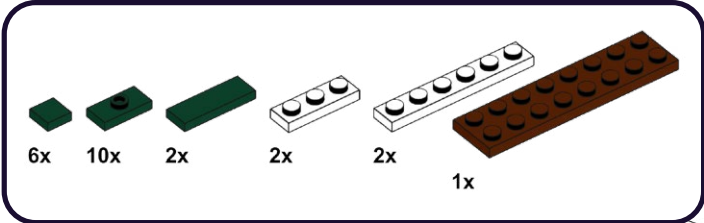

193

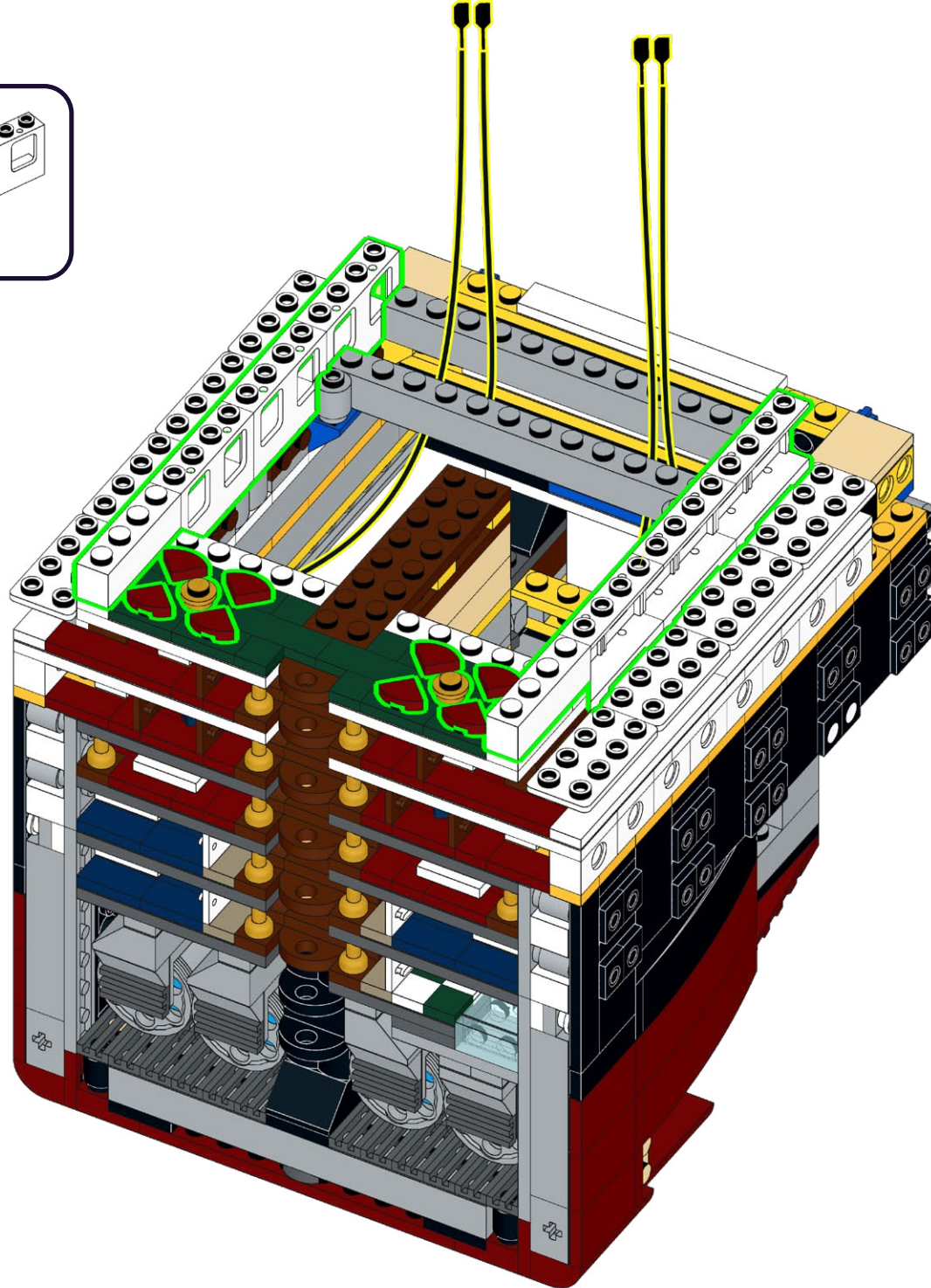
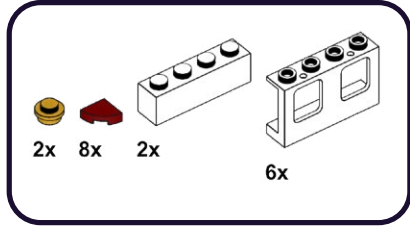

194

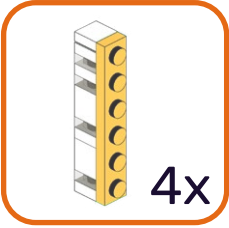
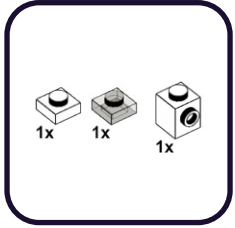

1

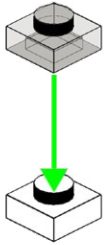

2

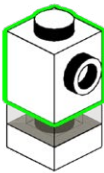

195

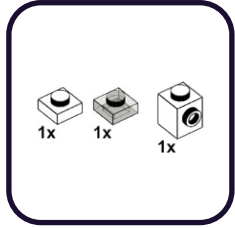

1

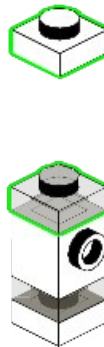

2



196

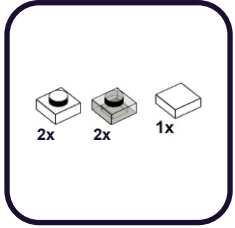

1

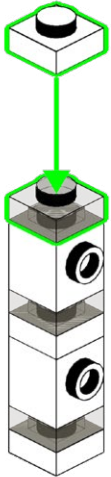

2

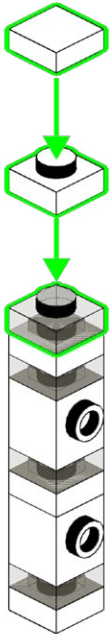

197

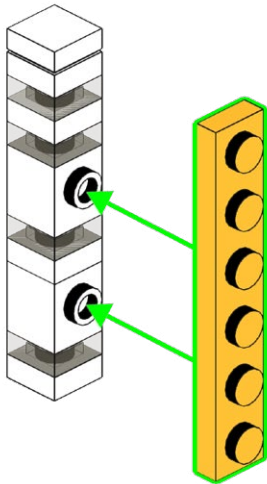
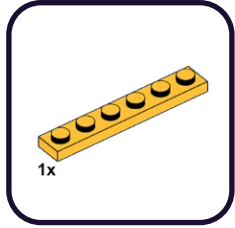

4x

198

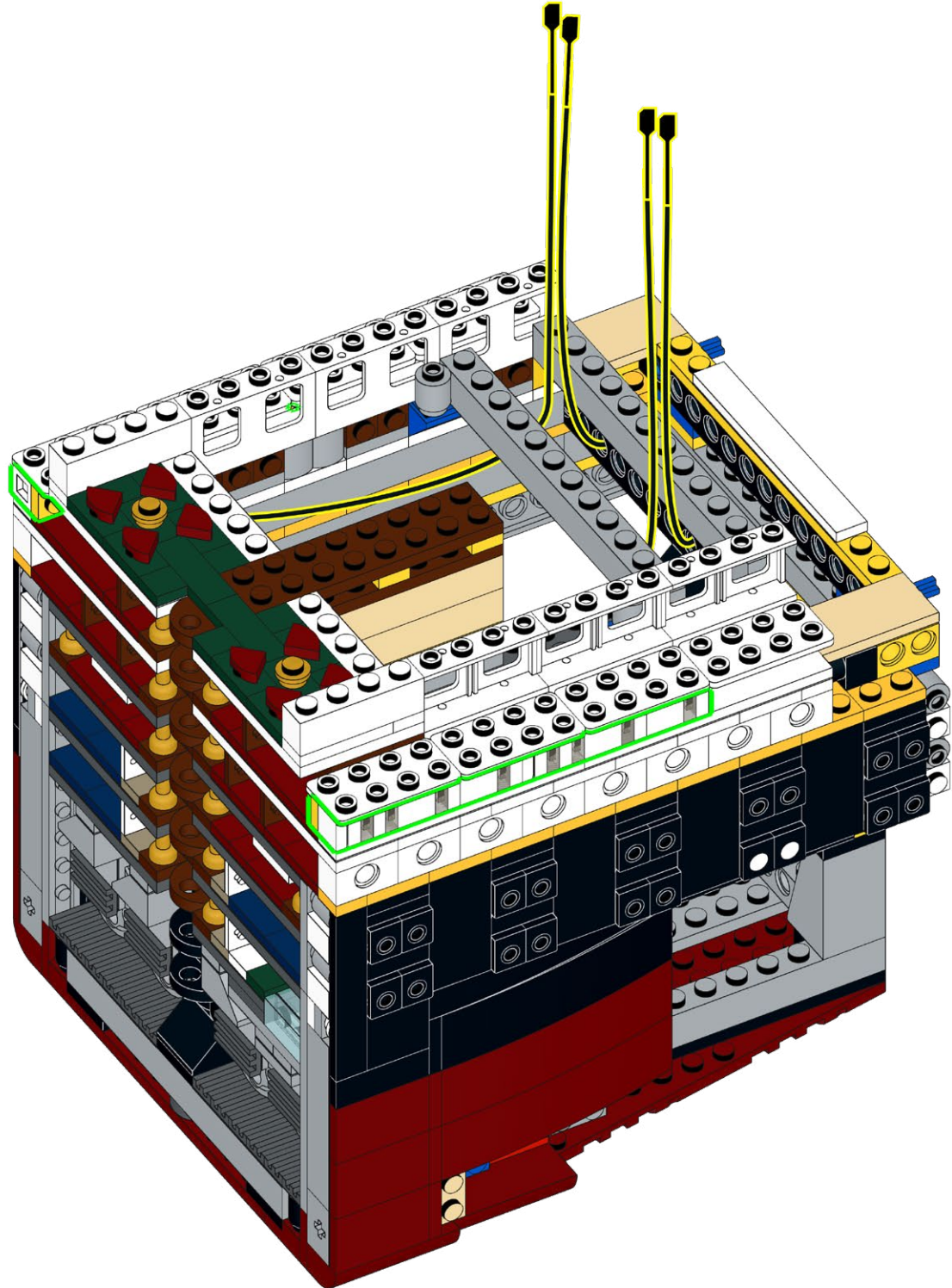

199

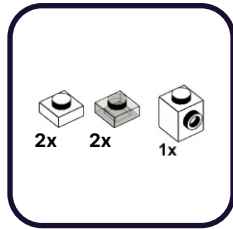

1

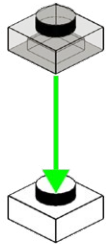

2

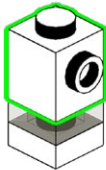

3

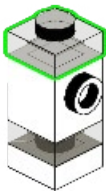
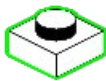

200

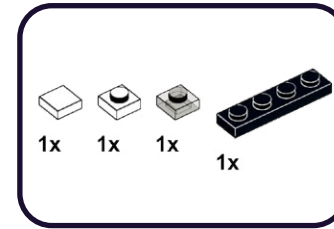

1

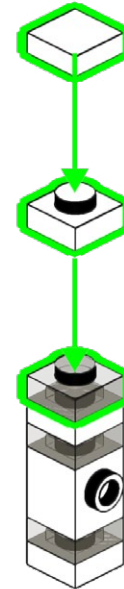

2

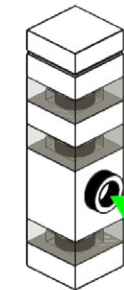

2x



201

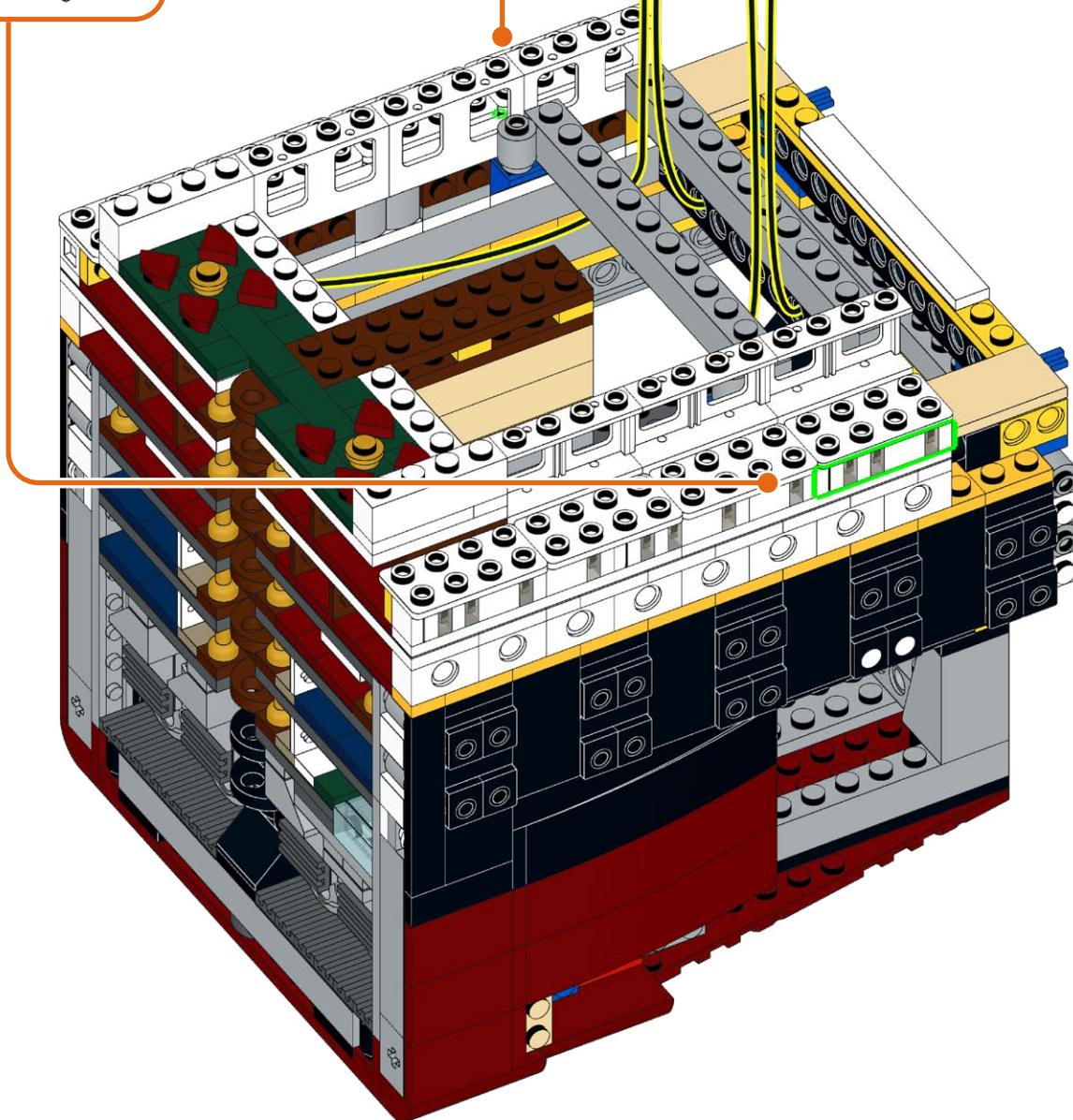
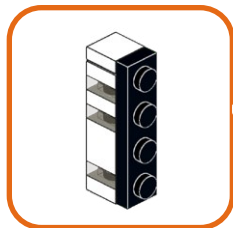

**HOLD UP!**

You might notice some bags aren't in order, as well as left over pieces, but that's ok! We're changing the way you build LEGO!

ATTENDEZ!

Vous remarquerez peut-être que certains sacs, ainsi que certaines pièces, ne sont pas dans le bon ordre. Mais pas de panique! Nous changeons simplement la façon avec laquelle vous construisez vos LEGO!

ASPETTA!

Potresti notare che alcuni sacchetti non sono in ordine, così come i pezzi avanzati, ma va bene così! Stiamo cambiando il modo in cui costruisci i LEGO!

HALT!

Sie werden möglicherweise bemerken, dass einige tüten durcheinander sind und teile übrig bleiben, aber das ist in Ordnung! Wir ändern die art und weise, wie Sie LEGO bauen!

¡ESPERA!

Es posible que notes que algunas bolsas están fuera de servicio, así como piezas sobrantes, ¡pero está bien! ¡Estamos cambiando la forma en que construyes LEGO!

暫停!

你可能会注意到一些袋子顺序错乱, 以及一些剩余的部件, 但没关系! 我们正在改变你搭建乐高的方式!

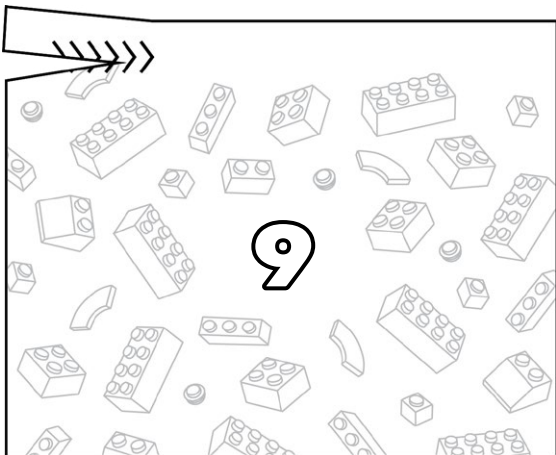
Open LEGO® Bag 9

202

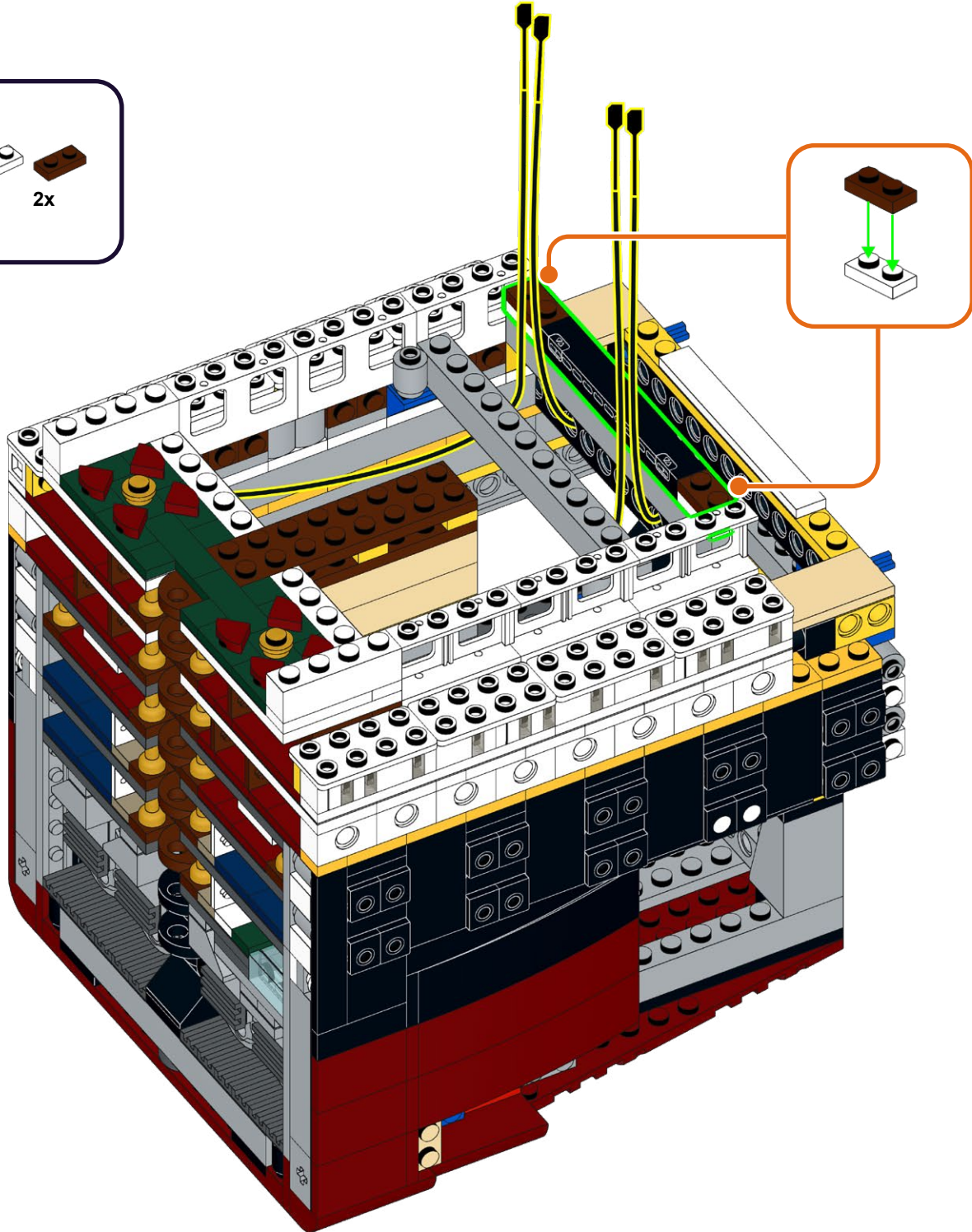
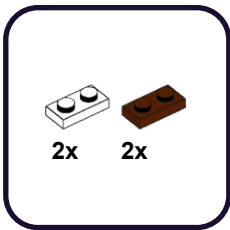
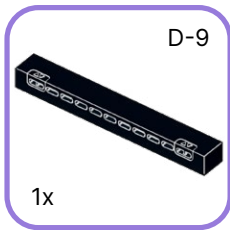

203

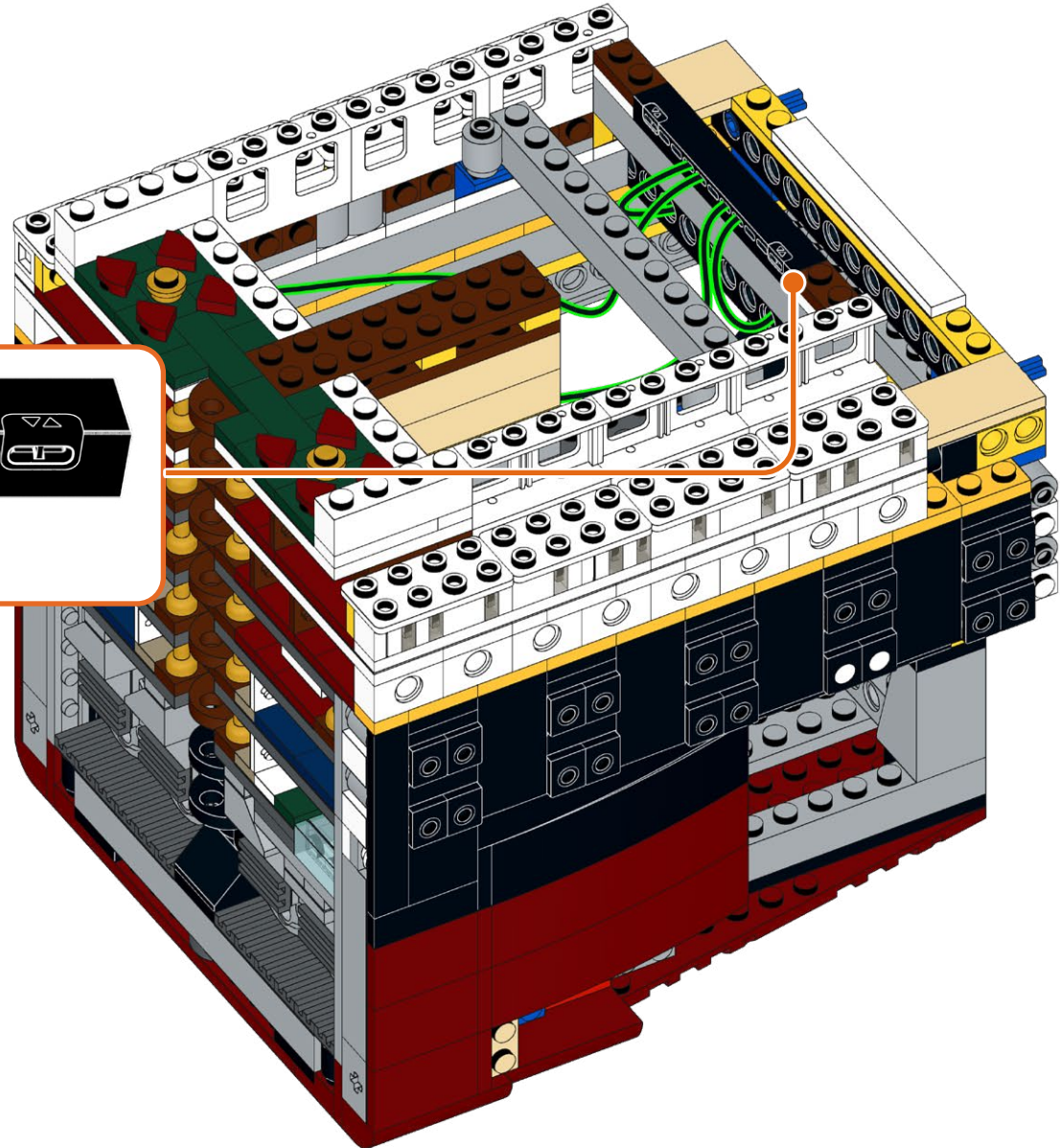

204

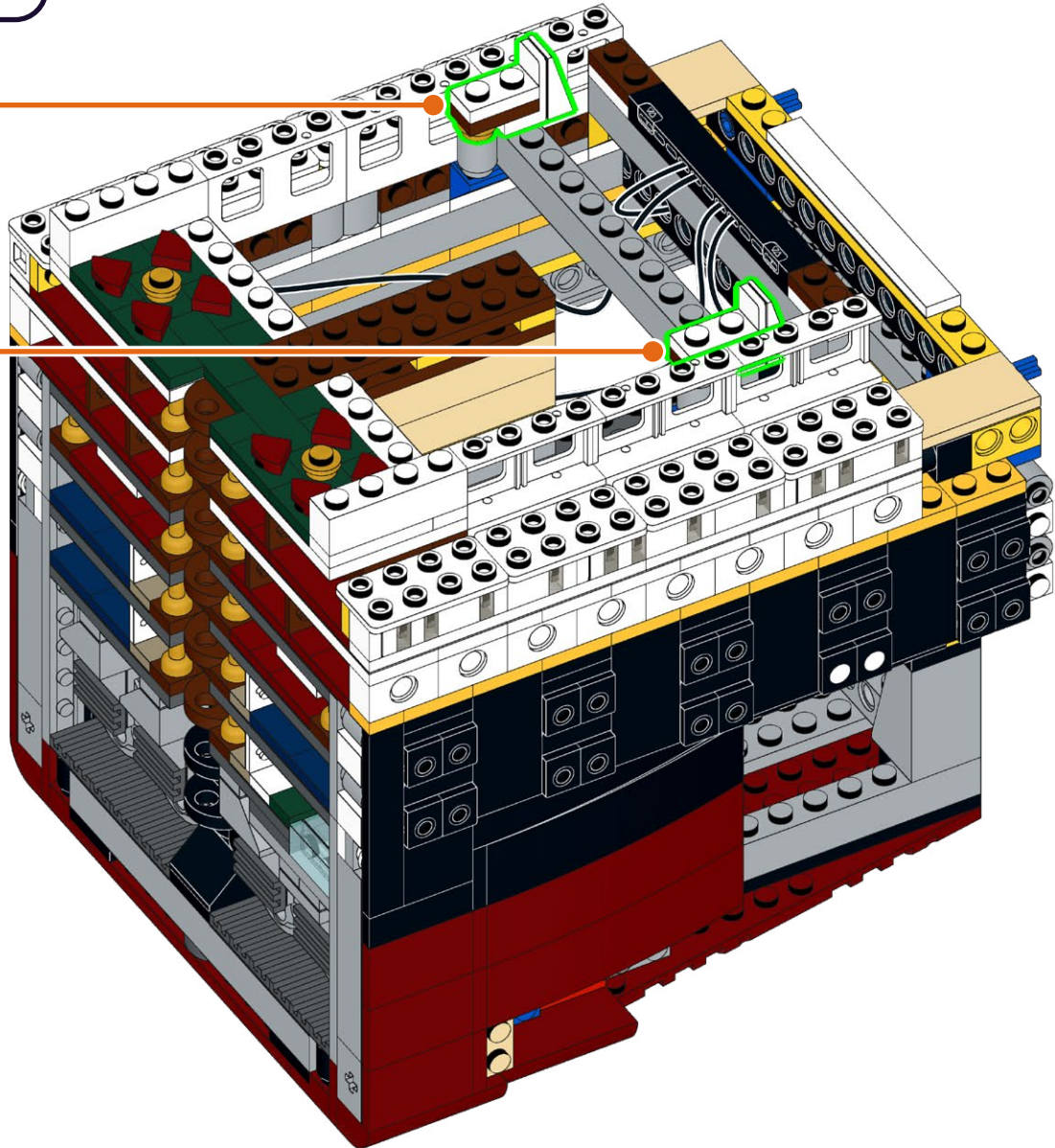
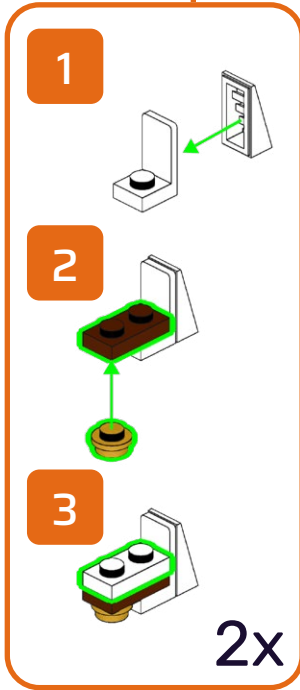
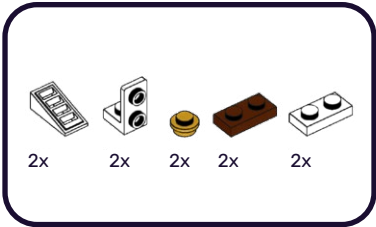

205

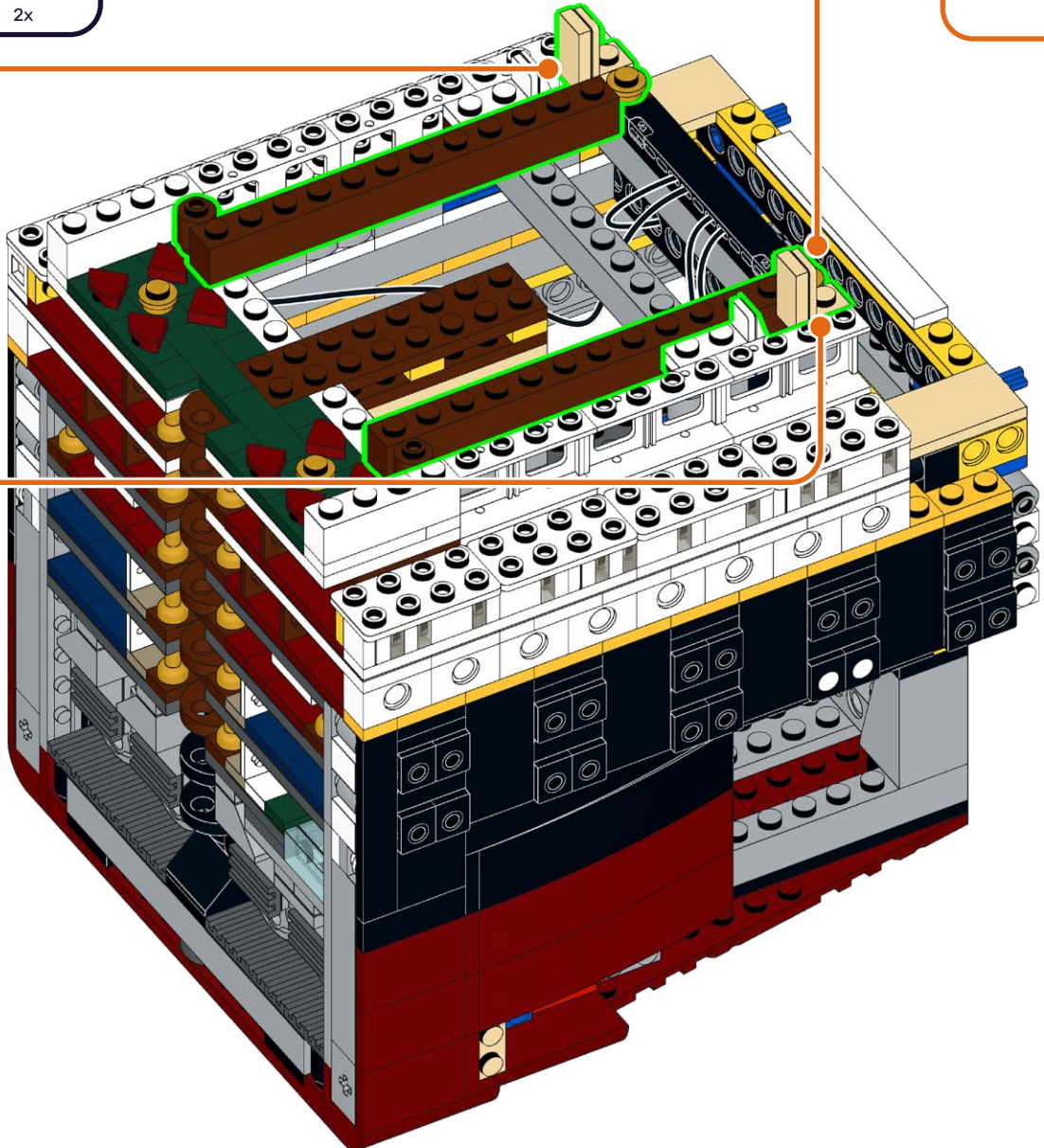
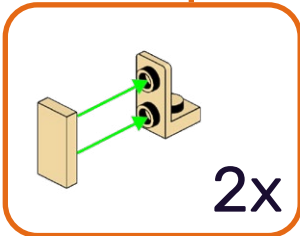
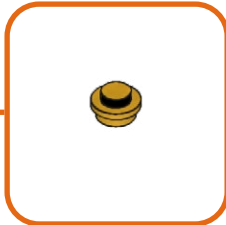
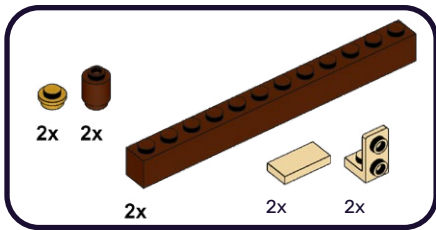

206

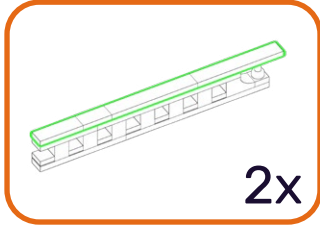
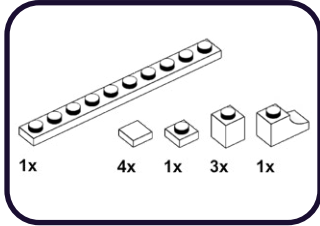

1

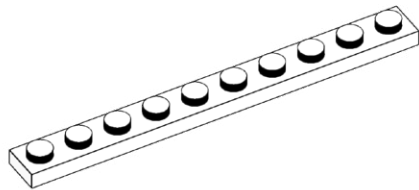

2

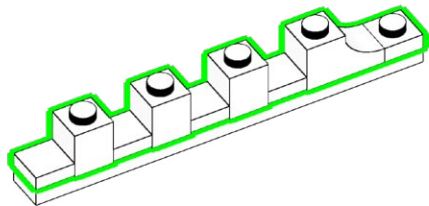

207

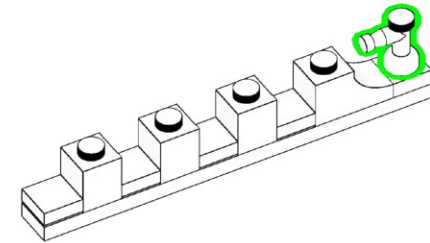
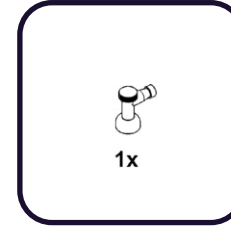

208

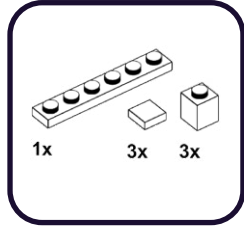

1

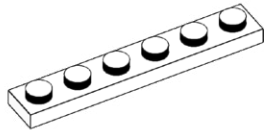

2

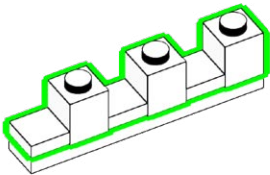

209

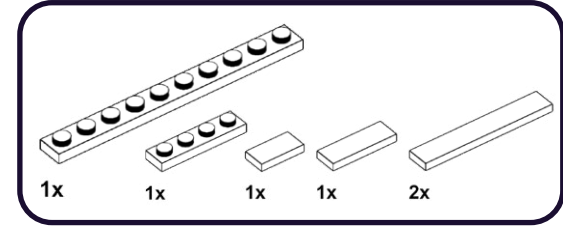

1

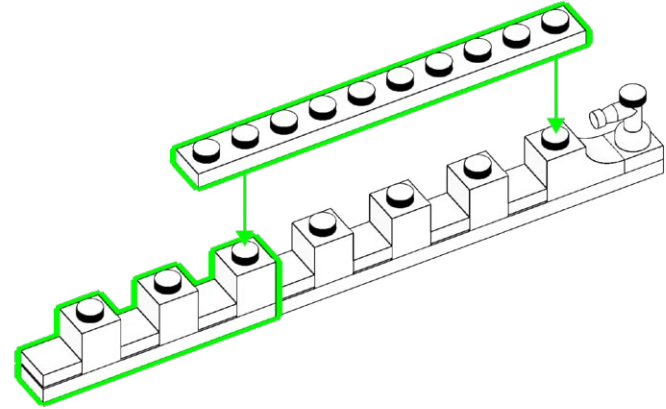

2

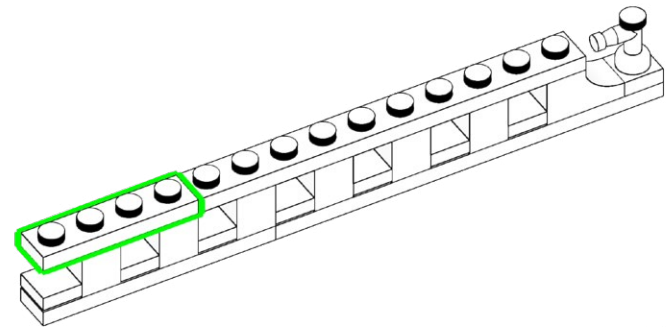

3

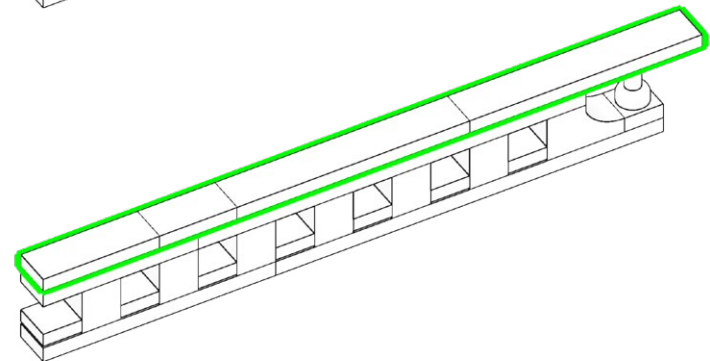

2x

210

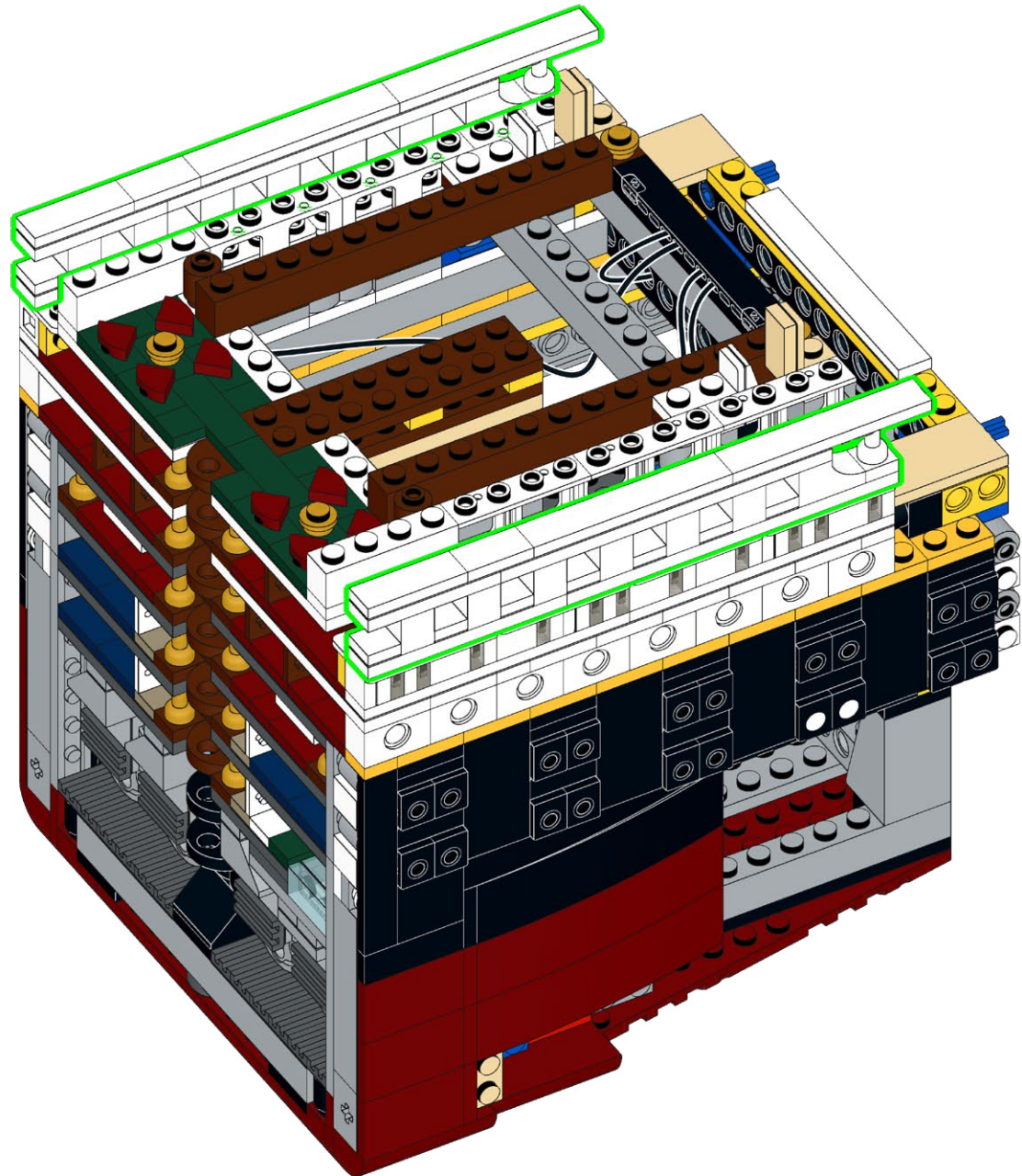

211

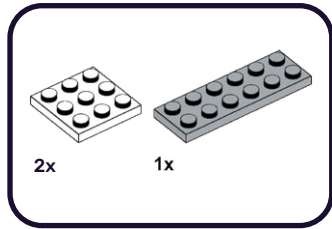

1

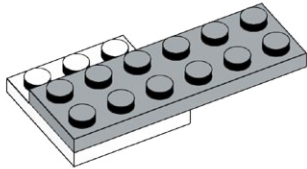

2

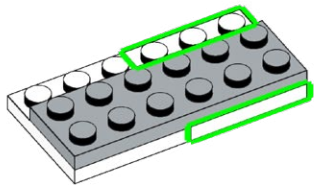

212

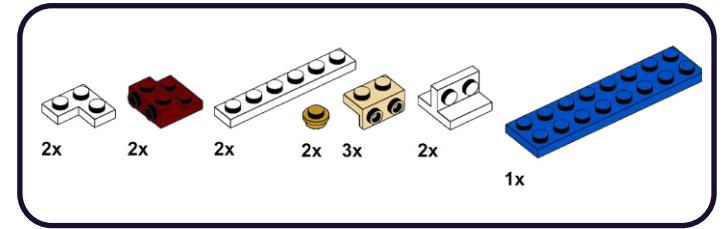

1

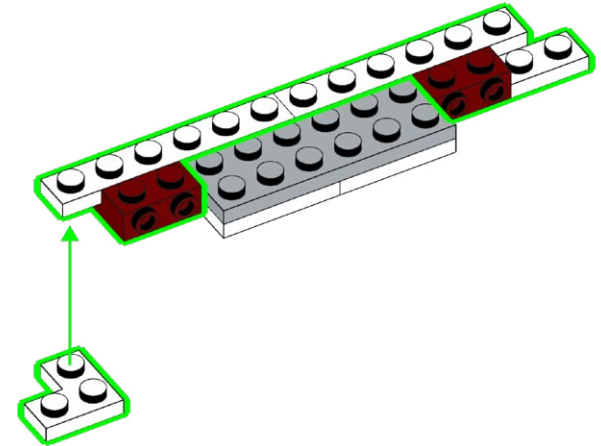

2

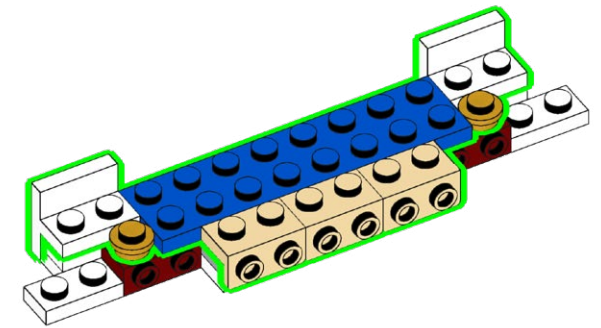

213

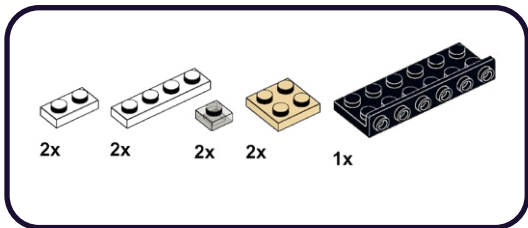

1

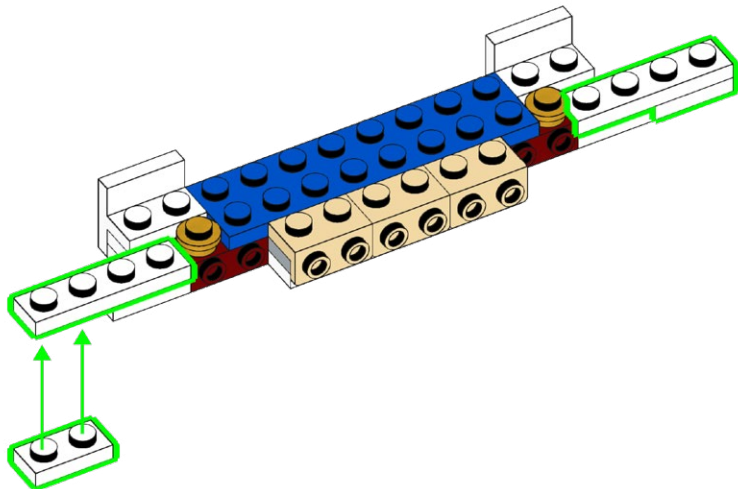

2

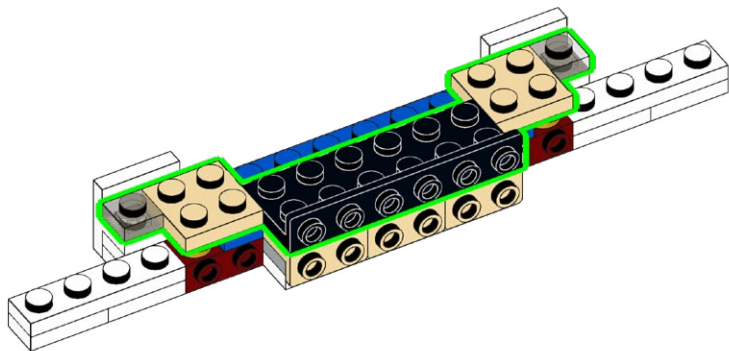

214

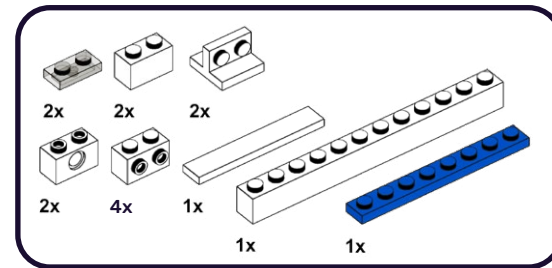

1

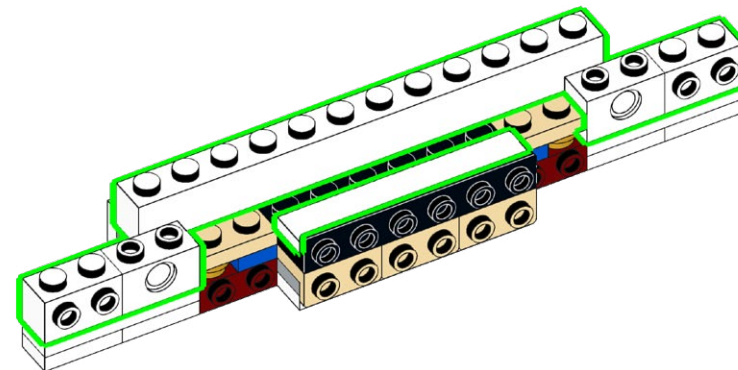

2

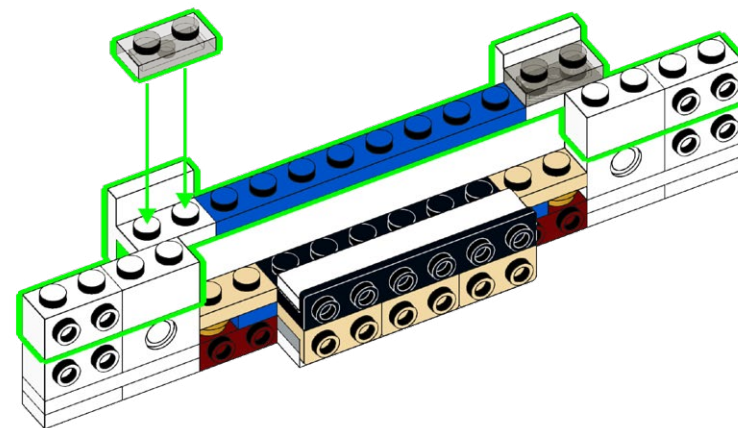

215

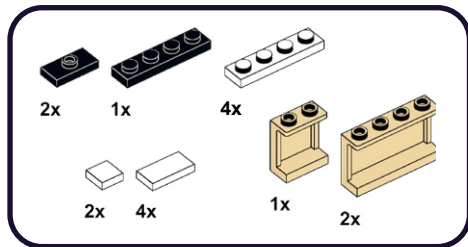

1

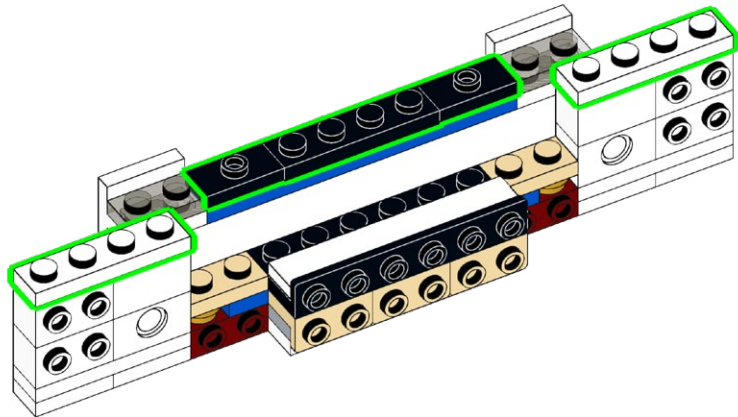

2

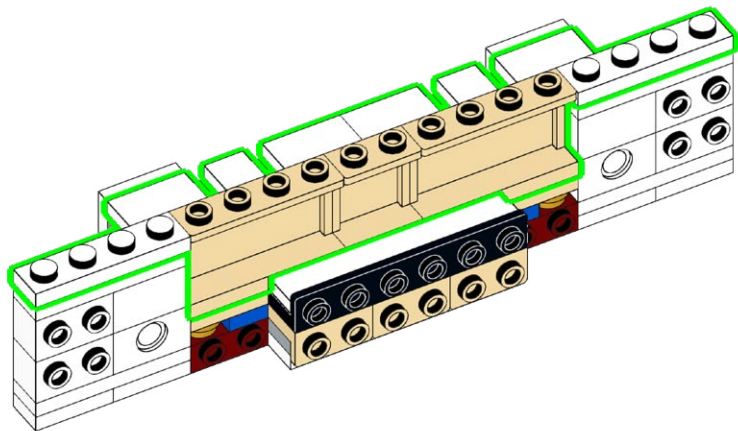

216

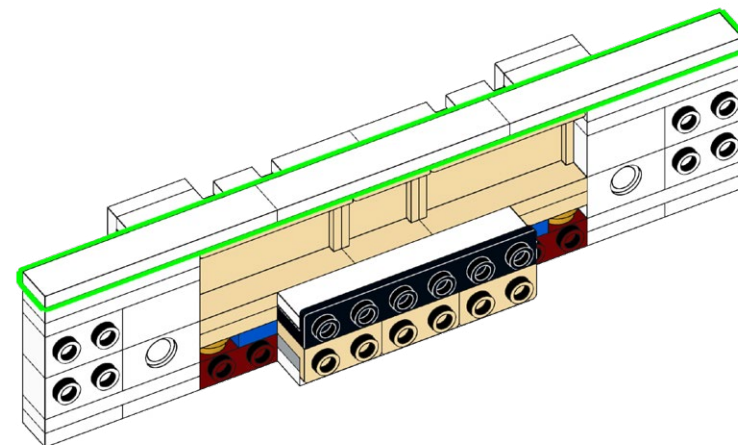
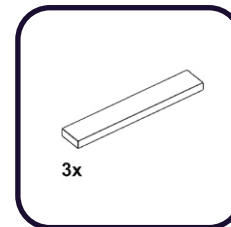

217

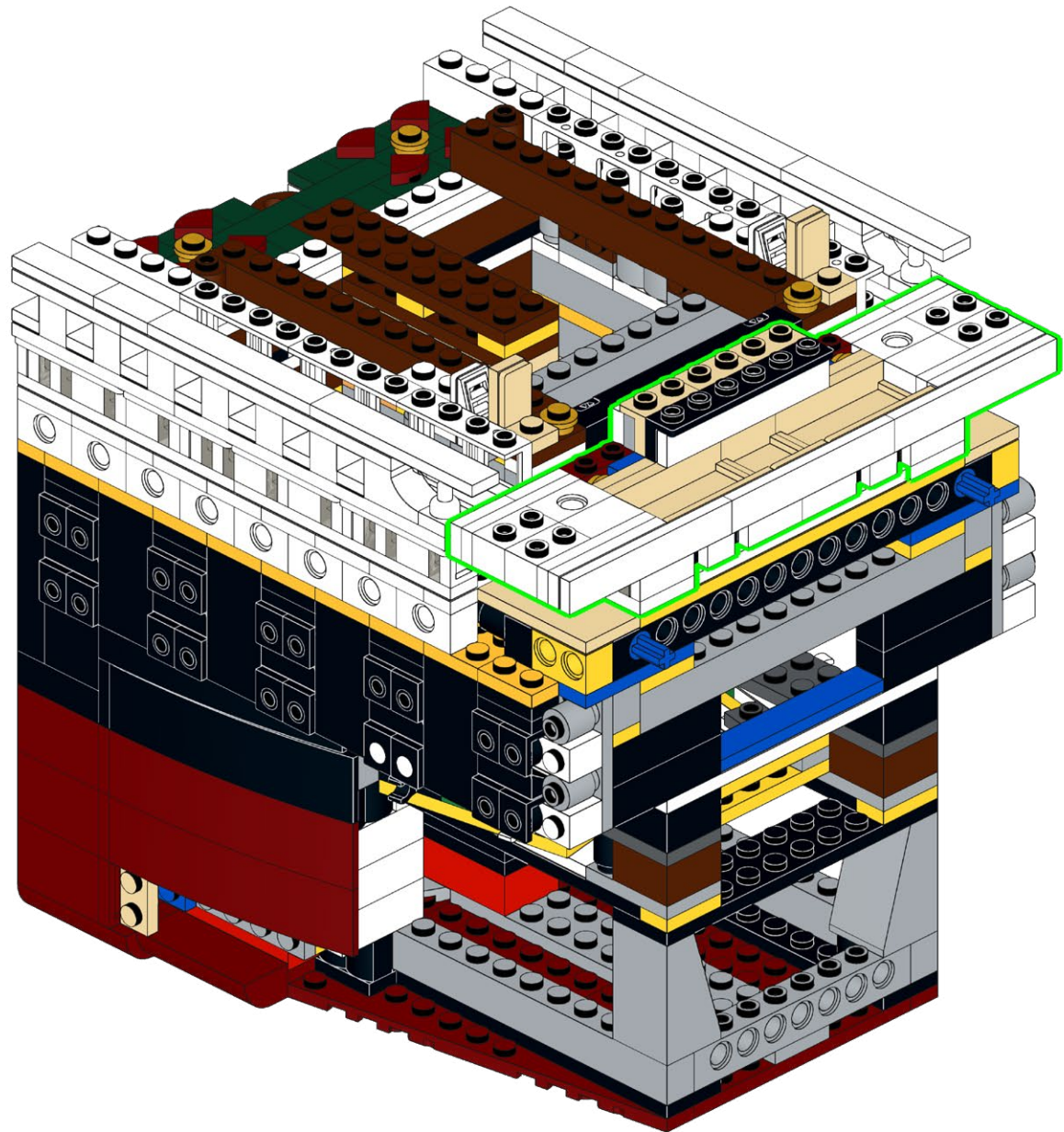

218

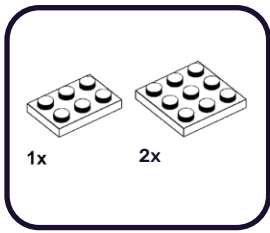

1

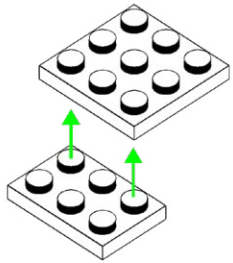

2

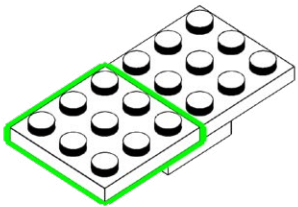

219

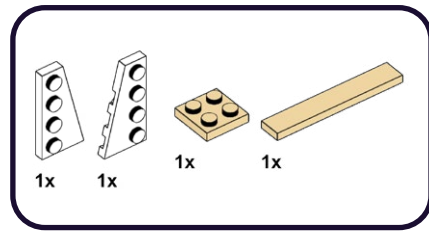

1

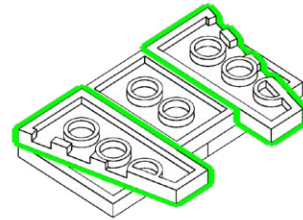
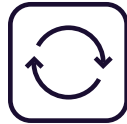

2

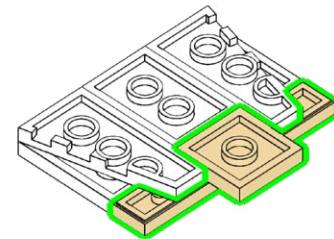

220

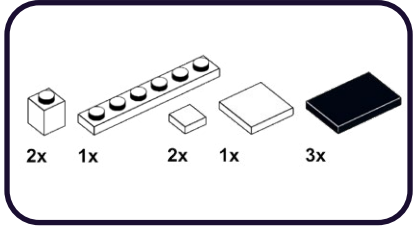

1

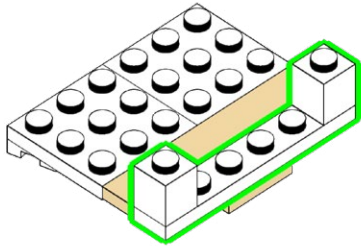

2

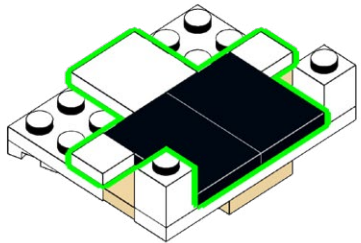

221

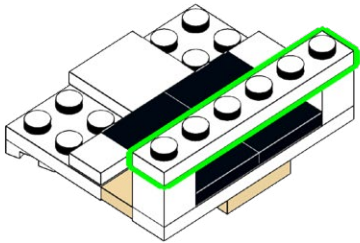
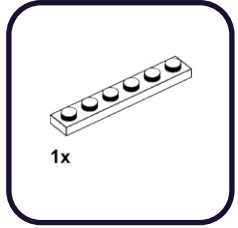

222

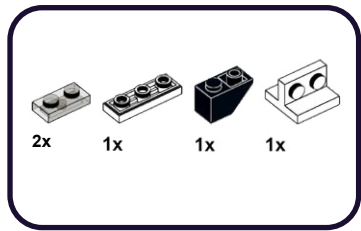

1

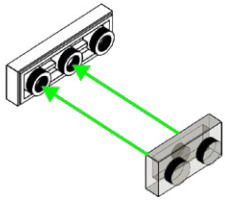

2

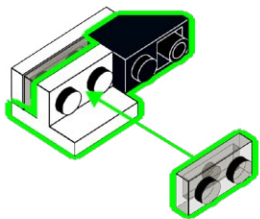

223

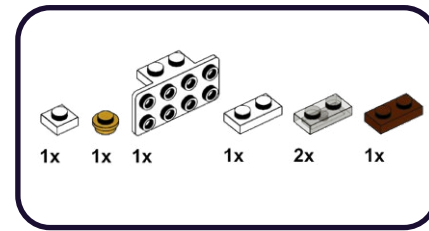

1

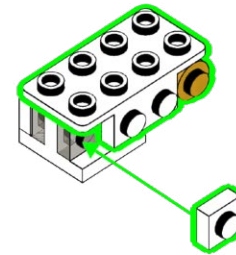

2

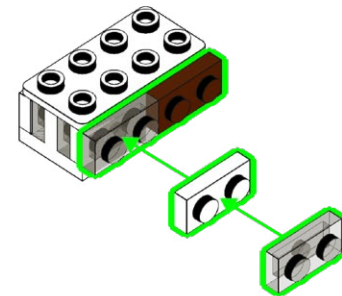

224

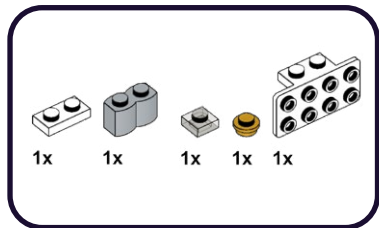

1

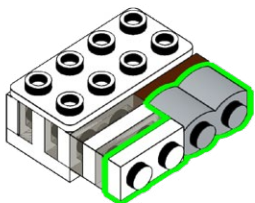

2

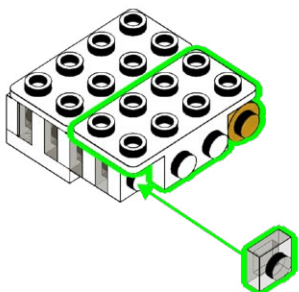

225

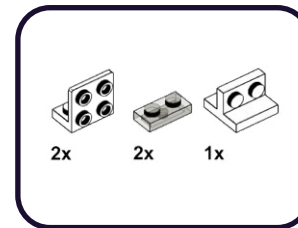

1

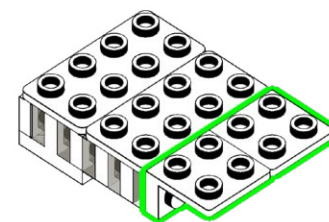

2

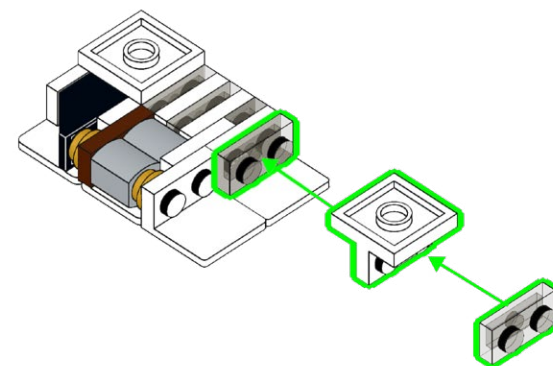
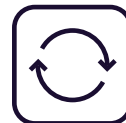

226

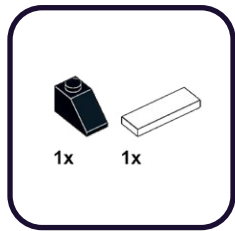

1

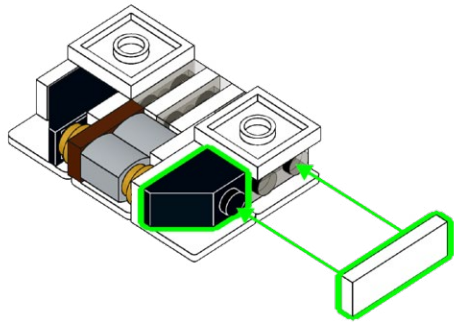

2

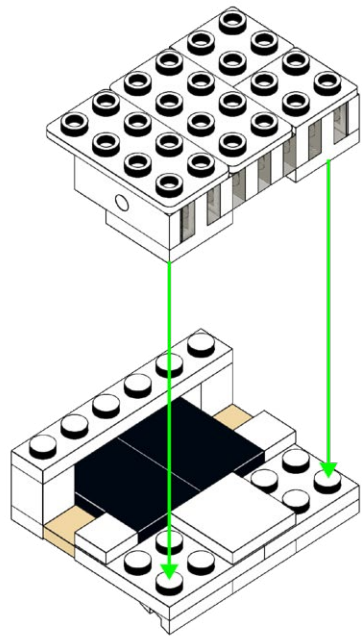

227

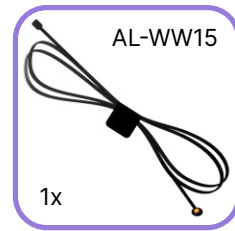
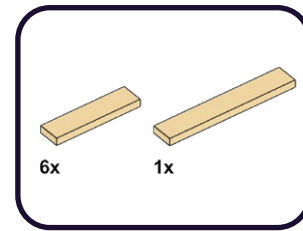

1

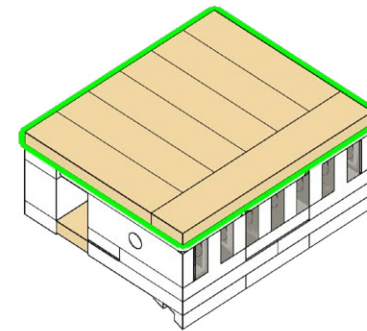

2

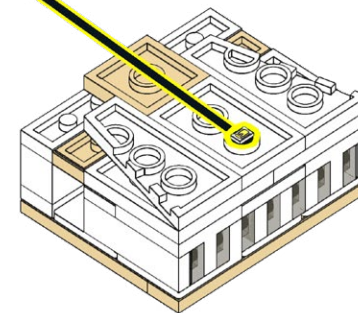
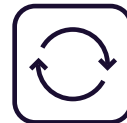

228

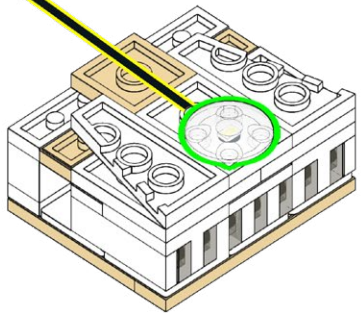
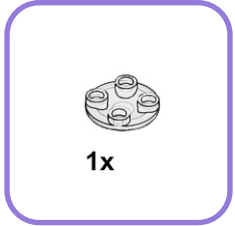

229

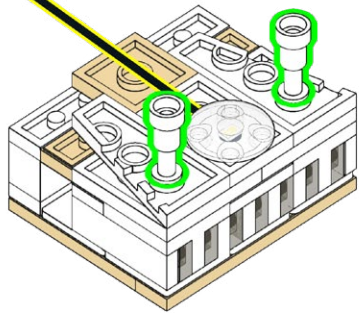
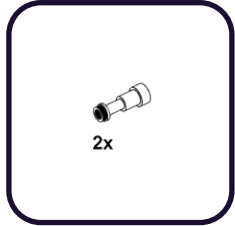

230

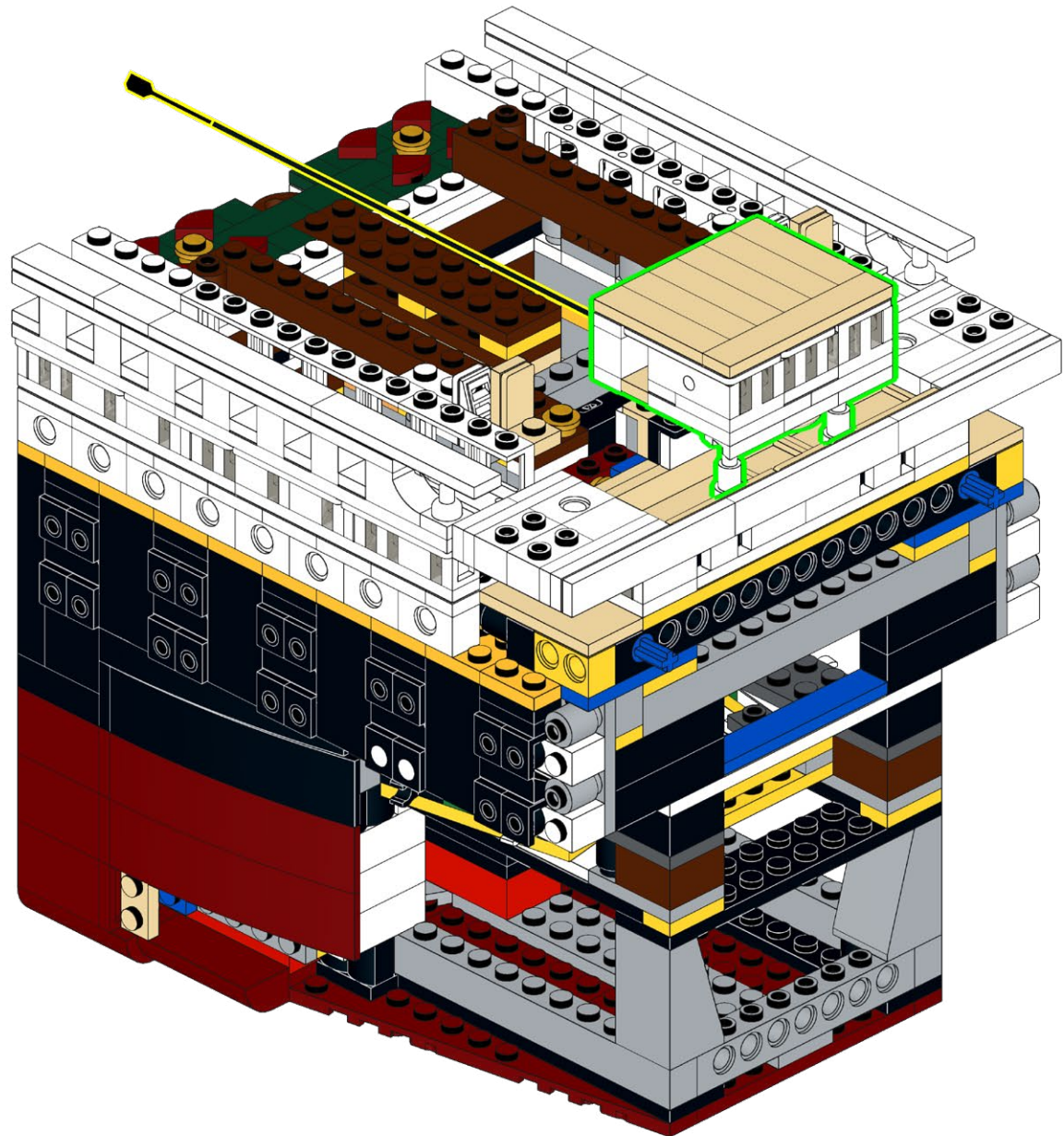

231

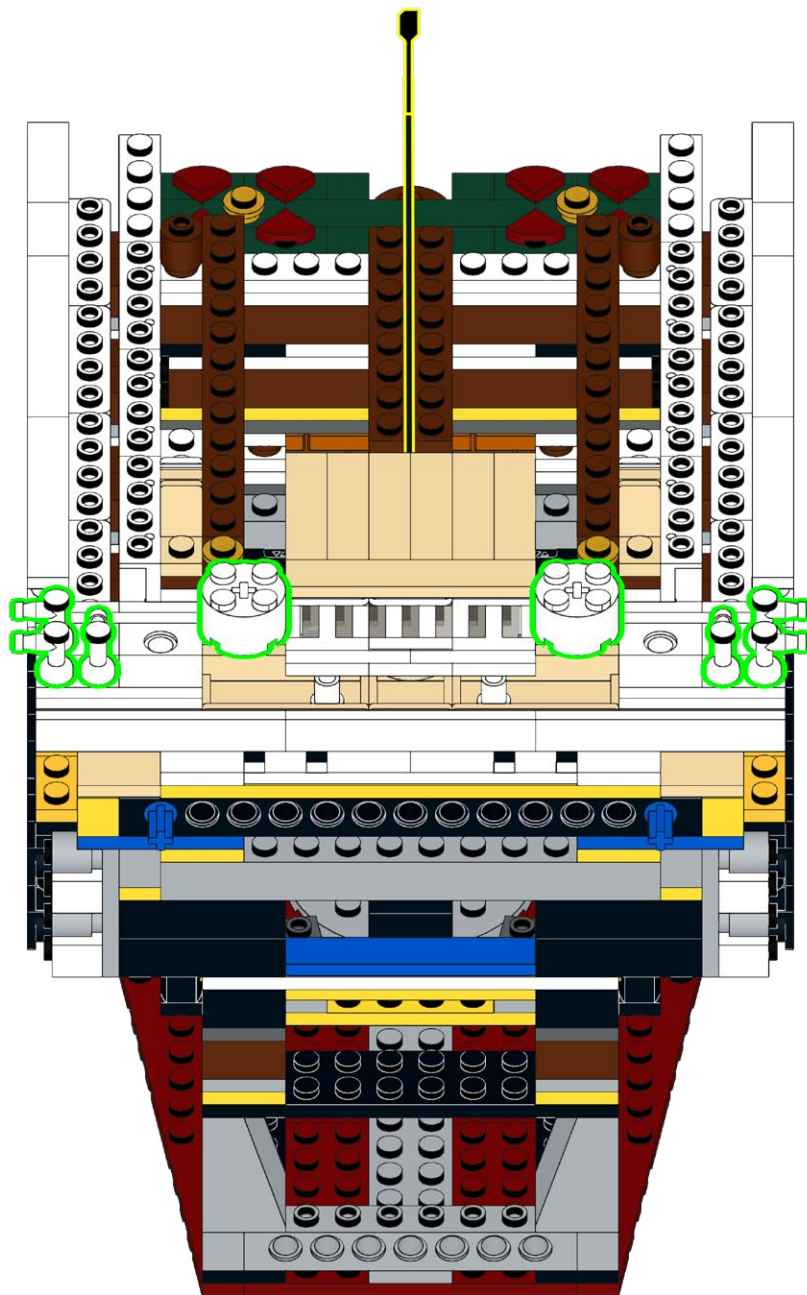
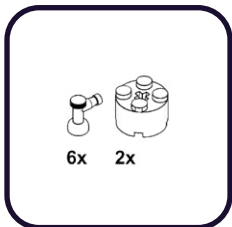

232

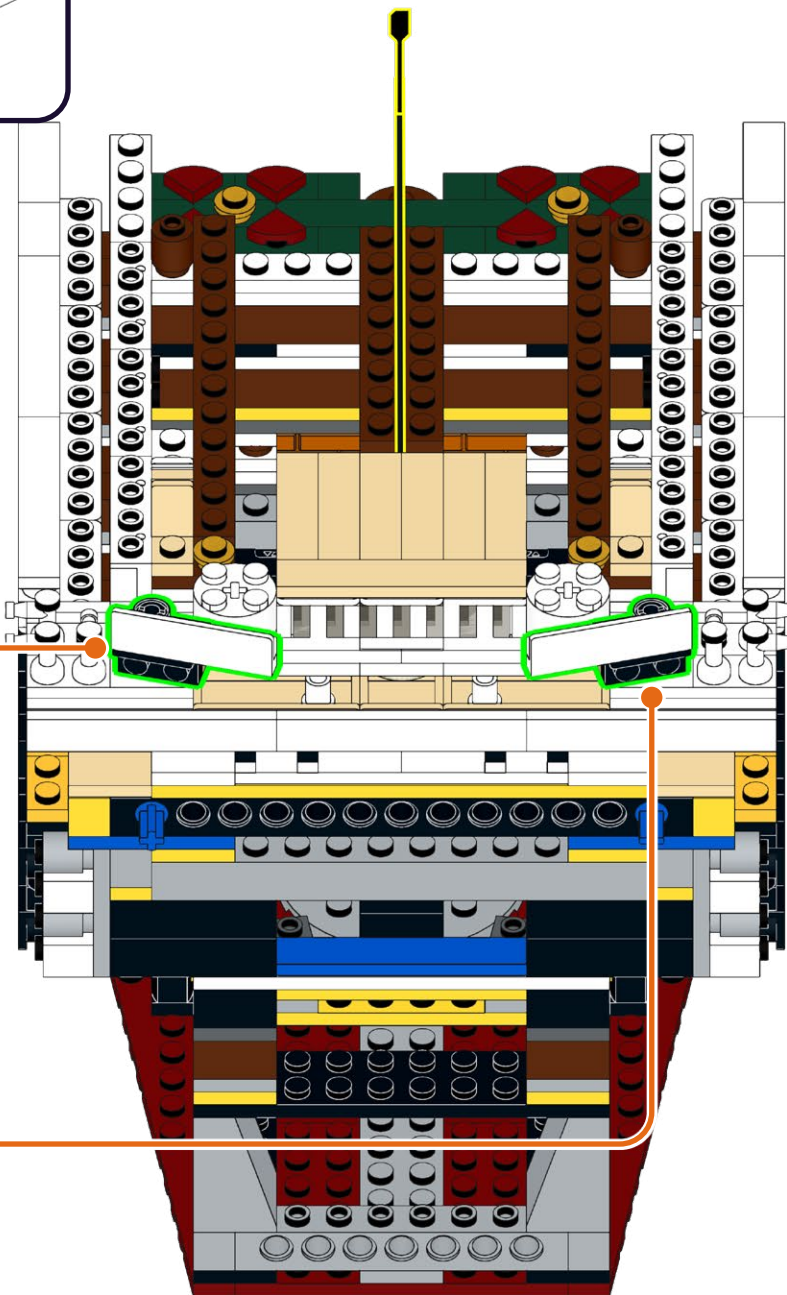
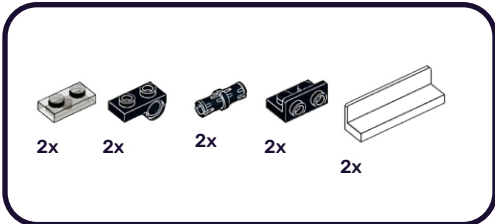

233

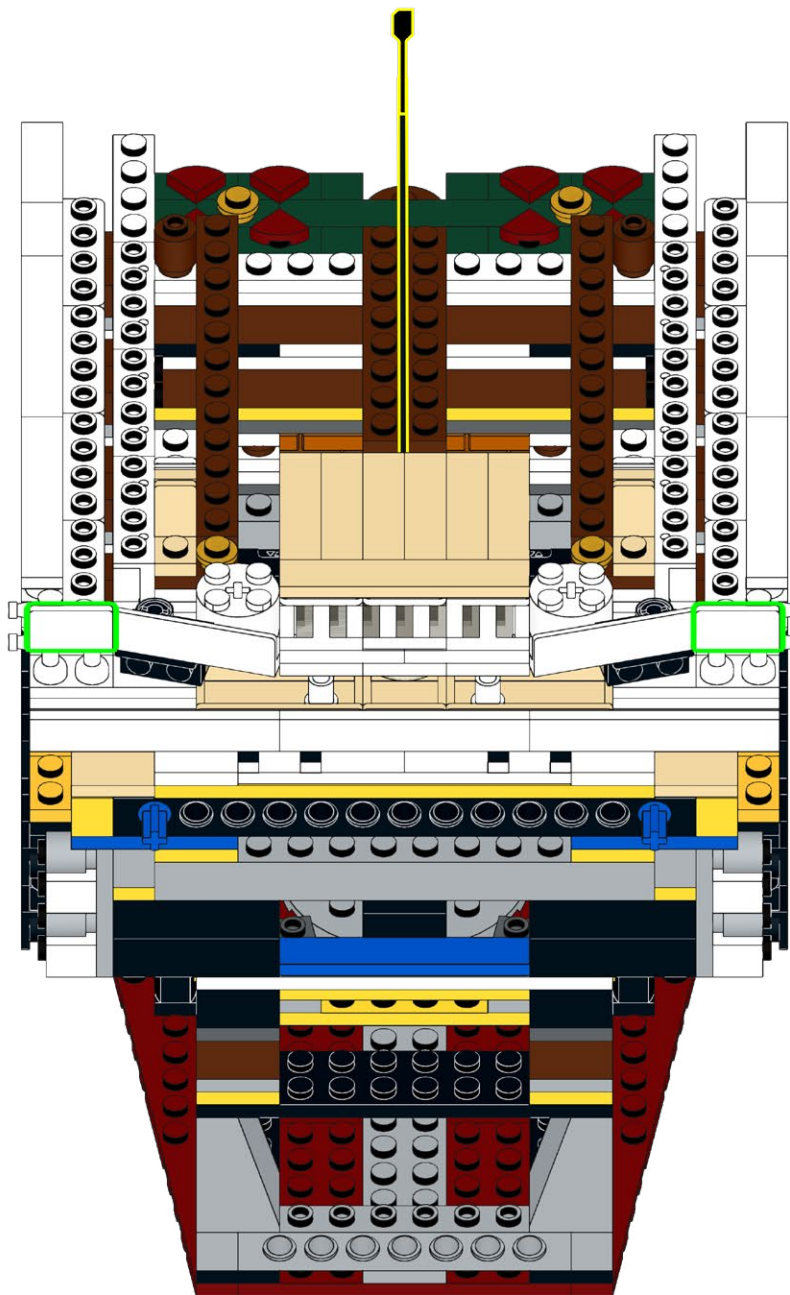
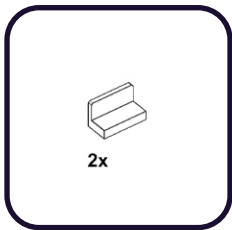

234

1x 1x 1x 1x

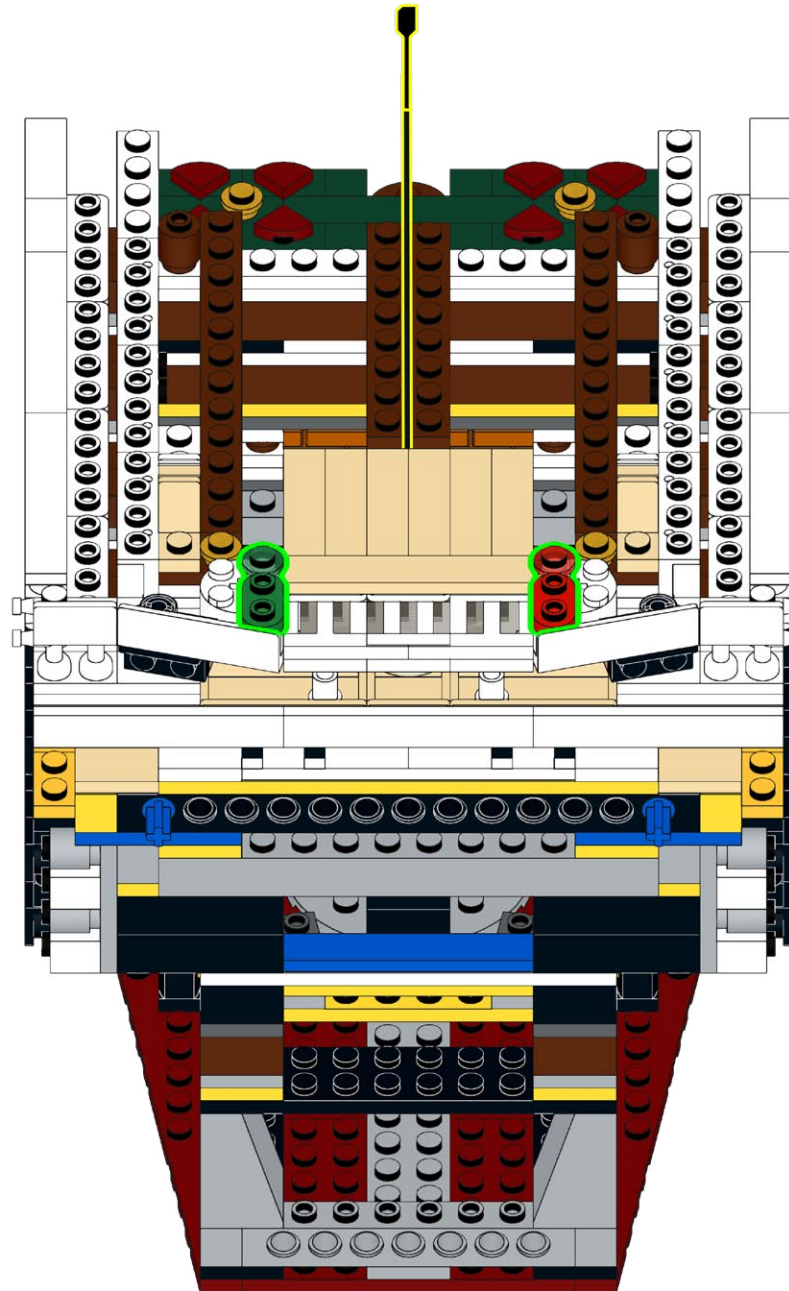

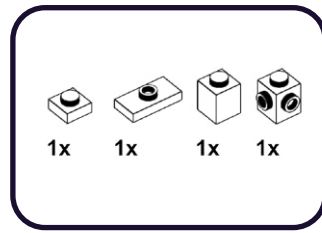
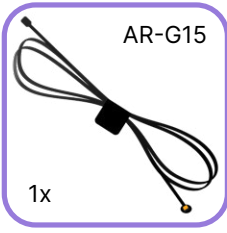
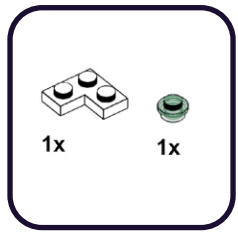

1

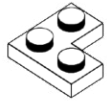

2



3

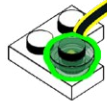

1

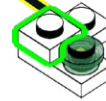

2



237

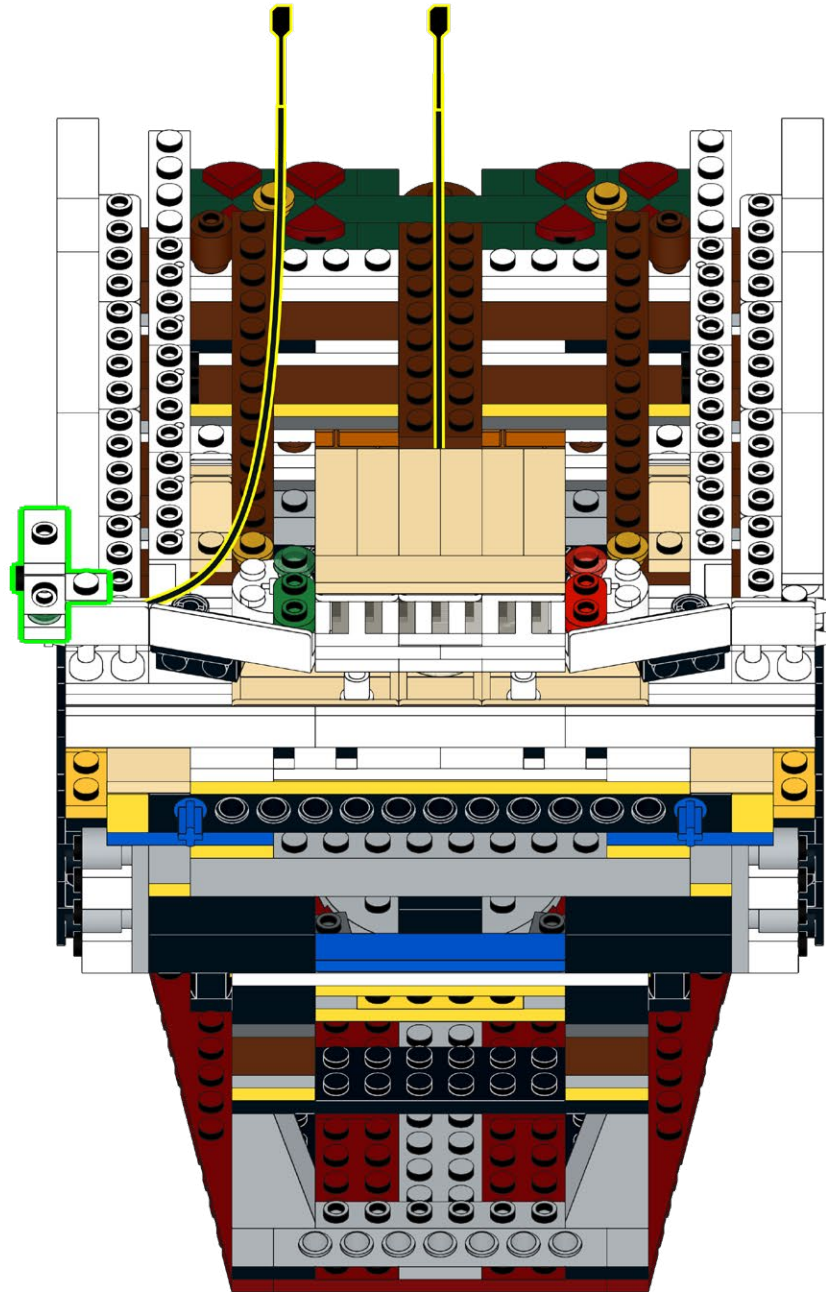

238

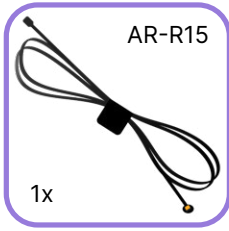
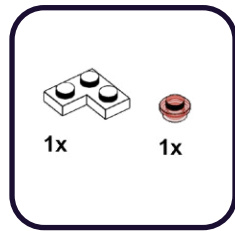

1

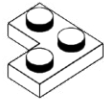

2

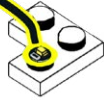

3

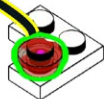

239

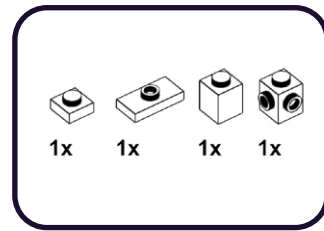

1

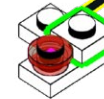

2

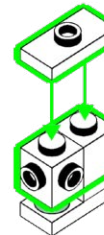

240

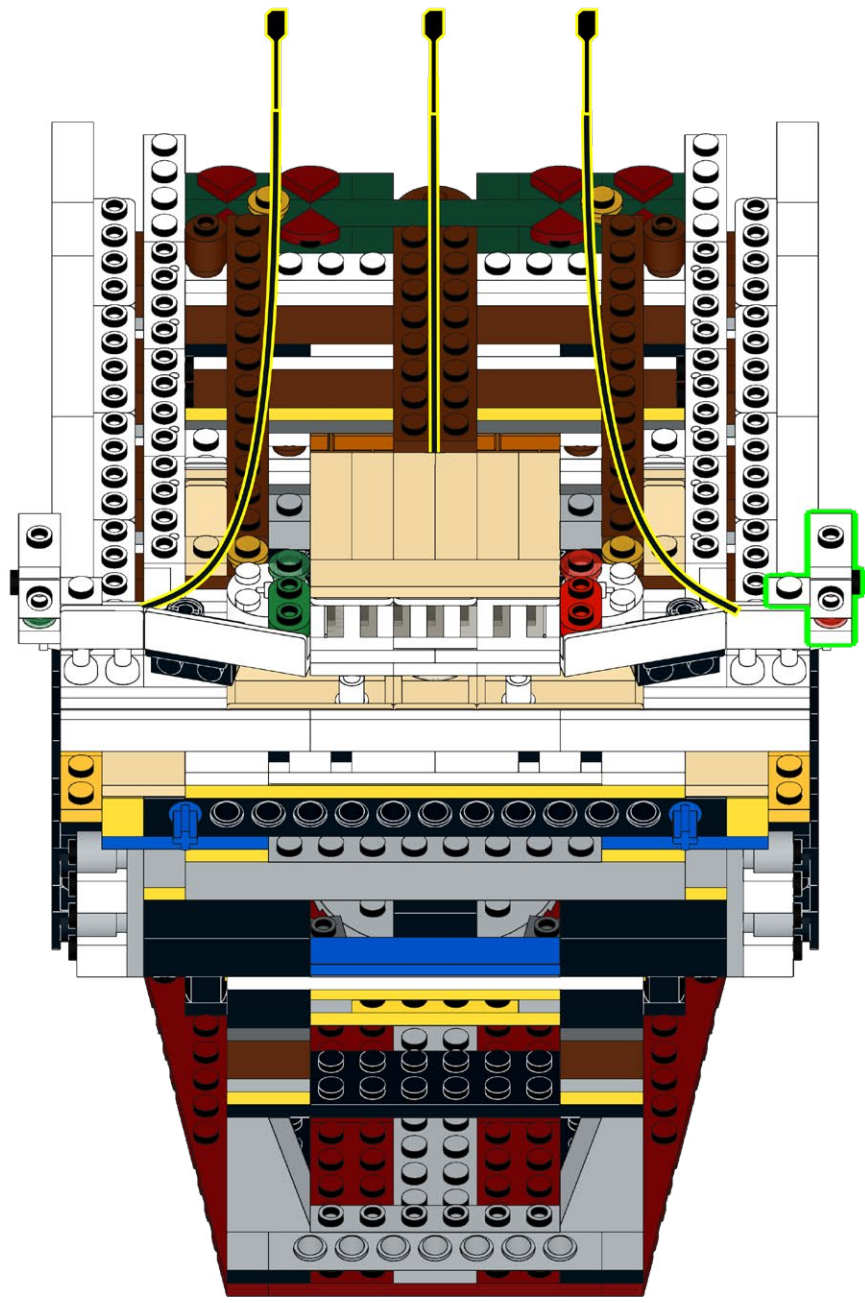

241

2x

2x

2x

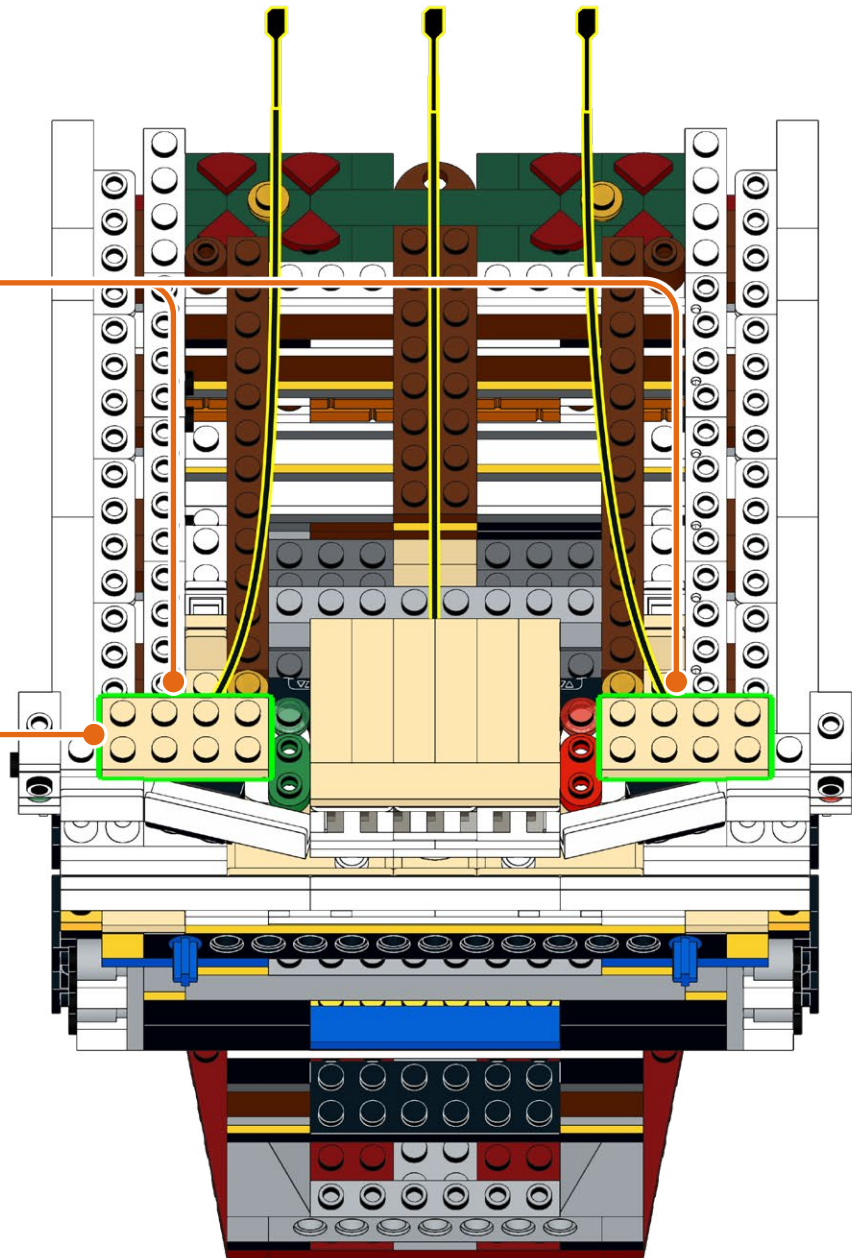
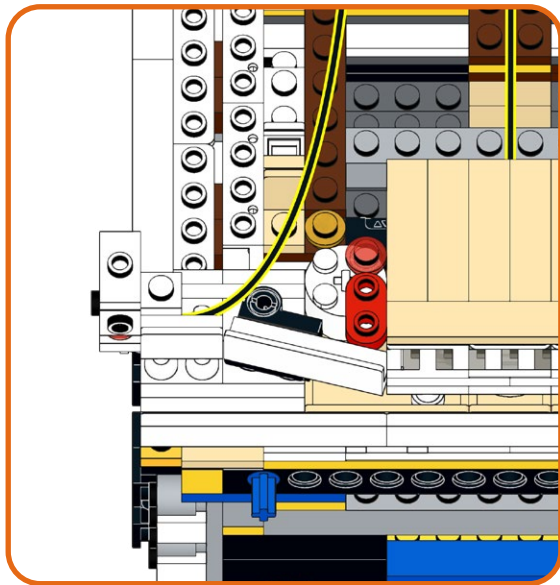

242

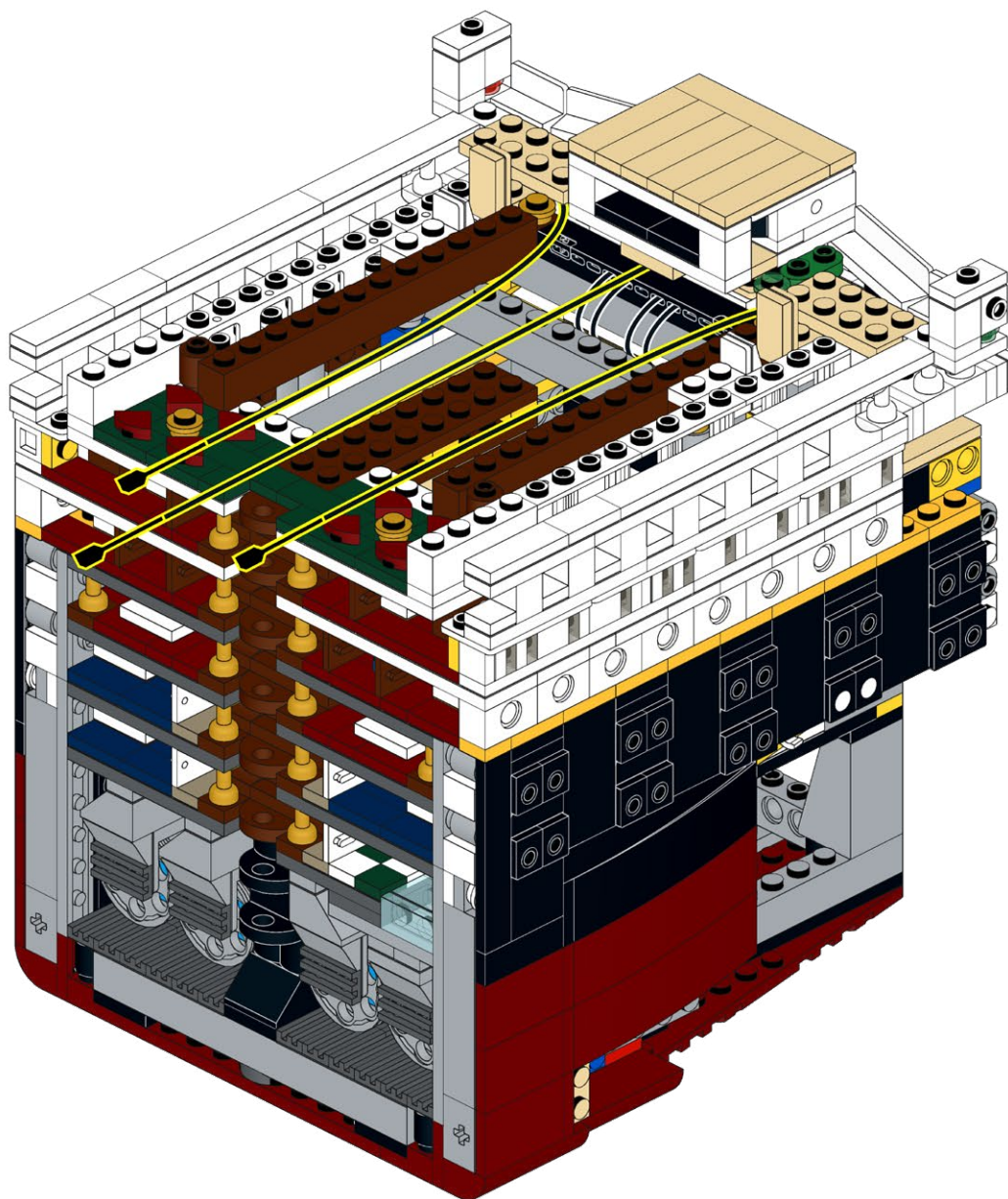

243

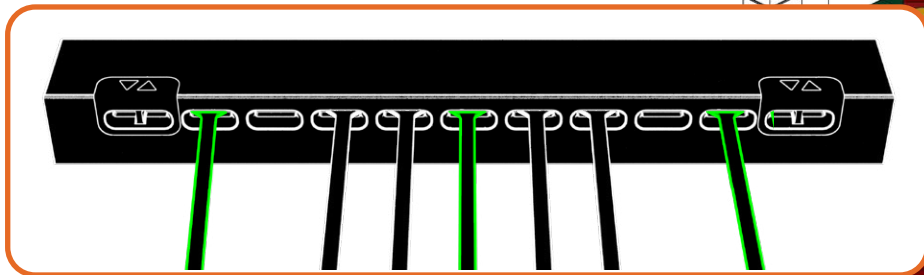
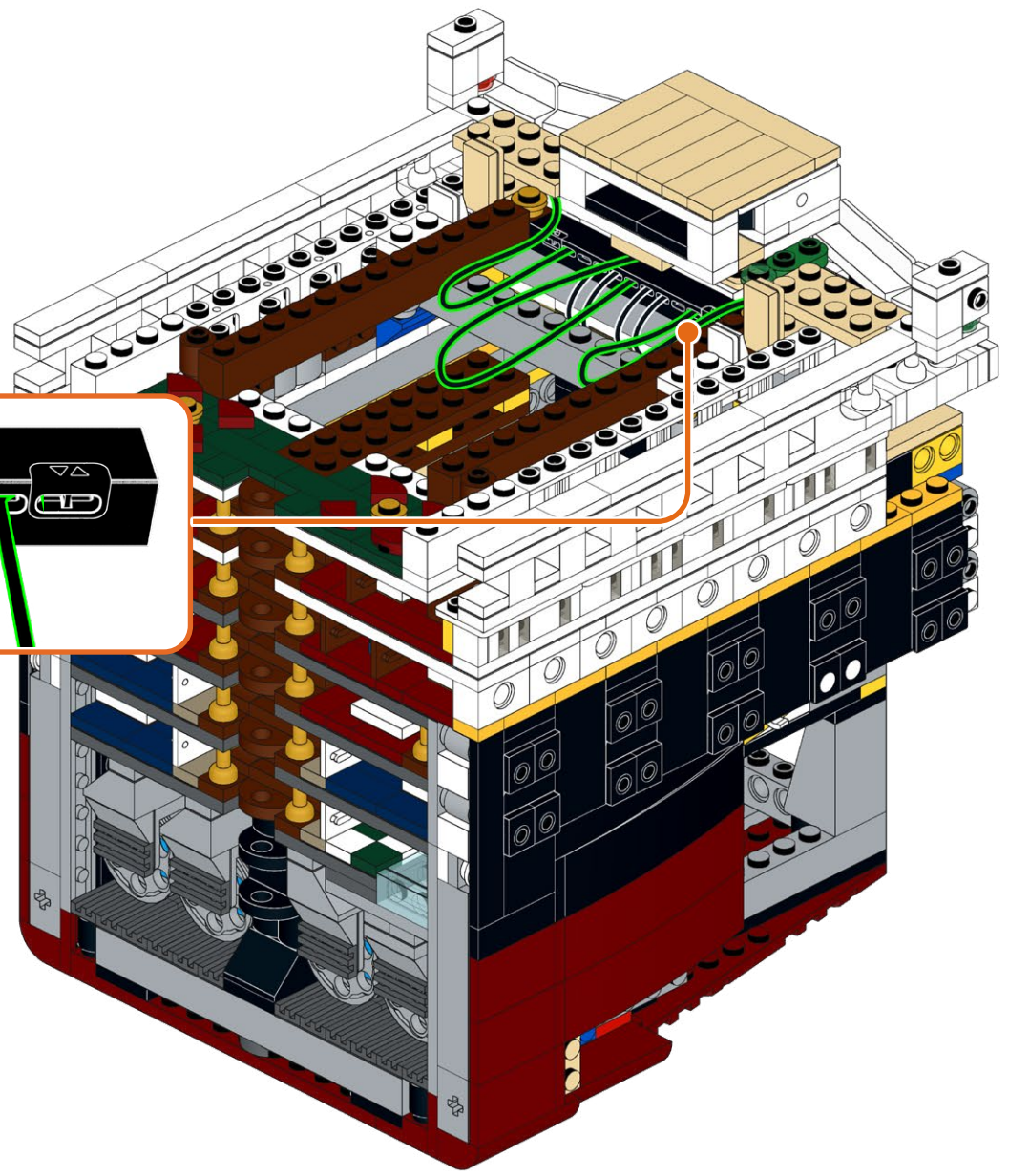

244

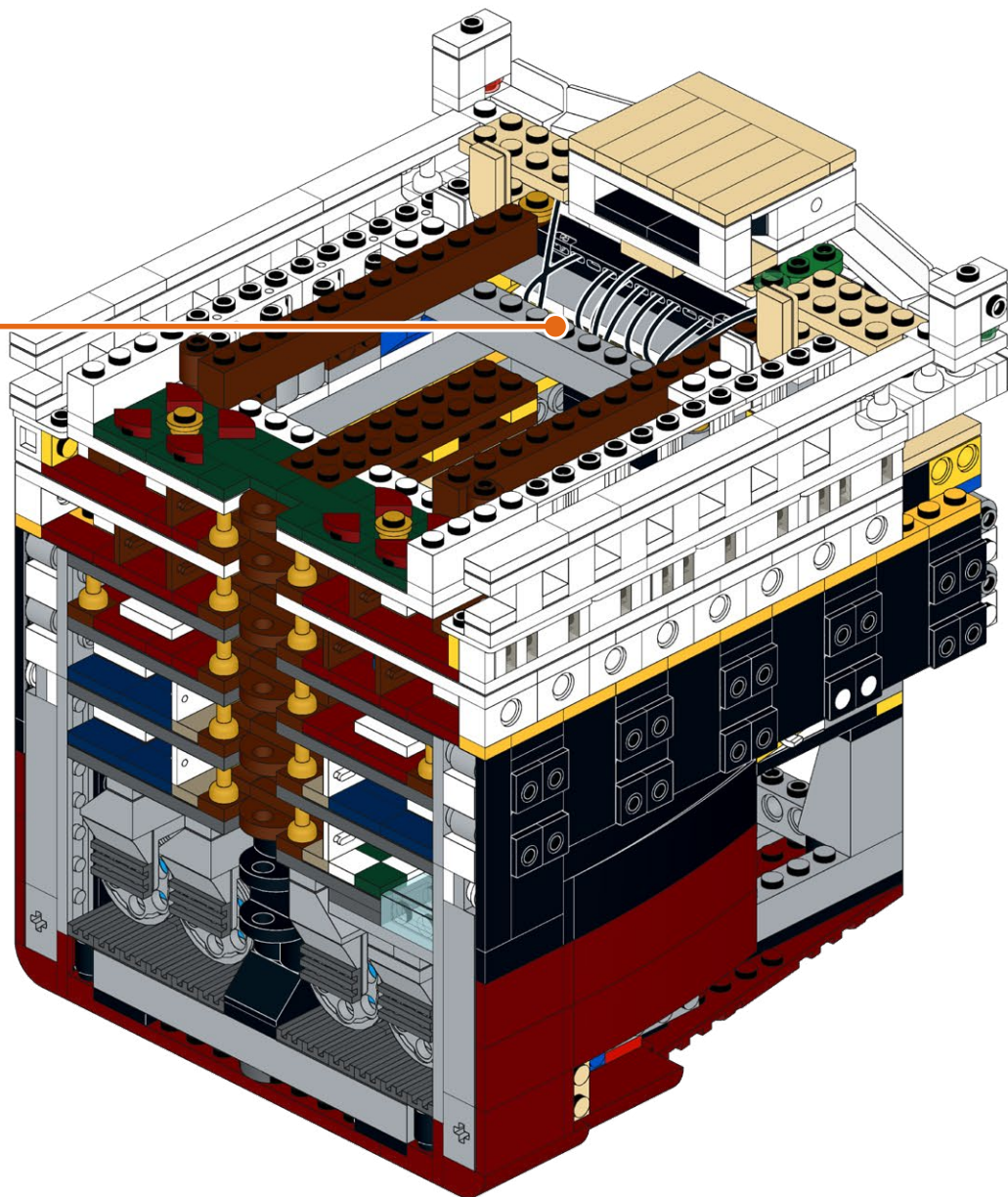
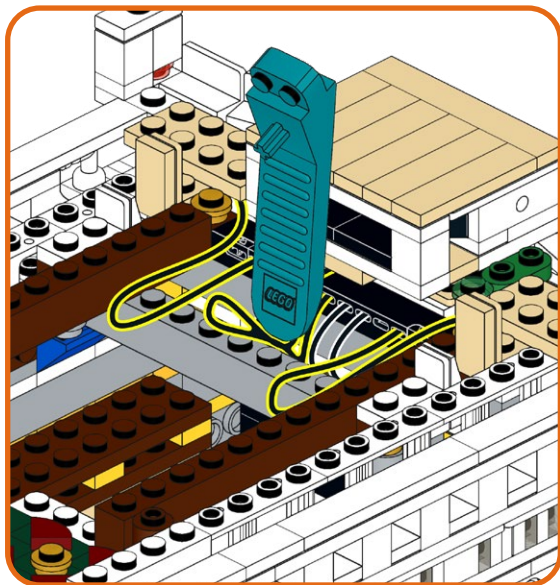

245

2x

4x

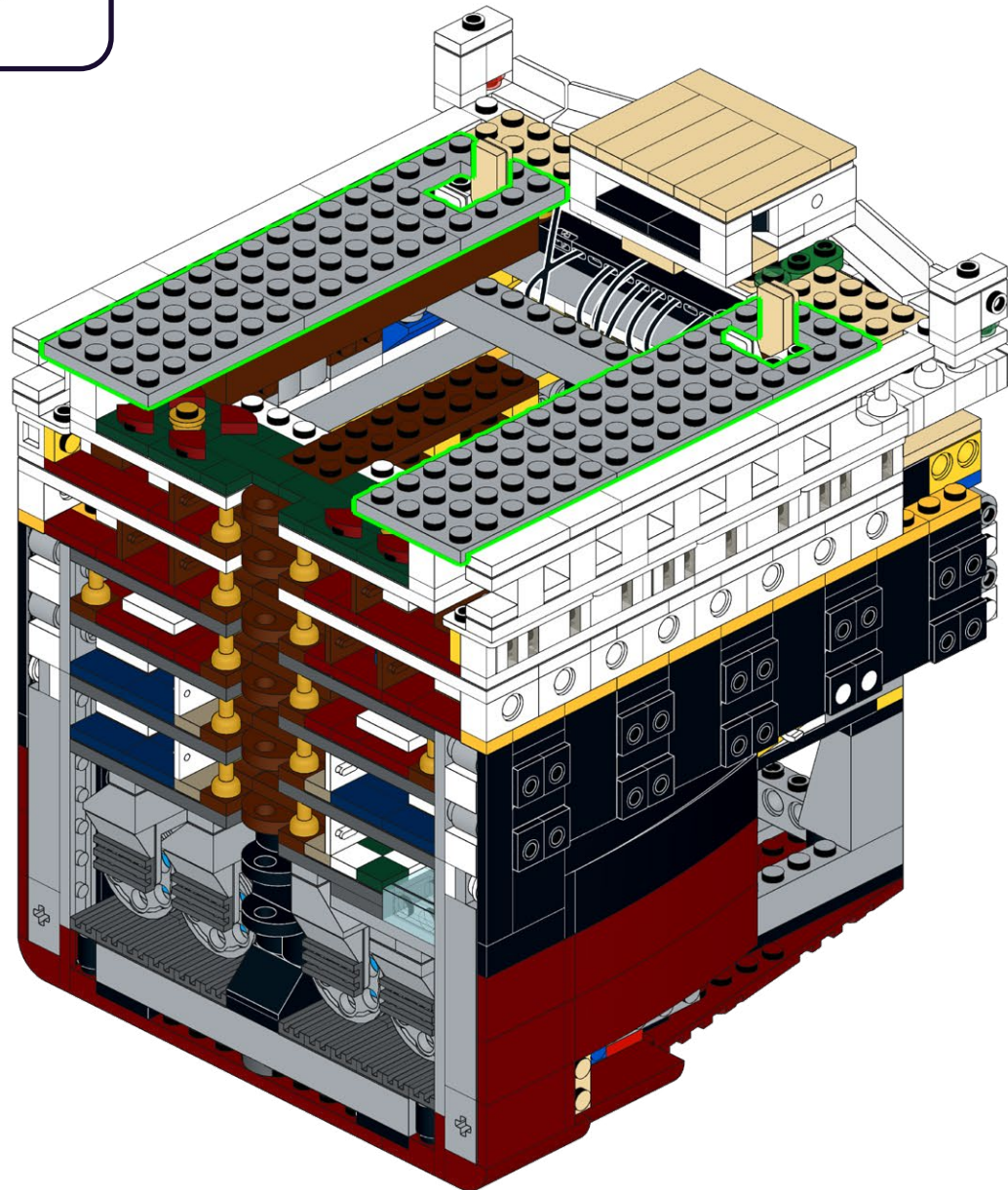

246

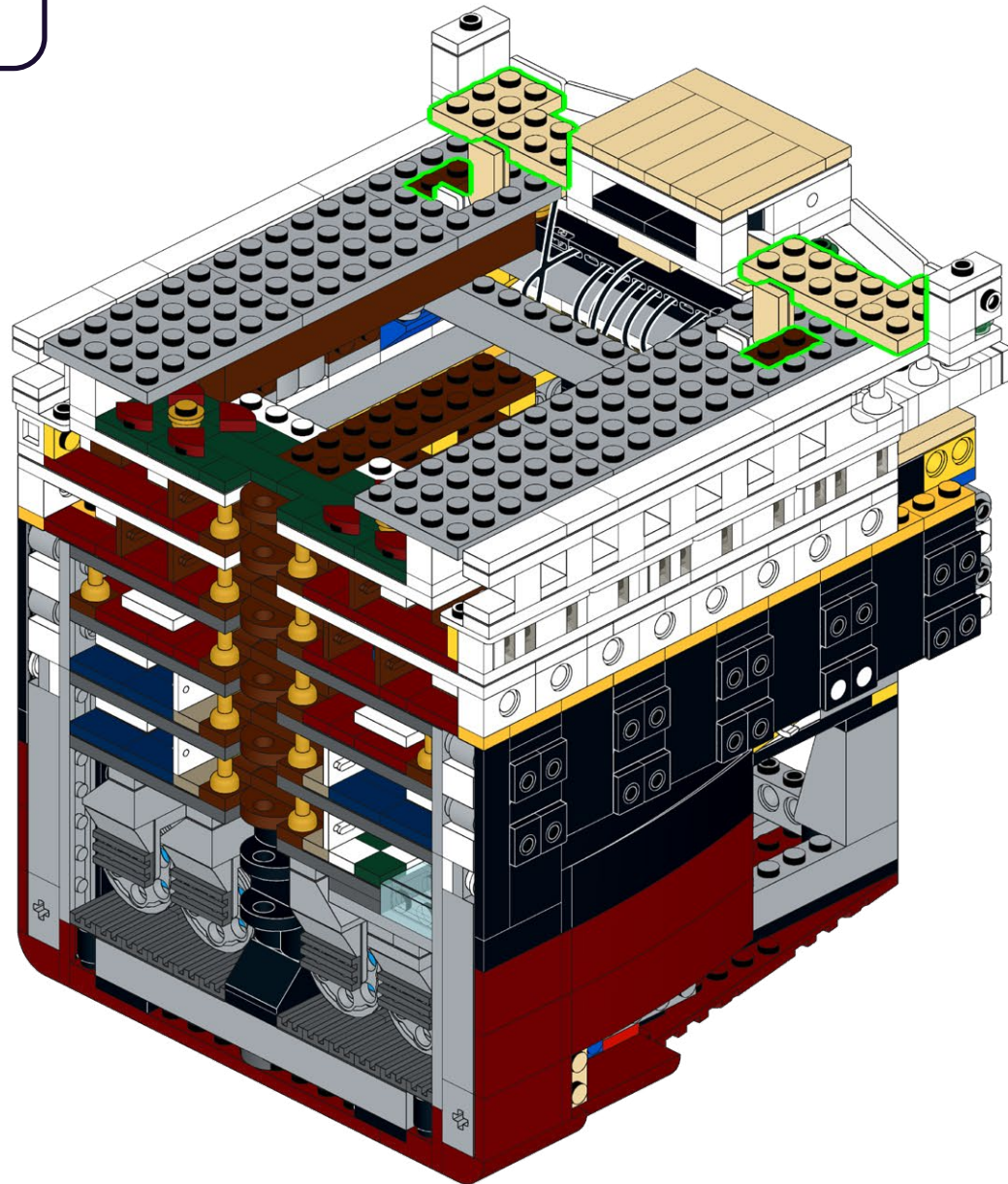
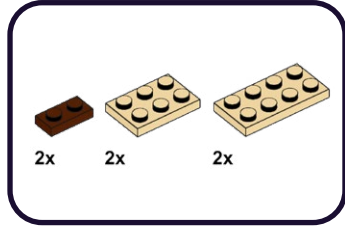

247

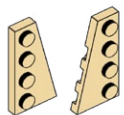

1x

1x

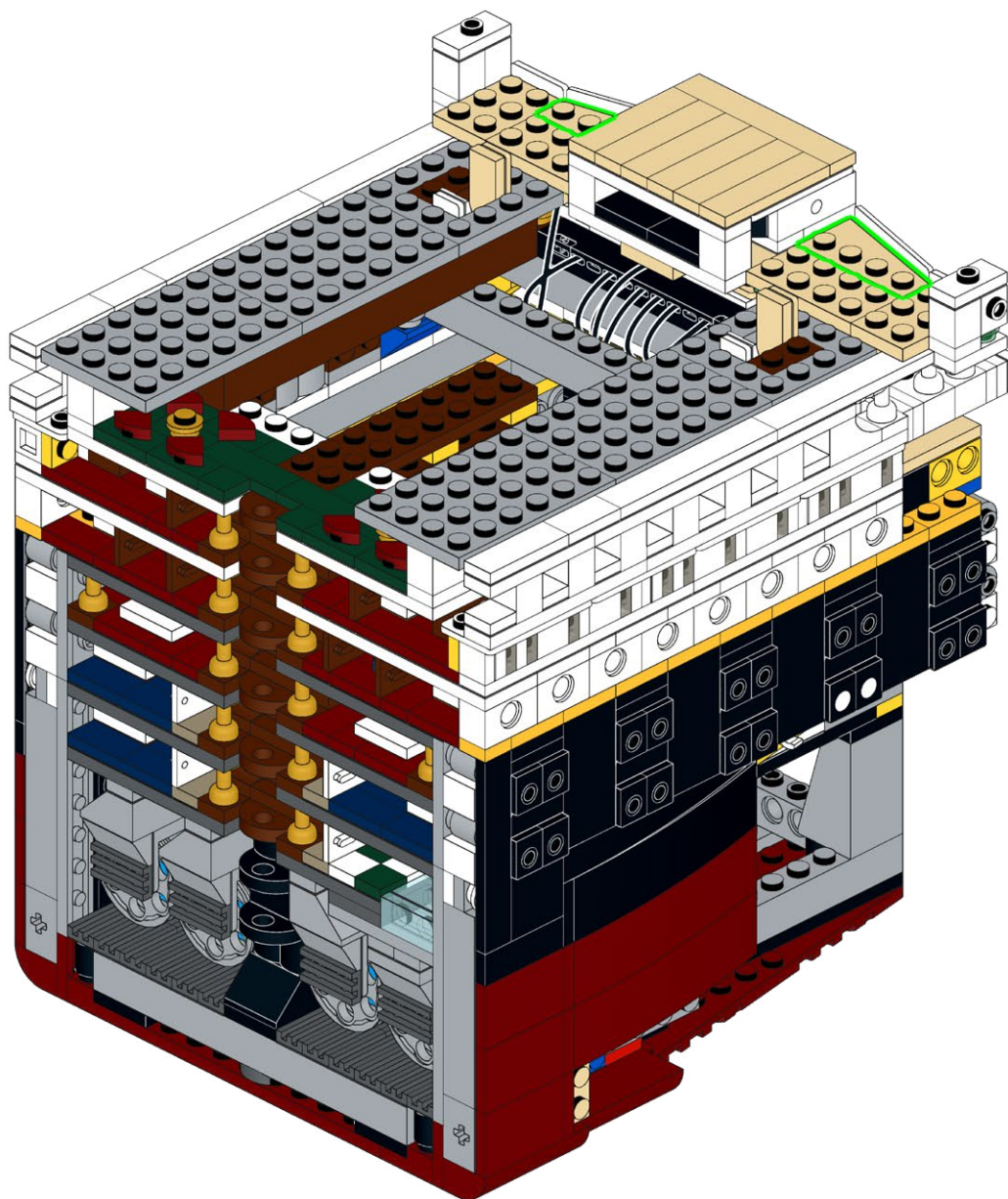

248



4x 2x

1

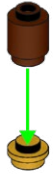

2



2x

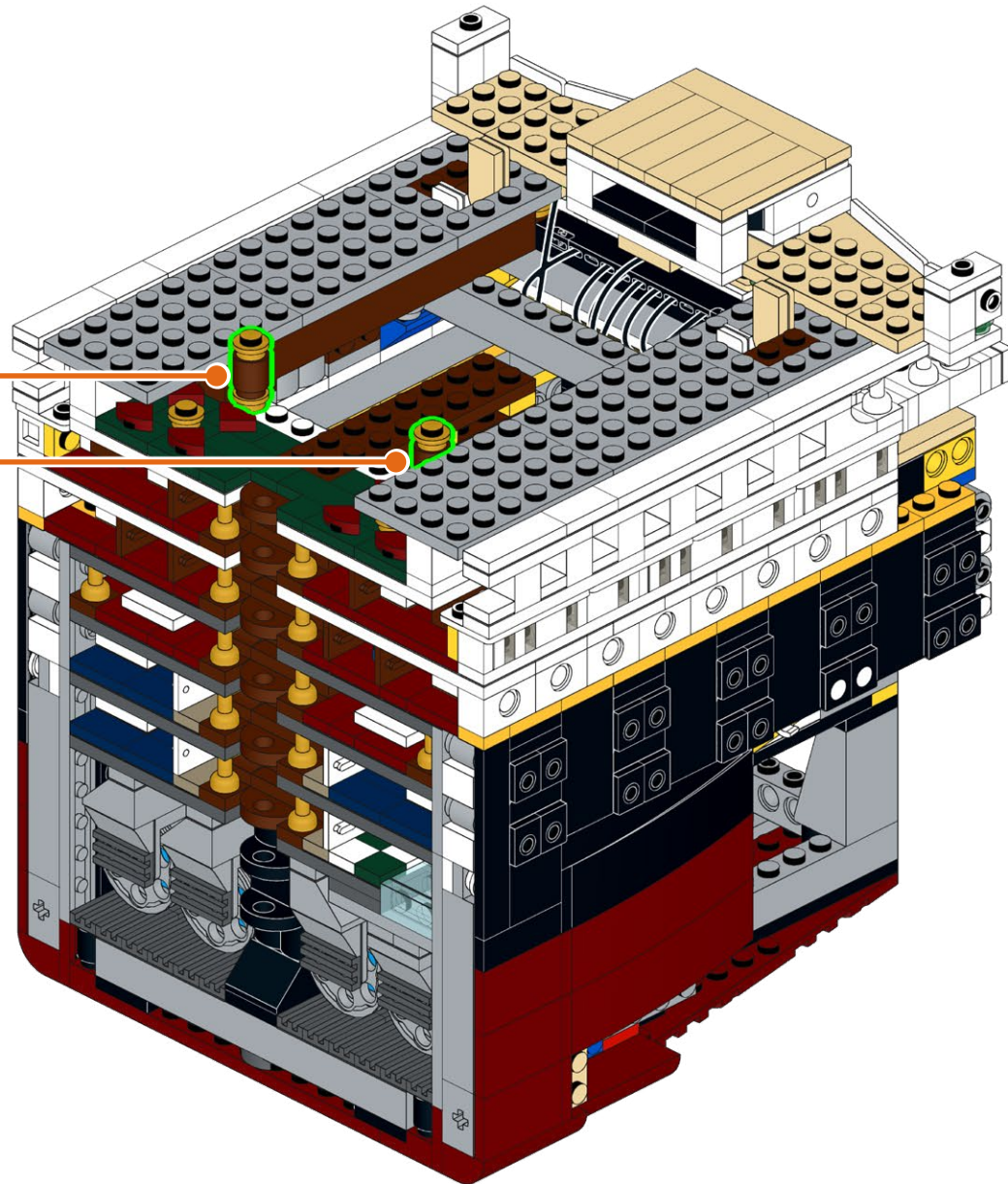

**HOLD UP!**

You might notice some bags aren't in order, as well as left over pieces, but that's ok! We're changing the way you build LEGO!

ATTENDEZ!

Vous remarquerez peut-être que certains sacs, ainsi que certaines pièces, ne sont pas dans le bon ordre. Mais pas de panique! Nous changeons simplement la façon avec laquelle vous construisez vos LEGO!

ASPETTA!

Potresti notare che alcuni sacchetti non sono in ordine, così come i pezzi avanzati, ma va bene così! Stiamo cambiando il modo in cui costruisci i LEGO!

HALT!

Sie werden möglicherweise bemerken, dass einige tüten durcheinander sind und teile übrig bleiben, aber das ist in Ordnung! Wir ändern die art und weise, wie Sie LEGO bauen!

¡ESPERA!

Es posible que notes que algunas bolsas están fuera de servicio, así como piezas sobrantes, ¡pero está bien! ¡Estamos cambiando la forma en que construyes LEGO!

暫停!

你可能会注意到一些袋子顺序错乱, 以及一些剩余的部件, 但没关系! 我们正在改变你搭建乐高的方式!

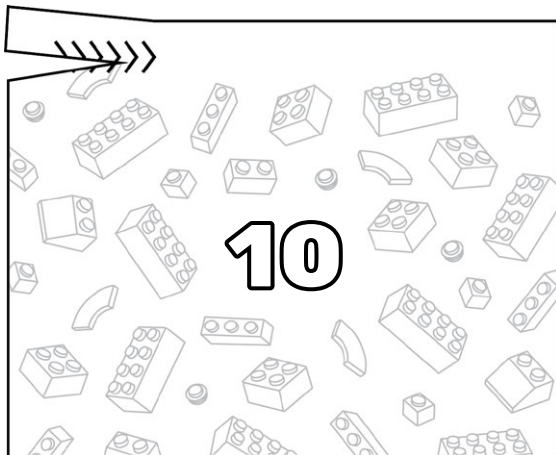
Open LEGO® Bag 10

249

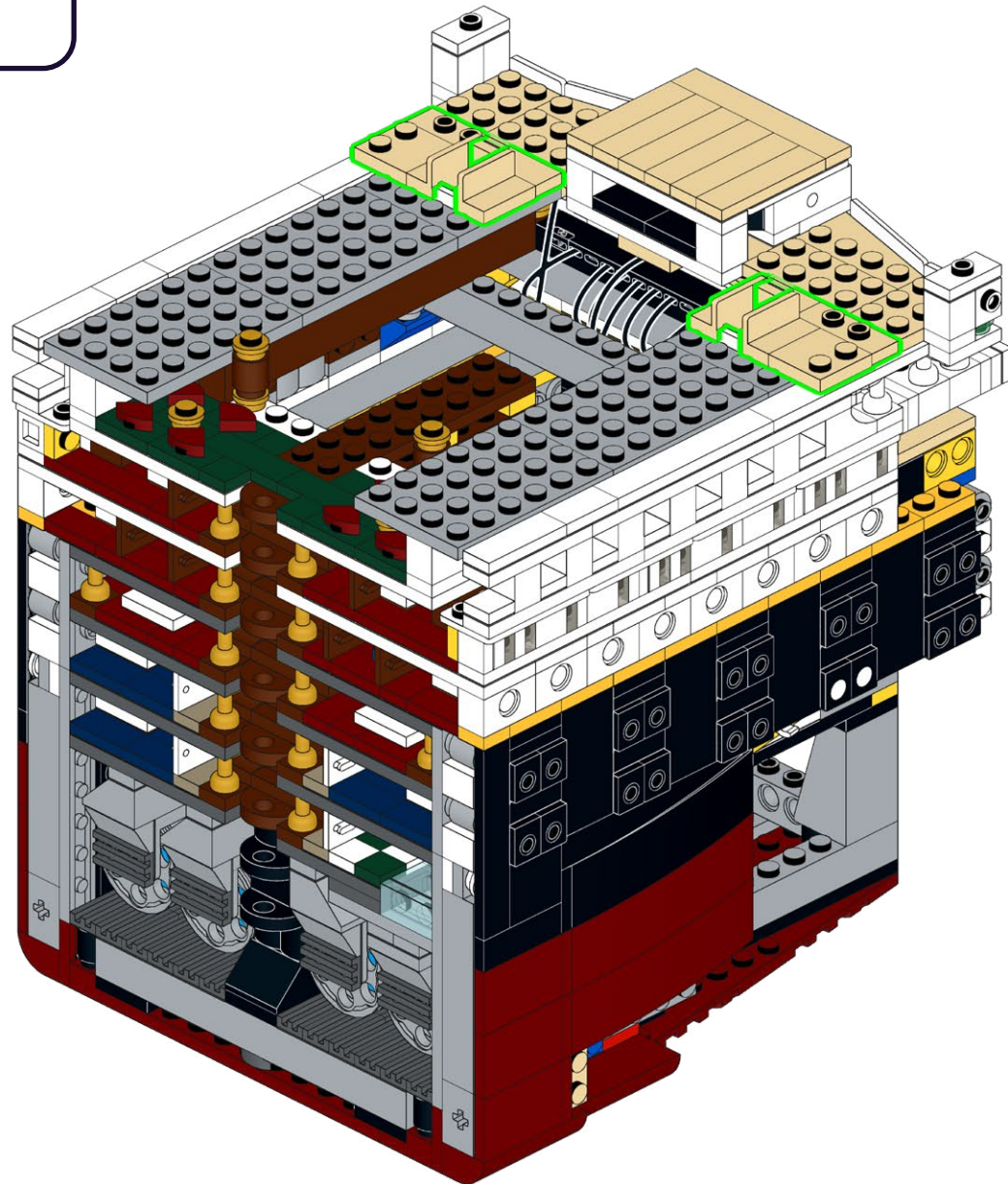
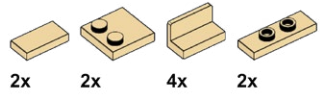

250

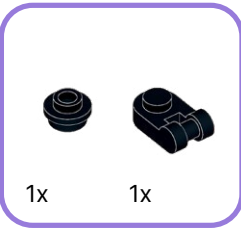
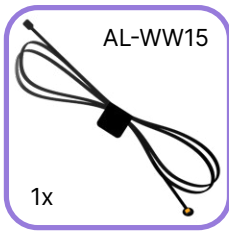

1

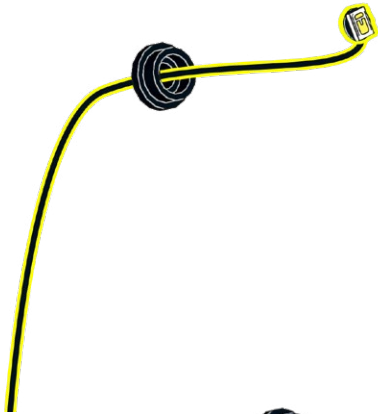

2

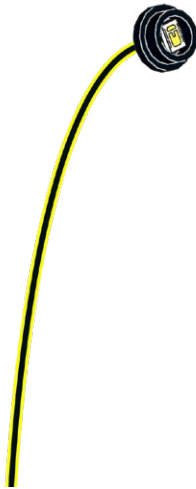

3



251

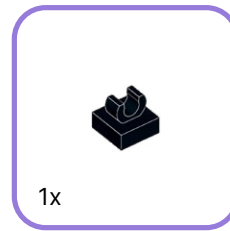

1



2

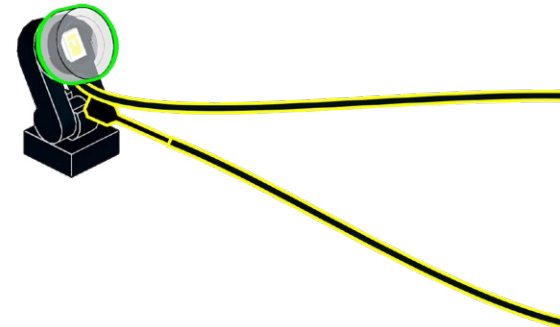

3



2x

252

2x

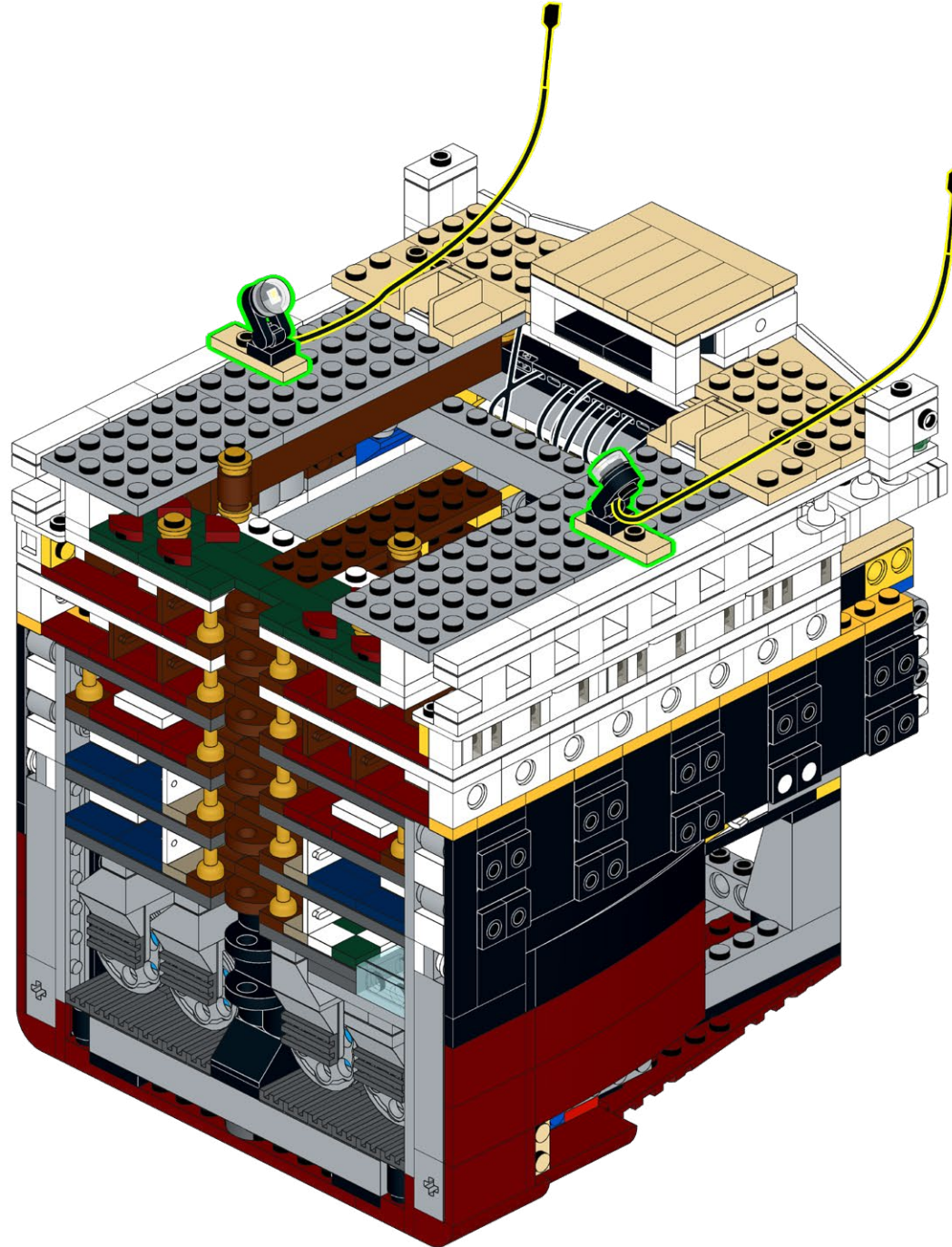

253

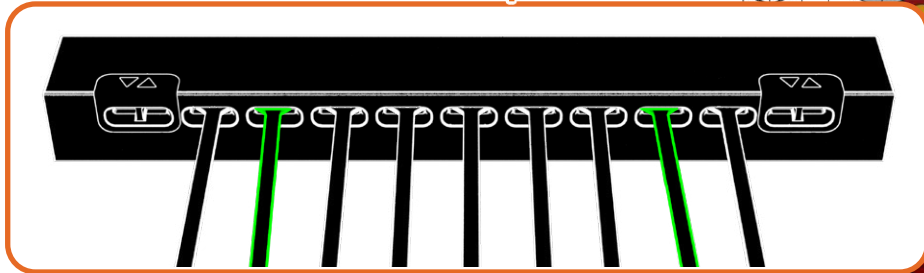
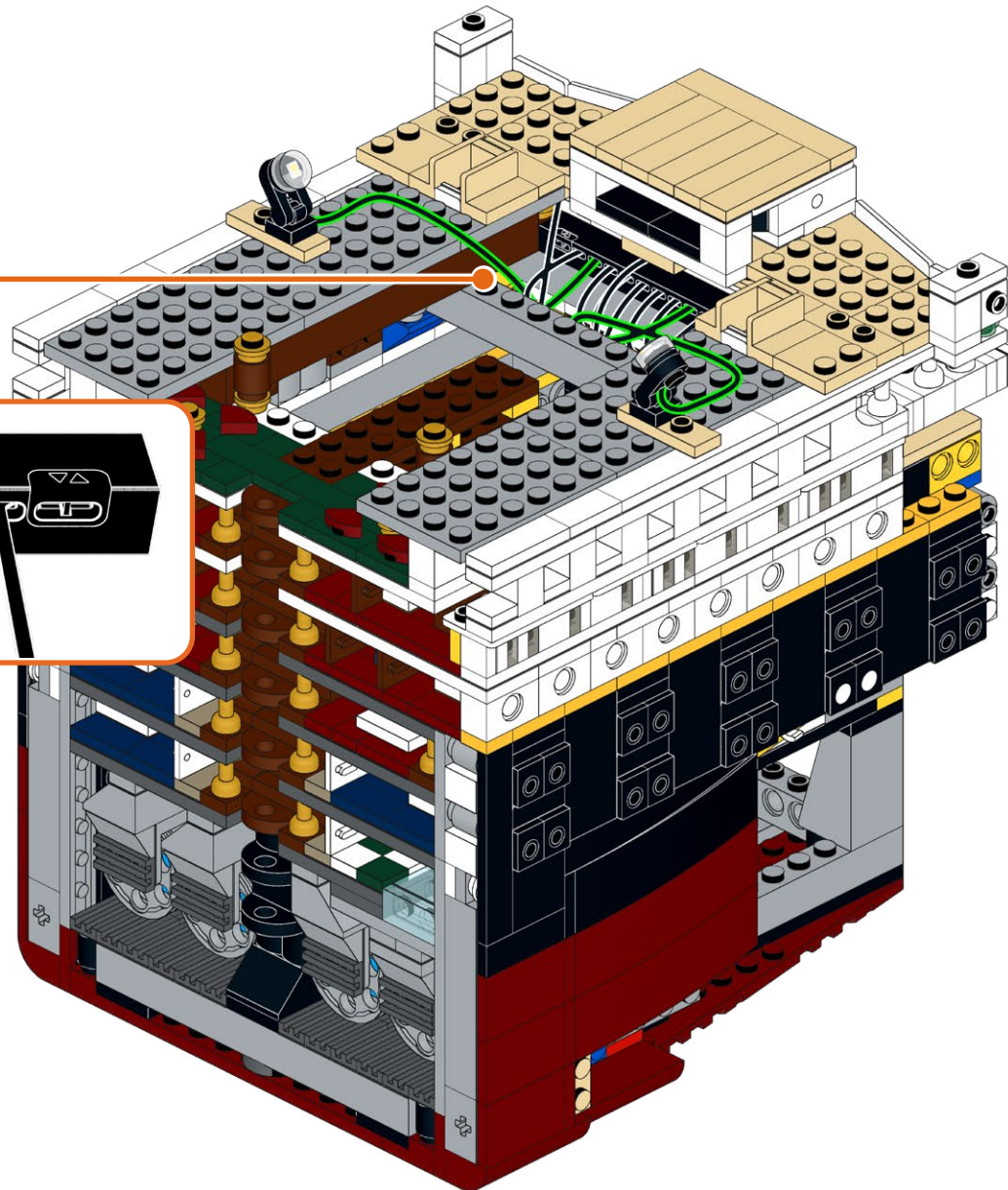

254

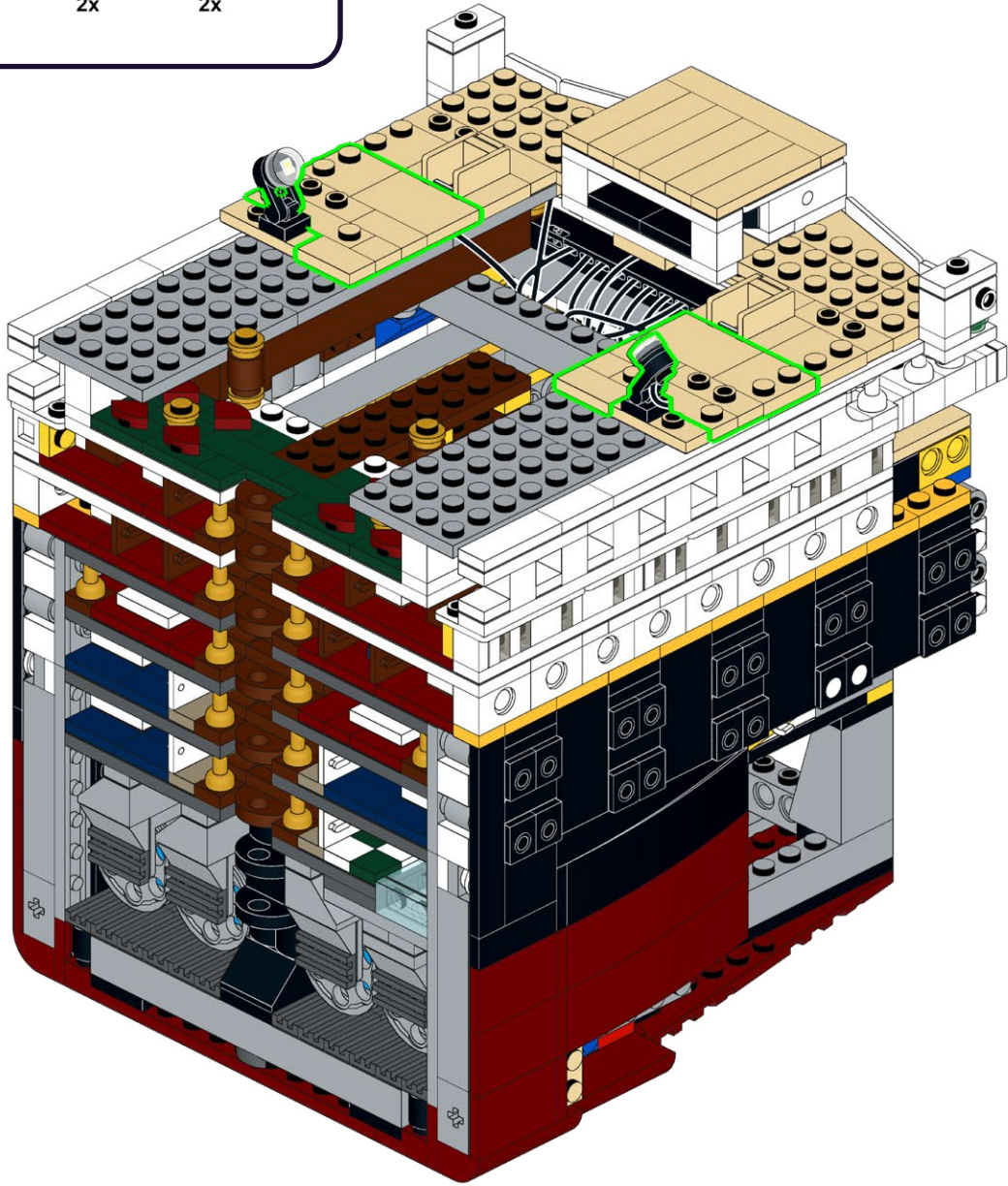
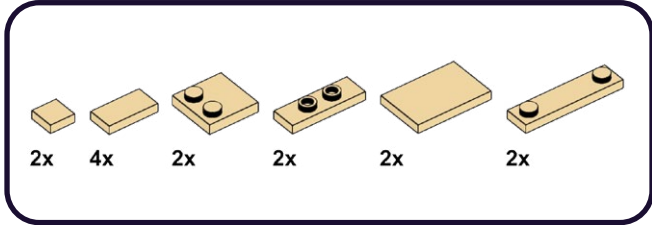

255

- 2x
- 6x
- 2x
- 4x
- 4x
- 4x
- 2x

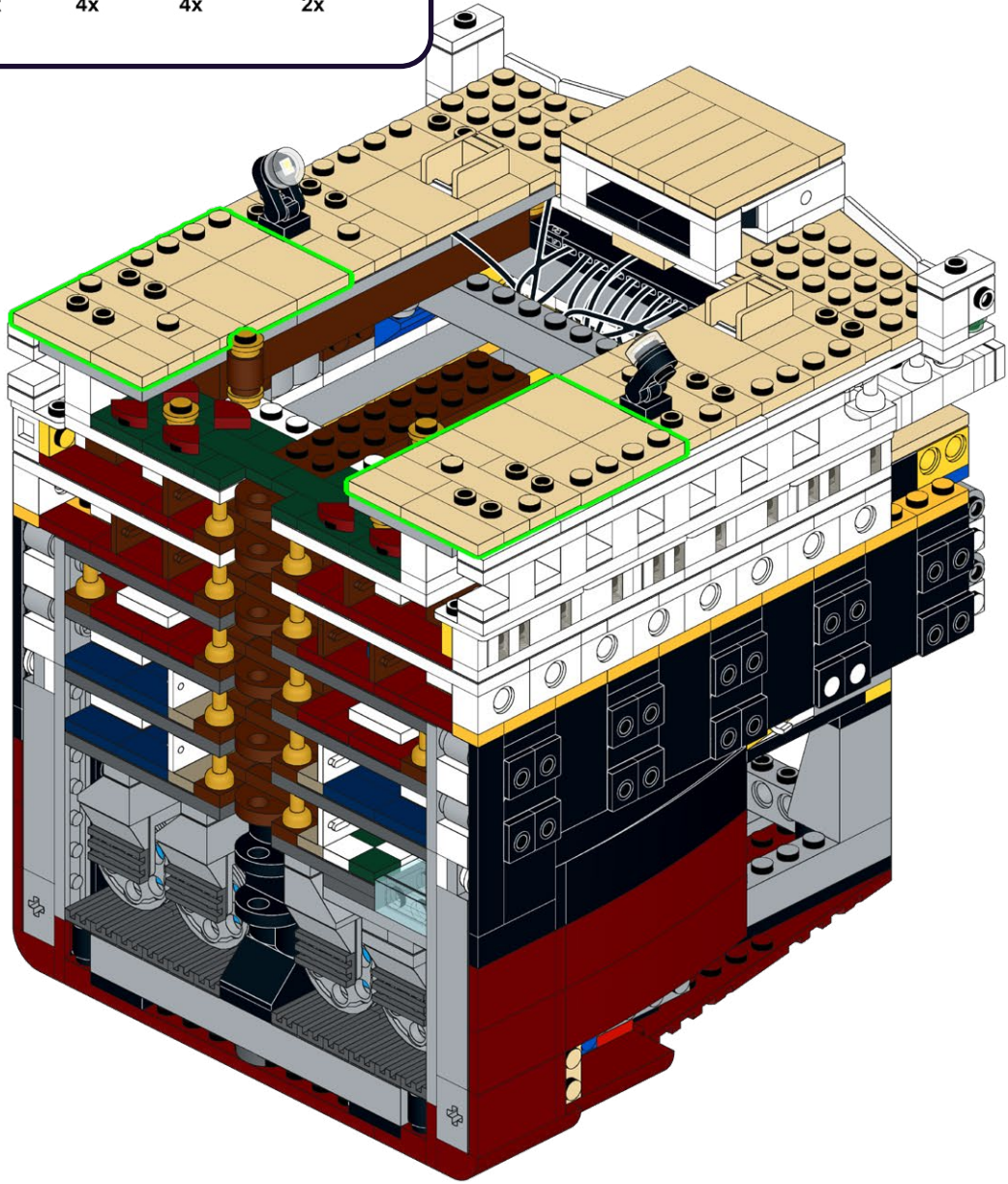

256

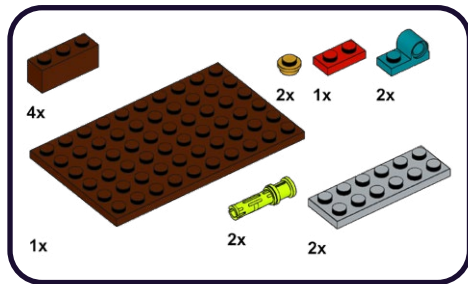

1

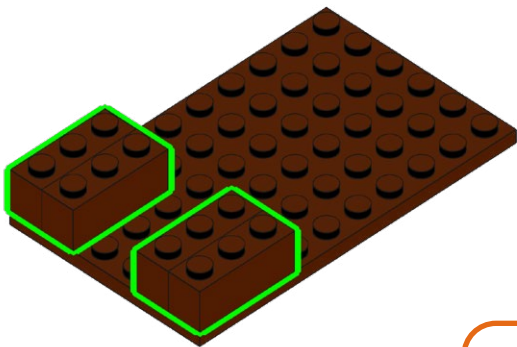

2

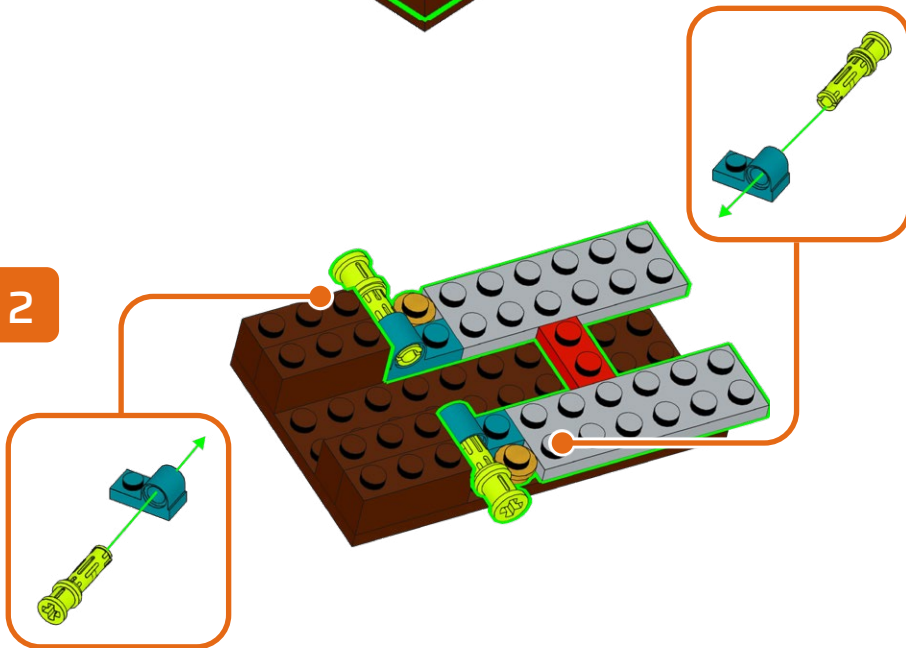

257

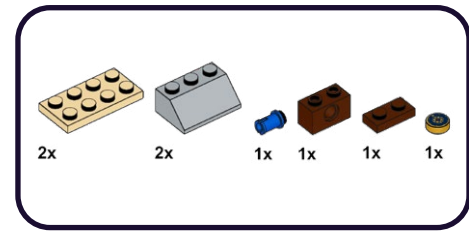

1

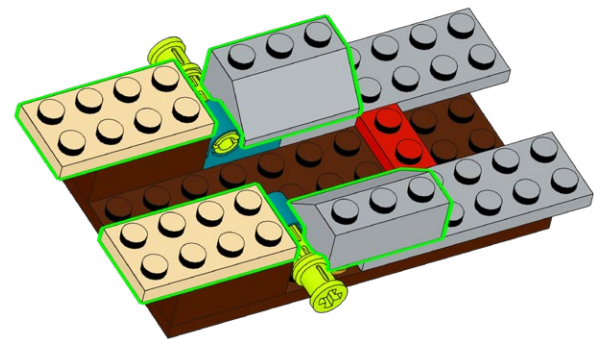

2

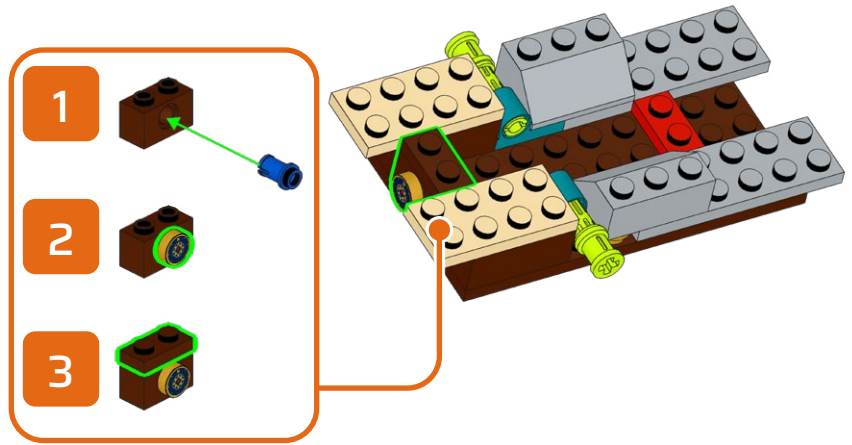

258

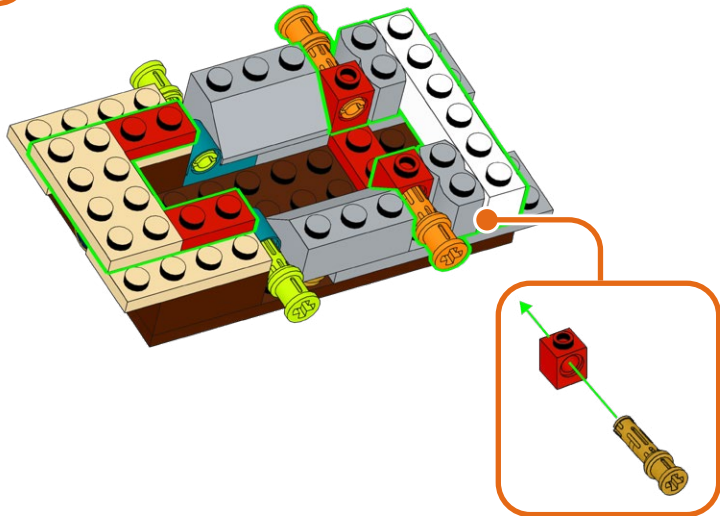
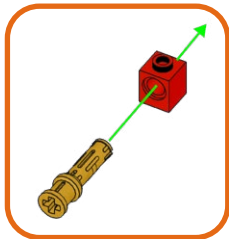
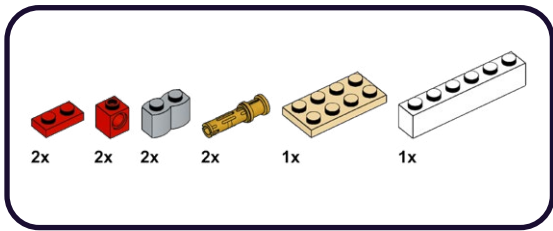

259

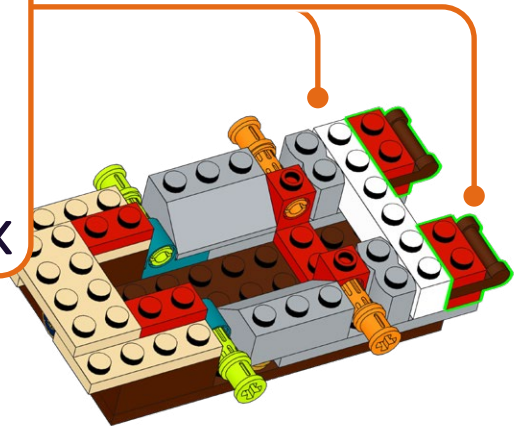
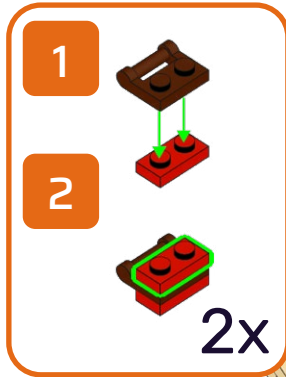
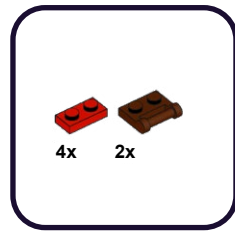

260

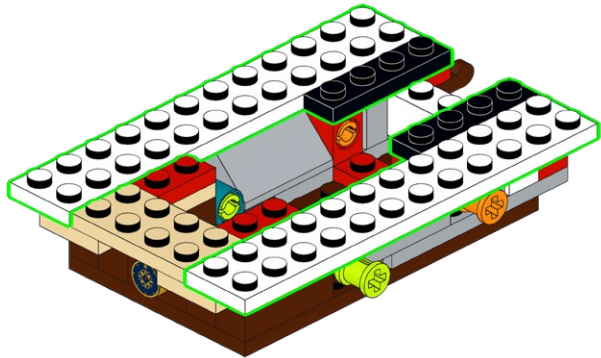
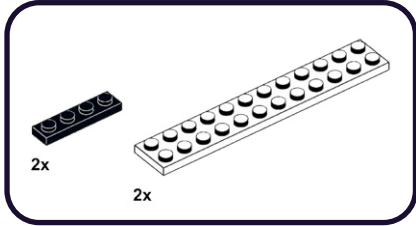

261

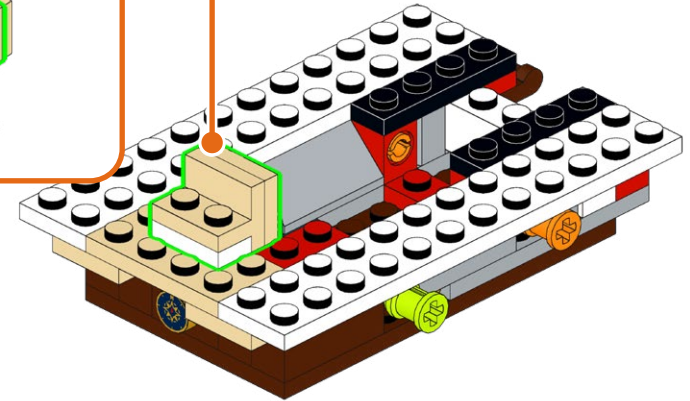
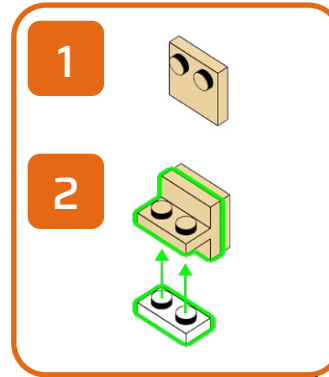
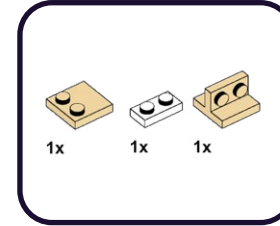

262

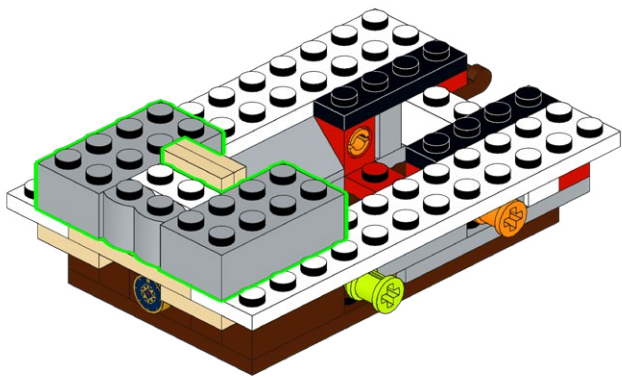
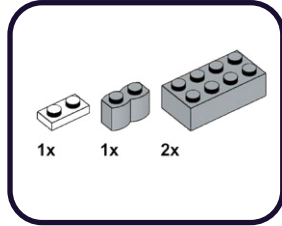

263

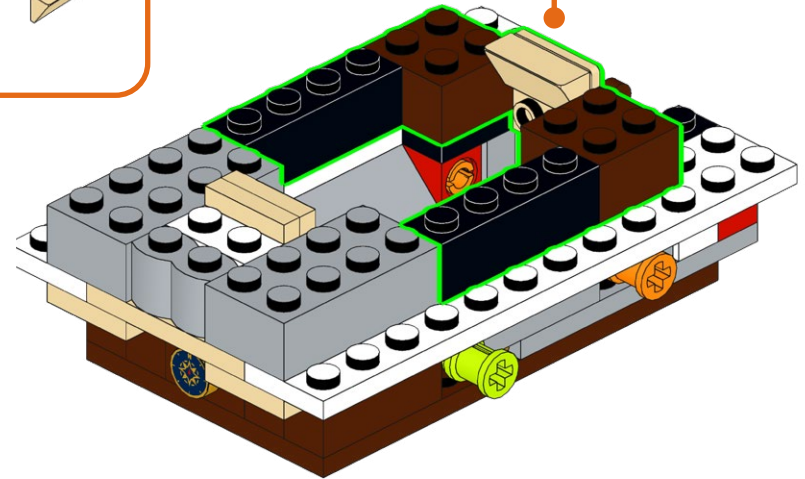
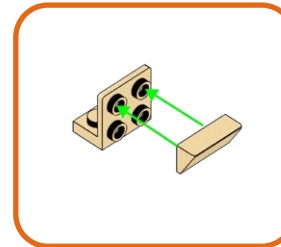
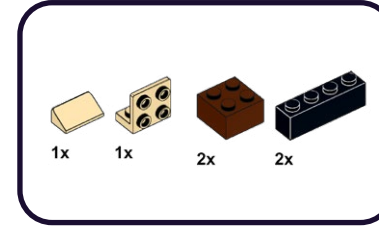

264

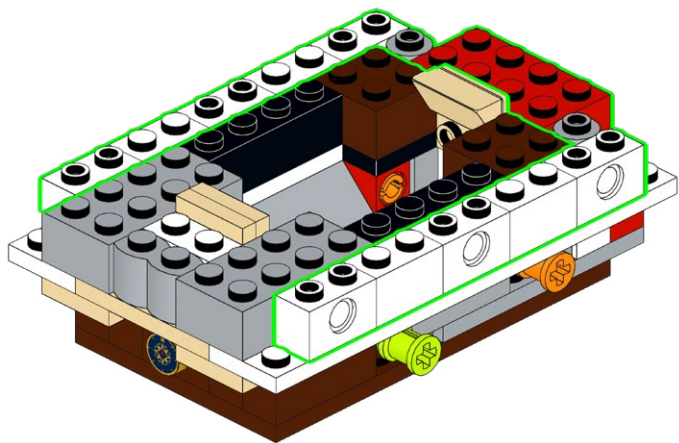
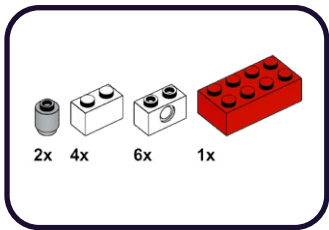

265

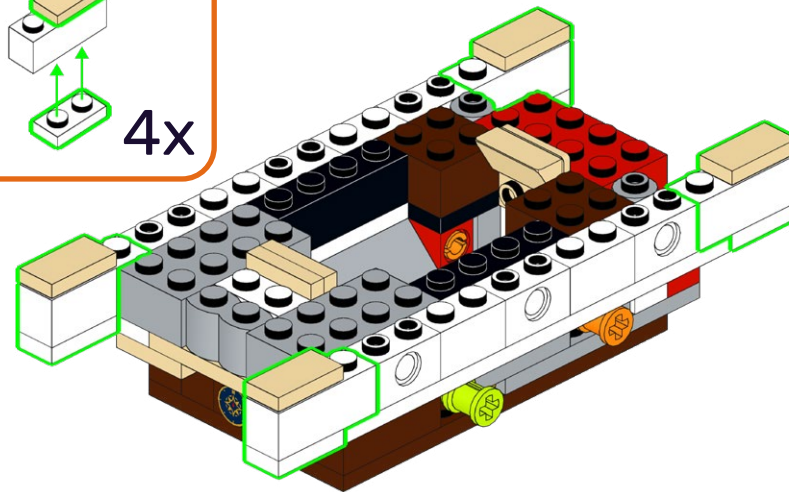
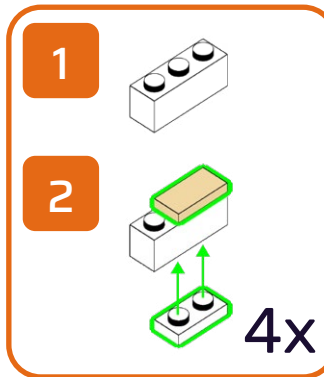
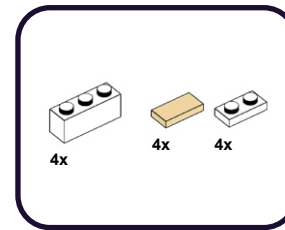

266

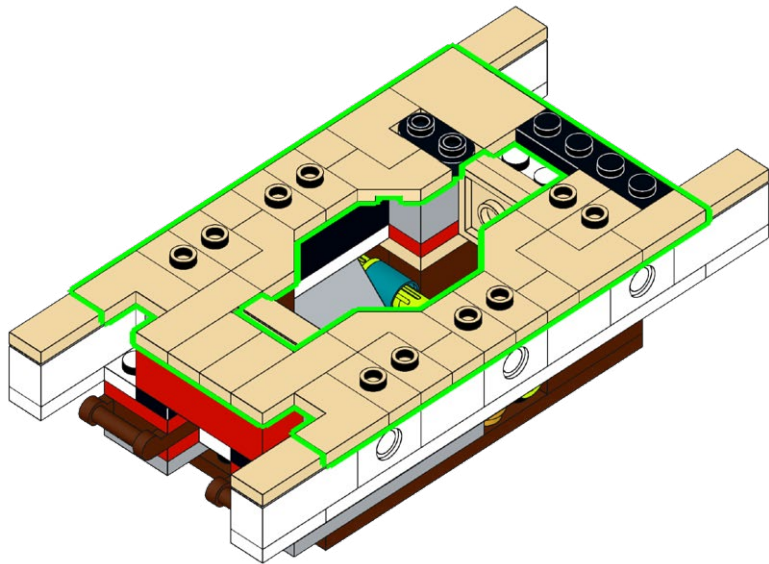
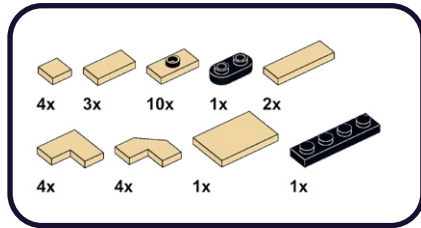

267

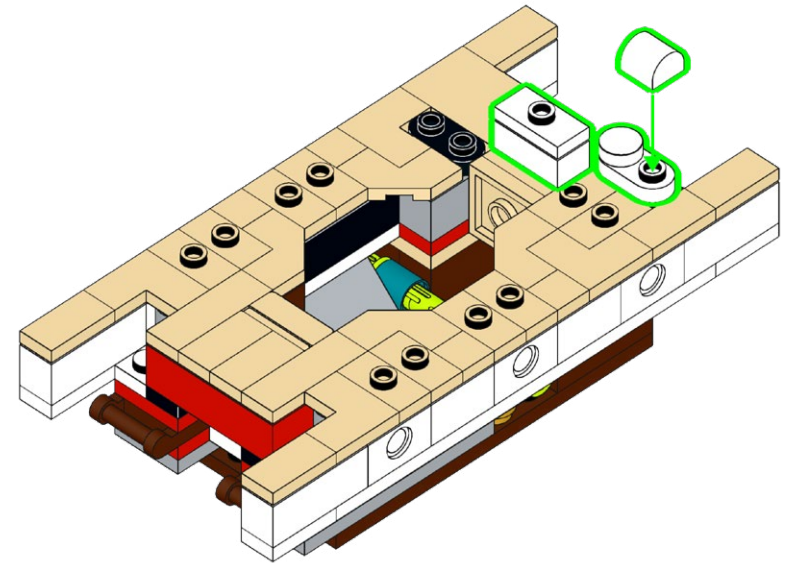
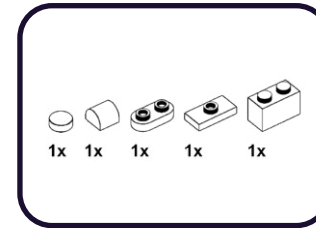

268

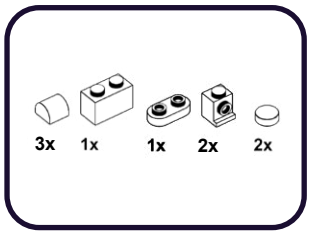

- 1
- 2
- 3

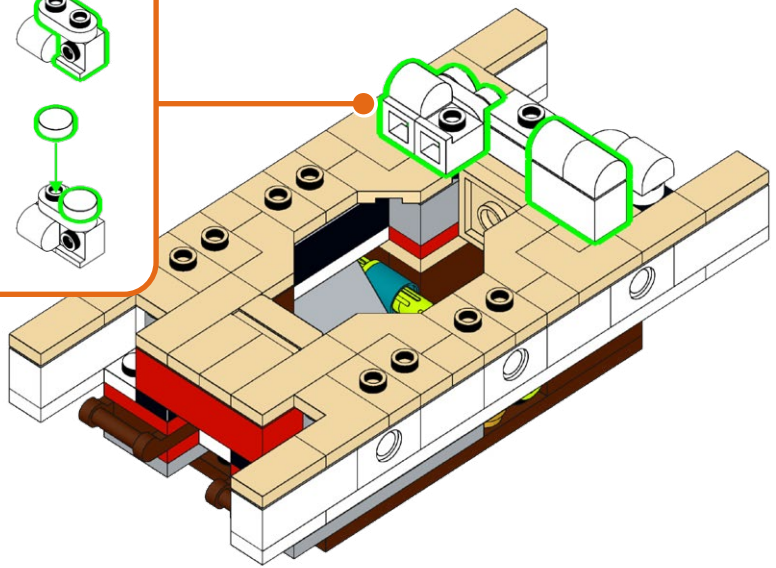

269

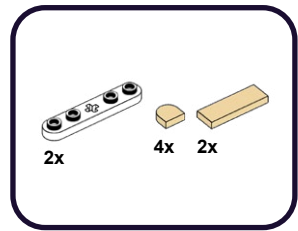

- 1
- 2 2x

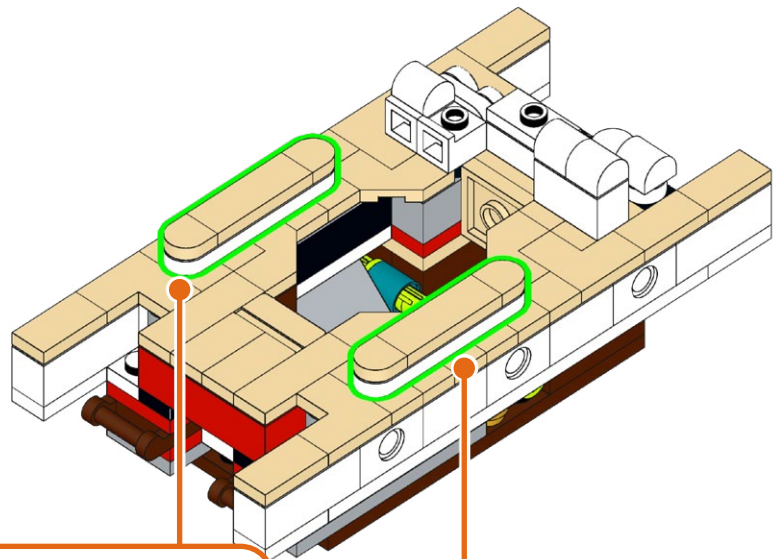

270

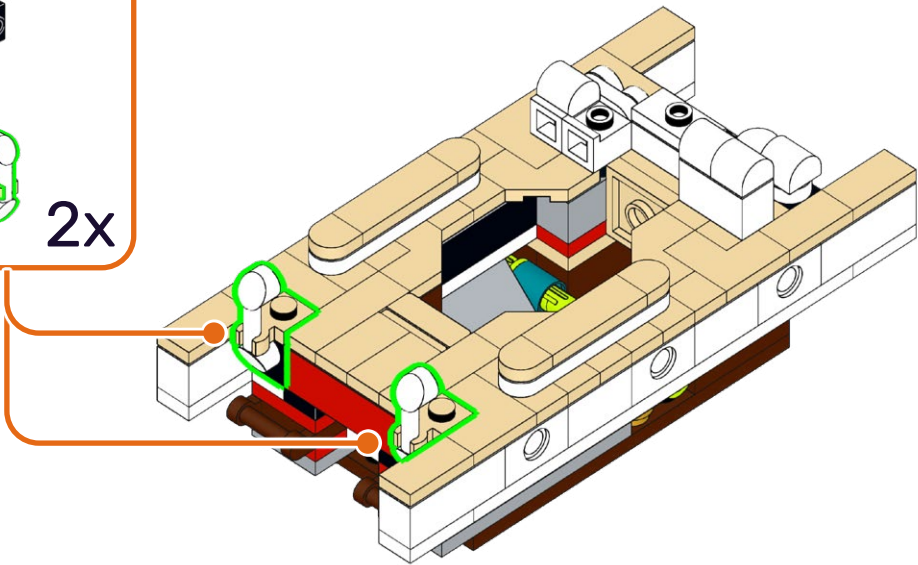
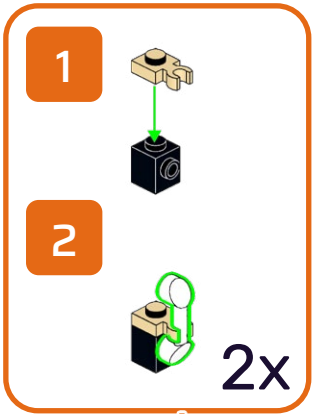
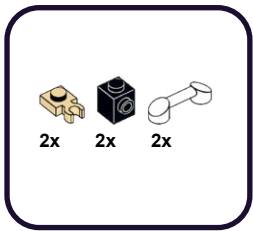

271

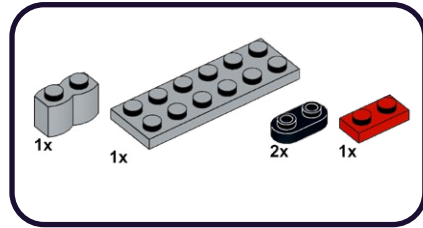

1

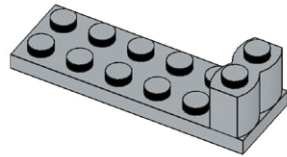

2

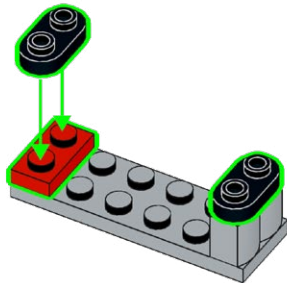

272

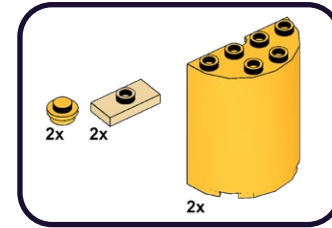

1

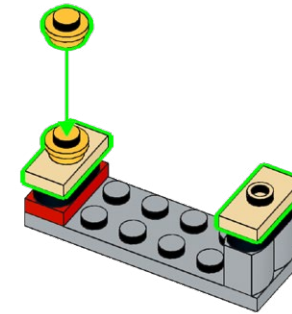

2

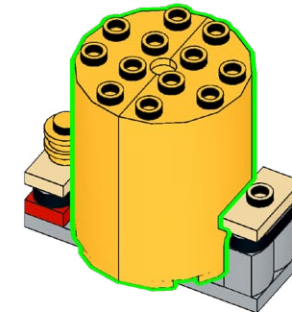

273

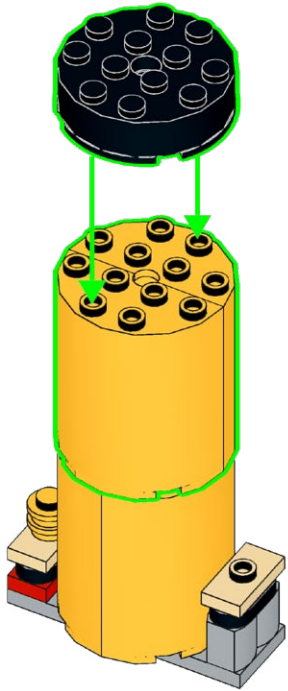
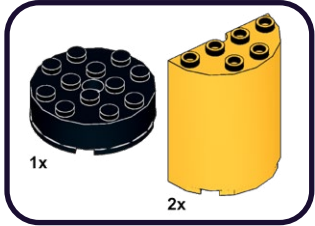

274

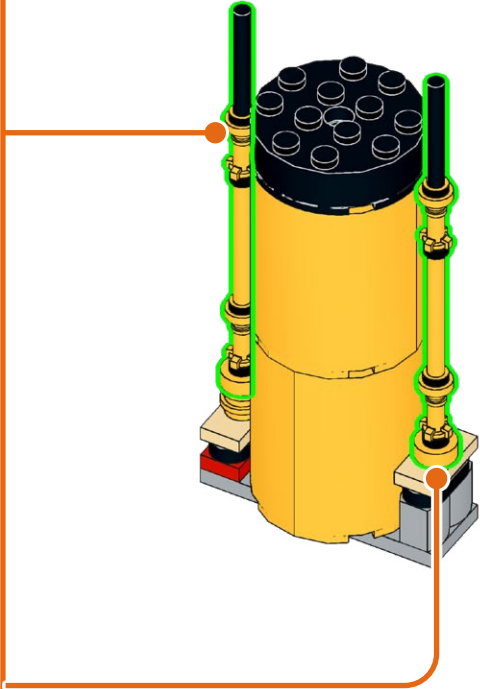
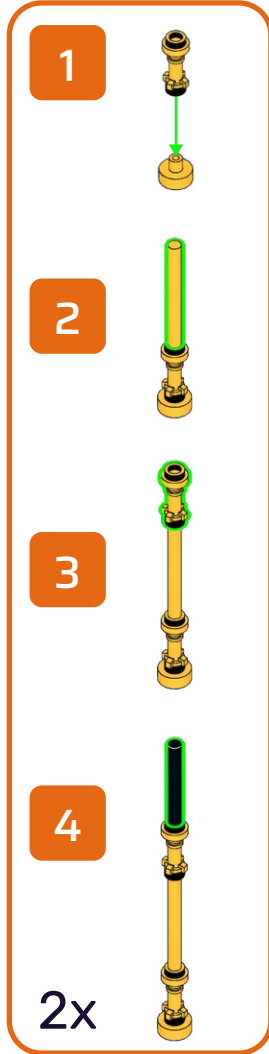
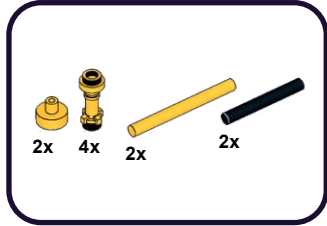

275

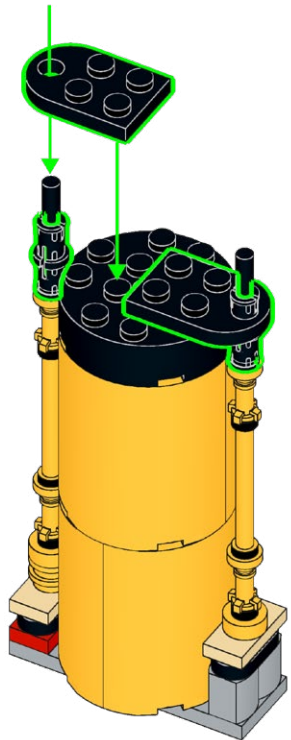

276

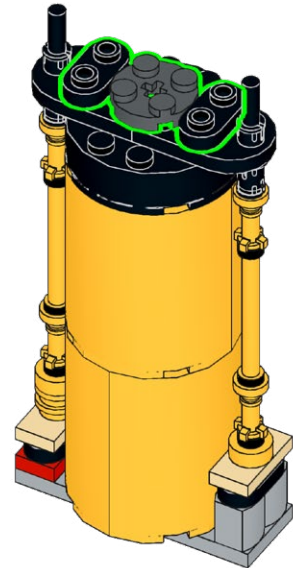
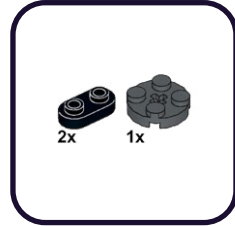

277

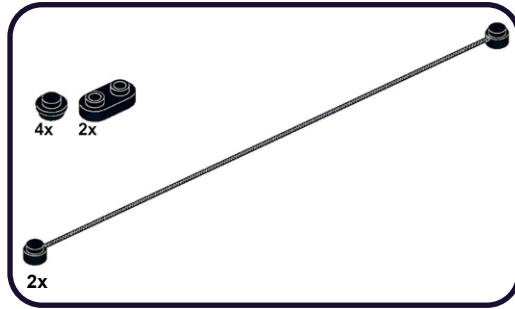

278

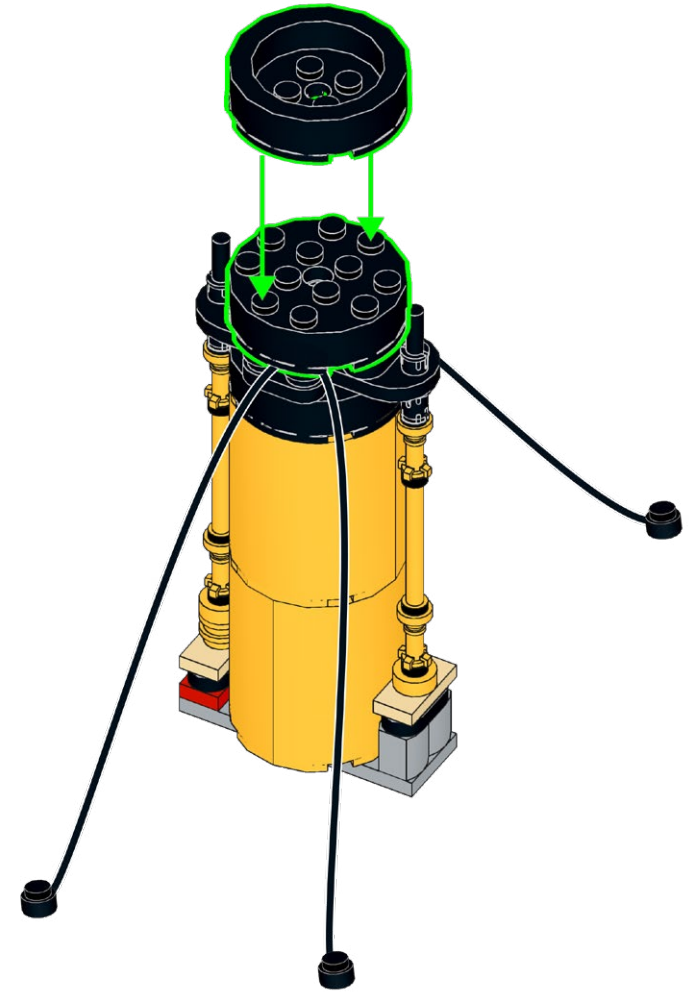
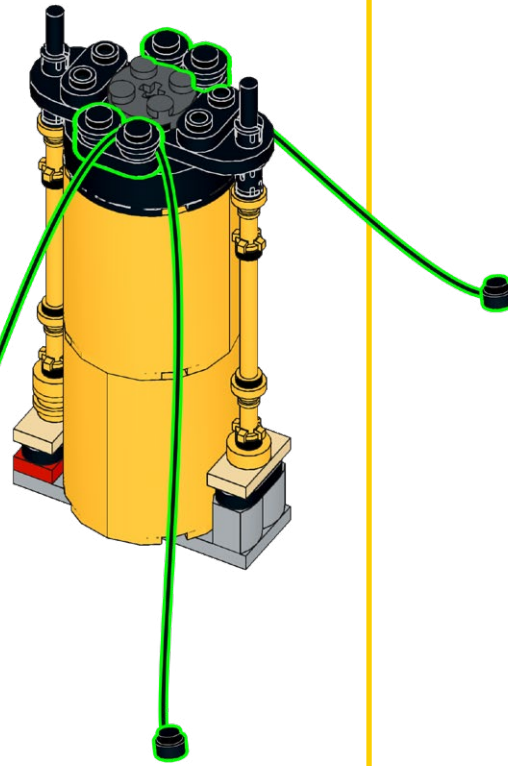

279

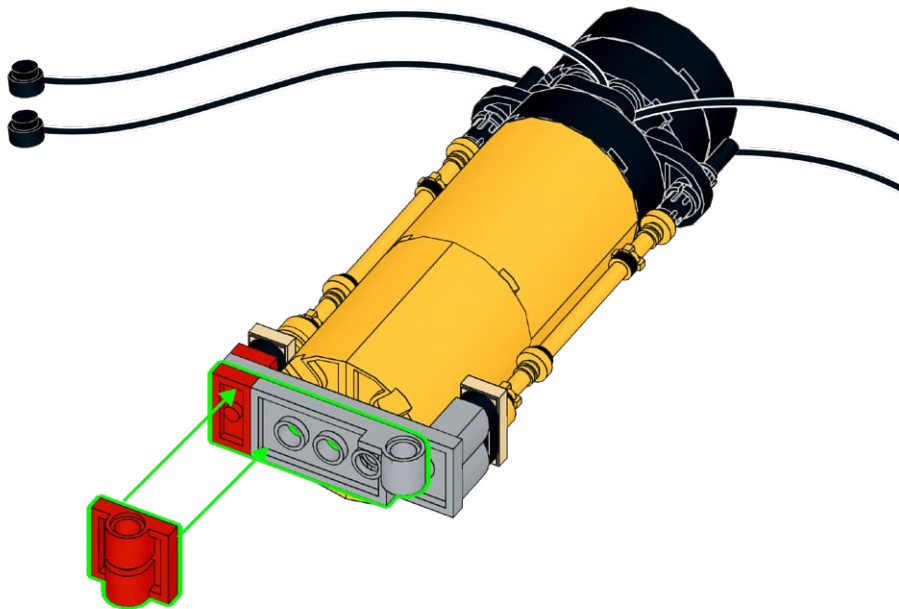
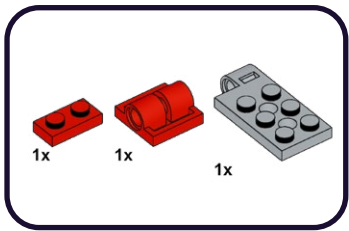

280

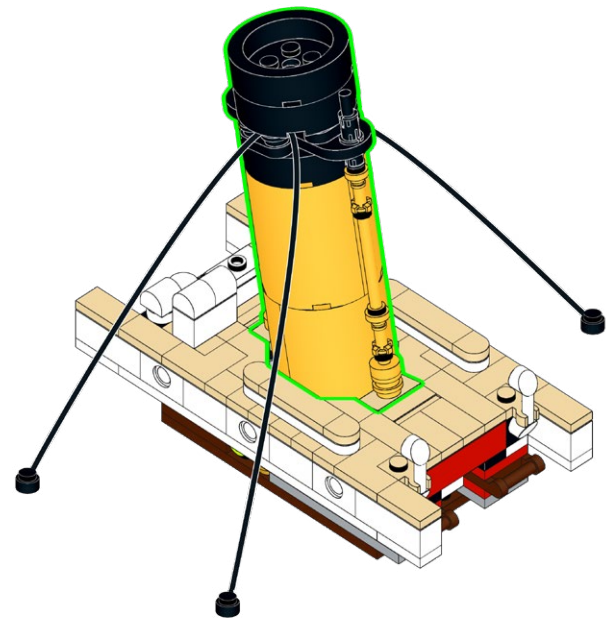
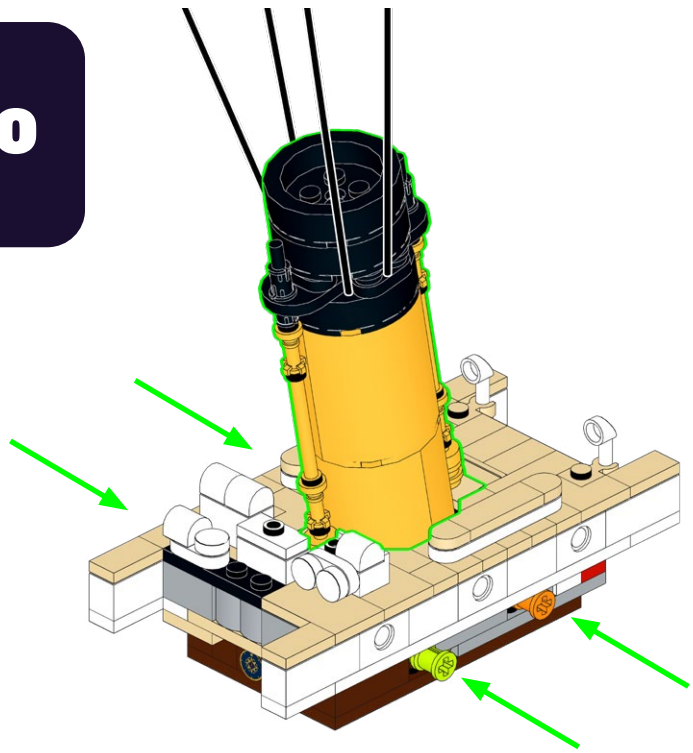

281

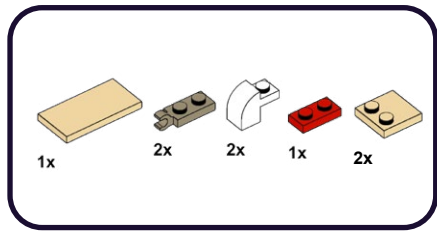

1

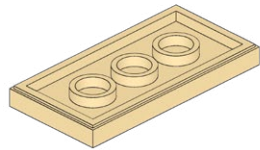

2

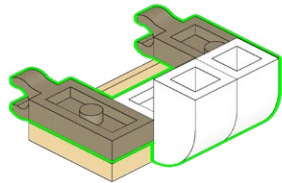

3

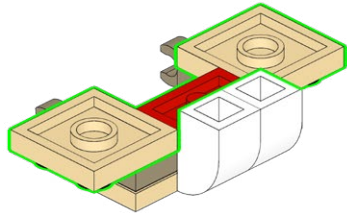

282

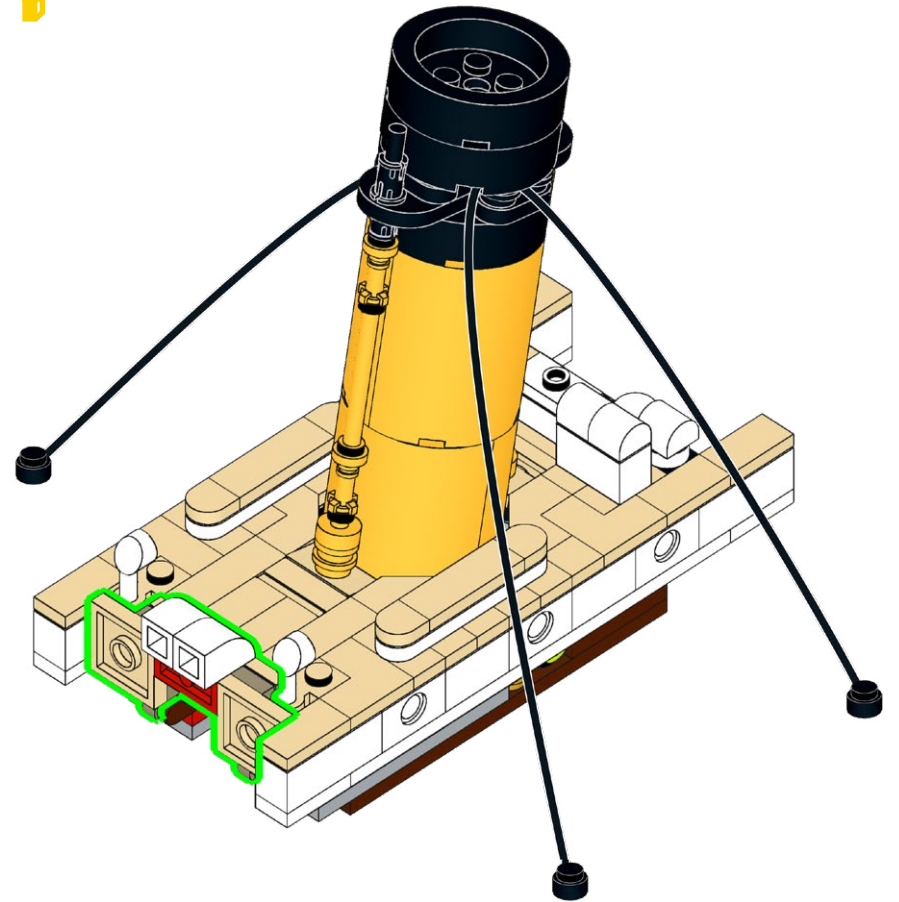

283

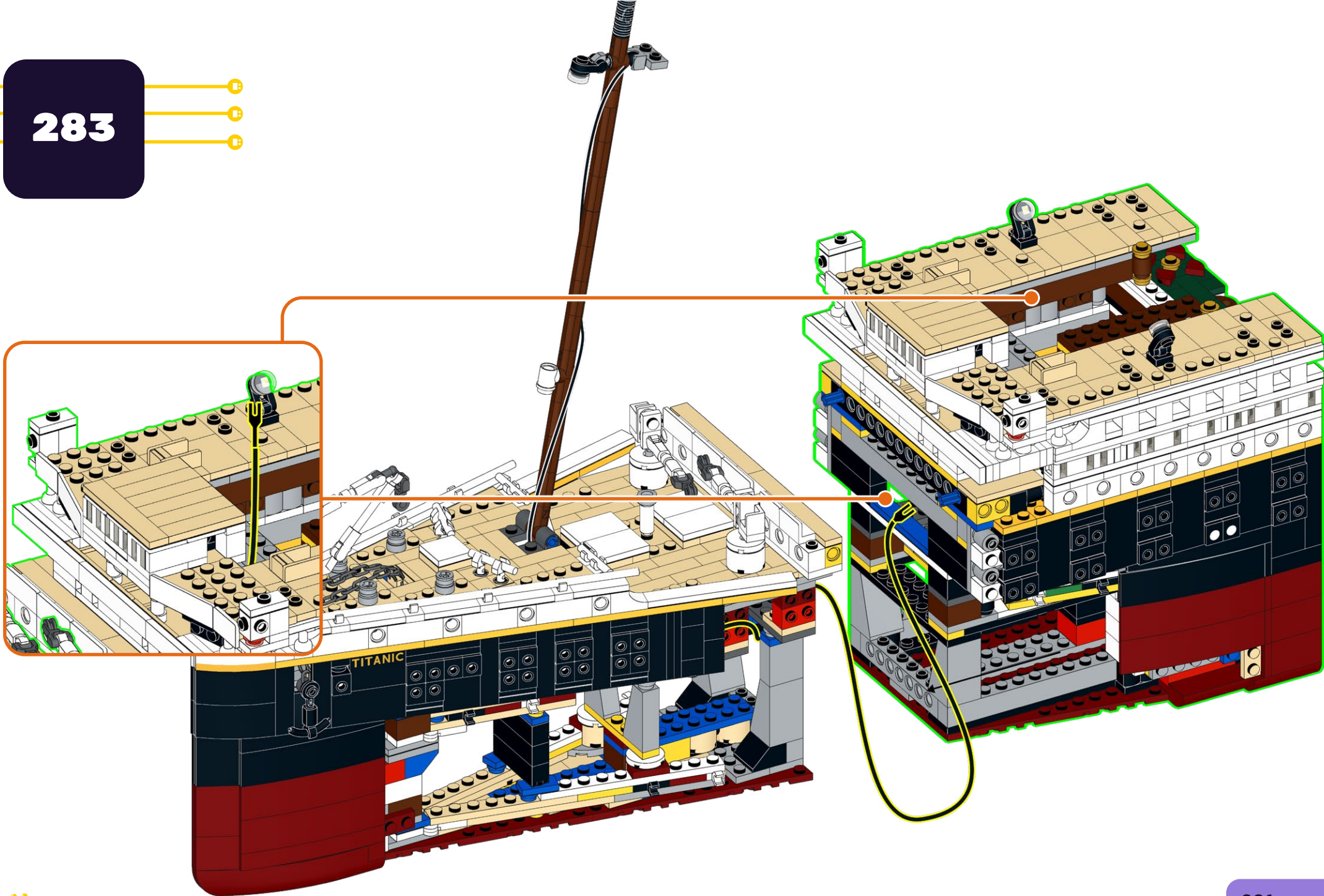

284

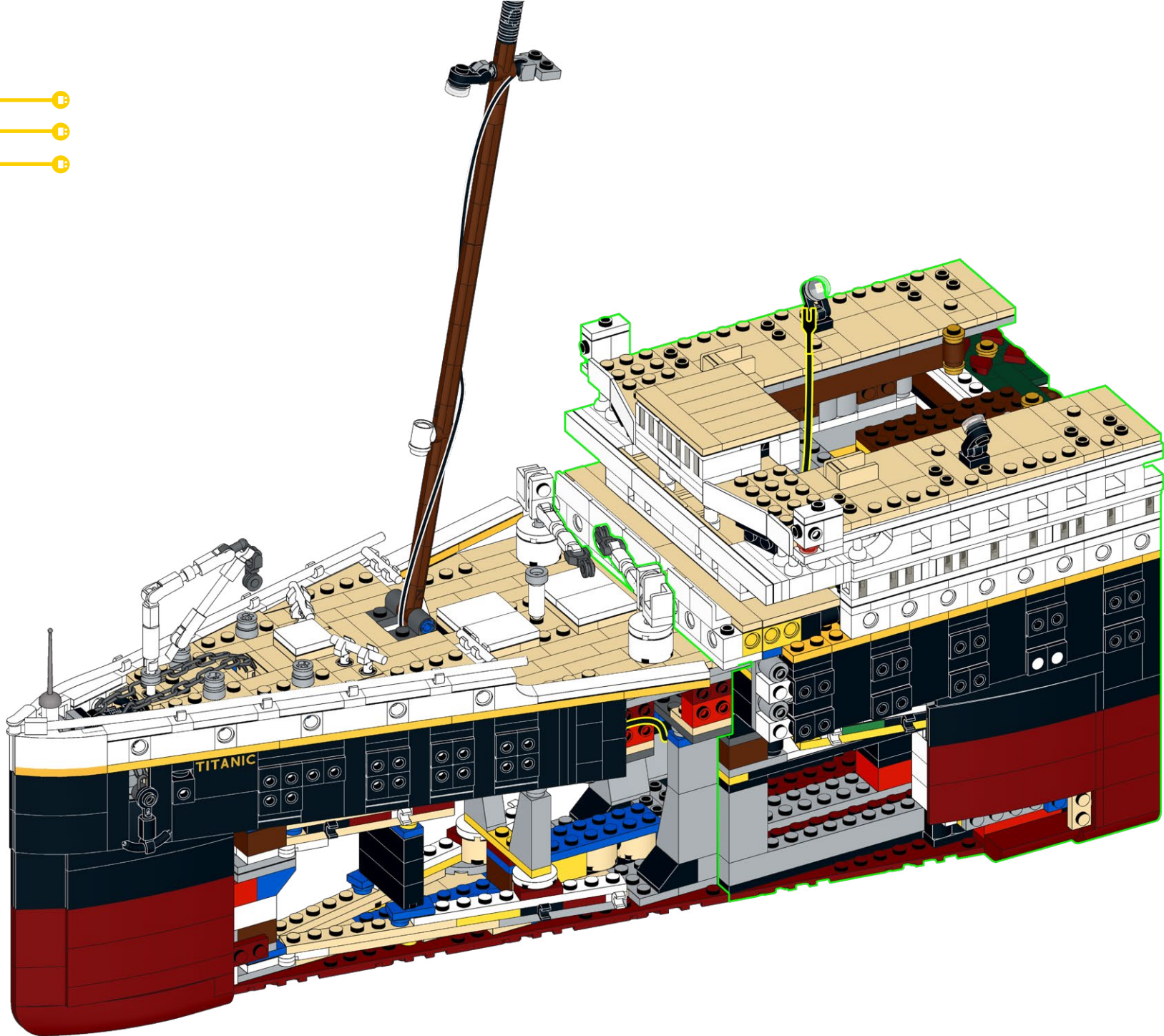

285

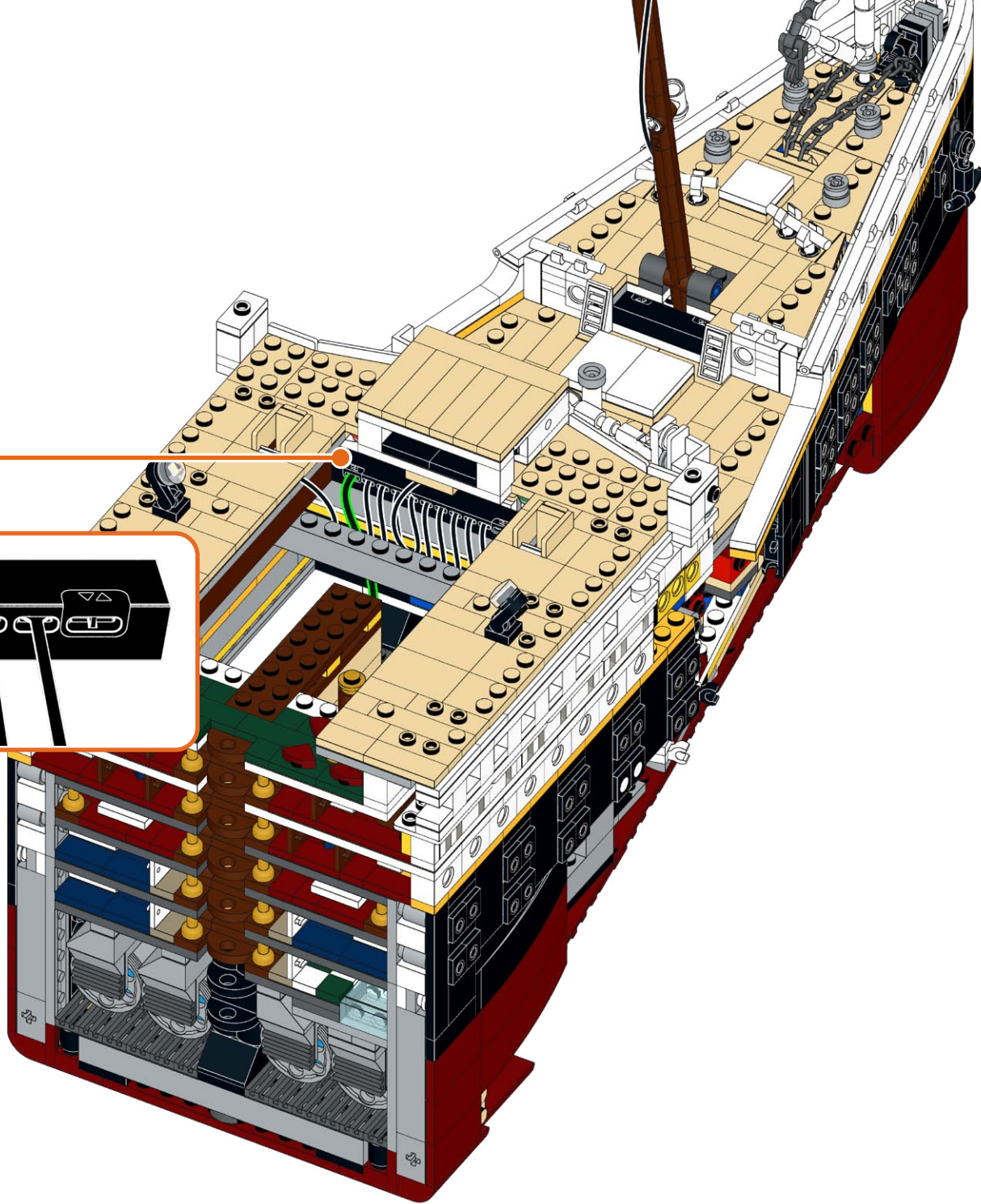
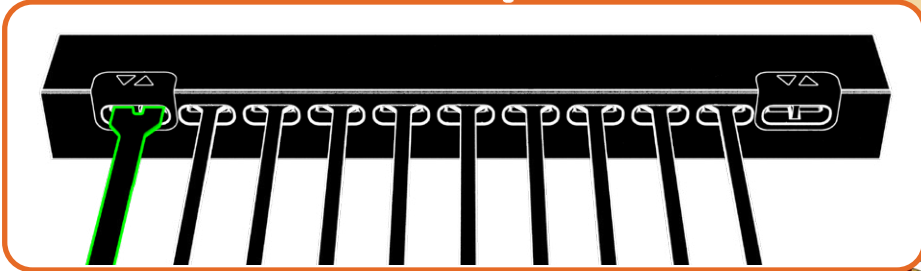

286

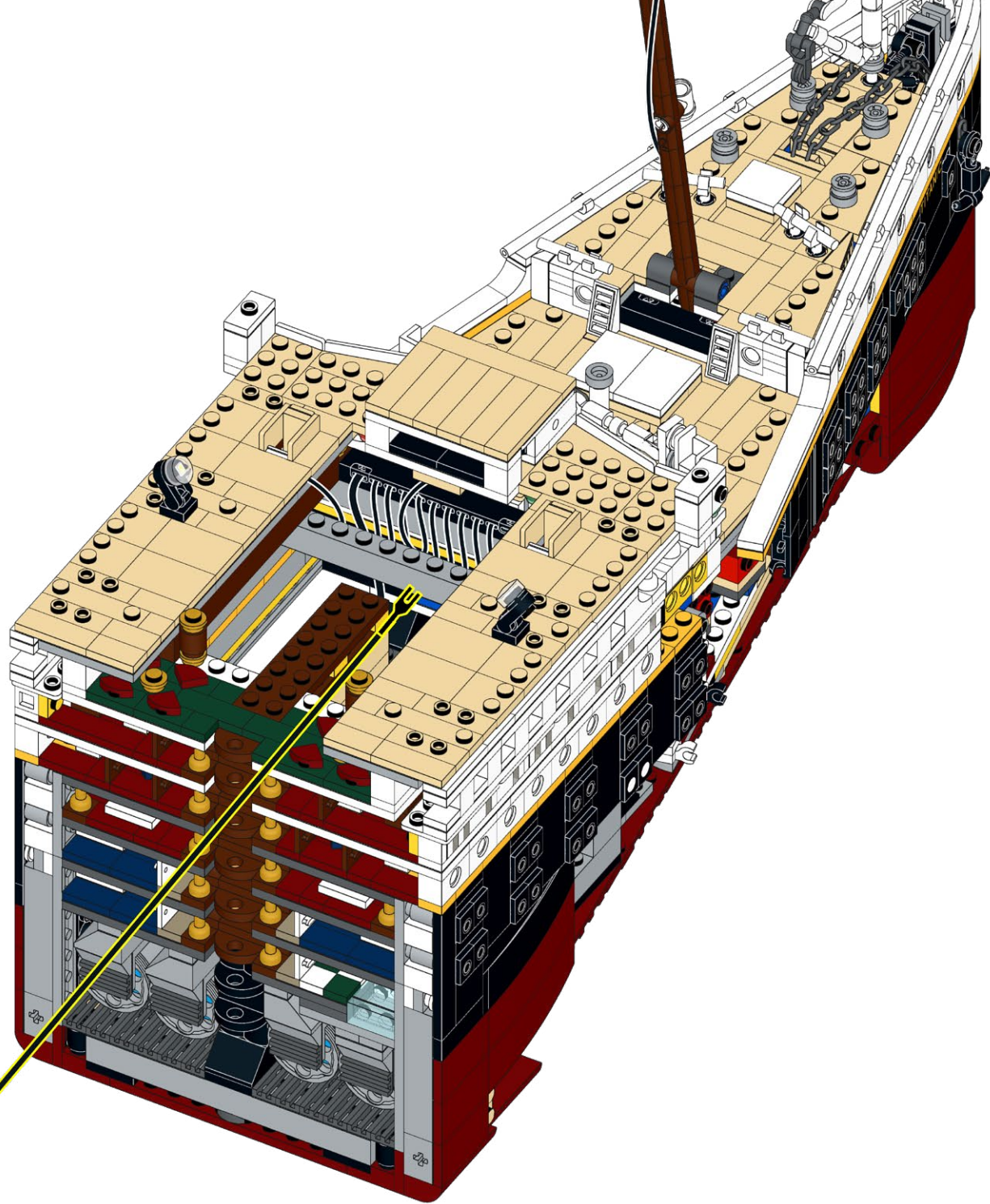
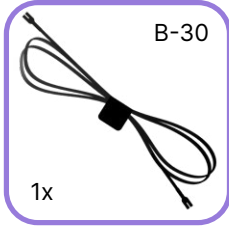

287

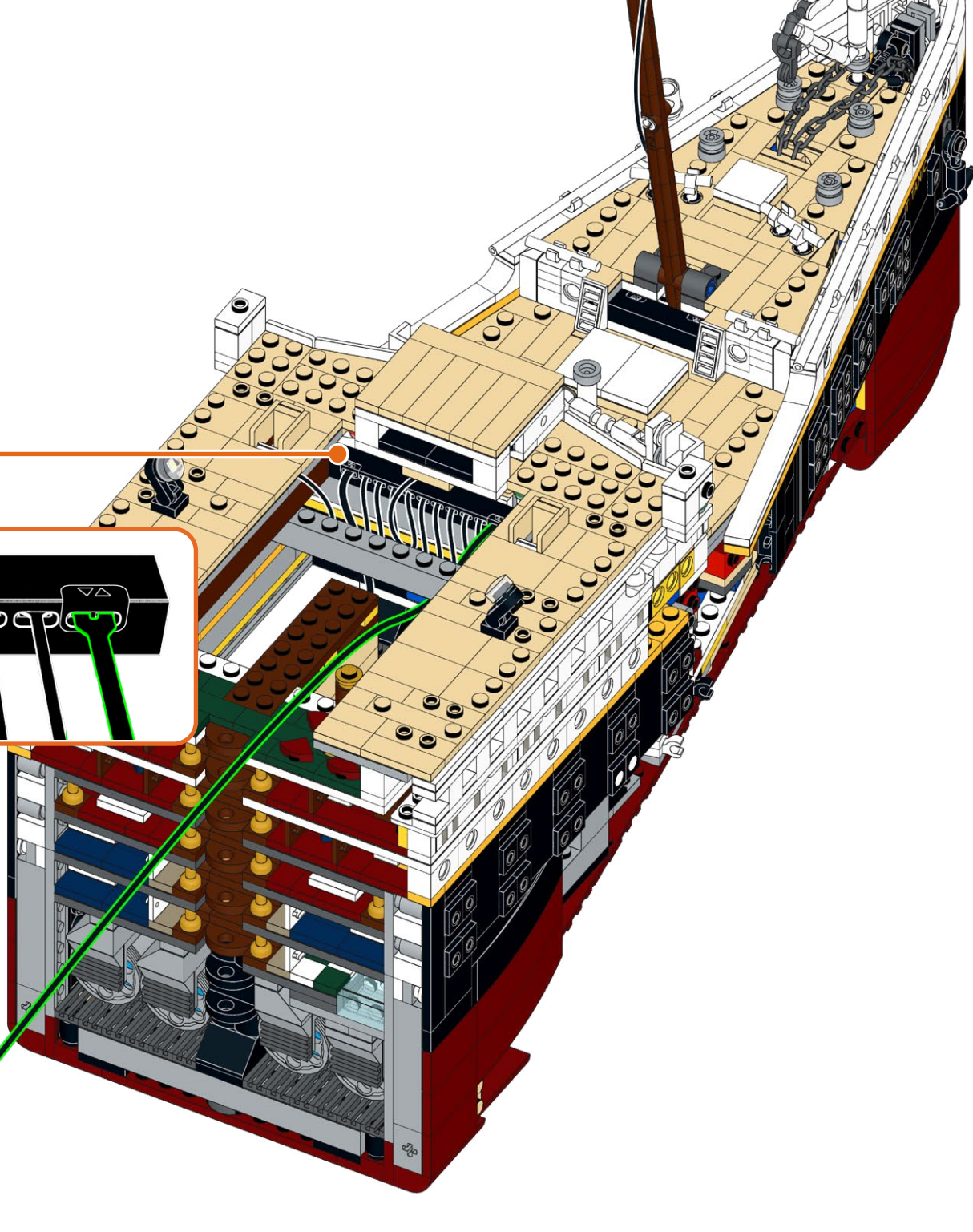
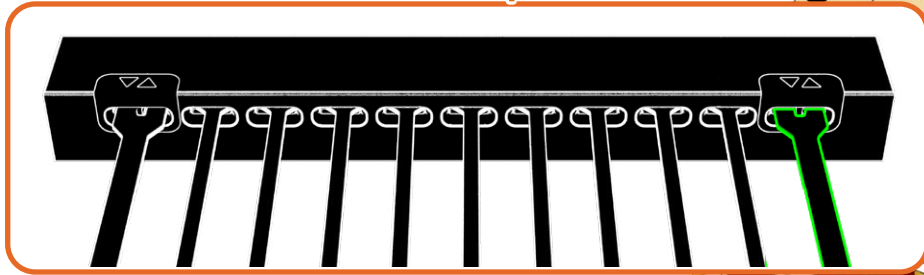

**HOLD UP!**

You might notice some bags aren't in order, as well as left over pieces, but that's ok! We're changing the way you build LEGO!

ATTENDEZ!

Vous remarquerez peut-être que certains sacs, ainsi que certaines pièces, ne sont pas dans le bon ordre. Mais pas de panique! Nous changeons simplement la façon avec laquelle vous construisez vos LEGO!

ASPETTA!

Potresti notare che alcuni sacchetti non sono in ordine, così come i pezzi avanzati, ma va bene così! Stiamo cambiando il modo in cui costruisci i LEGO!

HALT!

Sie werden möglicherweise bemerken, dass einige tüten durcheinander sind und teile übrig bleiben, aber das ist in Ordnung! Wir ändern die art und weise, wie Sie LEGO bauen!

¡ESPERA!

Es posible que notes que algunas bolsas están fuera de servicio, así como piezas sobrantes, ¡pero está bien! ¡Estamos cambiando la forma en que construyes LEGO!

暫停!

你可能会注意到一些袋子顺序错乱, 以及一些剩余的部件, 但没关系! 我们正在改变你搭建乐高的方式!

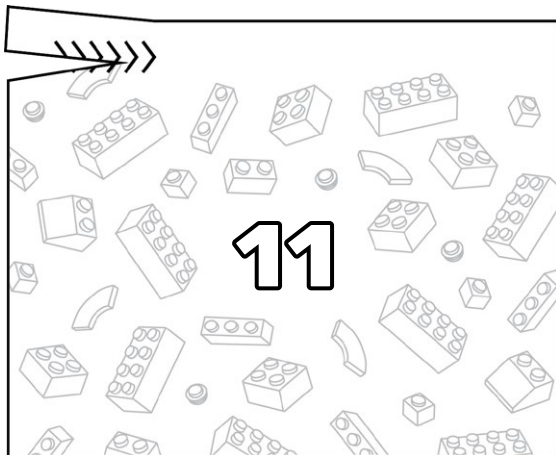
Open LEGO® Bag 11

288

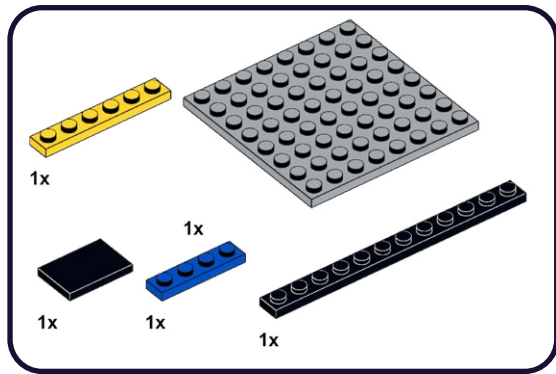

1

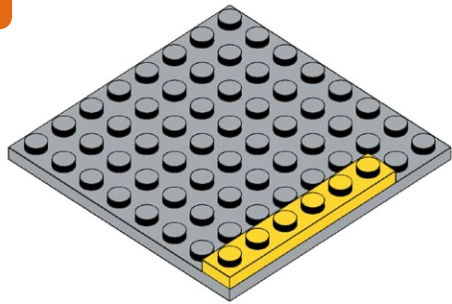

2

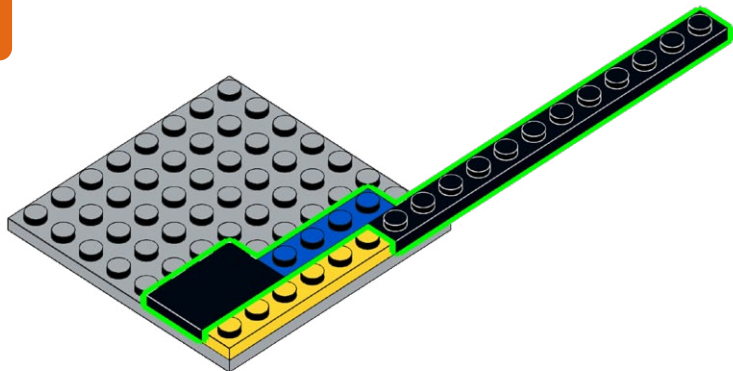

289

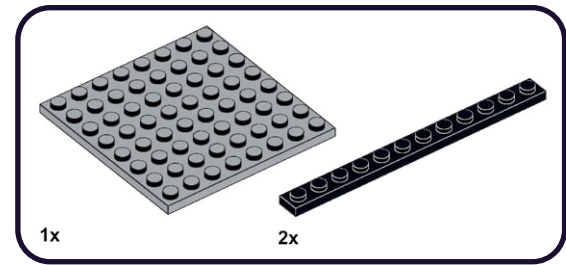

1

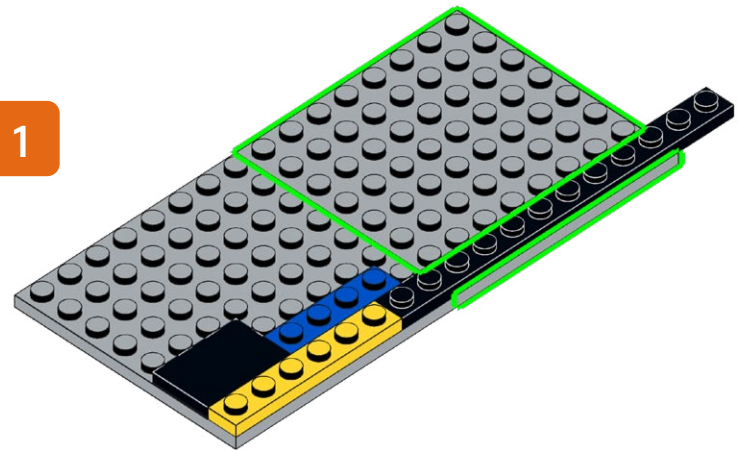

2

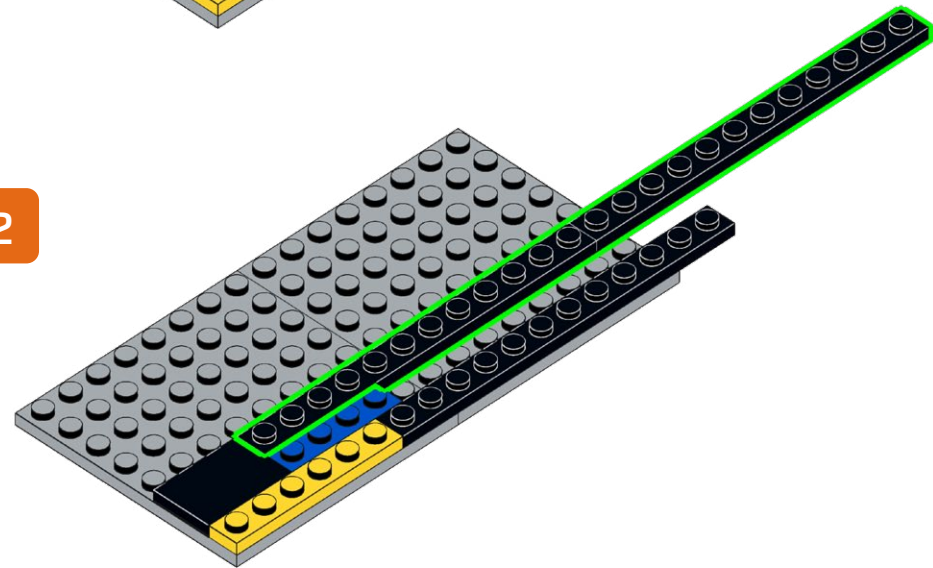

290

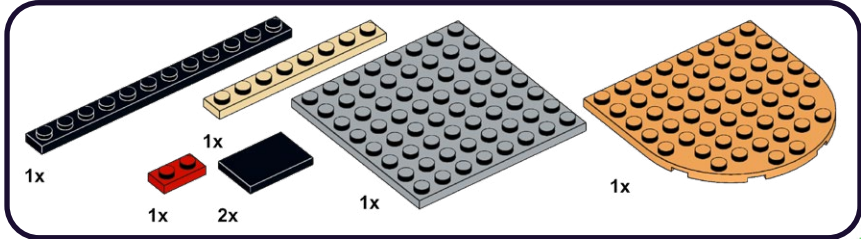

1

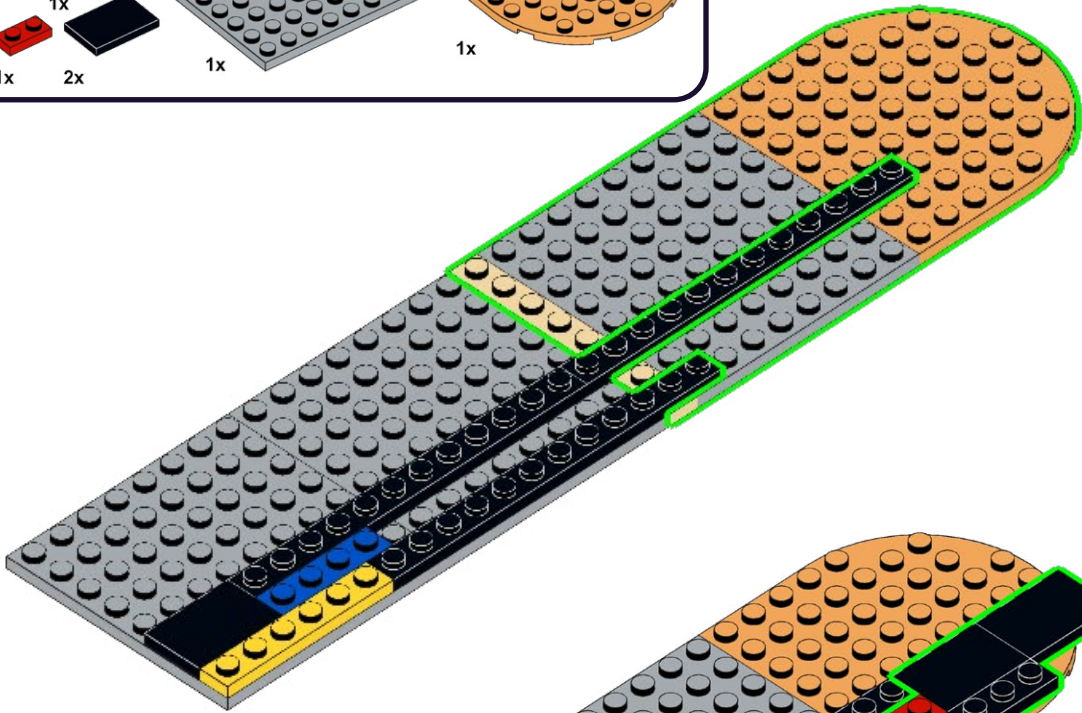

2

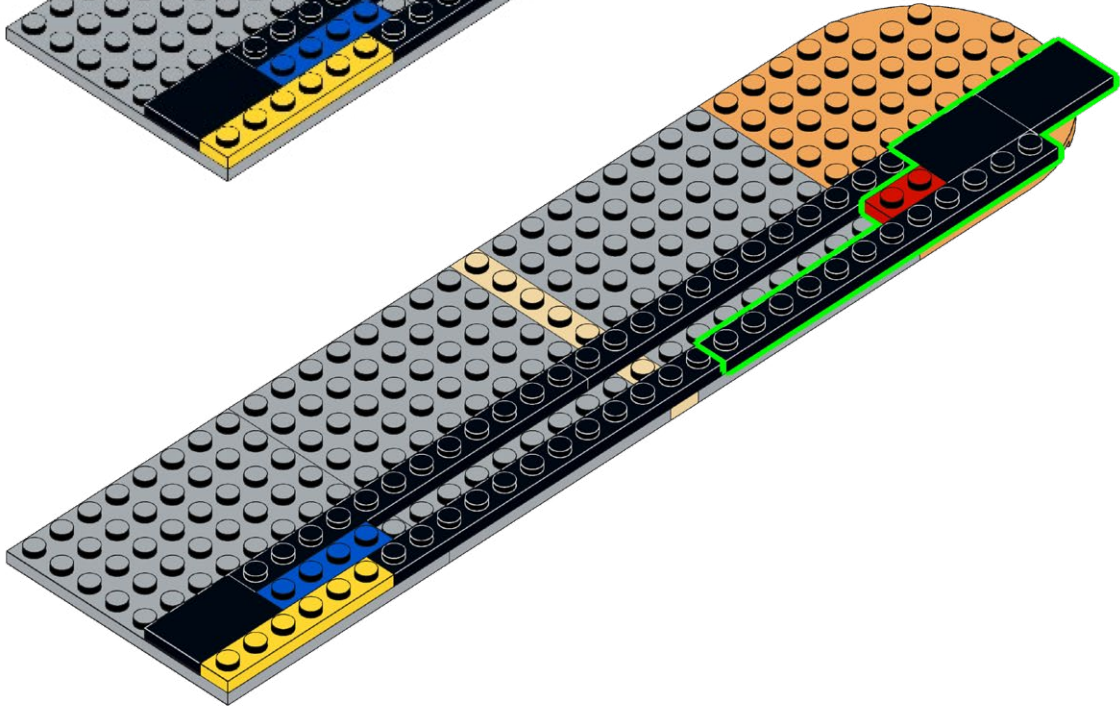

291

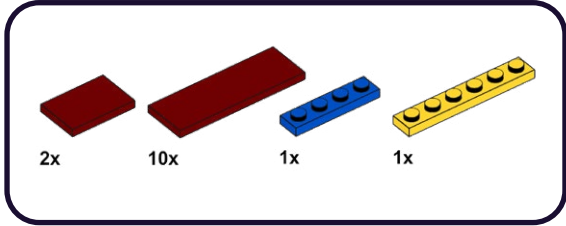

1

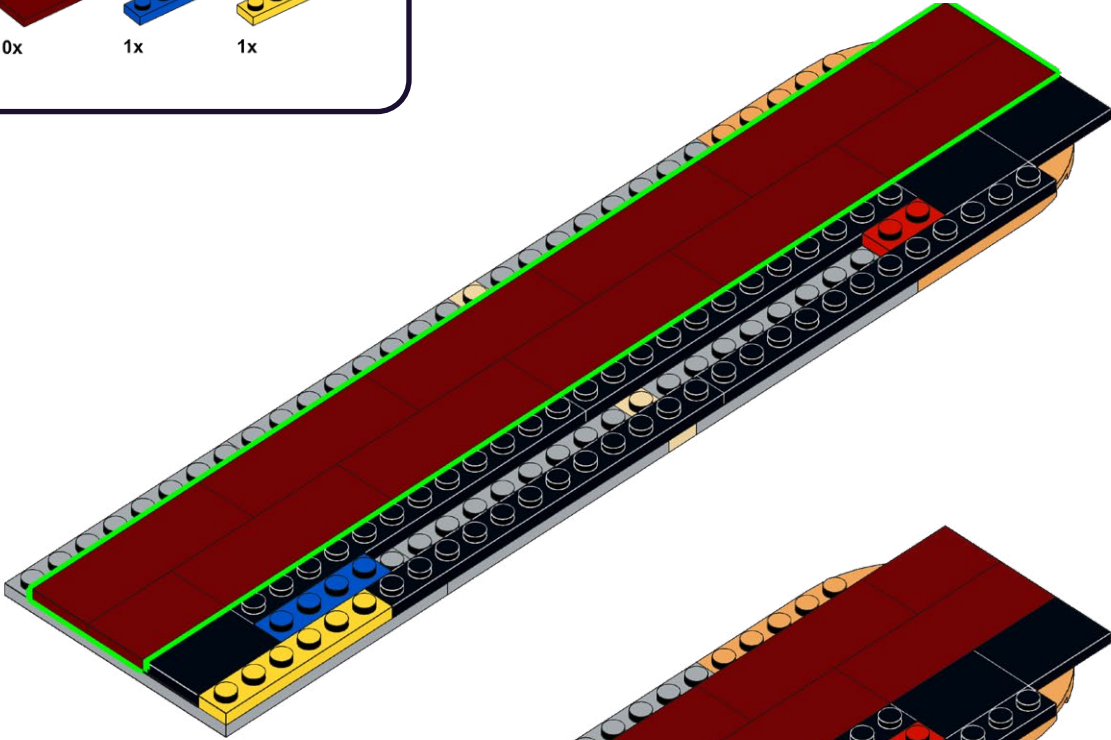

2

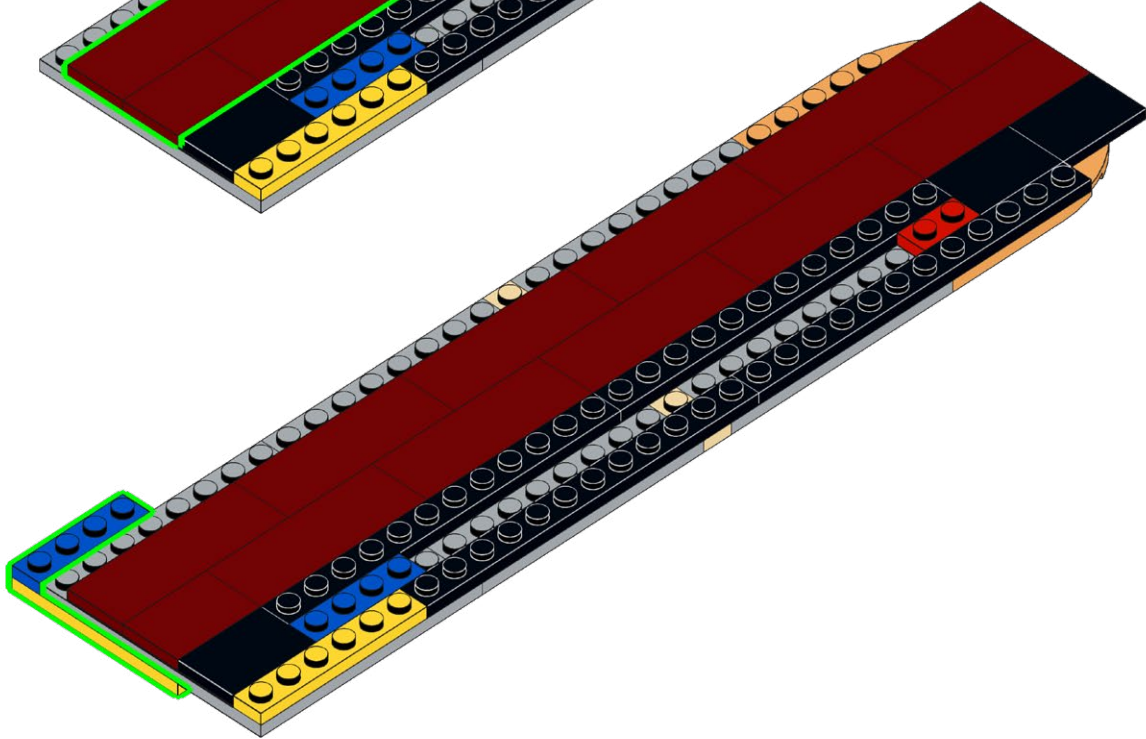

292



1

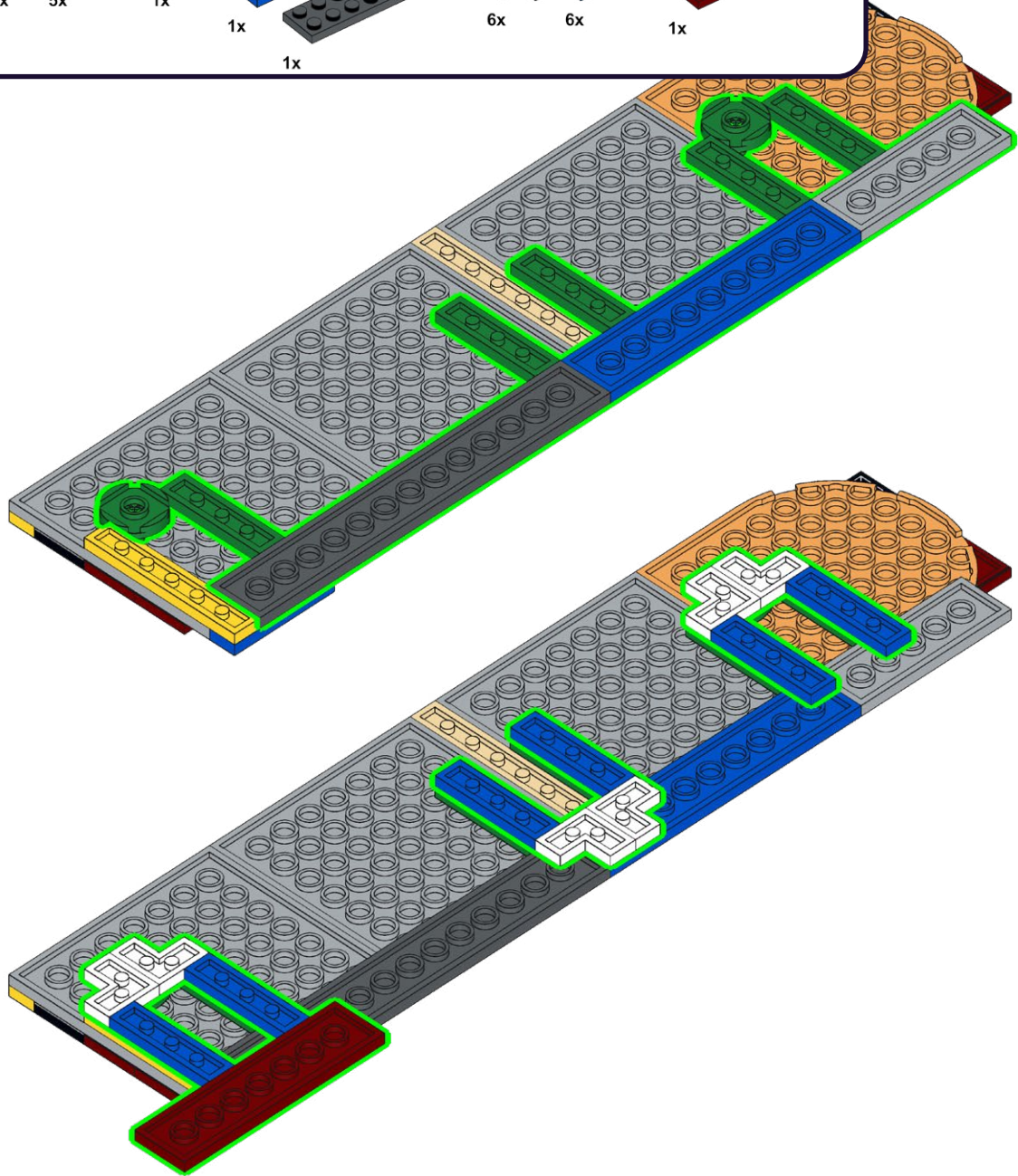
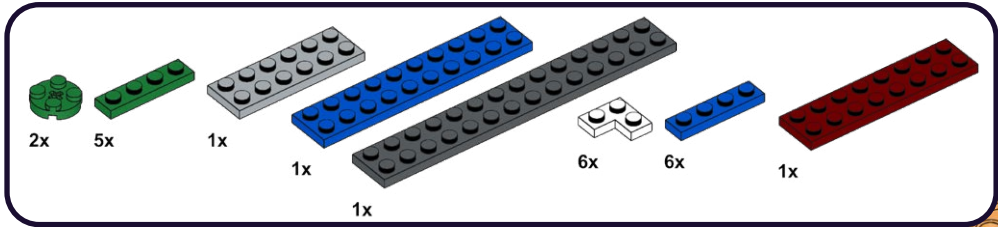

2

293

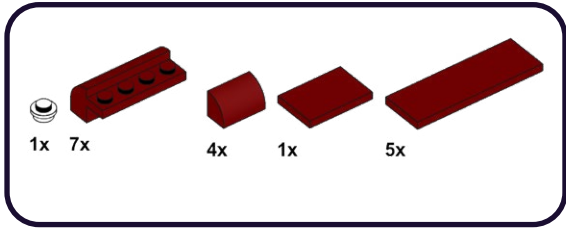

1

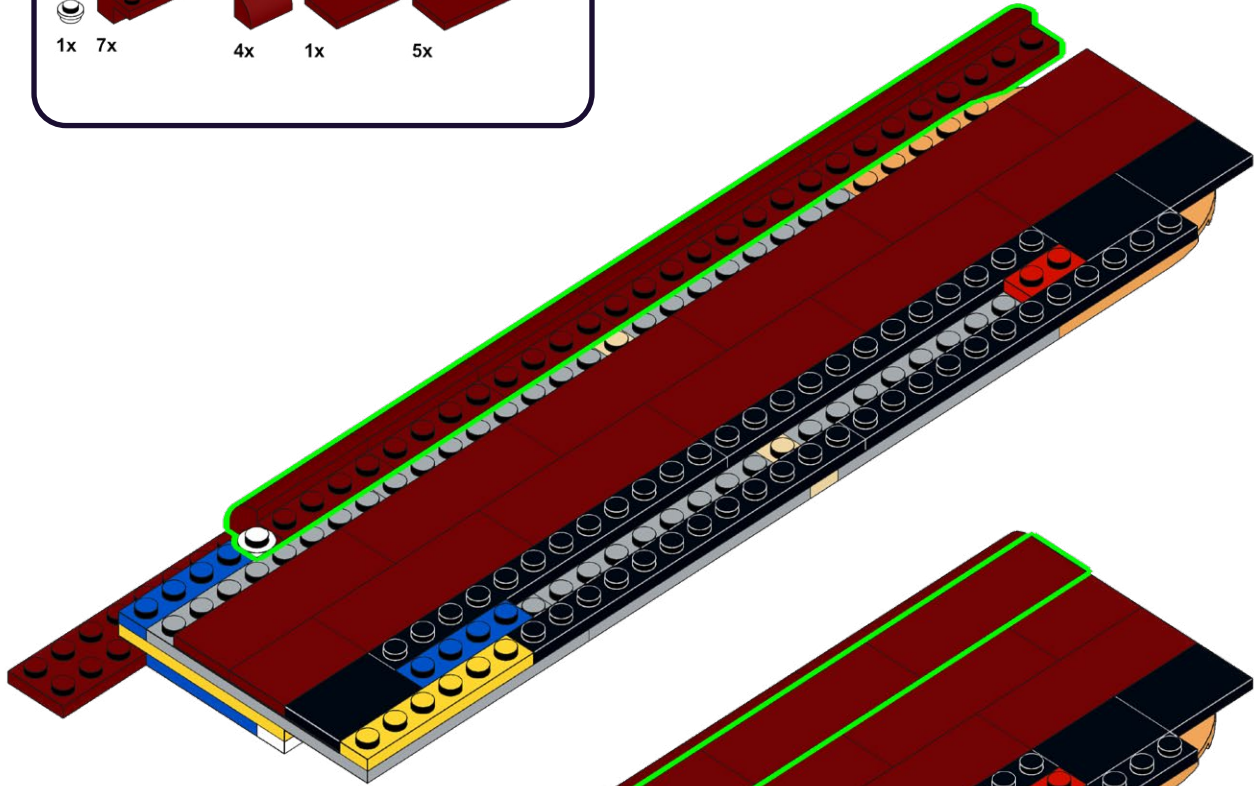

2

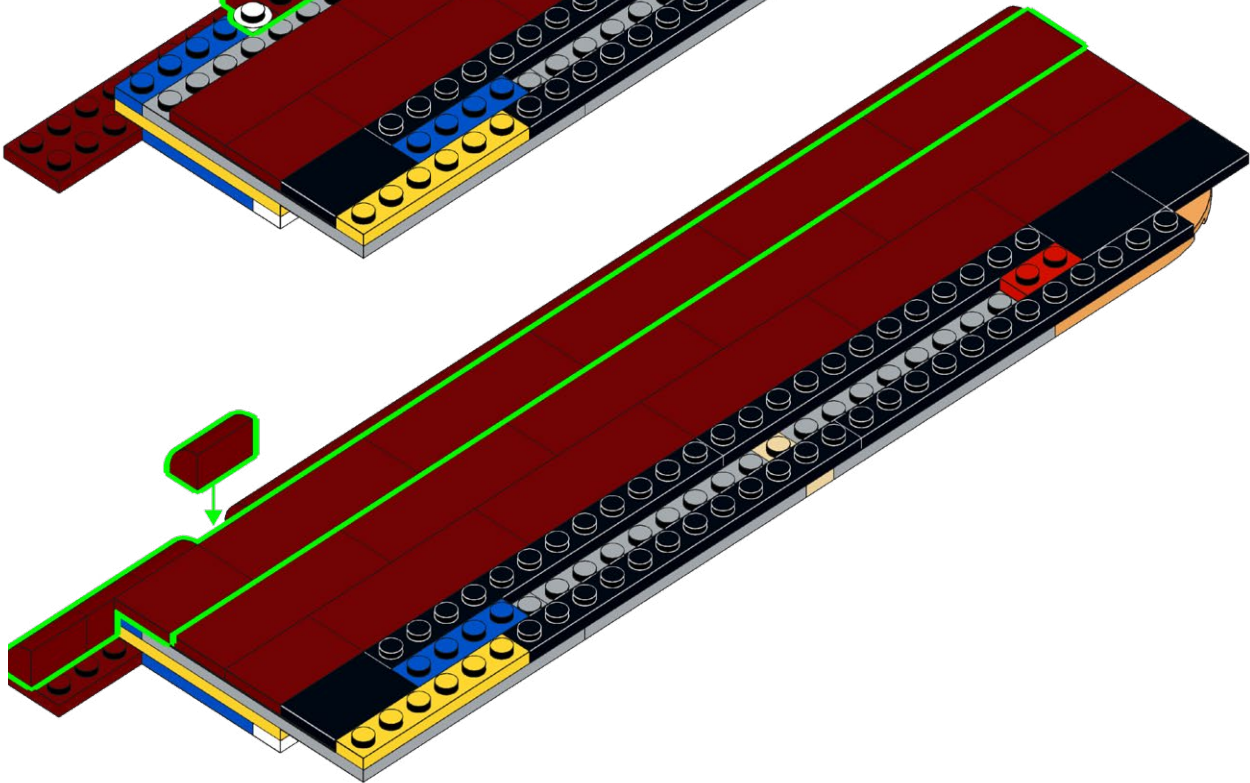

294

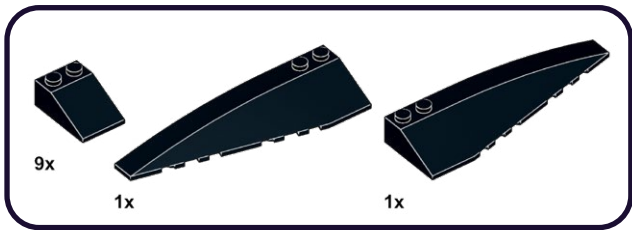

1

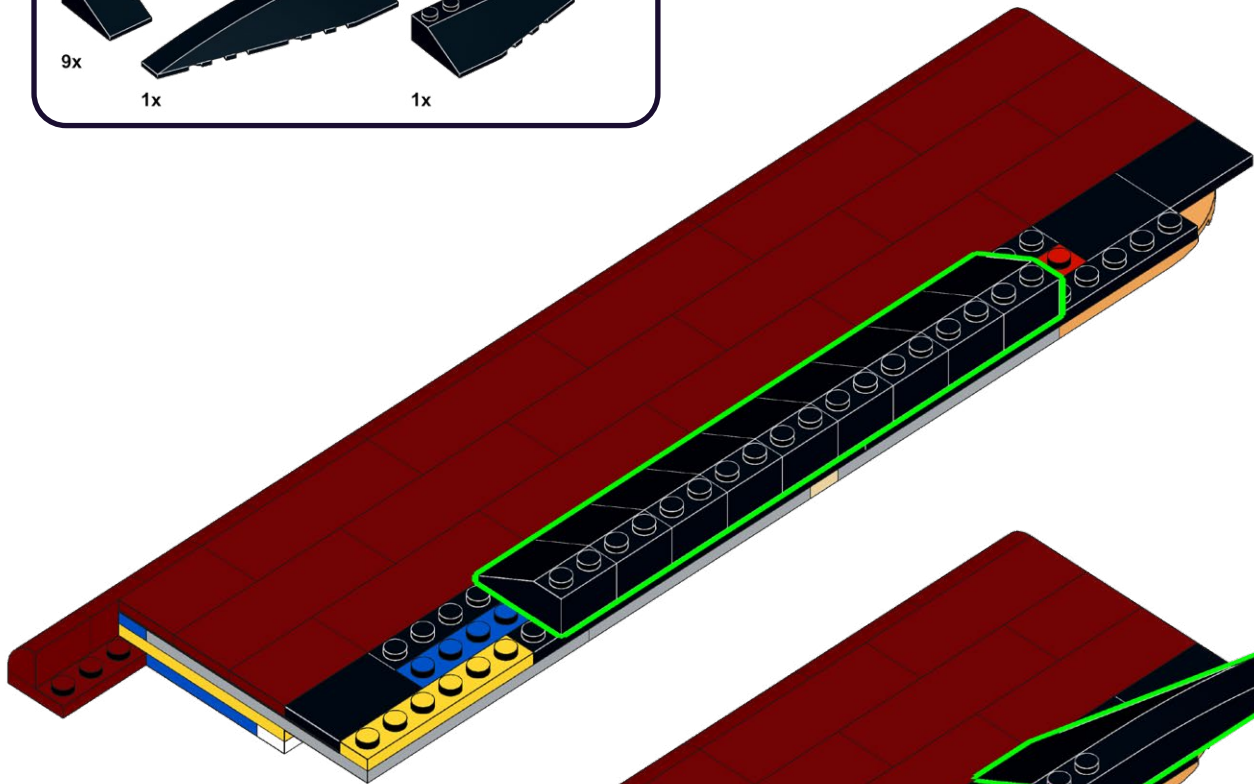

2

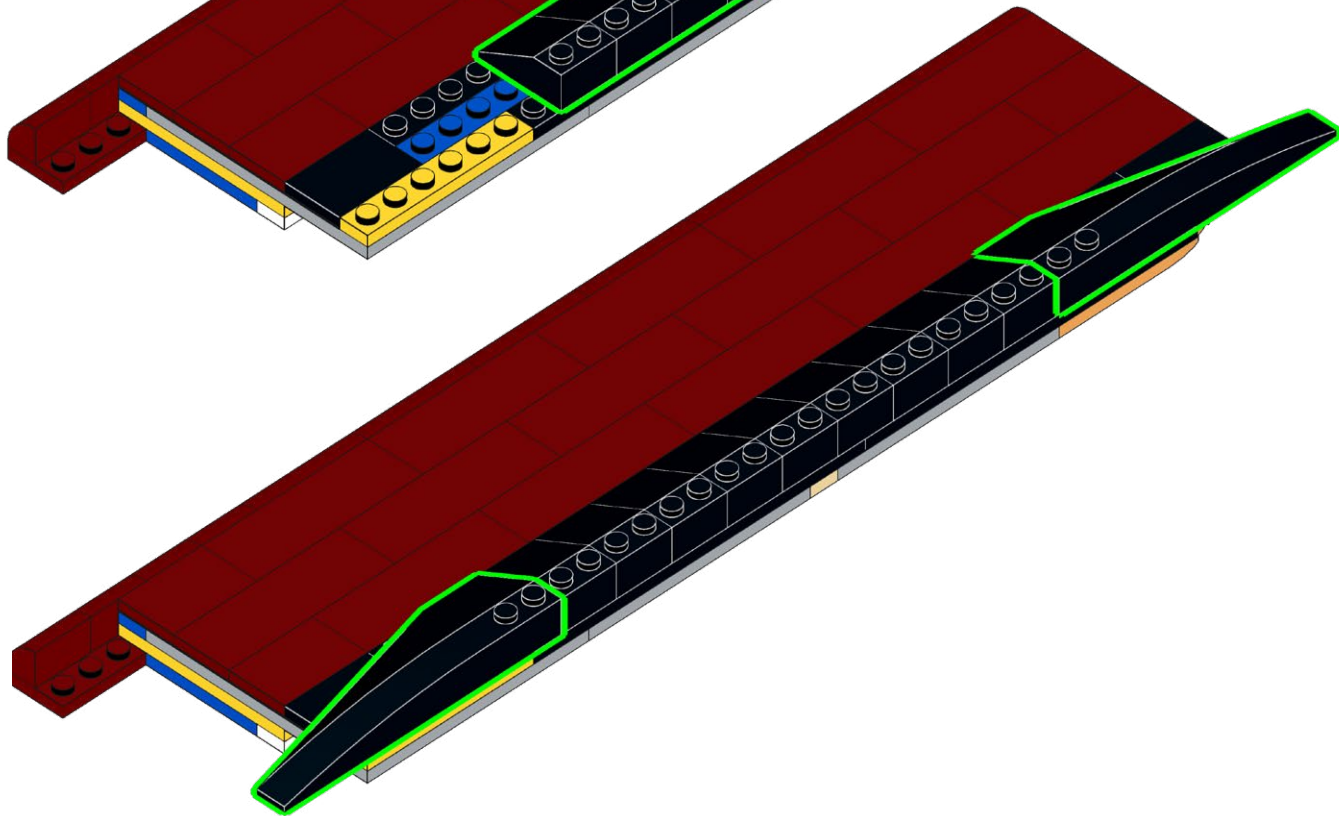

295

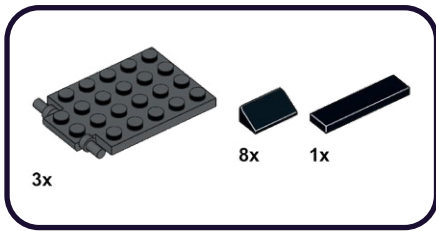

1

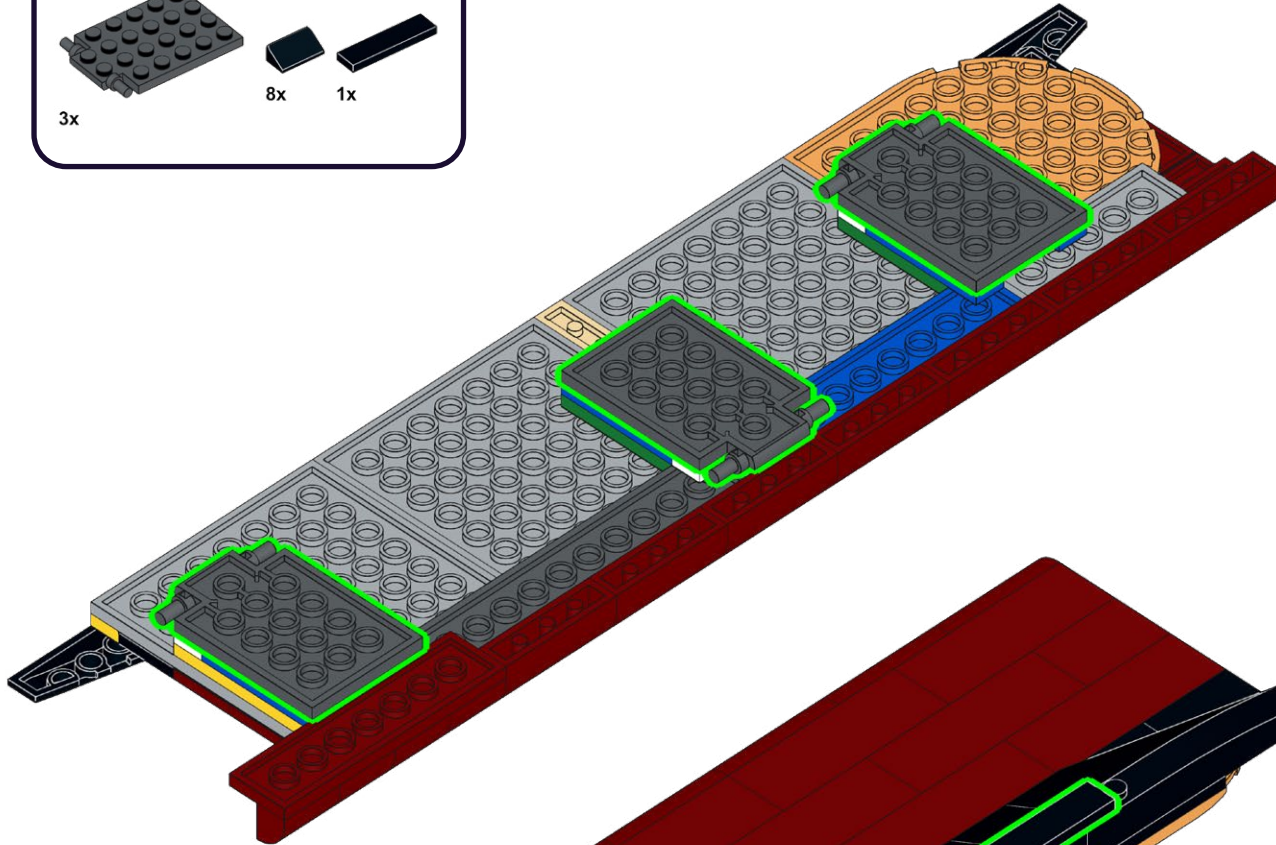

2

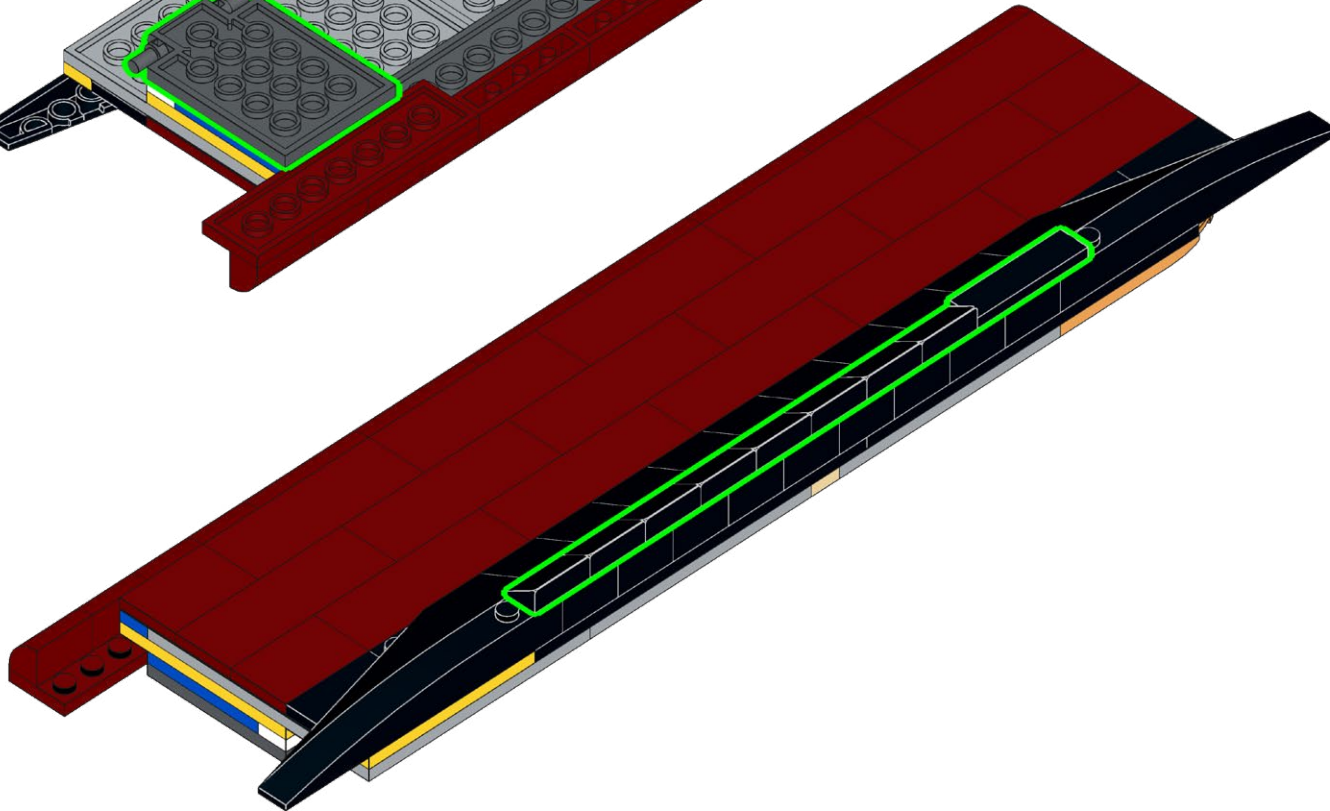

296

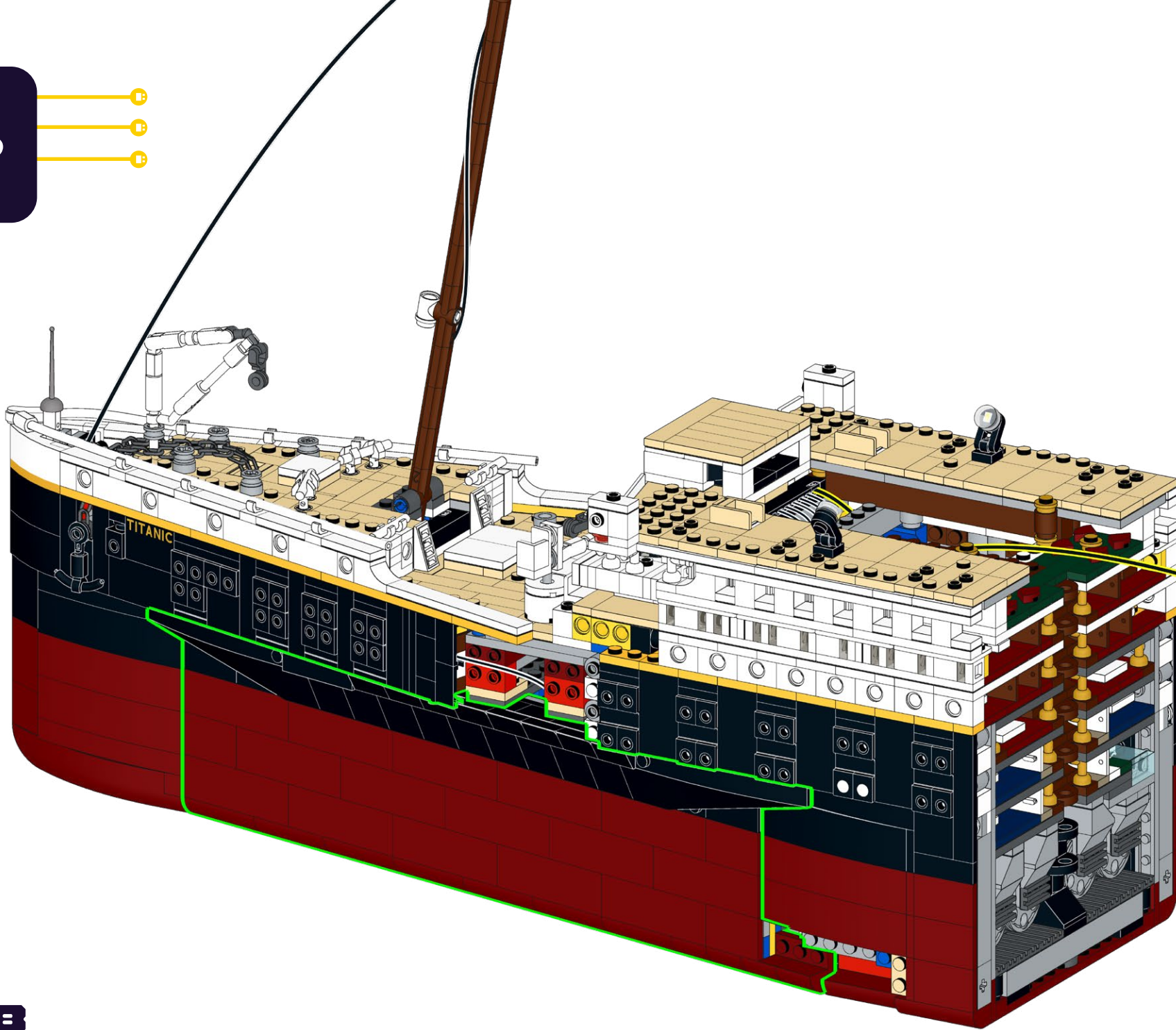

297

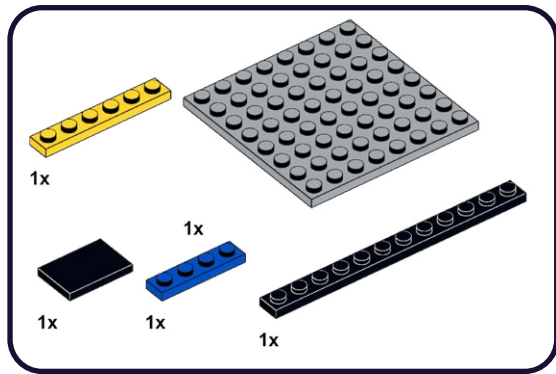

1

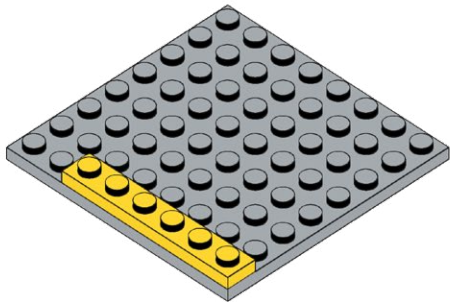

2

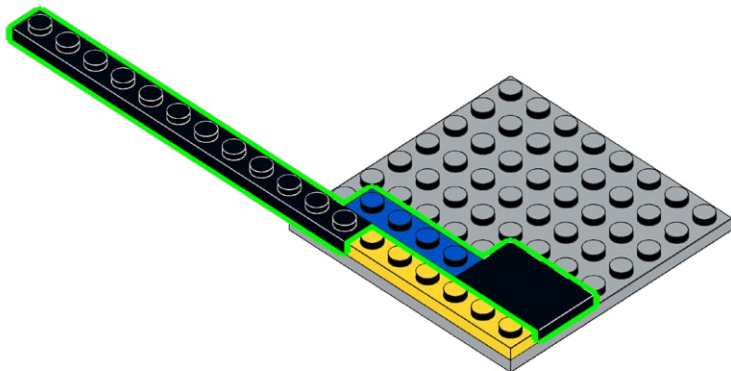

298

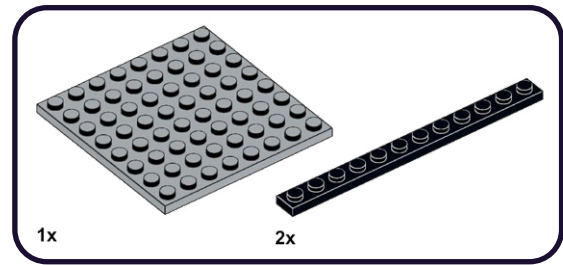

1

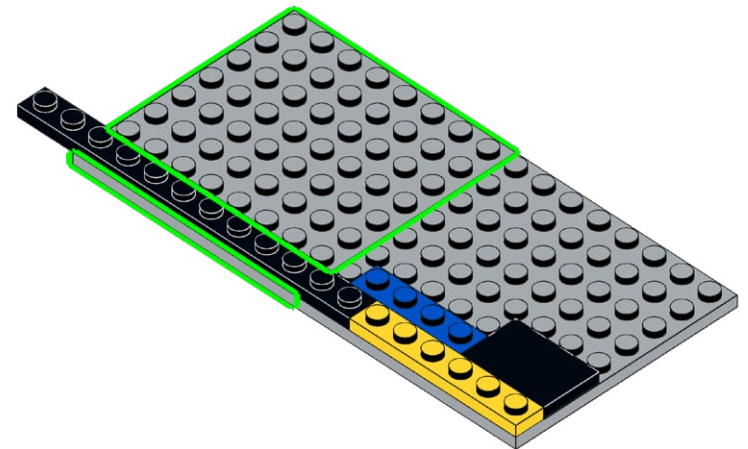

2

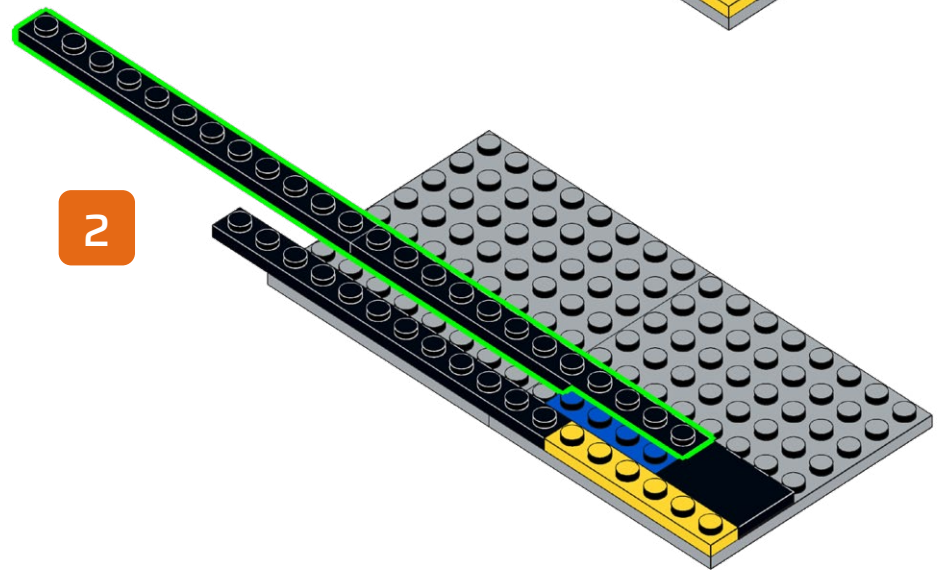

299

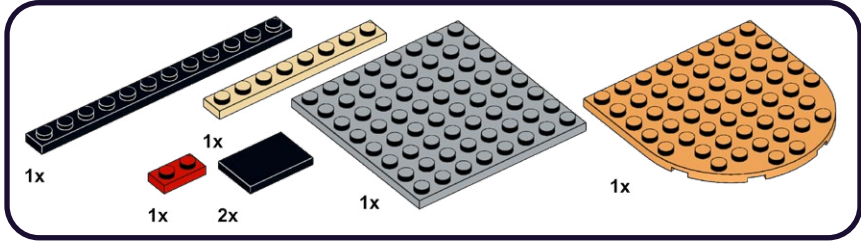

1

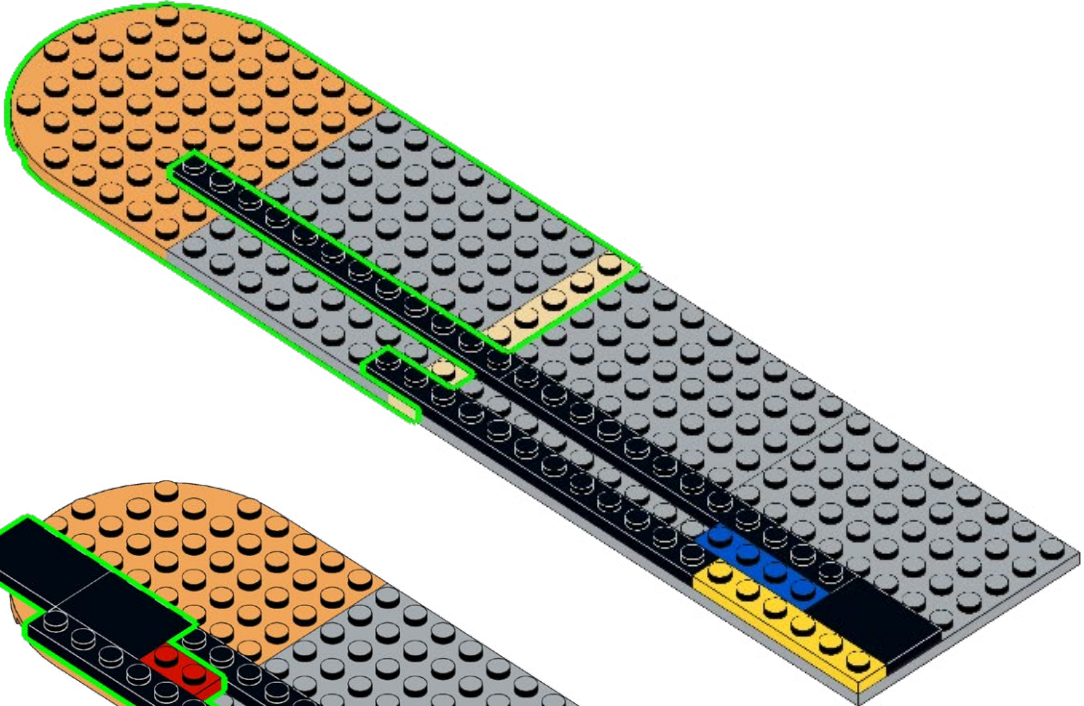

2

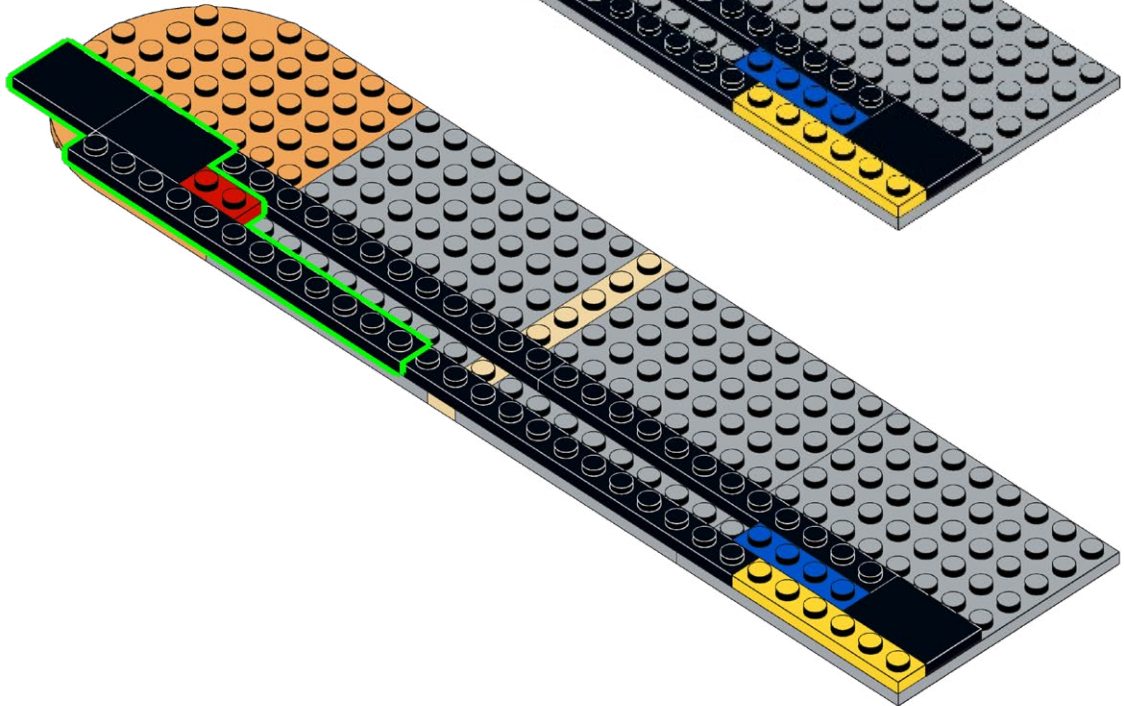

300

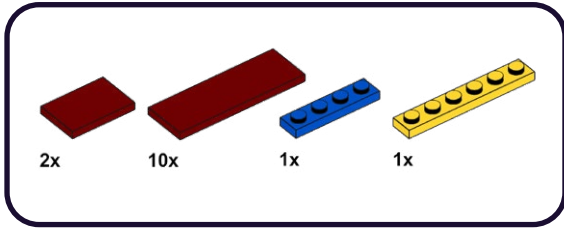

1

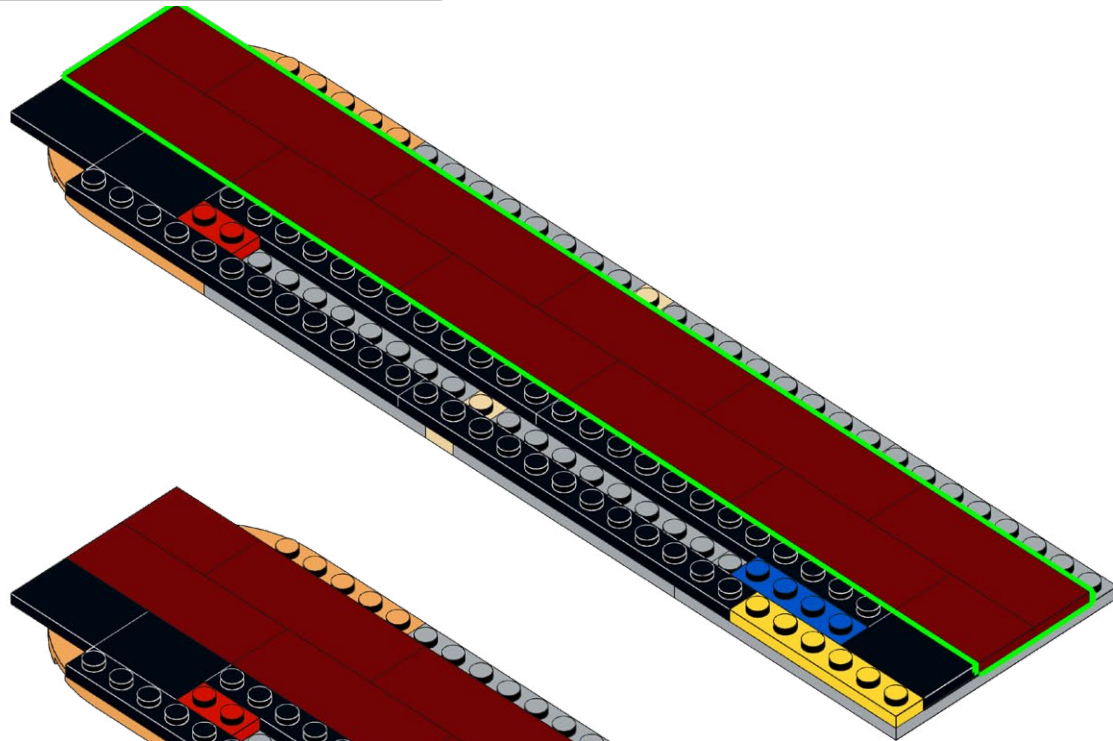

2

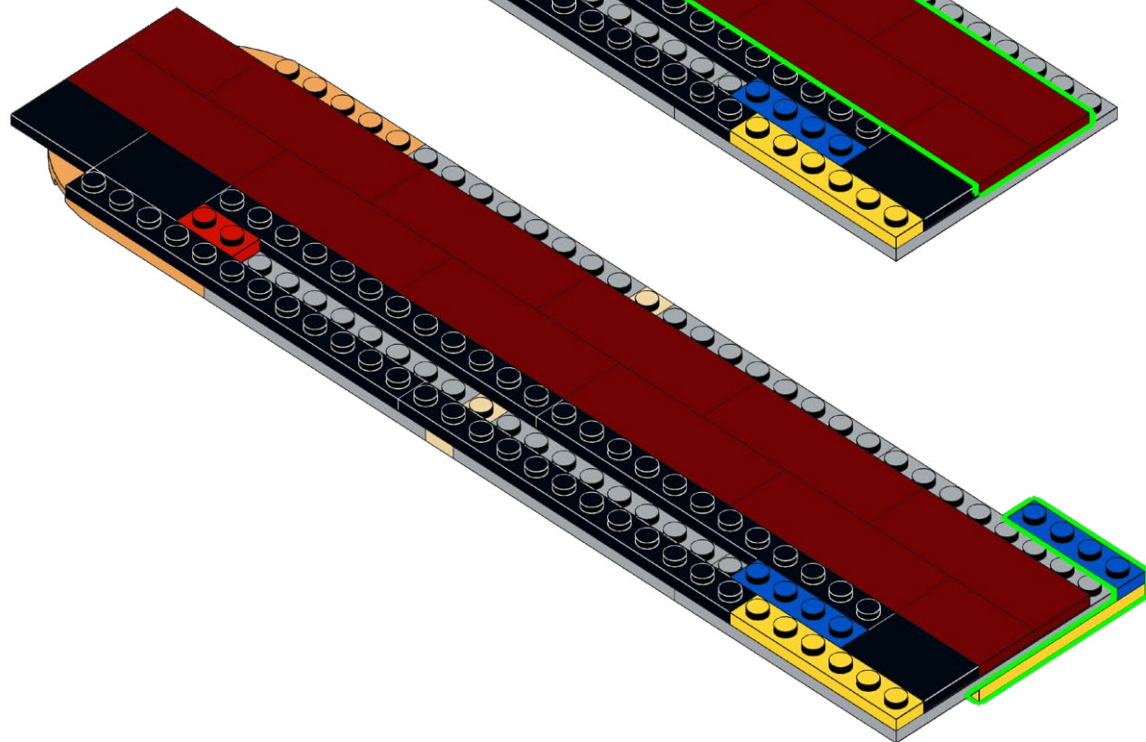

301

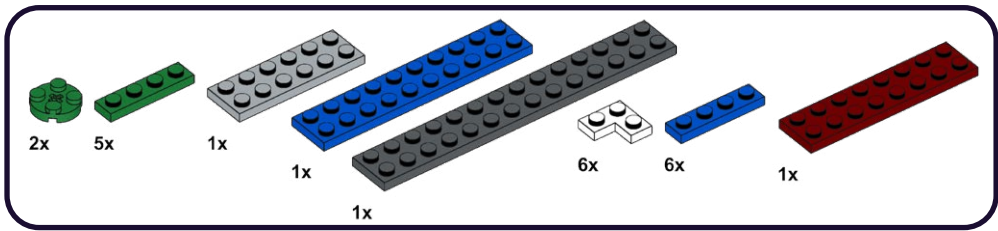

1

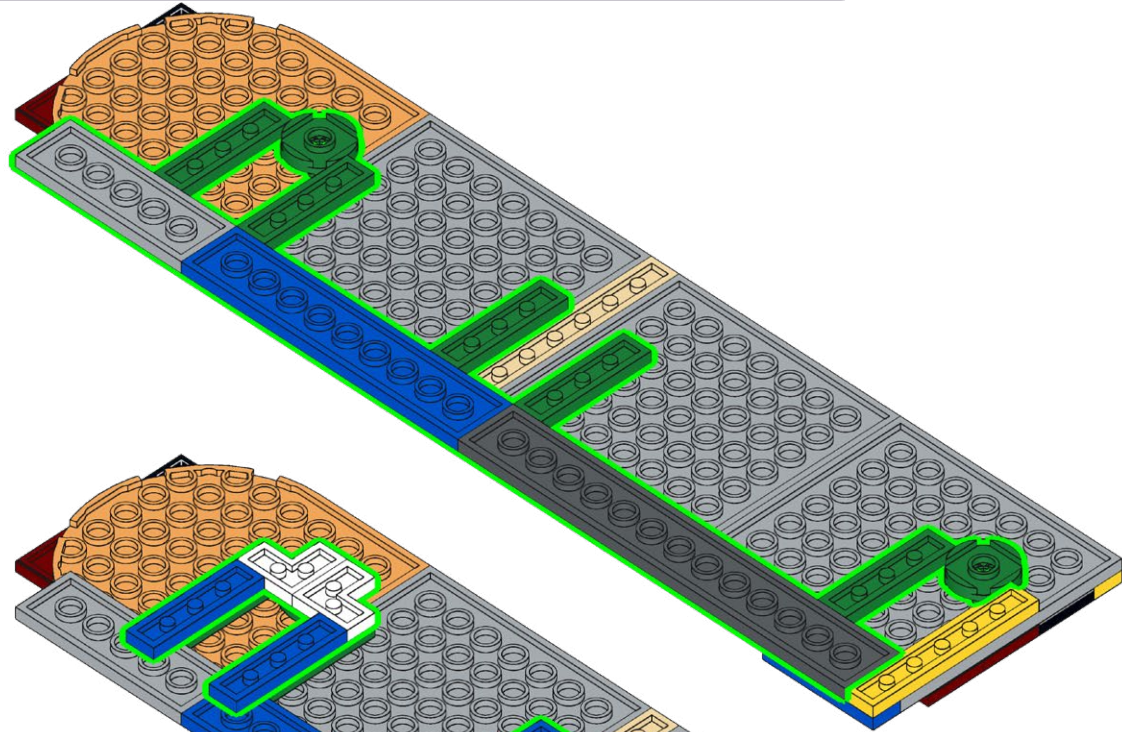

2

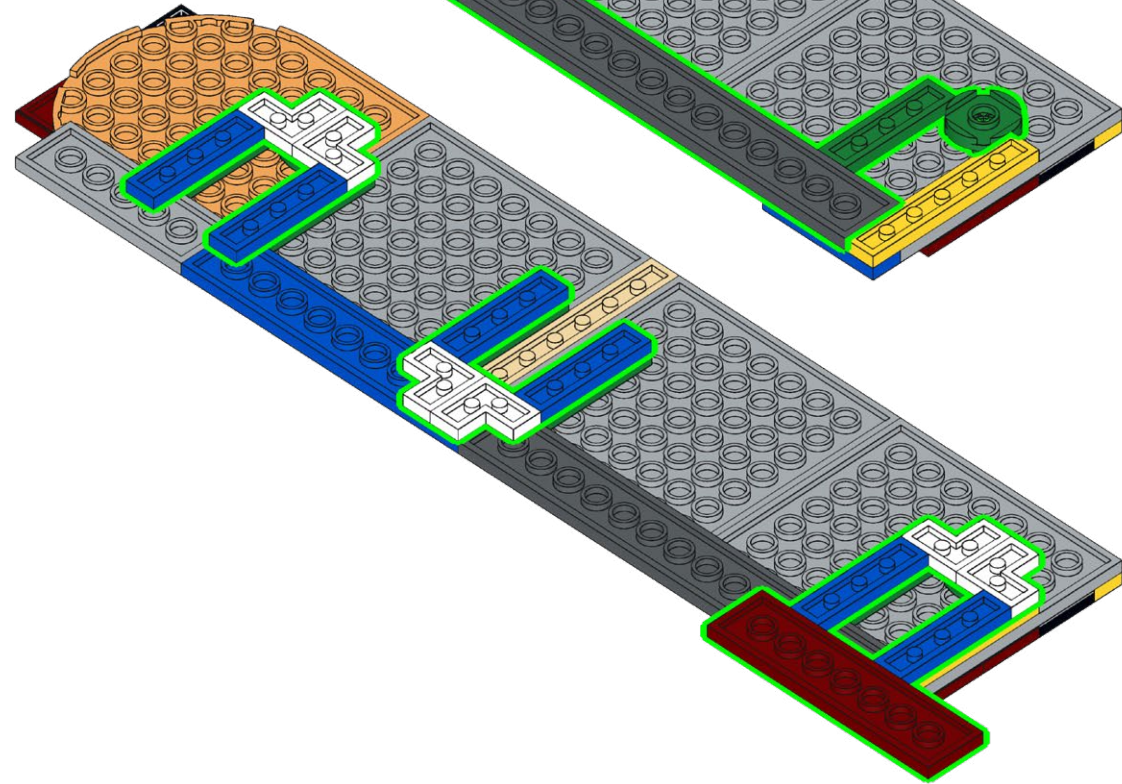

302

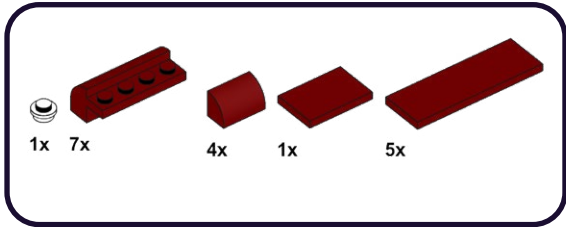

1

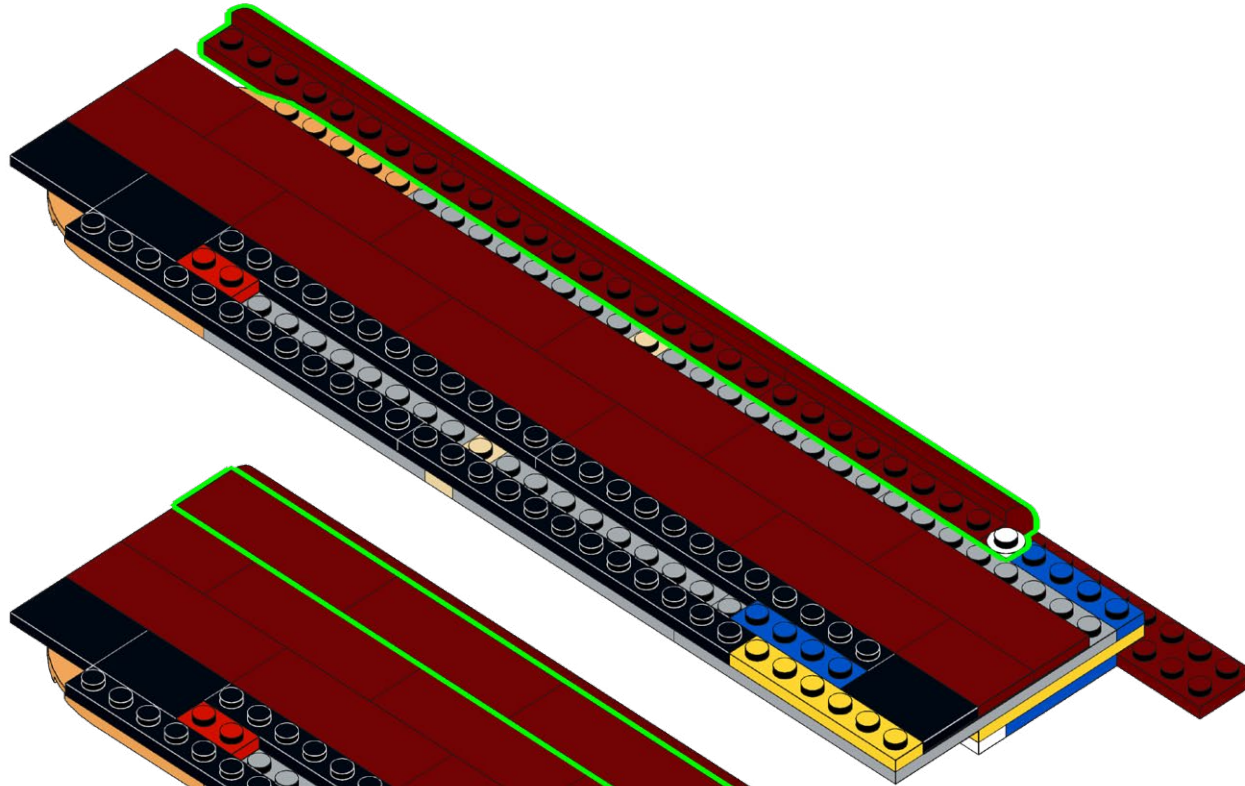

2

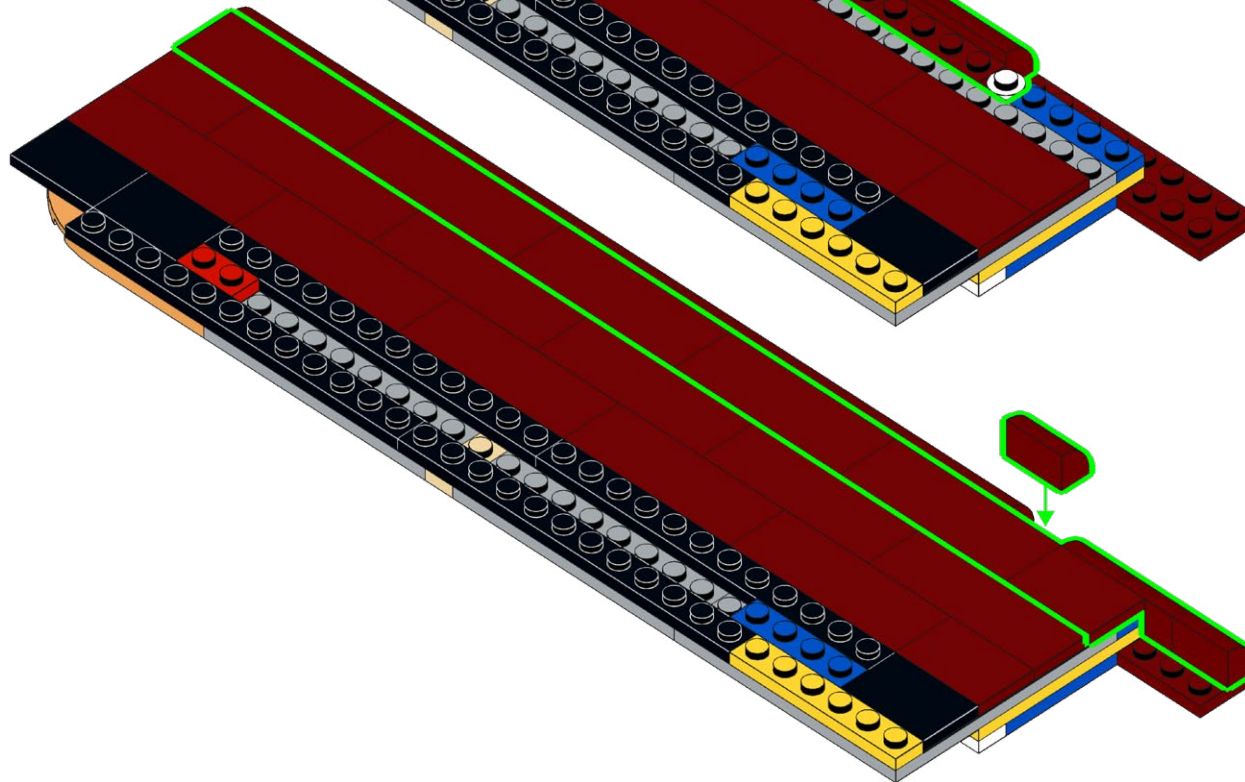

303

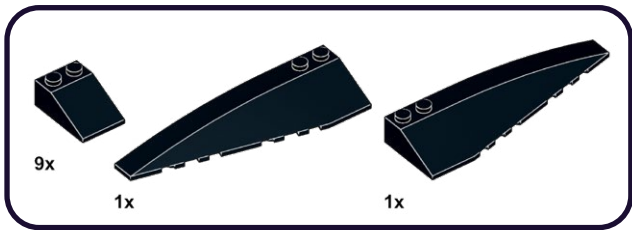

1

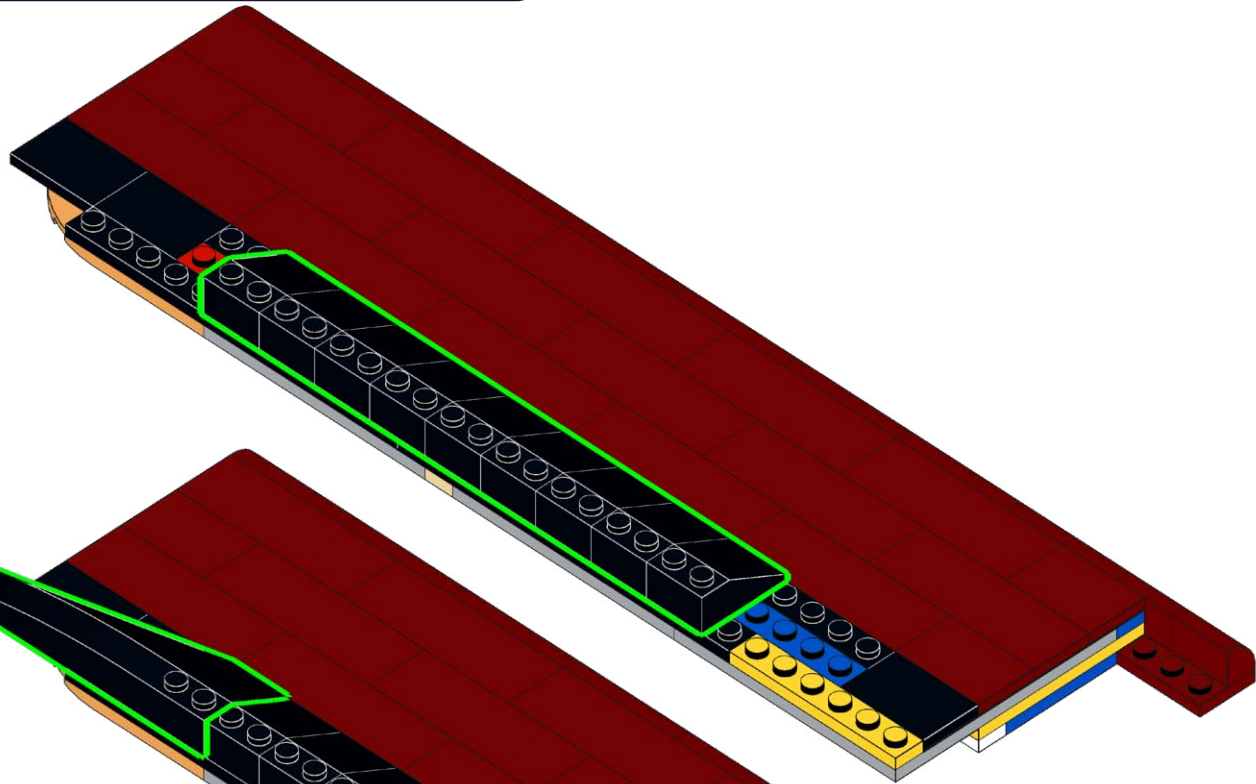

2

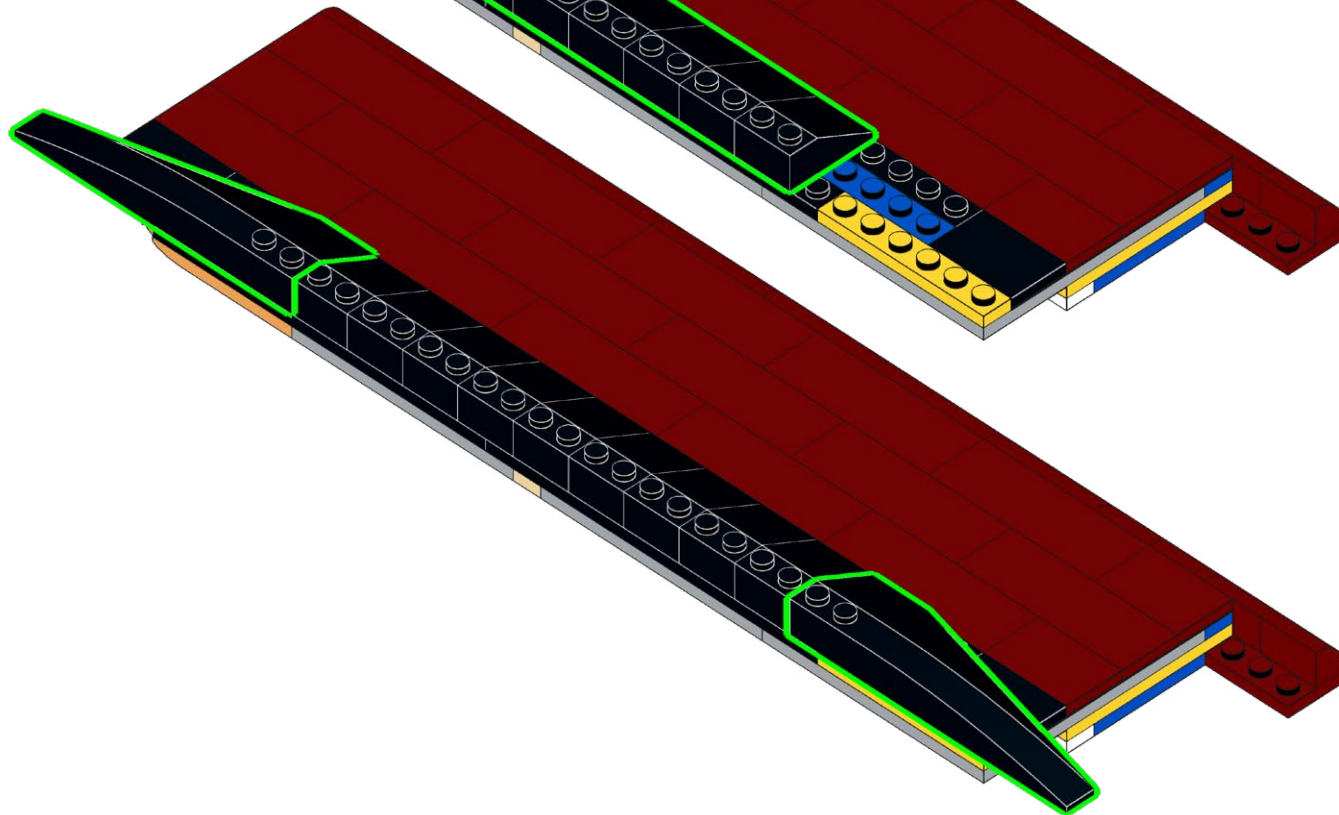

304

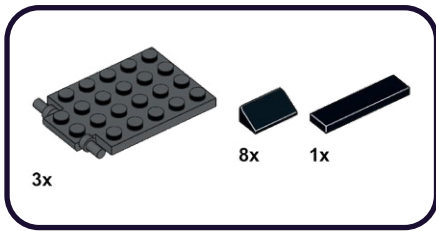

1



2

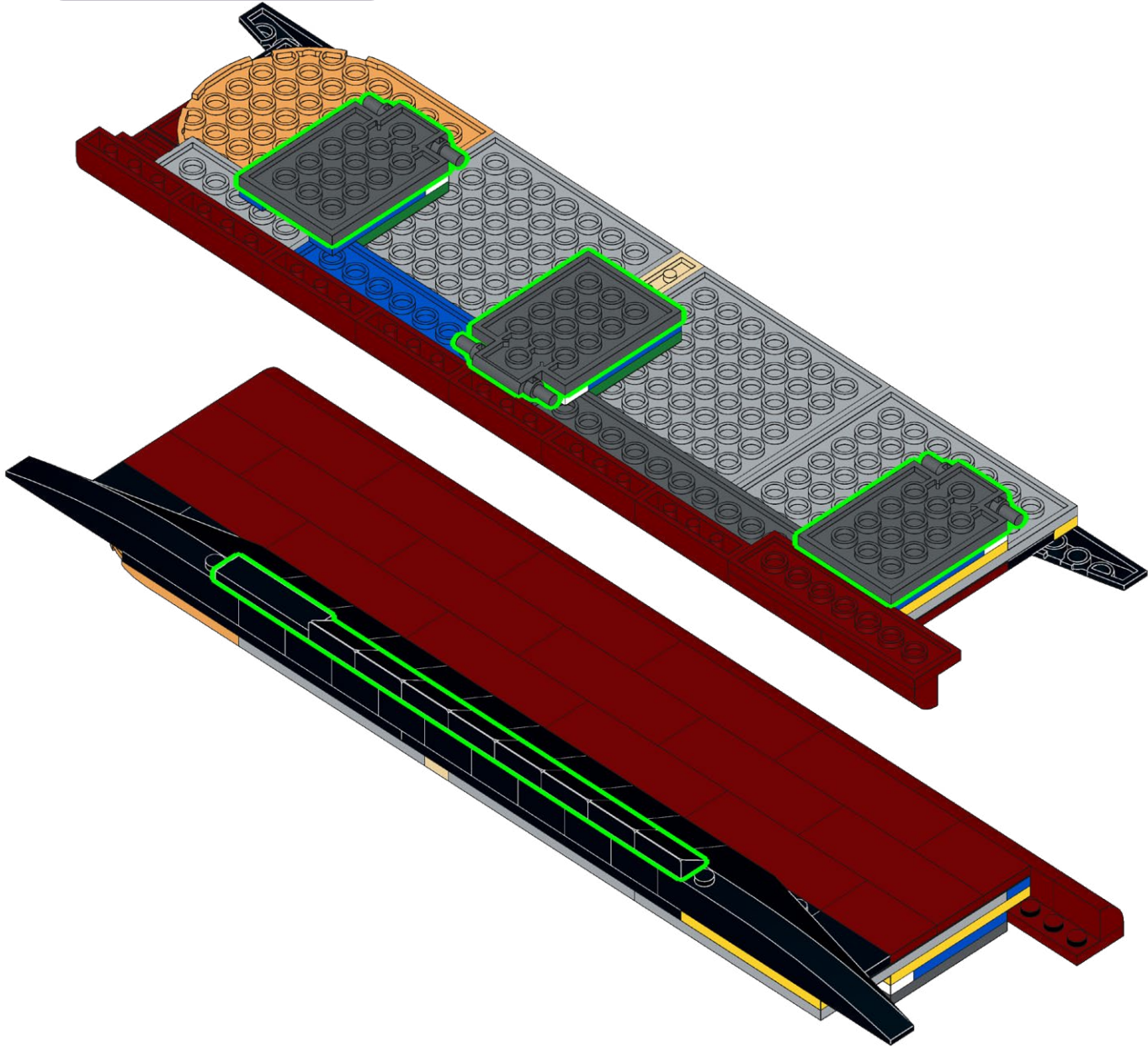

305

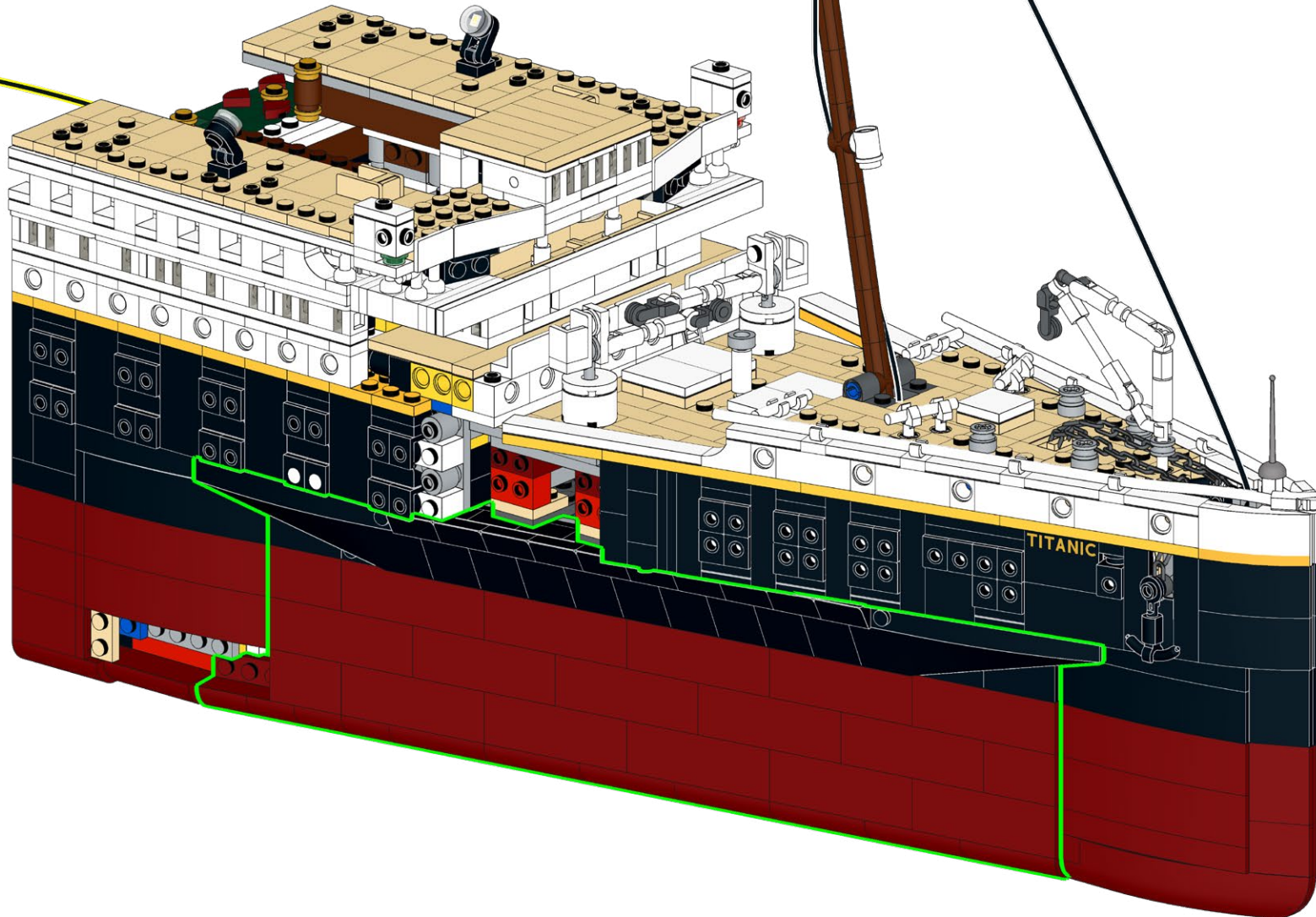

**HOLD UP!**

You might notice some bags aren't in order, as well as left over pieces, but that's ok! We're changing the way you build LEGO!

ATTENDEZ!

Vous remarquerez peut-être que certains sacs, ainsi que certaines pièces, ne sont pas dans le bon ordre. Mais pas de panique! Nous changeons simplement la façon avec laquelle vous construisez vos LEGO!

ASPETTA!

Potresti notare che alcuni sacchetti non sono in ordine, così come i pezzi avanzati, ma va bene così! Stiamo cambiando il modo in cui costruisci i LEGO!

HALT!

Sie werden möglicherweise bemerken, dass einige tüten durcheinander sind und teile übrig bleiben, aber das ist in Ordnung! Wir ändern die art und weise, wie Sie LEGO bauen!

¡ESPERA!

Es posible que notes que algunas bolsas están fuera de servicio, así como piezas sobrantes, ¡pero está bien! ¡Estamos cambiando la forma en que construyes LEGO!

暫停!

你可能会注意到一些袋子顺序错乱, 以及一些剩余的部件, 但没关系! 我们正在改变你搭建乐高的方式!

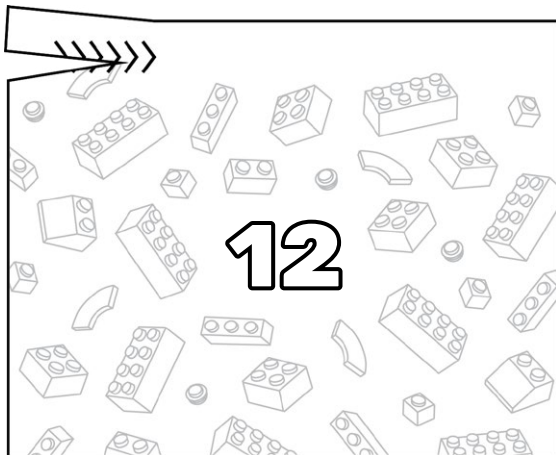
Open LEGO® Bag 12

306

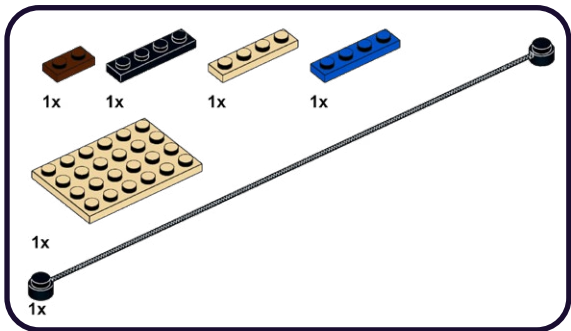

1

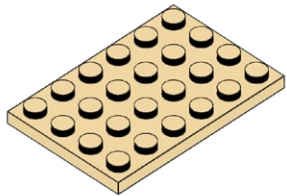

2

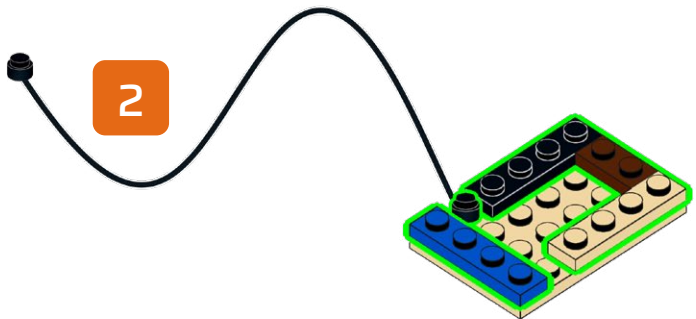

307

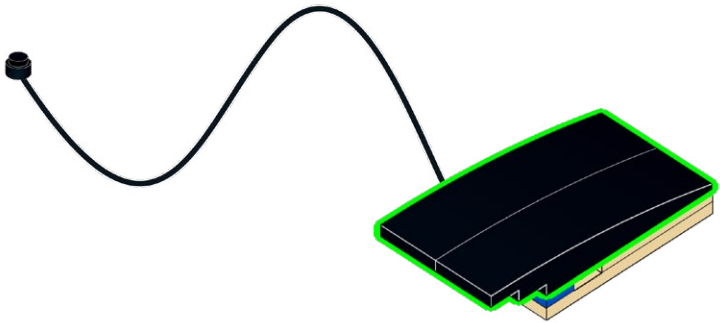

308

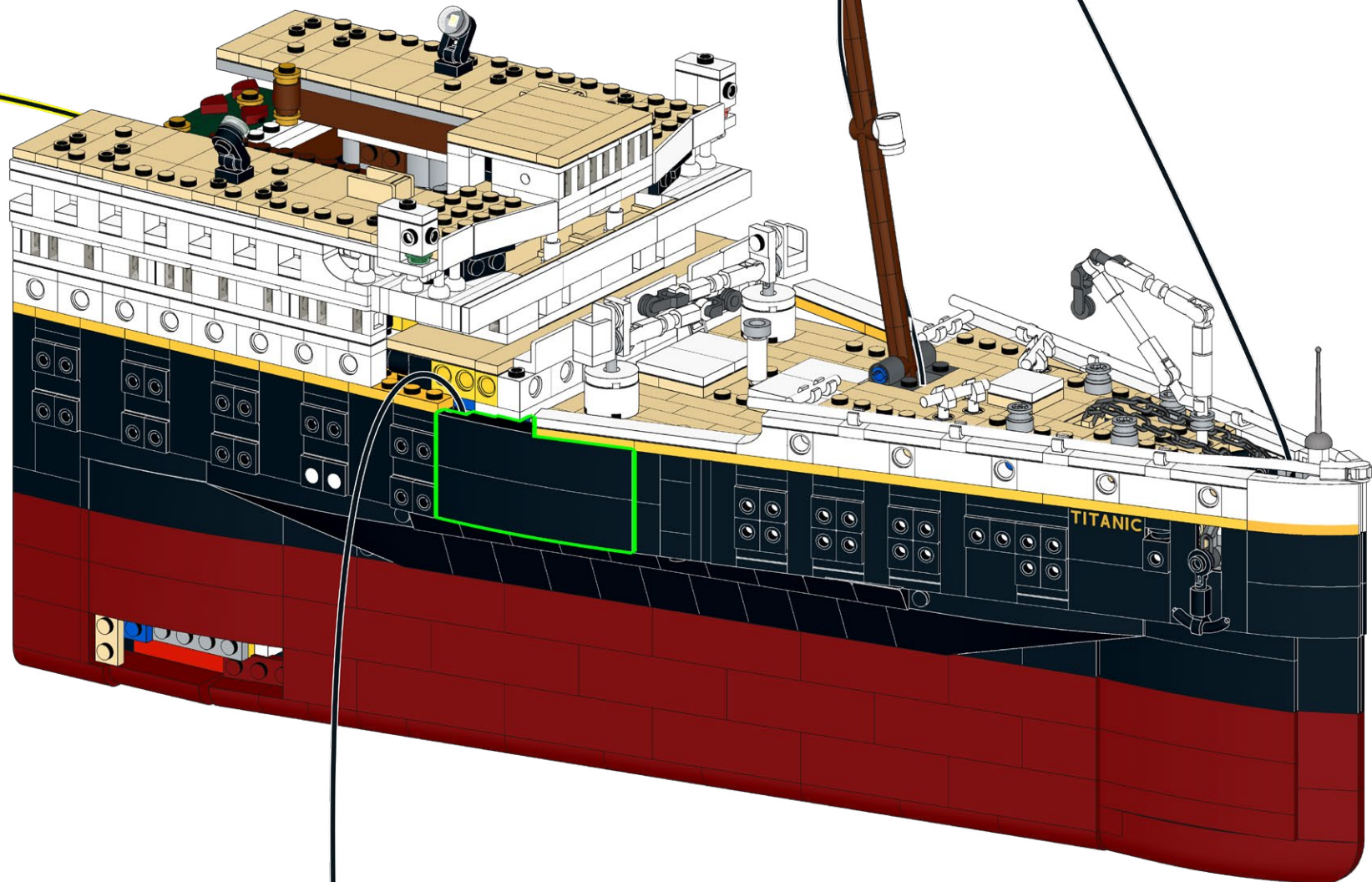

309

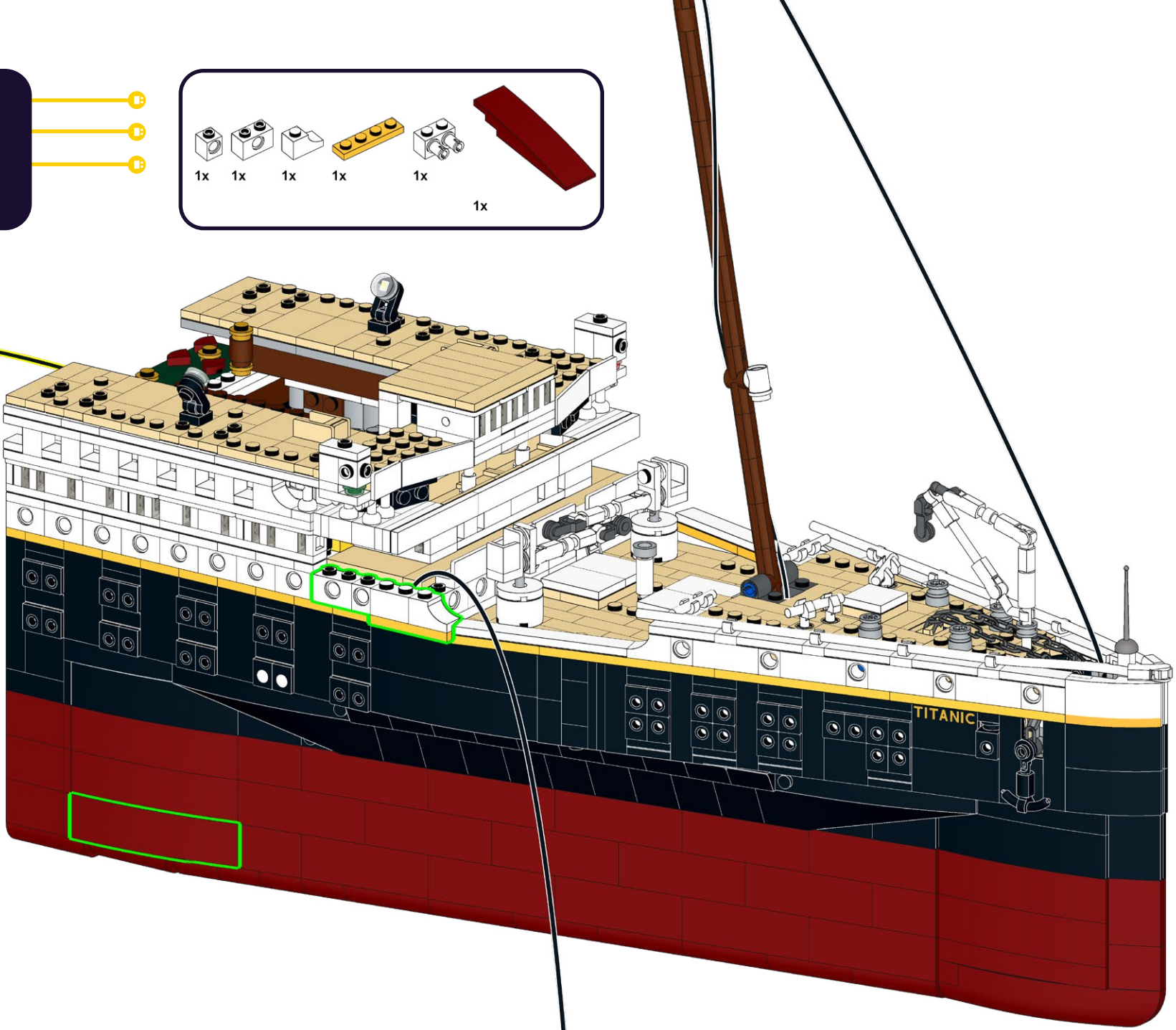
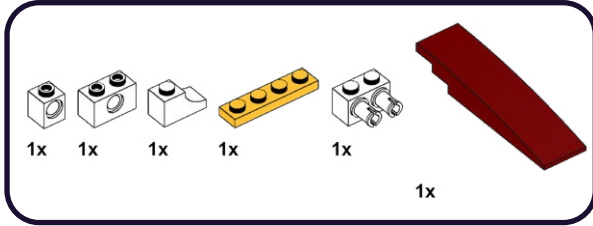

310

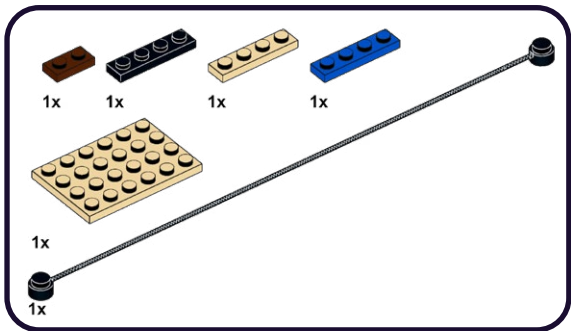

1

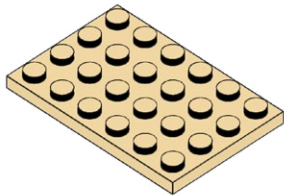

2

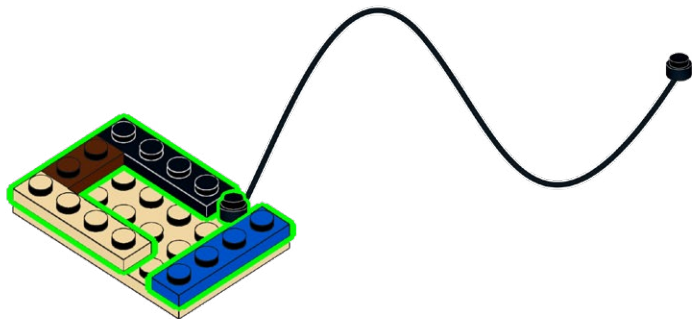

311

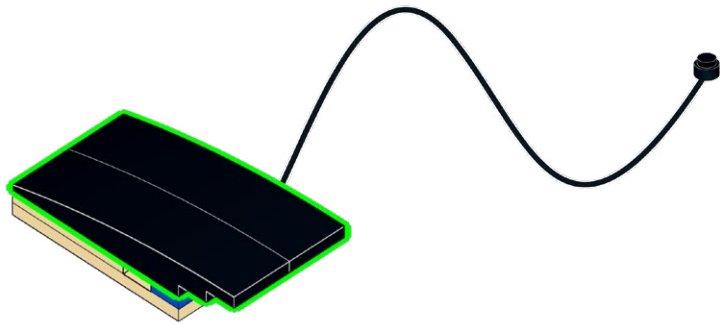

312

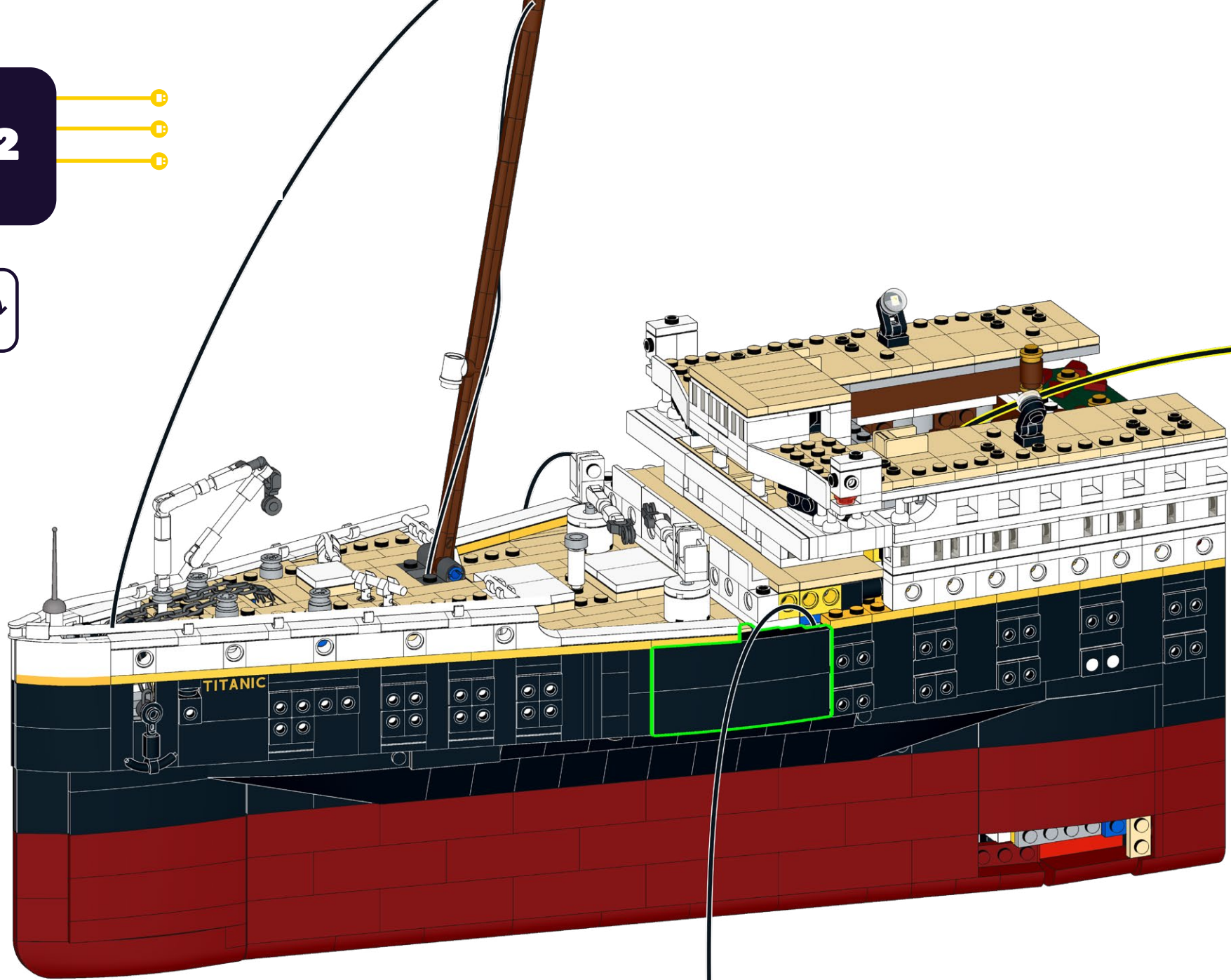

313

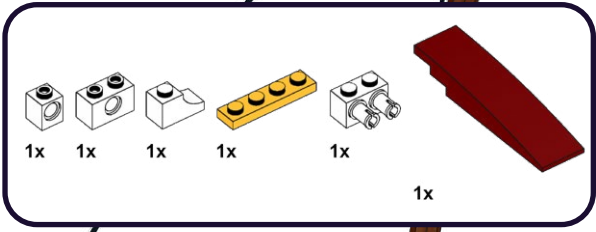

1x 1x 1x 1x 1x 1x

This inset box lists the required parts for step 313: one white 1x1 brick with a hole, one white 1x2 brick with a hole, one white 1x3 brick with a hole, one yellow 1x4 Technic beam, one white 1x2 brick with a hole and a grey axle, and one dark red 1x4 Technic beam.

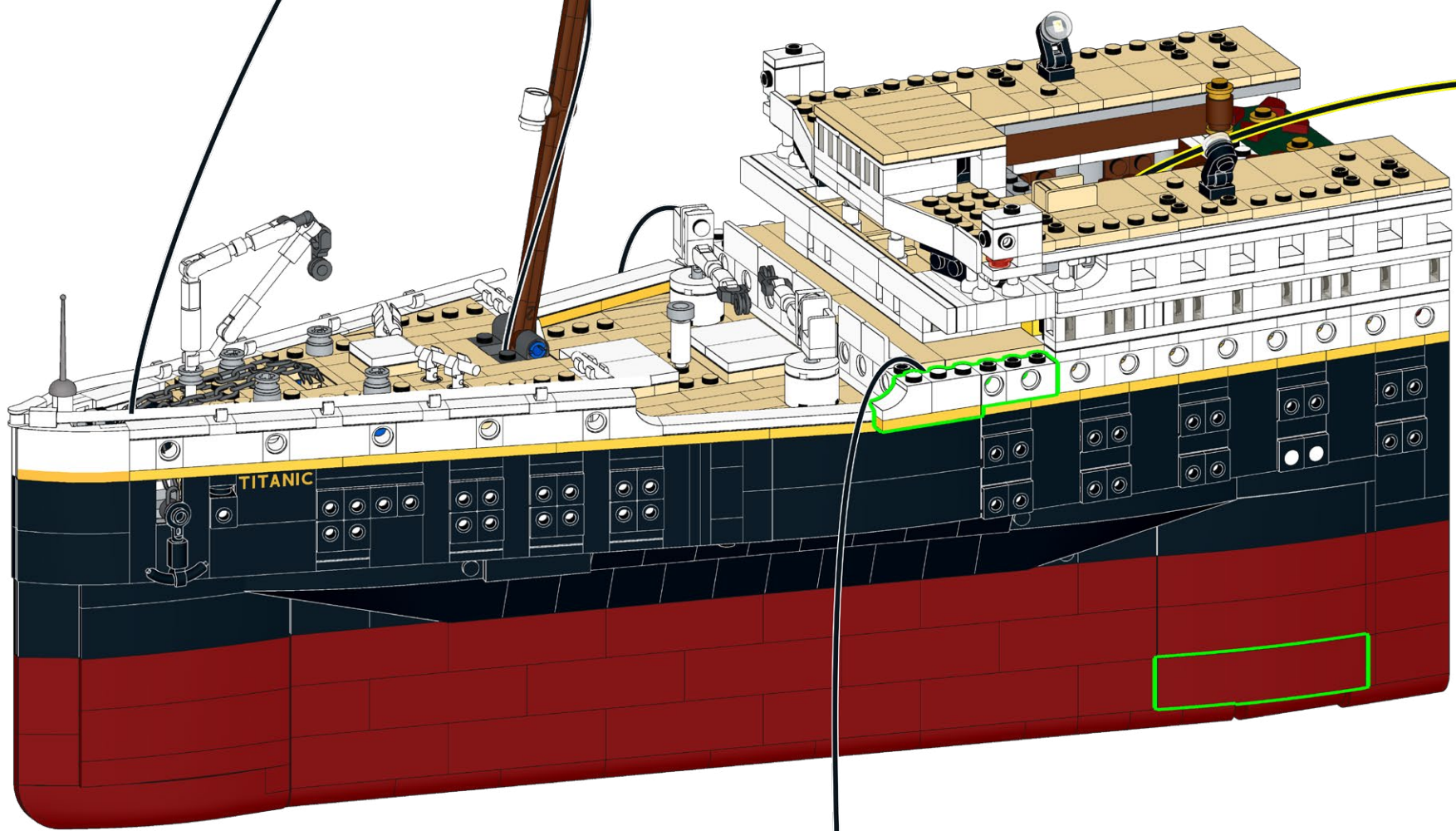

314

2x

2x

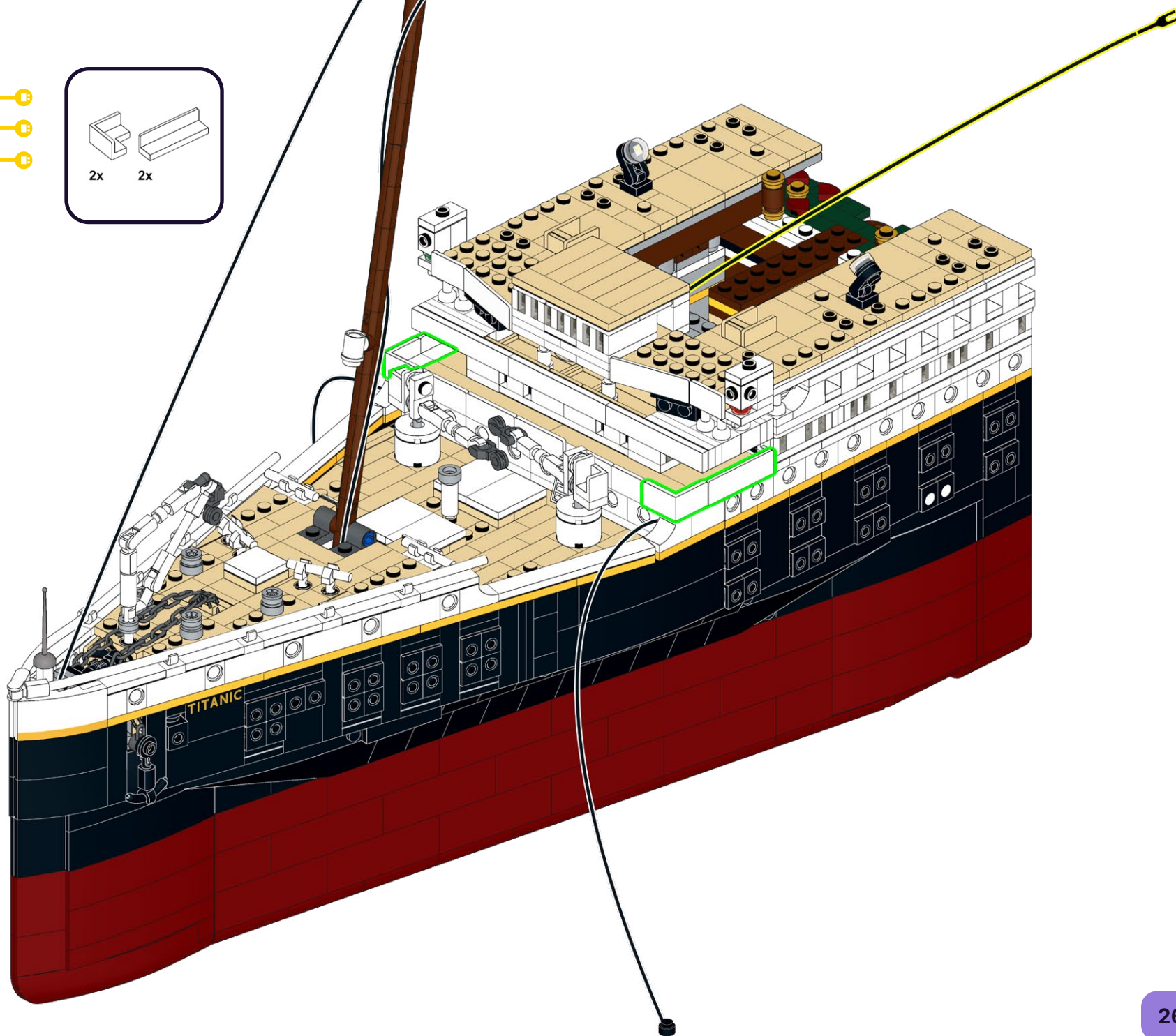

315



8x 8x



8x

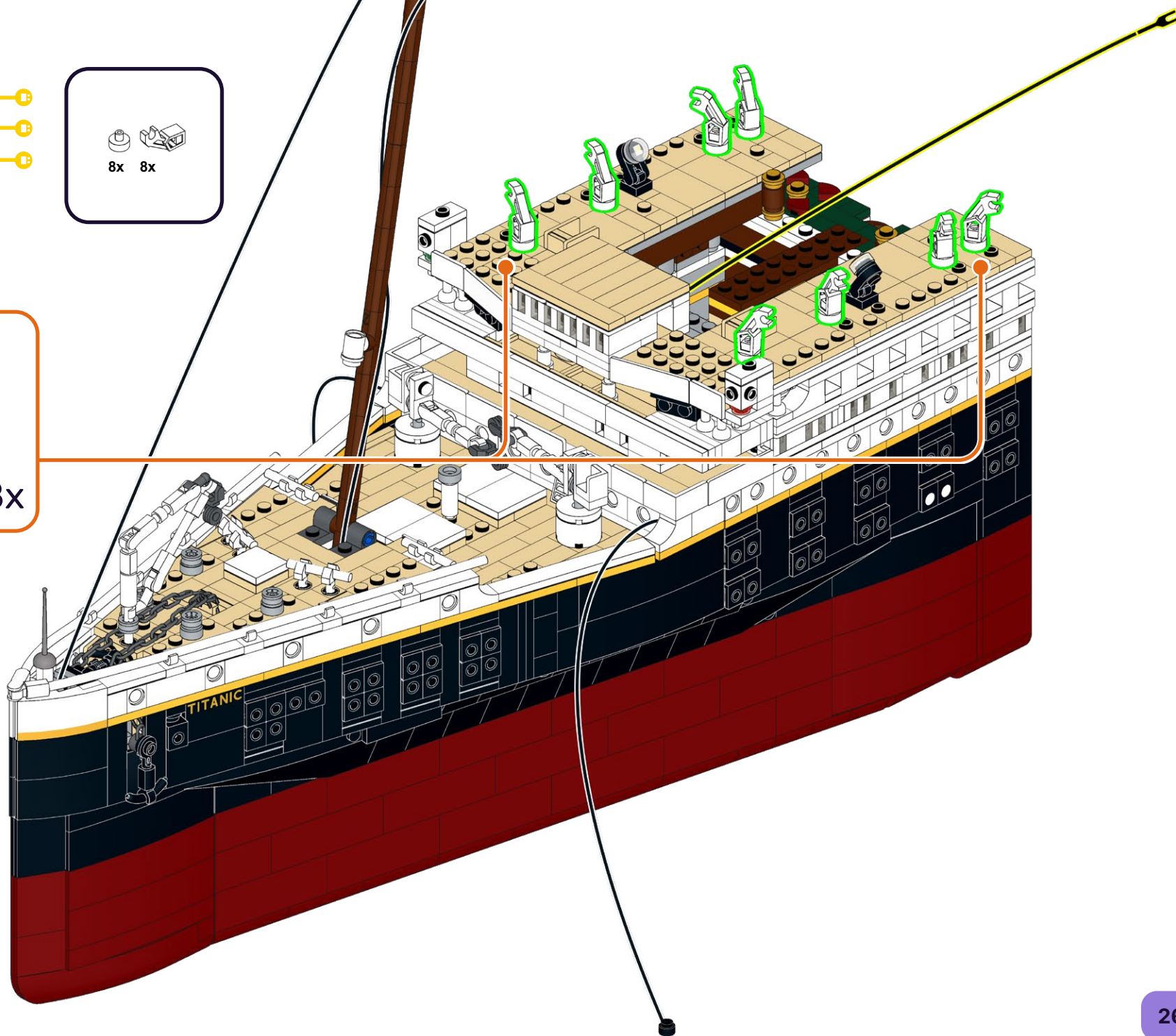

316

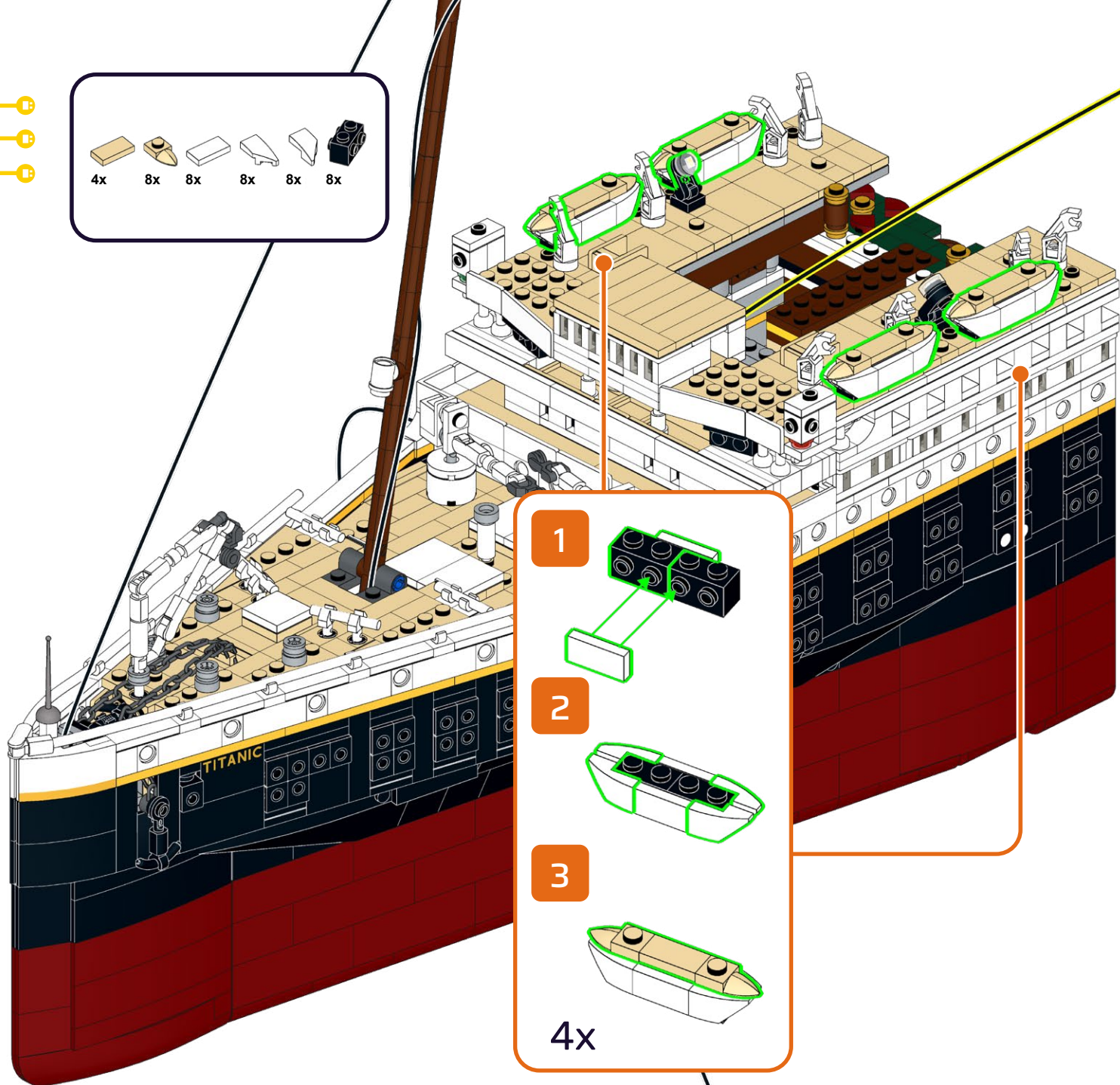
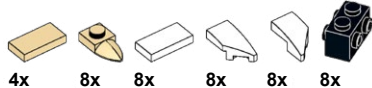

1

2

3

4x

317

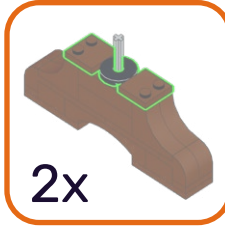
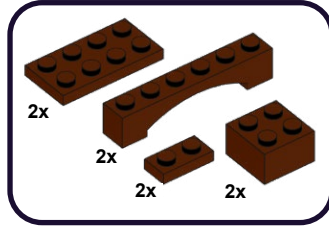

318

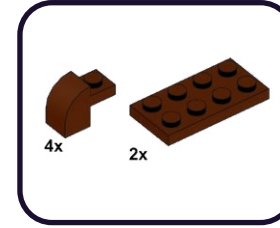

1

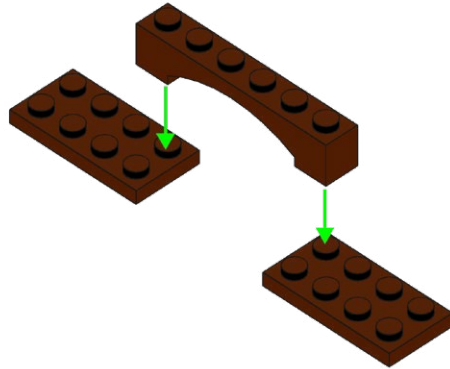

2

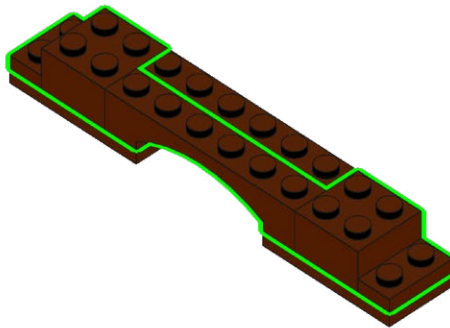

1

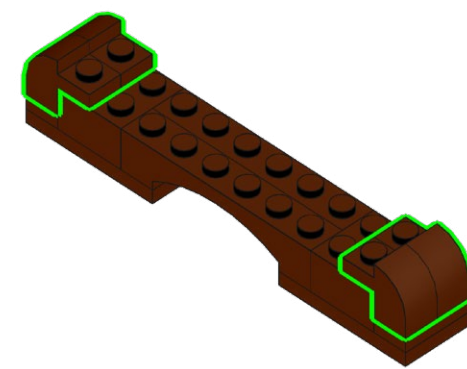

2

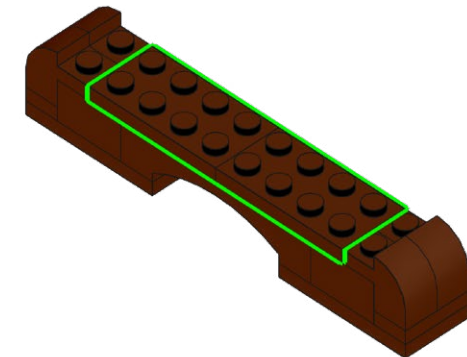

319

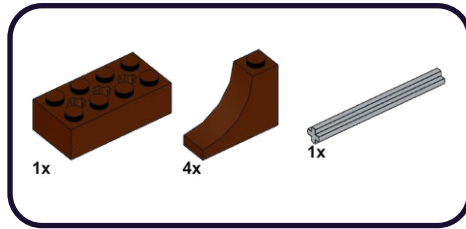

1

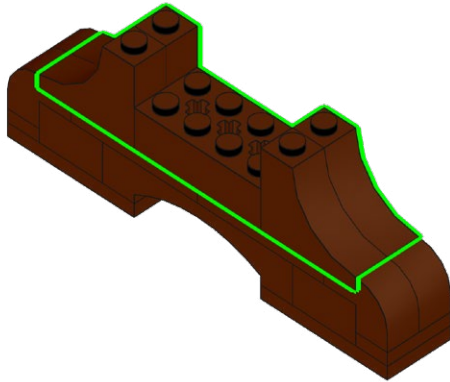

2

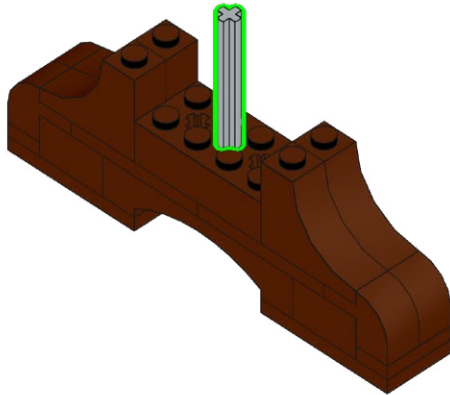

320

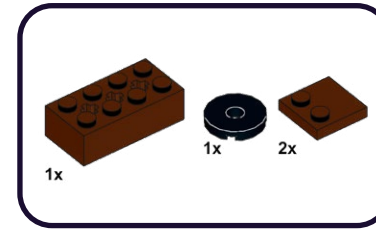

1

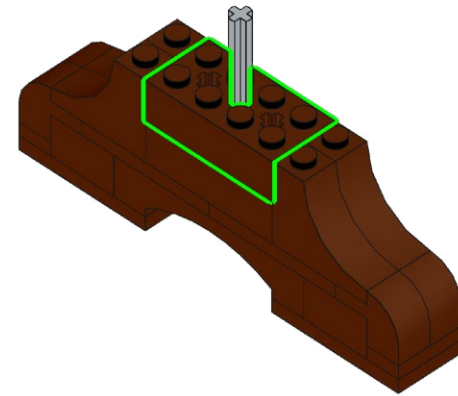

2

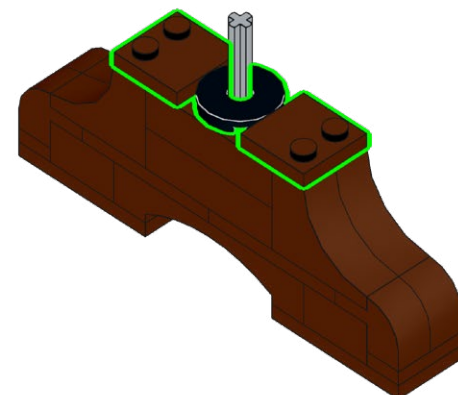

2x

321

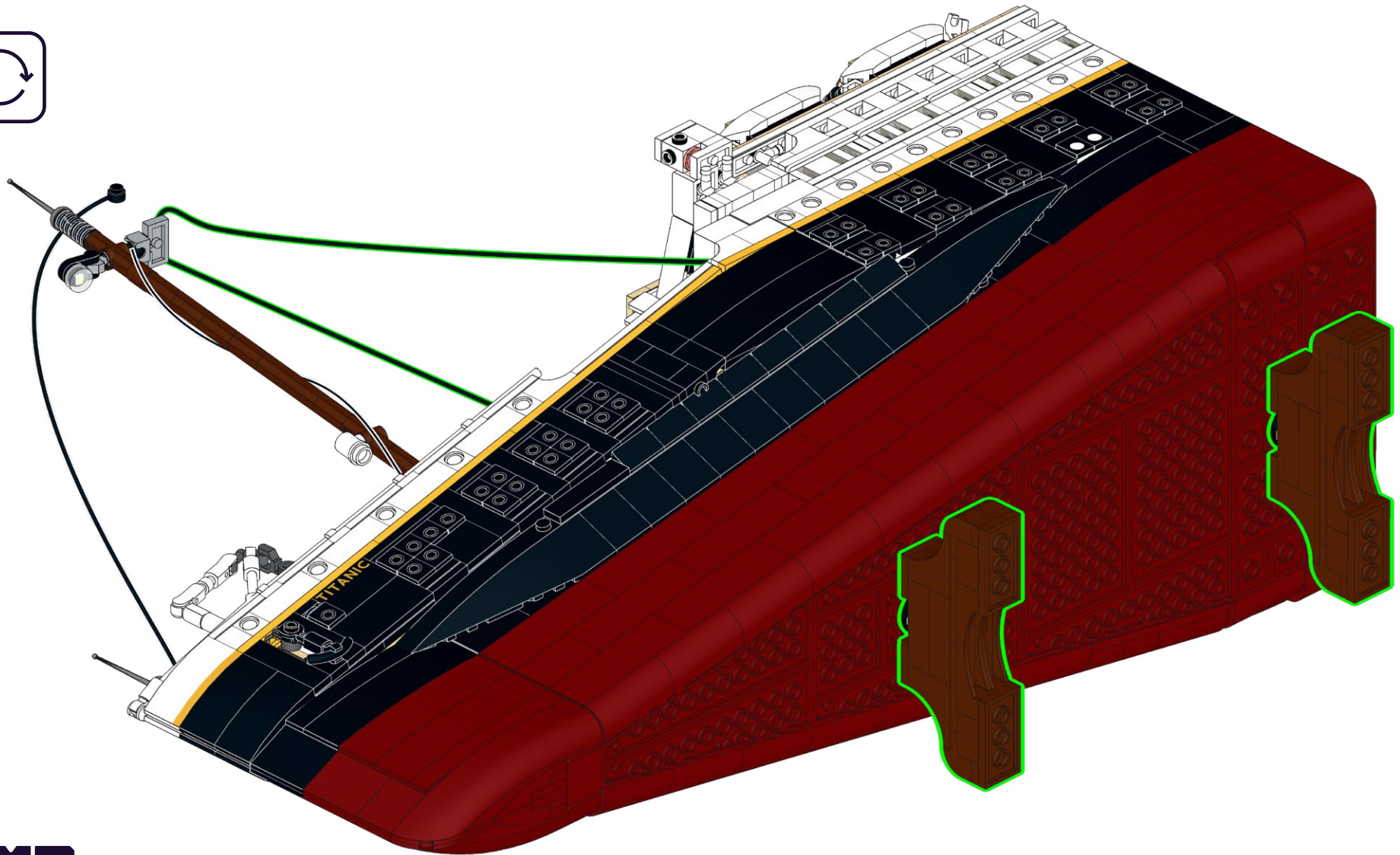

322

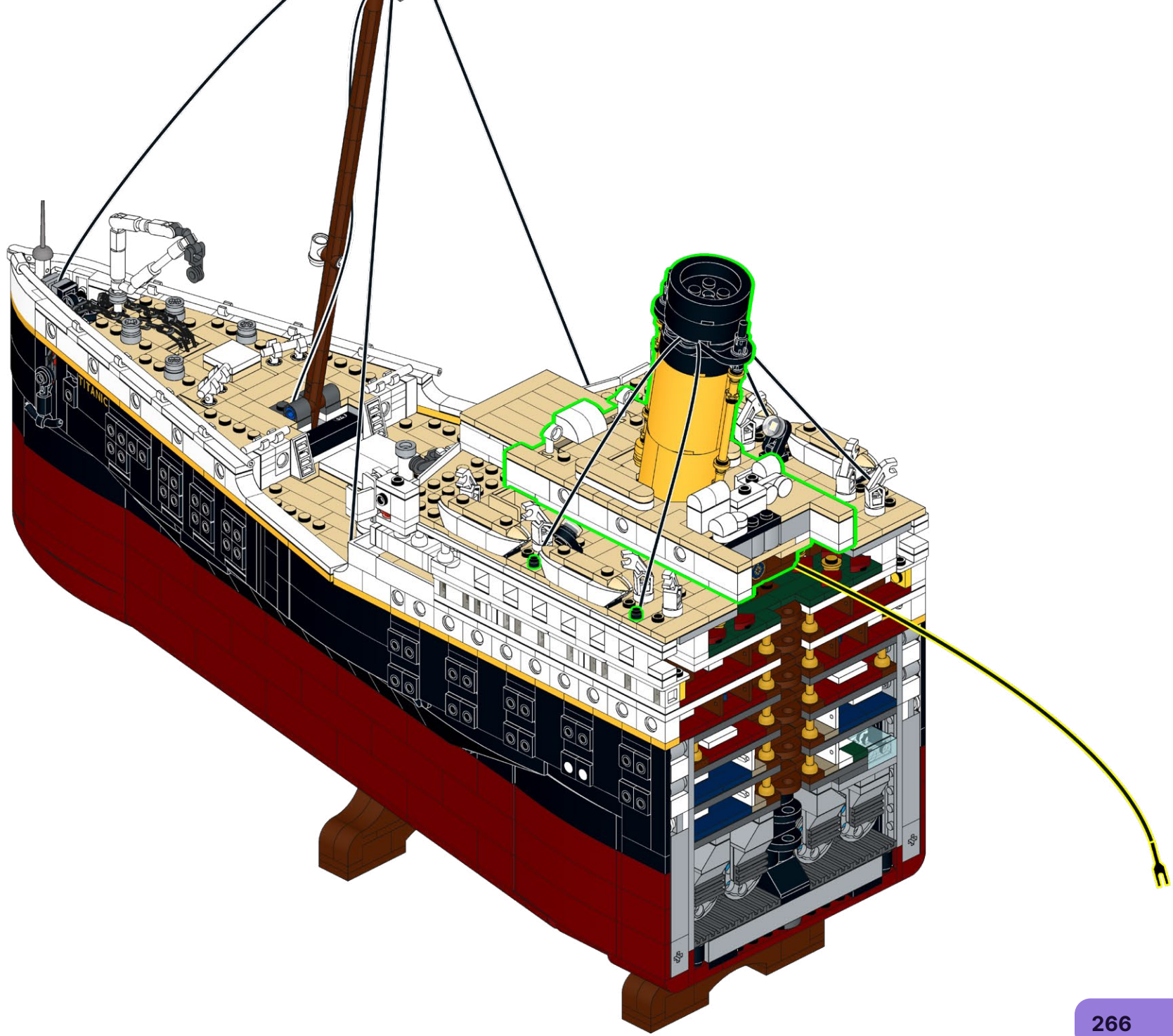

323

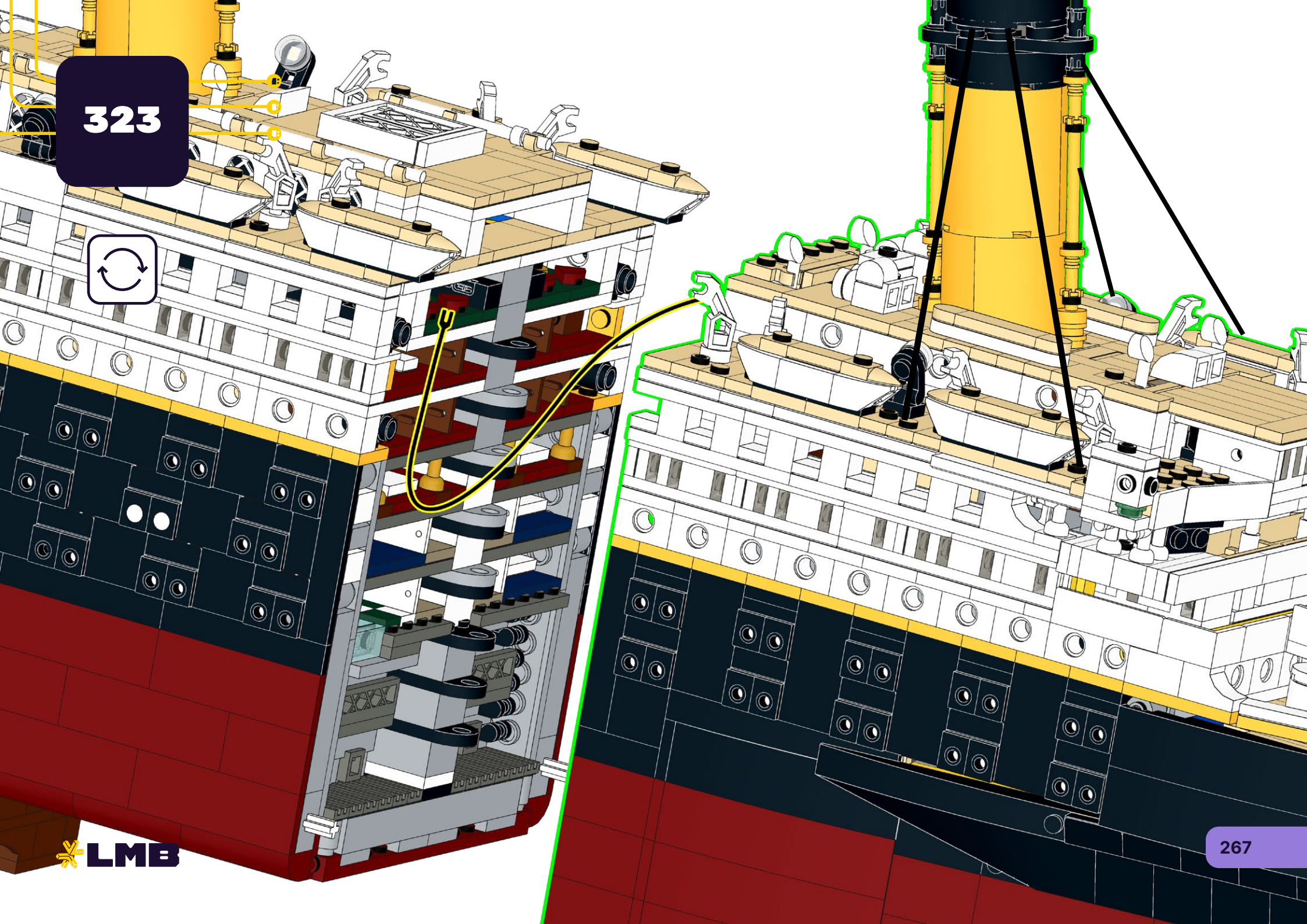

324

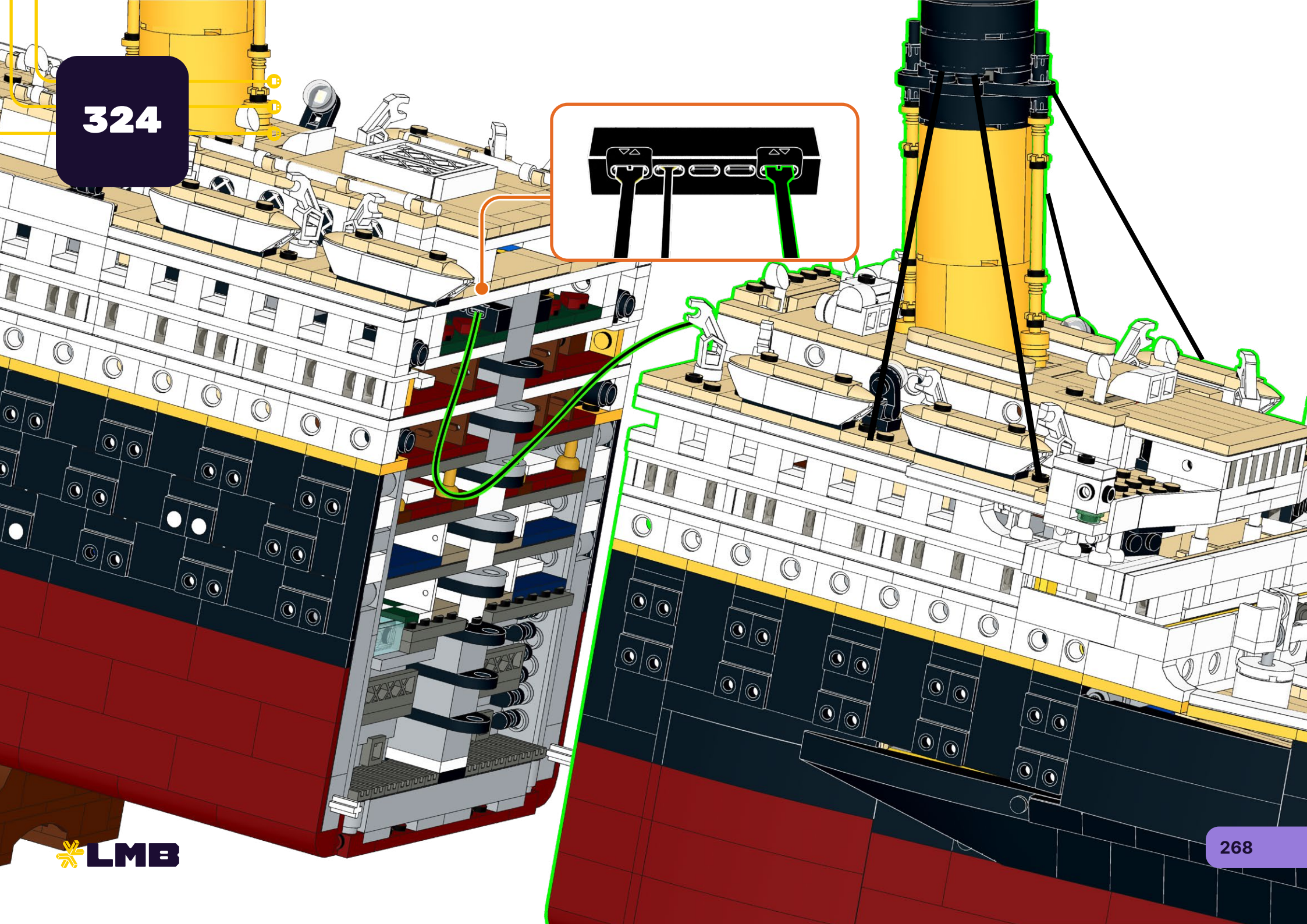

325

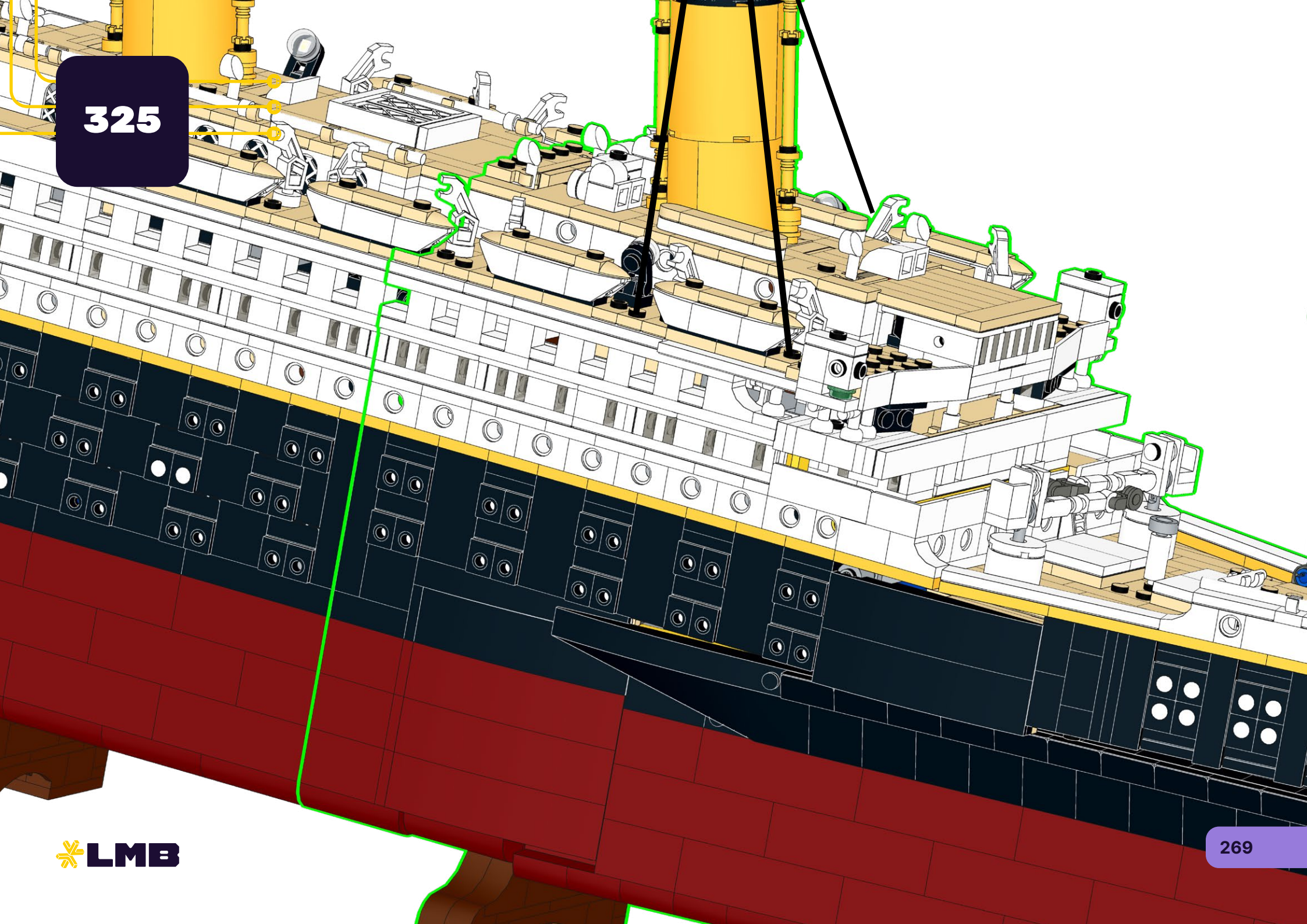

326

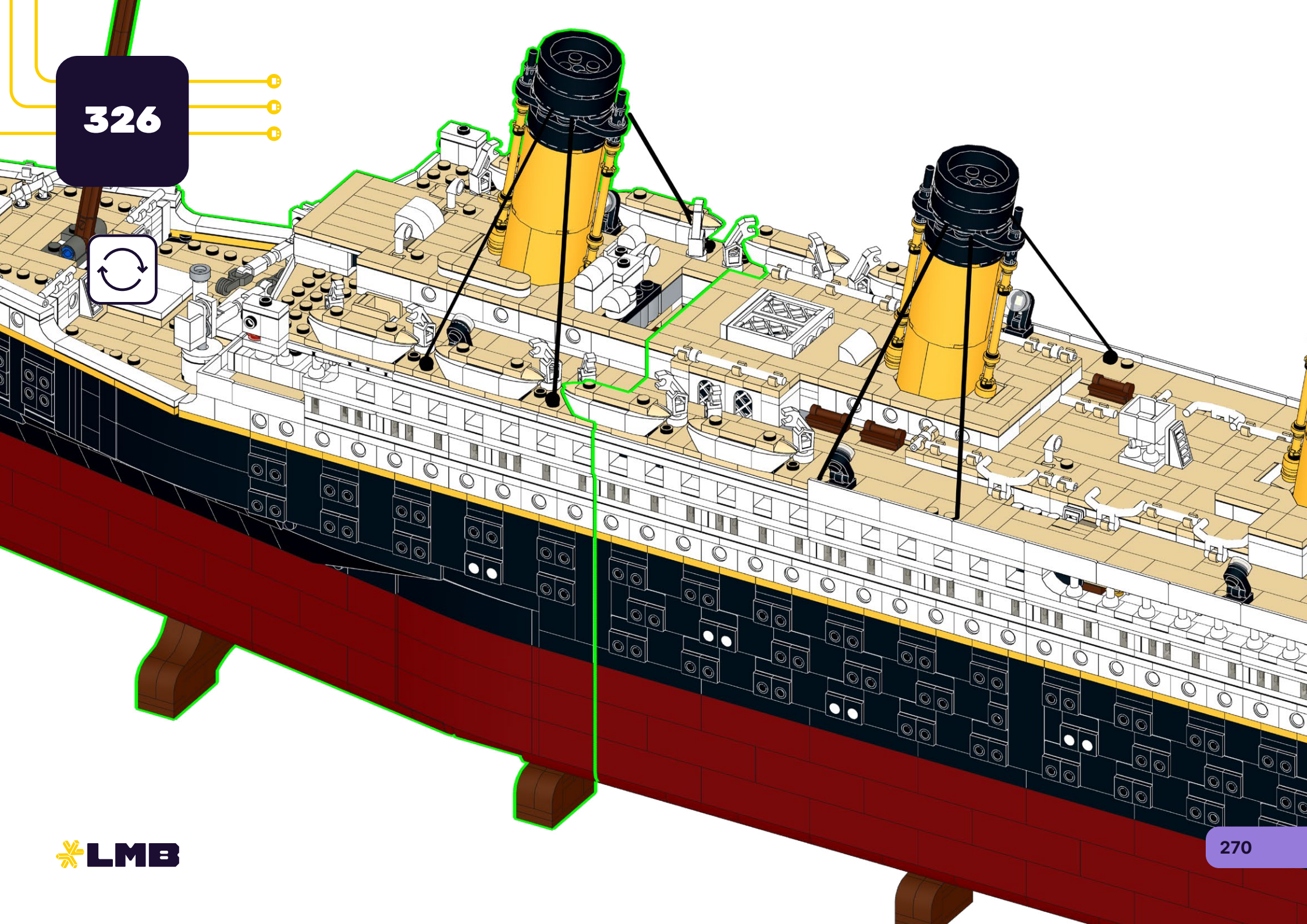

327

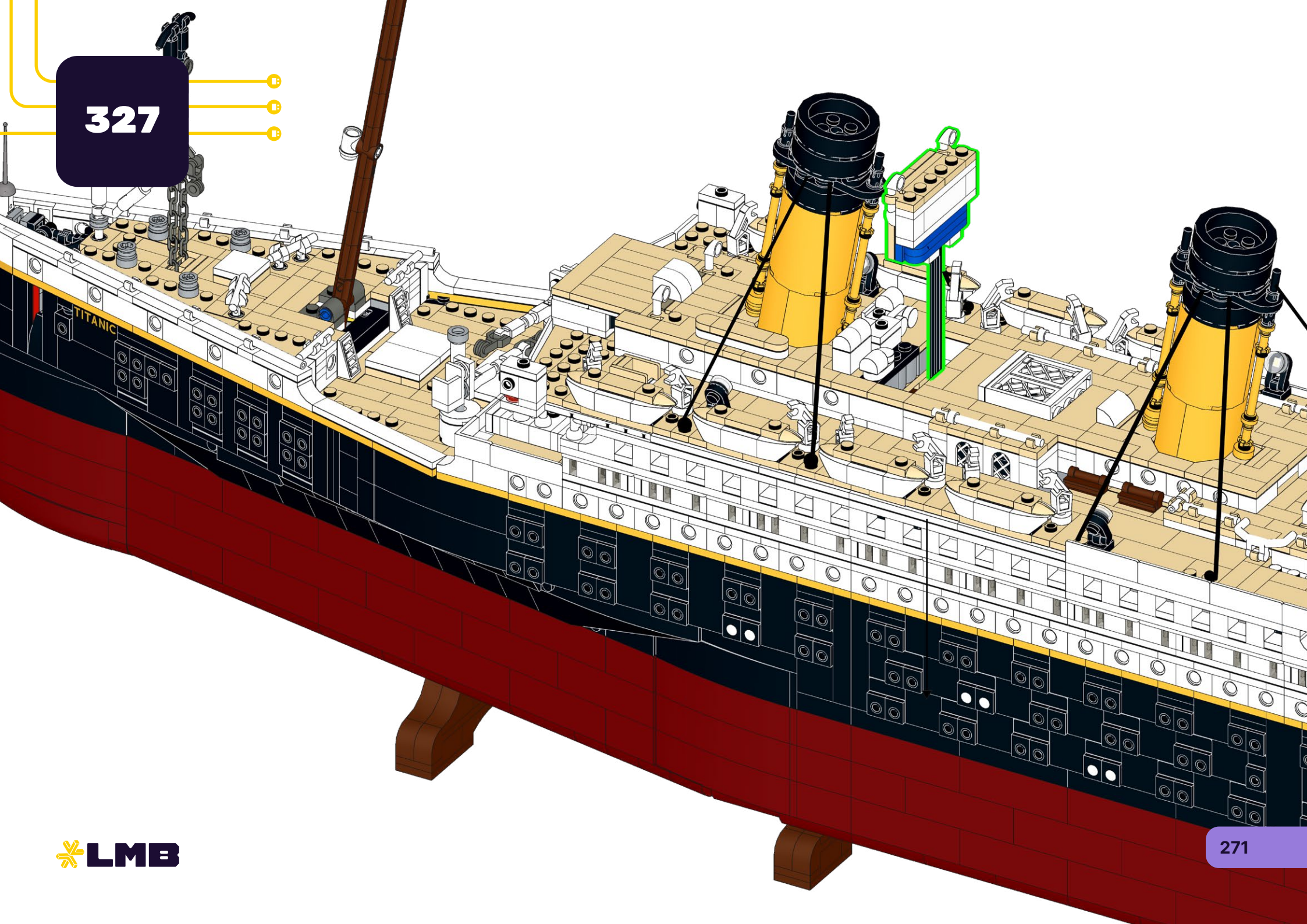

328

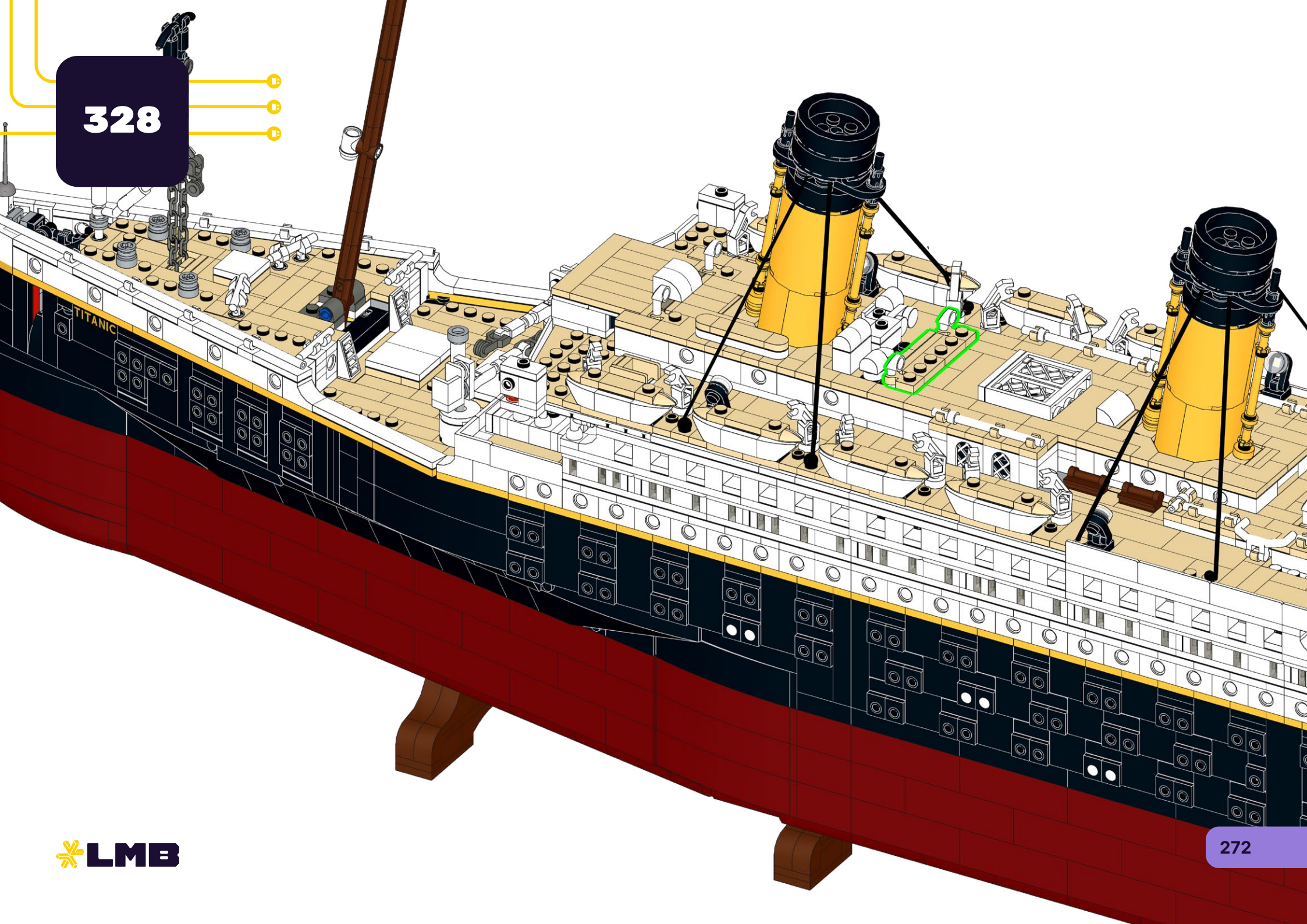

329

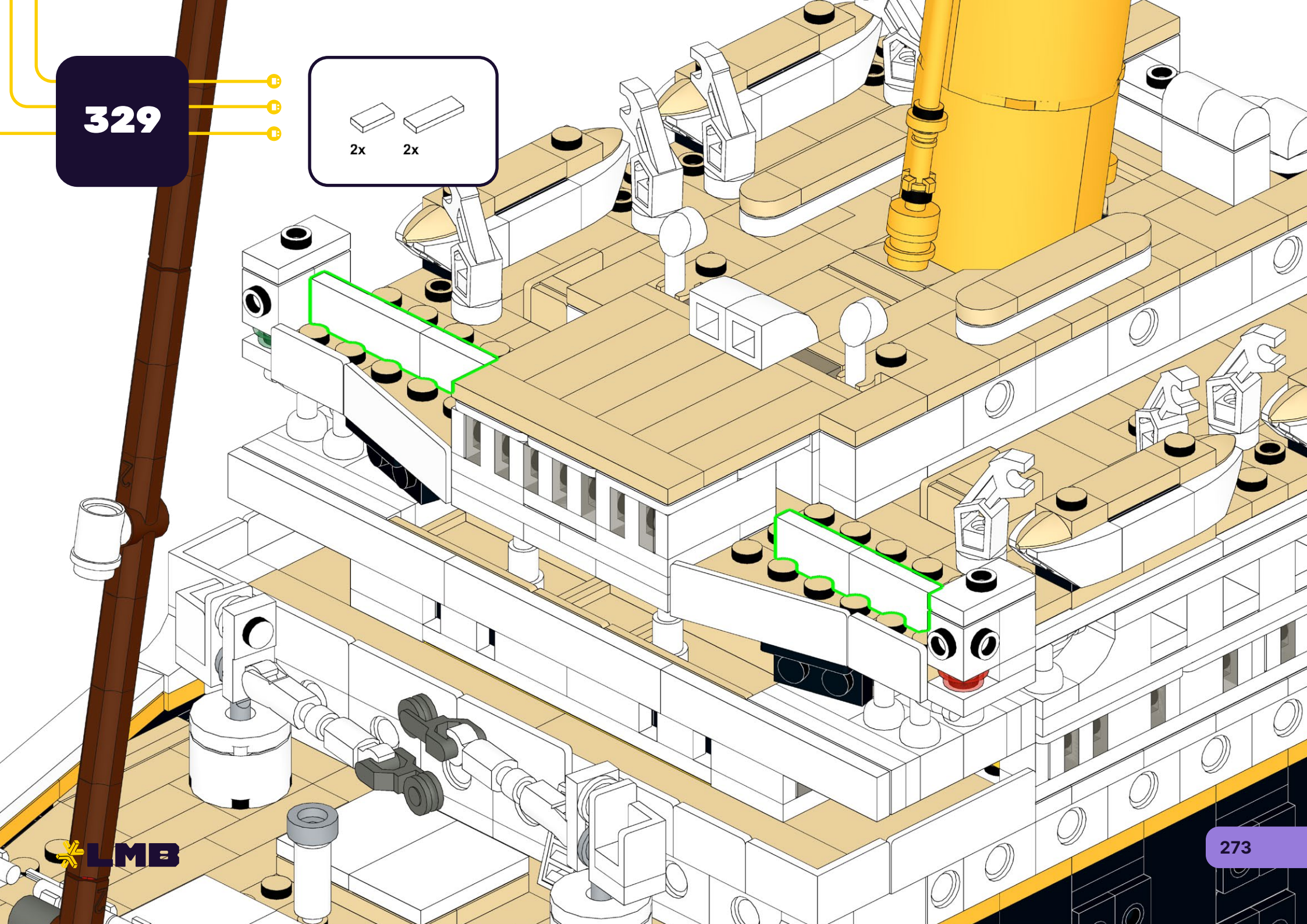
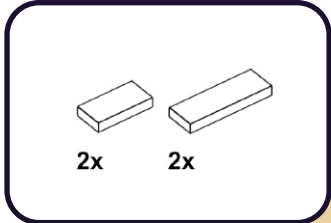

330

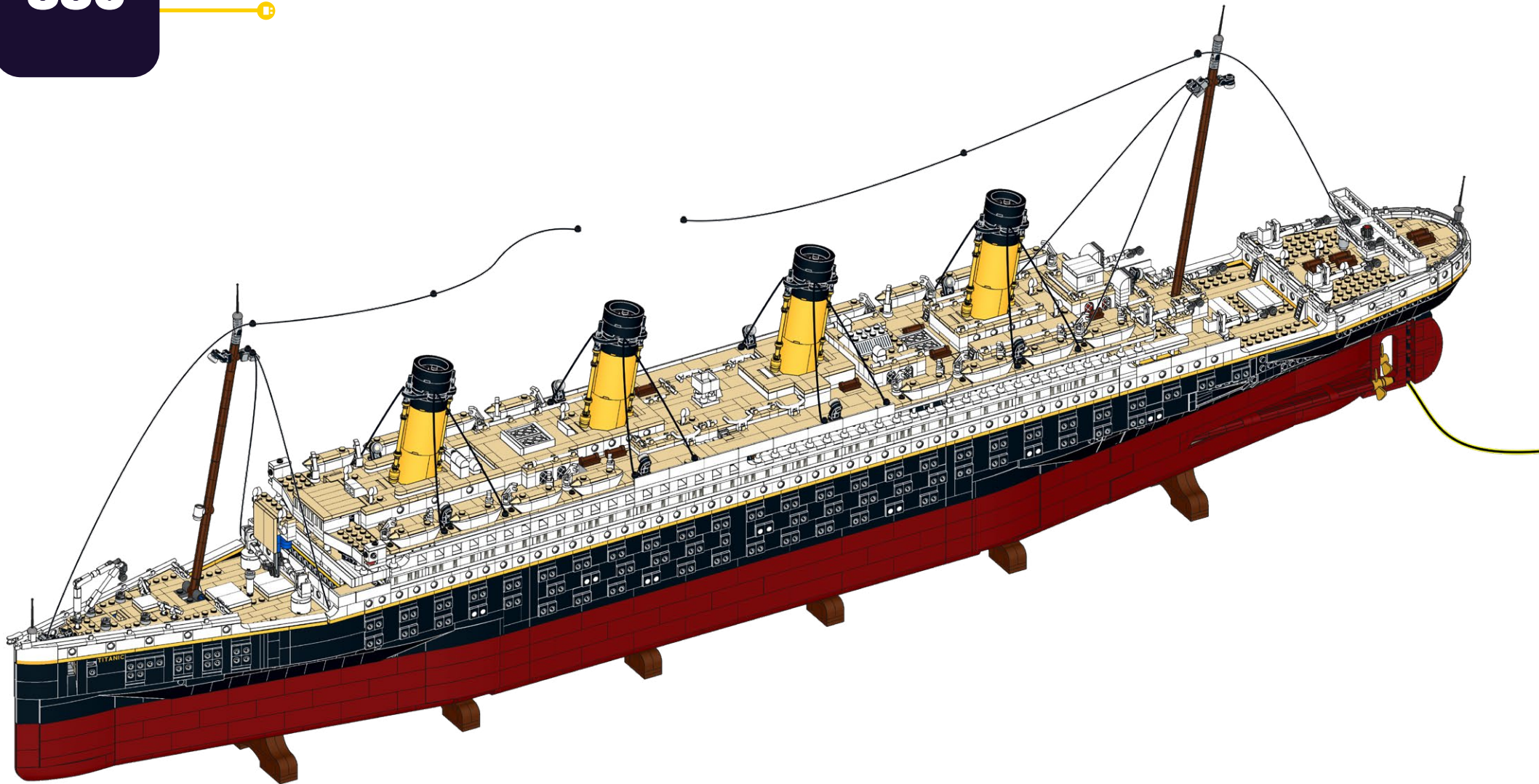

331

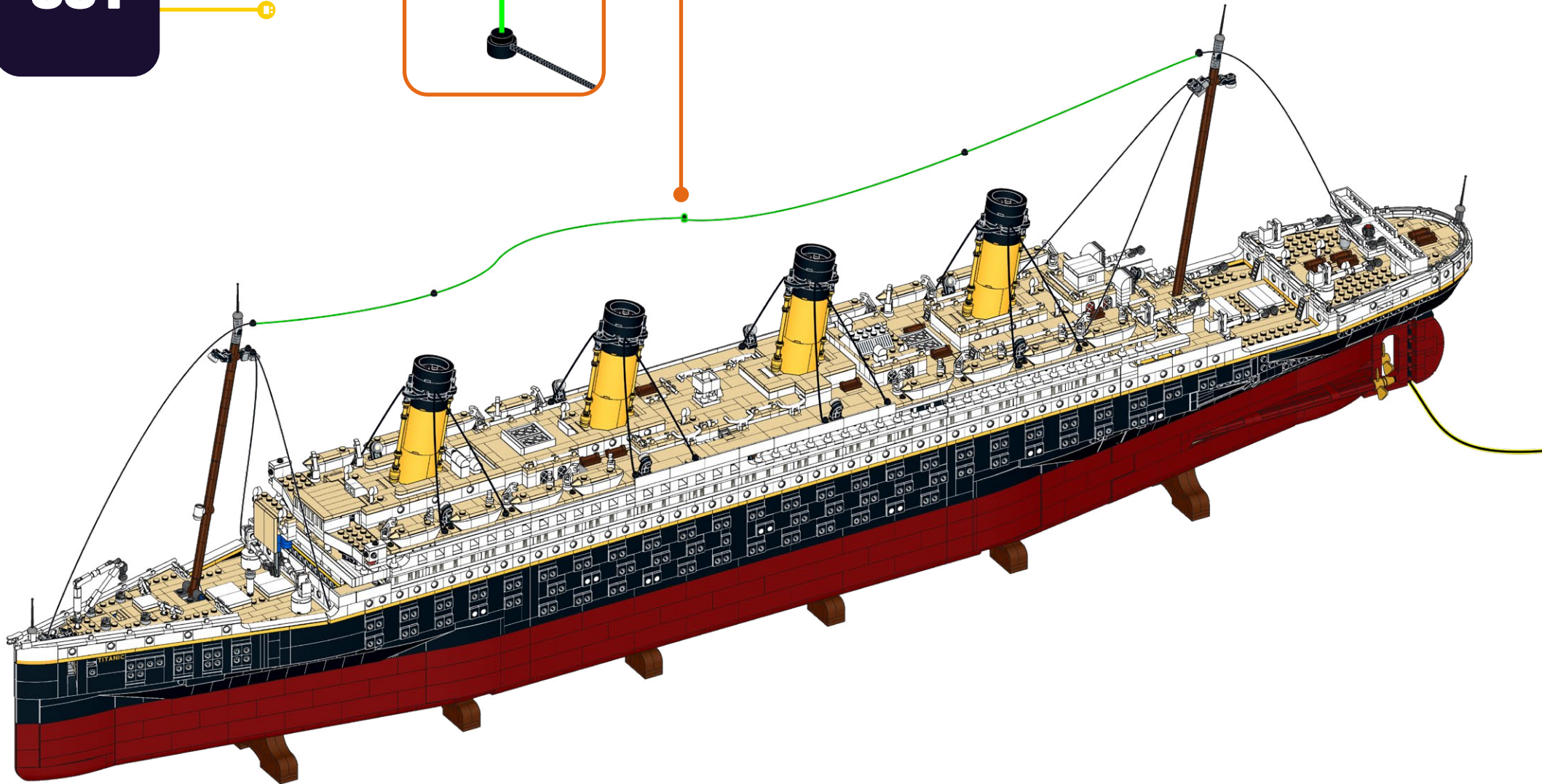
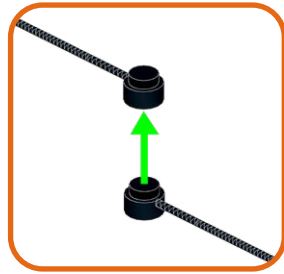

332

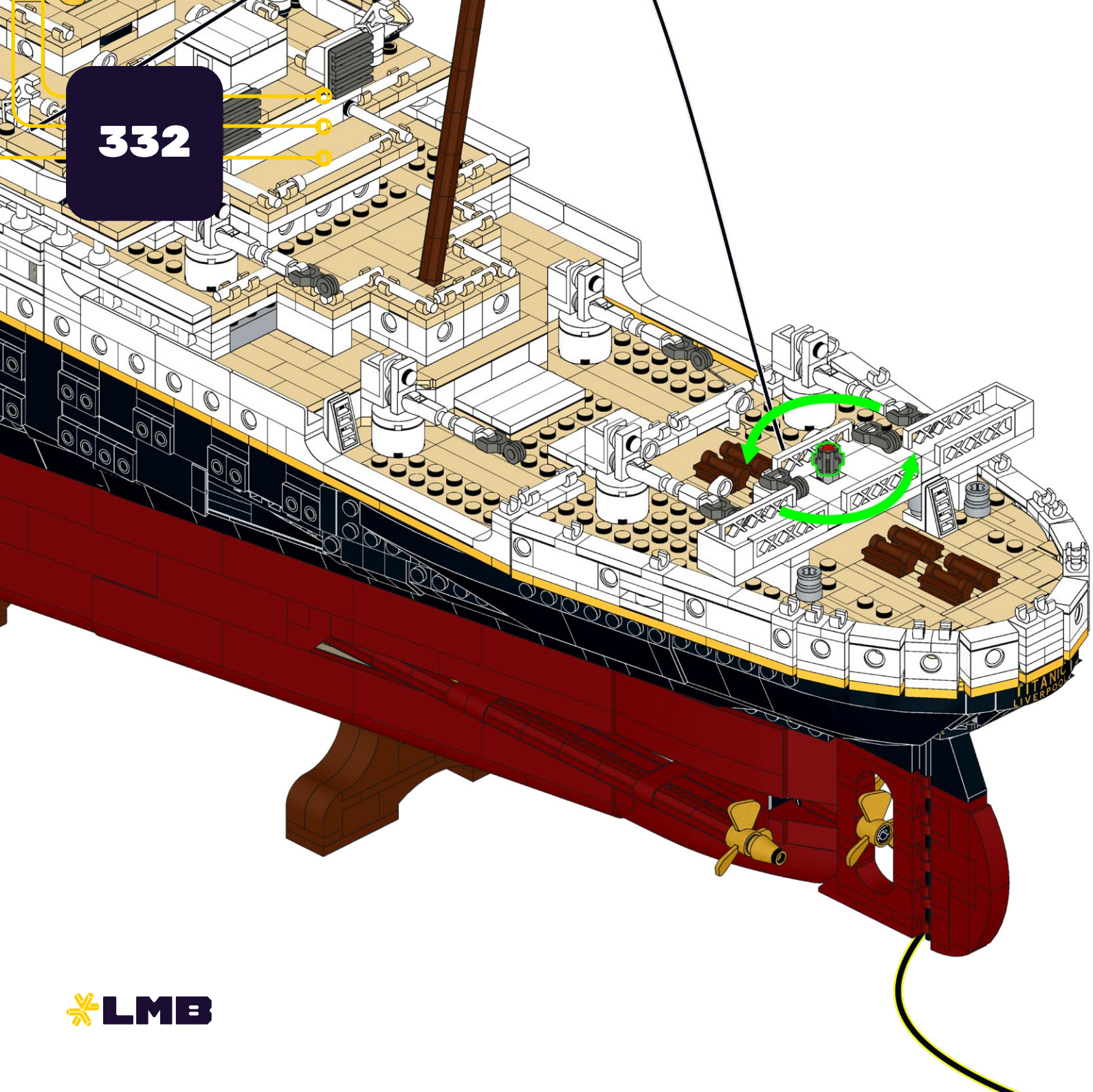

333

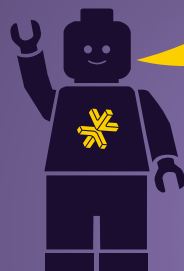

Power on Test
Test de mise sous tension
Test di Potenza
Stromtest
Prueba de Energía
电源测试

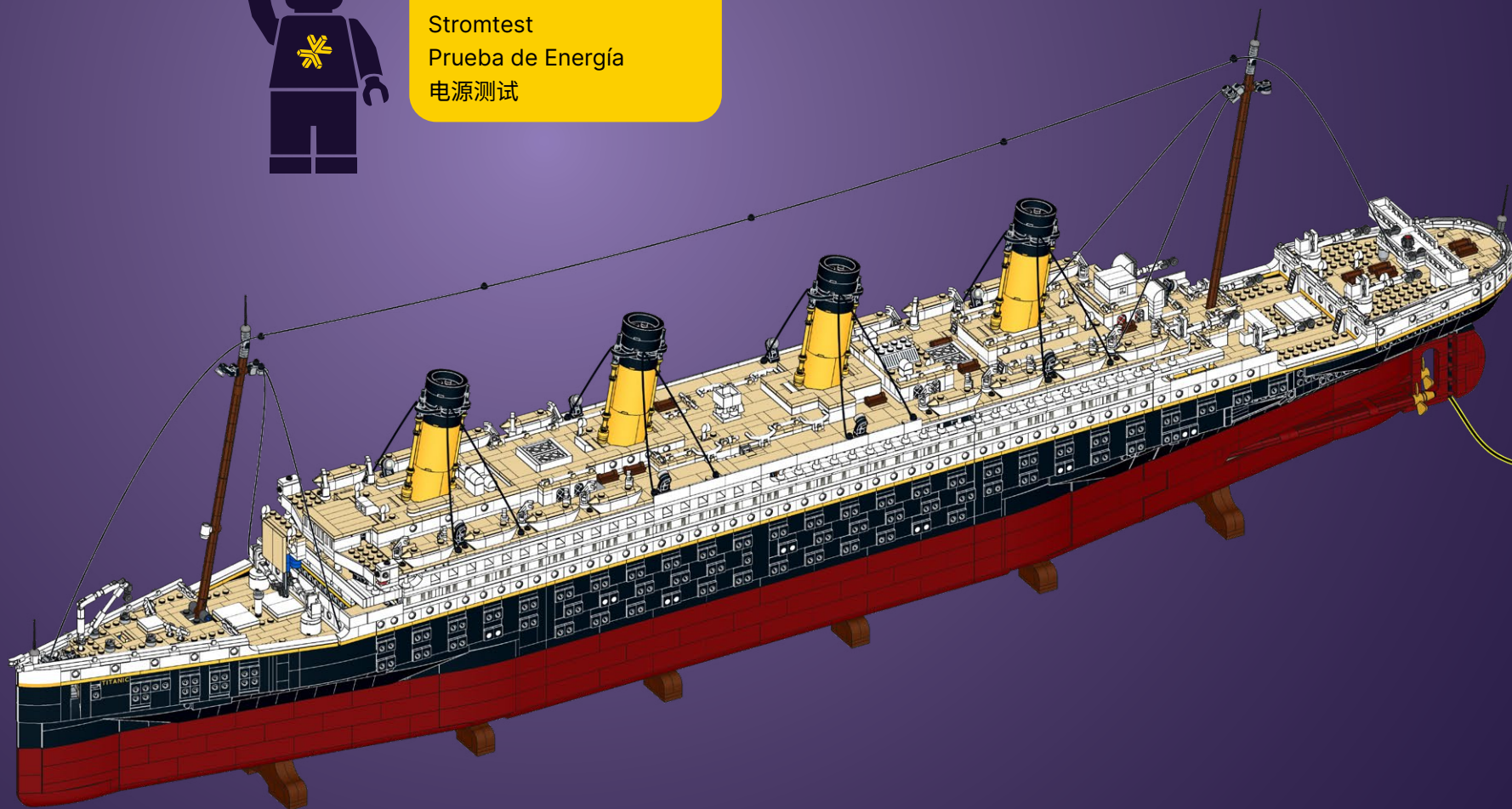

334



335



 **LMB**

FINAL PRODUCT



PACKAGE CONTENTS



29x AL-WW15
Astro Large
Warm White 15cm



29x AL-WW15
Astro Large
Warm White 15cm



3x B-30
Belt 30cm



8x AL-WW30
Astro Large
Warm White 30cm



8x AL-WW30
Astro Large
Warm White 30cm



2x B-15
Belt 15cm



14x AM-WW30
Astro Micro
Warm White 30cm



6x D-9
Dock 9



1x B-5
Belt 5cm



1x AR-R15
Astro Regular
Red 15cm



3x D-3
Dock 3



1x FLX-C
Flux Converter



1x AR-G15
Astro Regular
Green 15cm



3x B-50
Belt 50cm



1x T-4
Teather 1x4

PACKAGE CONTENTS



11x Astro Caps



8x Tile Modified 1x1
With Open O Clip
Black



1x Bracket 1 x 2 - 1 x 2
Inverted
Black



14x Technic, Brick 1x1
with hole
Black



14x Plate 1x2
White



24x Brick Round 1x1
Black



1x Plate Round 2x2
With Rounded Bottom
(Boat Stud)
Trans Clear



12x Plate Round 1x1
With Open Stud
Black



1x Bar 1L with Clip
Mechanical Claw - Cut
Edges and Hole on Side
Light bluish grey



10x Plate Round 1x1
With Bar Handle
Black



1x Plate Modified 1x1
With Open O Clip
(Horizontal Grip)
Black

CONTACT US

Click below for customer support, or general inquiries.

Cliquez ci-dessous pour accéder au support client ou aux renseignements généraux.

Clicca qui sotto per l'assistenza clienti o per richieste generali.

Contact Us



Contactez-nous



Contattaci



Klicken sie unten für kundensupport oder allgemeine anfragen.

Haga clic a continuación para atención al cliente o consultas generales.

点击下方获取客户支持或一般咨询。

Kontaktieren sie uns



Contáctanos



联系我们



TROUBLESHOOTING

If you're stuck, scan the QR code for troubleshooting.

Se sei bloccato, scansiona il codice QR per la risoluzione dei problemi.

Wenn Sie nicht weiterkommen, scannen Sie den QR-Code zur Fehlerbehebung.

Si vous êtes bloqué, scannez le code QR pour le dépannage

Si está atascado, escanee el código QR para solucionar el problema.

如果遇到问题, 请扫描二维码进行故障排除

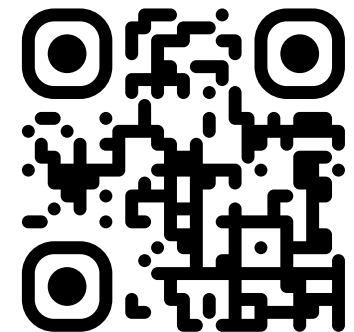



LIGHTMYBRICKS

lightmybricks.com



LEGO® is a trademark of the LEGO Group of companies, which does not sponsor, authorize or endorse this product. All LEGO® sets featured in images are sold separately. This is not a LEGO® product. The LEGO Group is not liable for any loss, injury or damage arising from the use or misuse of this product. ©2024 Light My Bricks Pty Ltd. All rights reserved. www.lightmybricks.com

Our components are designed and packaged in Australia by Light My Bricks Pty Ltd. Components are manufactured in China. 3fl bldg C, Shuanghuan Quanxin Technology Information Industry Park Baolong Street, Longgang District, Shenzhen, China. Imported in Australia by Light My Bricks Pty Ltd, 5/26 Rushdale St, Knoxfield, VIC, 3180, Australia.

WARNING: CHOKING HAZARD - Small parts. Not for children under 3 years.

AVERTISSEMENT : RISQUE D'ÉTOUFFEMENT - Petites pièces. Ne convient pas aux enfants de moins de 3 ans.

ATTENZIONE: PERICOLO DI SOFFOCAMENTO - Piccole parti. Non adatto a bambini di età inferiore a 3 anni.

WARNUNG: ERSTICKUNGSGEFAHR - Kleine Teile. Nicht für Kinder unter 3 Jahren geeignet.

ADVERTENCIA: PELIGRO DE ASFIXIA - Piezas pequeñas. No son apto para niños menores de 3 años.

警告：窒息危险 - 小零件。不适合3岁以下儿童。