

# LIGHT KIT INSTALLATION GUIDE

**STAR WARS  
MOS ESPA PODRACE™ DIORAMA**

**FOR  
LEGO SET  
#75380**

# CONTENTS



## 03

### Getting Started

- 04 Legend
- 05 Component Handling
- 06 Blueprint

## 07

### Instructions

- 07 LEGO Bag 1 - LMB Bag 1
- 44 LEGO Bag 2
- 57 LEGO Bag 5 - LMB Bag 2
- 86 LEGO Bag 4 - LMB Bag 3
- 113 LEGO Bag 3
- 142 LEGO Bag 6

## 167

### Final Product

- 168 Package Contents
- 170 Contact & Troubleshooting



# GETTING STARTED



Bold, beautiful and bright, Light My Bricks elevates your favourite LEGO set from knick-knack to statement piece. Create a talking point at home or in the office that speaks to your passions with Light My Bricks. To learn more, click below.

[Learn More](#)



Audacieux, beau et lumineux, Light My Bricks élève votre ensemble LEGO préféré du statut de bibelot à celui de pièce maîtresse. Que ce soit à la maison ou au bureau, partagez votre passion des LEGO avec Light My Bricks. Cliquez ci-dessous pour en savoir plus.

[En savoir plus](#)



Audace, bello e luminoso, Light My Bricks eleva il tuo set LEGO preferito da soprammobile a pezzo di tendenza. Crea un punto di discussione a casa o in ufficio che parli alle tue passioni con Light My Bricks. Per saperne di più, clicca qui sotto.

[Ulteriori Informazioni](#)



Mutig, schön und hell – Light My Bricks verwandelt Ihr Lieblings-LEGO-Set von einem schnickschnack in ein statement-stück. Schaffen sie einen gesprächspunkt zu hause oder im büro, der Ihre leidenschaften widerspiegelt, mit Light My Bricks. Um mehr zu erfahren, klicken sie unten.

[Mehr erfahren](#)



Audaz, hermoso y brillante, Light My Bricks eleva tu set LEGO favorito de una chuchería a una pieza llamativa. Crea un tema de conversación en casa o en la oficina que hable de tus pasiones con Light My Bricks. Para obtener más información, haga clic a continuación.

[Más información](#)



大胆、美丽而明亮，Light My Bricks 将你喜爱的乐高套装从小摆件提升为引人注目的装饰品。在家或办公室打造一个能表达你激情的话题，了解更多，请点击下方。

[了解更多](#)



# LEGEND

## Rotate Set



Retournez L'ensemble  
Ruota Set  
Set Drehen  
Rotar Conjunto  
旋转套件

## Add Part



Ajoutez une Pièce  
Aggiungi Parte  
Teil Hinzufügen  
Agregar Pieza  
添加零件

## Click



Cliquez  
Clic  
Klicken  
Clic  
点击

## Pinch/Fold



Pincez/Pliez  
Pizzicare/Piegare  
Kneifen/Falten  
Pellizcar/Doblar  
折叠

## Pull Cable



Tirez le Cable  
Tirare il Cavo  
Kabel Ziehen  
Tirar del Cable  
拉动电缆

## Repeat Step



Répétez  
Ripetere  
Wiederholen  
Repetir  
重复

## Sticker



Autocollant  
Adesivo  
Aufkleber  
Pegatina  
贴纸

## Power On Test



Test de mise sous tension  
Test di Potenza  
Stromtest  
Prueba de Energía  
电源测试

## Disconnect Power

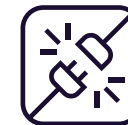

Débranchez L'alimentation  
Scollegare L'alimentazione  
Strom Trennen  
Desconectar la Energía  
断开电源

## Troubleshoot



Dépanner  
Risolvere  
Fehlerbehebung  
Solución de Problemas  
故障排除

# COMPONENT HANDLING

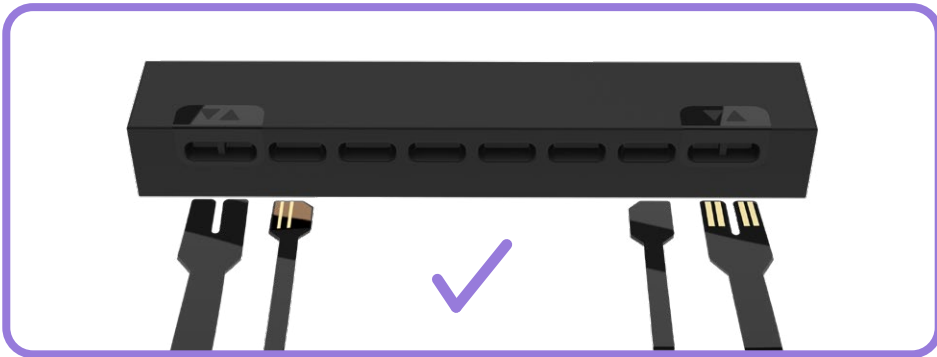
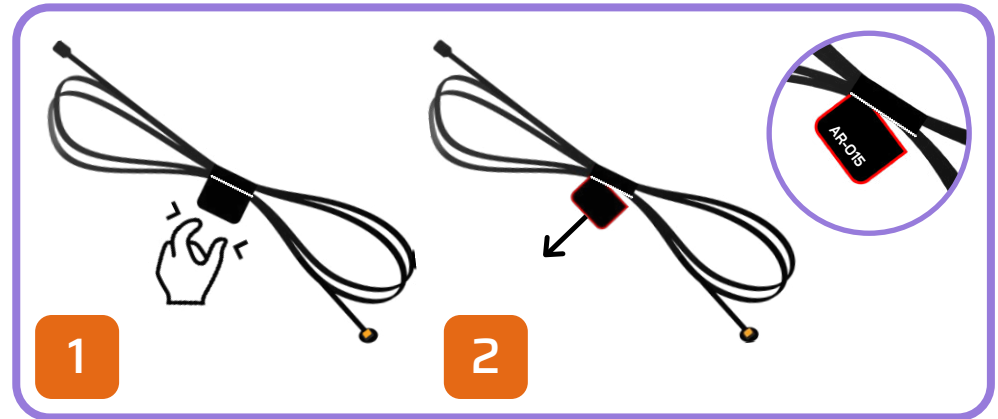
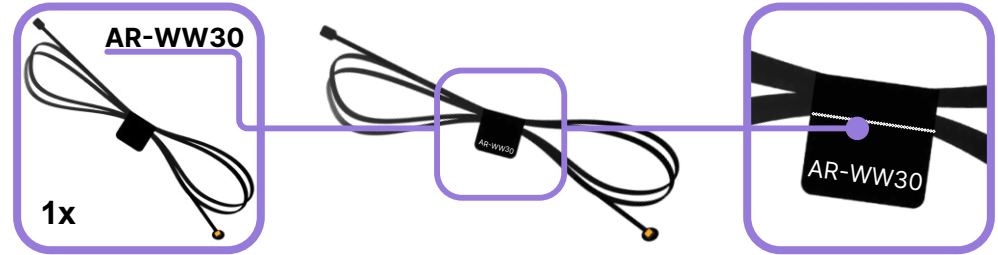
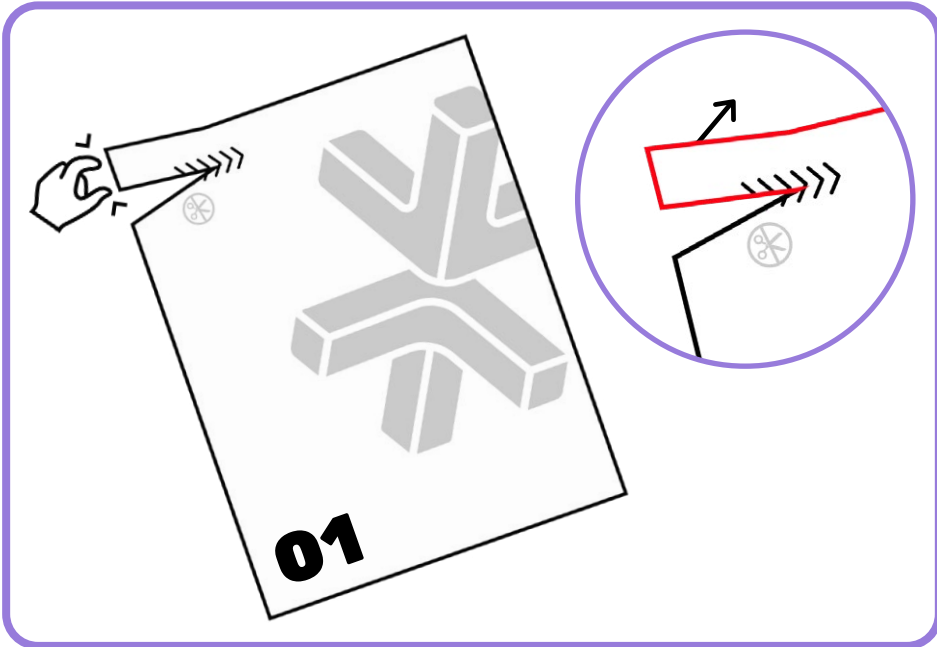

# BLUEPRINT

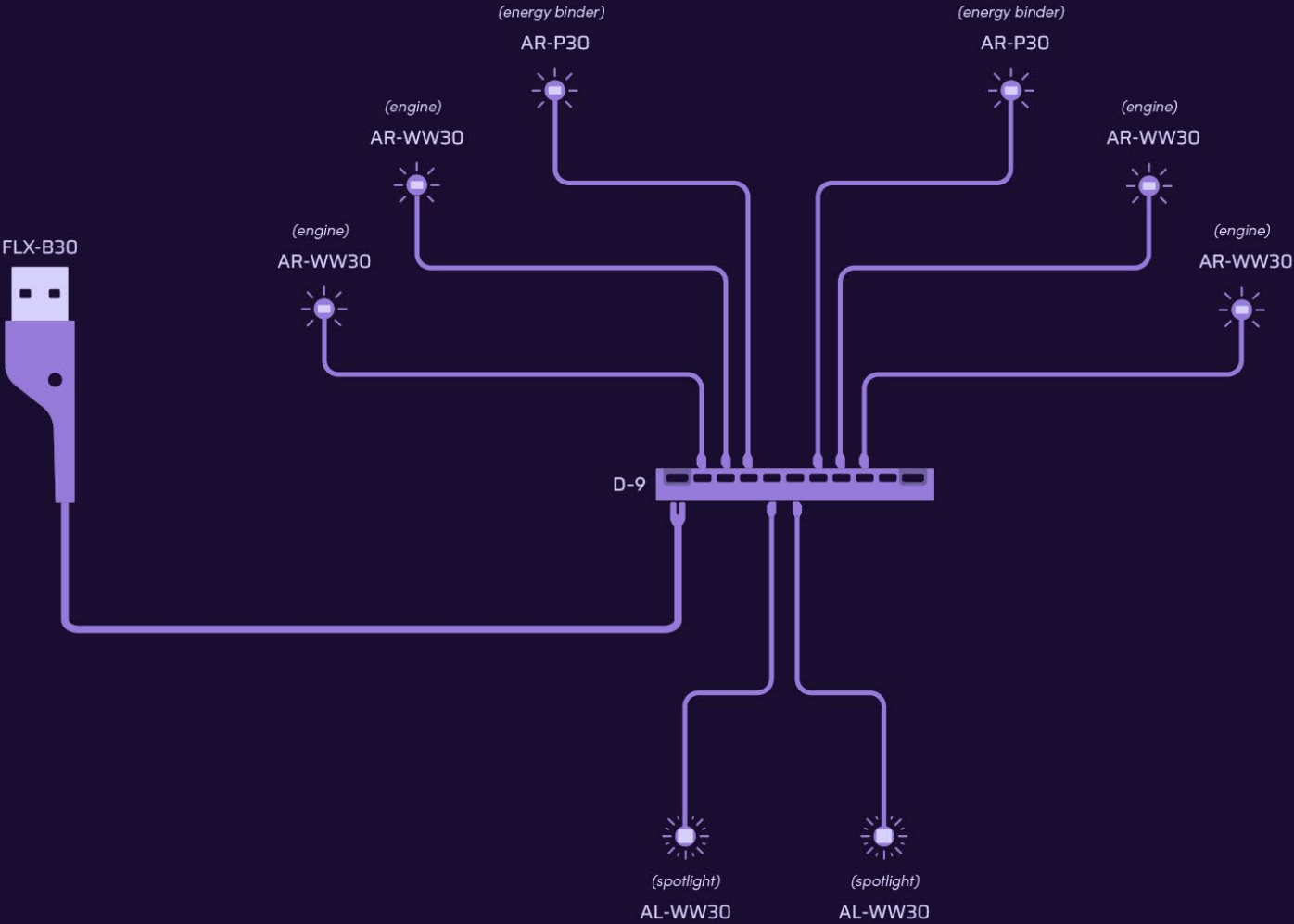





### **HOLD UP!**

You might notice some bags are out of order, as well as left over pieces, but that's ok! We're changing the way you build LEGO!

### **HALTEN!**

Möglicherweise stellen Sie fest, dass einige Beutel nicht in Ordnung sind und auch Teile übrig bleiben, aber das ist in Ordnung! Wir verändern die Art und Weise, wie Sie LEGO bauen!

### **TENIR BON!**

Vous remarquerez peut-être que certains sacs sont en panne, ainsi que des morceaux restants, mais ce n'est pas grave ! Nous changeons la façon dont vous construisez LEGO !

### **SOSTENERE!**

Potresti notare che alcune borse sono fuori uso, così come alcuni pezzi avanzati, ma va bene! Stiamo cambiando il modo in cui costruisci i LEGO!

### **¡SOSTENER!**

Puede que notes que algunas bolsas están fuera de orden, así como piezas sobrantes, ¡pero está bien! ¡Estamos cambiando la forma de construir LEGO!

### **耽误!**

您可能会注意到有些袋子坏了, 还有剩余的碎片, 但这没关系! 我们正在改变您搭建乐高的方式!

#### Open LEGO® Bag 1

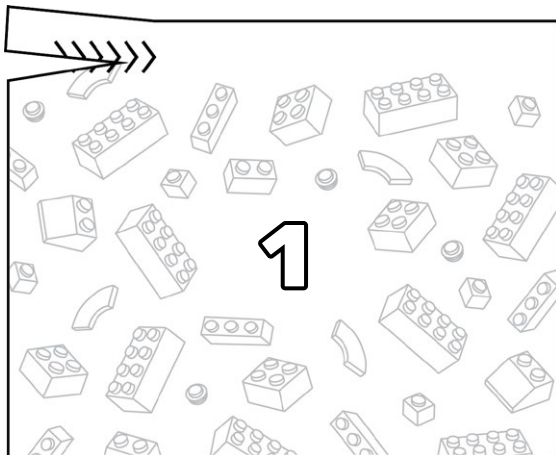

#### Open LMB Bag 01

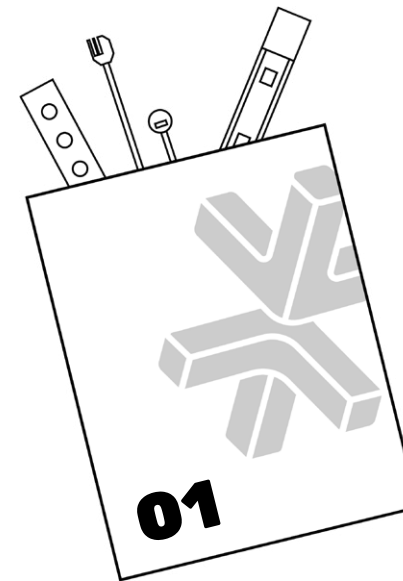

1

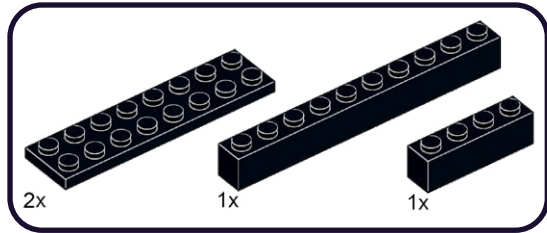

2

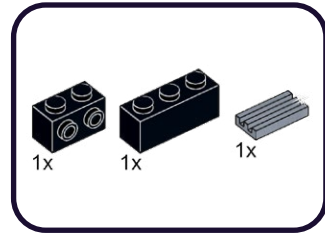

1

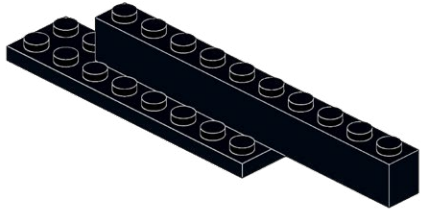

2

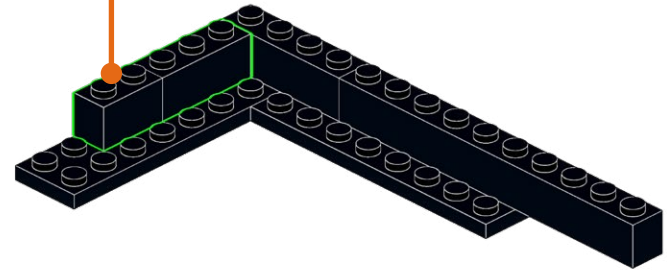
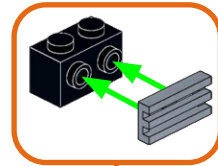
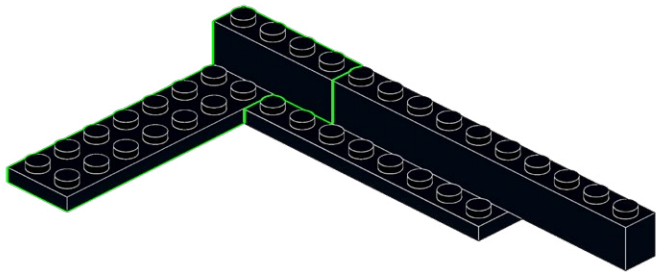

3

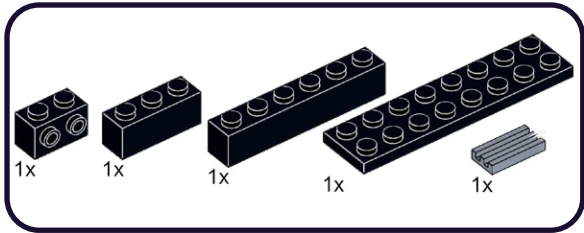

4

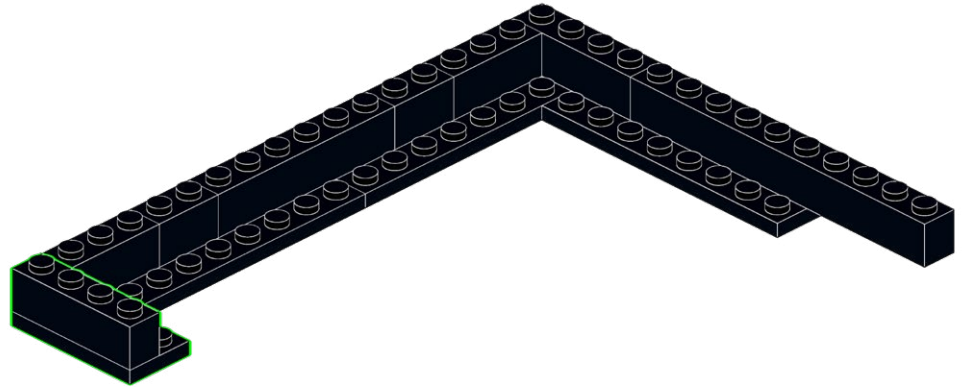
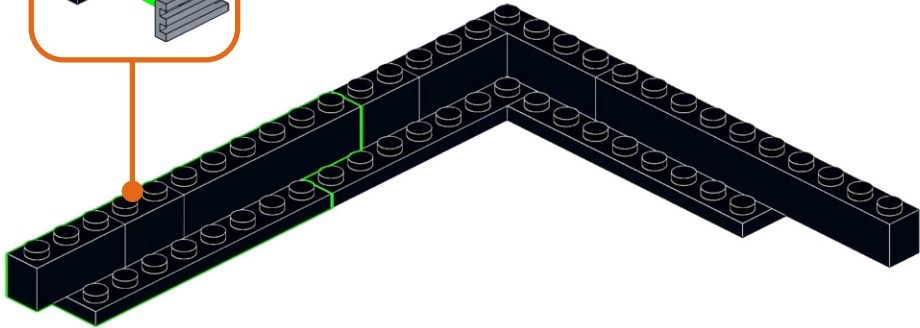
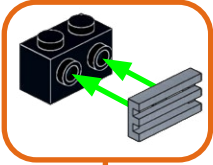
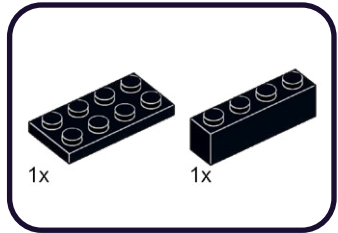

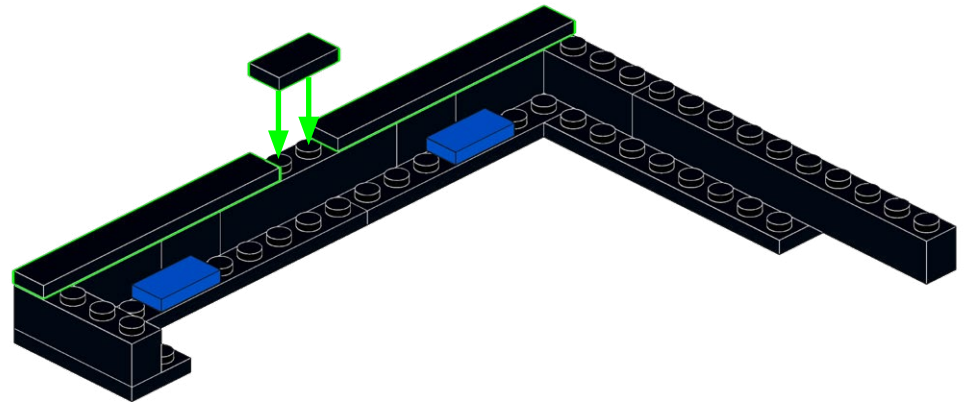
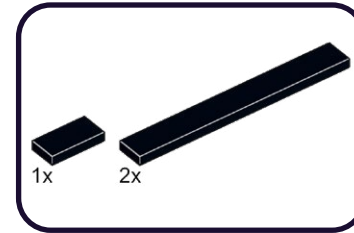
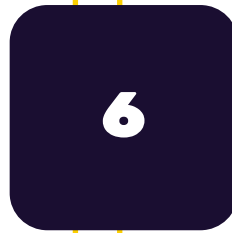
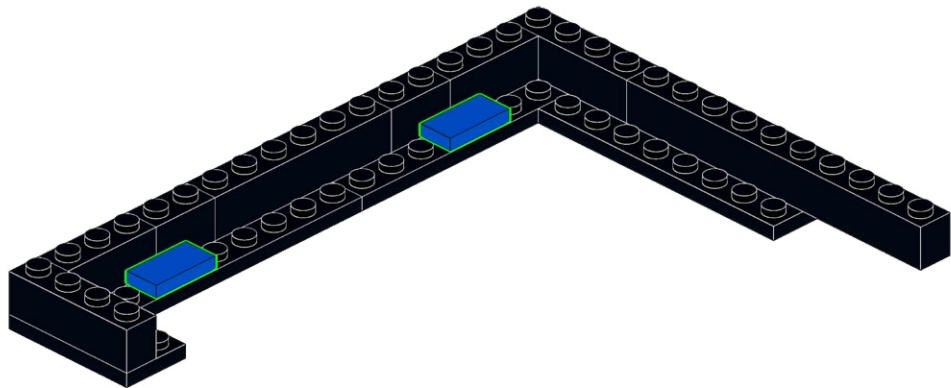
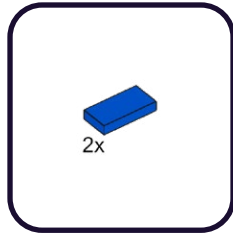



7

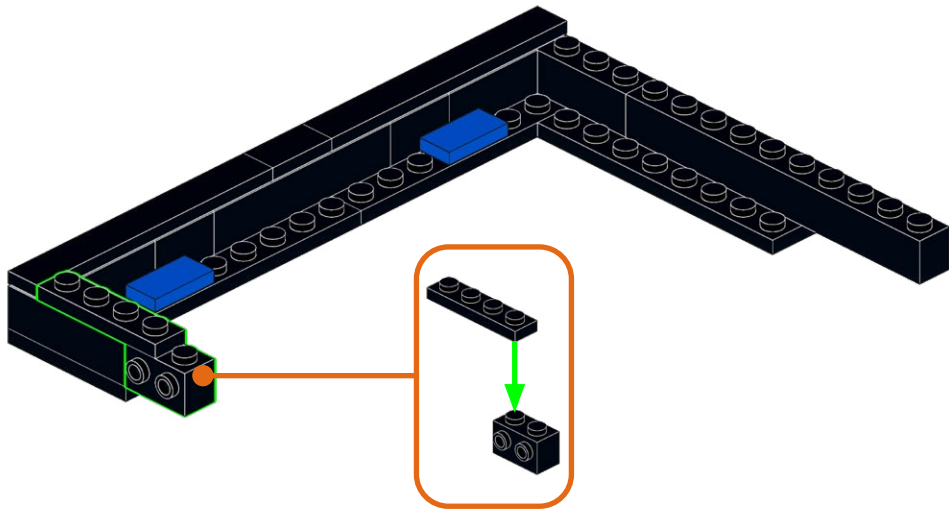
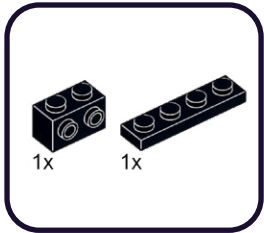

8

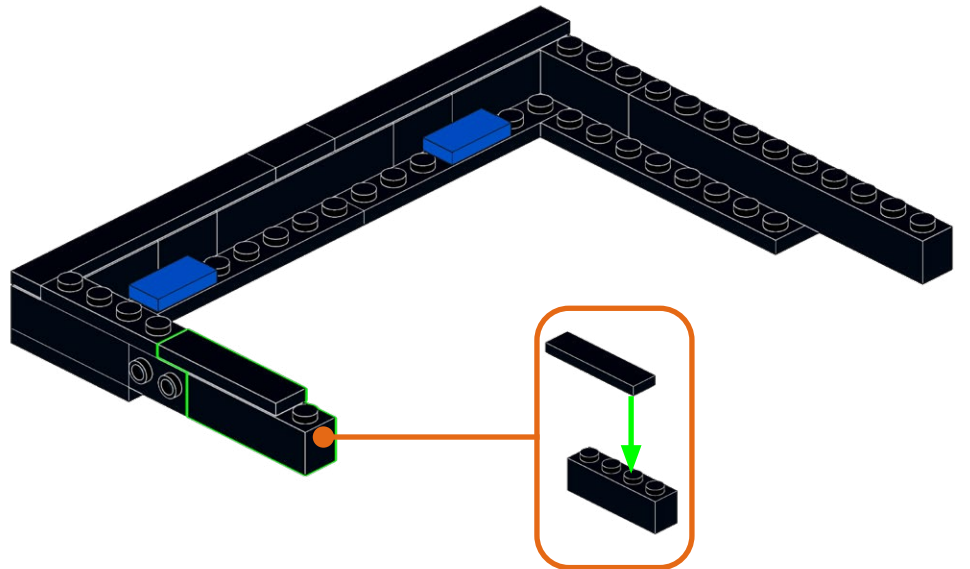
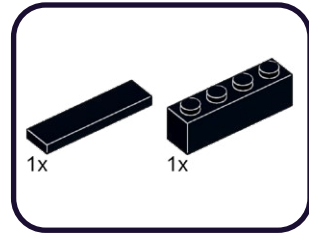

9

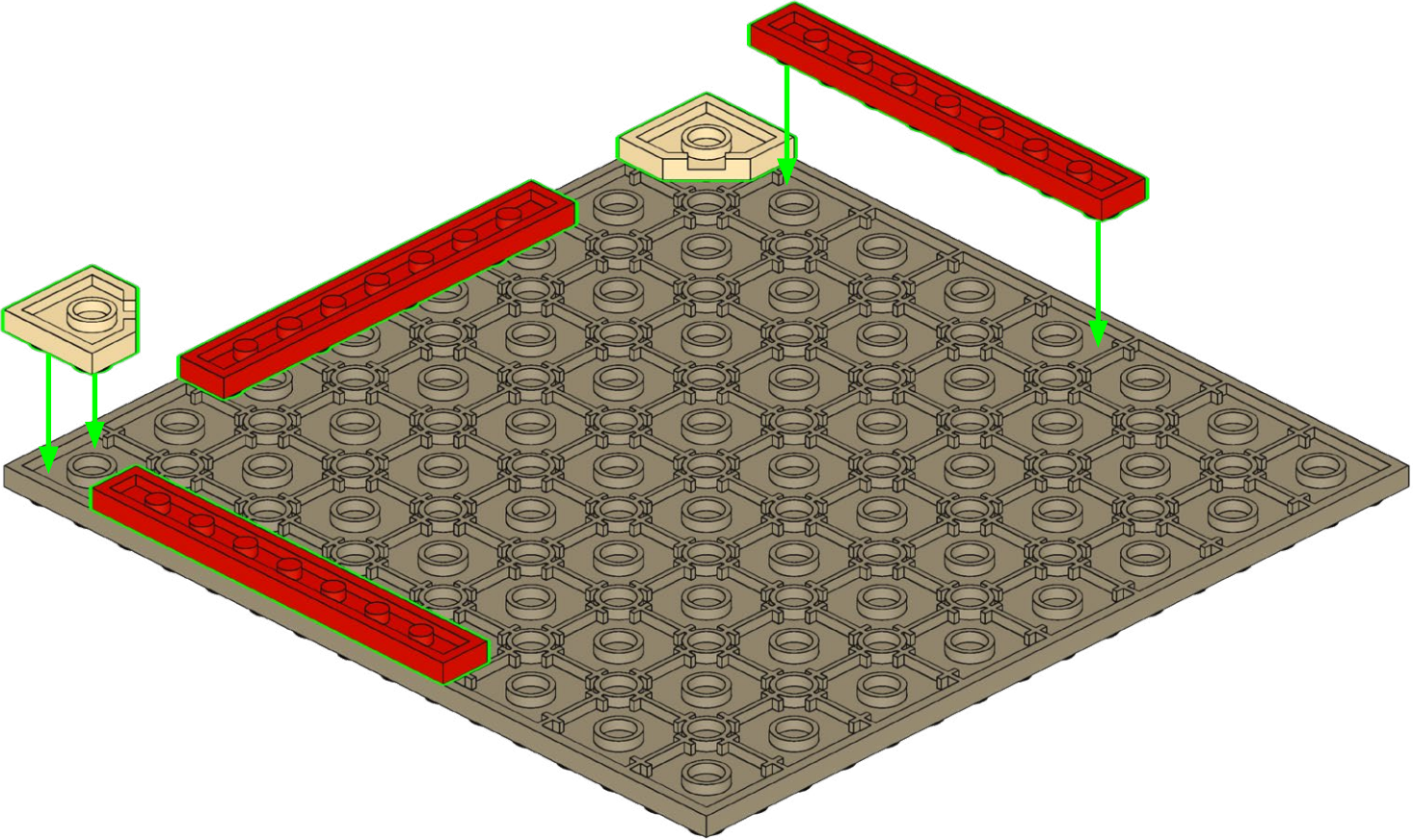
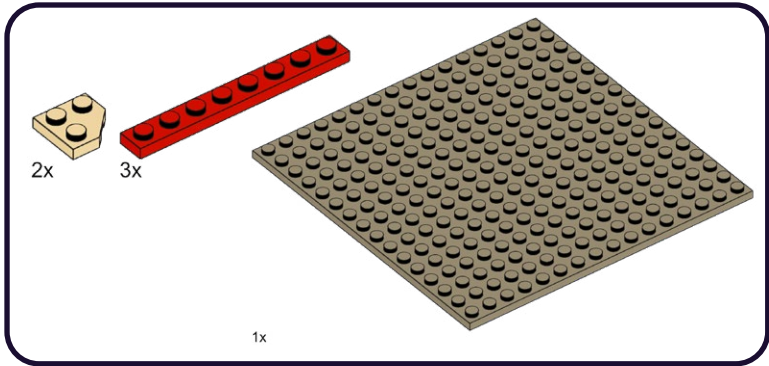

10

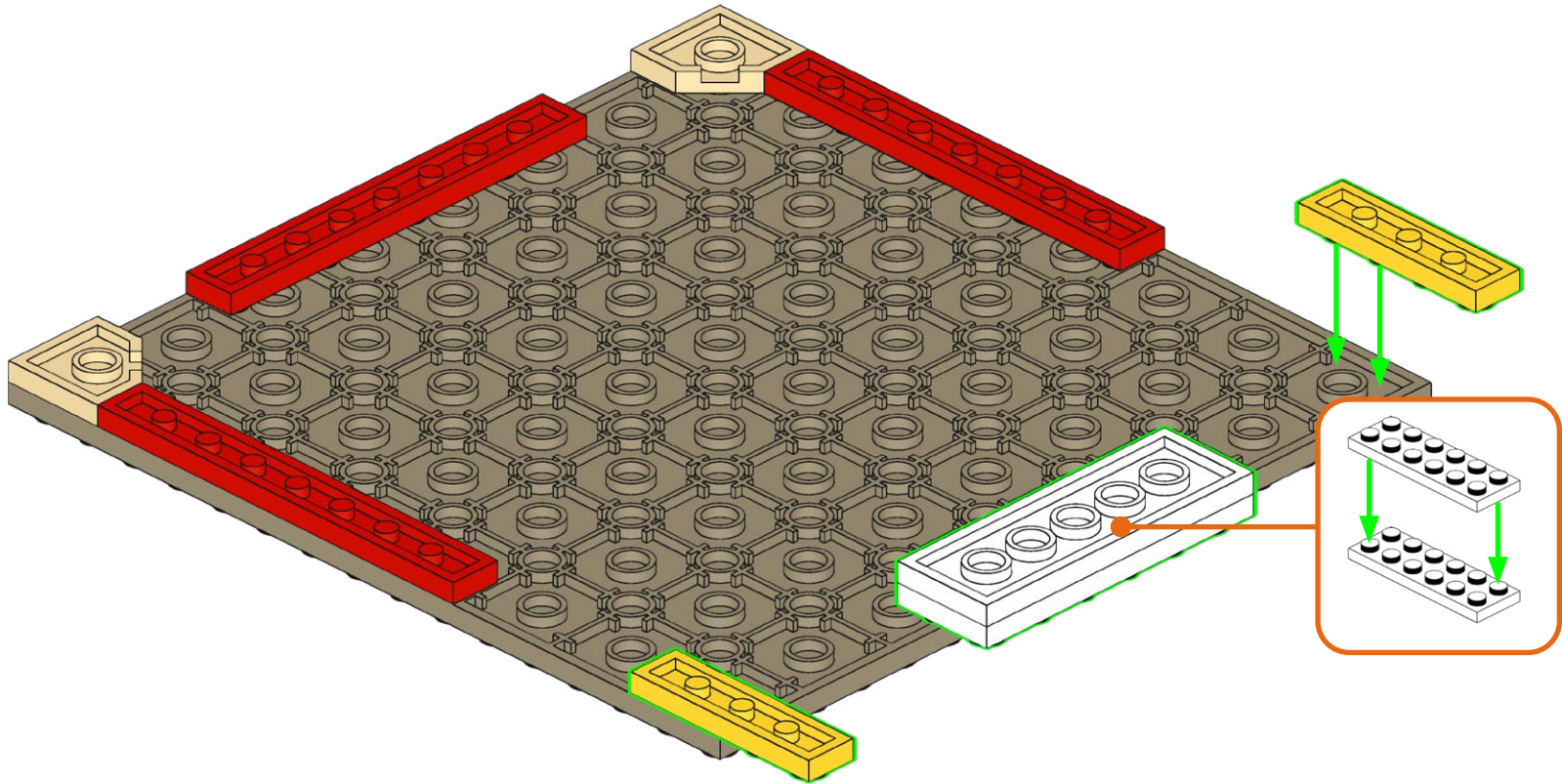
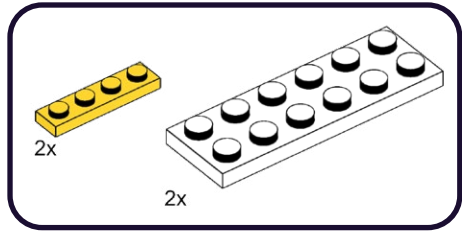



11

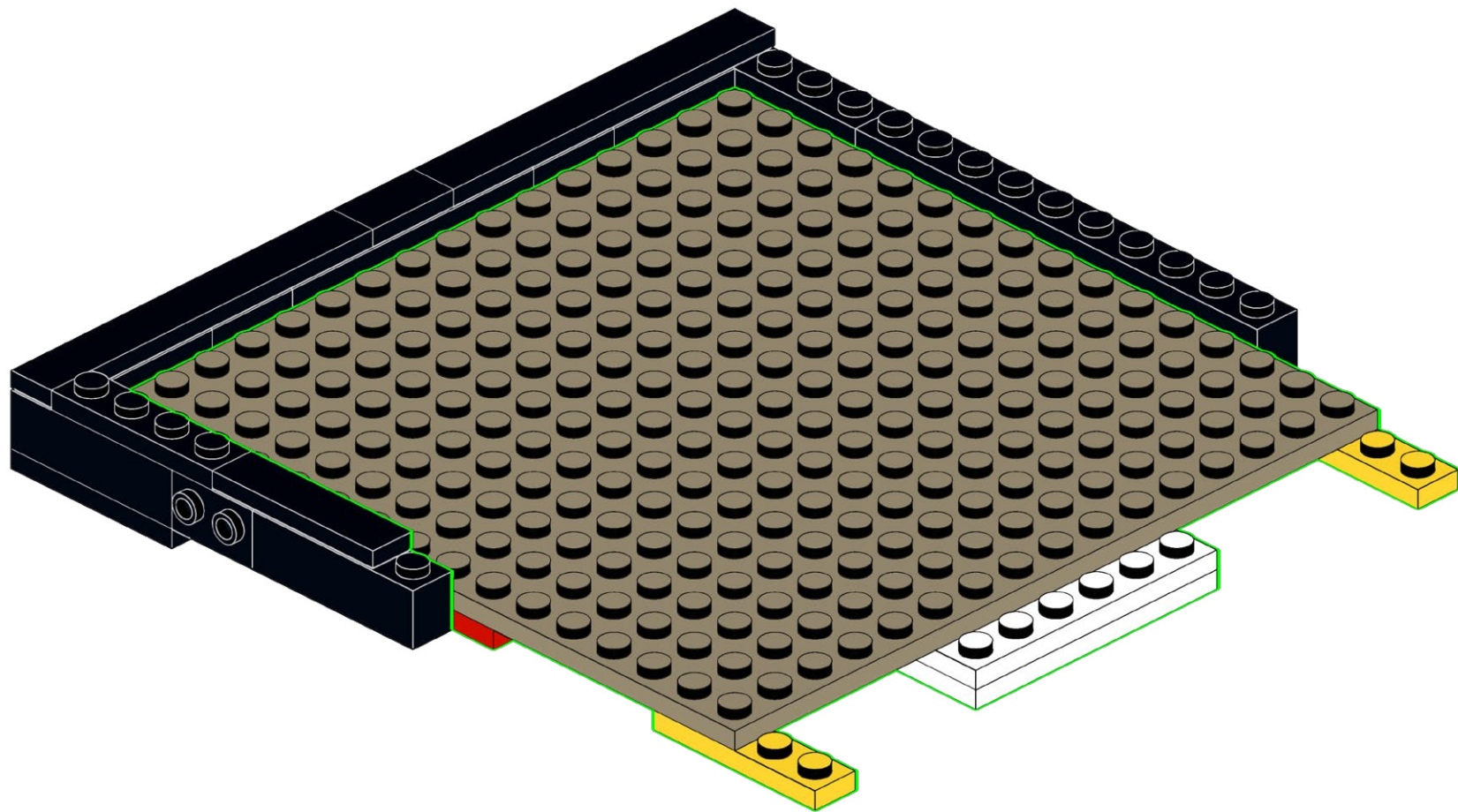



12

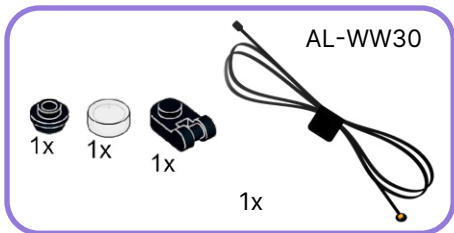

1

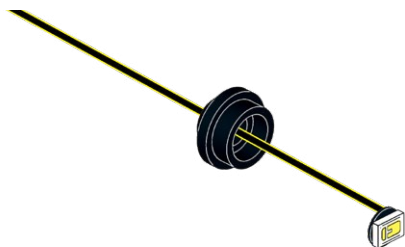

2

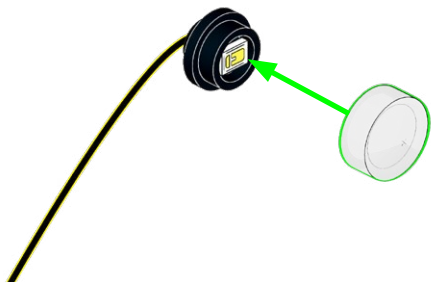

3

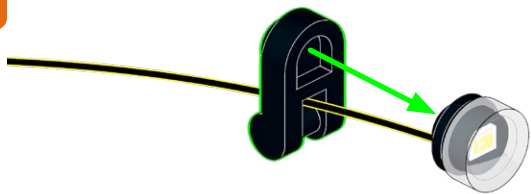

13

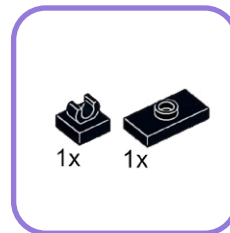

1

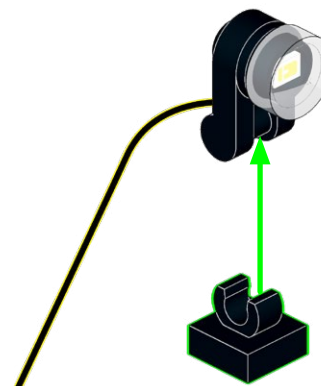

2

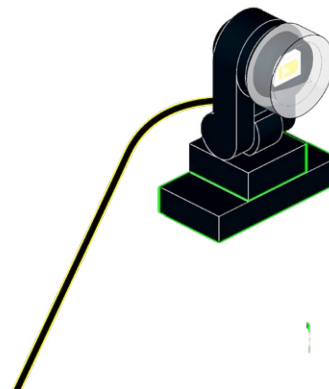

14

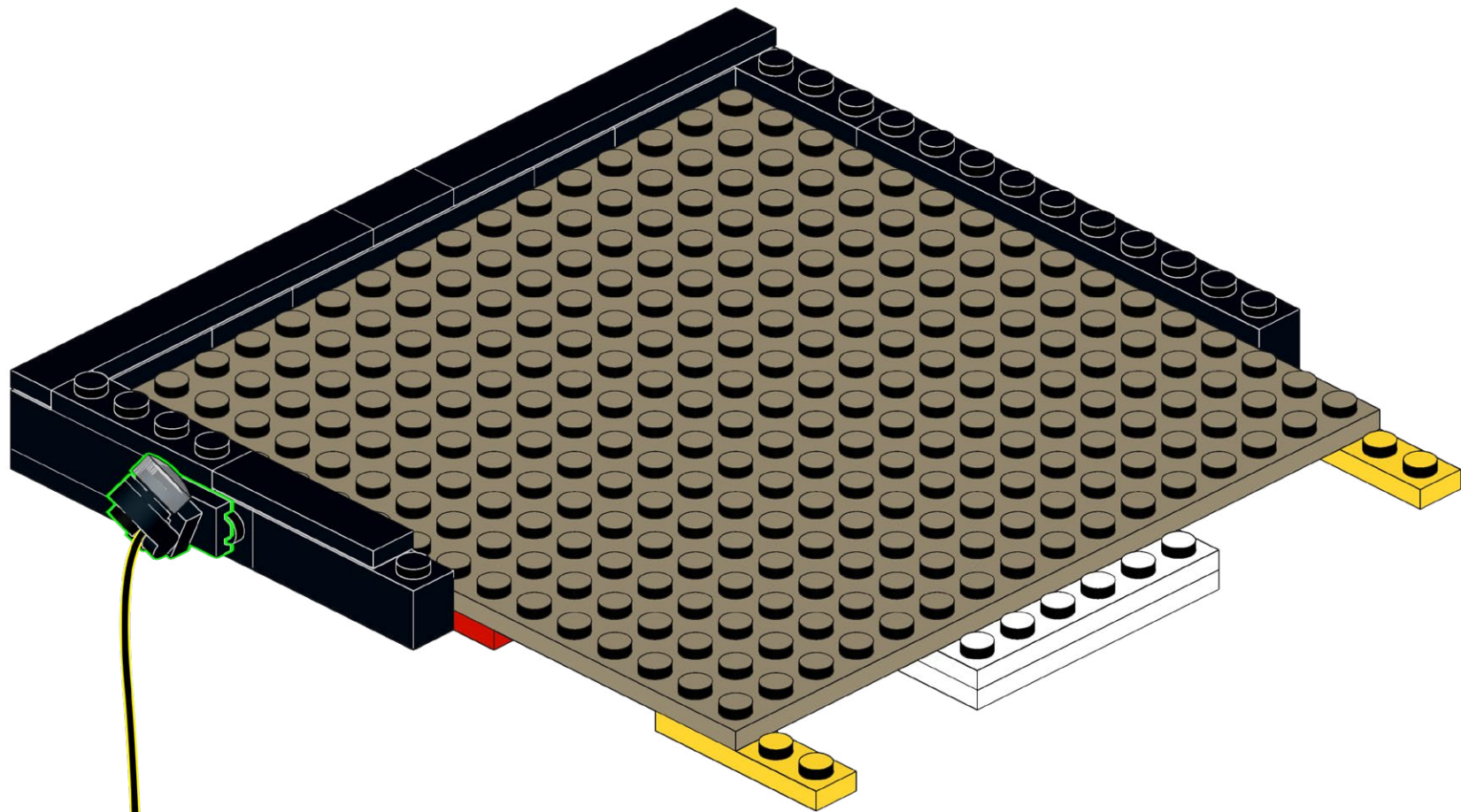

15

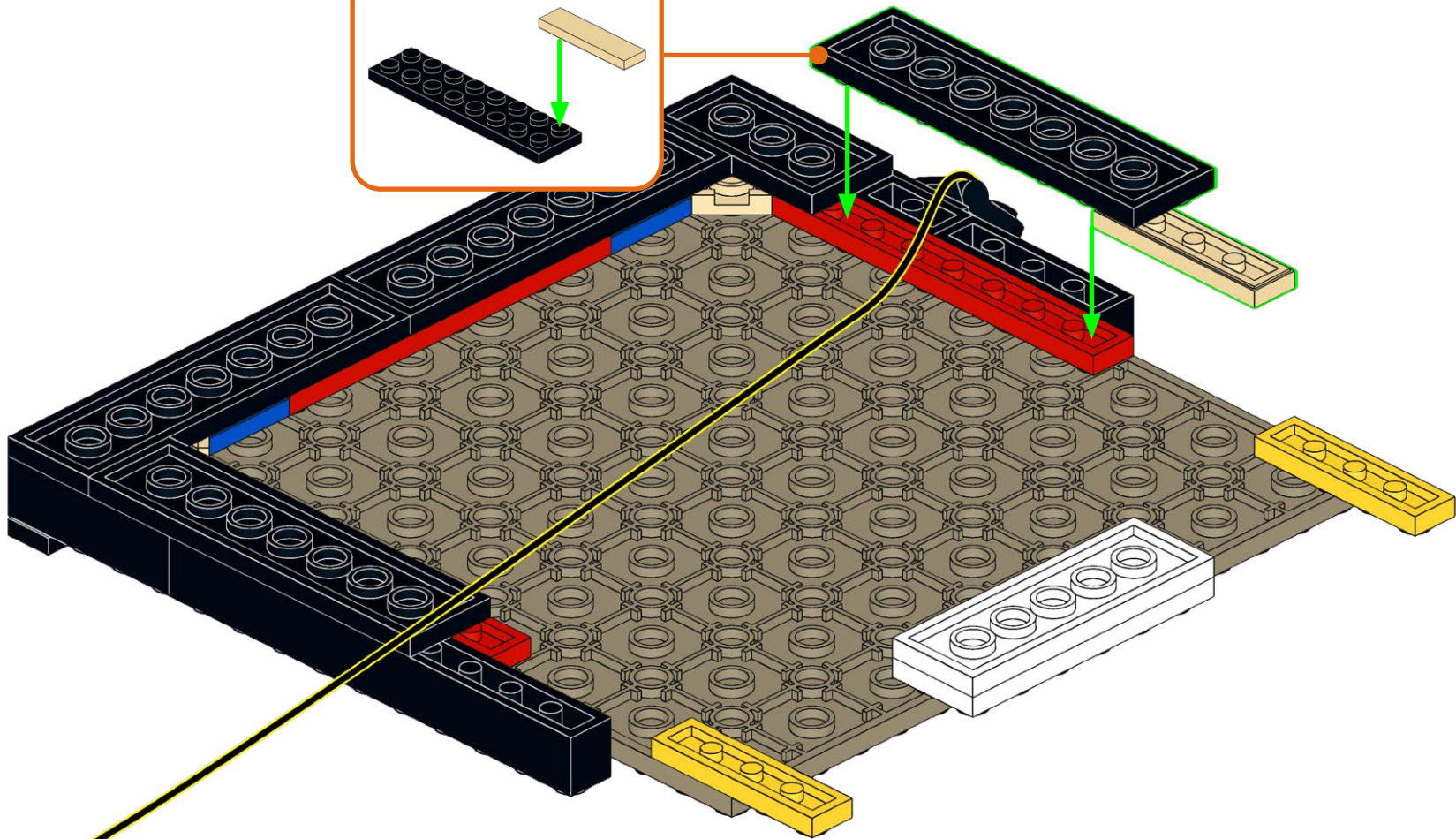
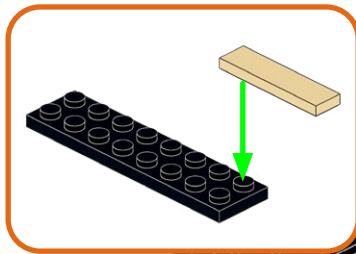
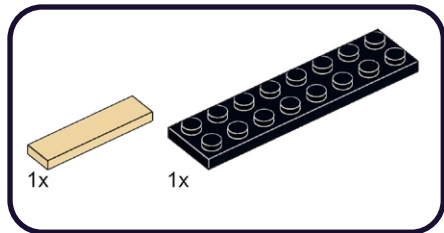



16

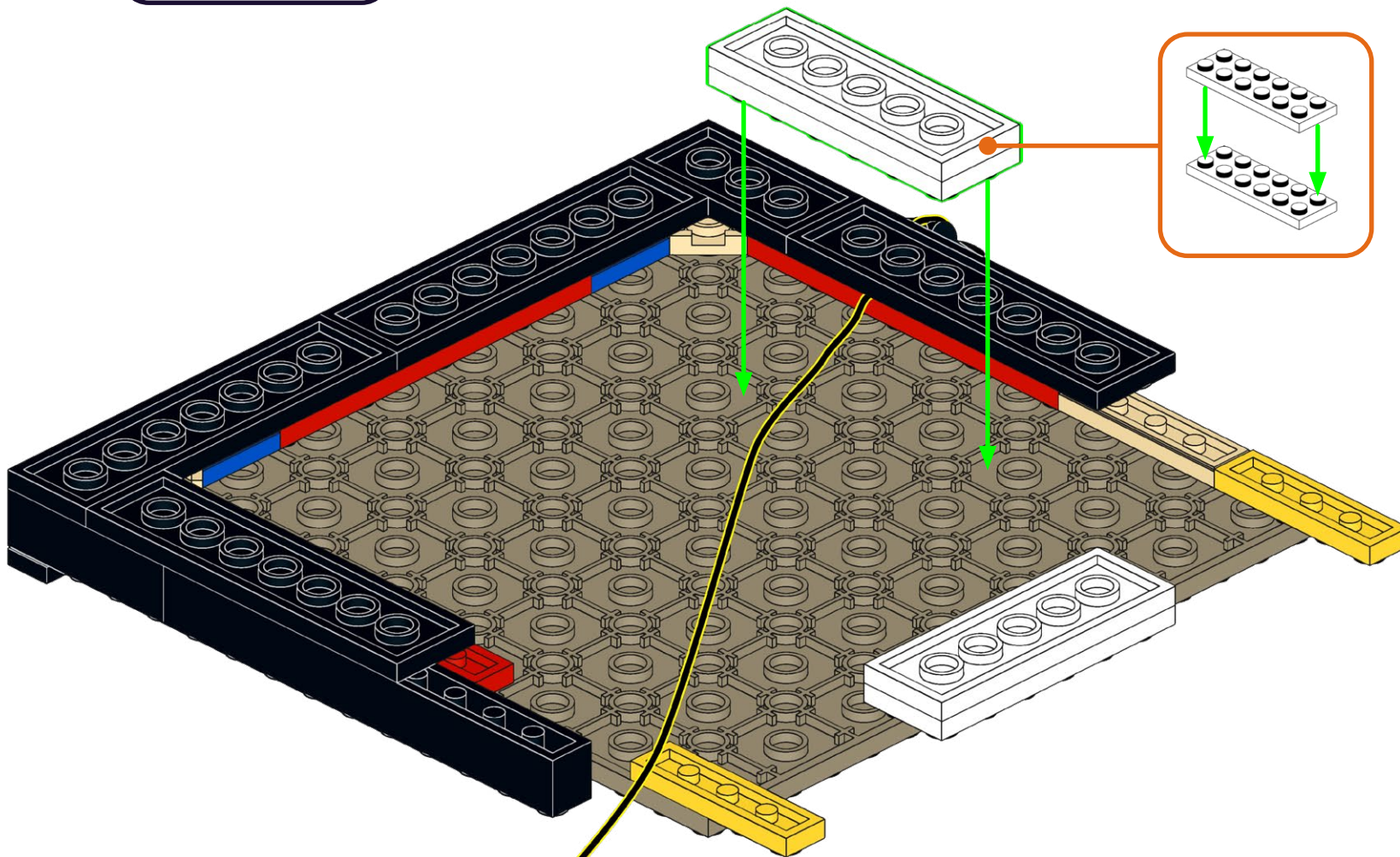
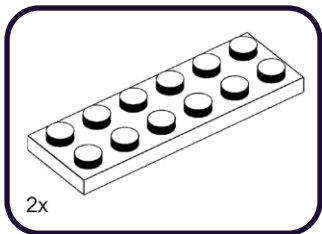



17

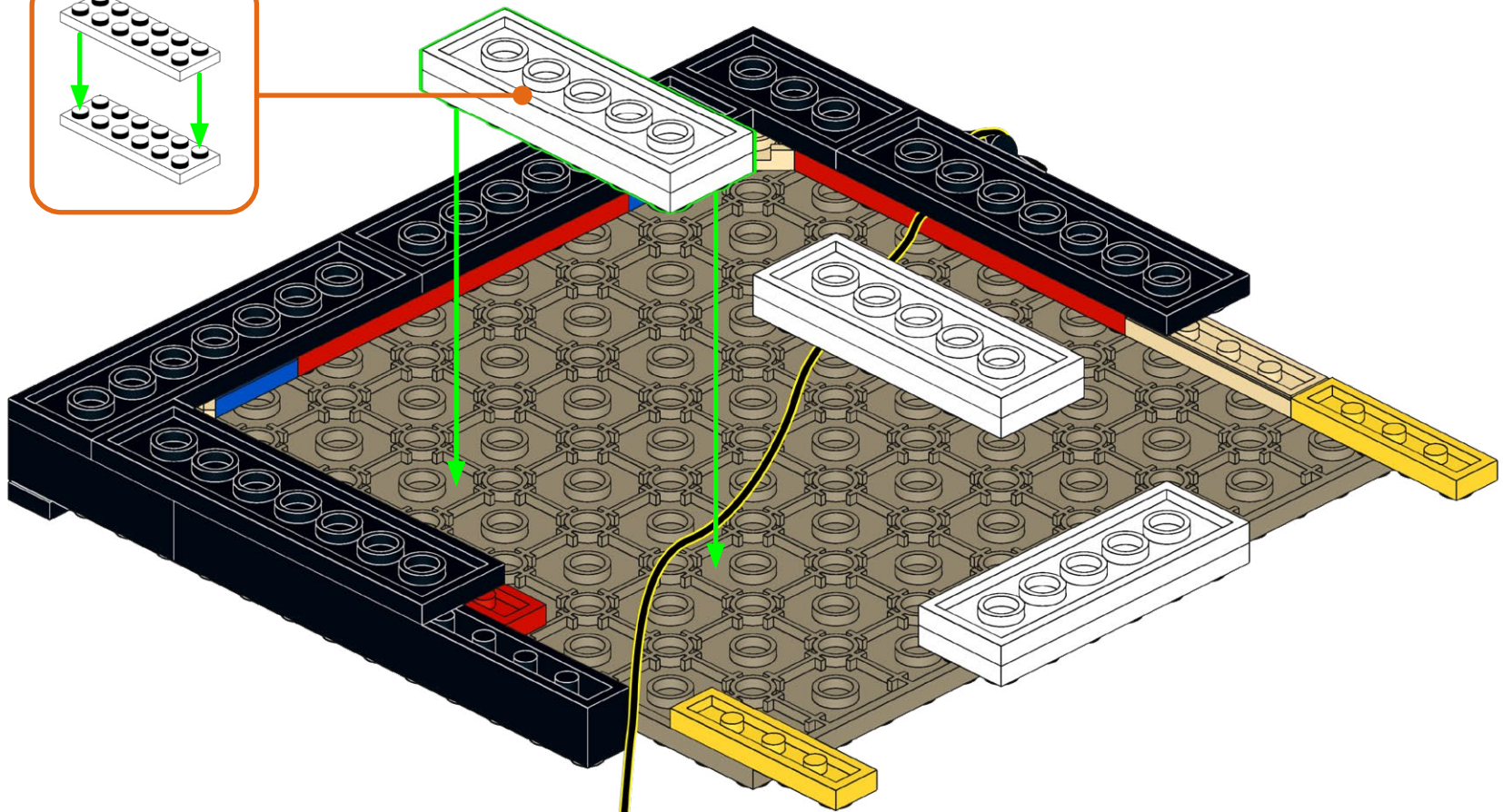
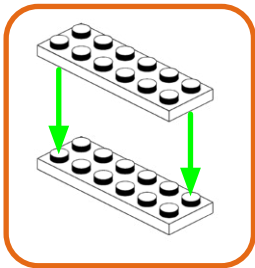
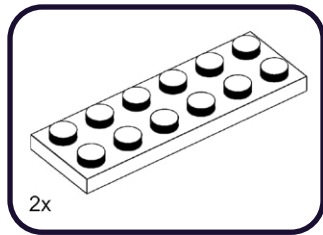

18

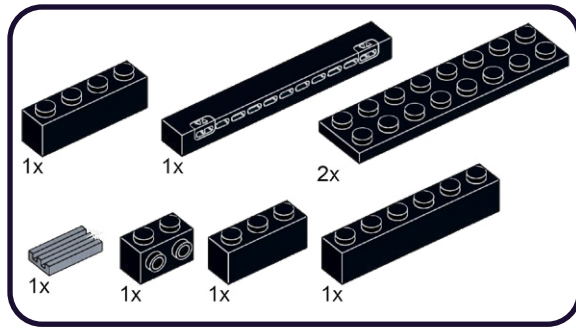

1

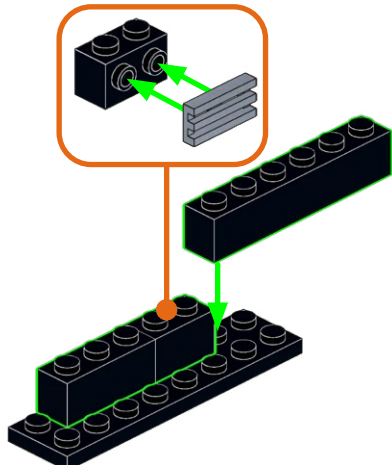

2

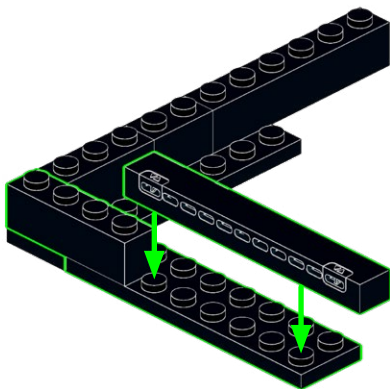

19

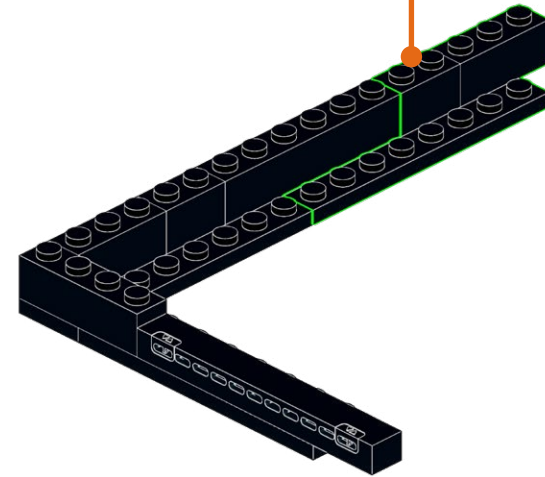
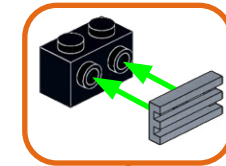
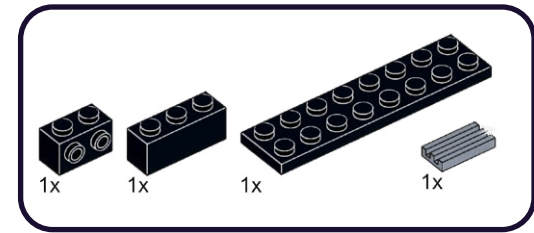

20

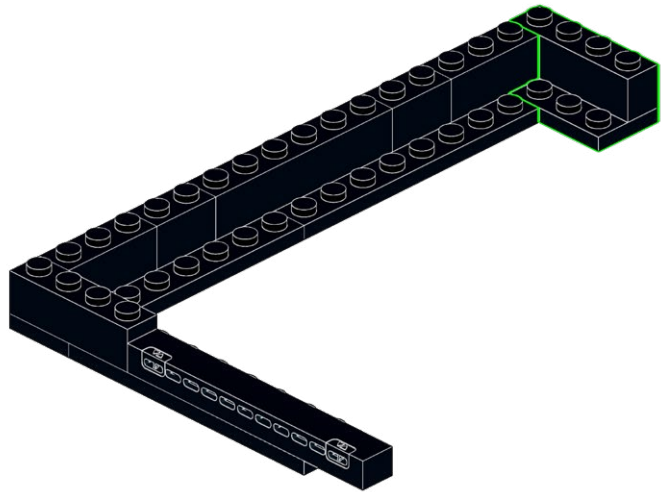
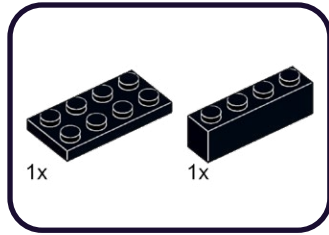

21

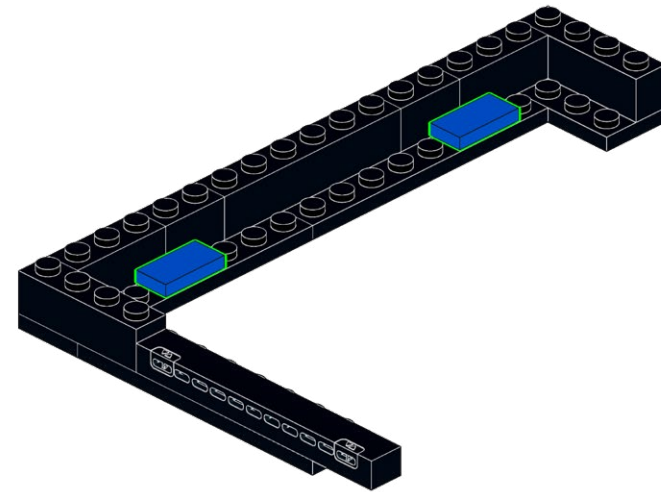
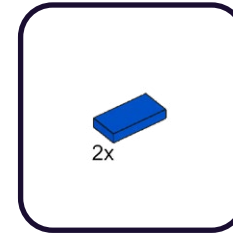

22

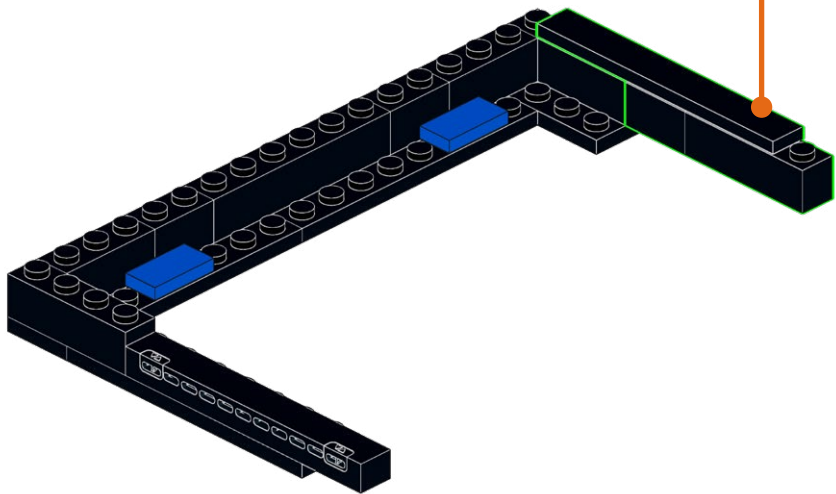
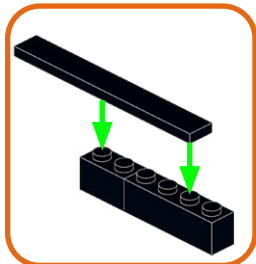
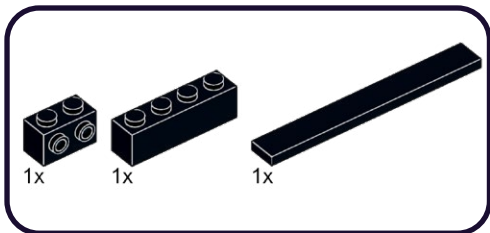

23

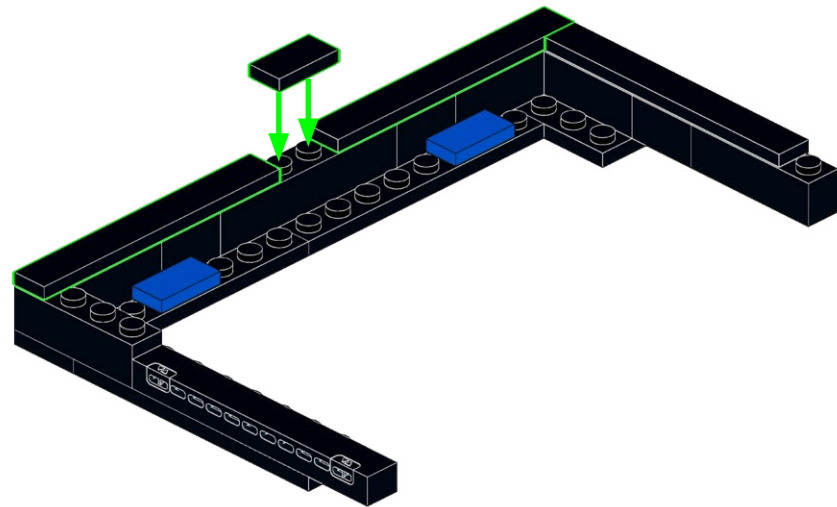
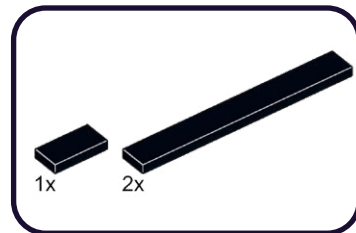



24

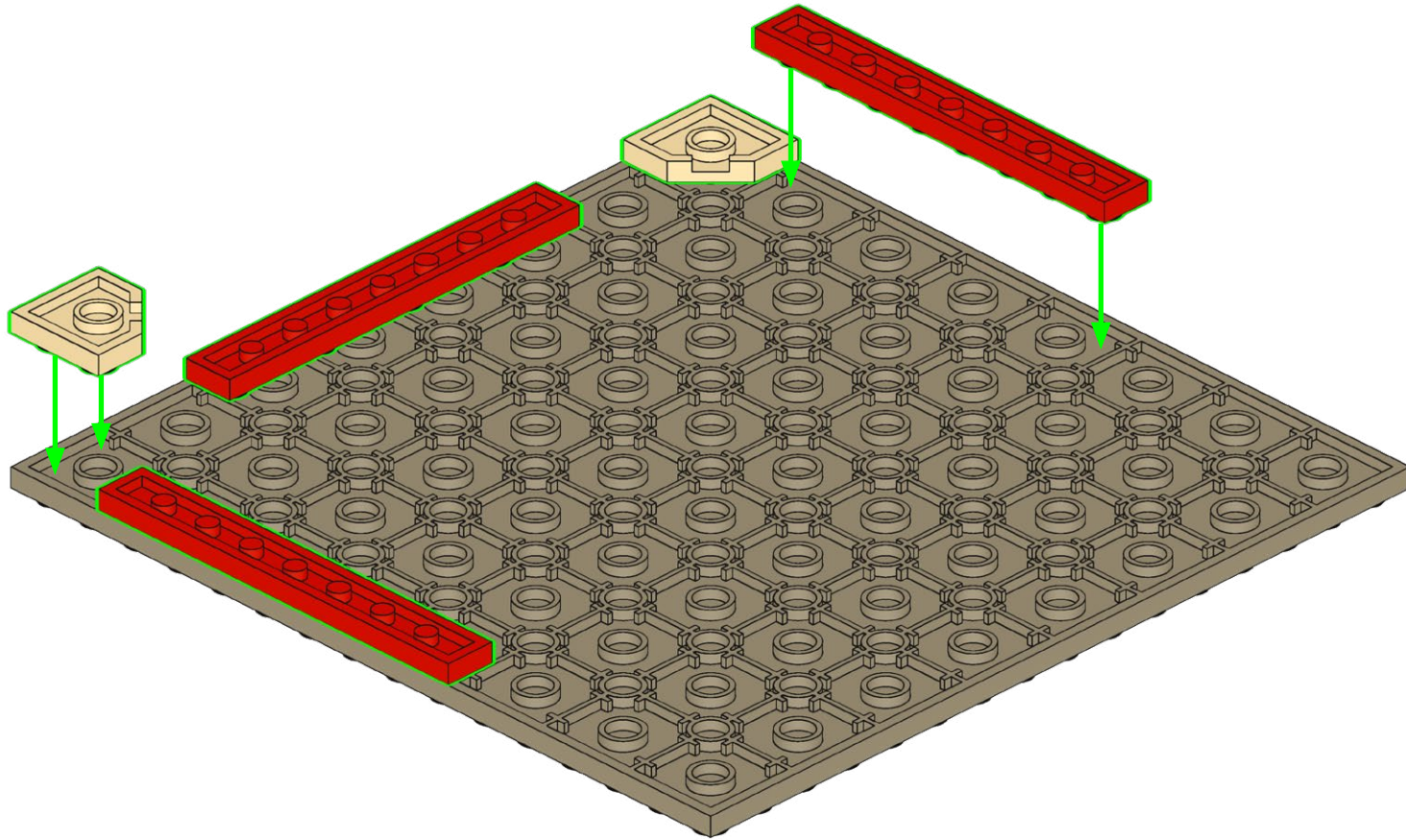
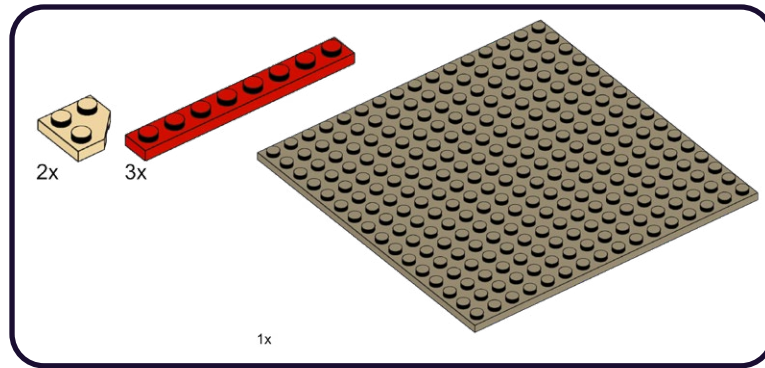

25

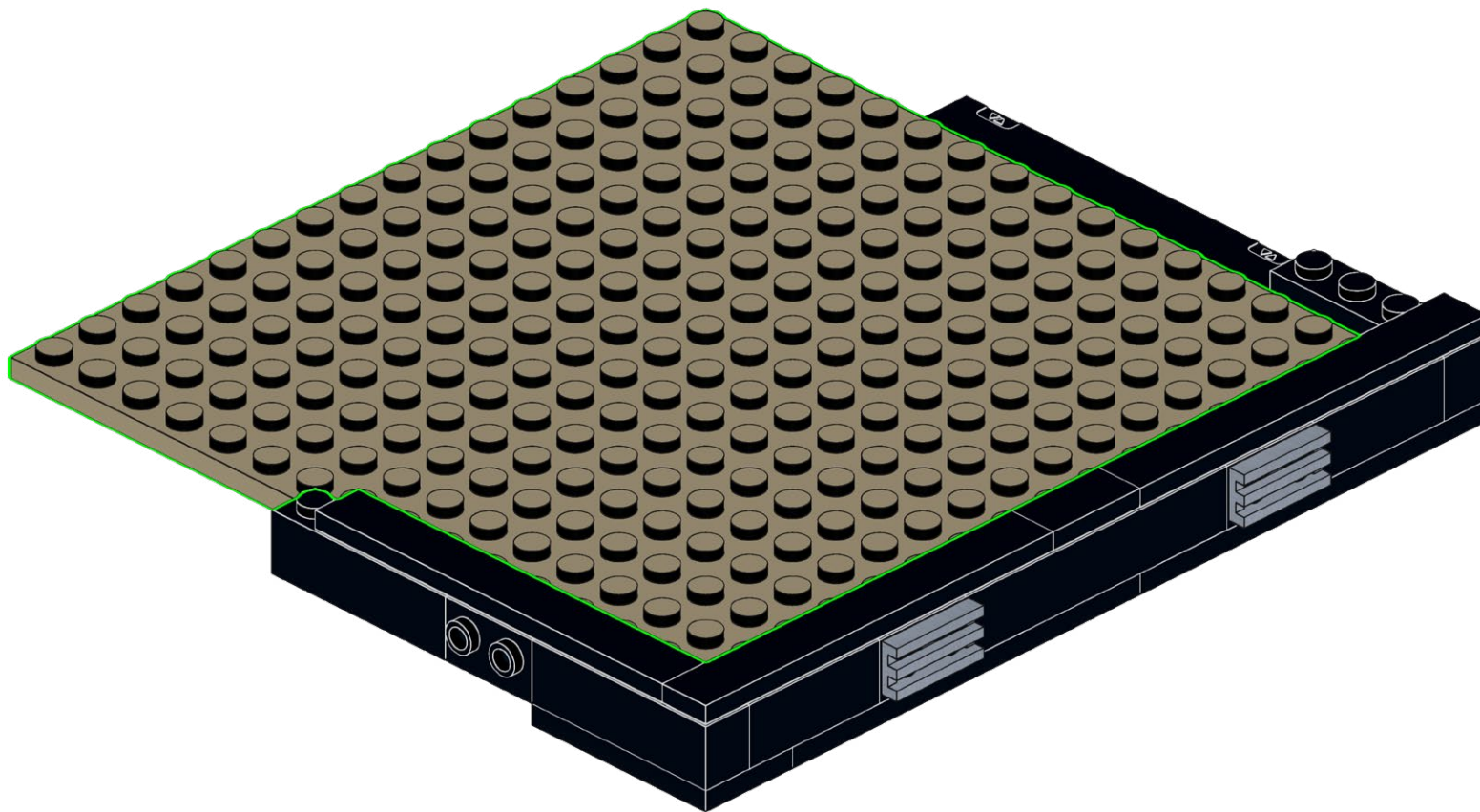



# 26

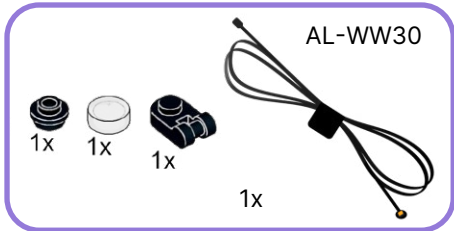

1

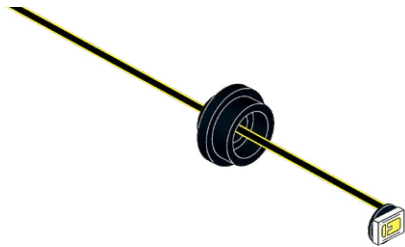

2

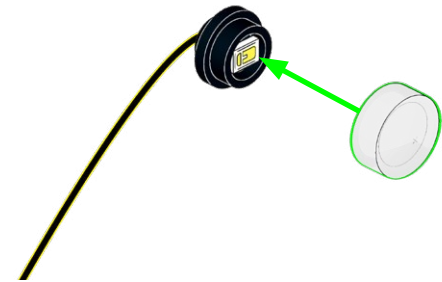

3

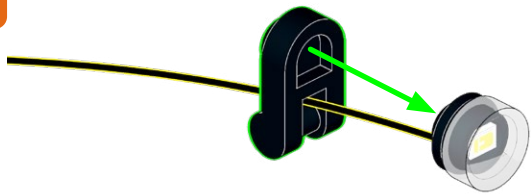

# 27

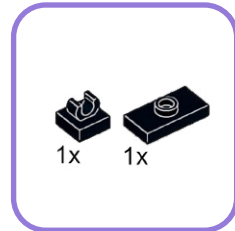

1

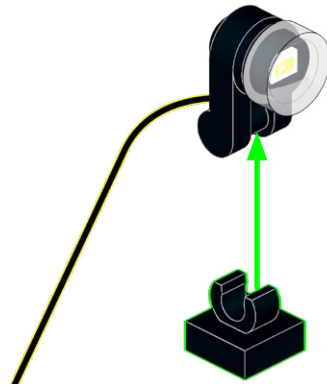

2

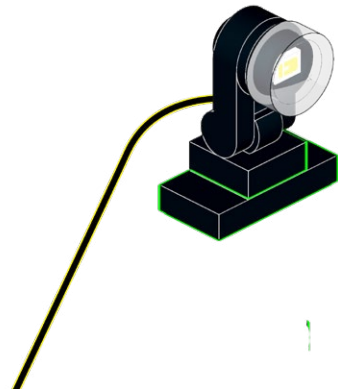

28

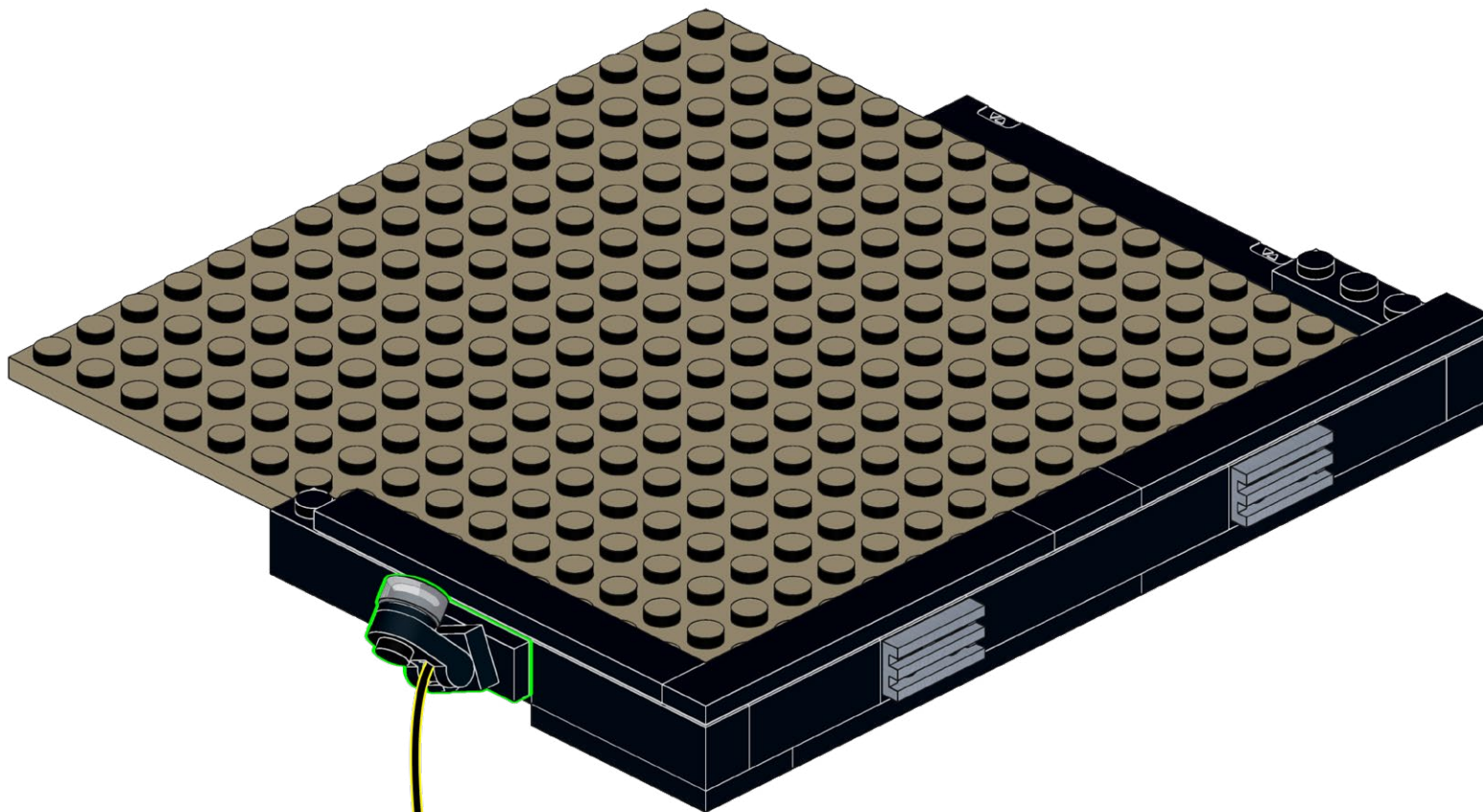

29

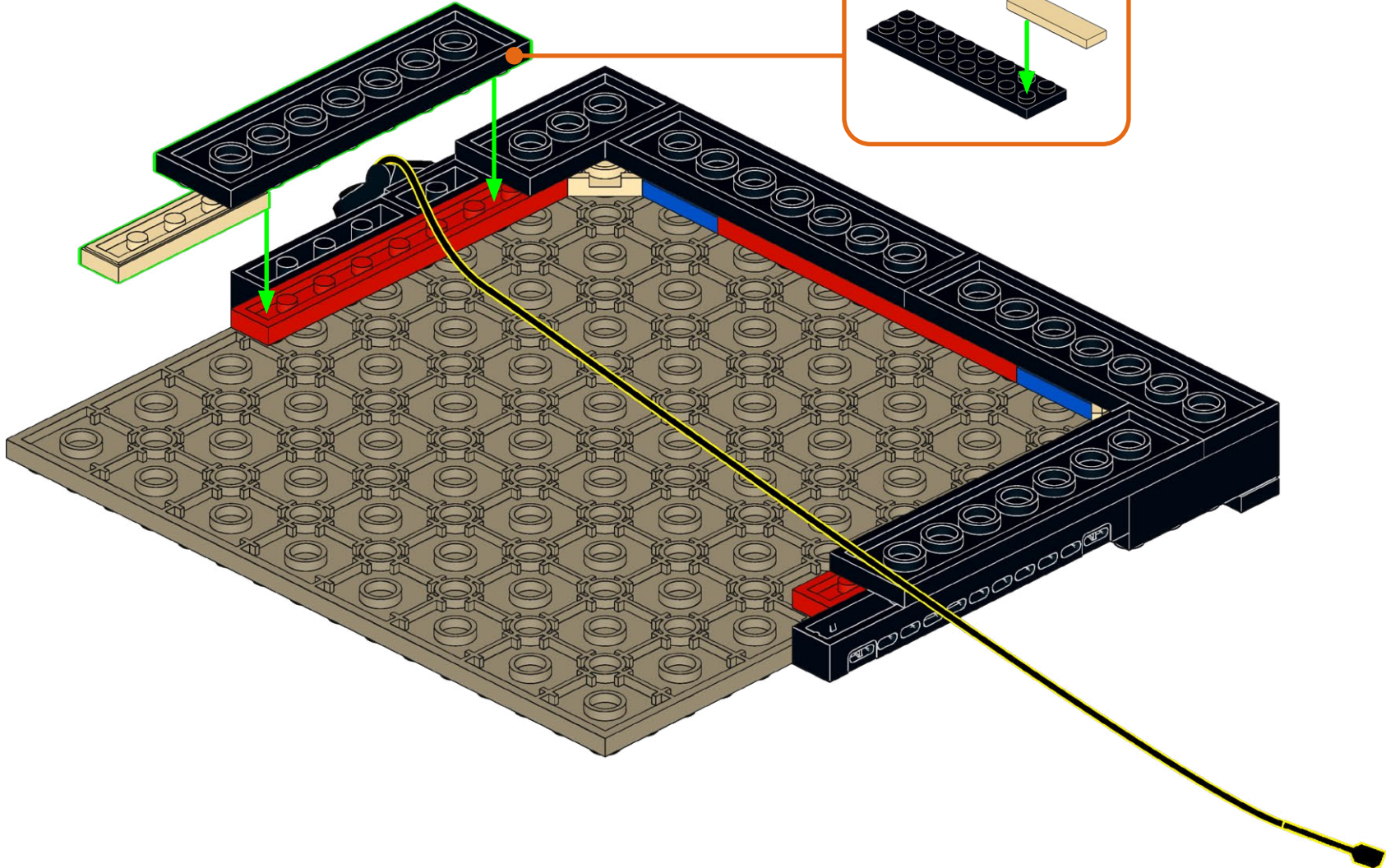
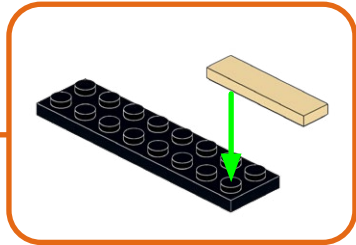
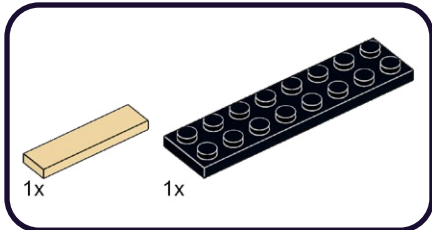



30

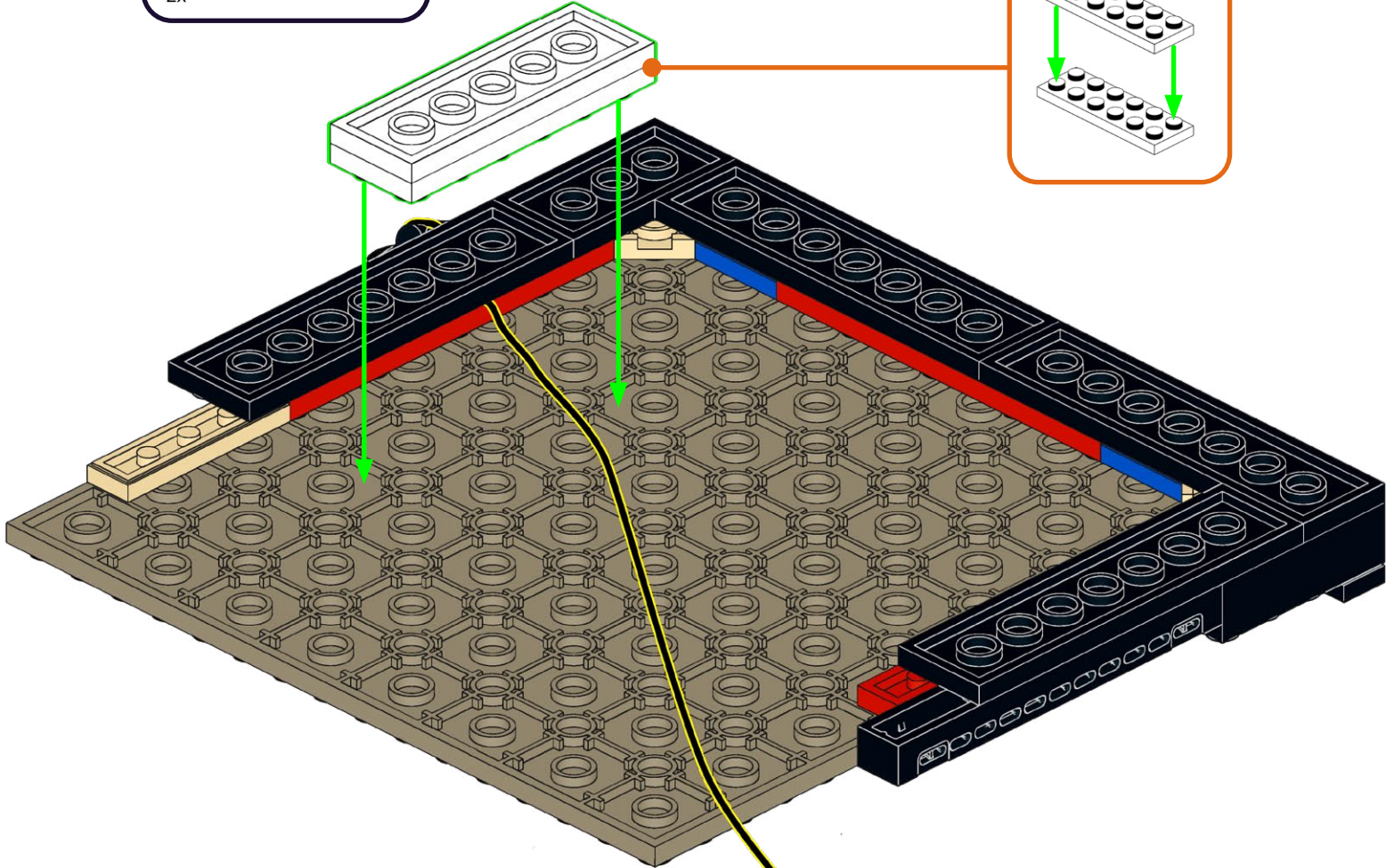
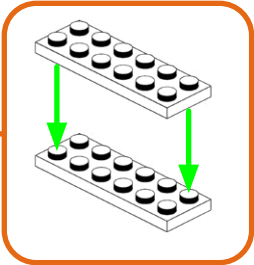
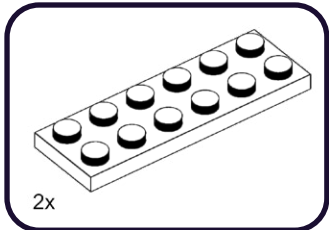



31

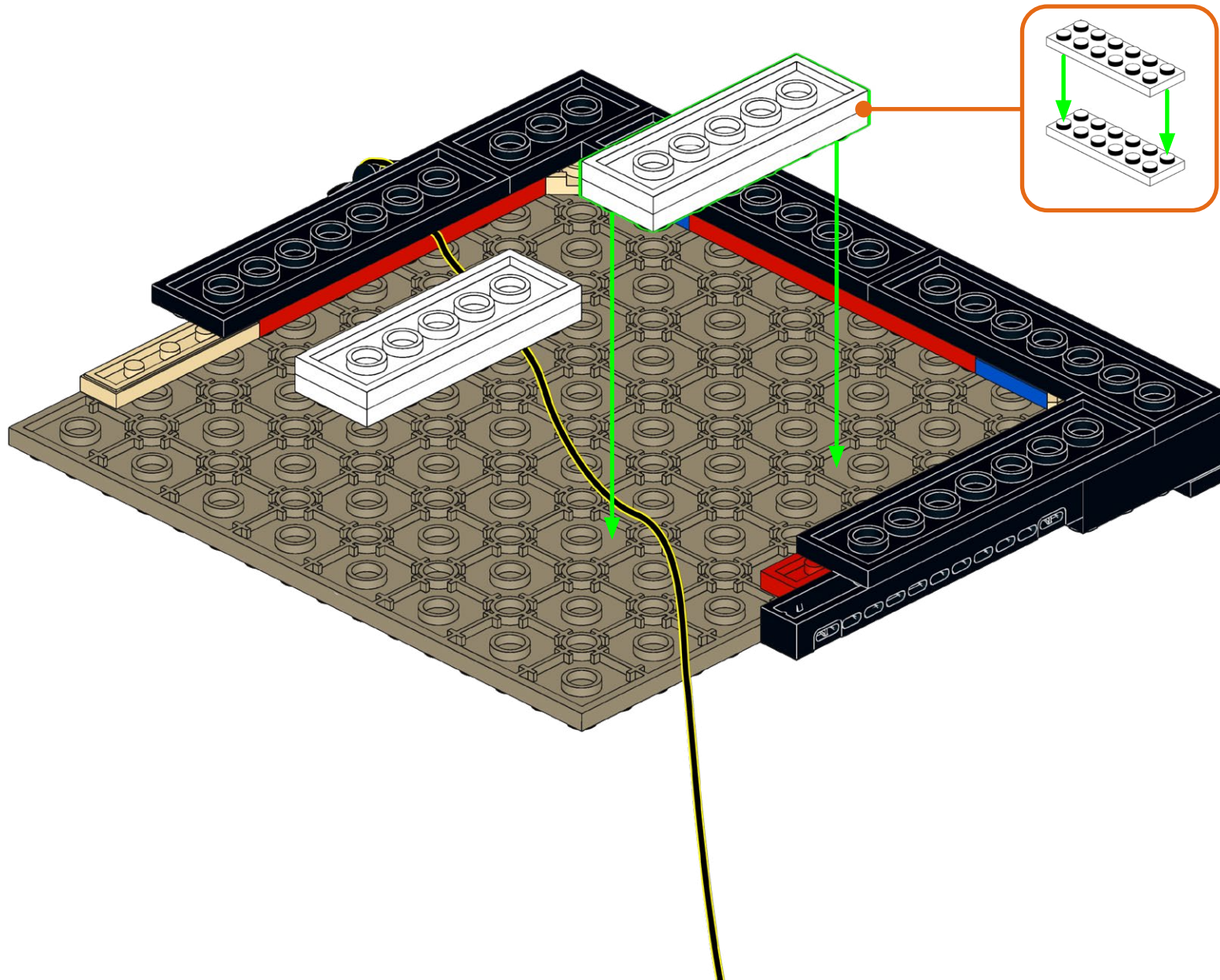
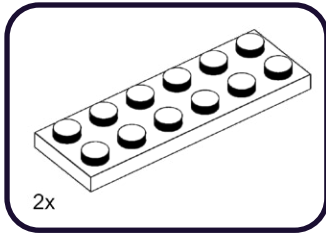

32

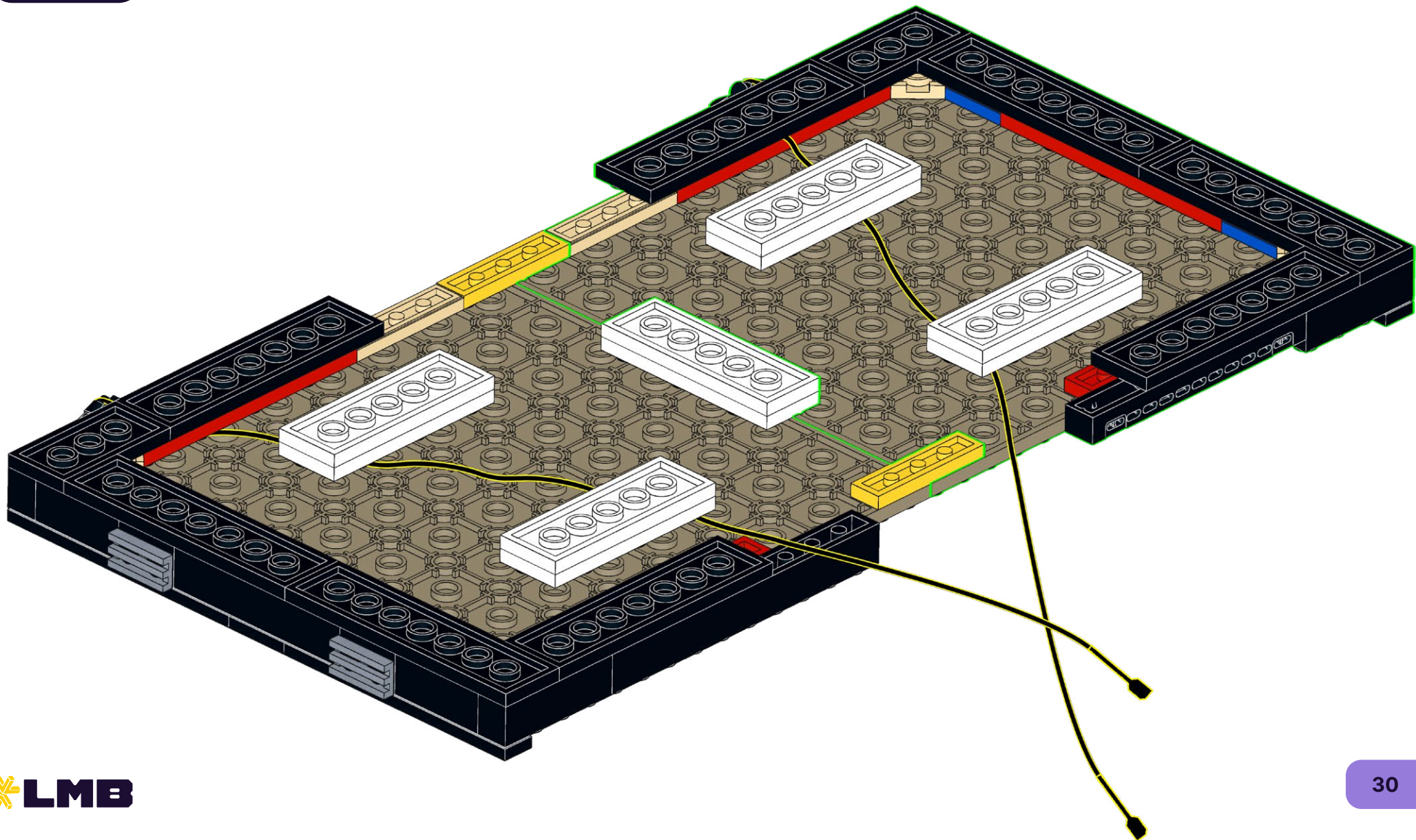



33

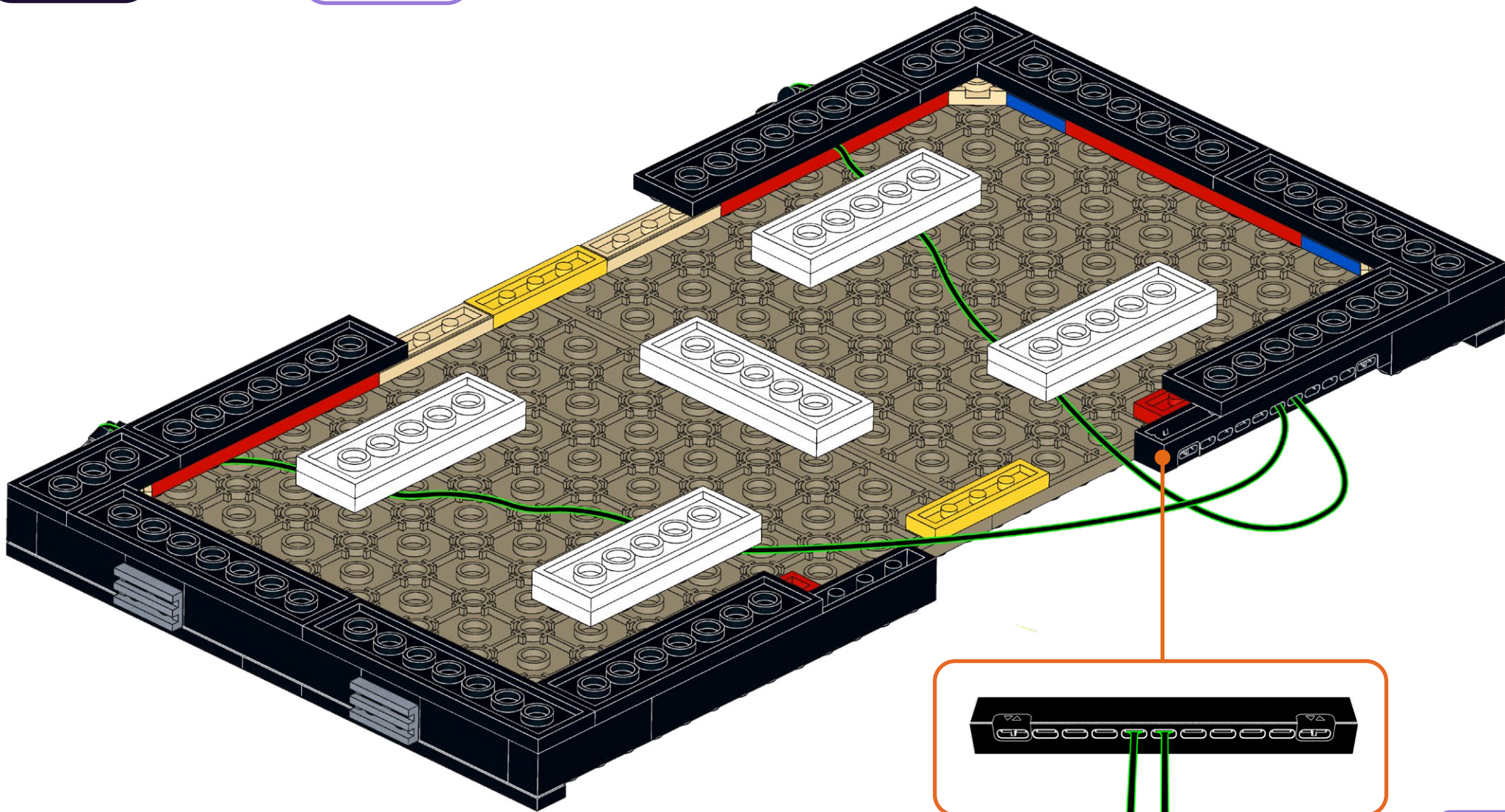
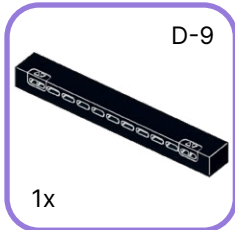



34

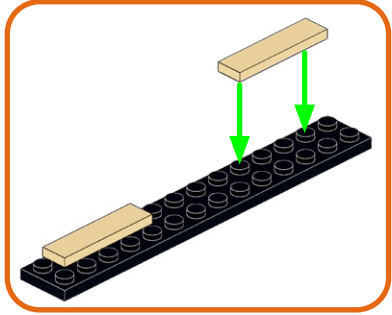
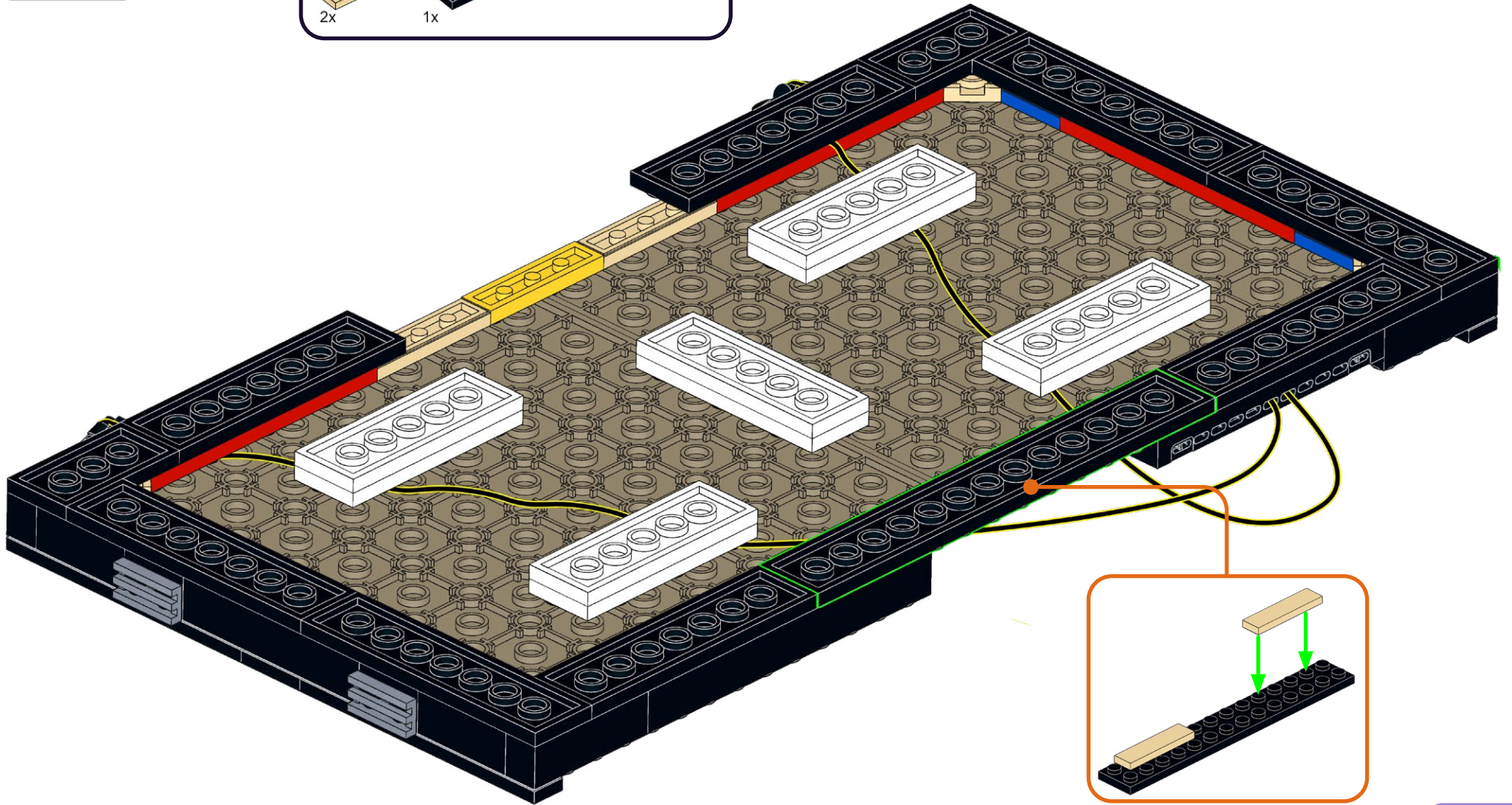
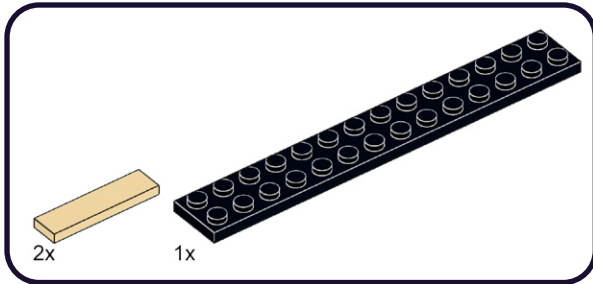



35

5x

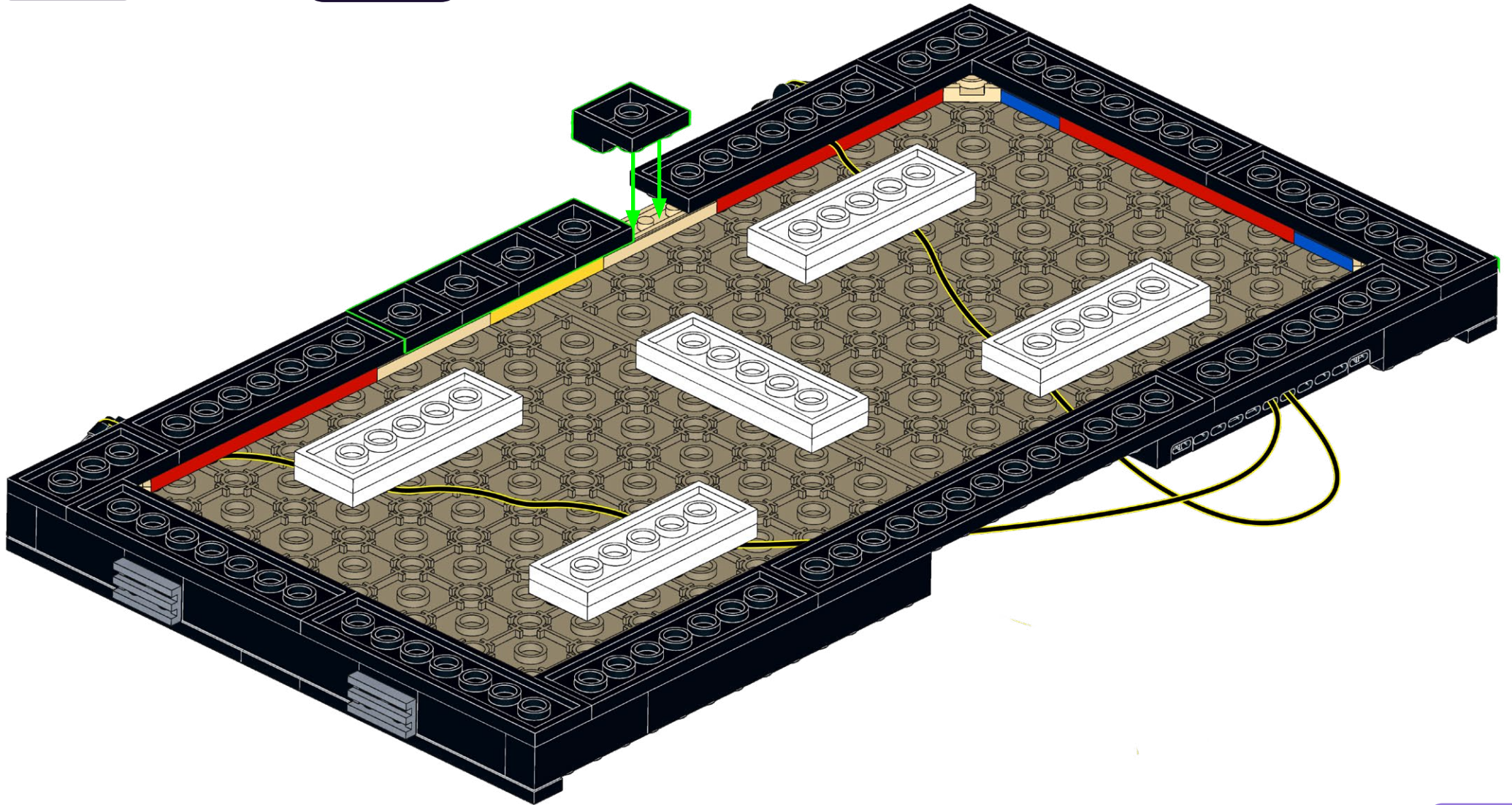

**36**

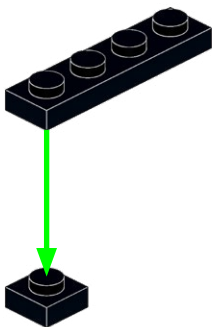
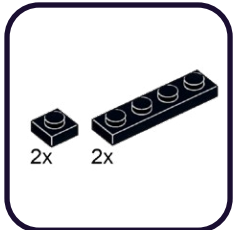

2x

**37**

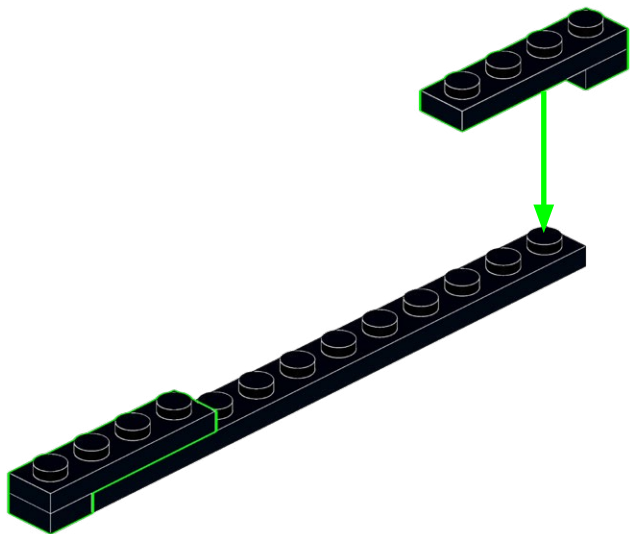
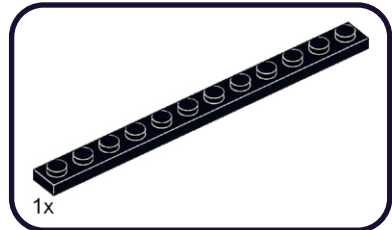

38

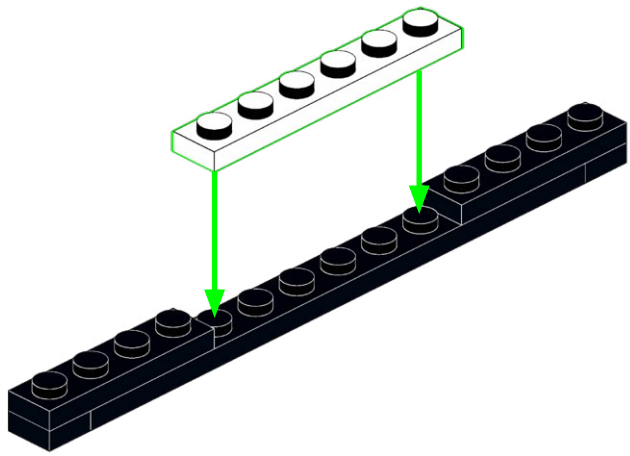
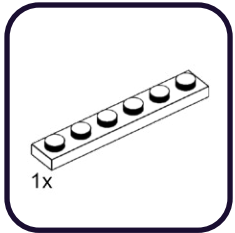

39

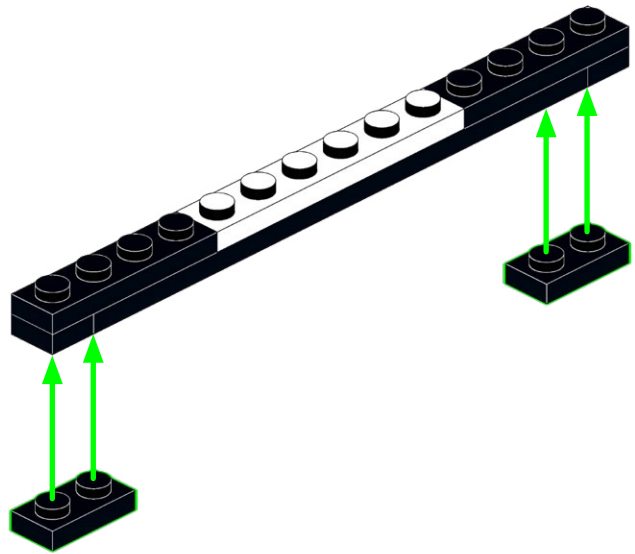
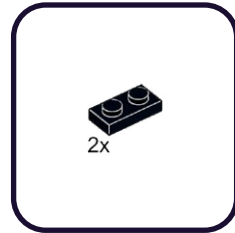



40

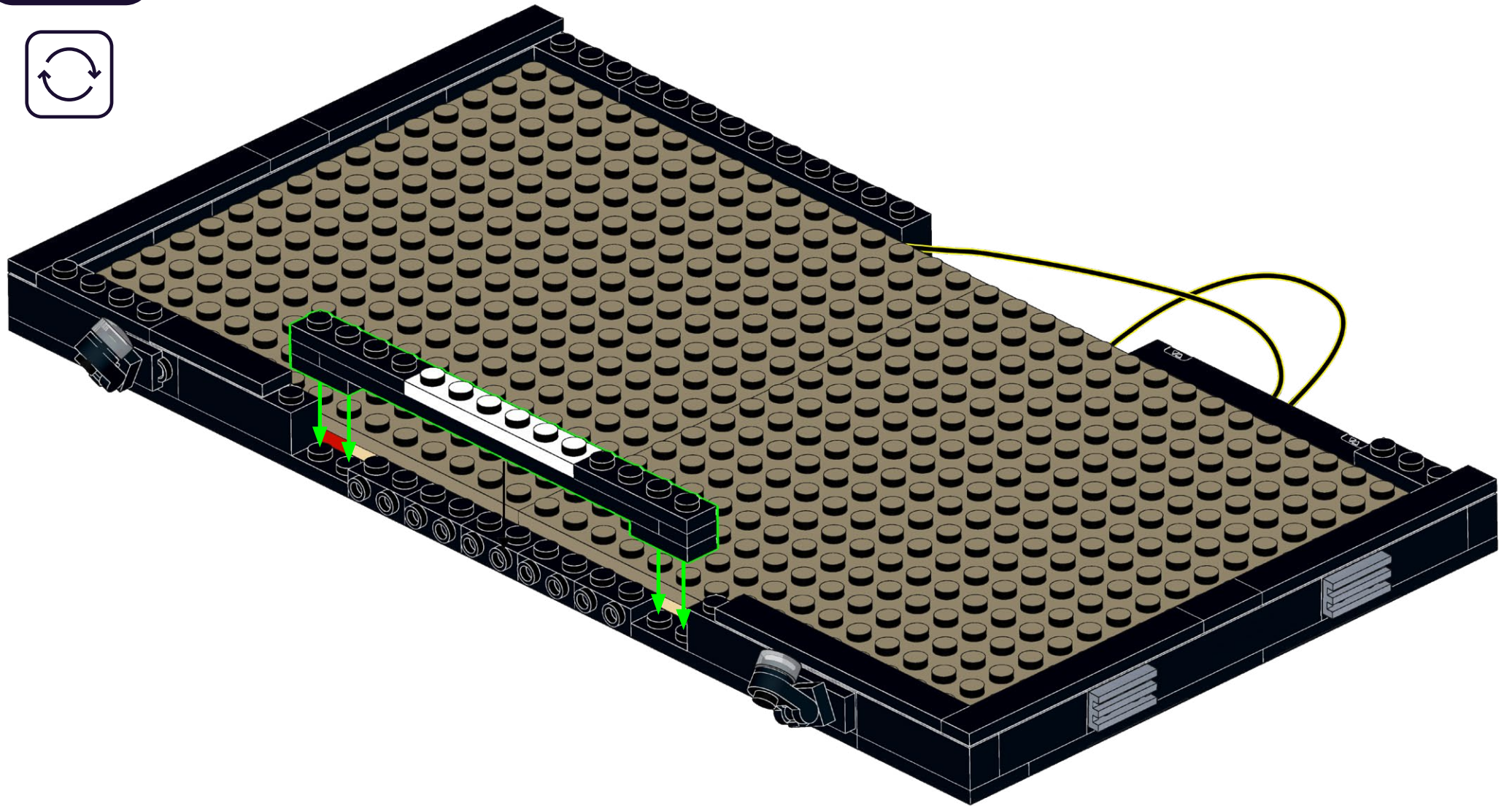



41

2x

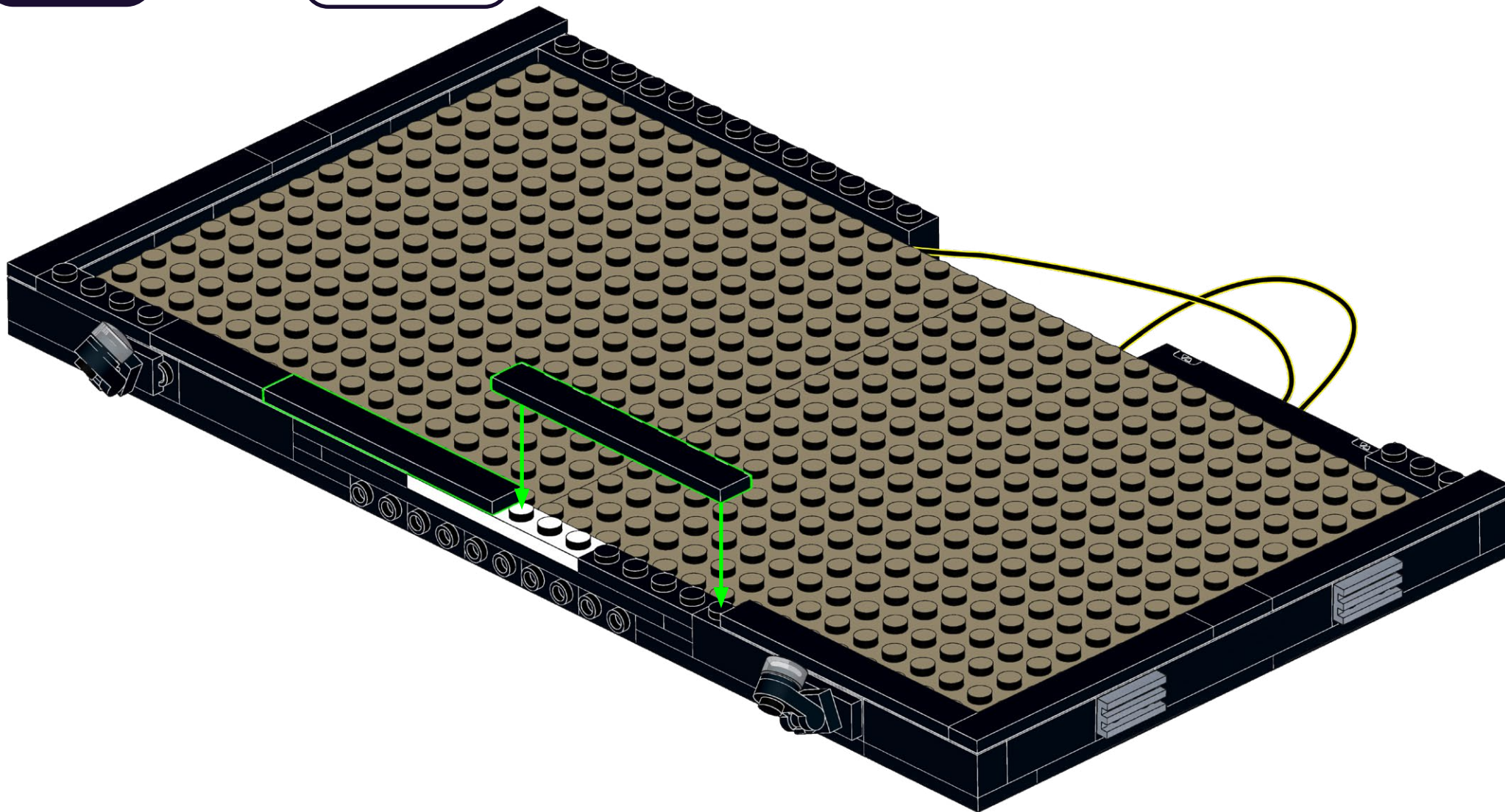

42

1x

1x

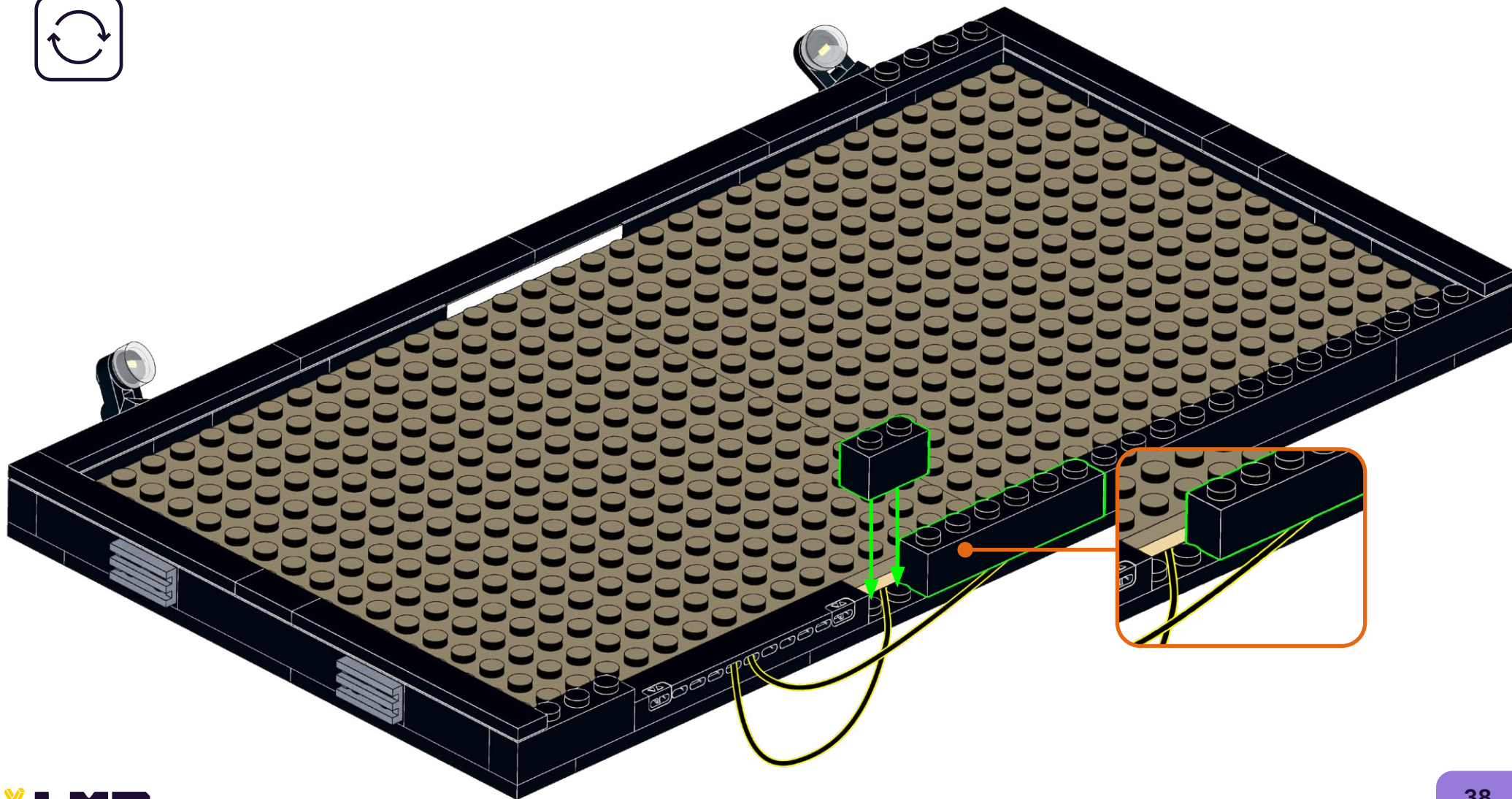



43

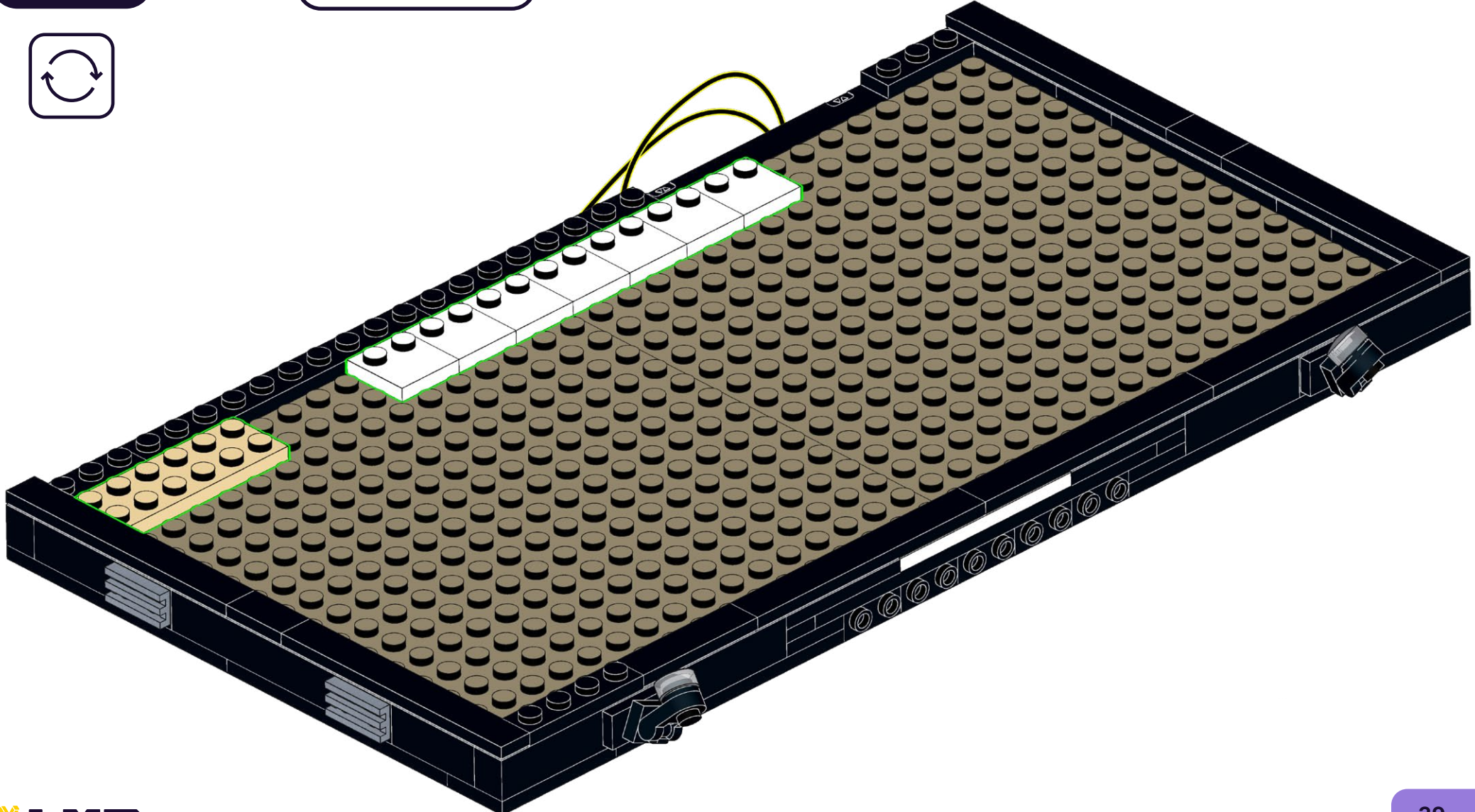
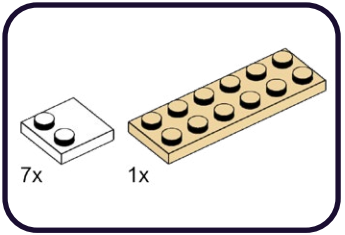

44

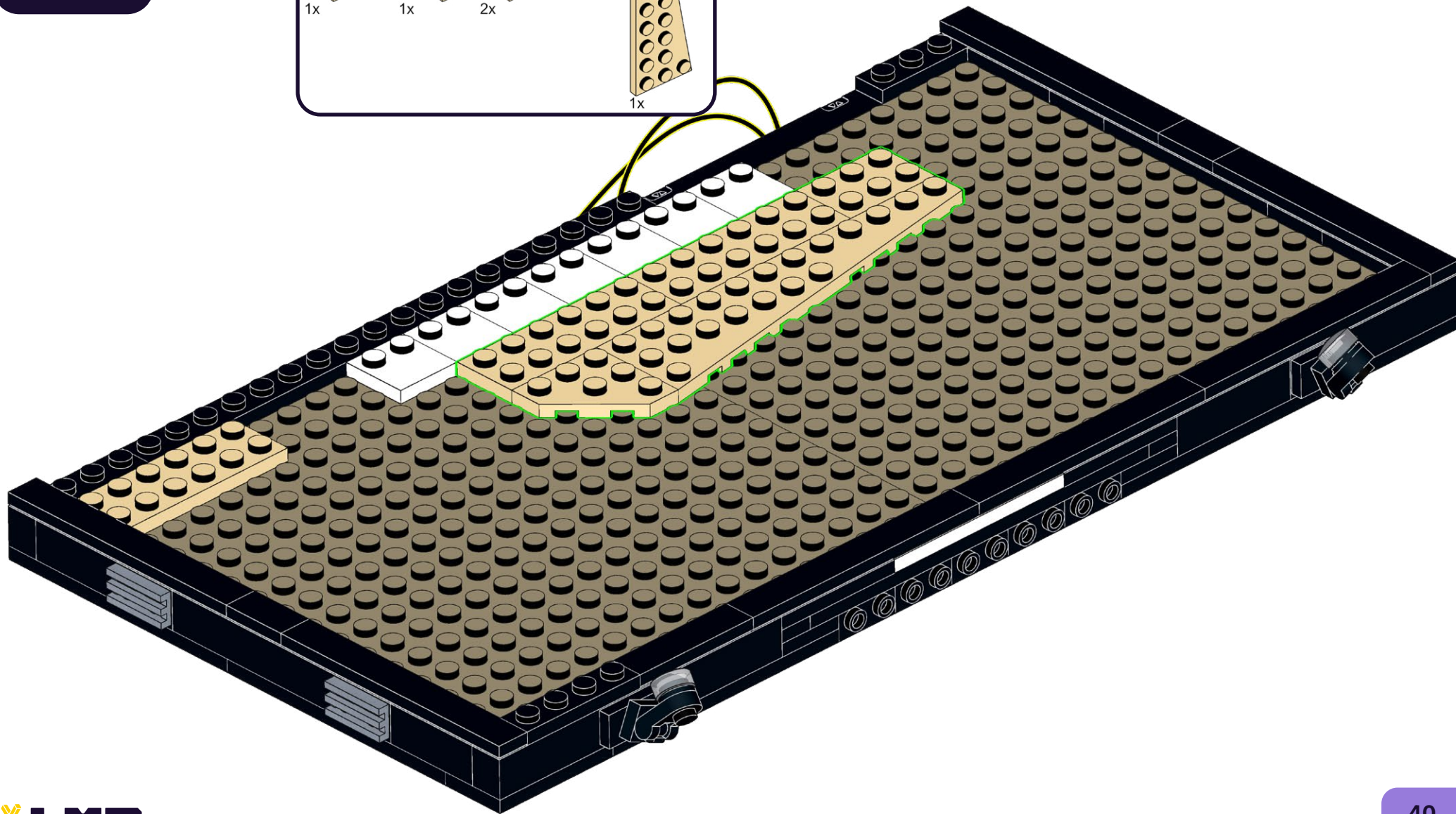
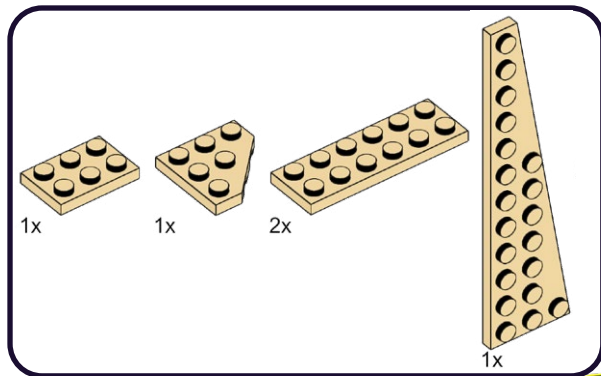





46

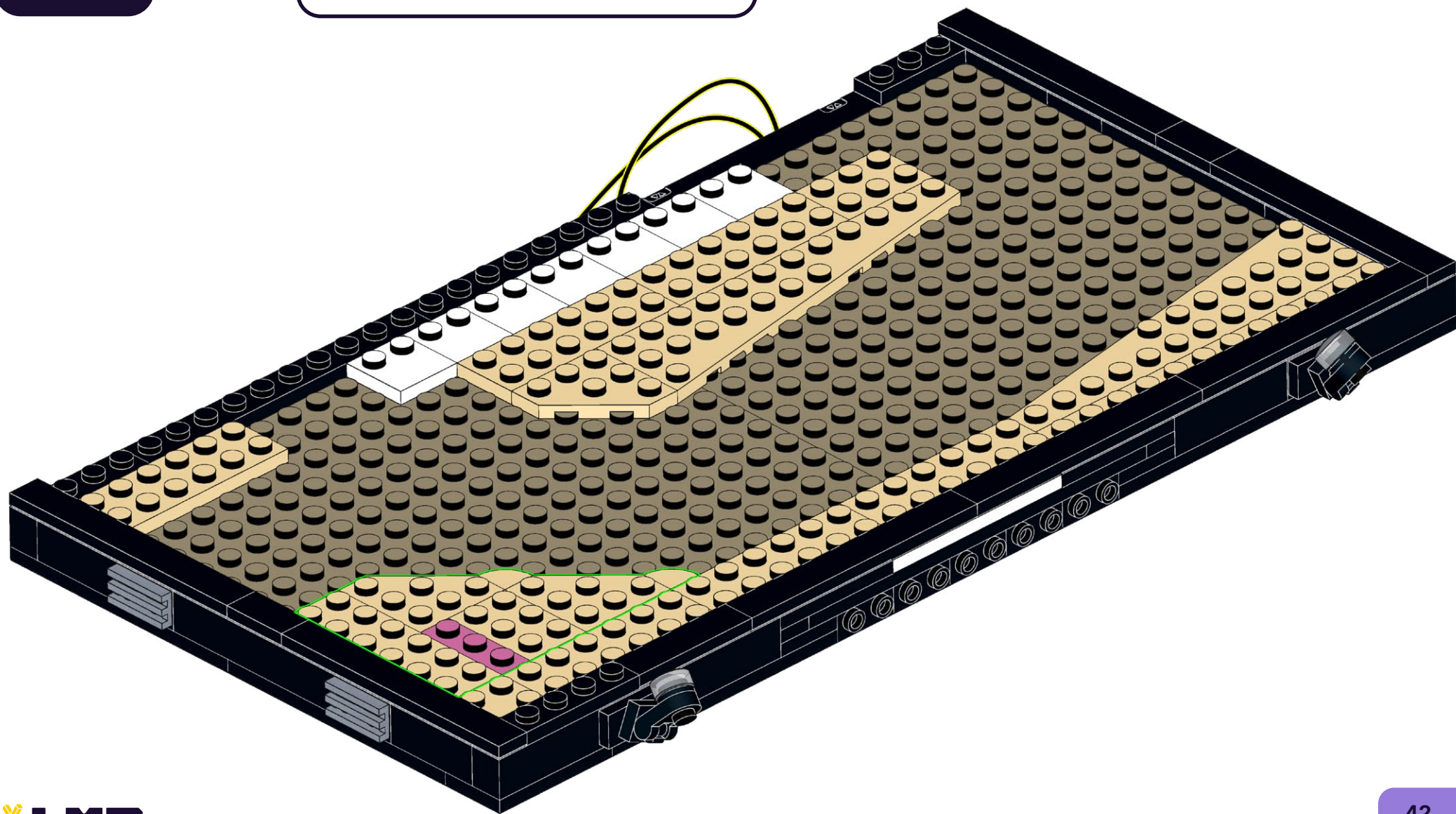
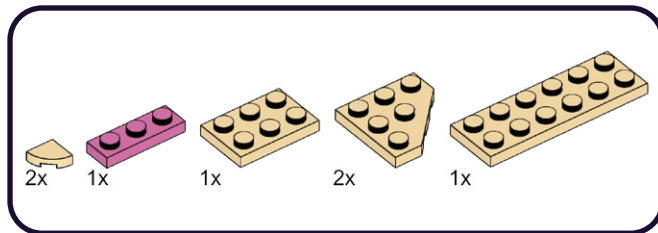



47

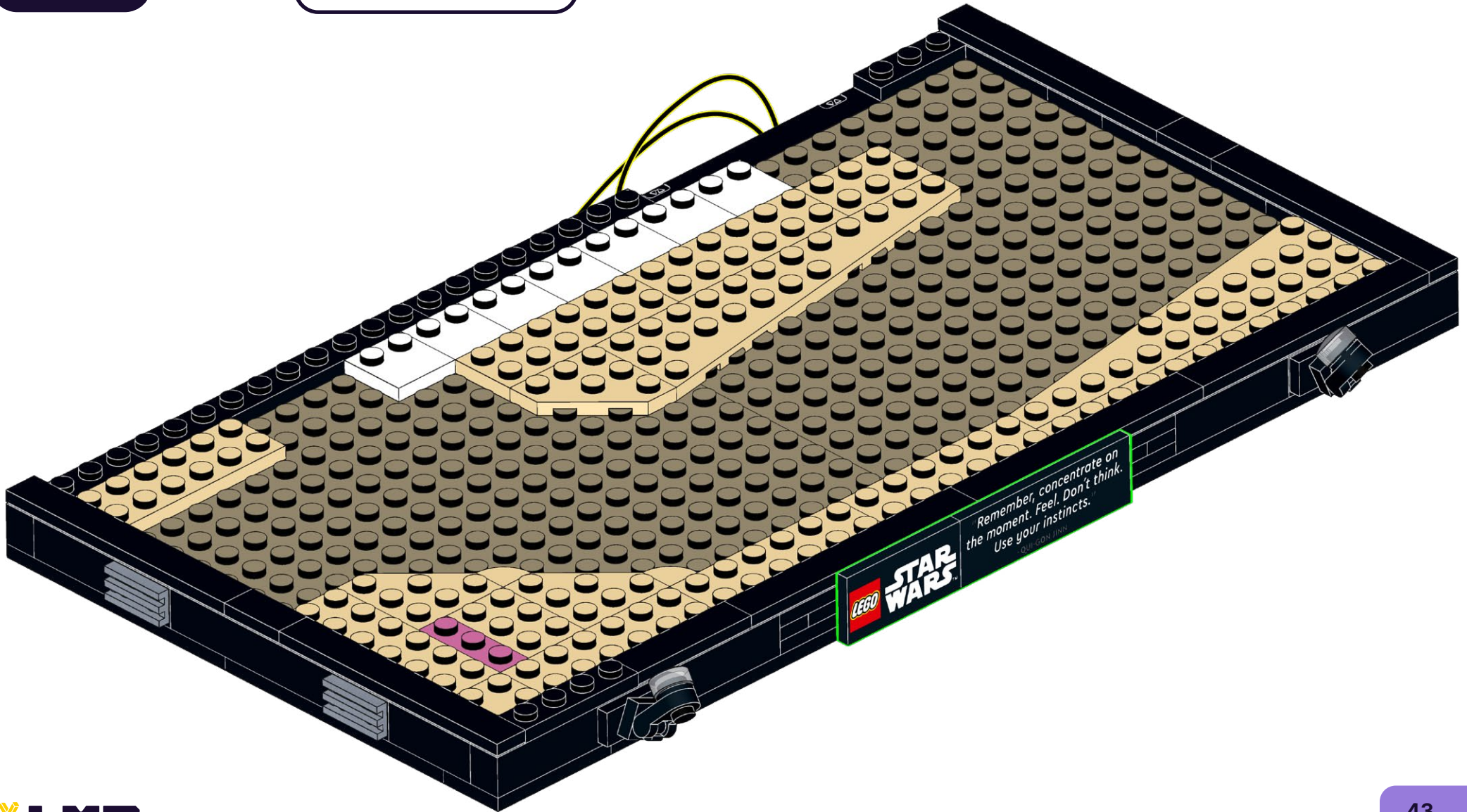
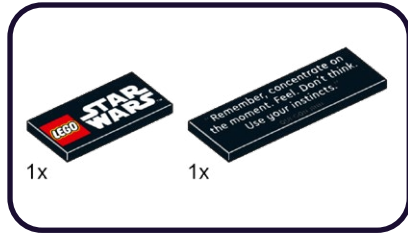

**HOLD UP!**

You might notice some bags are out of order, as well as left over pieces, but that's ok! We're changing the way you build LEGO!

**HALTEN!**

Möglicherweise stellen Sie fest, dass einige Beutel nicht in Ordnung sind und auch Teile übrig bleiben, aber das ist in Ordnung! Wir verändern die Art und Weise, wie Sie LEGO bauen!

**TENIR BON!**

Vous remarquerez peut-être que certains sacs sont en panne, ainsi que des morceaux restants, mais ce n'est pas grave ! Nous changeons la façon dont vous construisez LEGO !

**SOSTENERE!**

Potresti notare che alcune borse sono fuori uso, così come alcuni pezzi avanzati, ma va bene! Stiamo cambiando il modo in cui costruisci i LEGO!

**¡SOSTENER!**

Puede que notes que algunas bolsas están fuera de orden, así como piezas sobrantes, ¡pero está bien! ¡Estamos cambiando la forma de construir LEGO!

**耽误!**

您可能会注意到有些袋子坏了, 还有剩余的碎片, 但这没关系! 我们正在改变您搭建乐高的方式!

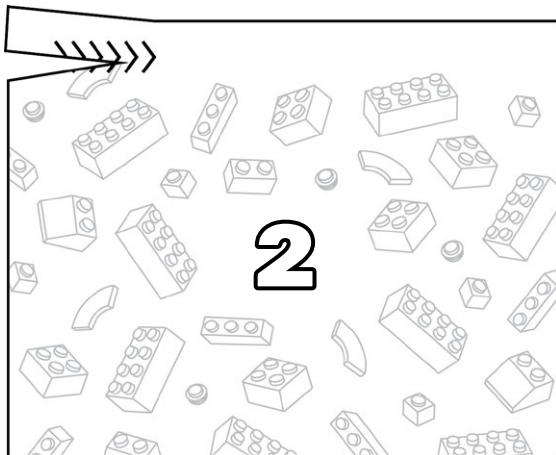
**Open LEGO® Bag 2**



48

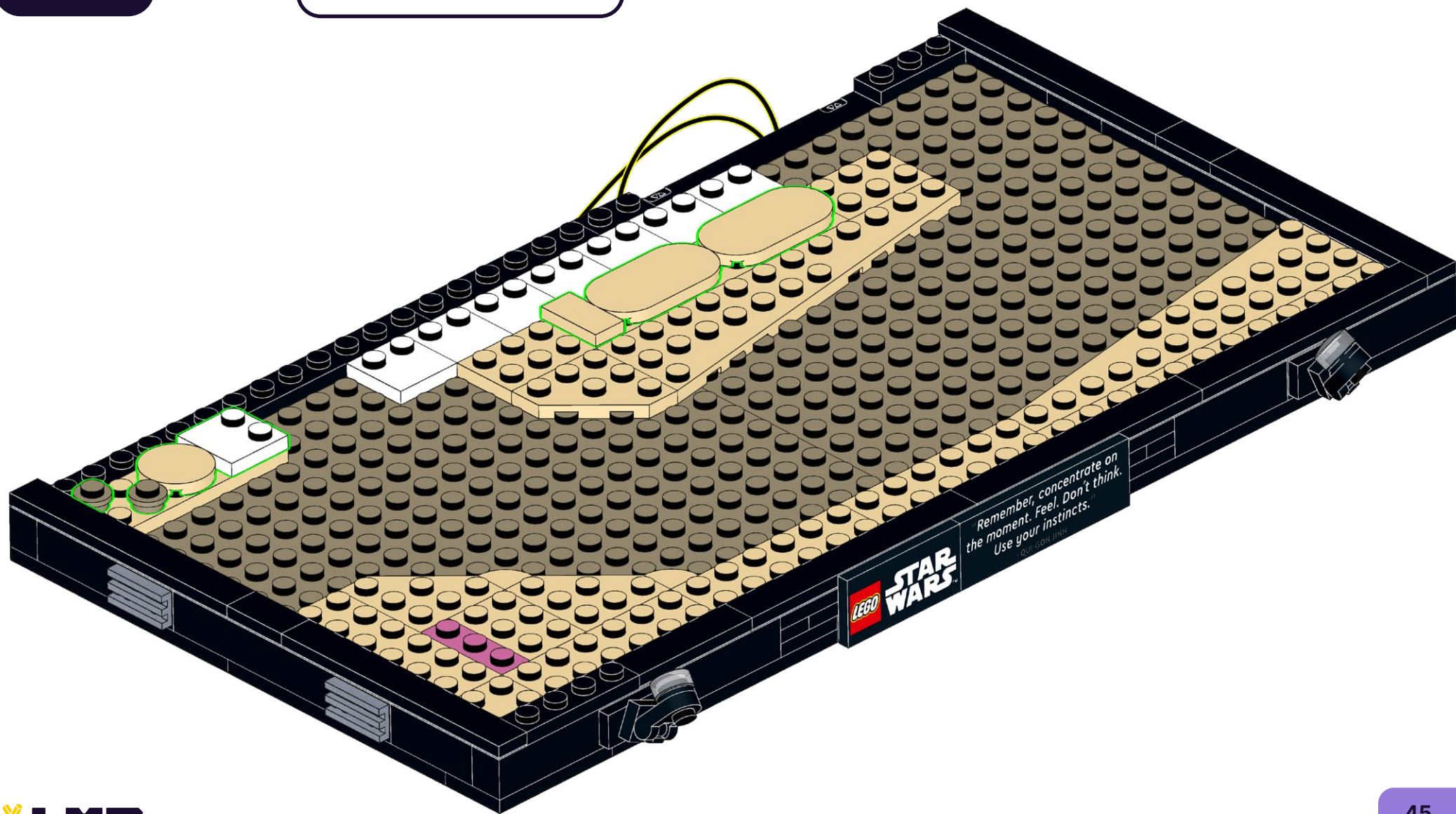
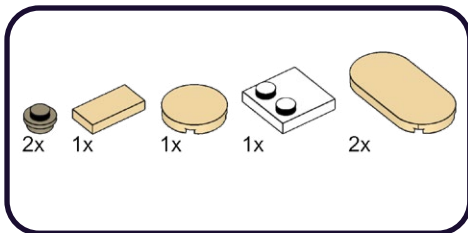





50

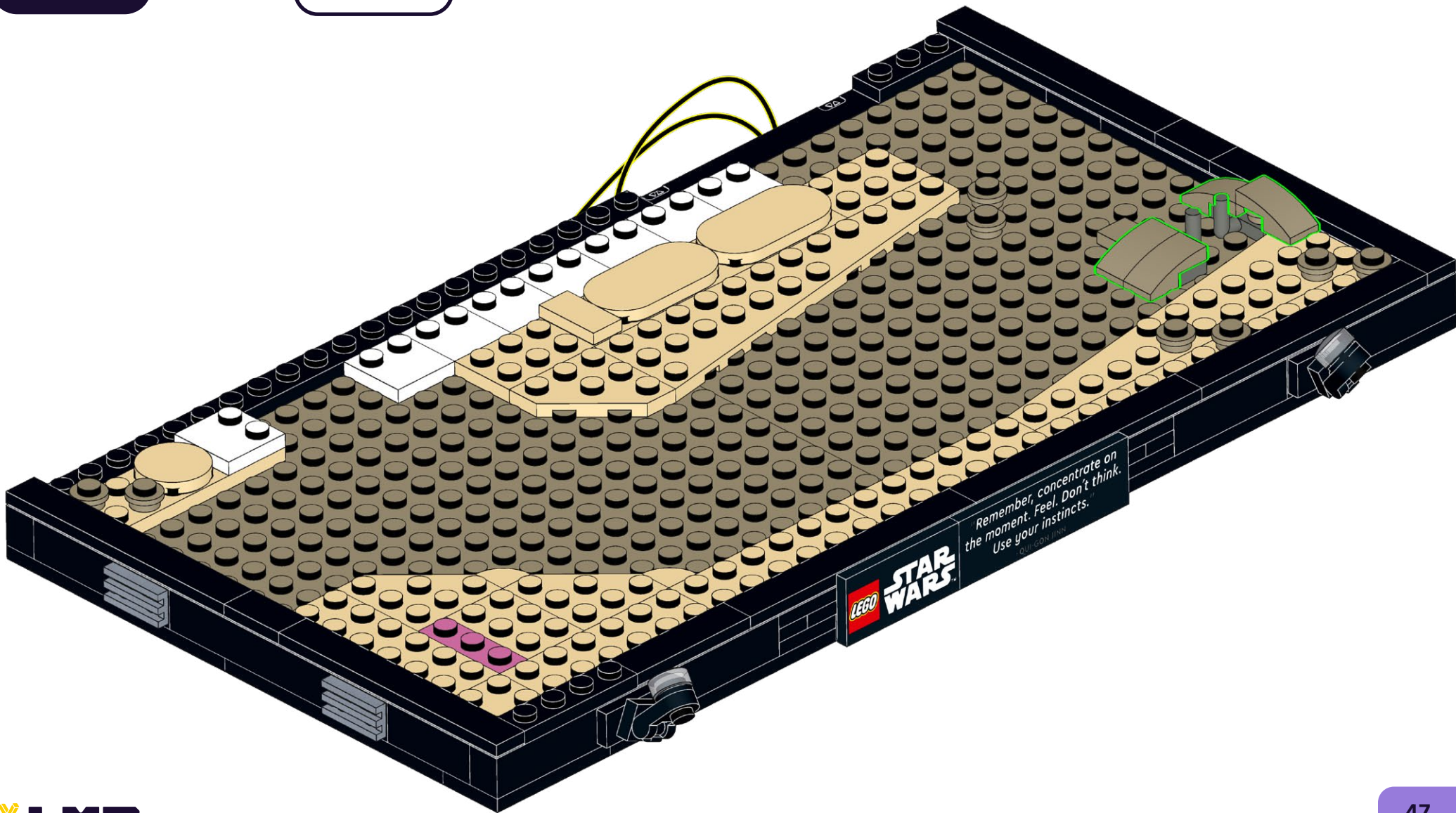
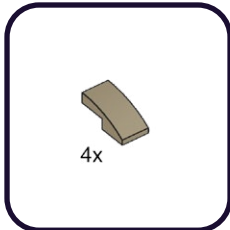



51

6x

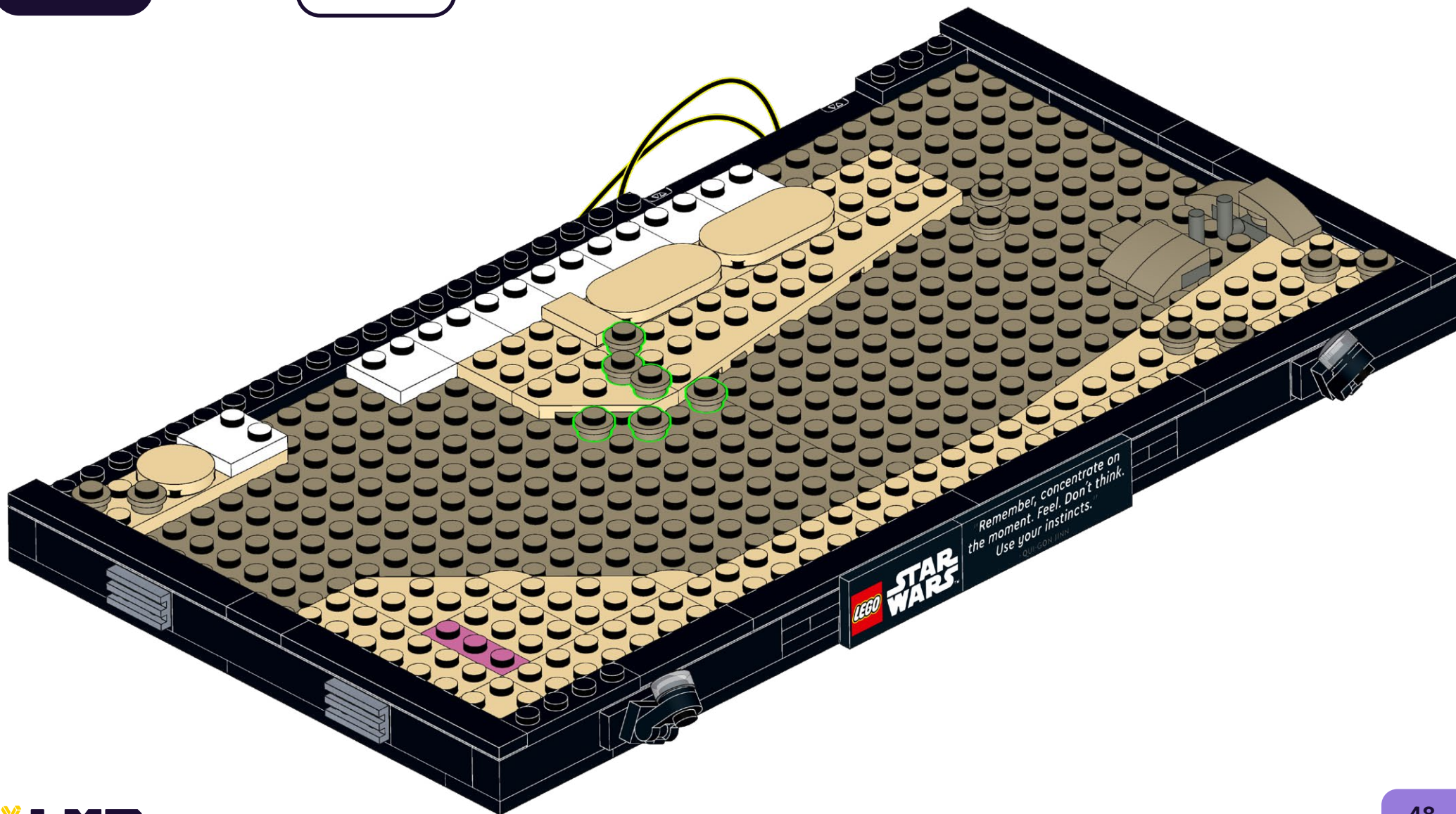

52

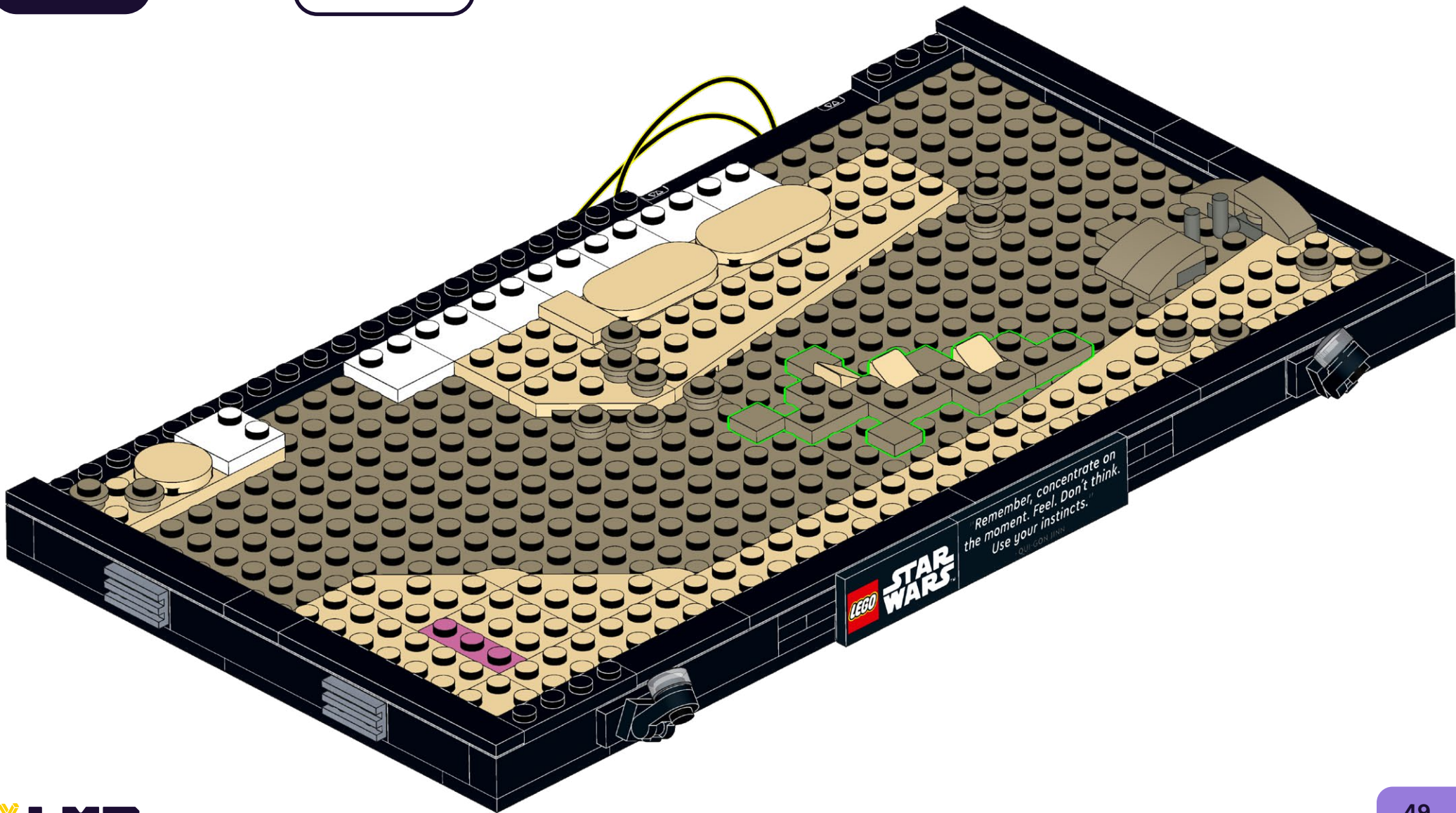
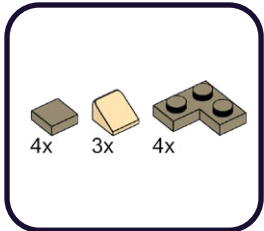



53

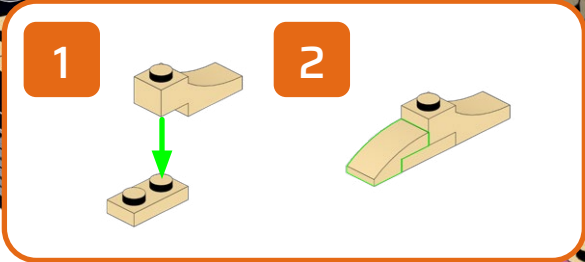
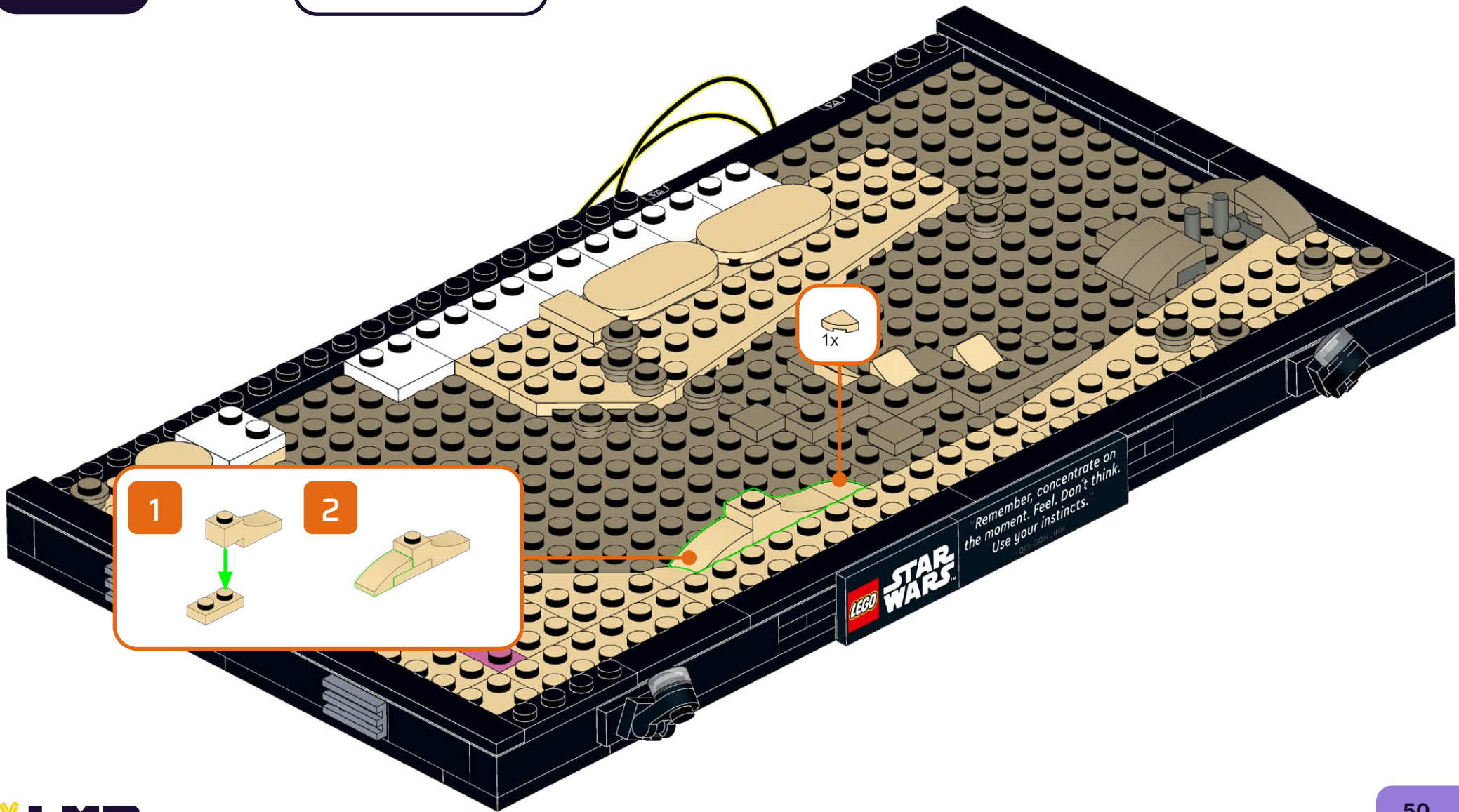
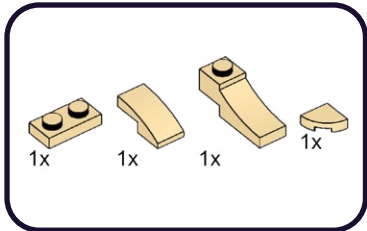

Remember, concentrate on the moment. Feel. Don't think. Use your instincts.



54

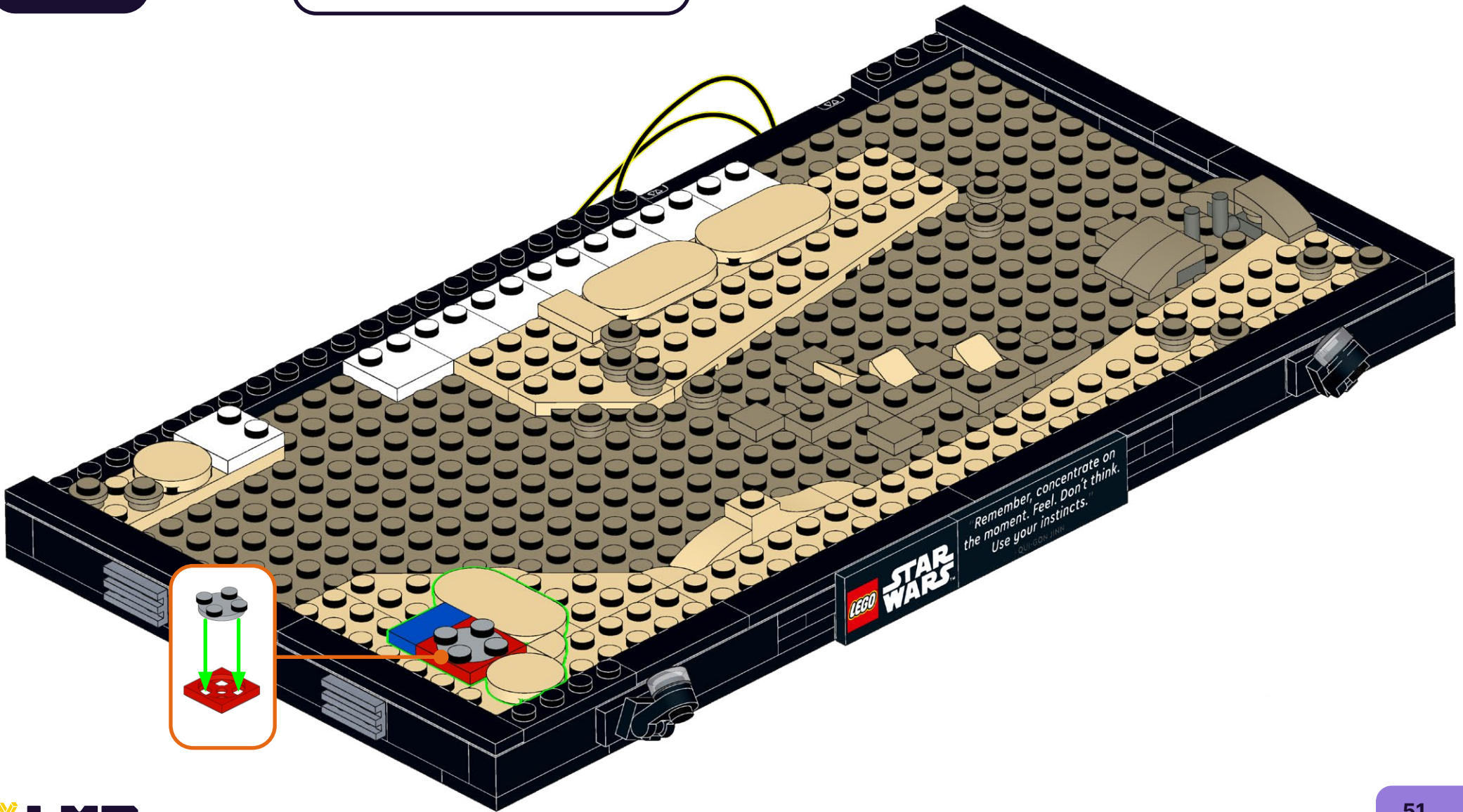
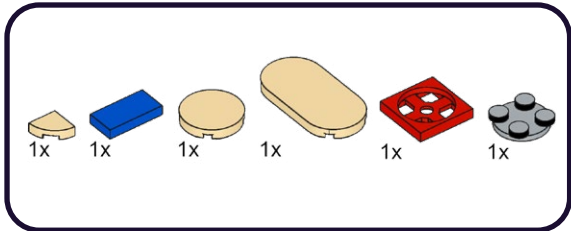

55

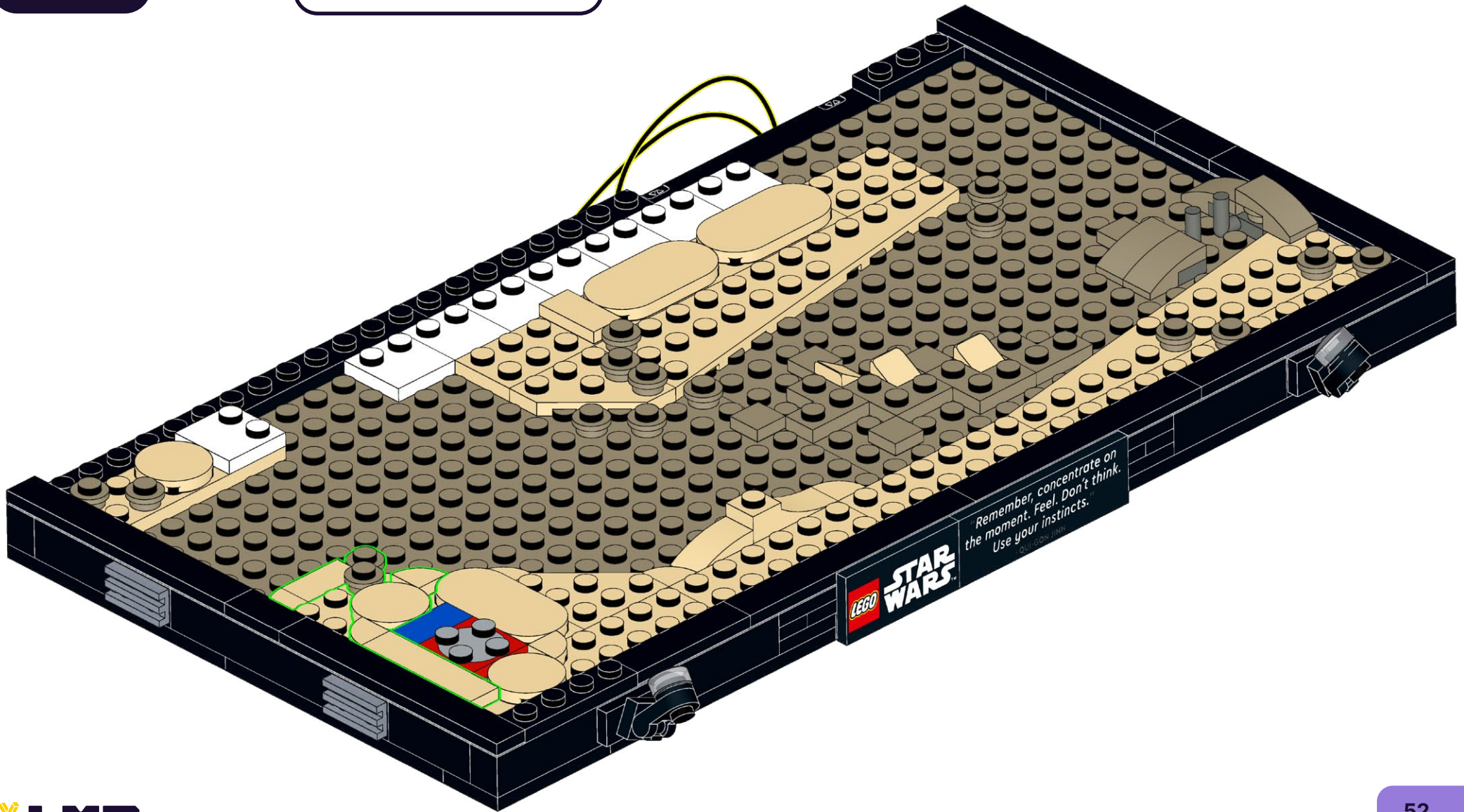
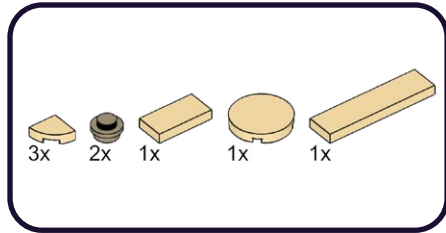



56

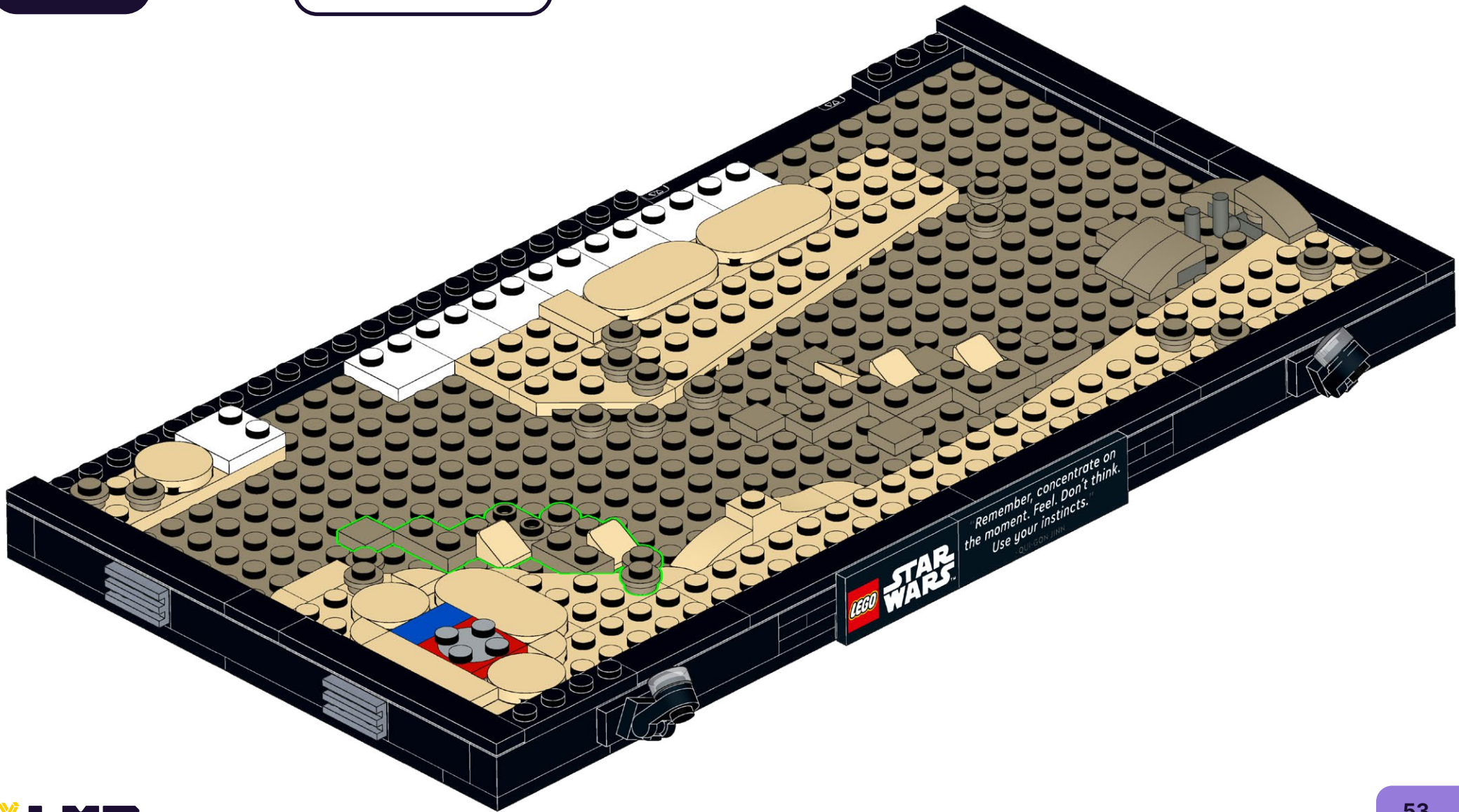
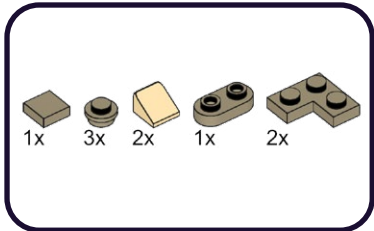



57

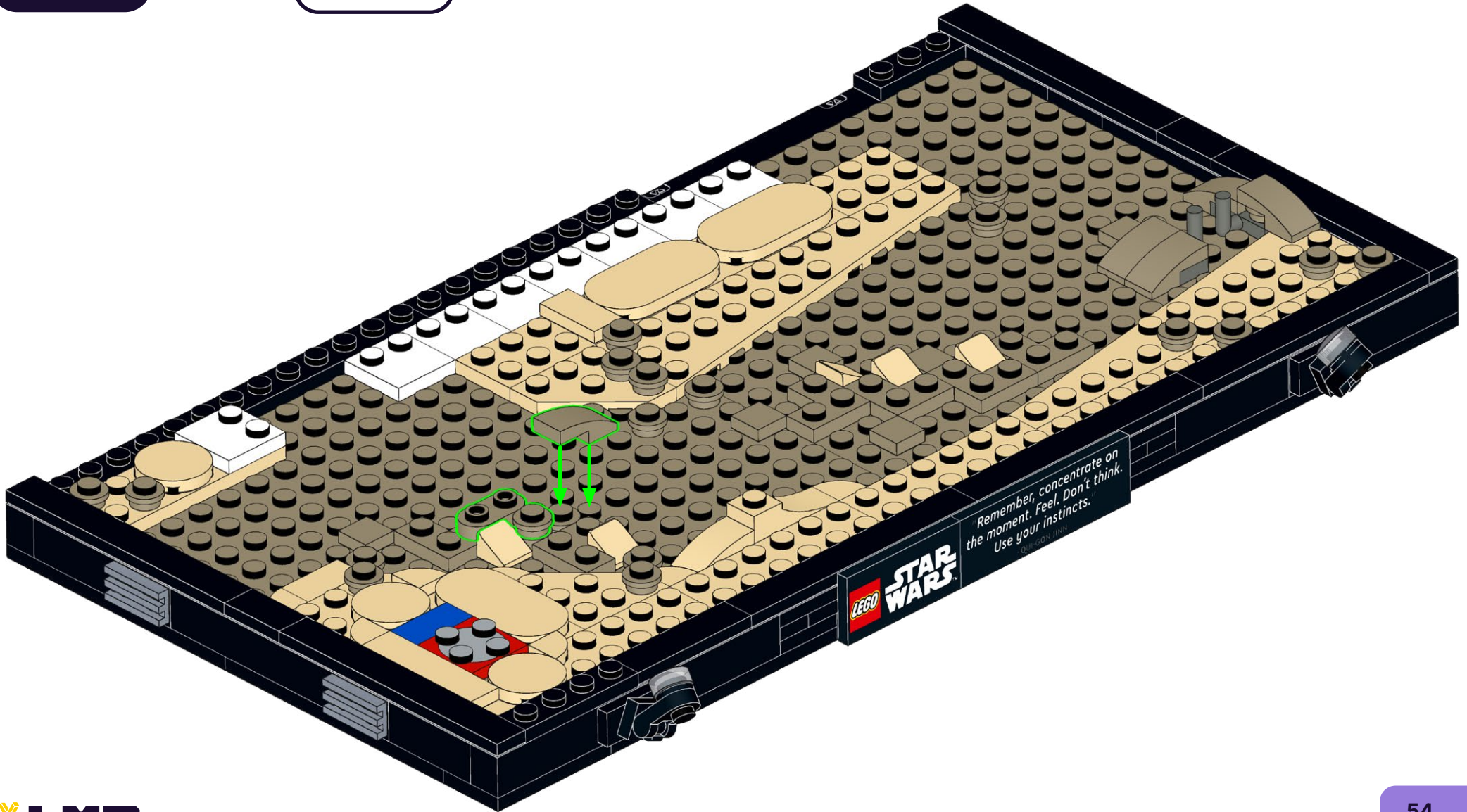
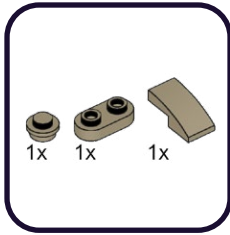

58

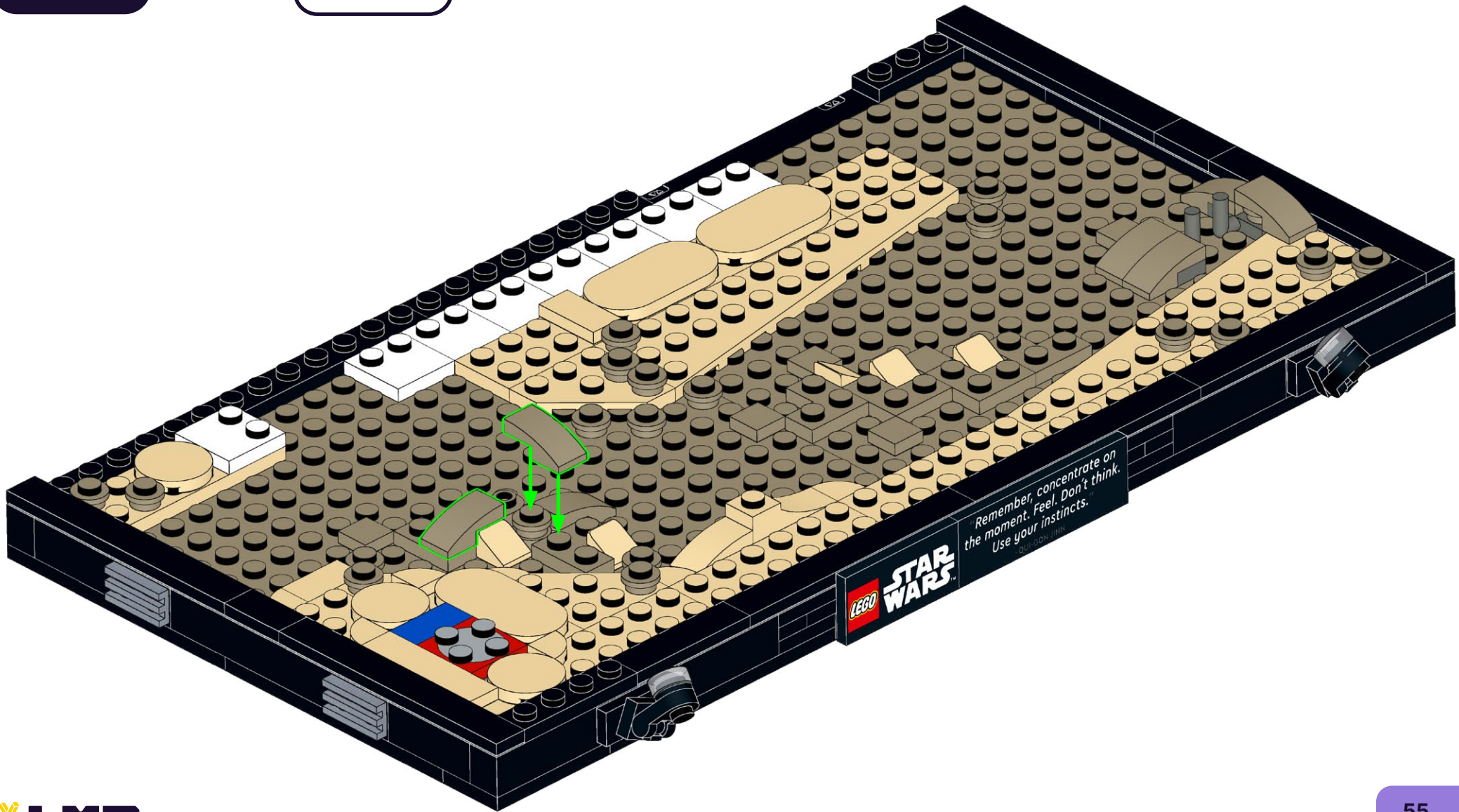
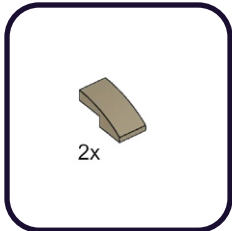



59

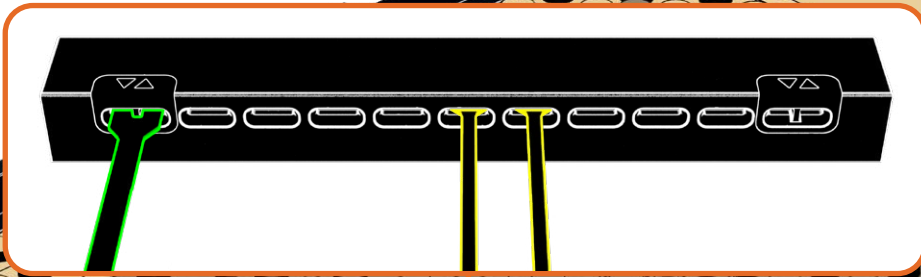



**HOLD UP!**

You might notice some bags are out of order, as well as left over pieces, but that's ok! We're changing the way you build LEGO!

**HALTEN!**

Möglicherweise stellen Sie fest, dass einige Beutel nicht in Ordnung sind und auch Teile übrig bleiben, aber das ist in Ordnung! Wir verändern die Art und Weise, wie Sie LEGO bauen!

**TENIR BON!**

Vous remarquerez peut-être que certains sacs sont en panne, ainsi que des morceaux restants, mais ce n'est pas grave ! Nous changeons la façon dont vous construisez LEGO !

**SOSTENERE!**

Potresti notare che alcune borse sono fuori uso, così come alcuni pezzi avanzati, ma va bene! Stiamo cambiando il modo in cui costruisci i LEGO!

**¡SOSTENER!**

Puede que notes que algunas bolsas están fuera de orden, así como piezas sobrantes, ¡pero está bien! ¡Estamos cambiando la forma de construir LEGO!

**耽误!**

您可能会注意到有些袋子坏了, 还有剩余的碎片, 但这没关系! 我们正在改变您搭建乐高的方式!

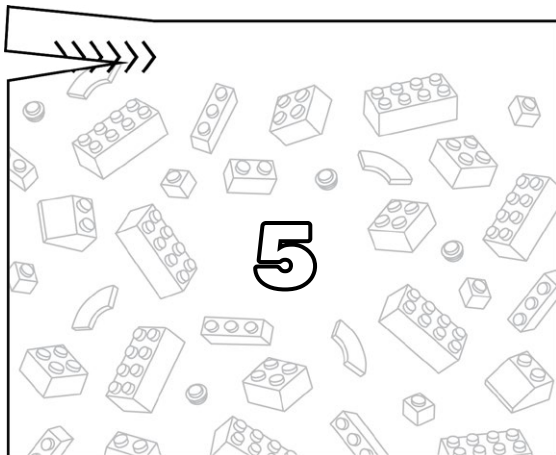
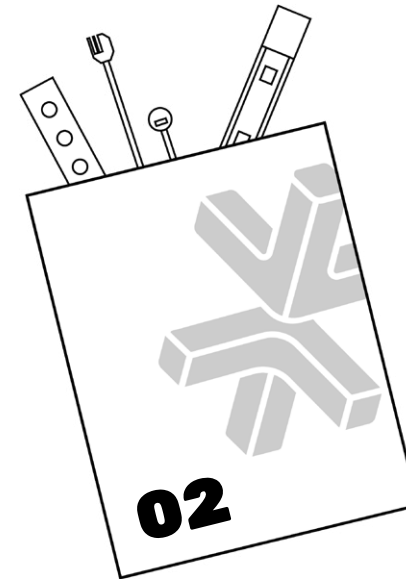
**Open LEGO® Bag 5****Open LMB Bag 02**

# 60

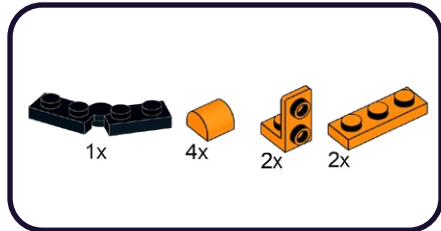

1

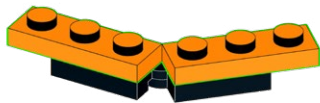

2

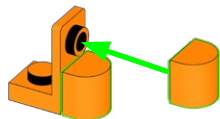

2x

# 61

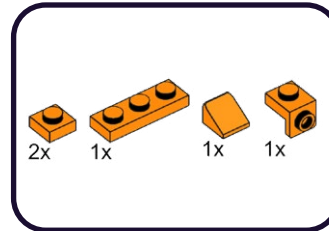

1

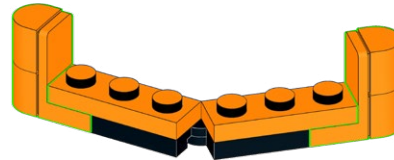

2

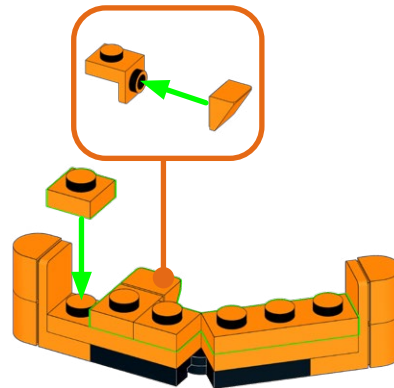

# 62

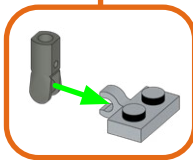
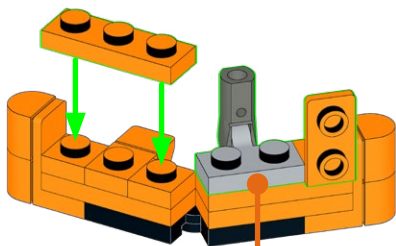
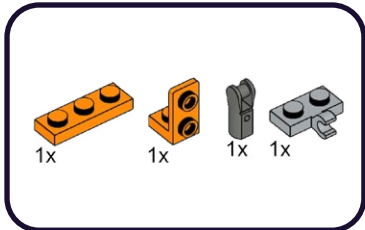

# 63

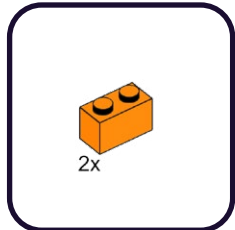

1

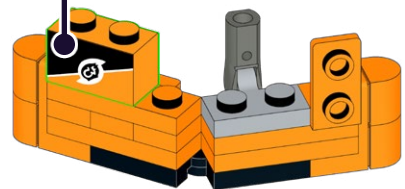

2

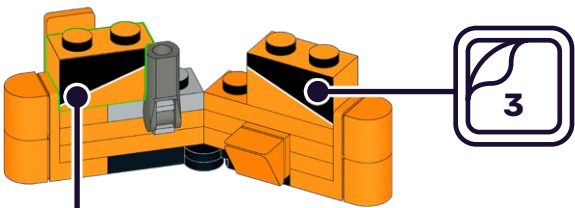



# 64

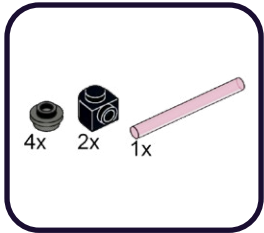

1

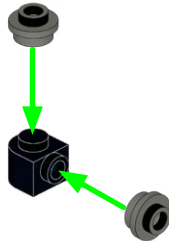

2x

2

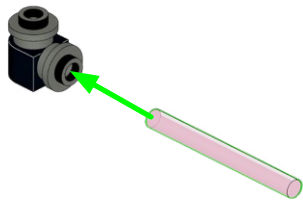

# 65

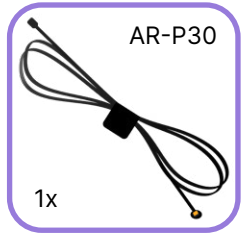

1

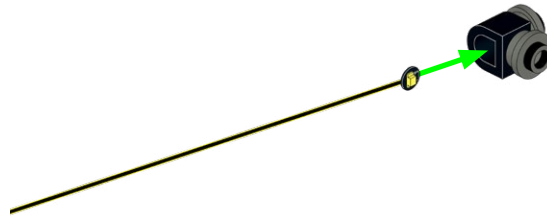

2

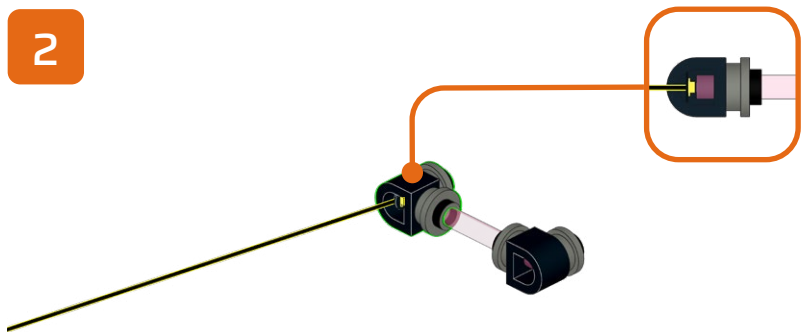

# 66



1

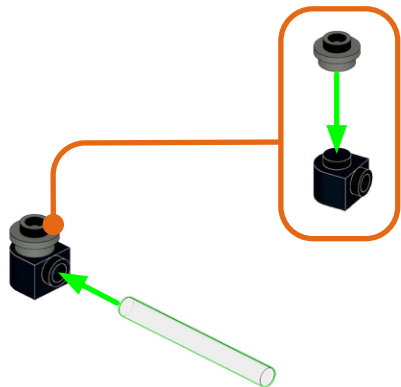

2

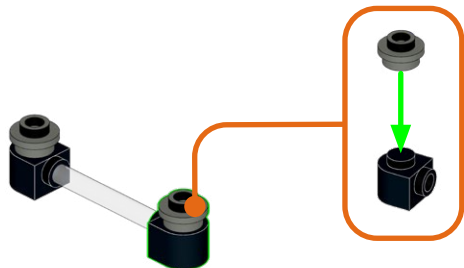

# 67

1

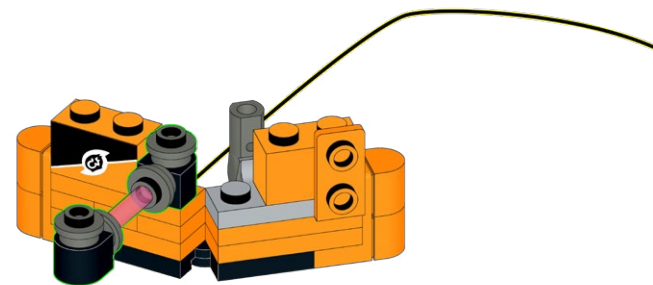

2

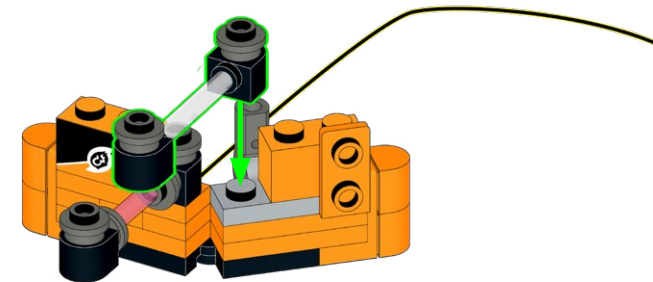

# 68

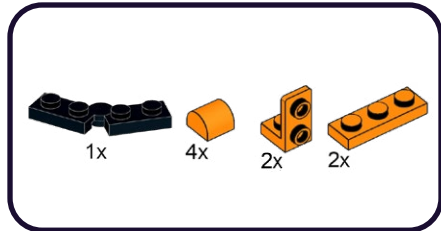

1



2

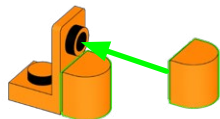

2x

# 69

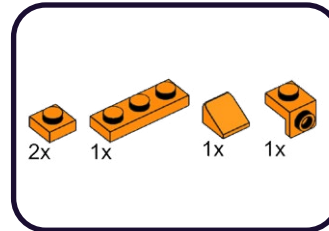

1

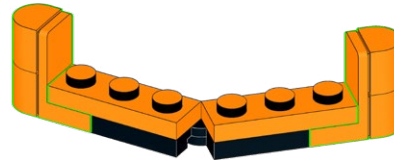

2

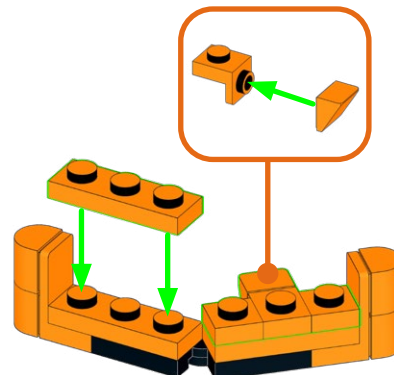



71

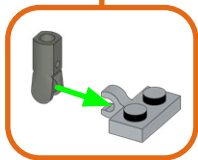
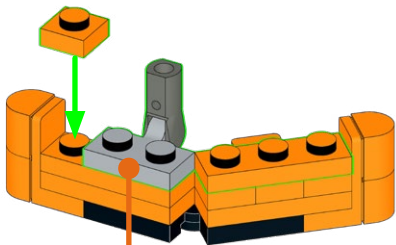
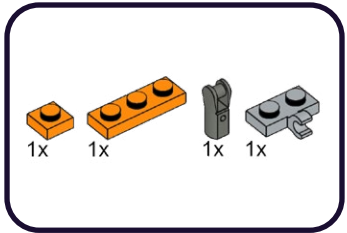

70

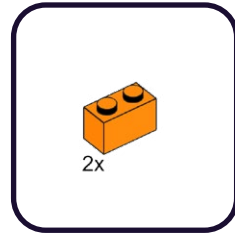

1

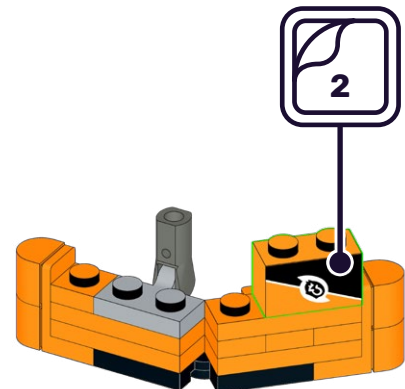

2

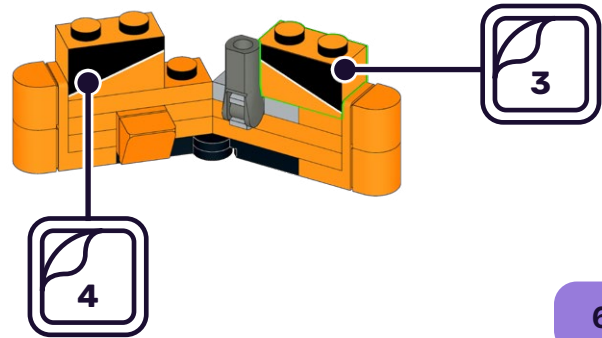

72

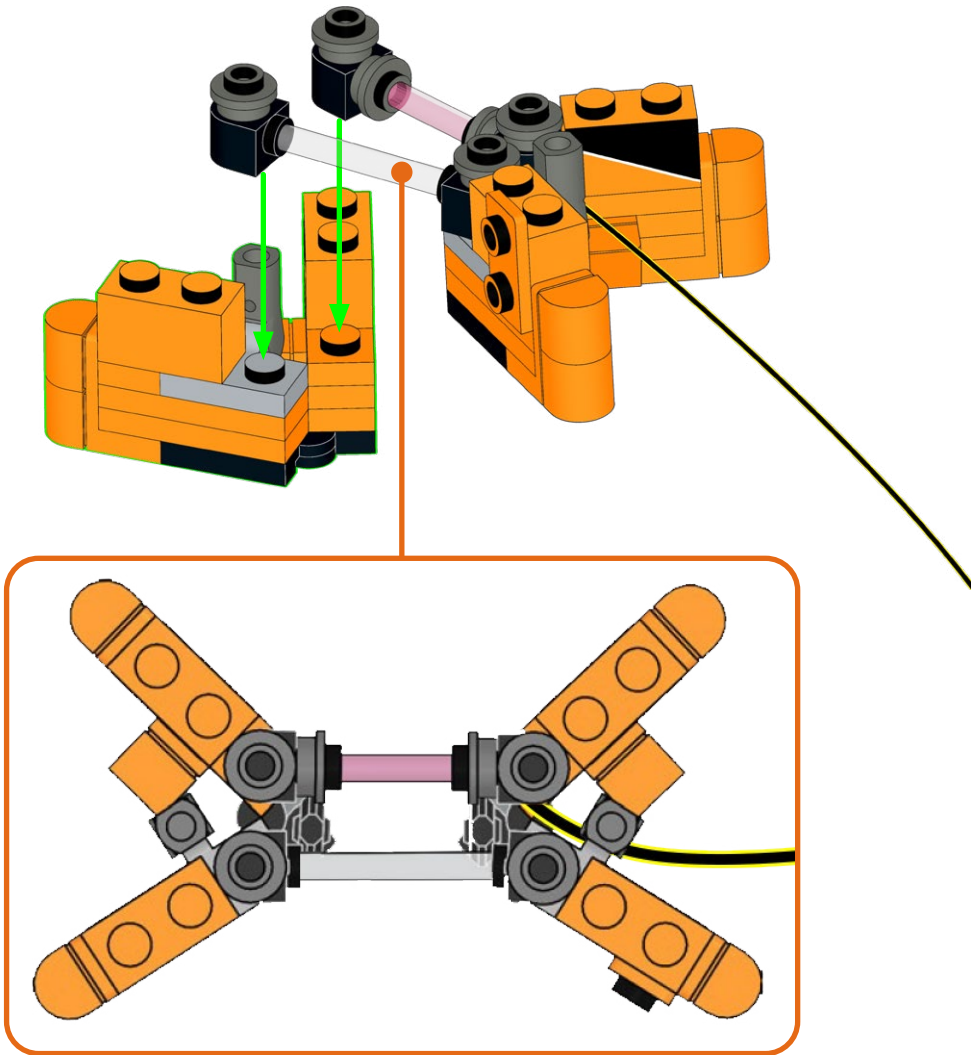

**73**

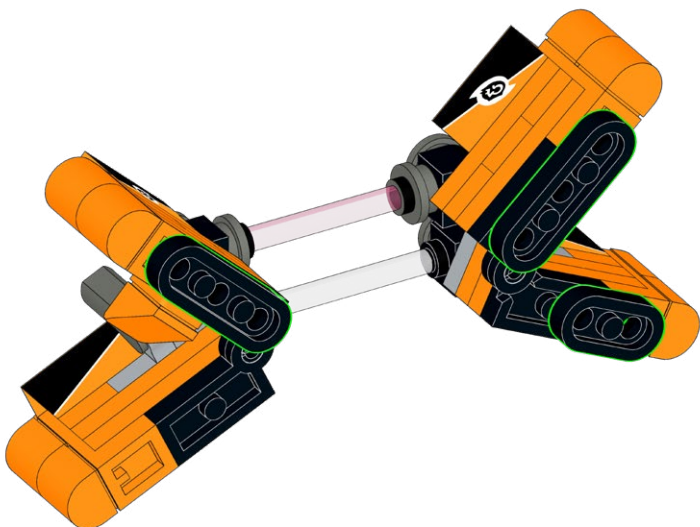
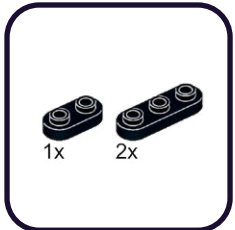

**74**

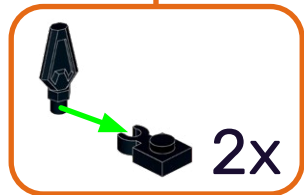
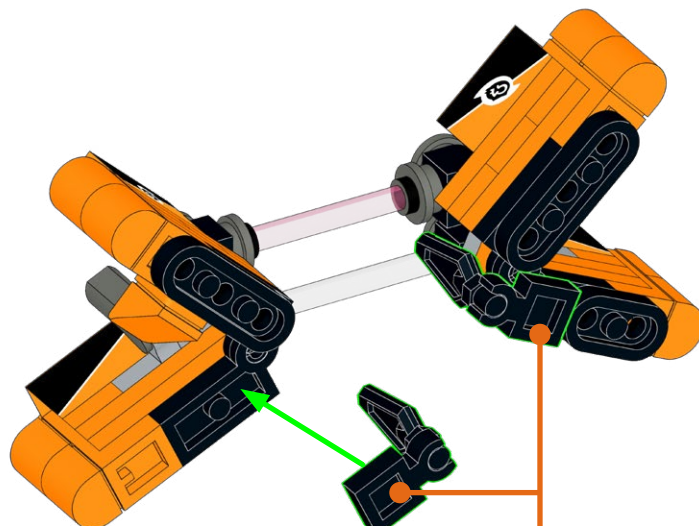
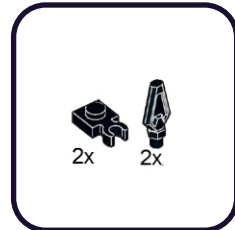



**75**

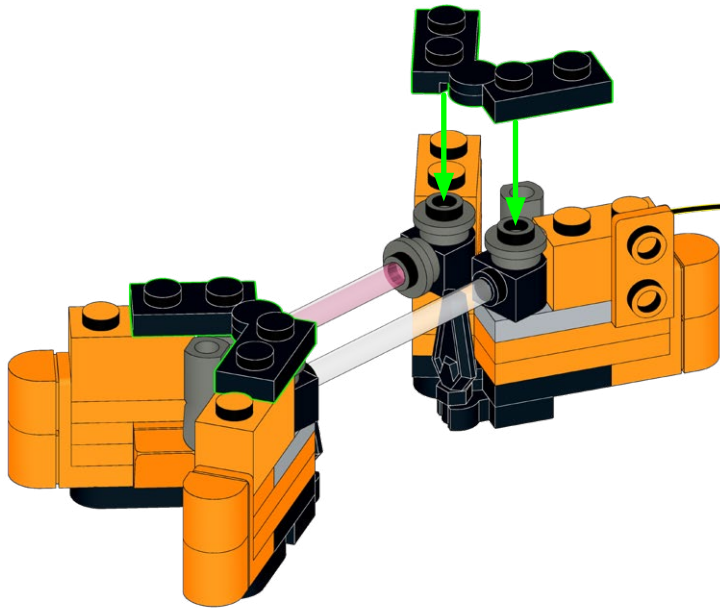

**76**

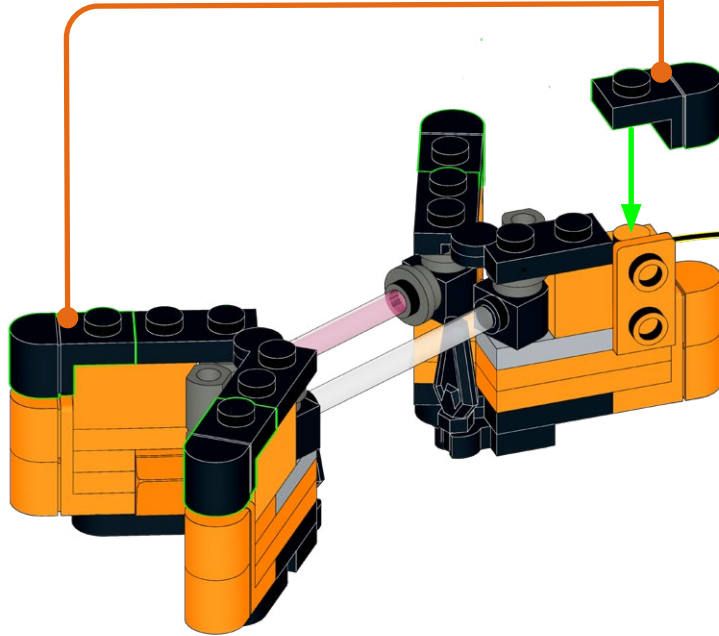
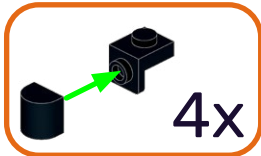
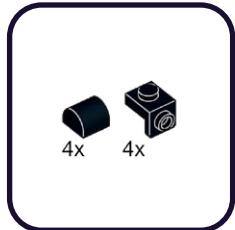

77

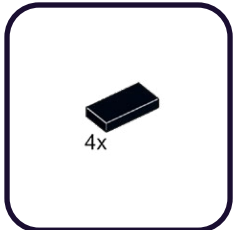

78

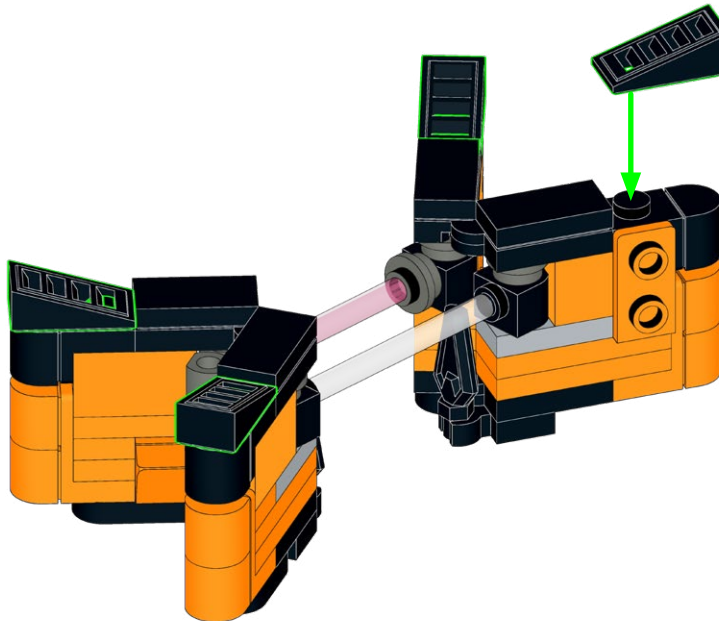
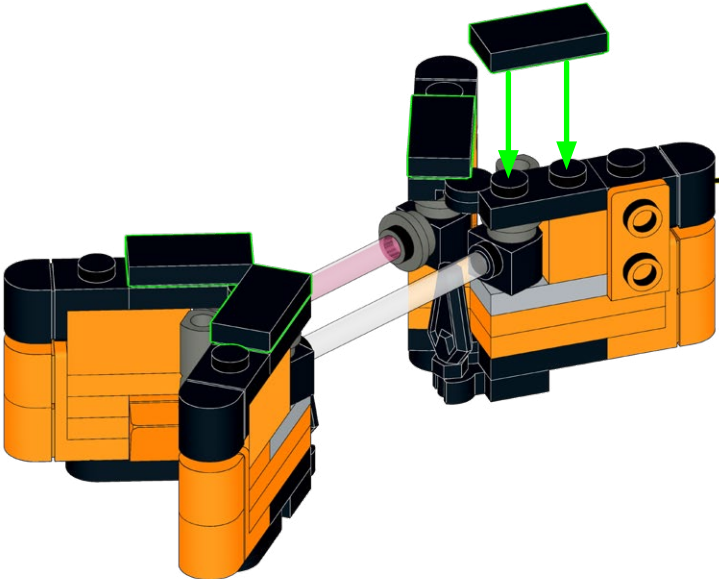
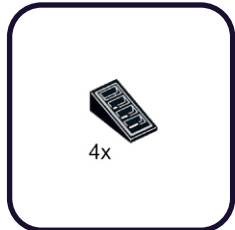

# 79

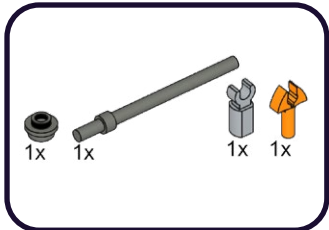

1

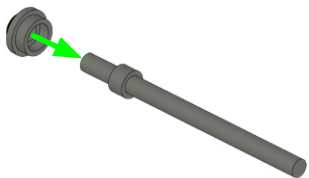

2

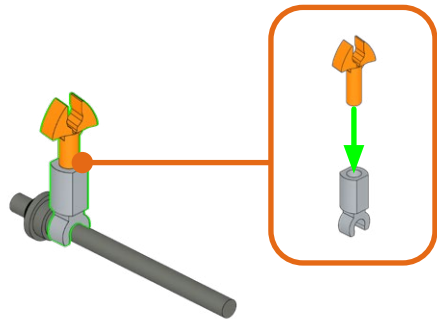

# 80

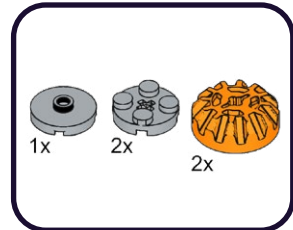

1

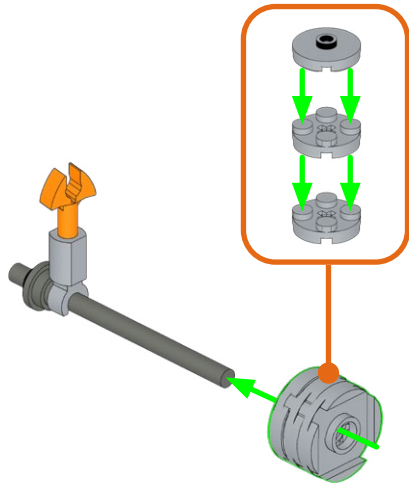

2

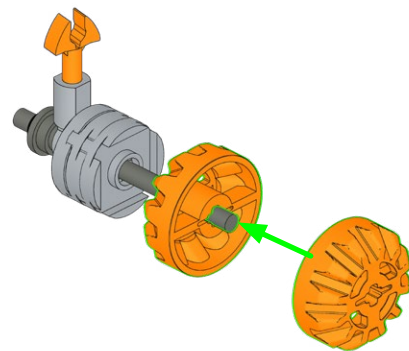



81

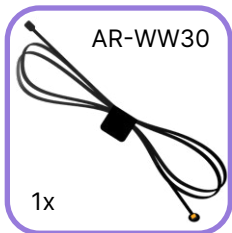
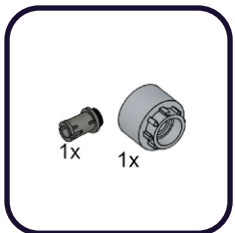

1

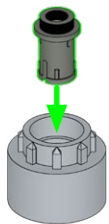

2

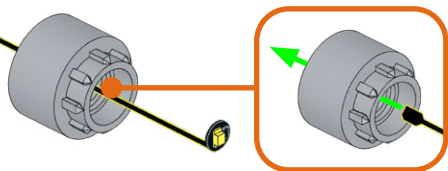

82

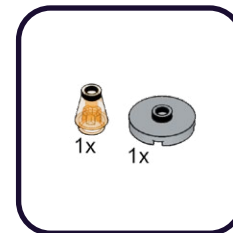

1

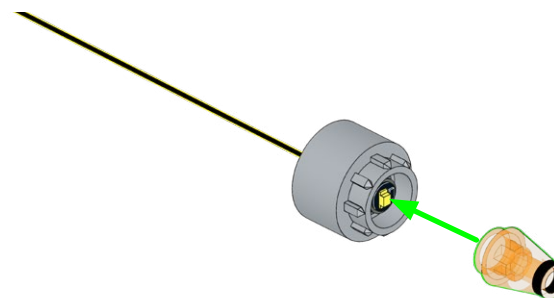

2

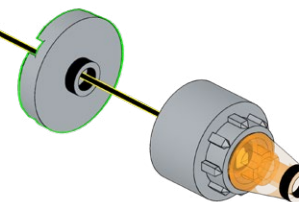

83

84

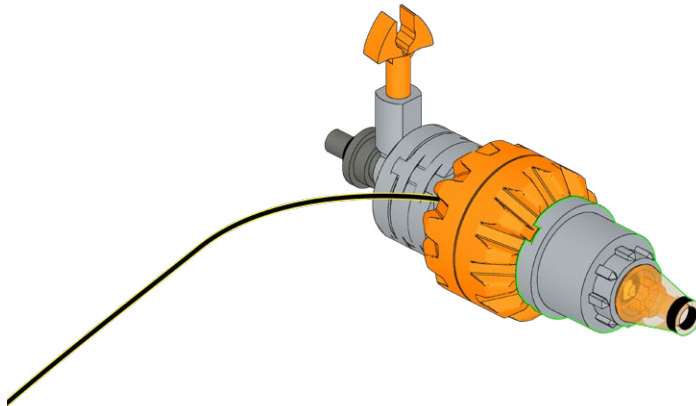
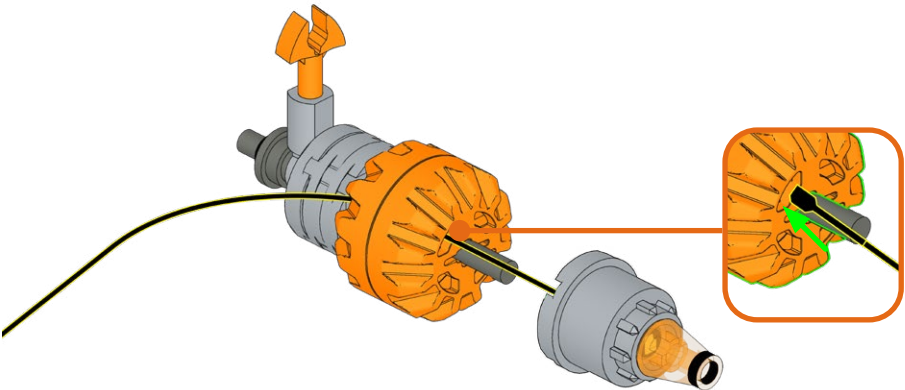

2x

85

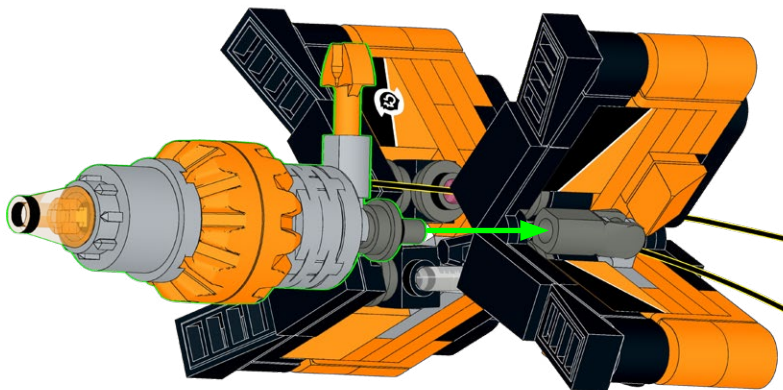

86

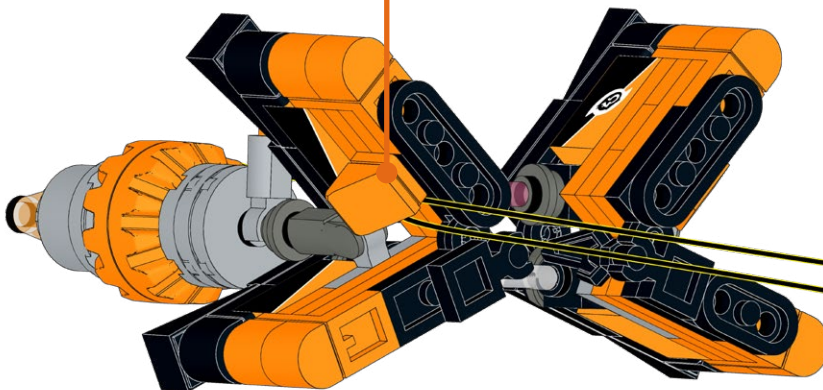
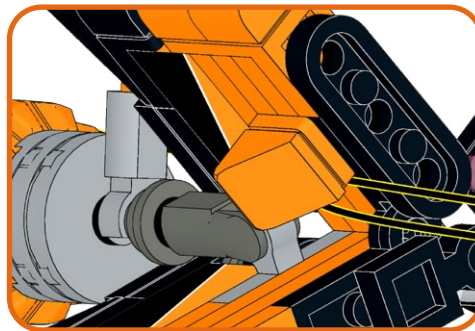



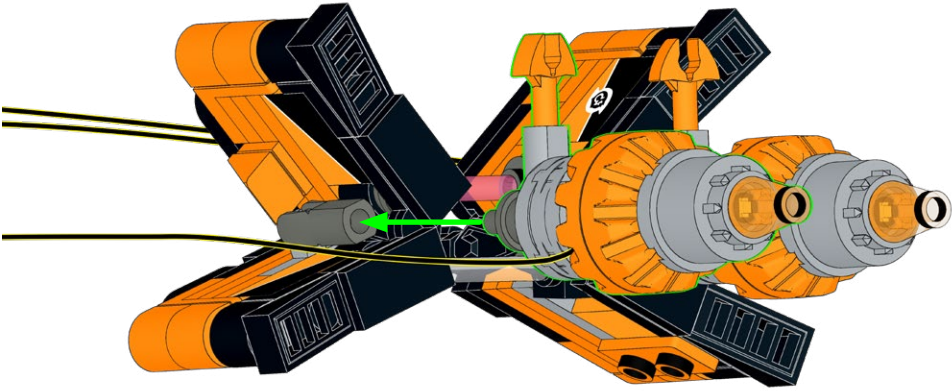

87

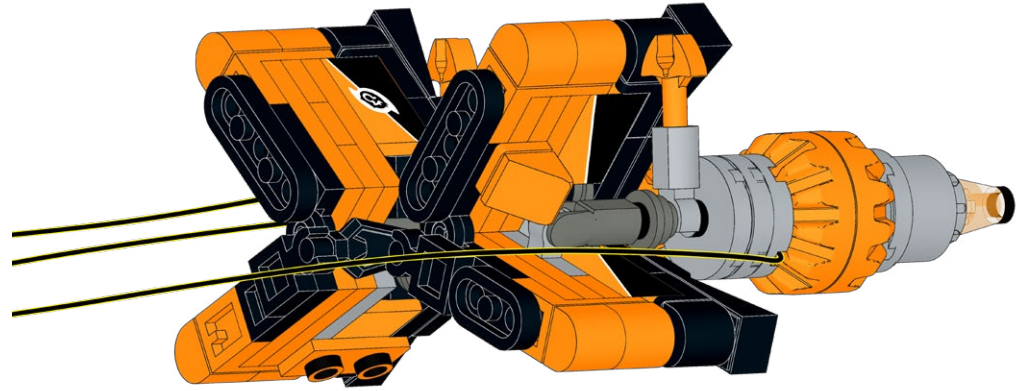

88



89

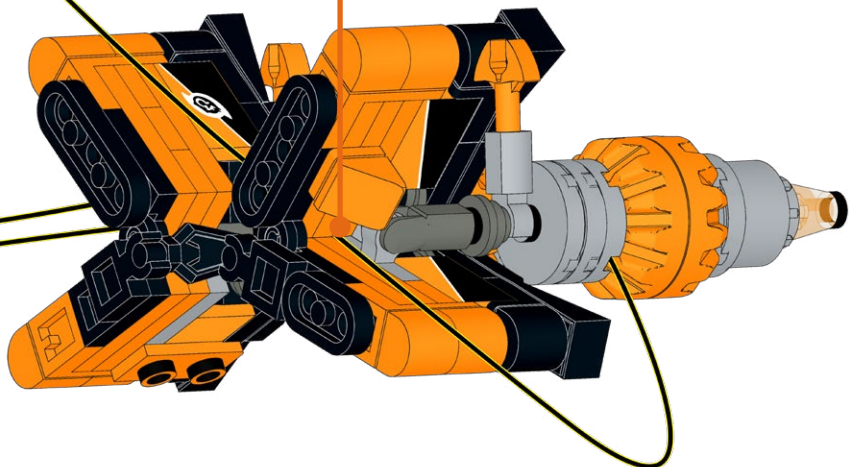
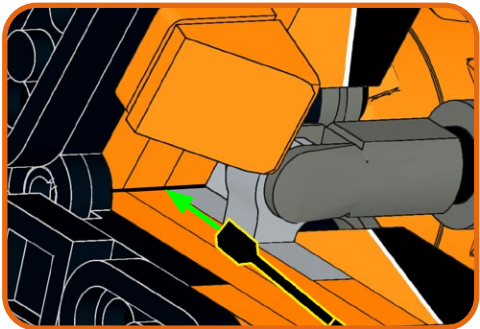

90

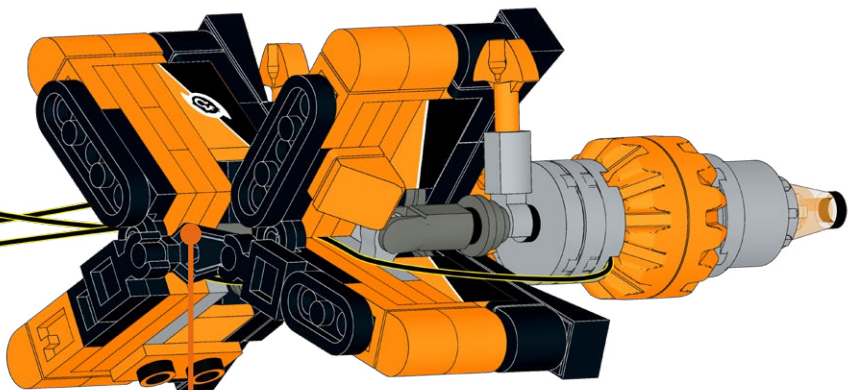
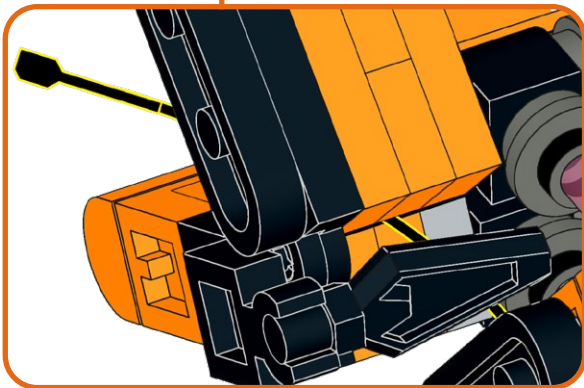

91

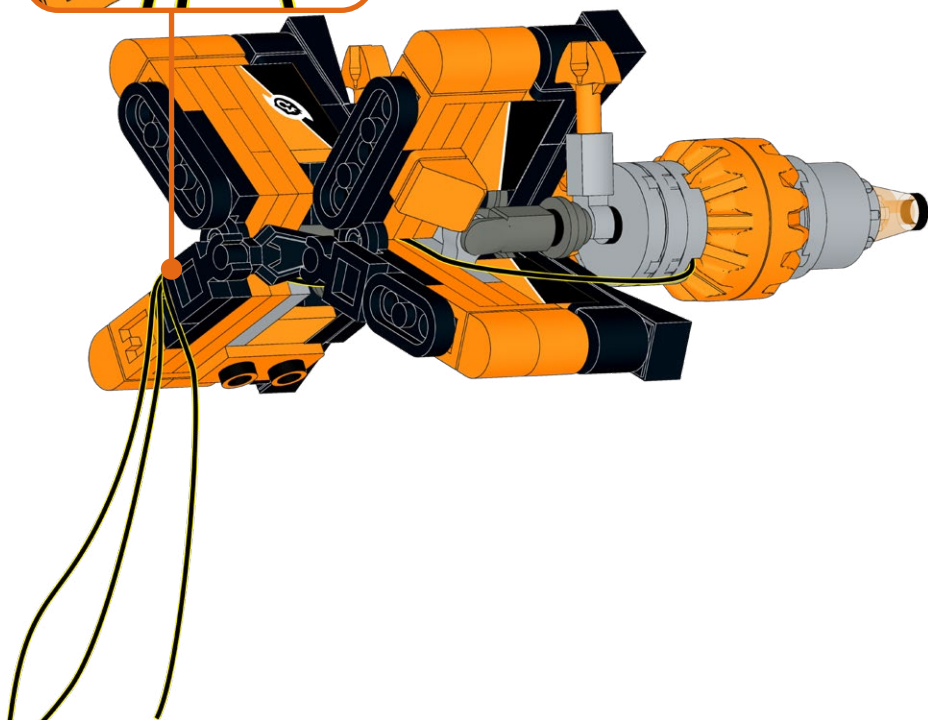
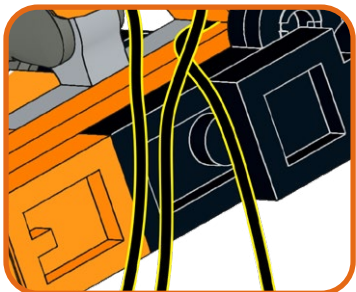

92

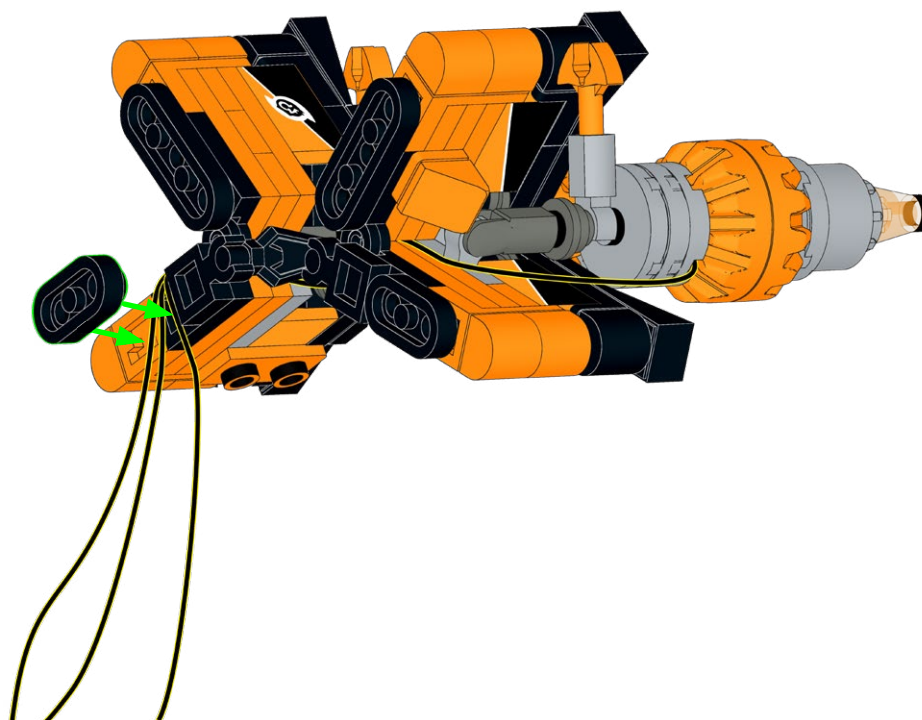
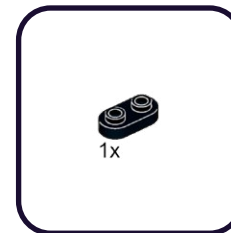



93

4x

94

1x

2x

1x

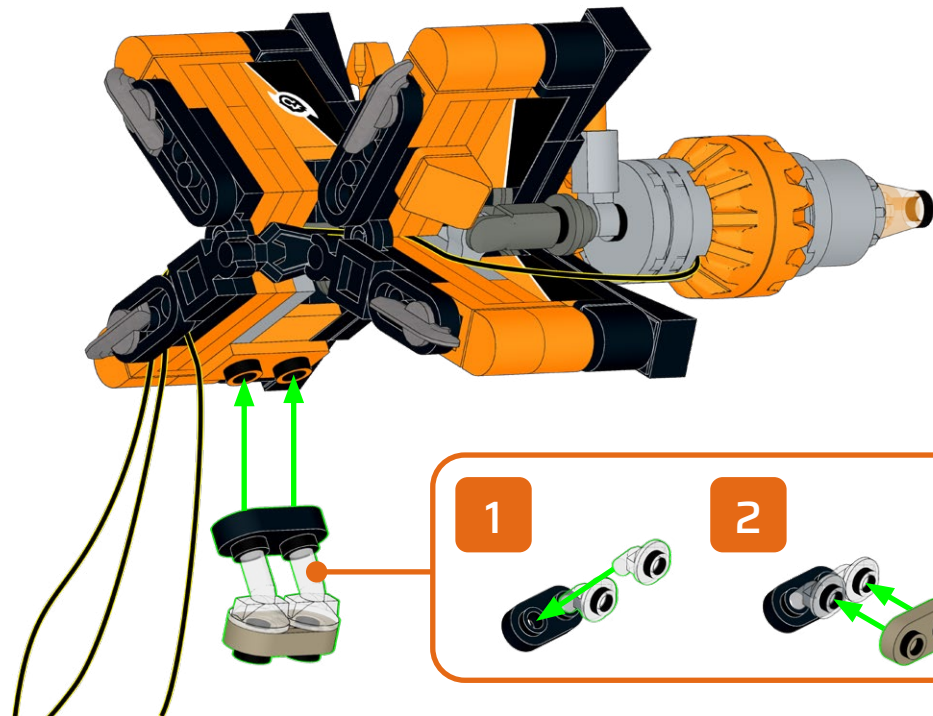
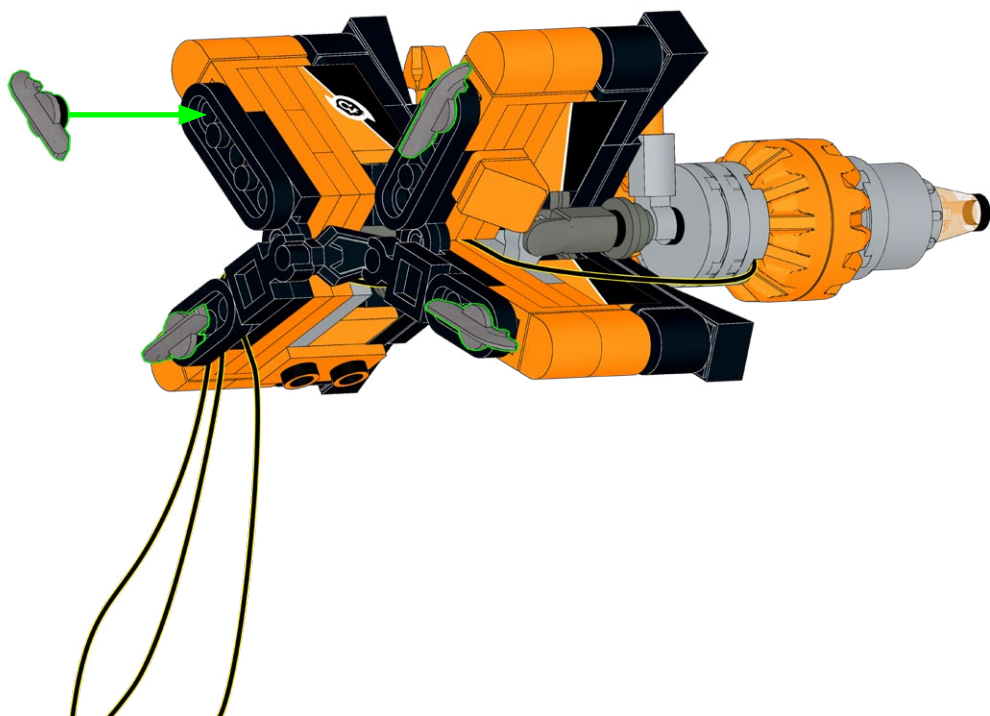

# 95



1

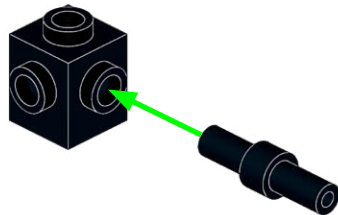

2

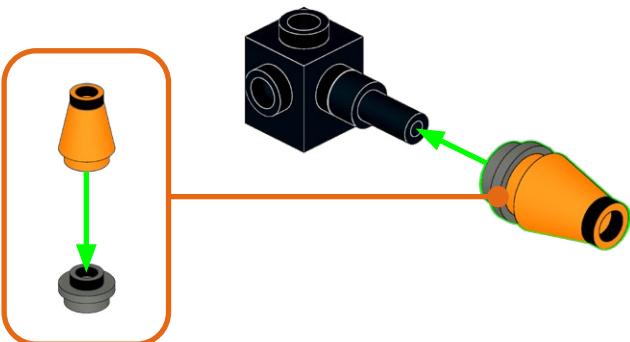

# 96

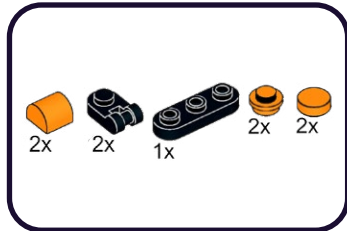

1

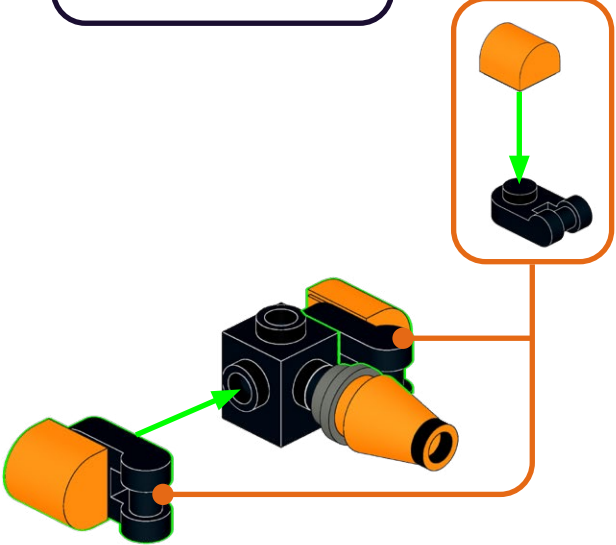

2

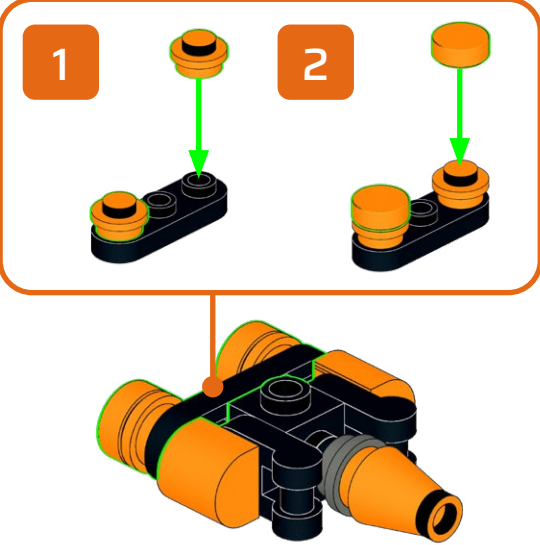

97

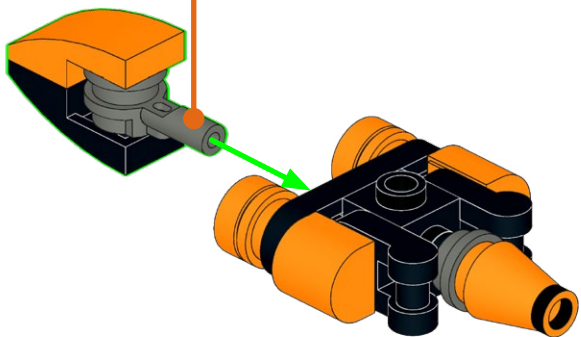
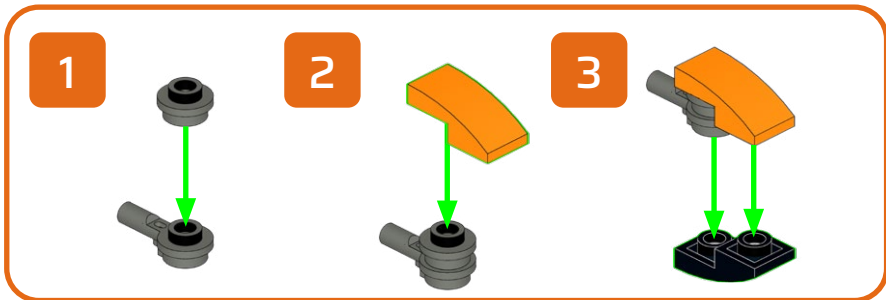
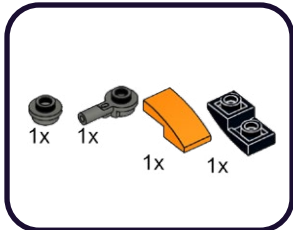

98

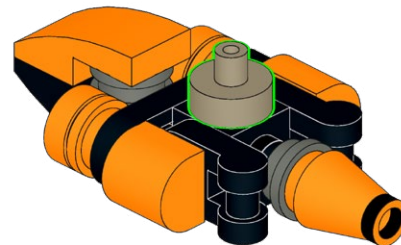
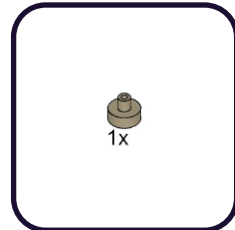



99

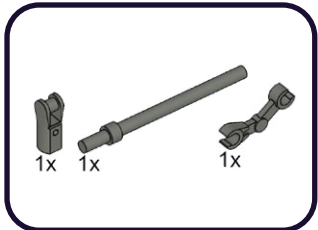

1

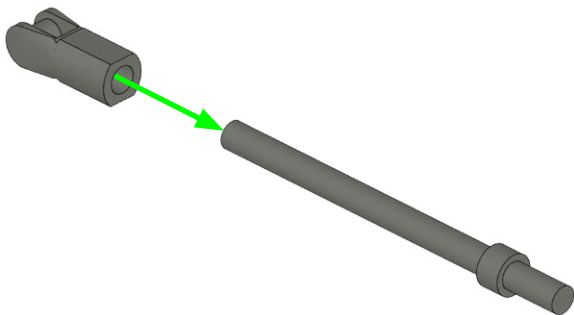

2

2x

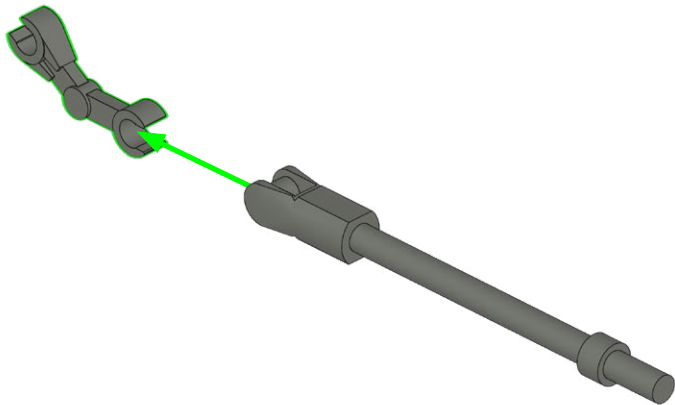

100

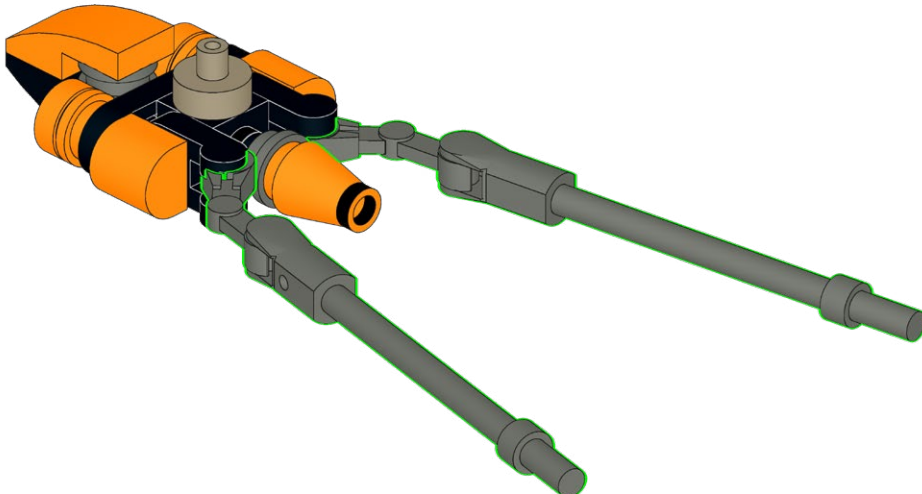

101

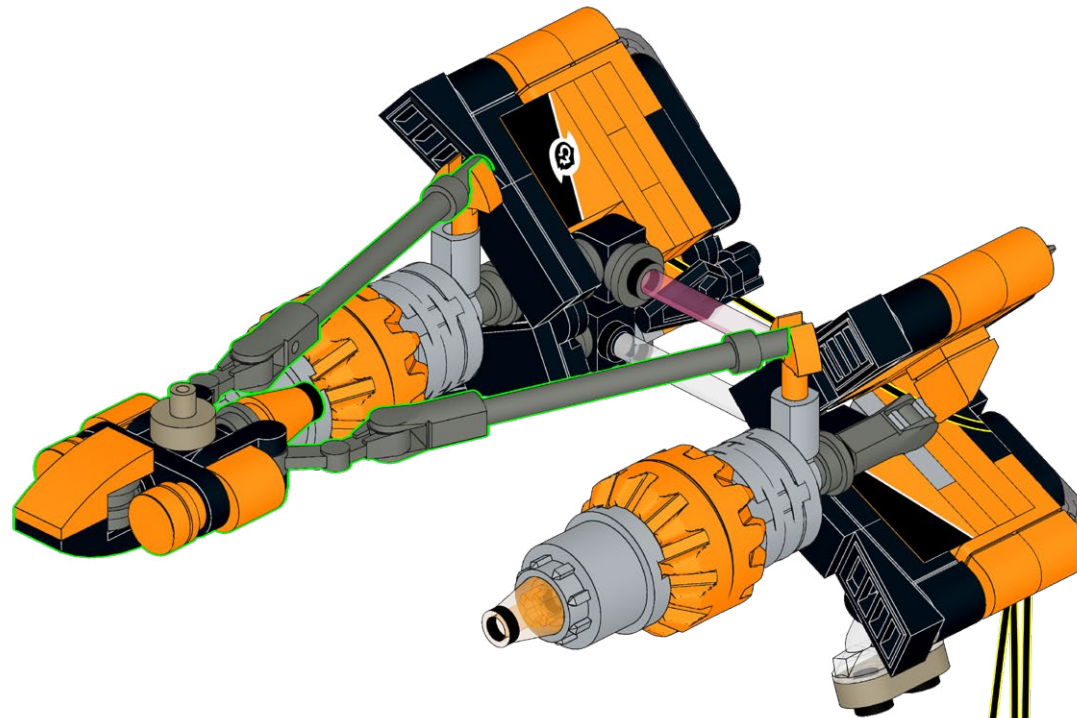

102

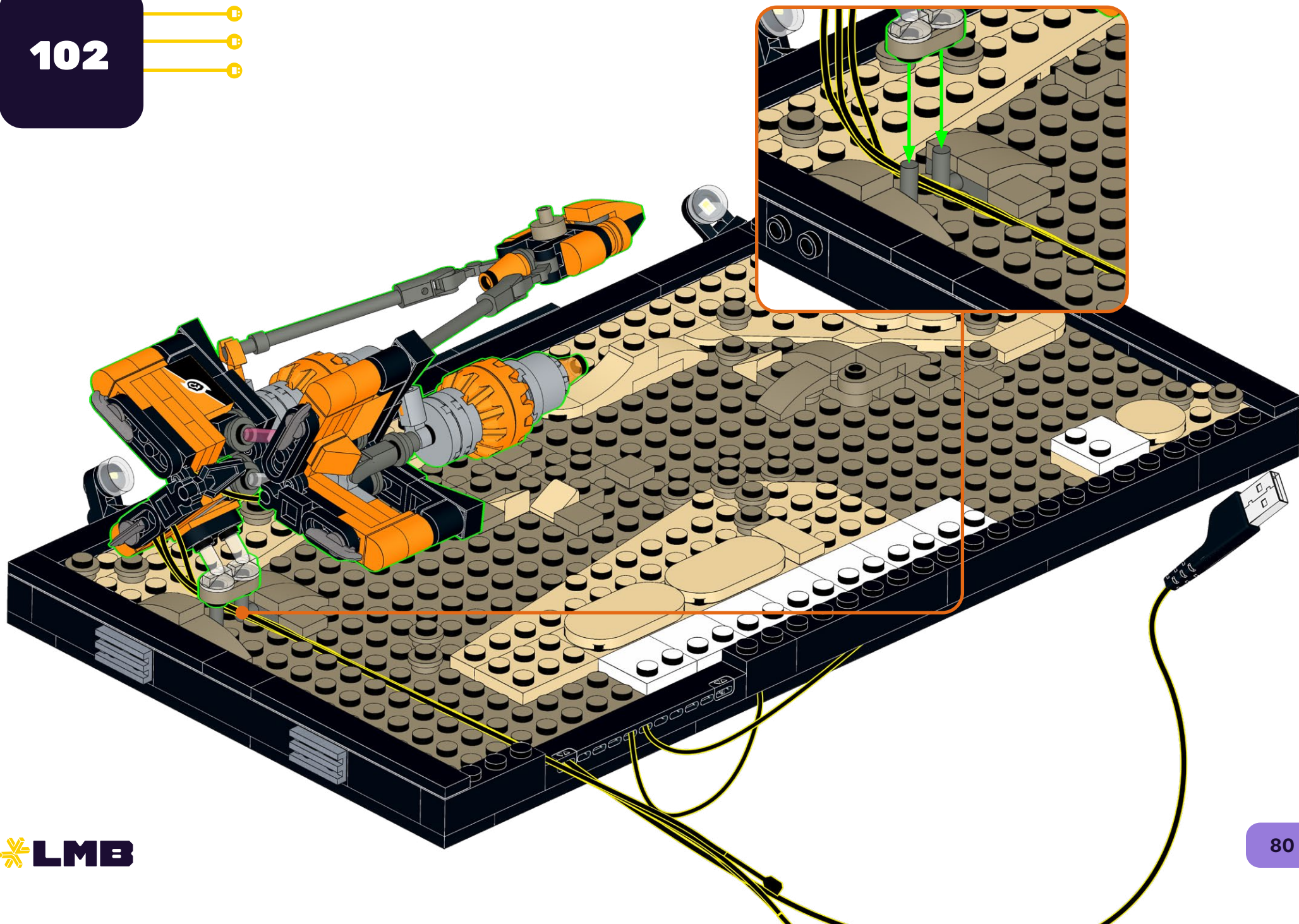



103

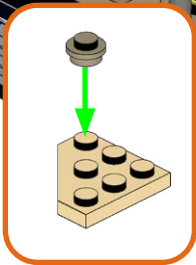
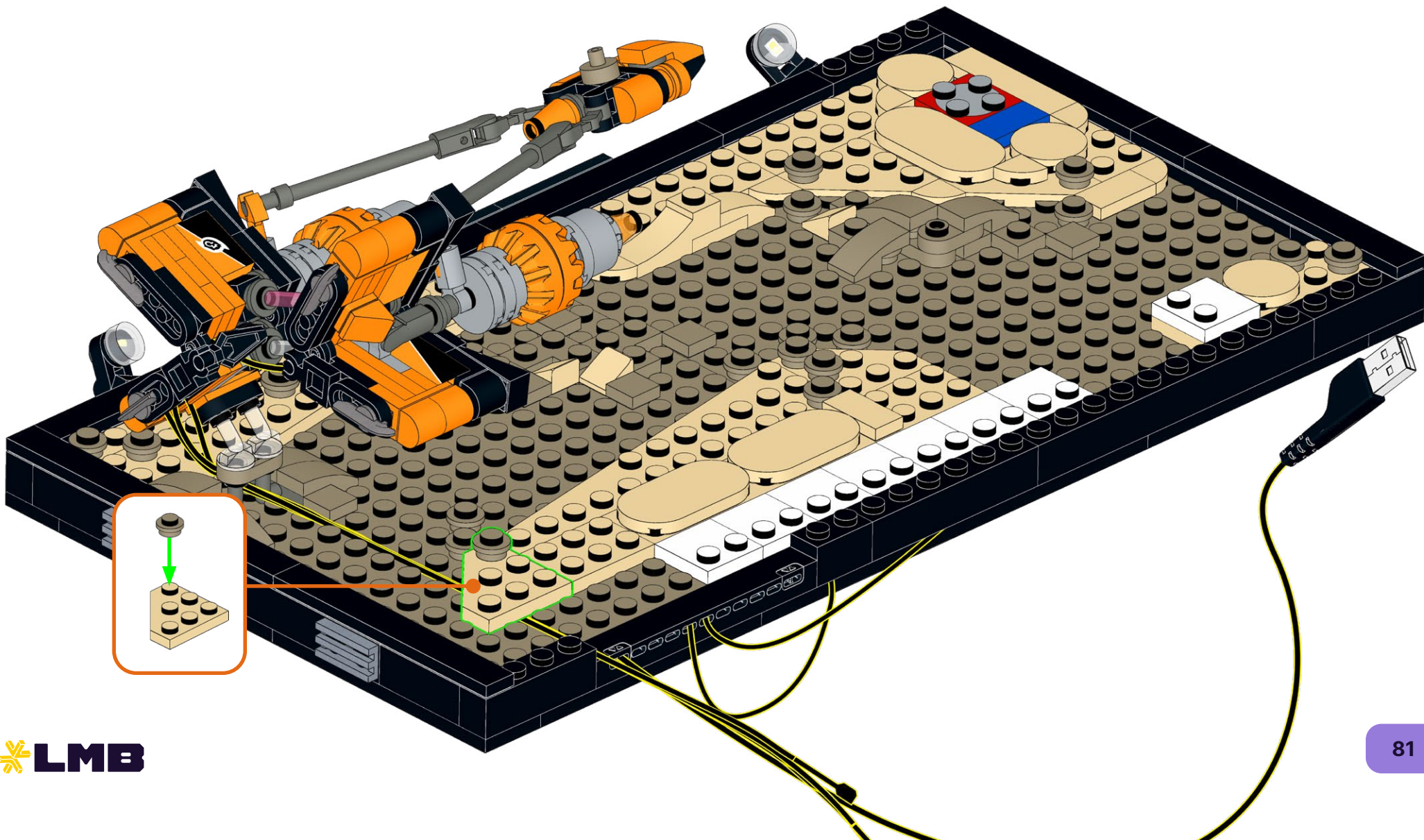
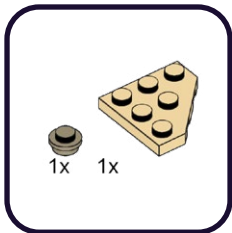



# 104

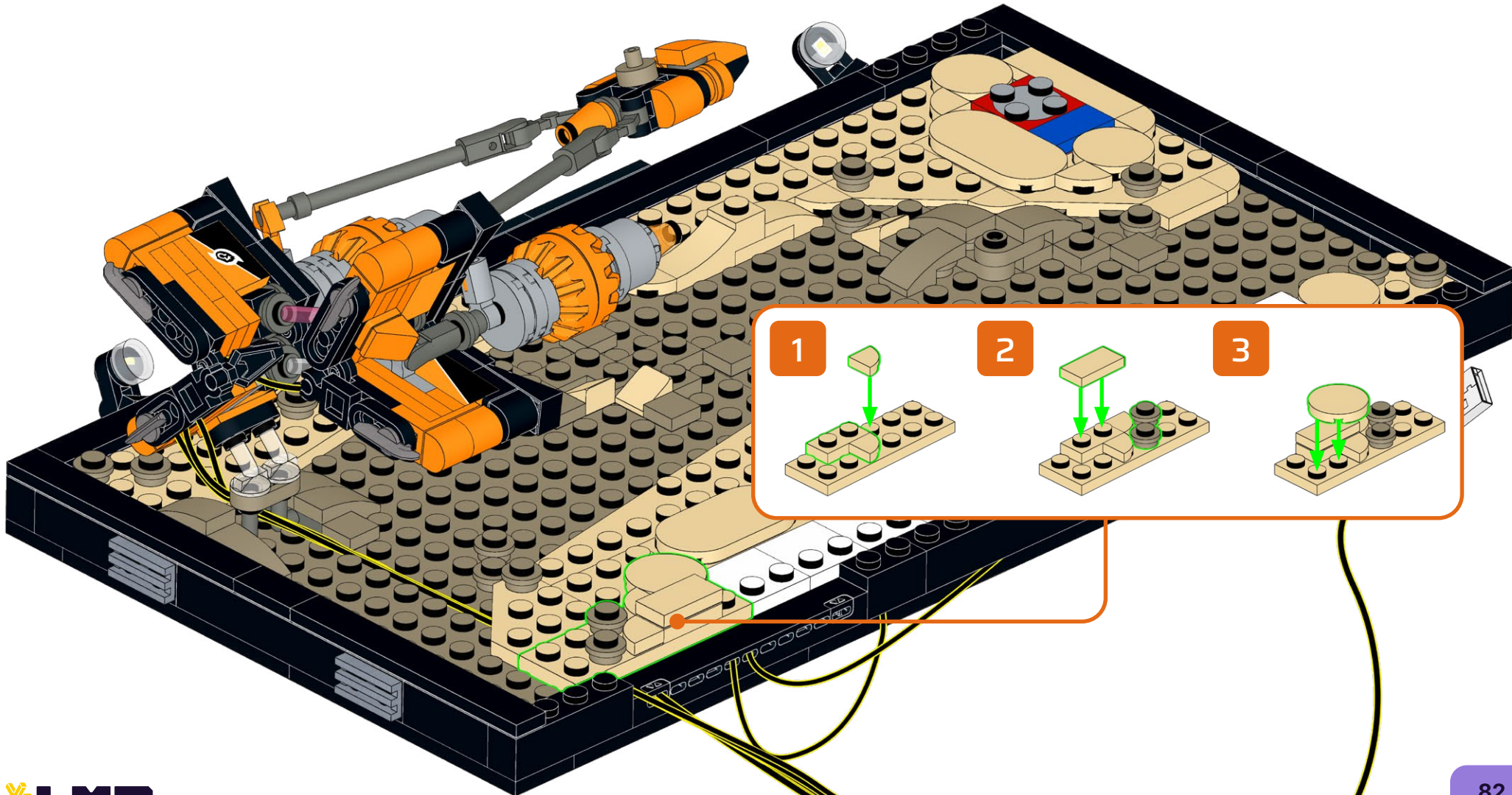
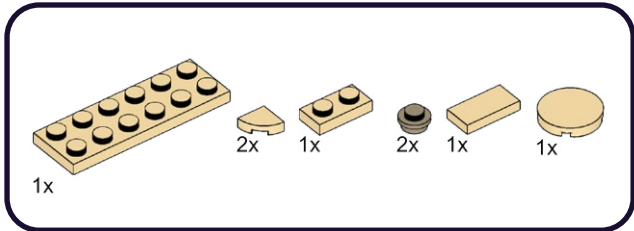



105

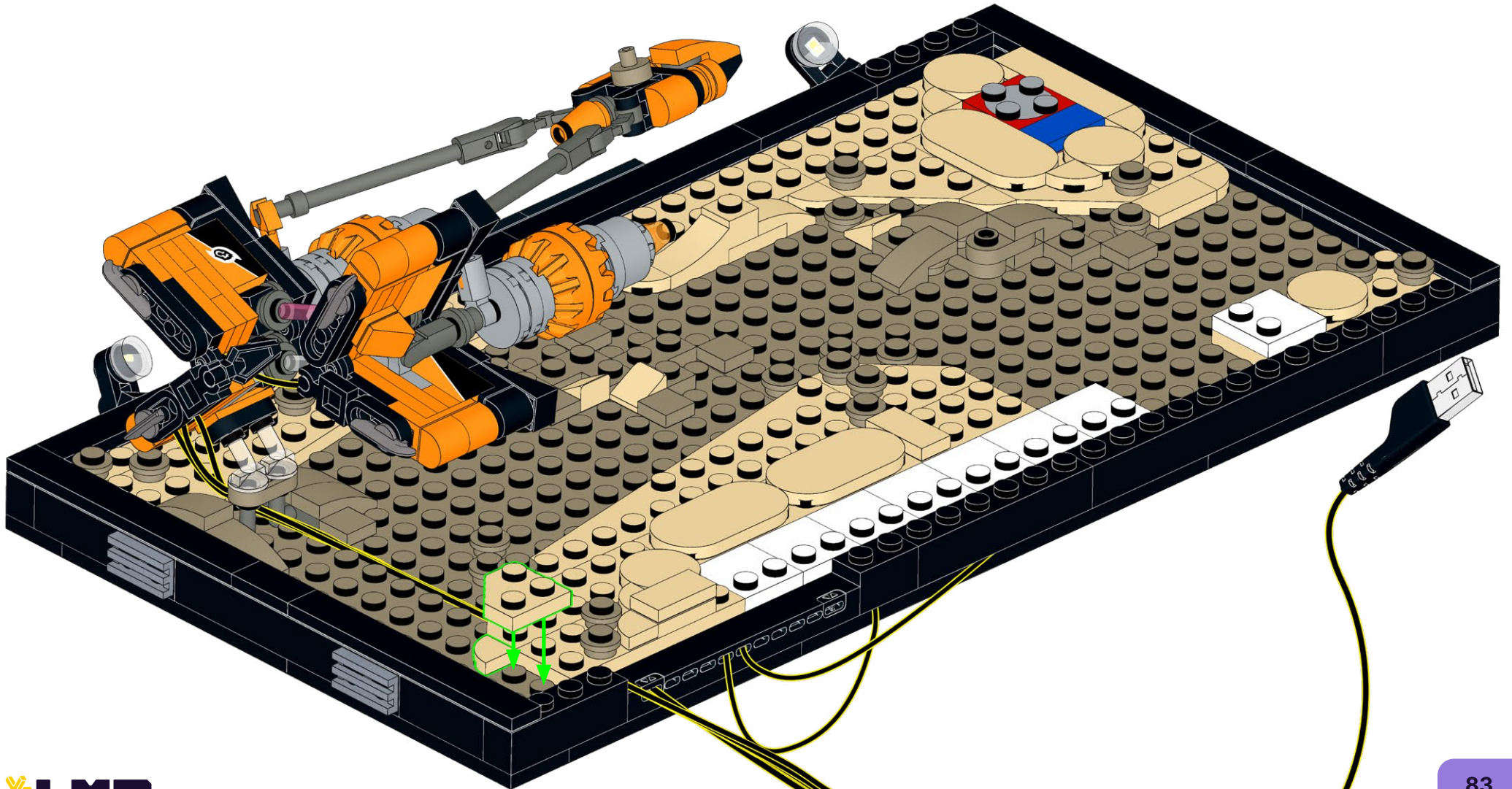
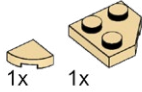



106

1x

1x

1x

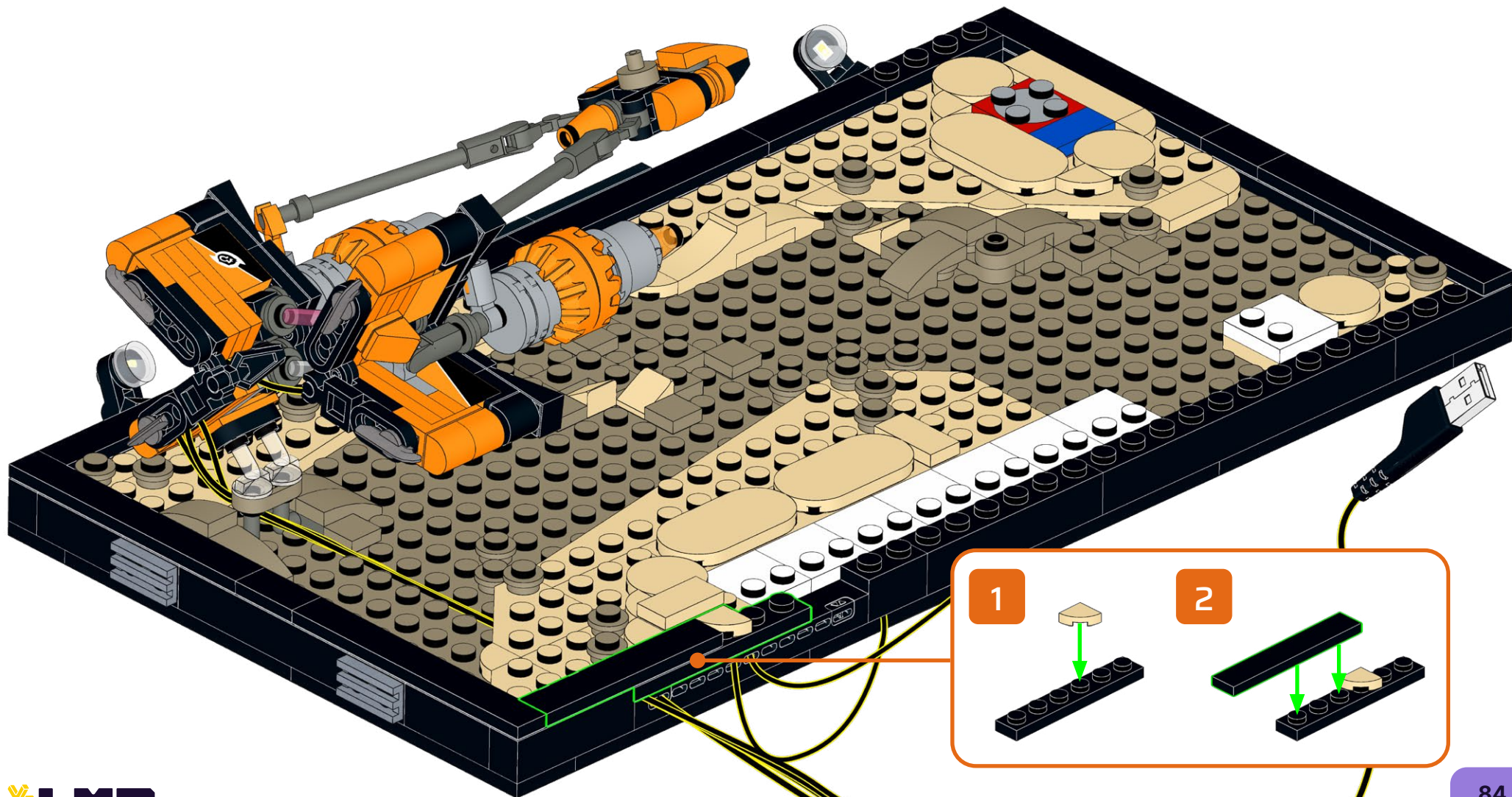

1

2

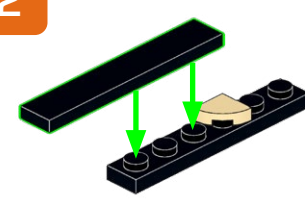
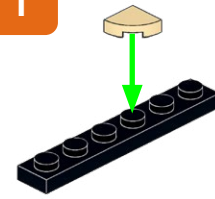



107

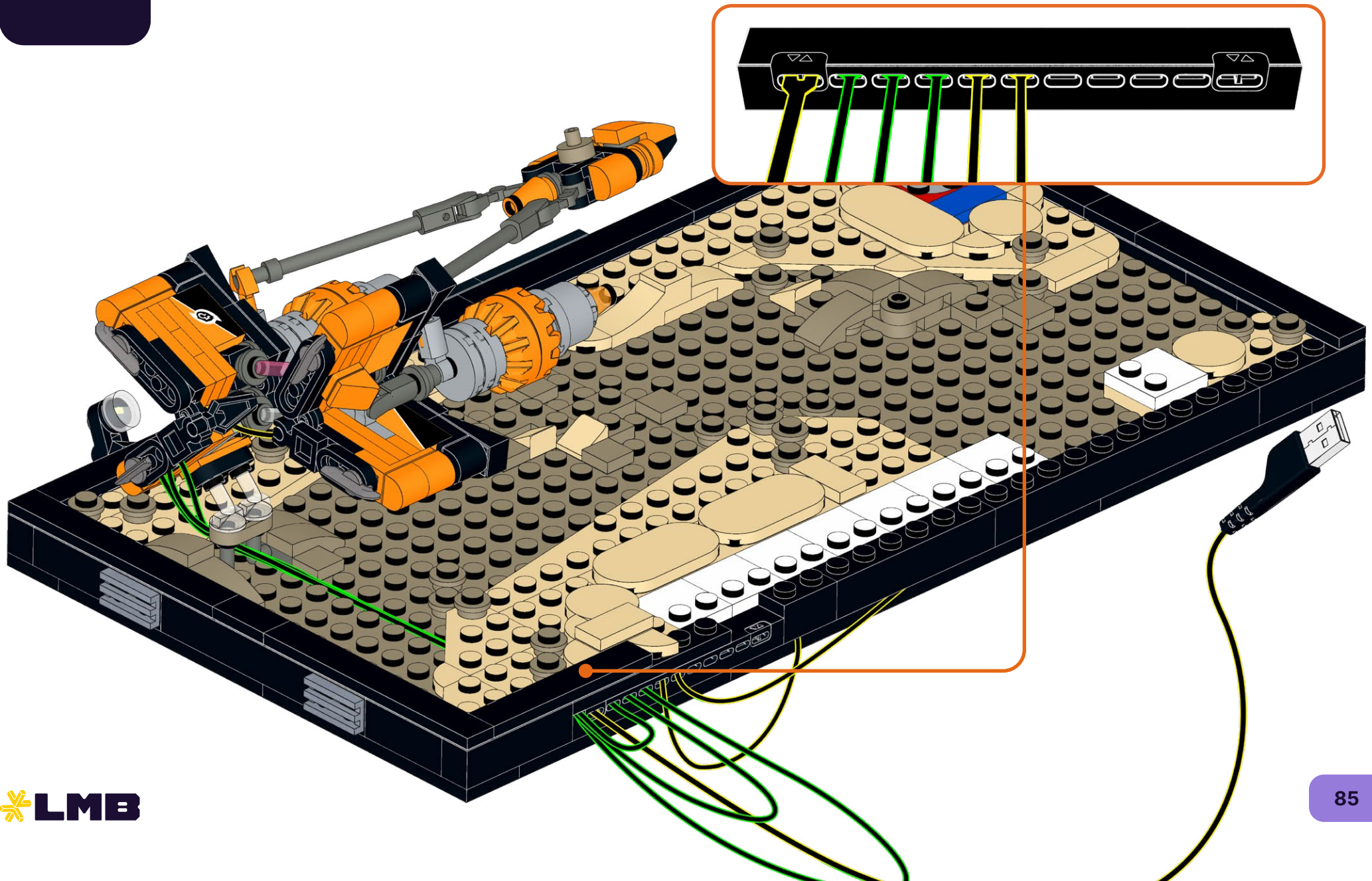

**HOLD UP!**

You might notice some bags are out of order, as well as left over pieces, but that's ok! We're changing the way you build LEGO!

**HALTEN!**

Möglicherweise stellen Sie fest, dass einige Beutel nicht in Ordnung sind und auch Teile übrig bleiben, aber das ist in Ordnung! Wir verändern die Art und Weise, wie Sie LEGO bauen!

**TENIR BON!**

Vous remarquerez peut-être que certains sacs sont en panne, ainsi que des morceaux restants, mais ce n'est pas grave ! Nous changeons la façon dont vous construisez LEGO !

**SOSTENERE!**

Potresti notare che alcune borse sono fuori uso, così come alcuni pezzi avanzati, ma va bene! Stiamo cambiando il modo in cui costruisci i LEGO!

**¡SOSTENER!**

Puede que notes que algunas bolsas están fuera de orden, así como piezas sobrantes, ¡pero está bien! ¡Estamos cambiando la forma de construir LEGO!

**耽误!**

您可能会注意到有些袋子坏了, 还有剩余的碎片, 但这没关系! 我们正在改变您搭建乐高的方式!

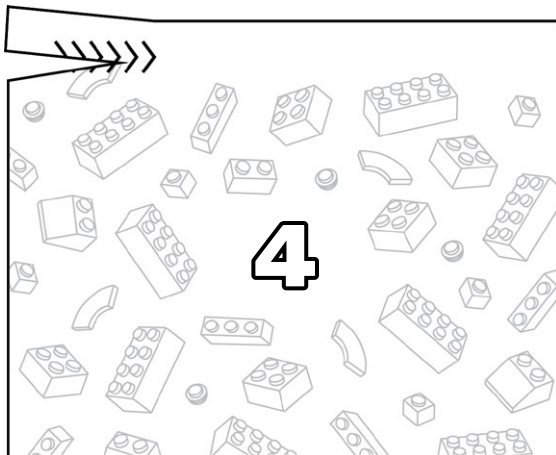
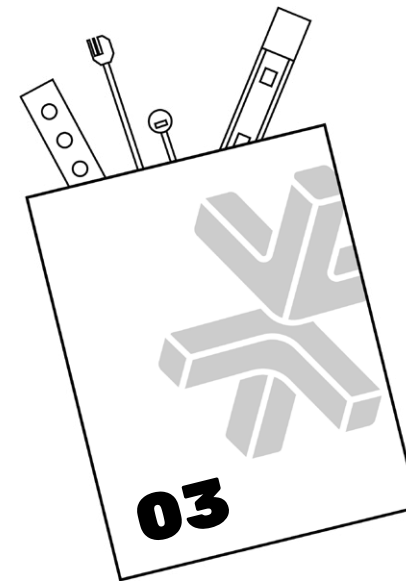
**Open LEGO® Bag 4****Open LMB Bag 03**



# 108

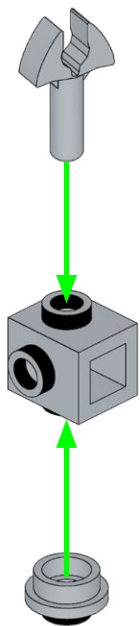
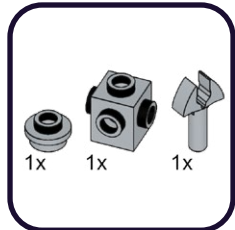

# 109

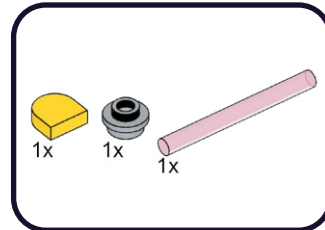

1

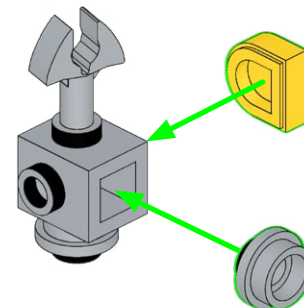

2

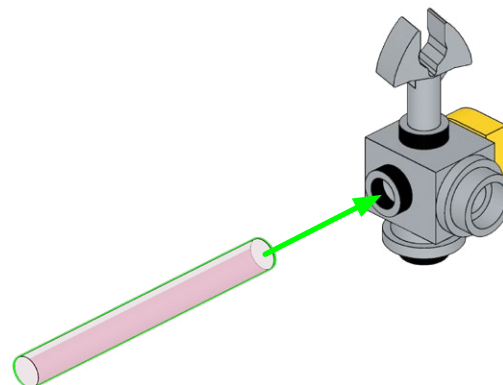

**110**

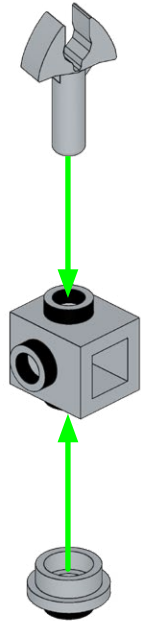
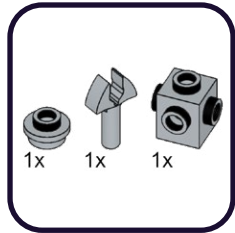

**111**

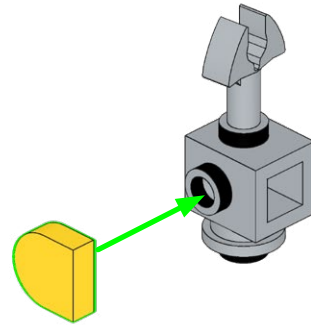
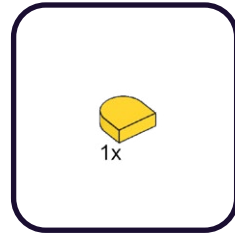

**112**

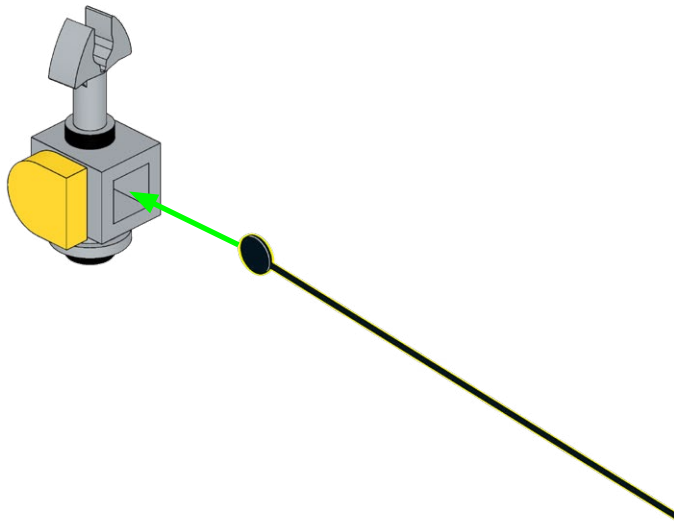
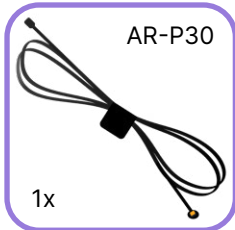

**113**

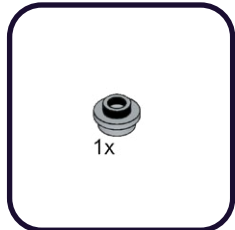

**1**

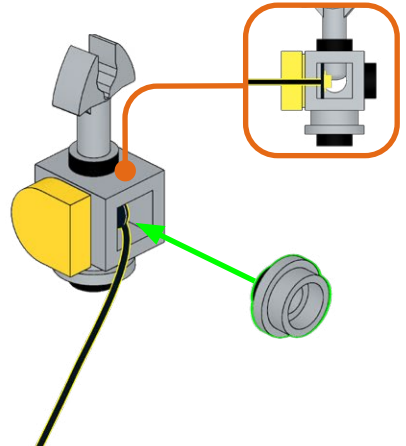

**2**

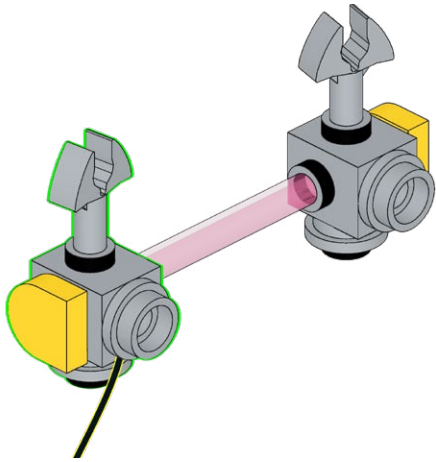



114

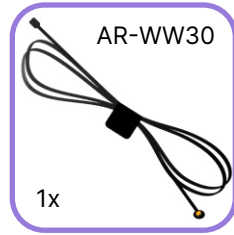
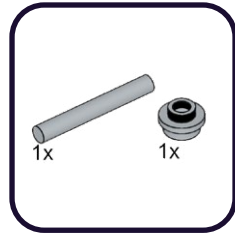

1

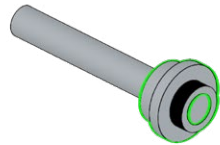

2

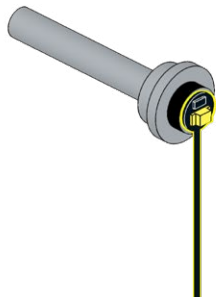

115

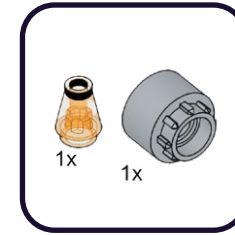

1

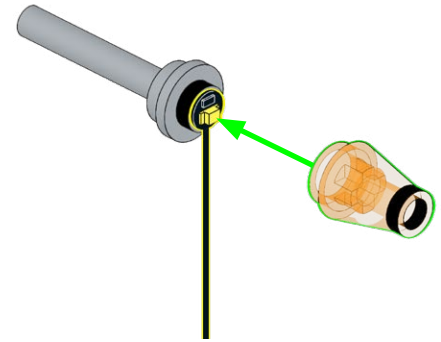

2

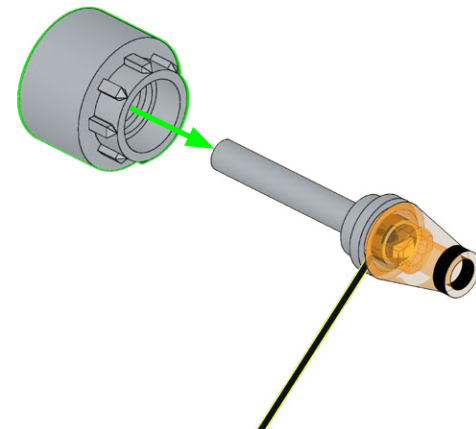

**116**



**1**

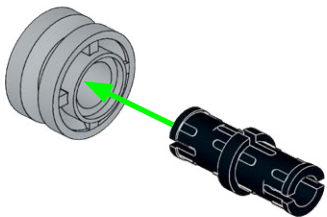

**2**

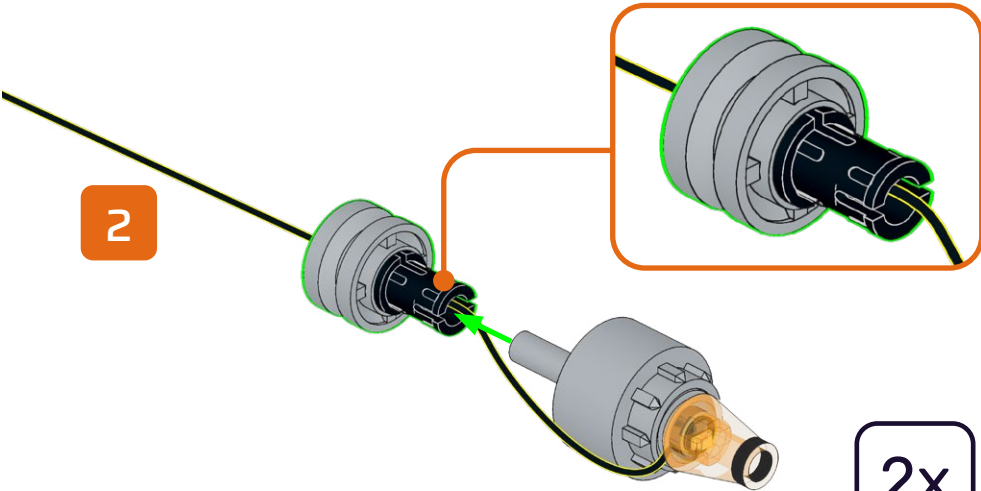

**2x**

**117**

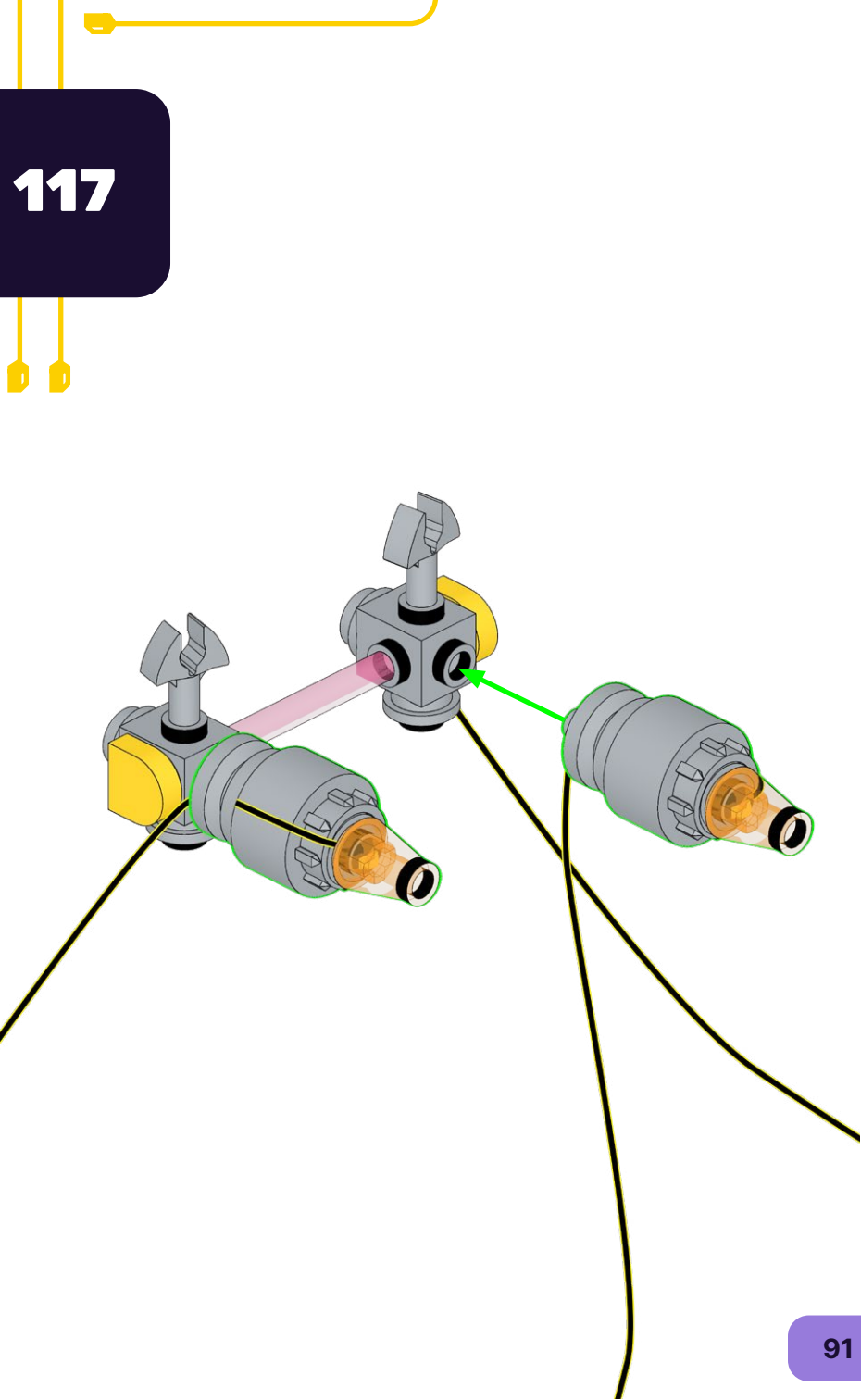

# 118

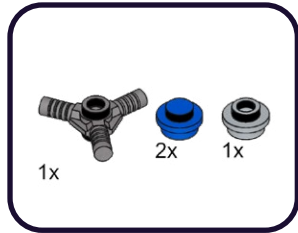

1

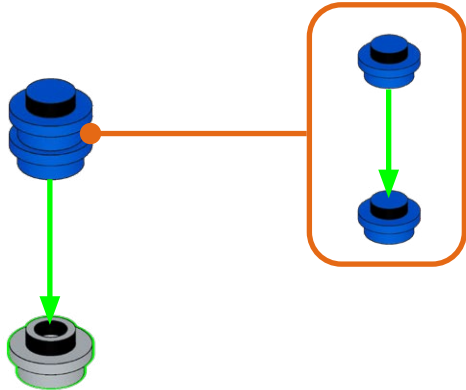

2

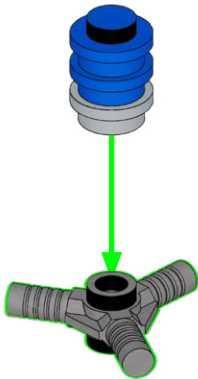

# 119

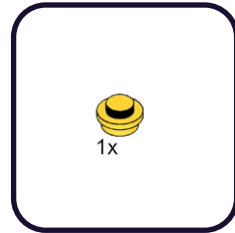

1

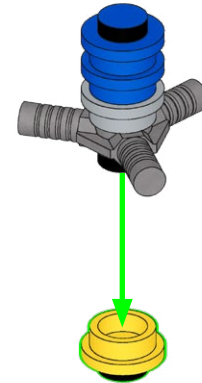

2x

2

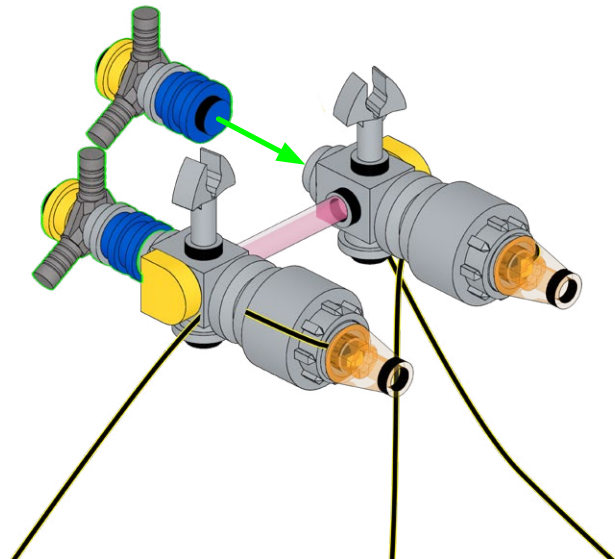



# 120

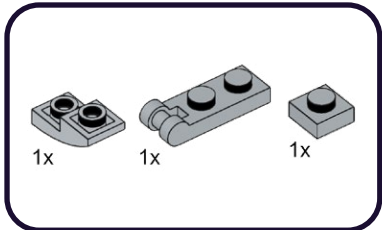

1

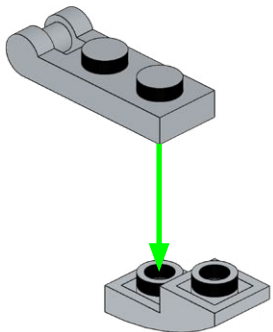

2

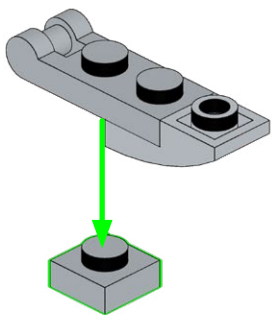

# 121

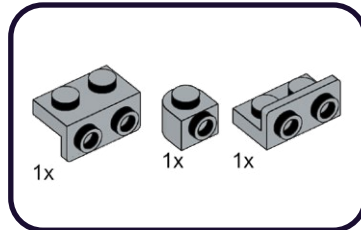

1

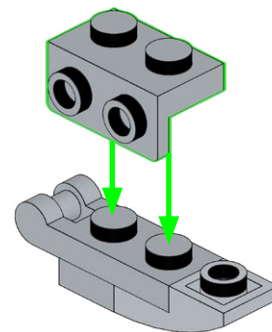

2

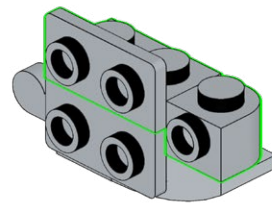

# 122

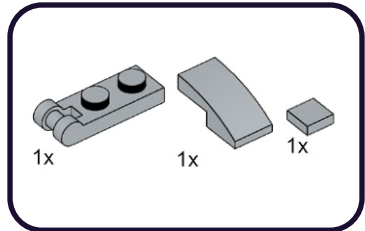

1

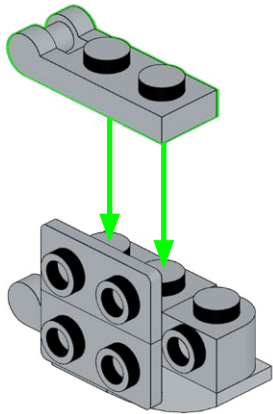

2

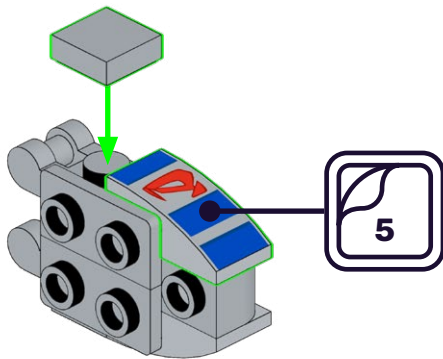

# 123

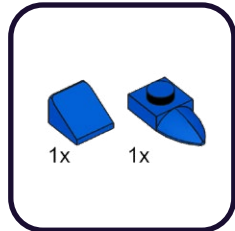

1

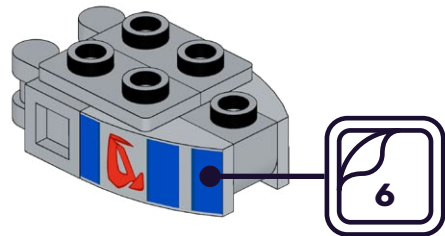
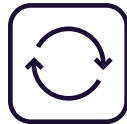

2

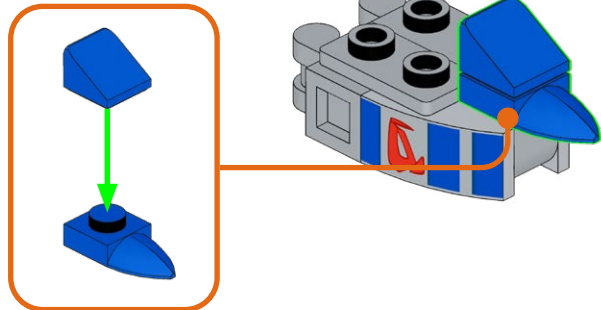

**124**

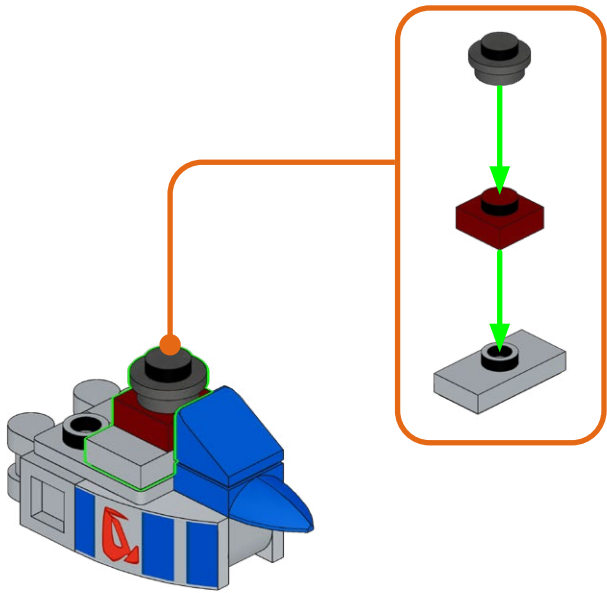
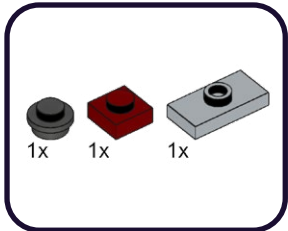

**125**

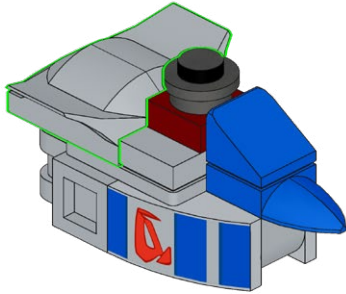
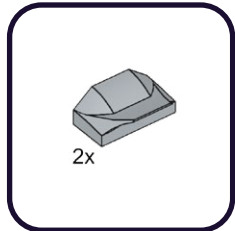



**126**

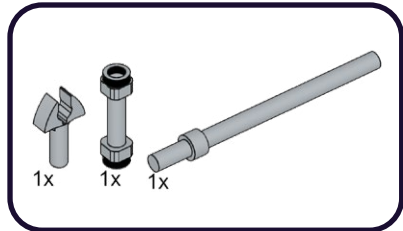

**1**

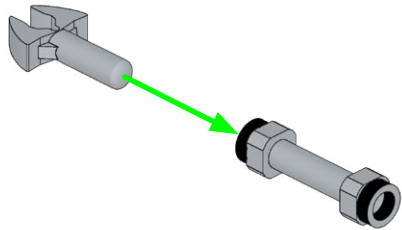

**2**

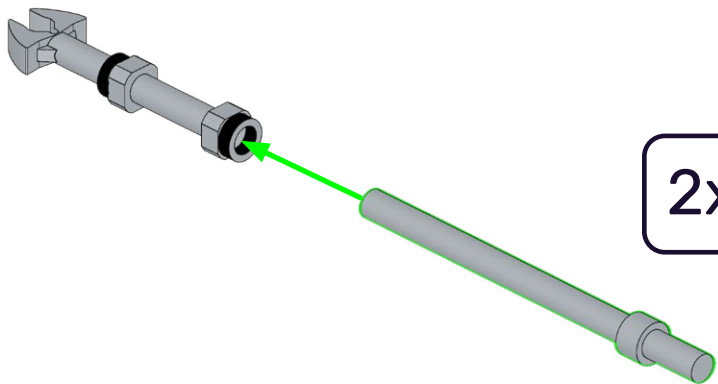

**2x**

**127**

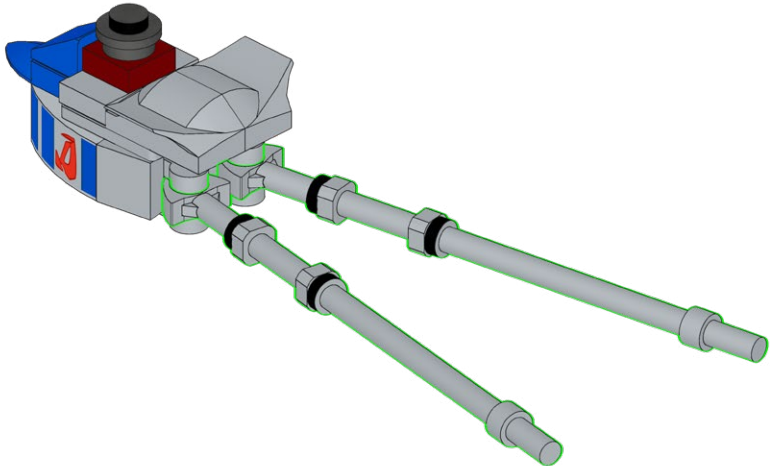

128

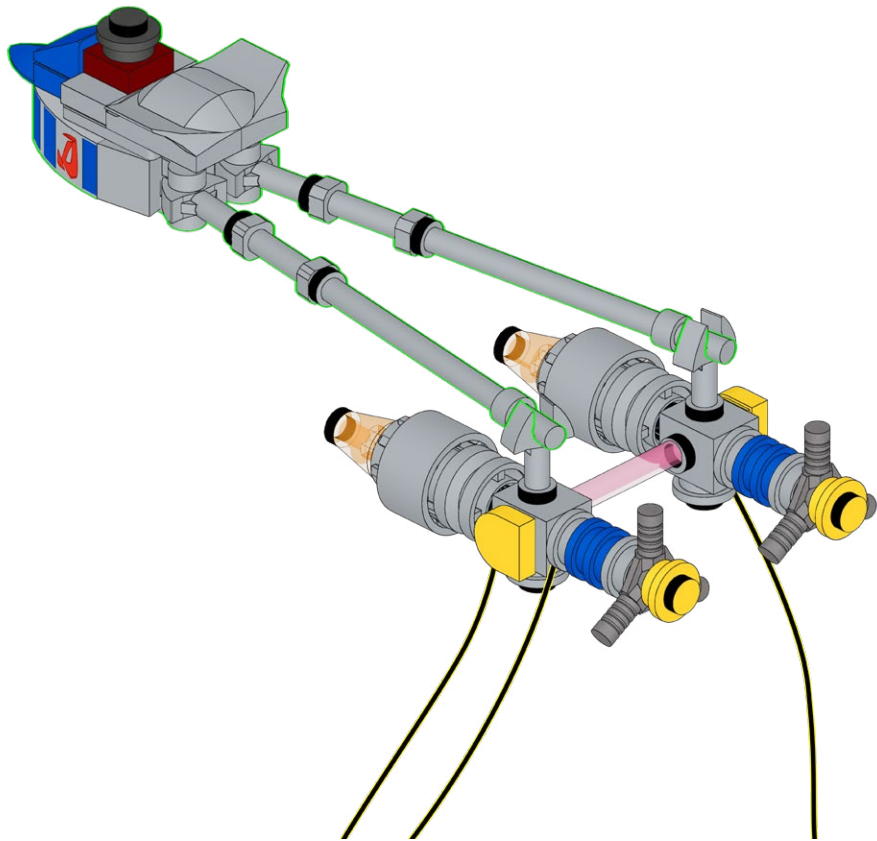

129

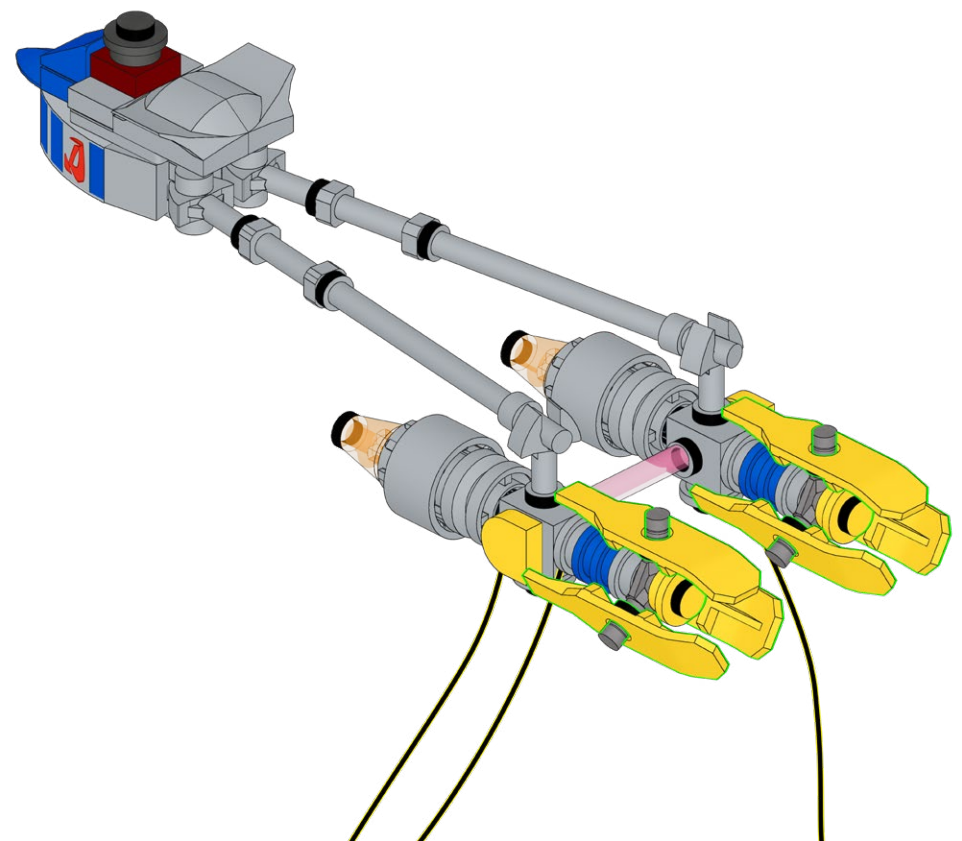
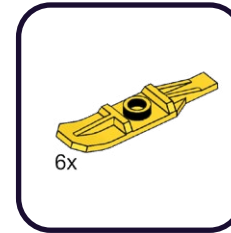

**130**

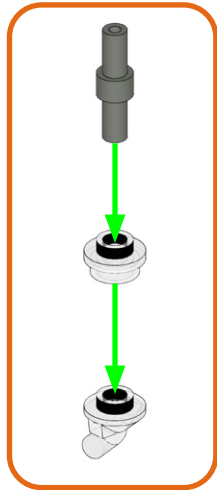
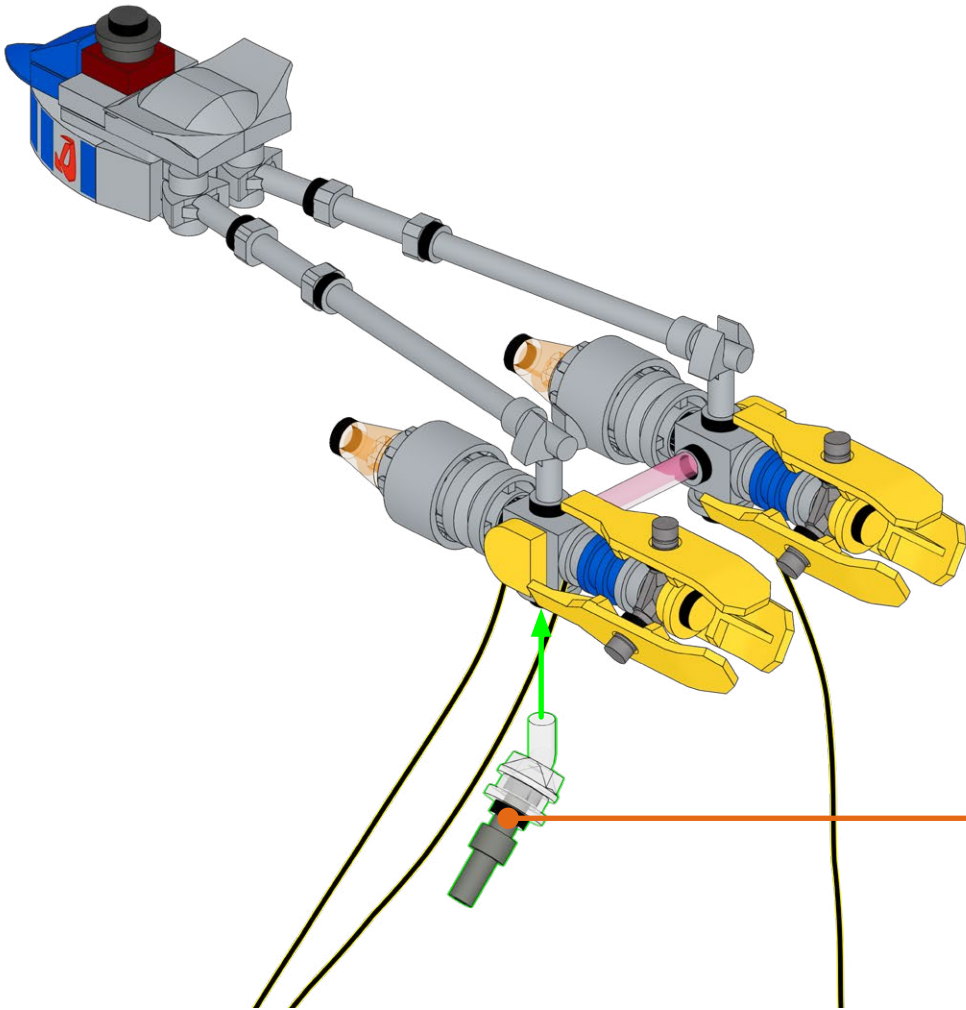
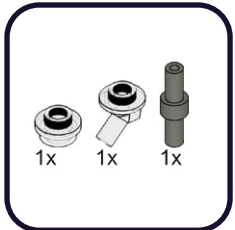



131

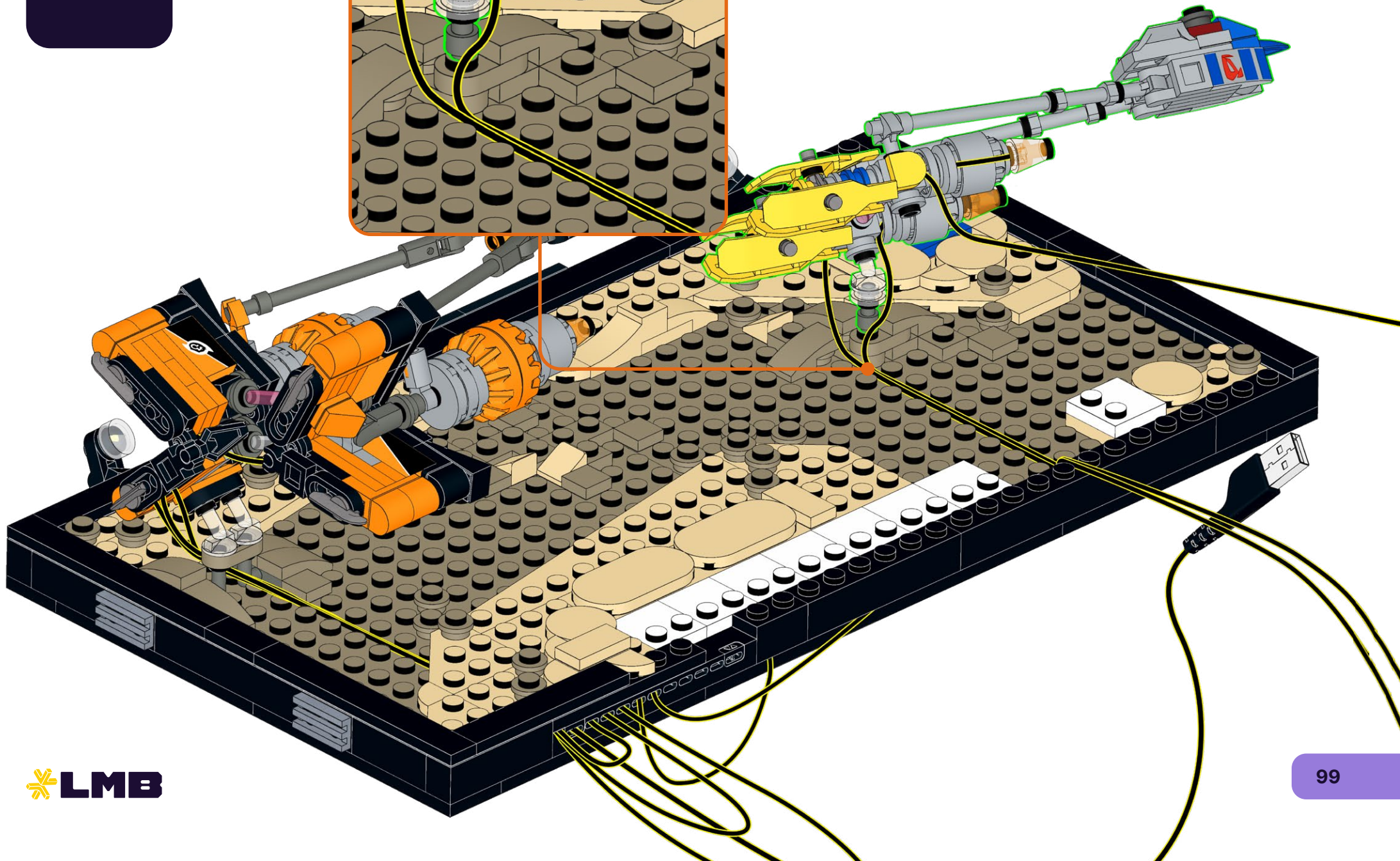
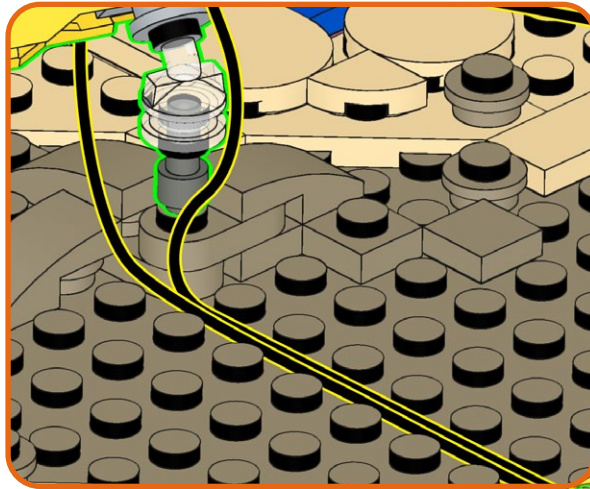



132

1x 1x

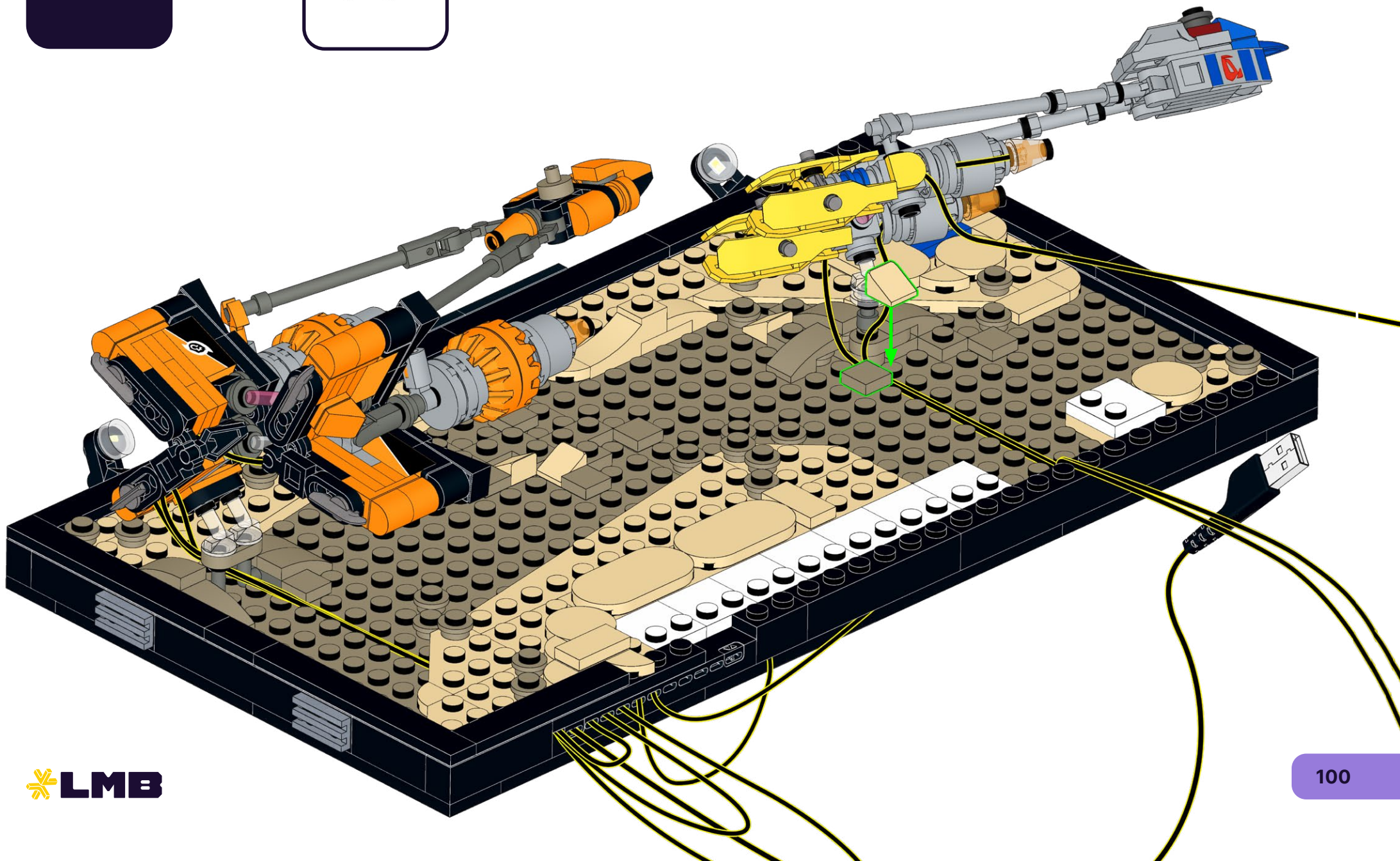



133

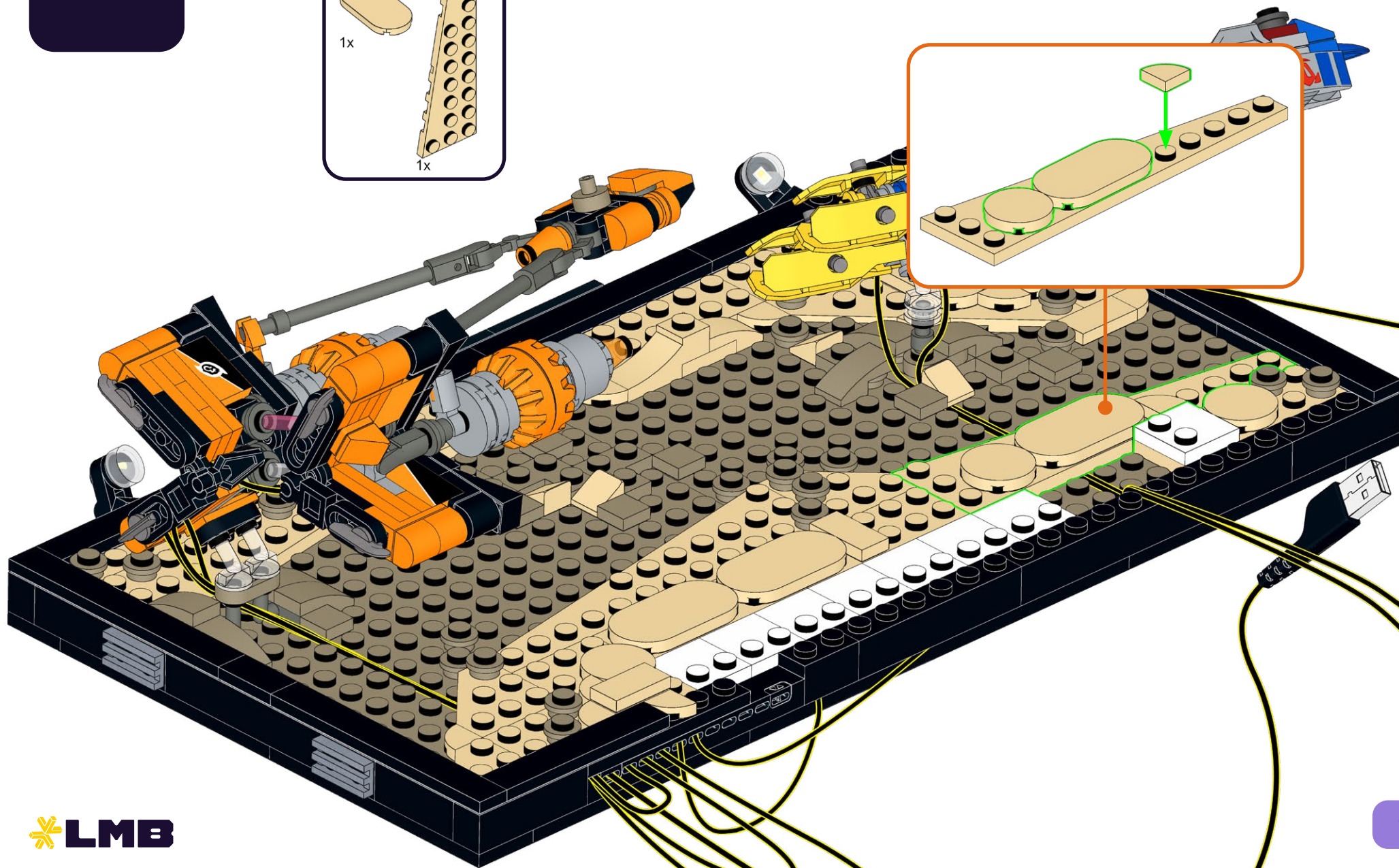
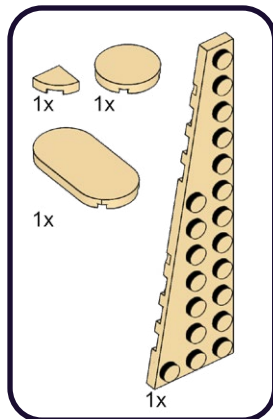



134

1x

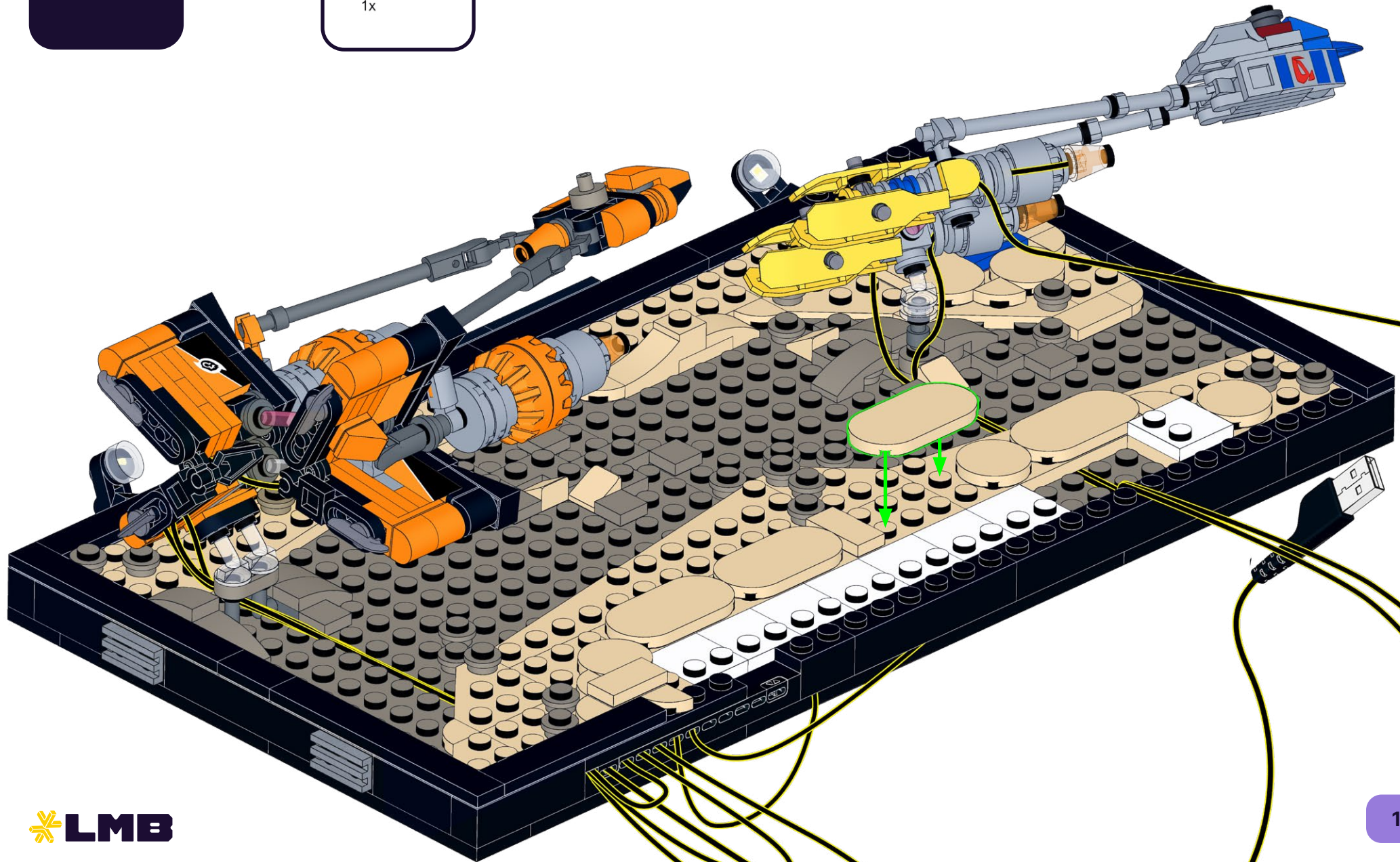



135

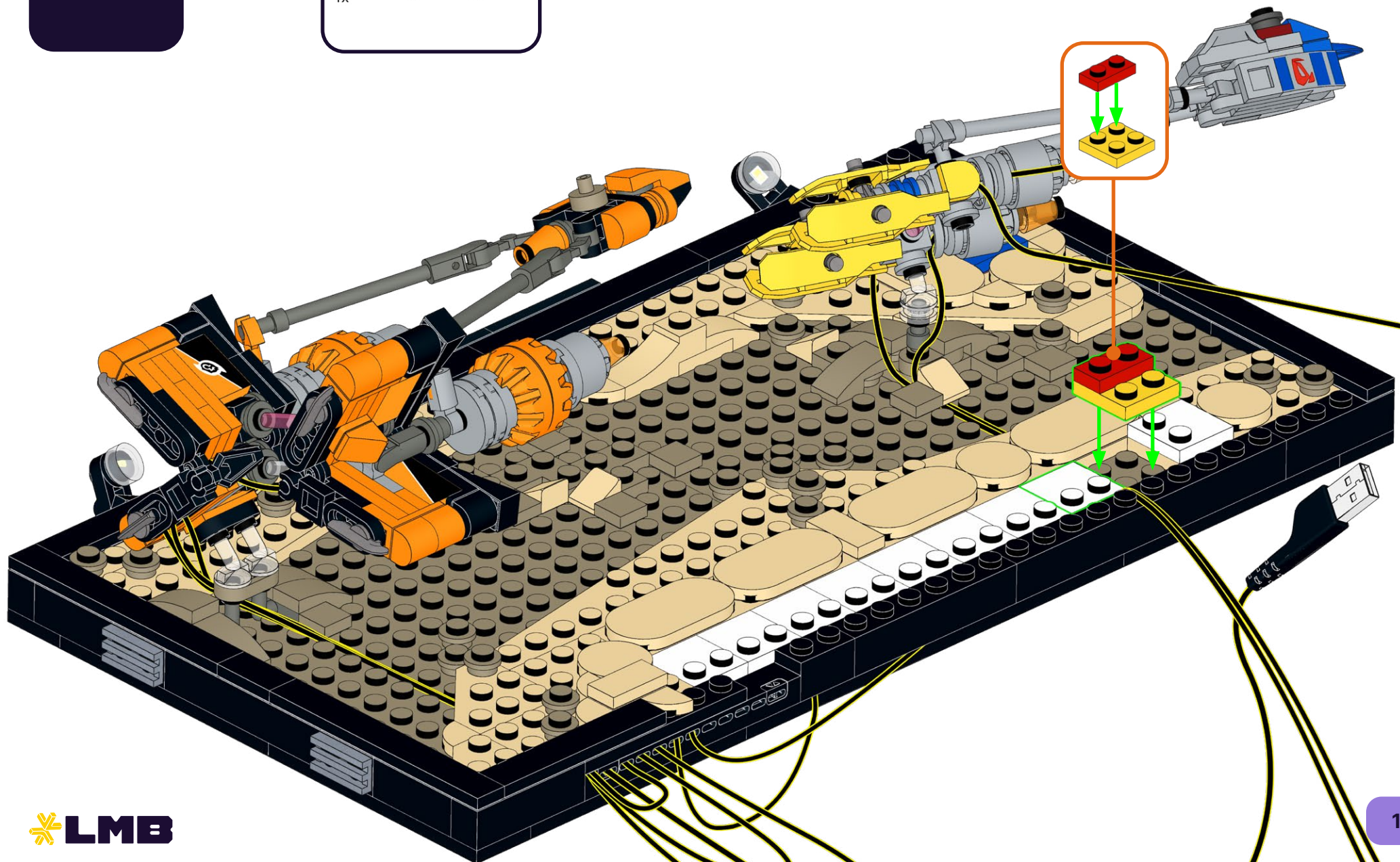
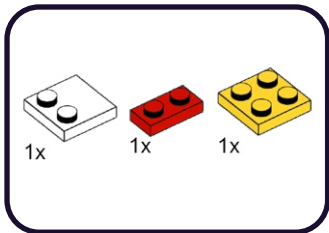

136

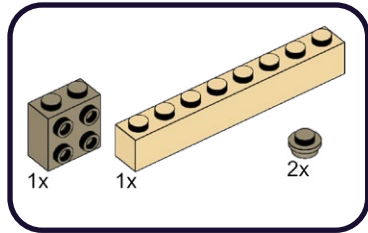

1

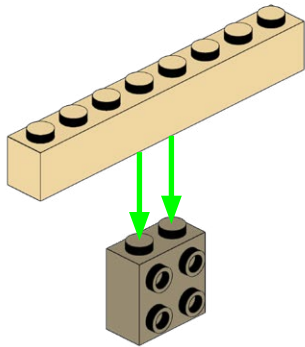

2

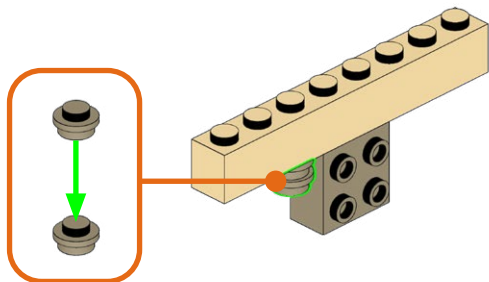

137

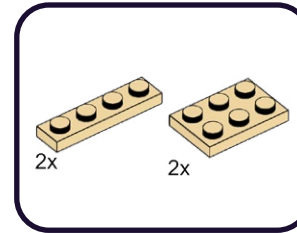

1

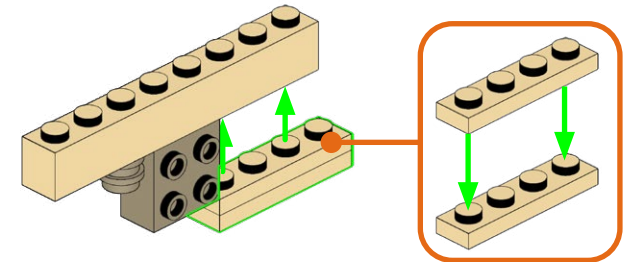

2

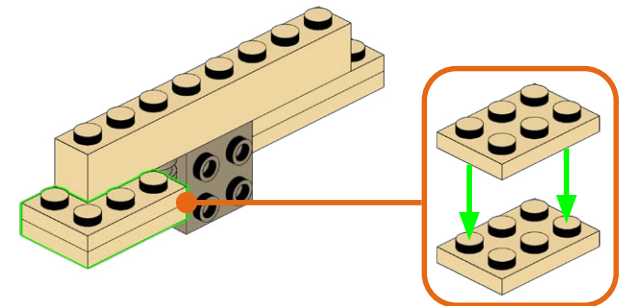



138

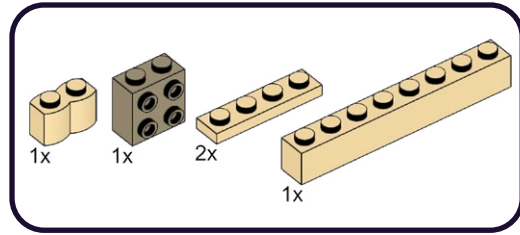

1

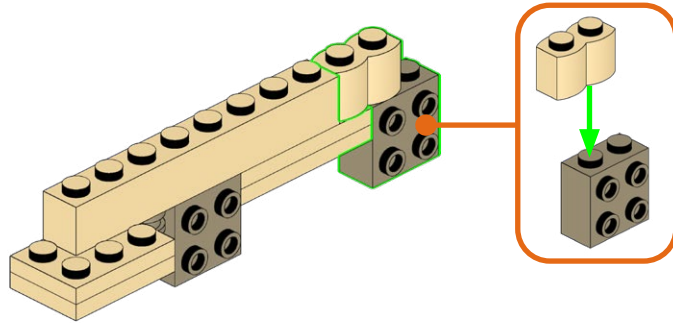

2

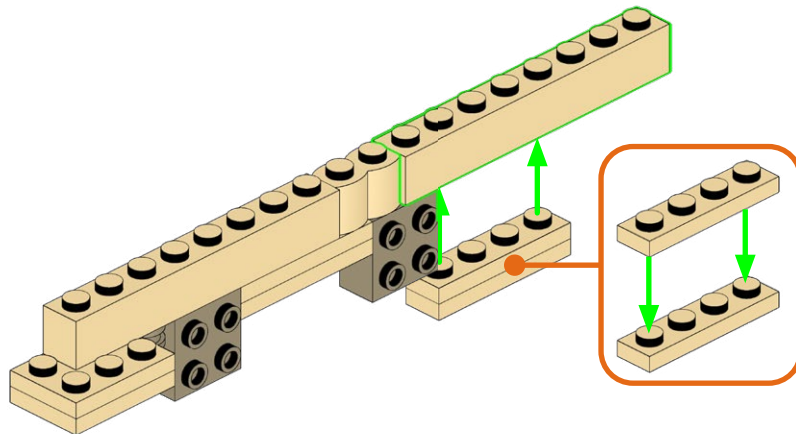

139

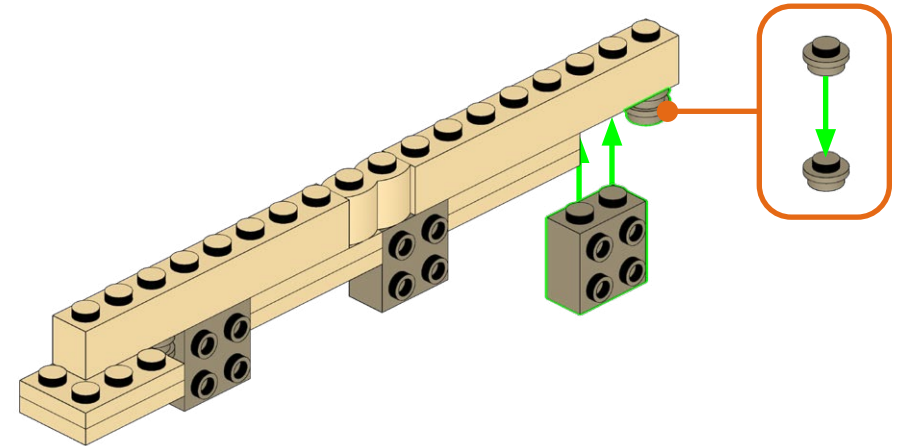
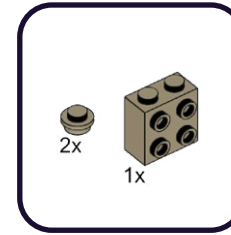

**140**

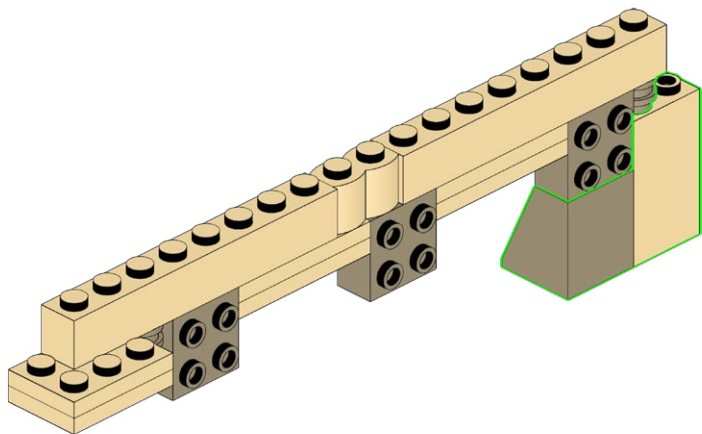
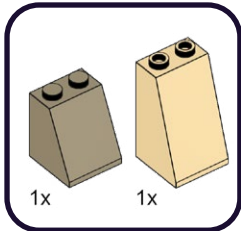

**141**

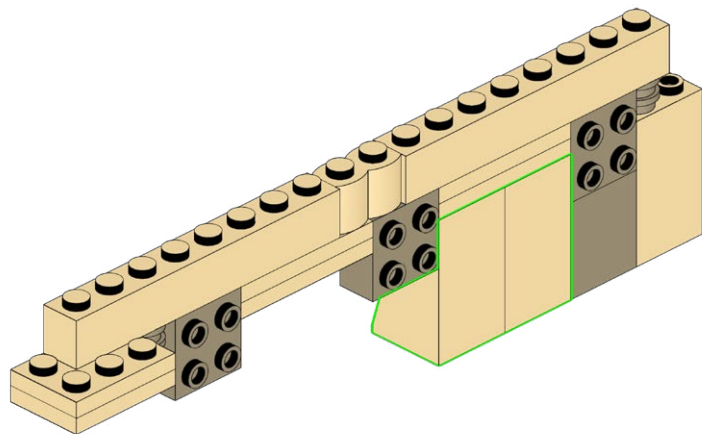
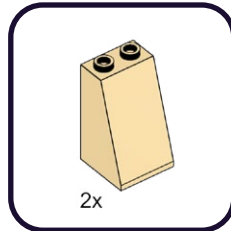

**142**

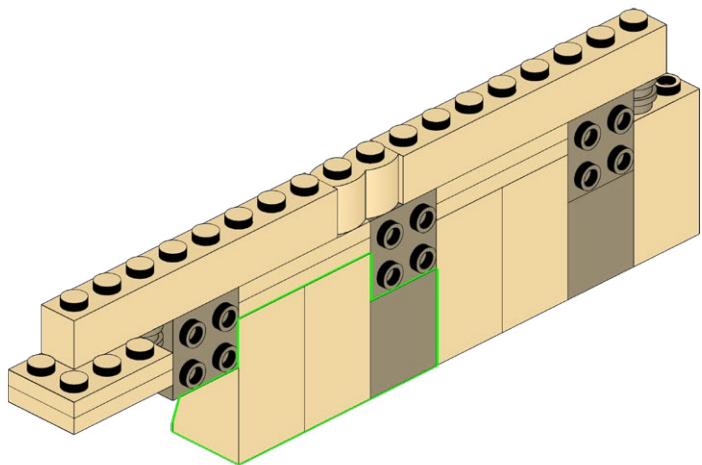
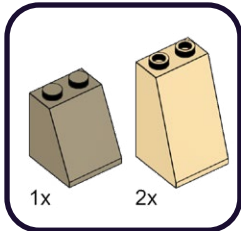

**143**

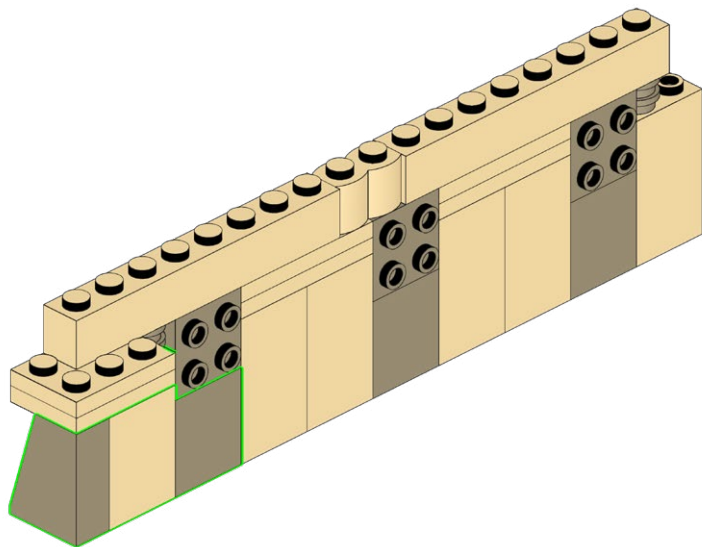
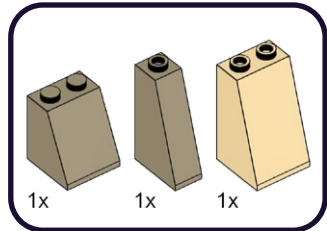



144

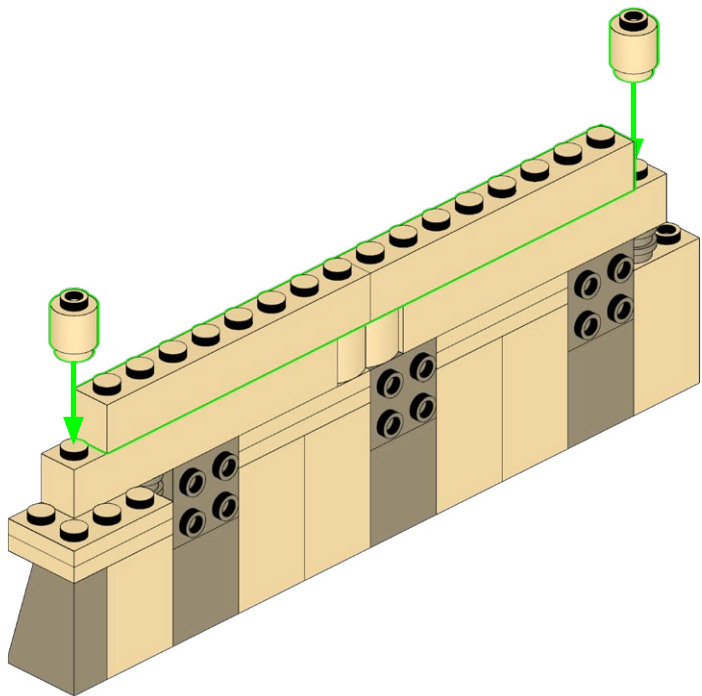
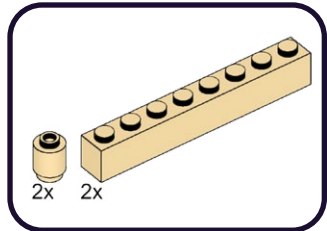

145

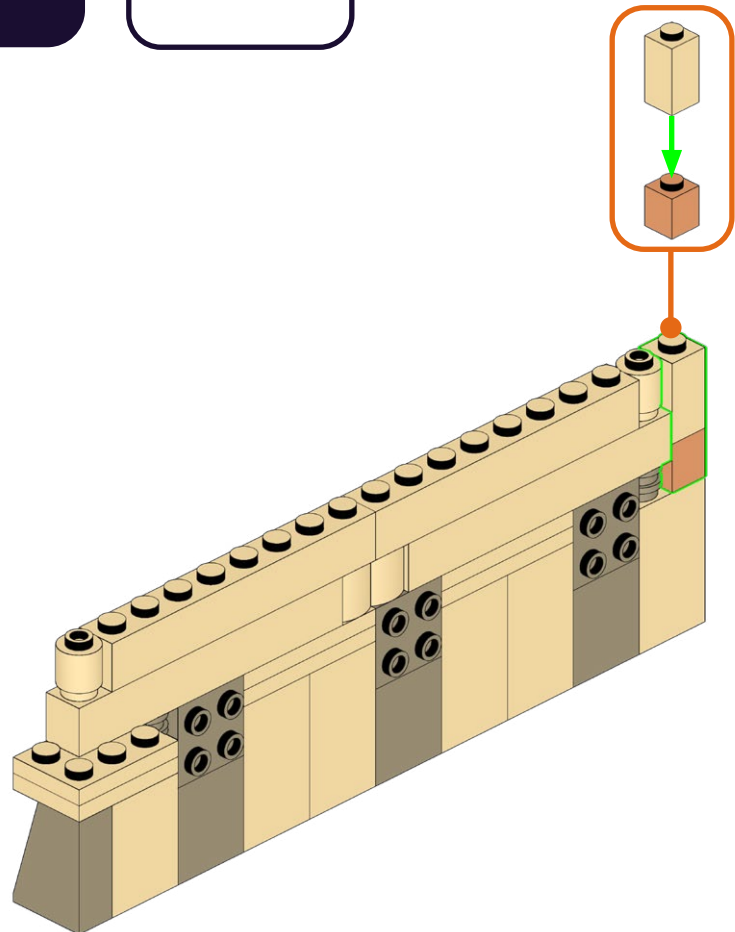
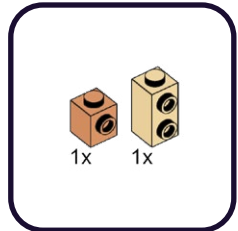

# 146

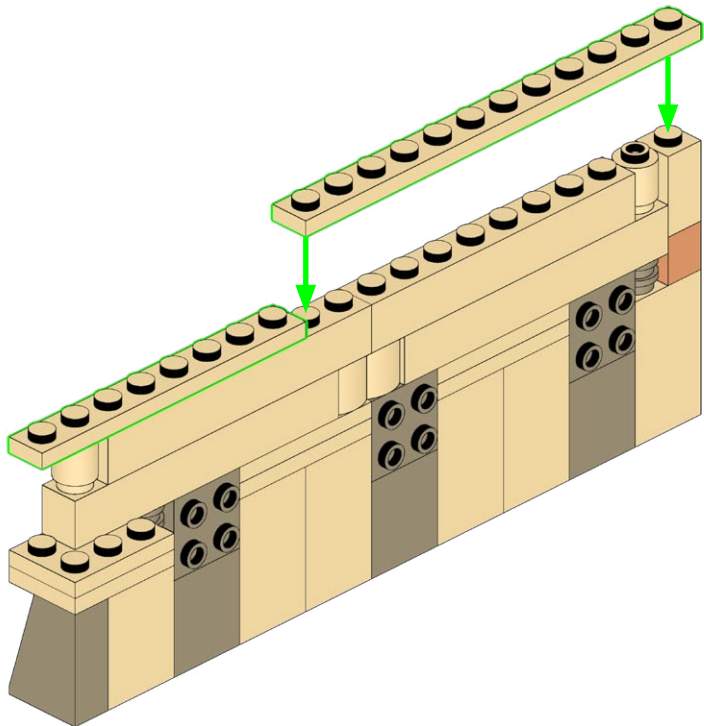
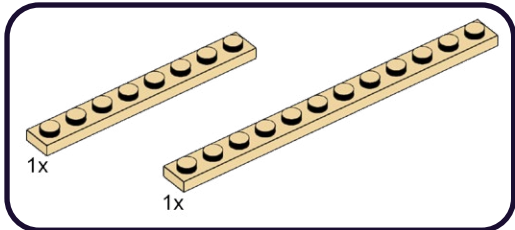

# 147

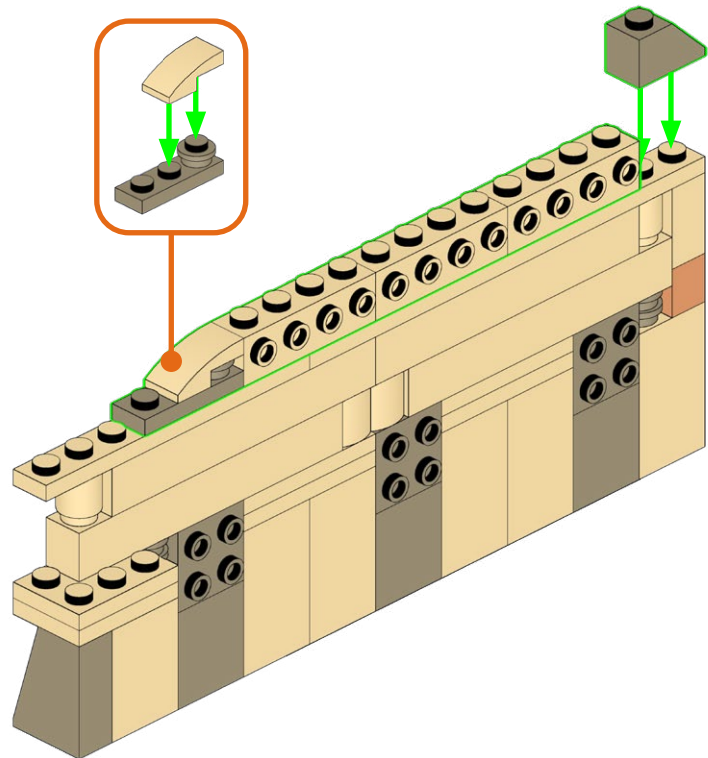
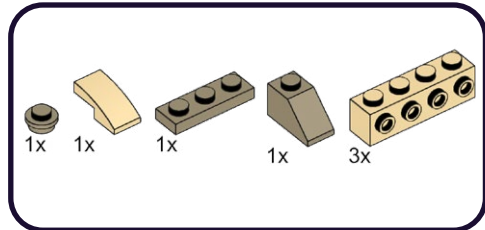

# 148

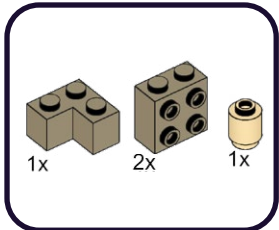

1

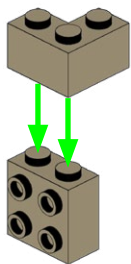

2

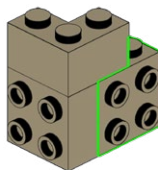

3

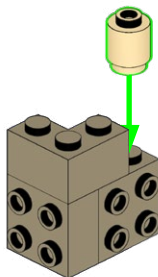

# 149

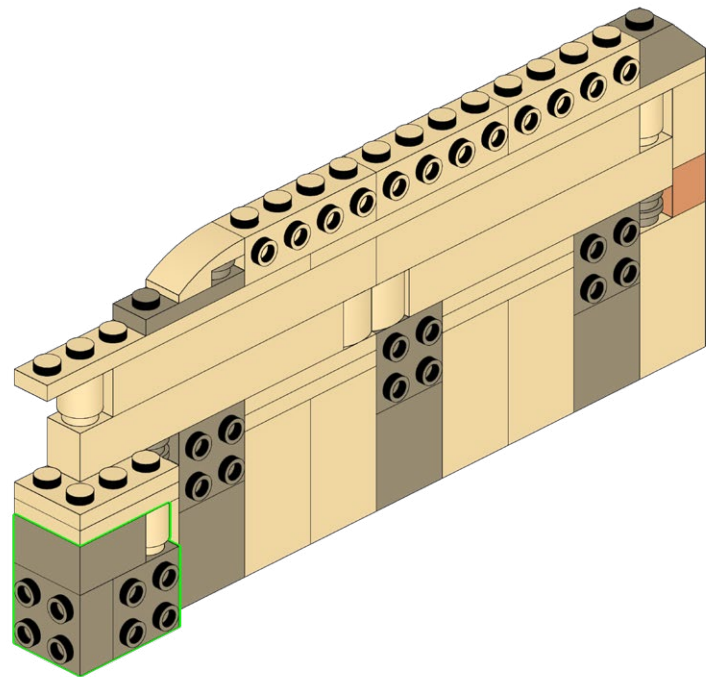



# 150

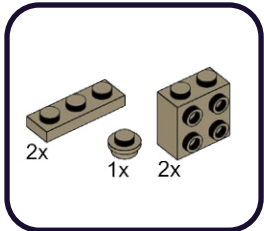

1

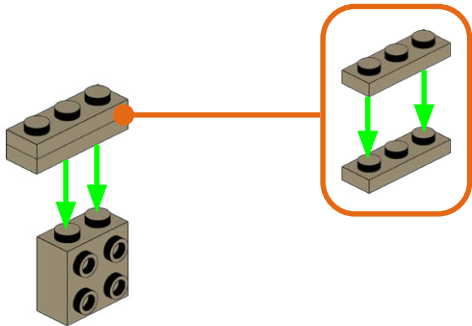

2

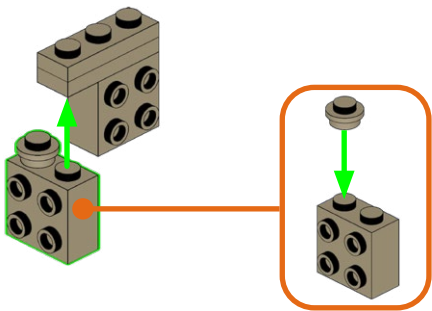

# 151

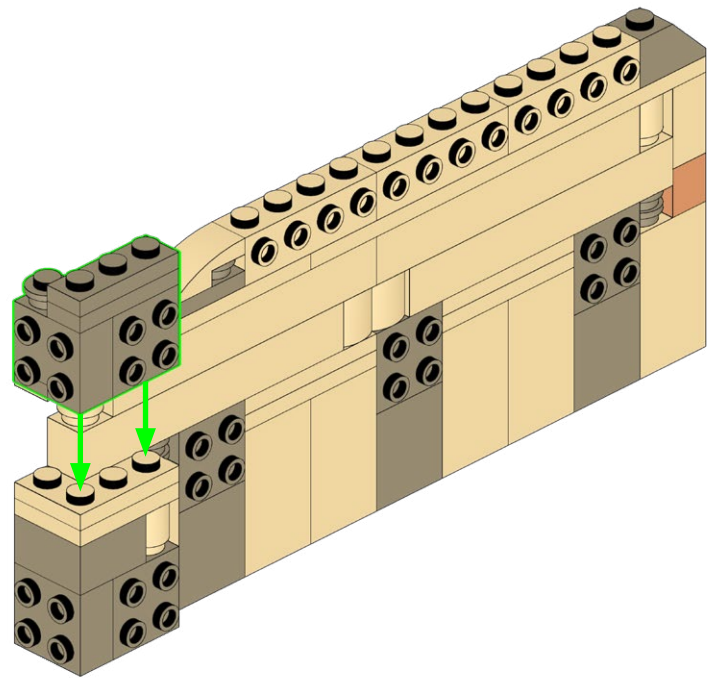

# 152

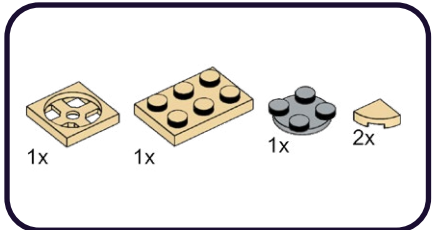

1

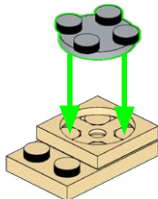

2

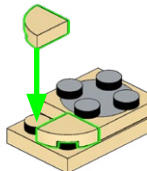

# 153

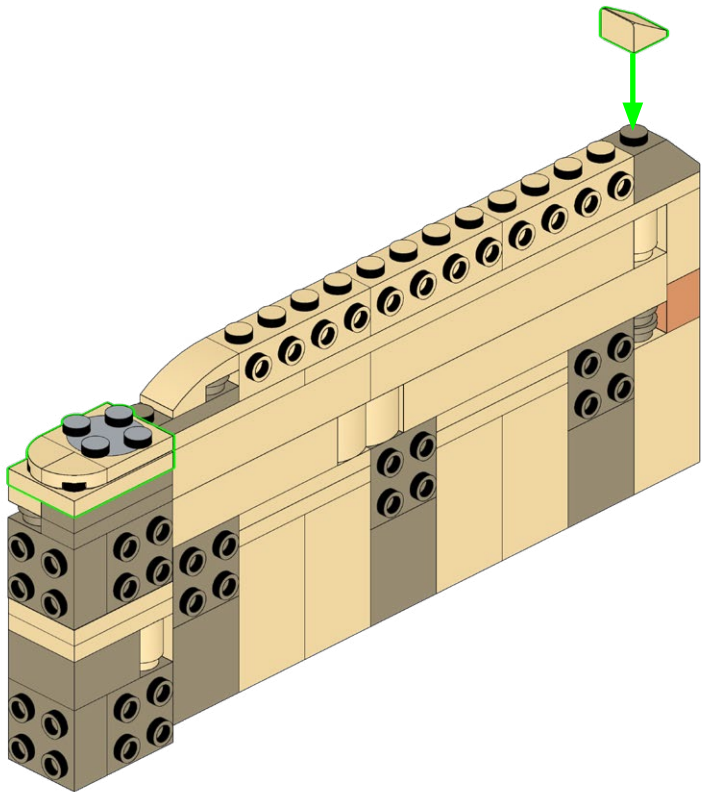
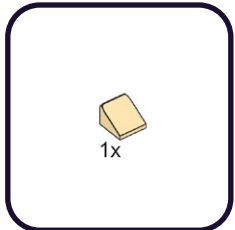

**HOLD UP!**

You might notice some bags are out of order, as well as left over pieces, but that's ok! We're changing the way you build LEGO!

**HALTEN!**

Möglicherweise stellen Sie fest, dass einige Beutel nicht in Ordnung sind und auch Teile übrig bleiben, aber das ist in Ordnung! Wir verändern die Art und Weise, wie Sie LEGO bauen!

**TENIR BON!**

Vous remarquerez peut-être que certains sacs sont en panne, ainsi que des morceaux restants, mais ce n'est pas grave ! Nous changeons la façon dont vous construisez LEGO !

**SOSTENERE!**

Potresti notare che alcune borse sono fuori uso, così come alcuni pezzi avanzati, ma va bene! Stiamo cambiando il modo in cui costruisci i LEGO!

**¡SOSTENER!**

Puede que notes que algunas bolsas están fuera de orden, así como piezas sobrantes, ¡pero está bien! ¡Estamos cambiando la forma de construir LEGO!

**耽误!**

您可能会注意到有些袋子坏了, 还有剩余的碎片, 但这没关系! 我们正在改变您搭建乐高的方式!

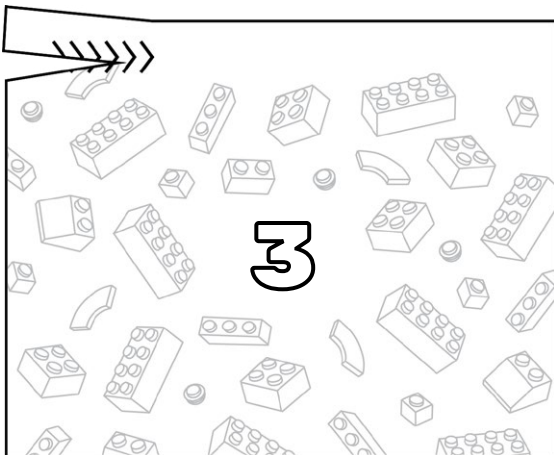
**Open LEGO® Bag 3**



154

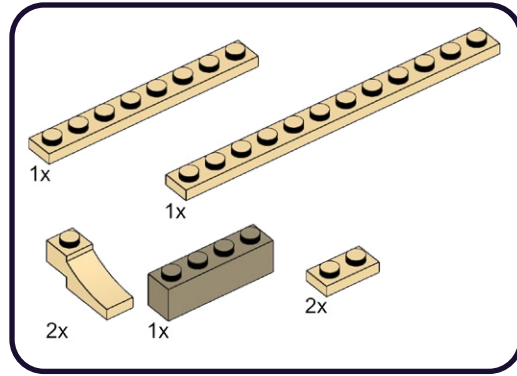

1

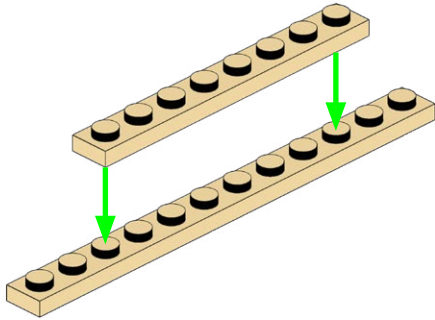

2

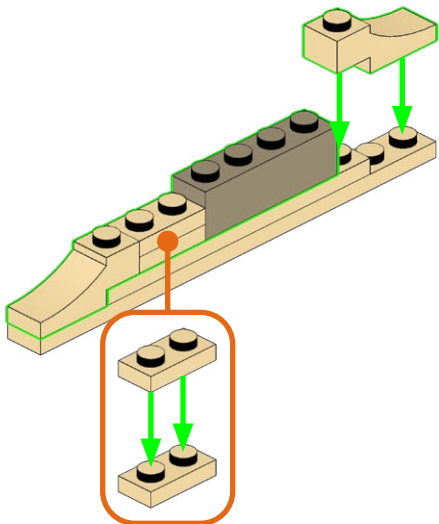

155

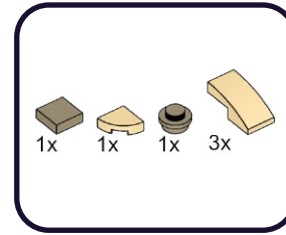

1

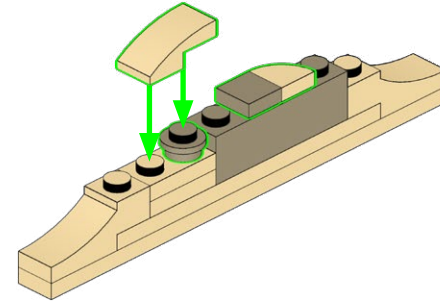

2

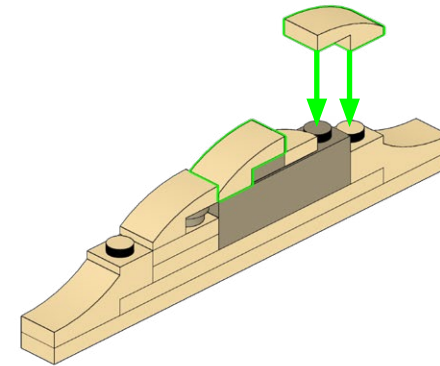

156

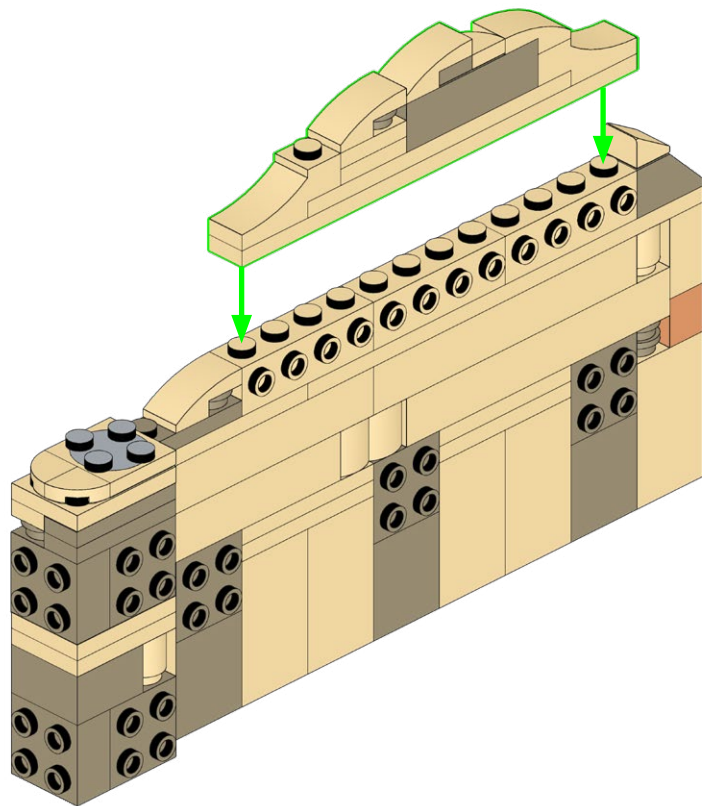

157

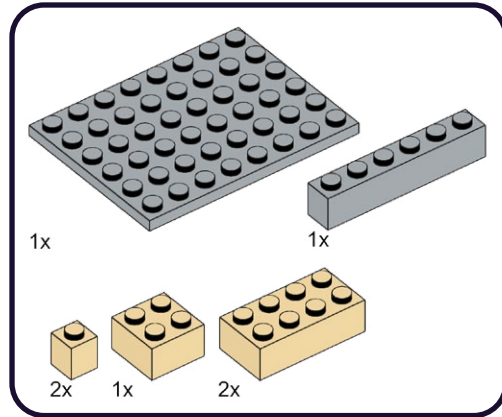

1

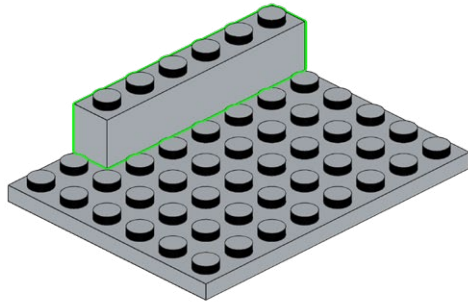

2

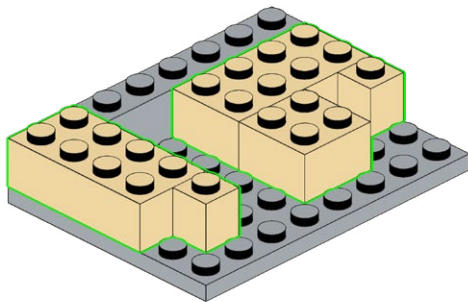

158

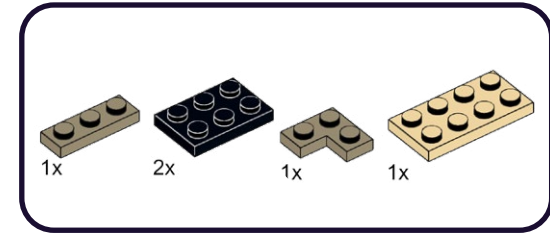

1

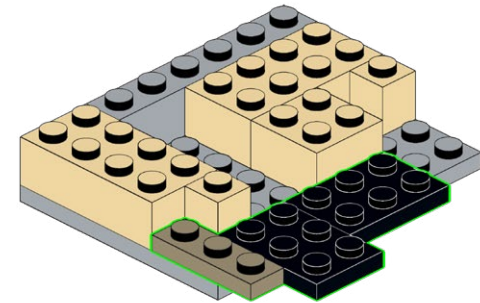

2

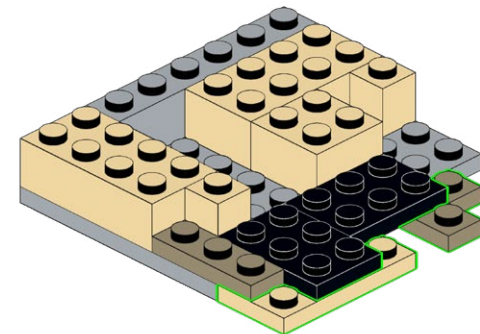





161

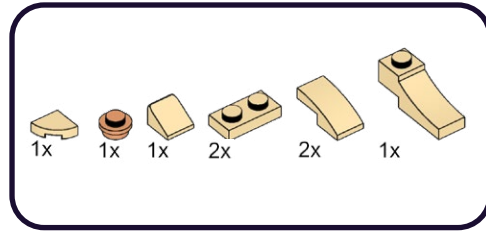

1

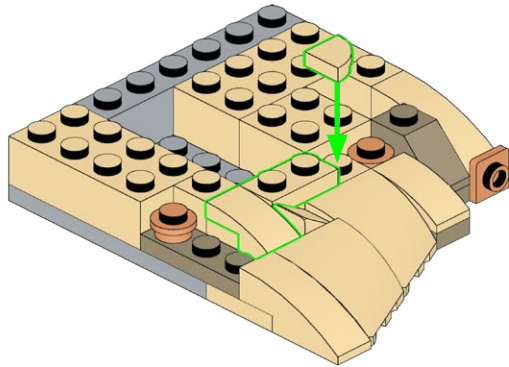

2

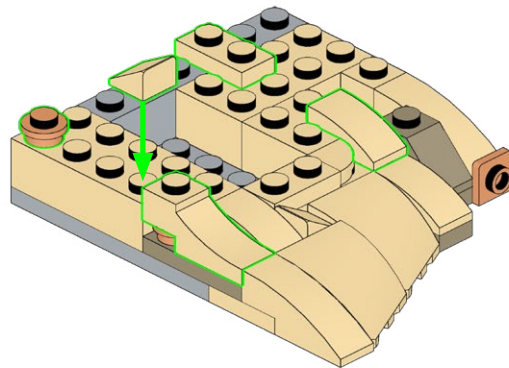

162

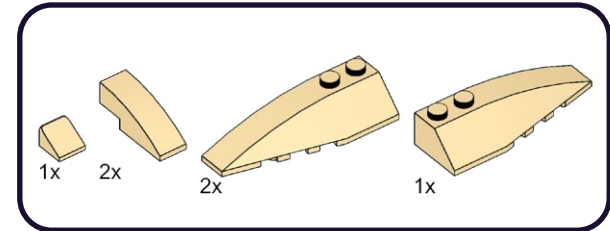

1

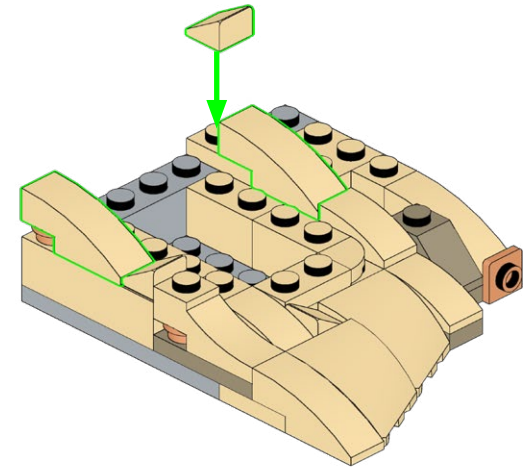

2

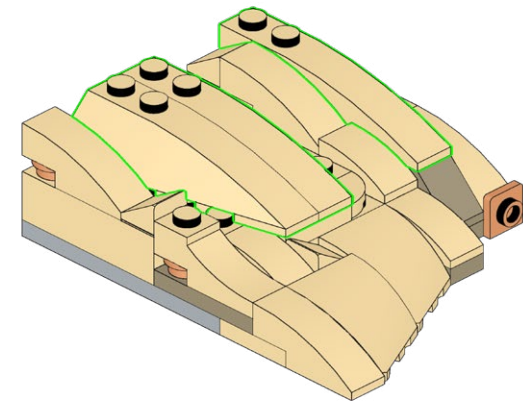

163

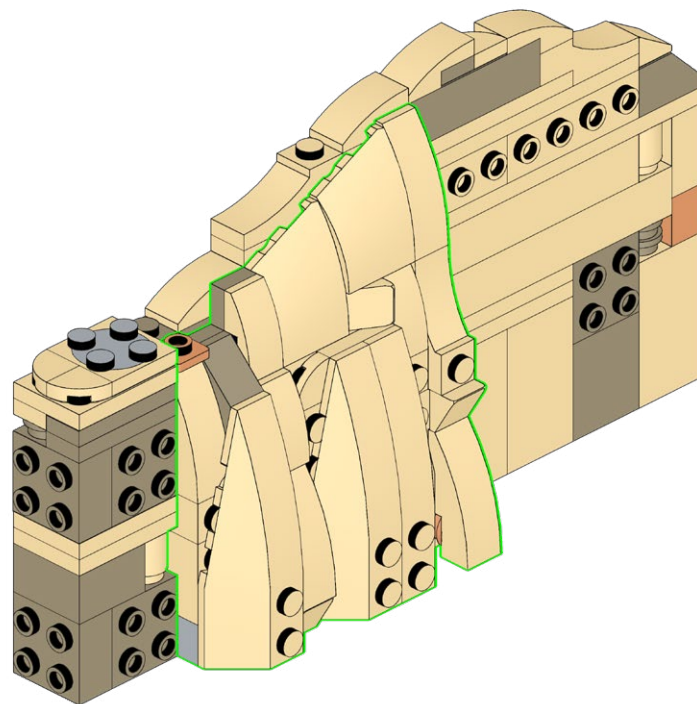



164

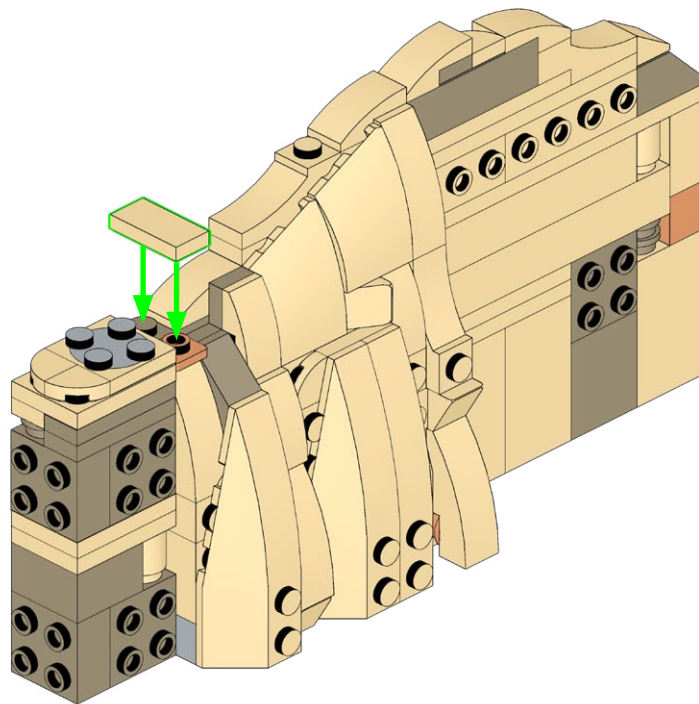
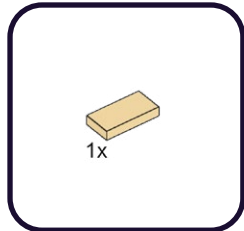

165

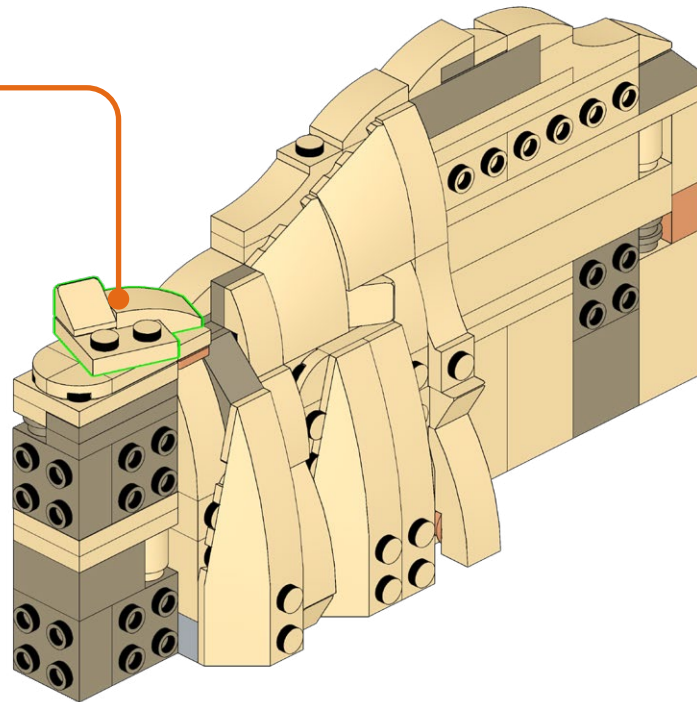
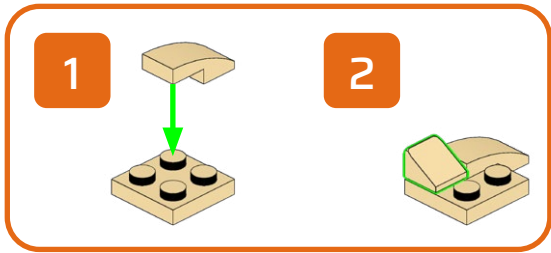
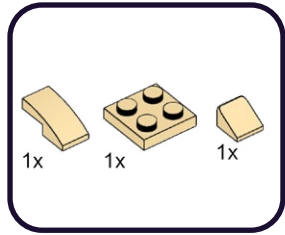

166

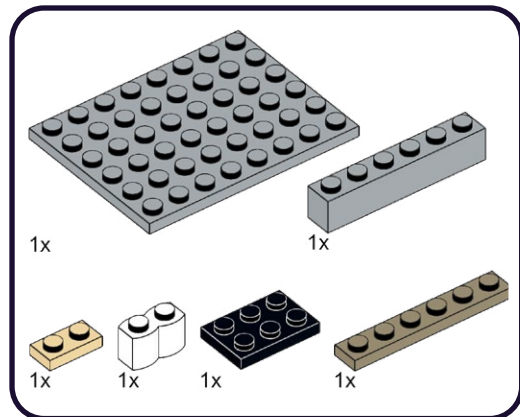

1

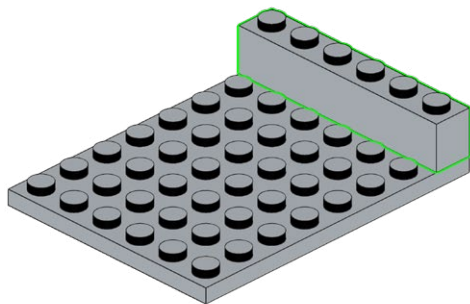

2

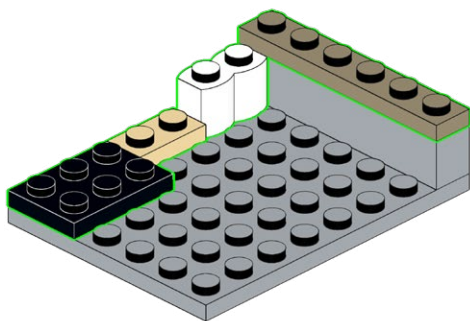

167

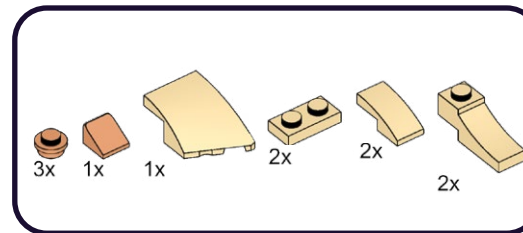

1

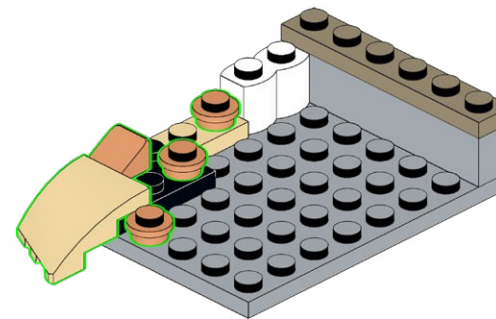

2

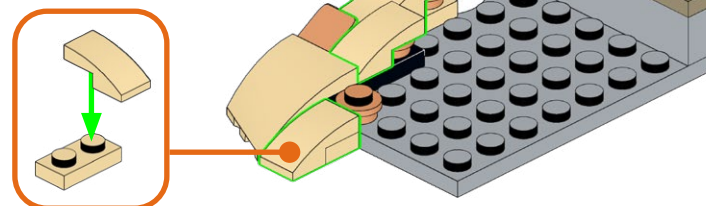



168

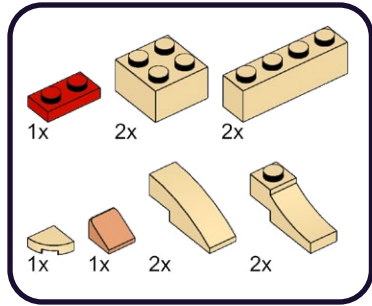

1

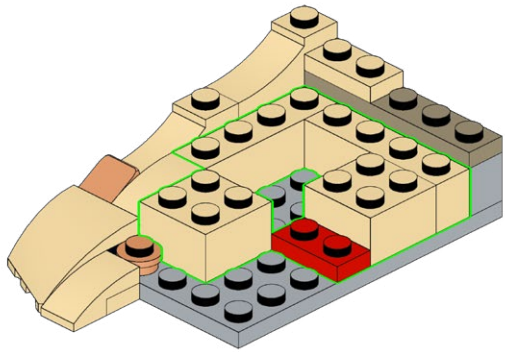

2

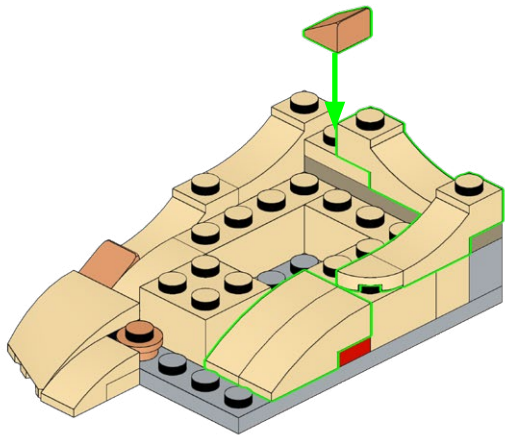

169

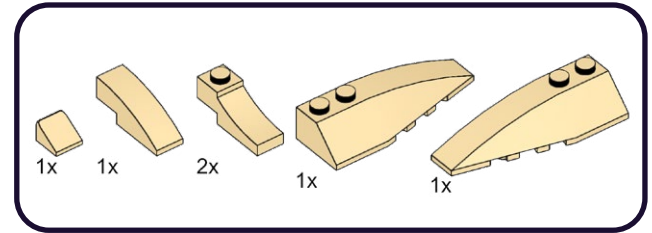

1

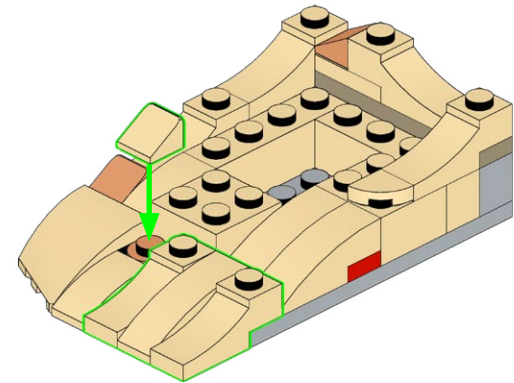

2

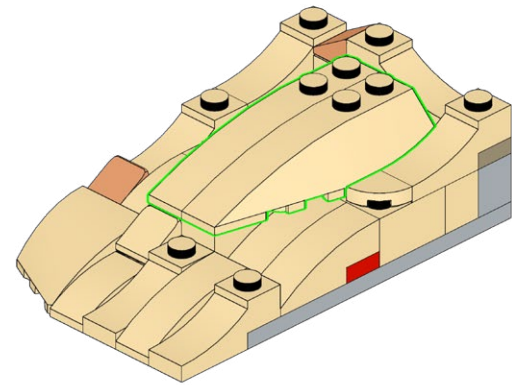

170

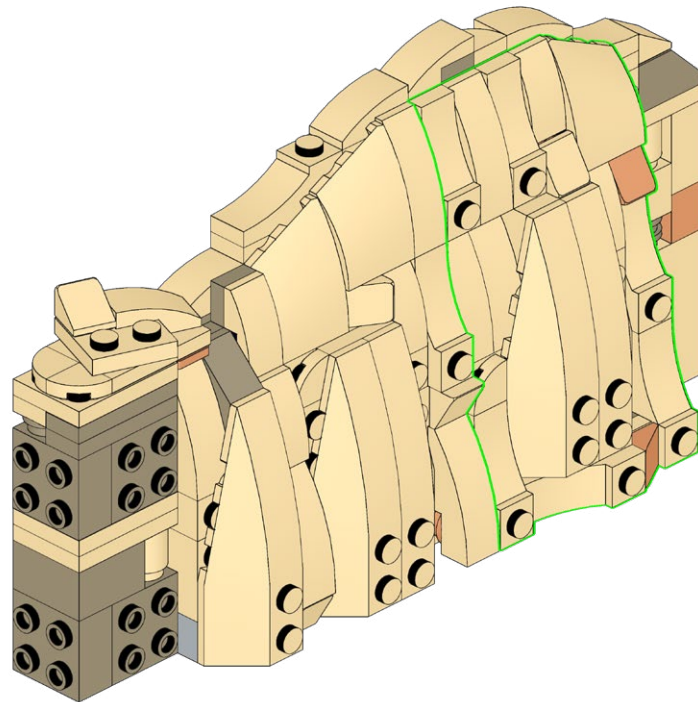

171

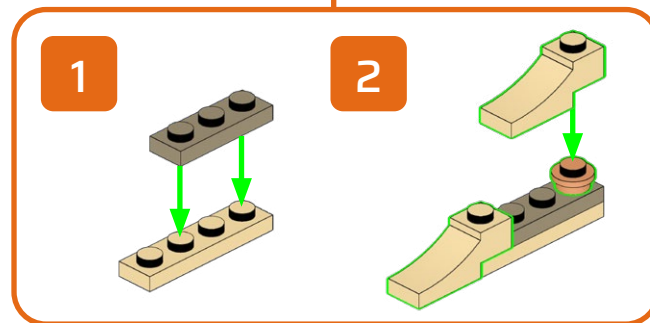
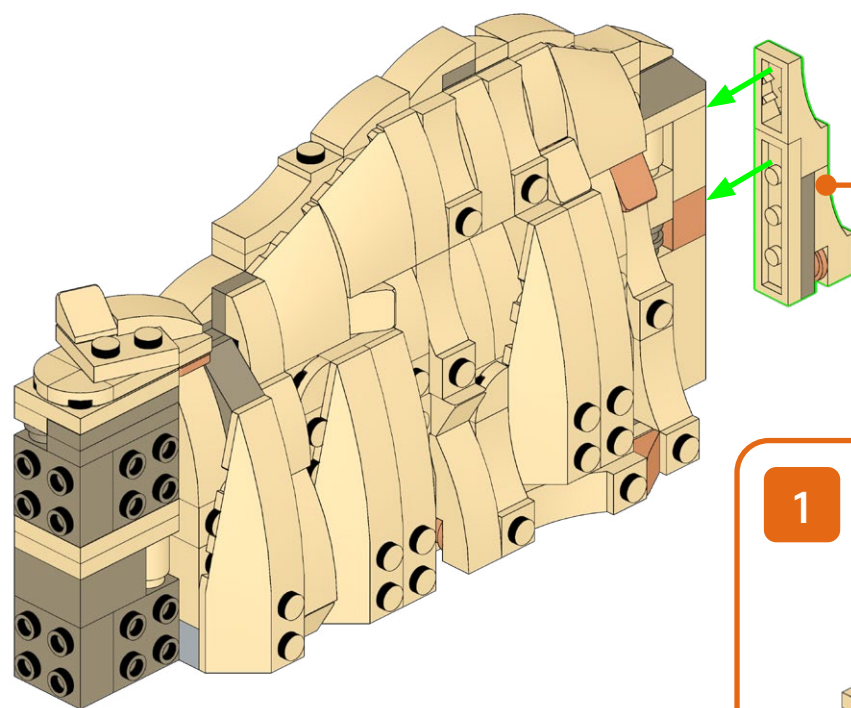
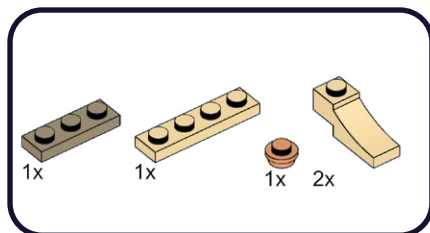



172

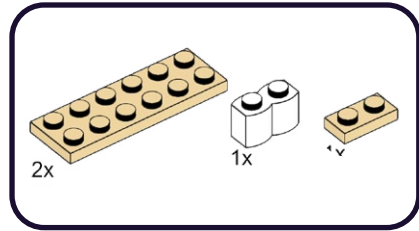

1

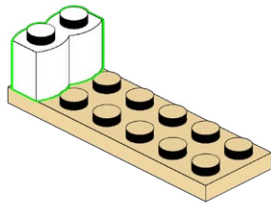

2

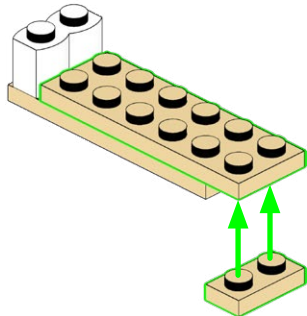

173

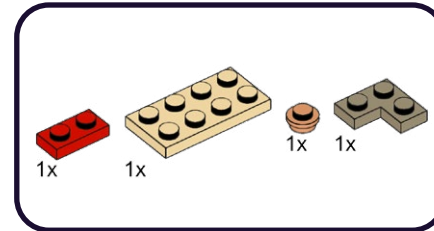

1

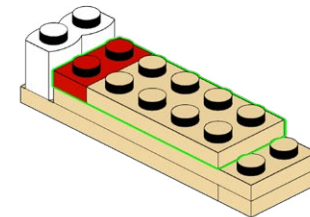

2

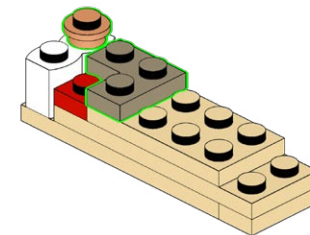

174

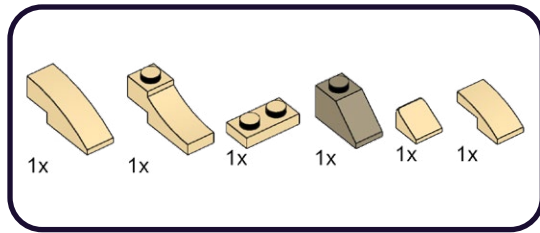

1

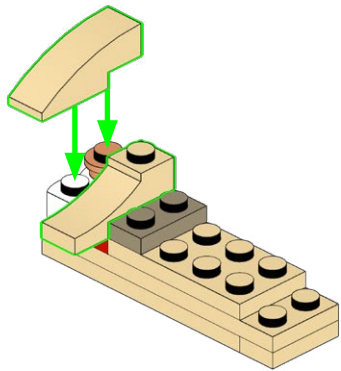

2

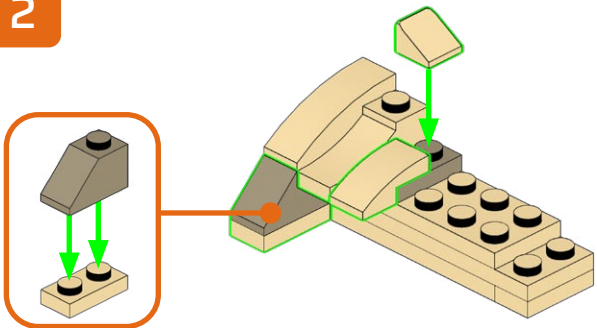

175

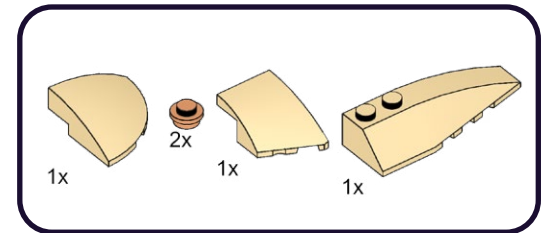

1

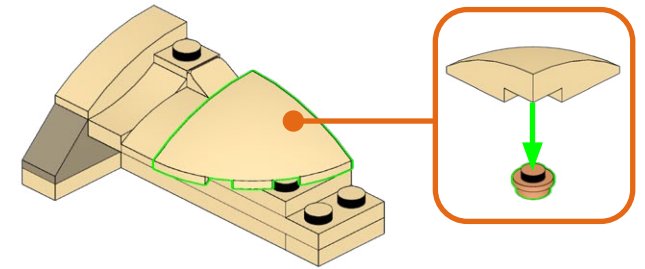

2

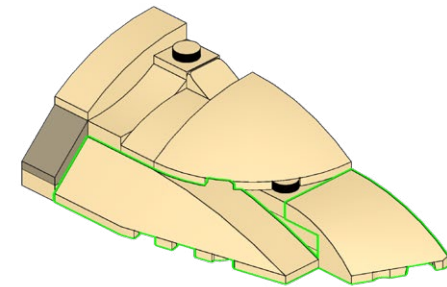

176

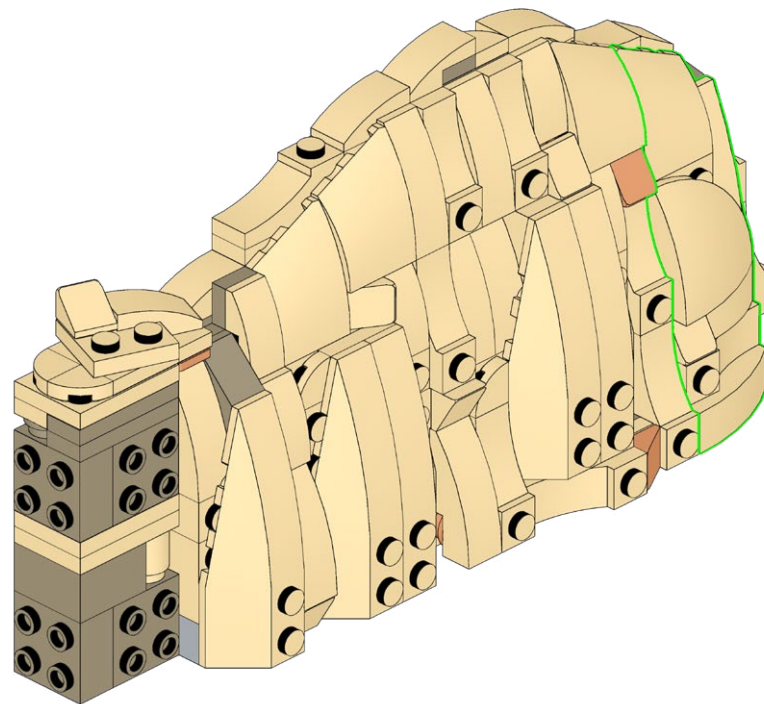



177

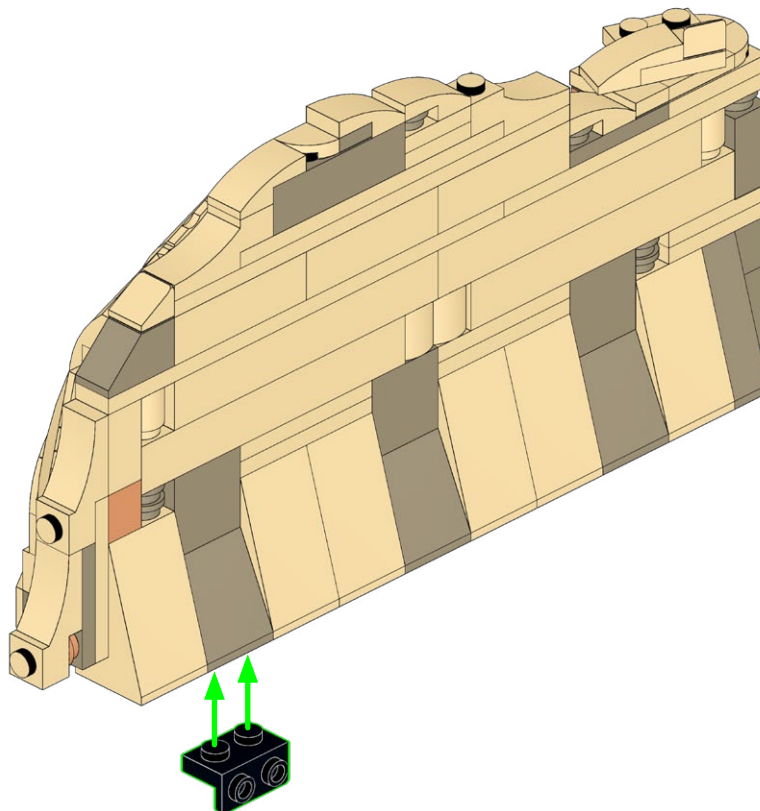
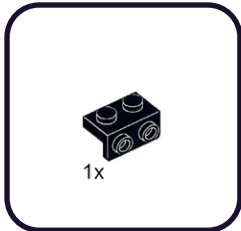

178

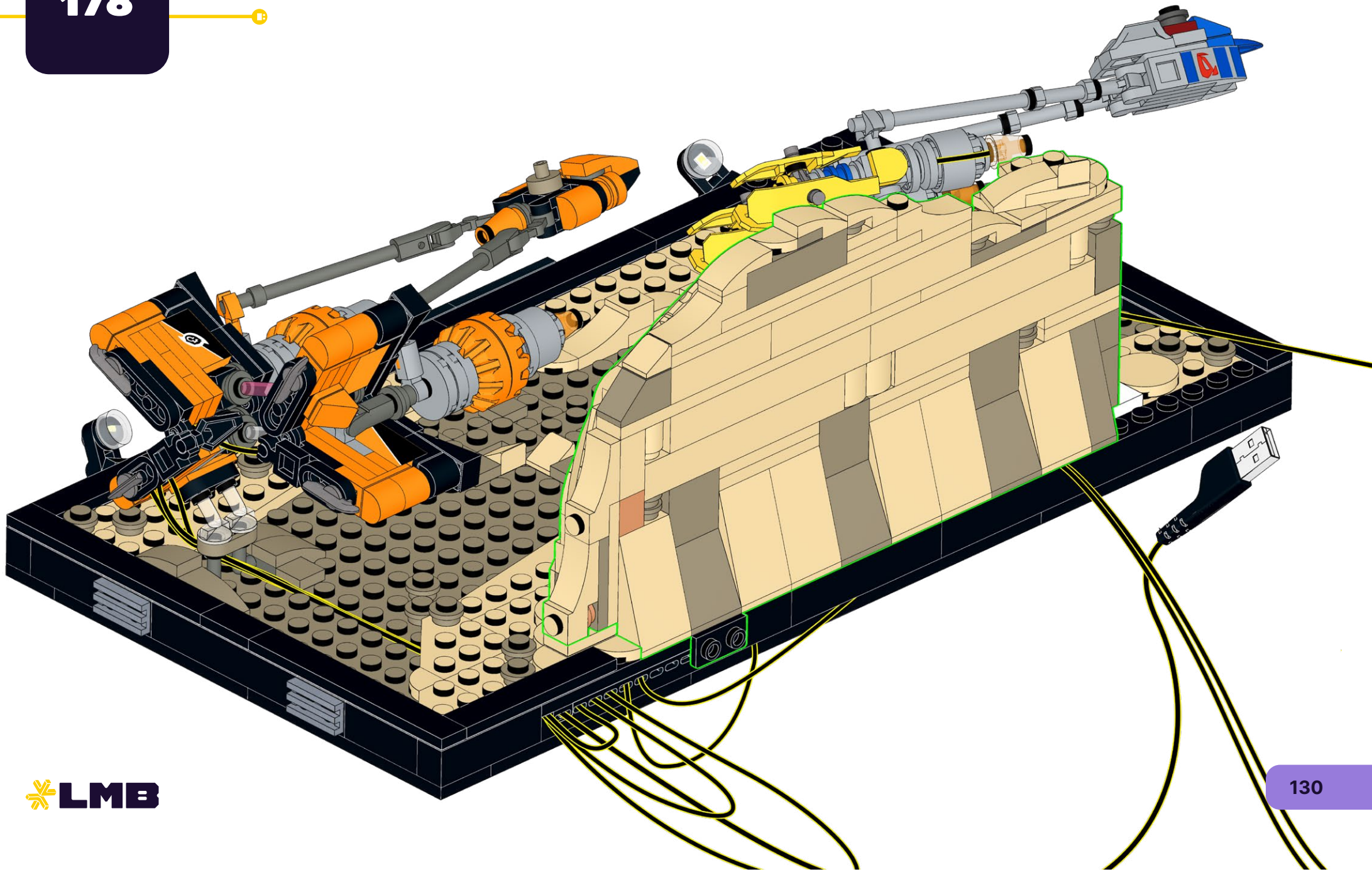

179

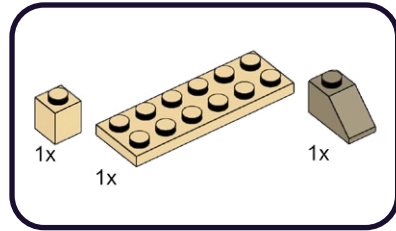

1

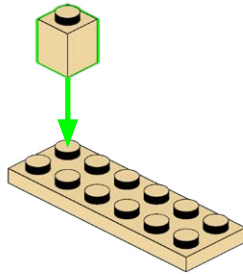

2

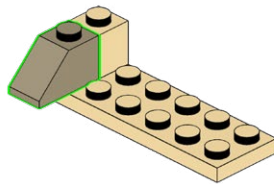

180

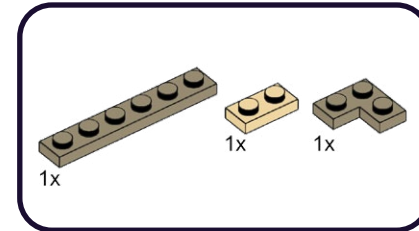

1

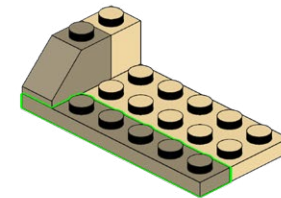

2

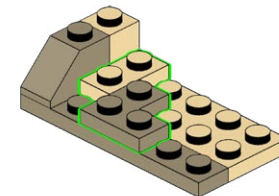



181

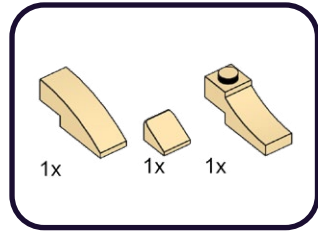

1

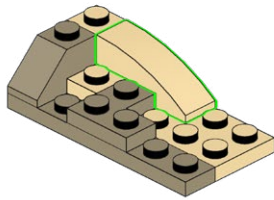

2

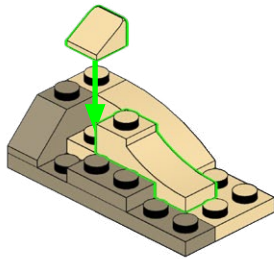

182

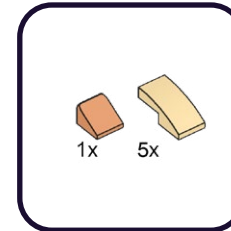

1

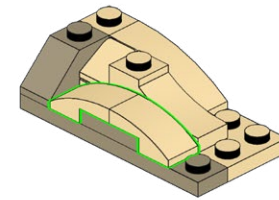

2

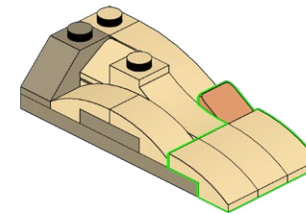

183

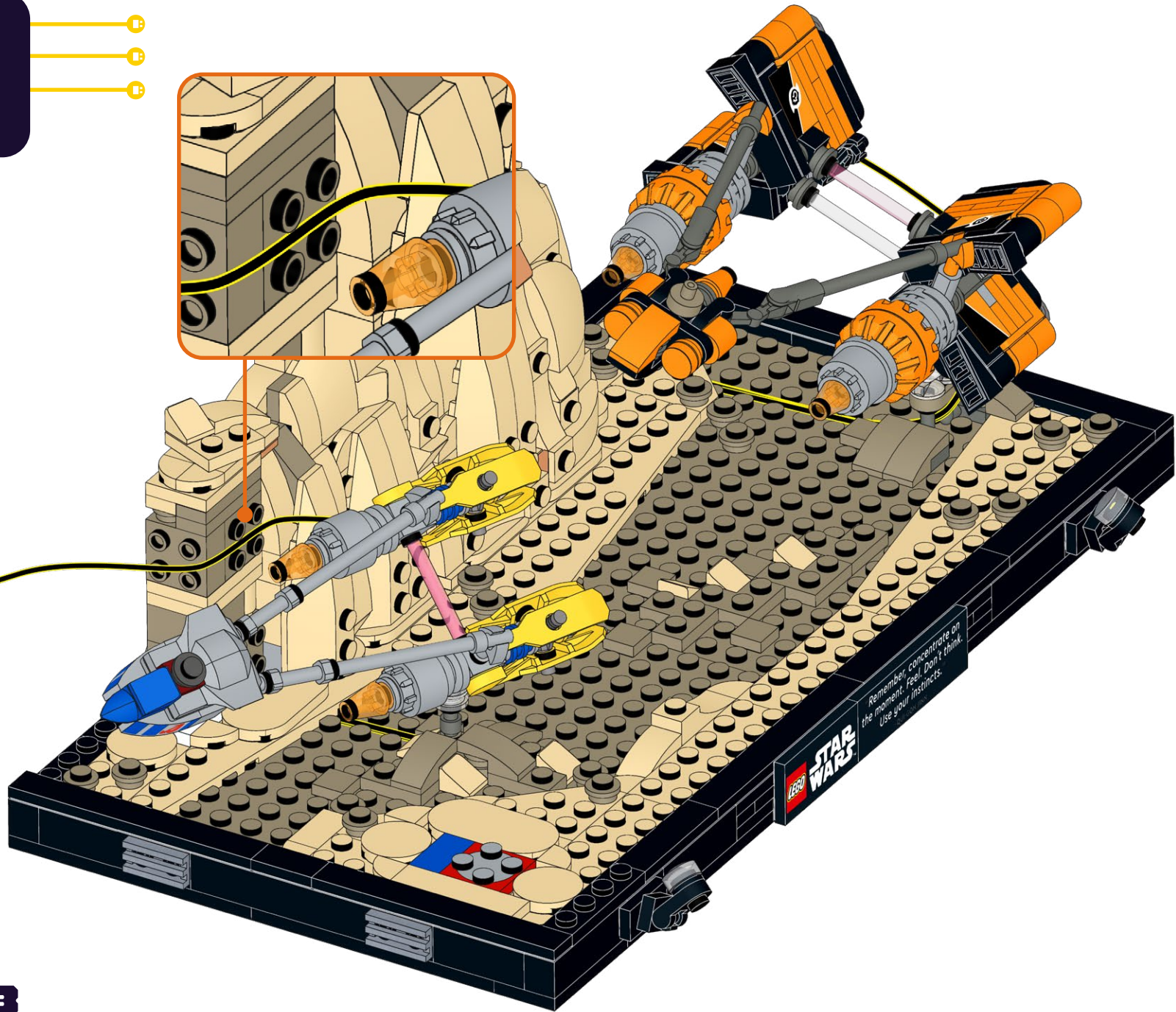



184

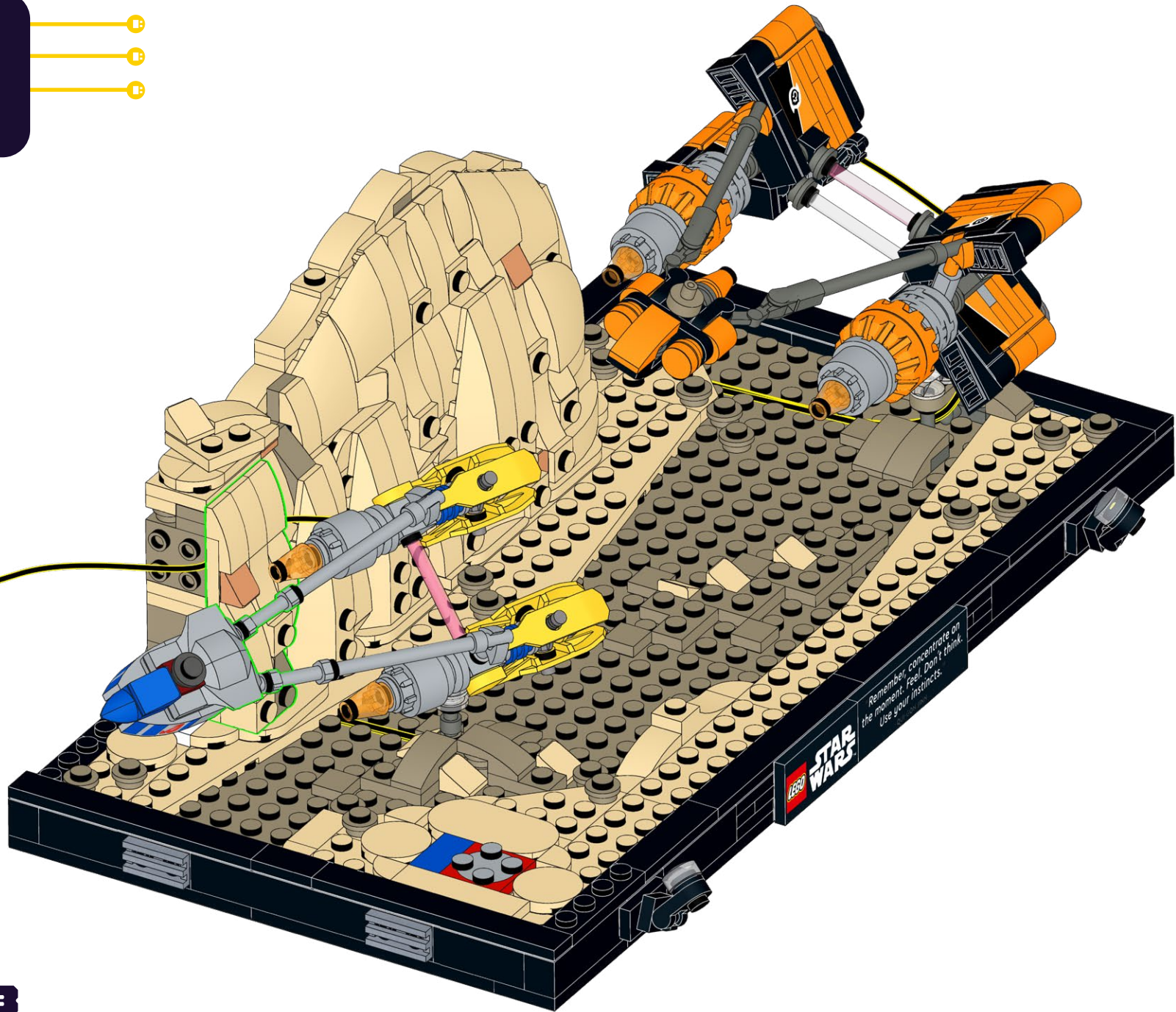



**185**

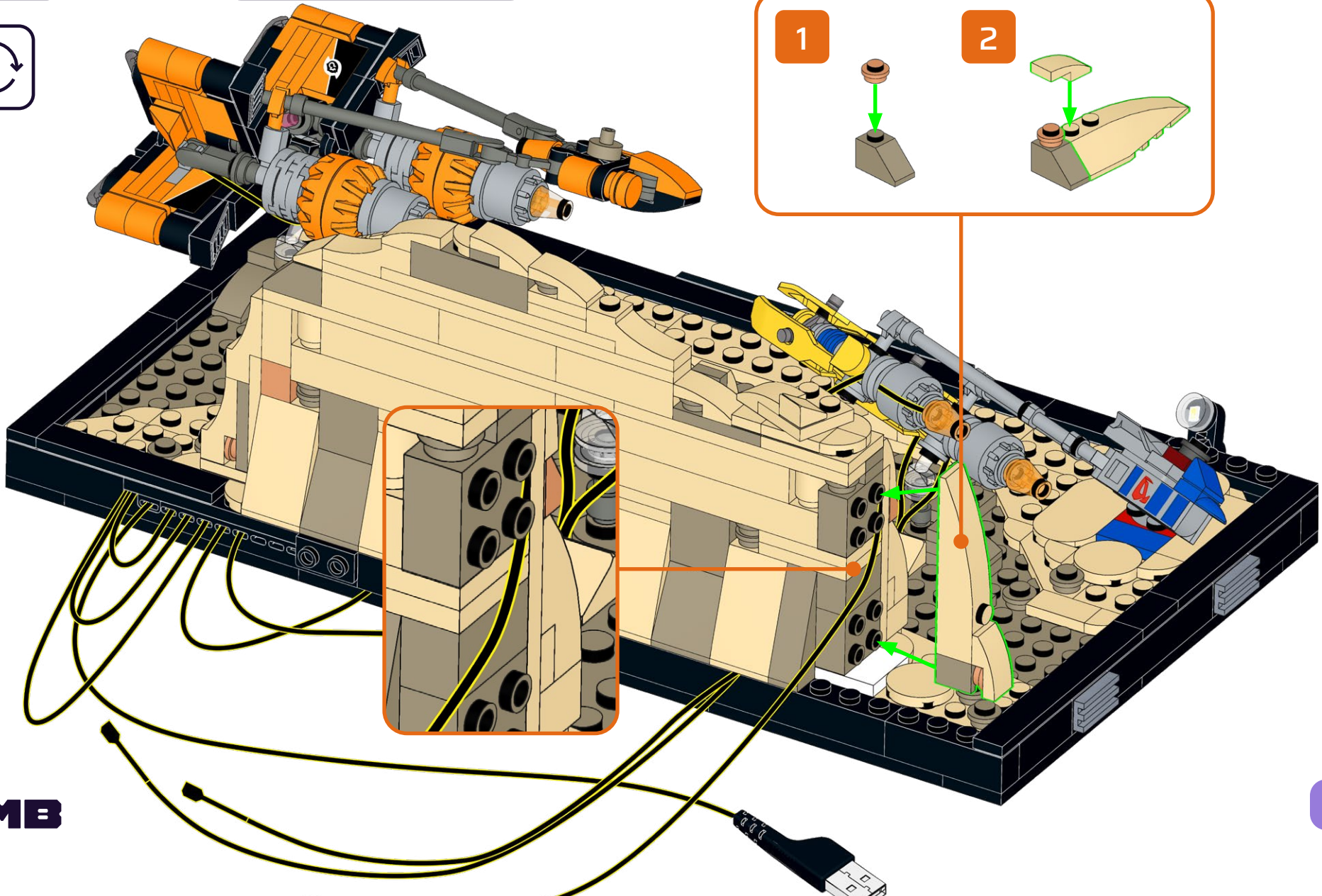
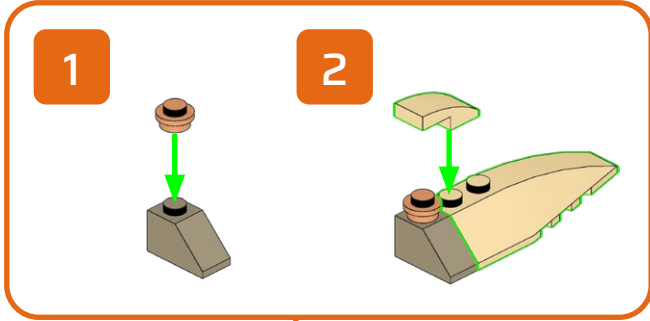
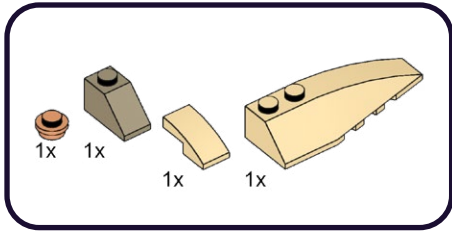

# 186

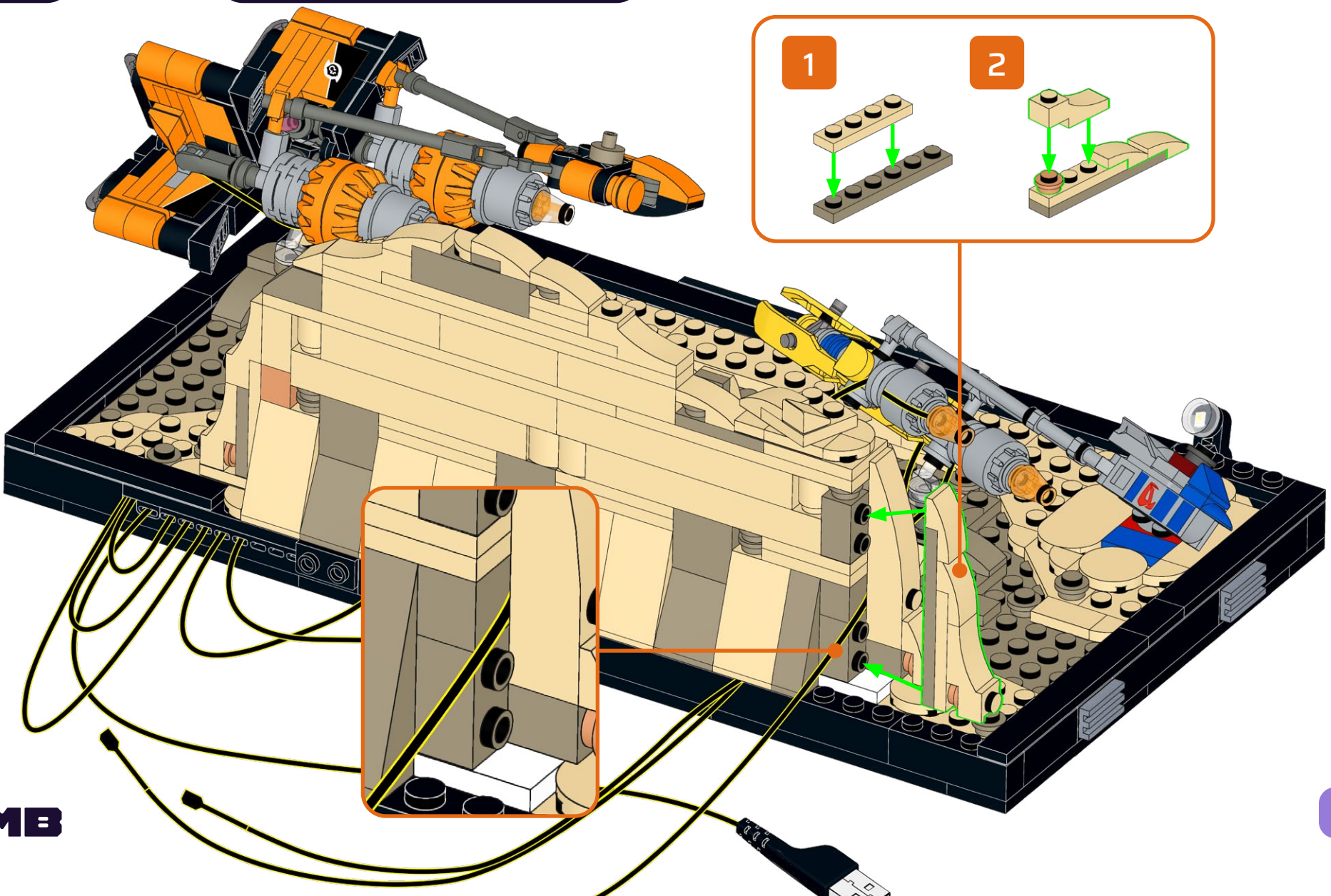
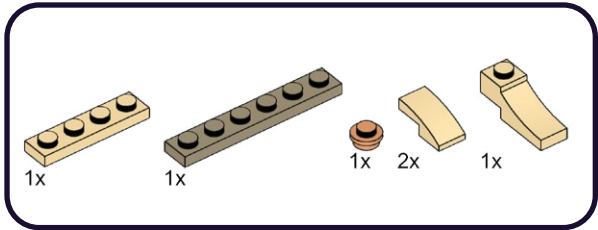



187

1x

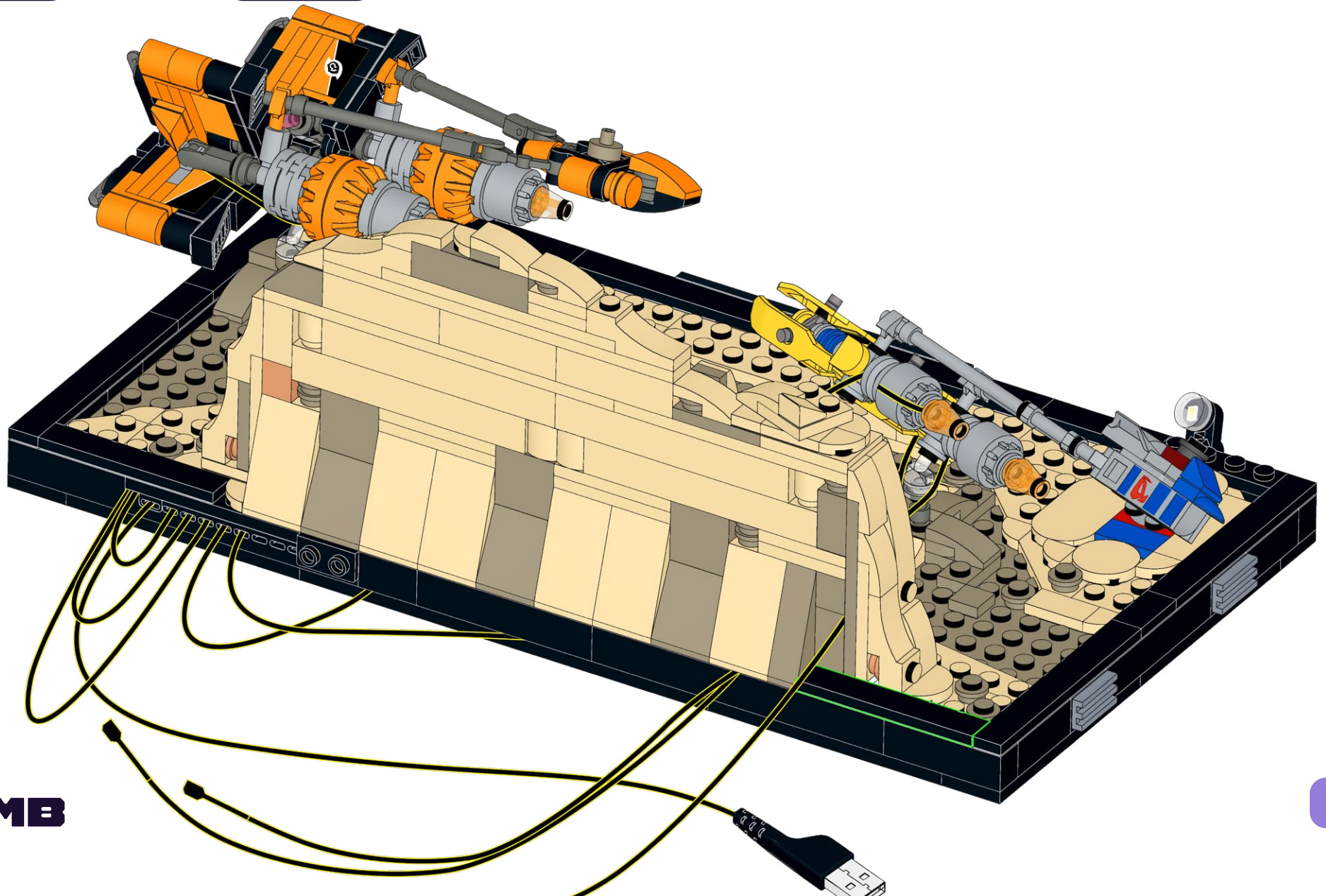



188

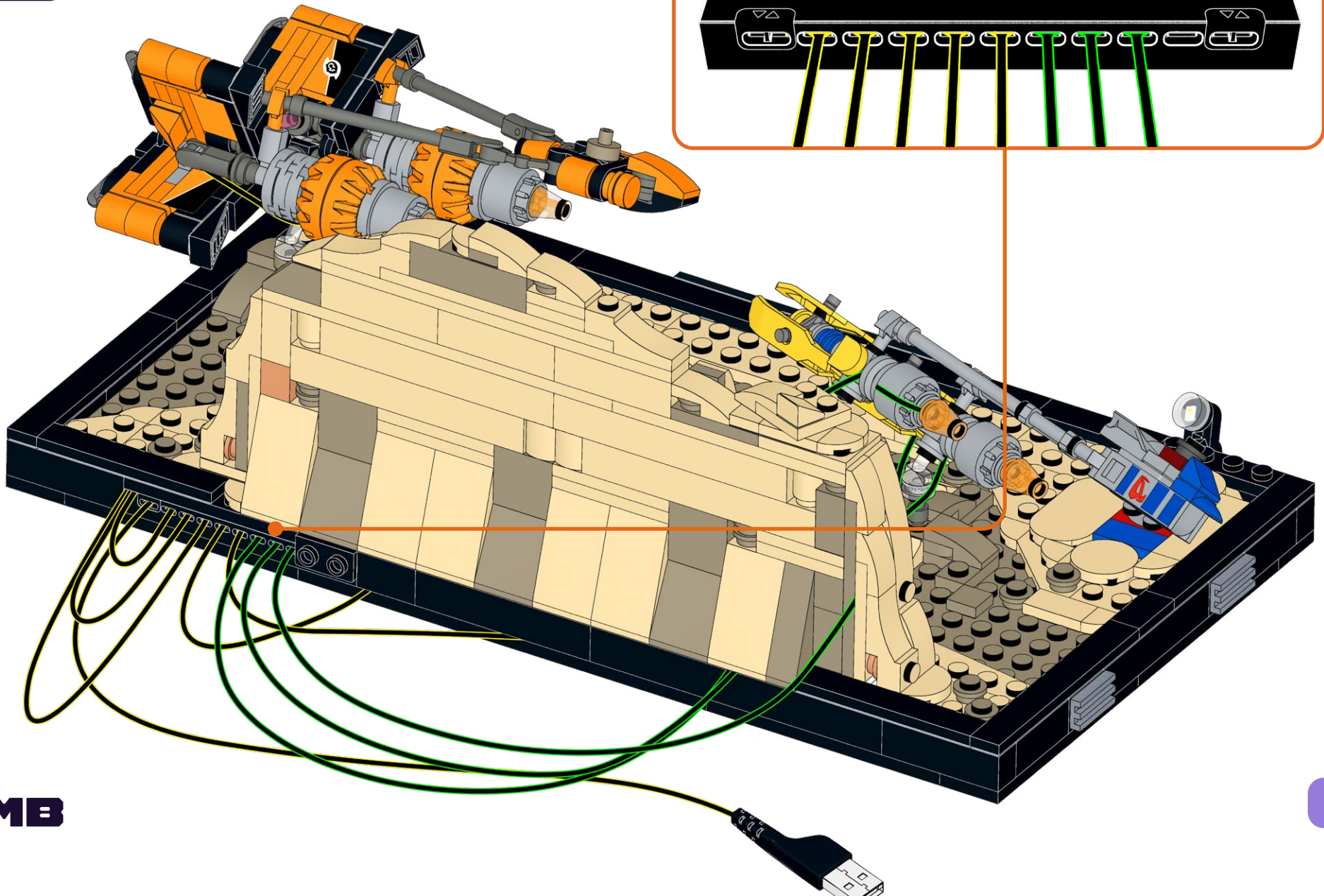

189

E-1x2

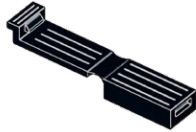

1x

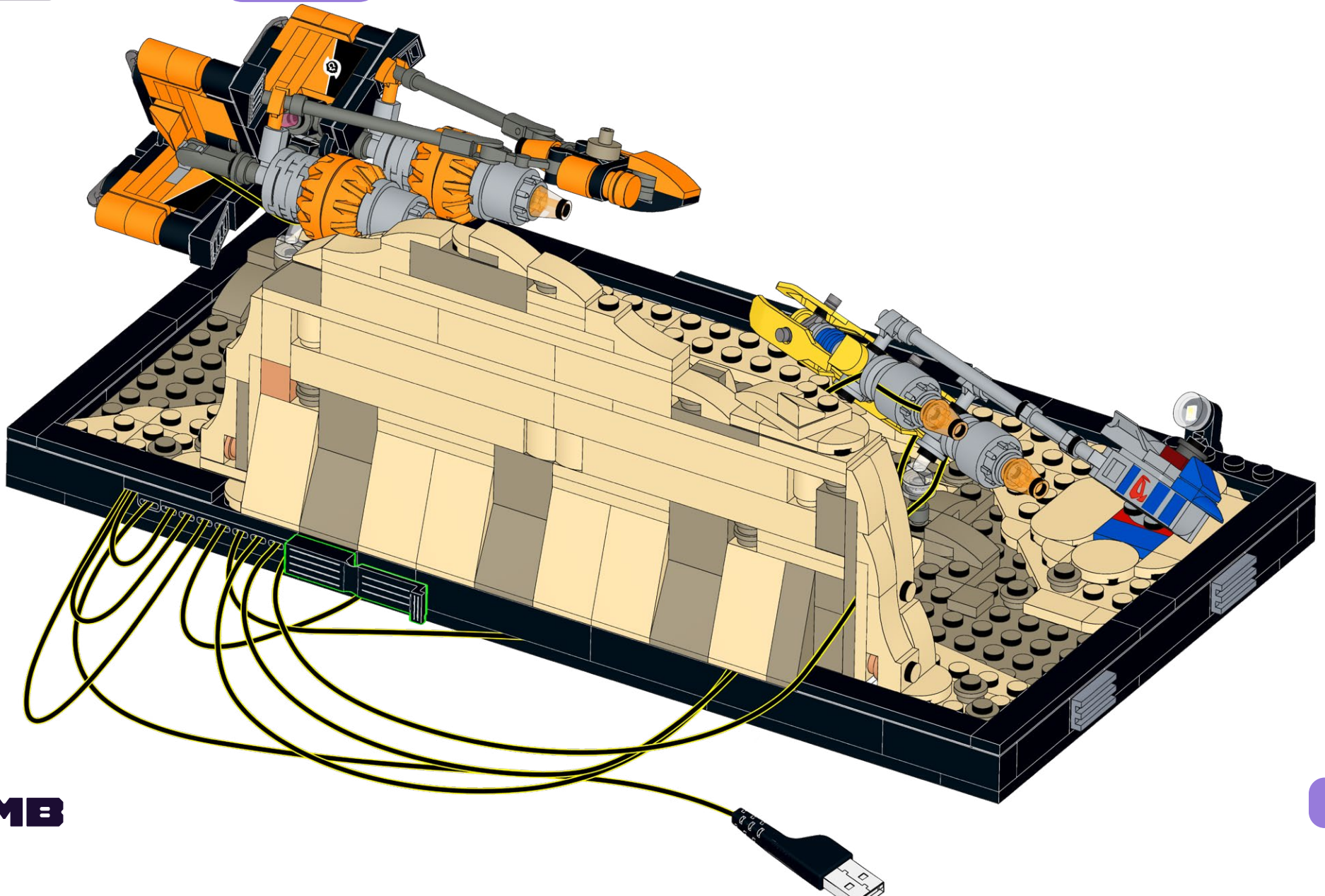



190

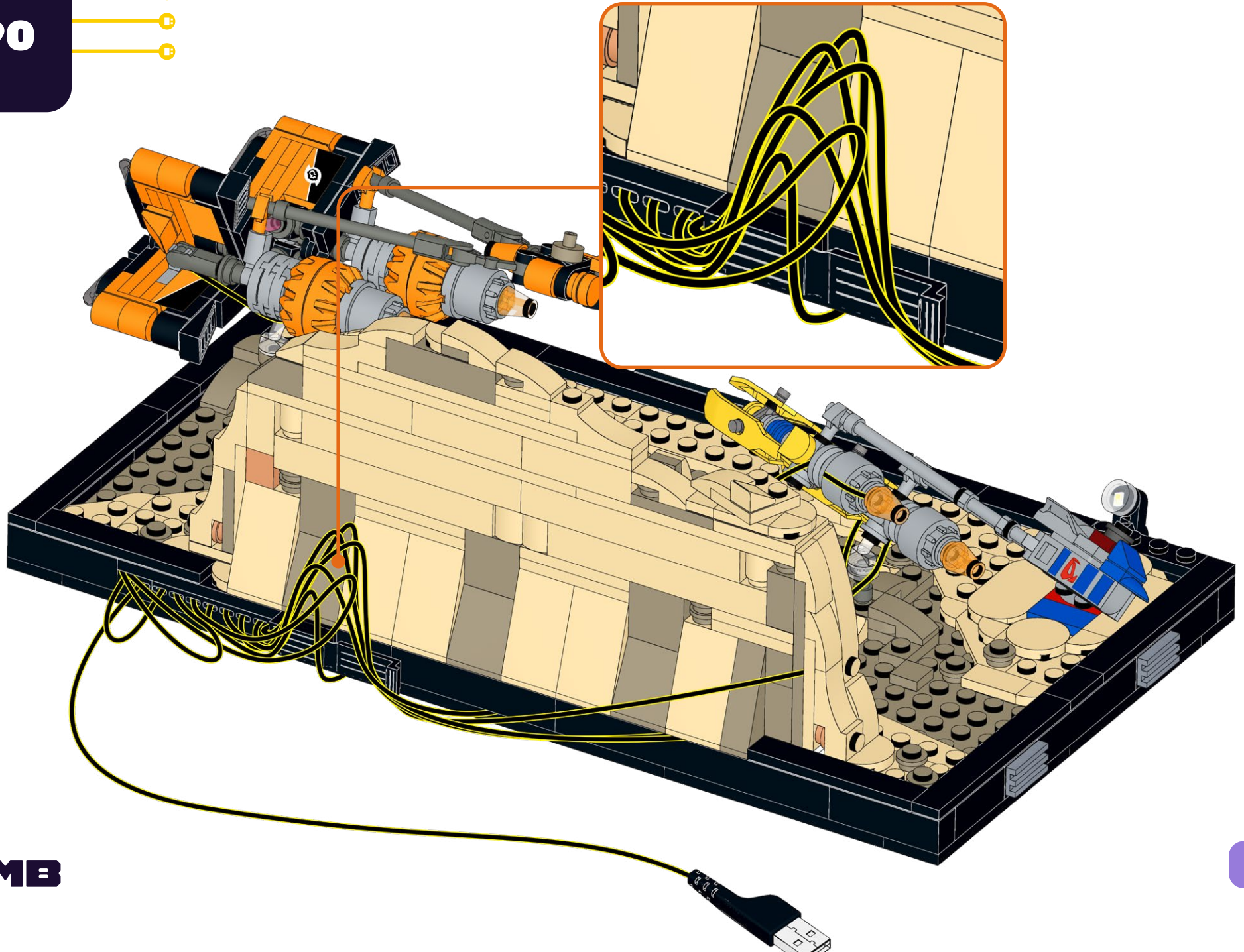



191

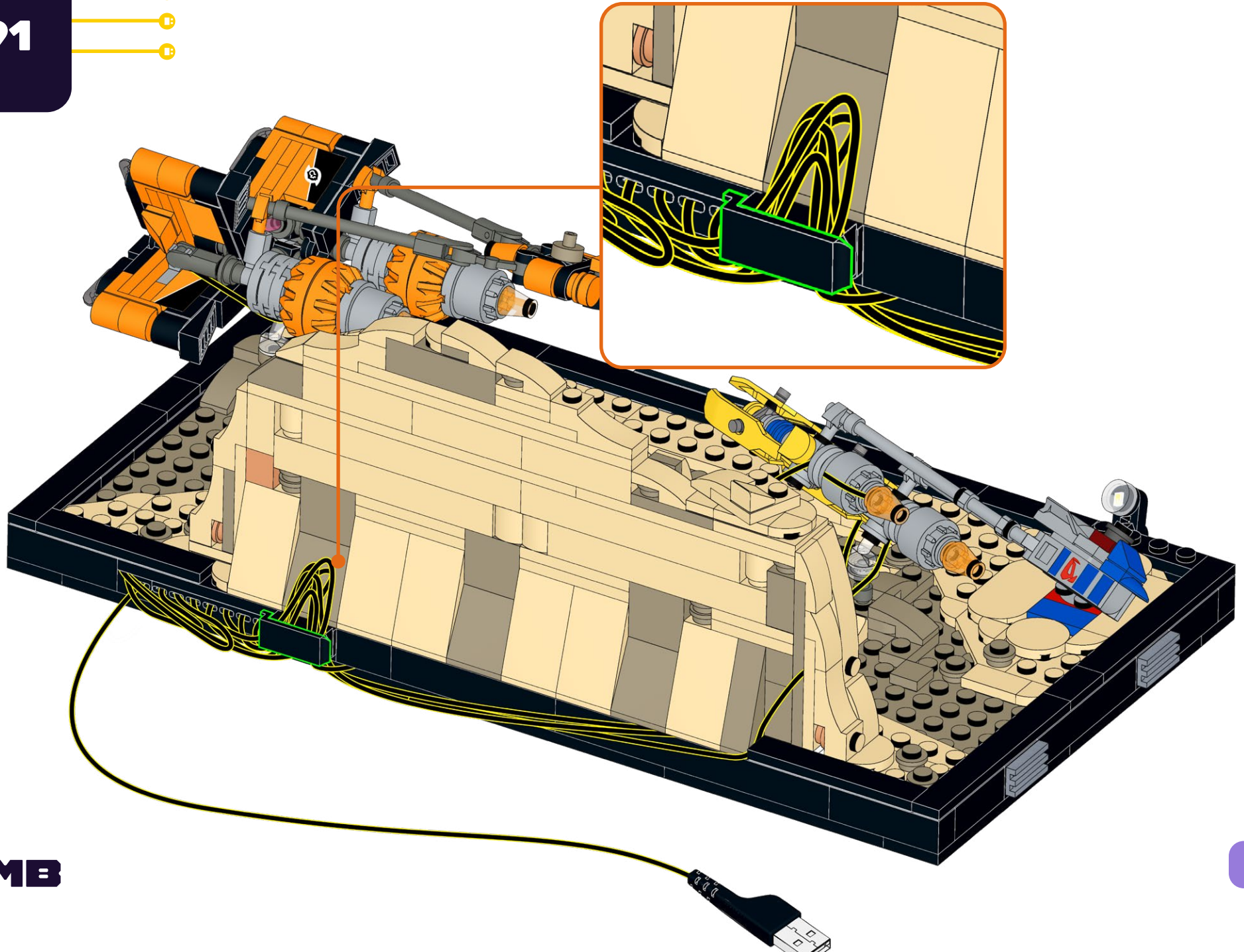

**HOLD UP!**

You might notice some bags are out of order, as well as left over pieces, but that's ok! We're changing the way you build LEGO!

**HALTEN!**

Möglicherweise stellen Sie fest, dass einige Beutel nicht in Ordnung sind und auch Teile übrig bleiben, aber das ist in Ordnung! Wir verändern die Art und Weise, wie Sie LEGO bauen!

**TENIR BON!**

Vous remarquerez peut-être que certains sacs sont en panne, ainsi que des morceaux restants, mais ce n'est pas grave ! Nous changeons la façon dont vous construisez LEGO !

**SOSTENERE!**

Potresti notare che alcune borse sono fuori uso, così come alcuni pezzi avanzati, ma va bene! Stiamo cambiando il modo in cui costruisci i LEGO!

**¡SOSTENER!**

Puede que notes que algunas bolsas están fuera de orden, así como piezas sobrantes, ¡pero está bien! ¡Estamos cambiando la forma de construir LEGO!

**耽误!**

您可能会注意到有些袋子坏了, 还有剩余的碎片, 但这没关系! 我们正在改变您搭建乐高的方式!

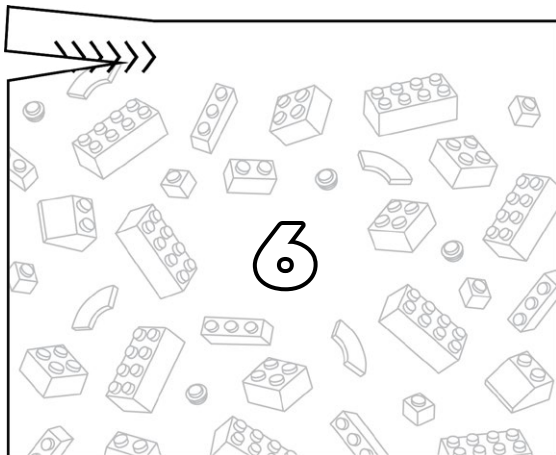
**Open LEGO® Bag 6**



192

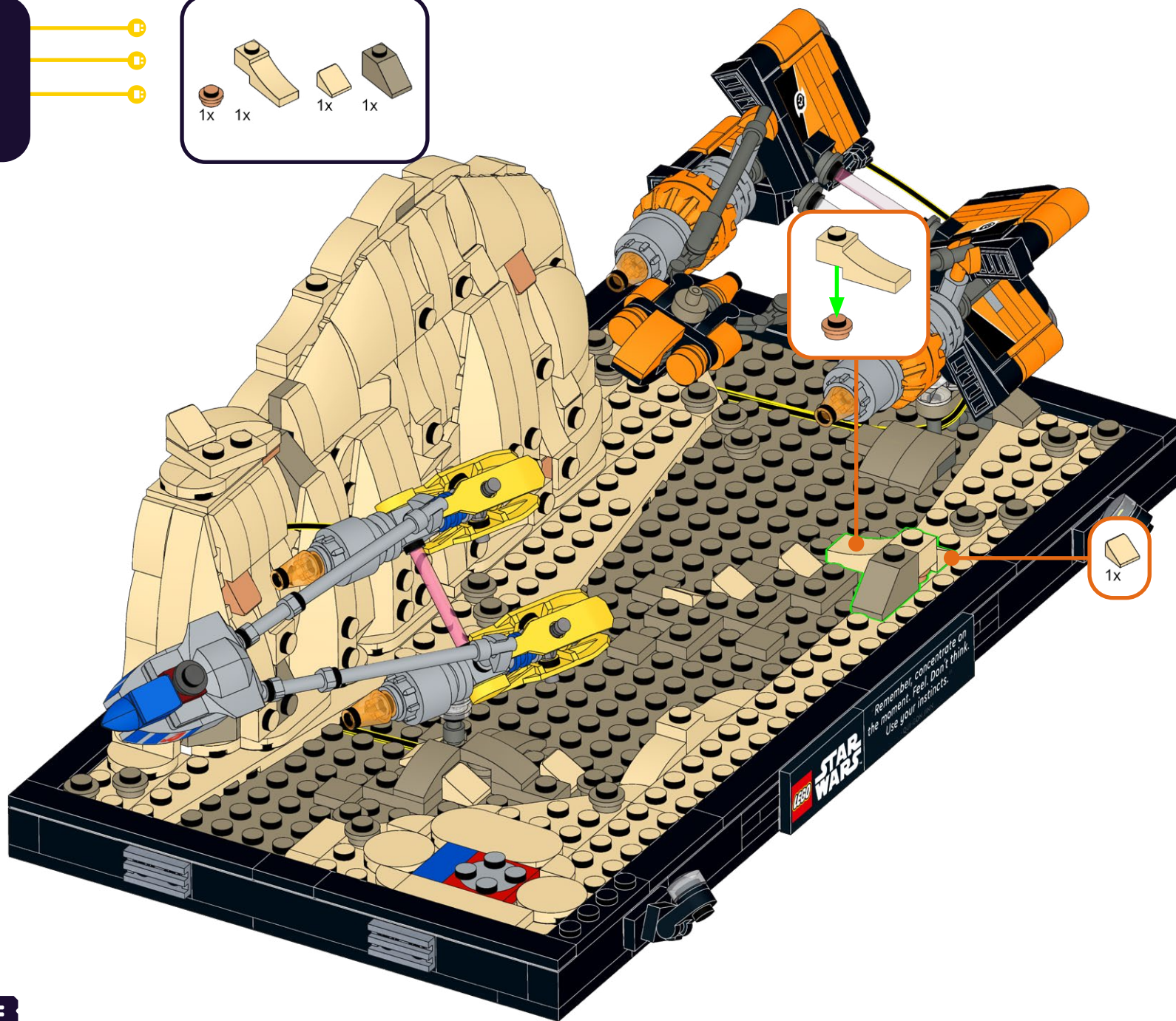
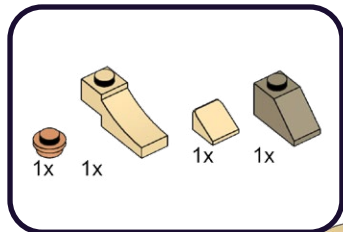



193

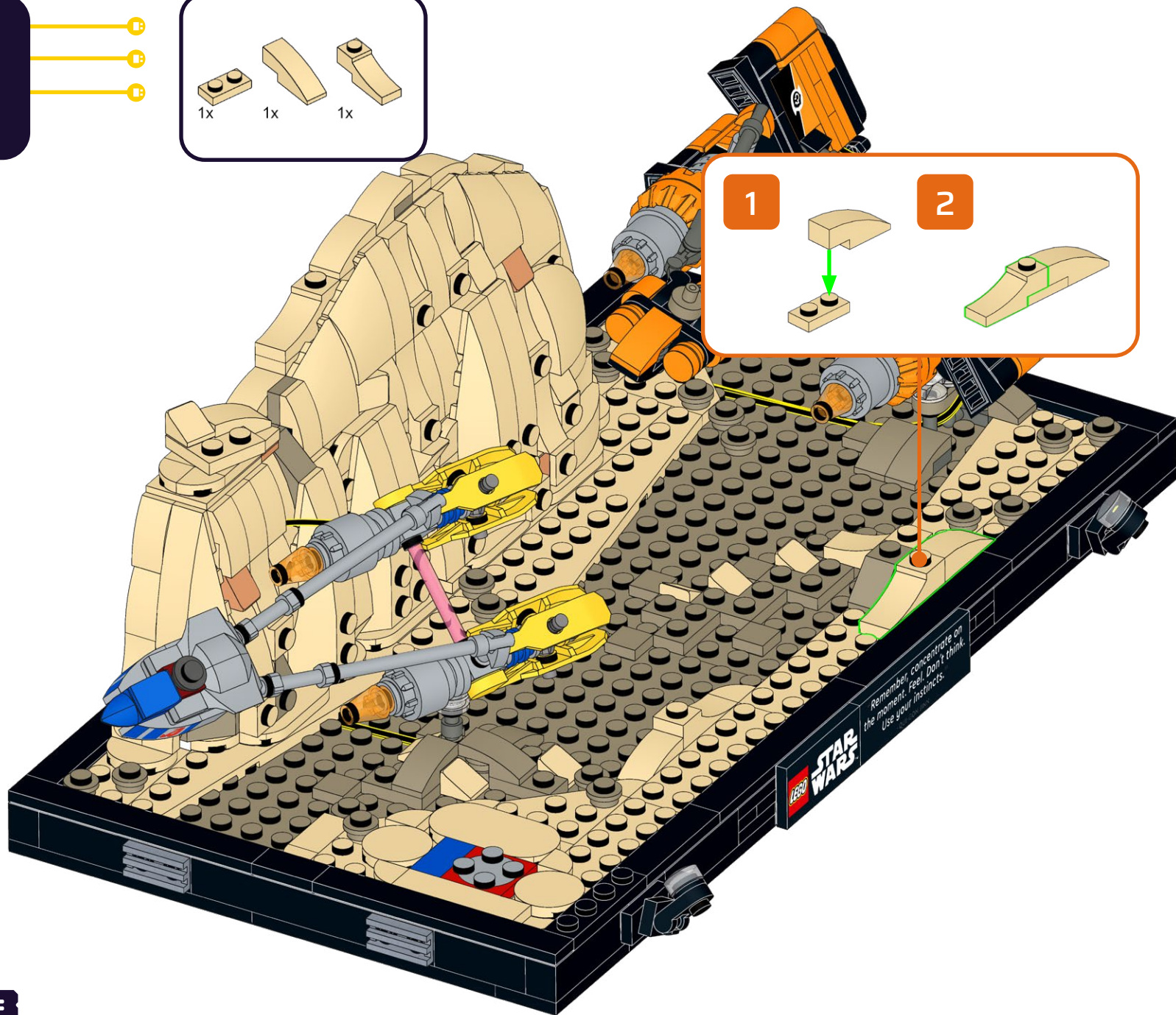
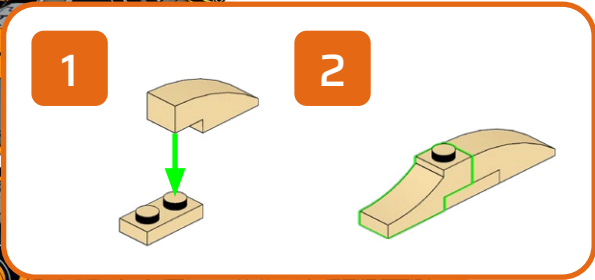
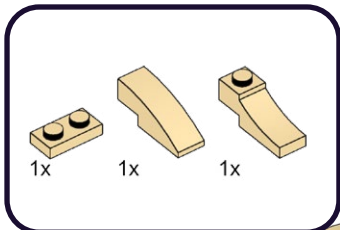

194

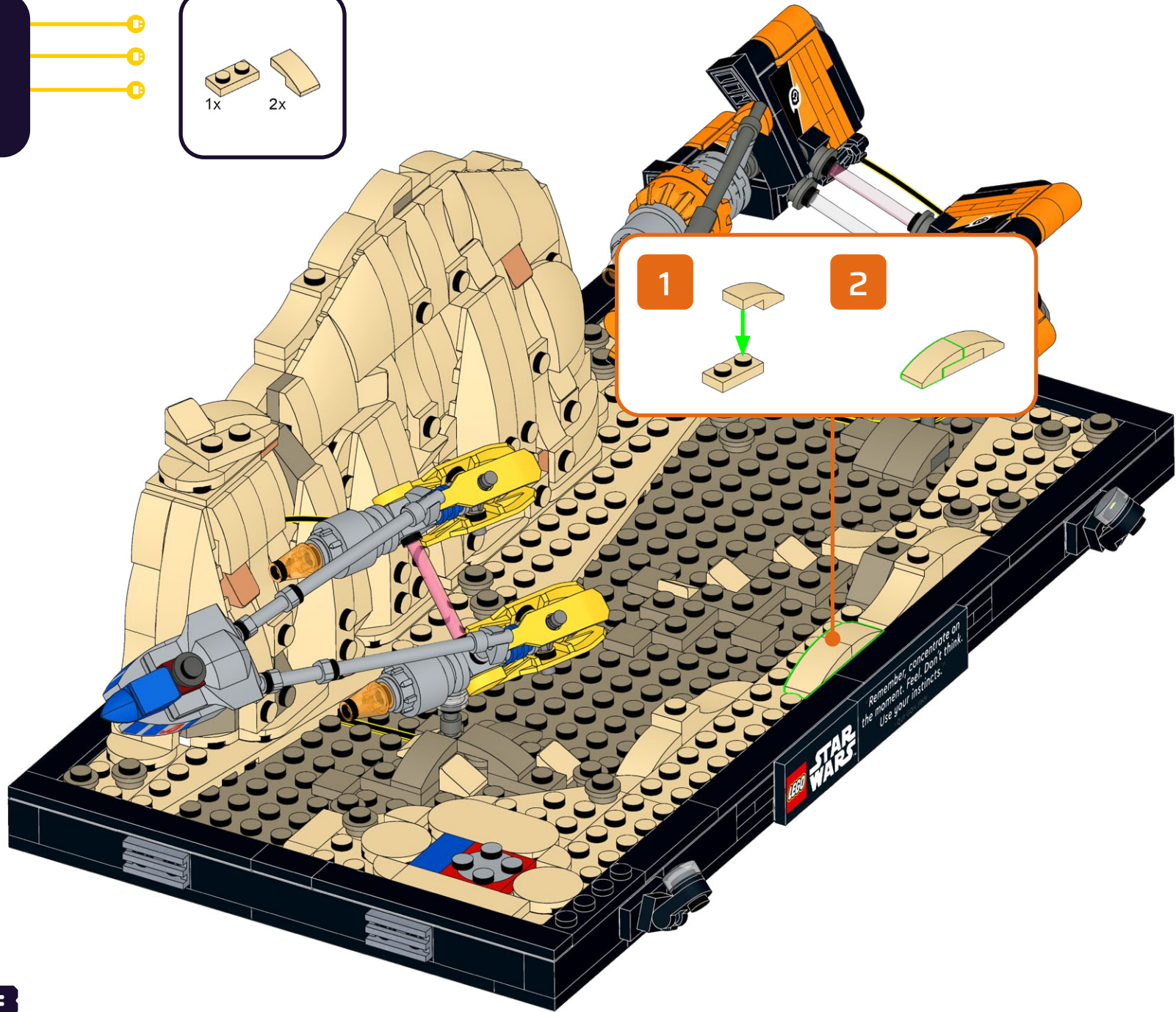
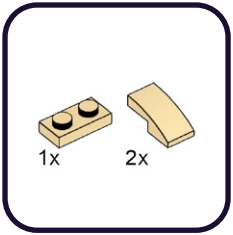



195

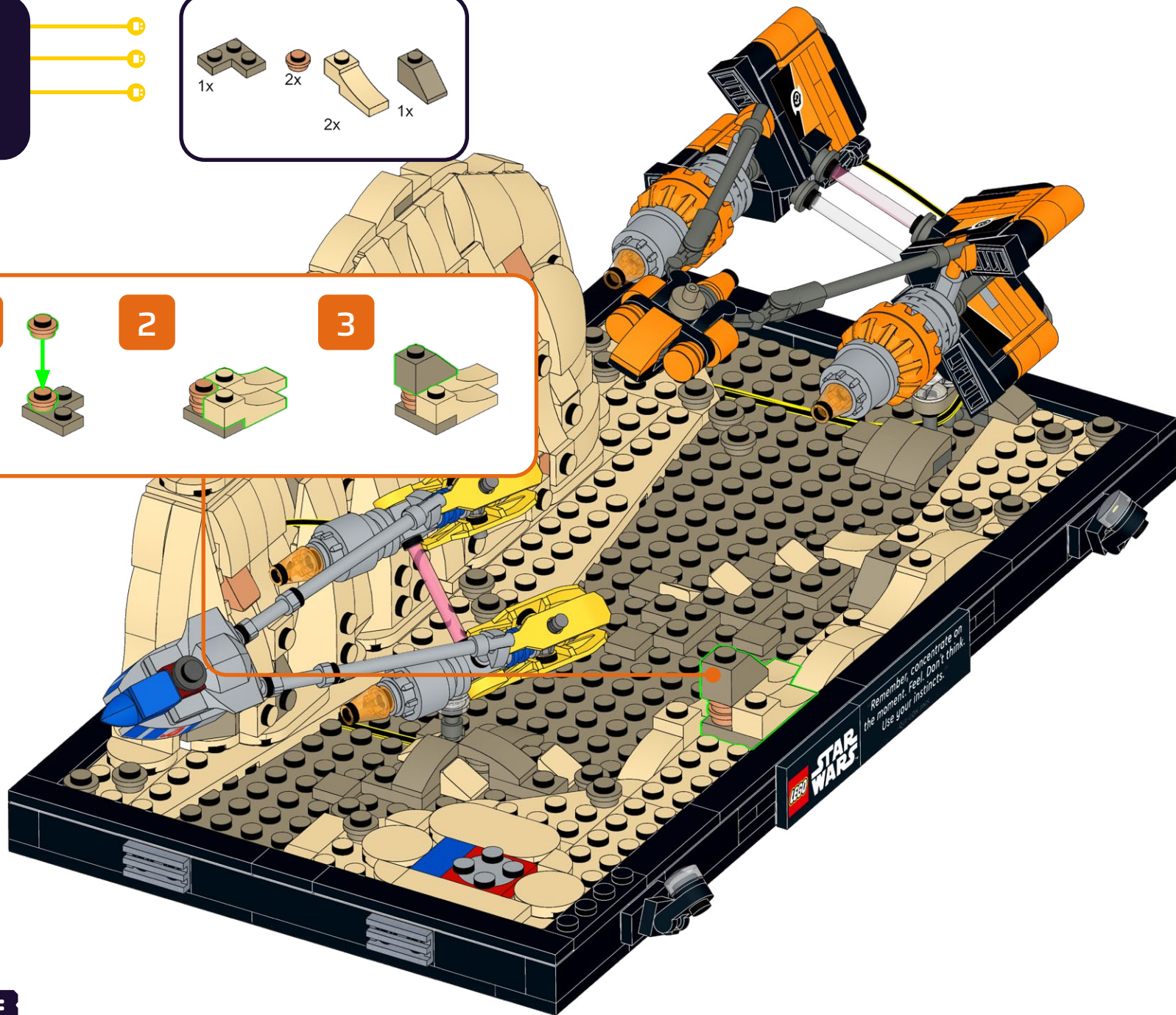
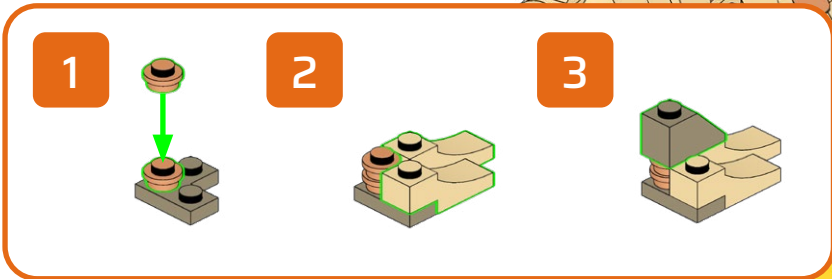
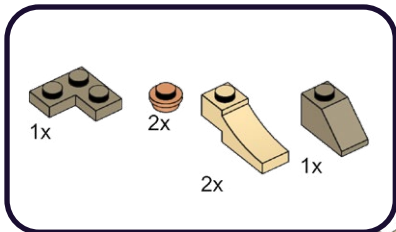



196

1x

1x

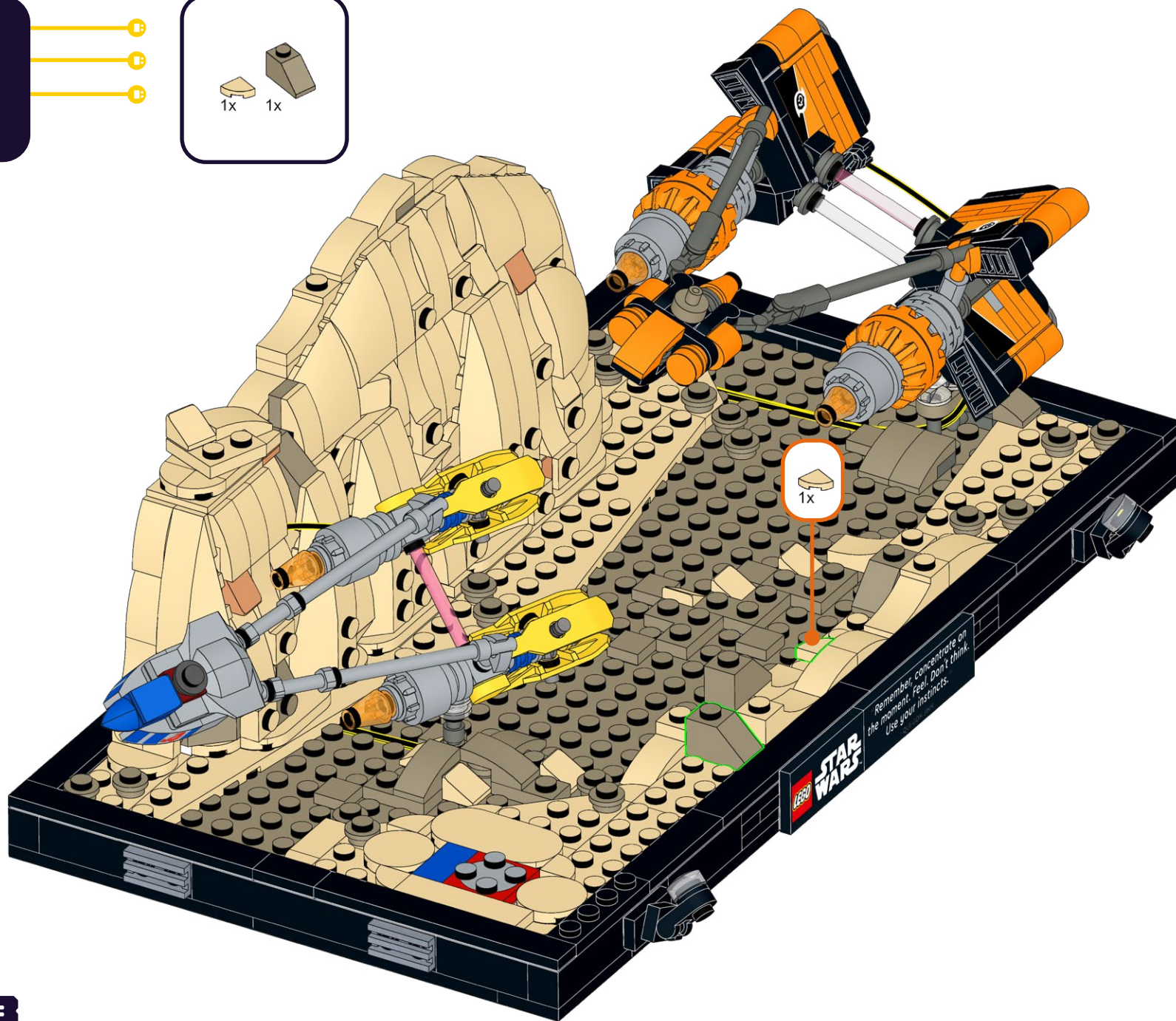



197

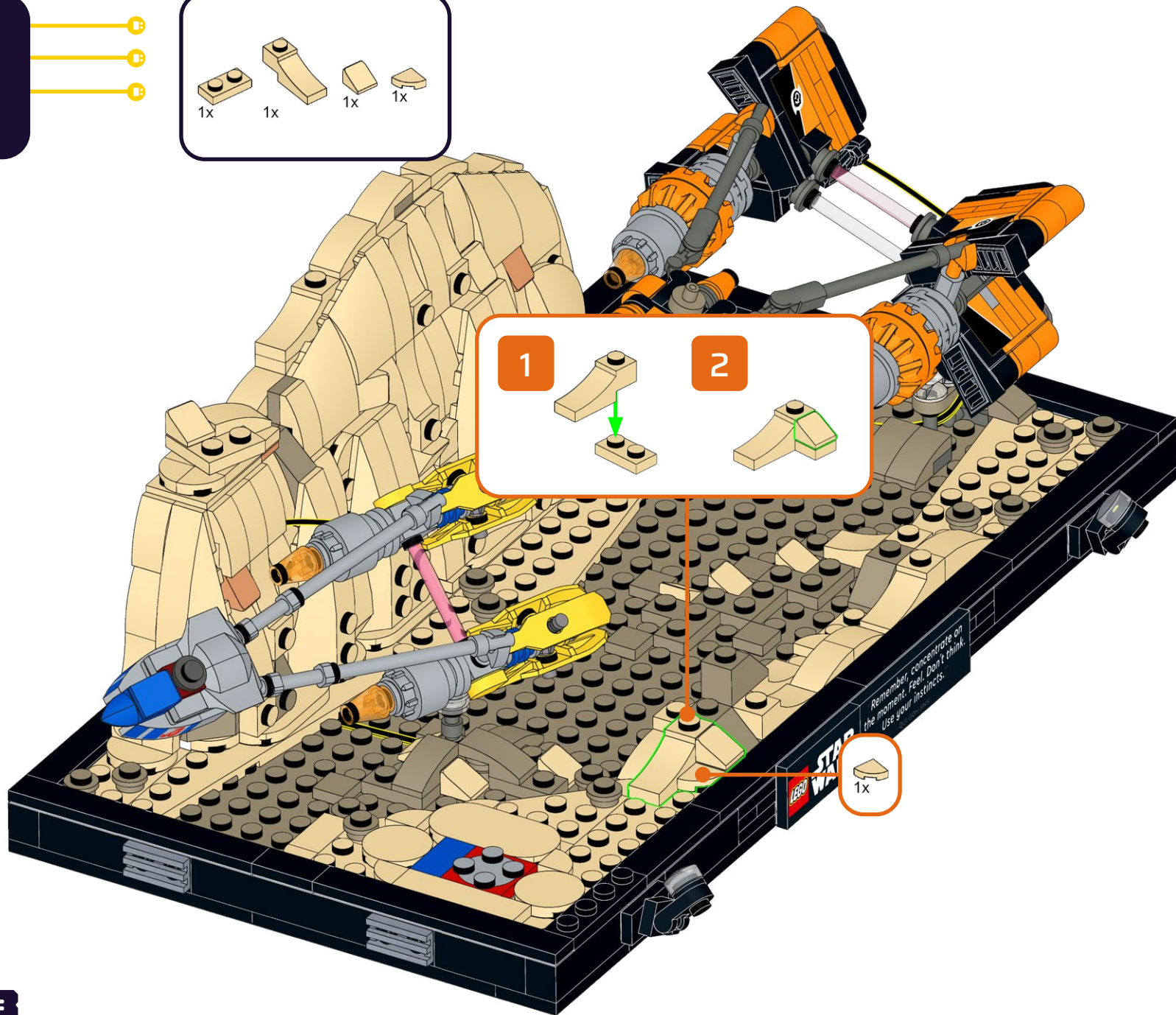
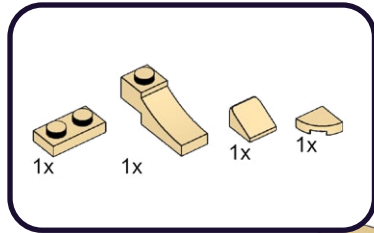

198

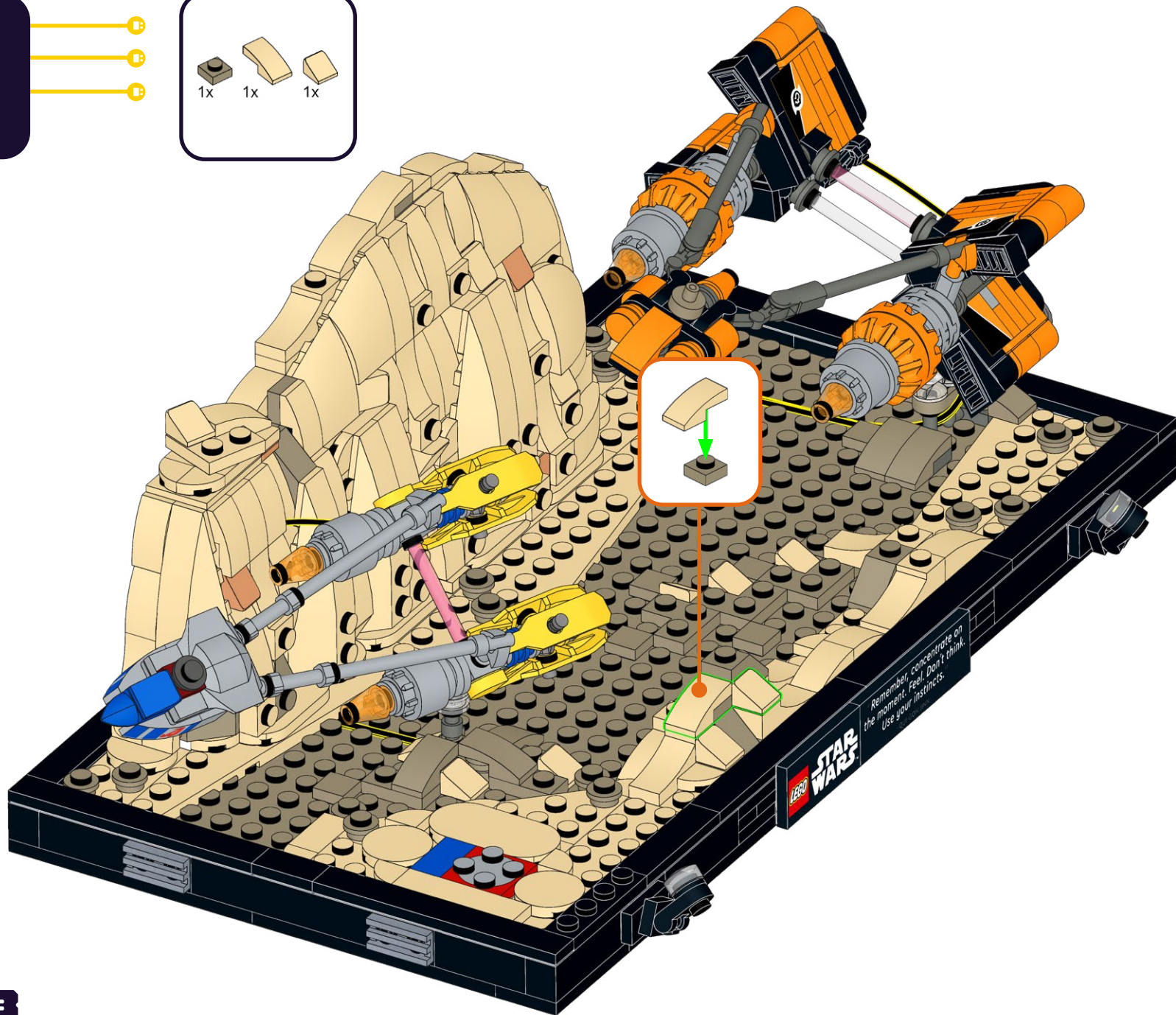
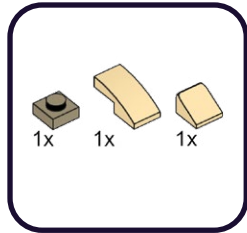



# 199

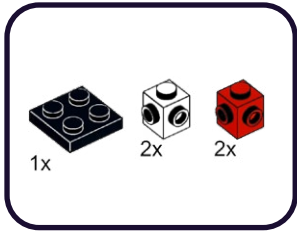

1

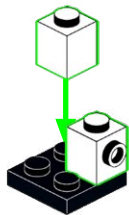

2



# 200

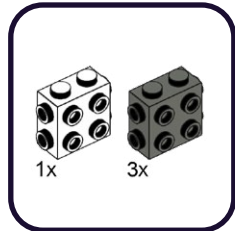

1



2

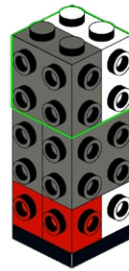

**201**

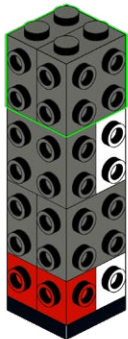
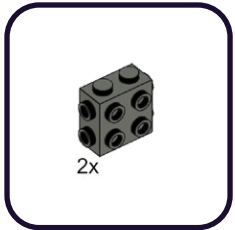

**202**

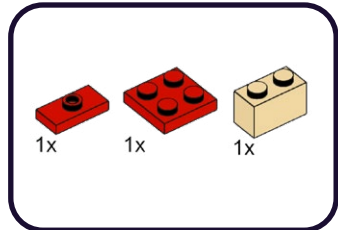

# 203

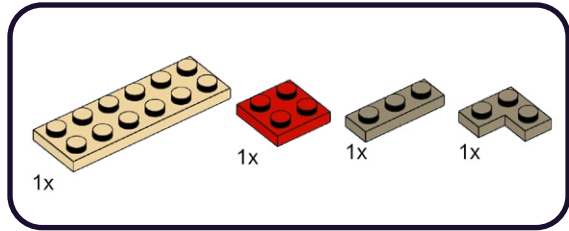

1

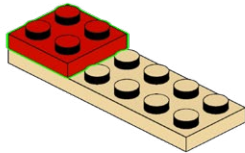

2

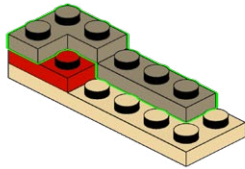

# 204

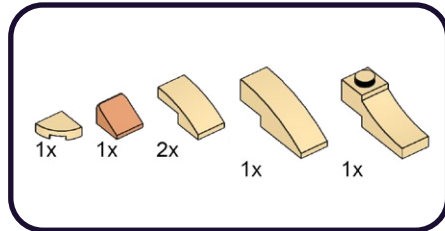

1

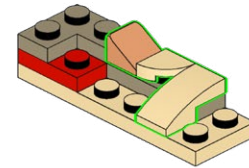

2

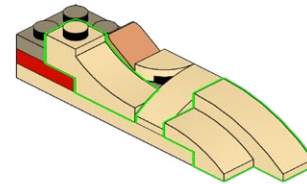



**205**

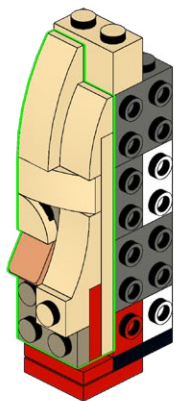

**206**

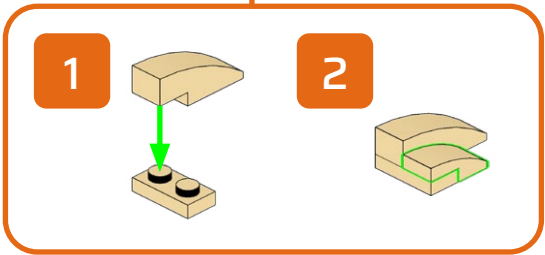
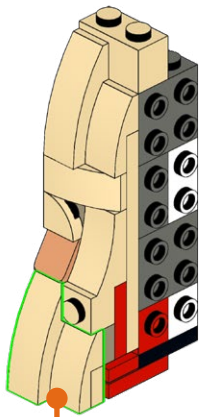
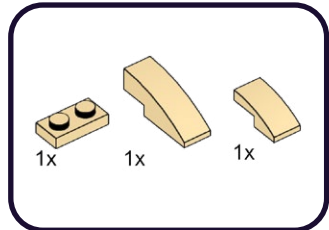

# 207

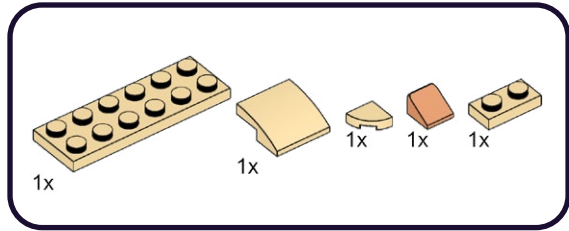

1

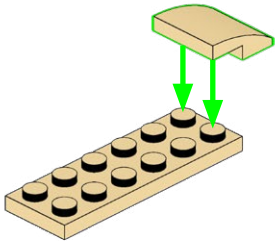

2

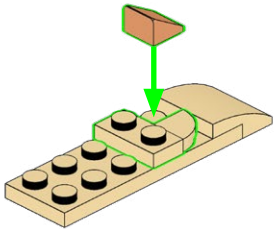

# 208

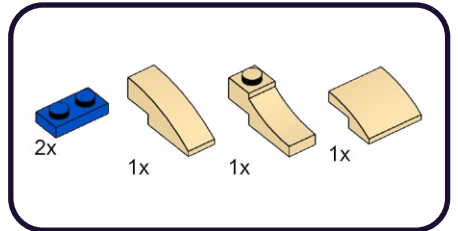

1

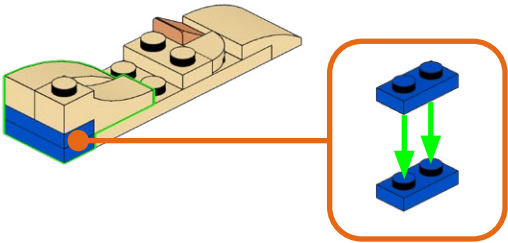

2

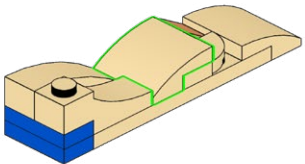





211

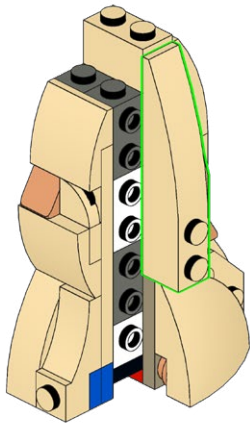
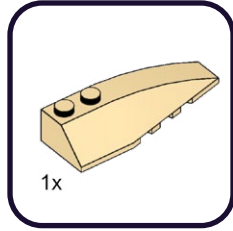

212

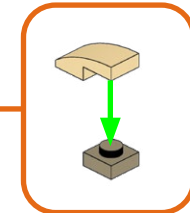
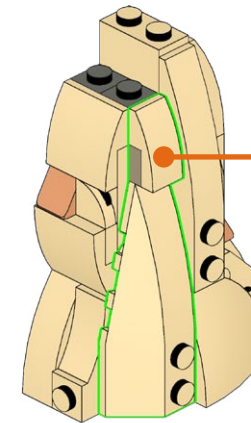
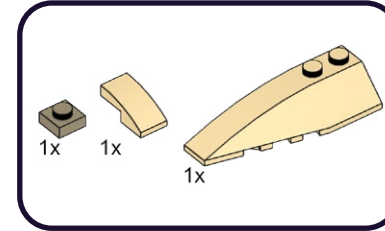

213

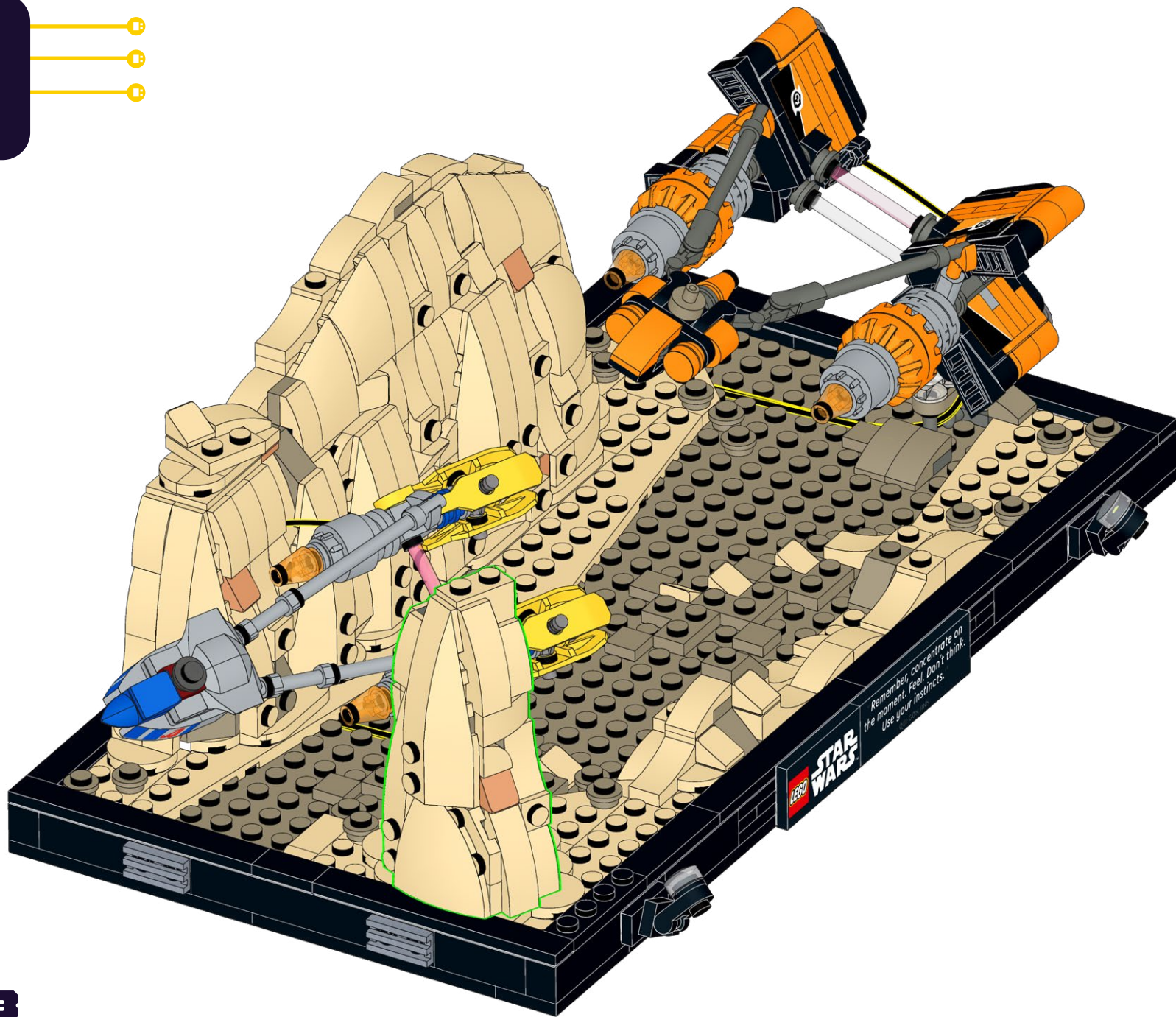





216

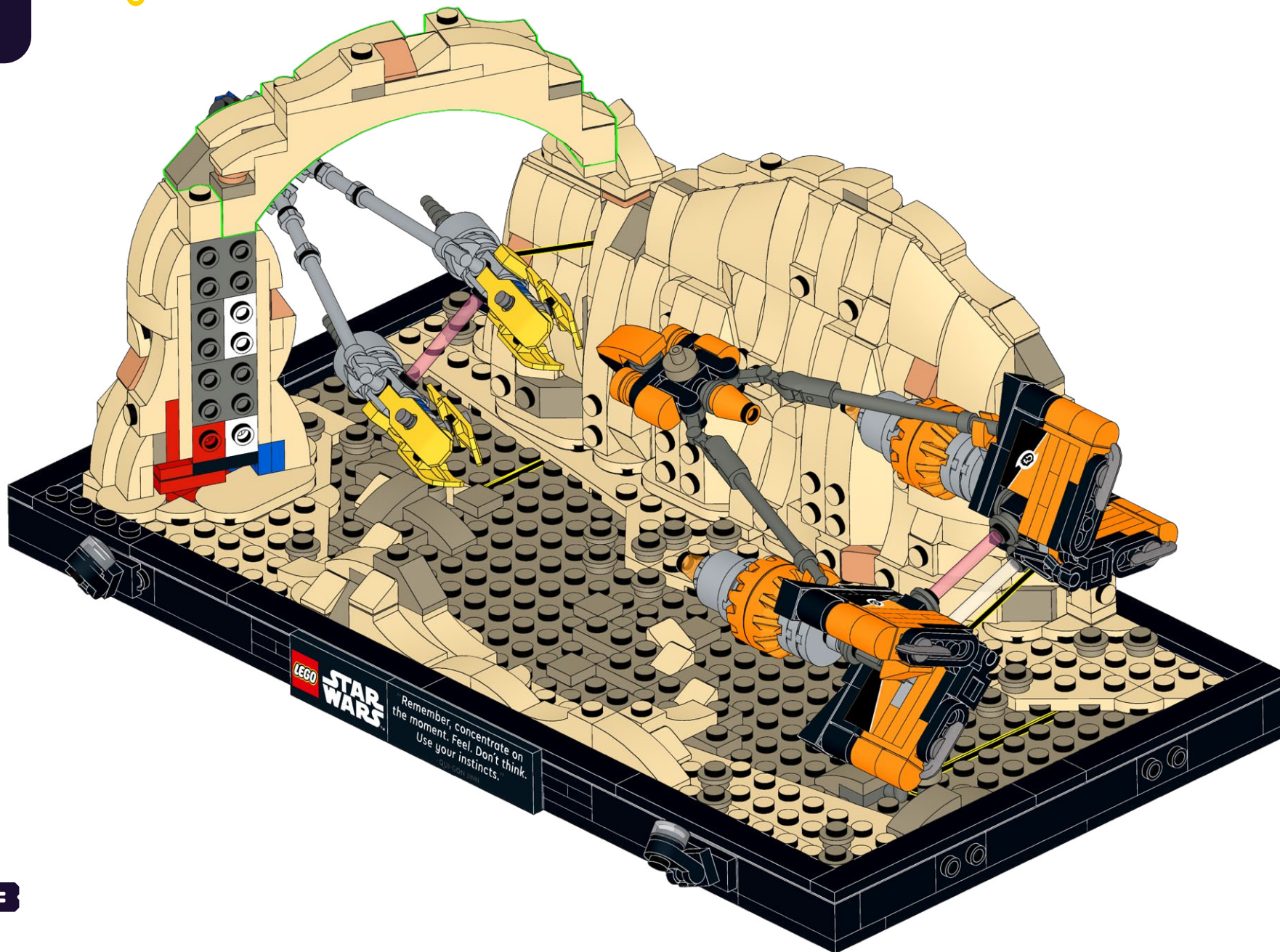



217

1x

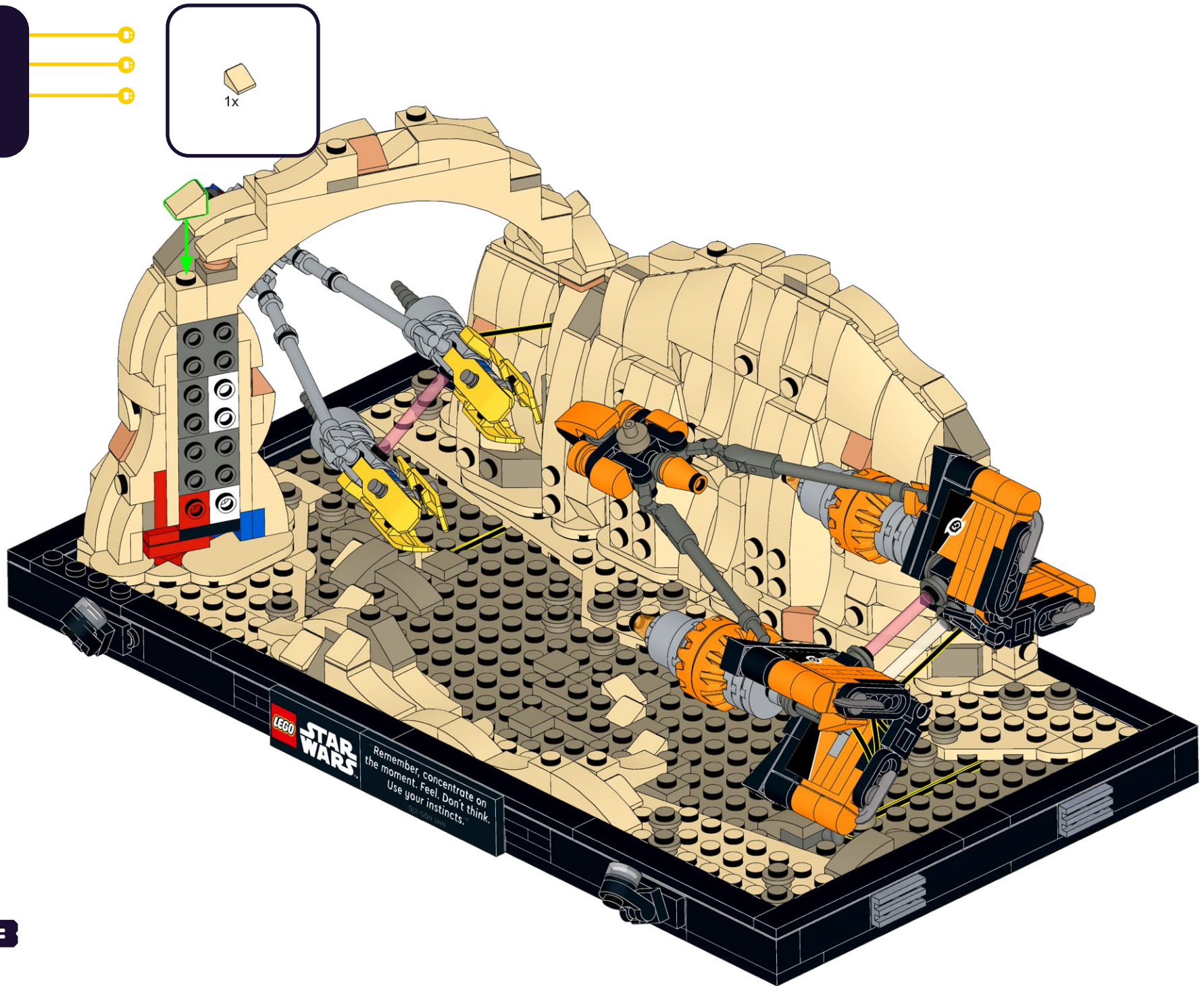



218

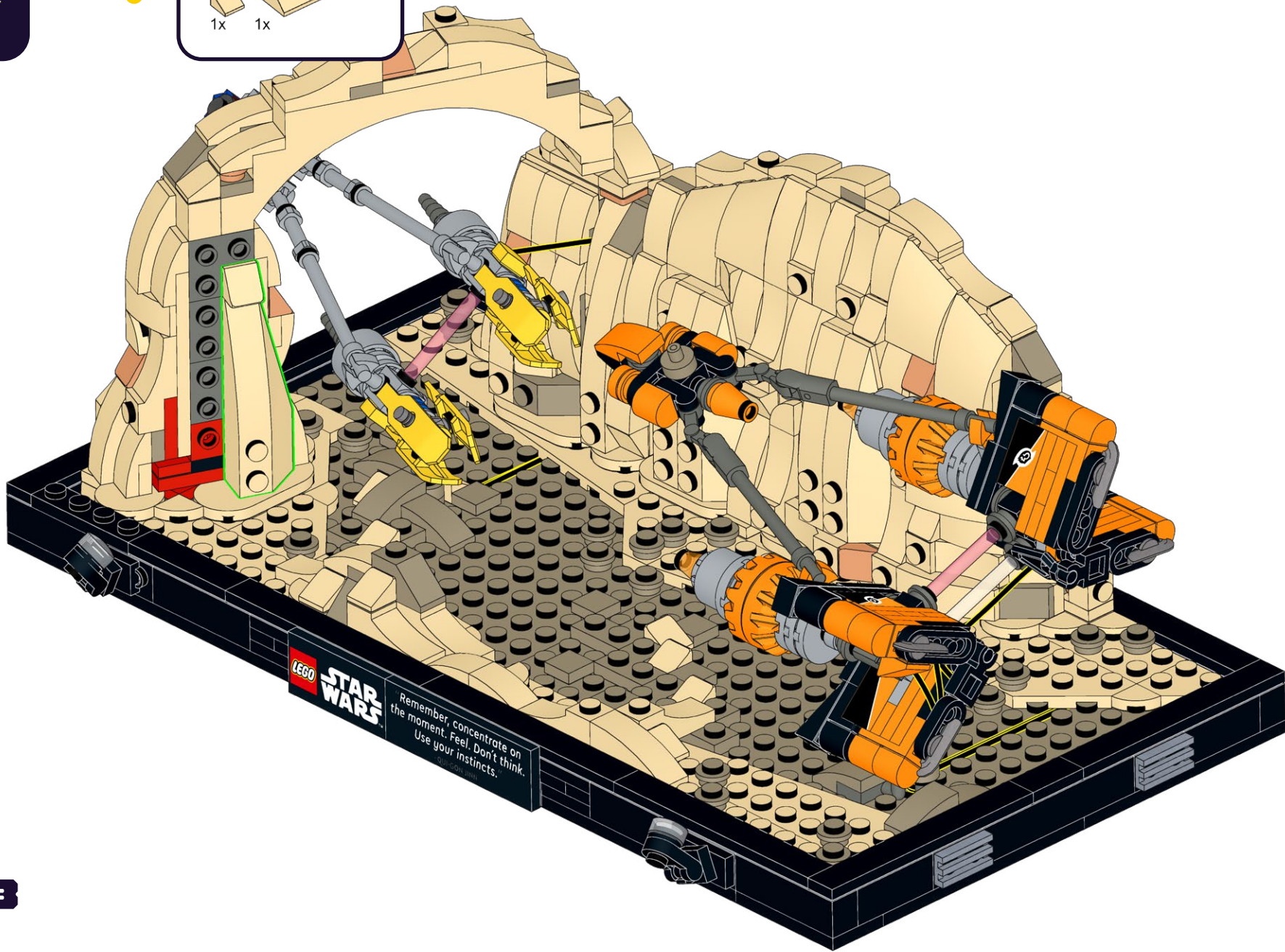
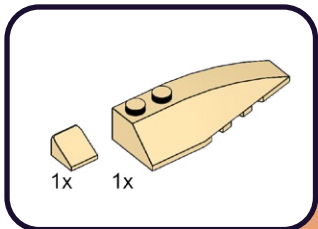



219

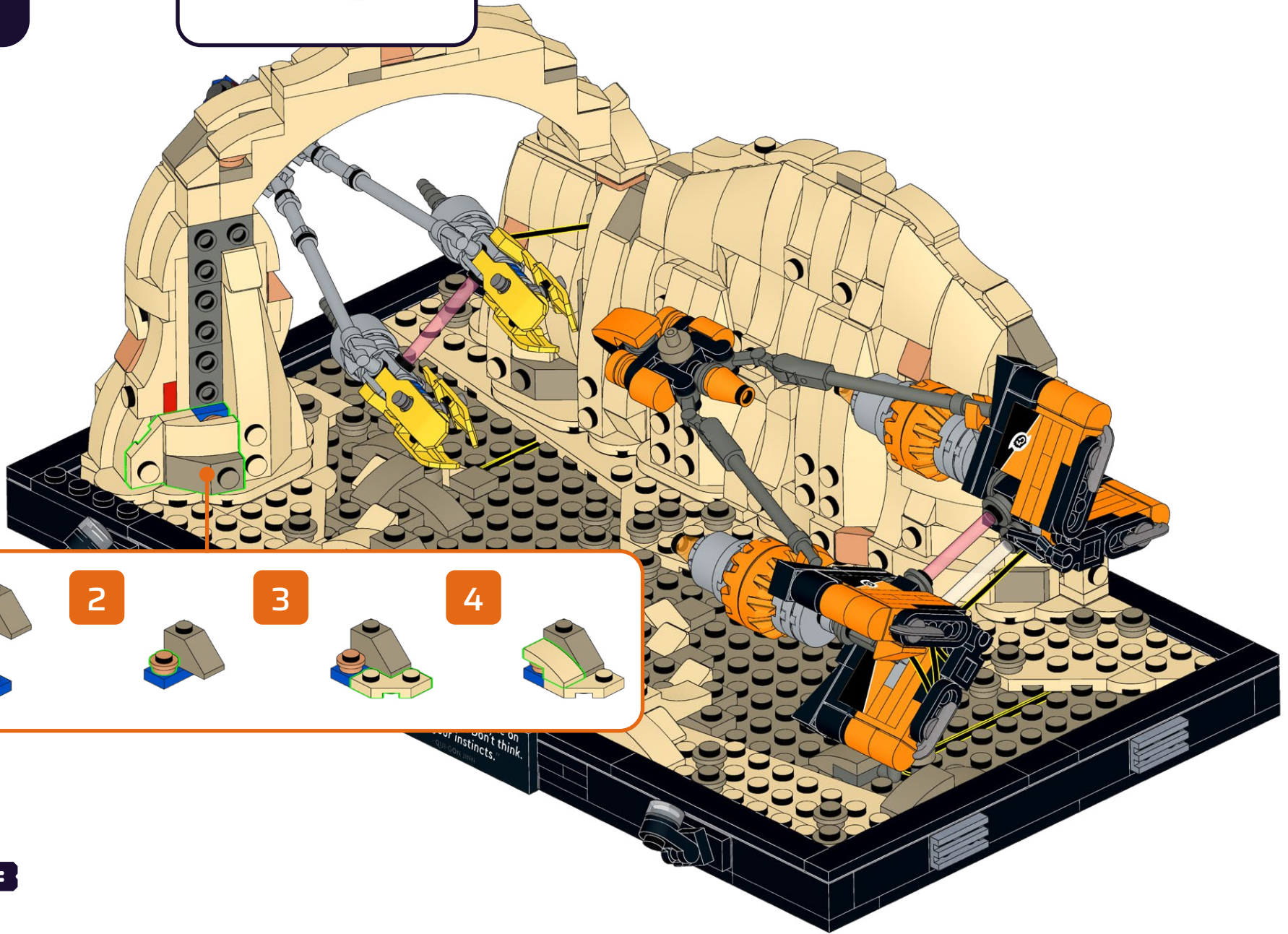
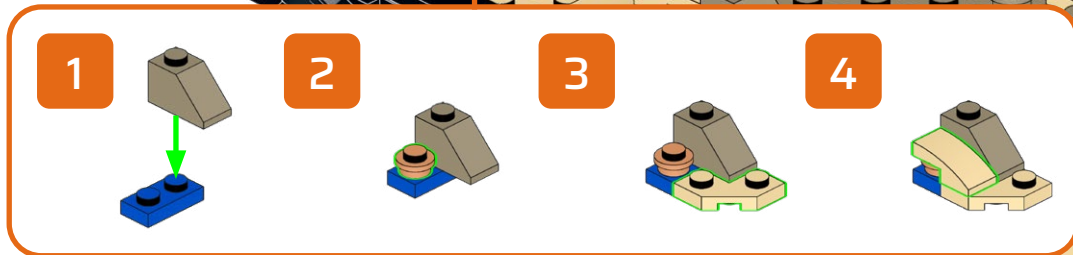
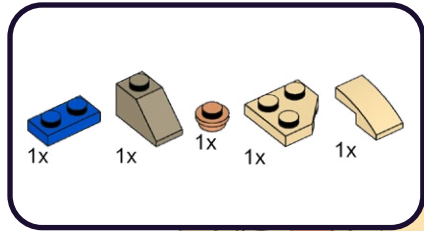



220

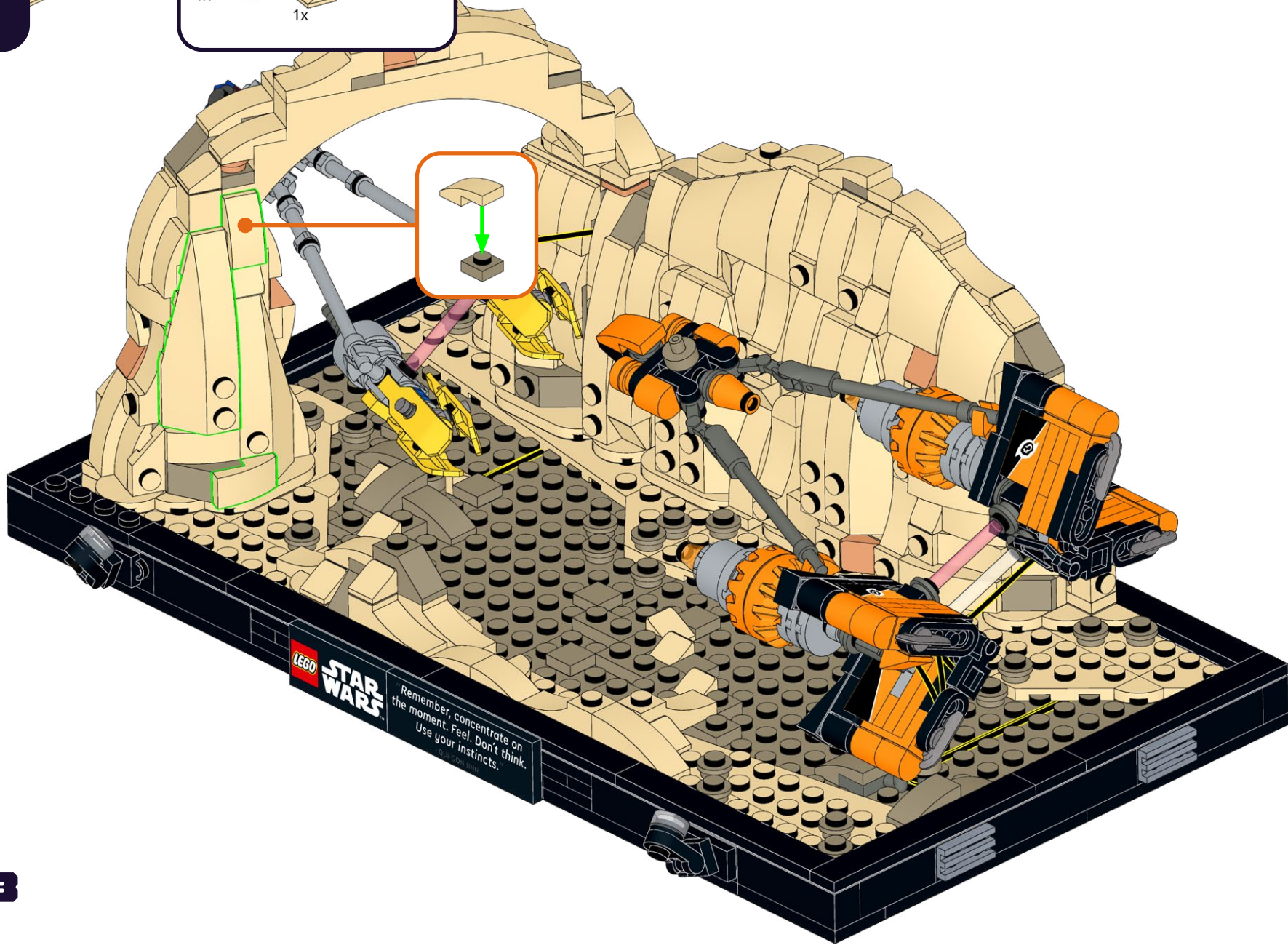
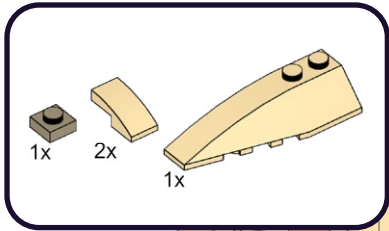



221

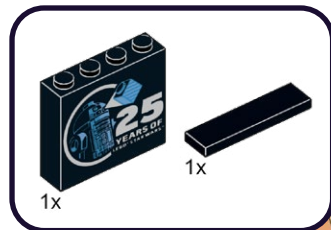



222



223





# FINAL PRODUCT





# PACKAGE CONTENTS



**4x** AR-WW30  
Astro Light Regular  
Warm White 30cm



**2x** A-CAP  
Astro Cap



**2x** AR-P30  
Astro Light Regular  
Pink 30cm



**1x** E-1x2  
Eclipse 1x2



**2x** AL-WW30  
Astro Light Large  
Warm White 30cm



**1x** Flex Belt-30  
Belt 30cm



**1x** D-9  
Dock-9

# PACKAGE CONTENTS



**2x** Tile, Modified 1 × 1 with Open O Clip  
Black



**2x** Round Plate 1×1 w Open Stud  
Black



**2x** Plate, Round 1 × 1 with Bar Handle  
Black

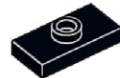

**2x** Plate, Modified 1 × 2 with 1 Stud with Groove (Jumper)  
Black



**4x** Cone 1×1 with Top Groove  
Trans-Orange

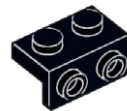

**1x** Bracket 1×2 - 1×2  
Black

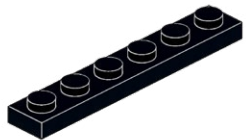

**1x** Plate 1×6  
Black

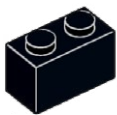

**1x** Brick 1×2  
Black

# CONTACT US

Click below for customer support, or general inquiries.

Cliquez ci-dessous pour accéder au support client ou aux renseignements généraux.

Clicca qui sotto per l'assistenza clienti o per richieste generali.

Contact Us



Contactez-nous



Contattaci



Klicken sie unten für kundensupport oder allgemeine anfragen.

Haga clic a continuación para atención al cliente o consultas generales.

点击下方获取客户支持或一般咨询。

Kontaktieren sie uns



Contáctanos



联系我们



## TROUBLESHOOTING

If you're stuck, scan the QR code for troubleshooting.

Se sei bloccato, scansiona il codice QR per la risoluzione dei problemi.

Wenn Sie nicht weiterkommen, scannen Sie den QR-Code zur Fehlerbehebung.

Si vous êtes bloqué, scannez le code QR pour le dépannage

Si está atascado, escanee el código QR para solucionar el problema.

如果遇到问题, 请扫描二维码进行故障排除

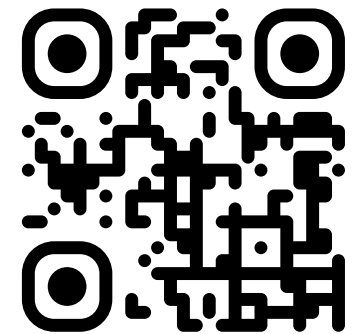





# LIGHTMYBRICKS

[lightmybricks.com](http://lightmybricks.com)



LEGO® is a trademark of the LEGO Group of companies, which does not sponsor, authorize or endorse this product. All LEGO® sets featured in images are sold separately. This is not a LEGO® product. The LEGO Group is not liable for any loss, injury or damage arising from the use or misuse of this product. ©2024 Light My Bricks Pty Ltd. All rights reserved. [www.lightmybricks.com](http://www.lightmybricks.com)

Our components are designed and packaged in Australia by Light My Bricks Pty Ltd. Components are manufactured in China. 3fl bldg C, Shuanghuan Quanxin Technology Information Industry Park Baolong Street, Longgang District, Shenzhen, China. Imported in Australia by Light My Bricks Pty Ltd, 5/26 Rushdale St, Knoxfield, VIC, 3180, Australia.

WARNING: CHOKING HAZARD - Small parts. Not for children under 3 years.

AVERTISSEMENT : RISQUE D'ÉTOUFFEMENT - Petites pièces. Ne convient pas aux enfants de moins de 3 ans.

ATTENZIONE: PERICOLO DI SOFFOCAMENTO - Piccole parti. Non adatto a bambini di età inferiore a 3 anni.

WARNUNG: ERSTICKUNGSGEFAHR - Kleine Teile. Nicht für Kinder unter 3 Jahren geeignet.

ADVERTENCIA: PELIGRO DE ASFIXIA - Piezas pequeñas. No son apto para niños menores de 3 años.

警告：窒息危险 - 小零件。不适合3岁以下儿童。