



# LIGHT KIT INSTALLATION GUIDE

**STAR WARS™ X-WING  
STARFIGHTER™**

FOR LEGO  
SET  
#75355

# CONTENTS



## 03

### Getting Started

- 04 Legend
- 05 Component Handling
- 06 Blueprint

## 07

### Instructions

- 07 LEGO Bag 1
- 48 LEGO Bag 2 - LMB Bag 02
- 99 LEGO Bag 3
- 131 LEGO Bag 4
- 172 LMB Bag 01
- 221 LEGO Bag 5 - LMB Bag 03
- 255 LEGO Bag 10
- 261 LEGO Bag 6
- 321 LEGO Bag 7
- 382 LEGO Bag 8
- 443 LEGO Bag 9

## 524

### Final Product

- 528 Package Contents
- 530 Contact & Troubleshooting



# GETTING STARTED



Bold, beautiful and bright, Light My Bricks elevates your favourite LEGO set from knick-knack to statement piece. Create a talking point at home or in the office that speaks to your passions with Light My Bricks. To learn more, click below.

[Learn More](#)



Audacieux, beau et lumineux, Light My Bricks élève votre ensemble LEGO préféré du statut de bibelot à celui de pièce maîtresse. Que ce soit à la maison ou au bureau, partagez votre passion des LEGO avec Light My Bricks. Cliquez ci-dessous pour en savoir plus.

[En savoir plus](#)



Audace, bello e luminoso, Light My Bricks eleva il tuo set LEGO preferito da soprammobile a pezzo di tendenza. Crea un punto di discussione a casa o in ufficio che parli alle tue passioni con Light My Bricks. Per saperne di più, clicca qui sotto.

[Ulteriori Informazioni](#)



Mutig, schön und hell – Light My Bricks verwandelt Ihr Lieblings-LEGO-Set von einem schnickschnack in ein statement-stück. Schaffen sie einen gesprächspunkt zu hause oder im büro, der Ihre leidenschaften widerspiegelt, mit Light My Bricks. Um mehr zu erfahren, klicken sie unten.

[Mehr erfahren](#)



Audaz, hermoso y brillante, Light My Bricks eleva tu set LEGO favorito de una chuchería a una pieza llamativa. Crea un tema de conversación en casa o en la oficina que hable de tus pasiones con Light My Bricks. Para obtener más información, haga clic a continuación.

[Más información](#)



大胆、美丽而明亮，Light My Bricks 将你喜爱的乐高套装从小摆件提升为引人注目的装饰品。在家或办公室打造一个能表达你激情的话题，了解更多，请点击下方。

[了解更多](#)



# LEGEND

## Rotate Set



Retournez L'ensemble  
Ruota Set  
Set Drehen  
Rotar Conjunto  
旋转套件

## Add Part



Ajoutez une Pièce  
Aggiungi Parte  
Teil Hinzufügen  
Agregar Pieza  
添加零件

## Click



Cliquez  
Clic  
Klicken  
Clic  
点击

## Pinch/Fold



Pincez/Pliez  
Pizzicare/Piegare  
Kneifen/Falten  
Pellizcar/Doblar  
折叠

## Pull Cable



Tirez le Cable  
Tirare il Cavo  
Kabel Ziehen  
Tirar del Cable  
拉动电缆

## Repeat Step



Répétez  
Ripetere  
Wiederholen  
Repetir  
重复

## Sticker



Autocollant  
Adesivo  
Aufkleber  
Pegatina  
贴纸

## Power On Test



Test de mise sous tension  
Test di Potenza  
Stromtest  
Prueba de Energía  
电源测试

## Disconnect Power



Débranchez L'alimentation  
Scollegare L'alimentazione  
Strom Trennen  
Desconectar la Energía  
断开电源

## Troubleshoot



Dépanner  
Risolvere  
Fehlerbehebung  
Solución de Problemas  
故障排除

# COMPONENT HANDLING

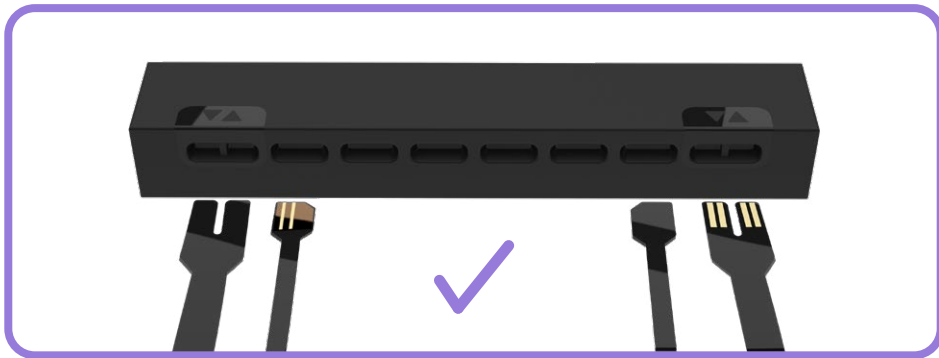
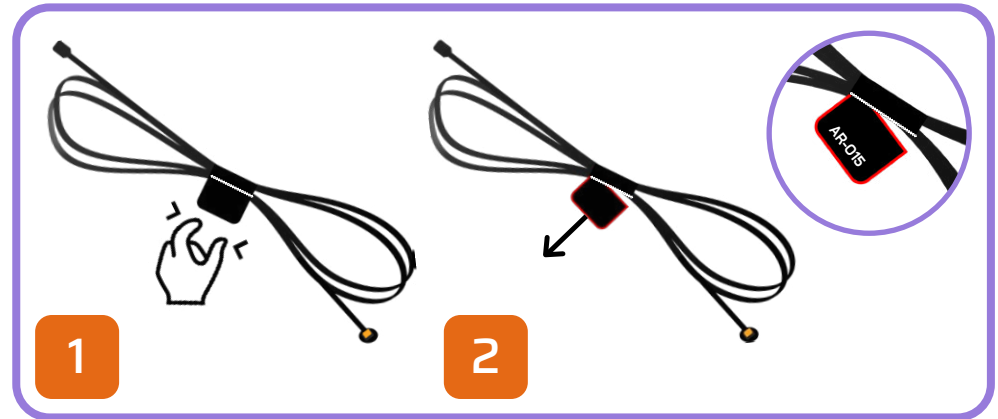
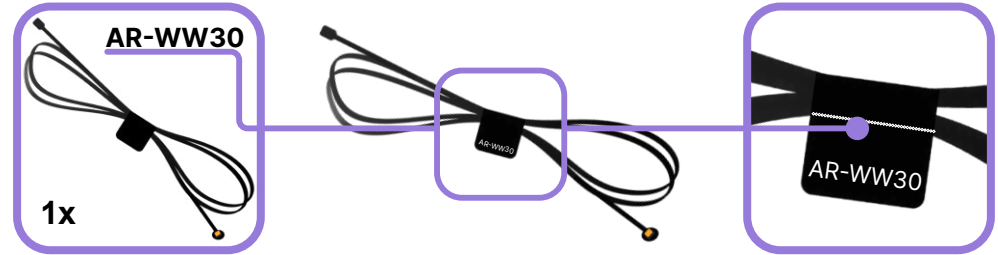
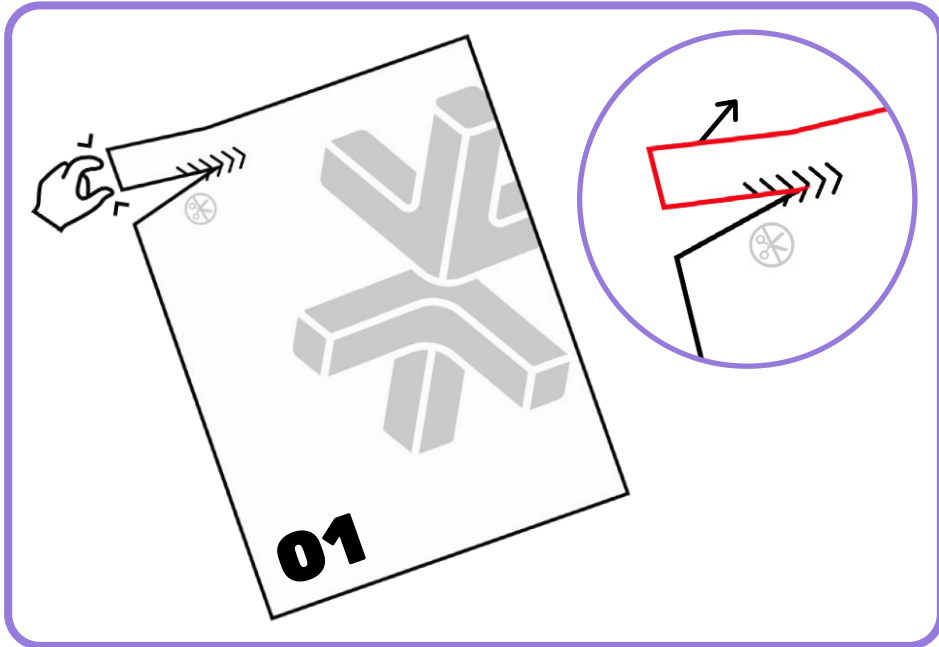

# BLUEPRINT

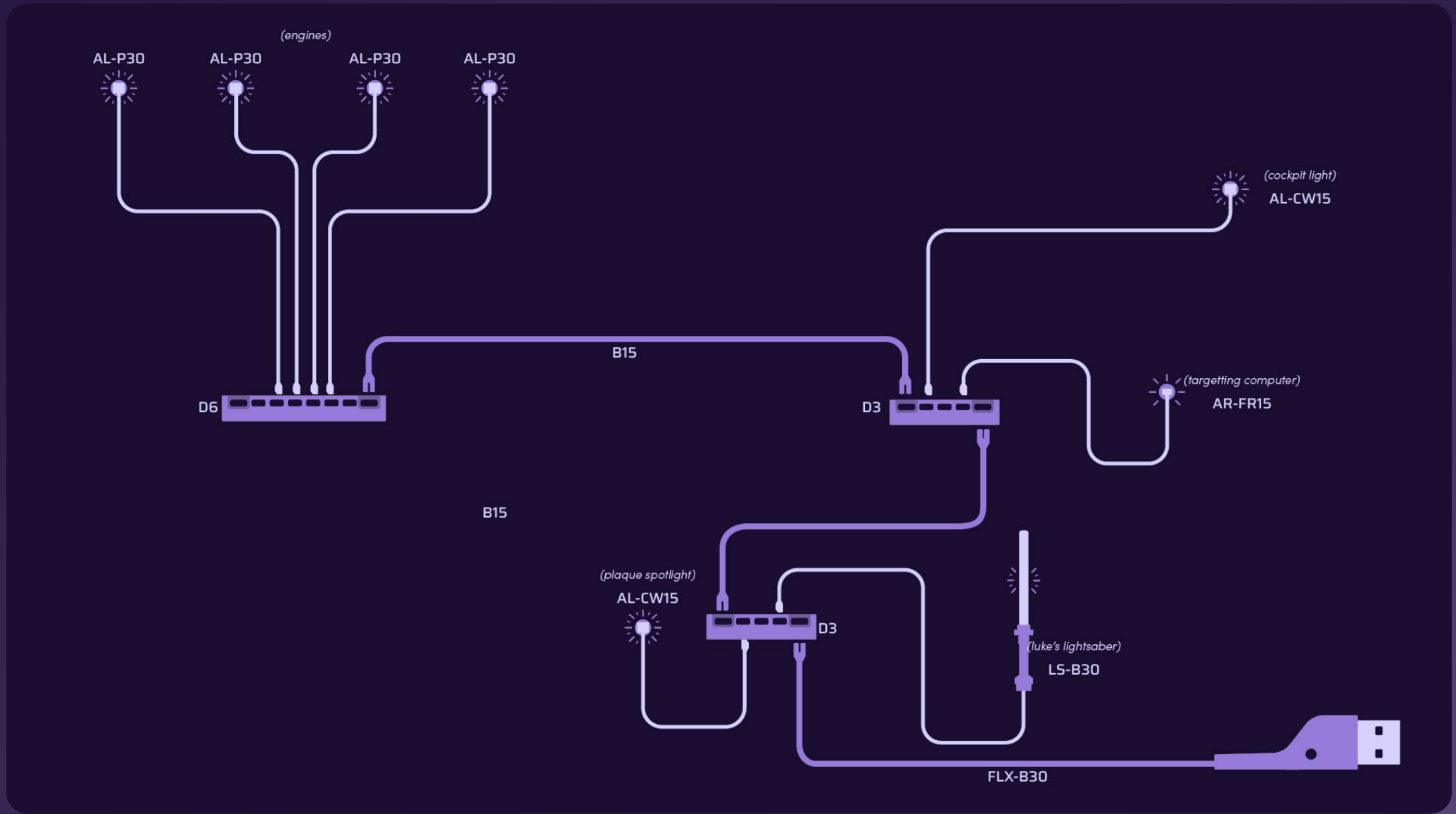

**HOLD UP!**

You might notice some bags aren't in order, as well as left over pieces, but that's ok! We're changing the way you build LEGO!

**ATTENDEZ!**

Vous remarquerez peut-être que certains sacs, ainsi que certaines pièces, ne sont pas dans le bon ordre. Mais pas de panique! Nous changeons simplement la façon avec laquelle vous construisez vos LEGO!

**ASPETTA!**

Potresti notare che alcuni sacchetti non sono in ordine, così come i pezzi avanzati, ma va bene così! Stiamo cambiando il modo in cui costruisci i LEGO!

**HALT!**

Sie werden möglicherweise bemerken, dass einige tüten durcheinander sind und teile übrig bleiben, aber das ist in Ordnung! Wir ändern die art und weise, wie Sie LEGO bauen!

**¡ESPERA!**

Es posible que notes que algunas bolsas están fuera de servicio, así como piezas sobrantes, ¡pero está bien! ¡Estamos cambiando la forma en que construyes LEGO!

**暫停!**

你可能会注意到一些袋子顺序错乱, 以及一些剩余的部件, 但没关系! 我们正在改变你搭建乐高的方式!

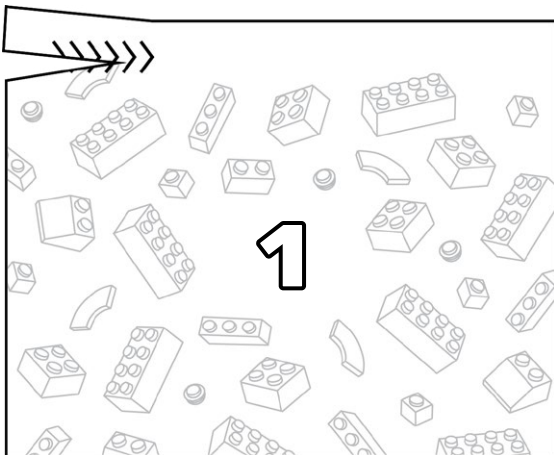
**Open LEGO® Bag 1**

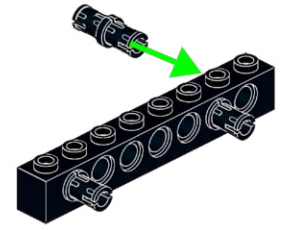
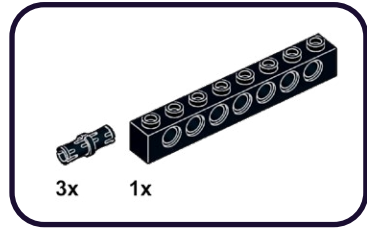
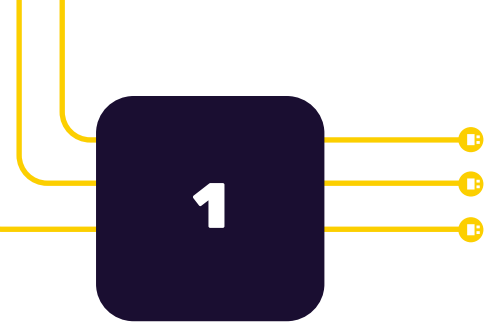



2

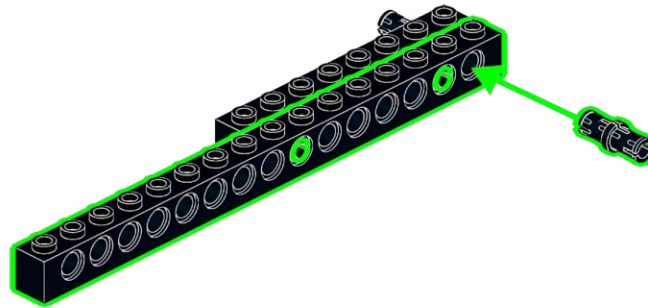
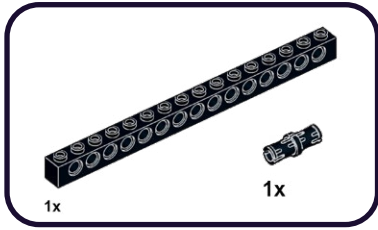

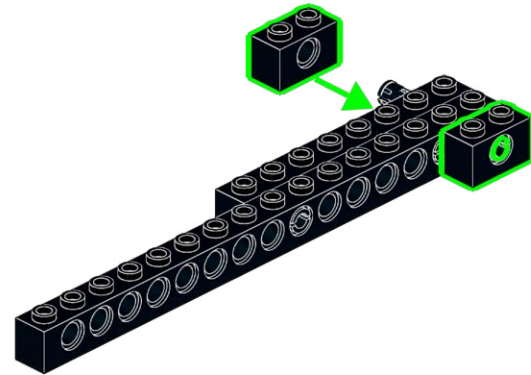

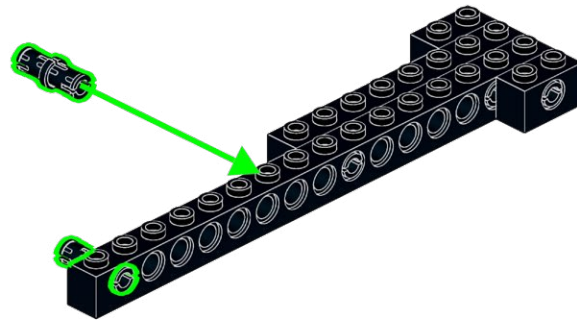
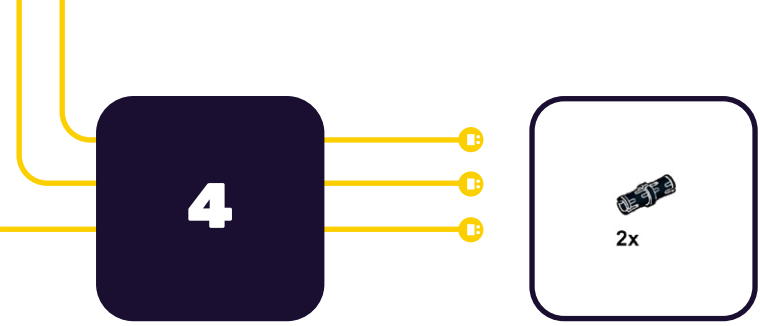

5

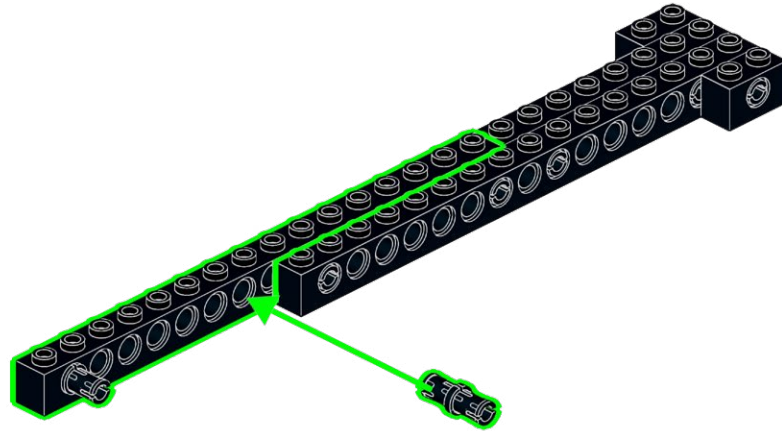
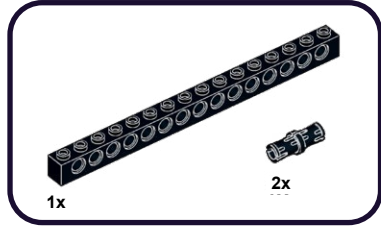

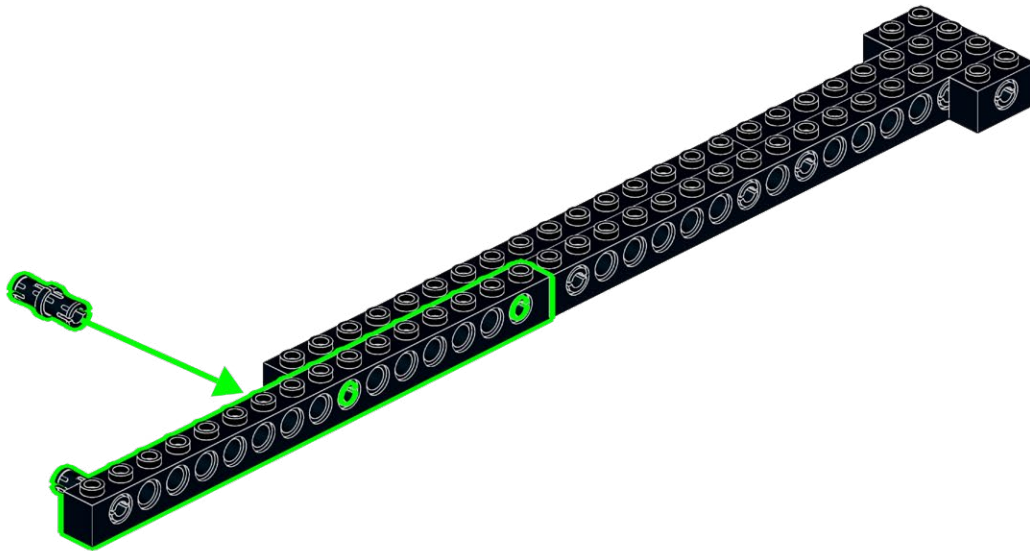
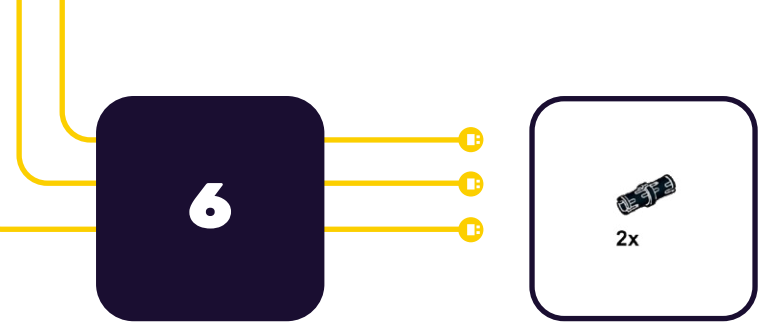

7

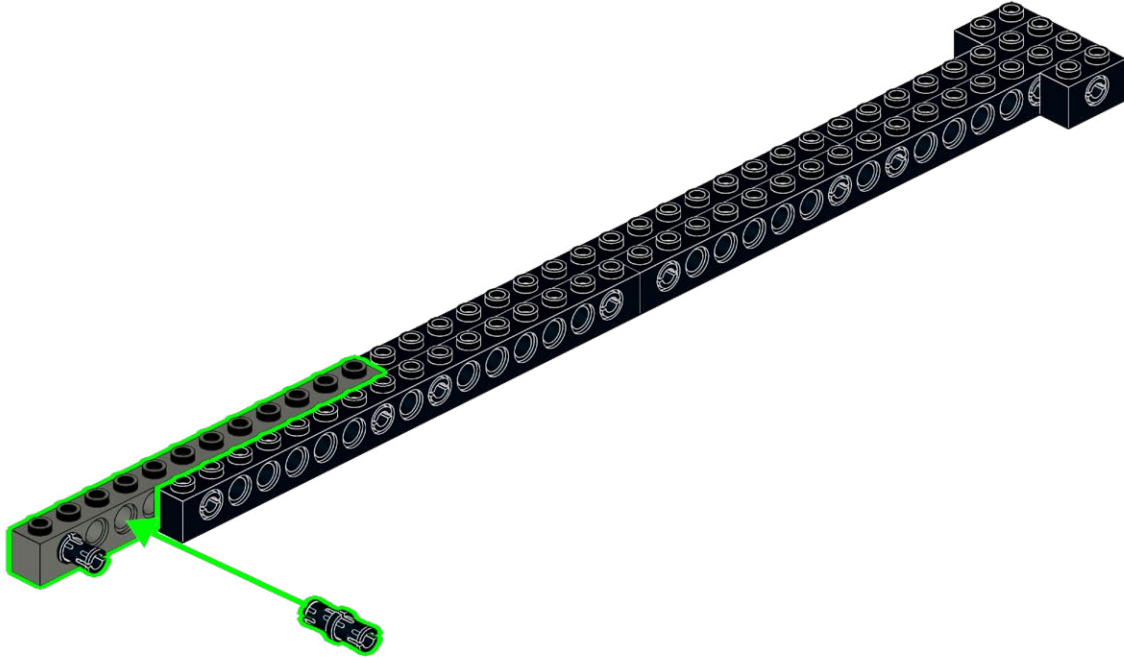
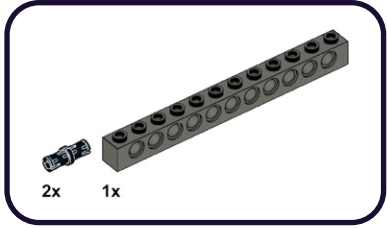



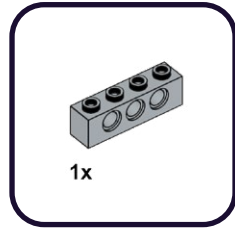
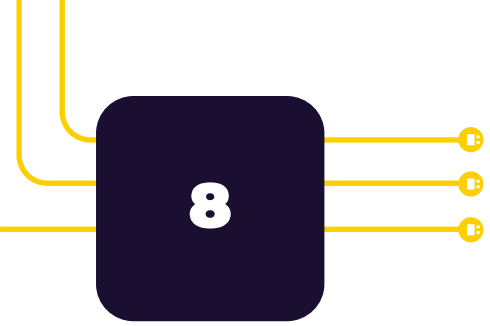

9

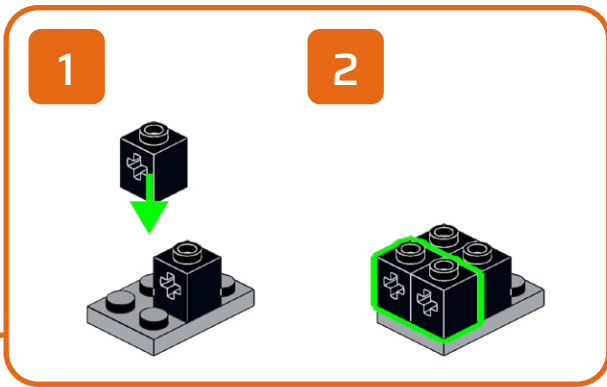
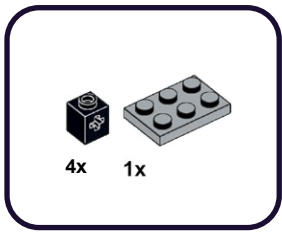

10

2x

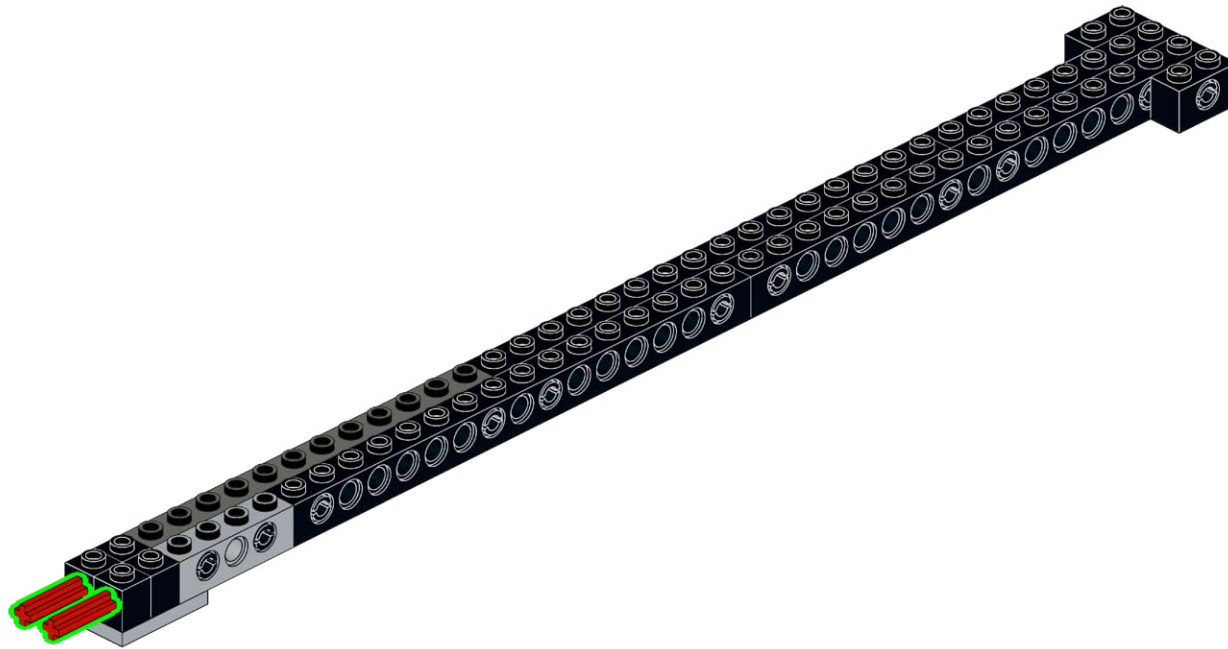

11

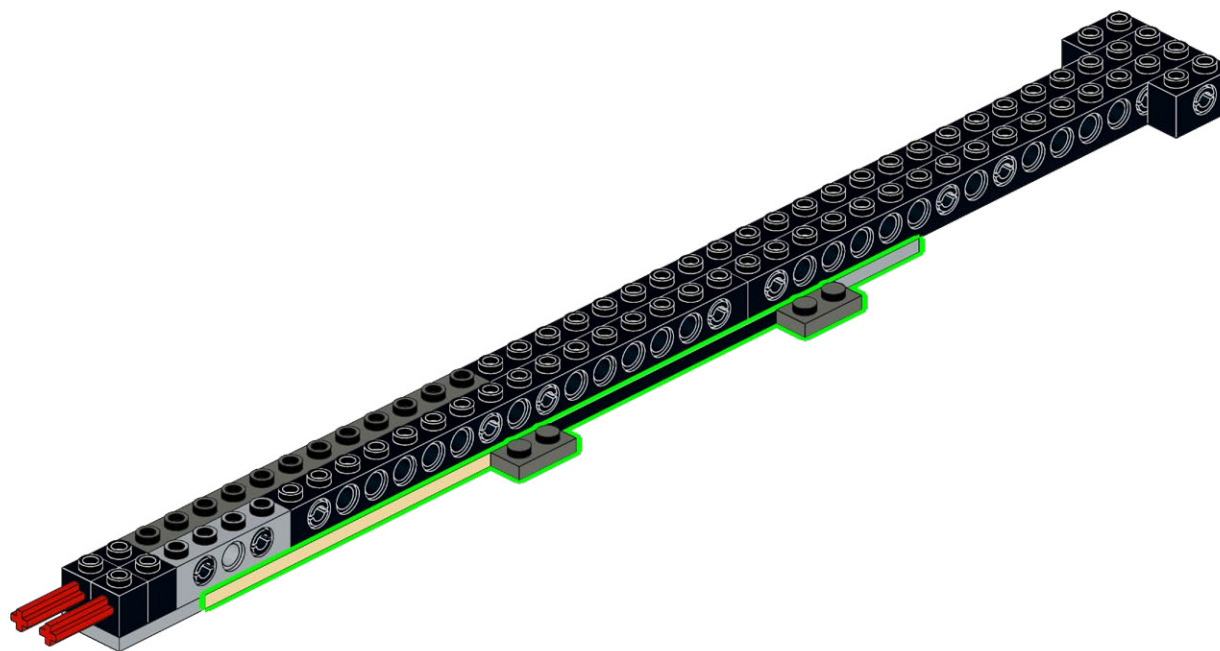
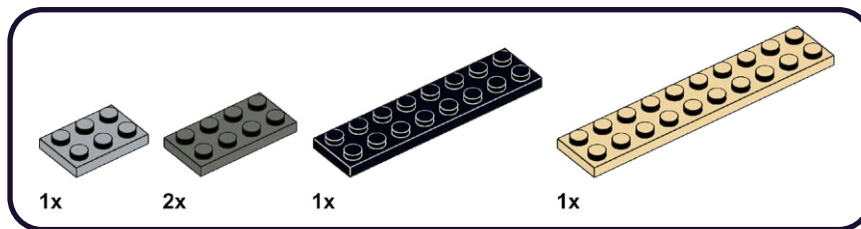

12

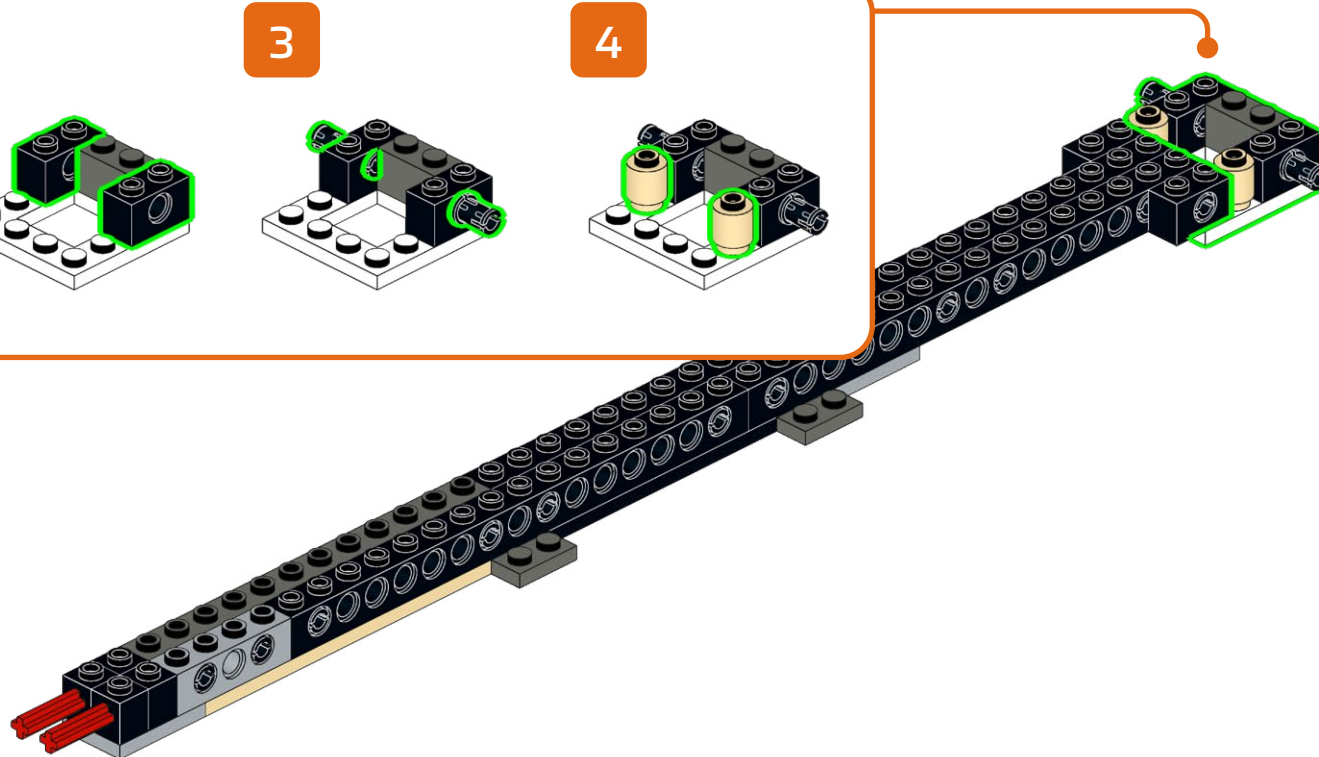
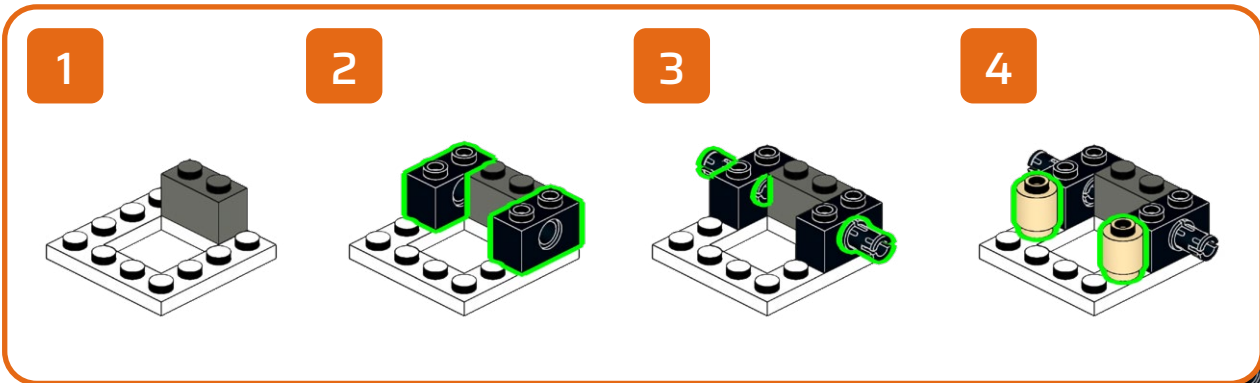
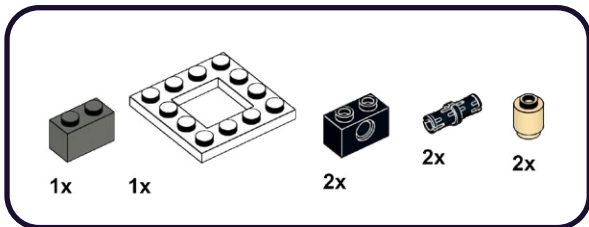

13

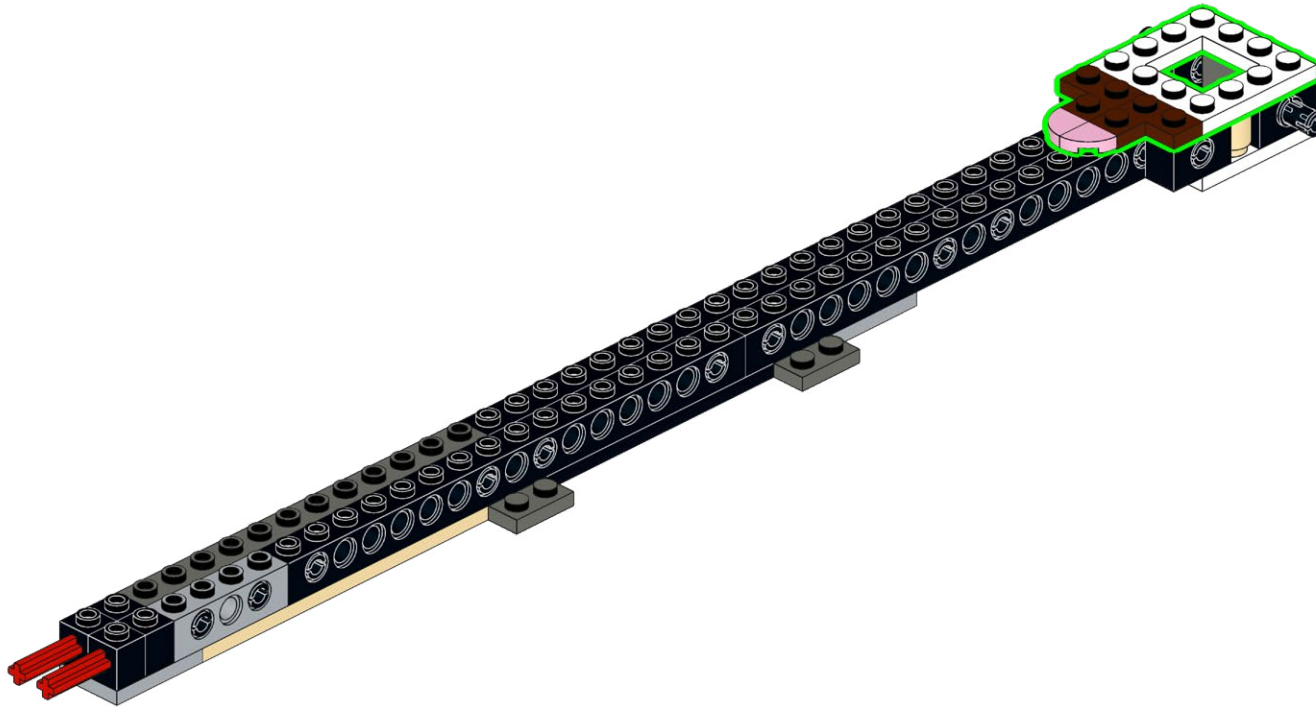
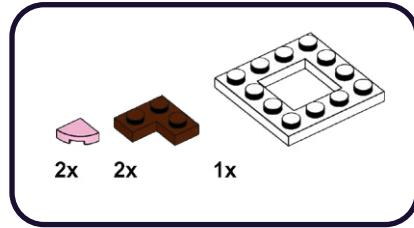



14

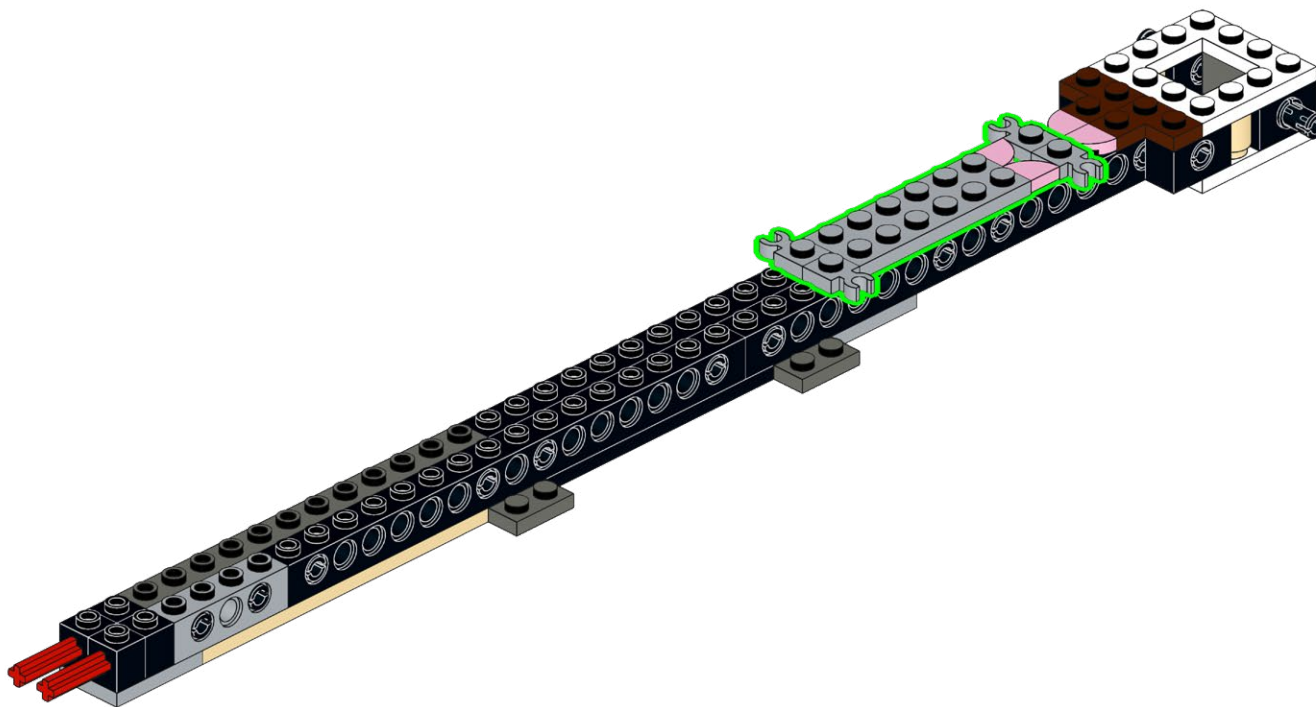
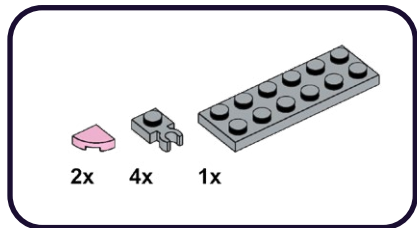

15

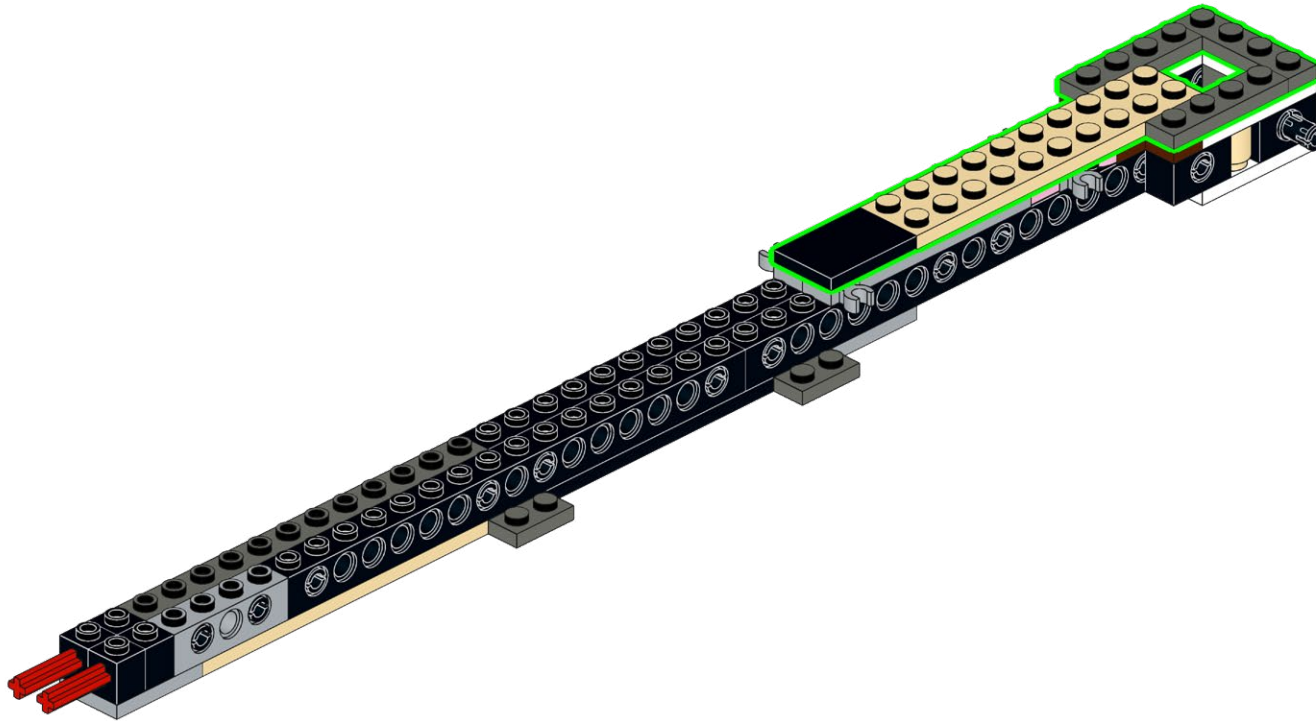
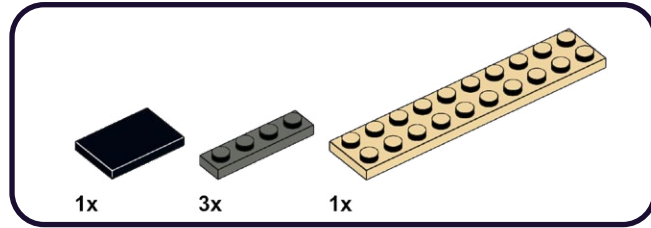

16

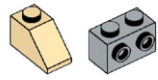

2x

2x

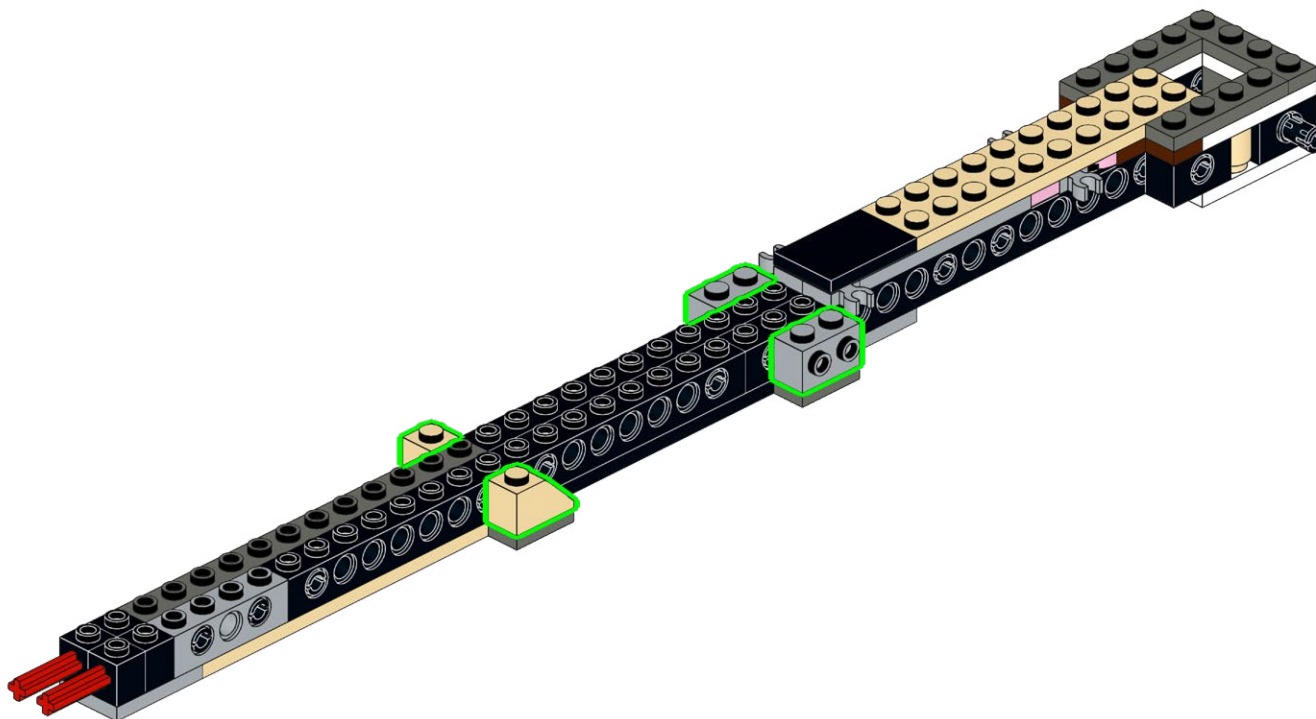

17

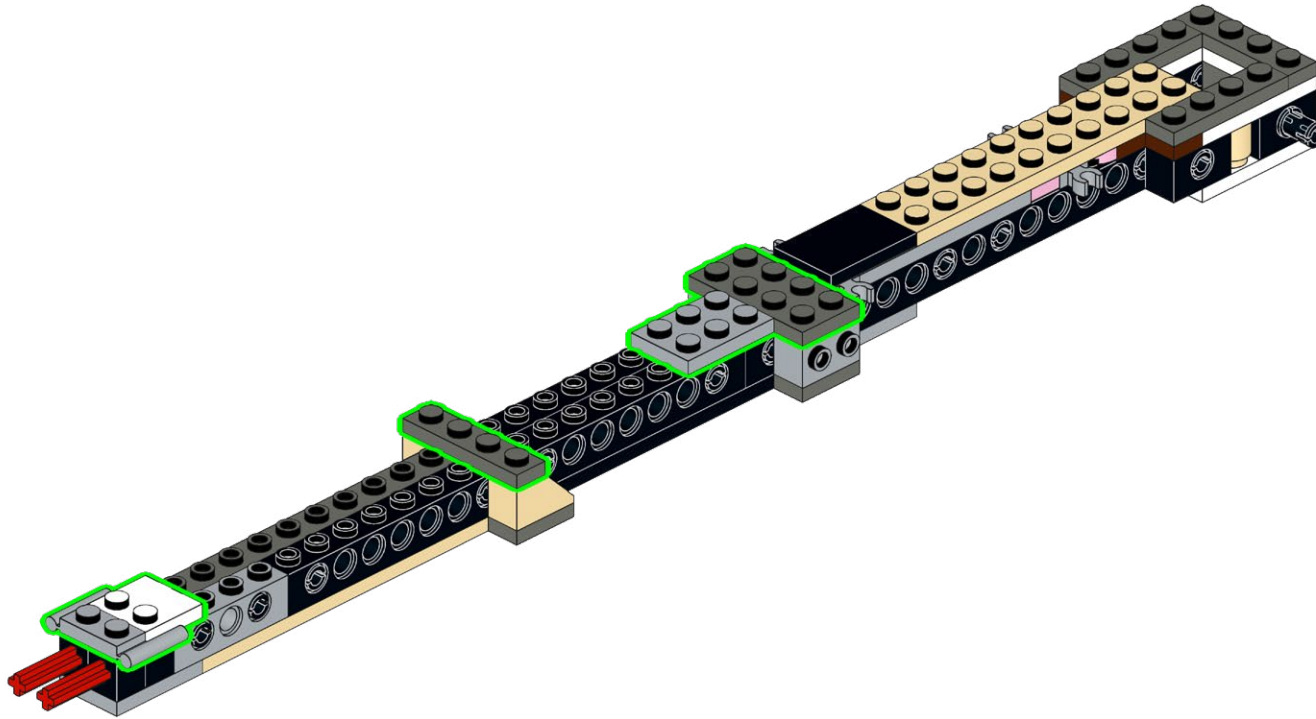
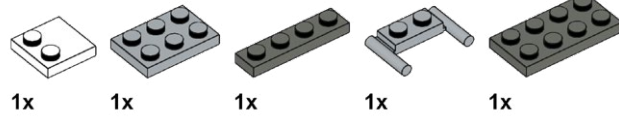

18

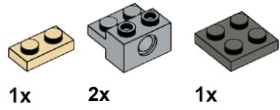

1

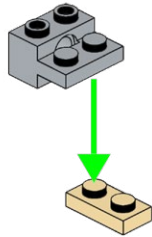

2

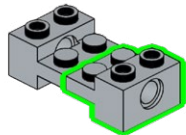

3

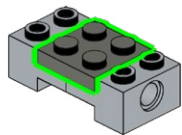

19

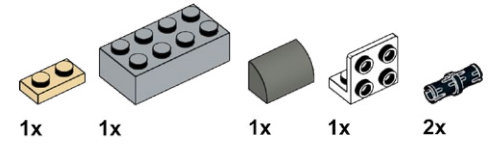

1

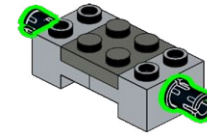

2

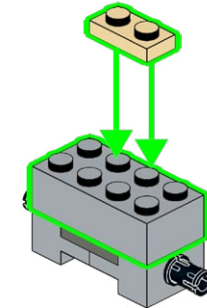

3

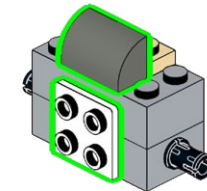

20

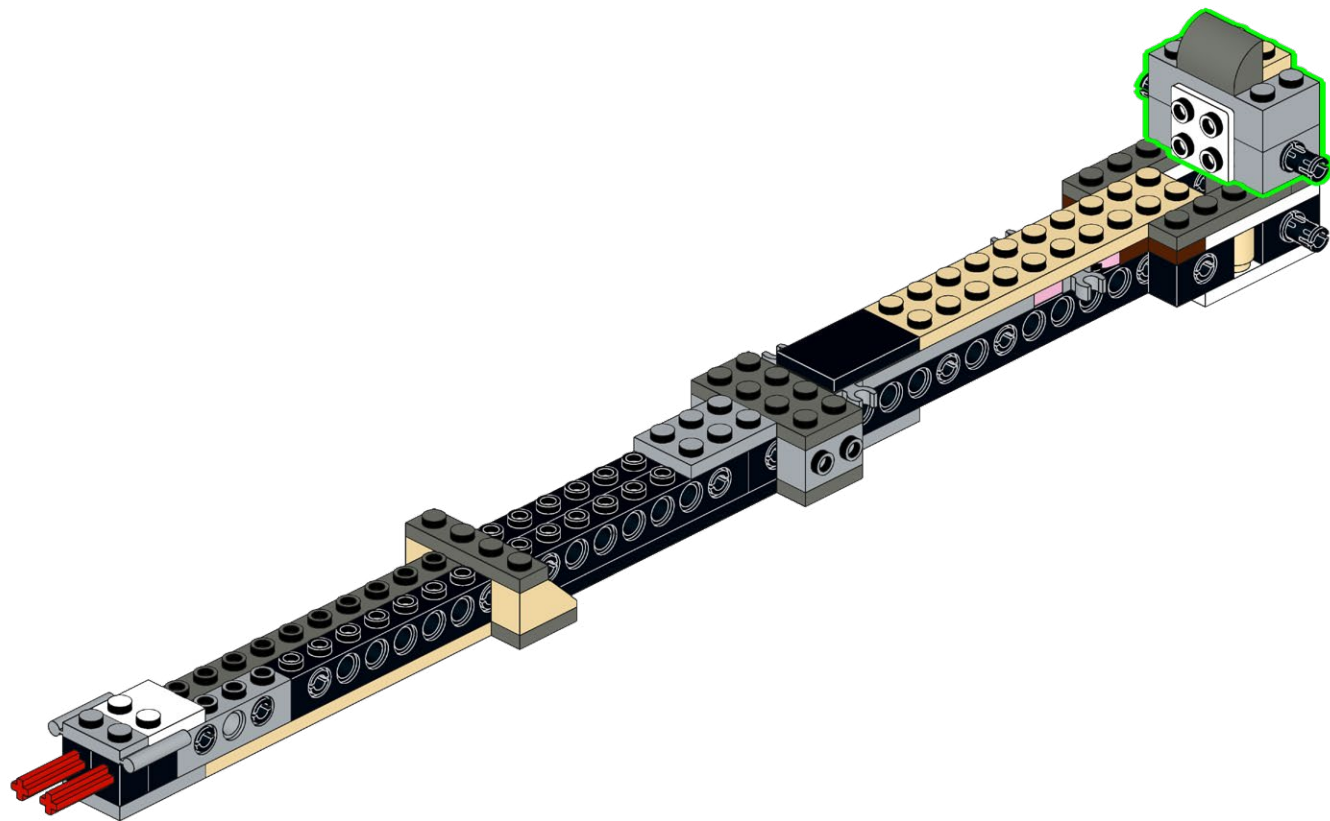



21

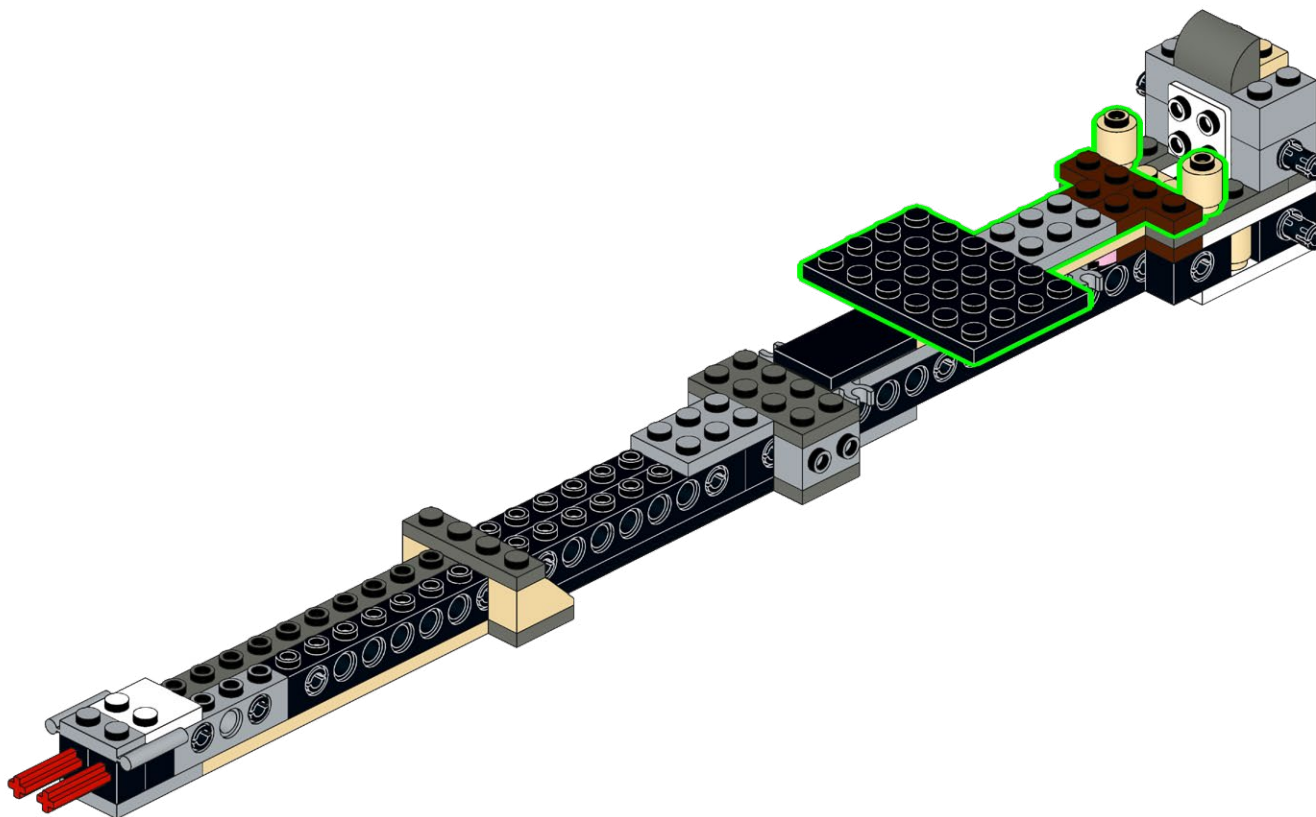
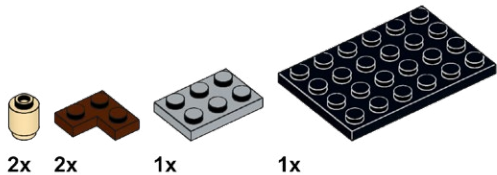

# 22

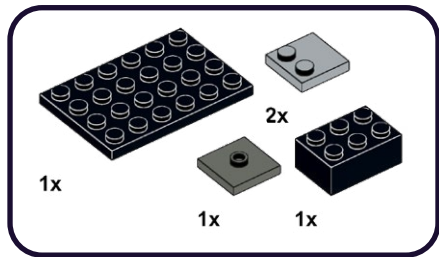

1

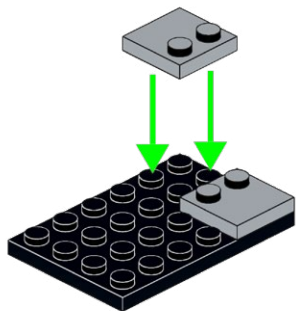

2

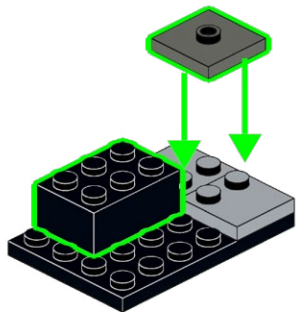

# 23

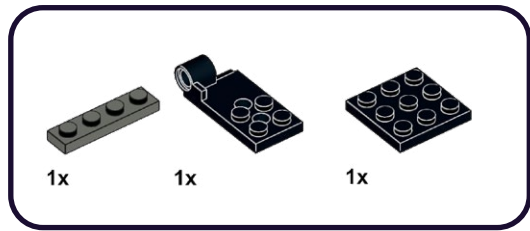

1

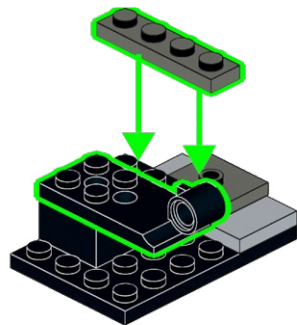

2

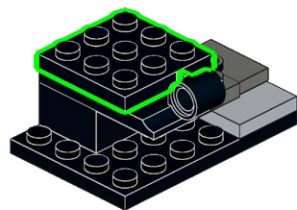

24

1x

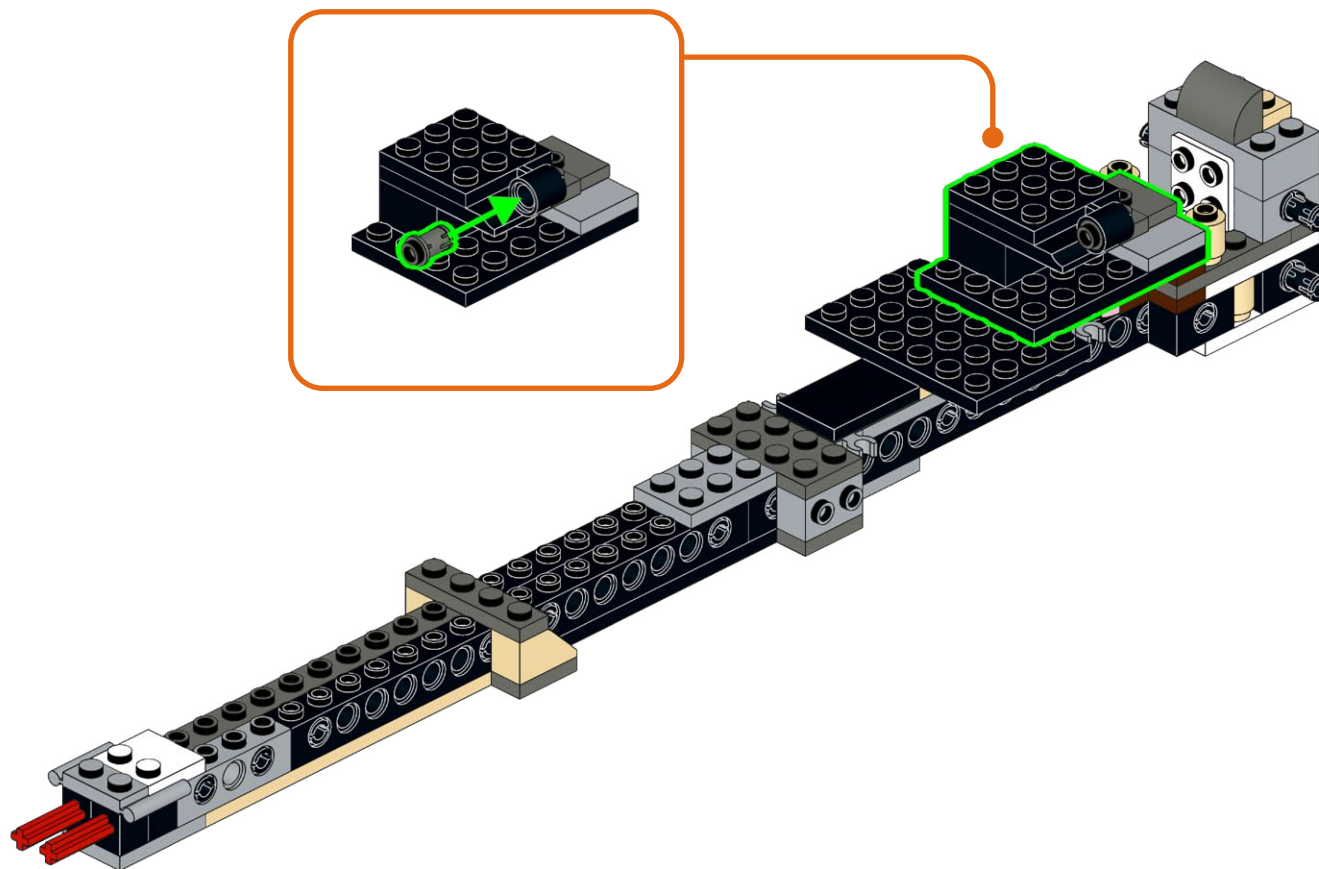

25

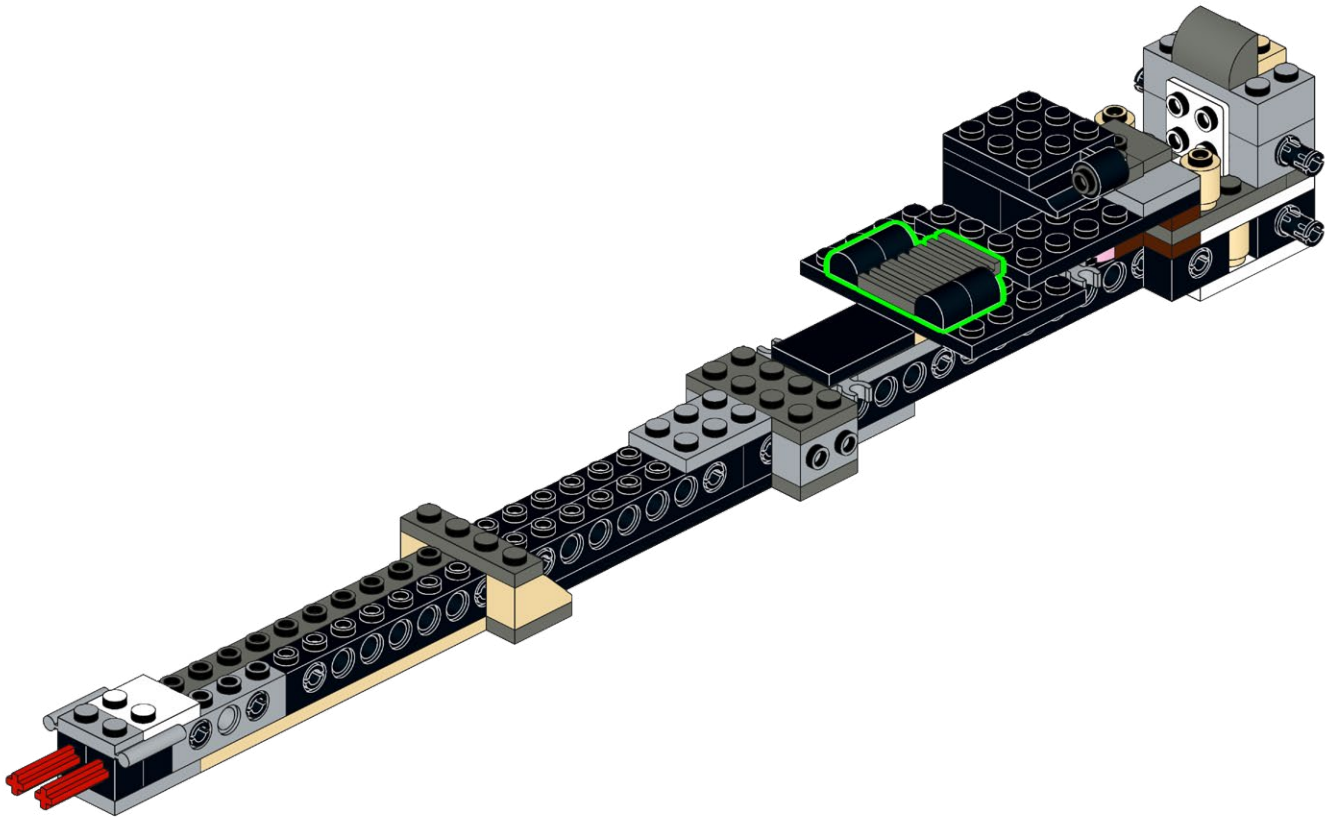
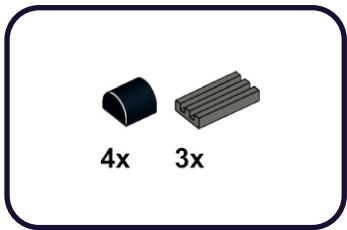

# 26

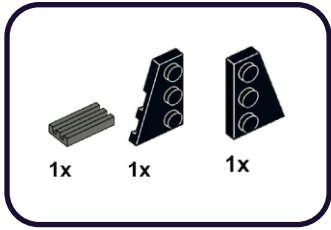

1

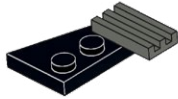

2

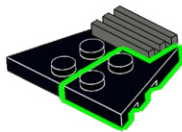

# 27

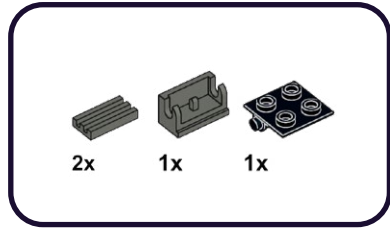

1

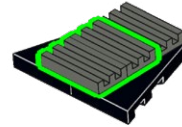

2

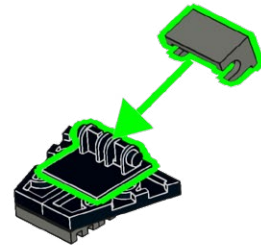

28

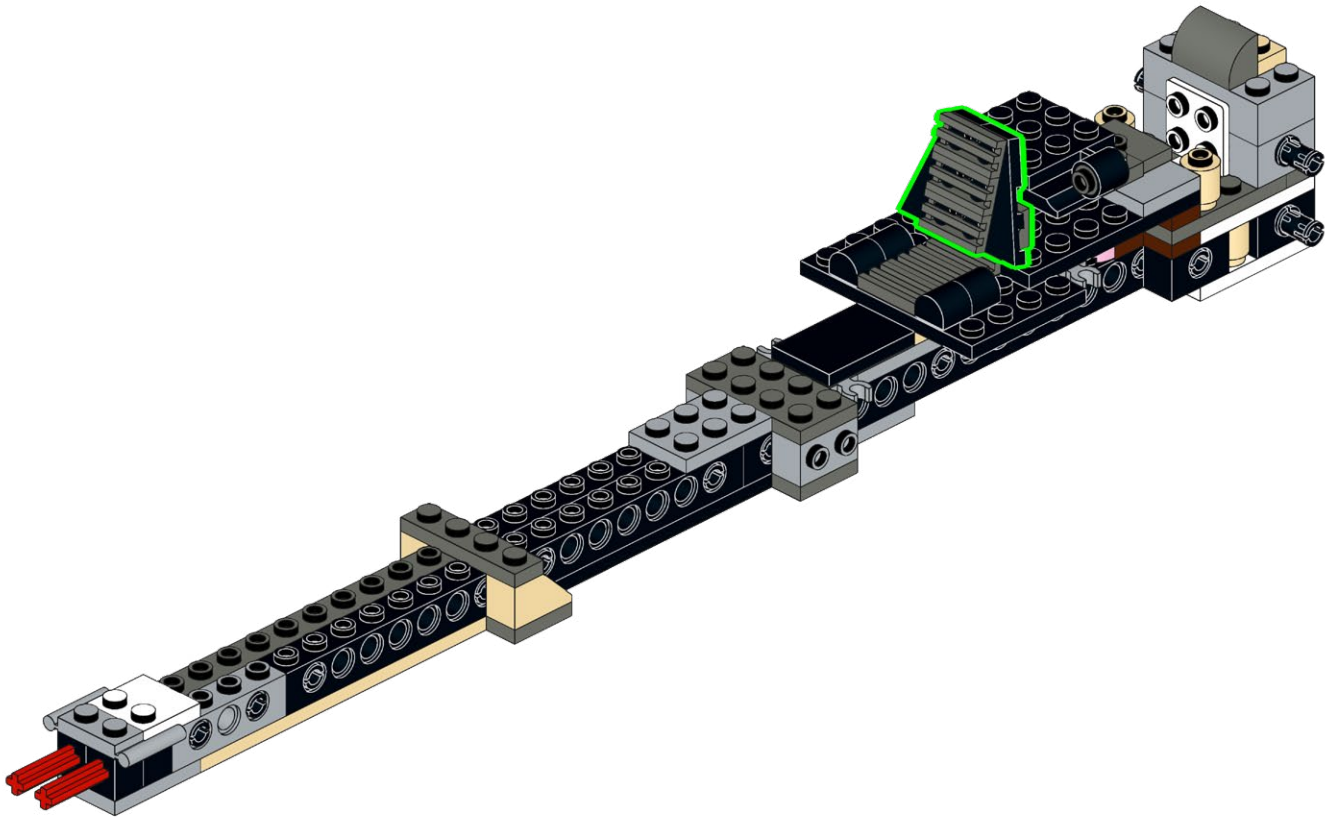

29

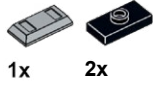

1

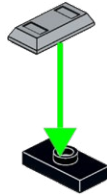

2

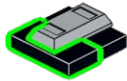

2x

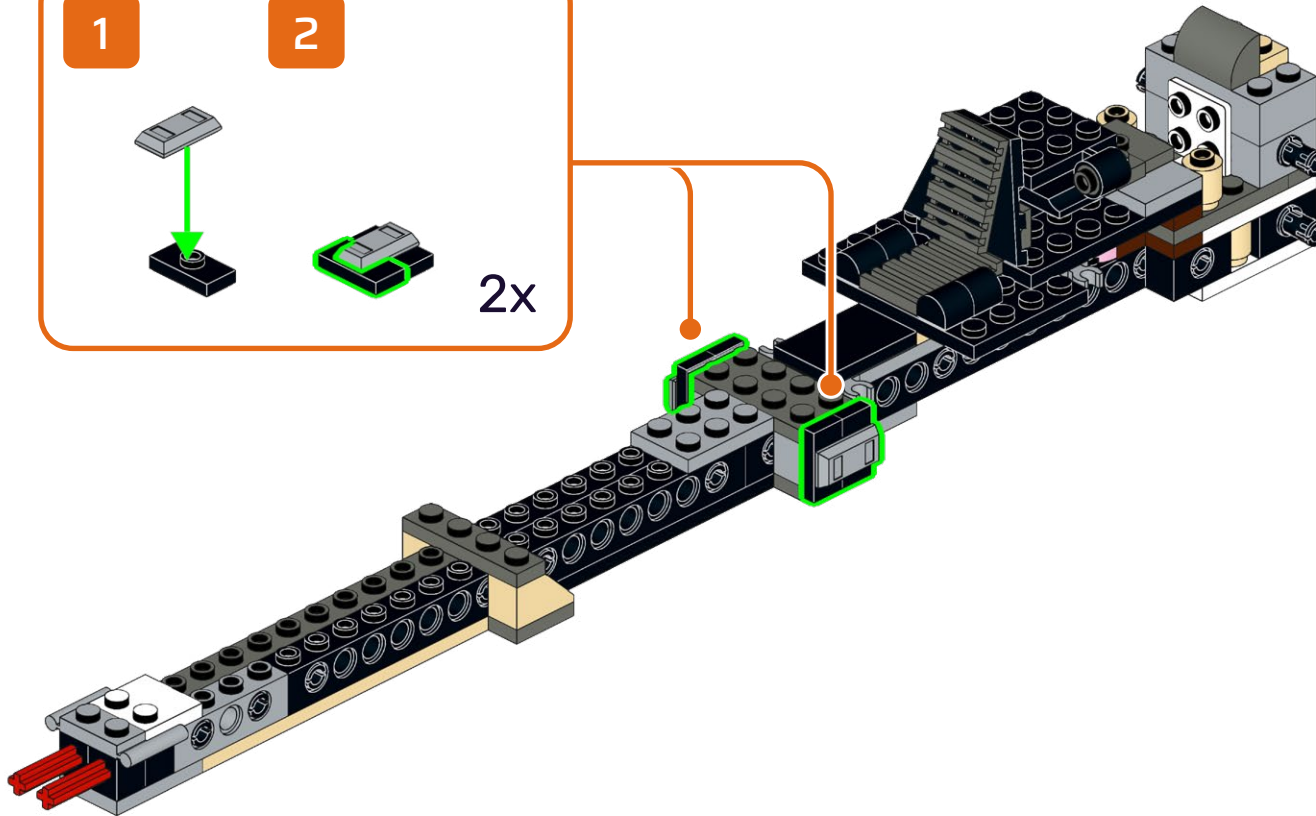

30

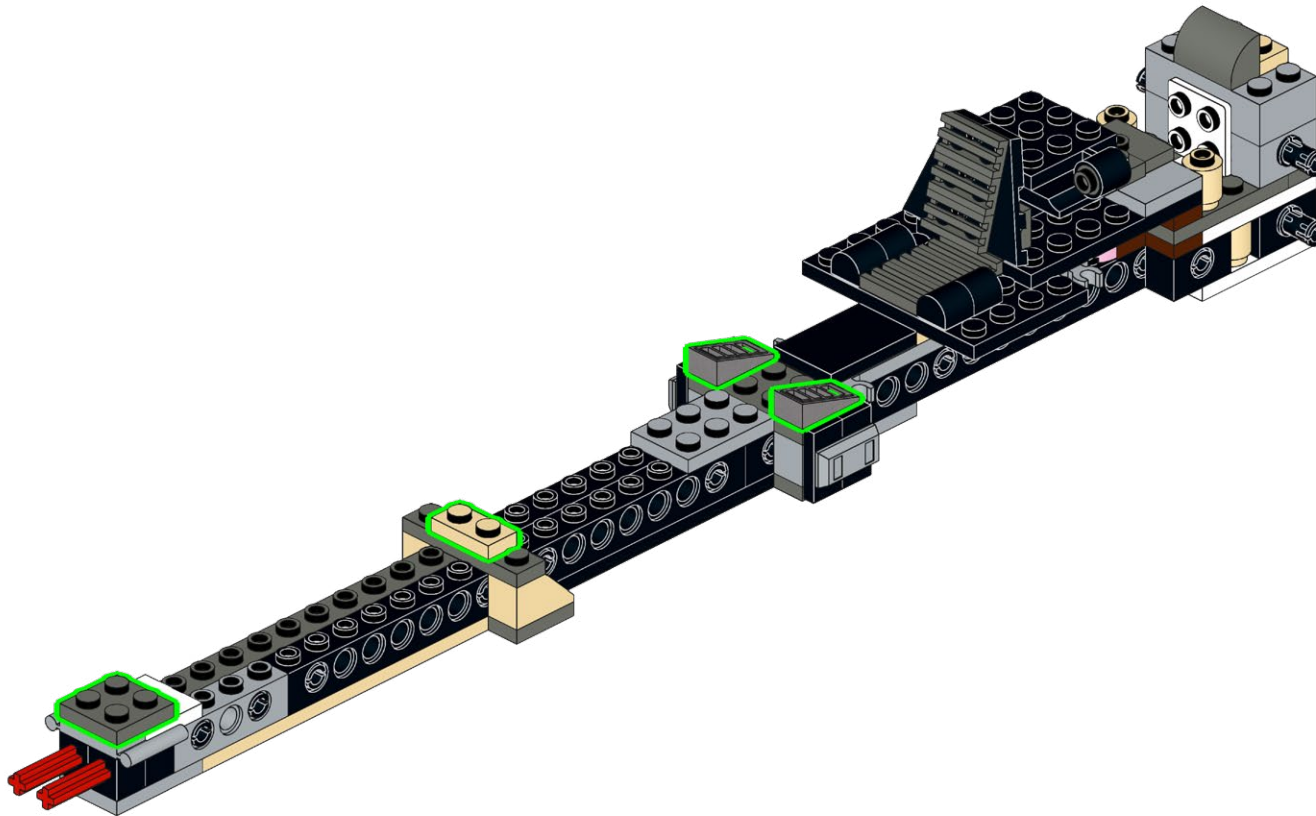
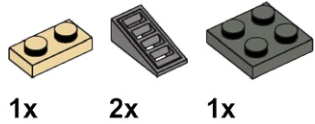



31

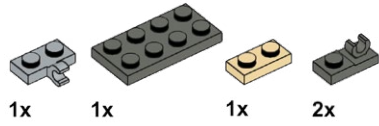

1

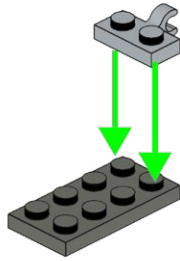

2

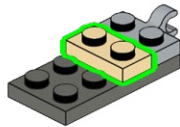

3

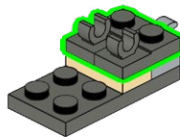

32



1

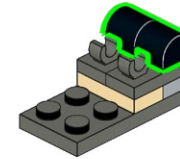

2

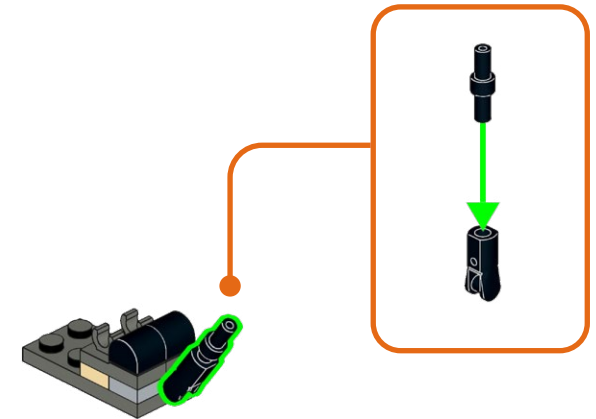

33

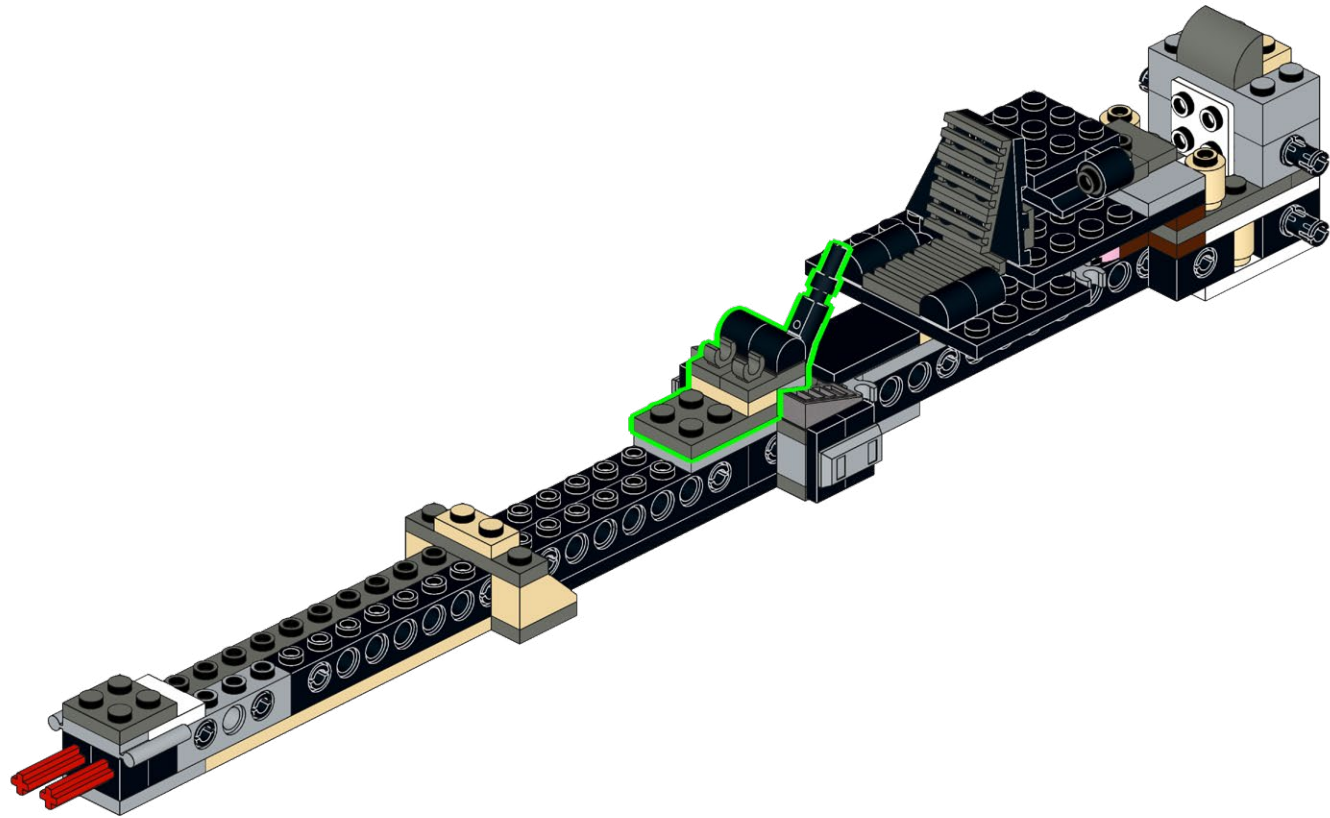

34

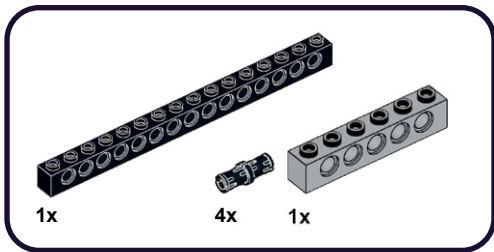

1

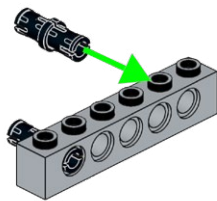

2

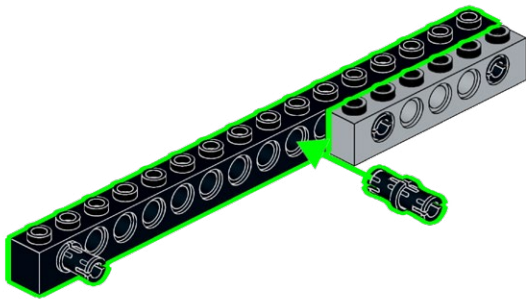

35

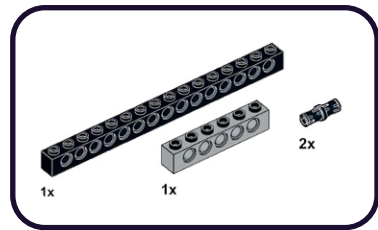

1

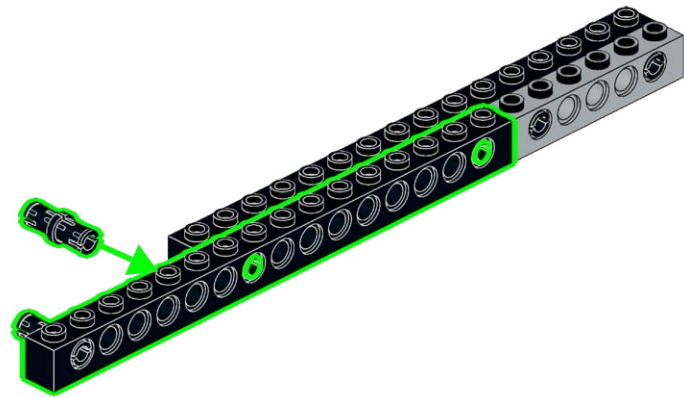

2

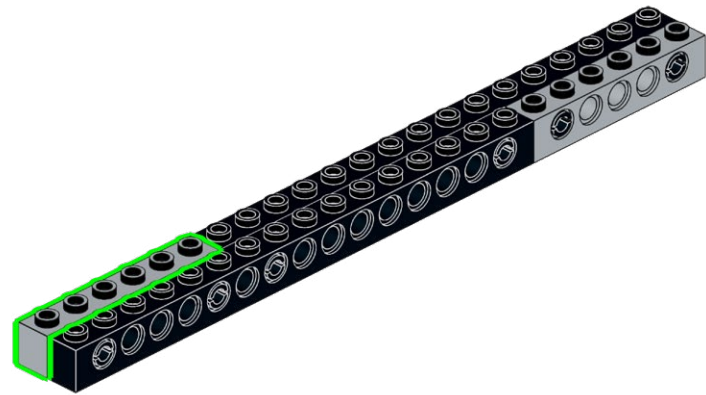

36

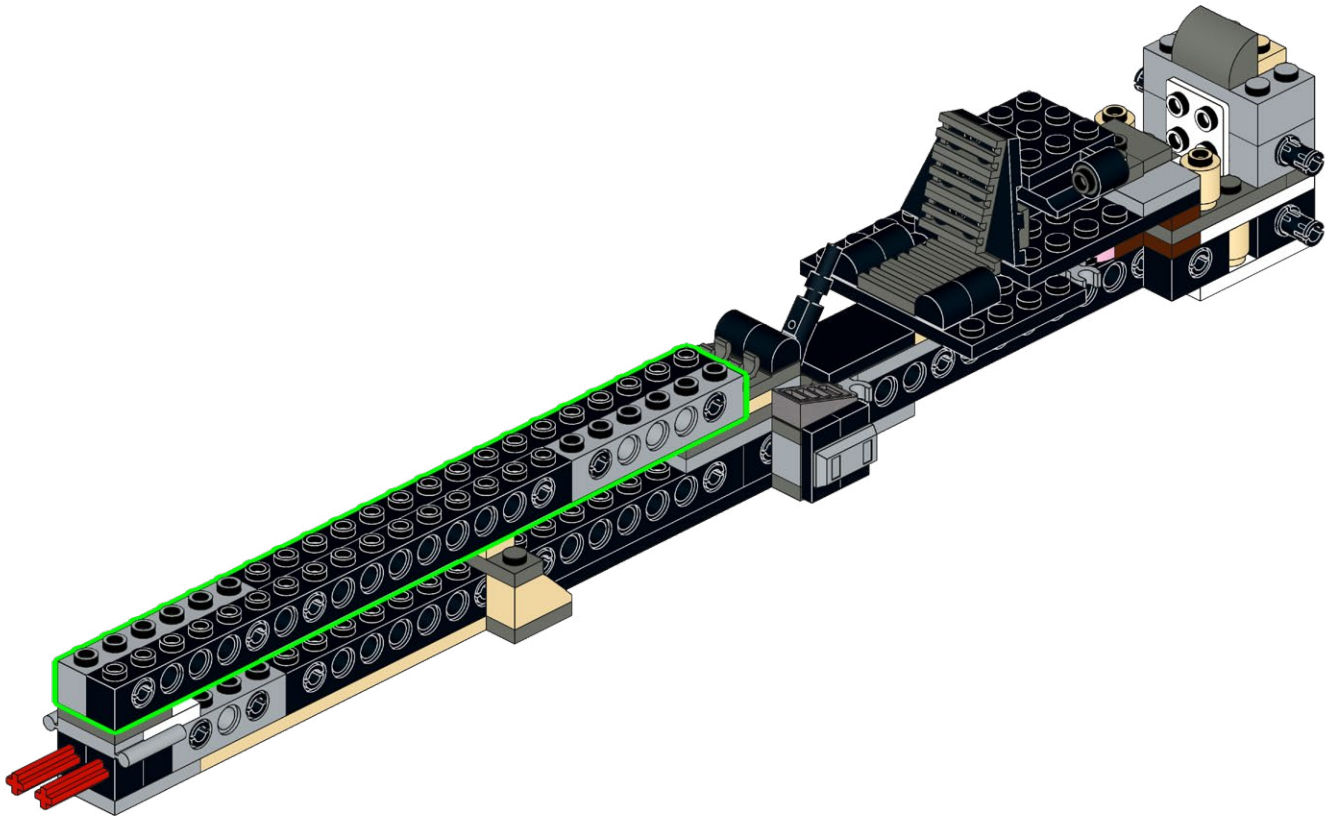

37

2x

2x

4x

1

2

2x

38

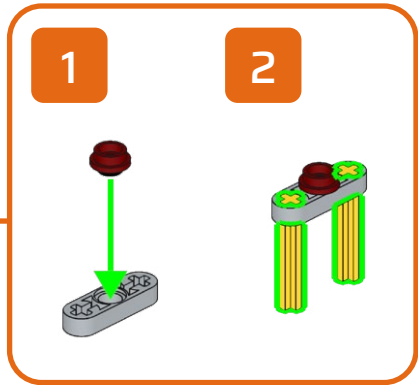
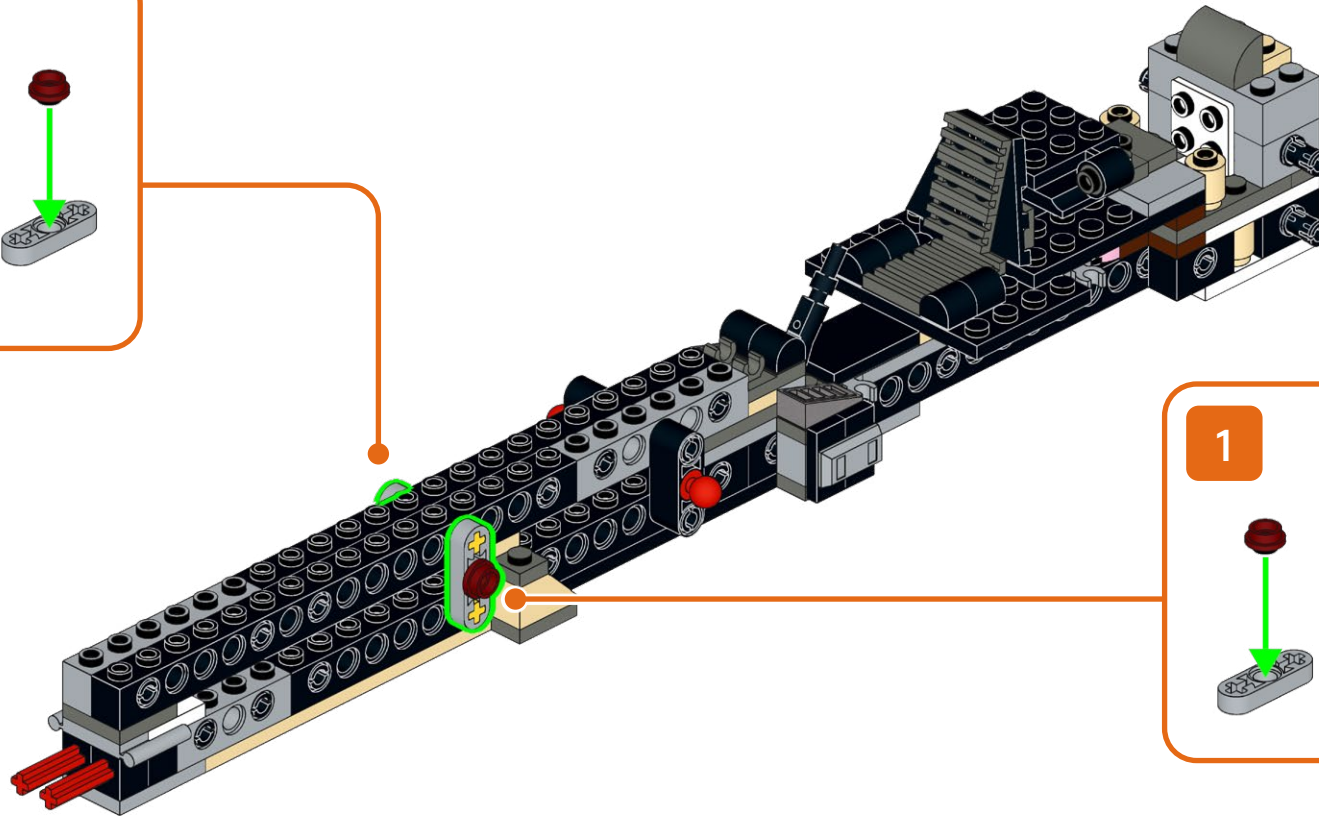
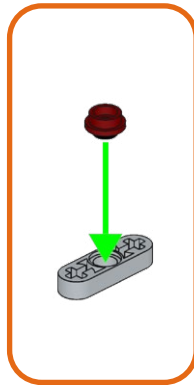
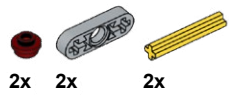

39

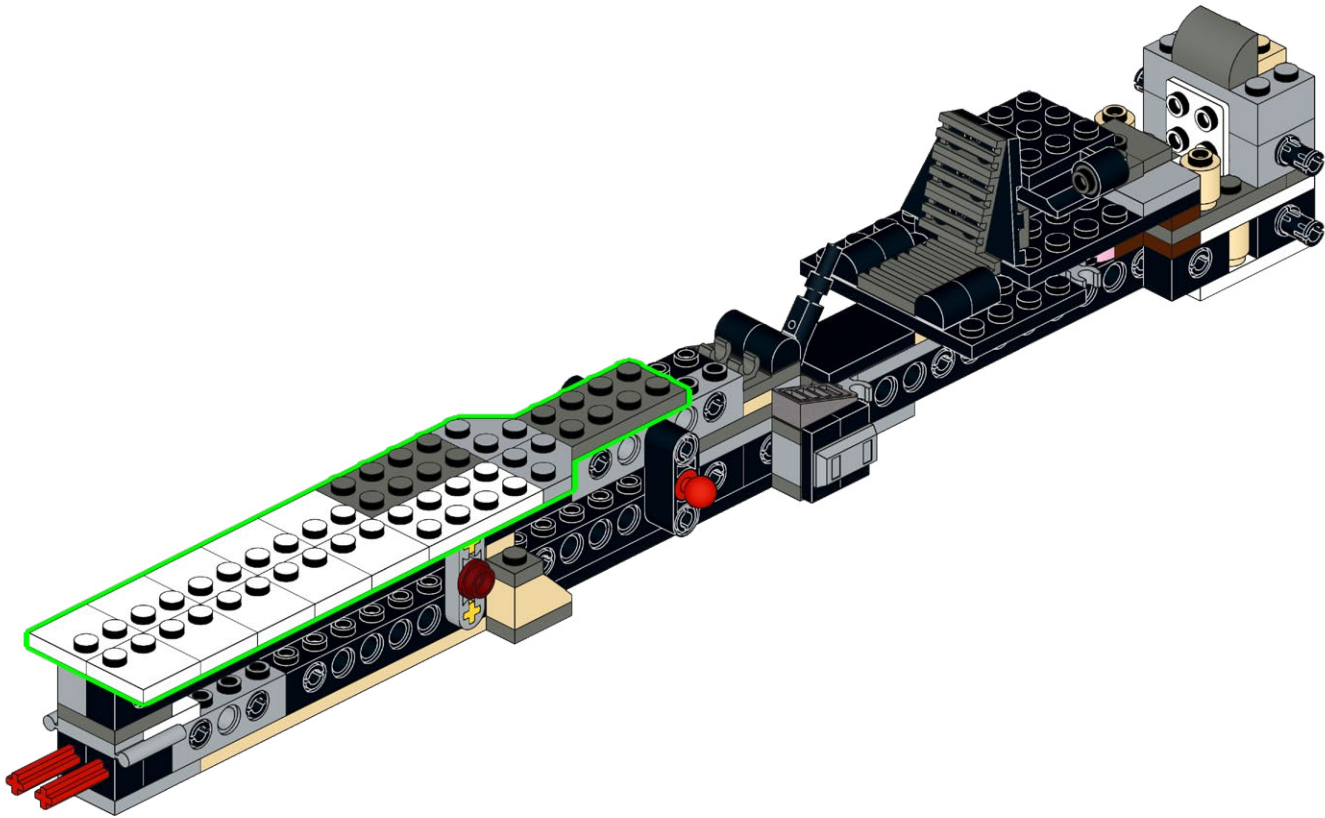
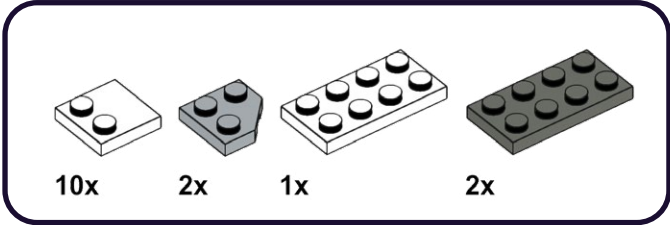



40

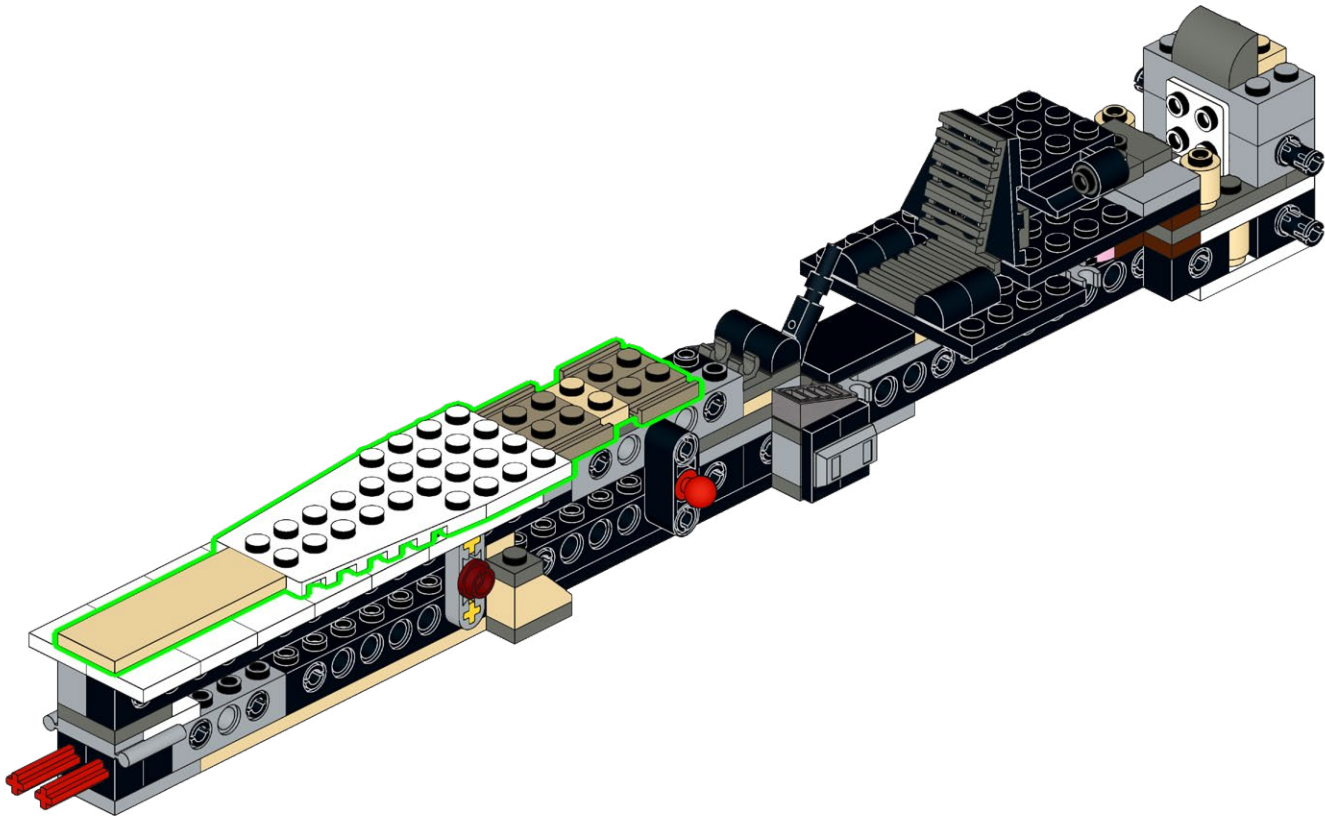
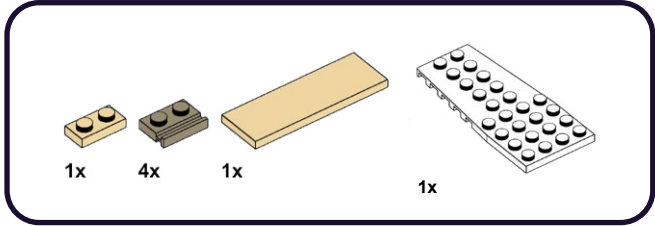



41

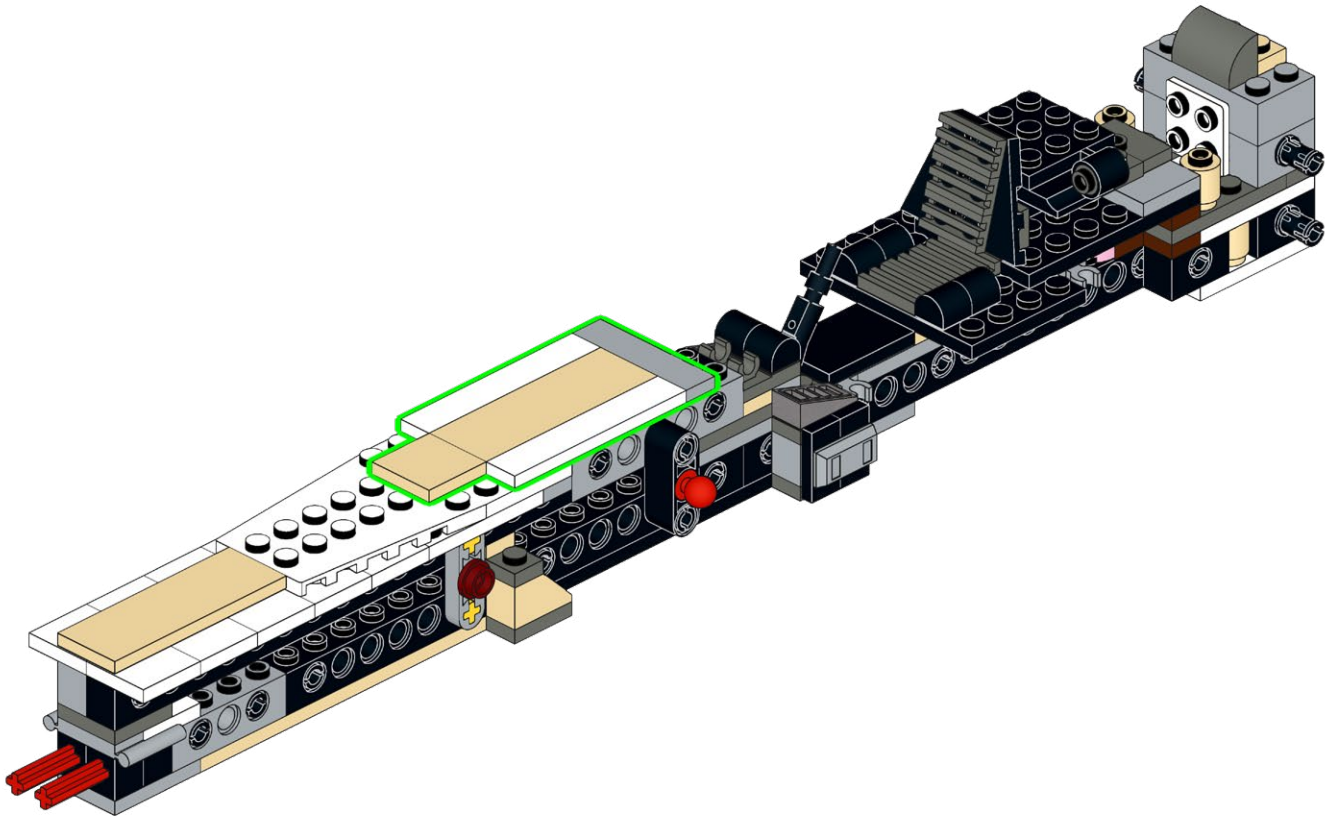
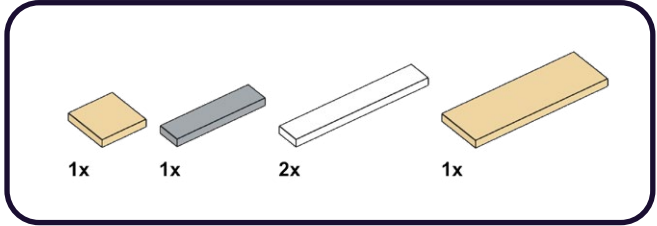

42

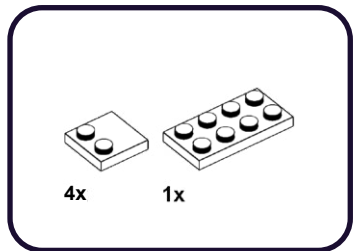

1

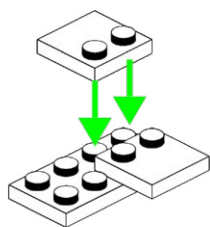

2

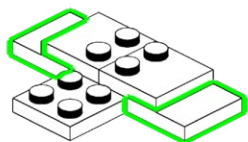

43

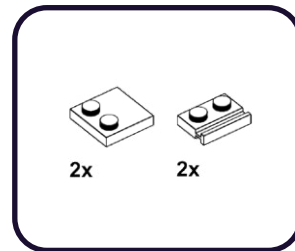

1

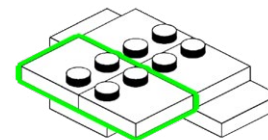

2

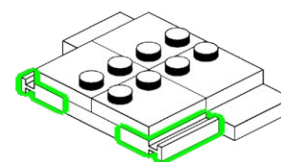

44

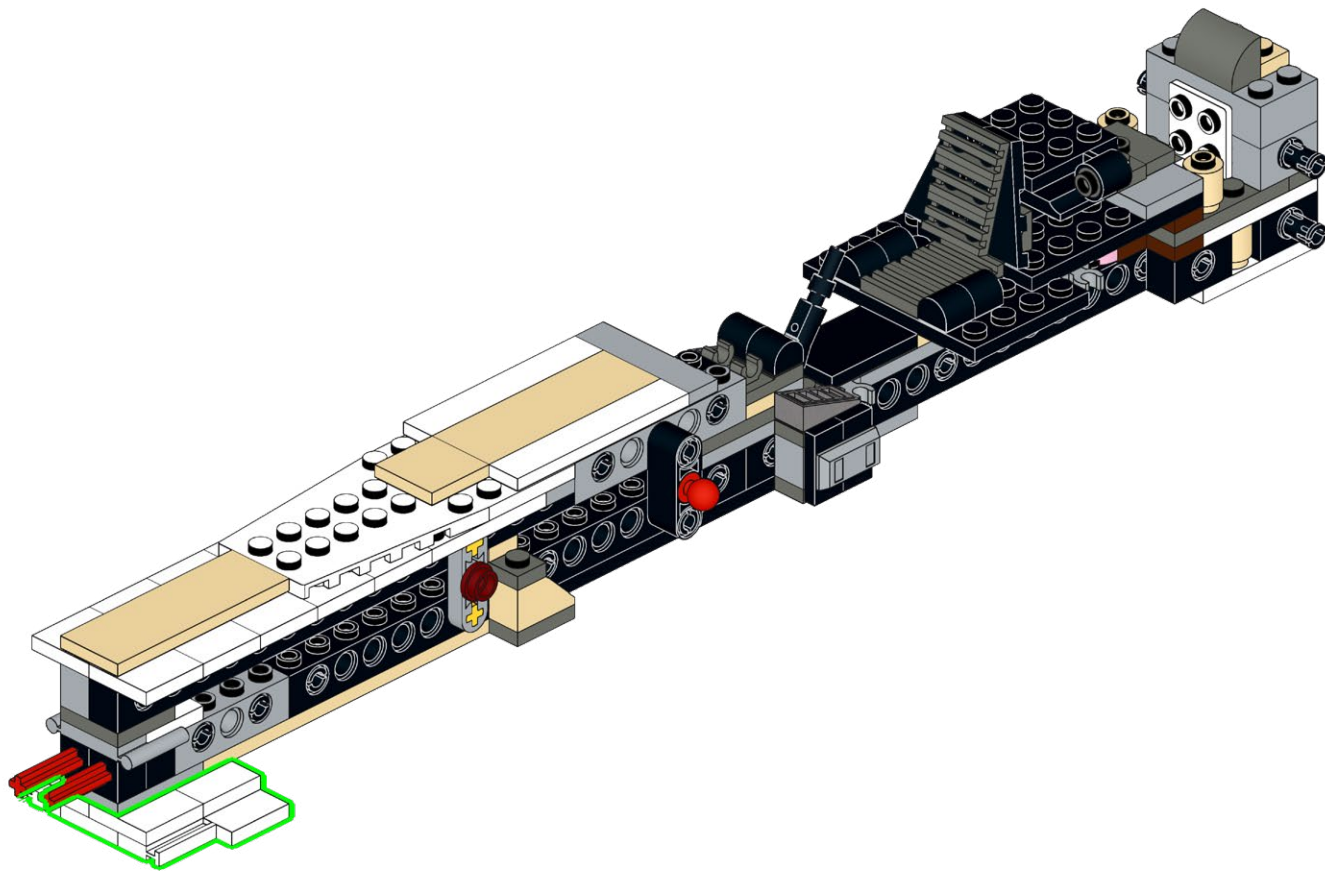

45

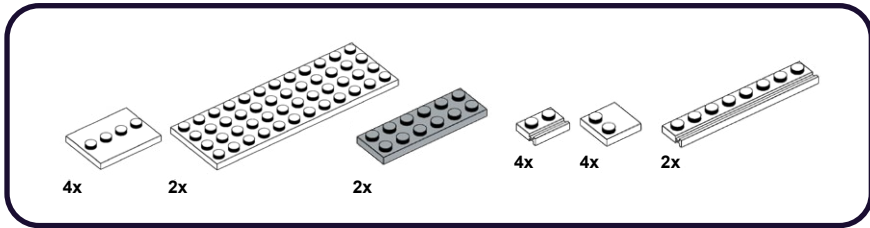

1

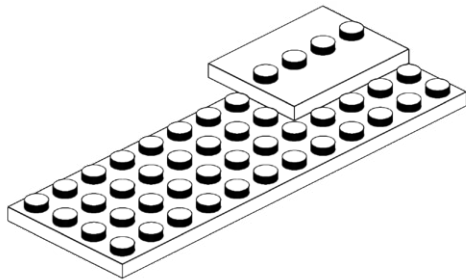

2

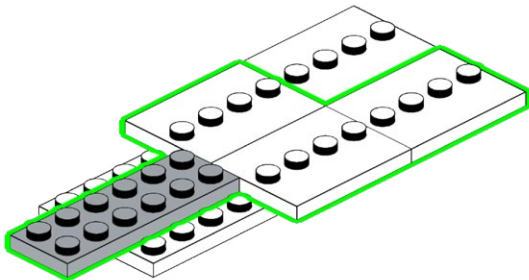

3

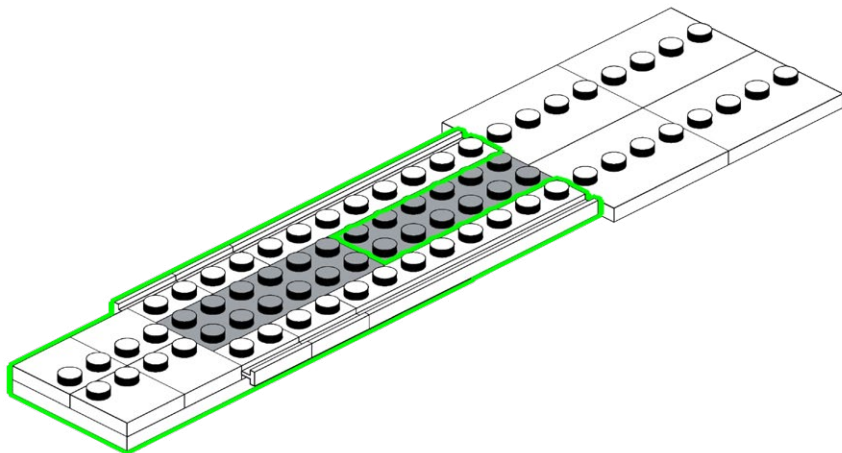

46

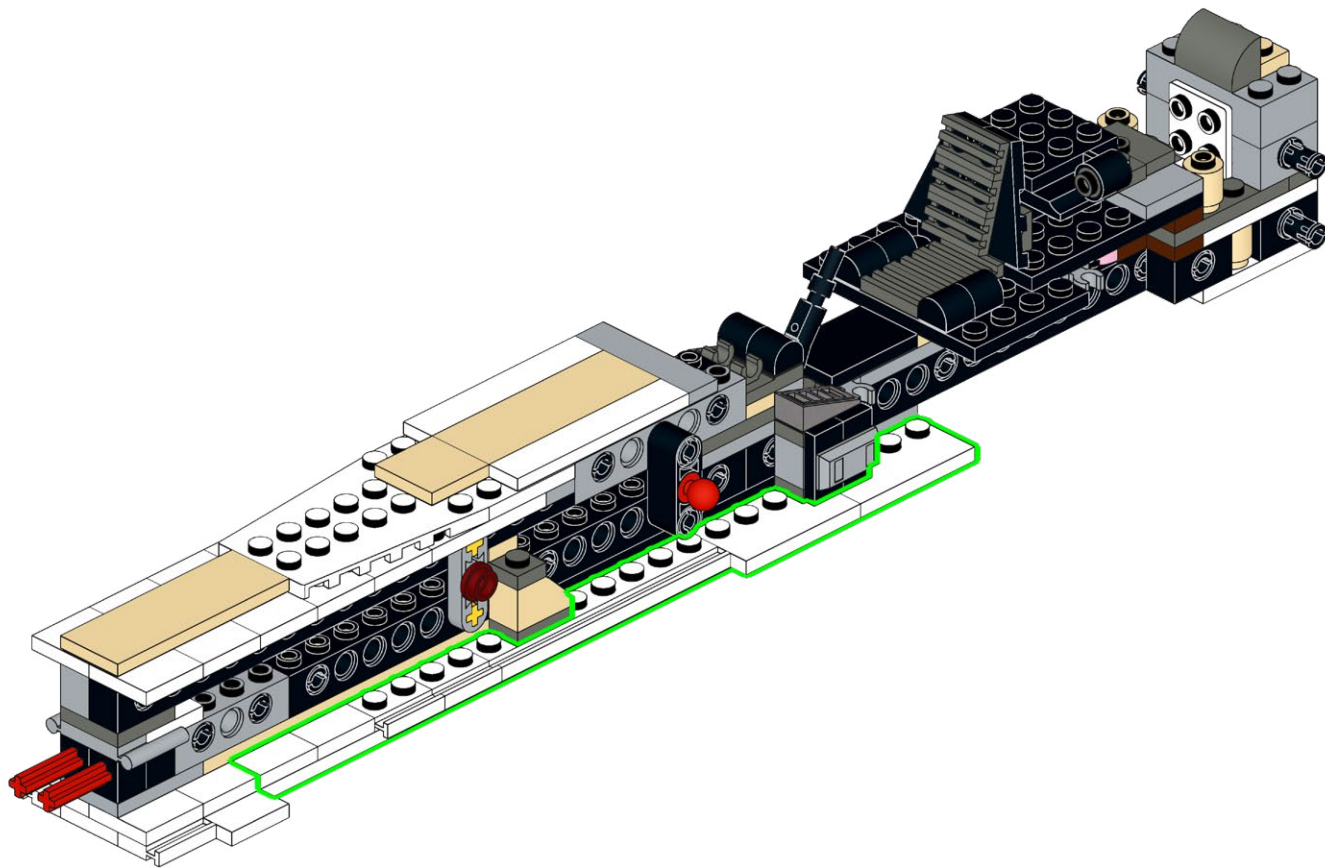

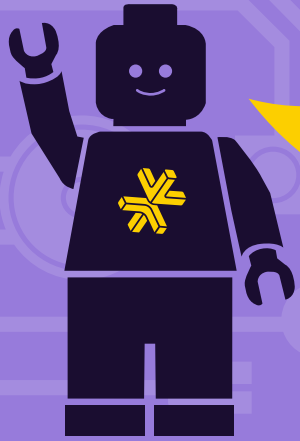
**HOLD UP!**

You might notice some bags aren't in order, as well as left over pieces, but that's ok! We're changing the way you build LEGO!

**ATTENDEZ!**

Vous remarquerez peut-être que certains sacs, ainsi que certaines pièces, ne sont pas dans le bon ordre. Mais pas de panique! Nous changeons simplement la façon avec laquelle vous construisez vos LEGO!

**ASPETTA!**

Potresti notare che alcuni sacchetti non sono in ordine, così come i pezzi avanzati, ma va bene così! Stiamo cambiando il modo in cui costruisci i LEGO!

**HALT!**

Sie werden möglicherweise bemerken, dass einige tüten durcheinander sind und teile übrig bleiben, aber das ist in Ordnung! Wir ändern die art und weise, wie Sie LEGO bauen!

**¡ESPERA!**

Es posible que notes que algunas bolsas están fuera de servicio, así como piezas sobrantes, ¡pero está bien! ¡Estamos cambiando la forma en que construyes LEGO!

**暫停!**

你可能会注意到一些袋子顺序错乱, 以及一些剩余的部件, 但没关系! 我们正在改变你搭建乐高的方式!

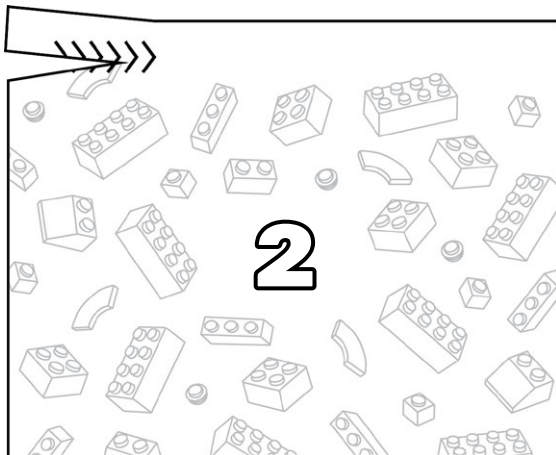
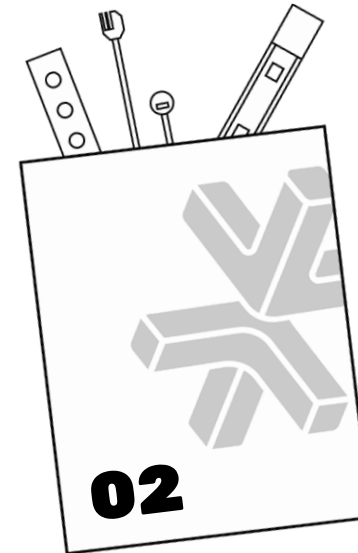
**Open LEGO® Bag 2****Open LMB Bags 02**

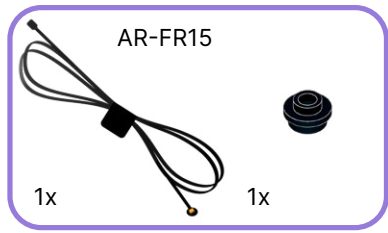

1



2

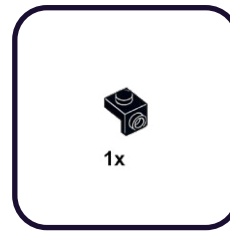
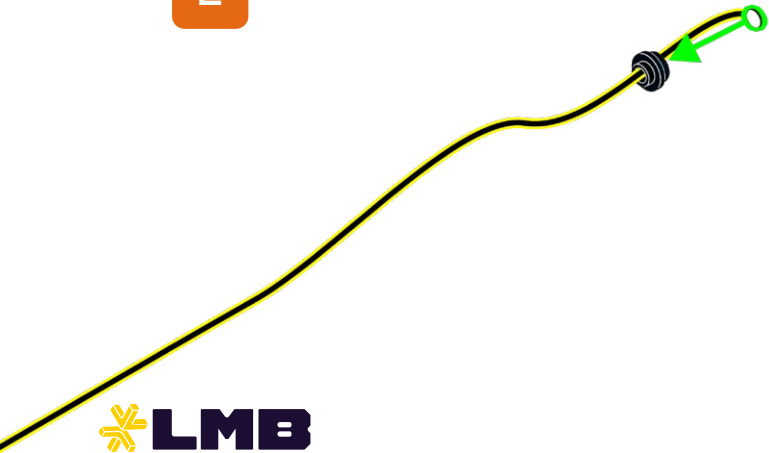

1



2

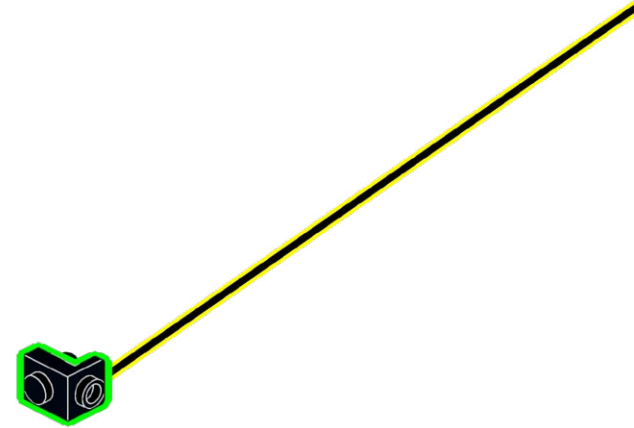

**49**

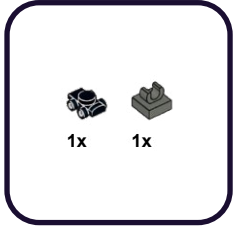

1



2



**50**

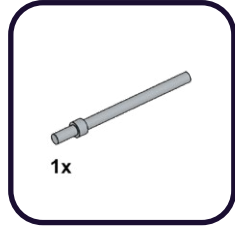

1

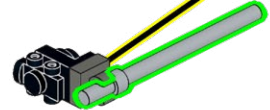

2

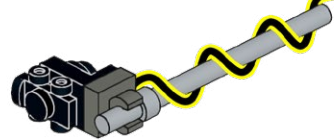



51

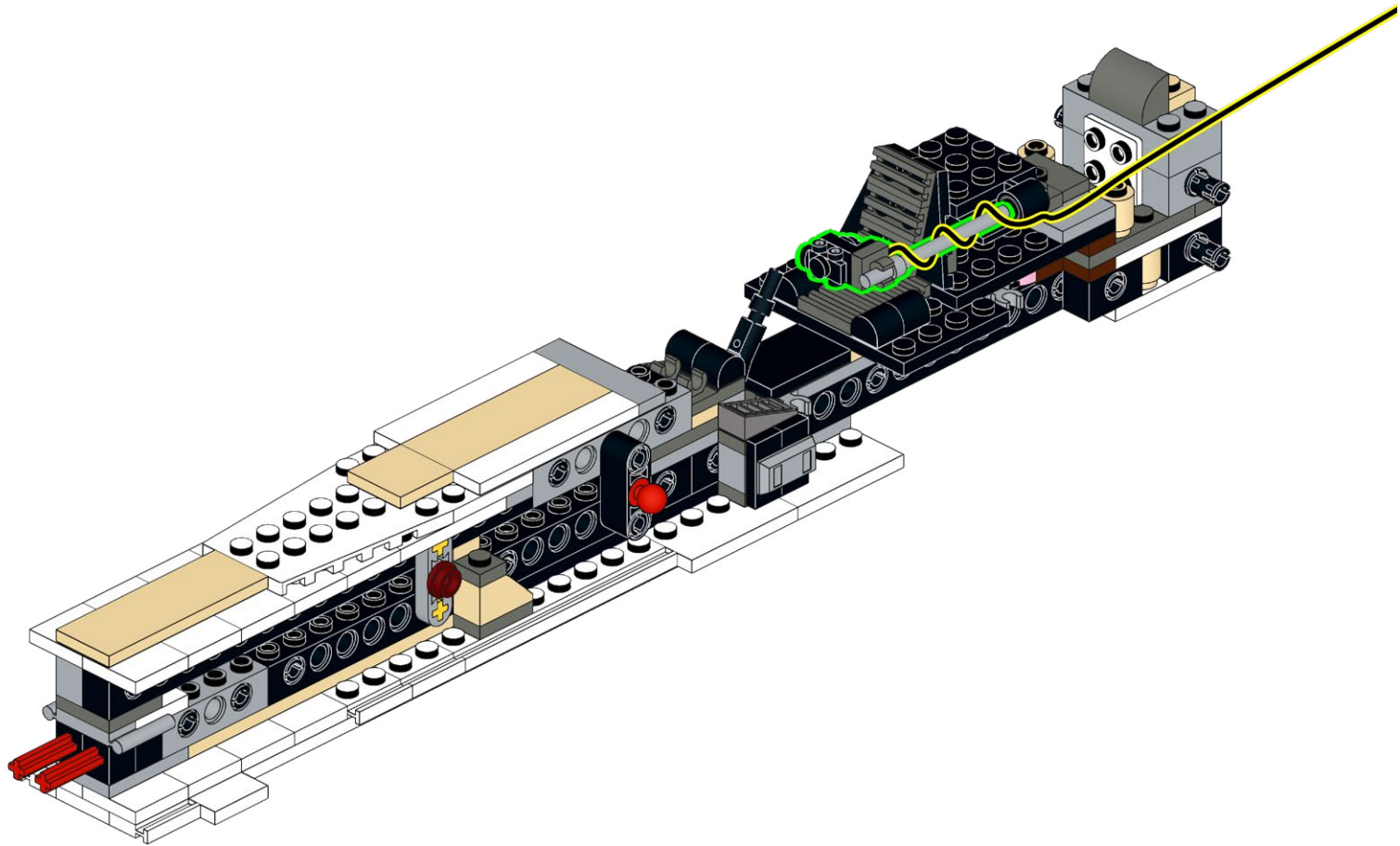

# 52

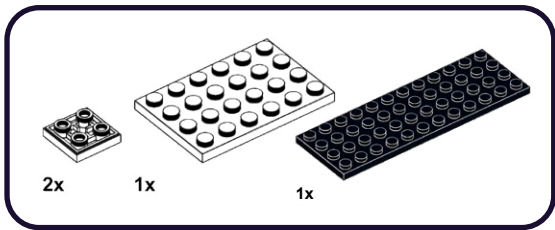

1

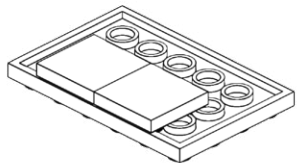

2

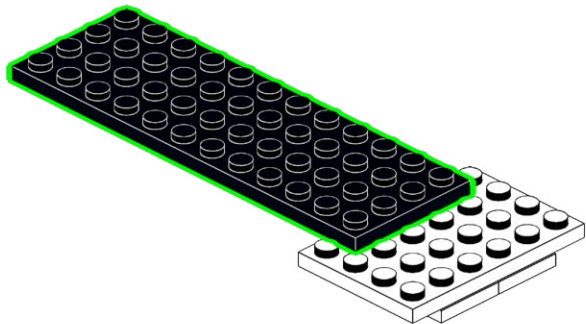

# 53

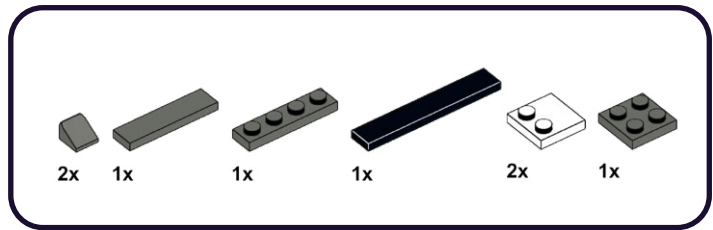

1

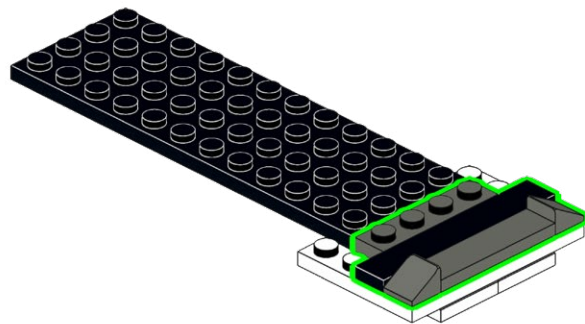

2

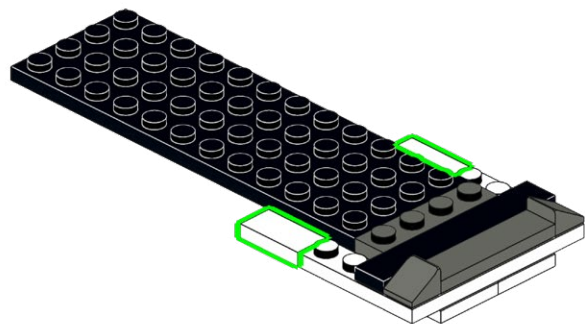

54

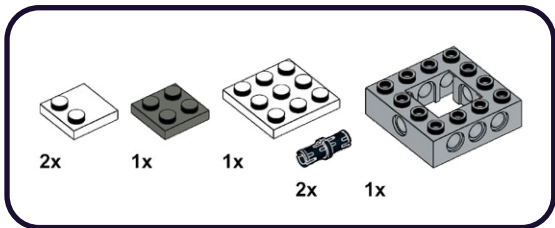

1

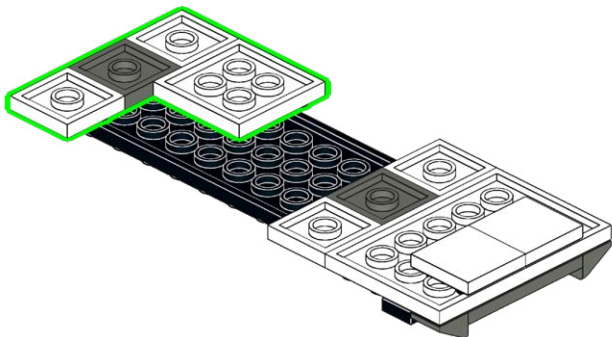

2

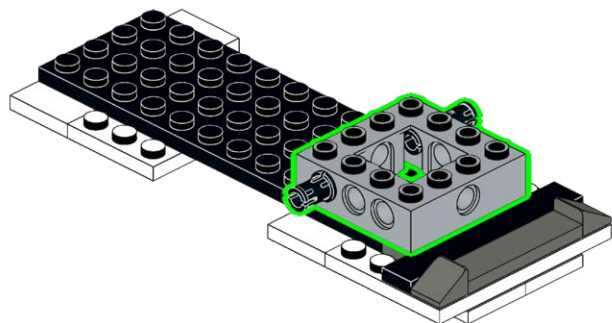

55

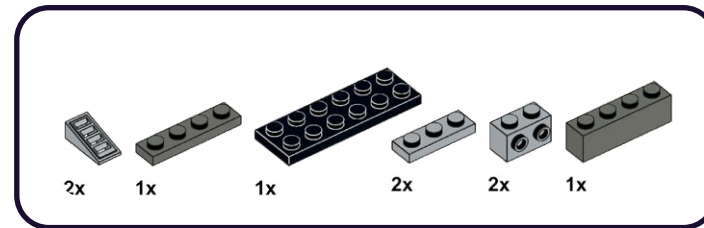

1

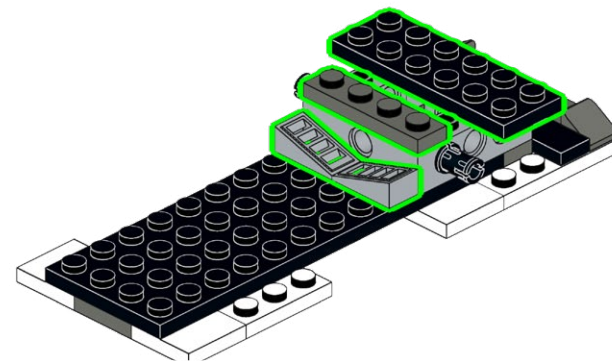

2

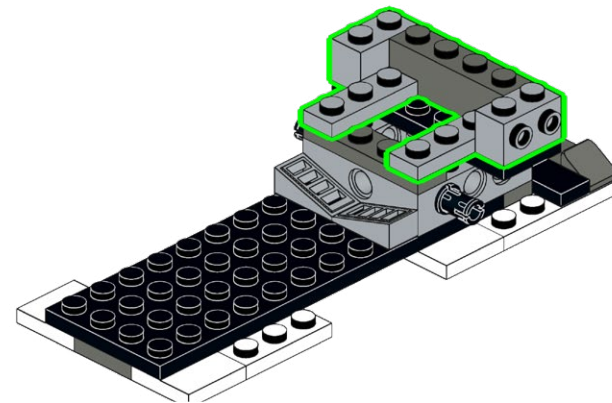

# 56

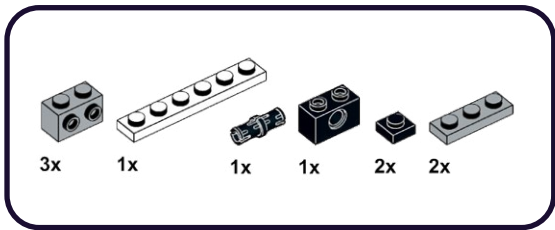

1

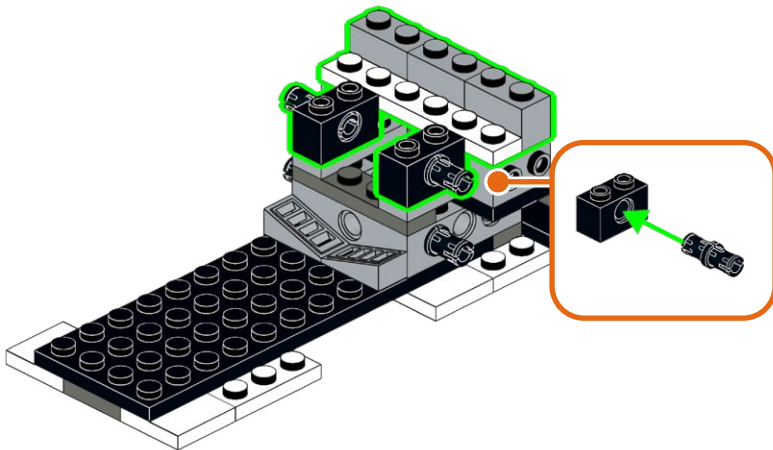

2

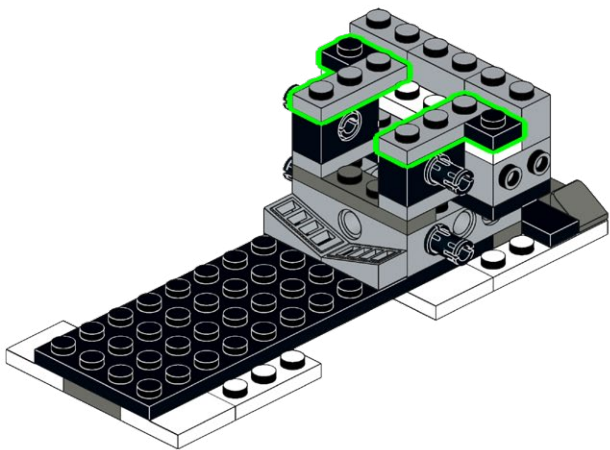

# 57

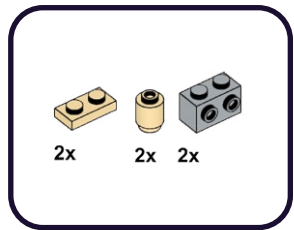

1

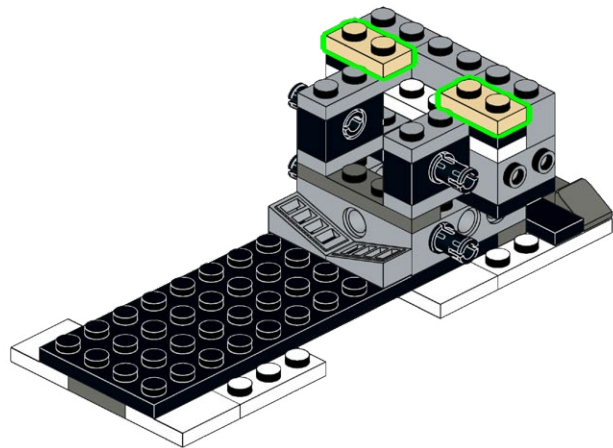

2

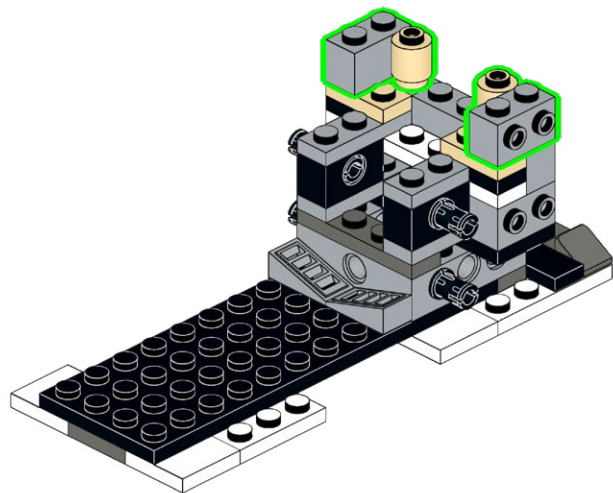

58

2x

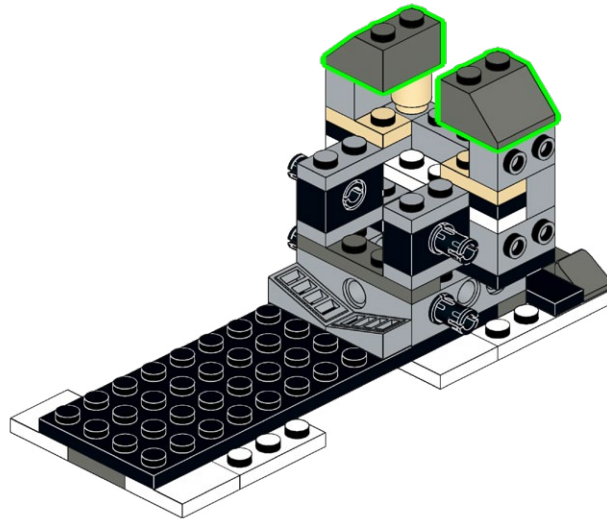

# 59

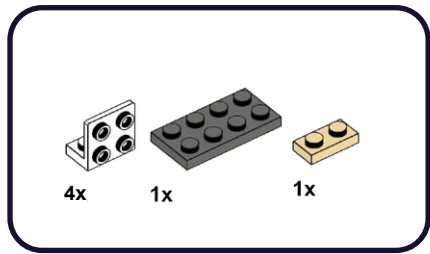

1

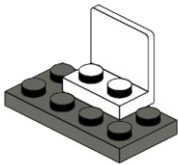

2

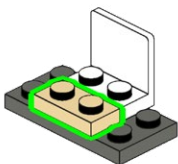

# 60

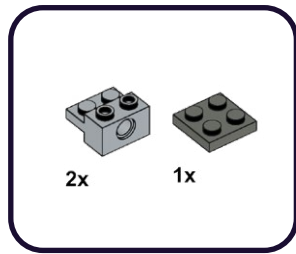

1

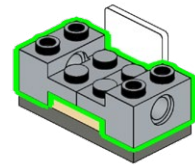

2

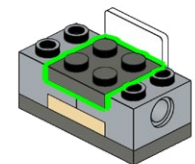

61



62

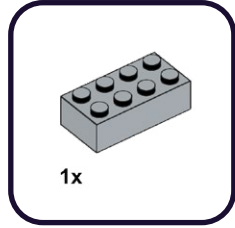

1

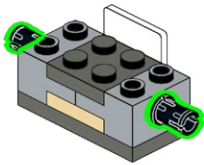

1

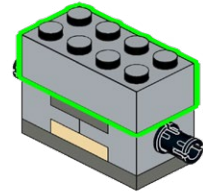



63

1

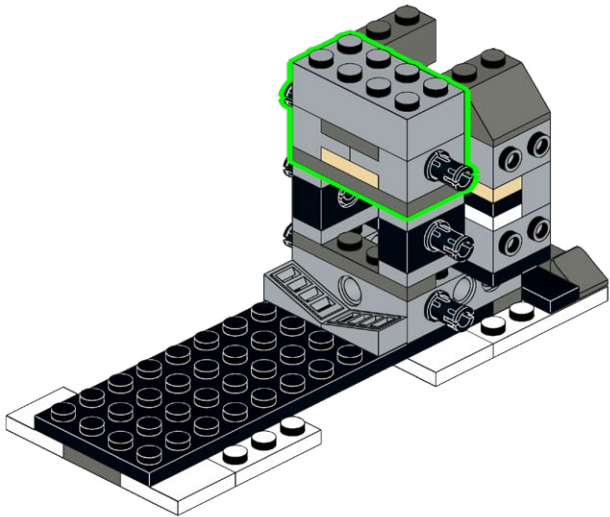

64

1

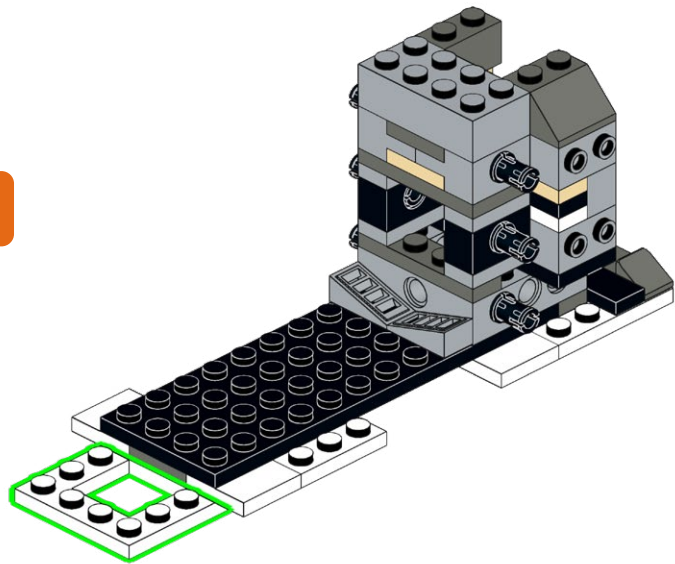
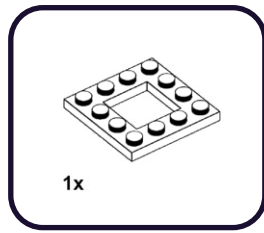



**65**

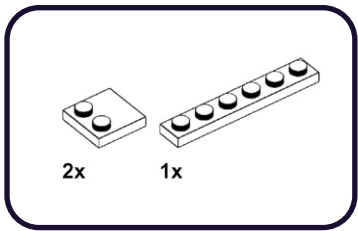

**1**

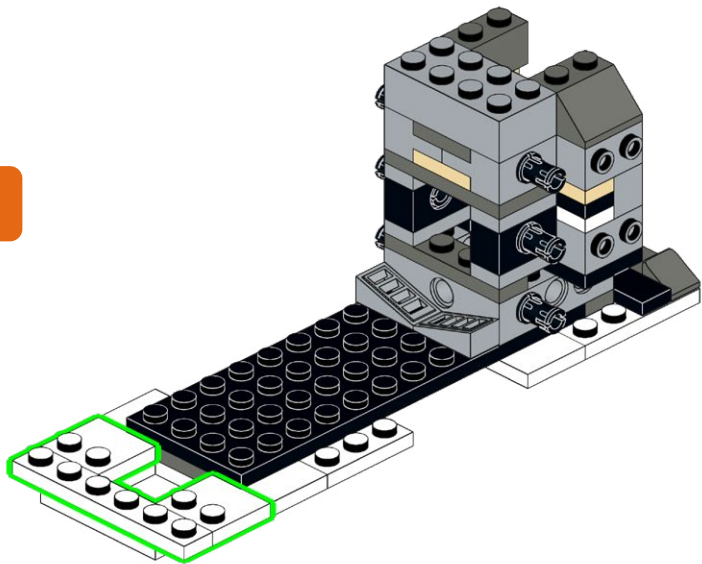

**66**

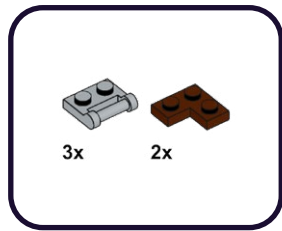

**1**

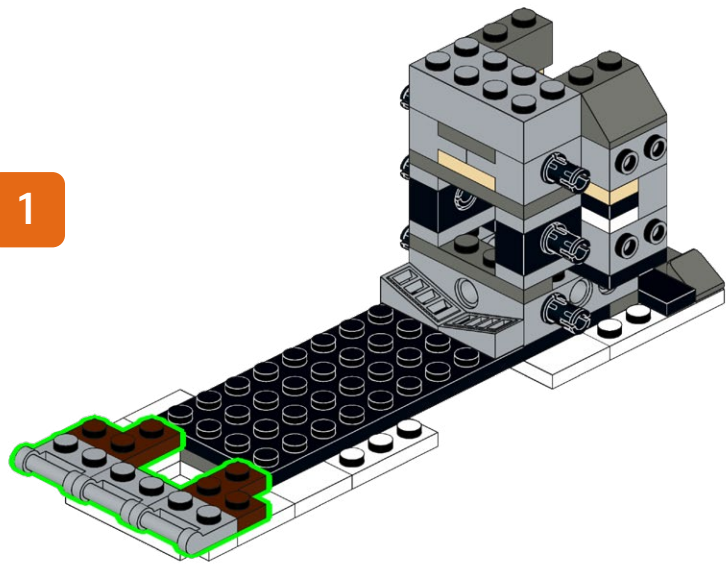

67

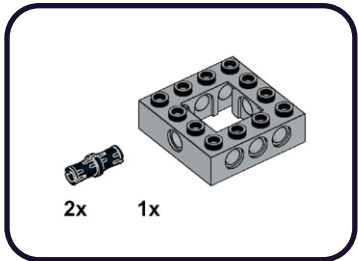

1

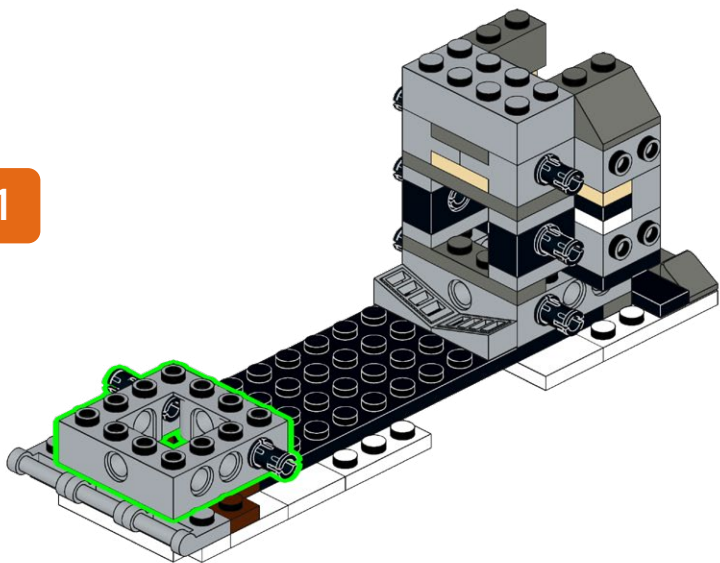

68

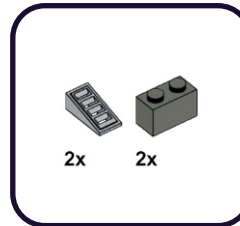

1

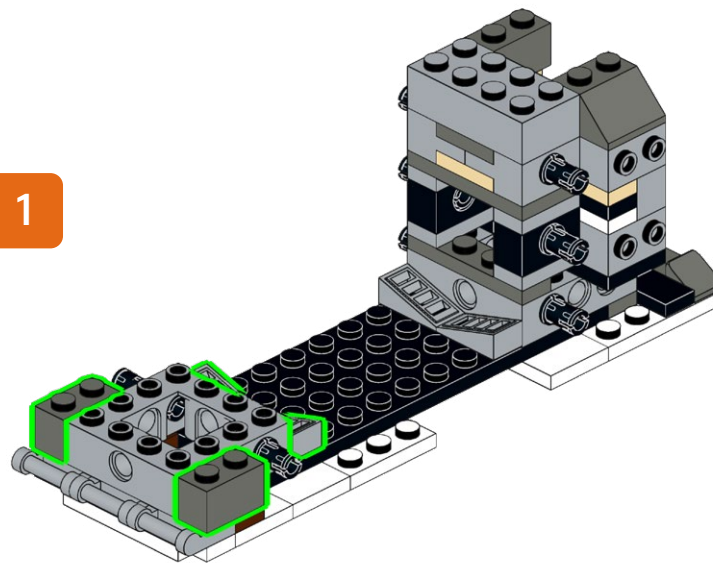

69

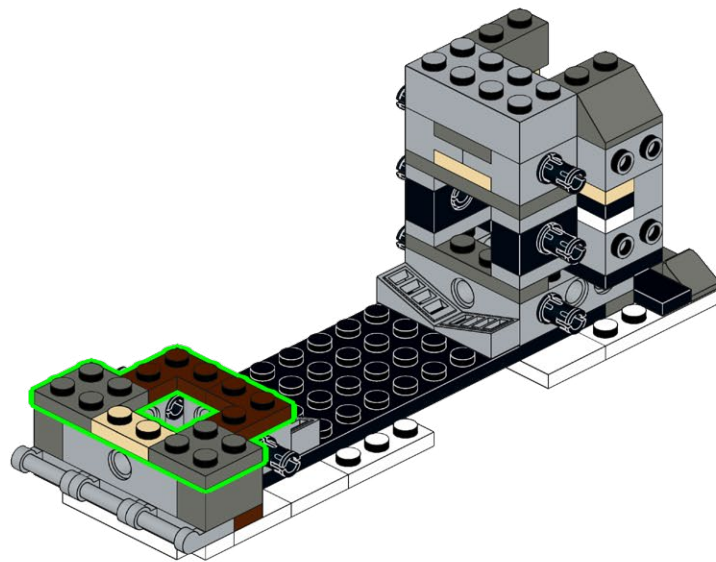
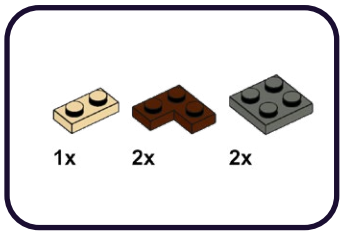

70



2x

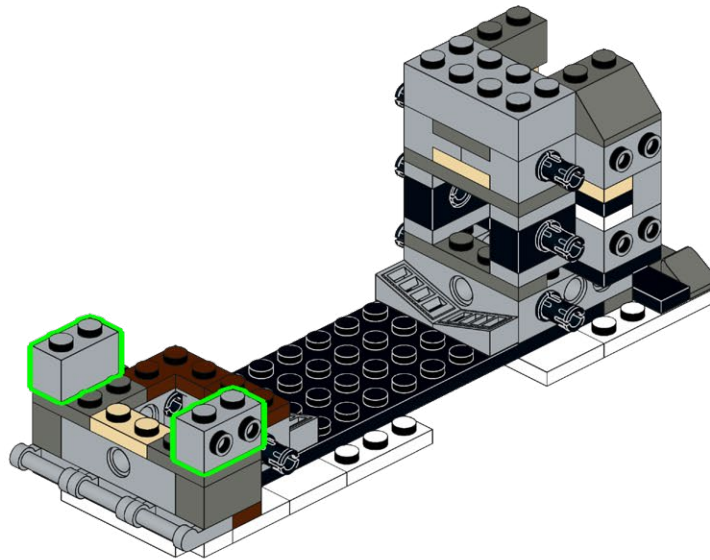

71

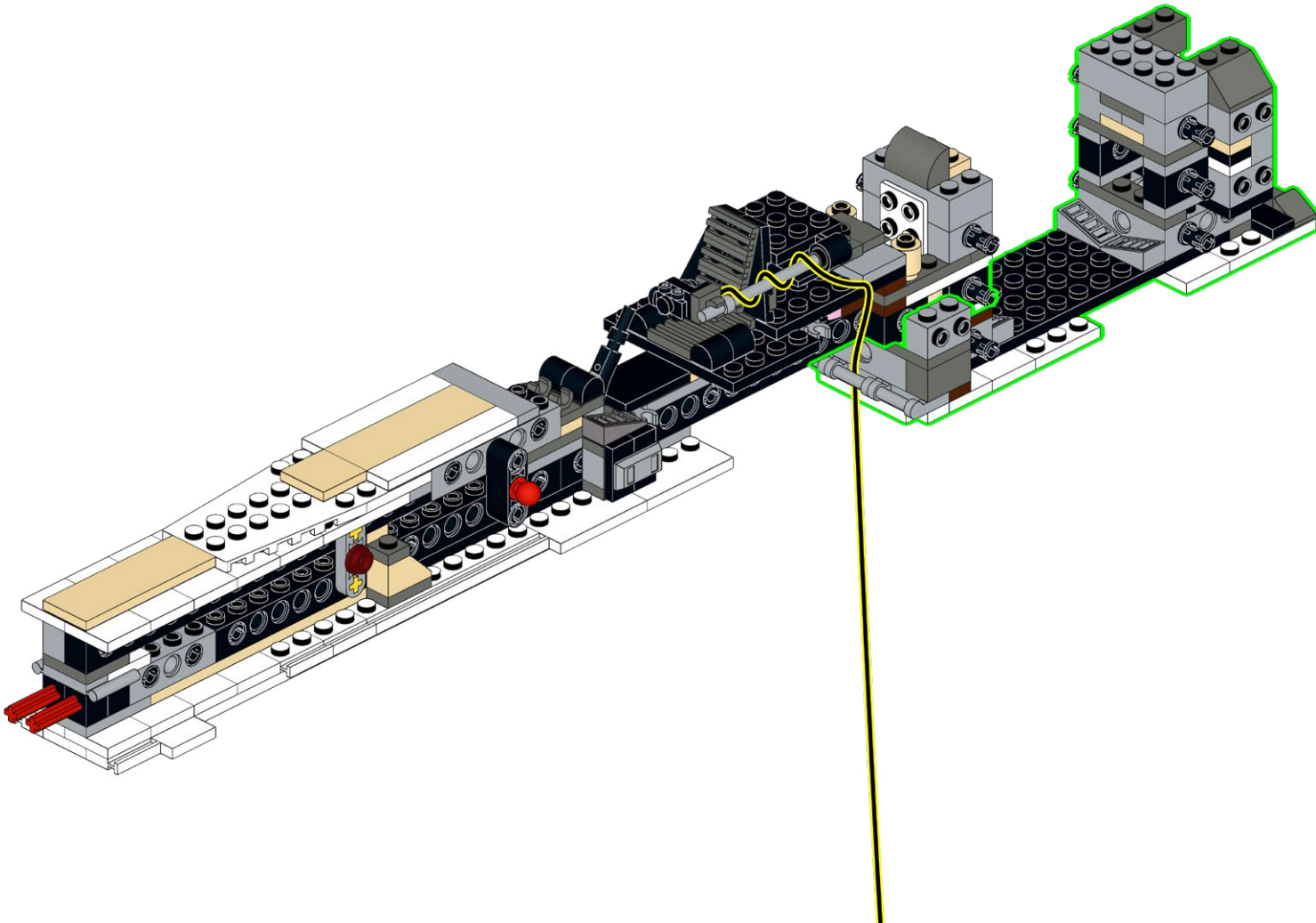

72

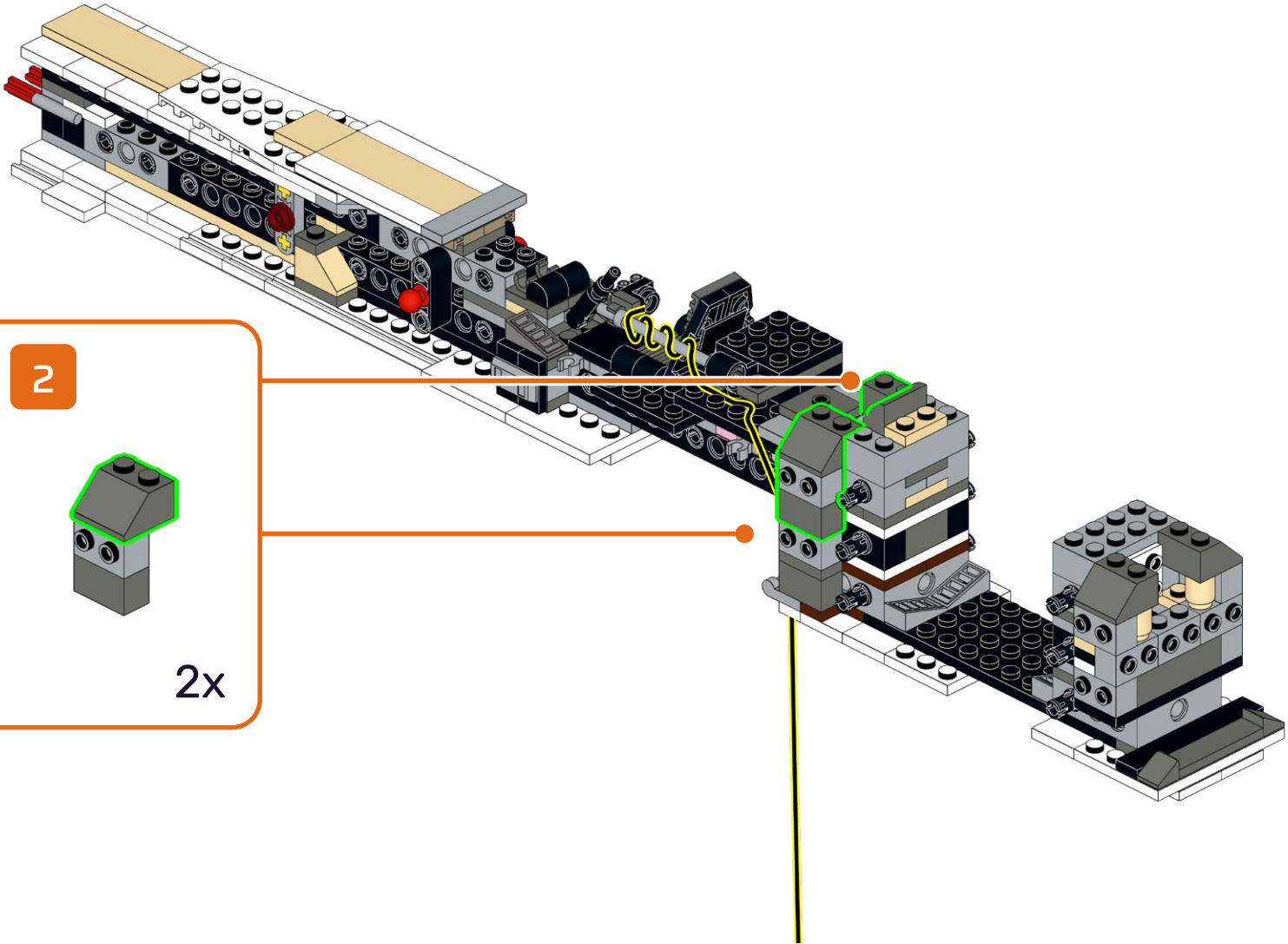
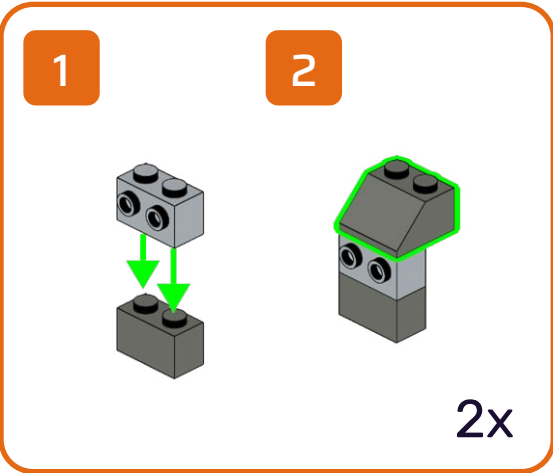
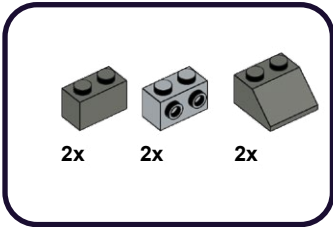



73

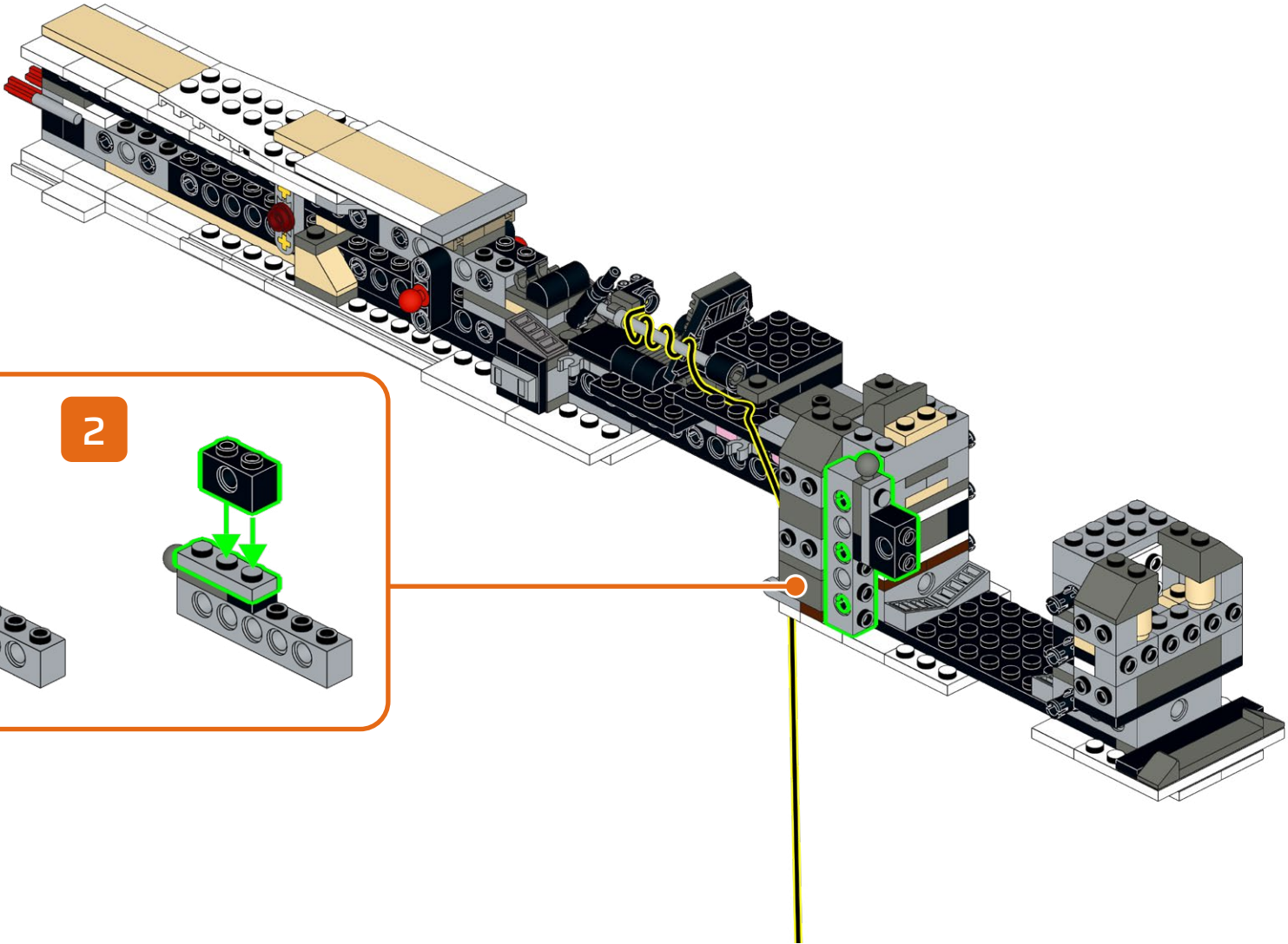
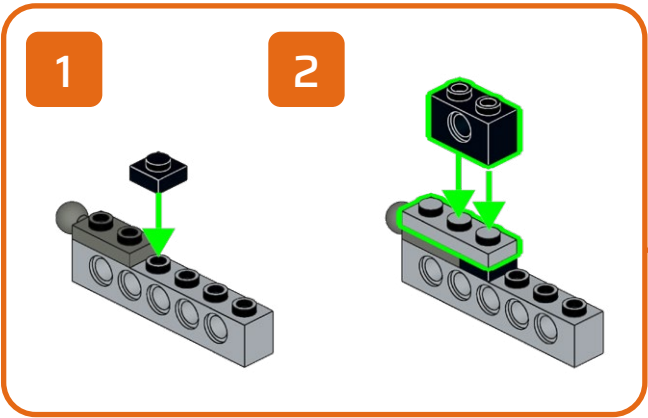
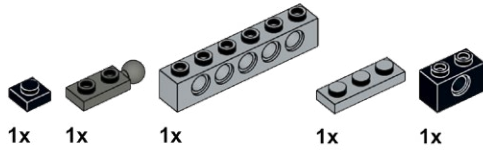

74

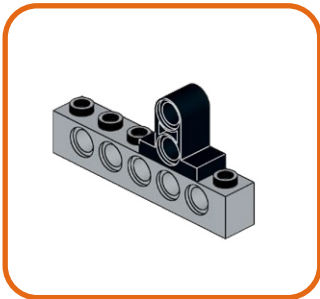
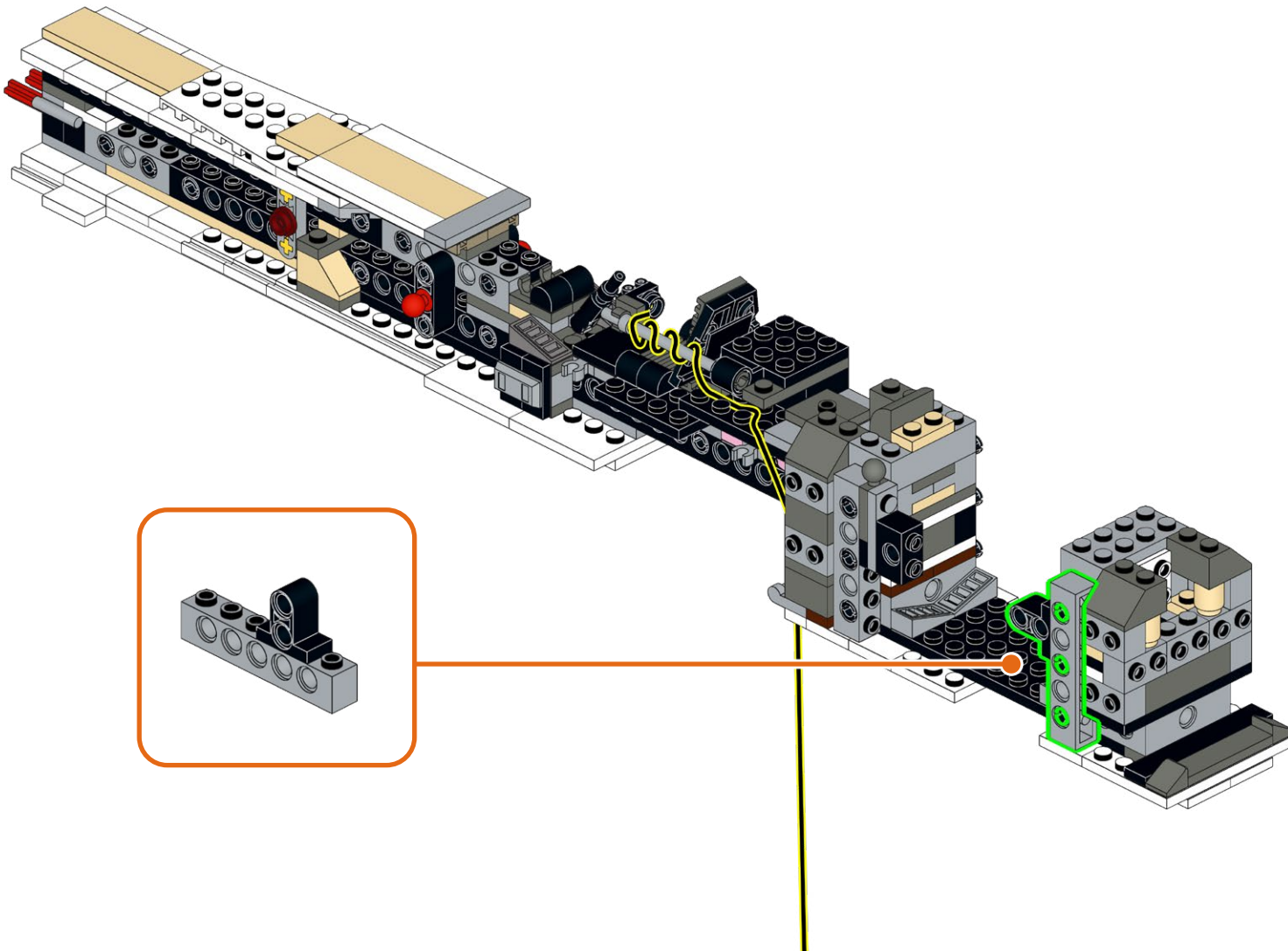
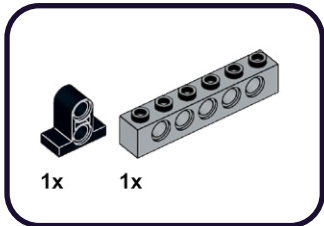



75

4x

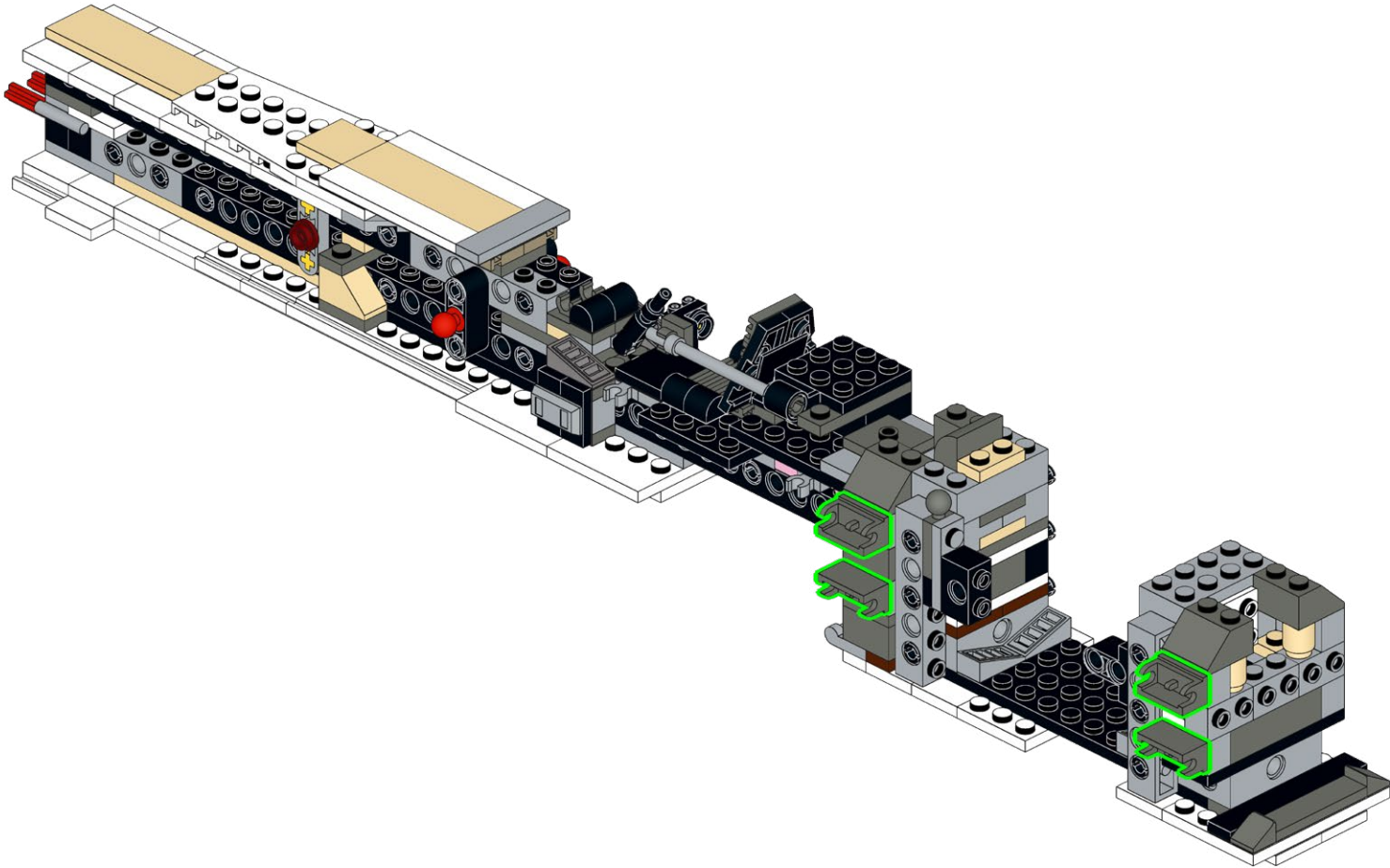

76

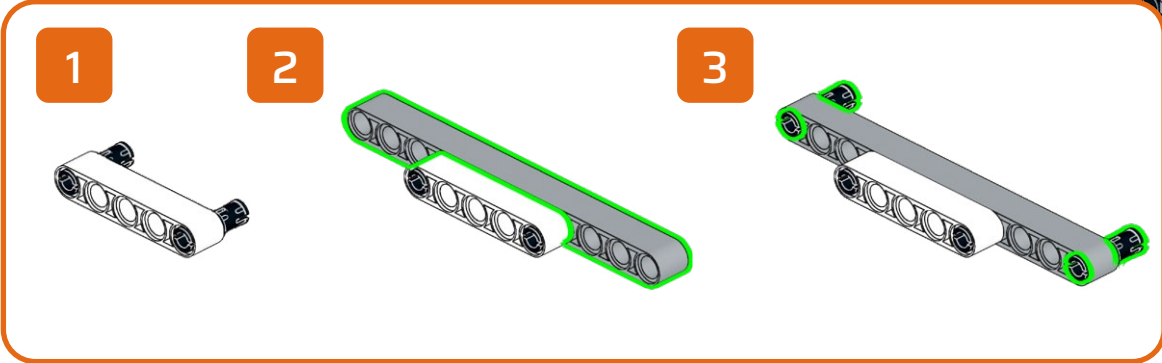
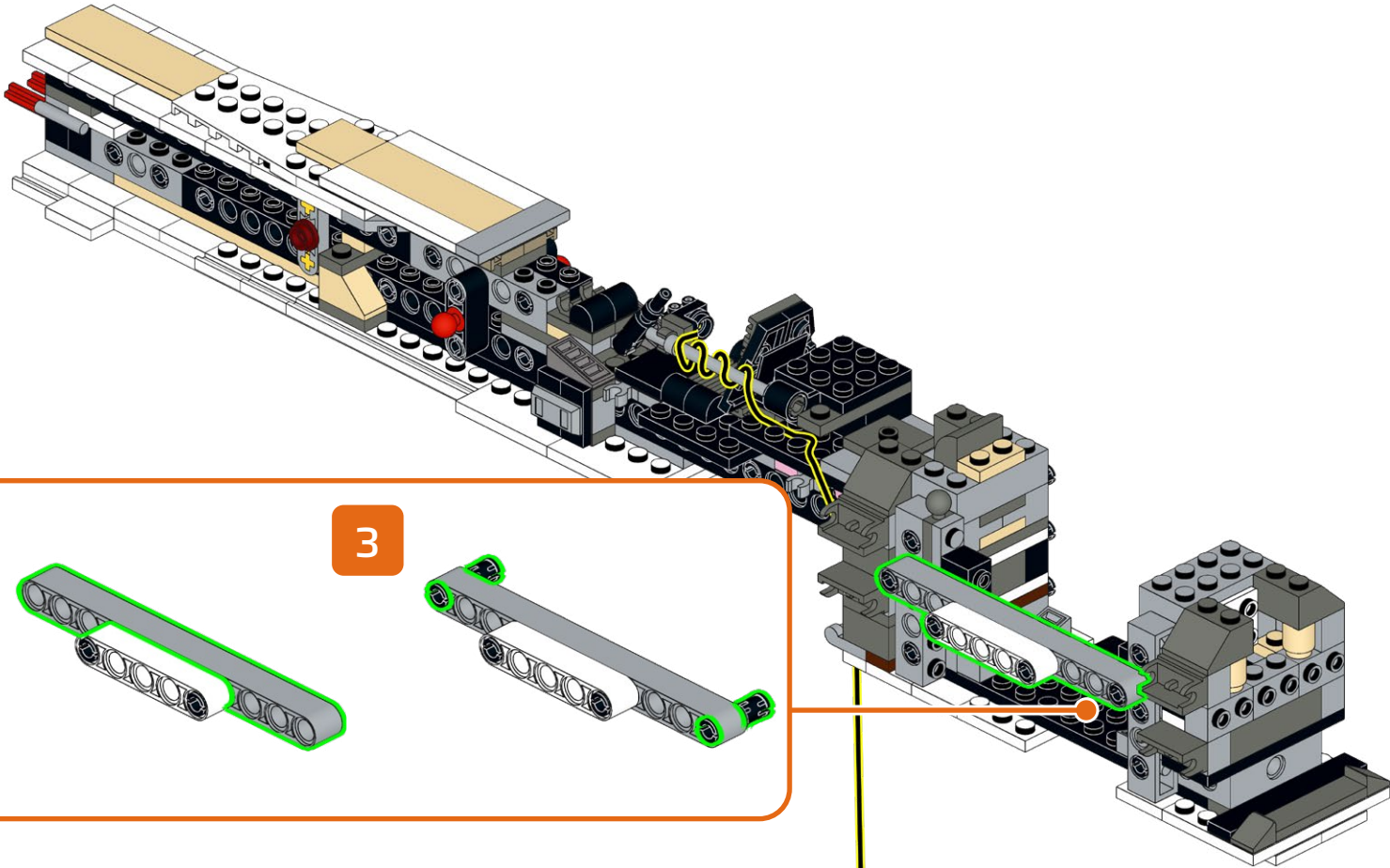
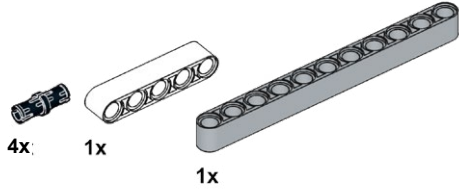

# 77

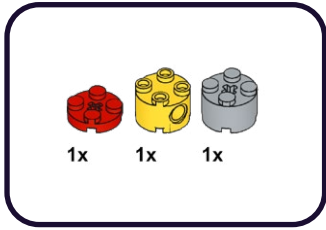

1

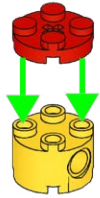

2

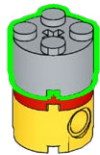

# 78

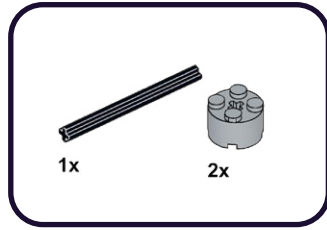

1

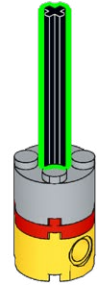

2

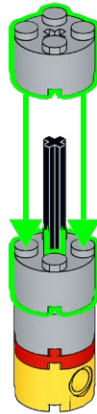

79

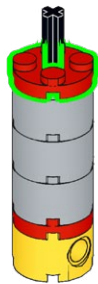
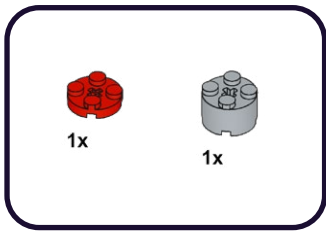

80

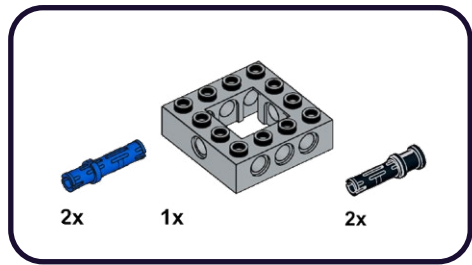

1

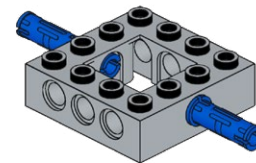

2

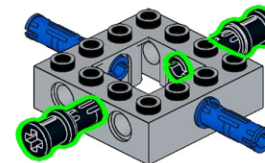

**81**

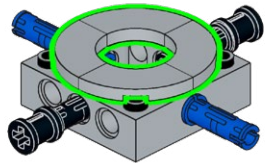
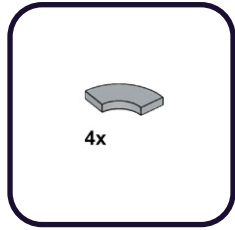

**82**

**1**

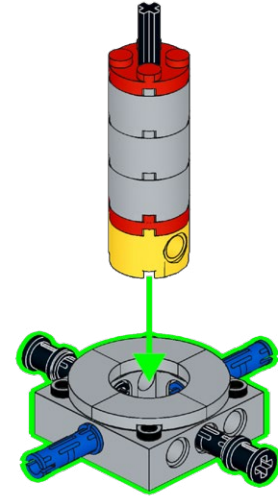

**2**

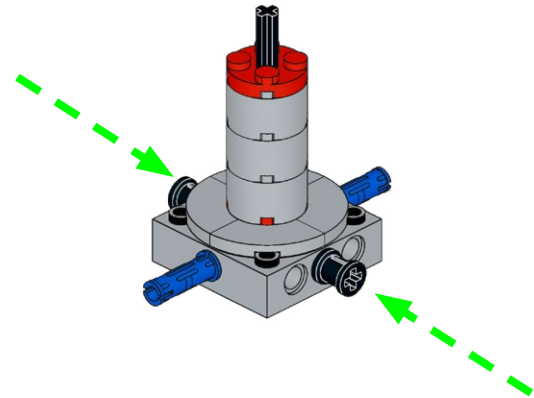

83

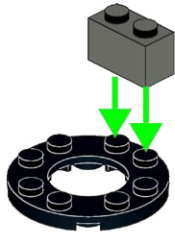
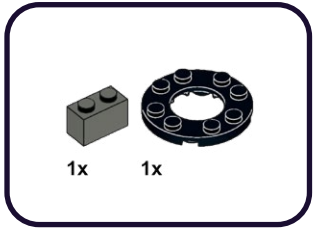

84

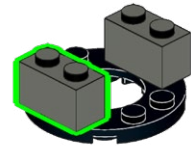
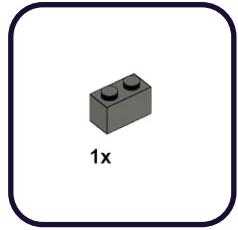

# 85

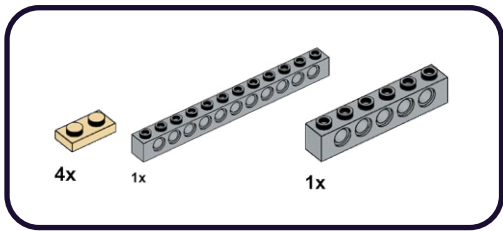

1

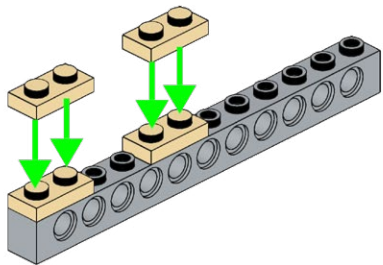

2

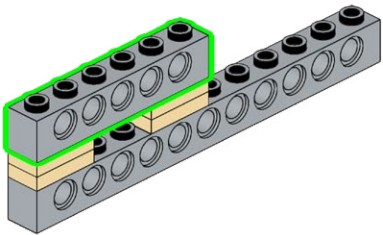

# 86

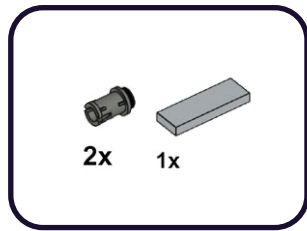

1

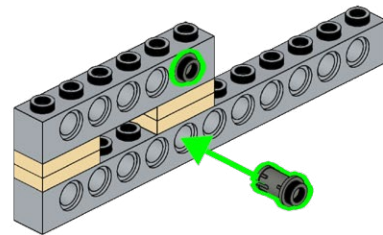

2

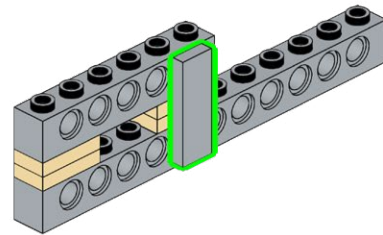

2x

87

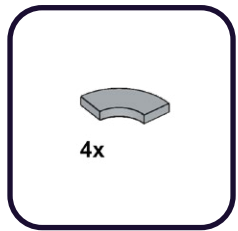

1

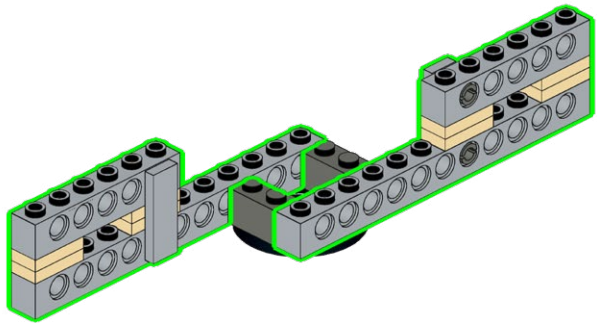

2

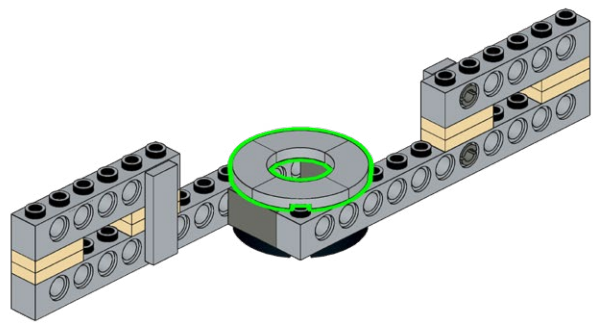

88

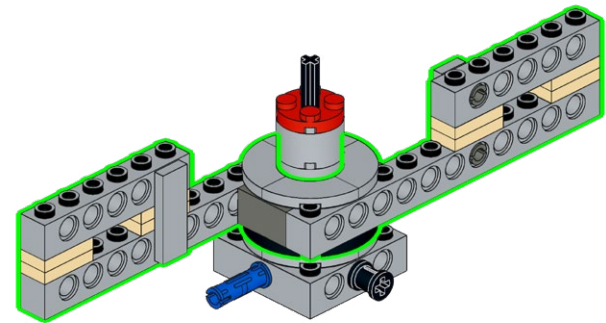



89

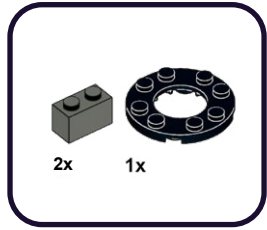

1

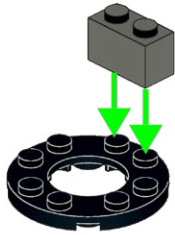

2

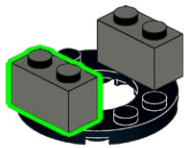

90

1

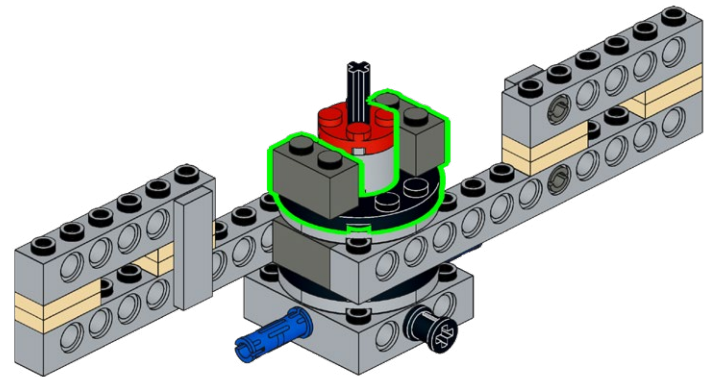

91

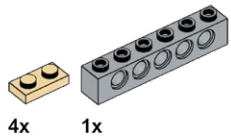

1

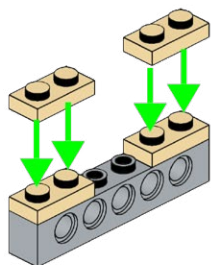

2

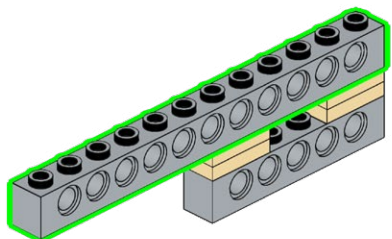

92

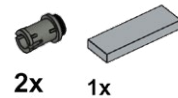

1

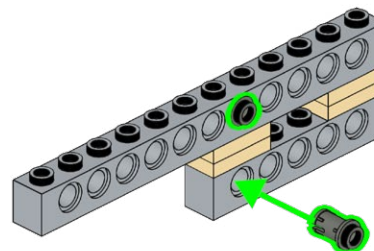

2

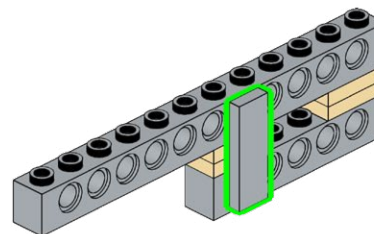

2x

93

94

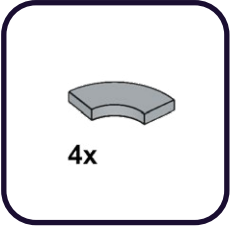

1

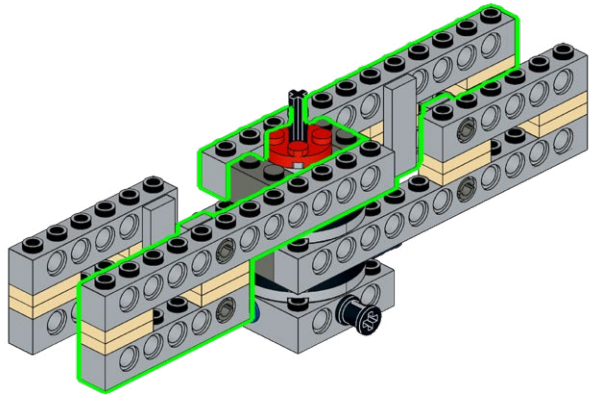

1

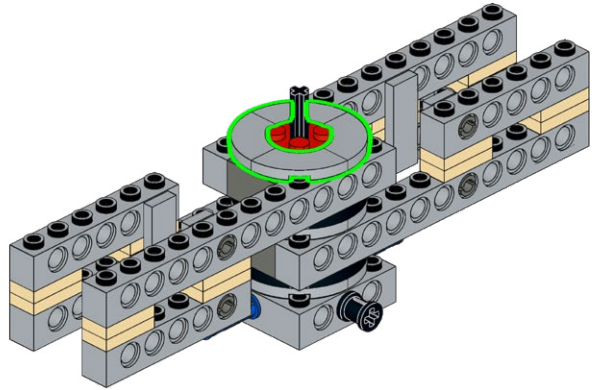

# 95

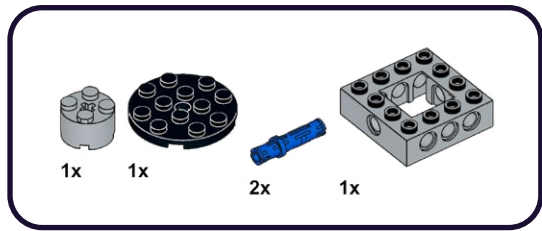

1

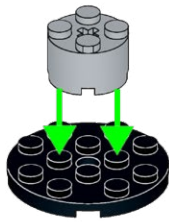

2

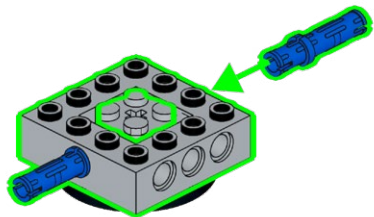

# 96

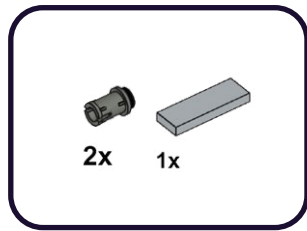

1

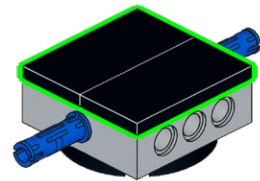

2

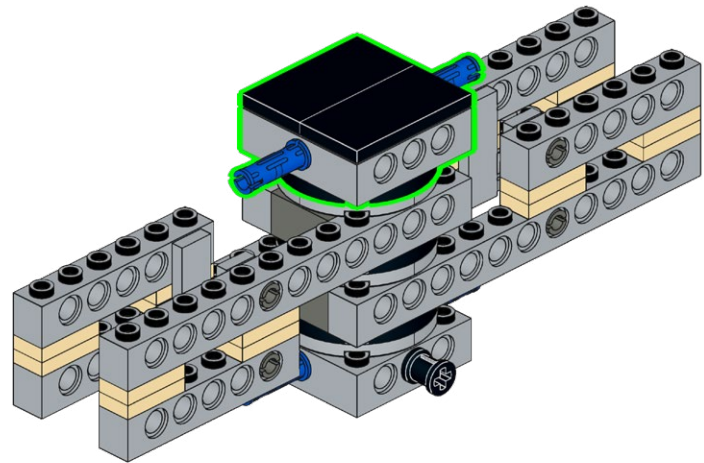

97

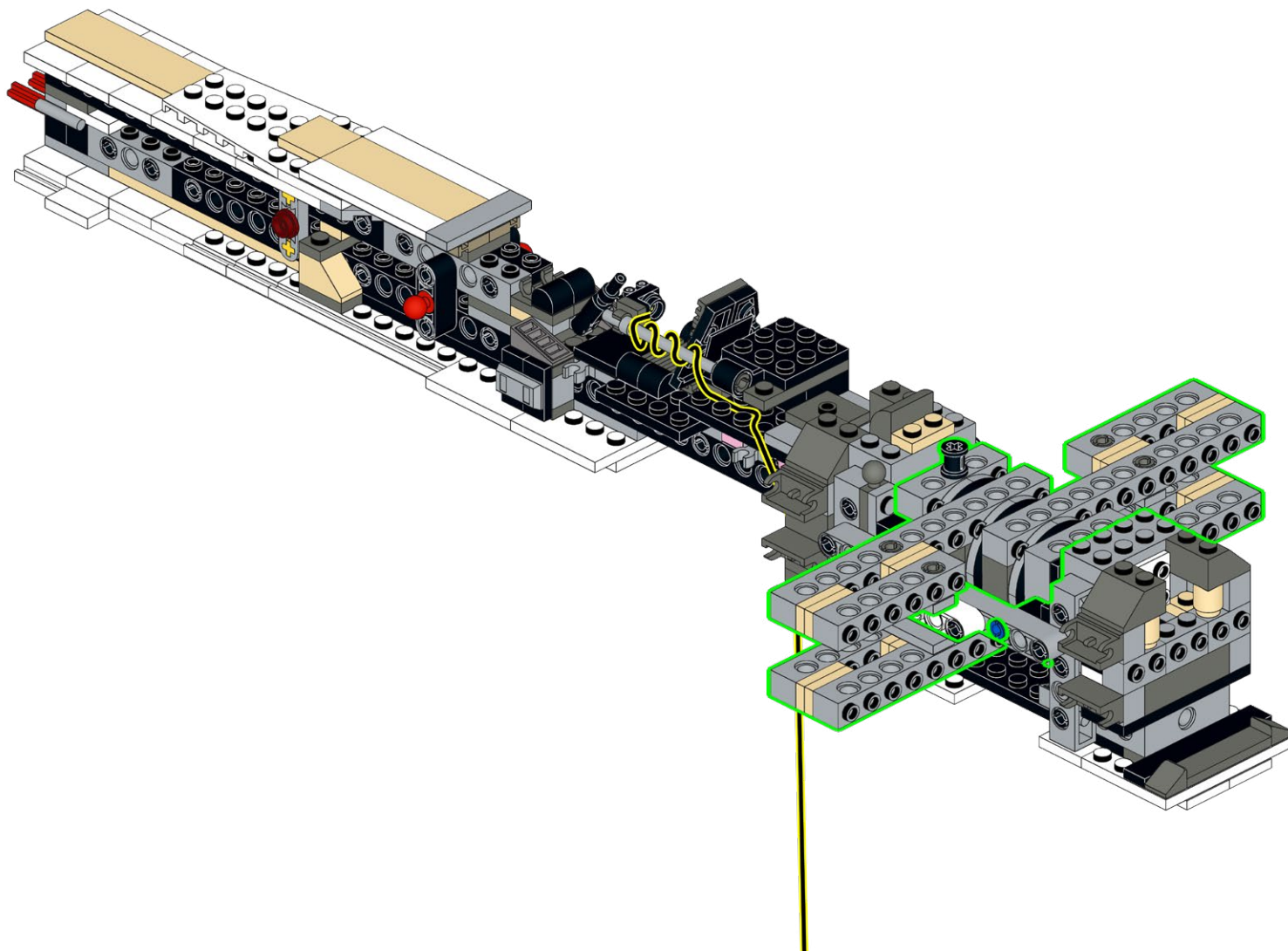

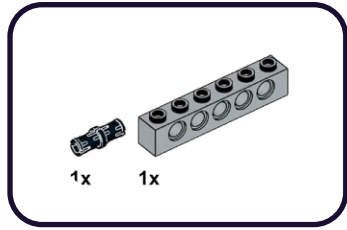

1

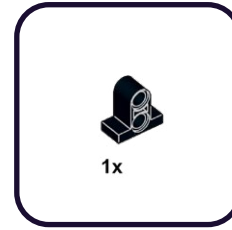
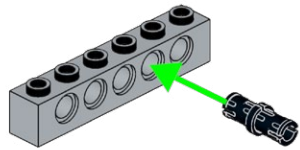

1

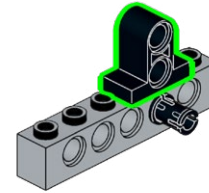

100

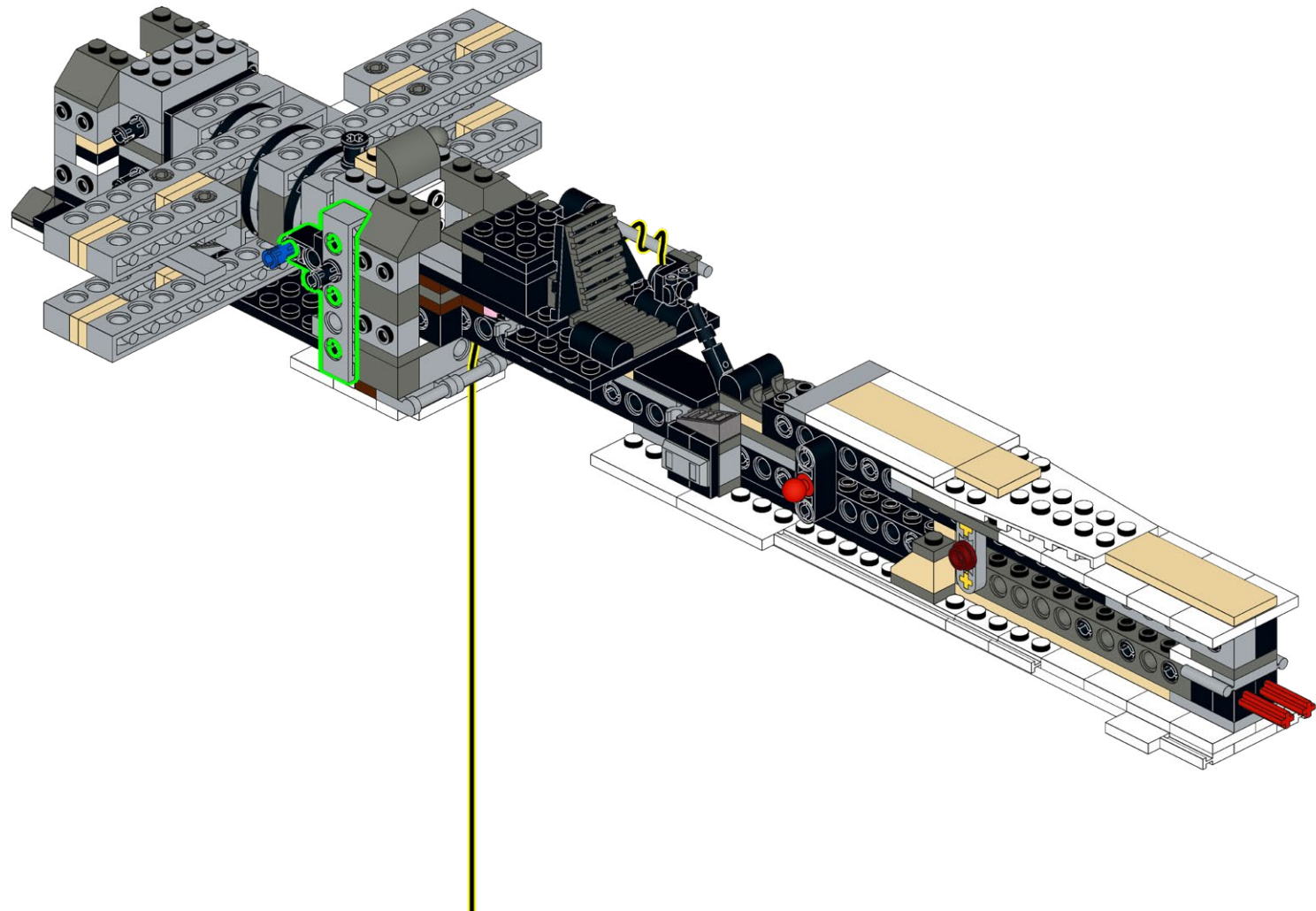

101

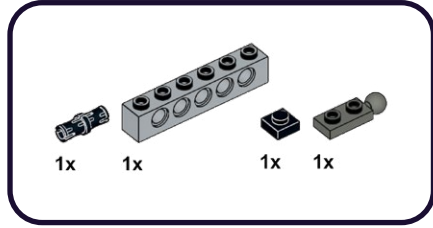

1

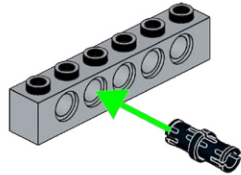

2

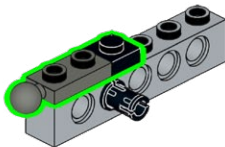

102

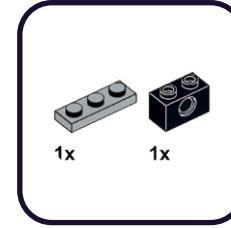

1

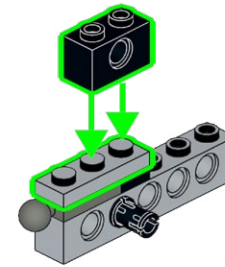



103

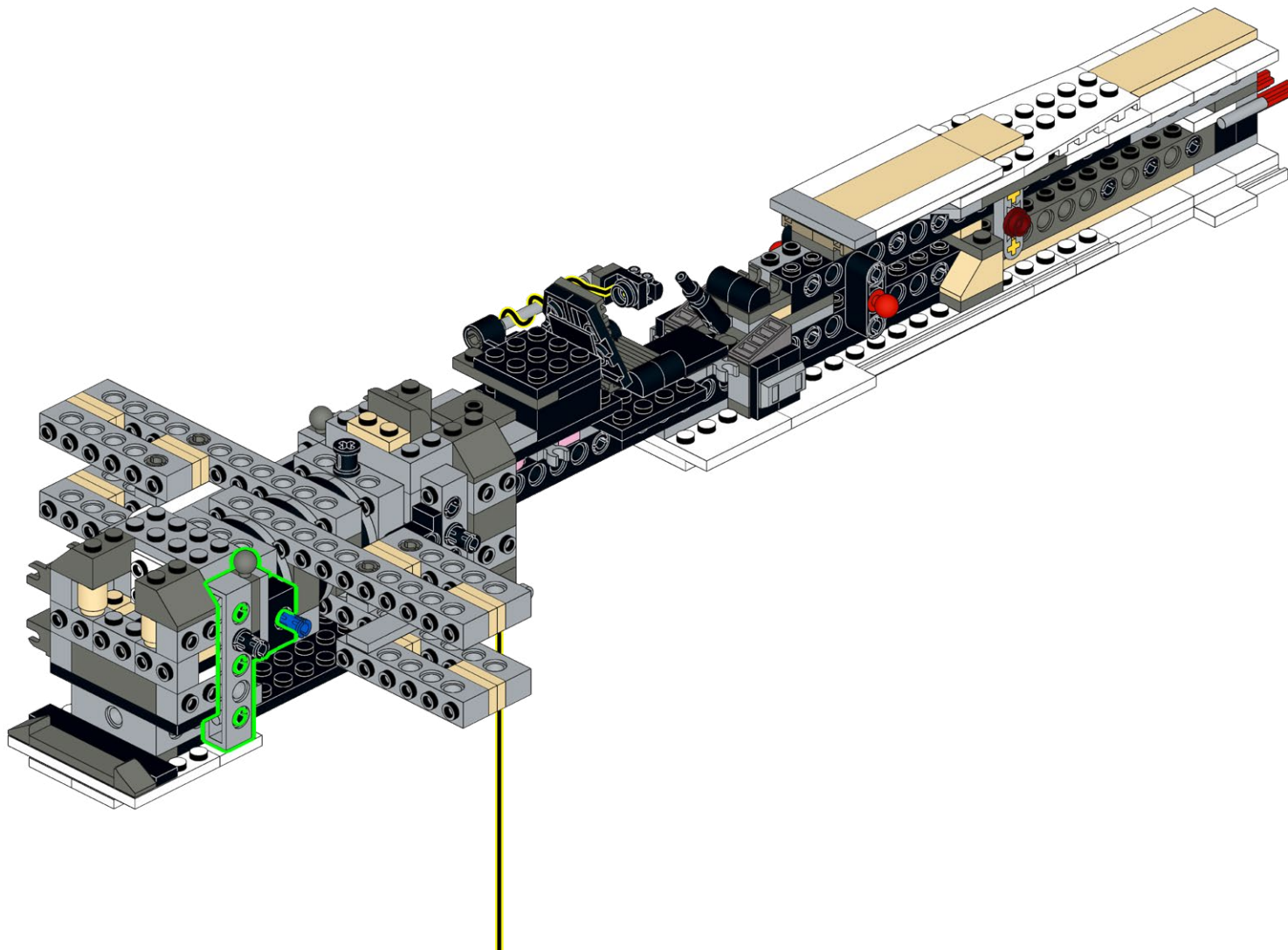

# 104

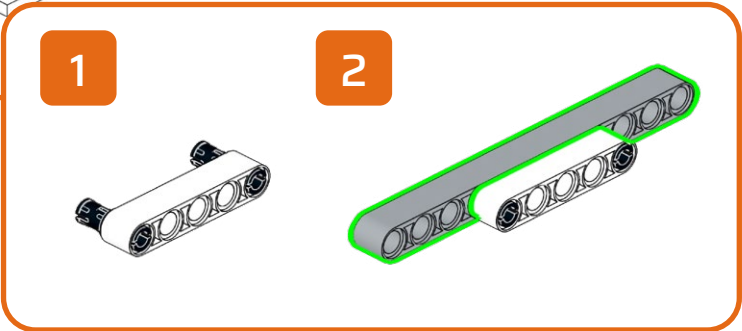
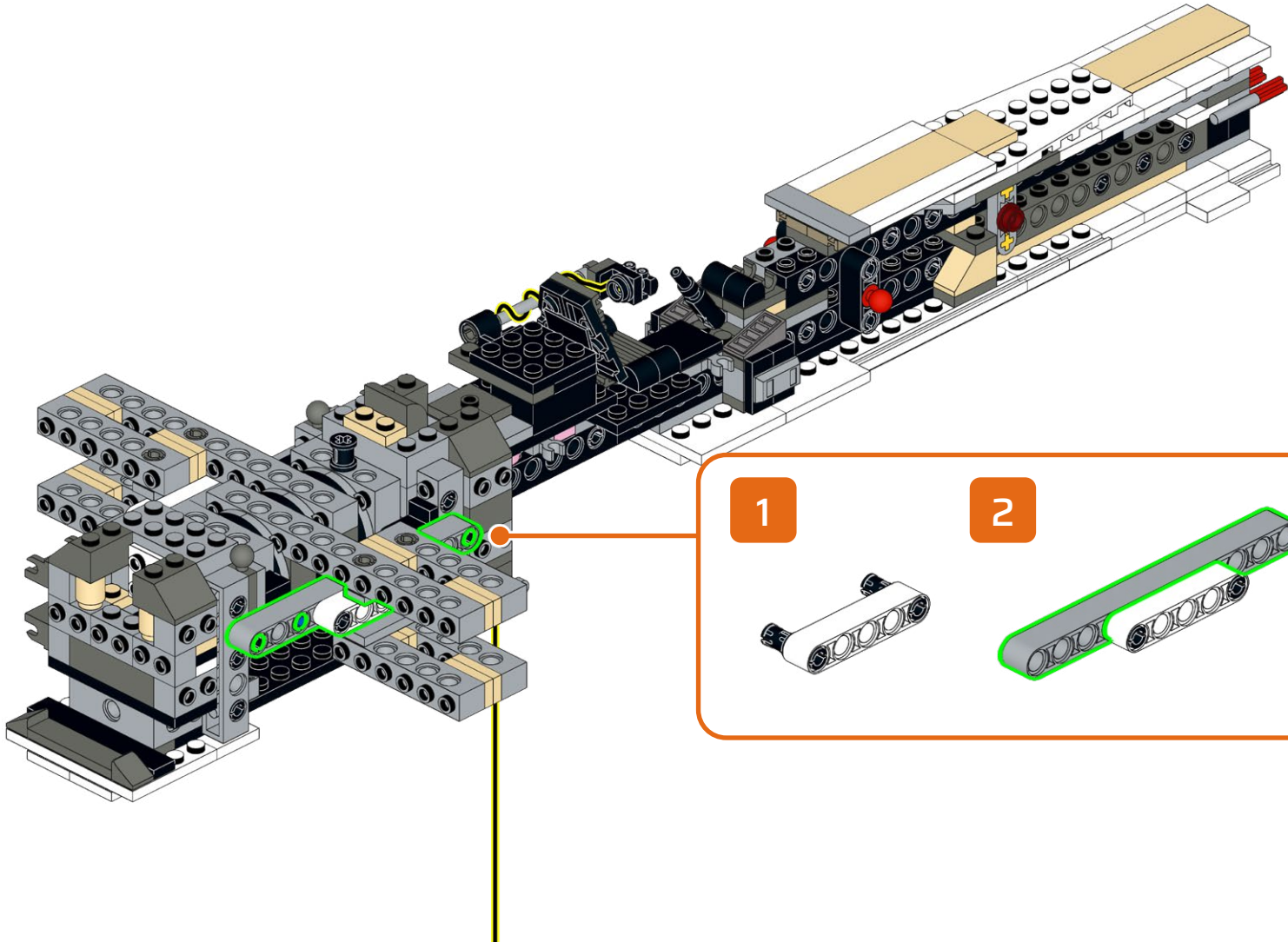
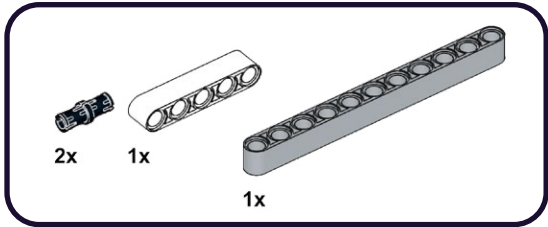

105



4x

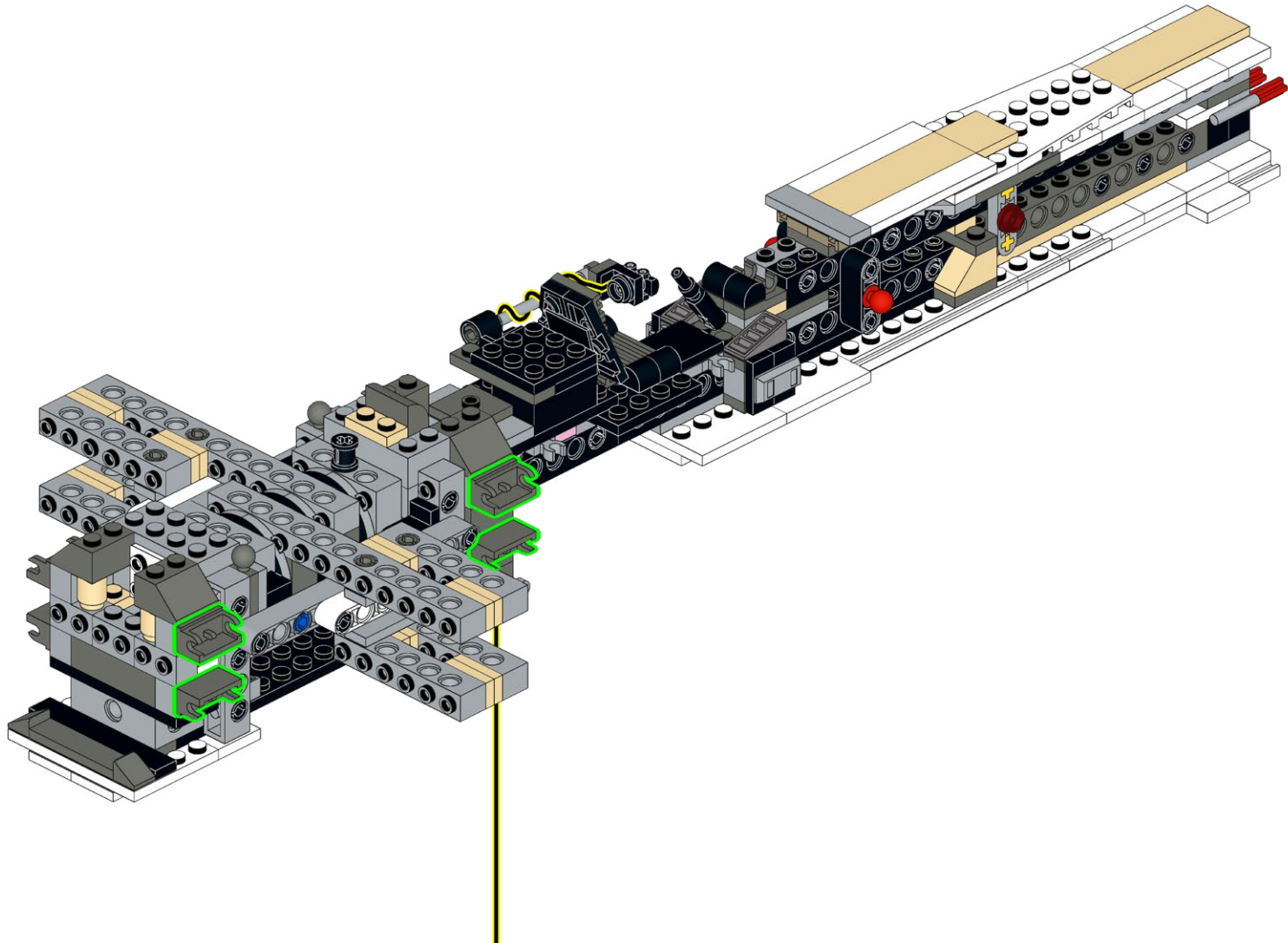

106

2x

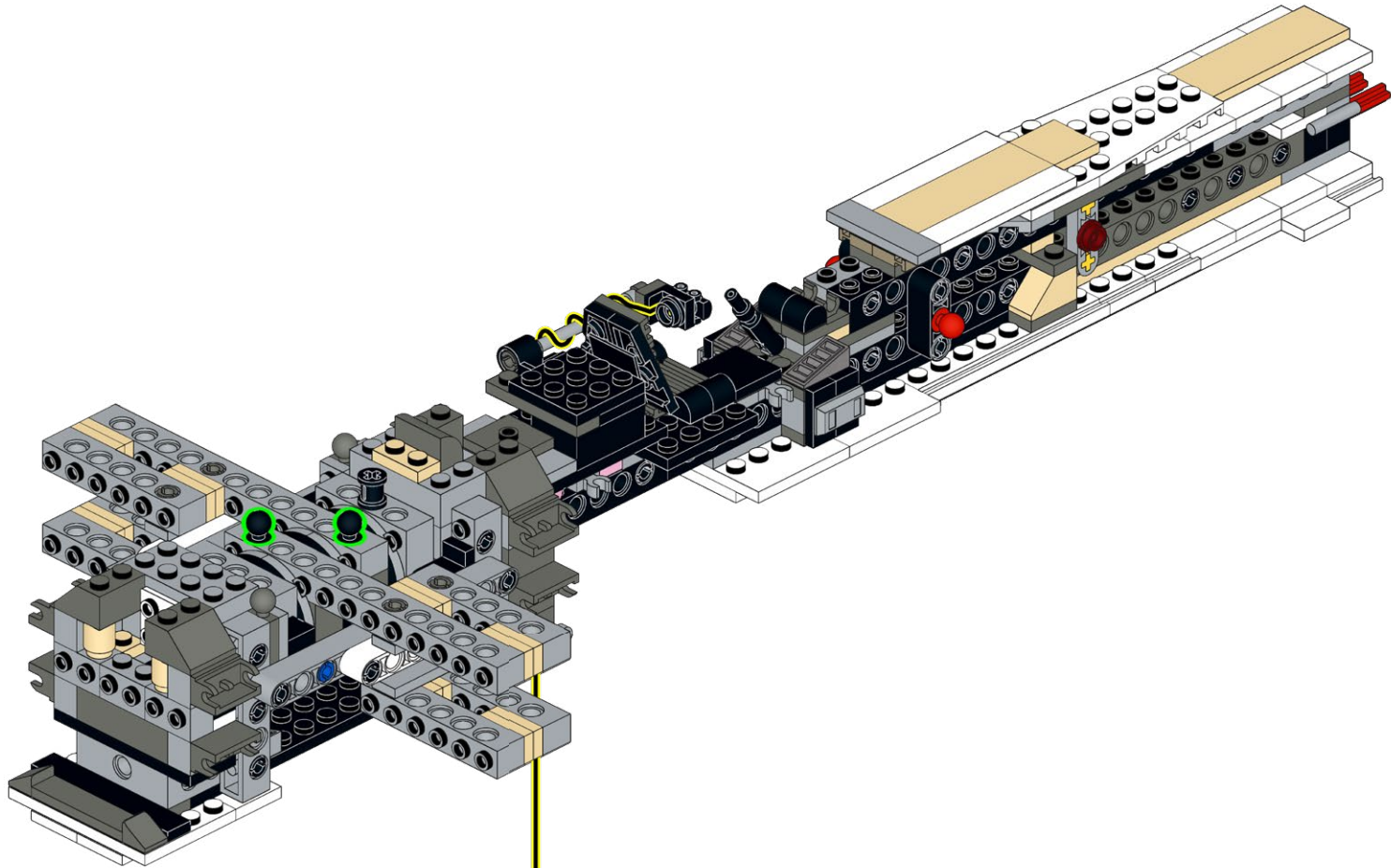



107

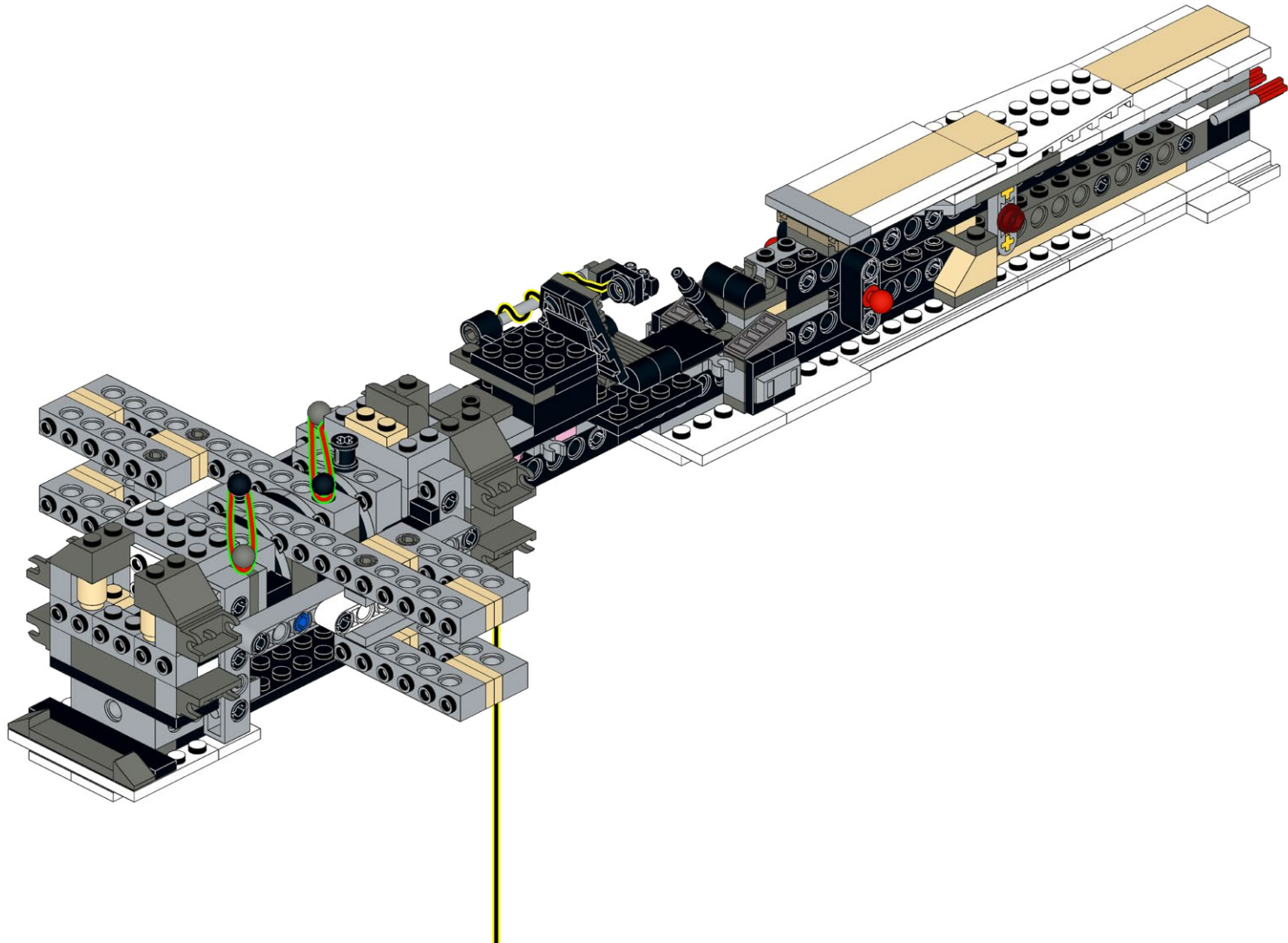

108

4x

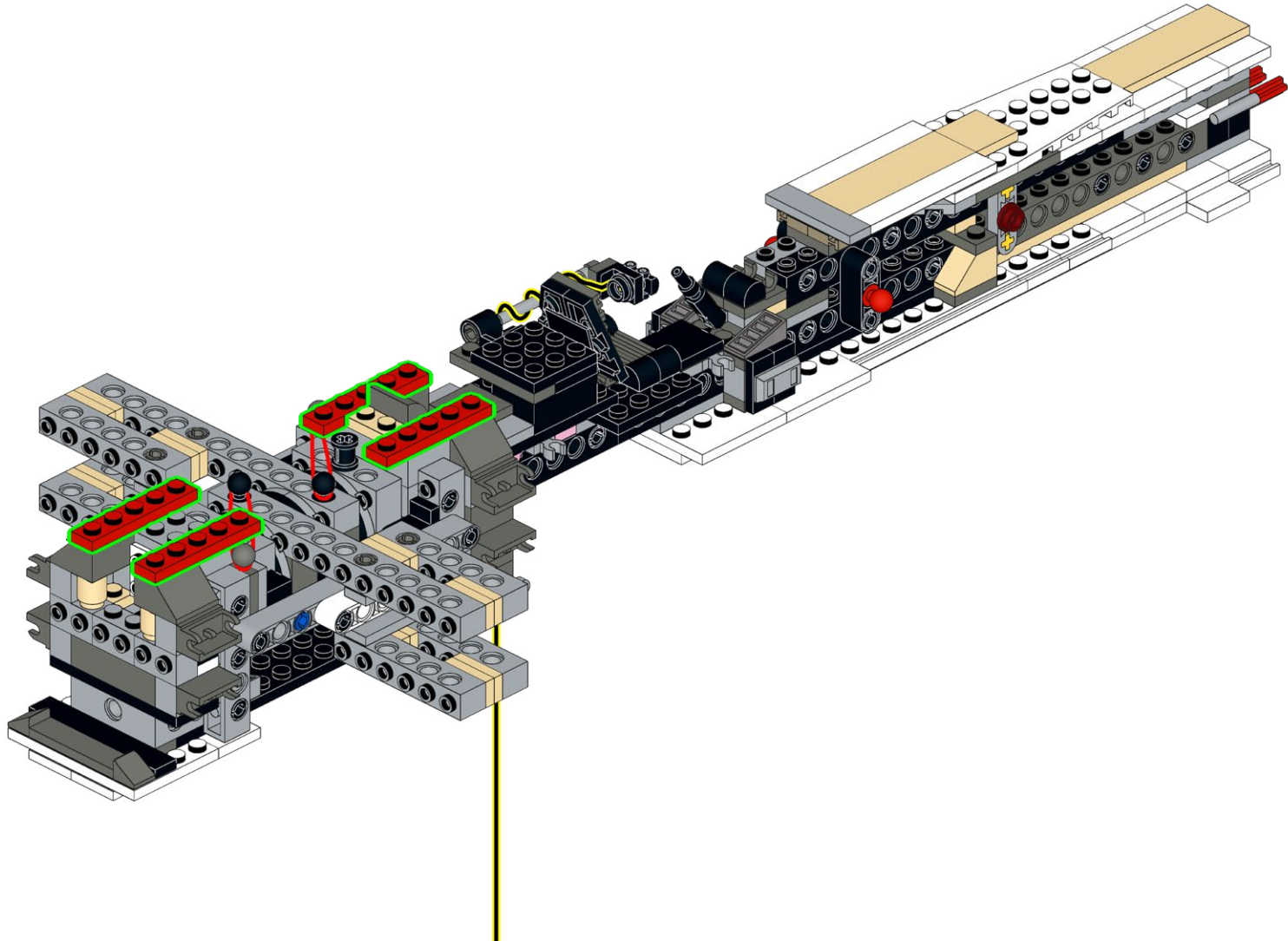

109



1x



1x

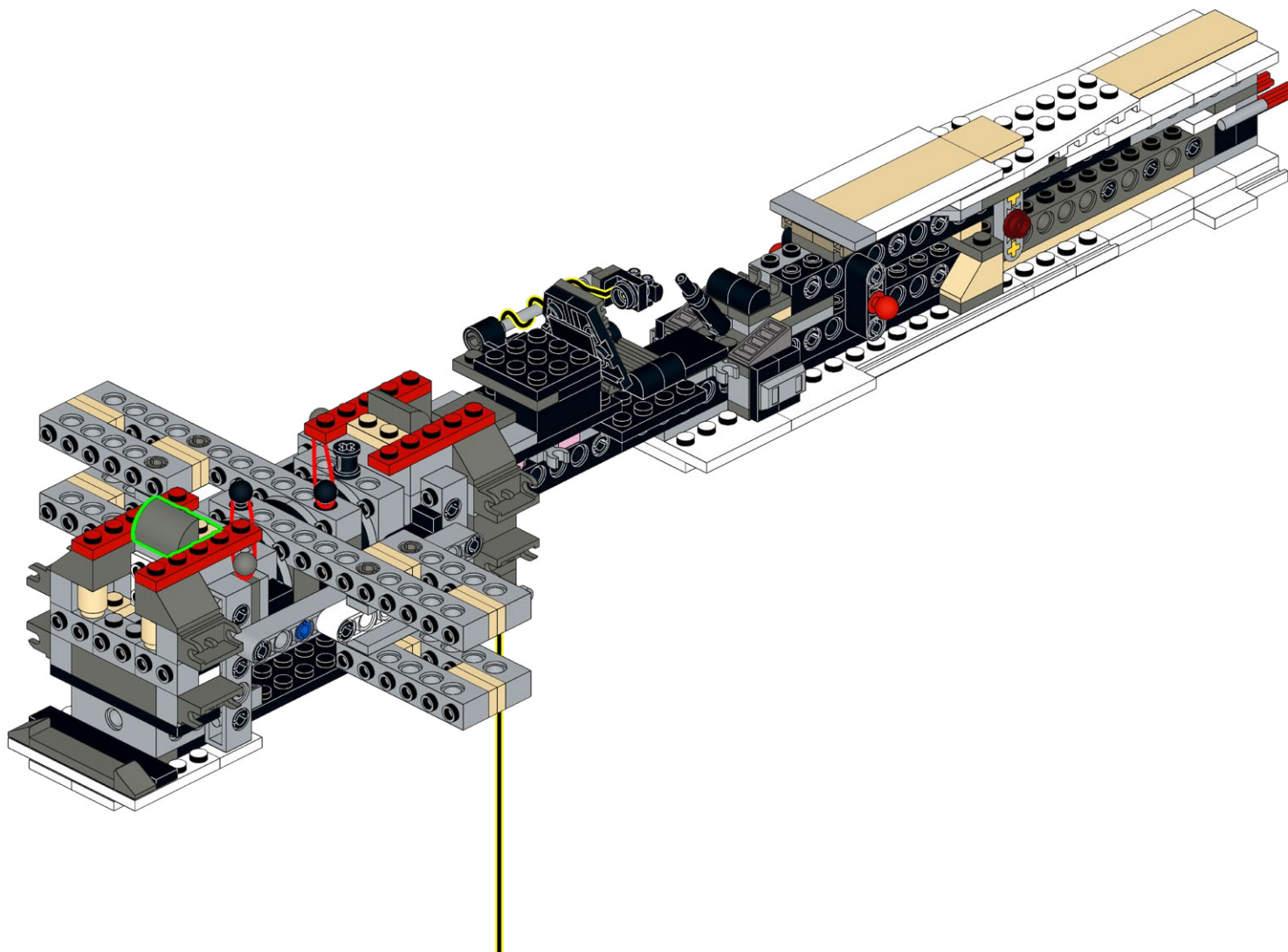

110

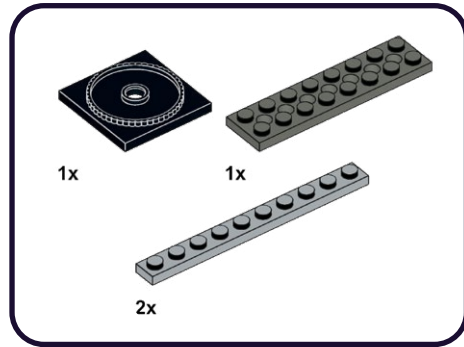

1



2



111

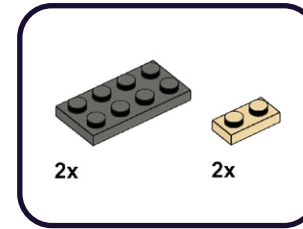

1



2



2x



112

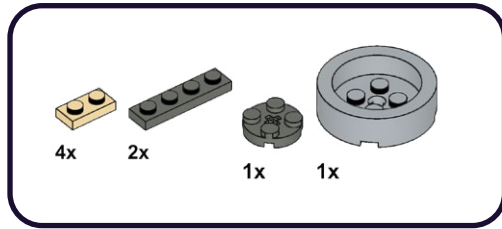

1

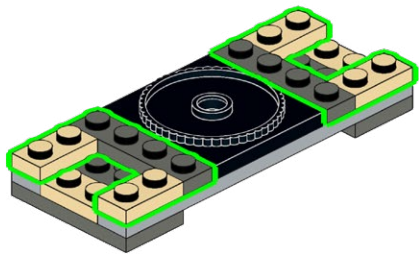

2

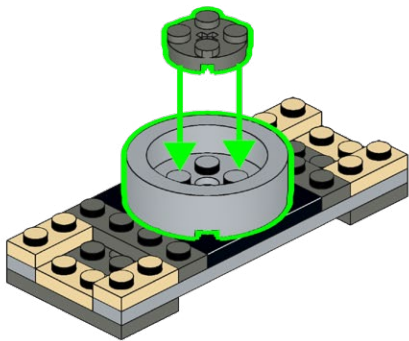

113

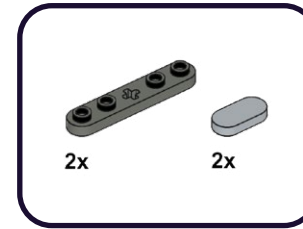

1

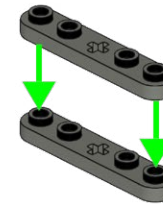

2

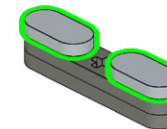

114

1x

1

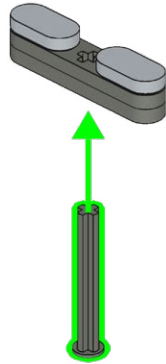

2

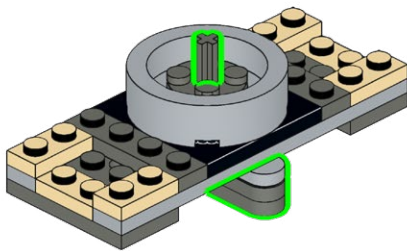

115

1x

1

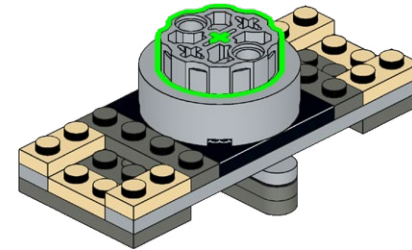

116

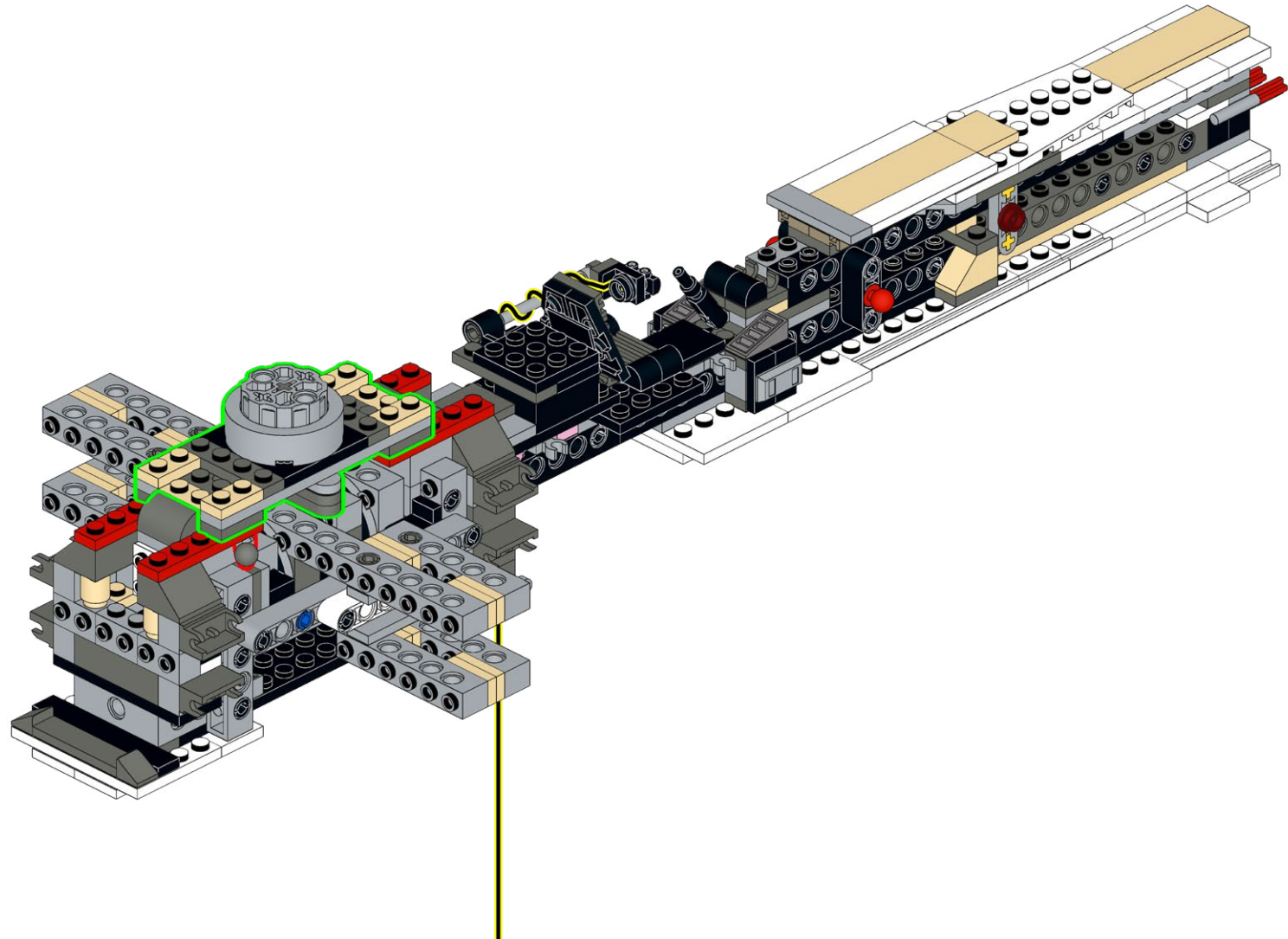

117

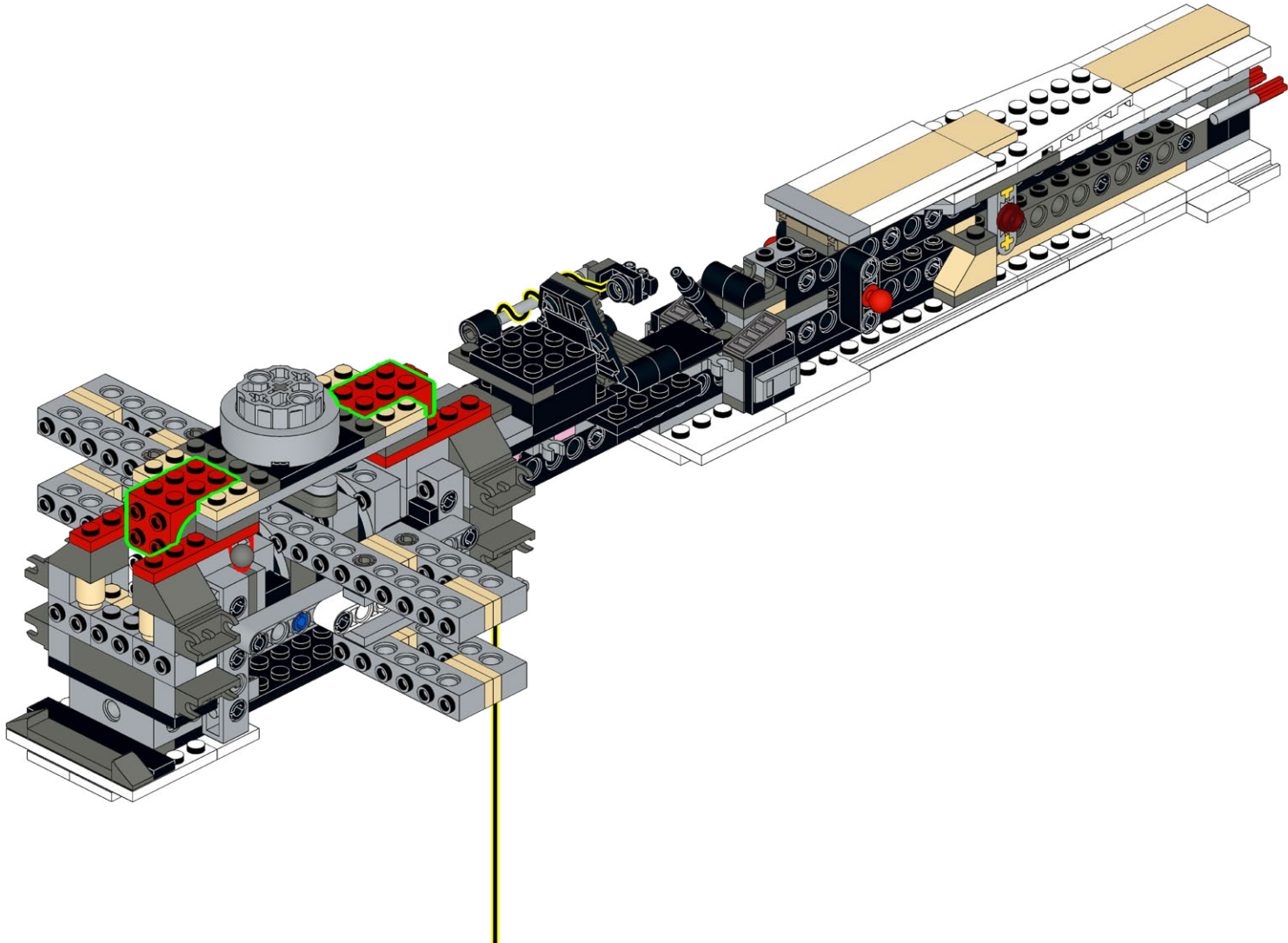
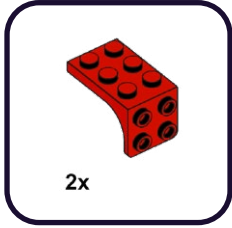

118

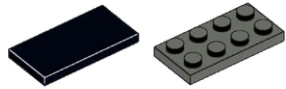

2x

2x

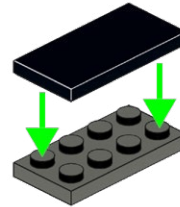
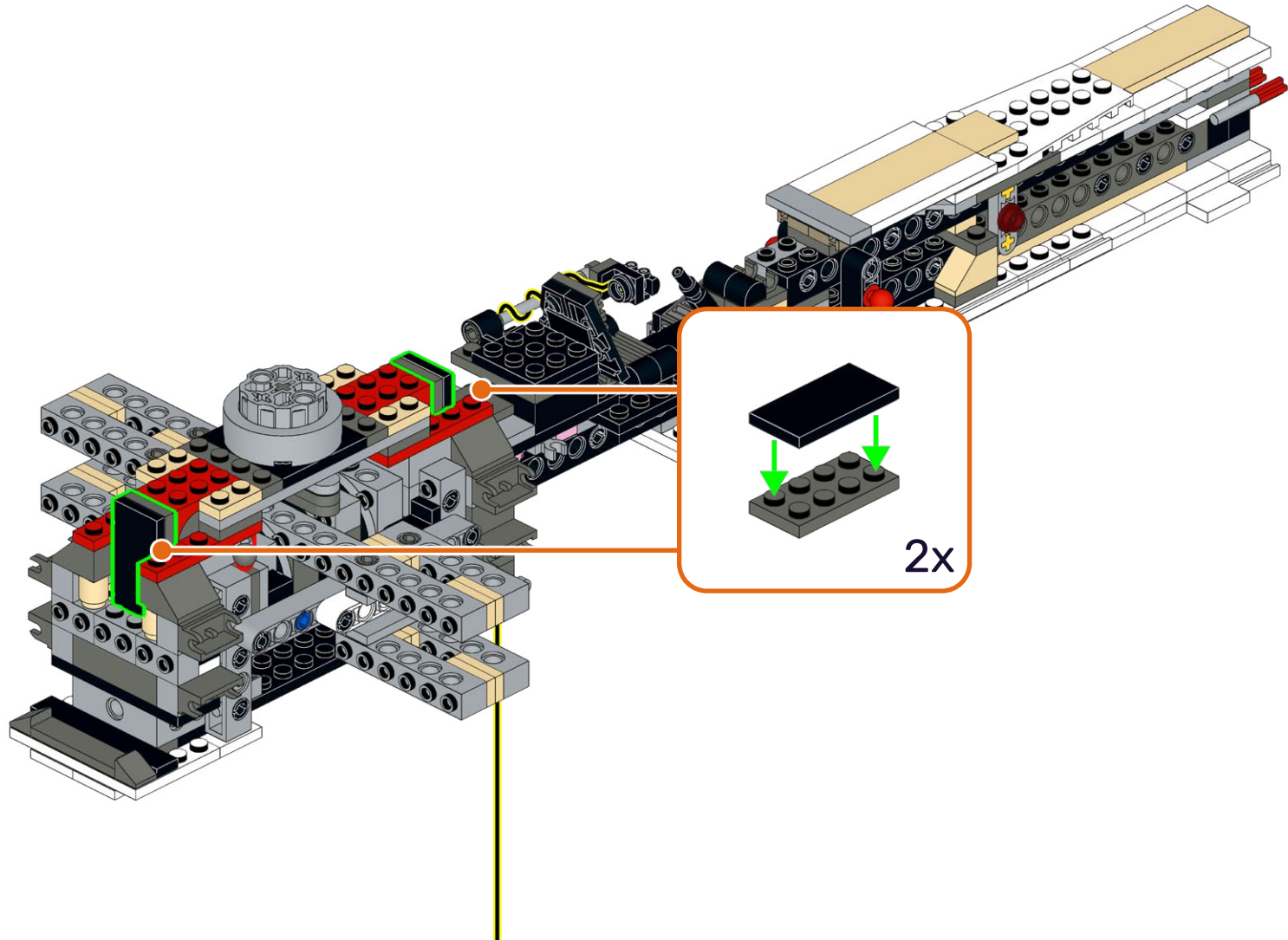

2x



119

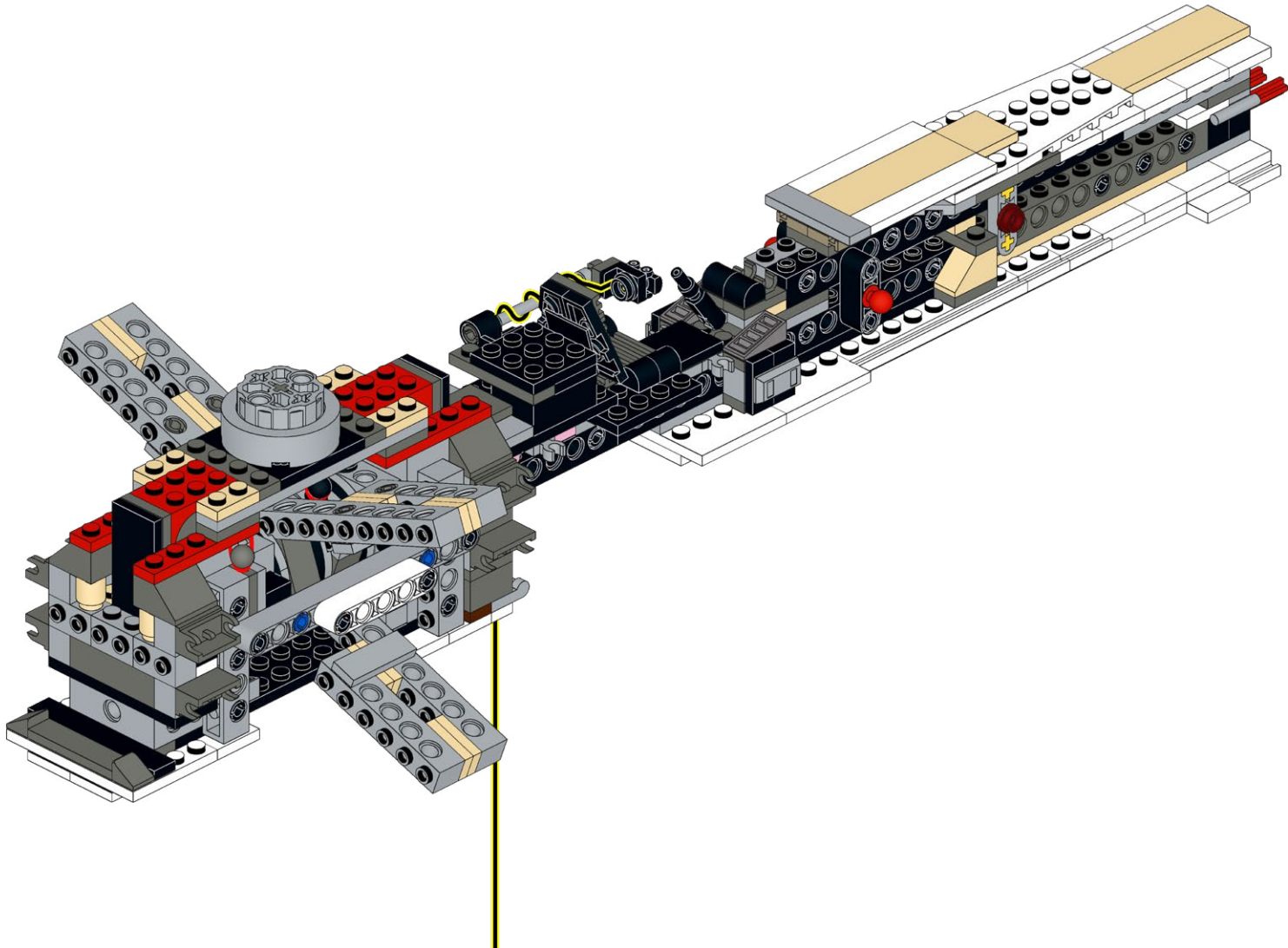

120

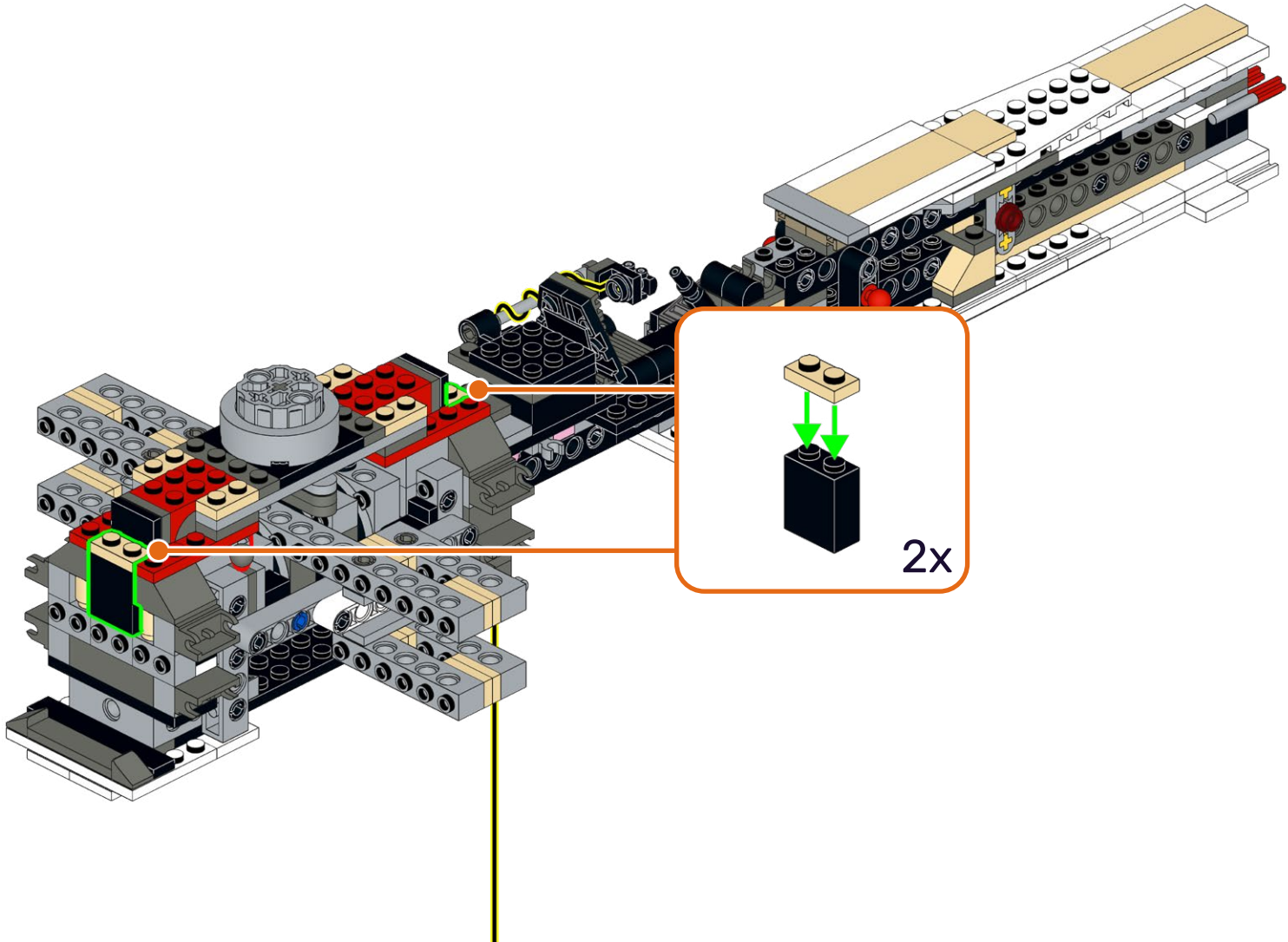
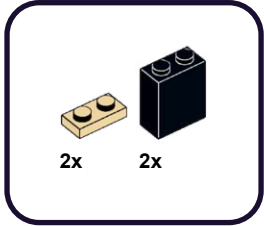



121

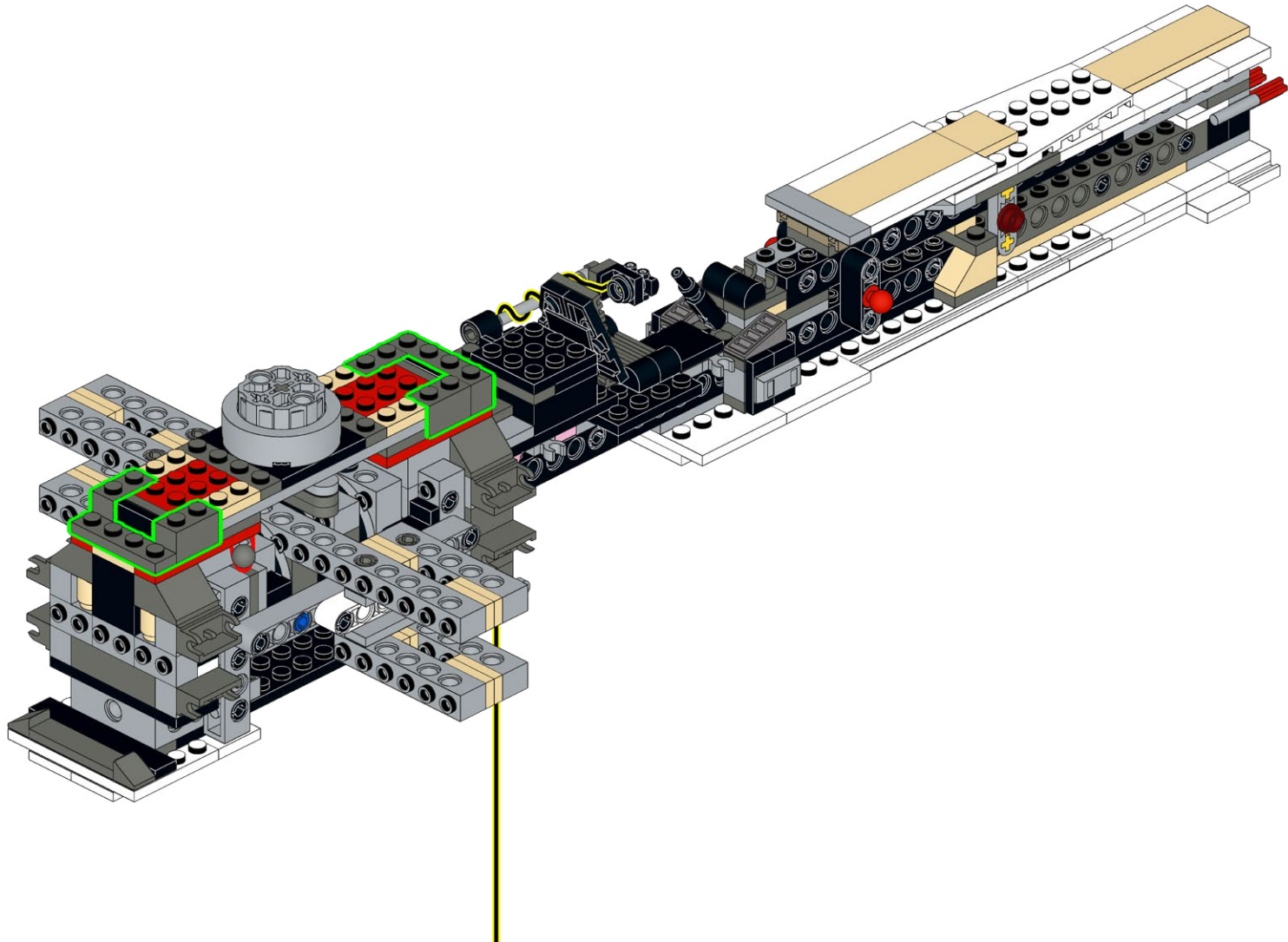
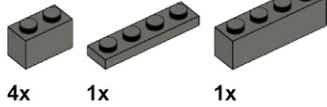

**HOLD UP!**

You might notice some bags aren't in order, as well as left over pieces, but that's ok! We're changing the way you build LEGO!

**ATTENDEZ!**

Vous remarquerez peut-être que certains sacs, ainsi que certaines pièces, ne sont pas dans le bon ordre. Mais pas de panique! Nous changeons simplement la façon avec laquelle vous construisez vos LEGO!

**ASPETTA!**

Potresti notare che alcuni sacchetti non sono in ordine, così come i pezzi avanzati, ma va bene così! Stiamo cambiando il modo in cui costruisci i LEGO!

**HALT!**

Sie werden möglicherweise bemerken, dass einige tüten durcheinander sind und teile übrig bleiben, aber das ist in Ordnung! Wir ändern die art und weise, wie Sie LEGO bauen!

**¡ESPERA!**

Es posible que notes que algunas bolsas están fuera de servicio, así como piezas sobrantes, ¡pero está bien! ¡Estamos cambiando la forma en que construyes LEGO!

**暫停!**

你可能会注意到一些袋子顺序错乱, 以及一些剩余的部件, 但没关系! 我们正在改变你搭建乐高的方式!

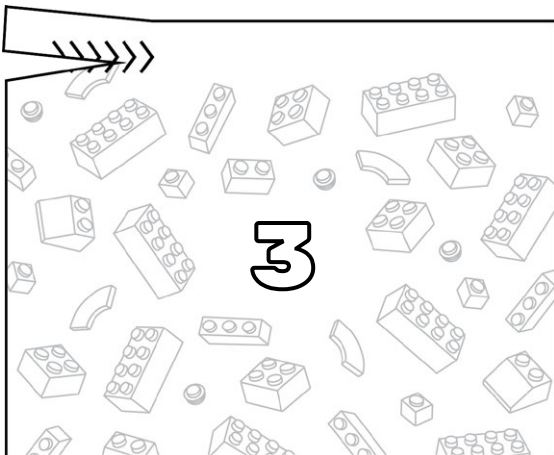
**Open LEGO® Bag 3**

122

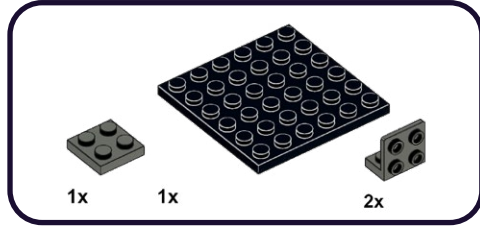

1

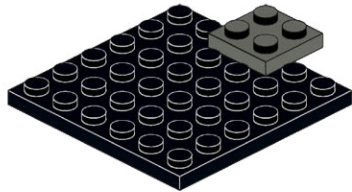

2

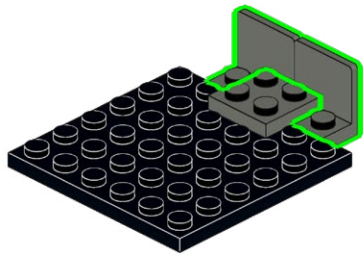

123

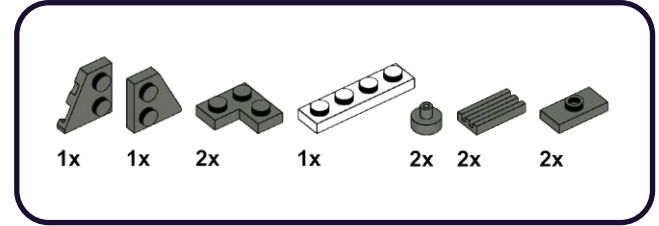

1

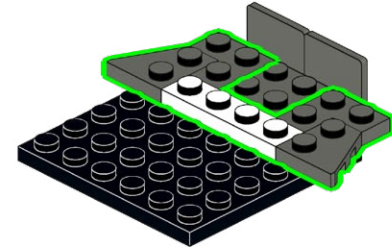

2

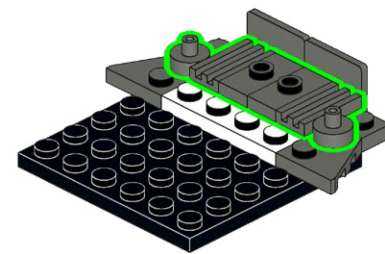

# 124

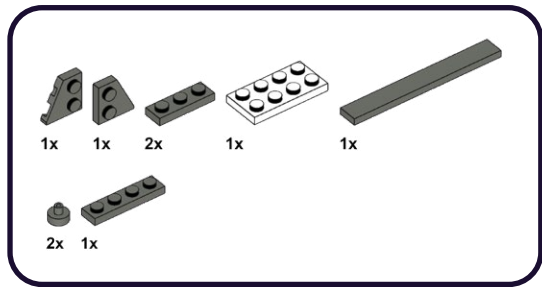

1

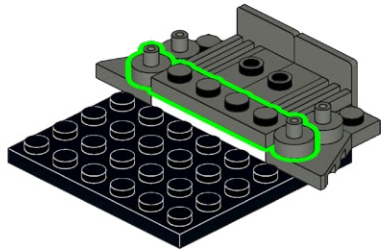

2

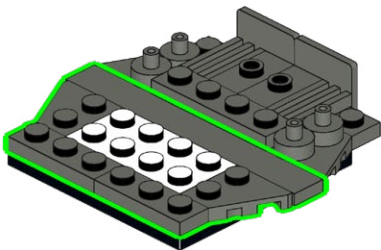

# 125

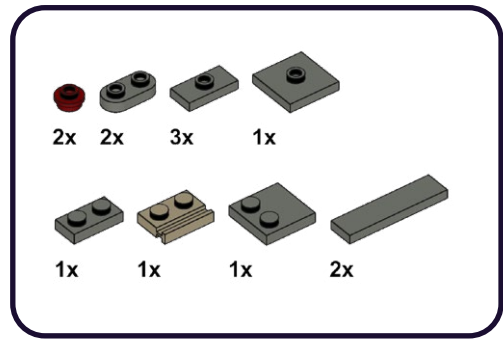

1

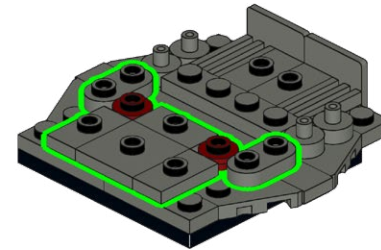

2

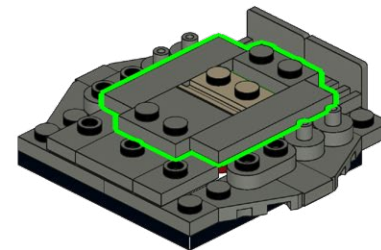

126

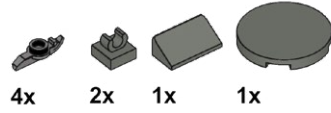

4x 2x 1x 1x

1

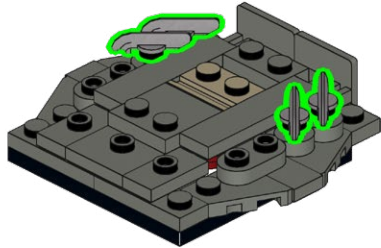

2

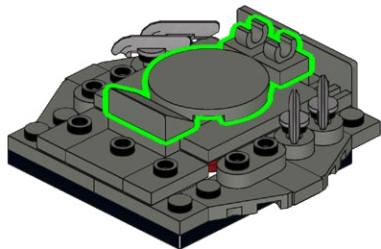

127

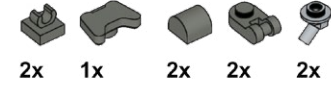

2x 1x 2x 2x 2x

1

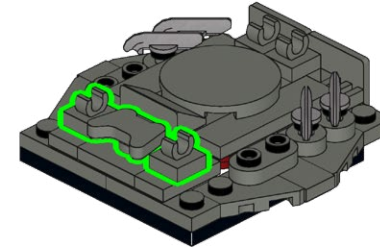

2

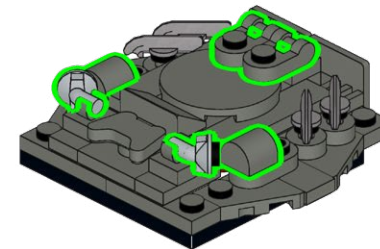

128

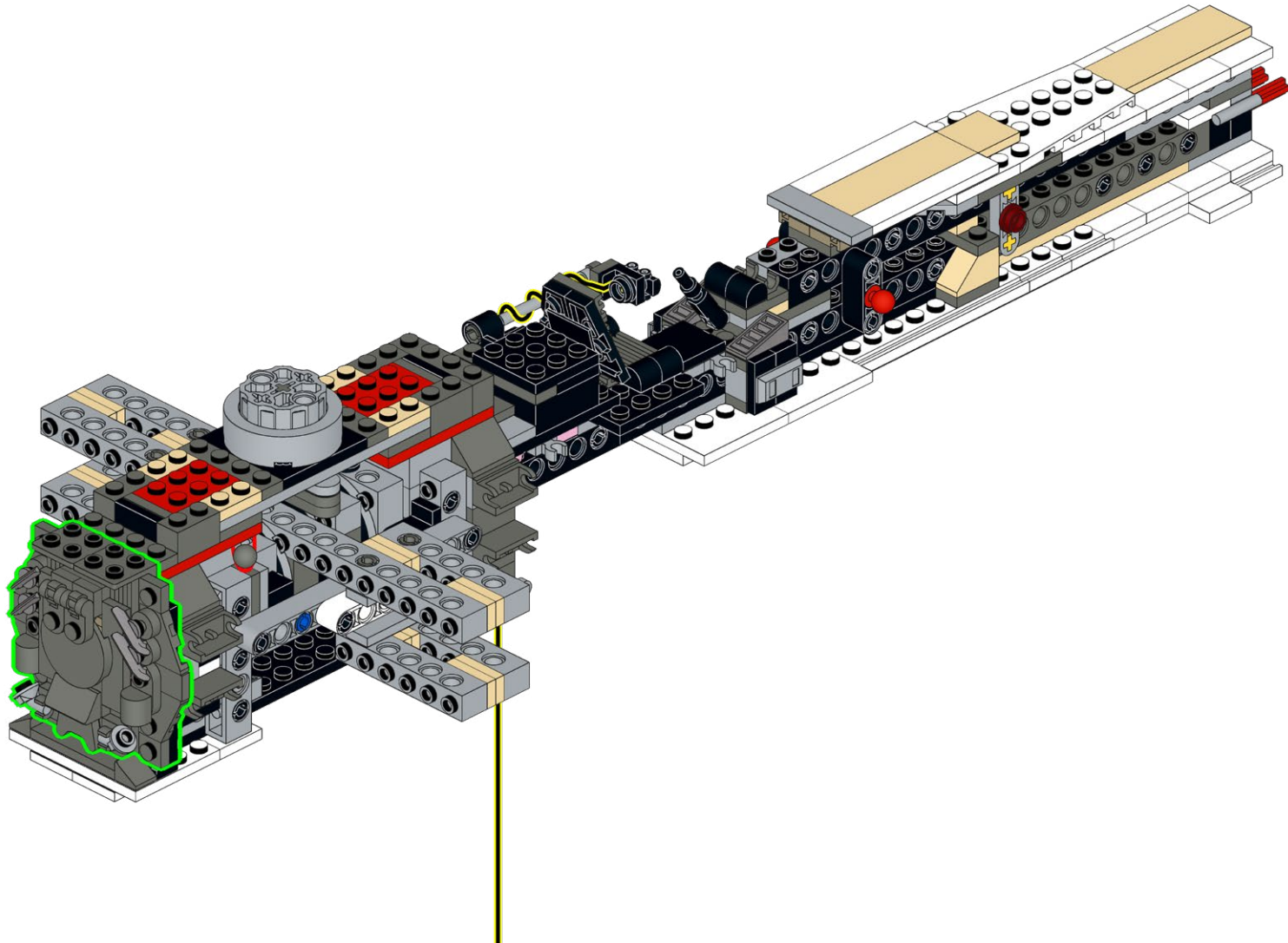



129

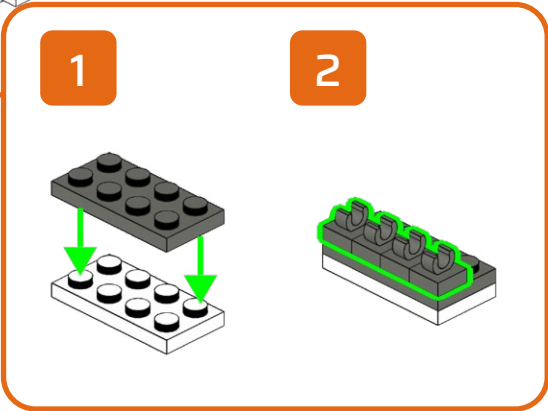
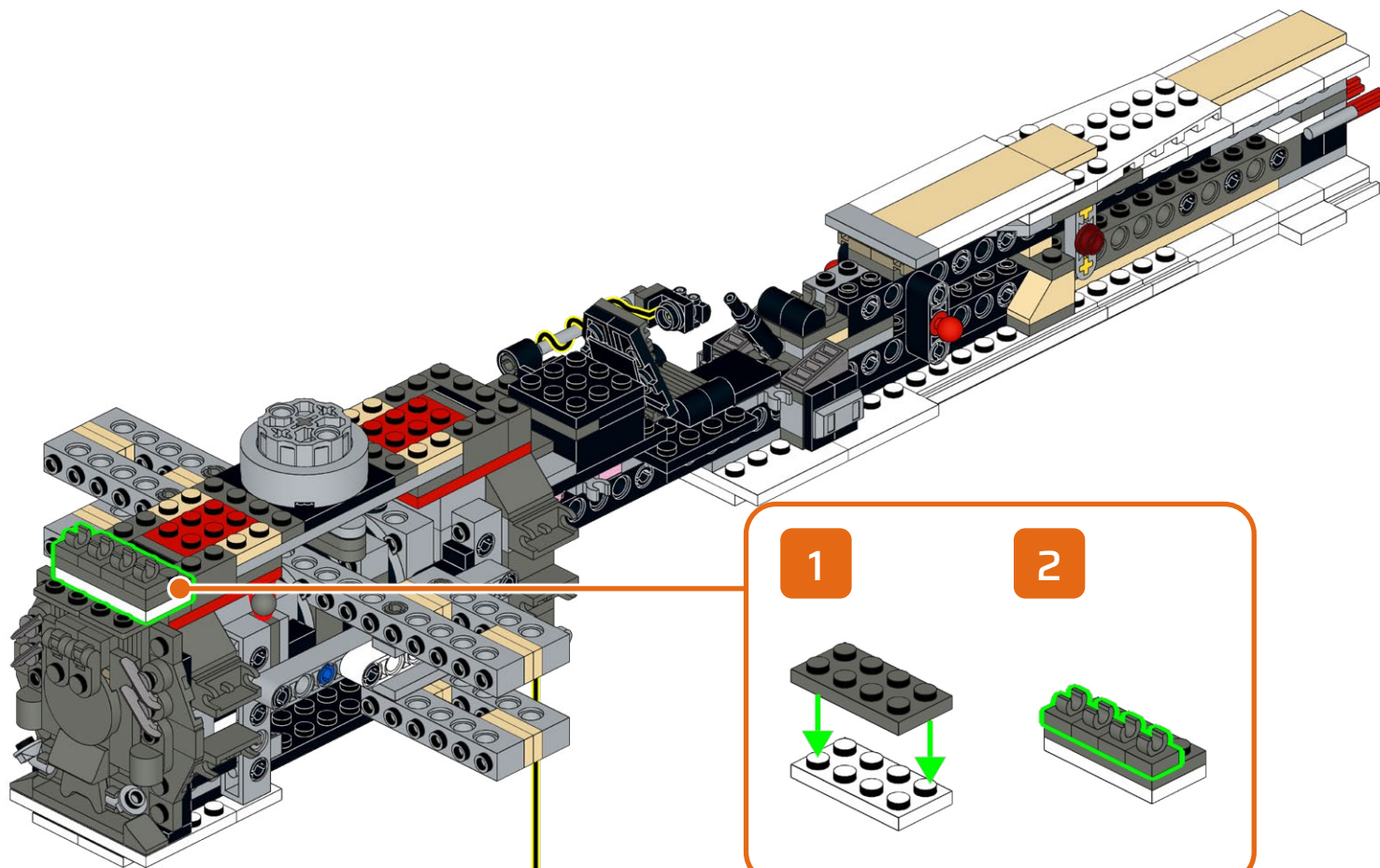
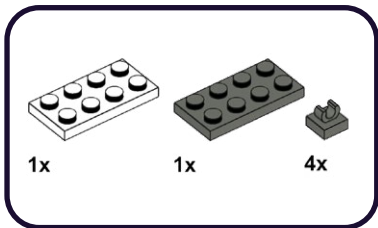



**130**

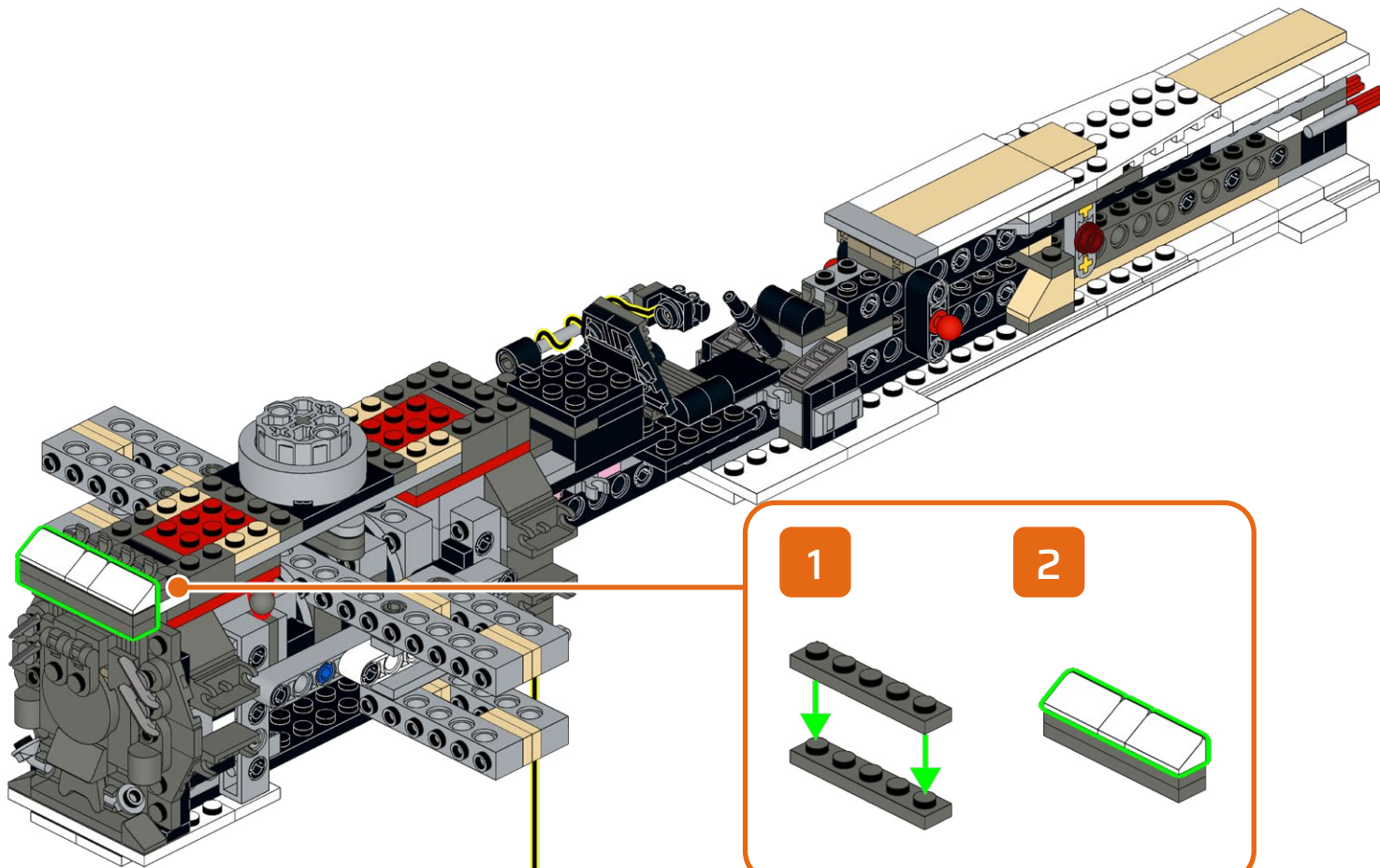
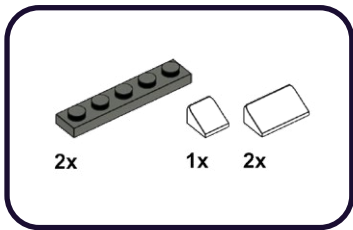

131

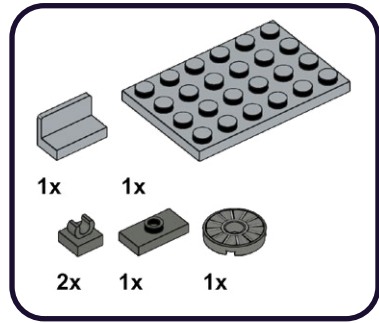

1

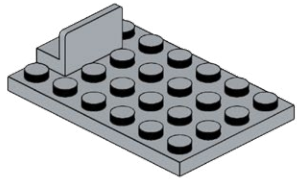

2

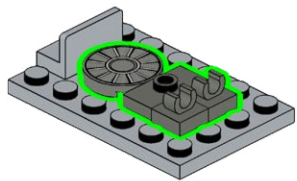

132

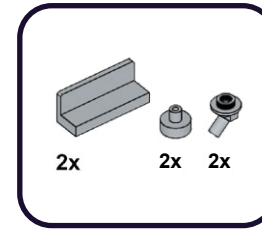

1

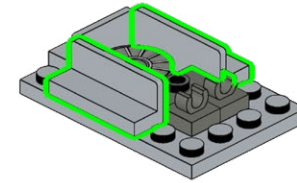

2

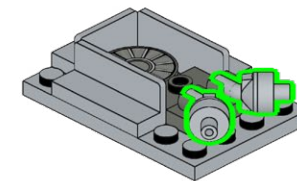

2x

133

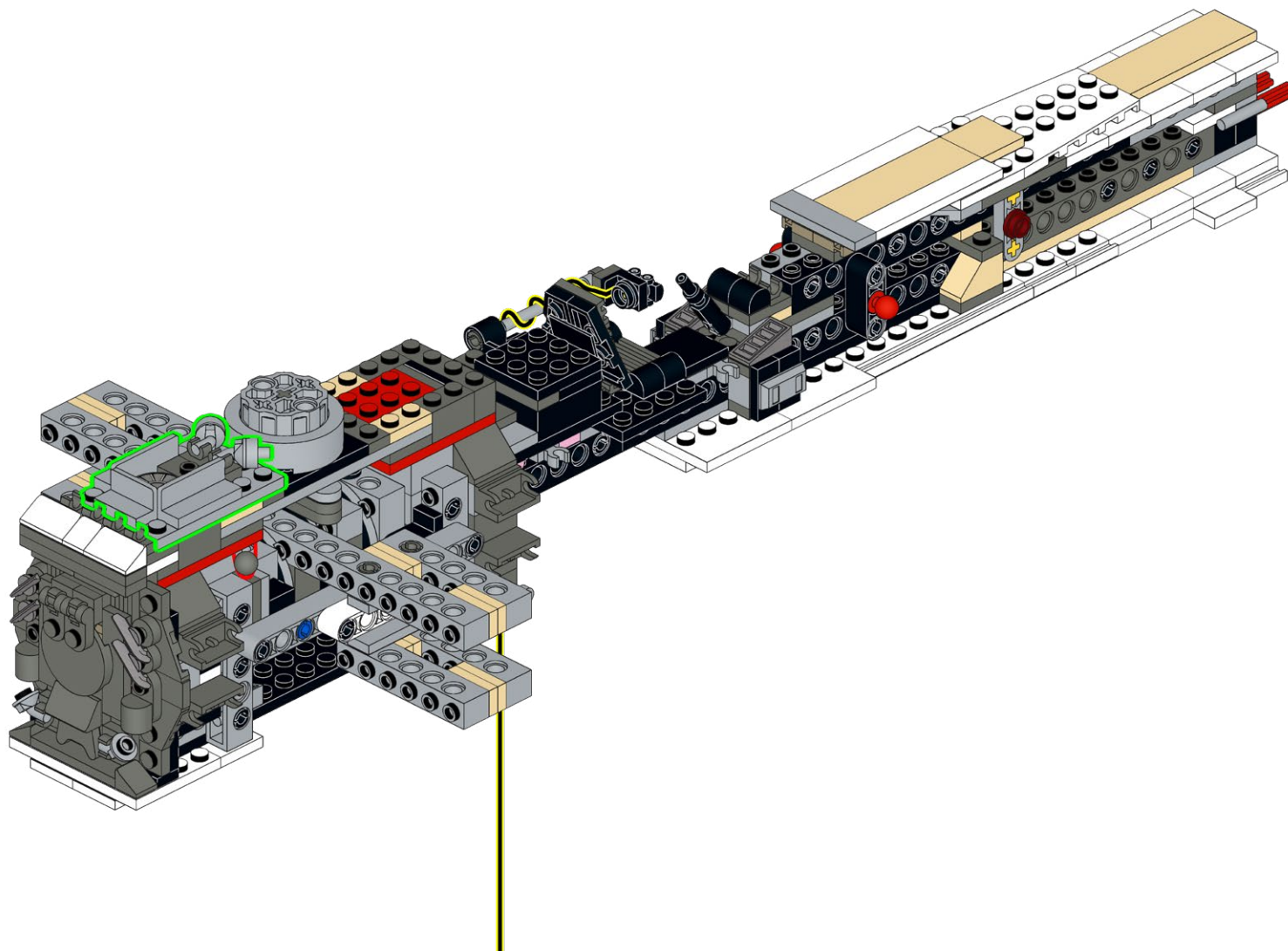

134

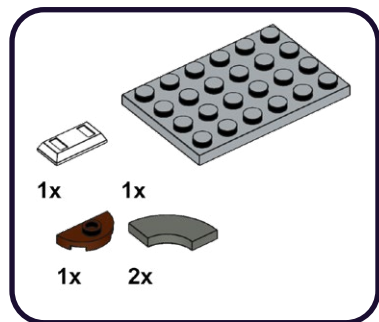

1

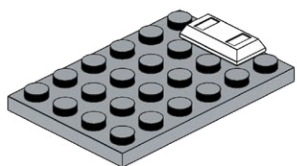

2

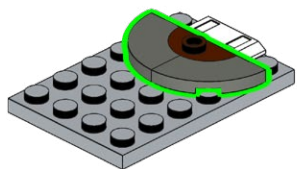

135

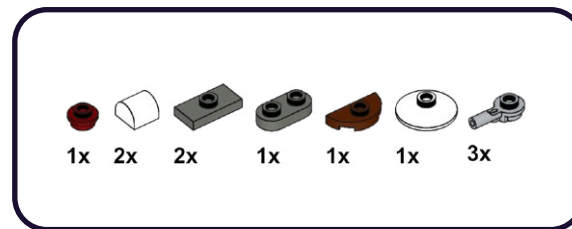

1

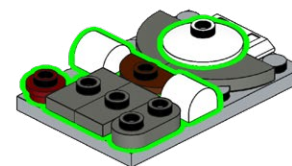

2

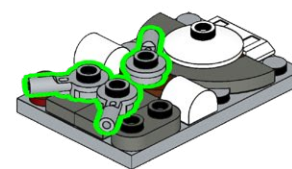

136

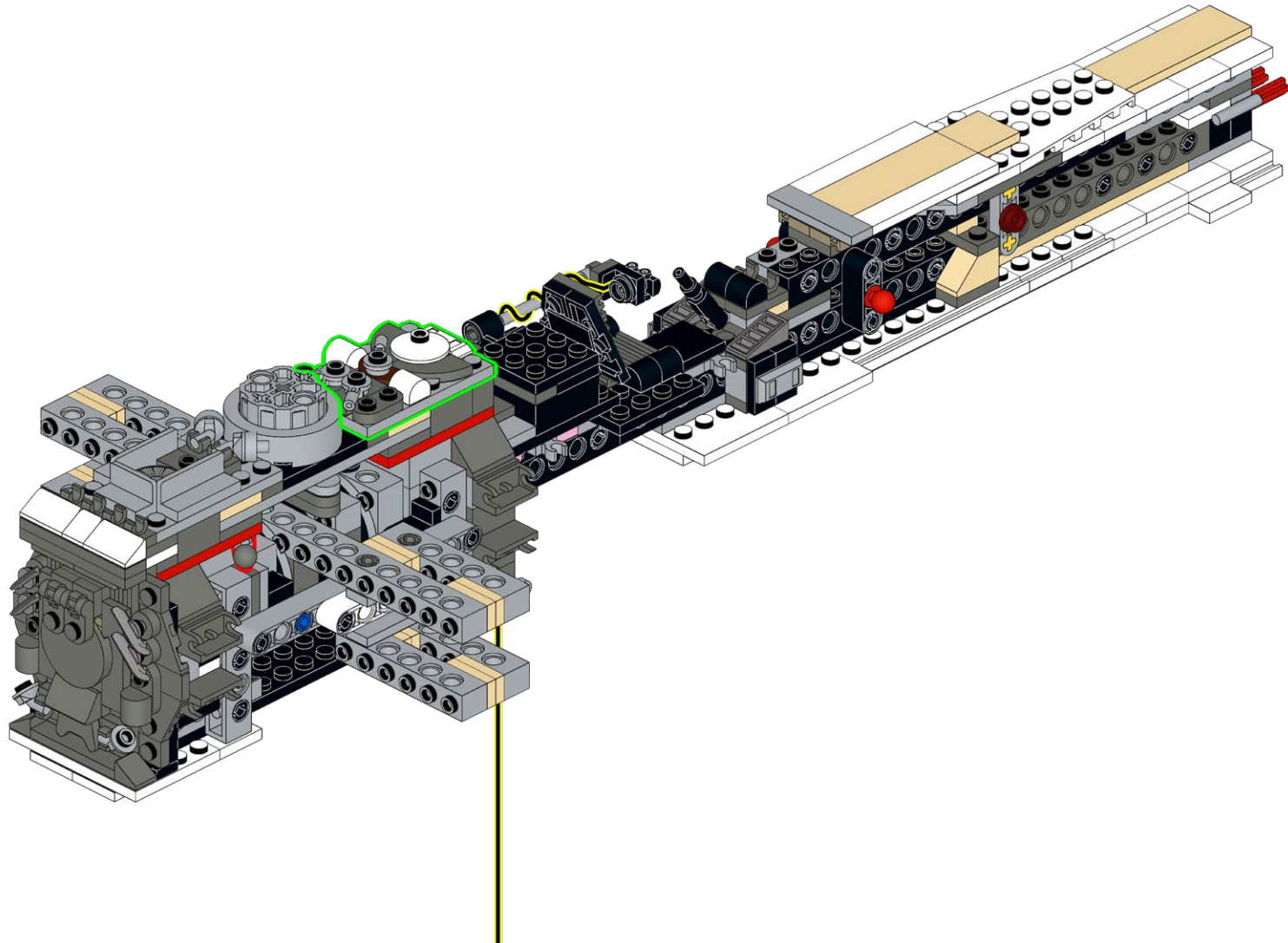

137

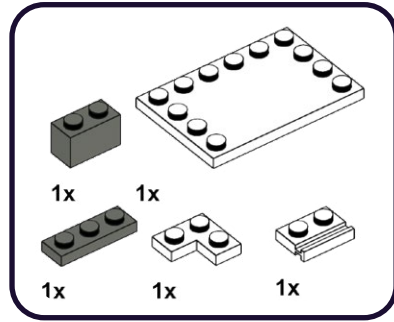

1

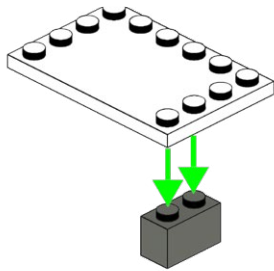

2

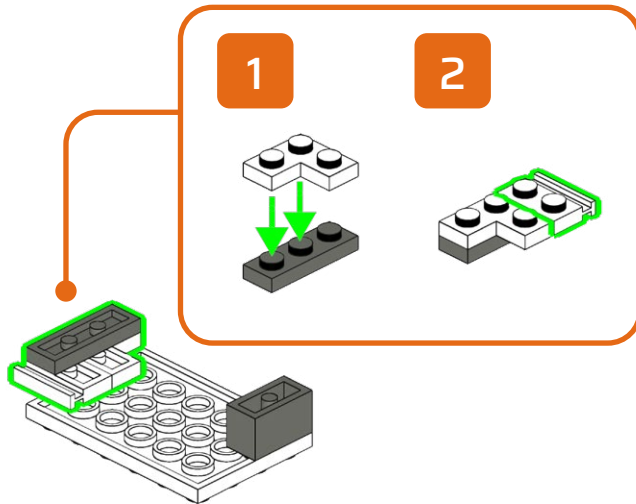

138

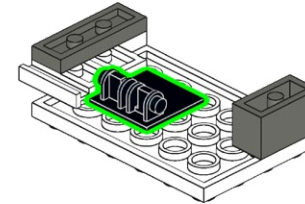
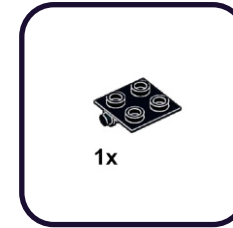



139

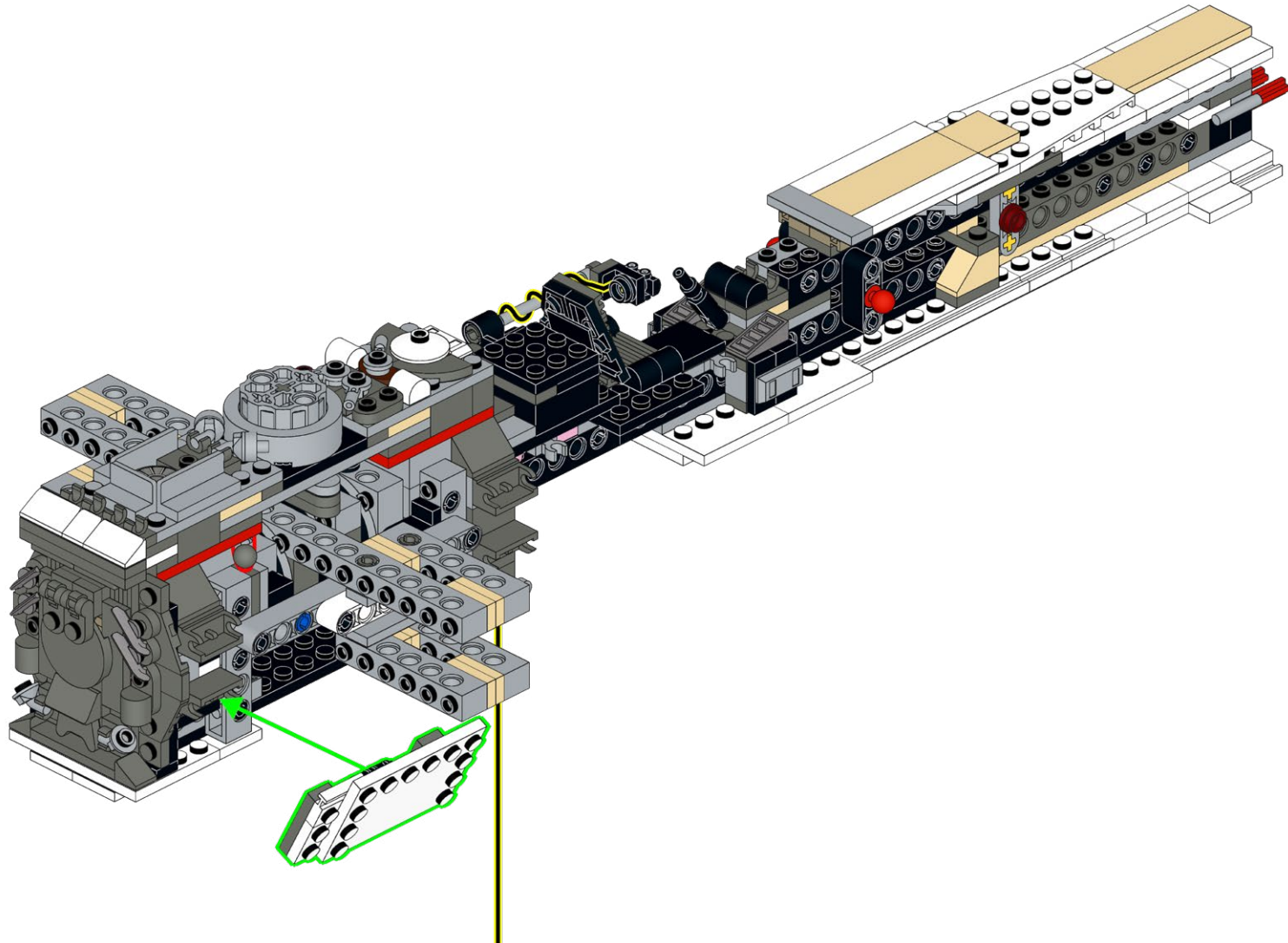



**140**

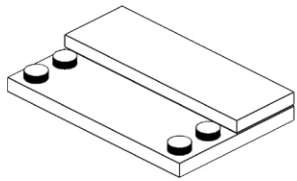
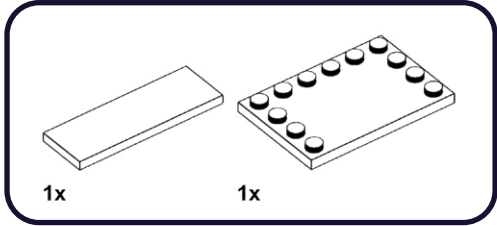

**141**

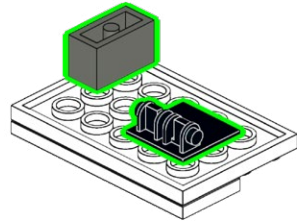
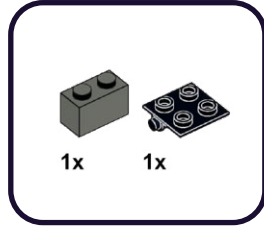

142

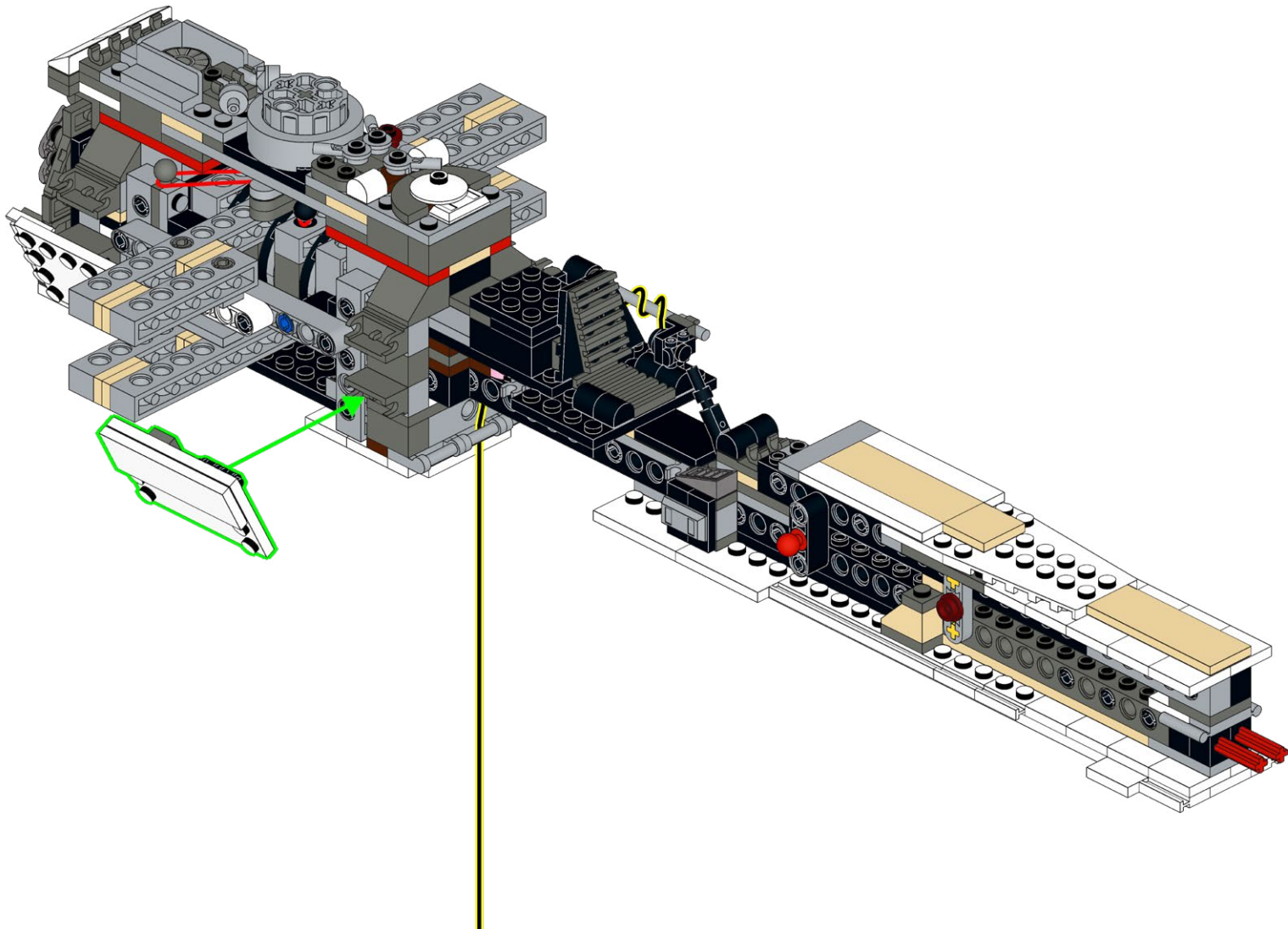

# 143

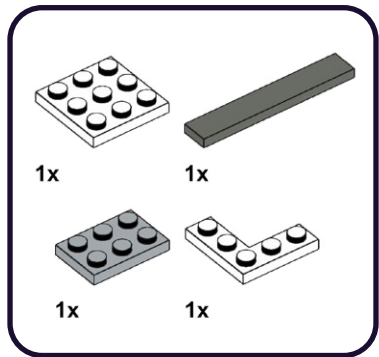

1

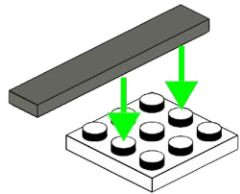

2

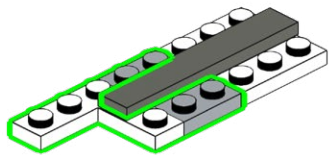

# 144

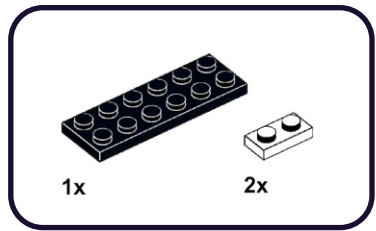

1

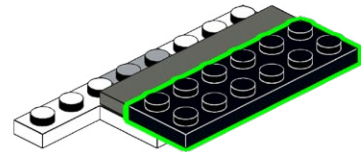

2

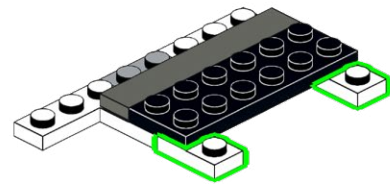

# 145

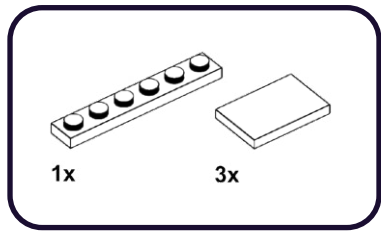

1

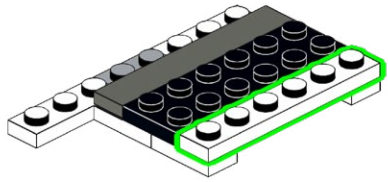

2

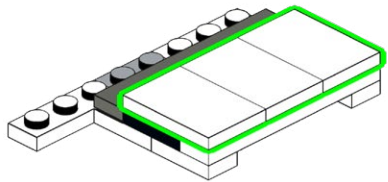

# 146

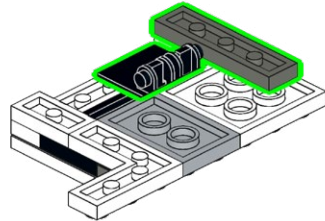
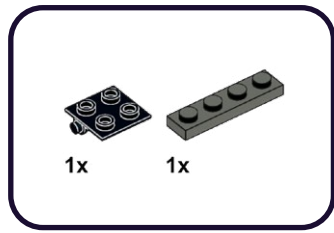

147

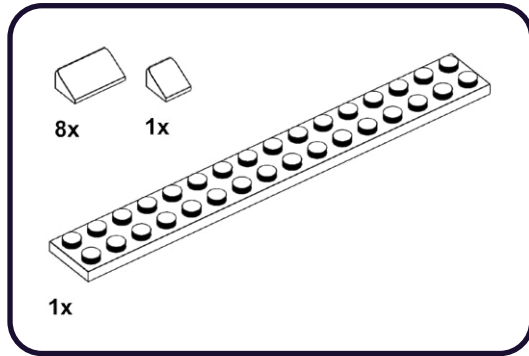

1

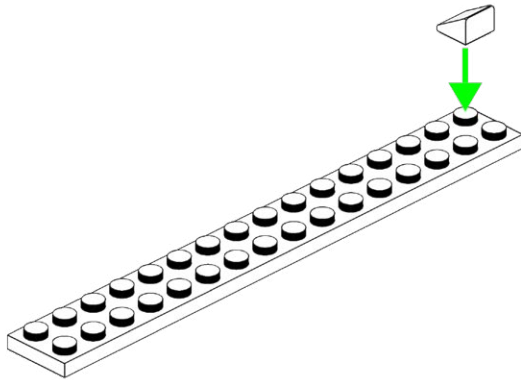

2

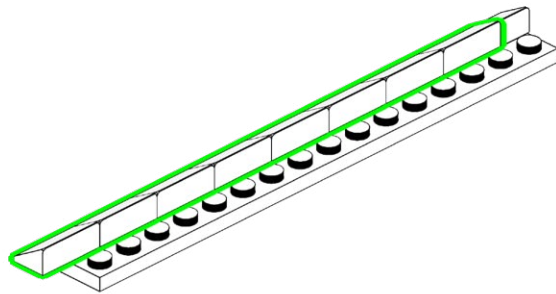

148

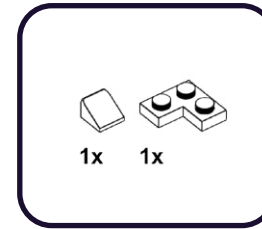

1

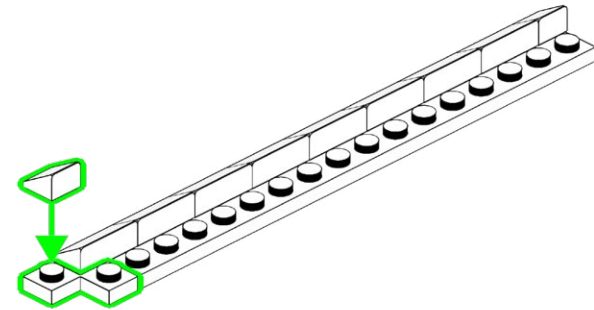

2

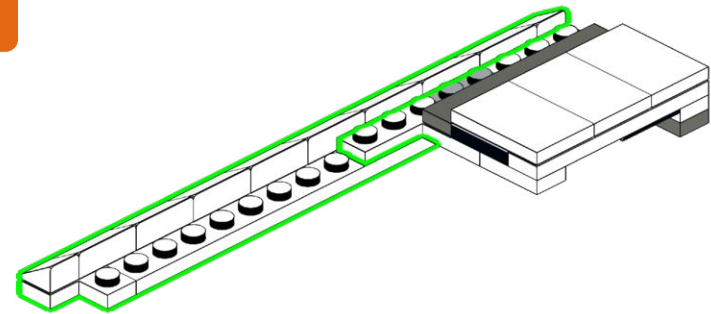

**149**

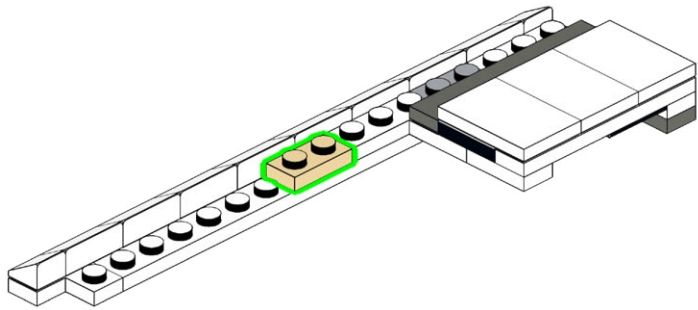
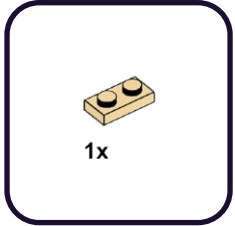

**150**

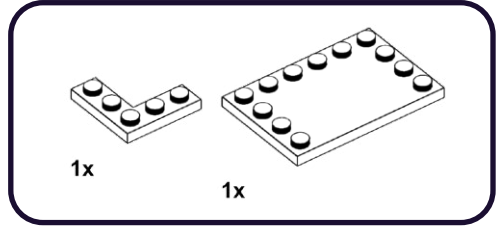

**1**

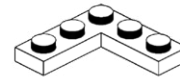

**2**

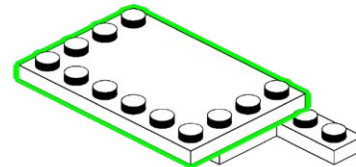

151

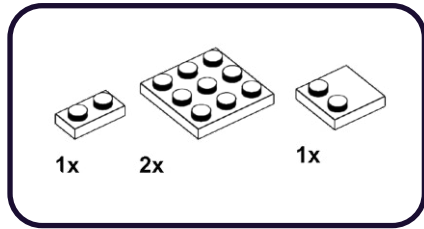

1

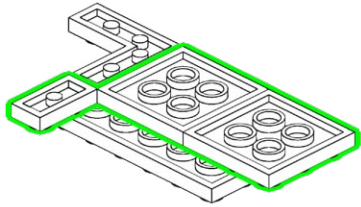

2

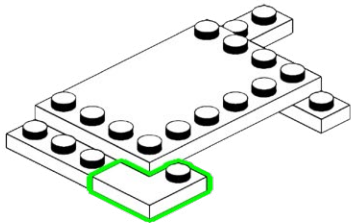

152

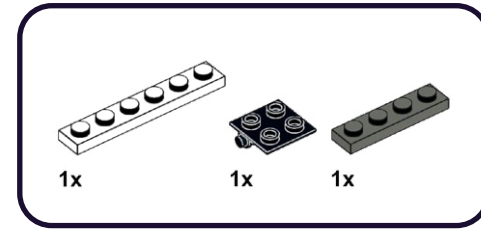

1

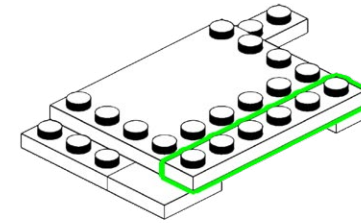

2

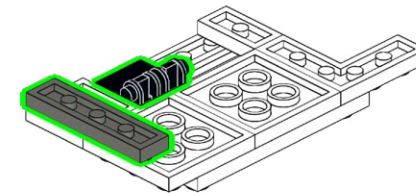



153

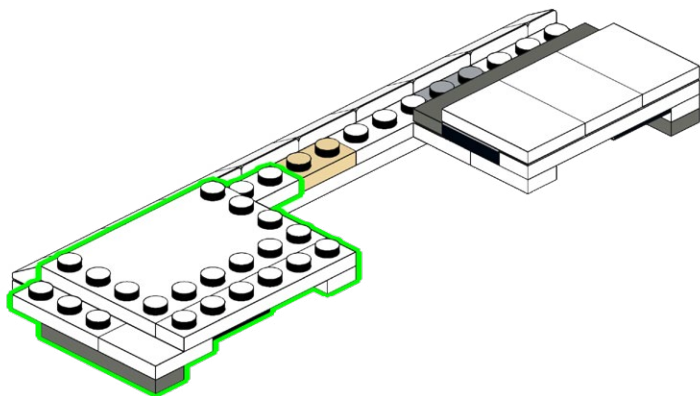

154

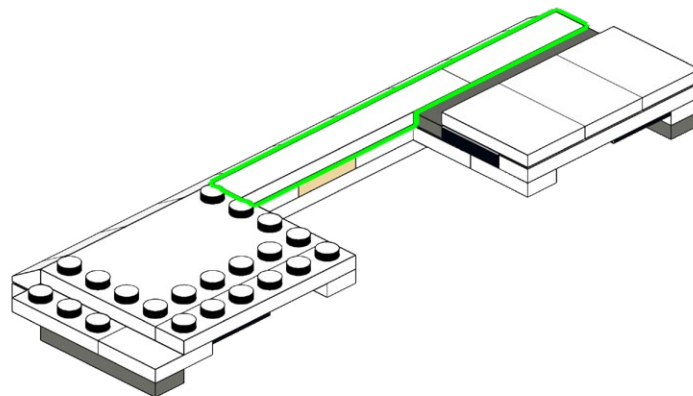
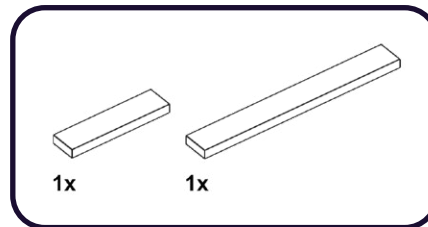

155

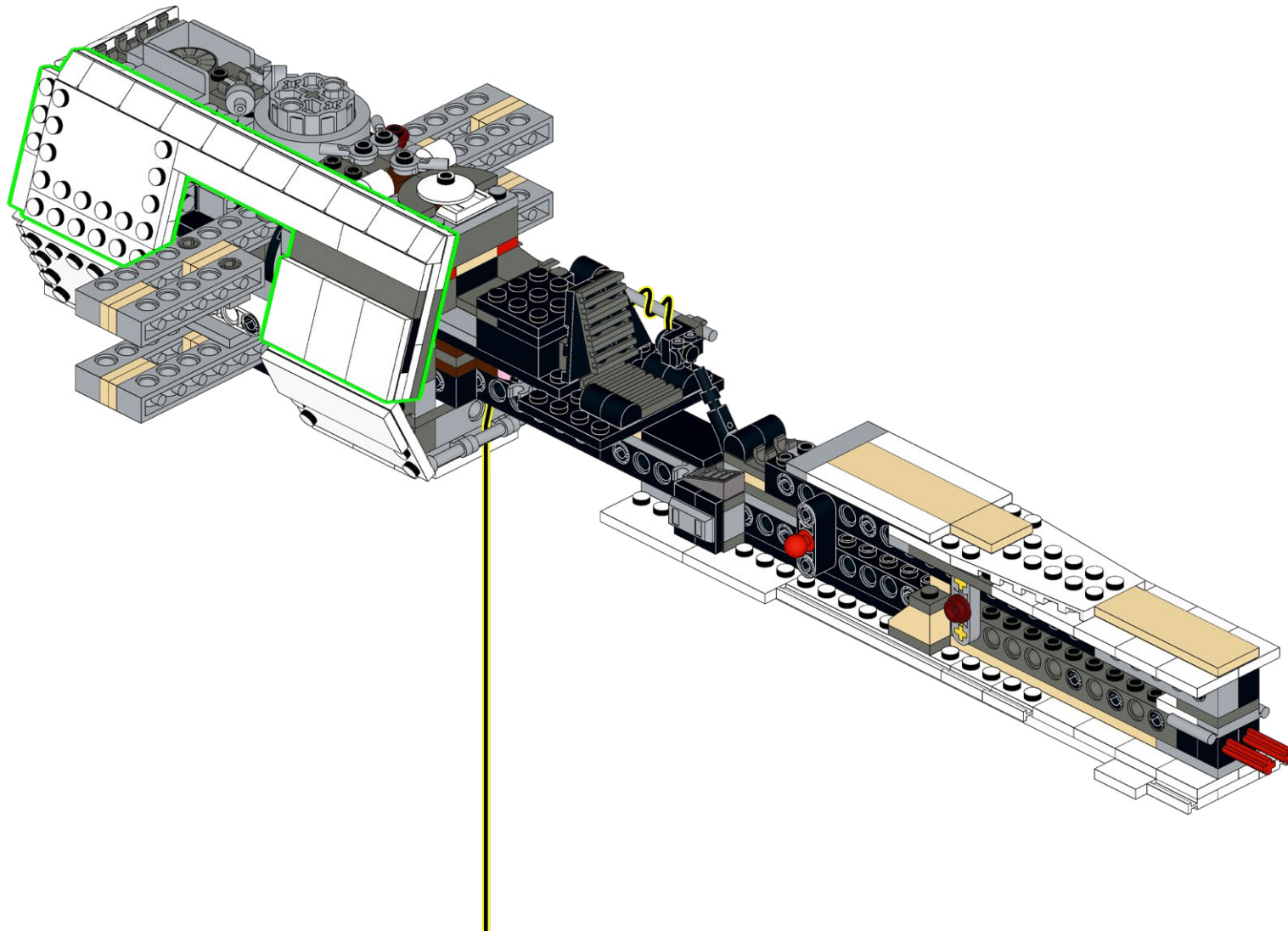

**156**

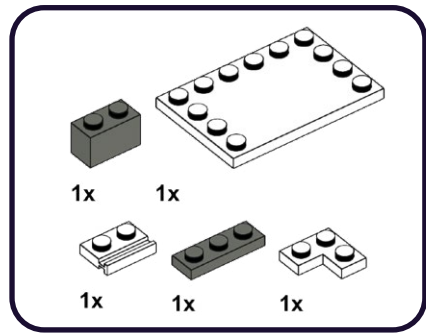

**1**

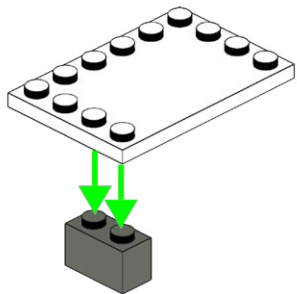

**1**

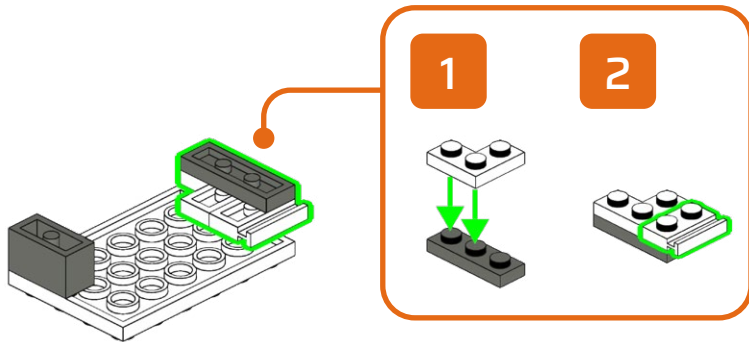

**157**

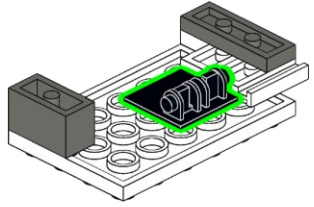

158

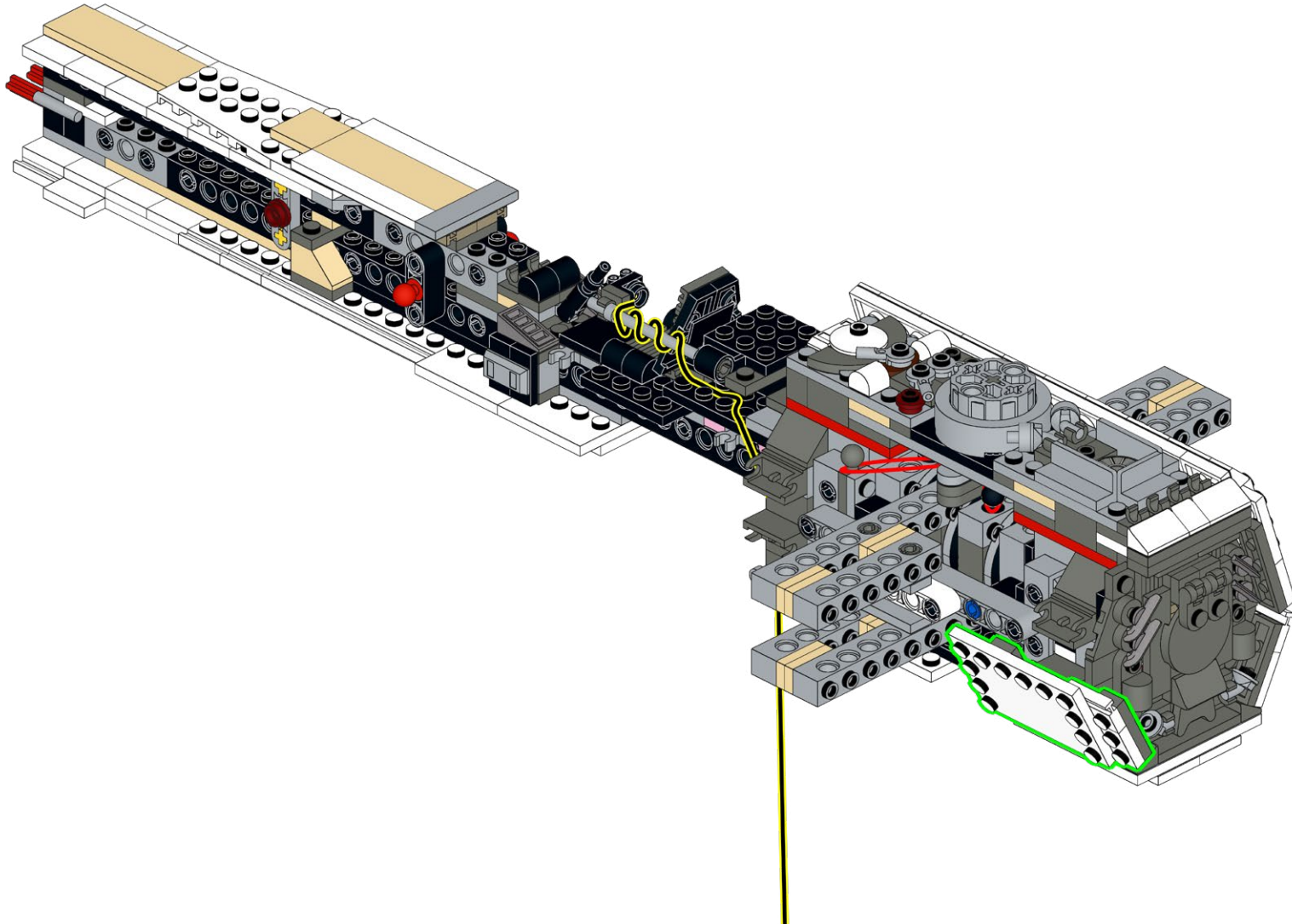

159

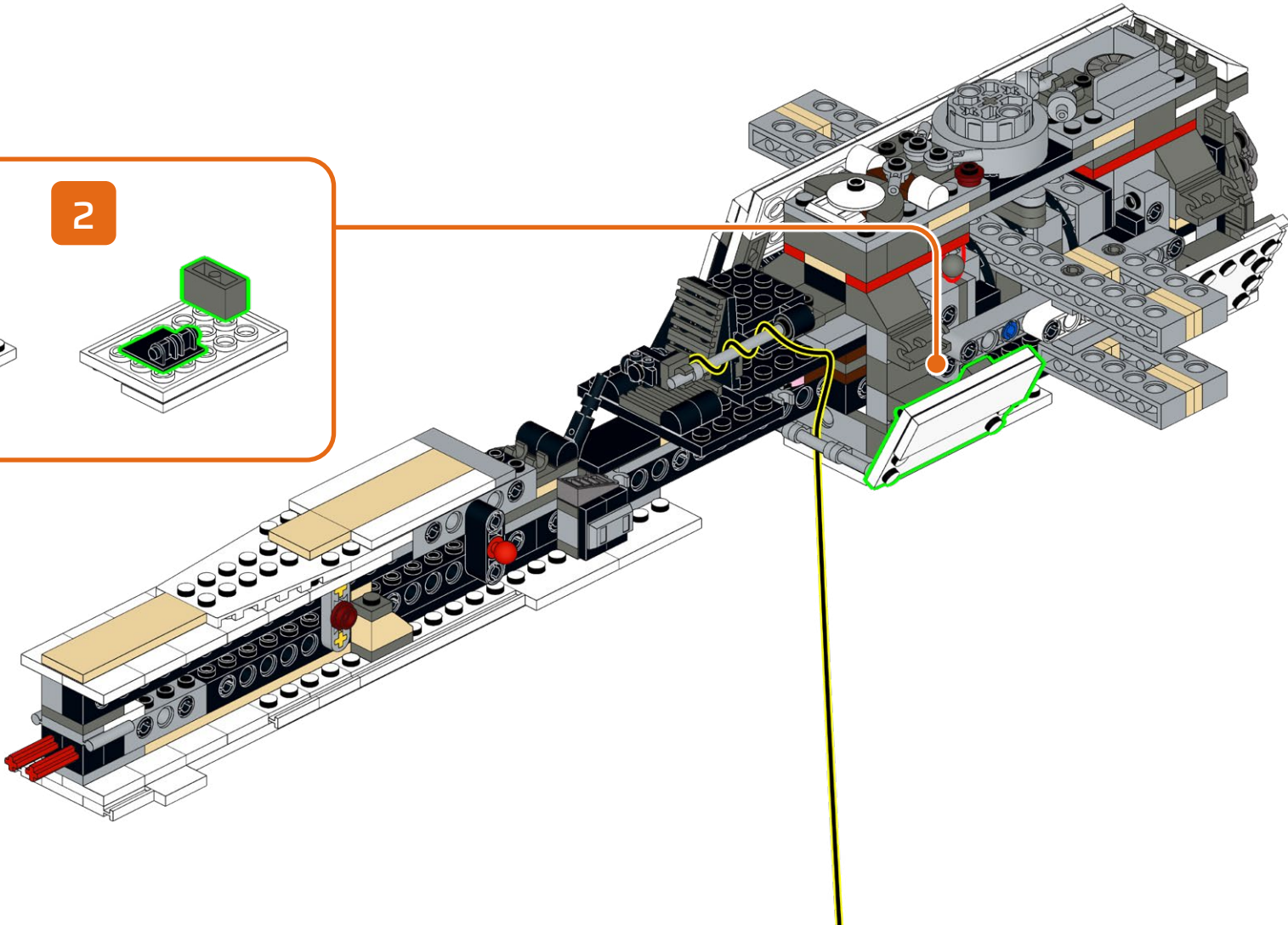
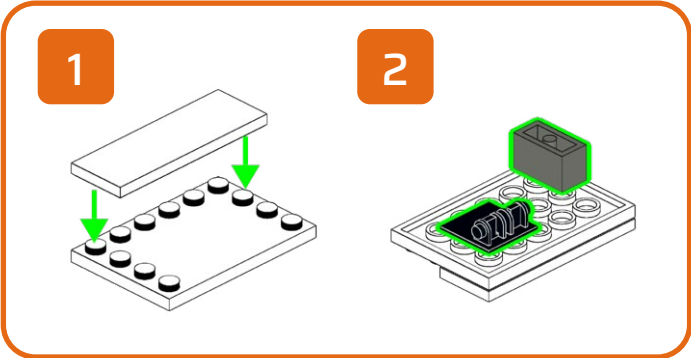
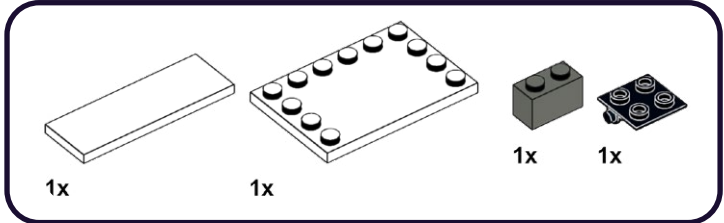

**160**

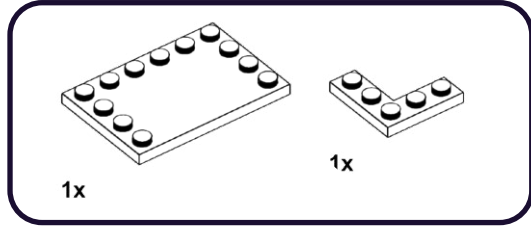

1

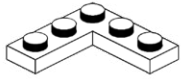

2

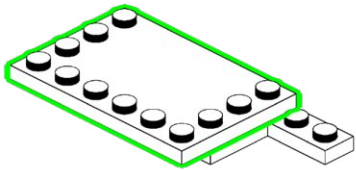

**161**

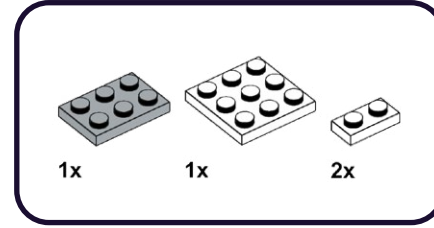

1

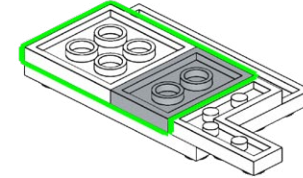

2

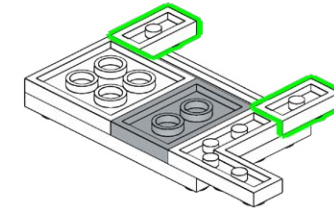



# 162

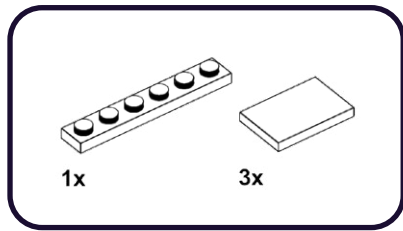

1

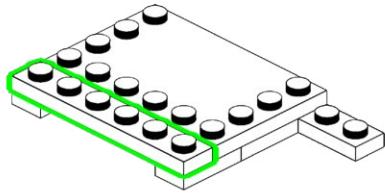

2

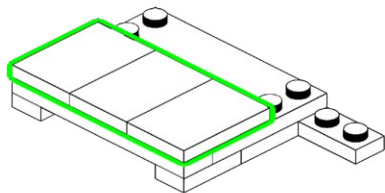

# 163

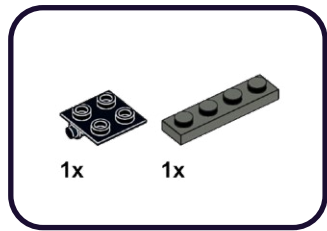

1

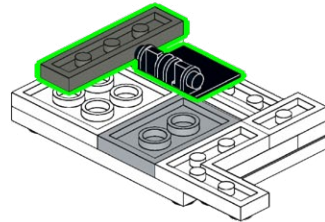



# 164

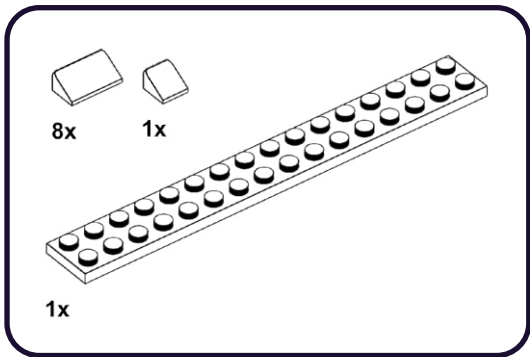

1

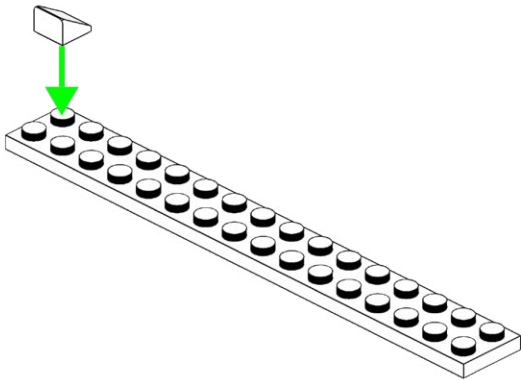

2

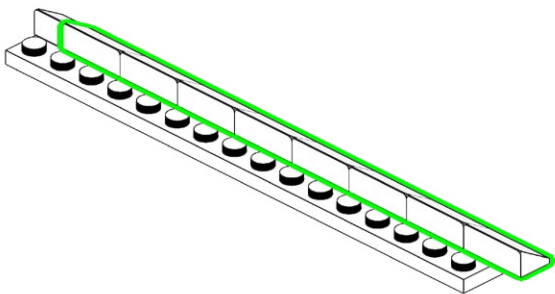

# 165

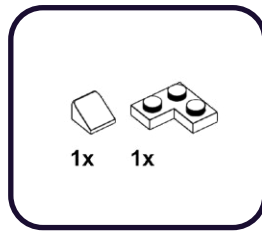

1

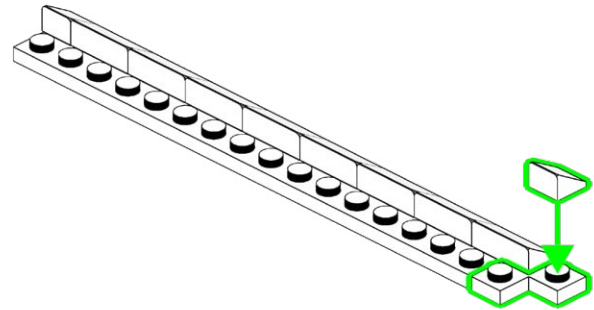

2

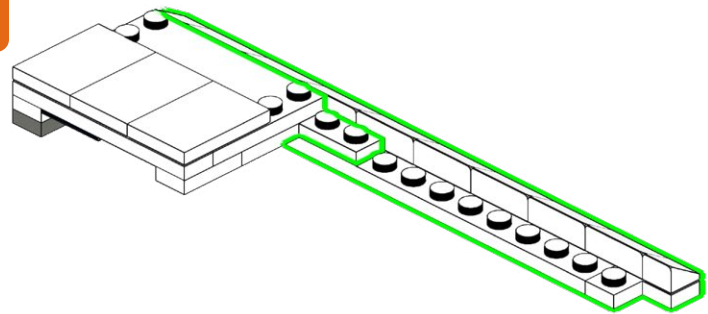

**166**

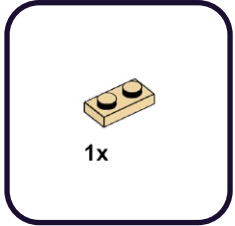

1

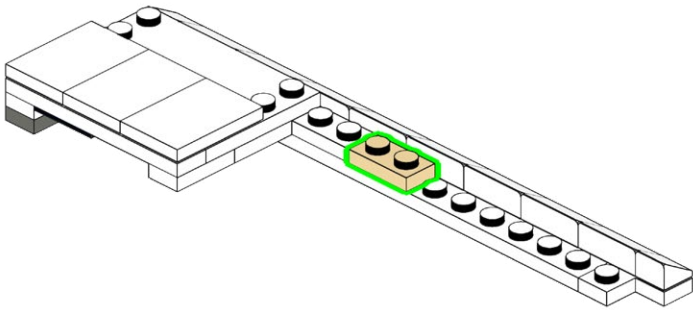

**167**

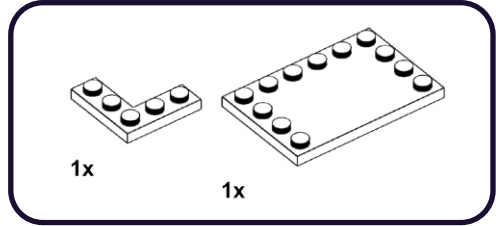

1

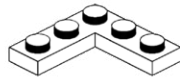

2

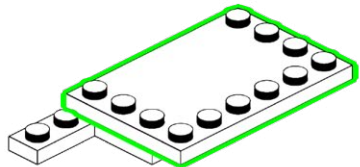

168

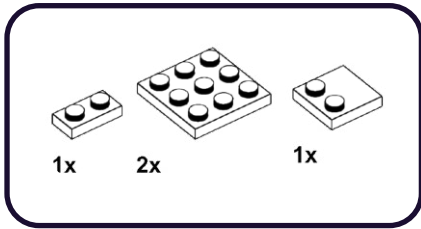

1

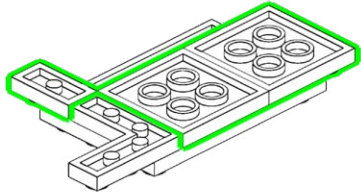

2

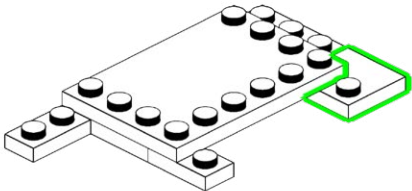

169

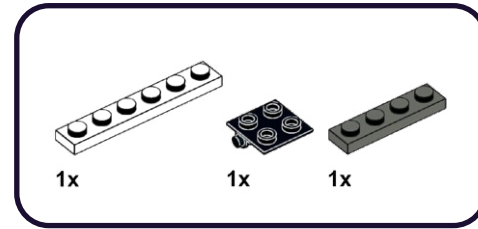

1

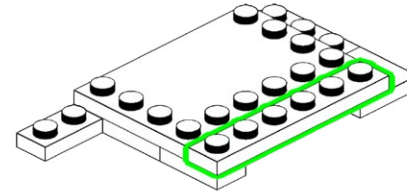

2

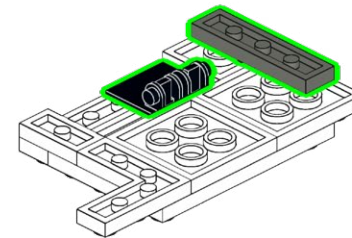

170

1

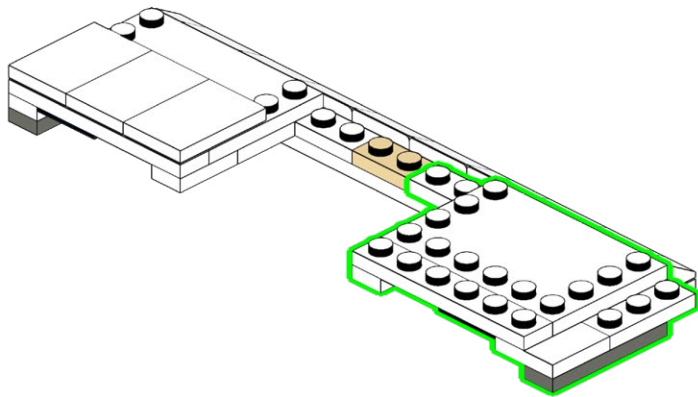

171

1x

1x

1

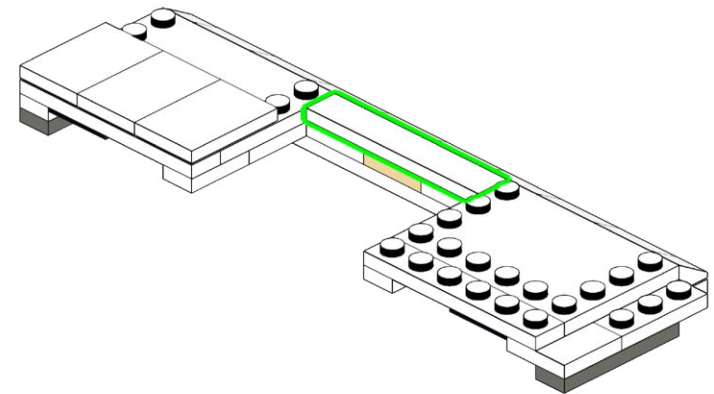

172

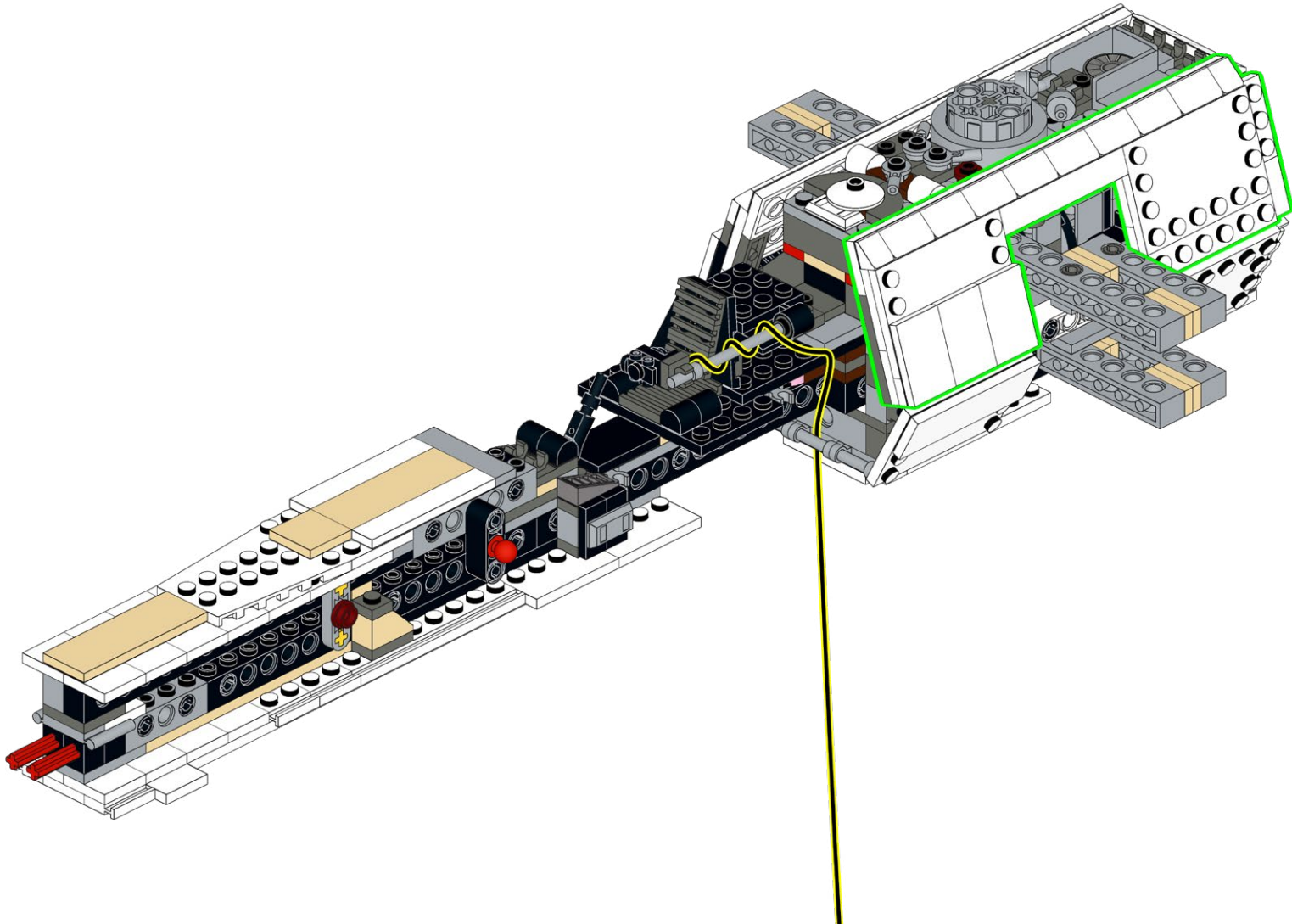

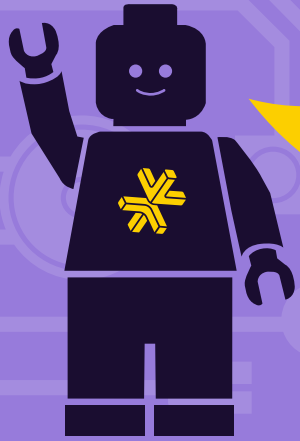
**HOLD UP!**

You might notice some bags aren't in order, as well as left over pieces, but that's ok! We're changing the way you build LEGO!

**ATTENDEZ!**

Vous remarquerez peut-être que certains sacs, ainsi que certaines pièces, ne sont pas dans le bon ordre. Mais pas de panique! Nous changeons simplement la façon avec laquelle vous construisez vos LEGO!

**ASPETTA!**

Potresti notare che alcuni sacchetti non sono in ordine, così come i pezzi avanzati, ma va bene così! Stiamo cambiando il modo in cui costruisci i LEGO!

**HALT!**

Sie werden möglicherweise bemerken, dass einige tüten durcheinander sind und teile übrig bleiben, aber das ist in Ordnung! Wir ändern die art und weise, wie Sie LEGO bauen!

**¡ESPERA!**

Es posible que notes que algunas bolsas están fuera de servicio, así como piezas sobrantes, ¡pero está bien! ¡Estamos cambiando la forma en que construyes LEGO!

**暫停!**

你可能会注意到一些袋子顺序错乱, 以及一些剩余的部件, 但没关系! 我们正在改变你搭建乐高的方式!

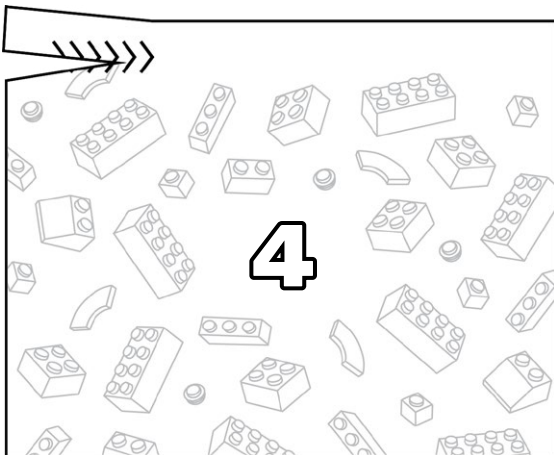
**Open LEGO® Bag 4**

173

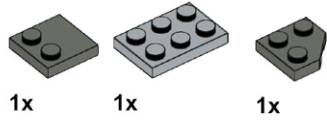

1

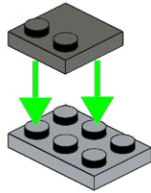

2

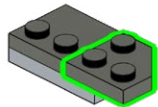

174

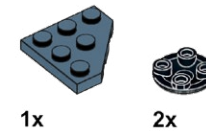

1

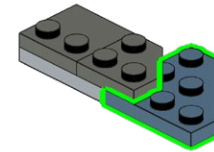

2

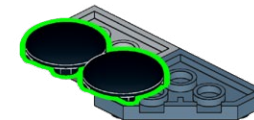



175

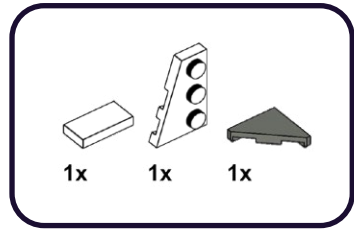

1

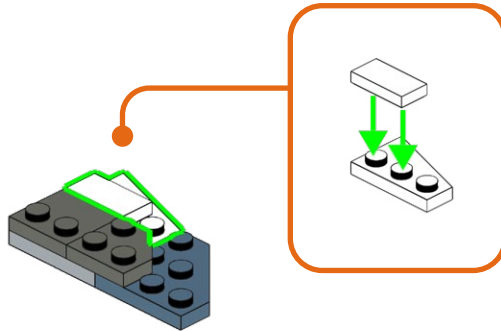

2

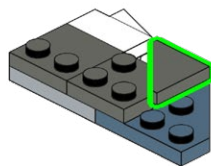

176

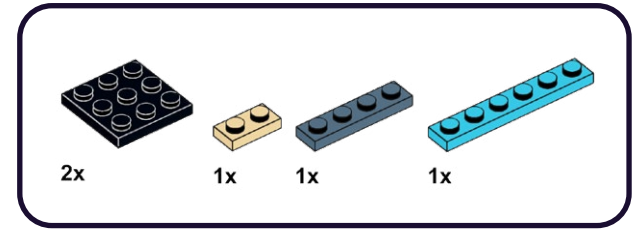

1

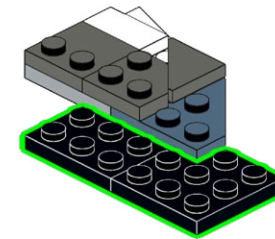

2

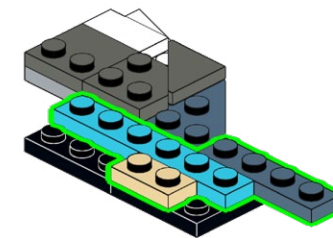

177

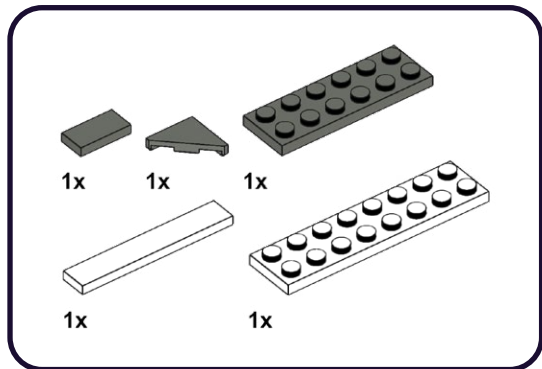

1

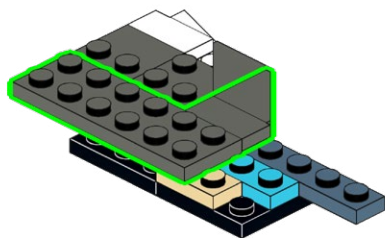

2

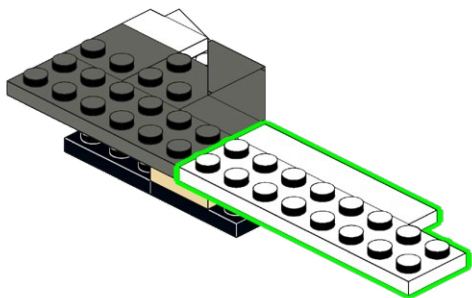

178

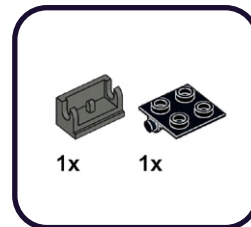

1

2



1

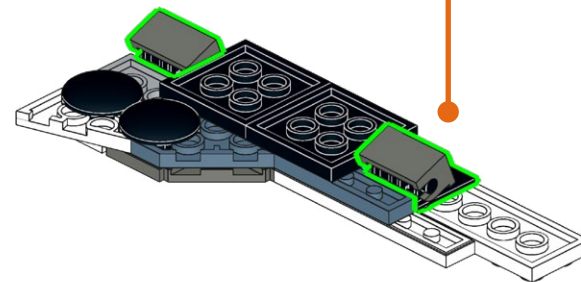

179

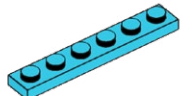

1x

1

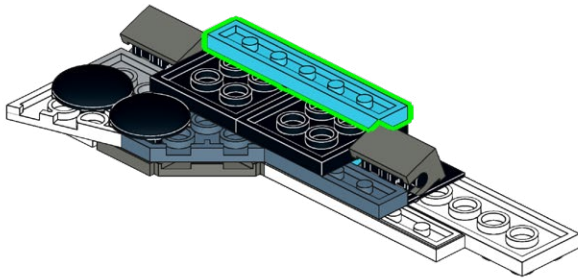

180

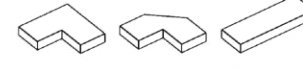

1x

1x

1x

1

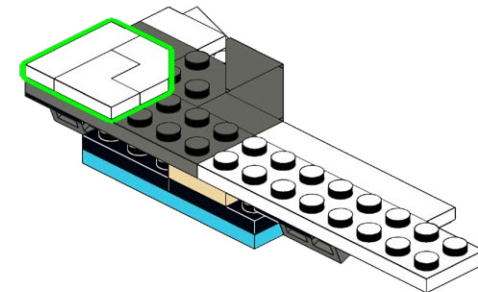

181

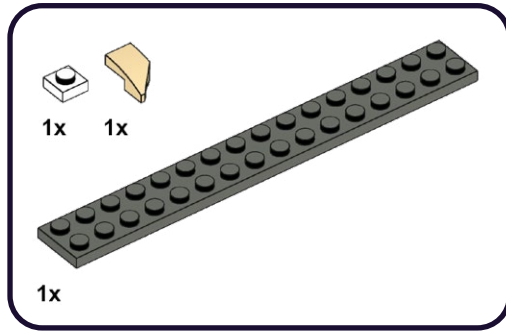

1

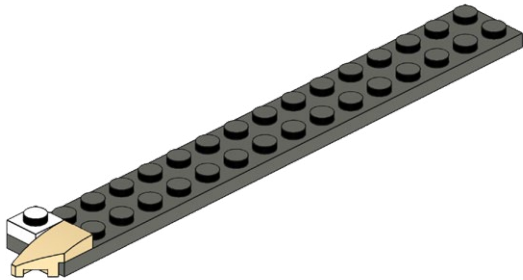

182

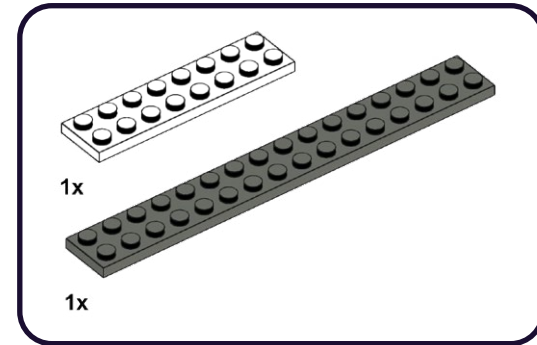

1

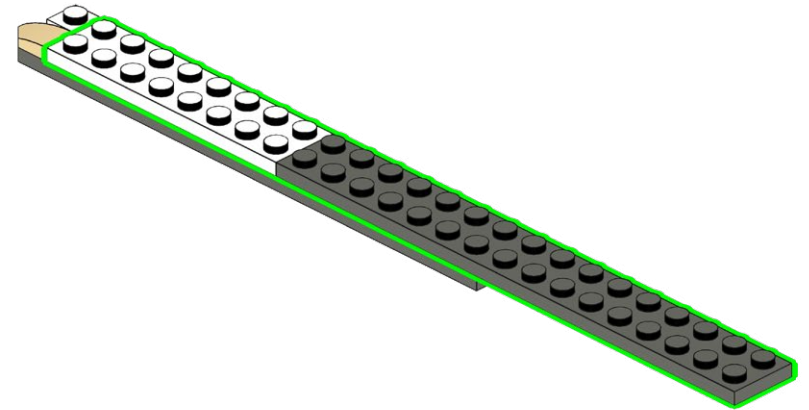

183

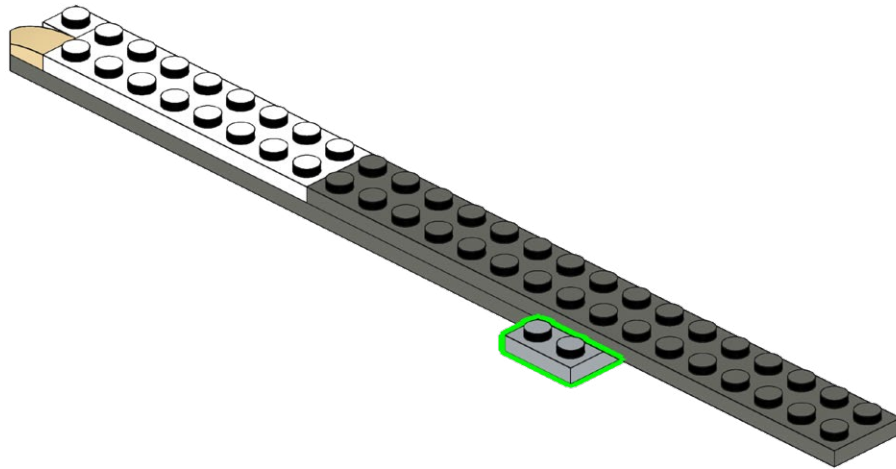
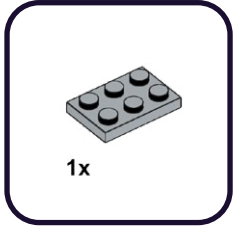

184

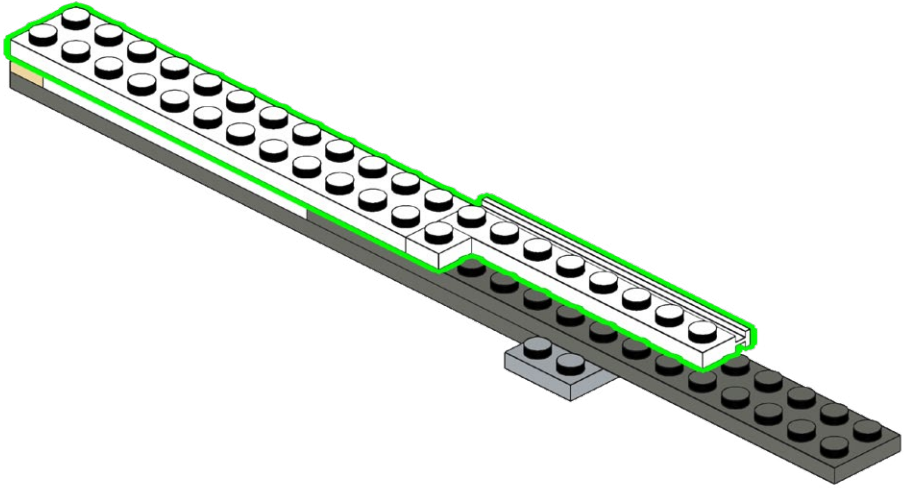
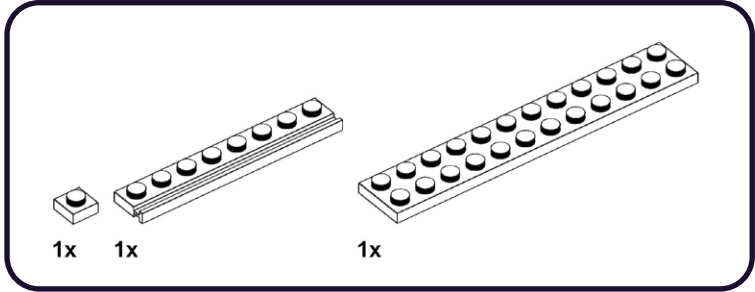

185

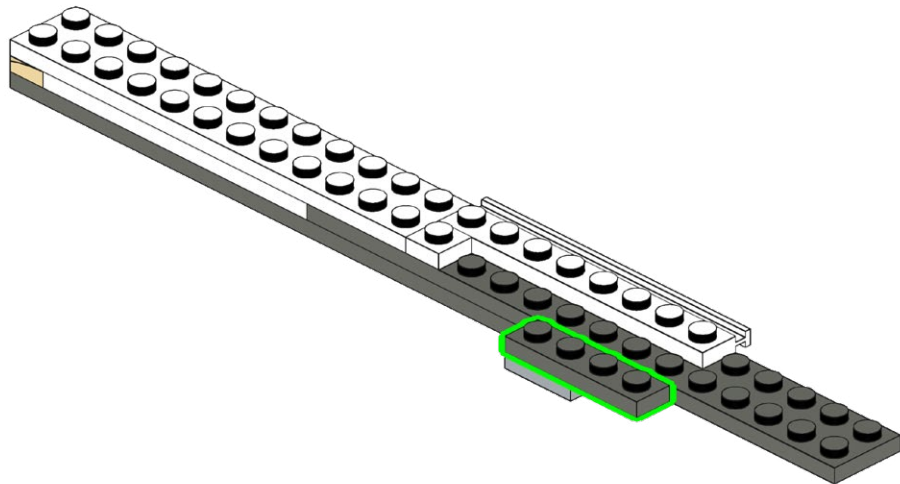
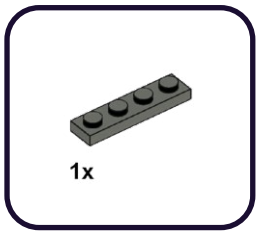



186

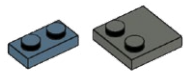

1x

4x

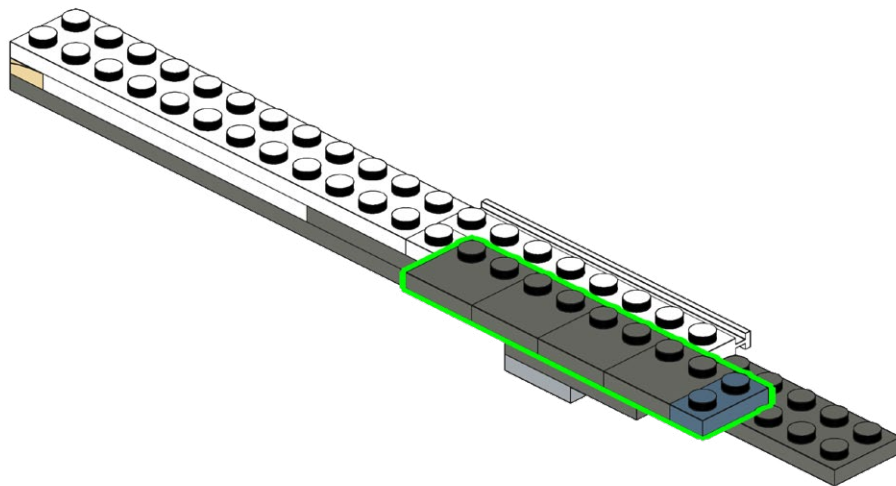

187

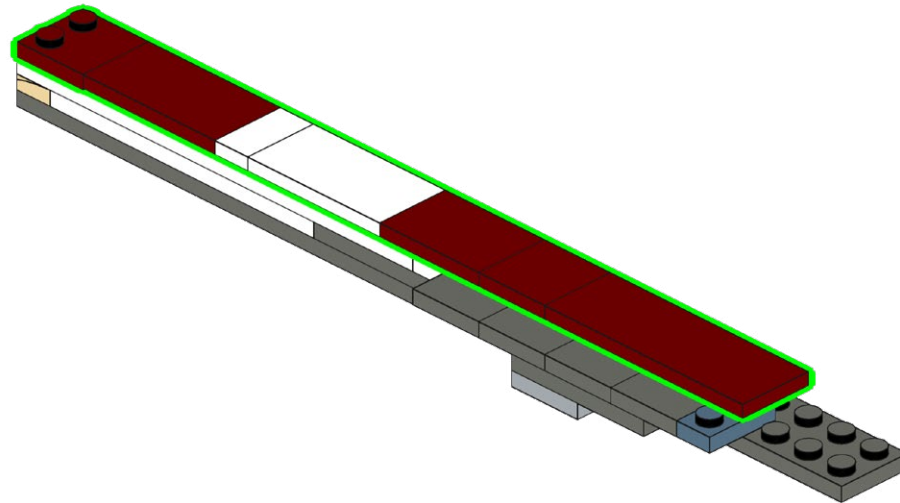
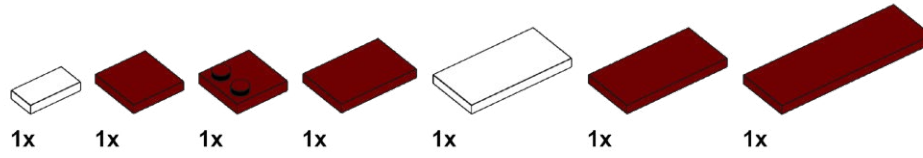

188

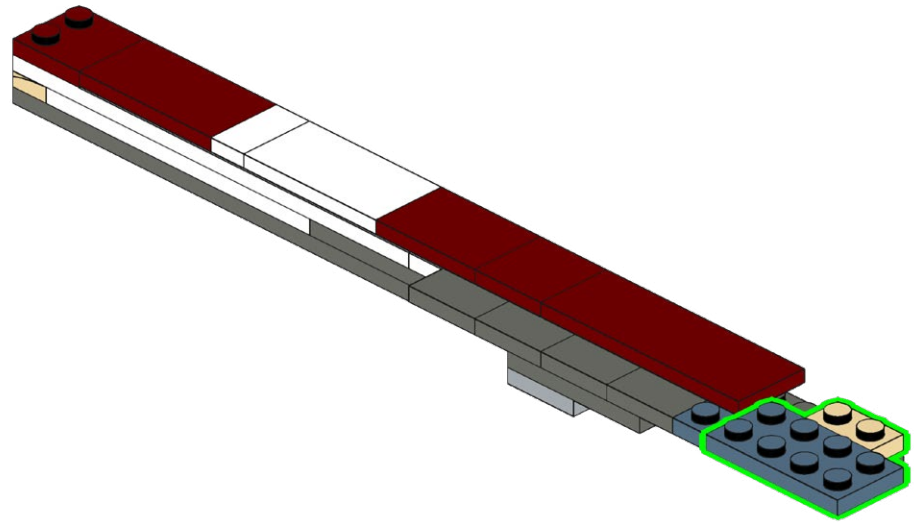
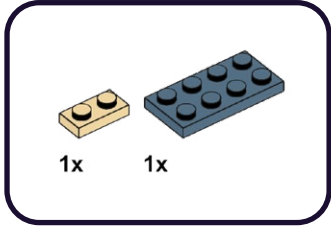

189

1x

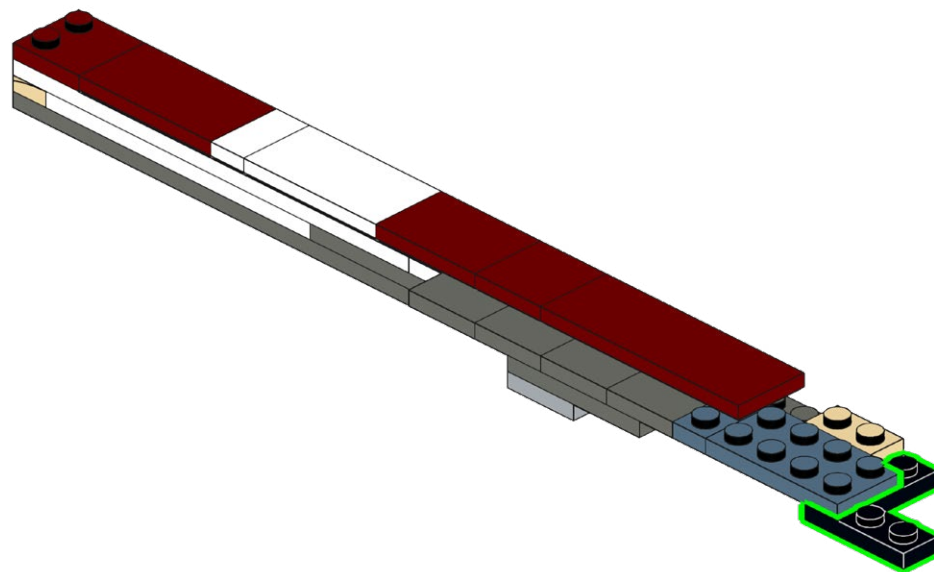

190

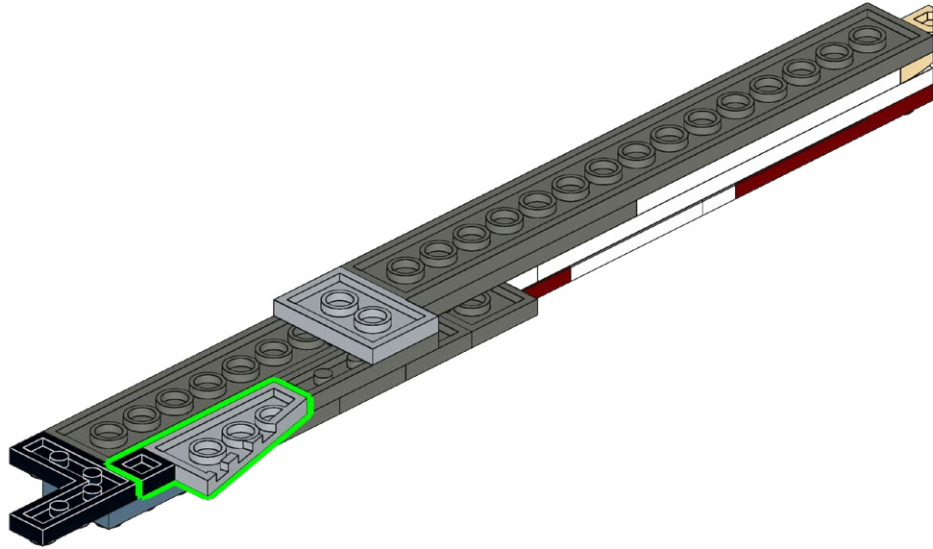
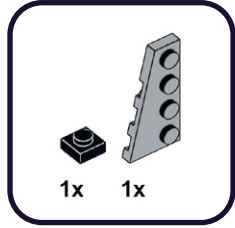

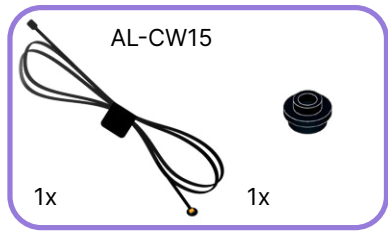

1



2

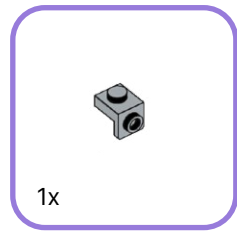

1

2



**193**

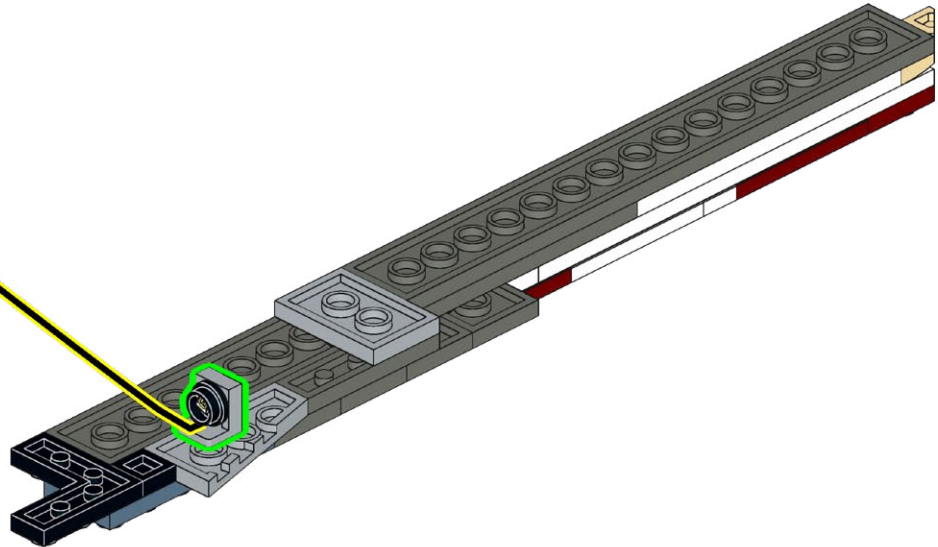
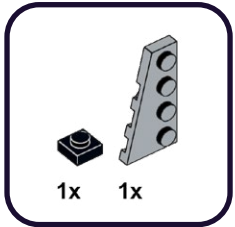



**194**

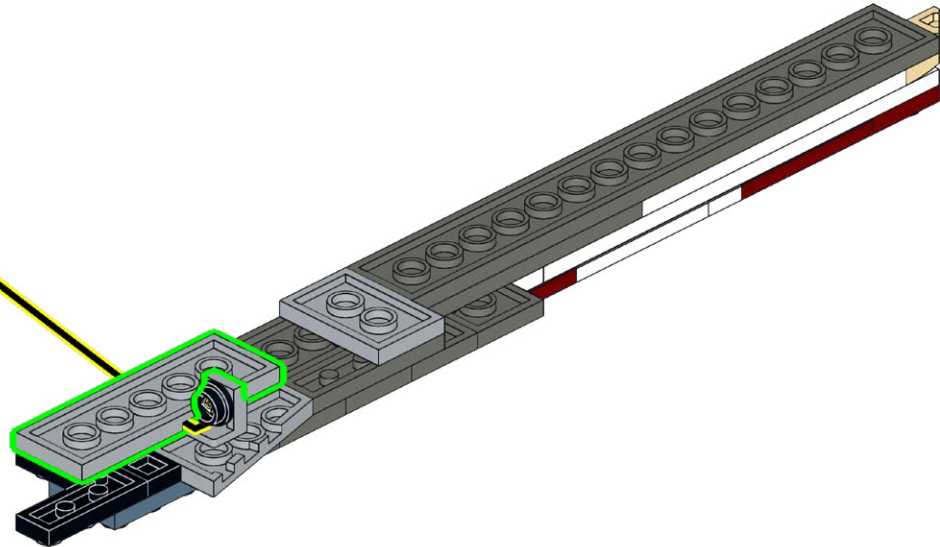
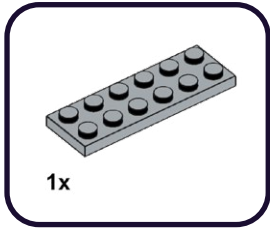

195

1x

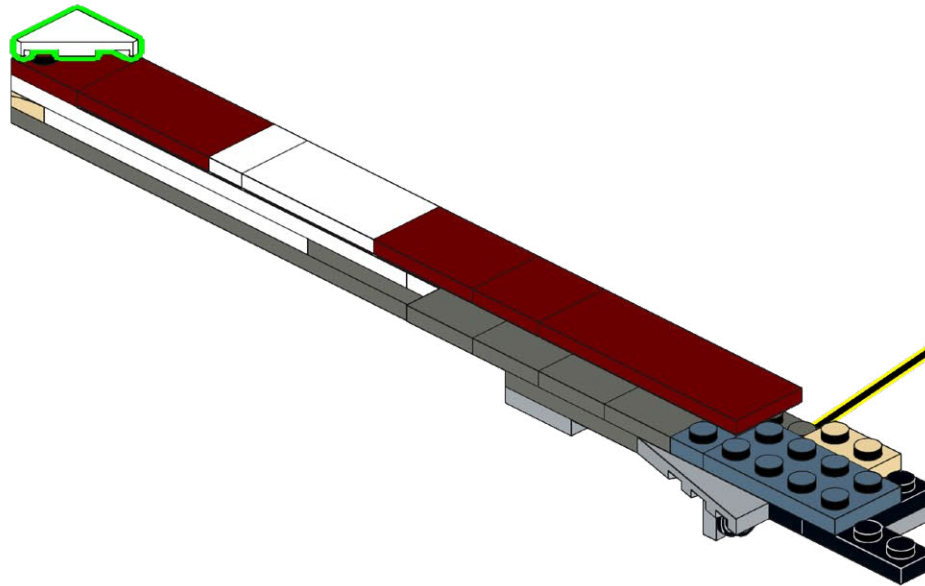

196

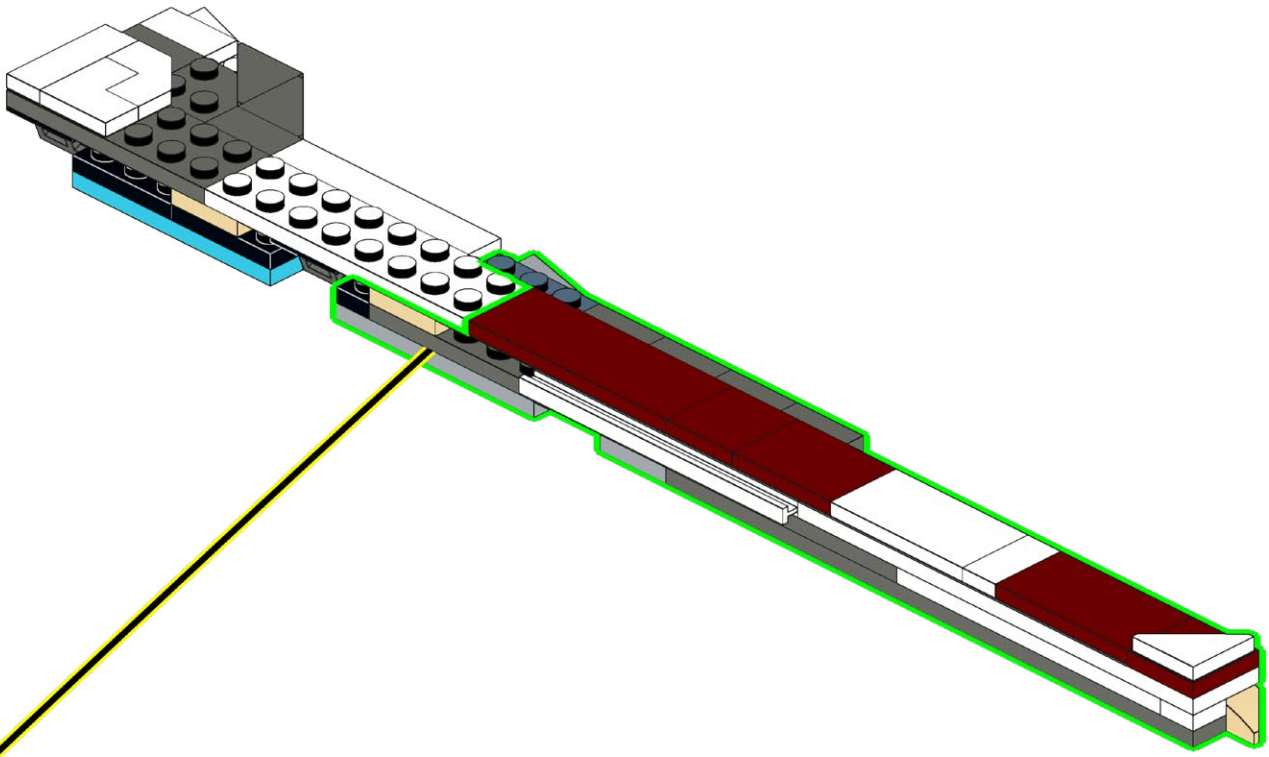

197

1x

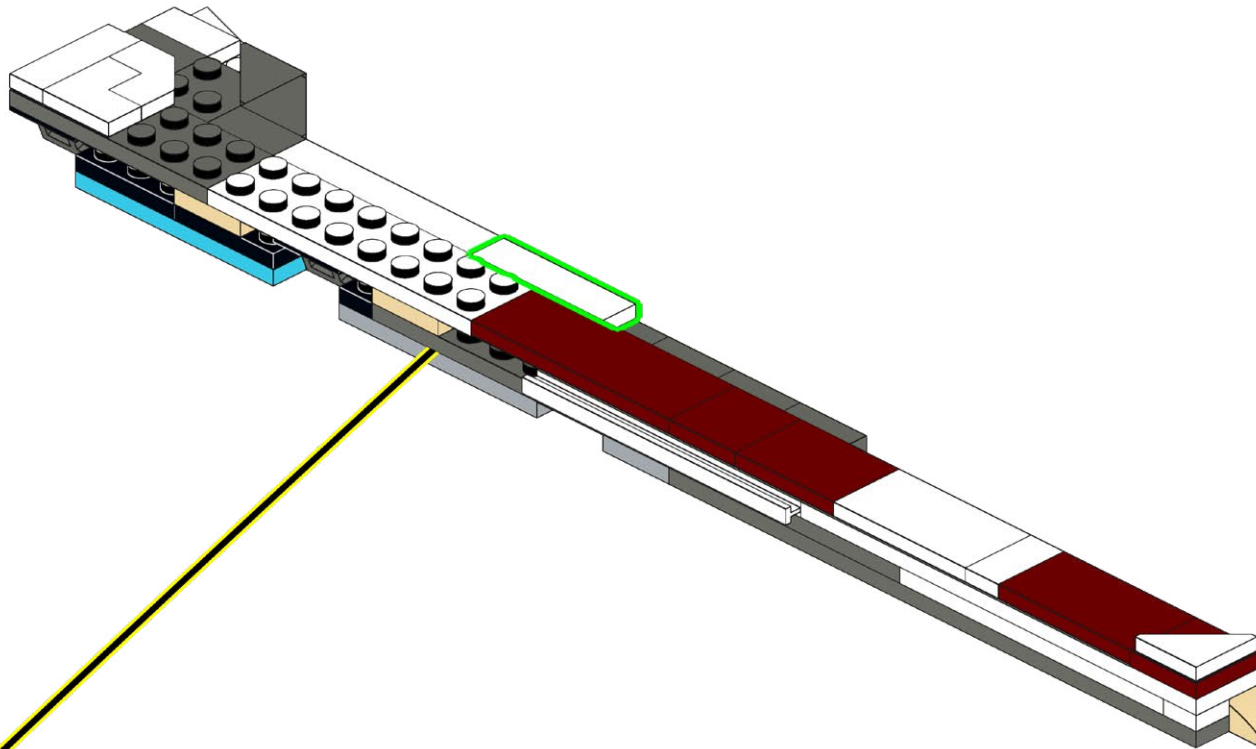

198

2x

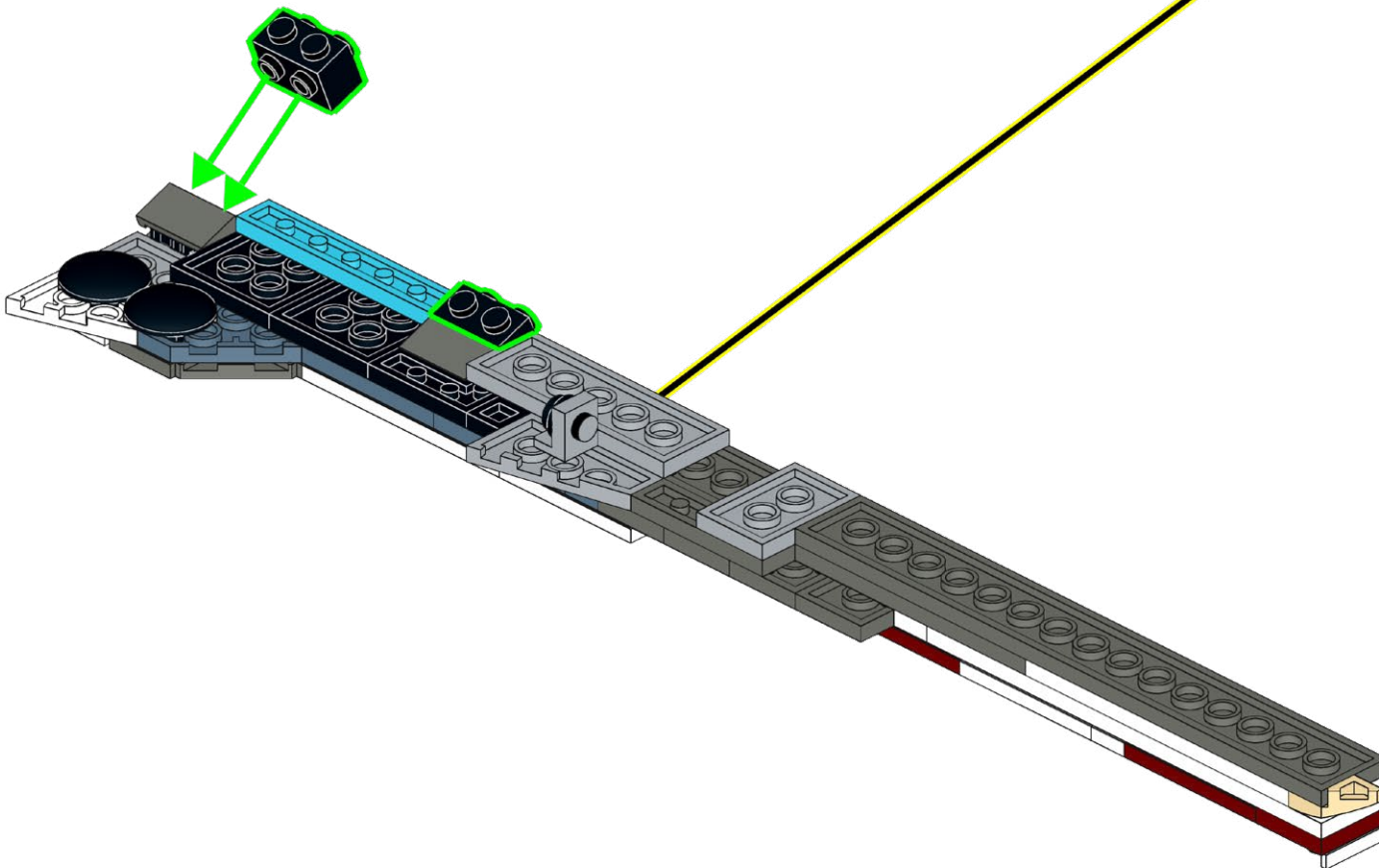

199

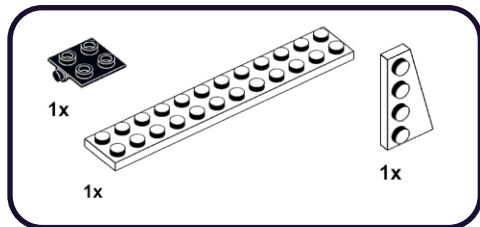

1

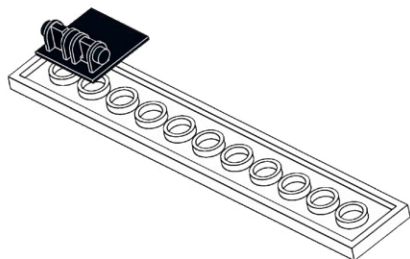

2

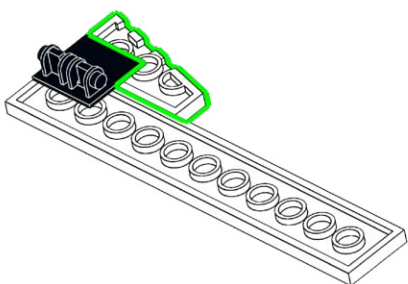

200

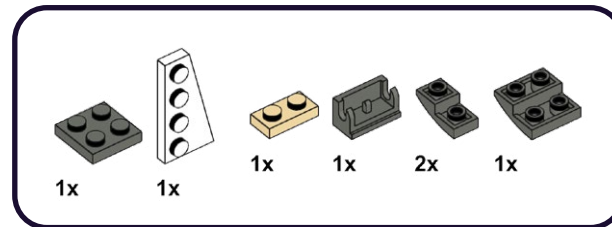

1

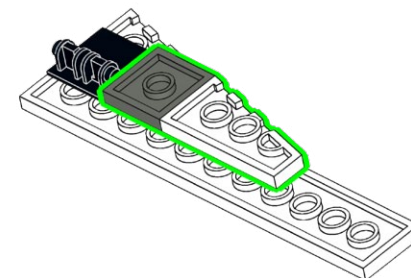

2

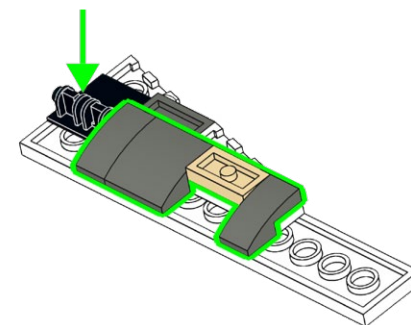

**201**

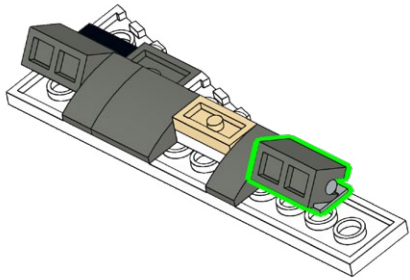
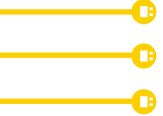

**202**

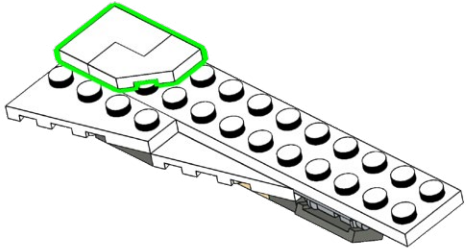
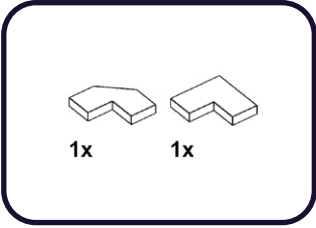



203

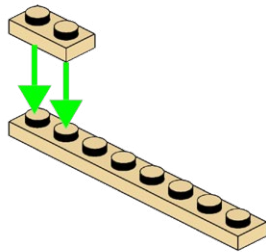
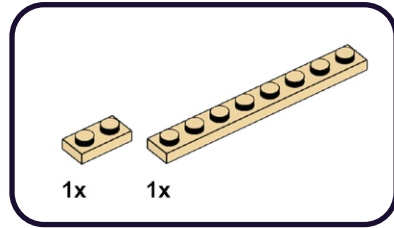

204

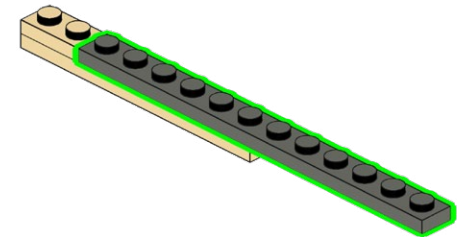
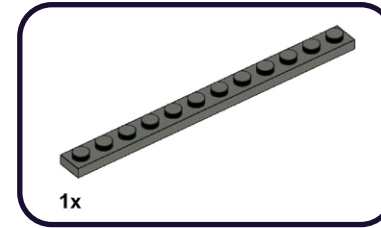

**205**

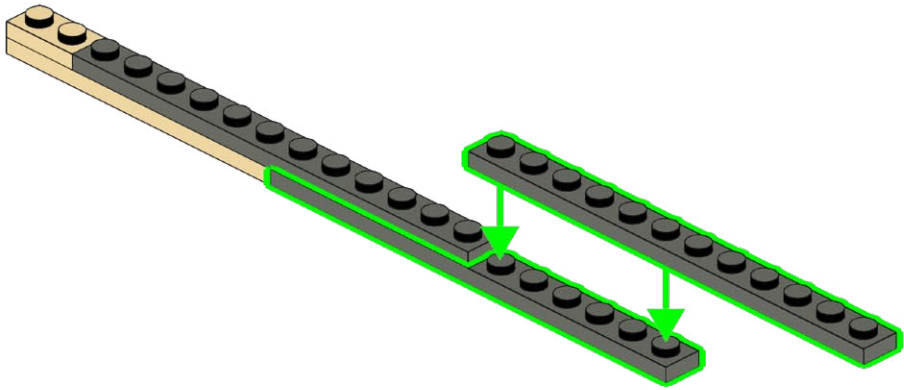
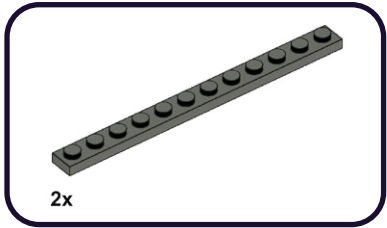

206

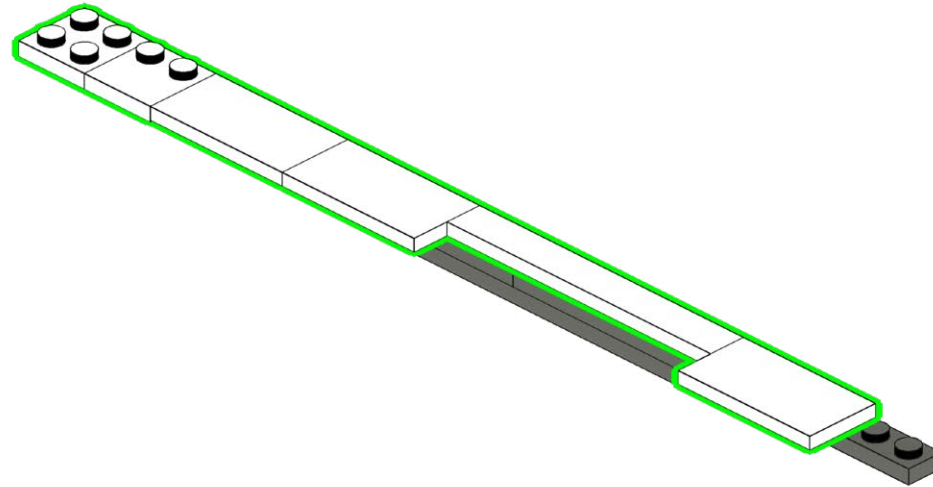
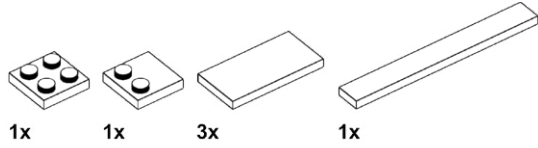

**207**

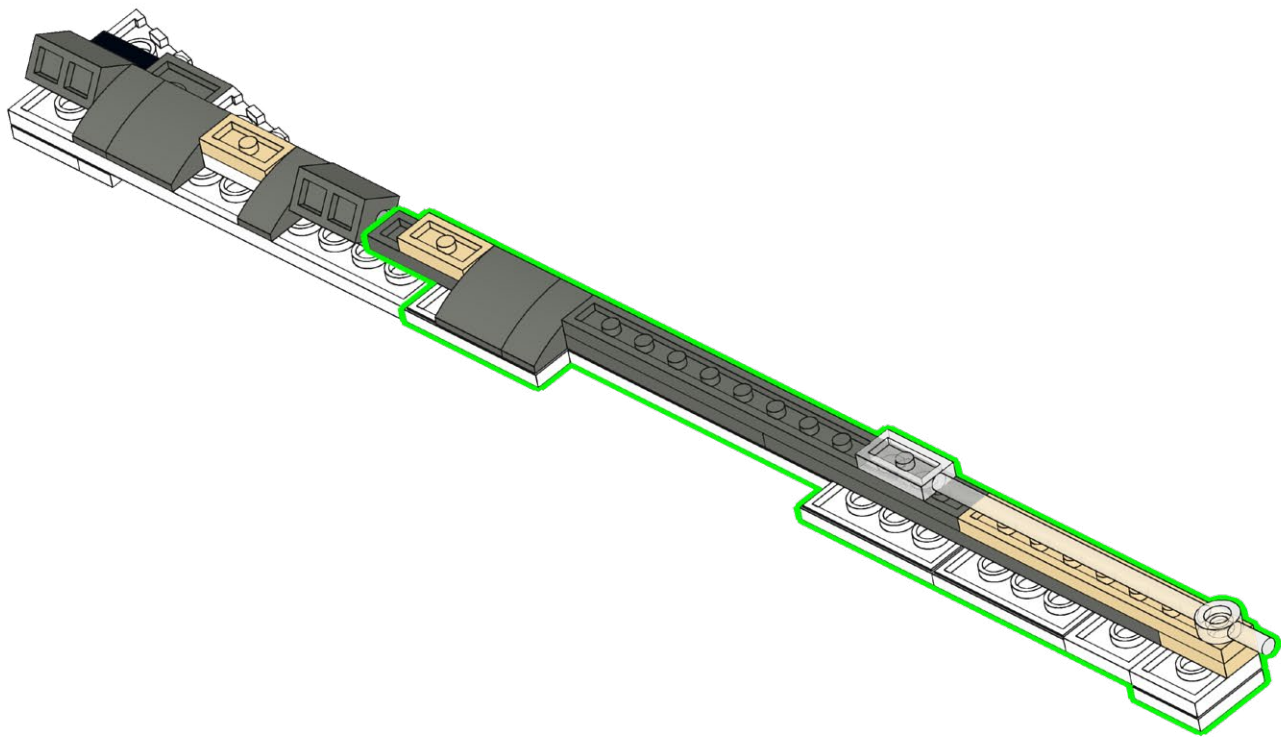
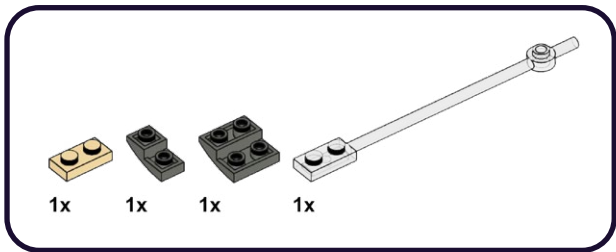

208

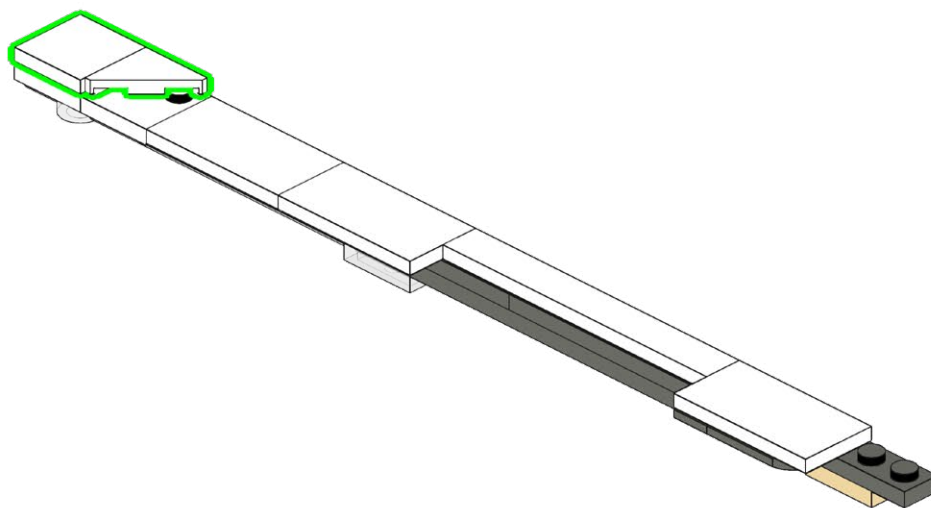
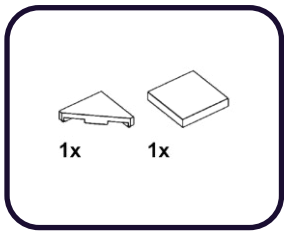

209

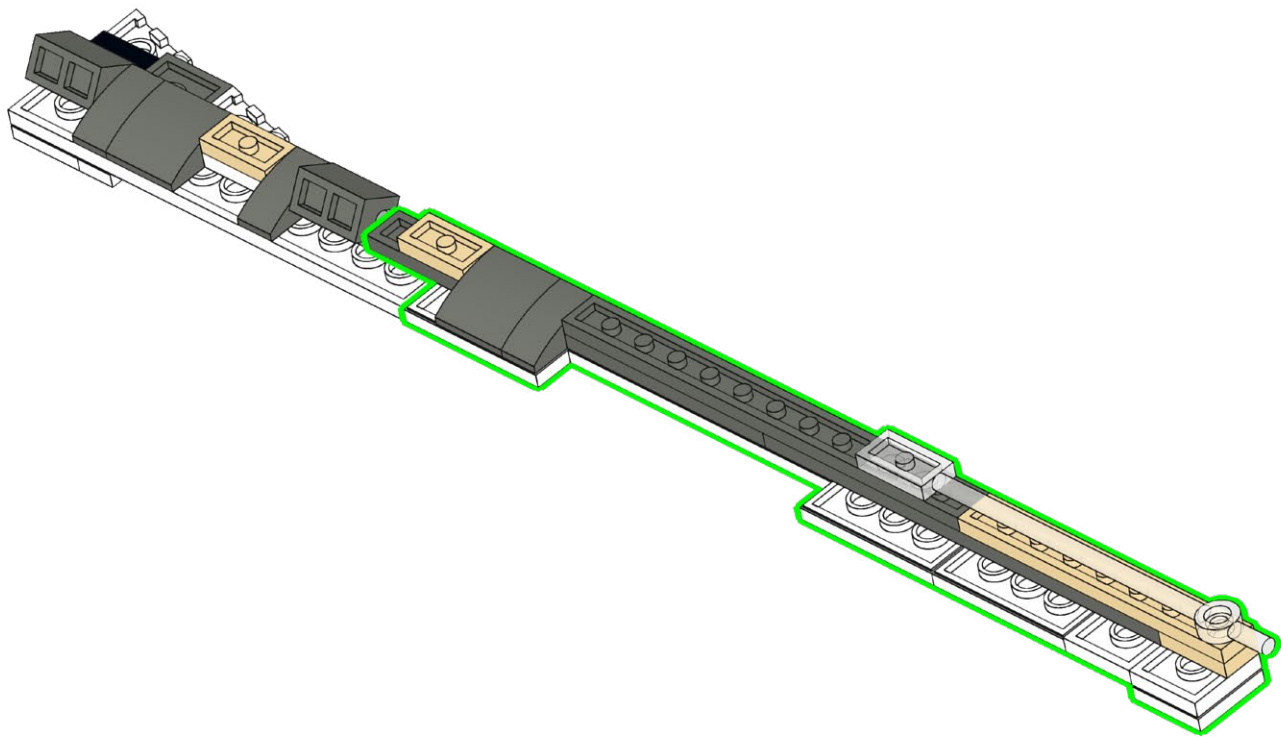

210

1x

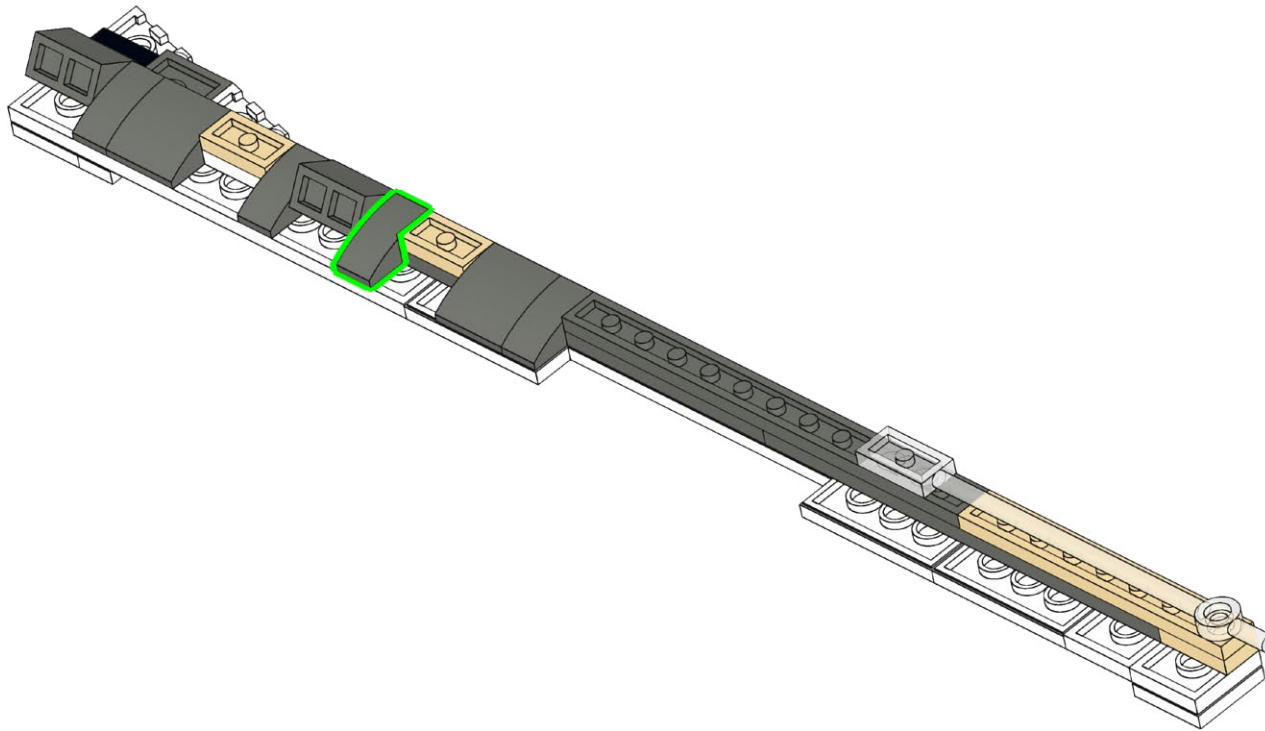



211

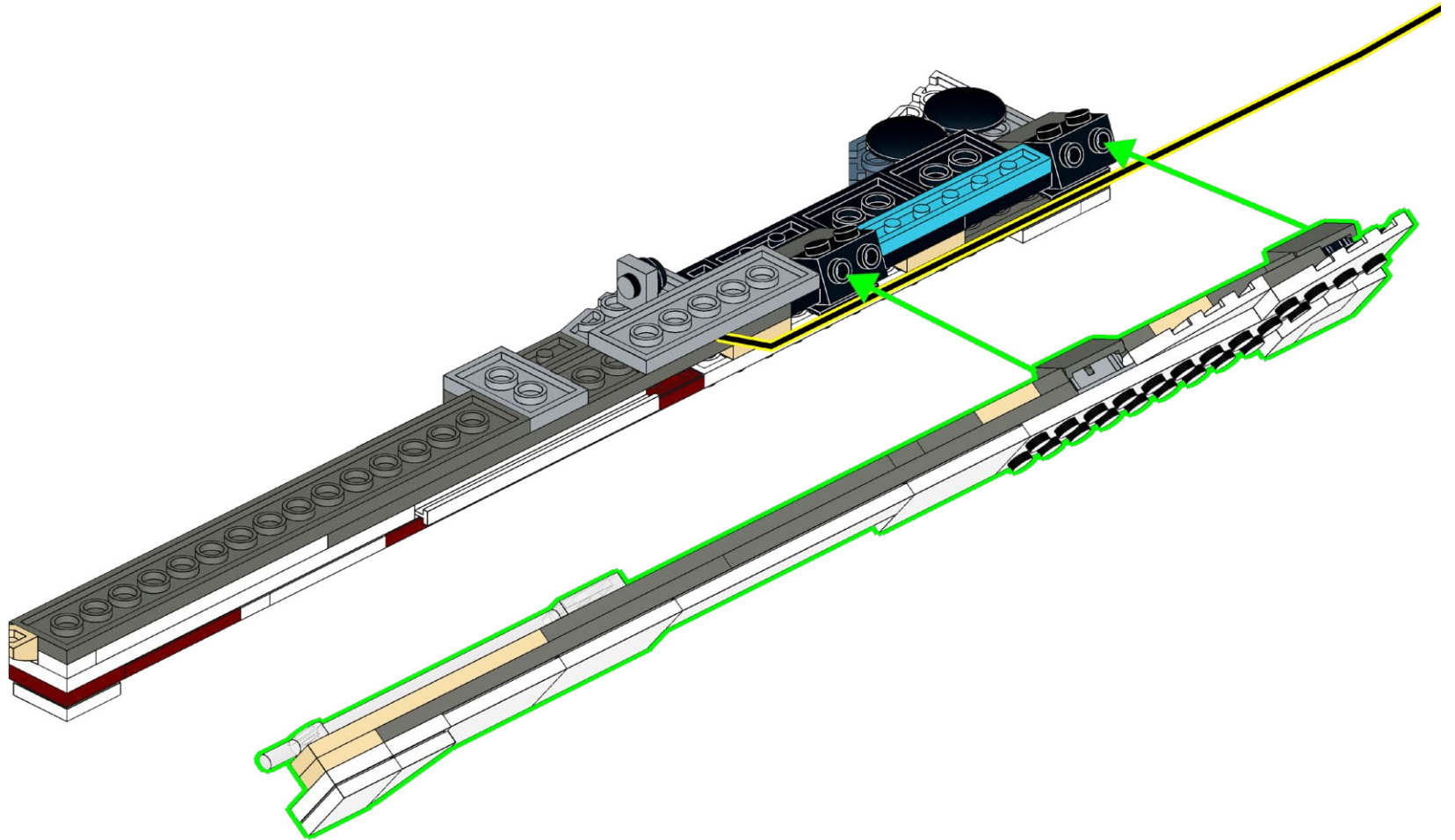

212

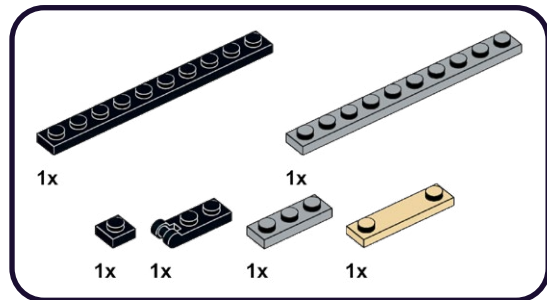

1

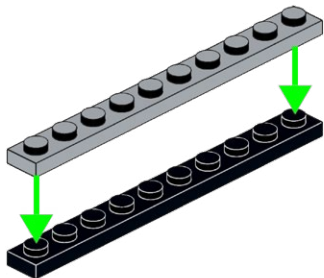

2

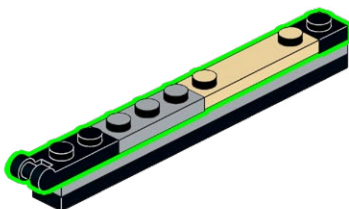

213

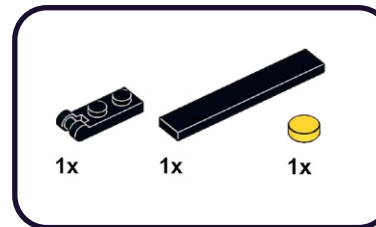

1

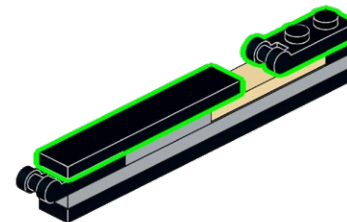

2

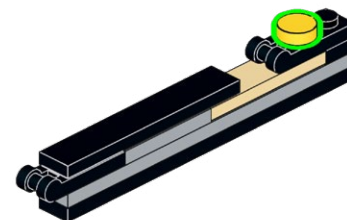

214

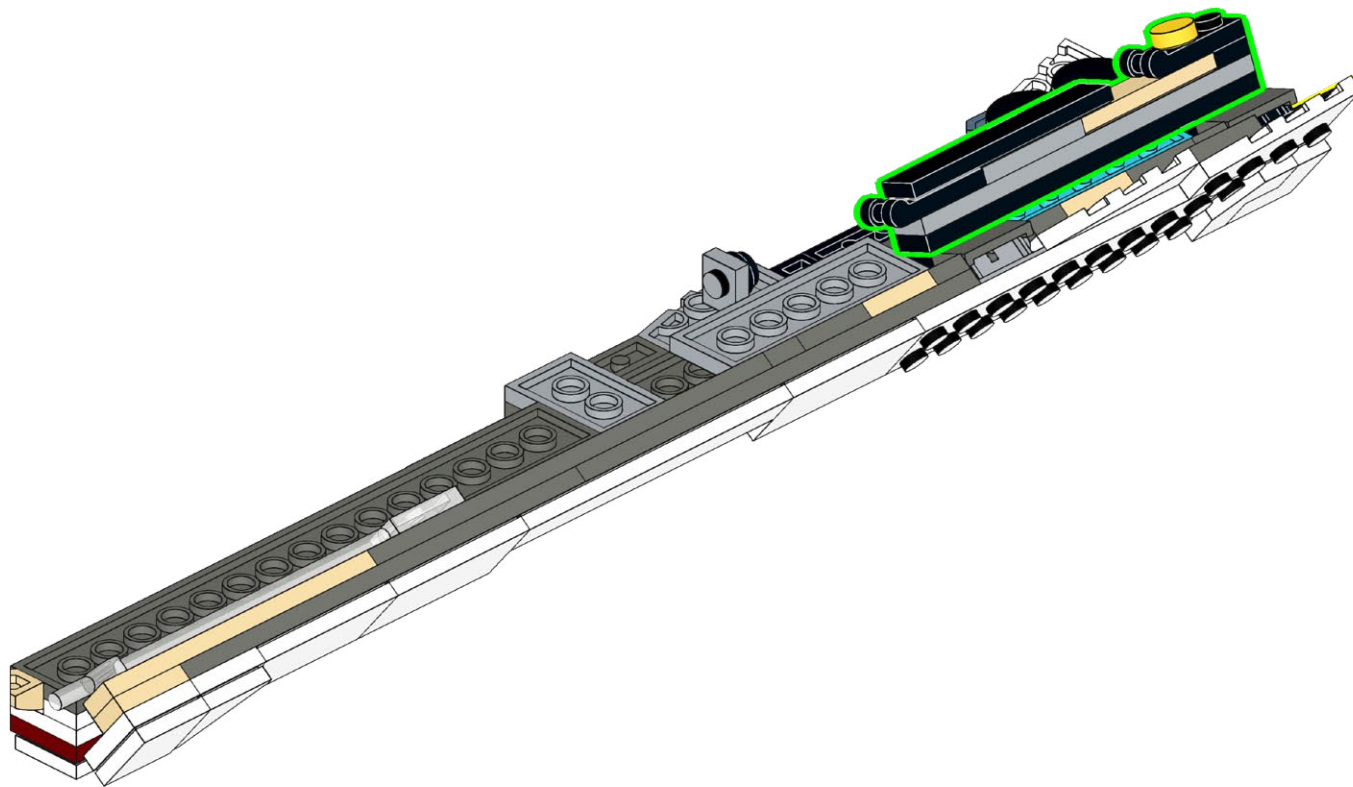

215

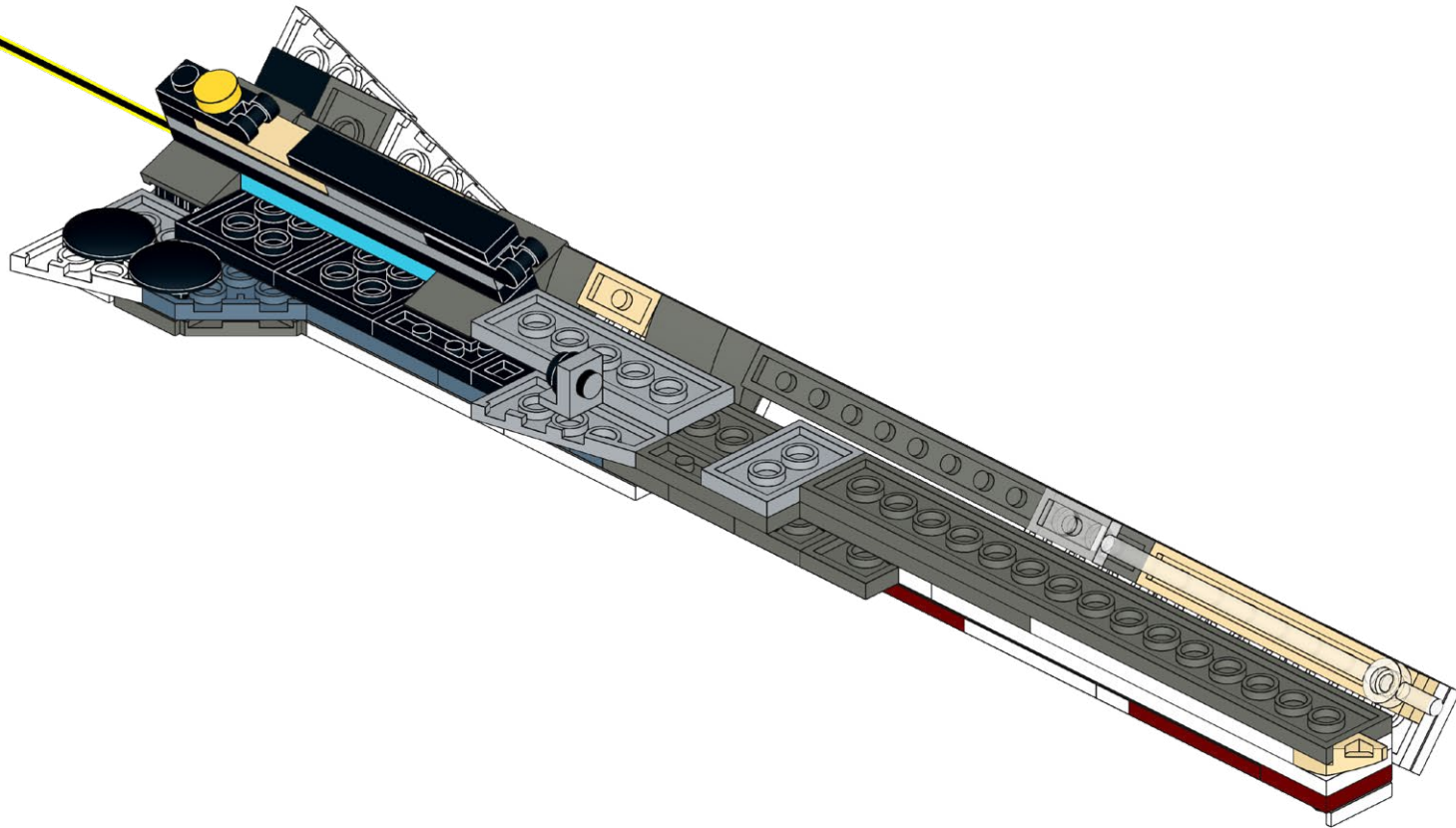

216

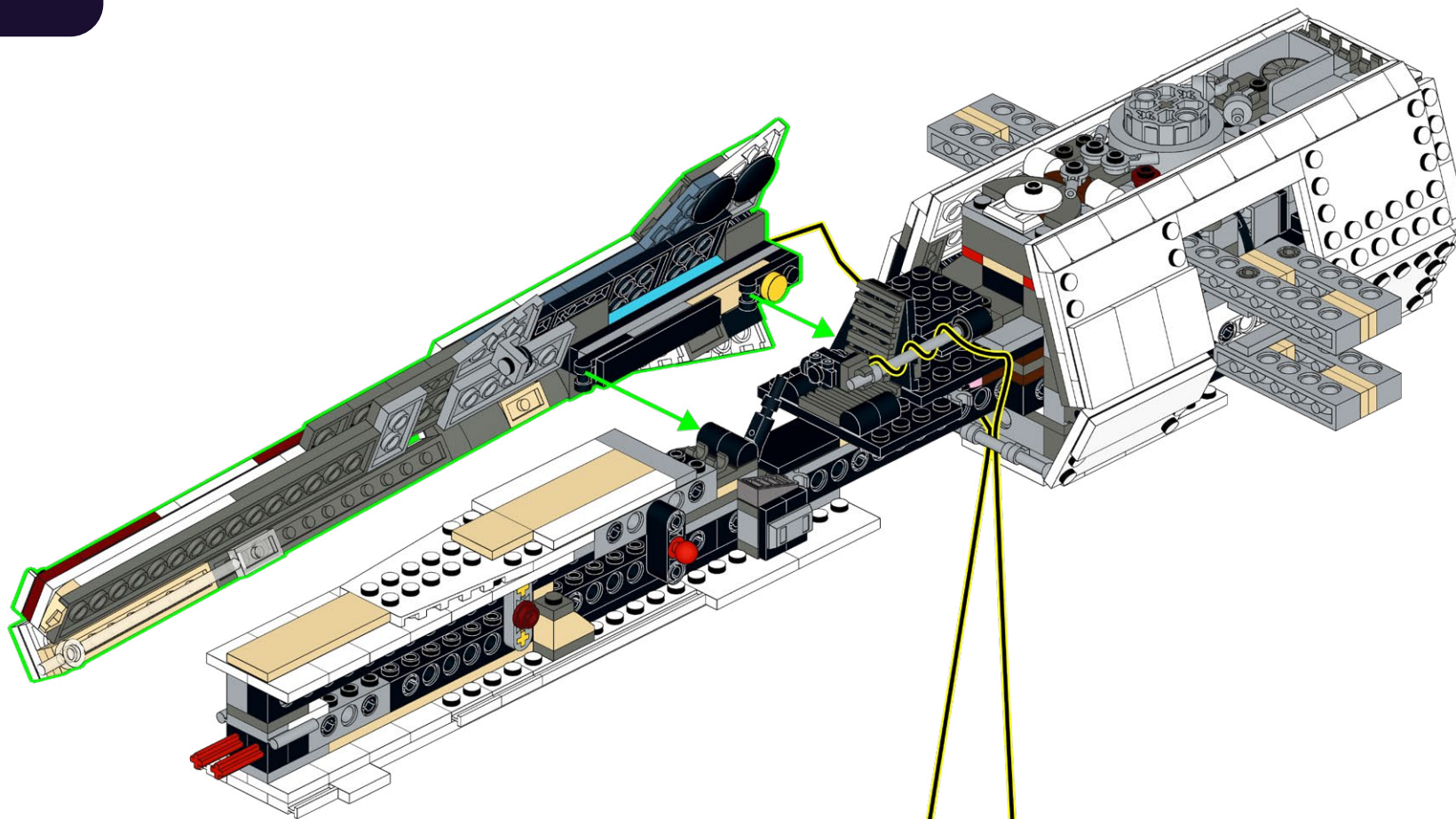

217

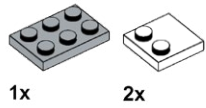

1



2

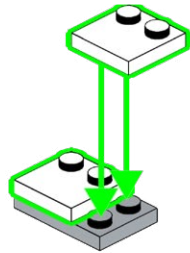

218

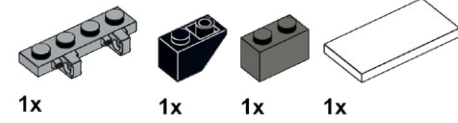

1

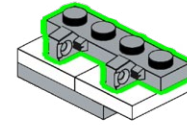

2

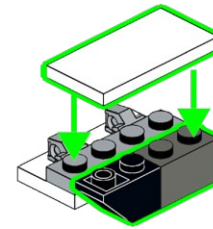



219

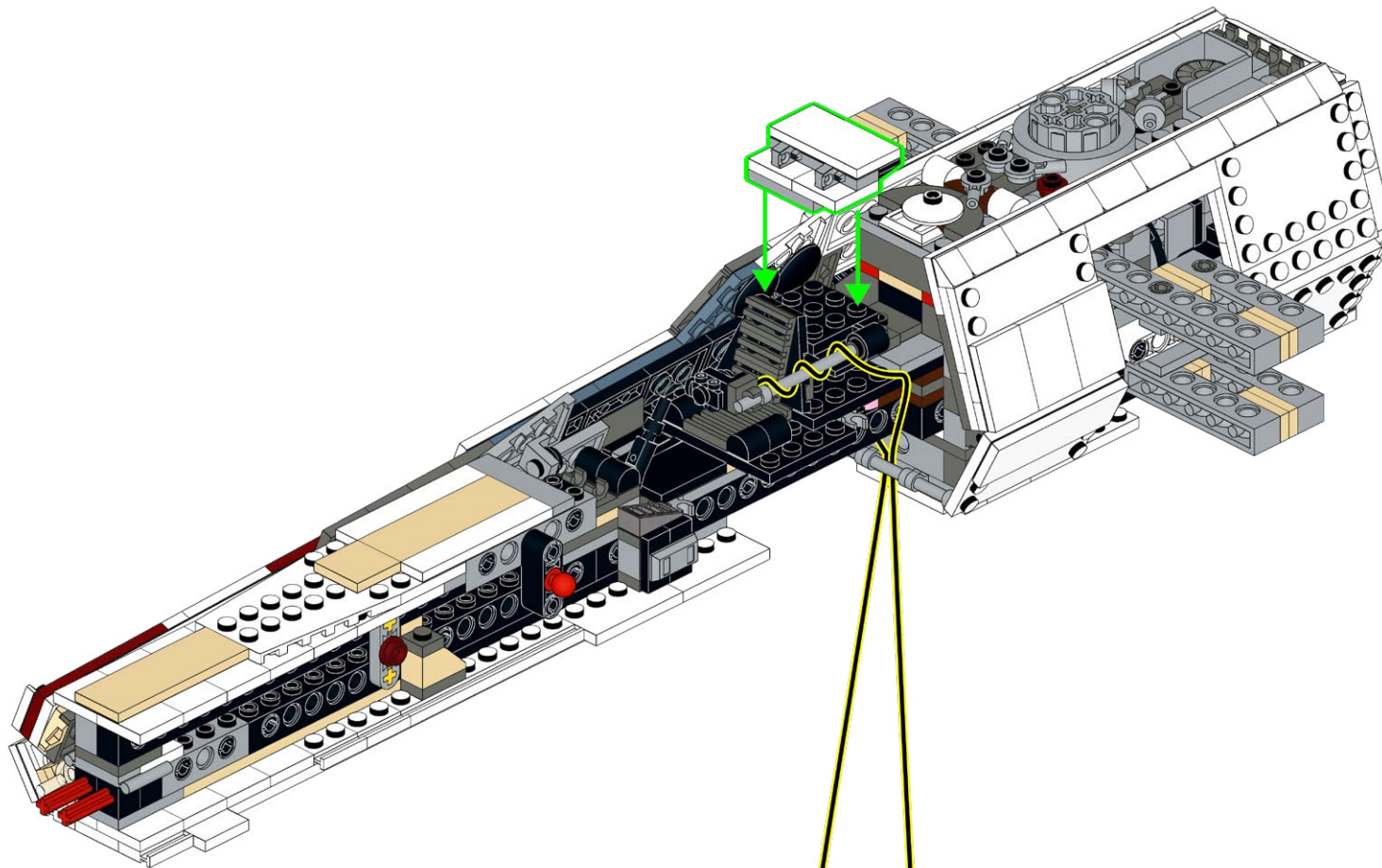



# 220

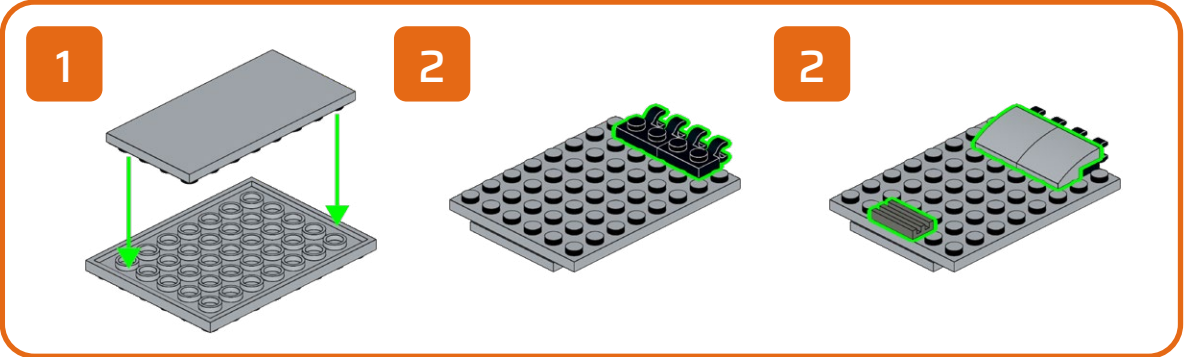
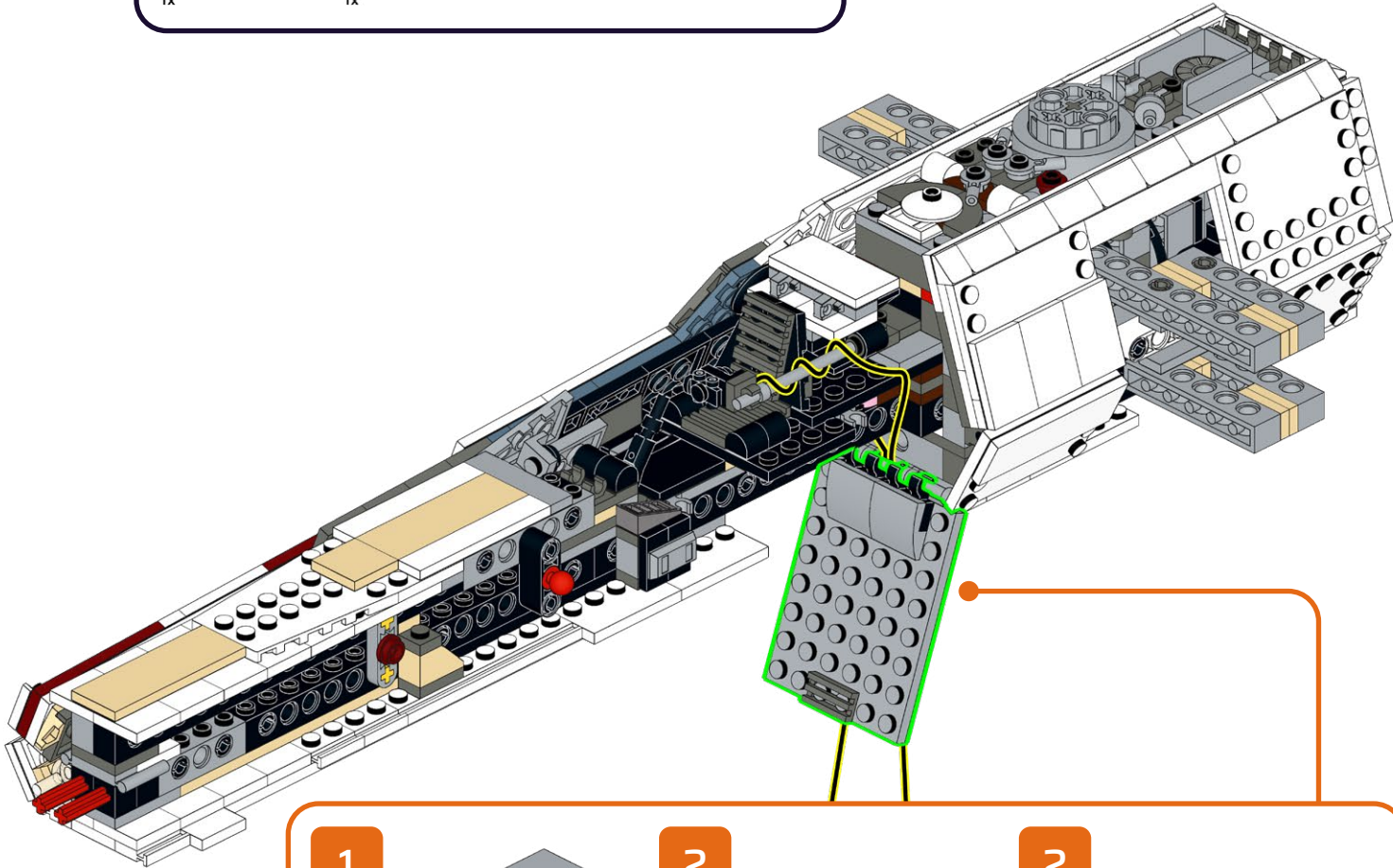
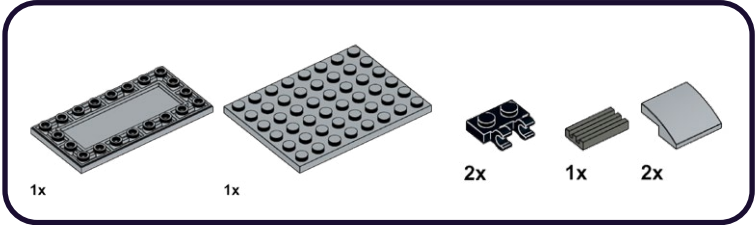

221

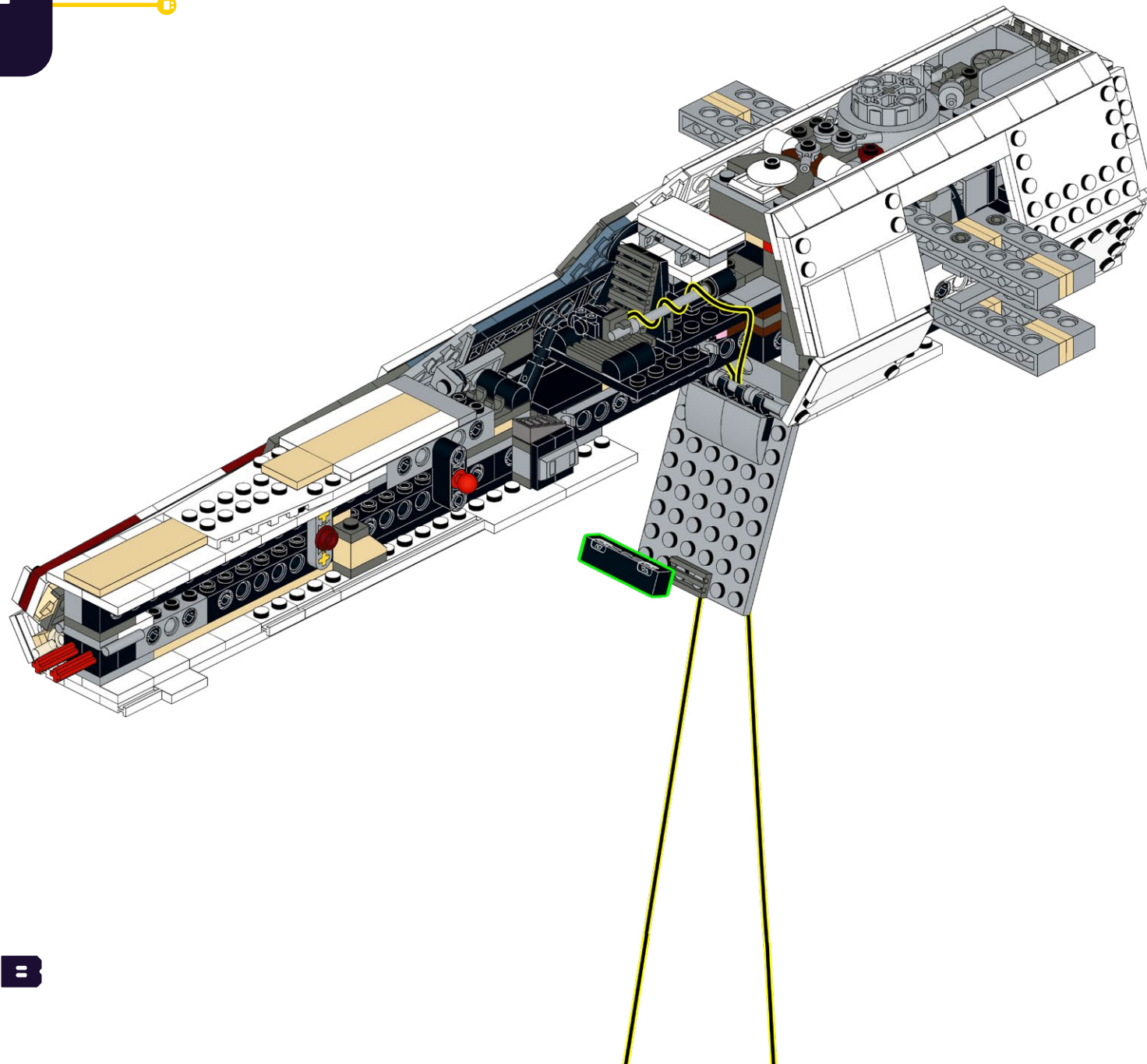

222

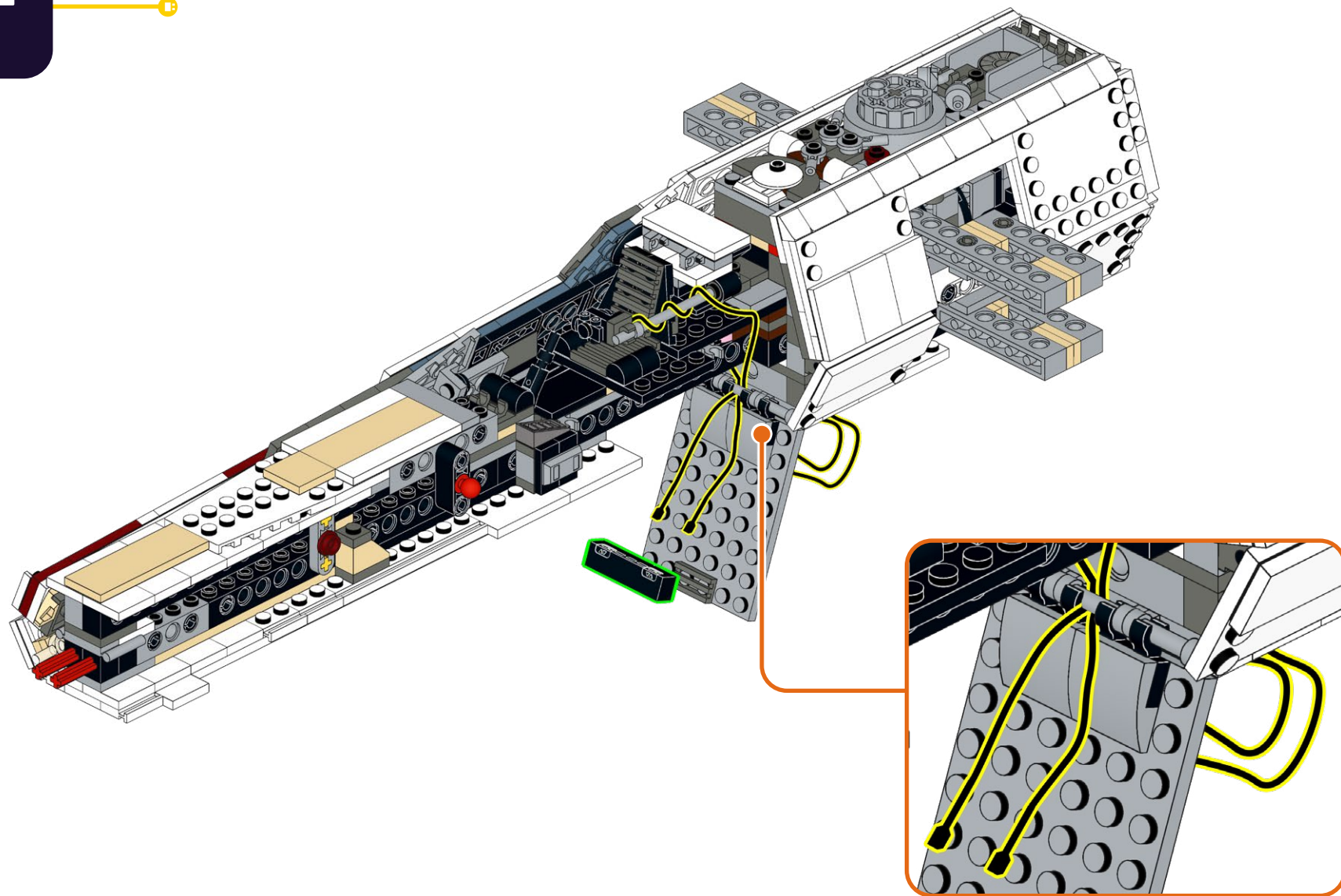



223

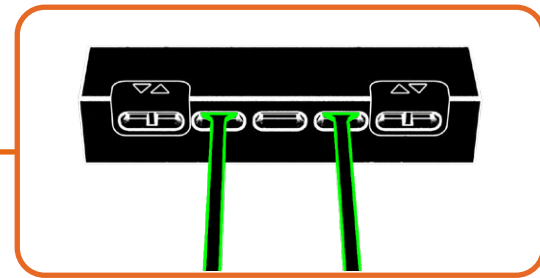
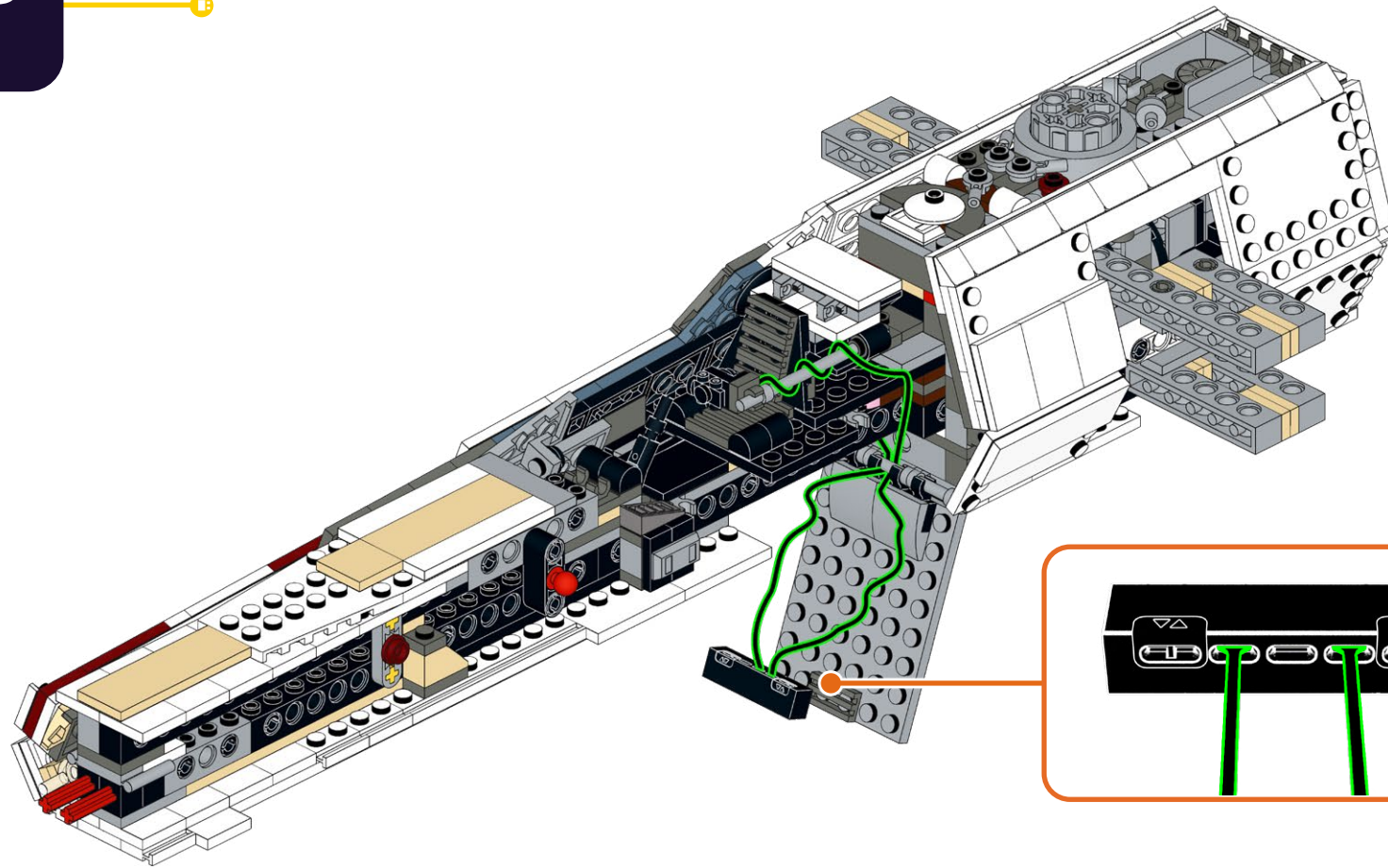



### **HOLD UP!**

You might notice some bags aren't in order, as well as left over pieces, but that's ok! We're changing the way you build LEGO!

### **ATTENDEZ!**

Vous remarquerez peut-être que certains sacs, ainsi que certaines pièces, ne sont pas dans le bon ordre. Mais pas de panique! Nous changeons simplement la façon avec laquelle vous construisez vos LEGO!

### **ASPETTA!**

Potresti notare che alcuni sacchetti non sono in ordine, così come i pezzi avanzati, ma va bene così! Stiamo cambiando il modo in cui costruisci i LEGO!

### **HALT!**

Sie werden möglicherweise bemerken, dass einige tüten durcheinander sind und teile übrig bleiben, aber das ist in Ordnung! Wir ändern die art und weise, wie Sie LEGO bauen!

### **¡ESPERA!**

Es posible que notes que algunas bolsas están fuera de servicio, así como piezas sobrantes, ¡pero está bien! ¡Estamos cambiando la forma en que construyes LEGO!

### **暫停!**

你可能会注意到一些袋子顺序错乱, 以及一些剩余的部件, 但没关系! 我们正在改变你搭建乐高的方式!

#### Open LMB Bag 01

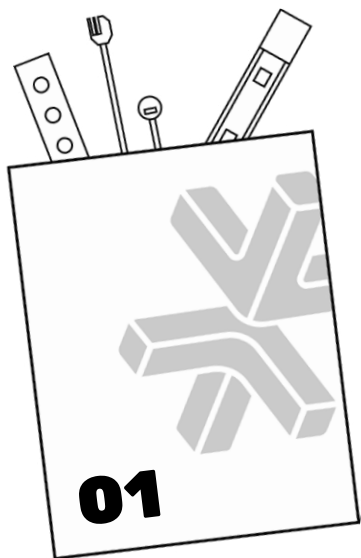

224

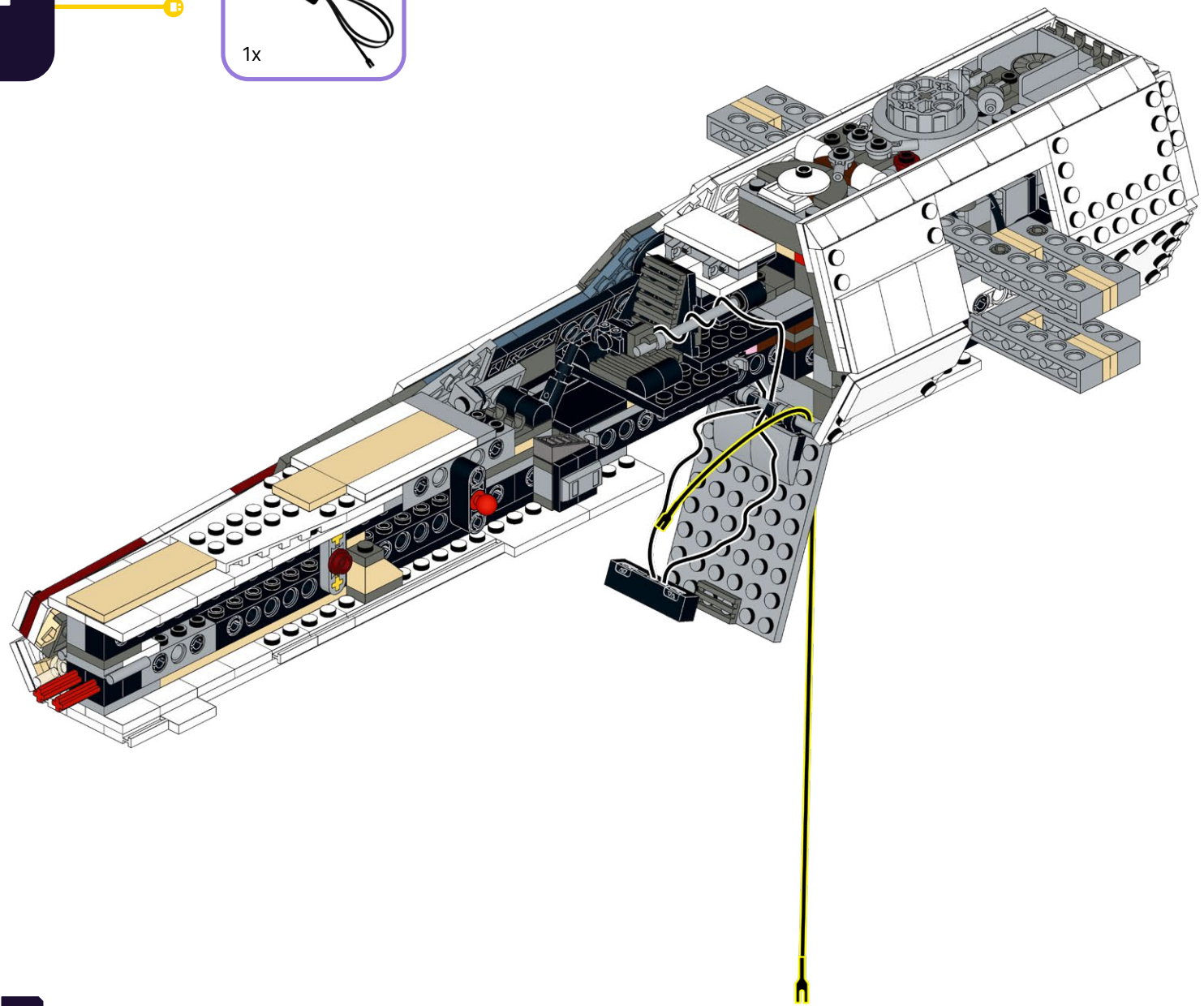
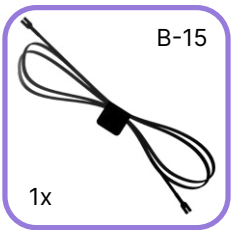

225

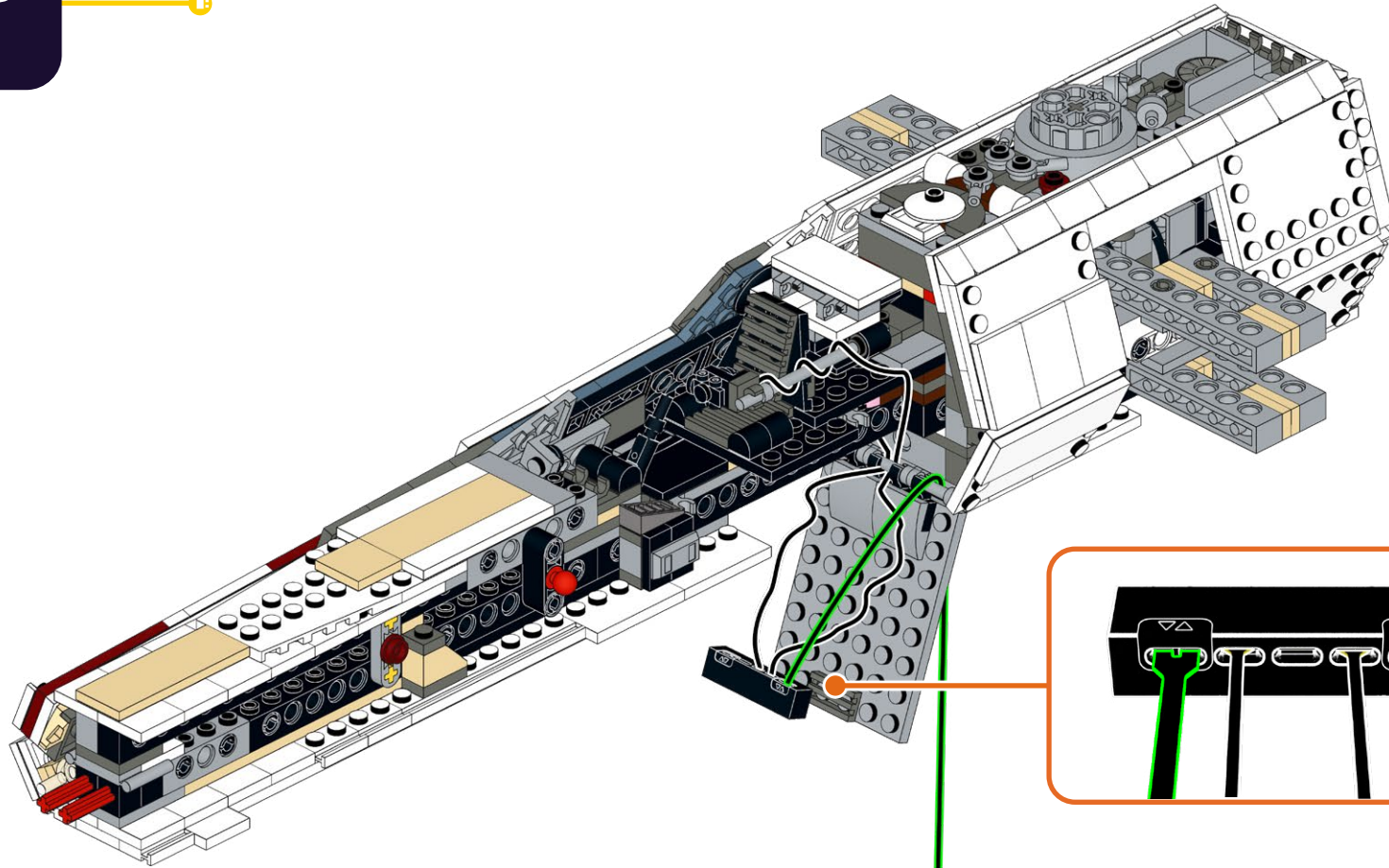



226

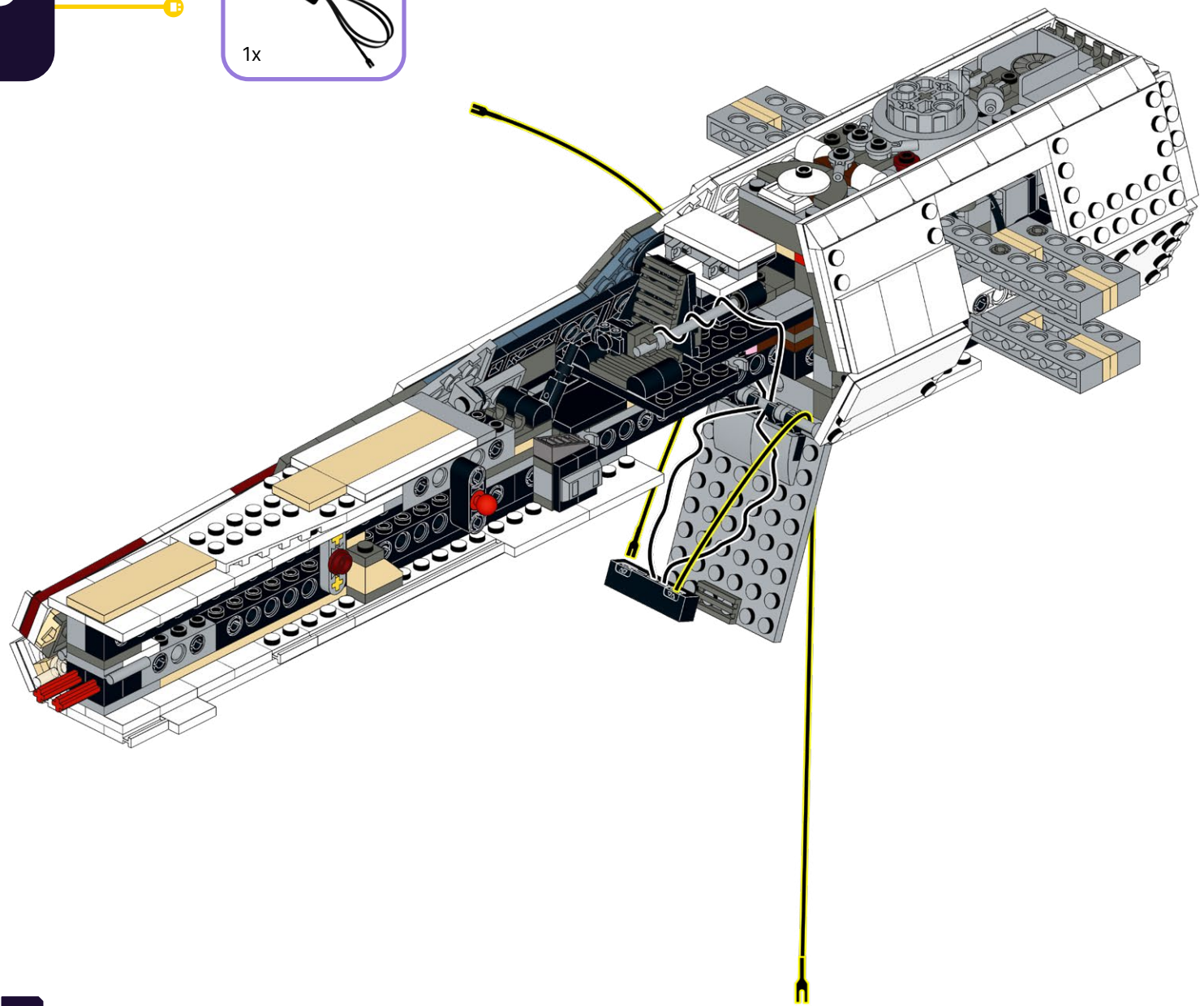
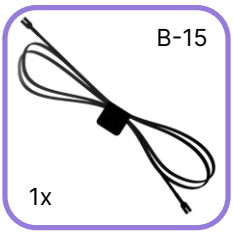

227

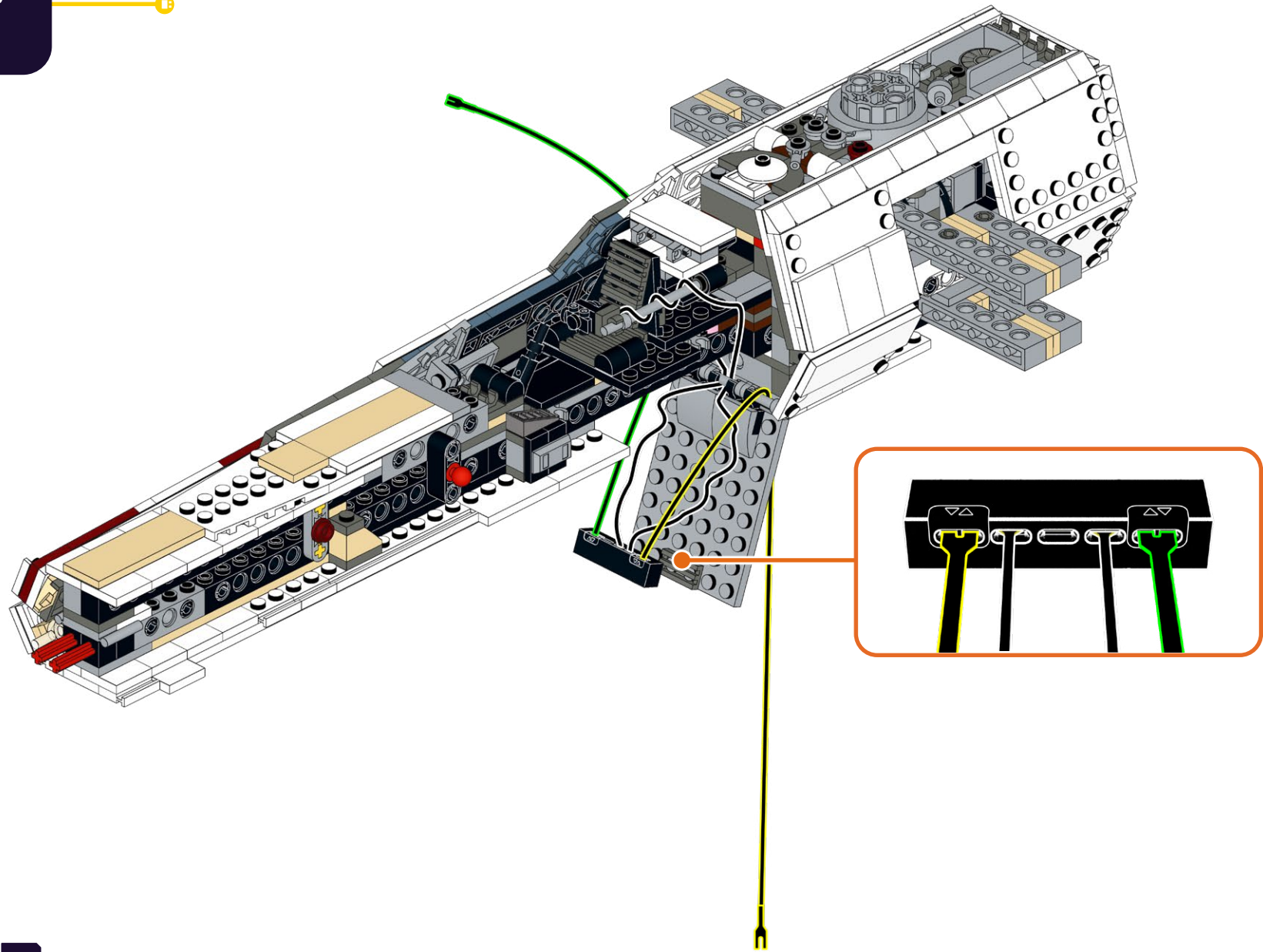

228

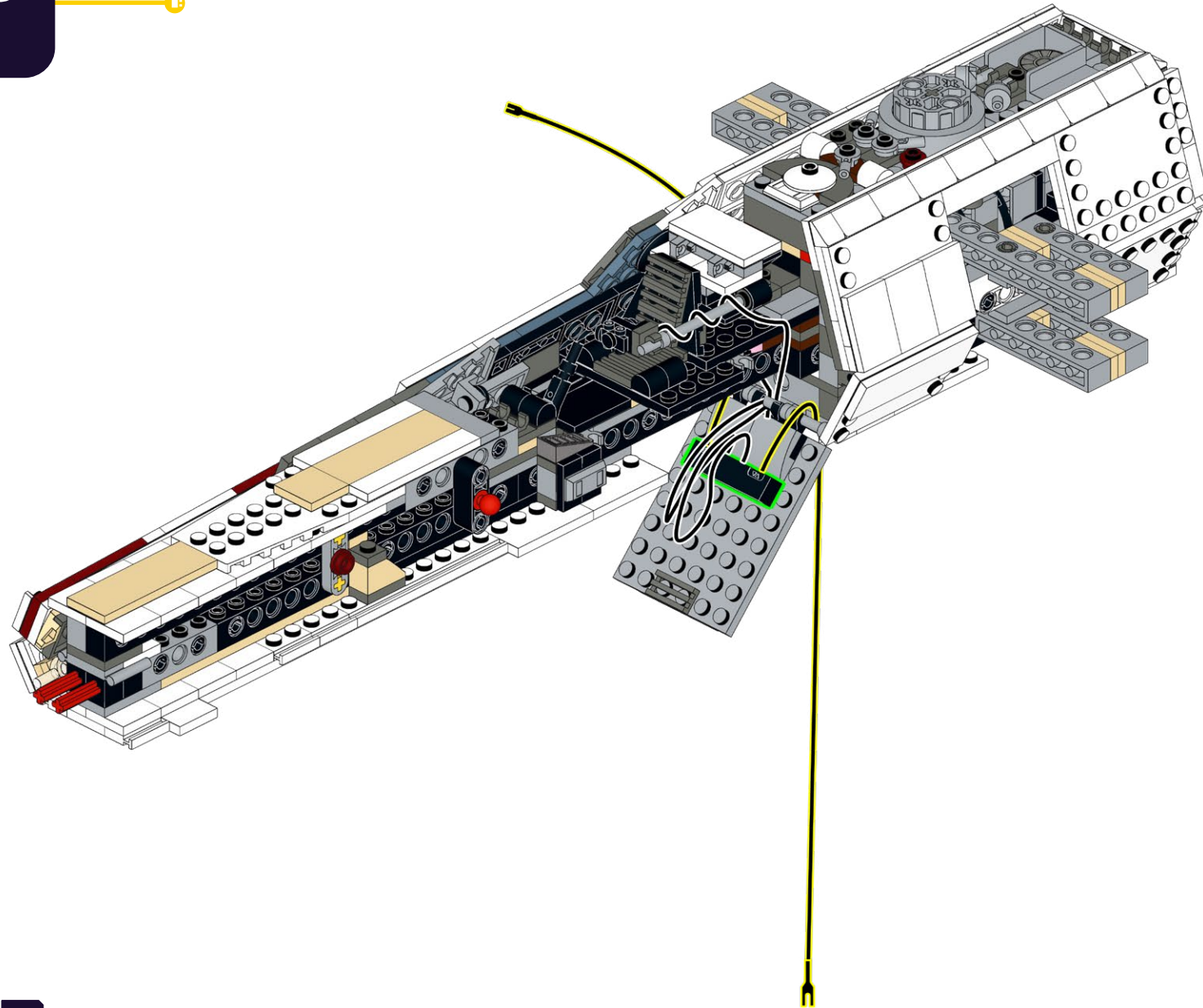

# 229

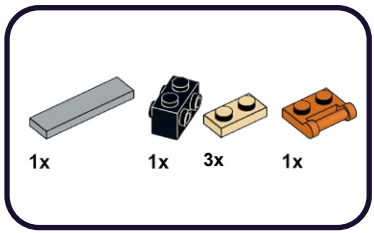

1

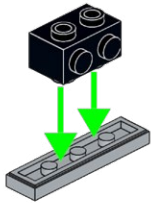

2

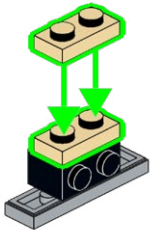

2

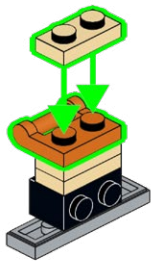

# 230

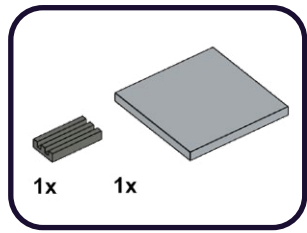

1

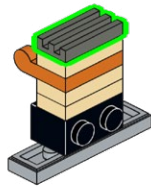

2

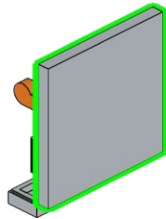

2

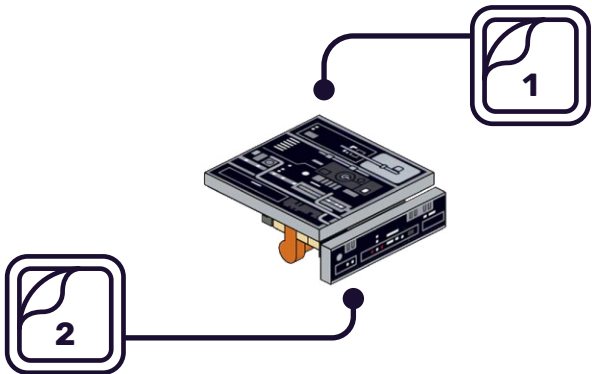



231

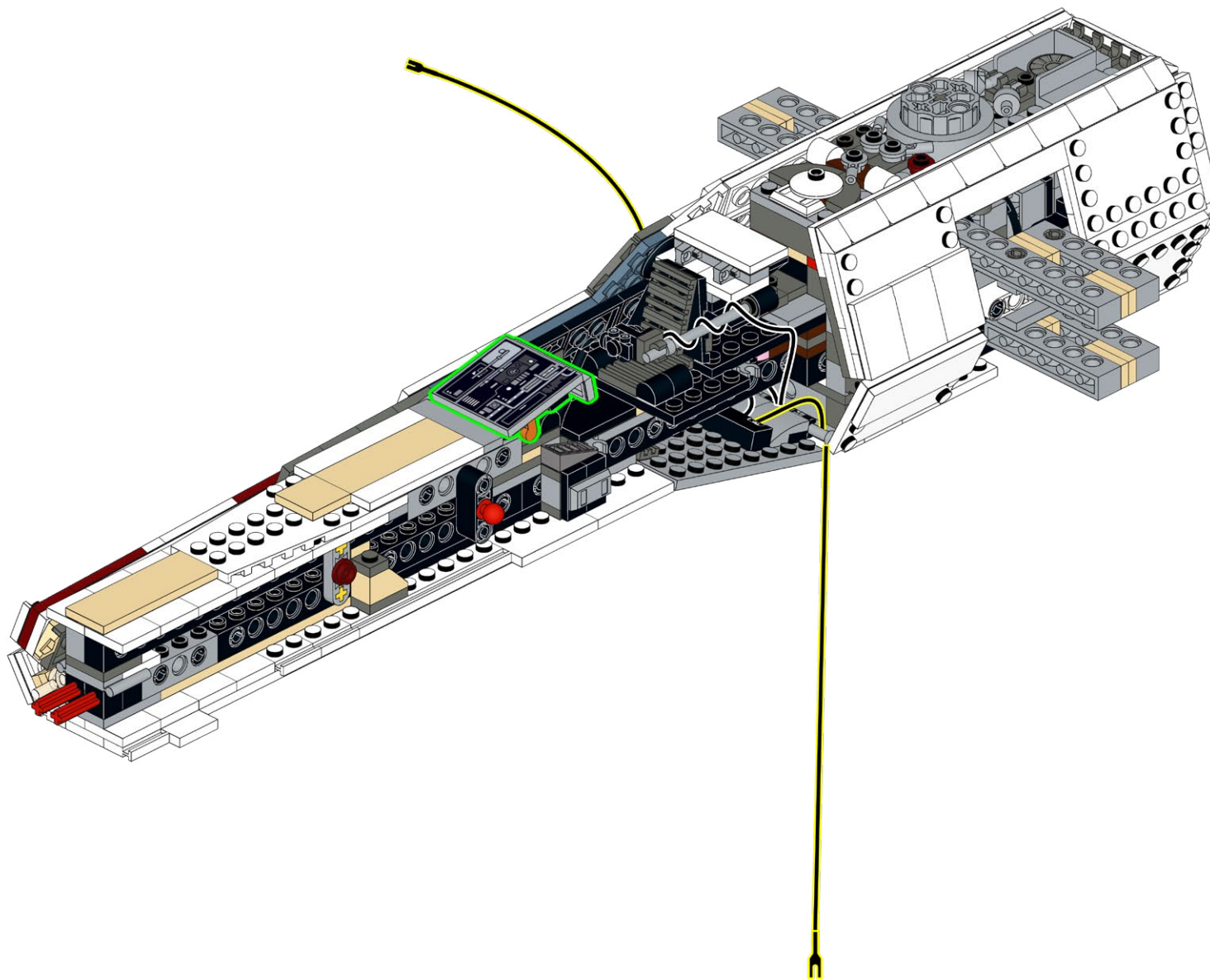

# 232

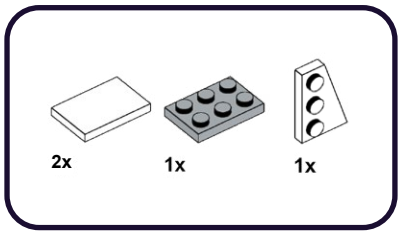

1

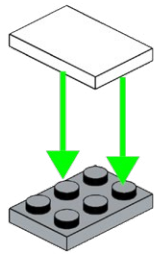

2

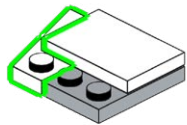

2

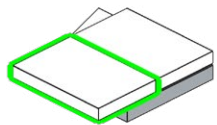

# 233

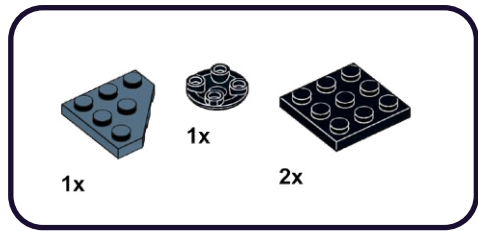

1

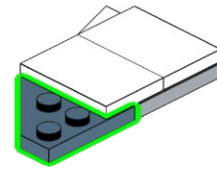

2

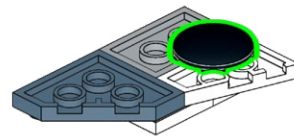

2

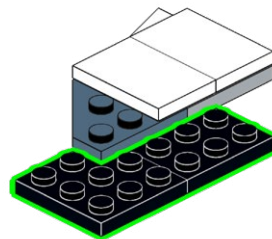

234

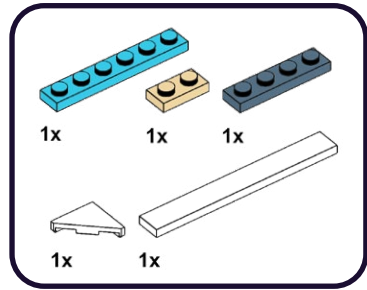

1

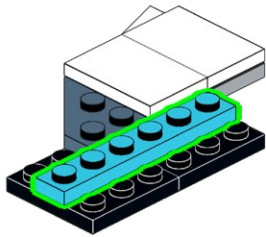

2

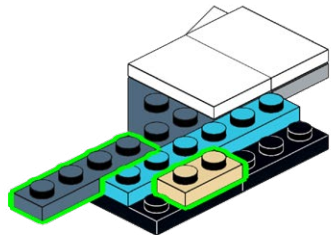

2

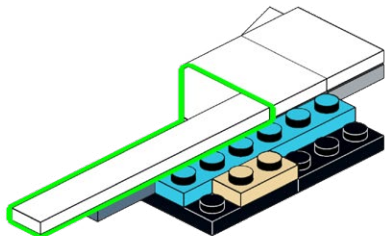

235

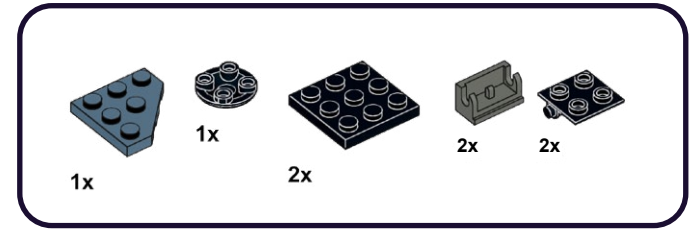

1

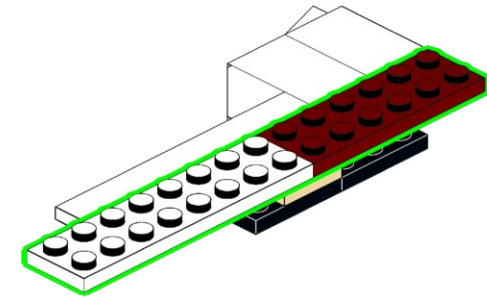

2

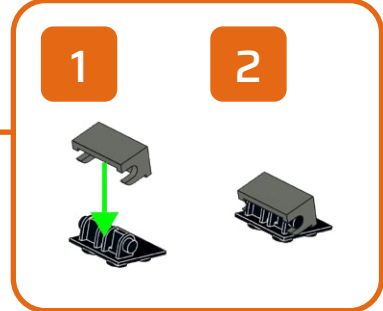
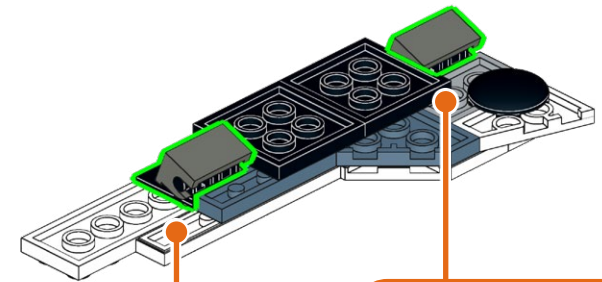



**236**

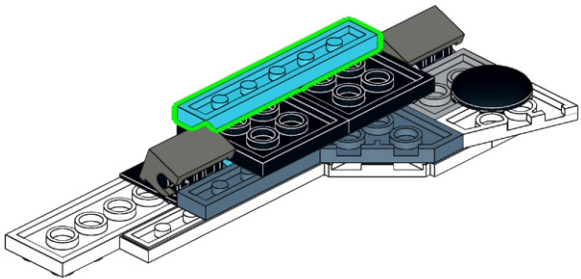
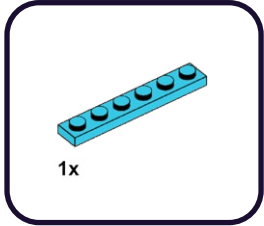

**237**

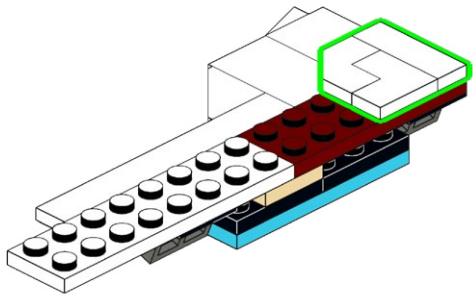
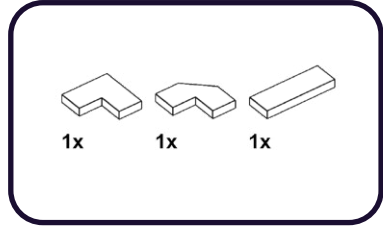

238

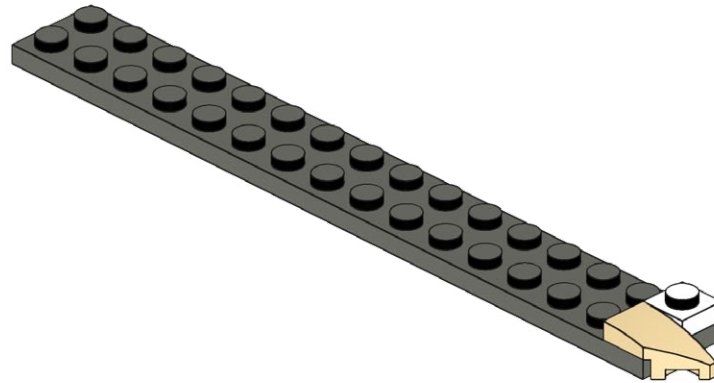
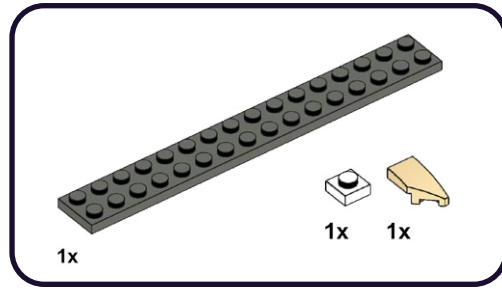

239

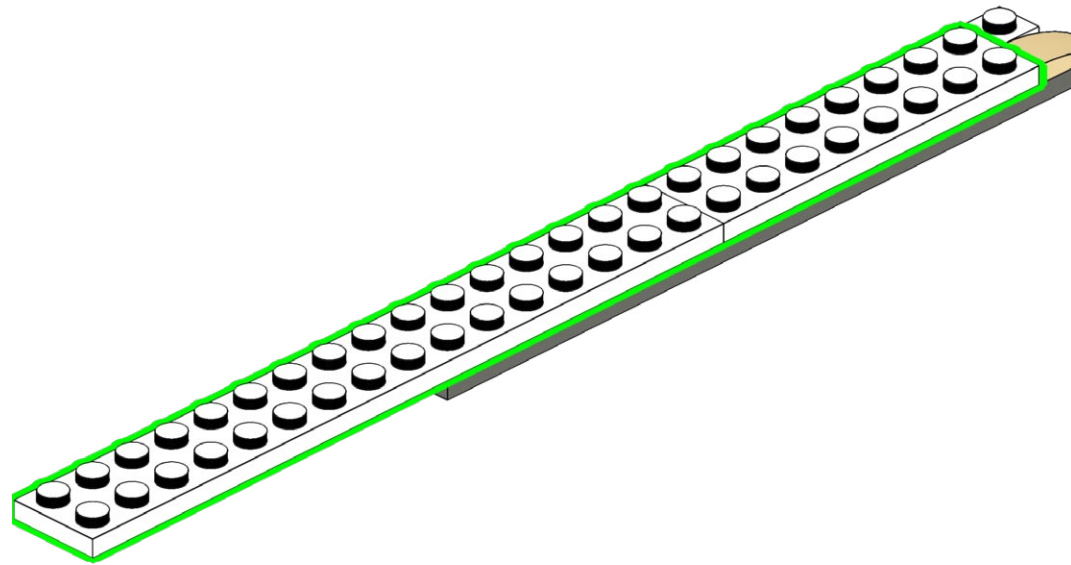
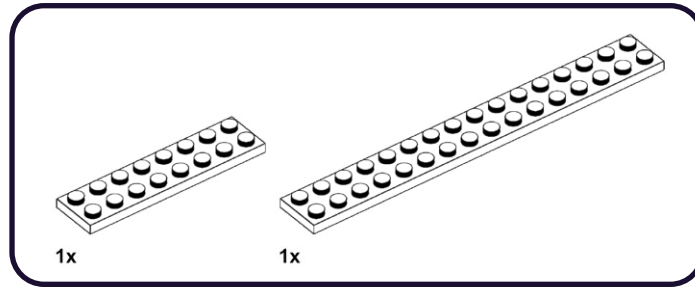

240

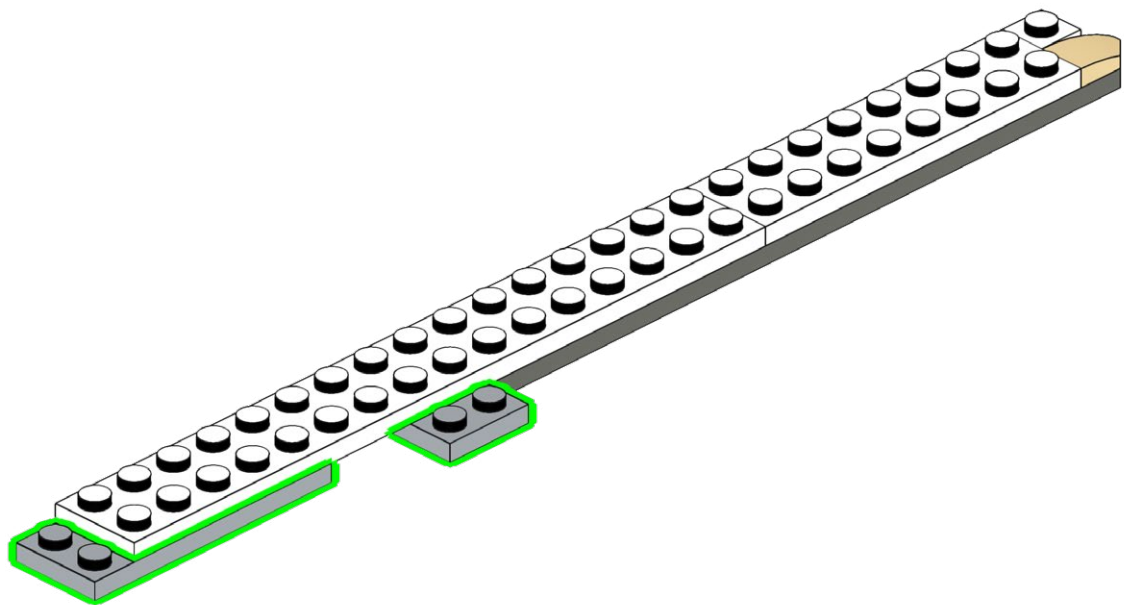
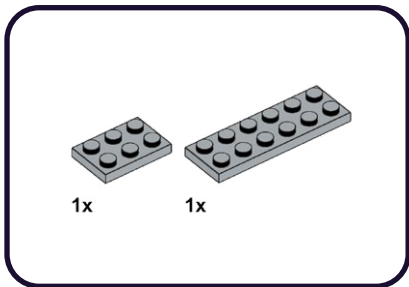

241

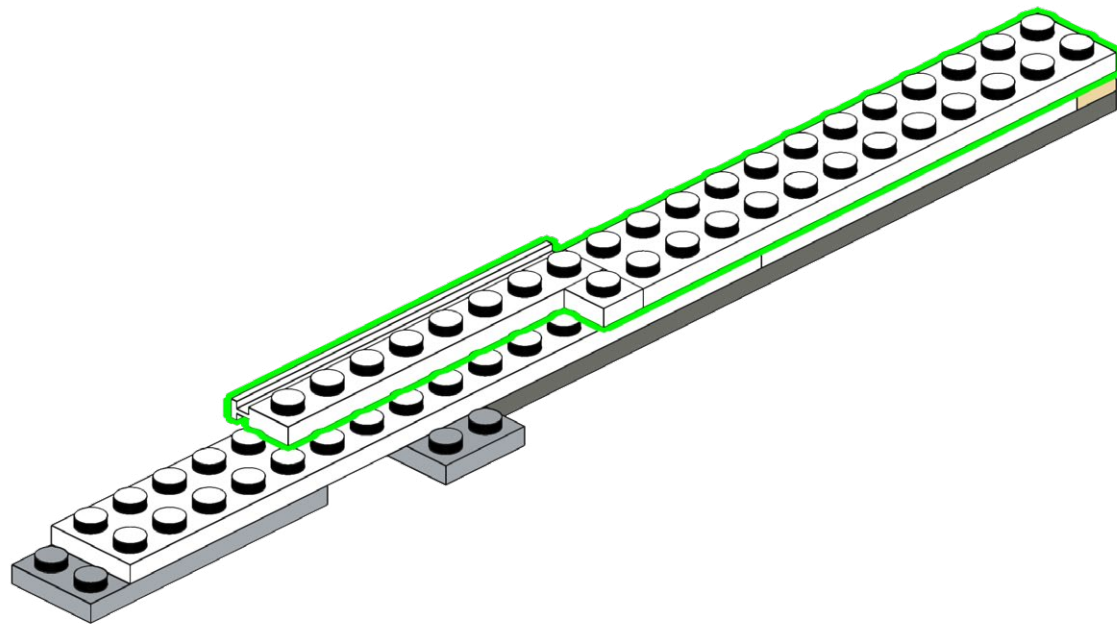
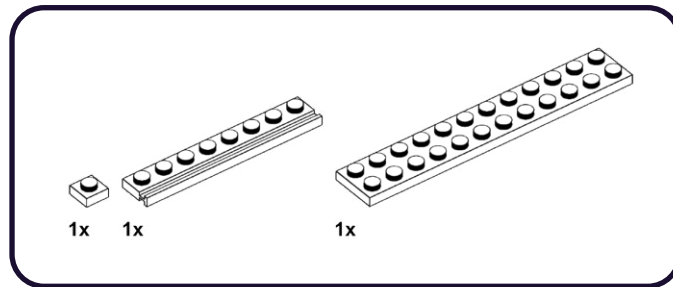

242

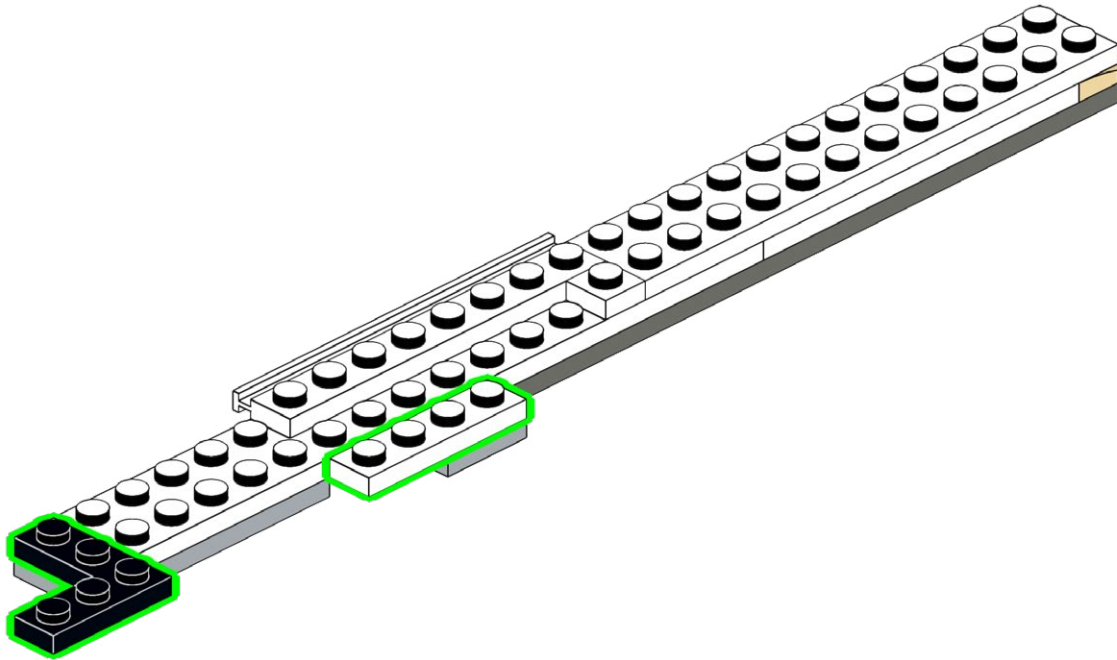
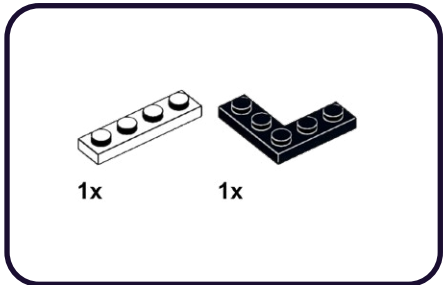

243

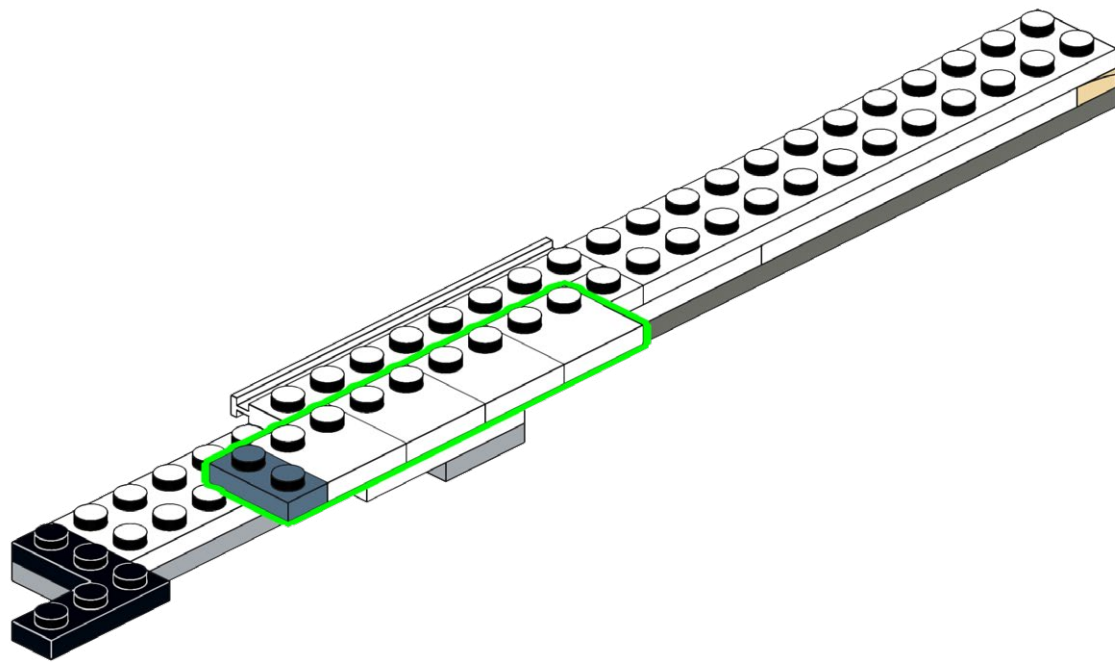
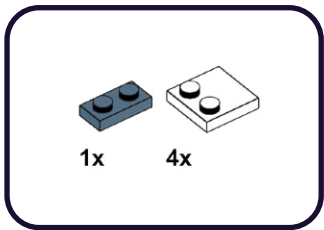



244

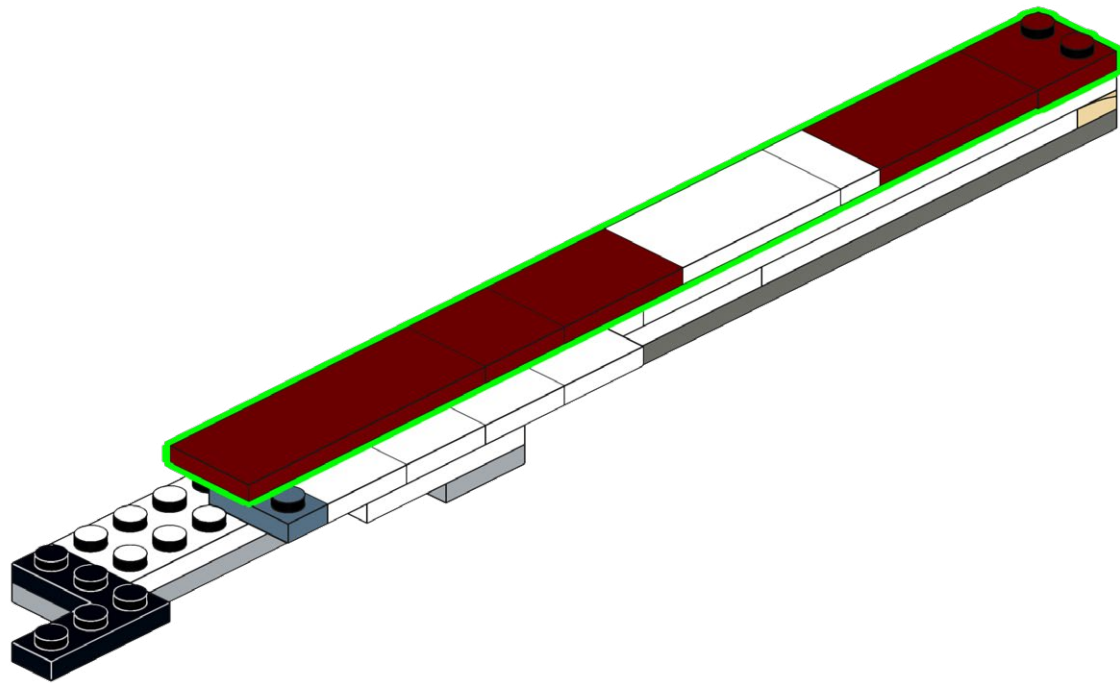
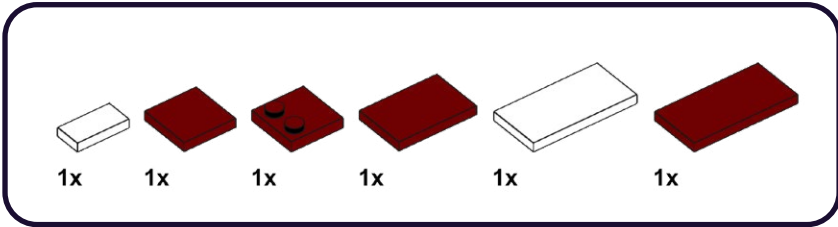

245

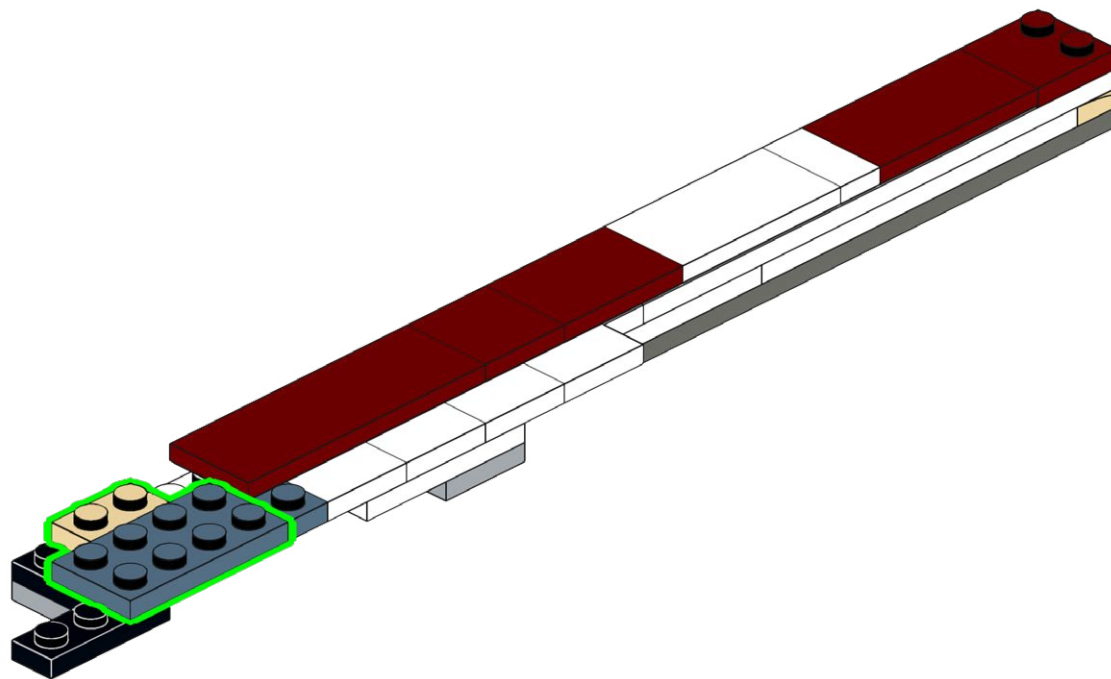
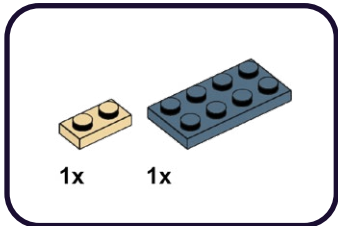

246

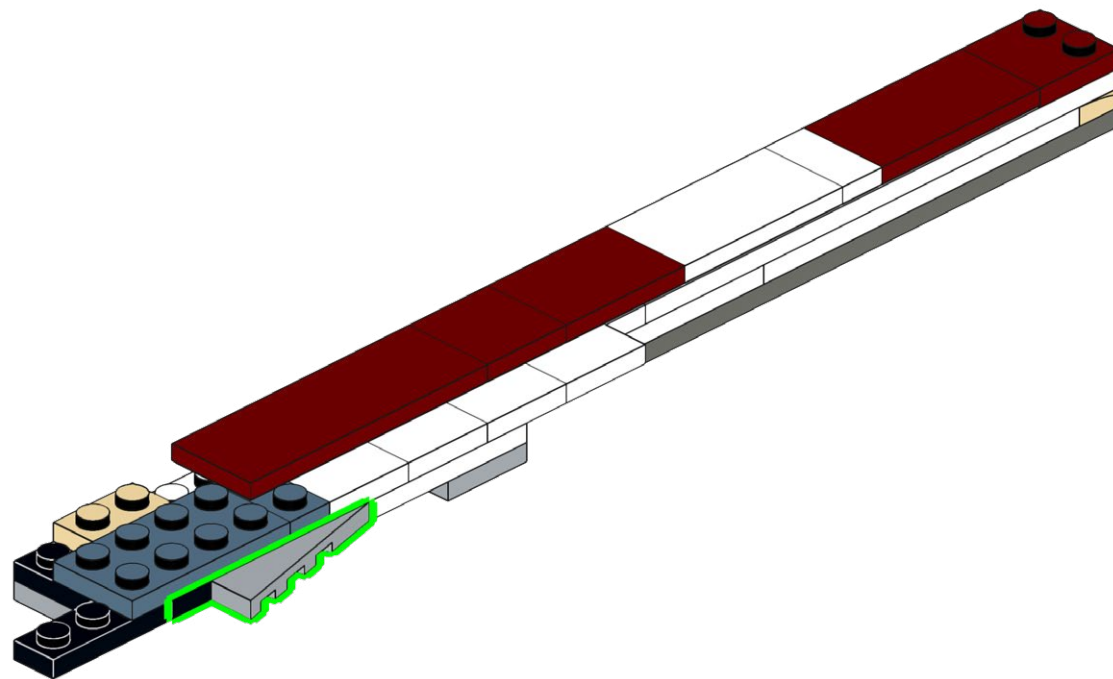
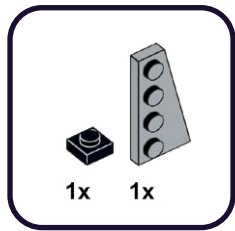

247

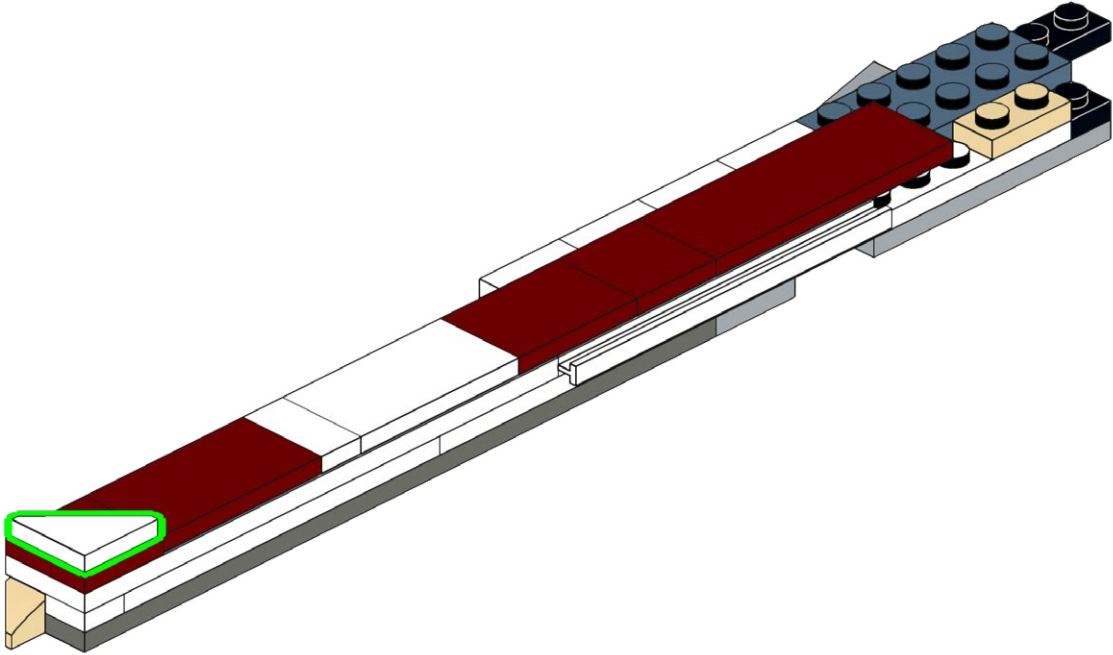
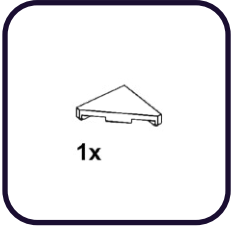

248

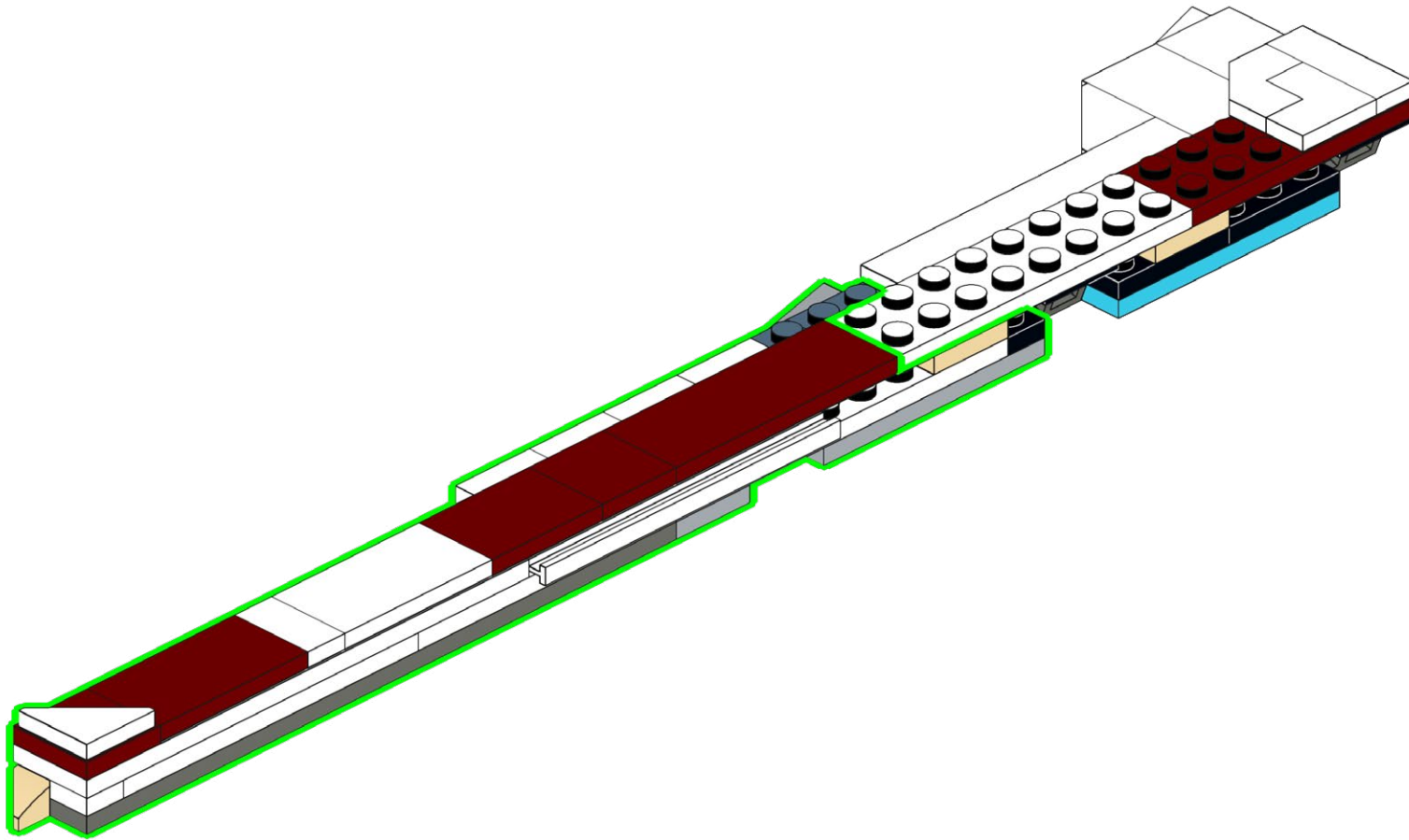

249

1x

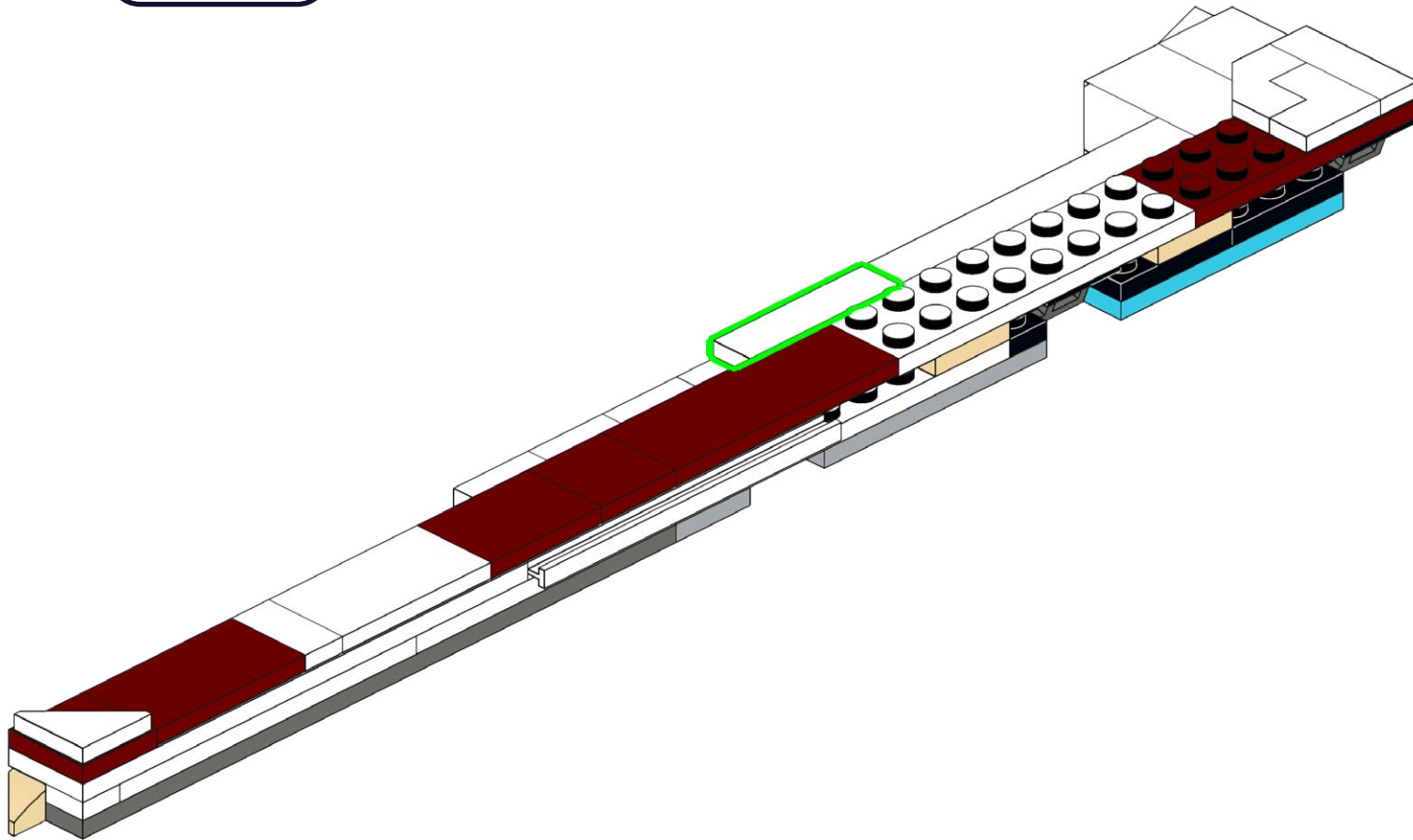

250

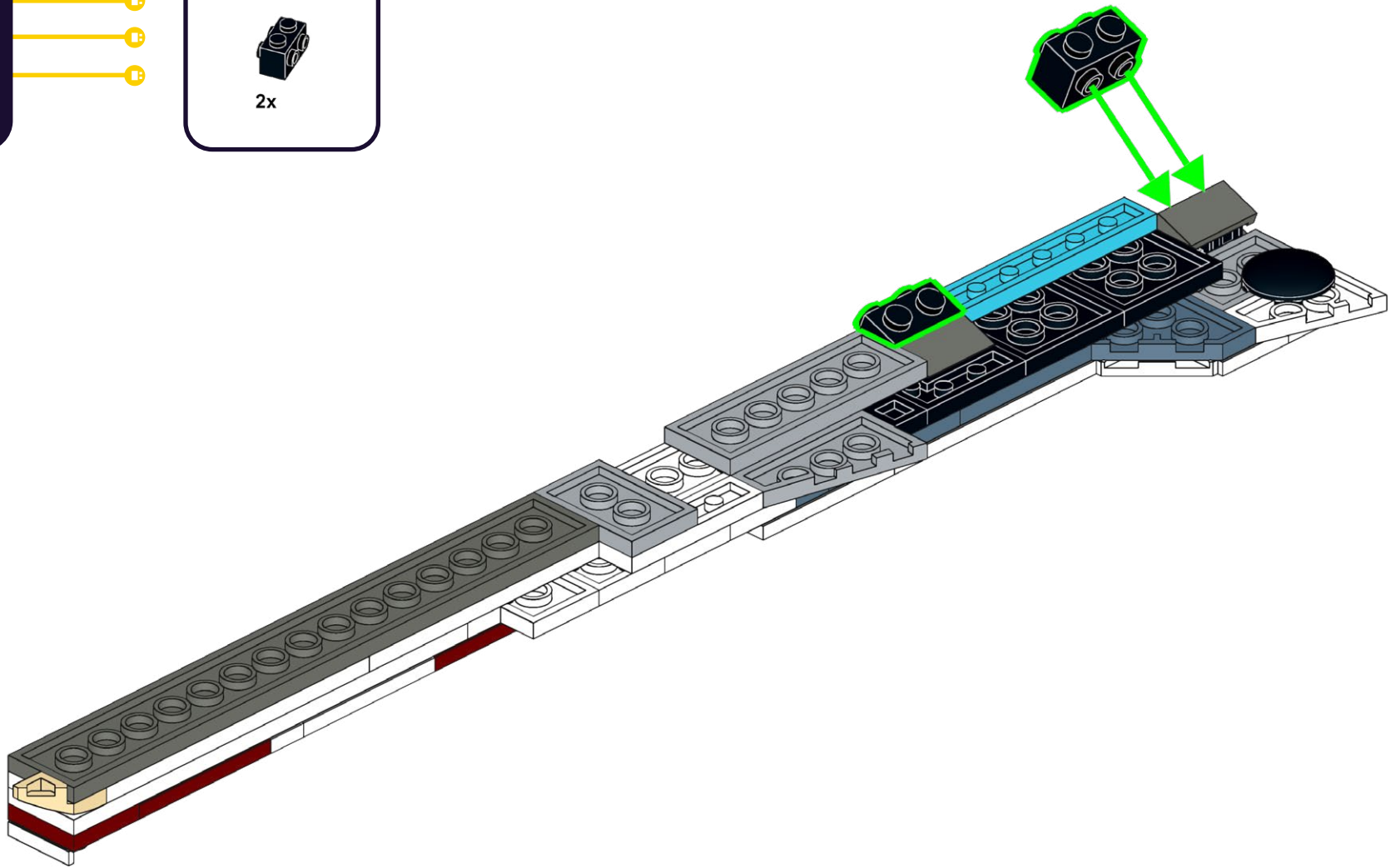



251

2x

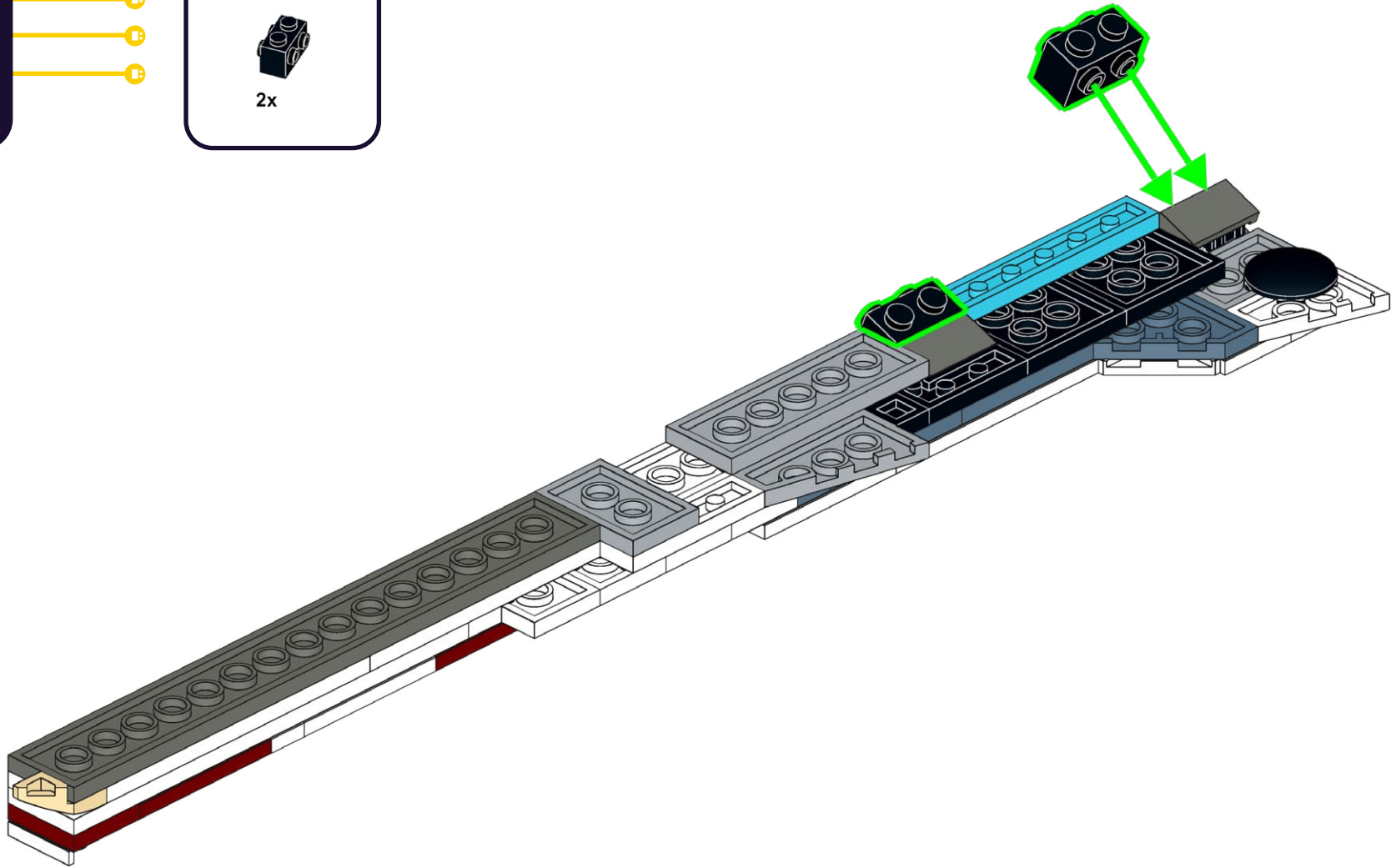

252

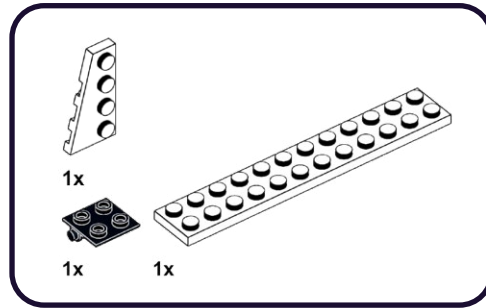

1

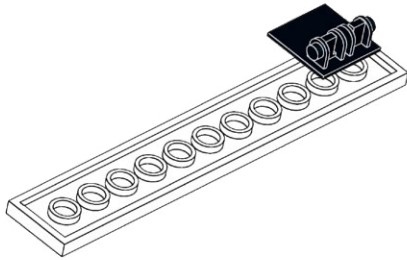

2

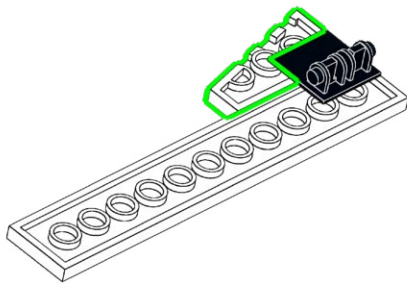

253

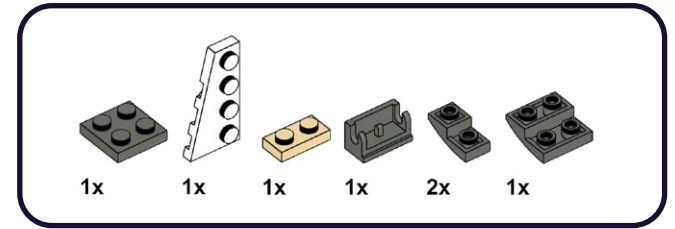

1

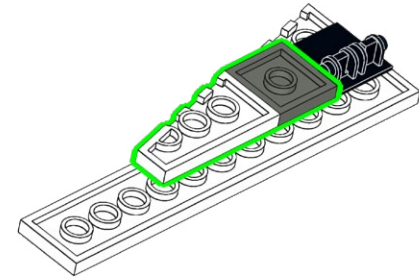

2

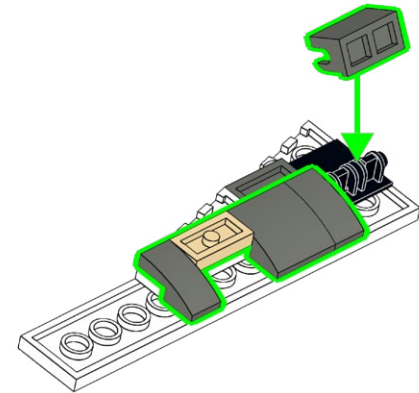

254

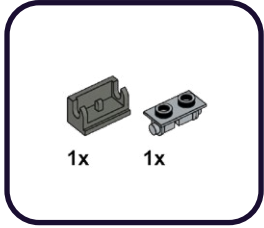

1

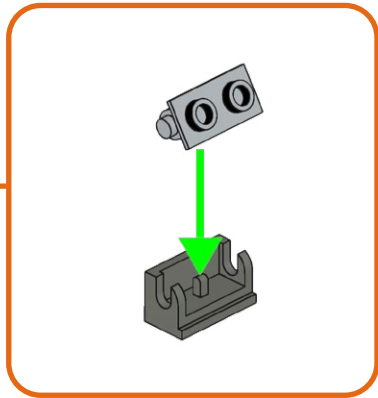
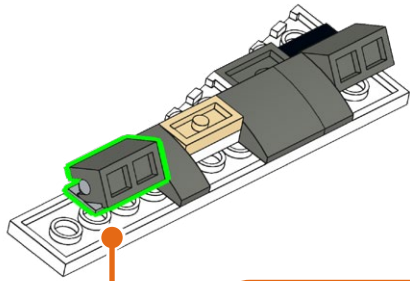

255

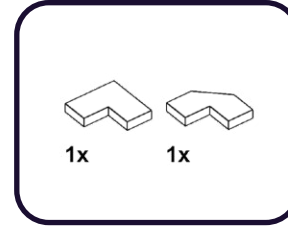

1

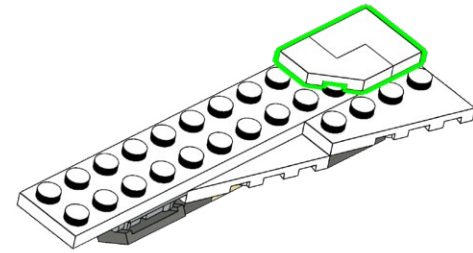

**256**

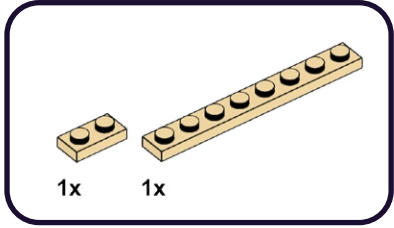

**1**

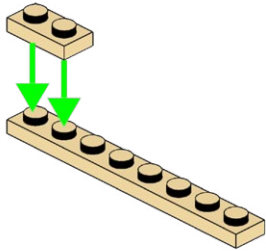

**257**

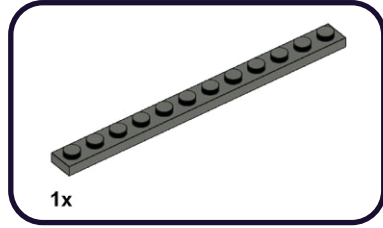

**1**

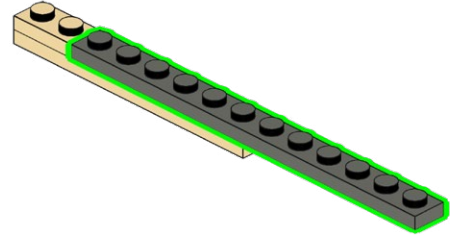

258

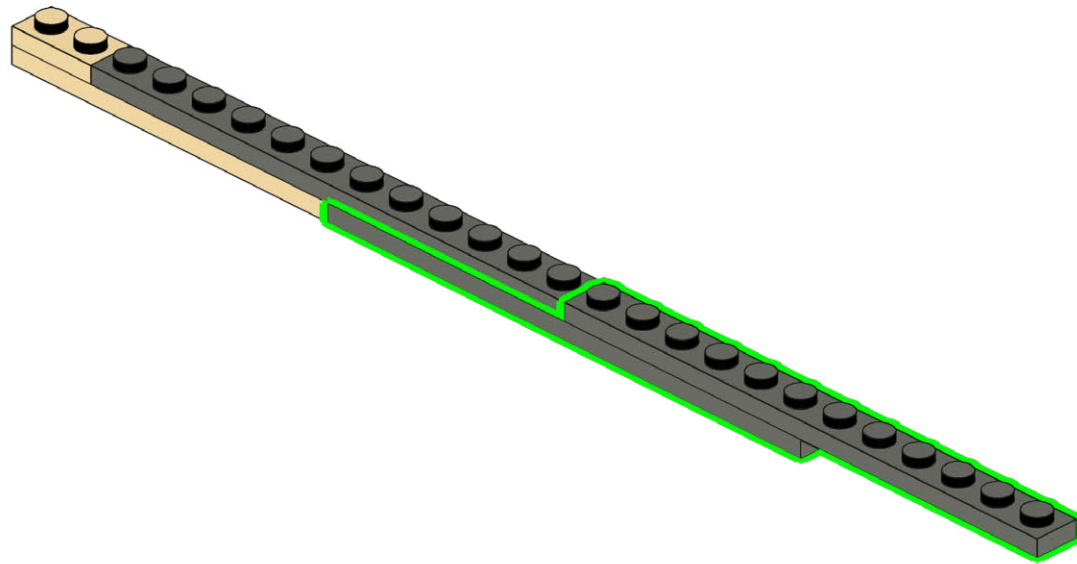
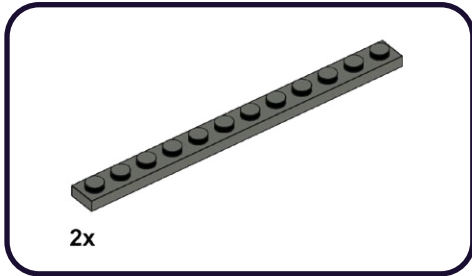

259

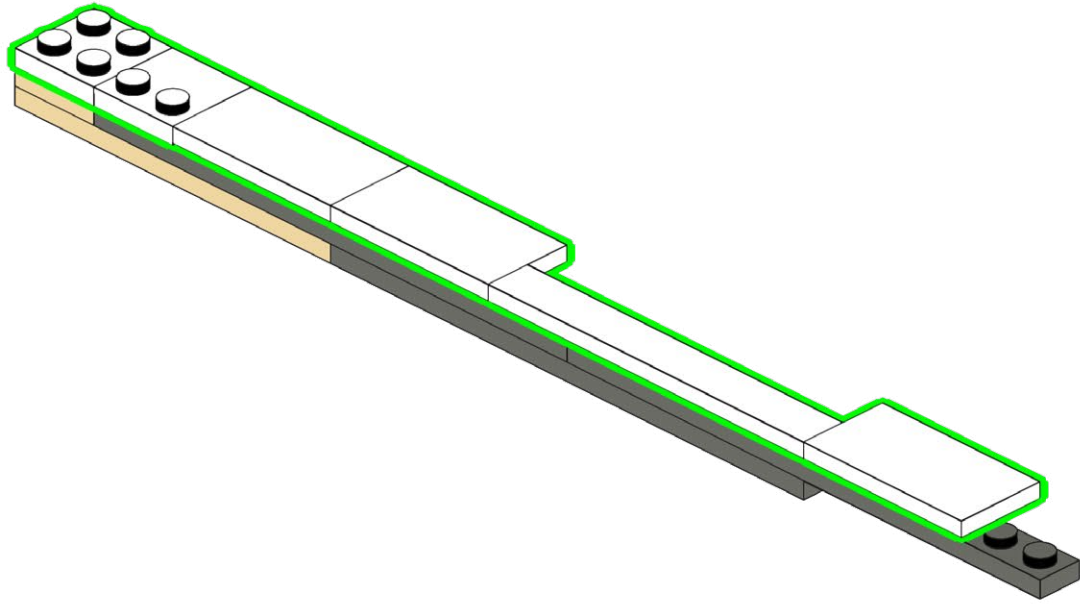
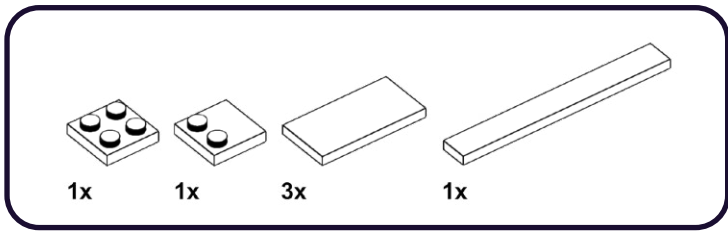

260

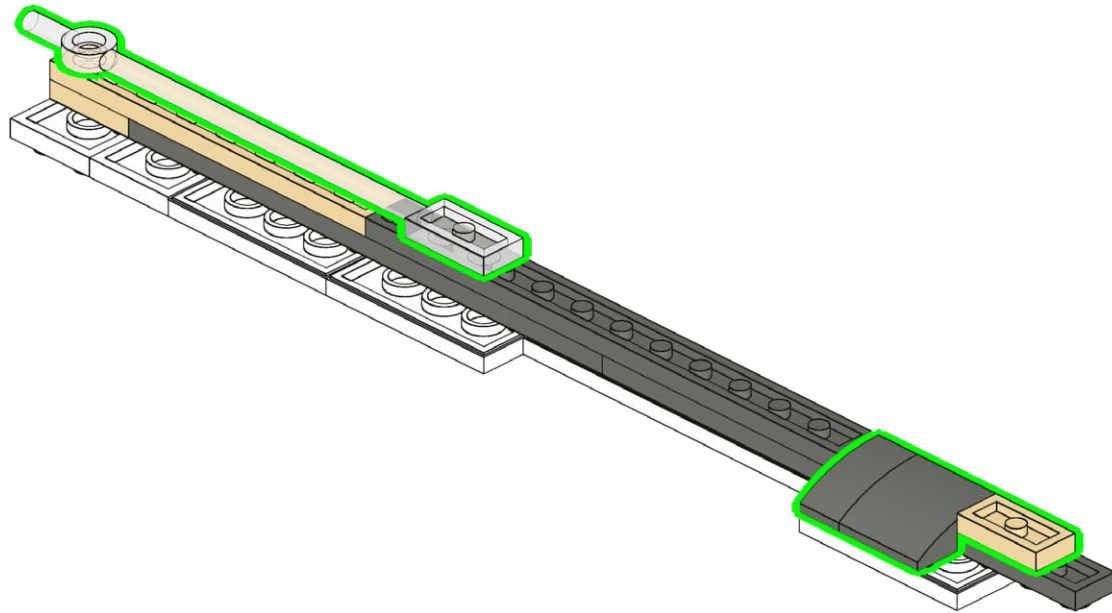
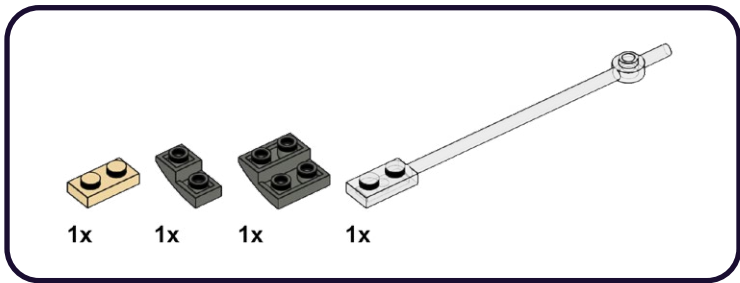



261

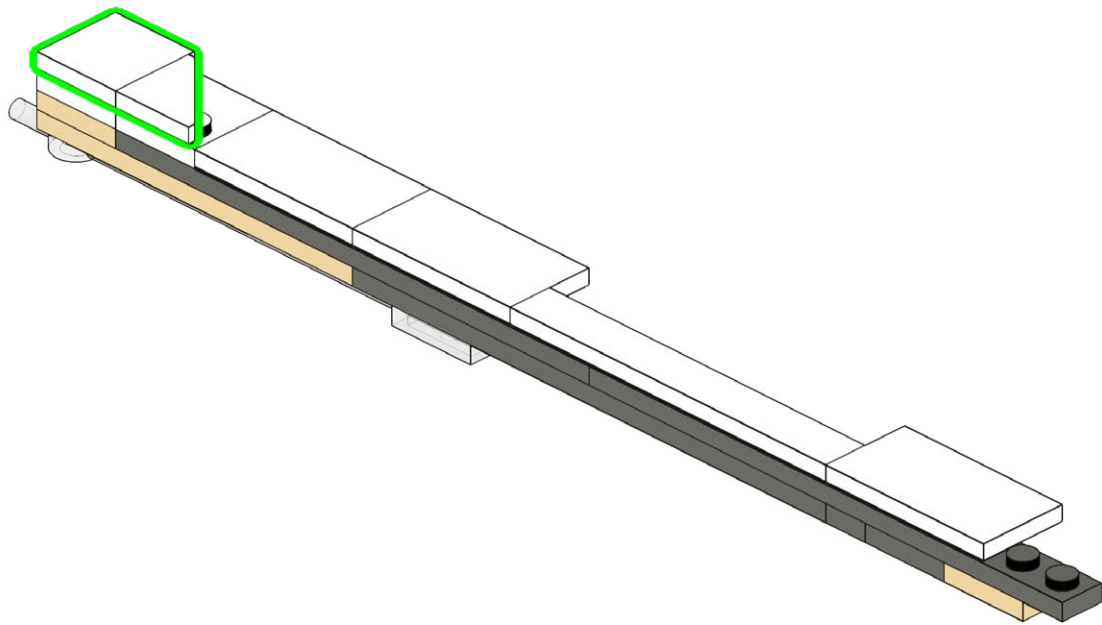
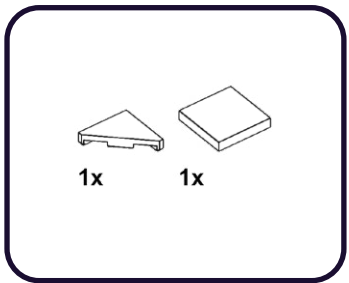

262

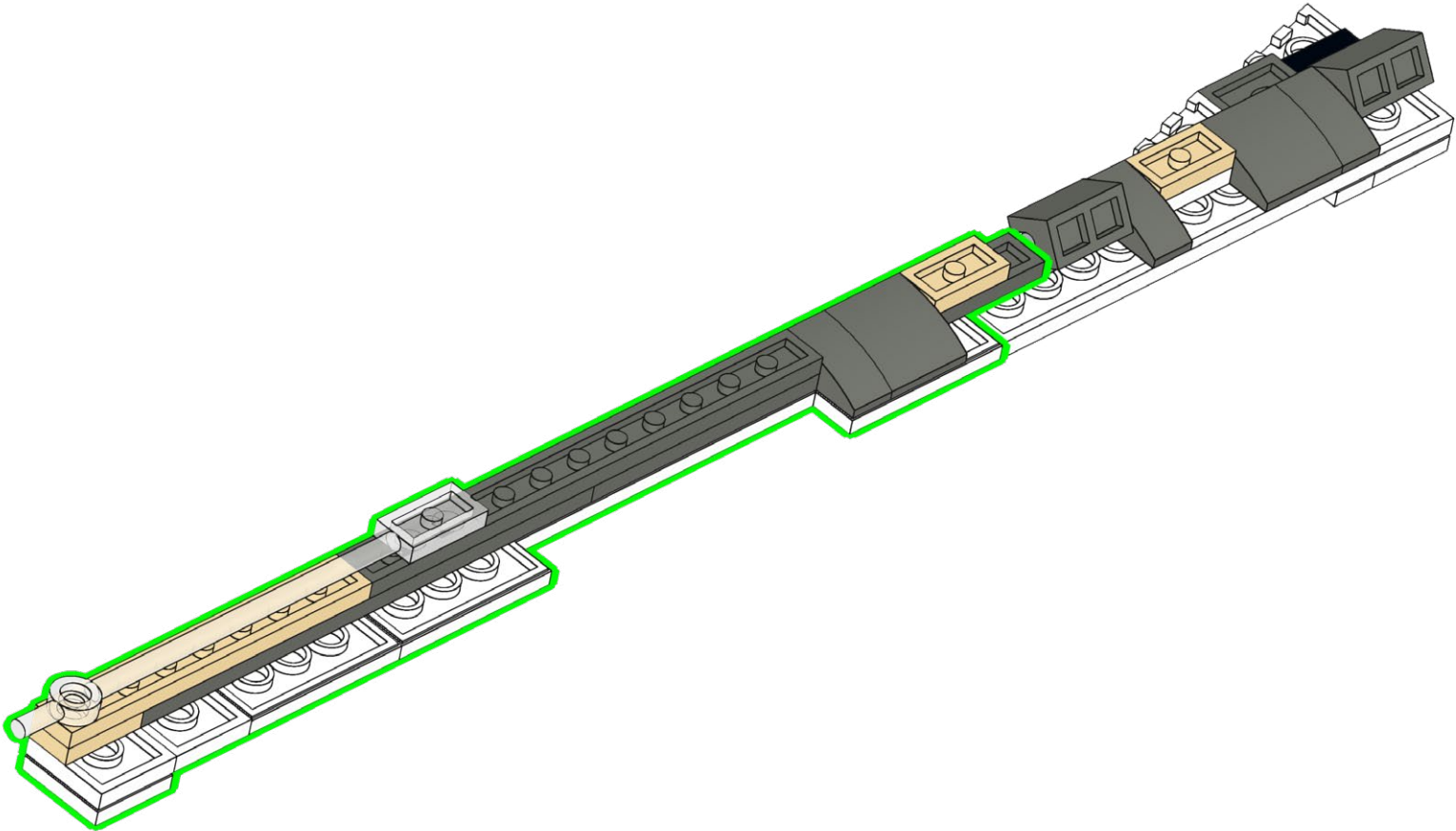

263



1x

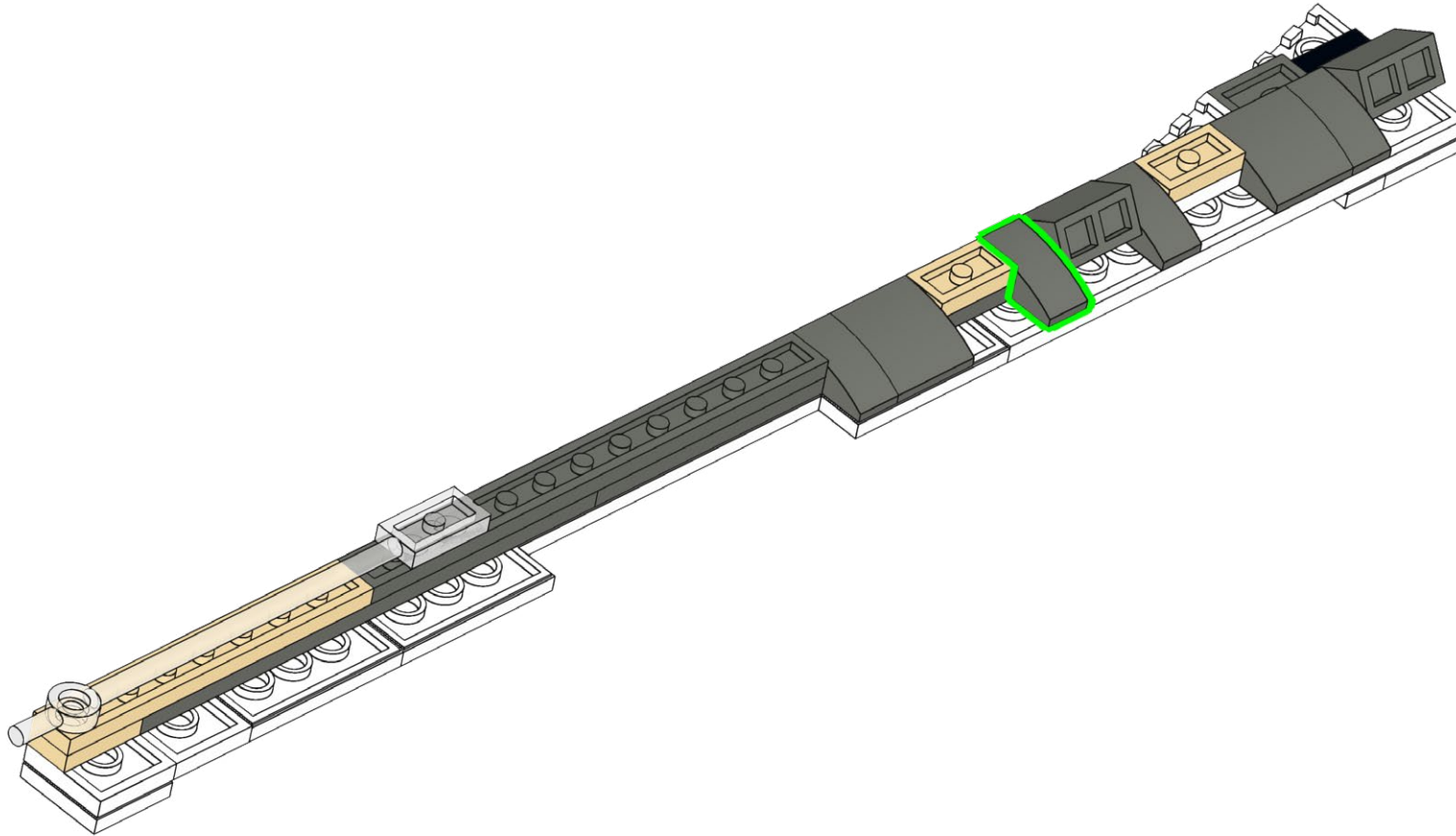

264



1x

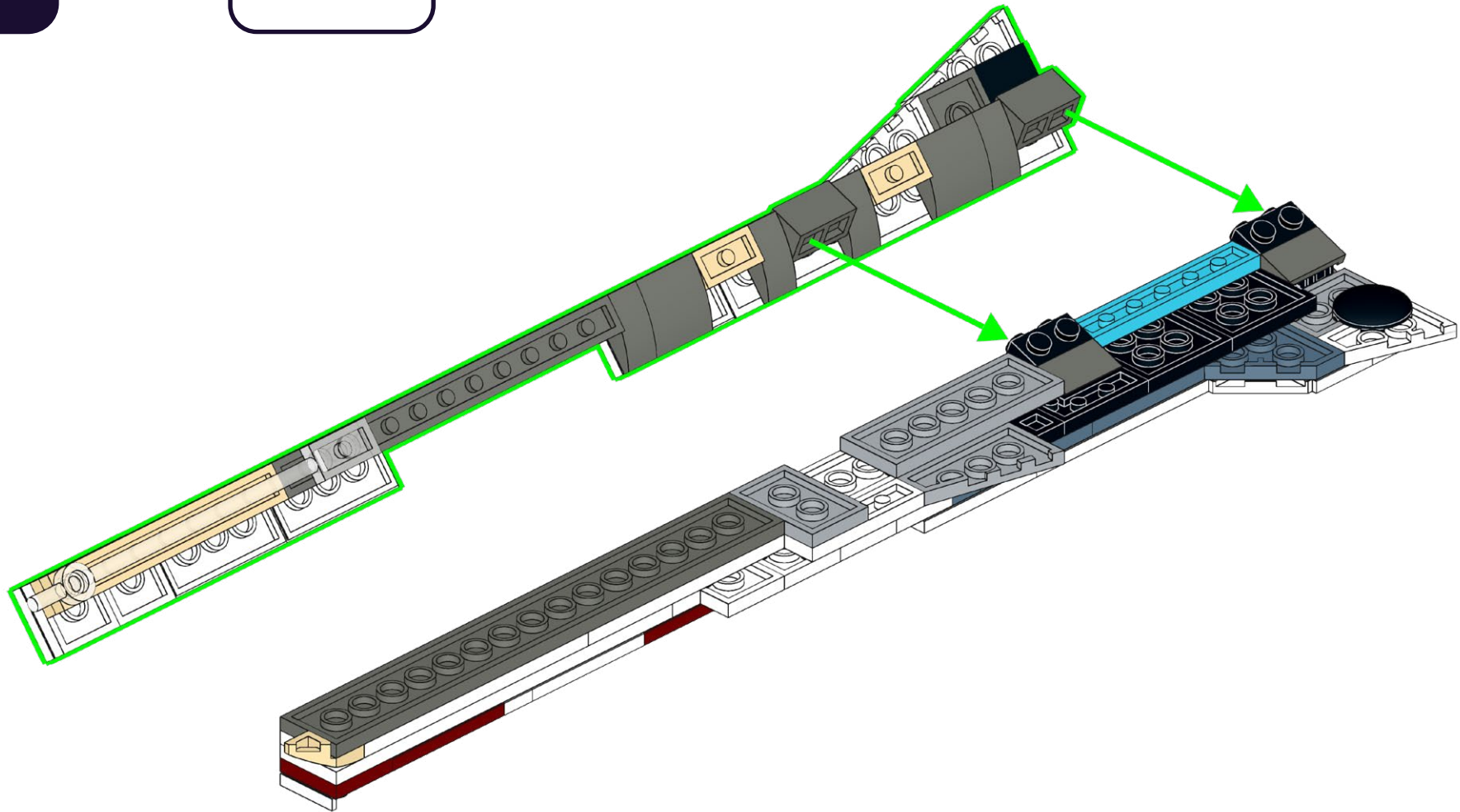

265

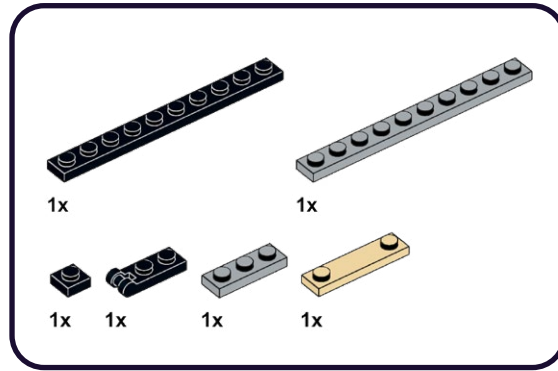

1

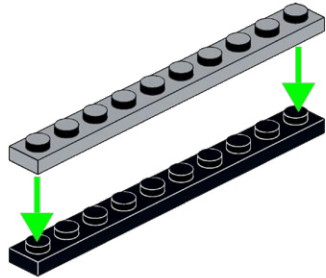

2

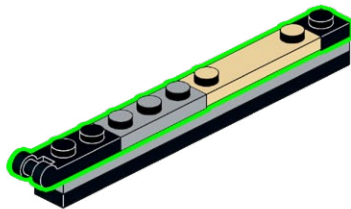

266

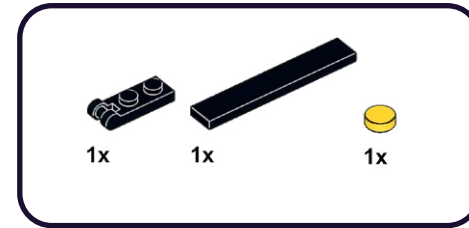

1

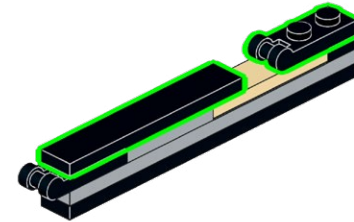

2

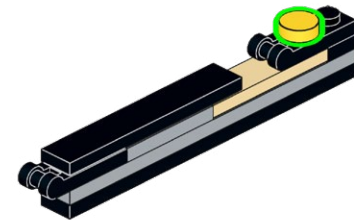

267

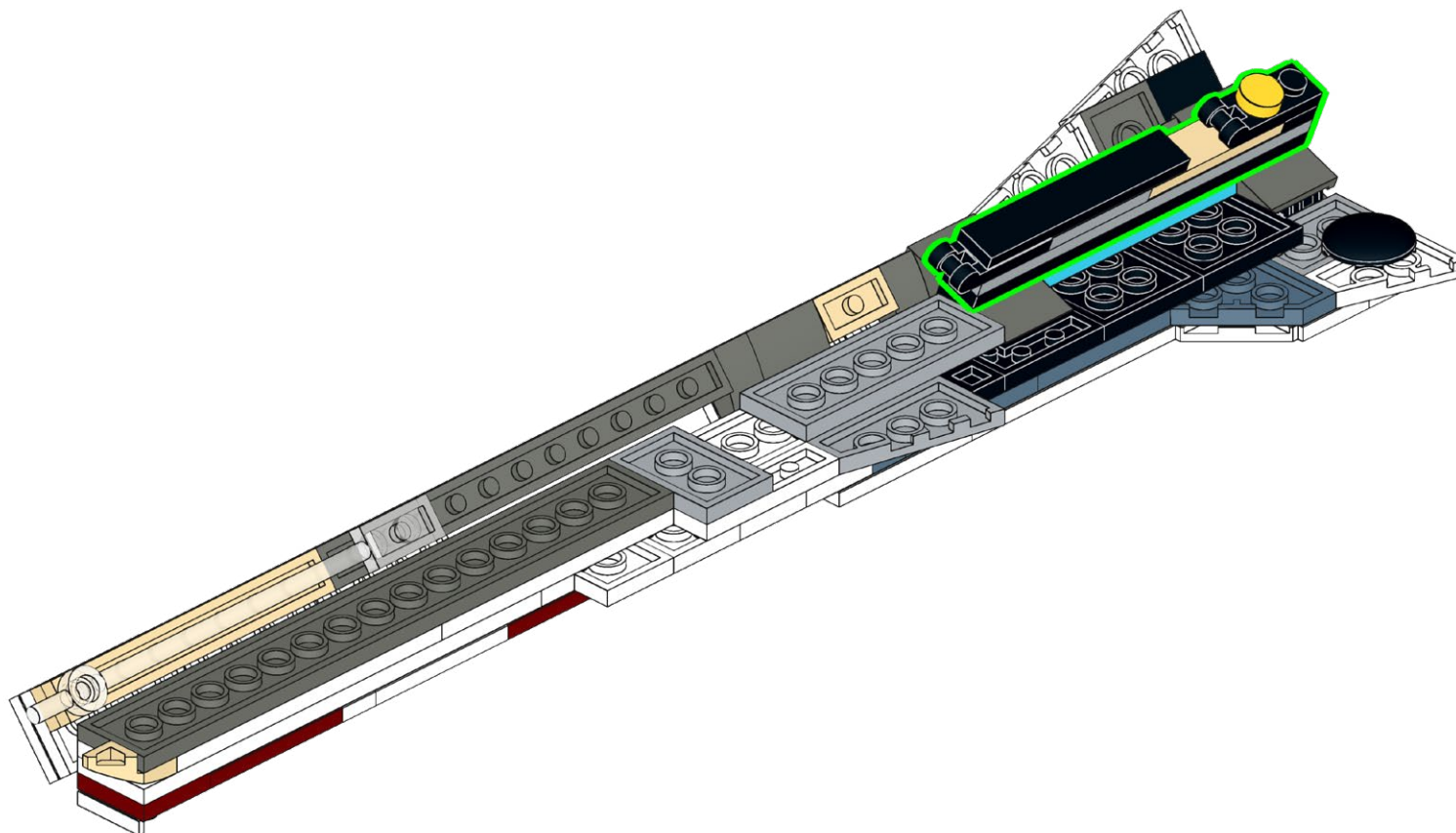



268

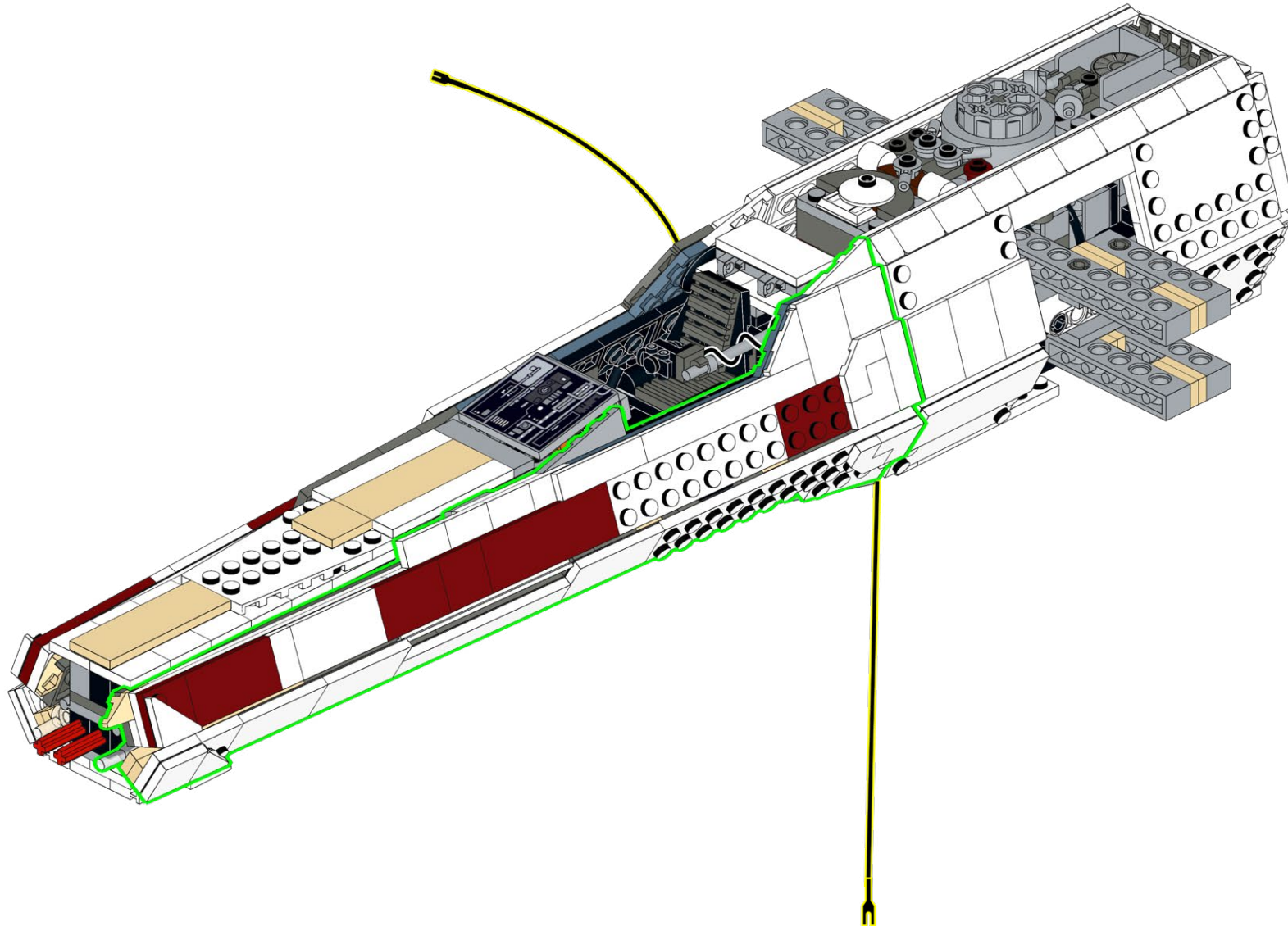



269

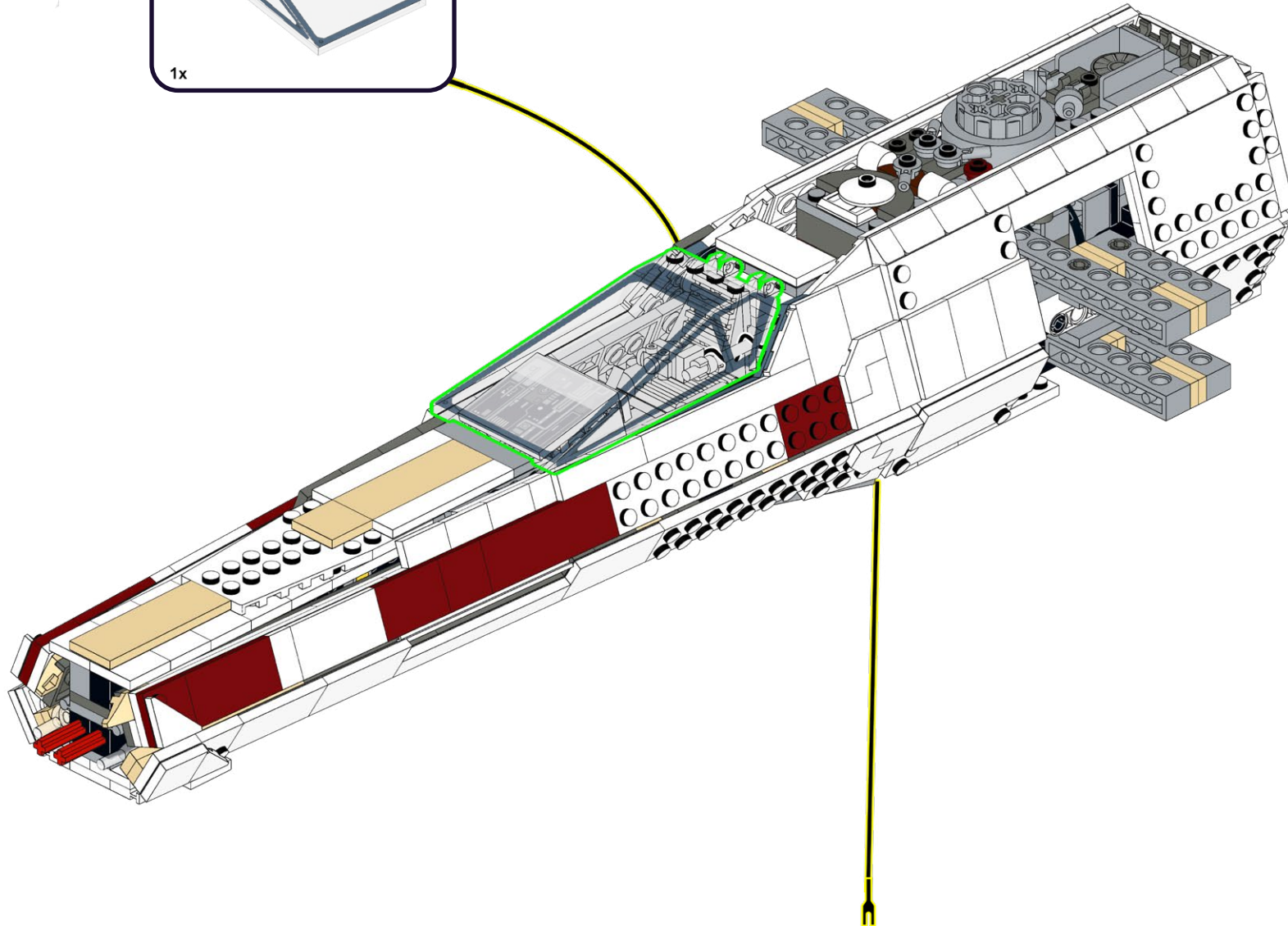
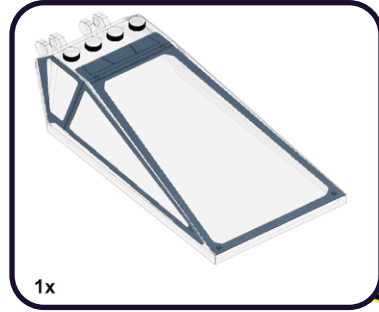

# 270

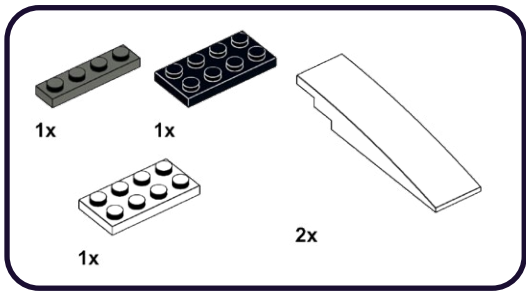

1

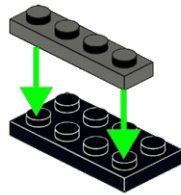

2

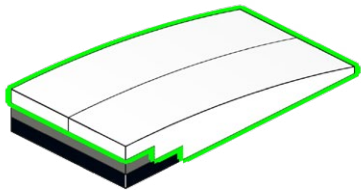

2

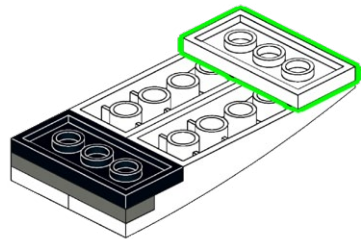

# 271

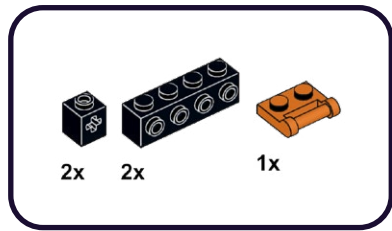

1

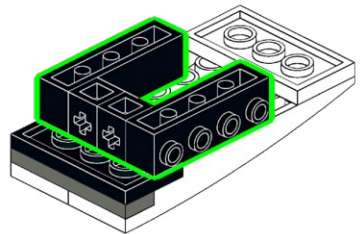

2

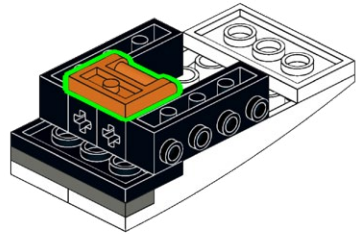

**272**

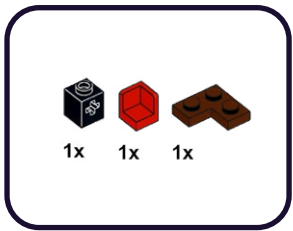

**1**

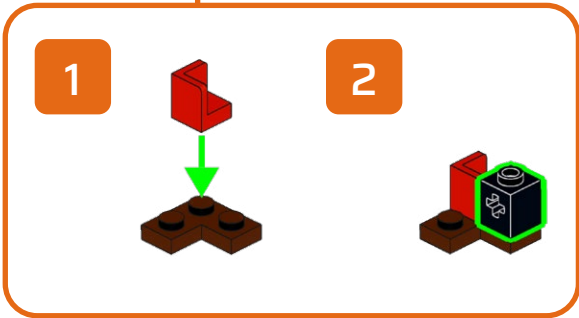
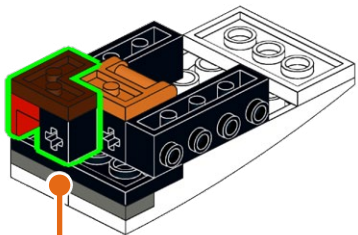

**273**

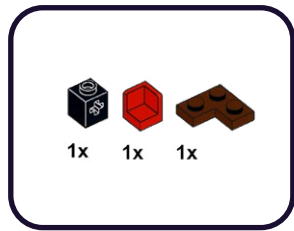

**1**

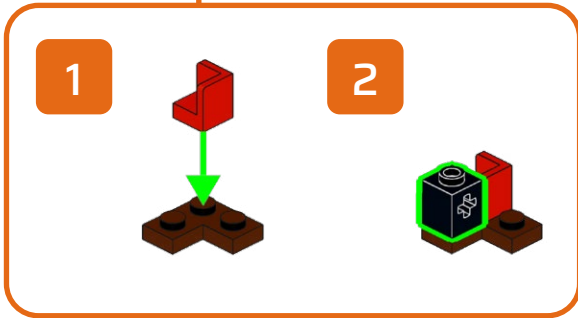
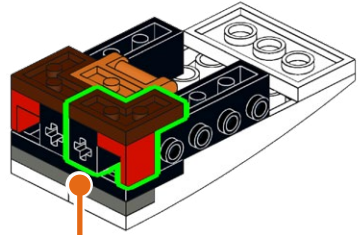

# 274

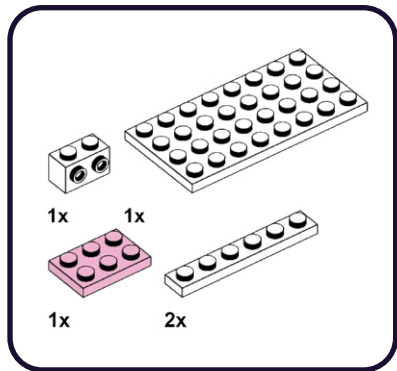

1

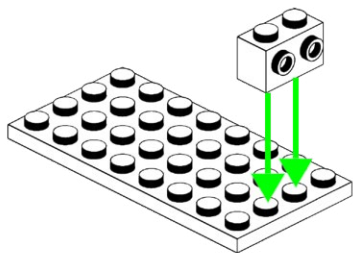

2

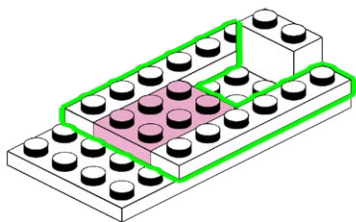

# 275

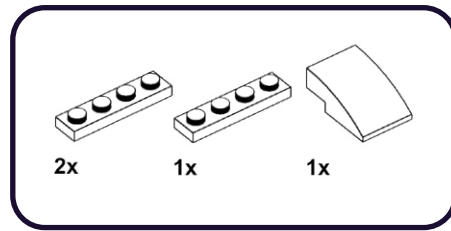

1

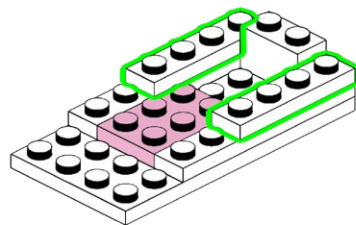

2

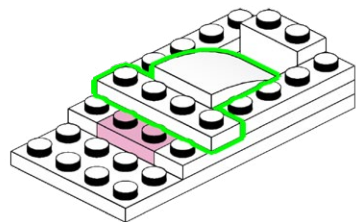

# 276

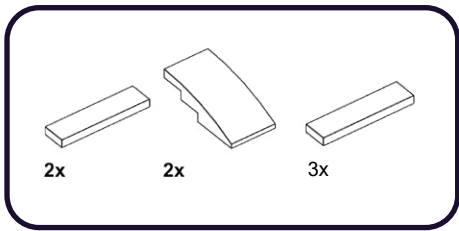

1

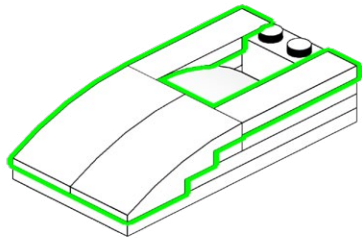

2

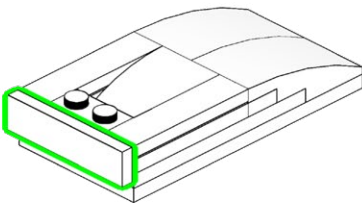

# 277

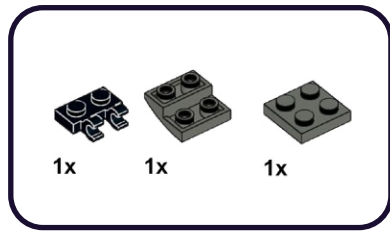

1

2

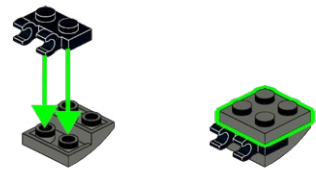

1

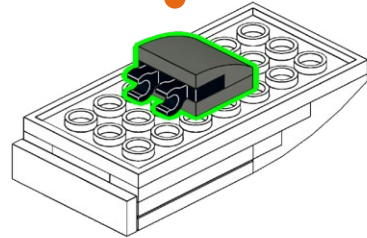

# 278

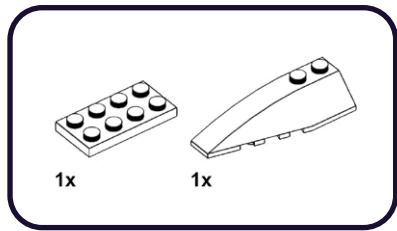

1

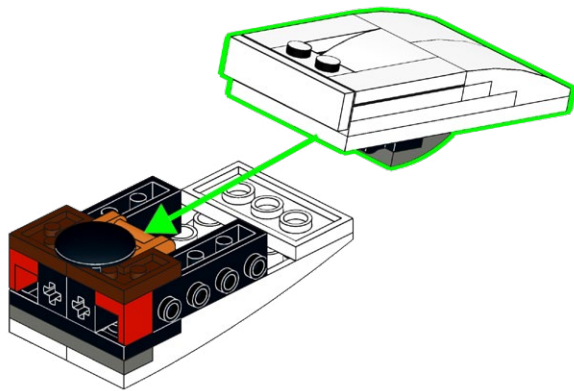

2

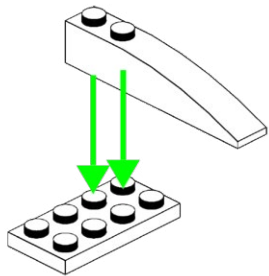

# 279

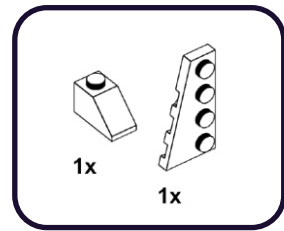

1

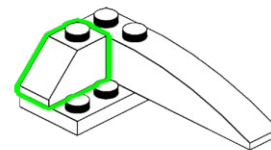

2

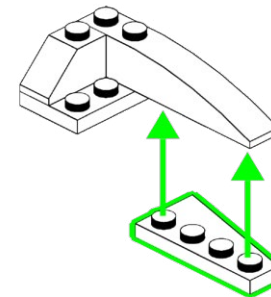

# 280

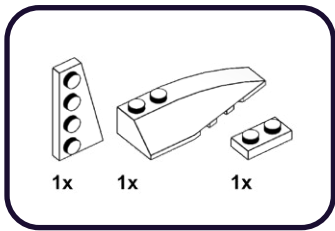

1

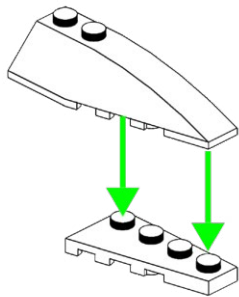

2

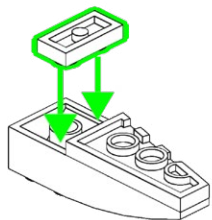

# 281

1

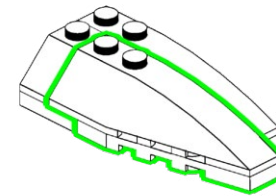

1

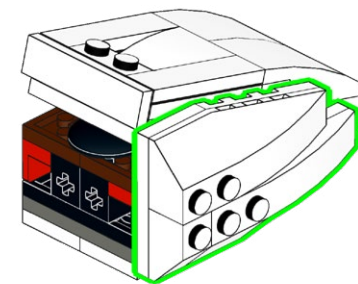



282

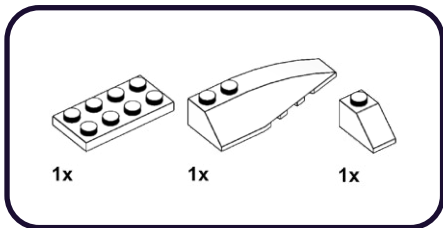

1

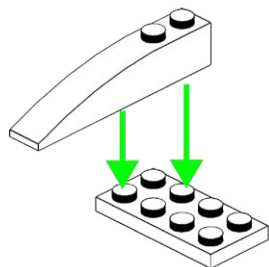

2

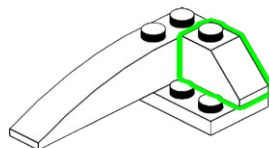

283

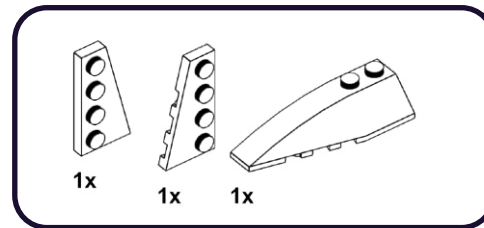

1

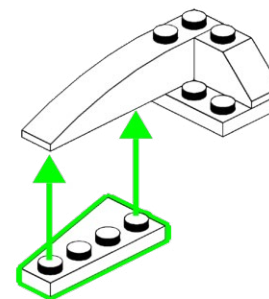

2

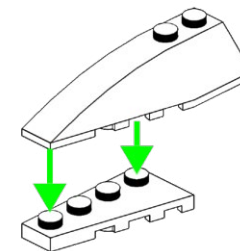

**284**

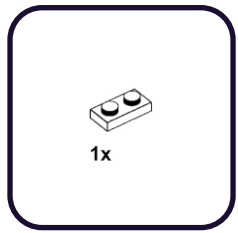

**1**

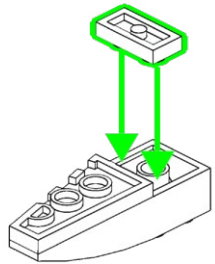

**2**

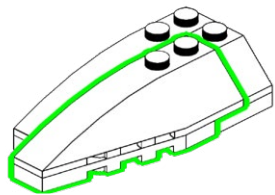

**285**

**1**

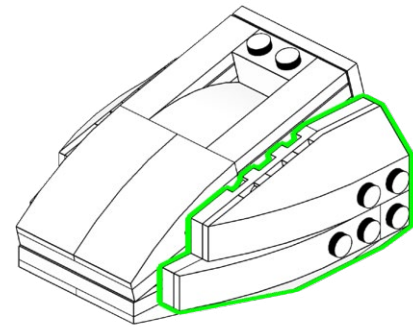

286

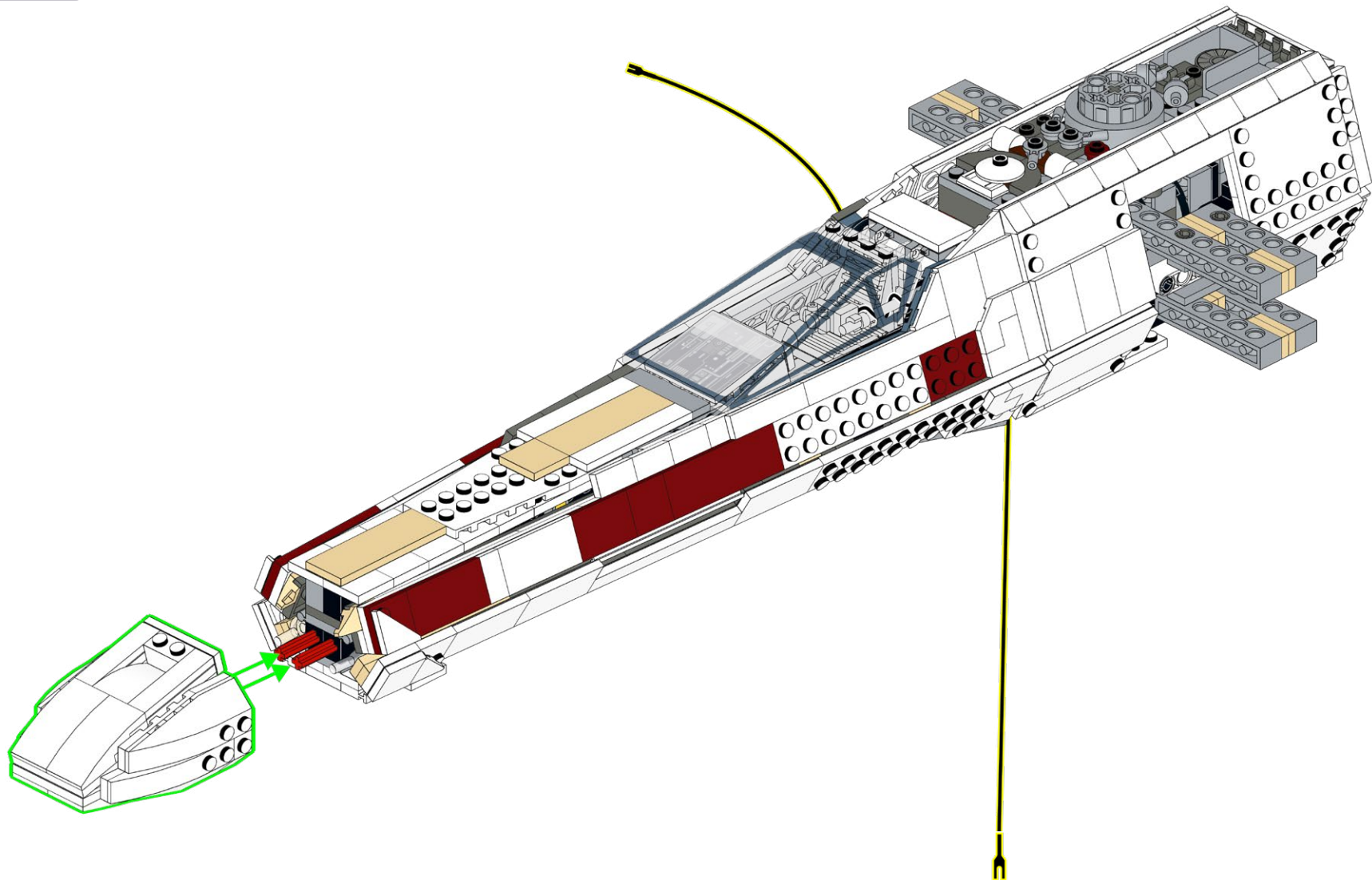

287

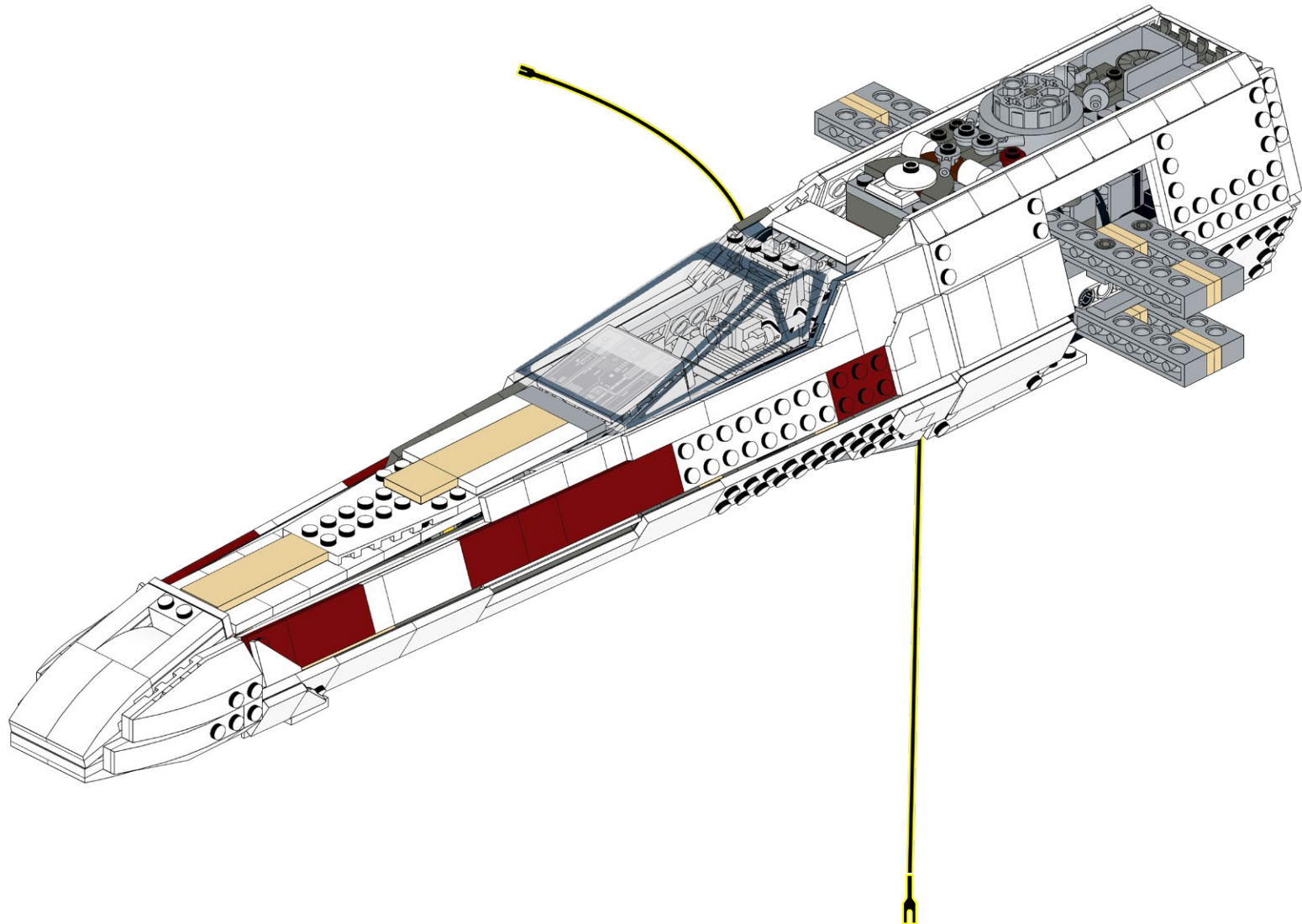

**HOLD UP!**

You might notice some bags aren't in order, as well as left over pieces, but that's ok! We're changing the way you build LEGO!

**ATTENDEZ!**

Vous remarquerez peut-être que certains sacs, ainsi que certaines pièces, ne sont pas dans le bon ordre. Mais pas de panique! Nous changeons simplement la façon avec laquelle vous construisez vos LEGO!

**ASPETTA!**

Potresti notare che alcuni sacchetti non sono in ordine, così come i pezzi avanzati, ma va bene così! Stiamo cambiando il modo in cui costruisci i LEGO!

**HALT!**

Sie werden möglicherweise bemerken, dass einige tüten durcheinander sind und teile übrig bleiben, aber das ist in Ordnung! Wir ändern die art und weise, wie Sie LEGO bauen!

**¡ESPERA!**

Es posible que notes que algunas bolsas están fuera de servicio, así como piezas sobrantes, ¡pero está bien! ¡Estamos cambiando la forma en que construyes LEGO!

**暫停!**

你可能会注意到一些袋子顺序错乱, 以及一些剩余的部件, 但没关系! 我们正在改变你搭建乐高的方式!

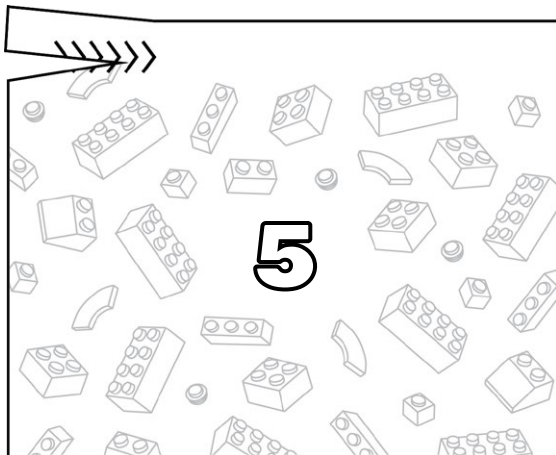
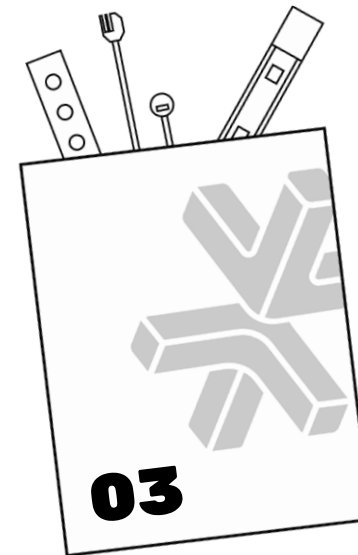
**Open LEGO® Bag 5****Open LMB Bags 03**

288

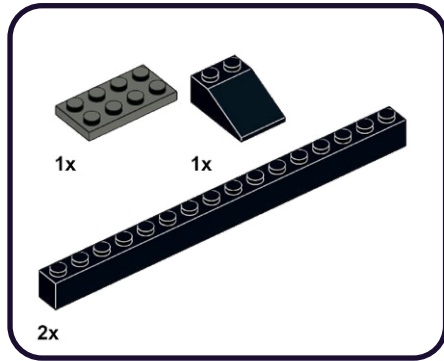

1

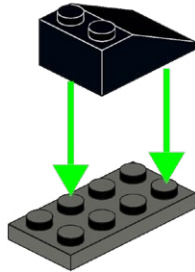

2

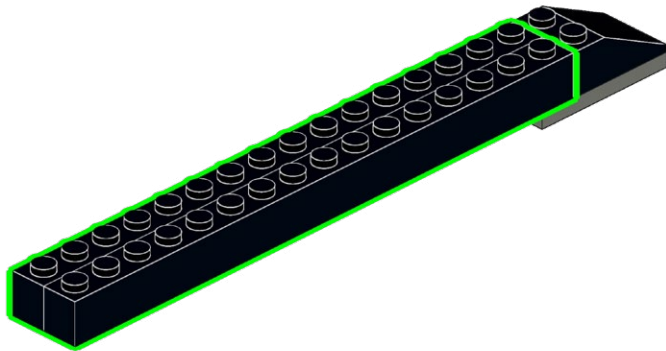

289

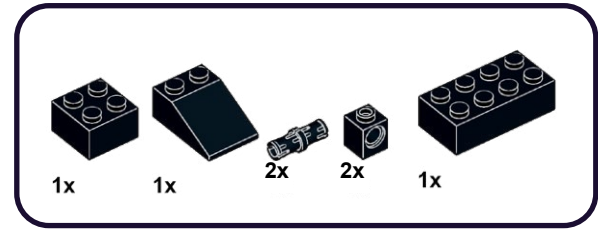

1

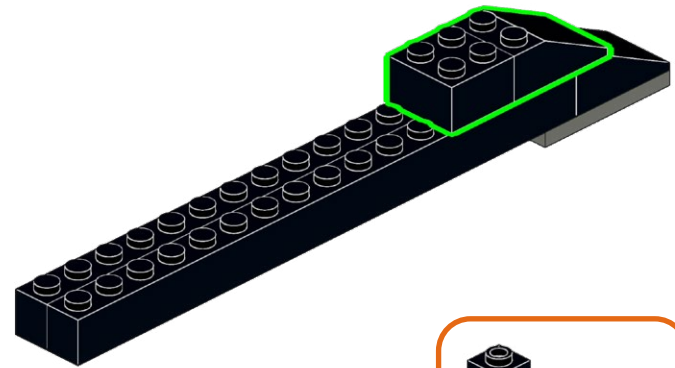

2

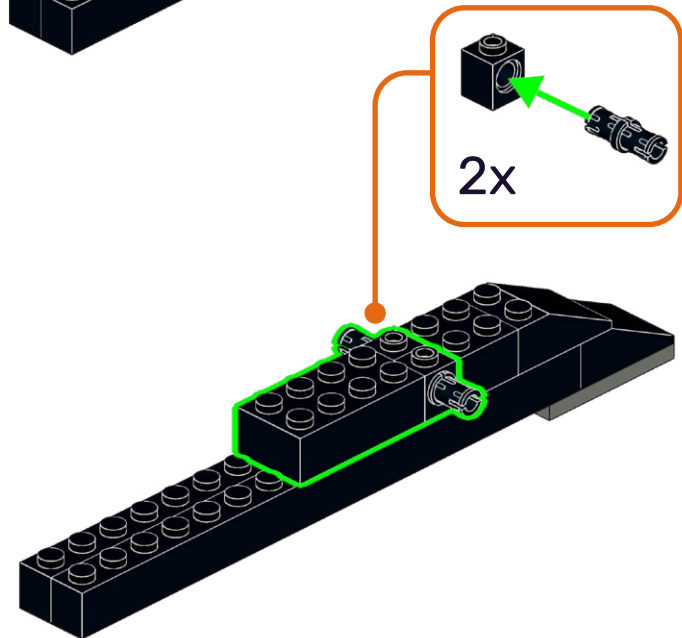

290

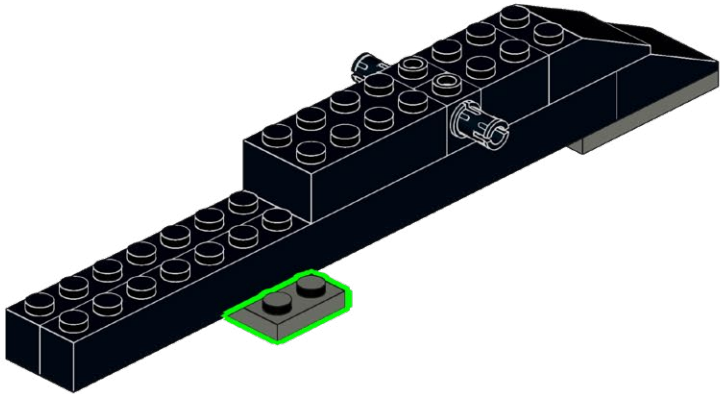
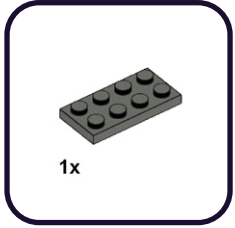



291

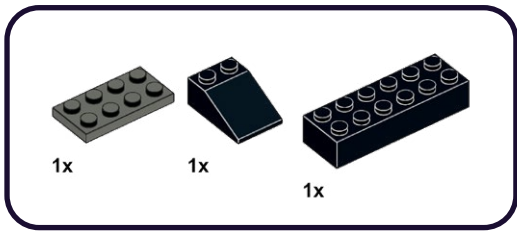

1

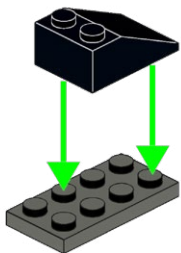

2

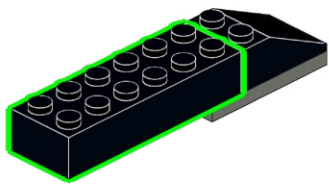

292

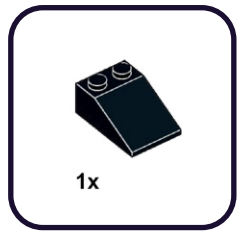

1

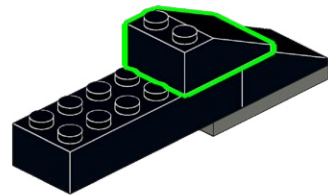

2x

293

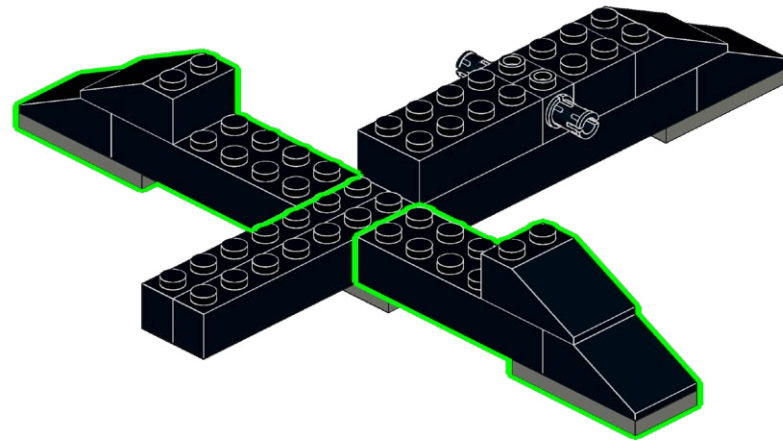

294

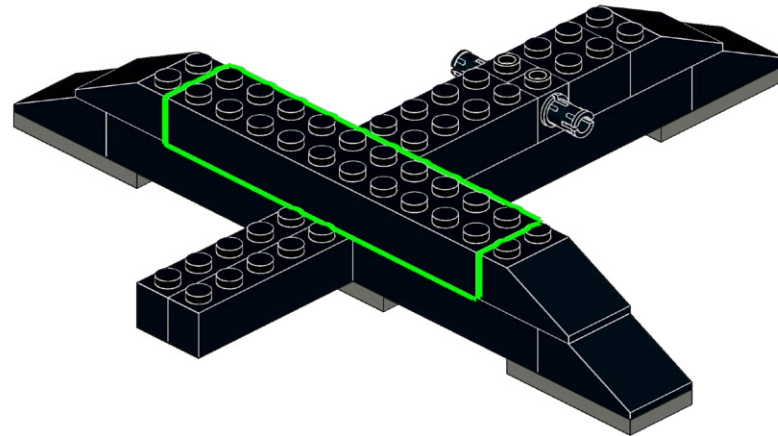
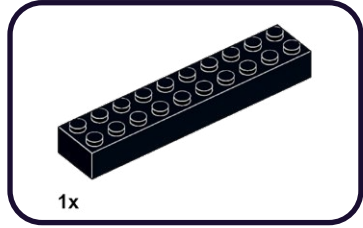

295

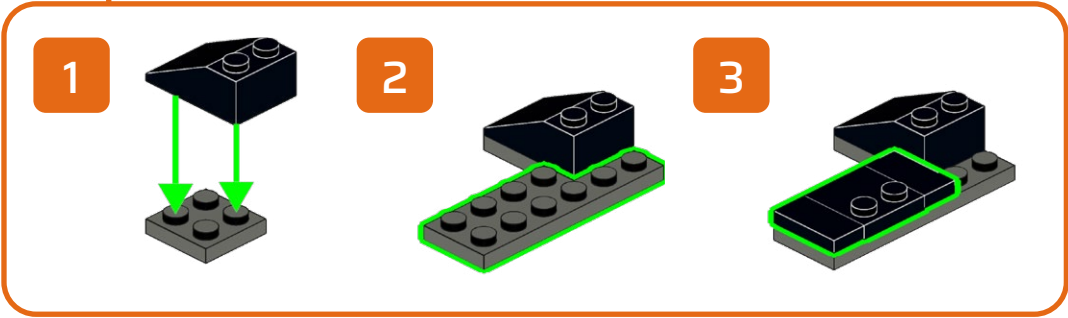
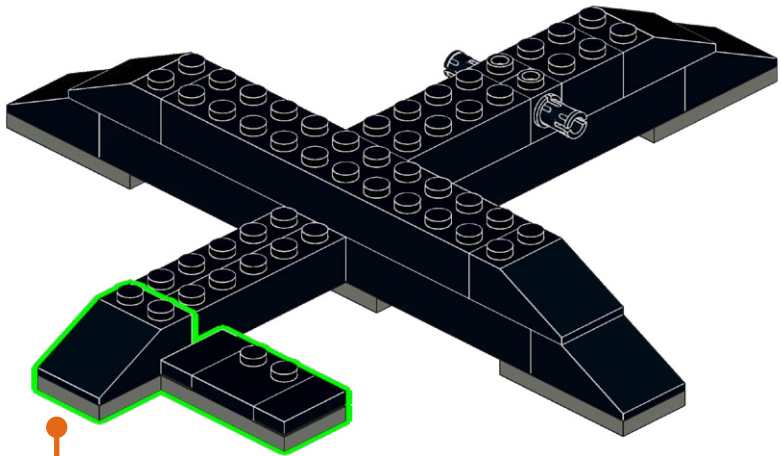
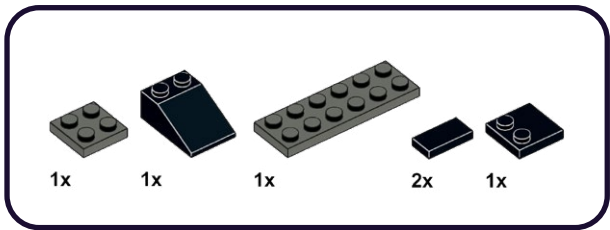

296

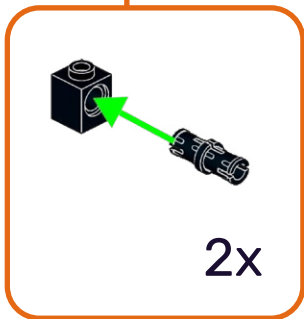
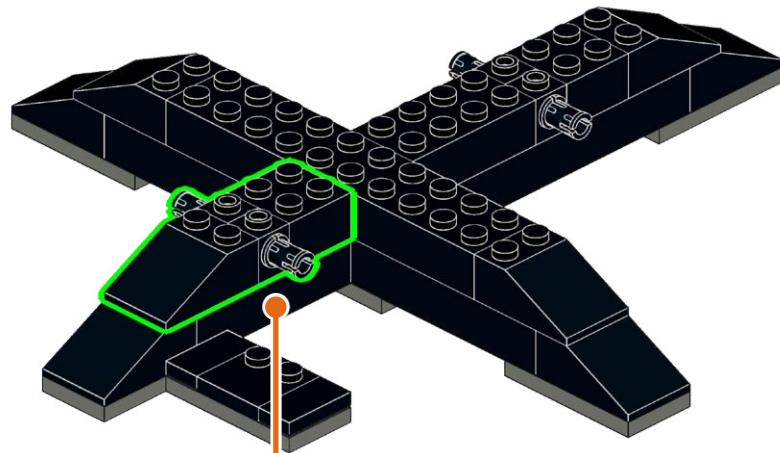
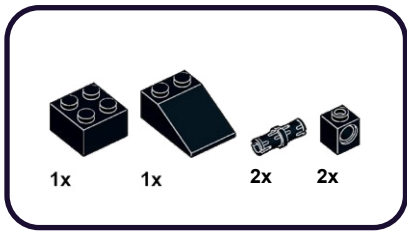

297

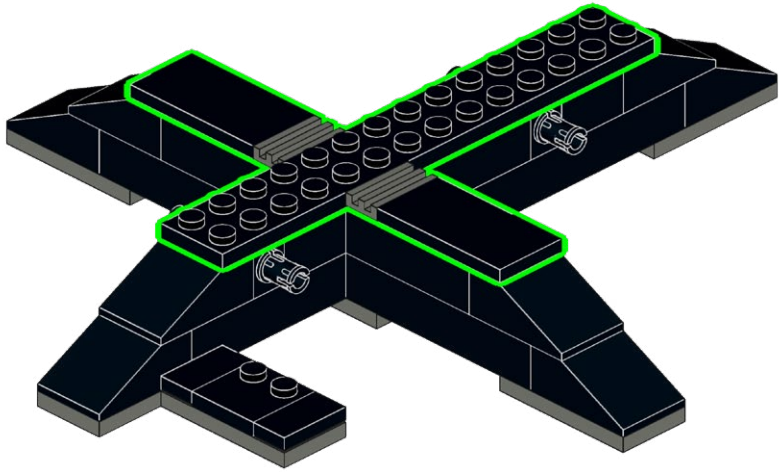
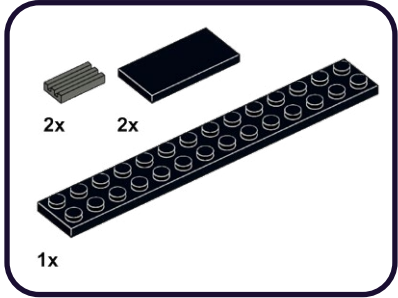

# 298

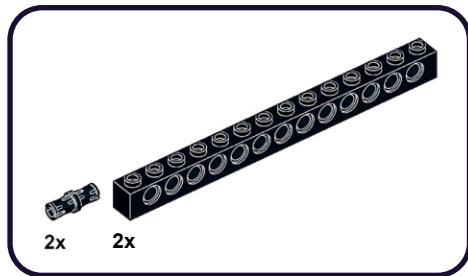

1

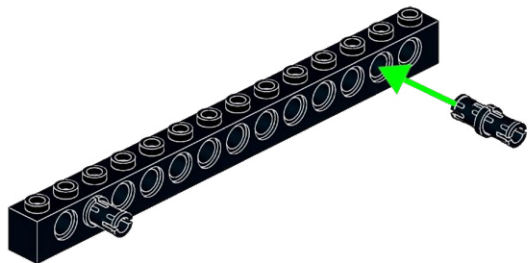

2

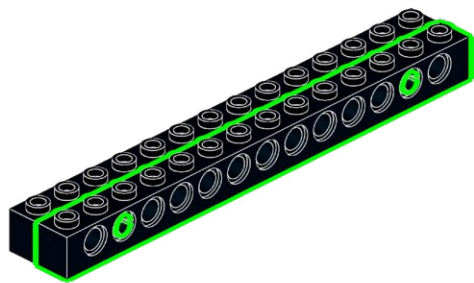

# 299

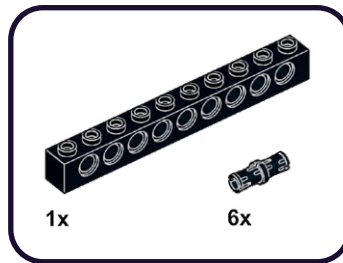

1

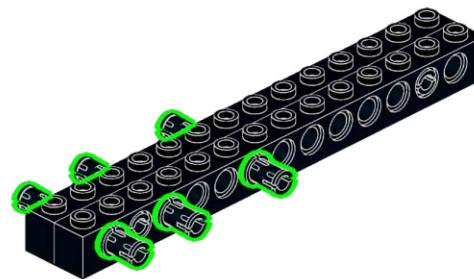

2

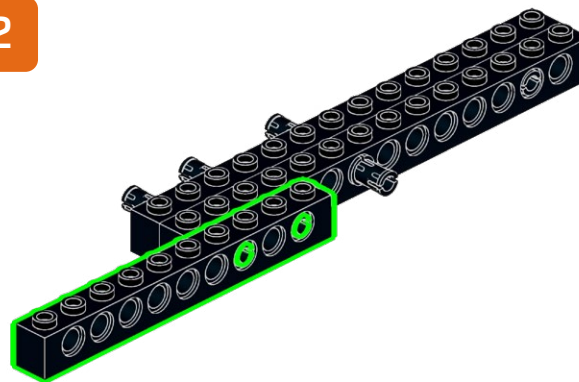



**300**

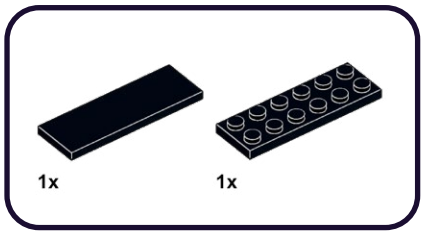

**1**

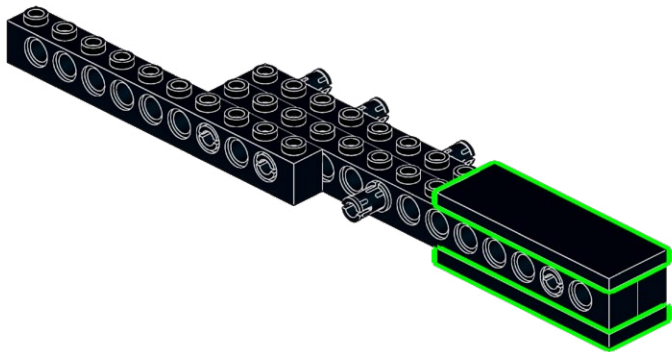

**301**

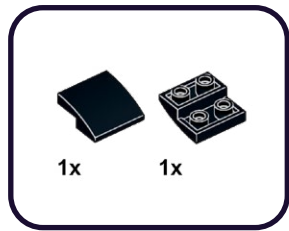

**1**

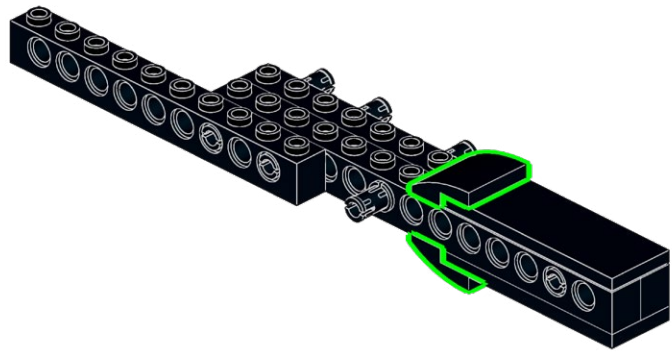

302

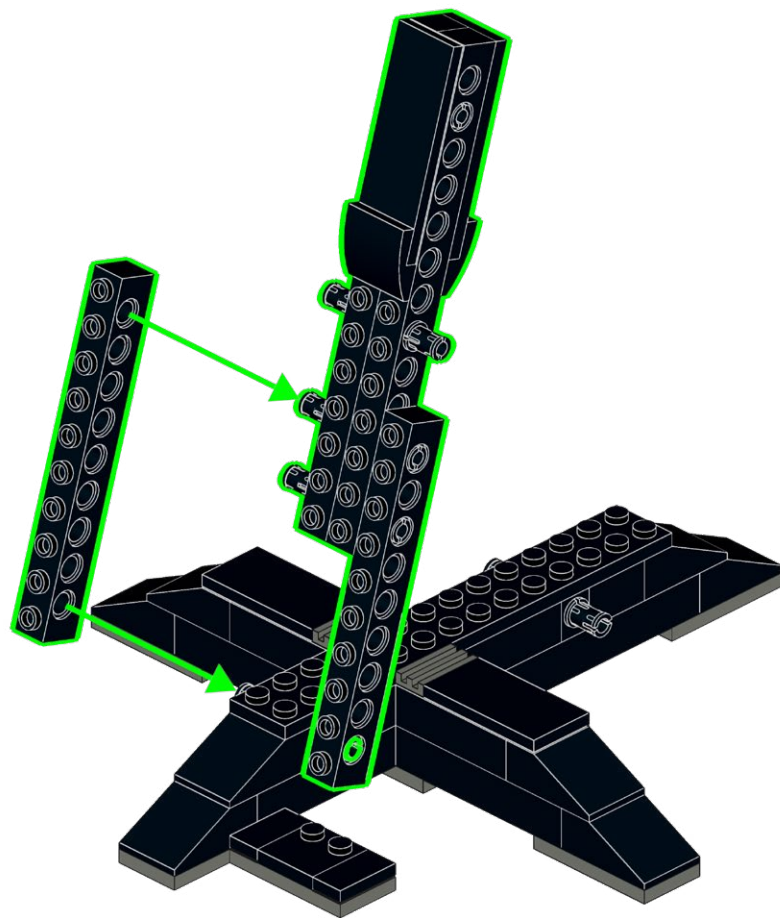
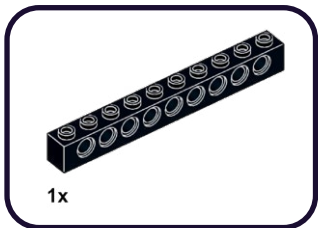

**303**

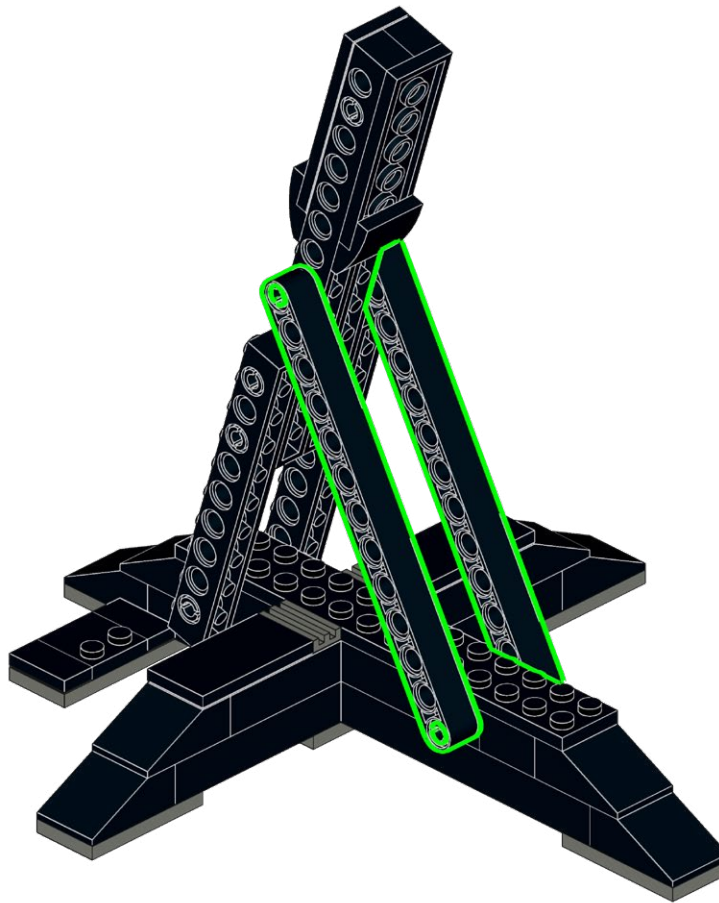
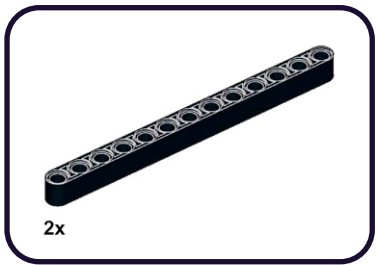

**304**

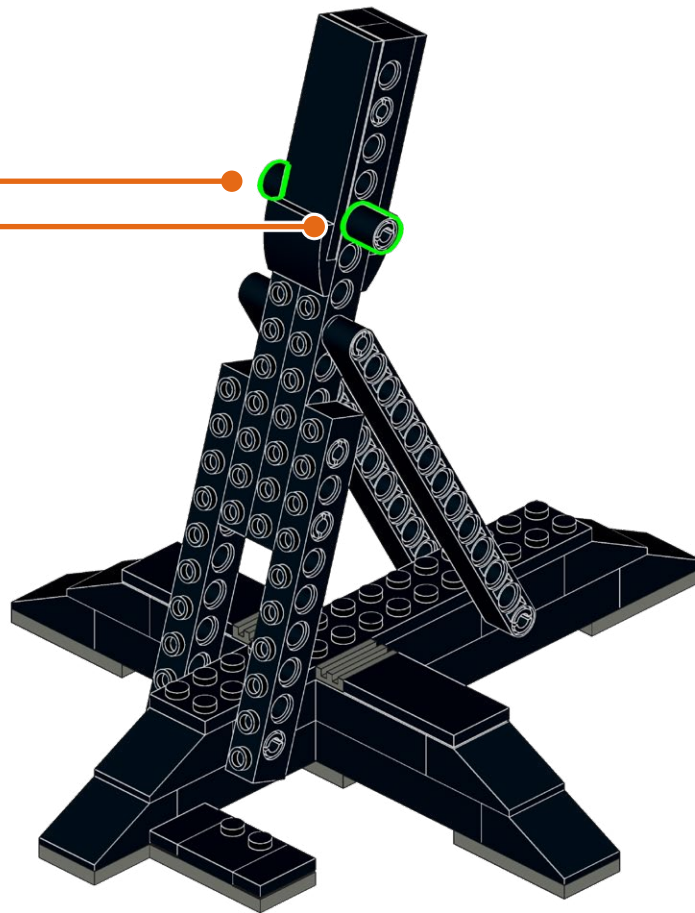

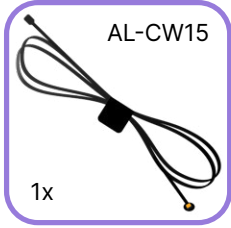

1



2

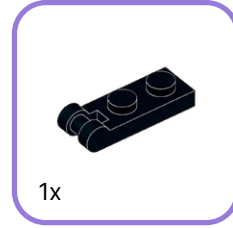

1



2



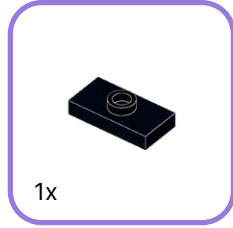
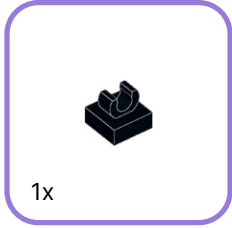

1

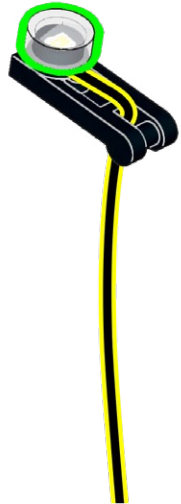

2

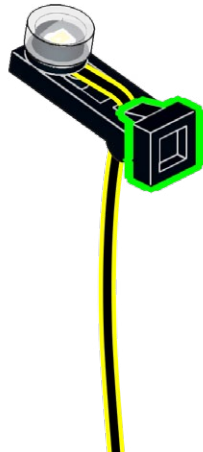

1

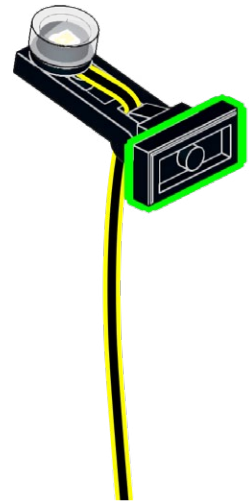

309

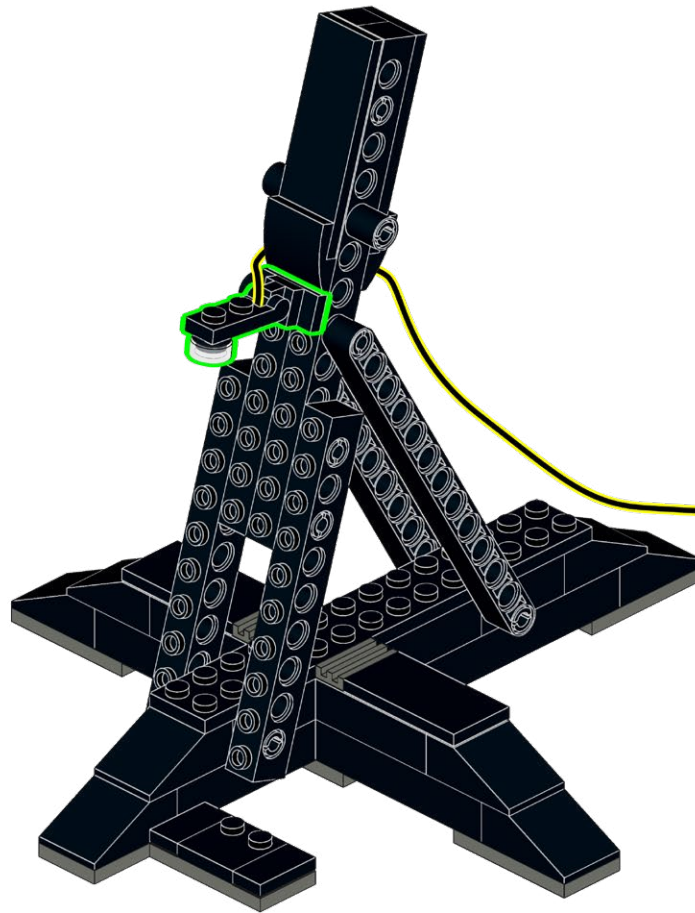





1

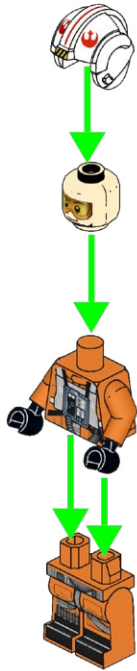

1

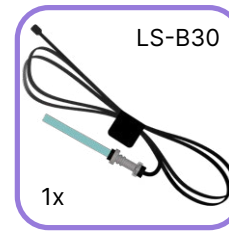

2

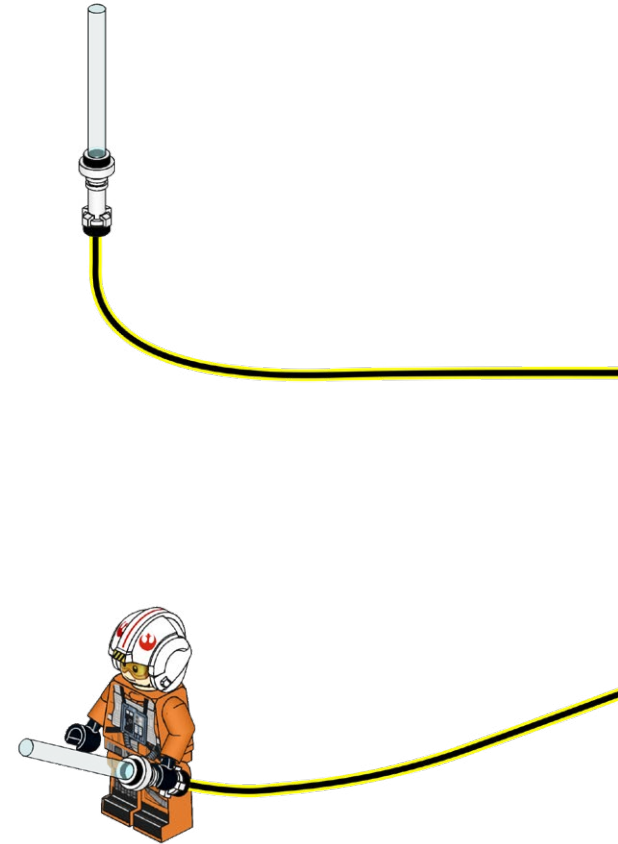

312

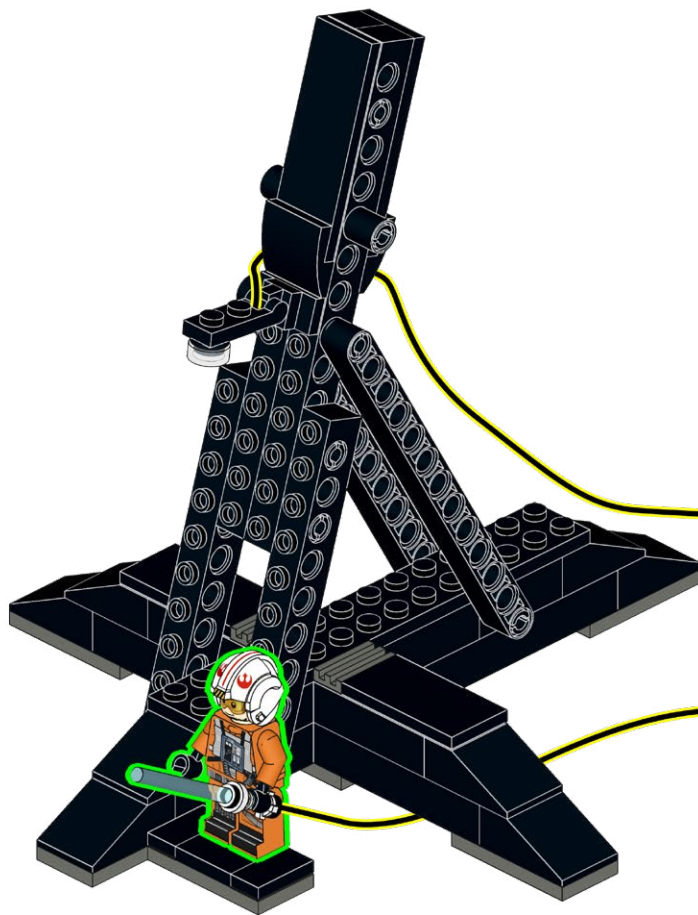

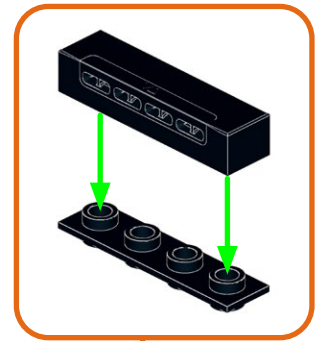
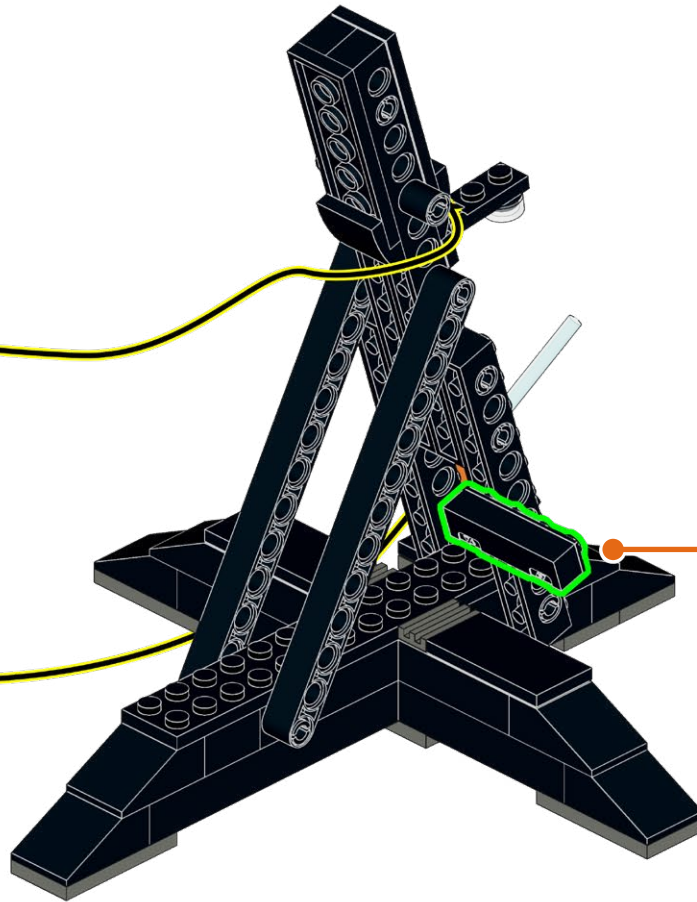
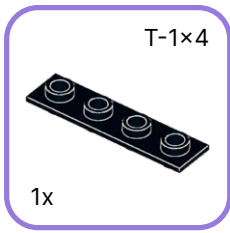
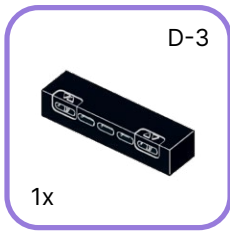

314

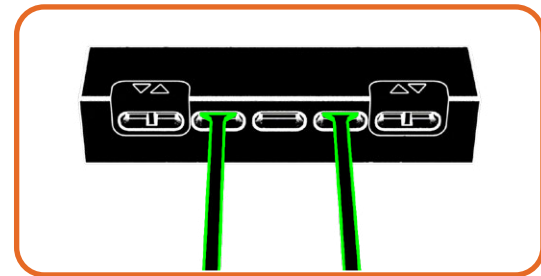
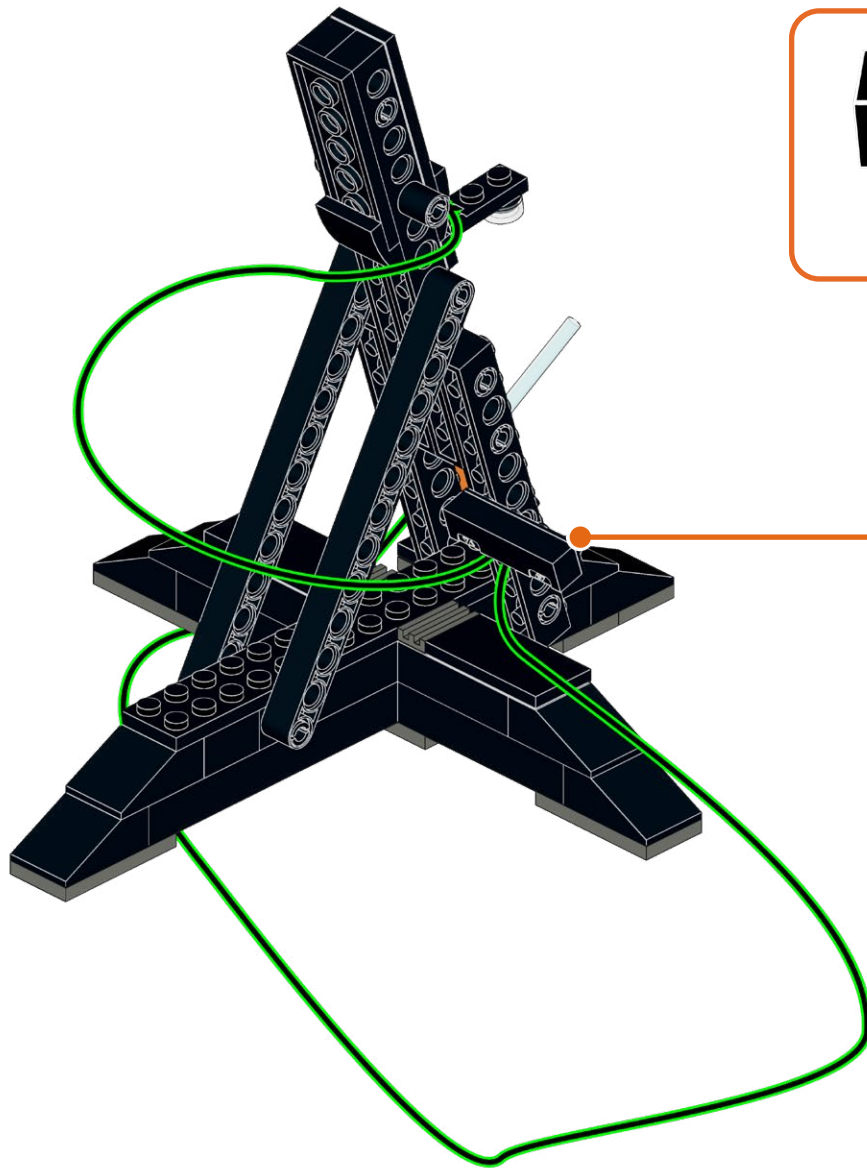

315

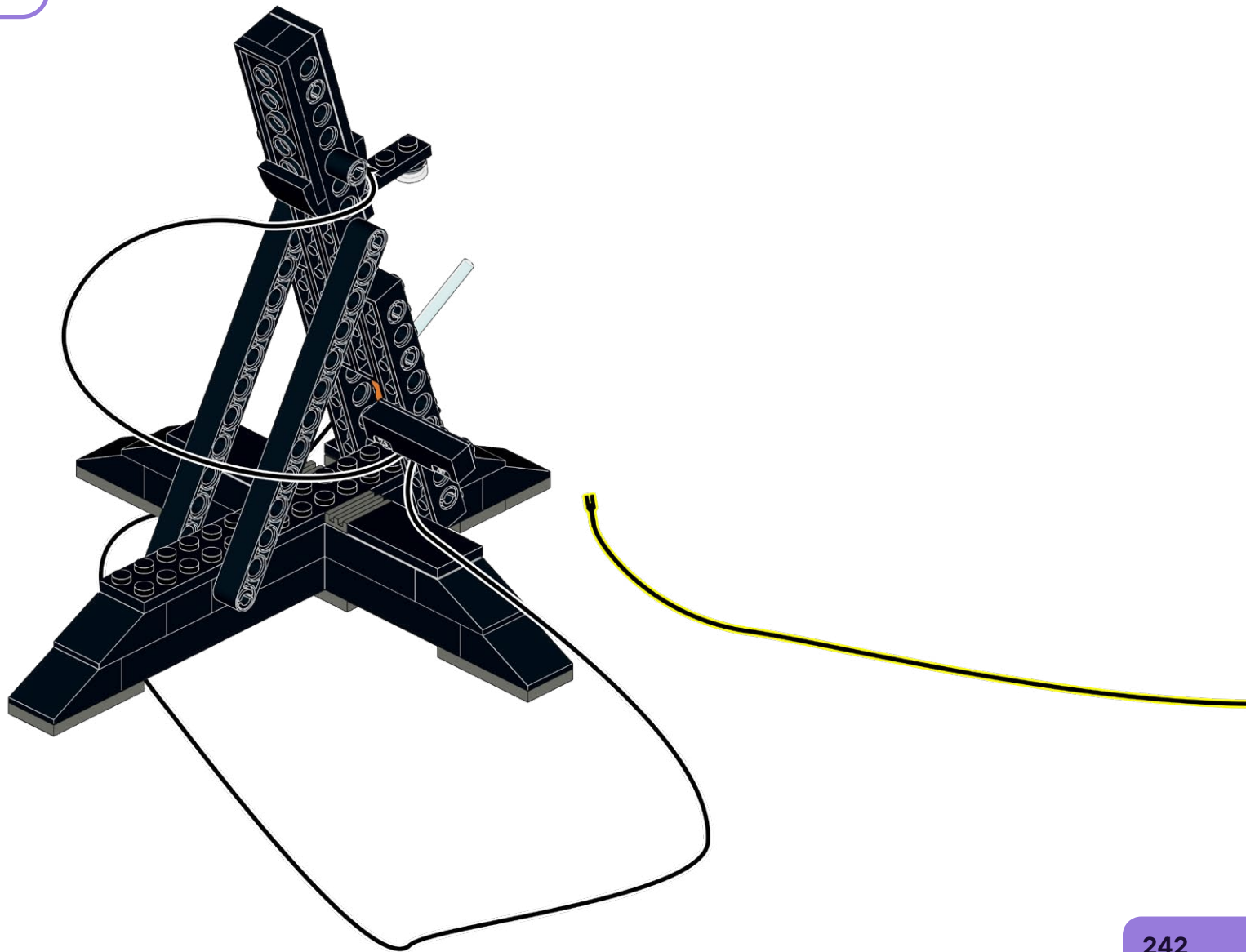

316

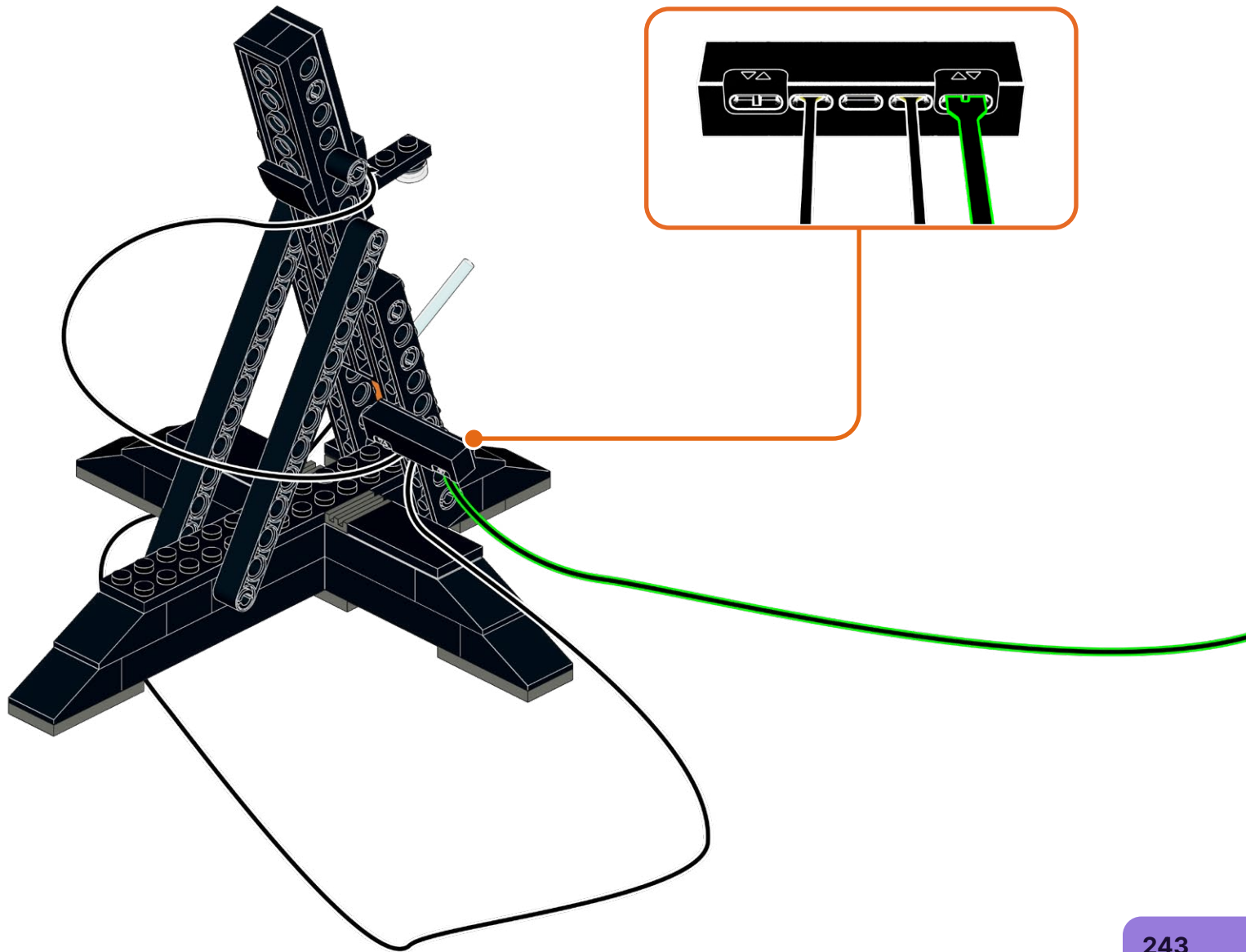



317

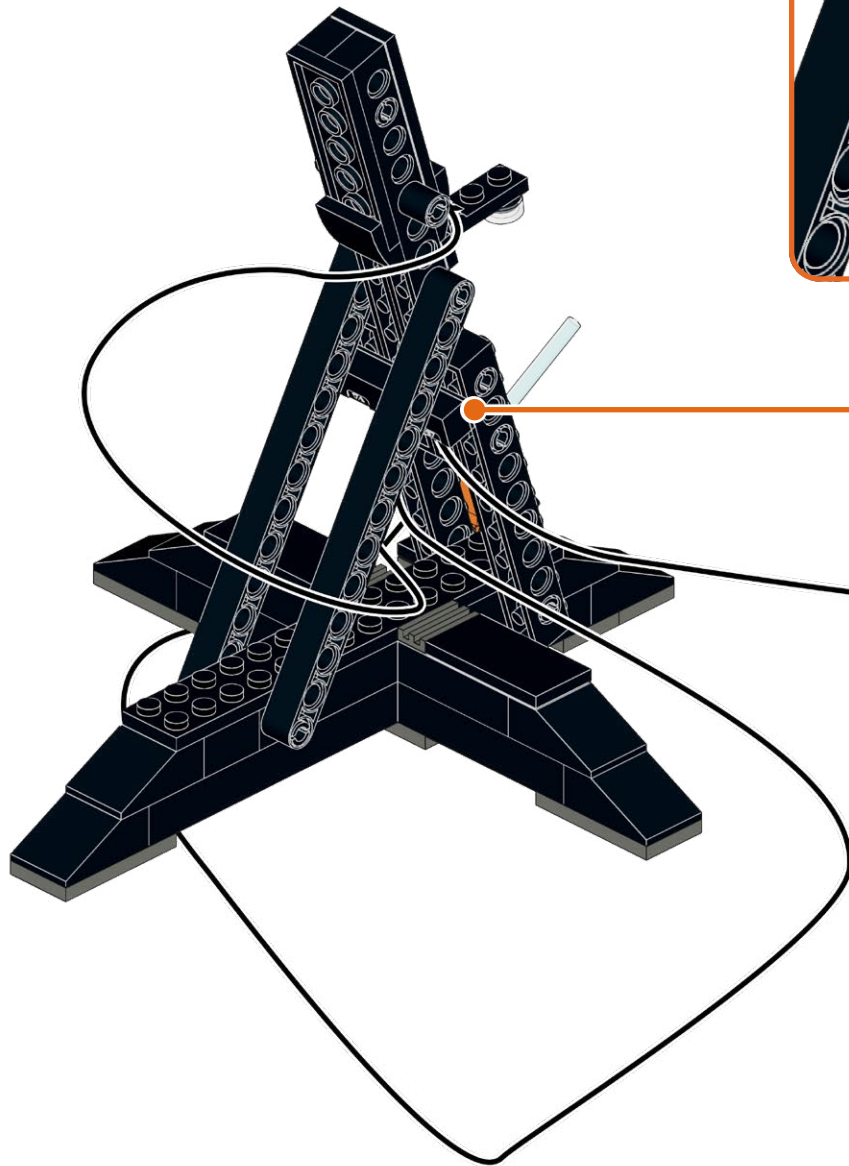



318

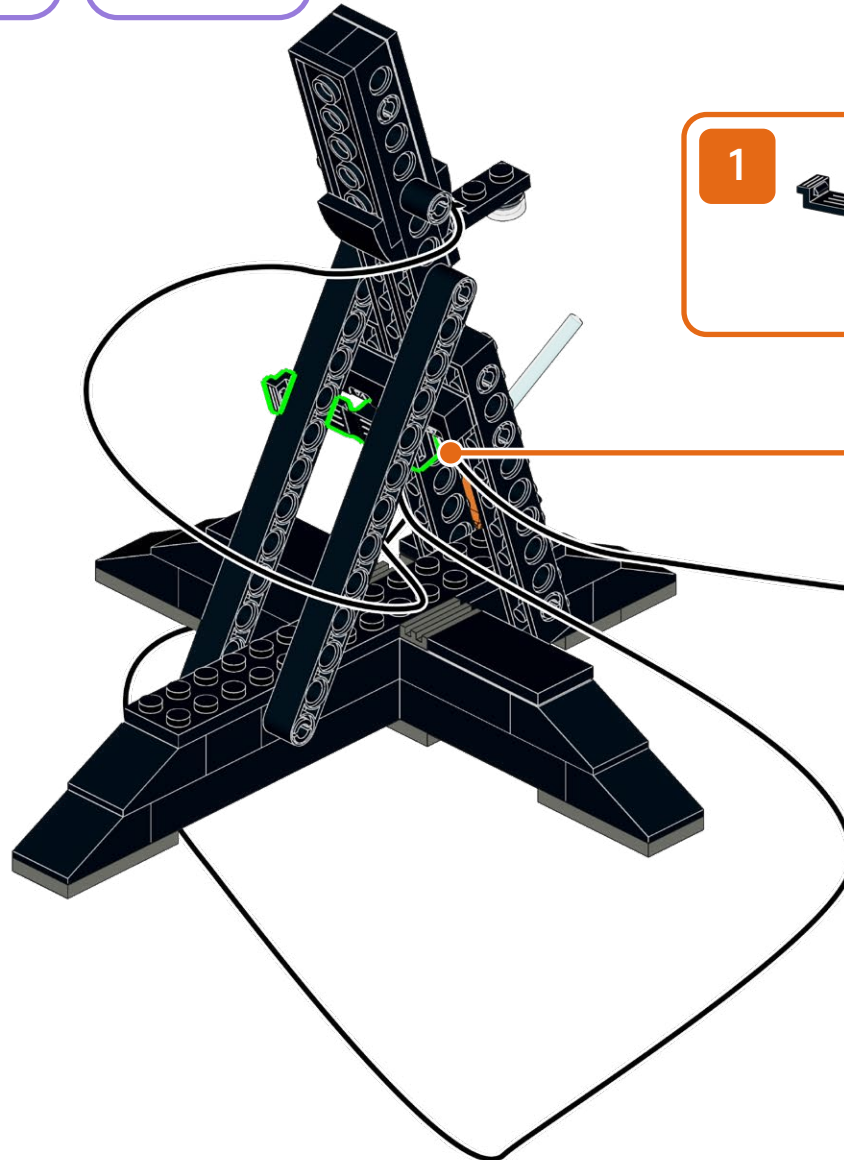
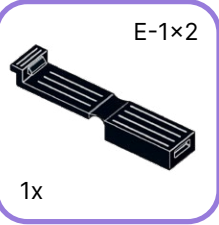

319

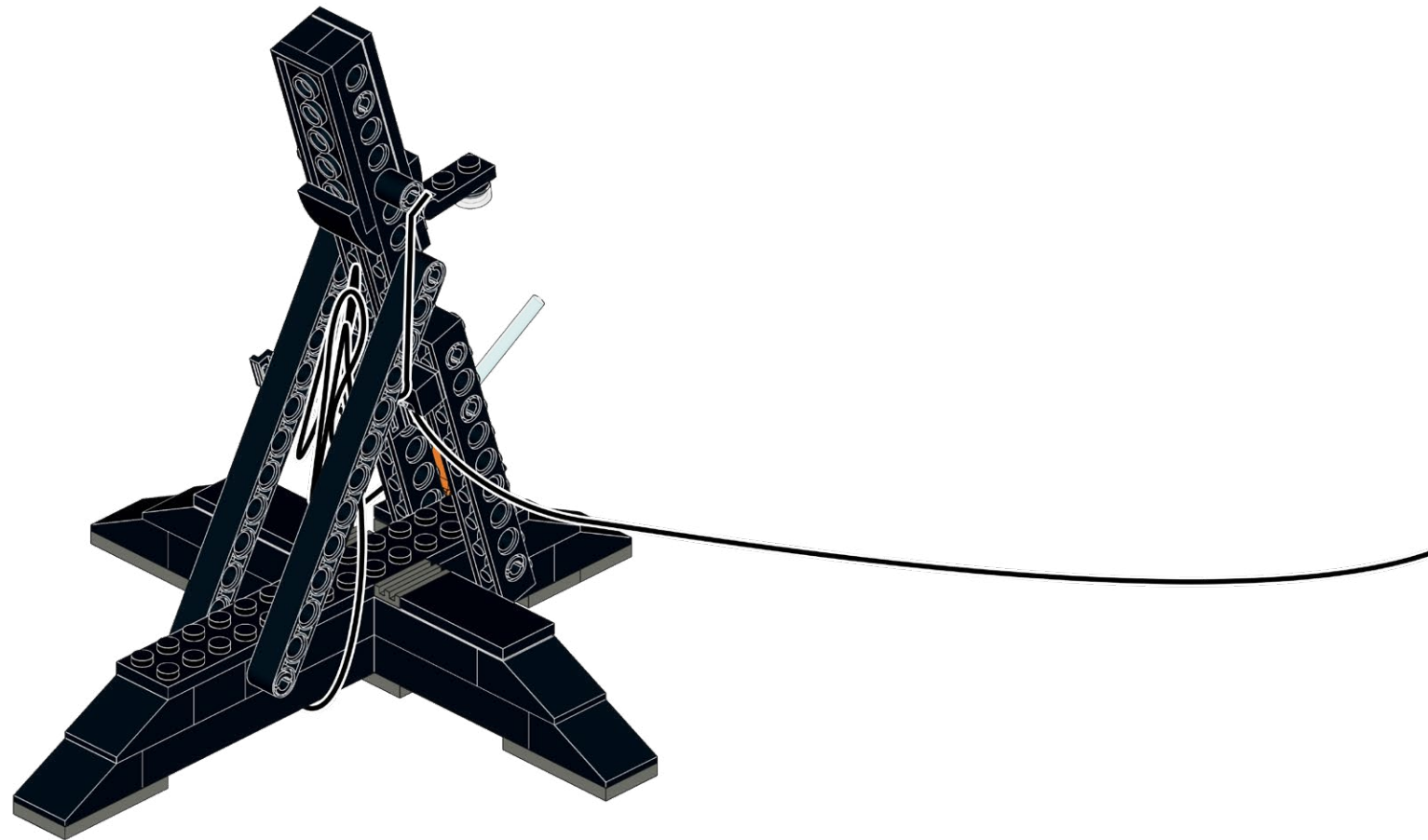

320

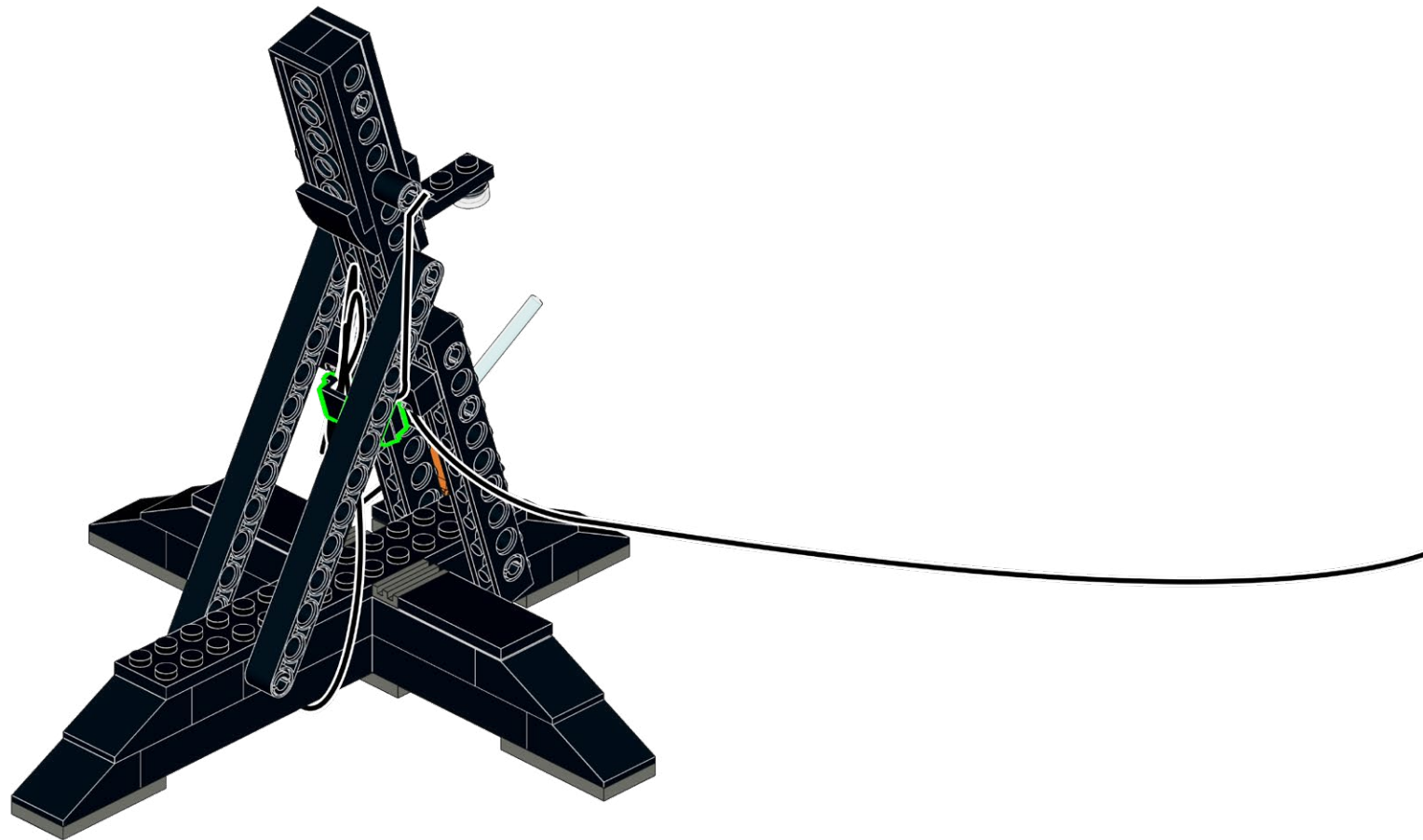

321

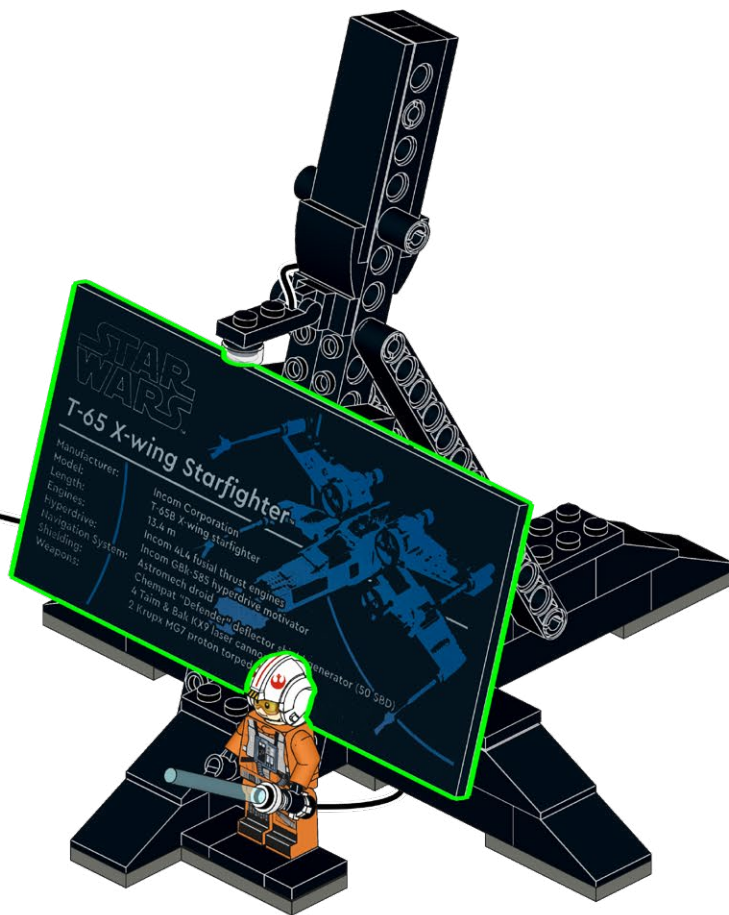

322

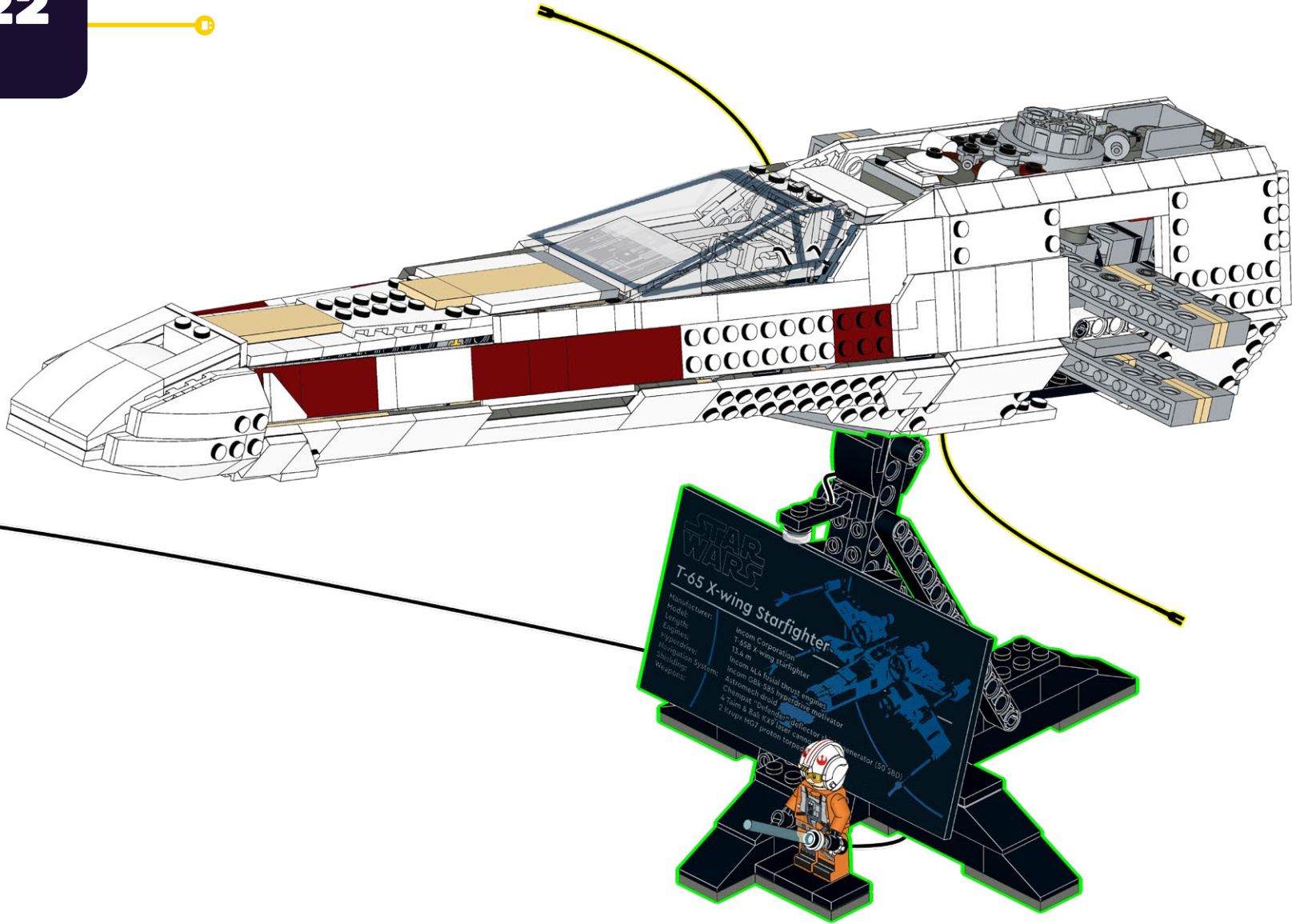



323

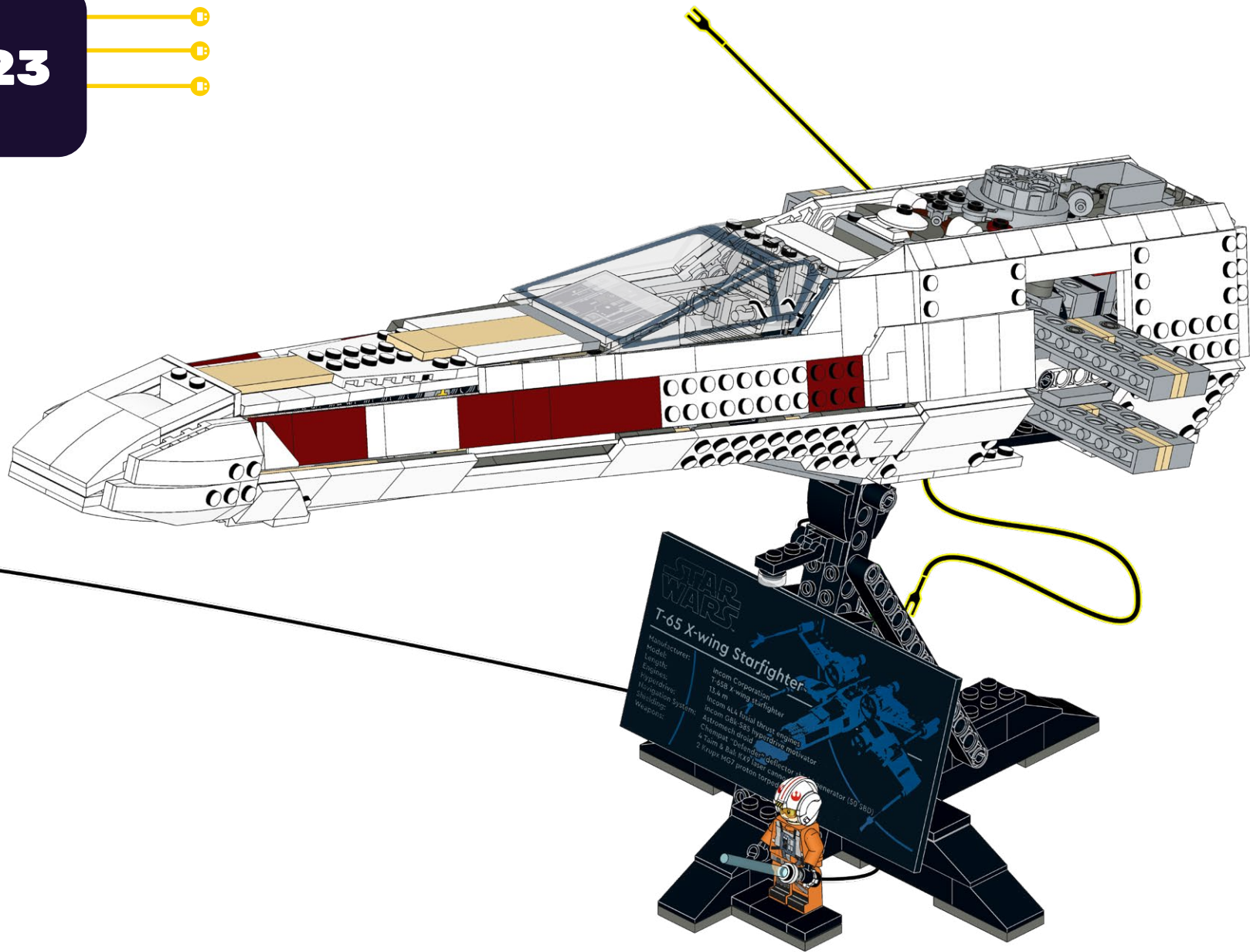

324

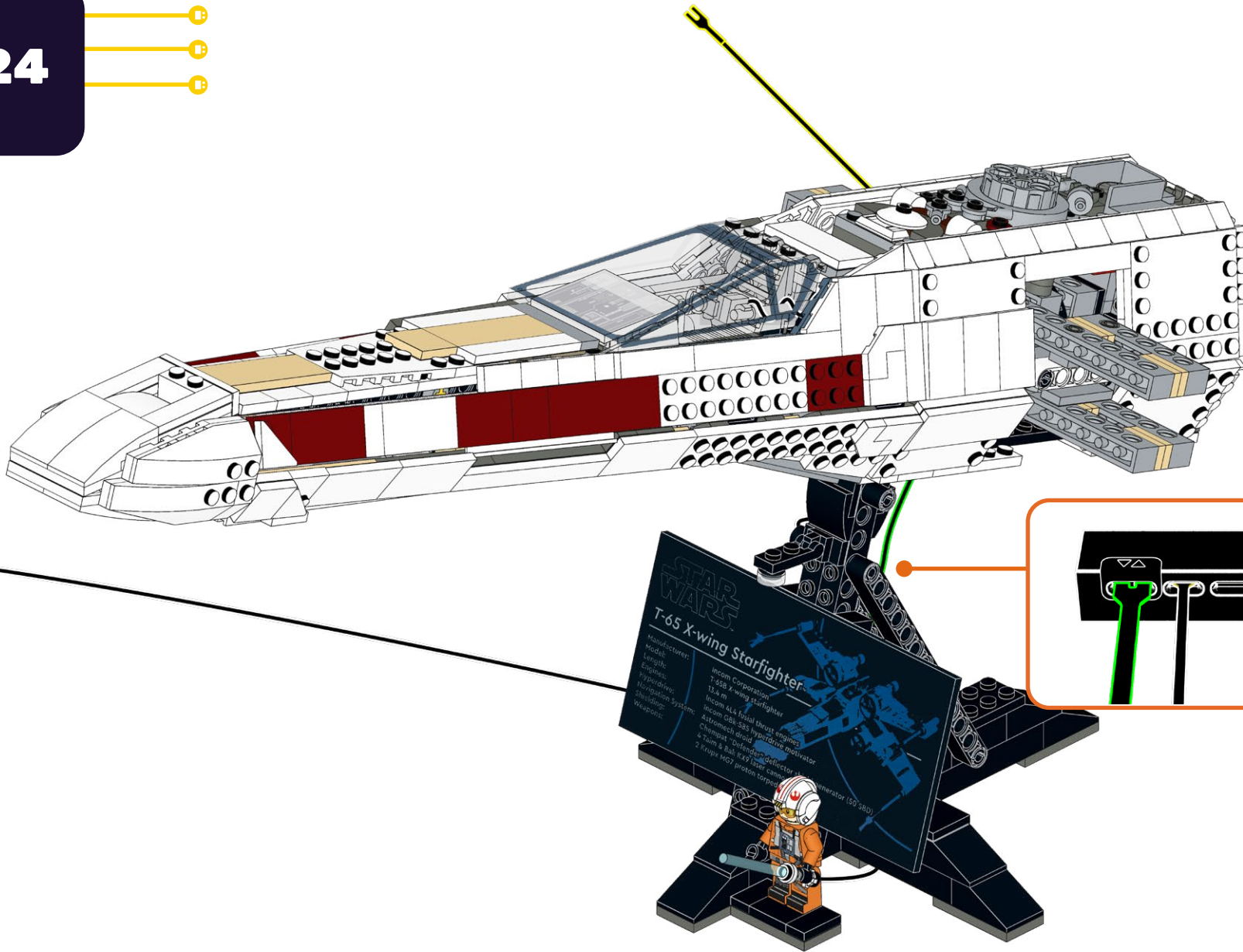

**STAR WARS**  
**T-65 X-wing Starfighter**

Manufacturer:	Incom Corporation
Model:	T-65B X-wing starfighter
Length:	13.4 m
Capacity:	Incom AL-4 total thrust engines
Propulsion System:	Astromech droid
Armaments:	4 Twin & Blaster cannons
Weapons:	2 Heavy MG7 proton torpedoes

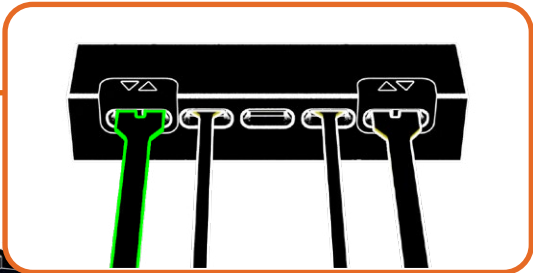



325

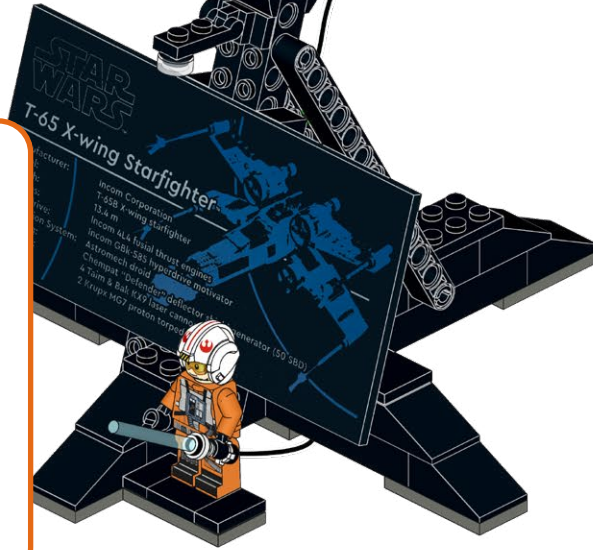
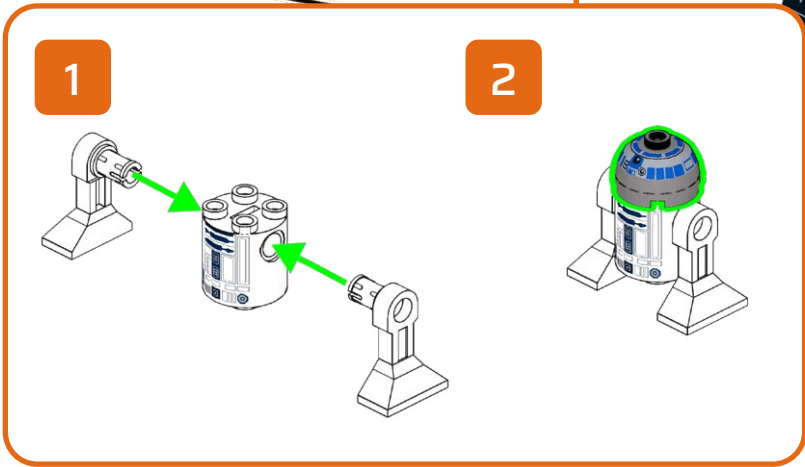
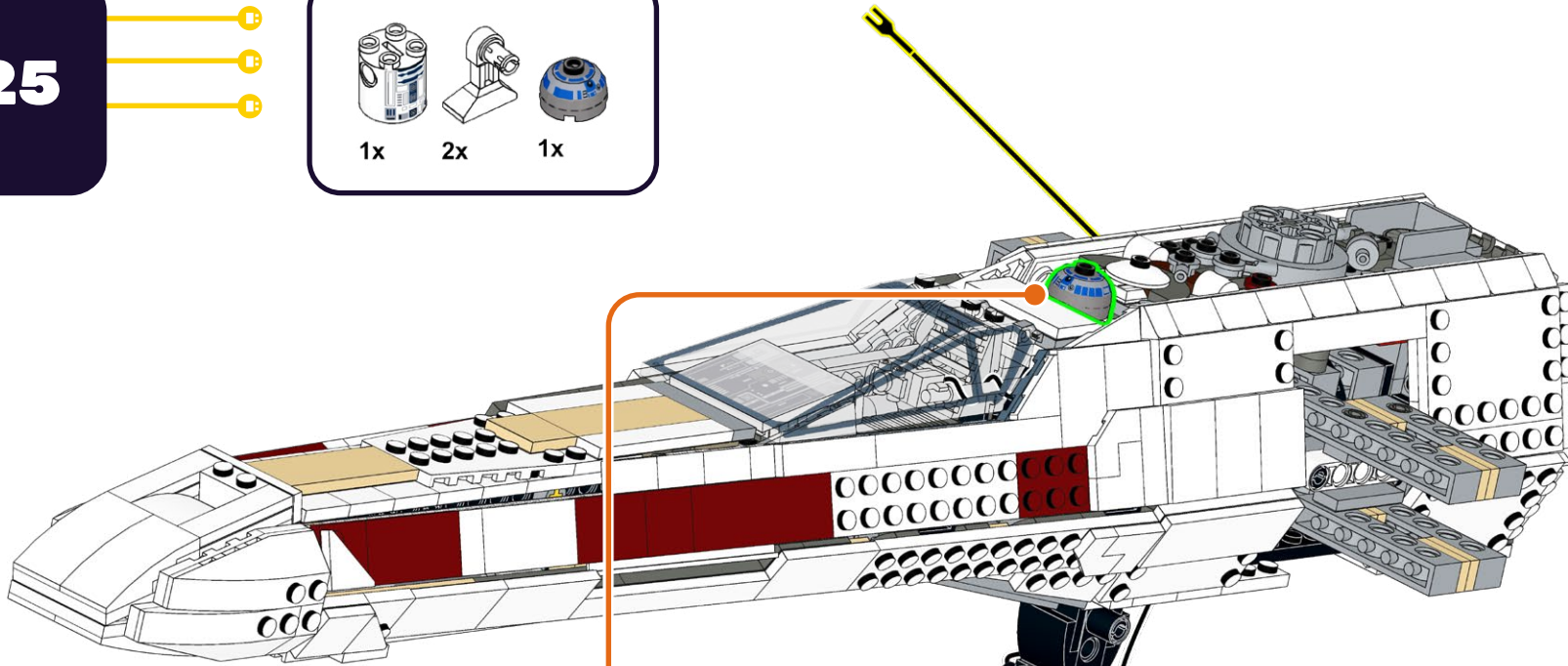
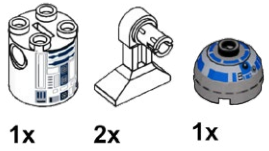

326

D-6



1x

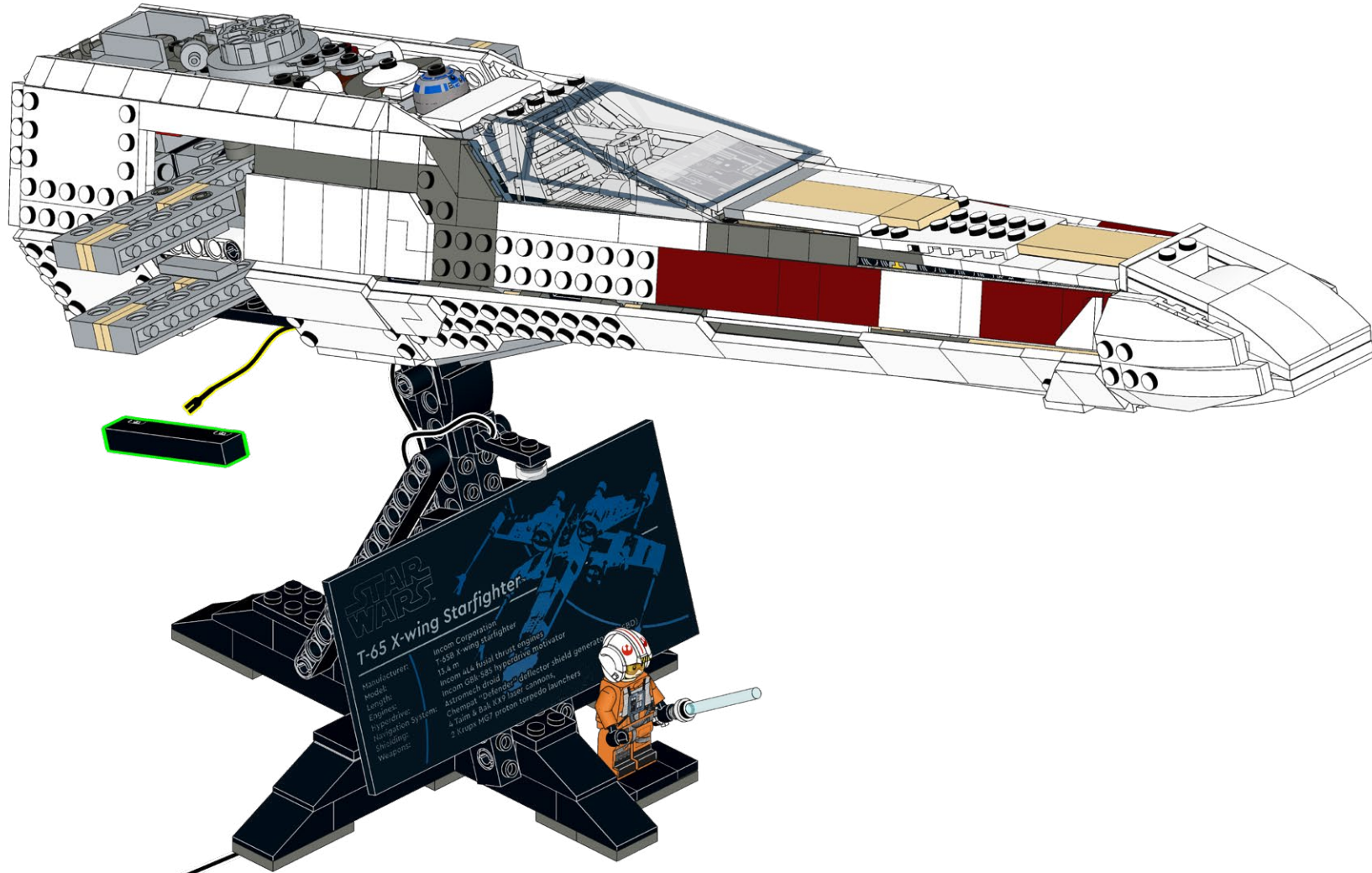

STAR WARS  
T-65 X-wing Starfighter

Manufacturer:  
Model:  
Length:  
Engine:  
Propulsion System:  
Shielding:  
Weapons:

Incon Corporation  
T-65 X-wing starfighter  
13.4 m  
Incon AL-4 Rebel thrust engines  
Incon GBL-550 hyperdrive motivator  
Astromech droid  
Chemical "Defender" shield generator  
4 Taim & Bak 430 laser cannons  
2 Kropp MG7 proton torpedo launchers

327

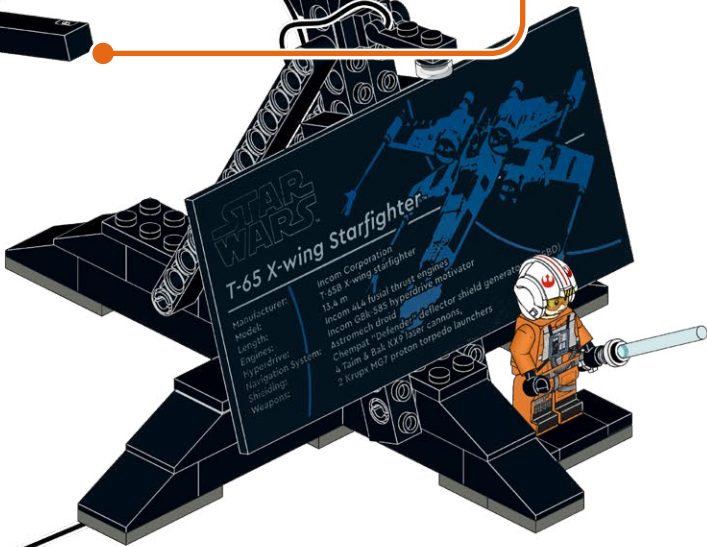
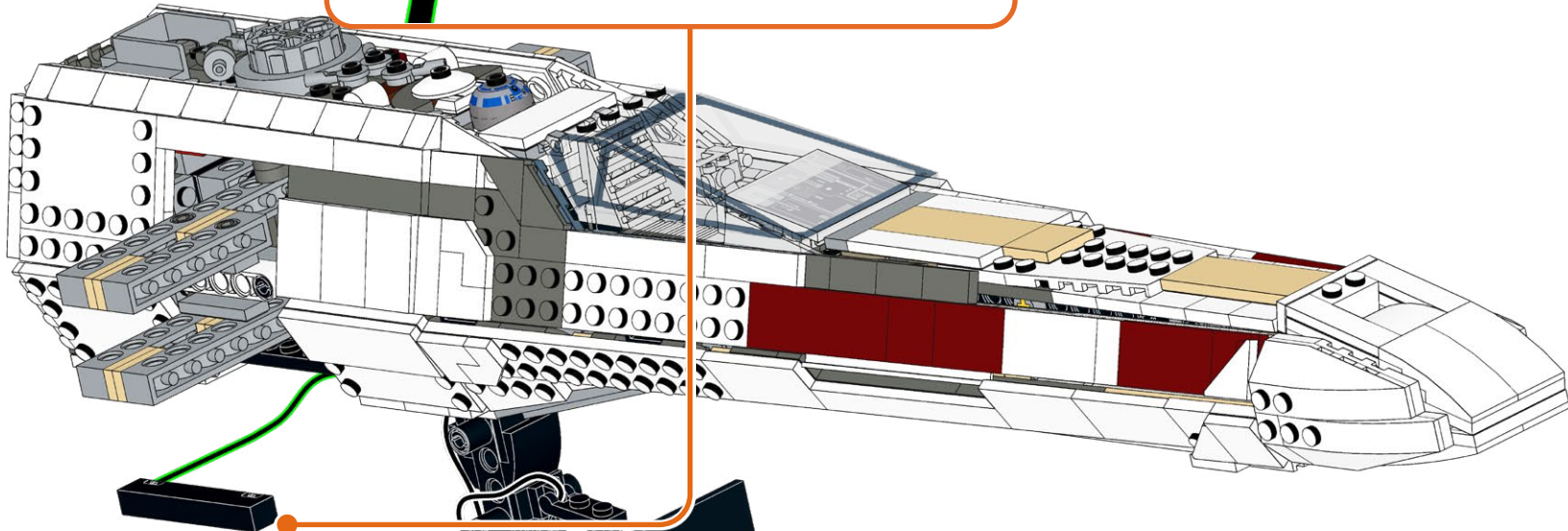



**HOLD UP!**

You might notice some bags aren't in order, as well as left over pieces, but that's ok! We're changing the way you build LEGO!

**ATTENDEZ!**

Vous remarquerez peut-être que certains sacs, ainsi que certaines pièces, ne sont pas dans le bon ordre. Mais pas de panique! Nous changeons simplement la façon avec laquelle vous construisez vos LEGO!

**ASPETTA!**

Potresti notare che alcuni sacchetti non sono in ordine, così come i pezzi avanzati, ma va bene così! Stiamo cambiando il modo in cui costruisci i LEGO!

**HALT!**

Sie werden möglicherweise bemerken, dass einige tüten durcheinander sind und teile übrig bleiben, aber das ist in Ordnung! Wir ändern die art und weise, wie Sie LEGO bauen!

**¡ESPERA!**

Es posible que notes que algunas bolsas están fuera de servicio, así como piezas sobrantes, ¡pero está bien! ¡Estamos cambiando la forma en que construyes LEGO!

**暫停!**

你可能会注意到一些袋子顺序错乱, 以及一些剩余的部件, 但没关系! 我们正在改变你搭建乐高的方式!

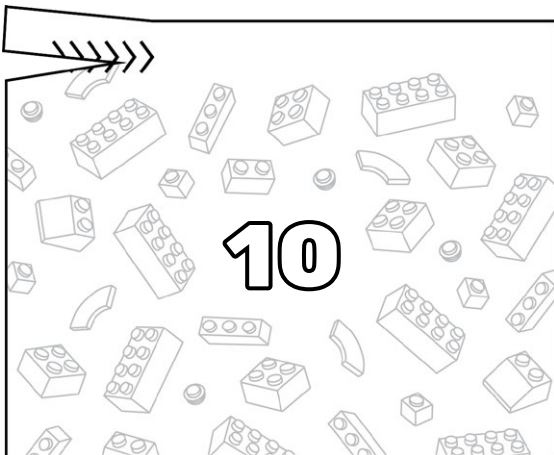
**Open LEGO® Bag 10**

**328**

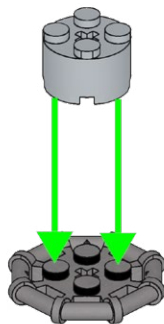
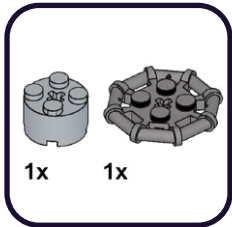
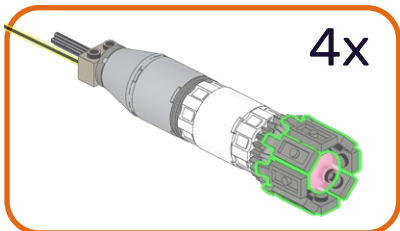

**329**

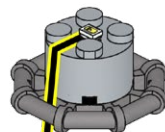
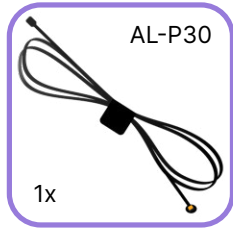

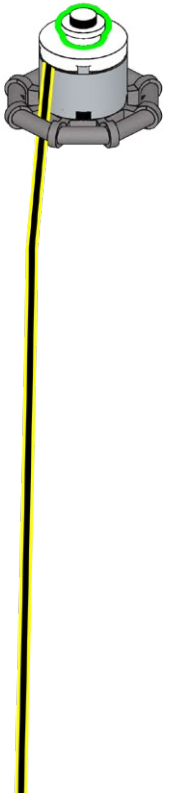
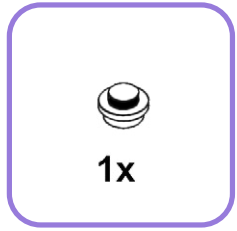
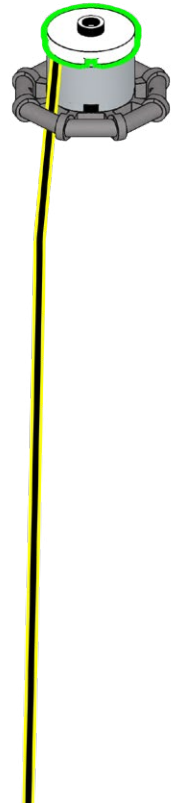
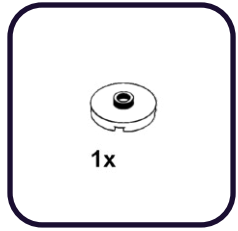

**332**

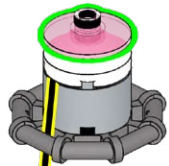
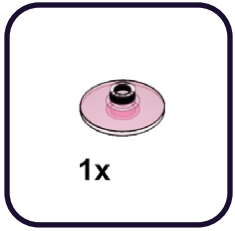

**333**

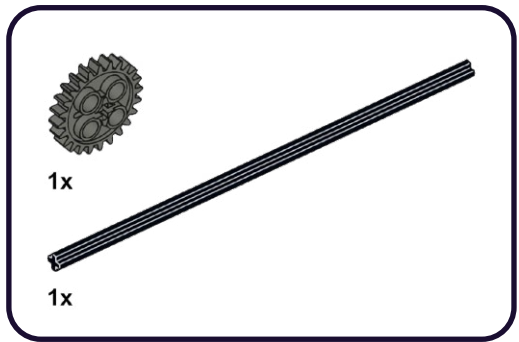

1

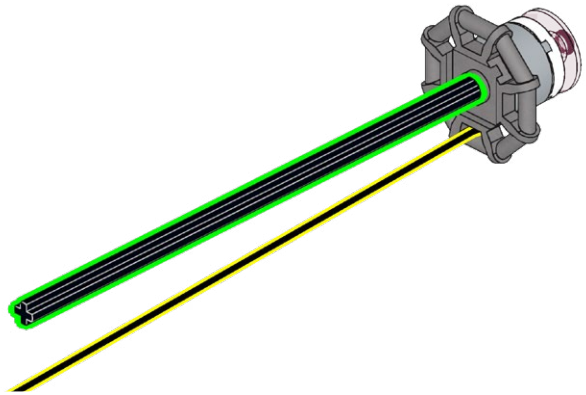

2

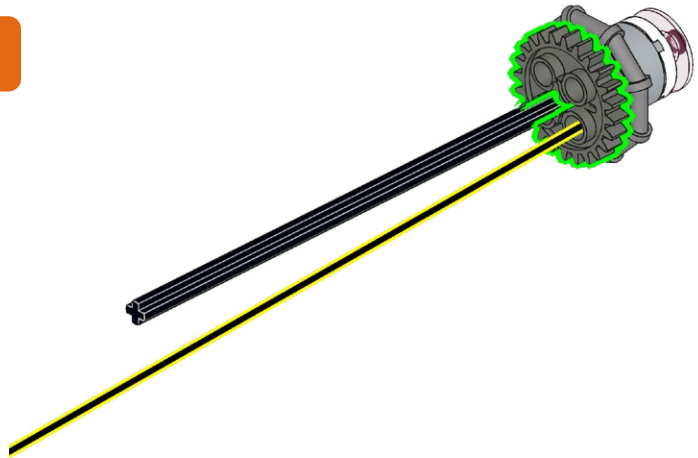



**334**

1x

1x

**335**

1x

1x

1

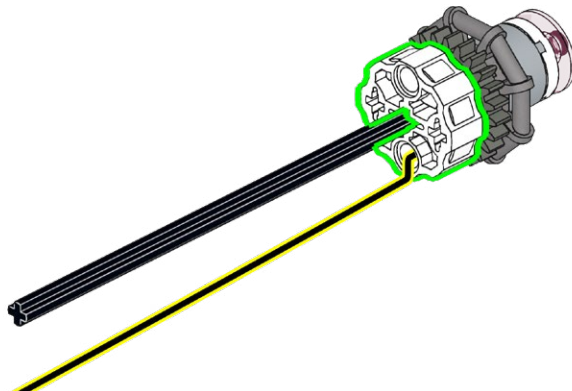

2

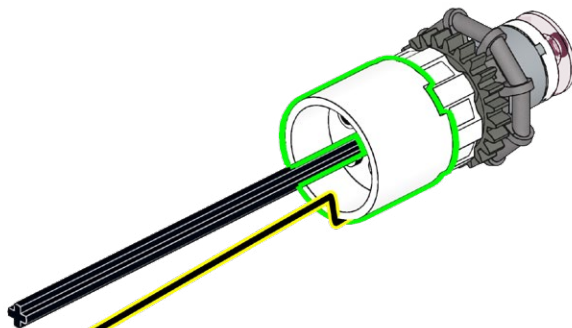

1

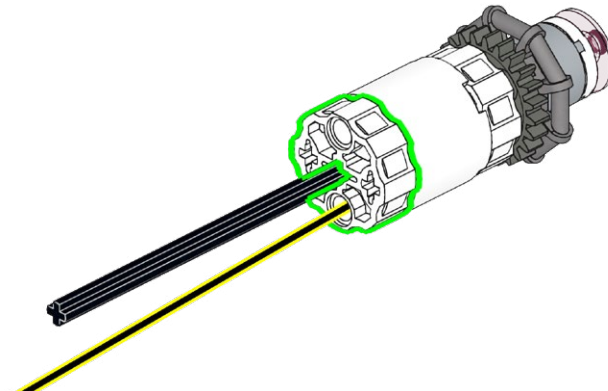

2

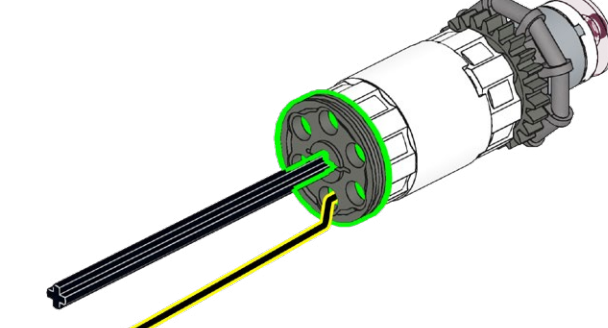

**336**

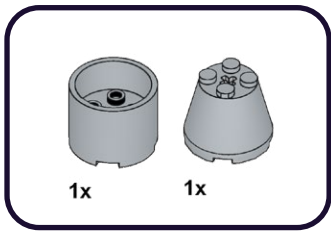

1

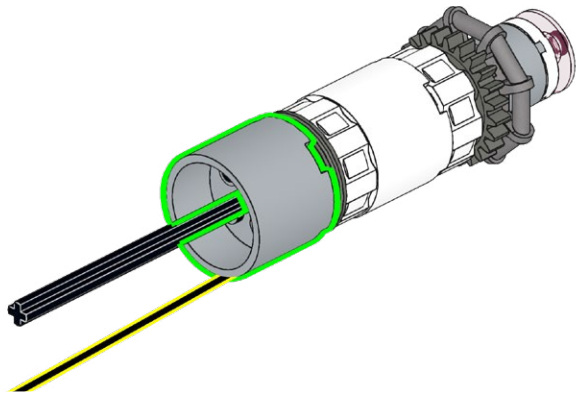

2

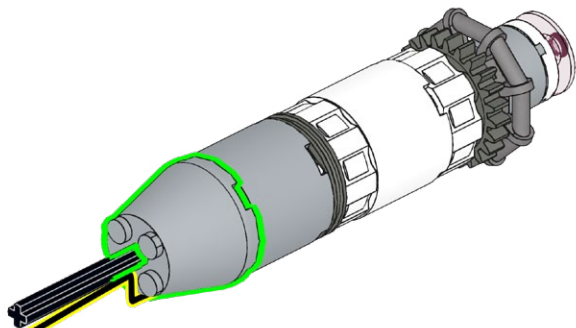

**337**

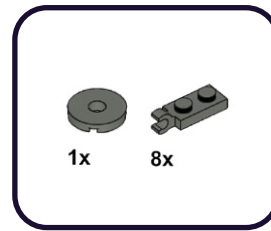

1

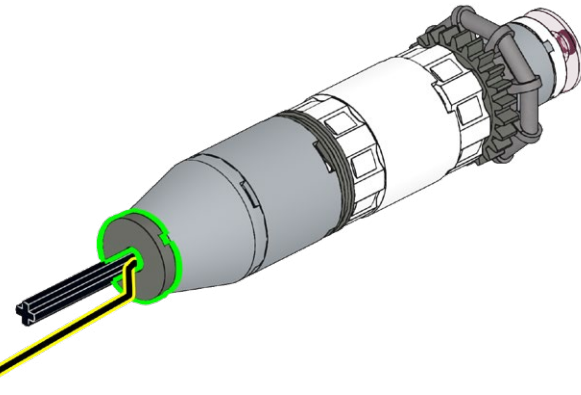

2

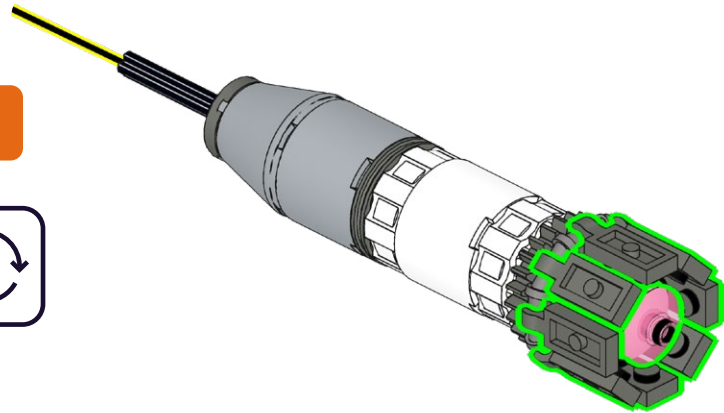
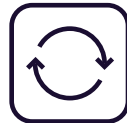

4x

**HOLD UP!**

You might notice some bags aren't in order, as well as left over pieces, but that's ok! We're changing the way you build LEGO!

**ATTENDEZ!**

Vous remarquerez peut-être que certains sacs, ainsi que certaines pièces, ne sont pas dans le bon ordre. Mais pas de panique! Nous changeons simplement la façon avec laquelle vous construisez vos LEGO!

**ASPETTA!**

Potresti notare che alcuni sacchetti non sono in ordine, così come i pezzi avanzati, ma va bene così! Stiamo cambiando il modo in cui costruisci i LEGO!

**HALT!**

Sie werden möglicherweise bemerken, dass einige tüten durcheinander sind und teile übrig bleiben, aber das ist in Ordnung! Wir ändern die art und weise, wie Sie LEGO bauen!

**¡ESPERA!**

Es posible que notes que algunas bolsas están fuera de servicio, así como piezas sobrantes, ¡pero está bien! ¡Estamos cambiando la forma en que construyes LEGO!

**暫停!**

你可能会注意到一些袋子顺序错乱, 以及一些剩余的部件, 但没关系! 我们正在改变你搭建乐高的方式!

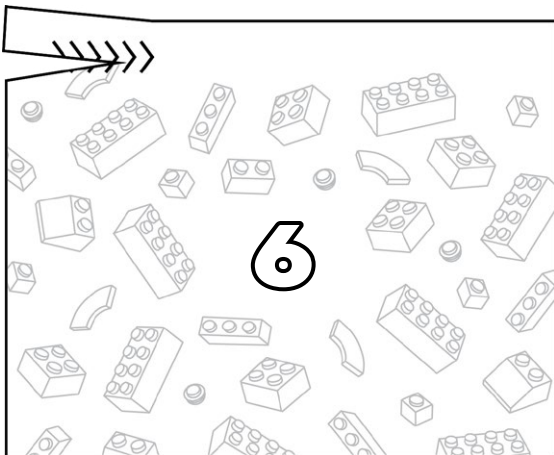
**Open LEGO® Bag 6**

338

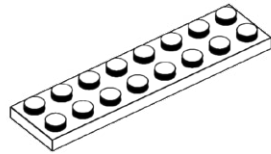

1x

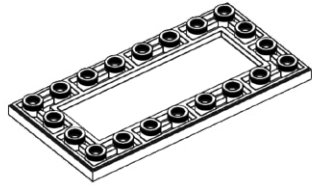

1x

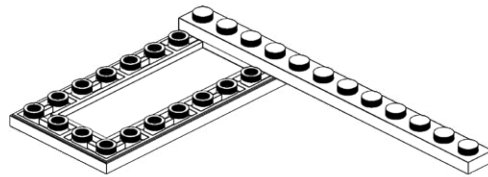

339

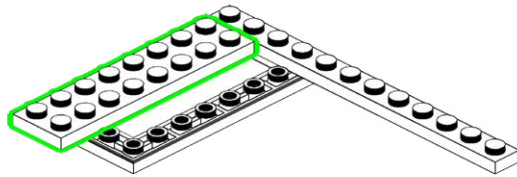
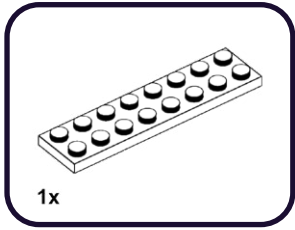

340

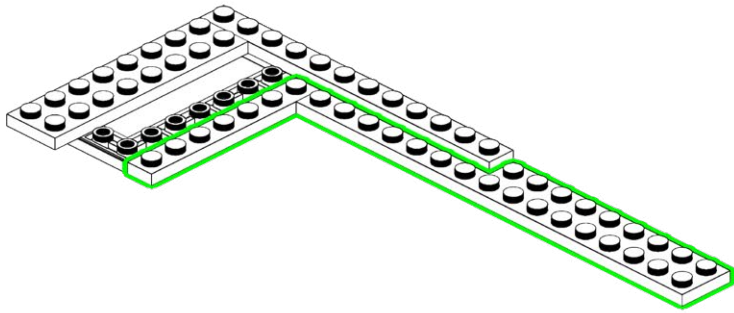
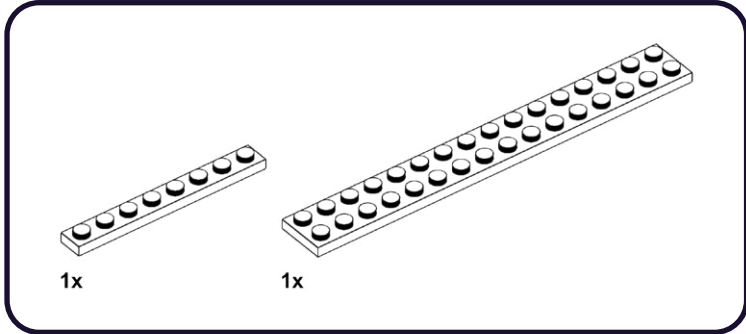

341

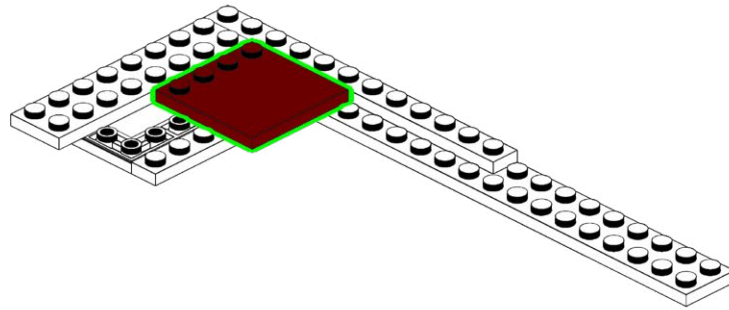
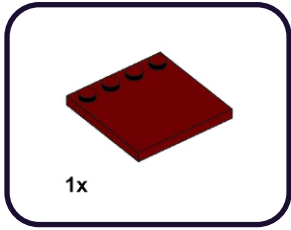



342

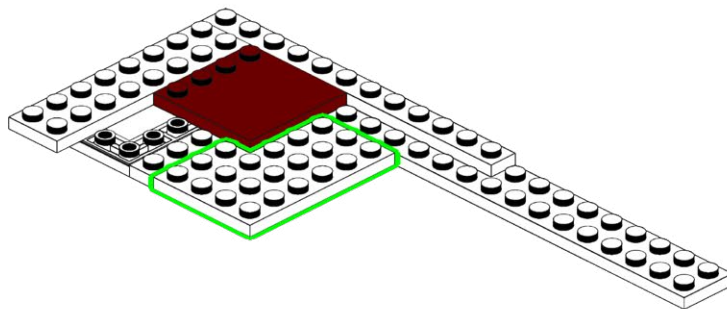
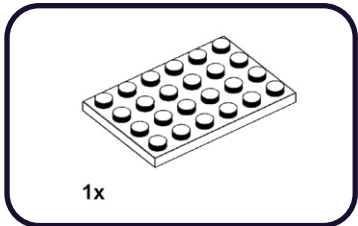

**343**

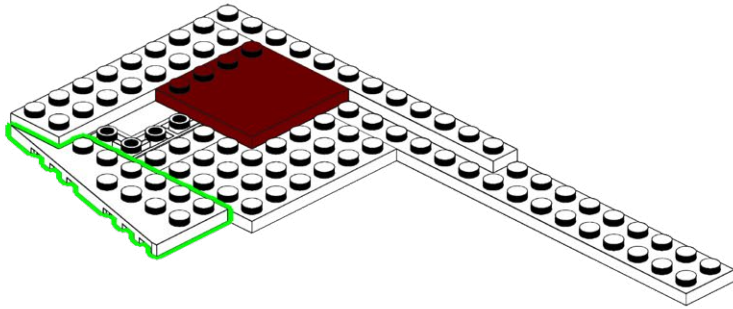
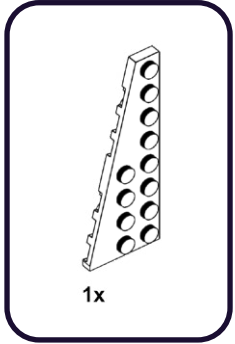

344

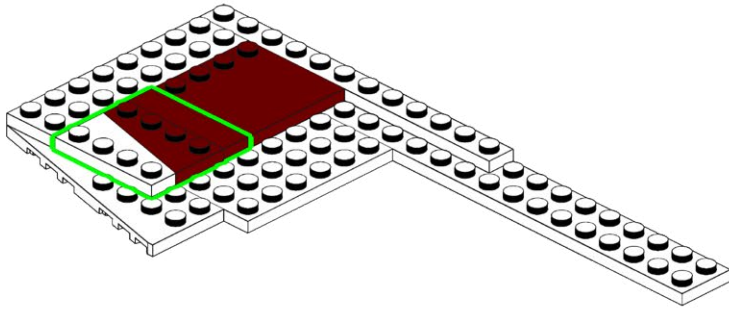
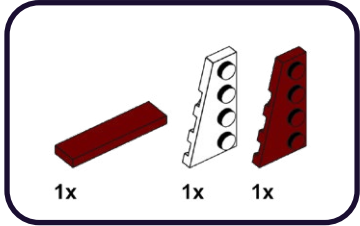

345

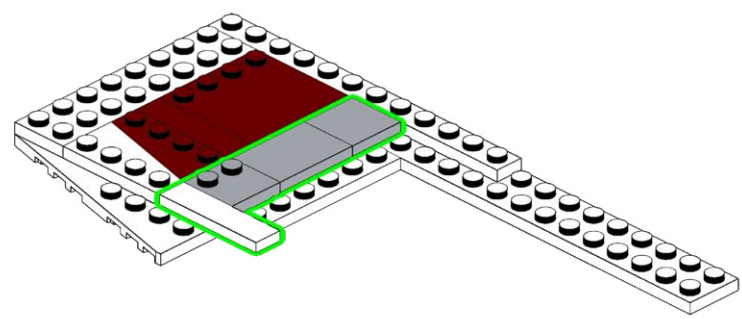
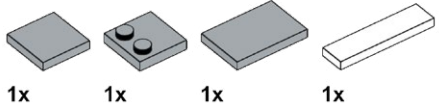

346

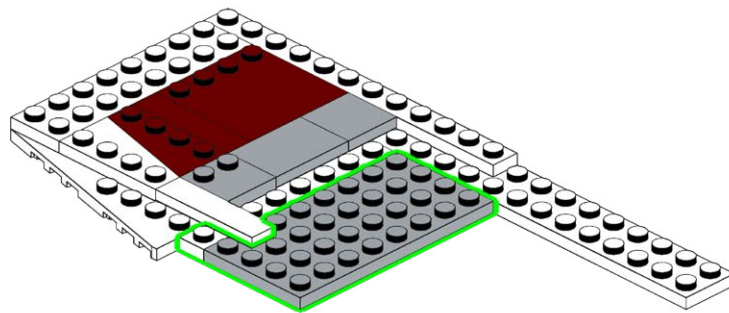
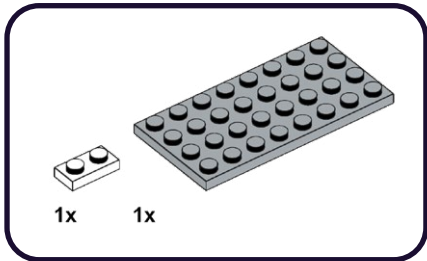

**347**

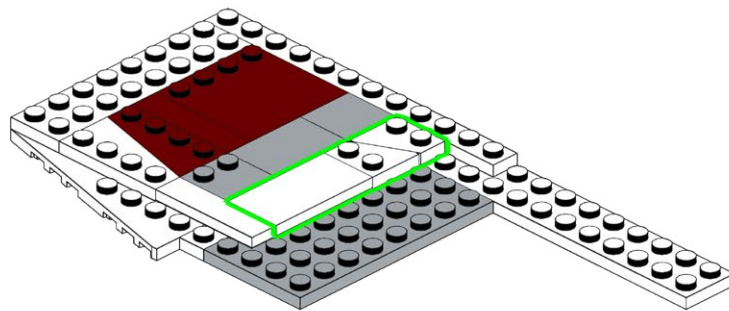
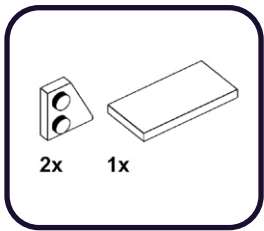

348

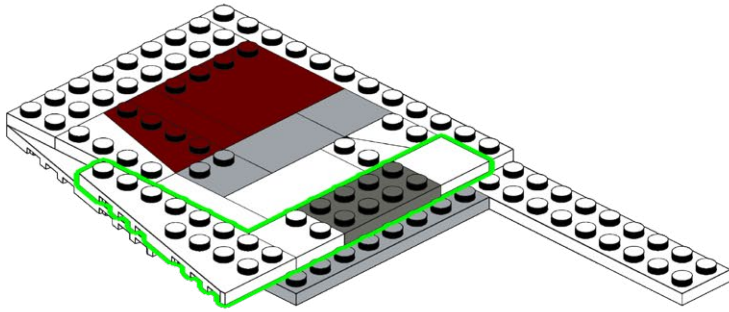
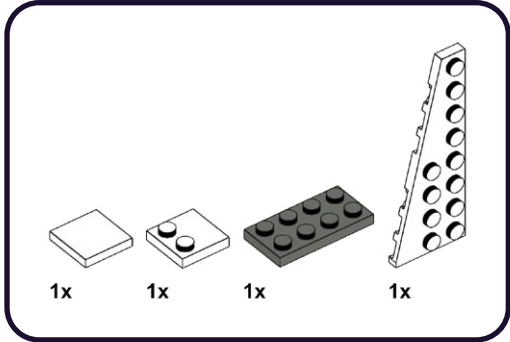



349

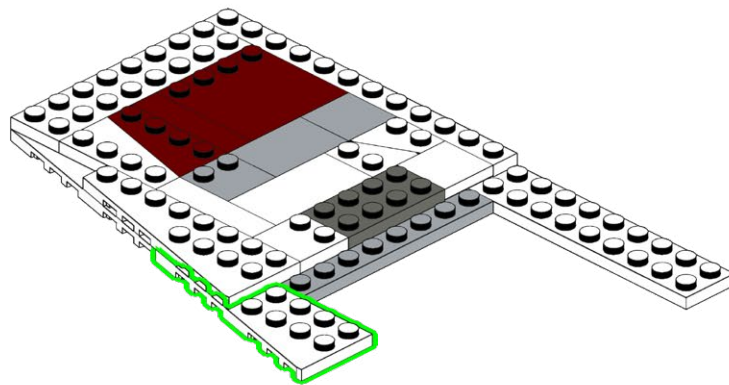
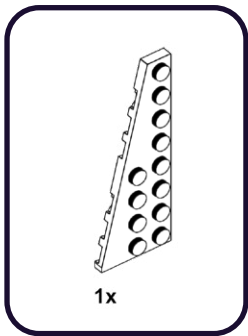

**350**

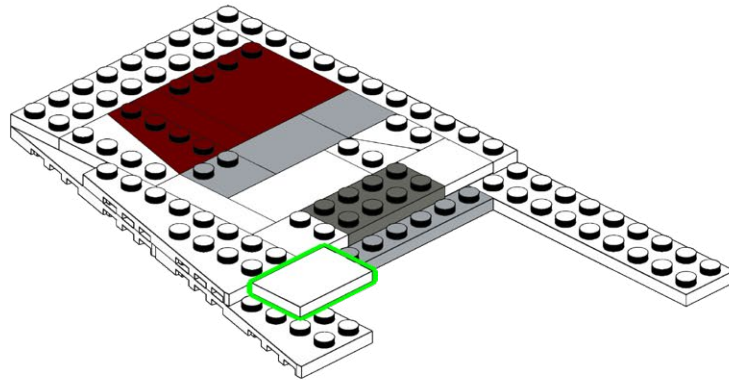
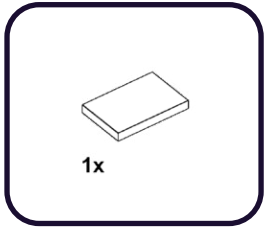

351

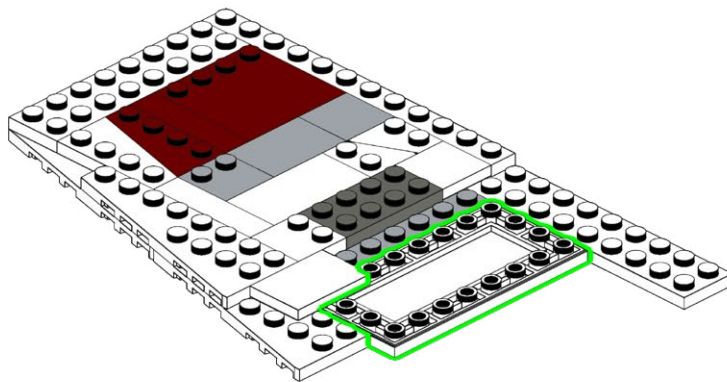
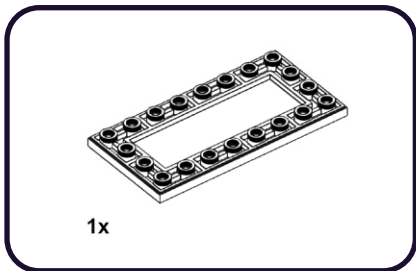

352

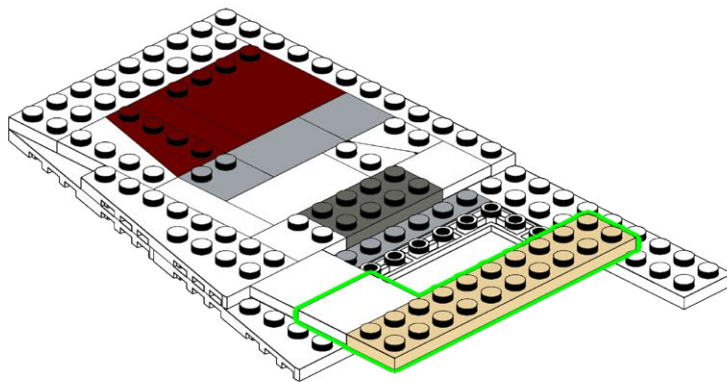
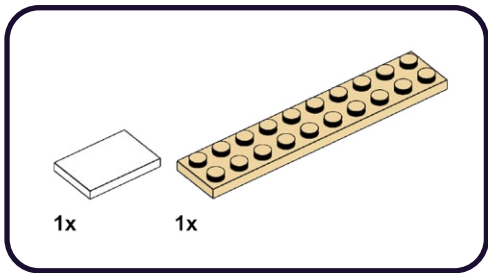

353

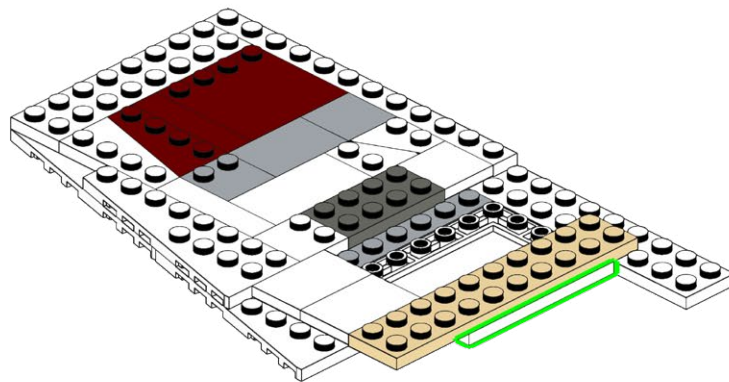
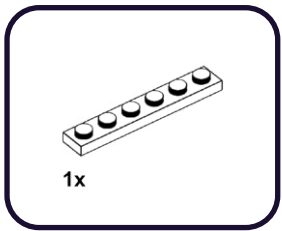

354

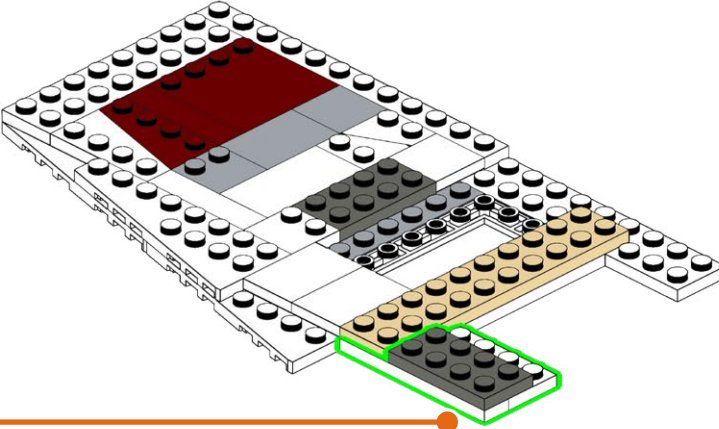
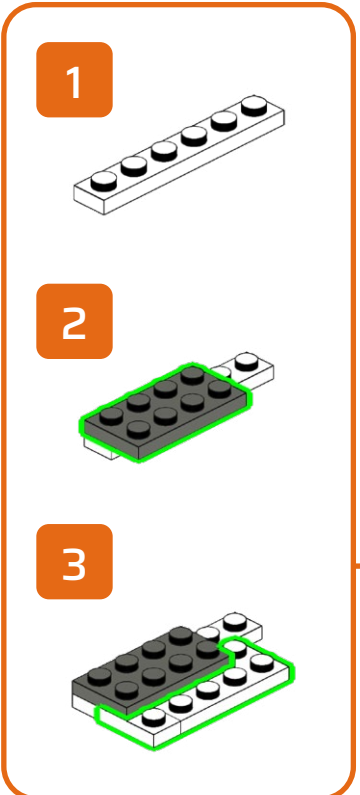
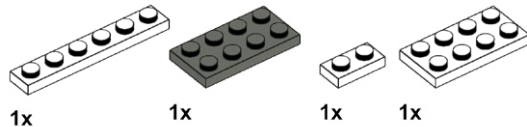

355

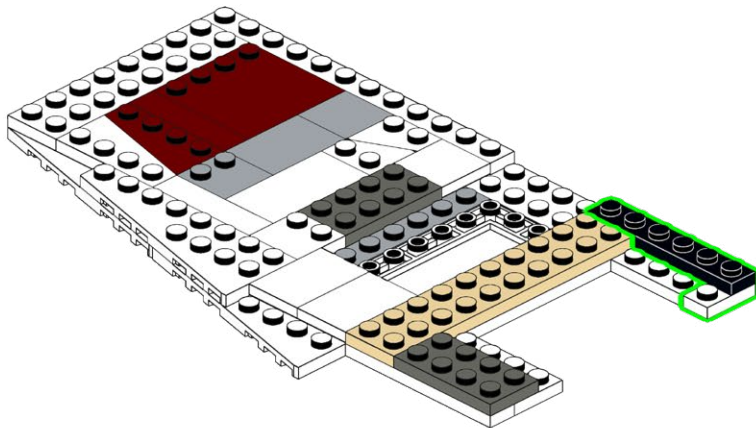
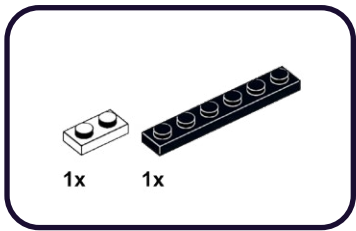



**356**

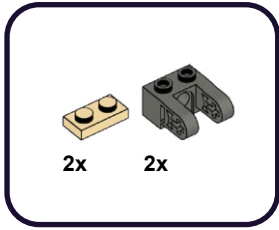

1

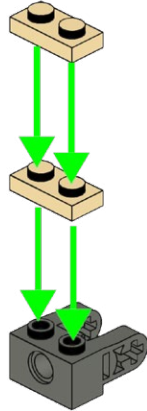

2

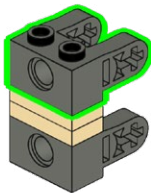

**357**

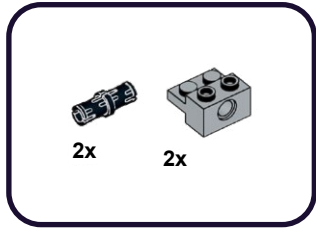

1

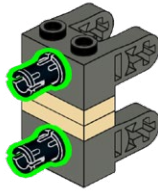

2

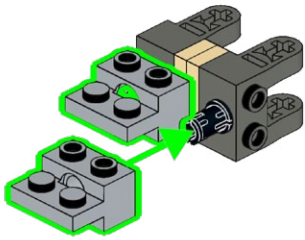

358

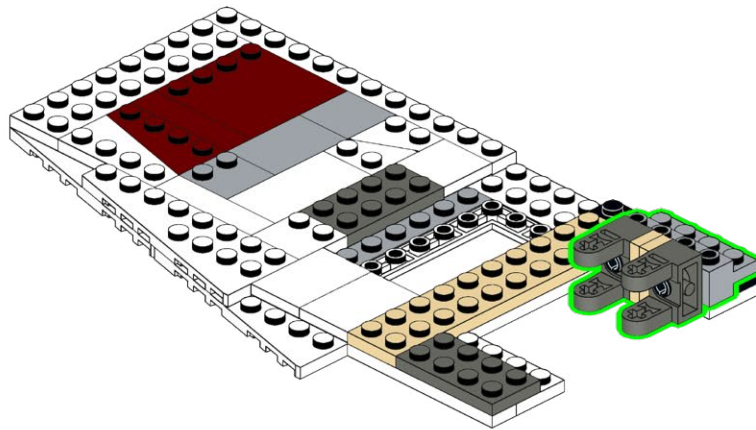

# 359

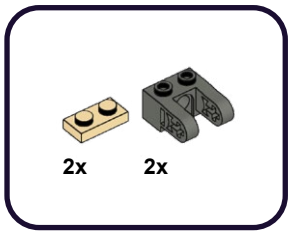

1

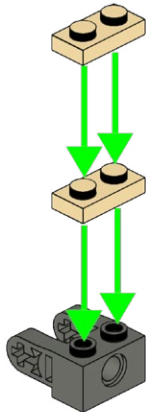

2

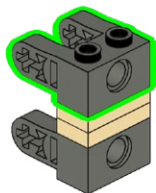

# 360

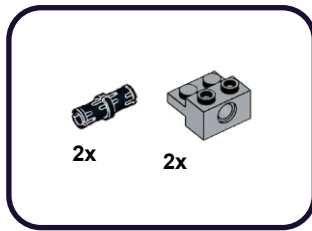

1

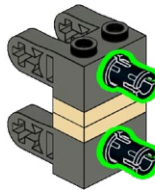

2

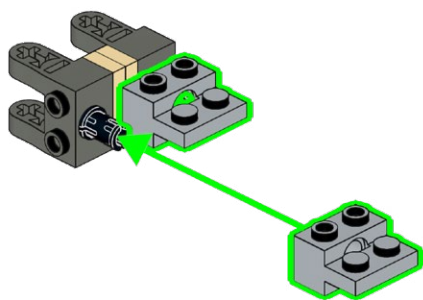

361

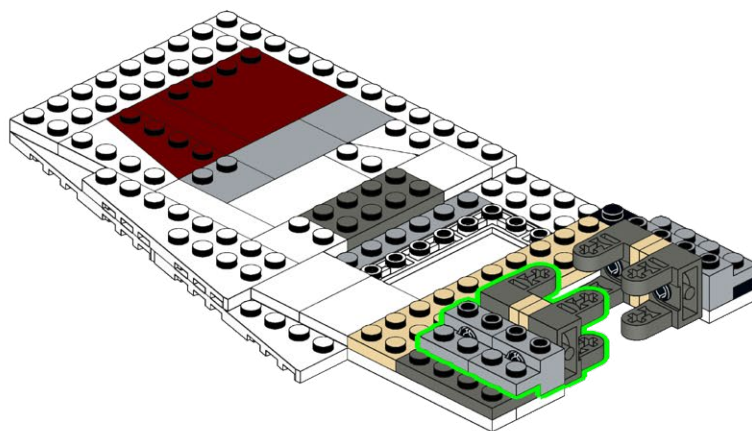

**362**

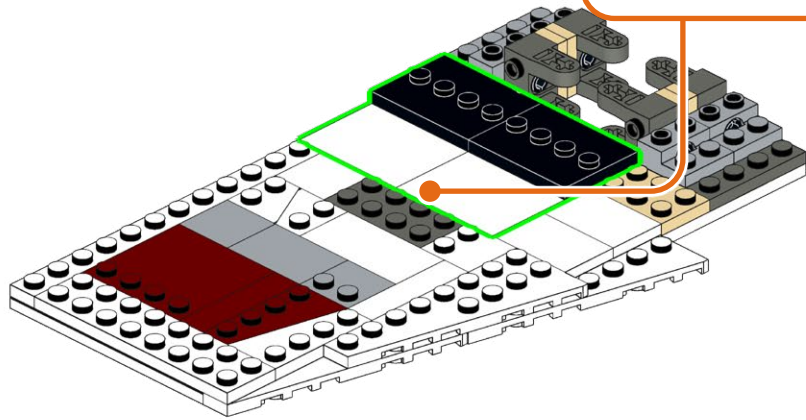
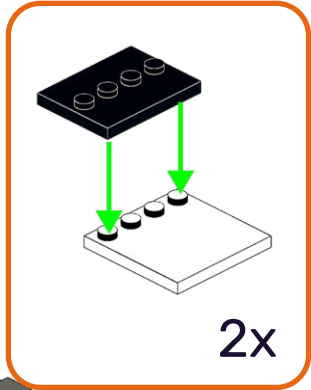
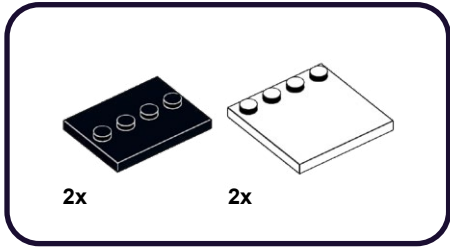

363

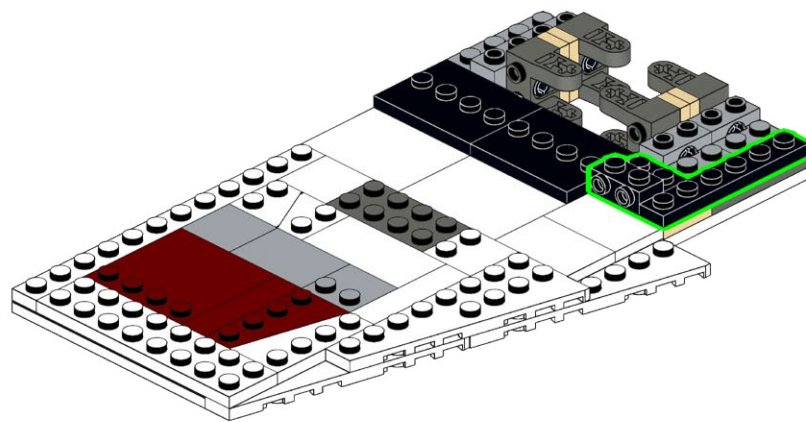
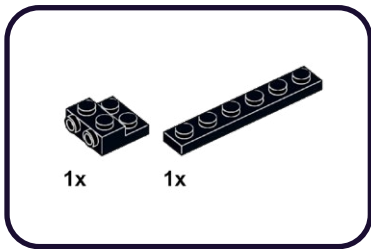

364

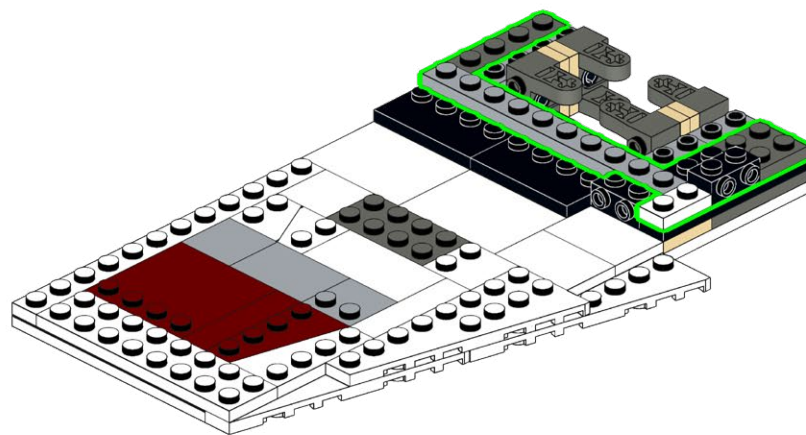
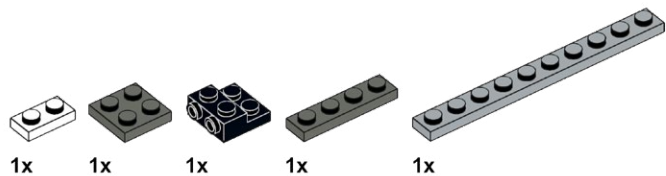



365

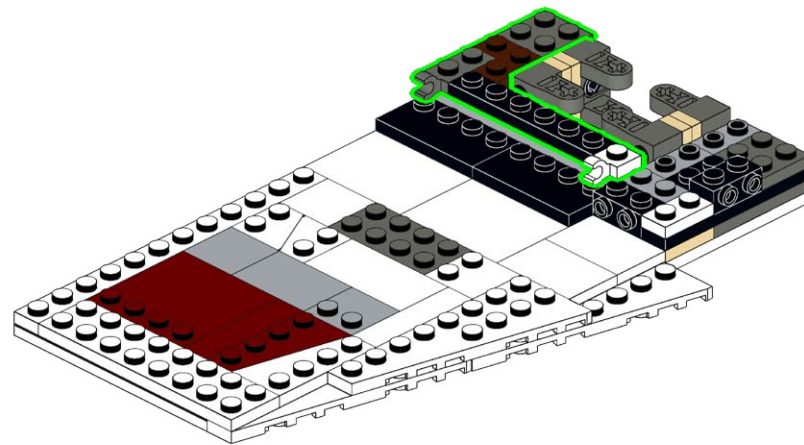
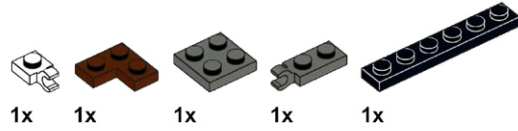

366

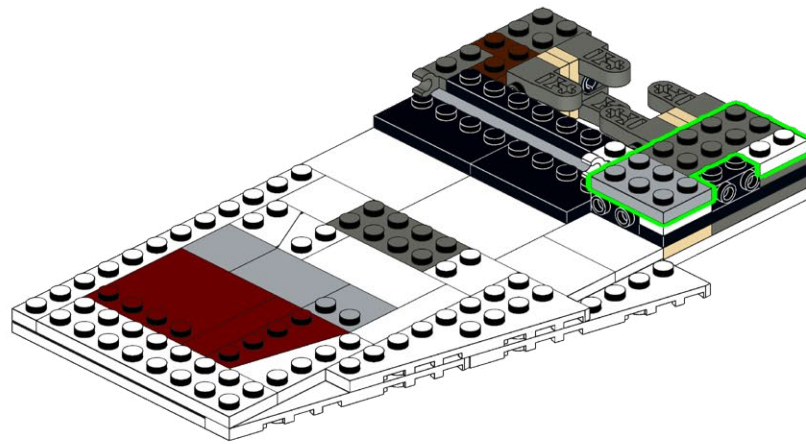
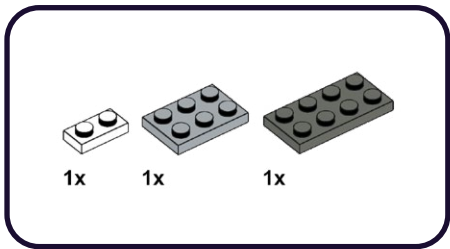

**367**

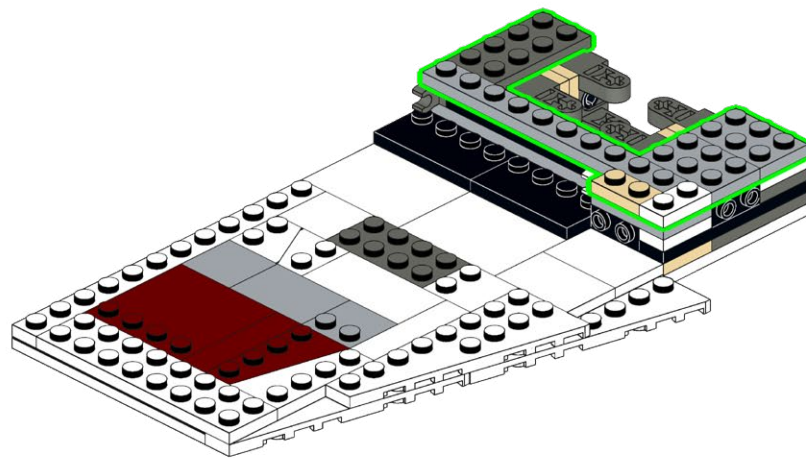
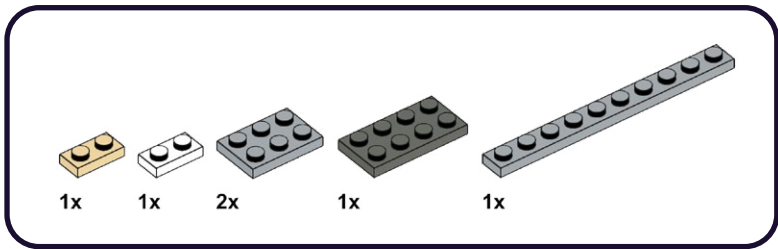

368

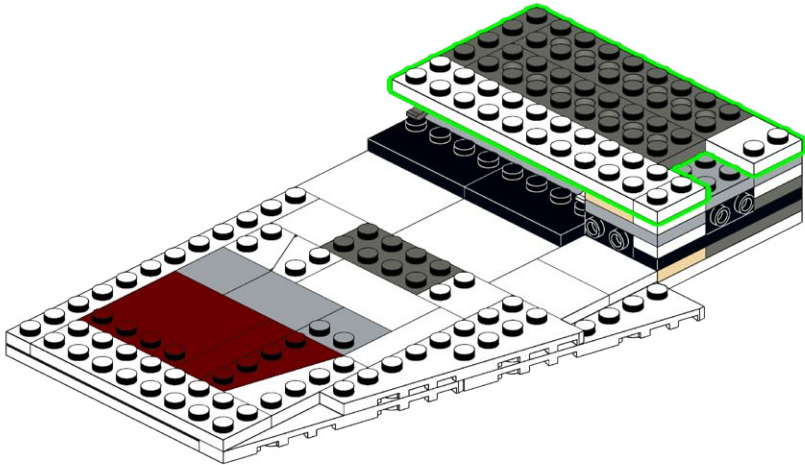
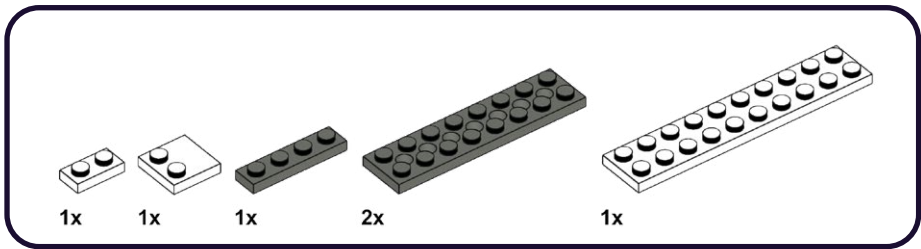

369

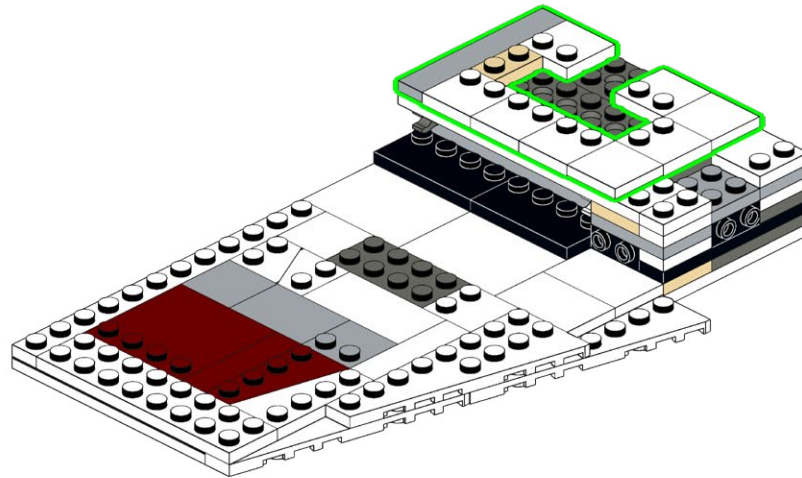
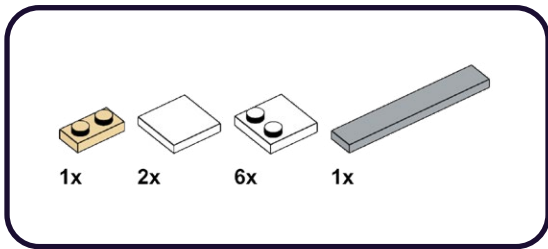

**370**

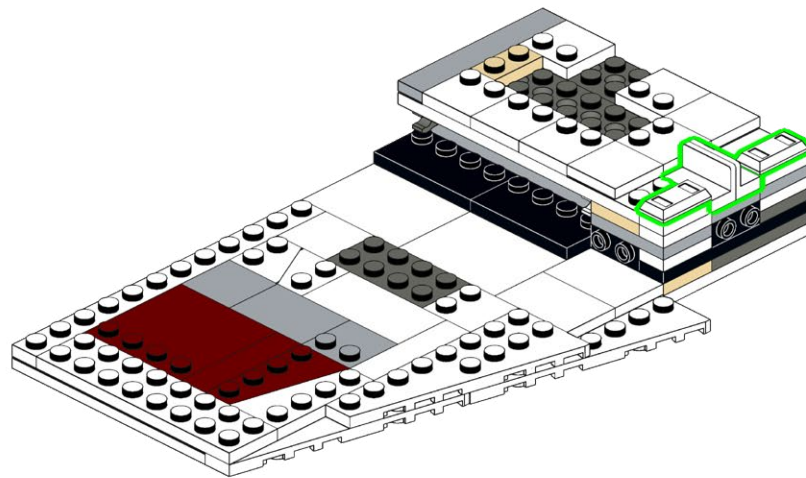
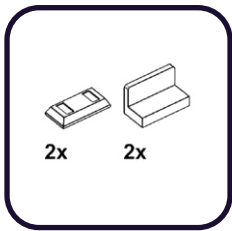

371

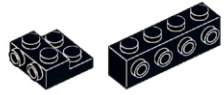

2x

1x

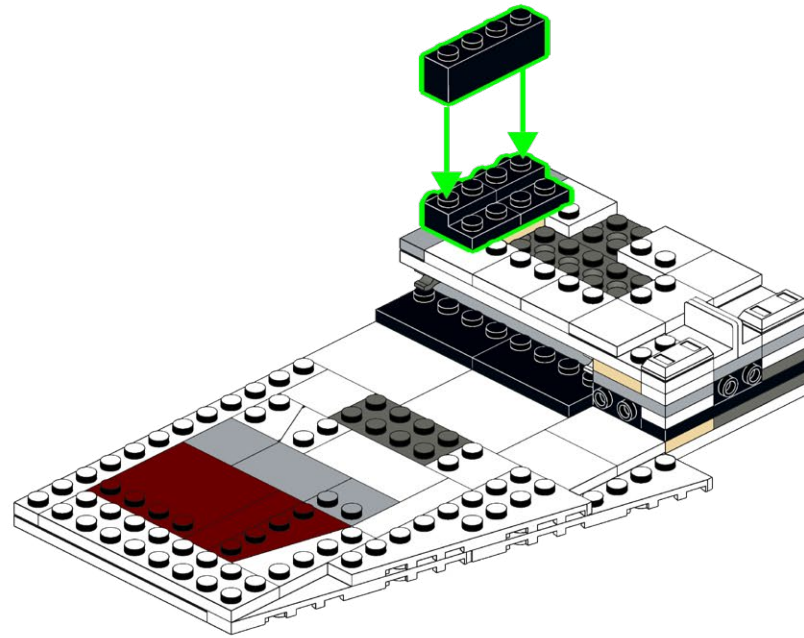



**372**

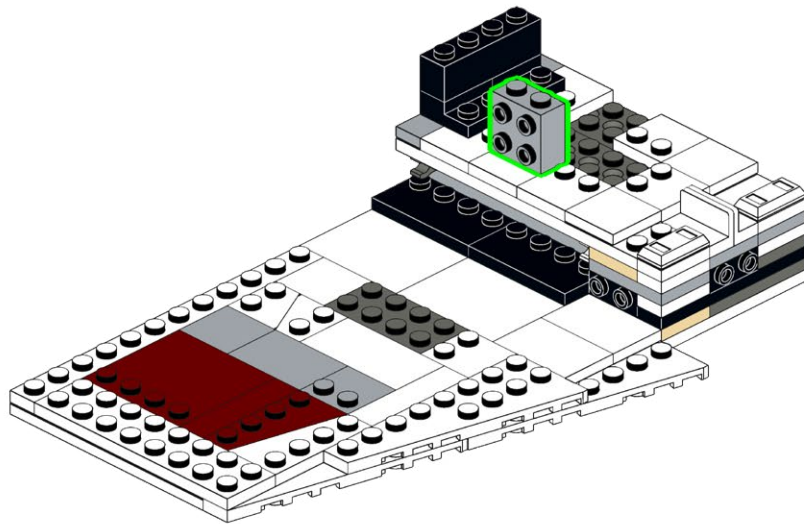
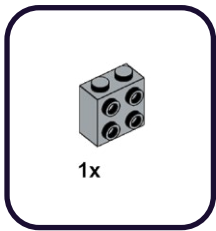

**373**

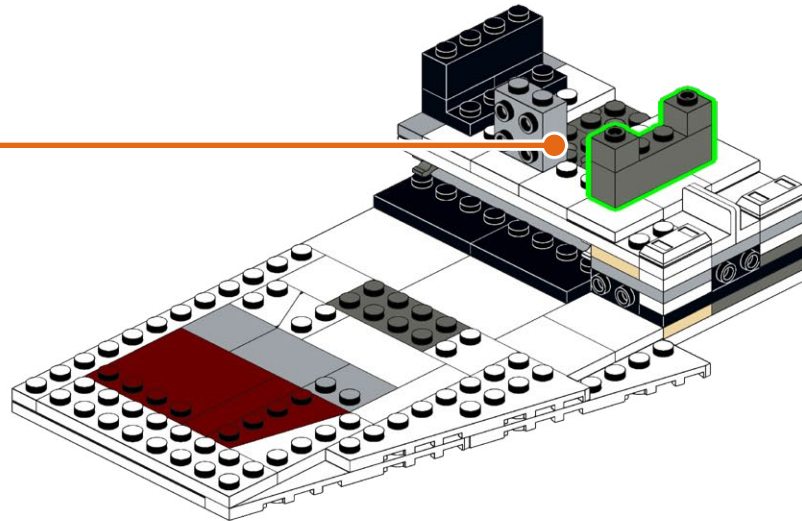
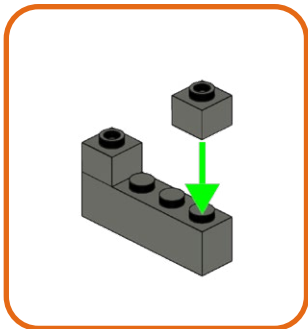
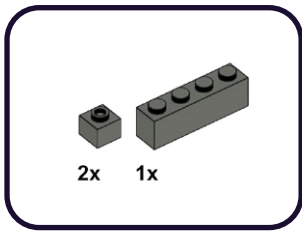

**374**

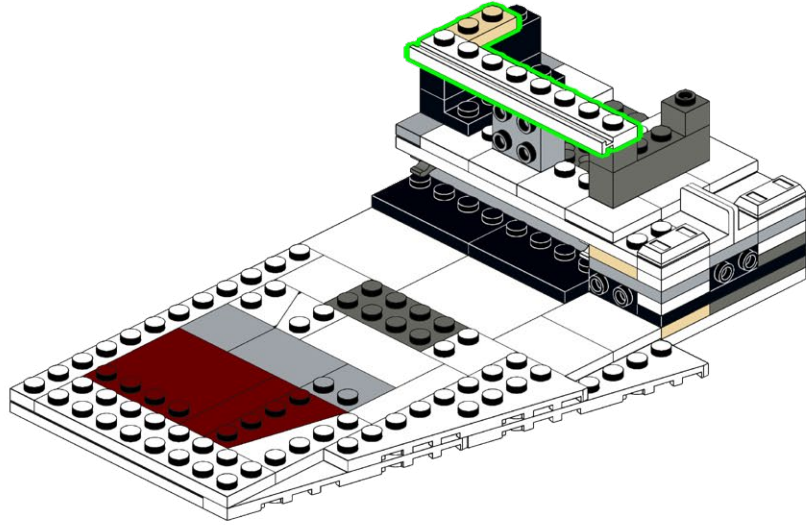
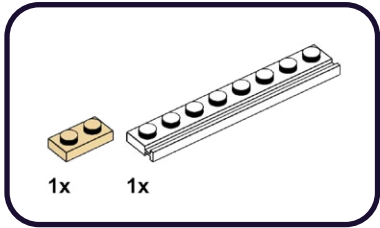

**375**

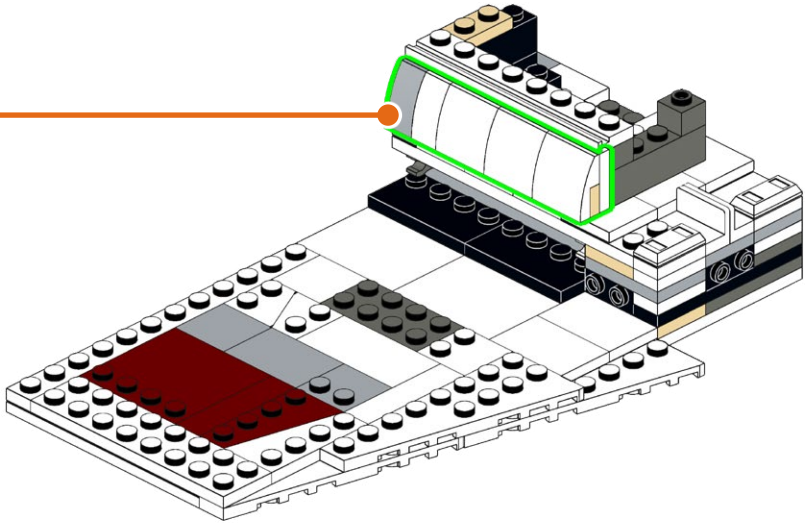
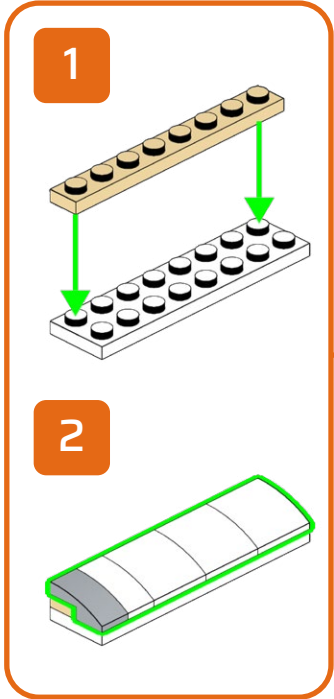
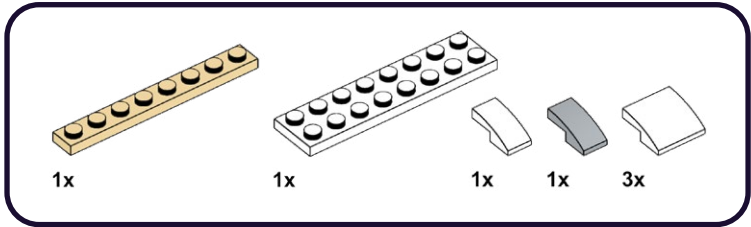

**376**

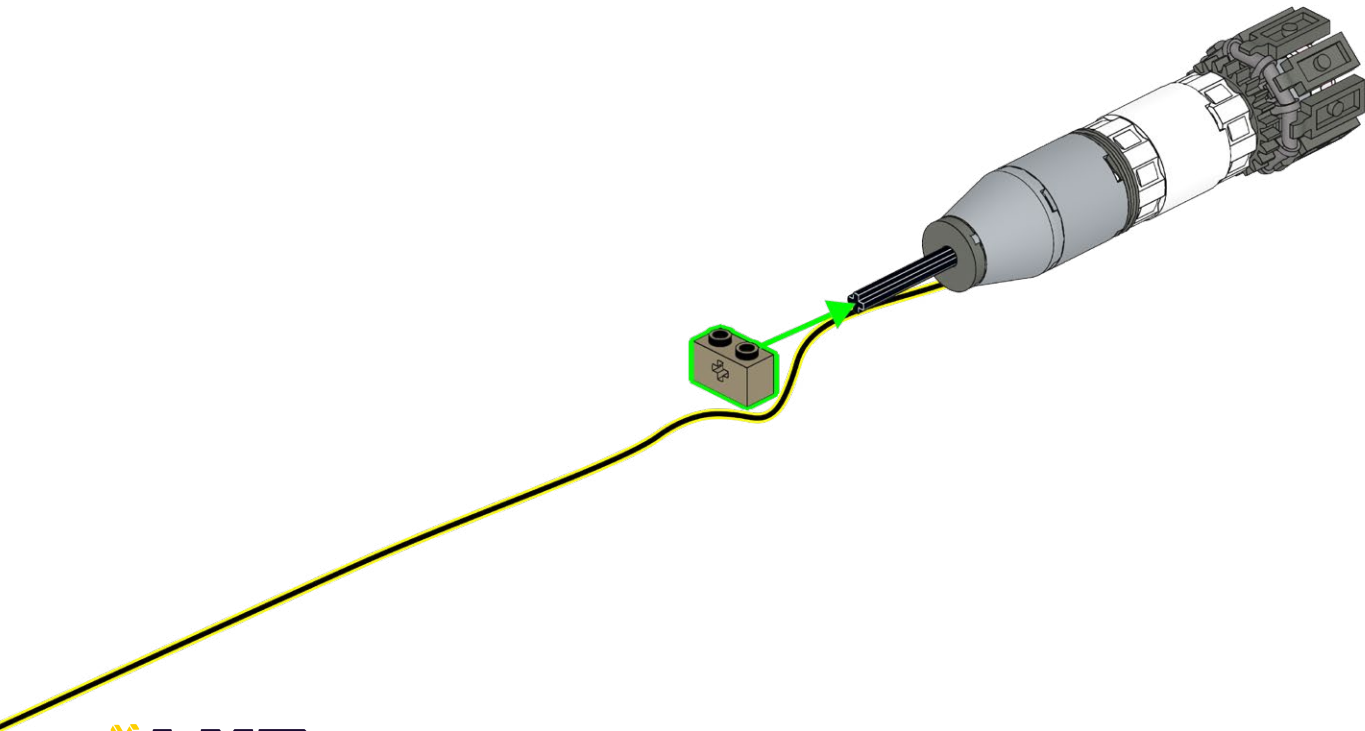
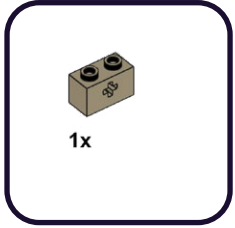

**377**

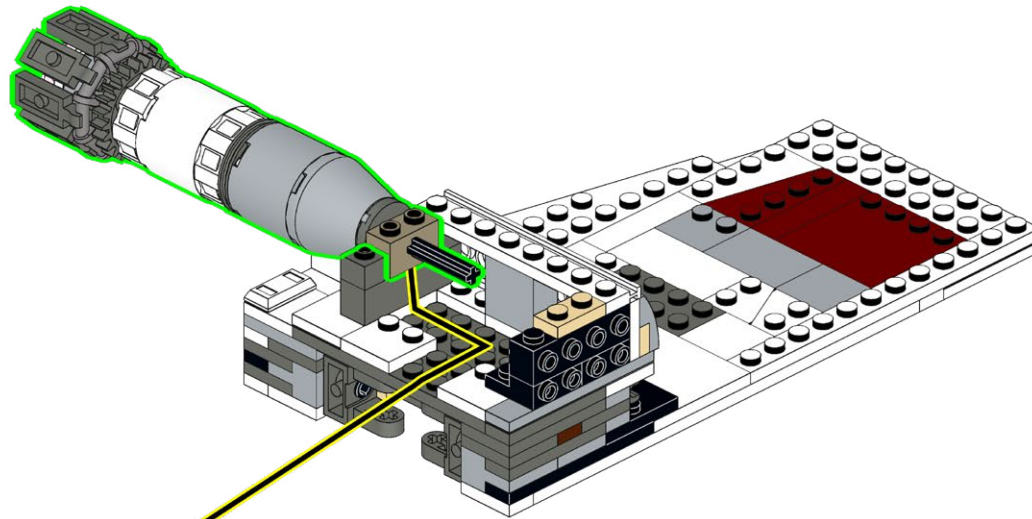

**378**

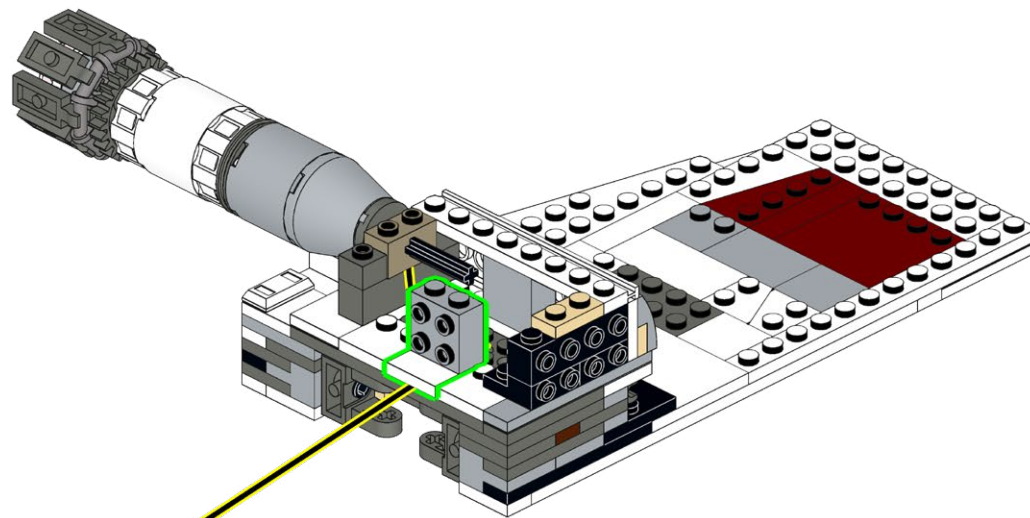
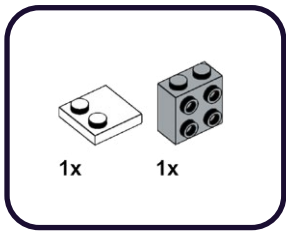



**379**

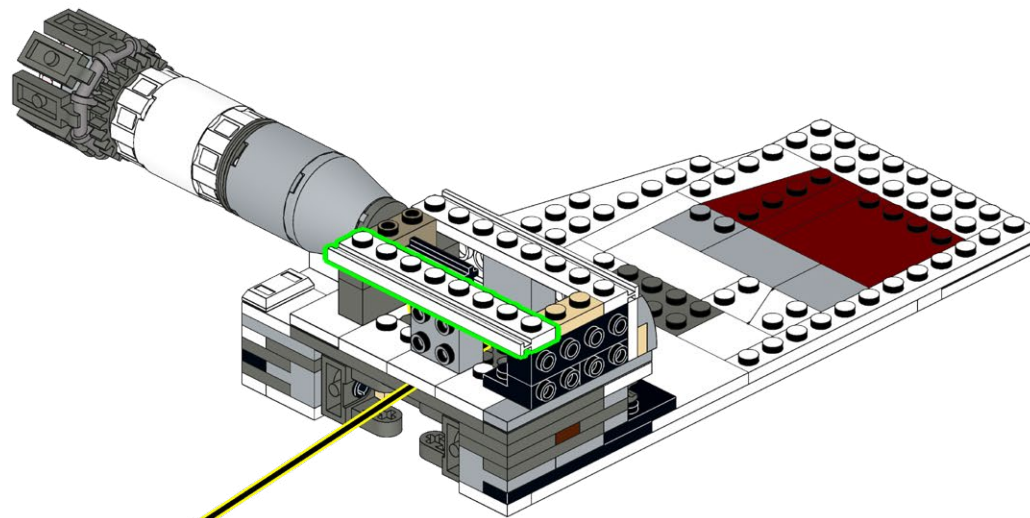
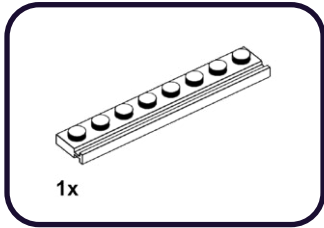

380

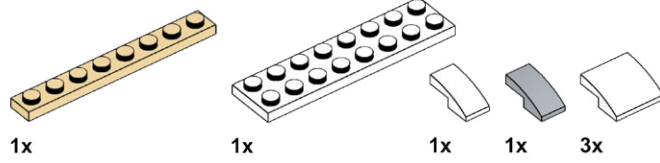

1

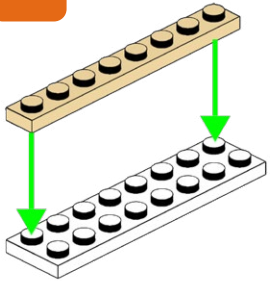

2

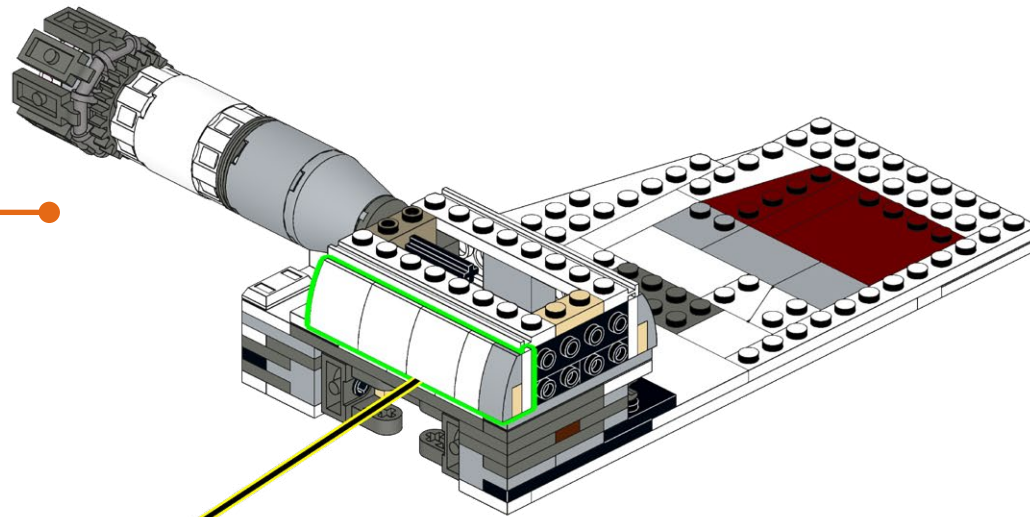
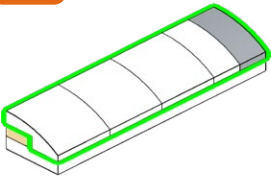

381

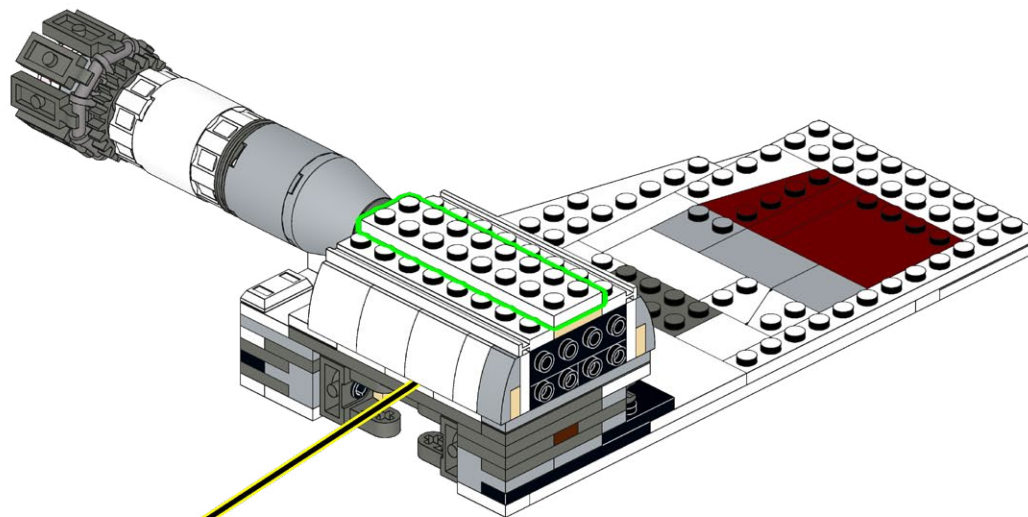
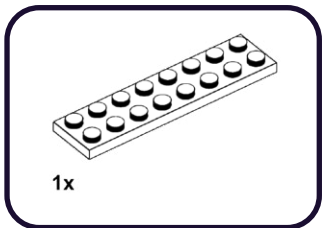

382

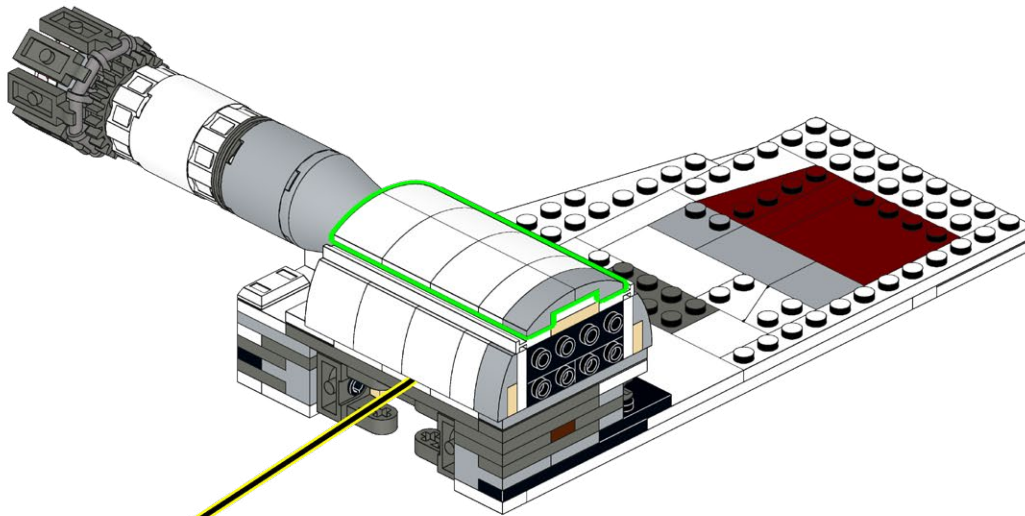
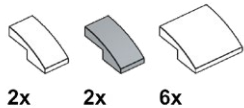

383

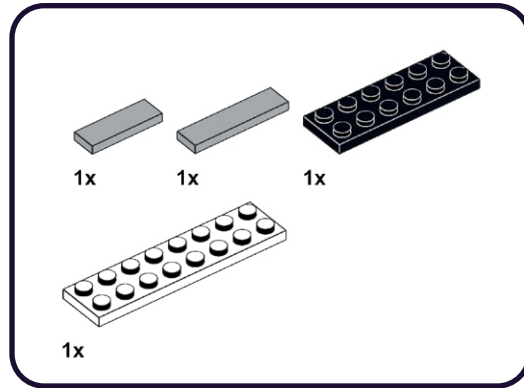

1

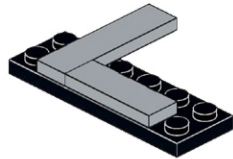

2

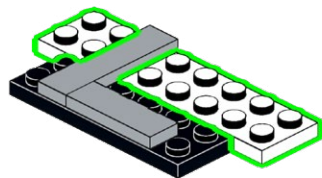

384

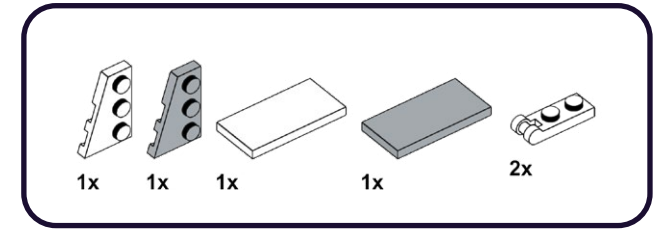

1

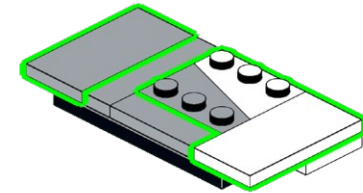

2

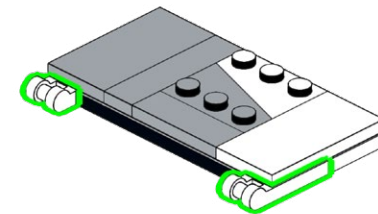

385

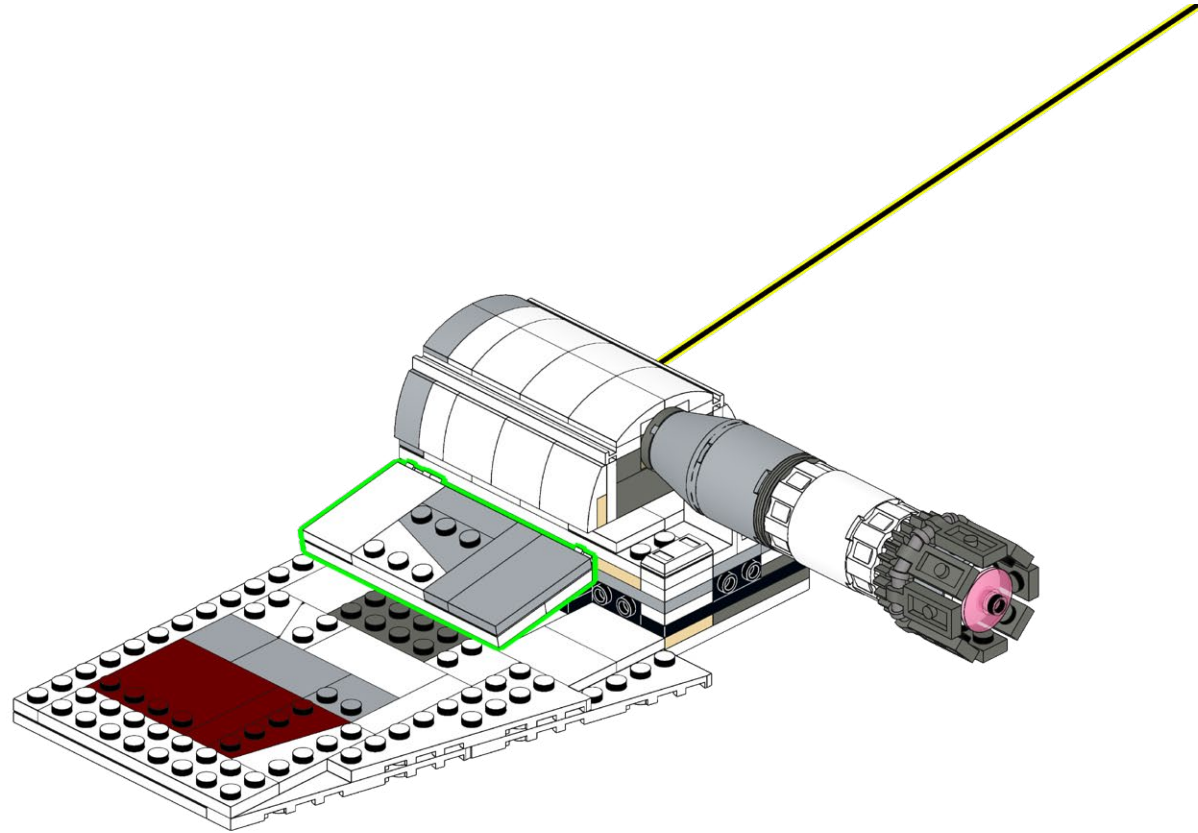

**386**

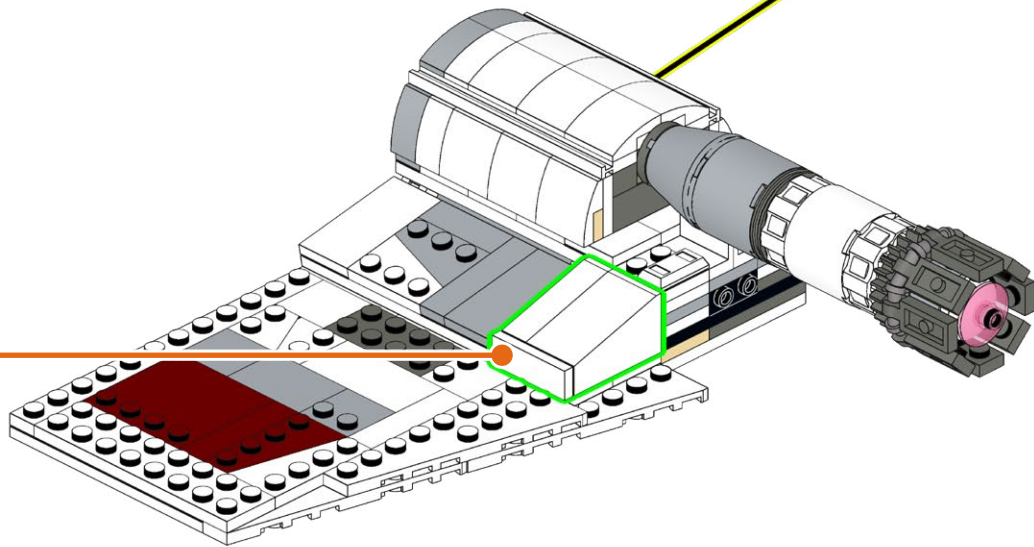
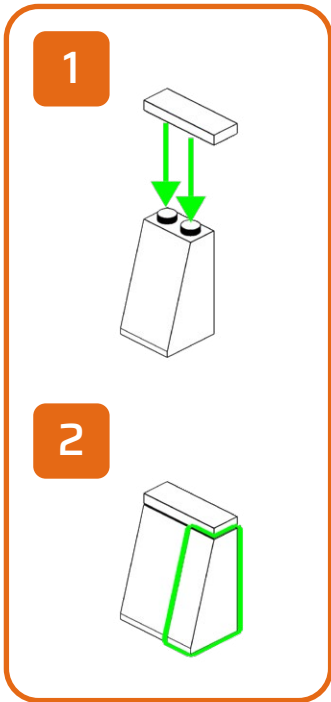
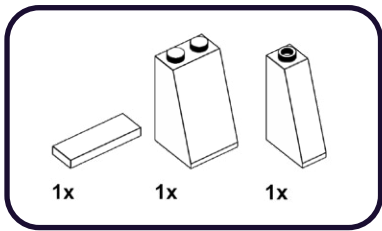



**387**

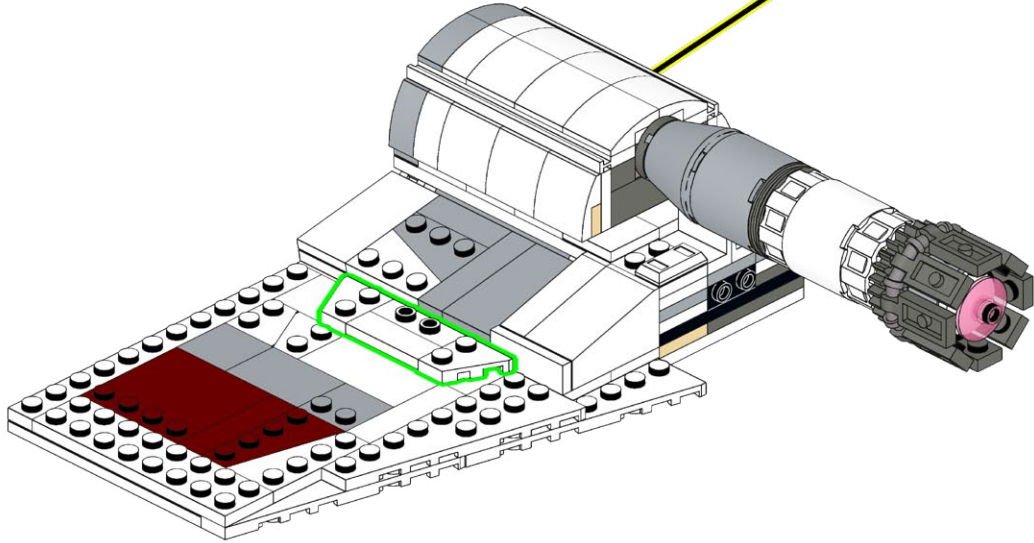
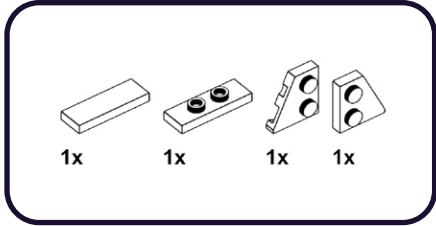

388



1x



5x



1x

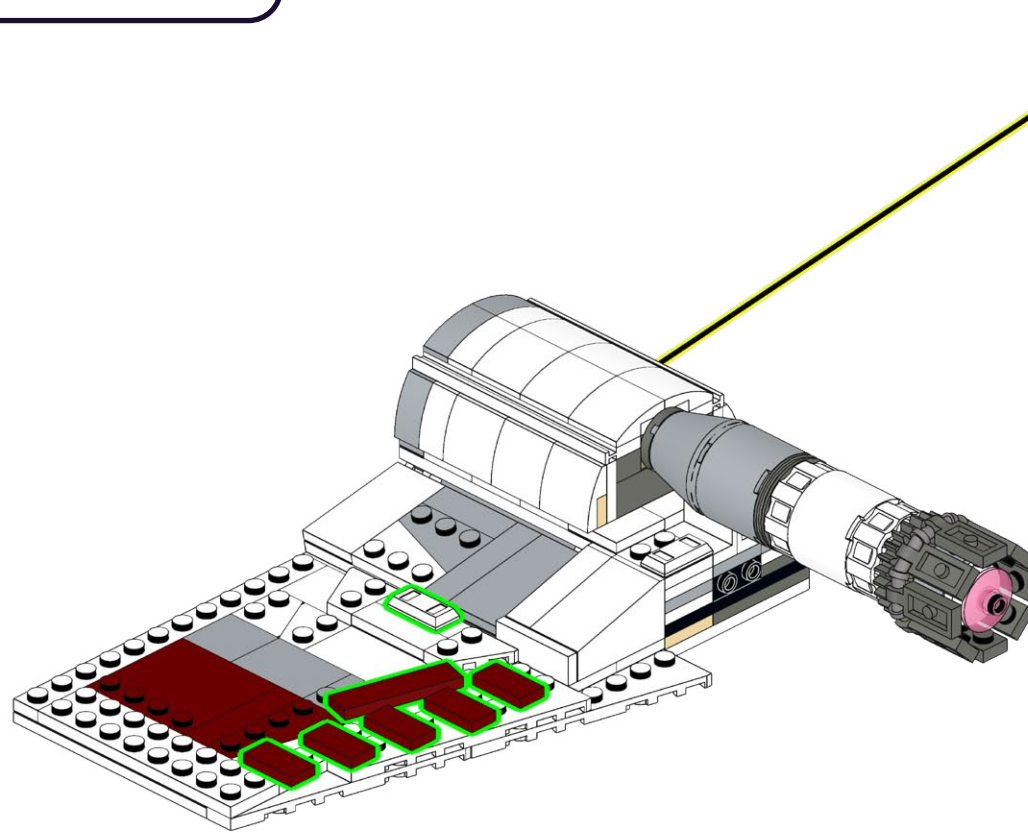

389

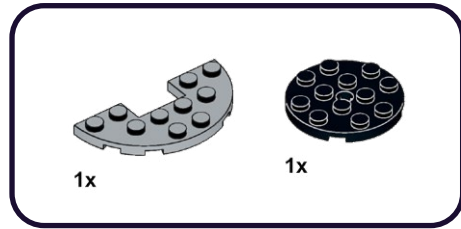

1

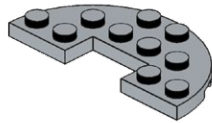

2

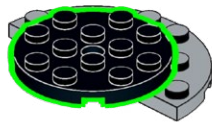

390

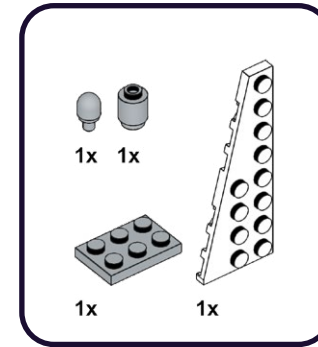

1

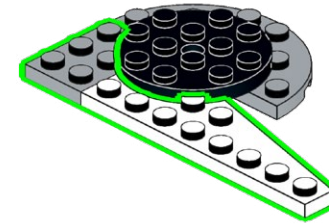

2

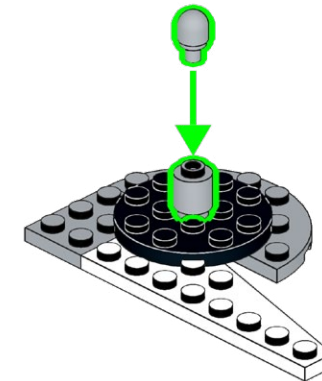

**391**

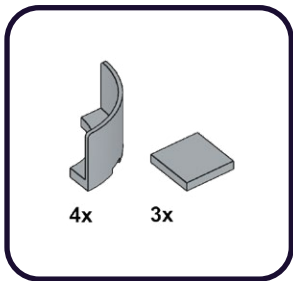

1

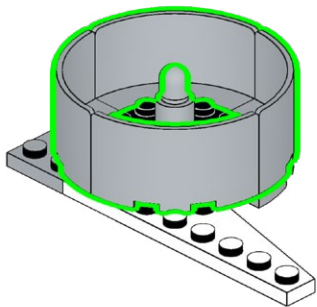

2

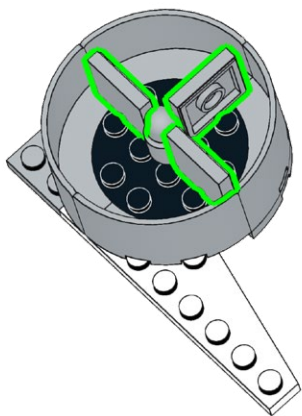

**392**

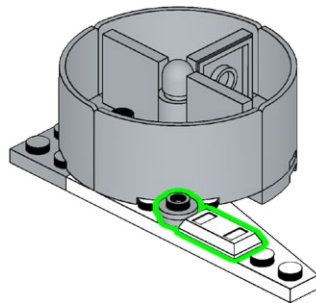
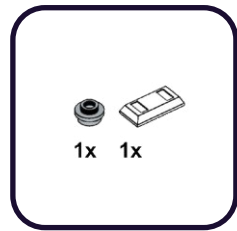

393

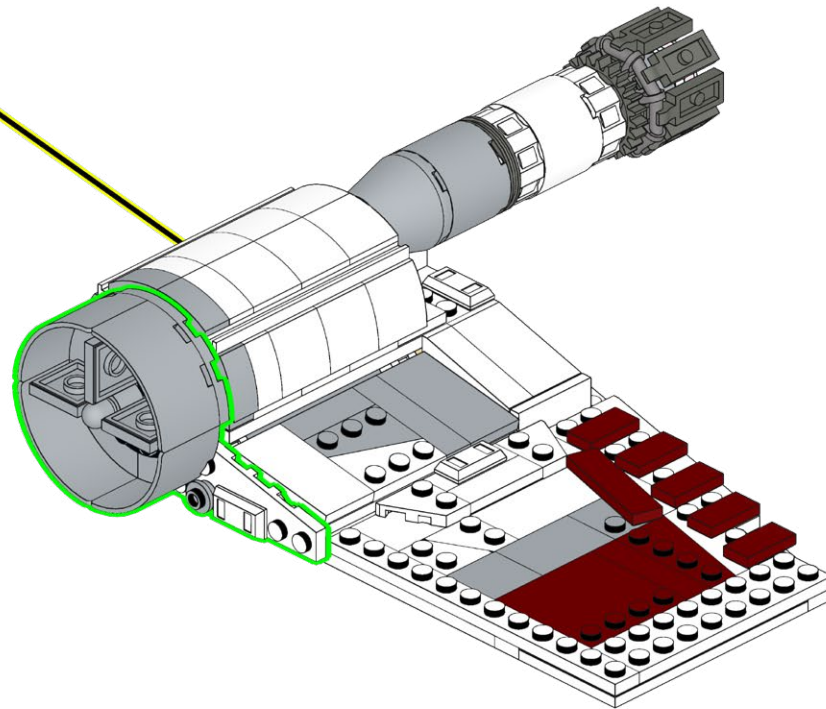

**394**

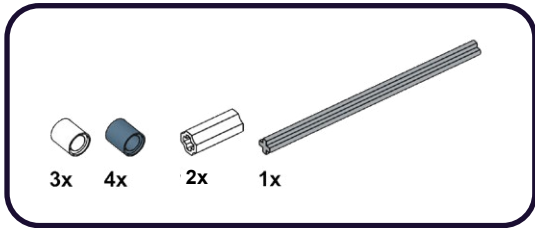

**1**

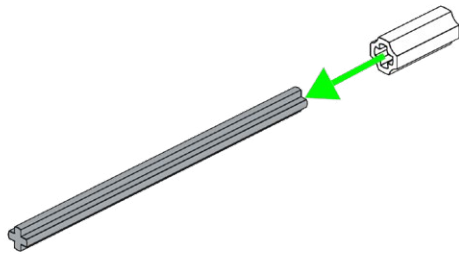

**2**

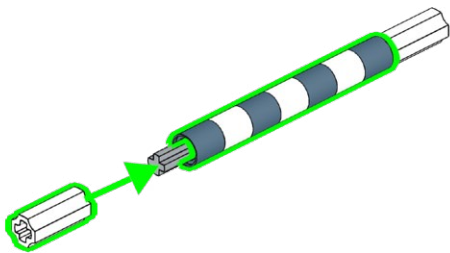

**395**

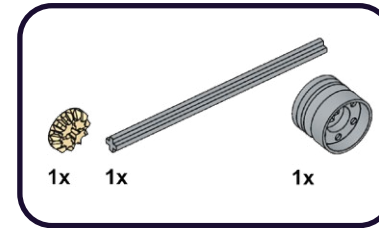

**1**

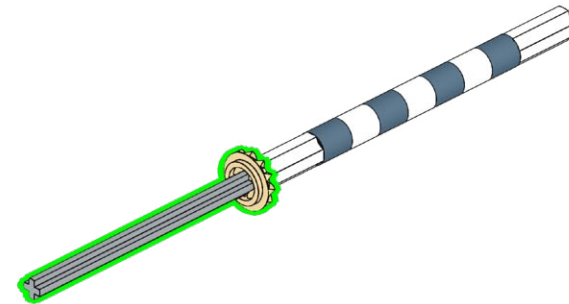

**2**

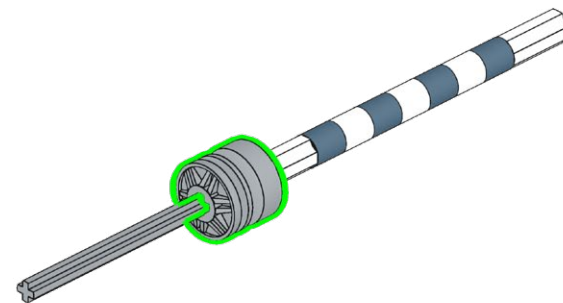

**396**

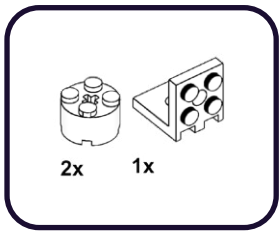

1

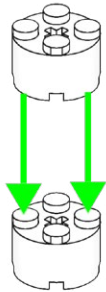

2

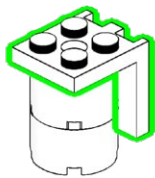

**397**

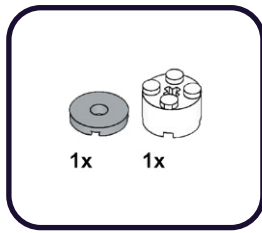

1

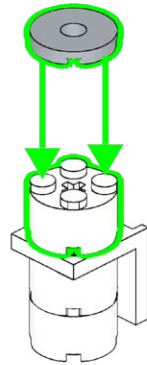

2

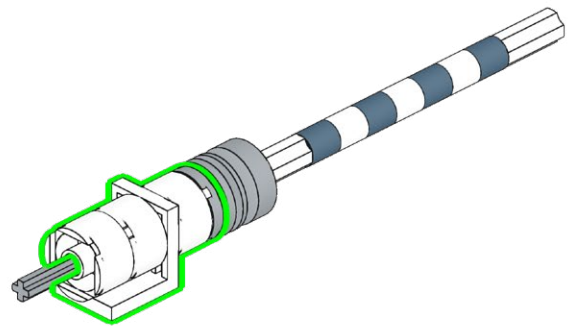



# 398

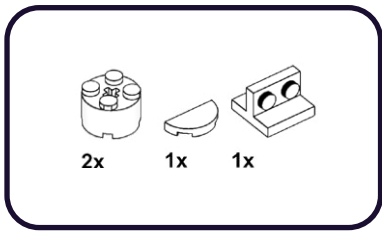

1

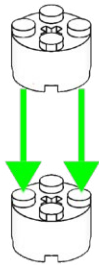

2

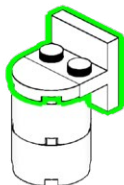

# 399

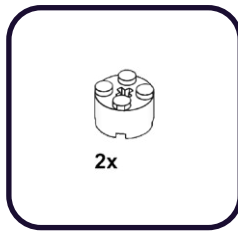

1

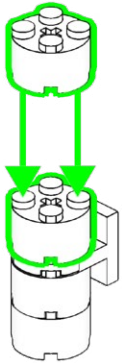

2

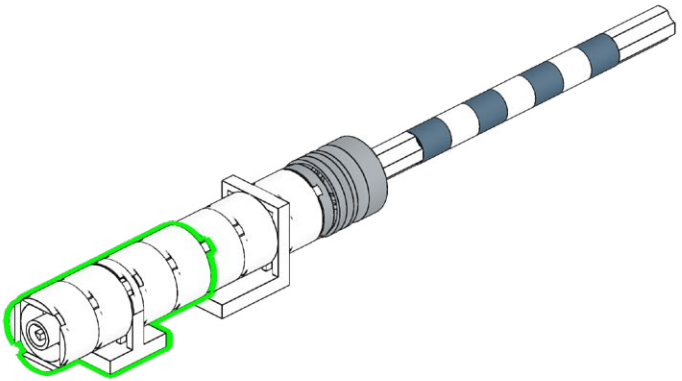

**400**

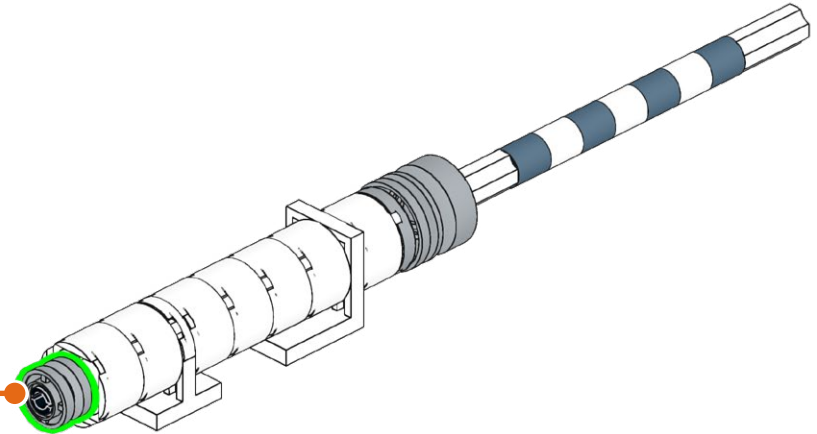
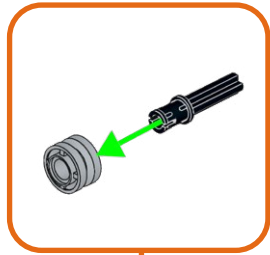
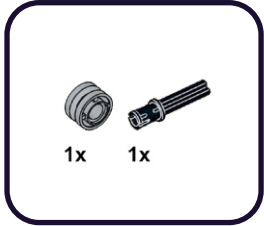

**401**

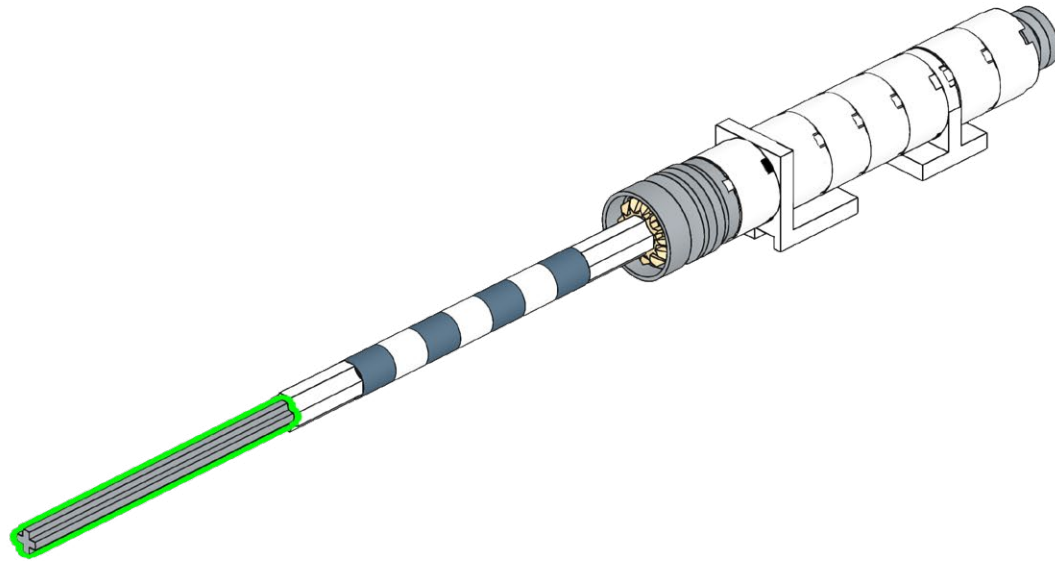
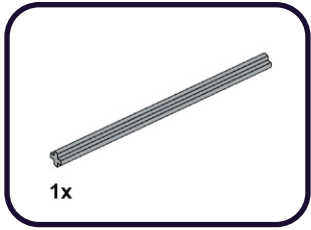
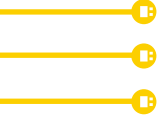

**402**

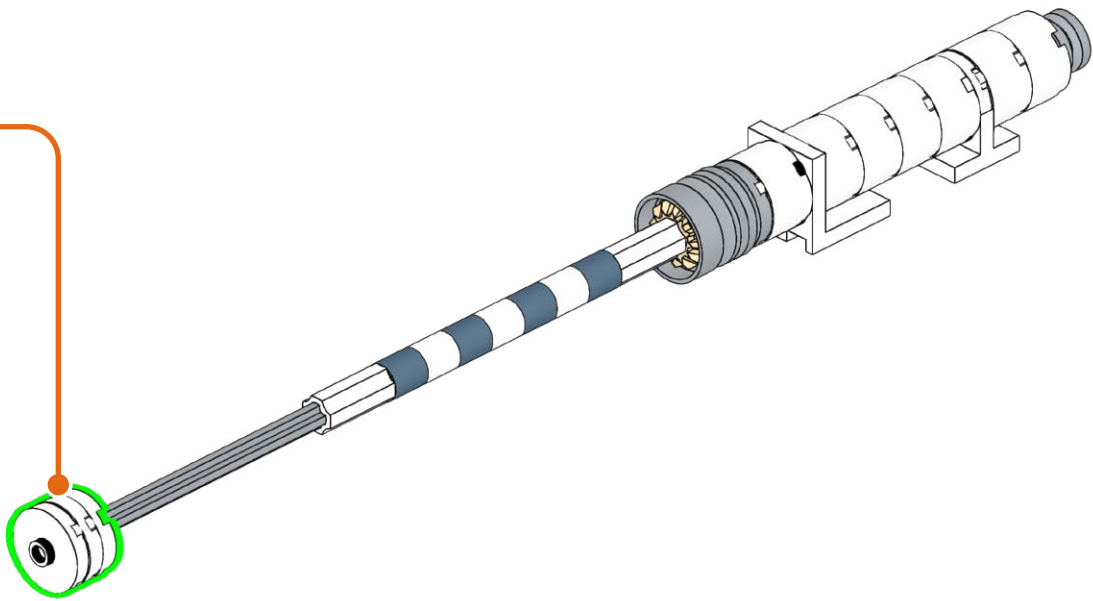
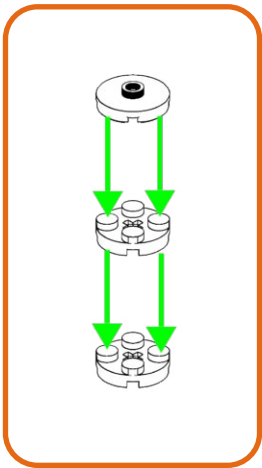
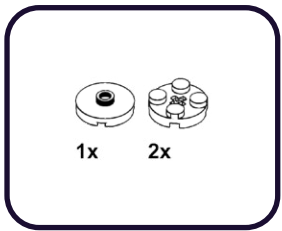

403

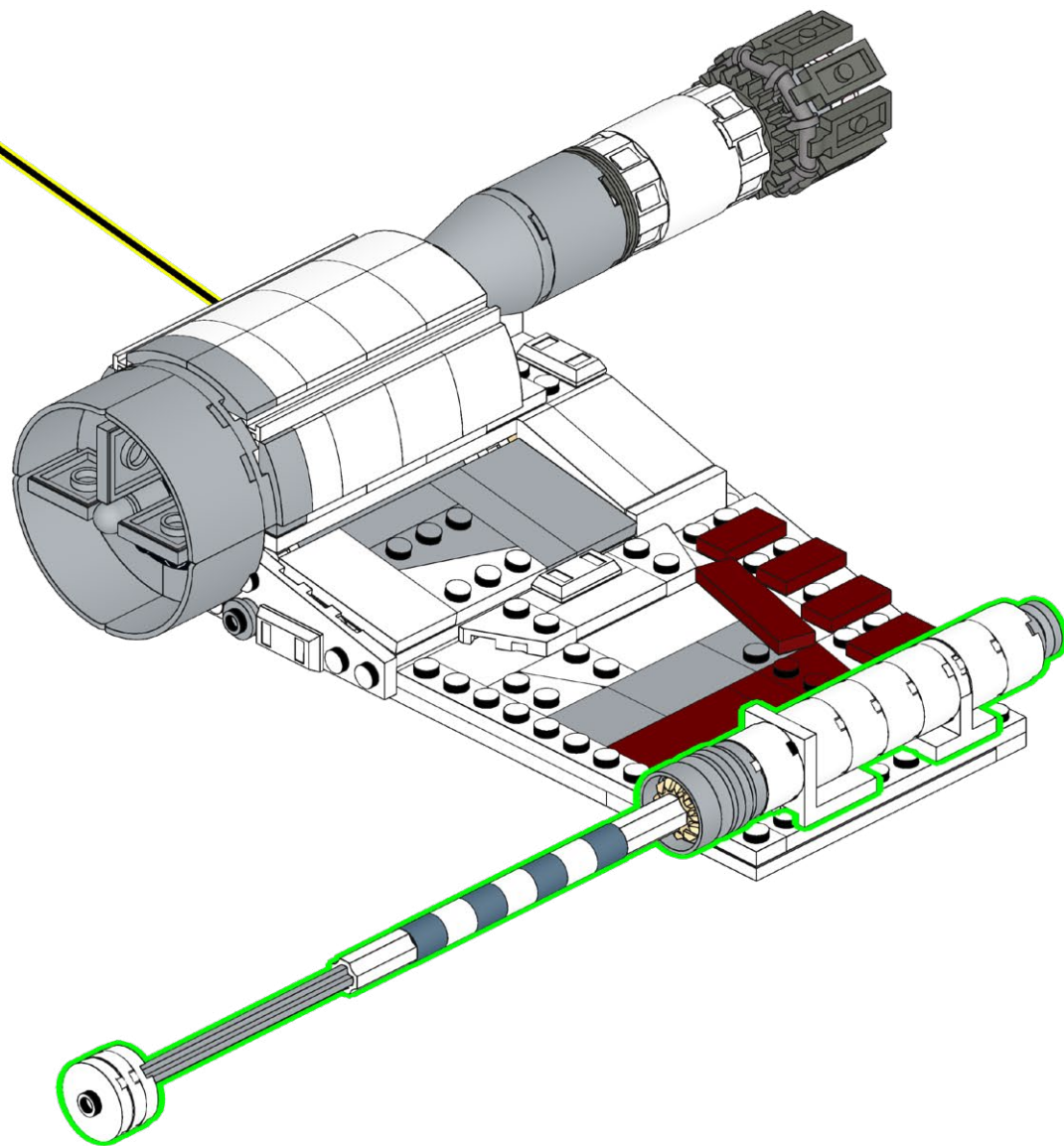

404

4x

4



4x

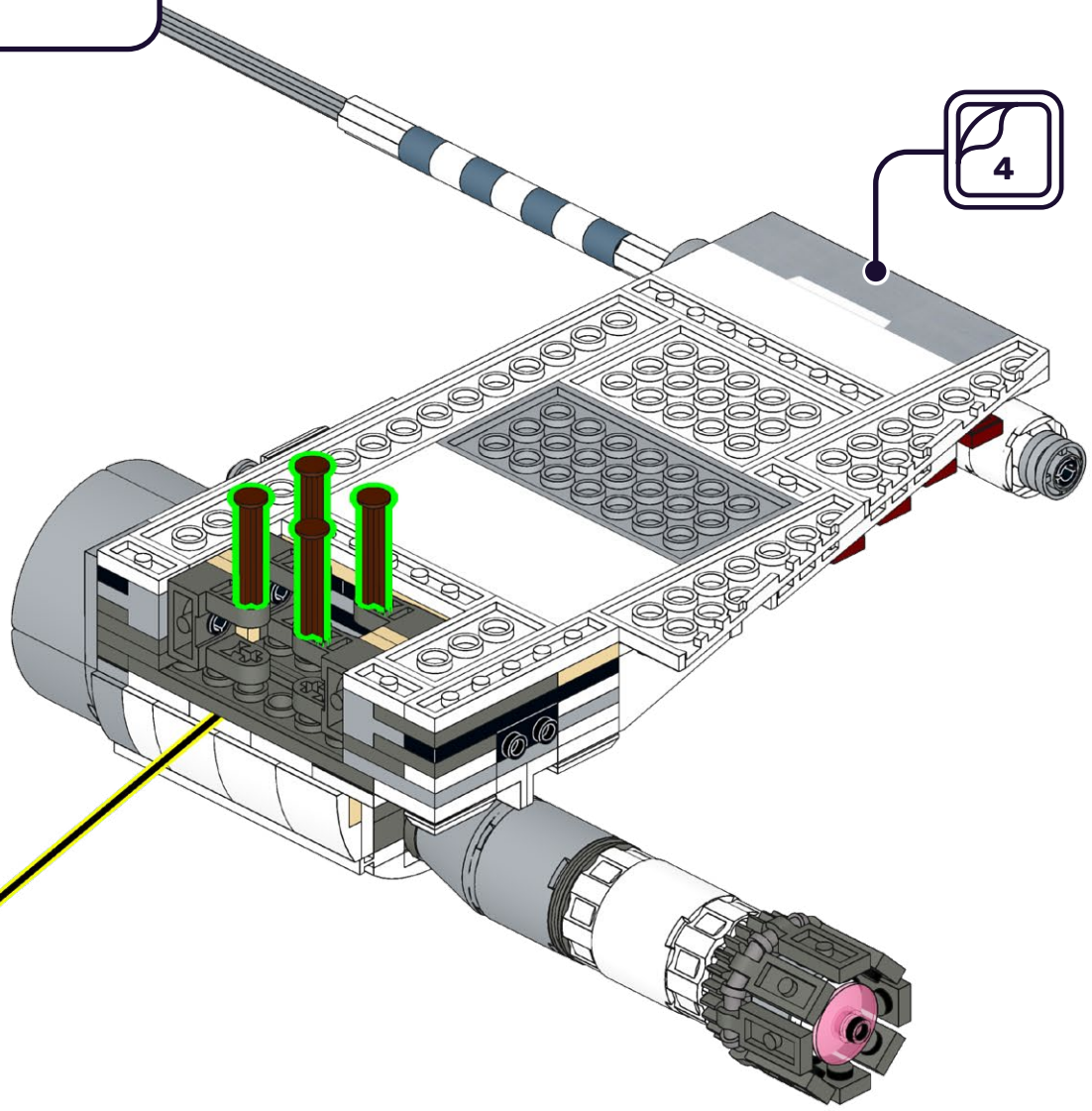
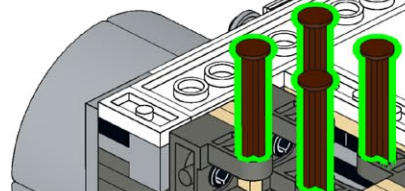

**HOLD UP!**

You might notice some bags aren't in order, as well as left over pieces, but that's ok! We're changing the way you build LEGO!

**ATTENDEZ!**

Vous remarquerez peut-être que certains sacs, ainsi que certaines pièces, ne sont pas dans le bon ordre. Mais pas de panique! Nous changeons simplement la façon avec laquelle vous construisez vos LEGO!

**ASPETTA!**

Potresti notare che alcuni sacchetti non sono in ordine, così come i pezzi avanzati, ma va bene così! Stiamo cambiando il modo in cui costruisci i LEGO!

**HALT!**

Sie werden möglicherweise bemerken, dass einige tüten durcheinander sind und teile übrig bleiben, aber das ist in Ordnung! Wir ändern die art und weise, wie Sie LEGO bauen!

**¡ESPERA!**

Es posible que notes que algunas bolsas están fuera de servicio, así como piezas sobrantes, ¡pero está bien! ¡Estamos cambiando la forma en que construyes LEGO!

**暫停!**

你可能会注意到一些袋子顺序错乱, 以及一些剩余的部件, 但没关系! 我们正在改变你搭建乐高的方式!

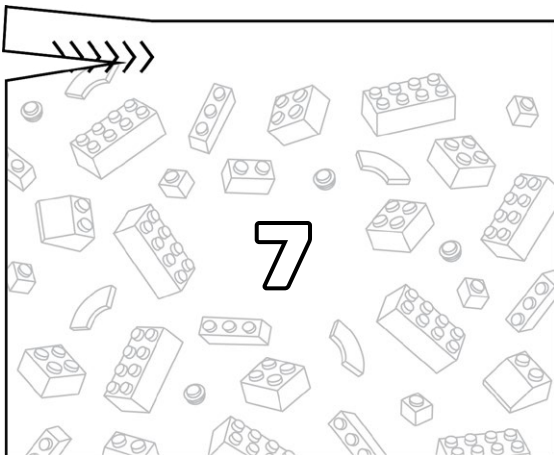
**Open LEGO® Bag 7**

405

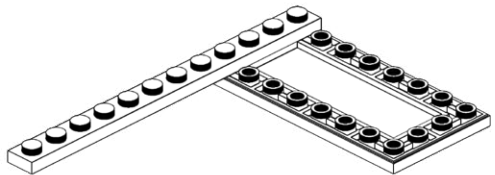
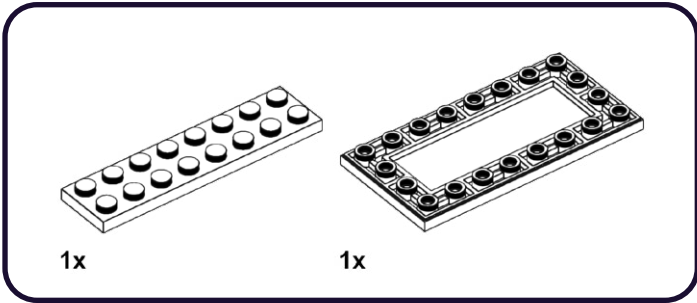



406

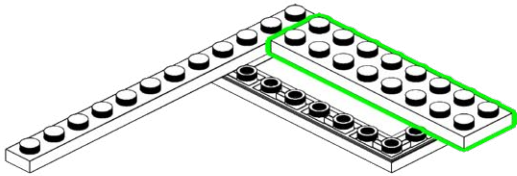
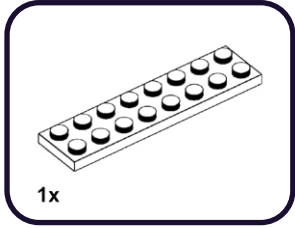

407

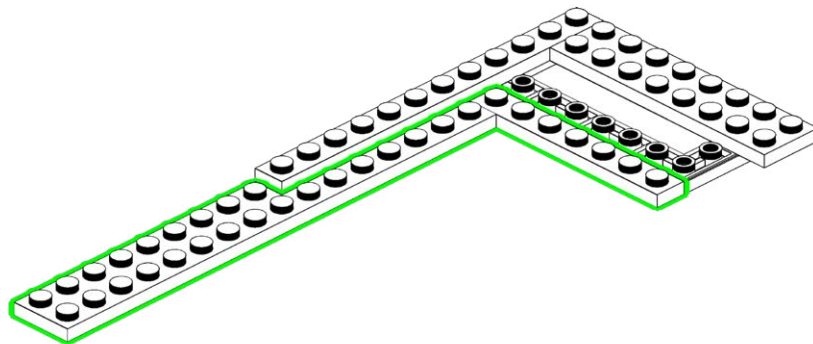
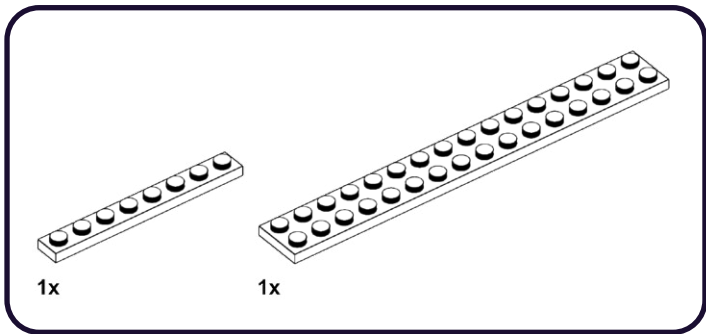

408

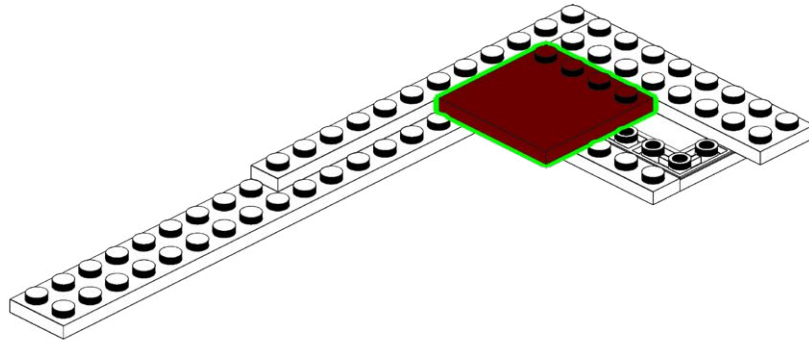
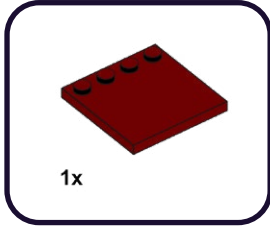

409

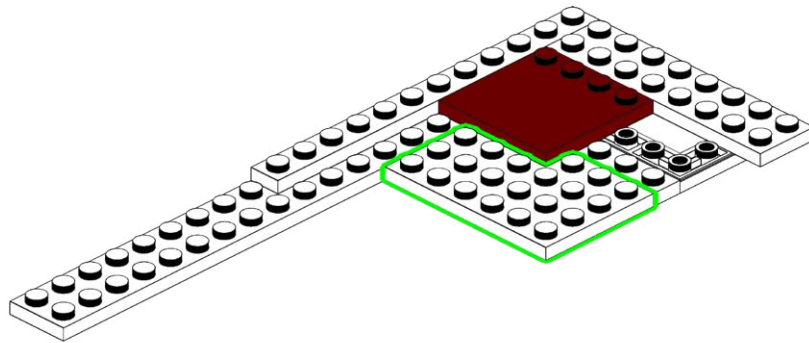
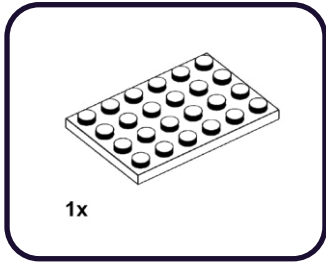

**410**

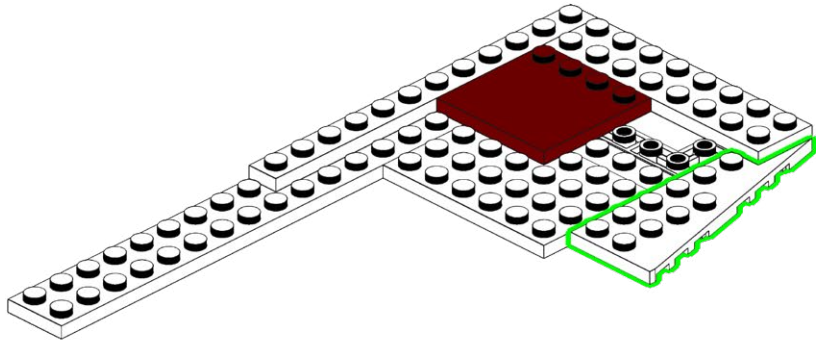
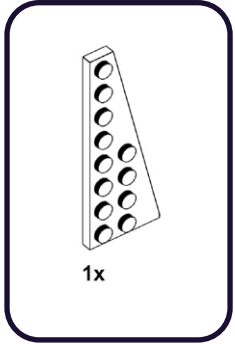

411

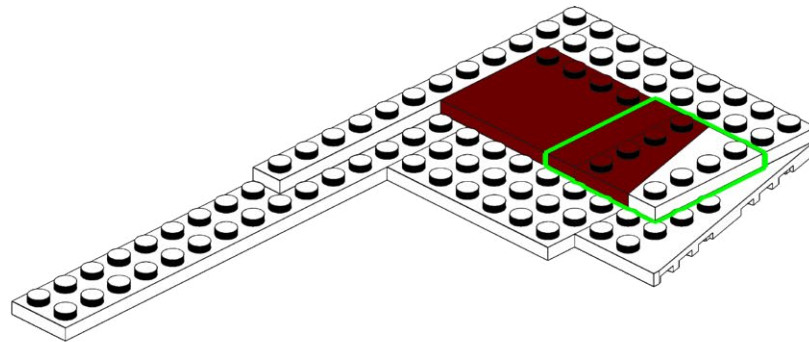
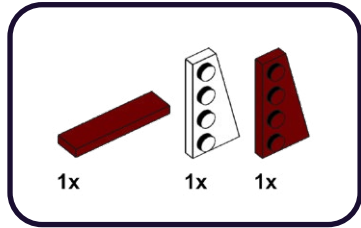

412



1x



1x

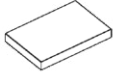

1x

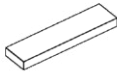

1x

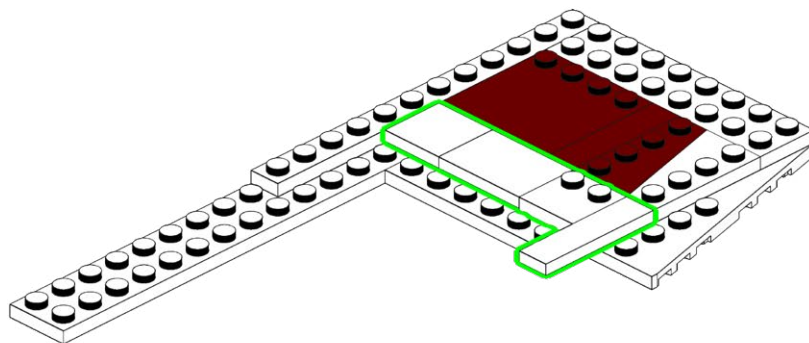

413

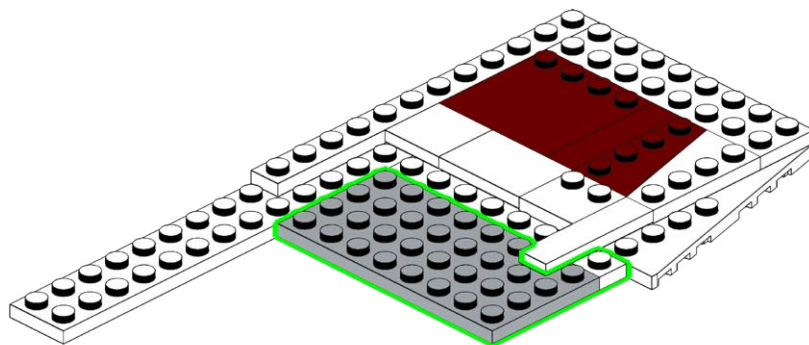
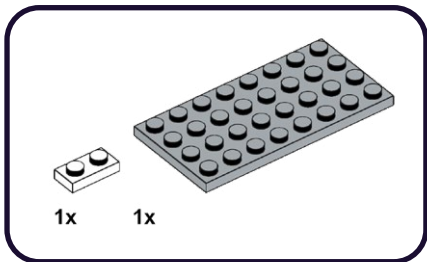



414

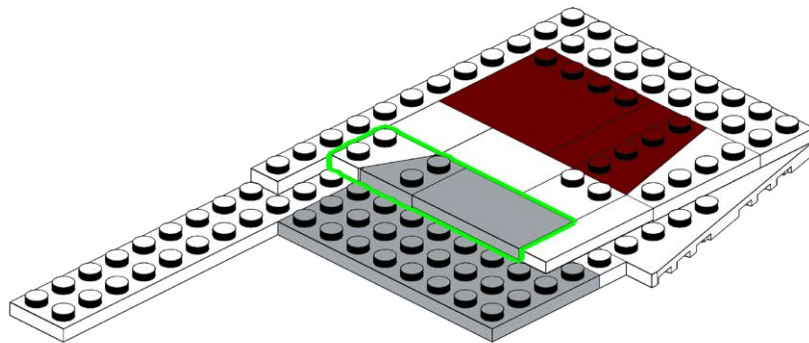
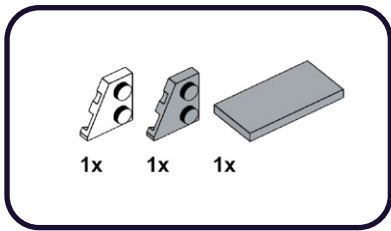

415

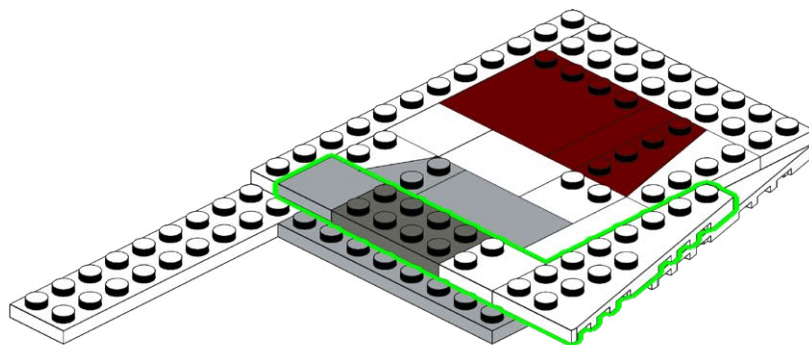
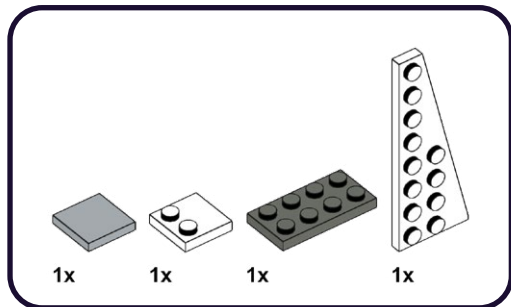

416

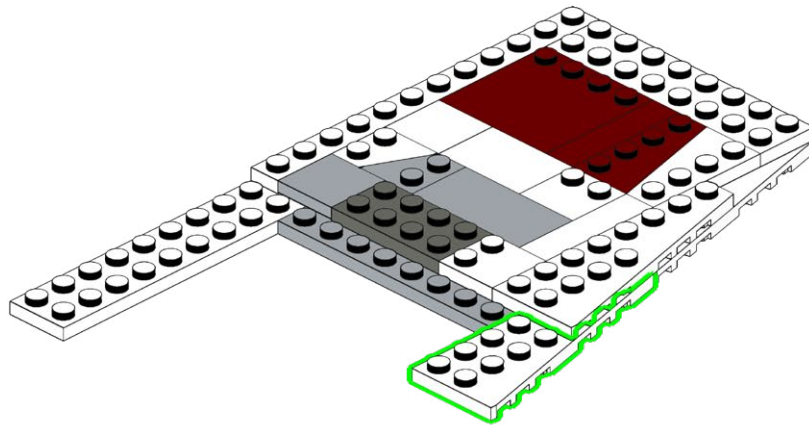
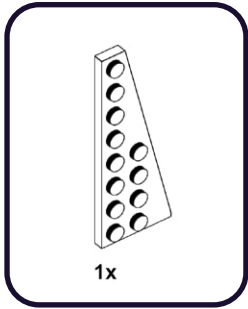

417

1x

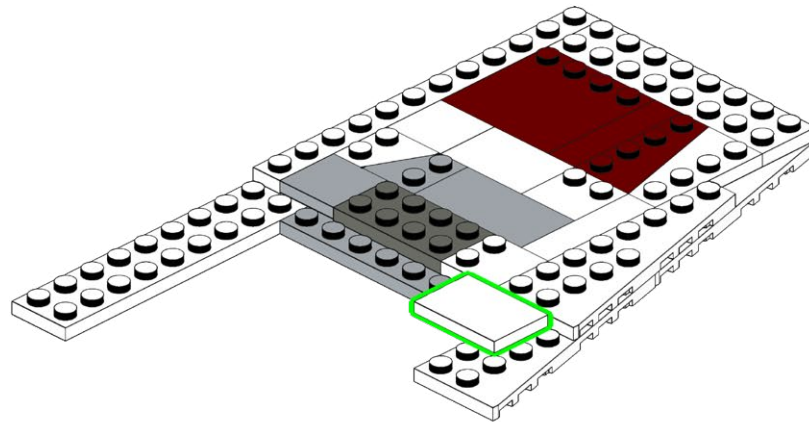

418

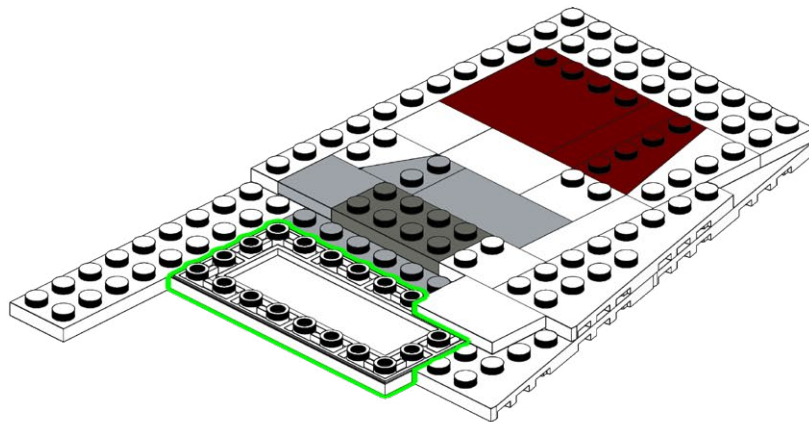
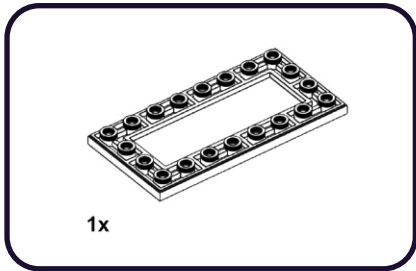

419

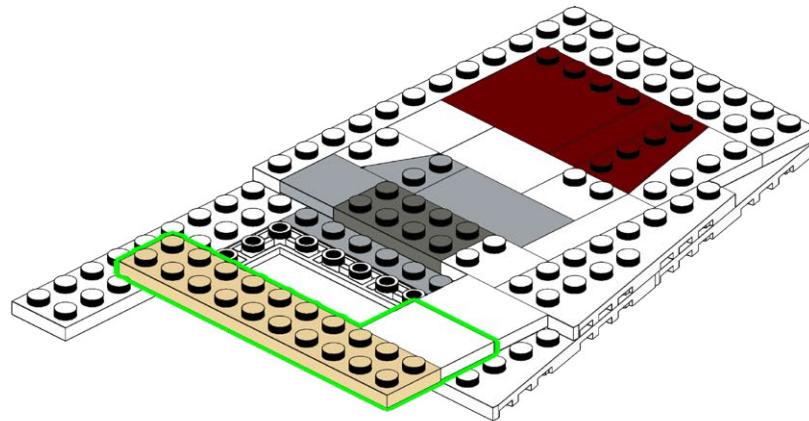
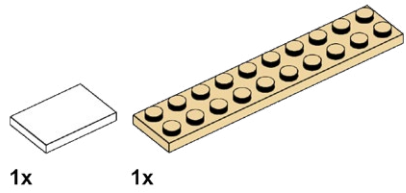

420

1x

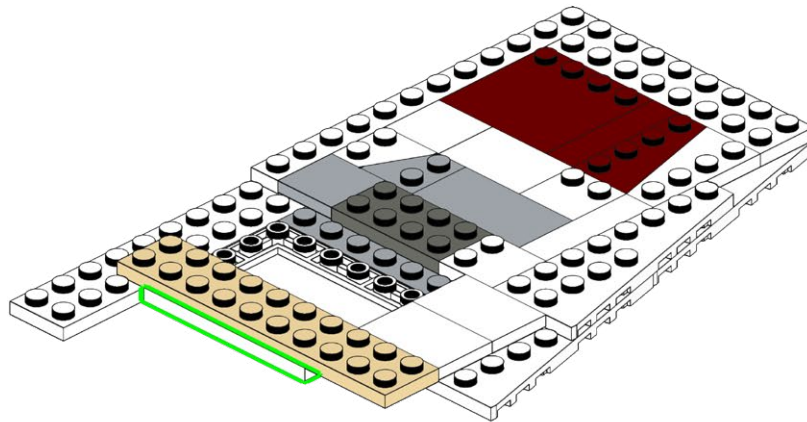

421

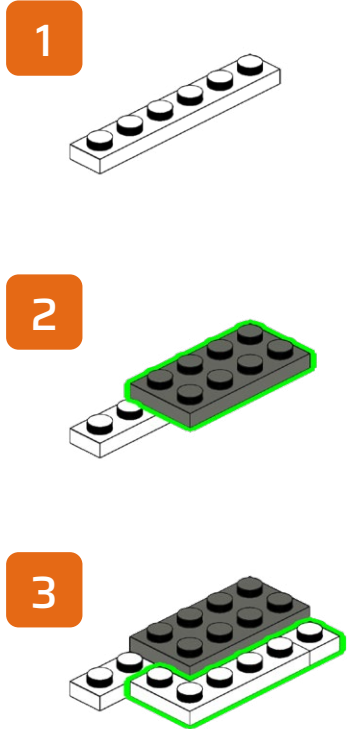
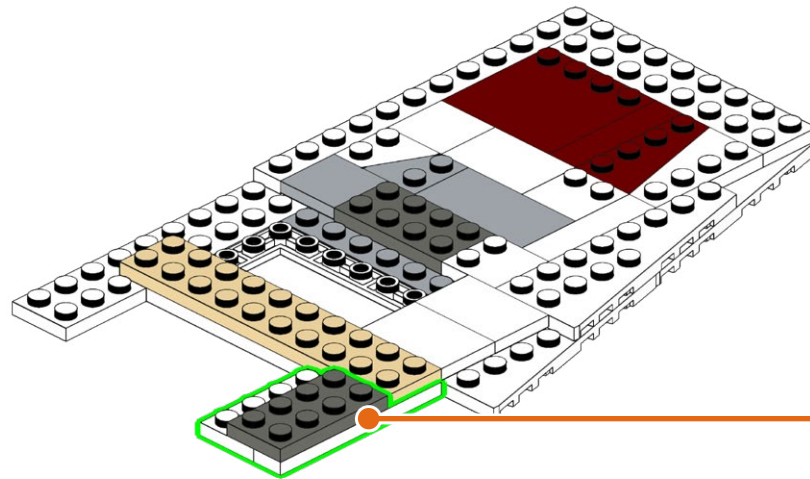
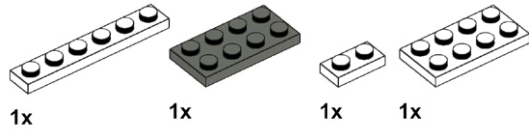



422

1x

1x

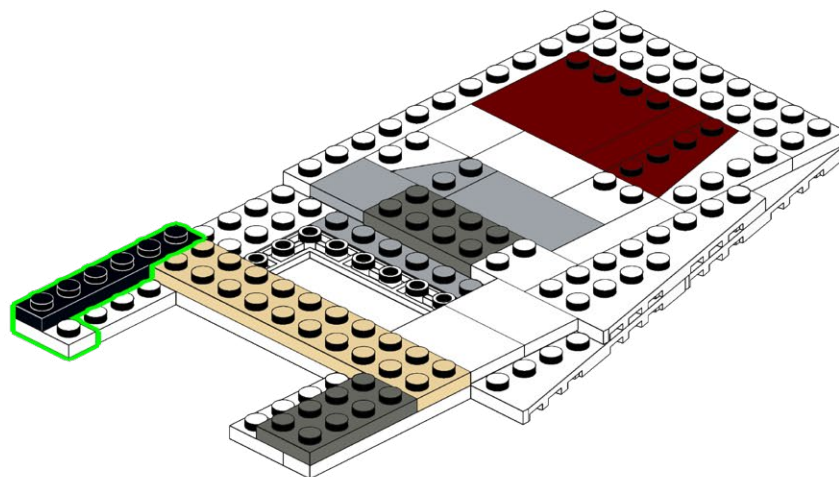

423

2x 2x

1

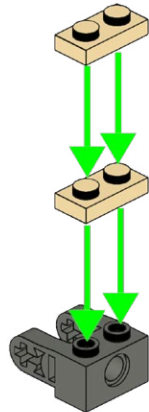

2

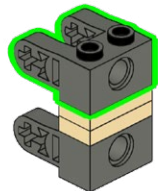

424

2x 2x

1

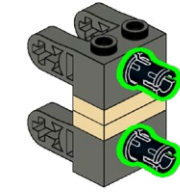

2

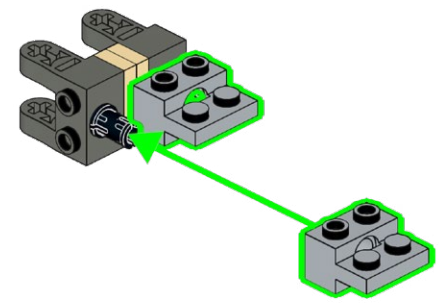
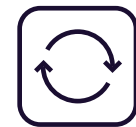

425

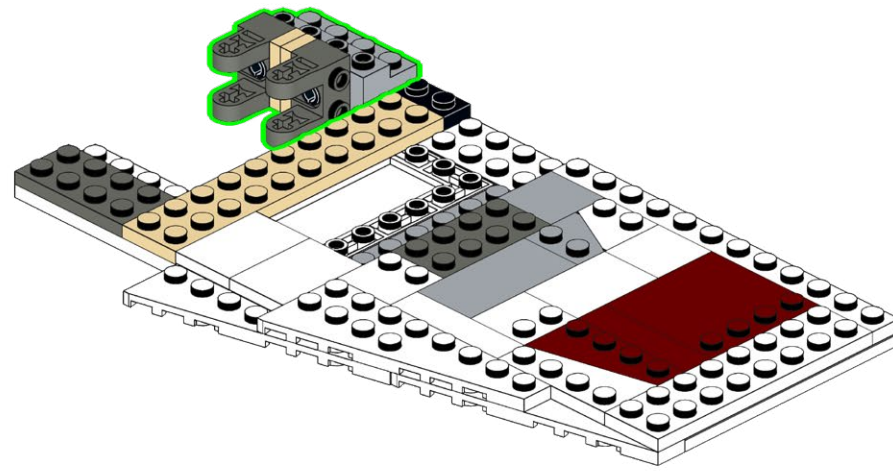

426

2x

2x

1

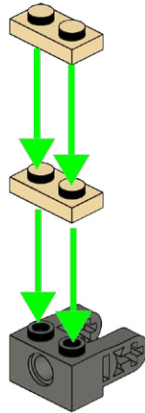

2

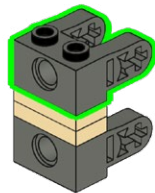

427

2x

2x

1

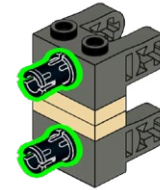

2

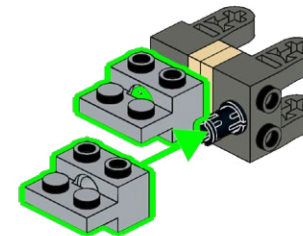

428

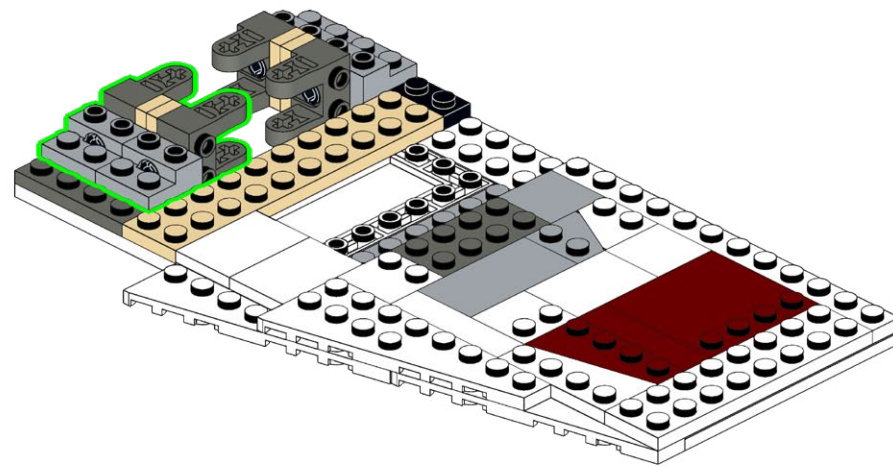

429

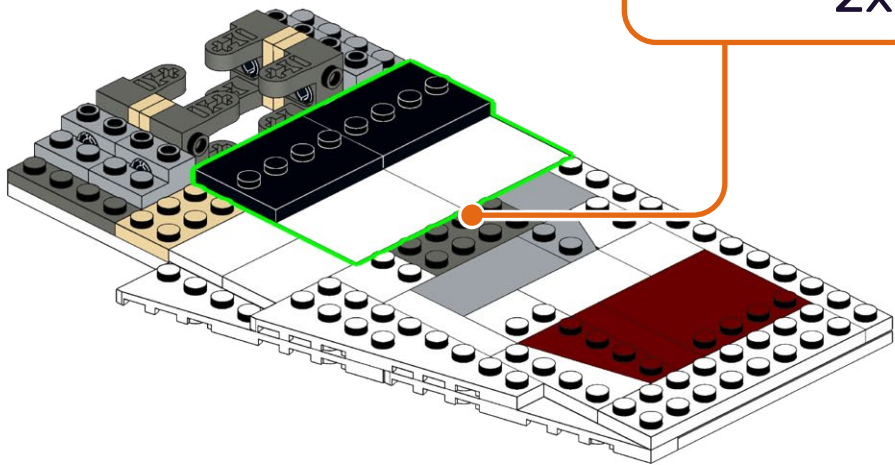
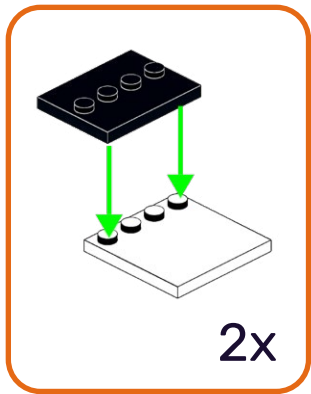
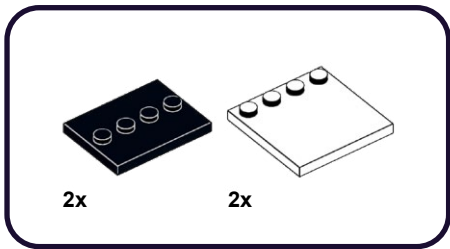

430

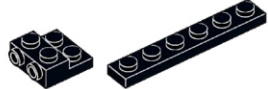

1x

1x

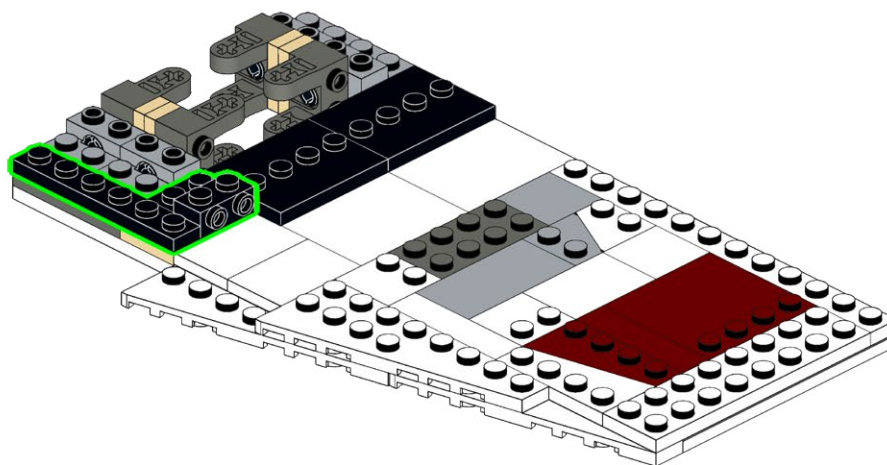

431

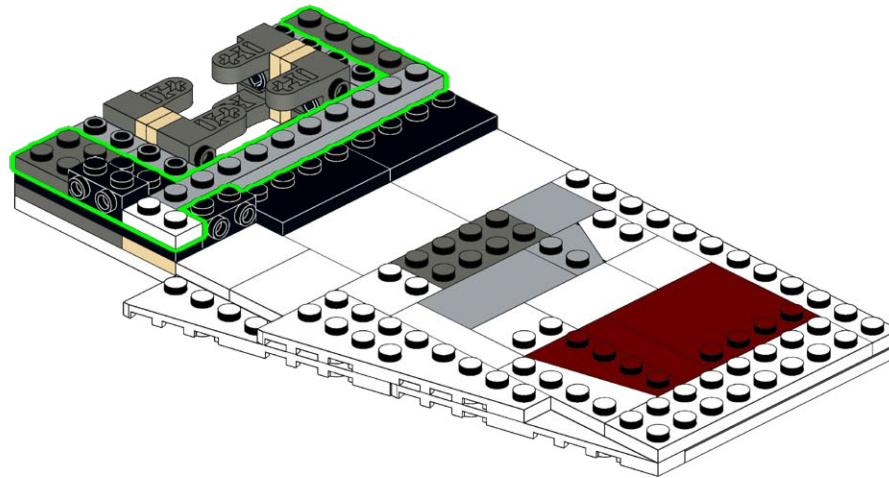
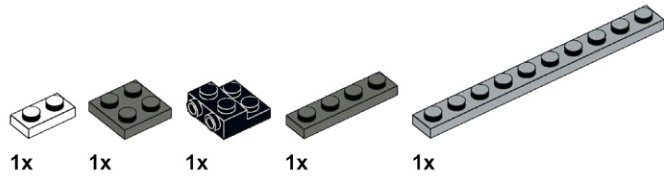



432

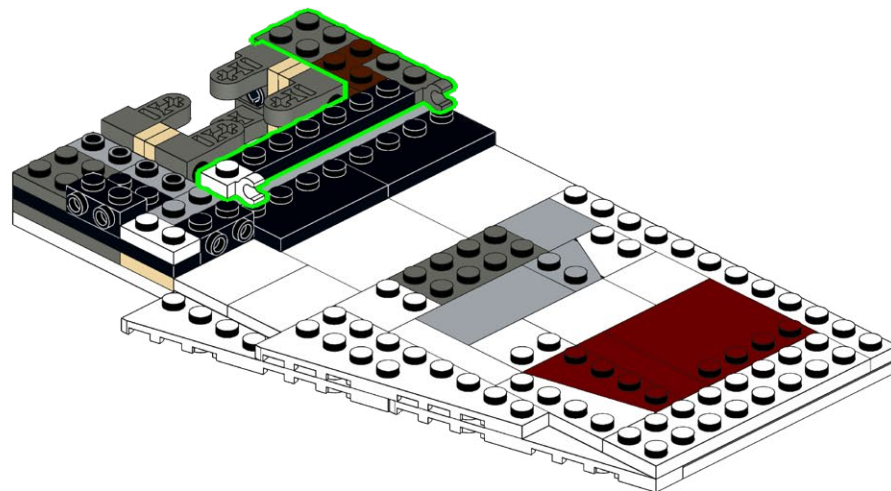
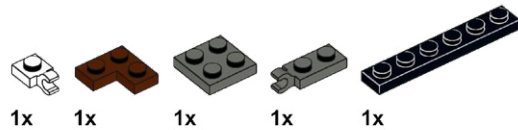

433

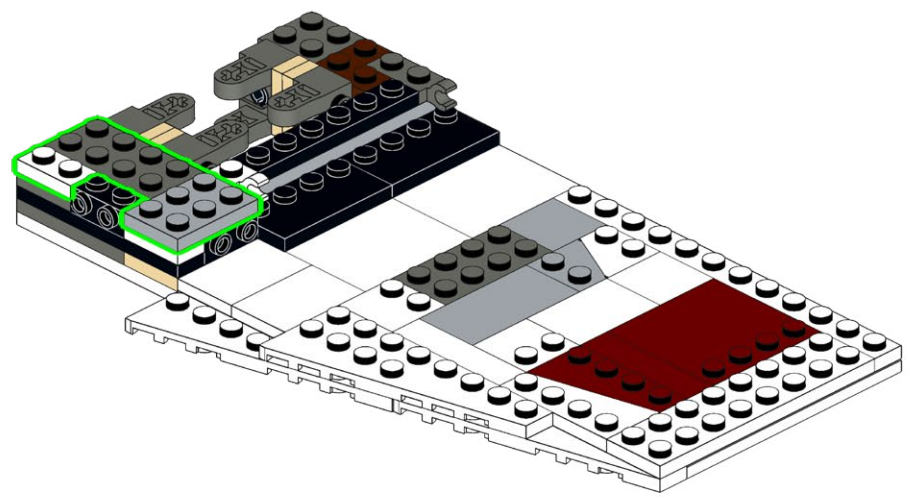
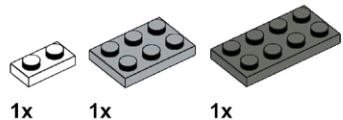

434

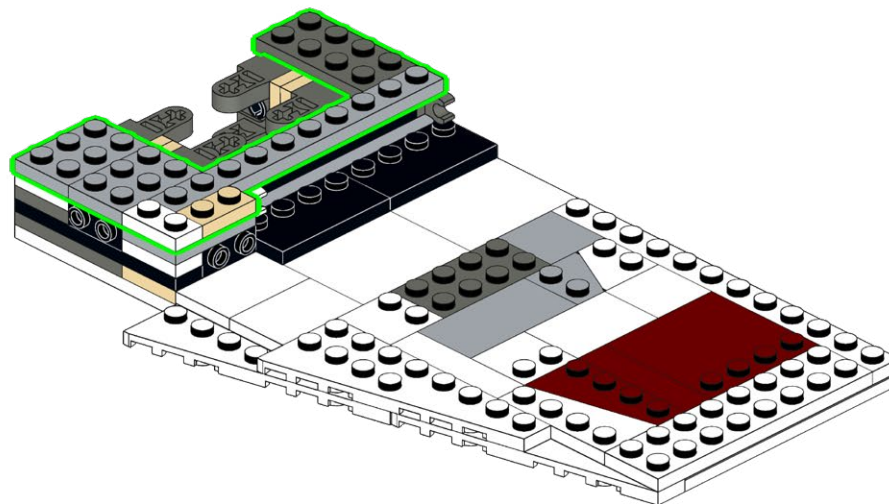
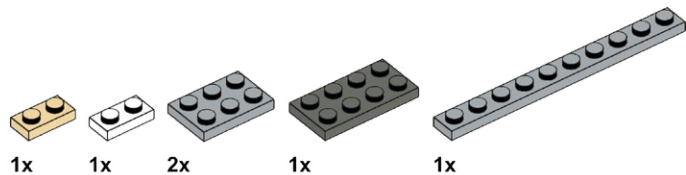

435

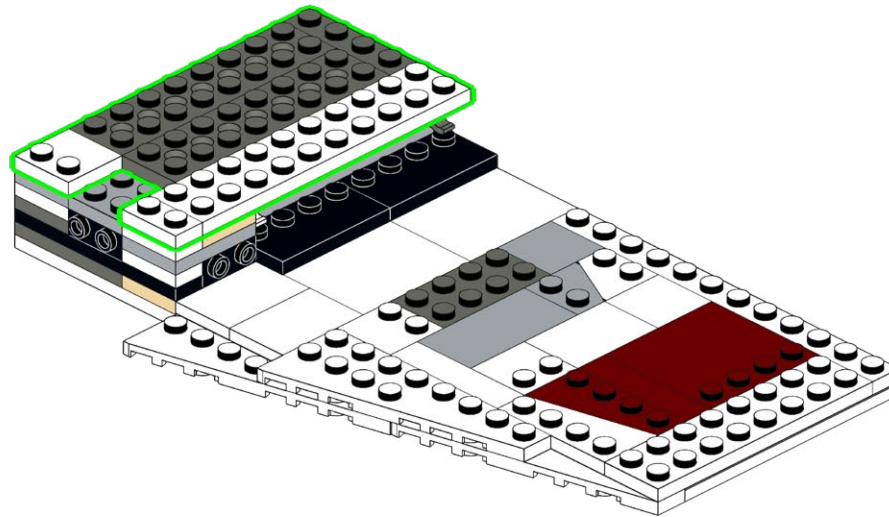
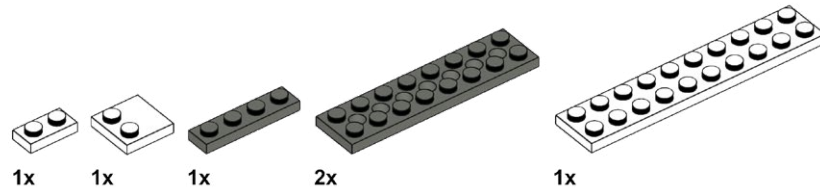

436

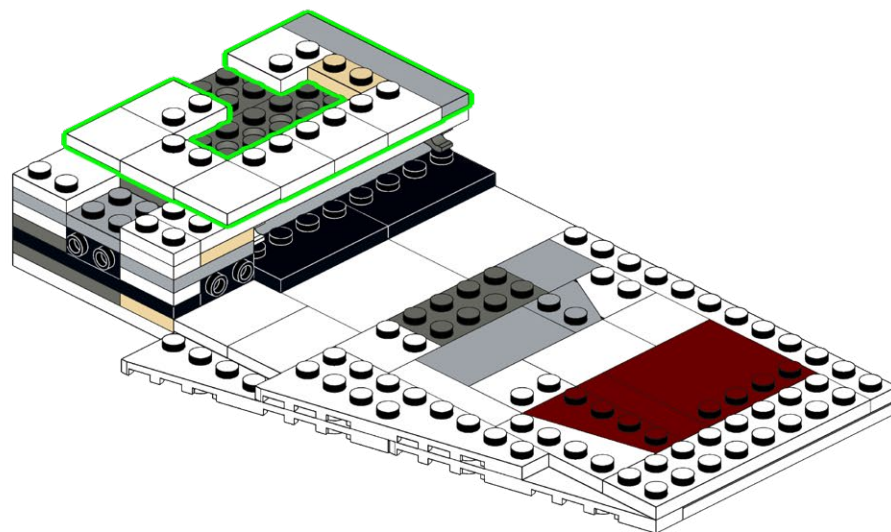
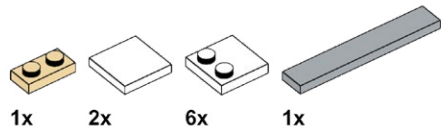

437

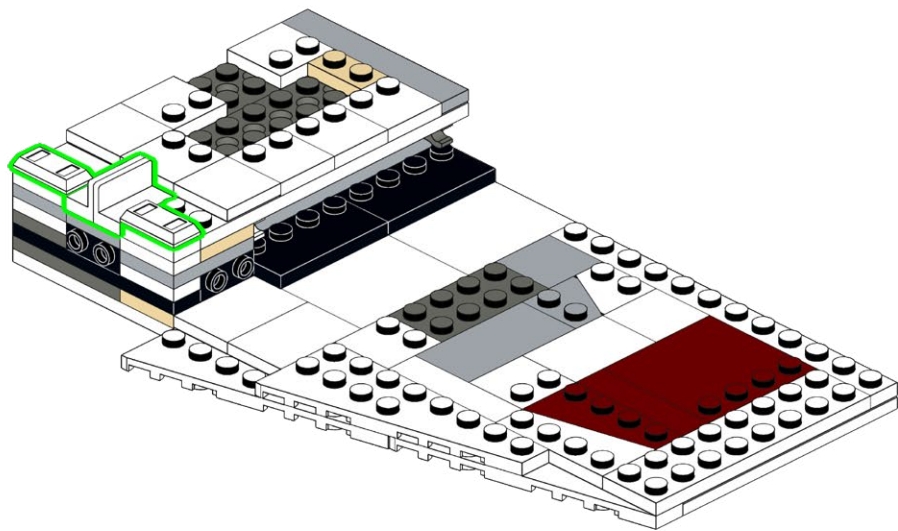
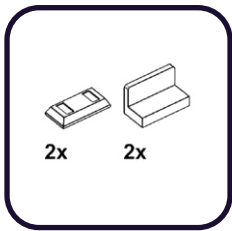

438

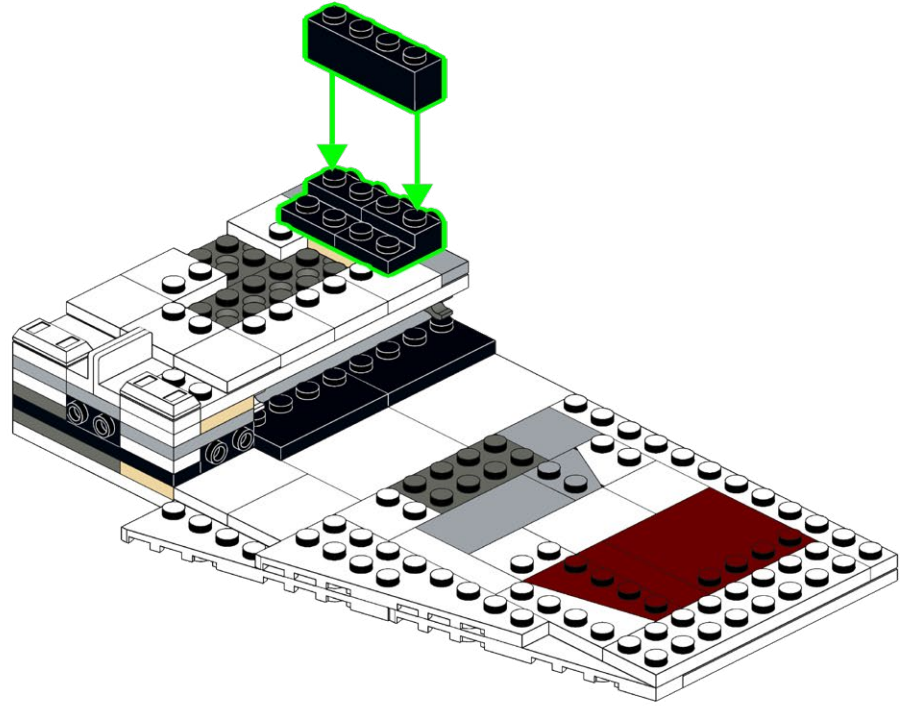
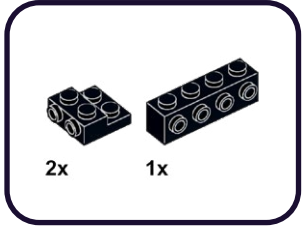

439



1x

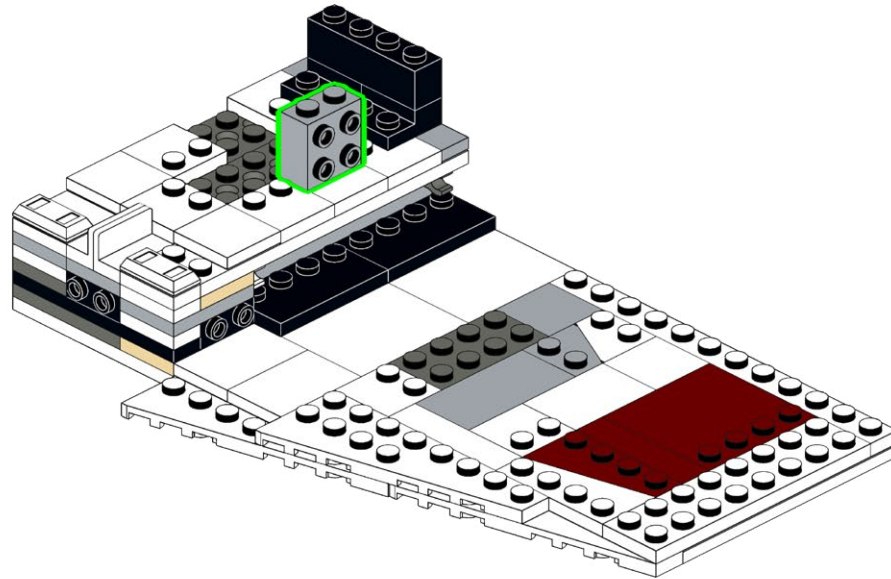



440

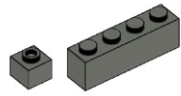

2x 1x

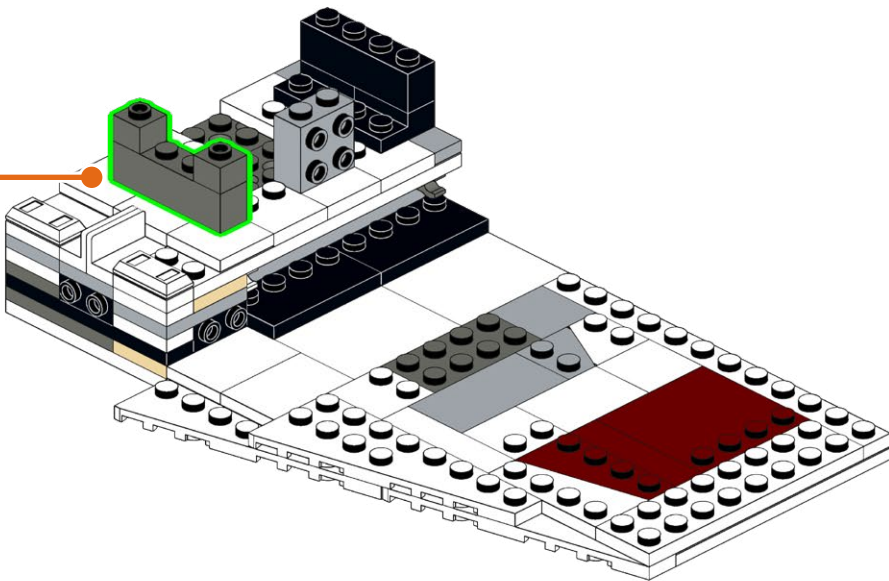
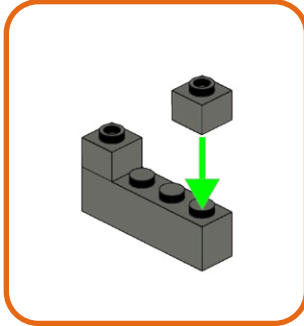

441

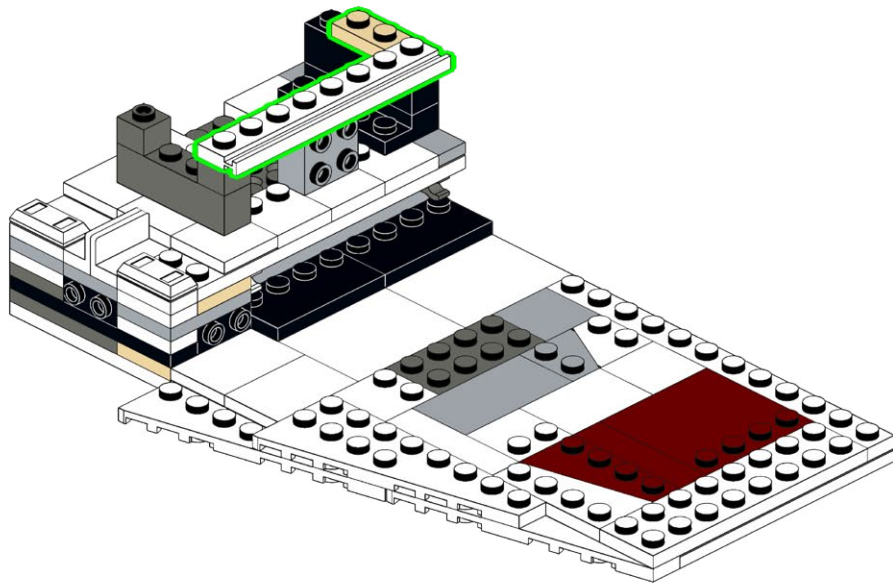
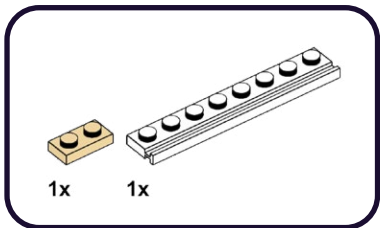

442

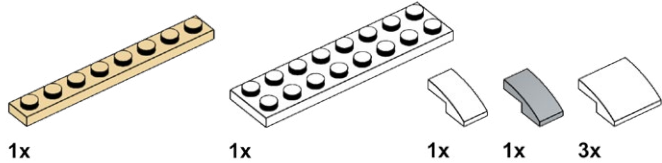

1

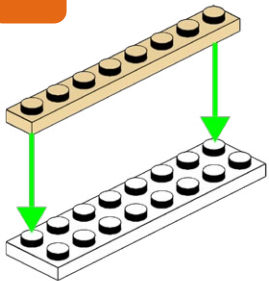

2

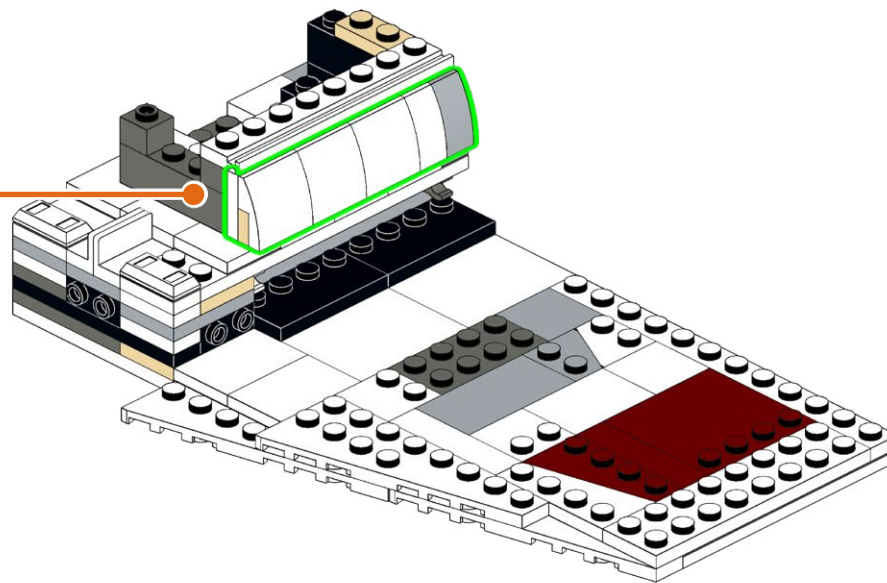
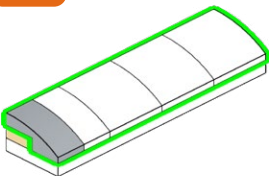

**443**

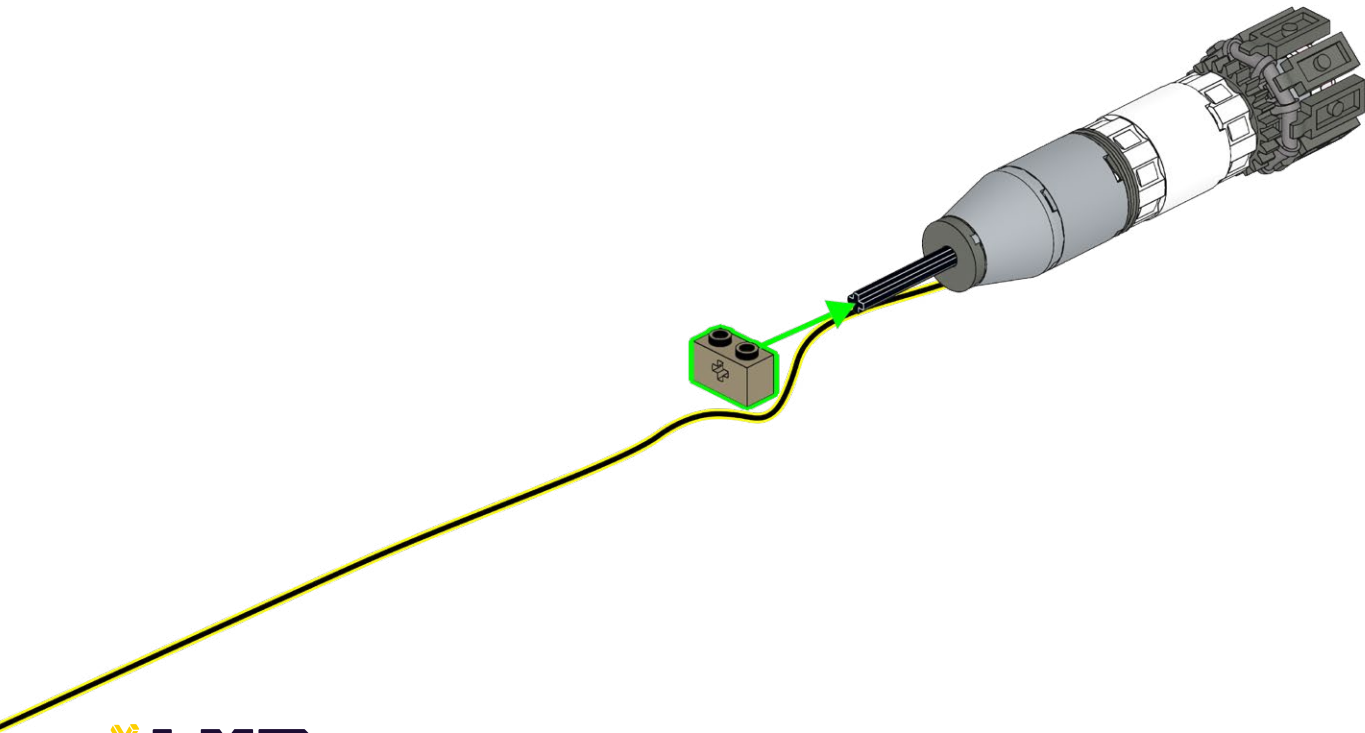
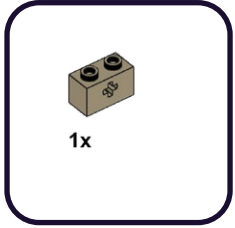

444

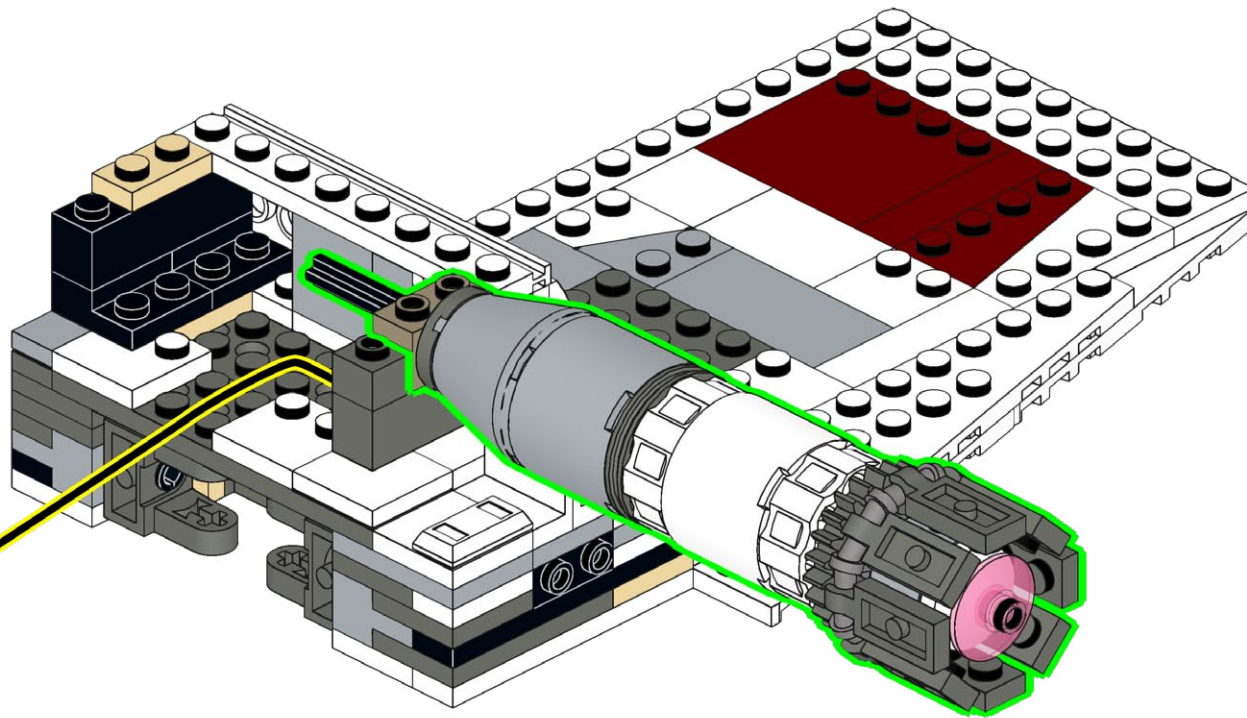

445

1x

1x

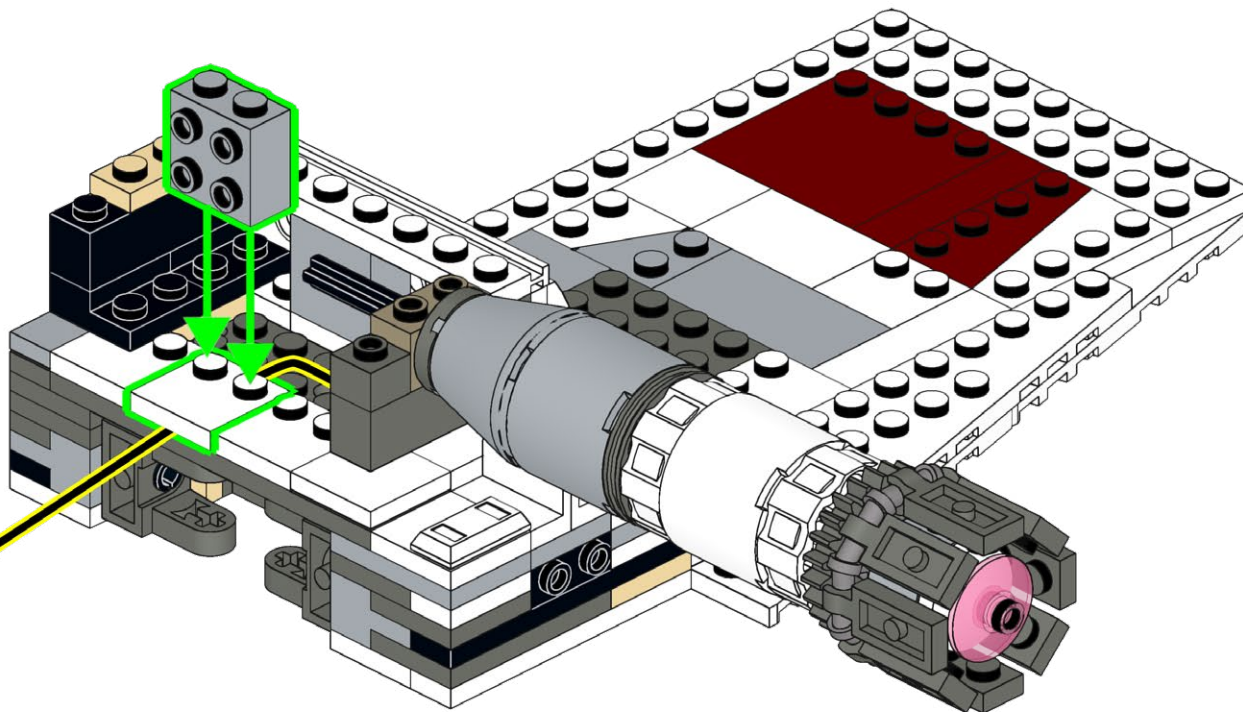
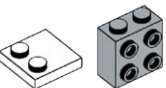



446

1x

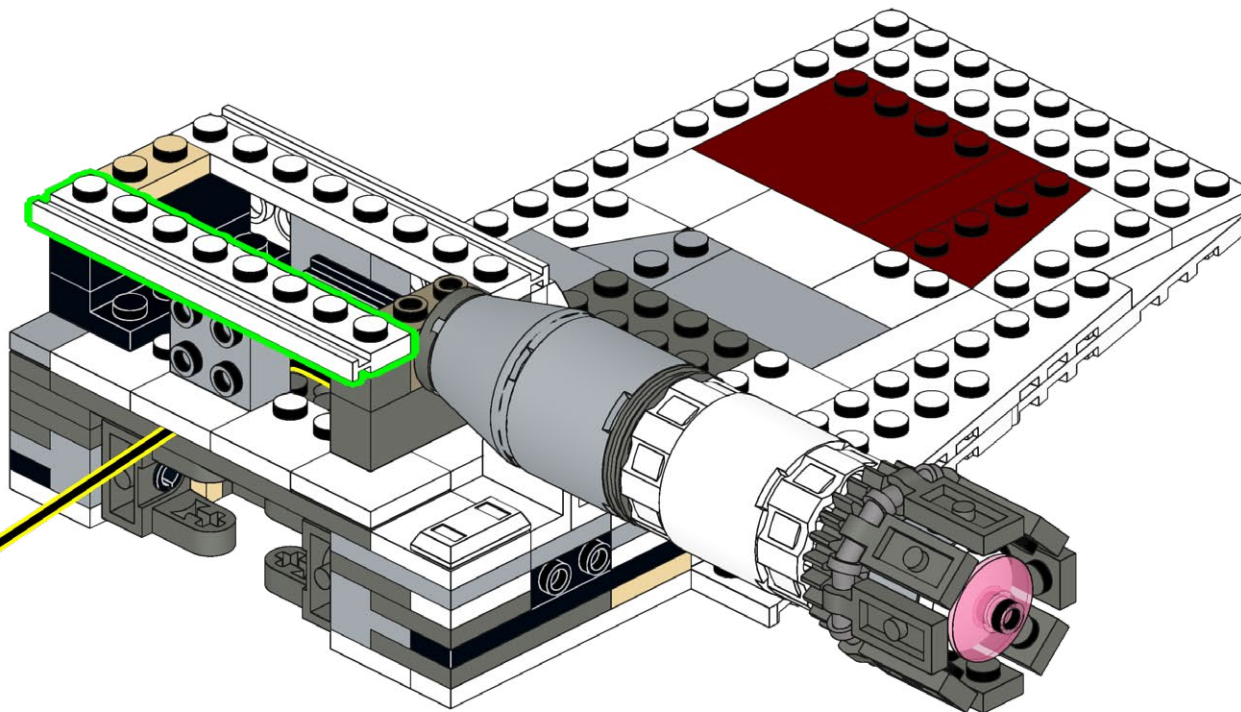
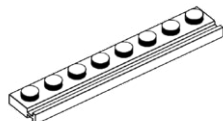

447

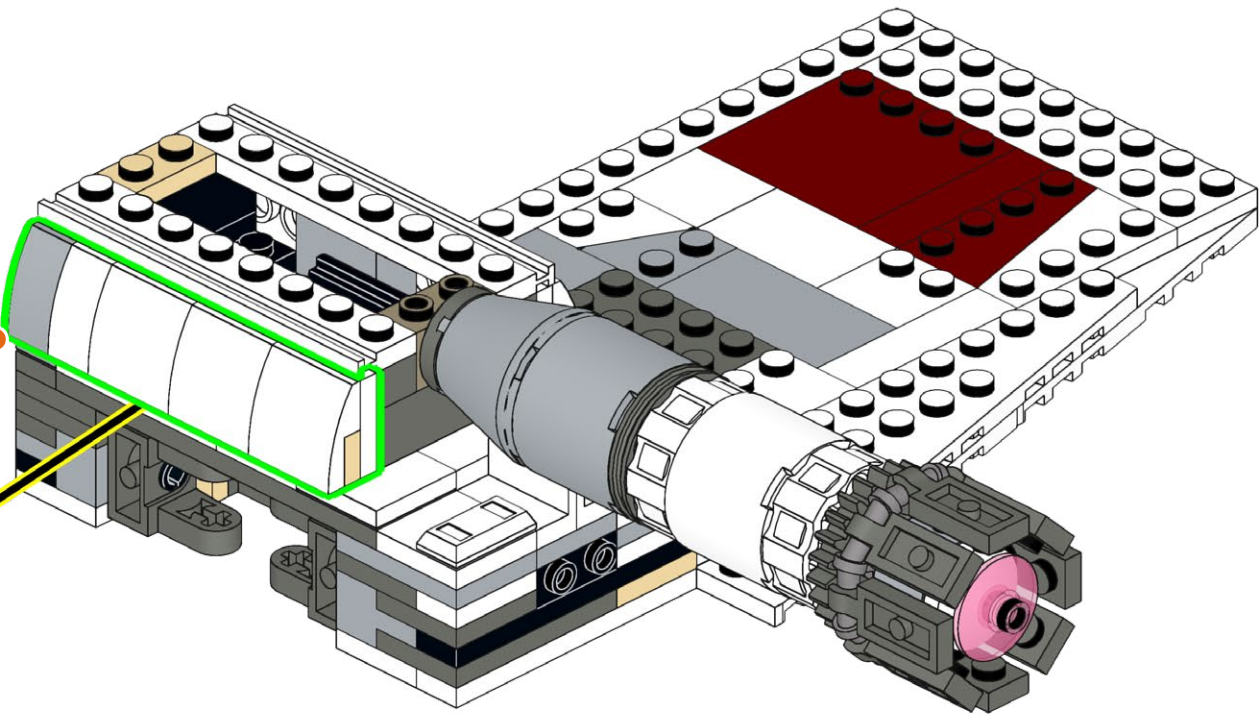
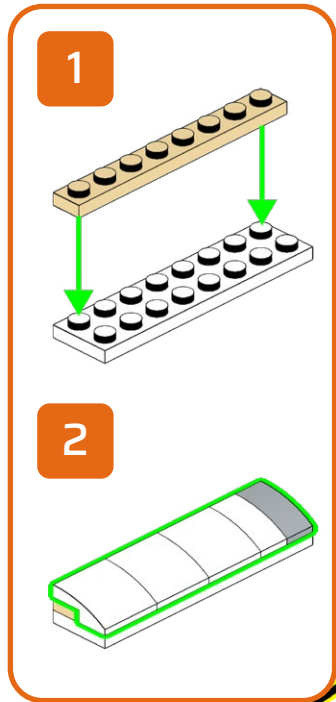
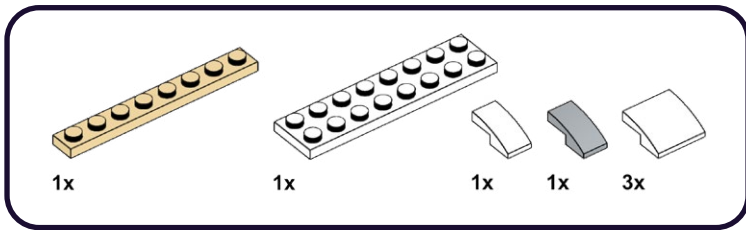



448

1x

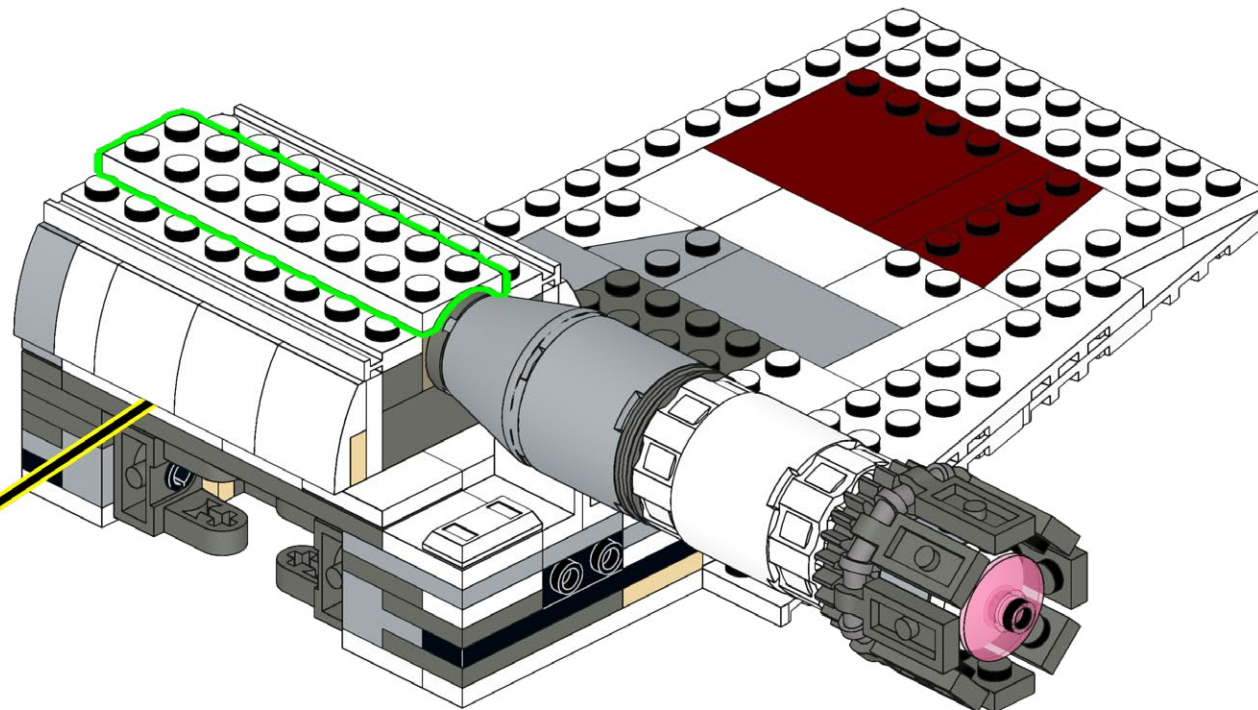
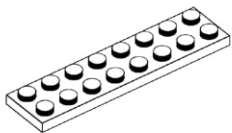

449

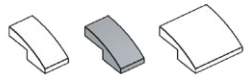

2x

2x

6x

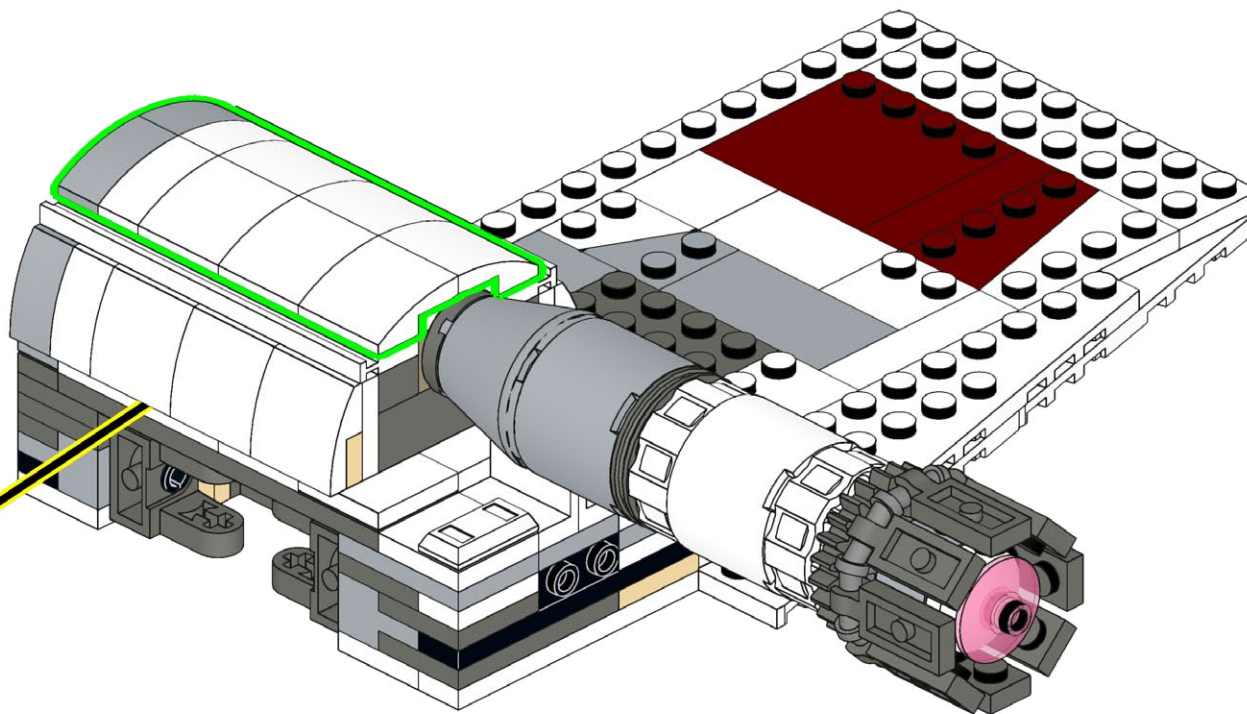

450

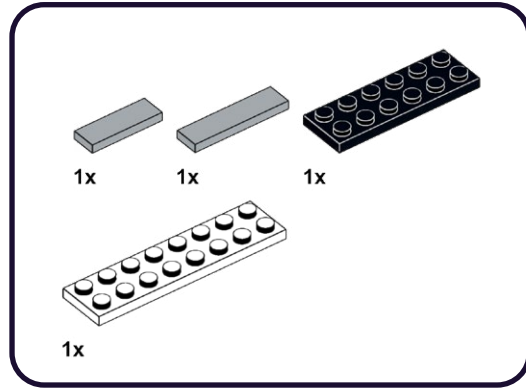

1

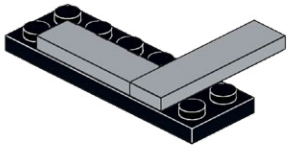

2

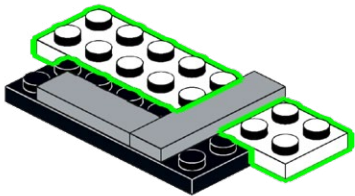

451

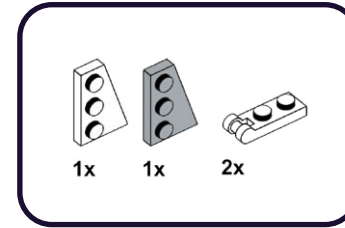

1

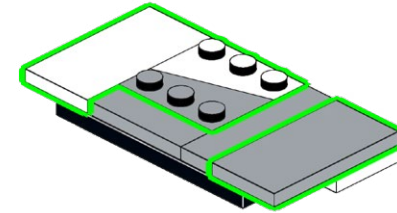

2

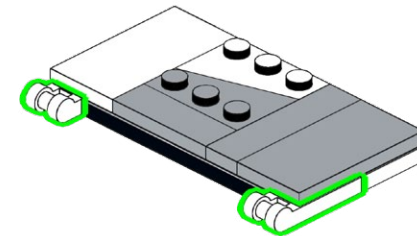

452

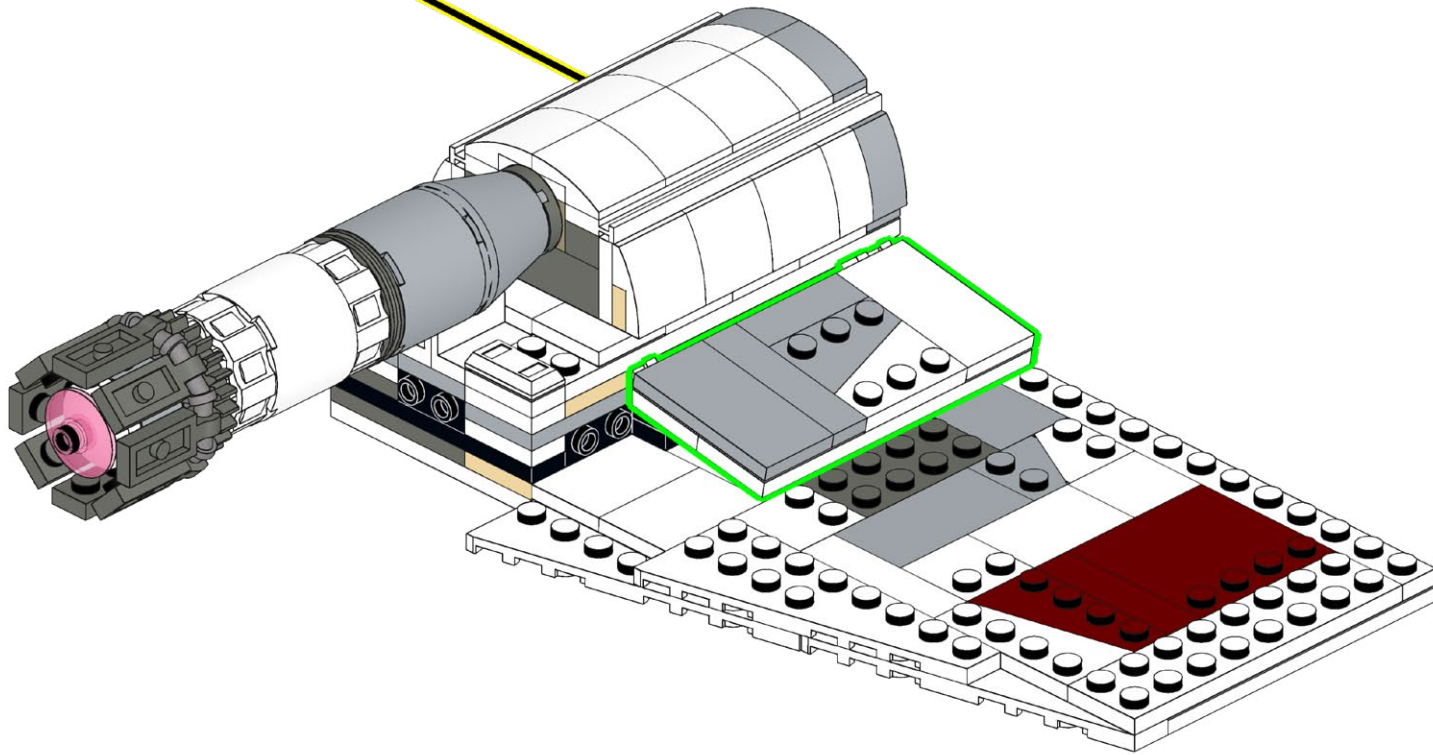

453

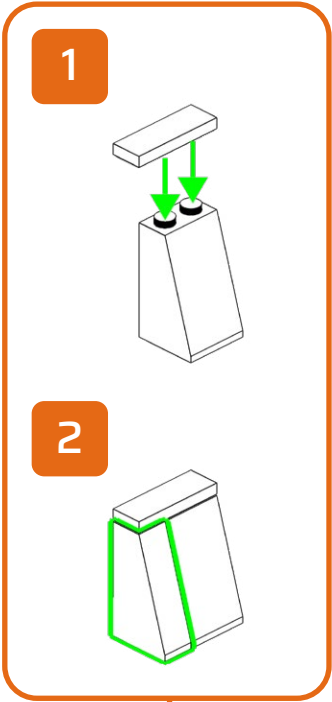
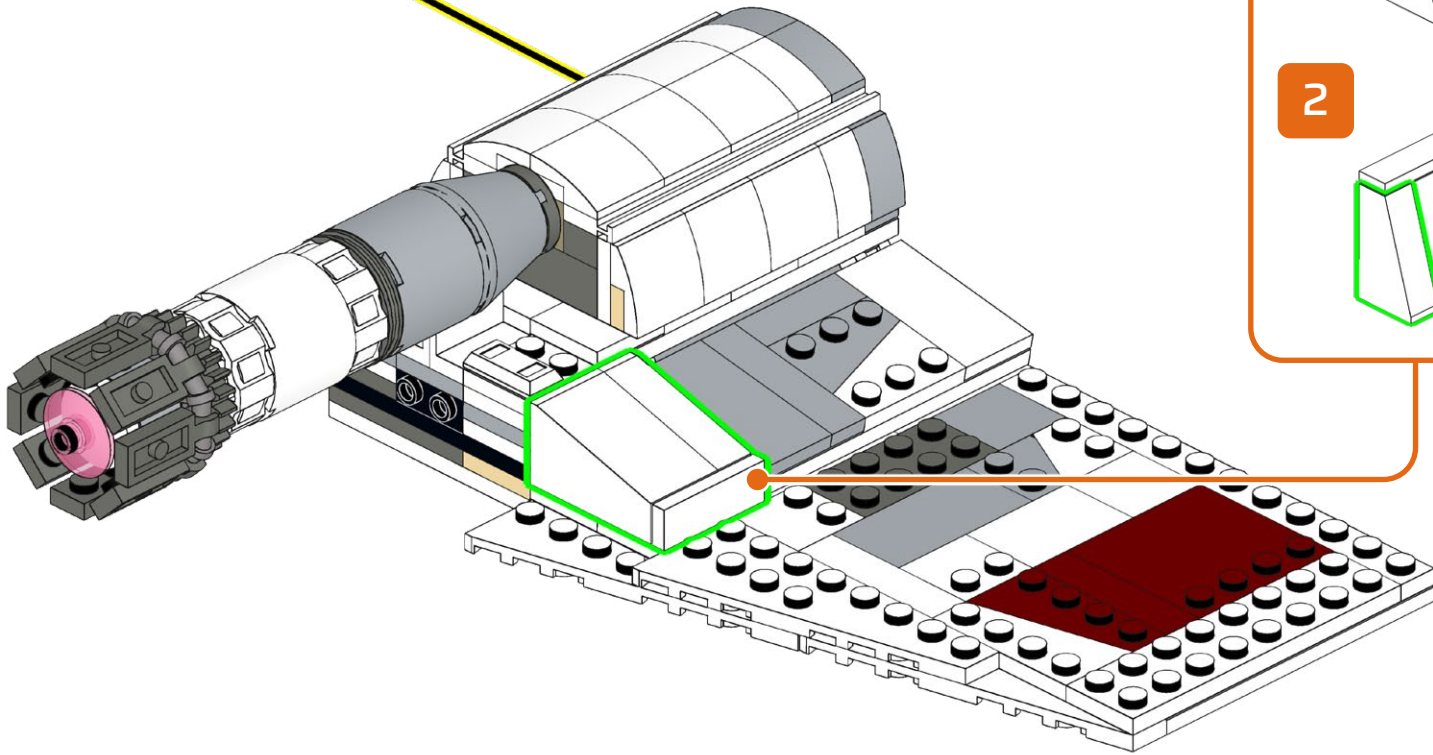
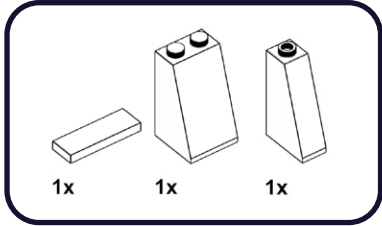



454

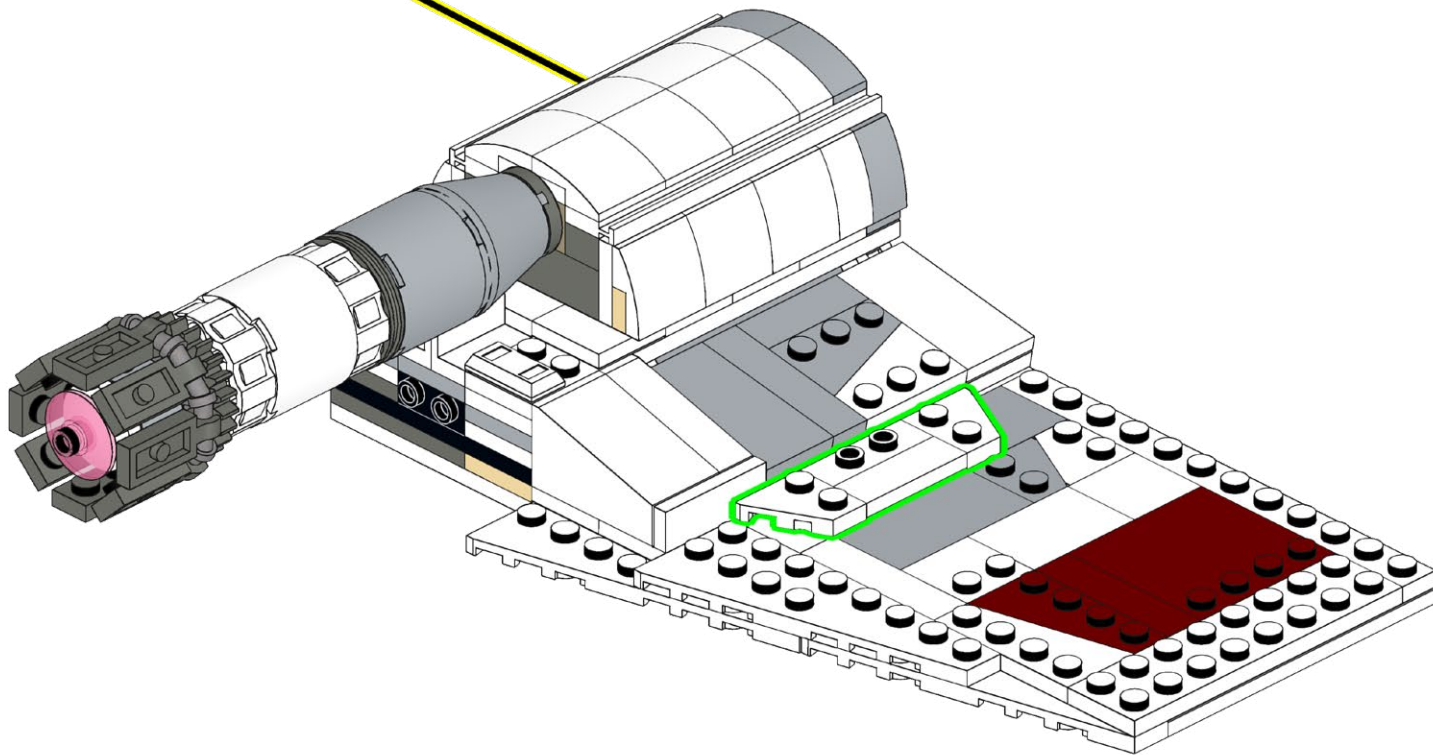
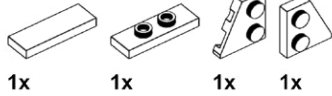

455



1x



5x



1x

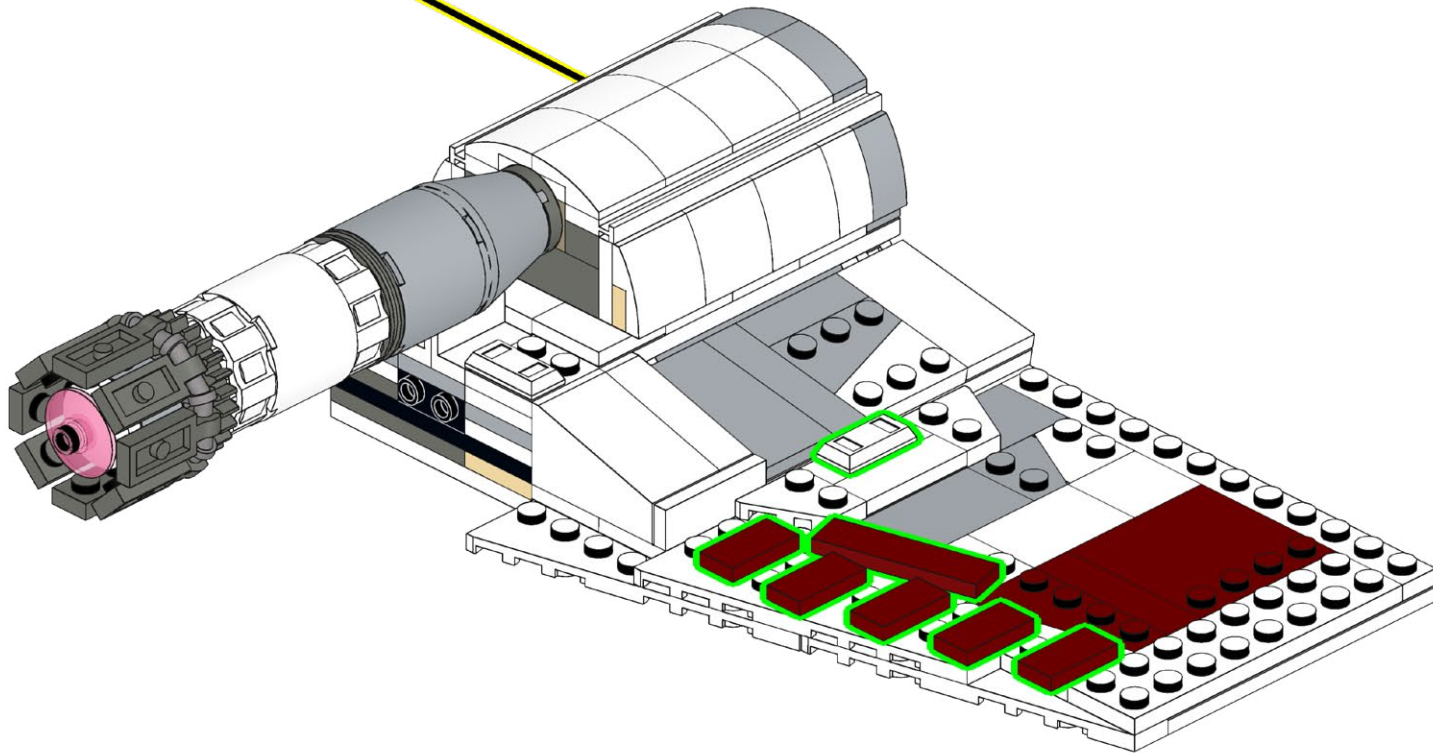

456

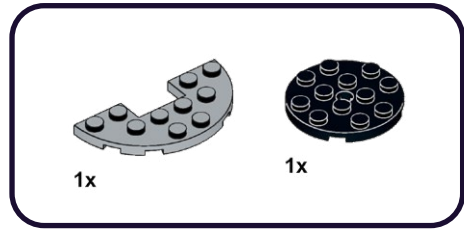

1

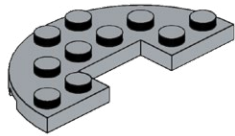

2

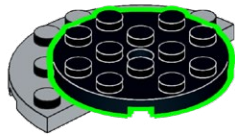

457

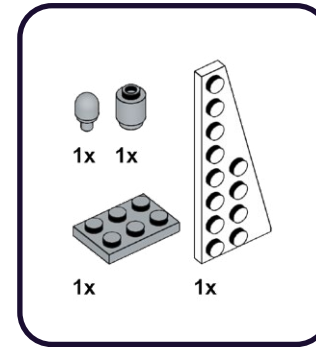

1

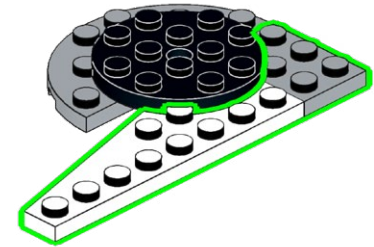

2

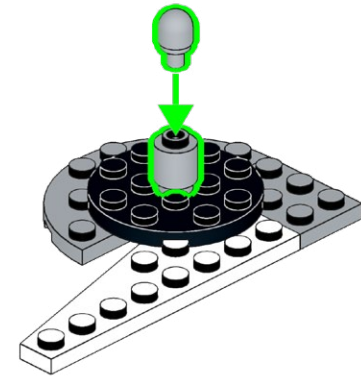



458

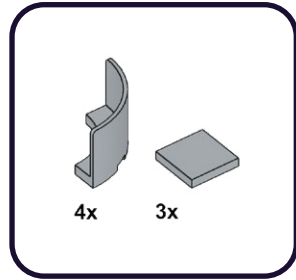

1

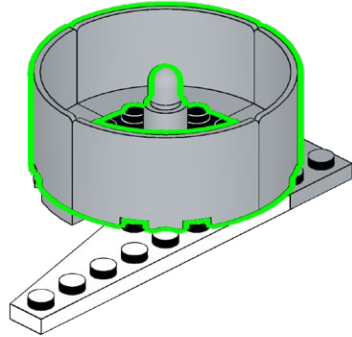

2

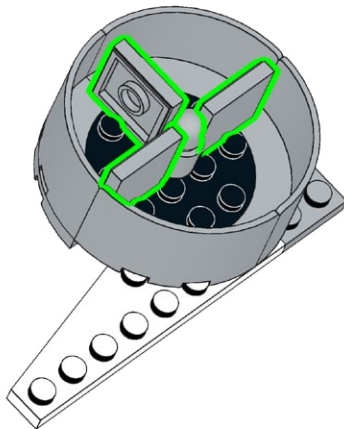

459

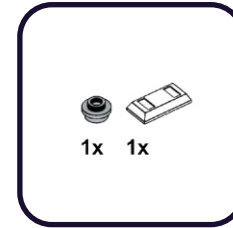

1

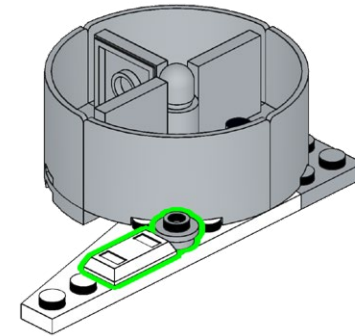

460

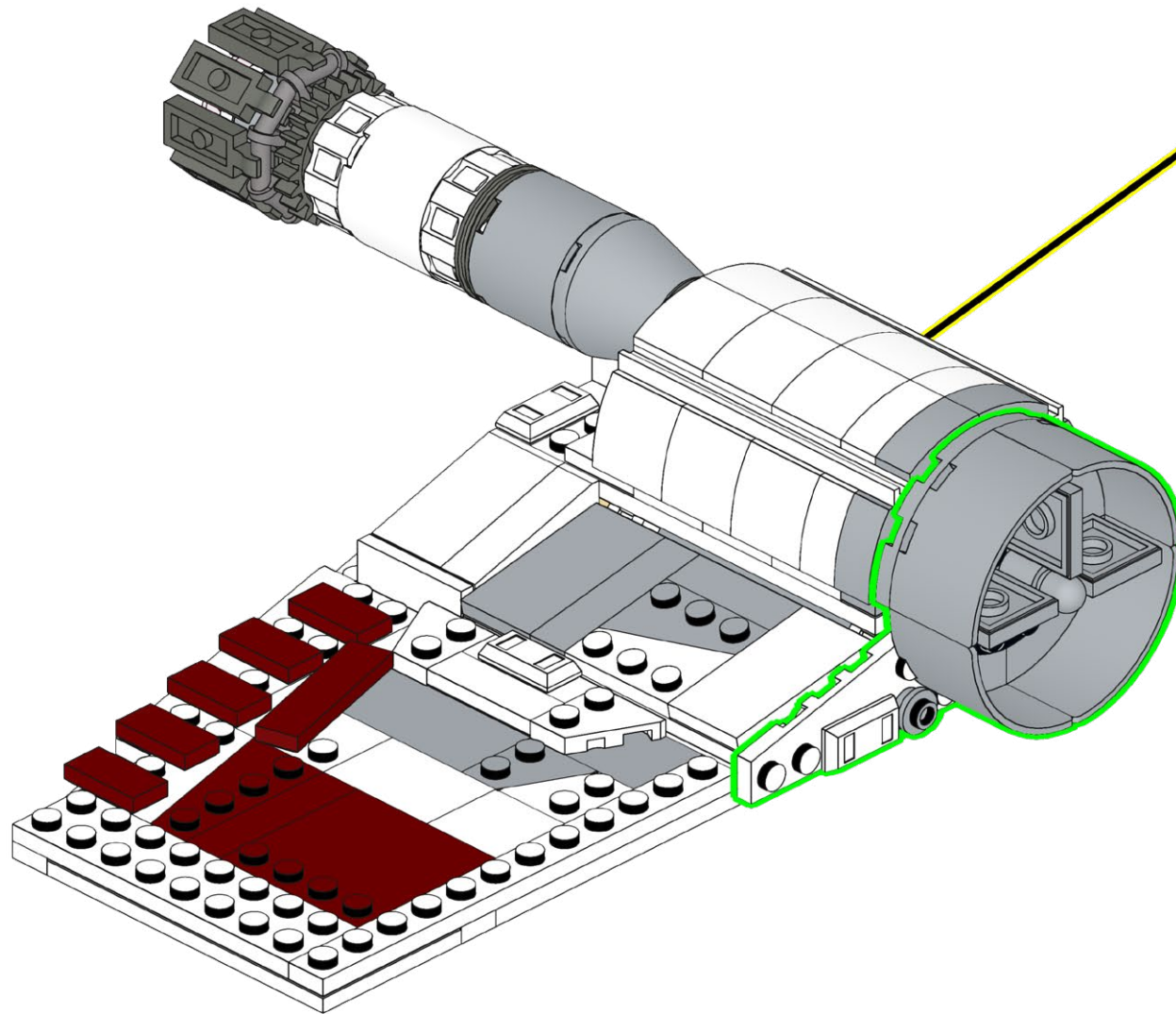

461

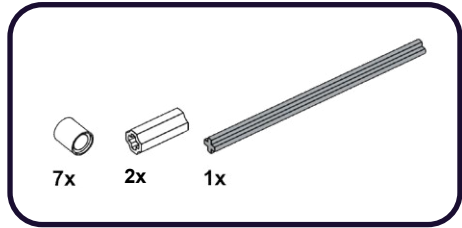

1

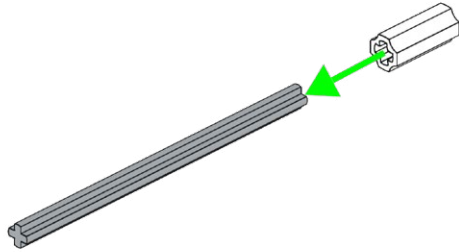

2

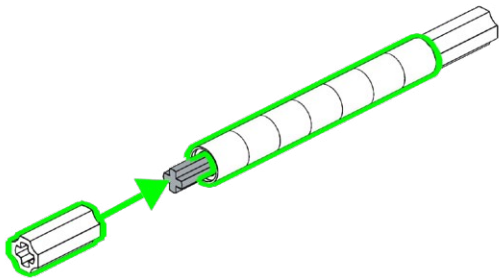

462

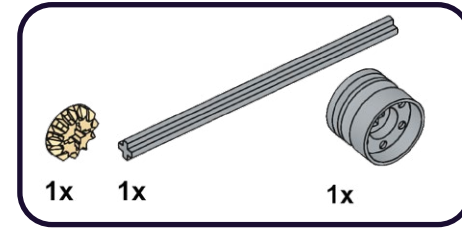

1

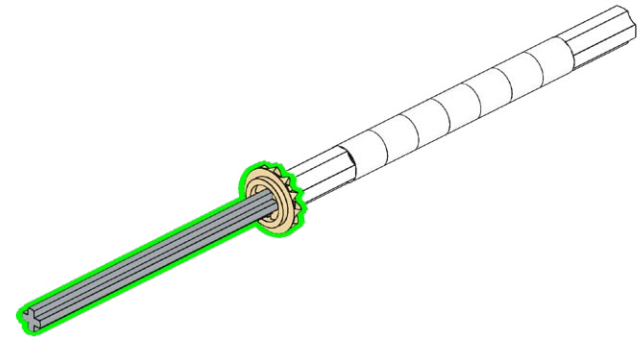

2

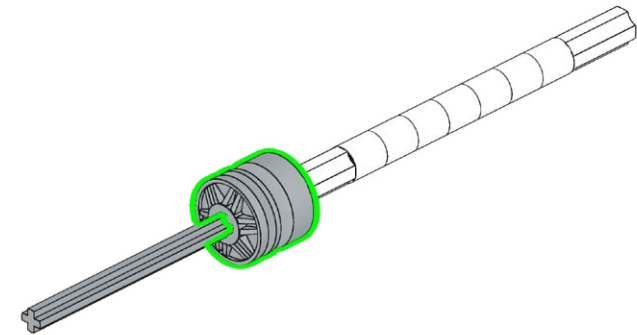

# 463

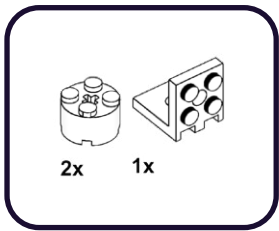

1

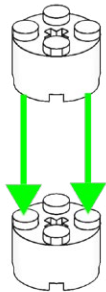

2

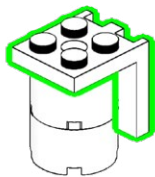

# 464

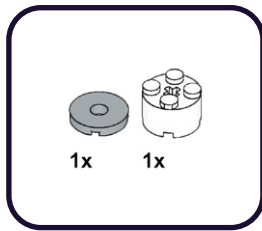

1

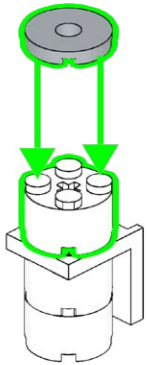

2

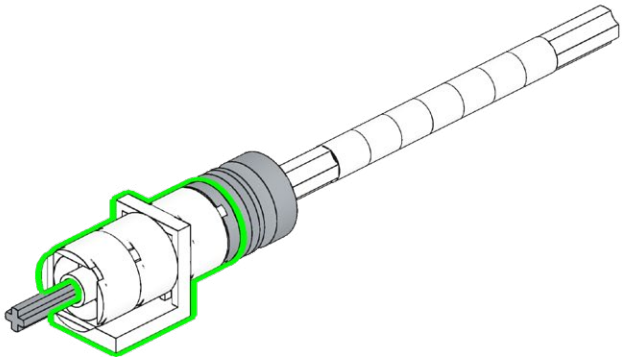

**465**

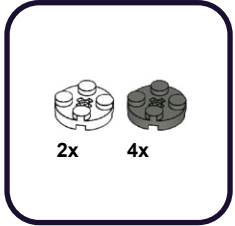

1

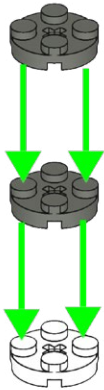

2

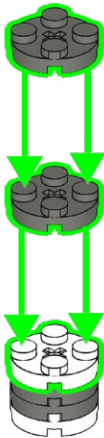

**466**

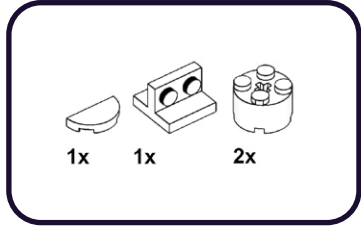

1

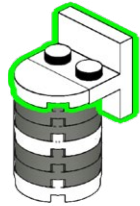

2

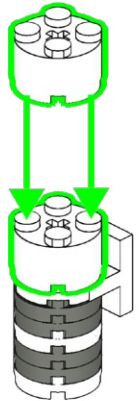

467

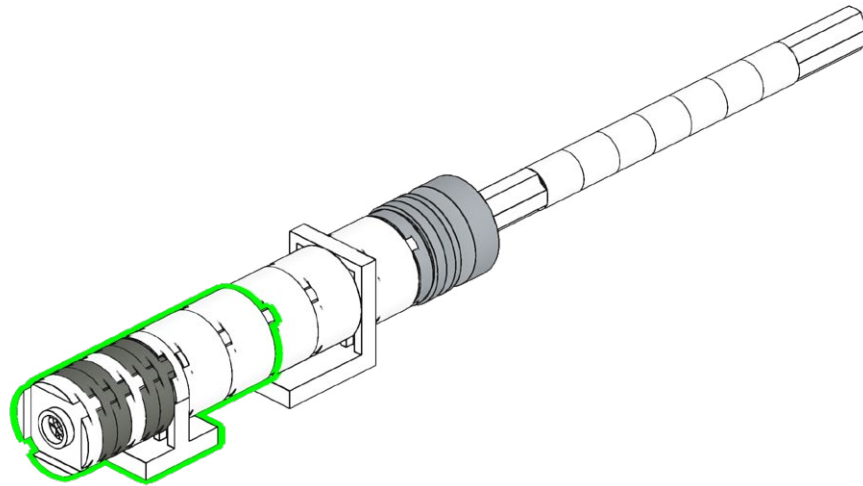

468

1x

1x

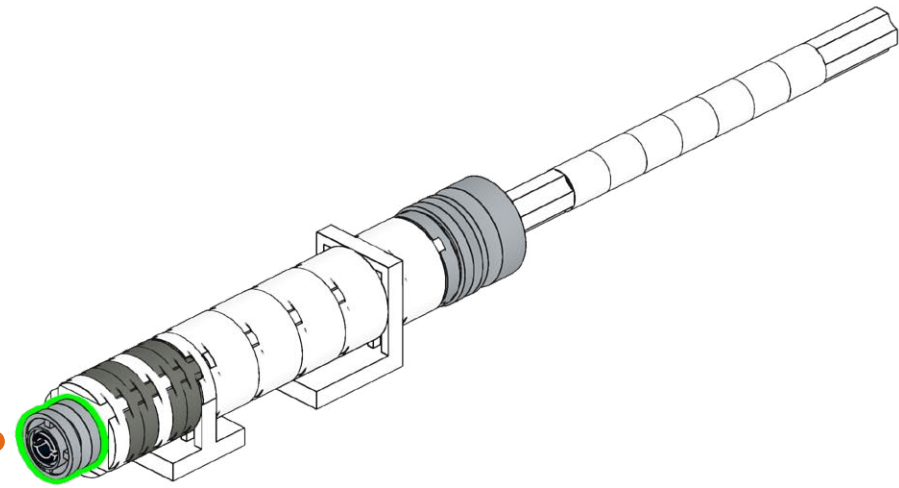
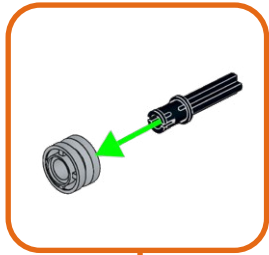

**469**

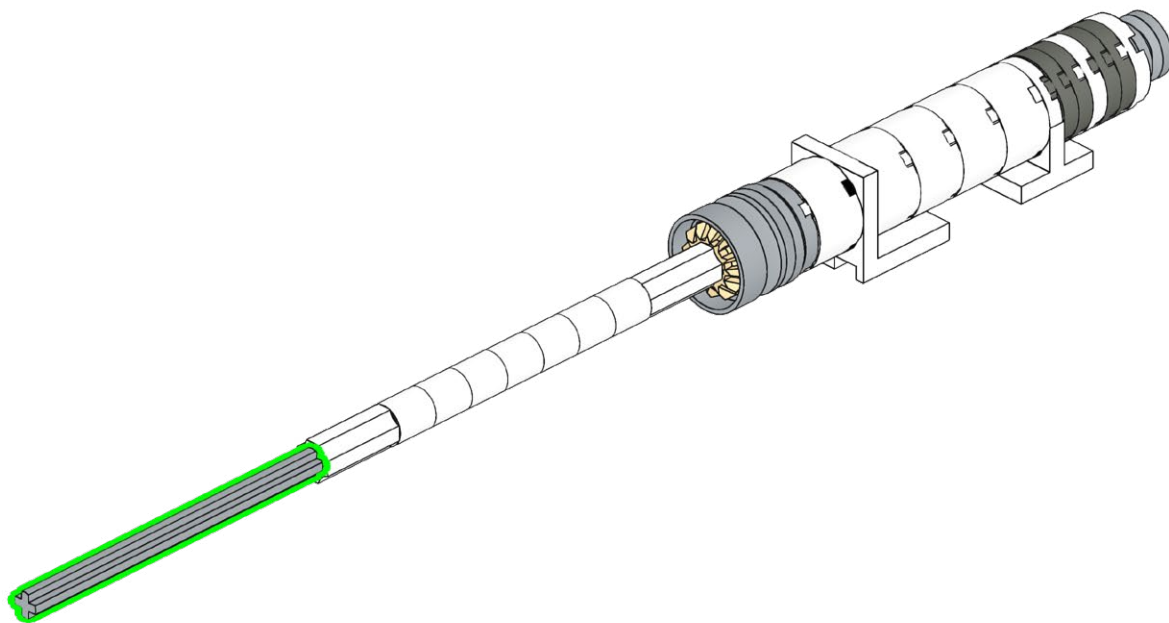
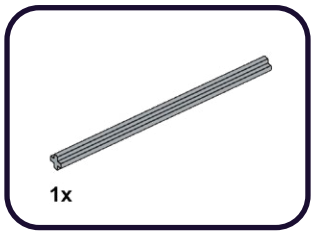



**470**

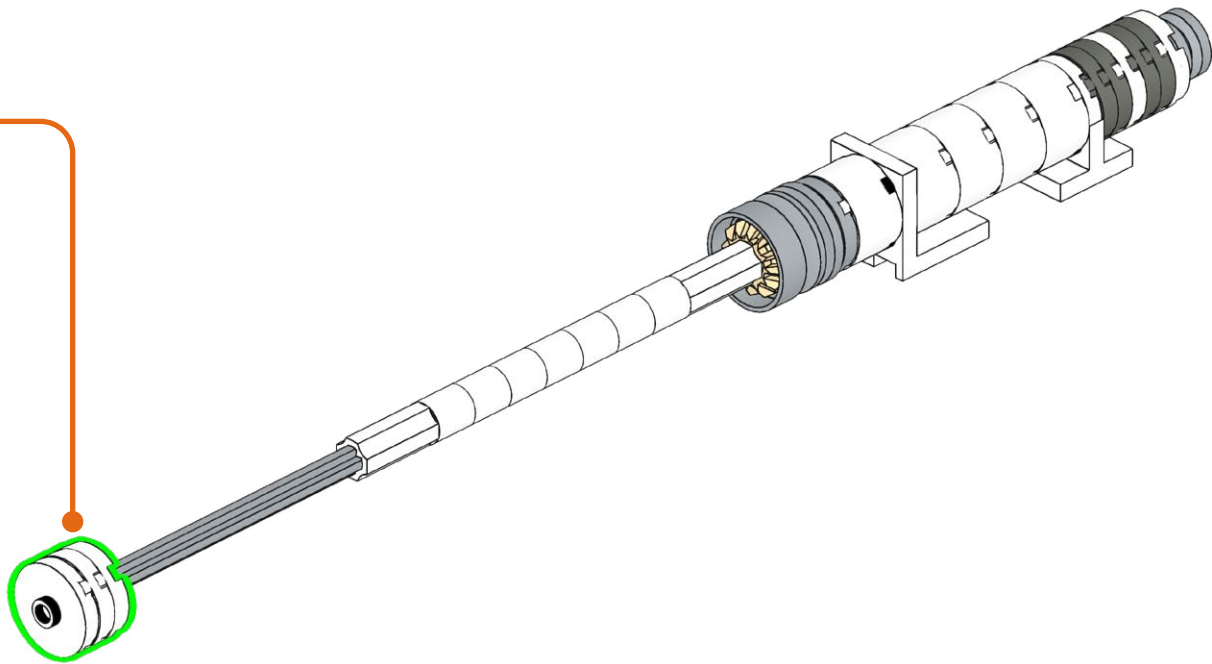
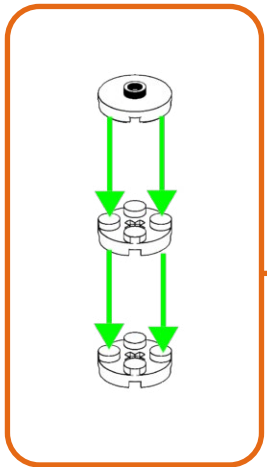
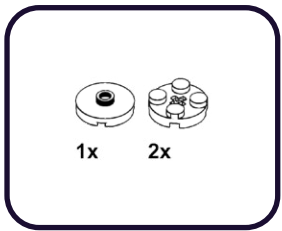

471

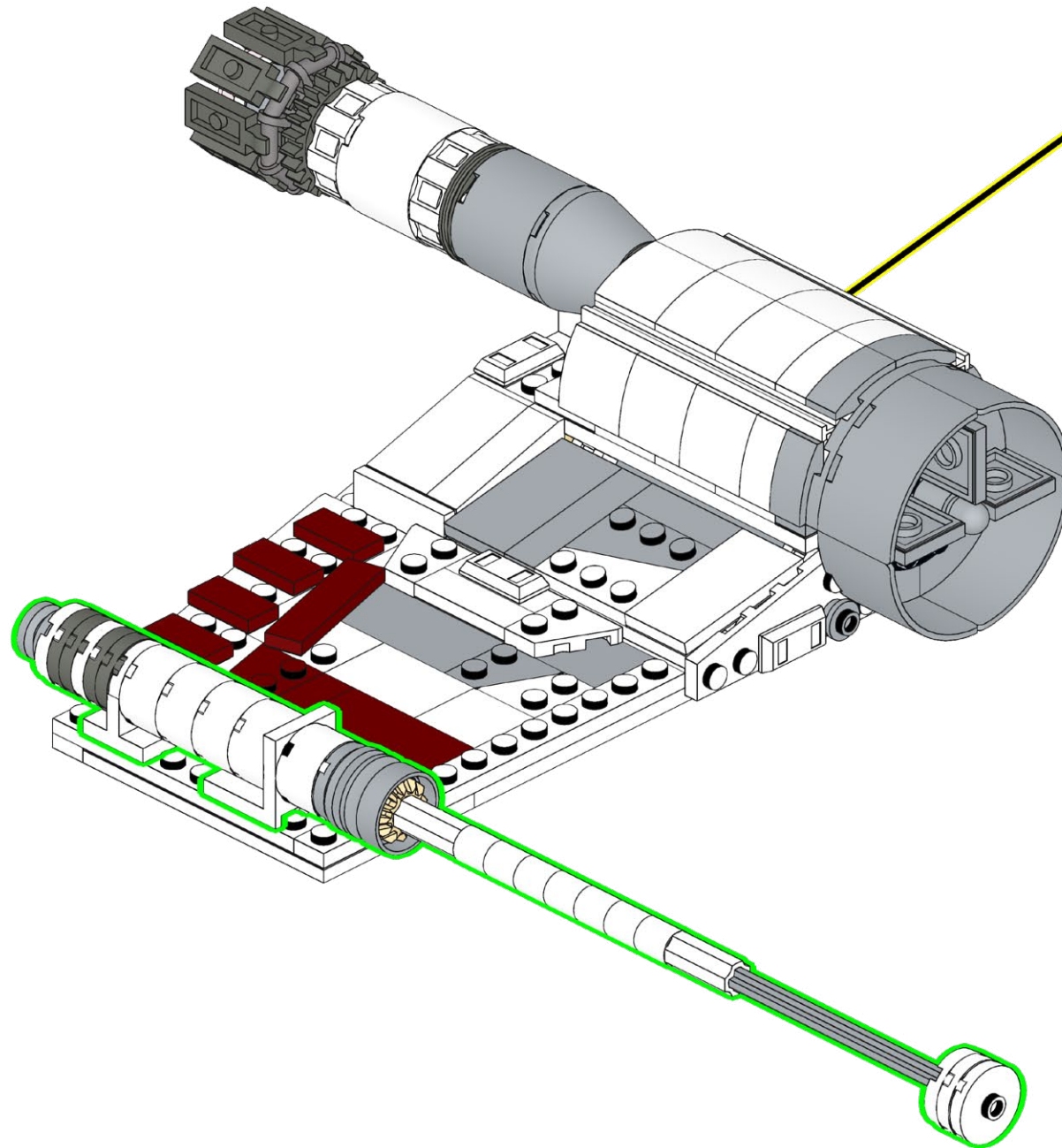

472

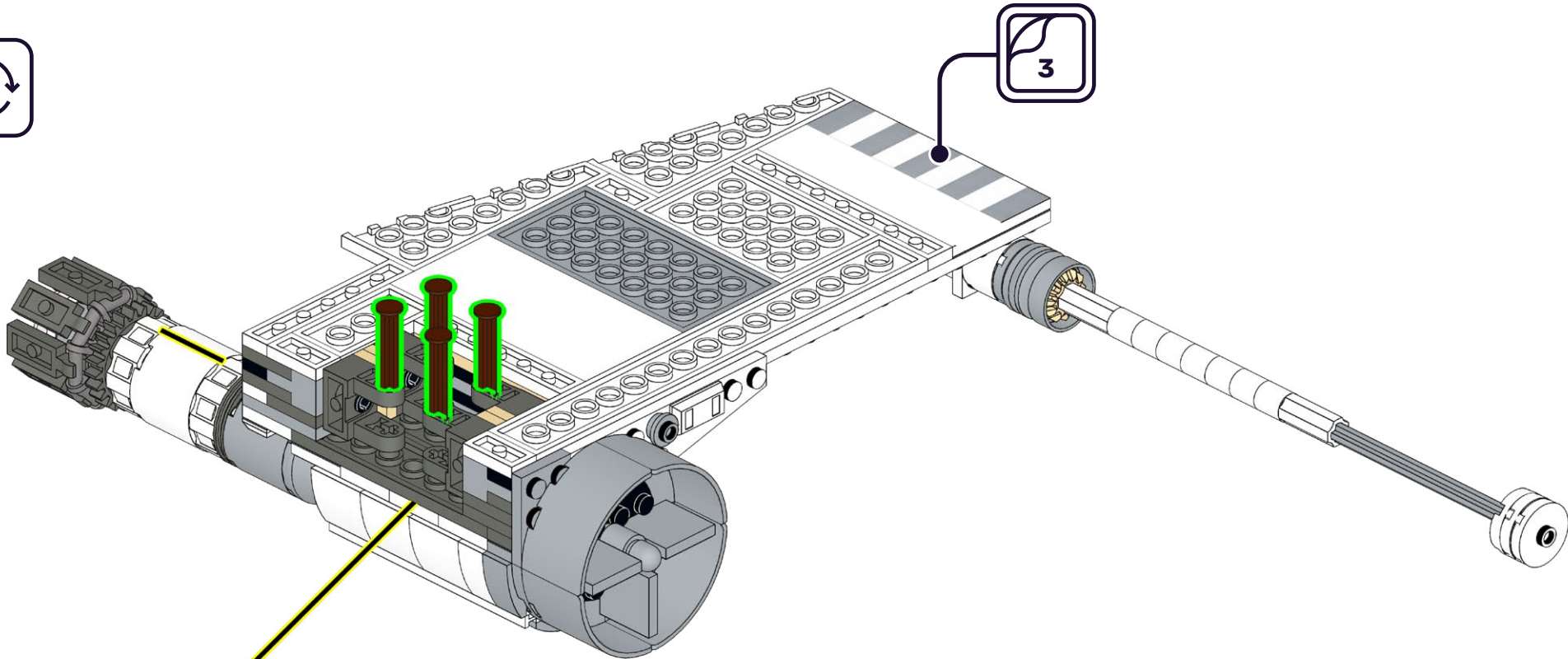
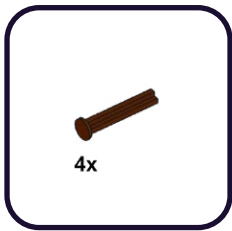

**HOLD UP!**

You might notice some bags aren't in order, as well as left over pieces, but that's ok! We're changing the way you build LEGO!

**ATTENDEZ!**

Vous remarquerez peut-être que certains sacs, ainsi que certaines pièces, ne sont pas dans le bon ordre. Mais pas de panique! Nous changeons simplement la façon avec laquelle vous construisez vos LEGO!

**ASPETTA!**

Potresti notare che alcuni sacchetti non sono in ordine, così come i pezzi avanzati, ma va bene così! Stiamo cambiando il modo in cui costruisci i LEGO!

**HALT!**

Sie werden möglicherweise bemerken, dass einige tüten durcheinander sind und teile übrig bleiben, aber das ist in Ordnung! Wir ändern die art und weise, wie Sie LEGO bauen!

**¡ESPERA!**

Es posible que notes que algunas bolsas están fuera de servicio, así como piezas sobrantes, ¡pero está bien! ¡Estamos cambiando la forma en que construyes LEGO!

**暫停!**

你可能会注意到一些袋子顺序错乱, 以及一些剩余的部件, 但没关系! 我们正在改变你搭建乐高的方式!

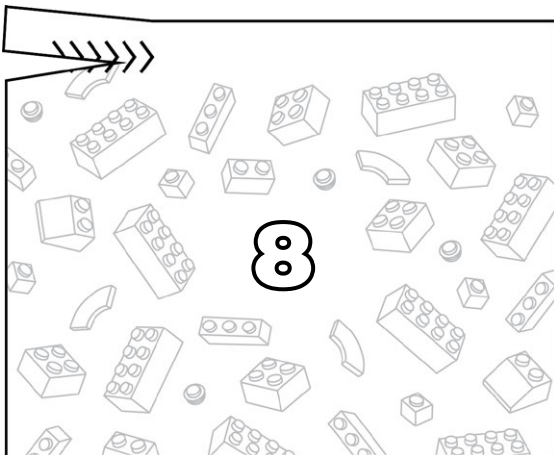
**Open LEGO® Bag 8**

473

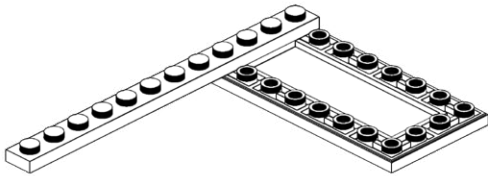
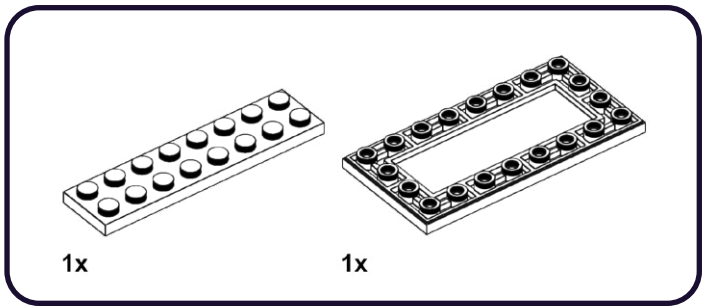

474

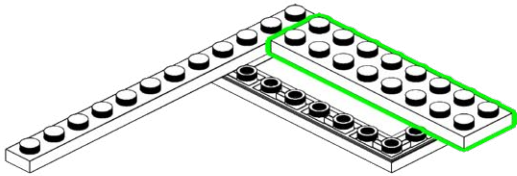
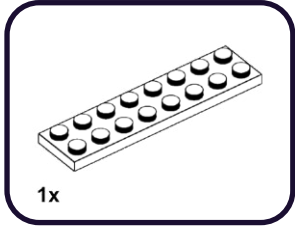

**475**

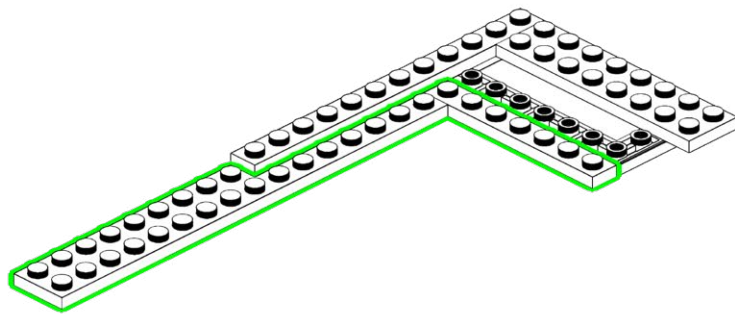
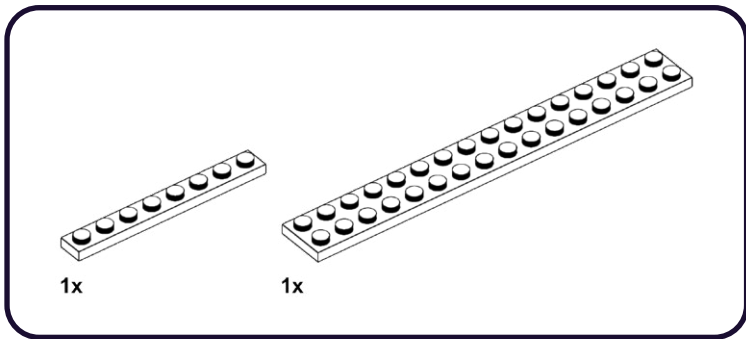

476

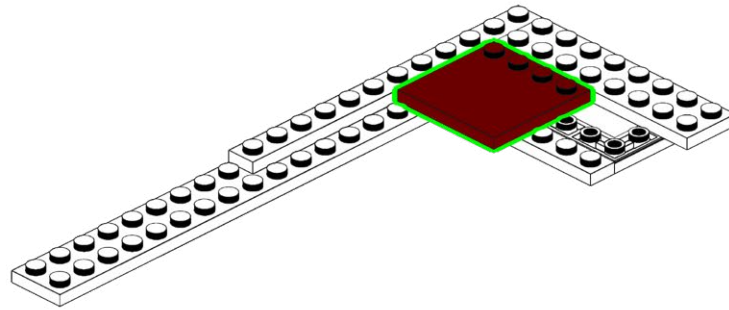
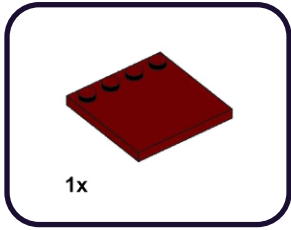



477

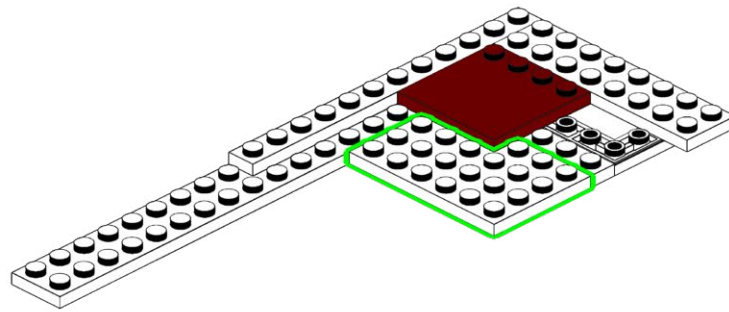
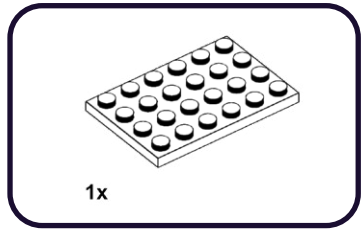

478

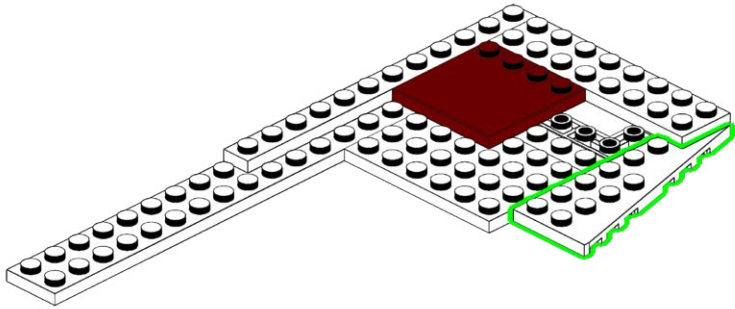
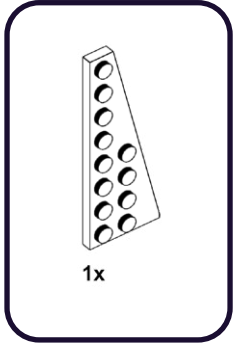

479

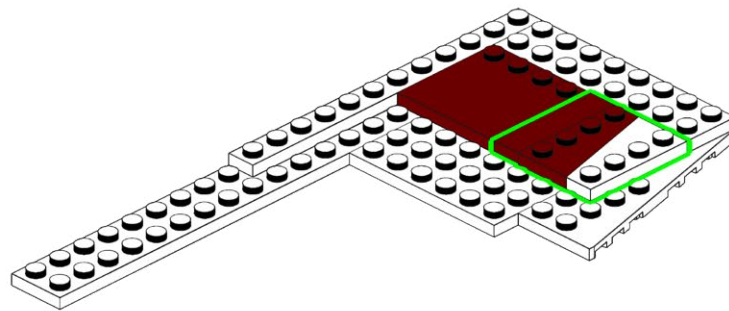
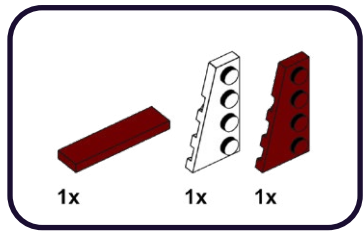

480

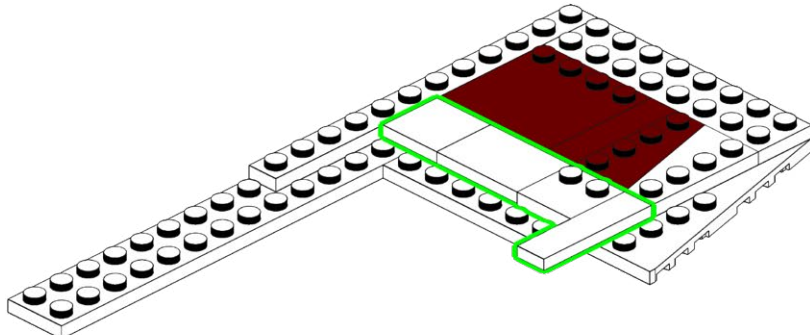
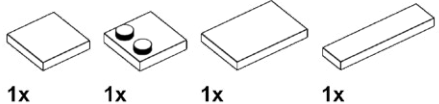

481

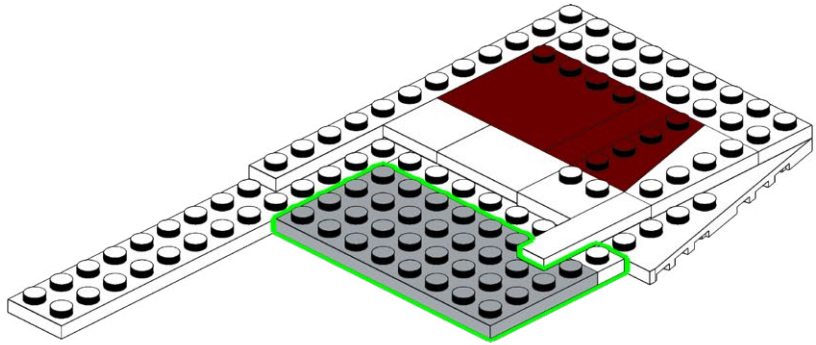
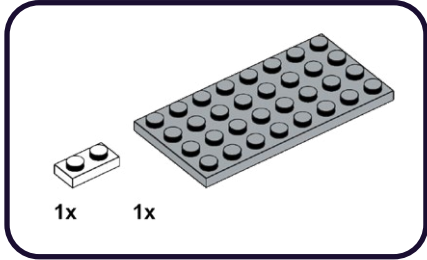

482

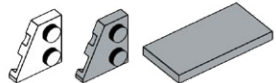

1x 1x 1x

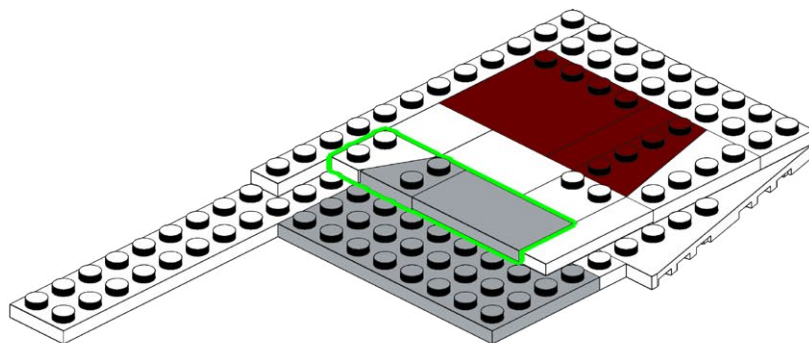

483

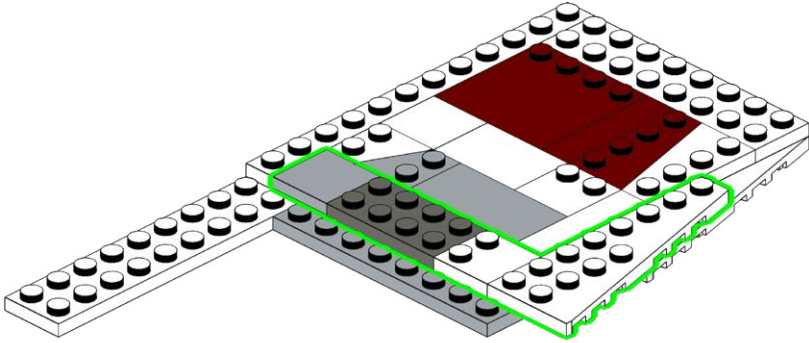
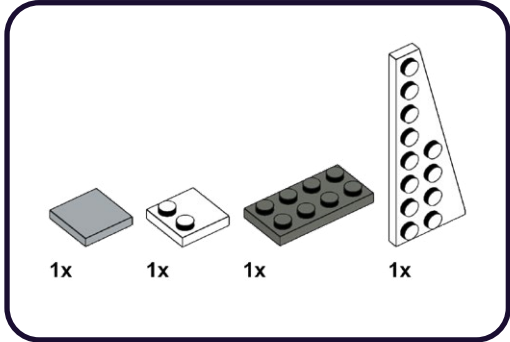

484

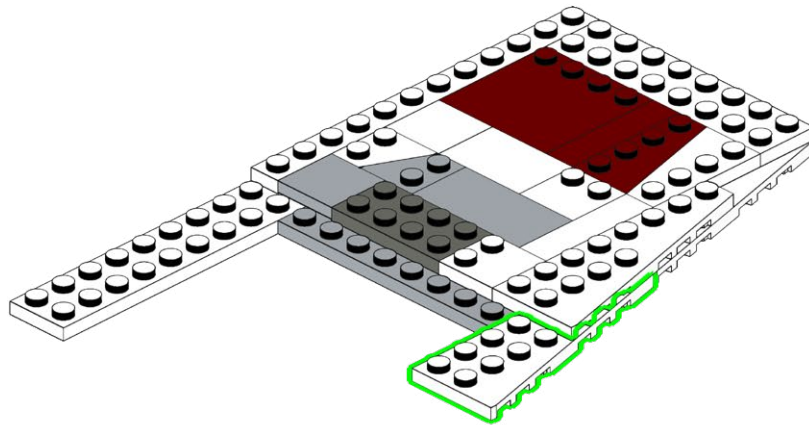
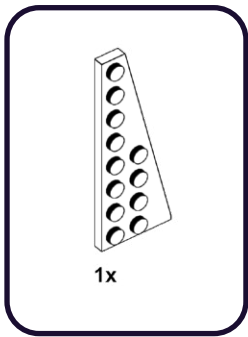



**485**

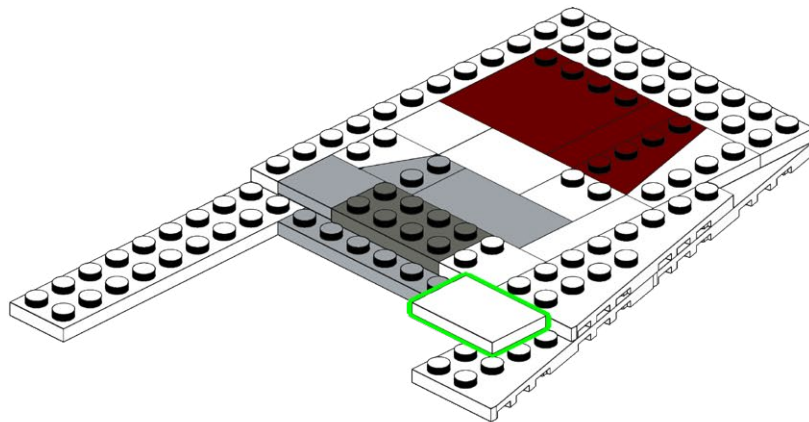
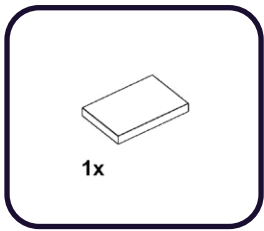

486

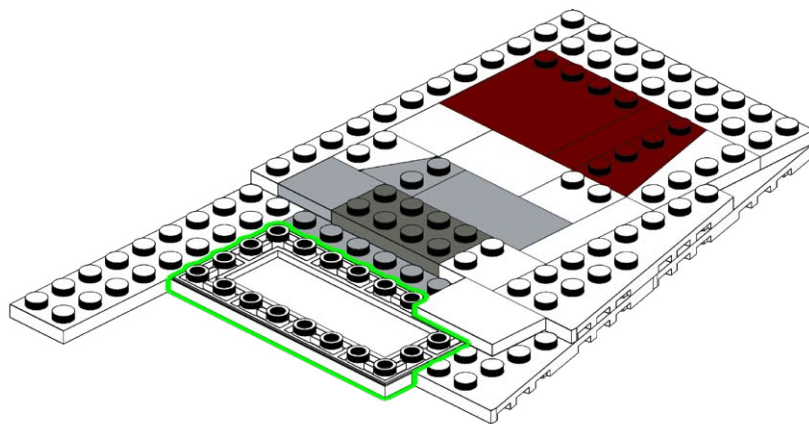
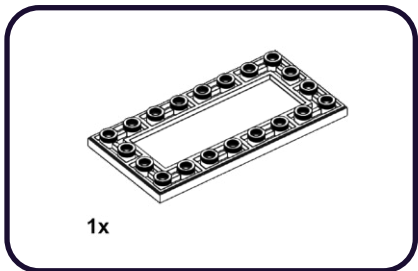

487

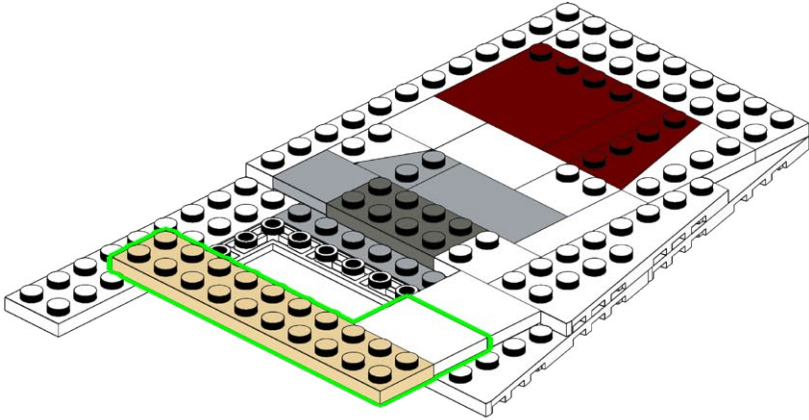
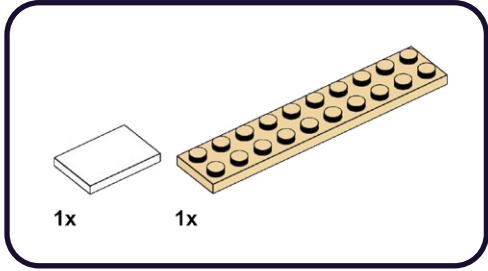

488

1x

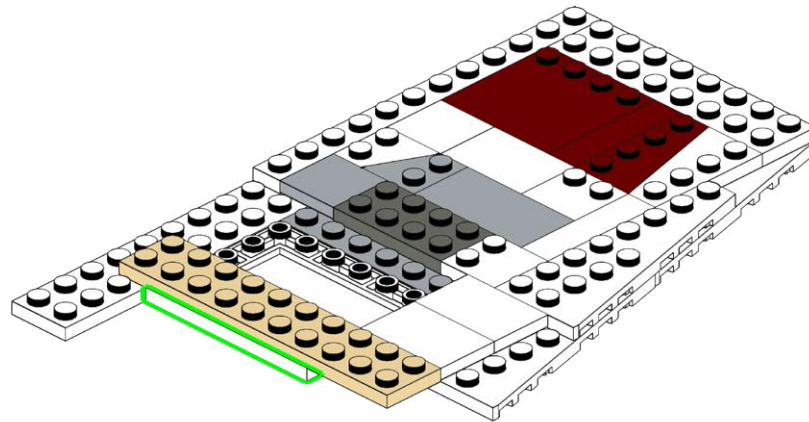

489

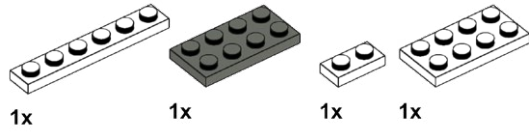

- 1
- 2
- 3

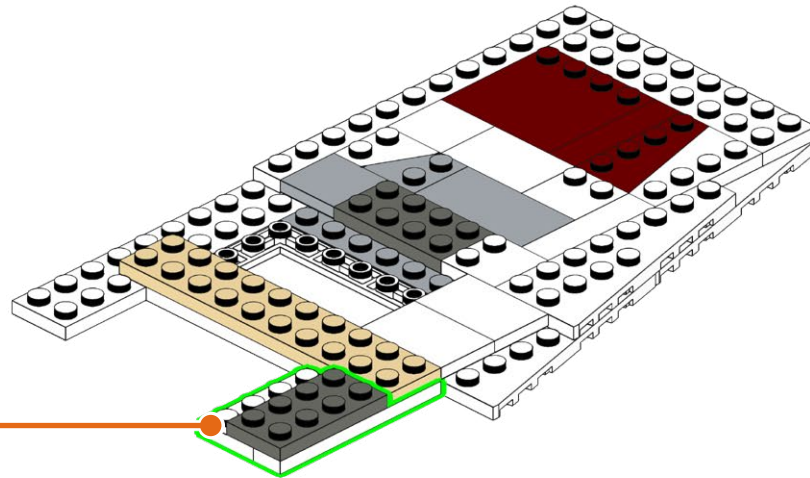

490

1x

1x

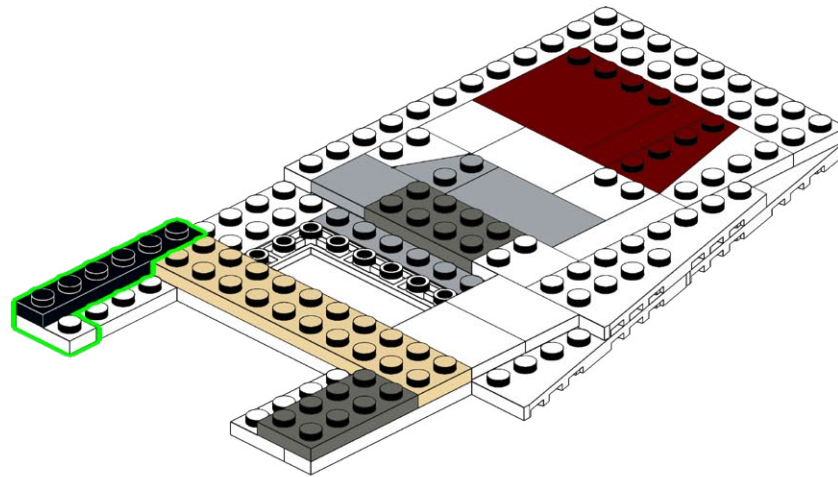

# 491

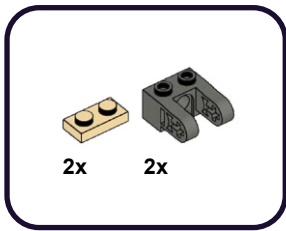

1

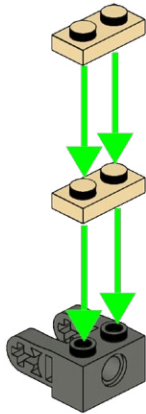

2

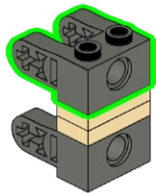

# 492

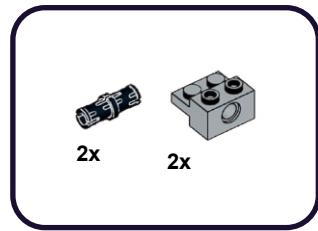

1

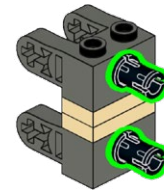

2

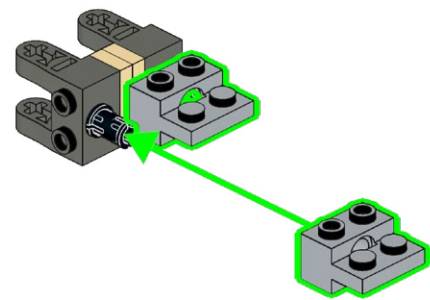

493

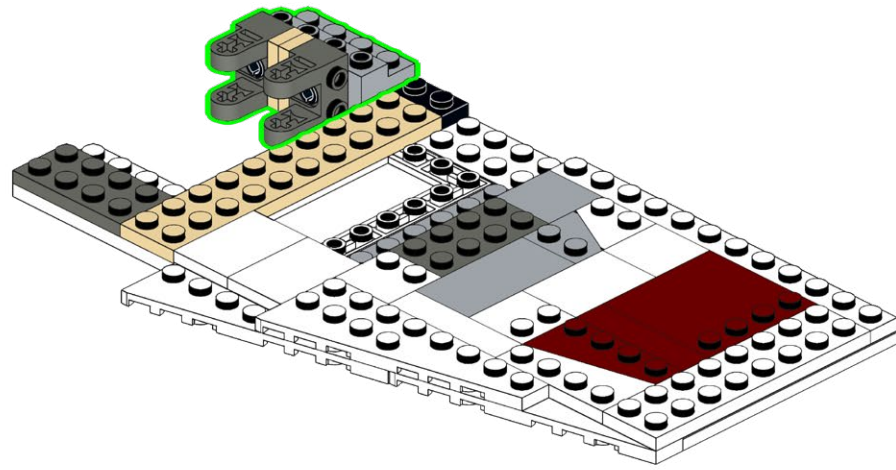



494

2x

2x

1

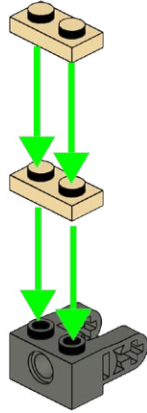

2

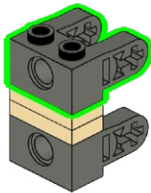

495

2x

2x

1

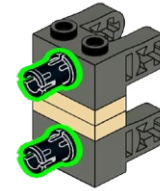

2

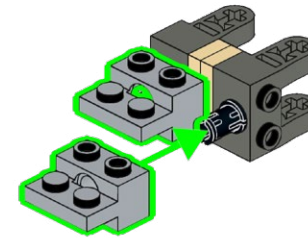

496

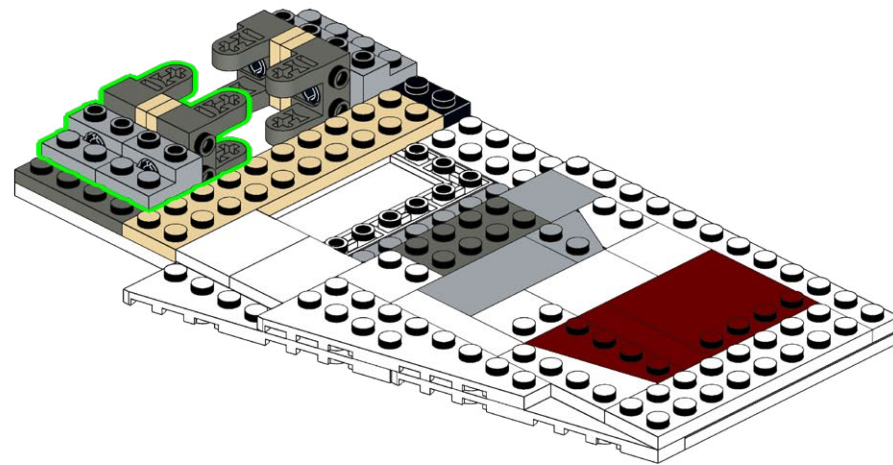

497

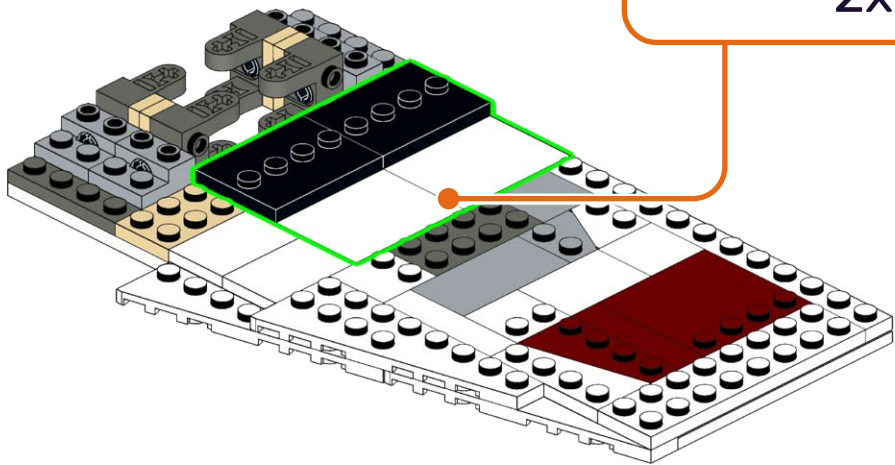
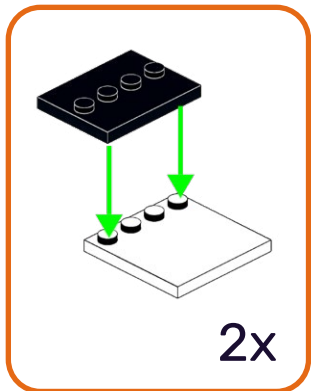
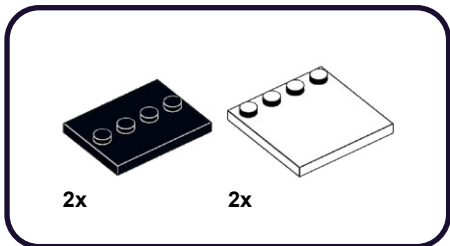

498

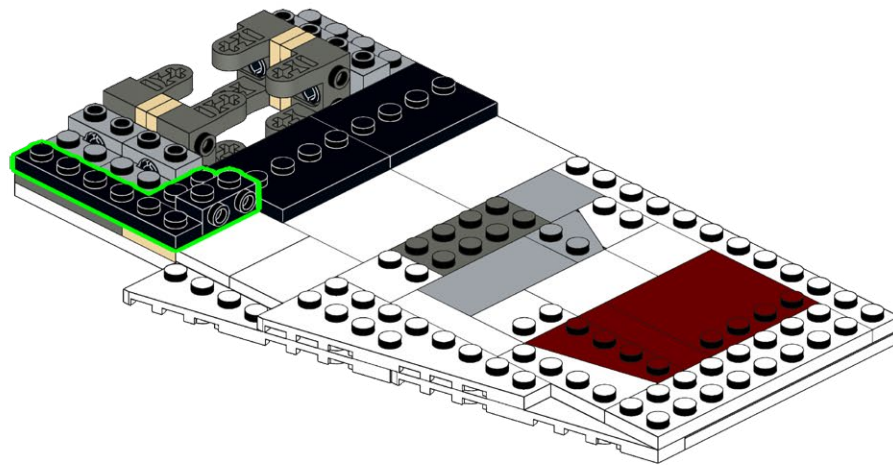

499

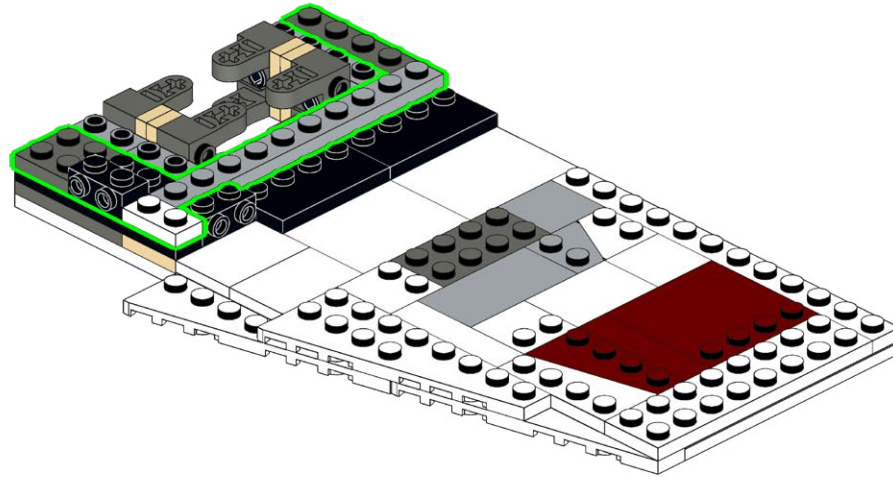
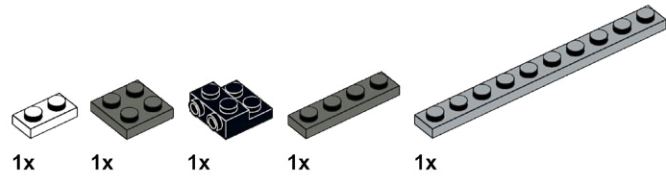

500

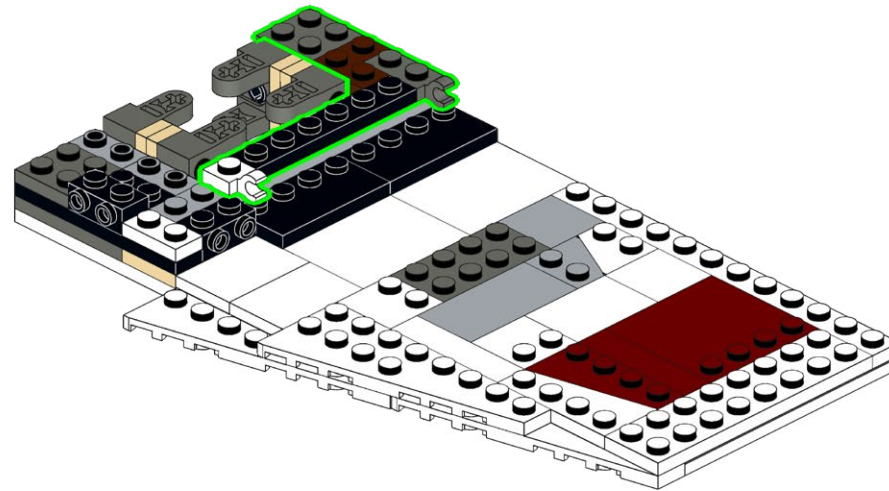
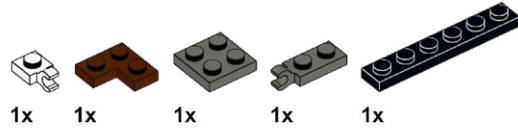

501

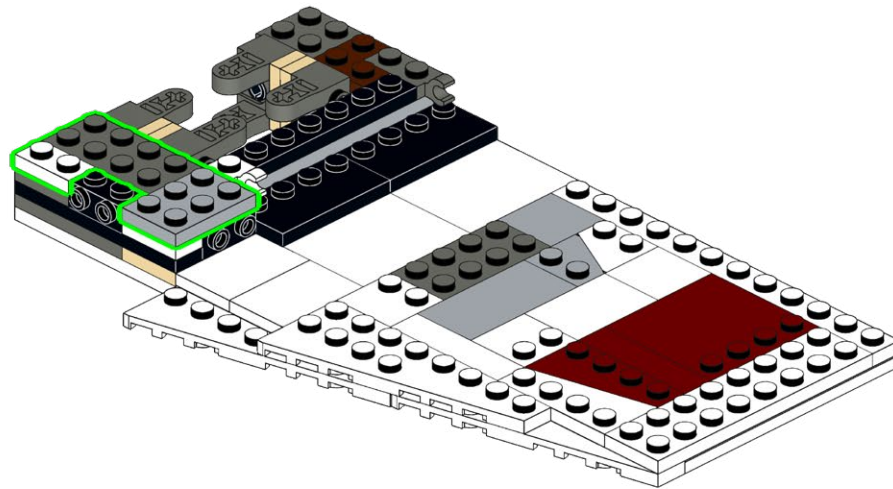
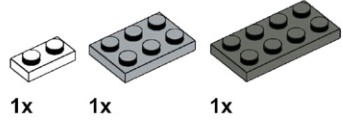

**502**

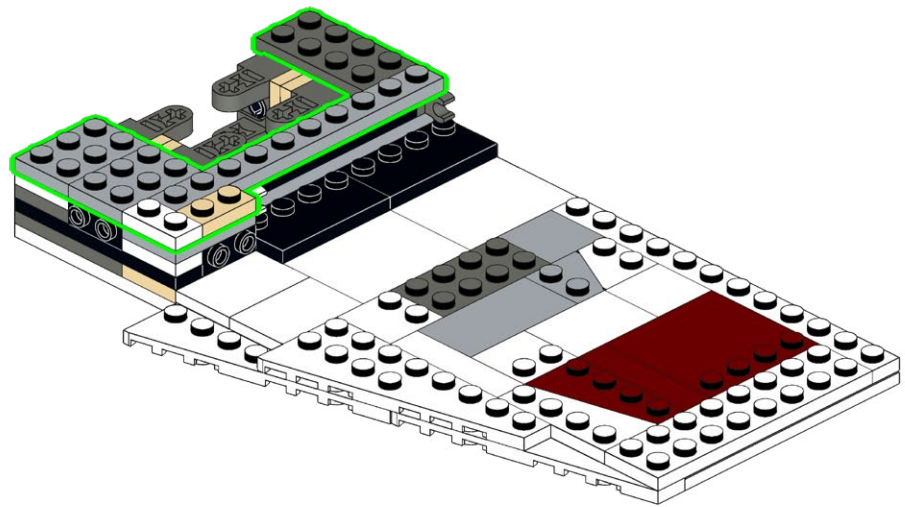
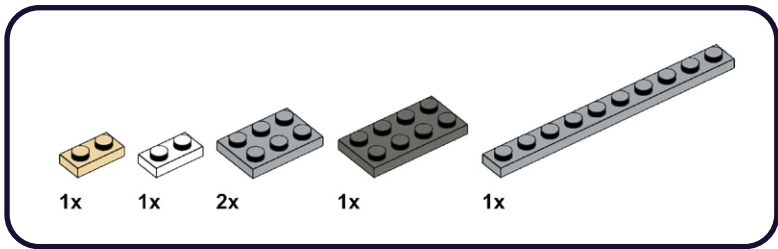



503

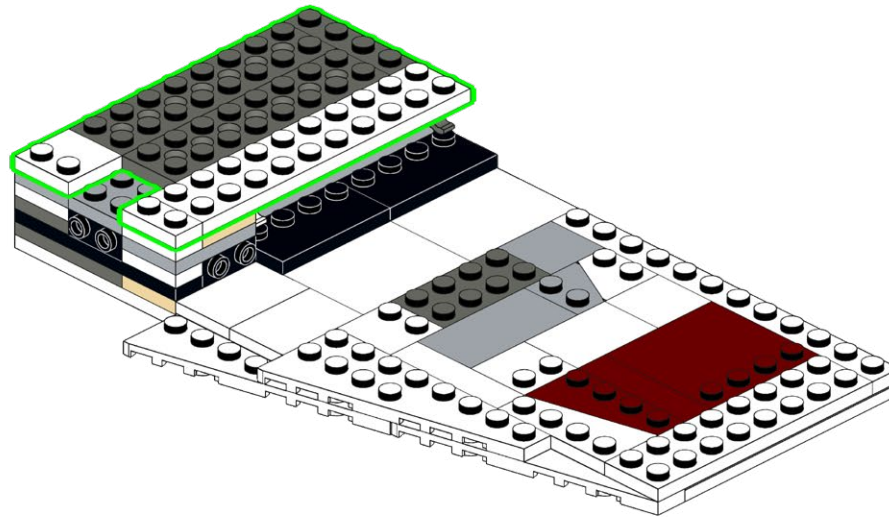
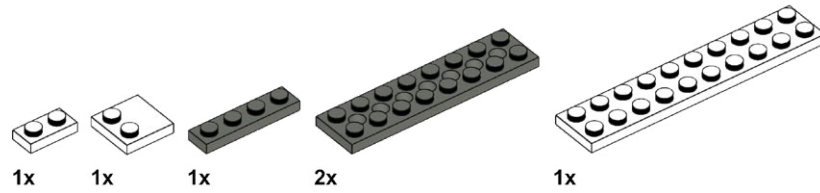

504

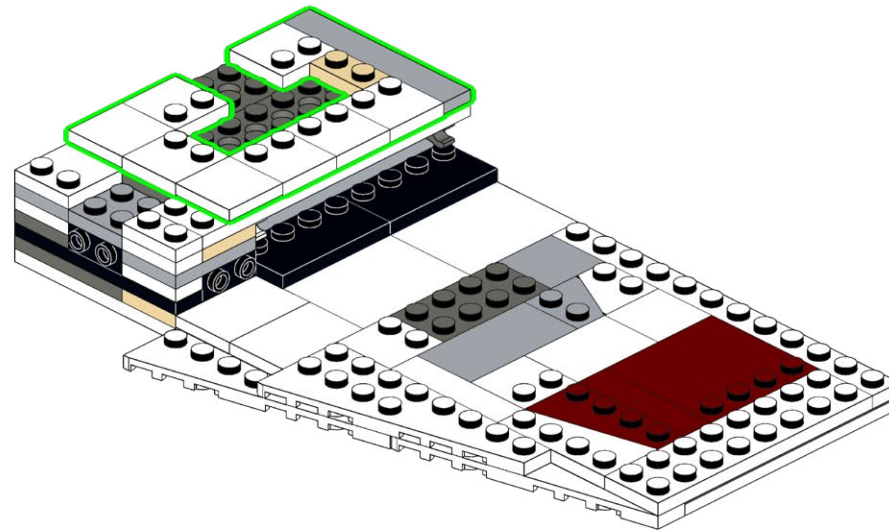
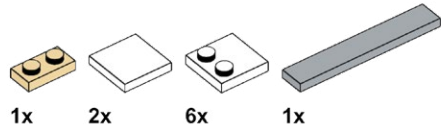

505

2x

2x

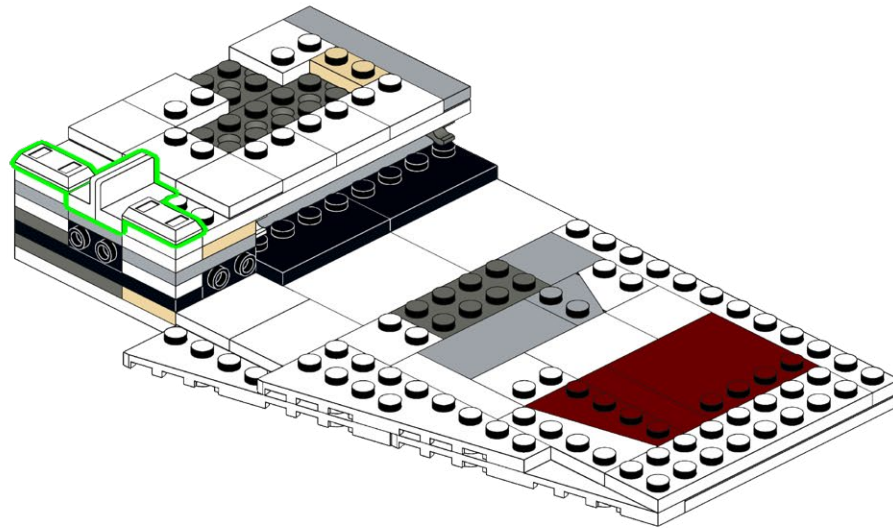

**506**

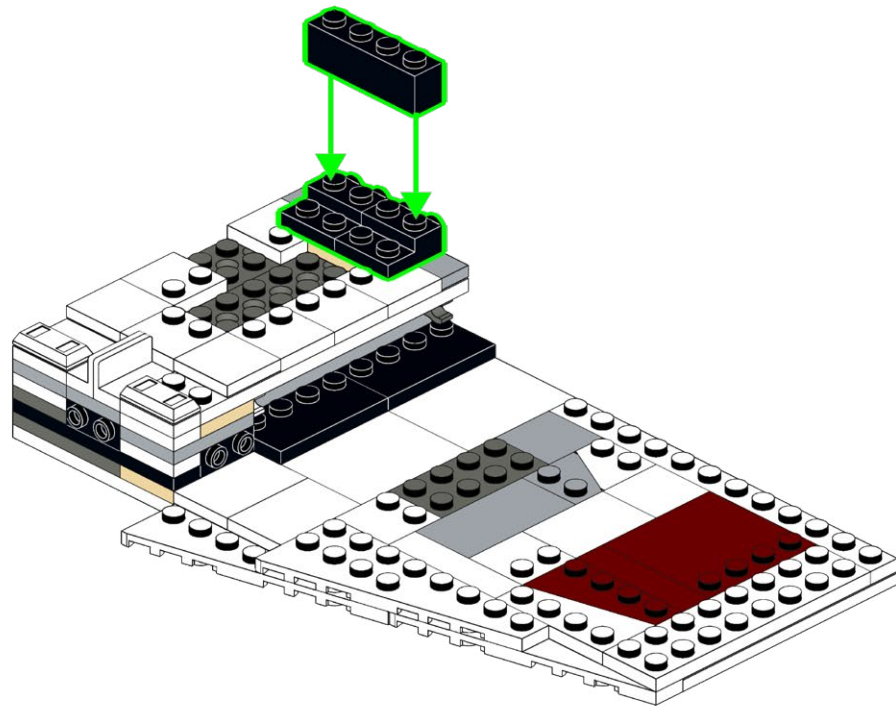
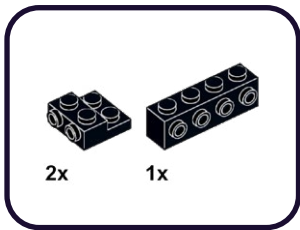

**507**

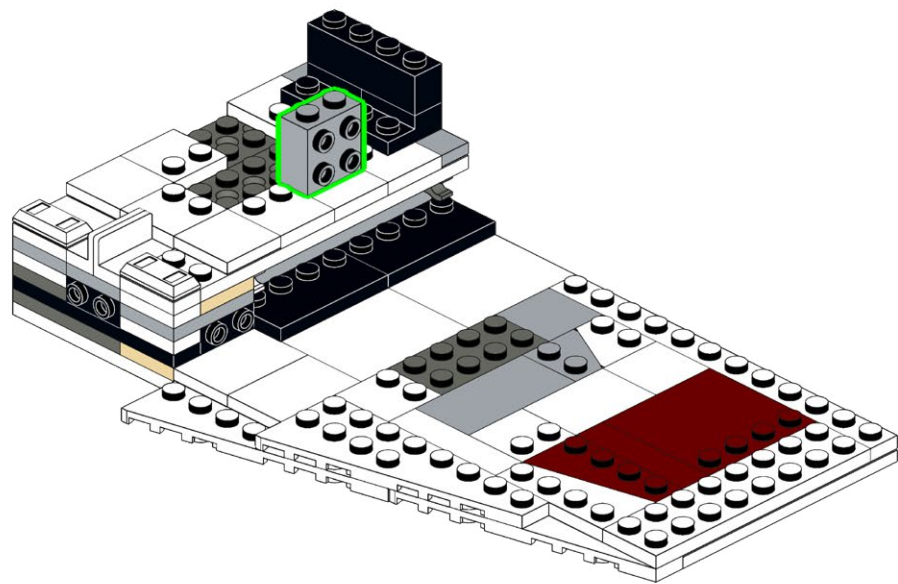
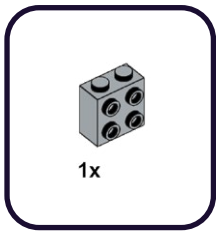

508

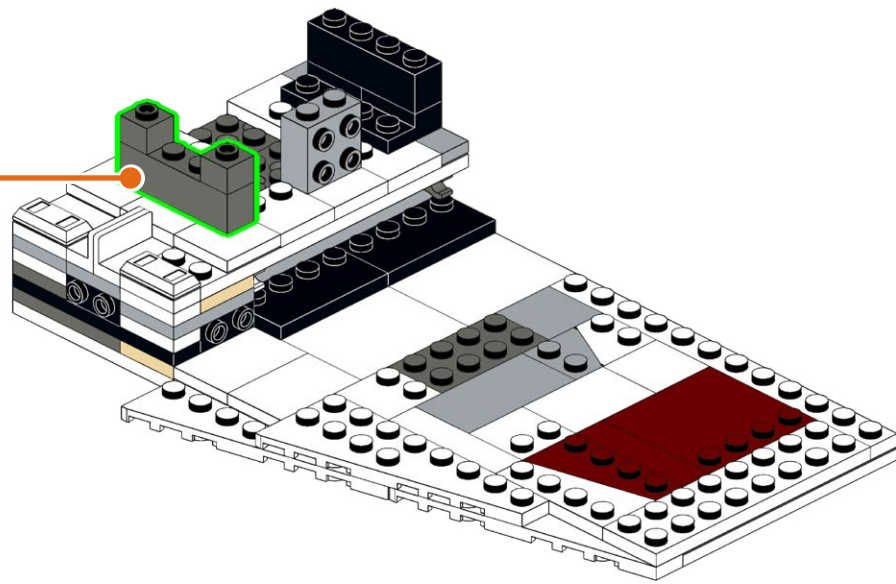
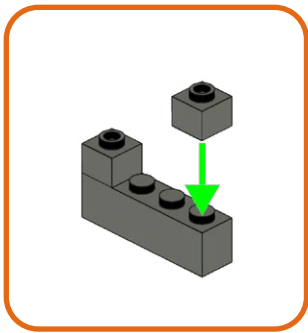
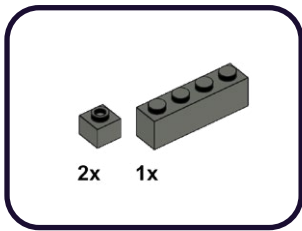

509

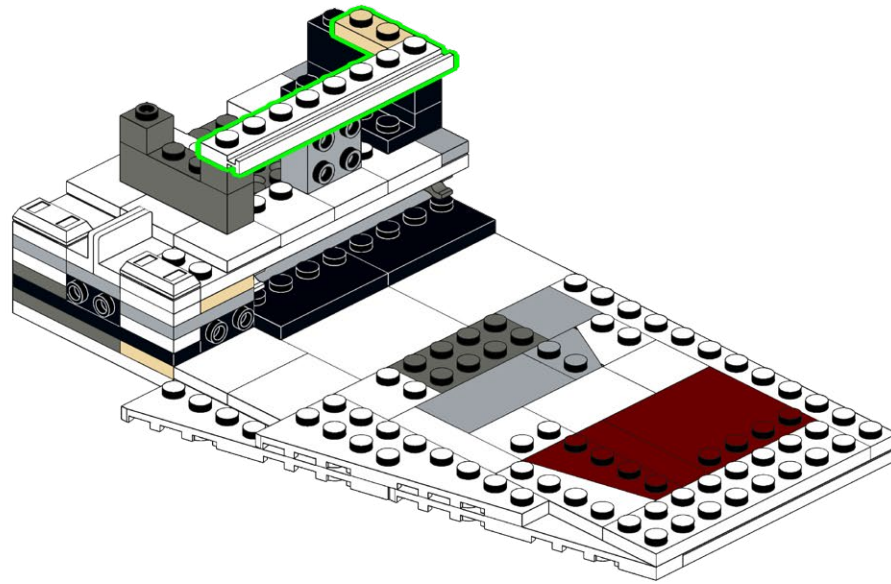
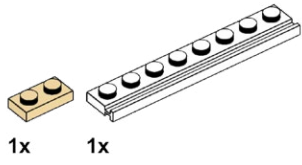

510

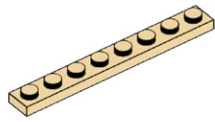

1x

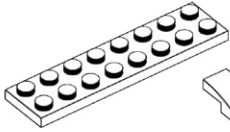

1x



1x



1x



3x

1

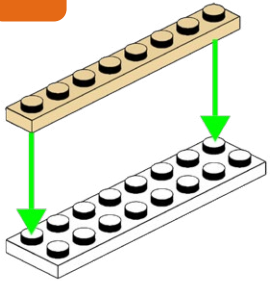

2

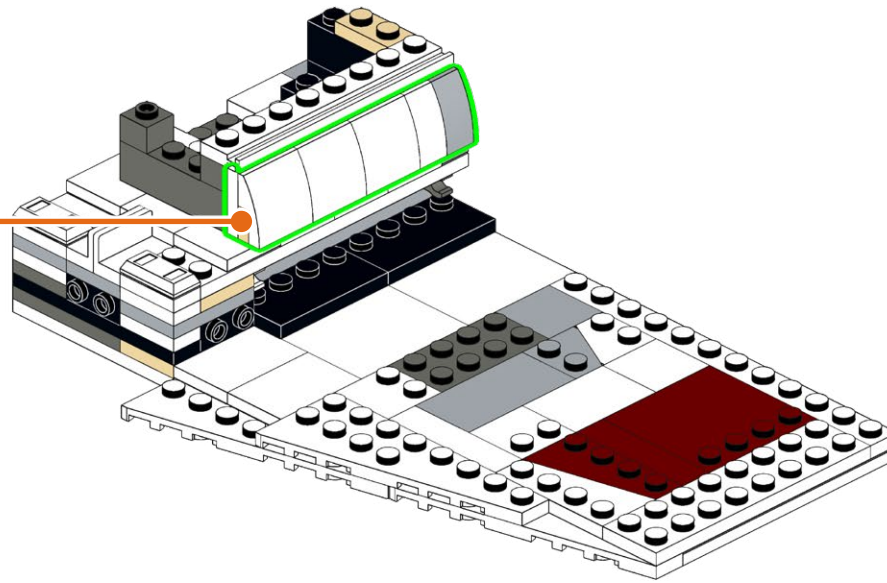
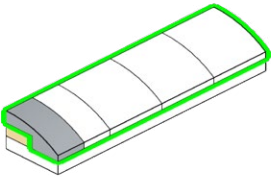



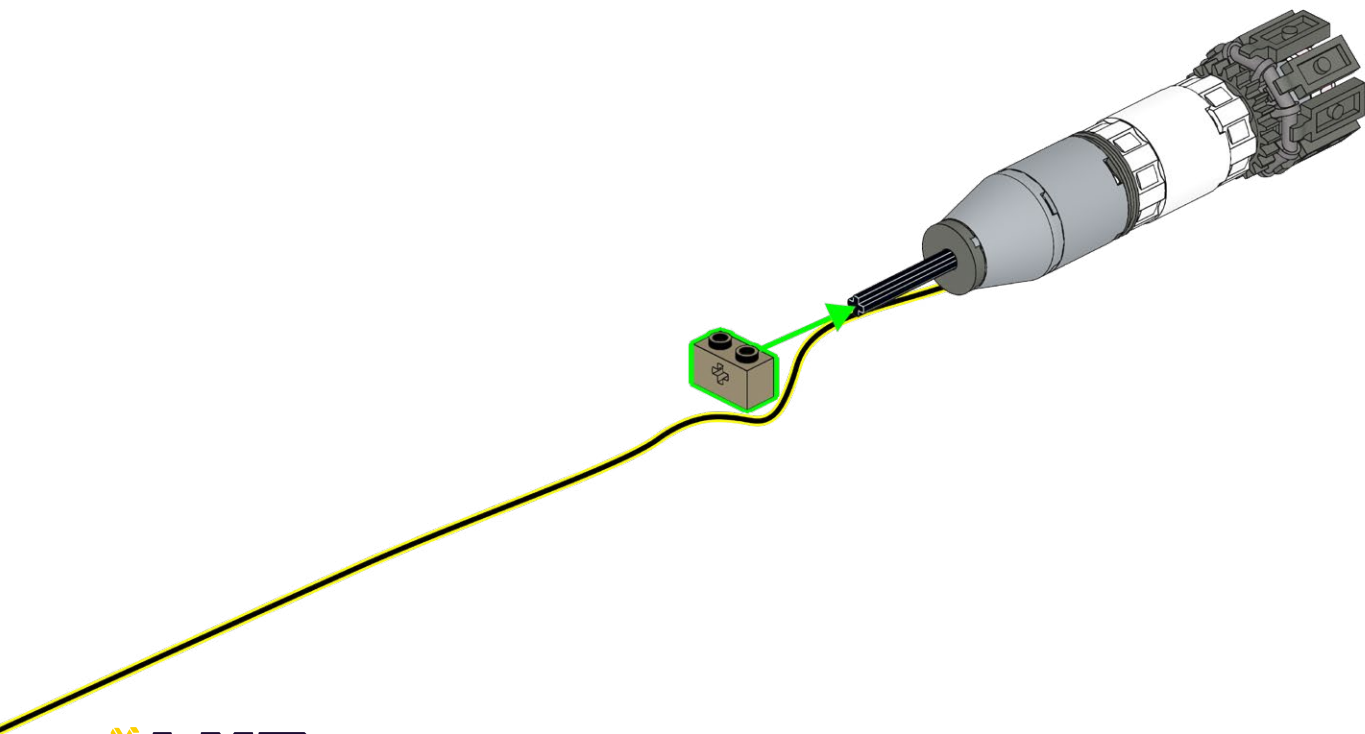
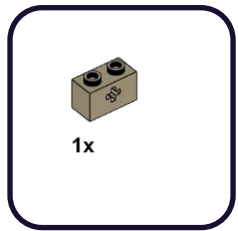

512

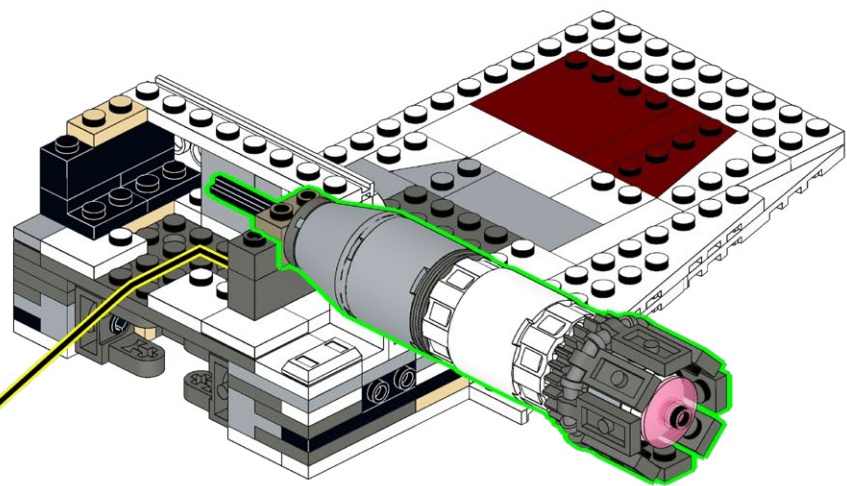

513



1x



1x

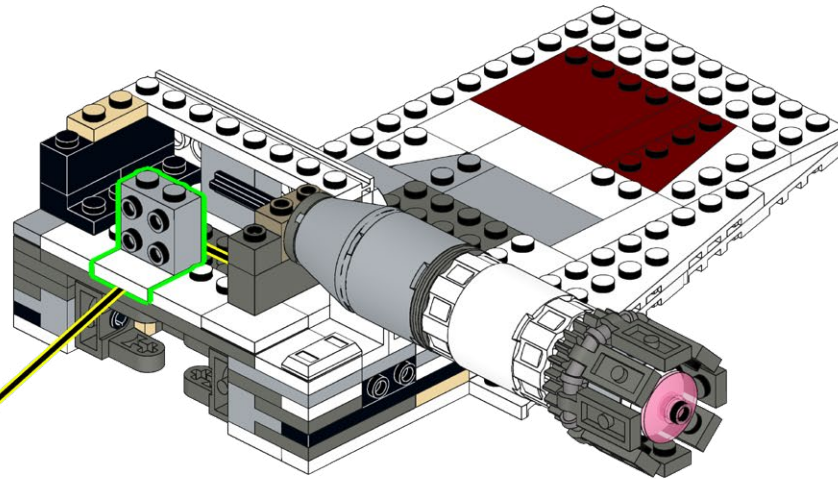

514

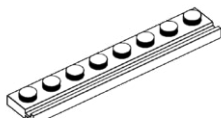

1x

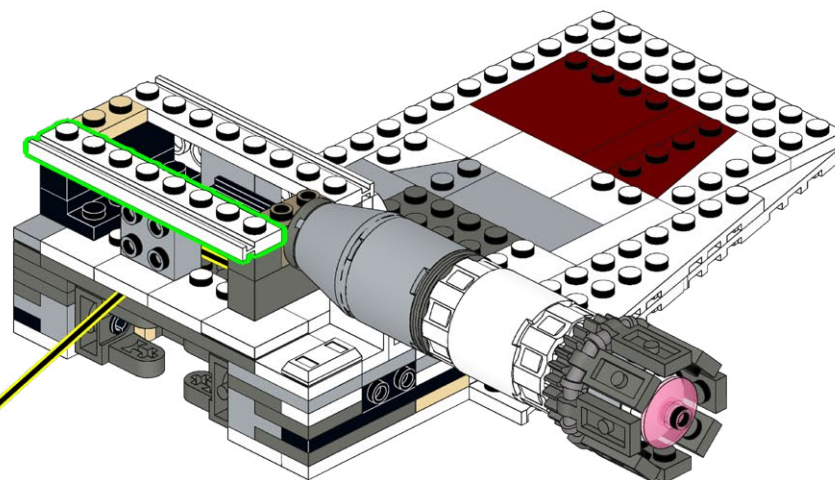

515

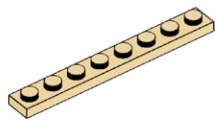

1x

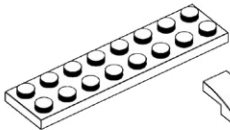

1x



1x



1x



3x

1

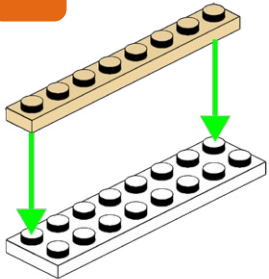

2

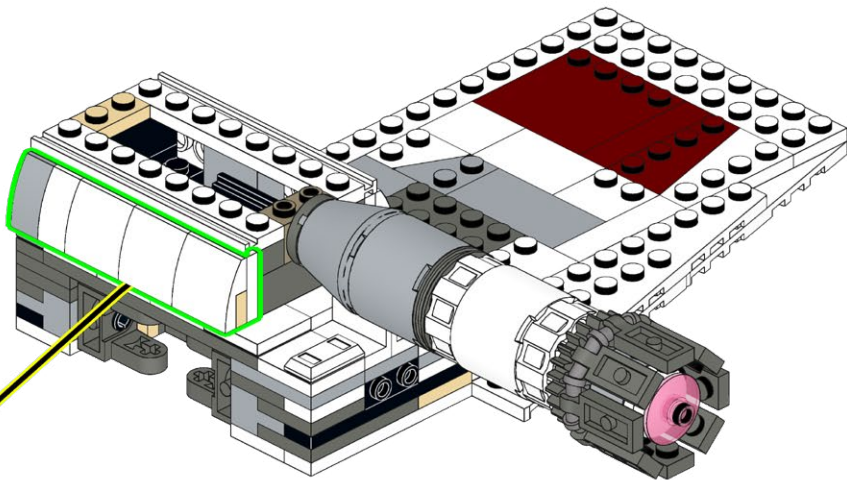
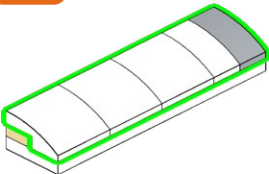

516

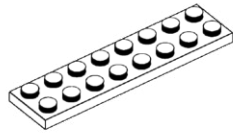

1x

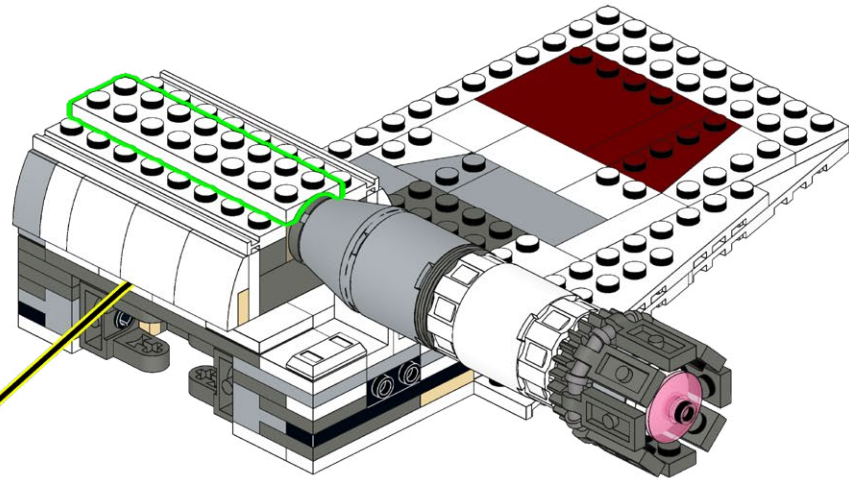

517

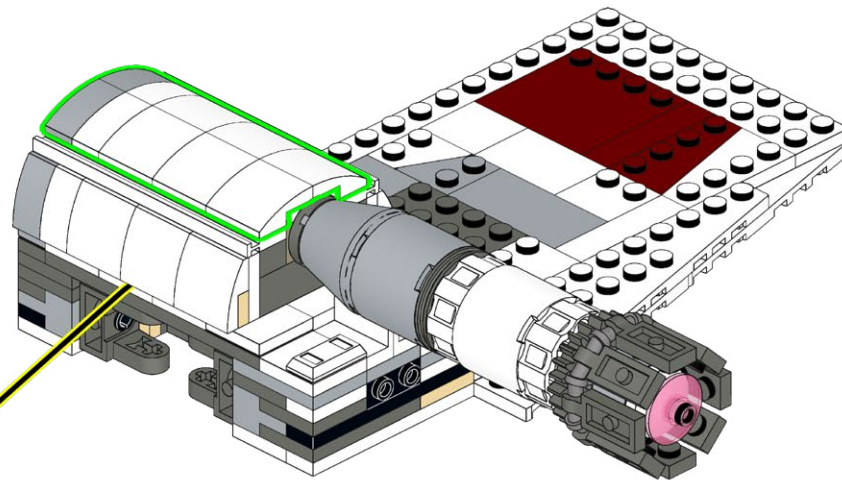
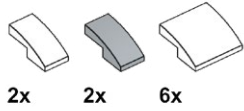

518

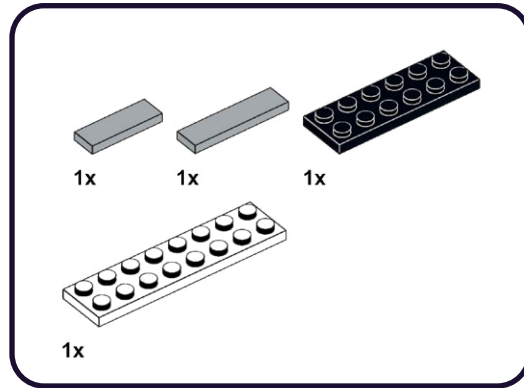

1

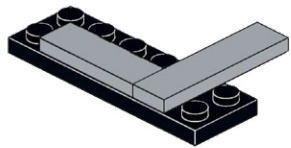

2

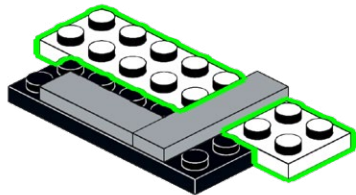

519

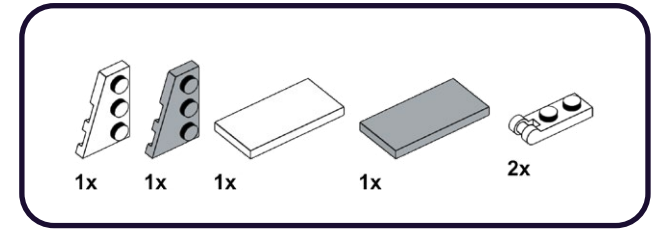

1

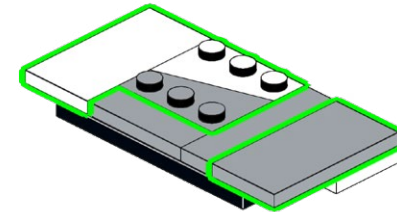

2

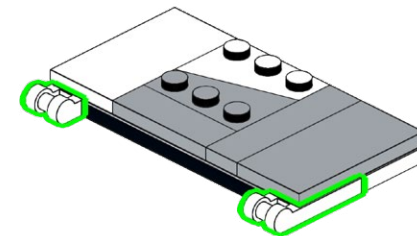



520

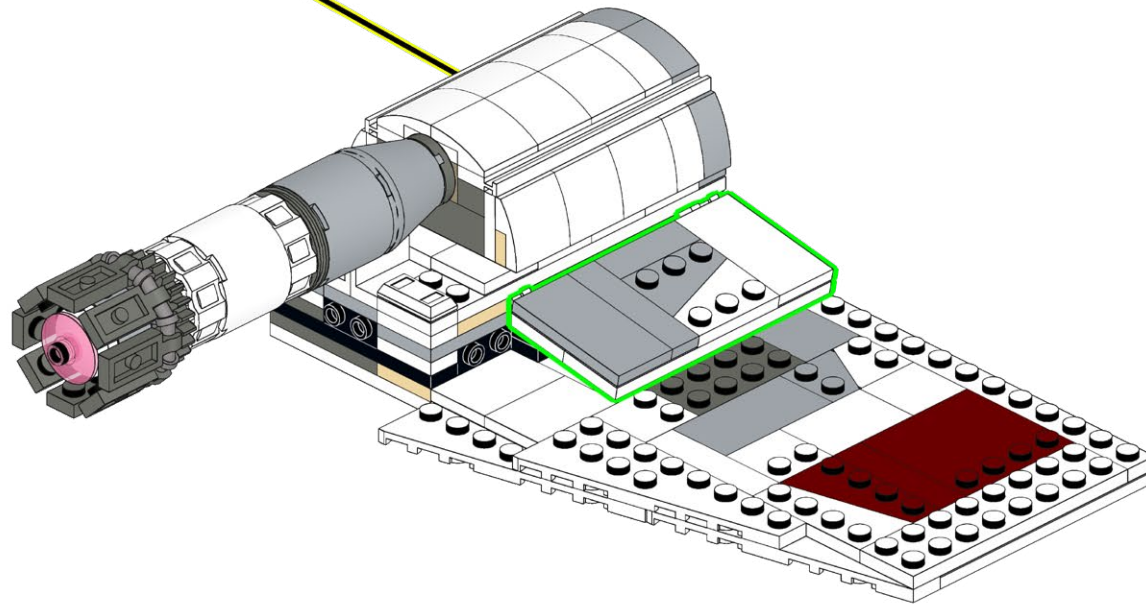

521

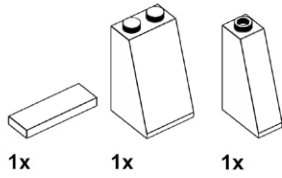

1

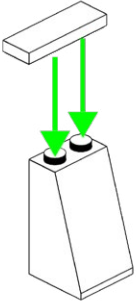

2

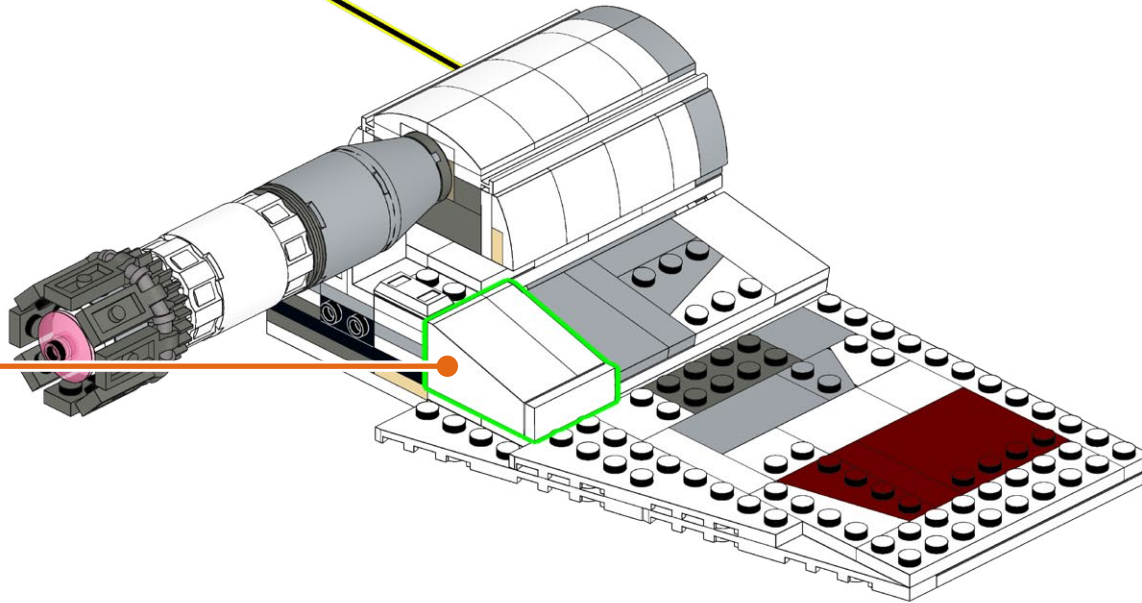
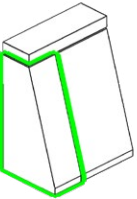

**522**

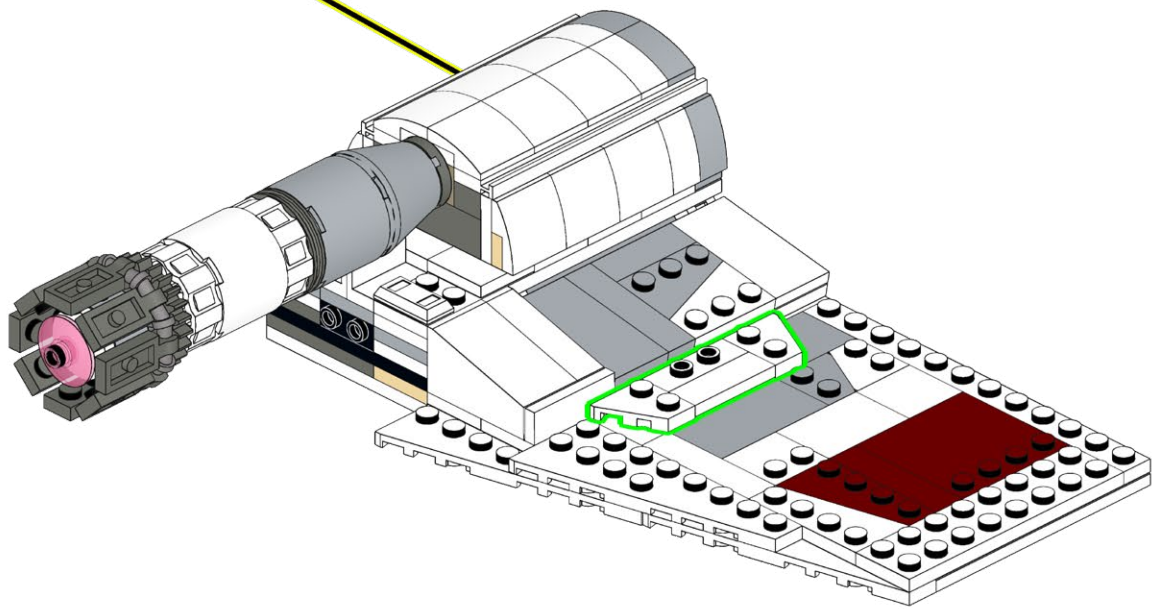
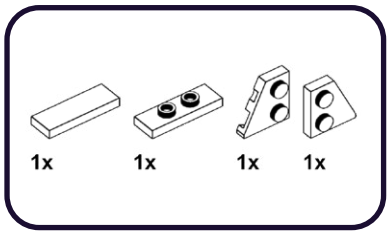

523

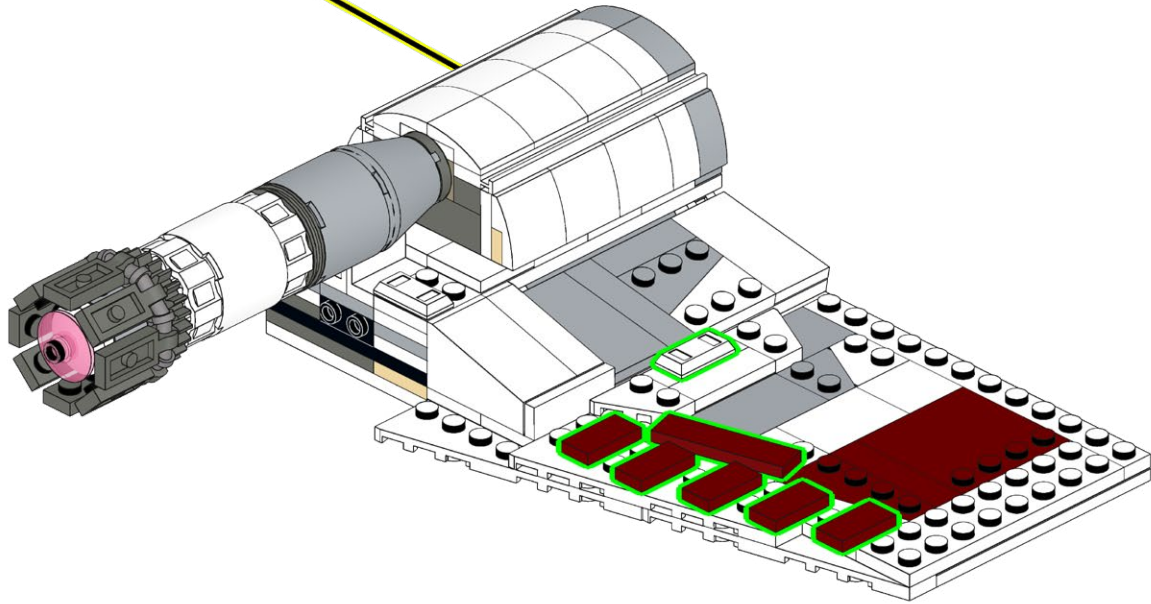
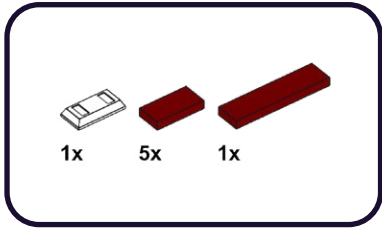

524

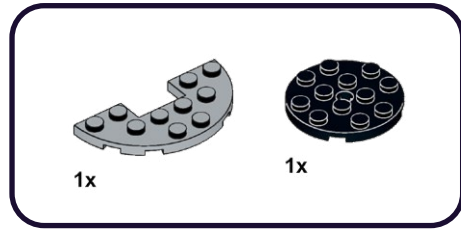

1

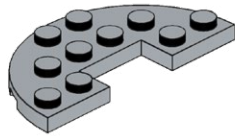

2

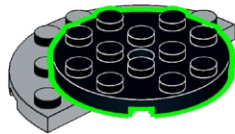

525

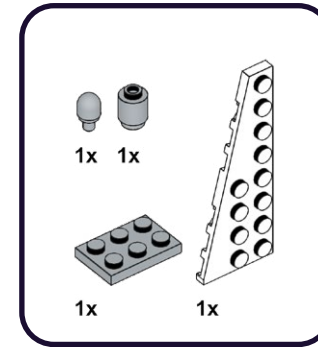

1

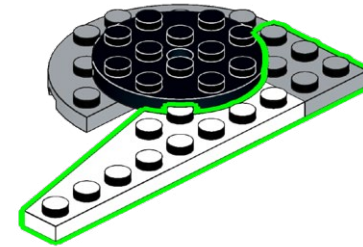

2

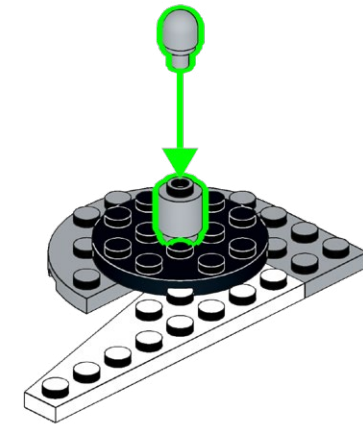

**526**

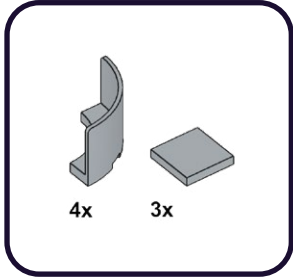

1

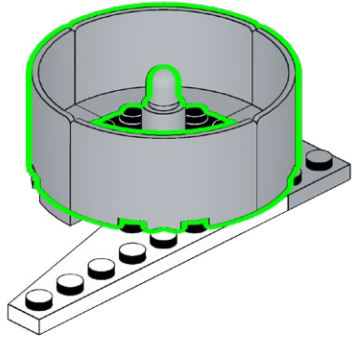

2

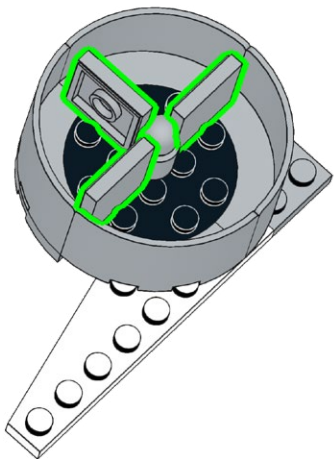

**527**

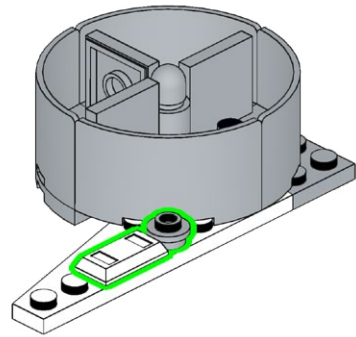
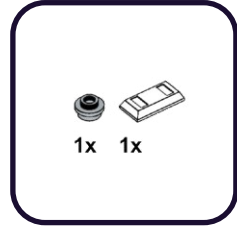

528

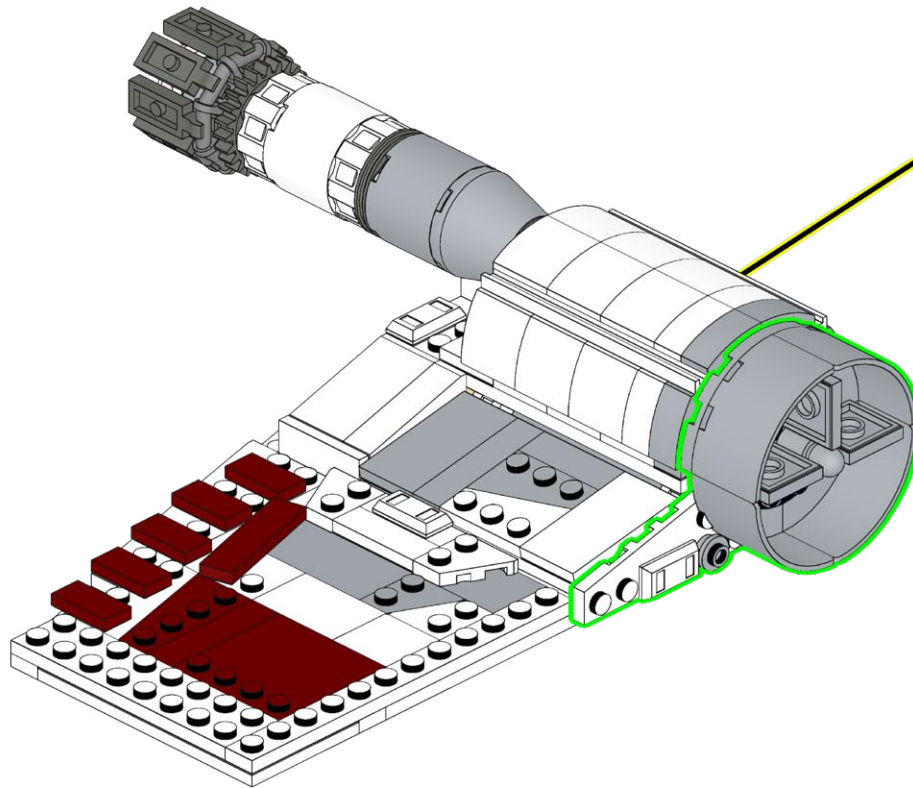

529

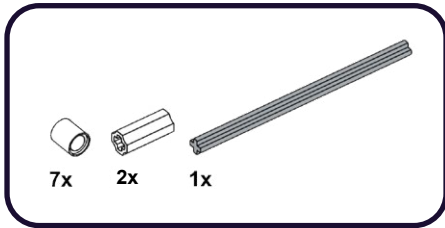

1

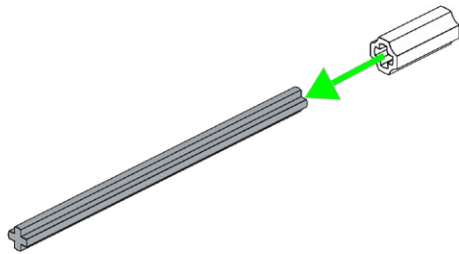

2

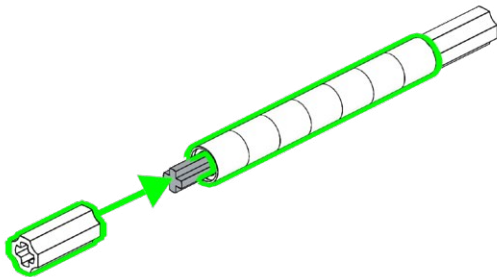

530

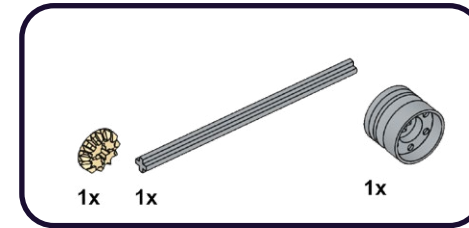

1

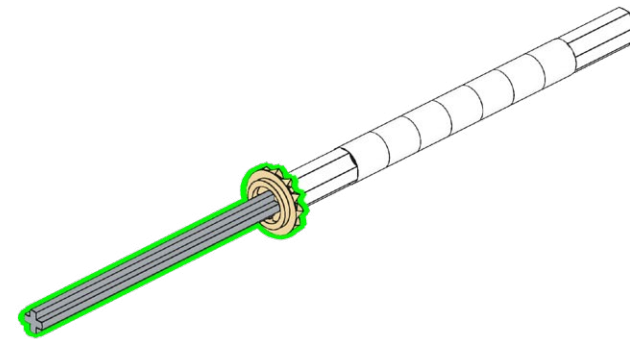

2

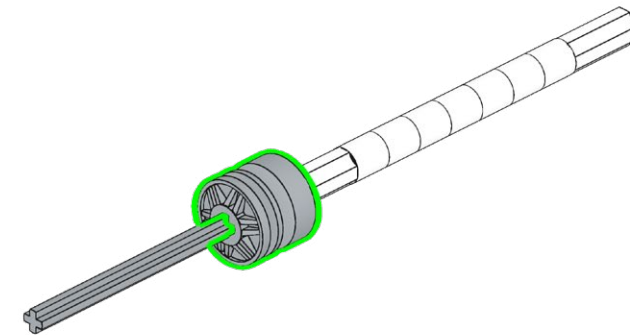



# 531

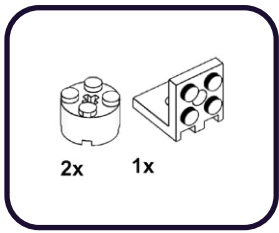

1

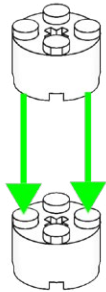

2

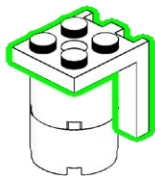

# 532

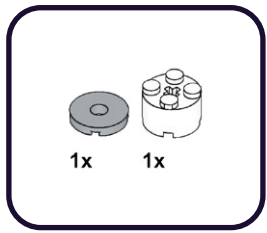

1

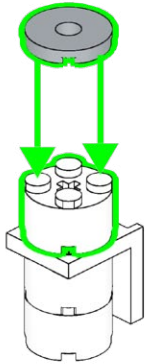

2

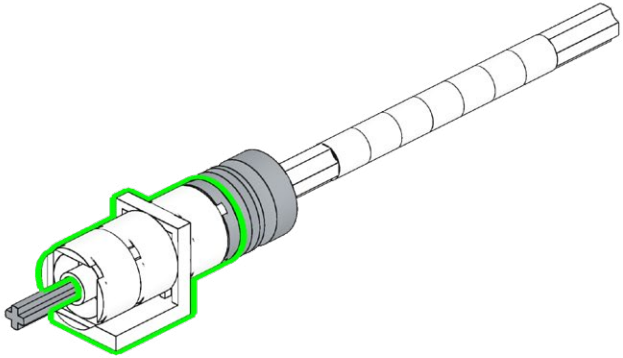

**533**

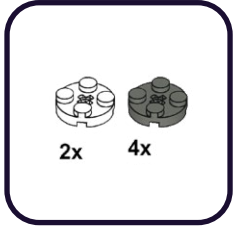

1

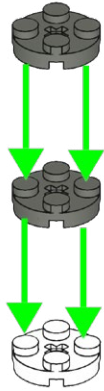

2

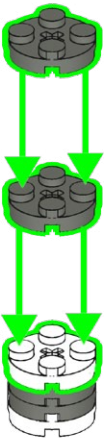

**534**

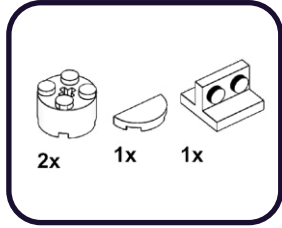

1

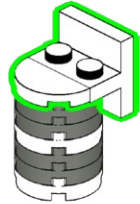

2

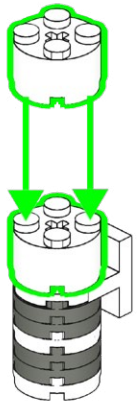

**535**

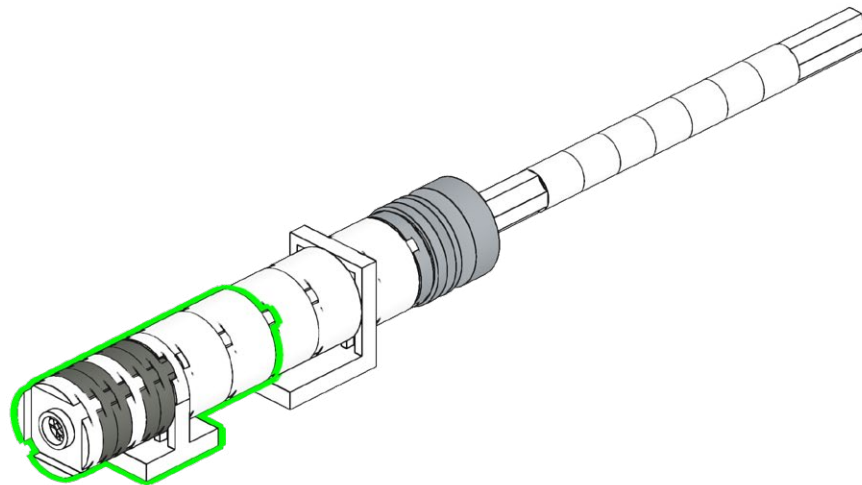

**536**

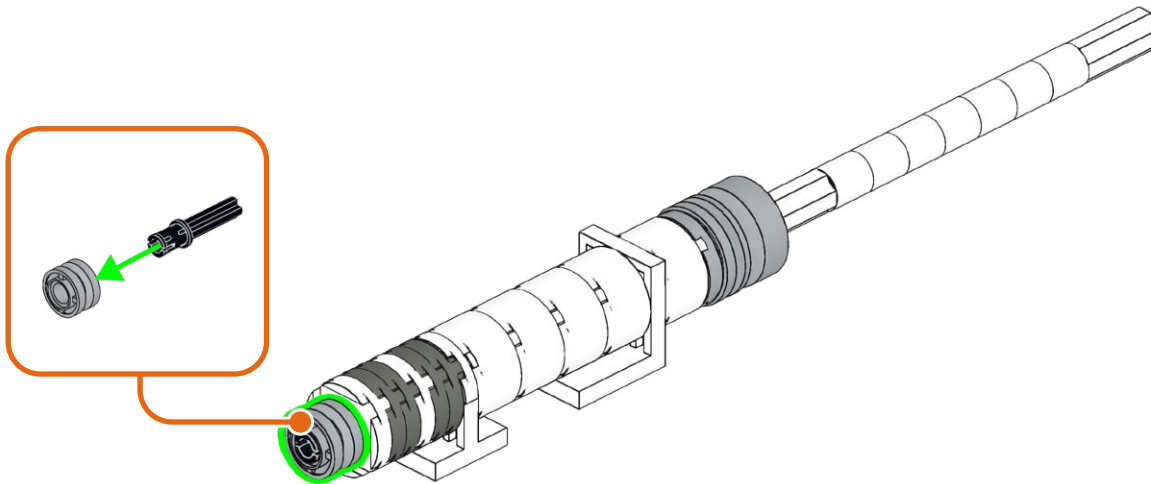
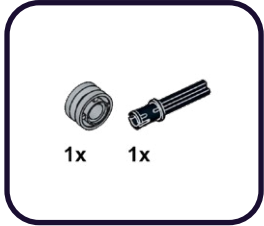

**537**

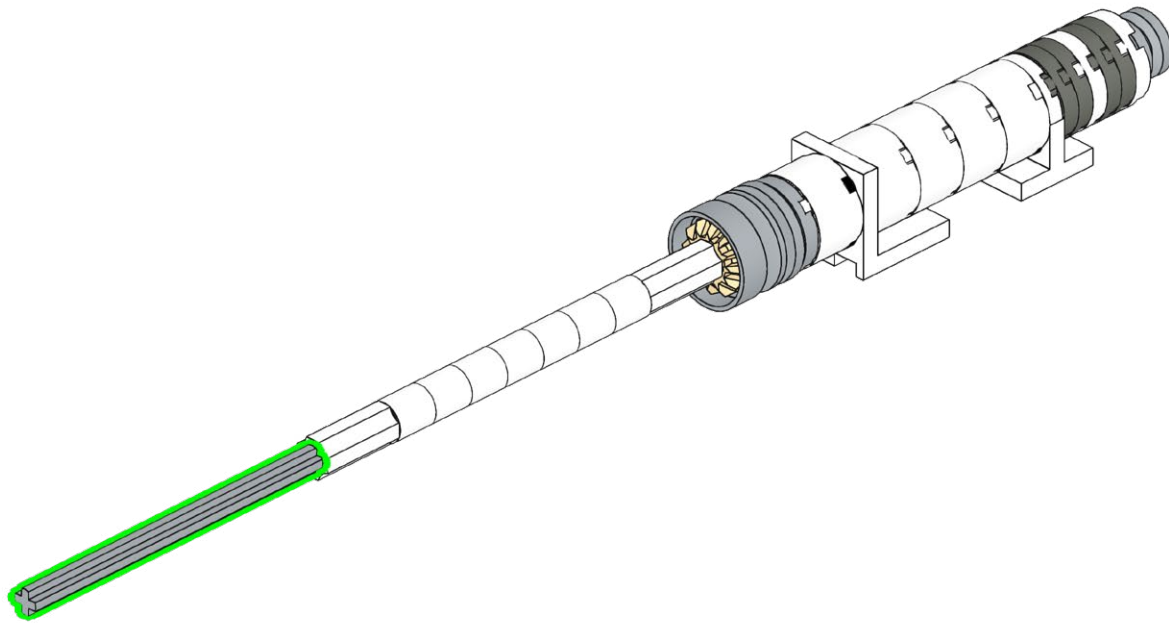
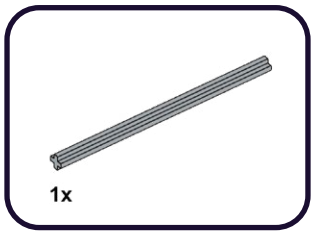

**538**

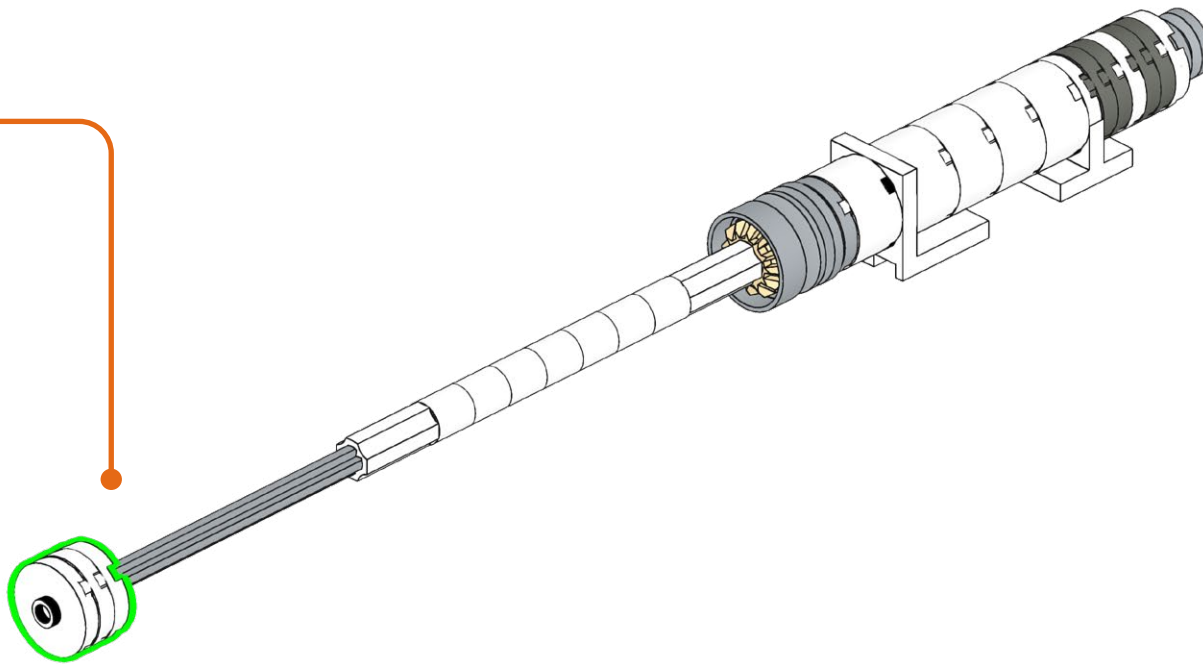
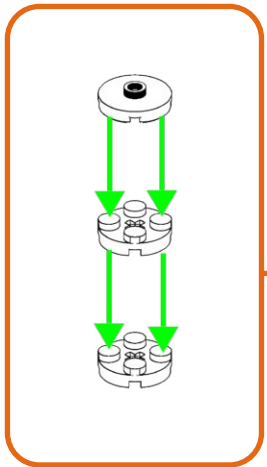
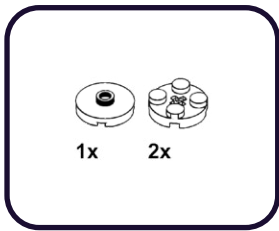

539

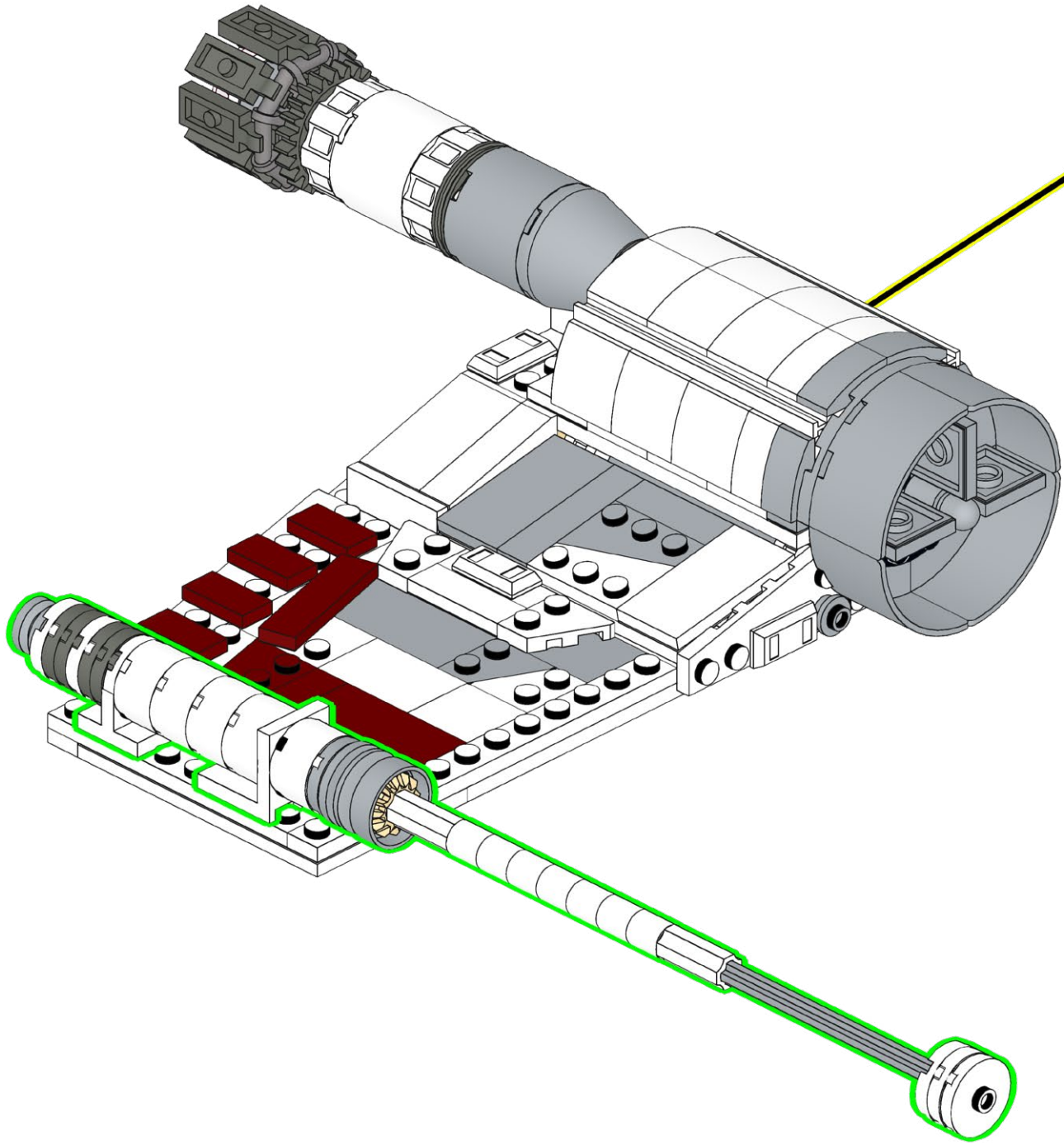

**540**

**4x**

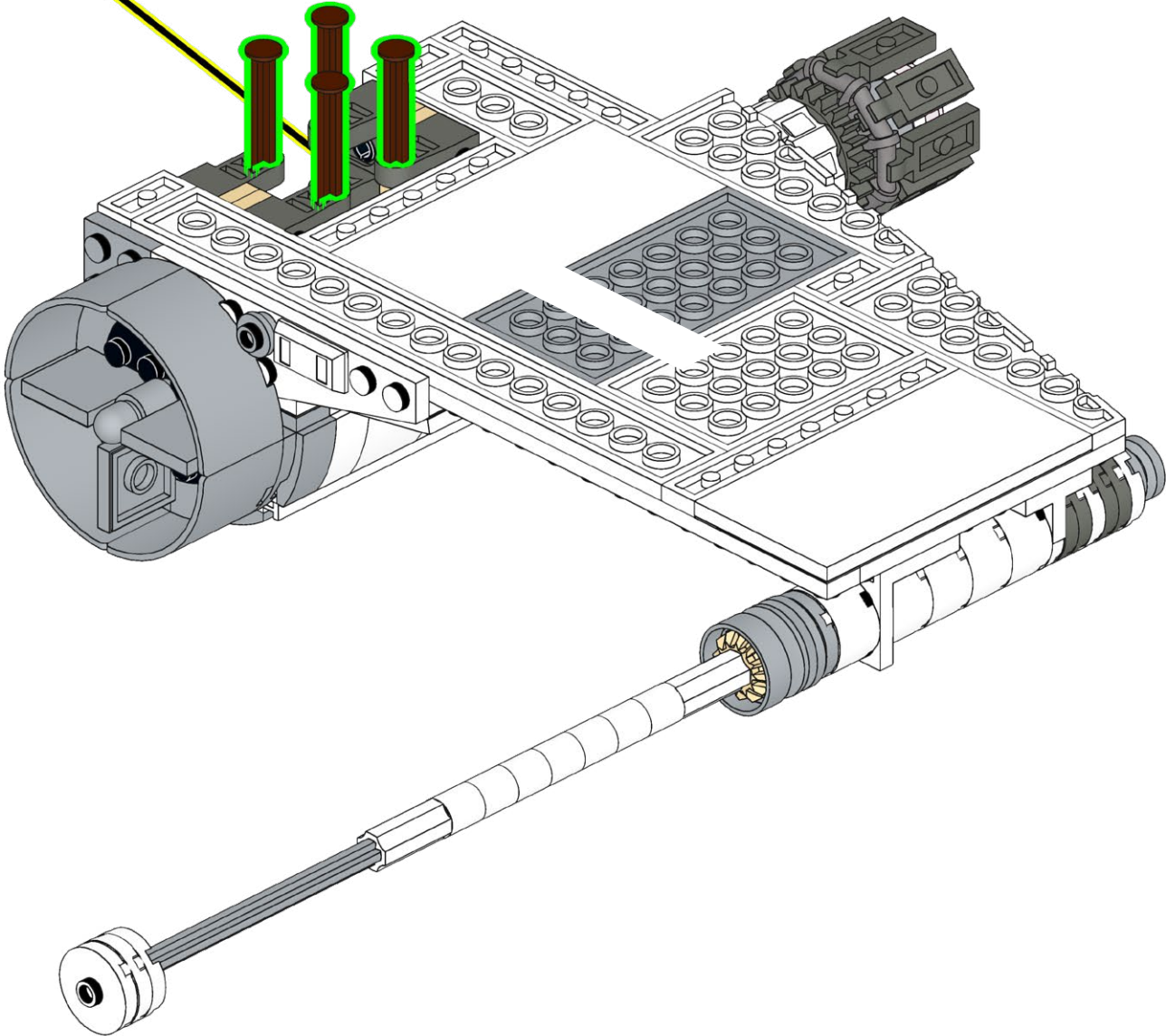



**HOLD UP!**

You might notice some bags aren't in order, as well as left over pieces, but that's ok! We're changing the way you build LEGO!

**ATTENDEZ!**

Vous remarquerez peut-être que certains sacs, ainsi que certaines pièces, ne sont pas dans le bon ordre. Mais pas de panique! Nous changeons simplement la façon avec laquelle vous construisez vos LEGO!

**ASPETTA!**

Potresti notare che alcuni sacchetti non sono in ordine, così come i pezzi avanzati, ma va bene così! Stiamo cambiando il modo in cui costruisci i LEGO!

**HALT!**

Sie werden möglicherweise bemerken, dass einige tüten durcheinander sind und teile übrig bleiben, aber das ist in Ordnung! Wir ändern die art und weise, wie Sie LEGO bauen!

**¡ESPERA!**

Es posible que notes que algunas bolsas están fuera de servicio, así como piezas sobrantes, ¡pero está bien! ¡Estamos cambiando la forma en que construyes LEGO!

**暫停!**

你可能会注意到一些袋子顺序错乱, 以及一些剩余的部件, 但没关系! 我们正在改变你搭建乐高的方式!

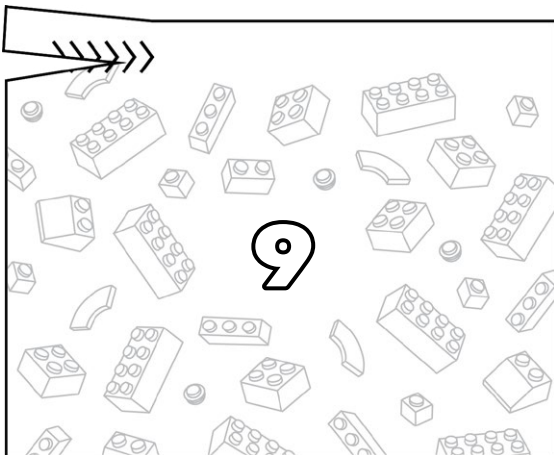
**Open LEGO® Bag 9**

541

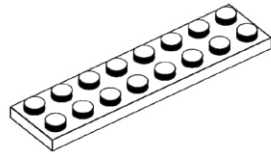

1x

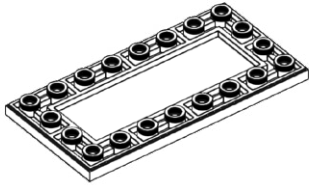

1x

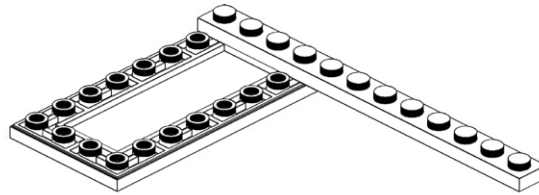

542

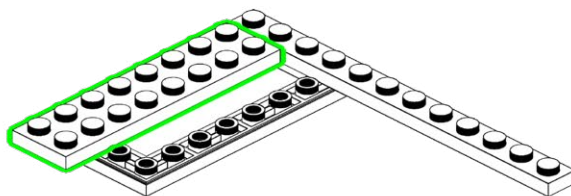
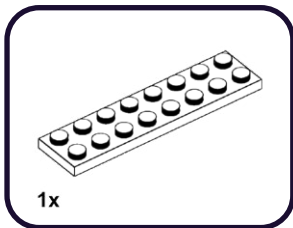

543

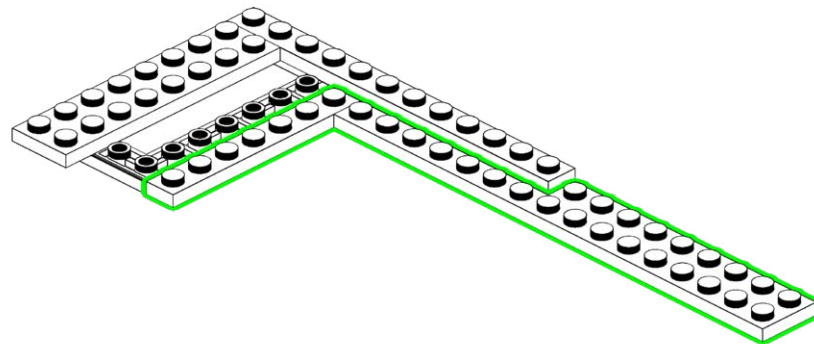
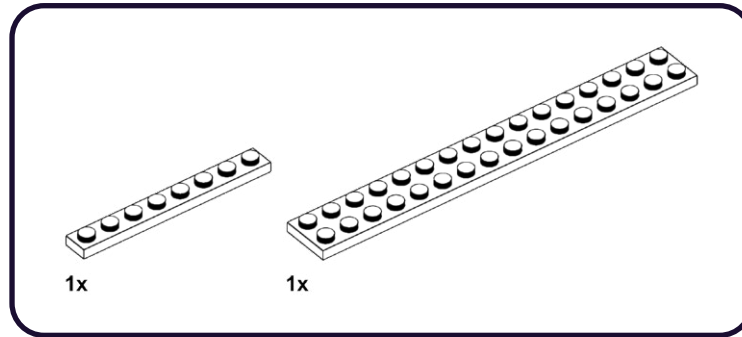

544

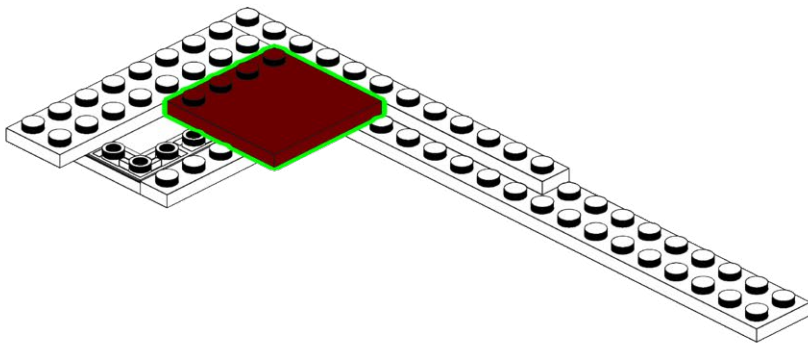
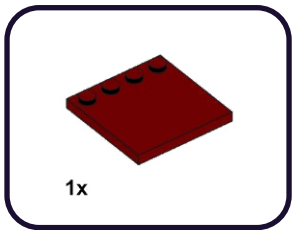

545

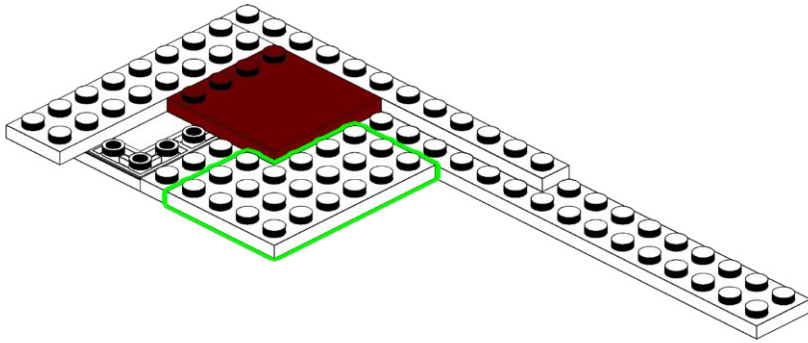
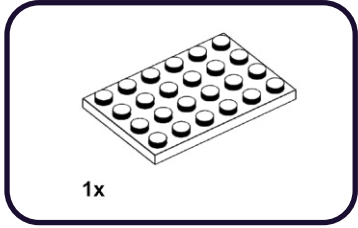

**546**

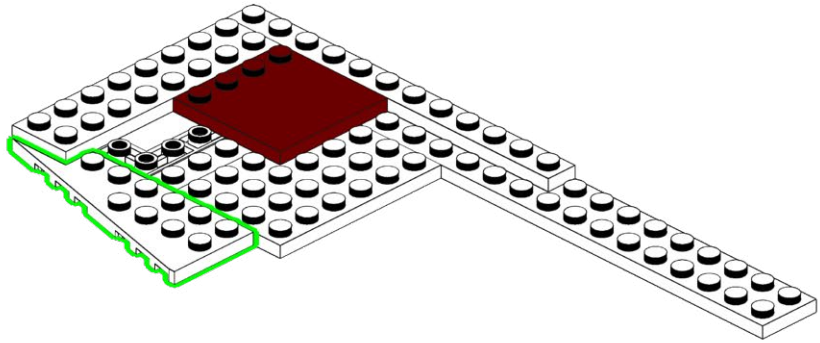
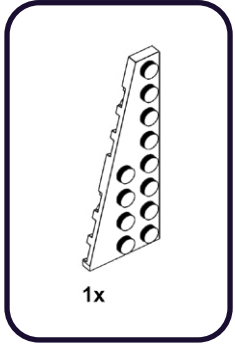

547

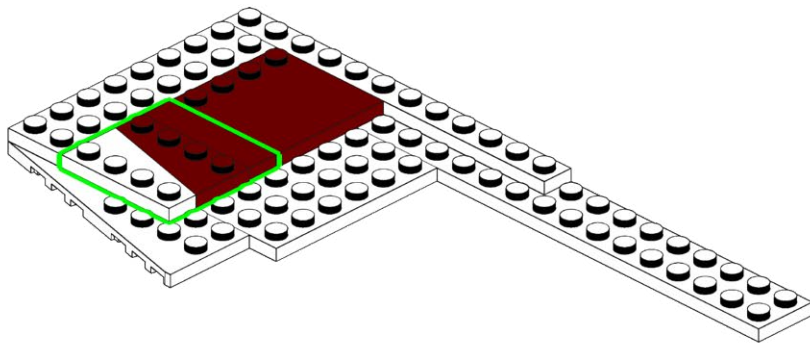
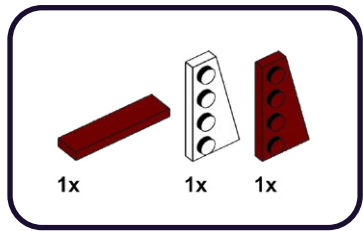



548

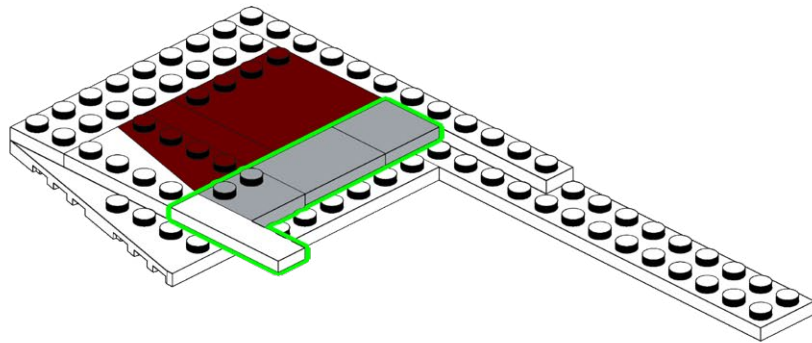
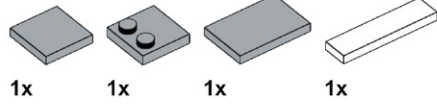

549

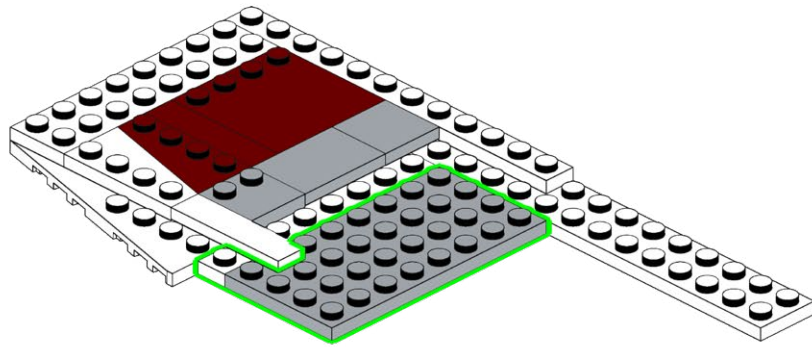
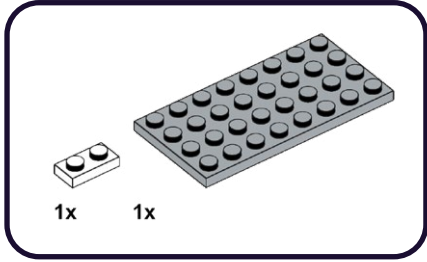

**550**

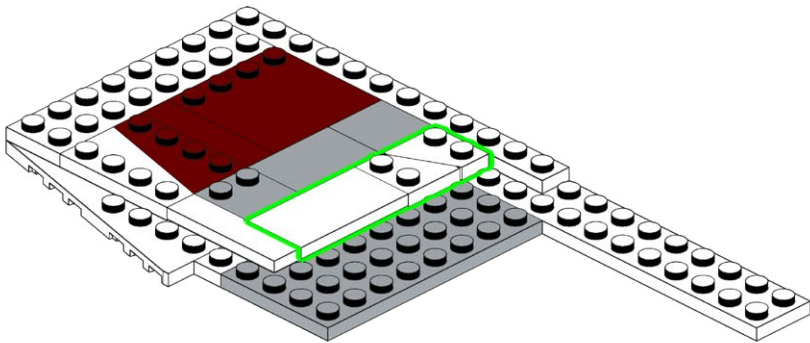
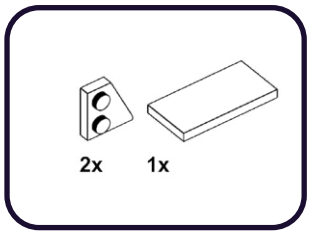

551

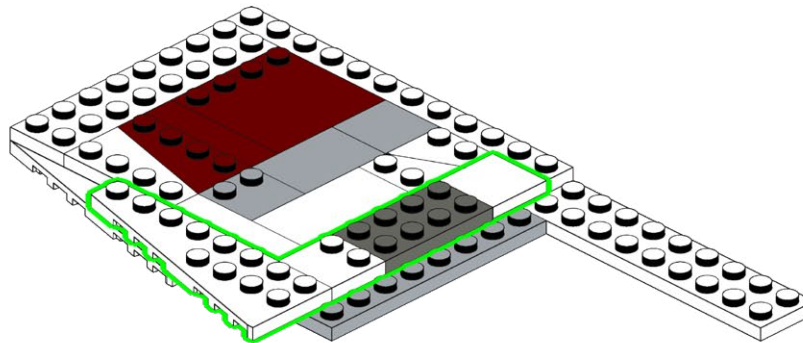
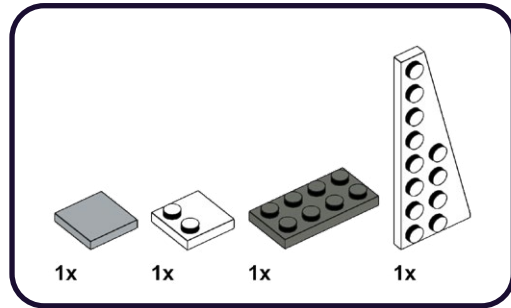

552

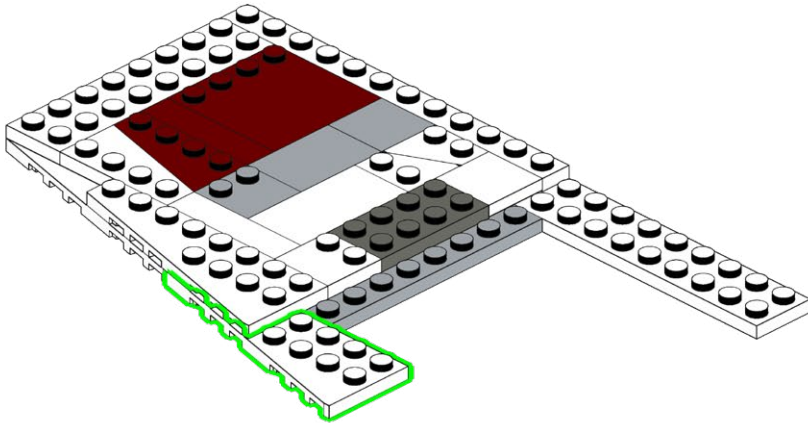
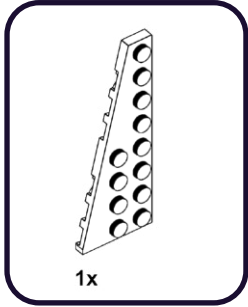

553

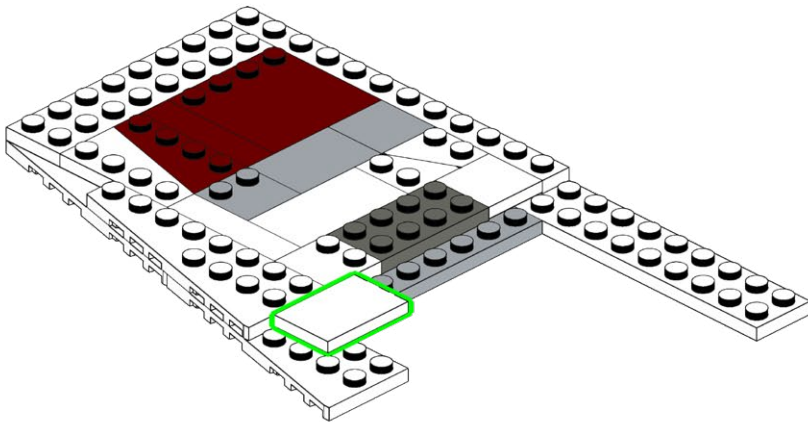
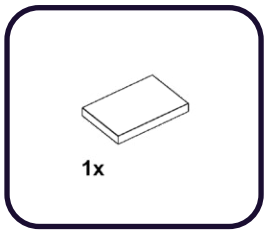

554

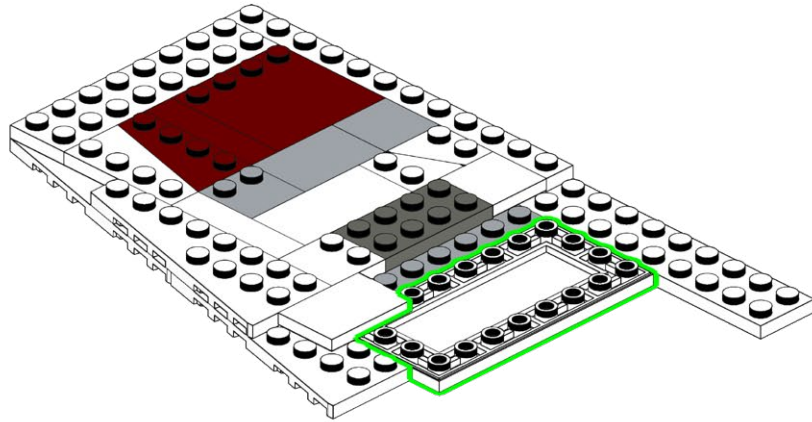
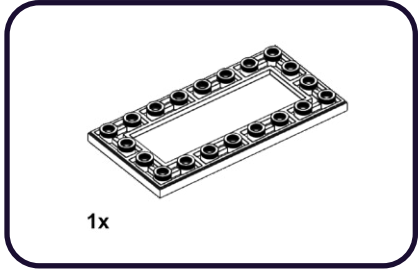

**555**

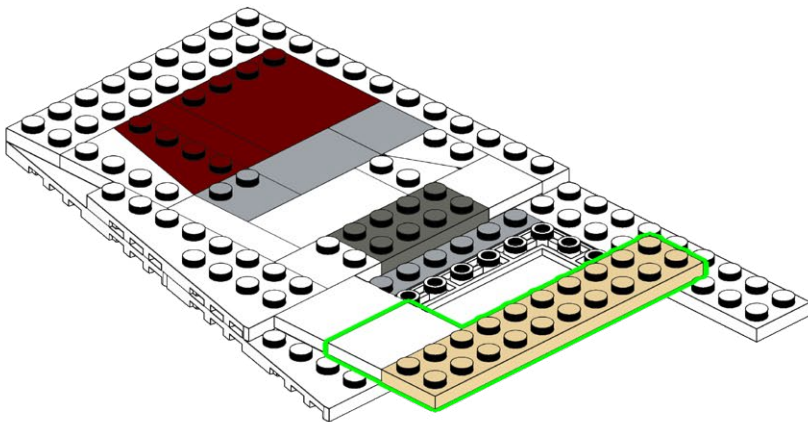
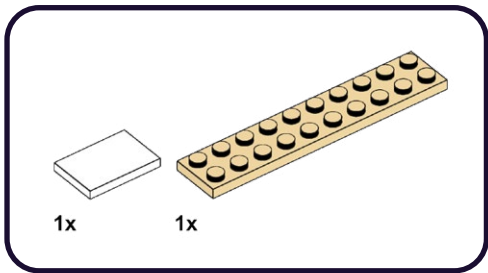



556

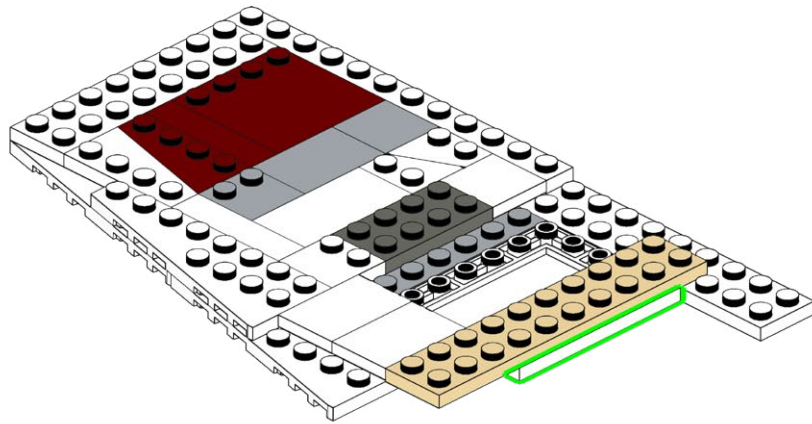
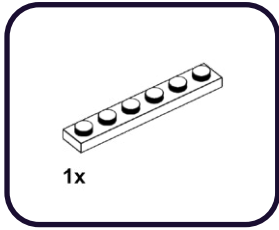

557

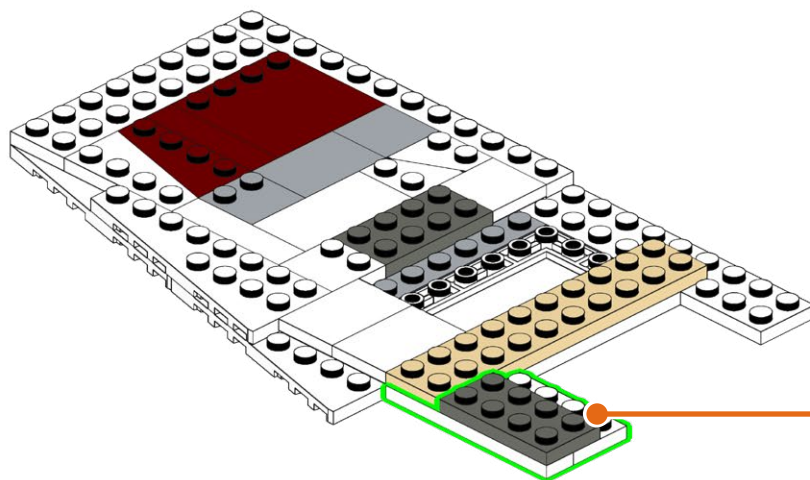
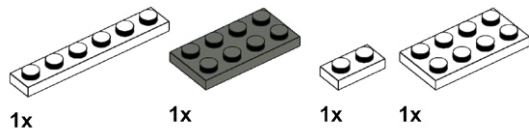

1

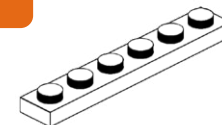

2

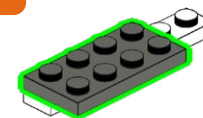

3

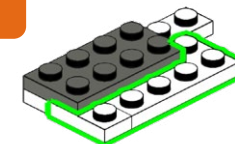

558

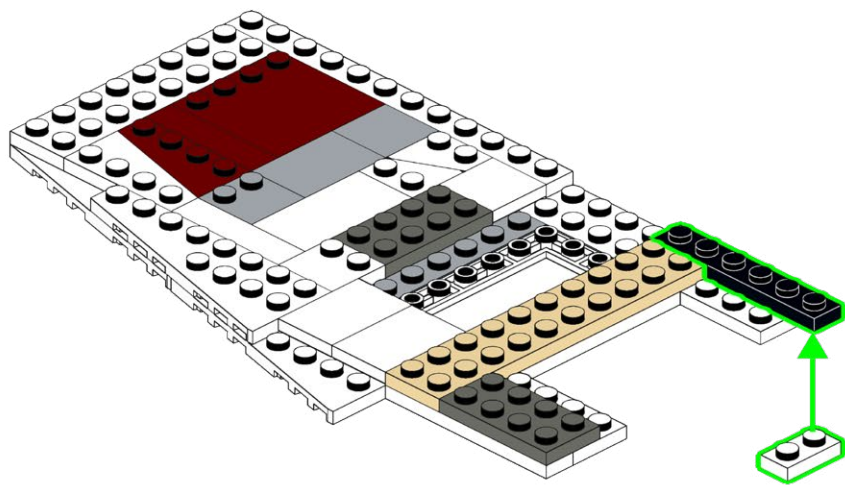
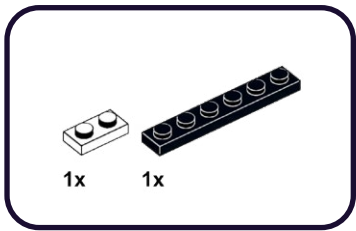

# 559

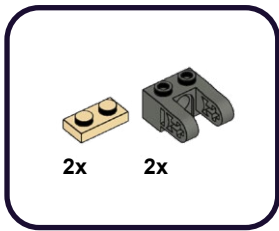

1

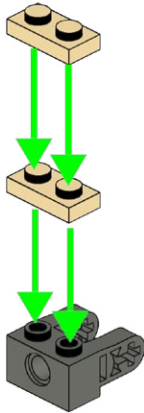

2

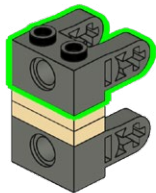

# 560

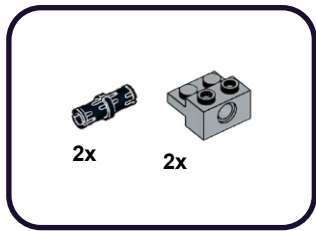

1

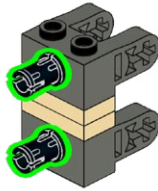

2

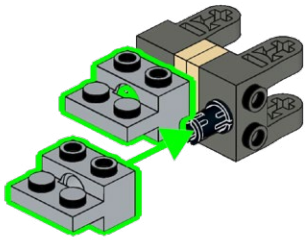

561

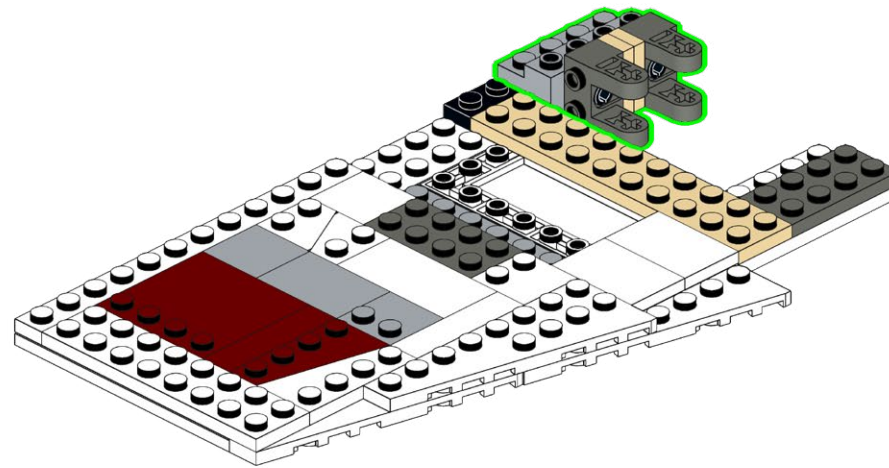

# 562

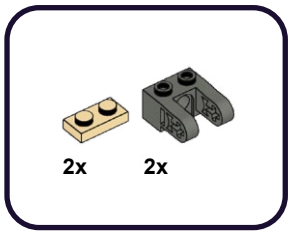

1

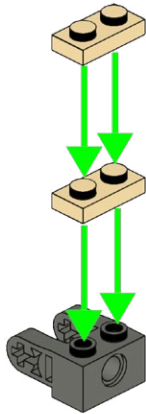

2

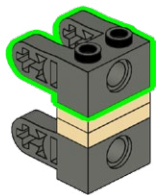

# 563

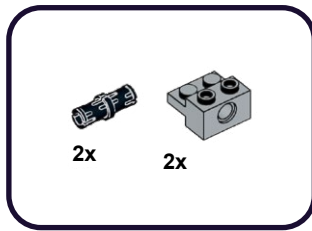

1

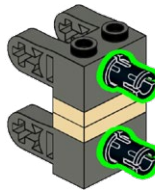

2

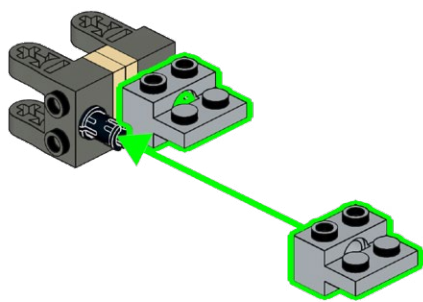

564

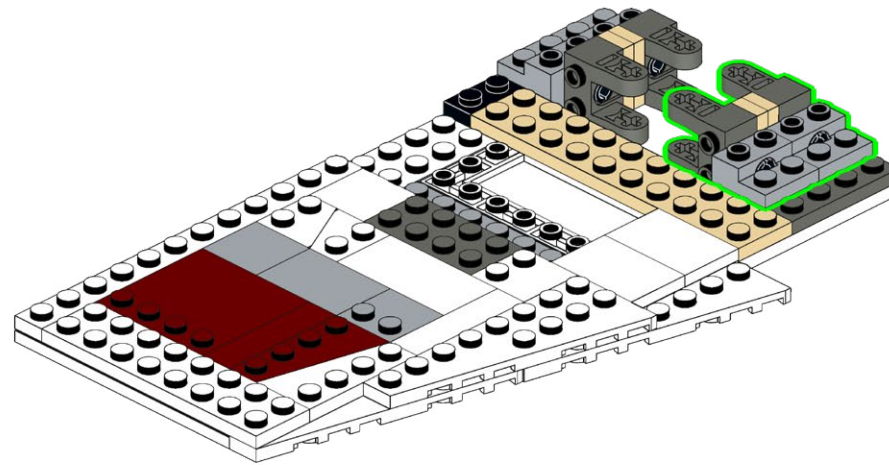

**565**

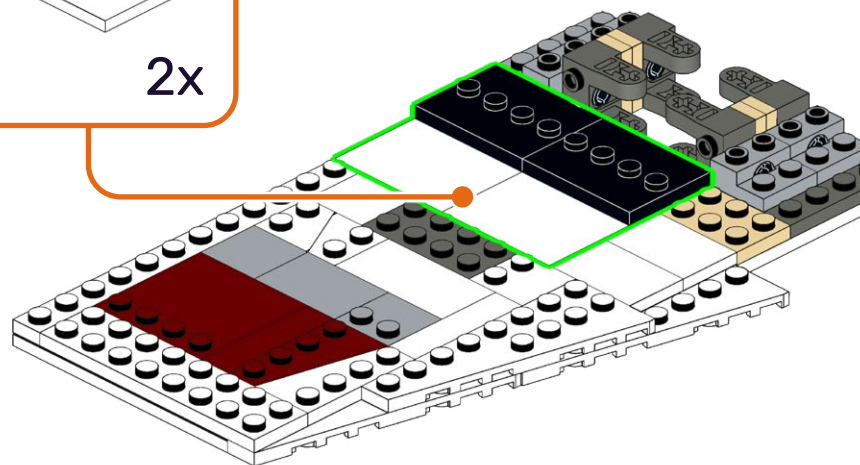
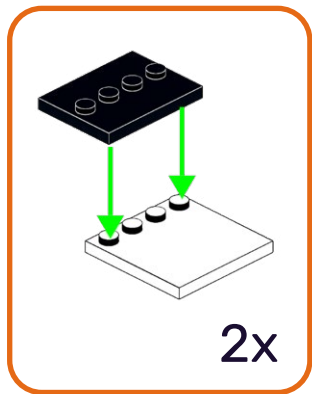
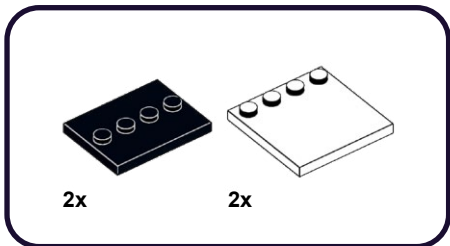



566

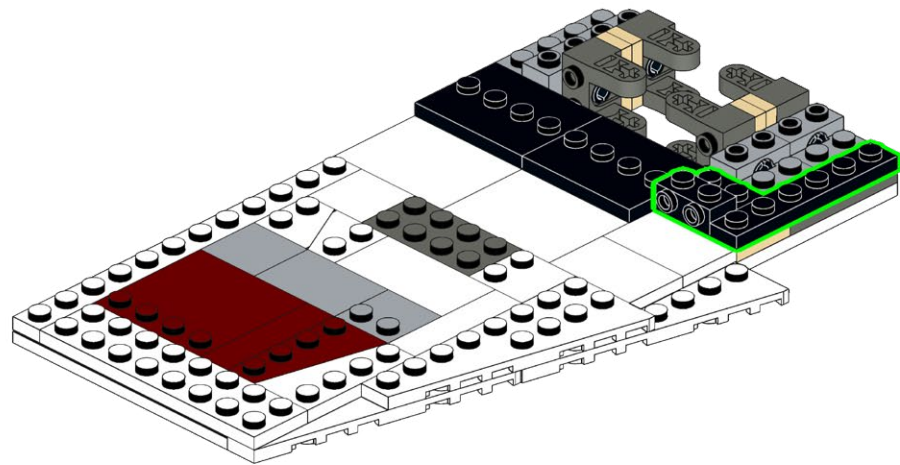
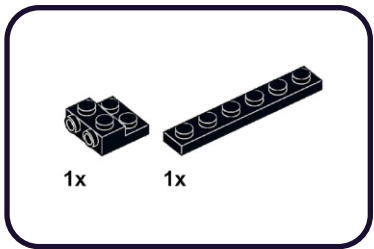

567

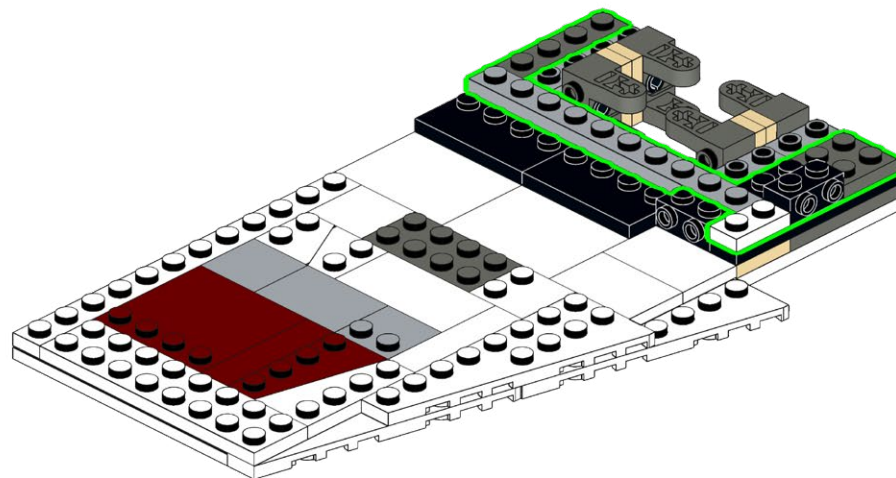
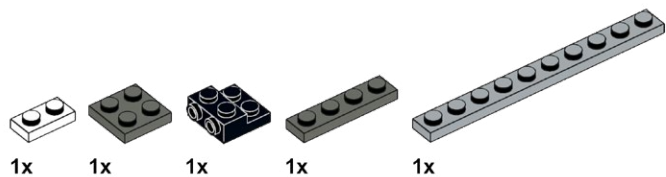

568

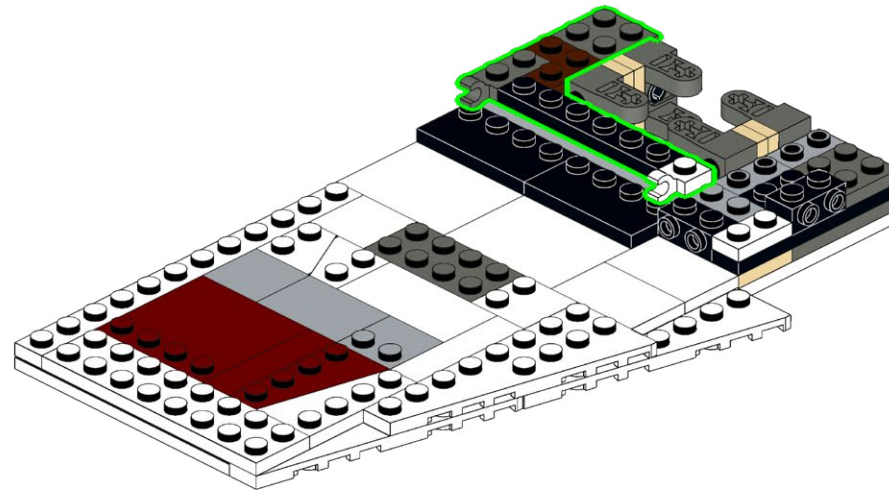
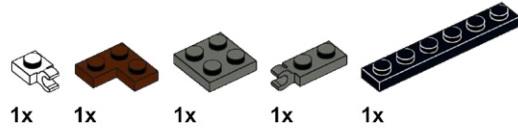

569

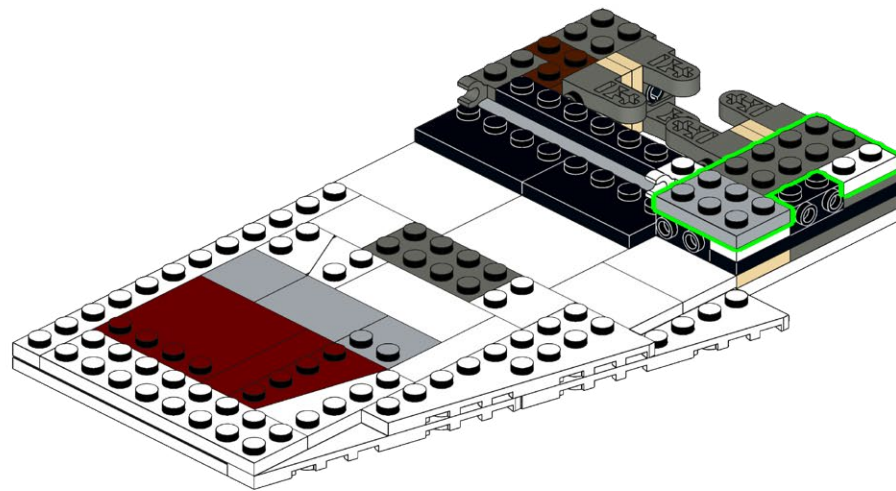
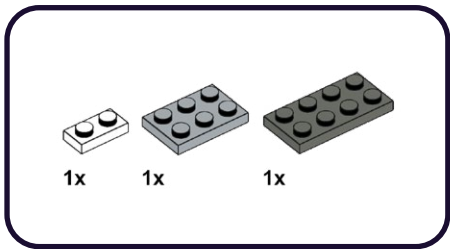

**570**

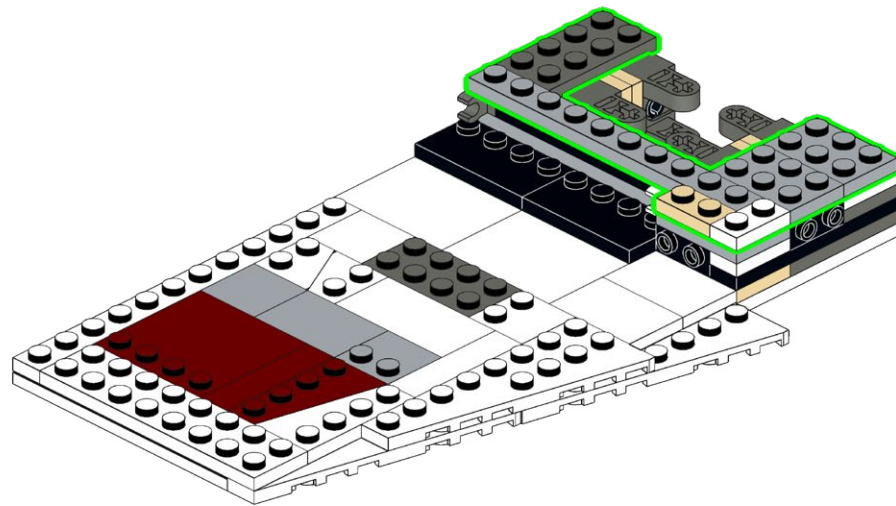
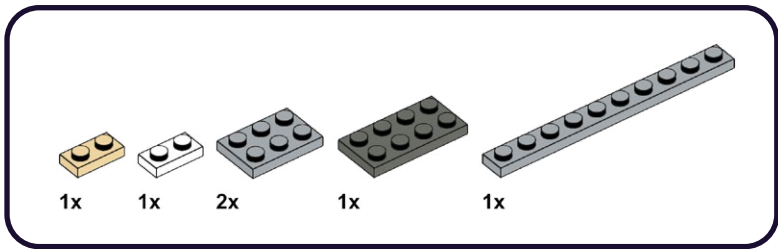

571

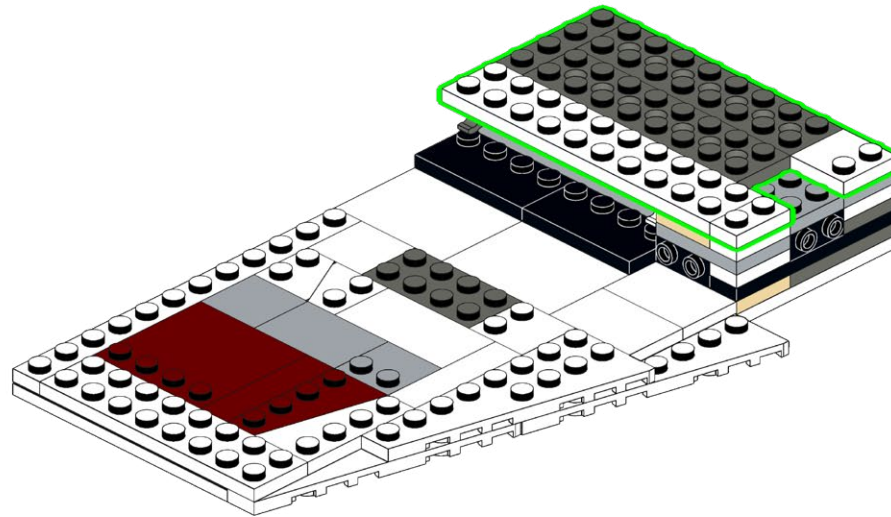
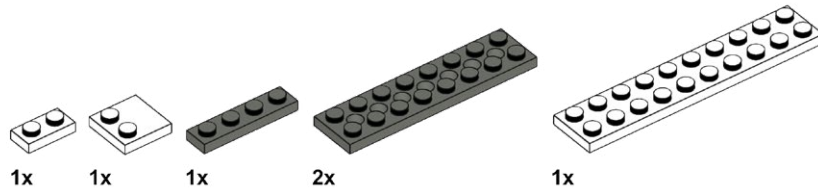

**572**

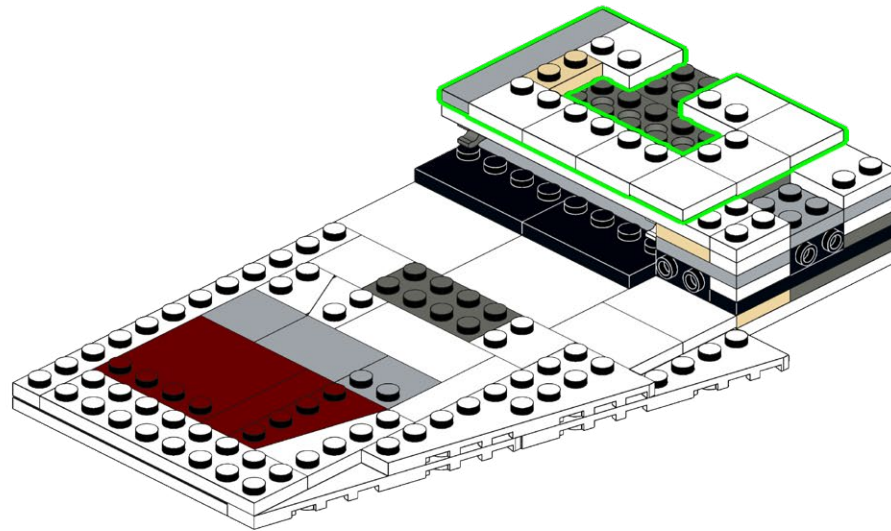
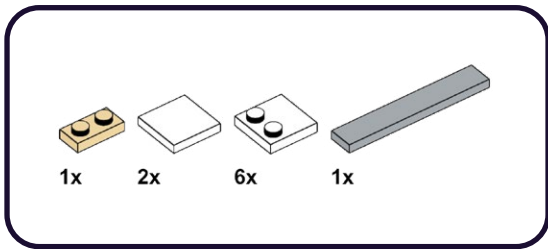

**573**

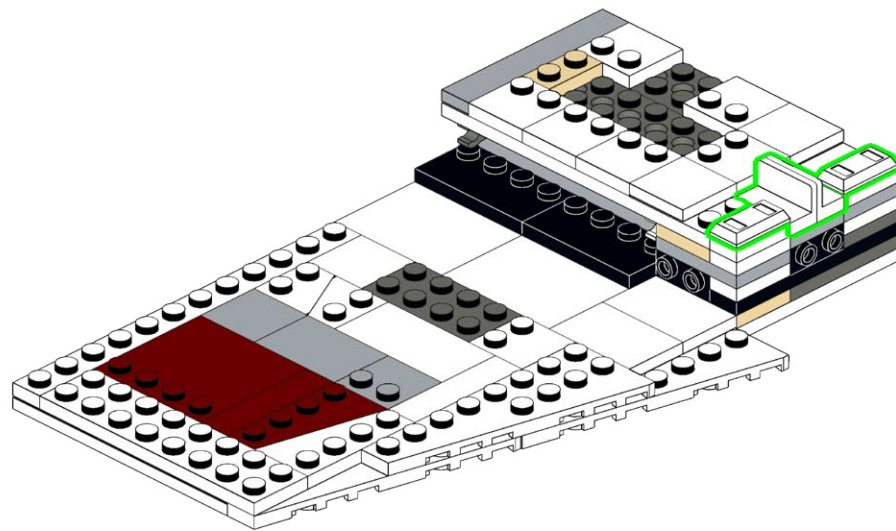
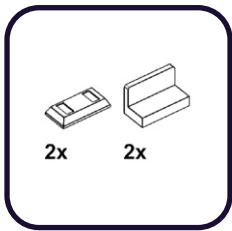



574

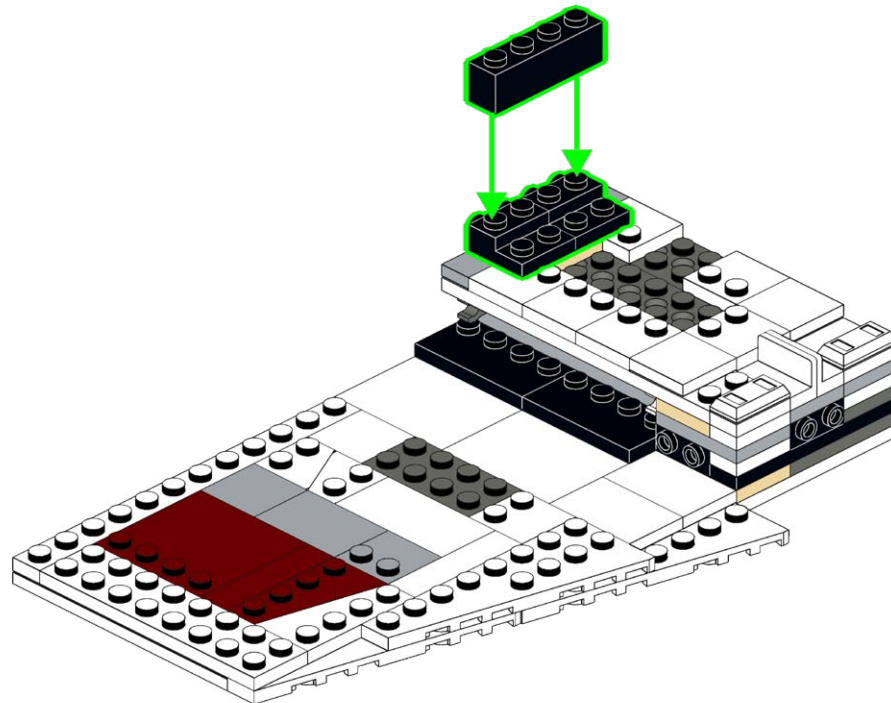
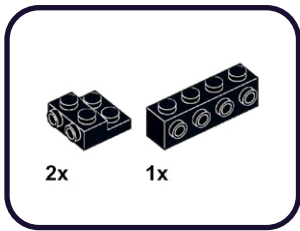

**575**

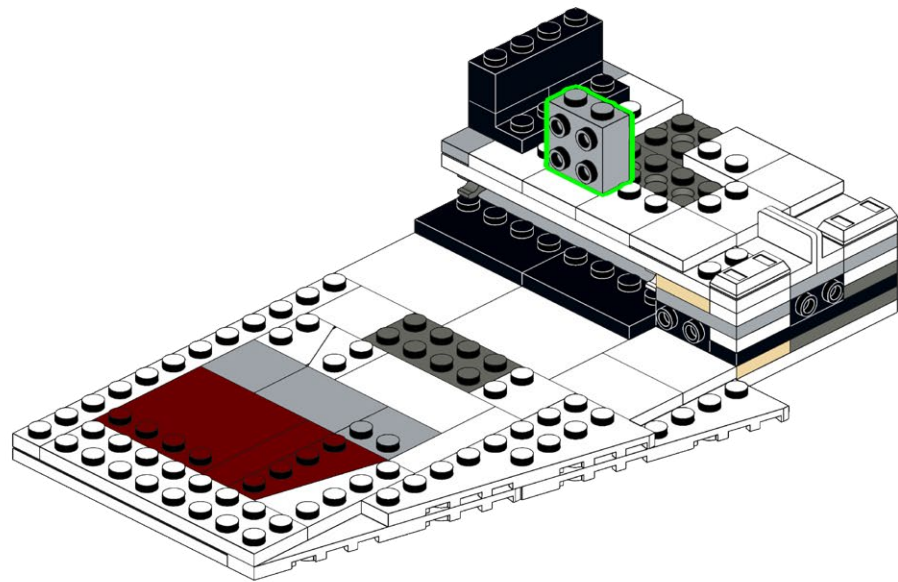
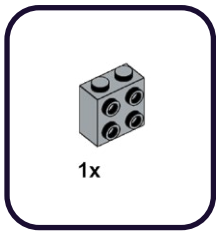

576

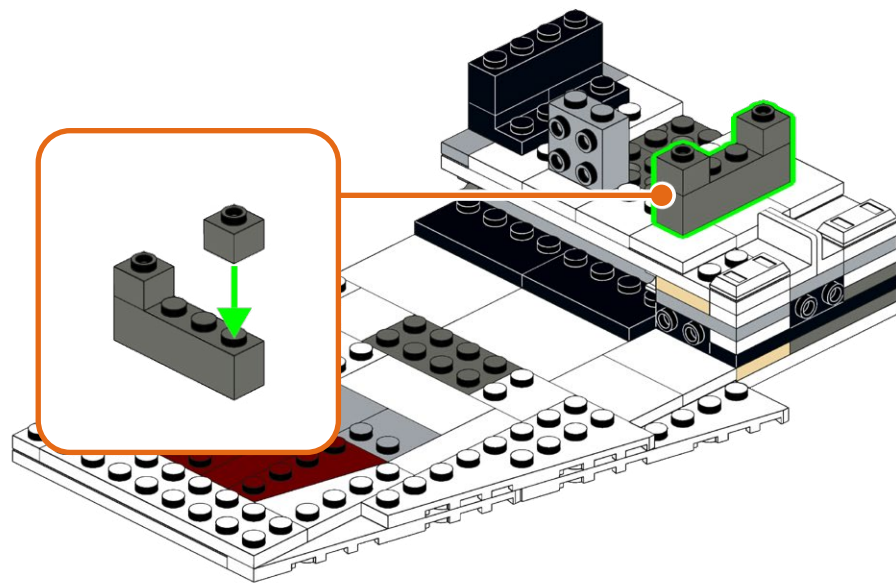
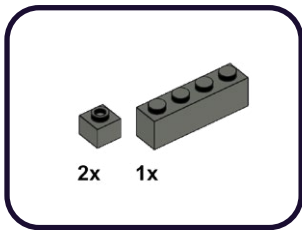

577

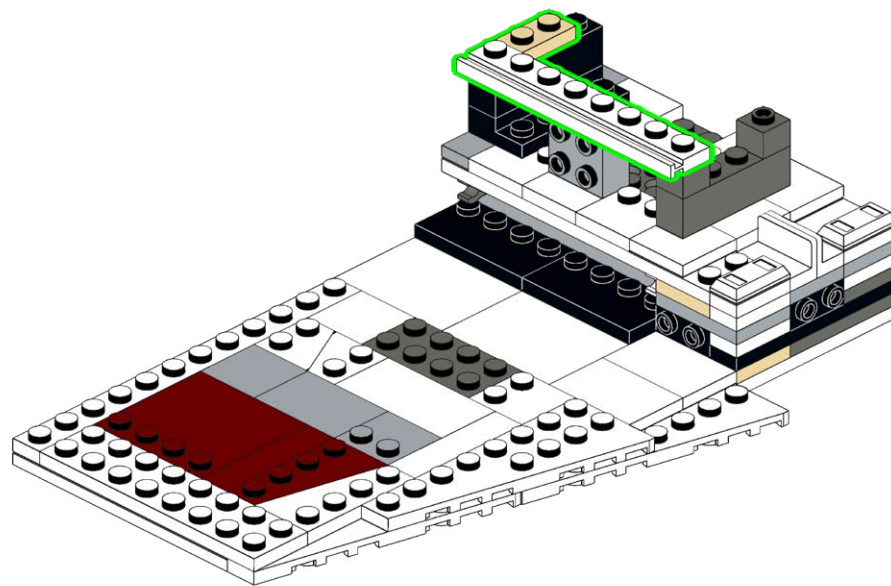
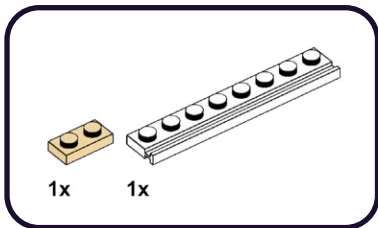

**578**

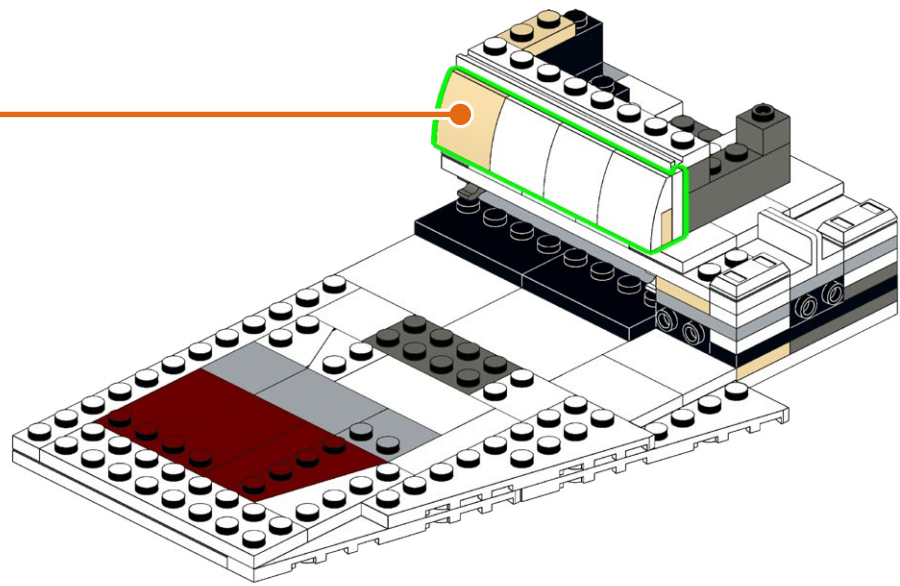
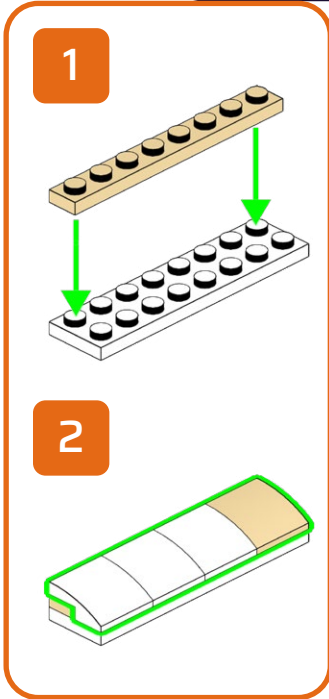
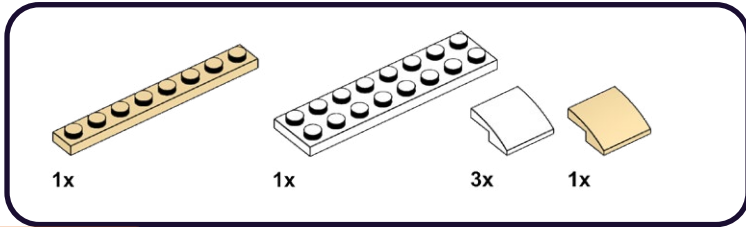

**579**

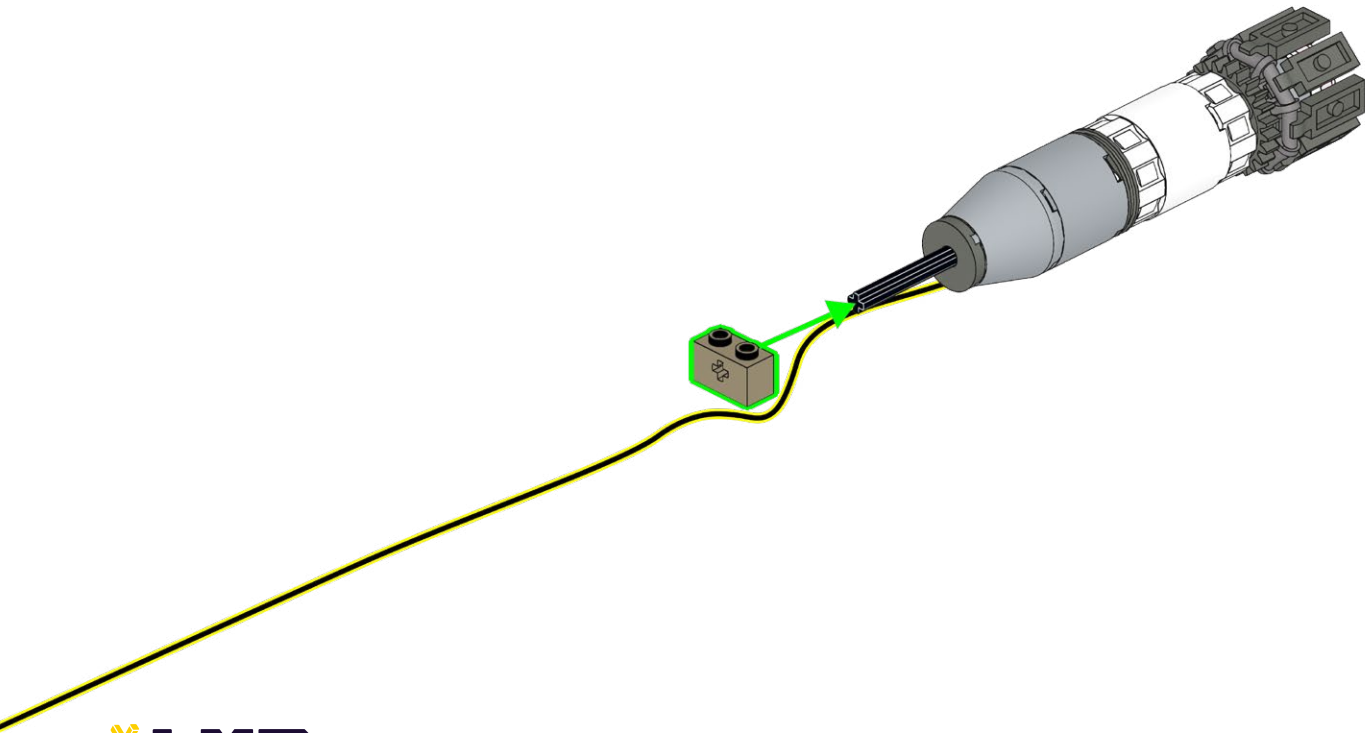
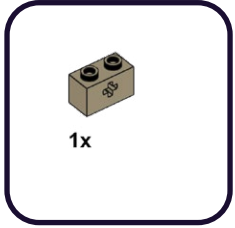

580

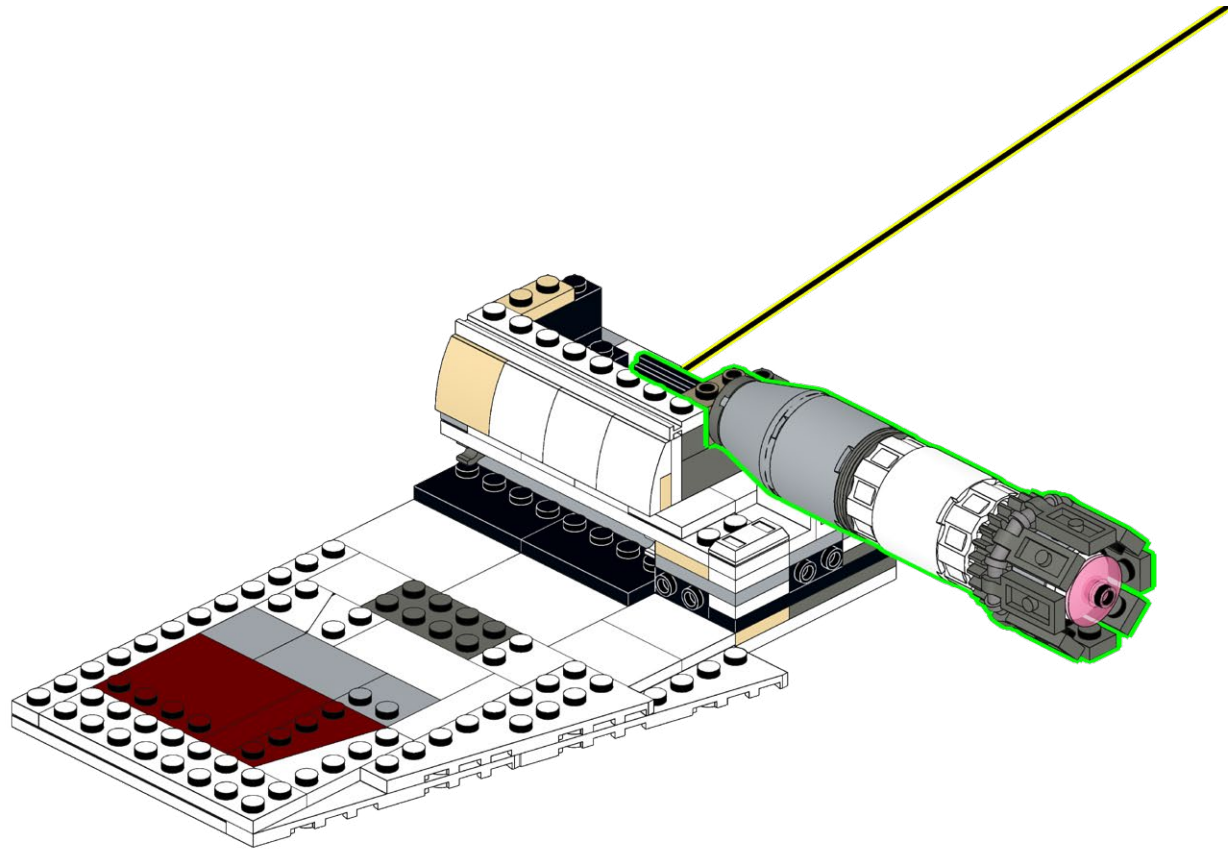

581

1x

1x

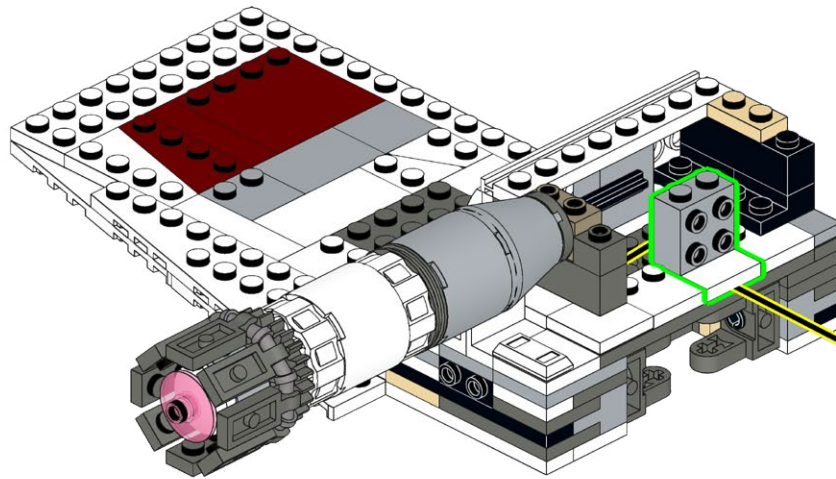



582

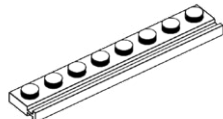

1x

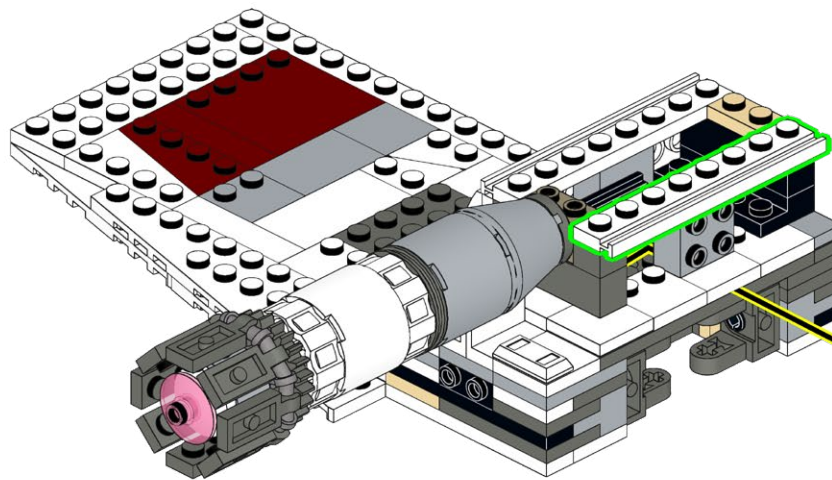

583

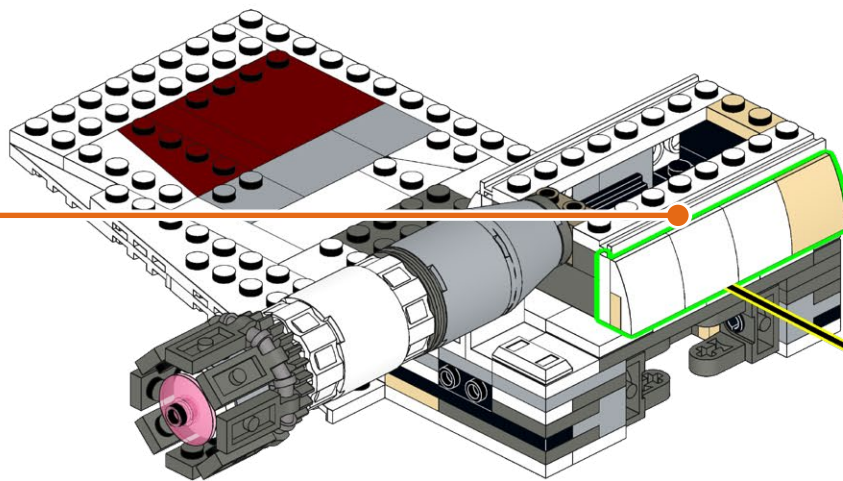
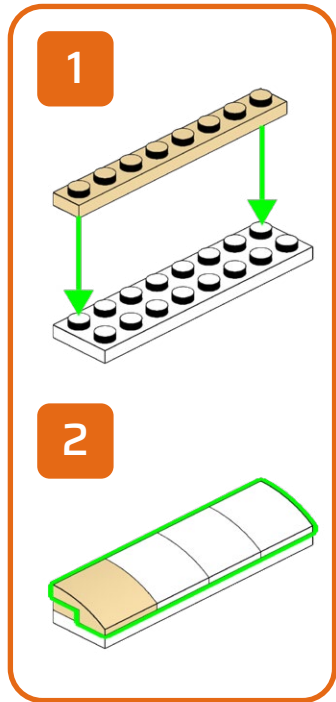
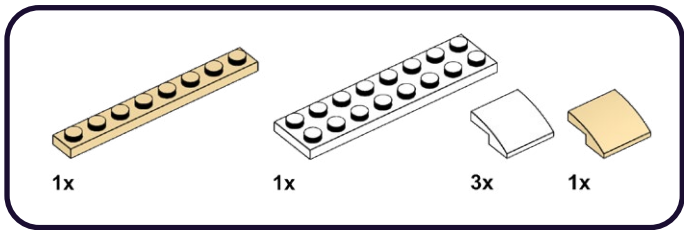

584

1x

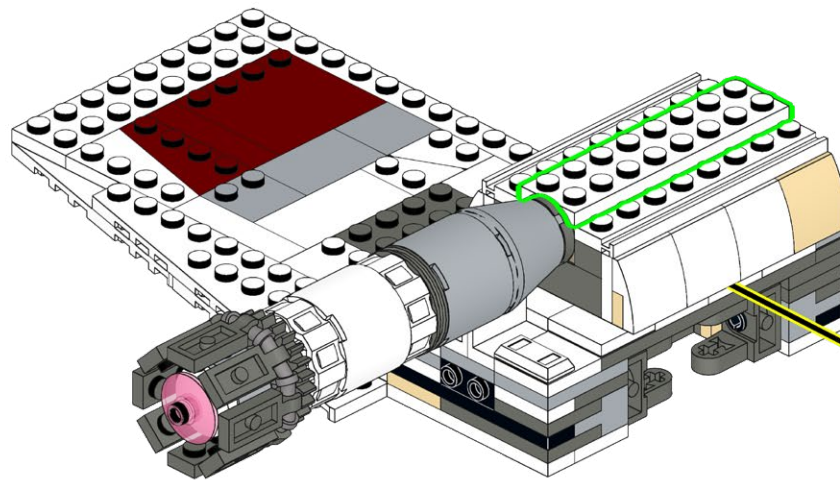

585

1x

1x

5x

2x

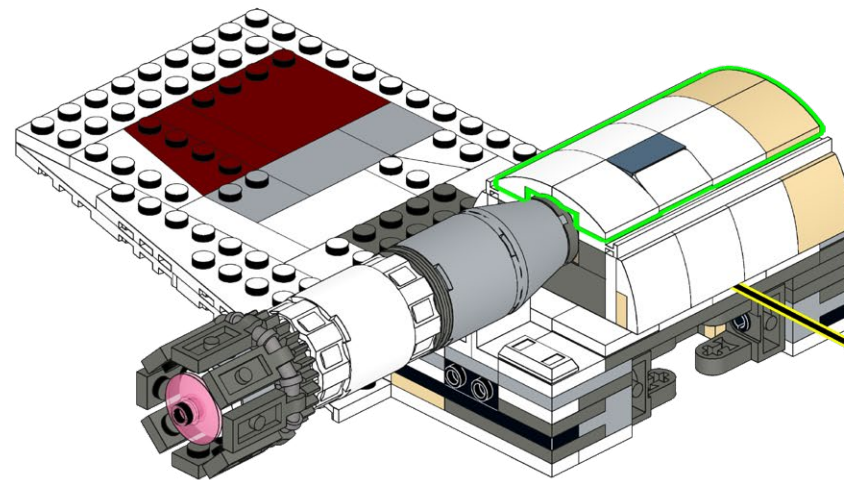

586

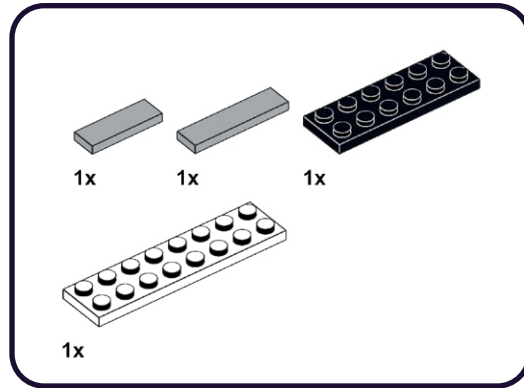

1

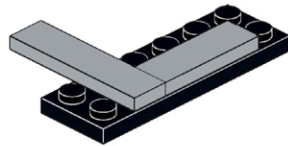

2

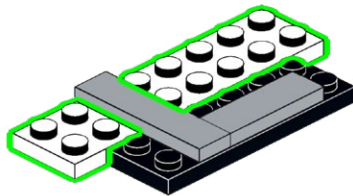

587

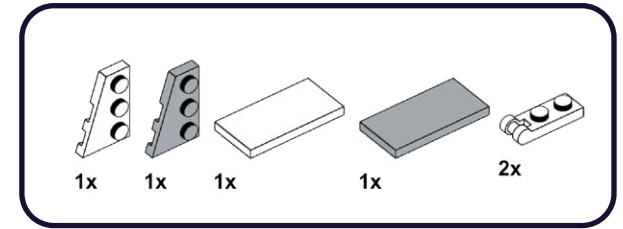

1

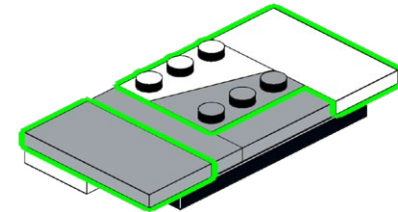

2

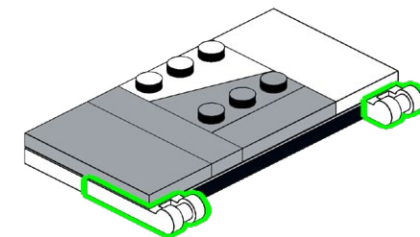

588

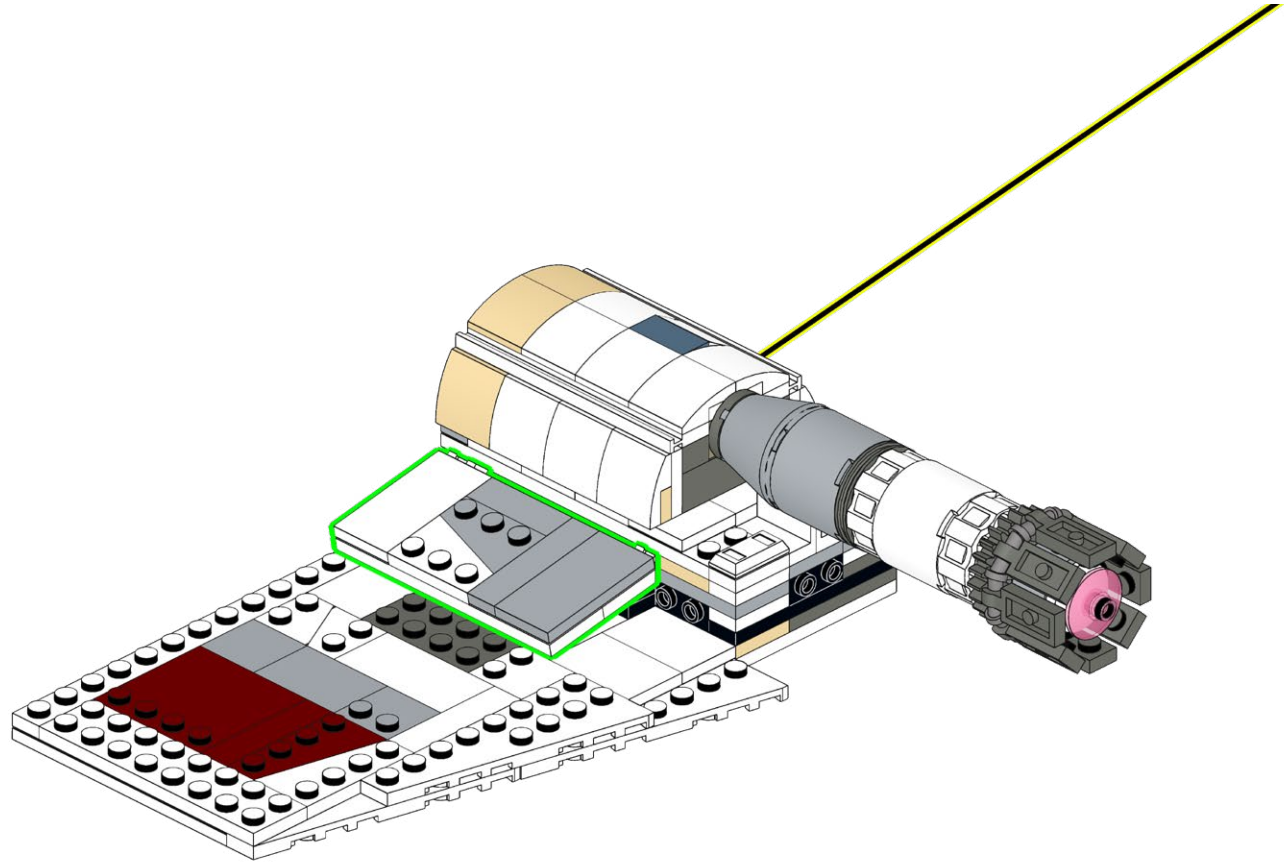

589

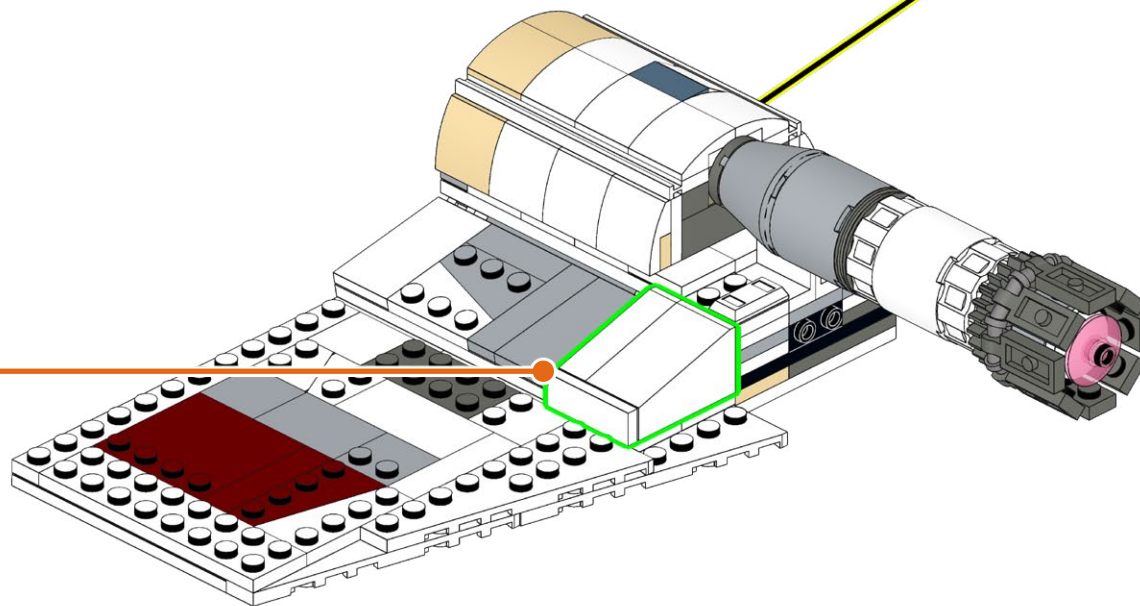
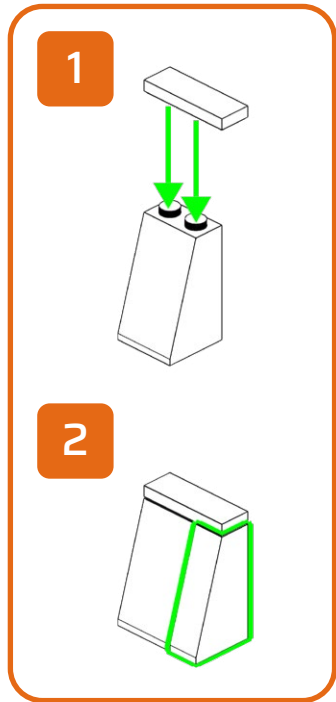
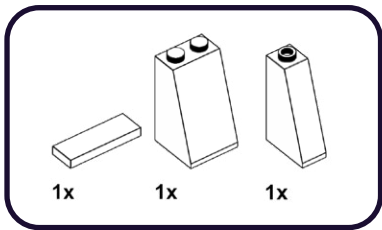



**590**

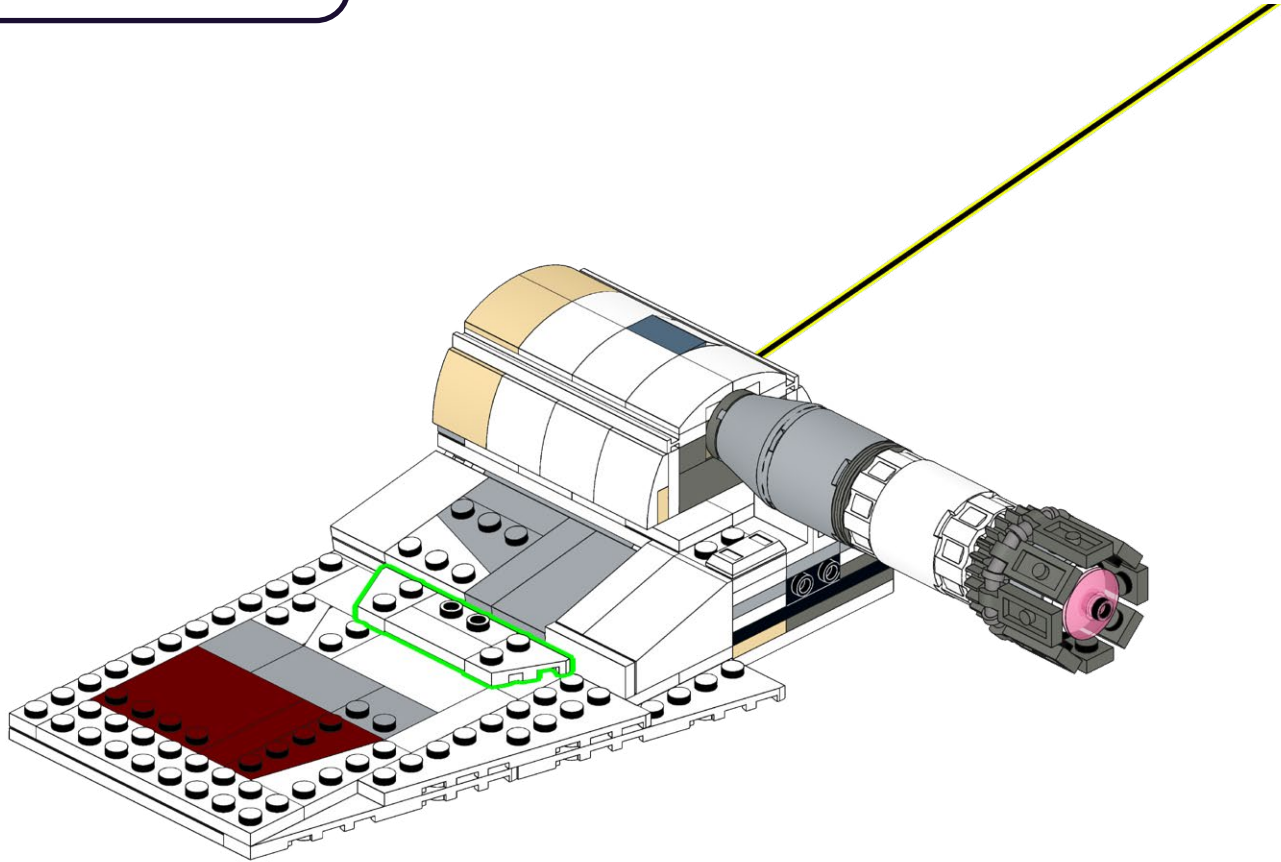
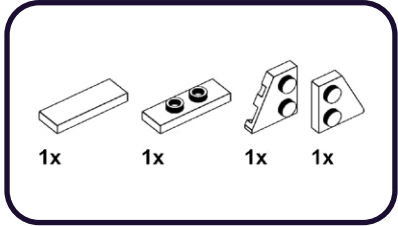



591

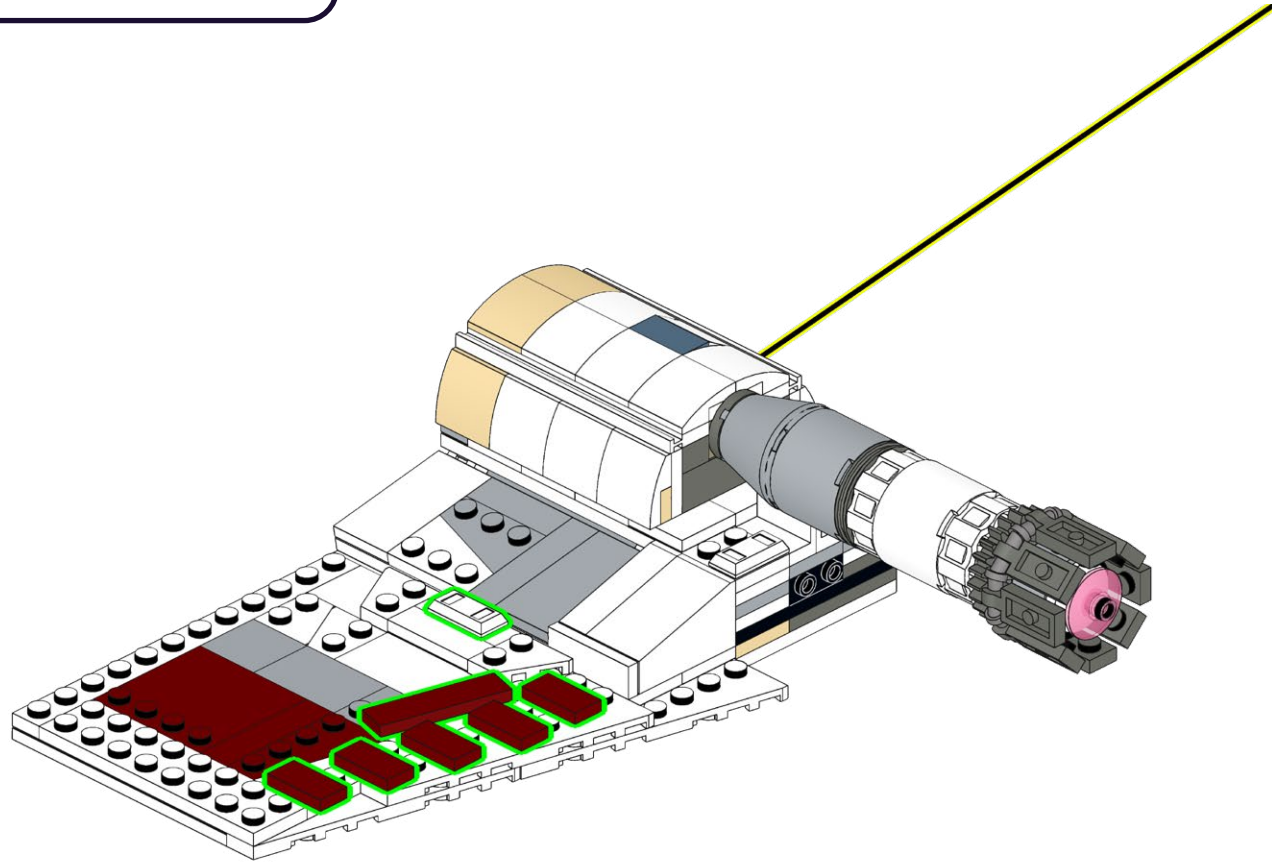
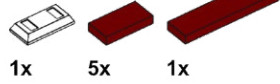

592

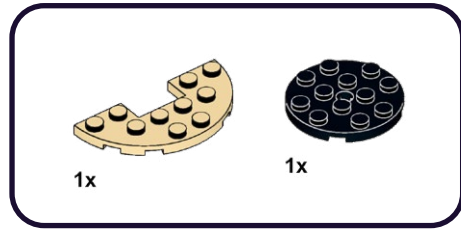

1

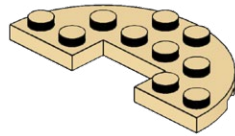

2

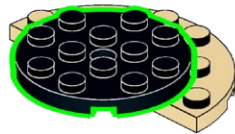

593

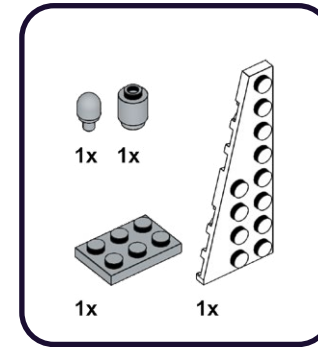

1

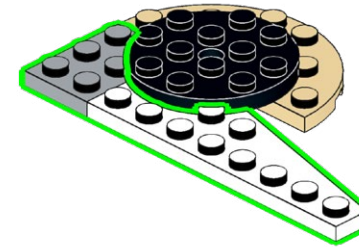

2

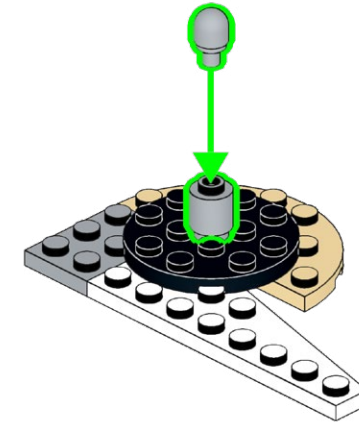

594

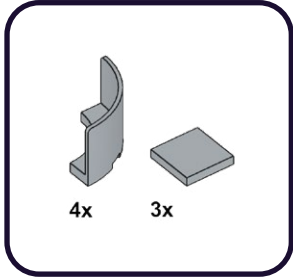

1

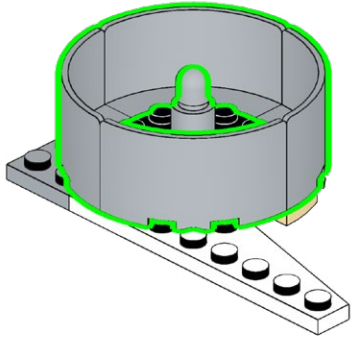

2

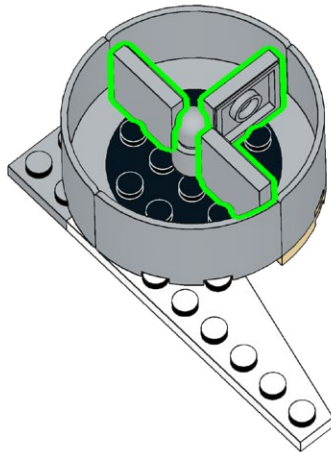

595

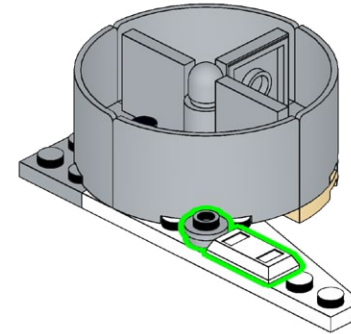
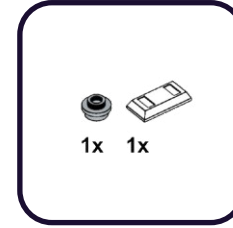

596

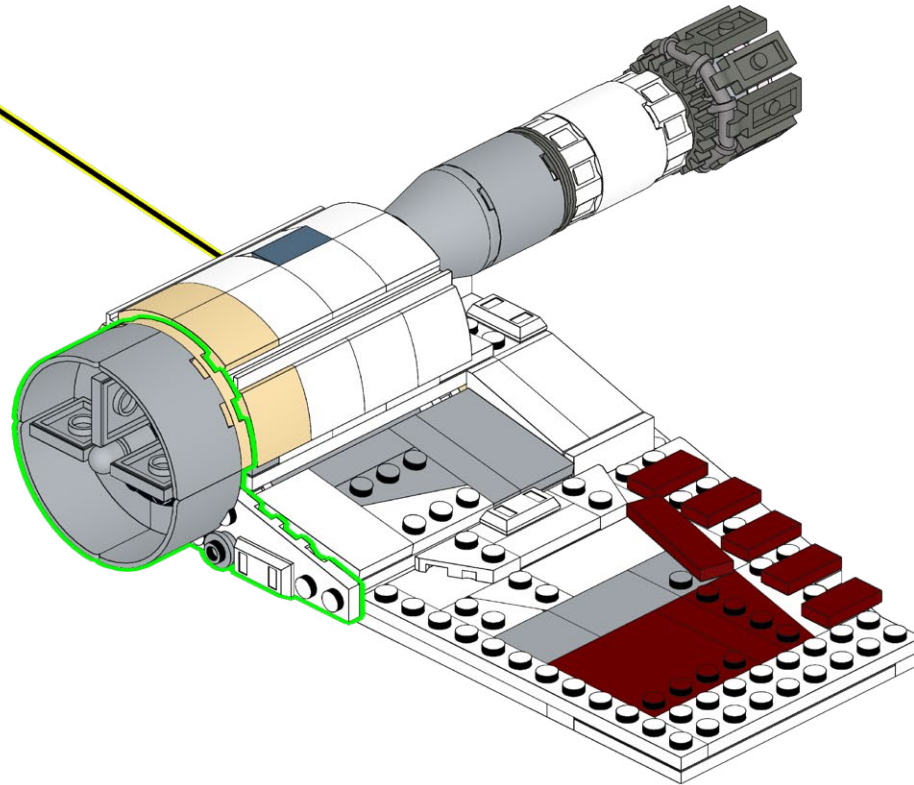

**597**

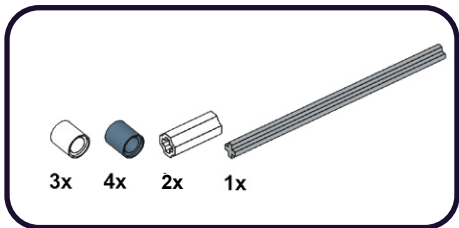

**1**

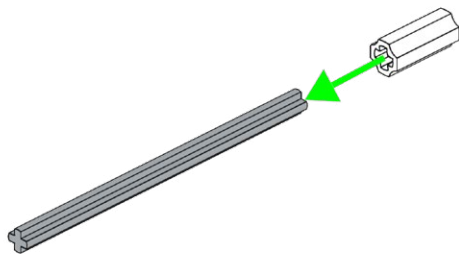

**2**

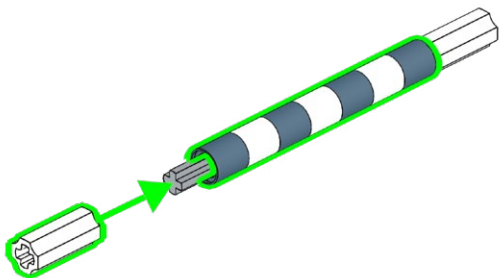

**598**

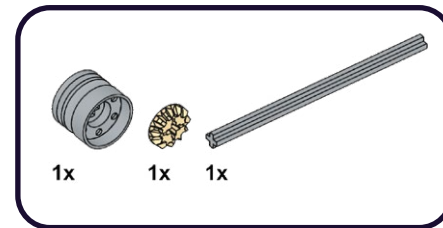

**1**

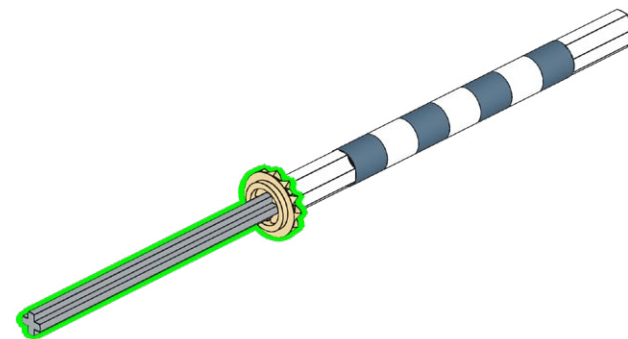

**2**

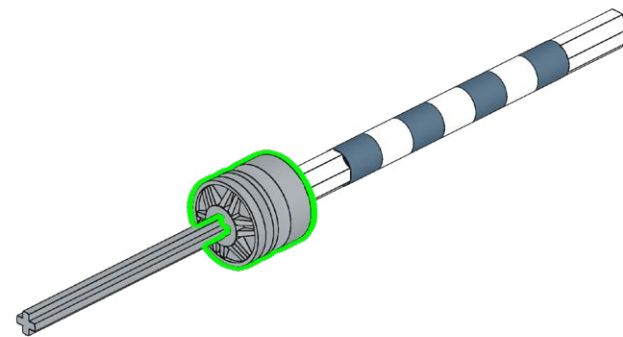

**599**

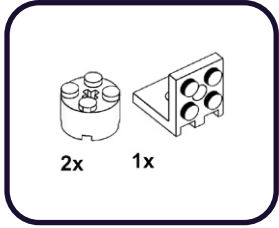

1

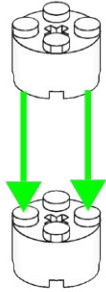

2

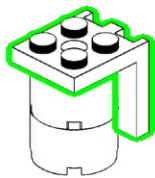

**600**

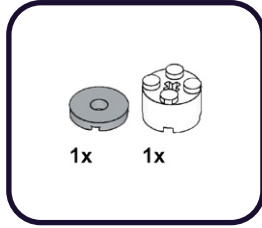

1

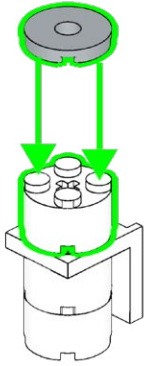

2

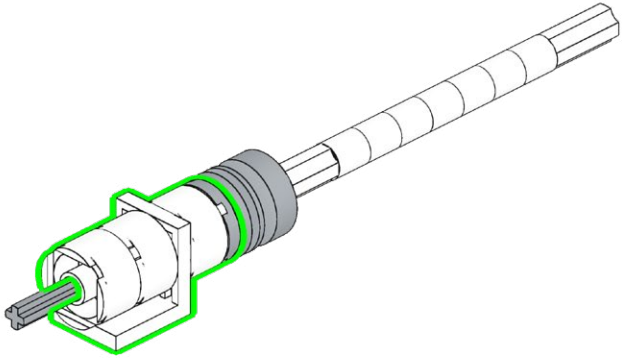

# 601

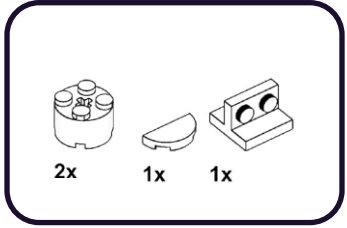

1

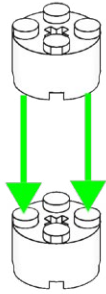

2

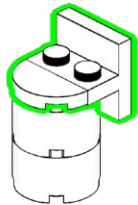

# 602

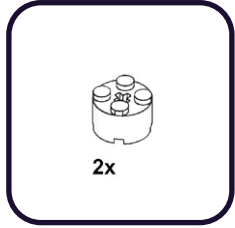

1

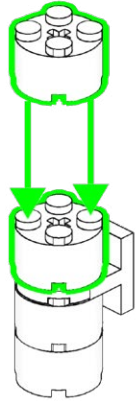

2

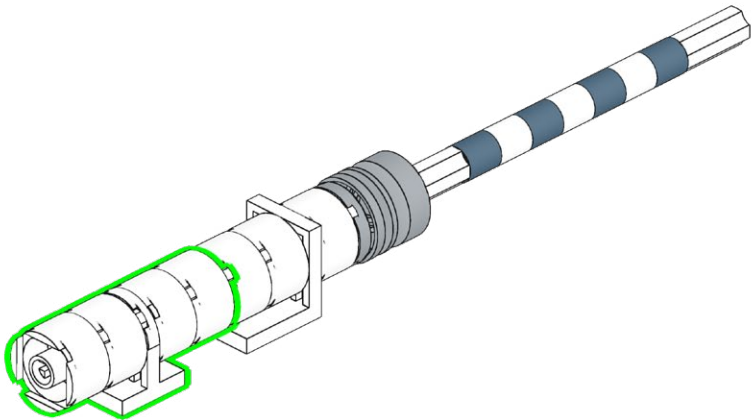

603

1x

1x

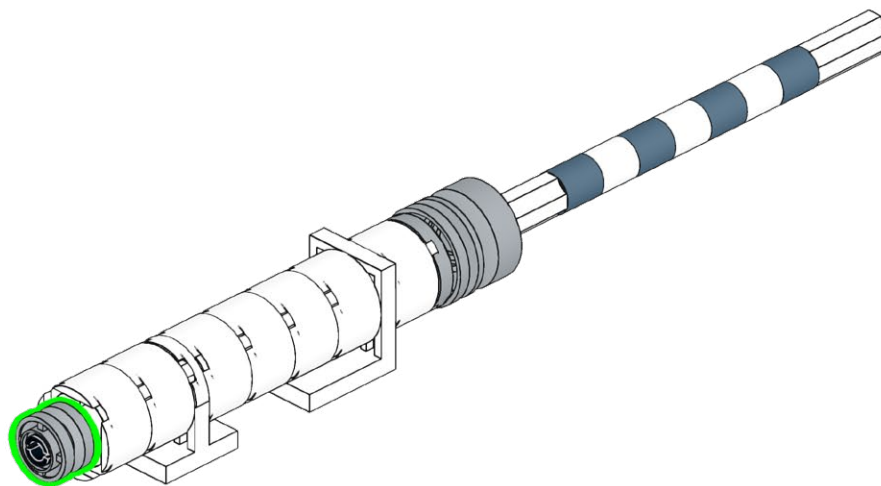
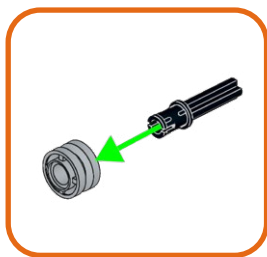



**604**

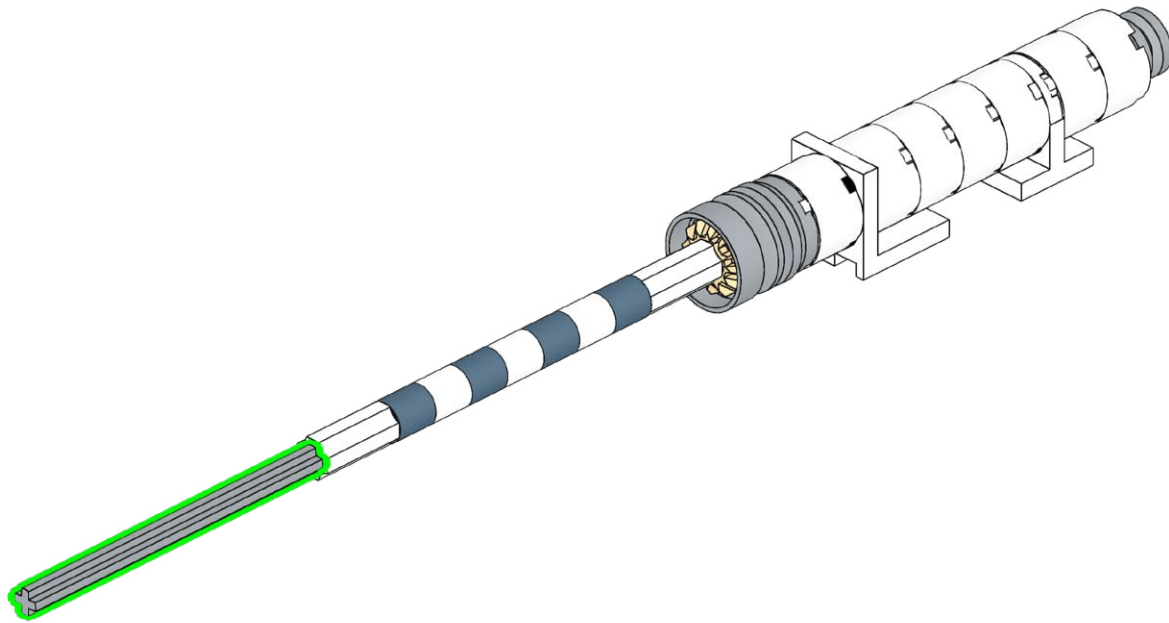
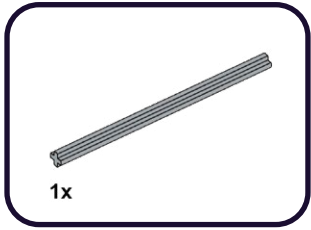

**605**

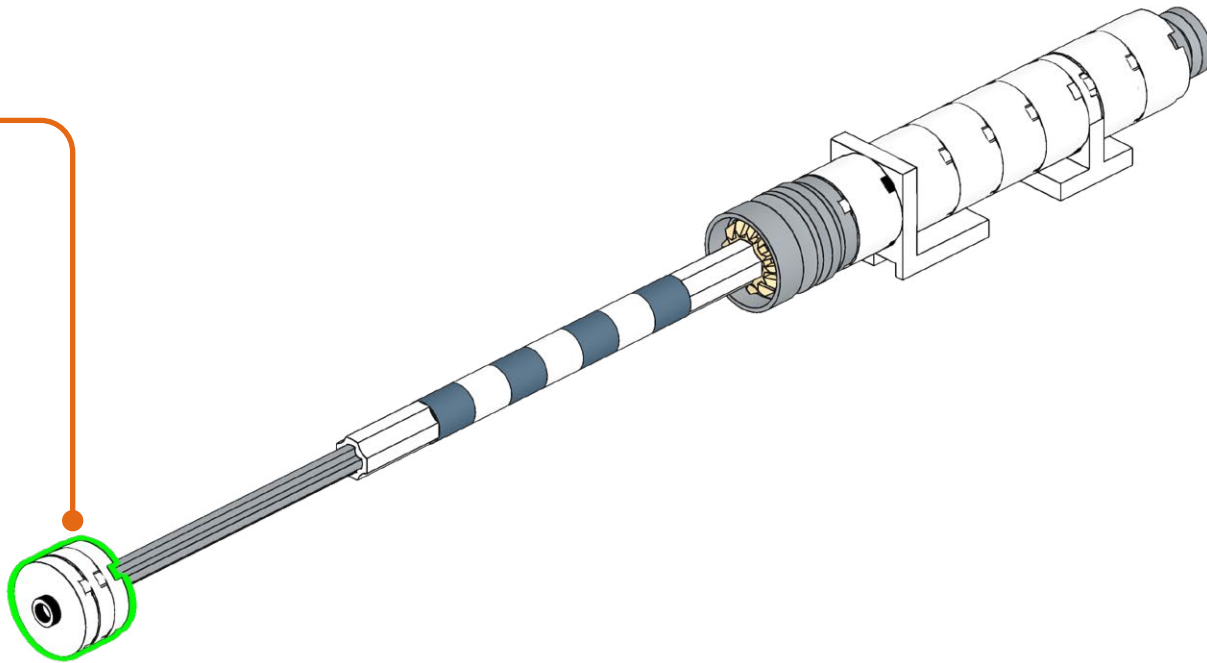
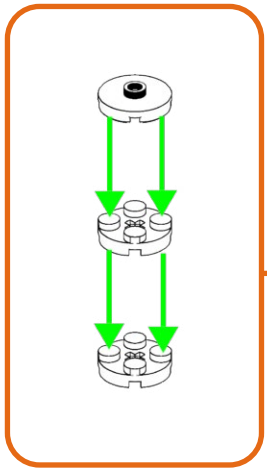
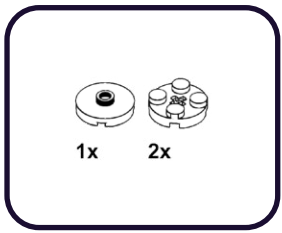

606

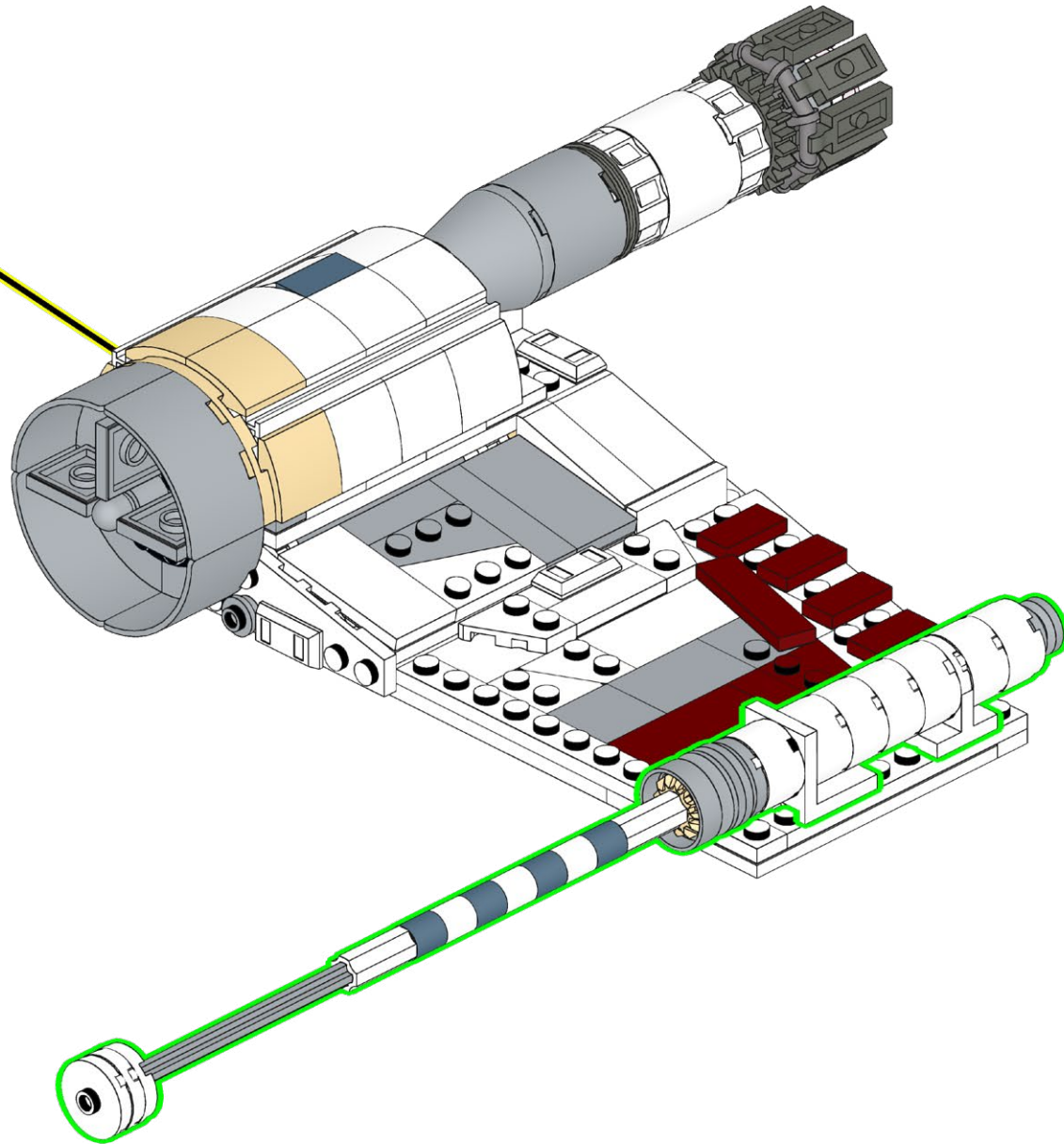

607

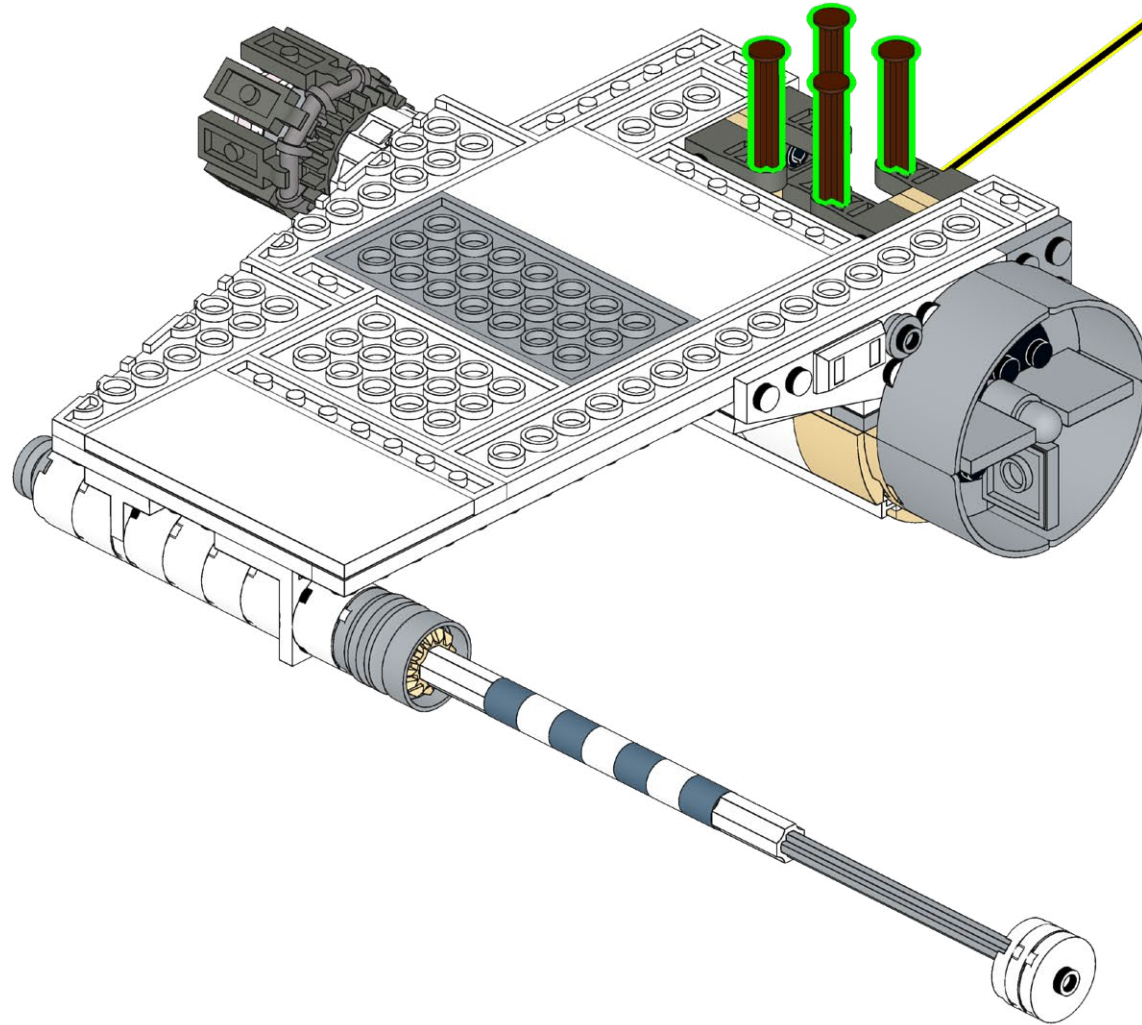
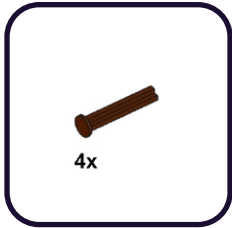

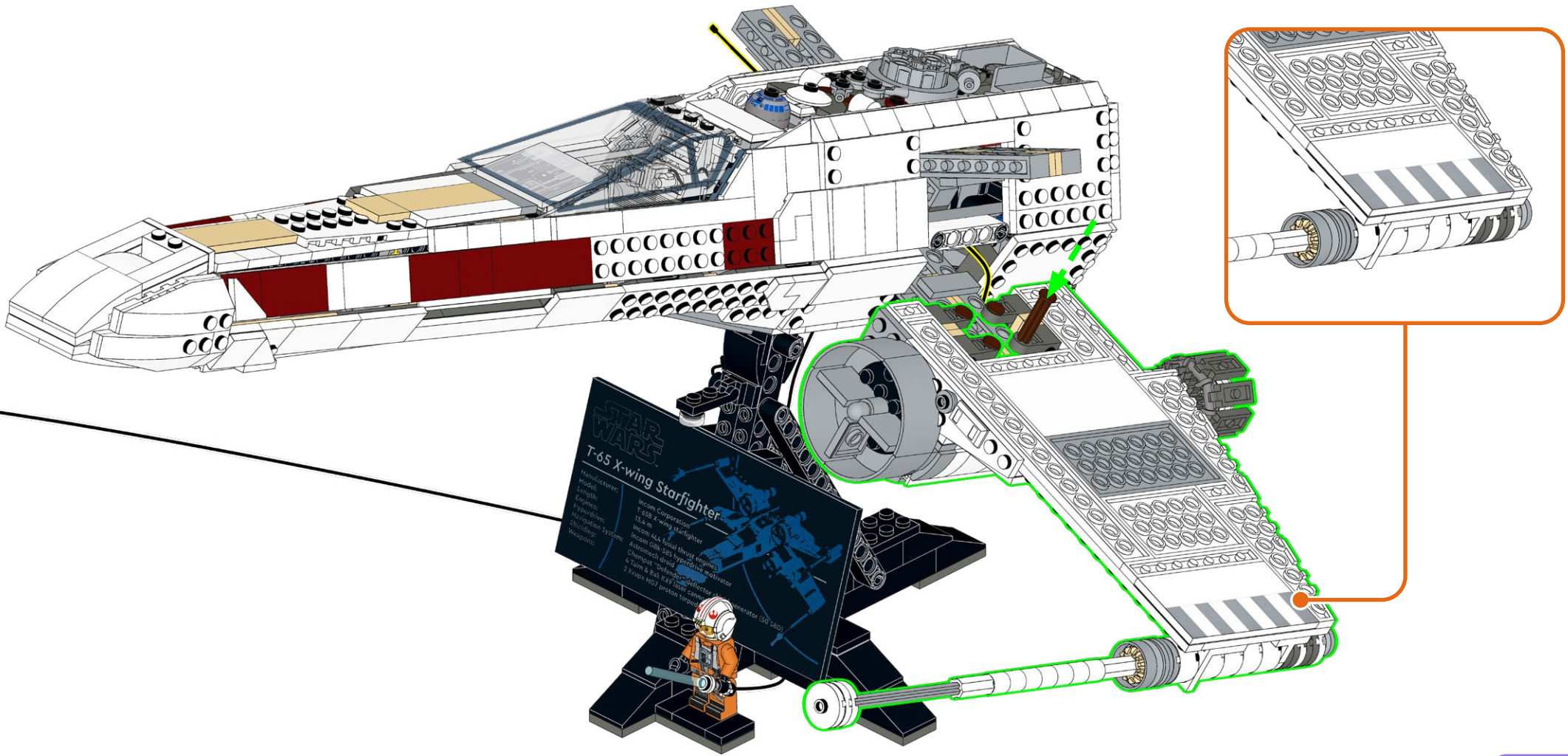



609

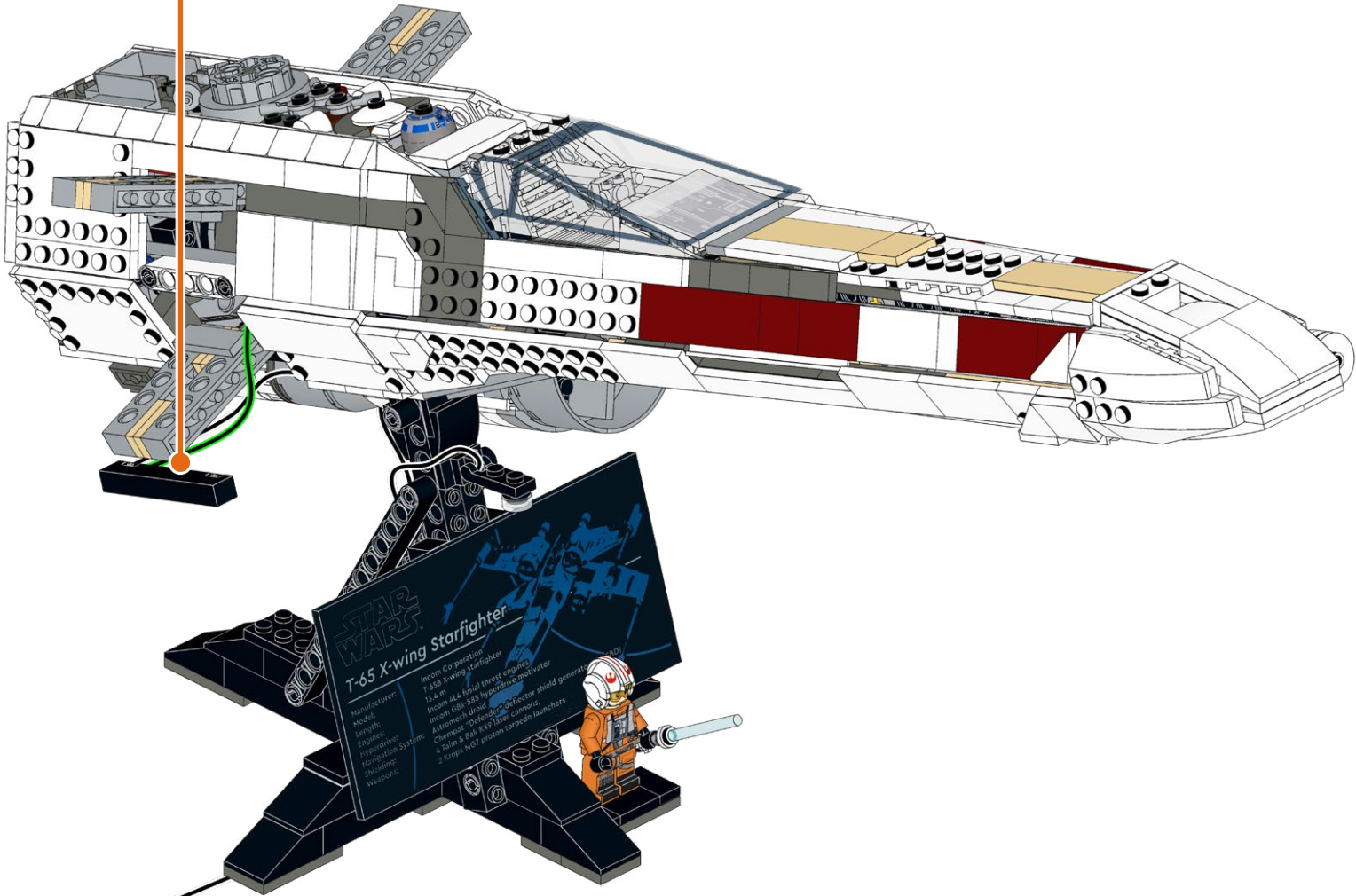
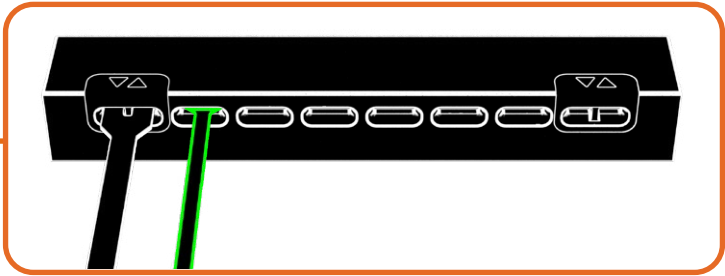

# 610

- 1x [Image of a grey Technic pin]
- 2x [Image of a grey Technic bush]
- 2x [Image of a grey Technic axle]
- 1x [Image of a grey Technic axle]

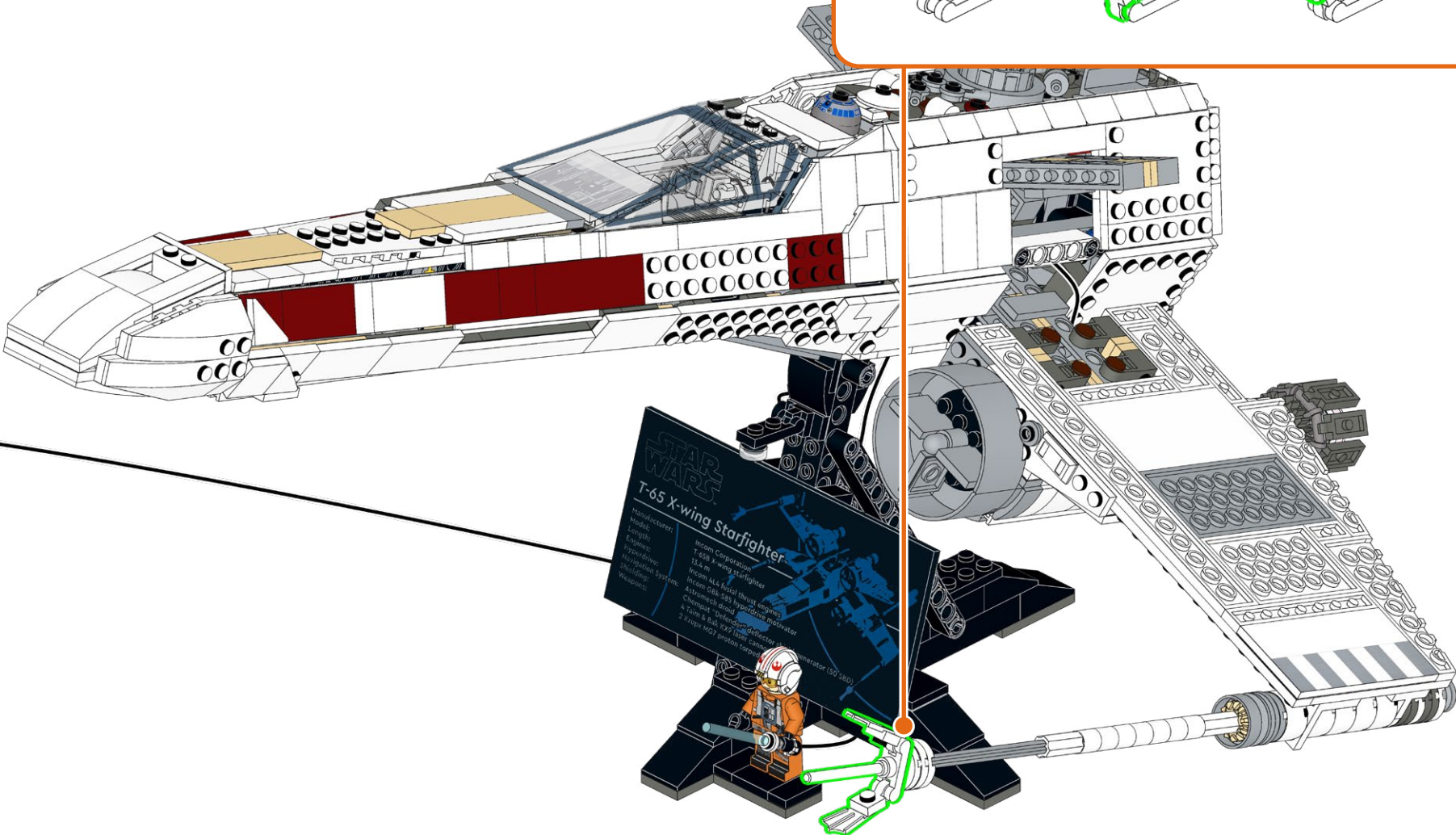
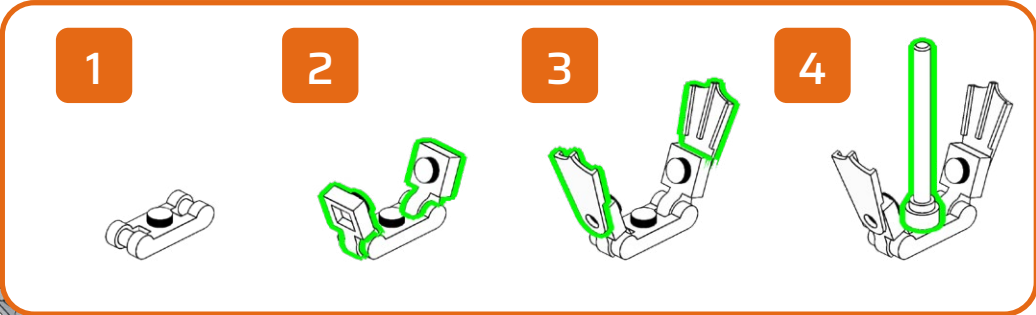



611

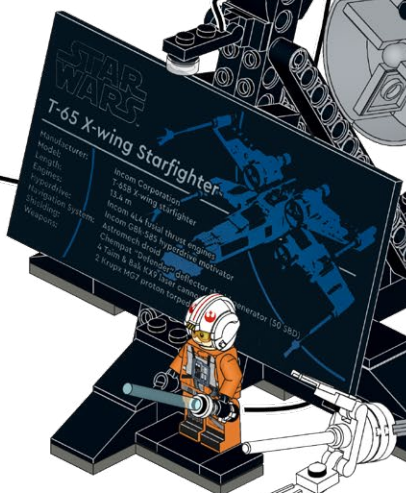
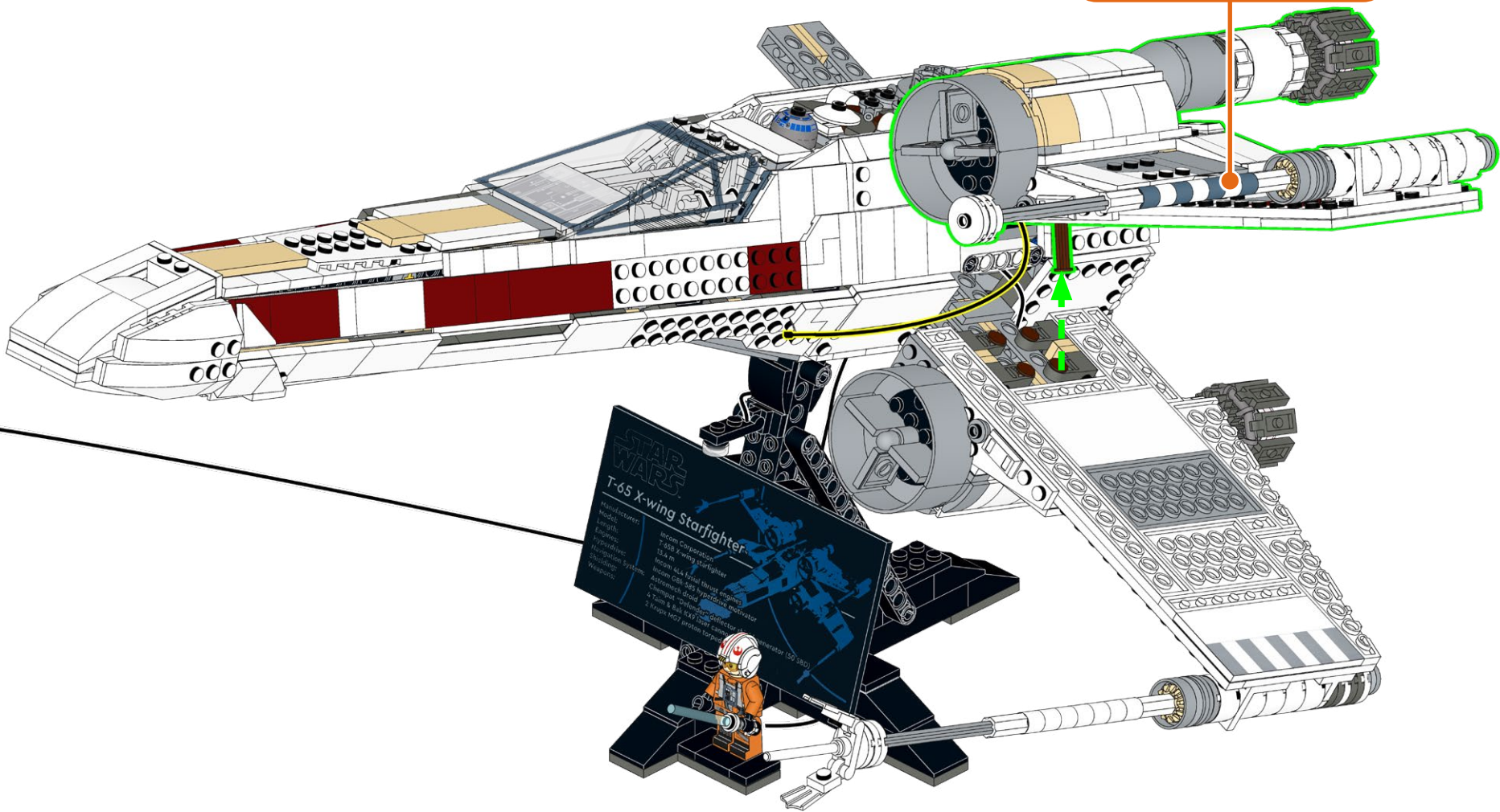



612

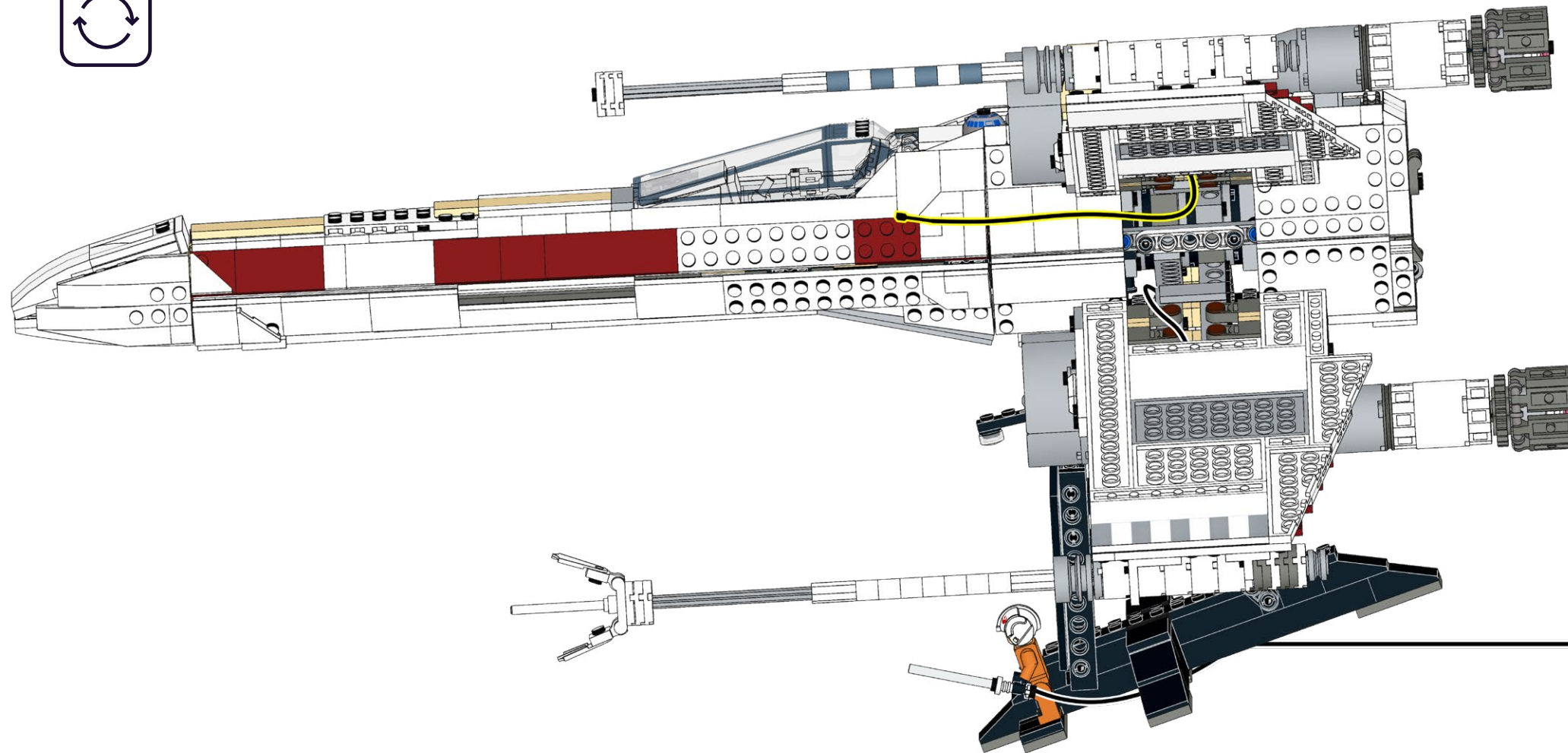

613

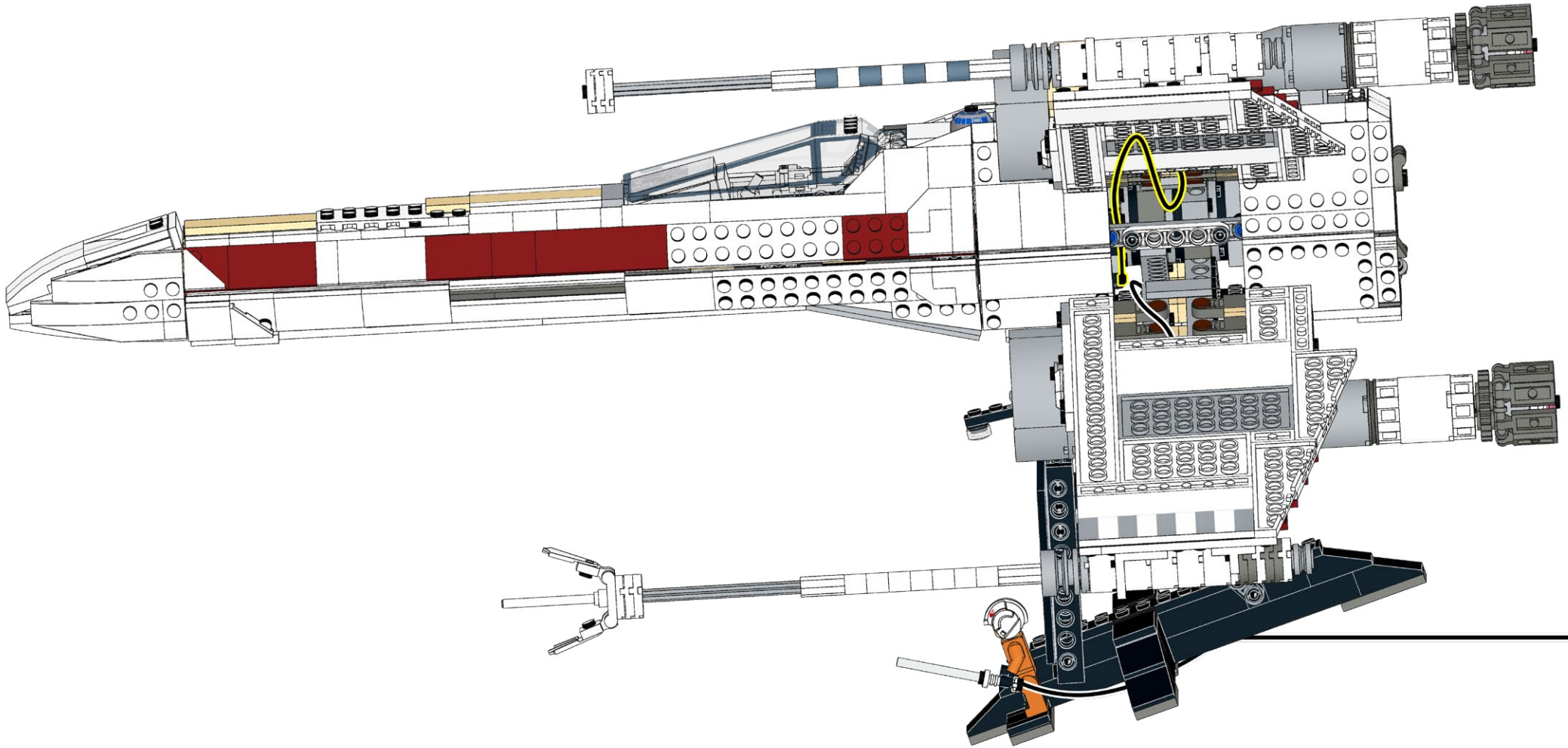

614

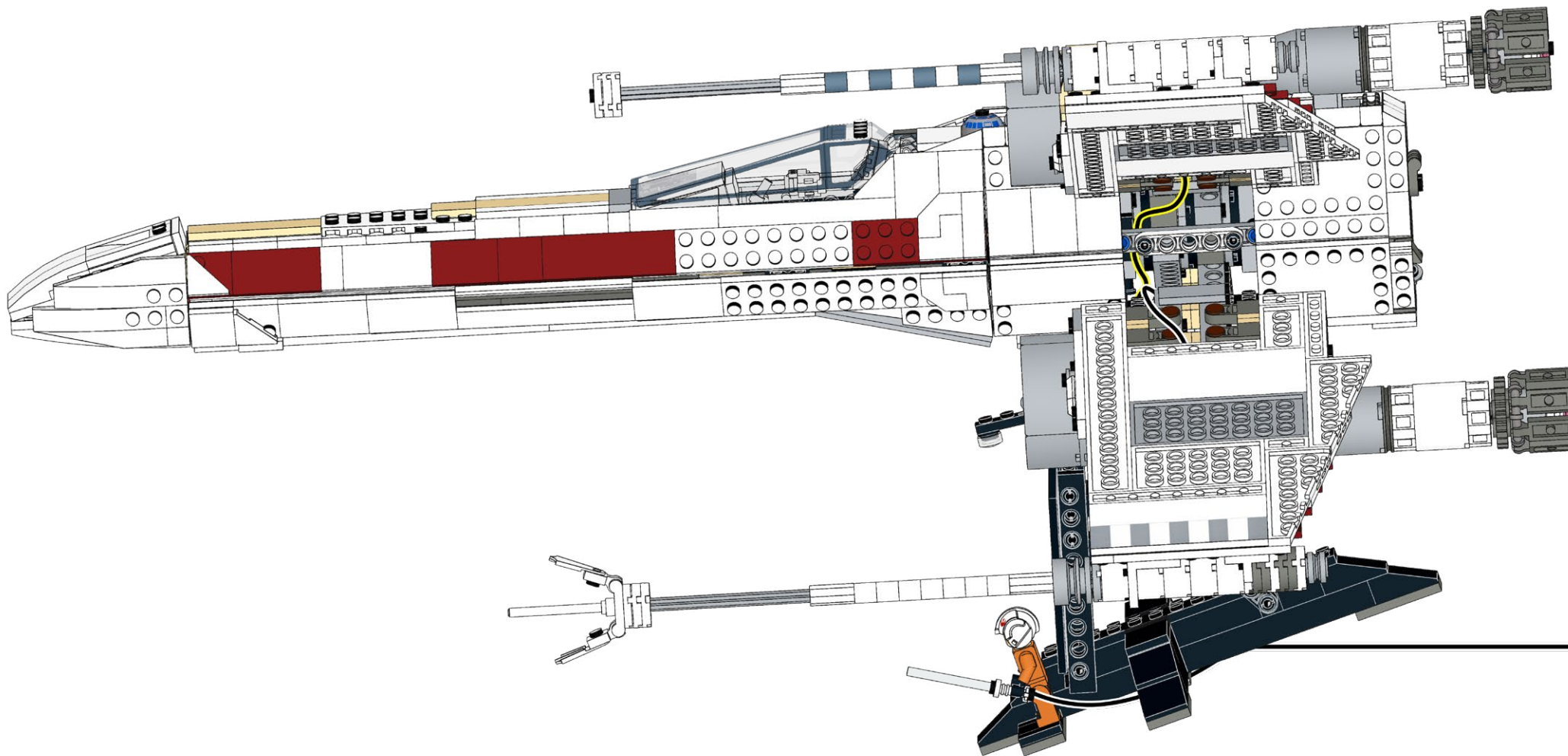





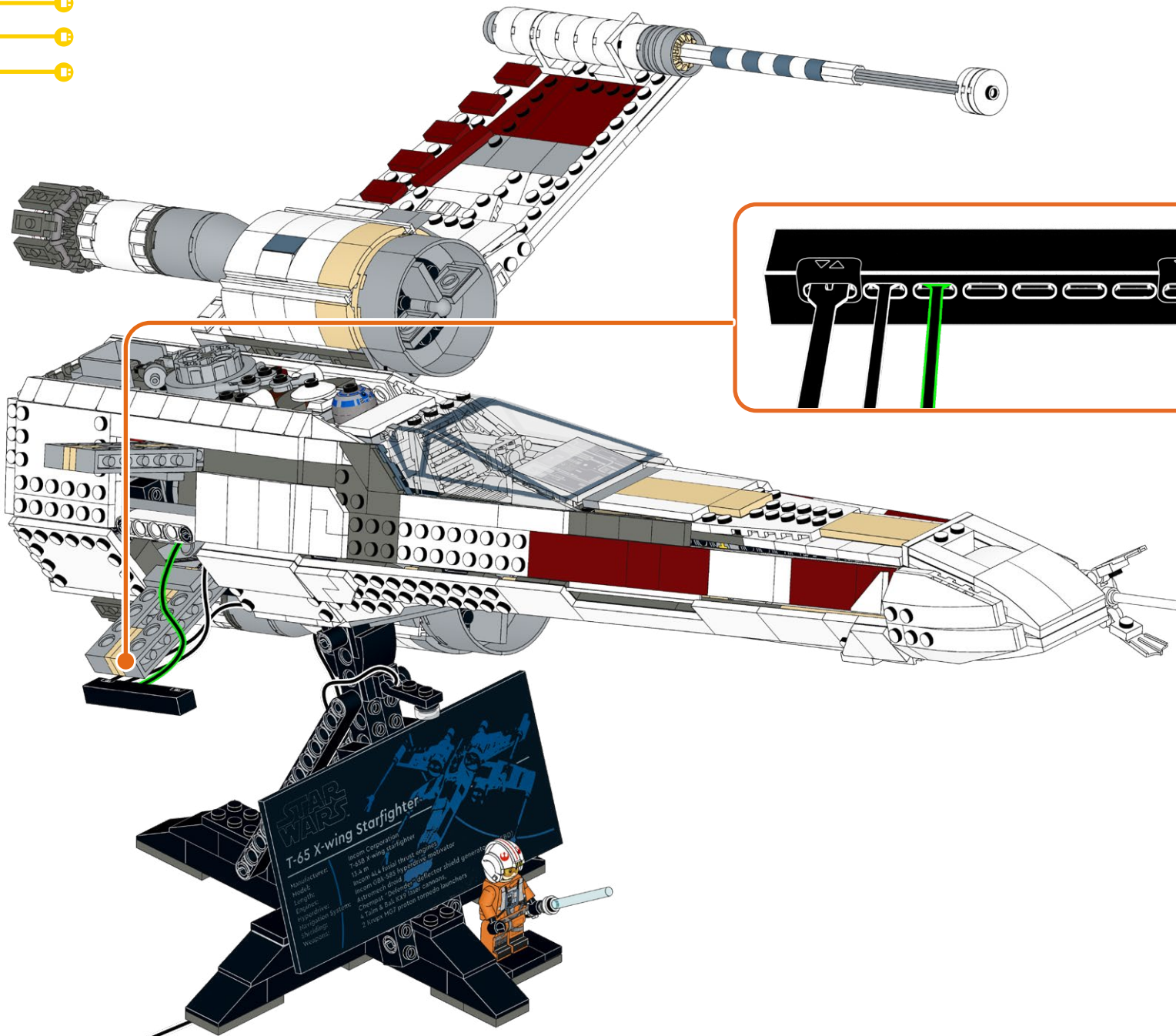

615



616

- 1x 
- 2x 
- 2x 
- 1x 

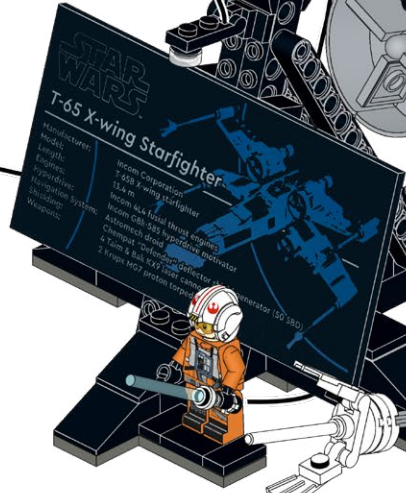
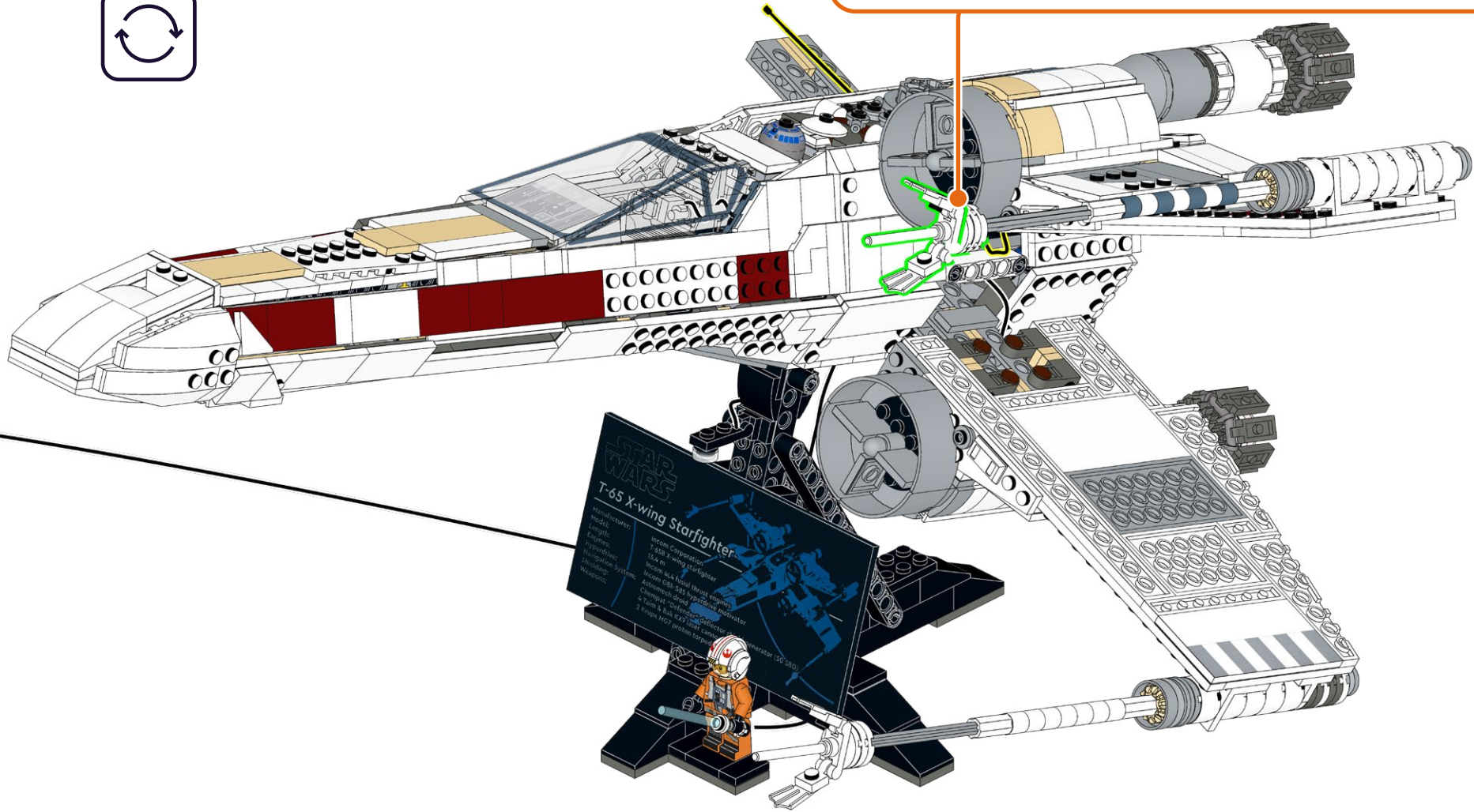
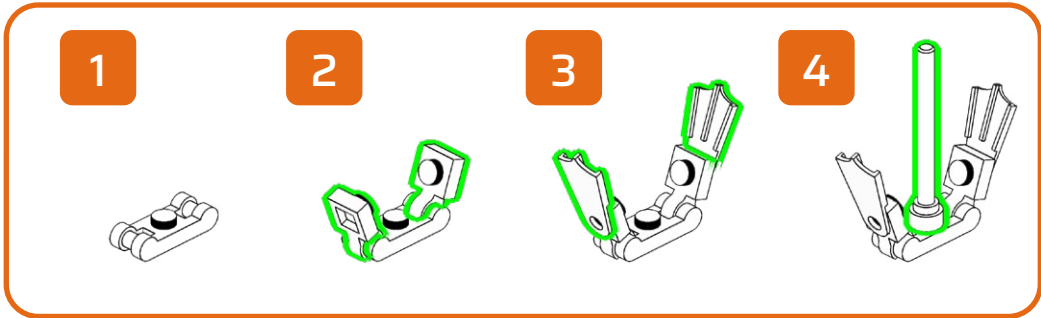
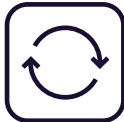



617

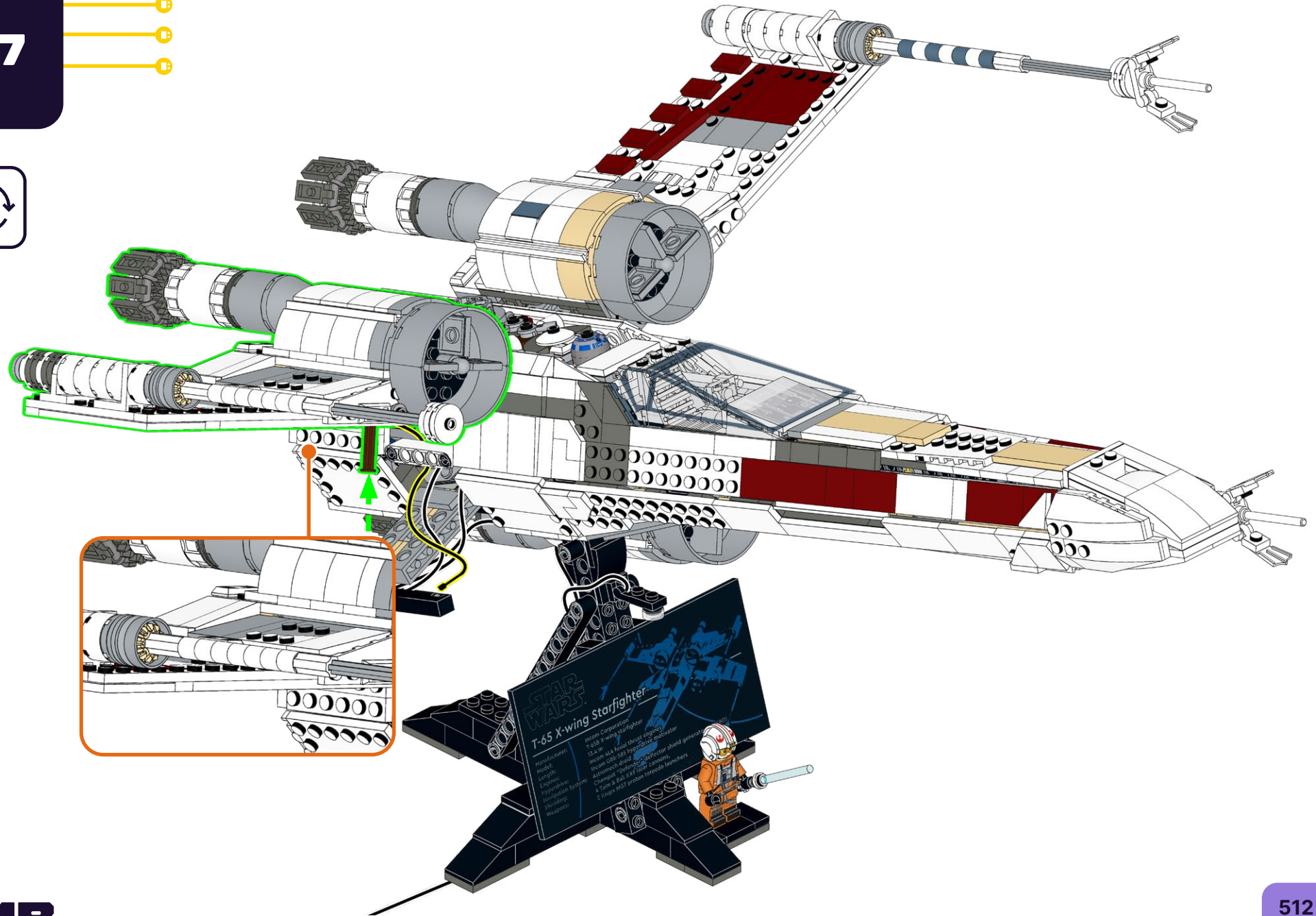
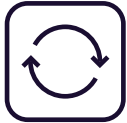

618

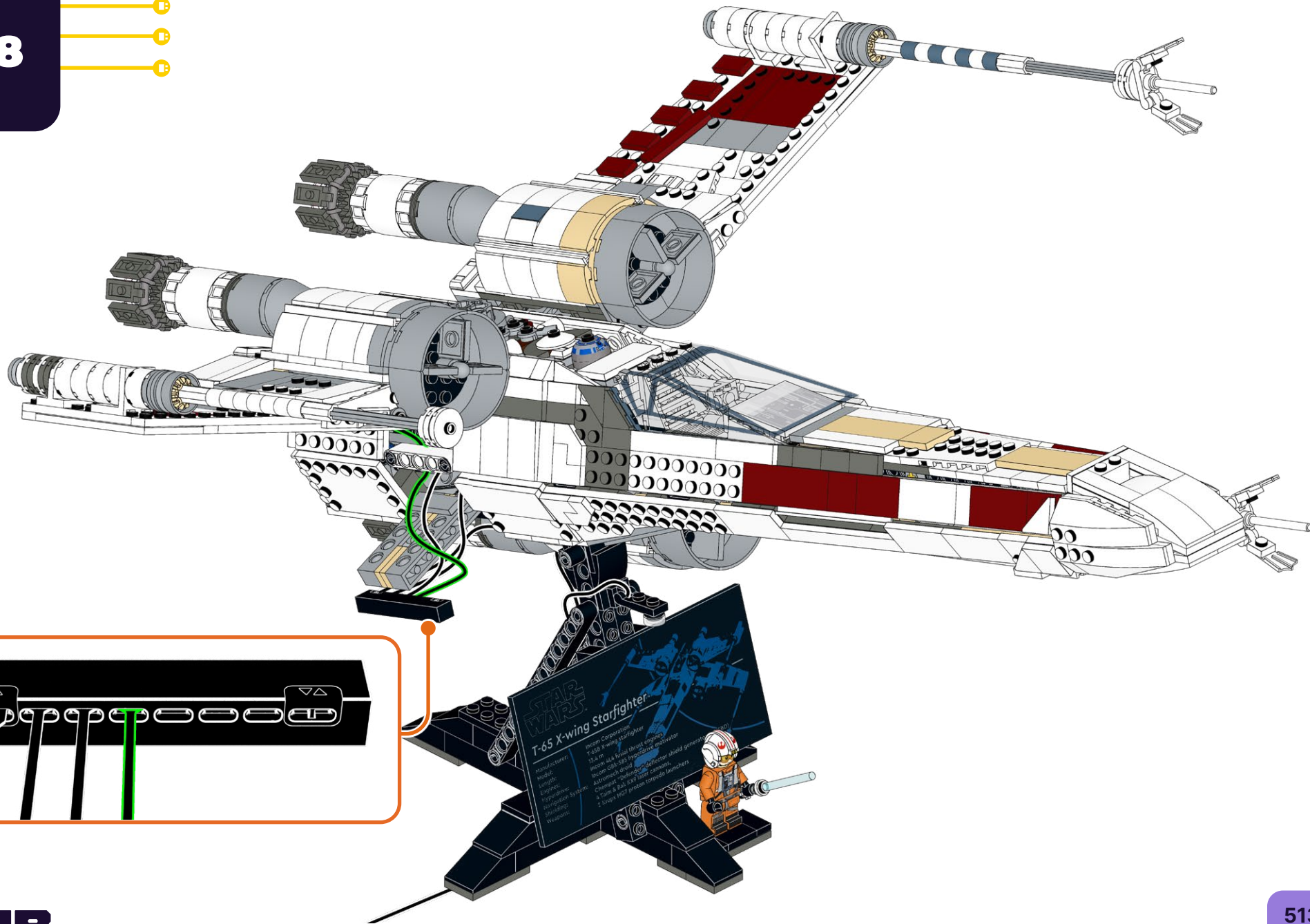



619

- 1x
- 2x
- 2x
- 1x

1

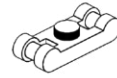

2

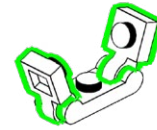

3

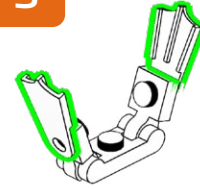

4

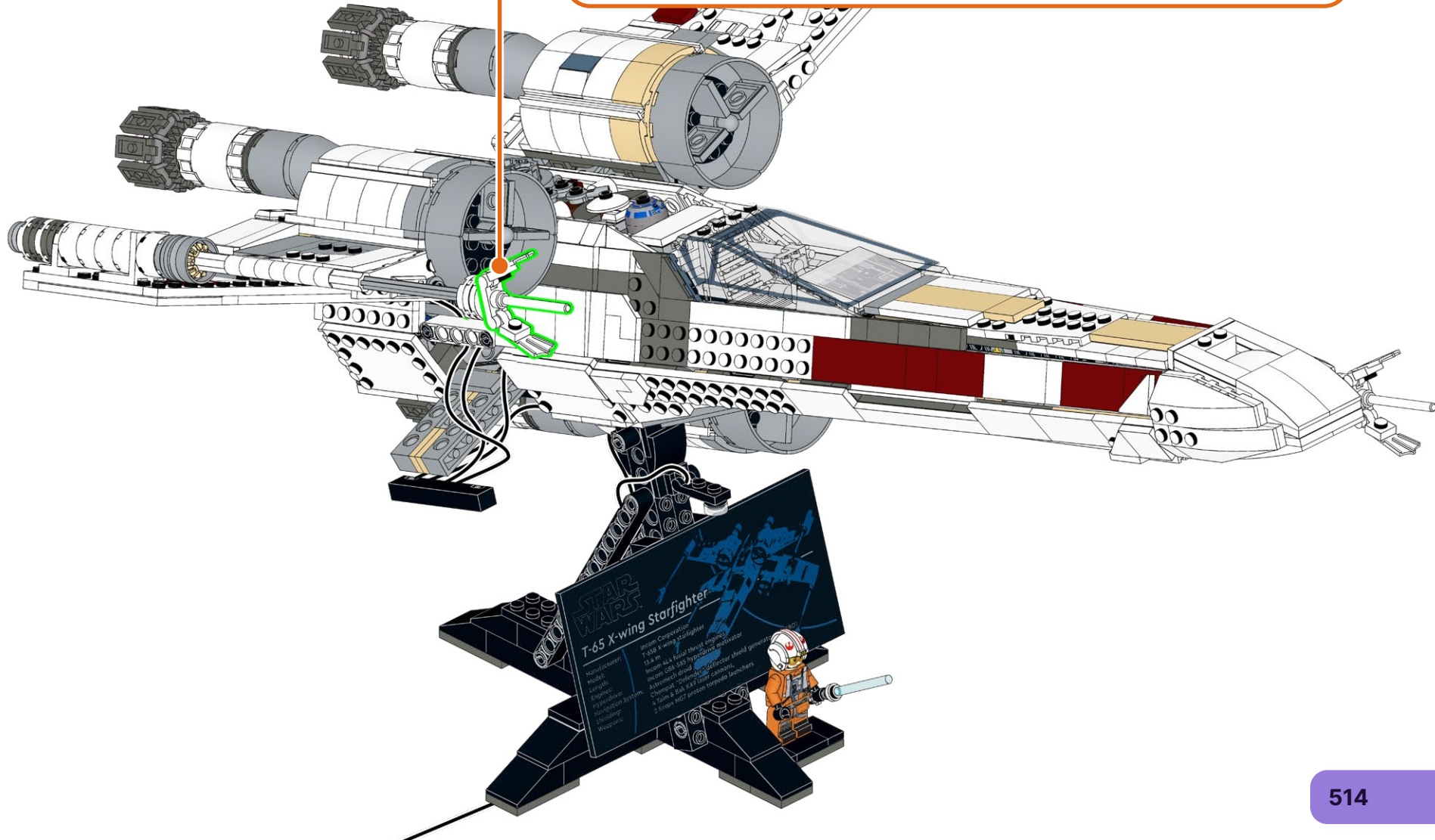
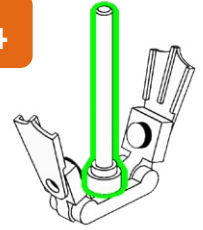



620

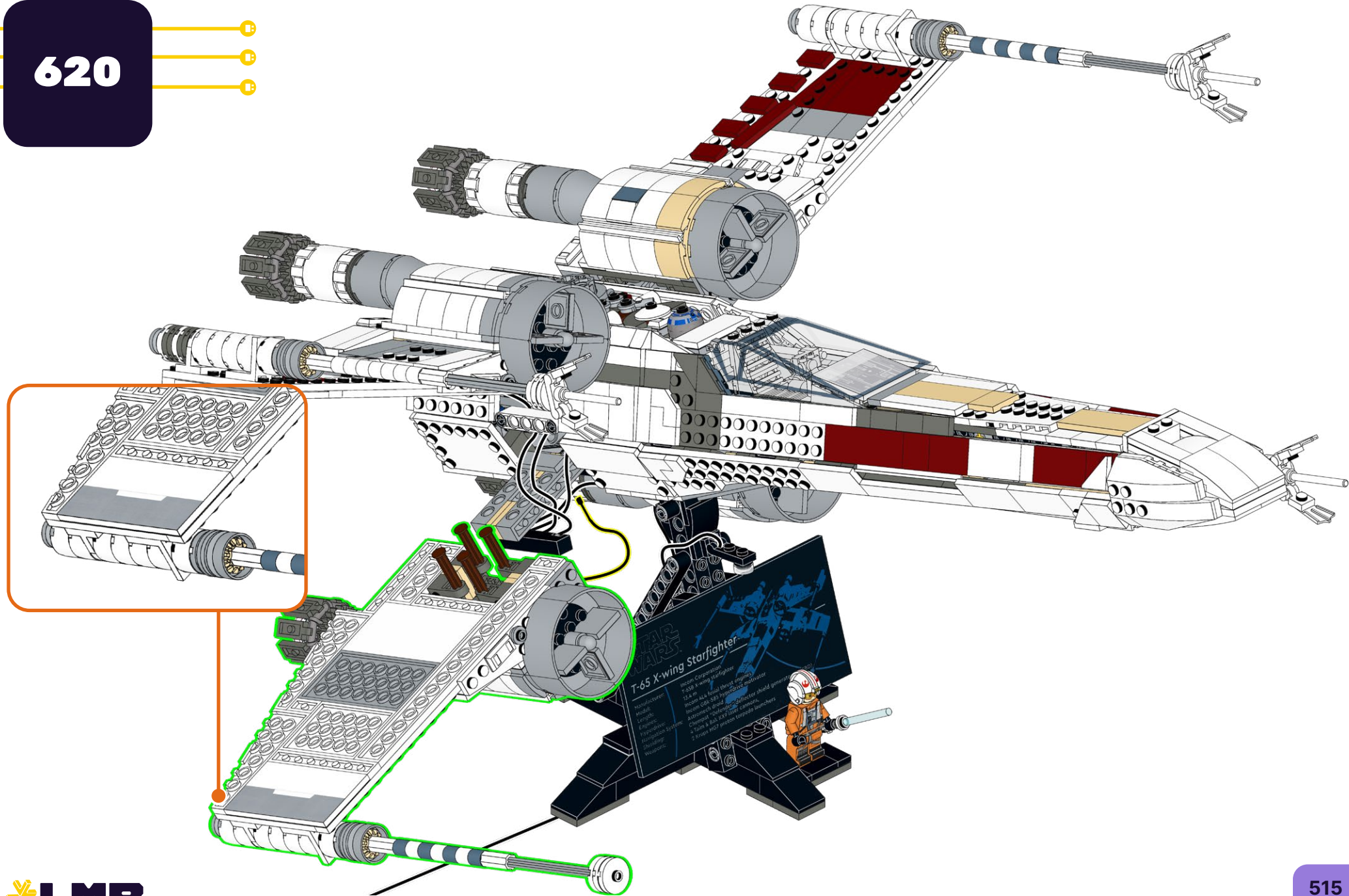

621

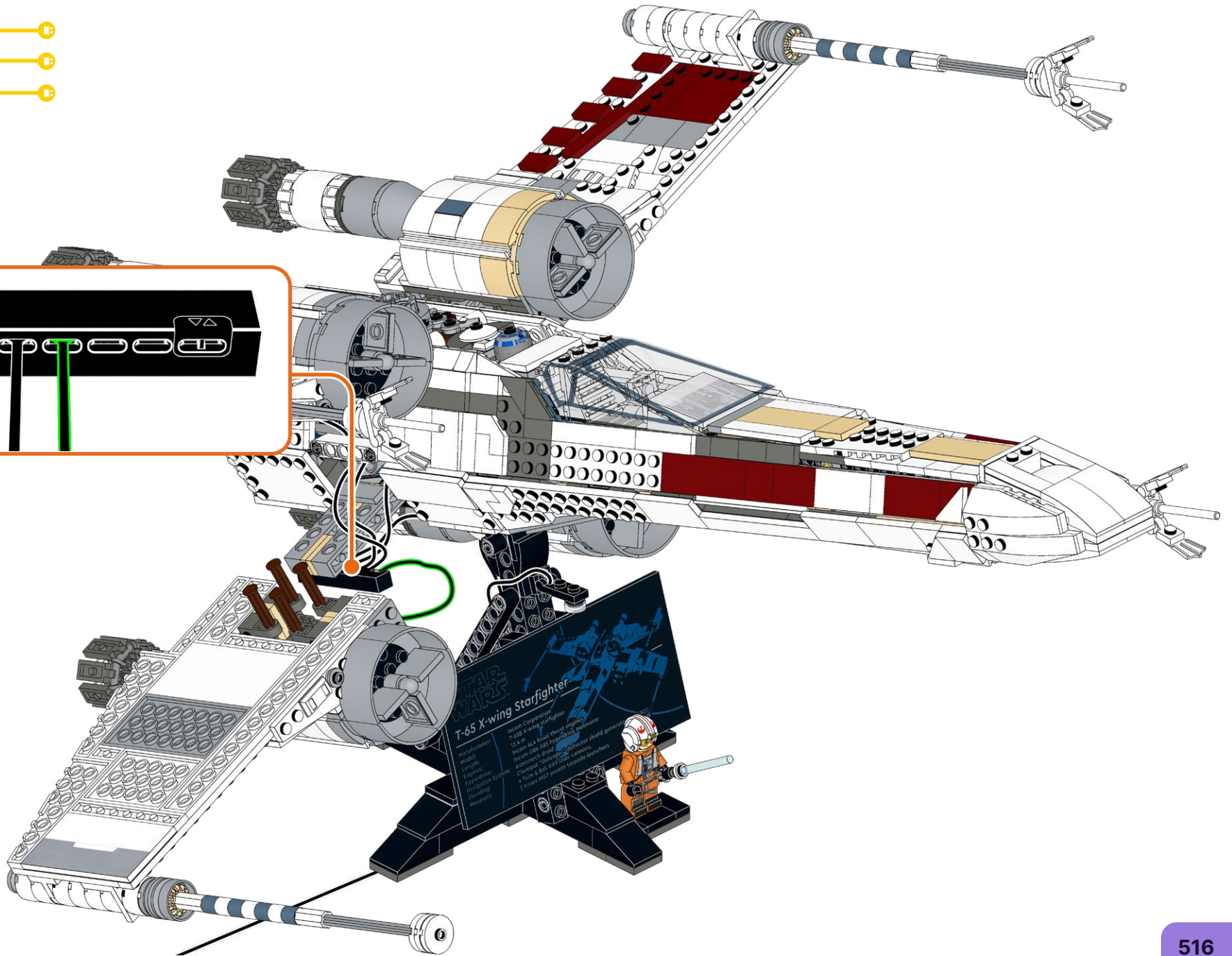
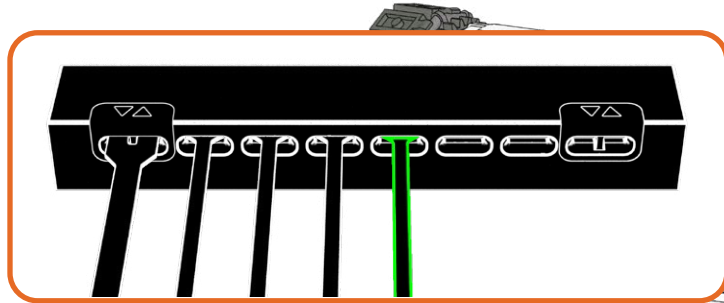

**622**

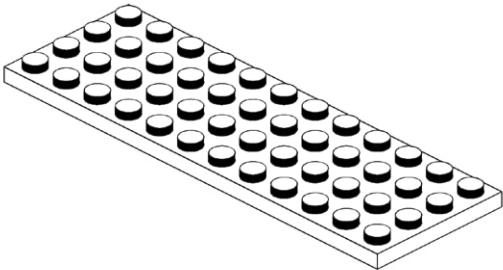
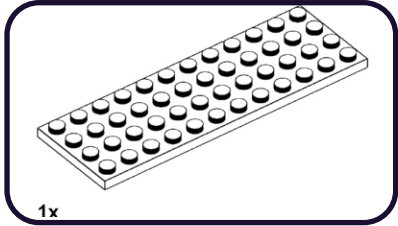

**623**

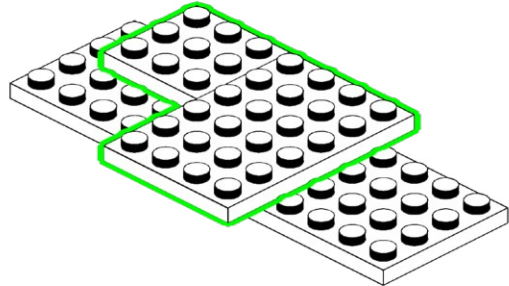
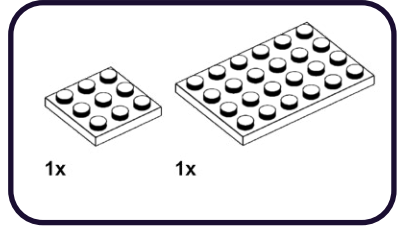



624

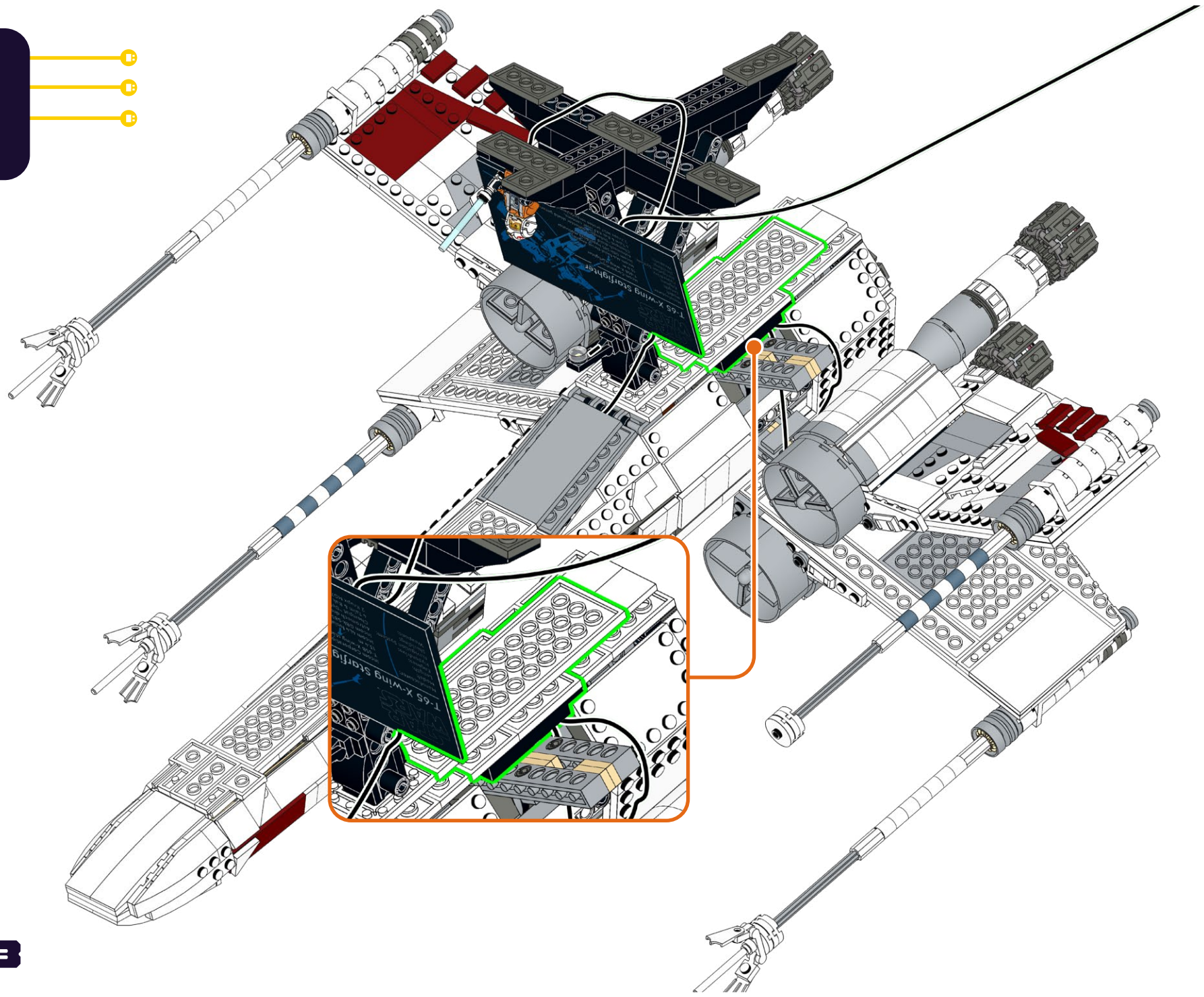

625

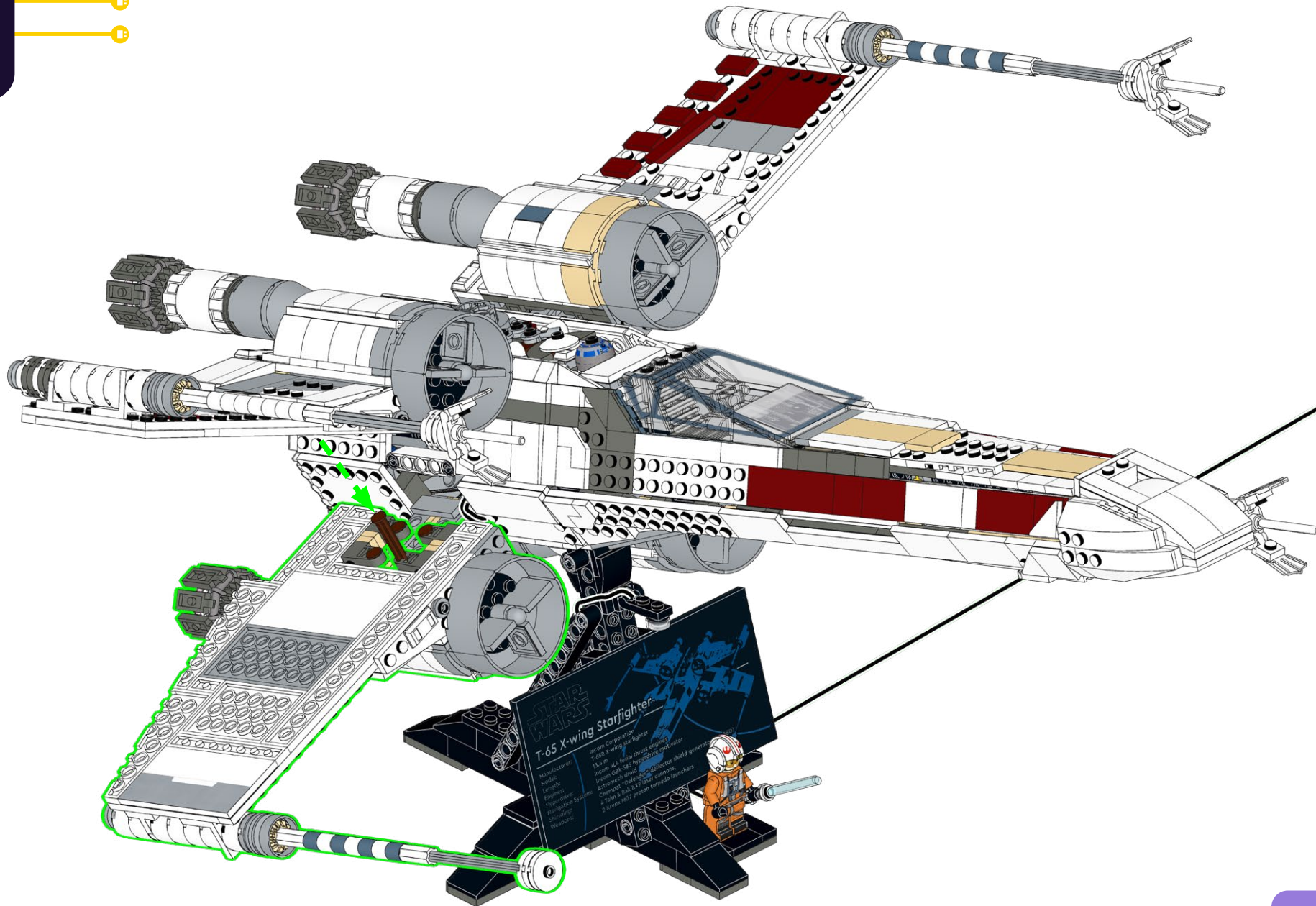



626

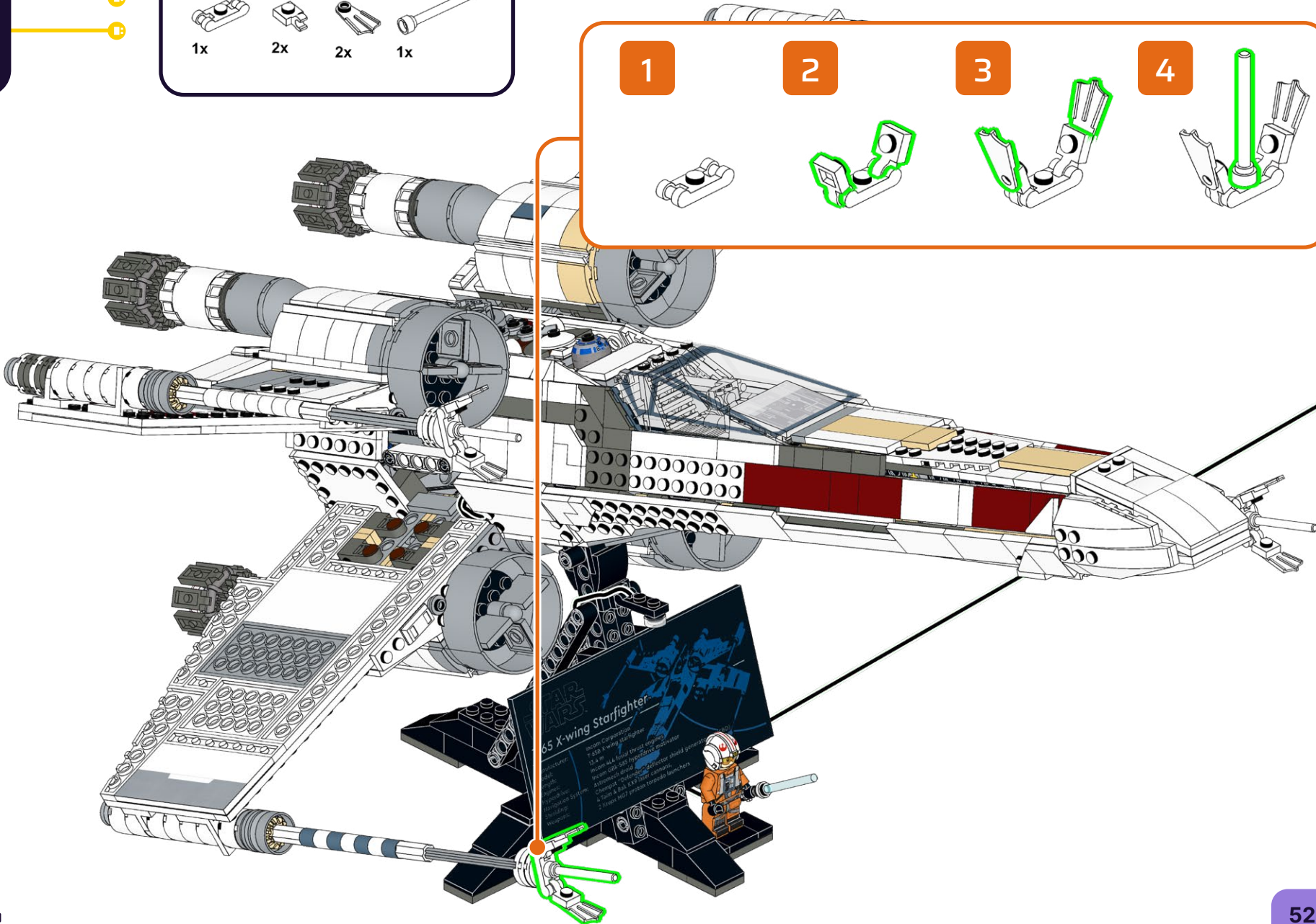
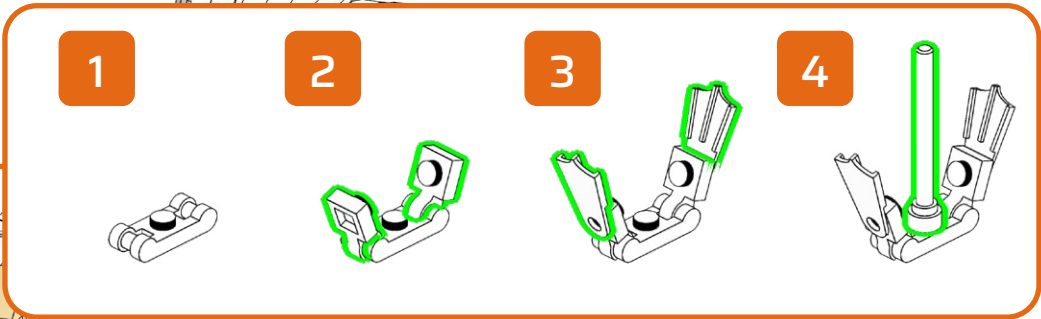
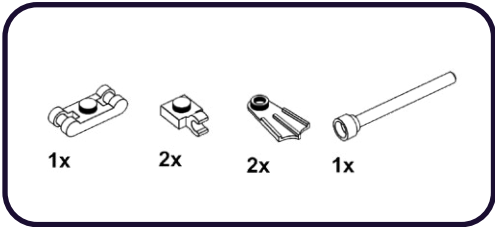

# 627

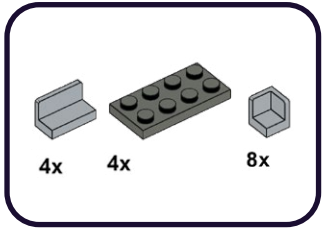

1

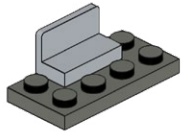

2

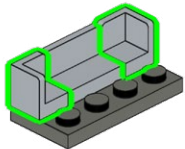

# 628

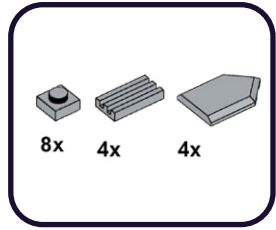

1

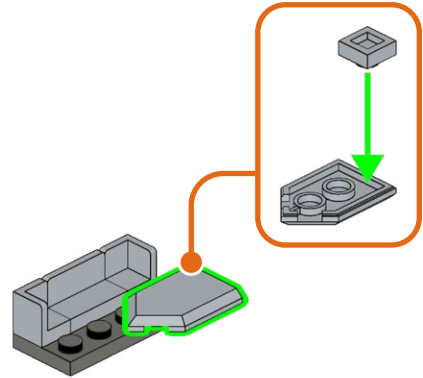

2

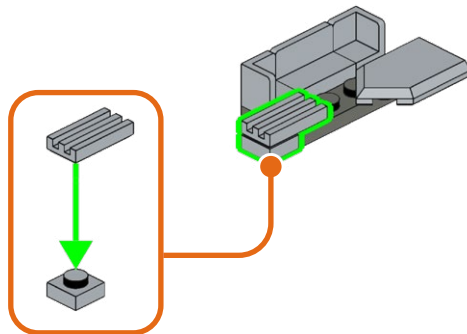

4x

629

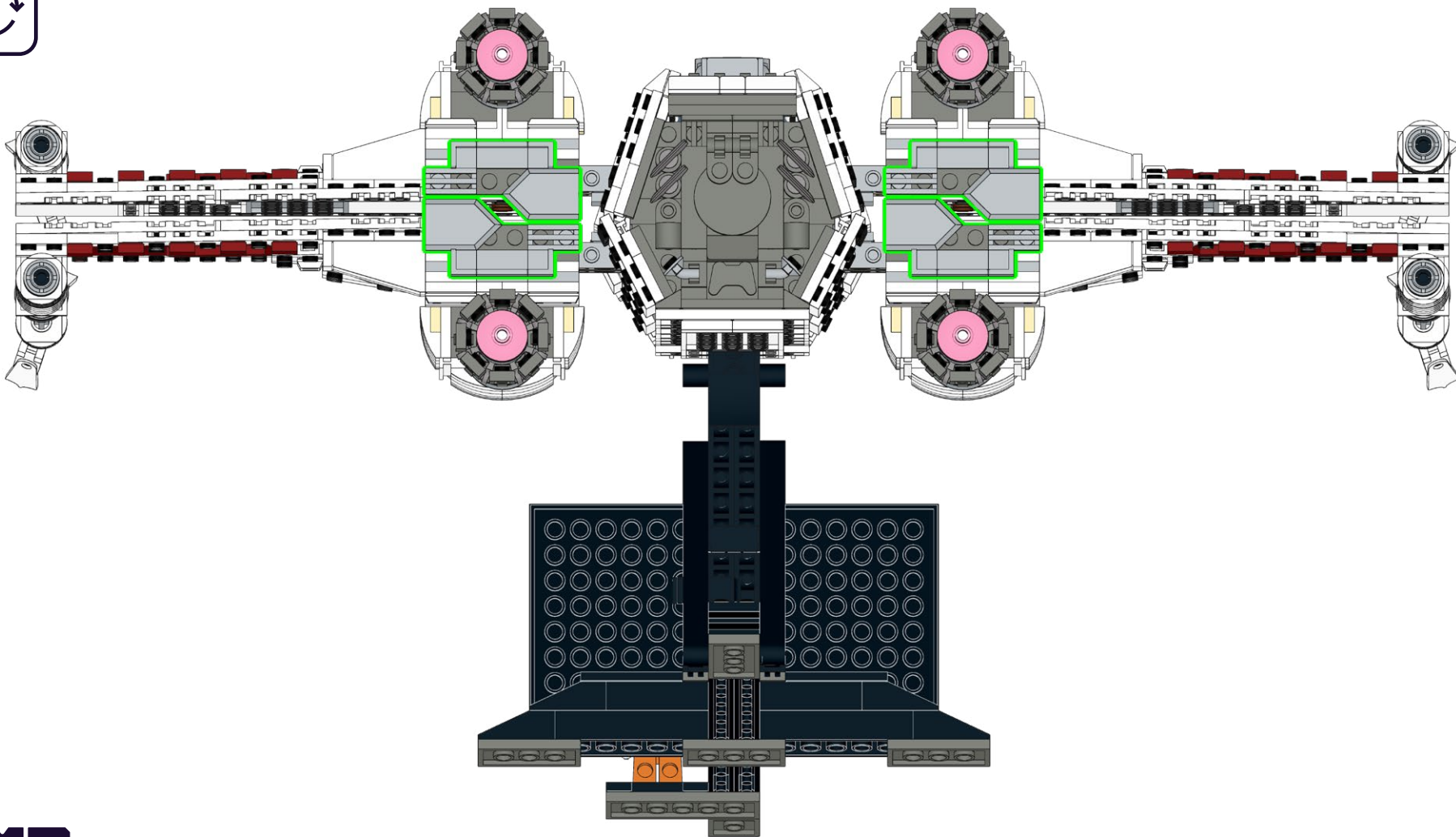



630

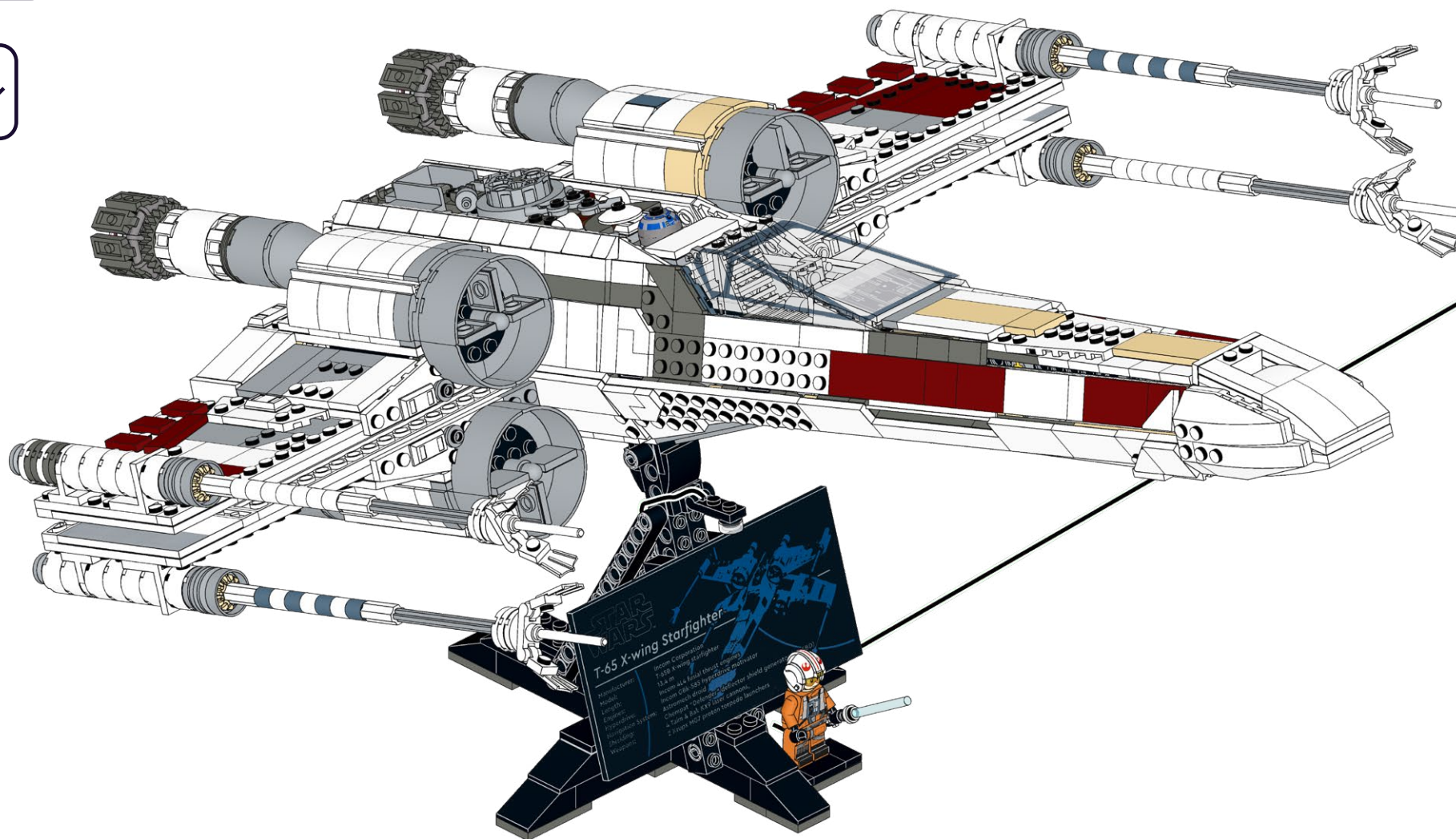

631





632



633





# FINAL PRODUCT



**STAR WARS**  
**T-65 X-wing Starfighter**

Manufacturer:	Incom Corporation
Height:	12.4 m
Length:	13.4 m
Wingspan:	13.4 m
Propulsion:	4 Ion engines
Armaments:	2 proton torpedoes
Defenses:	Deflector shield generator (100 SBD)



# PACKAGE CONTENTS



**4x** AL-P30  
Astro Light Large  
Pink 30cm



**1x** FLX-B  
Flux Belt



**1x** T-1x4  
Tether 1x4



**2x** AL-CW15  
Astro Light Large  
Cool White 15cm



**2x** D-3  
Dock-3



**2x** A-CAP  
Astro Cap



**1x** AR-FR15  
Astro Light Regular  
Flashing Red 15cm



**1x** D-6  
Dock-6



**1x** LS-B30  
Astro Lightsaber  
Blue 30cm



**1x** E-1x2  
Eclipse 1x2



**2x** B-15  
Belt 15cm

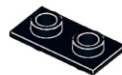

**1x** T-1x2  
Tether 1x2

# PACKAGE CONTENTS



**4x** Round Plate 1x1 - White



**1x** Tile, Modified 1x1 with Open O Clip - Black



**3x** Round Plate 1x1 w Open Stud - Black

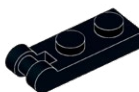

**1x** Plate, Modified 1x2 with Bar Handle on End - Black



**1x** Bracket, 1x1 - 1x1 Light Grey

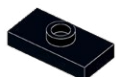

**1x** Plate, Modified 1x2 with 1 Stud with Groove and Bottom Stud Holder (Jumper) - Black

# CONTACT US

Click below for customer support, or general inquiries.

Cliquez ci-dessous pour accéder au support client ou aux renseignements généraux.

Clicca qui sotto per l'assistenza clienti o per richieste generali.

Contact Us



Contactez-nous



Contattaci



Klicken sie unten für kundensupport oder allgemeine anfragen.

Haga clic a continuación para atención al cliente o consultas generales.

点击下方获取客户支持或一般咨询。

Kontaktieren sie uns



Contáctanos



联系我们



## TROUBLESHOOTING

If you're stuck, scan the QR code for troubleshooting.

Se sei bloccato, scansiona il codice QR per la risoluzione dei problemi.

Wenn Sie nicht weiterkommen, scannen Sie den QR-Code zur Fehlerbehebung.

Si vous êtes bloqué, scannez le code QR pour le dépannage

Si está atascado, escanee el código QR para solucionar el problema.

如果遇到问题, 请扫描二维码进行故障排除

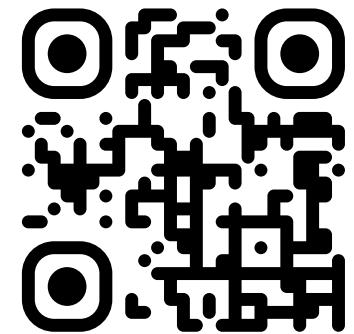





# LIGHTMYBRICKS

[lightmybricks.com](http://lightmybricks.com)



LEGO® is a trademark of the LEGO Group of companies, which does not sponsor, authorize or endorse this product. All LEGO® sets featured in images are sold separately. This is not a LEGO® product. The LEGO Group is not liable for any loss, injury or damage arising from the use or misuse of this product. ©2024 Light My Bricks Pty Ltd. All rights reserved. [www.lightmybricks.com](http://www.lightmybricks.com)

Our components are designed and packaged in Australia by Light My Bricks Pty Ltd. Components are manufactured in China. 3fl bldg C, Shuanghuan Quanxin Technology Information Industry Park Baolong Street, Longgang District, Shenzhen, China. Imported in Australia by Light My Bricks Pty Ltd, 5/26 Rushdale St, Knoxfield, VIC, 3180, Australia.

WARNING: CHOKING HAZARD - Small parts. Not for children under 3 years.

AVERTISSEMENT : RISQUE D'ÉTOUFFEMENT - Petites pièces. Ne convient pas aux enfants de moins de 3 ans.

ATTENZIONE: PERICOLO DI SOFFOCAMENTO - Piccole parti. Non adatto a bambini di età inferiore a 3 anni.

WARNUNG: ERSTICKUNGSGEFAHR - Kleine Teile. Nicht für Kinder unter 3 Jahren geeignet.

ADVERTENCIA: PELIGRO DE ASFIXIA - Piezas pequeñas. No son apto para niños menores de 3 años.

警告：窒息危险 - 小零件。不适合3岁以下儿童。