

LIGHT KIT INSTALLATION GUIDE

DISNEY 'UP' HOUSE

FOR
LEGO SET
#43217



CONTENTS



03

Getting Started

- 04** Legend
- 05** Component Handling
- 06** Blueprint

06

Instructions

- 06** LEGO Bag 1
- 41** LMB Bag 01
- 44** LEGO Bag 2
- 77** LEGO Bag 3
- 94** LMB Bag 02 & LEGO Bag 4
- 115** LMB Bag 03 & 04

179

Final Product

- 180** Package Contents
- 181** Contact & Troubleshooting

GETTING STARTED



Bold, beautiful and bright, Light My Bricks elevates your favourite LEGO set from knick-knack to statement piece. Create a talking point at home or in the office that speaks to your passions with Light My Bricks. To learn more, click below.

[Learn More](#)



Audacieux, beau et lumineux, Light My Bricks élève votre ensemble LEGO préféré du statut de bibelot à celui de pièce maîtresse. Que ce soit à la maison ou au bureau, partagez votre passion des LEGO avec Light My Bricks. Cliquez ci-dessous pour en savoir plus.

[En savoir plus](#)



Audace, bello e luminoso, Light My Bricks eleva il tuo set LEGO preferito da soprammobile a pezzo di tendenza. Crea un punto di discussione a casa o in ufficio che parli alle tue passioni con Light My Bricks. Per saperne di più, clicca qui sotto.

[Ulteriori Informazioni](#)



Mutig, schön und hell – Light My Bricks verwandelt Ihr Lieblings-LEGO-Set von einem schnickschnack in ein statement-stück. Schaffen sie einen gesprächspunkt zu hause oder im büro, der Ihre leidenschaften widerspiegelt, mit Light My Bricks. Um mehr zu erfahren, klicken sie unten.

[Mehr erfahren](#)



Audaz, hermoso y brillante, Light My Bricks eleva tu set LEGO favorito de una chuchería a una pieza llamativa. Crea un tema de conversación en casa o en la oficina que hable de tus pasiones con Light My Bricks. Para obtener más información, haga clic a continuación.

[Más información](#)



大胆、美丽而明亮，Light My Bricks 将你喜爱的乐高套装从小摆件提升为引人注目的装饰品。在家或办公室打造一个能表达你激情的话题，了解更多，请点击下方。

[了解更多](#)



LEGEND

Rotate Set



Girar
Drehen
Tourner
Ruotare
Вращать
旋转
回転する
دوراتسا

Add Part



Voltear
Umkippen
Basculer
Ribaltarsi
Опрокидываться
翻倒
転がる
نارود

Click



Clic
Klick
Cliquer
Clic
Нажмите
点击
クリック
انقر

Pinch/Fold



Pliegue
Falte
Pli
Piega
Отключить
折痕
折り目
دعجت

Pull Cable



Tire del Cable
Kabel Ziehen
Câble de Traction
Tirare il Cavo
Тяговый Кабель
拉线
ケーブルを引く
لباك دش

Repeat Step



Repetir
Wiederholen
Répéter
Ripetere
Повторить
重复
繰り返す
ررركي

Sticker



Pegatina
Aufkleber
Autocollant
Etichetta
Наклейка
贴纸
ステッカー
ملصق

Power On Test



Encender
Einschalten
Allumer
Accendere
Включить
打开
電源オン
عوض ل لايغش ت ب مق

Disconnect Power



Desconectar
Trennen
Déconnecter
Disconnetti
Отключить
断开
電気を切る
ءابرهكك ل لصف

Troubleshoot



Resolución de Problemas
Probleme Lösen
Résolution De Problème
Risoluzione Dei Problemi
Решение проблем
解决问题
問題解決
لك اشمل ل ح

BLUEPRINT

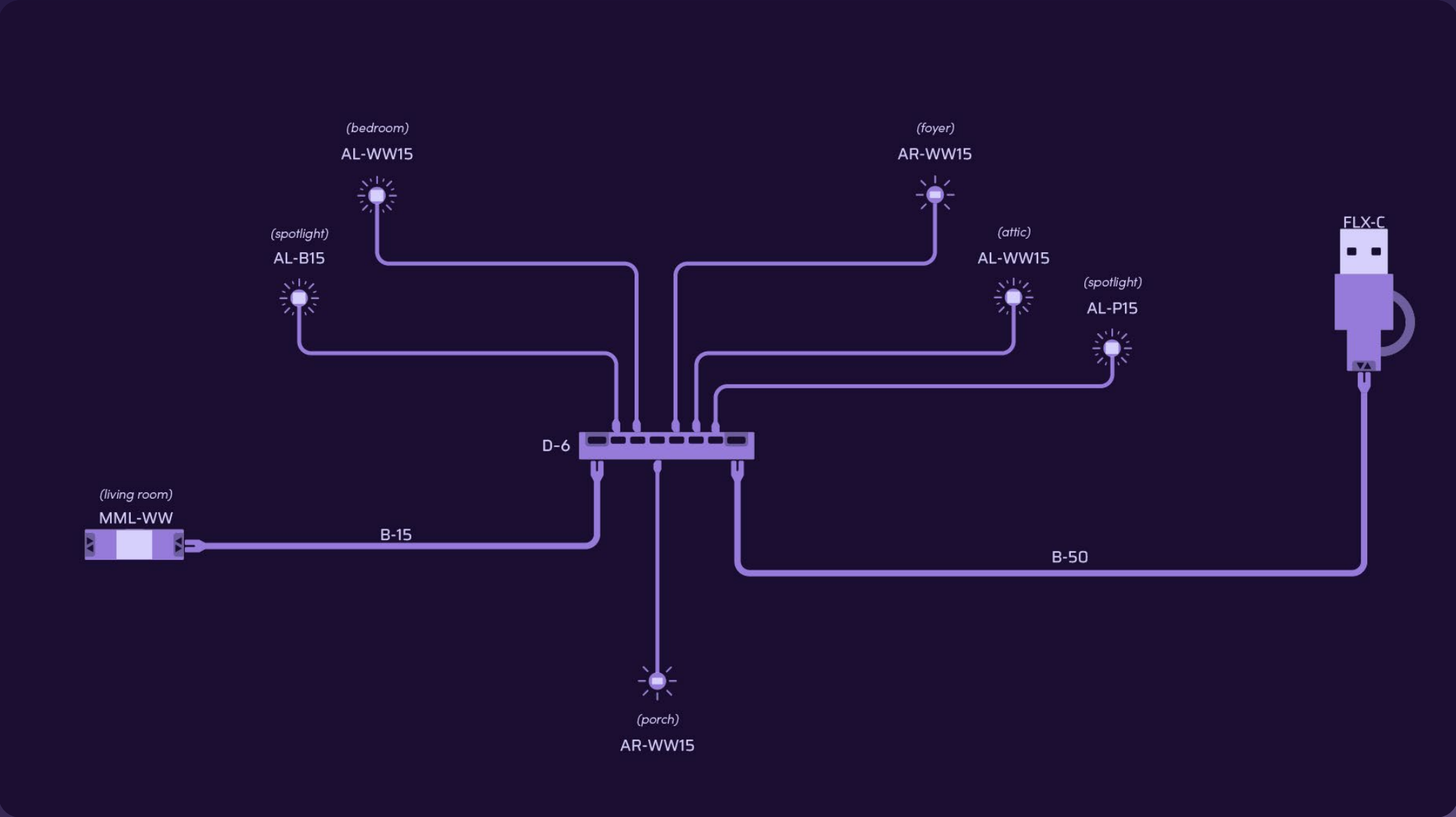

**HOLD UP!**

You might notice some bags are out of order, as well as left over pieces, but that's ok! We're changing the way you build LEGO!

HALTEN!

Möglicherweise stellen Sie fest, dass einige Beutel nicht in Ordnung sind und auch Teile übrig bleiben, aber das ist in Ordnung! Wir verändern die Art und Weise, wie Sie LEGO bauen!

TENIR BON!

Vous remarquerez peut-être que certains sacs sont en panne, ainsi que des morceaux restants, mais ce n'est pas grave ! Nous changeons la façon dont vous construisez LEGO !

SOSTENERE!

Potresti notare che alcune borse sono fuori uso, così come alcuni pezzi avanzati, ma va bene! Stiamo cambiando il modo in cui costruisci i LEGO!

¡SOSTENER!

Puede que notes que algunas bolsas están fuera de orden, así como piezas sobrantes, ¡pero está bien! ¡Estamos cambiando la forma de construir LEGO!

耽误!

您可能会注意到有些袋子坏了, 还有剩余的碎片, 但这没关系! 我们正在改变您搭建乐高的方式!

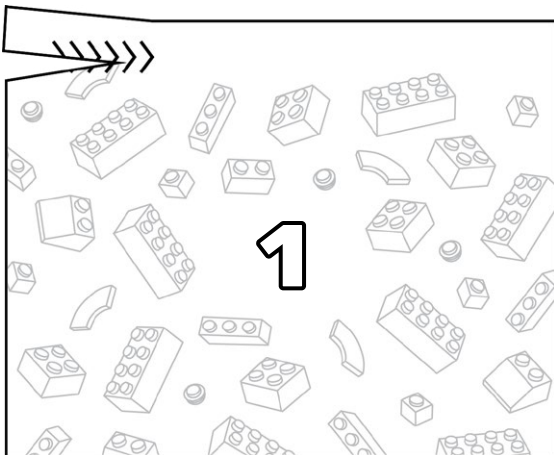
Open LEGO® Bag 1

1

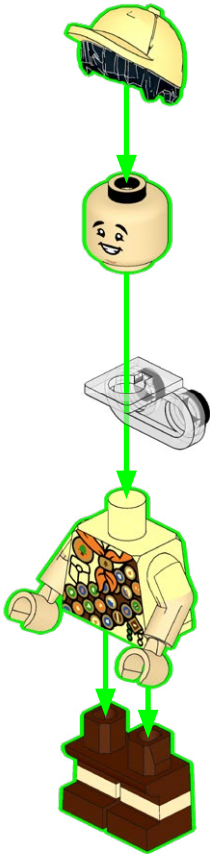
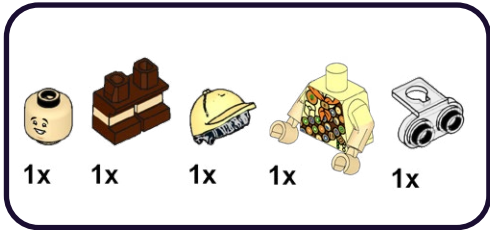

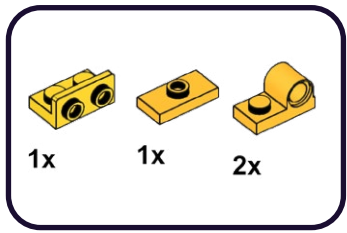

1

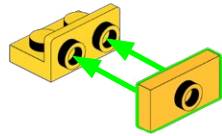

2

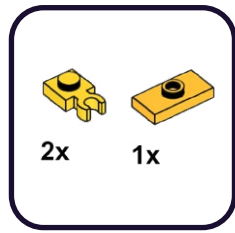
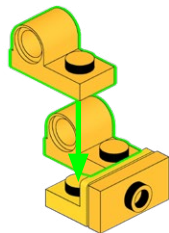

1

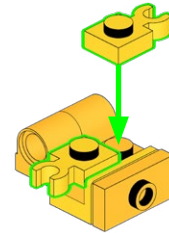

2

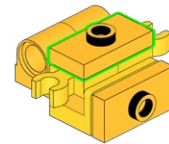

4

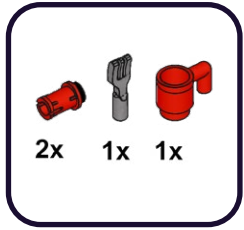

1

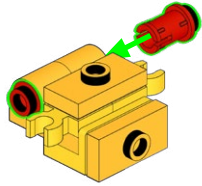

2

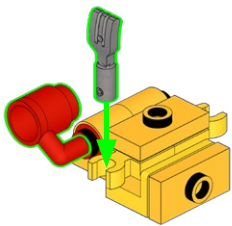

5

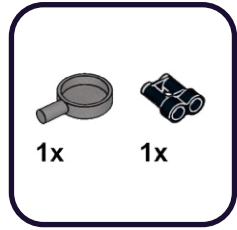

1

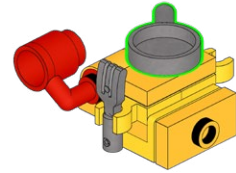

2

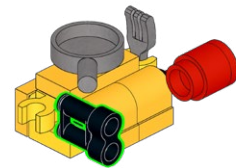
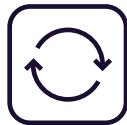

6

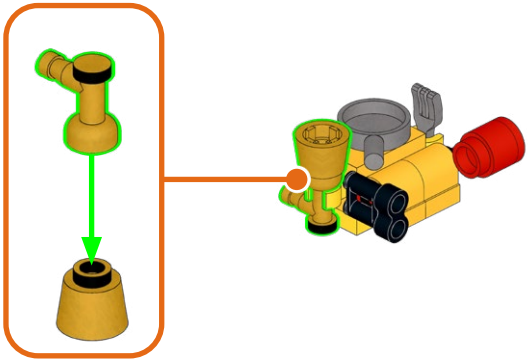
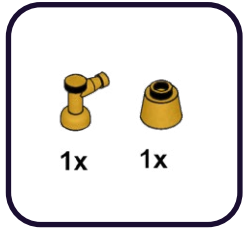

7

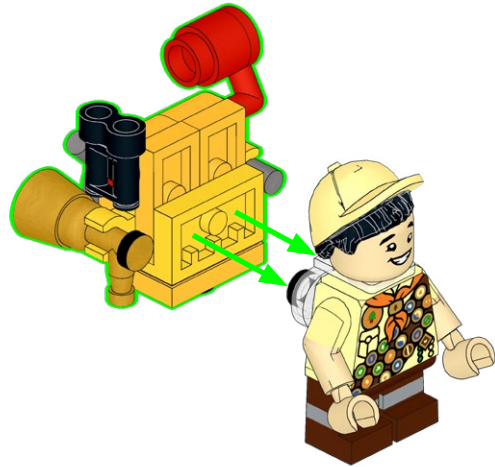

8

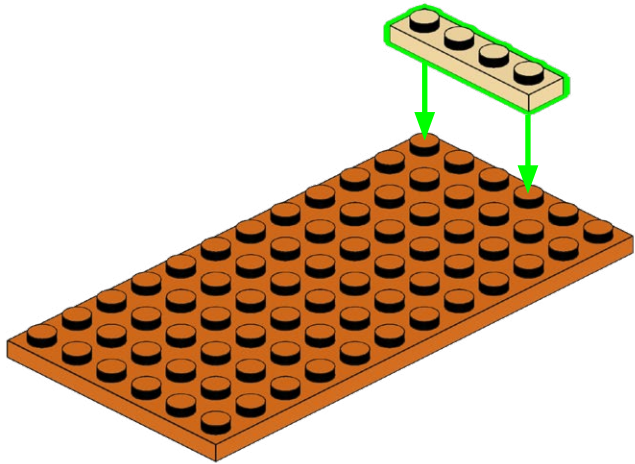
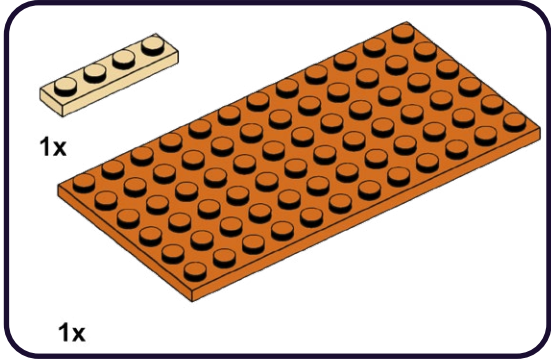

9

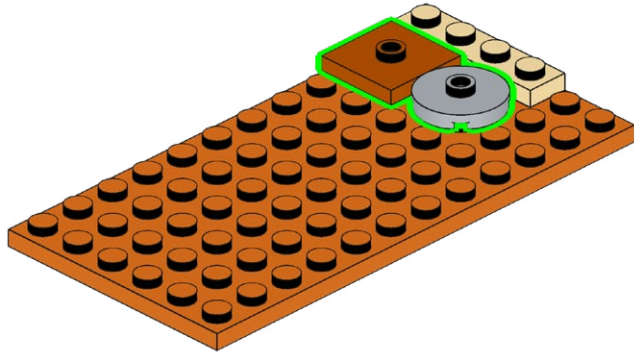
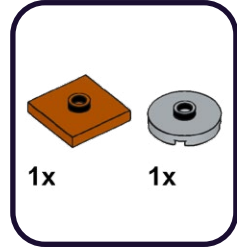

10



1x

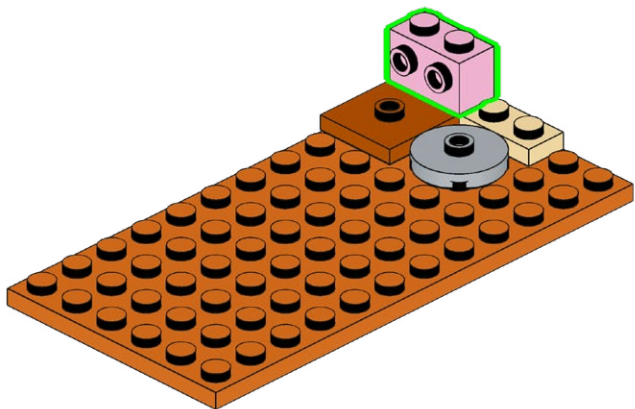

11



1x



1x

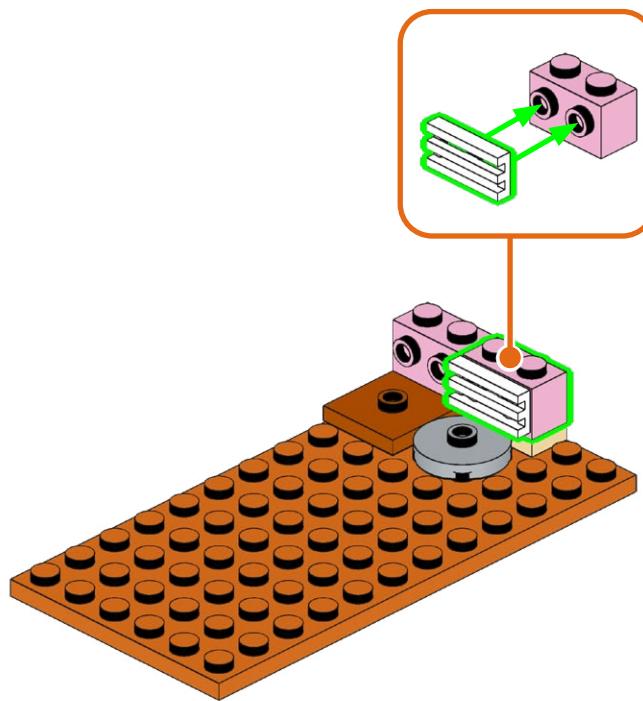

12

1x

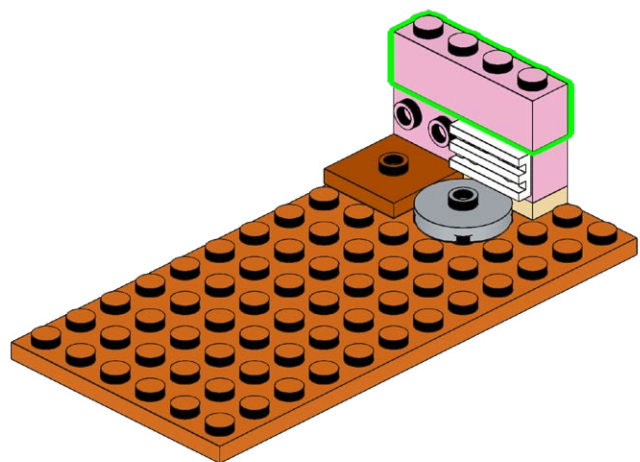
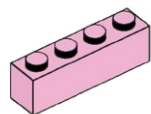

13

1x

1x

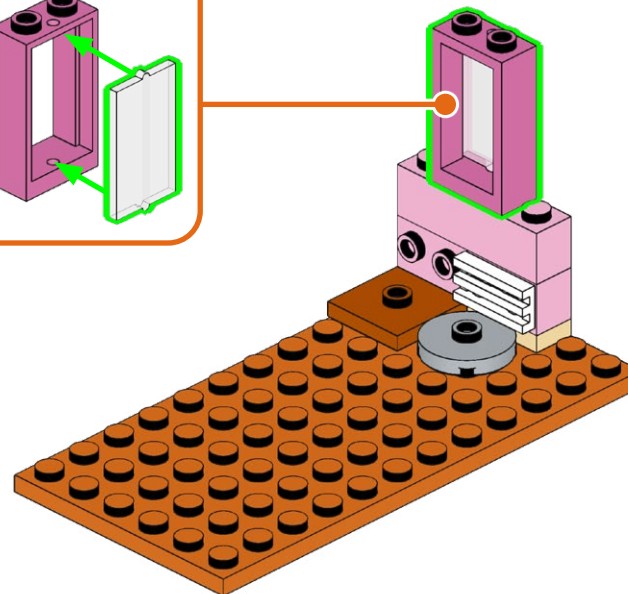
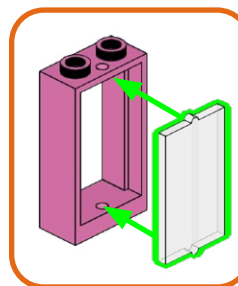
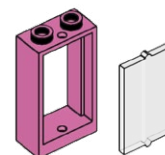

14



6x

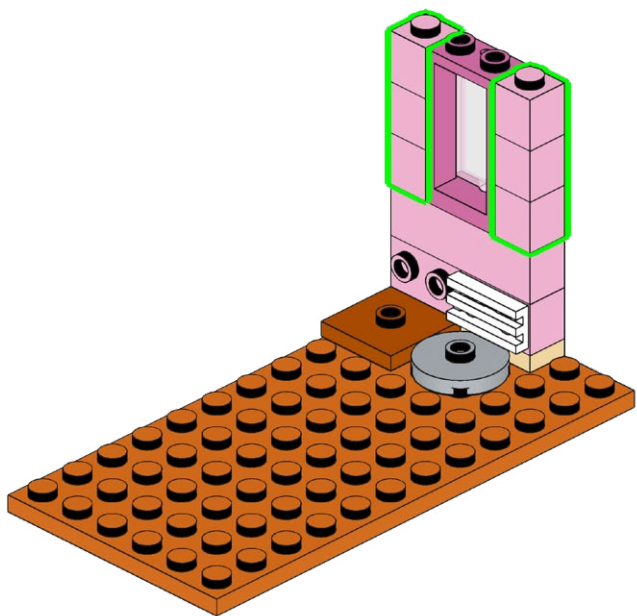

15

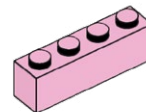

1x



2x

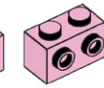

1x



1x

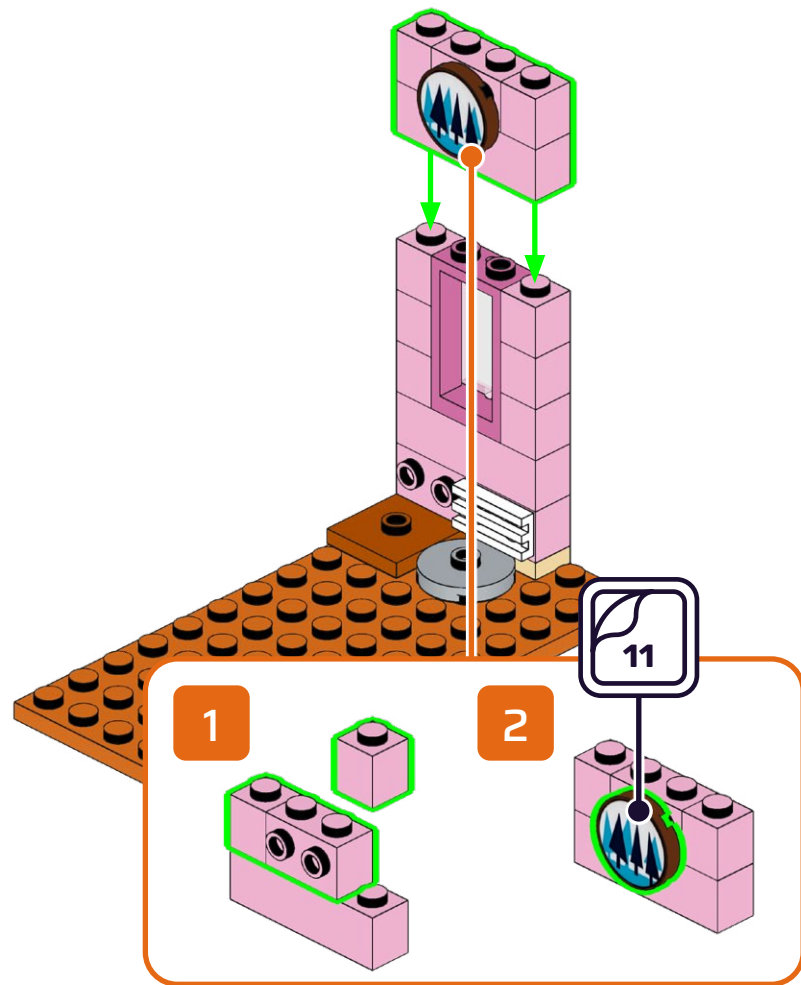

11

1

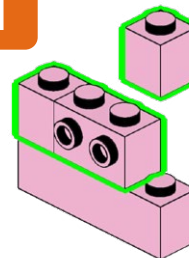

2

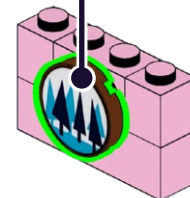

16

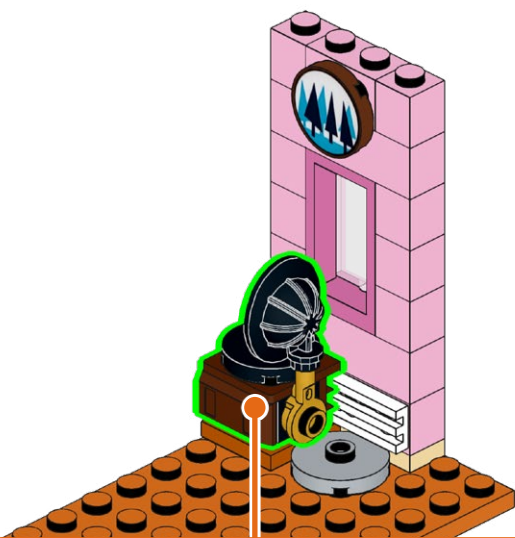
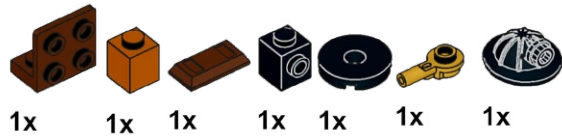

1

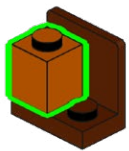

2

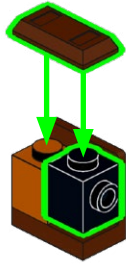

3



4



17

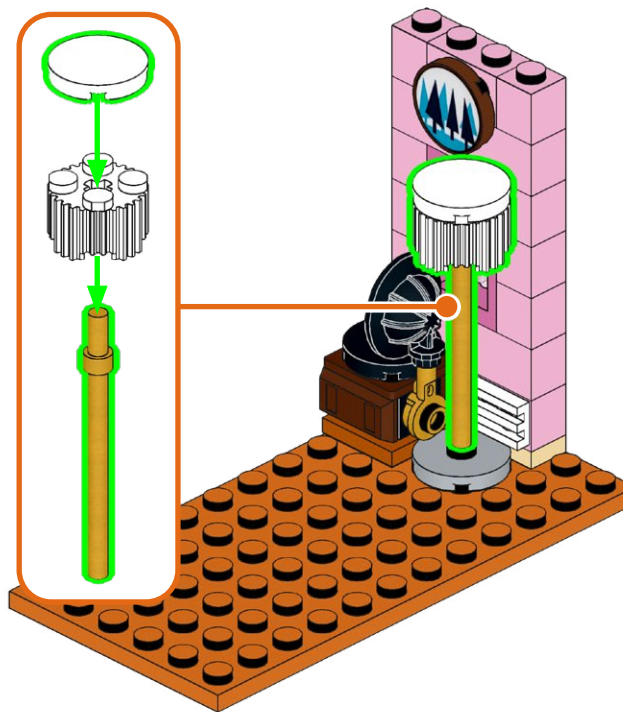
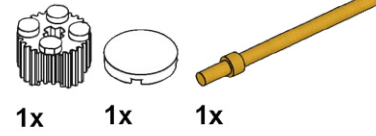

18

1x

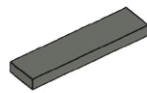

1x

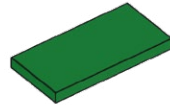

1x

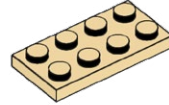

19

1x

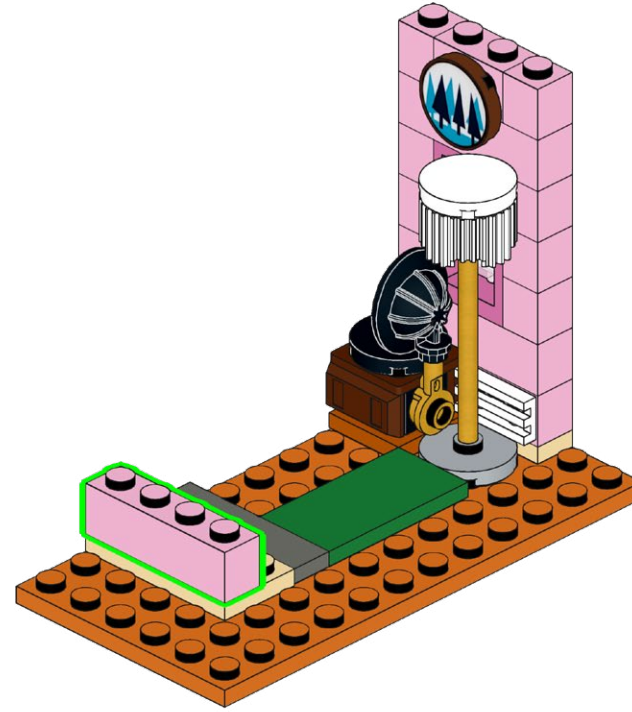
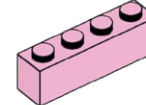

20

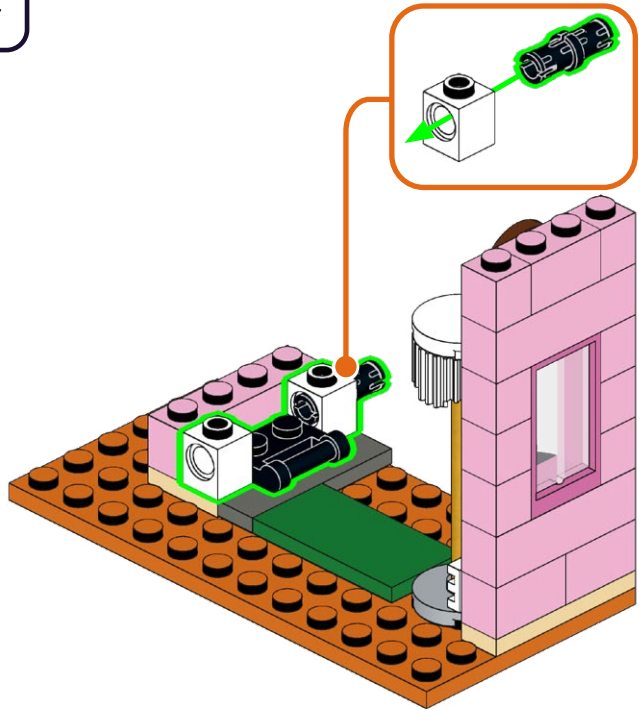
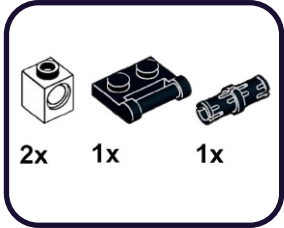

21

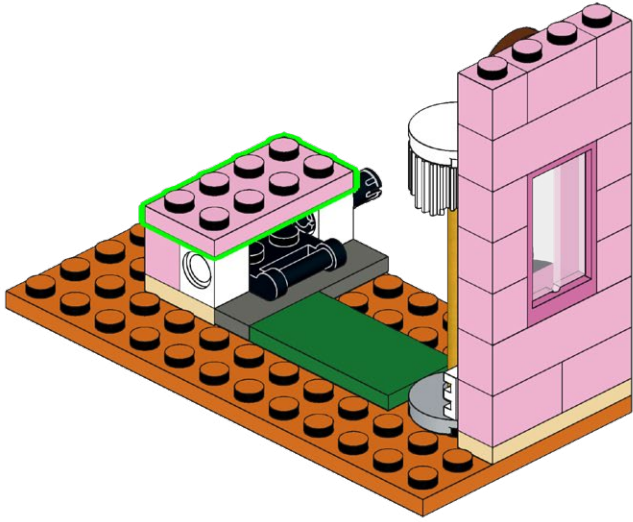
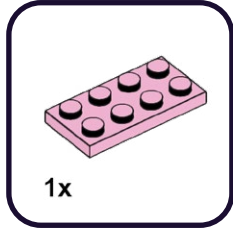

22

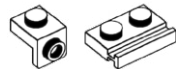

2x 1x

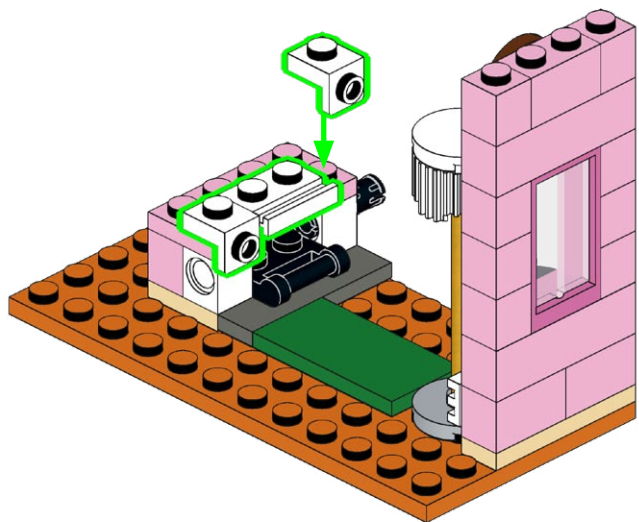

23

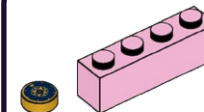

1x 1x

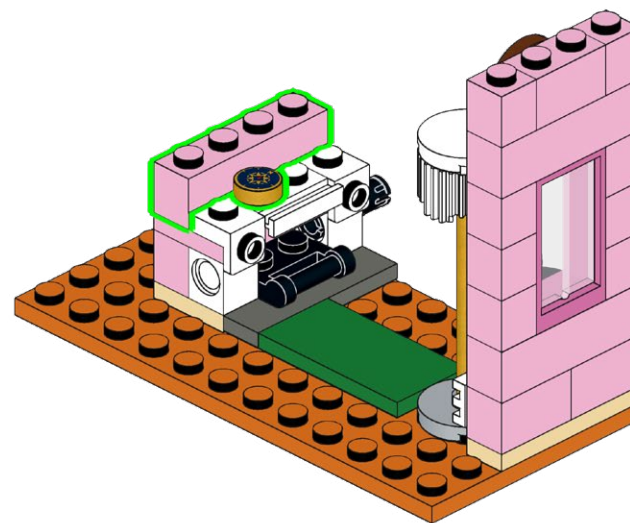

24

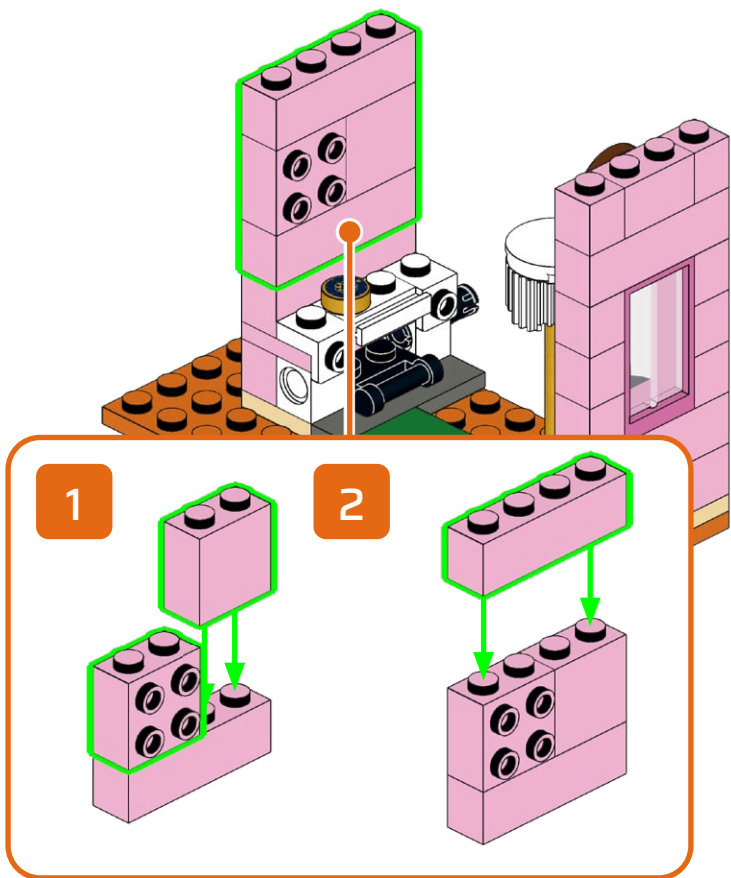
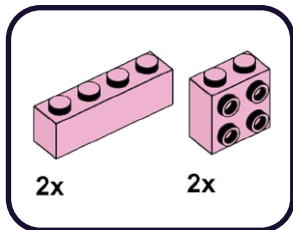

25

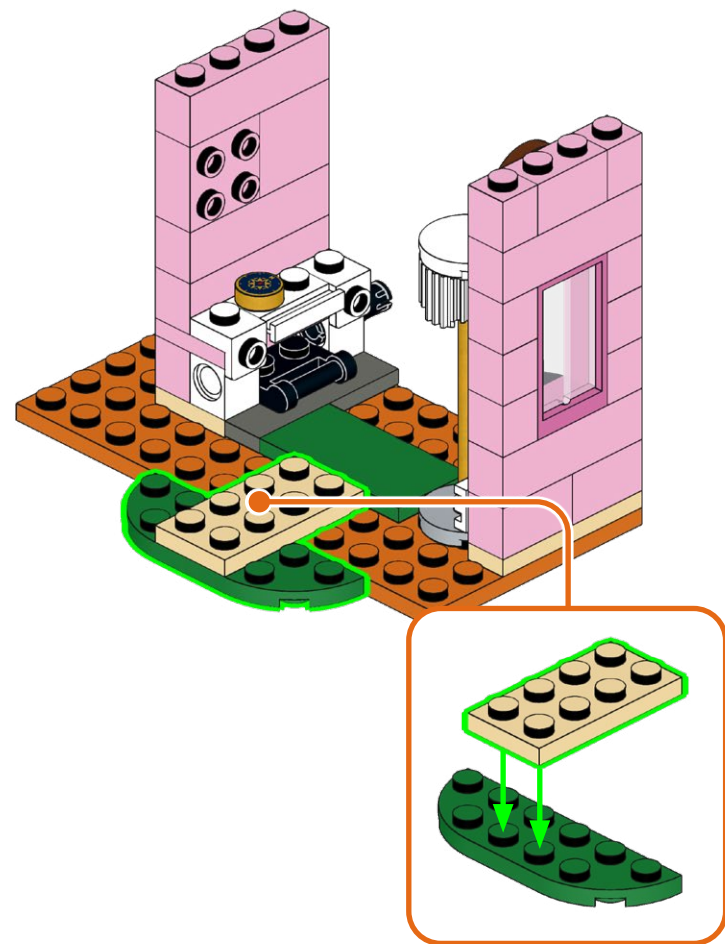
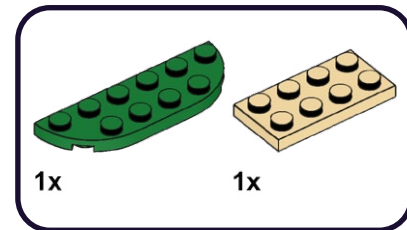

26

2x

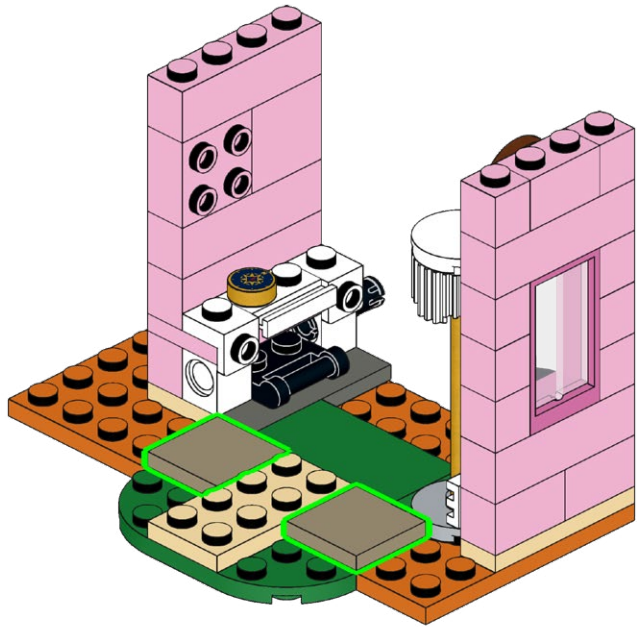

27

1x 2x

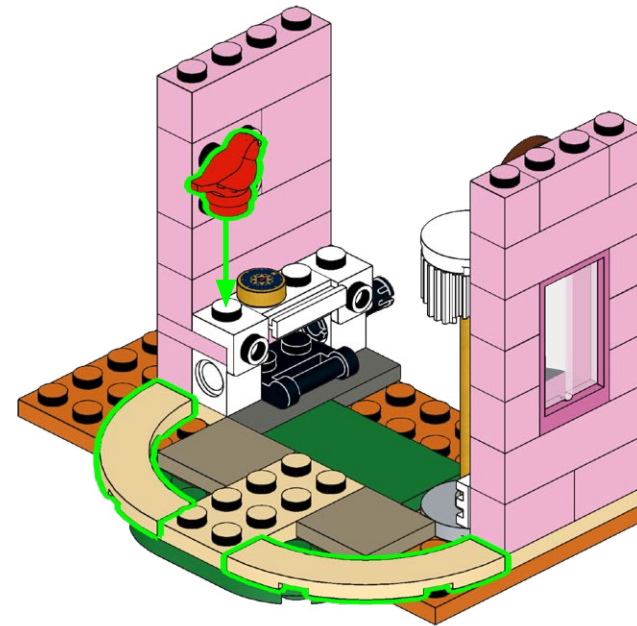

28

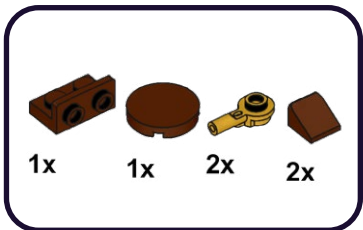

29

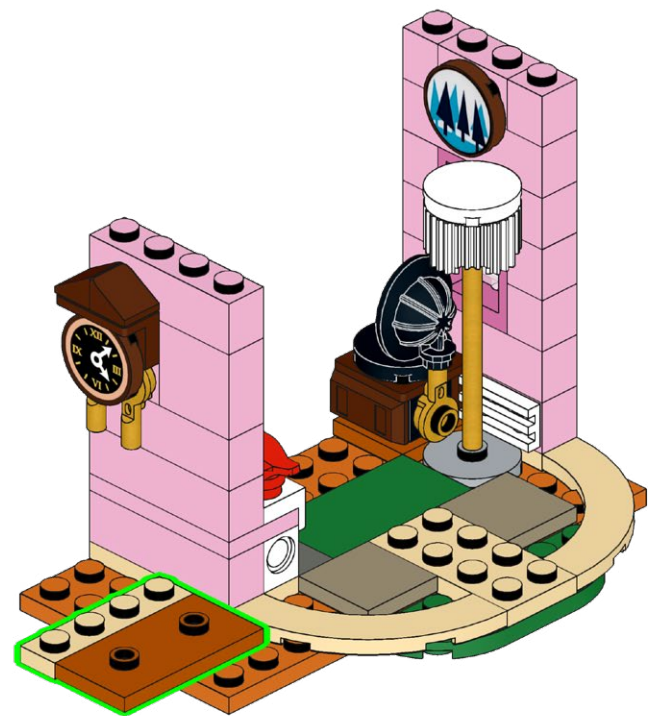
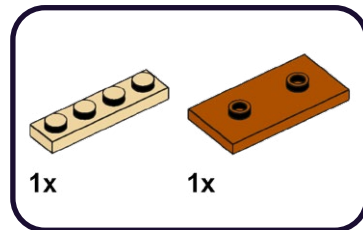

30

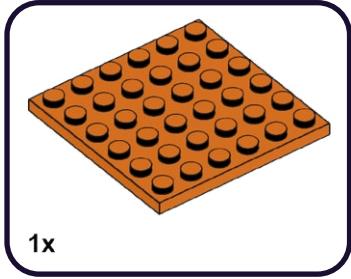

31

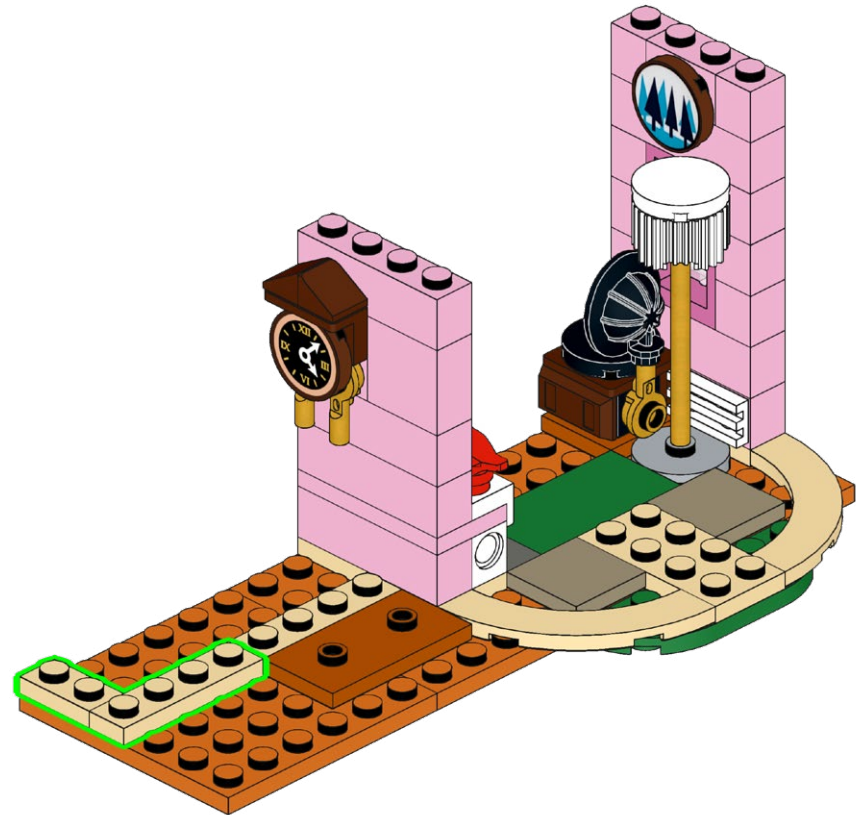
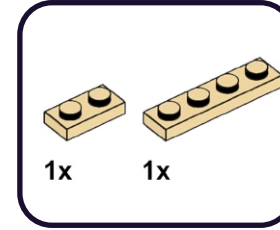

32

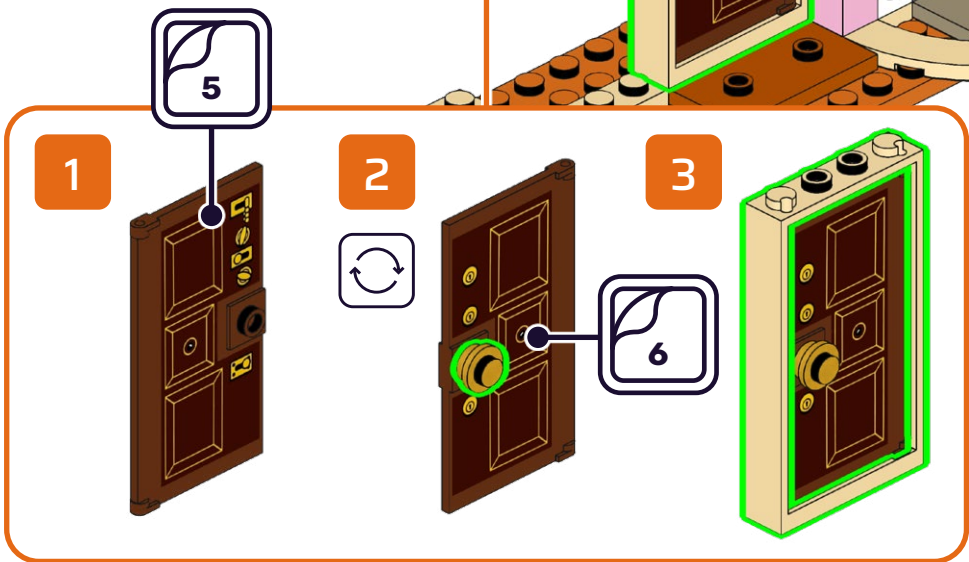
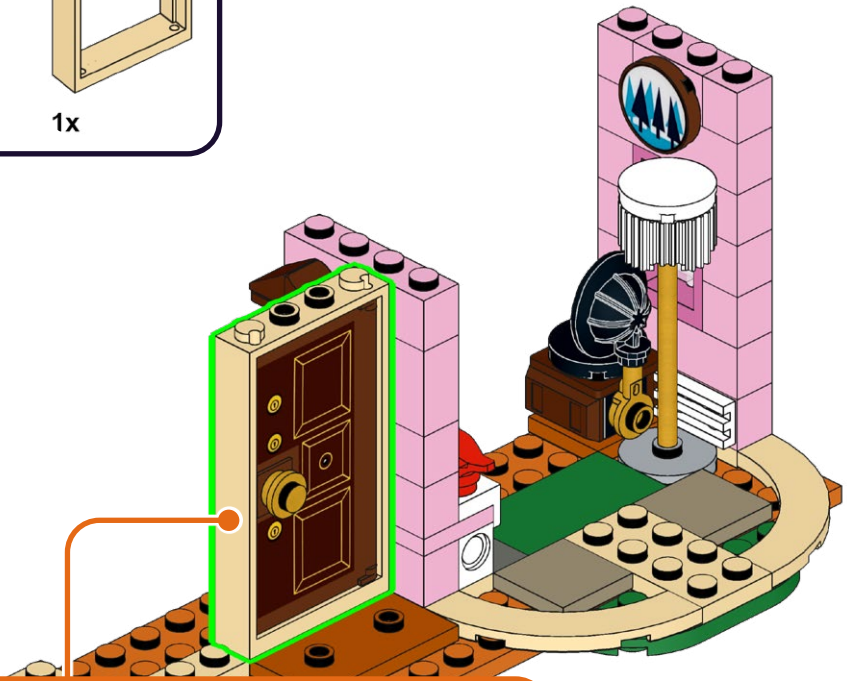
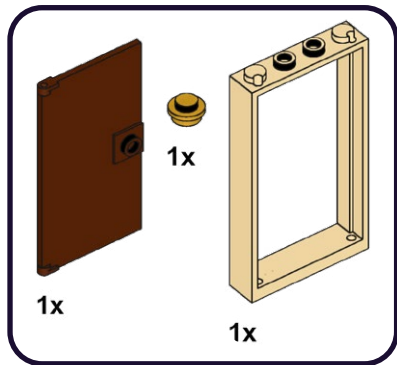

33

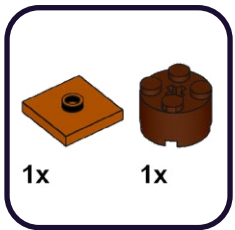

34

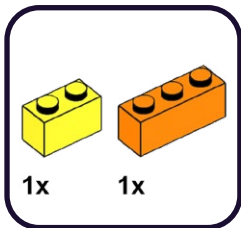

35

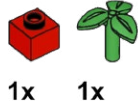

36

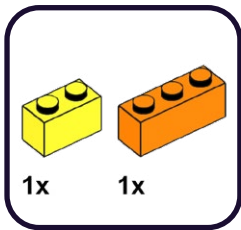

37

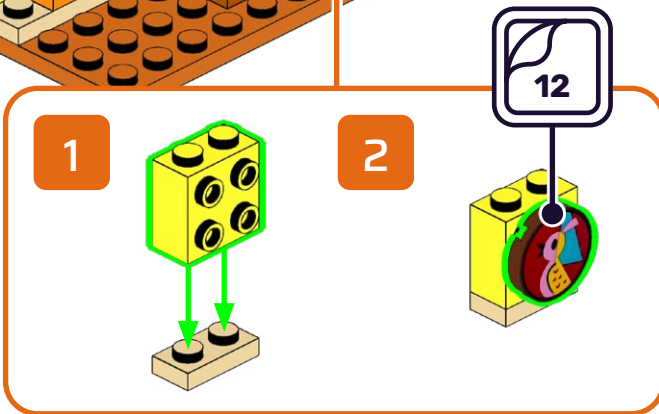
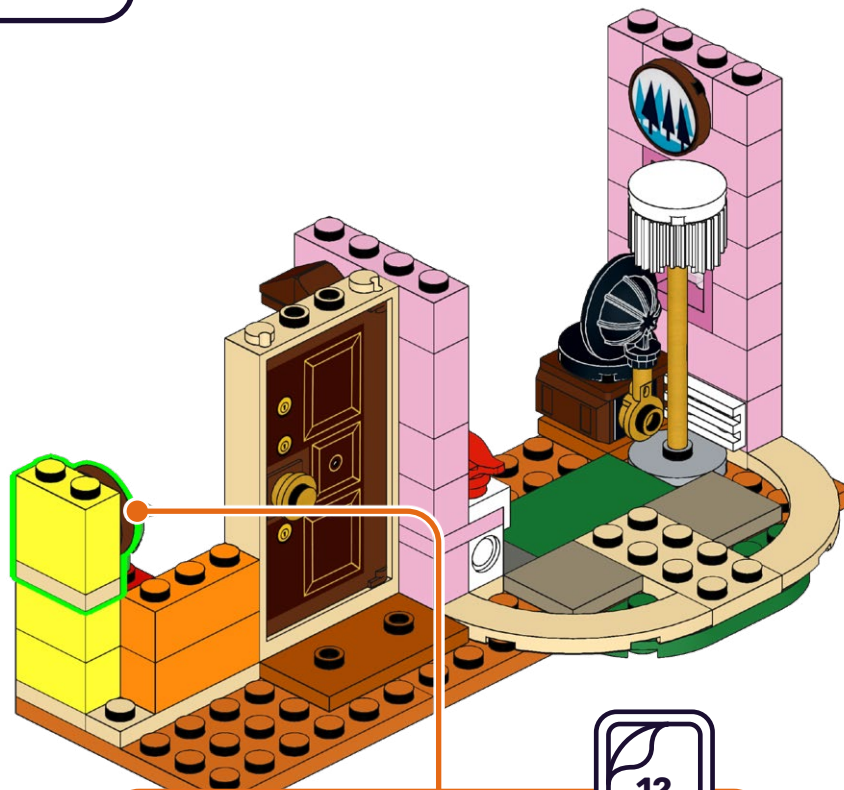
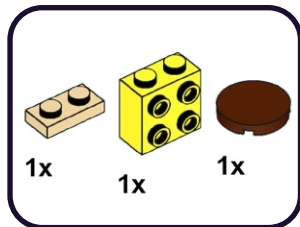

38

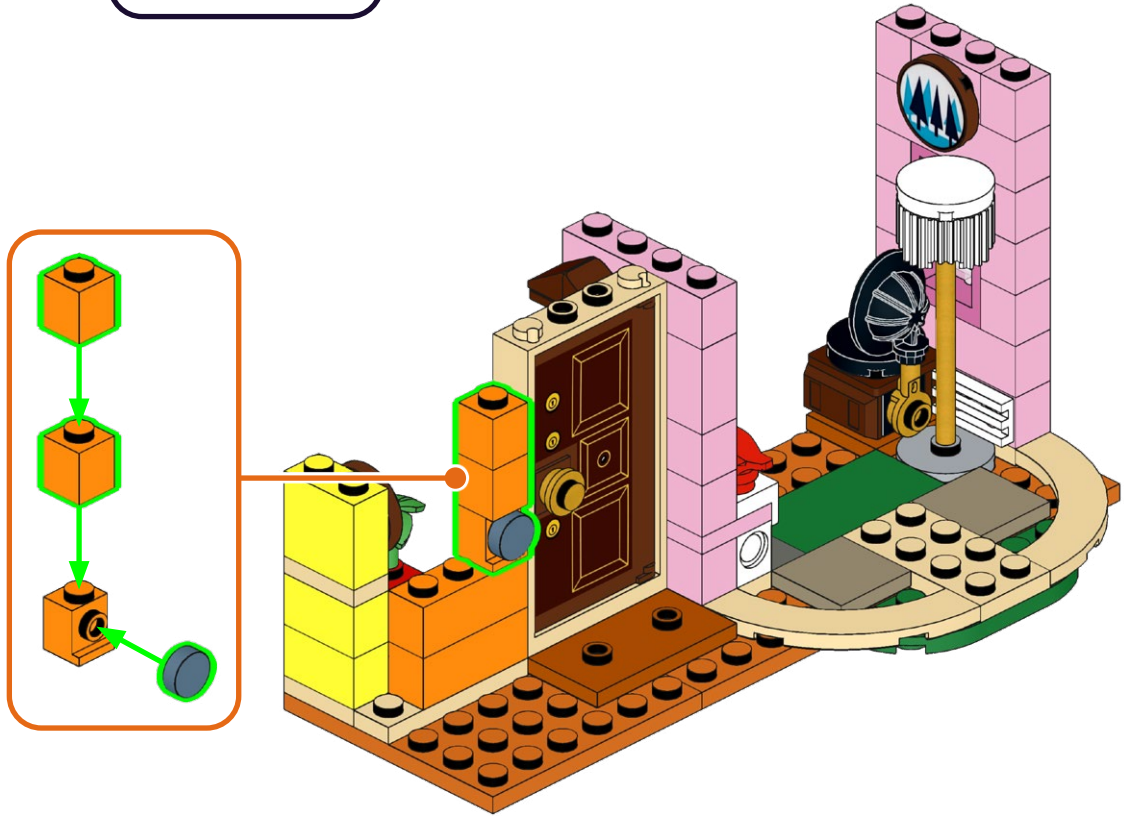
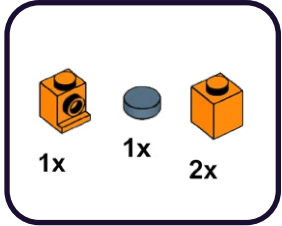

39

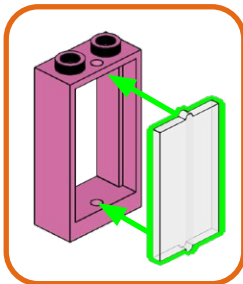
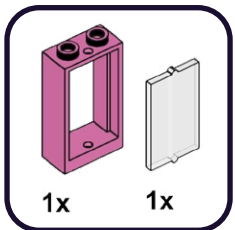

40

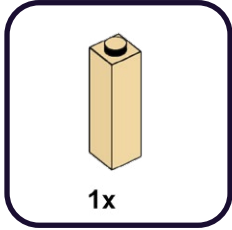

41

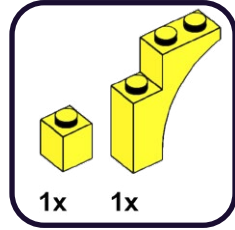

42

1x

1x



43

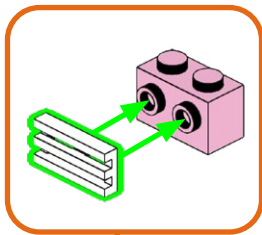
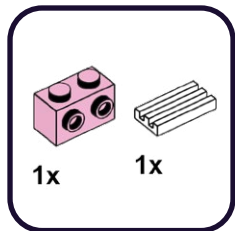

44

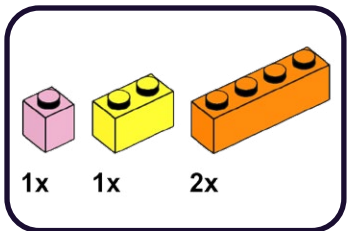

45

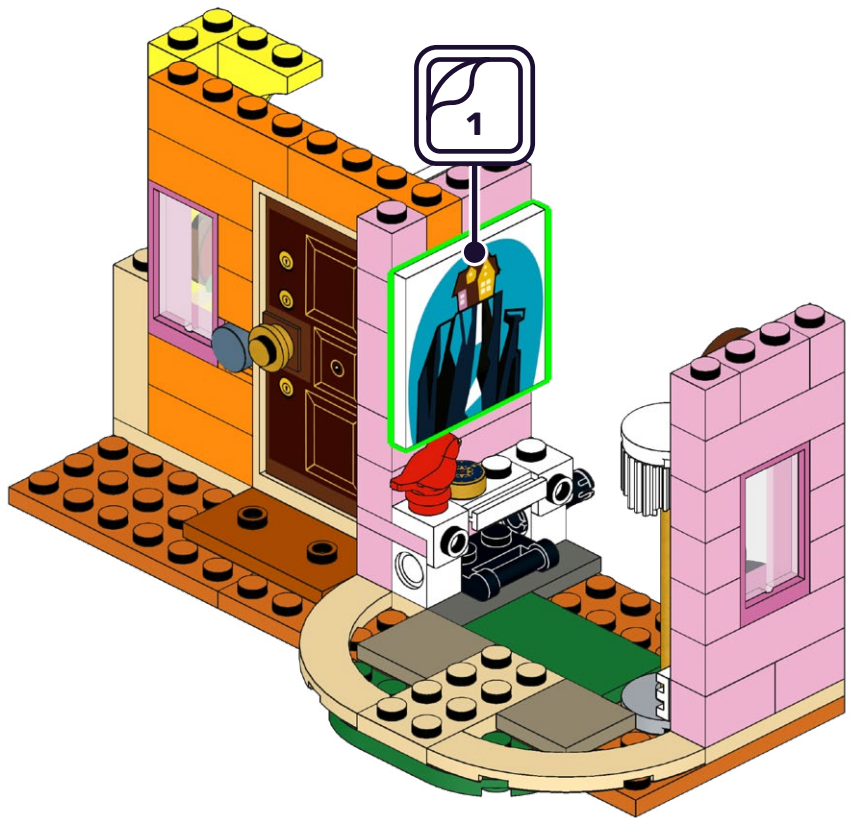
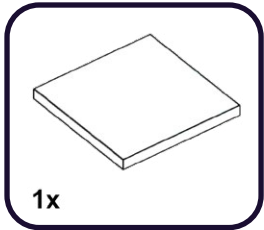

46



4x

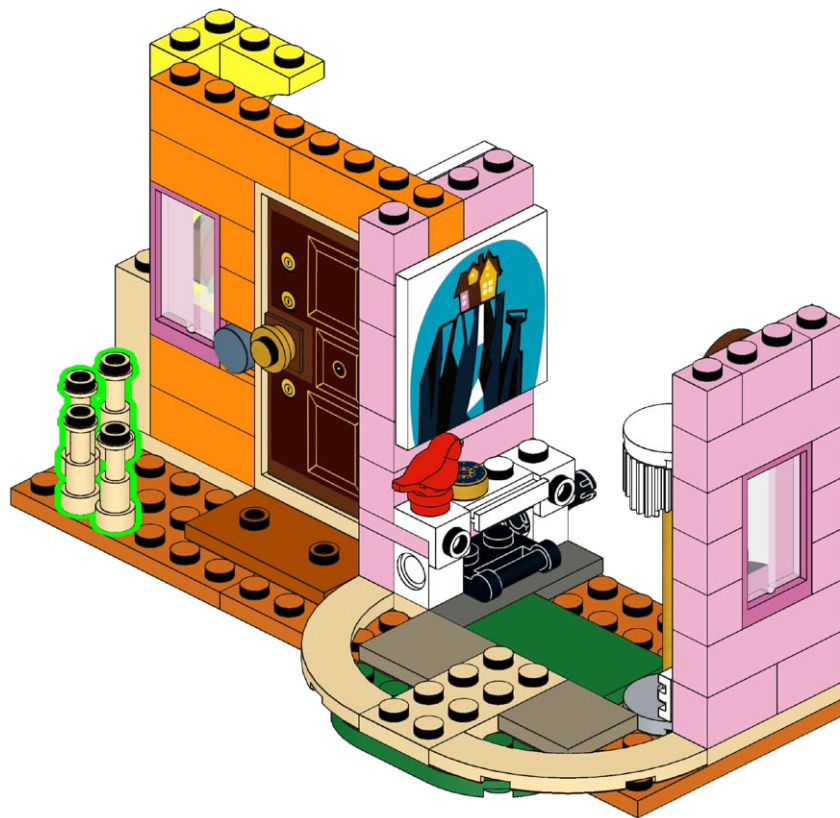

47

2x



48

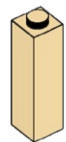

2x

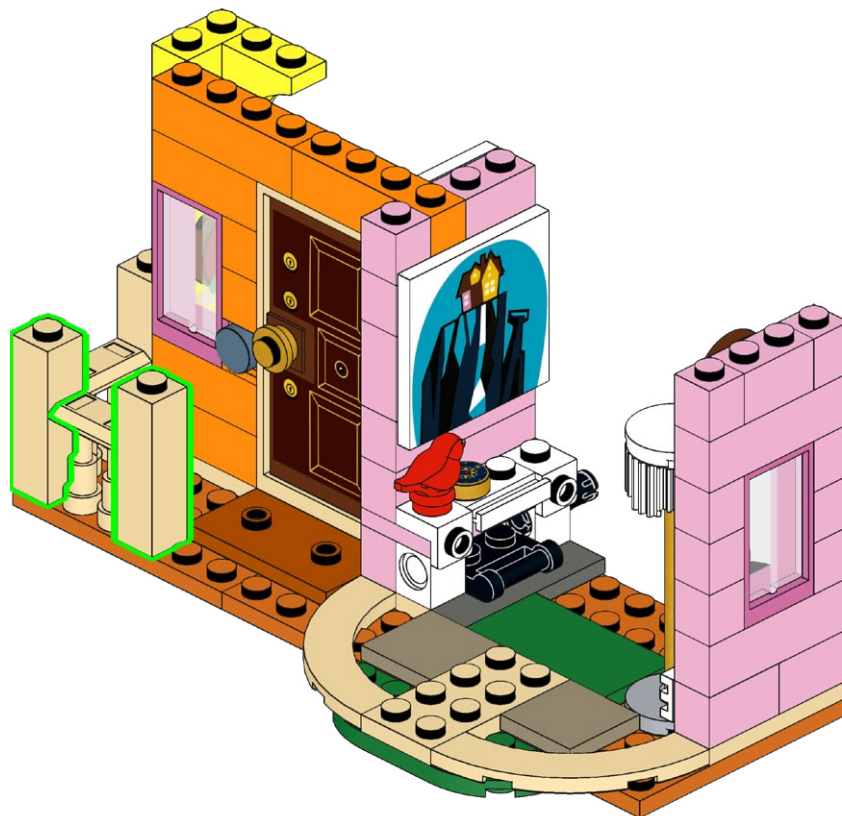

49

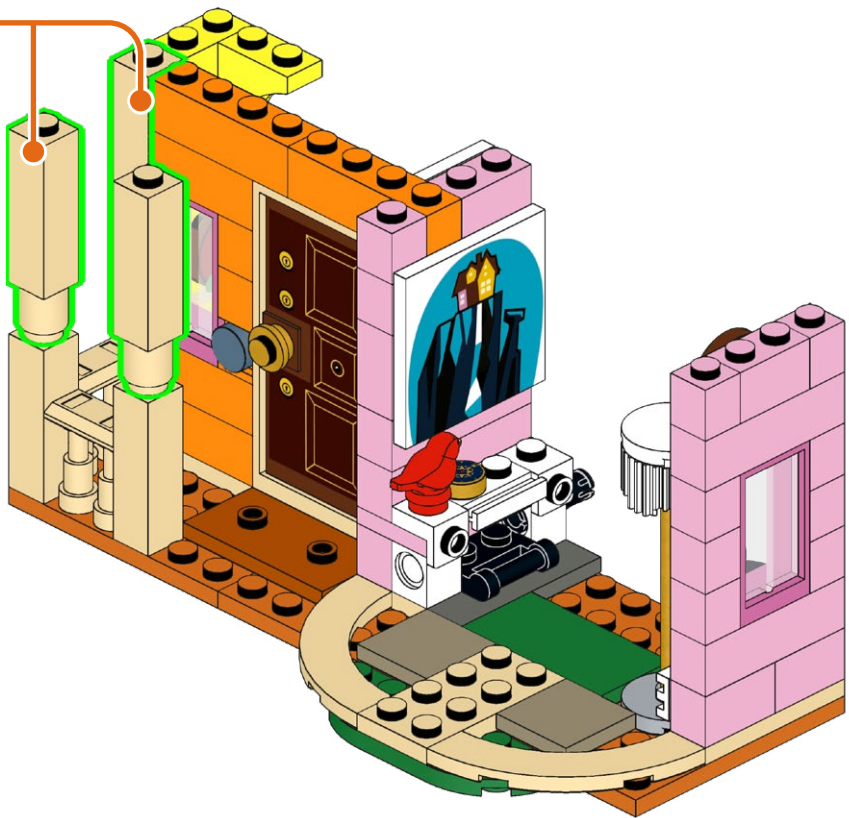
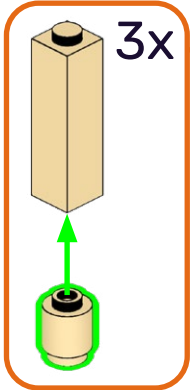
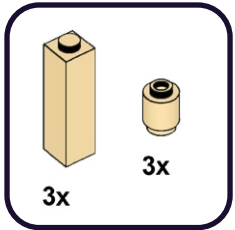

**HOLD UP!**

You might notice some bags are out of order, as well as left over pieces, but that's ok! We're changing the way you build LEGO!

HALTEN!

Möglicherweise stellen Sie fest, dass einige Beutel nicht in Ordnung sind und auch Teile übrig bleiben, aber das ist in Ordnung! Wir verändern die Art und Weise, wie Sie LEGO bauen!

TENIR BON!

Vous remarquerez peut-être que certains sacs sont en panne, ainsi que des morceaux restants, mais ce n'est pas grave ! Nous changeons la façon dont vous construisez LEGO !

SOSTENERE!

Potresti notare che alcune borse sono fuori uso, così come alcuni pezzi avanzati, ma va bene! Stiamo cambiando il modo in cui costruisci i LEGO!

¡SOSTENER!

Puede que notes que algunas bolsas están fuera de orden, así como piezas sobrantes, ¡pero está bien! ¡Estamos cambiando la forma de construir LEGO!

耽误!

您可能会注意到有些袋子坏了, 还有剩余的碎片, 但这没关系! 我们正在改变您搭建乐高的方式!

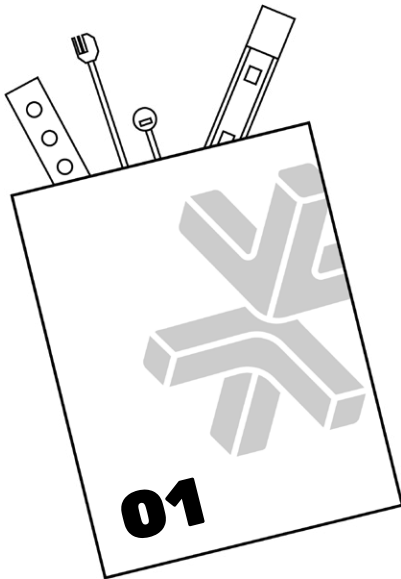
Open LMB Bag 01

50

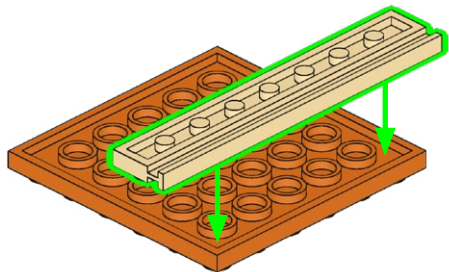
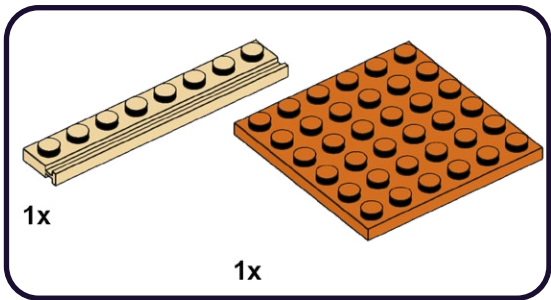

51

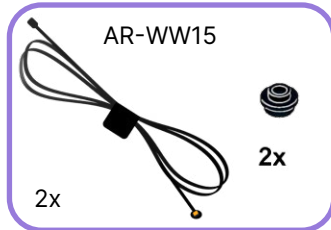

1

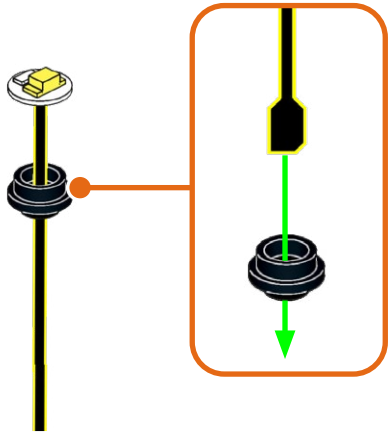

2x

2

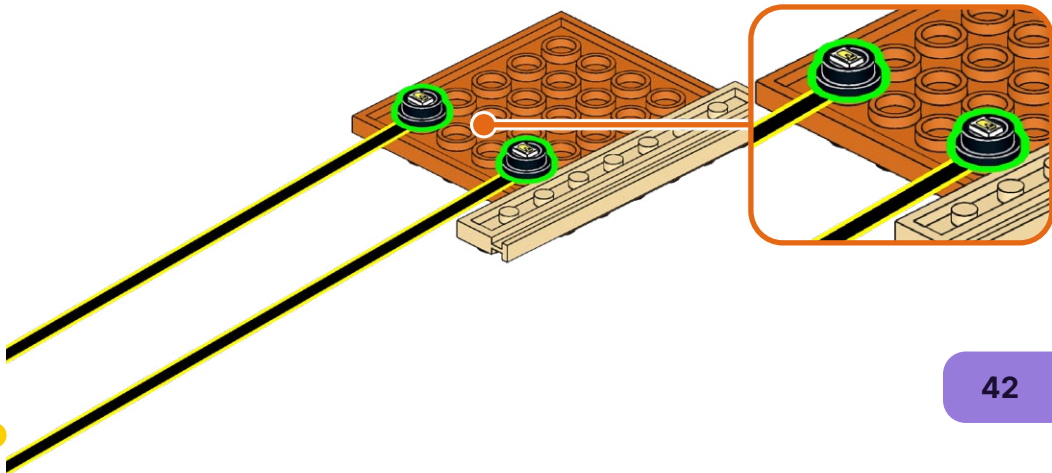

52

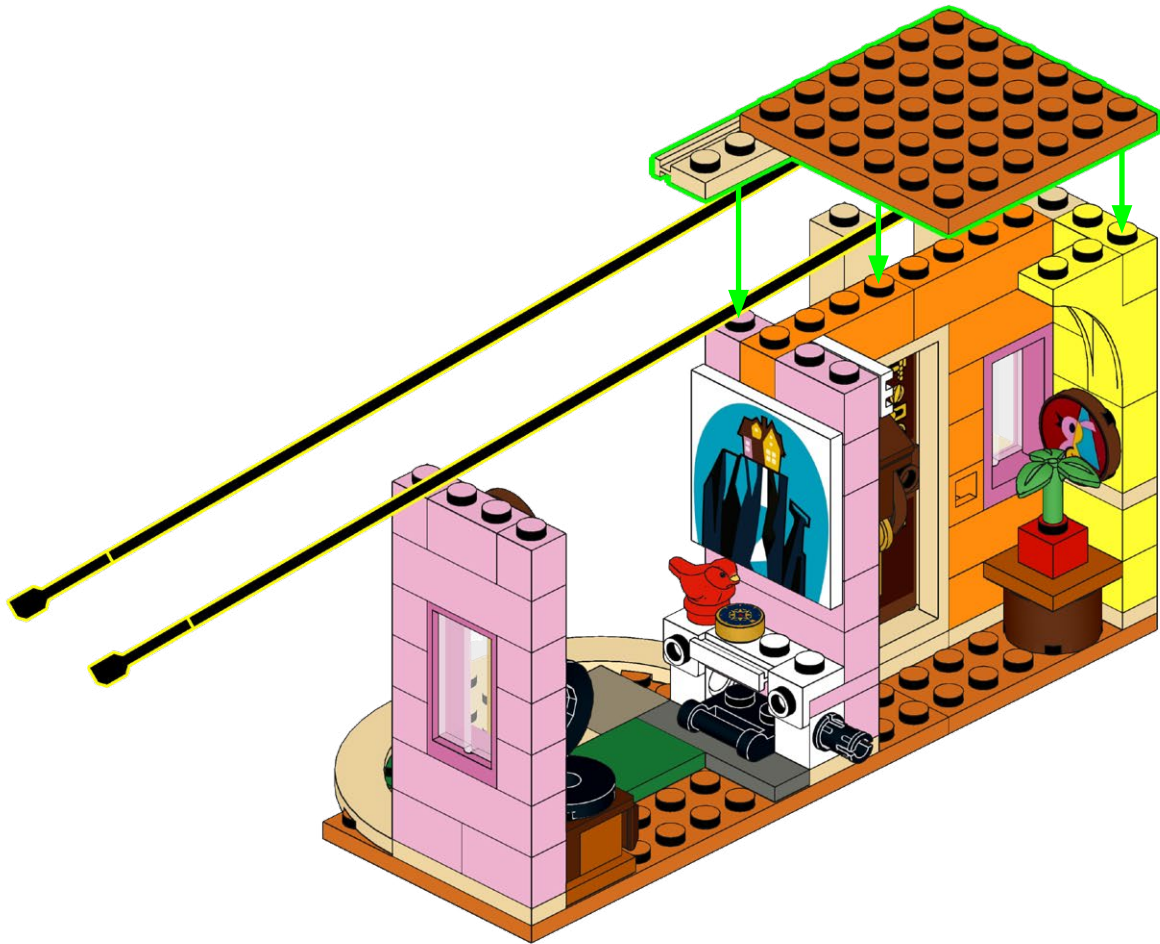

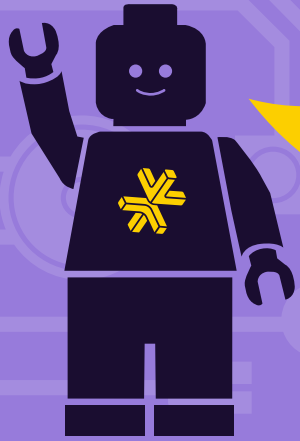
**HOLD UP!**

You might notice some bags are out of order, as well as left over pieces, but that's ok! We're changing the way you build LEGO!

HALTEN!

Möglicherweise stellen Sie fest, dass einige Beutel nicht in Ordnung sind und auch Teile übrig bleiben, aber das ist in Ordnung! Wir verändern die Art und Weise, wie Sie LEGO bauen!

TENIR BON!

Vous remarquerez peut-être que certains sacs sont en panne, ainsi que des morceaux restants, mais ce n'est pas grave ! Nous changeons la façon dont vous construisez LEGO !

SOSTENERE!

Potresti notare che alcune borse sono fuori uso, così come alcuni pezzi avanzati, ma va bene! Stiamo cambiando il modo in cui costruisci i LEGO!

¡SOSTENER!

Puede que notes que algunas bolsas están fuera de orden, así como piezas sobrantes, ¡pero está bien! ¡Estamos cambiando la forma de construir LEGO!

耽误!

您可能会注意到有些袋子坏了, 还有剩余的碎片, 但这没关系! 我们正在改变您搭建乐高的方式!

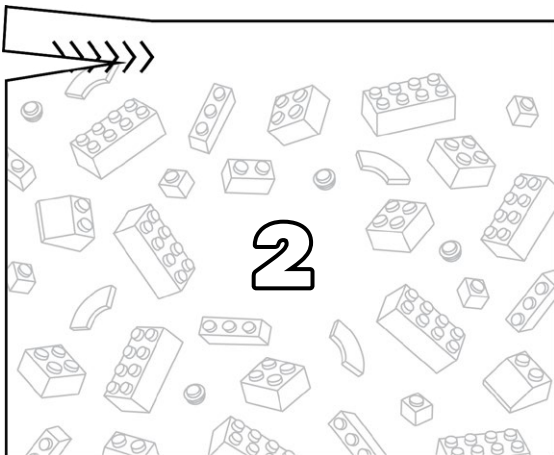
Open LEGO® Bag 2

53

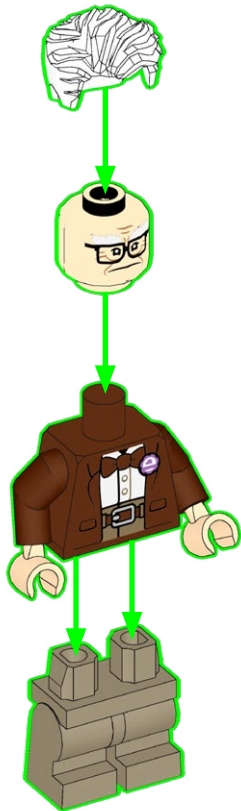
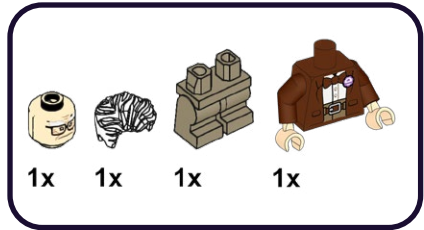

54

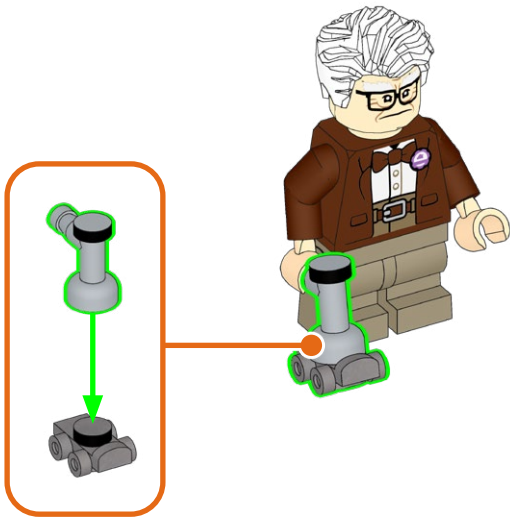
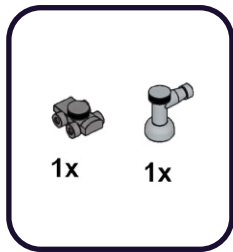

55

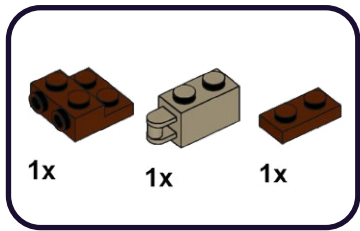

1

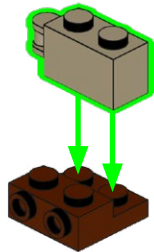

2

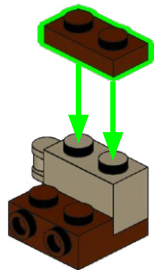

56

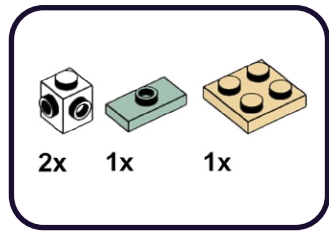

1

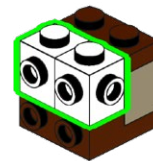

2

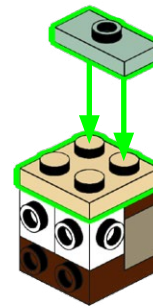

57

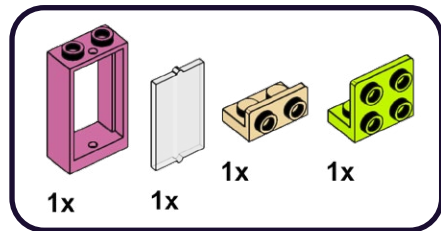

1

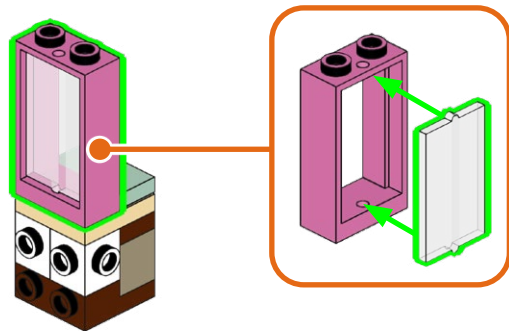

2

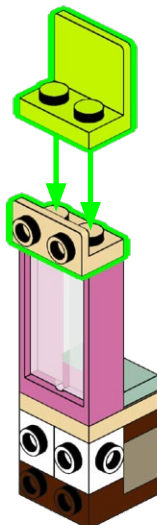

58

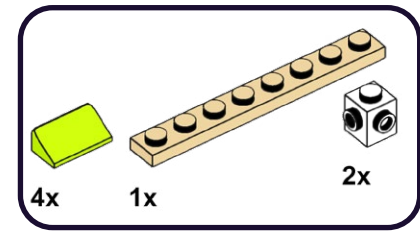

1



2

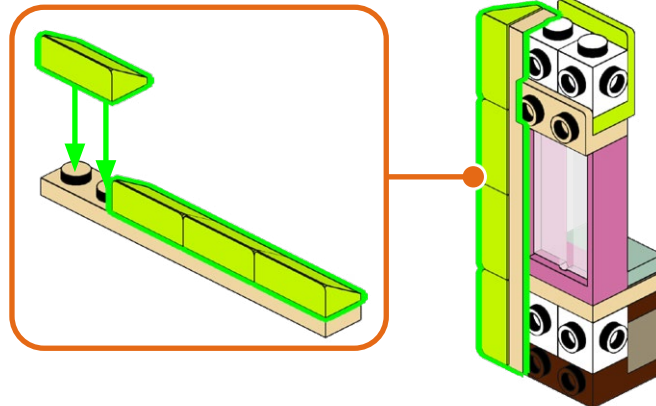

59

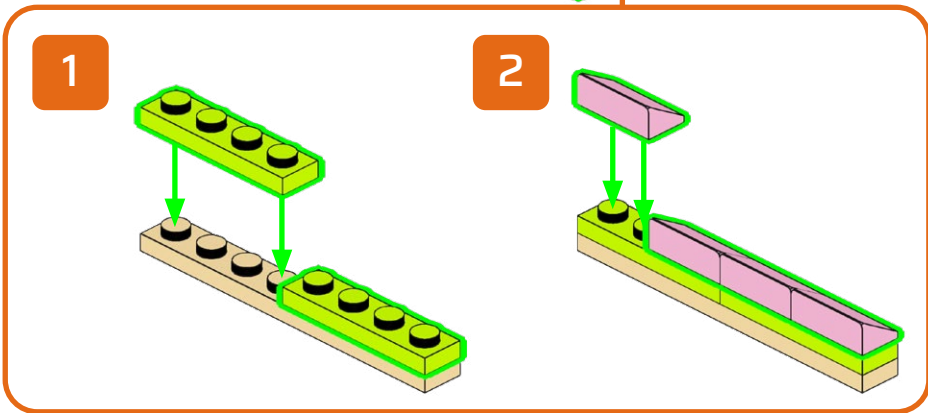
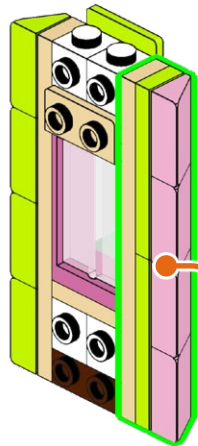
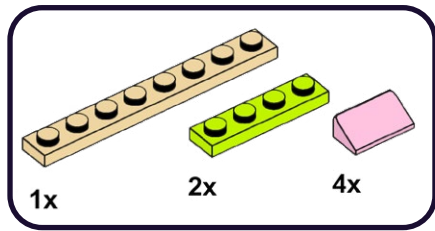

60

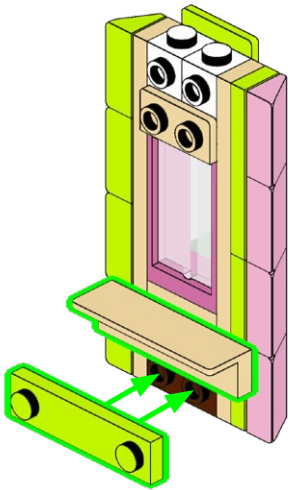
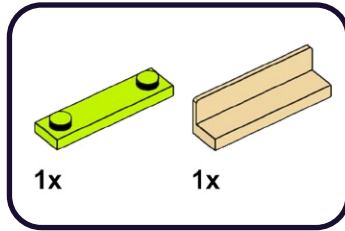

61

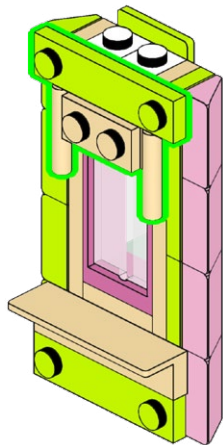
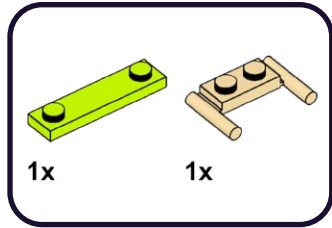

62

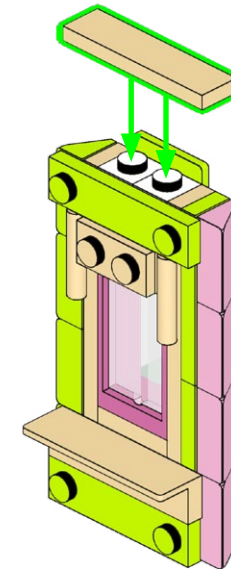
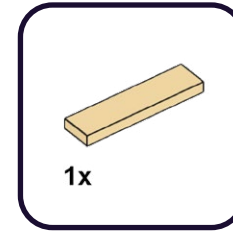

63

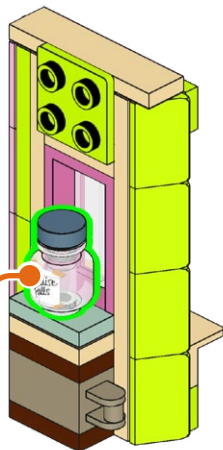
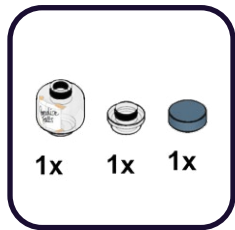

64

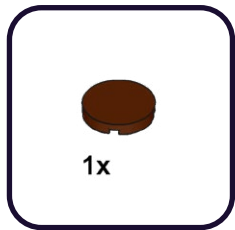

65

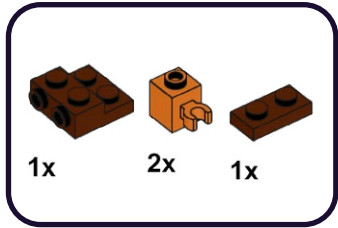

1

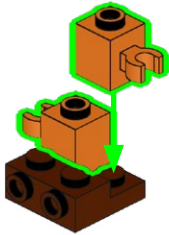

2

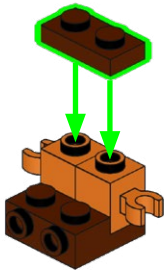

66

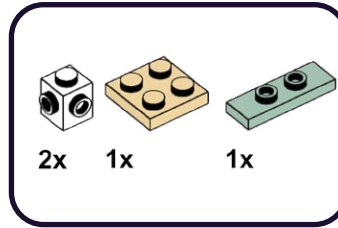

1

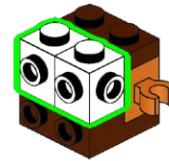

2

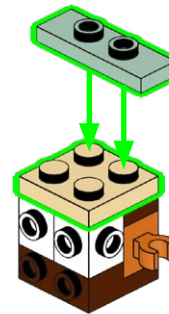

67

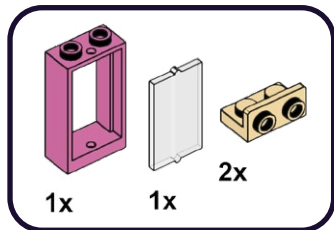

1

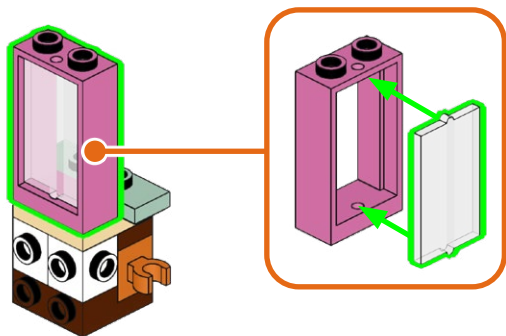

2

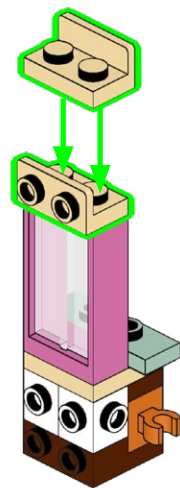

68

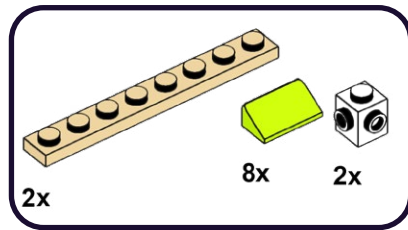

1

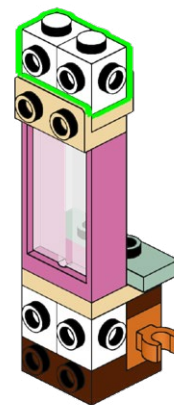

2

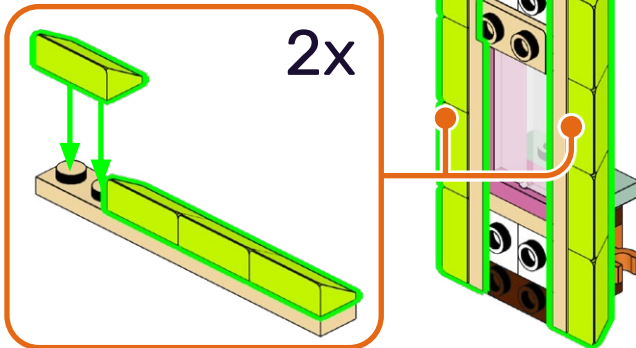

69

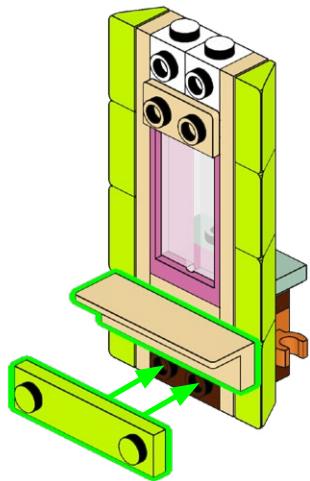
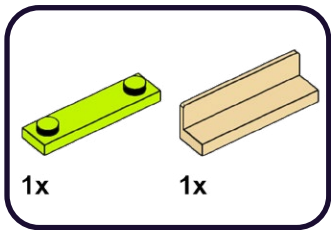

70

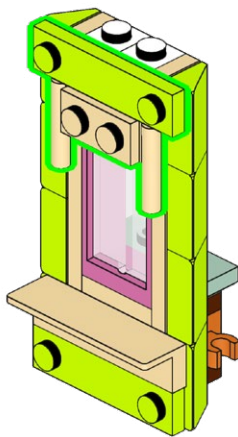
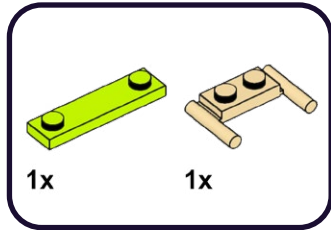

71

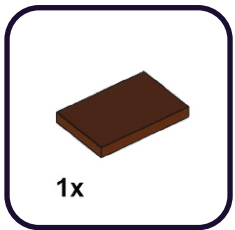

1x



72

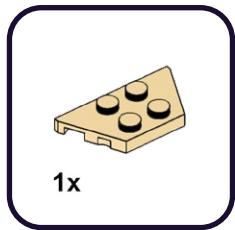

1x



73



74

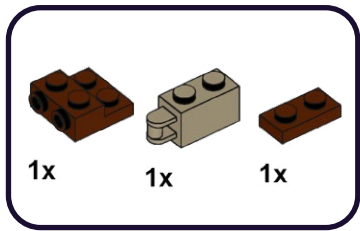

1

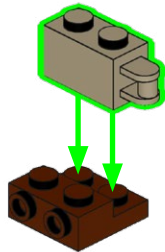

2

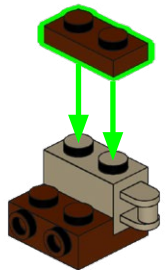

75

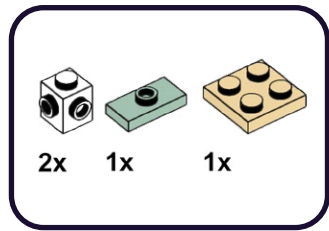

1

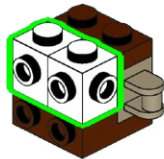

2

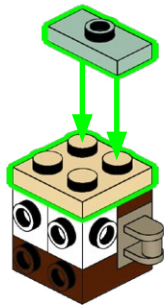

76

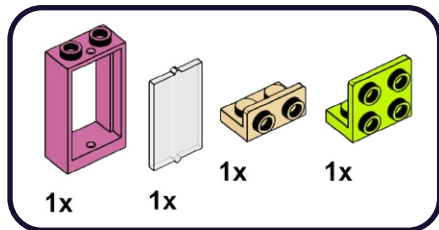

1

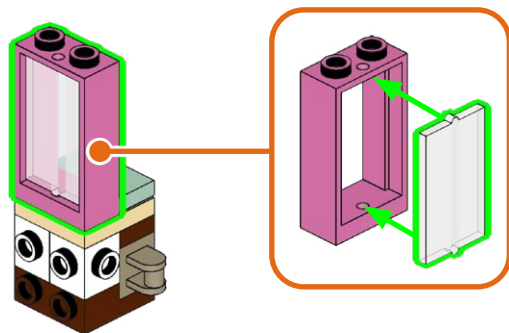

2

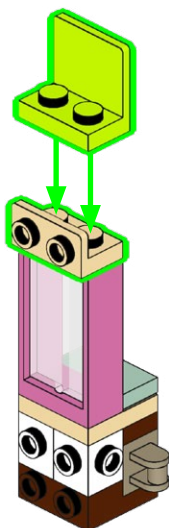

77

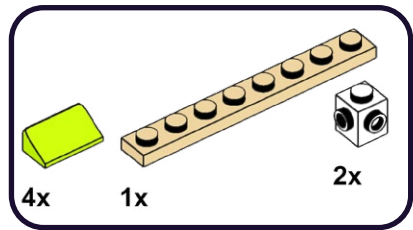

1



2

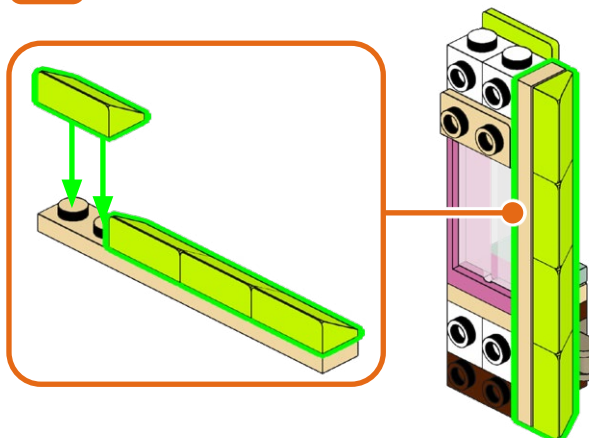

78

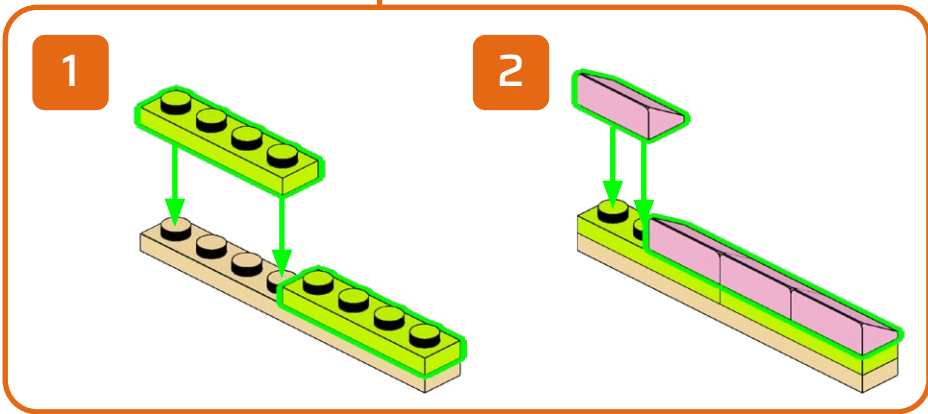
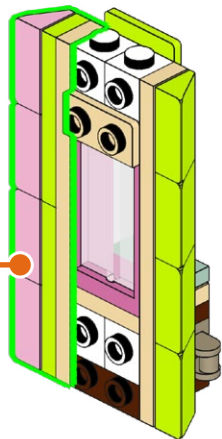
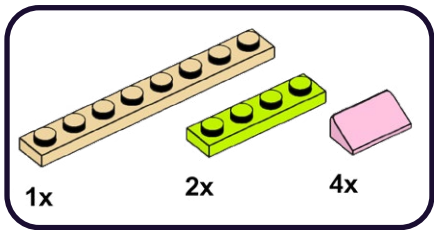

79

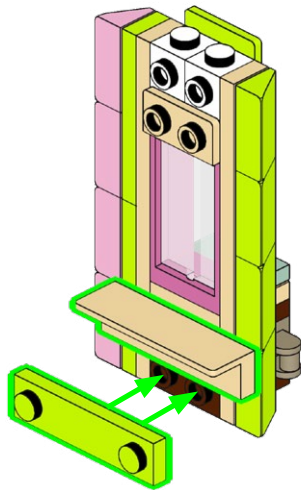
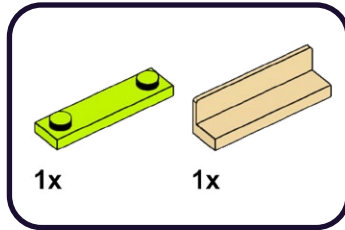

80

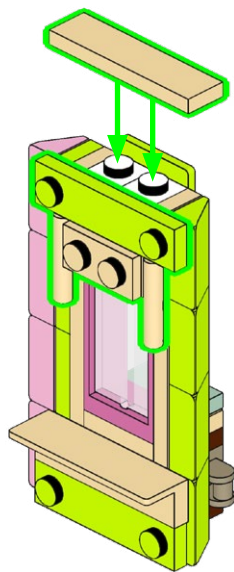
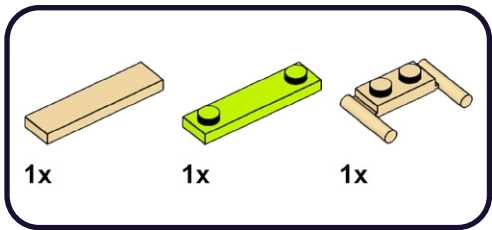

81

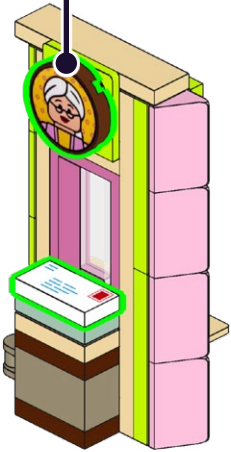
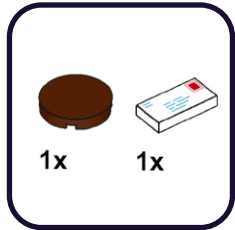





84

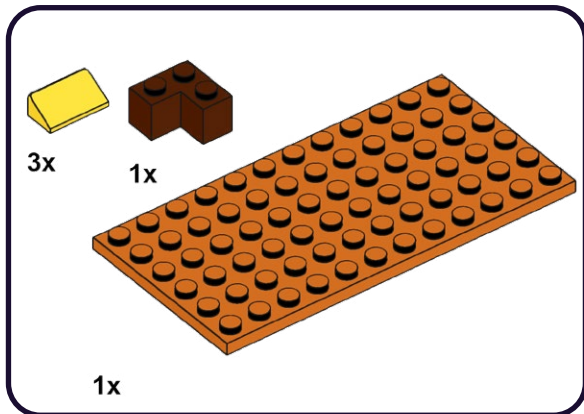

1

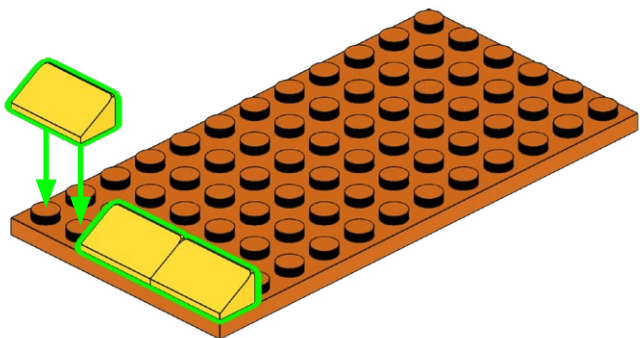

2

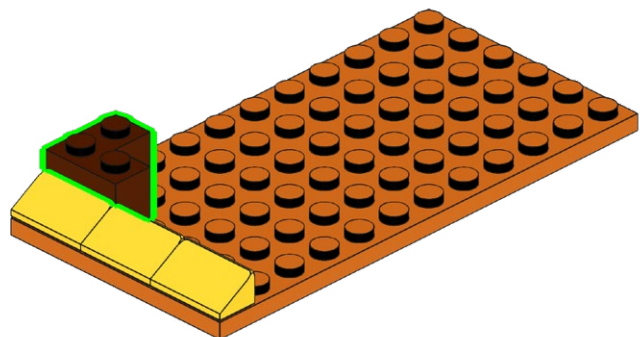

85

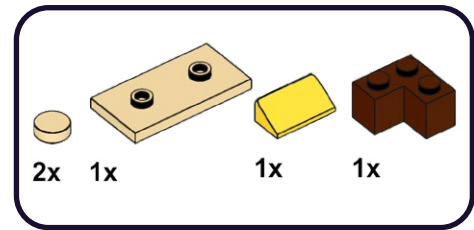

1

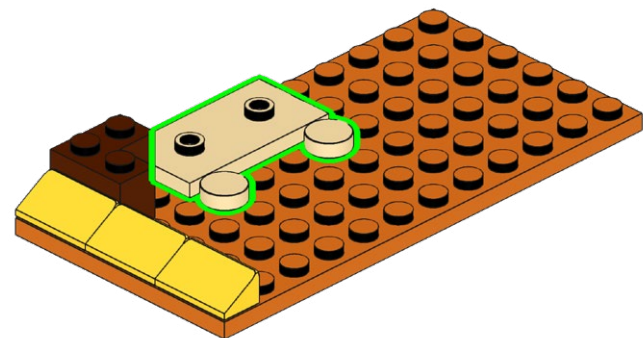

2

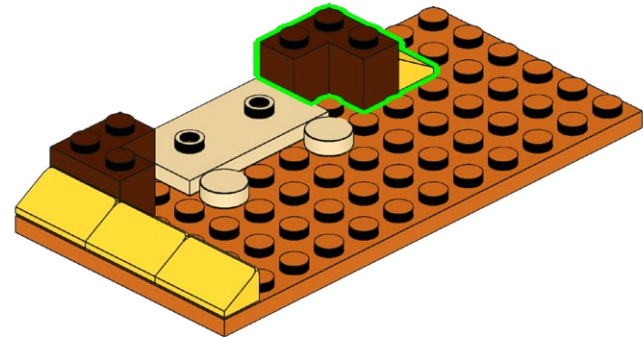

86

MML-WW T-1x3

1x 1x

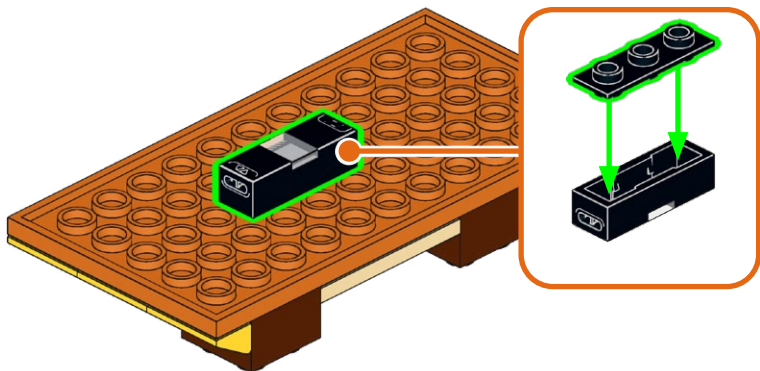

87

B-15

1x

1

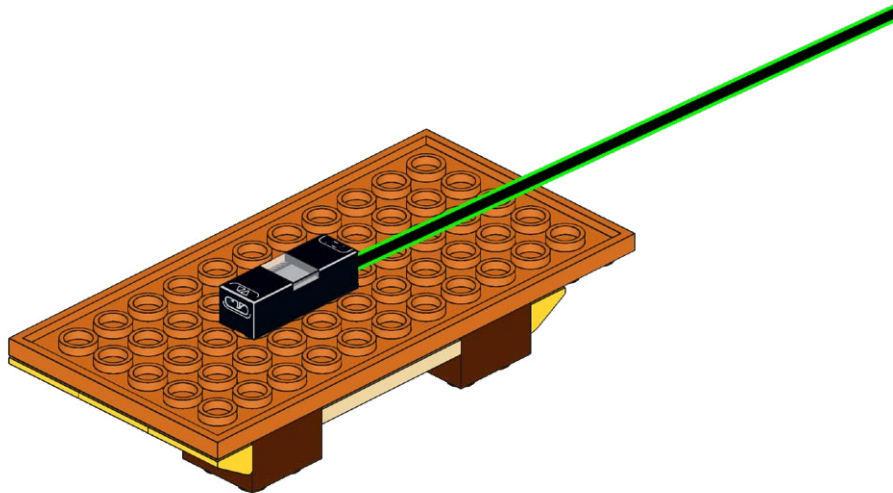

2

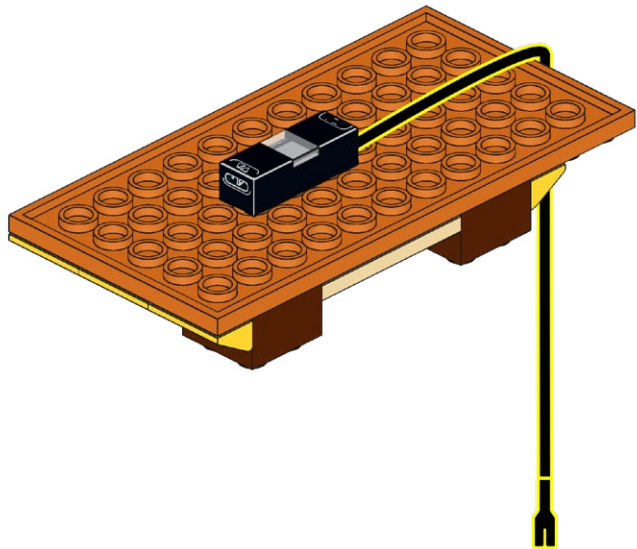

88



89



90

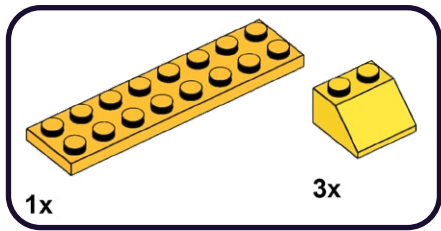

1

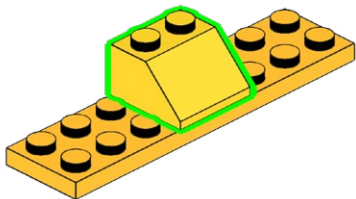

2

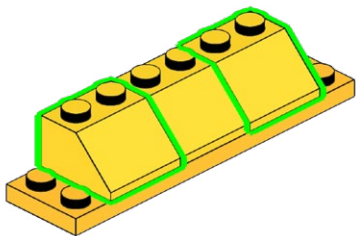

91

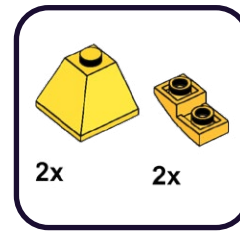

1

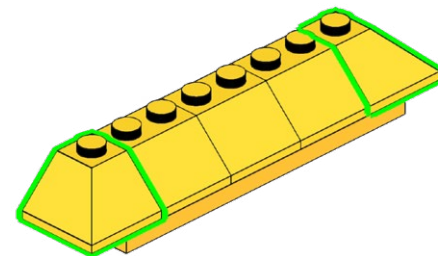

2

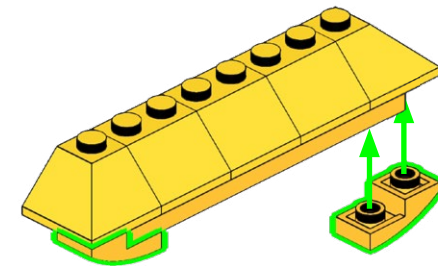

92

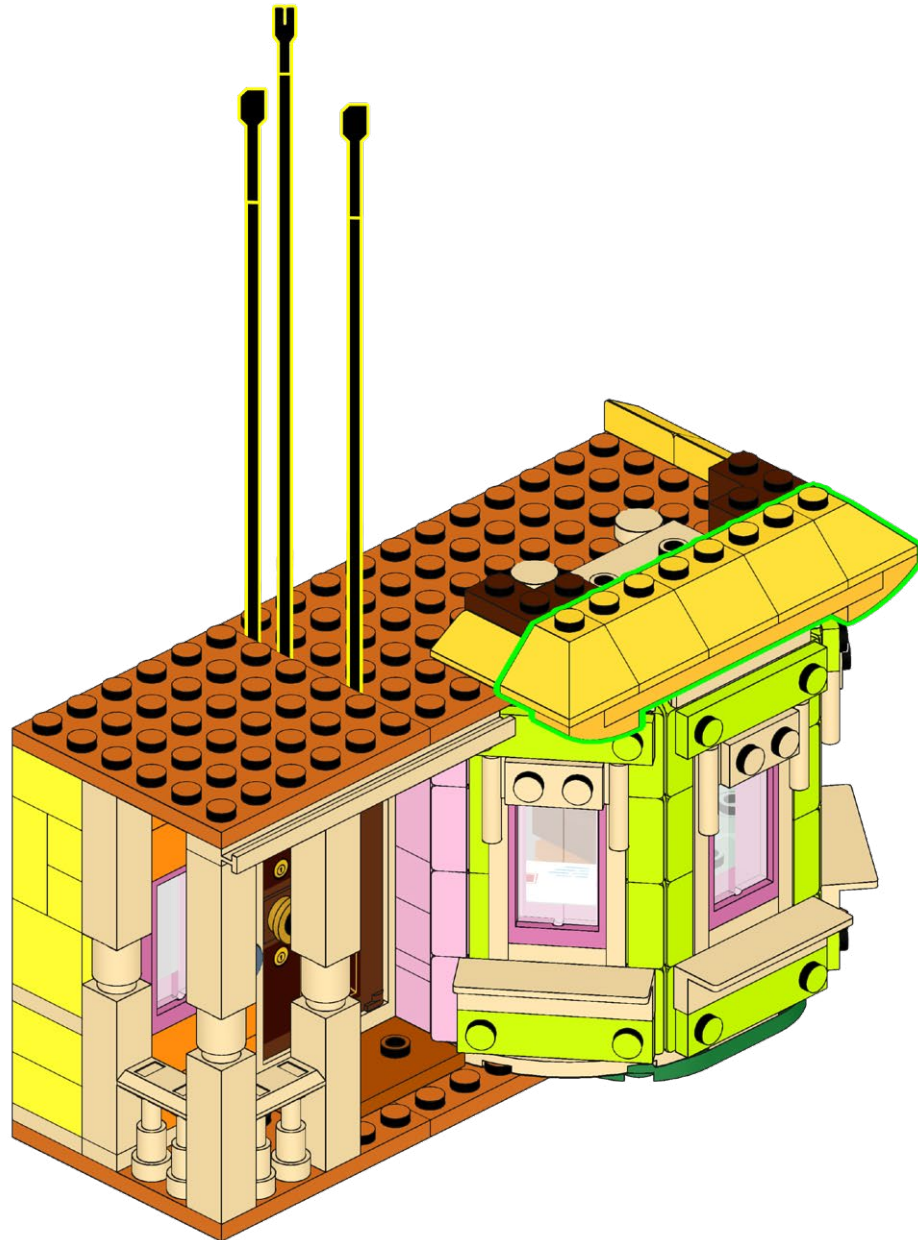

93

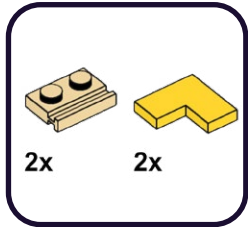

94

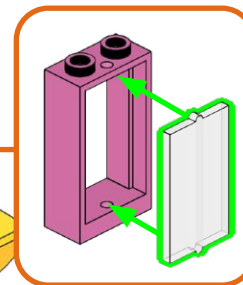
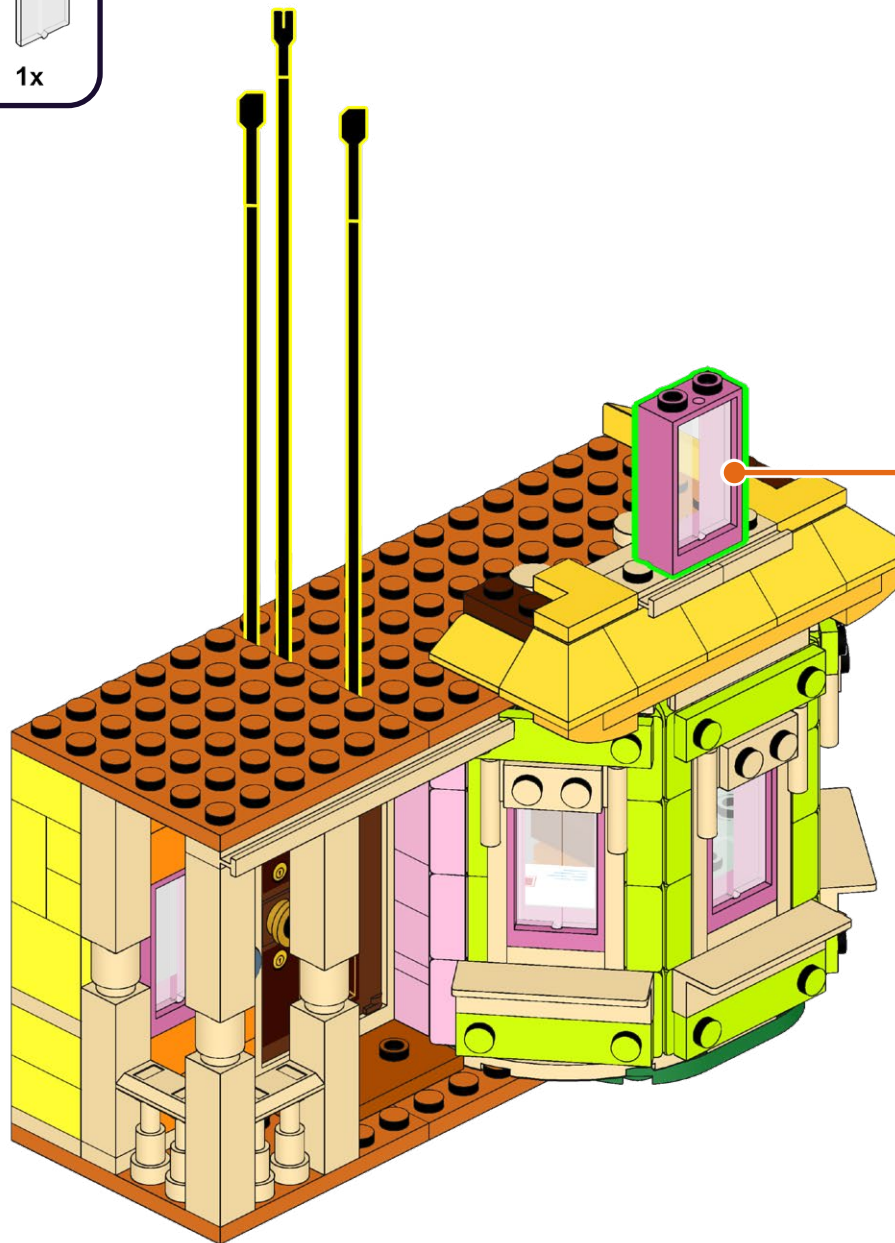
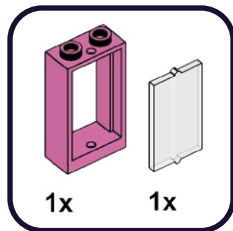

95

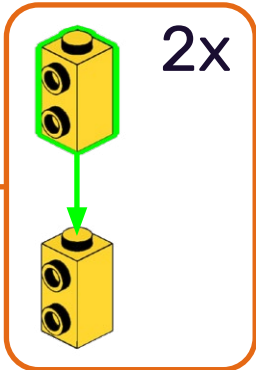
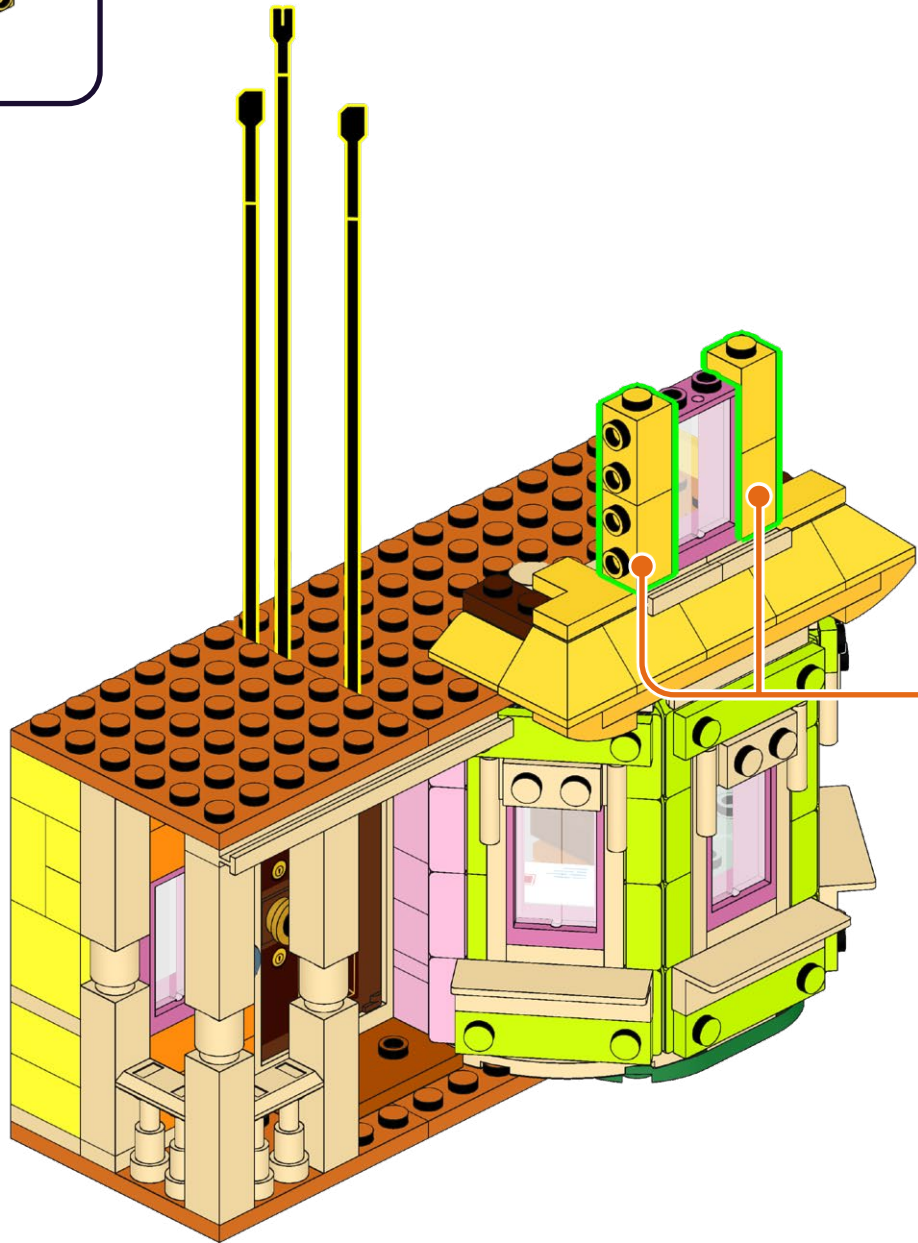
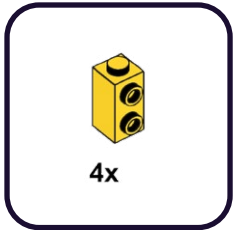

96

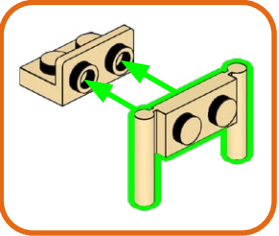
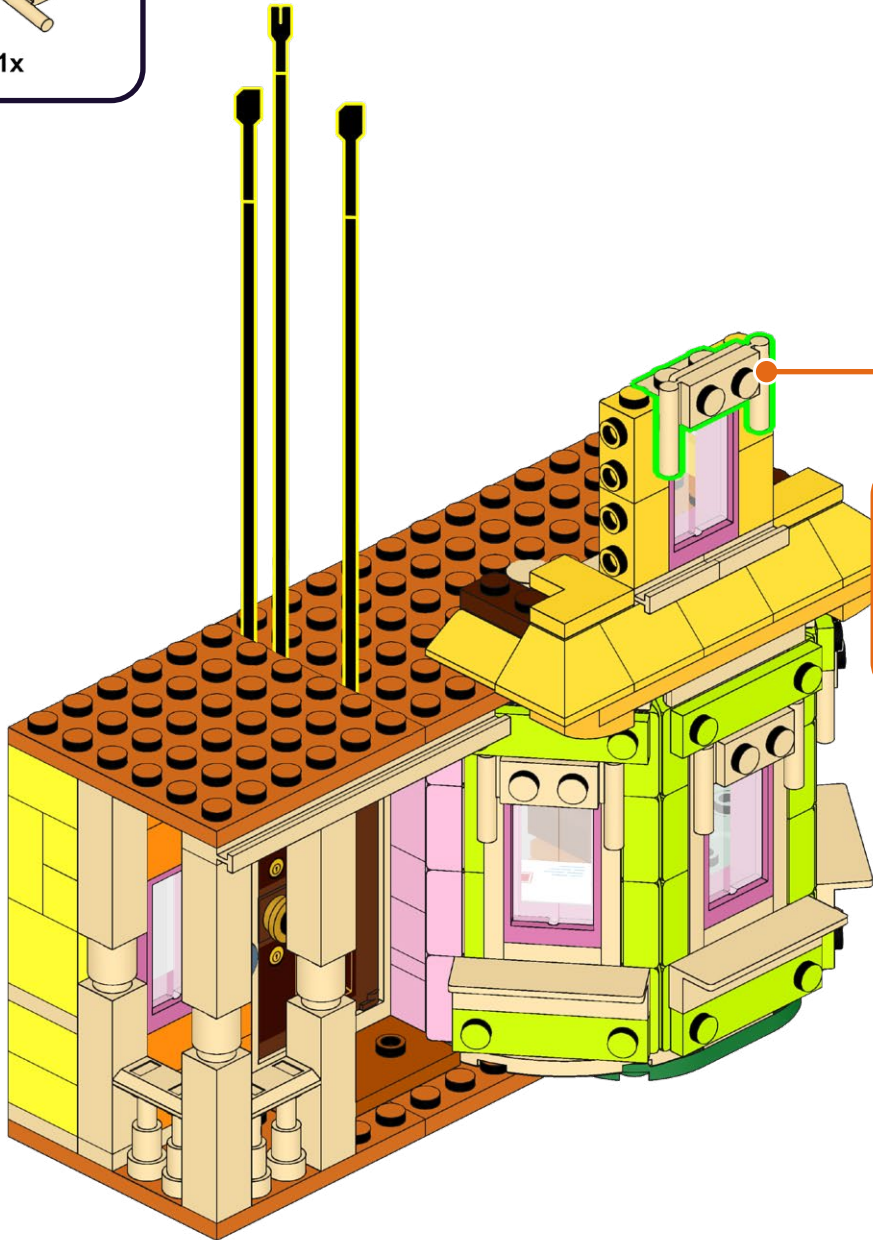
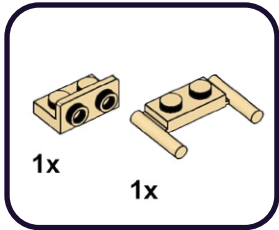

97

1x

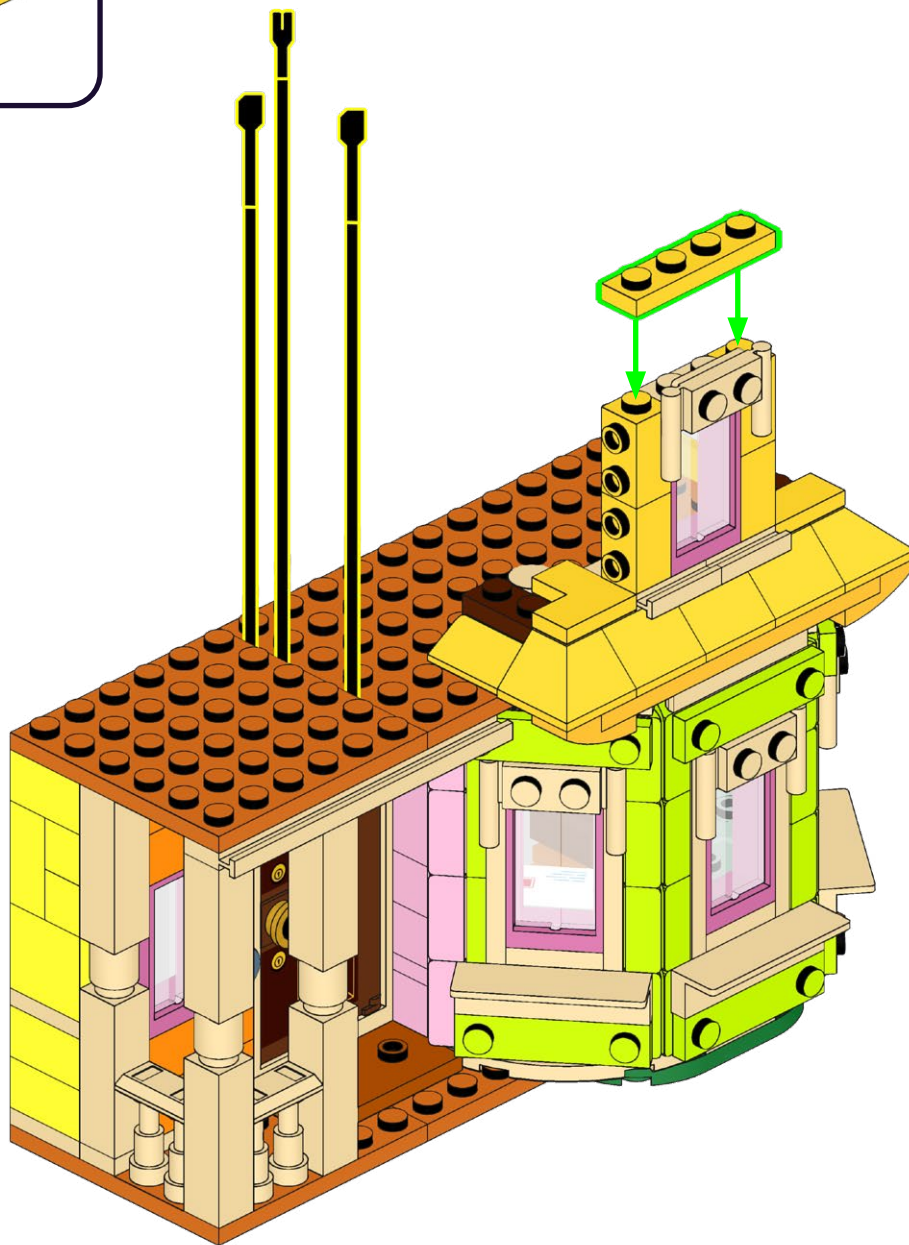

98

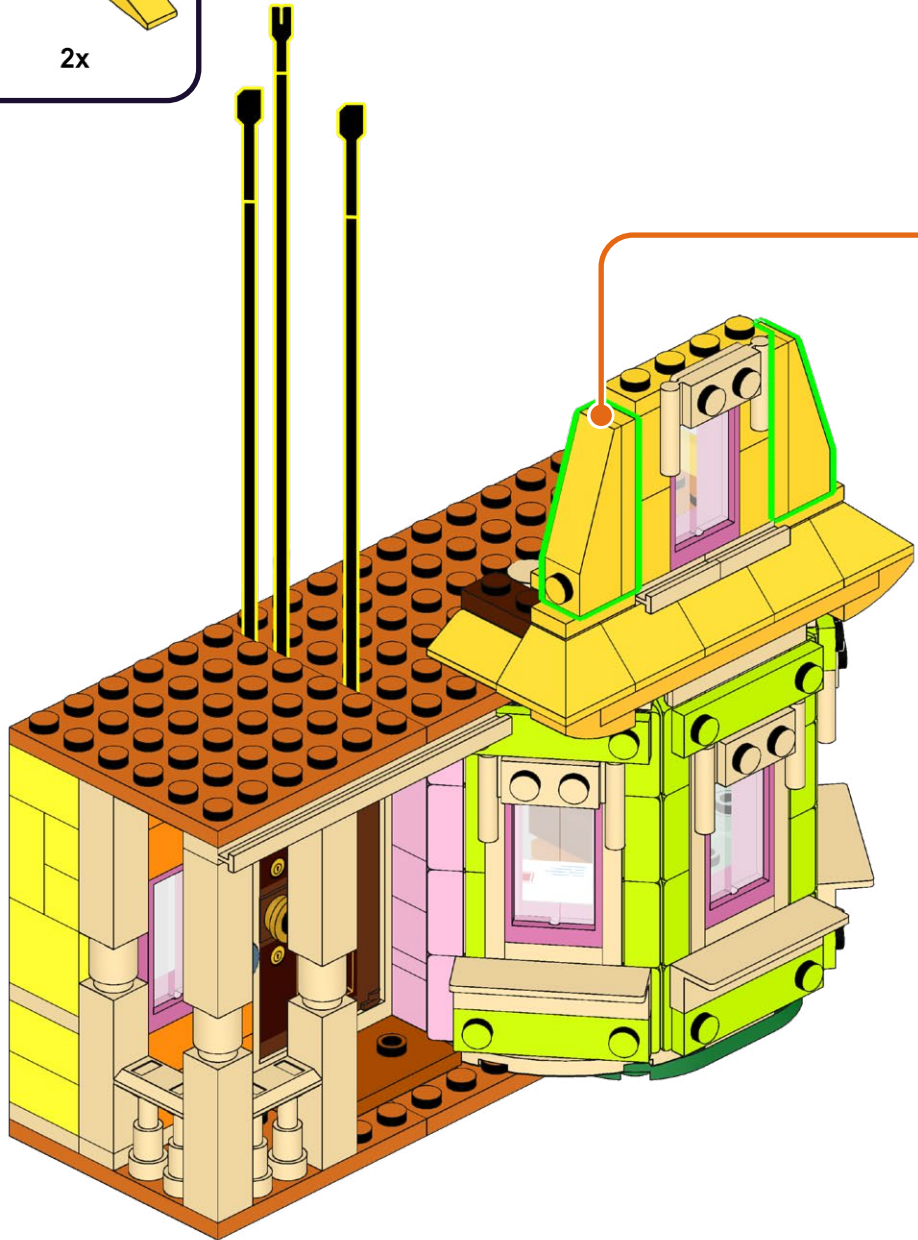
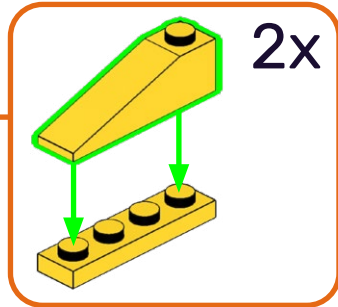
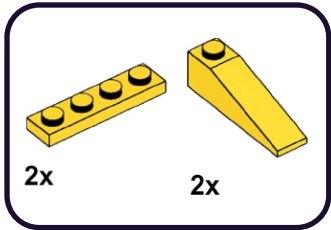

99

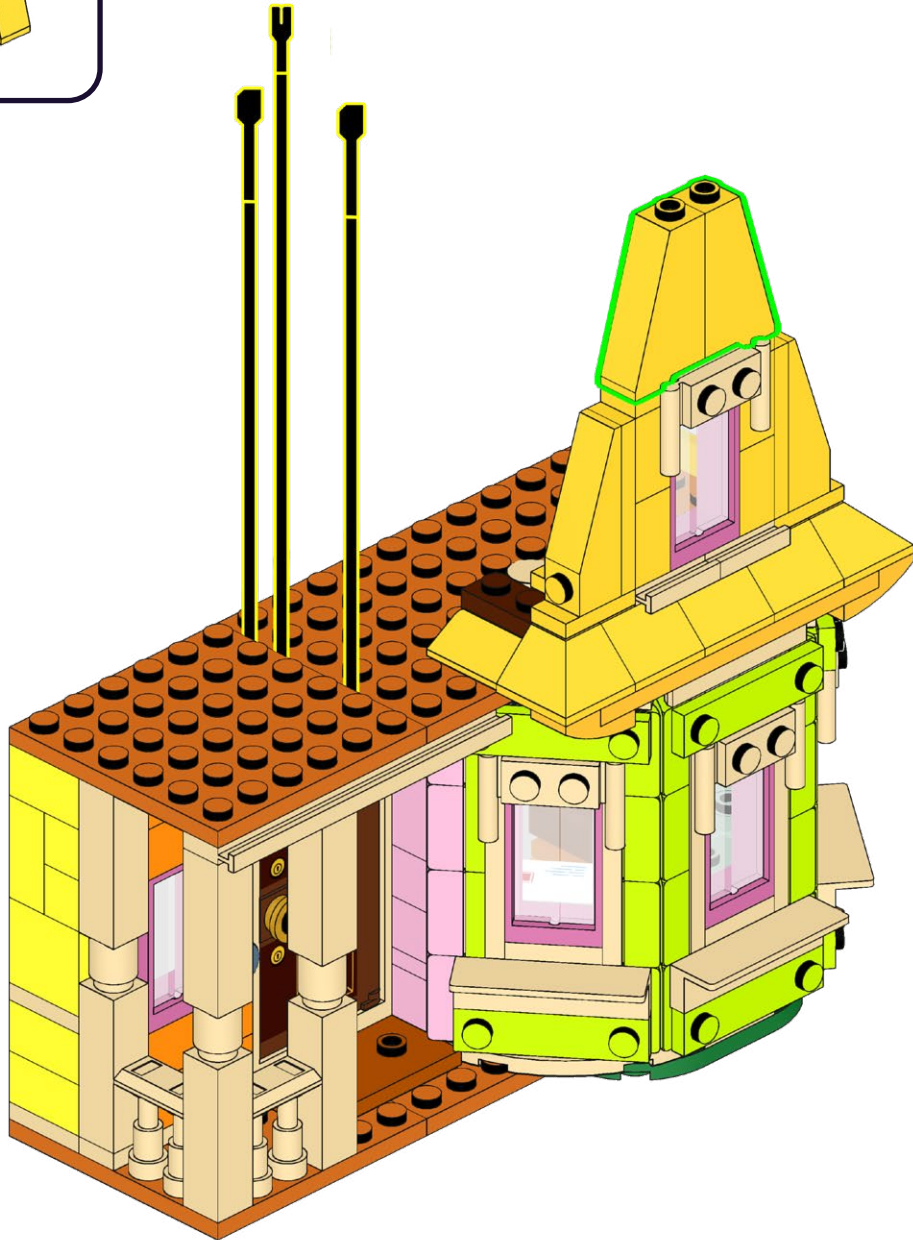
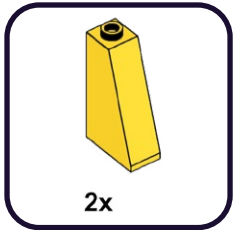

100

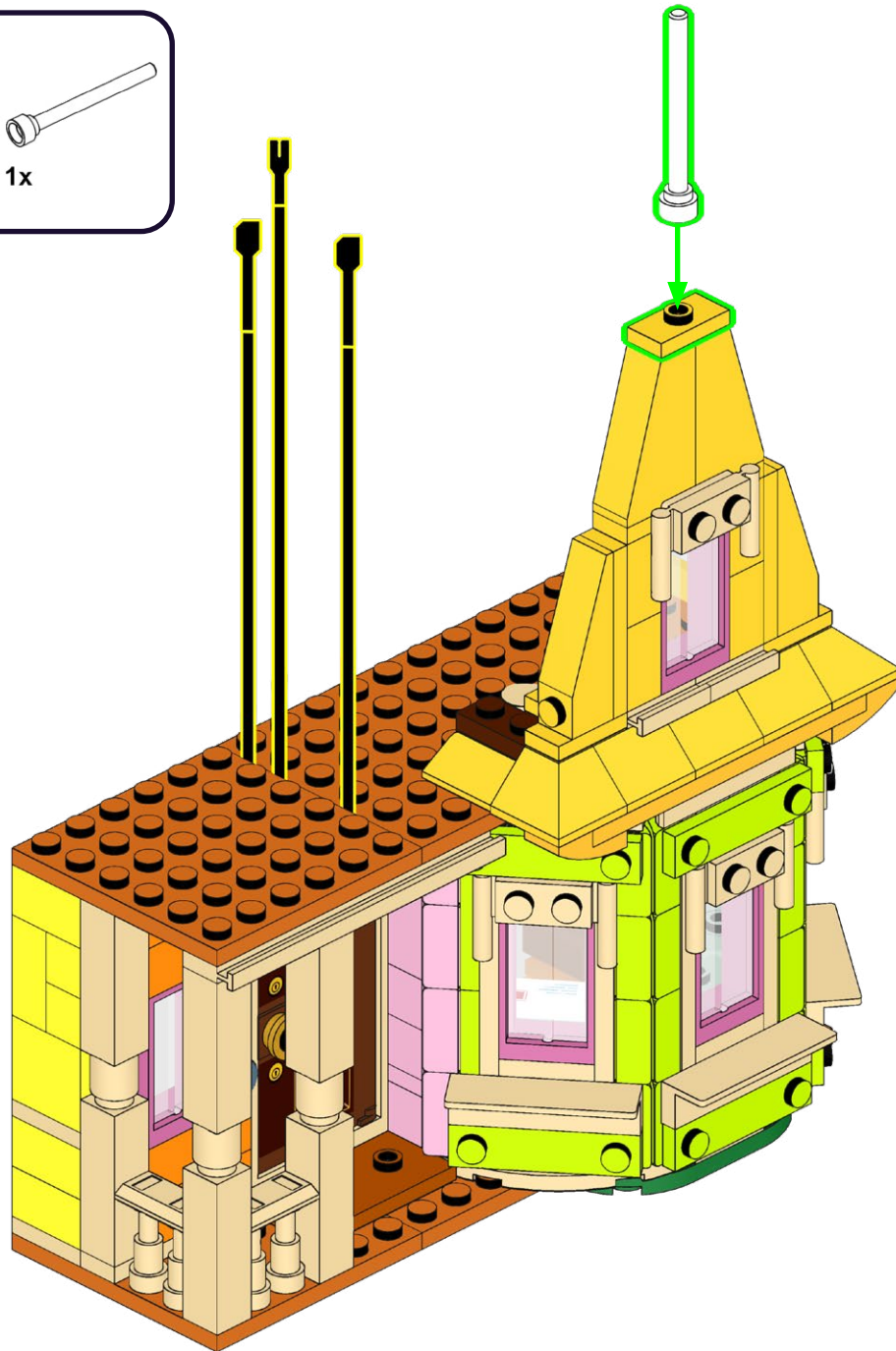
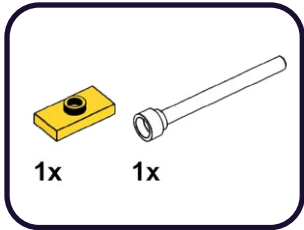

101

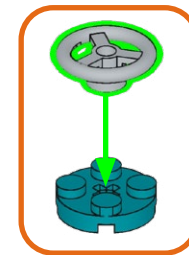
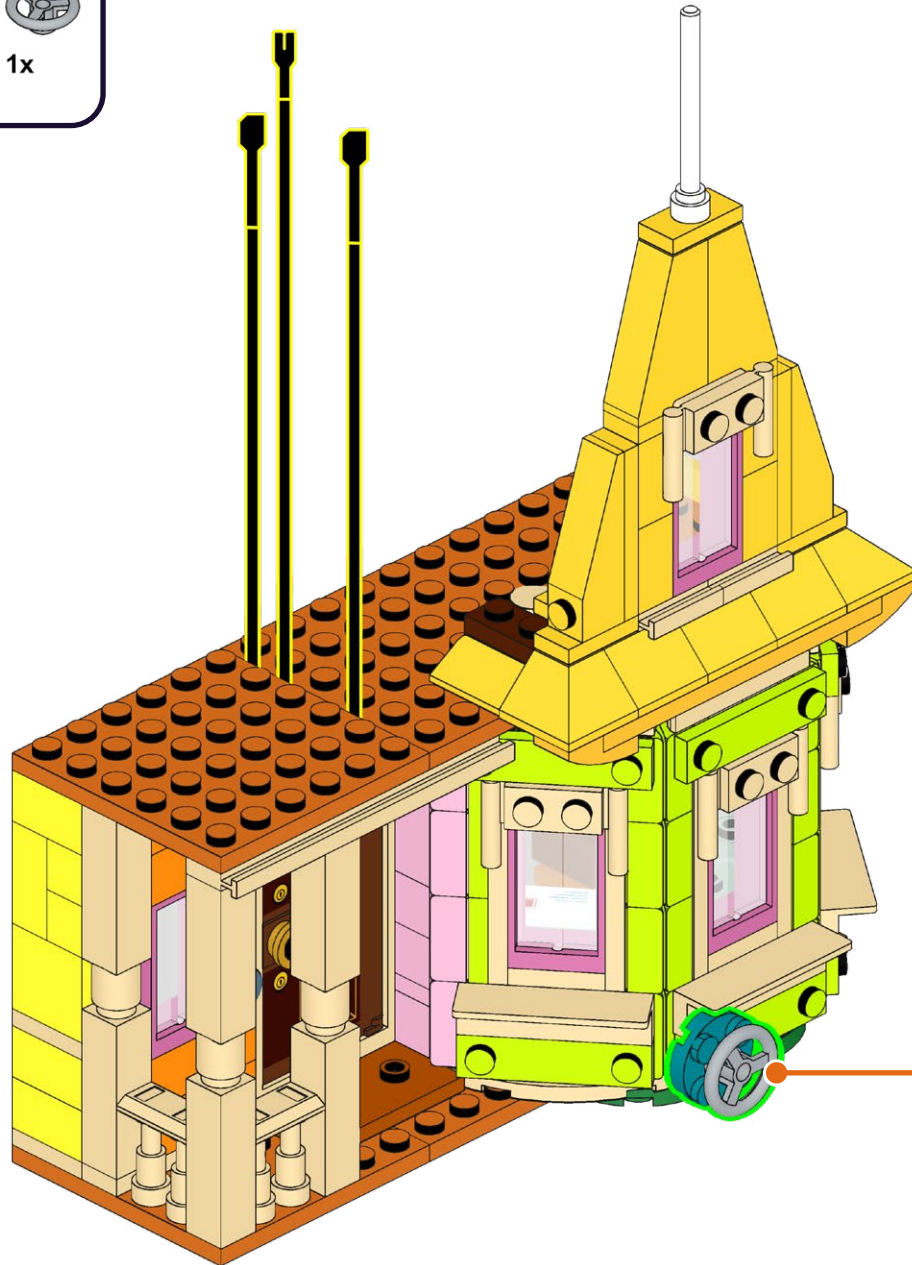
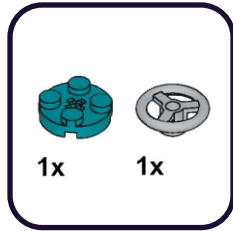

102

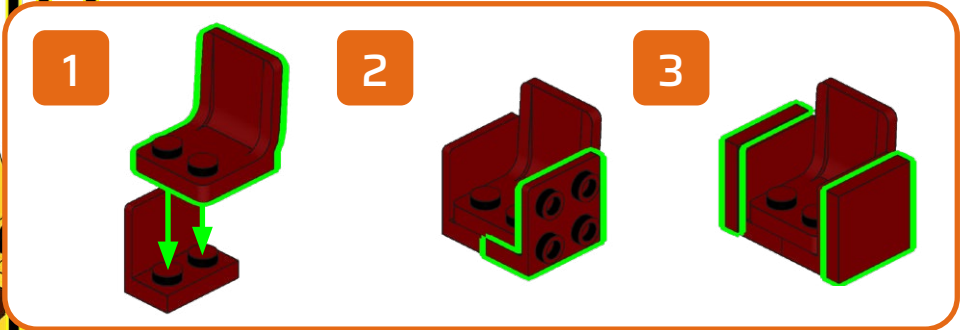
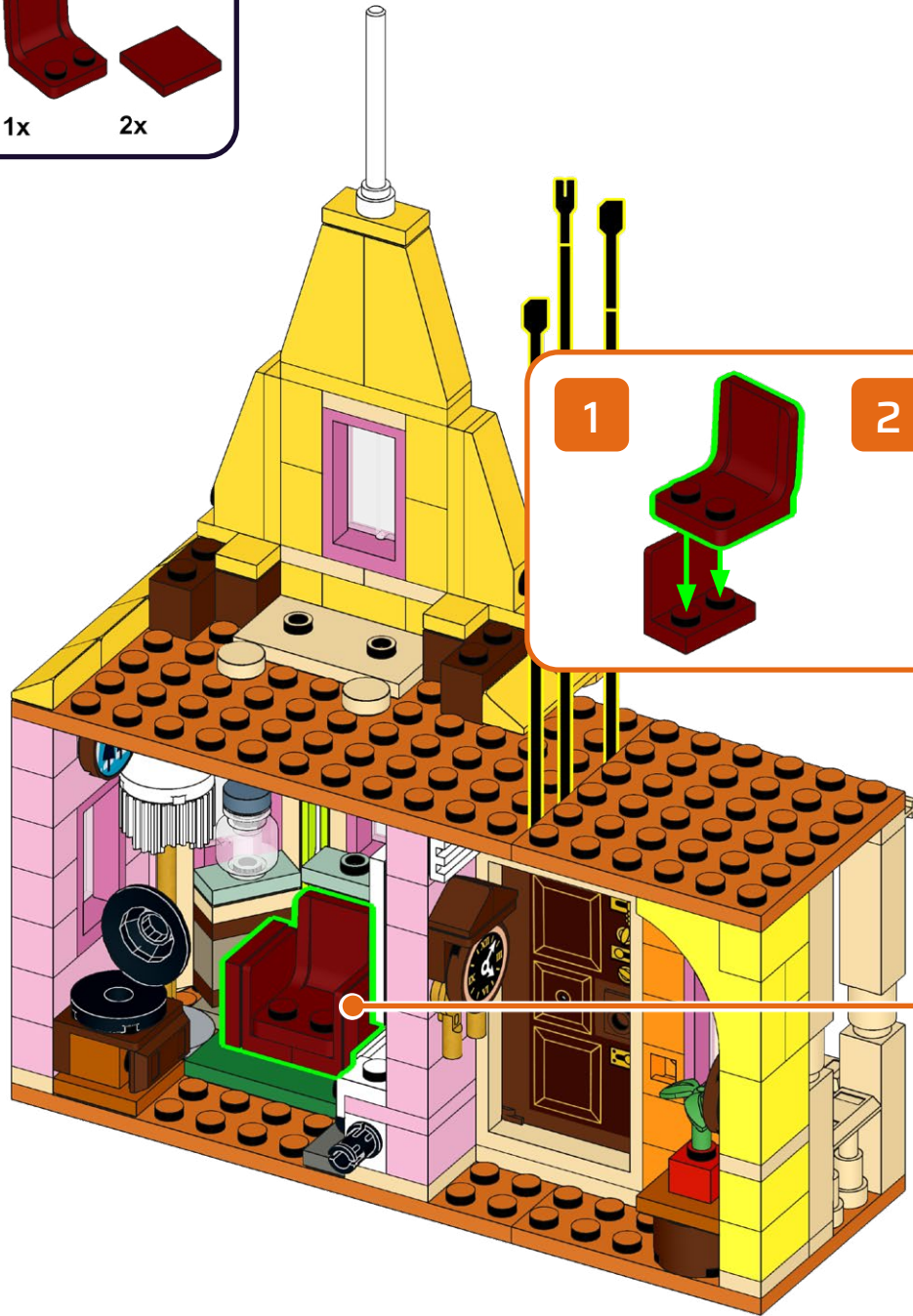
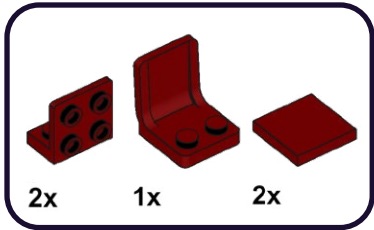

**HOLD UP!**

You might notice some bags are out of order, as well as left over pieces, but that's ok! We're changing the way you build LEGO!

HALTEN!

Möglicherweise stellen Sie fest, dass einige Beutel nicht in Ordnung sind und auch Teile übrig bleiben, aber das ist in Ordnung! Wir verändern die Art und Weise, wie Sie LEGO bauen!

TENIR BON!

Vous remarquerez peut-être que certains sacs sont en panne, ainsi que des morceaux restants, mais ce n'est pas grave ! Nous changeons la façon dont vous construisez LEGO !

SOSTENERE!

Potresti notare che alcune borse sono fuori uso, così come alcuni pezzi avanzati, ma va bene! Stiamo cambiando il modo in cui costruisci i LEGO!

¡SOSTENER!

Puede que notes que algunas bolsas están fuera de orden, así como piezas sobrantes, ¡pero está bien! ¡Estamos cambiando la forma de construir LEGO!

耽误!

您可能会注意到有些袋子坏了, 还有剩余的碎片, 但这没关系! 我们正在改变您搭建乐高的方式!

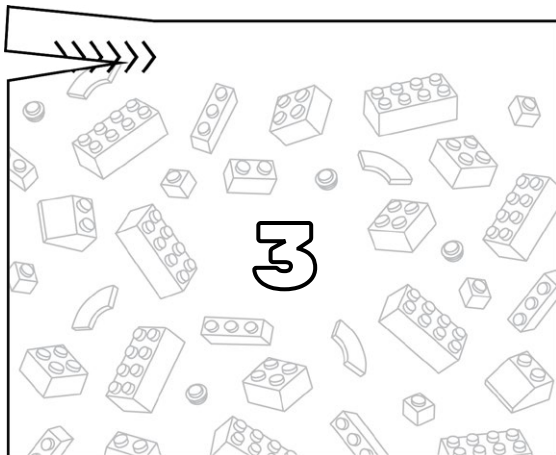
Open LEGO® Bag 3

103

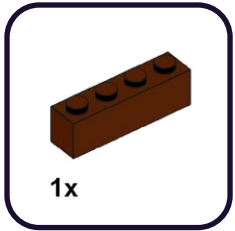

104



105

8x



106

2x



107



108

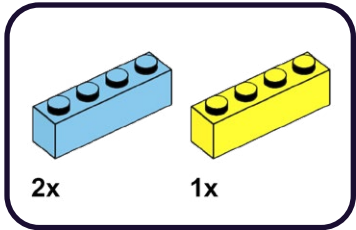

109

3x



110

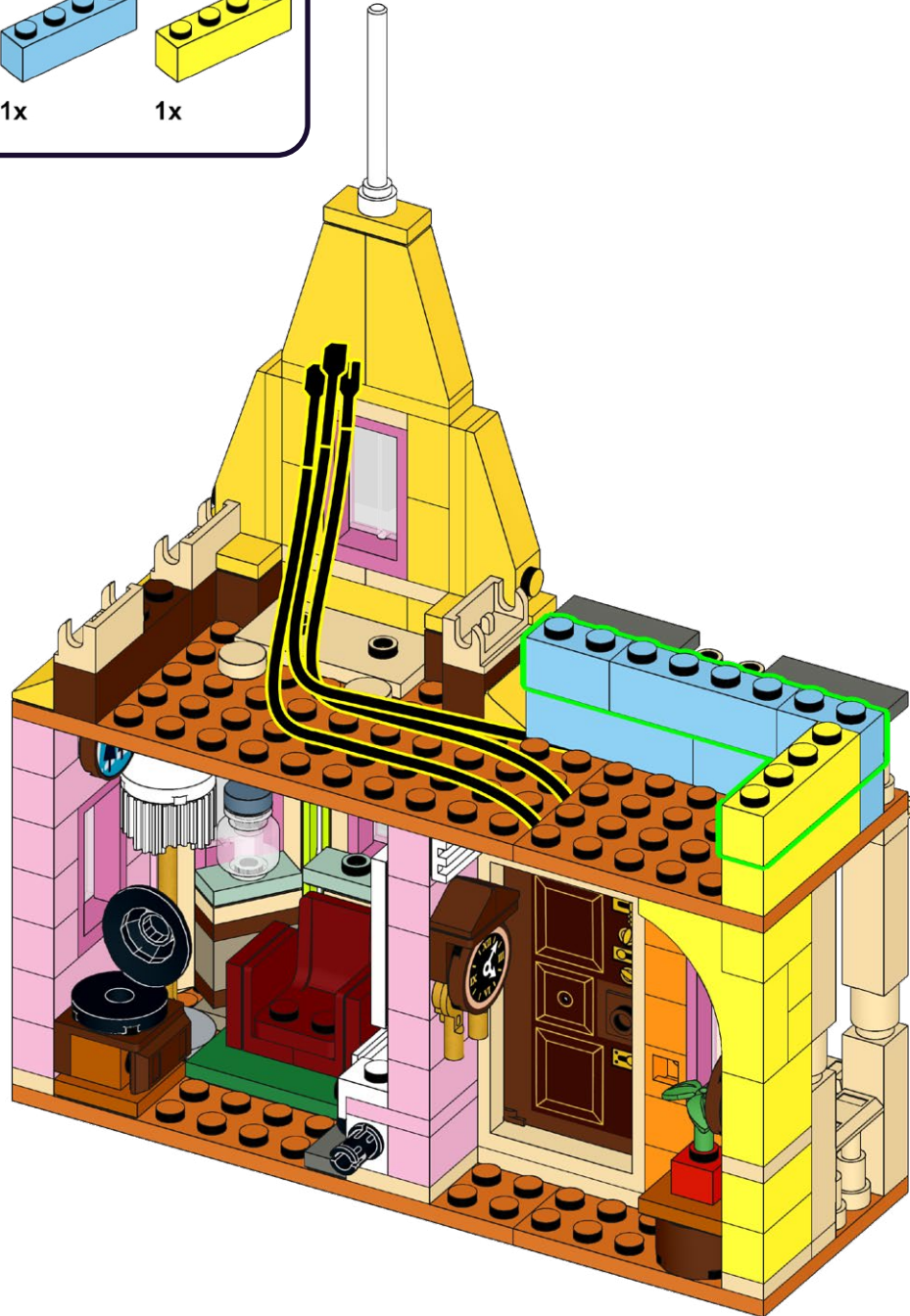
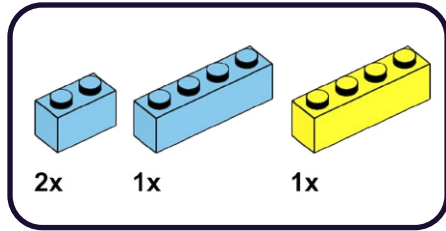

111

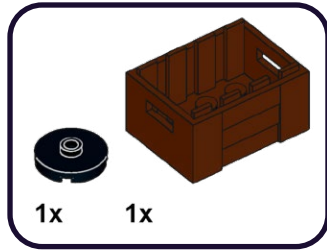

112

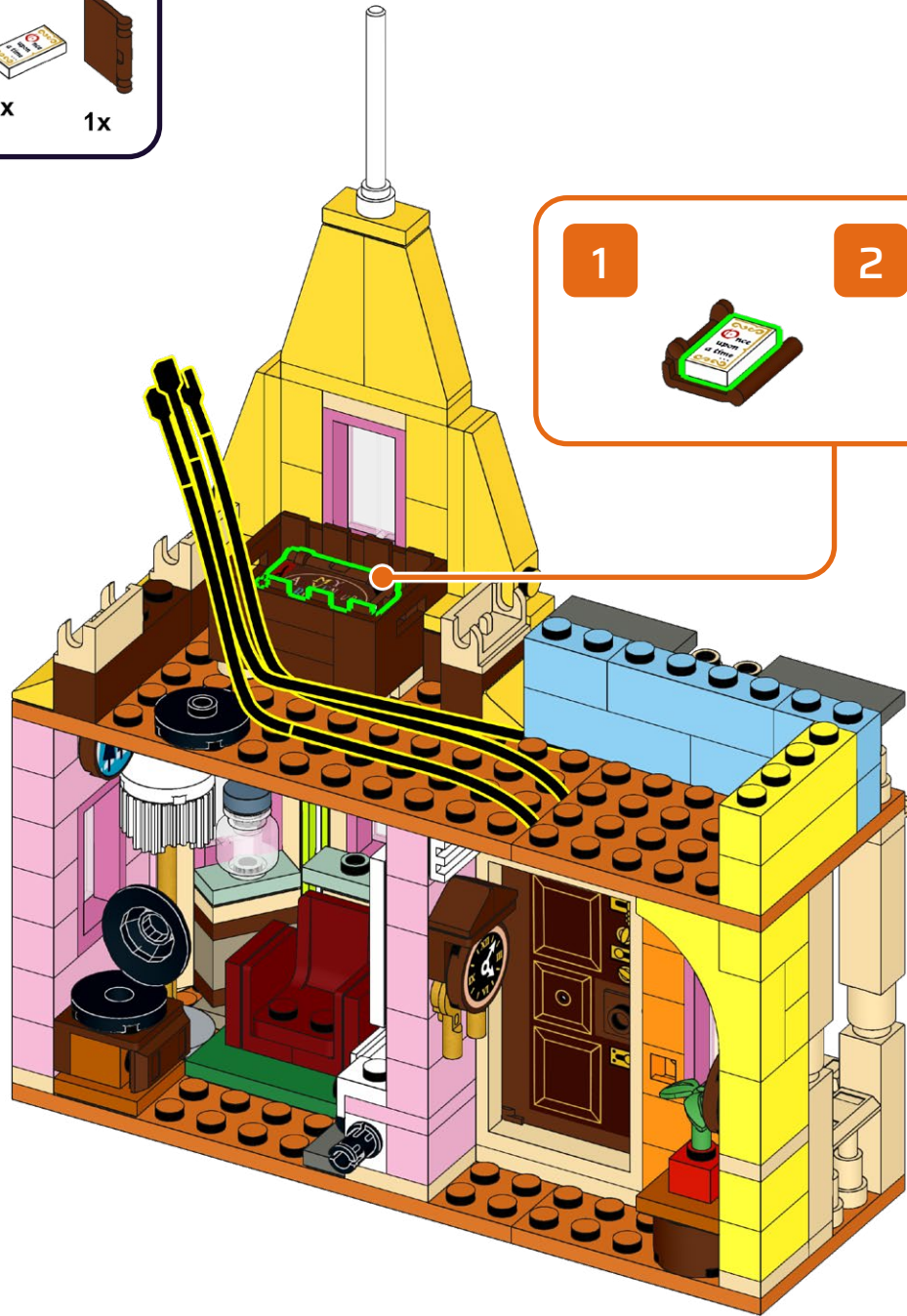
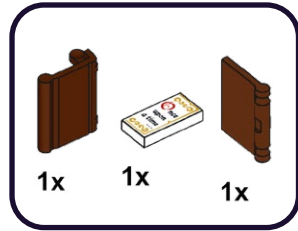

113

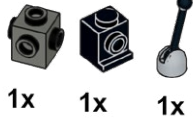

1

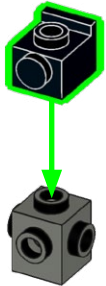

2



114

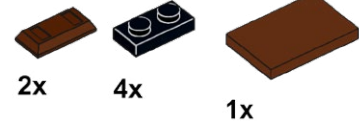

1

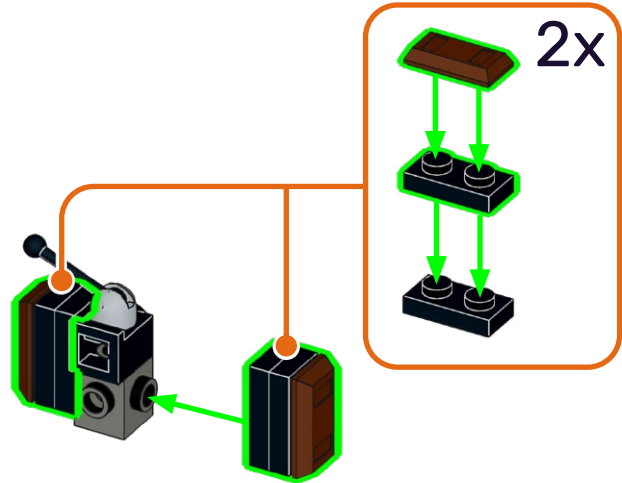

2



115



116



117



2x



118

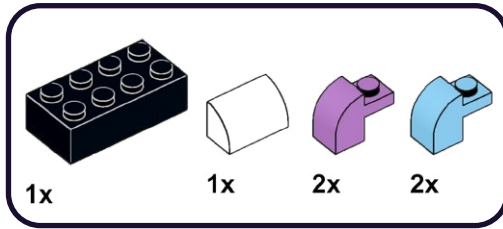

1

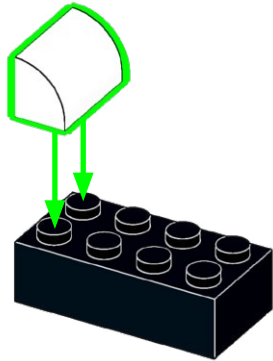

2

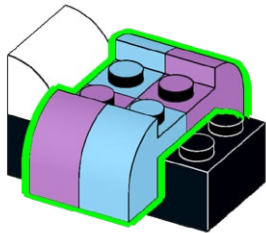

119

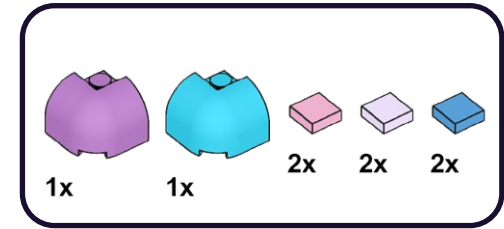

1

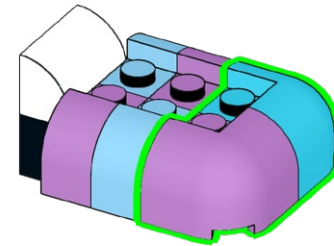

2

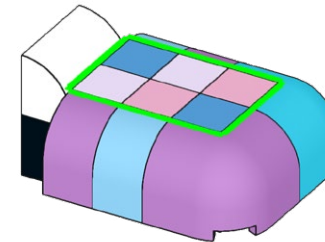

120





HOLD UP!

You might notice some bags are out of order, as well as left over pieces, but that's ok! We're changing the way you build LEGO!

HALTEN!

Möglicherweise stellen Sie fest, dass einige Beutel nicht in Ordnung sind und auch Teile übrig bleiben, aber das ist in Ordnung! Wir verändern die Art und Weise, wie Sie LEGO bauen!

TENIR BON!

Vous remarquerez peut-être que certains sacs sont en panne, ainsi que des morceaux restants, mais ce n'est pas grave ! Nous changeons la façon dont vous construisez LEGO !

SOSTENERE!

Potresti notare che alcune borse sono fuori uso, così come alcuni pezzi avanzati, ma va bene! Stiamo cambiando il modo in cui costruisci i LEGO!

¡SOSTENER!

Puede que notes que algunas bolsas están fuera de orden, así como piezas sobrantes, ¡pero está bien! ¡Estamos cambiando la forma de construir LEGO!

耽误!

您可能会注意到有些袋子坏了, 还有剩余的碎片, 但这没关系! 我们正在改变您搭建乐高的方式!

Open LMB Bag 02

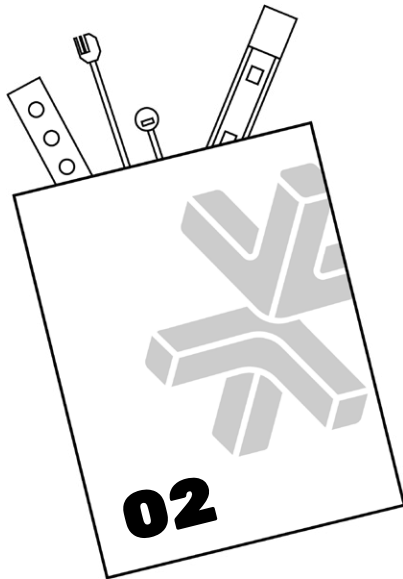

Open LEGO® Bag 4

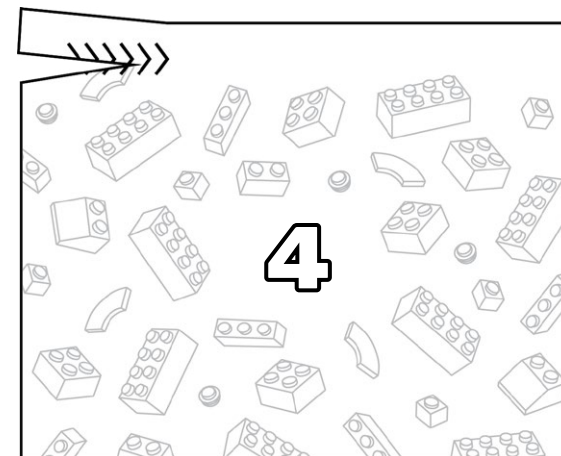

121

1x

AL-P15

1x

1x

1x

1

2

3

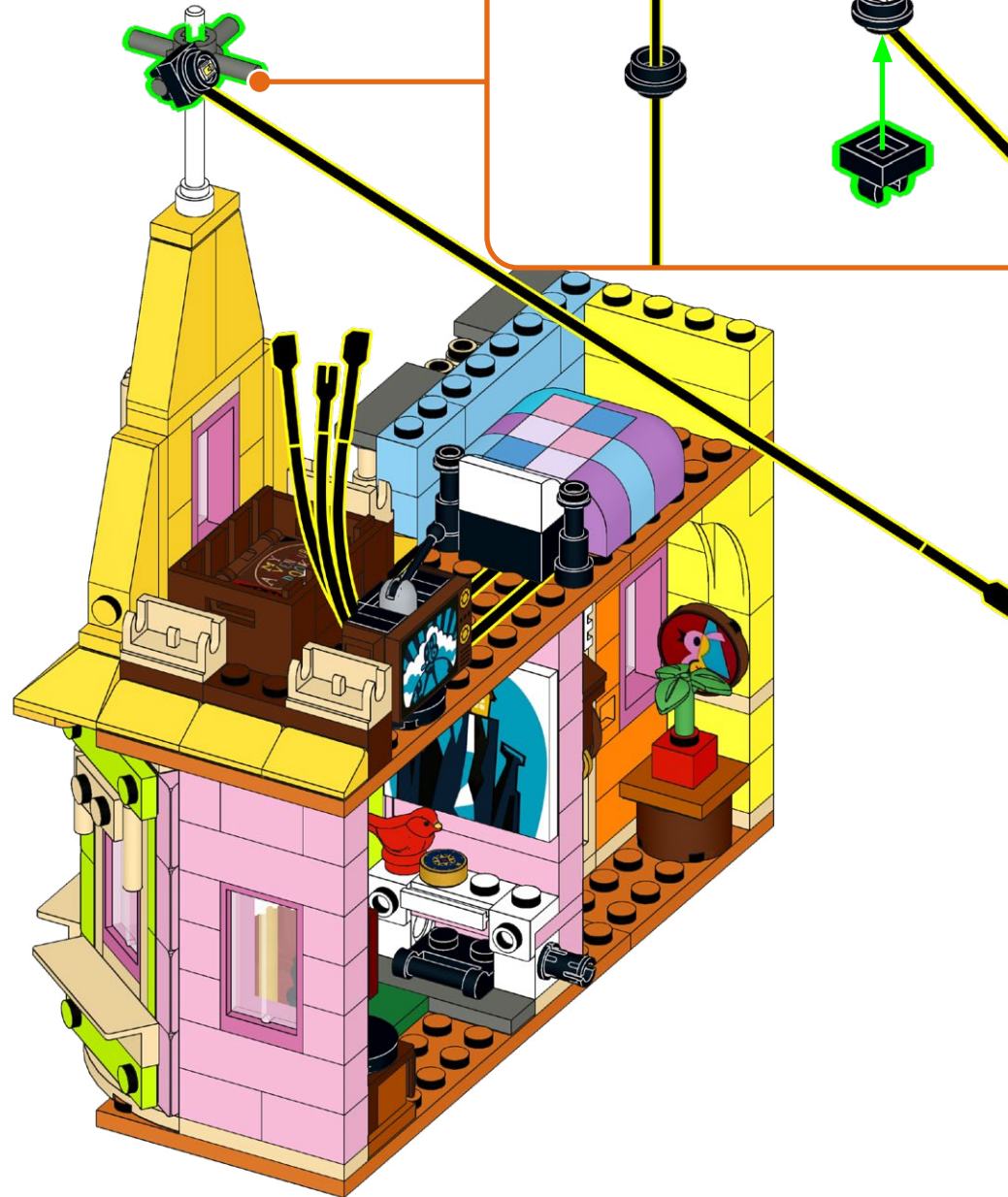

122



1x 1x

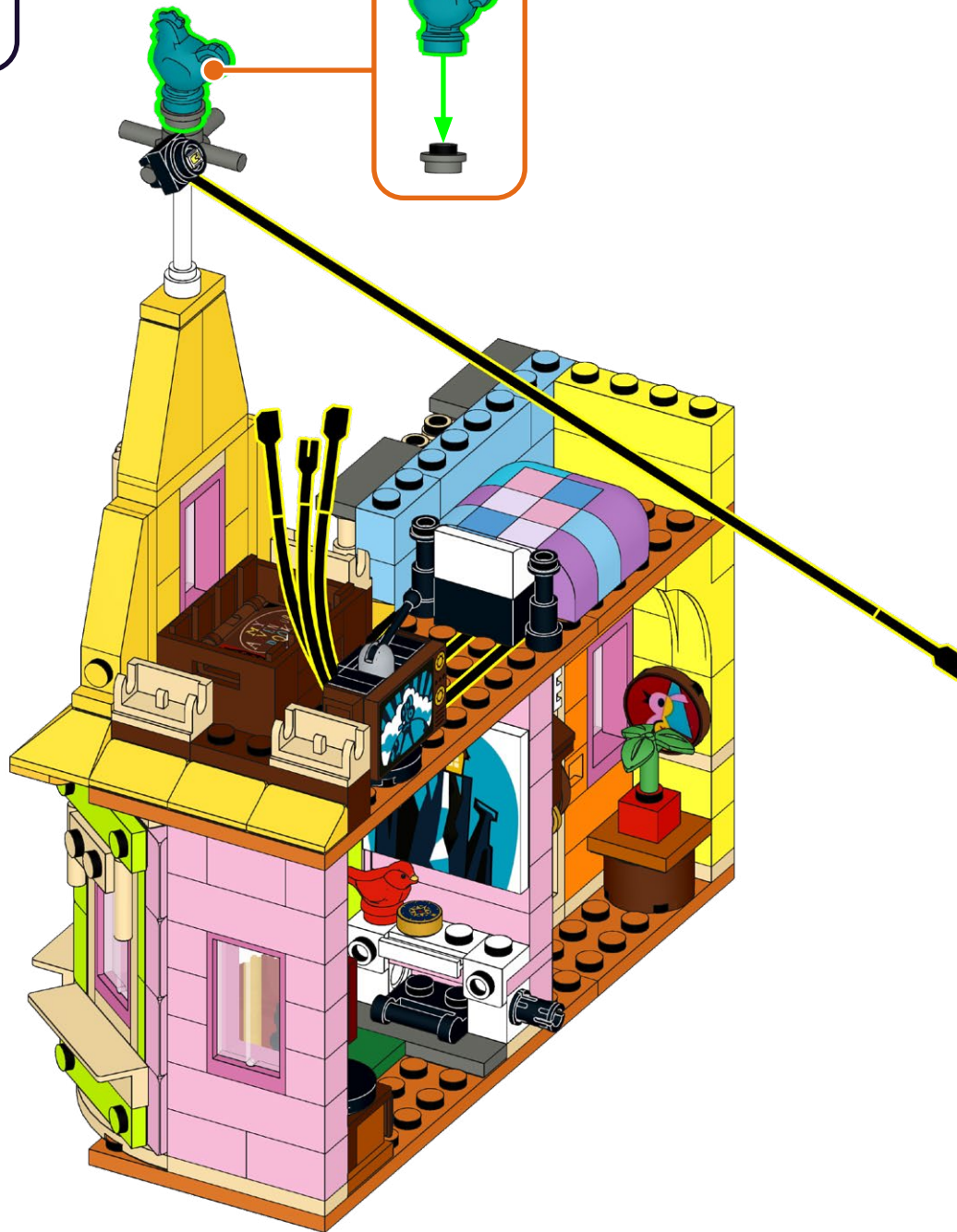
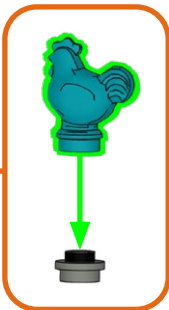

123

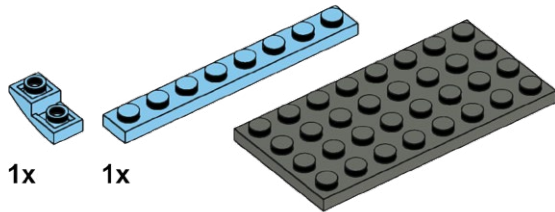

1x

1x

1x

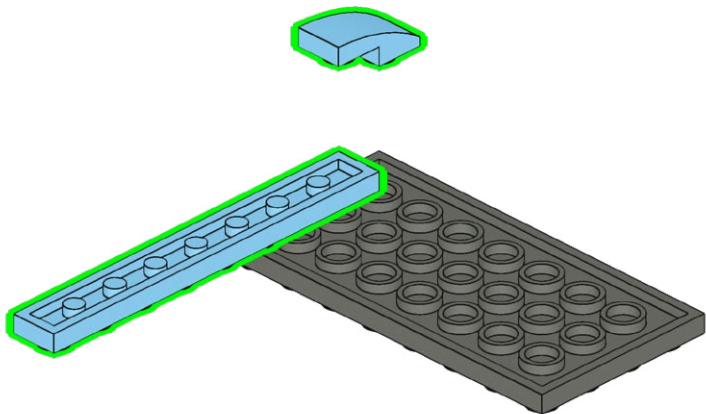

124

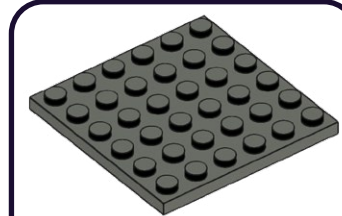

1x

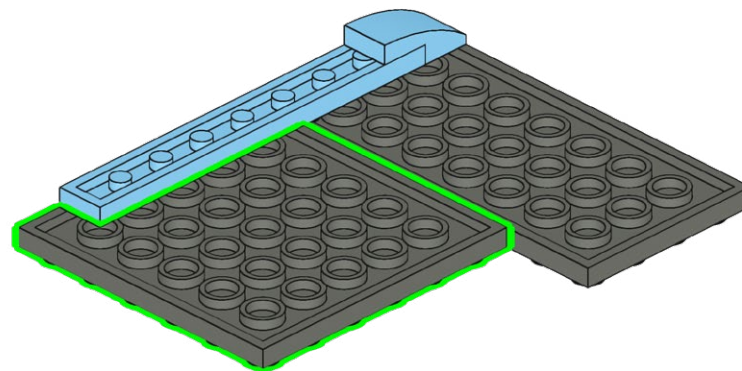

125

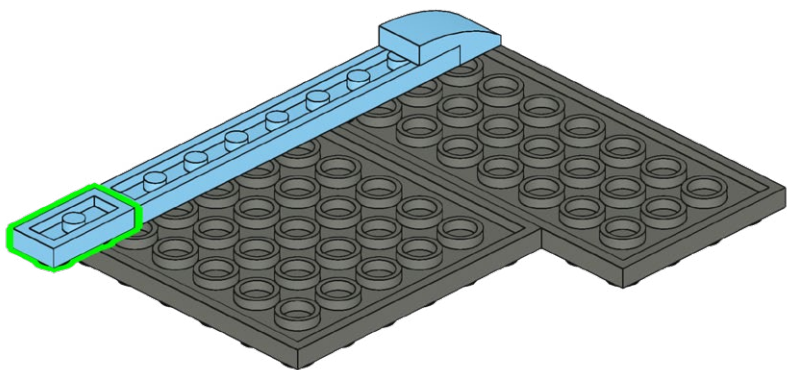
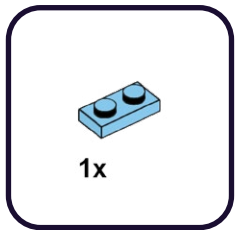

126

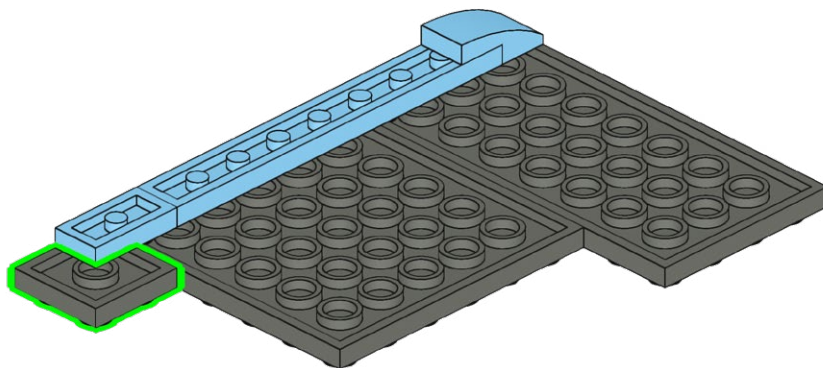
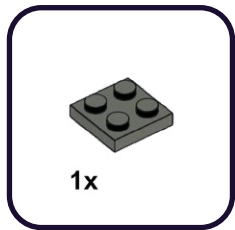

127

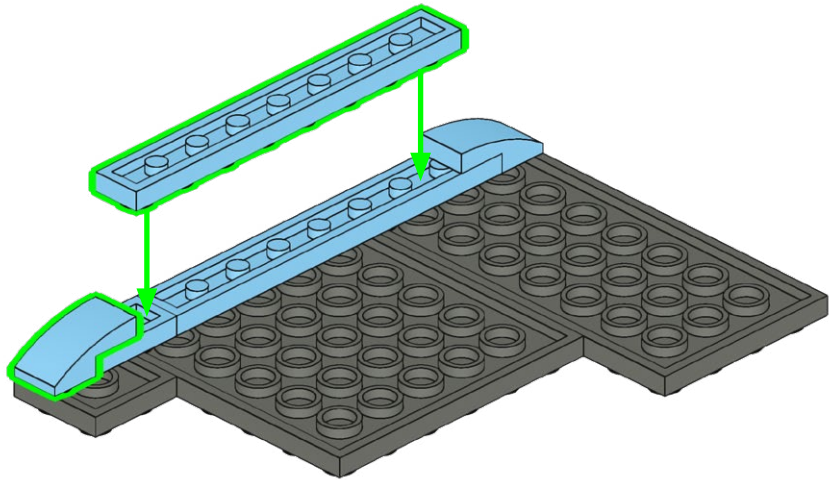
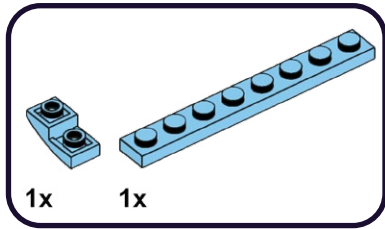

128

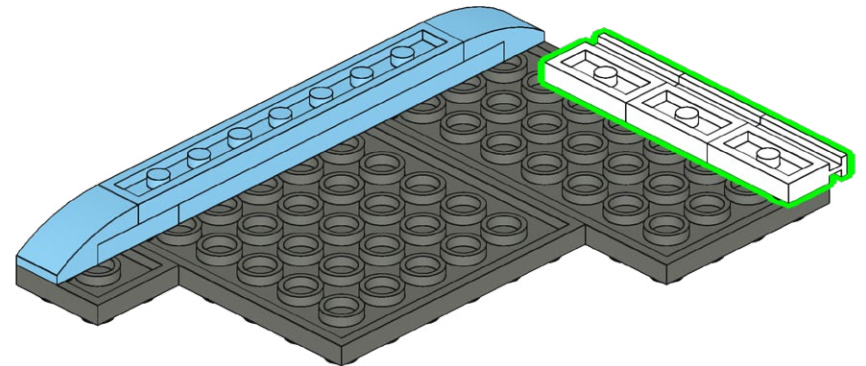
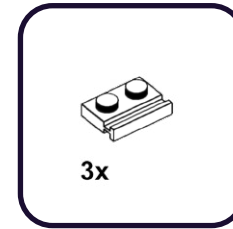

129

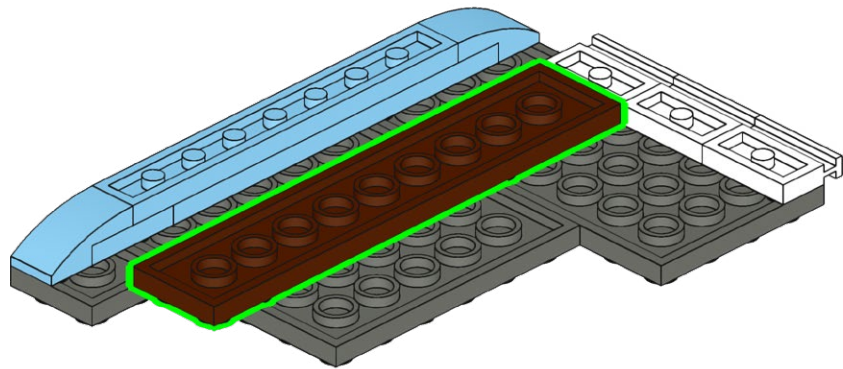
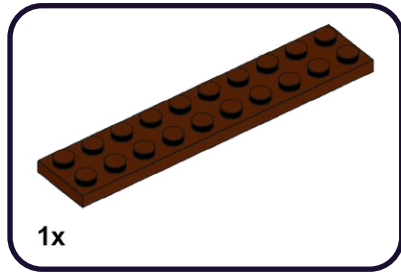

130

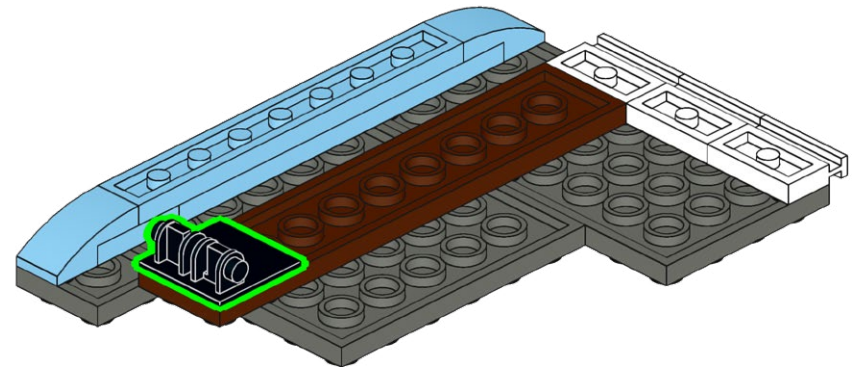
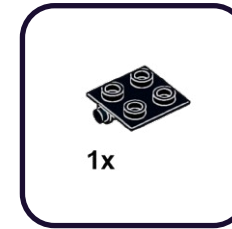

131

AL-WW15

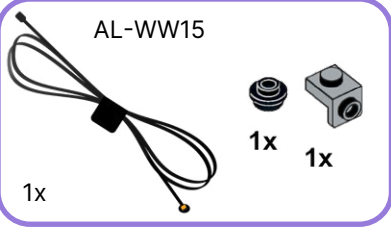

132

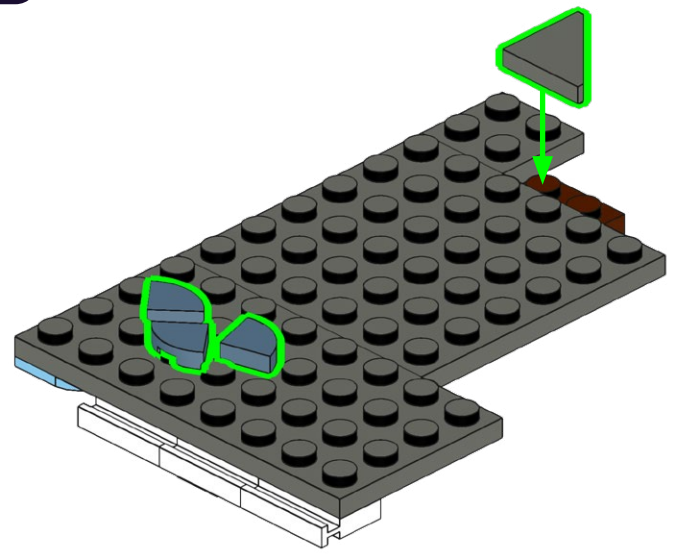
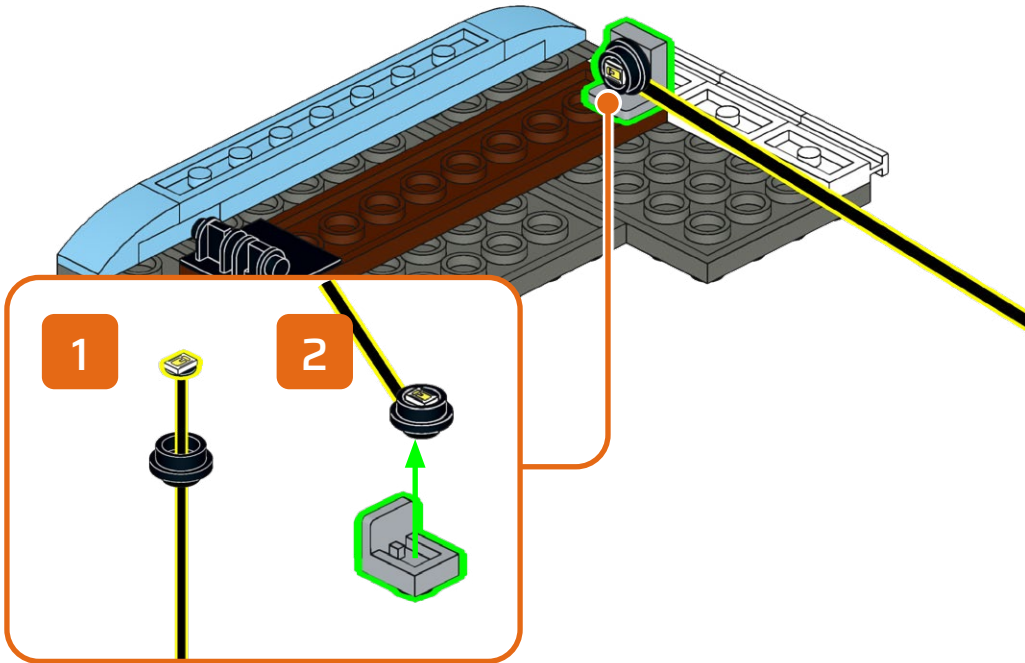
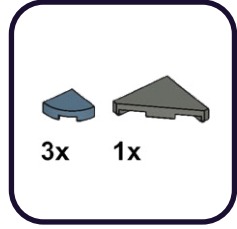

133

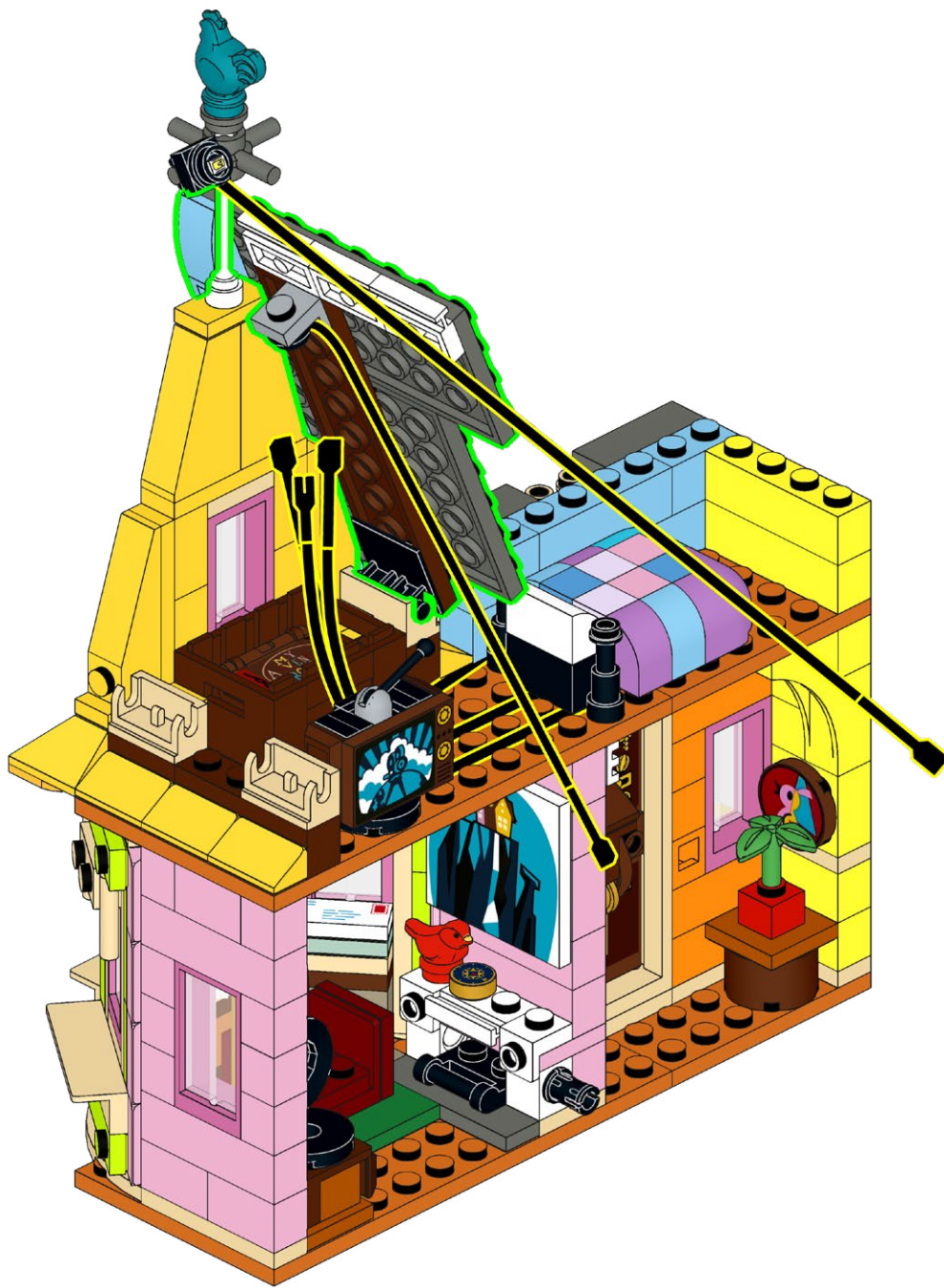

134



135

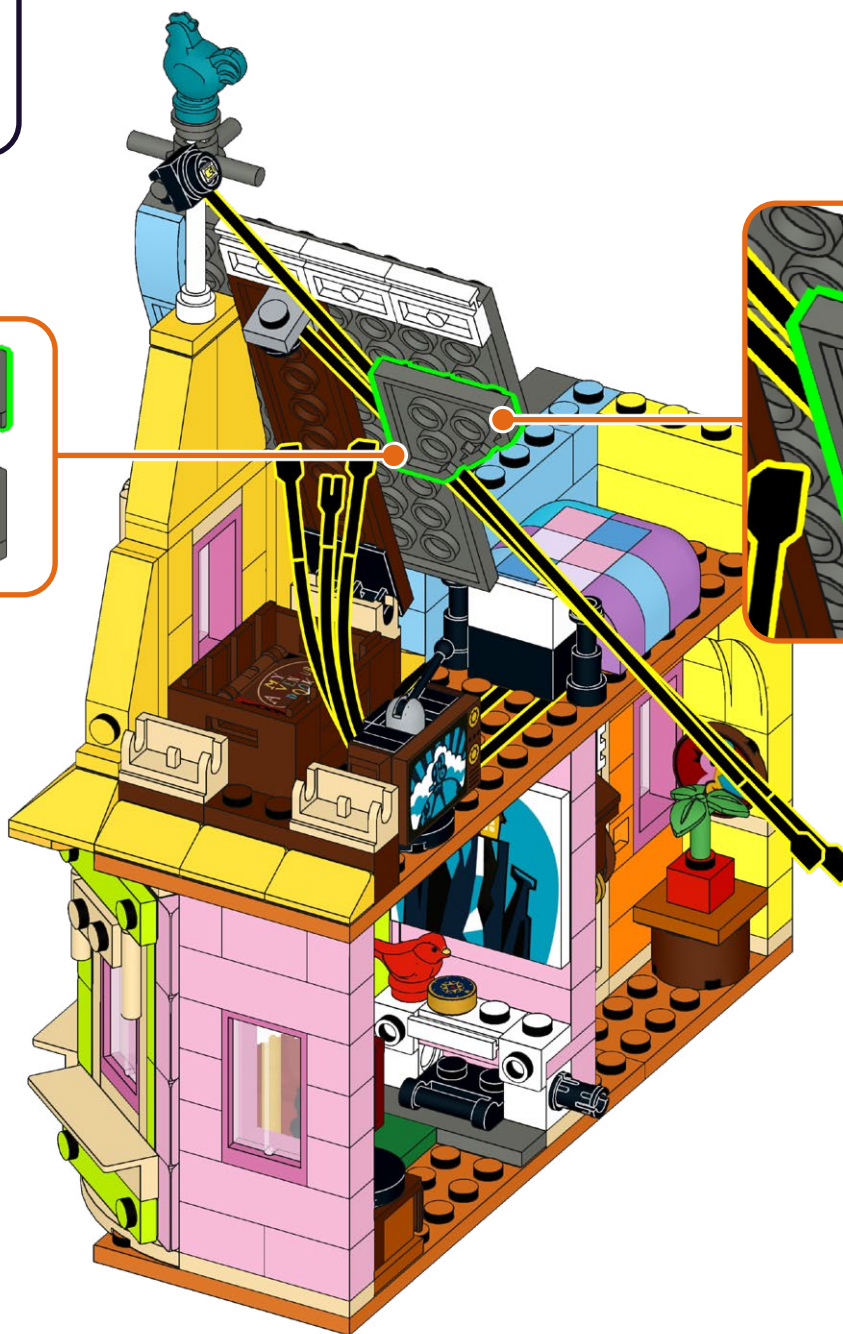
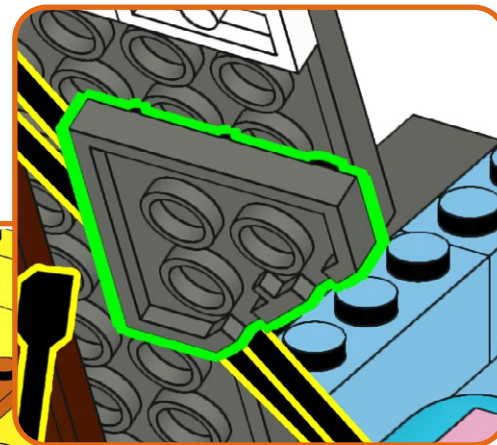
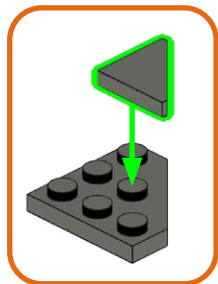
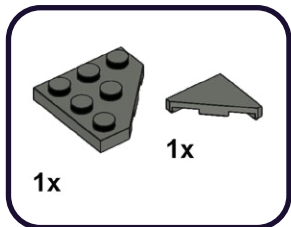

136

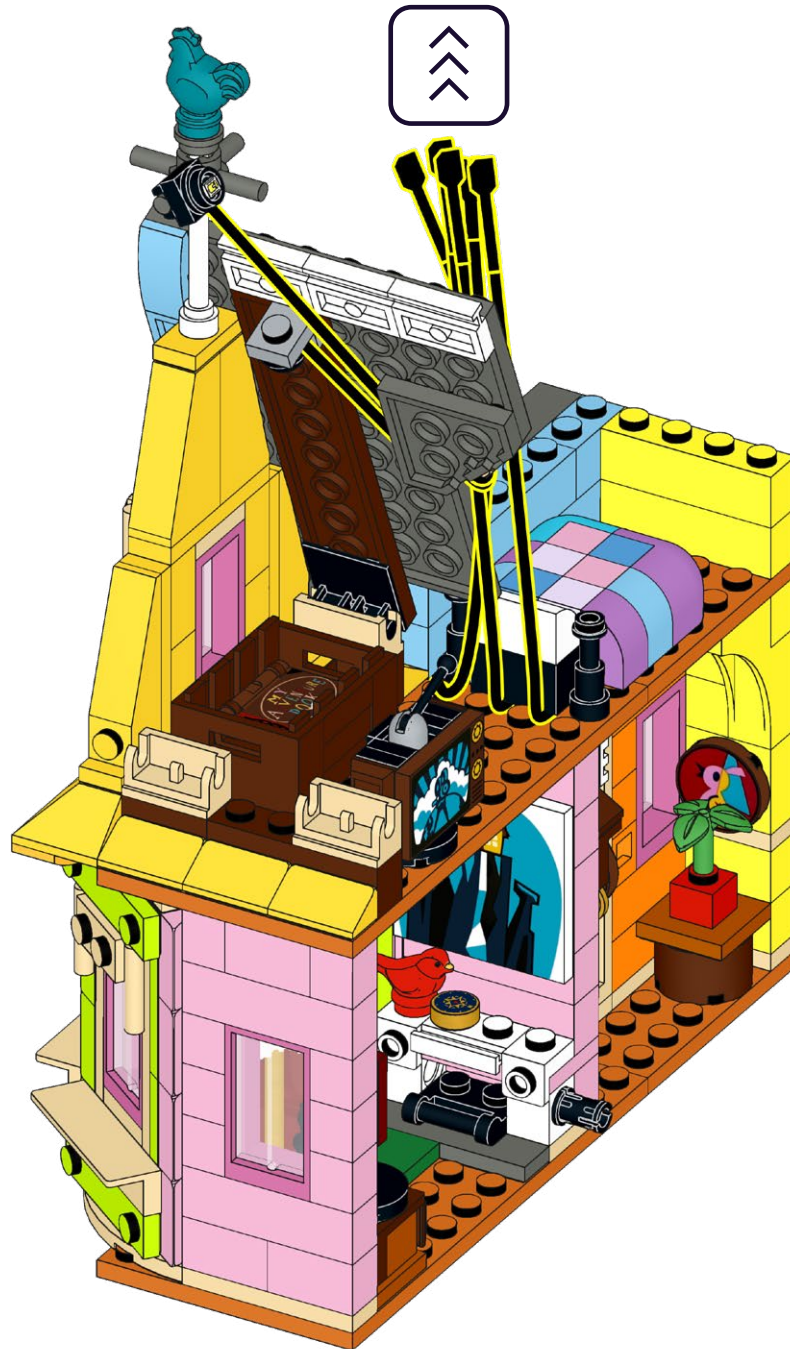

137

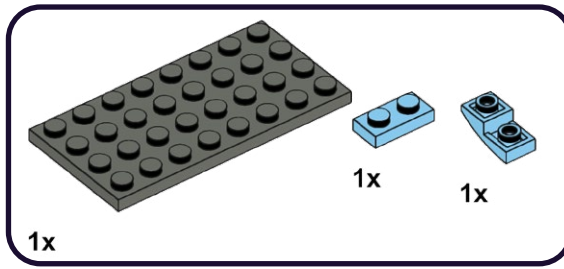

1

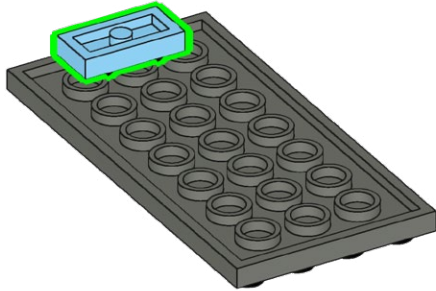

2

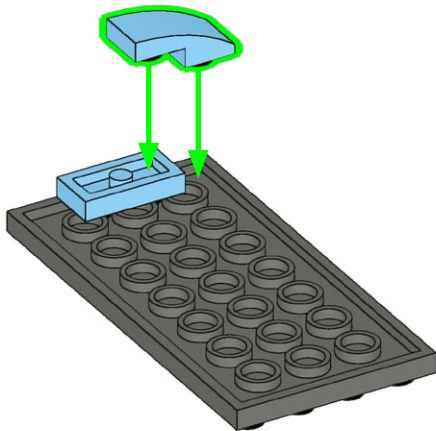

138

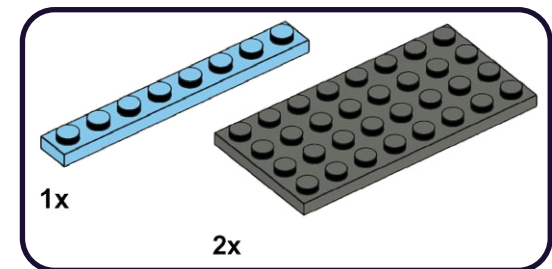

1

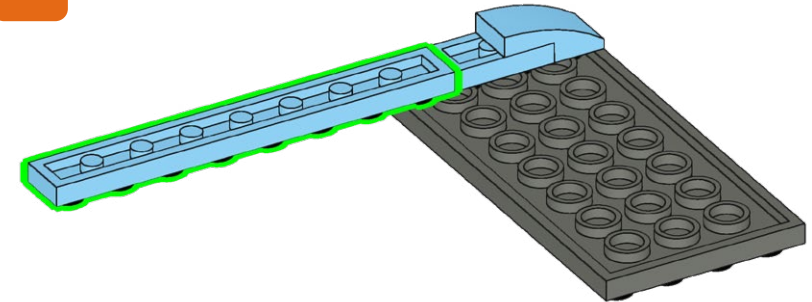

2

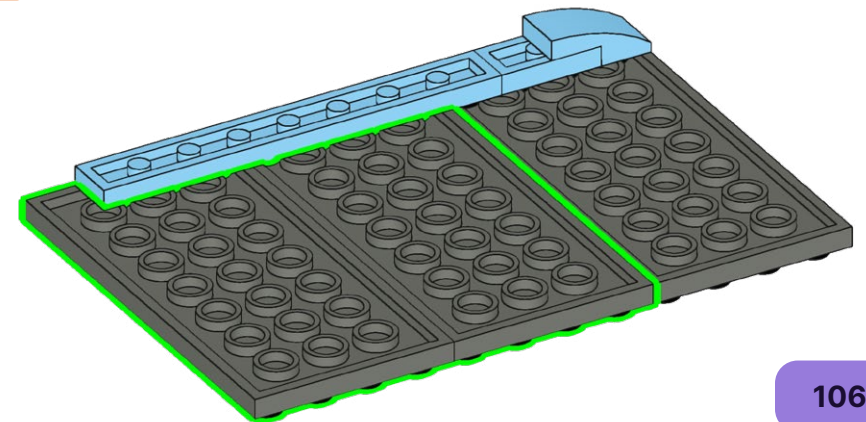

139

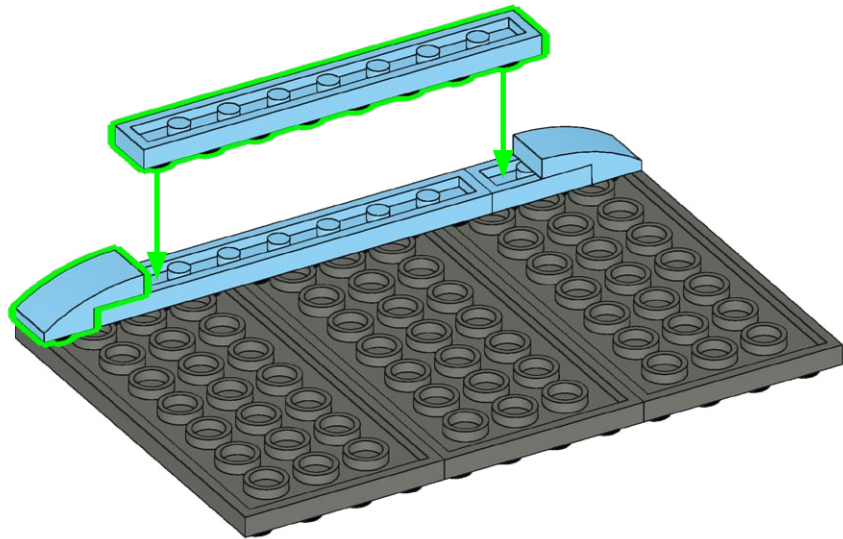
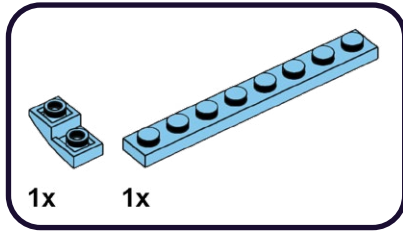

140

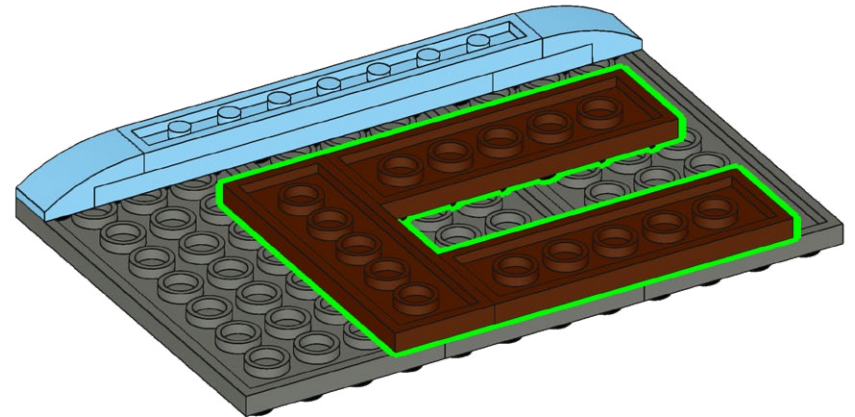
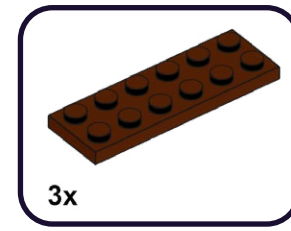

141



2x

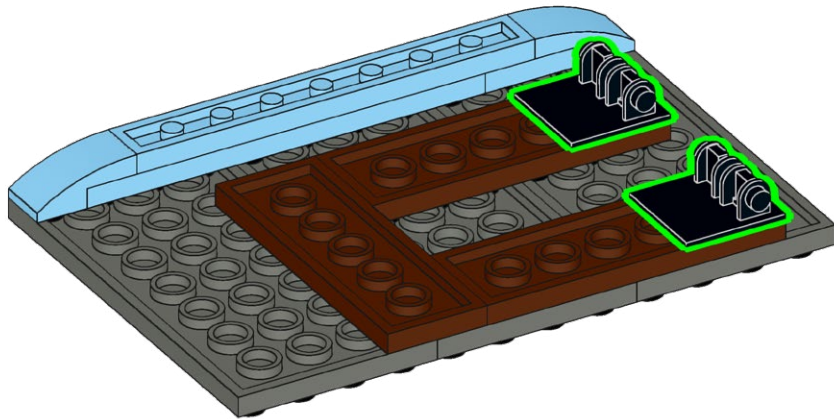

142



6x

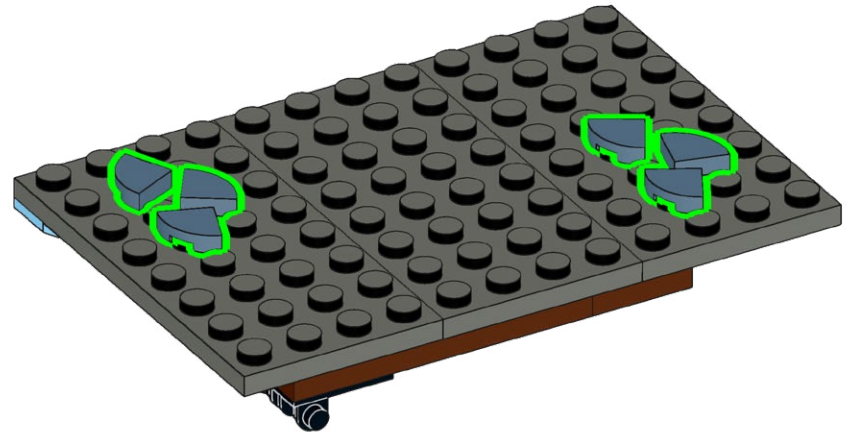
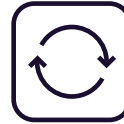

143

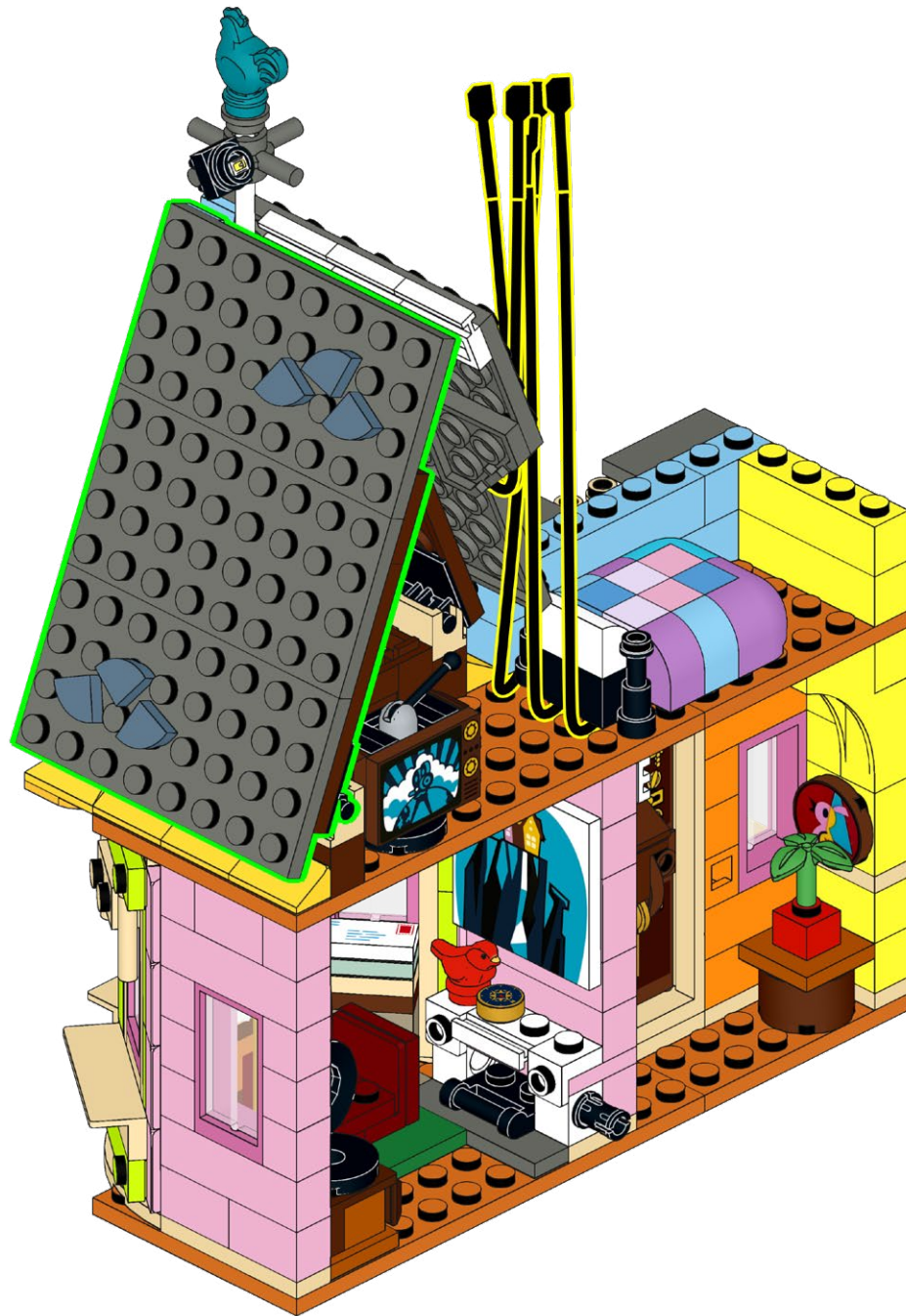

144

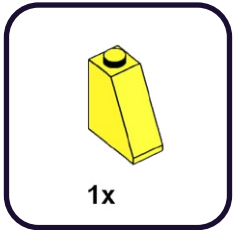

145

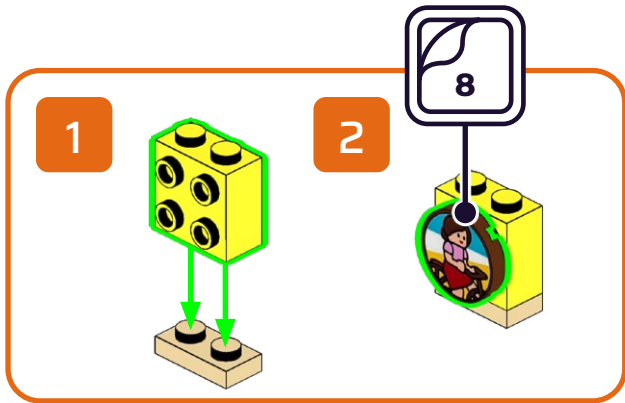
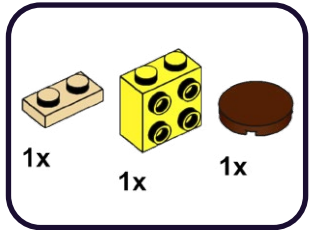

146

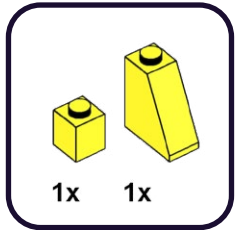

147

1x



148



**HOLD UP!**

You might notice some bags are out of order, as well as left over pieces, but that's ok! We're changing the way you build LEGO!

HALTEN!

Möglicherweise stellen Sie fest, dass einige Beutel nicht in Ordnung sind und auch Teile übrig bleiben, aber das ist in Ordnung! Wir verändern die Art und Weise, wie Sie LEGO bauen!

TENIR BON!

Vous remarquerez peut-être que certains sacs sont en panne, ainsi que des morceaux restants, mais ce n'est pas grave ! Nous changeons la façon dont vous construisez LEGO !

SOSTENERE!

Potresti notare che alcune borse sono fuori uso, così come alcuni pezzi avanzati, ma va bene! Stiamo cambiando il modo in cui costruisci i LEGO!

¡SOSTENER!

Puede que notes que algunas bolsas están fuera de orden, así como piezas sobrantes, ¡pero está bien! ¡Estamos cambiando la forma de construir LEGO!

耽误!

您可能会注意到有些袋子坏了, 还有剩余的碎片, 但这没关系! 我们正在改变您搭建乐高的方式!

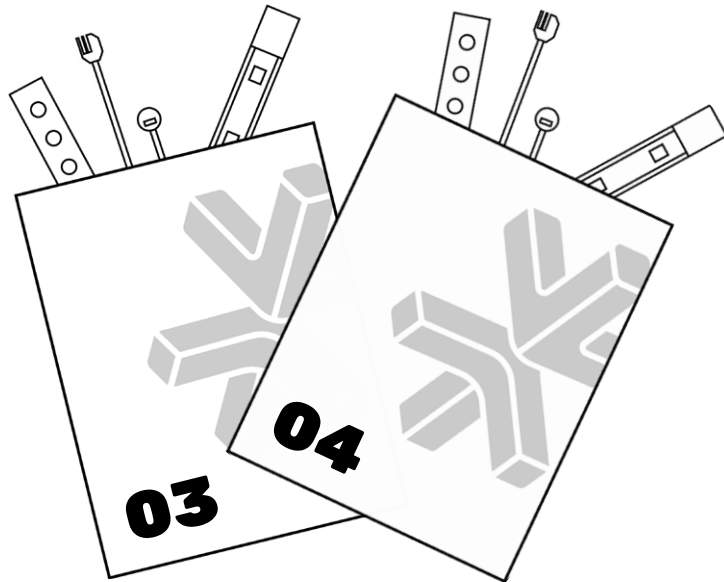
Open LMB Bags 03 & 04

149

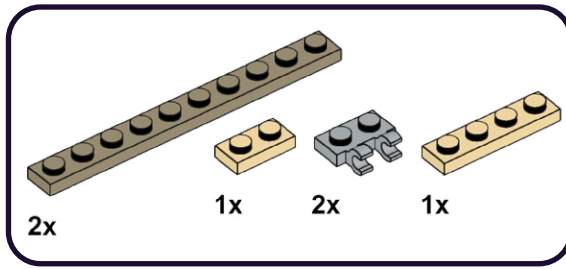

1

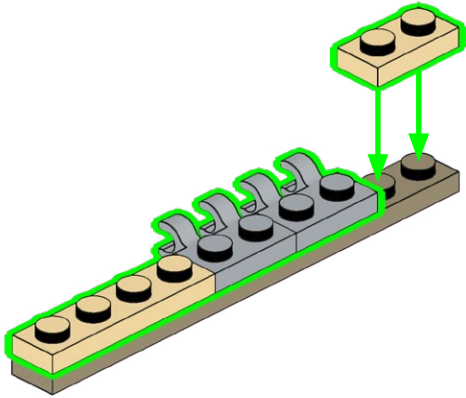

2

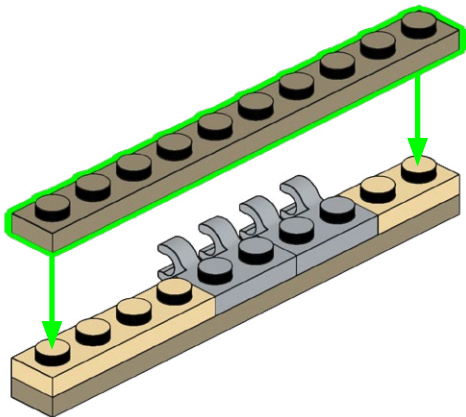

150

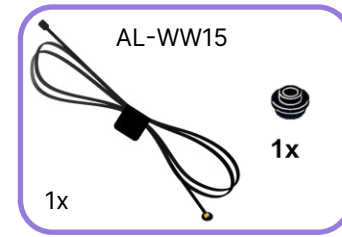

1

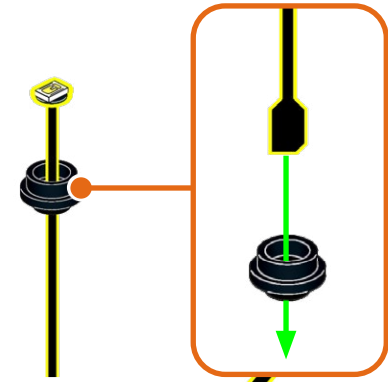

2

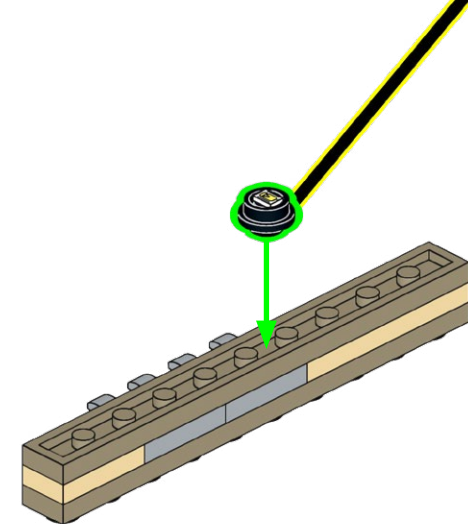
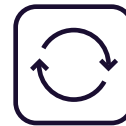

151



152

1x



153

AL-B15

1x

1x 1x 1x

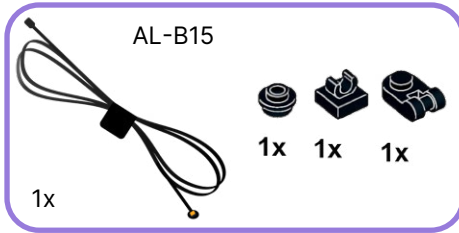

1 2 3

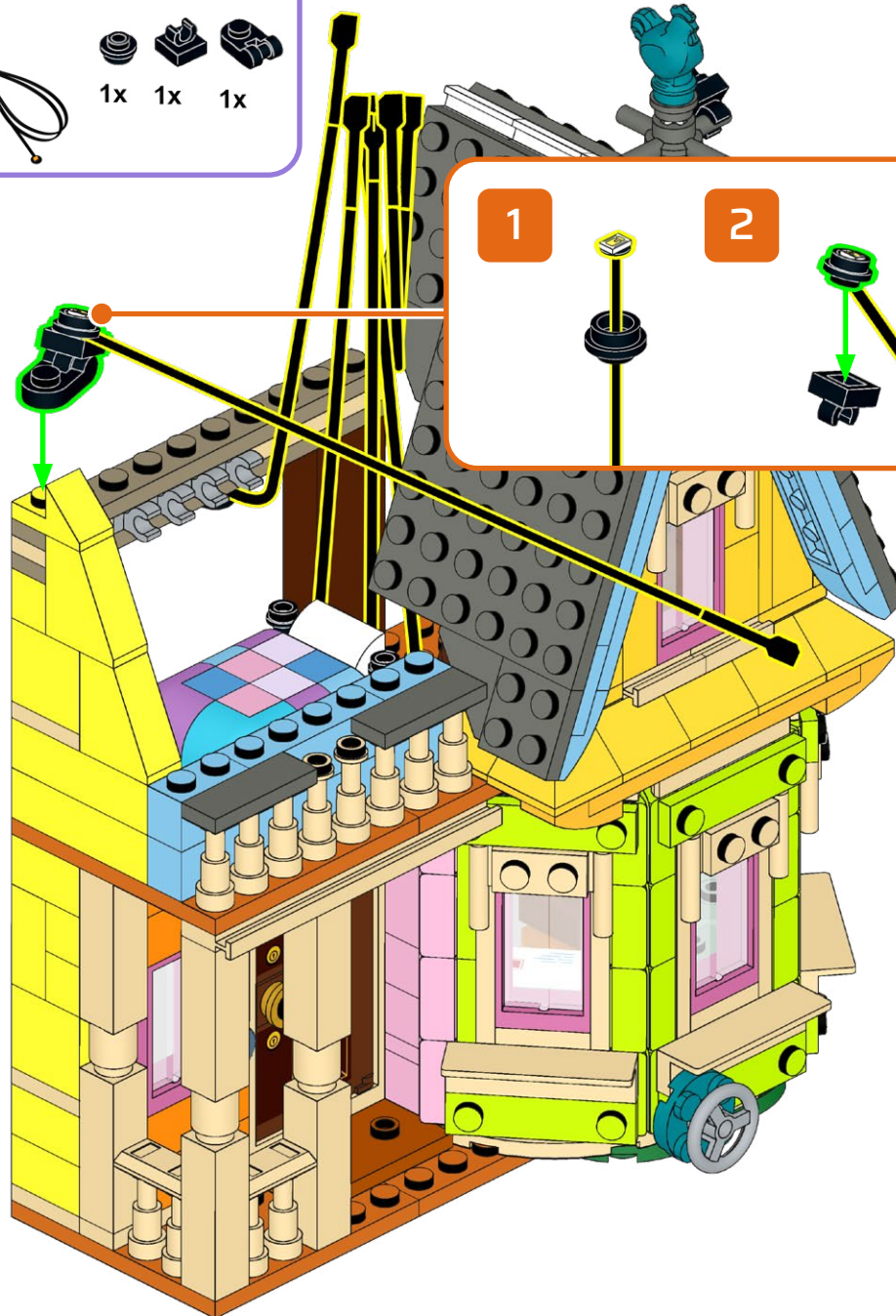
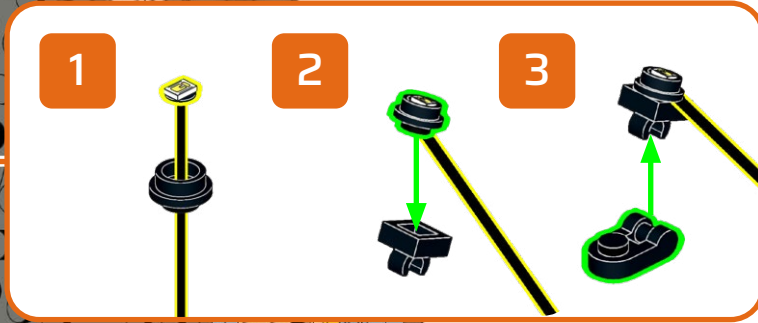

154



1x

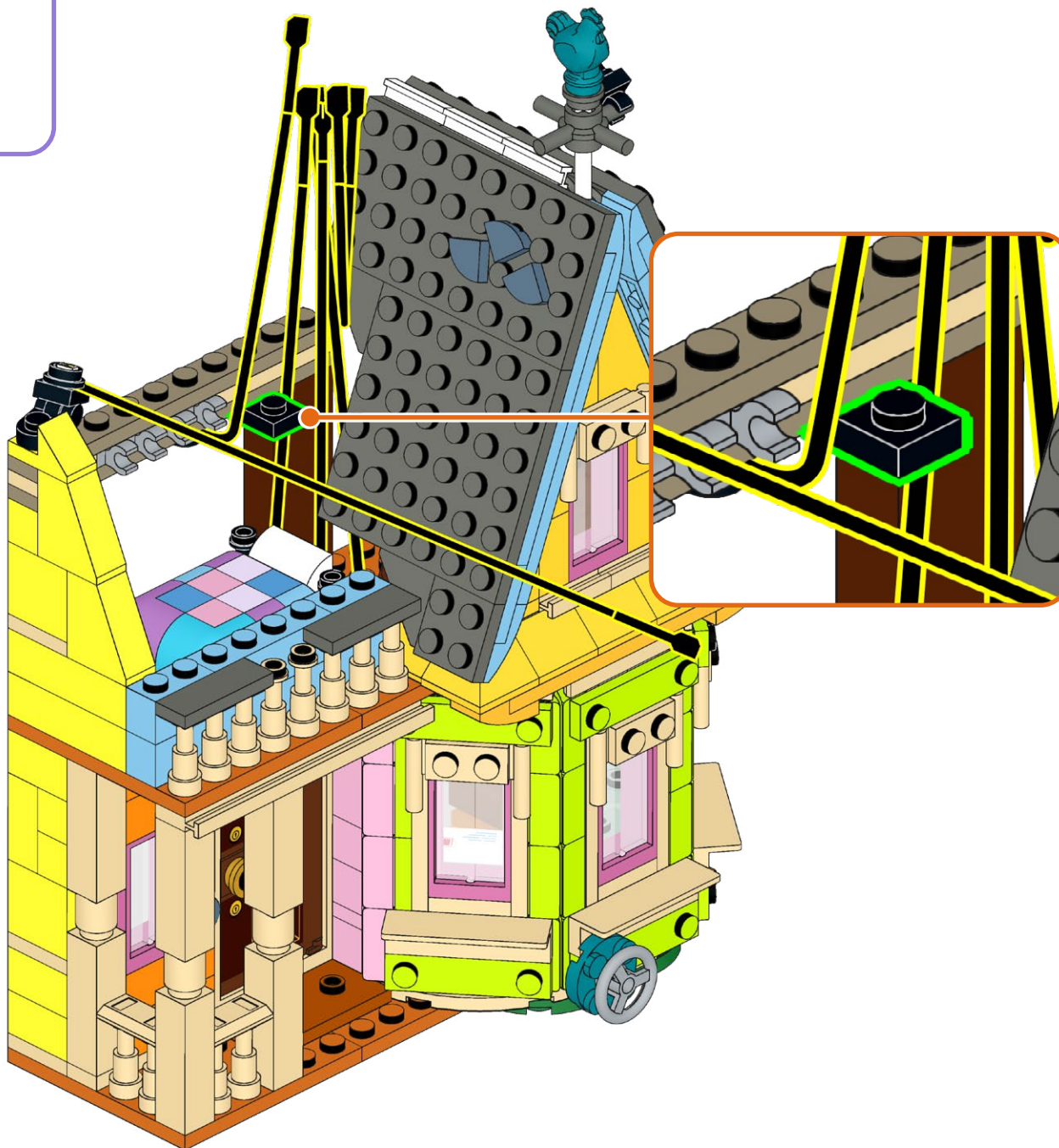

155

D-6



1x



156

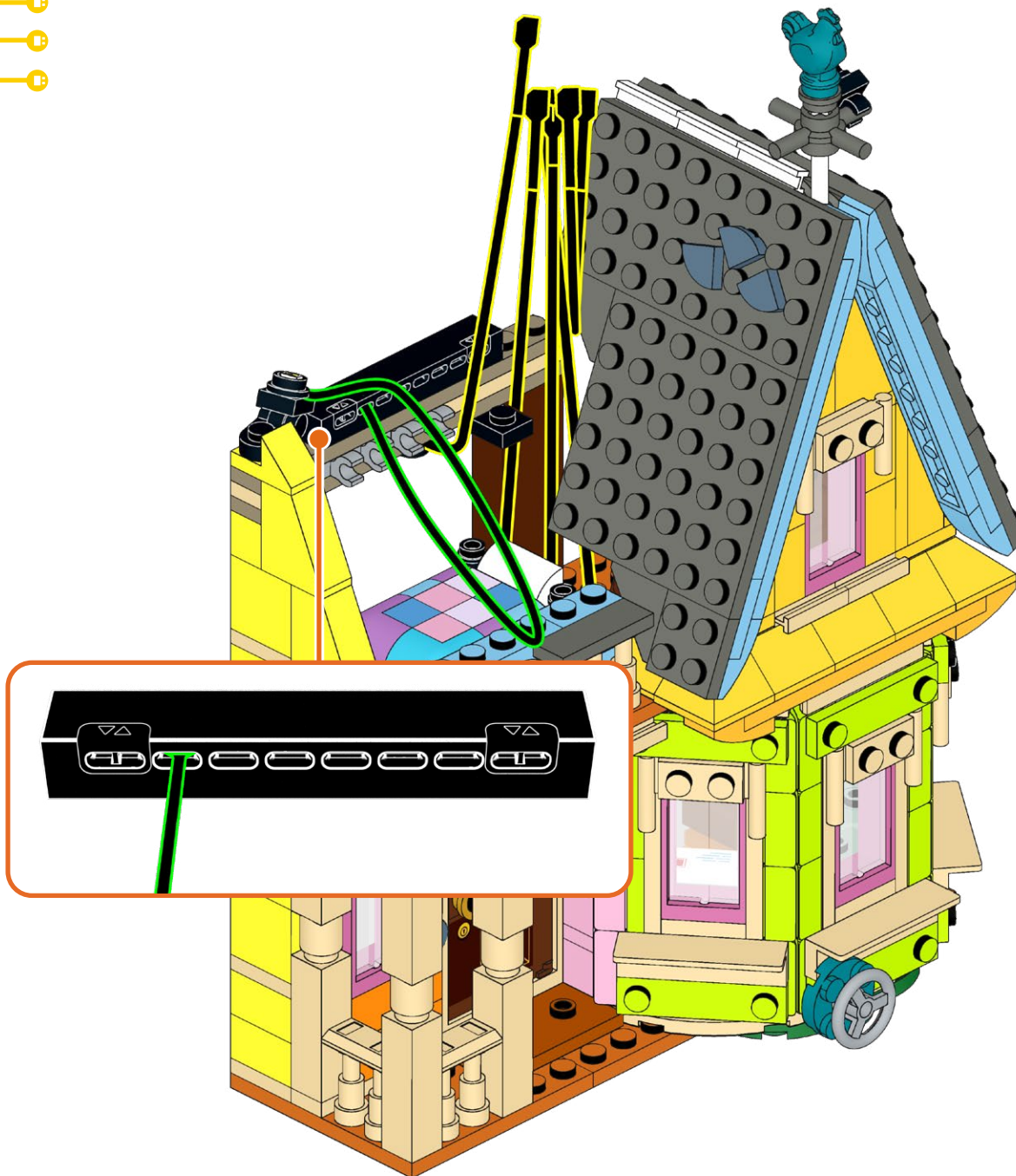

157

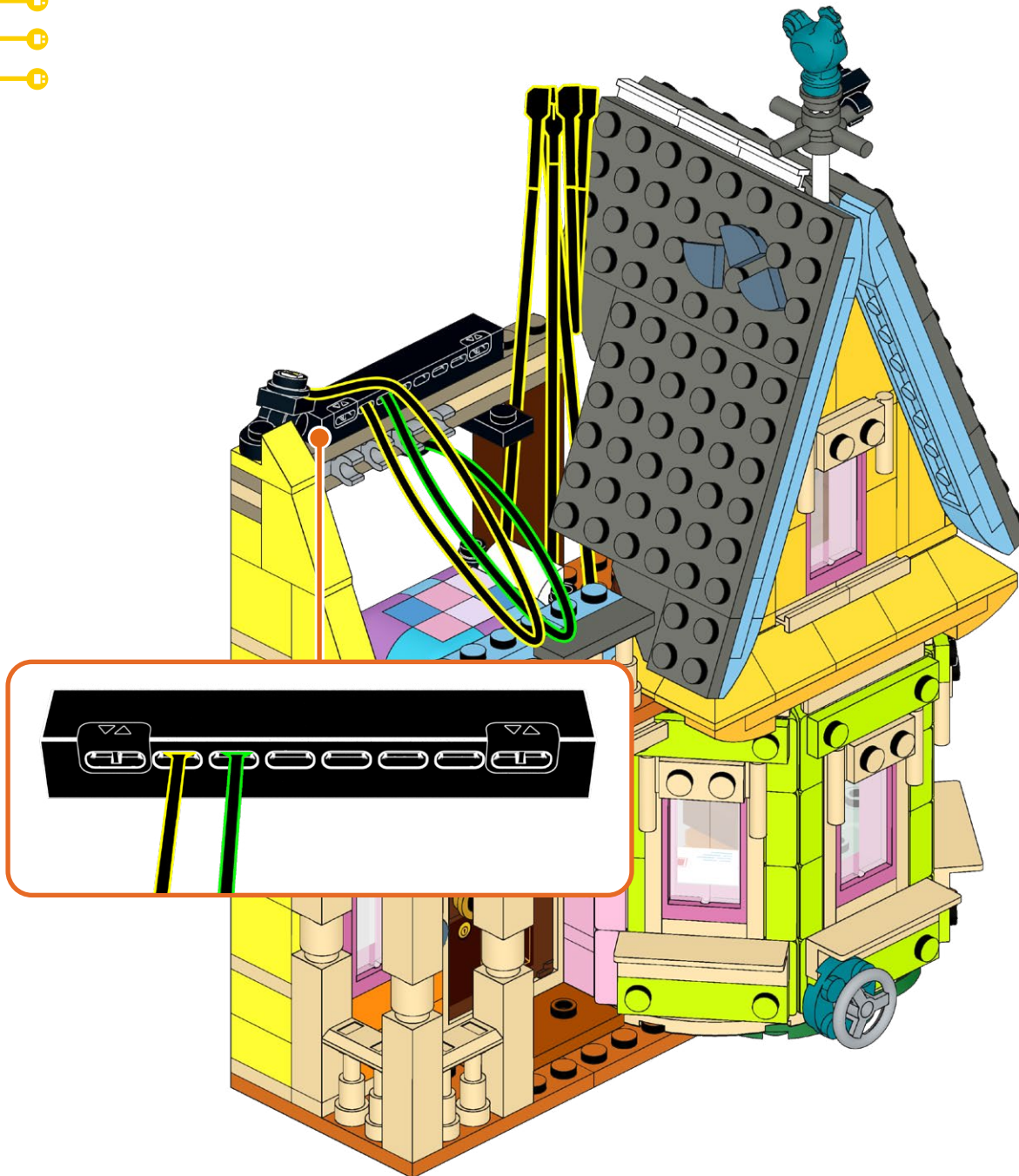

158

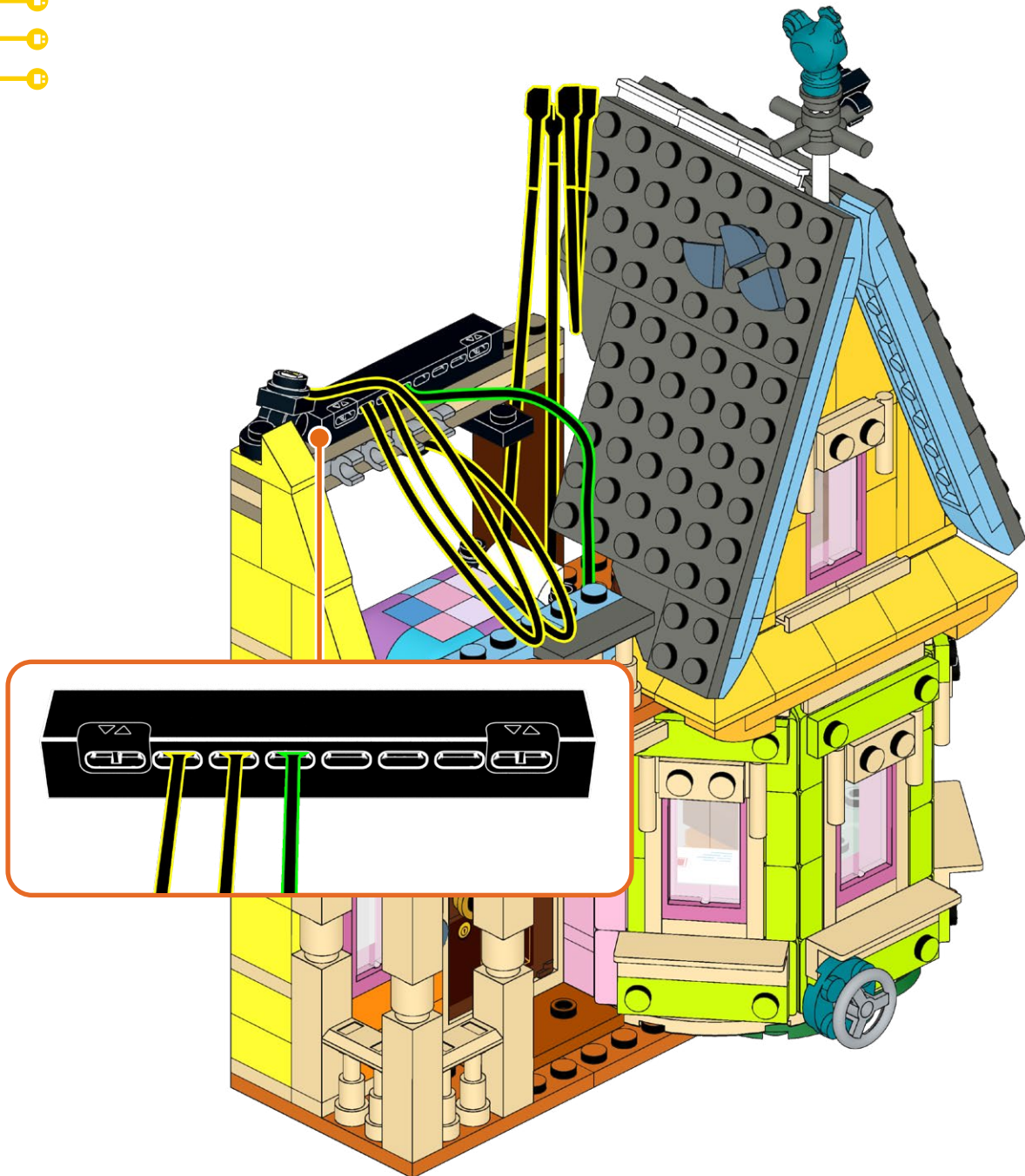

159

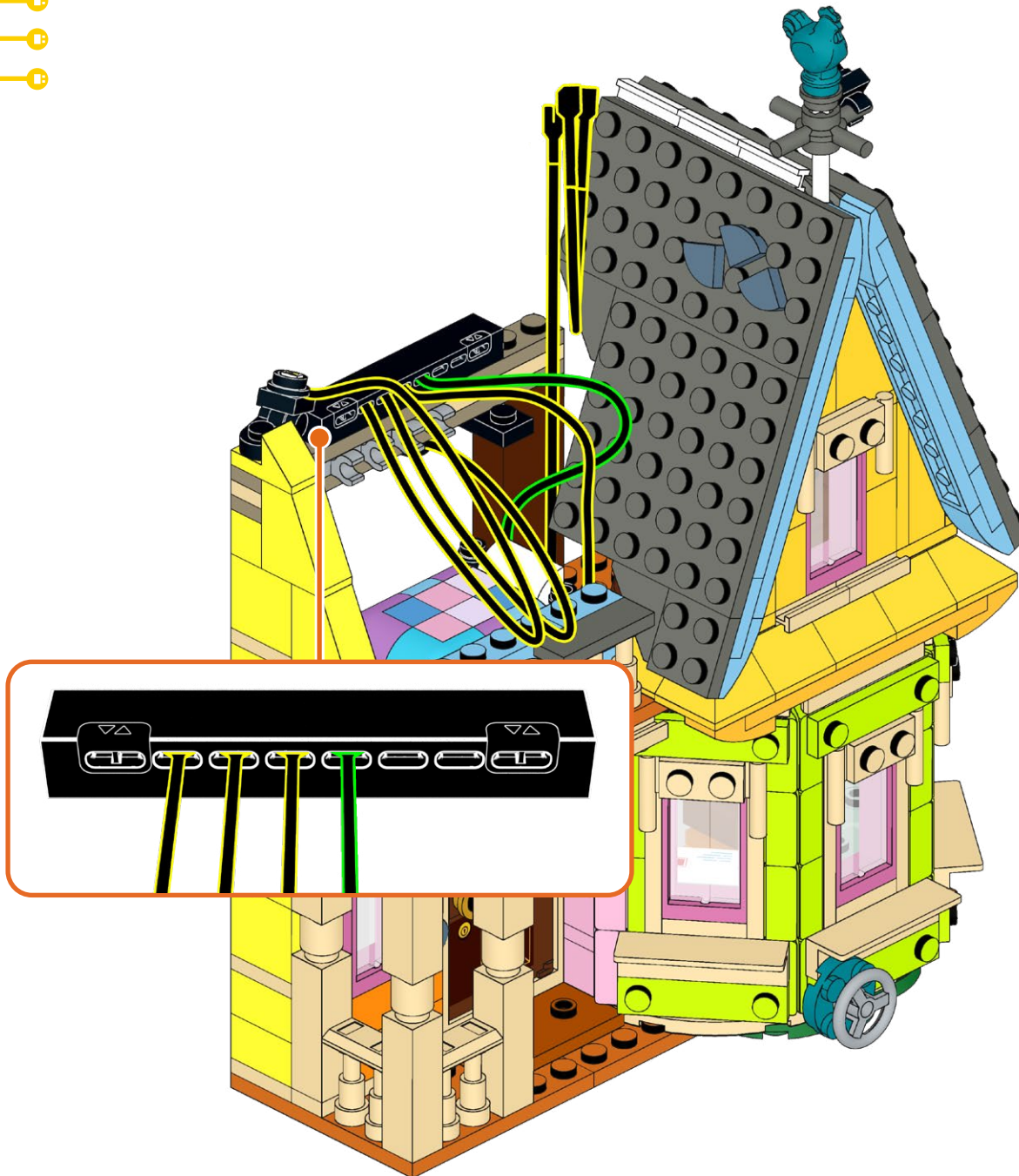

160

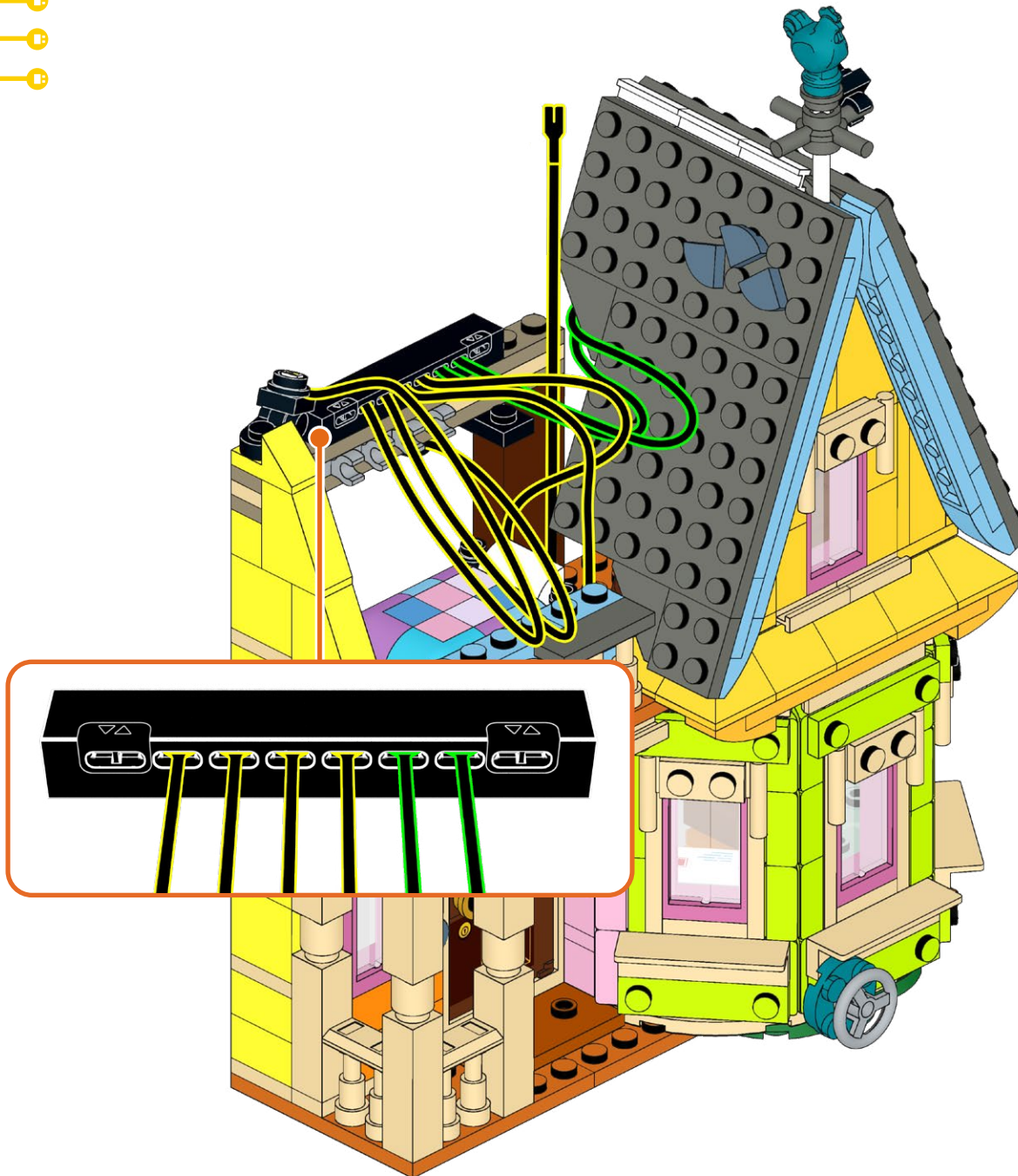

161

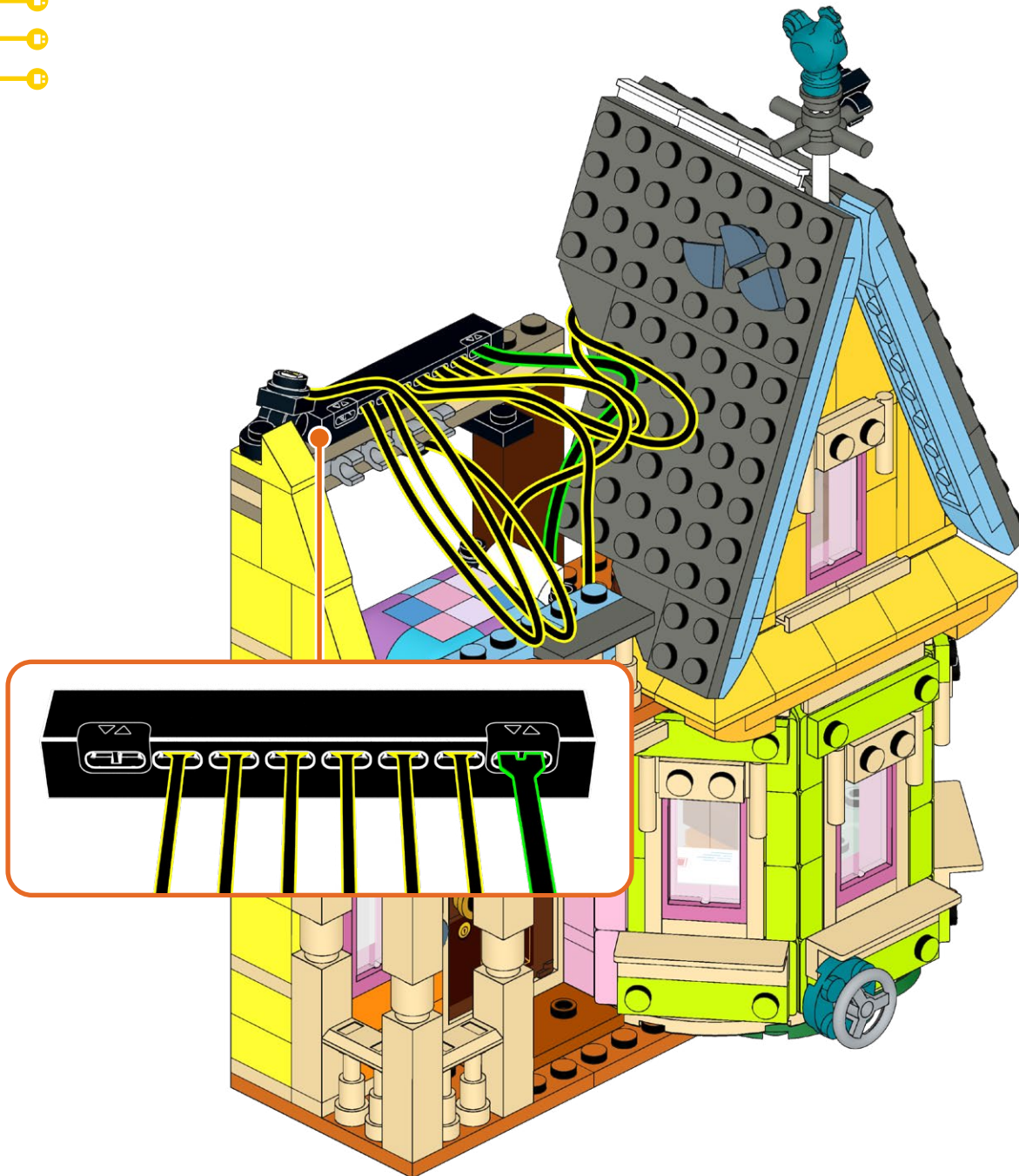

162

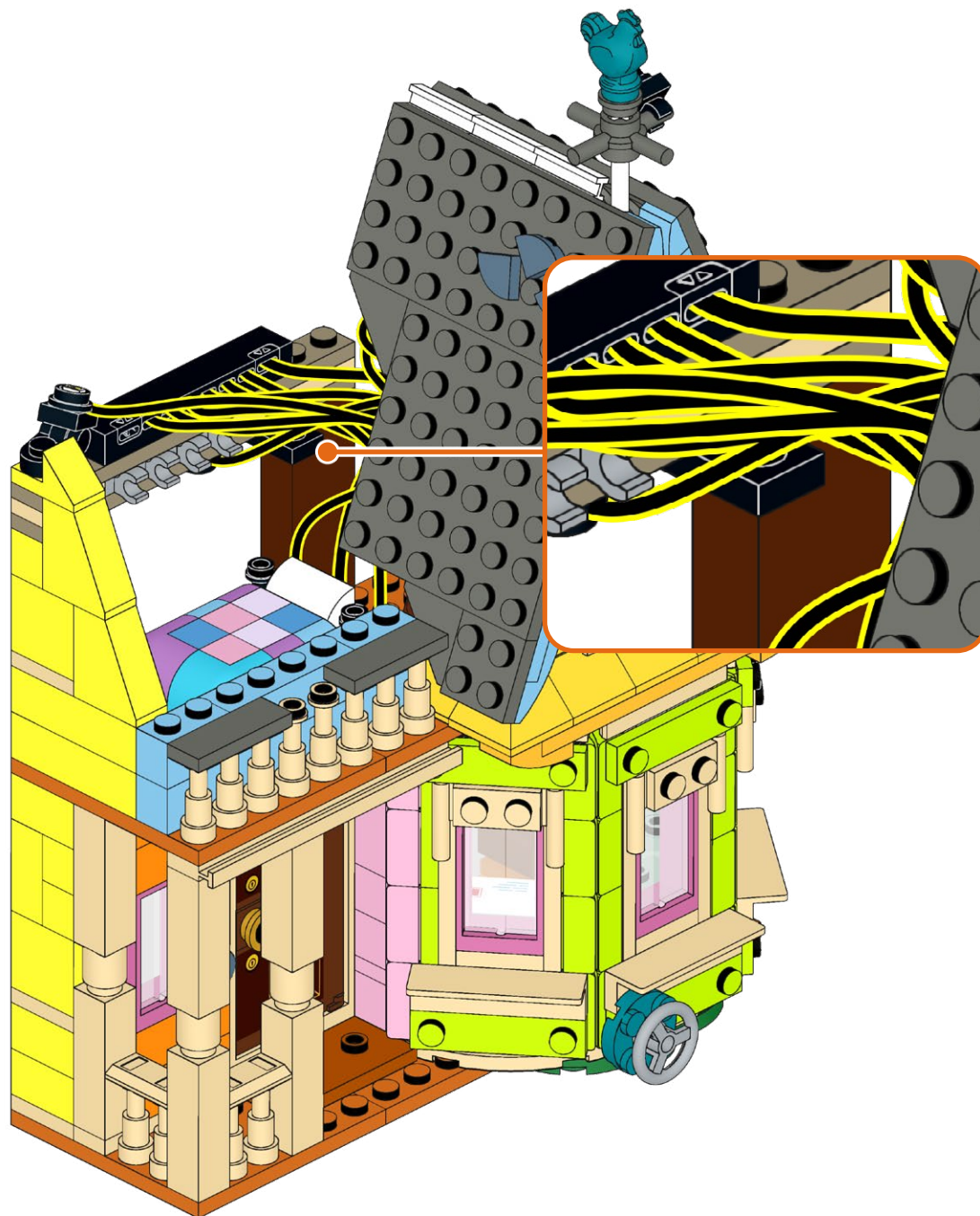

163

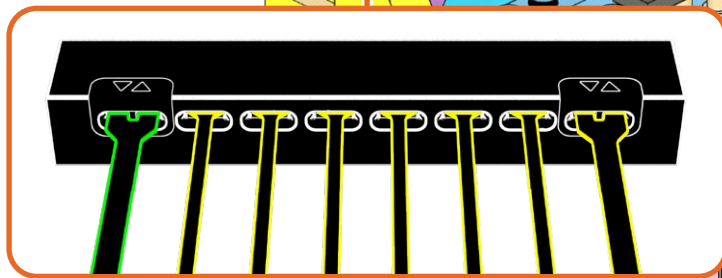
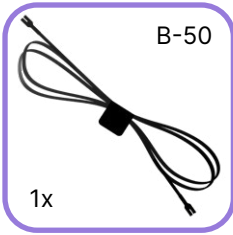

164

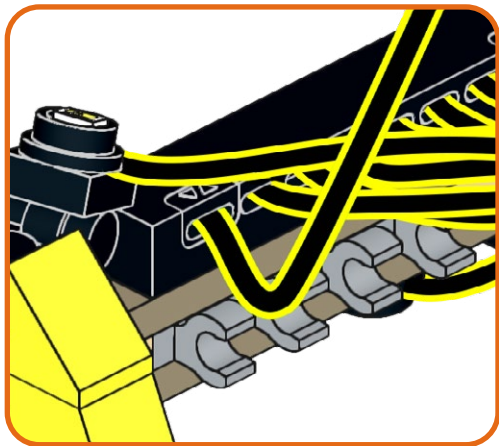

165

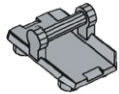

1x



166



167

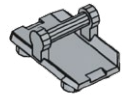

1x



168

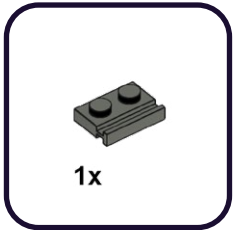

169

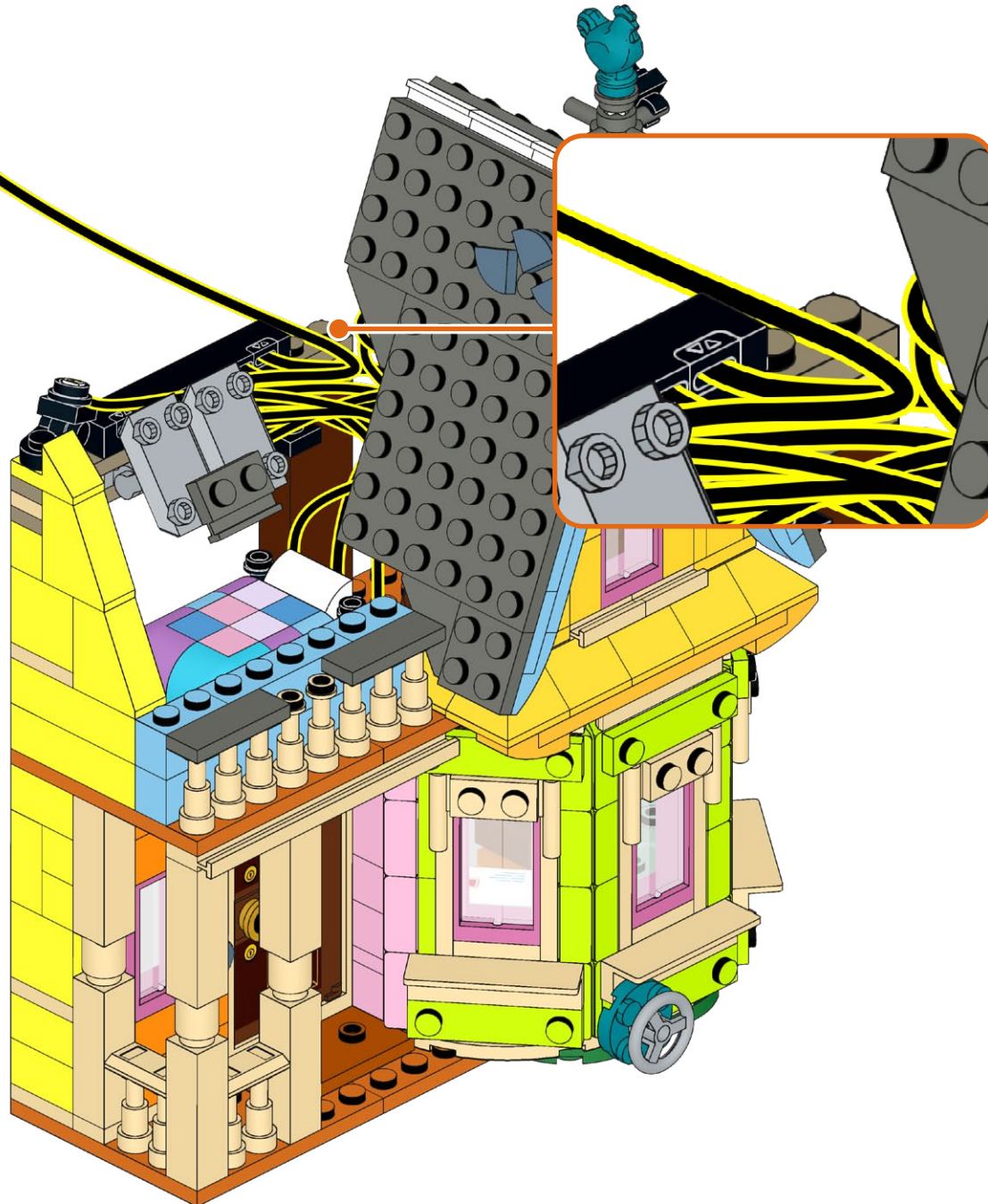

170

1x

1x



171

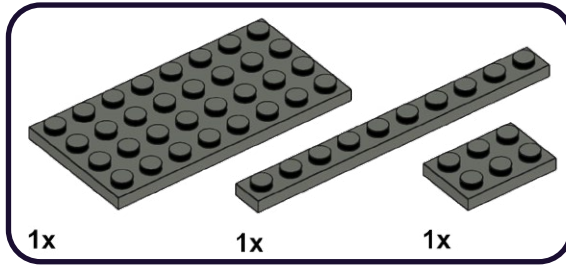

1

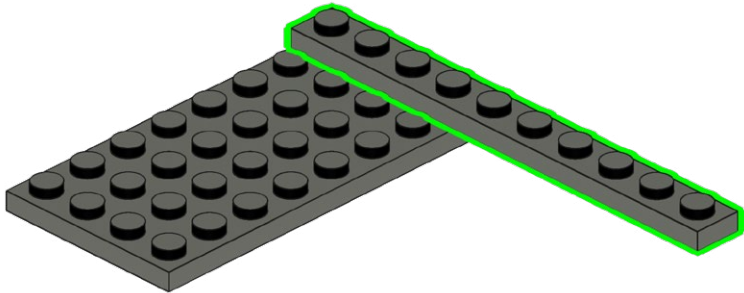

2

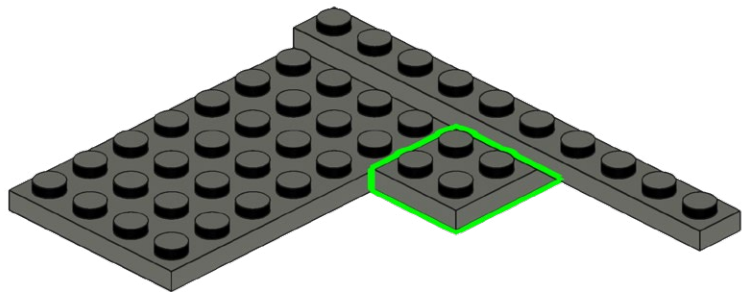

172

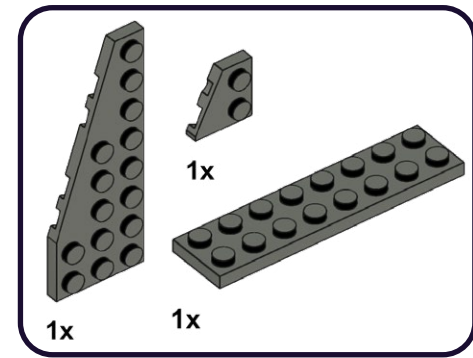

1

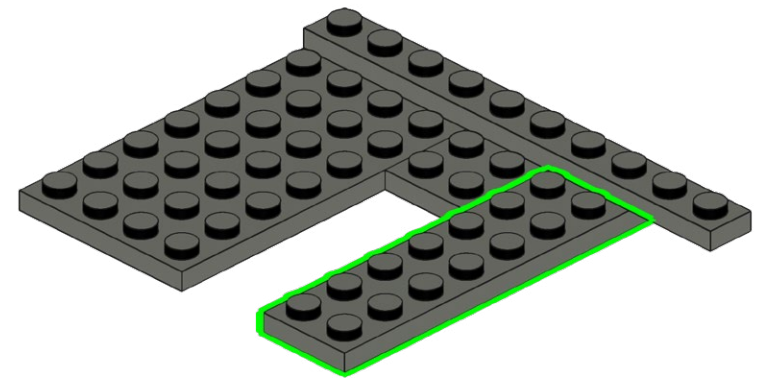

2

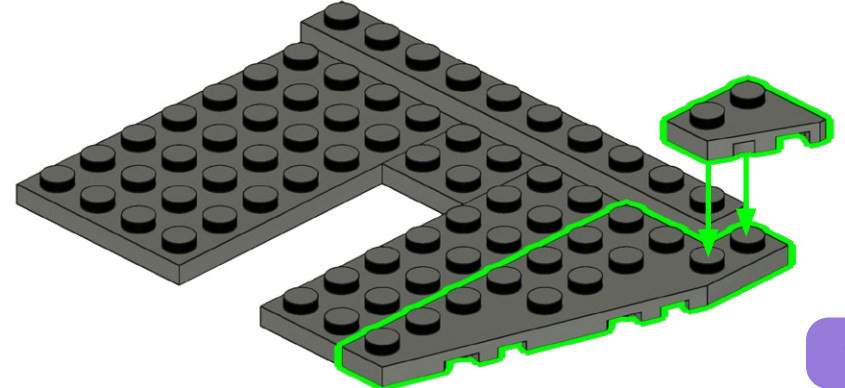

173

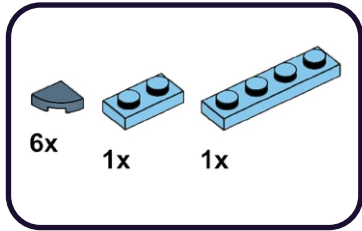

1

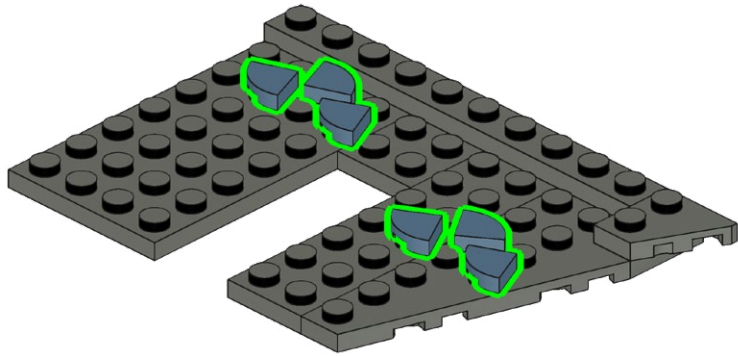

2

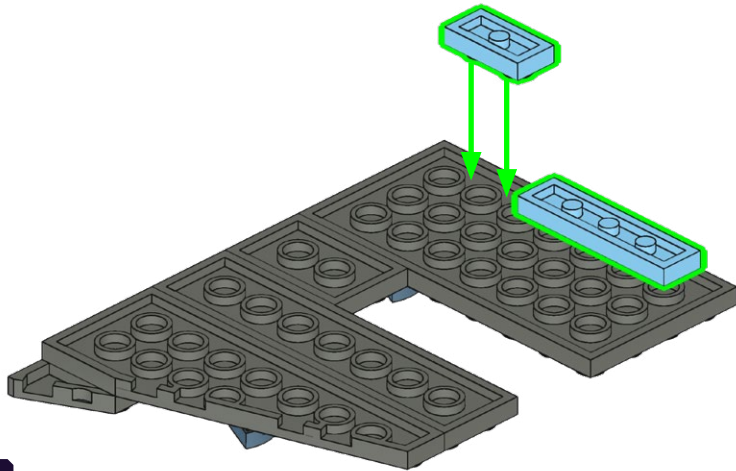

174

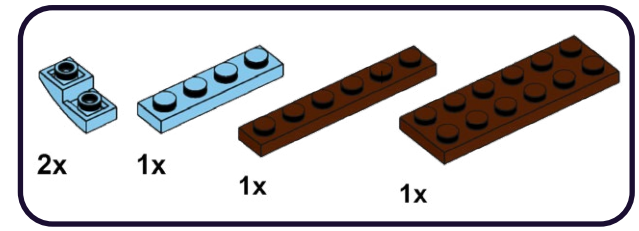

1

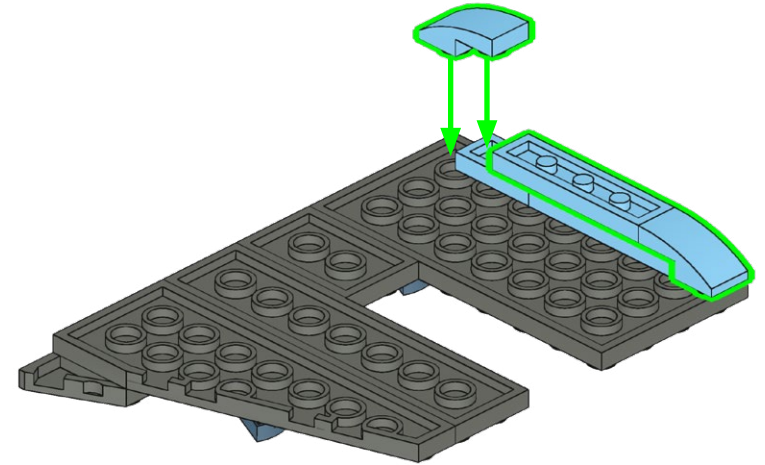

2

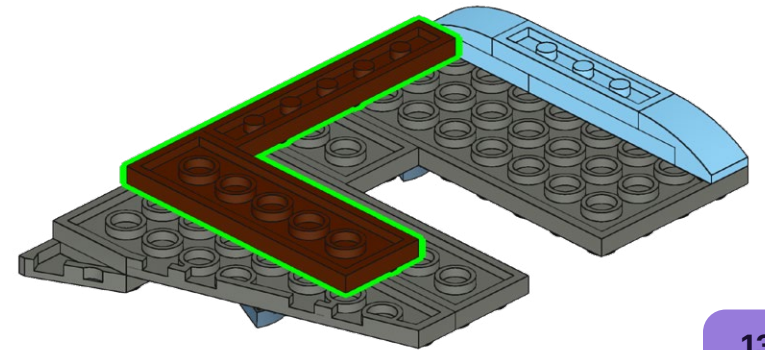

175

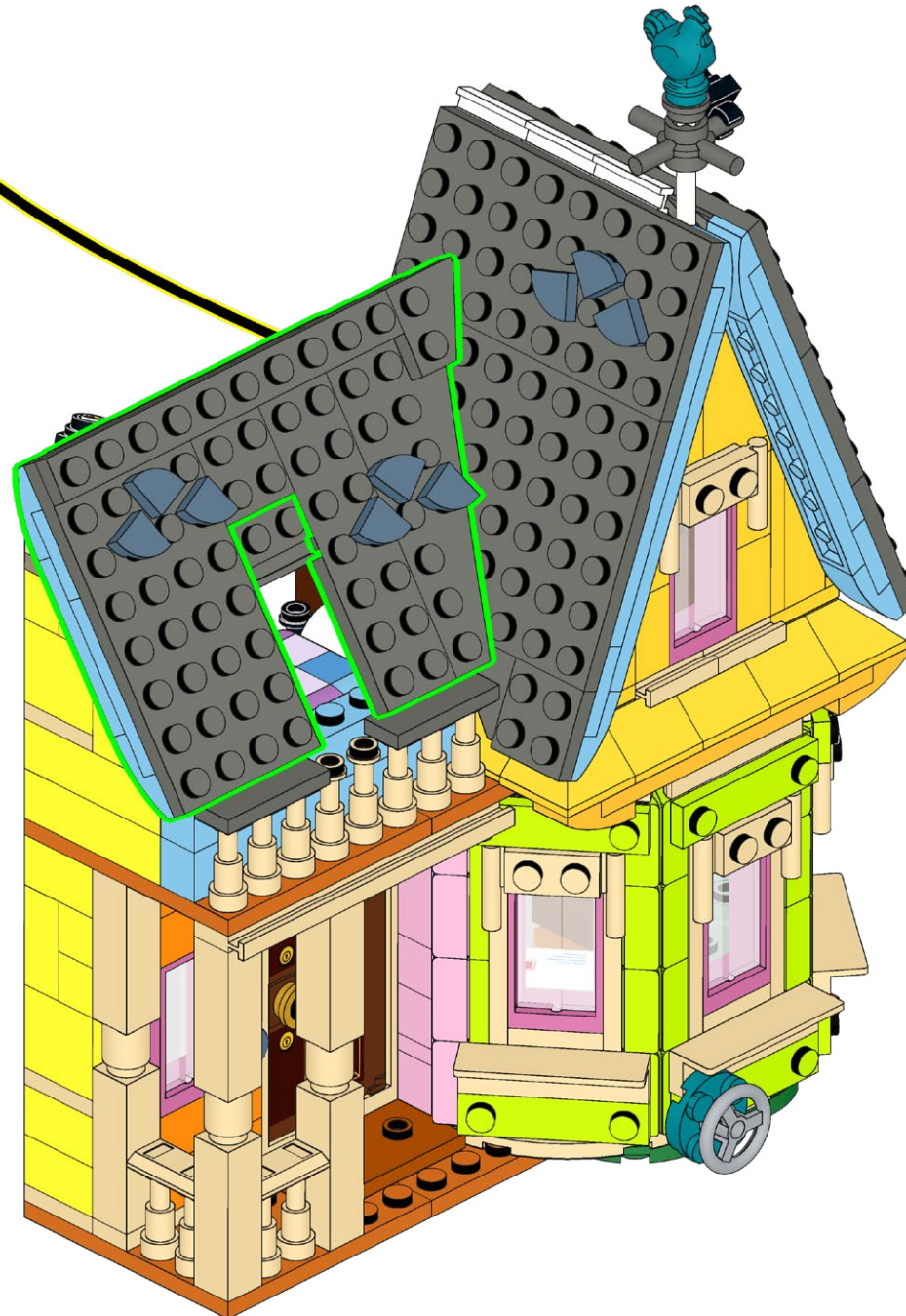

176

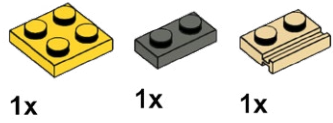

1

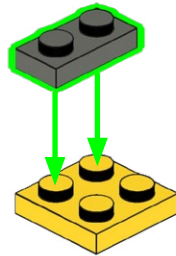

2

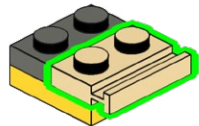

177

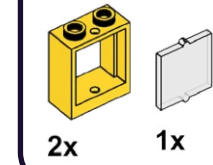

1

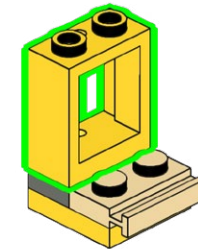

2

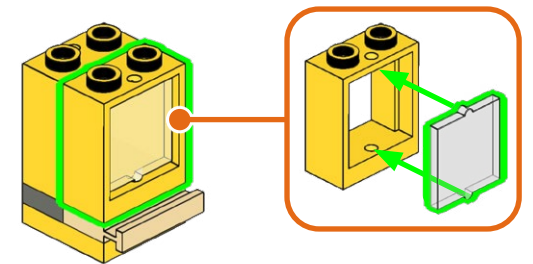

178

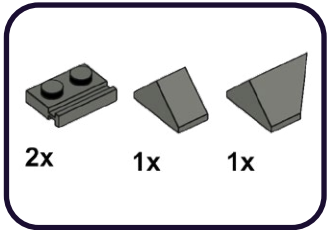

1

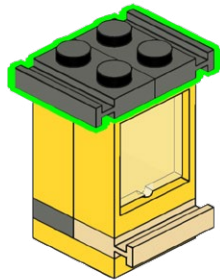

2

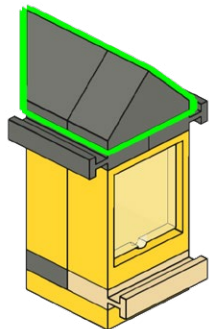

179

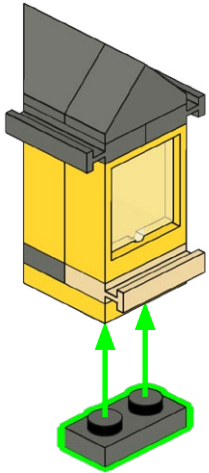
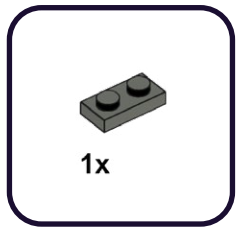

180



181

2x

1x

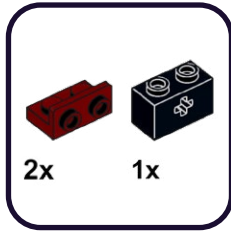

1

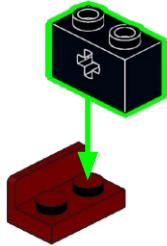

2

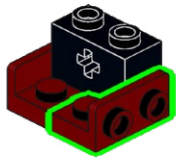

182

1x

2x

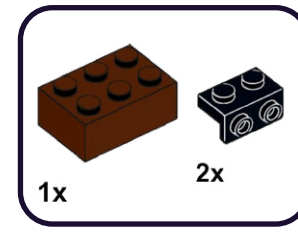

1

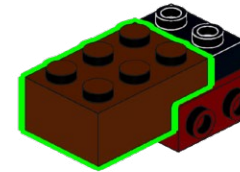

2

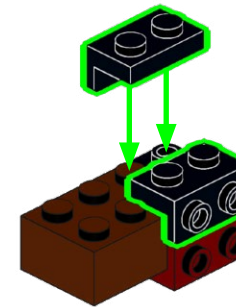

183

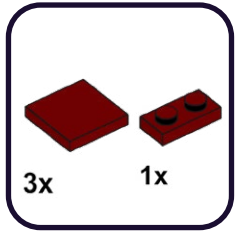

1

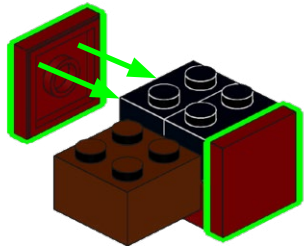

2

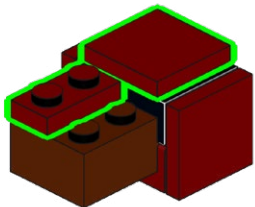

184

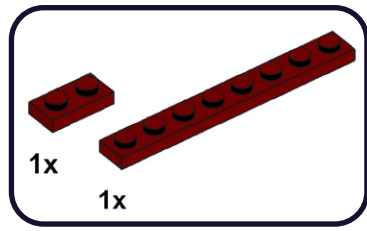

1

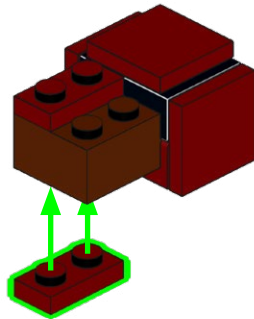

2

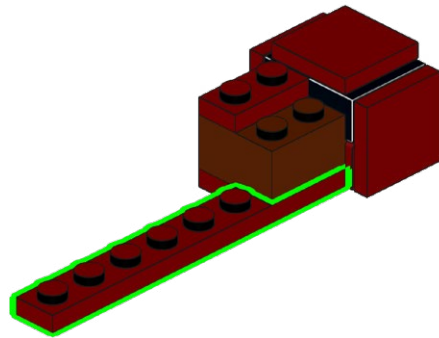

185

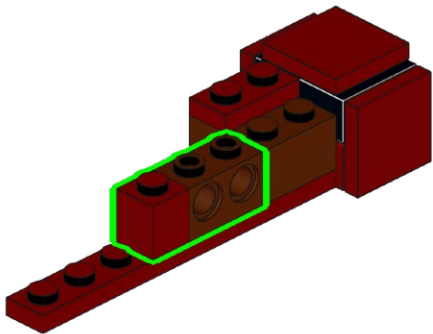
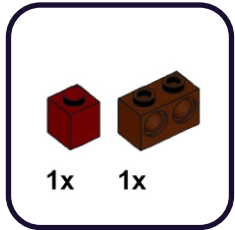

186

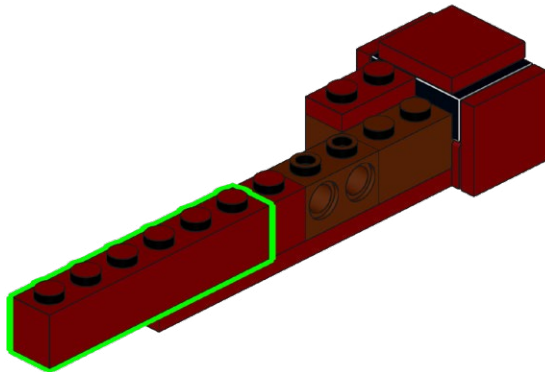
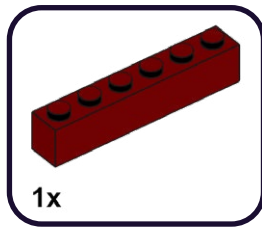

187

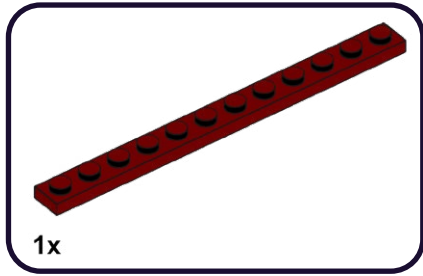

188

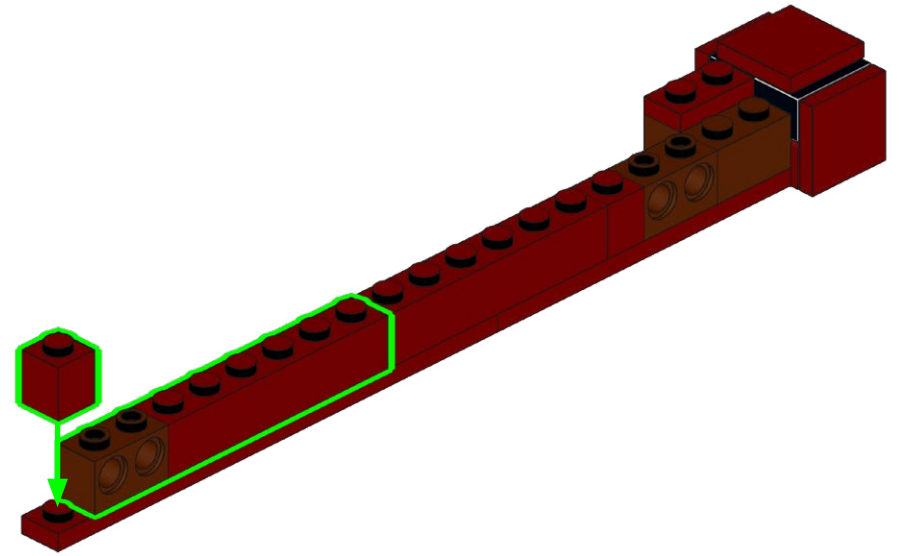
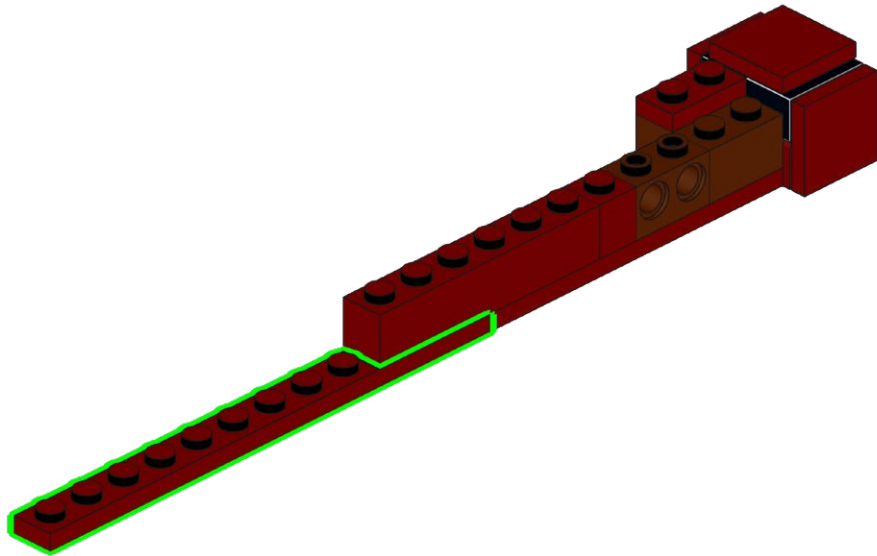
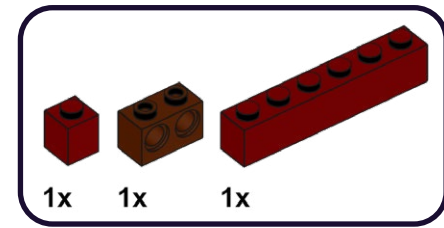

189

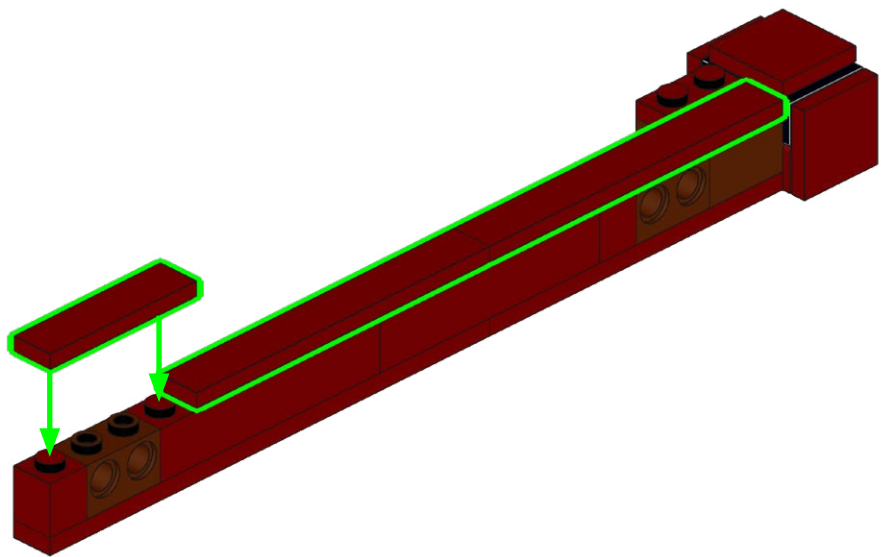
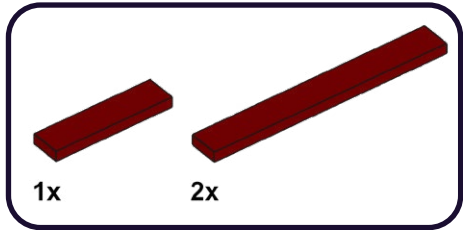

190

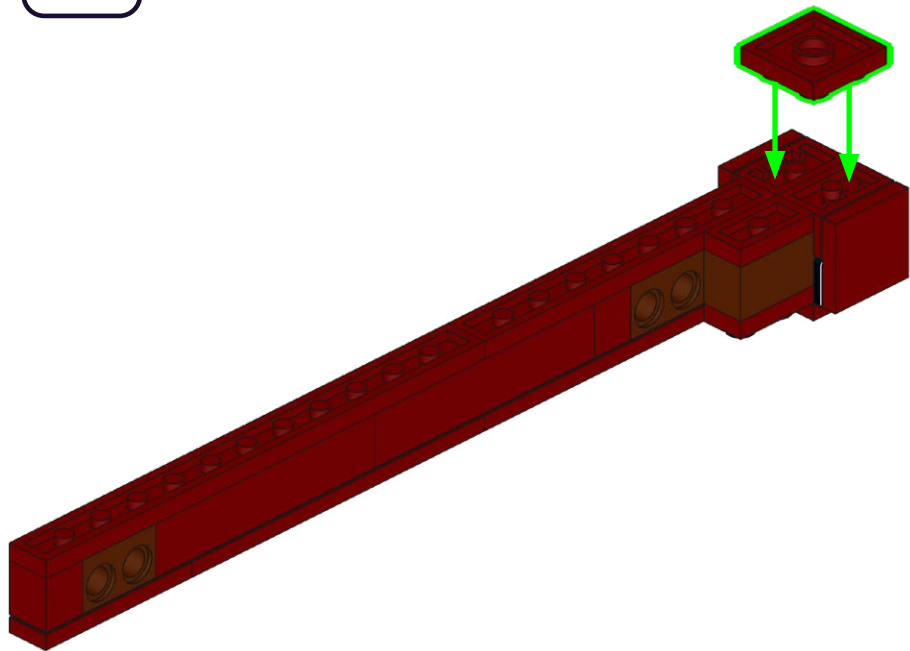
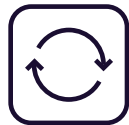
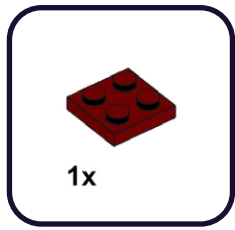

191



192



193



194

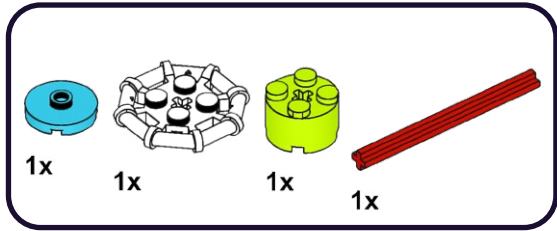

1

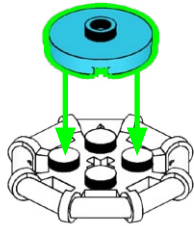

2

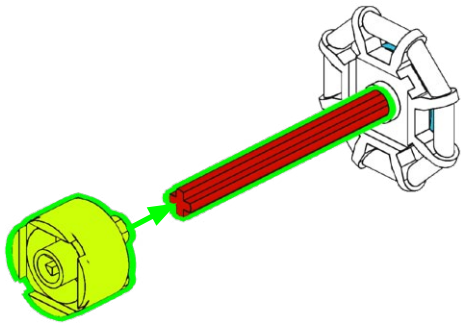

195

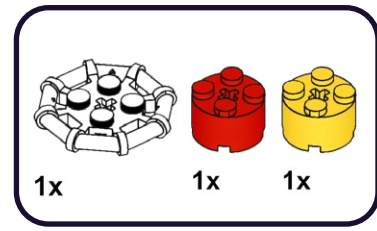

1

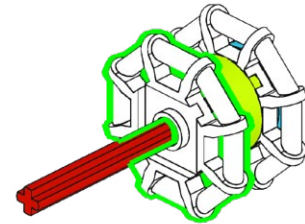

2

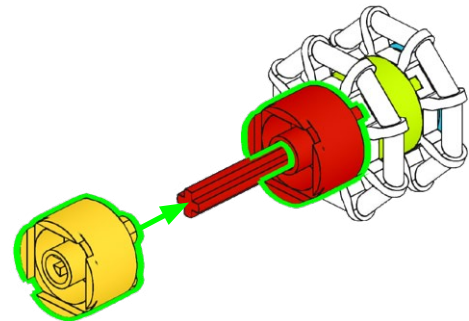

196



1x

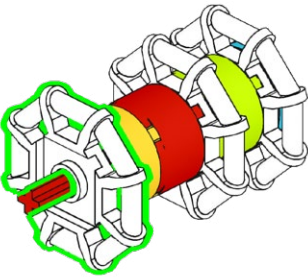

197

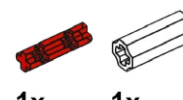

1x

1x

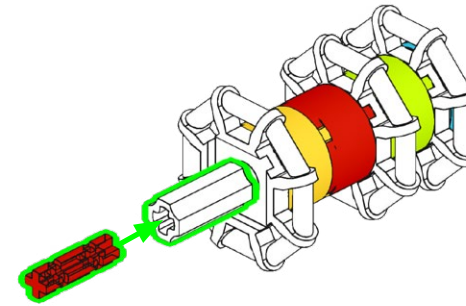

198

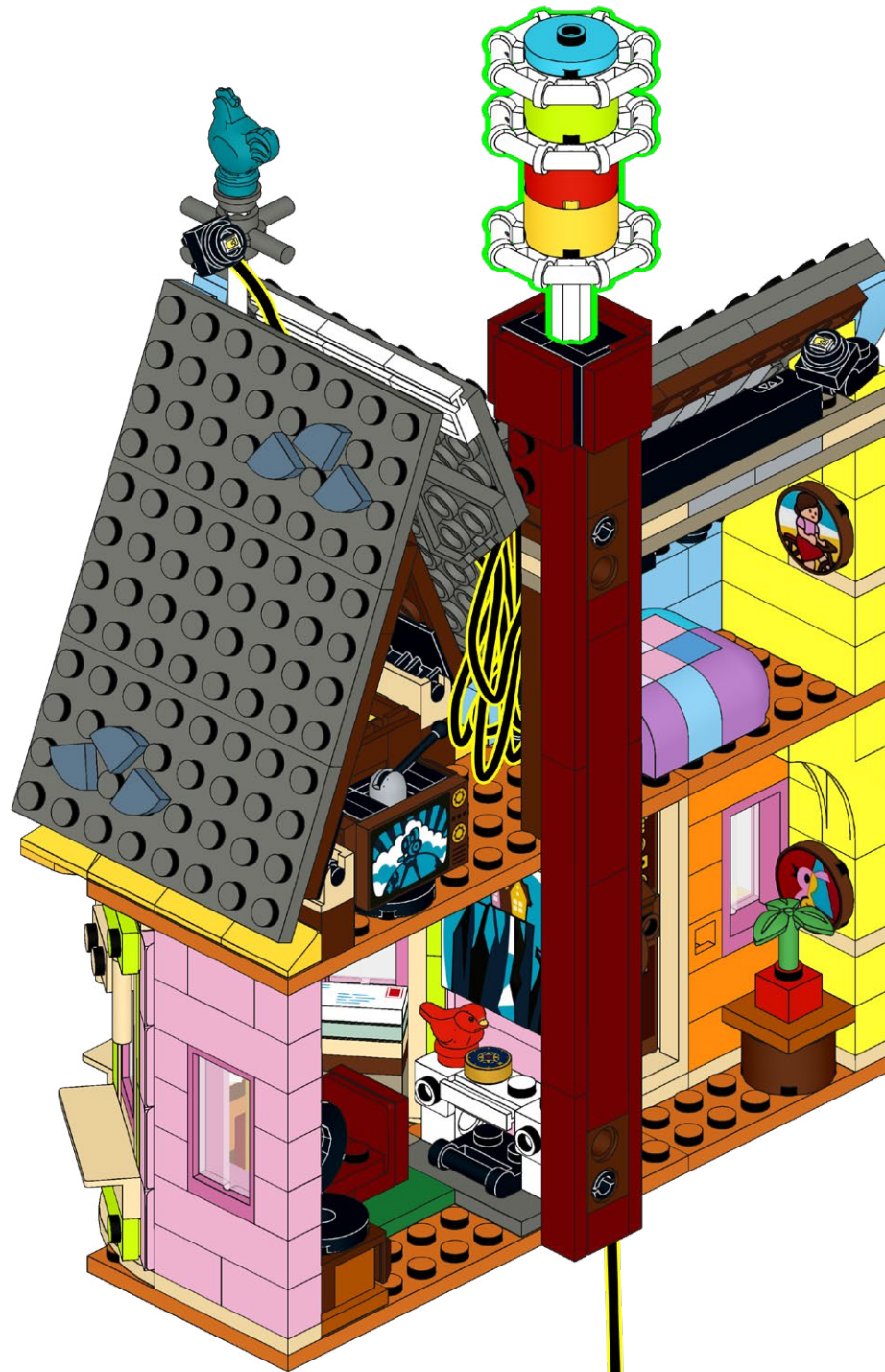

199

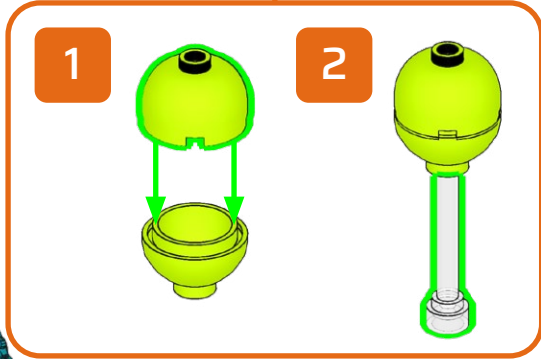
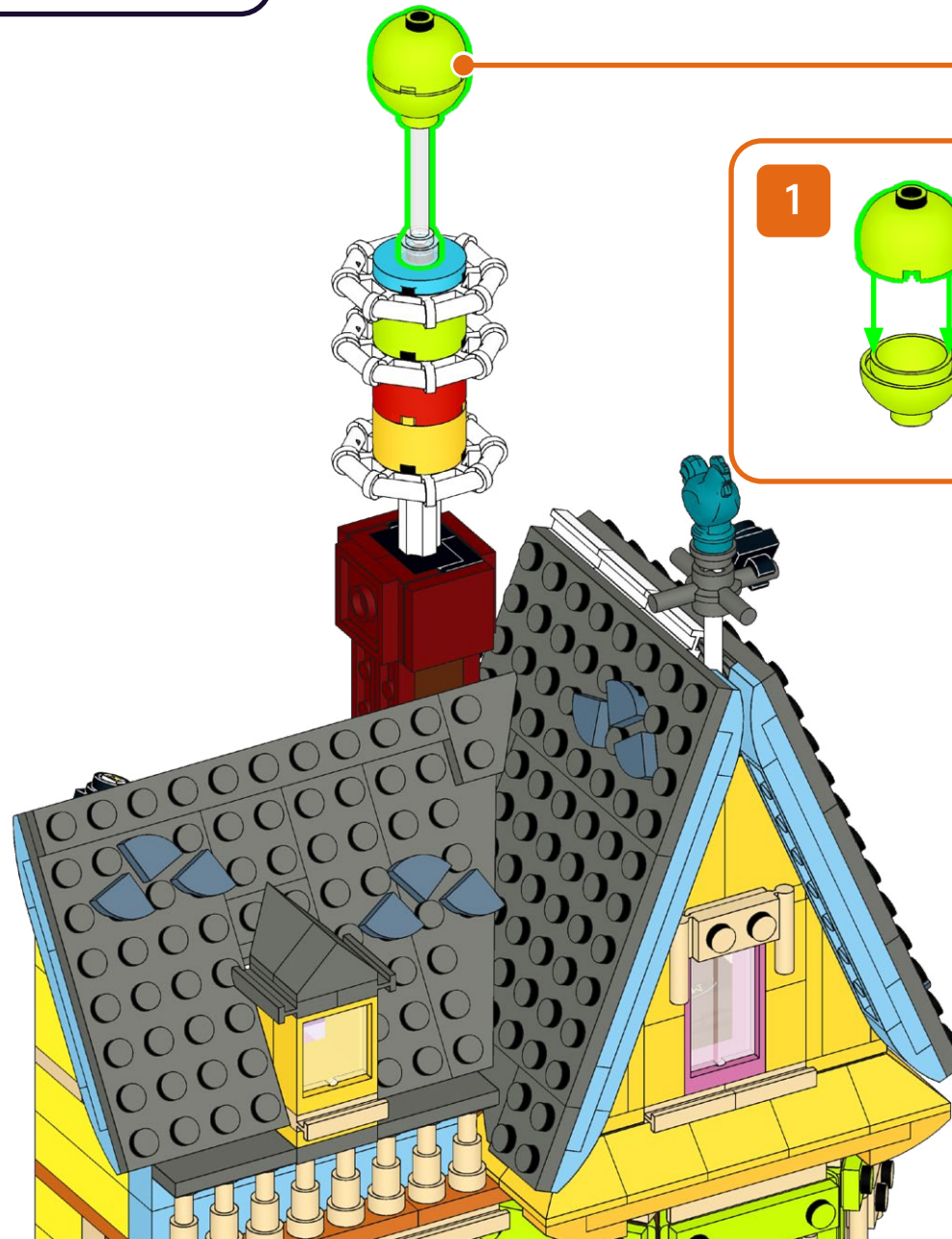
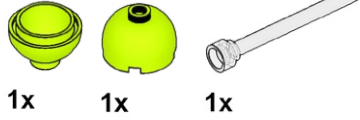





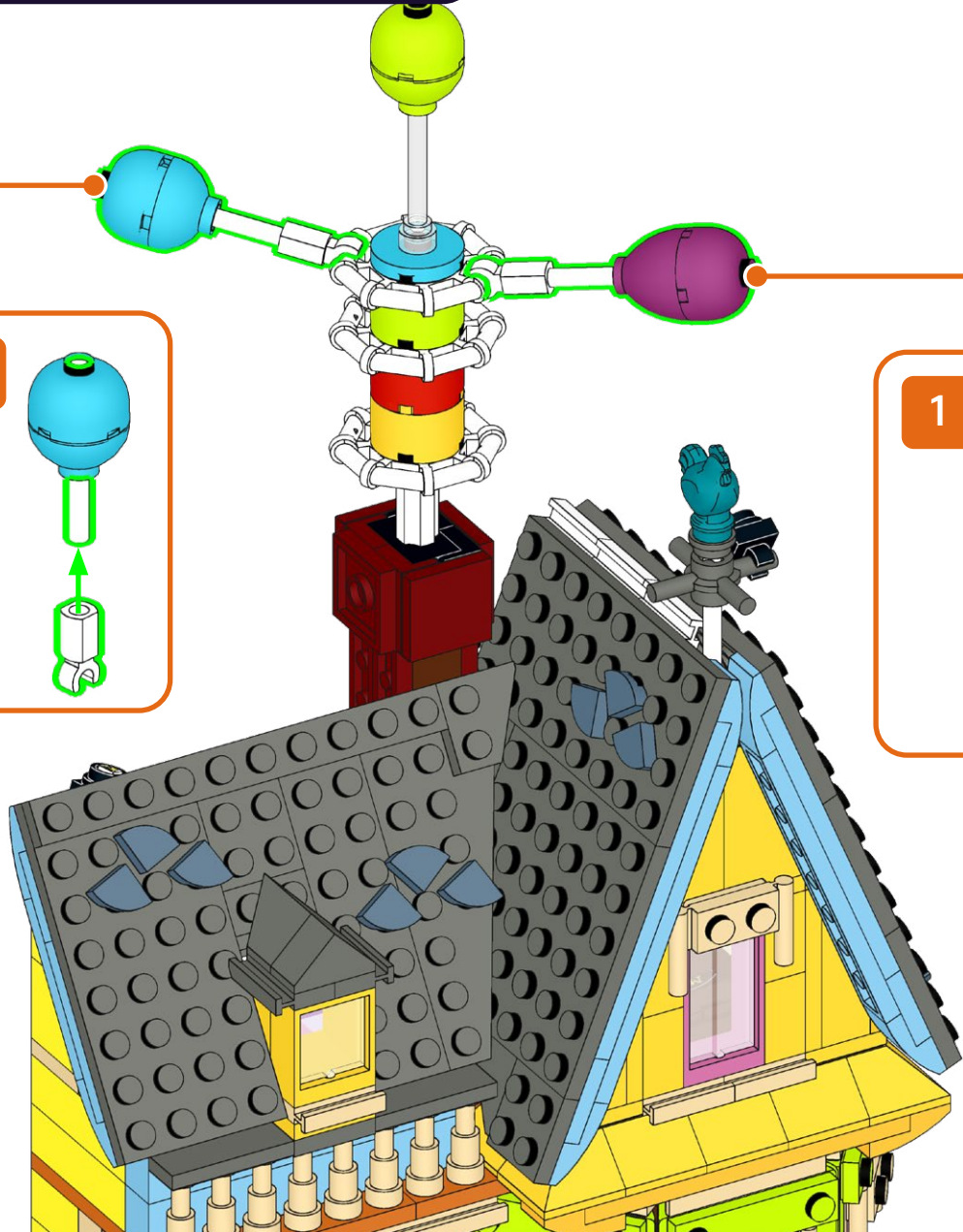
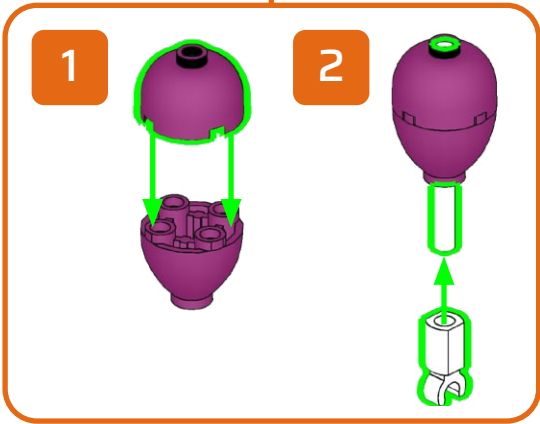
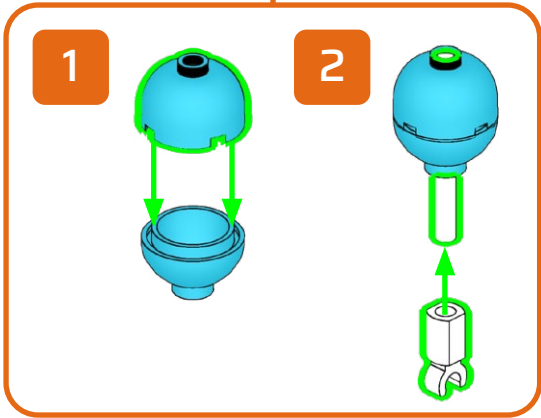

200

- 1x (Blue dome)
- 1x (Blue dome)
- 2x (White axle)
- 2x (White axle)
- 1x (Purple dome)
- 1x (Purple dome)

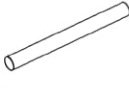

201

- 1x 
- 1x 
- 2x 
- 2x 
- 1x 
- 1x 

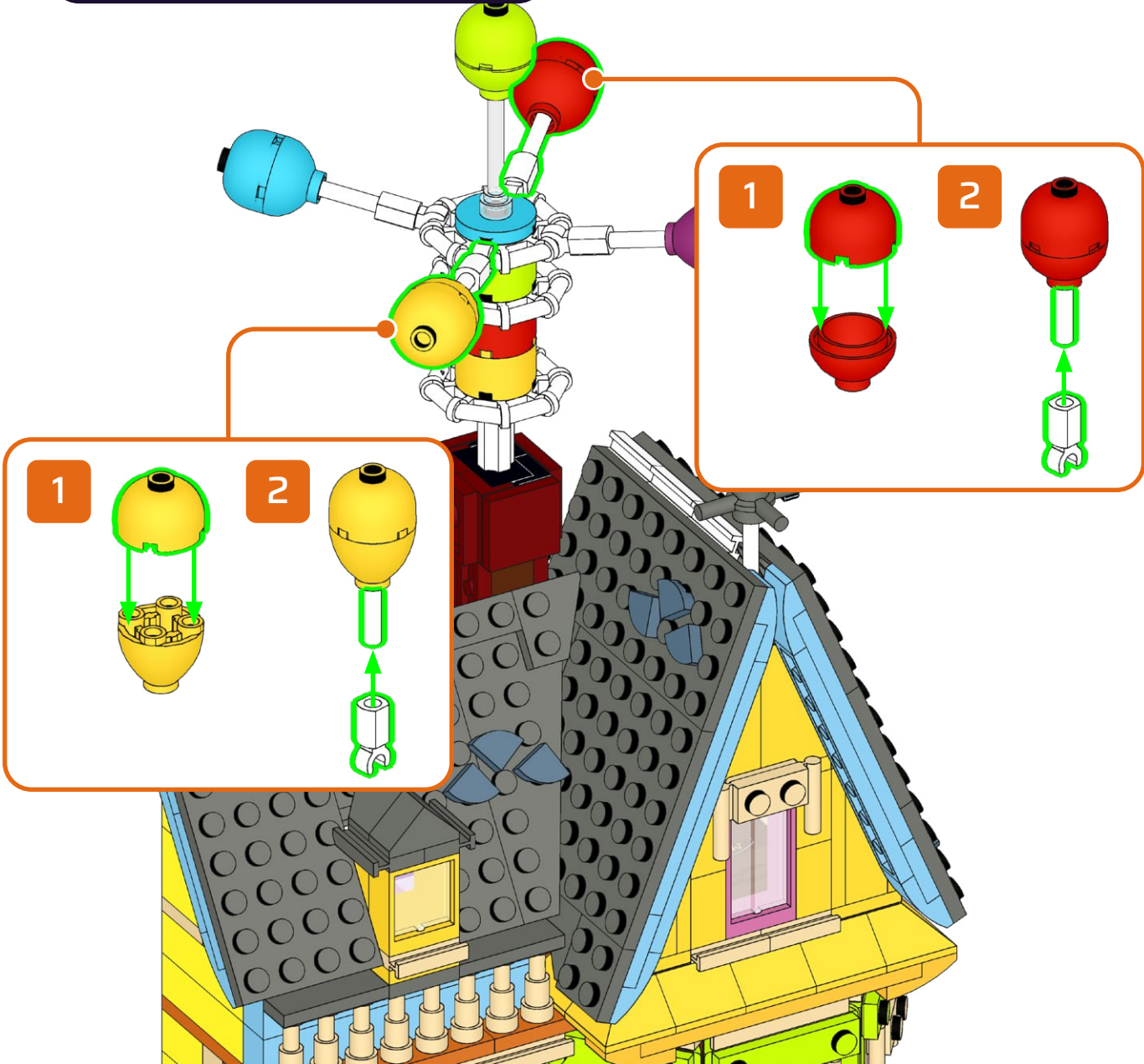

202

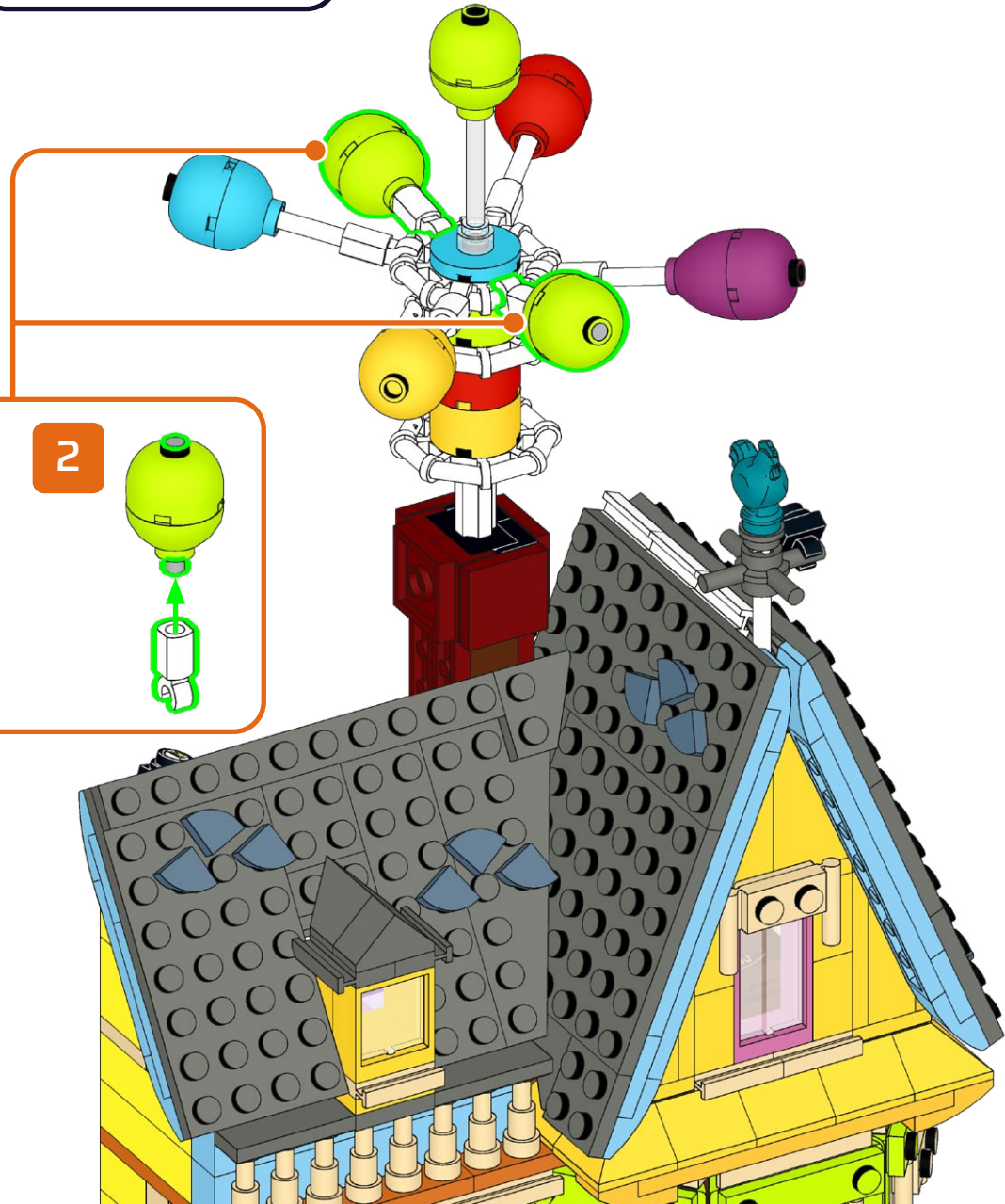
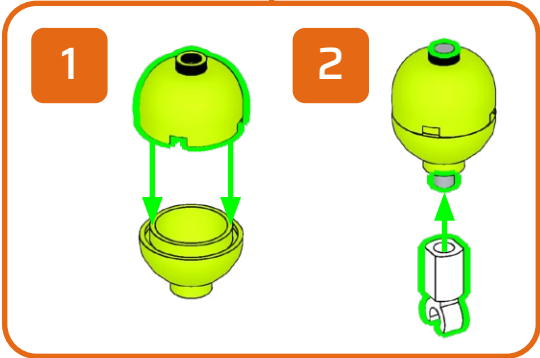
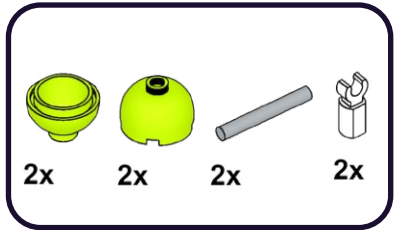

203

- 1x
- 1x
- 2x
- 2x
- 1x
- 1x

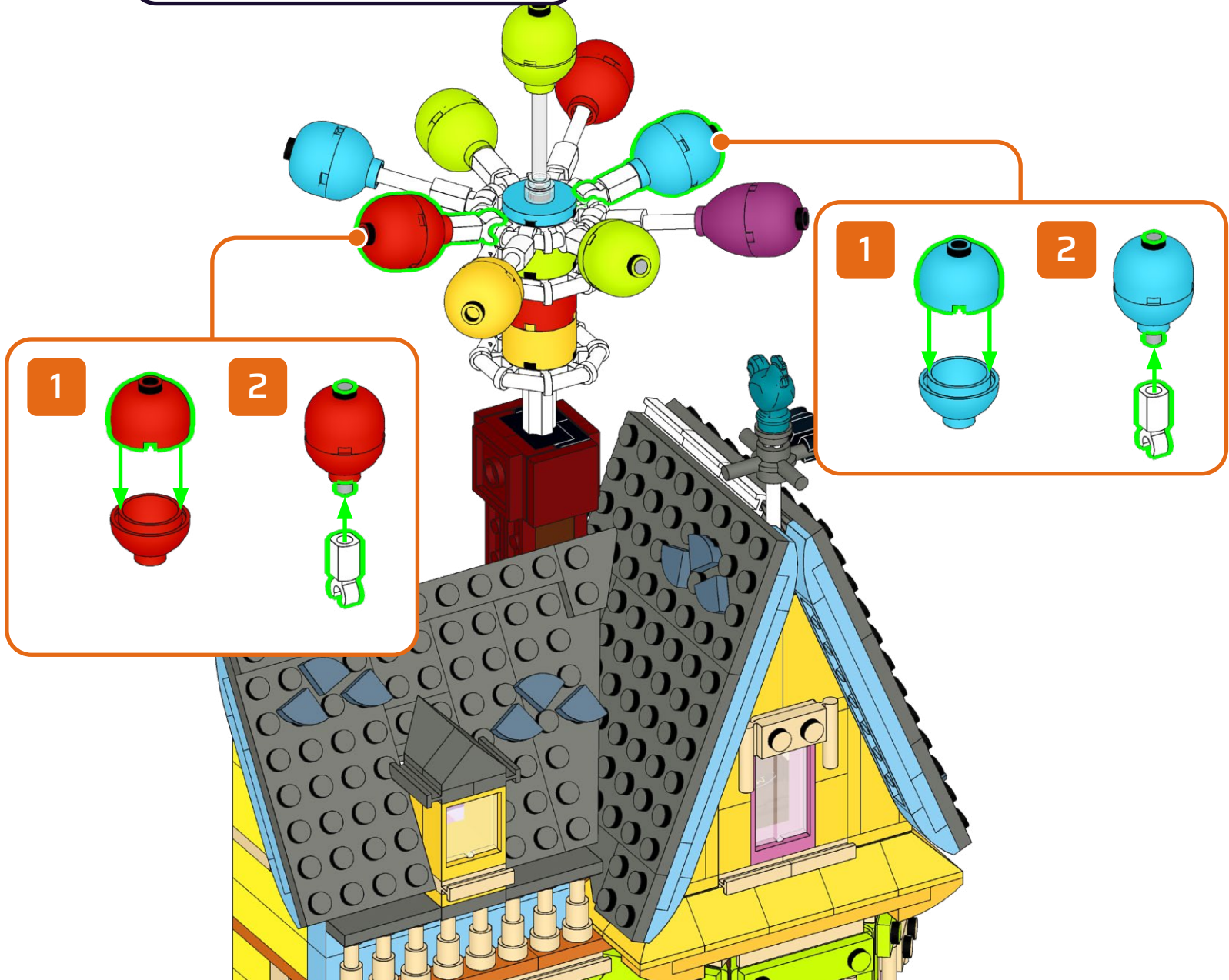

204



205

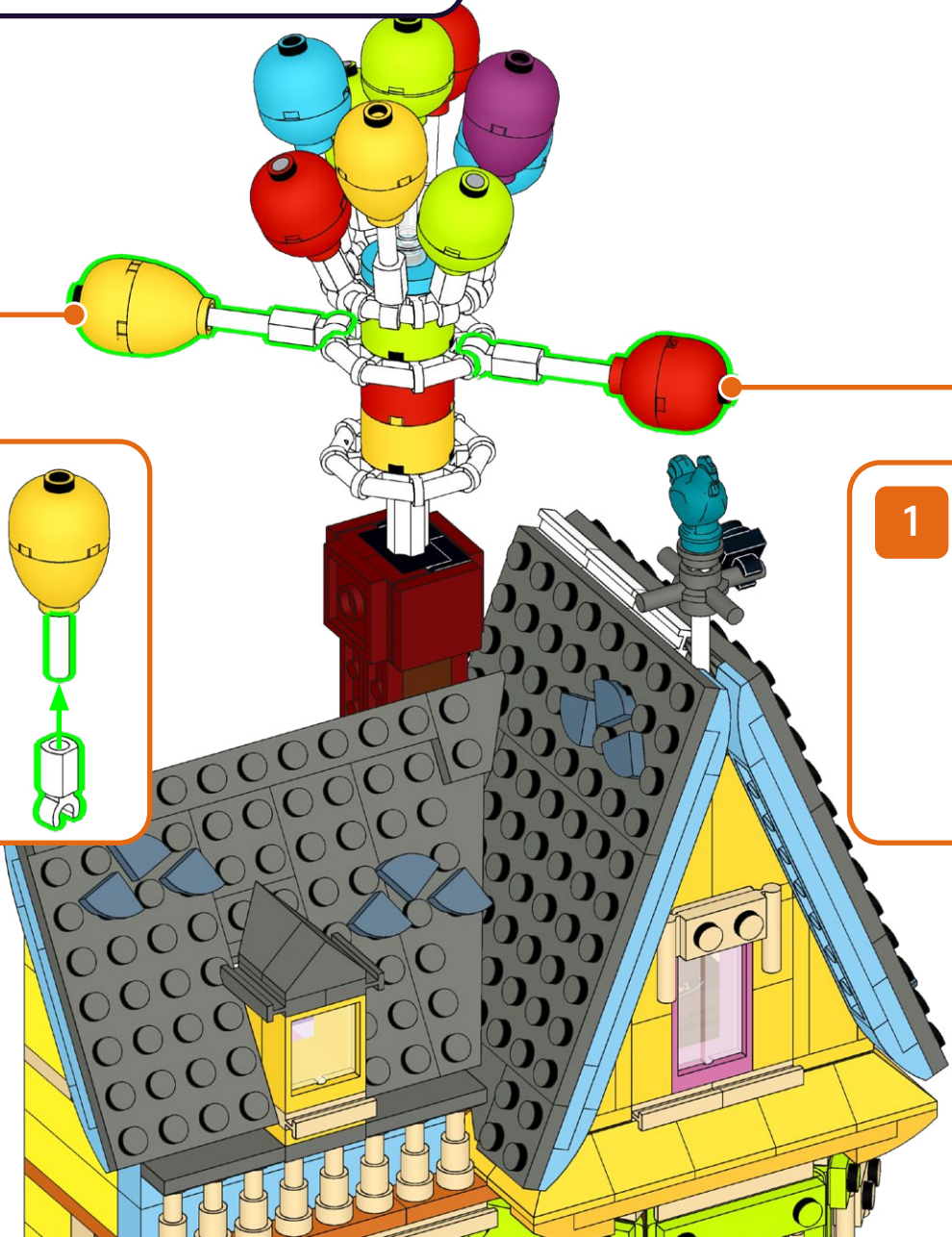
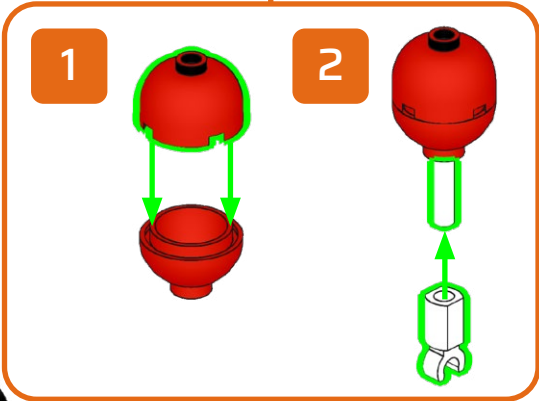
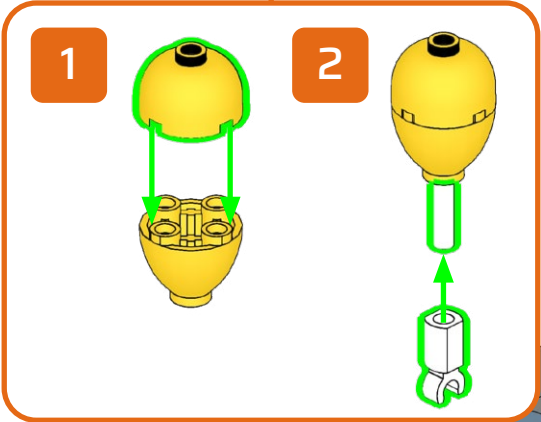
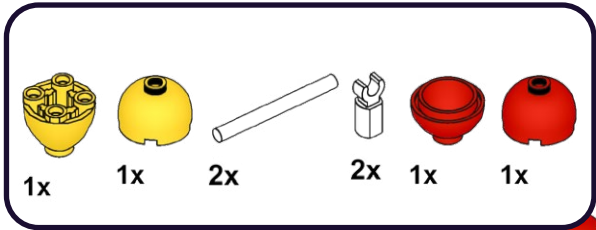

206

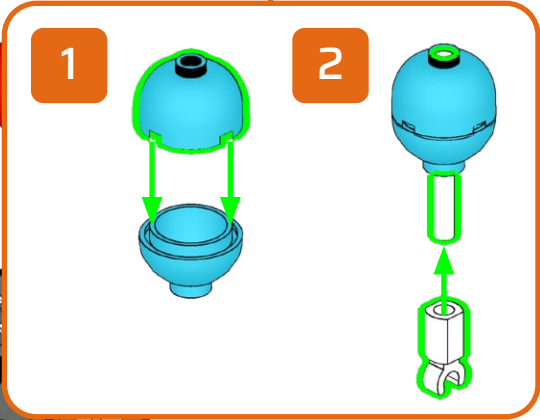
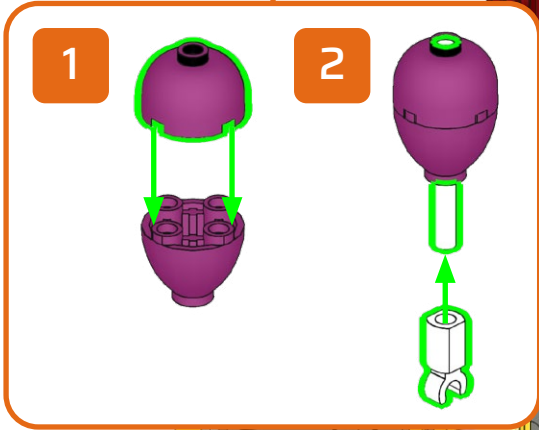
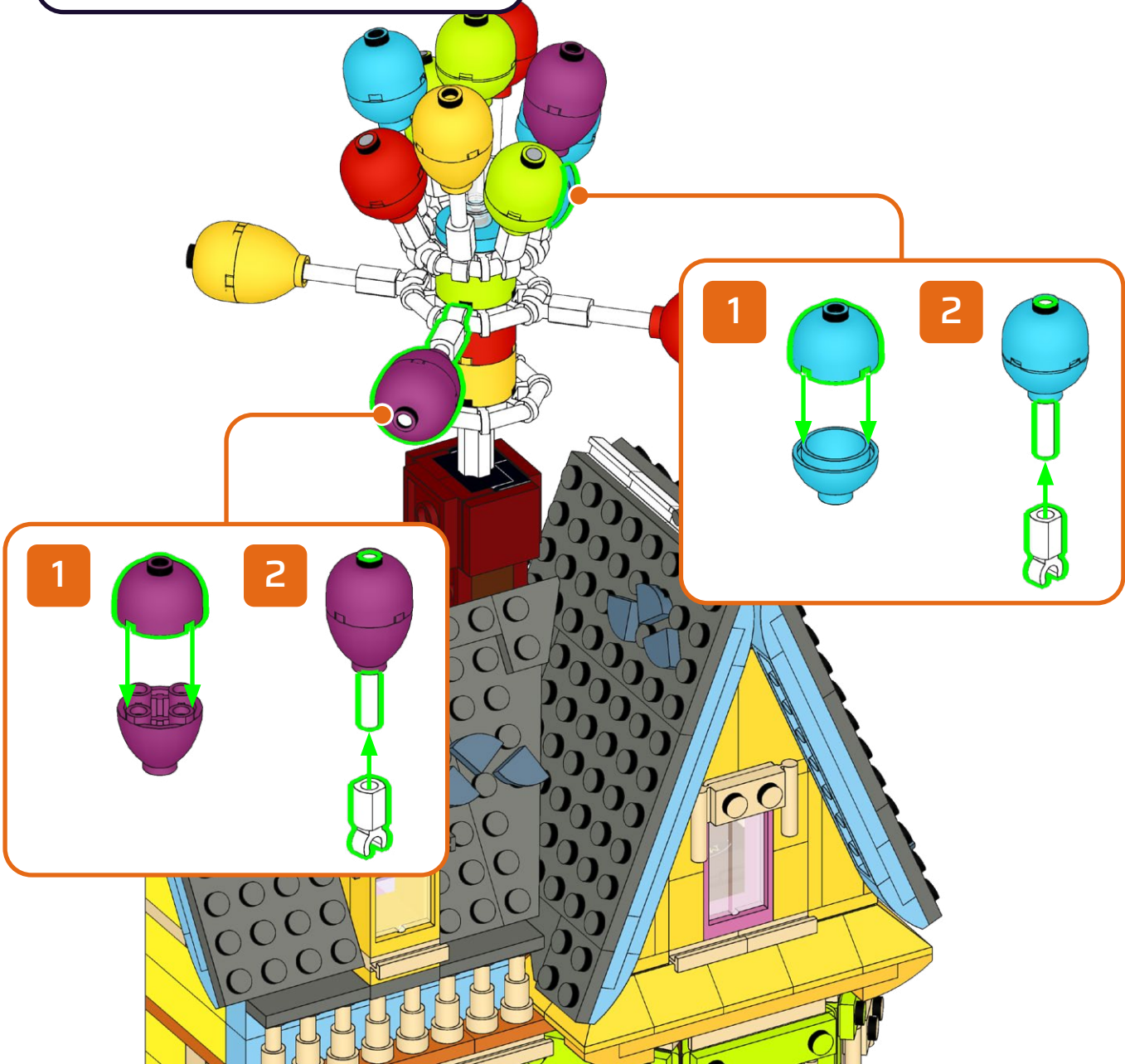
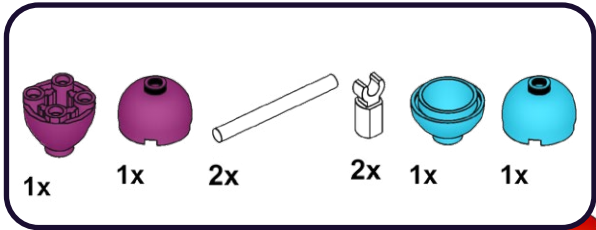

207

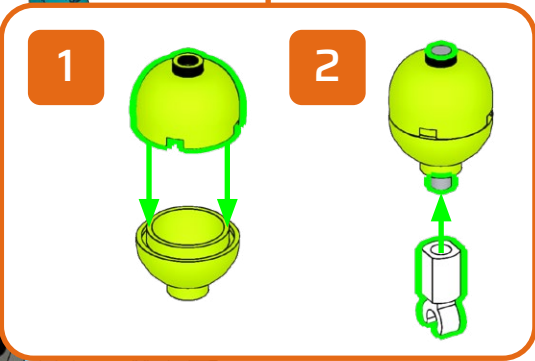
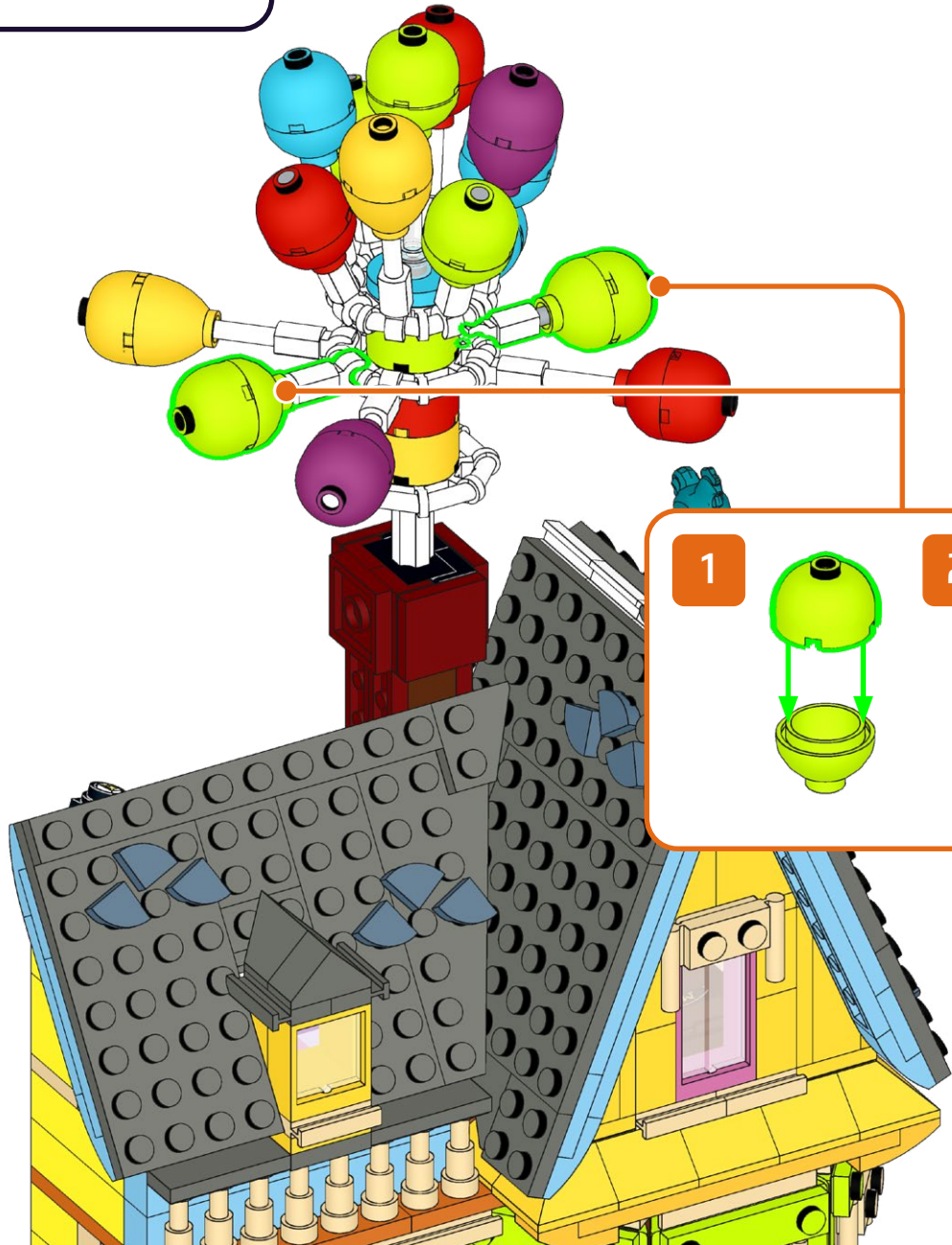
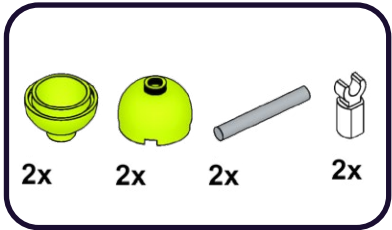

208

- 1x (Red dome)
- 1x (Red dome)
- 2x (Grey axle)
- 2x (White axle)
- 1x (Blue dome)
- 1x (Blue dome)

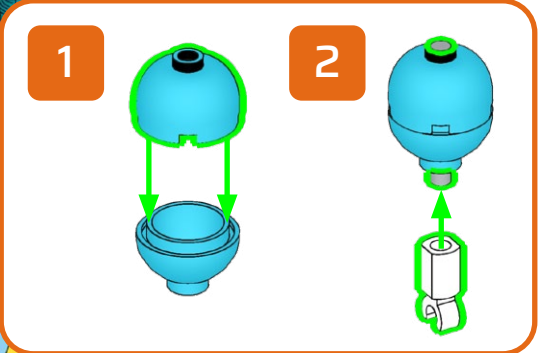
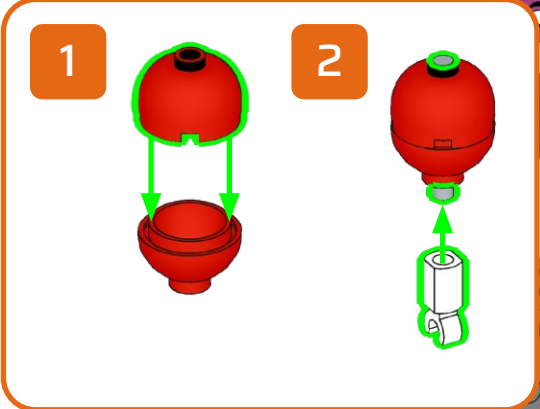
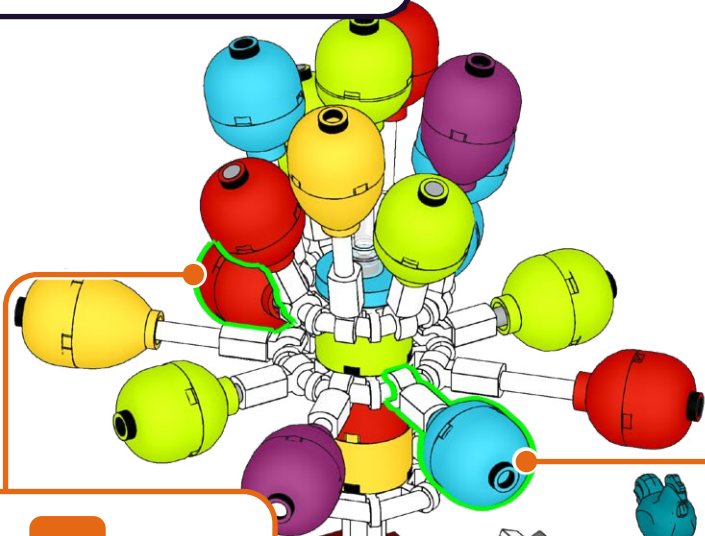

209



210

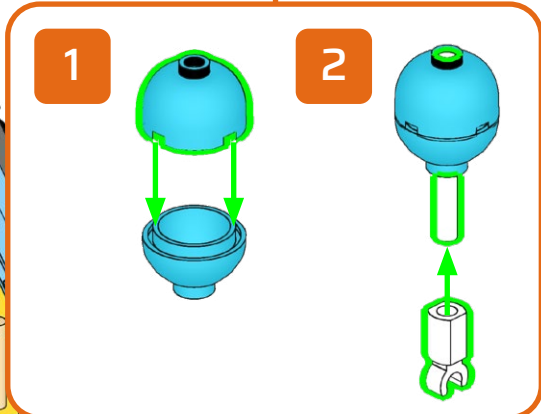
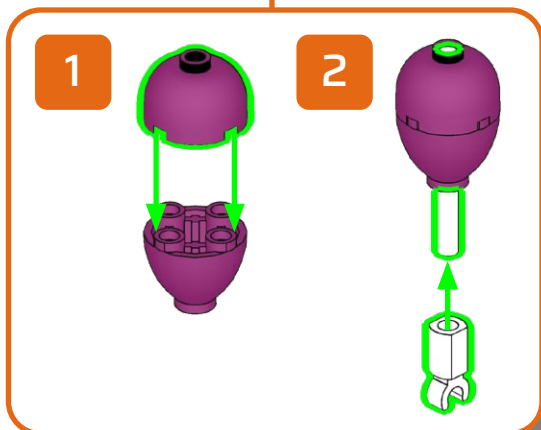
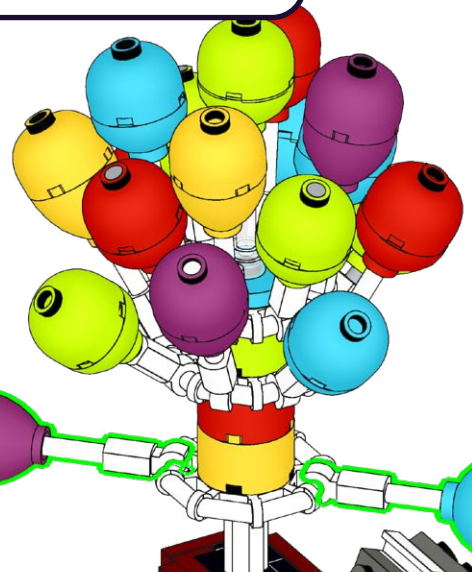
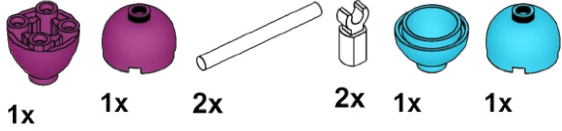



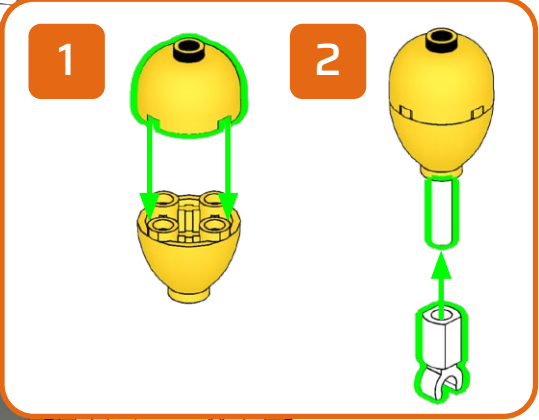
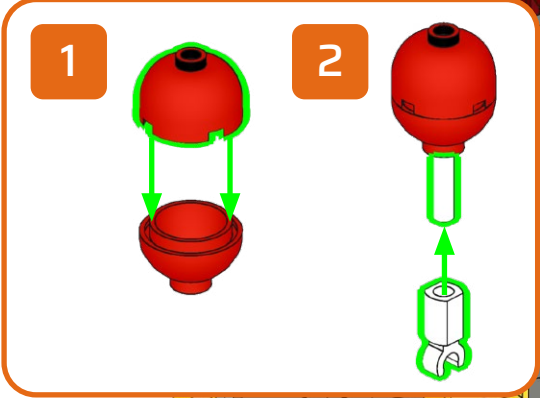
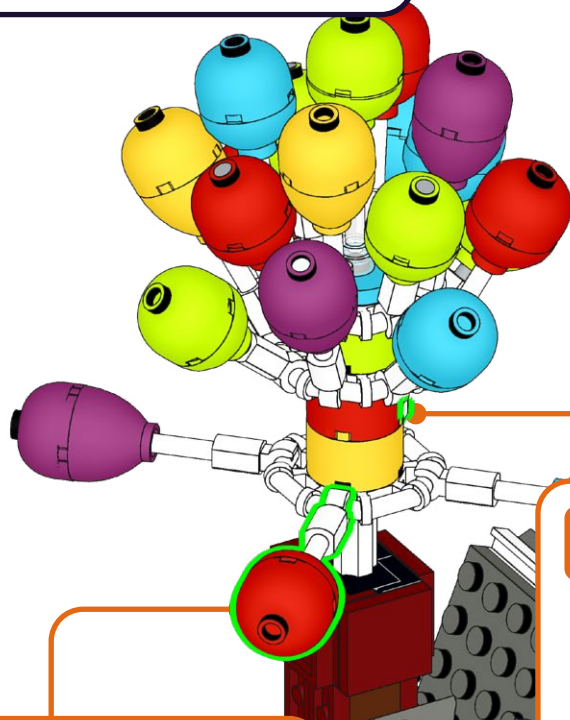
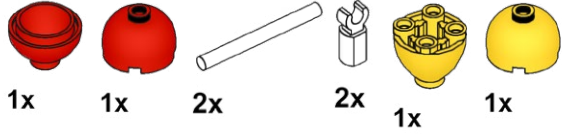

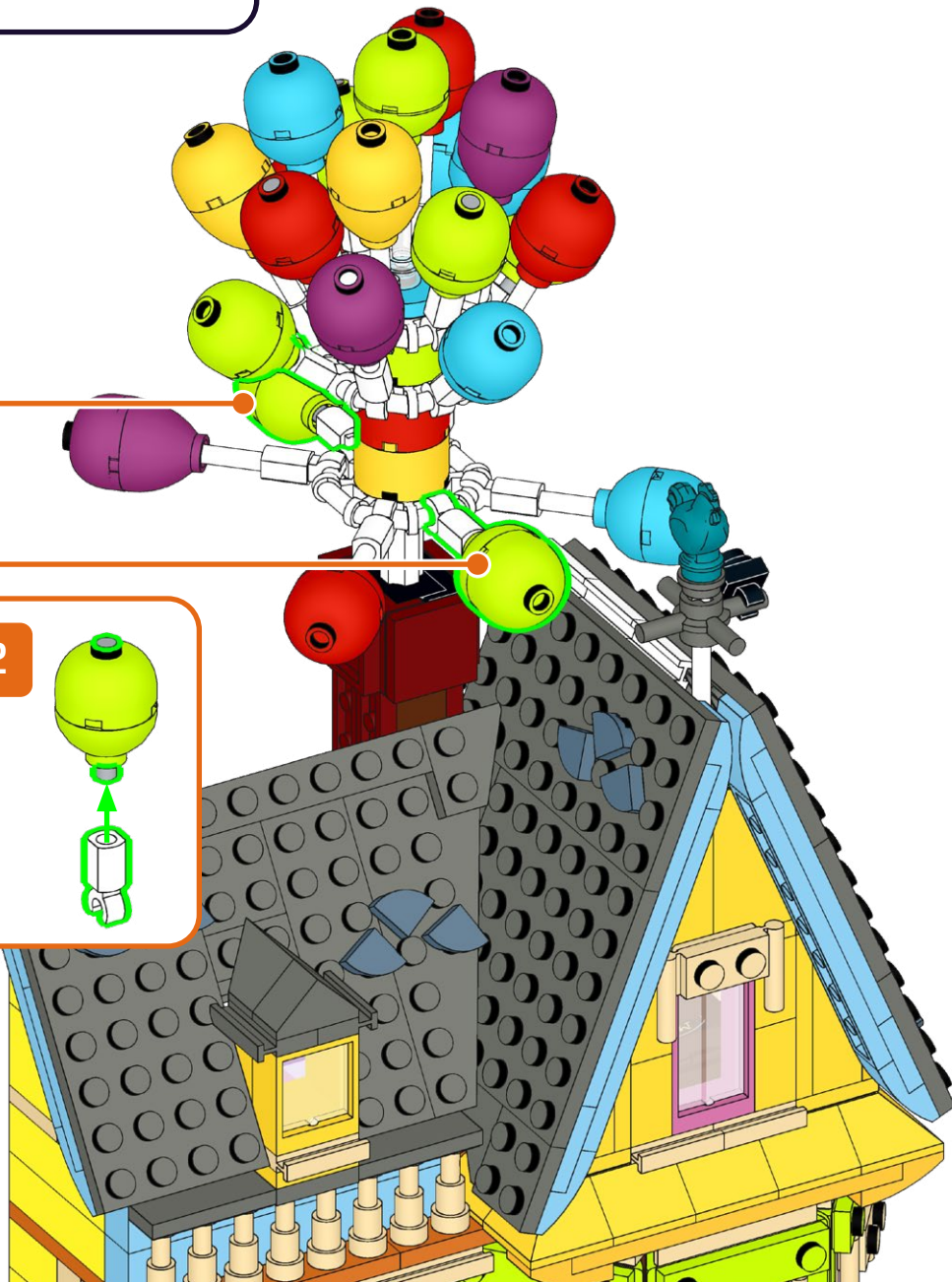
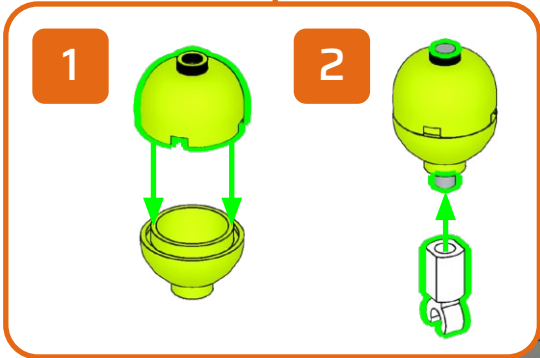
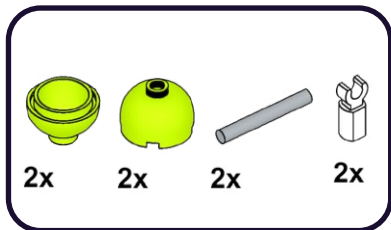

211



212



213

- 1x 
- 1x 
- 2x 
- 2x 
- 1x 
- 1x 

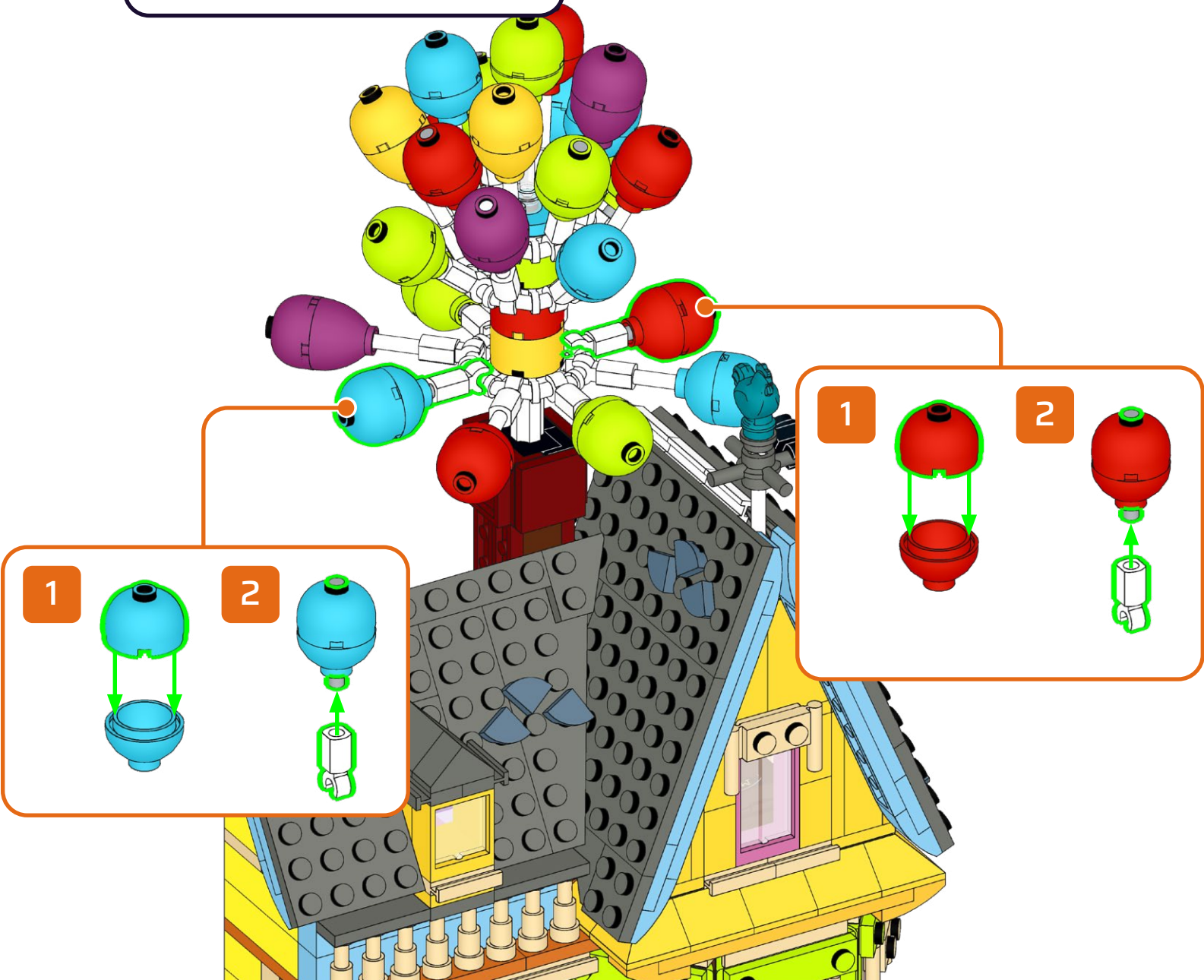

214

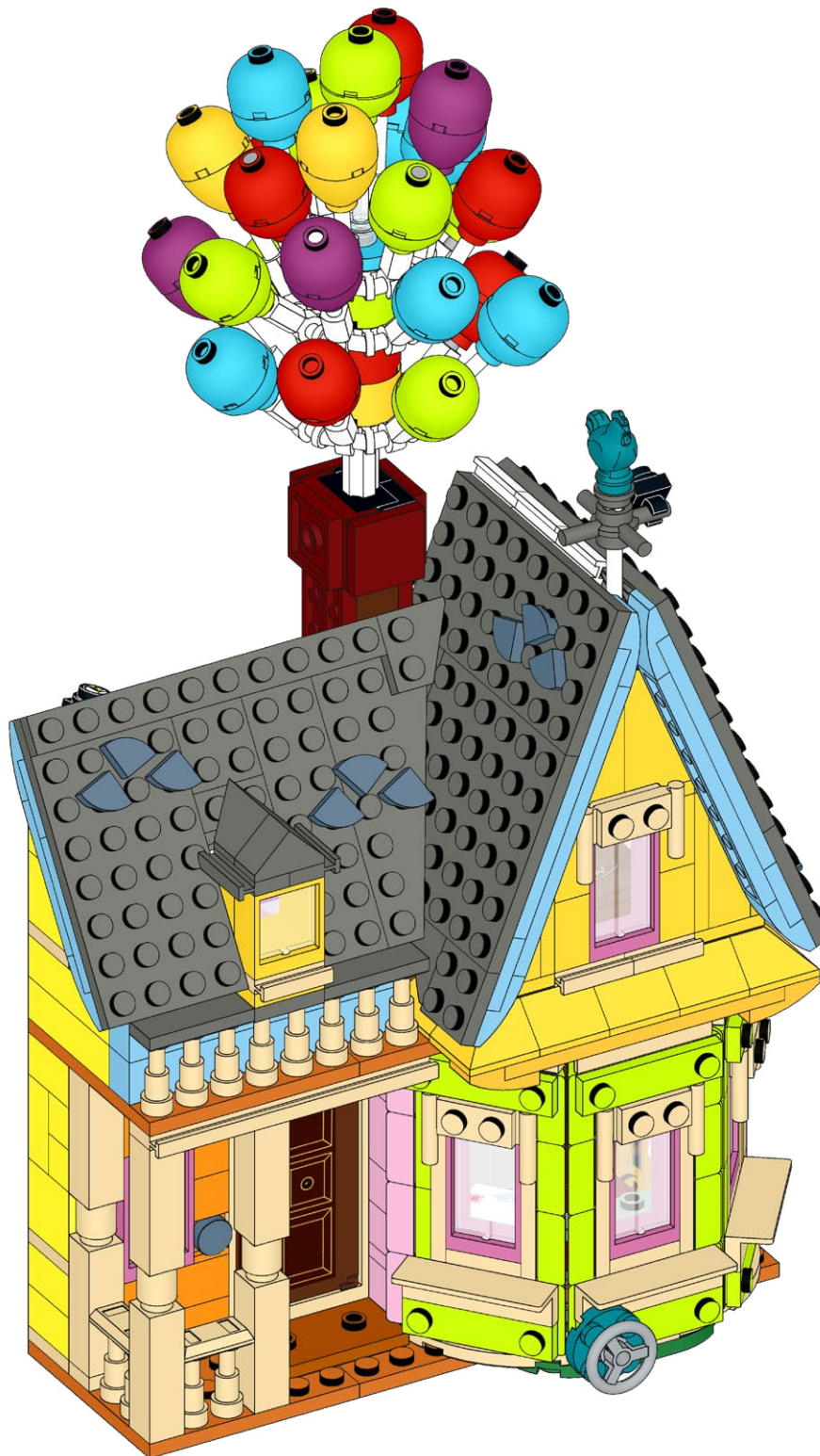

215

FLX-C

1x

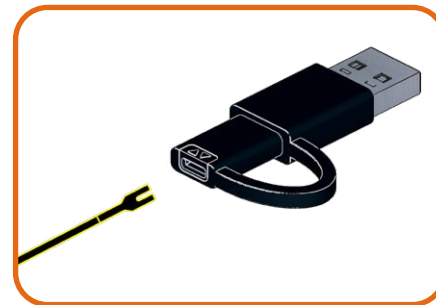
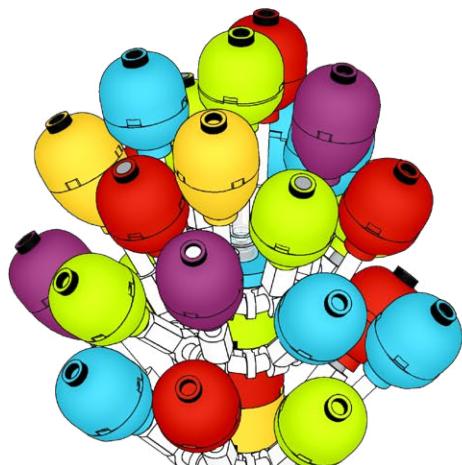

216

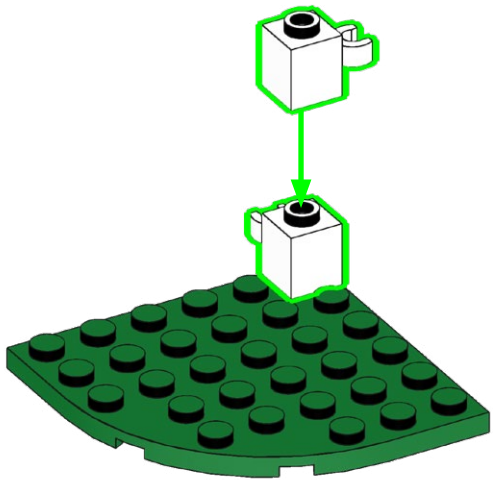
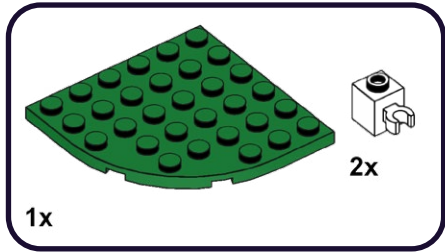

217

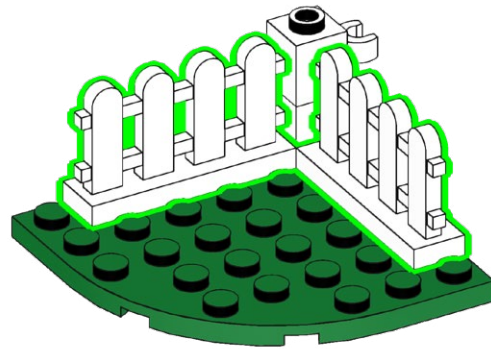
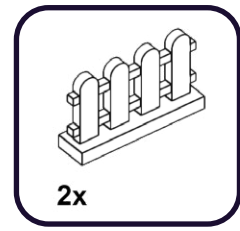

218



2x

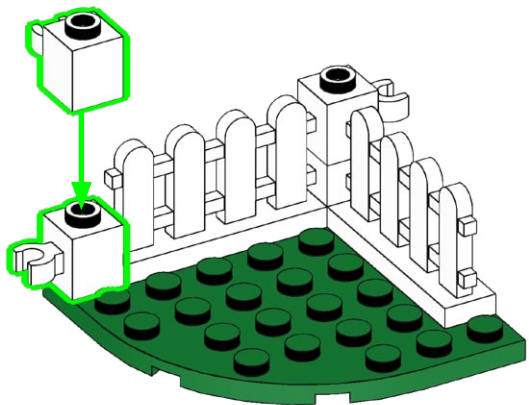

219



2x



1x

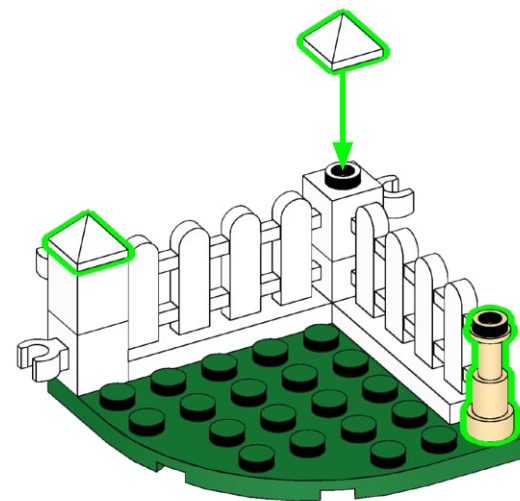

220

2x

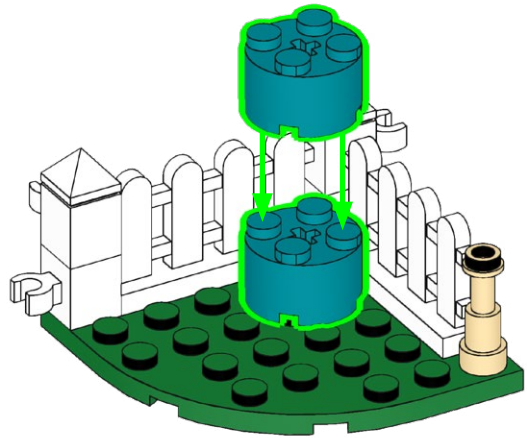

221

1x

2x

1x

4x

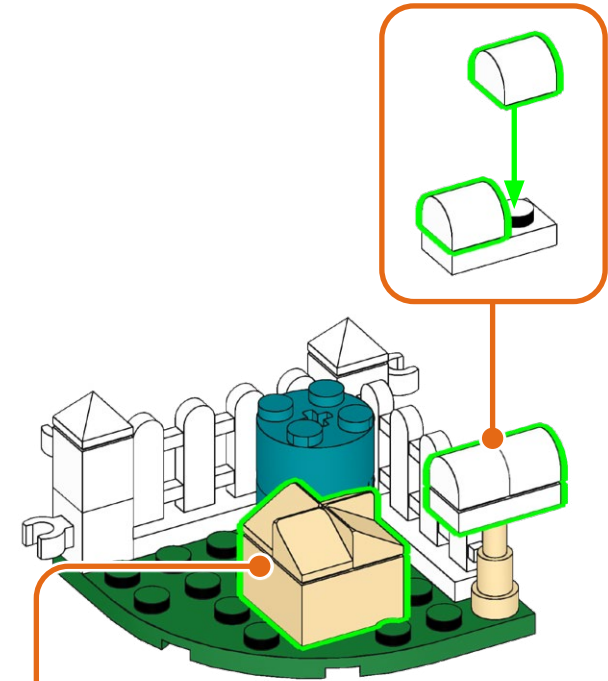

1

2

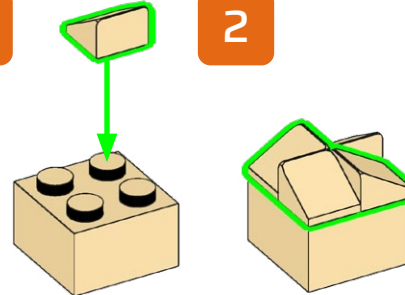

222

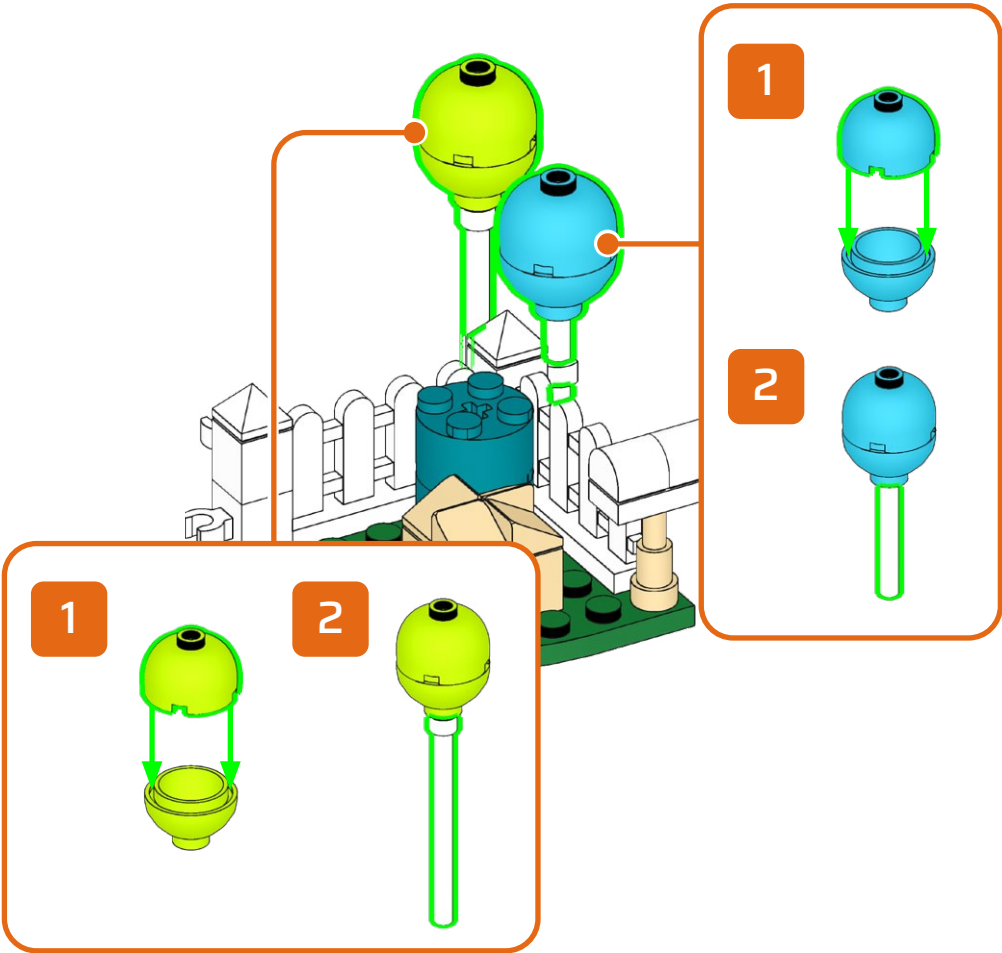
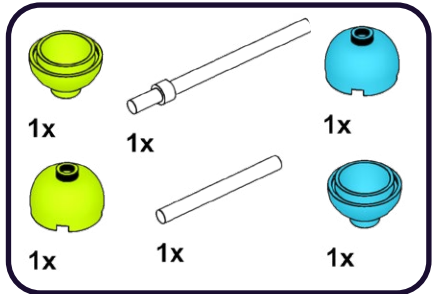

223

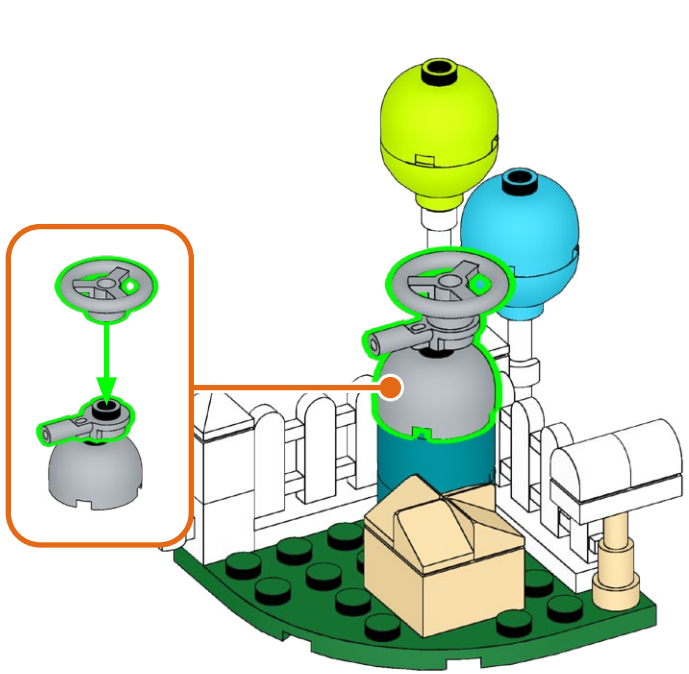
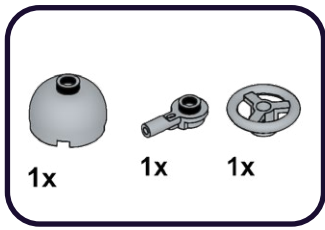

224

1x

1x

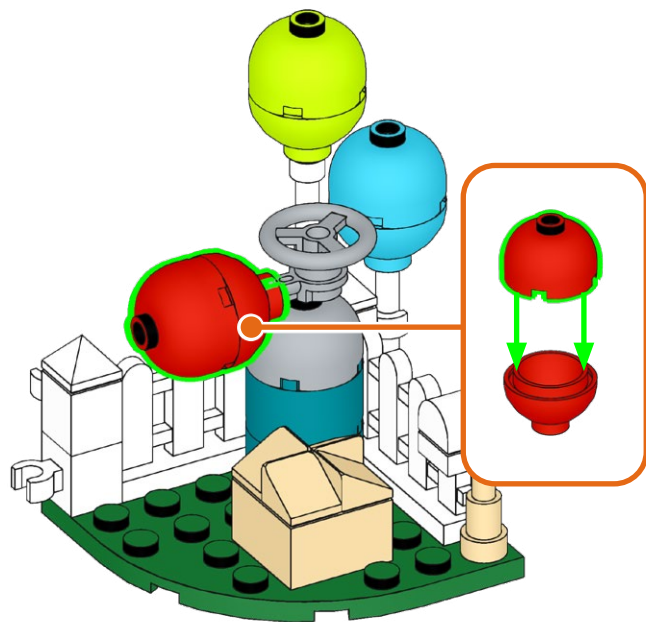

225

1x

1x

1x

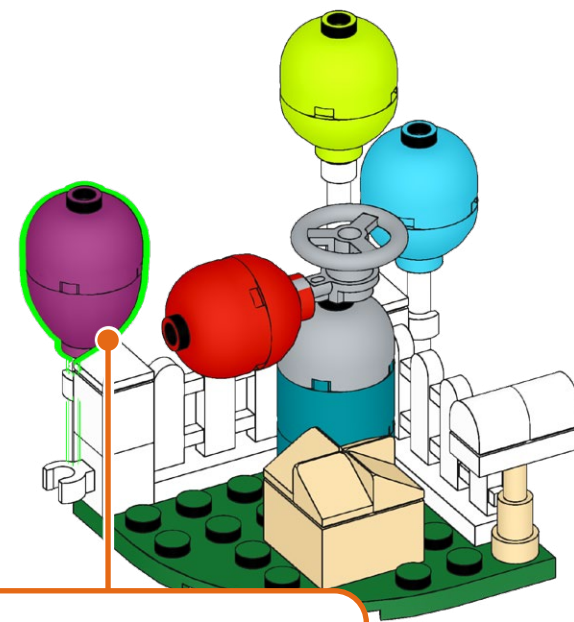

1

2

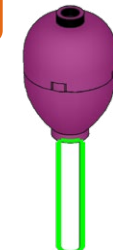
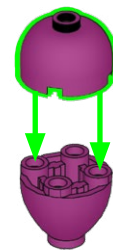

226



1x



1x

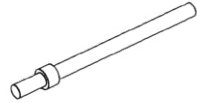

1x

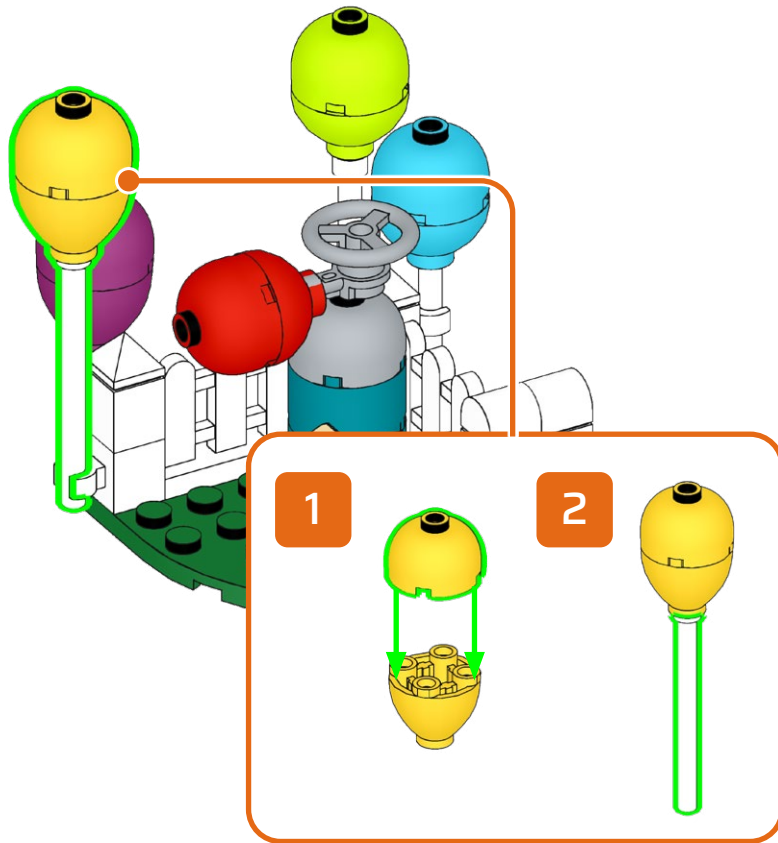

227



1x

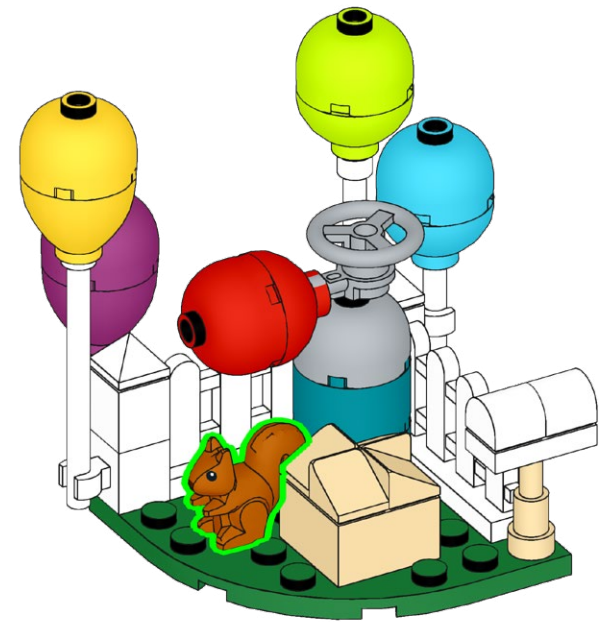

228

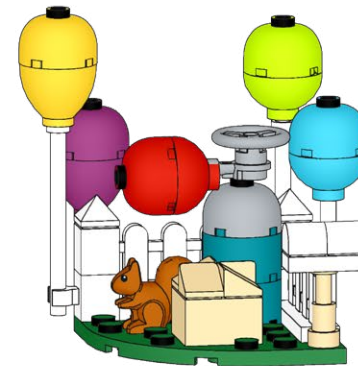

229



230



FINAL PRODUCT



CONTENTS & GLOSSARY



2x AR-WW15
Astro Light Regular
Warm White 15cm



2x AL-WW15
Astro Light Large
Warm White 15cm



1x AL-P15
Astro Light Large
Pink 15cm



1x AL-B15
Astro Light Large
Blue 15cm

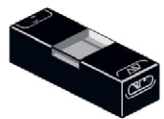

1x MML-WW
Micro Meteor Light



1x D-6
6 Dock



1x T-1x3
Tether 1x3



1x B-15
Belt-15



1x B-50
Belt-50



1x FLX-C
Flux Converter



6x Plate, Round 1x1 with
Open Stud
Black



2x Tile, Modified 1x1
with Open O Clip
Black



1x Plate, Round 1x1
with Bar Handle
Black



1x Plate, 1x2
Black



1x Bracket, 1x1 - 1x1
Light Bluish Gray

CONTACT US

Click below for customer support, or general inquiries.

Cliquez ci-dessous pour accéder au support client ou aux renseignements généraux.

Clicca qui sotto per l'assistenza clienti o per richieste generali.

Contact Us



Contactez-nous



Contattaci



Klicken sie unten für kundensupport oder allgemeine anfragen.

Haga clic a continuación para atención al cliente o consultas generales.

点击下方获取客户支持或一般咨询。

Kontaktieren sie uns



Contáctanos



联系我们



TROUBLESHOOTING

If you're stuck, scan the QR code for troubleshooting.

Se sei bloccato, scansiona il codice QR per la risoluzione dei problemi.

Wenn Sie nicht weiterkommen, scannen Sie den QR-Code zur Fehlerbehebung.

Si vous êtes bloqué, scannez le code QR pour le dépannage

Si está atascado, escanee el código QR para solucionar el problema.

如果遇到问题, 请扫描二维码进行故障排除

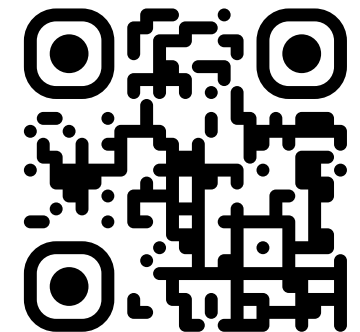



LIGHT MY BRICKS

lightmybricks.com



LEGO® is a trademark of the LEGO Group of companies, which does not sponsor, authorize or endorse this product. All LEGO® sets featured in images are sold separately. This is not a LEGO® product. The LEGO Group is not liable for any loss, injury or damage arising from the use or misuse of this product. ©2023 Light My Bricks Pty Ltd. All rights reserved. www.nightmode.com

Night Mode lighting products are designed and packaged in Australia by Light My Bricks Pty Ltd. Components are manufactured in China. Floor 4, Building 10, Qingnianmenggongchang, Dalang Street, Longhua District, Shenzhen City, Guangdong Province, China. Imported in Australia by Light My Bricks Pty Ltd, 4/26 Rushdale St, Knoxfield, VIC, 3180, Australia.

WARNING: CHOKING HAZARD - Small parts. Not for children under 3 years.

¡ADVERTENCIA! Peligro de asfixia - piezas pequeñas

WARNUNG! Erstickungsgefahr - Kleinteile

AVERTISSEMENT! Risque d'étouffement - Petites pièces

AVVERTIMENTO! Pericolo di soffocamento - Piccole parti

ПРЕДУПРЕЖДЕНИЕ! Опасность удушья - мелкие детали

单警告！窒息危险 - 小零件

警告！窒息の危険 - 小さな部品

ةريغص ءازجاً - قانتخال ا رطخ! اريذحت