

LIGHT KIT INSTALLATION GUIDE

**TALES OF THE
SPACE AGE**

FOR LEGO
SET
#21340

CONTENTS



03

Getting Started

- 04 Legend
- 05 Component Handling
- 06 Blueprint

07

Instructions

- 07 LMB Bag 01
- 056 LMB Bag 02
- 111 LMB Bag 03
- 170 LMB Bag 04
- 229 Power Test

237

Final Product

- 233 Package Contents
- 235 Contact & Troubleshooting

GETTING STARTED



Bold, beautiful and bright, Light My Bricks elevates your favourite LEGO set from knick-knack to statement piece. Create a talking point at home or in the office that speaks to your passions with Light My Bricks. To learn more, click below.

[Learn More](#)



Audacieux, beau et lumineux, Light My Bricks élève votre ensemble LEGO préféré du statut de bibelot à celui de pièce maîtresse. Que ce soit à la maison ou au bureau, partagez votre passion des LEGO avec Light My Bricks. Cliquez ci-dessous pour en savoir plus.

[En savoir plus](#)



Audace, bello e luminoso, Light My Bricks eleva il tuo set LEGO preferito da soprammobile a pezzo di tendenza. Crea un punto di discussione a casa o in ufficio che parli alle tue passioni con Light My Bricks. Per saperne di più, clicca qui sotto.

[Ulteriori Informazioni](#)



Mutig, schön und hell – Light My Bricks verwandelt Ihr Lieblings-LEGO-Set von einem schnickschnack in ein statement-stück. Schaffen sie einen gesprächspunkt zu hause oder im büro, der Ihre leidenschaften widerspiegelt, mit Light My Bricks. Um mehr zu erfahren, klicken sie unten.

[Mehr erfahren](#)



Audaz, hermoso y brillante, Light My Bricks eleva tu set LEGO favorito de una chuchería a una pieza llamativa. Crea un tema de conversación en casa o en la oficina que hable de tus pasiones con Light My Bricks. Para obtener más información, haga clic a continuación.

[Más información](#)



大胆、美丽而明亮，Light My Bricks 将你喜爱的乐高套装从小摆件提升为引人注目的装饰品。在家或办公室打造一个能表达你激情的话题，了解更多，请点击下方。

[了解更多](#)



LEGEND

Rotate Set



Retournez L'ensemble
Ruota Set
Set Drehen
Rotar Conjunto
旋转套件

Add Part



Ajoutez une Pièce
Aggiungi Parte
Teil Hinzufügen
Agregar Pieza
添加零件

Click



Cliquez
Clic
Klicken
Clic
点击

Pinch/Fold



Pincez/Pliez
Pizzicare/Piegare
Kneifen/Falten
Pellizcar/Doblar
折叠

Pull Cable



Tirez le Cable
Tirare il Cavo
Kabel Ziehen
Tirar del Cable
拉动电缆

Repeat Step



Répétez
Ripetere
Wiederholen
Repetir
重复

Sticker



Autocollant
Adesivo
Aufkleber
Pegatina
贴纸

Power On Test



Test de mise sous tension
Test di Potenza
Stromtest
Prueba de Energía
电源测试

Disconnect Power



Débranchez L'alimentation
Scollegare L'alimentazione
Strom Trennen
Desconectar la Energía
断开电源

Troubleshoot



Dépanner
Risolvere
Fehlerbehebung
Solución de Problemas
故障排除

COMPONENT HANDLING

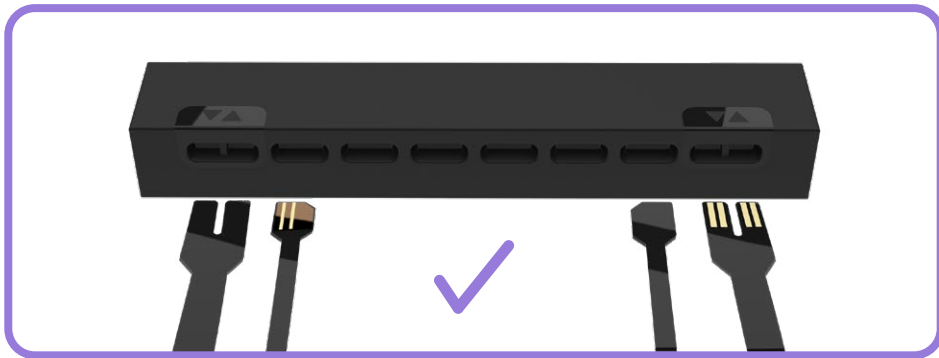
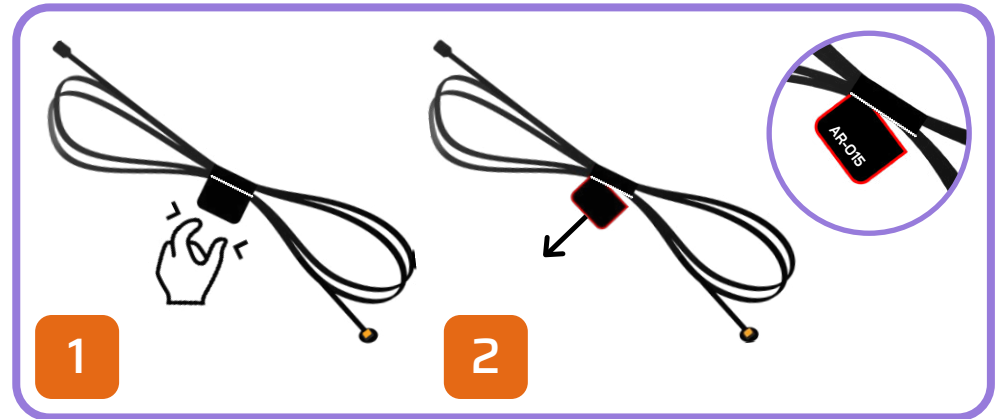
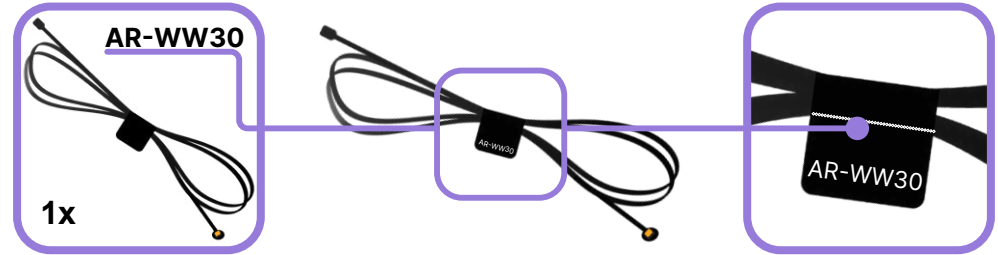
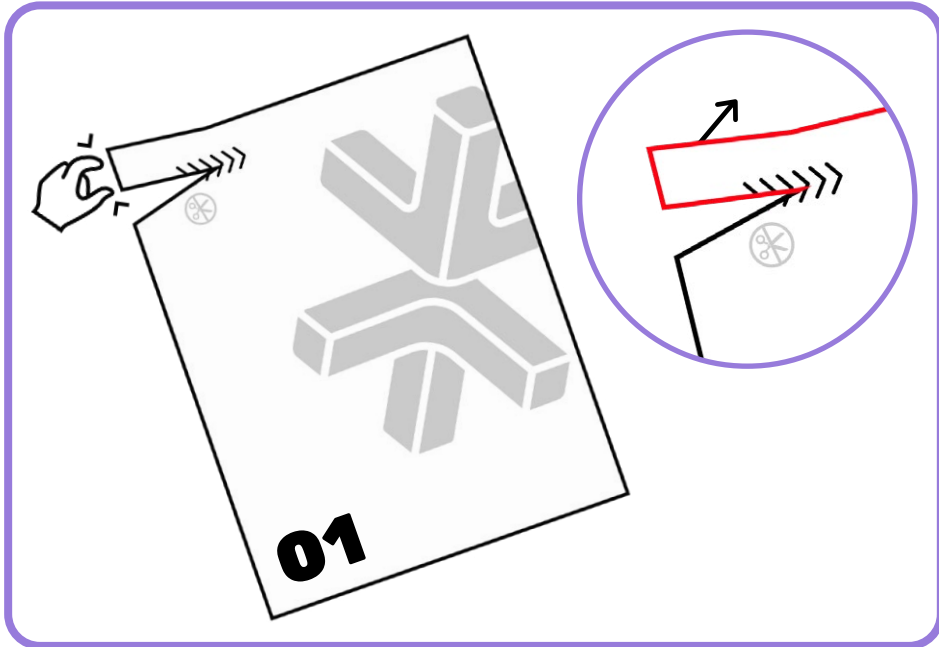

BLUEPRINT

Comet

(banner spotlight)
AL-B15

(banner spotlight)
ALF-015



B-15



Eclipse

(banner spotlight)
AL-015



(banner spotlight)
2x AR-CW30



B-15

Rocket

(banner spotlight)
AL-P15



(banner spotlight)
AR-WW15



(banner spotlight)
ARF-WW15



B-15

Black Hole

(banner spotlight)
AL-G15



(banner spotlight)
2x AR-CW15



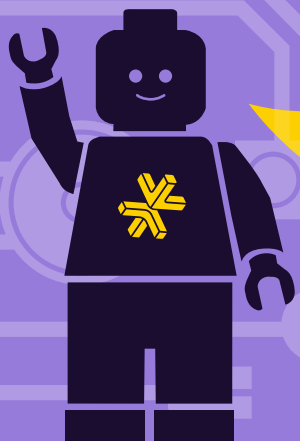

HOLD UP!

You might notice some bags aren't in order, as well as left over pieces, but that's ok! We're changing the way you build LEGO!

ATTENDEZ!

Vous remarquerez peut-être que certains sacs, ainsi que certaines pièces, ne sont pas dans le bon ordre. Mais pas de panique! Nous changeons simplement la façon avec laquelle vous construisez vos LEGO!

ASPETTA!

Potresti notare che alcuni sacchetti non sono in ordine, così come i pezzi avanzati, ma va bene così! Stiamo cambiando il modo in cui costruisci i LEGO!

HALT!

Sie werden möglicherweise bemerken, dass einige tüten durcheinander sind und teile übrig bleiben, aber das ist in Ordnung! Wir ändern die art und weise, wie Sie LEGO bauen!

¡ESPERA!

Es posible que notes que algunas bolsas están fuera de servicio, así como piezas sobrantes, ¡pero está bien! ¡Estamos cambiando la forma en que construyes LEGO!

暫停!

你可能会注意到一些袋子顺序错乱, 以及一些剩余的部件, 但没关系! 我们正在改变你搭建乐高的方式!

Open LMB Bag 01

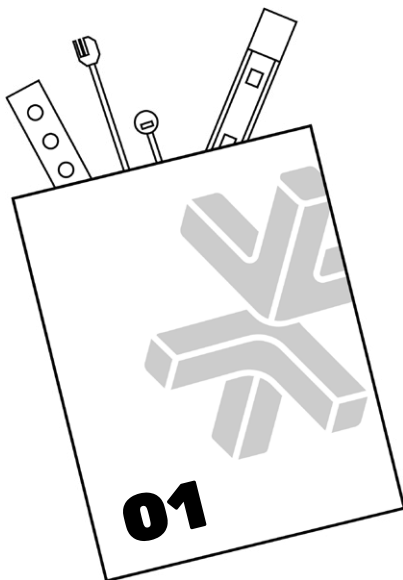

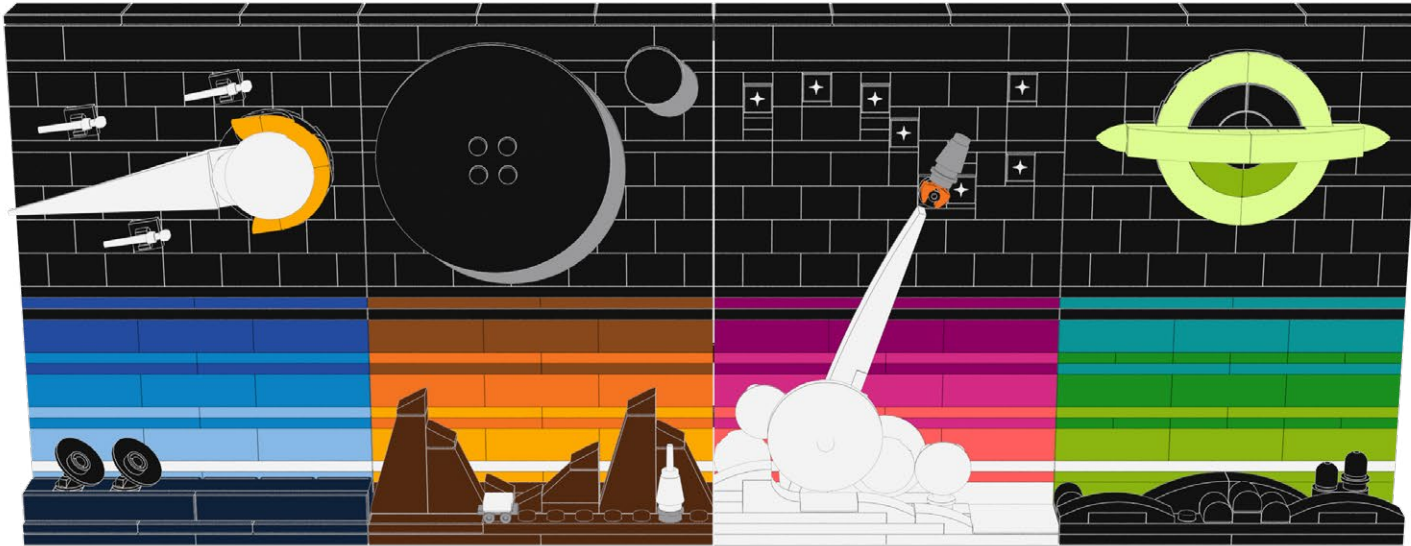

2

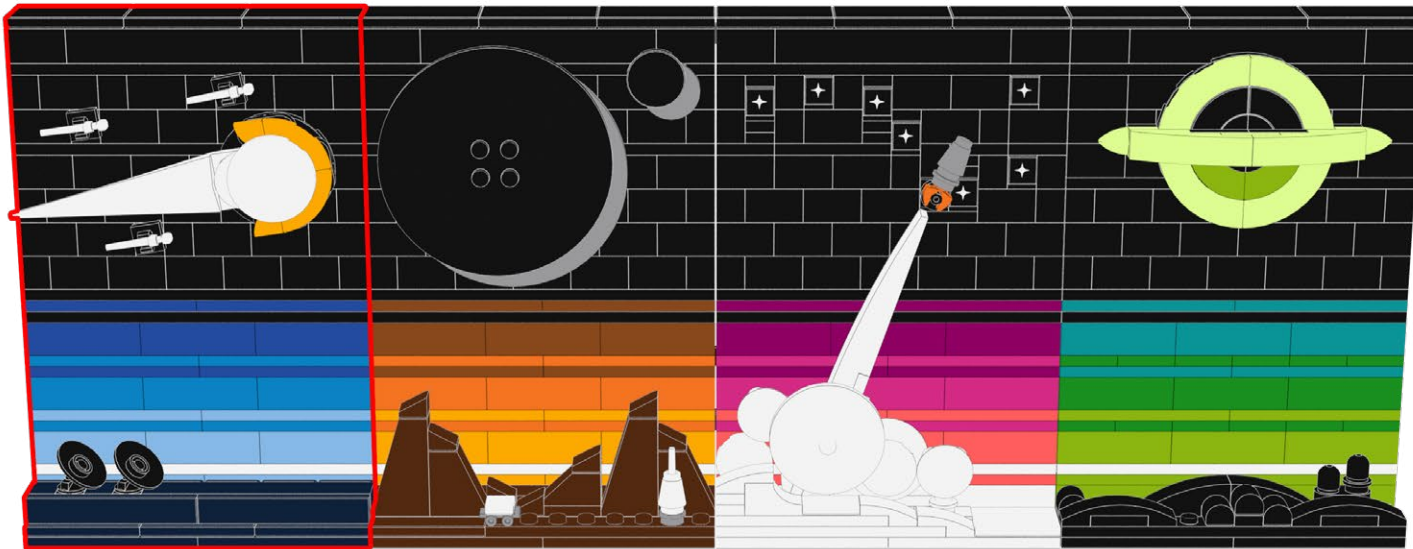

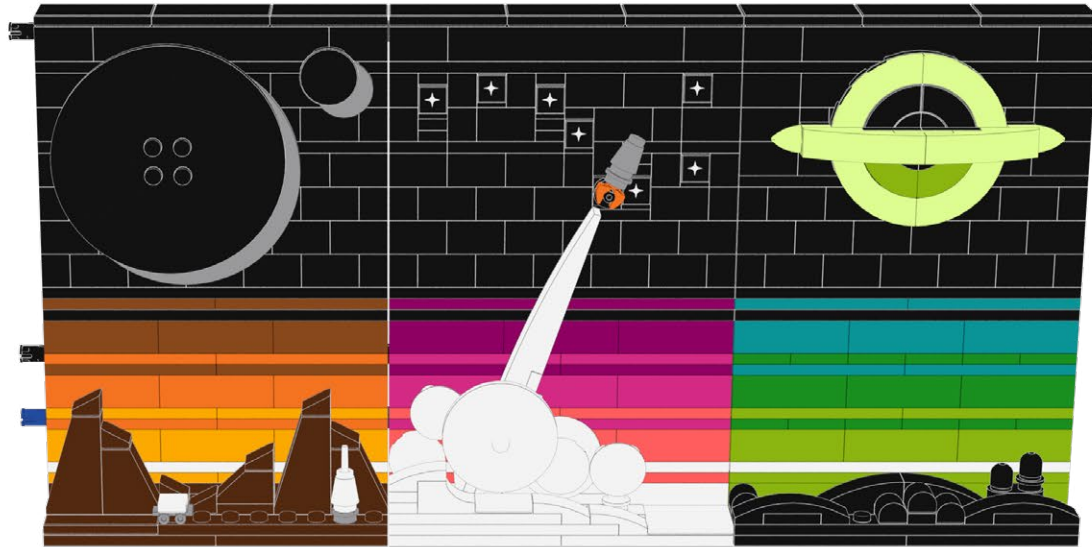
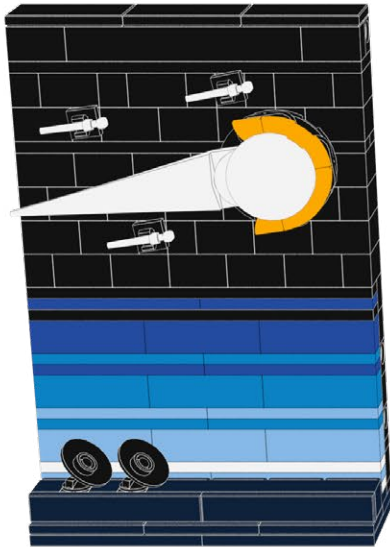



1

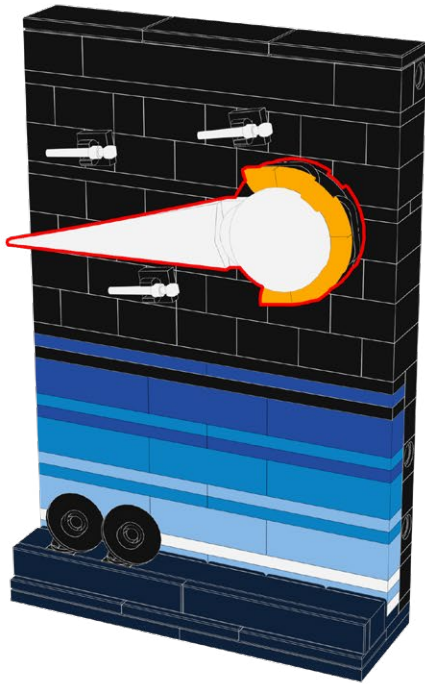

2

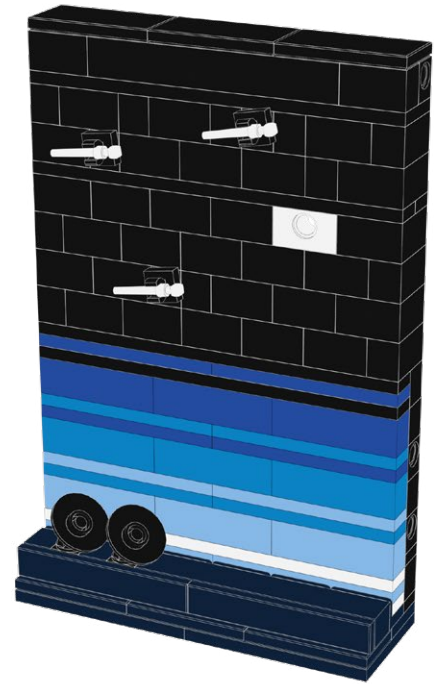
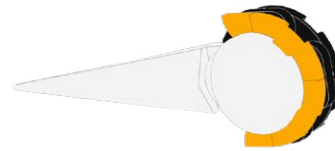

1

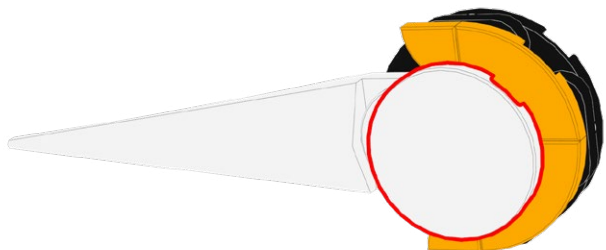

2

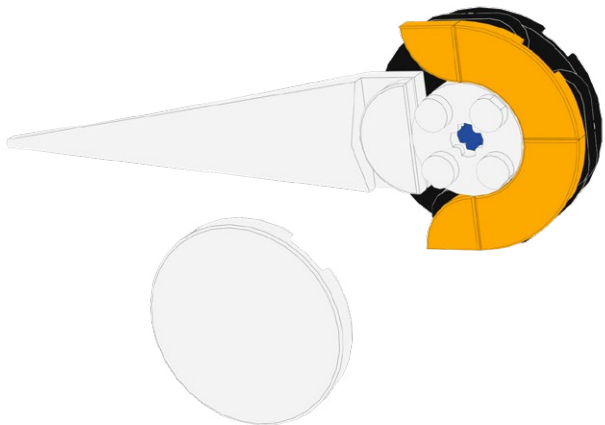

3

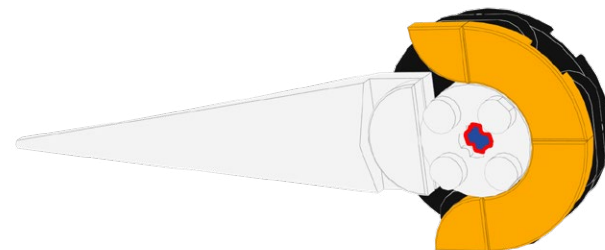

4

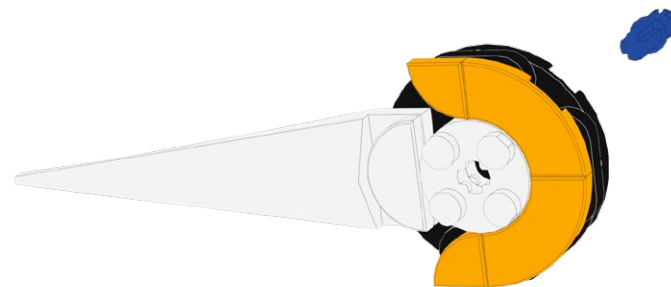

1

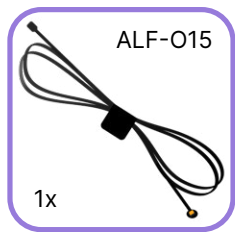
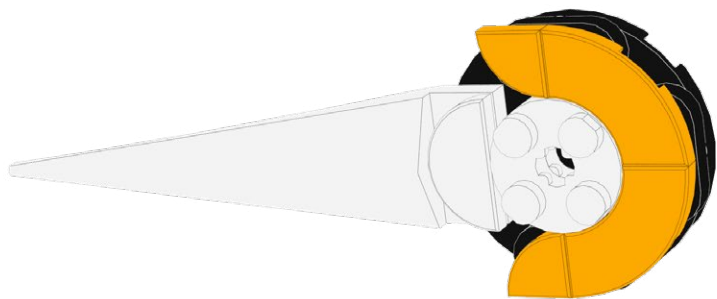

2

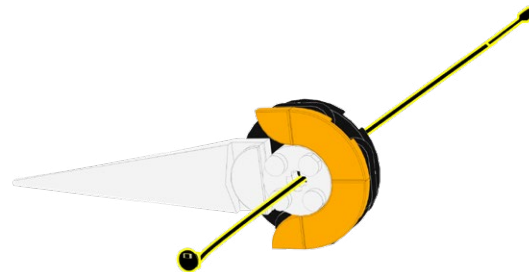

3

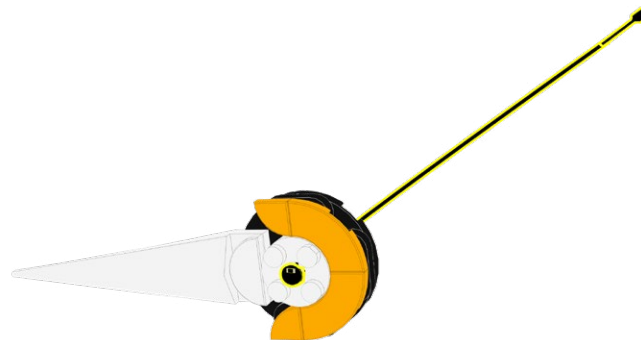

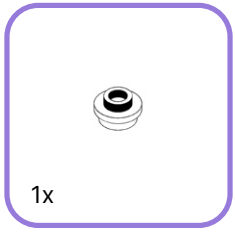

1

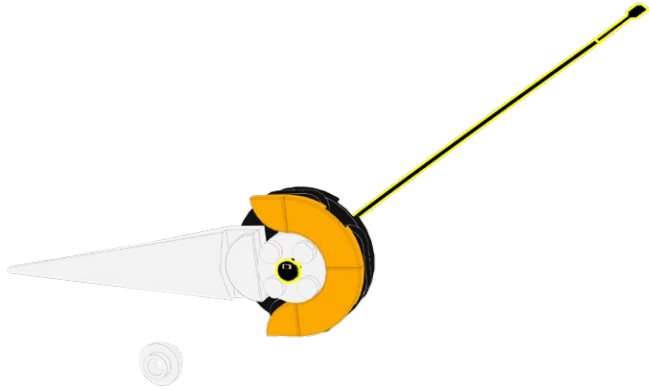

2

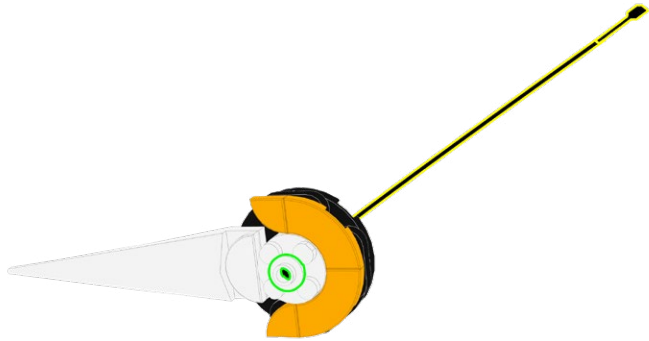

3

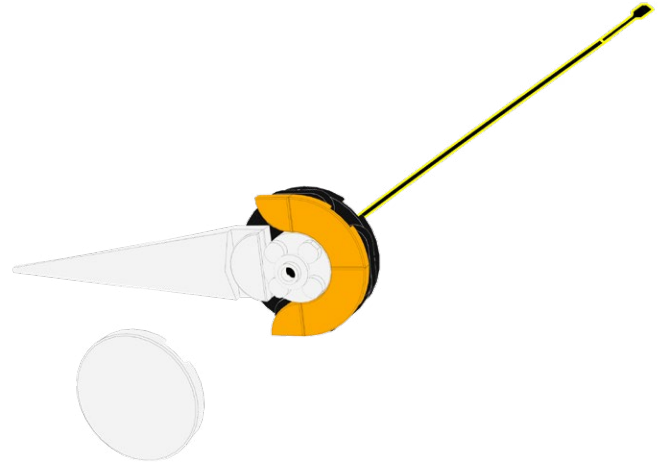

4

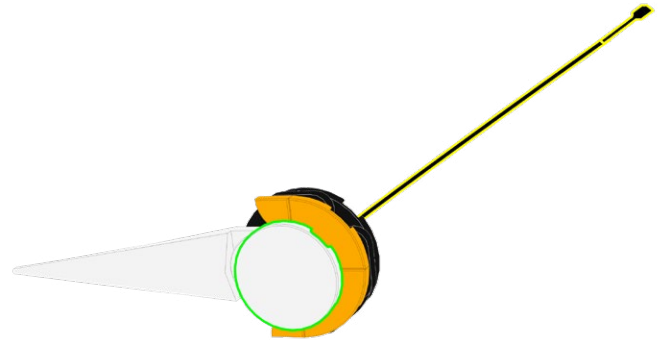

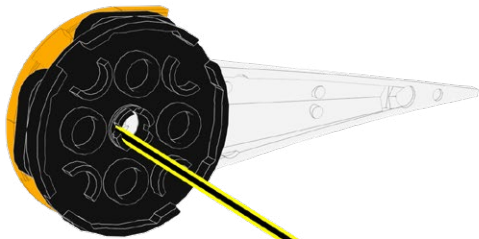
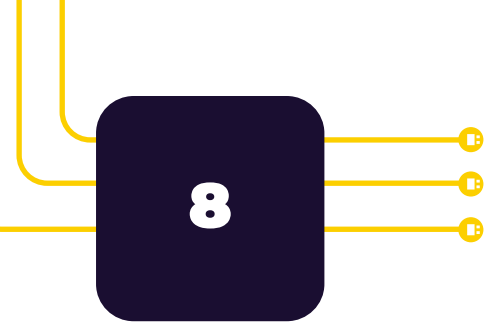

2

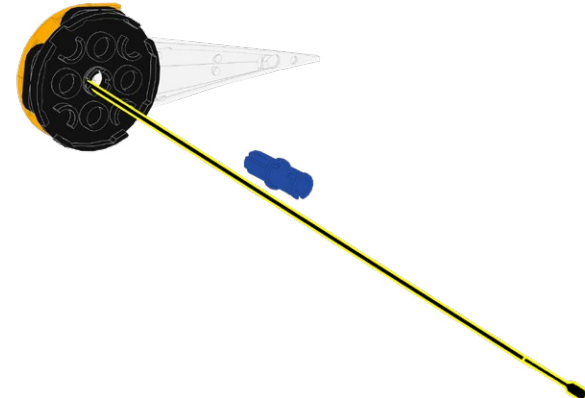

3

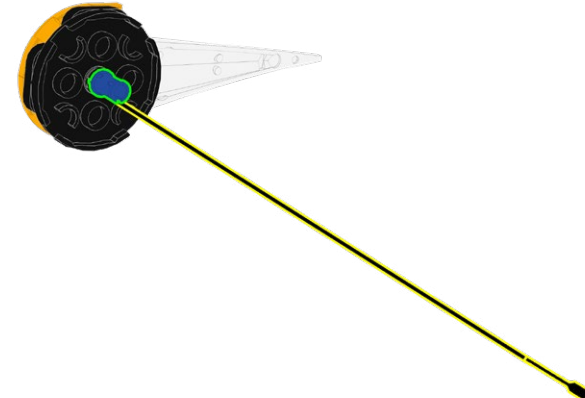

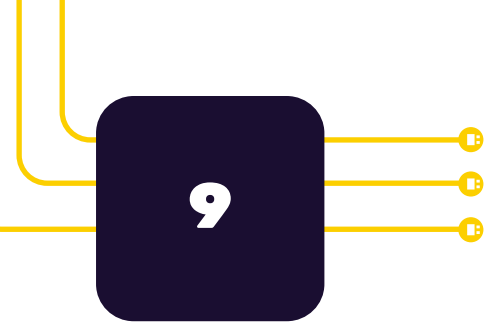

1

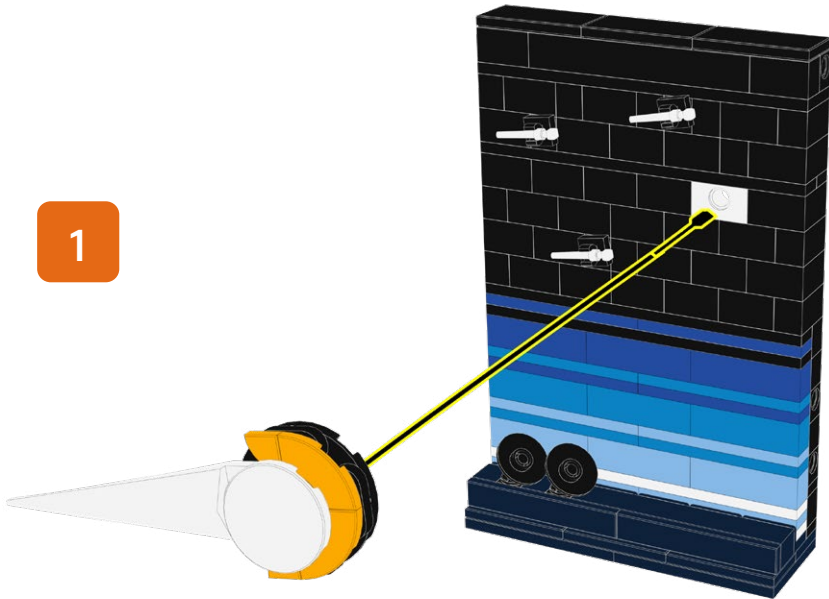

2

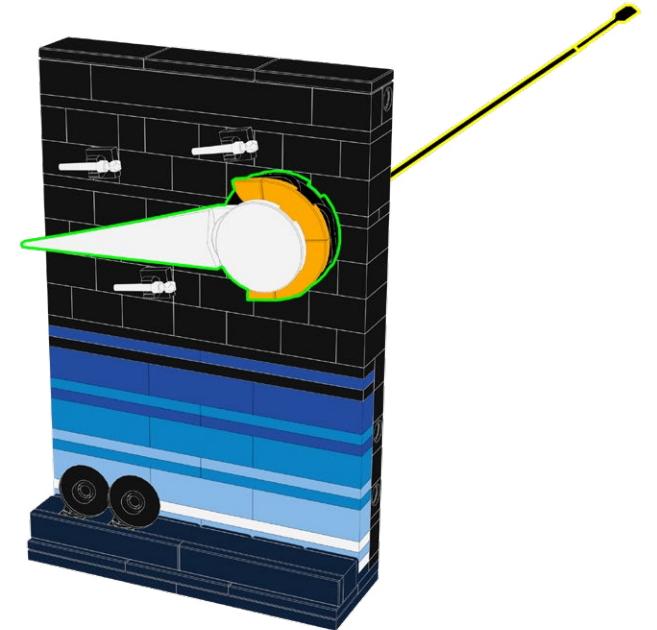

10

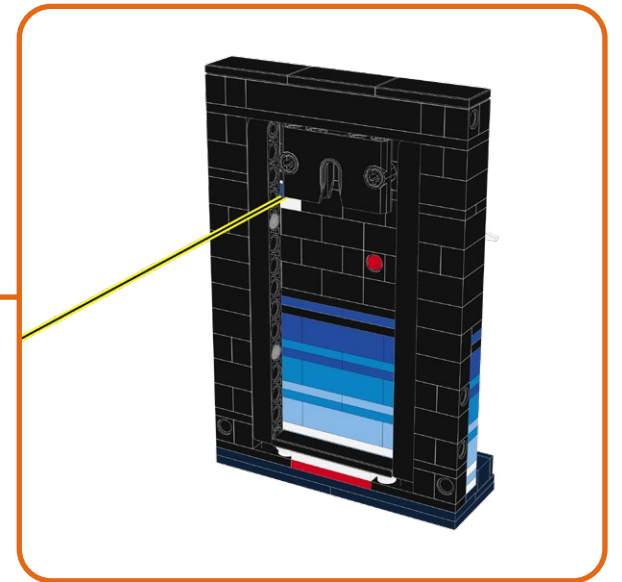
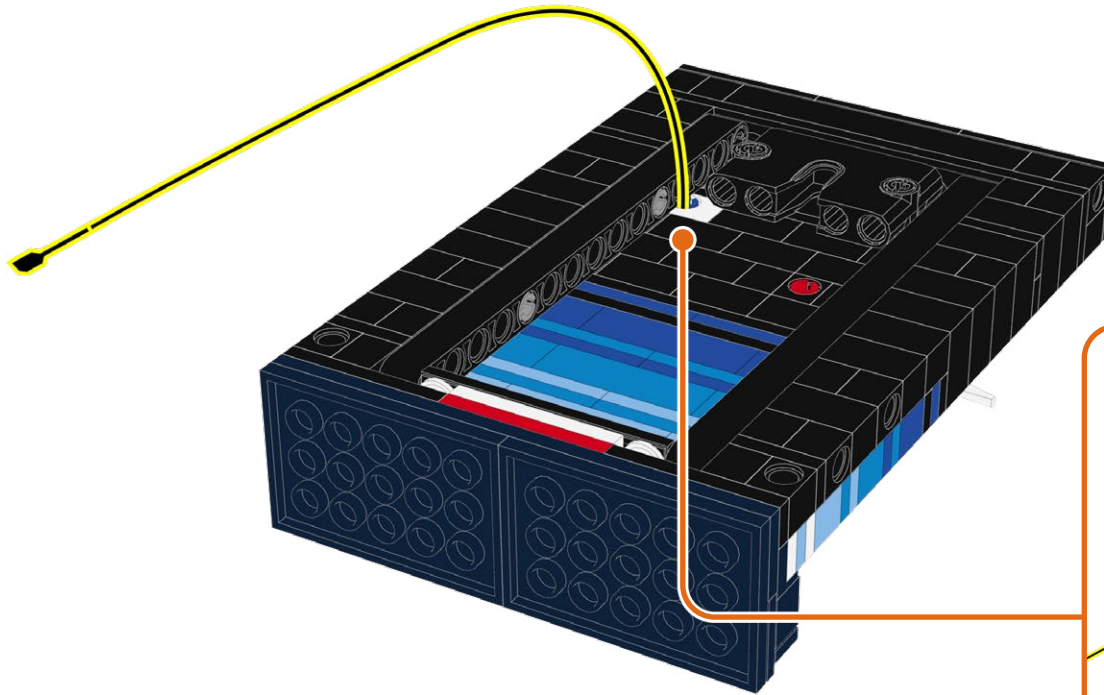

11

2x

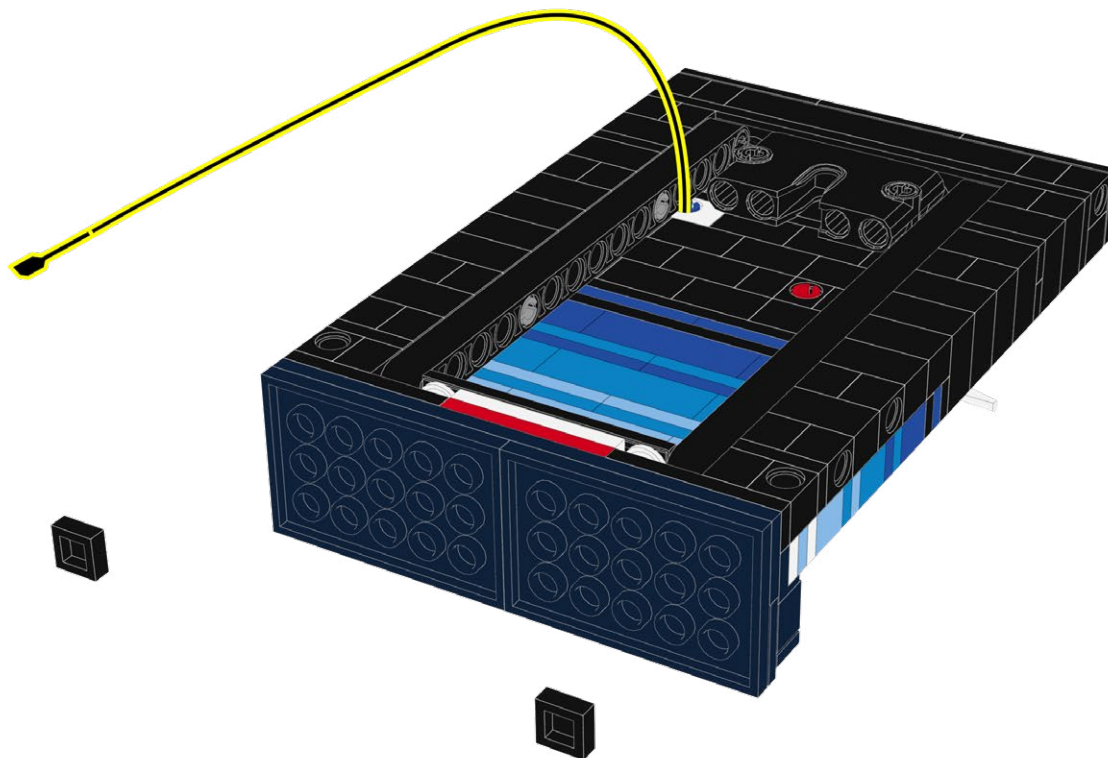

12

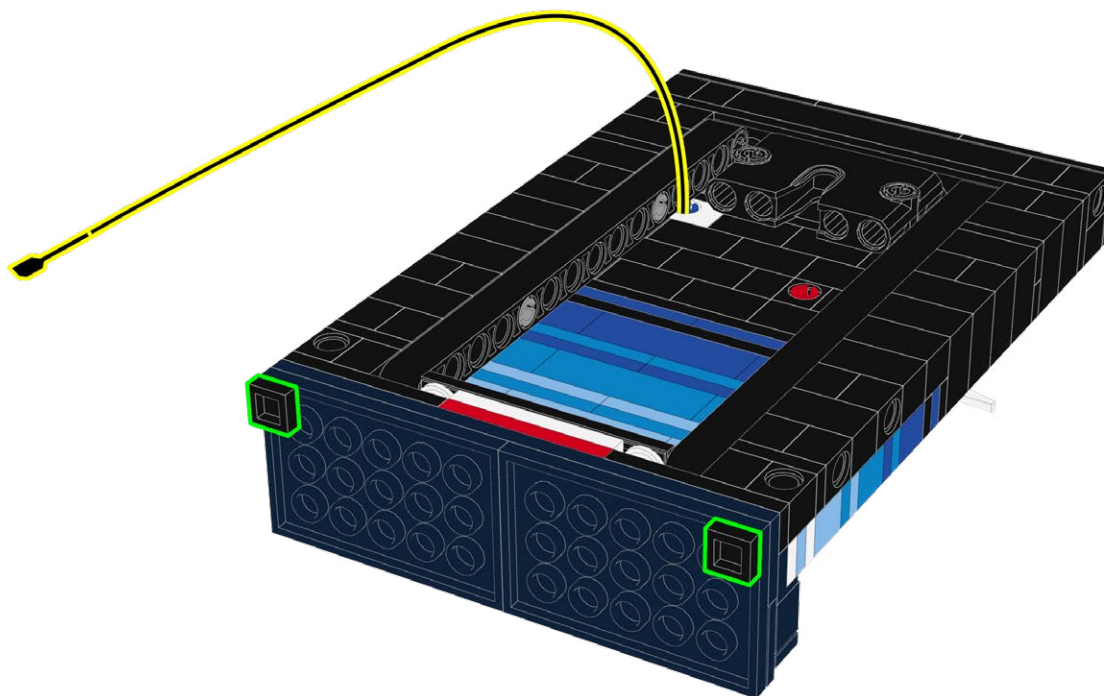

13

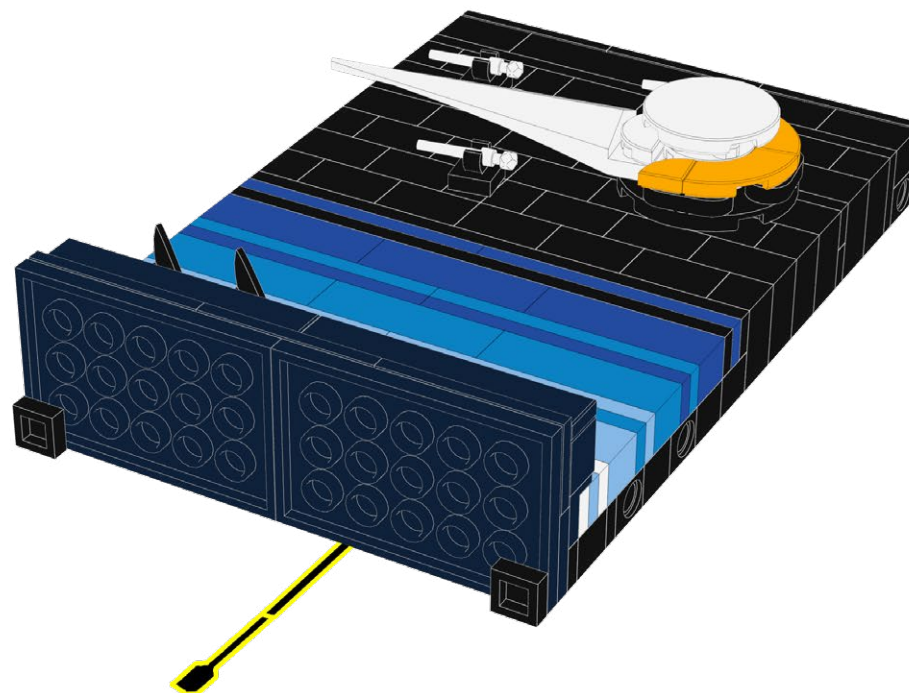

14

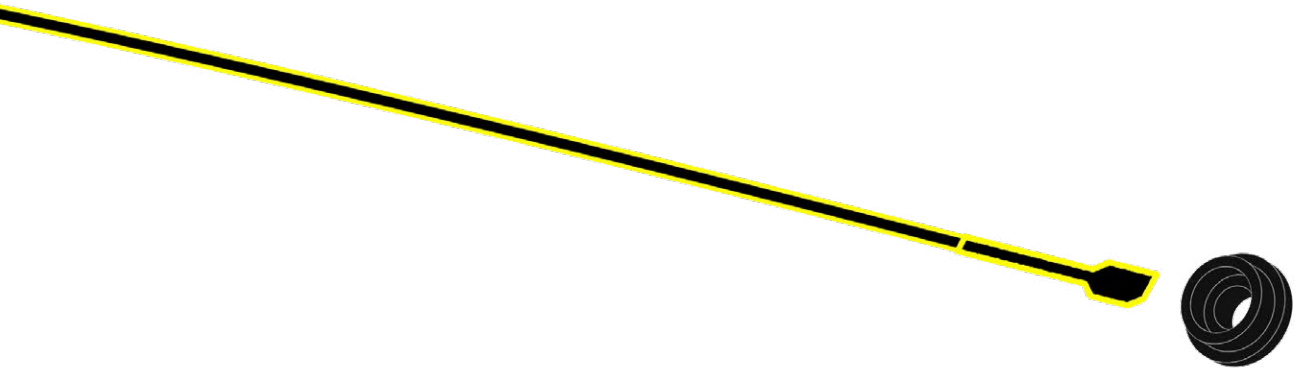
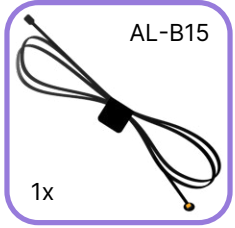

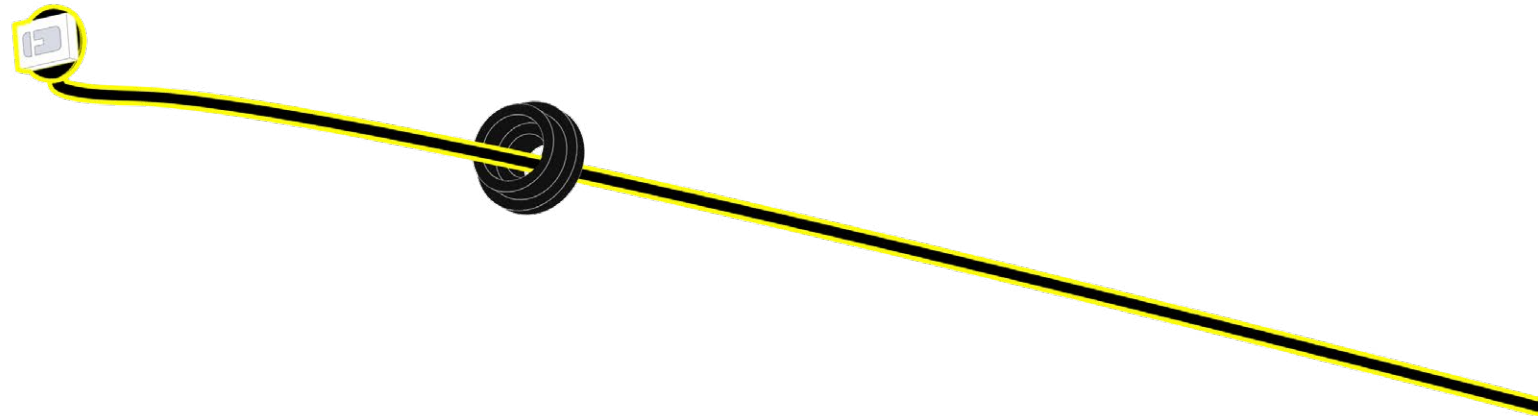



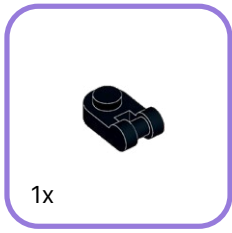

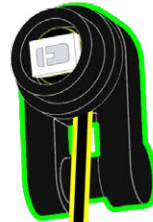

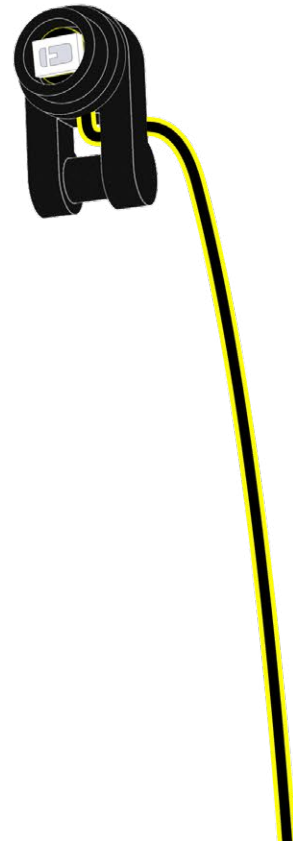

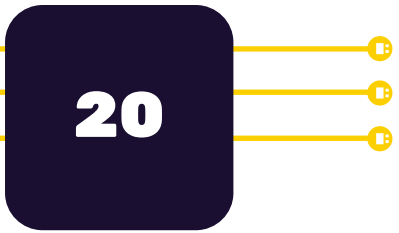

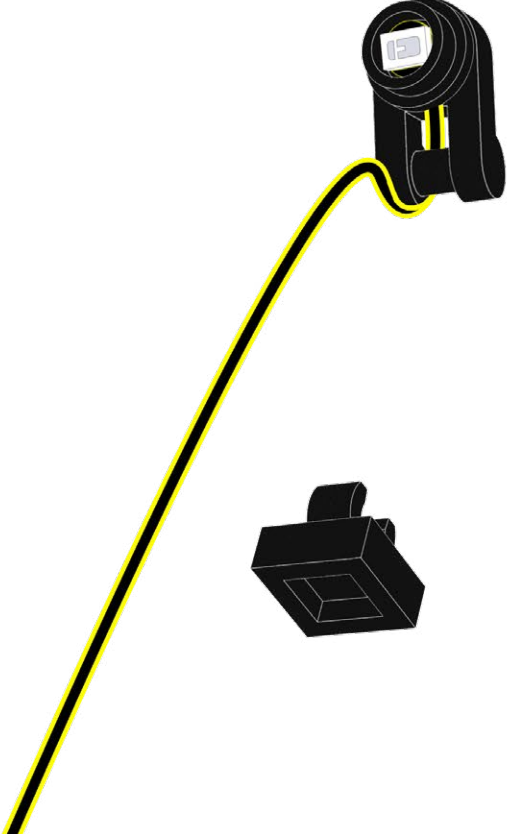
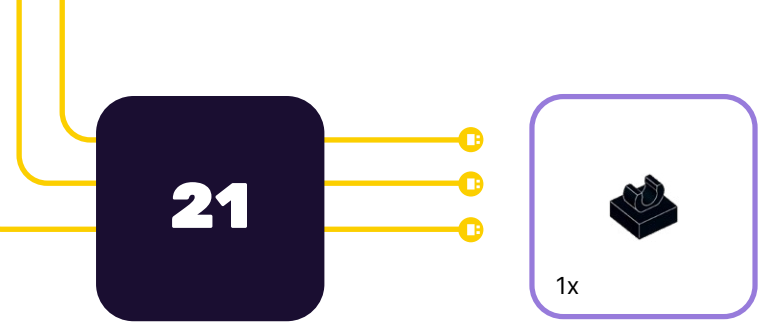

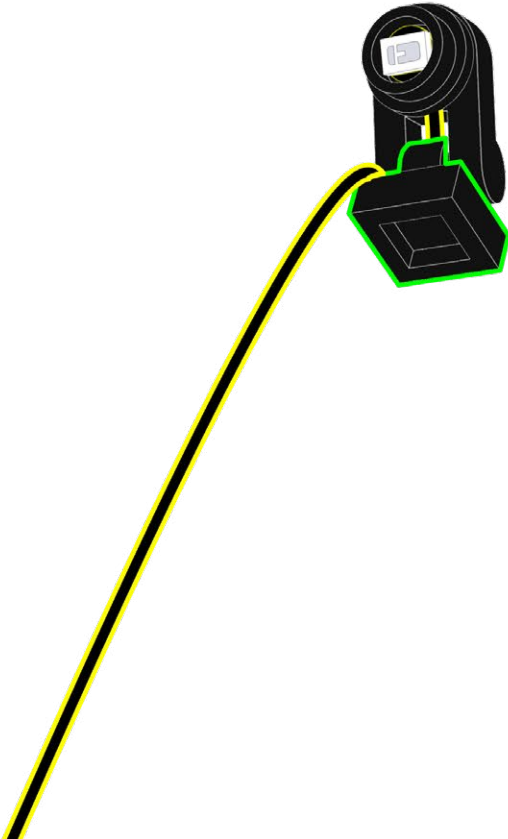
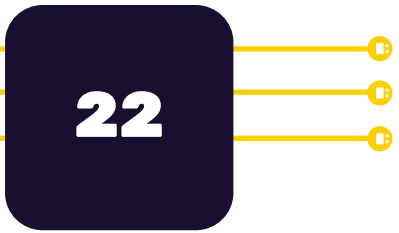

23

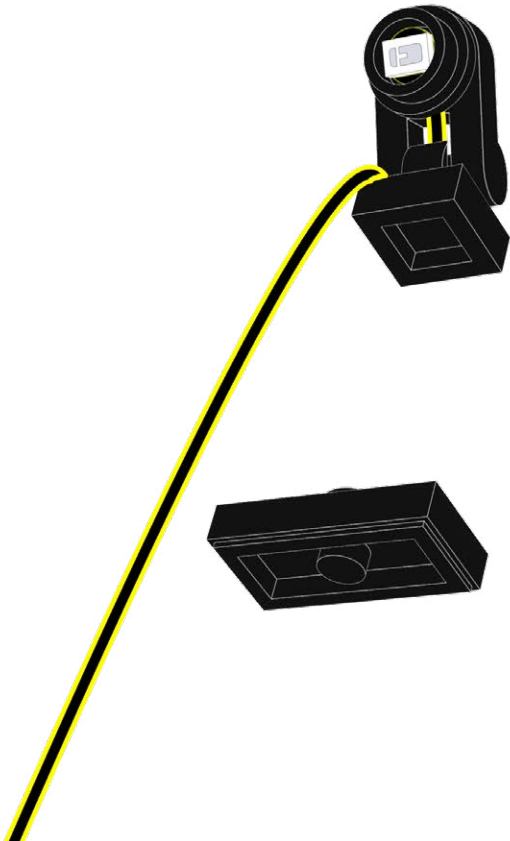
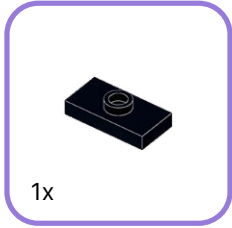

24

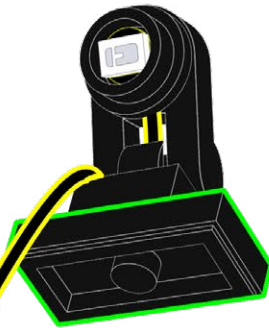

25

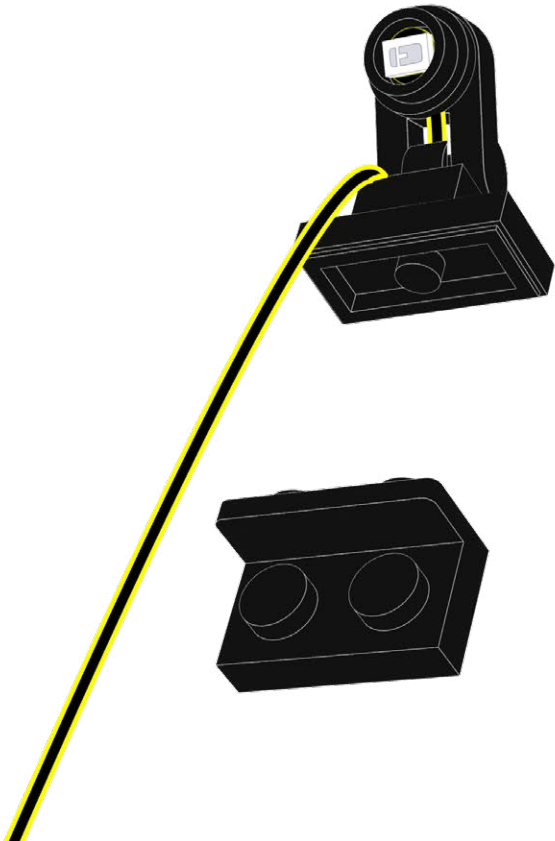
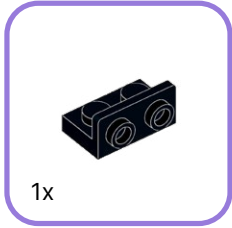

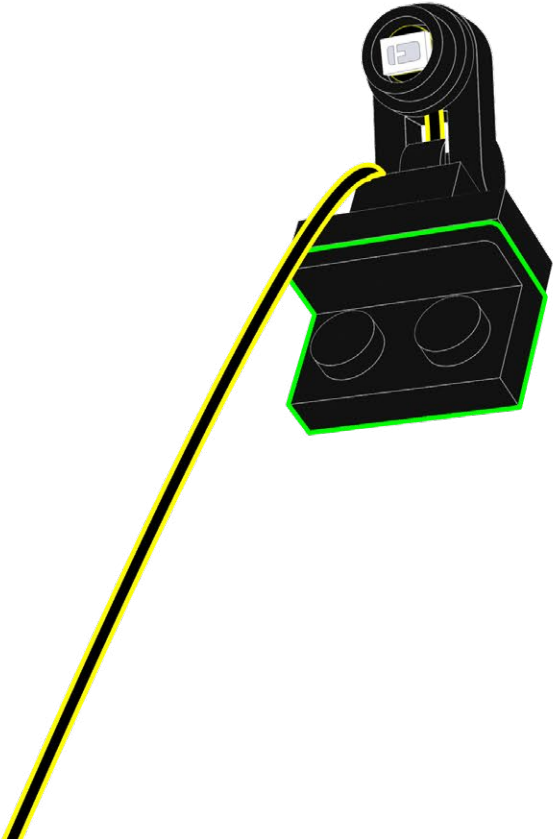

27

Astro Cap Clear



1x

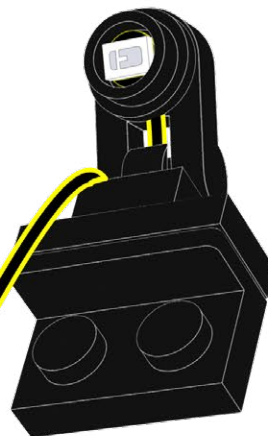
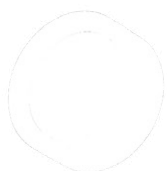

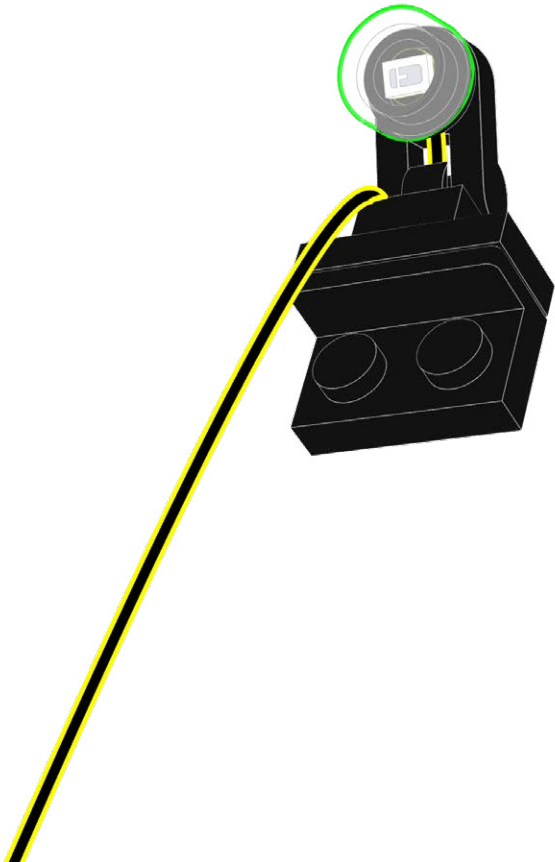

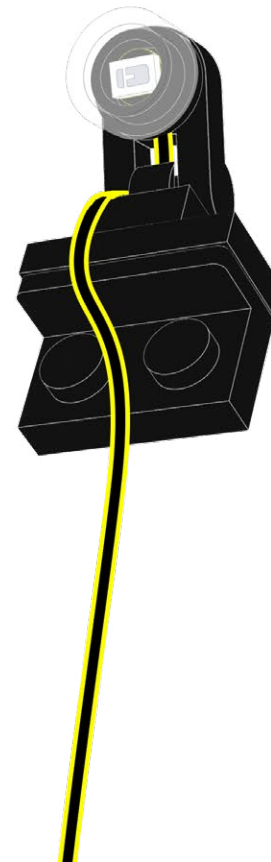
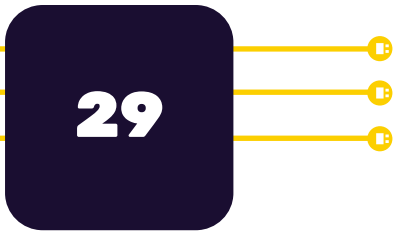

30



31

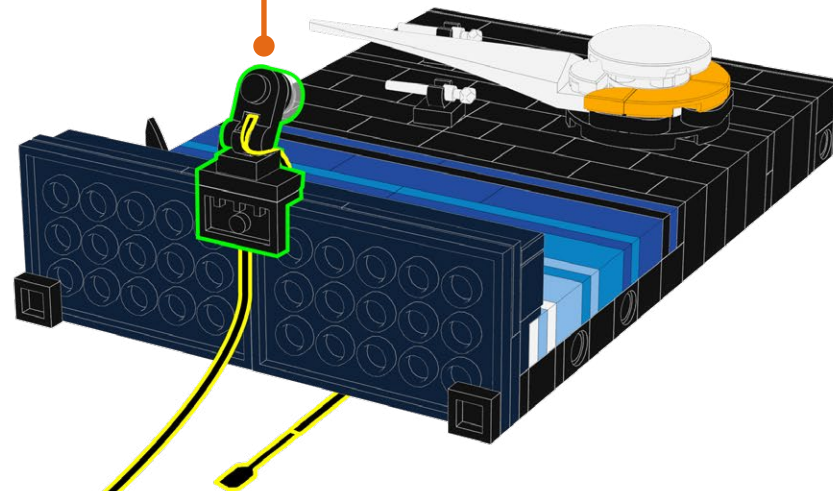
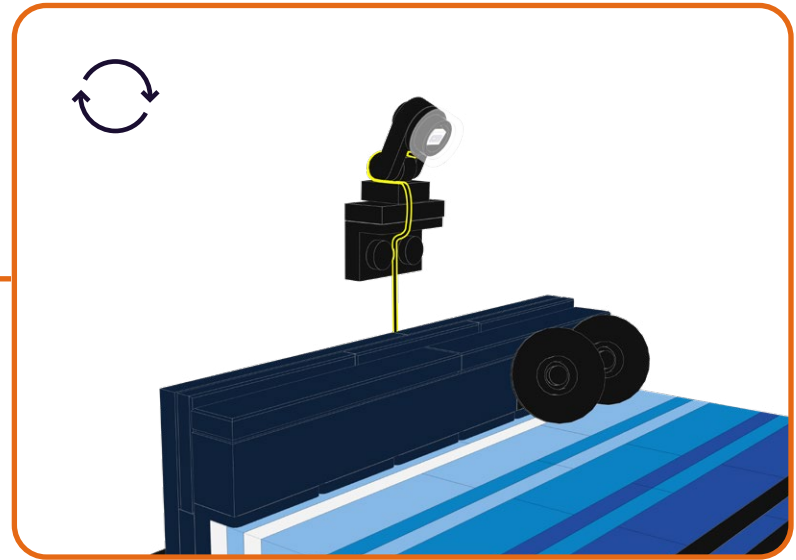

32

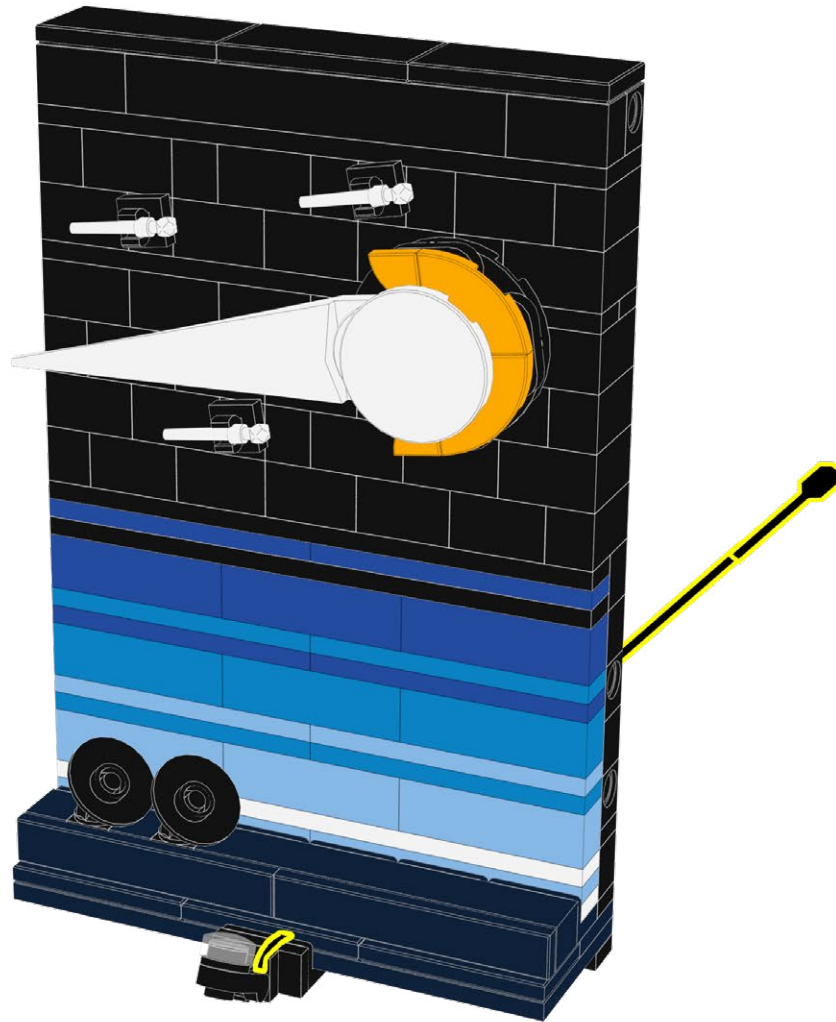

33

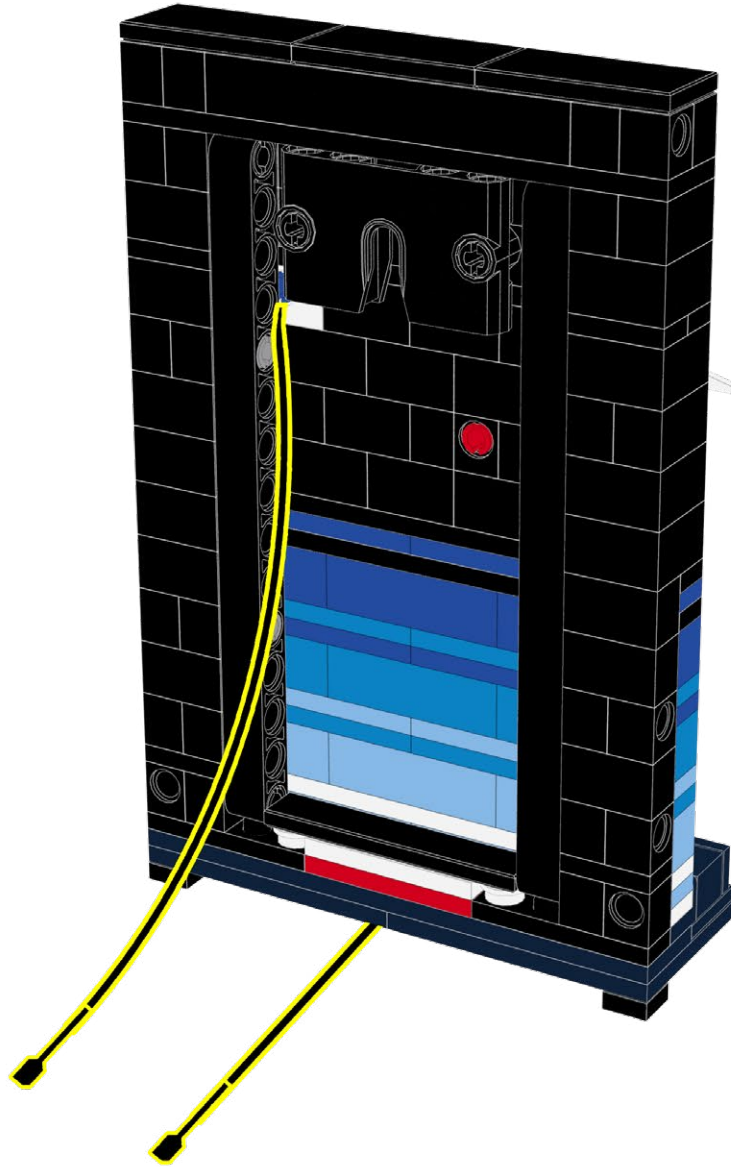

34

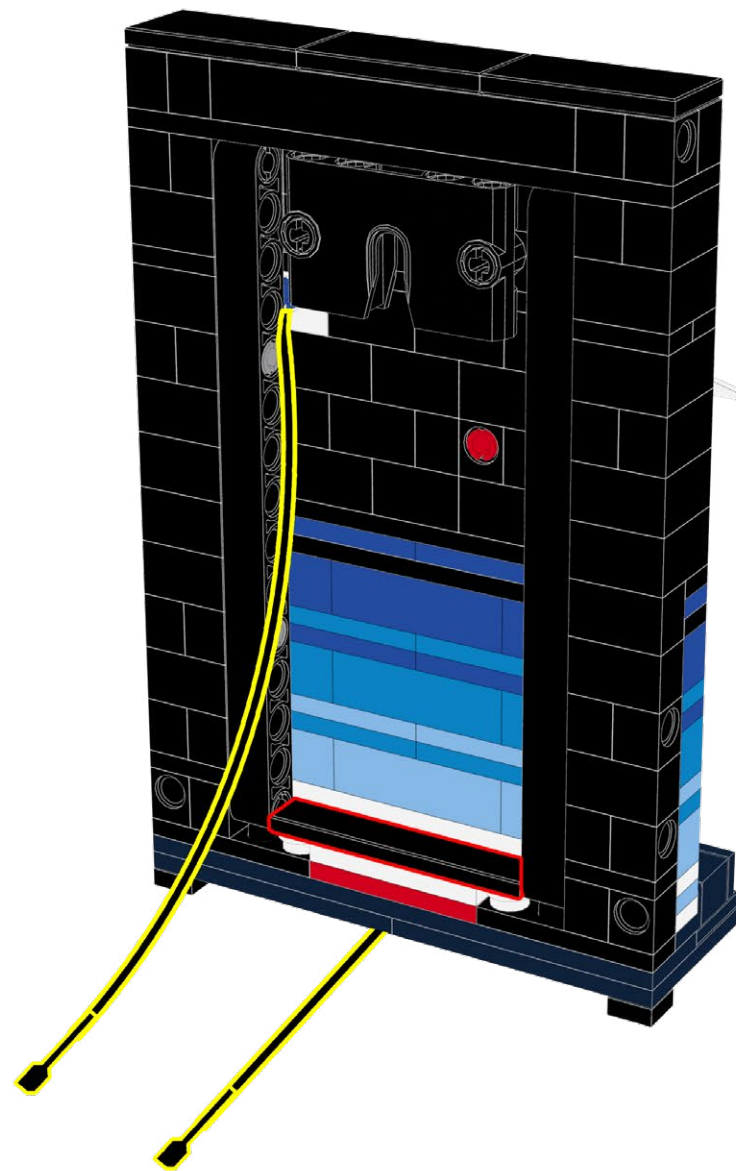

35

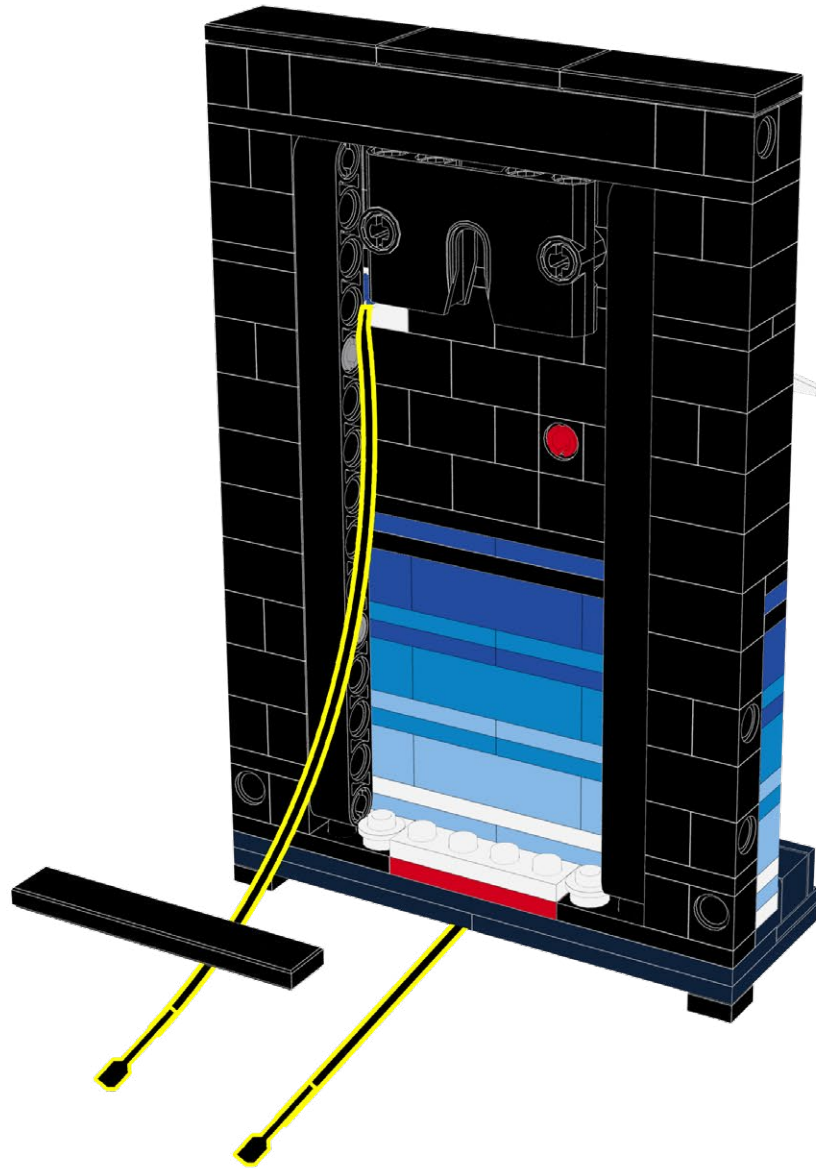

36

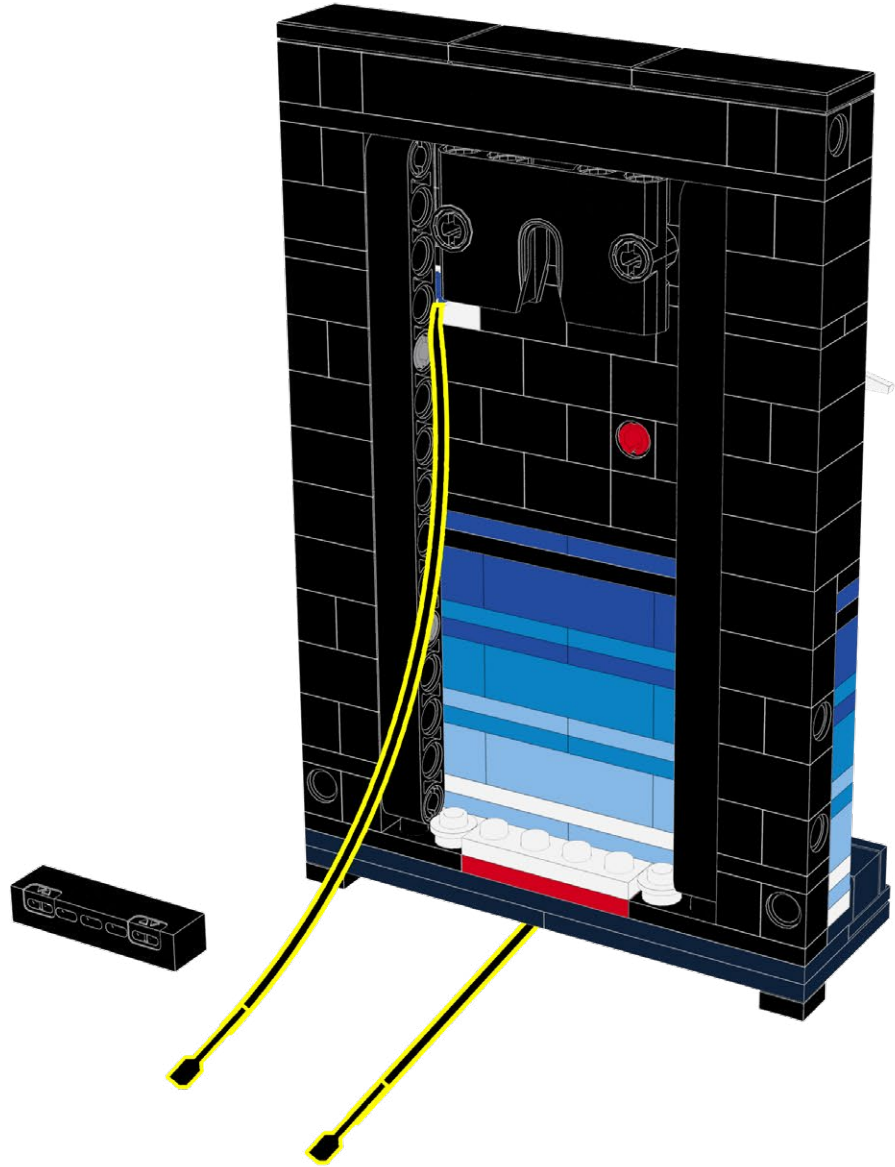
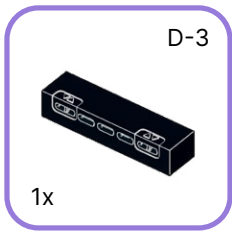

37

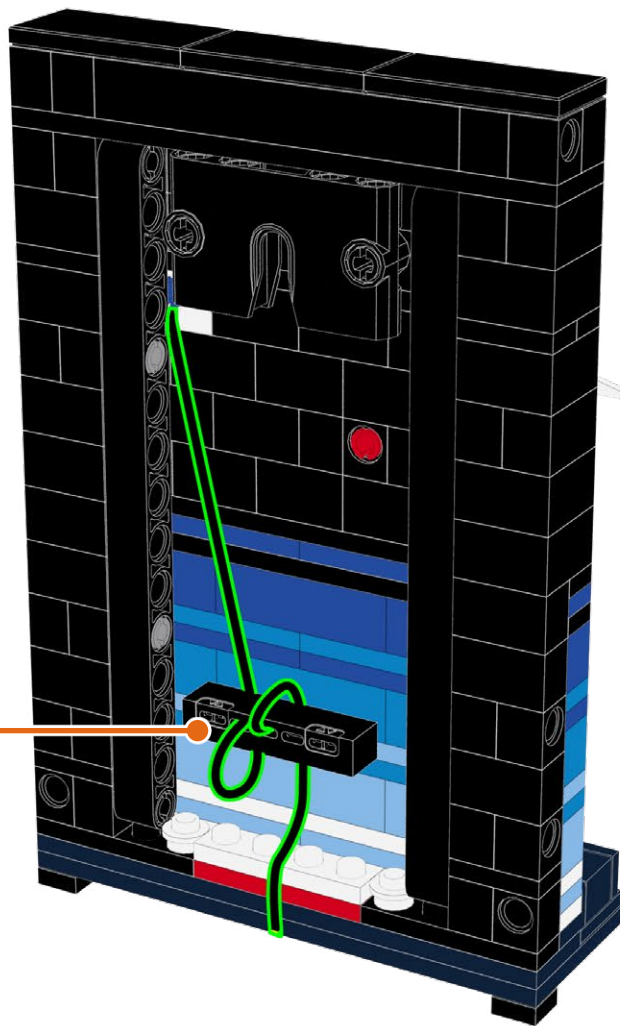
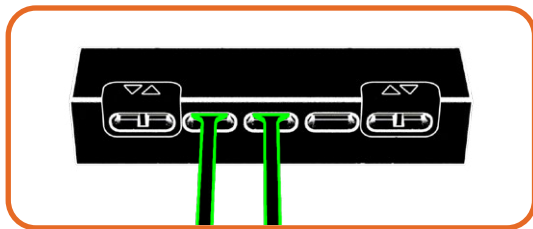

38

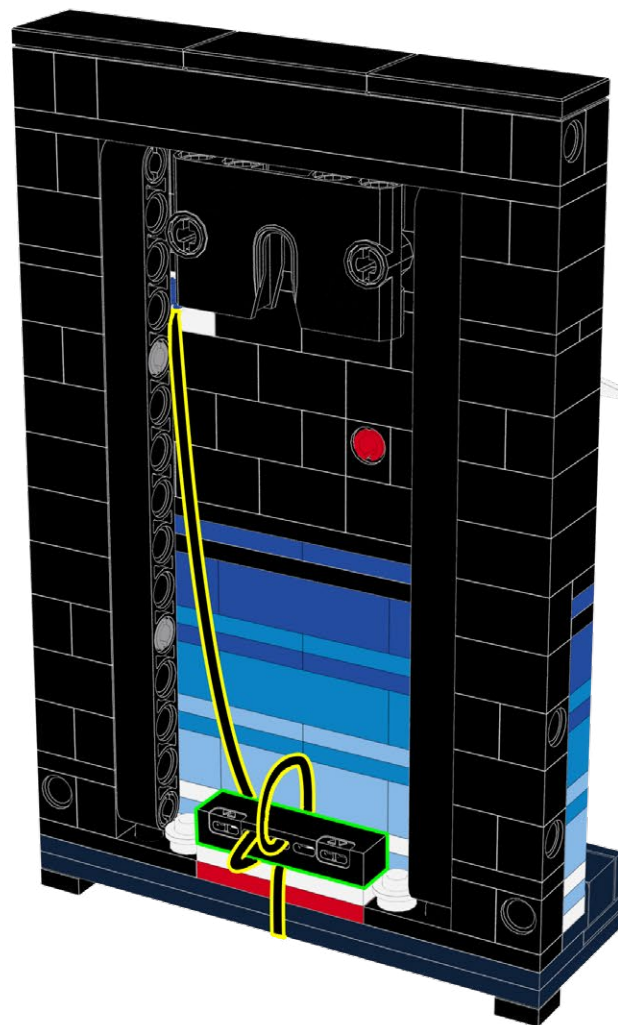

39

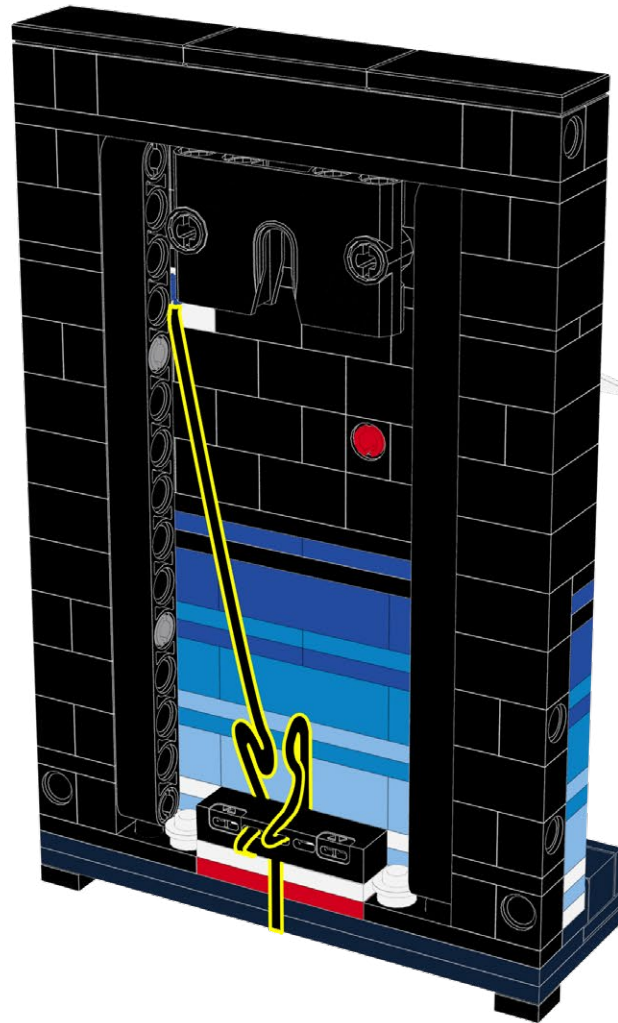

40

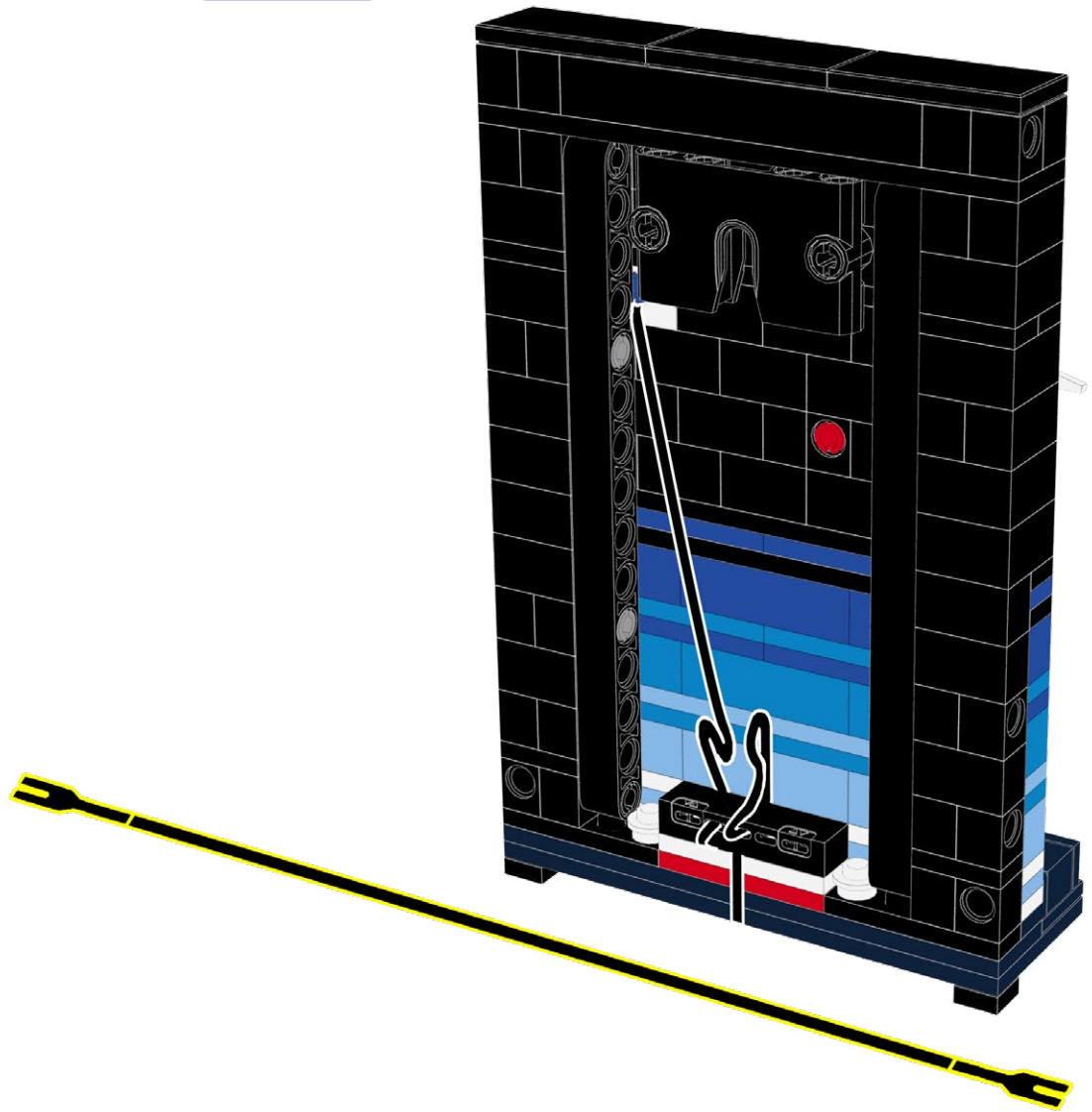
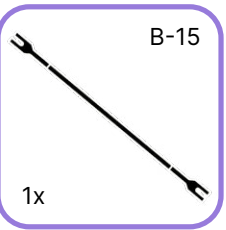

41

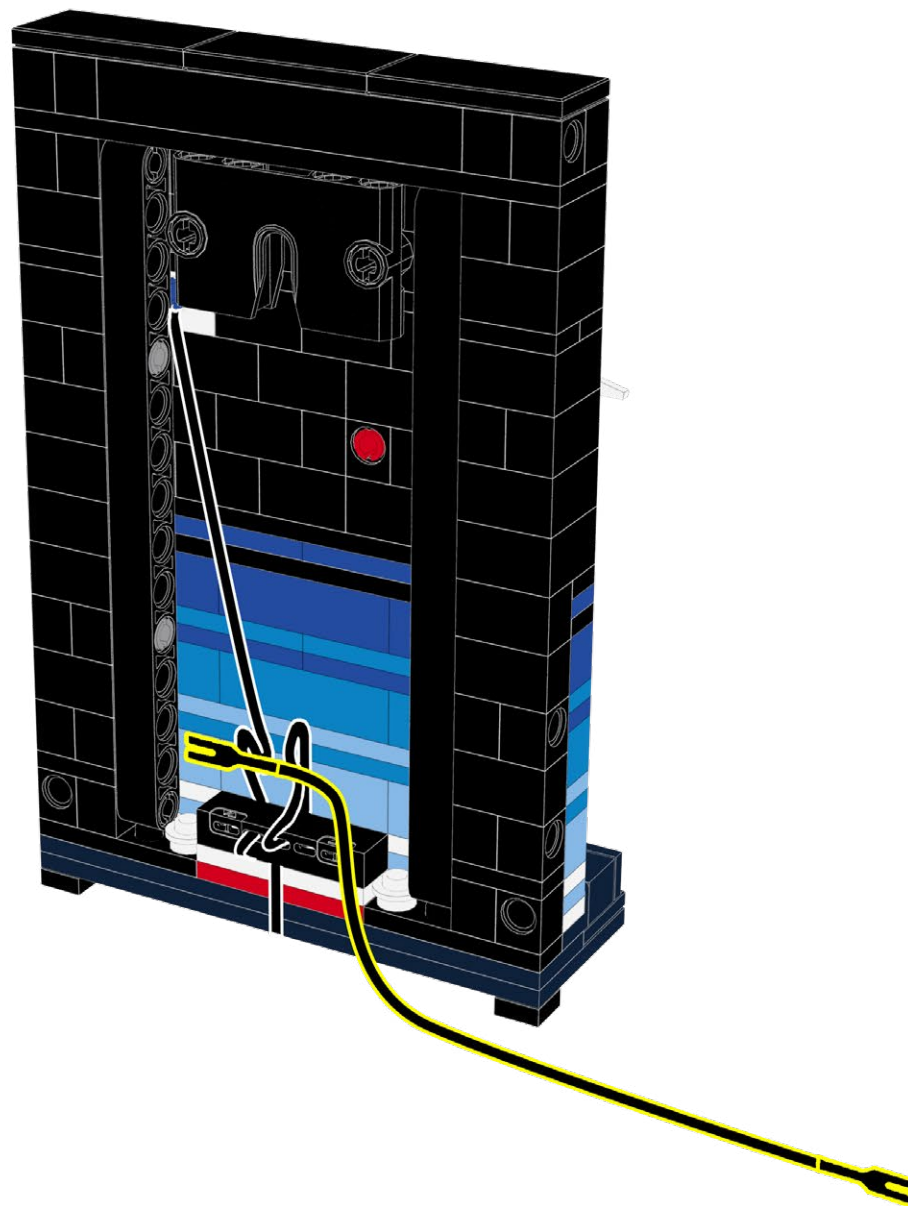

42

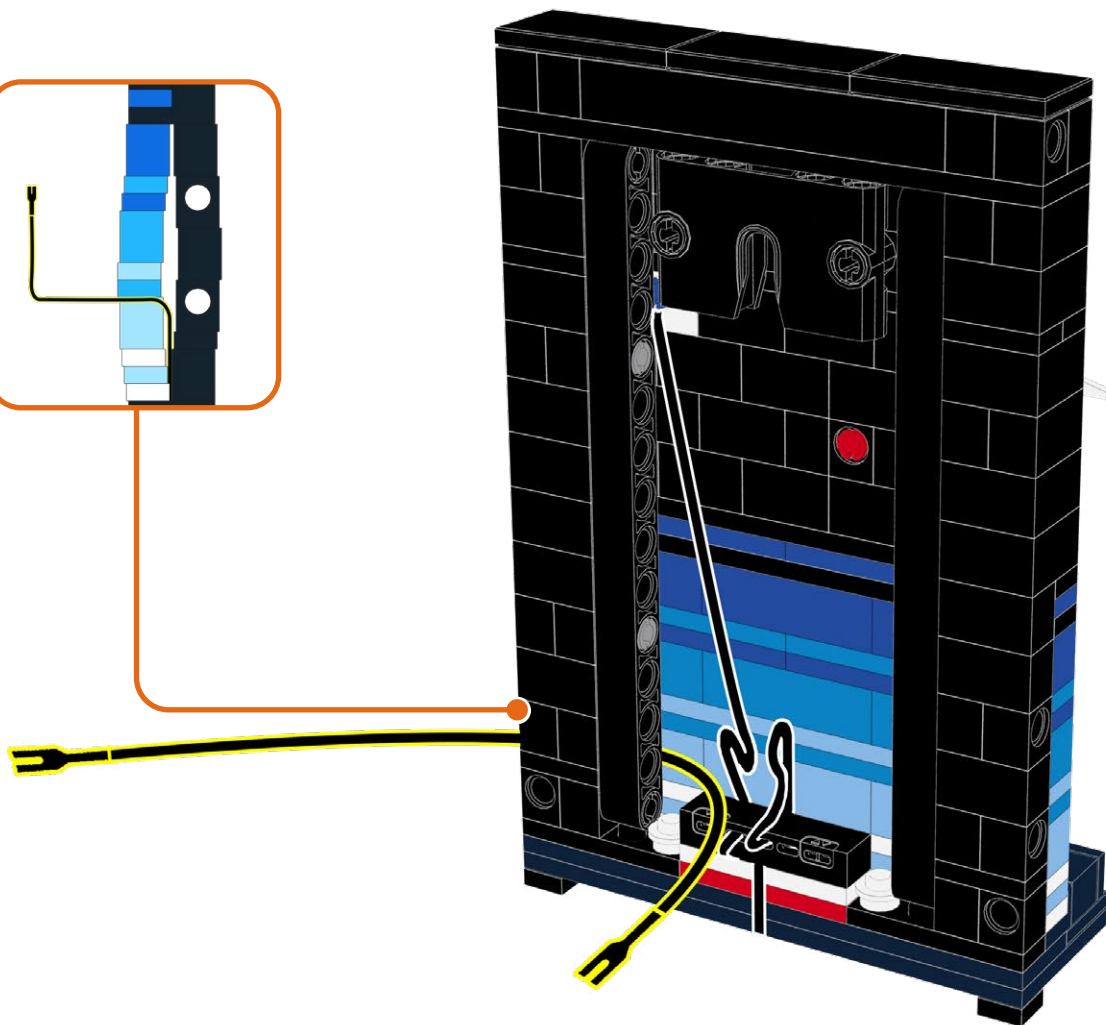
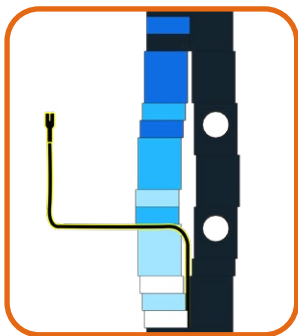

43

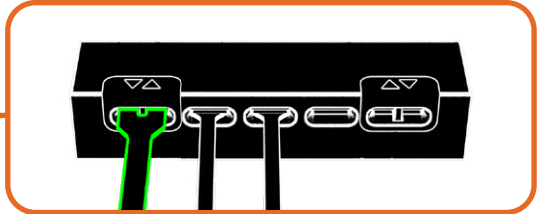
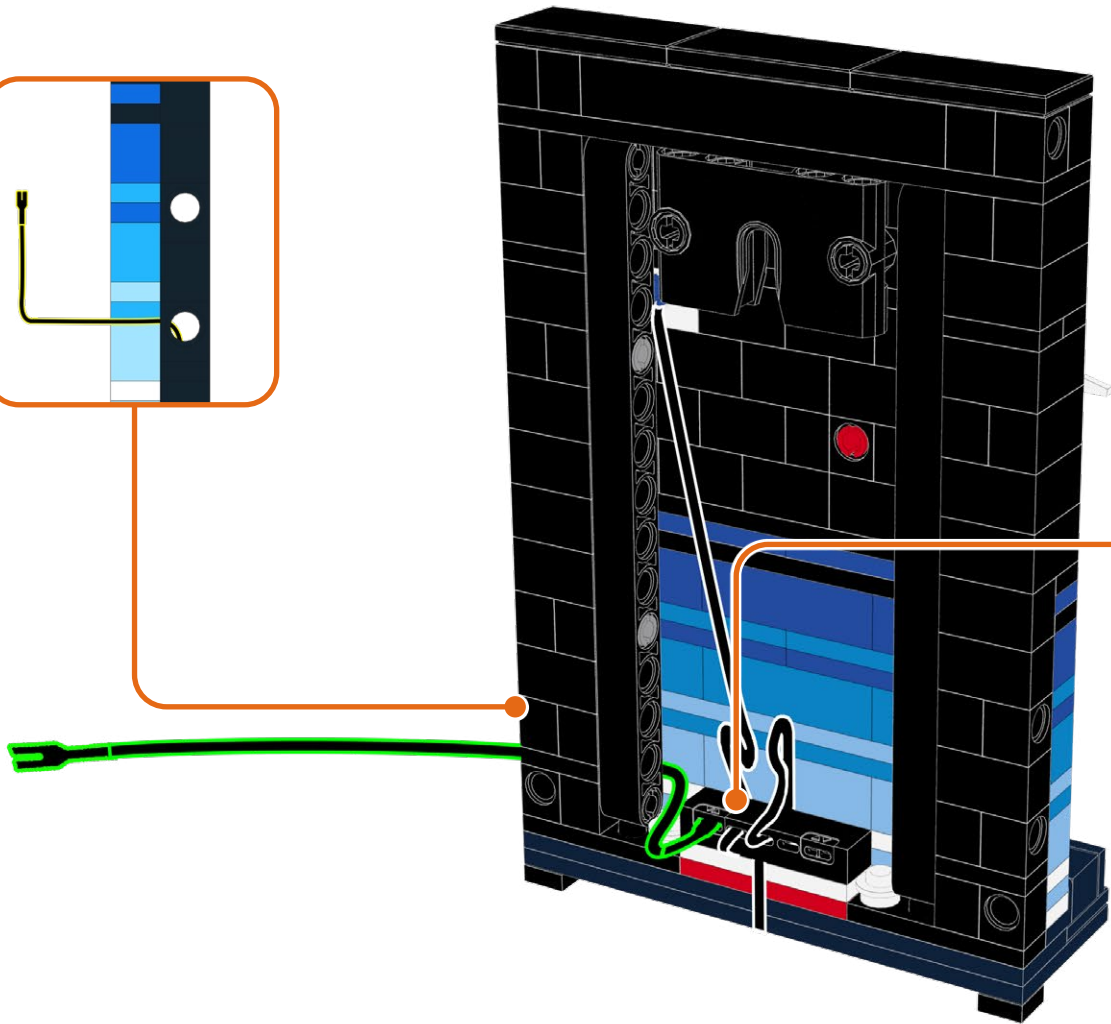
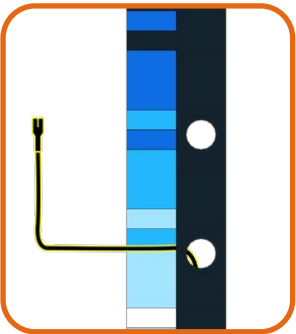

44

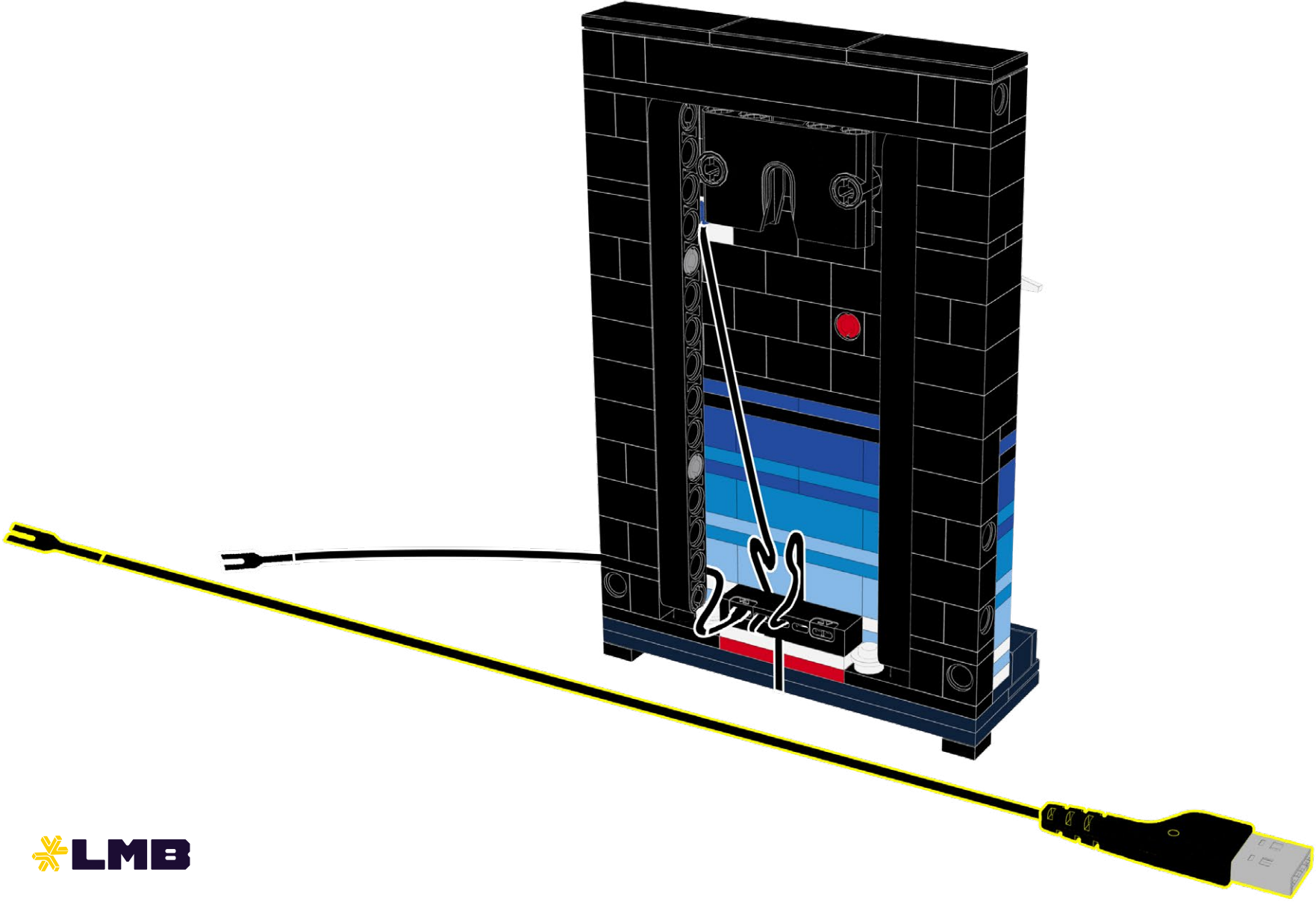

45

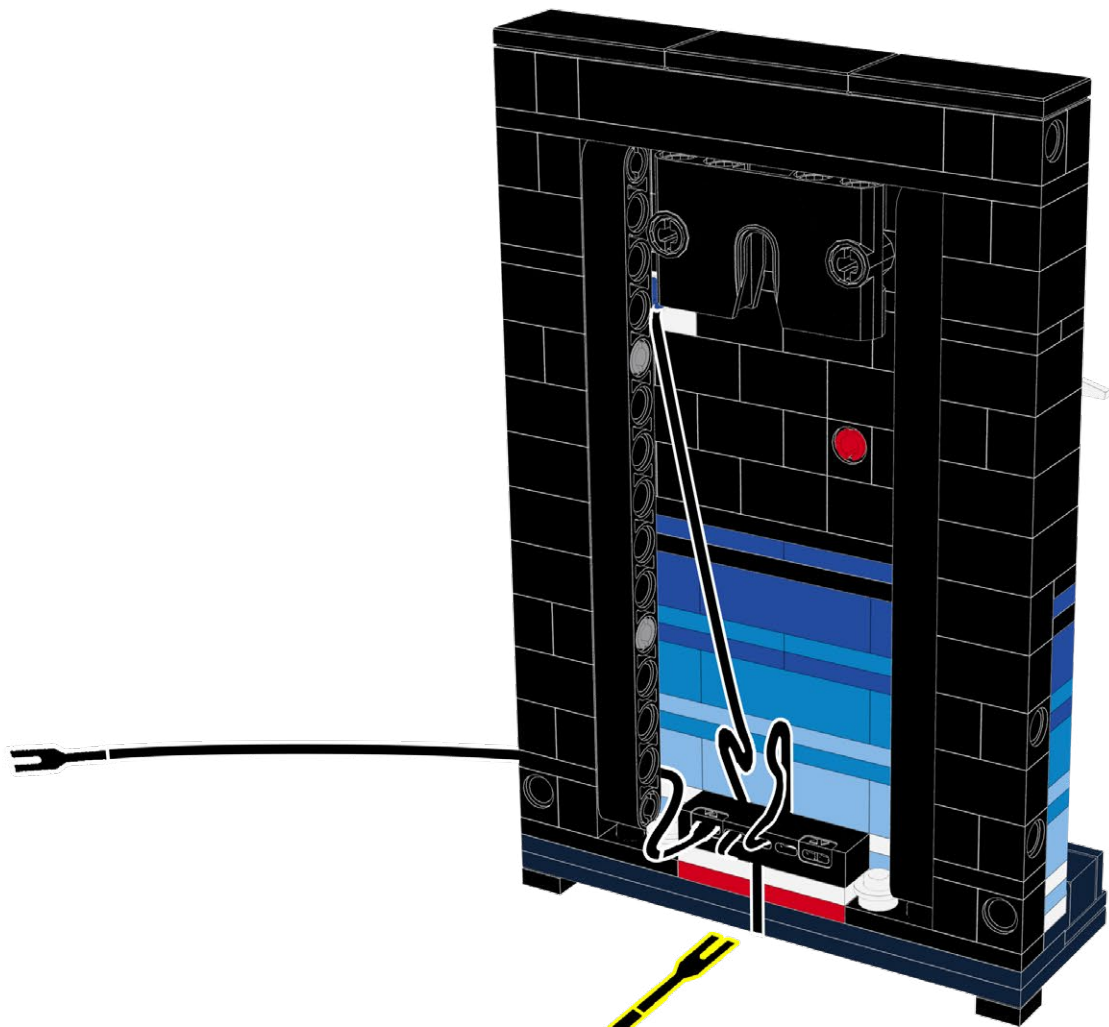

46

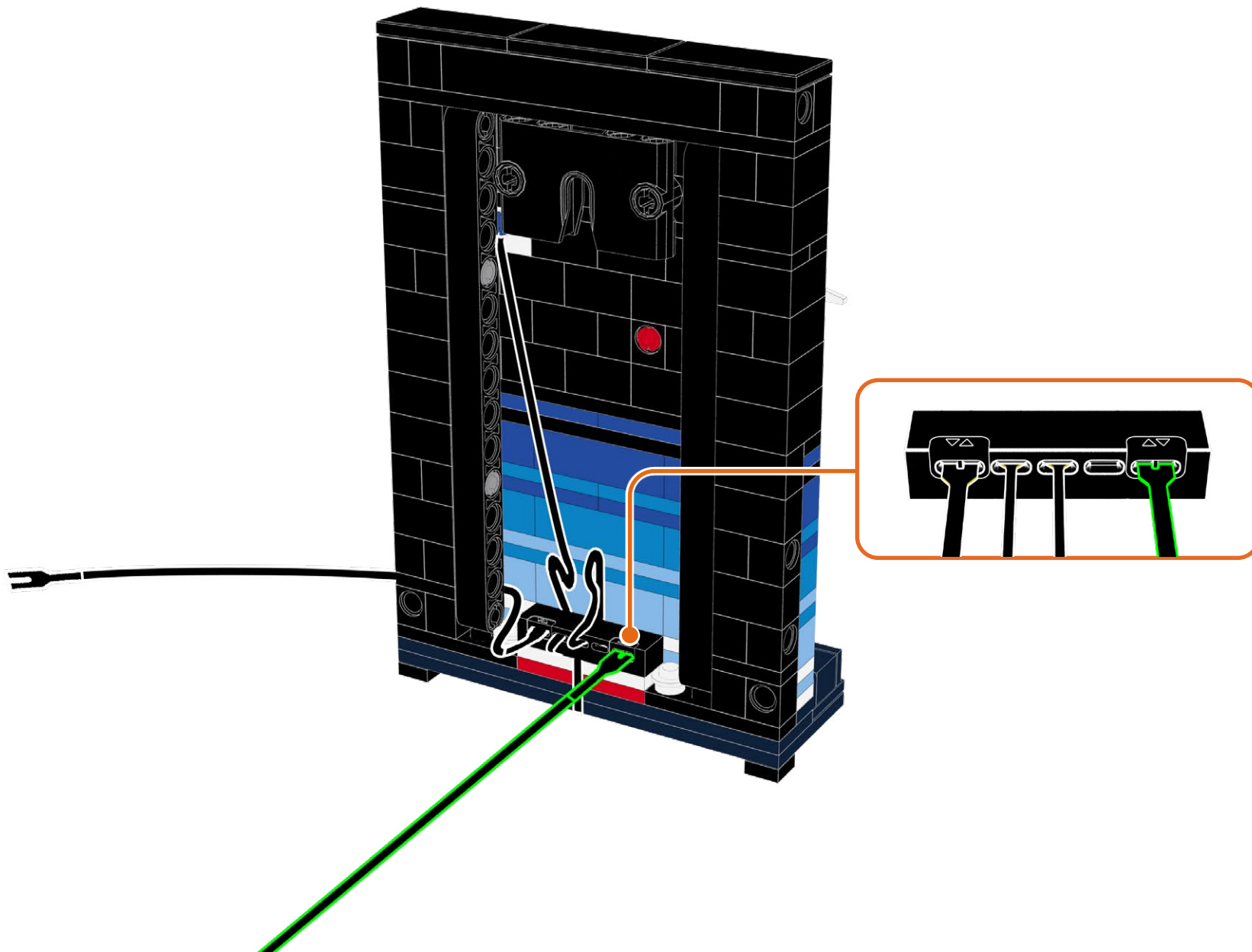

47

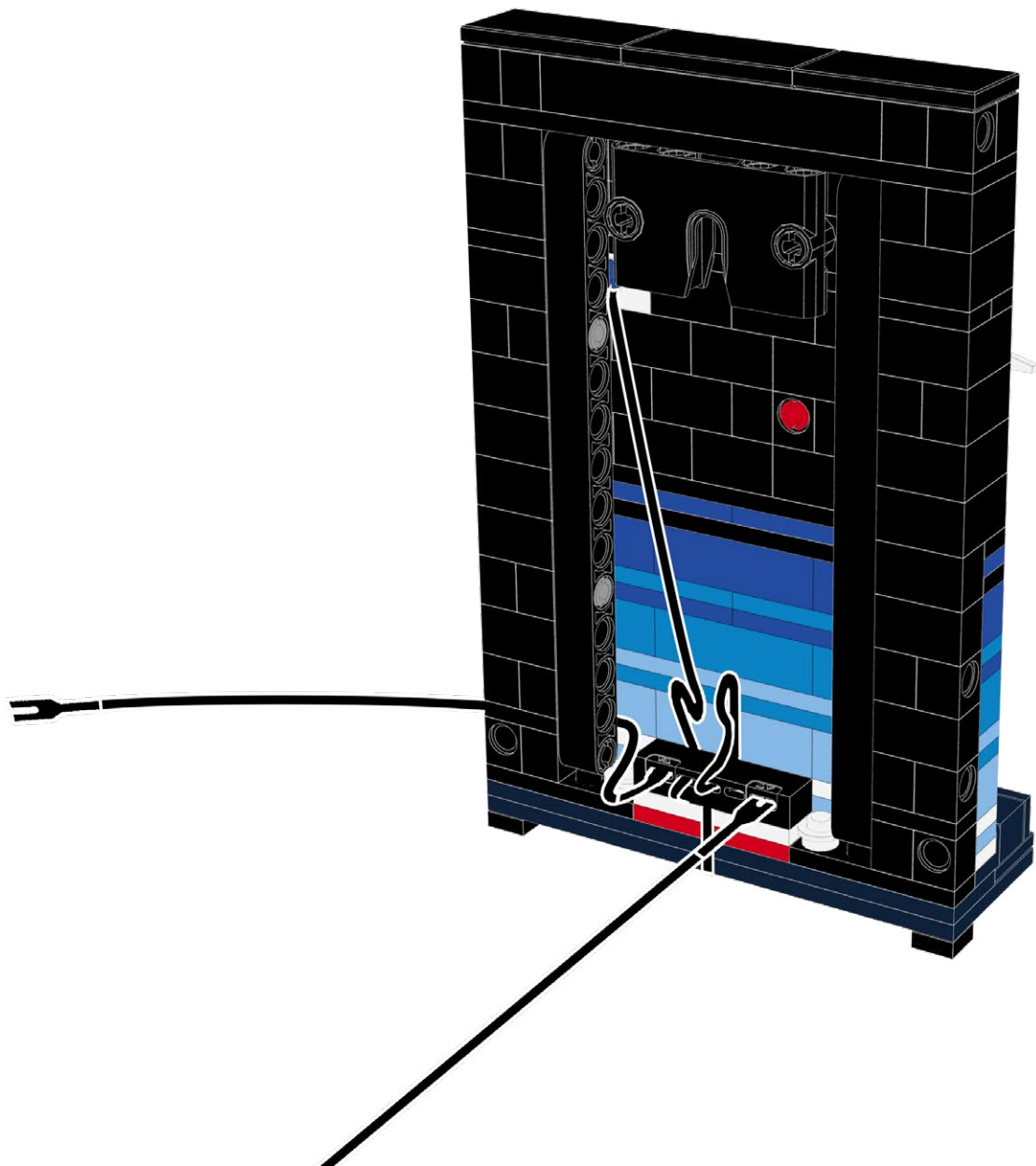

48

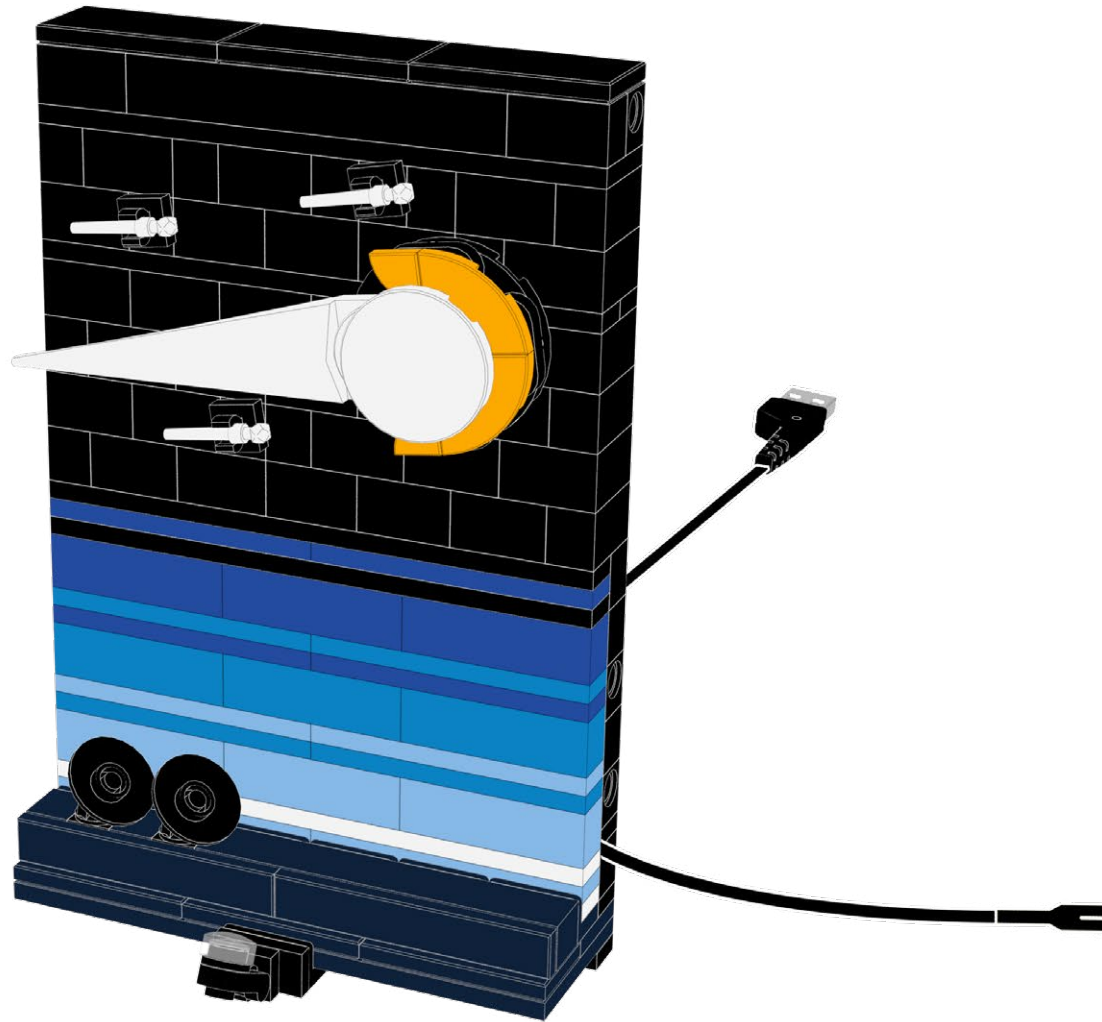

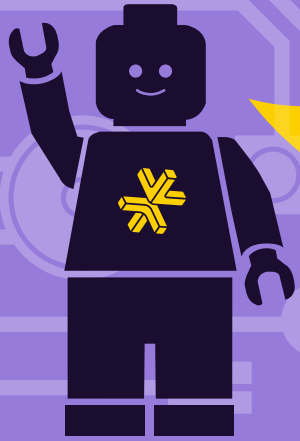

HOLD UP!

You might notice some bags aren't in order, as well as left over pieces, but that's ok! We're changing the way you build LEGO!

ATTENDEZ!

Vous remarquerez peut-être que certains sacs, ainsi que certaines pièces, ne sont pas dans le bon ordre. Mais pas de panique! Nous changeons simplement la façon avec laquelle vous construisez vos LEGO!

ASPETTA!

Potresti notare che alcuni sacchetti non sono in ordine, così come i pezzi avanzati, ma va bene così! Stiamo cambiando il modo in cui costruisci i LEGO!

HALT!

Sie werden möglicherweise bemerken, dass einige tüten durcheinander sind und teile übrig bleiben, aber das ist in Ordnung! Wir ändern die art und weise, wie Sie LEGO bauen!

¡ESPERA!

Es posible que notes que algunas bolsas están fuera de servicio, así como piezas sobrantes, ¡pero está bien! ¡Estamos cambiando la forma en que construyes LEGO!

暫停!

你可能会注意到一些袋子顺序错乱, 以及一些剩余的部件, 但没关系! 我们正在改变你搭建乐高的方式!

Open LMB Bag 02

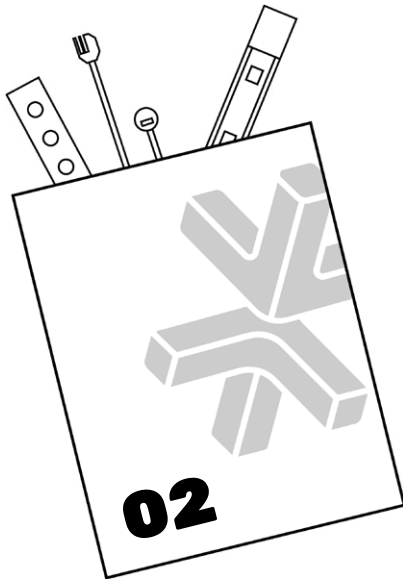

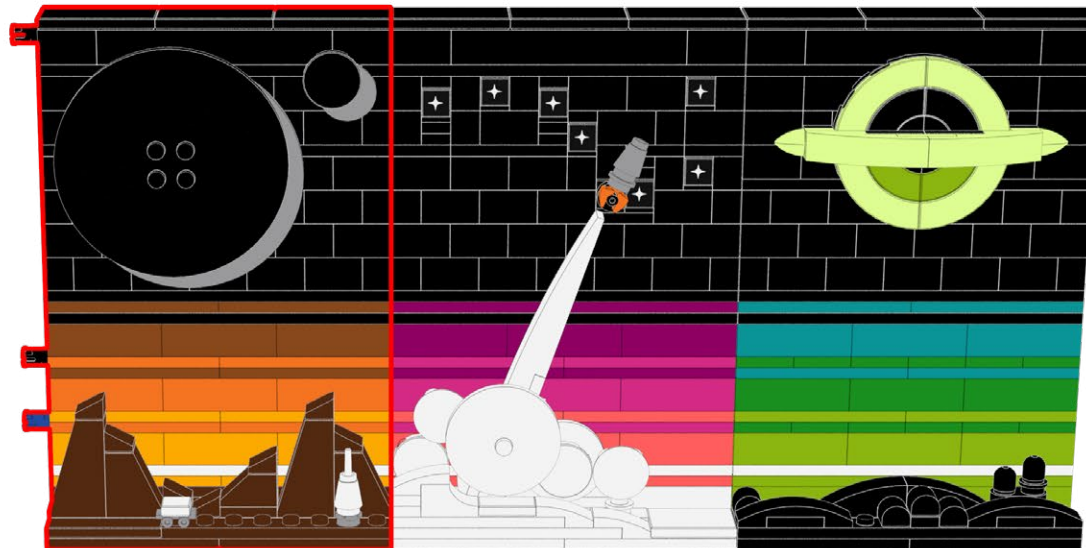

50

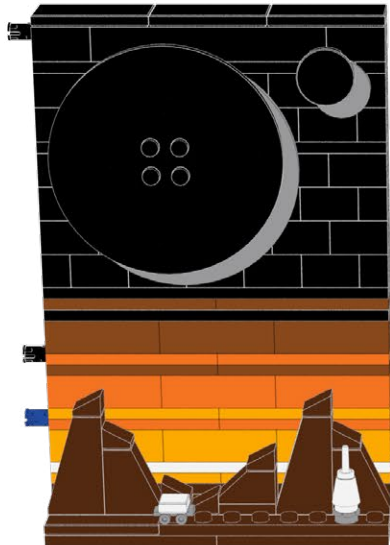

51

1

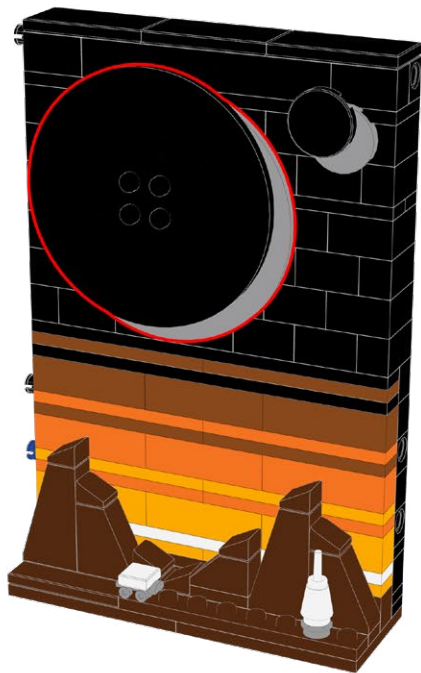

2

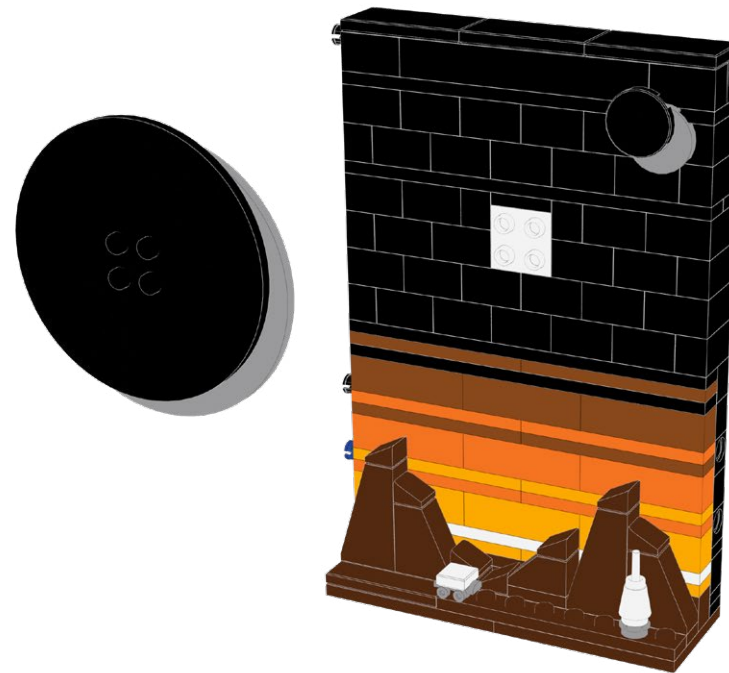



1



2

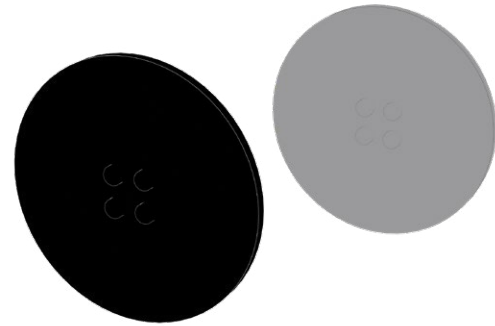

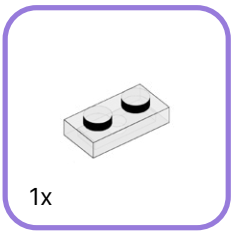
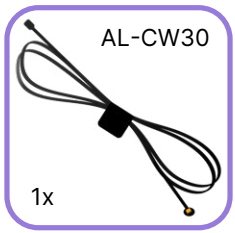

1

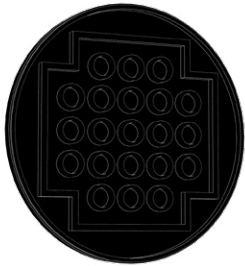

2

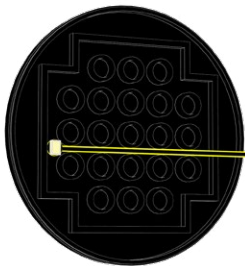

3

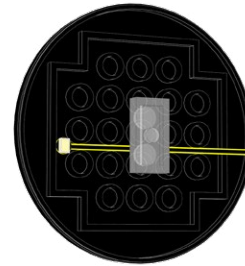

4

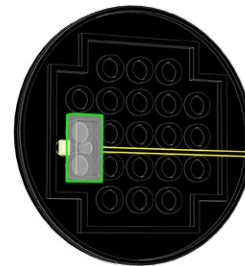

54

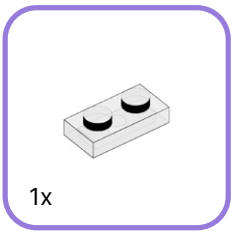
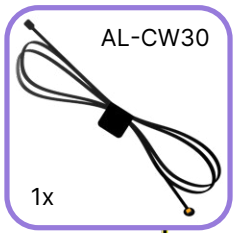

1

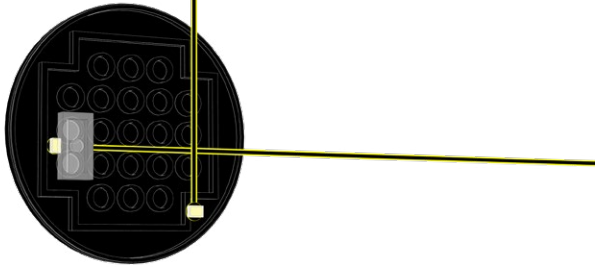

2

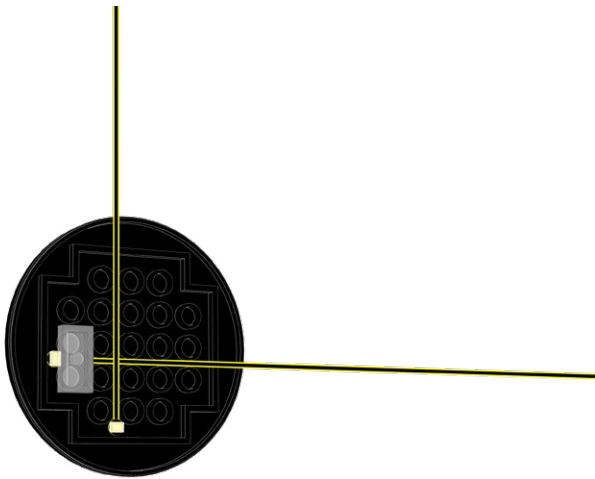

3

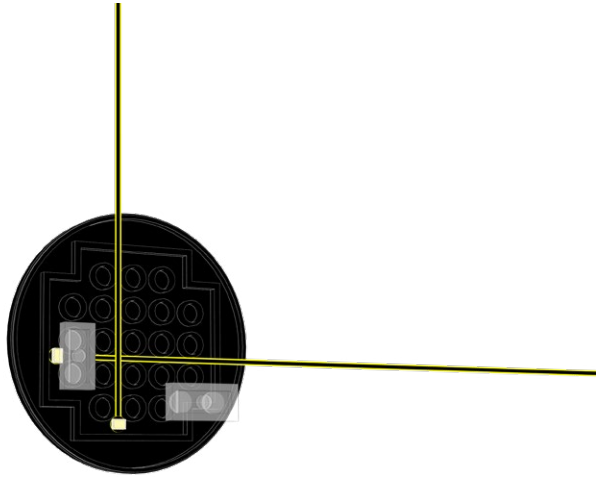

4

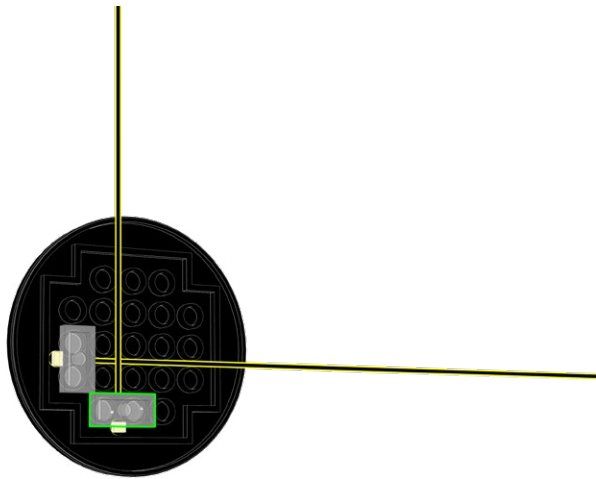

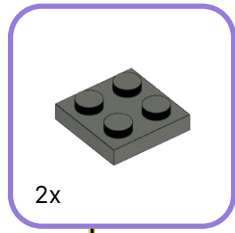
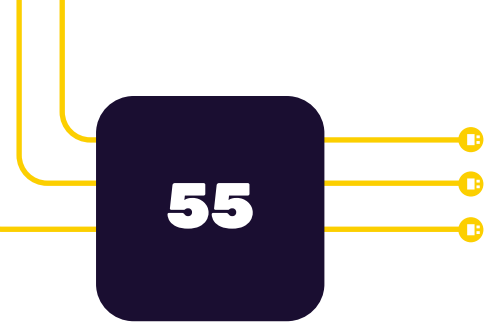

1

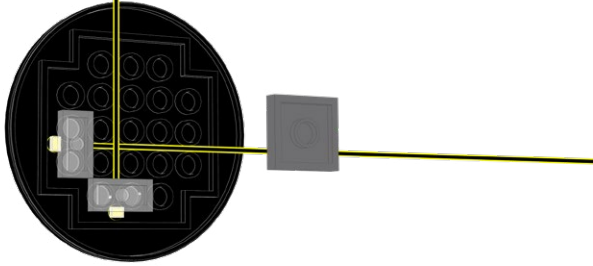

2

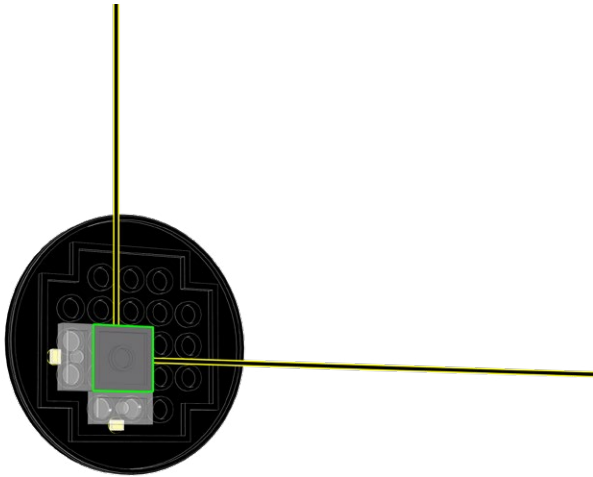

3

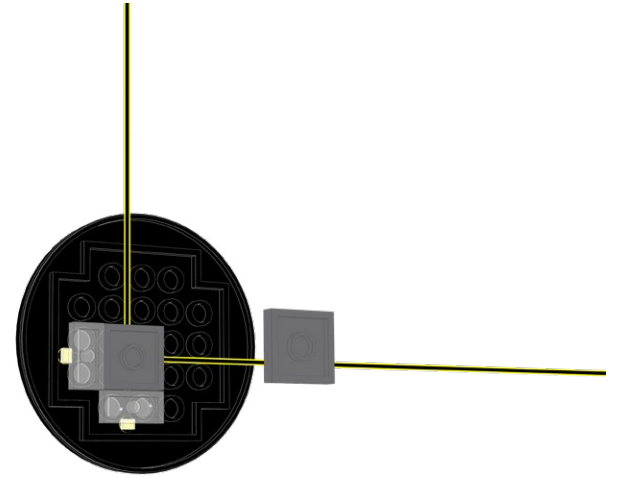

4

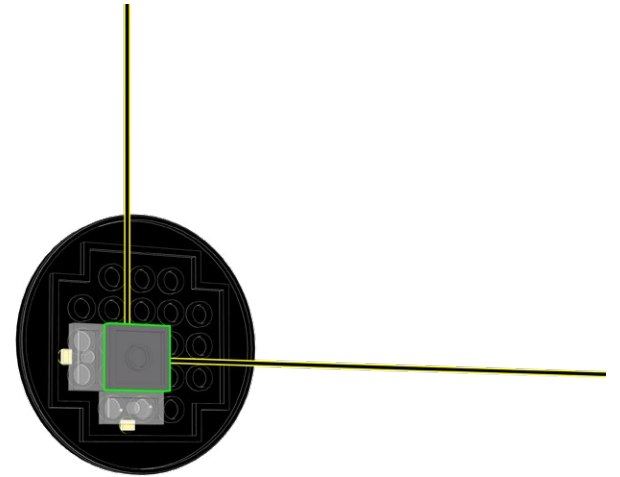



1

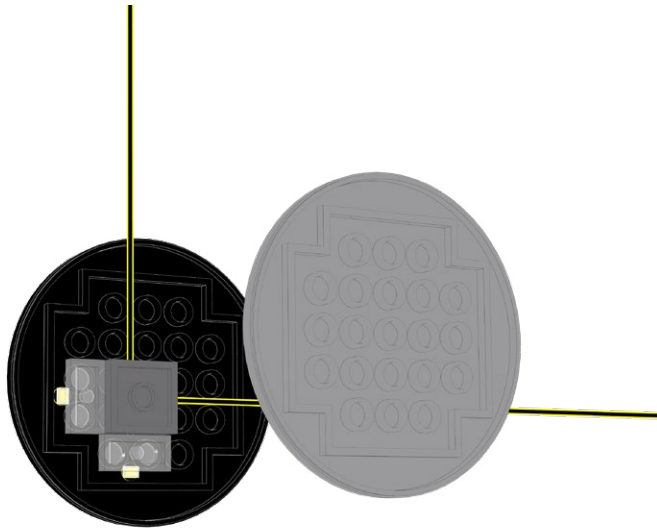

2

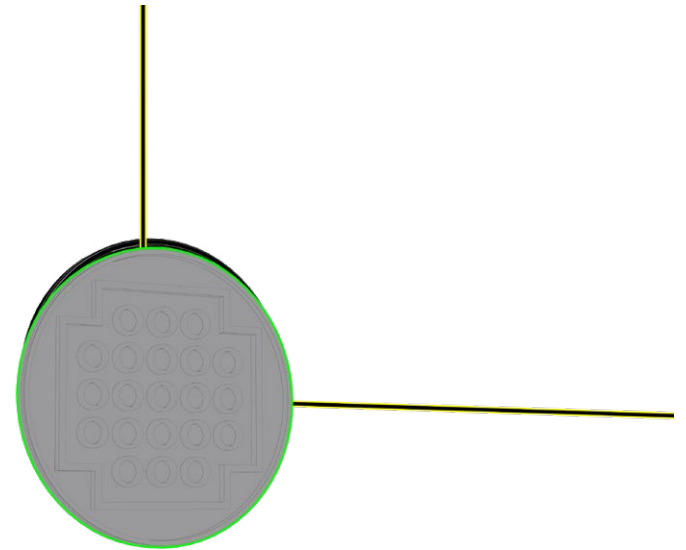

57

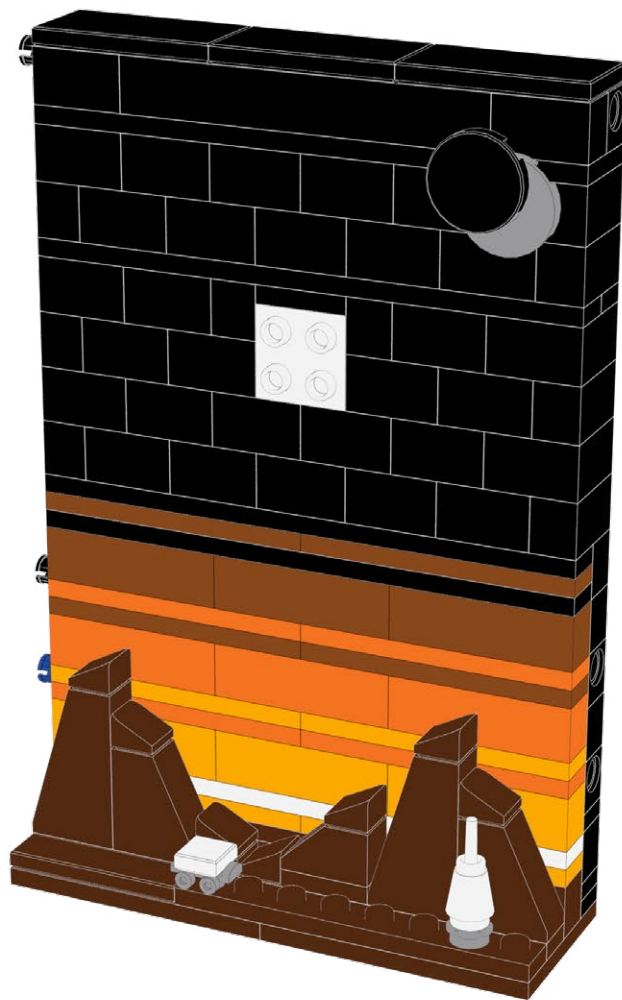

58

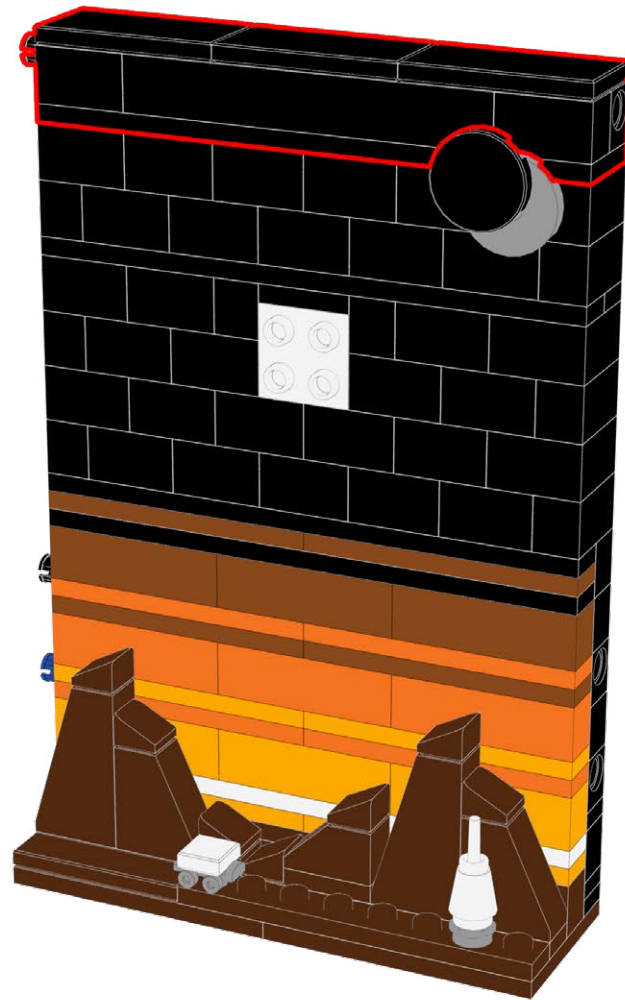

59

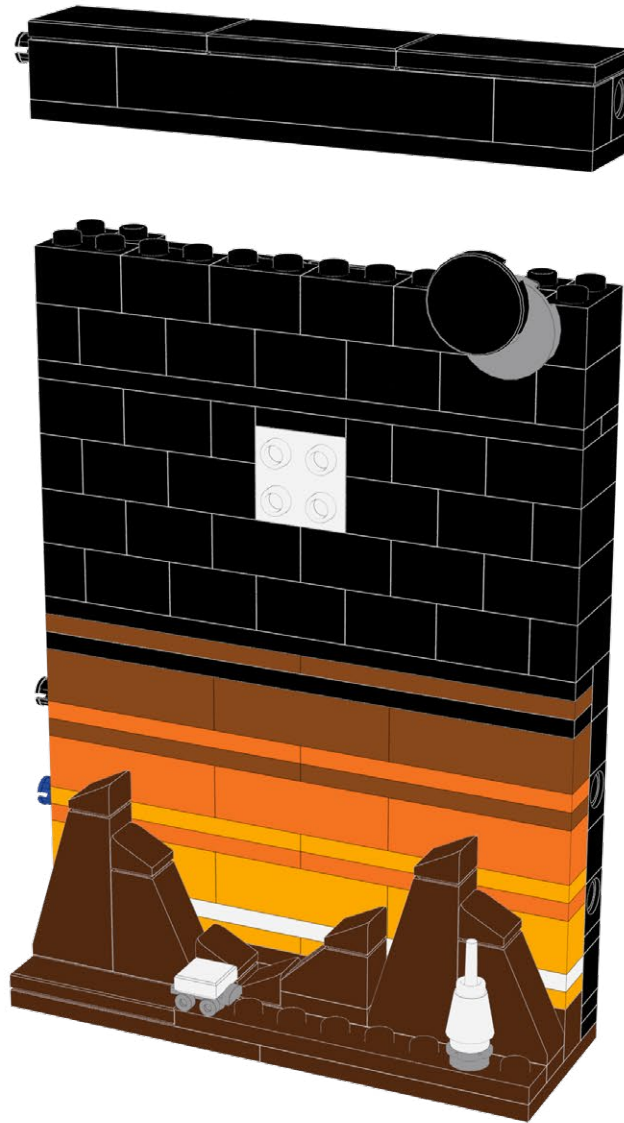

60

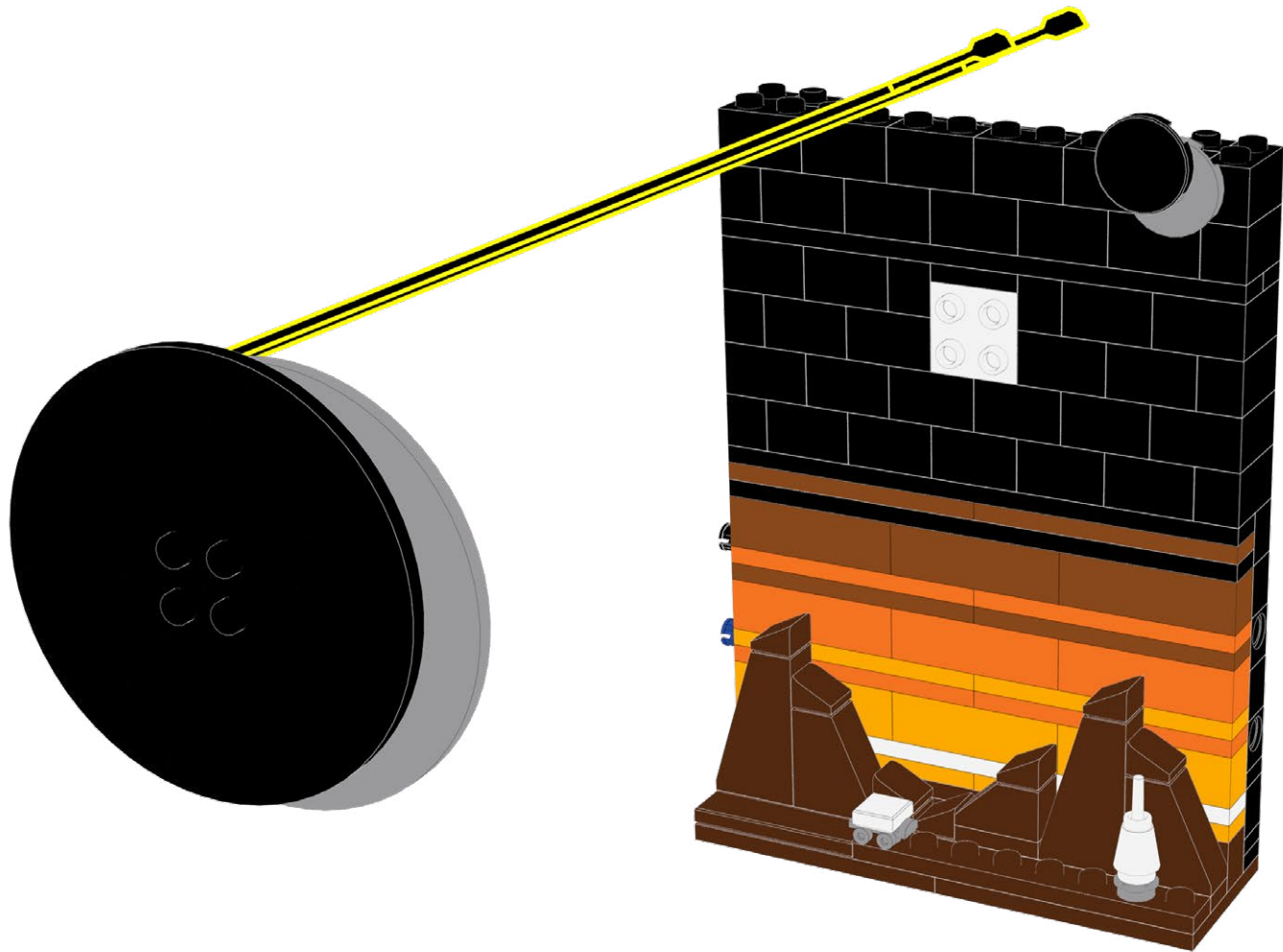

61

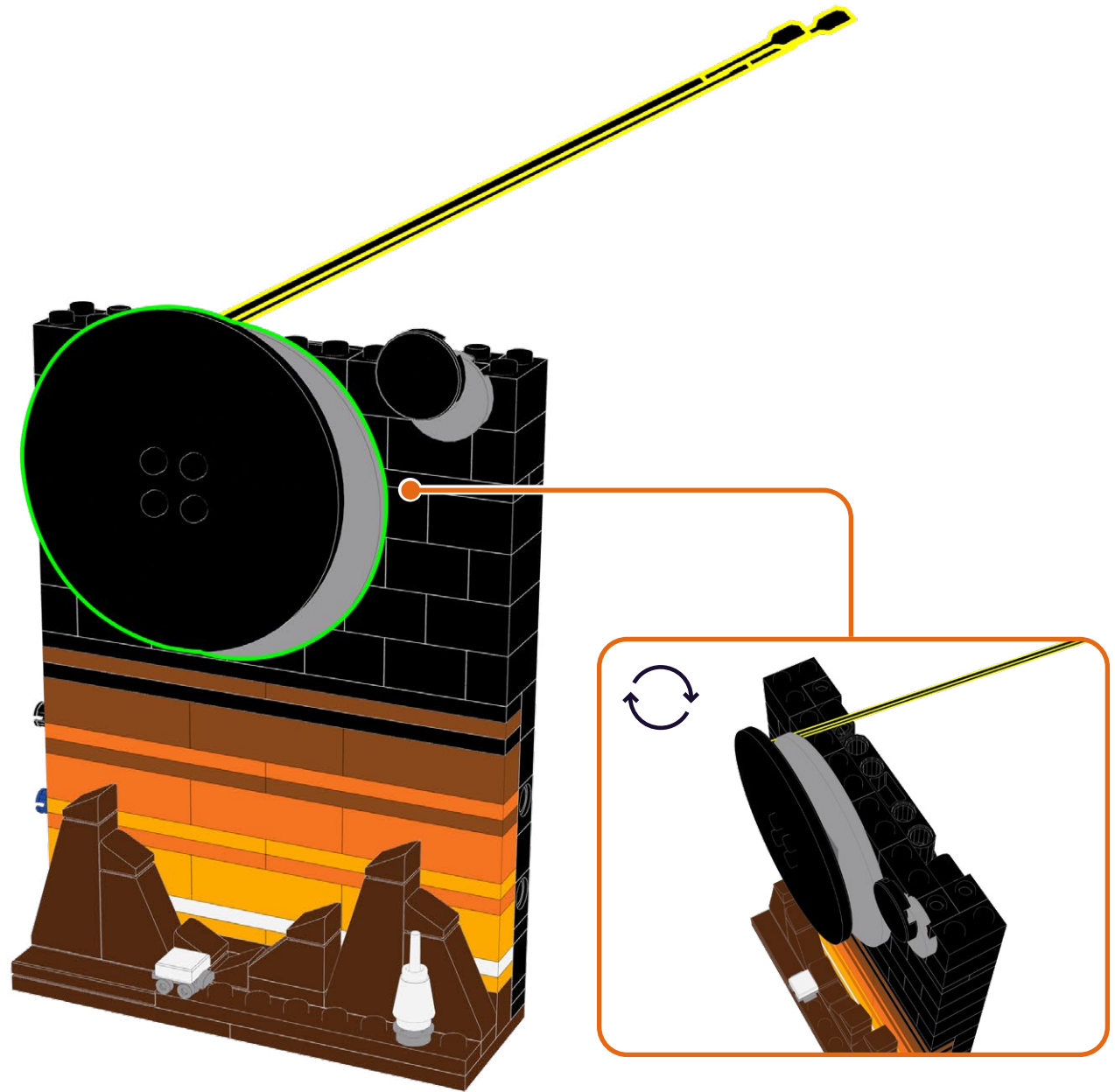

62

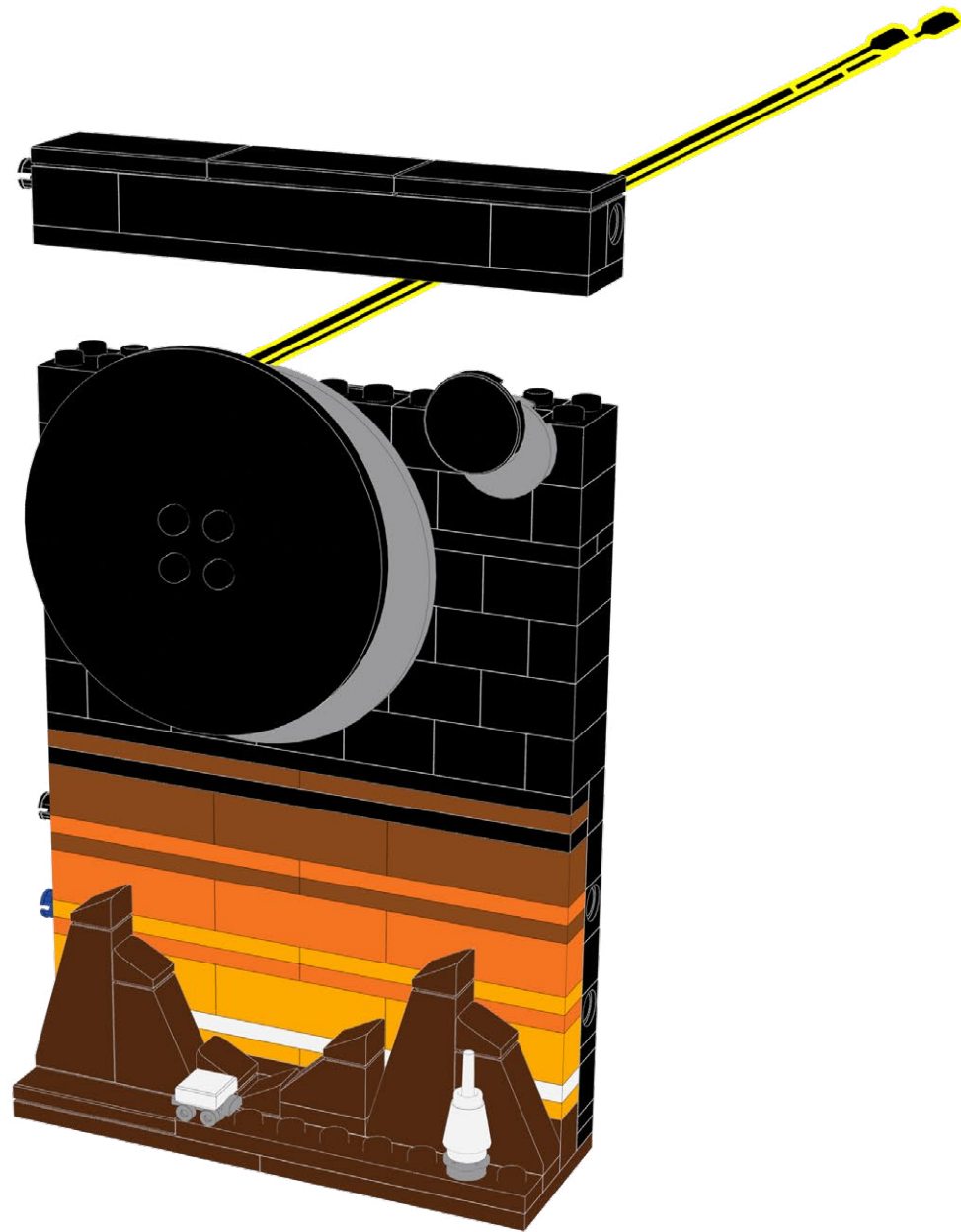

63

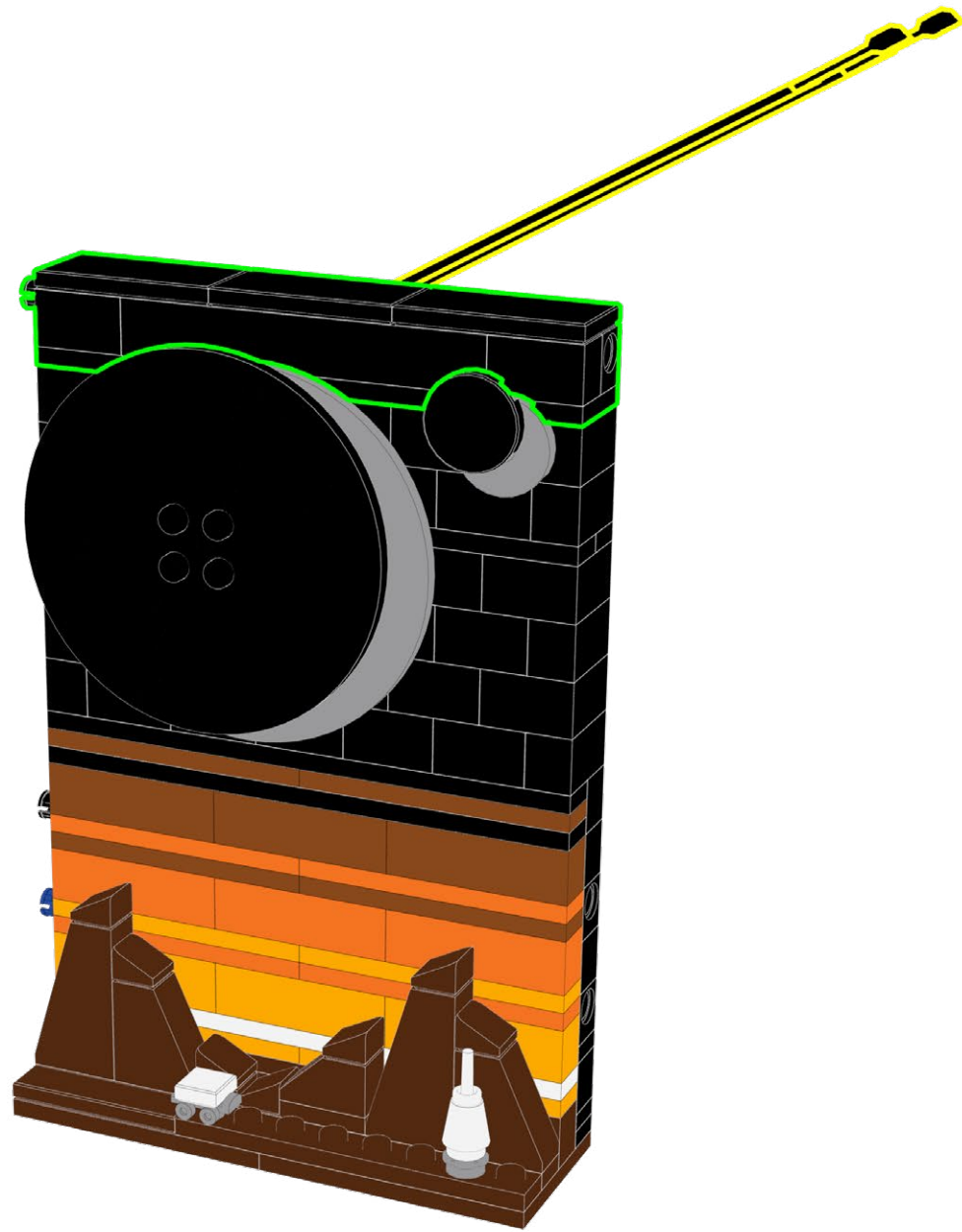

64

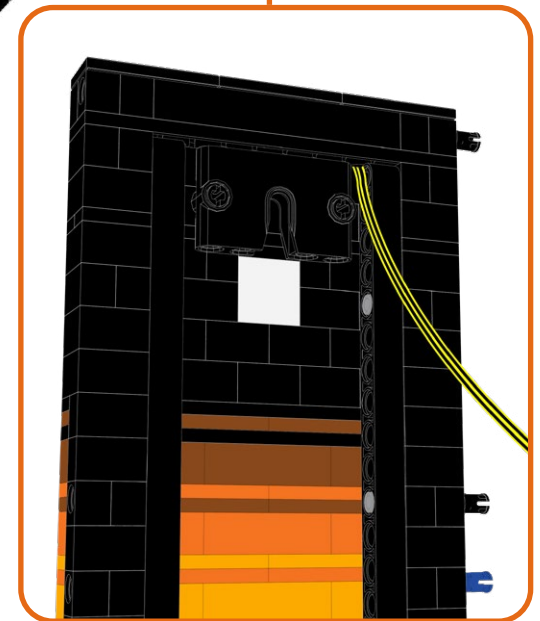
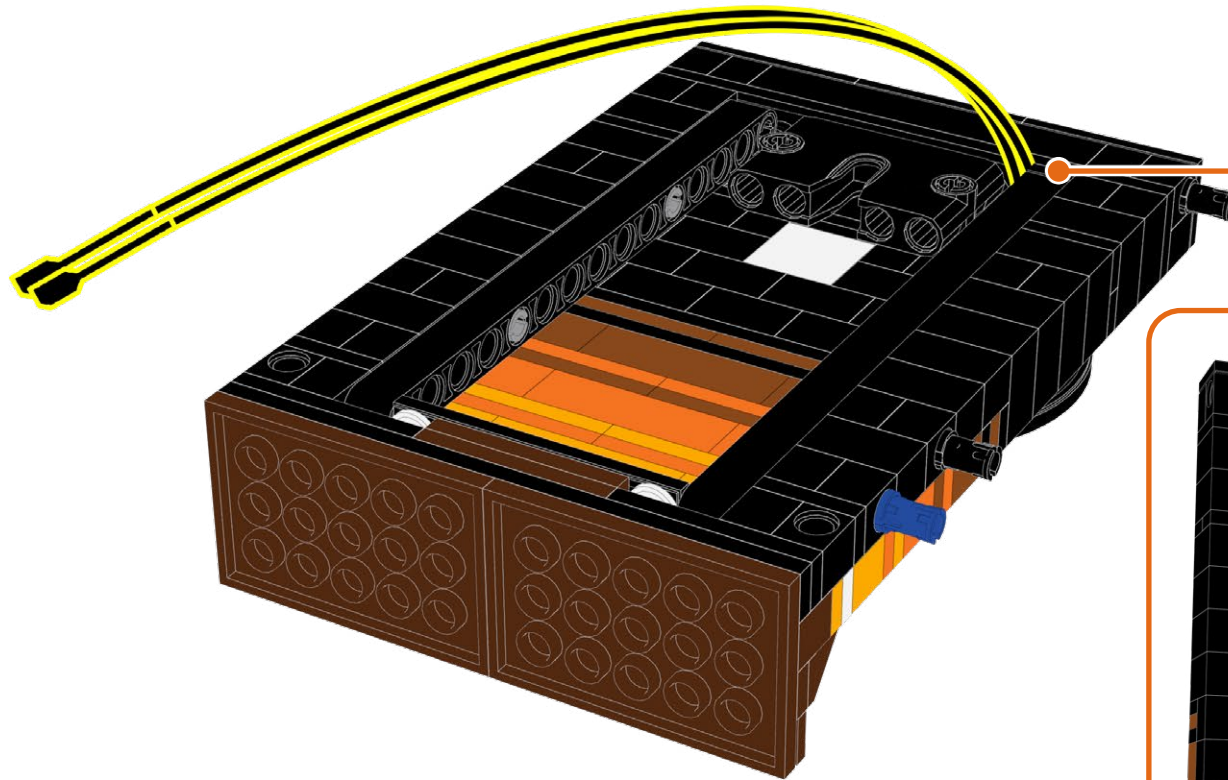

65

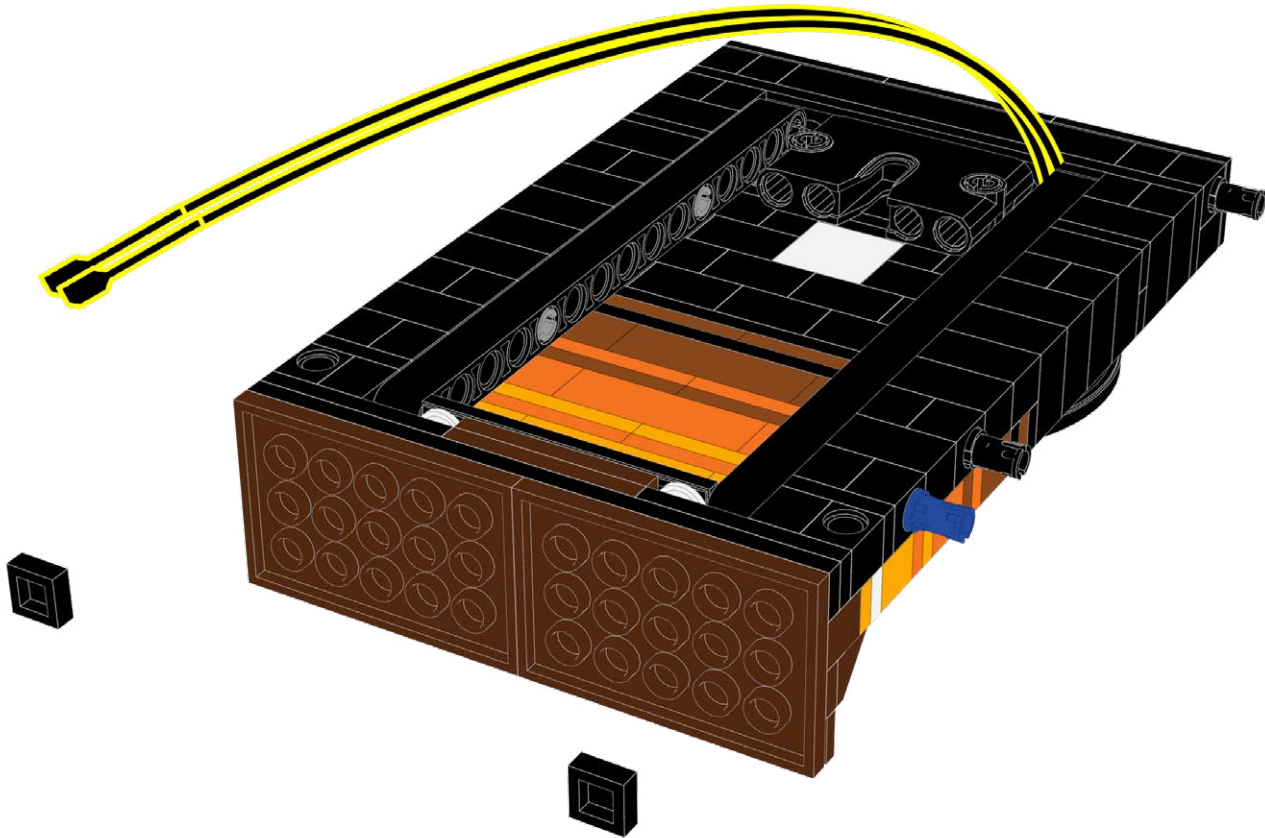
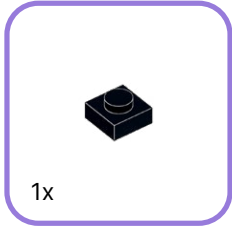

66

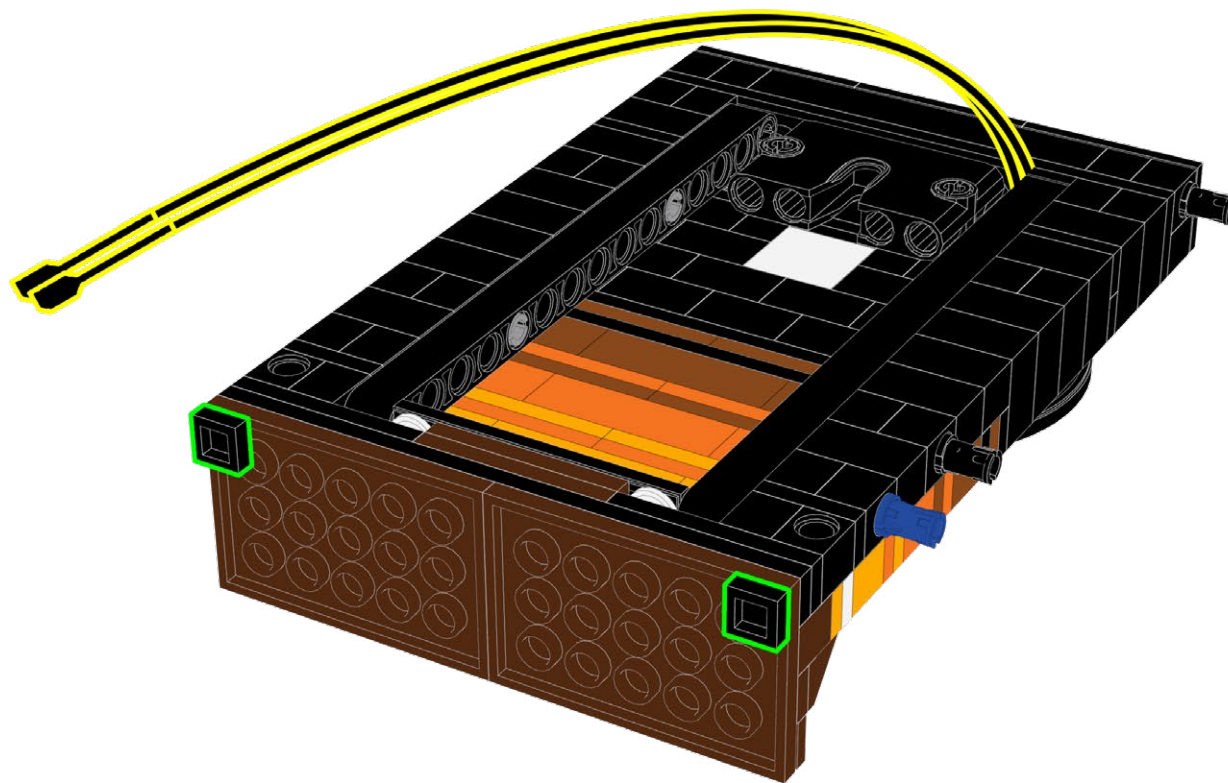

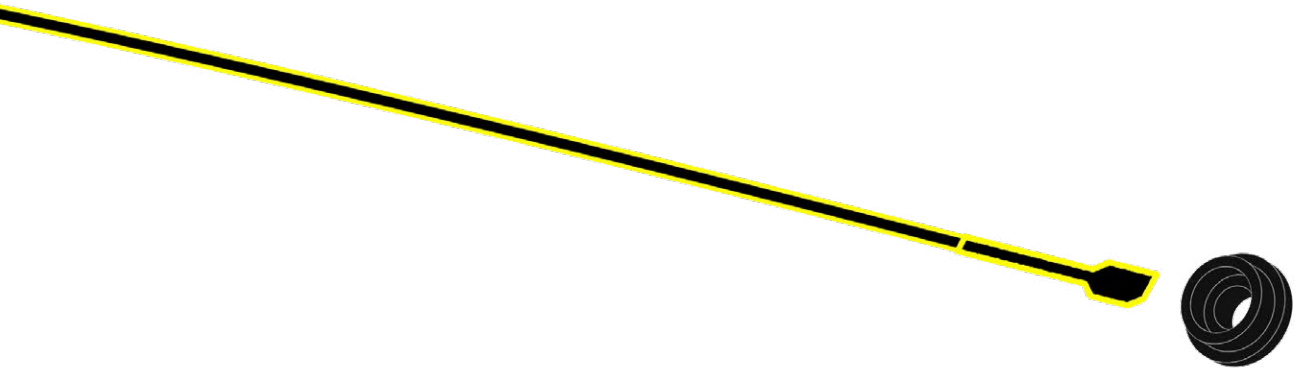
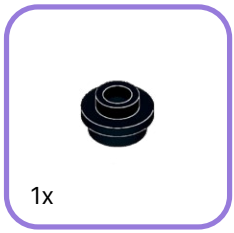
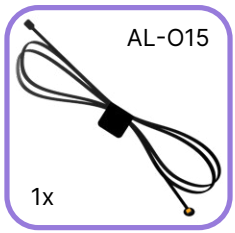

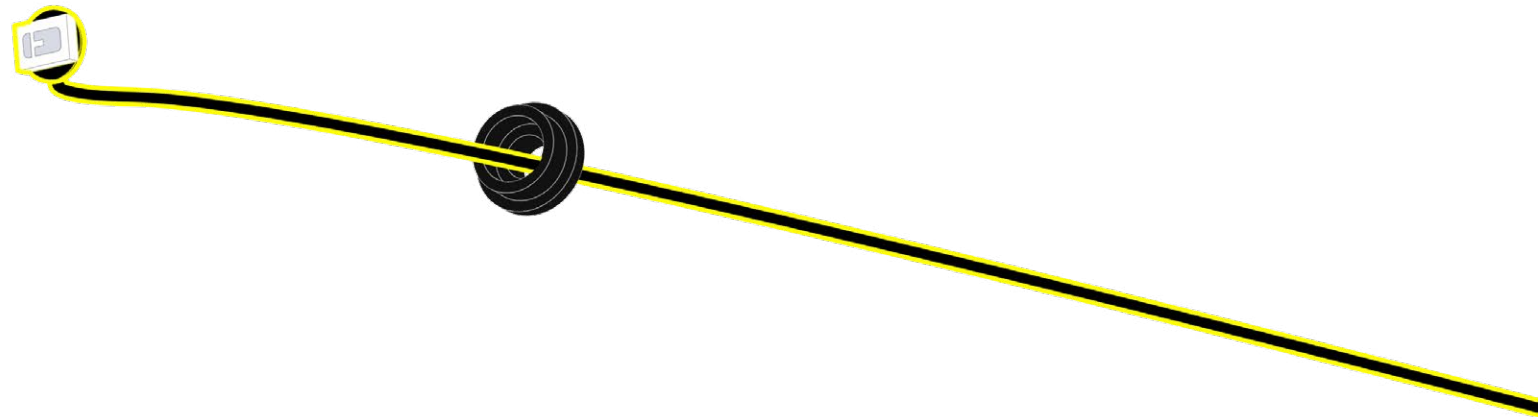

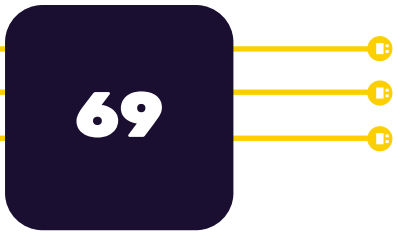

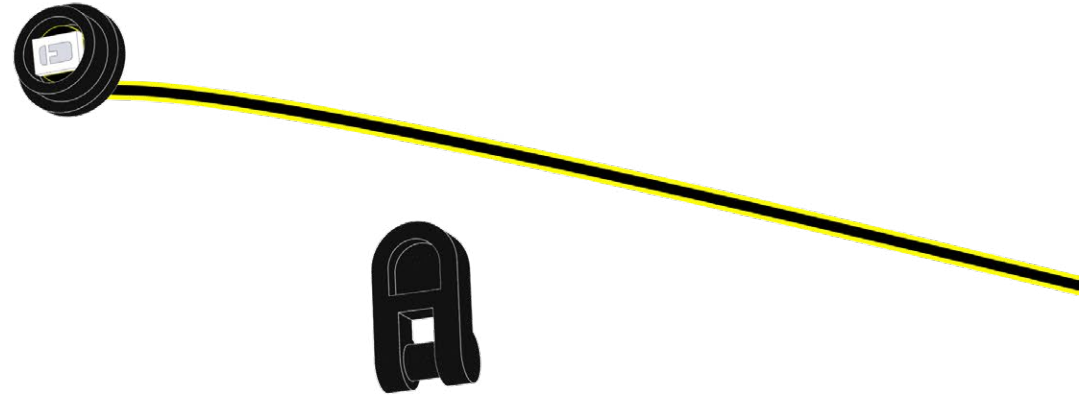
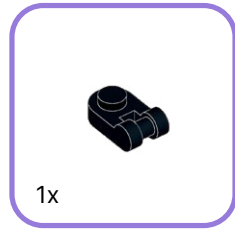
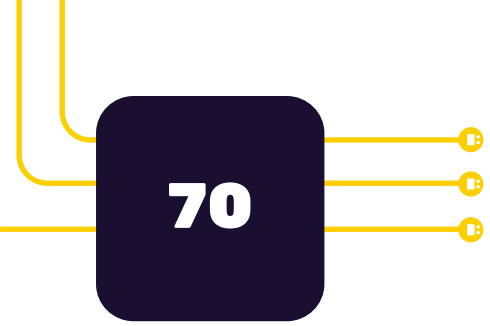

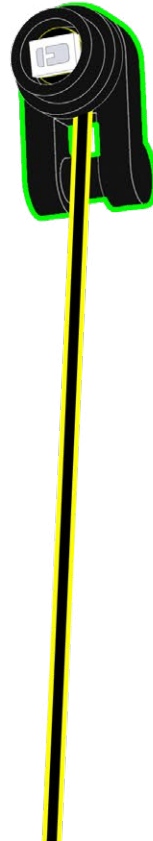

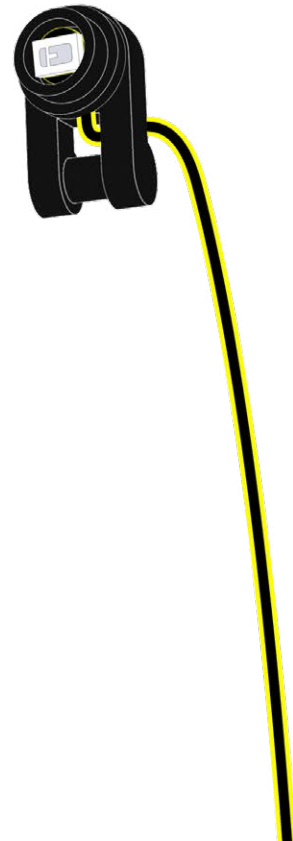



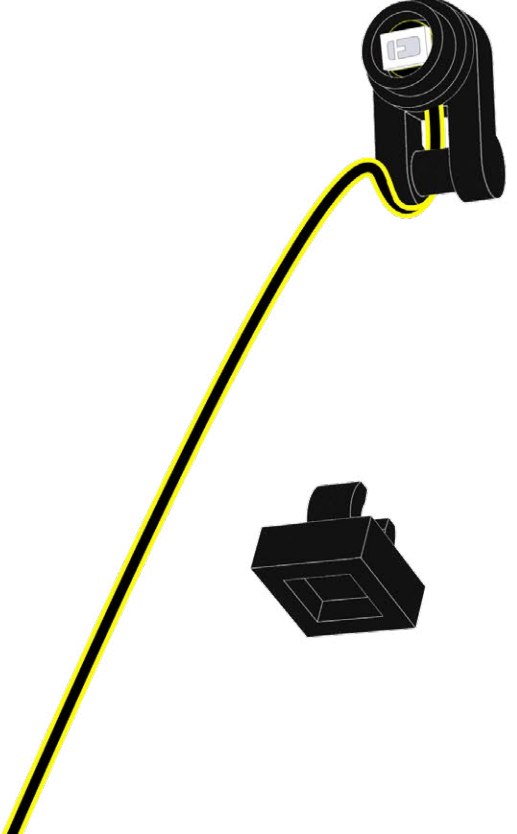

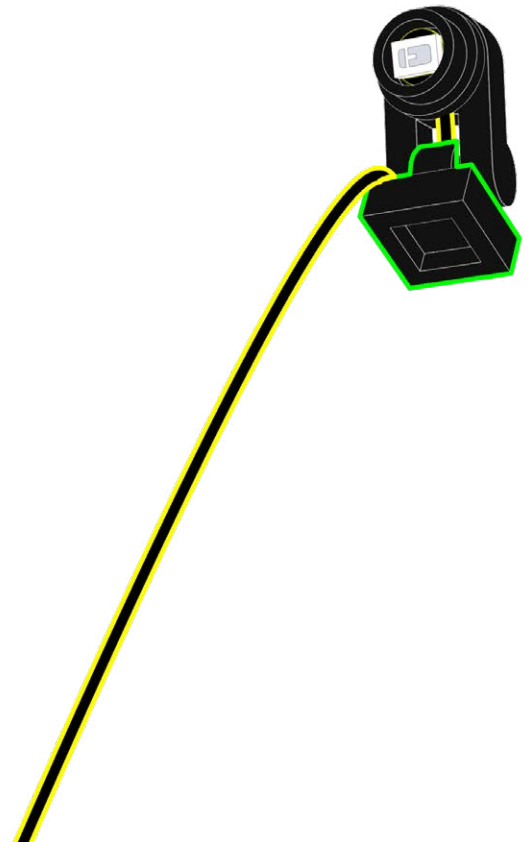
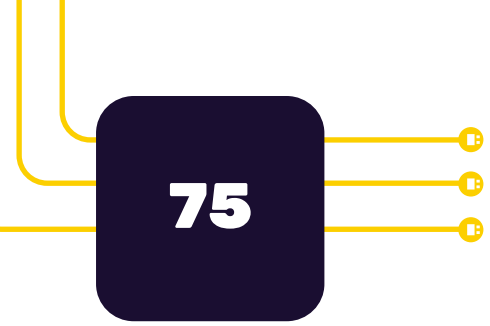

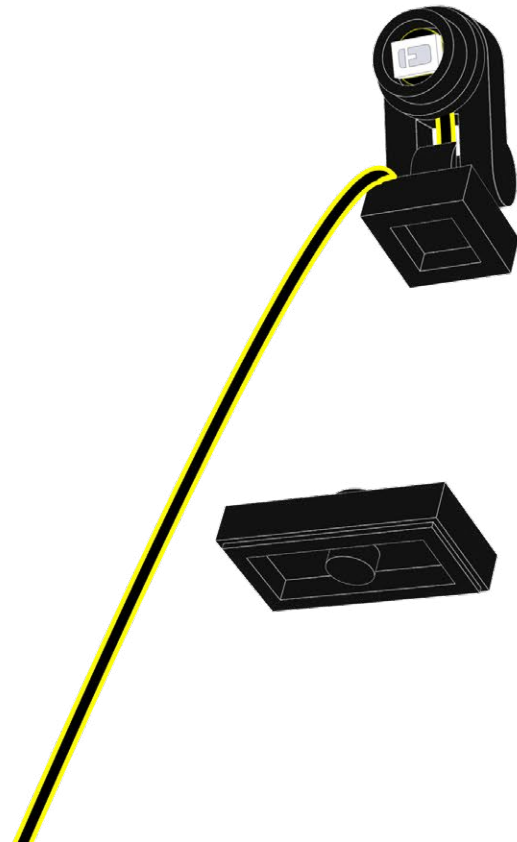
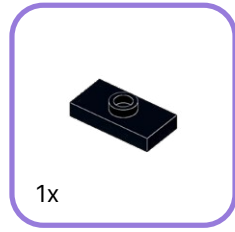
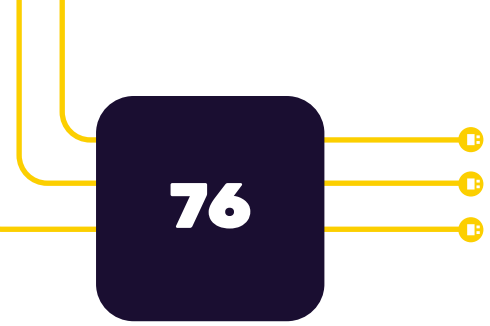

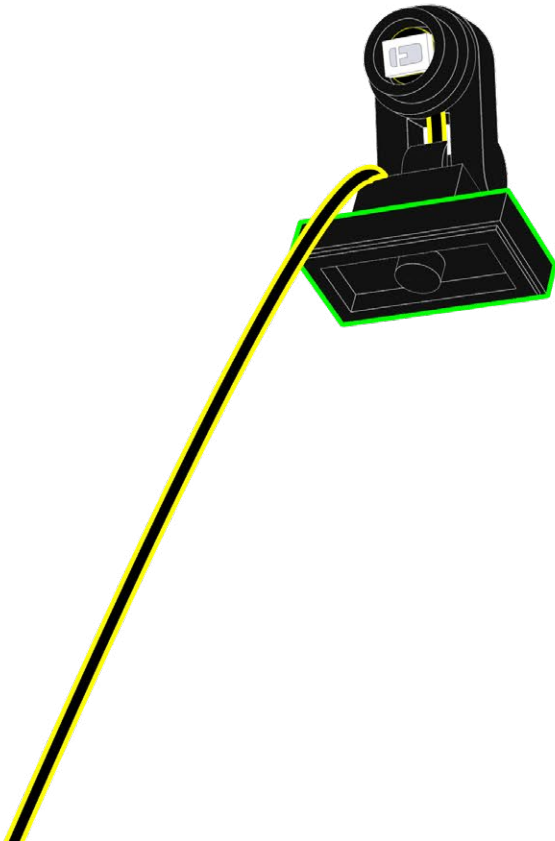

78

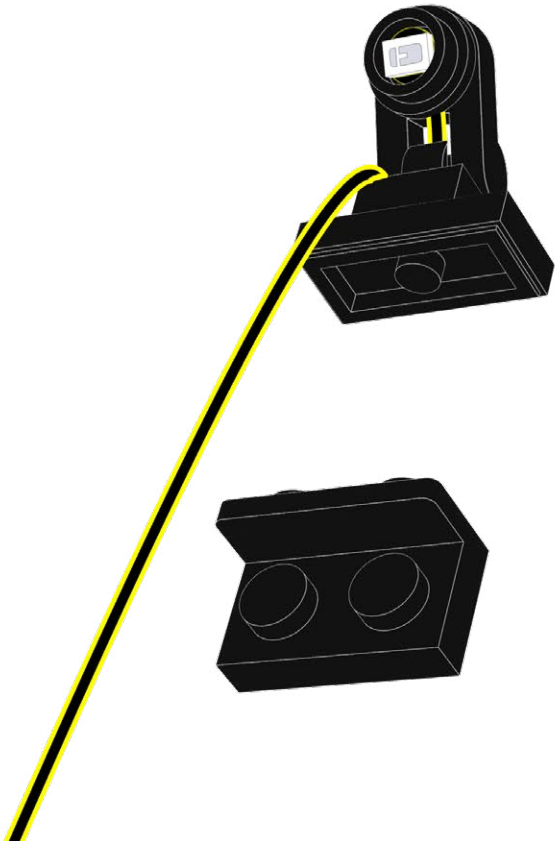
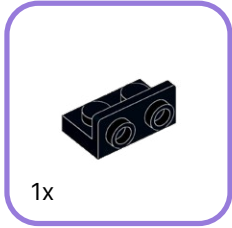

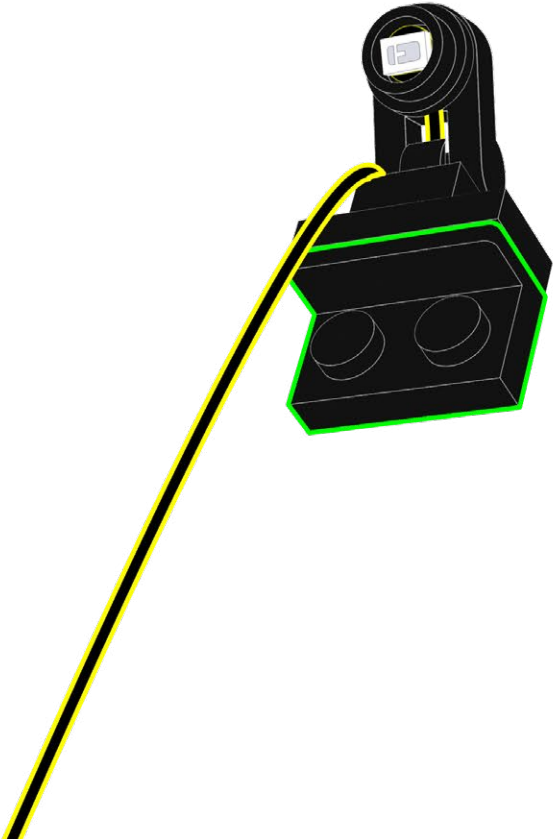
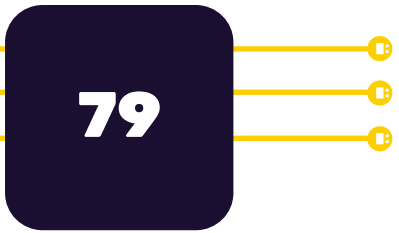



Astro Cap Clear

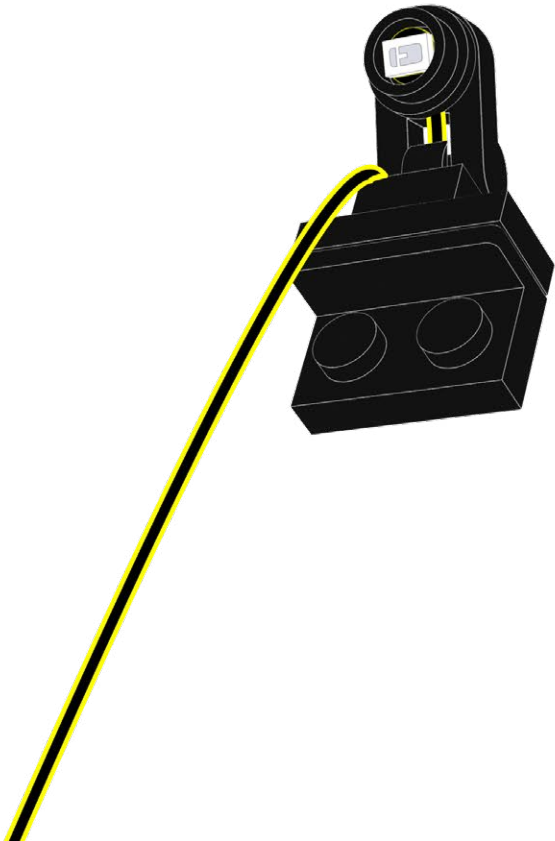
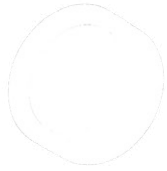

1x

A rounded rectangular box with a purple border. It contains the text "Astro Cap Clear" at the top, a simple line drawing of a clear circular cap in the center, and "1x" at the bottom.

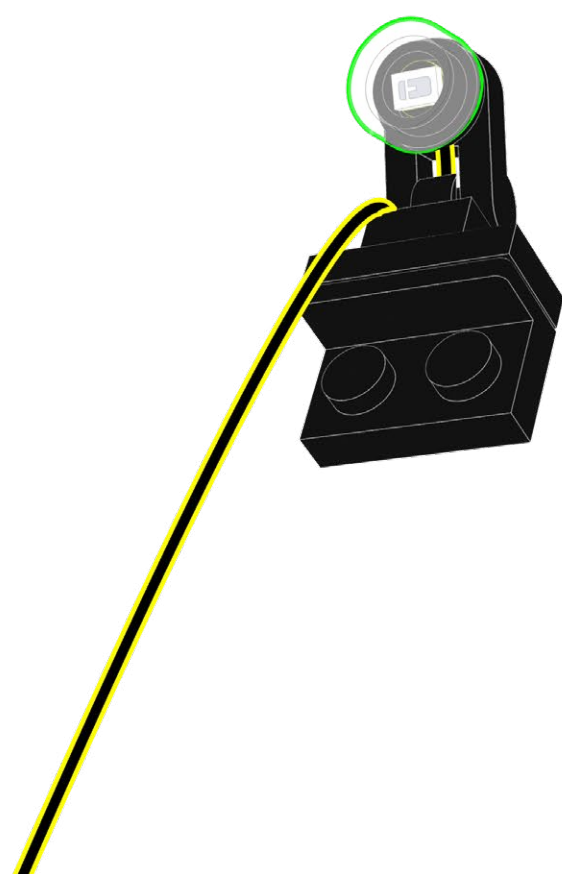
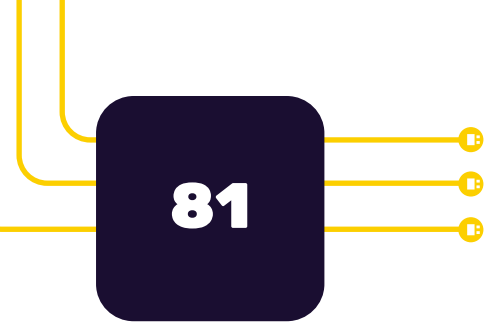

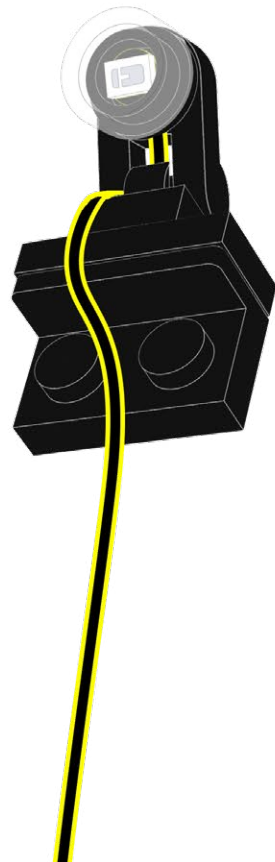
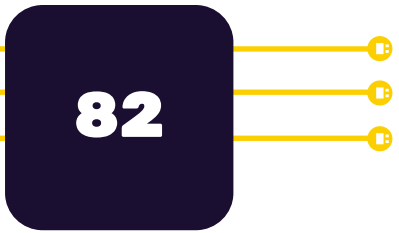

83

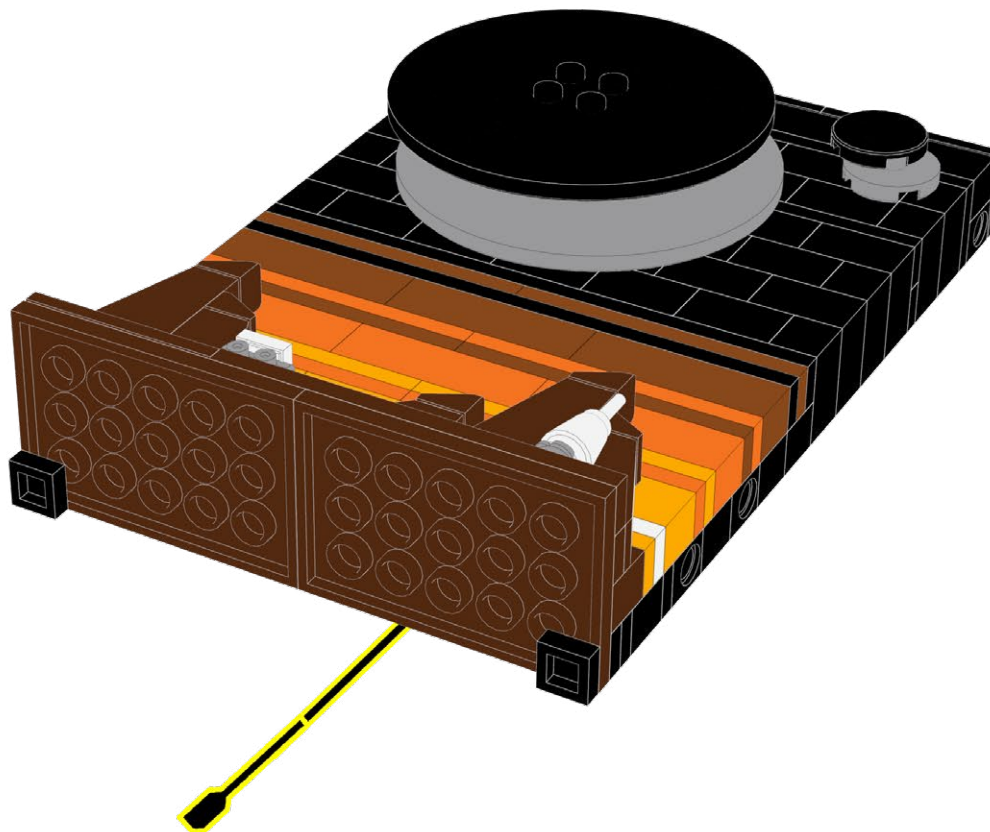

84

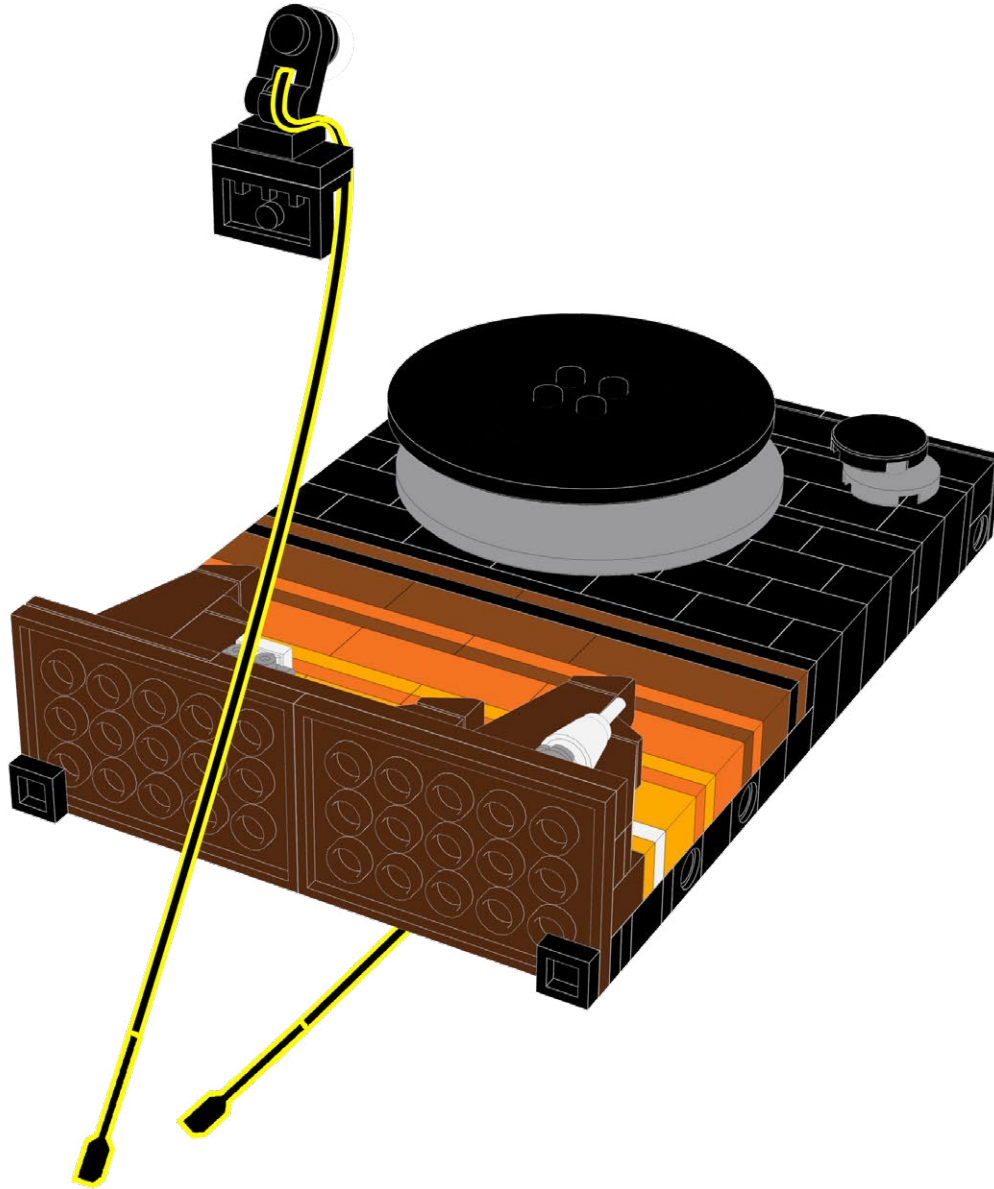

85

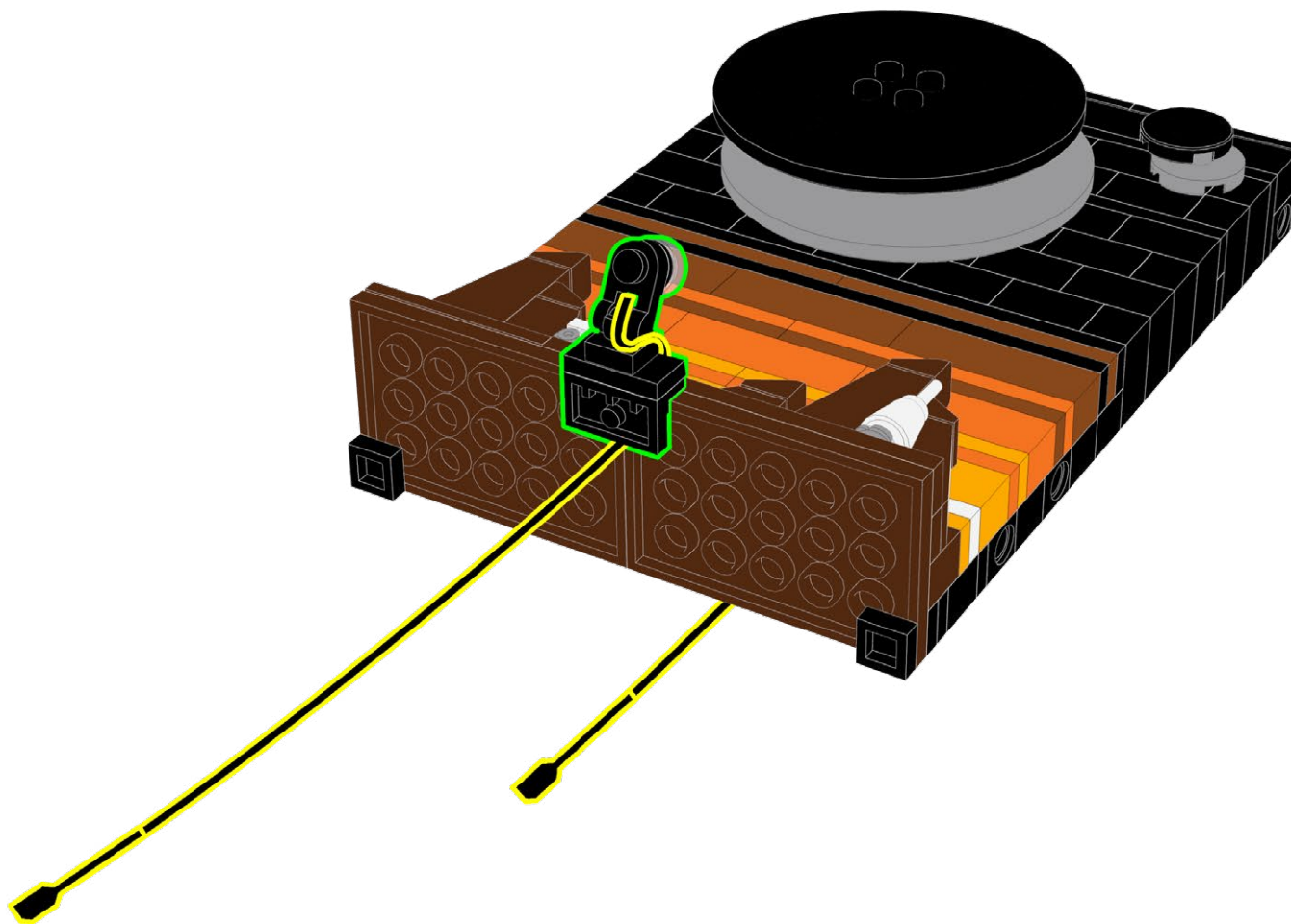
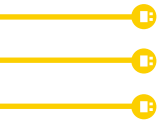

86

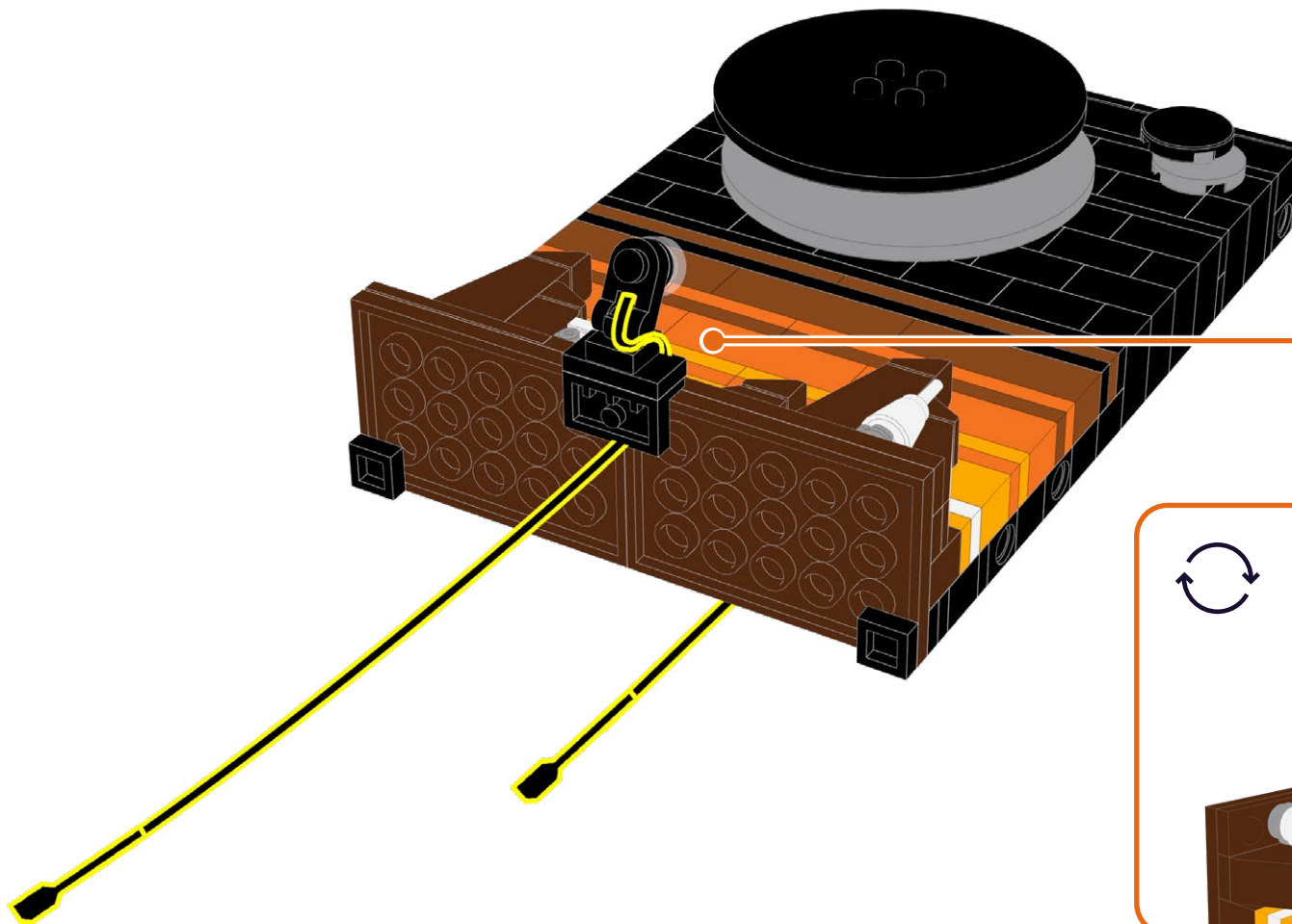

87

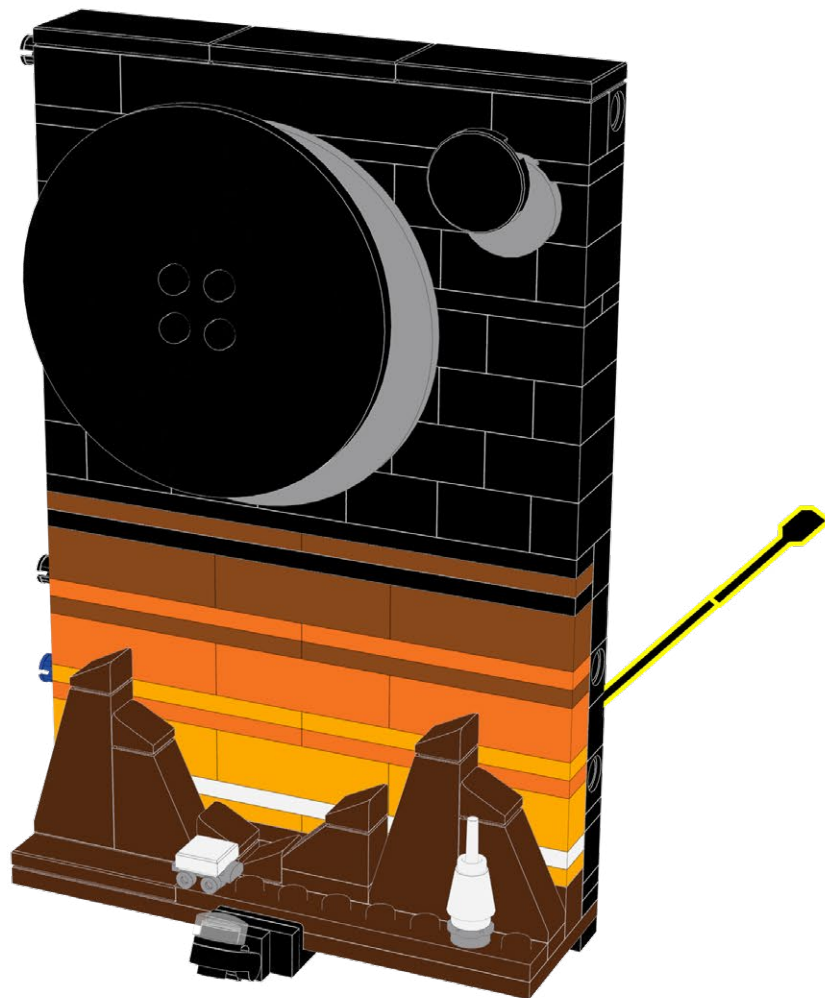

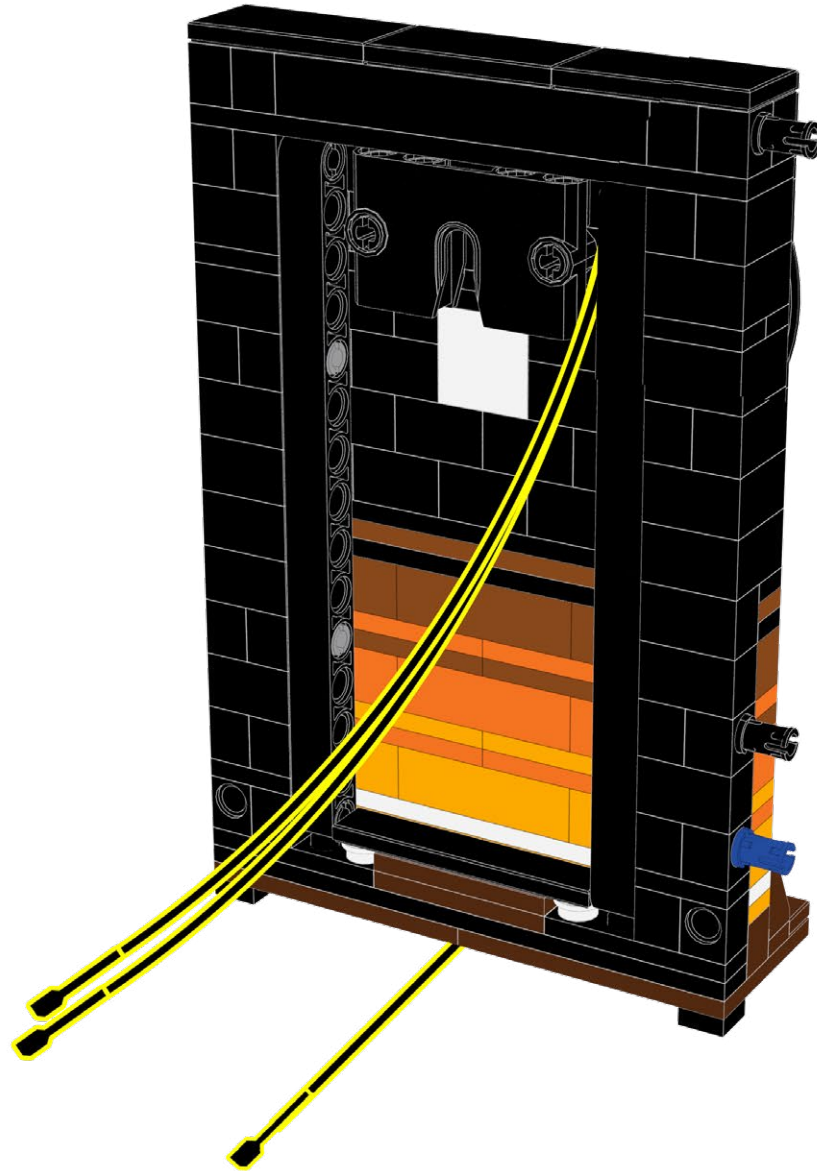
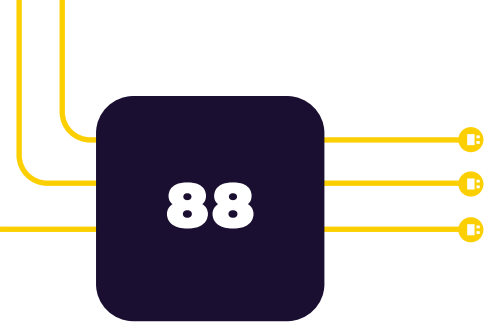

89

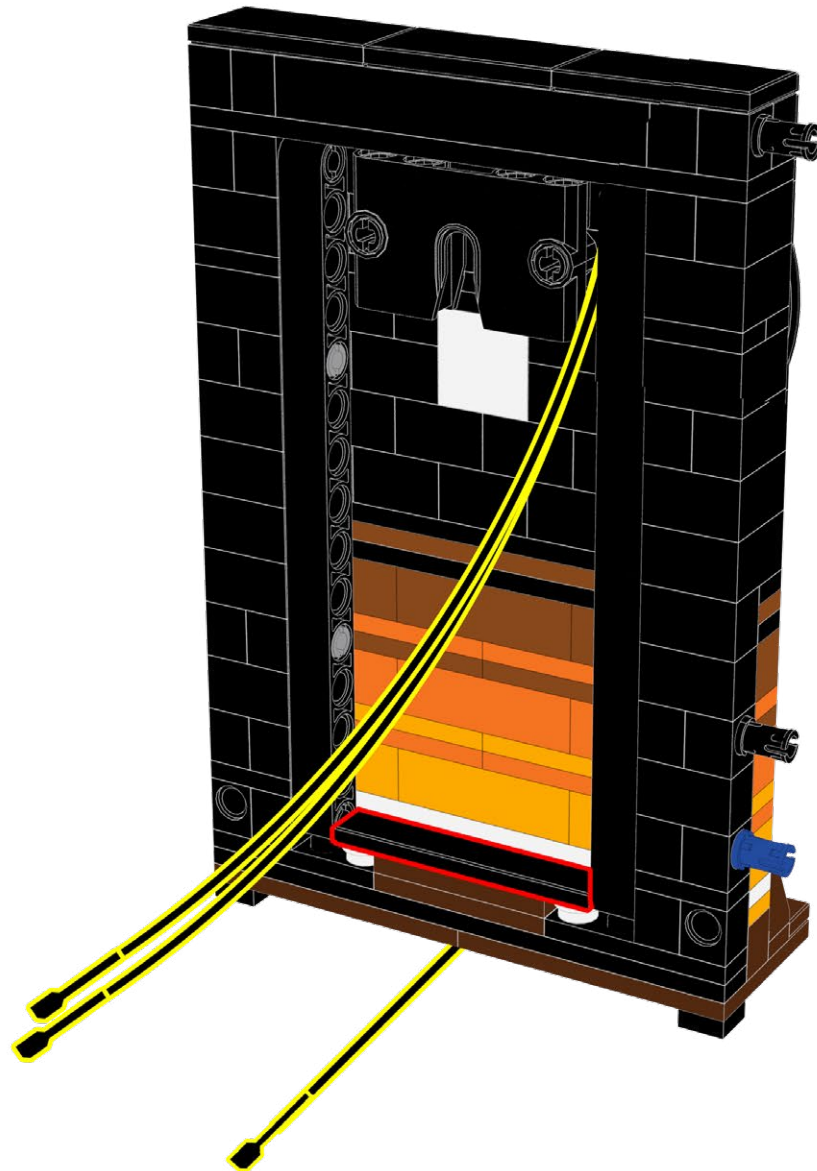

90

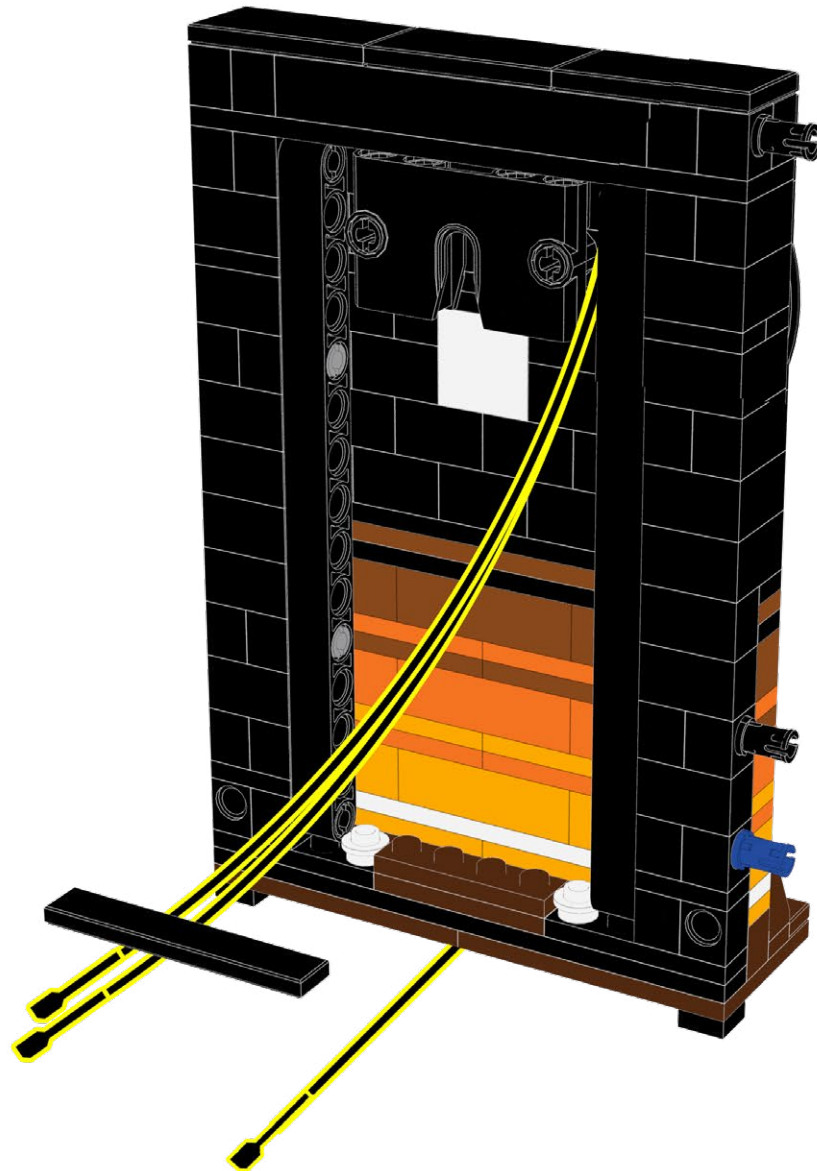

91

D-3

1x

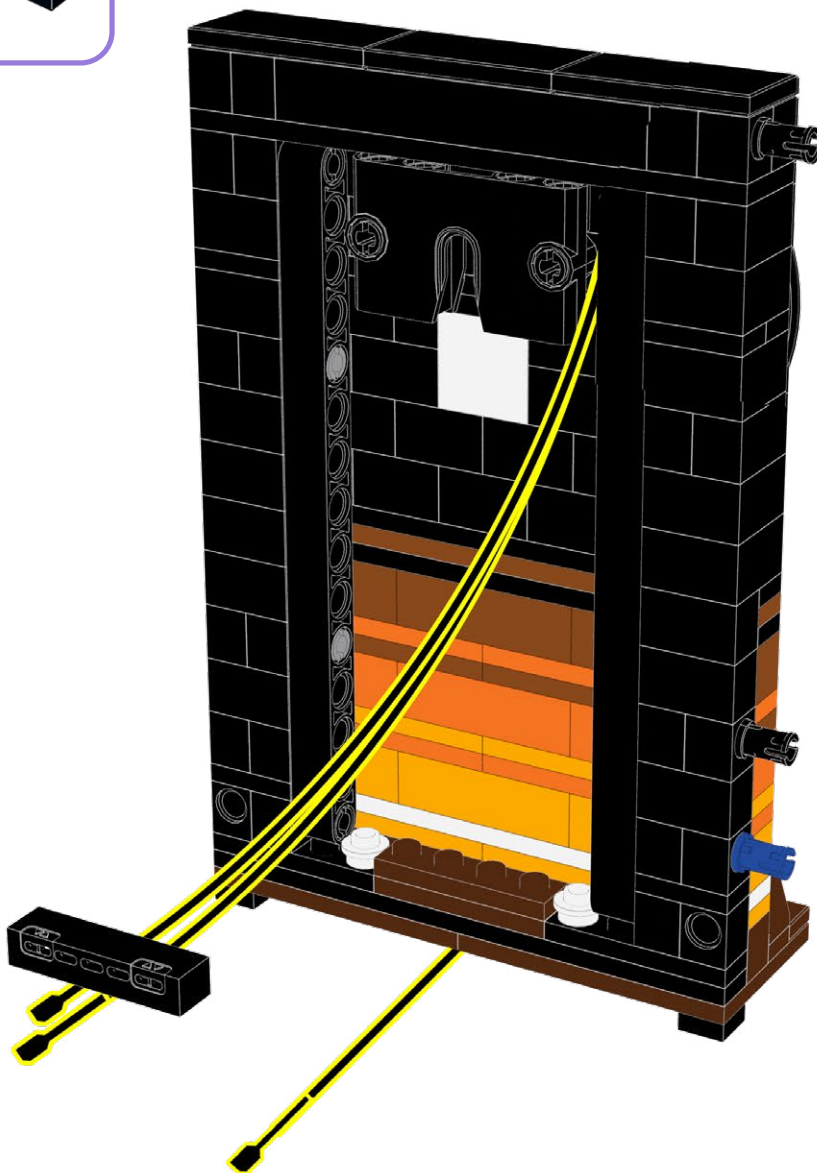

92

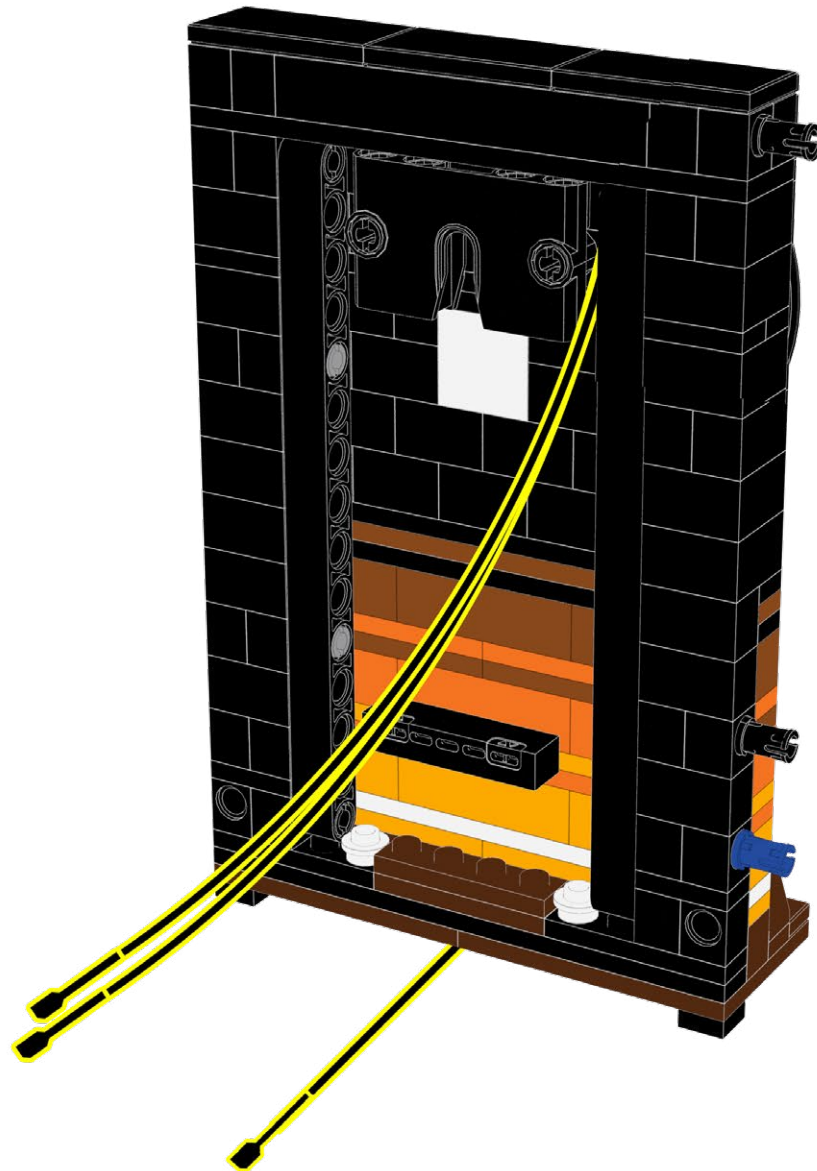

93

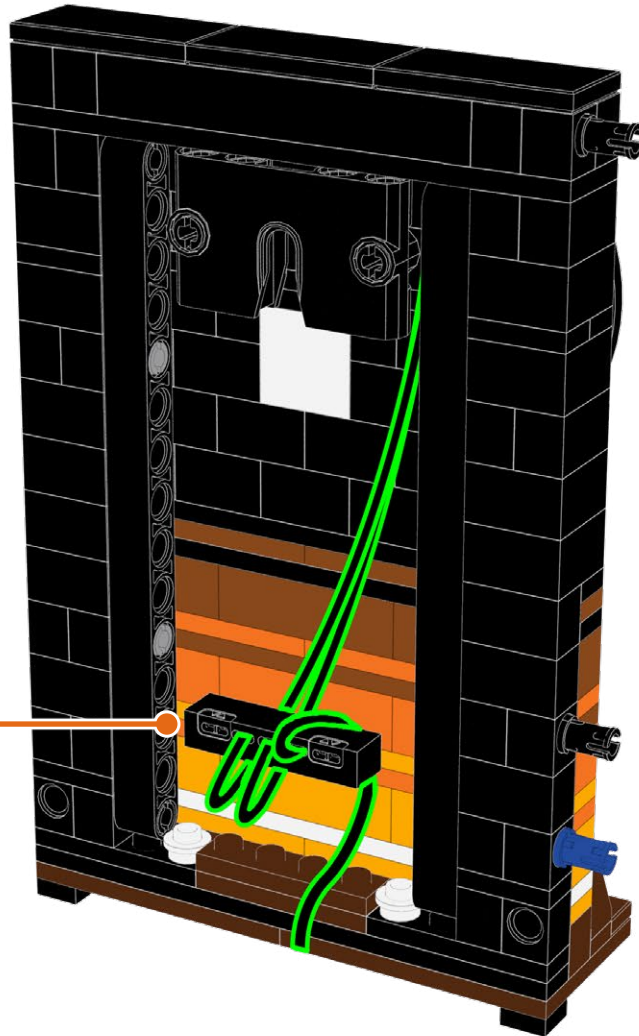
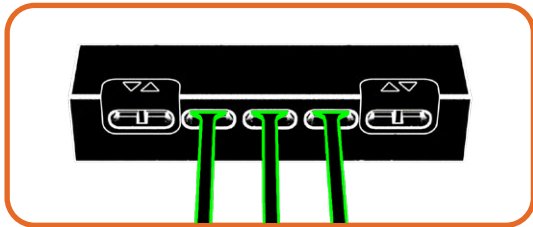

94

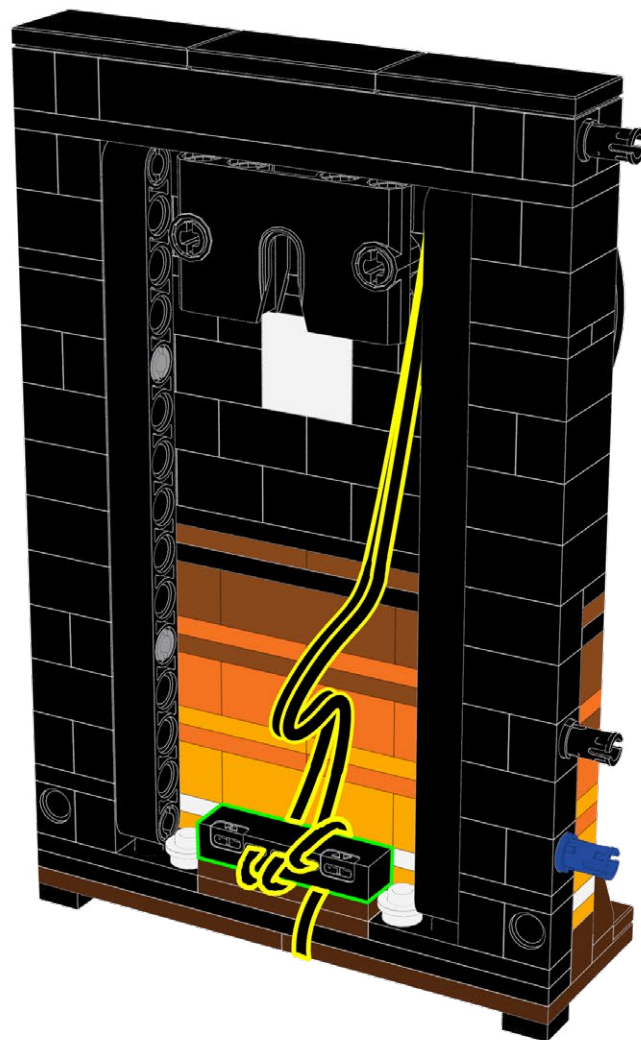

95

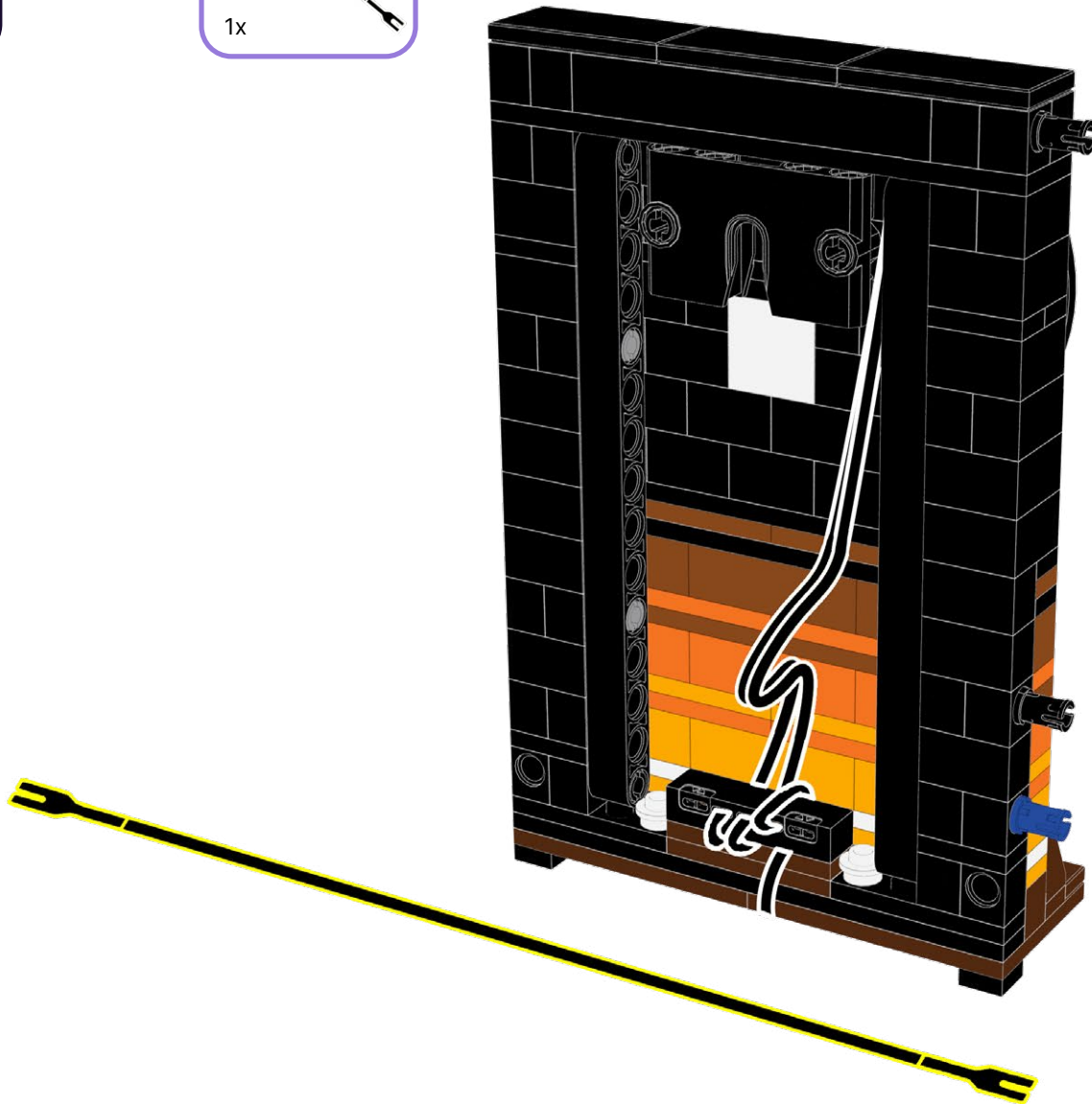
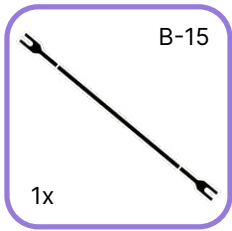

96

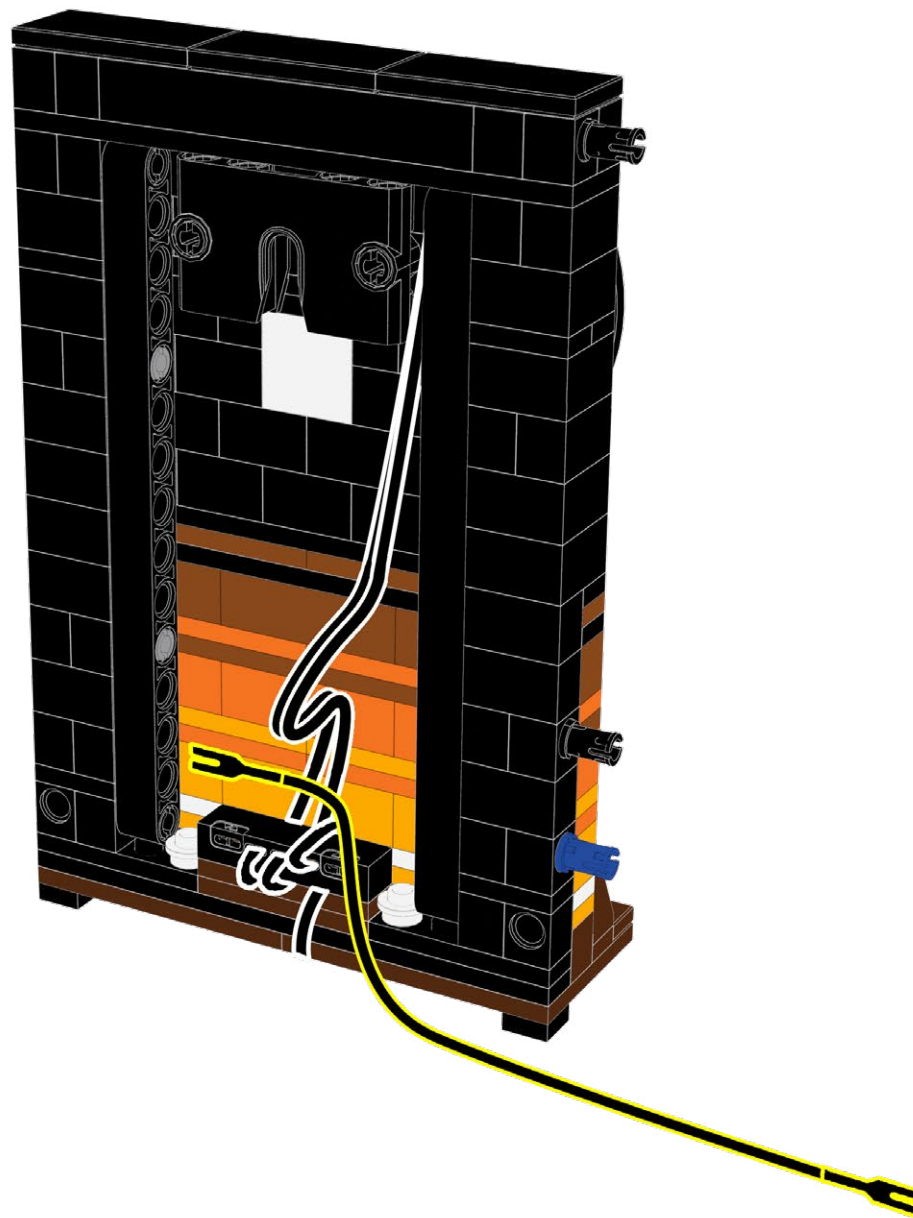

97

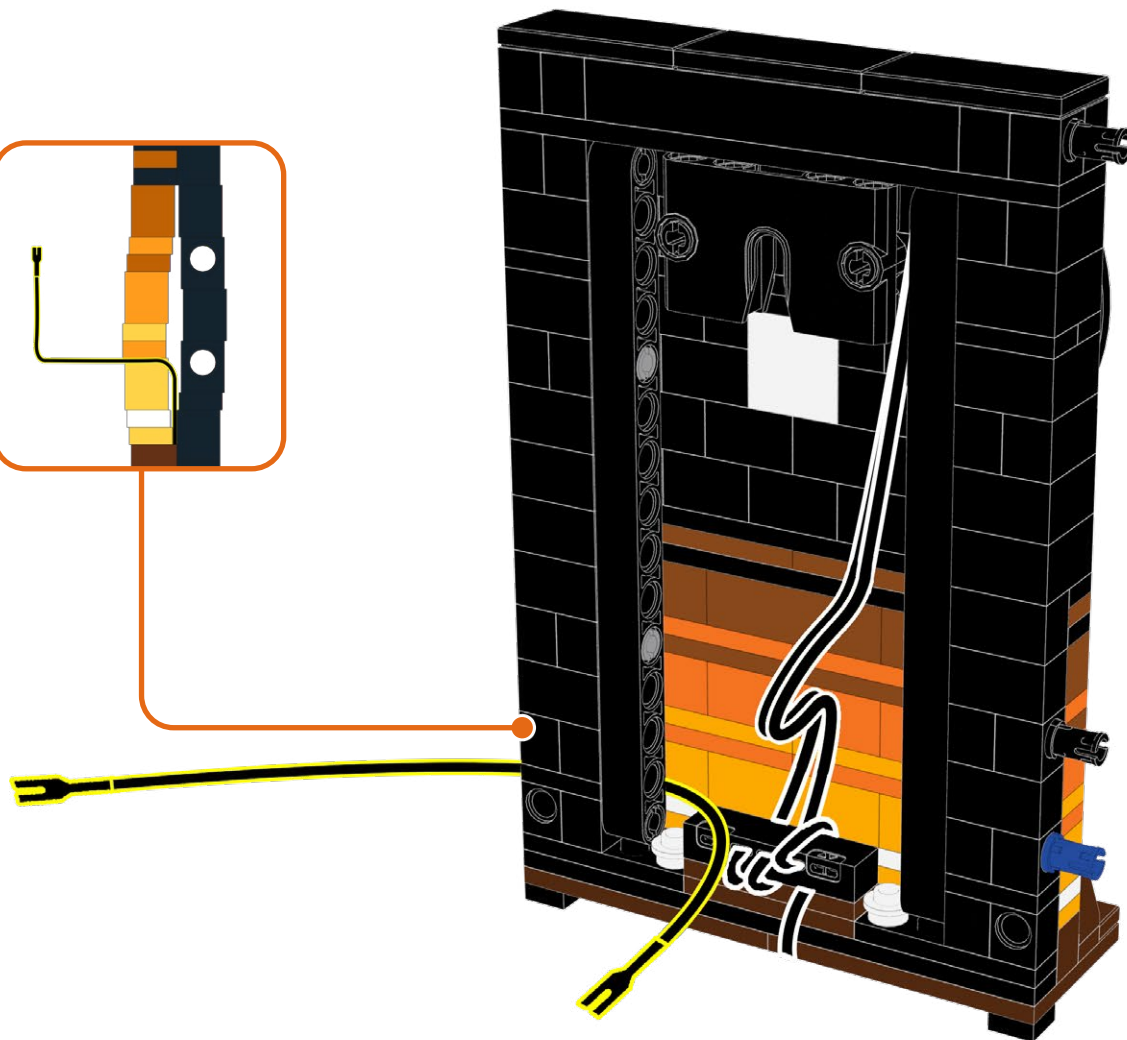
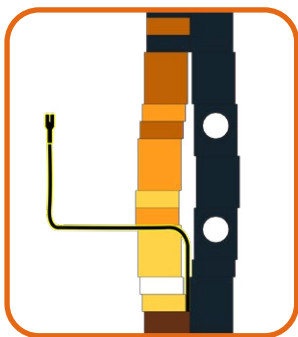

98

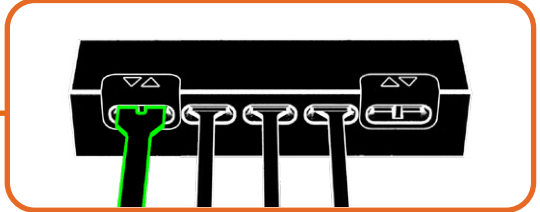
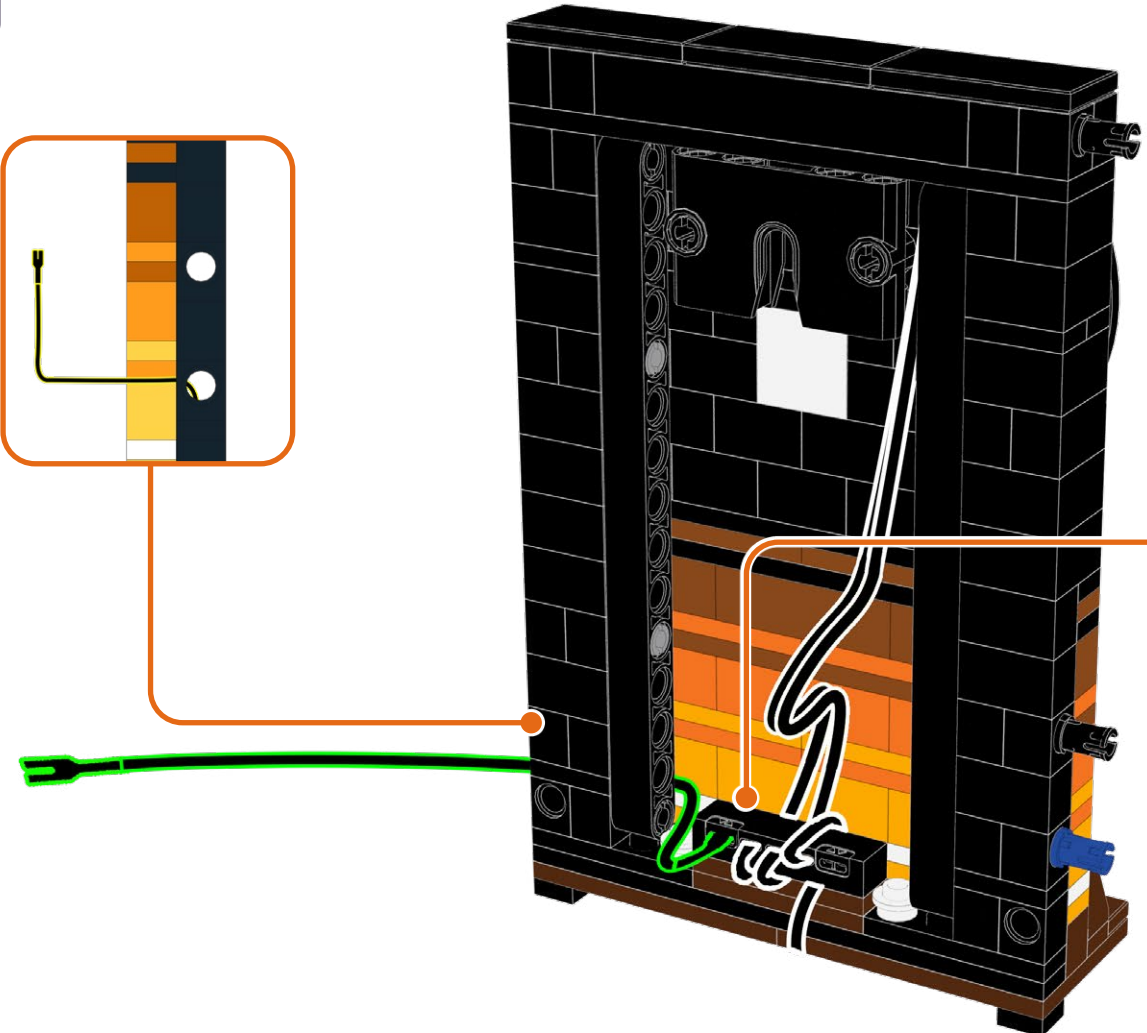
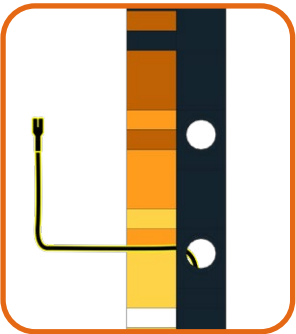

99

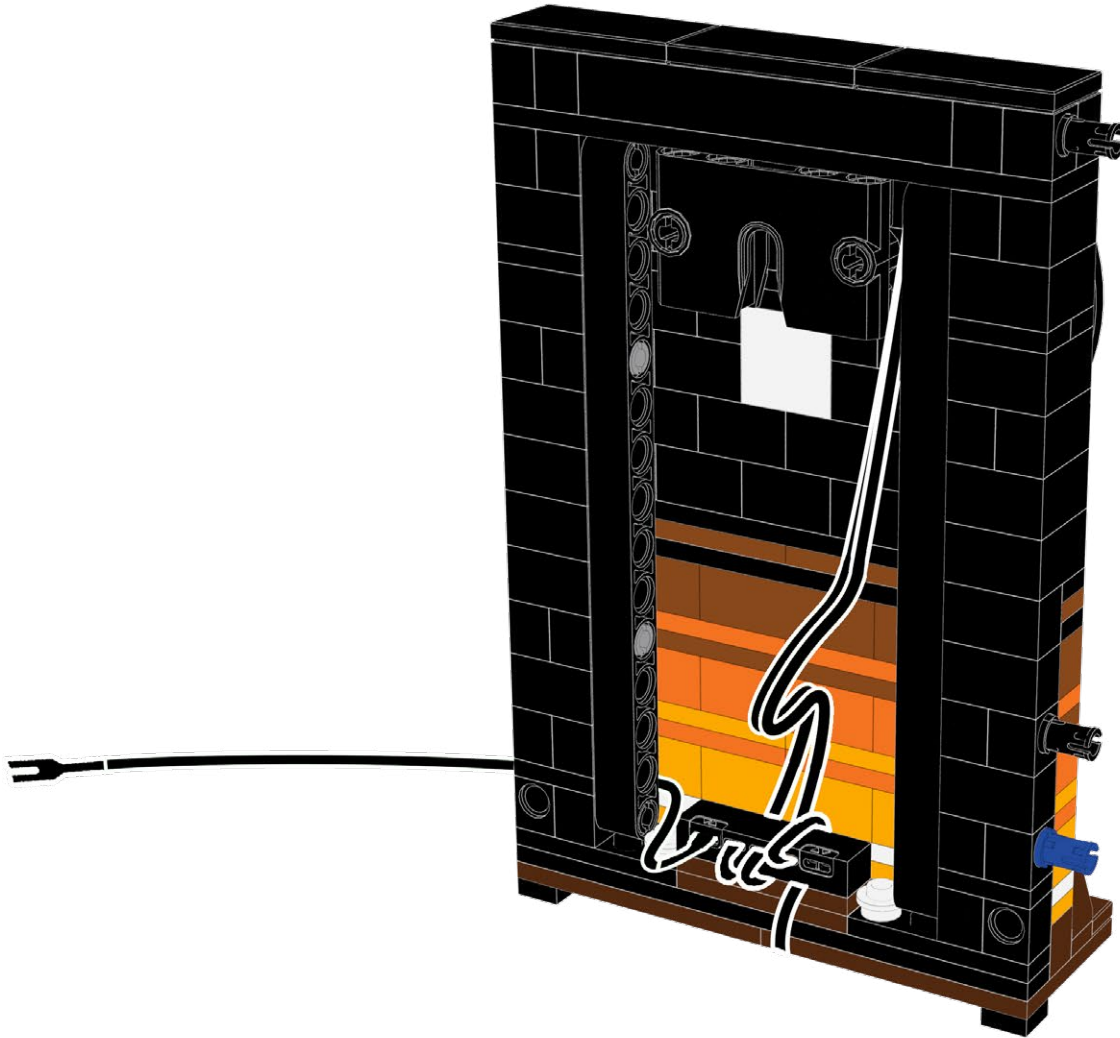

100

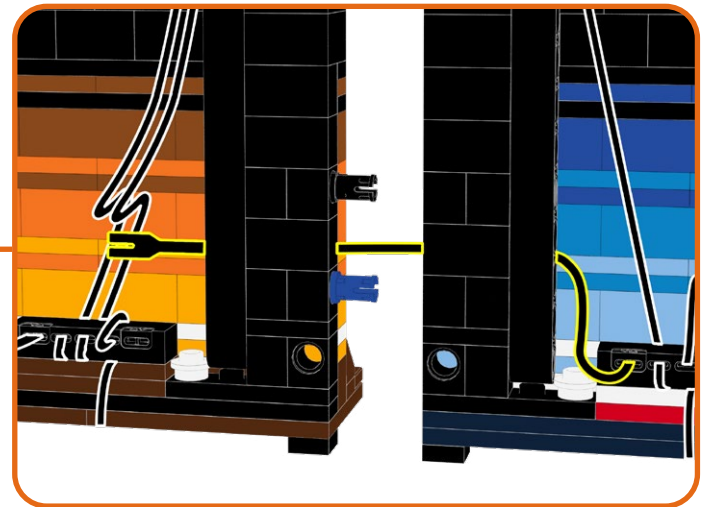
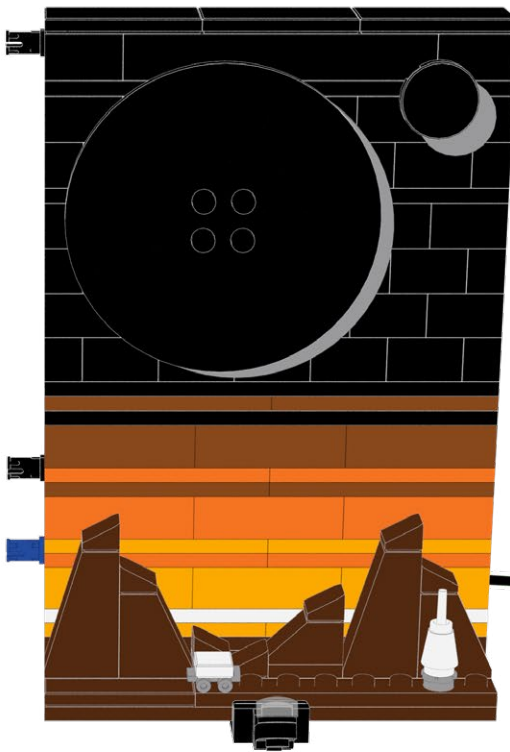
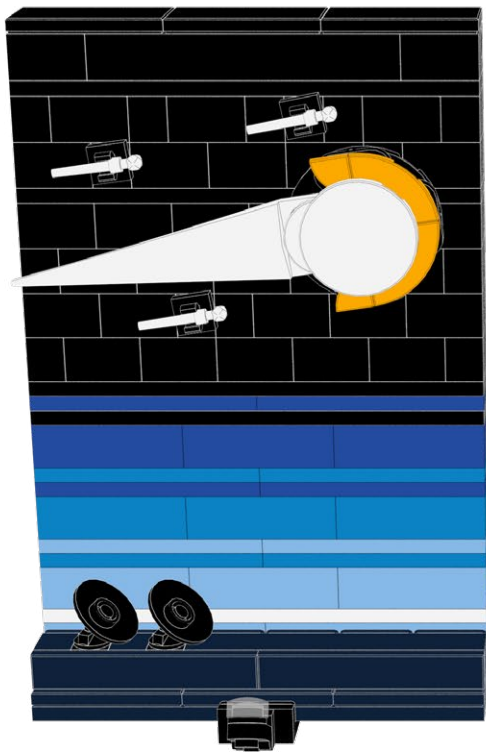

101

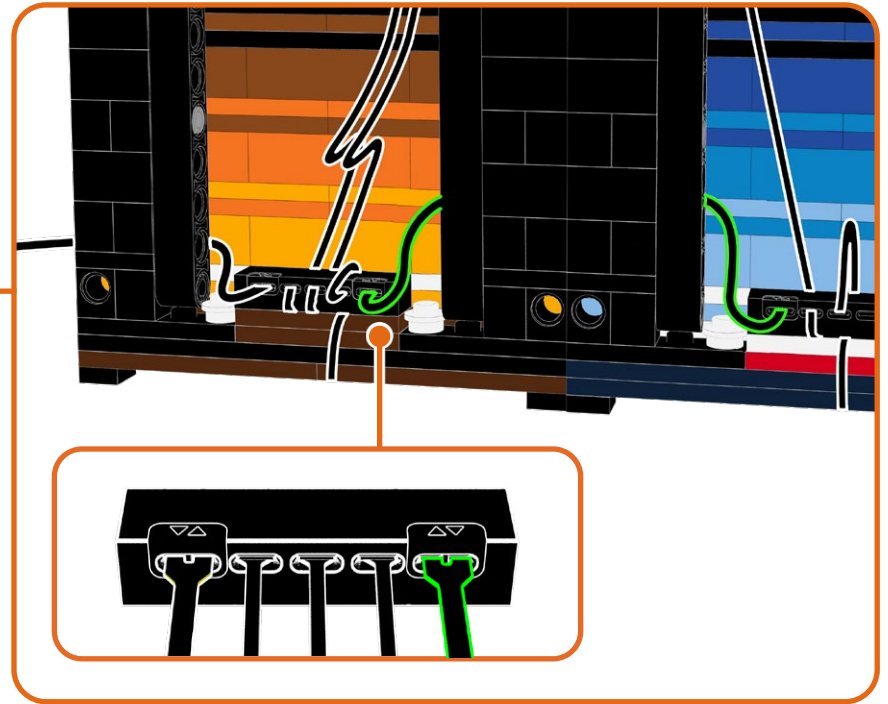
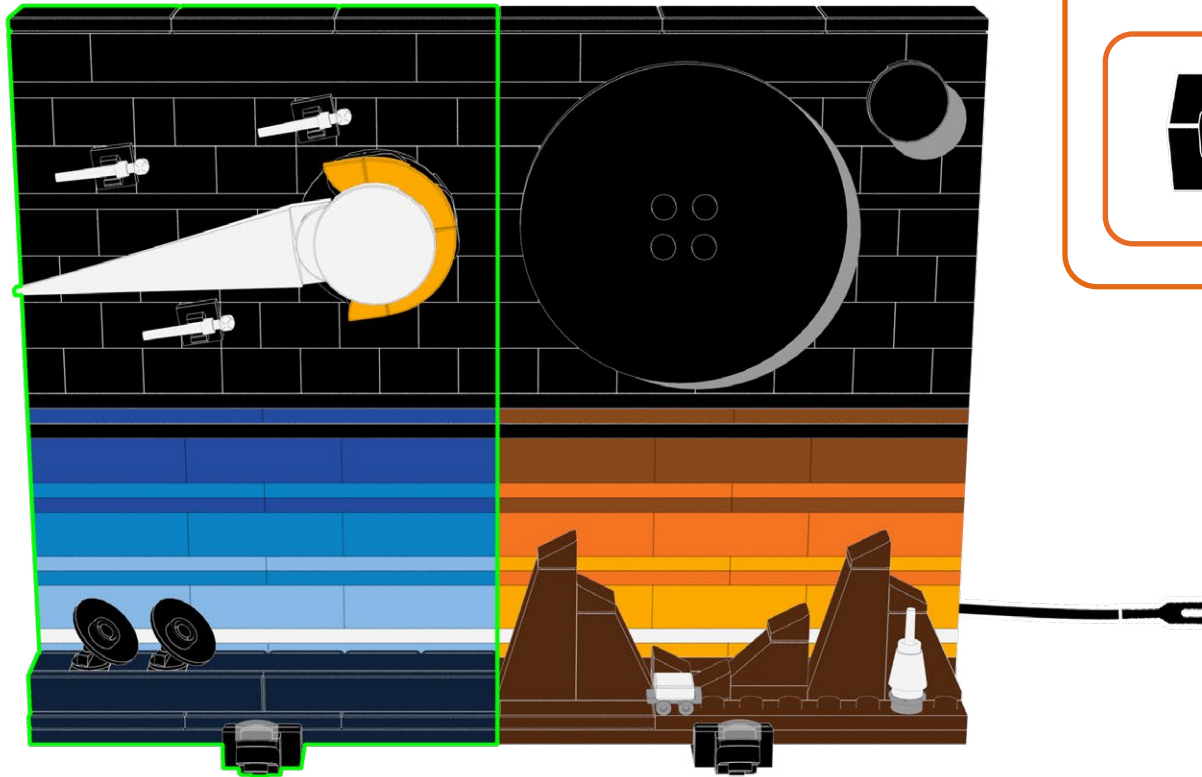

102

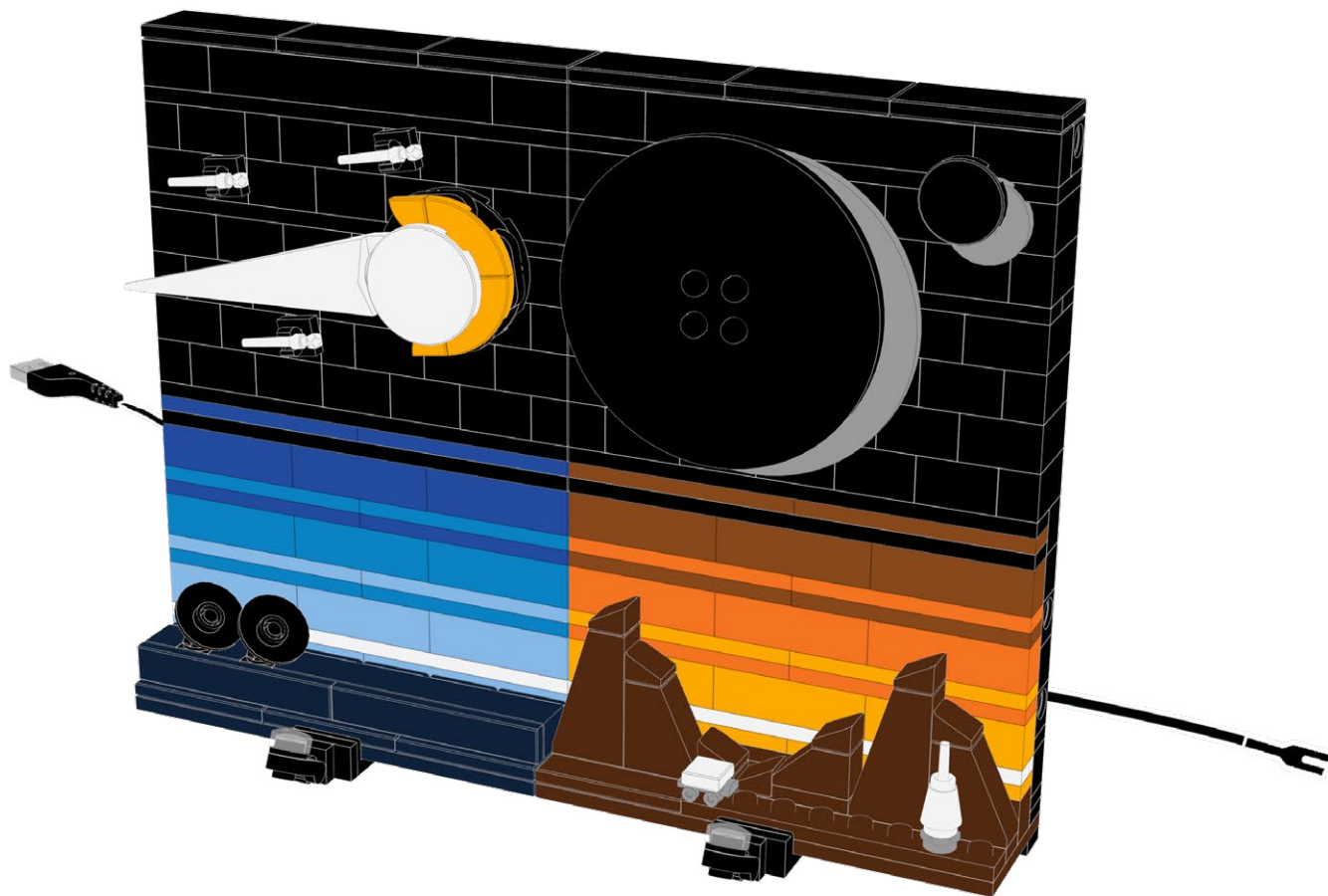

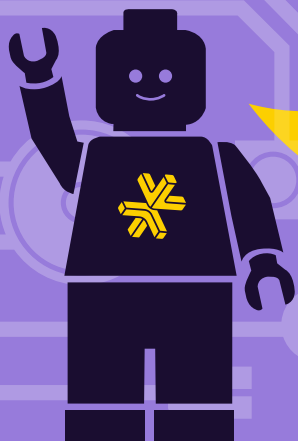

HOLD UP!

You might notice some bags aren't in order, as well as left over pieces, but that's ok! We're changing the way you build LEGO!

ATTENDEZ!

Vous remarquerez peut-être que certains sacs, ainsi que certaines pièces, ne sont pas dans le bon ordre. Mais pas de panique! Nous changeons simplement la façon avec laquelle vous construisez vos LEGO!

ASPETTA!

Potresti notare che alcuni sacchetti non sono in ordine, così come i pezzi avanzati, ma va bene così! Stiamo cambiando il modo in cui costruisci i LEGO!

HALT!

Sie werden möglicherweise bemerken, dass einige tüten durcheinander sind und teile übrig bleiben, aber das ist in Ordnung! Wir ändern die art und weise, wie Sie LEGO bauen!

¡ESPERA!

Es posible que notes que algunas bolsas están fuera de servicio, así como piezas sobrantes, ¡pero está bien! ¡Estamos cambiando la forma en que construyes LEGO!

暫停!

你可能会注意到一些袋子顺序错乱, 以及一些剩余的部件, 但没关系! 我们正在改变你搭建乐高的方式!

Open LMB Bag 03

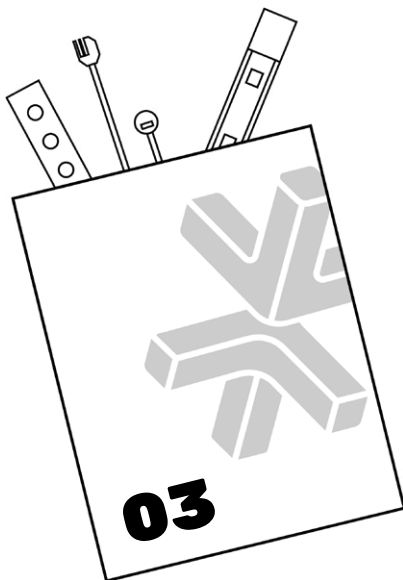

103

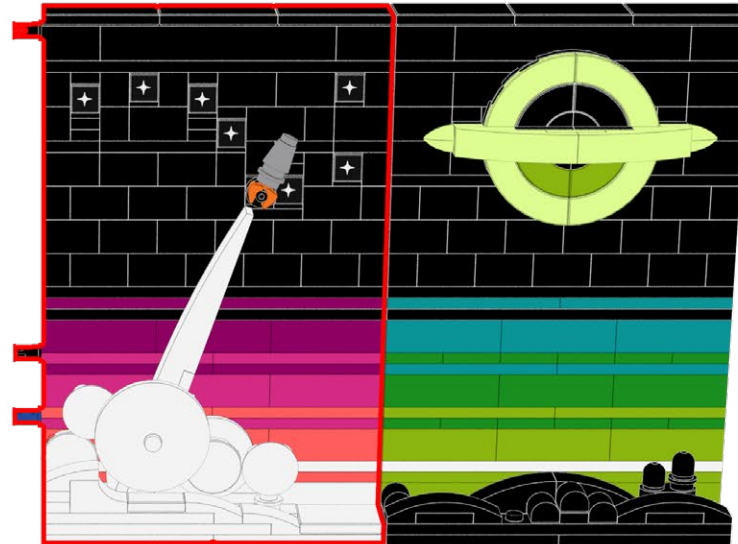

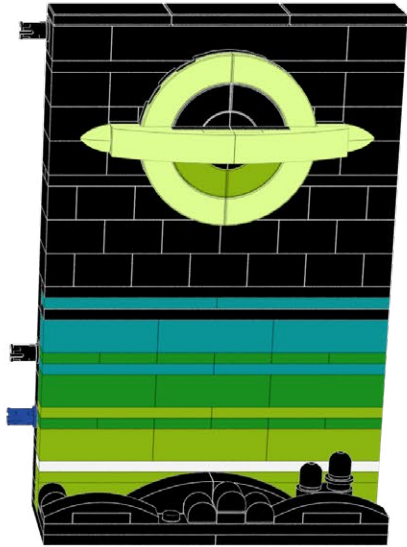
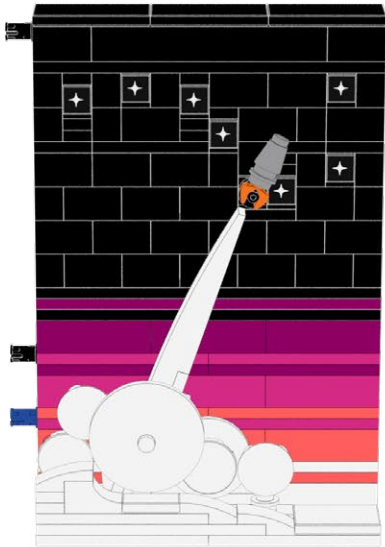

105

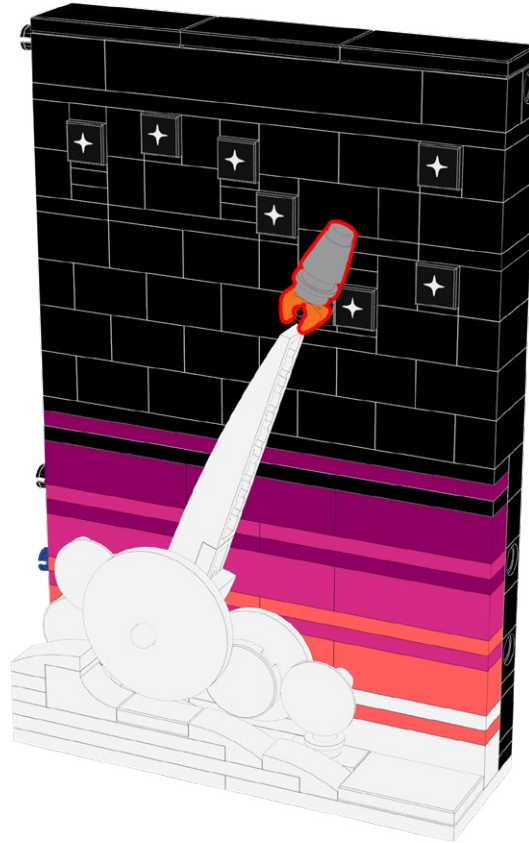

106

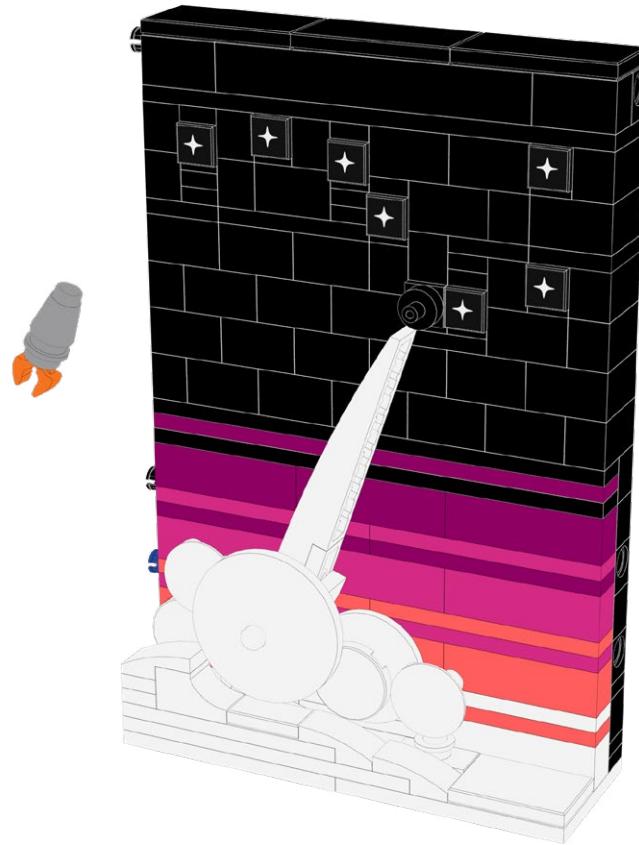

107

1

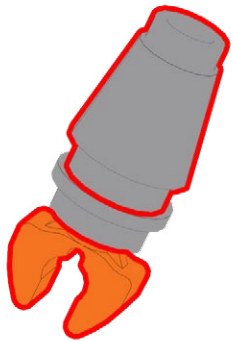

2

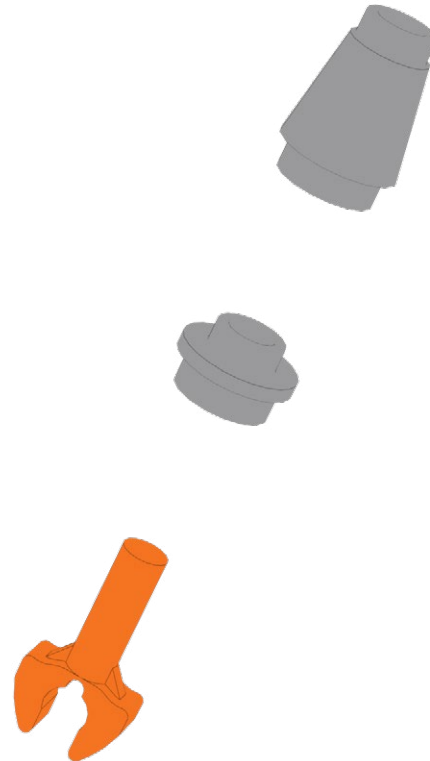

108

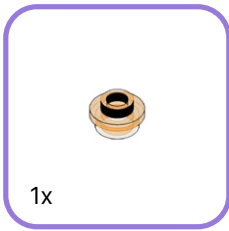
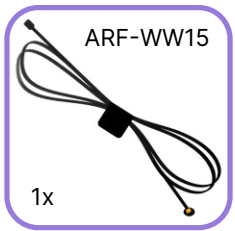

1

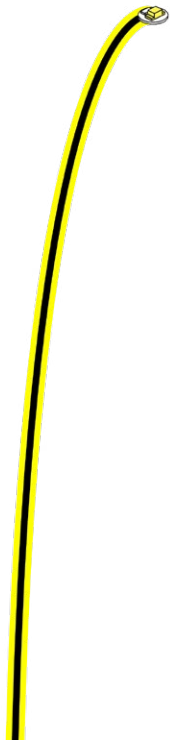

2

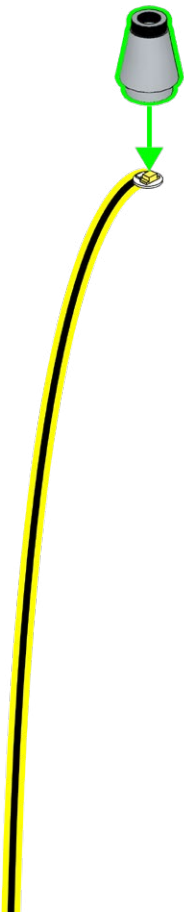

3

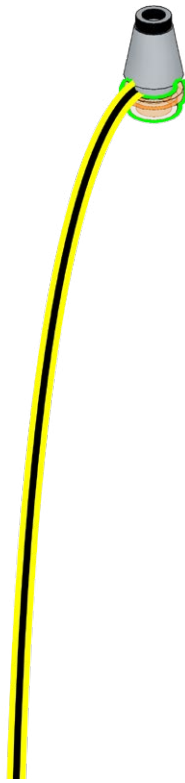

4

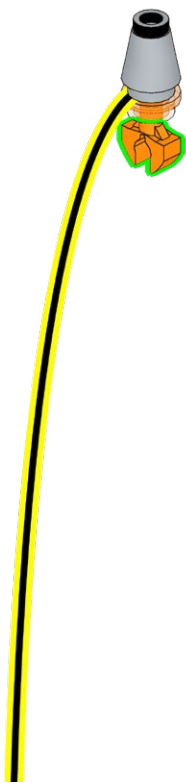

109

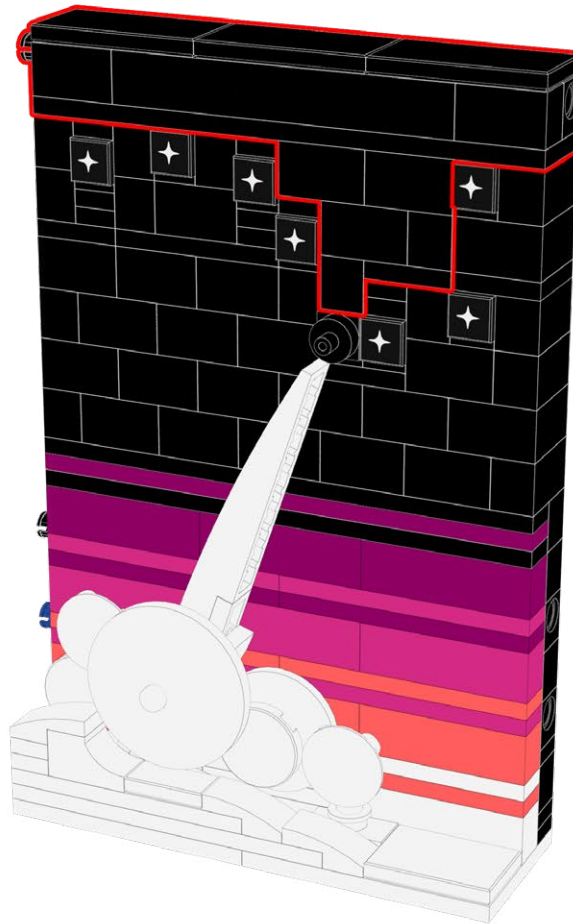

110

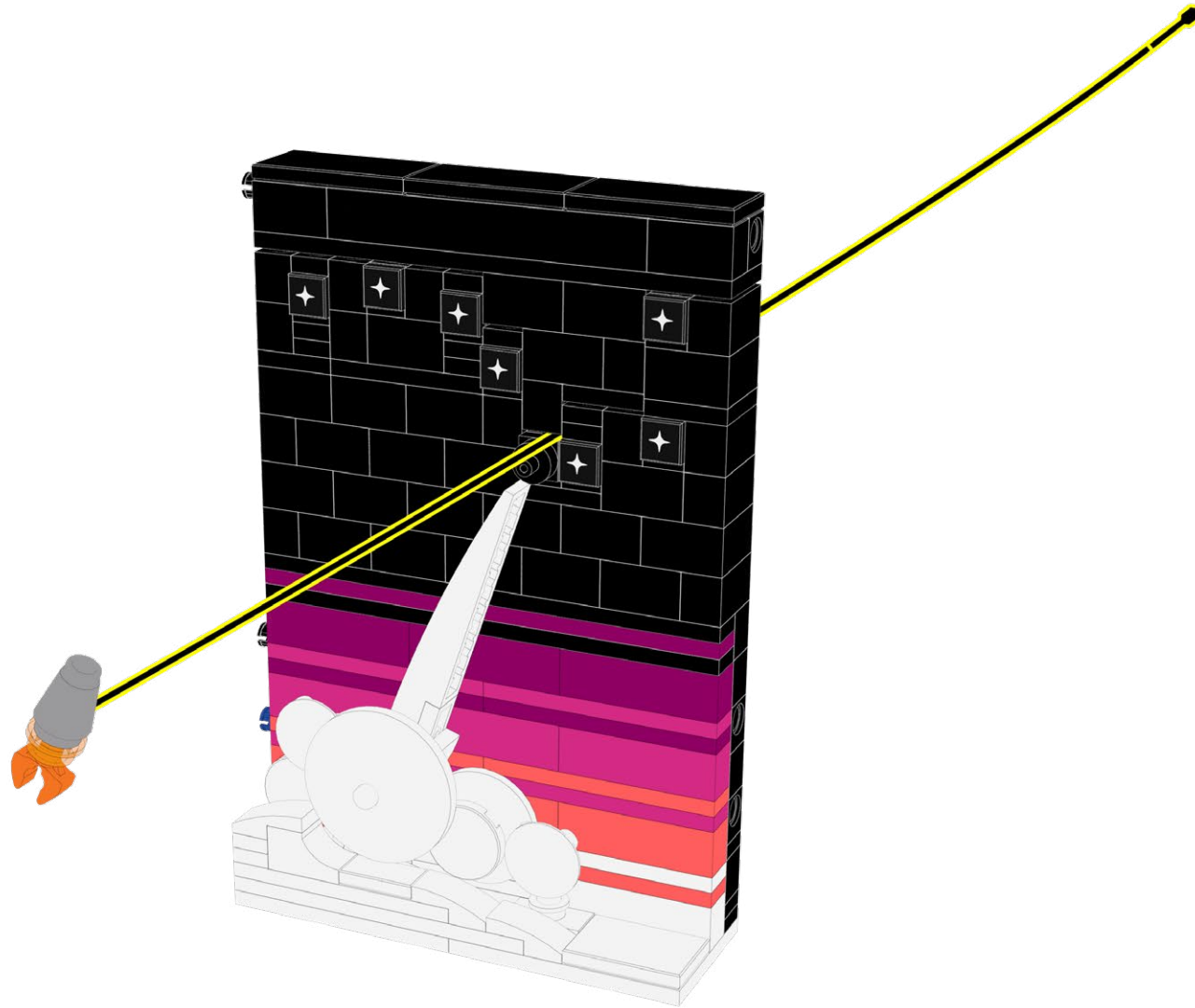

111

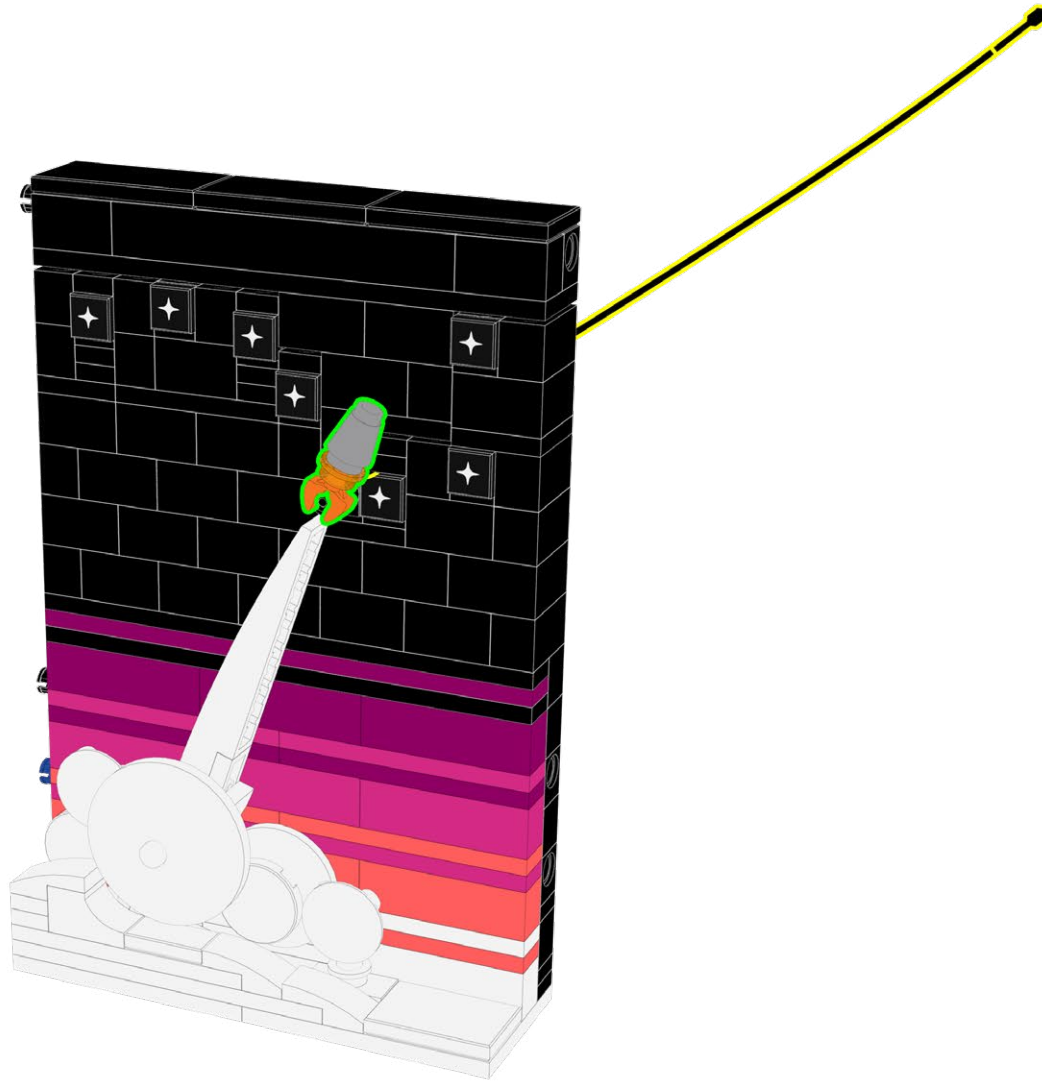

112

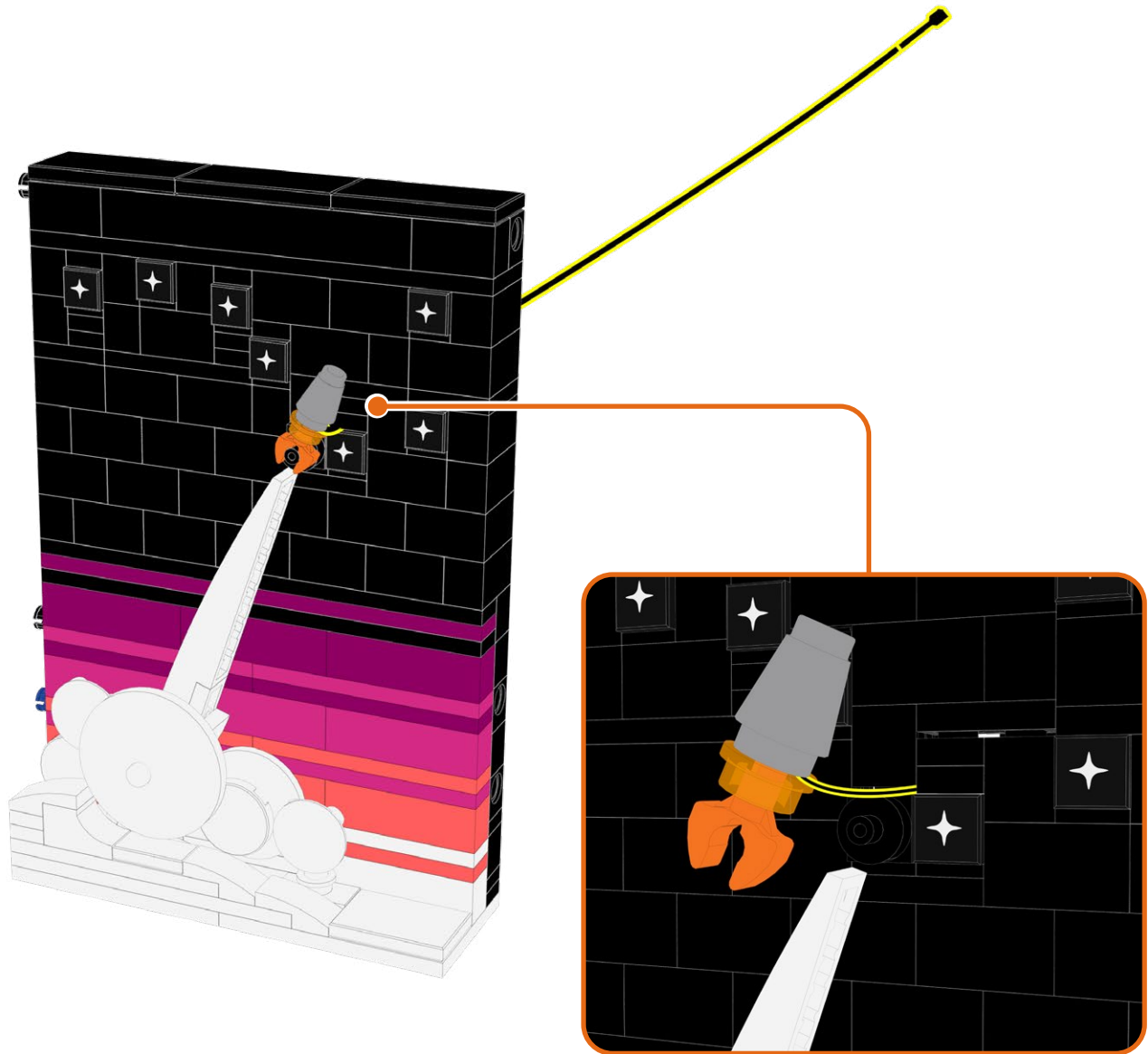

113

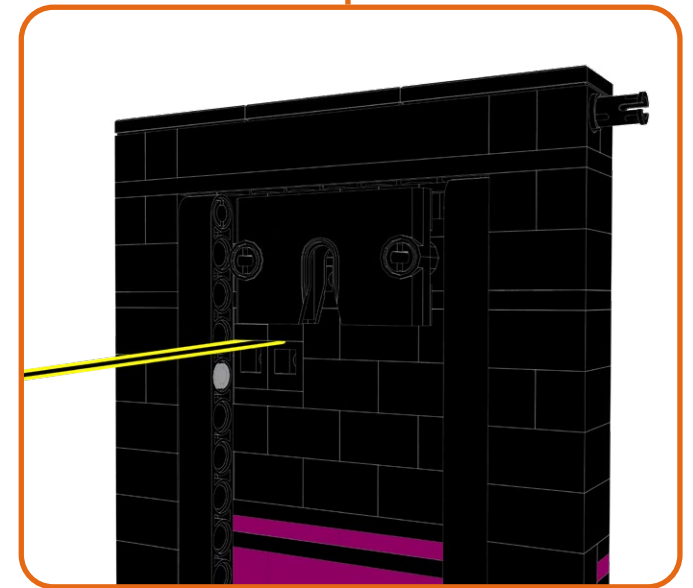
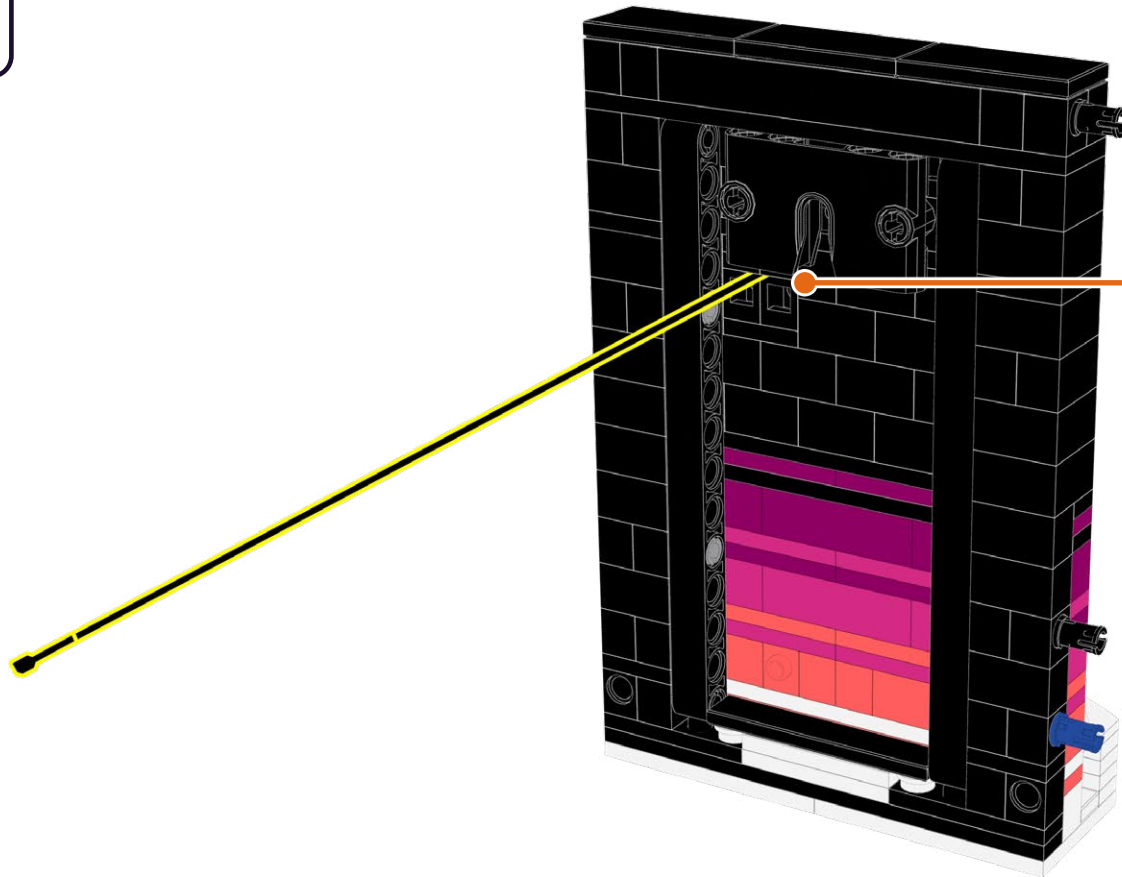

114

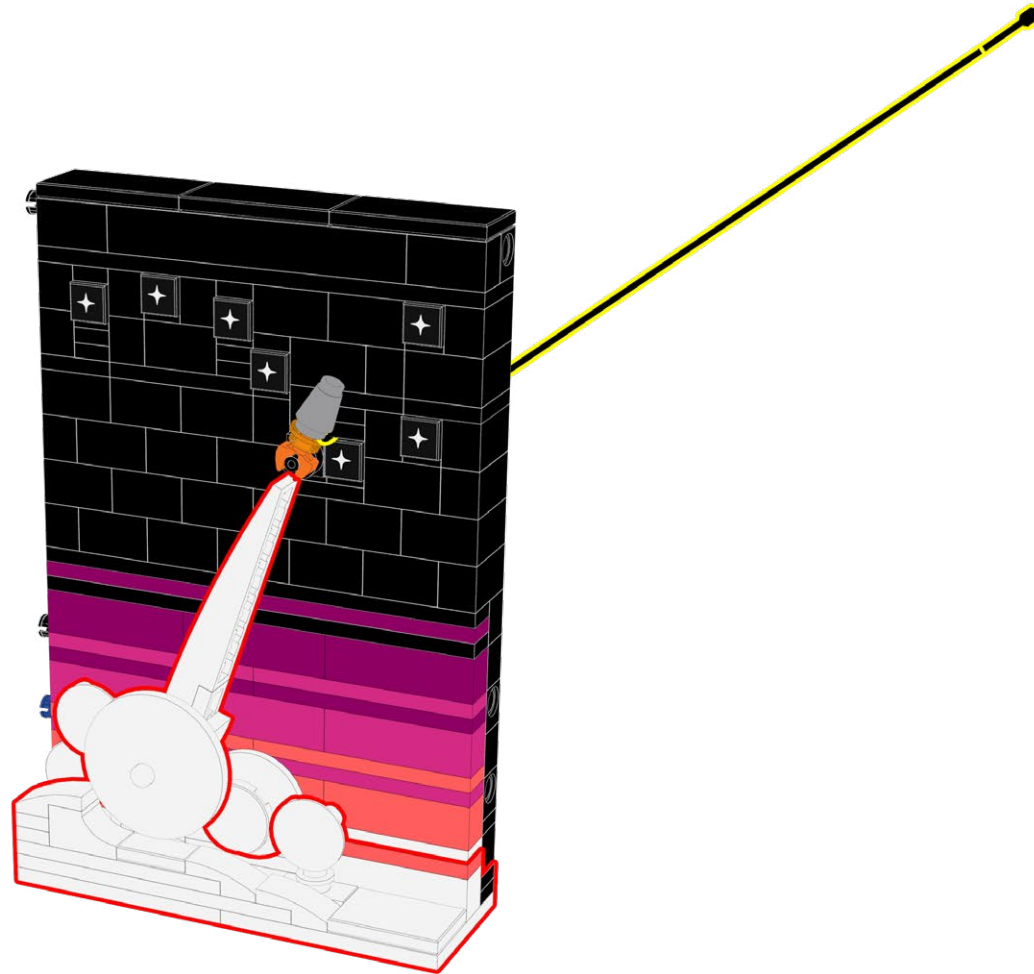

115

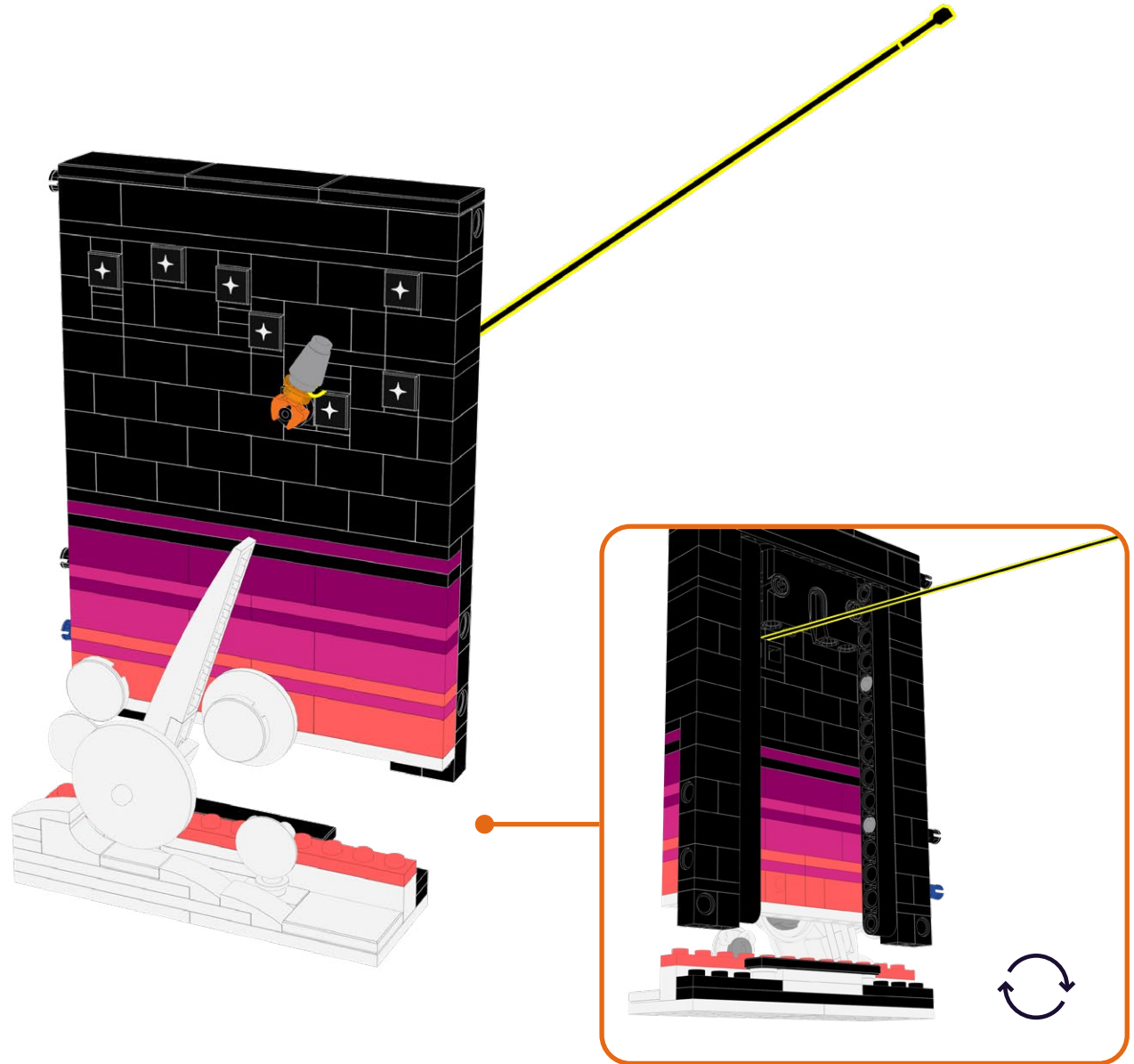

116

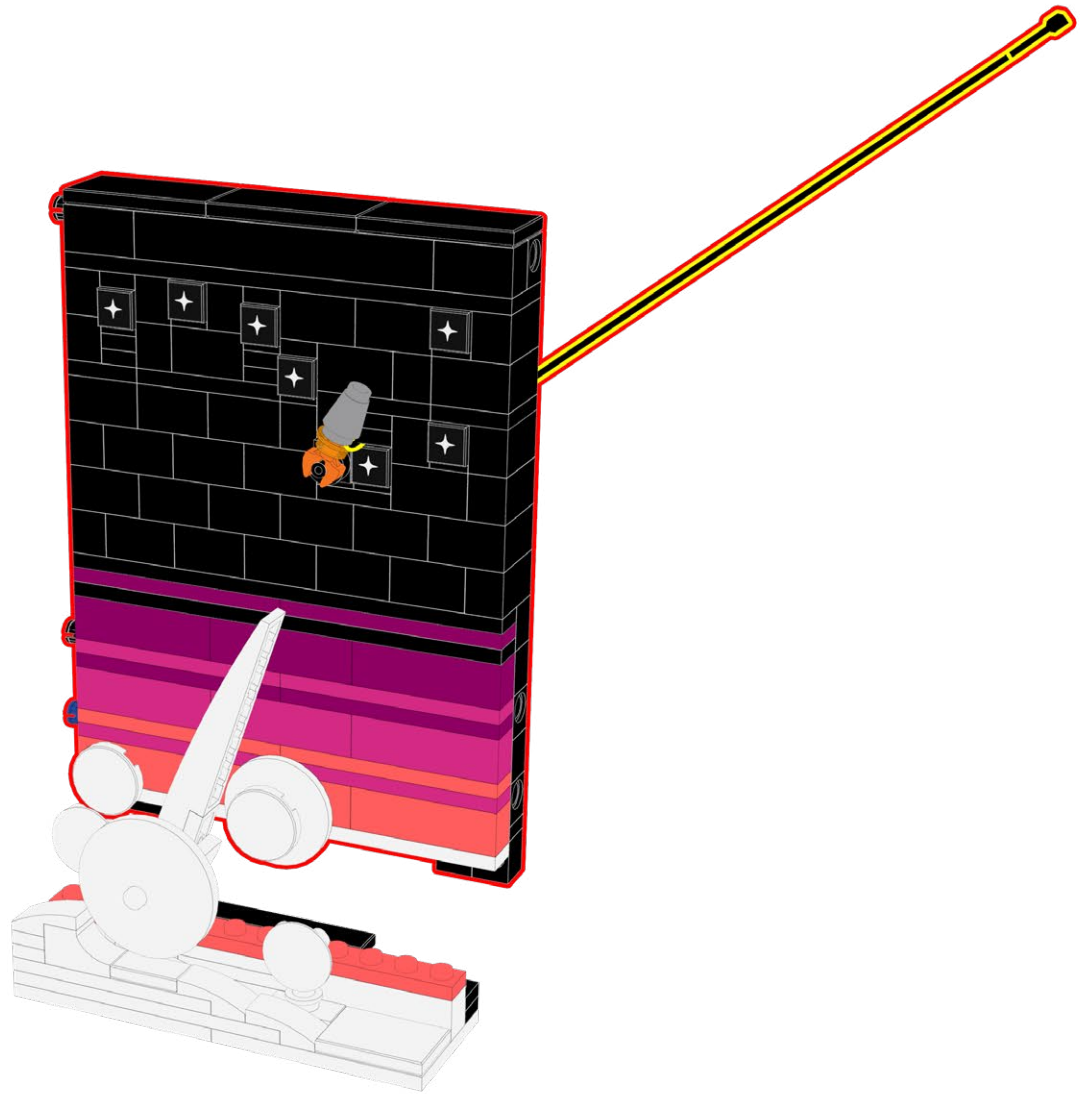

117

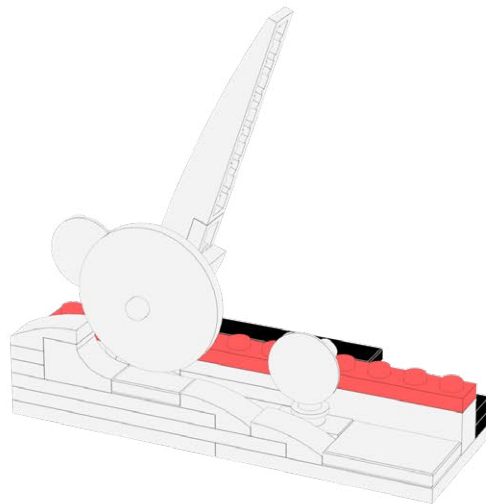

118

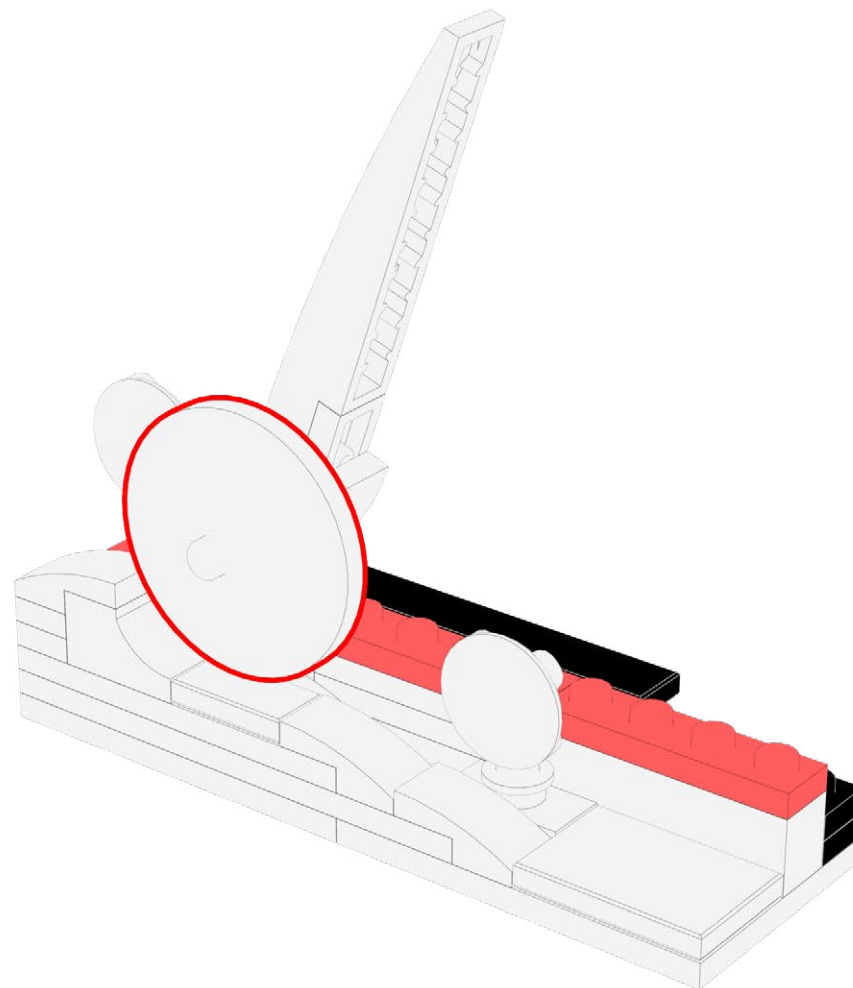

119

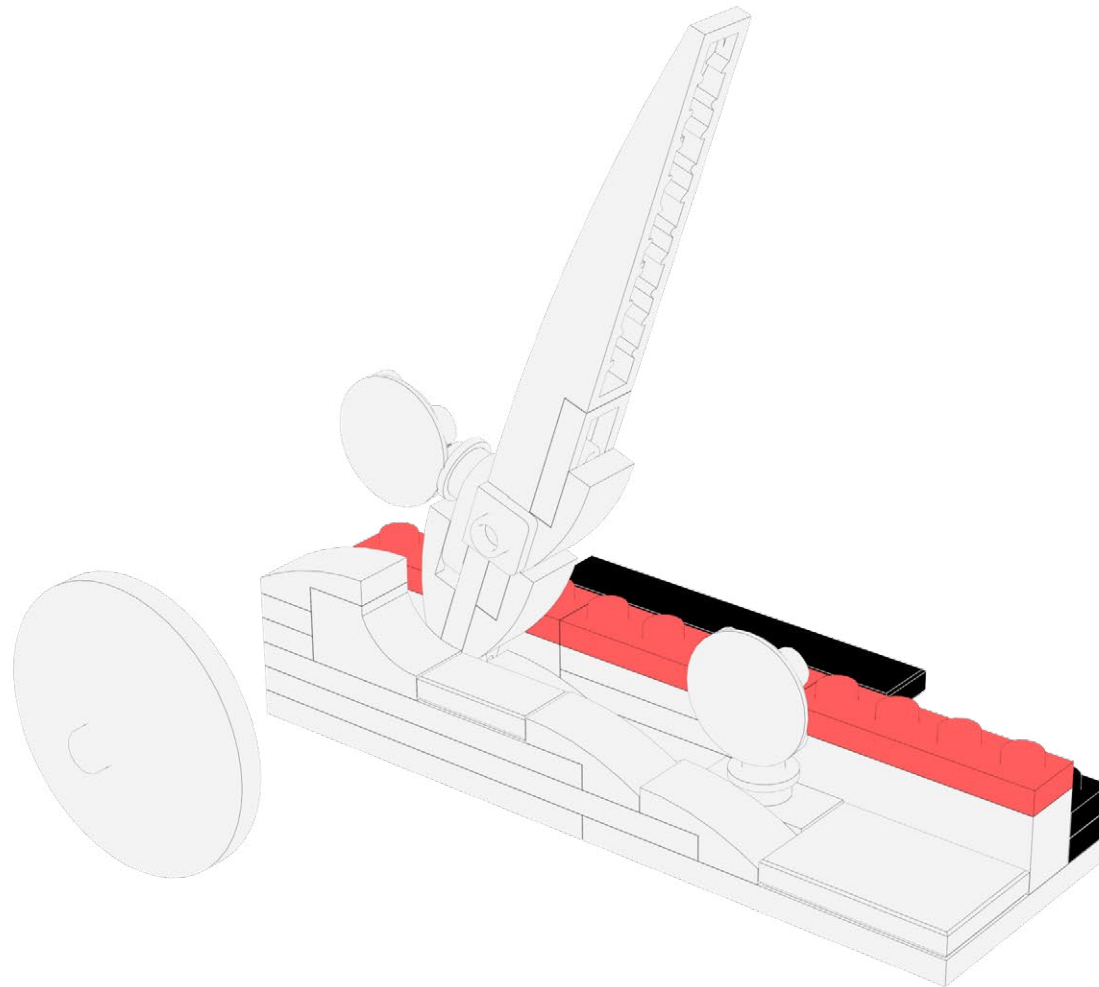

120

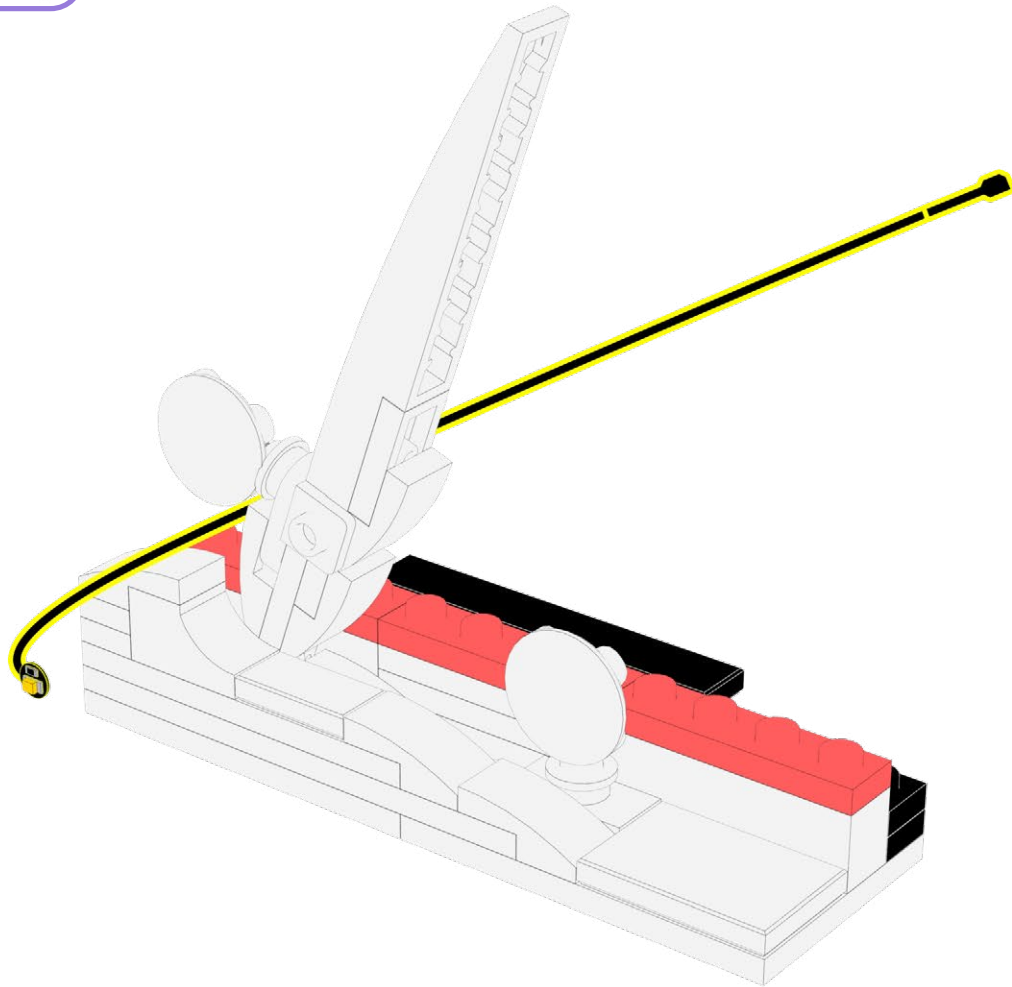
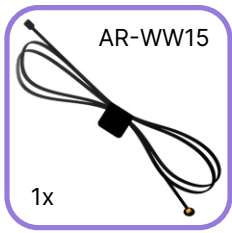

121

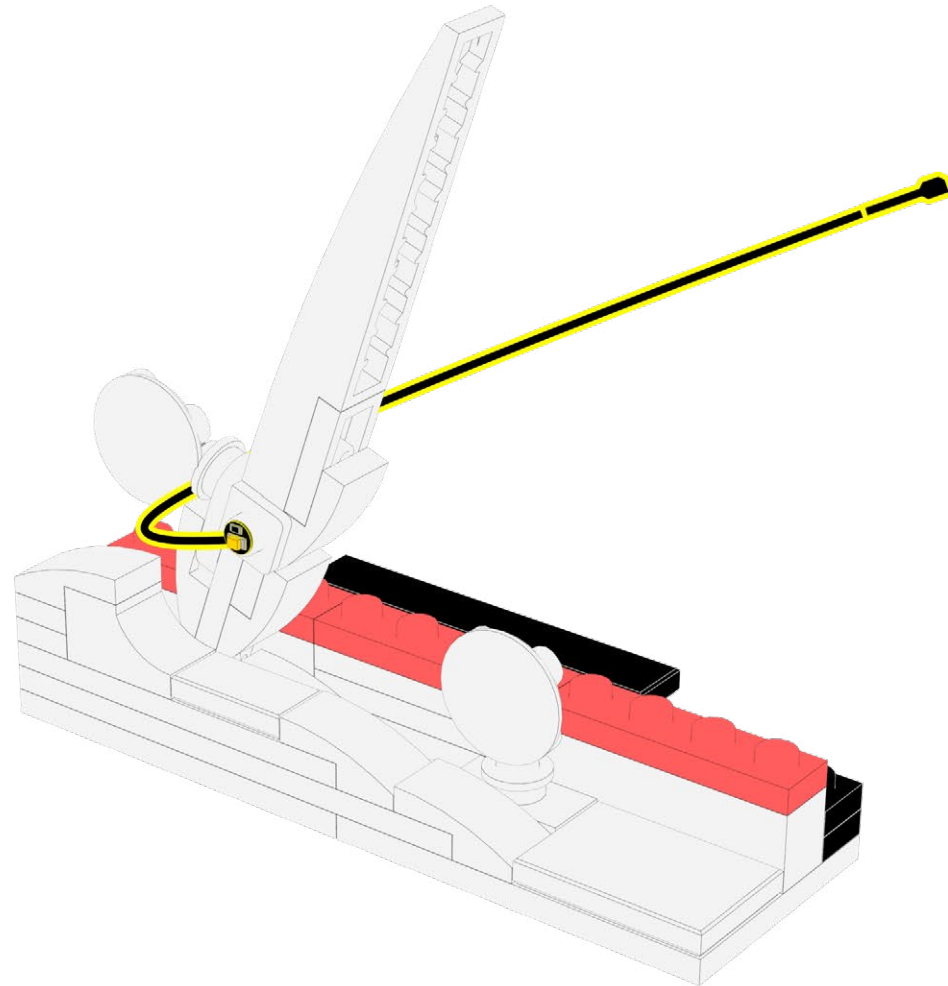

122

1x

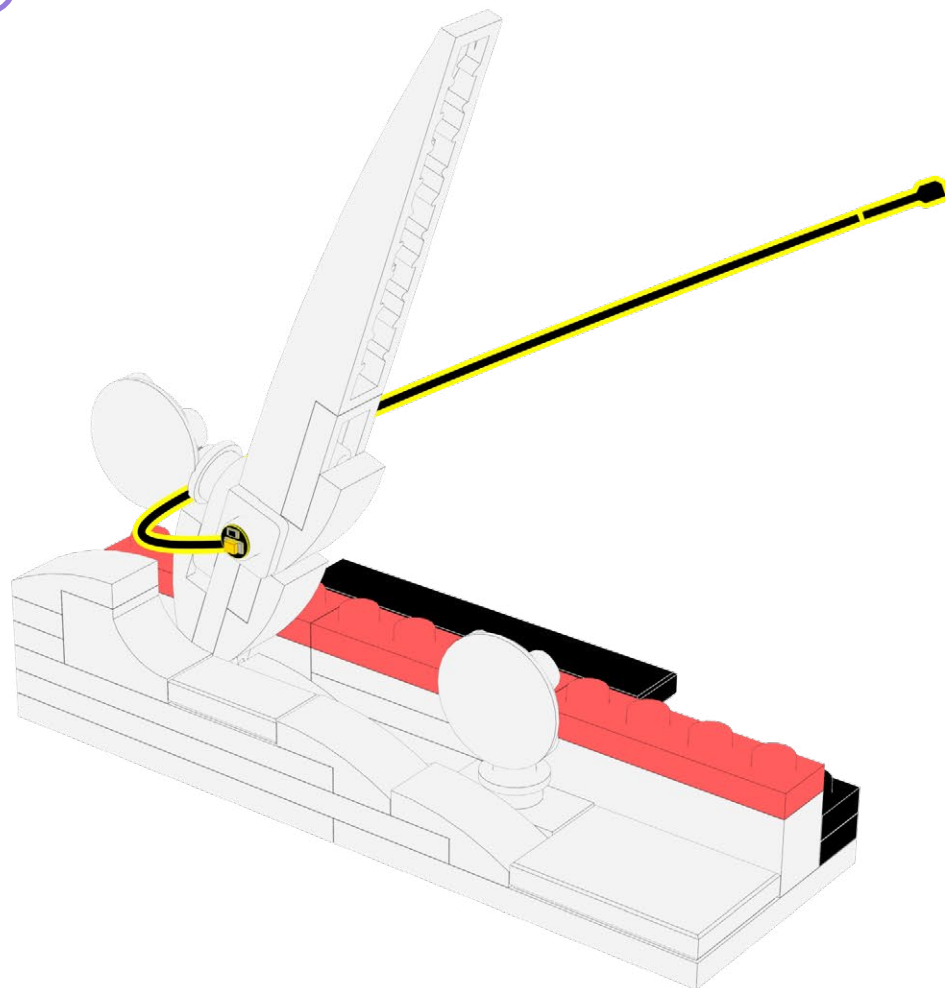

123

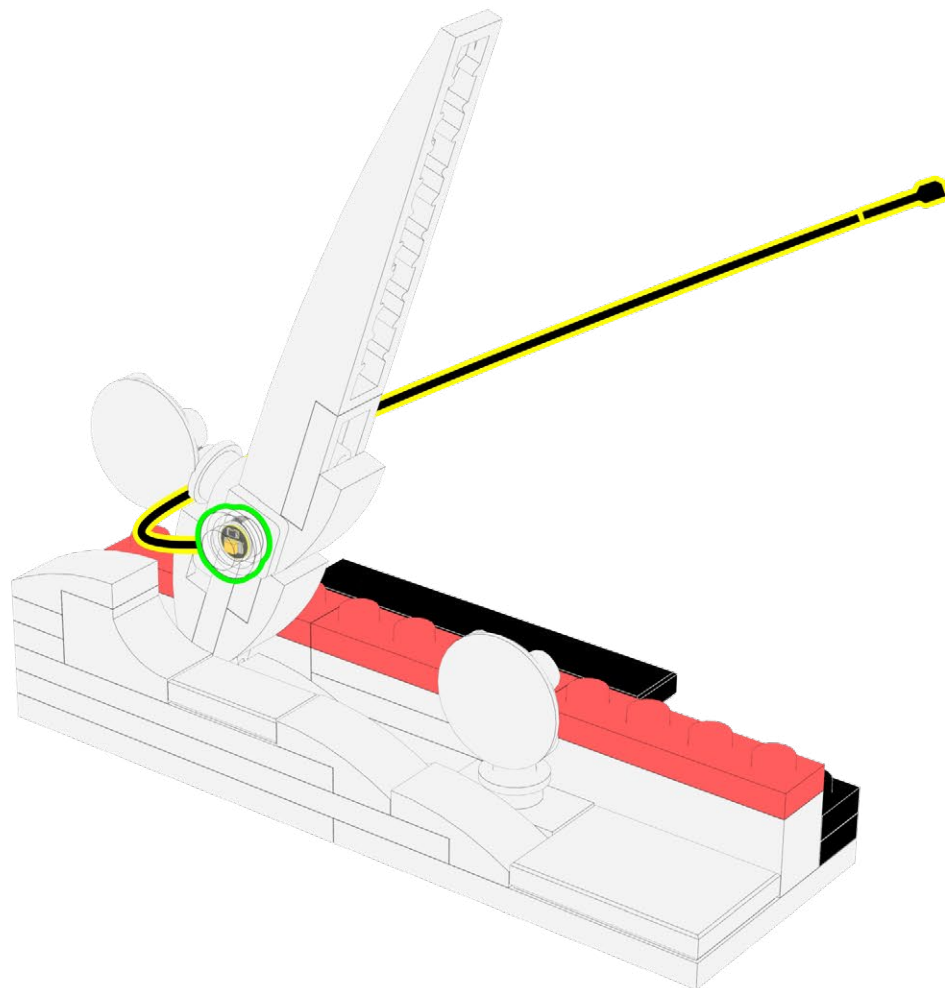

124

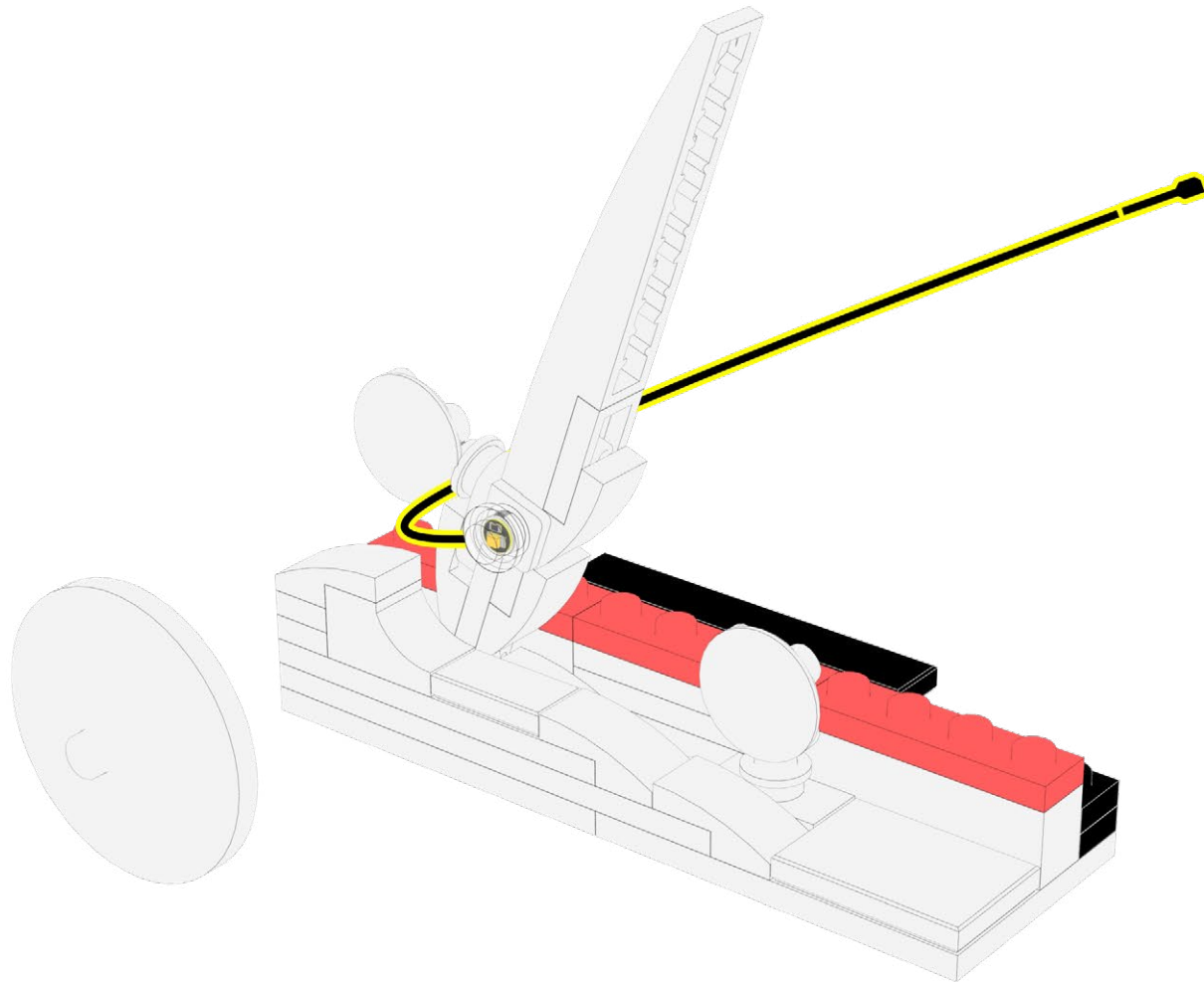

125

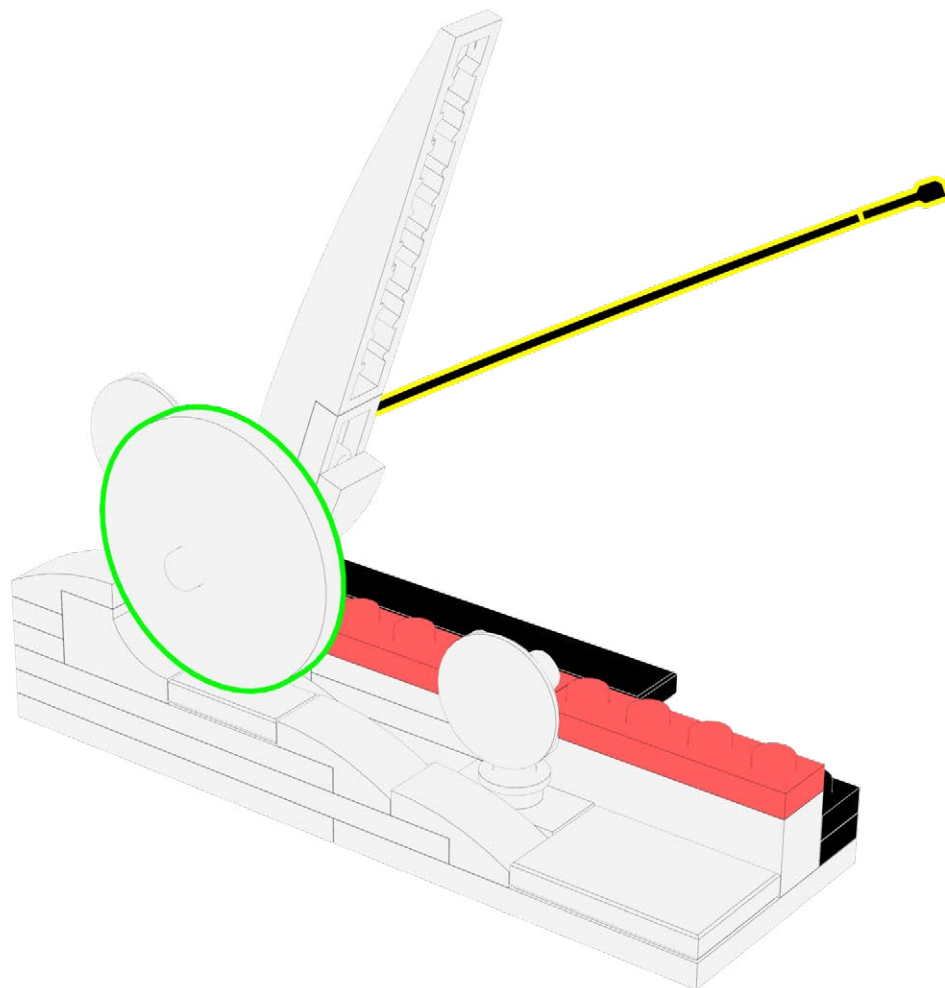

126

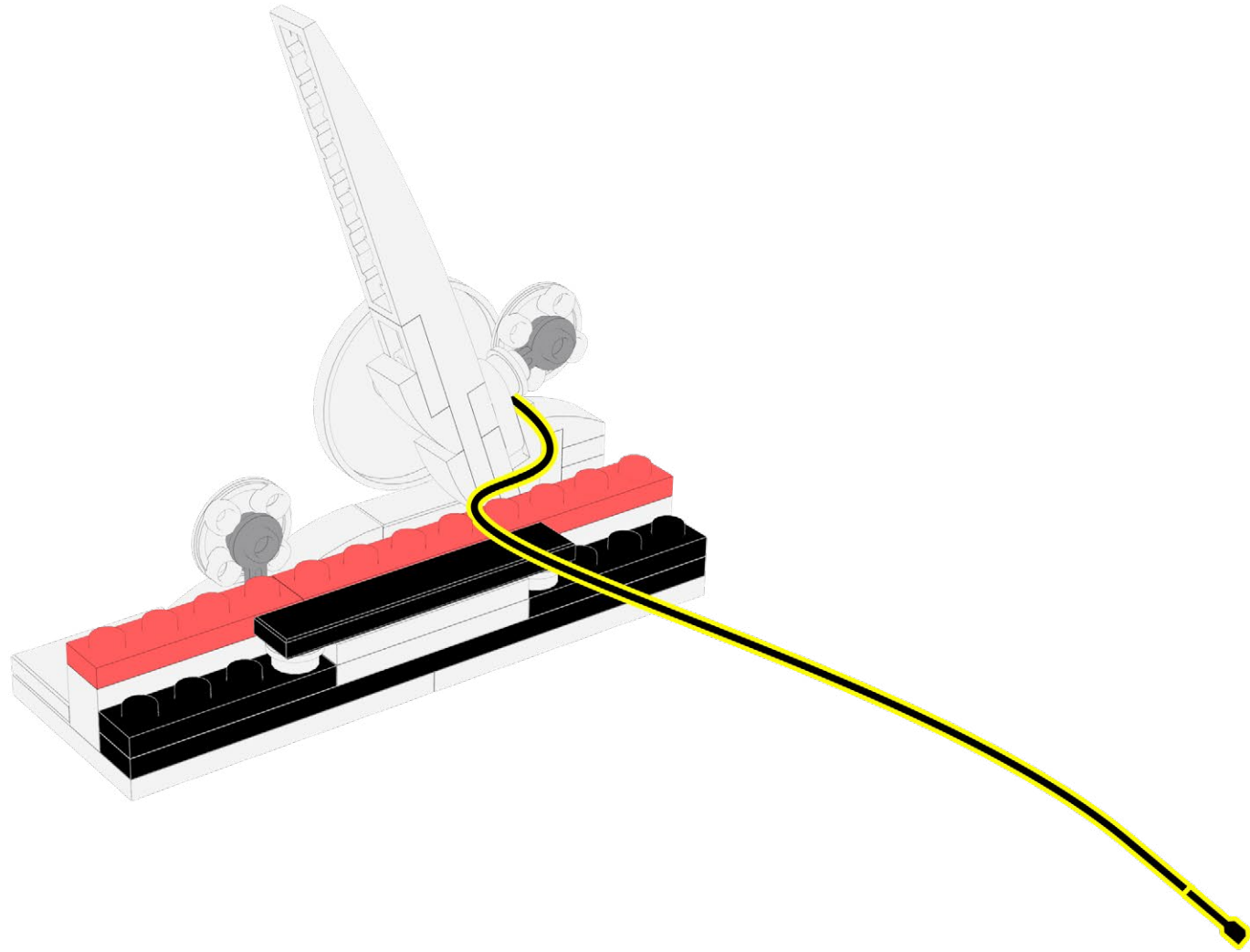

127

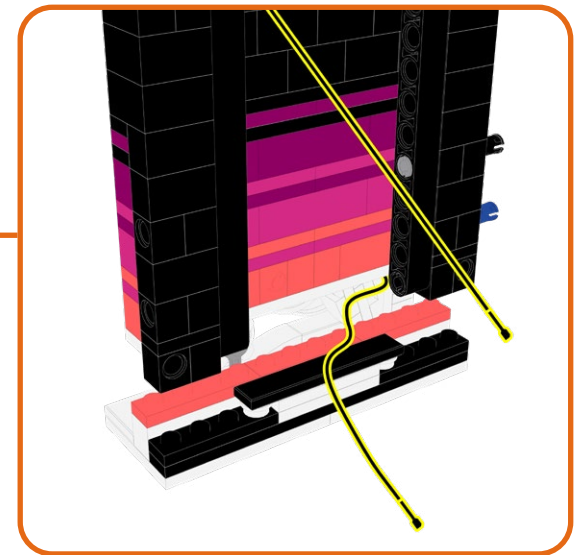
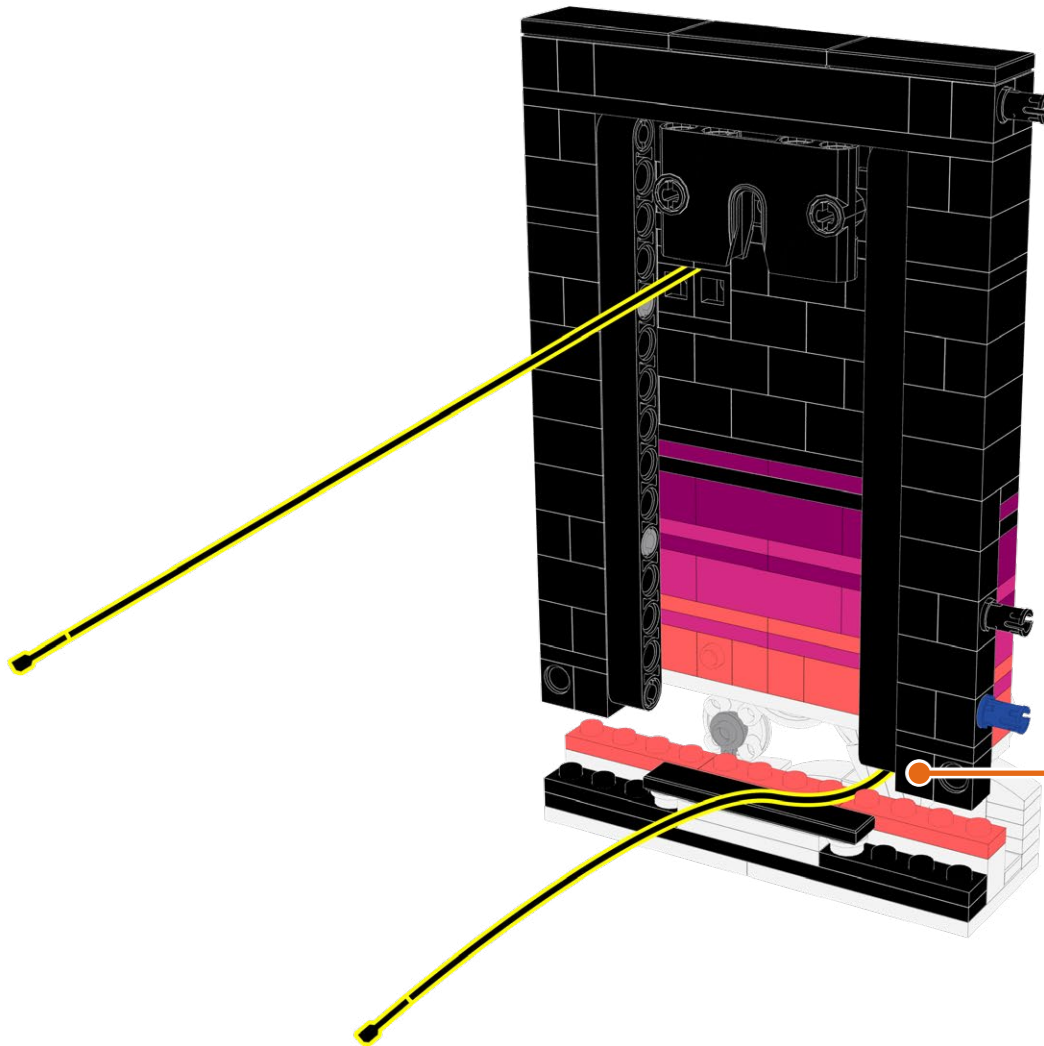

128

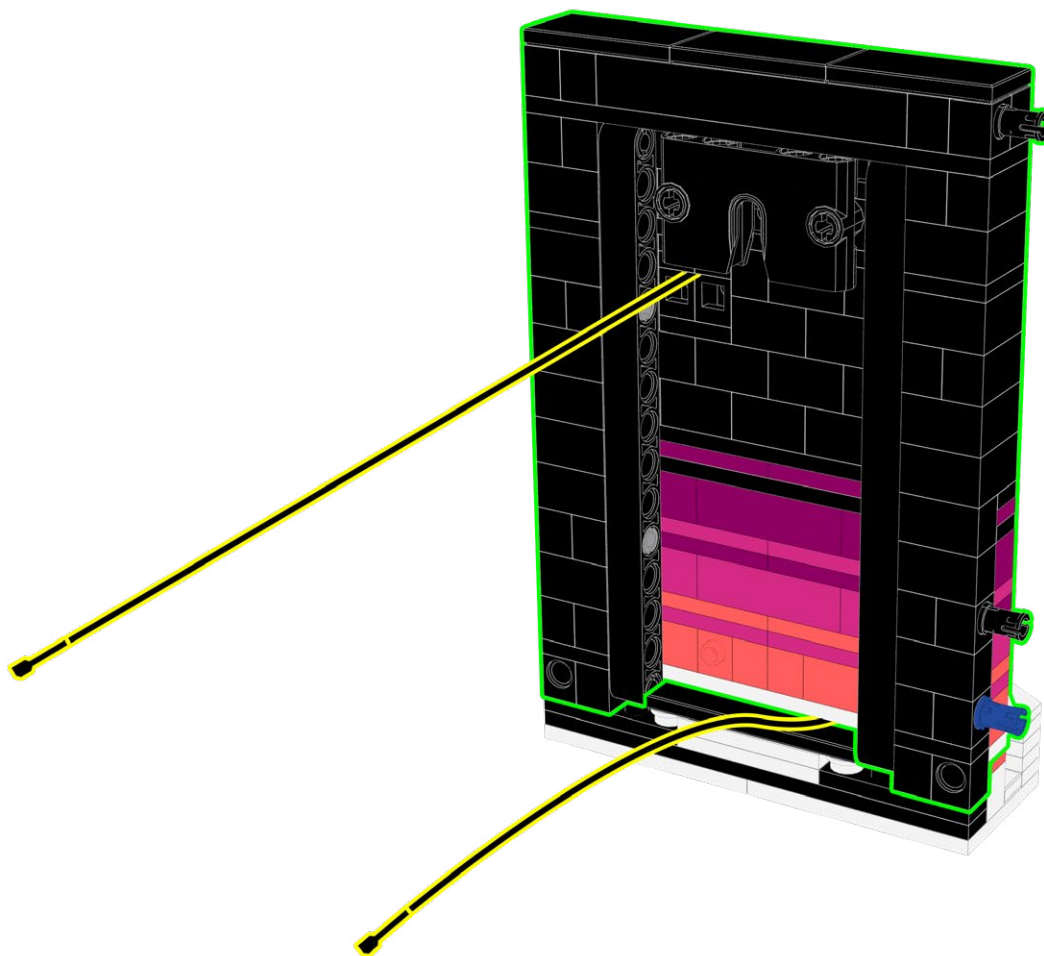

129

2x

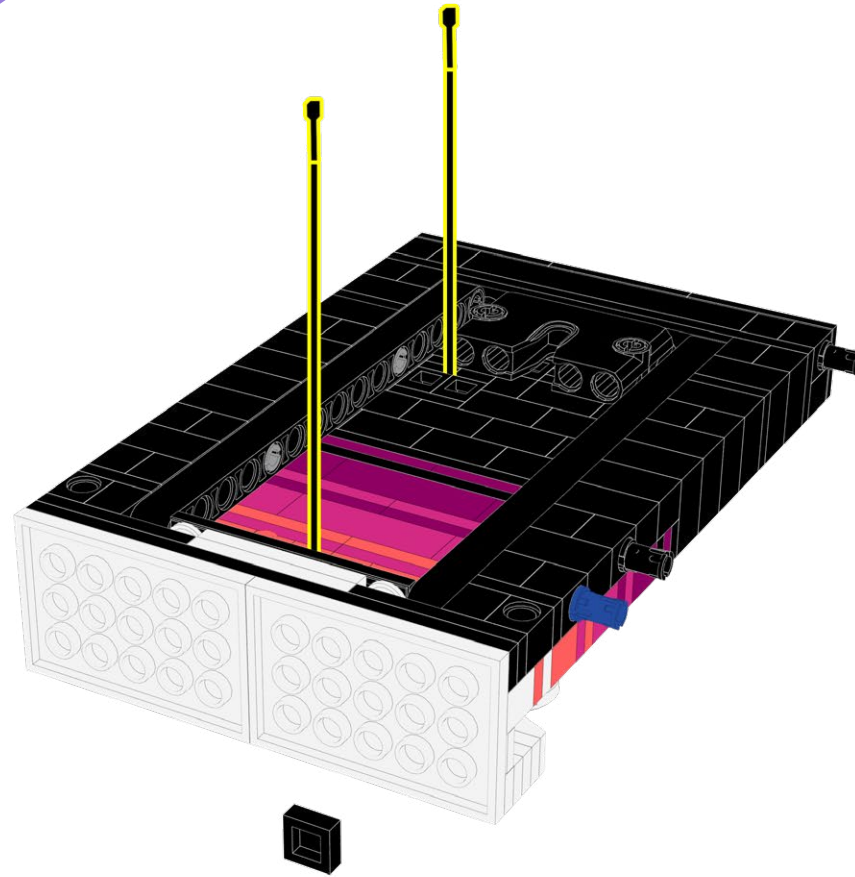

130

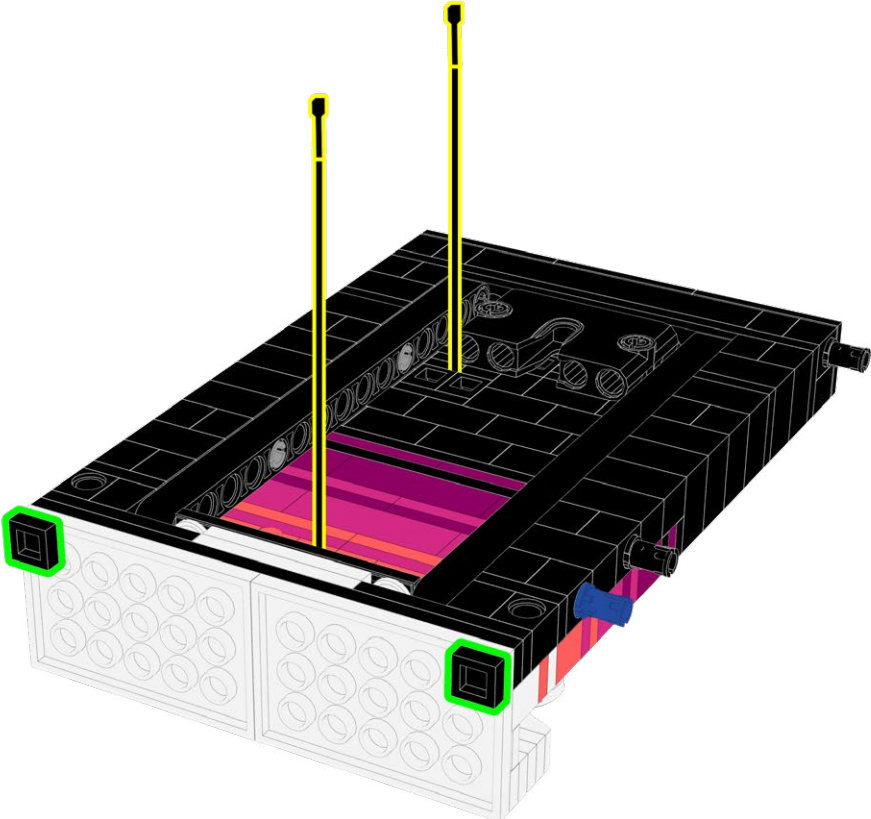

131

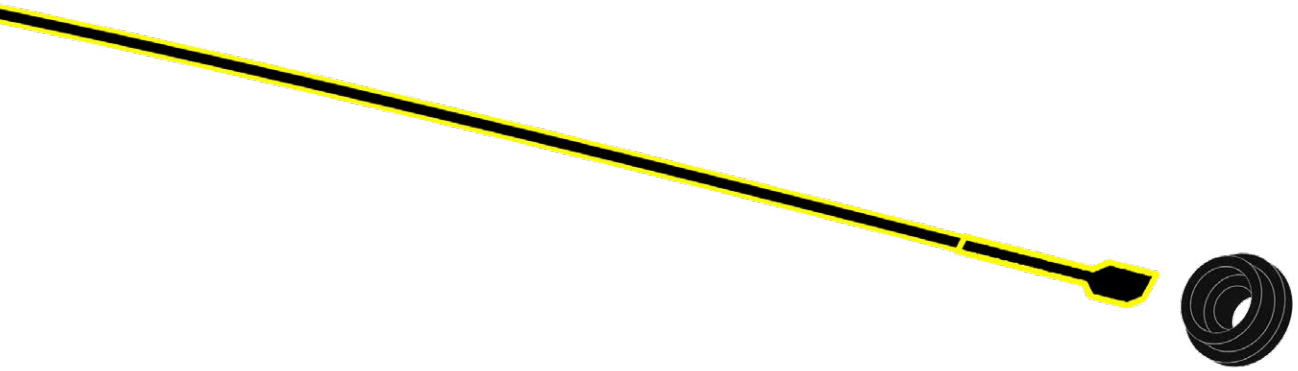
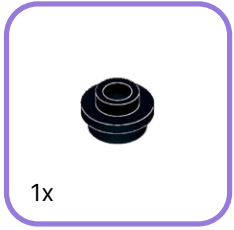
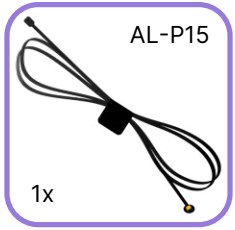

132





134



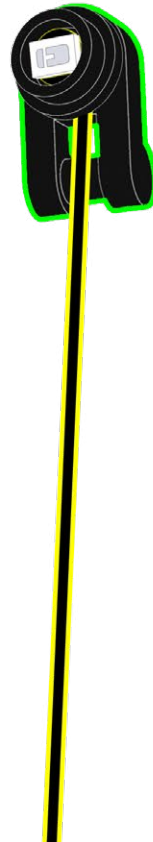

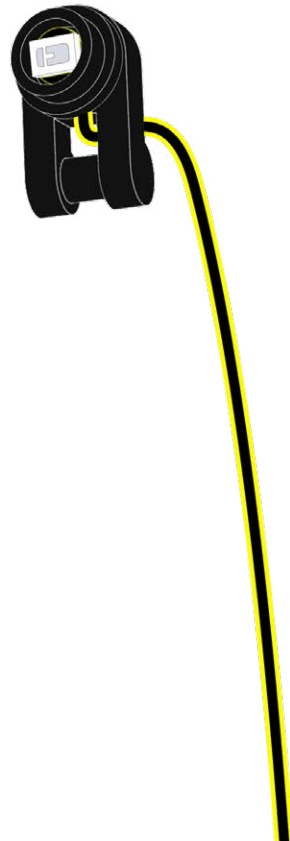



138

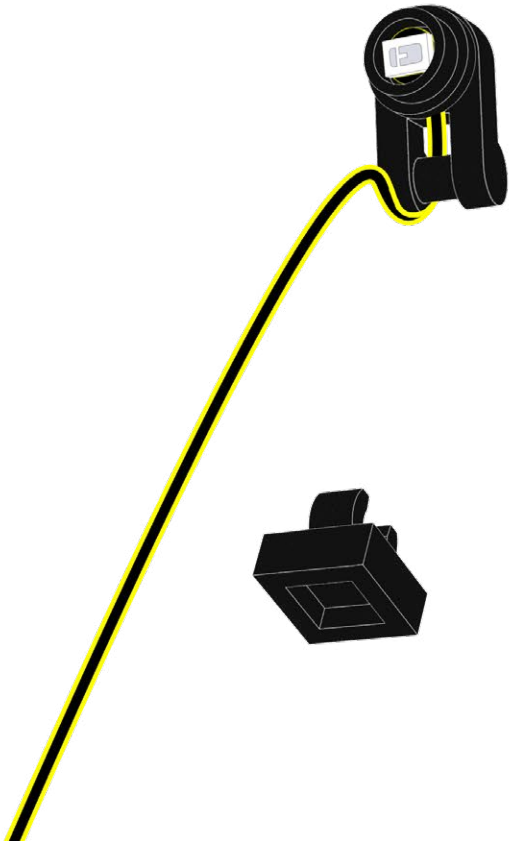
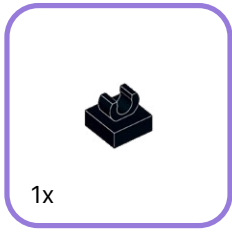

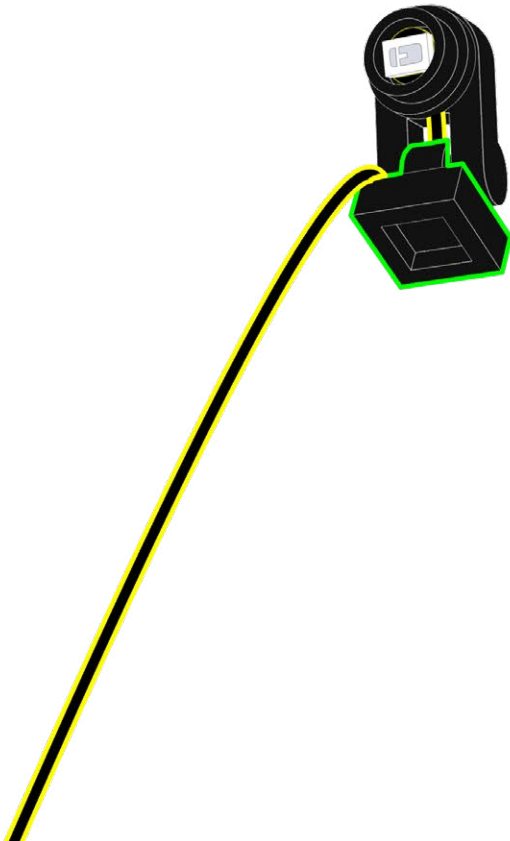

140

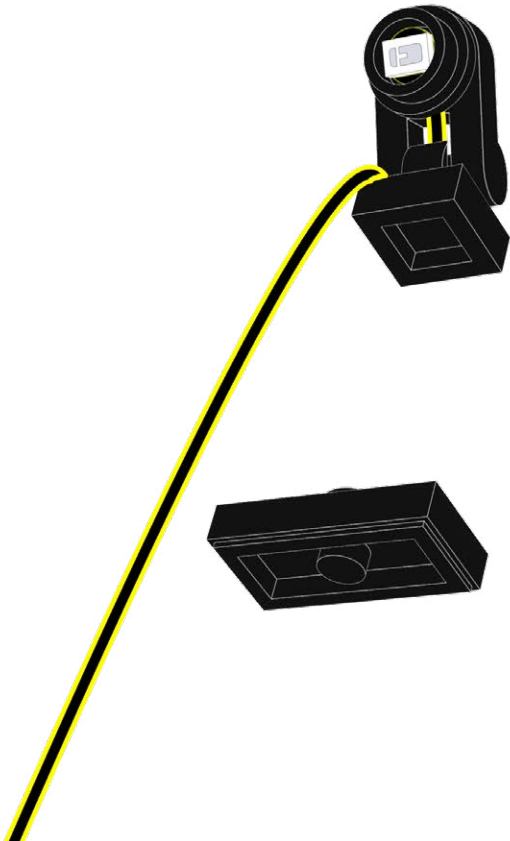
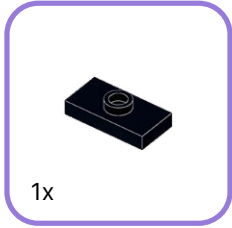

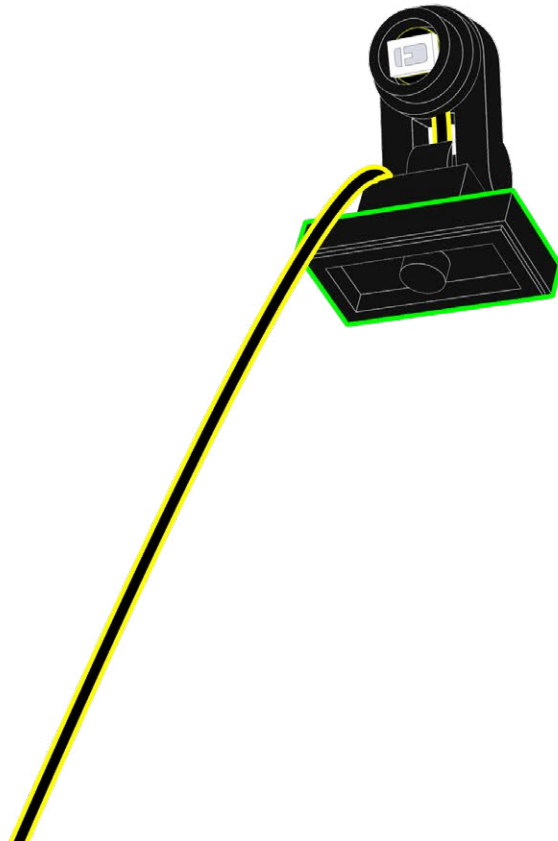

142

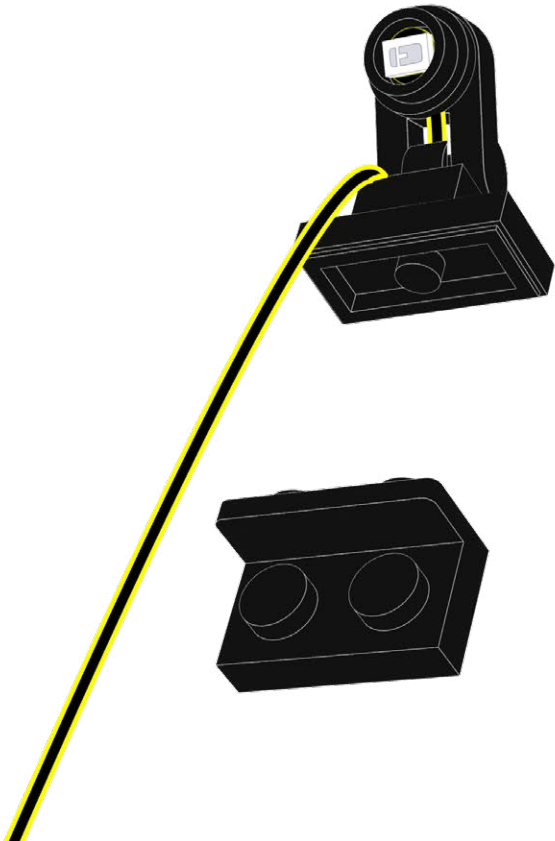
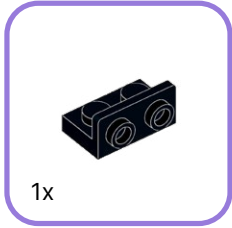

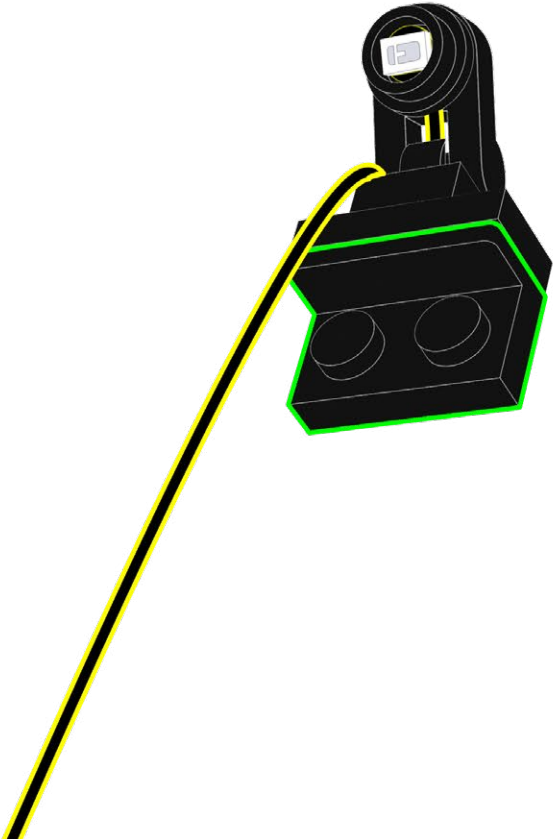

144

Astro Cap Clear



1x

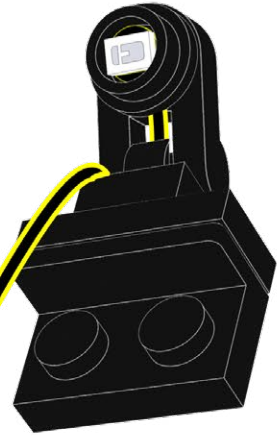
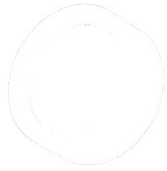

145

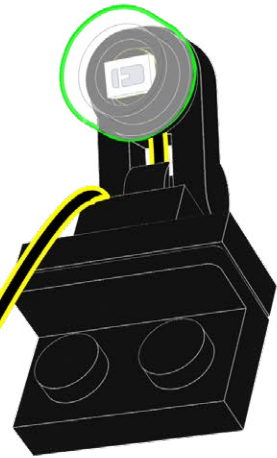

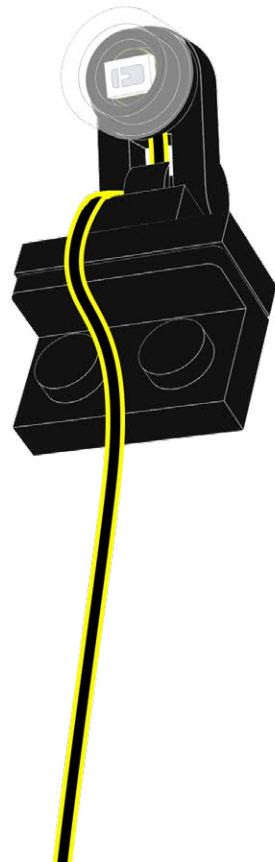

147

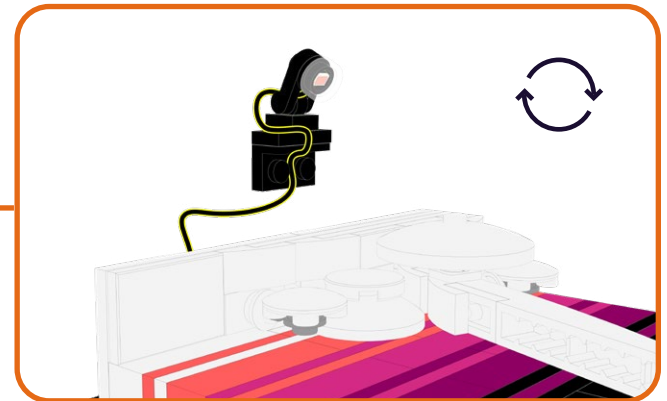
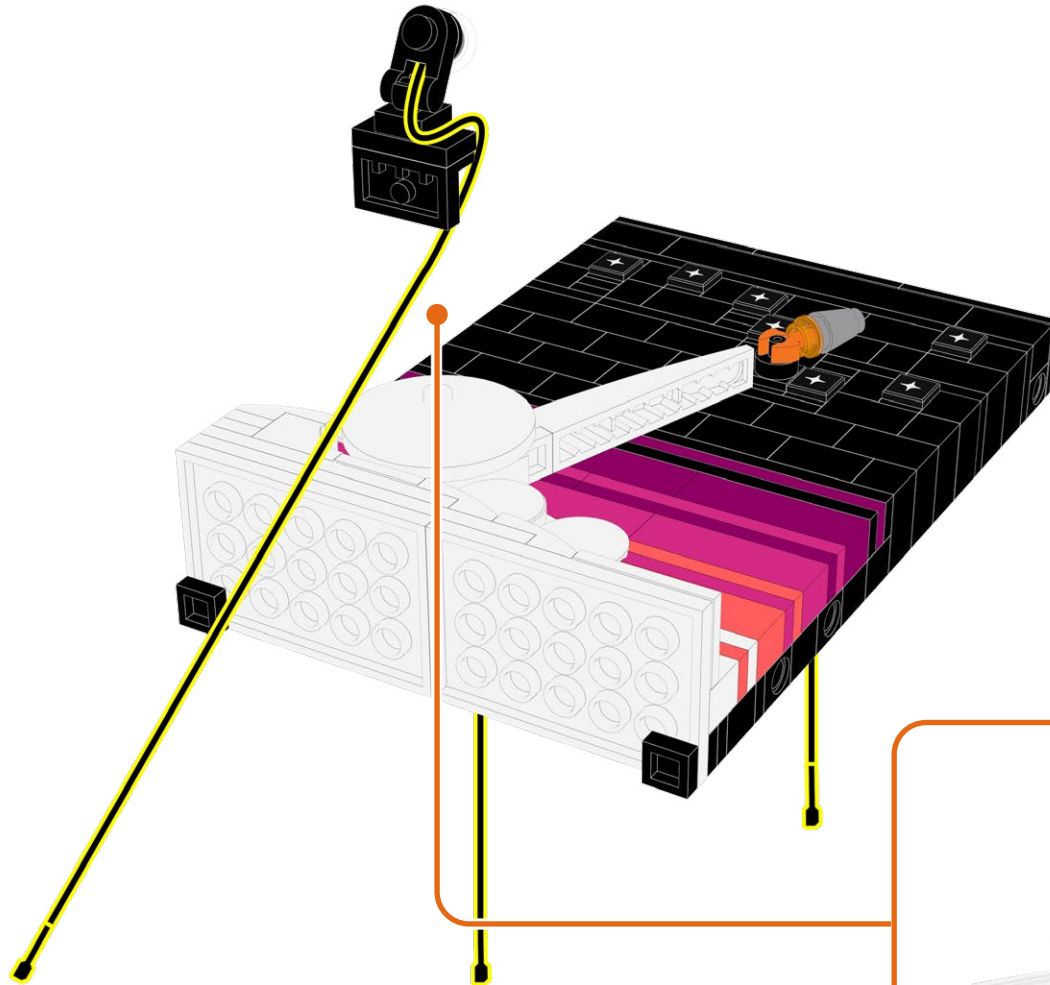

148

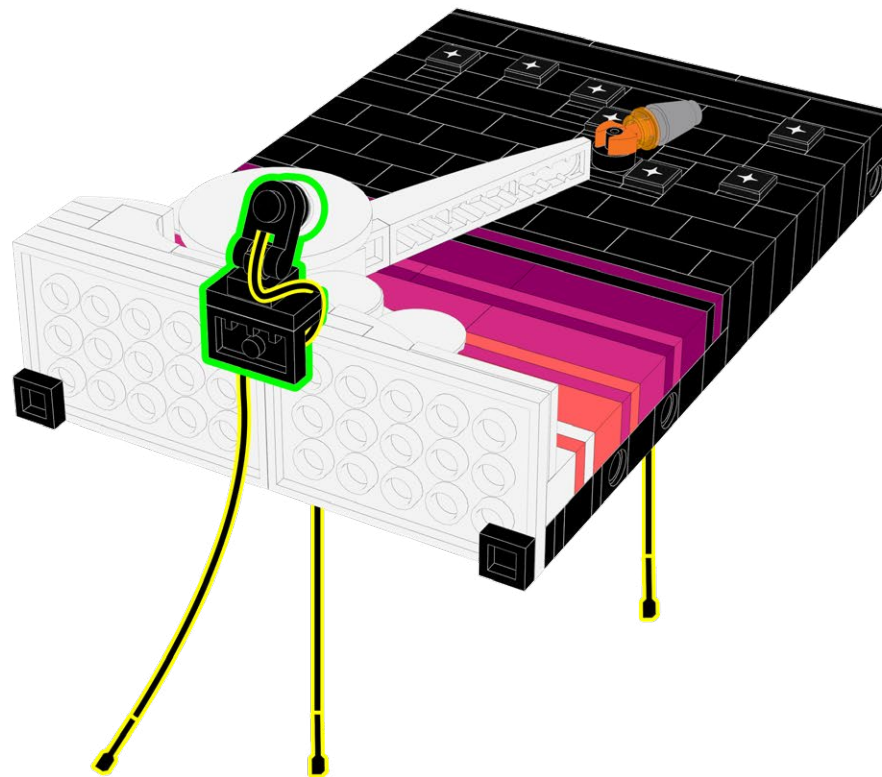

149

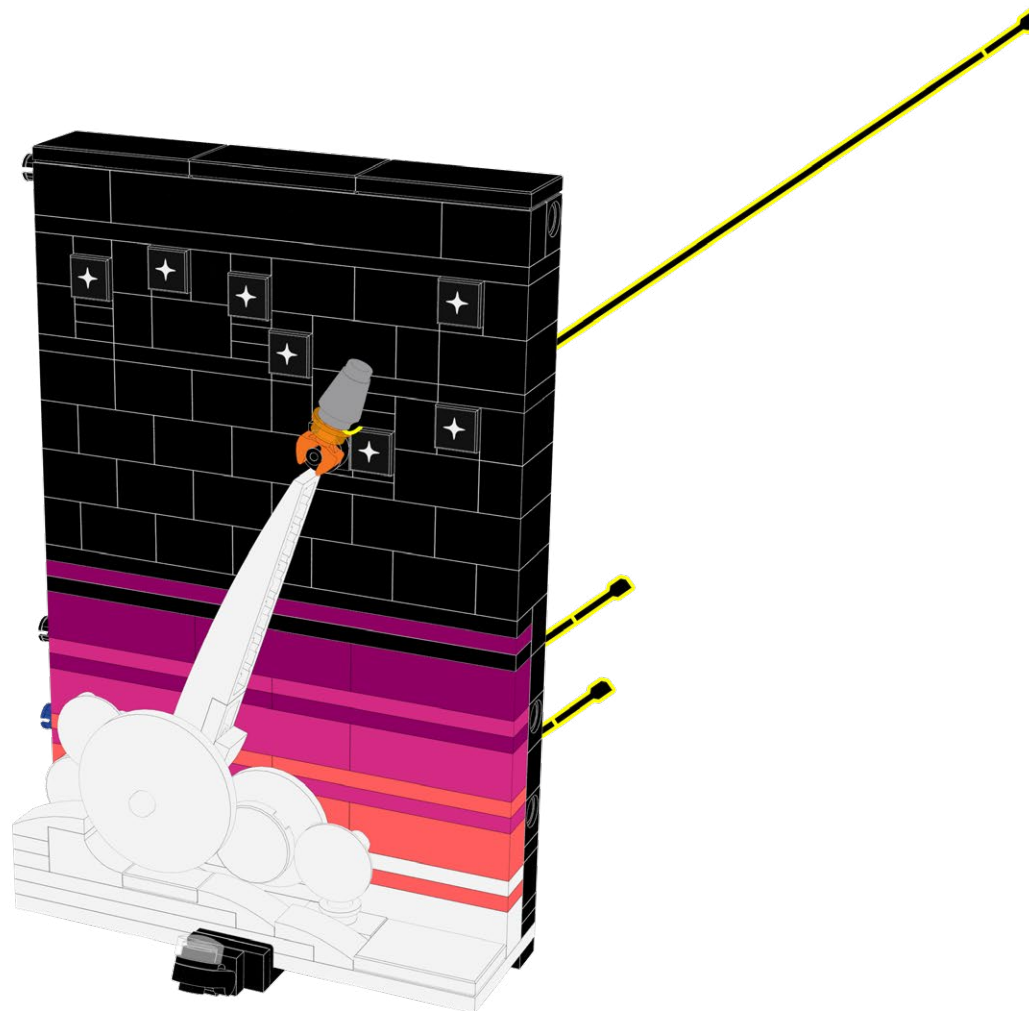

150

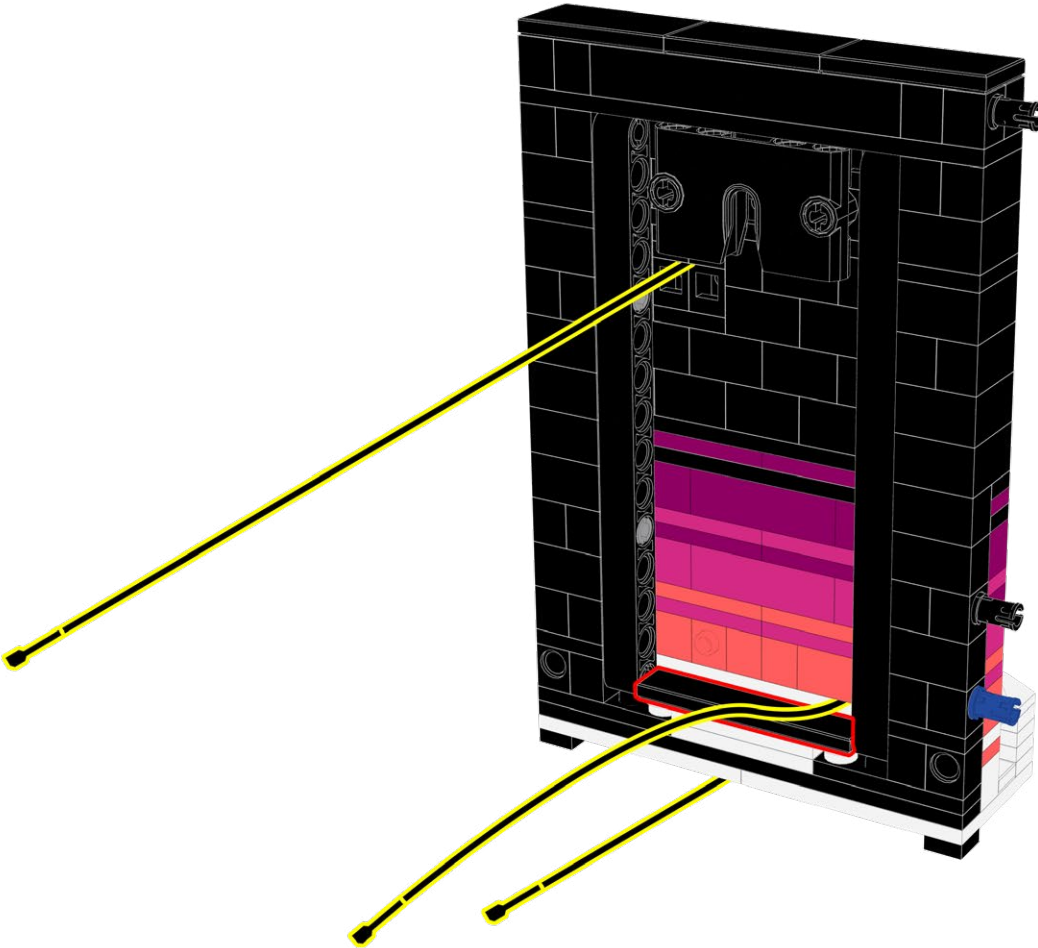

151

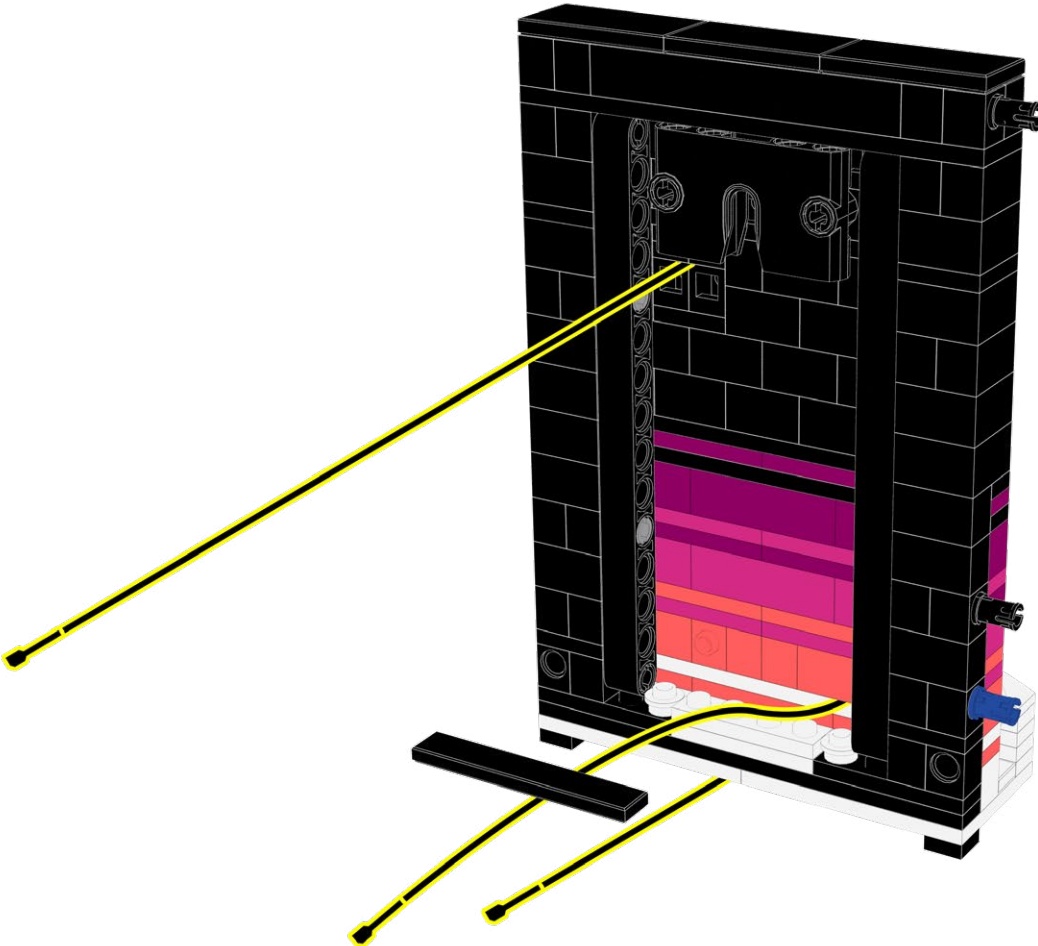

152

D-3

1x

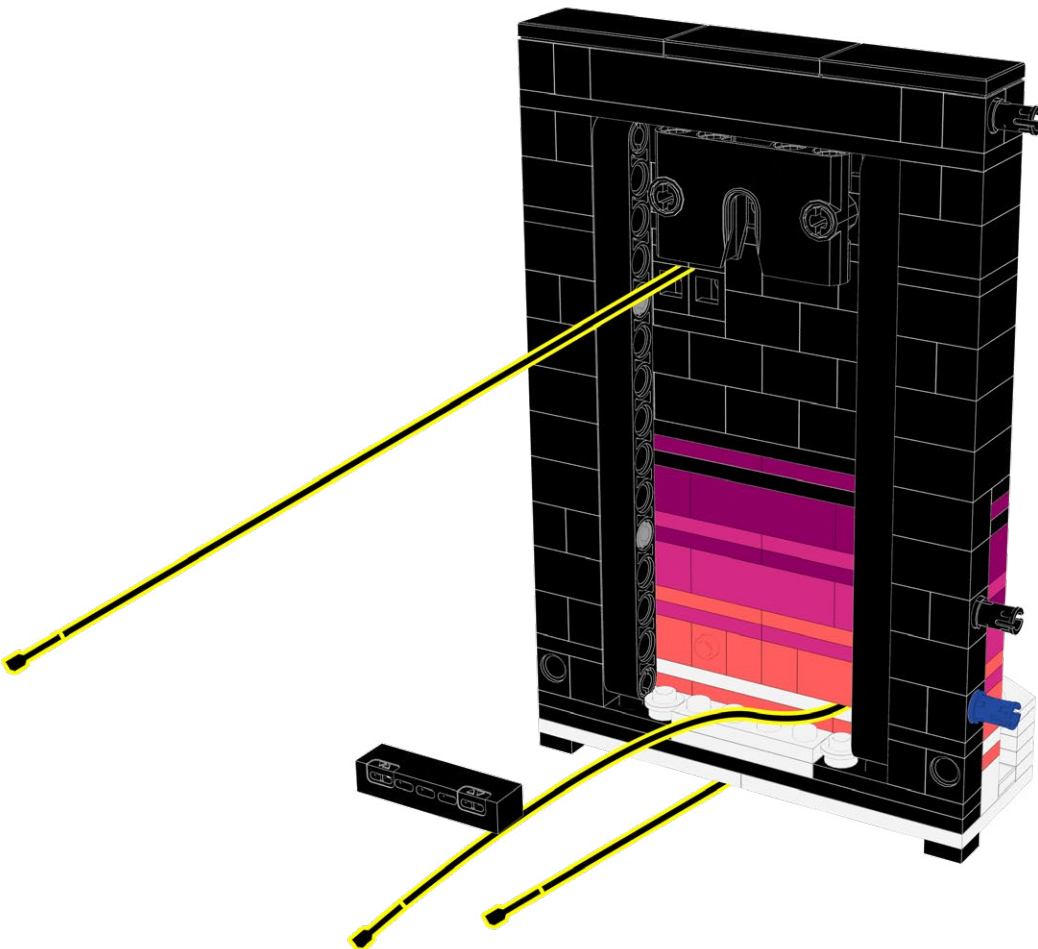

153

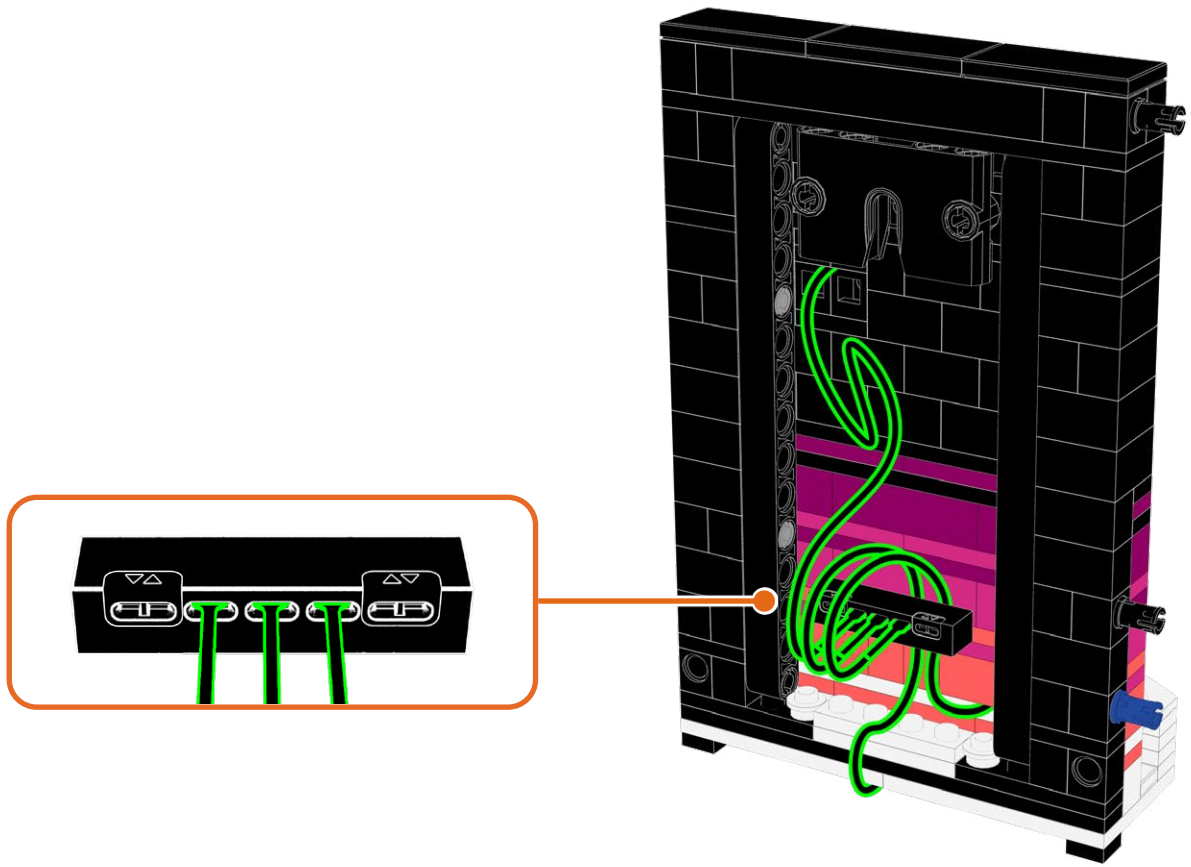

154

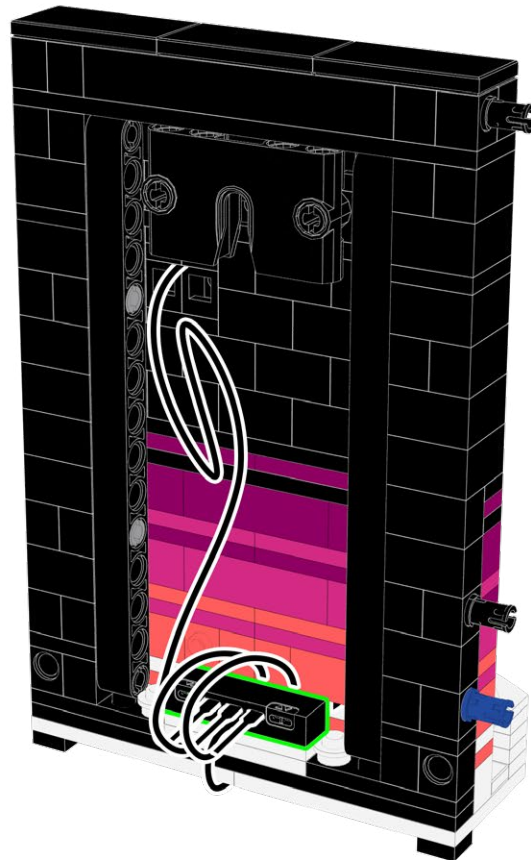

155

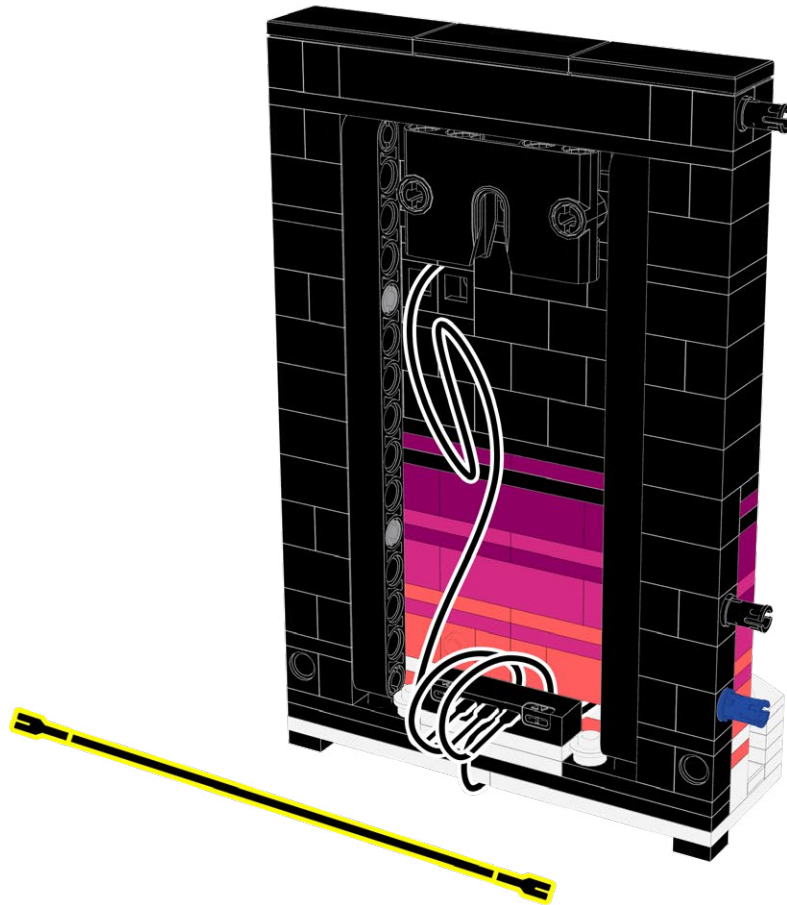
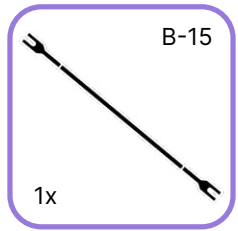

156



157

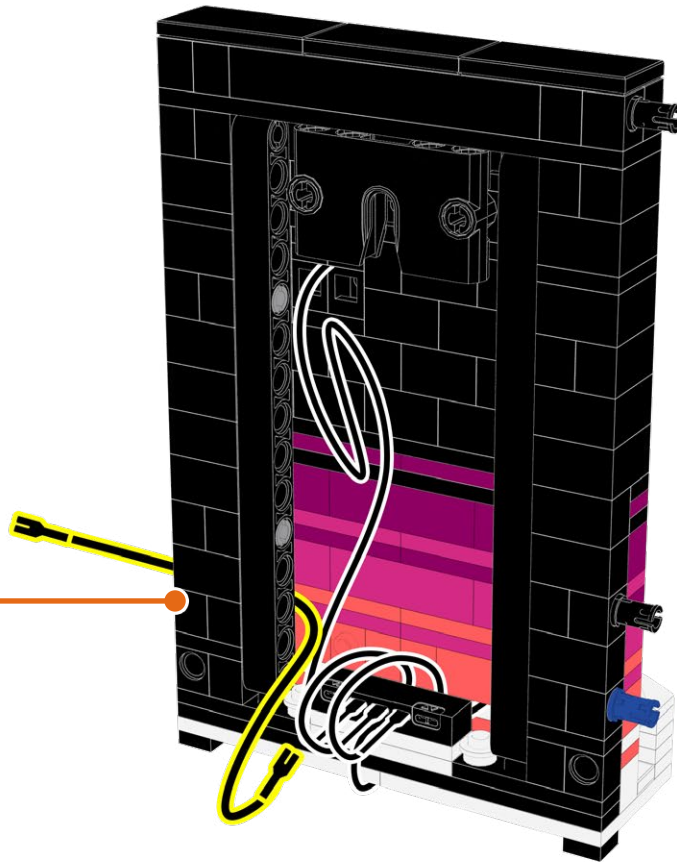
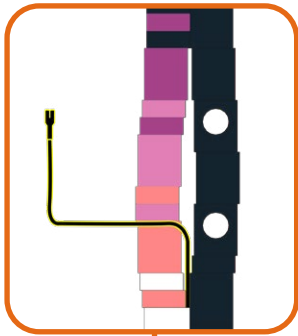

158

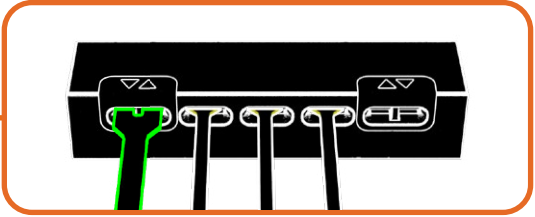
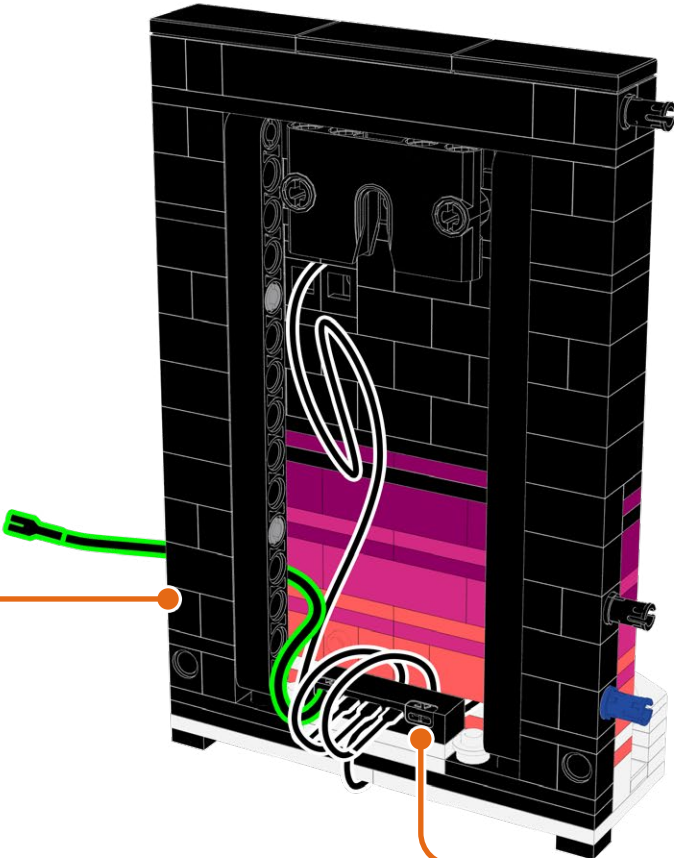
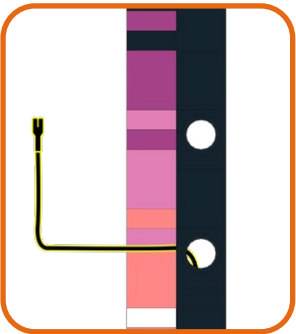
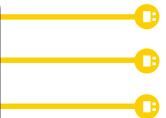

159

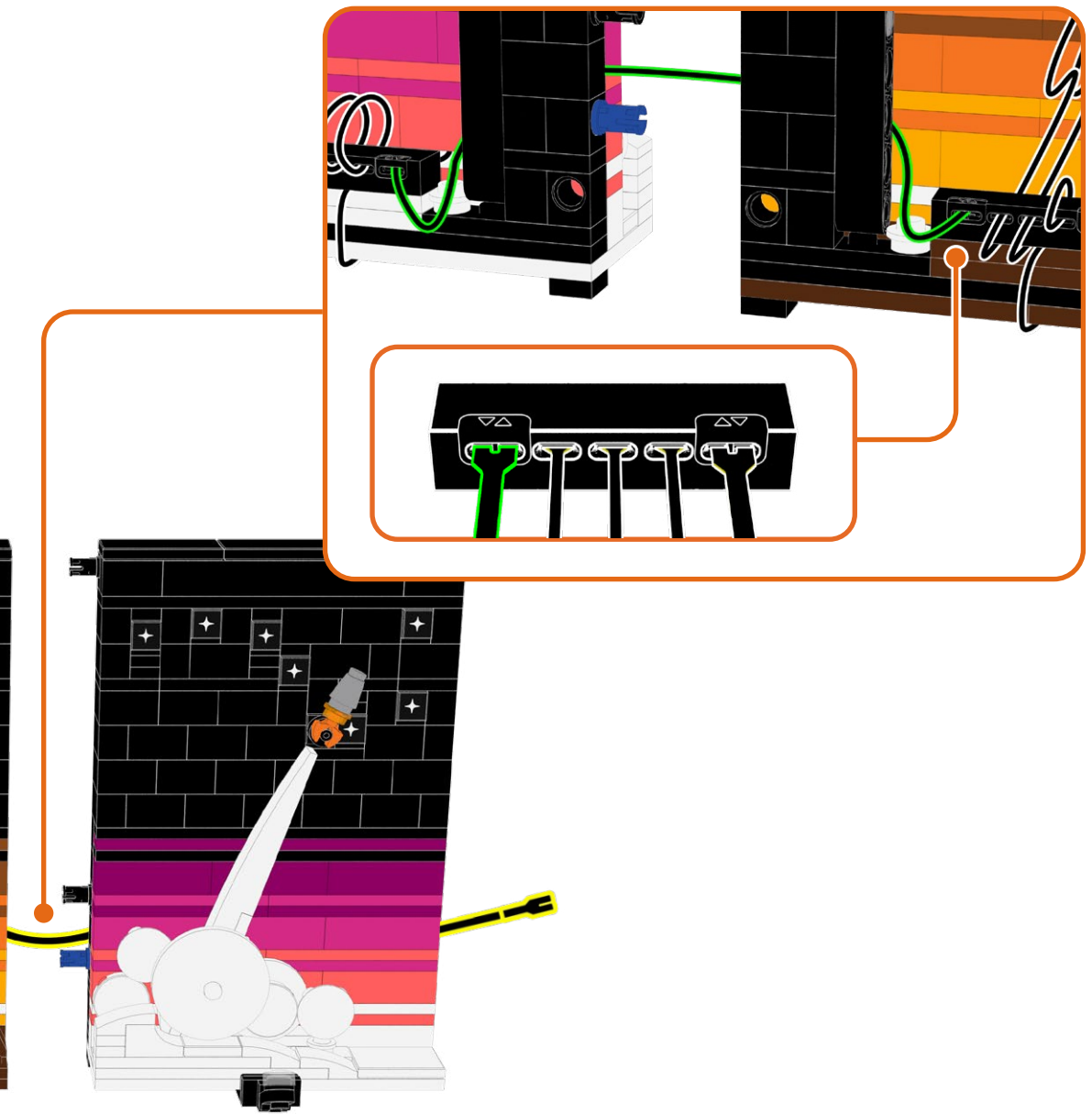

160

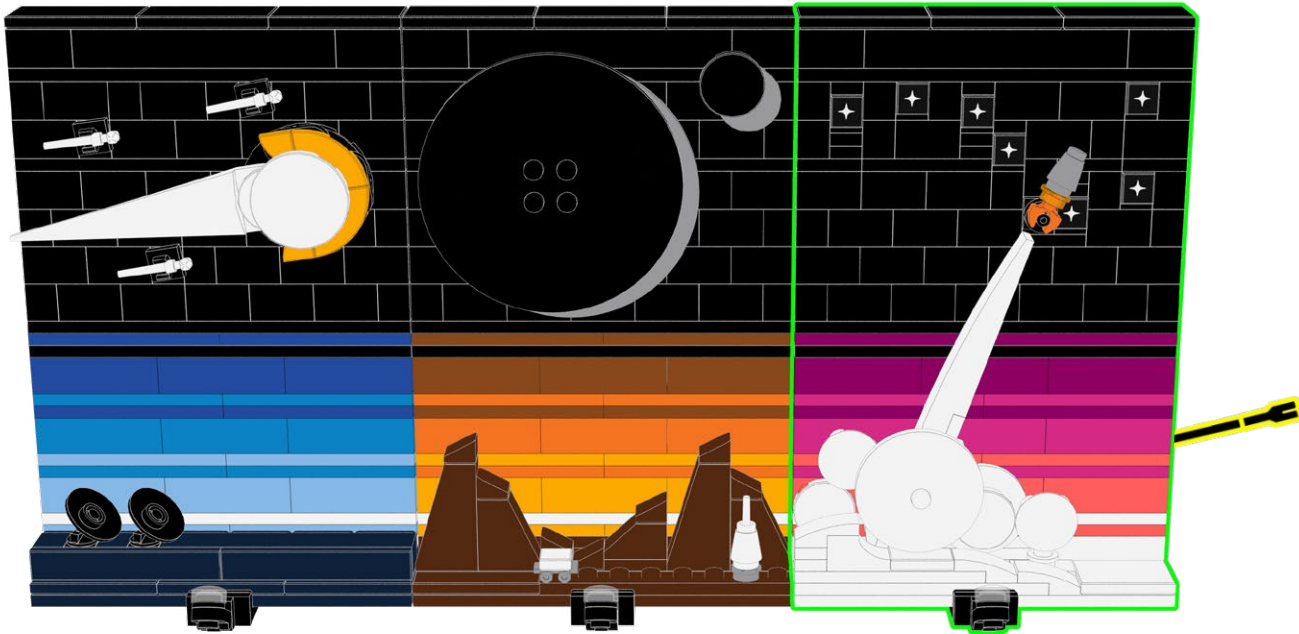

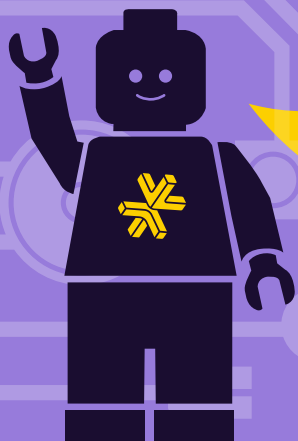

HOLD UP!

You might notice some bags aren't in order, as well as left over pieces, but that's ok! We're changing the way you build LEGO!

ATTENDEZ!

Vous remarquerez peut-être que certains sacs, ainsi que certaines pièces, ne sont pas dans le bon ordre. Mais pas de panique! Nous changeons simplement la façon avec laquelle vous construisez vos LEGO!

ASPETTA!

Potresti notare che alcuni sacchetti non sono in ordine, così come i pezzi avanzati, ma va bene così! Stiamo cambiando il modo in cui costruisci i LEGO!

HALT!

Sie werden möglicherweise bemerken, dass einige tüten durcheinander sind und teile übrig bleiben, aber das ist in Ordnung! Wir ändern die art und weise, wie Sie LEGO bauen!

¡ESPERA!

Es posible que notes que algunas bolsas están fuera de servicio, así como piezas sobrantes, ¡pero está bien! ¡Estamos cambiando la forma en que construyes LEGO!

暫停!

你可能会注意到一些袋子顺序错乱, 以及一些剩余的部件, 但没关系! 我们正在改变你搭建乐高的方式!

Open LMB Bag 04

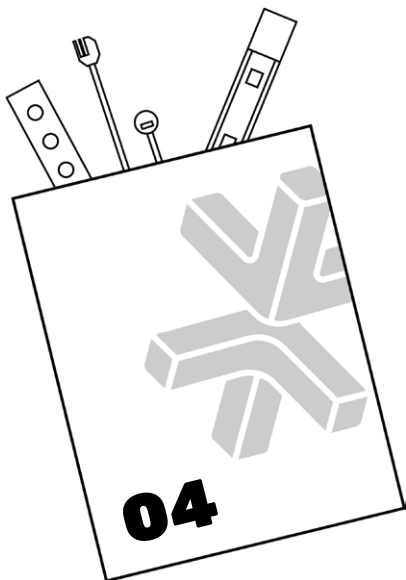

161

1

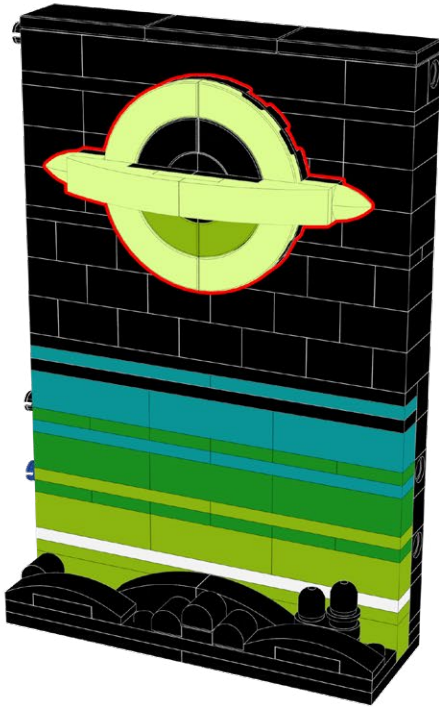

2

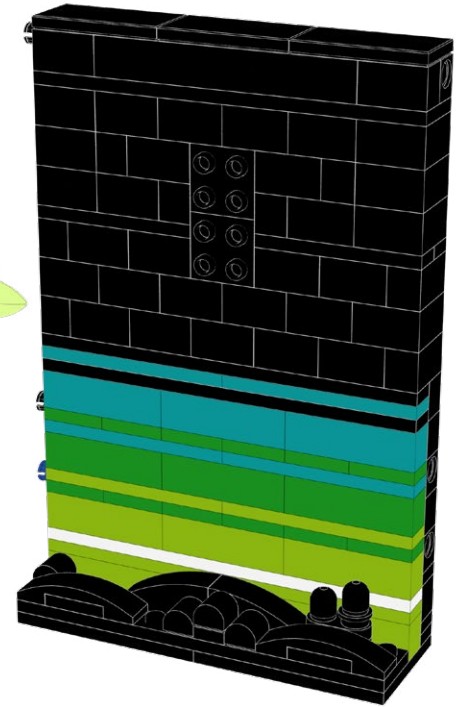
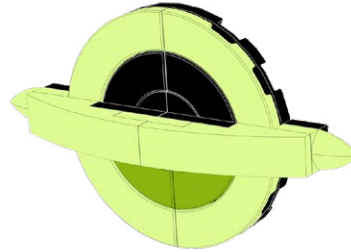

162

1

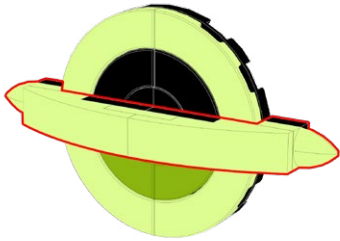

2

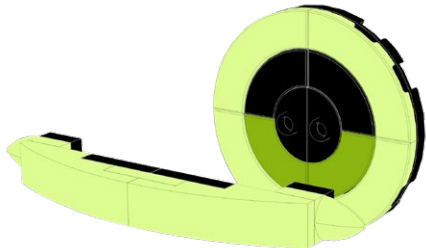

3

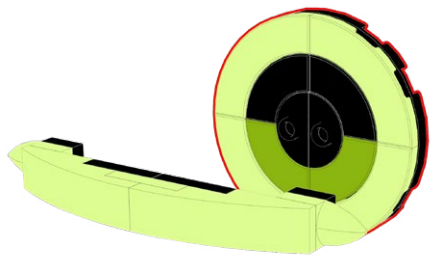

4



5

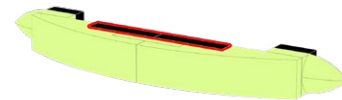

6

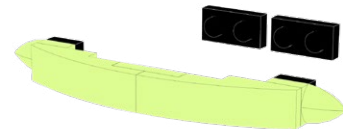

163

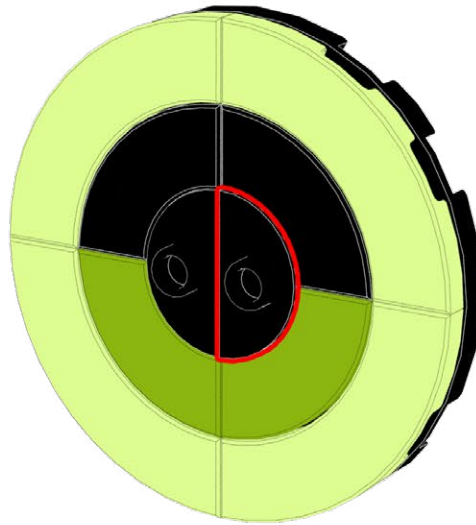

164

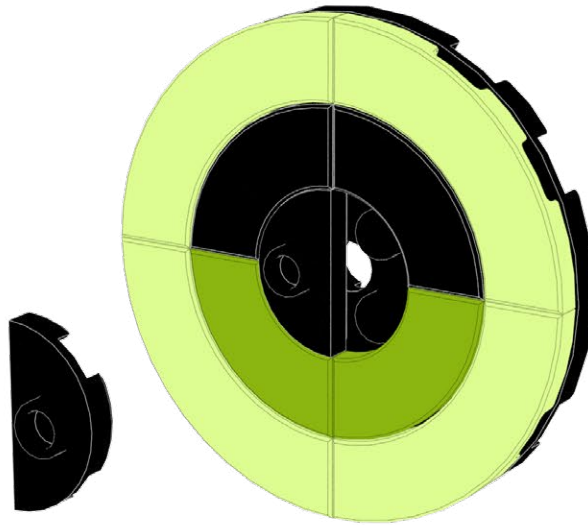

165

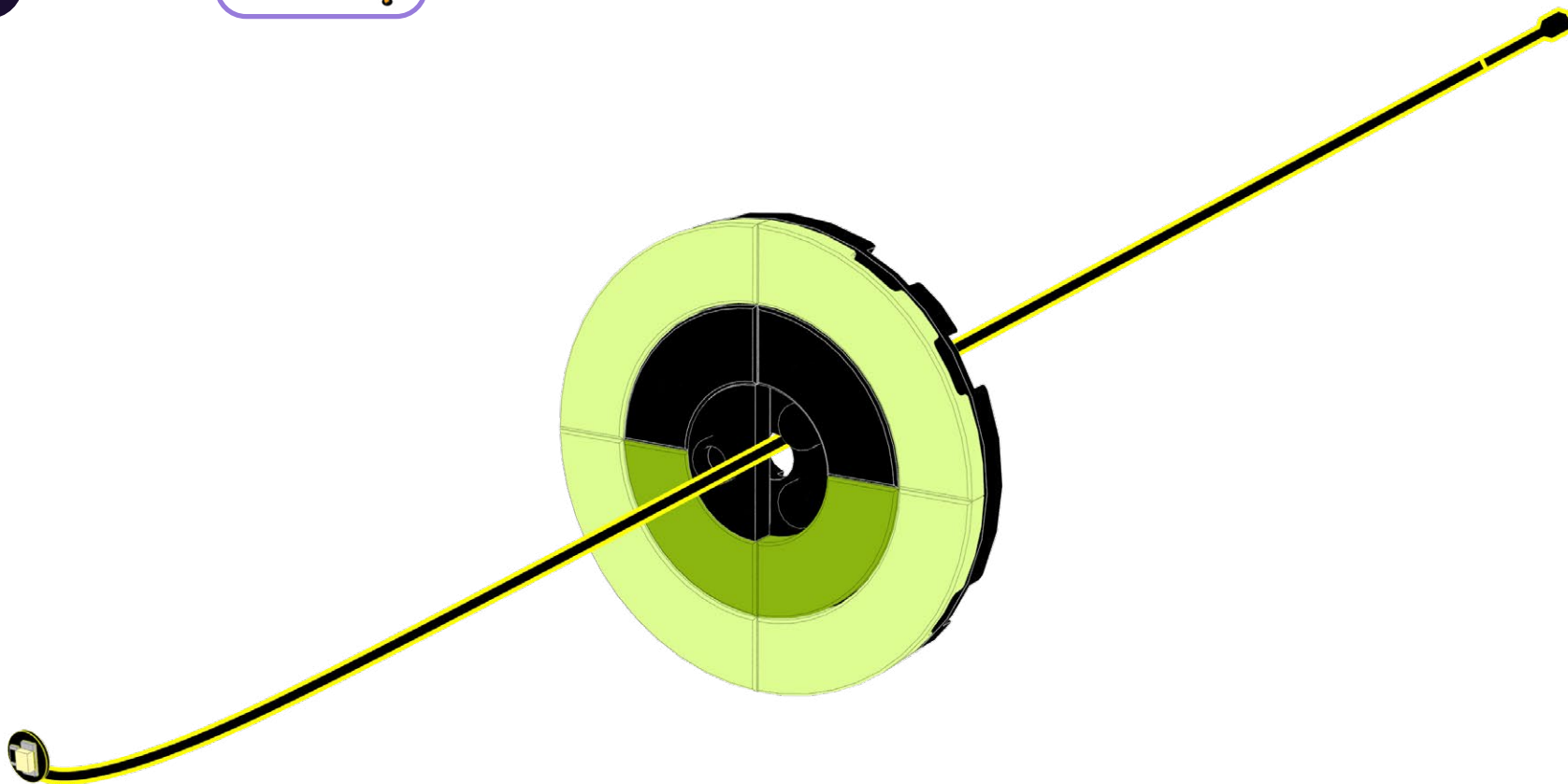
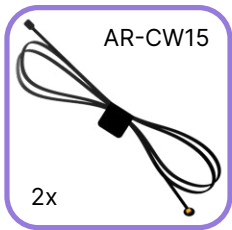

166

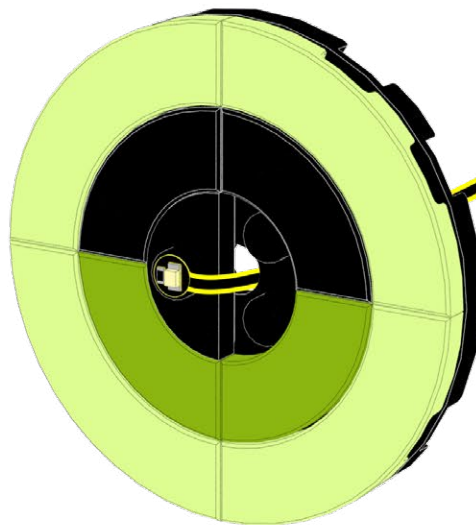

167

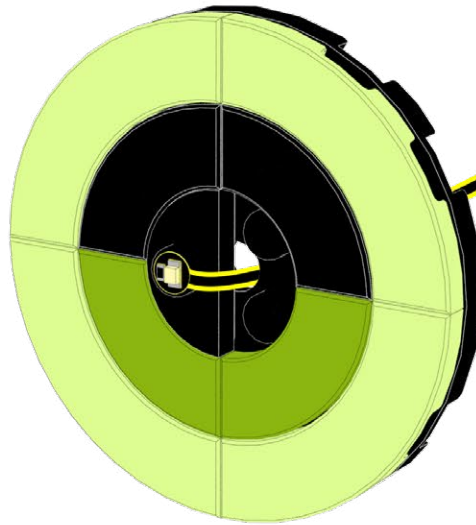
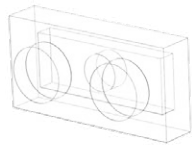
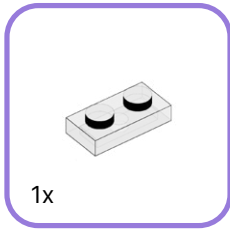

168

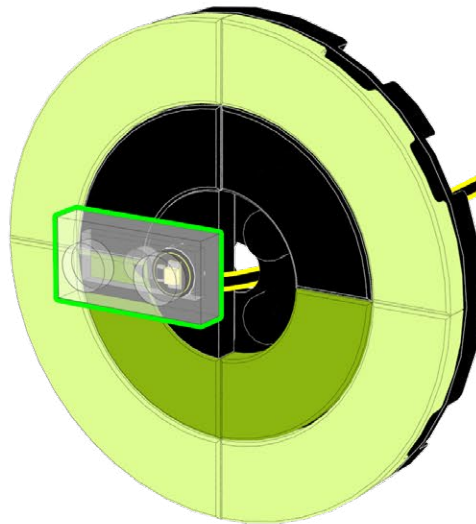

169

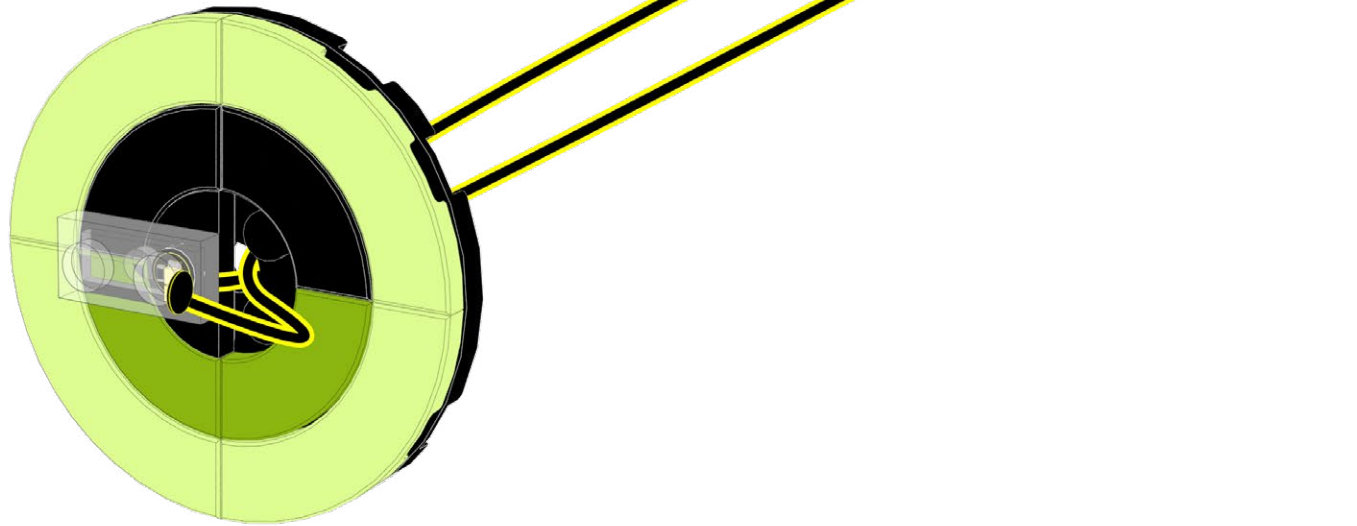

170

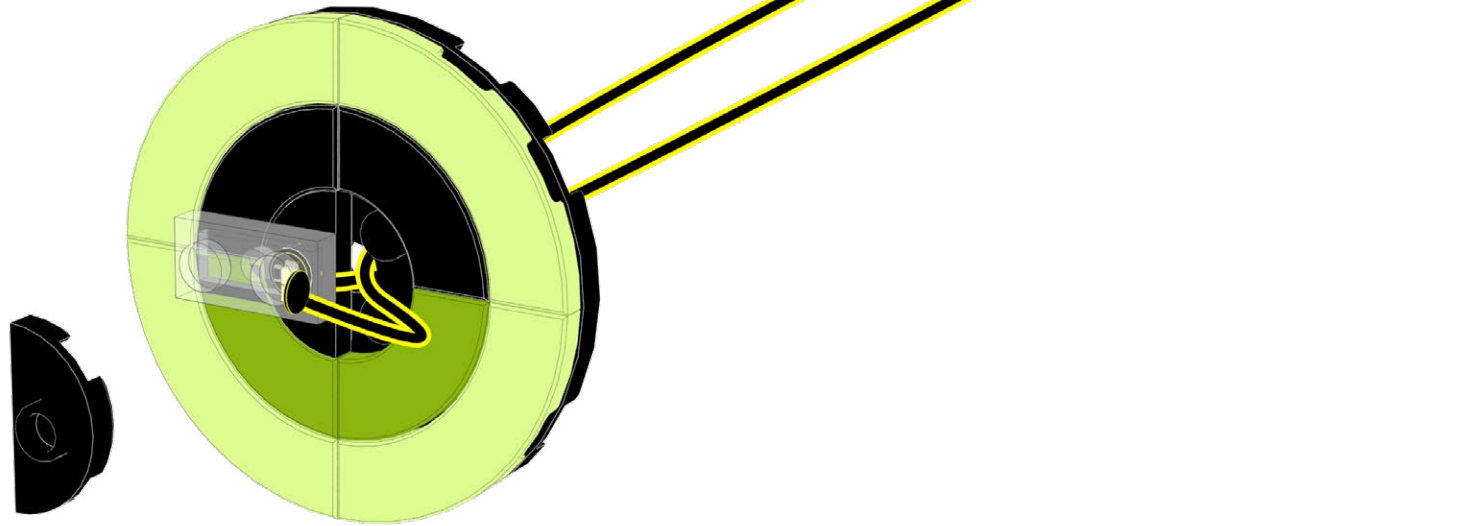

171

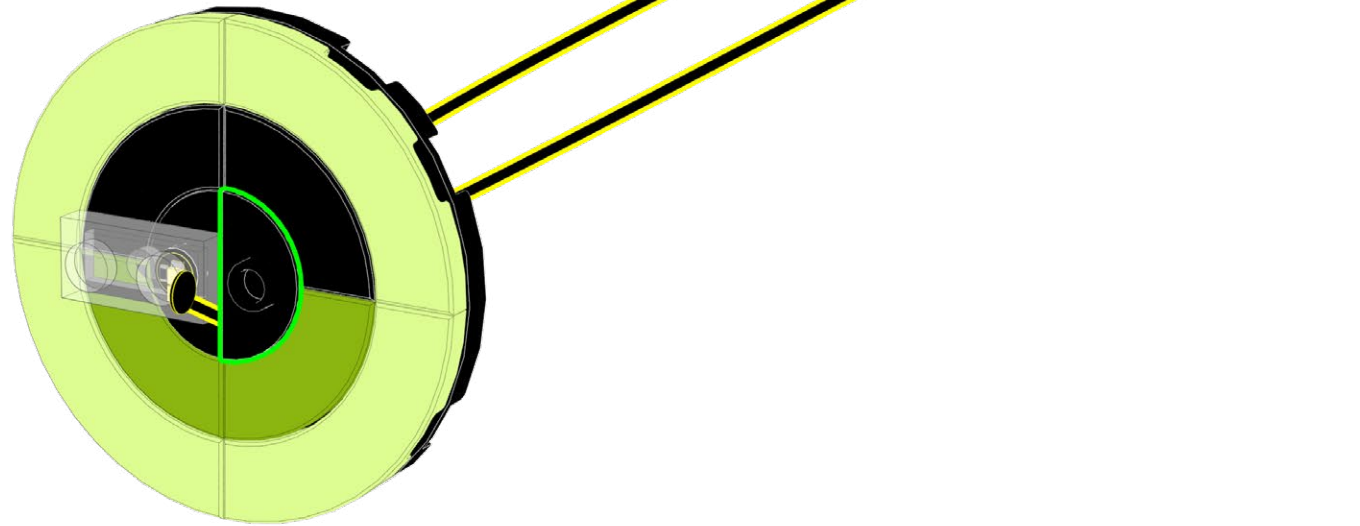

172

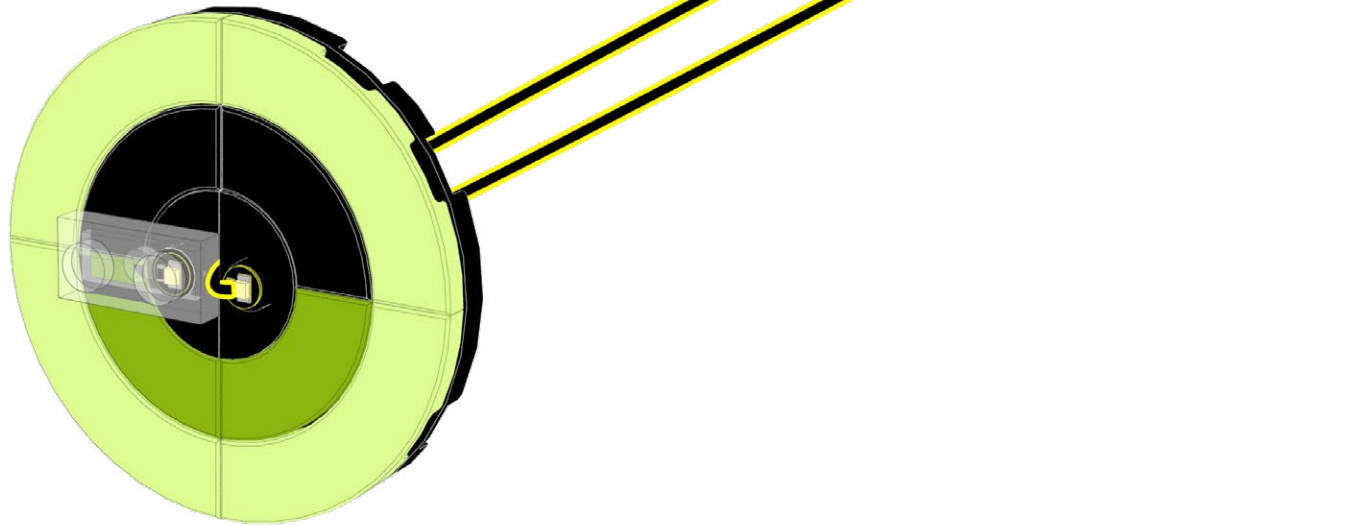

173

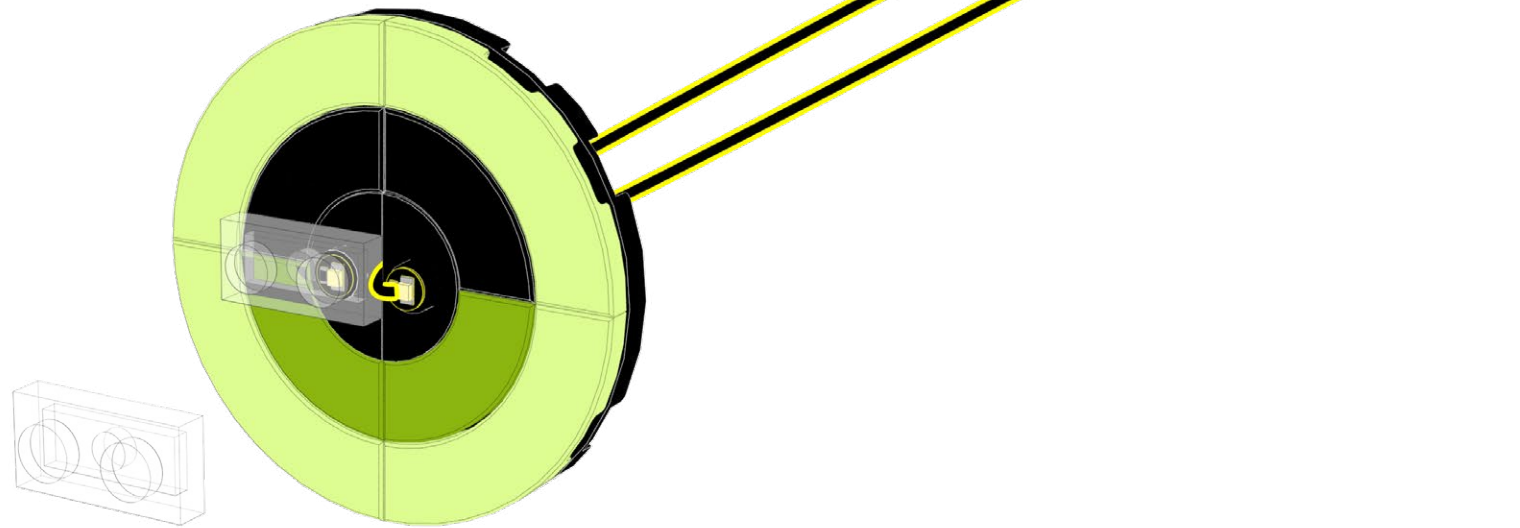
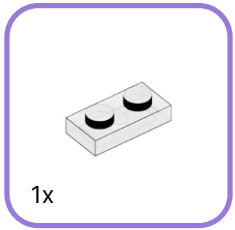

174

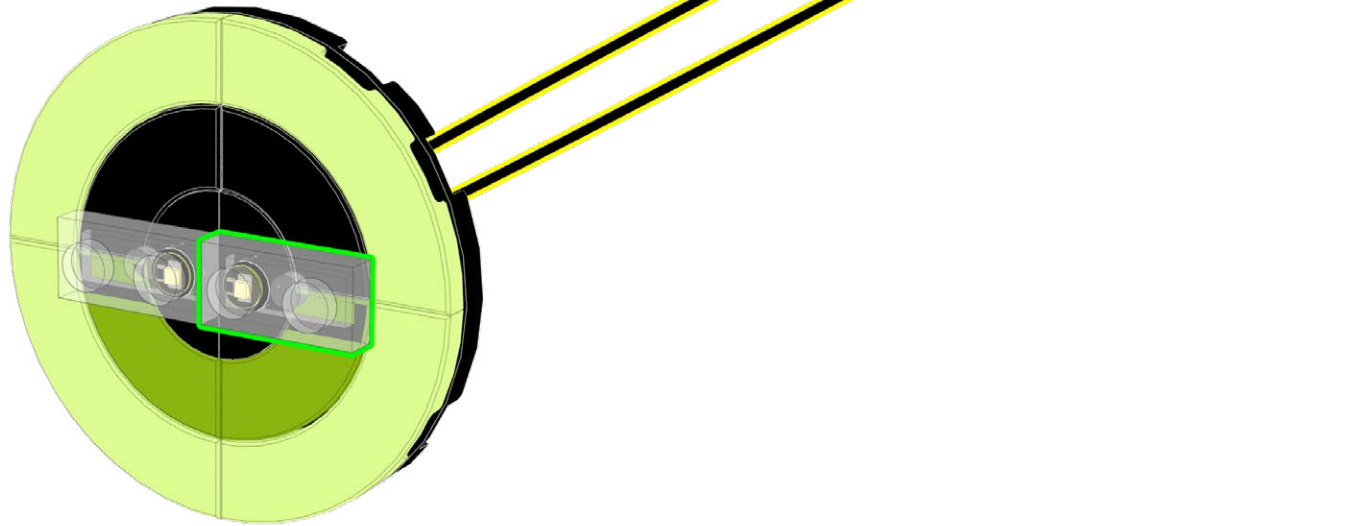

175

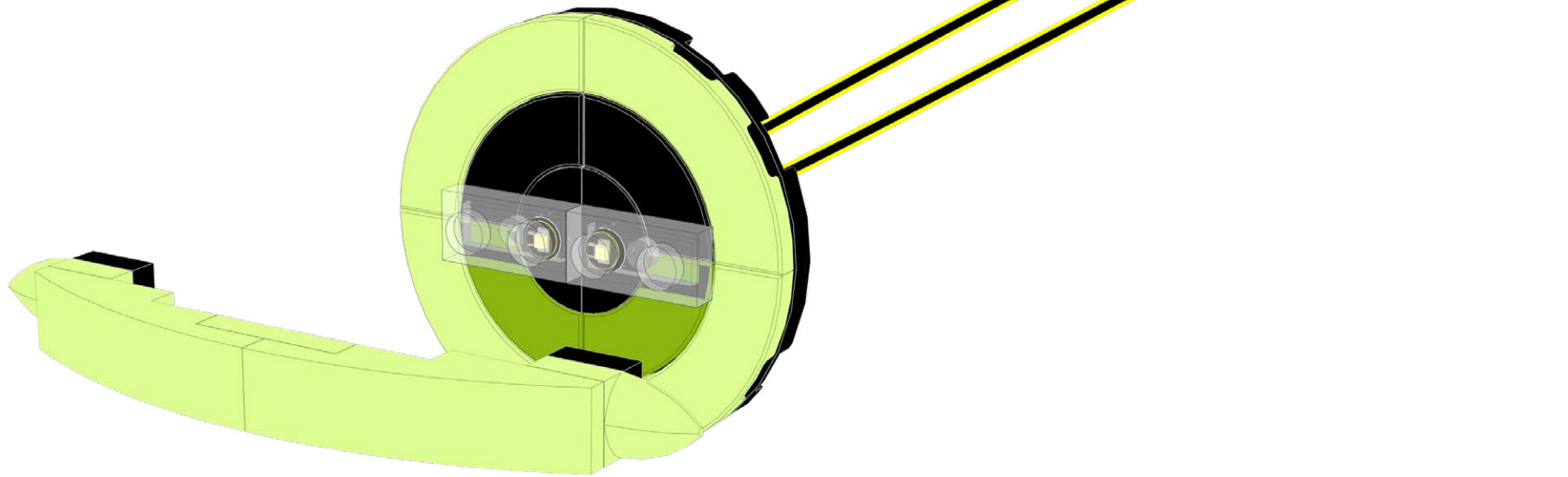

176

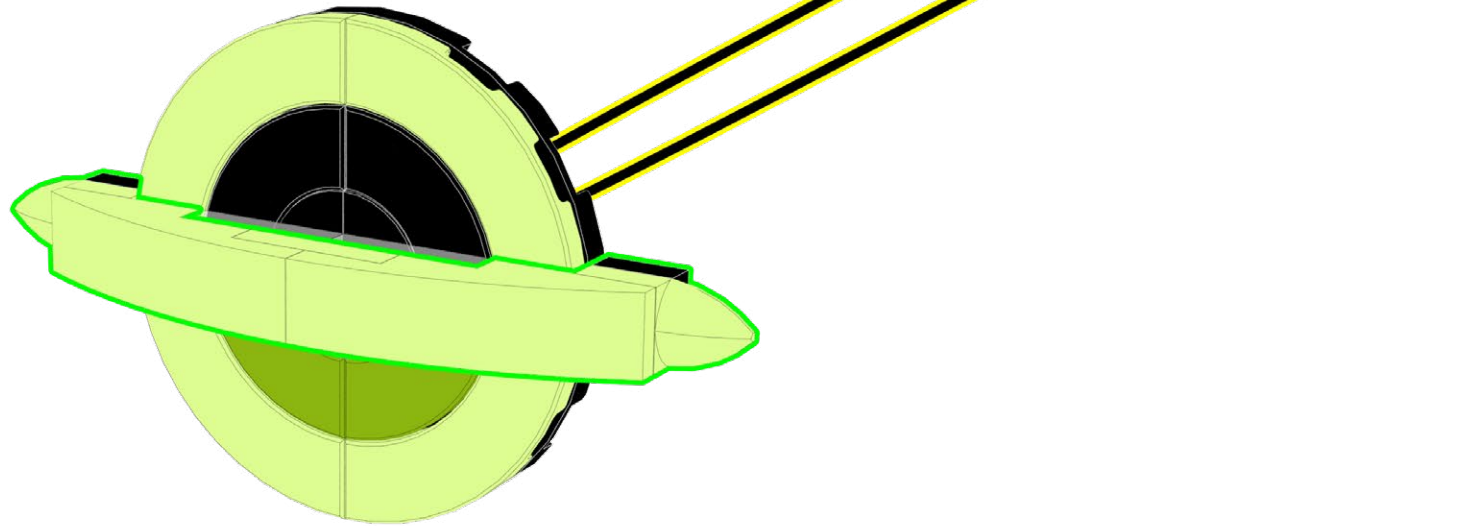

177

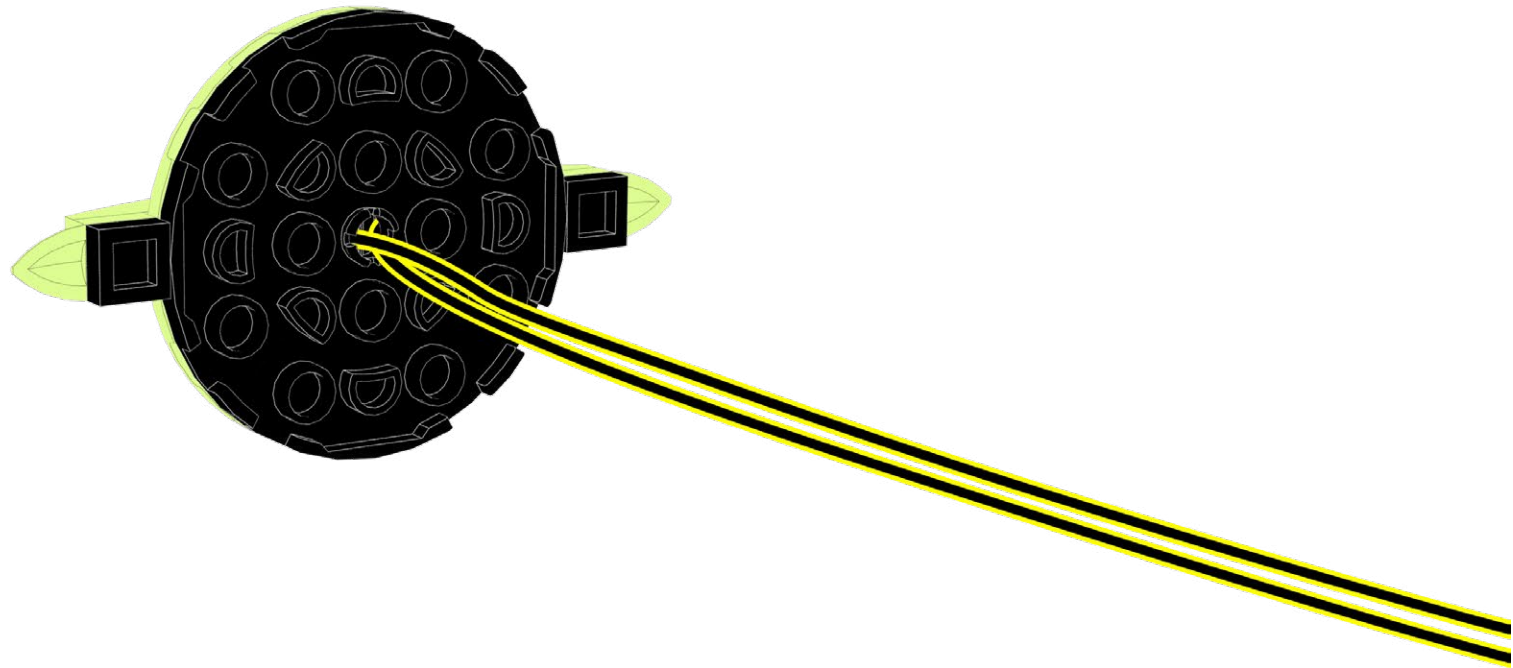

178

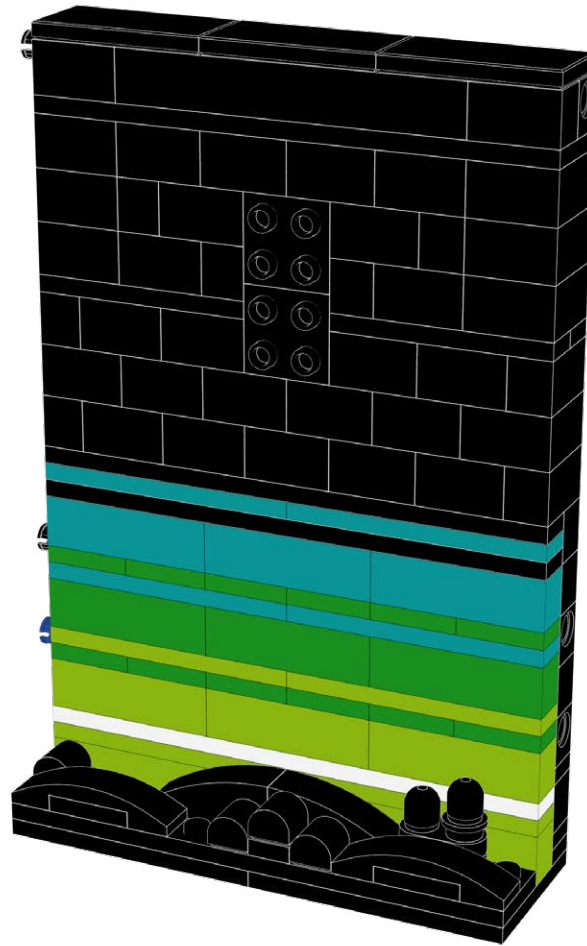

179

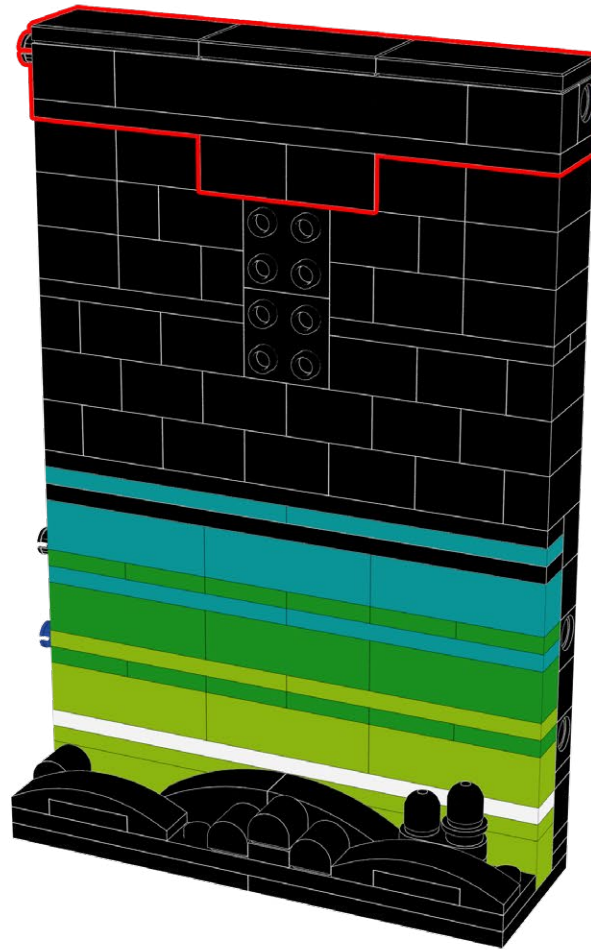

180

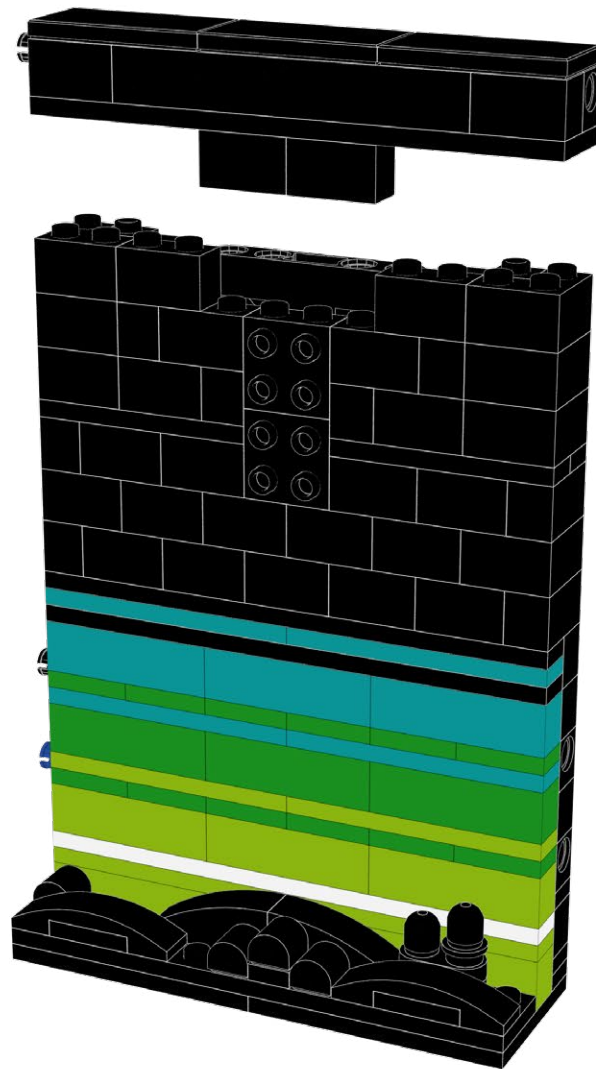

181

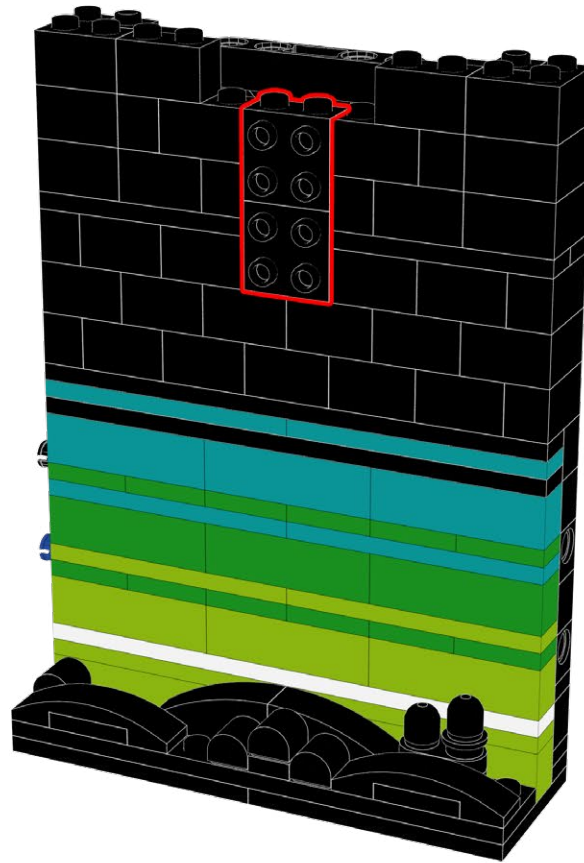

182

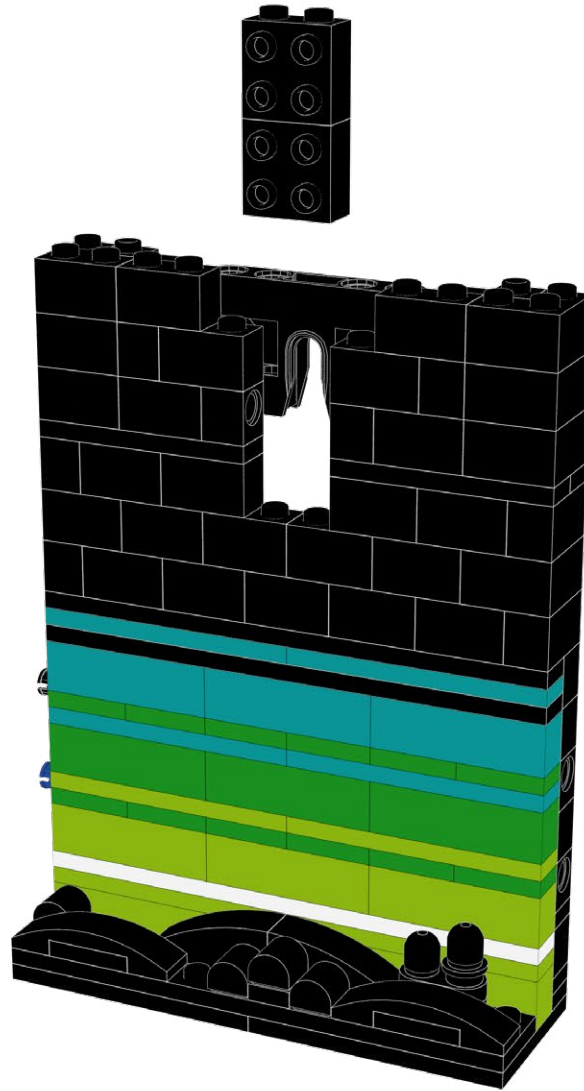

183

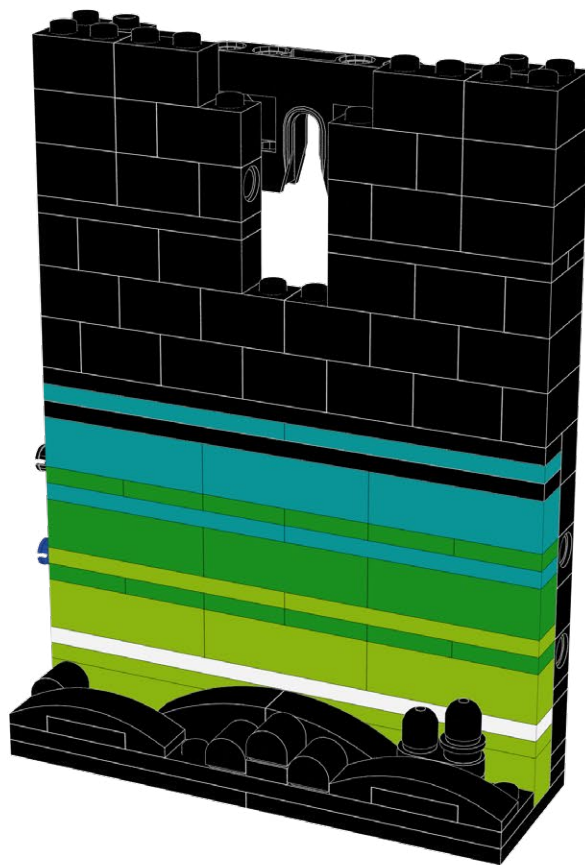

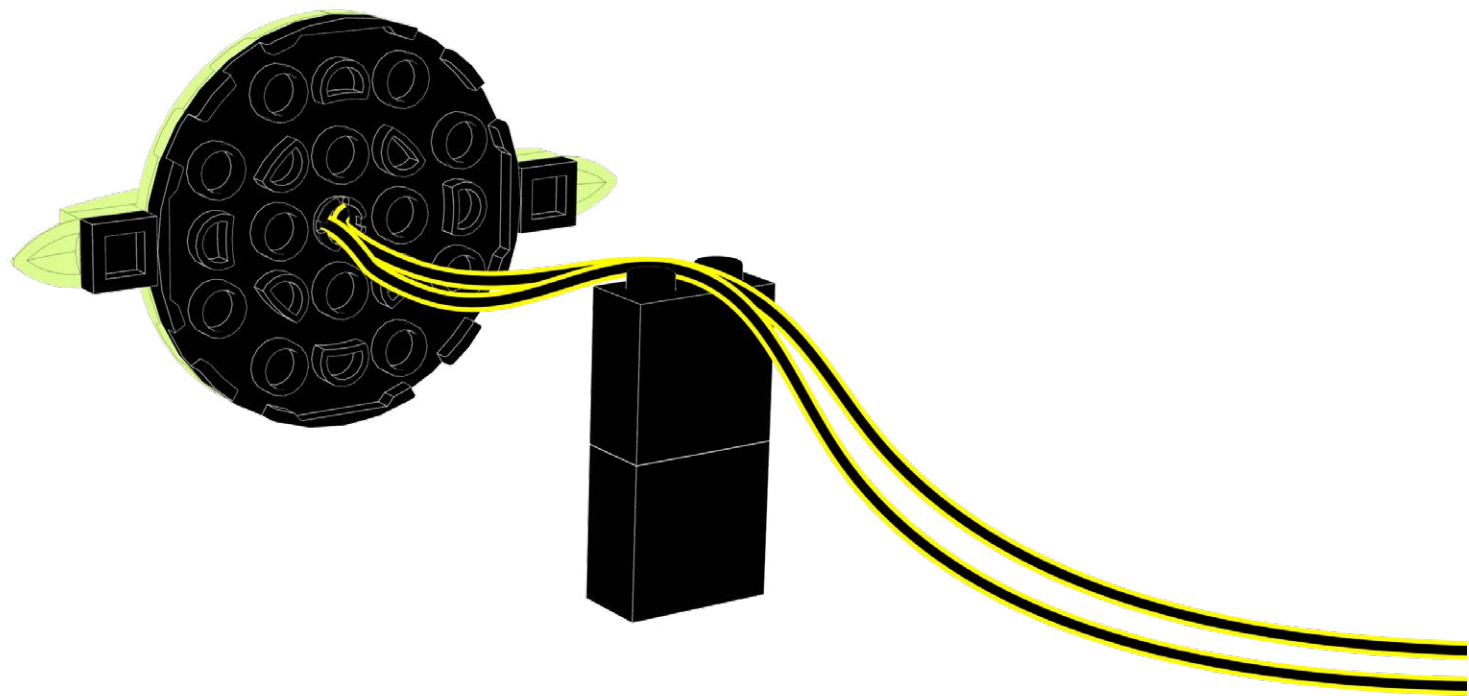

185

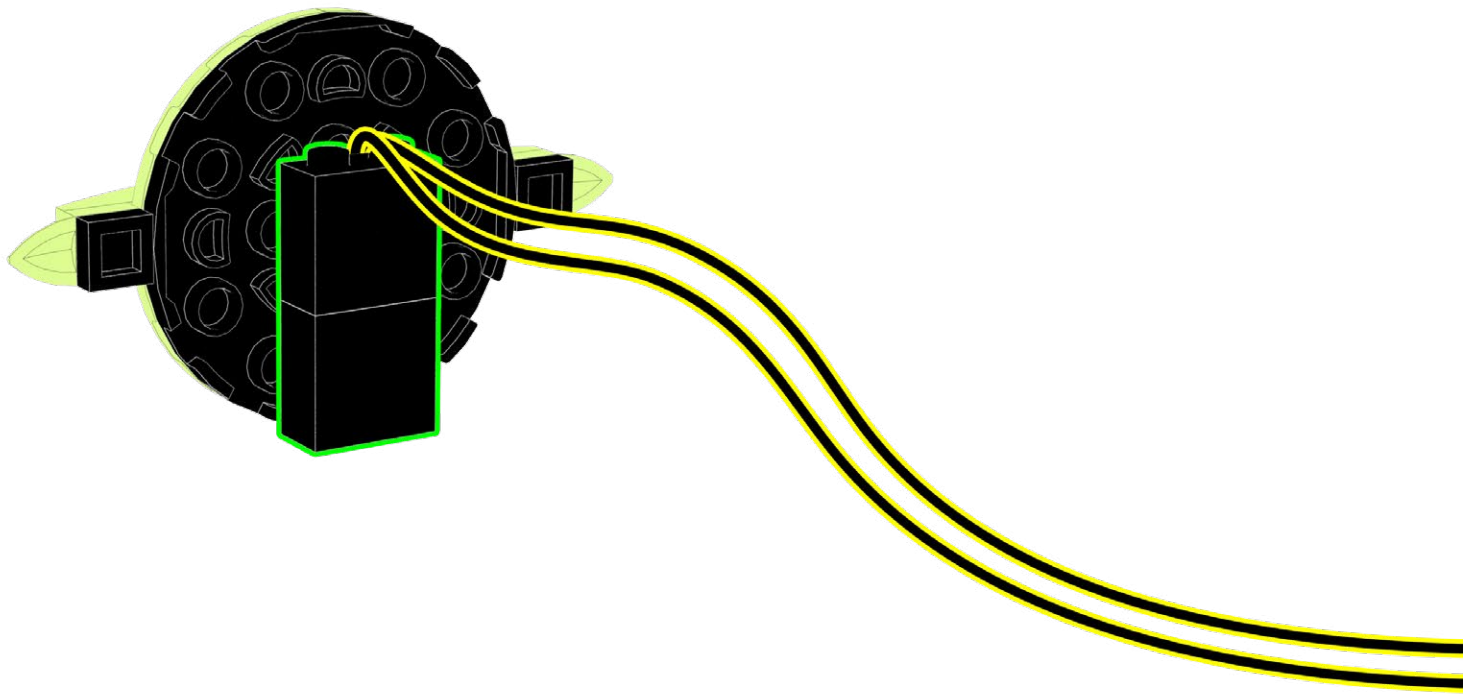

186

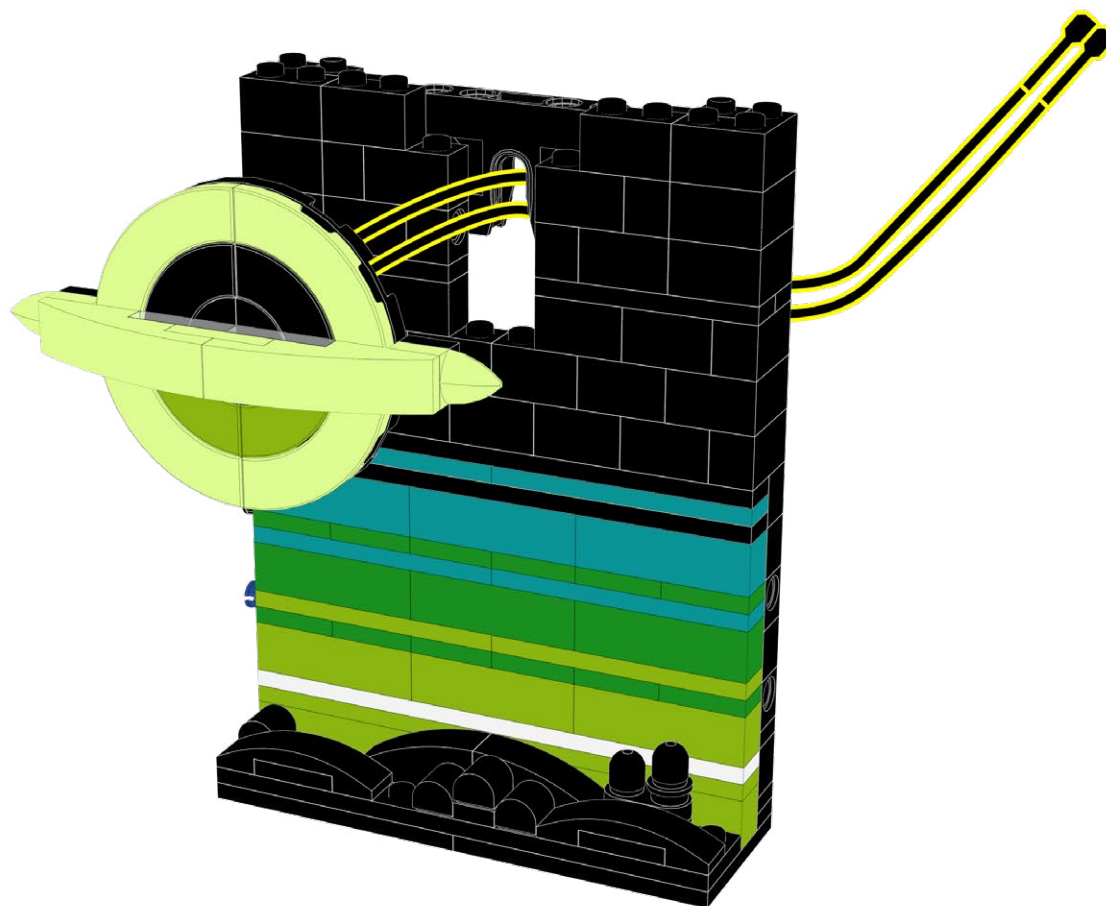

187

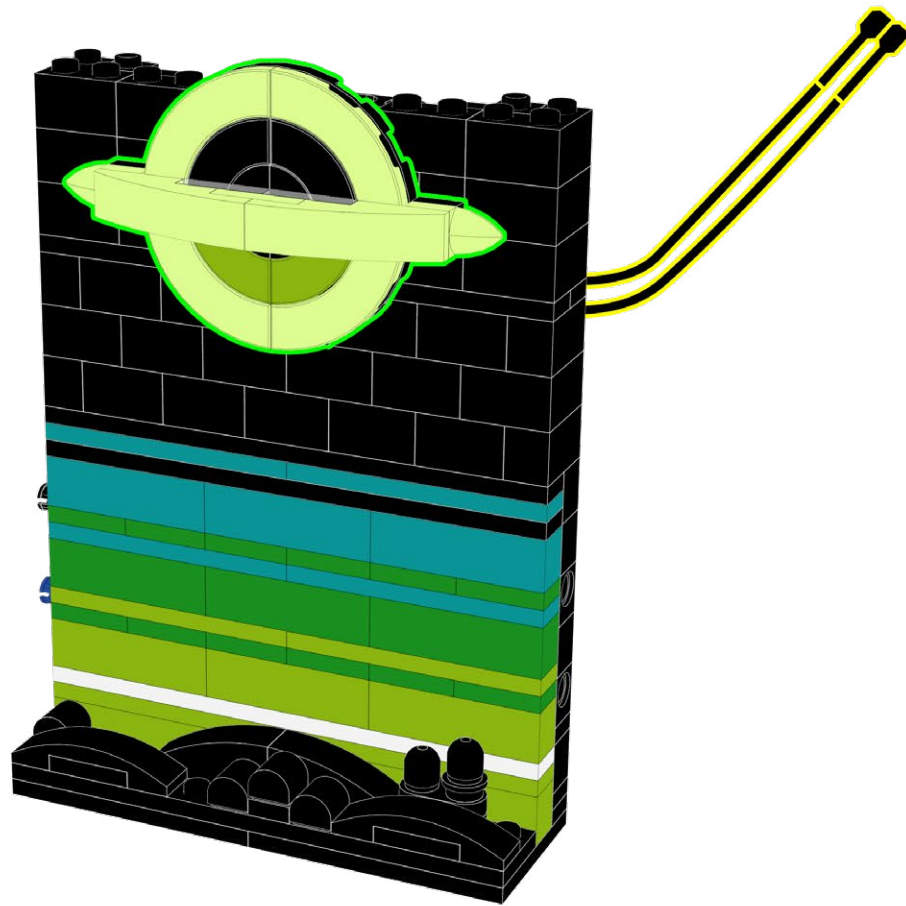

188

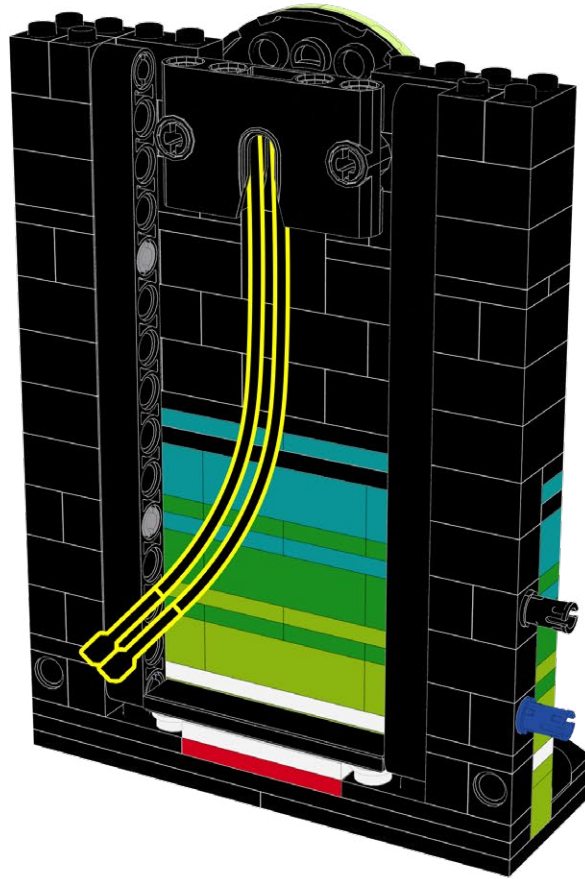

189



190

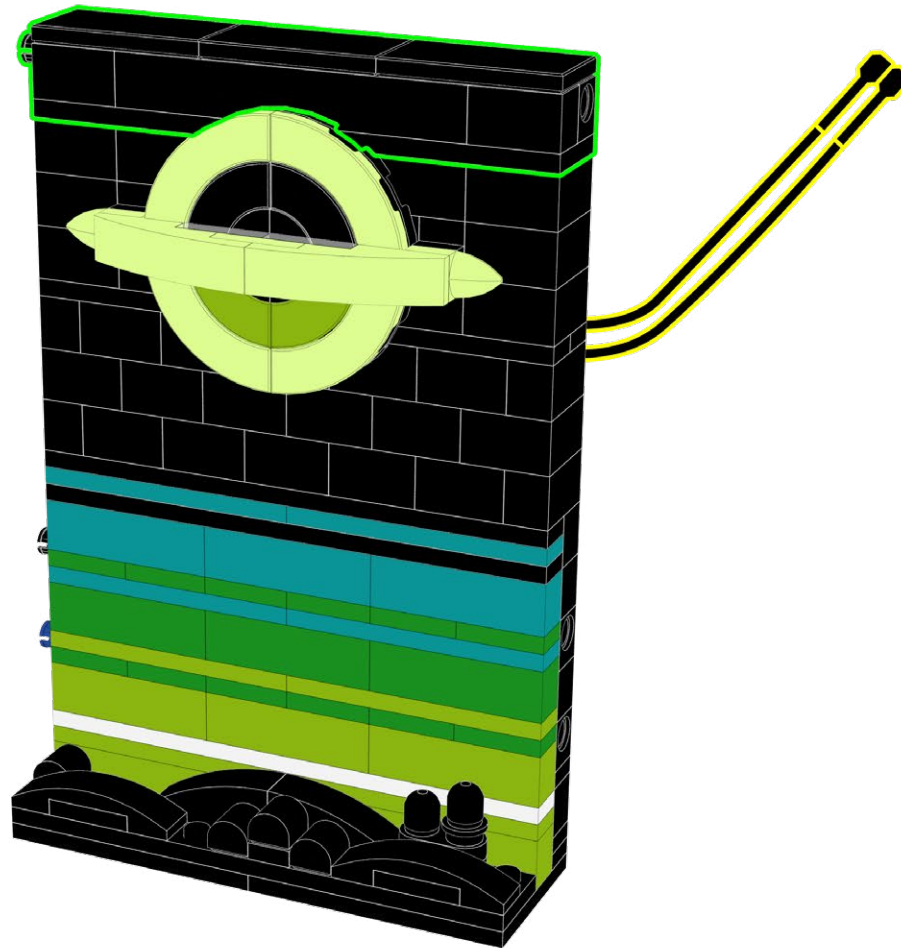

191

2x

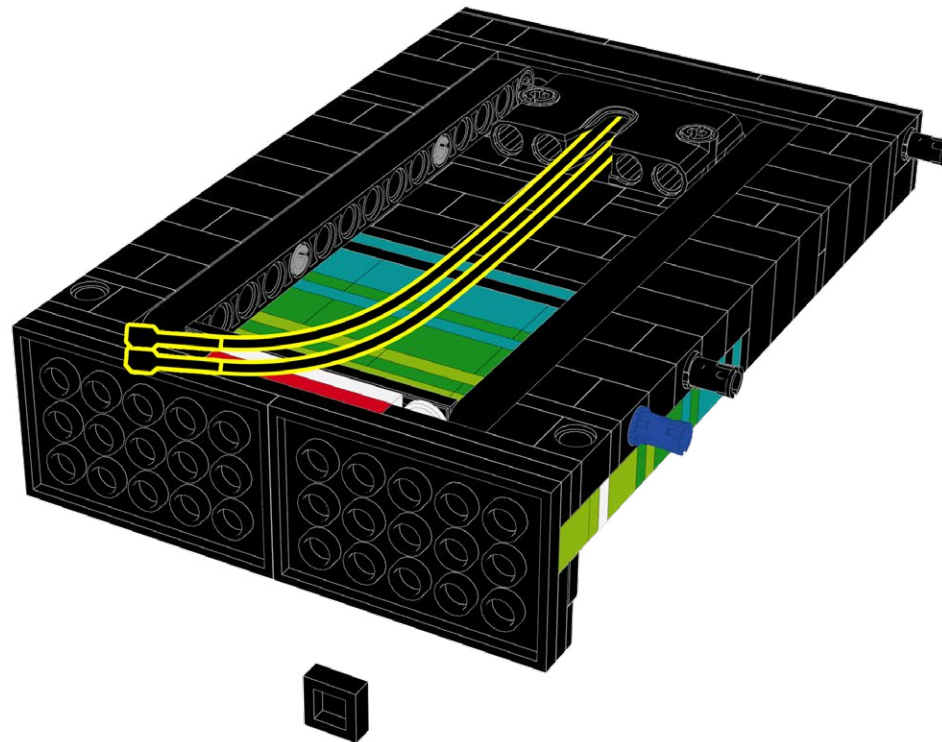

192

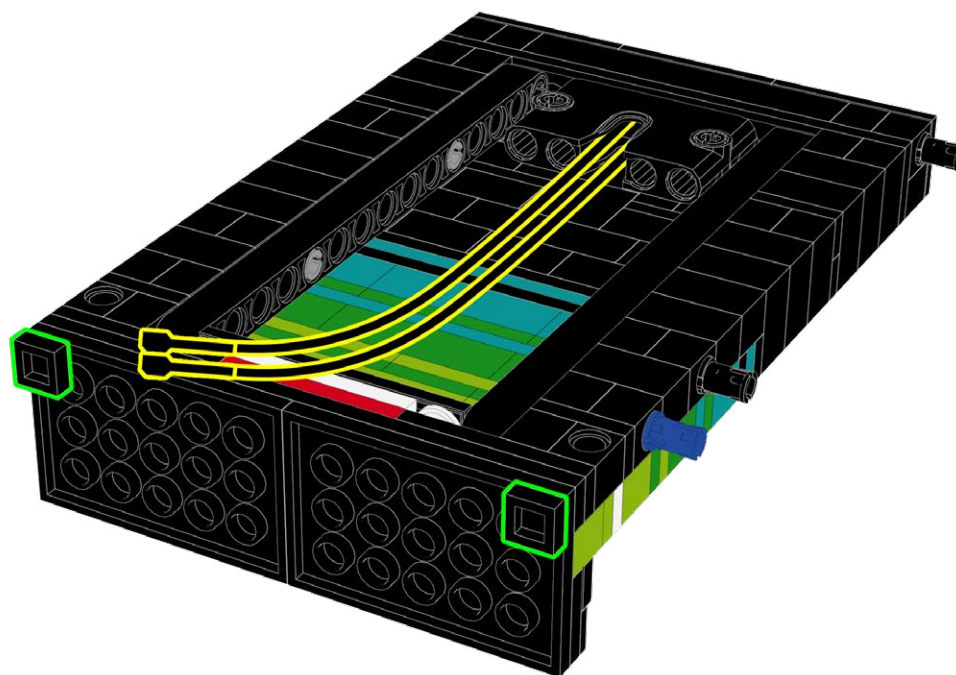

193

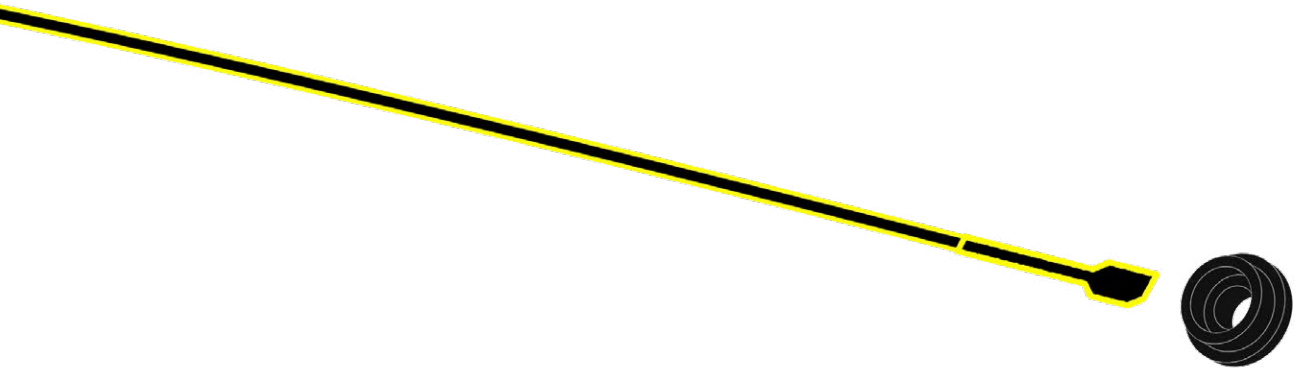
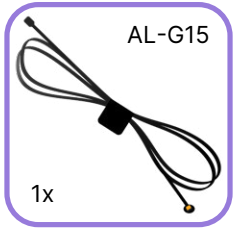

194





196

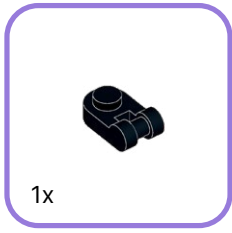

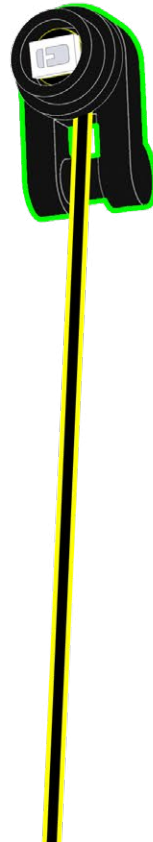
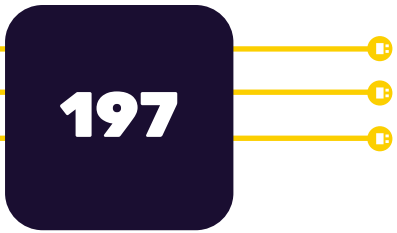

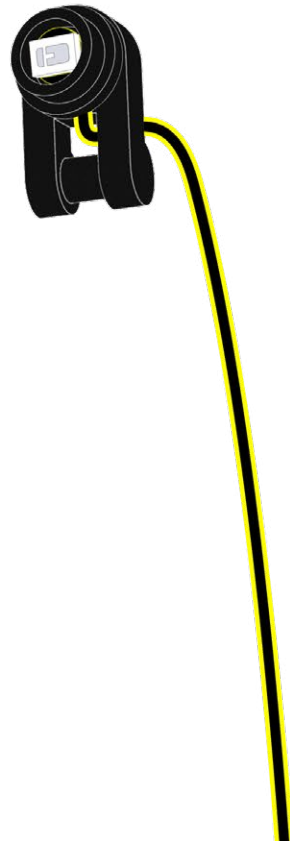
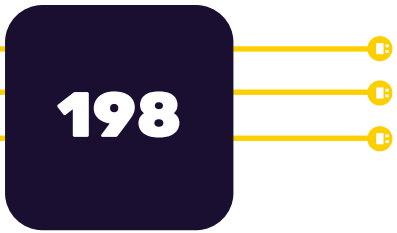

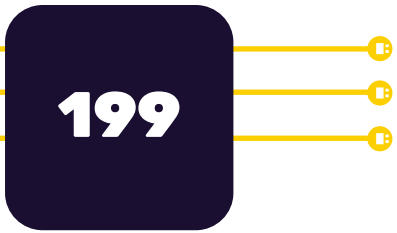

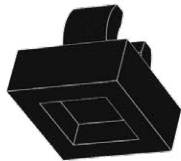
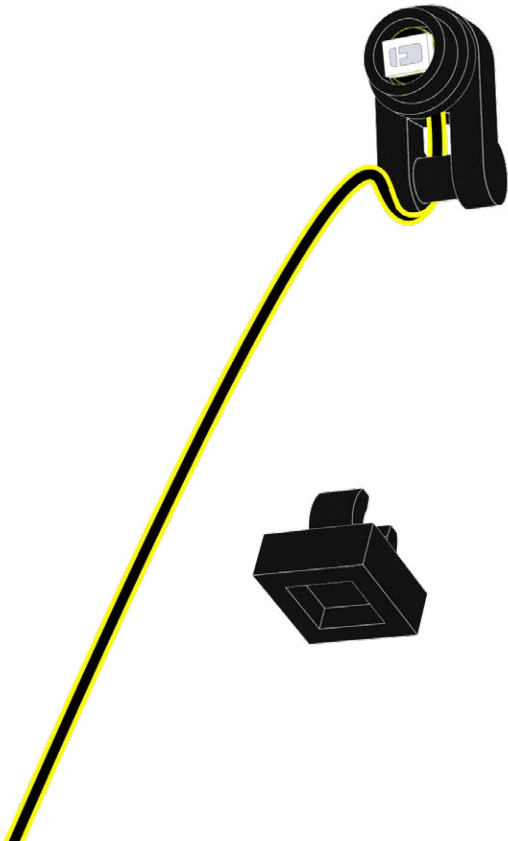
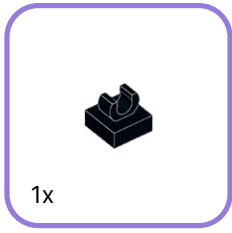
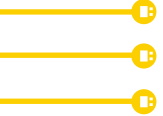

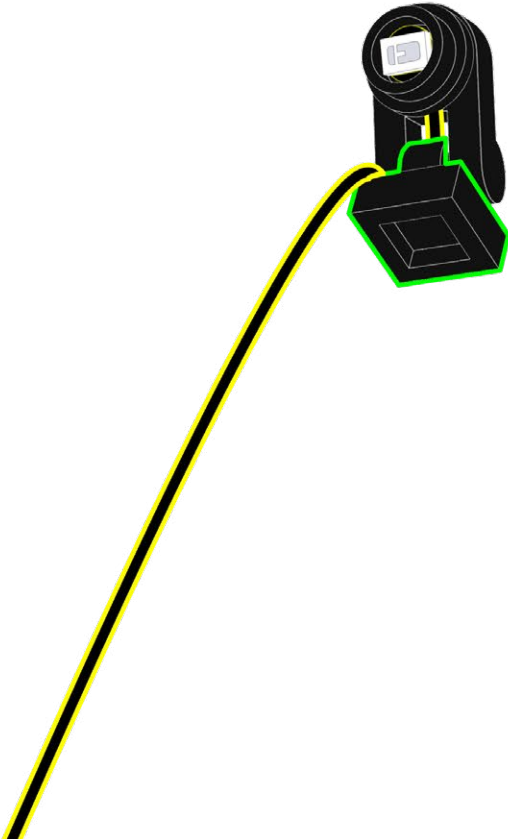

202

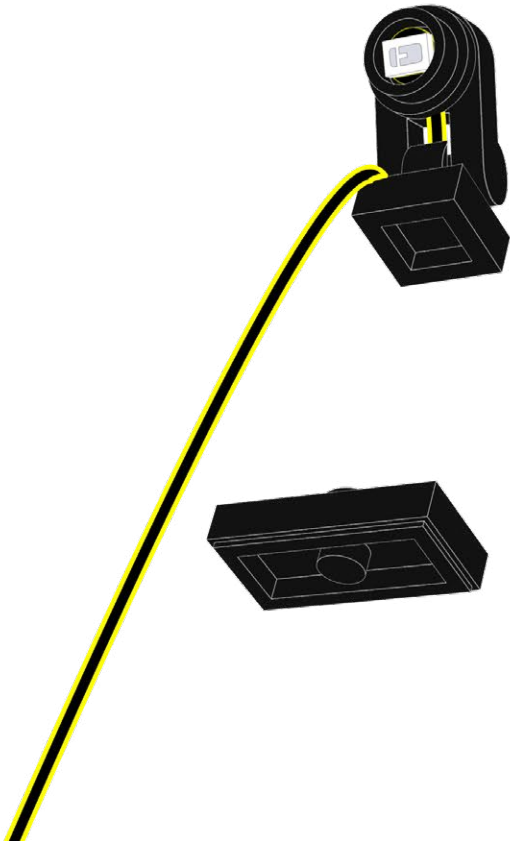
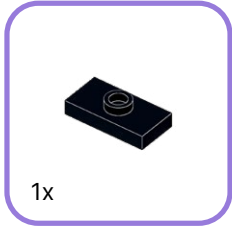

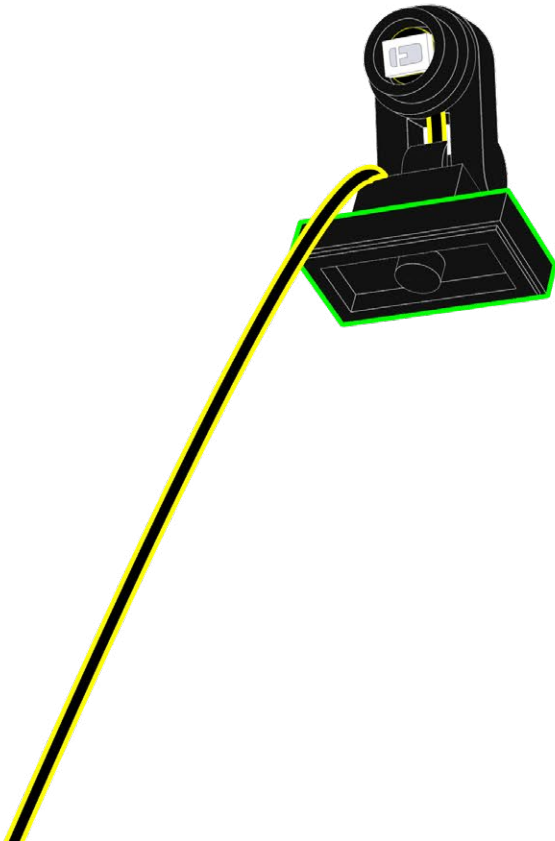

204

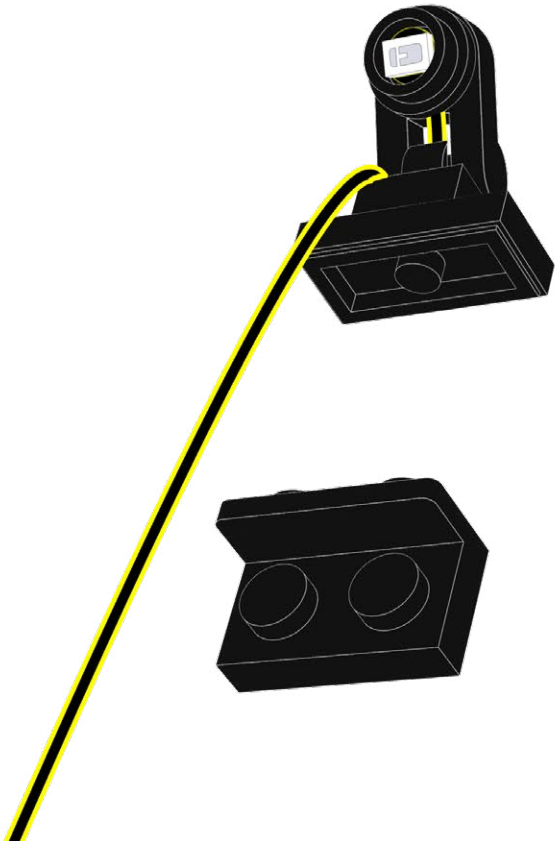
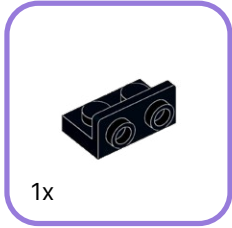

205

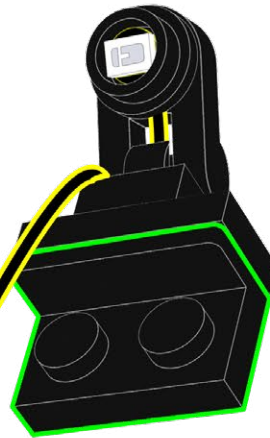

206

Astro Cap Clear



1x

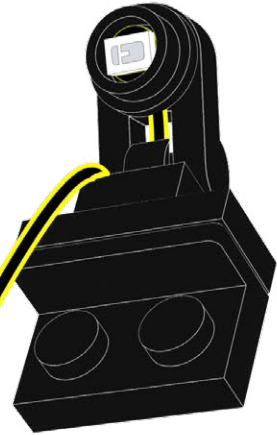
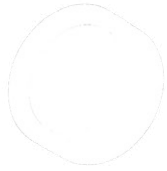

207

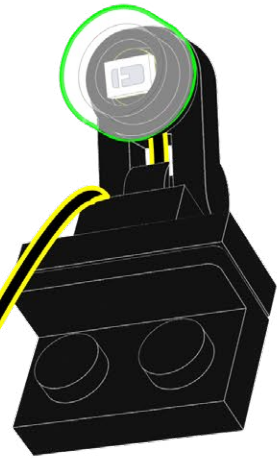

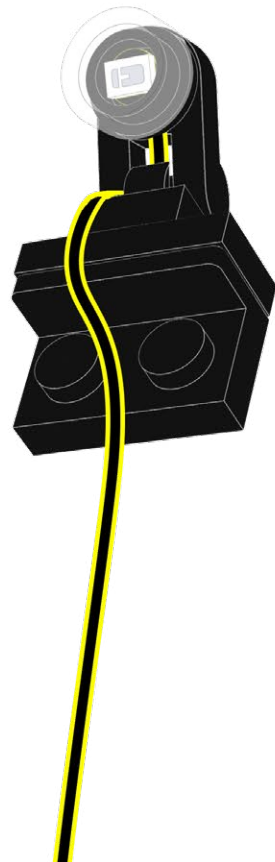

209

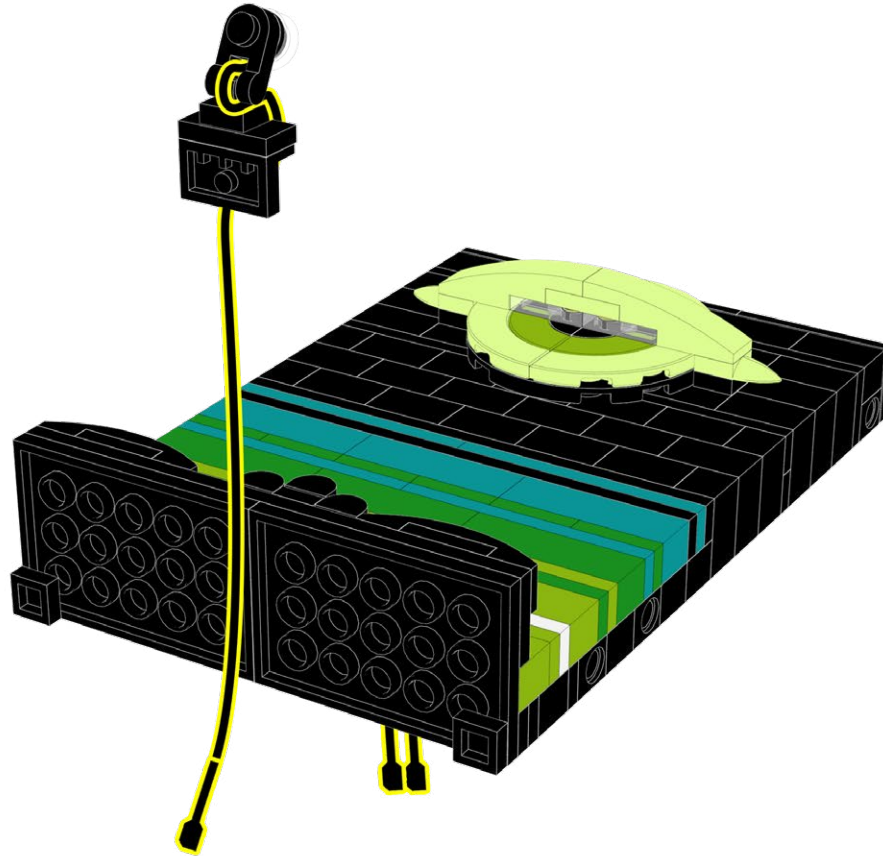

210

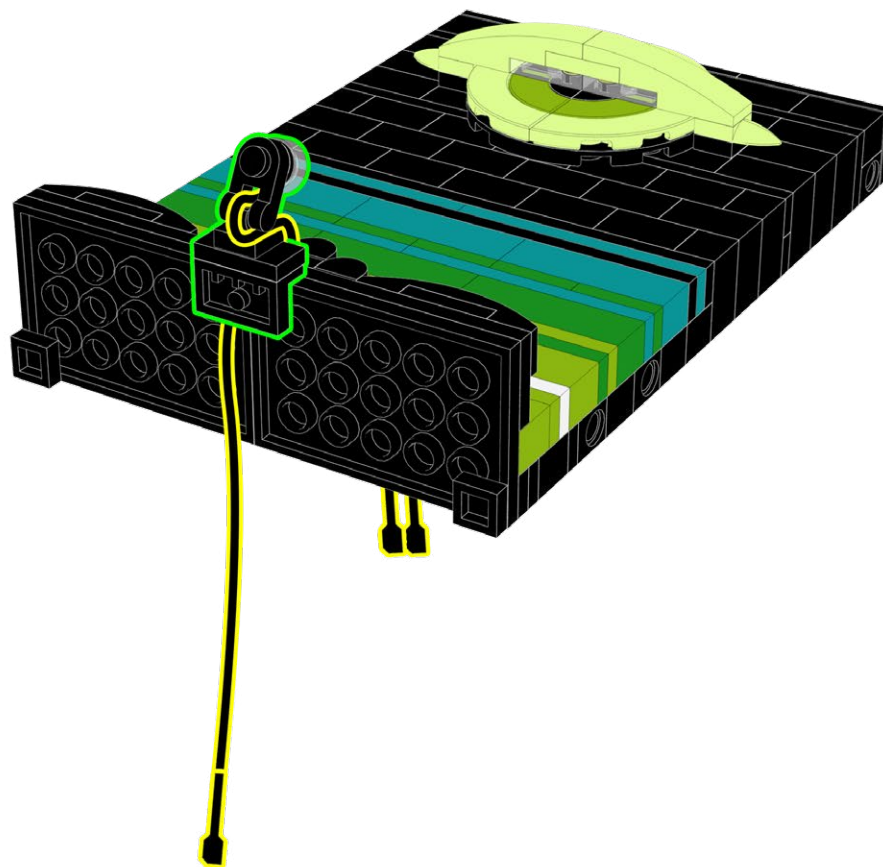

211

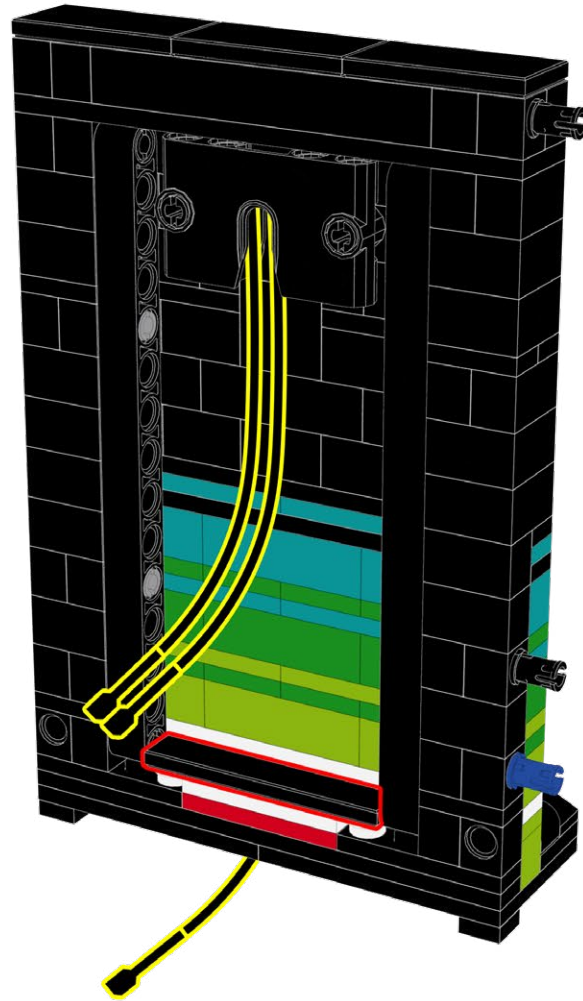

212

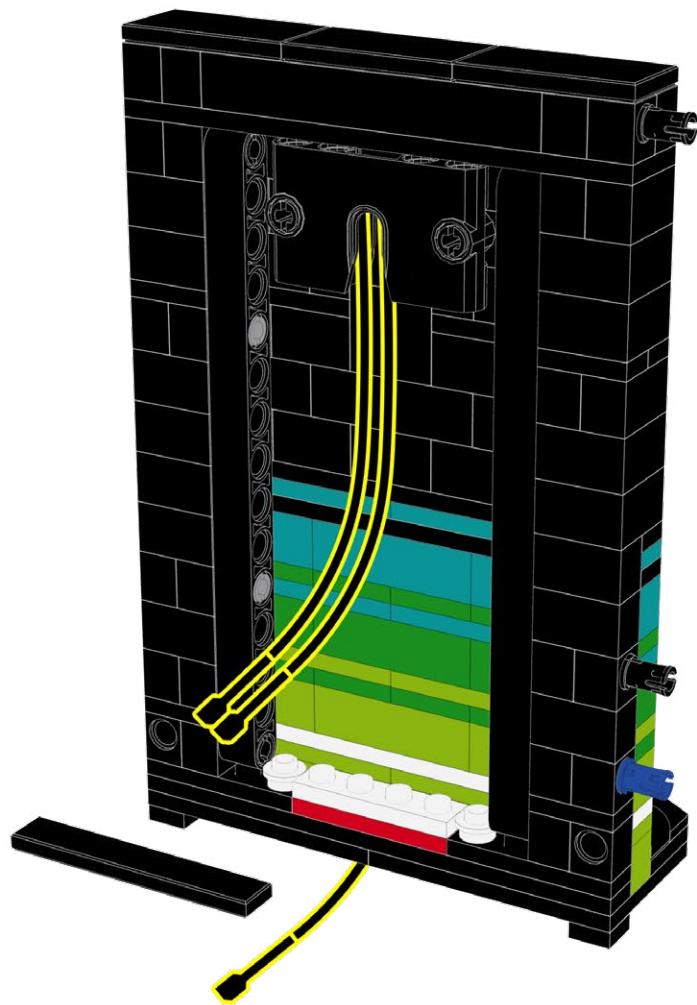

213

D-3

1x

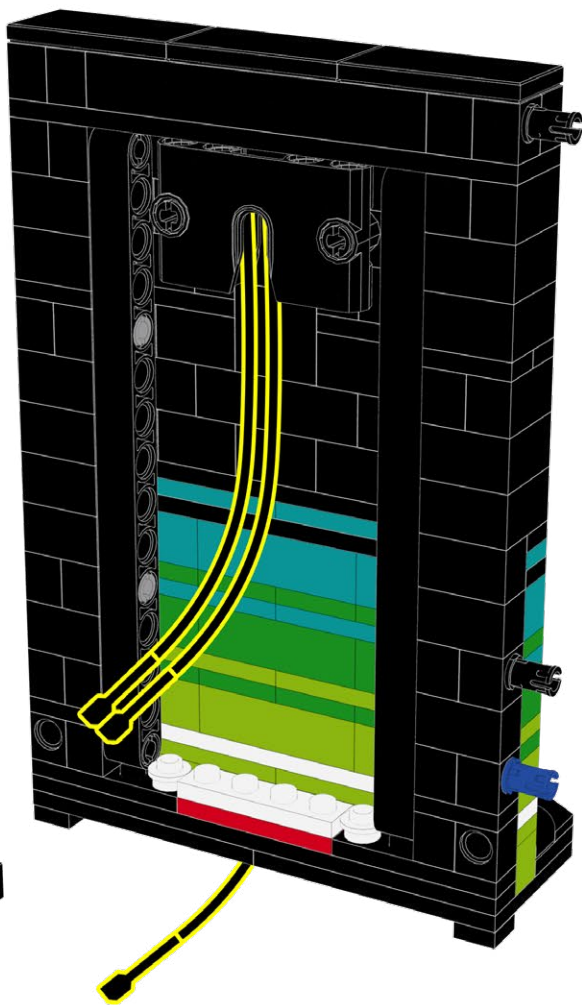

214

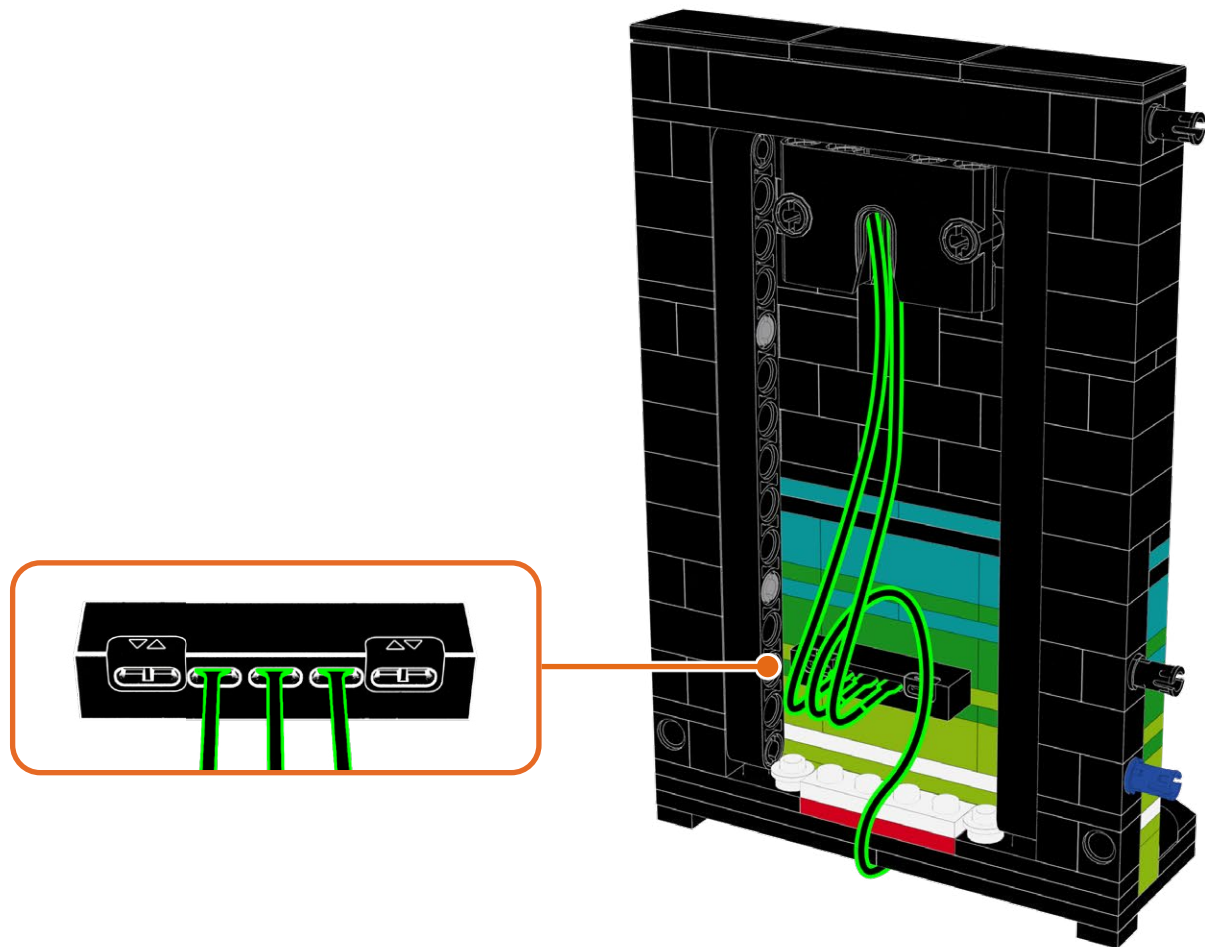

215

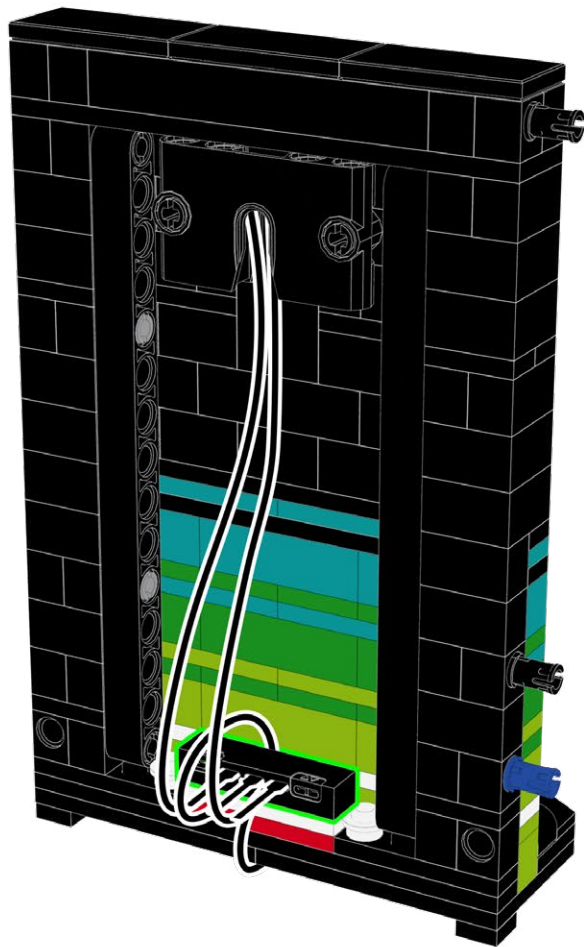

216

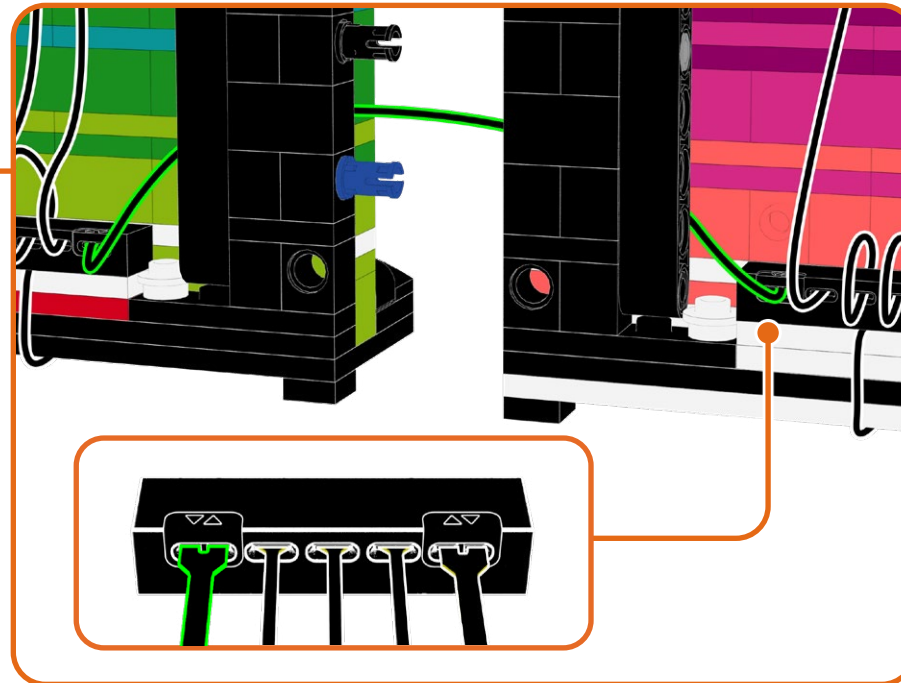
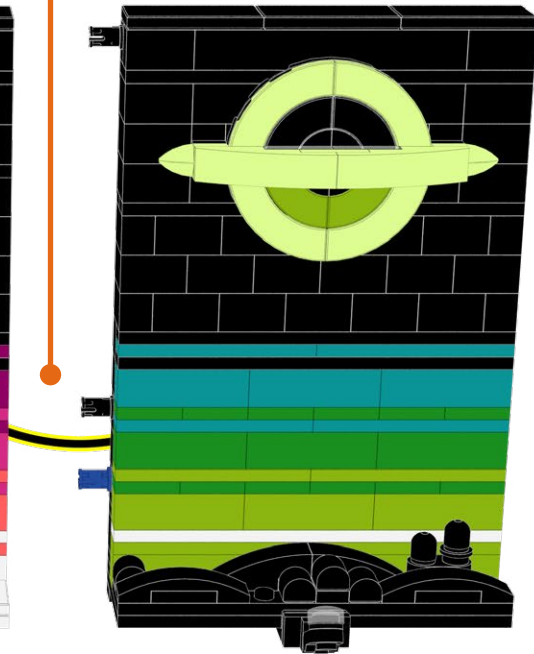
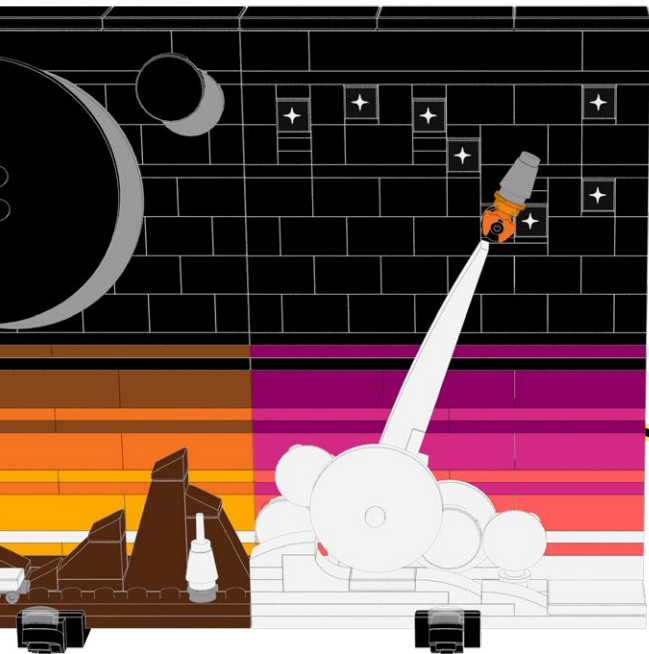

217

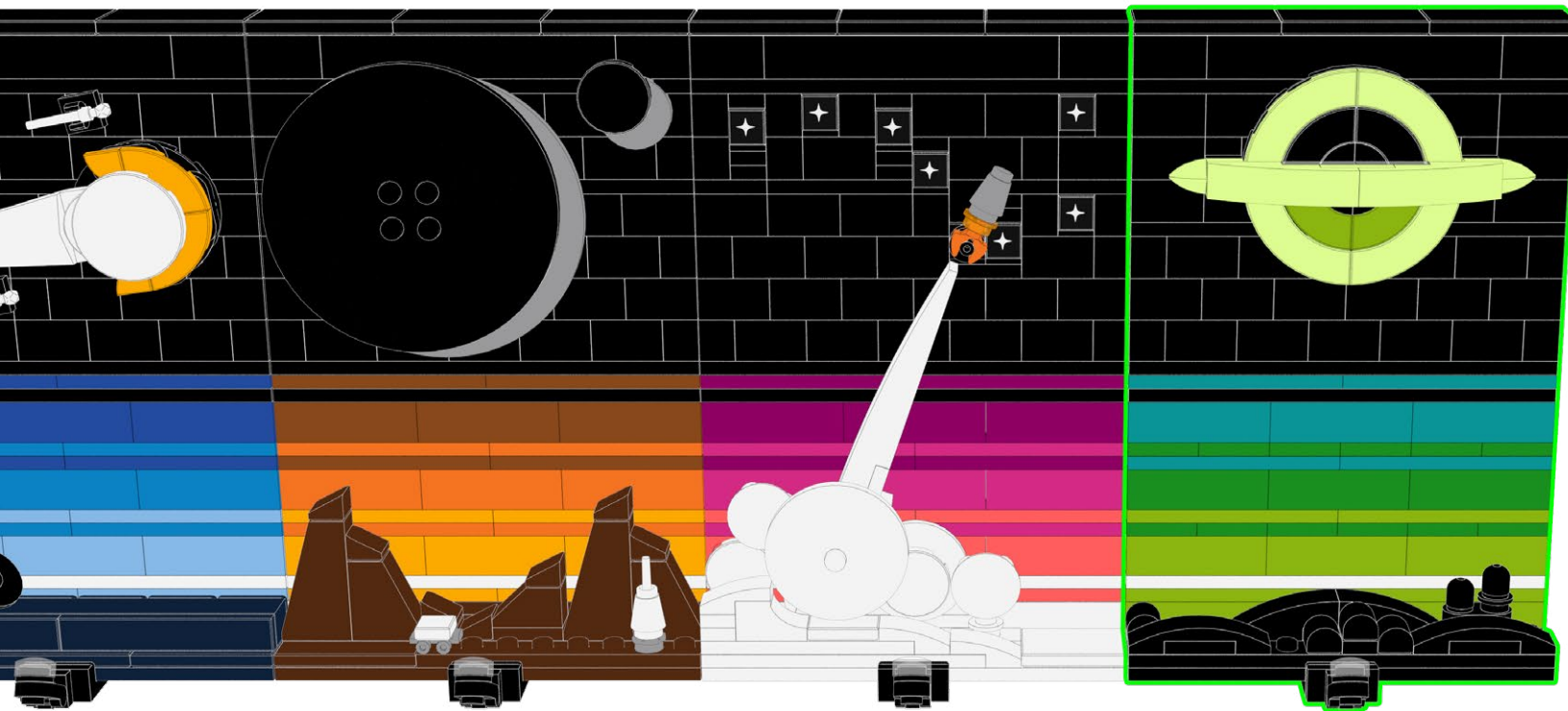

218

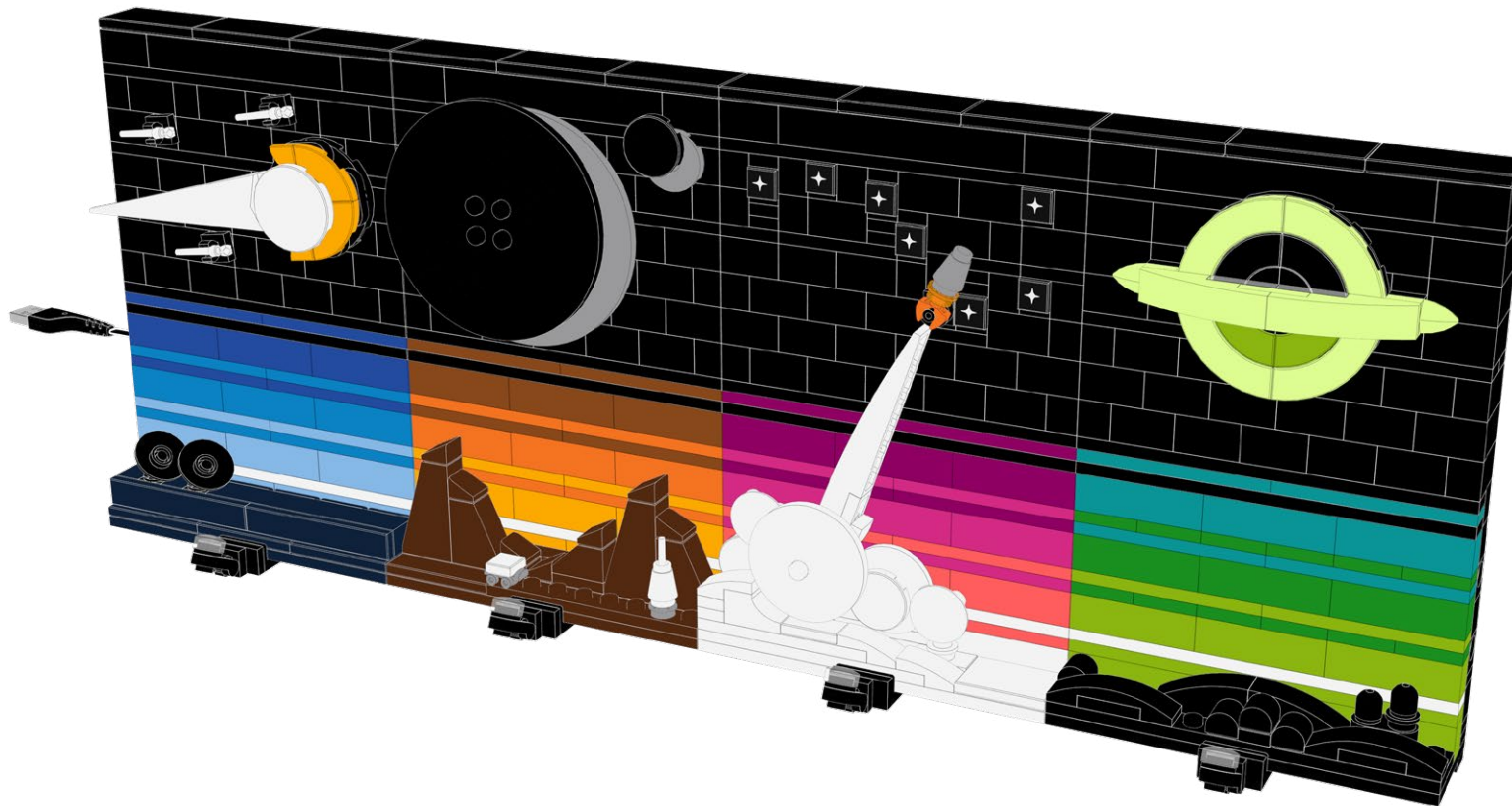

219

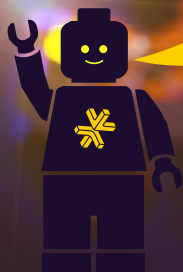

Power on Test
Test de mise sous tension
Test di Potenza
Stromtest
Prueba de Energía
电源测试



220



221

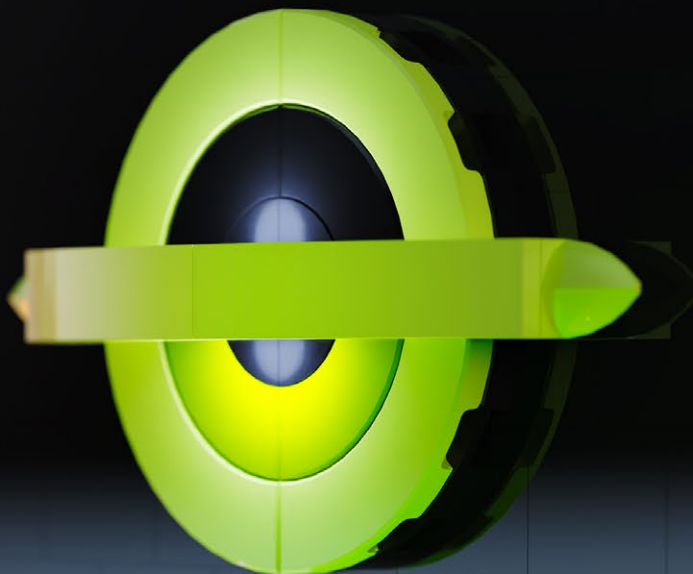

FINAL PRODUCT



PACKAGE CONTENTS



1x AL-B15
Astro Light Large
Blue 15cm



1x AL-O15
Astro Light Large
Orange 15cm



1x AL-P15
Astro Light Large
Pink 15cm



1x AL-G15
Astro Light Large
Green 15cm



2x AL-CW30
Astro Light Large
Cool White 30cm



1x AR-WW15
Astro Light Regular
Warm White 15cm



2x AR-CW15
Astro Light Regular
Cool White 15cm



1x ALF-O15
Astro Light Flicker
Large
Orange 15cm



1x ARF-WW15
Astro Light Flicker
Regular
Warm White 15cm



3x B-15
Belt 15cm



1x FLX-B
Flux Belt 30cm



4x D-3
Dock-3



4x Astro Cap

PACKAGE CONTENTS



1x Round Plate 1x1
Trans Clear



4x Modified Tile 1x1
with Open O Clip
Black

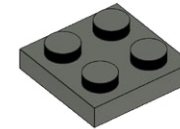

2x Plate 2x2
Dark Bluish Grey



1x Round Plate 1x1
with Open Stud
White

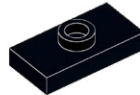

4x Modified Plate 1x2
with 1 Stud with Groove
and Bottom Stud Holder
(Jumper)
Black



1x Round Plate 1x1
with Open Stud
Orange

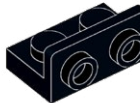

4x Bracket 1x2 - 1x2
Inverted
Black



4x Round Plate 1x1
with Open Stud
Black



8x Plate 1x1
Black



4x Round Plate 1x1
with Bar Handle
Black

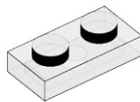

4x Plate 1x2
Trans Clear

CONTACT US

Click below for customer support, or general inquiries.

Cliquez ci-dessous pour accéder au support client ou aux renseignements généraux.

Clicca qui sotto per l'assistenza clienti o per richieste generali.

Contact Us



Contactez-nous



Contattaci



Klicken sie unten für kundensupport oder allgemeine anfragen.

Haga clic a continuación para atención al cliente o consultas generales.

点击下方获取客户支持或一般咨询。

Kontaktieren sie uns



Contáctanos



联系我们



TROUBLESHOOTING

If you're stuck, scan the QR code for troubleshooting.

Se sei bloccato, scansiona il codice QR per la risoluzione dei problemi.

Wenn Sie nicht weiterkommen, scannen Sie den QR-Code zur Fehlerbehebung.

Si vous êtes bloqué, scannez le code QR pour le dépannage

Si está atascado, escanee el código QR para solucionar el problema.

如果遇到问题, 请扫描二维码进行故障排除

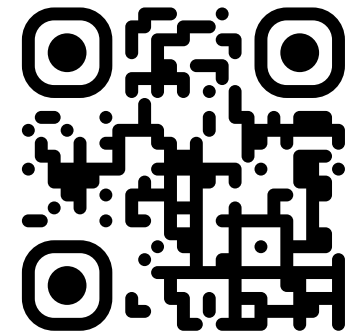



LIGHT MY BRICKS

lightmybricks.com



LEGO® is a trademark of the LEGO Group of companies, which does not sponsor, authorize or endorse this product. All LEGO® sets featured in images are sold separately. This is not a LEGO® product. The LEGO Group is not liable for any loss, injury or damage arising from the use or misuse of this product. ©2024 Light My Bricks Pty Ltd. All rights reserved. www.lightmybricks.com

Our components are designed and packaged in Australia by Light My Bricks Pty Ltd. Components are manufactured in China. 3fl bldg C, Shuanghuan Quanxin Technology Information Industry Park Baolong Street, Longgang District, Shenzhen, China. Imported in Australia by Light My Bricks Pty Ltd, 5/26 Rushdale St, Knoxfield, VIC, 3180, Australia.

WARNING: CHOKING HAZARD - Small parts. Not for children under 3 years.

AVERTISSEMENT : RISQUE D'ÉTOUFFEMENT - Petites pièces. Ne convient pas aux enfants de moins de 3 ans.

ATTENZIONE: PERICOLO DI SOFFOCAMENTO - Piccole parti. Non adatto a bambini di età inferiore a 3 anni.

WARNUNG: ERSTICKUNGSGEFAHR - Kleine Teile. Nicht für Kinder unter 3 Jahren geeignet.

ADVERTENCIA: PELIGRO DE ASFIXIA - Piezas pequeñas. No son apto para niños menores de 3 años.

警告：窒息危險 - 小零件。不适合3岁以下儿童。