



# LIGHT KIT INSTALLATION GUIDE

**VINCENT VAN GOGH  
THE STARRY NIGHT**

FOR LEGO  
SET  
#21333

# CONTENTS



## 03

### Getting Started

- 04** Legend
- 05** Component Handling
- 06** Blueprint

## 07

### Instructions

- 07** LEGO Bag 1
- 30** LEGO Bag 2
- 51** LEGO Bag 3
- 73** LEGO Bag 4 - LMB Bag 5
- 102** LEGO Bag 9
- 136** LEGO Bags 5 & 7 - LMB Bag 1 & 4
- 185** LMB Bag 2
- 249** LMB Bag 3
- 259** Lego Bag 6
- 288** Lego Bag 8

## 324

### Final Product

- 327** Package Contents
- 329** Contact & Troubleshooting



# GETTING STARTED



Bold, beautiful and bright, Light My Bricks elevates your favourite LEGO set from knick-knack to statement piece. Create a talking point at home or in the office that speaks to your passions with Light My Bricks. To learn more, click below.

[Learn More](#)



Audacieux, beau et lumineux, Light My Bricks élève votre ensemble LEGO préféré du statut de bibelot à celui de pièce maîtresse. Que ce soit à la maison ou au bureau, partagez votre passion des LEGO avec Light My Bricks. Cliquez ci-dessous pour en savoir plus.

[En savoir plus](#)



Audace, bello e luminoso, Light My Bricks eleva il tuo set LEGO preferito da soprammobile a pezzo di tendenza. Crea un punto di discussione a casa o in ufficio che parli alle tue passioni con Light My Bricks. Per saperne di più, clicca qui sotto.

[Ulteriori Informazioni](#)



Mutig, schön und hell – Light My Bricks verwandelt Ihr Lieblings-LEGO-Set von einem schnickschnack in ein statement-stück. Schaffen sie einen gesprächspunkt zu hause oder im büro, der Ihre leidenschaften widerspiegelt, mit Light My Bricks. Um mehr zu erfahren, klicken sie unten.

[Mehr erfahren](#)



Audaz, hermoso y brillante, Light My Bricks eleva tu set LEGO favorito de una chuchería a una pieza llamativa. Crea un tema de conversación en casa o en la oficina que hable de tus pasiones con Light My Bricks. Para obtener más información, haga clic a continuación.

[Más información](#)



大胆、美丽而明亮，Light My Bricks 将你喜爱的乐高套装从小摆件提升为引人注目的装饰品。在家或办公室打造一个能表达你激情的话题，了解更多，请点击下方。

[了解更多](#)



# LEGEND

## Rotate Set



Retournez L'ensemble  
Ruota Set  
Set Drehen  
Rotar Conjunto  
旋转套件

## Add Part



Ajoutez une Pièce  
Aggiungi Parte  
Teil Hinzufügen  
Agregar Pieza  
添加零件

## Click



Cliquez  
Clic  
Klicken  
Clic  
点击

## Pinch/Fold



Pincez/Pliez  
Pizzicare/Piegare  
Kneifen/Falten  
Pellizcar/Doblar  
折叠

## Pull Cable



Tirez le Cable  
Tirare il Cavo  
Kabel Ziehen  
Tirar del Cable  
拉动电缆

## Repeat Step



Répétez  
Ripetere  
Wiederholen  
Repetir  
重复

## Sticker



Autocollant  
Adesivo  
Aufkleber  
Pegatina  
贴纸

## Power On Test



Test de mise sous tension  
Test di Potenza  
Stromtest  
Prueba de Energía  
电源测试

## Disconnect Power

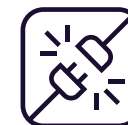

Débranchez L'alimentation  
Scollegare L'alimentazione  
Strom Trennen  
Desconectar la Energía  
断开电源

## Troubleshoot



Dépanner  
Risolvere  
Fehlerbehebung  
Solución de Problemas  
故障排除

# COMPONENT HANDLING

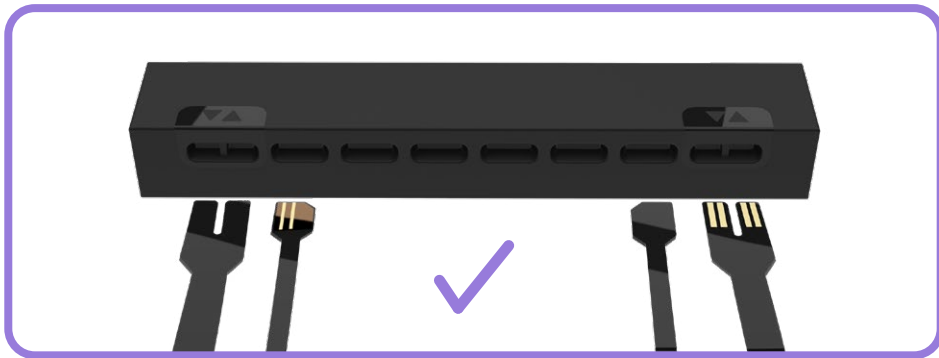
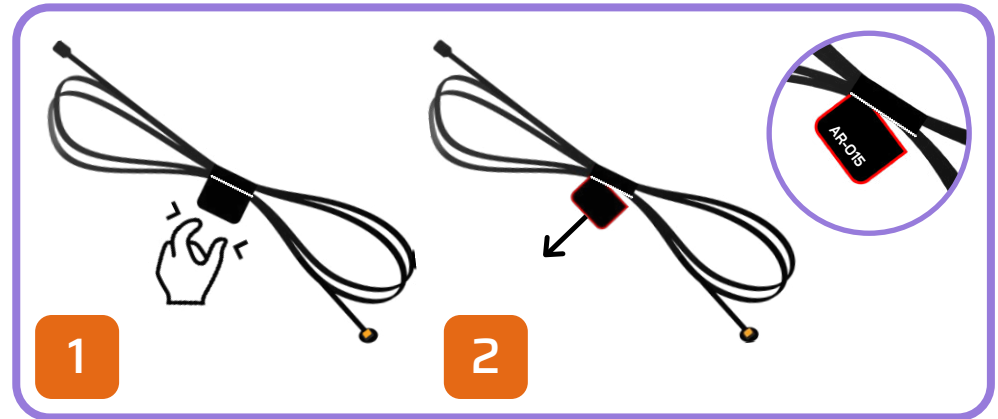
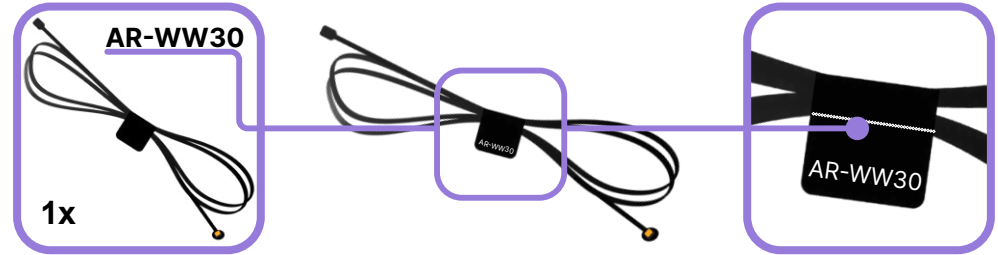
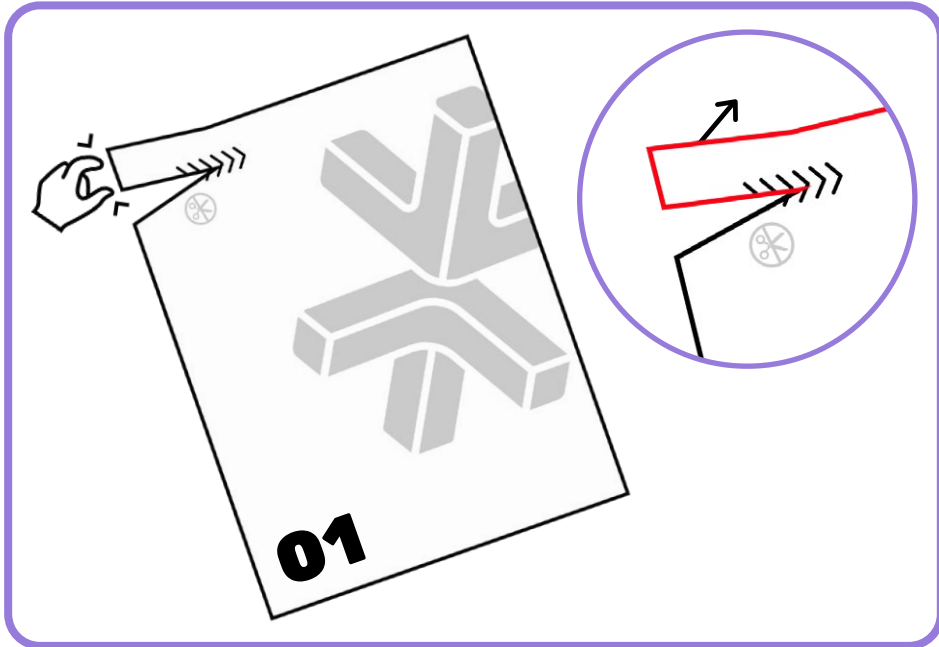

# BLUEPRINT

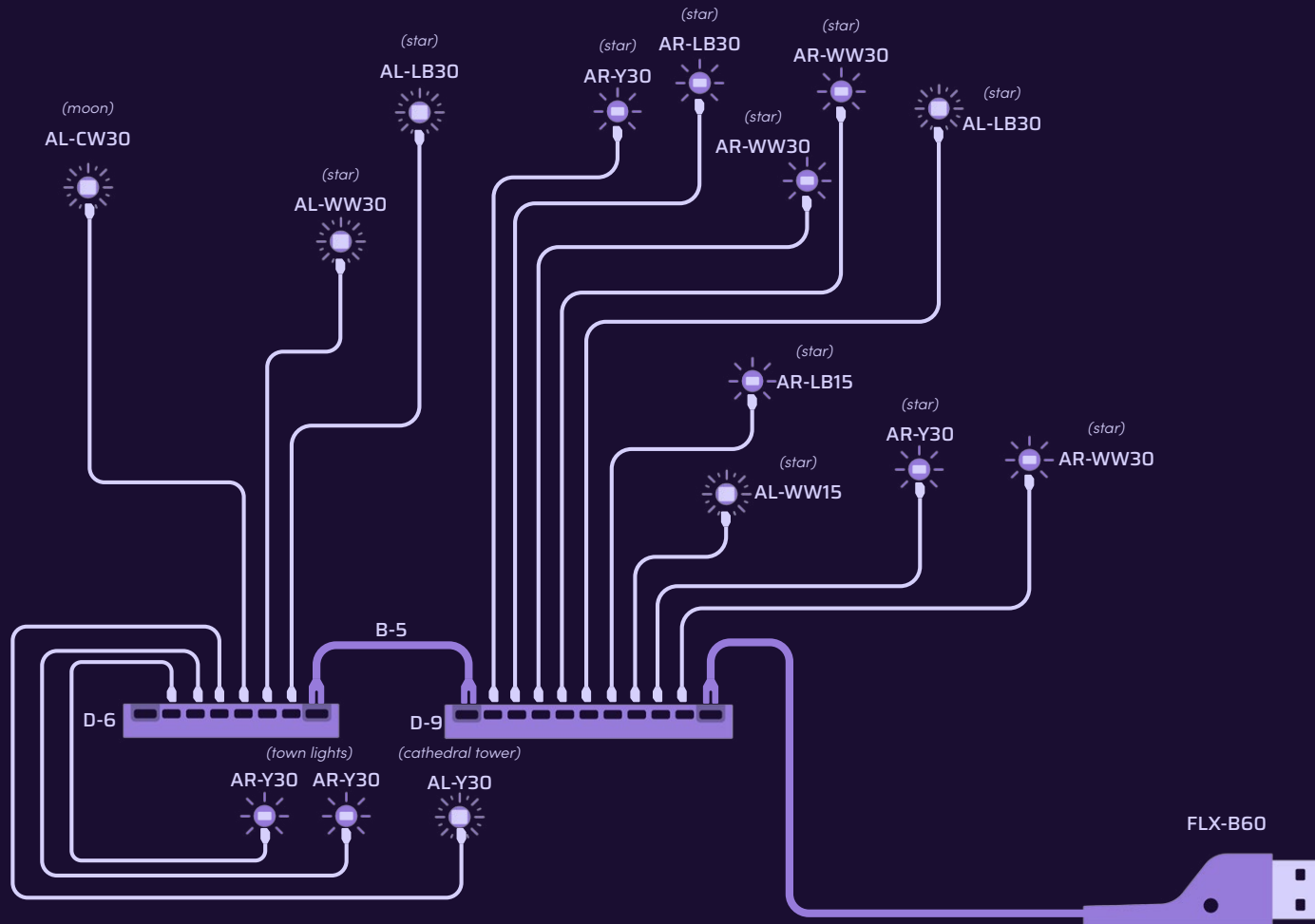

**HOLD UP!**

You might notice some bags aren't in order, as well as left over pieces, but that's ok! We're changing the way you build LEGO!

**ATTENDEZ!**

Vous remarquerez peut-être que certains sacs, ainsi que certaines pièces, ne sont pas dans le bon ordre. Mais pas de panique! Nous changeons simplement la façon avec laquelle vous construisez vos LEGO!

**ASPETTA!**

Potresti notare che alcuni sacchetti non sono in ordine, così come i pezzi avanzati, ma va bene così! Stiamo cambiando il modo in cui costruisci i LEGO!

**HALT!**

Sie werden möglicherweise bemerken, dass einige tüten durcheinander sind und teile übrig bleiben, aber das ist in Ordnung! Wir ändern die art und weise, wie Sie LEGO bauen!

**¡ESPERA!**

Es posible que notes que algunas bolsas están fuera de servicio, así como piezas sobrantes, ¡pero está bien! ¡Estamos cambiando la forma en que construyes LEGO!

**暫停!**

你可能会注意到一些袋子顺序错乱, 以及一些剩余的部件, 但没关系! 我们正在改变你搭建乐高的方式!

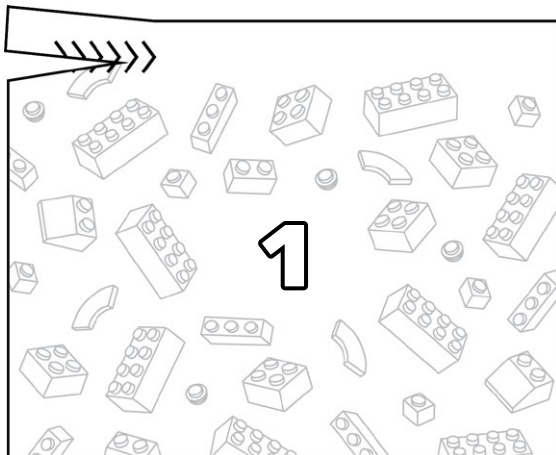
**Open LEGO® Bag 1**



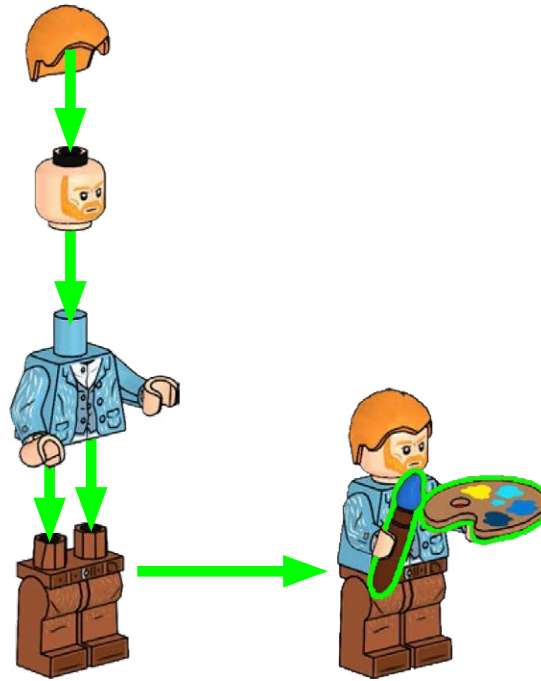
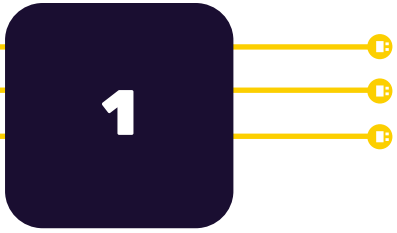

# 2

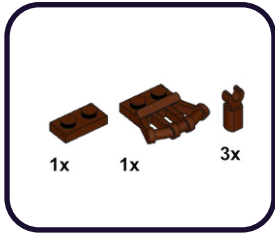

1

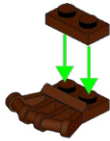

2



# 3

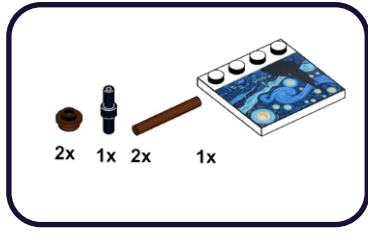

1

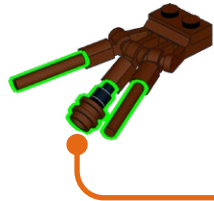

2

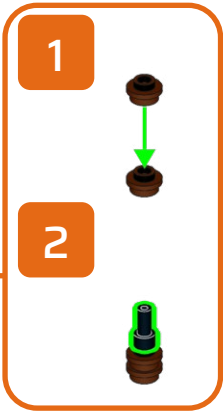

4

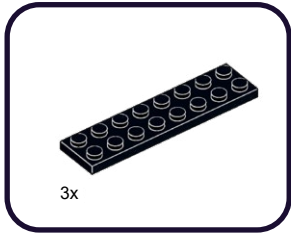

1



2

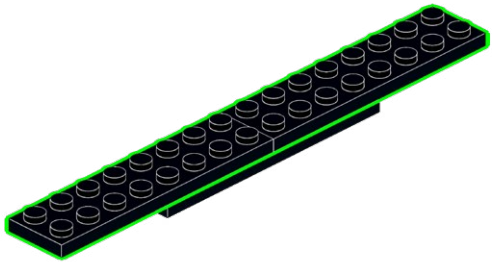

5

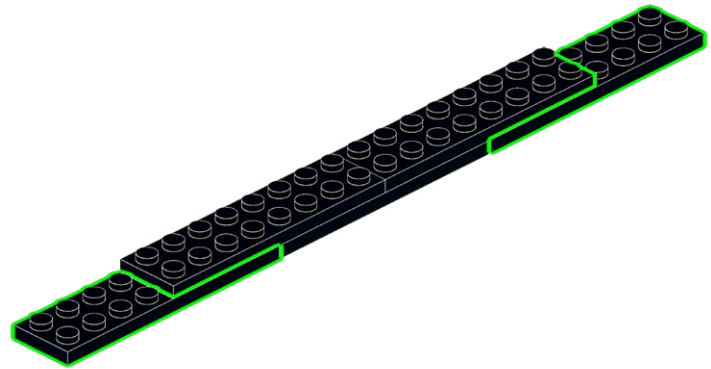
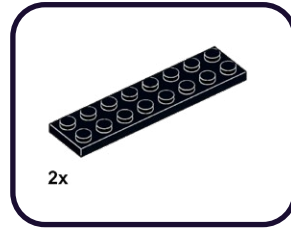

6

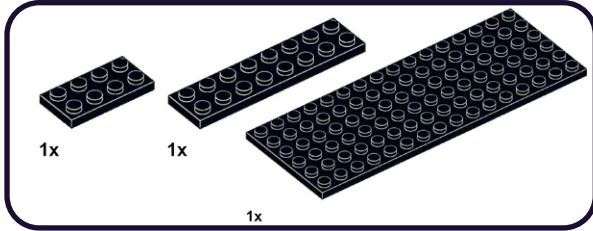

1

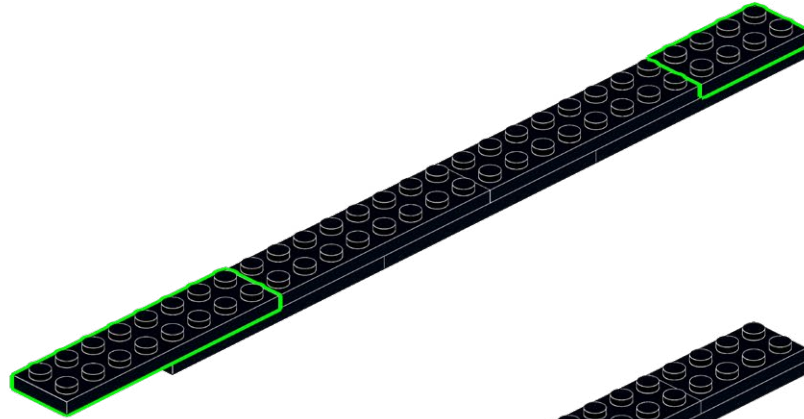

2

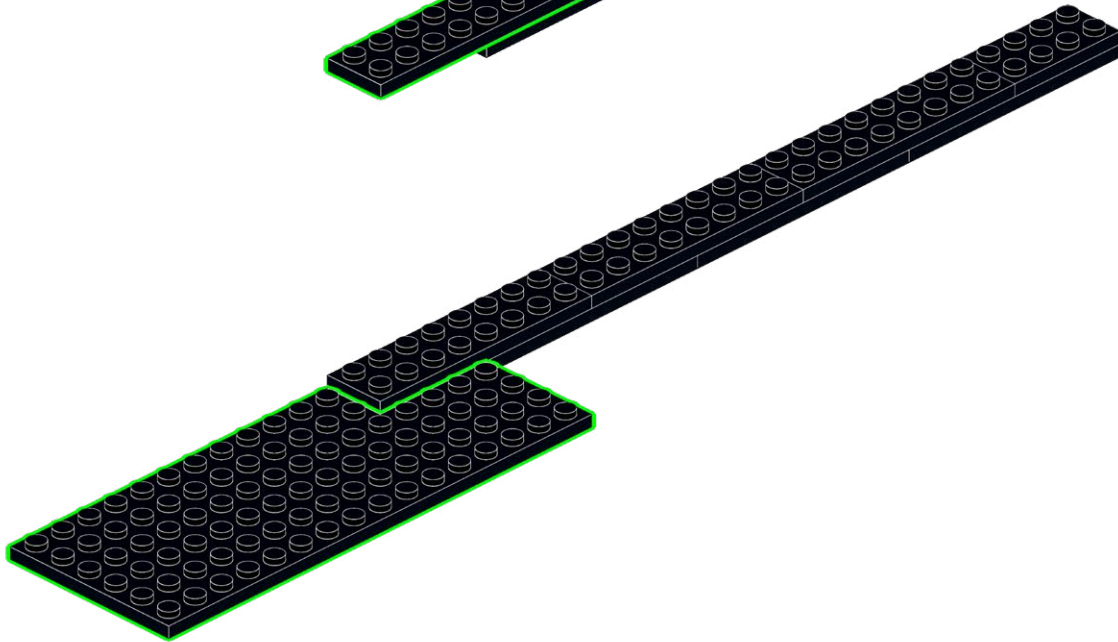

7

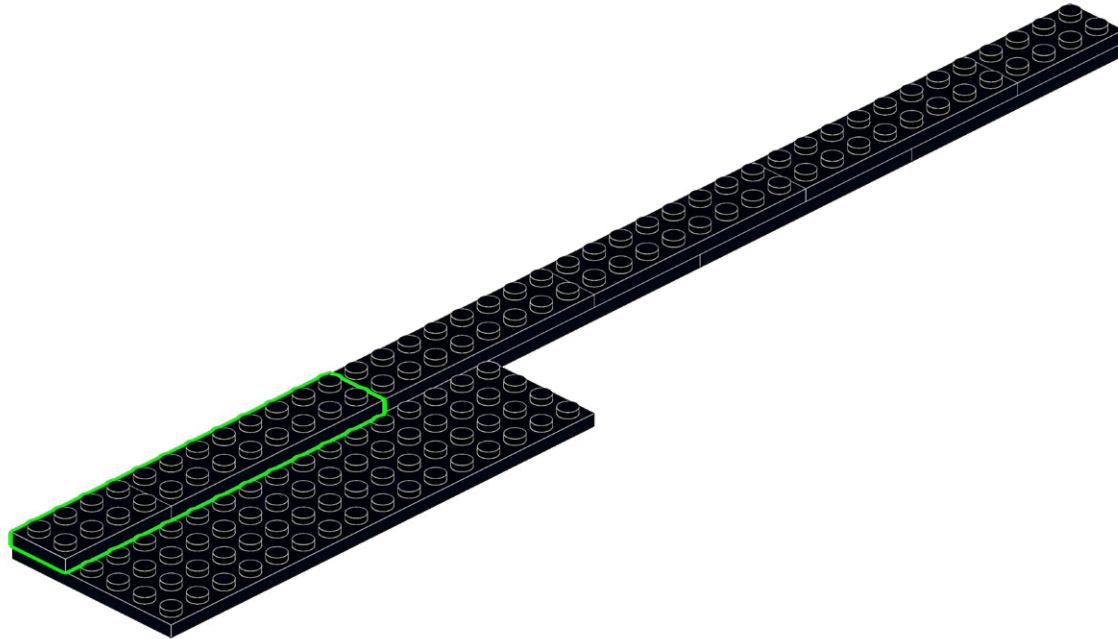
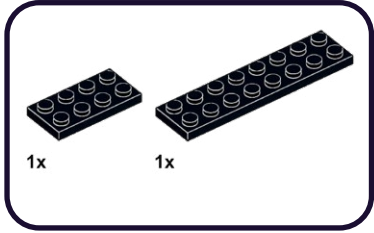



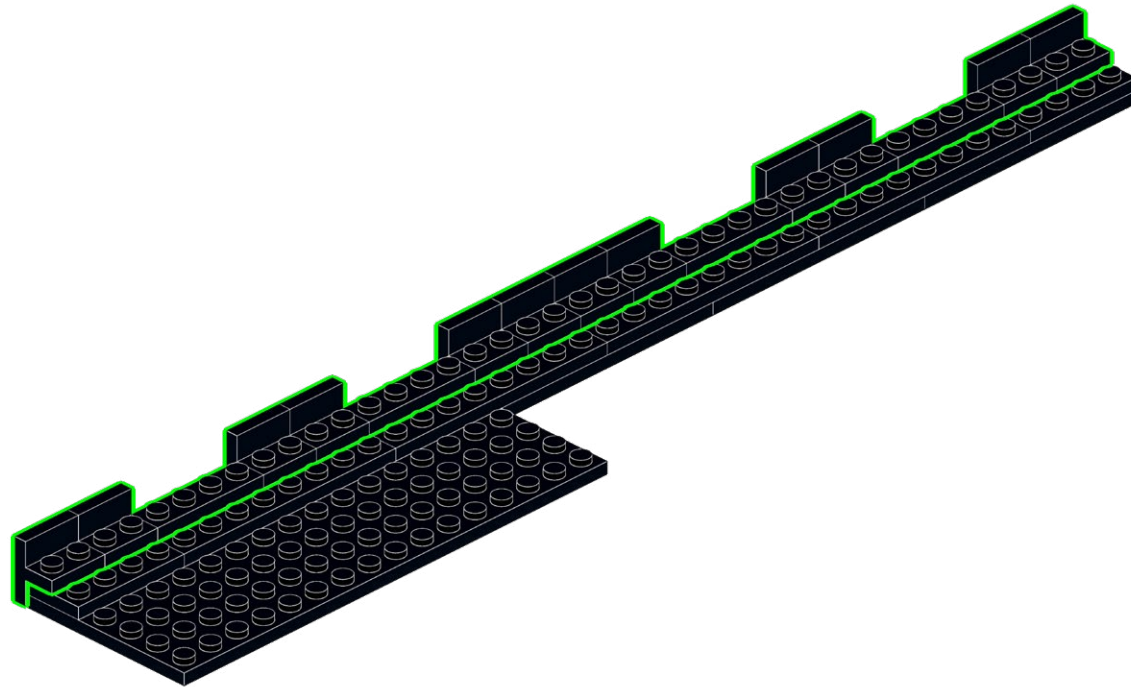
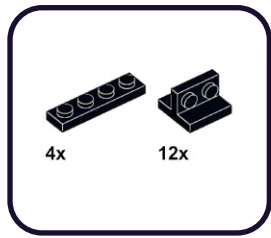

9

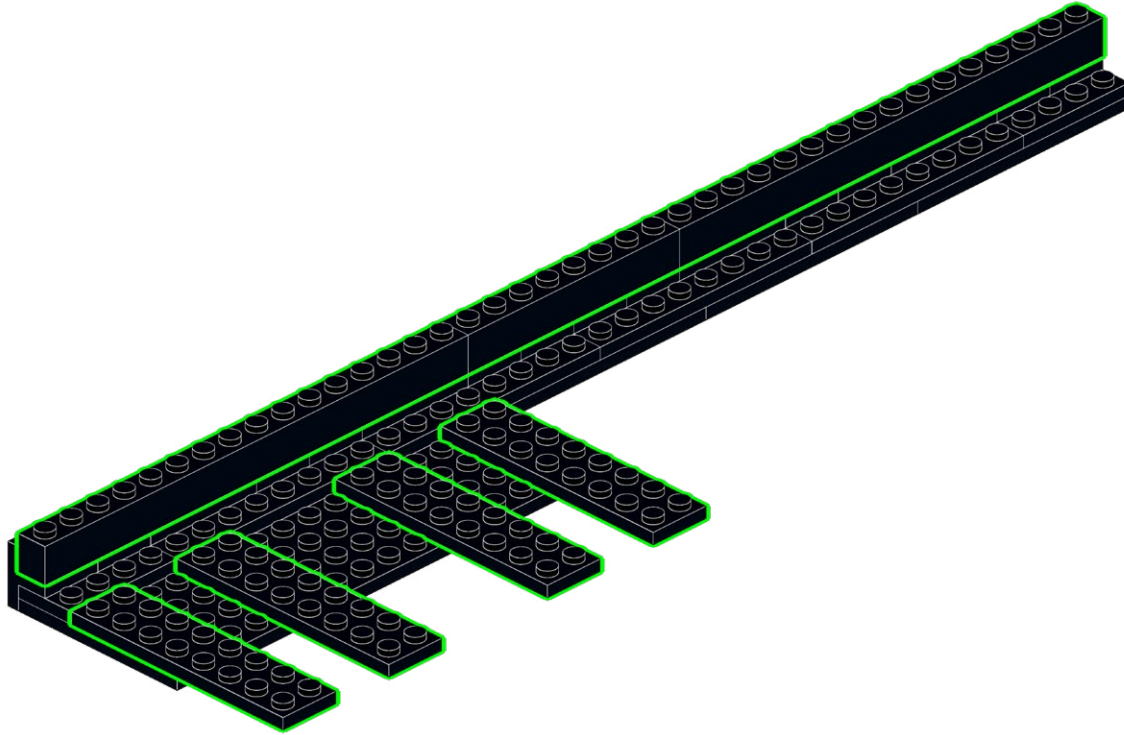
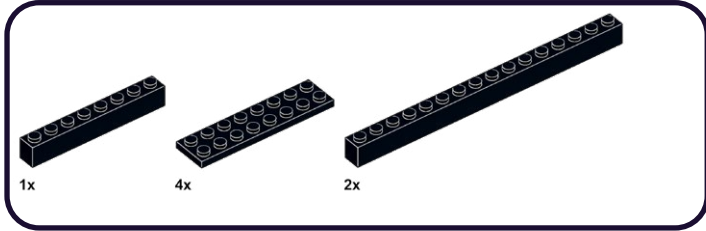

10

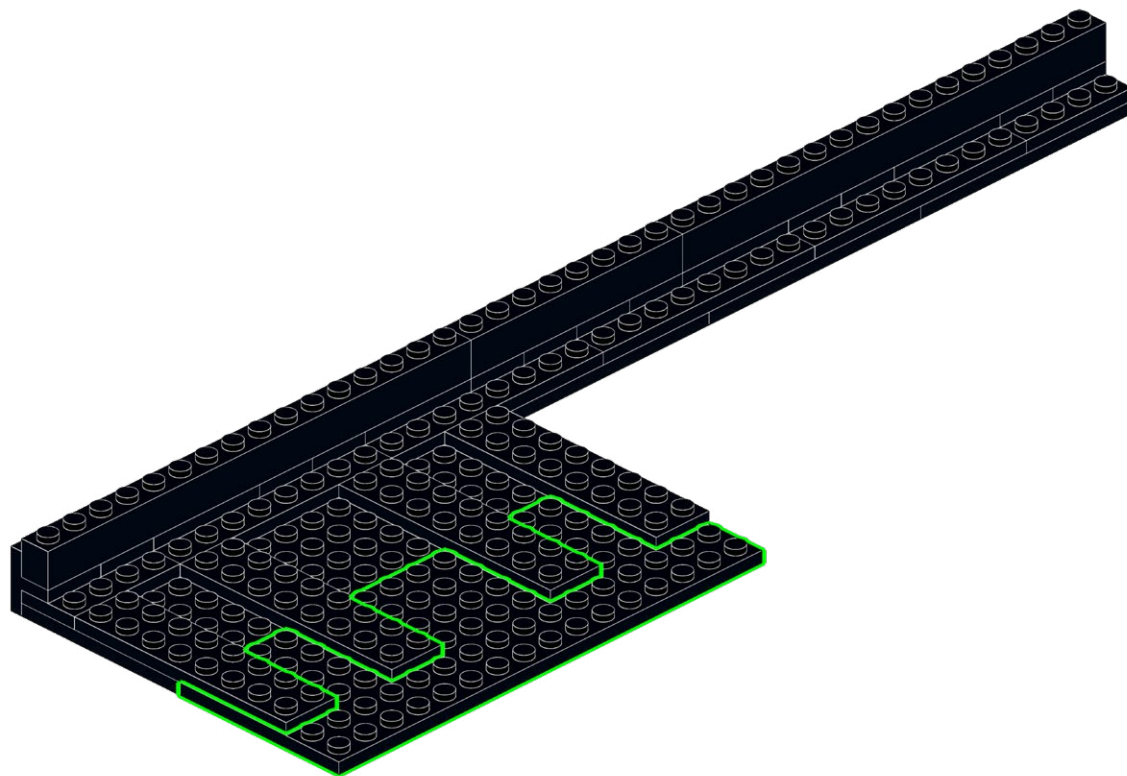

11

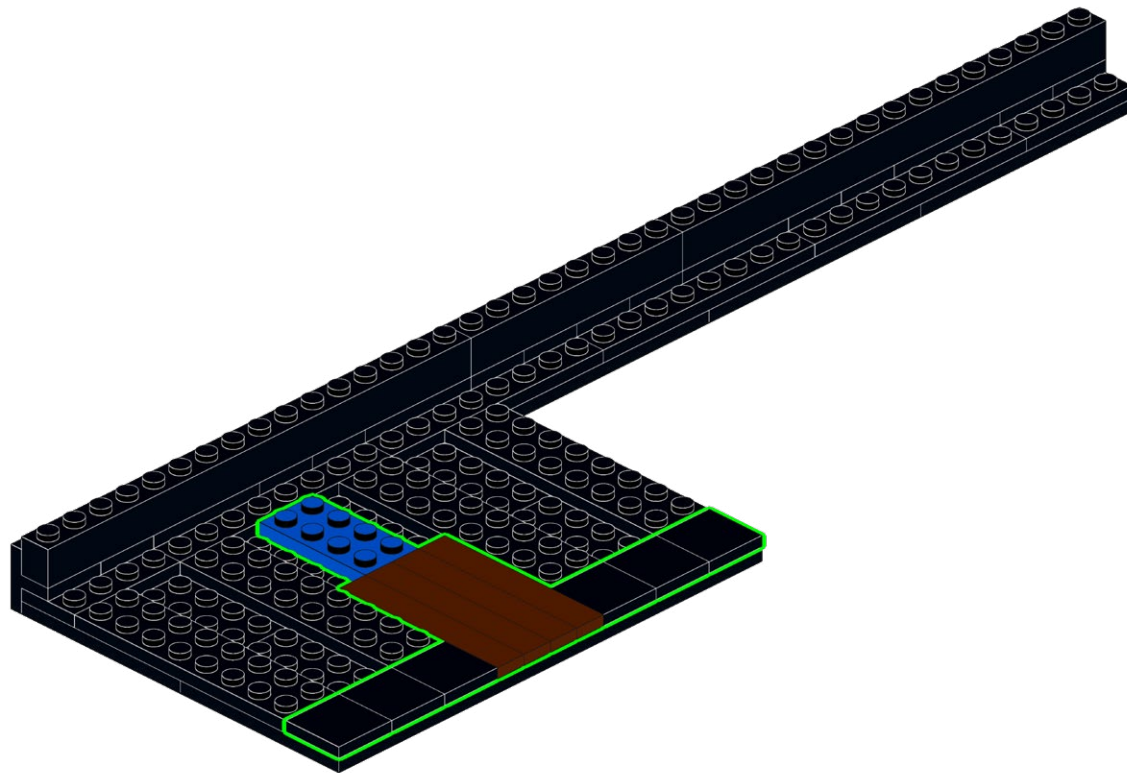
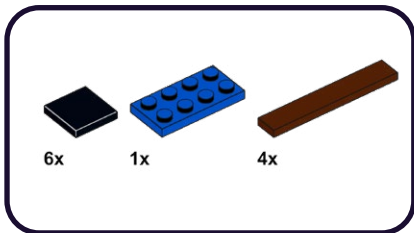

12

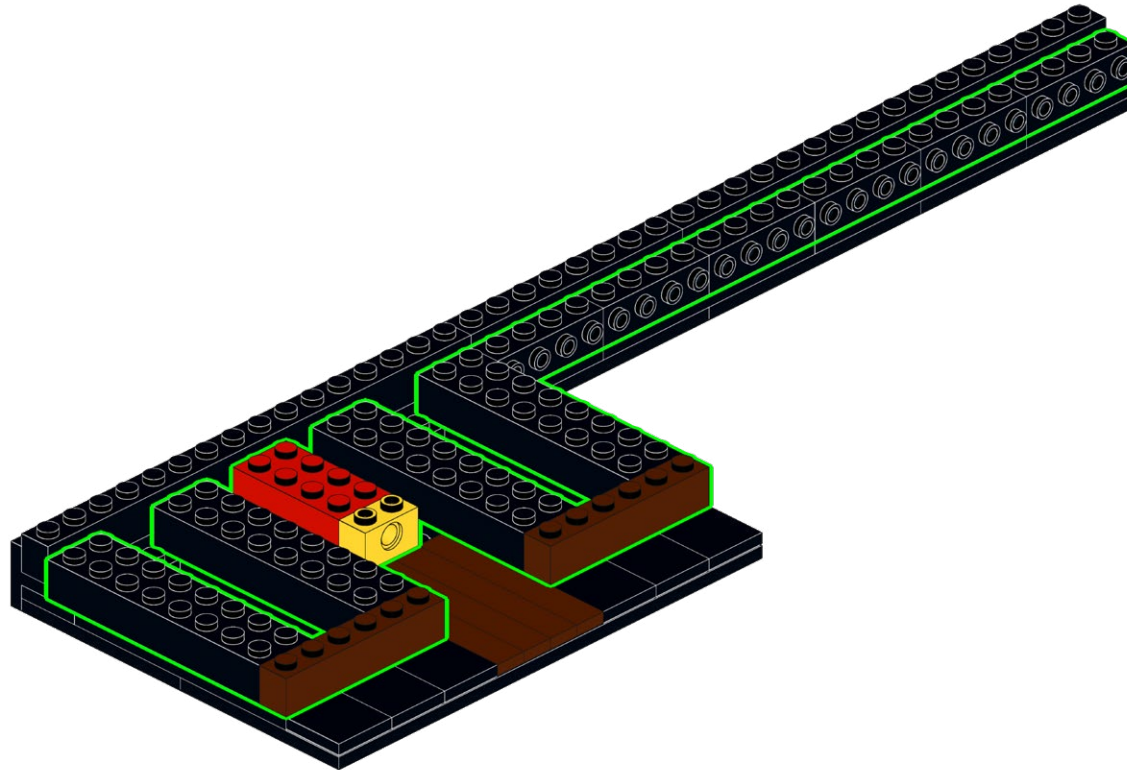
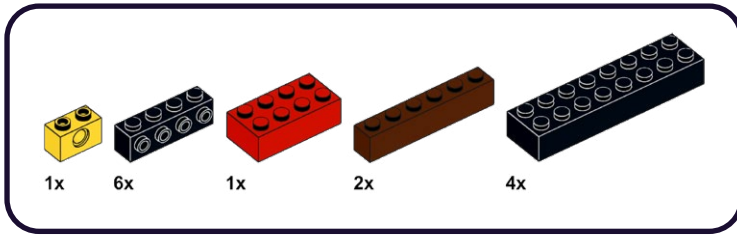



13

5x

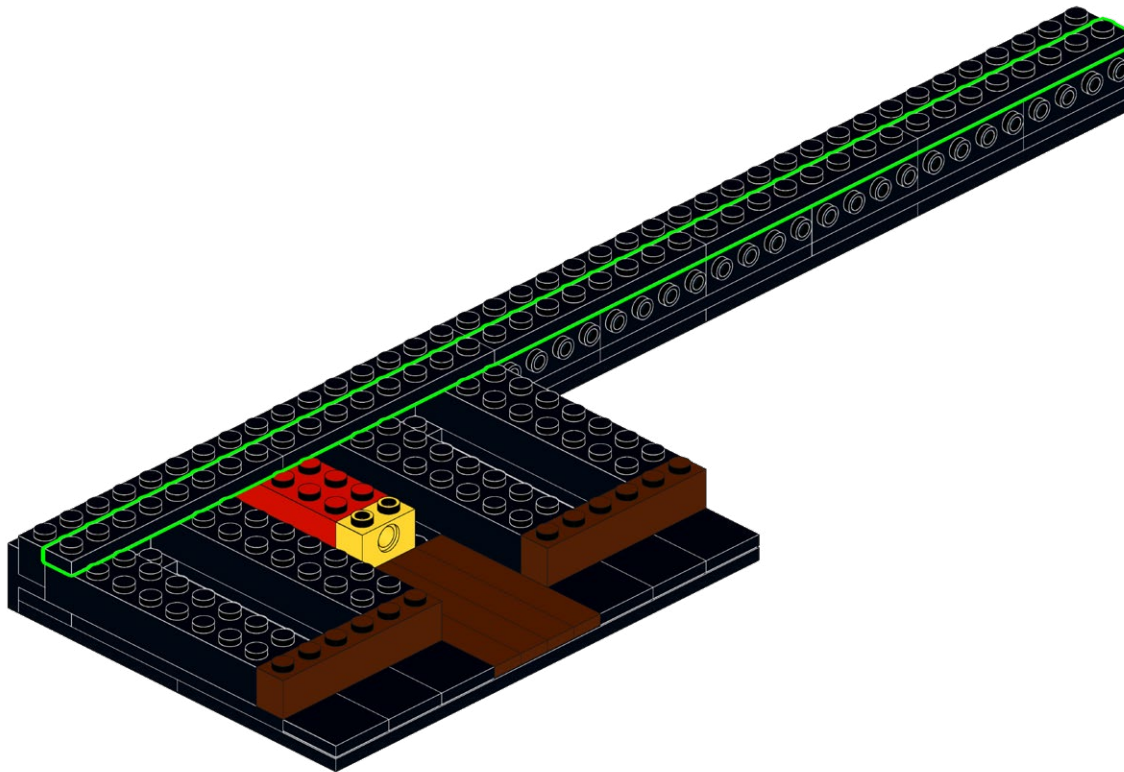

14

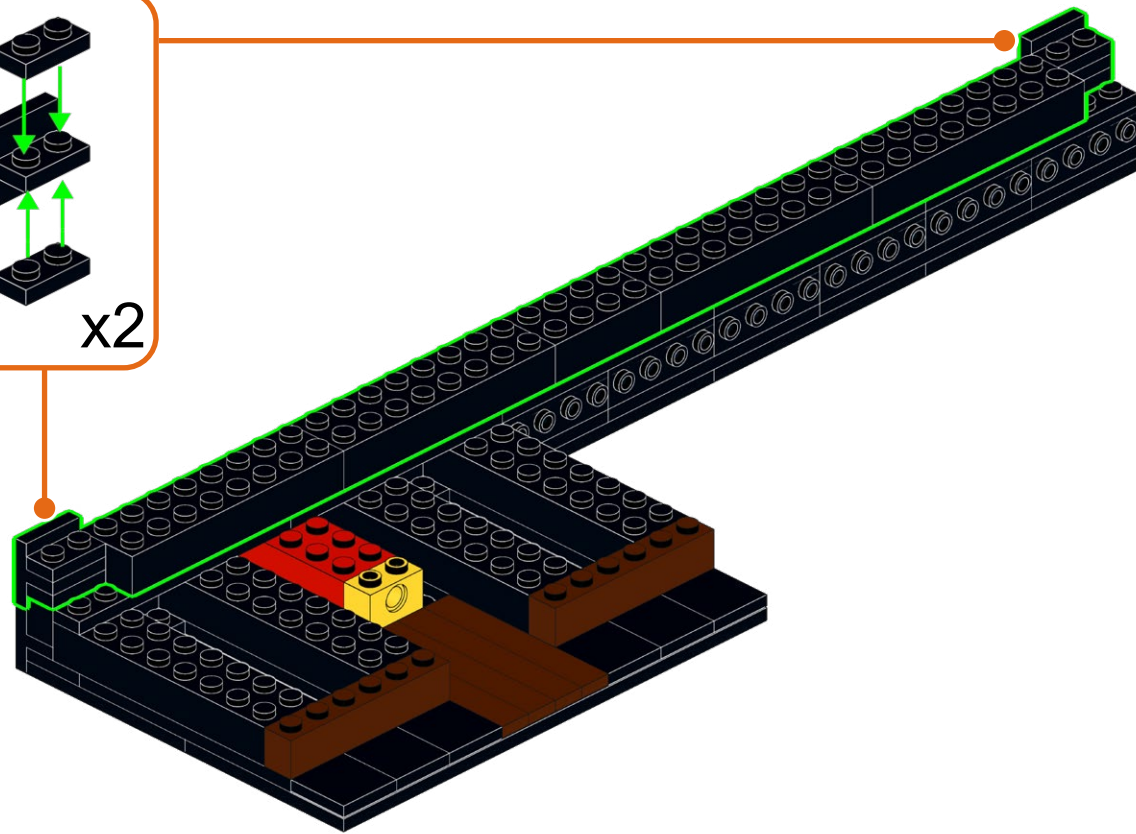
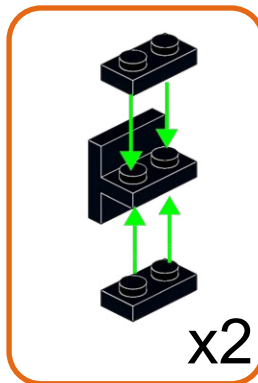
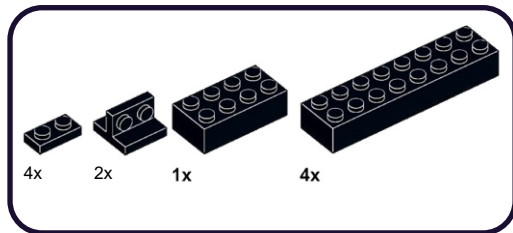

15

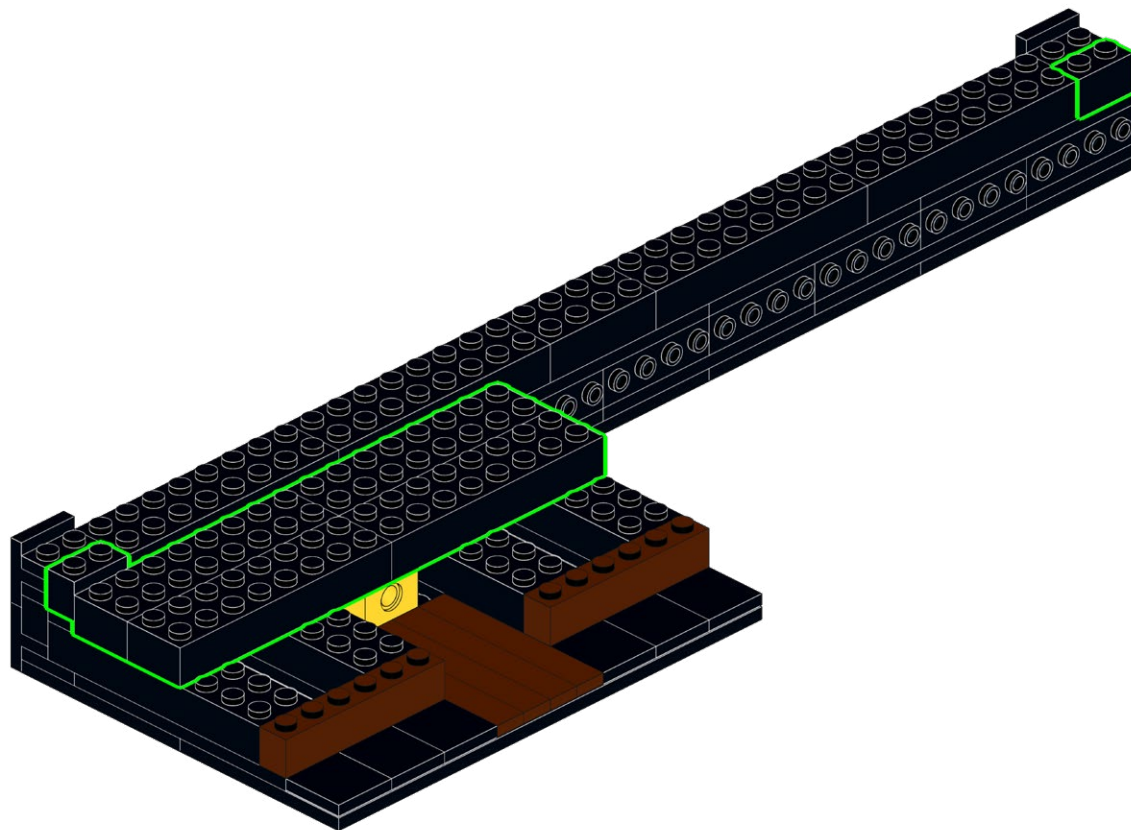
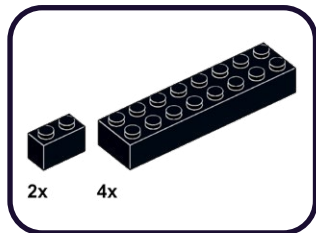

16

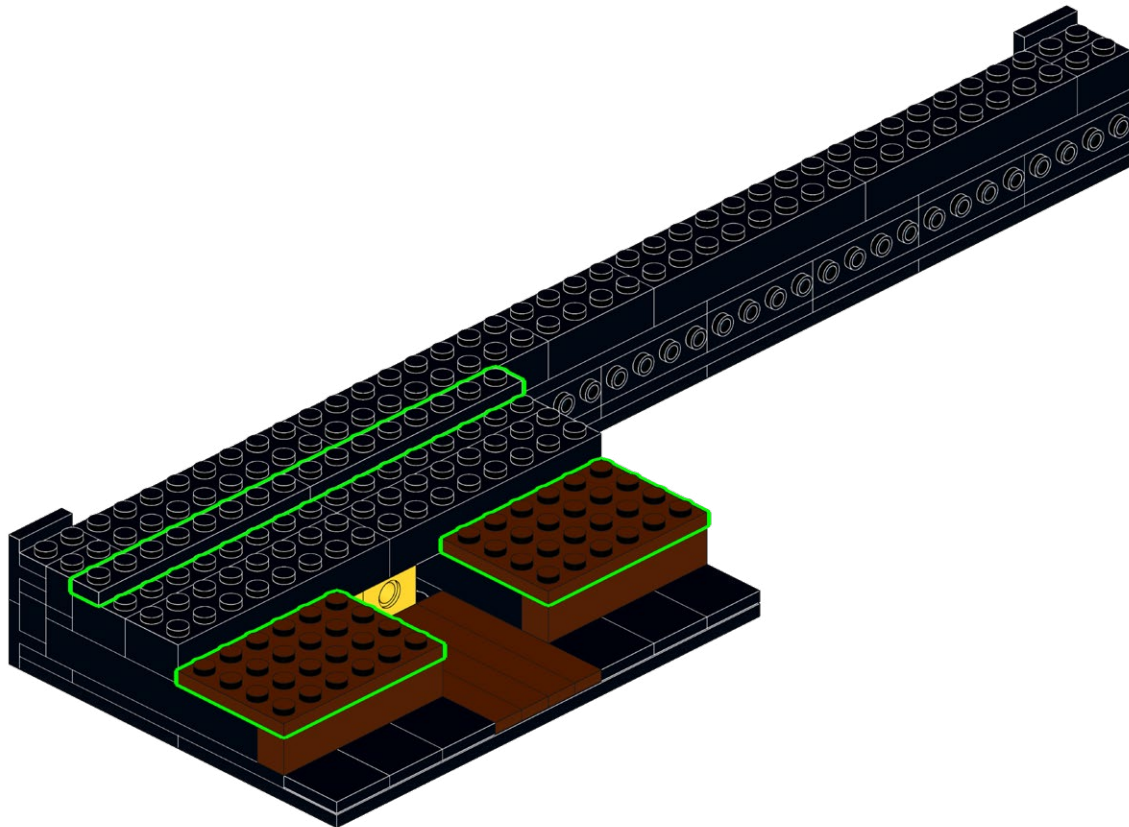
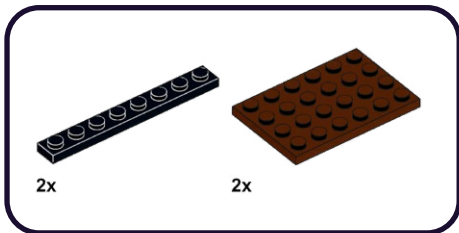

17

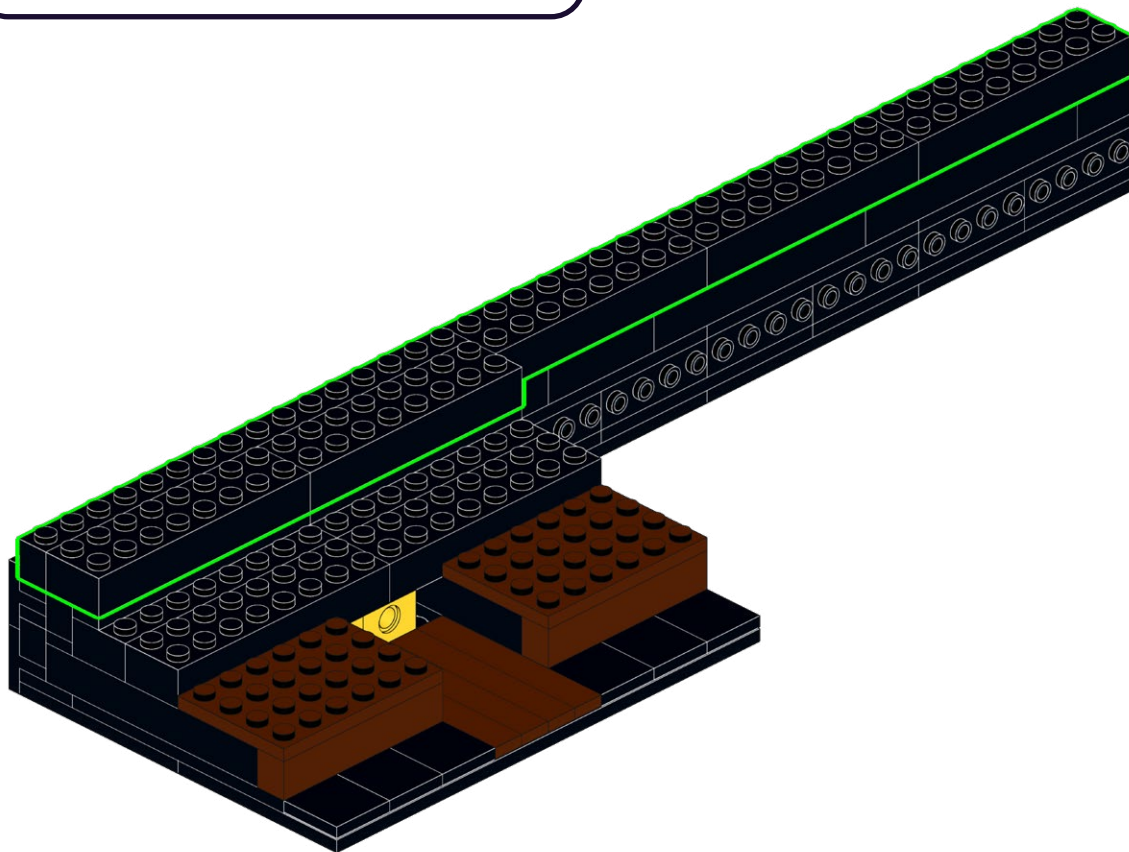
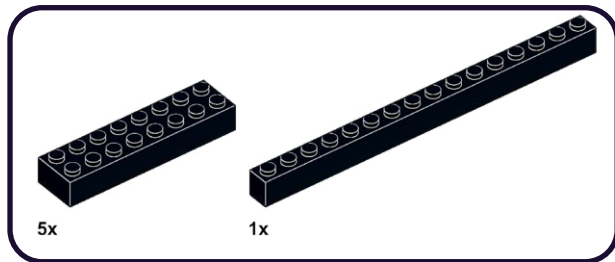



18

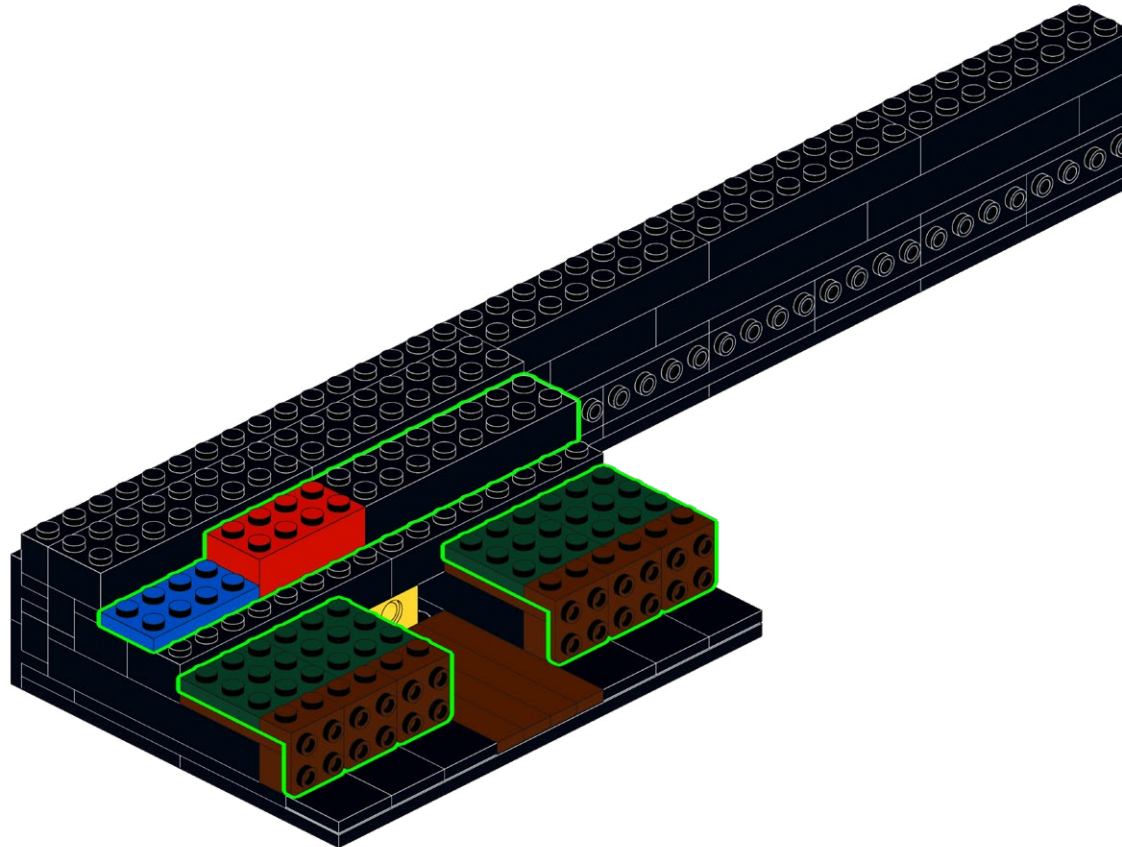
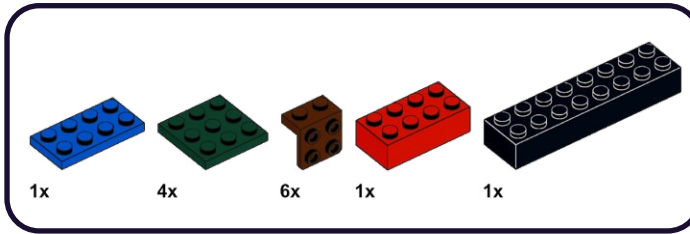

19

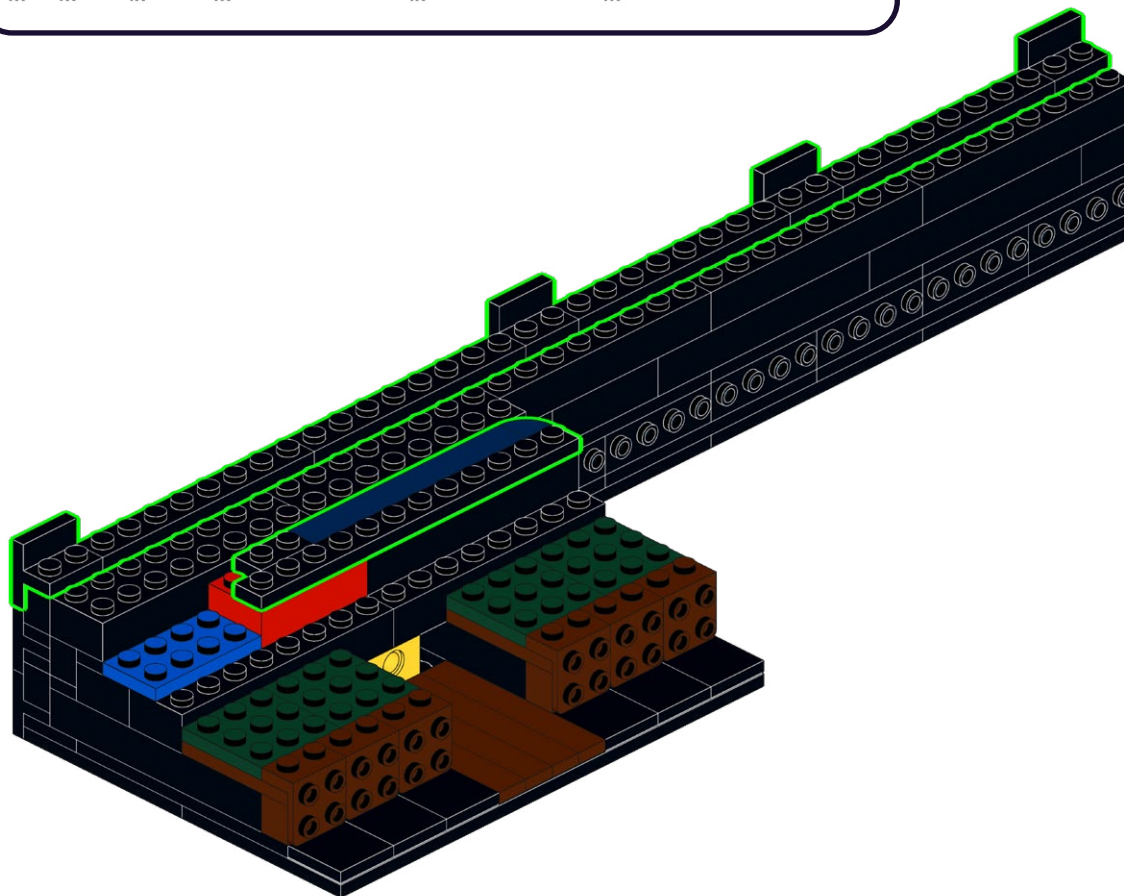
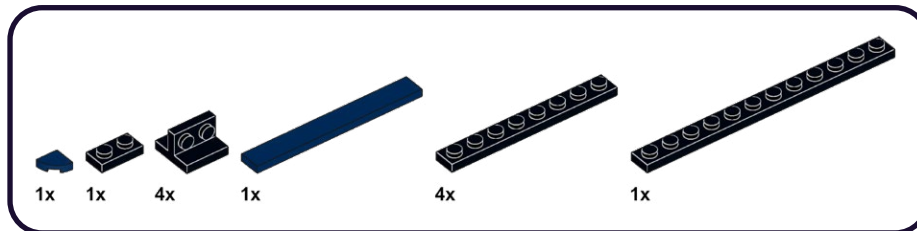

20

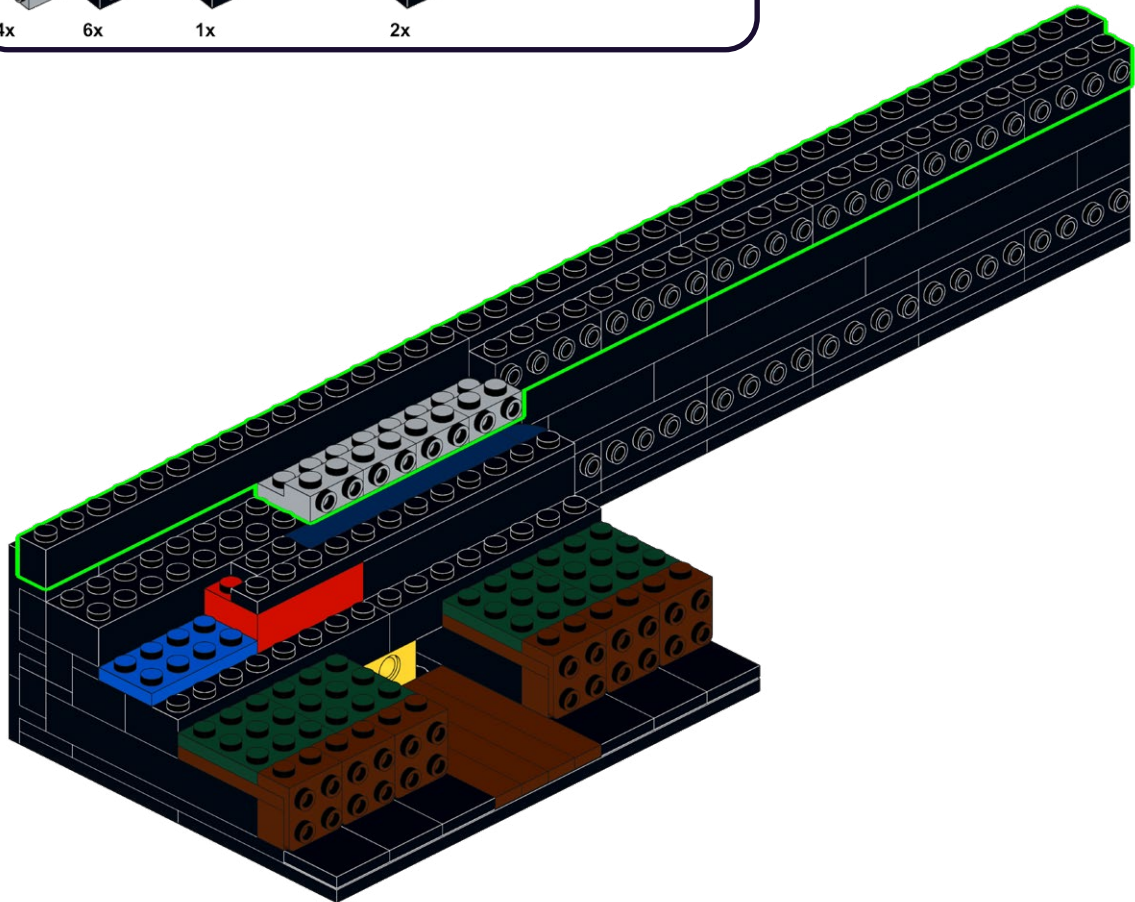
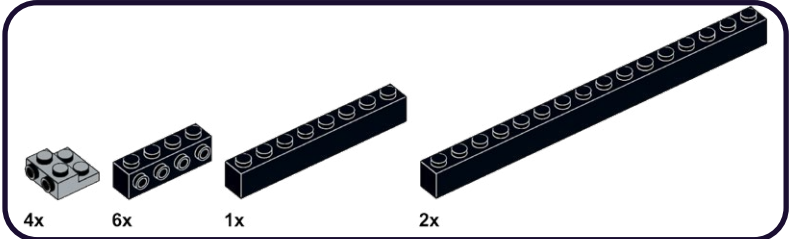

21

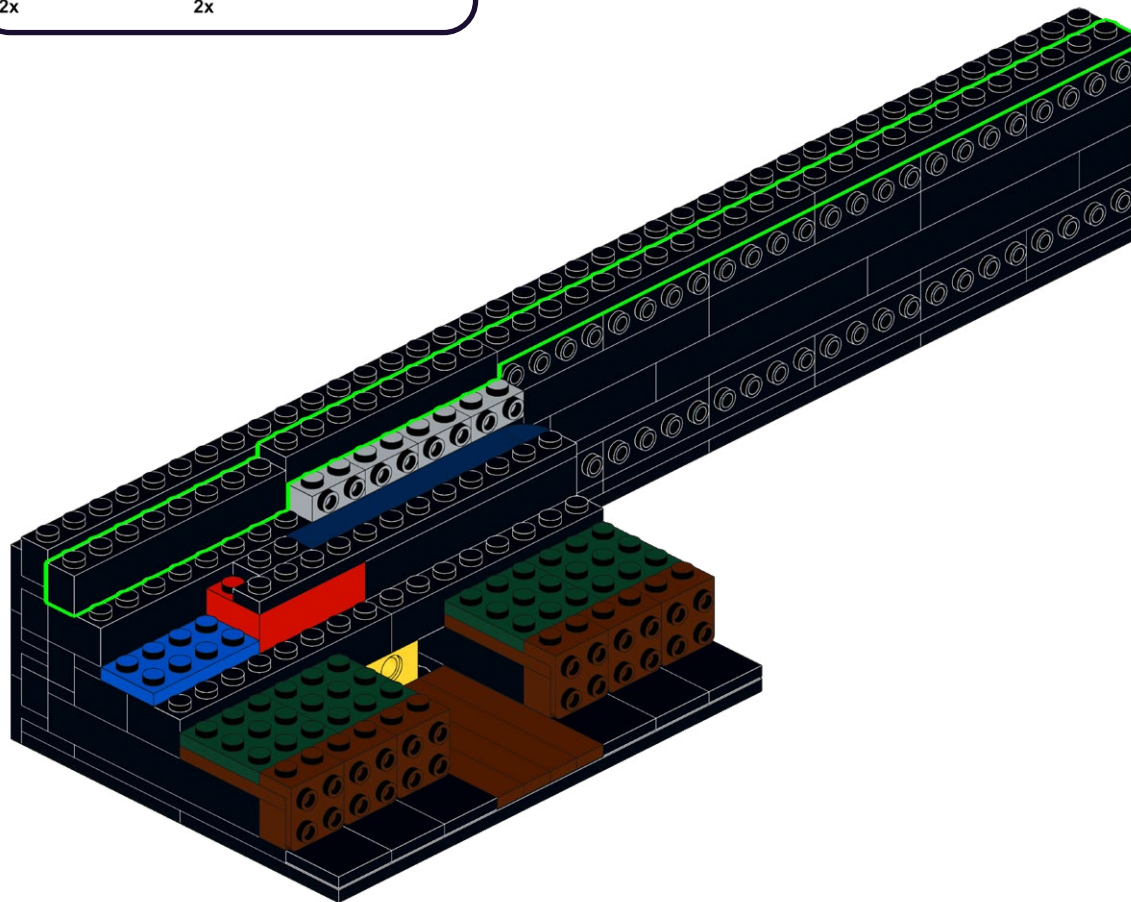
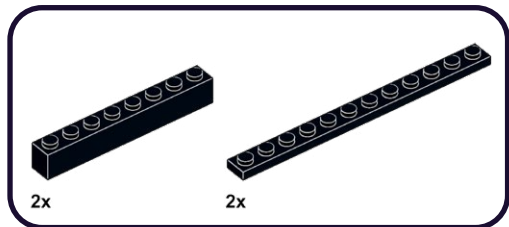

22

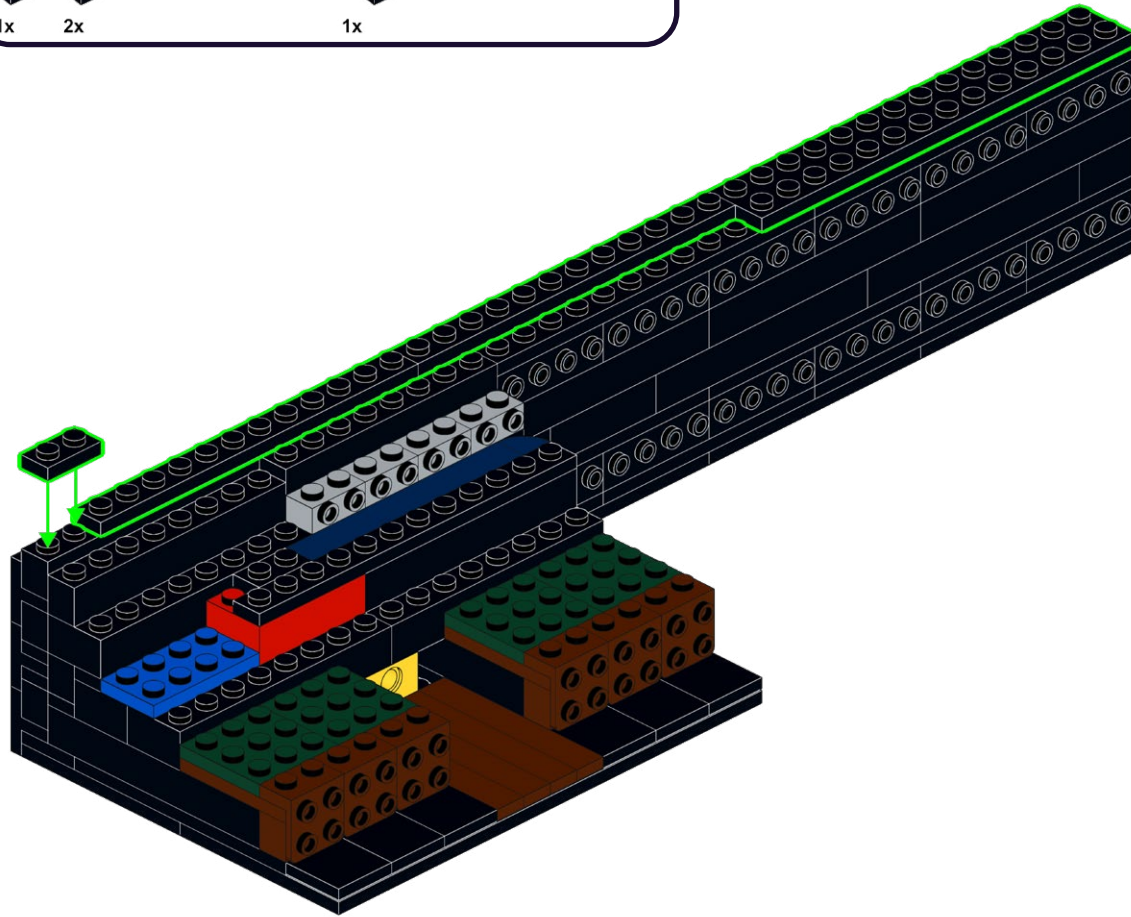
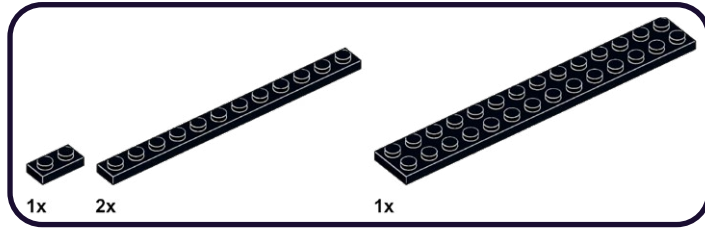



23

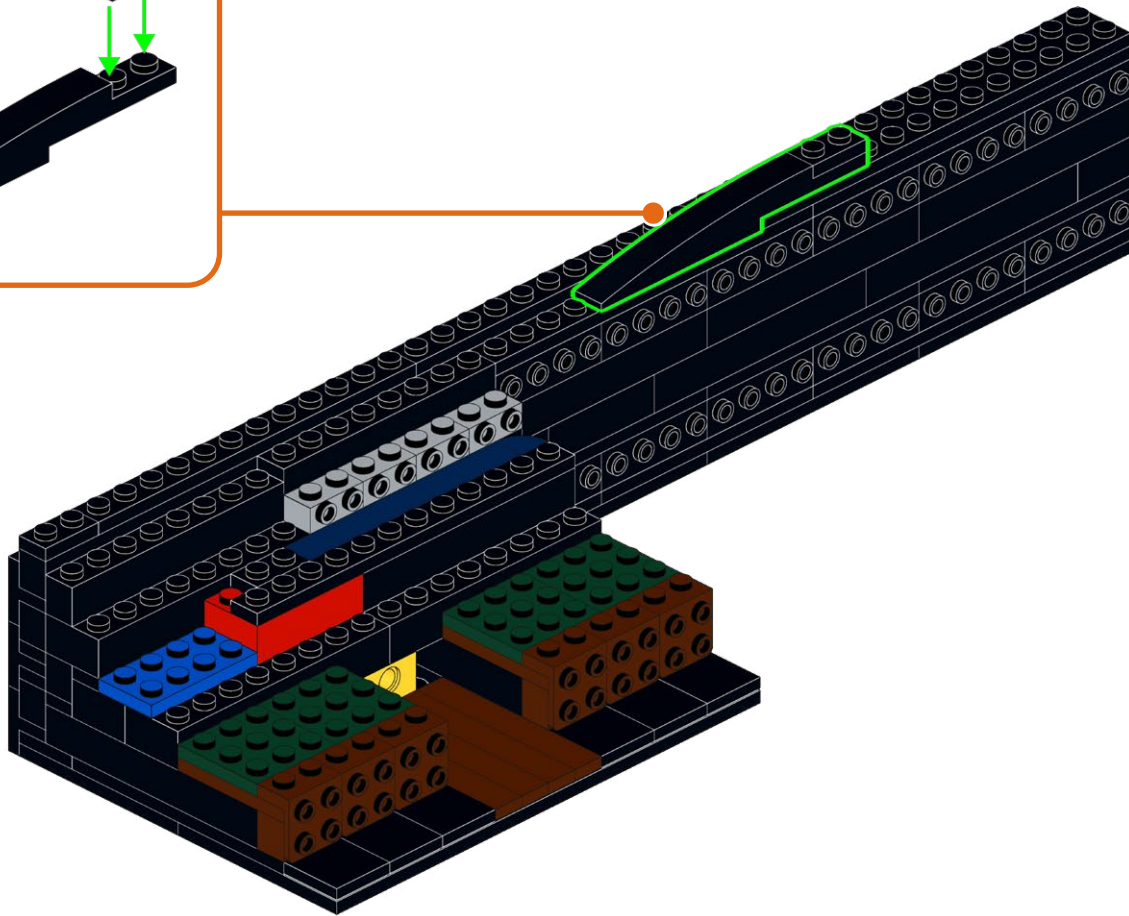
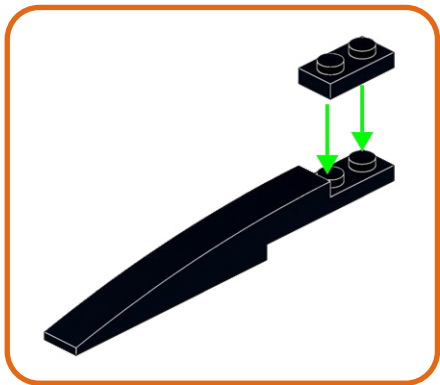
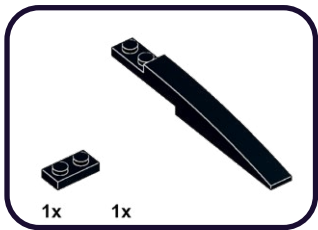

24

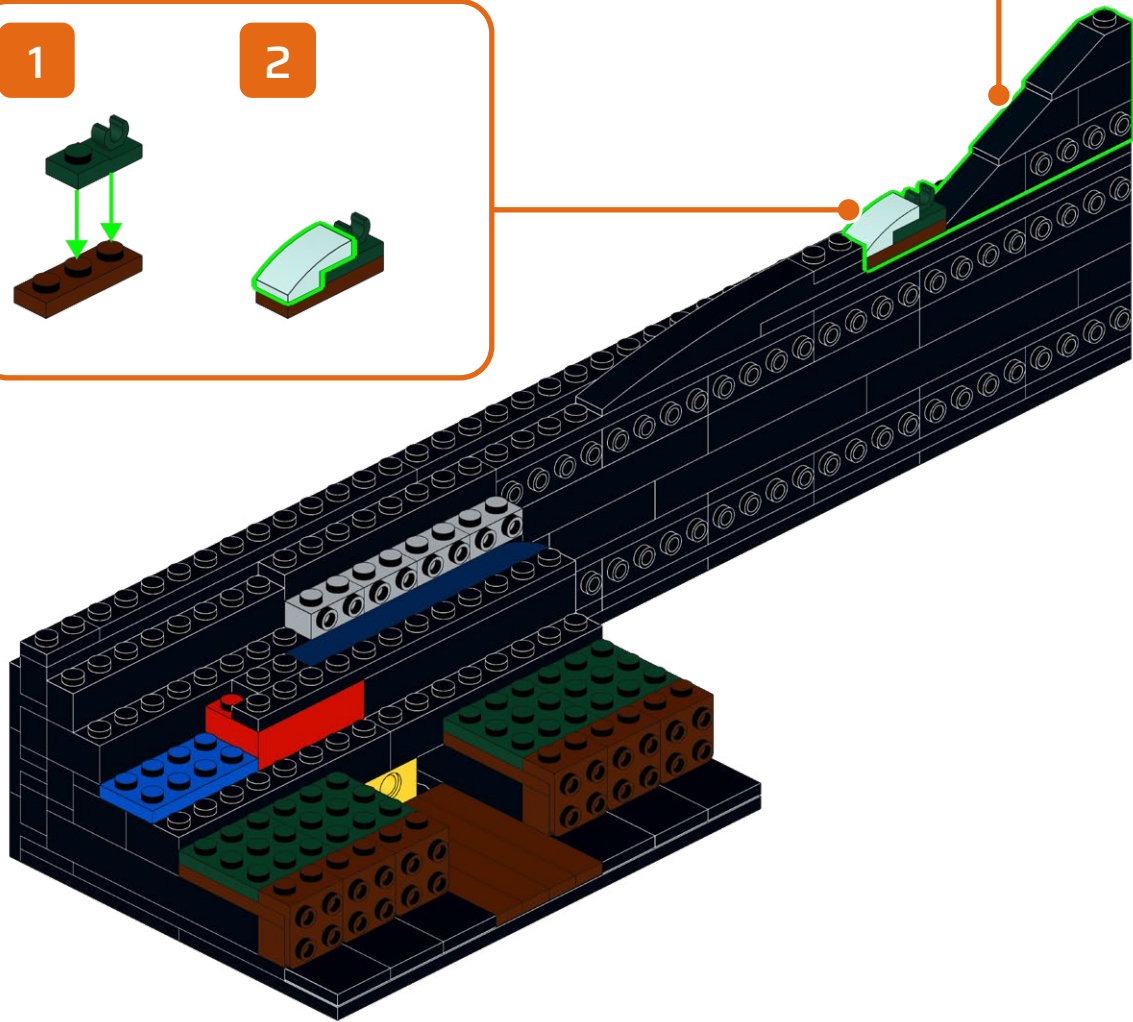
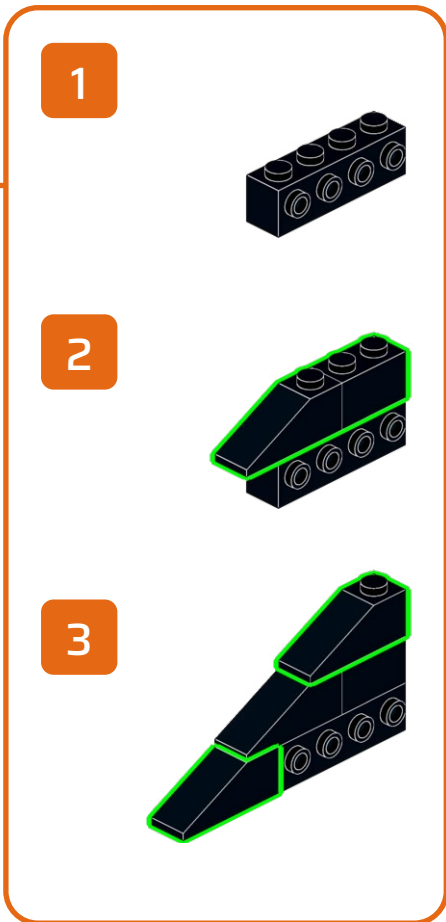
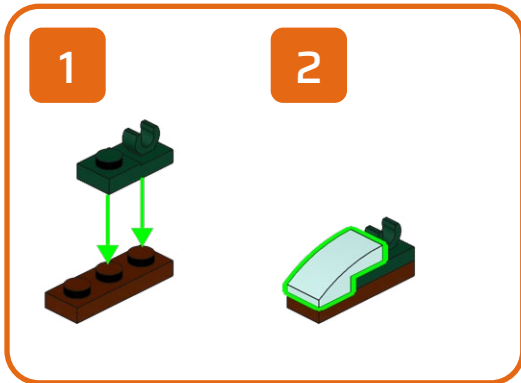
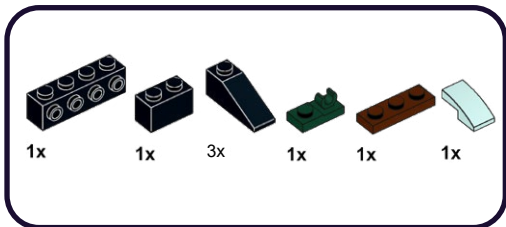



### **HOLD UP!**

You might notice some bags aren't in order, as well as left over pieces, but that's ok! We're changing the way you build LEGO!

### **ATTENDEZ!**

Vous remarquerez peut-être que certains sacs, ainsi que certaines pièces, ne sont pas dans le bon ordre. Mais pas de panique! Nous changeons simplement la façon avec laquelle vous construisez vos LEGO!

### **ASPETTA!**

Potresti notare che alcuni sacchetti non sono in ordine, così come i pezzi avanzati, ma va bene così! Stiamo cambiando il modo in cui costruisci i LEGO!

### **HALT!**

Sie werden möglicherweise bemerken, dass einige tüten durcheinander sind und teile übrig bleiben, aber das ist in Ordnung! Wir ändern die art und weise, wie Sie LEGO bauen!

### **¡ESPERA!**

Es posible que notes que algunas bolsas están fuera de servicio, así como piezas sobrantes, ¡pero está bien! ¡Estamos cambiando la forma en que construyes LEGO!

### **暫停!**

你可能会注意到一些袋子顺序错乱, 以及一些剩余的部件, 但没关系! 我们正在改变你搭建乐高的方式!

### Open LEGO® Bag 2

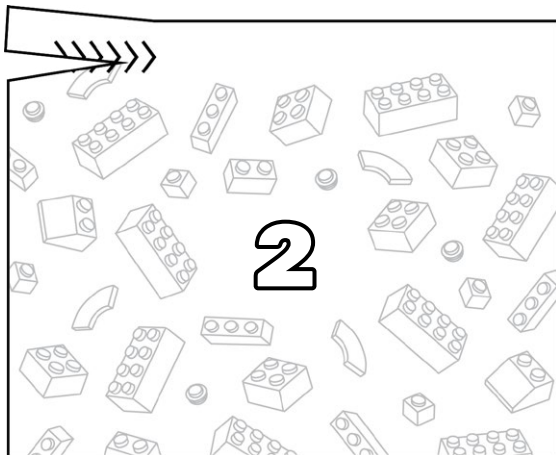



# 25

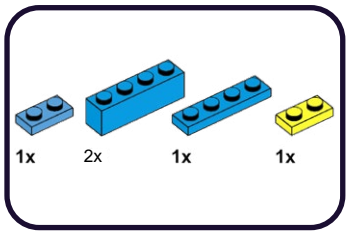

1

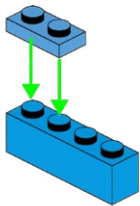

2

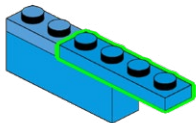

3

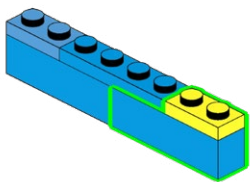

# 26

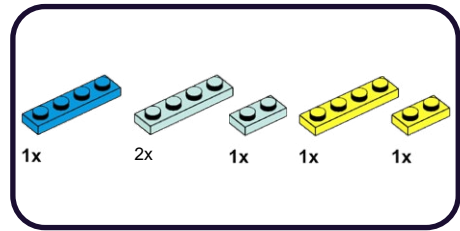

1

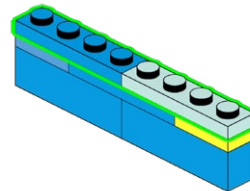

2

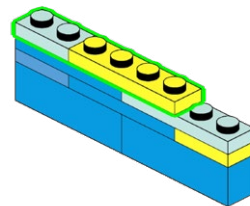

3

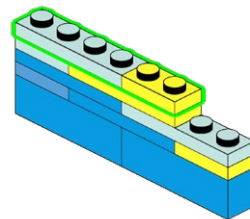

# 27

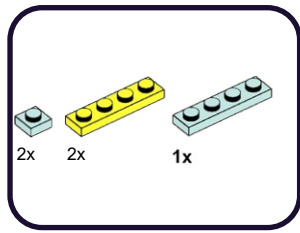

1

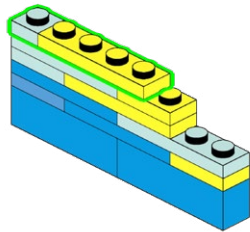

2

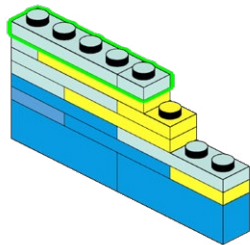

3

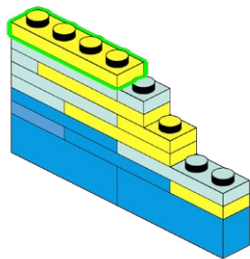

# 28

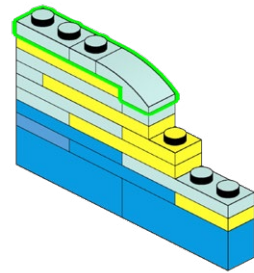
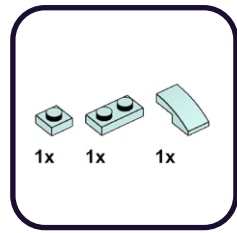

29

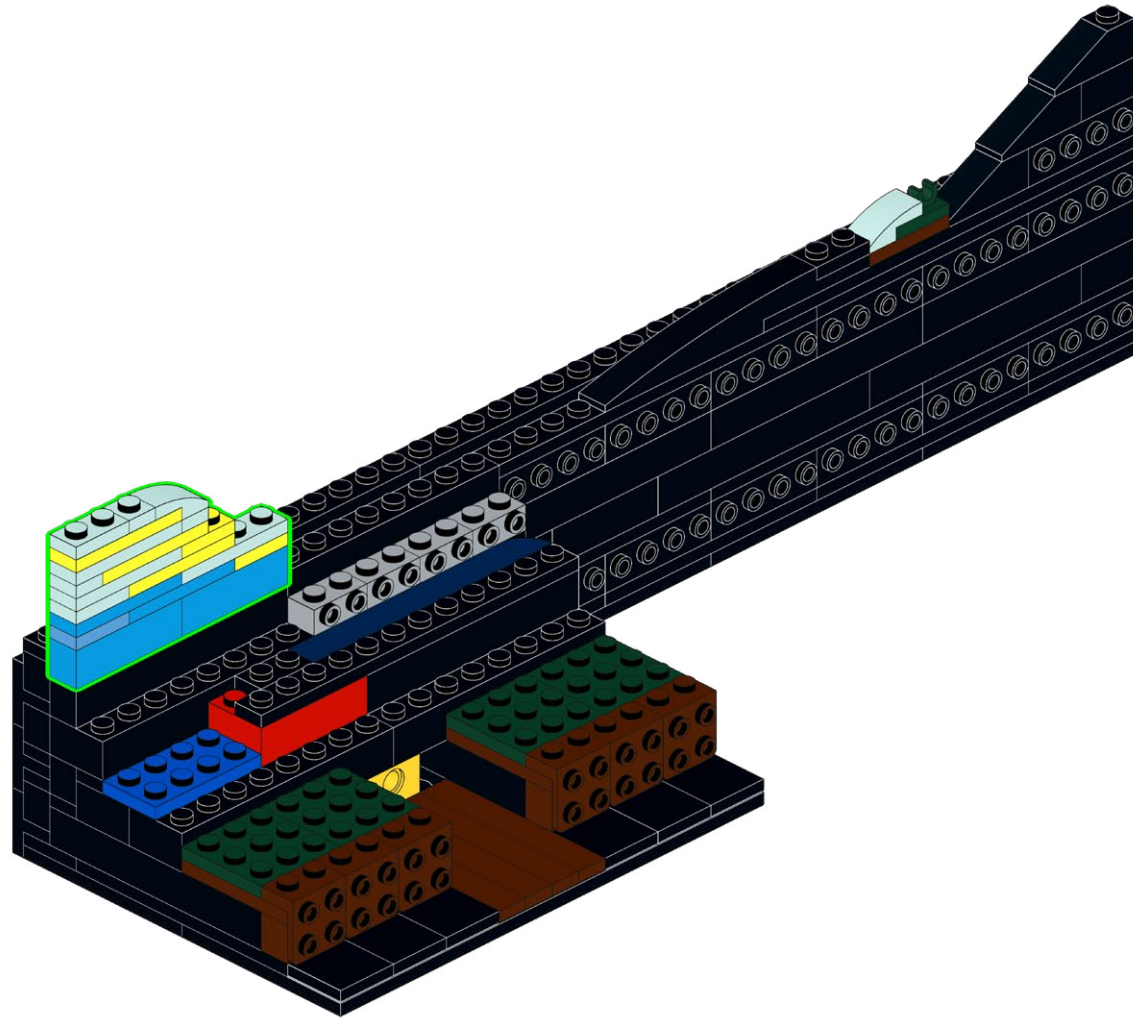

30

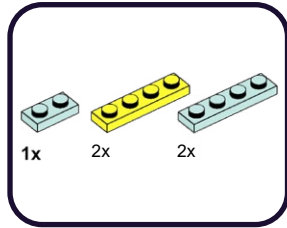

1

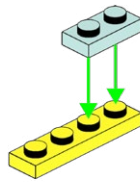

2

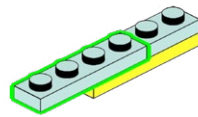

3

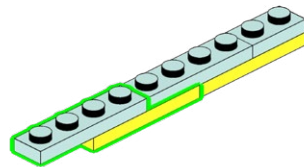

31

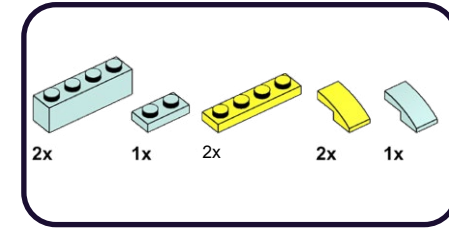

1

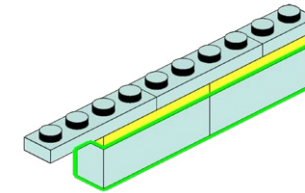

2

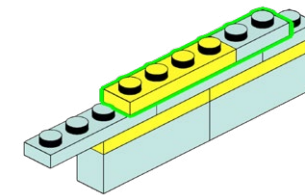

3

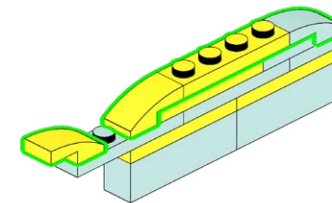

32

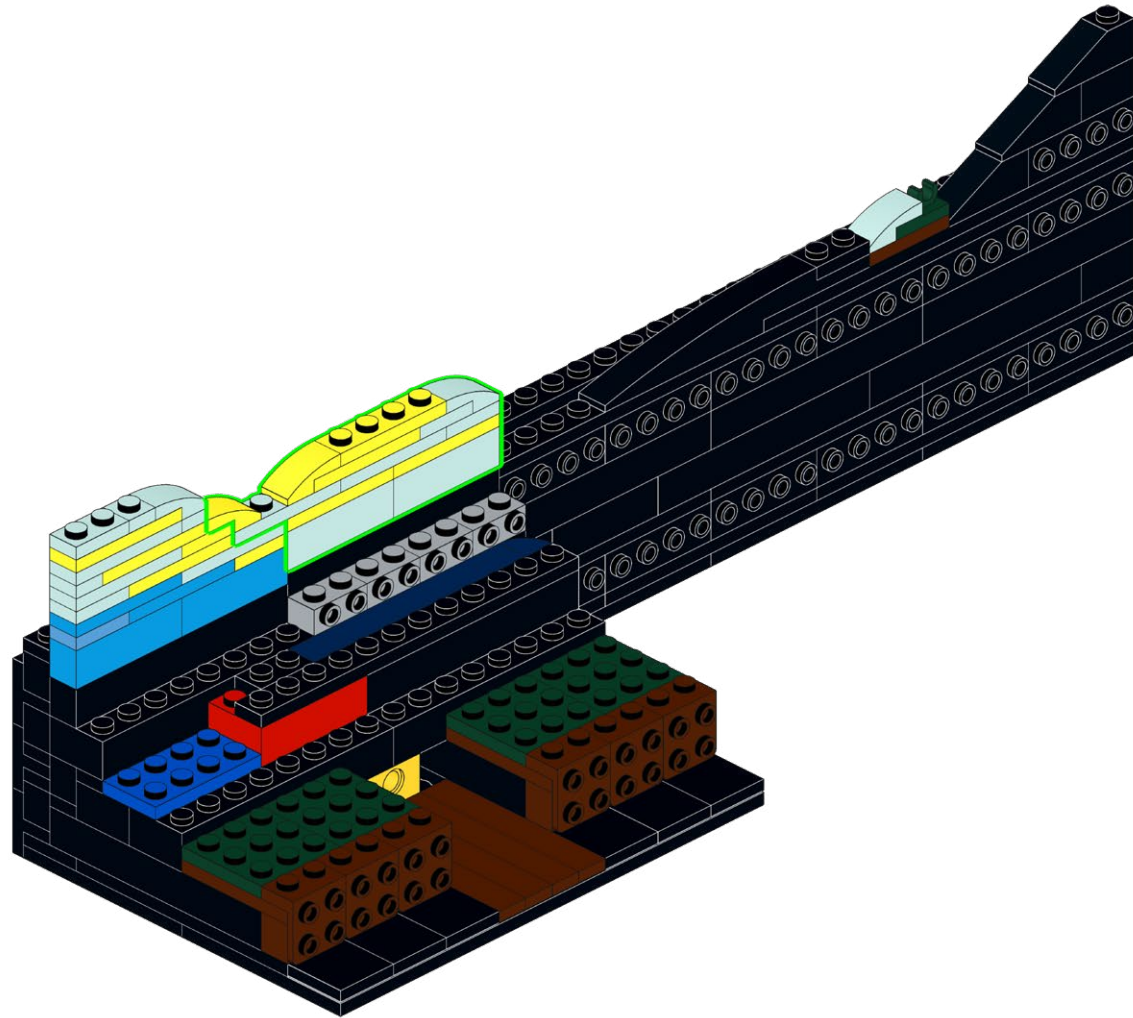

# 33

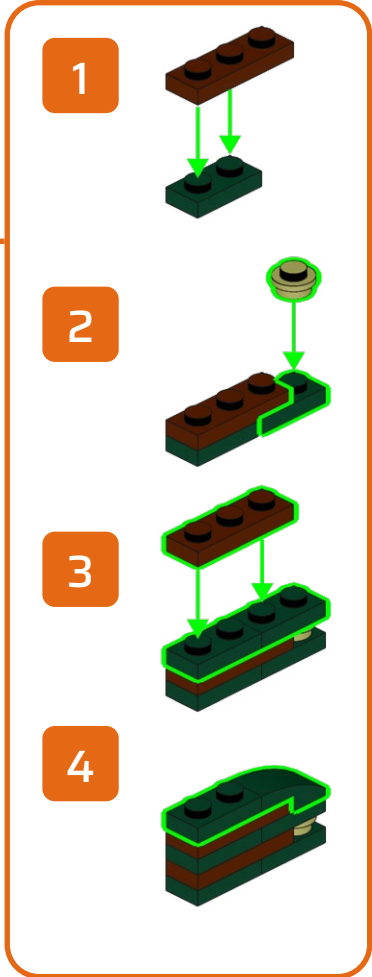
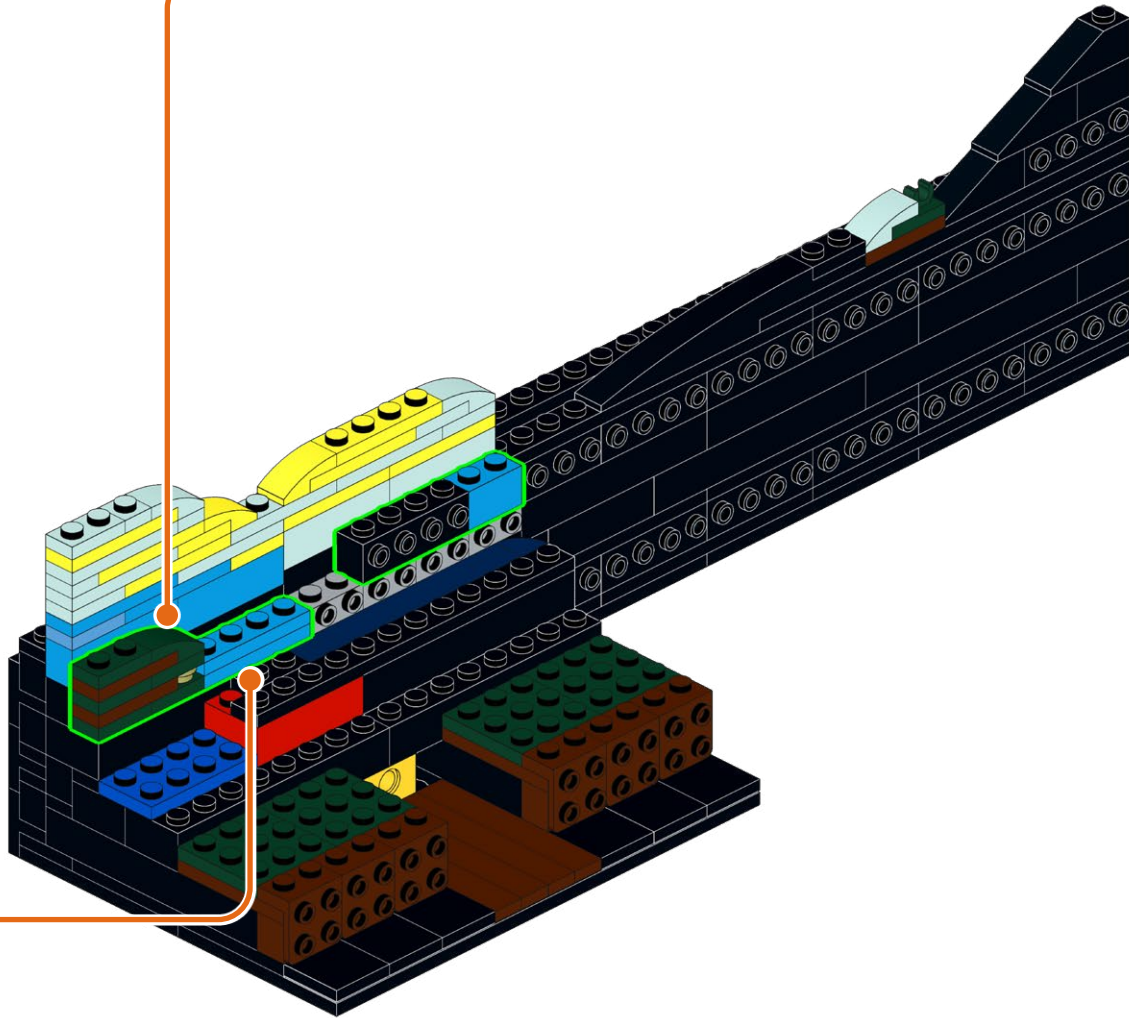
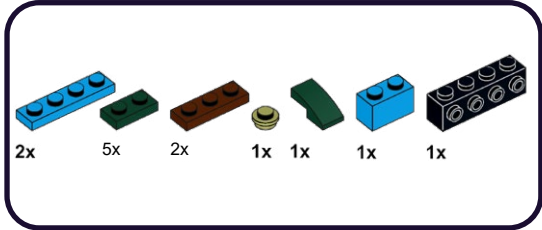



34

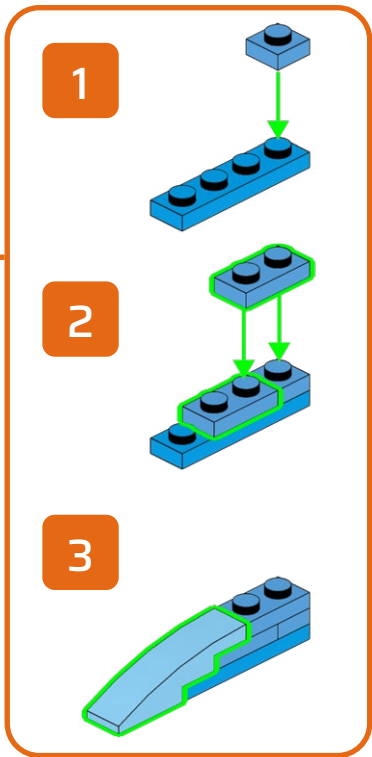
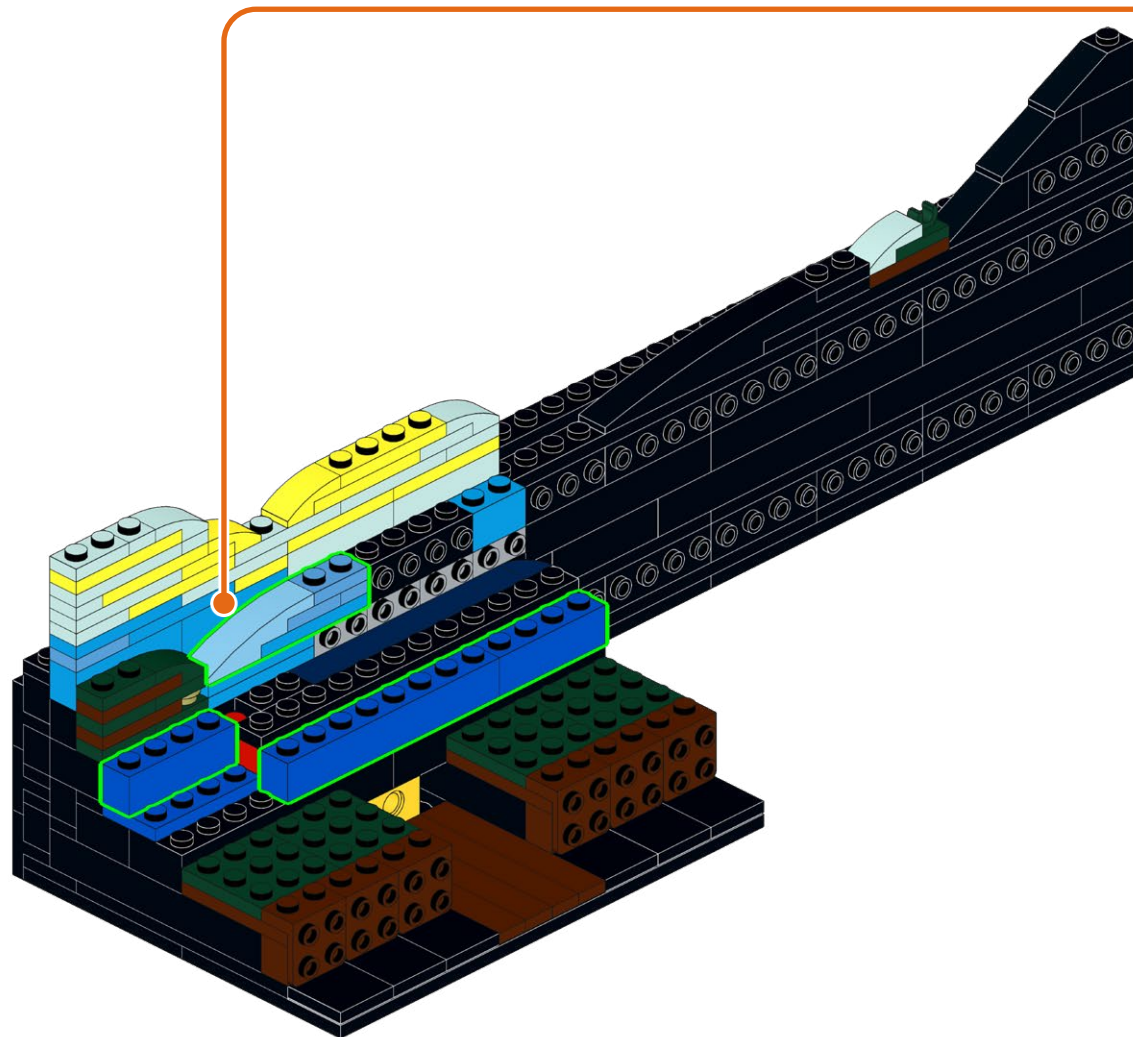
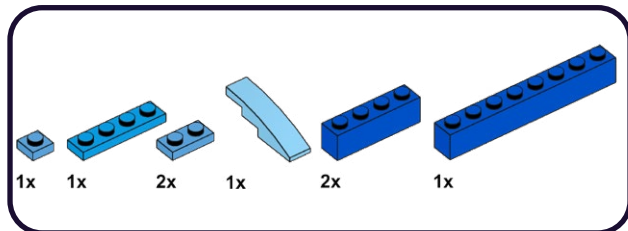

# 35

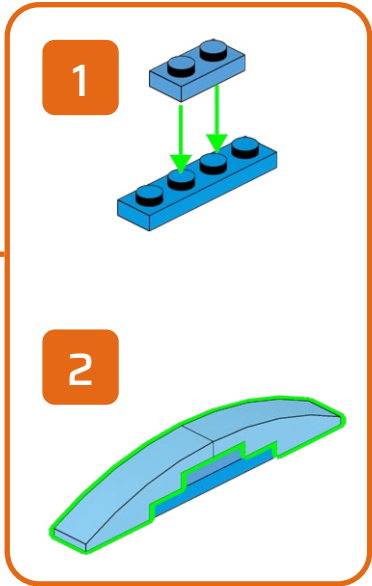
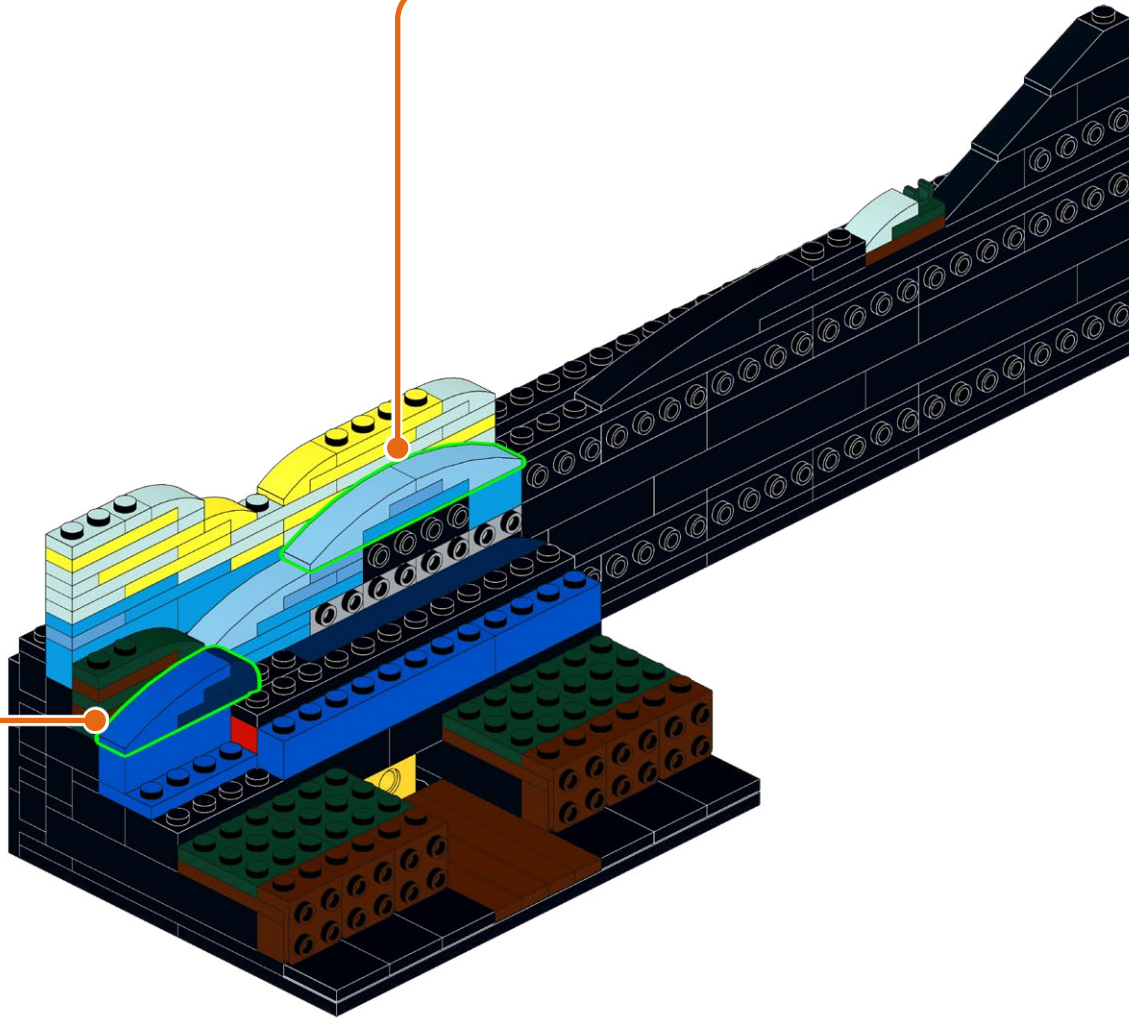
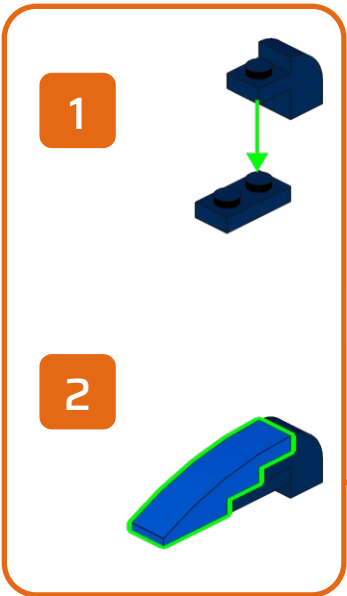
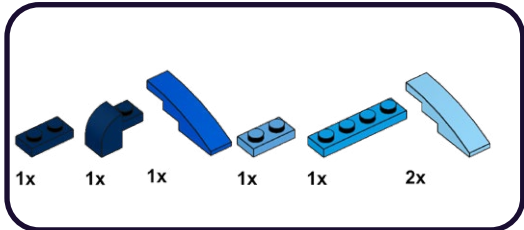



36

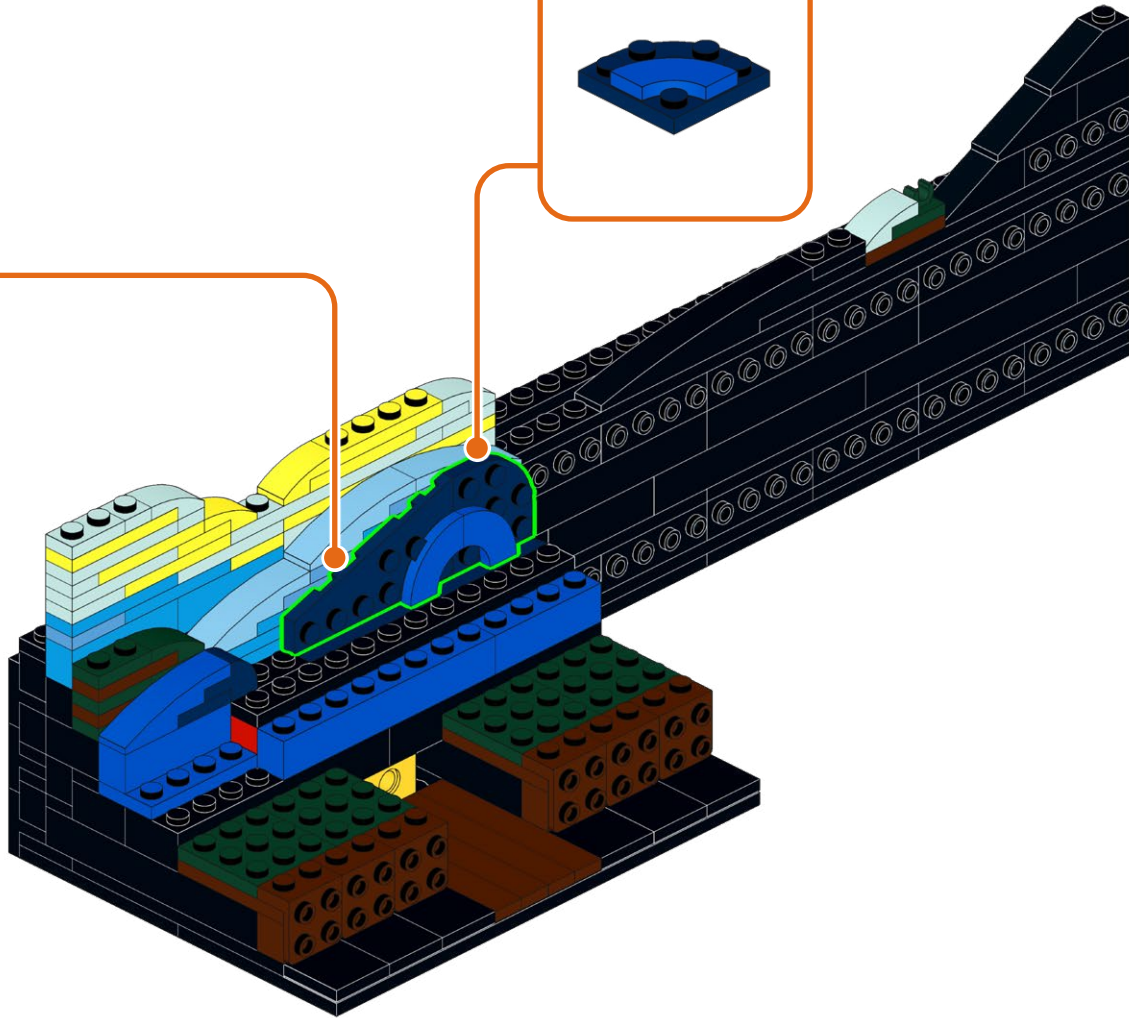
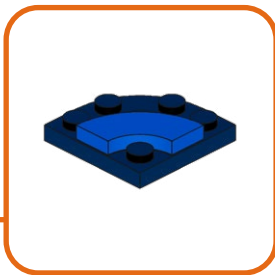
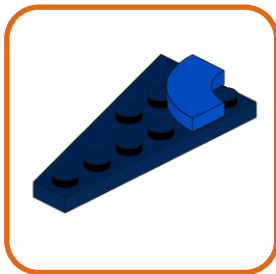
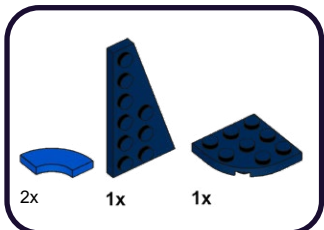

37

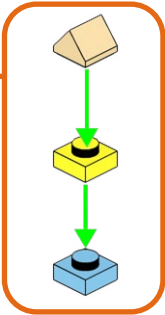
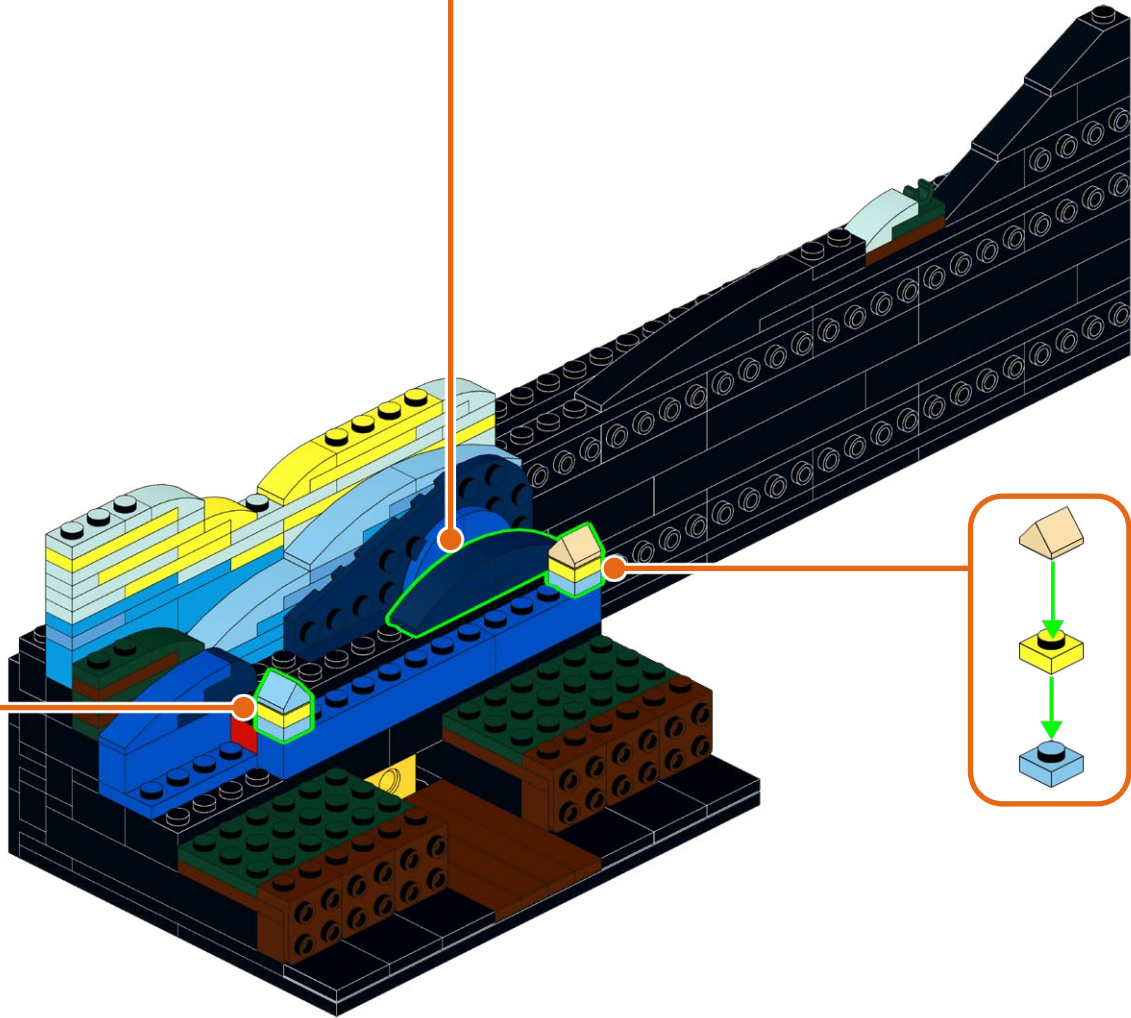
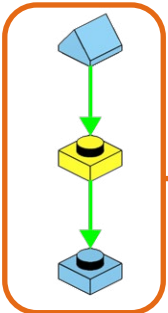
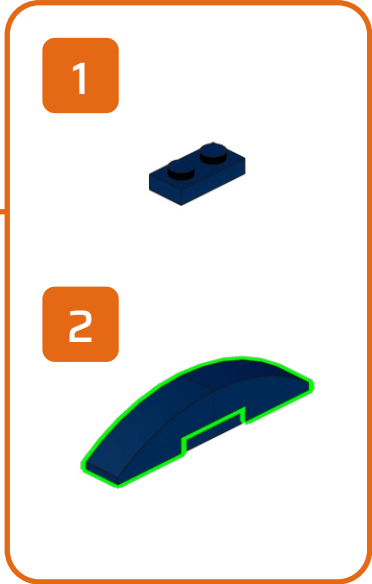
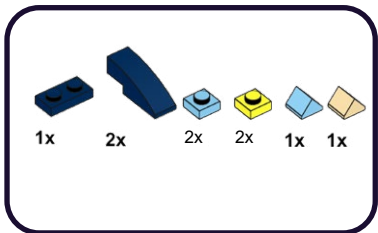

# 38

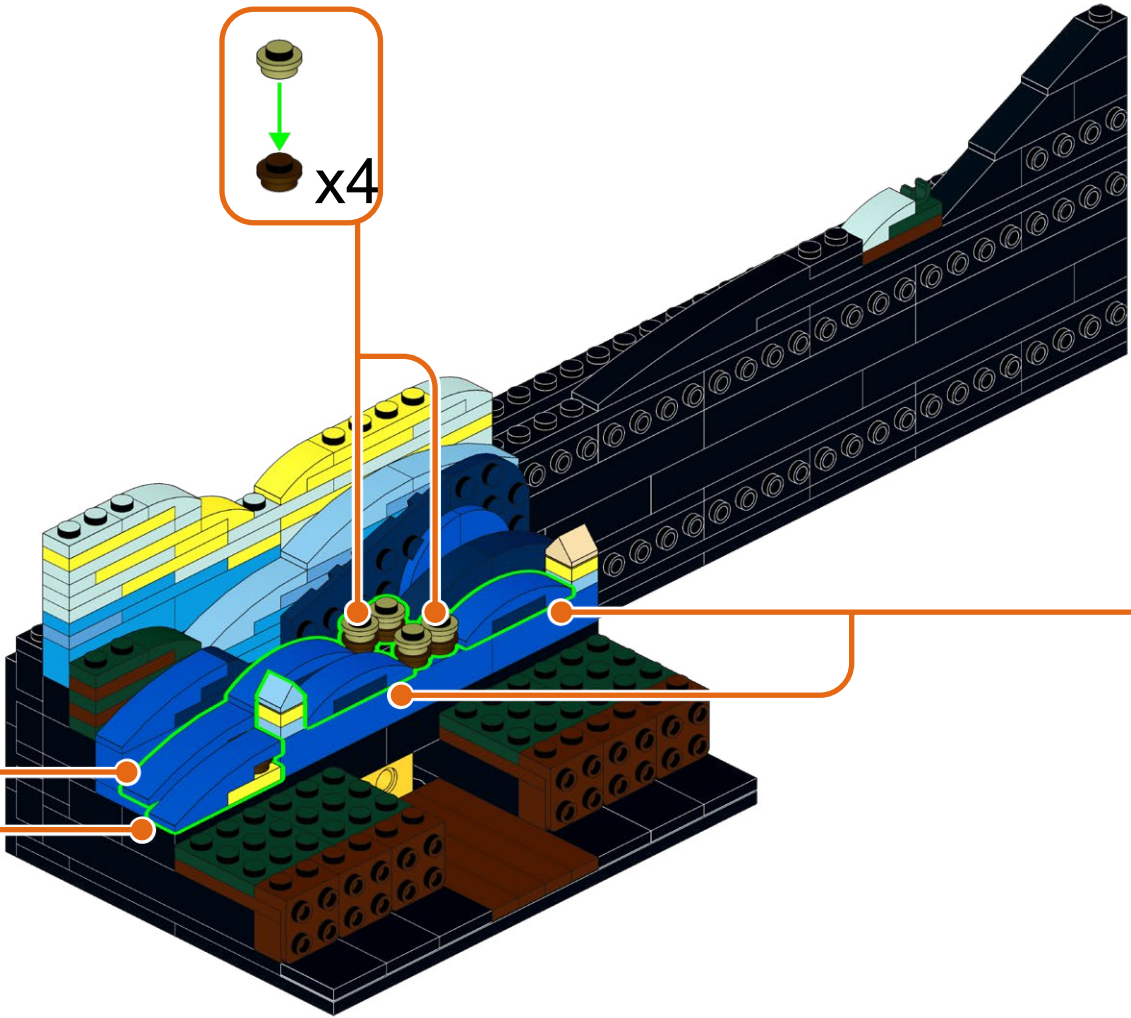
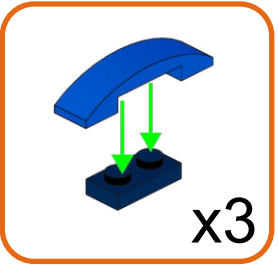
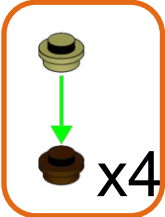
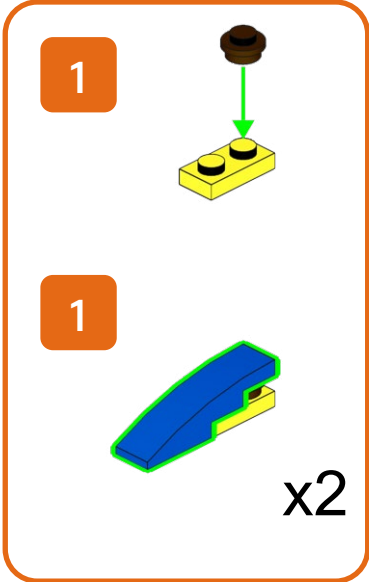
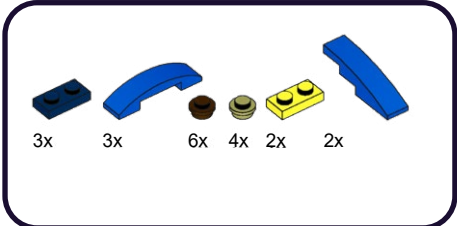

39

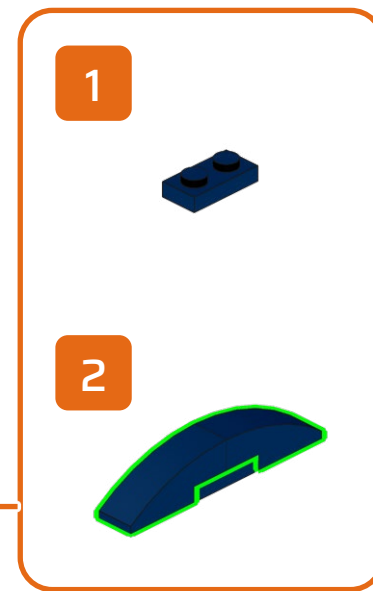
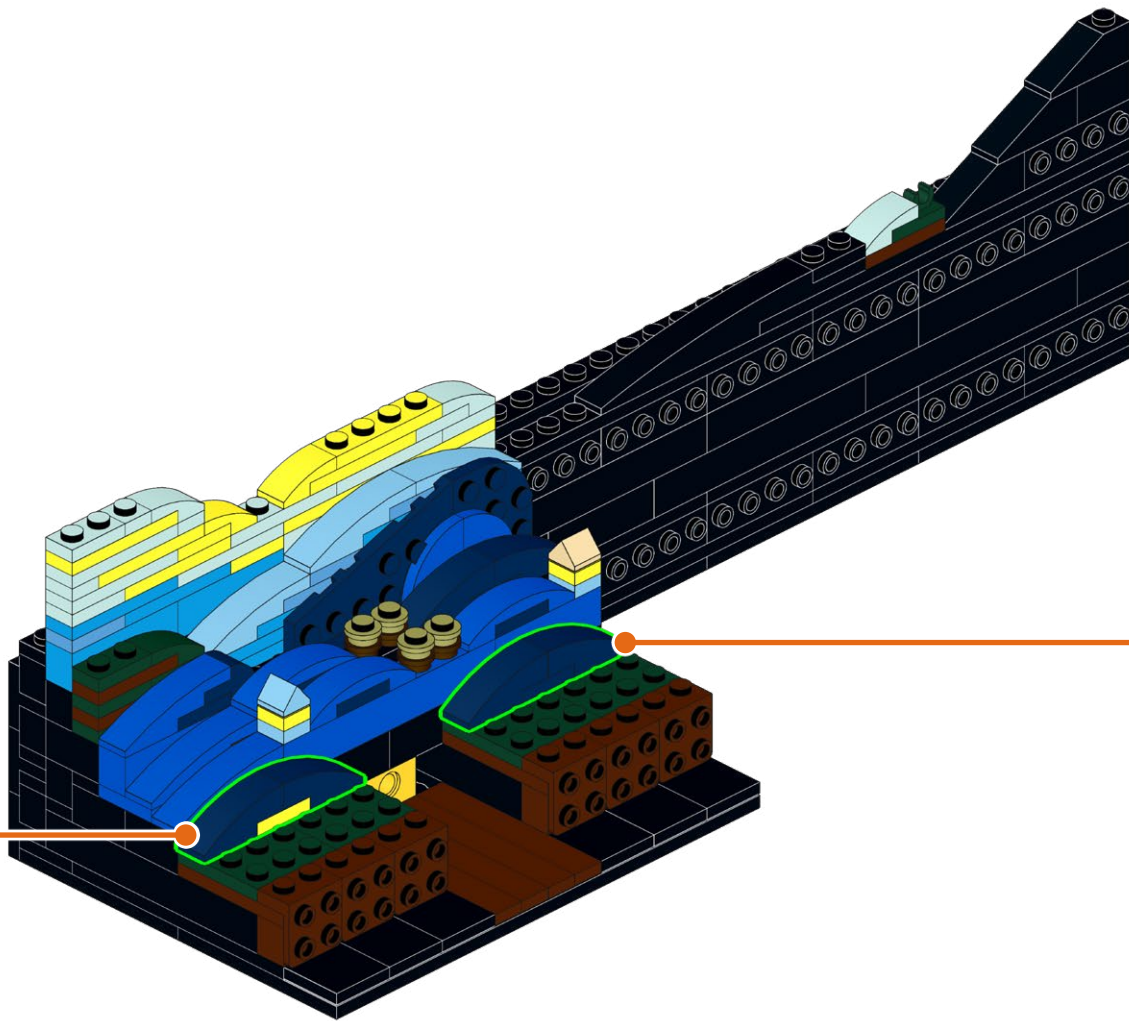
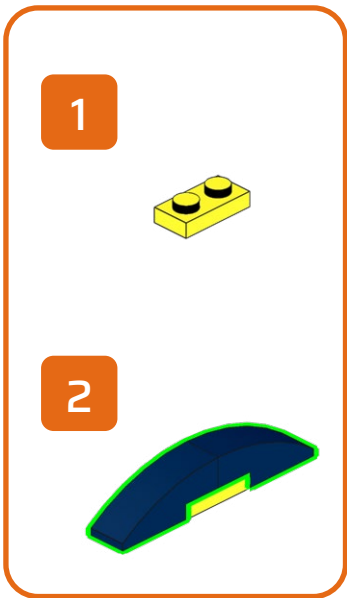
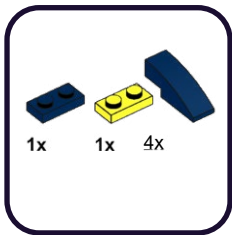

# 40

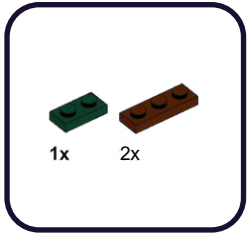

1

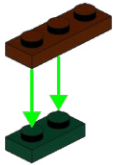

2

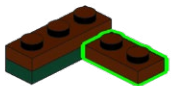

# 41

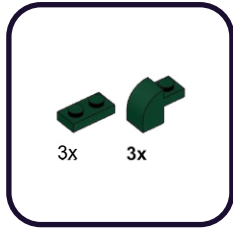

1

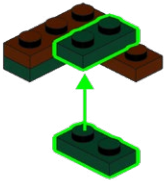

2

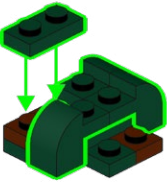

42

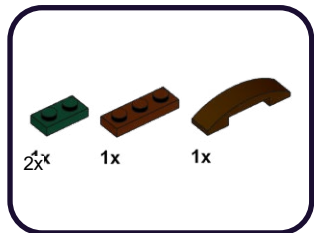

1

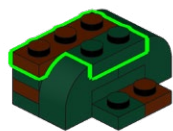

2

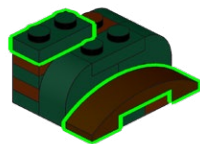

43

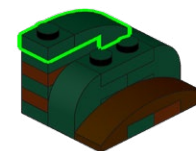
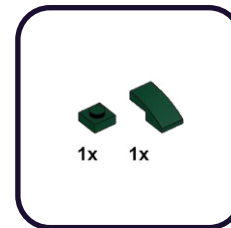



44

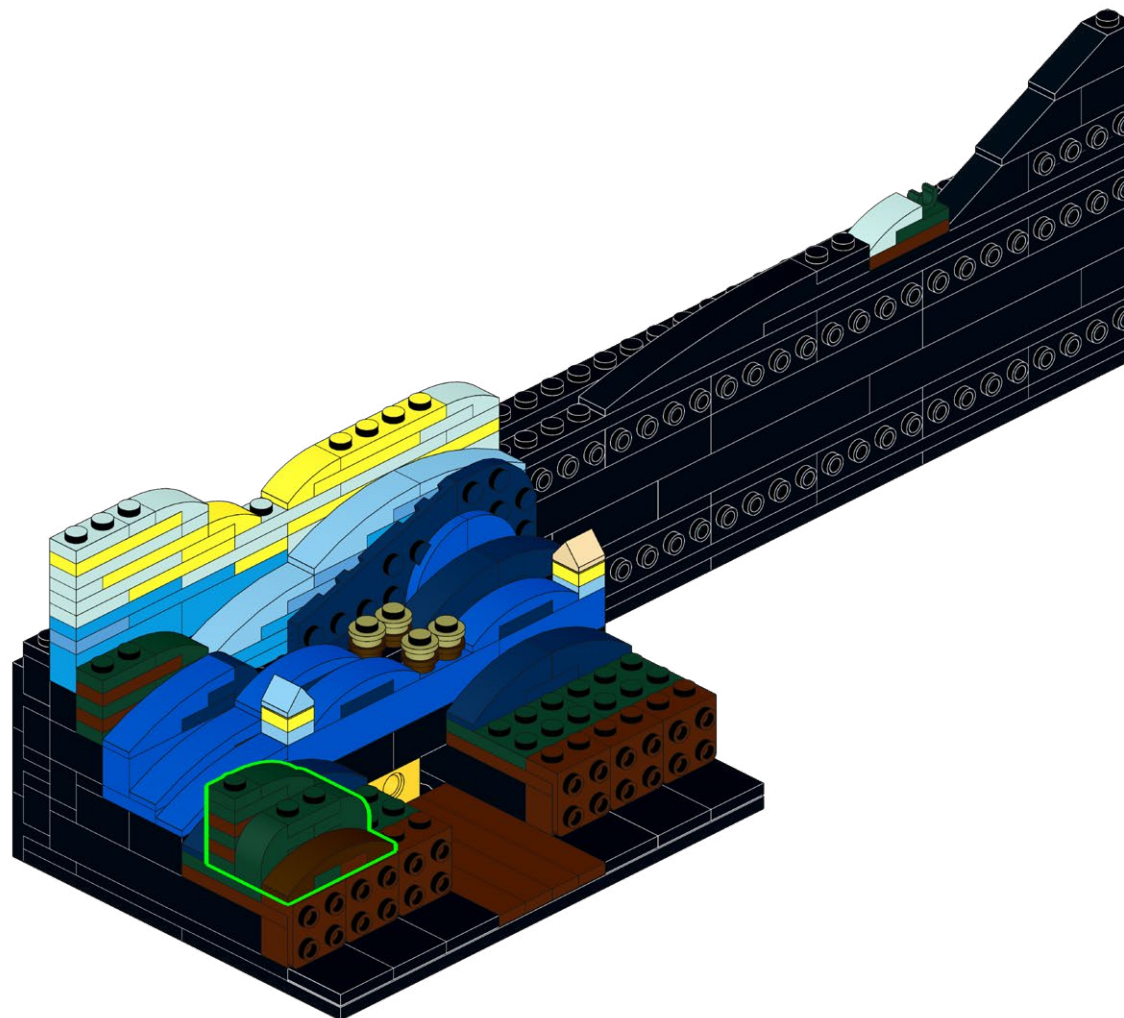



45

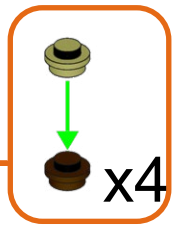
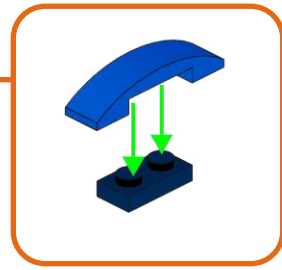
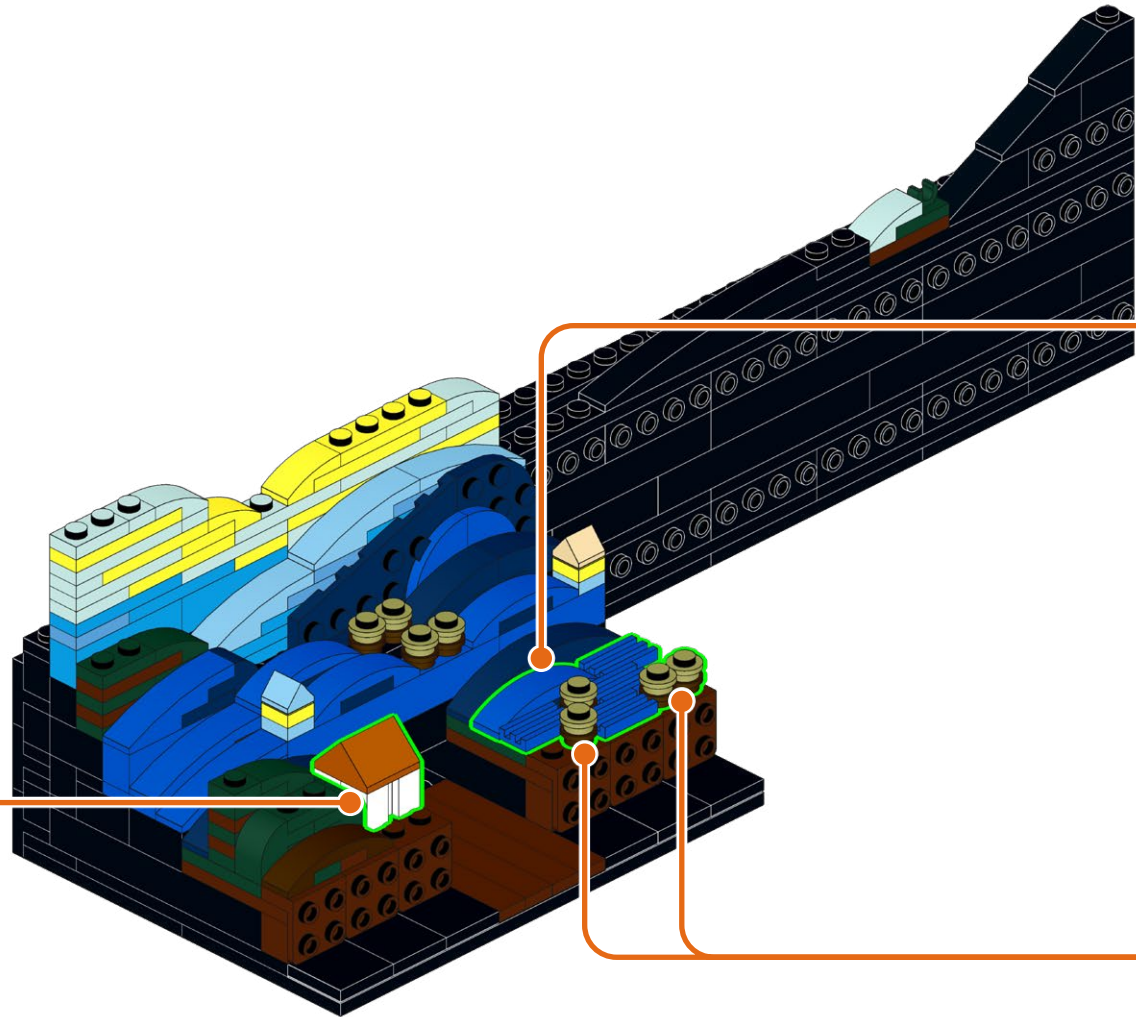
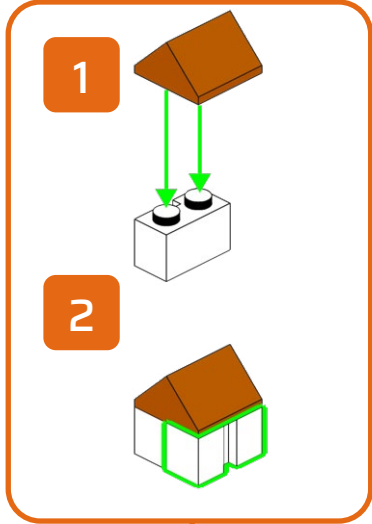
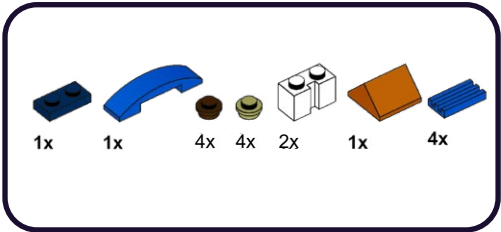

46

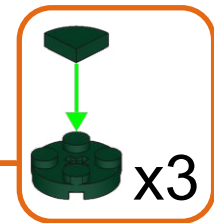
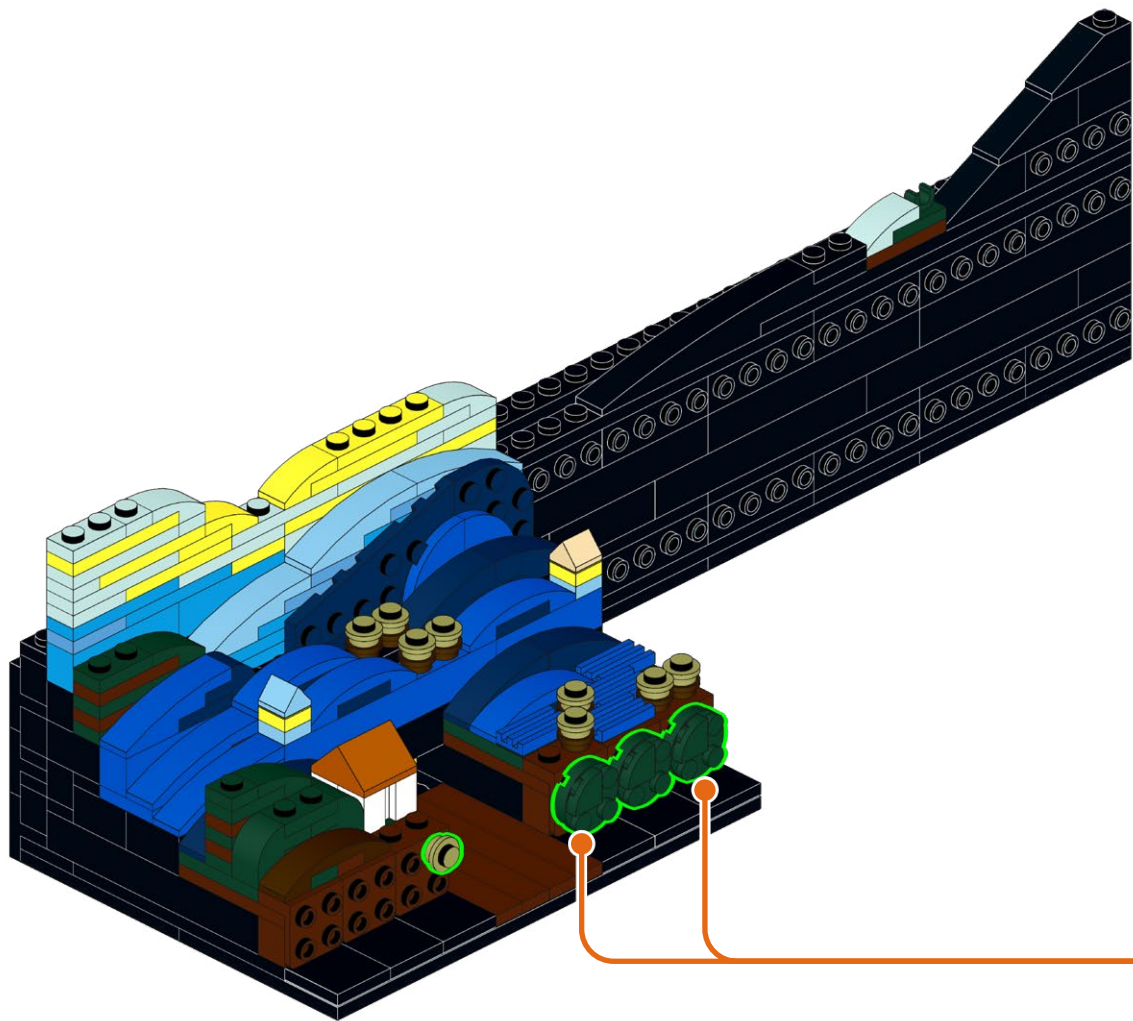

# 47

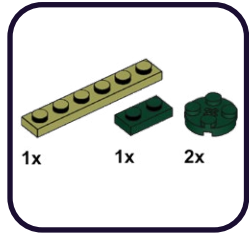

1

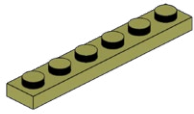

2

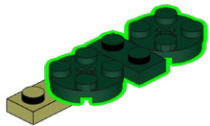

# 48

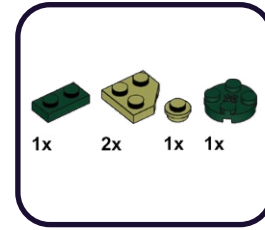

1

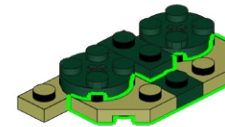

2

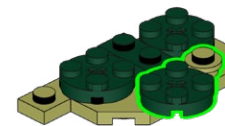

49



1

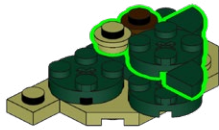

2



50

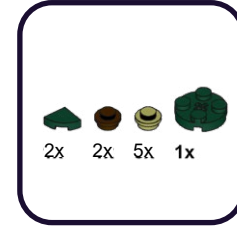

1

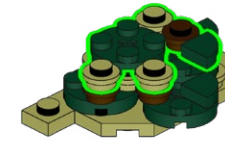

2

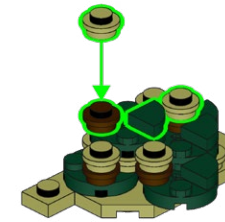

51

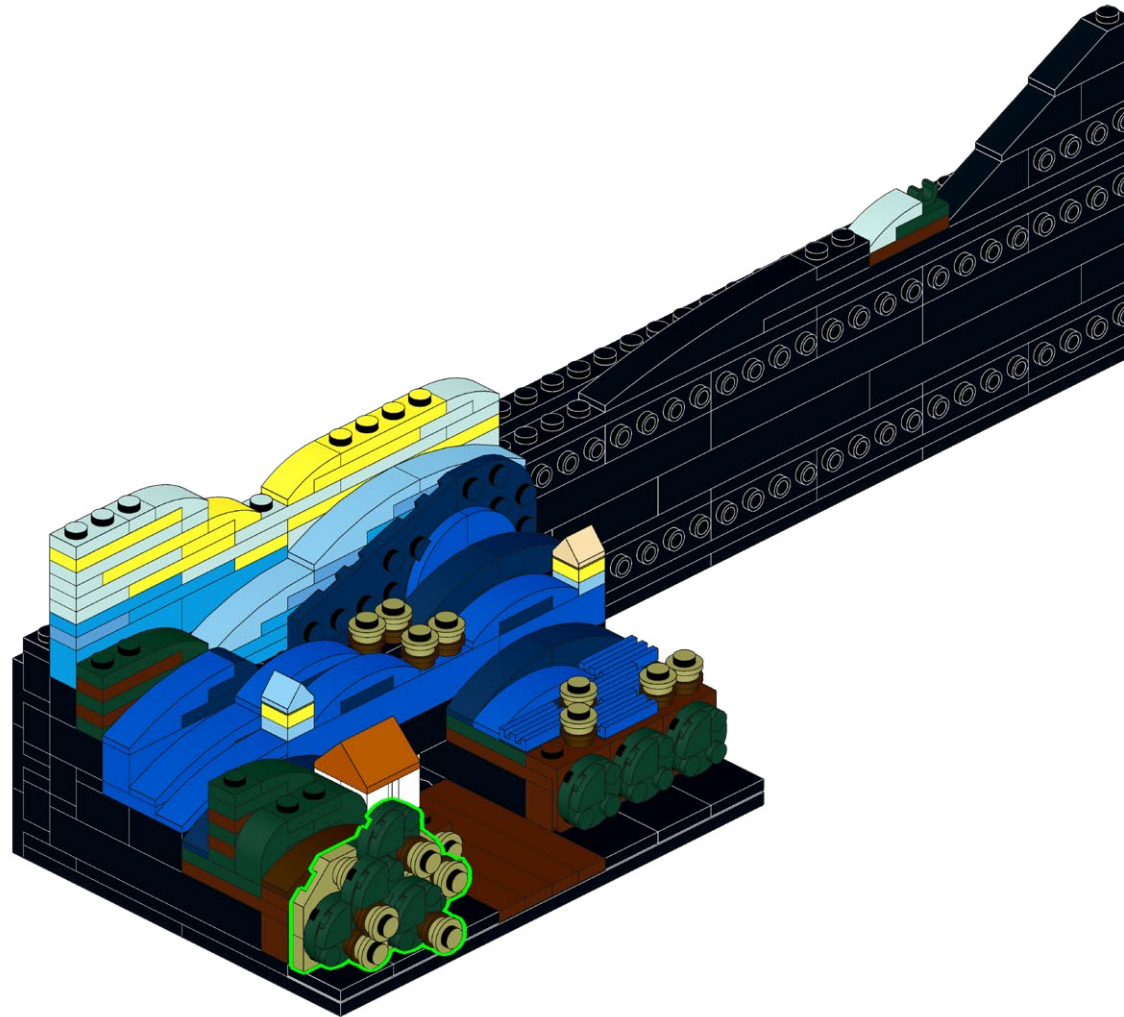

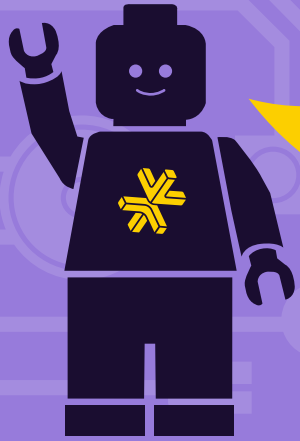

### **HOLD UP!**

You might notice some bags aren't in order, as well as left over pieces, but that's ok! We're changing the way you build LEGO!

### **ATTENDEZ!**

Vous remarquerez peut-être que certains sacs, ainsi que certaines pièces, ne sont pas dans le bon ordre. Mais pas de panique! Nous changeons simplement la façon avec laquelle vous construisez vos LEGO!

### **ASPETTA!**

Potresti notare che alcuni sacchetti non sono in ordine, così come i pezzi avanzati, ma va bene così! Stiamo cambiando il modo in cui costruisci i LEGO!

### **HALT!**

Sie werden möglicherweise bemerken, dass einige tüten durcheinander sind und teile übrig bleiben, aber das ist in Ordnung! Wir ändern die art und weise, wie Sie LEGO bauen!

### **¡ESPERA!**

Es posible que notes que algunas bolsas están fuera de servicio, así como piezas sobrantes, ¡pero está bien! ¡Estamos cambiando la forma en que construyes LEGO!

### **暫停!**

你可能会注意到一些袋子顺序错乱, 以及一些剩余的部件, 但没关系! 我们正在改变你搭建乐高的方式!

### Open LEGO® Bag 3

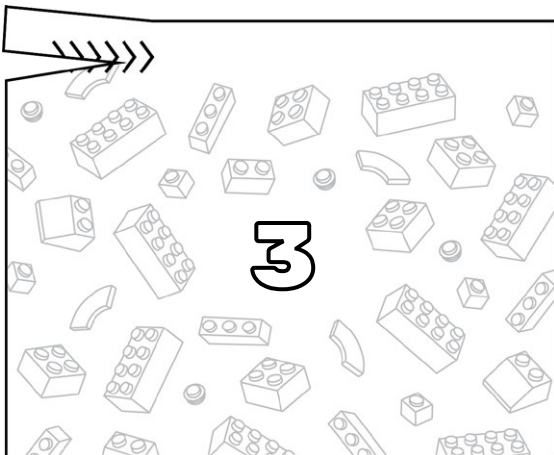



# 52

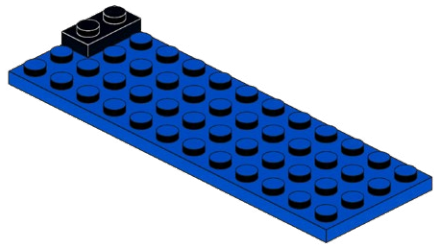
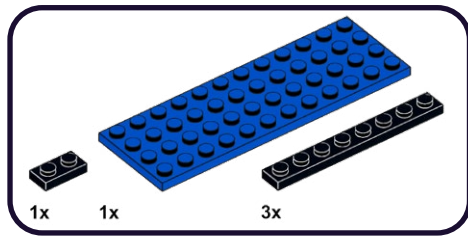

1

2

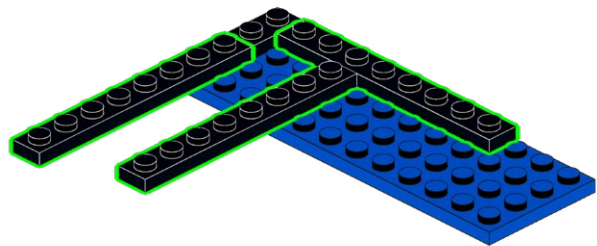

# 53

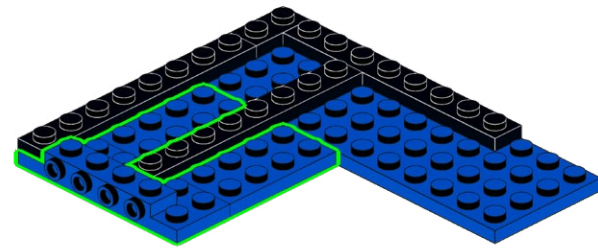
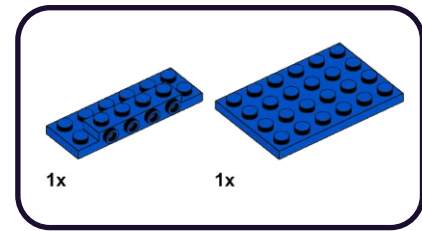



54

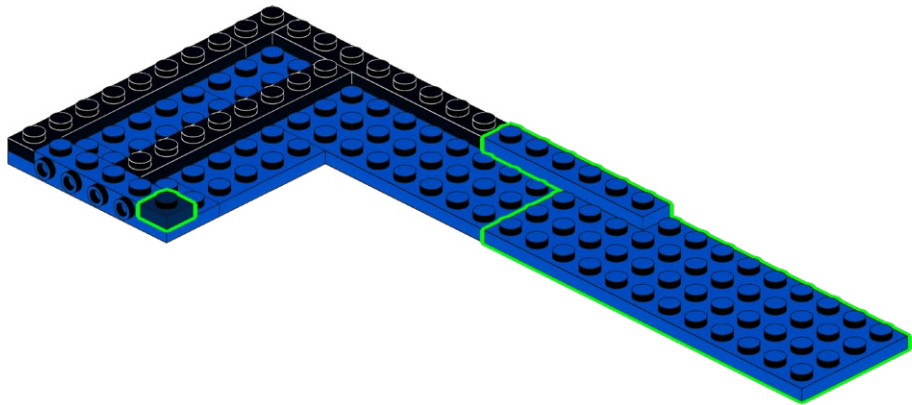
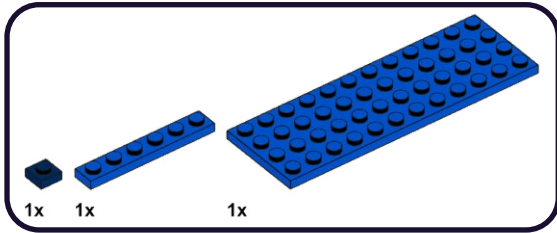

55

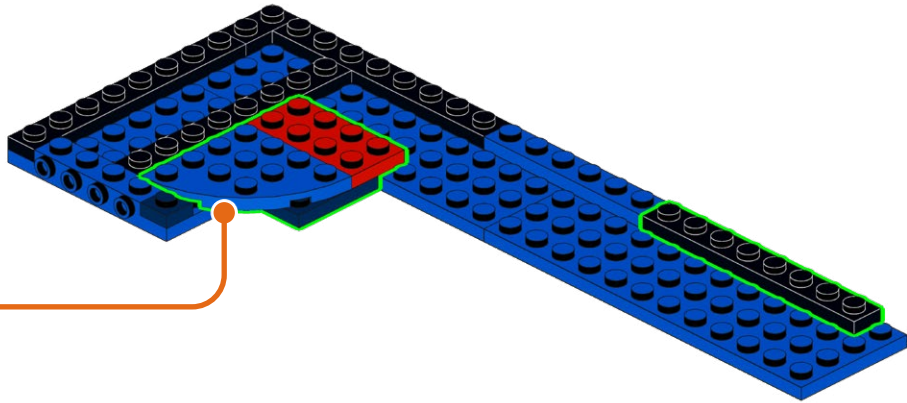
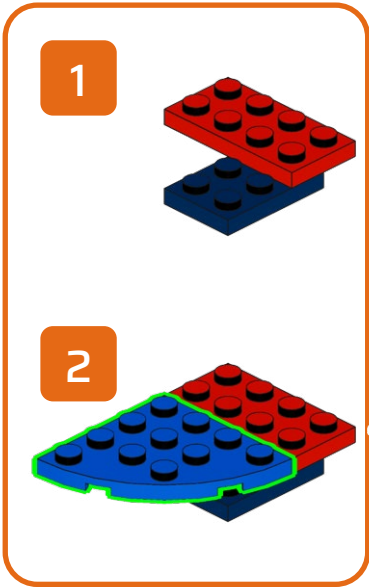
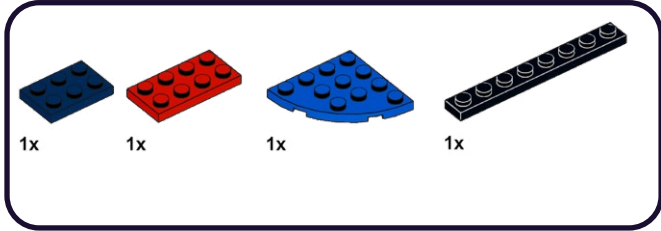

# 56

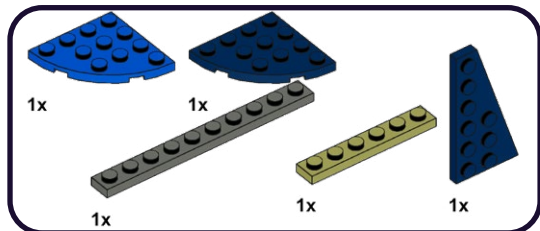

1

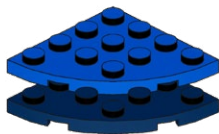

2

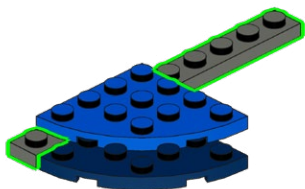

3

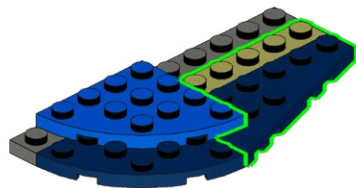

# 57

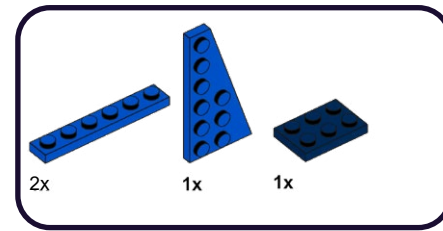

4

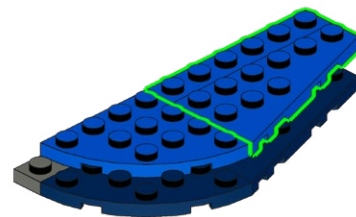

5

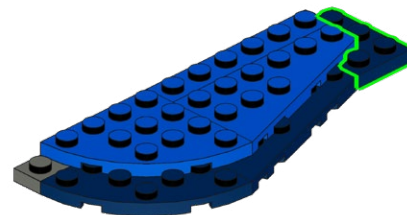

6

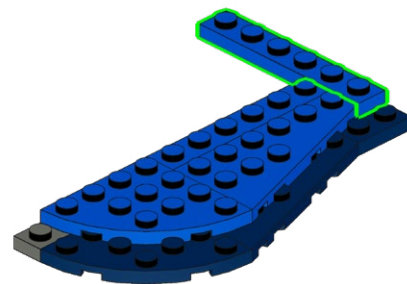

58

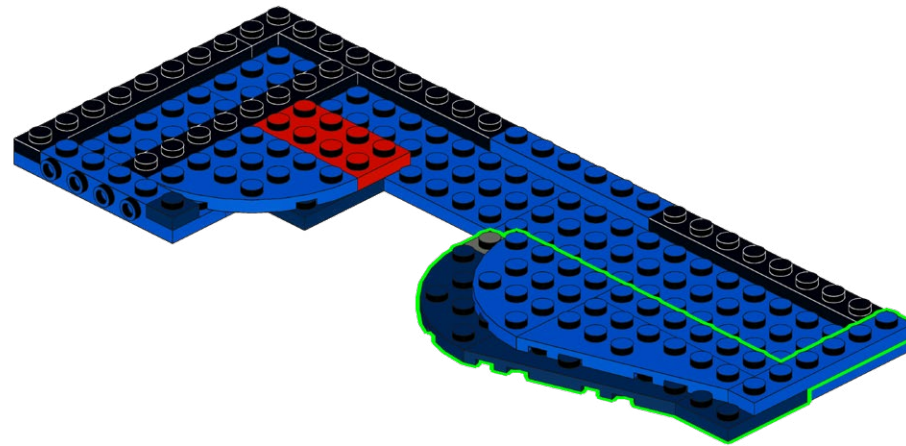

59

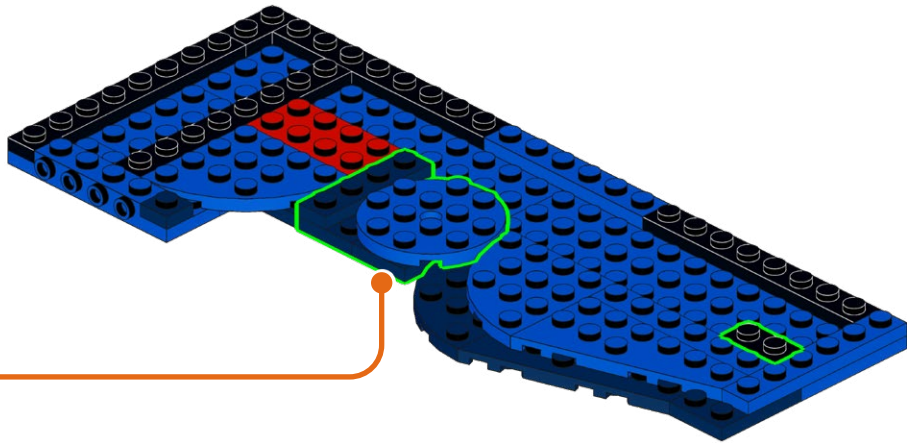
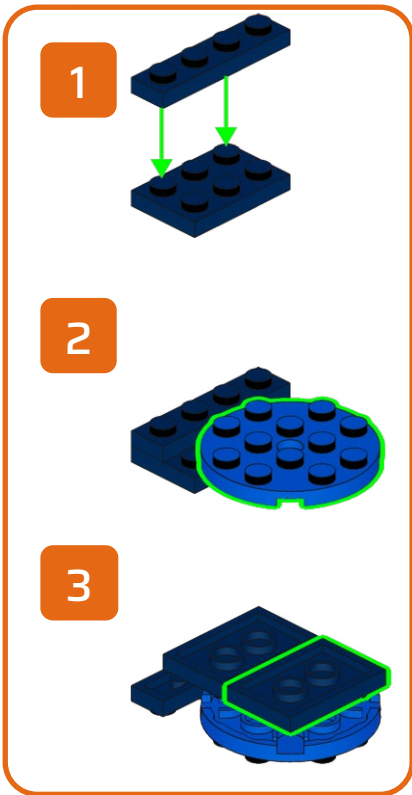
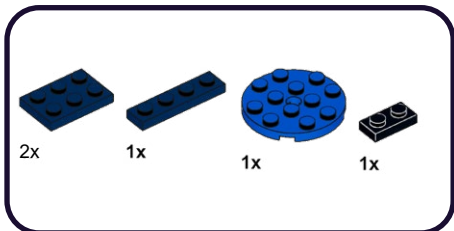

60

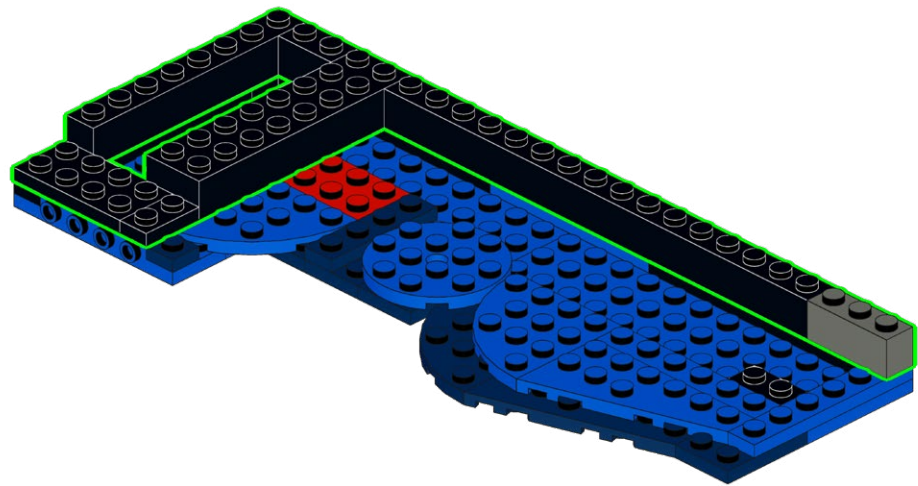
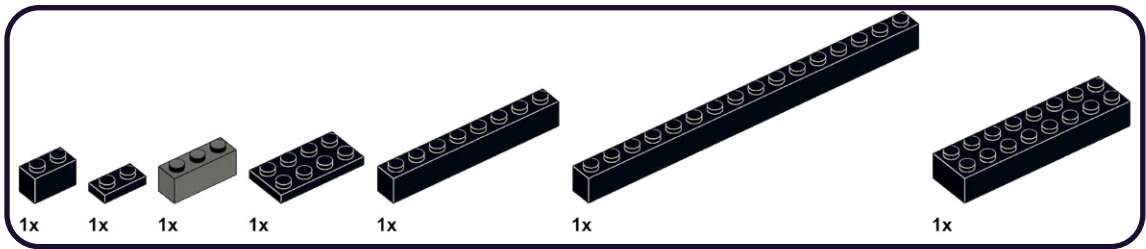



61

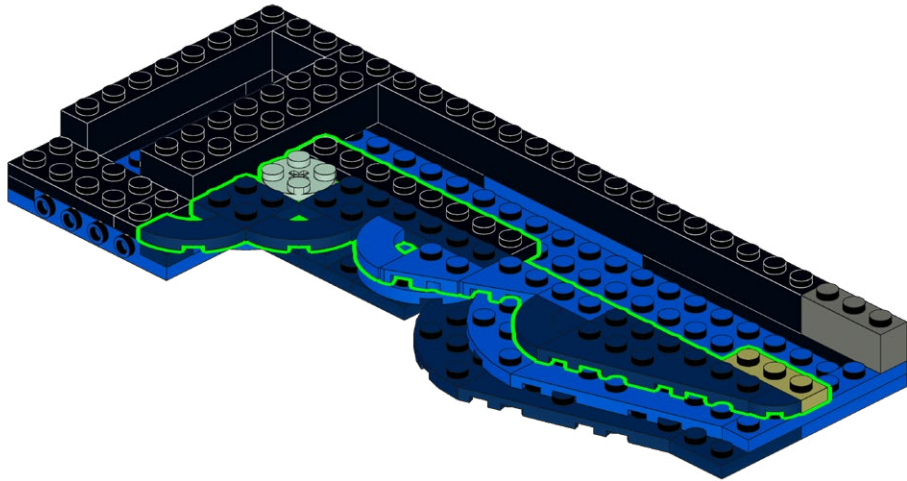
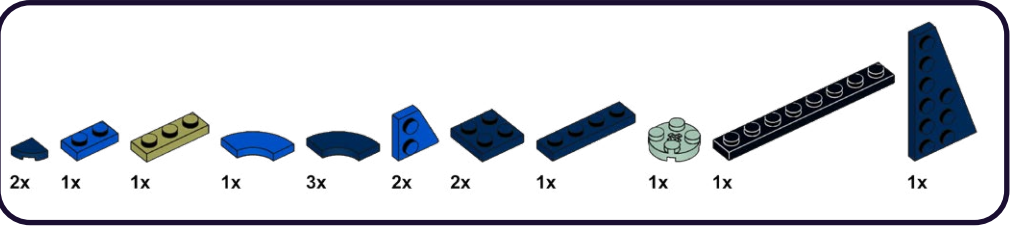

62

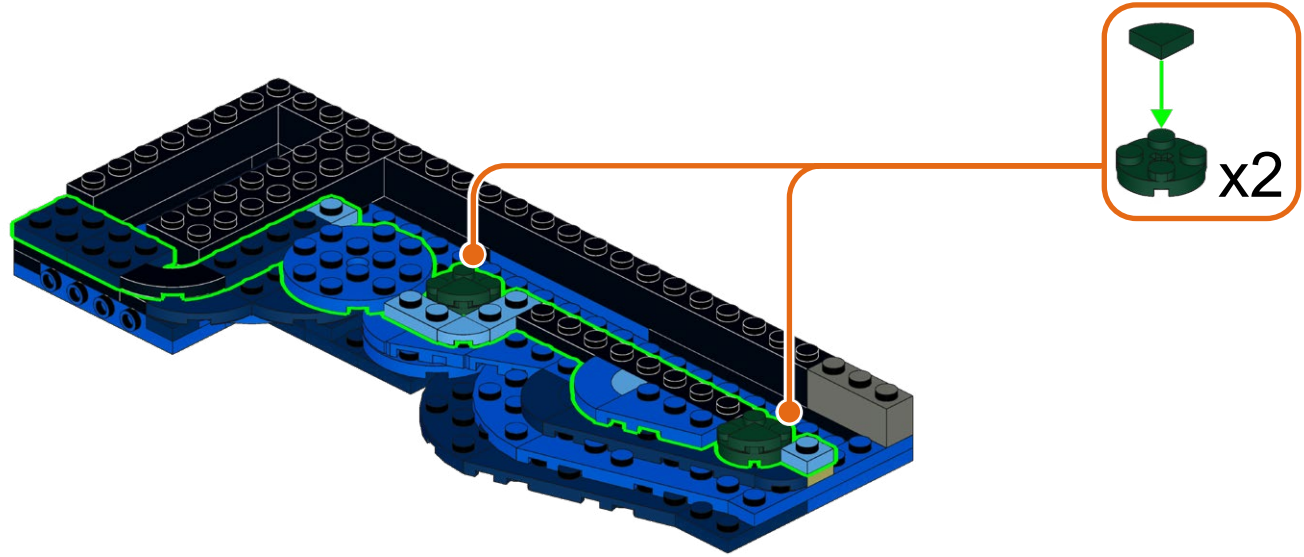
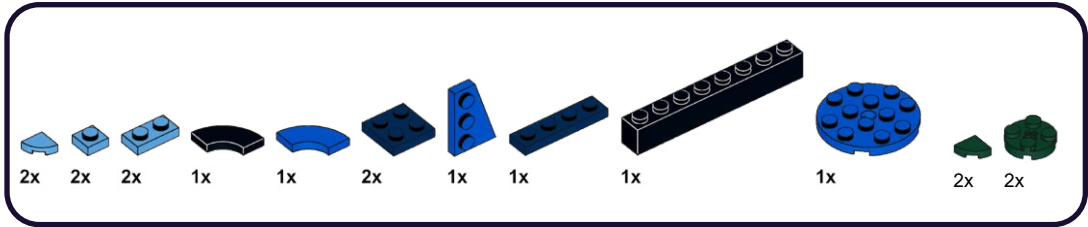

# 63

- 1x [Blue 1x2 Technic Brick]
- 1x [Blue 1x2 Technic Brick with Hole]
- 2x [Black 1x2 Technic Brick]
- 1x [Tan 1x2 Technic Brick]
- 2x [Blue 1x2 Technic Arch]
- 1x [Blue 1x2 Technic Arch]
- 1x [Black 1x2 Technic Brick]
- 2x [Grey 1x2 Technic Axle Connector]
- 1x [Tan 1x2 Technic Brick]
- 1x [White 1x2 Technic Brick]
- 1x [Blue 1x2 Technic Brick]
- 1x [Blue 1x2 Technic Brick]

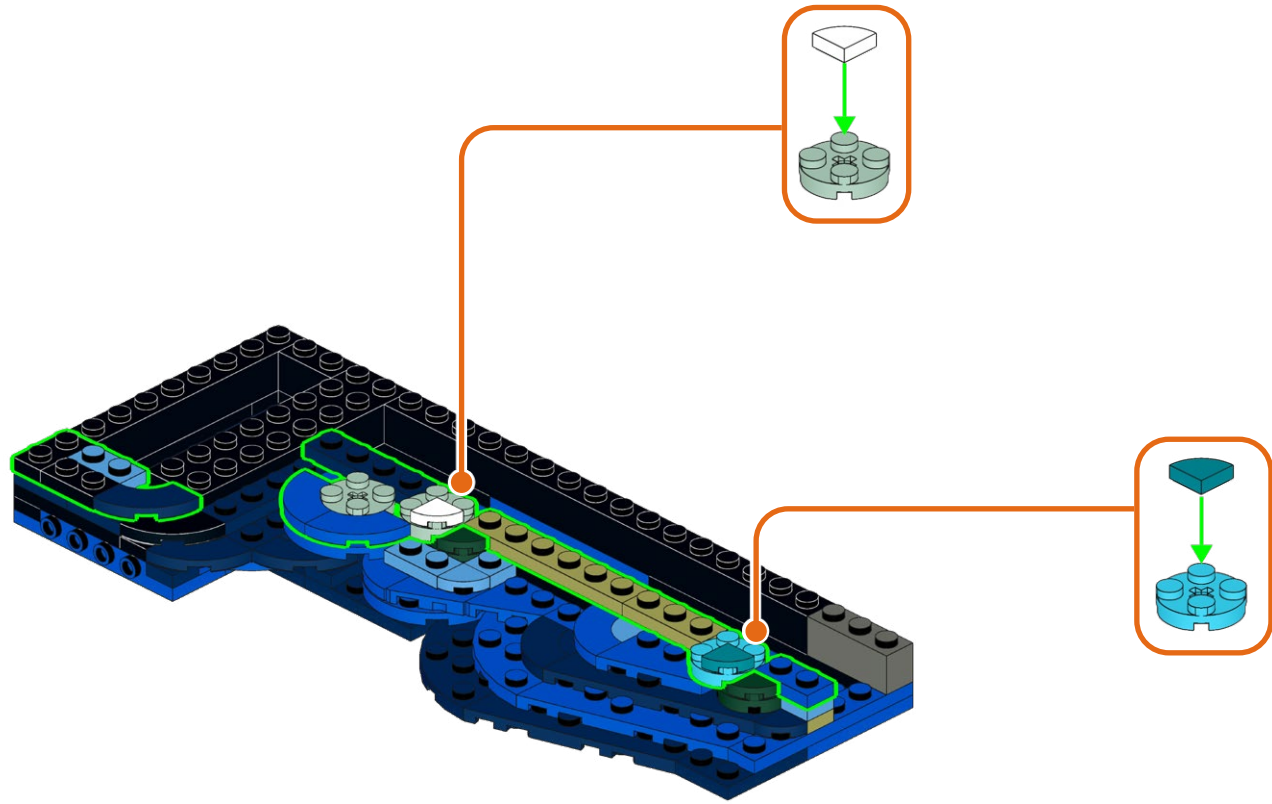

64

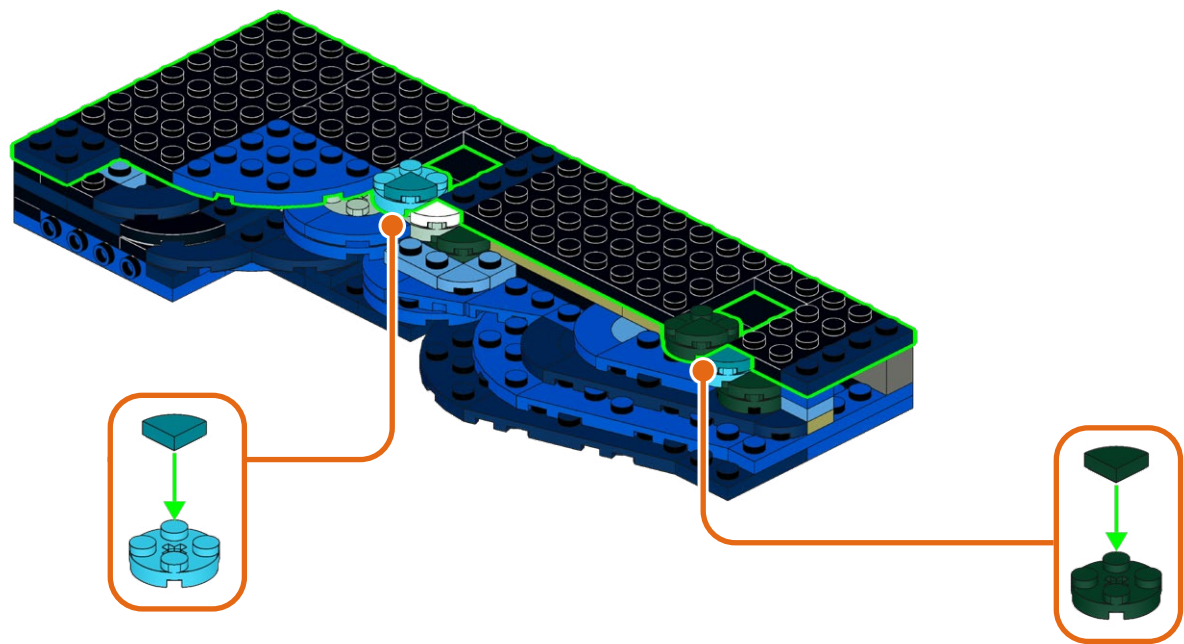
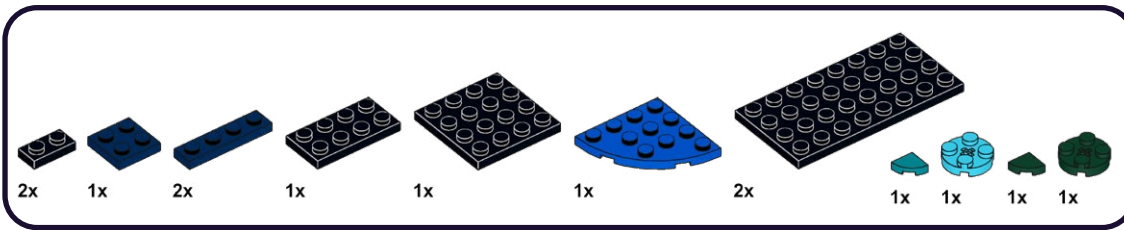

65

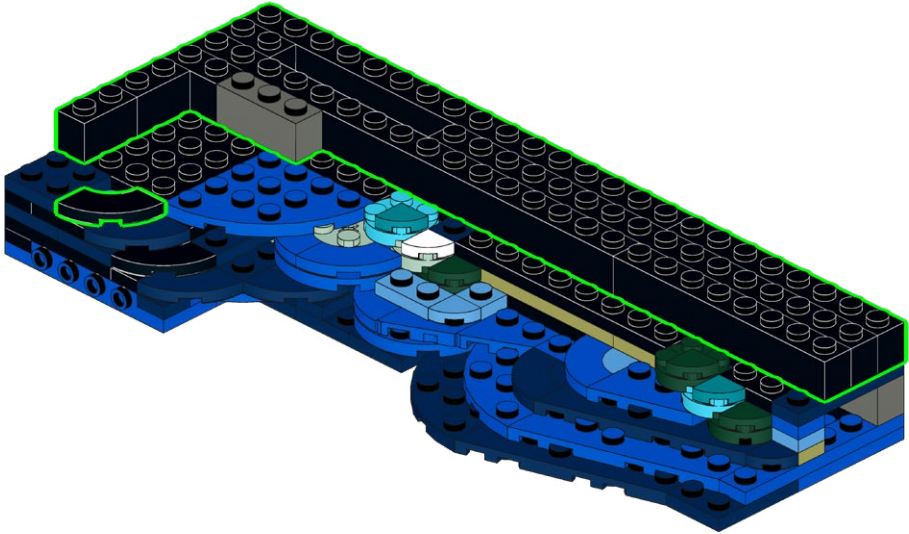
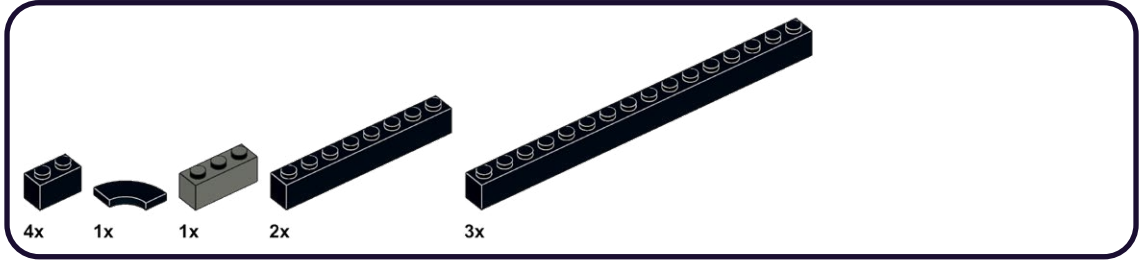

66

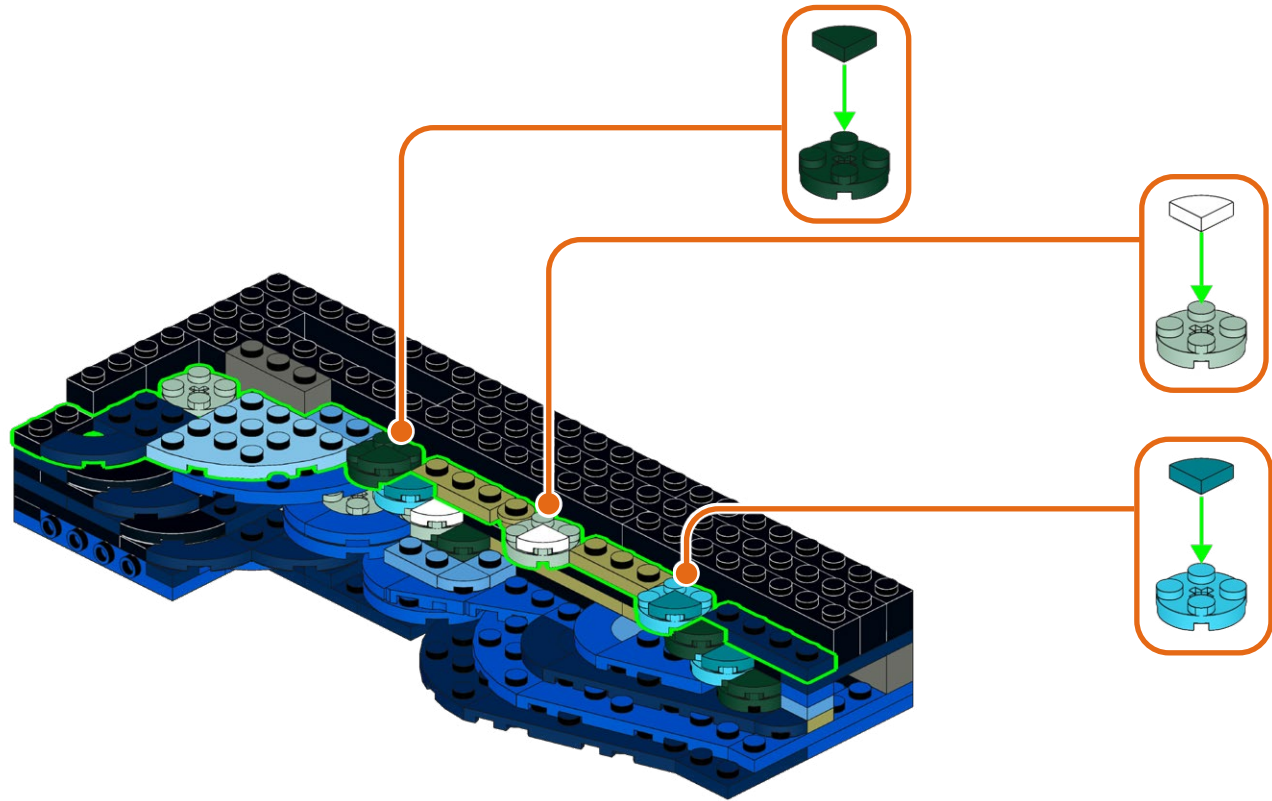
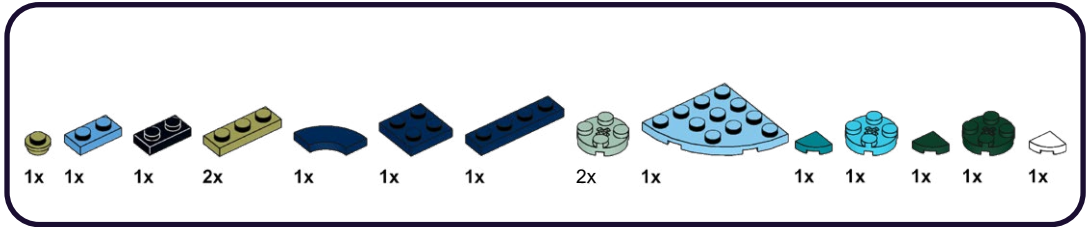



67

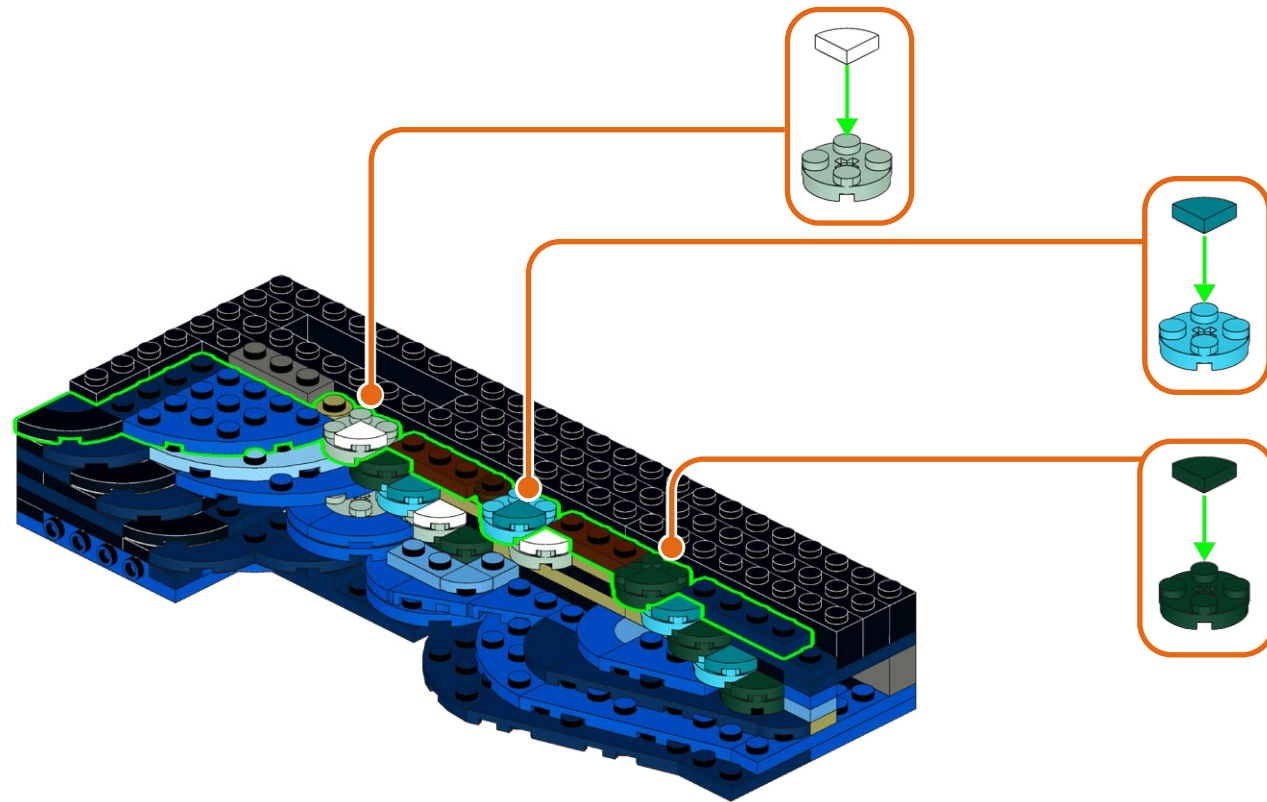
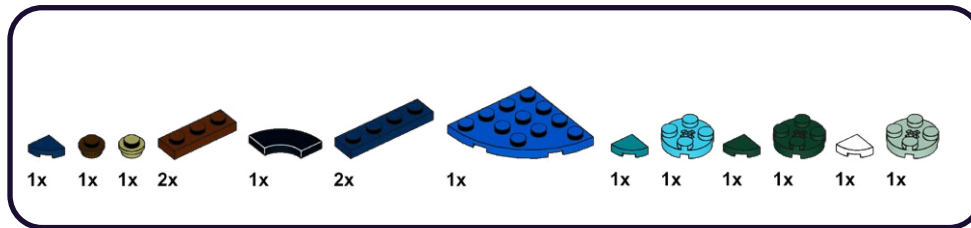

68

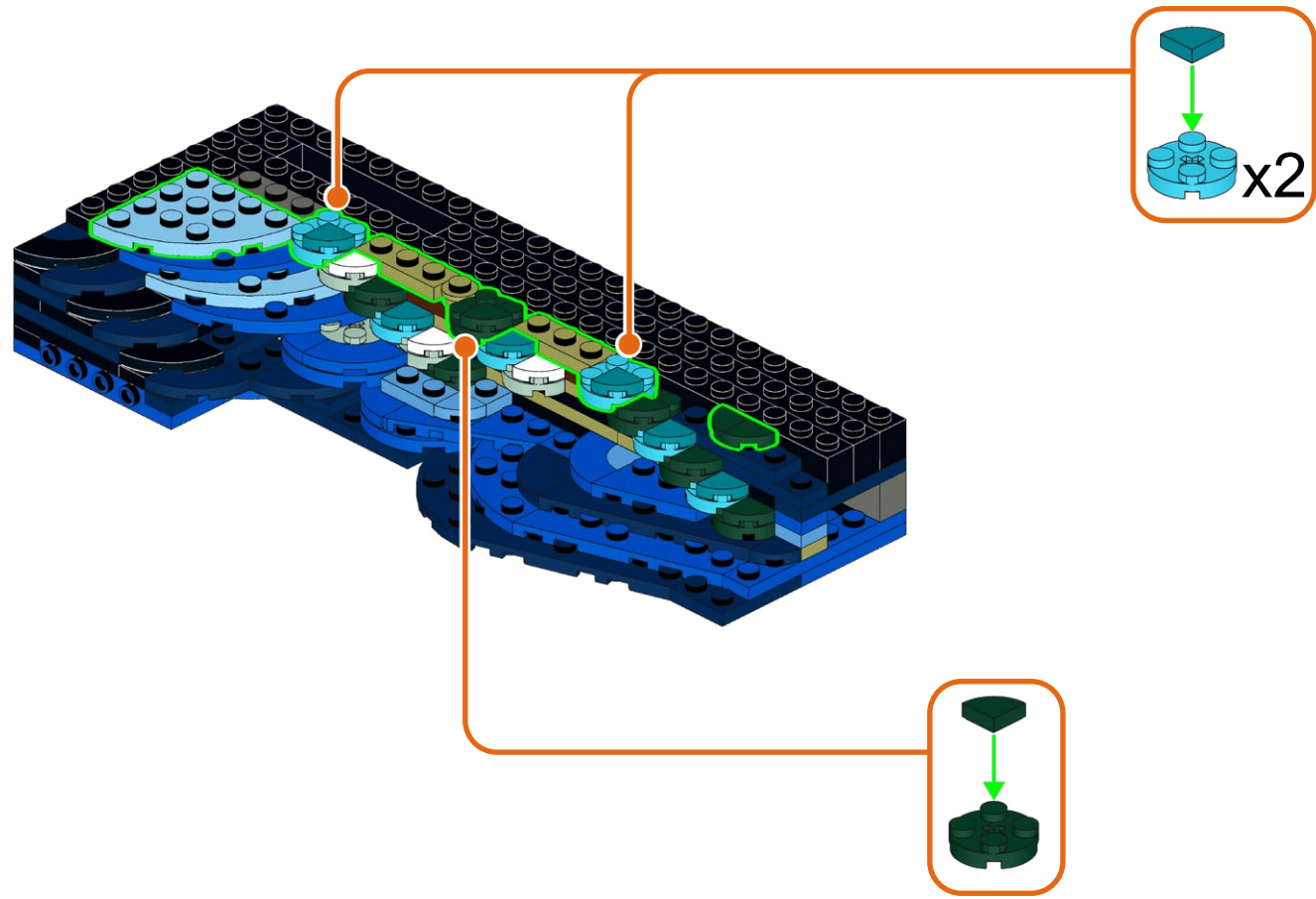
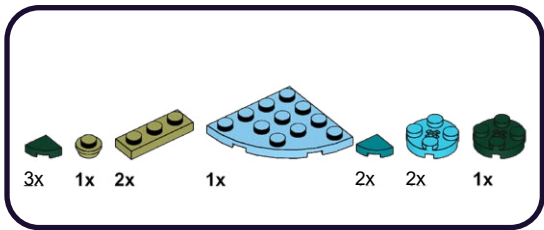

# 69

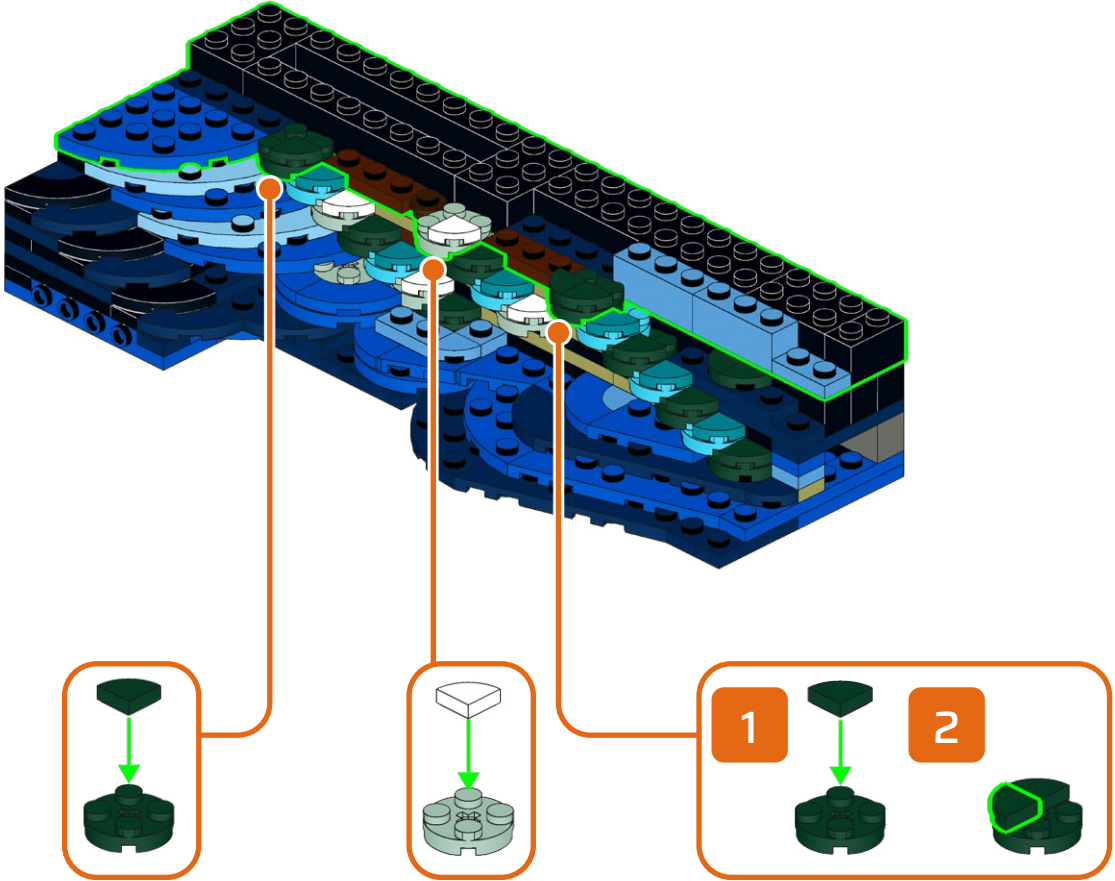
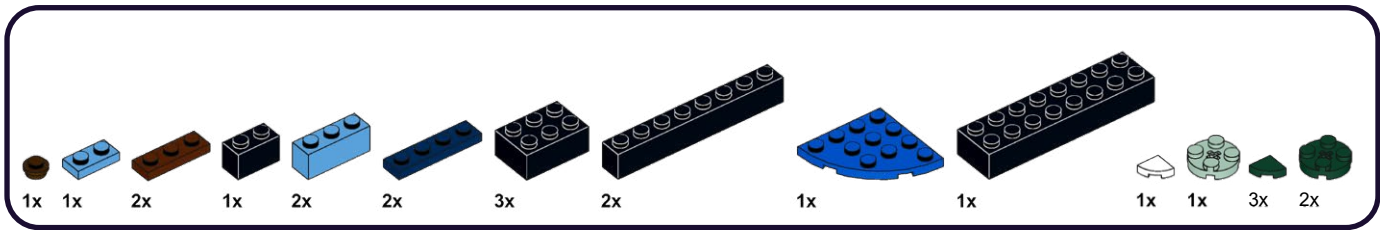

70

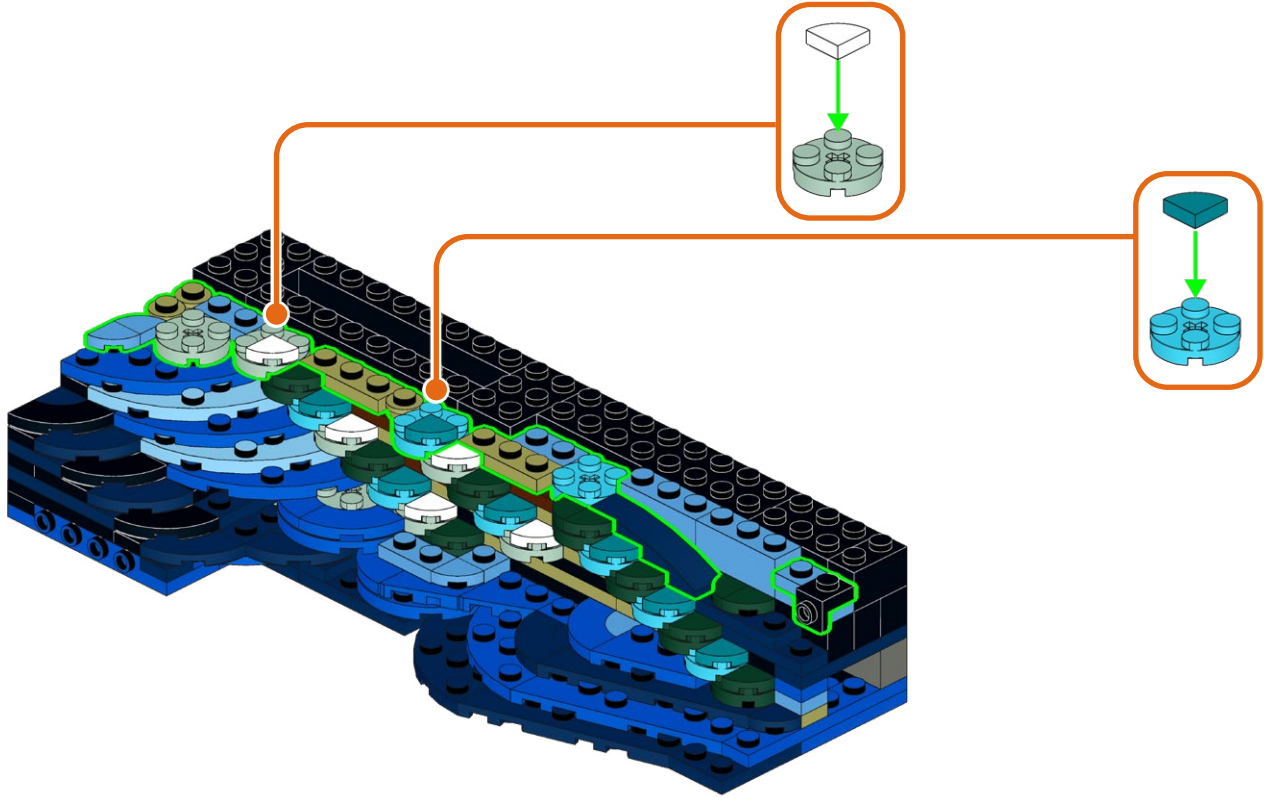
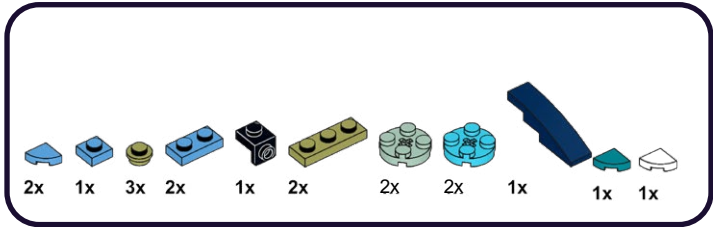

71

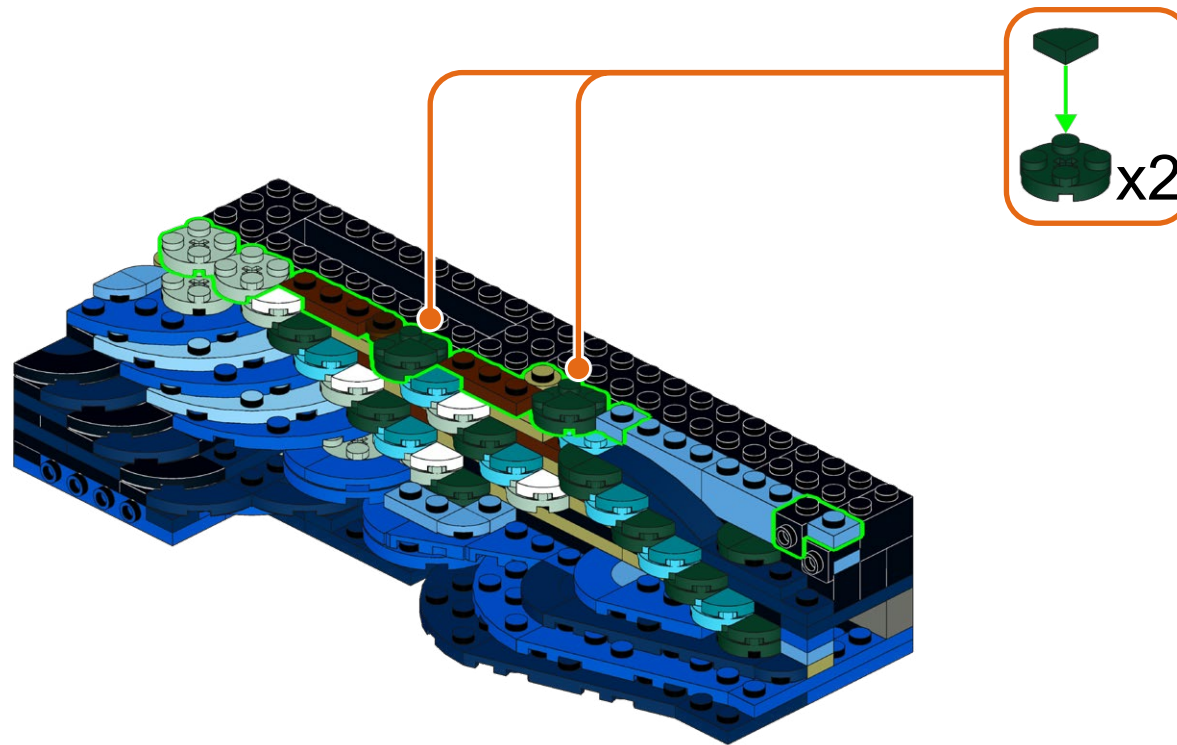
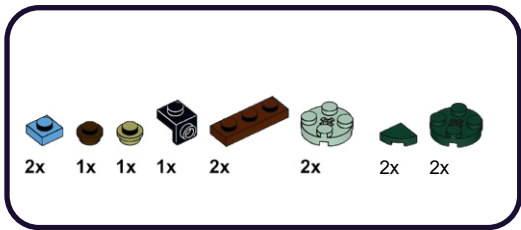

72

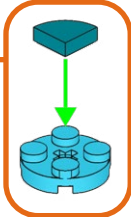
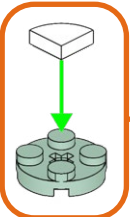
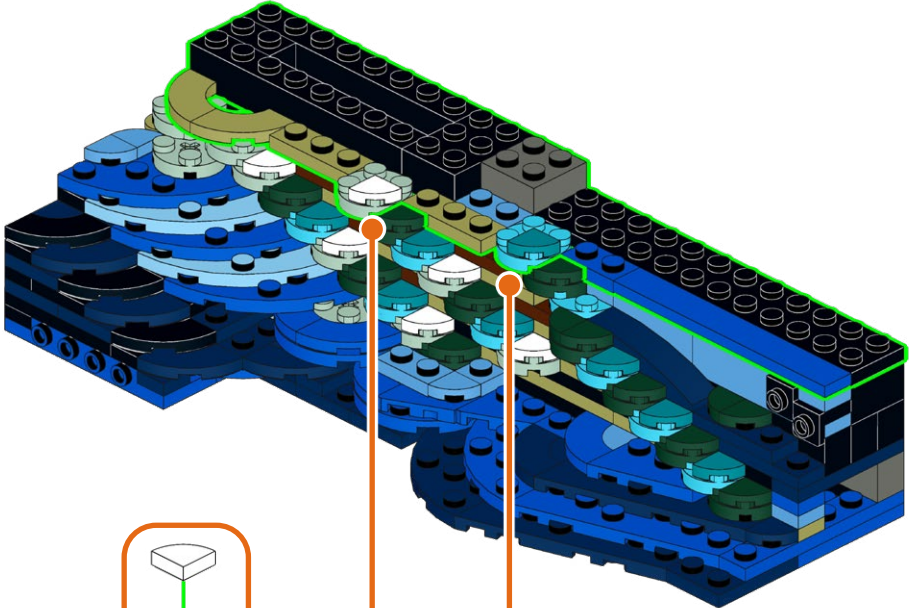
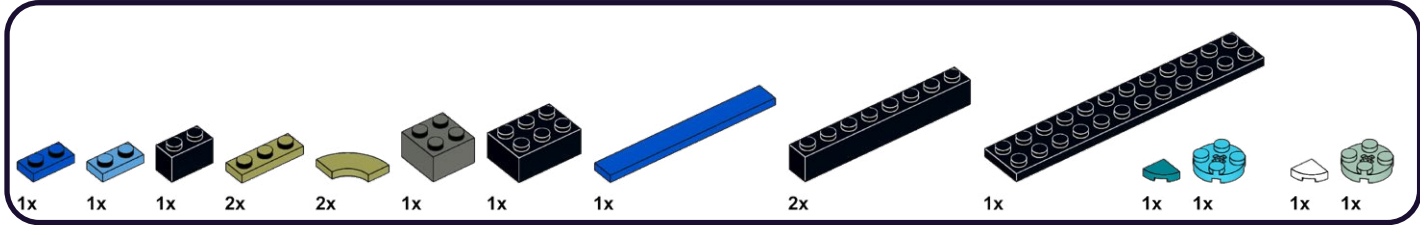



73

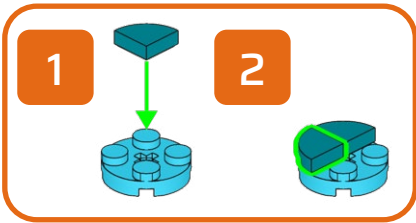
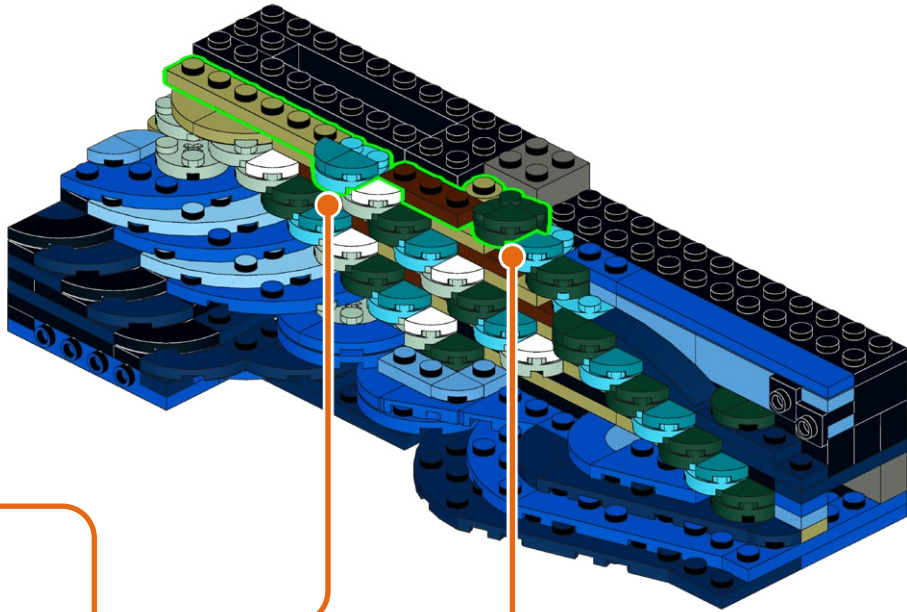
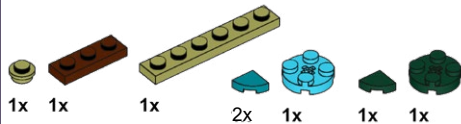

2

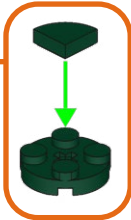

74

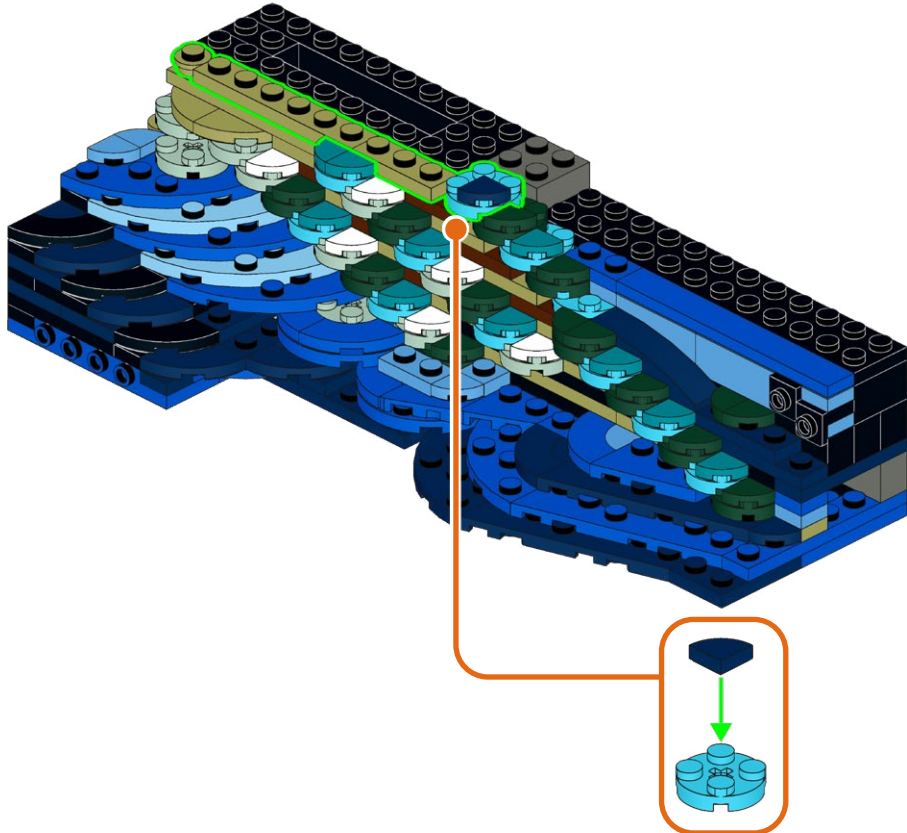
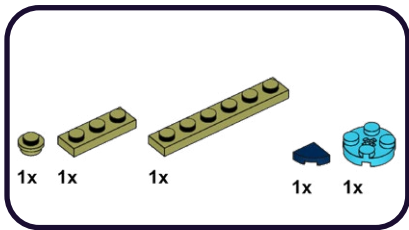

**HOLD UP!**

You might notice some bags aren't in order, as well as left over pieces, but that's ok! We're changing the way you build LEGO!

**ATTENDEZ!**

Vous remarquerez peut-être que certains sacs, ainsi que certaines pièces, ne sont pas dans le bon ordre. Mais pas de panique! Nous changeons simplement la façon avec laquelle vous construisez vos LEGO!

**ASPETTA!**

Potresti notare che alcuni sacchetti non sono in ordine, così come i pezzi avanzati, ma va bene così! Stiamo cambiando il modo in cui costruisci i LEGO!

**HALT!**

Sie werden möglicherweise bemerken, dass einige tüten durcheinander sind und teile übrig bleiben, aber das ist in Ordnung! Wir ändern die art und weise, wie Sie LEGO bauen!

**¡ESPERA!**

Es posible que notes que algunas bolsas están fuera de servicio, así como piezas sobrantes, ¡pero está bien! ¡Estamos cambiando la forma en que construyes LEGO!

**暫停!**

你可能会注意到一些袋子顺序错乱, 以及一些剩余的部件, 但没关系! 我们正在改变你搭建乐高的方式!

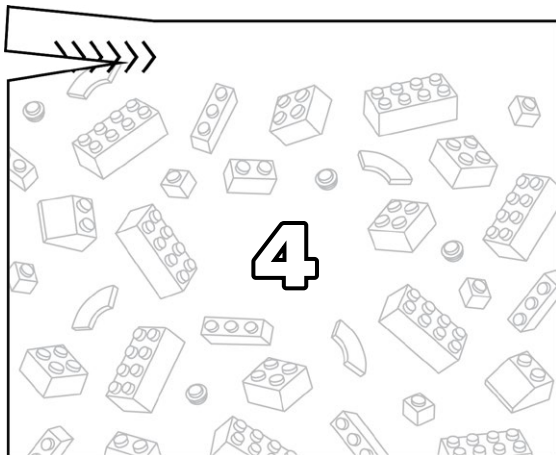
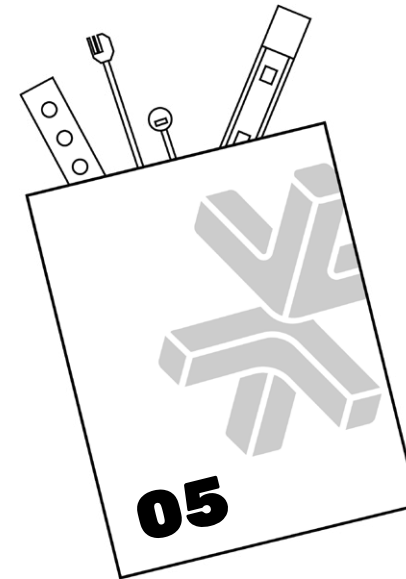
**Open LEGO® Bag 4****Open LMB Bag 05**

75

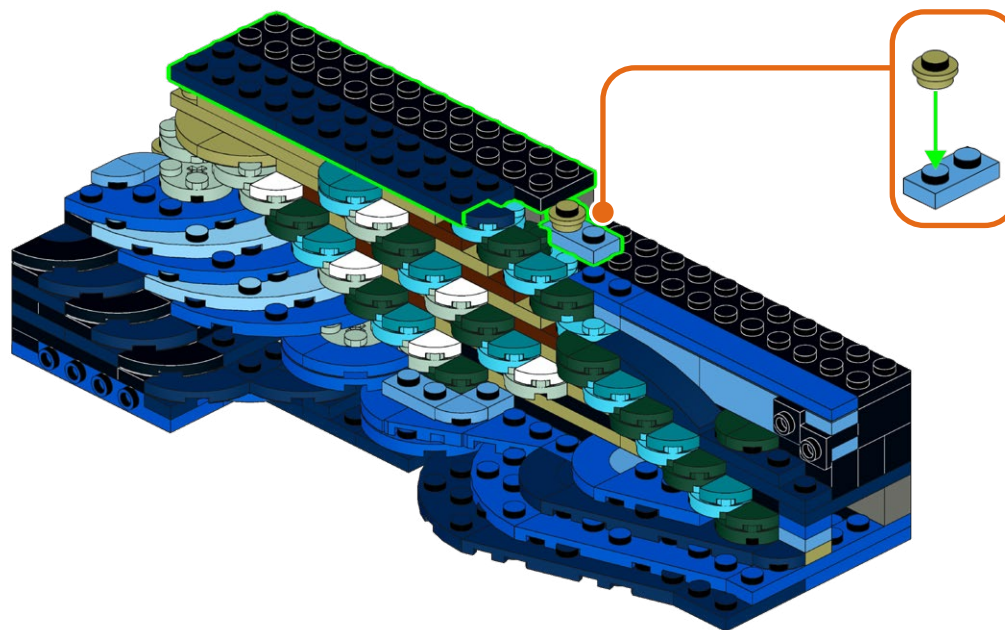
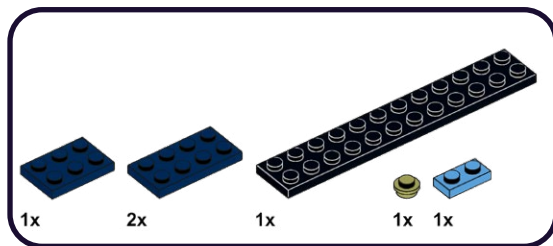

76

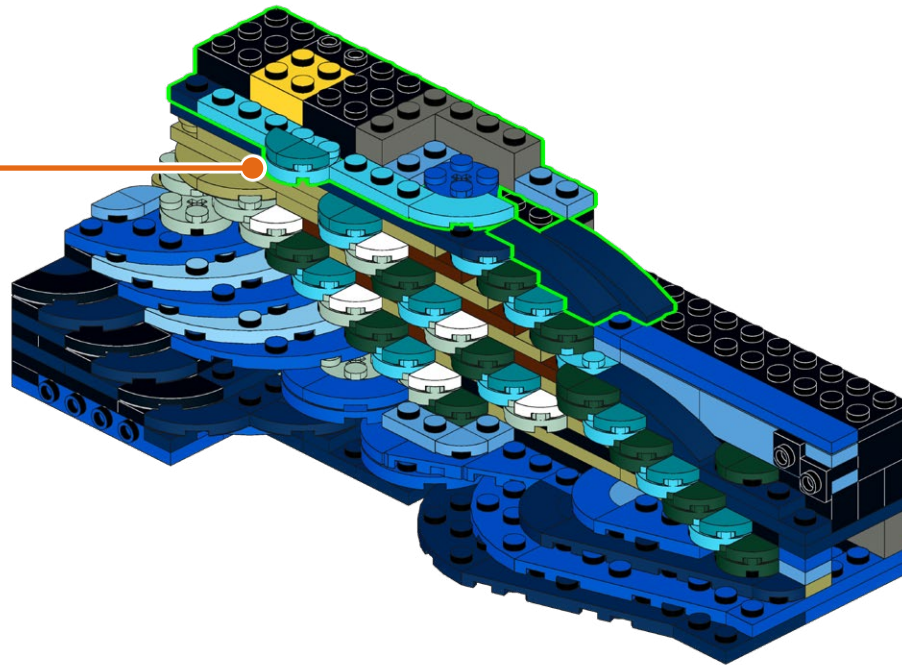
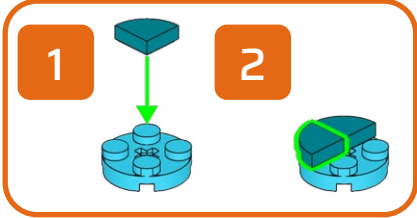
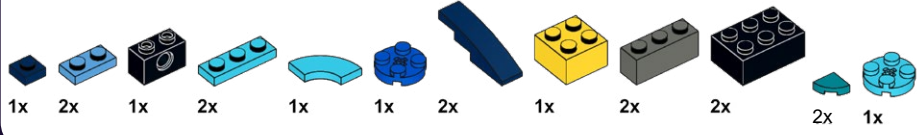

77

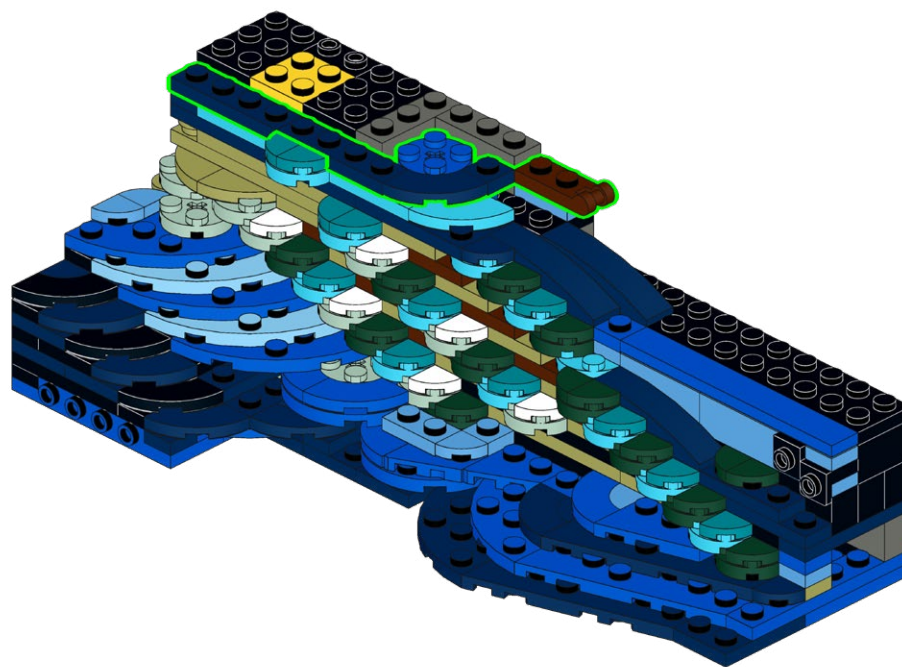
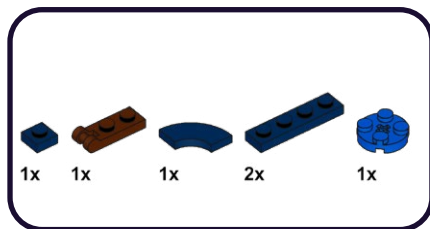



78

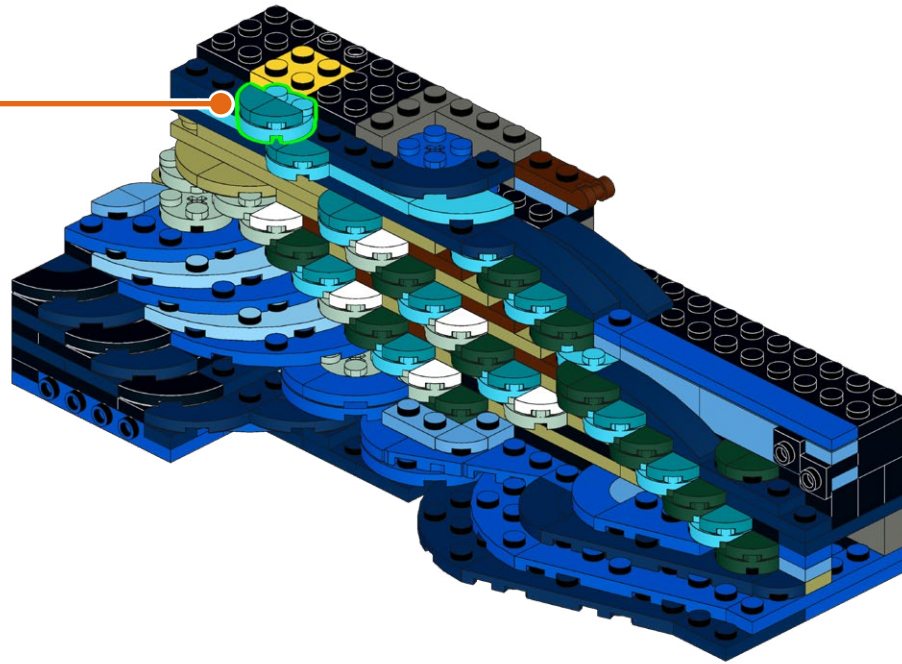
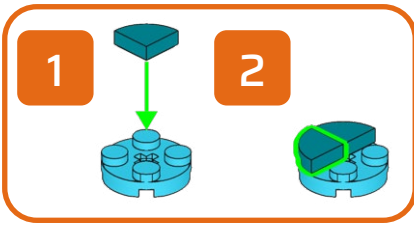
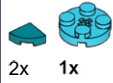

79

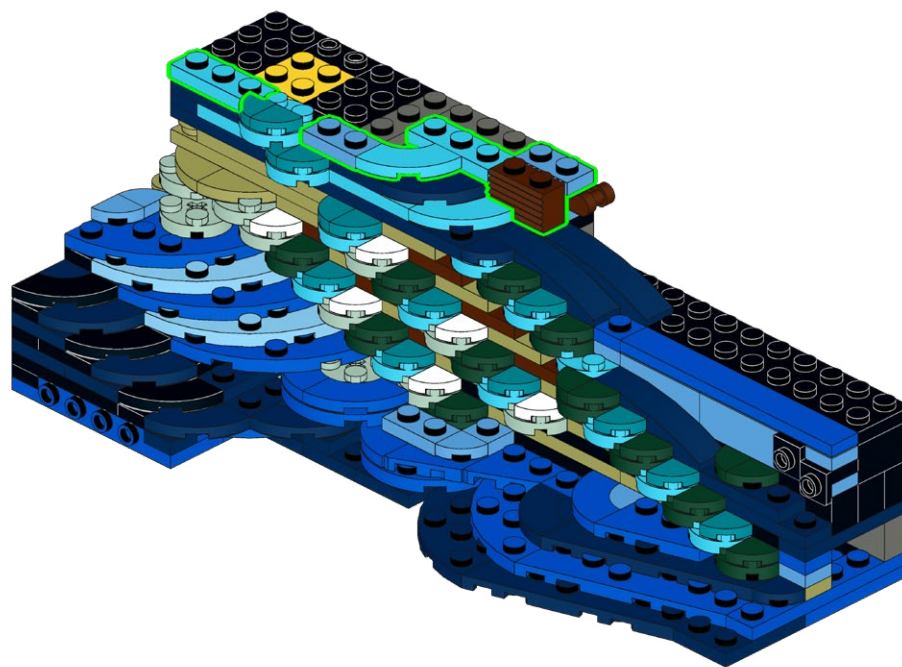
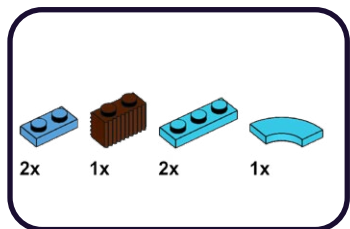

80

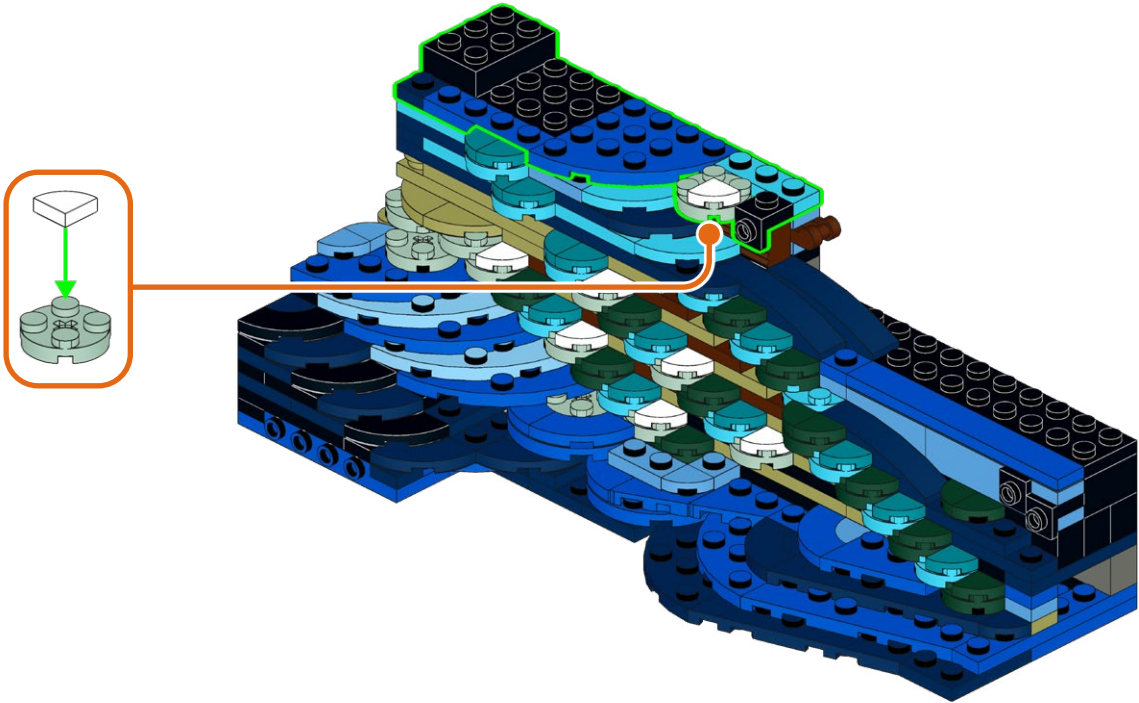
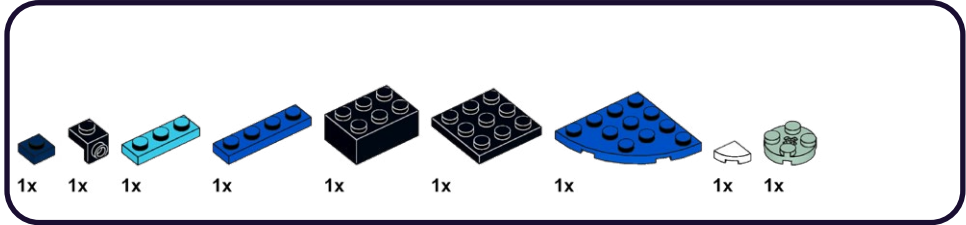

81

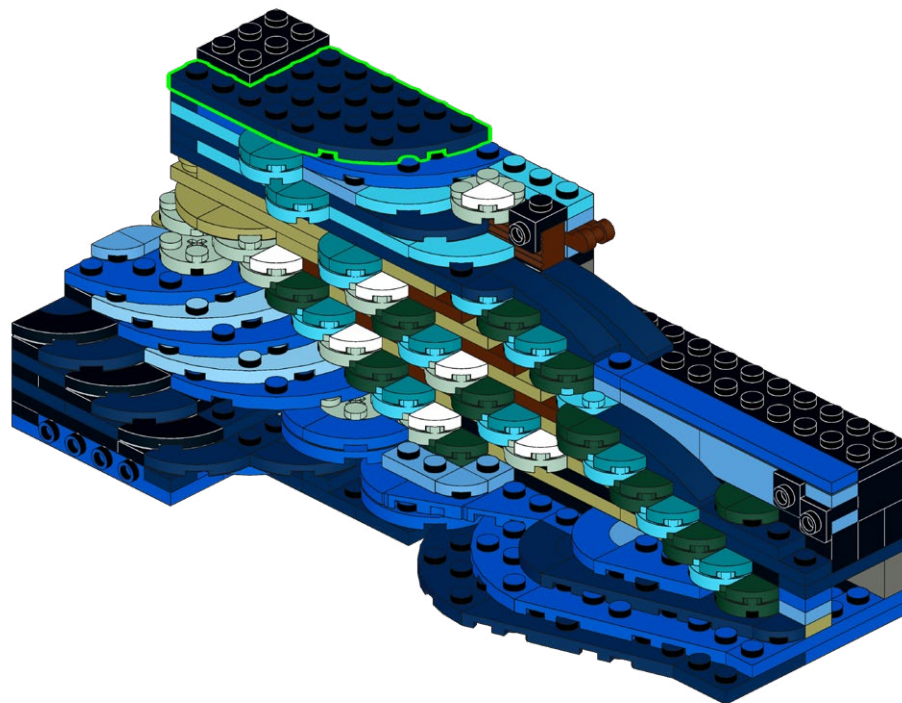
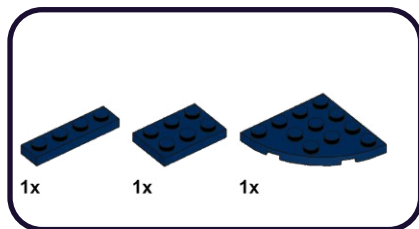

82

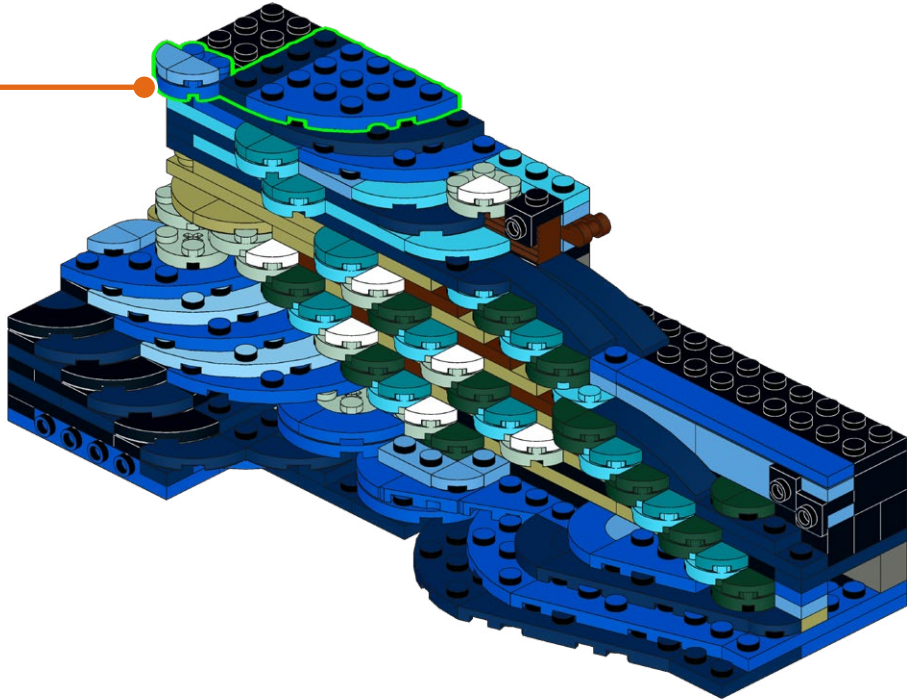
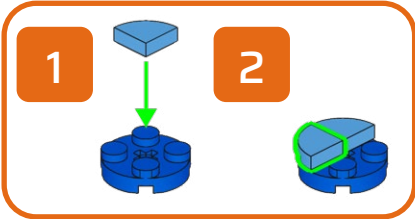
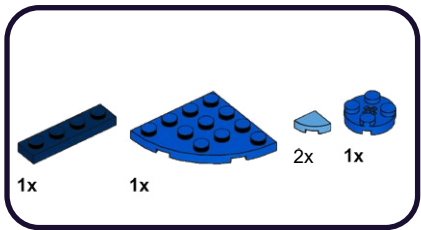

# 83

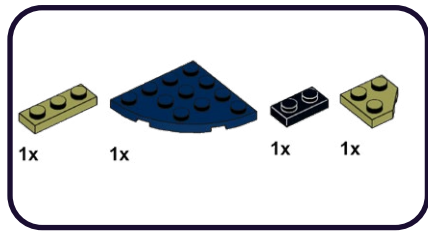

1

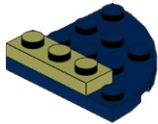

2

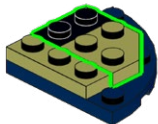

# 84



1

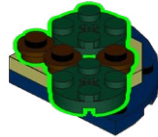

2

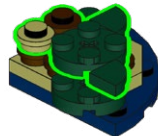



# 85

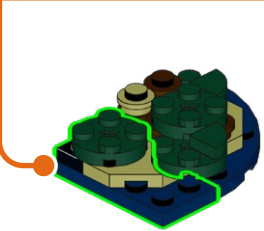
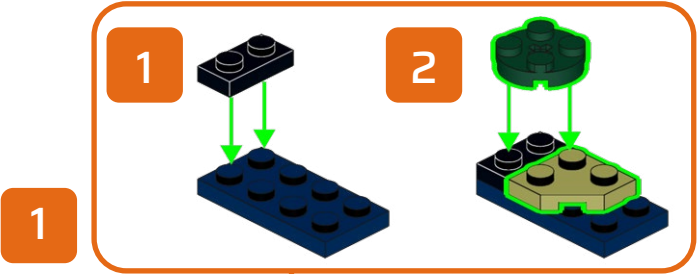
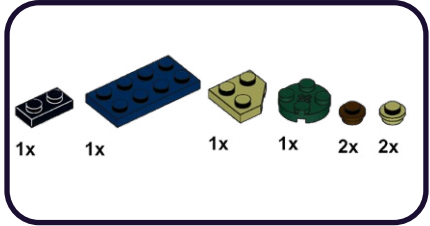

2

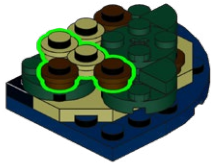

# 86



1

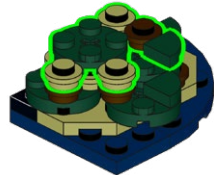

1

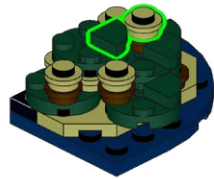

87

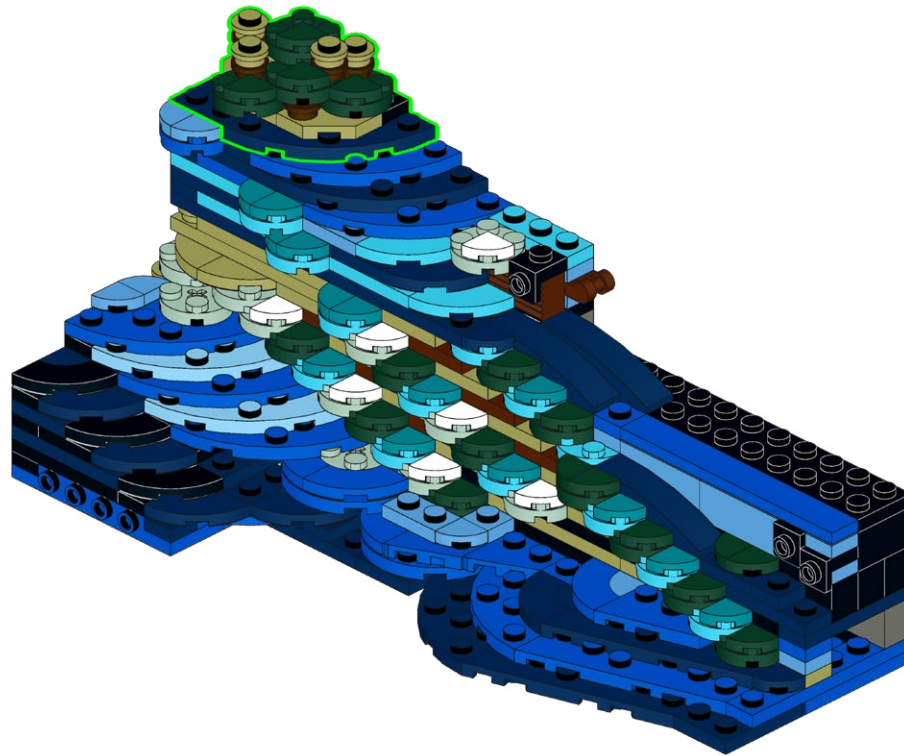

88

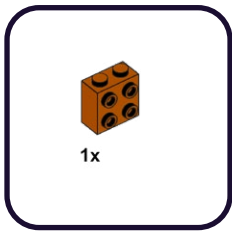

89

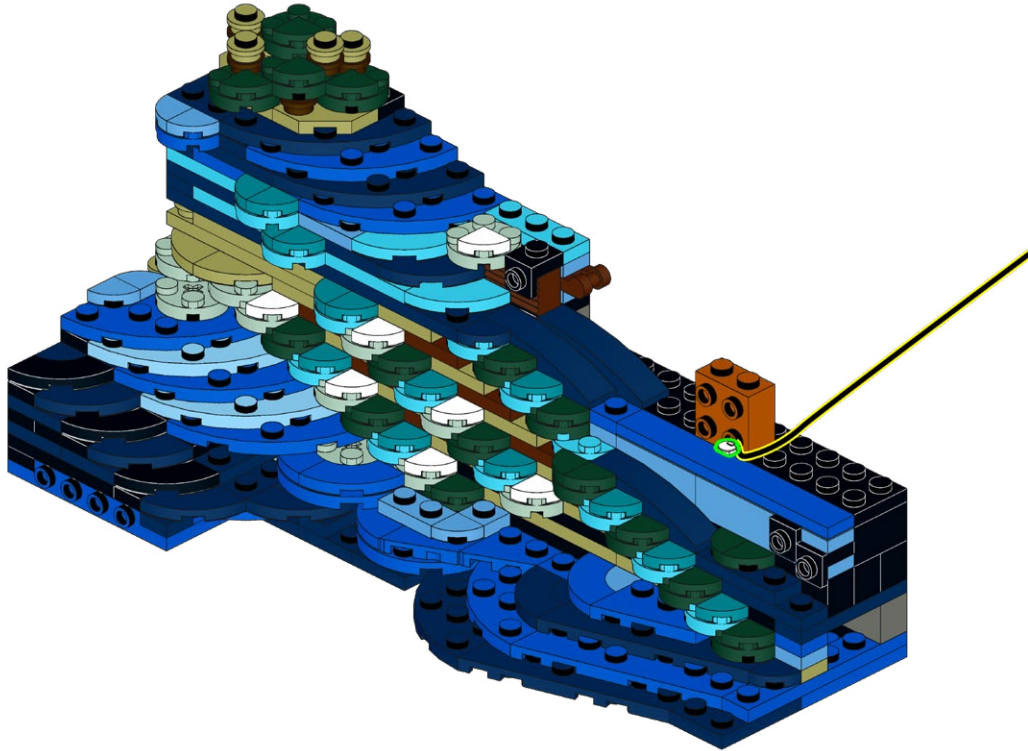
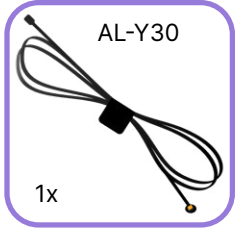

90

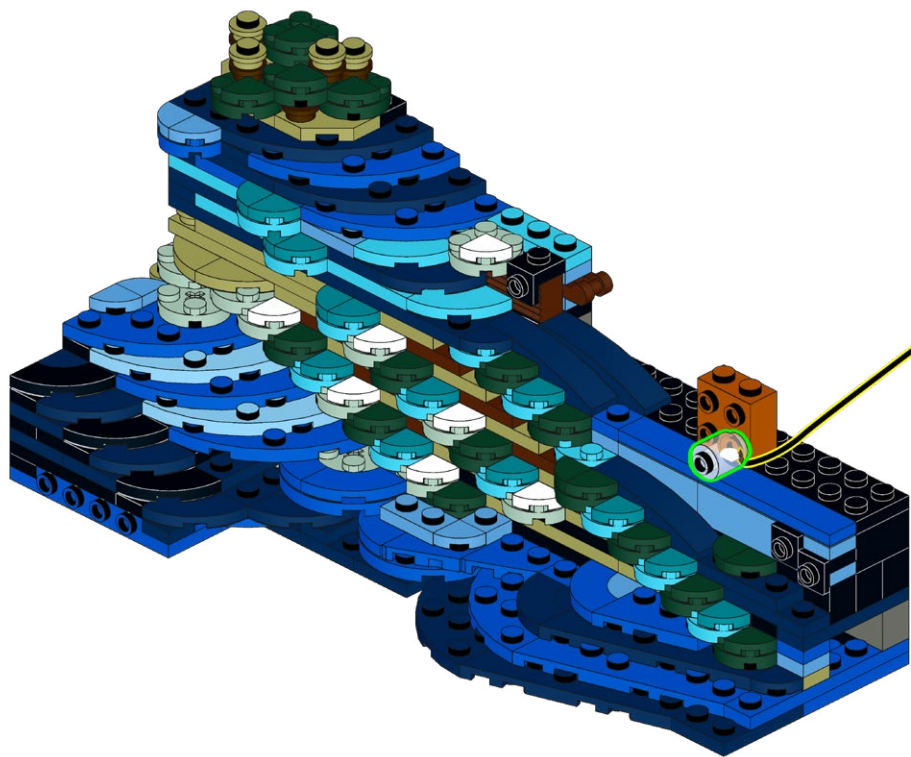
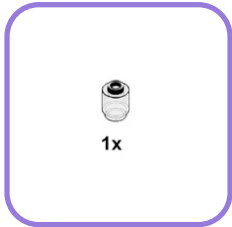

91

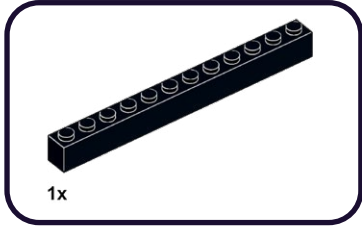



92

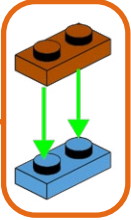
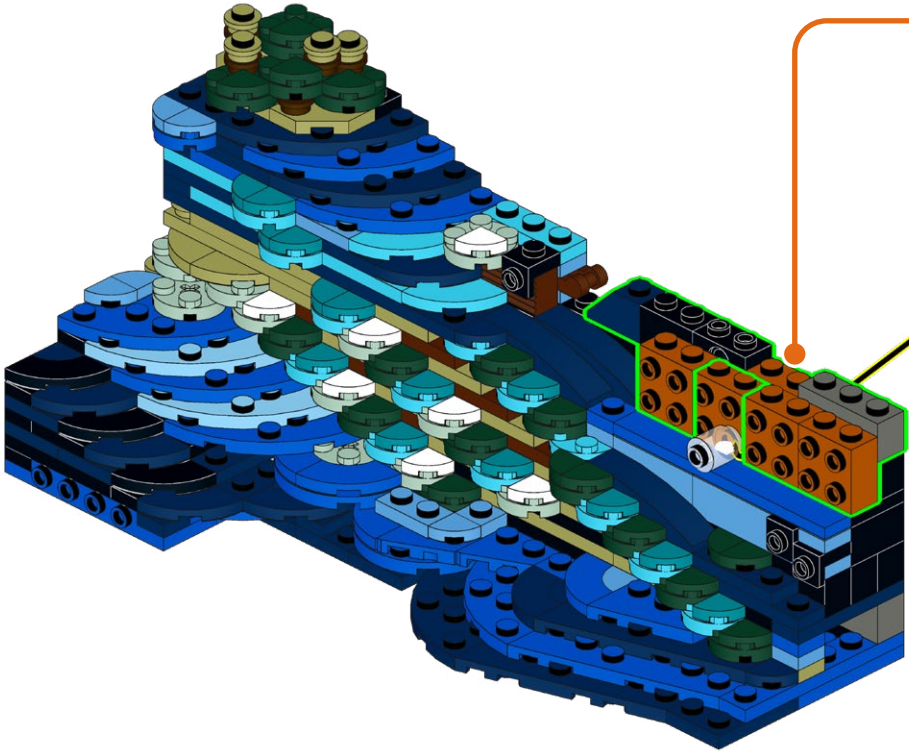
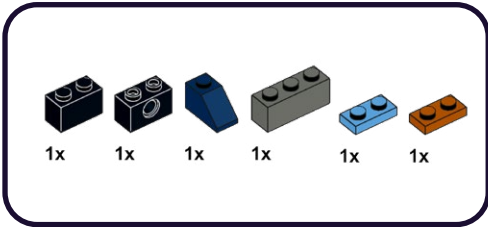

93

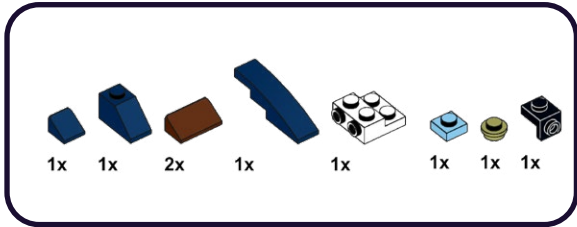

94

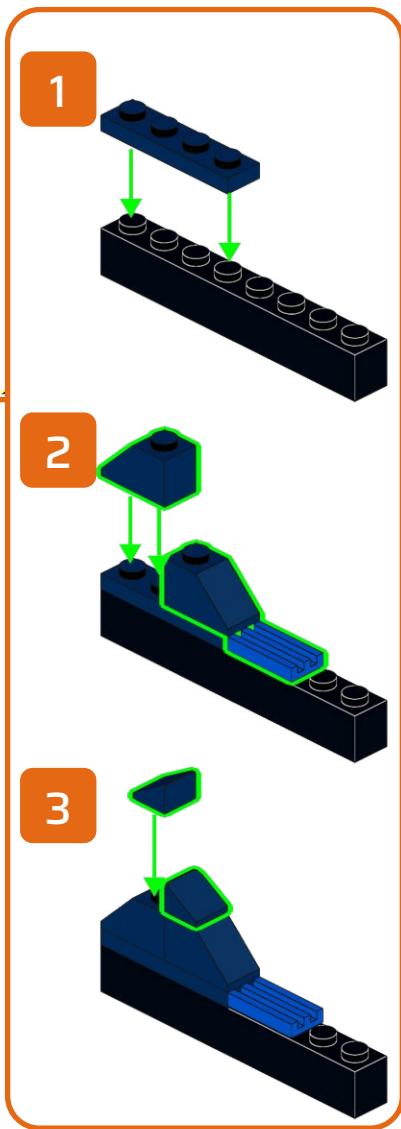
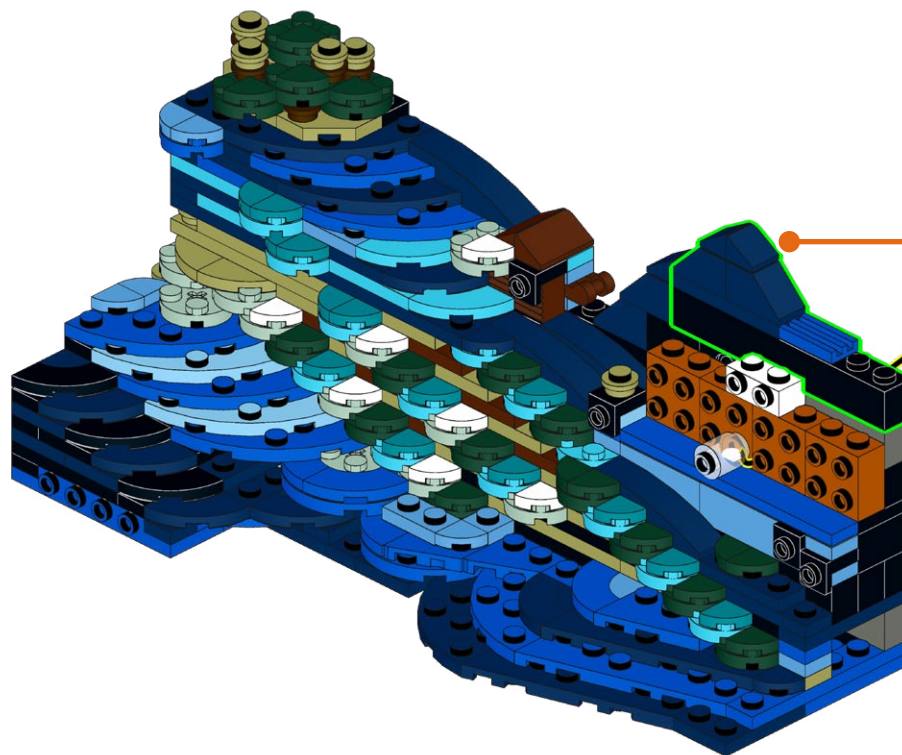
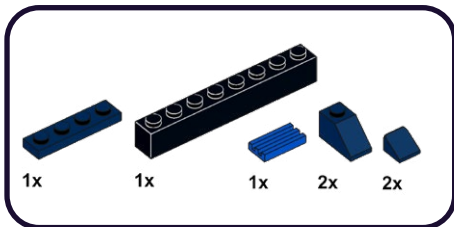

95

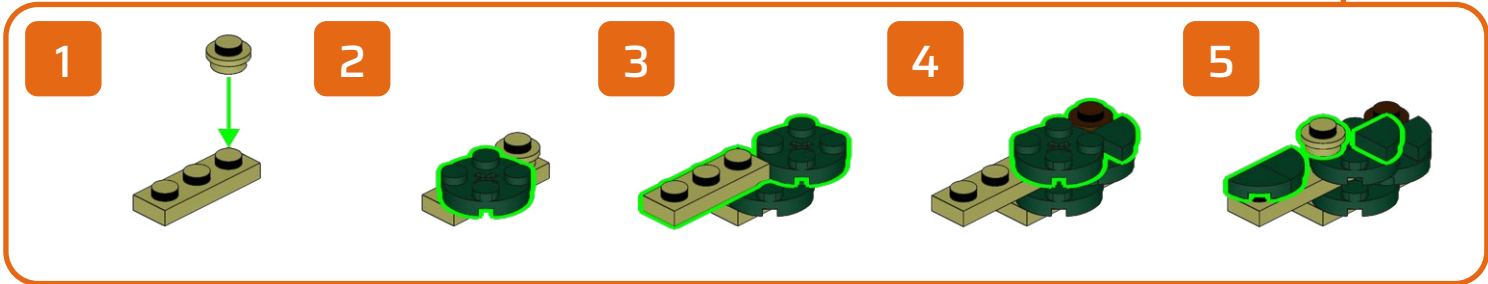
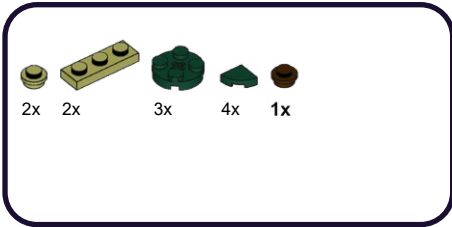



96

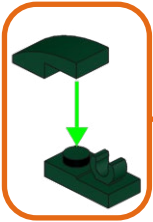
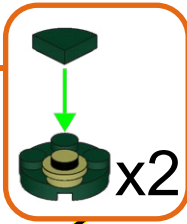
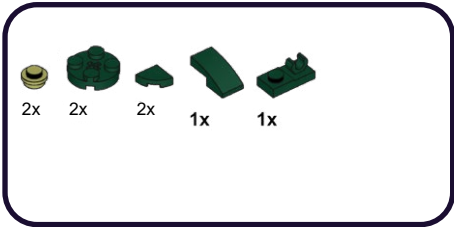

97

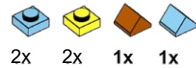

2x

2x

1x

1x

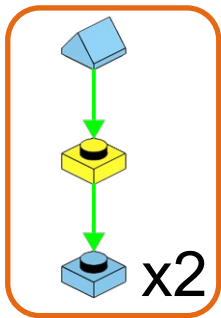

x2

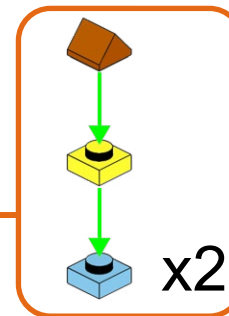
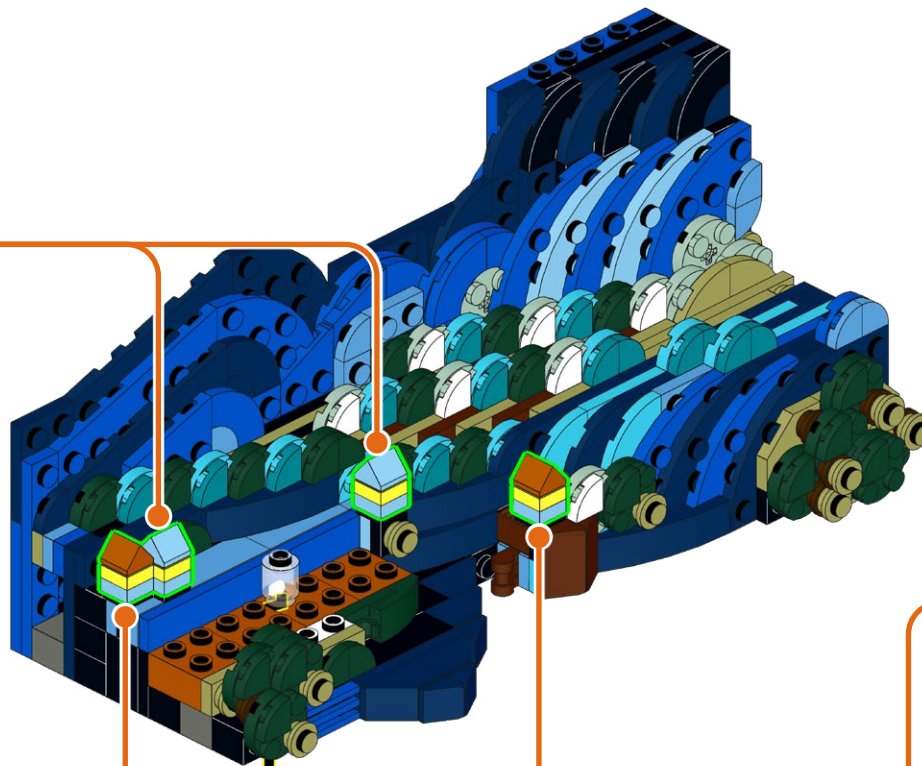

x2



98

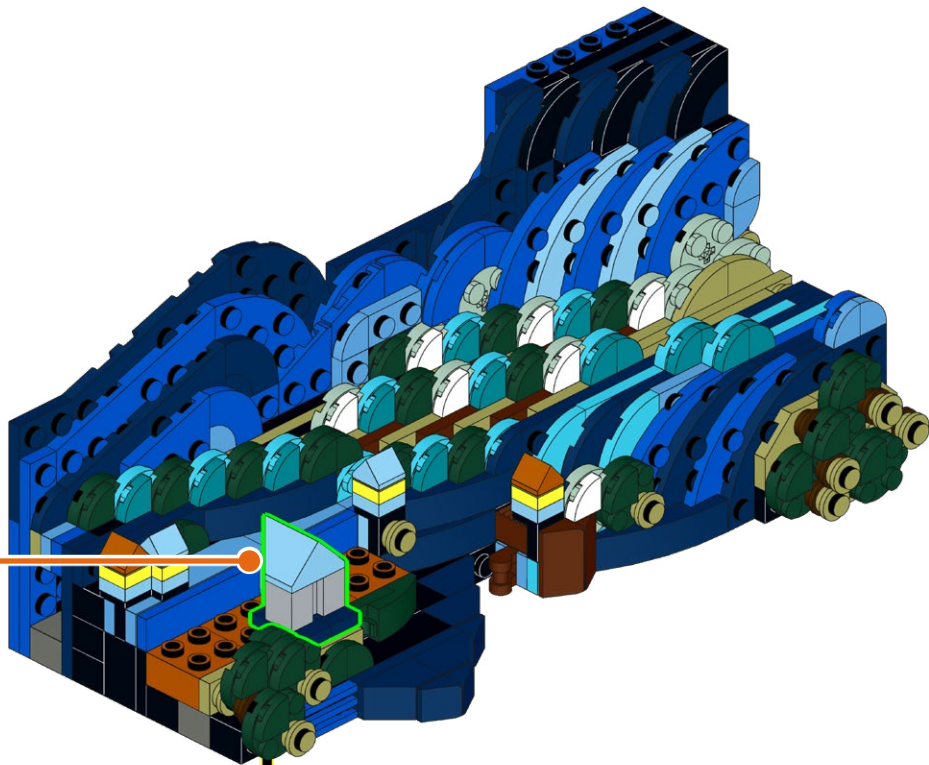
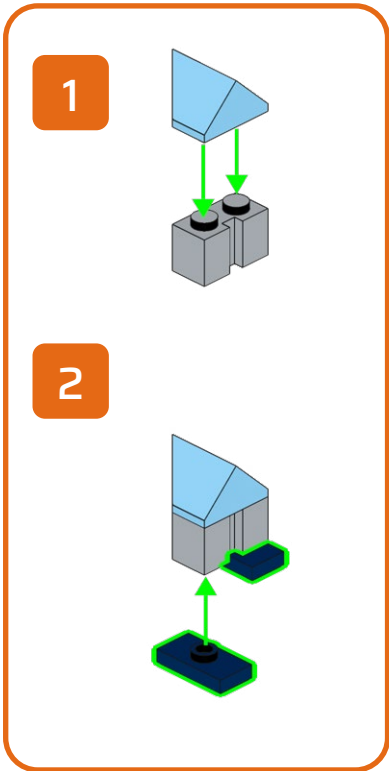
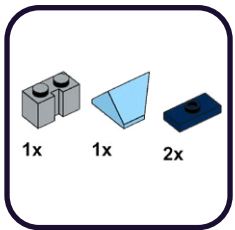

99

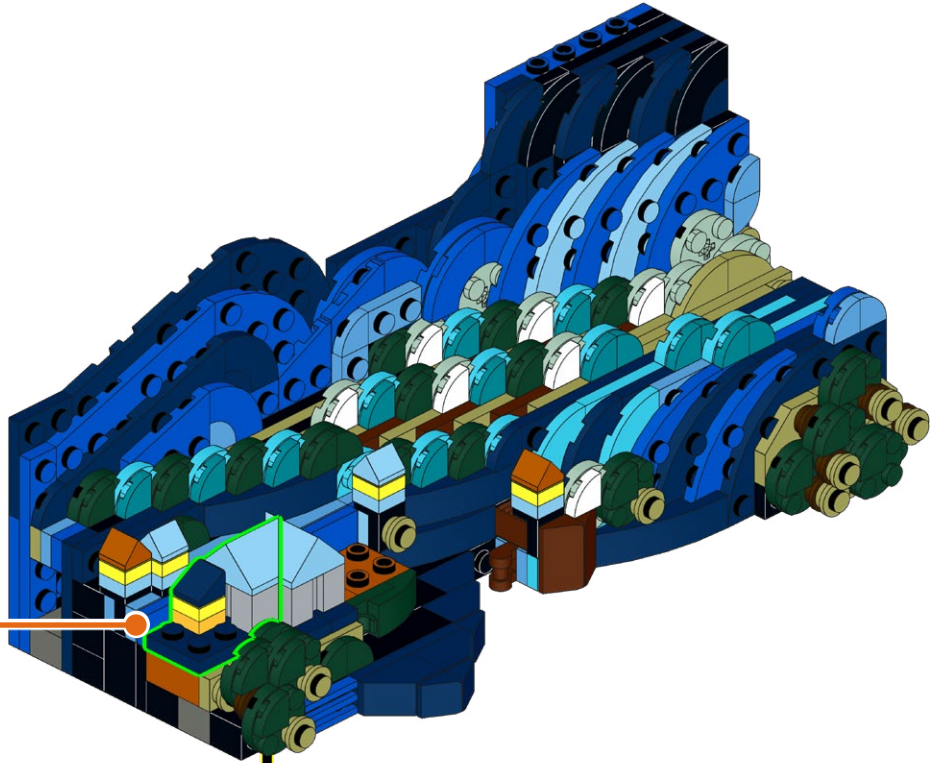
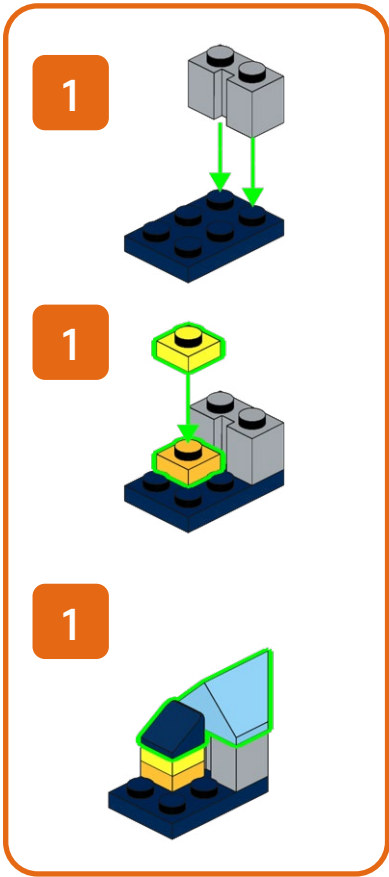
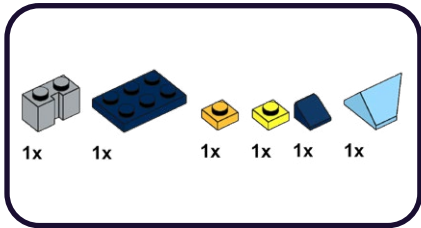

# 100

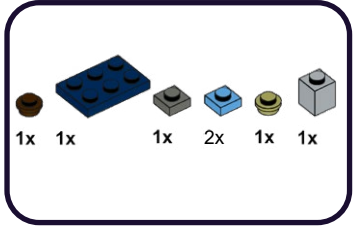

1

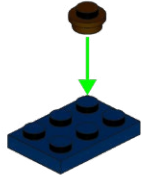

2

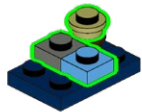

3

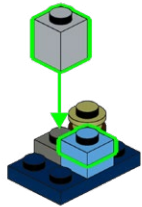

# 101

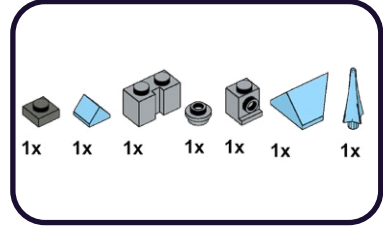

4

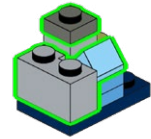

5

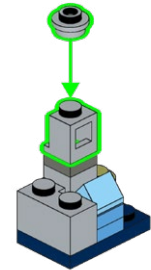

6

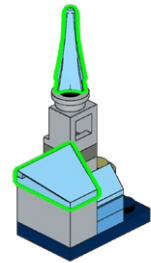

102

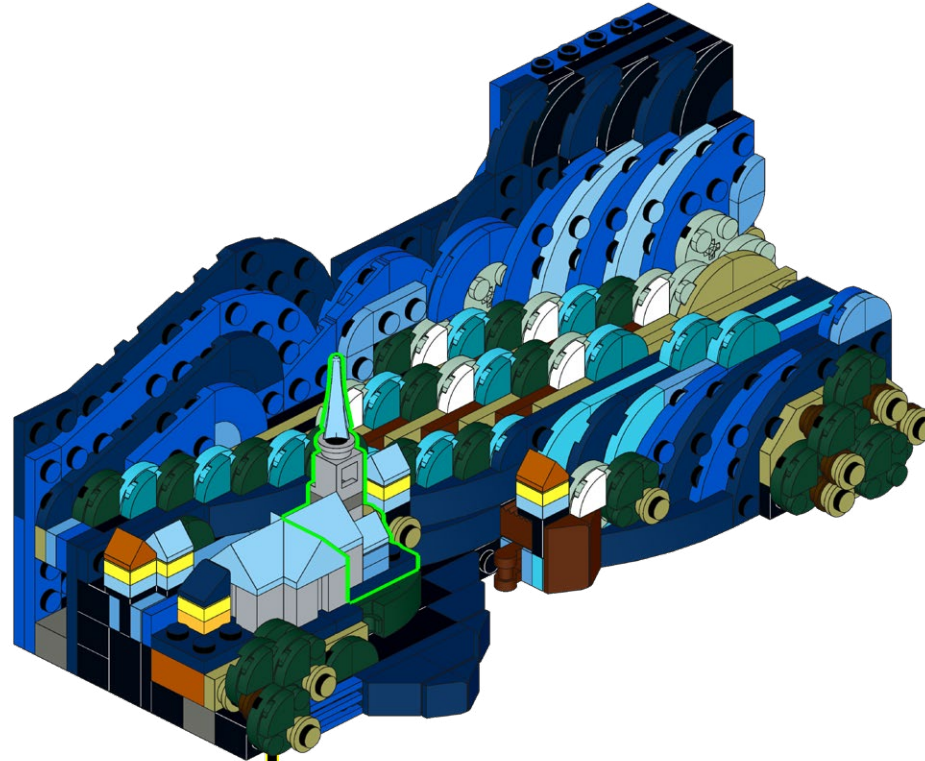

103

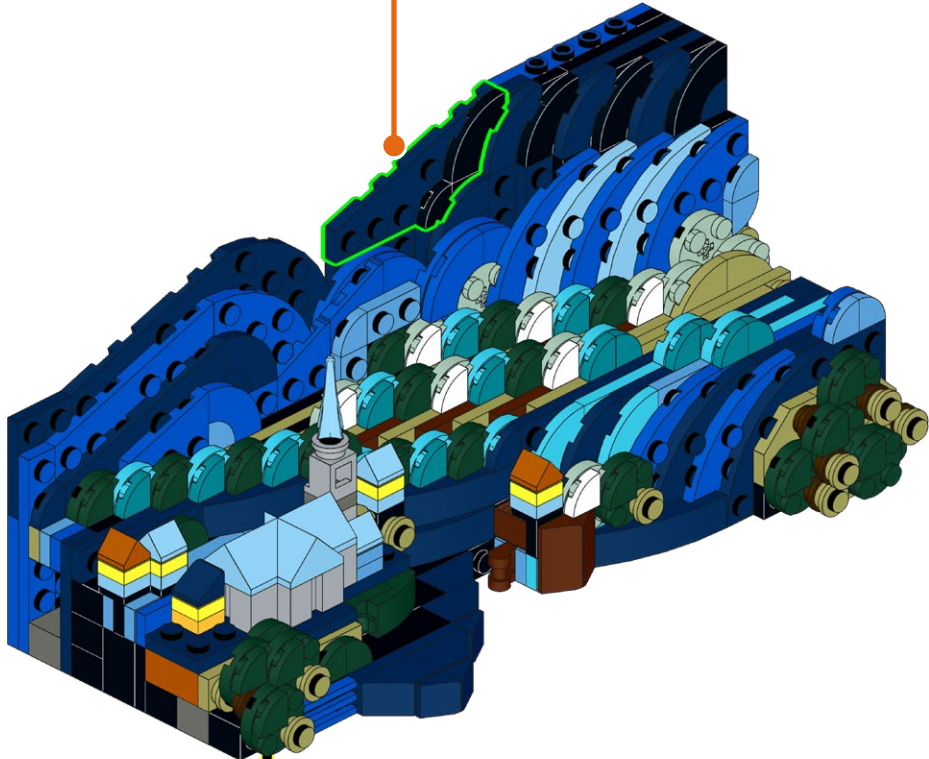
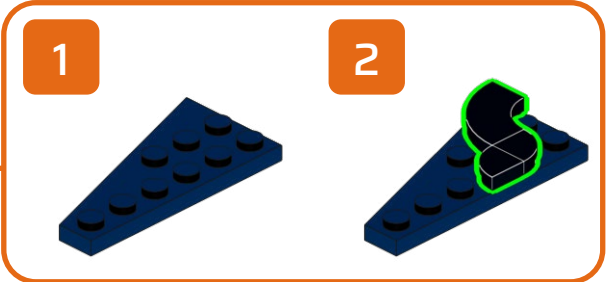
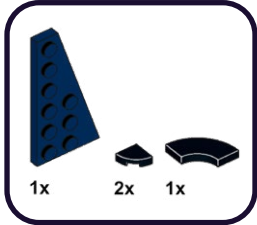



104

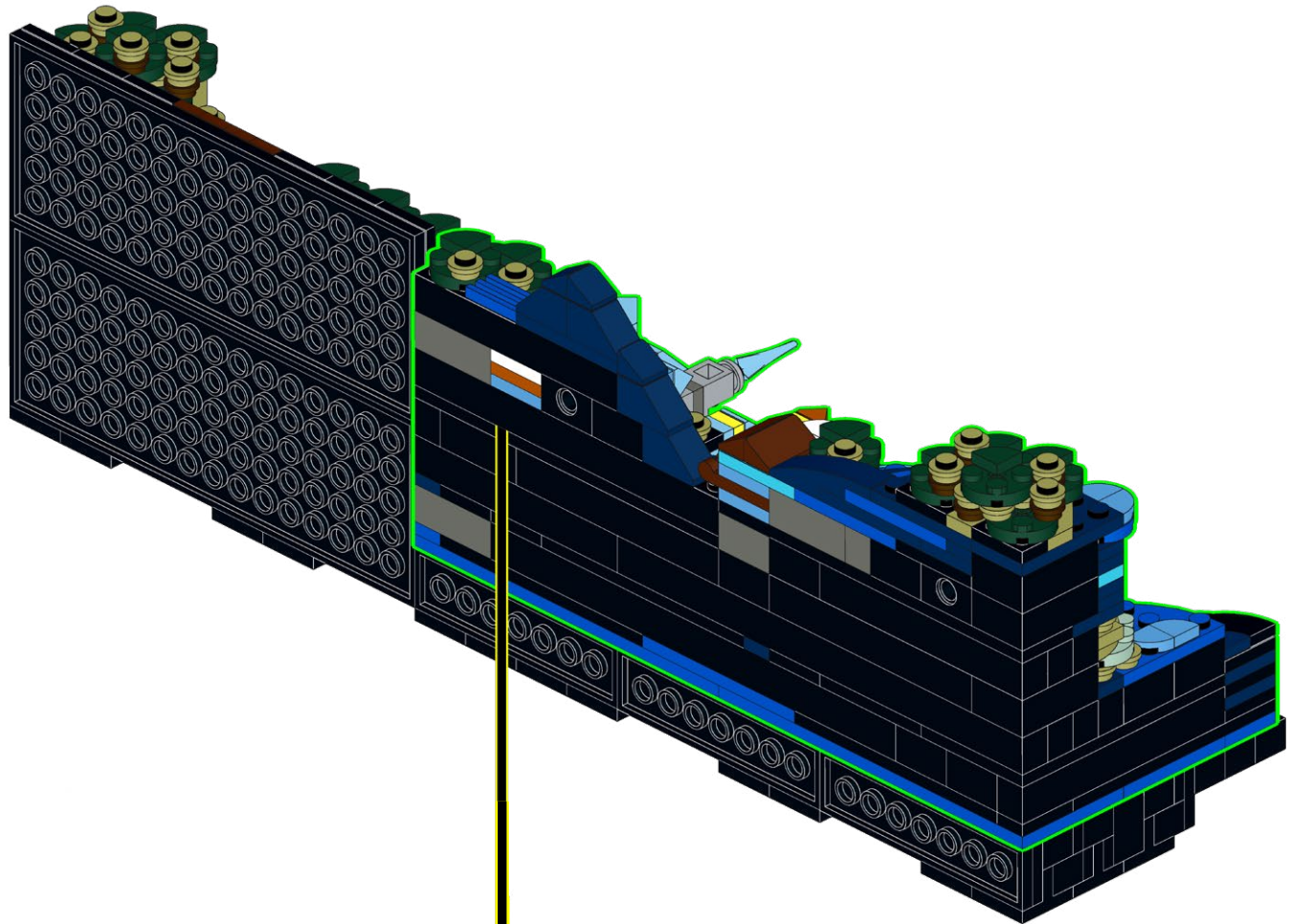



**105**

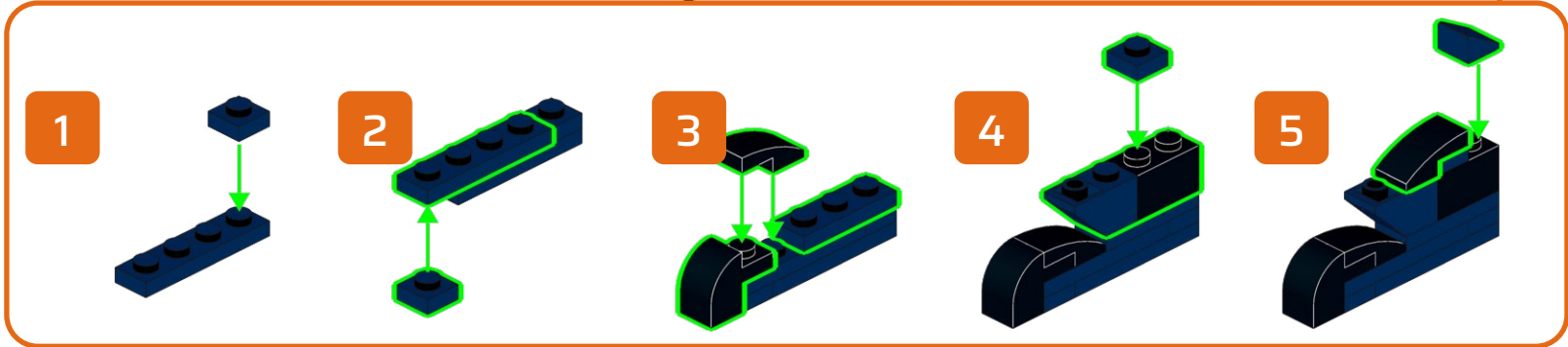
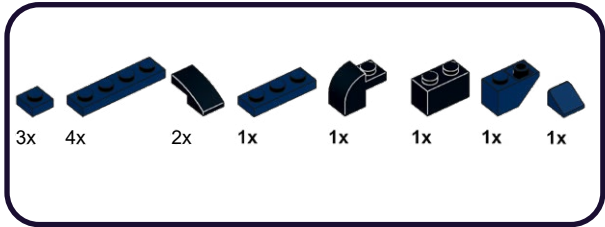

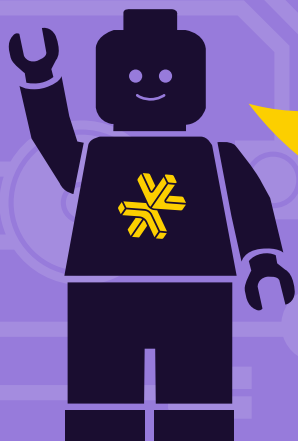

### **HOLD UP!**

You might notice some bags aren't in order, as well as left over pieces, but that's ok! We're changing the way you build LEGO!

### **ATTENDEZ!**

Vous remarquerez peut-être que certains sacs, ainsi que certaines pièces, ne sont pas dans le bon ordre. Mais pas de panique! Nous changeons simplement la façon avec laquelle vous construisez vos LEGO!

### **ASPETTA!**

Potresti notare che alcuni sacchetti non sono in ordine, così come i pezzi avanzati, ma va bene così! Stiamo cambiando il modo in cui costruisci i LEGO!

### **HALT!**

Sie werden möglicherweise bemerken, dass einige tüten durcheinander sind und teile übrig bleiben, aber das ist in Ordnung! Wir ändern die art und weise, wie Sie LEGO bauen!

### **¡ESPERA!**

Es posible que notes que algunas bolsas están fuera de servicio, así como piezas sobrantes, ¡pero está bien! ¡Estamos cambiando la forma en que construyes LEGO!

### **暫停!**

你可能会注意到一些袋子顺序错乱, 以及一些剩余的部件, 但没关系! 我们正在改变你搭建乐高的方式!

### Open LEGO® Bag 9

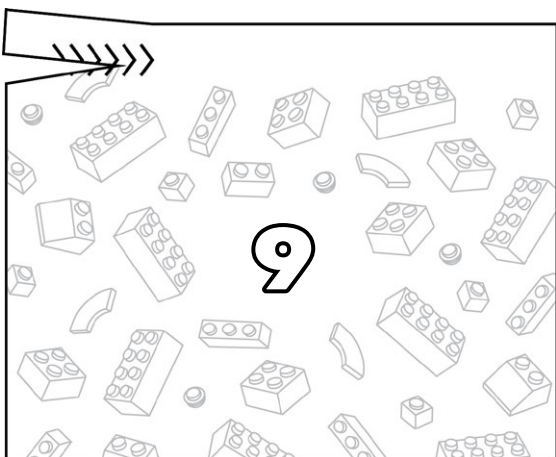

# 106

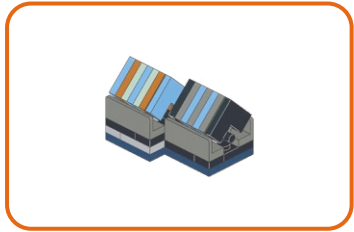
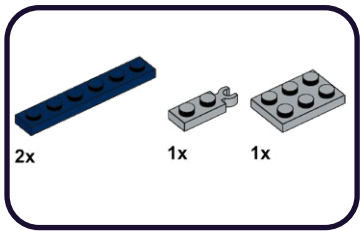

1



1

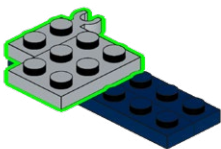

# 107

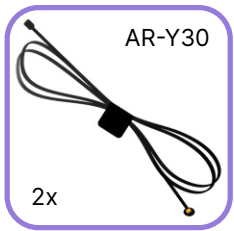
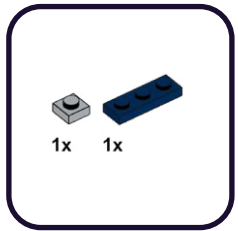

1

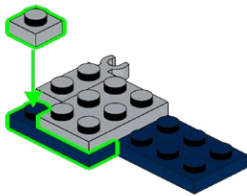

1

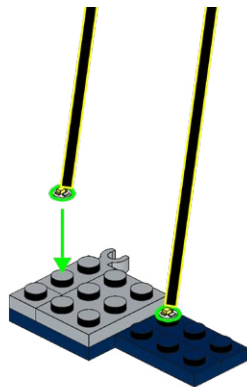

# 108

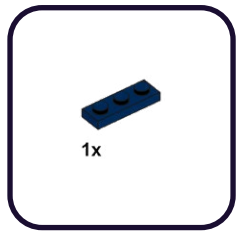

1x

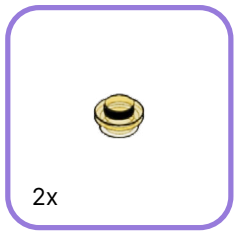

2x

1

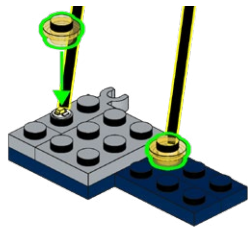

110

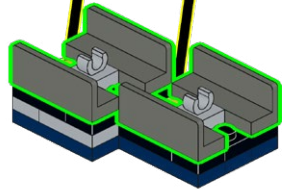
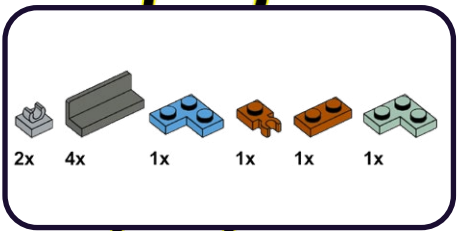

1

2

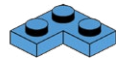

3

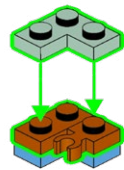

111

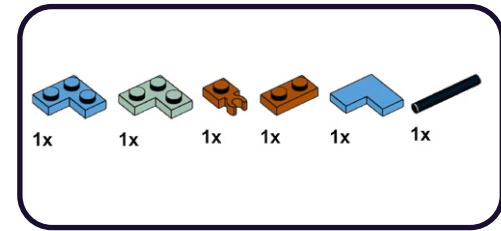

1

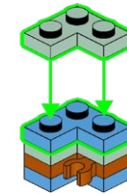

2

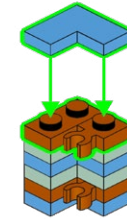

3

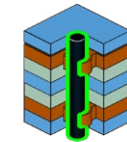

112

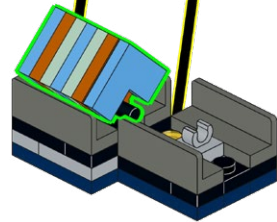
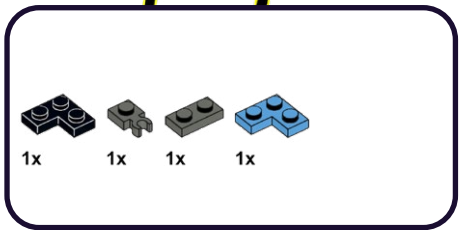

1

2

2

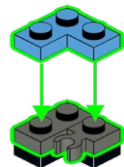

113

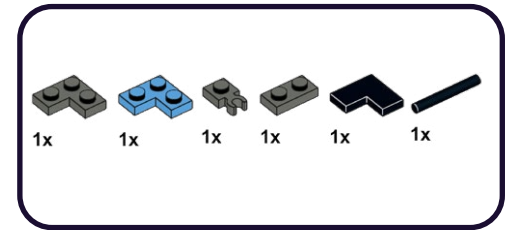

1

2

2

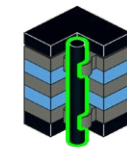
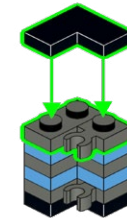
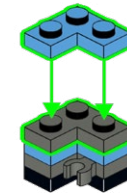



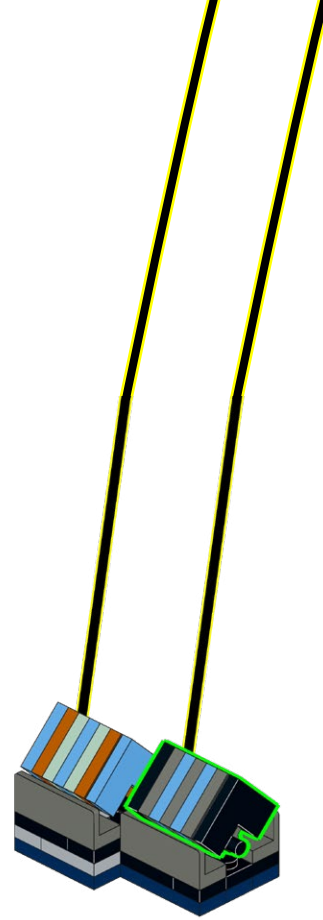
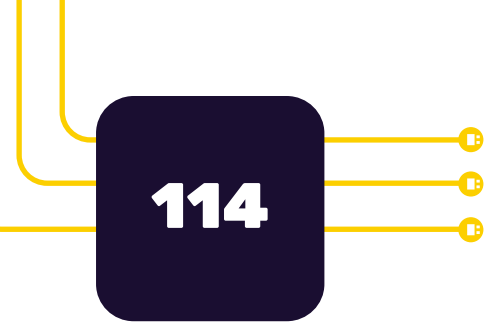

115

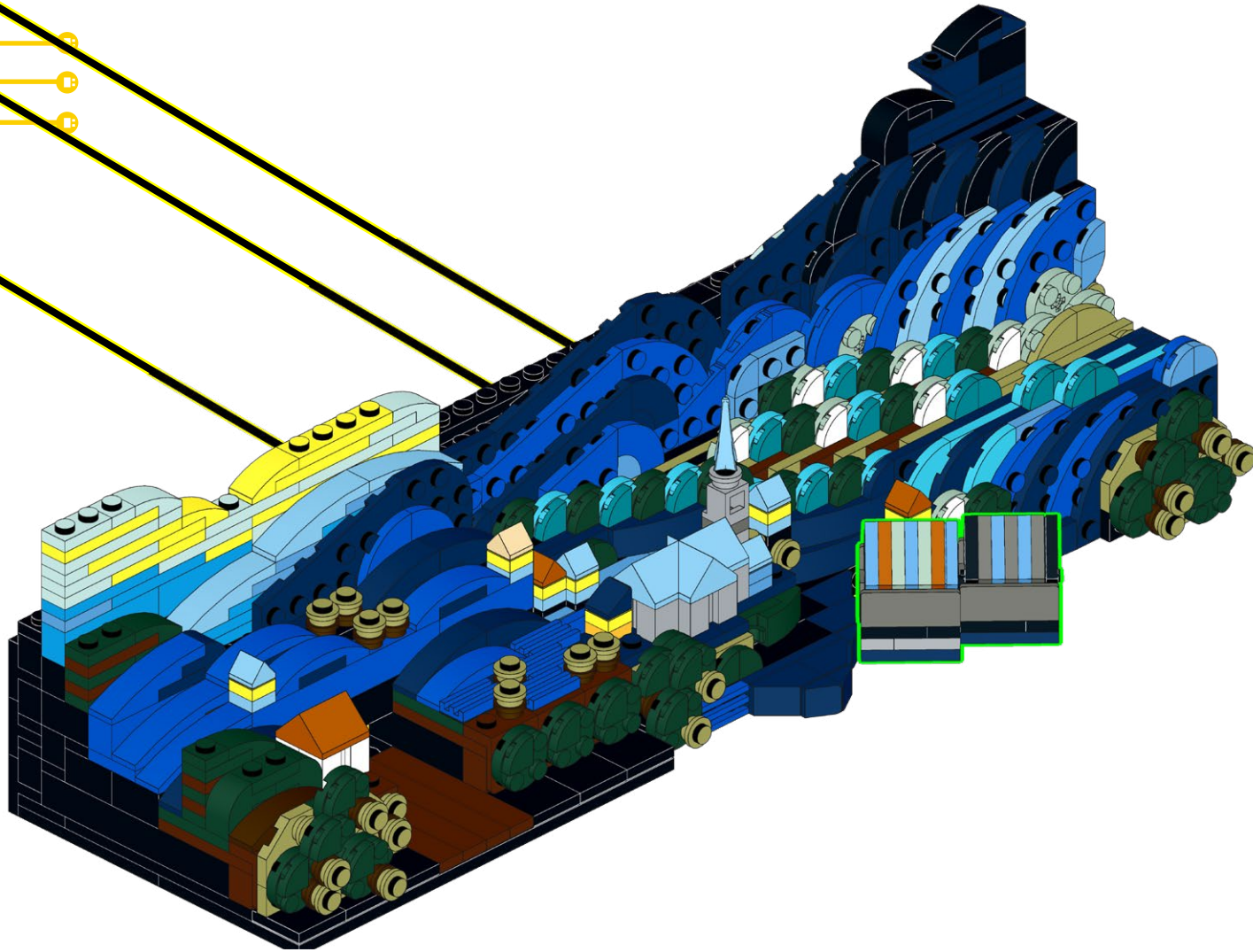

116

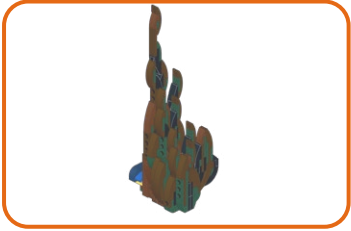
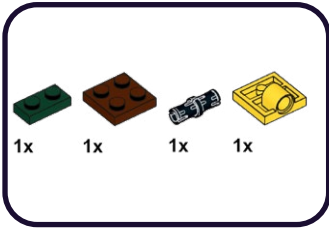

1

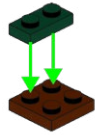

2

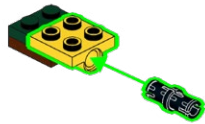

117

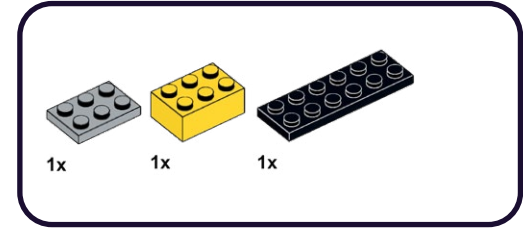

1



2

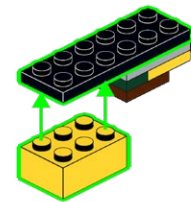
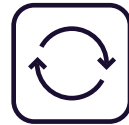

118

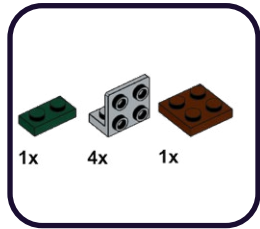

1

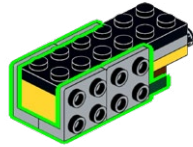

2

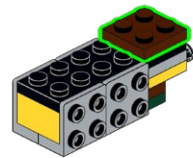

119

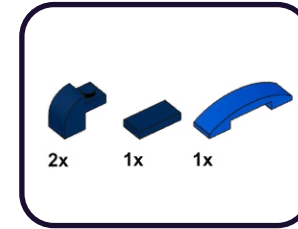

1

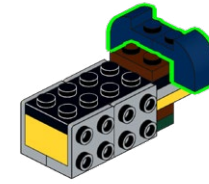

2

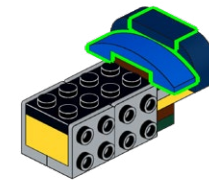

# 120

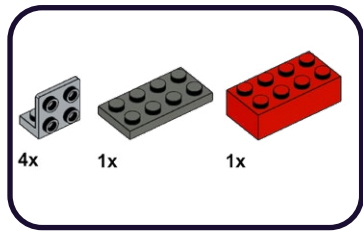

1

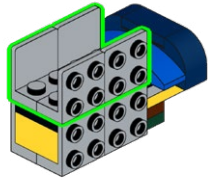

2

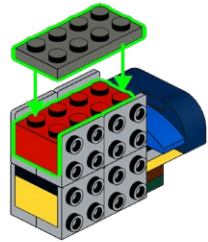

# 121

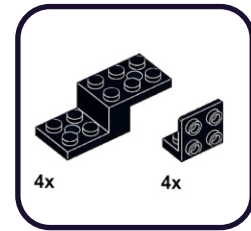

1

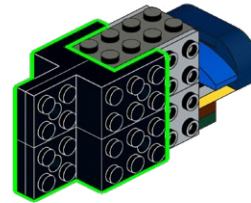

2

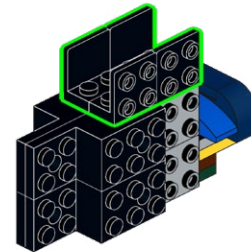

# 122

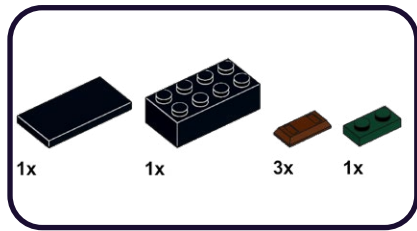

1

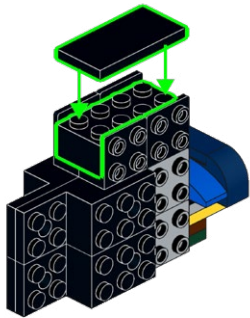

2

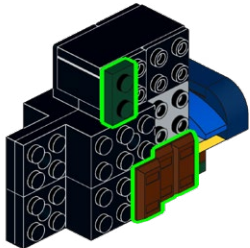

# 123

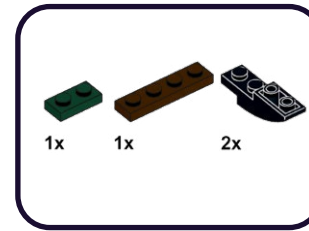

1

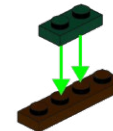

2

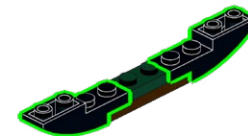



# 124

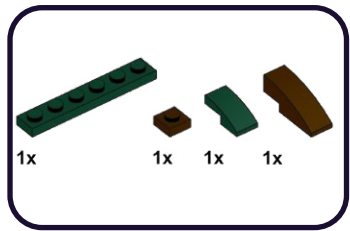

1

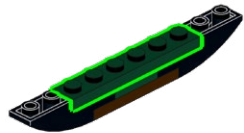

2

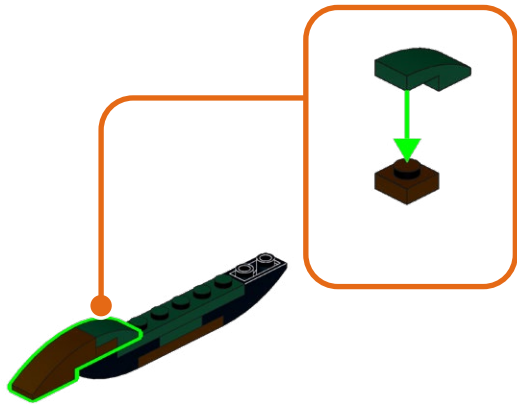

# 125

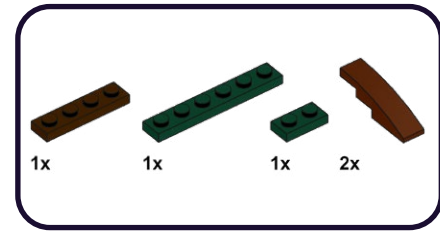

1

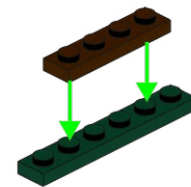

2

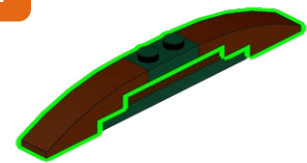

# 126

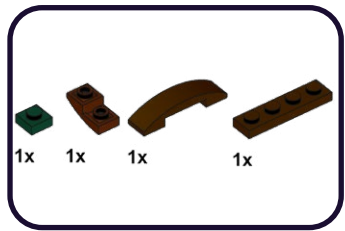

1

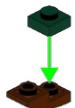

2

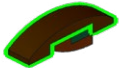

3

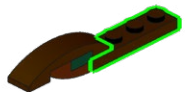

# 127

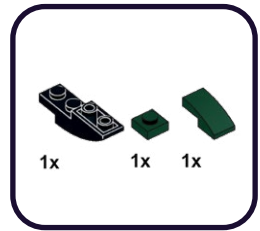

1

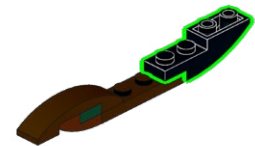

2

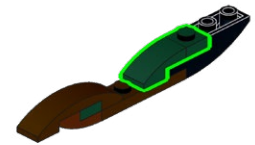

3

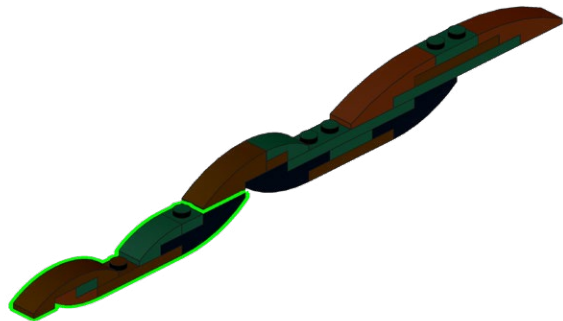

128



129

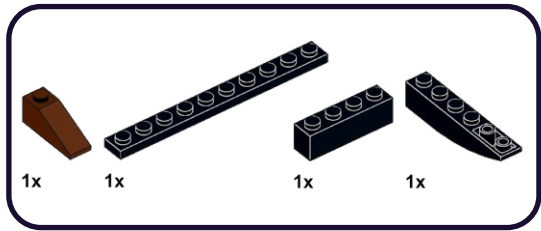

1

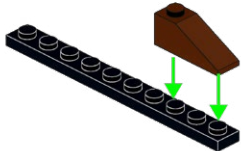

2

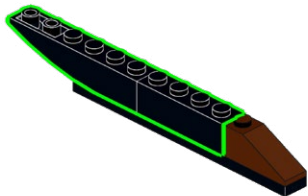

# 130

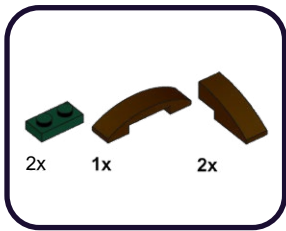

1

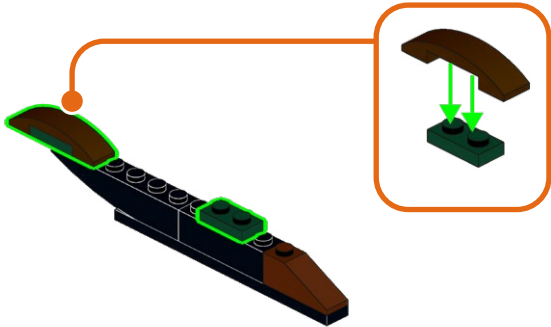

2

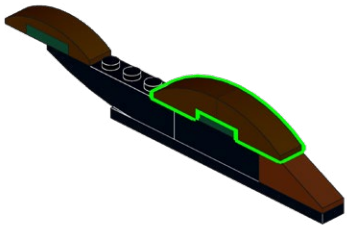

# 131

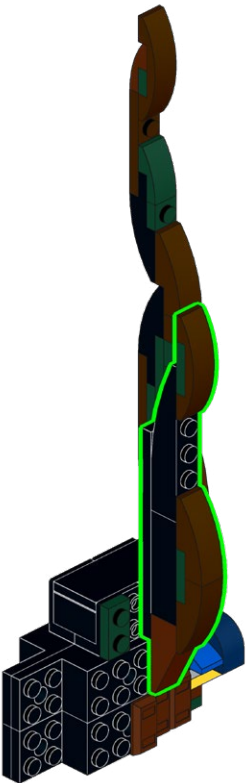

# 132

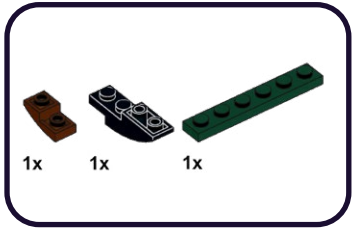

1

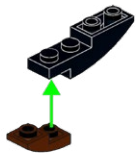

2



# 133

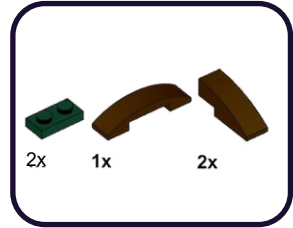

1

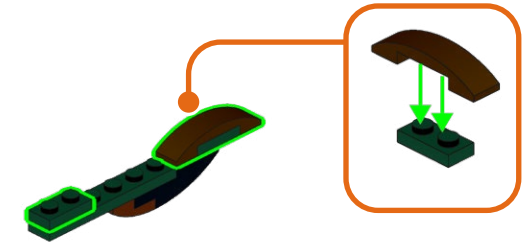

2

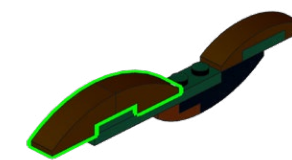

134

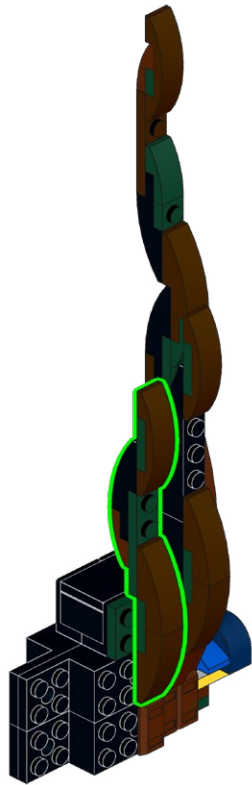

135

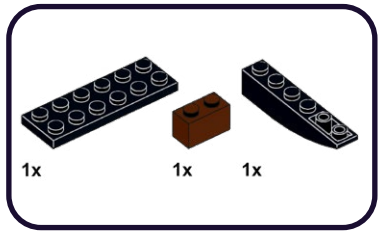

1



2

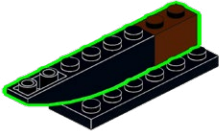



136

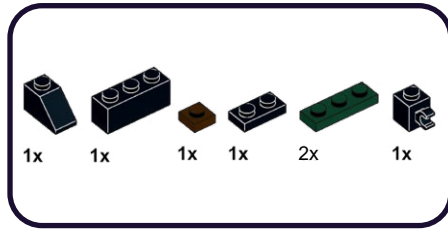

1

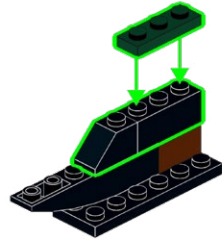

2

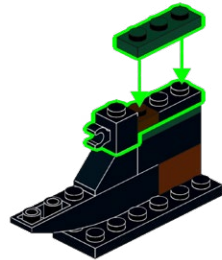

137

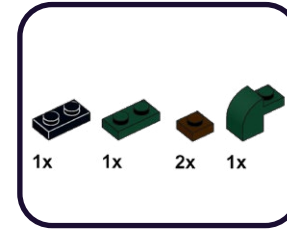

1

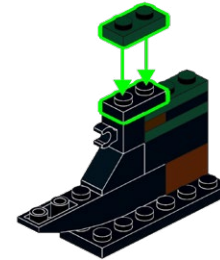

2

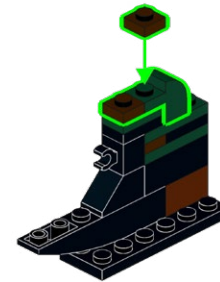

# 138

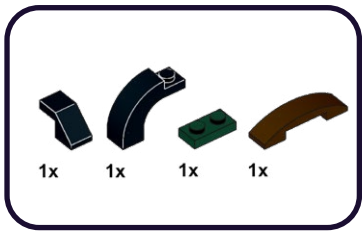

1

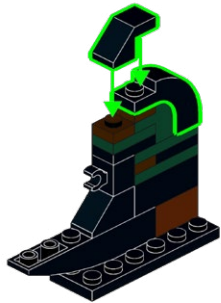

2

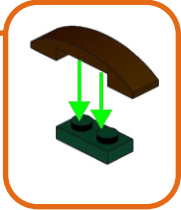
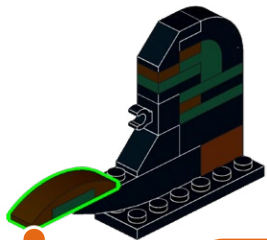

# 139

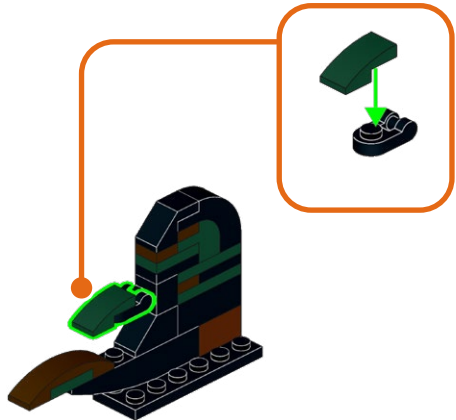
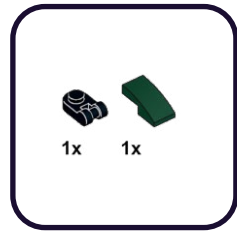

# 140

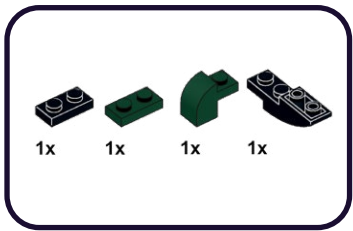

1

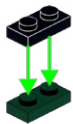

2



3

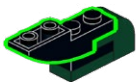

# 141

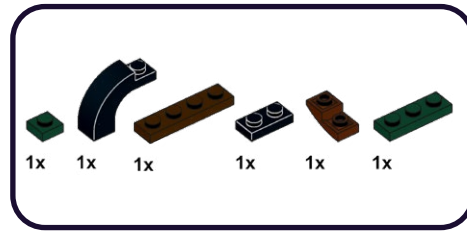

1

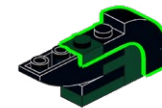

2

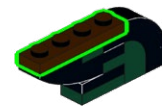

3

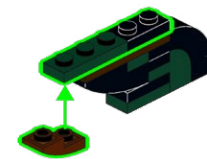

142

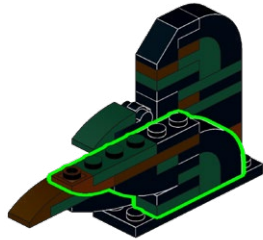

143

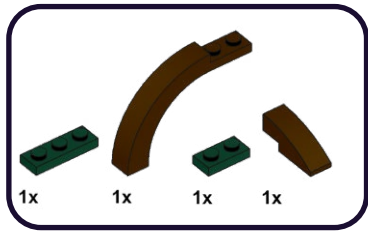

1

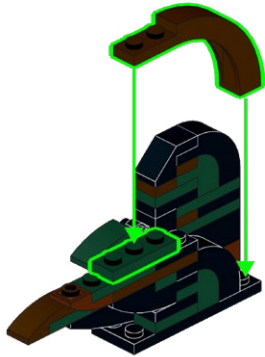

2

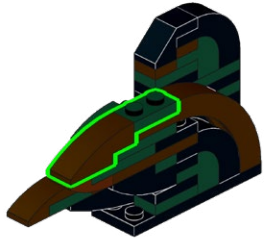

144

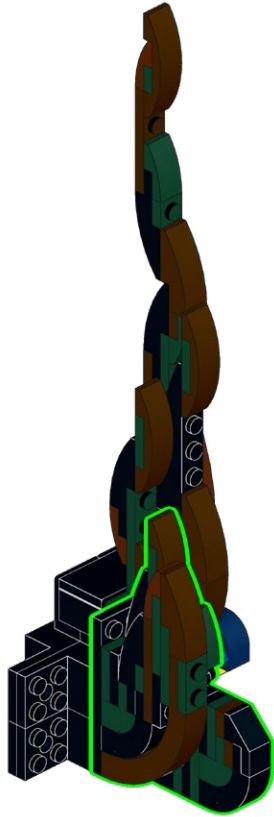

145

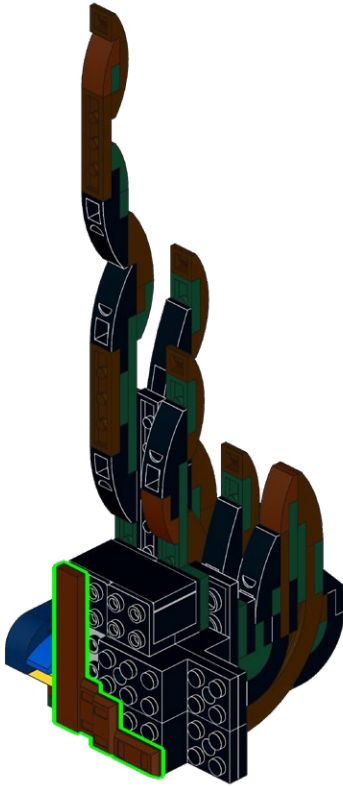
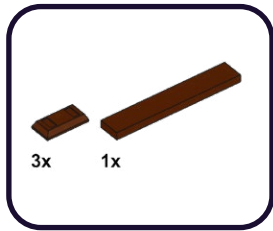

146

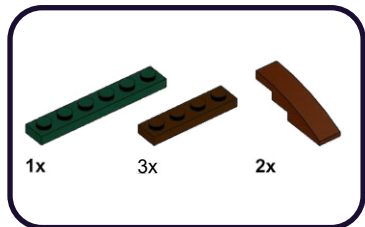

1



2

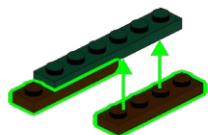

3

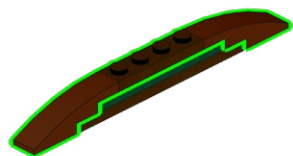

147

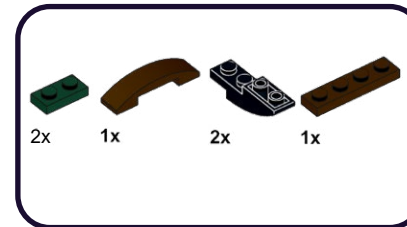

1

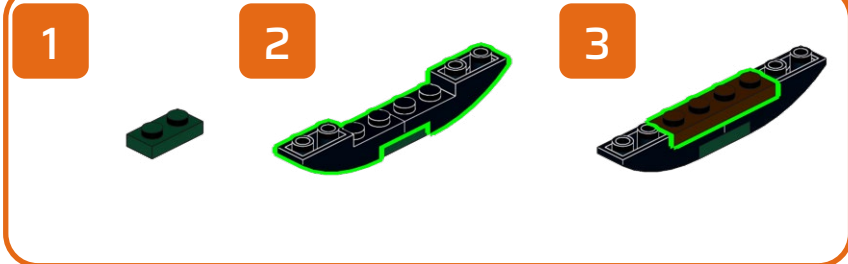
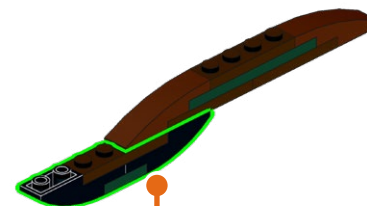

2

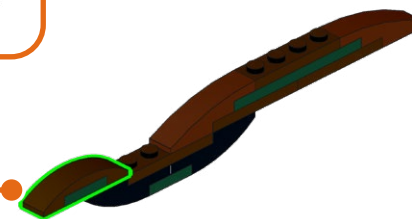
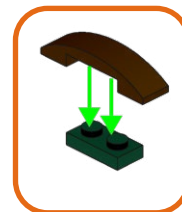



148

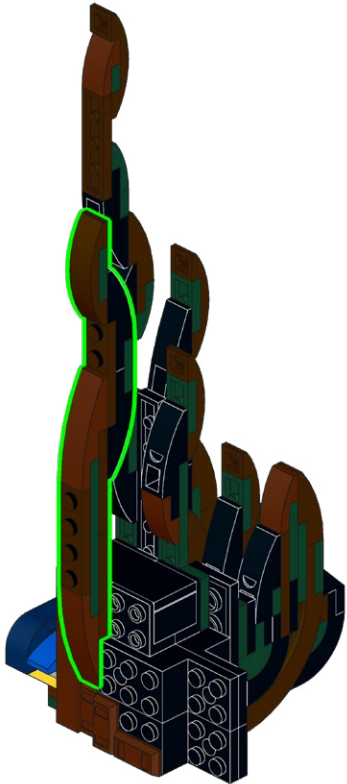

149

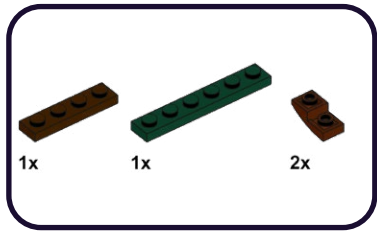

1

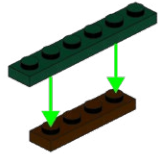

2

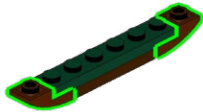

# 150

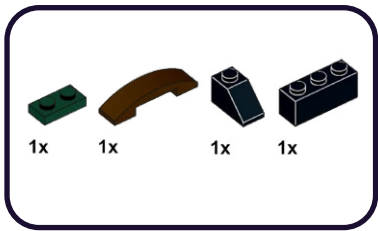

1

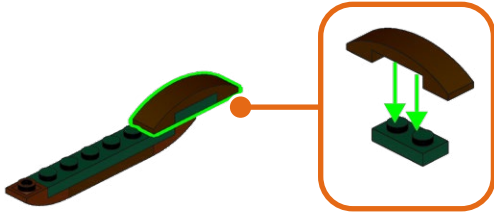

2

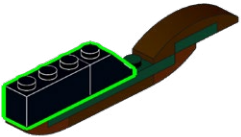

# 151

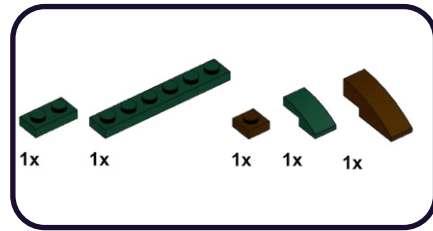

1

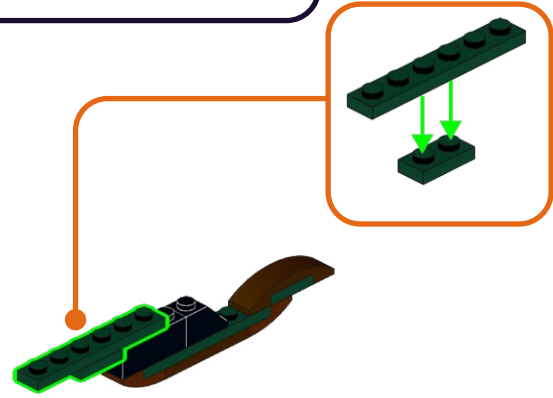

2

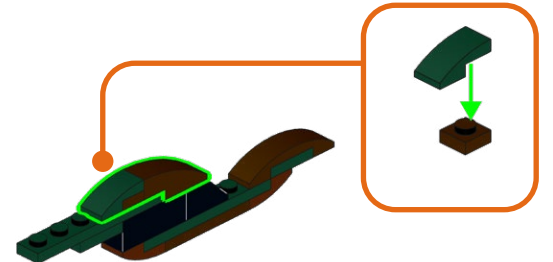

**152**

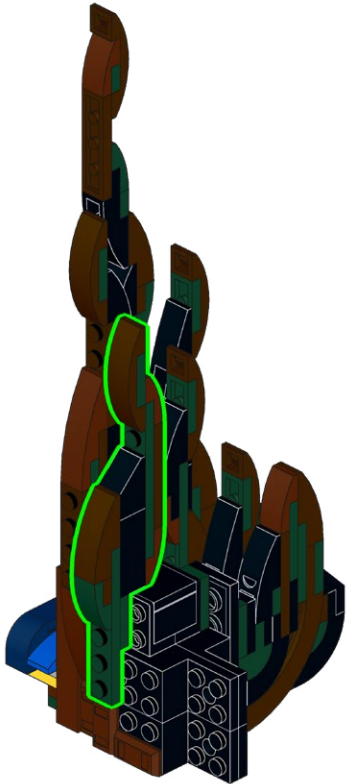

**153**

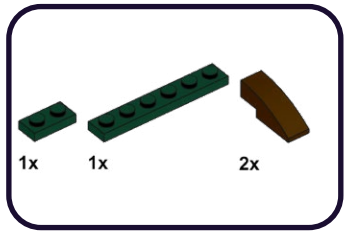

**1**

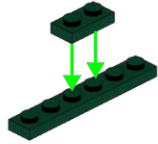

**2**

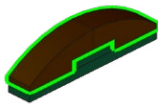

# 154

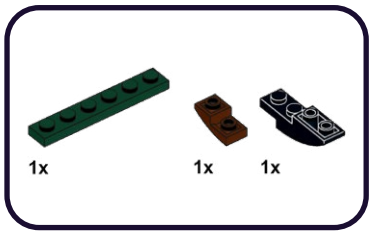

1

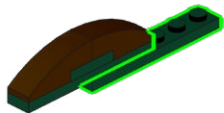

2

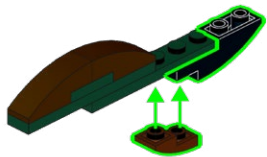

# 155

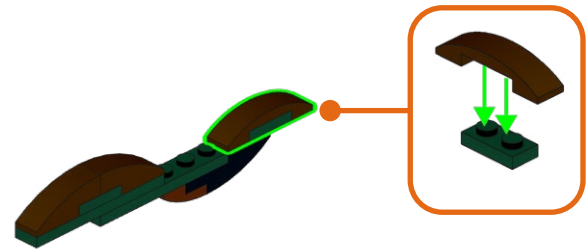
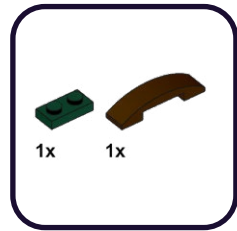

156

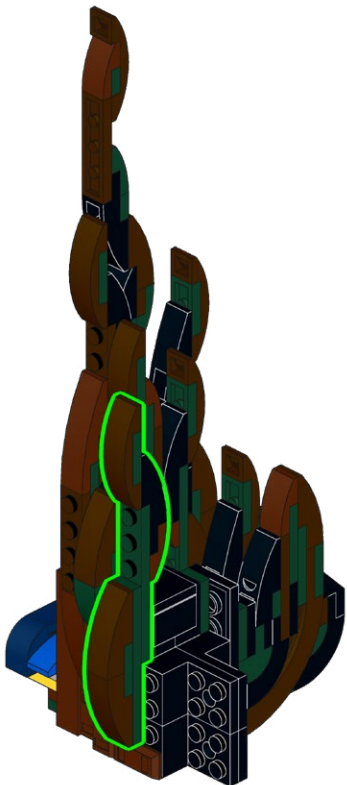

157

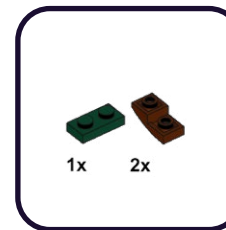

1



2

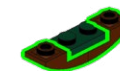

158

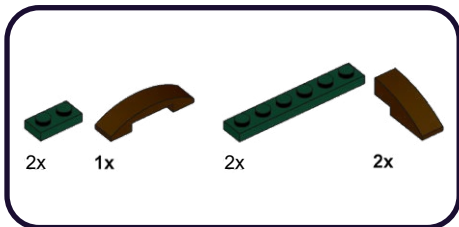

1

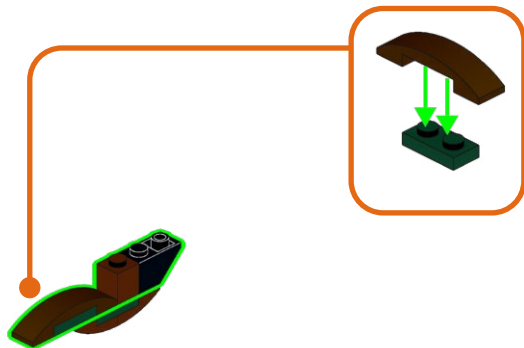

2

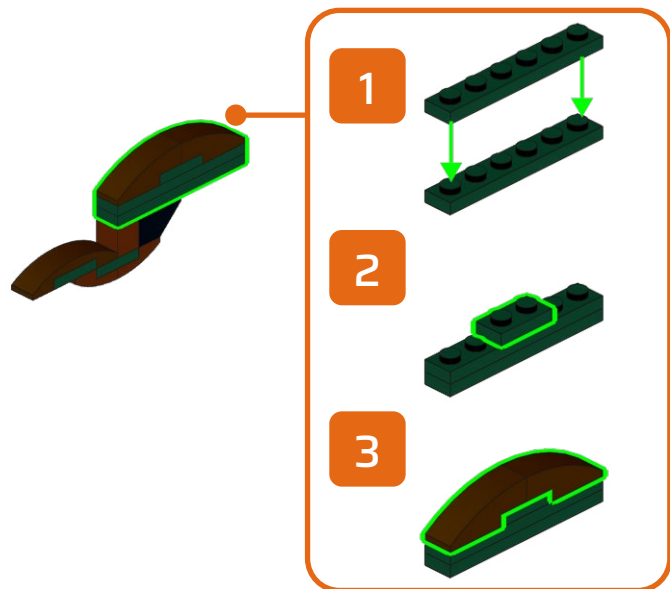

159

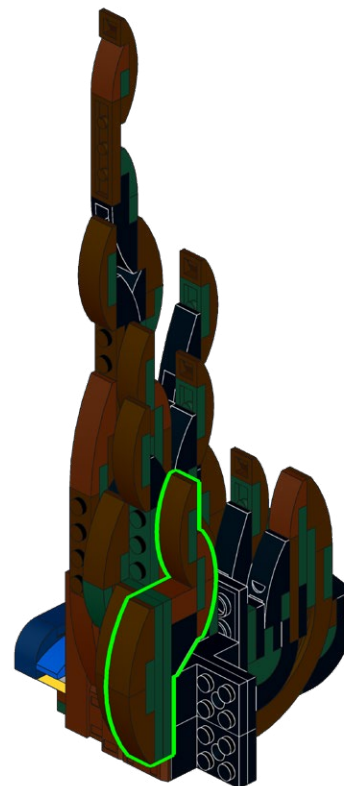

# 160

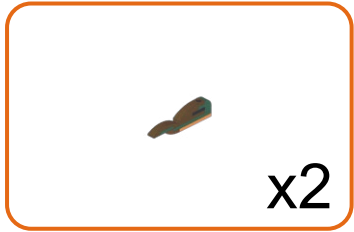
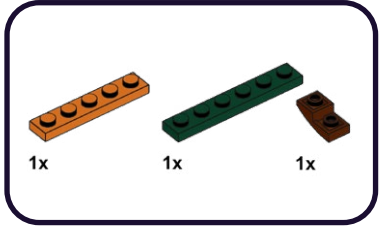

1

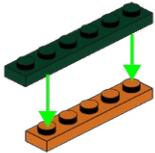

2

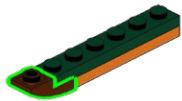

# 161

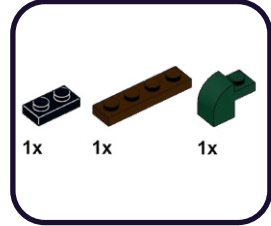

1

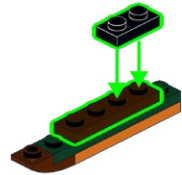

2

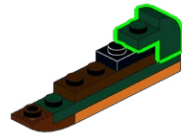



**162**

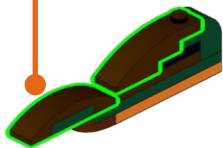
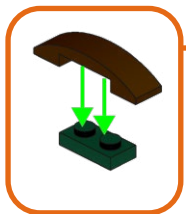
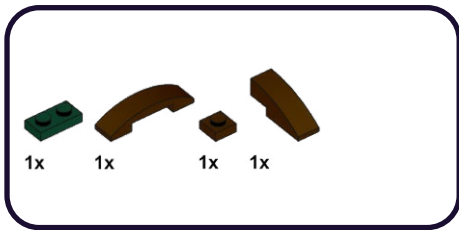

2x

**163**

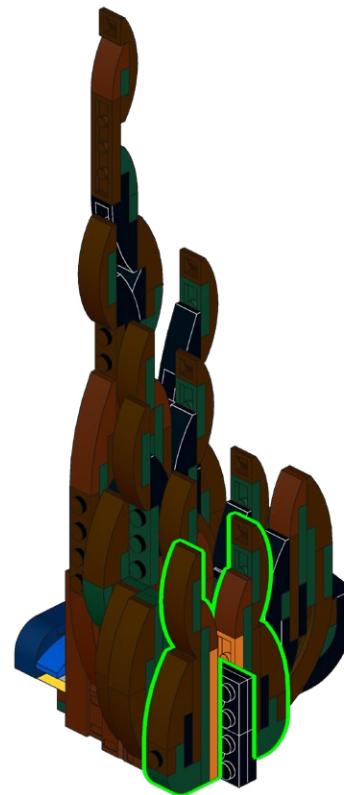

164

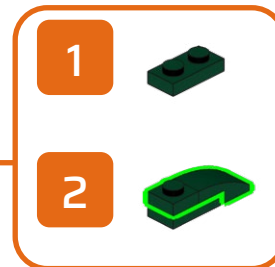
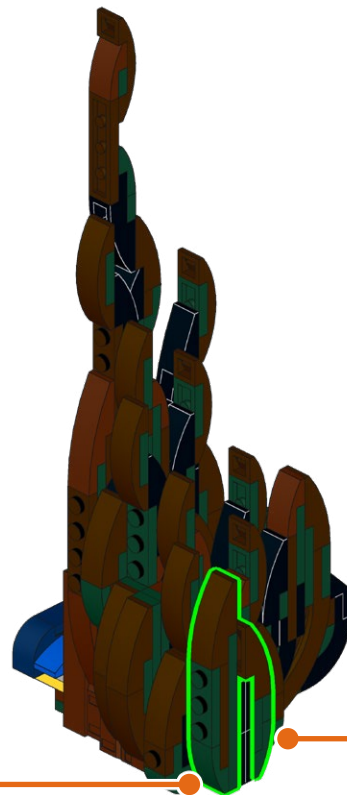
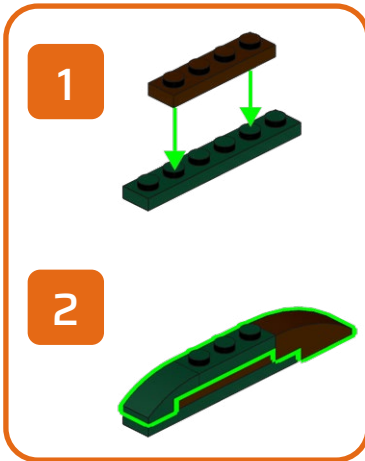
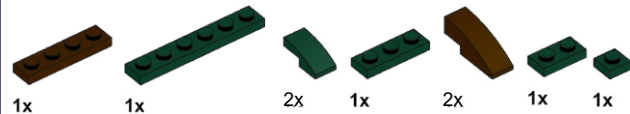

To be used later  
A utiliser plus tard  
Da utilizzare dopo  
Zur späteren Verwendung  
Para ser utilizado más tarde  
稍后使用

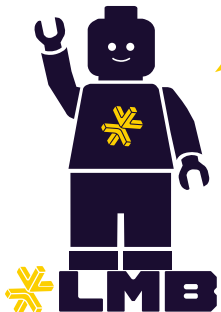

165

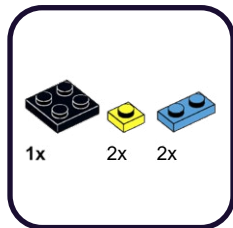

1



2



3



166

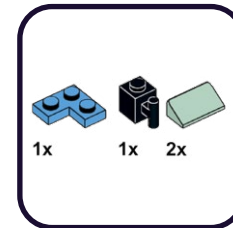

1



2

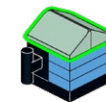

To be used later  
 A utiliser plus tard  
 Da utilizzare dopo  
 Zur späteren Verwendung  
 Para ser utilizado más tarde  
 稍后使用

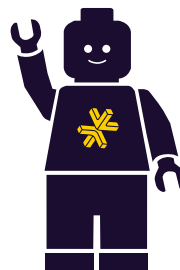

167

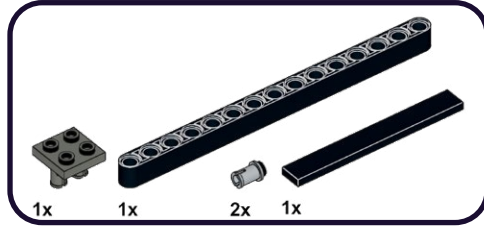

1



2

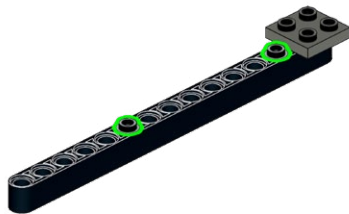

3



168

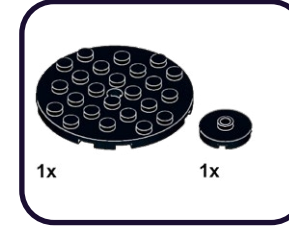

1

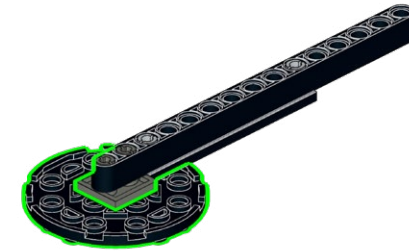

2

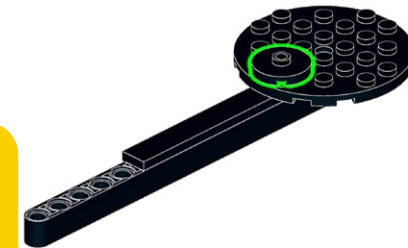
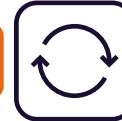

To be used later  
 A utiliser plus tard  
 Da utilizzare dopo  
 Zur späteren Verwendung  
 Para ser utilizado más tarde  
 稍后使用

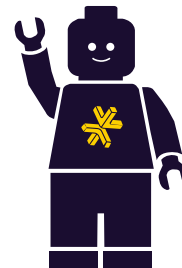



### **HOLD UP!**

You might notice some bags aren't in order, as well as left over pieces, but that's ok! We're changing the way you build LEGO!

### **ATTENDEZ!**

Vous remarquerez peut-être que certains sacs, ainsi que certaines pièces, ne sont pas dans le bon ordre. Mais pas de panique! Nous changeons simplement la façon avec laquelle vous construisez vos LEGO!

### **ASPETTA!**

Potresti notare che alcuni sacchetti non sono in ordine, così come i pezzi avanzati, ma va bene così! Stiamo cambiando il modo in cui costruisci i LEGO!

### **HALT!**

Sie werden möglicherweise bemerken, dass einige tüten durcheinander sind und teile übrig bleiben, aber das ist in Ordnung! Wir ändern die art und weise, wie Sie LEGO bauen!

### **¡ESPERA!**

Es posible que notes que algunas bolsas están fuera de servicio, así como piezas sobrantes, ¡pero está bien! ¡Estamos cambiando la forma en que construyes LEGO!

### **暫停!**

你可能会注意到一些袋子顺序错乱, 以及一些剩余的部件, 但没关系! 我们正在改变你搭建乐高的方式!

#### Open LEGO® Bag 5 & 7

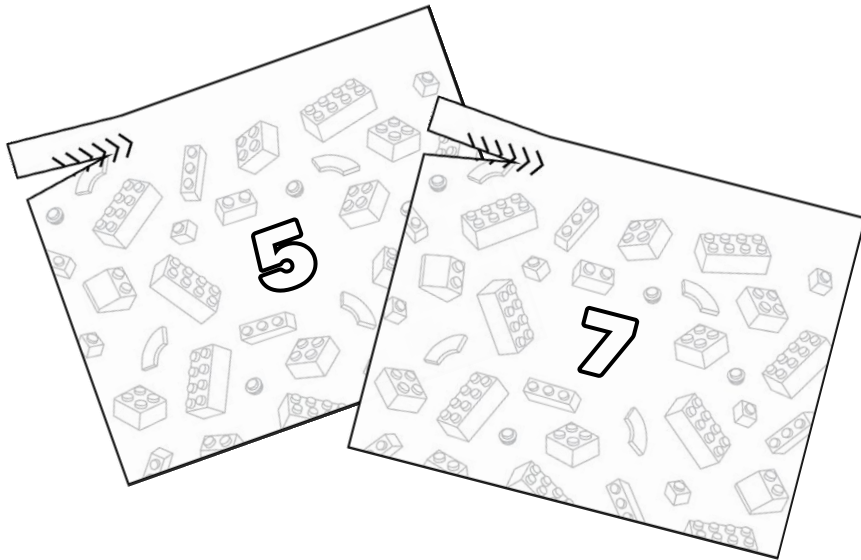

#### Open LMB Bags 01 & 04

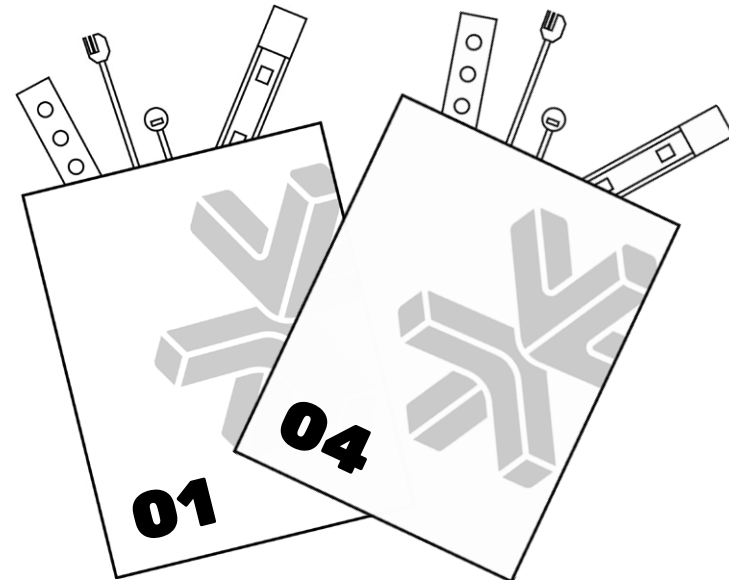

169

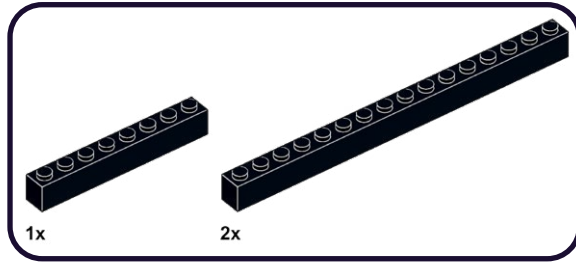
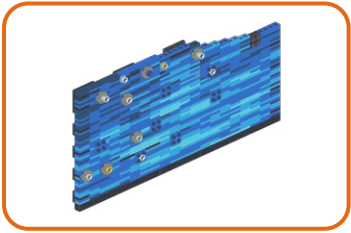

170

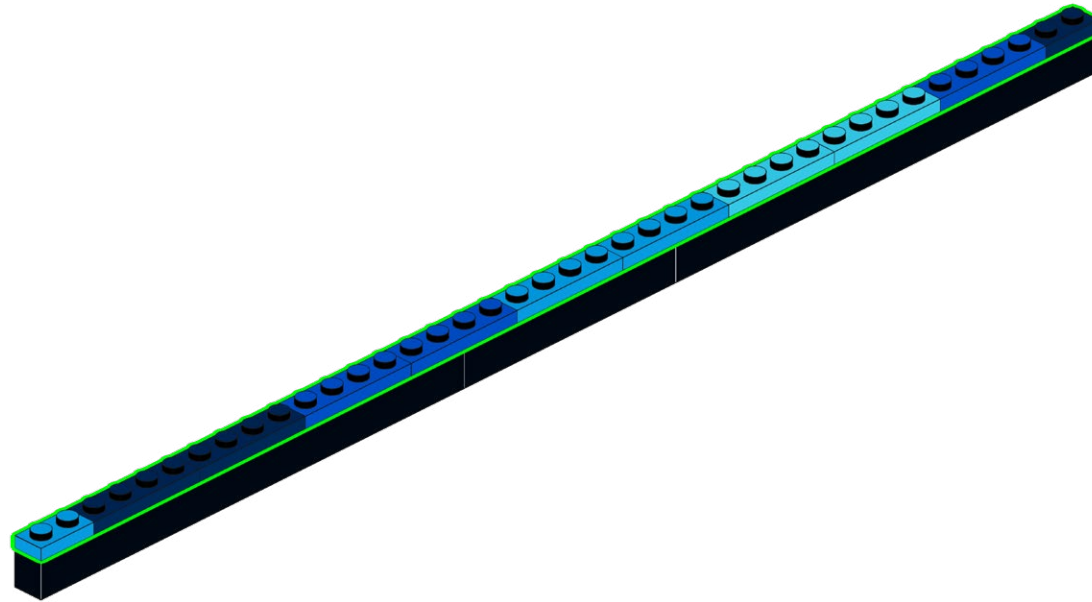
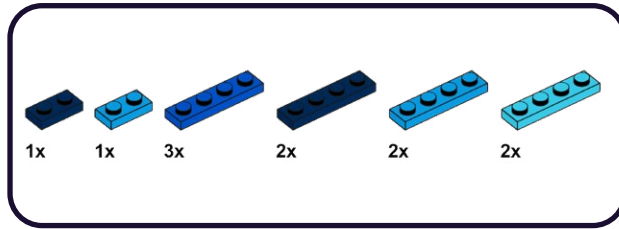



171

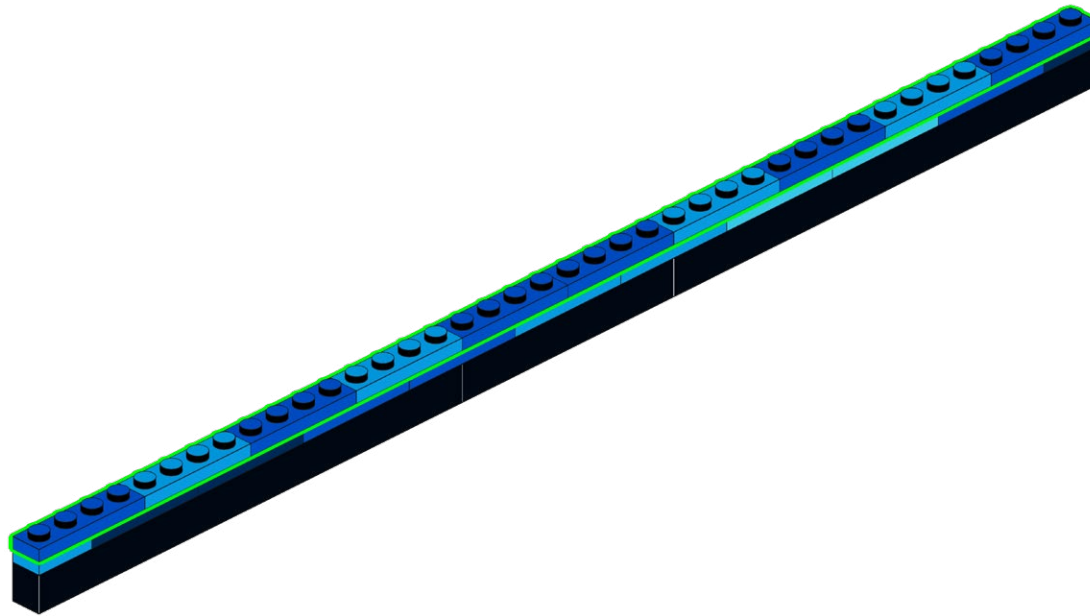
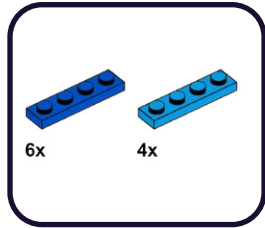

172

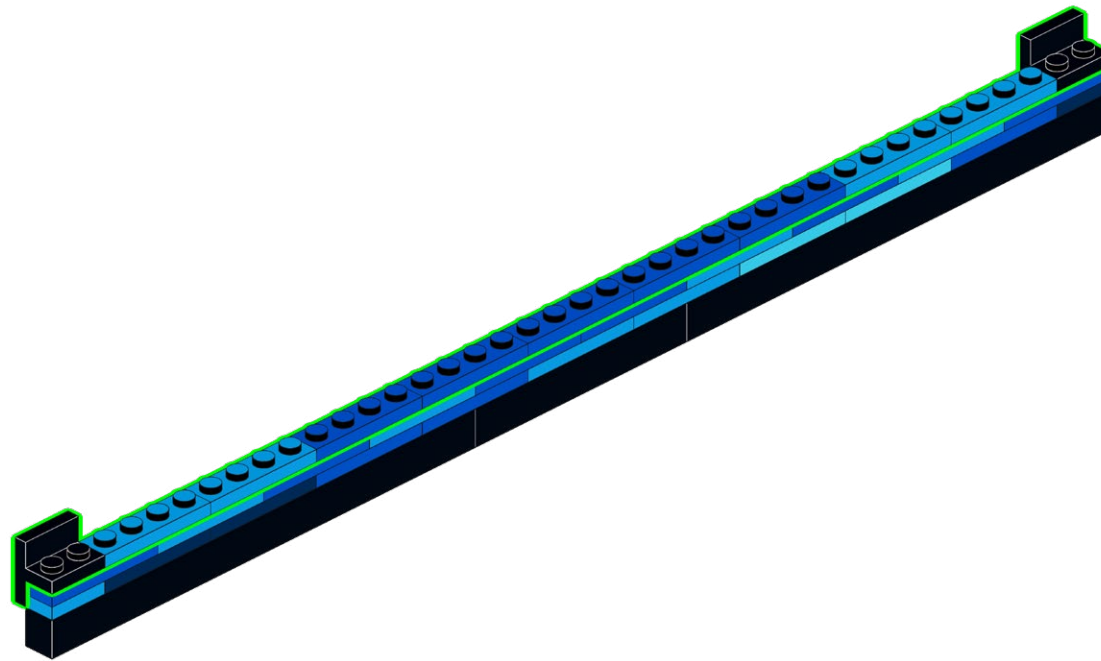
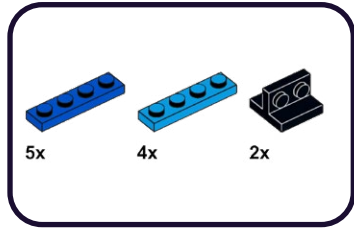

173

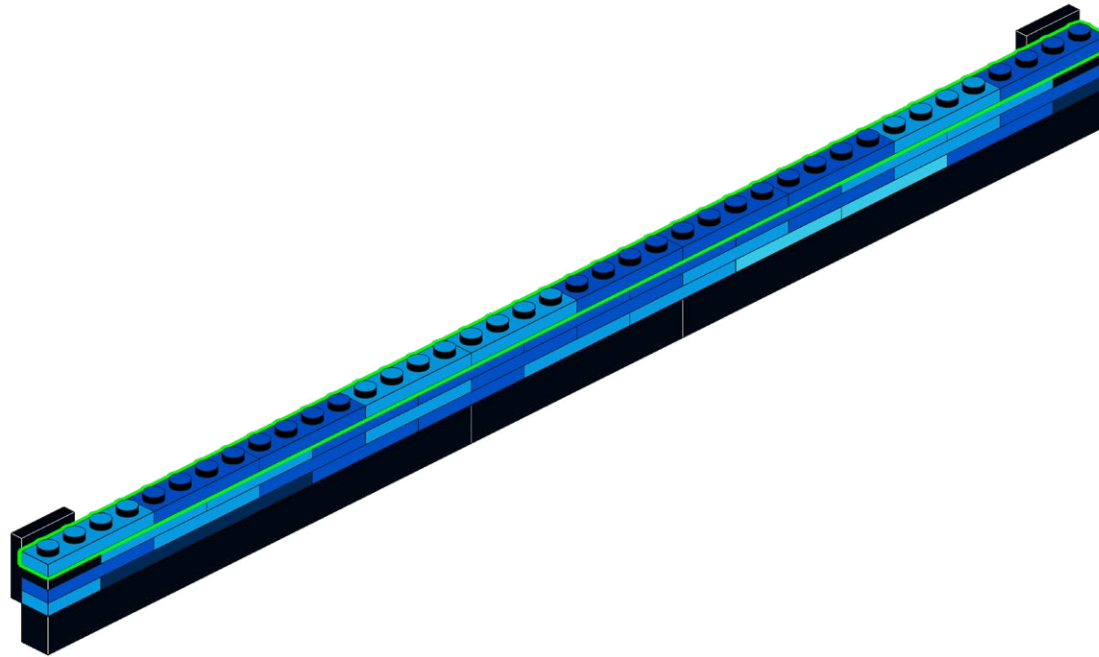
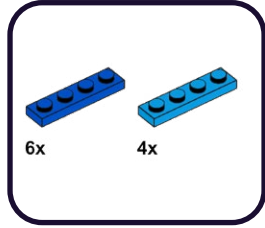

174

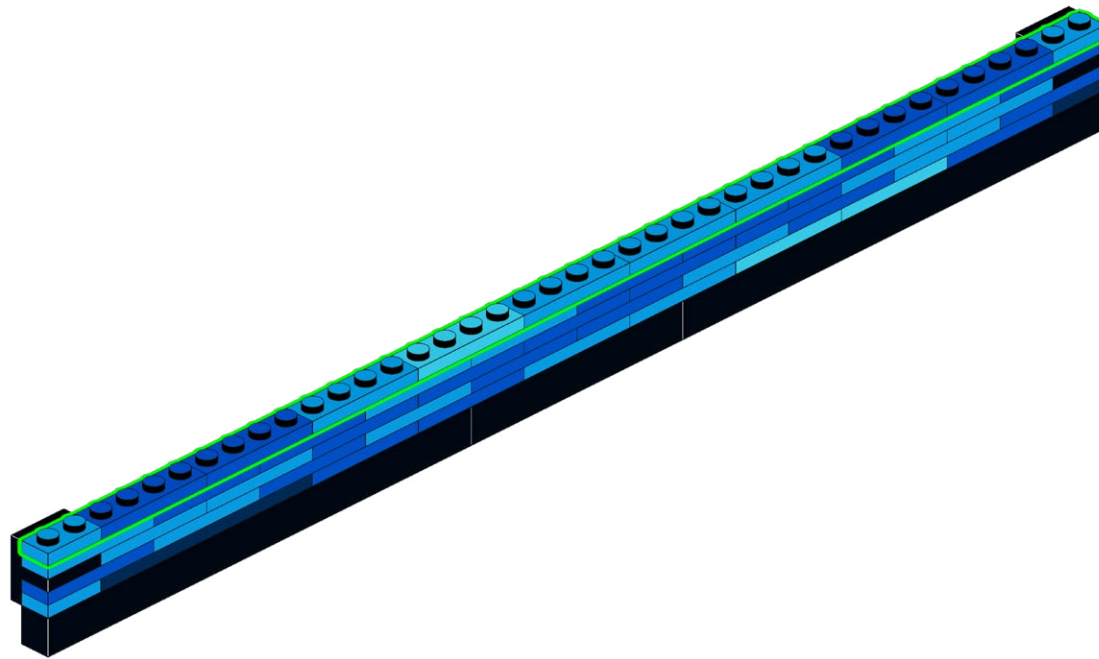
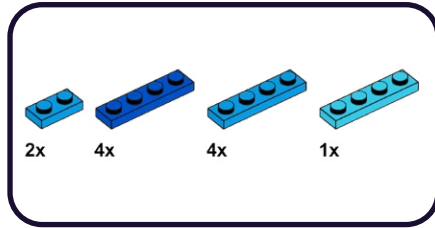

175

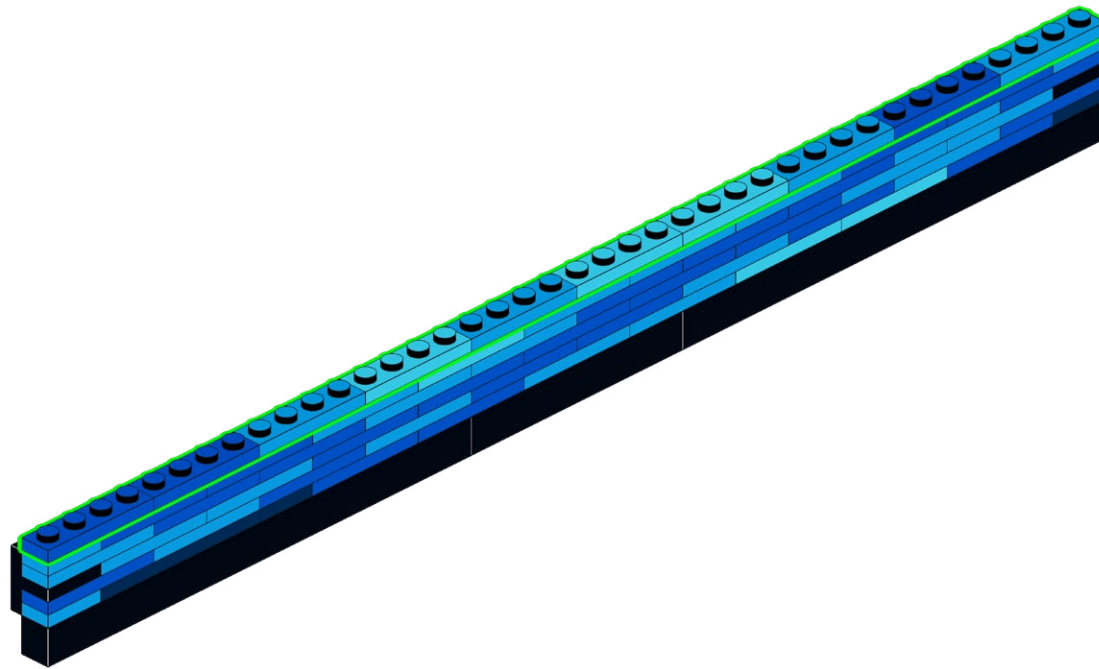
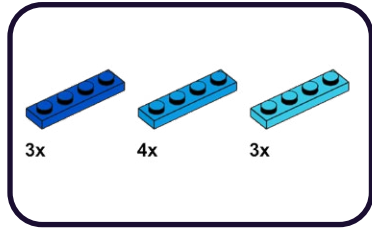

176

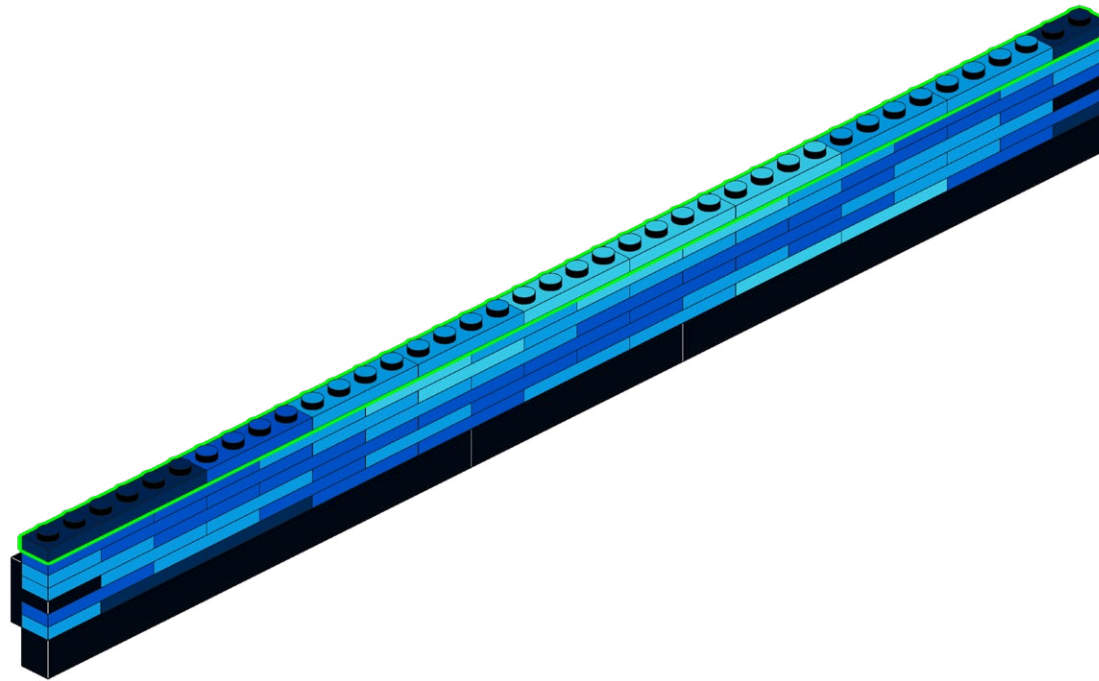
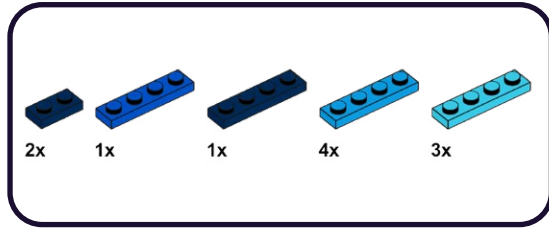

177

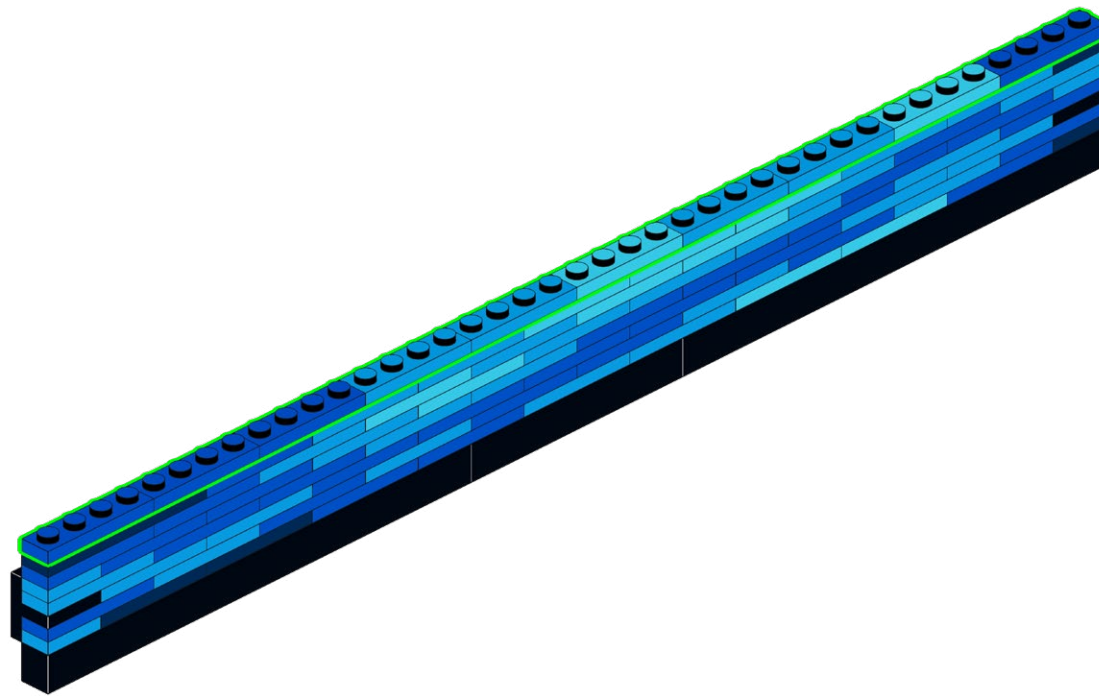
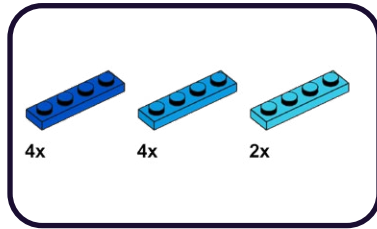



178

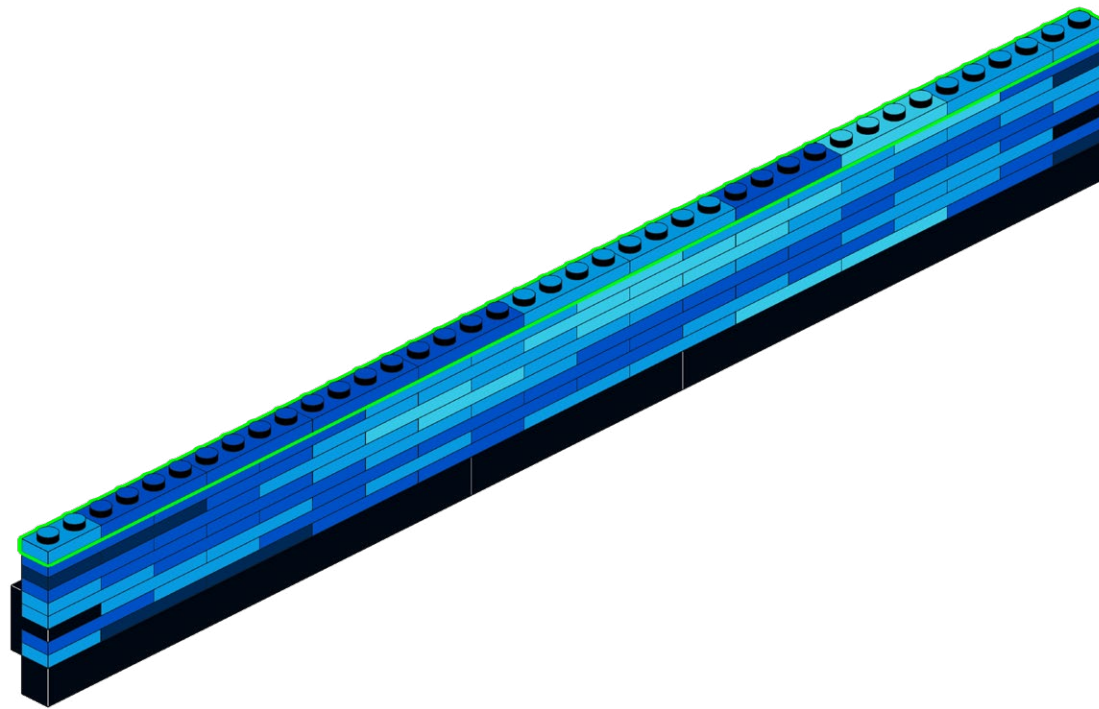
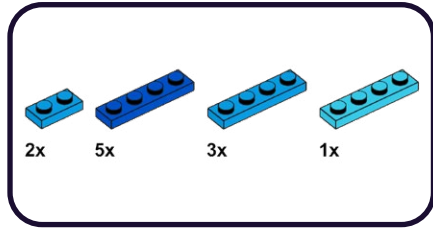

179

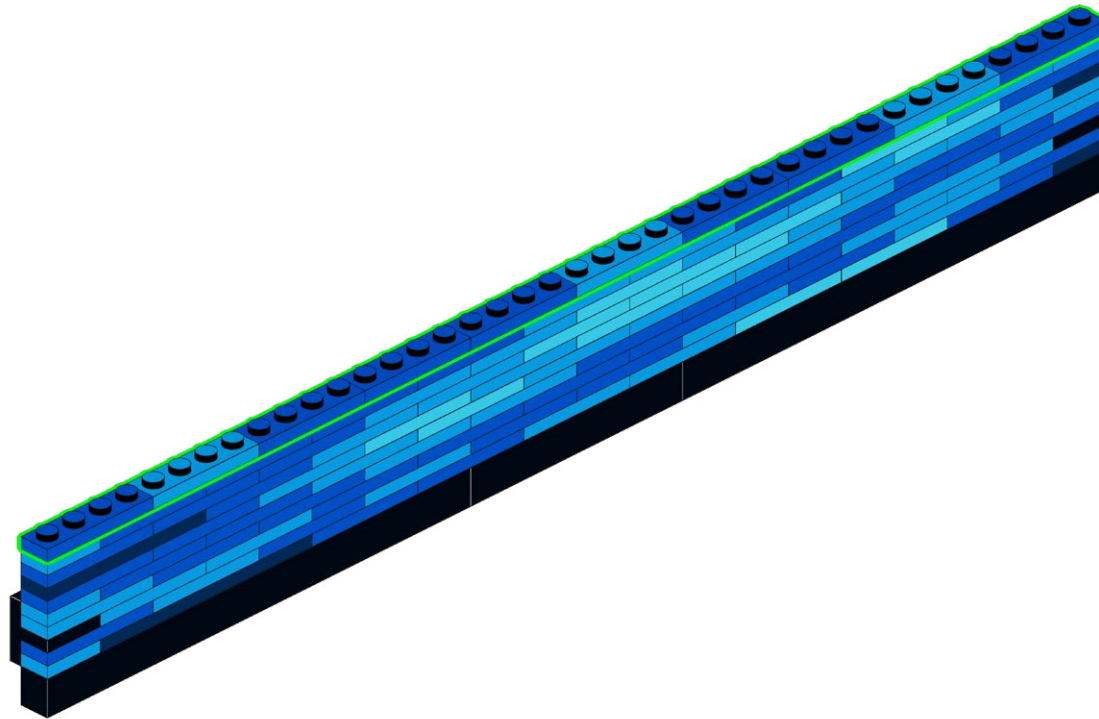
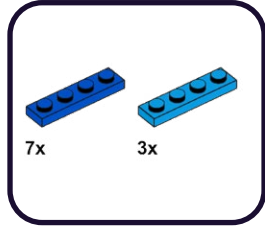

180

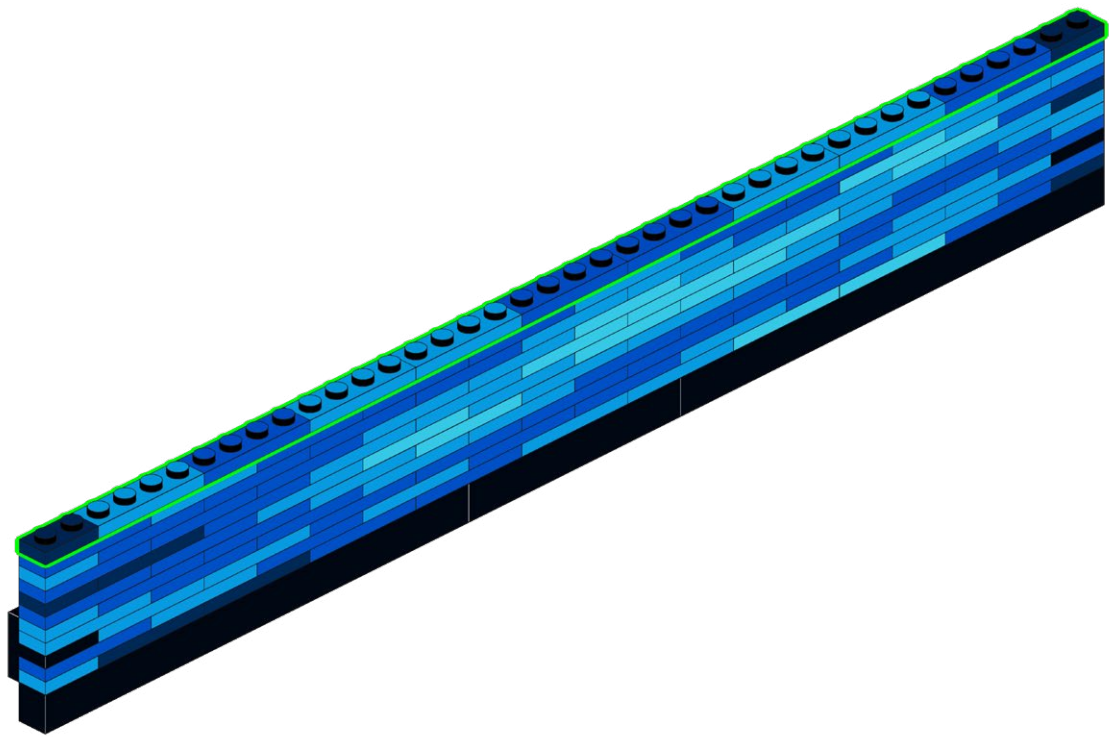
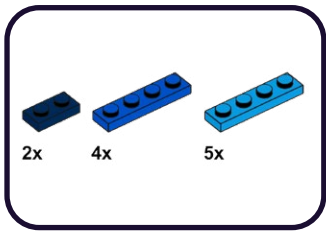

181

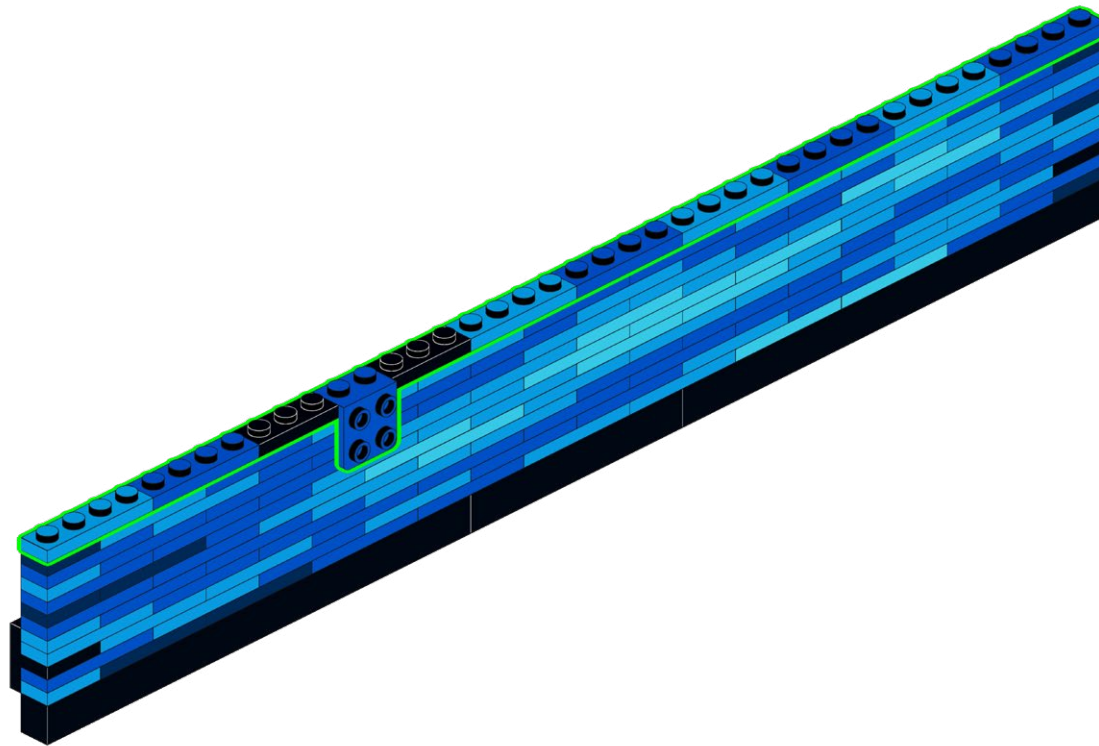
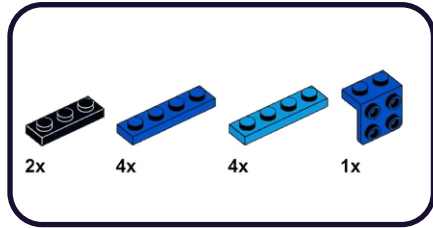

**182**

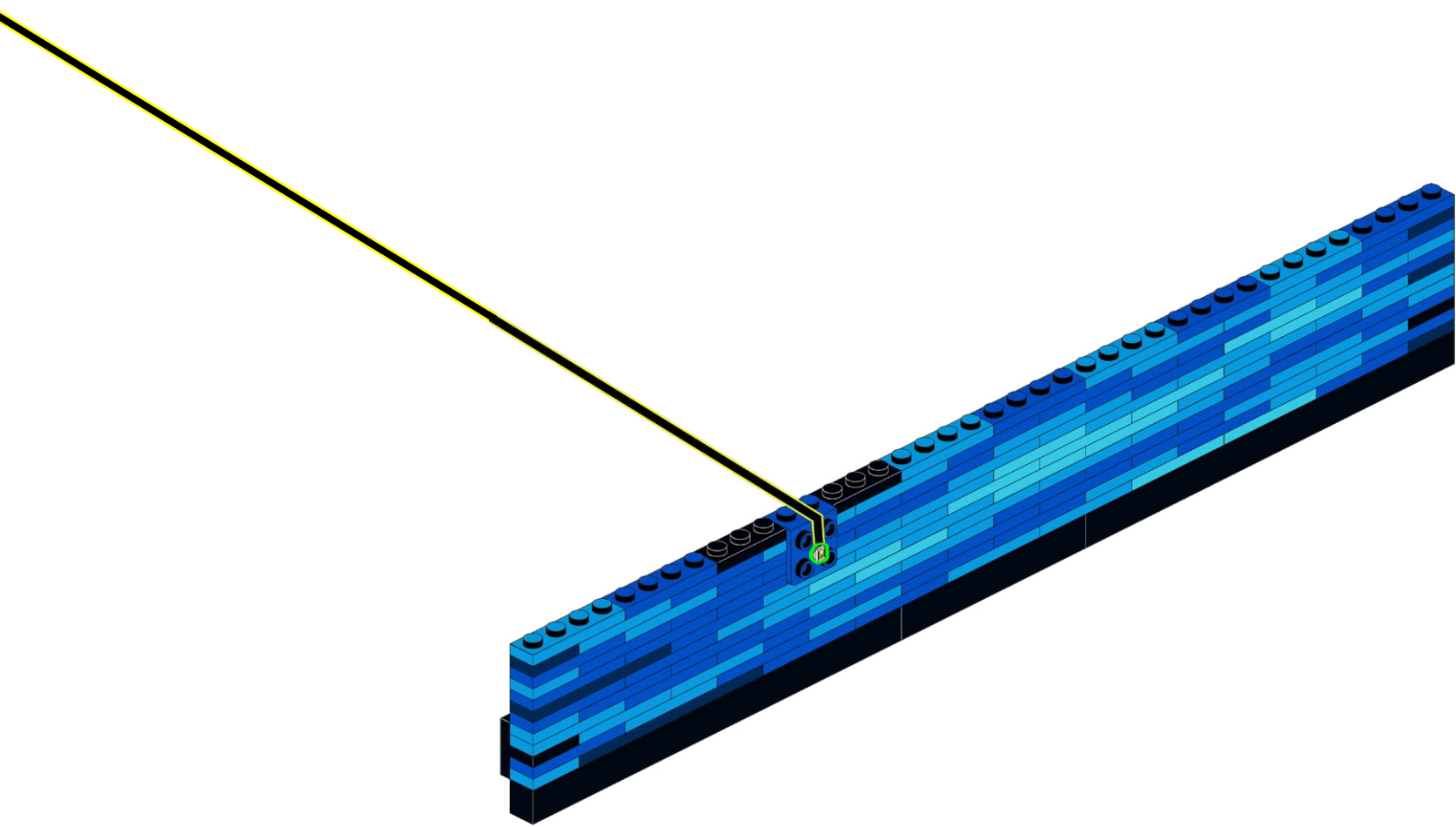
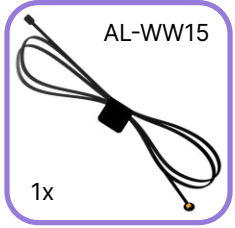

**183**

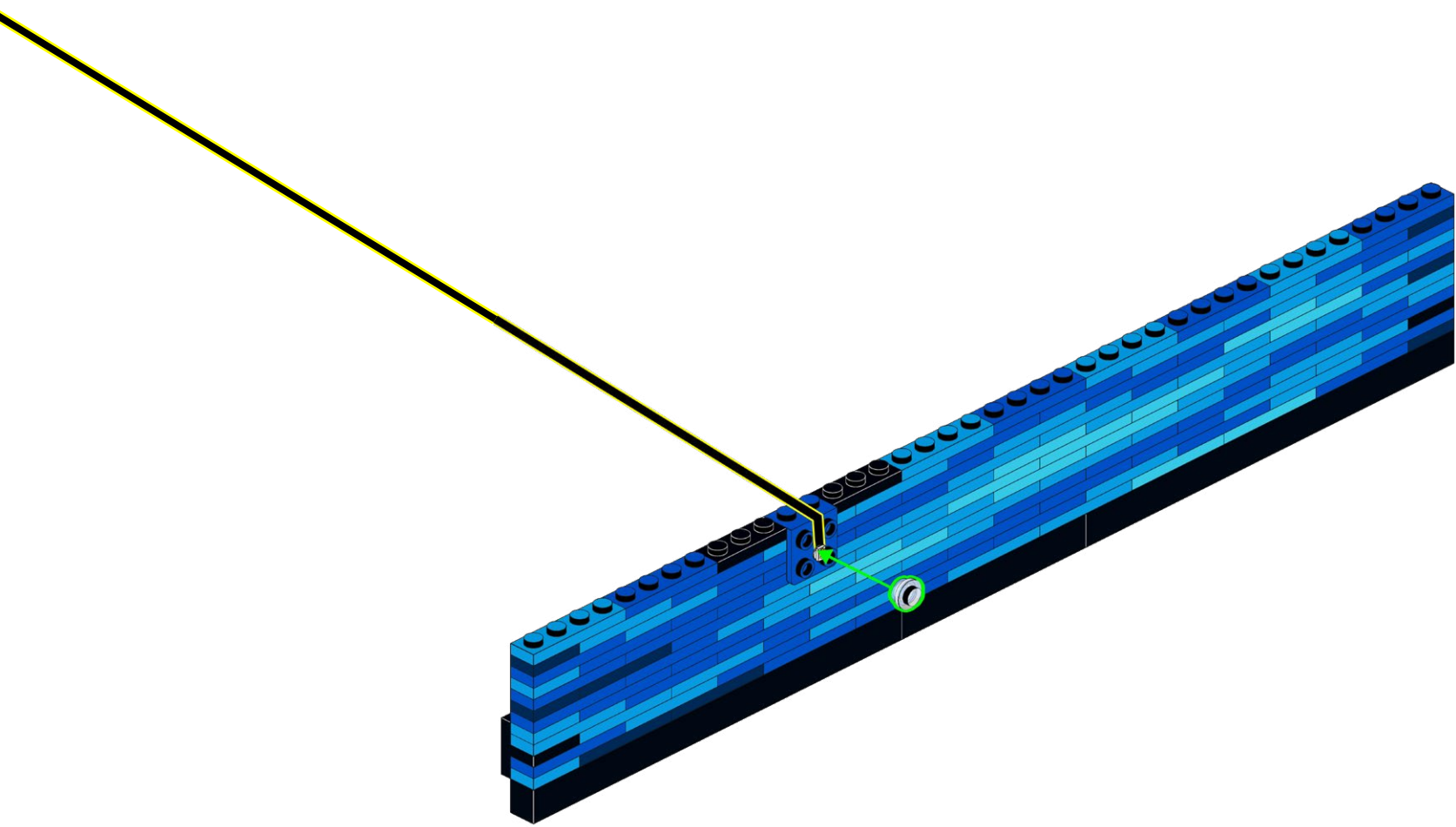
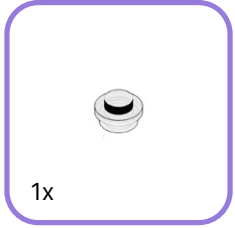

184

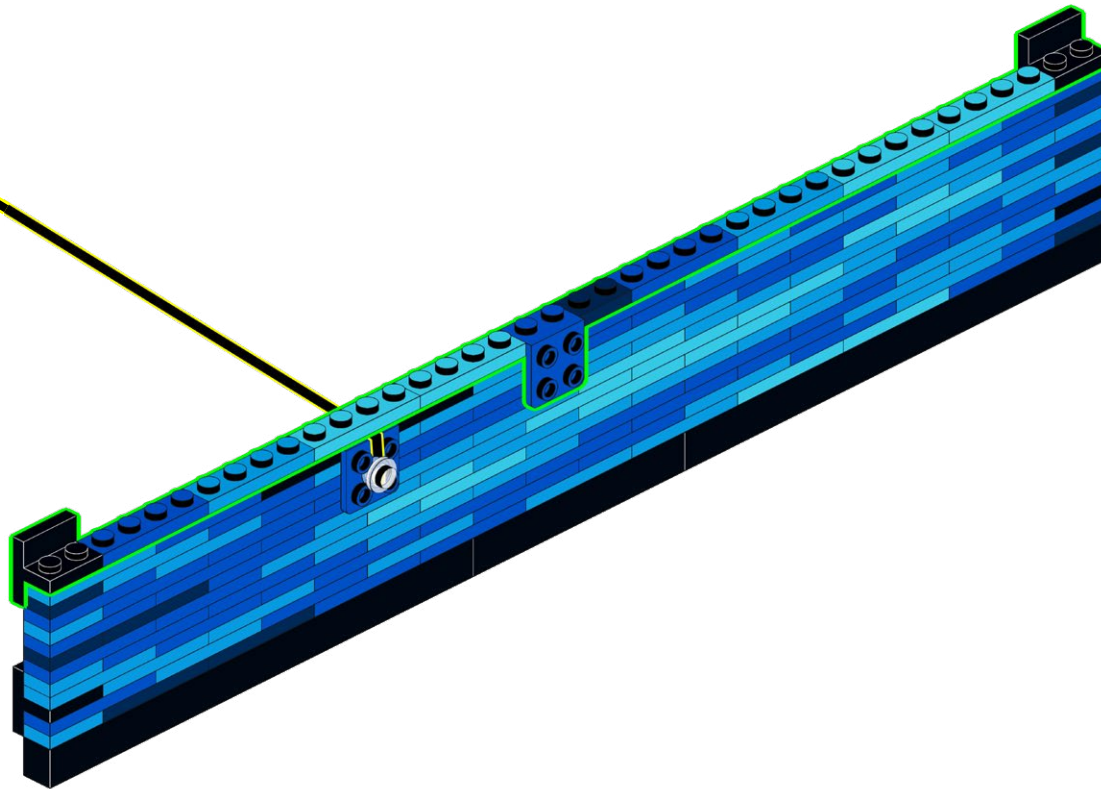
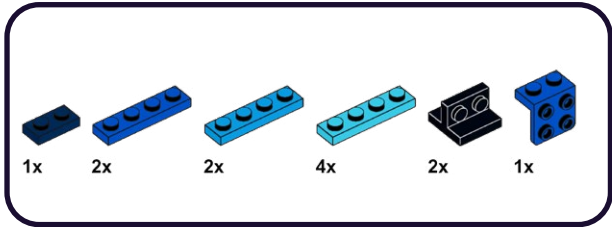



185

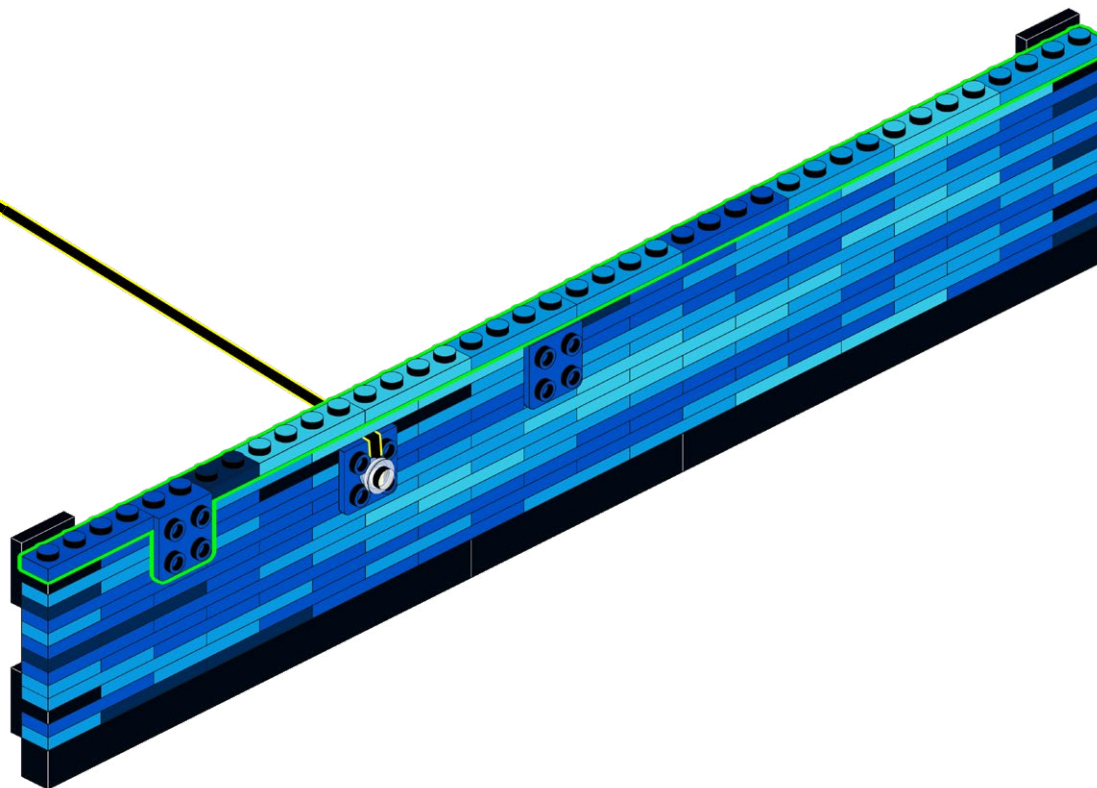
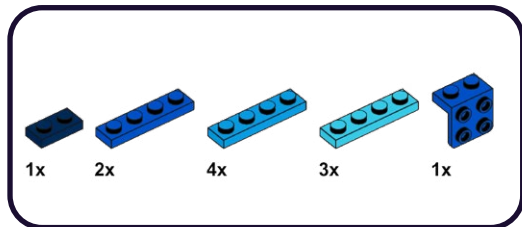

186

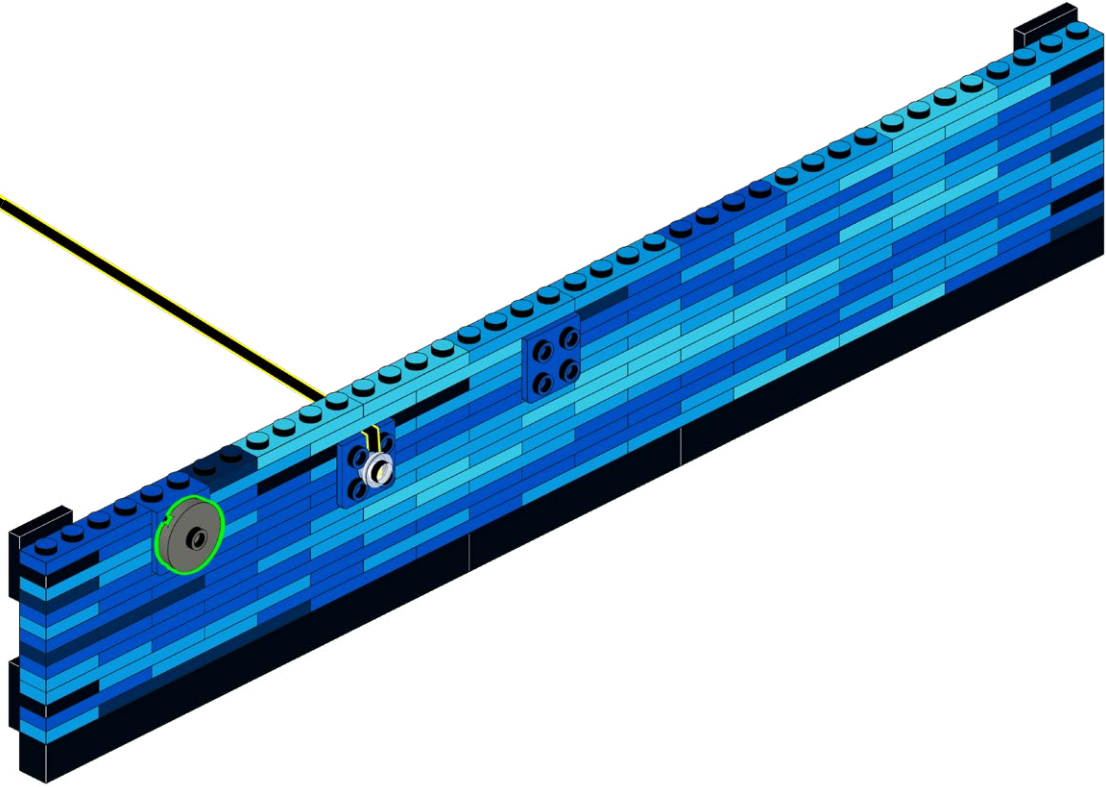
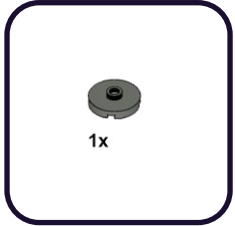

187

AR-Y30

1x

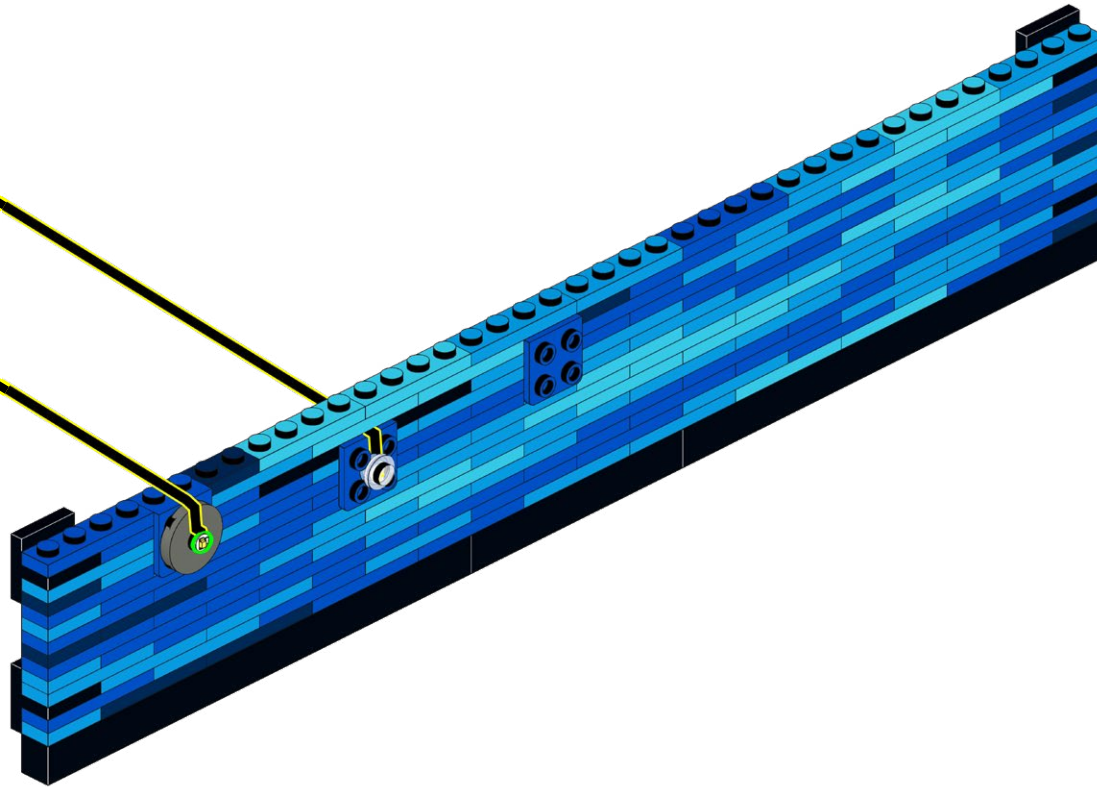
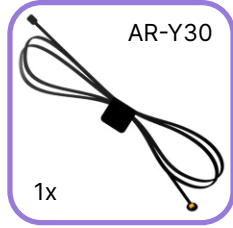

188

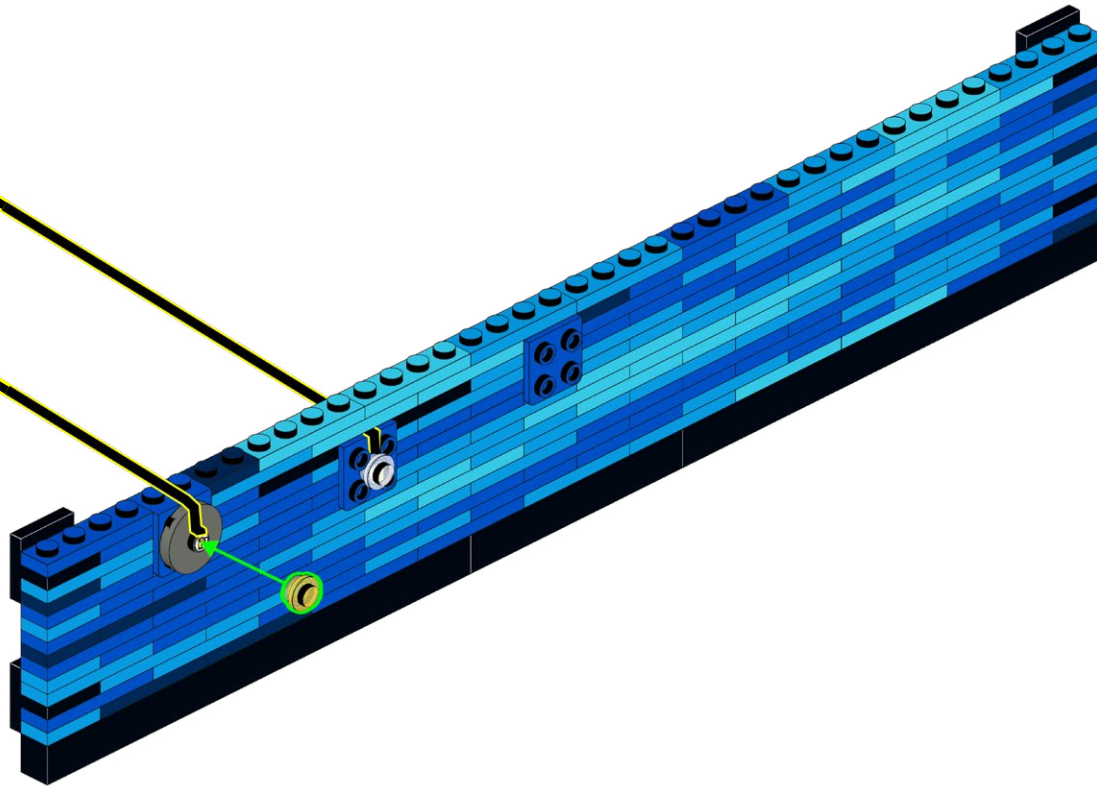
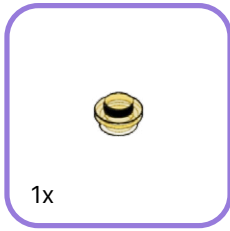

189

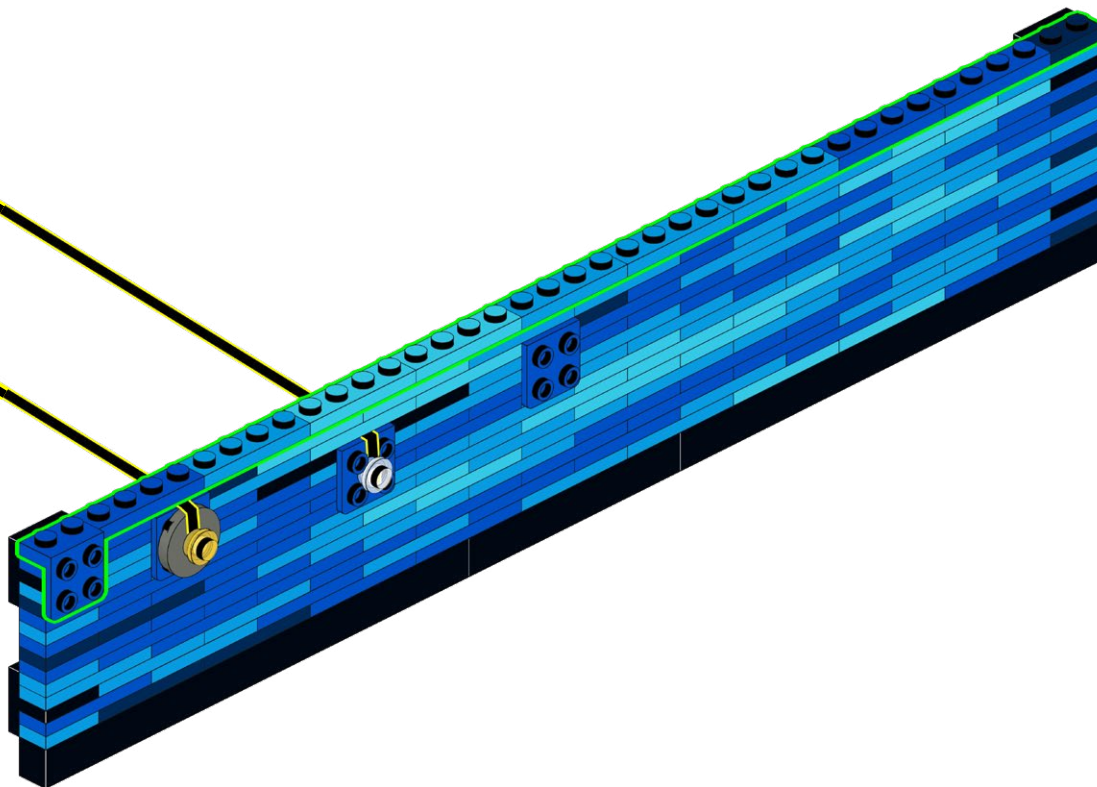
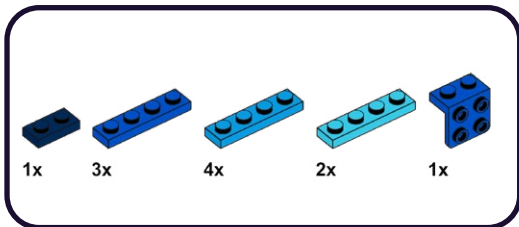

**190**

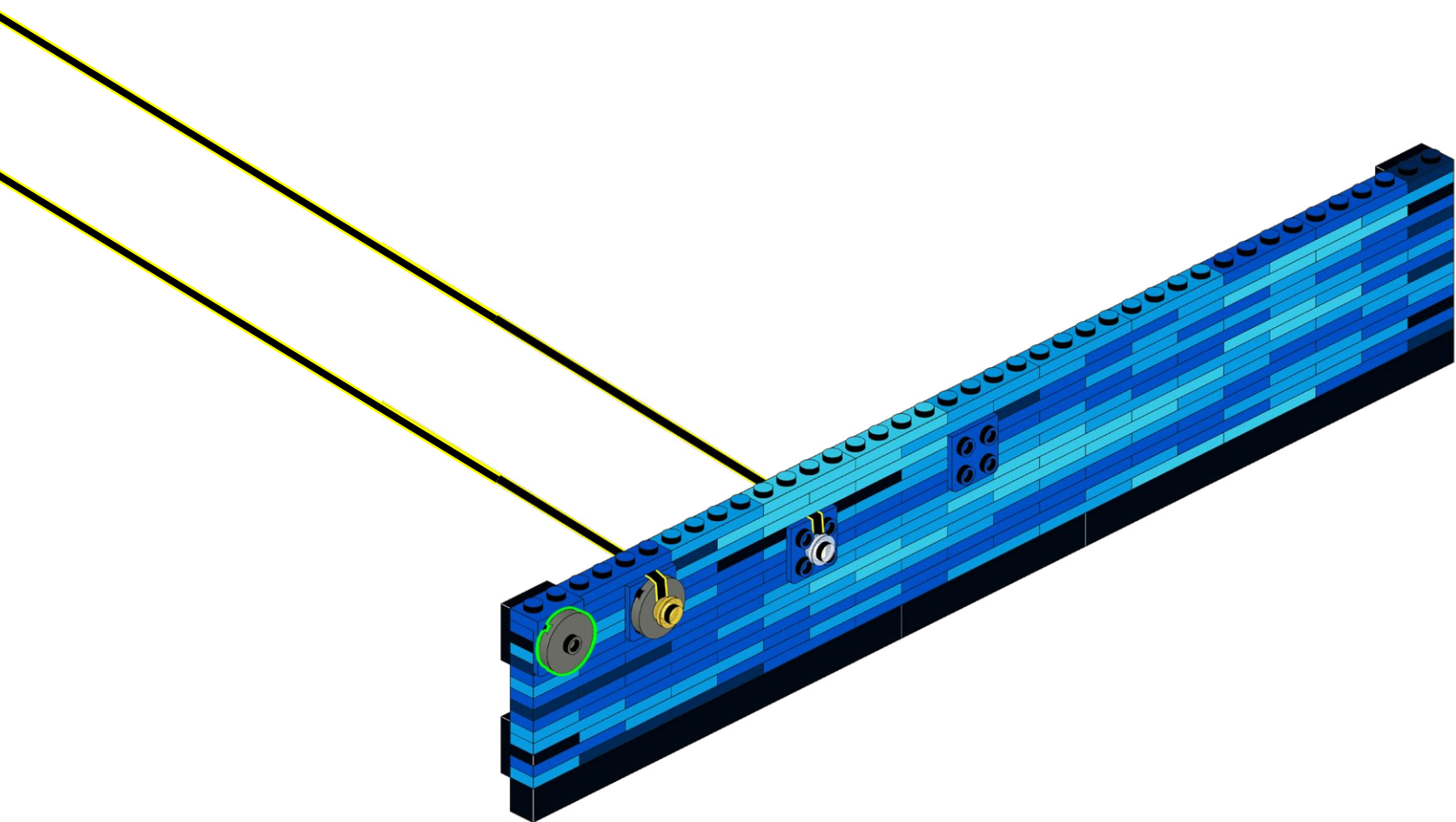



191

AR-WW30

1x

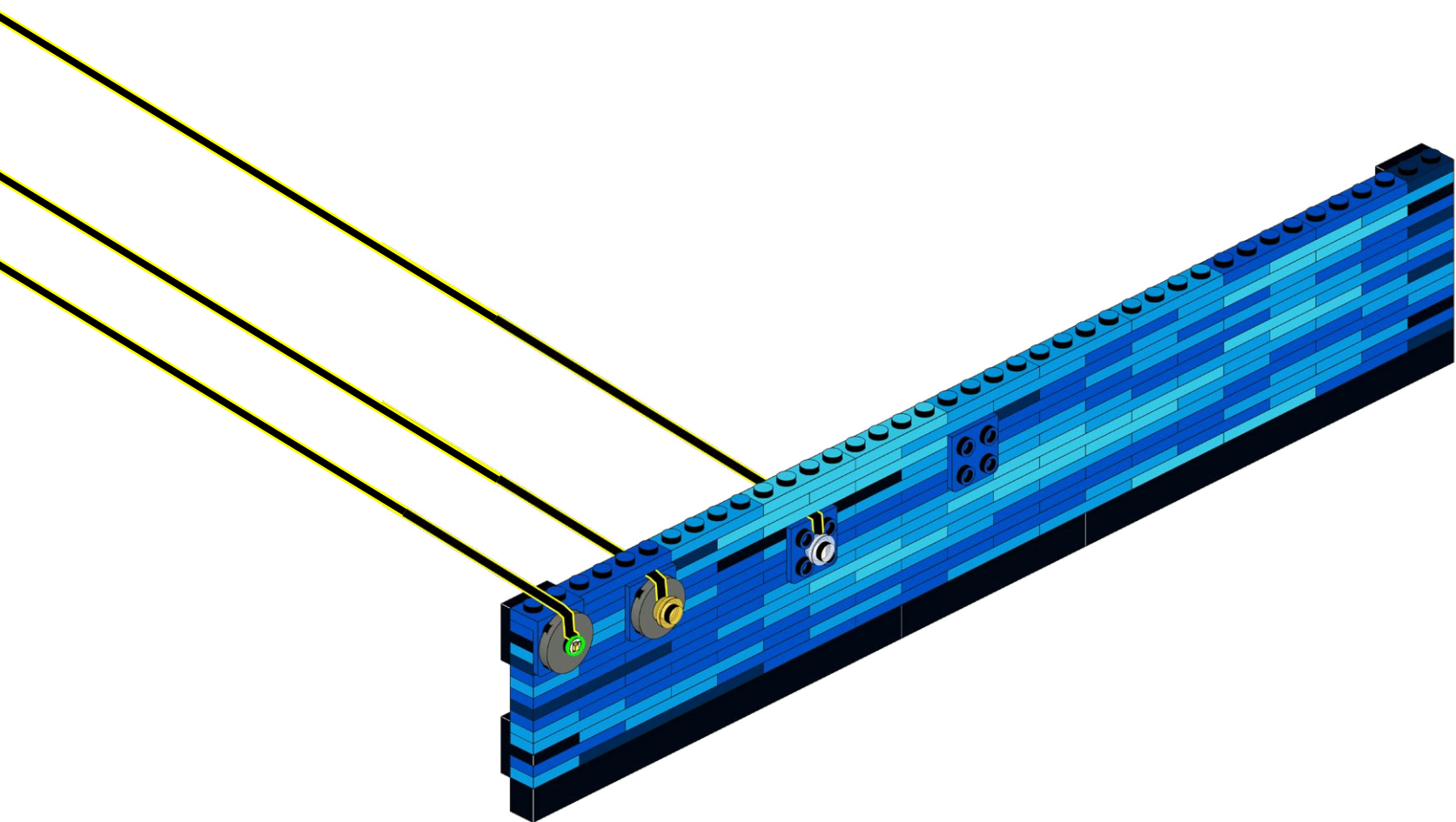
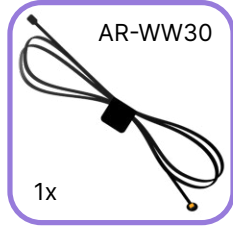



192

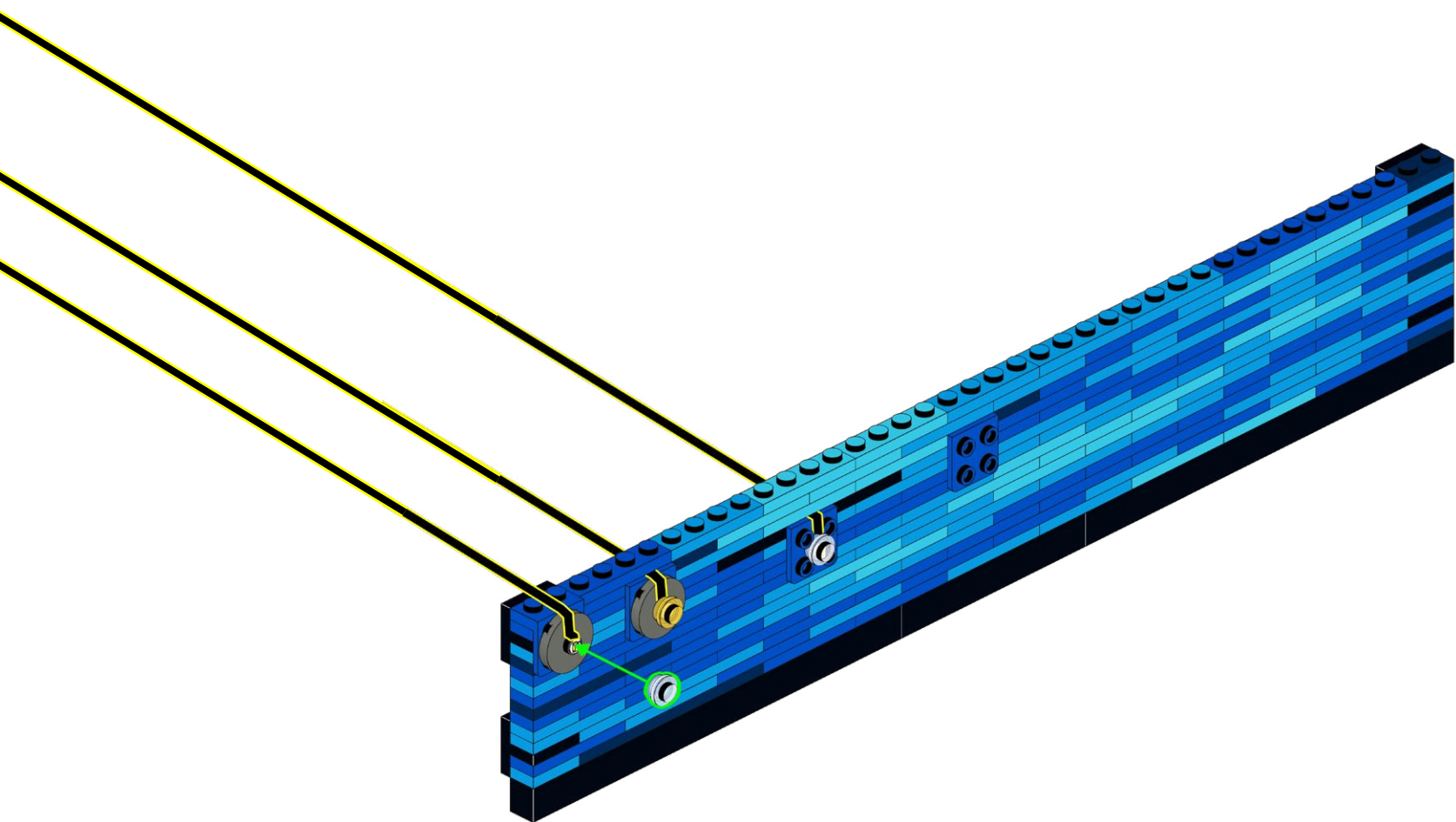
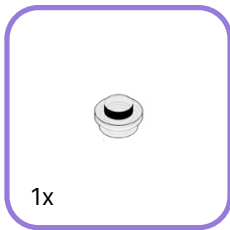

193

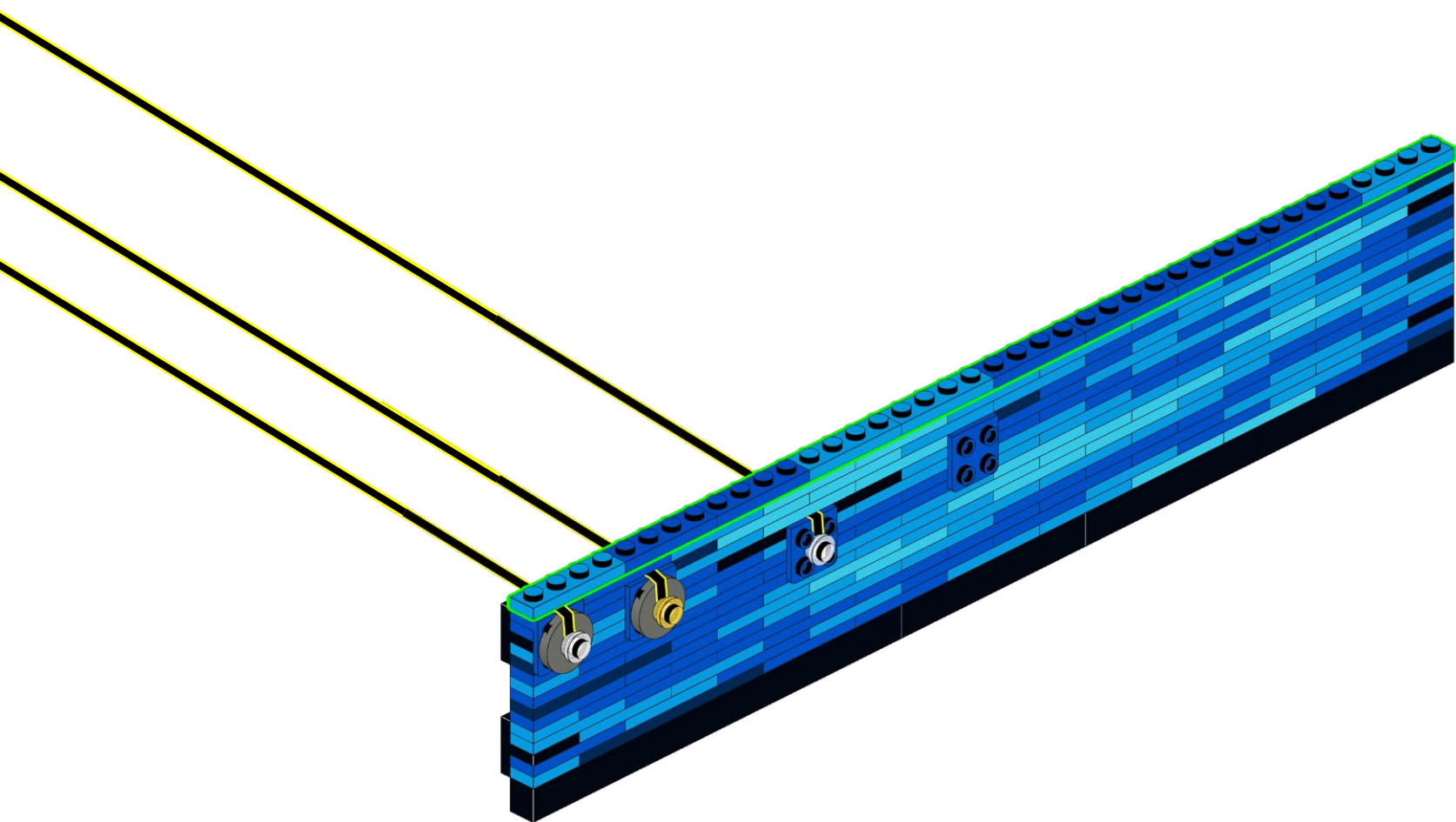
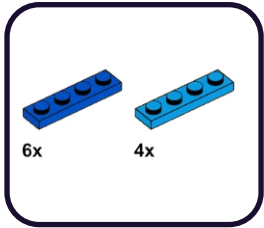

194

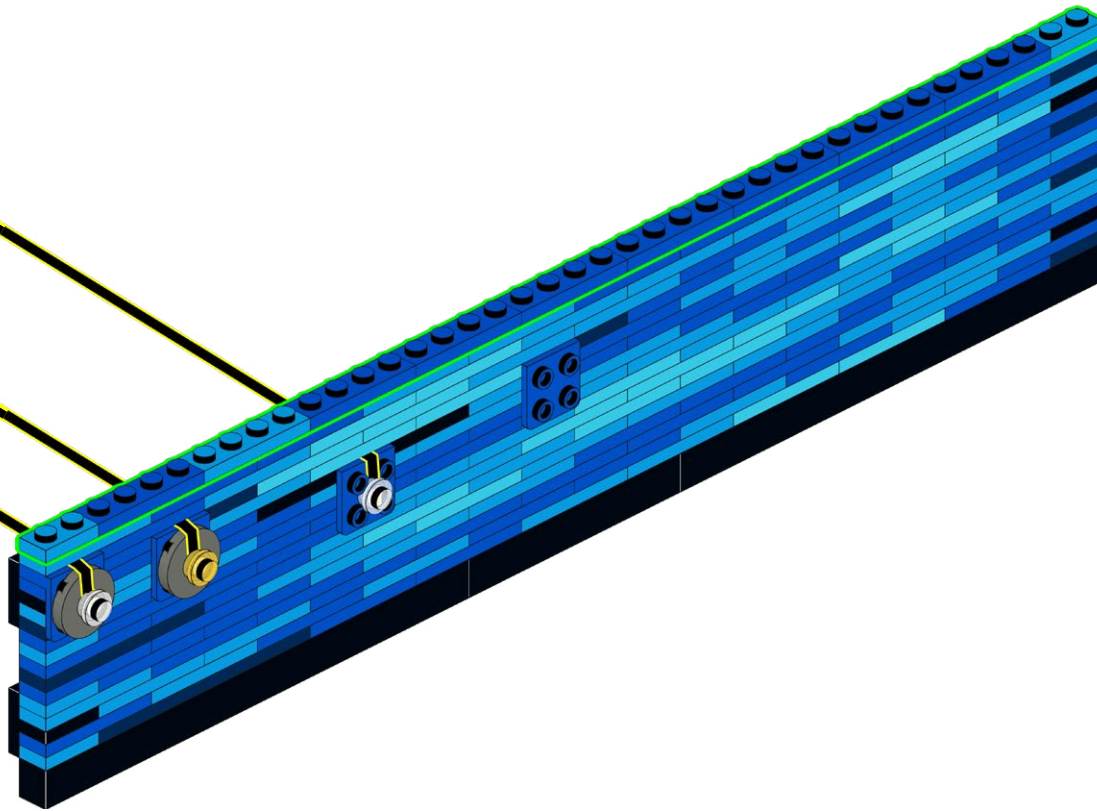
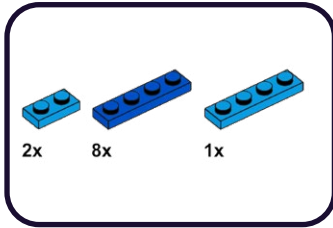

195

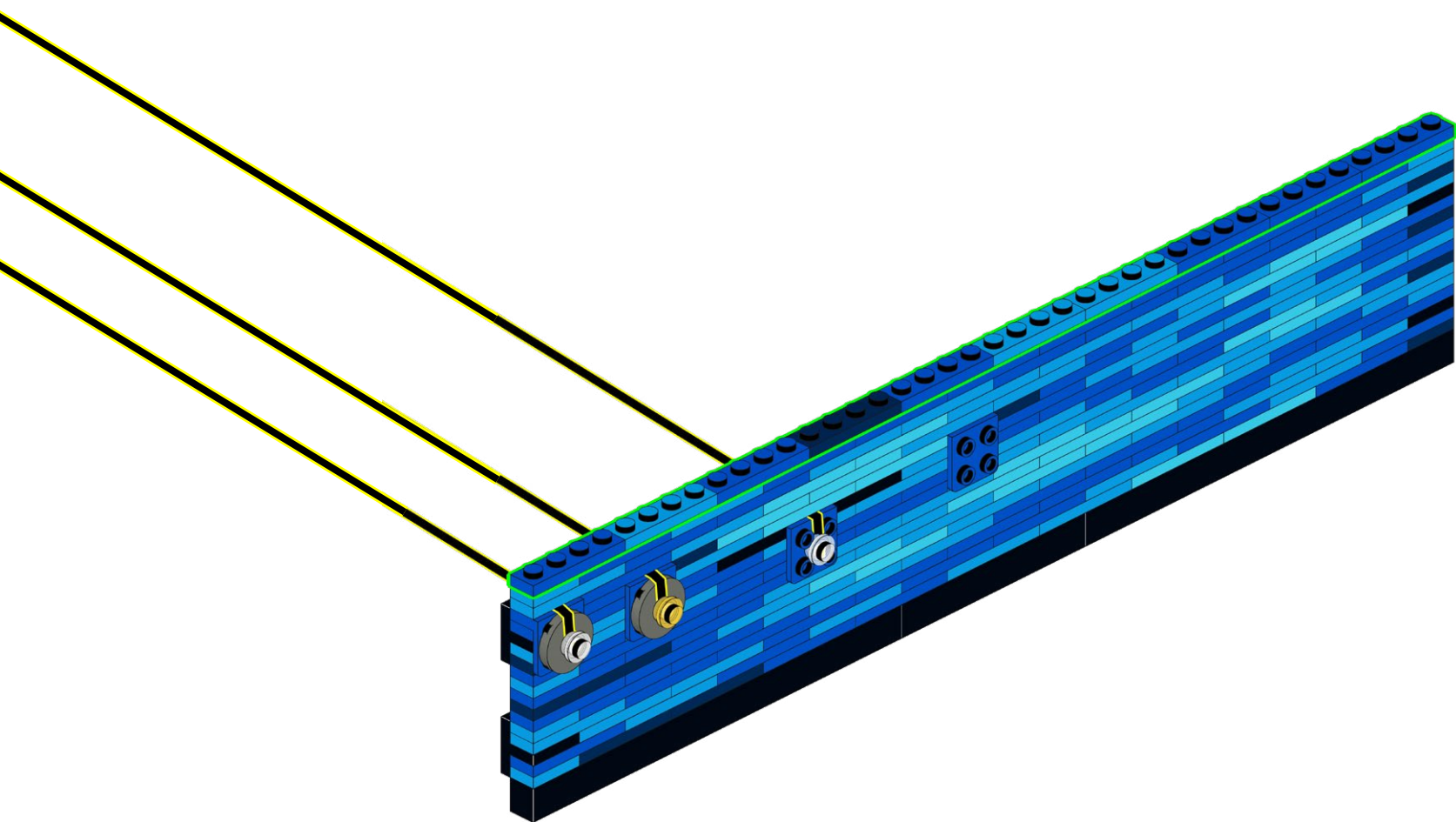
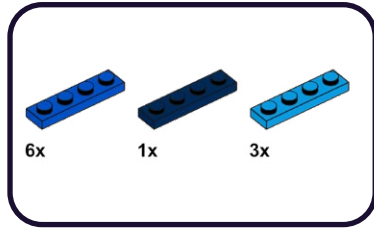

196

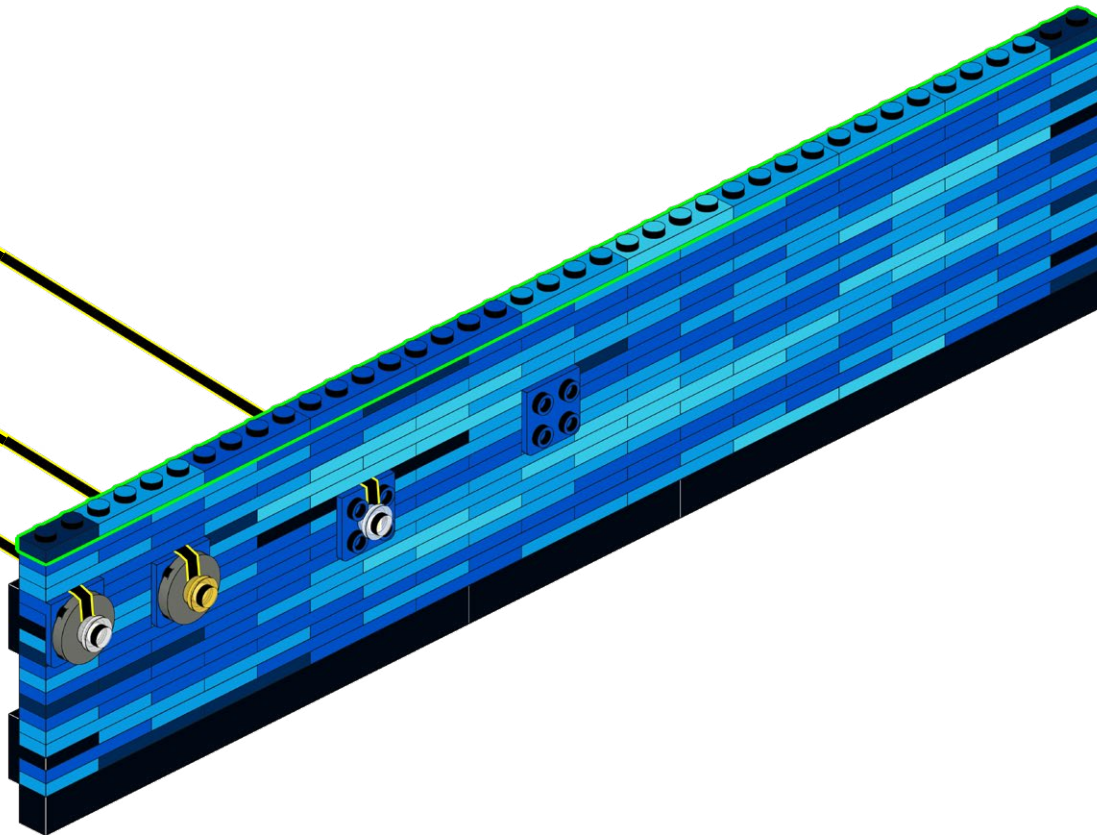
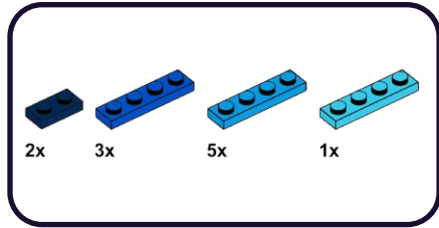



197

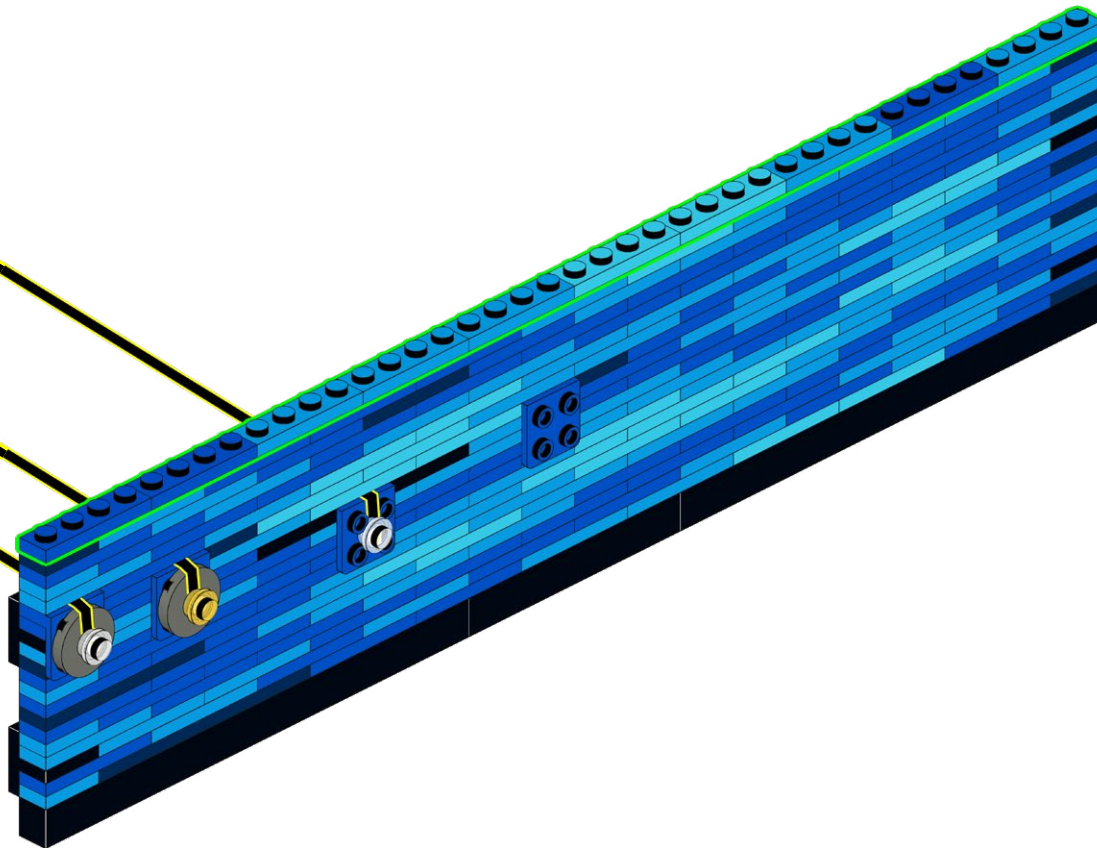
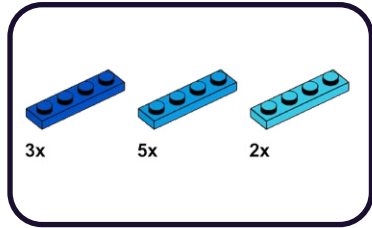

198

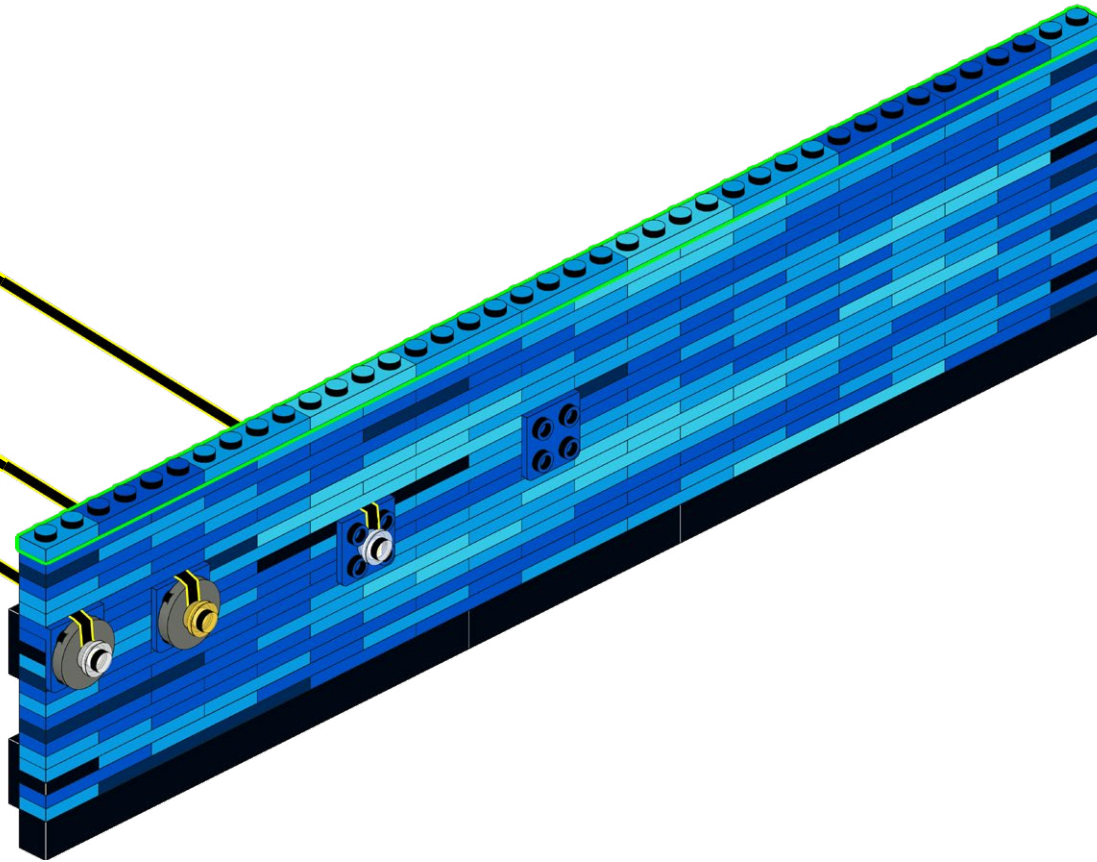
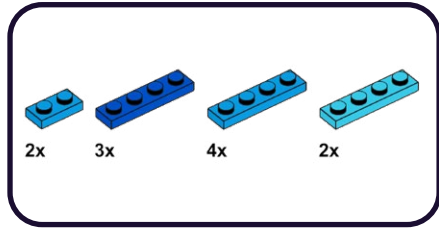



199

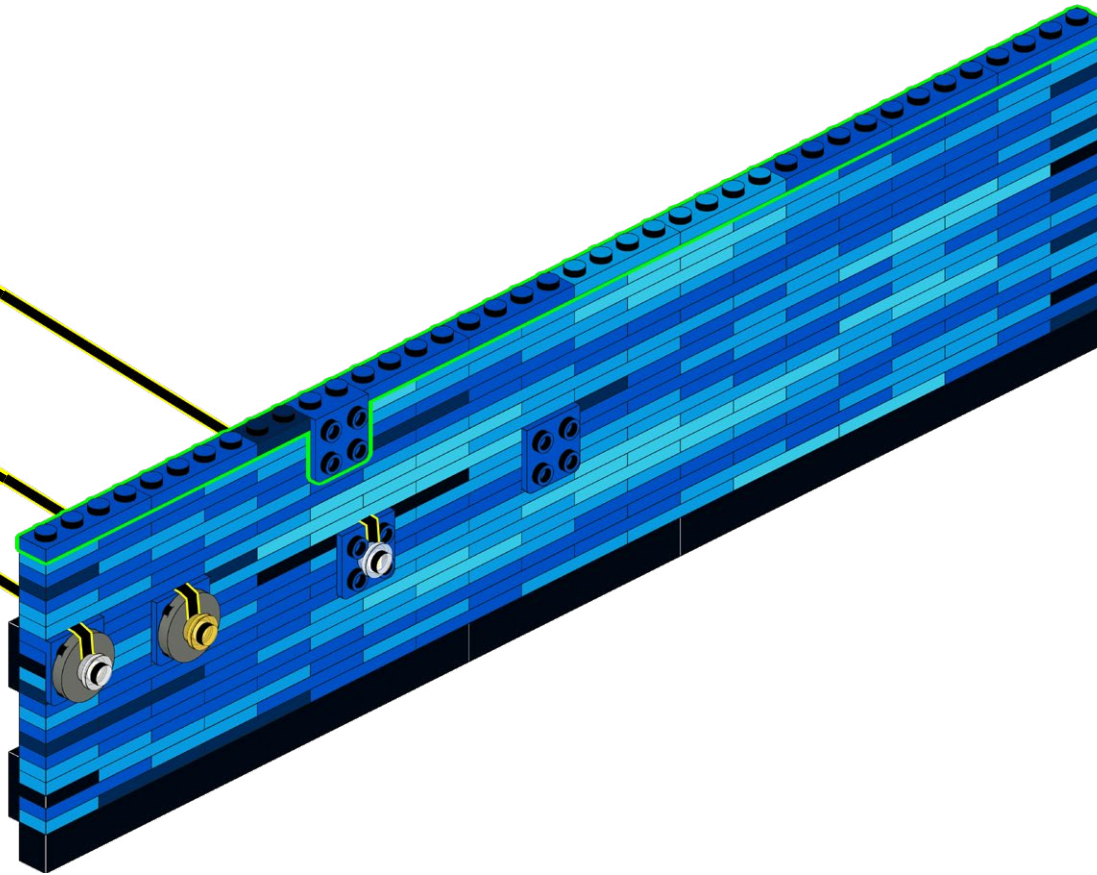
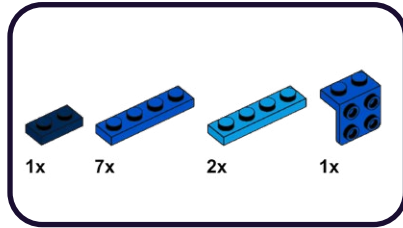

200

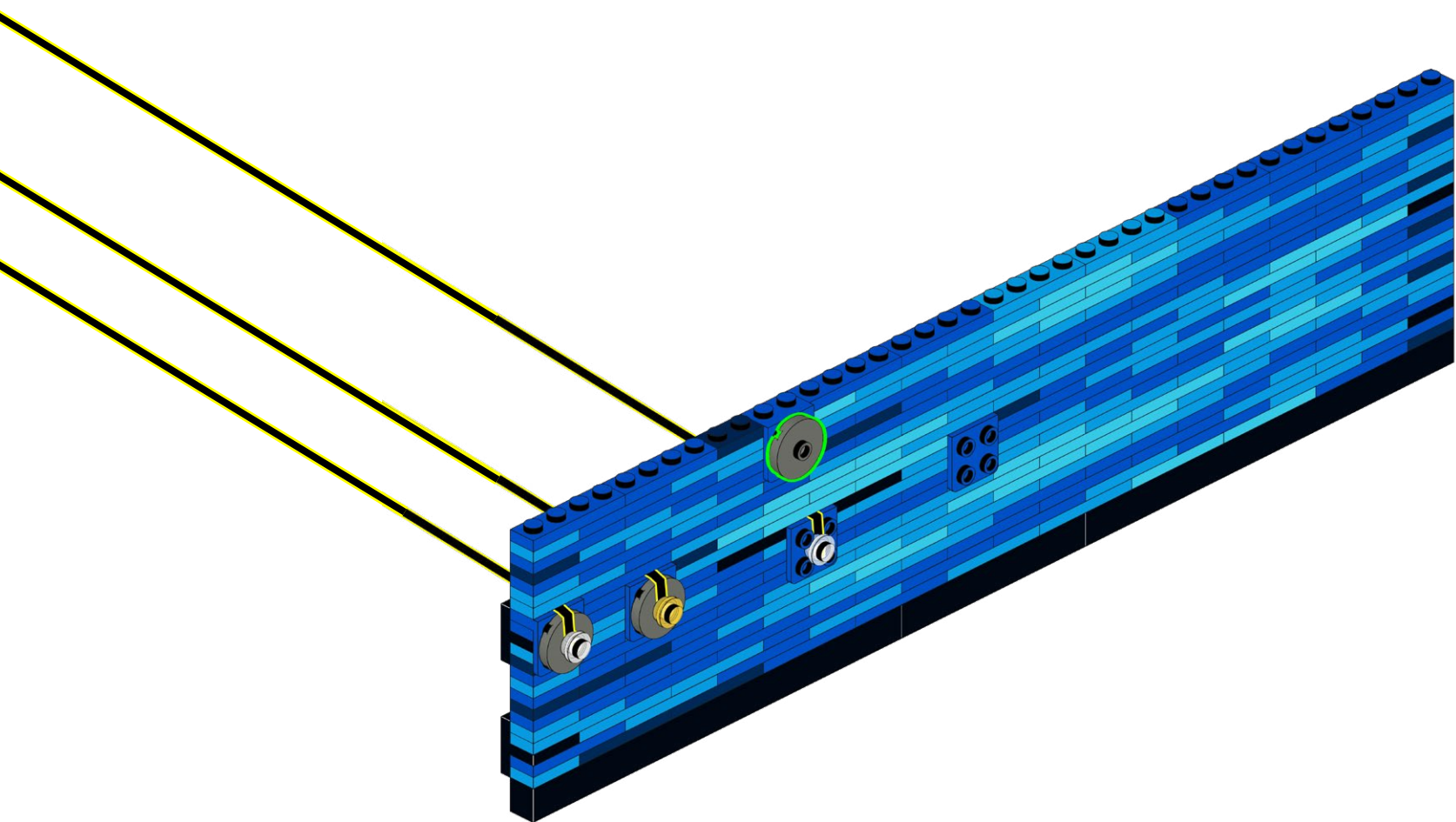
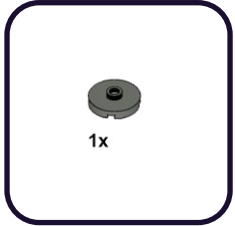

**201**

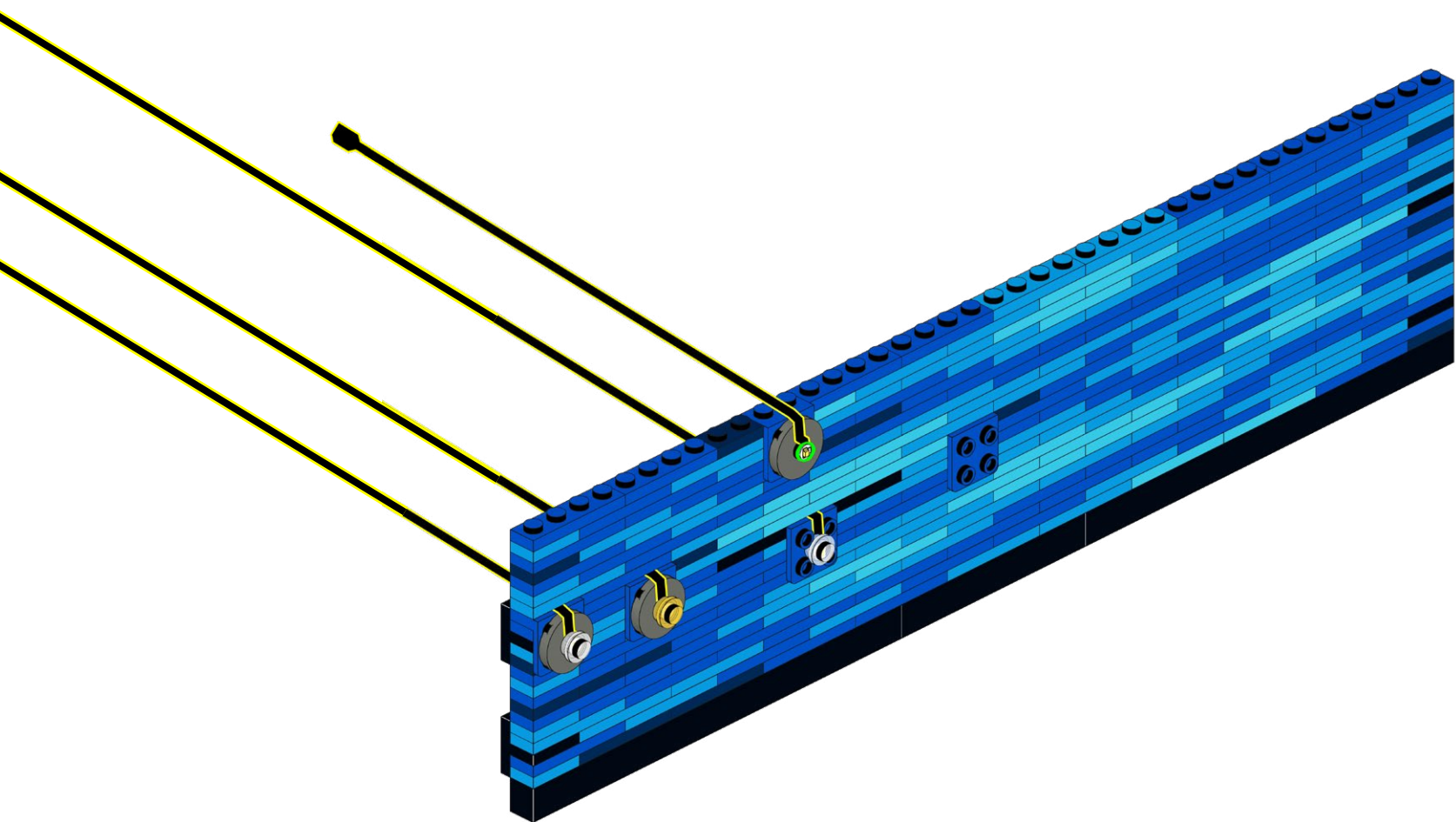
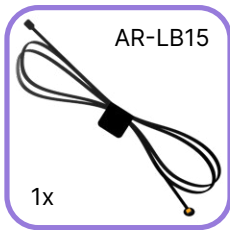

202

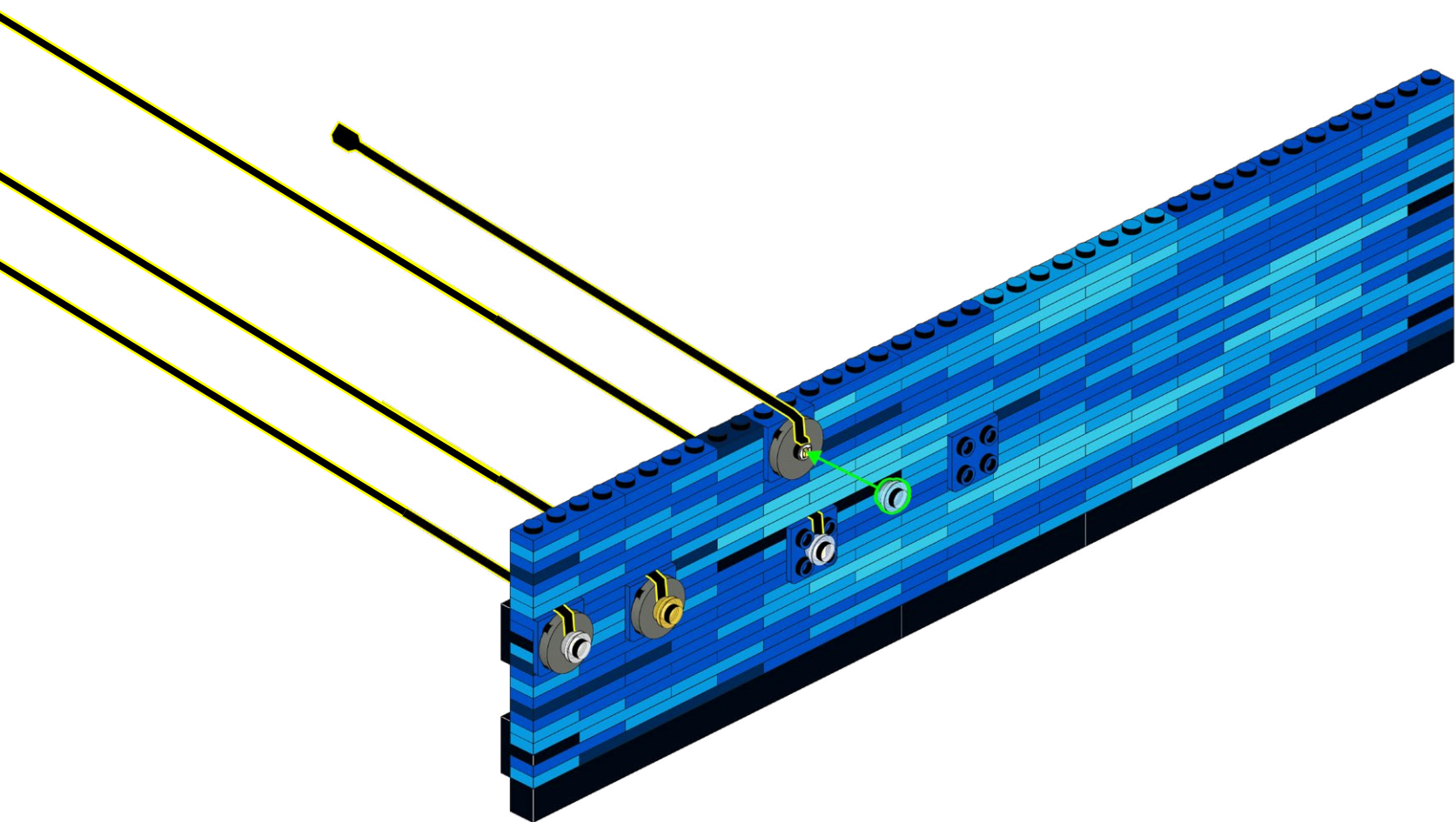
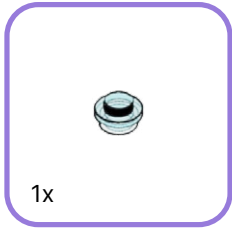



**203**

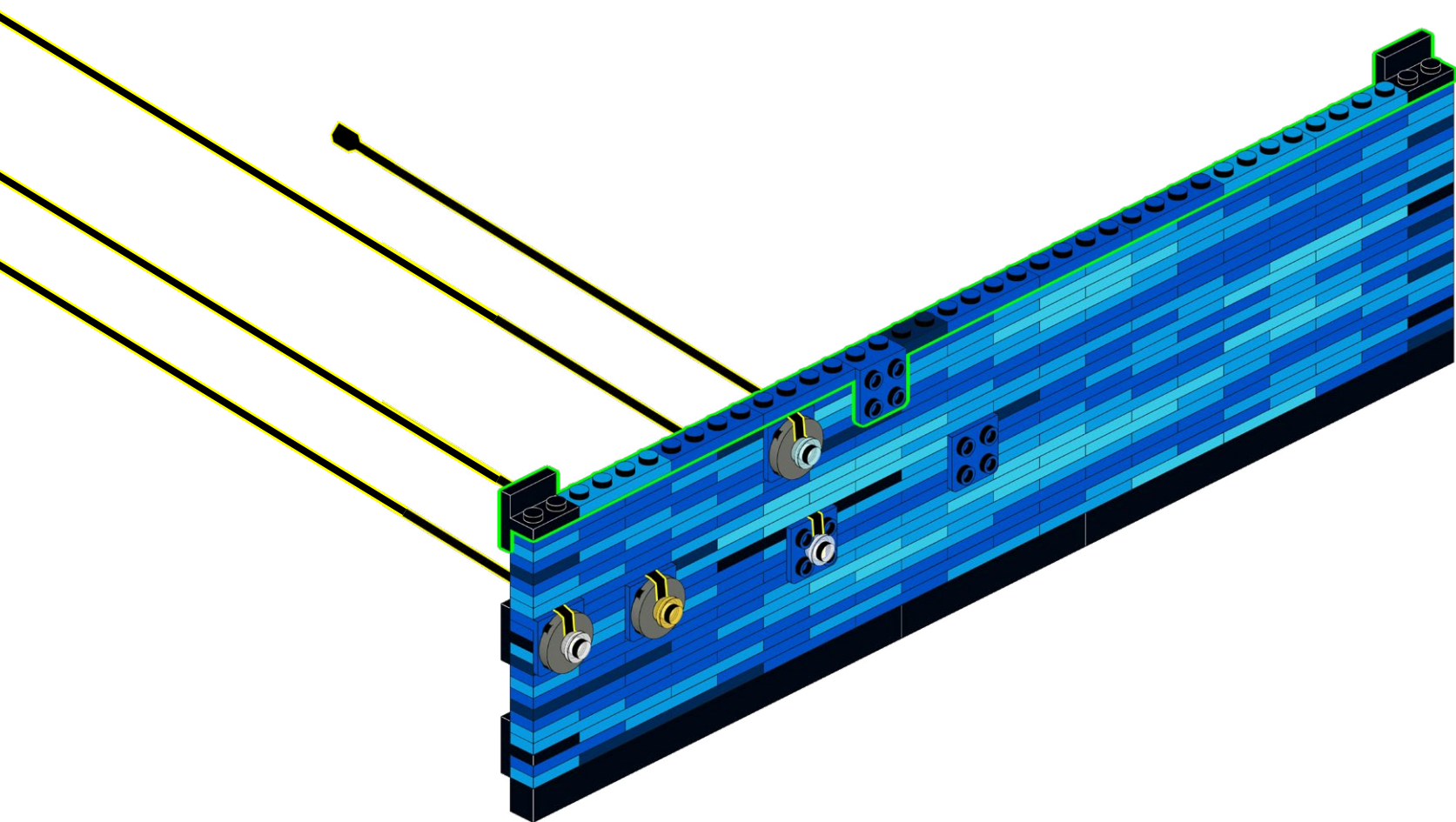
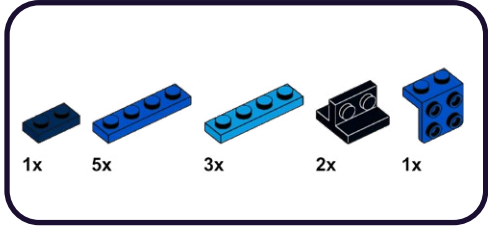

204

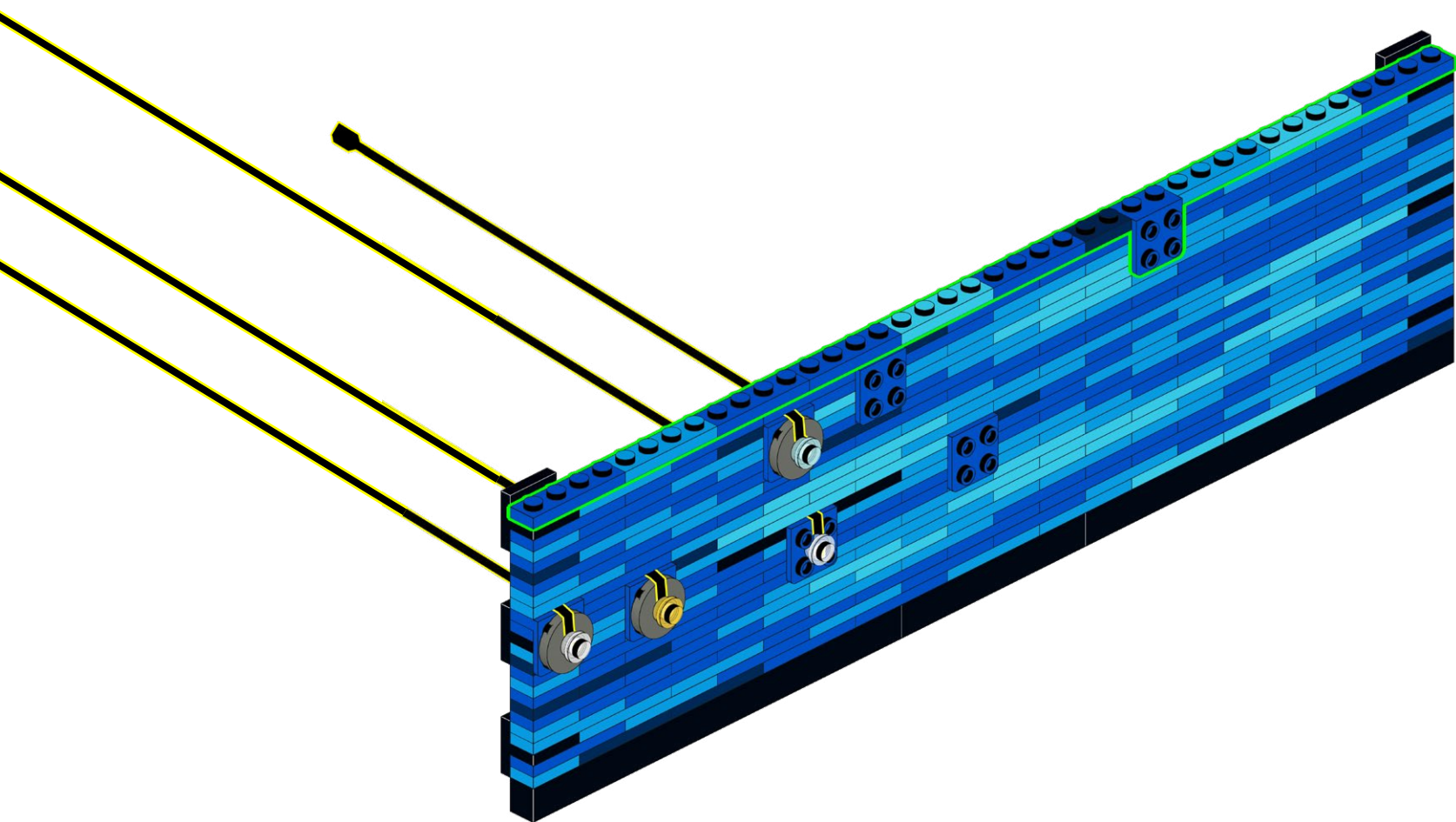
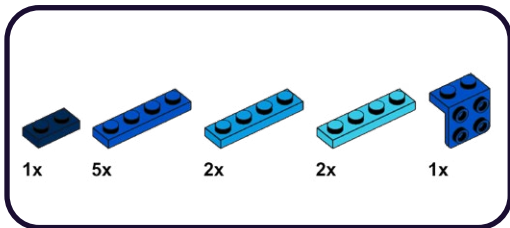

**205**

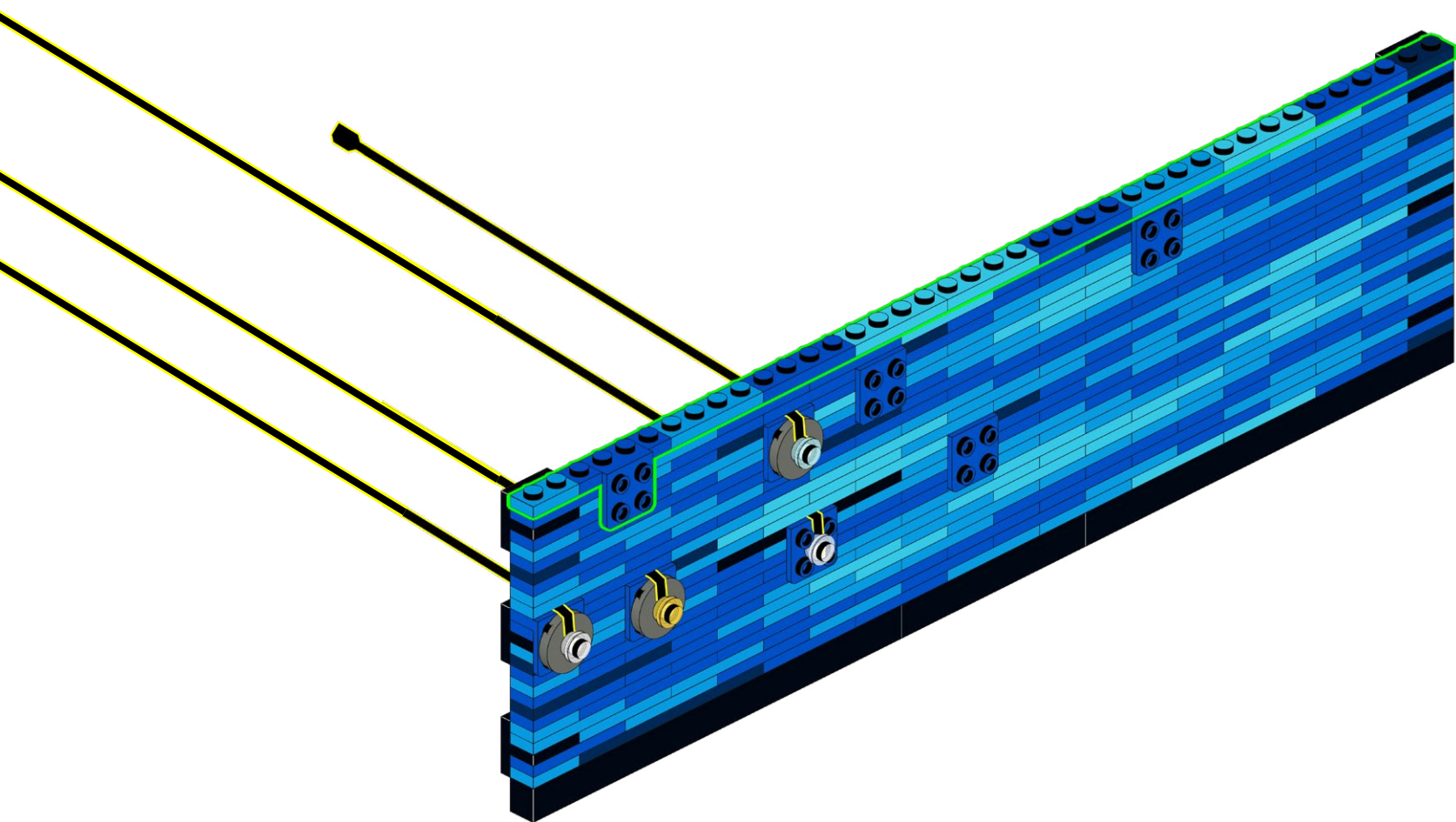
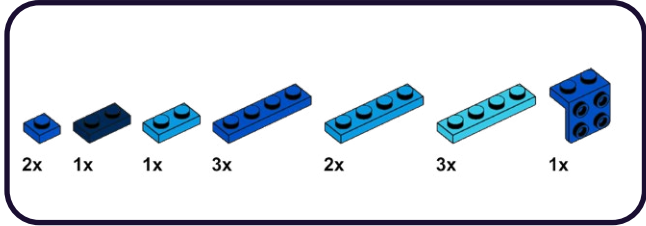



206

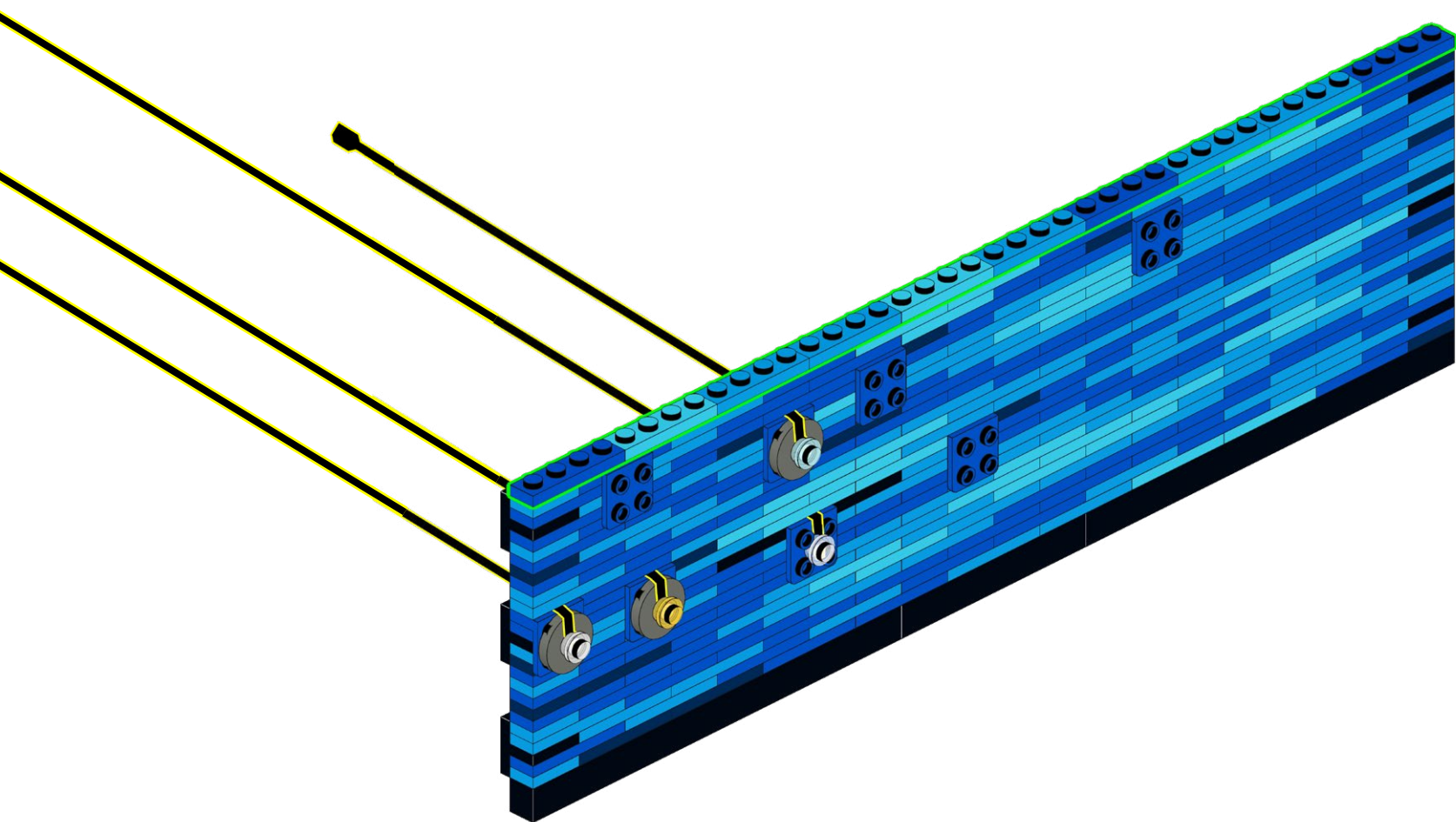
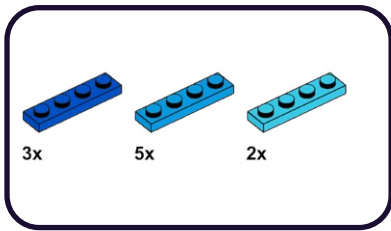

207

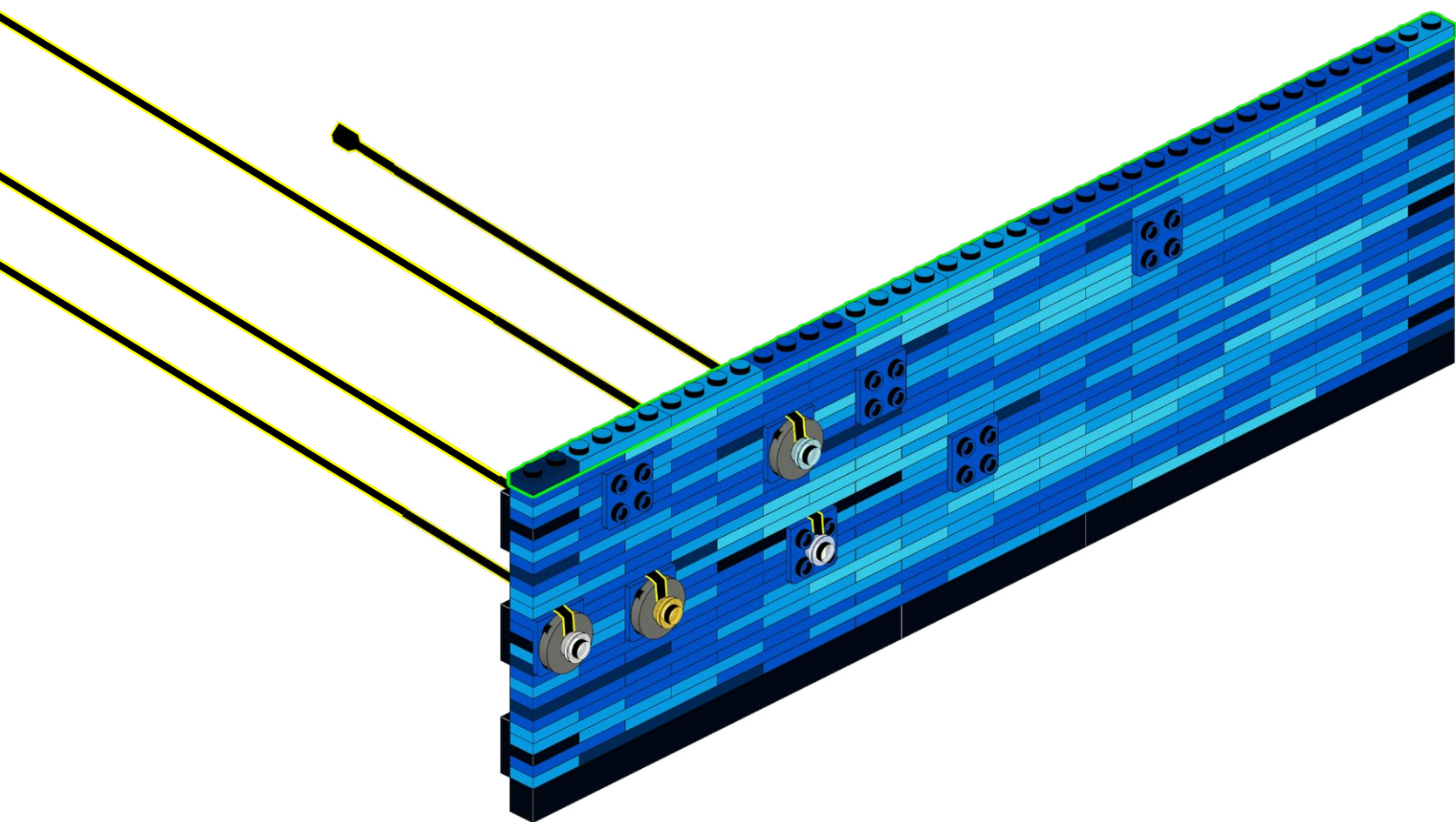
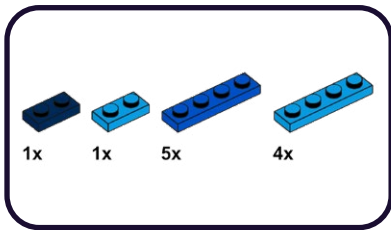

208

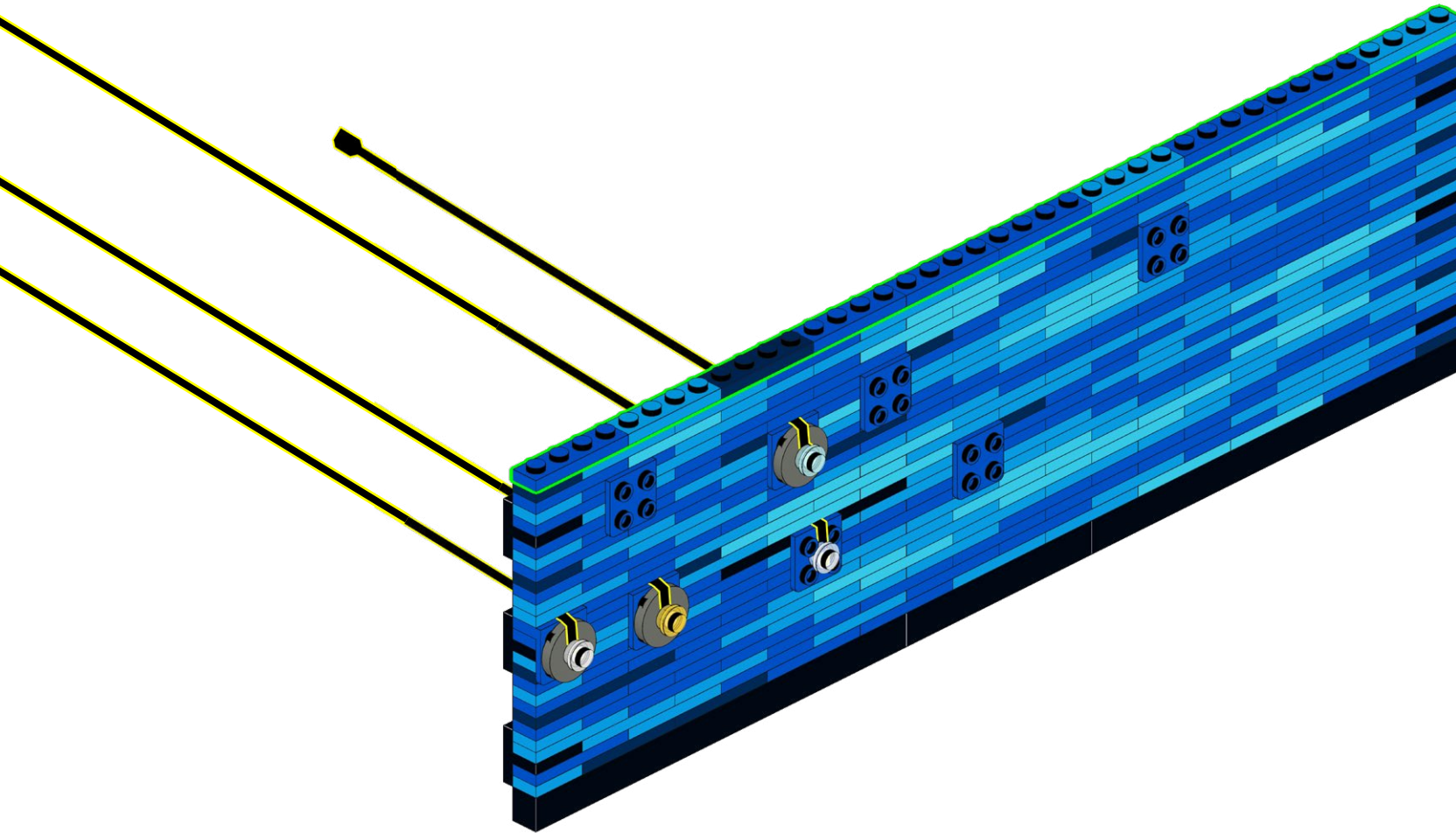
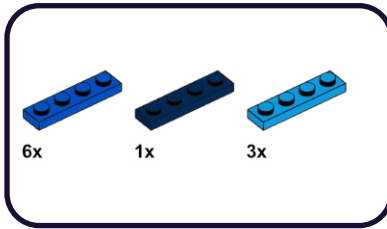

209

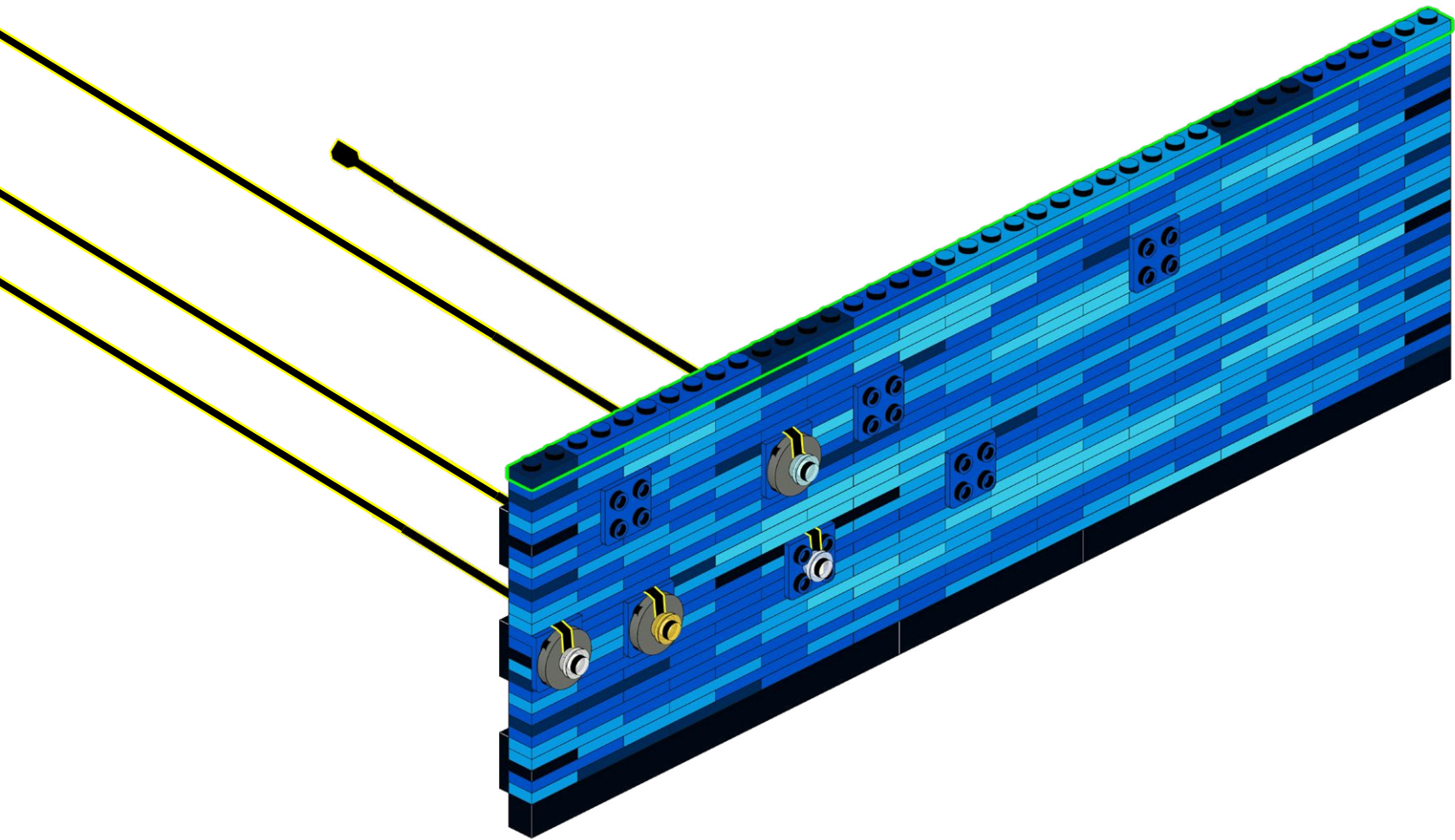
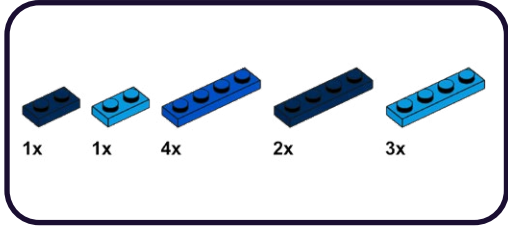



210

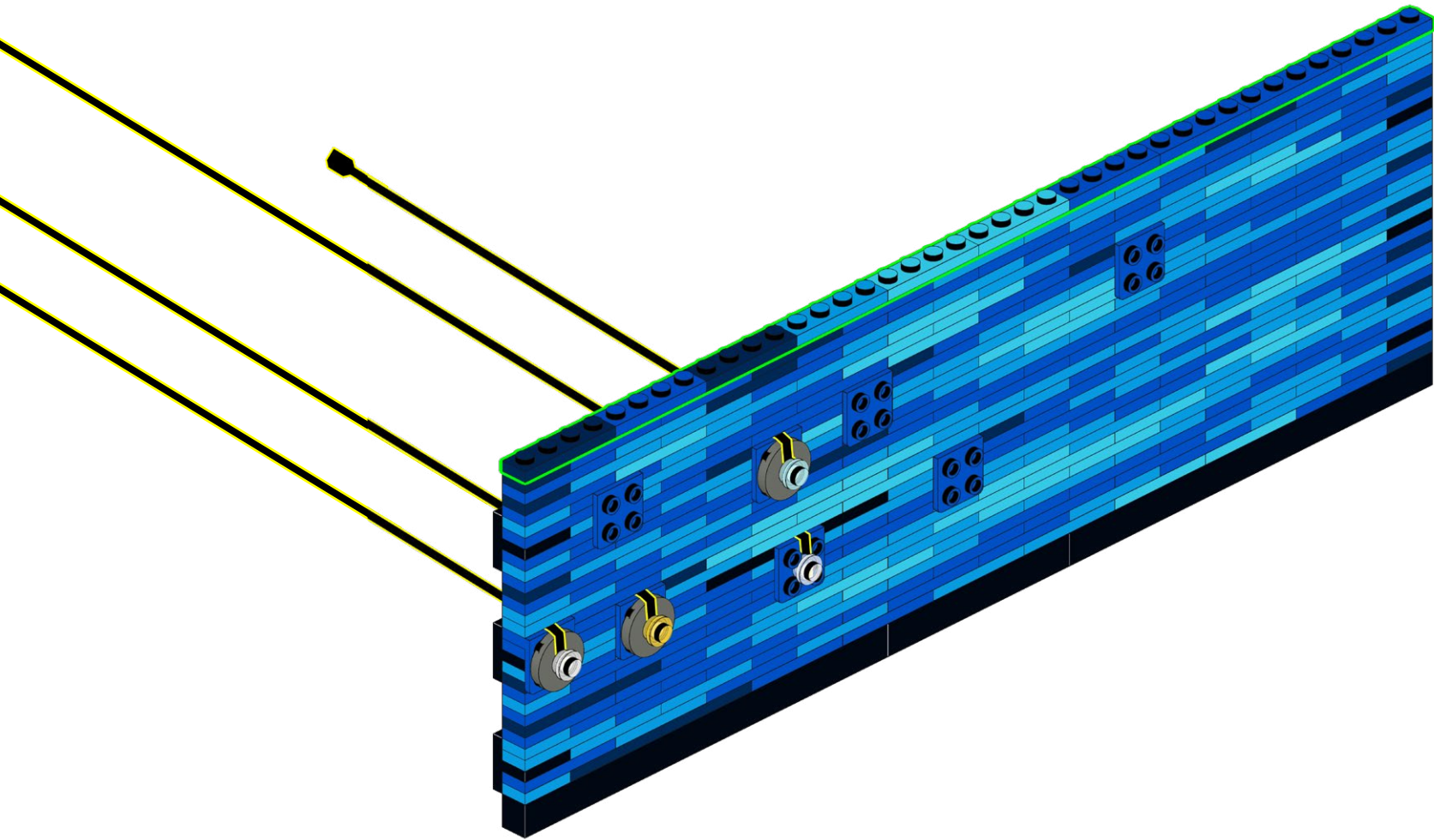
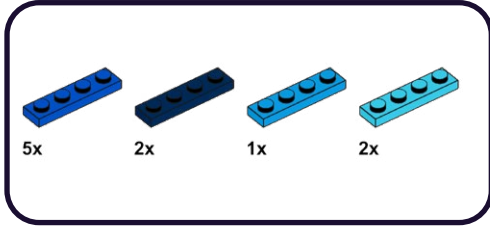

211

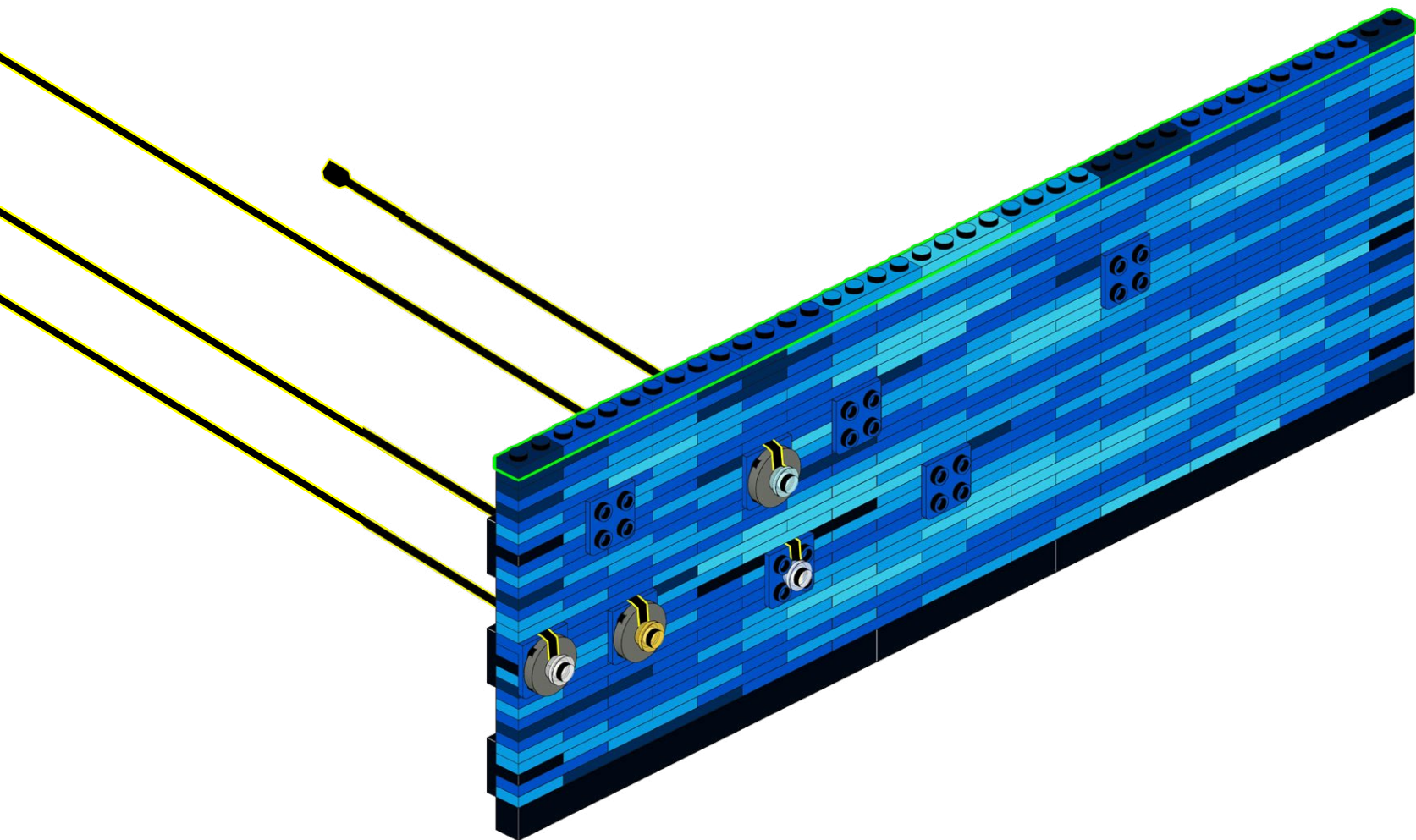
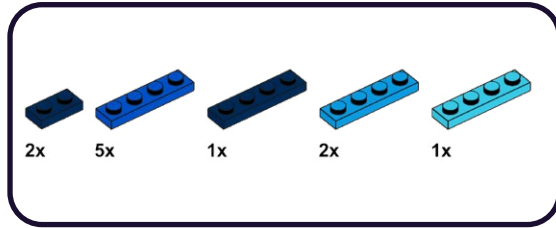

212

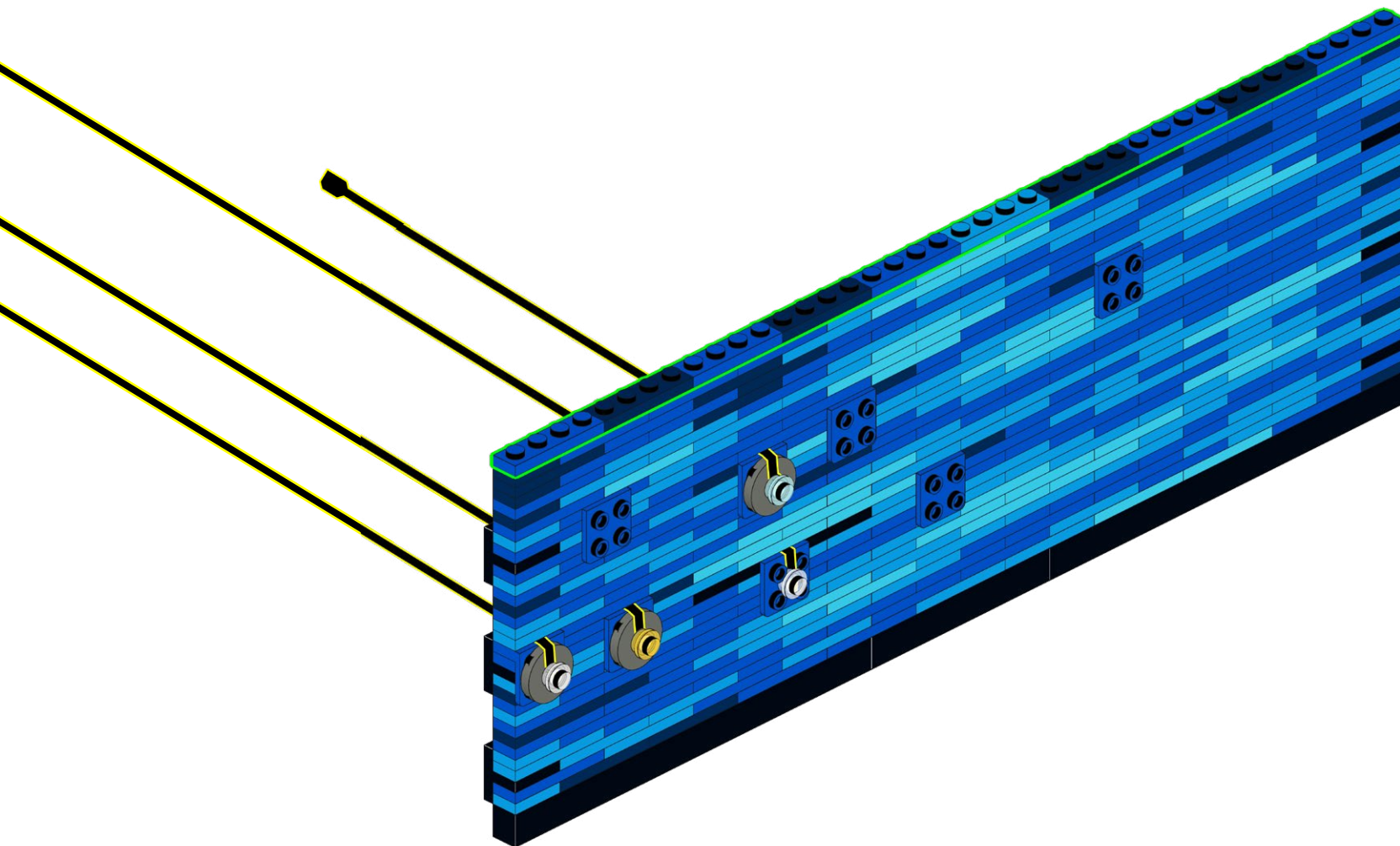
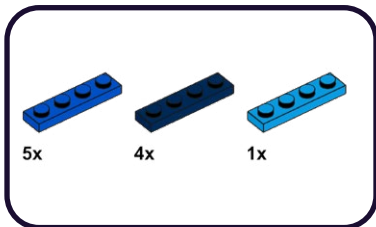



213

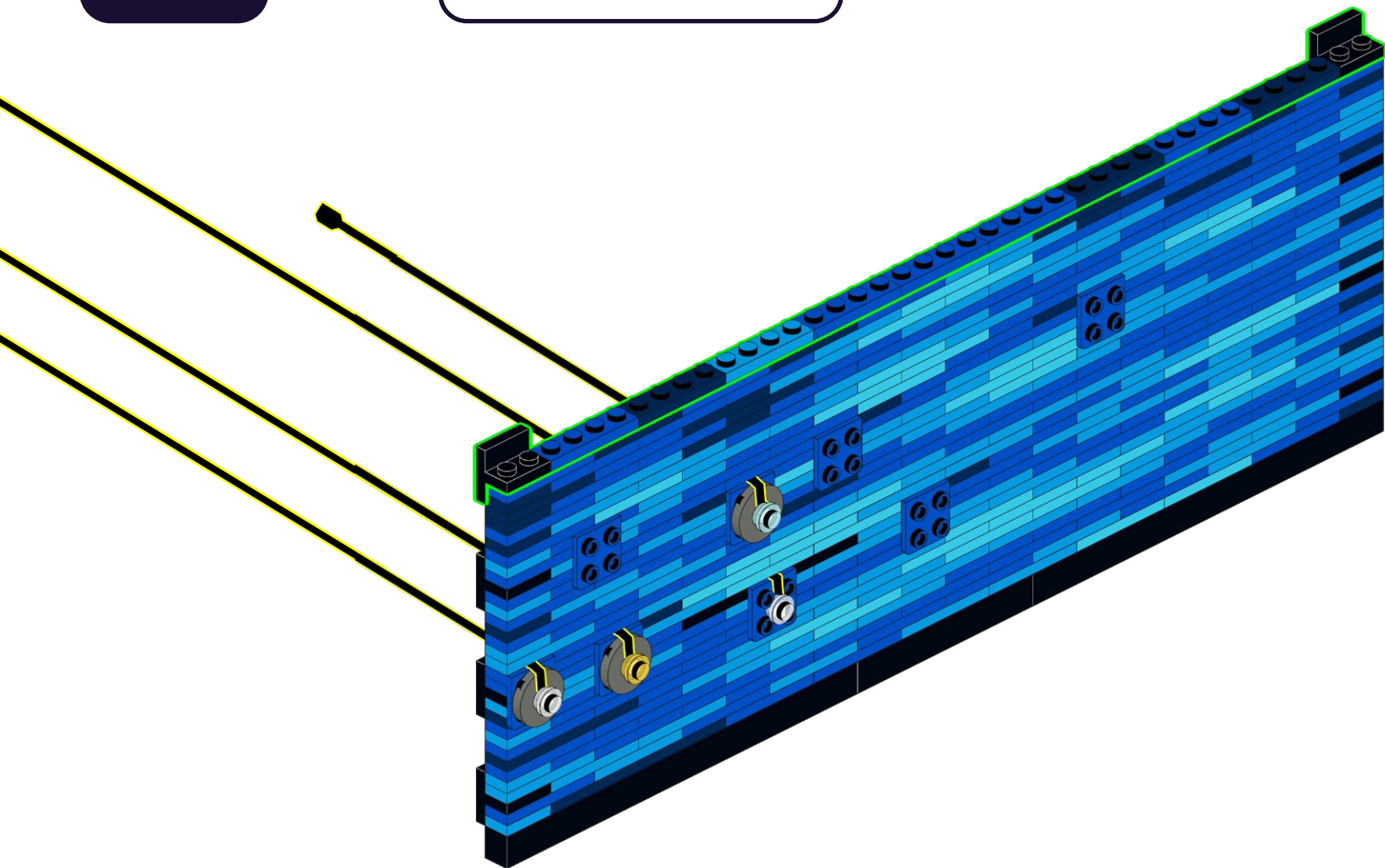
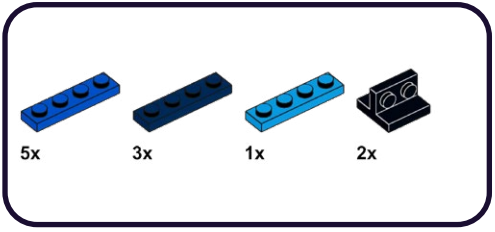

214

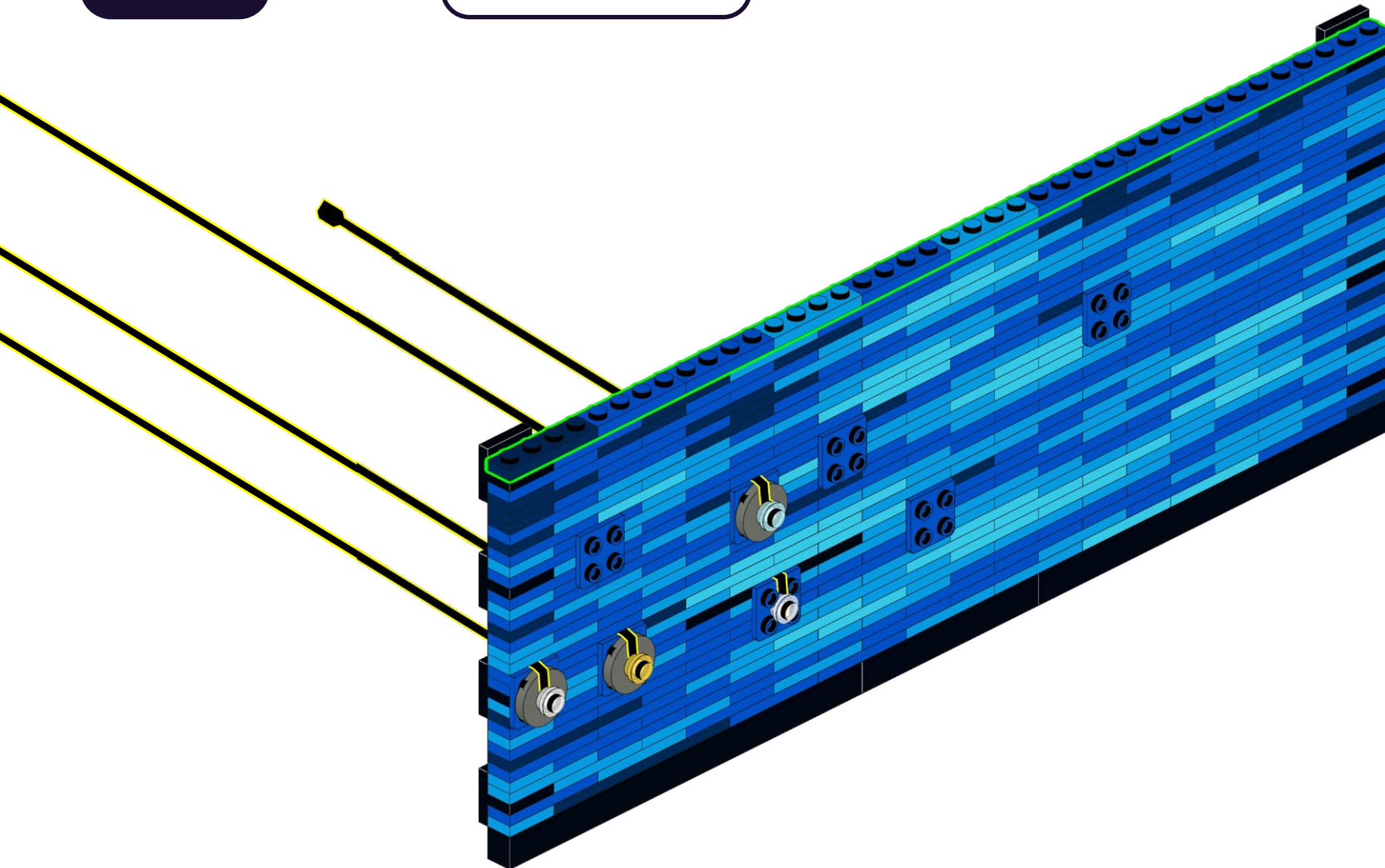
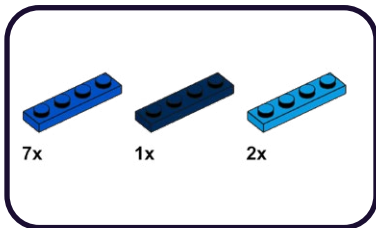

215

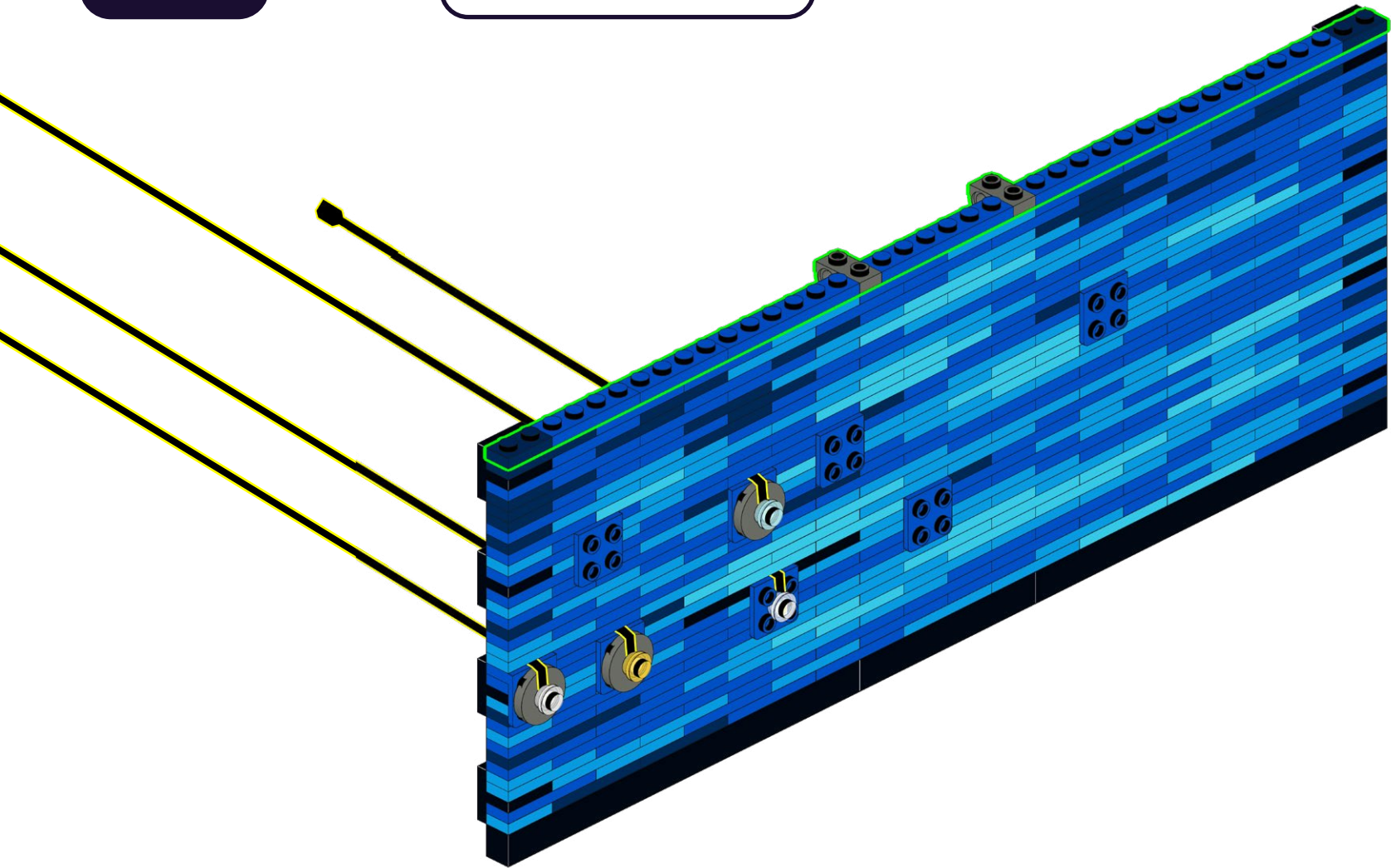
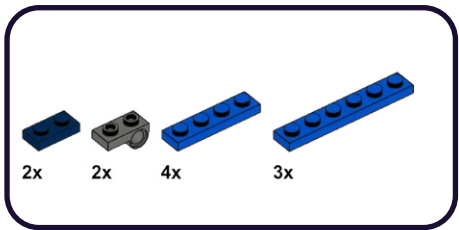



216

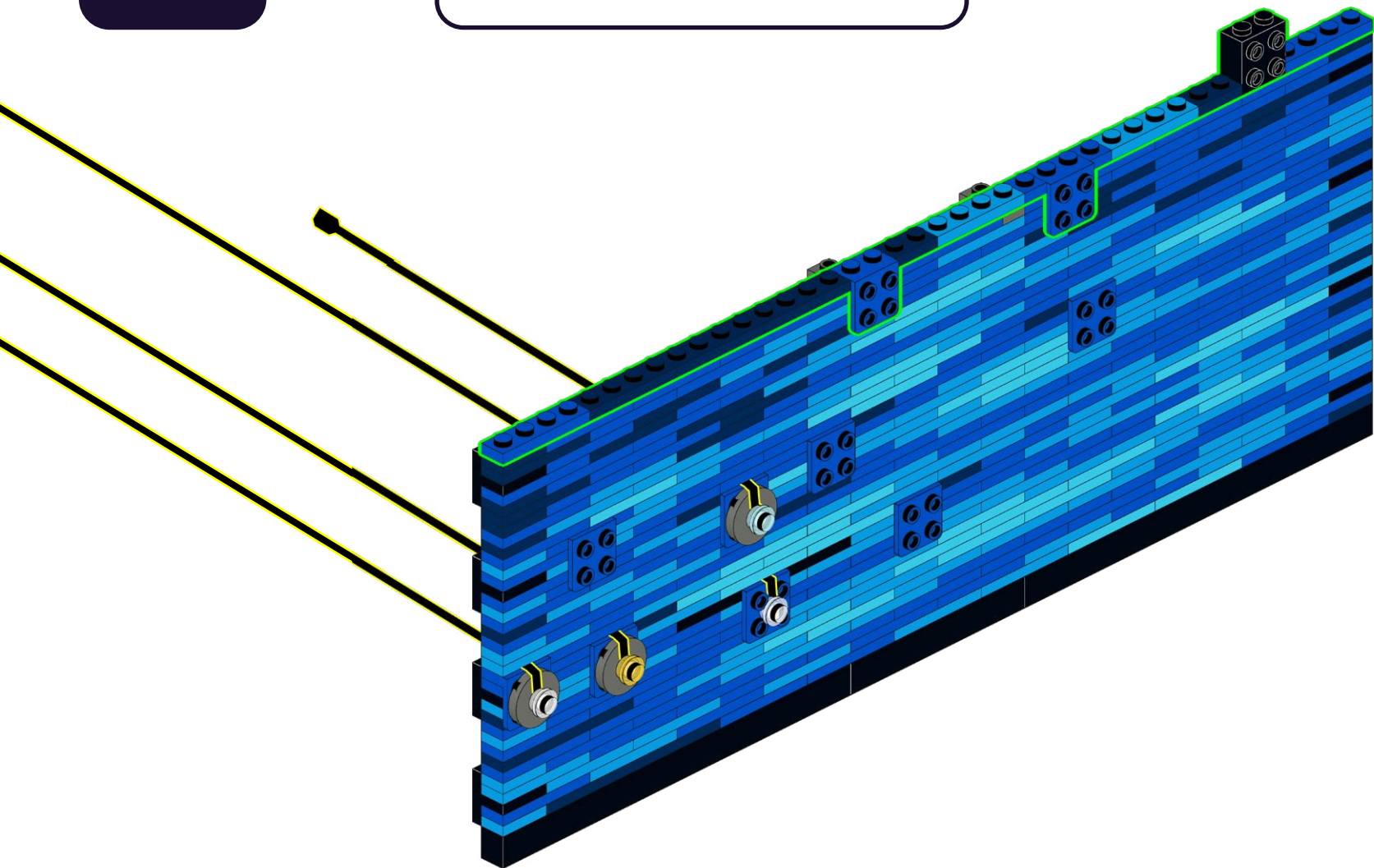
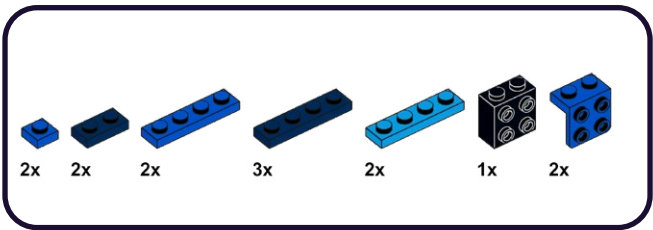

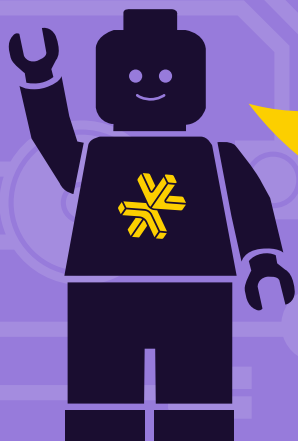

### **HOLD UP!**

You might notice some bags aren't in order, as well as left over pieces, but that's ok! We're changing the way you build LEGO!

### **ATTENDEZ!**

Vous remarquerez peut-être que certains sacs, ainsi que certaines pièces, ne sont pas dans le bon ordre. Mais pas de panique! Nous changeons simplement la façon avec laquelle vous construisez vos LEGO!

### **ASPETTA!**

Potresti notare che alcuni sacchetti non sono in ordine, così come i pezzi avanzati, ma va bene così! Stiamo cambiando il modo in cui costruisci i LEGO!

### **HALT!**

Sie werden möglicherweise bemerken, dass einige tüten durcheinander sind und teile übrig bleiben, aber das ist in Ordnung! Wir ändern die art und weise, wie Sie LEGO bauen!

### **¡ESPERA!**

Es posible que notes que algunas bolsas están fuera de servicio, así como piezas sobrantes, ¡pero está bien! ¡Estamos cambiando la forma en que construyes LEGO!

### **暫停!**

你可能会注意到一些袋子顺序错乱, 以及一些剩余的部件, 但没关系! 我们正在改变你搭建乐高的方式!

#### Open LMB Bag 02

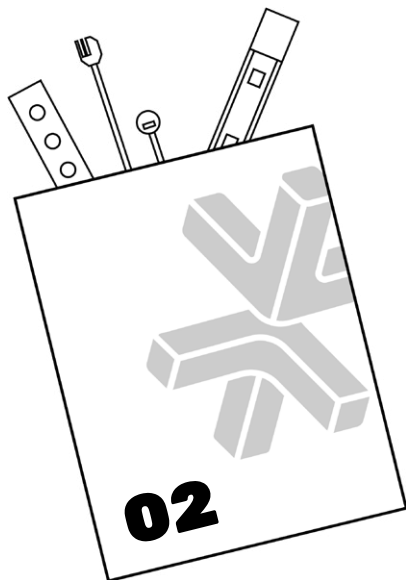

217

AL-WW30

1x

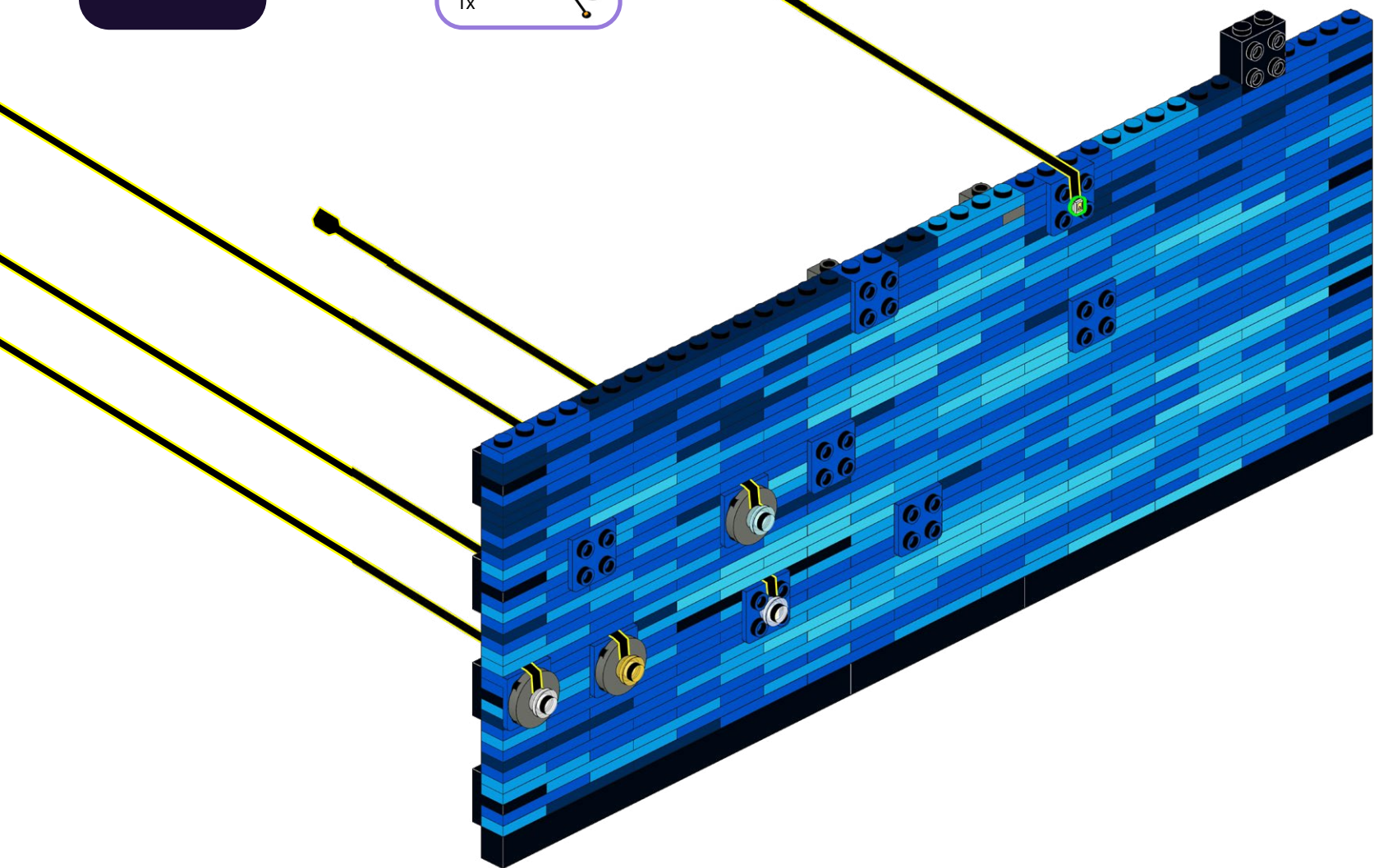
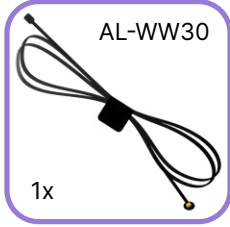



218

1x

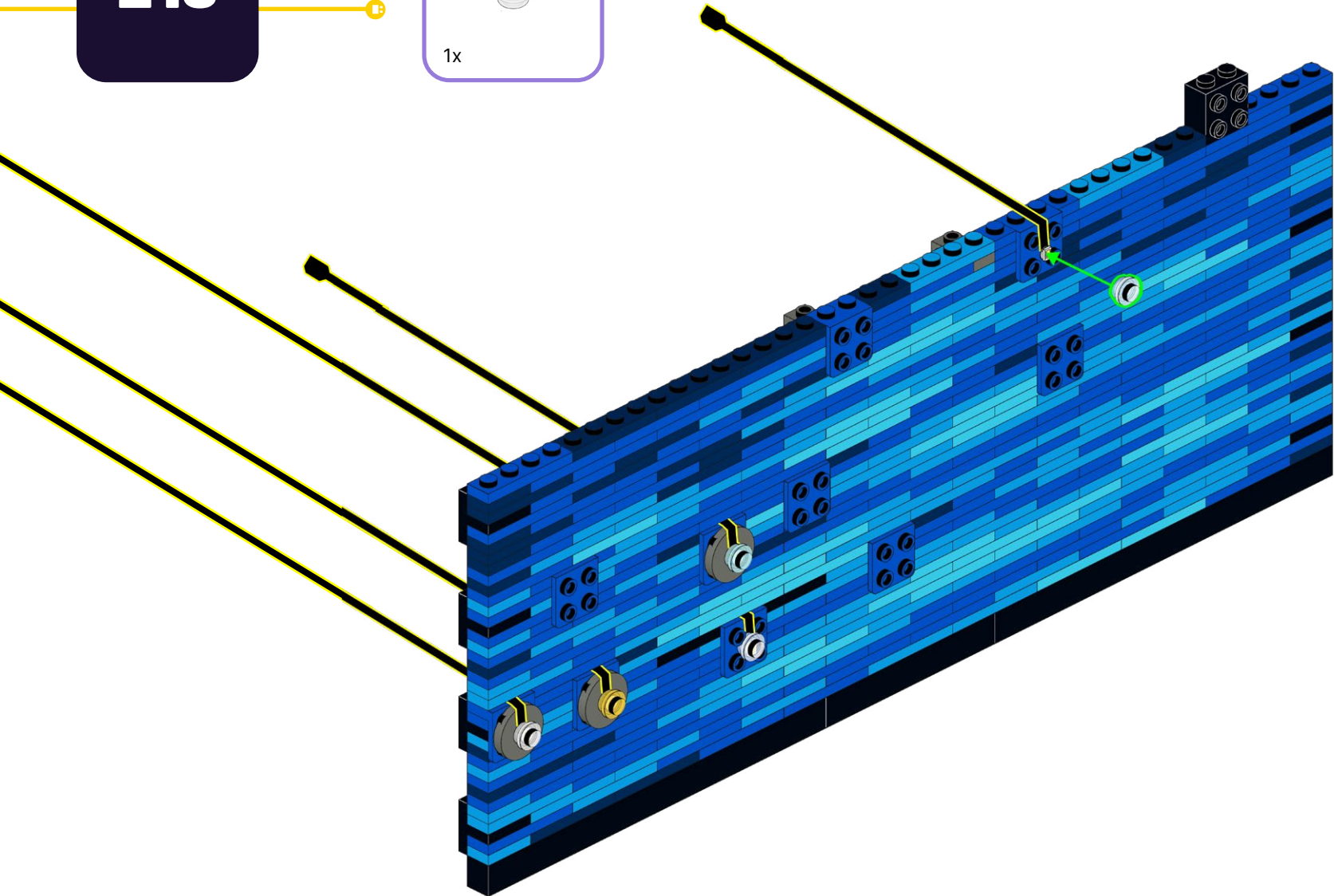
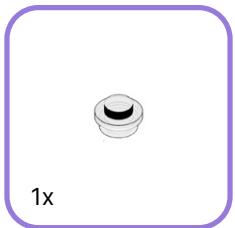

219

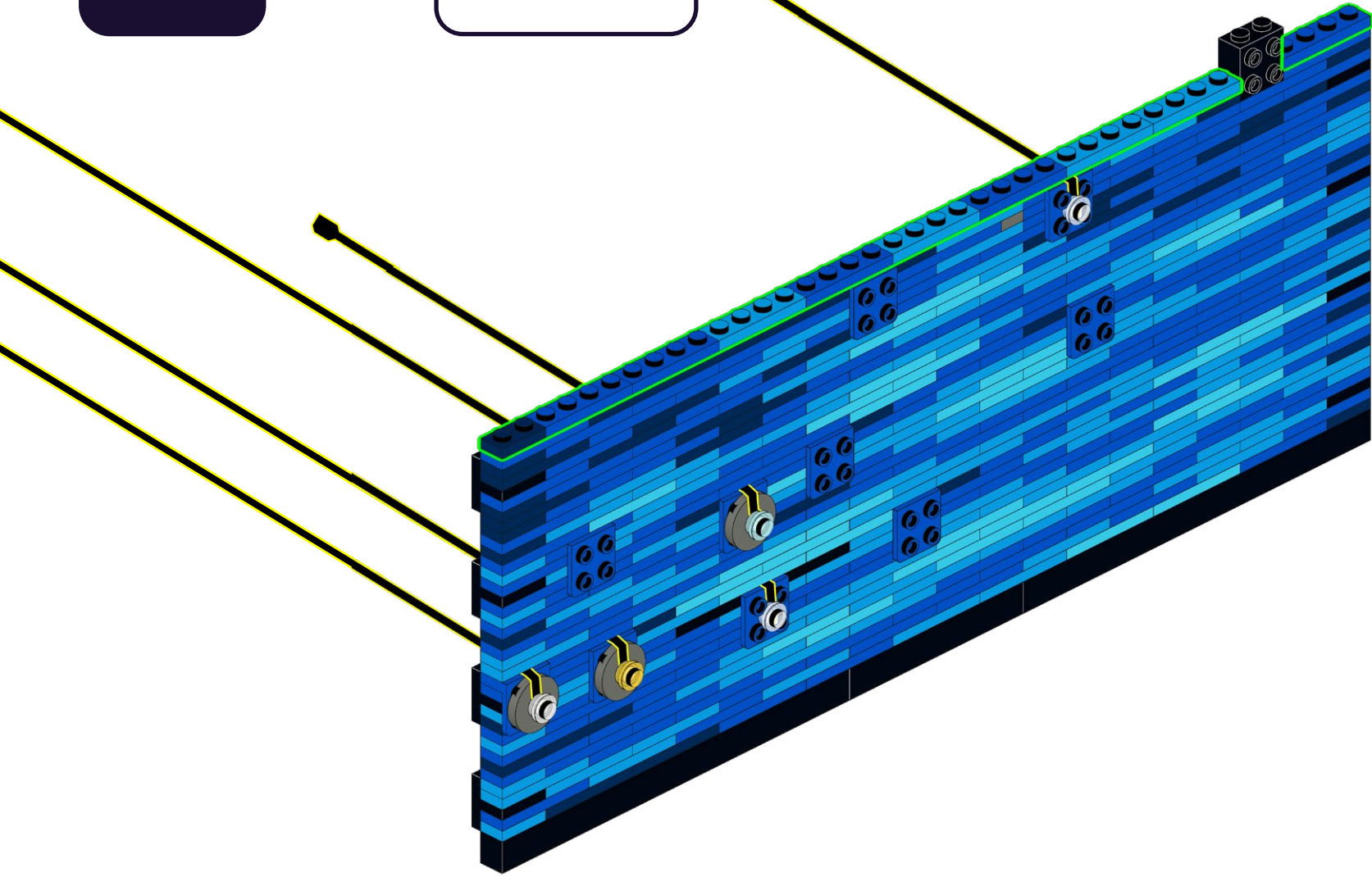
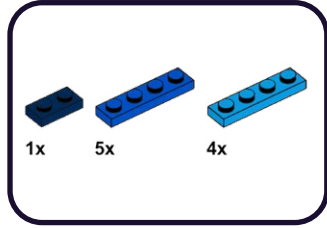

220

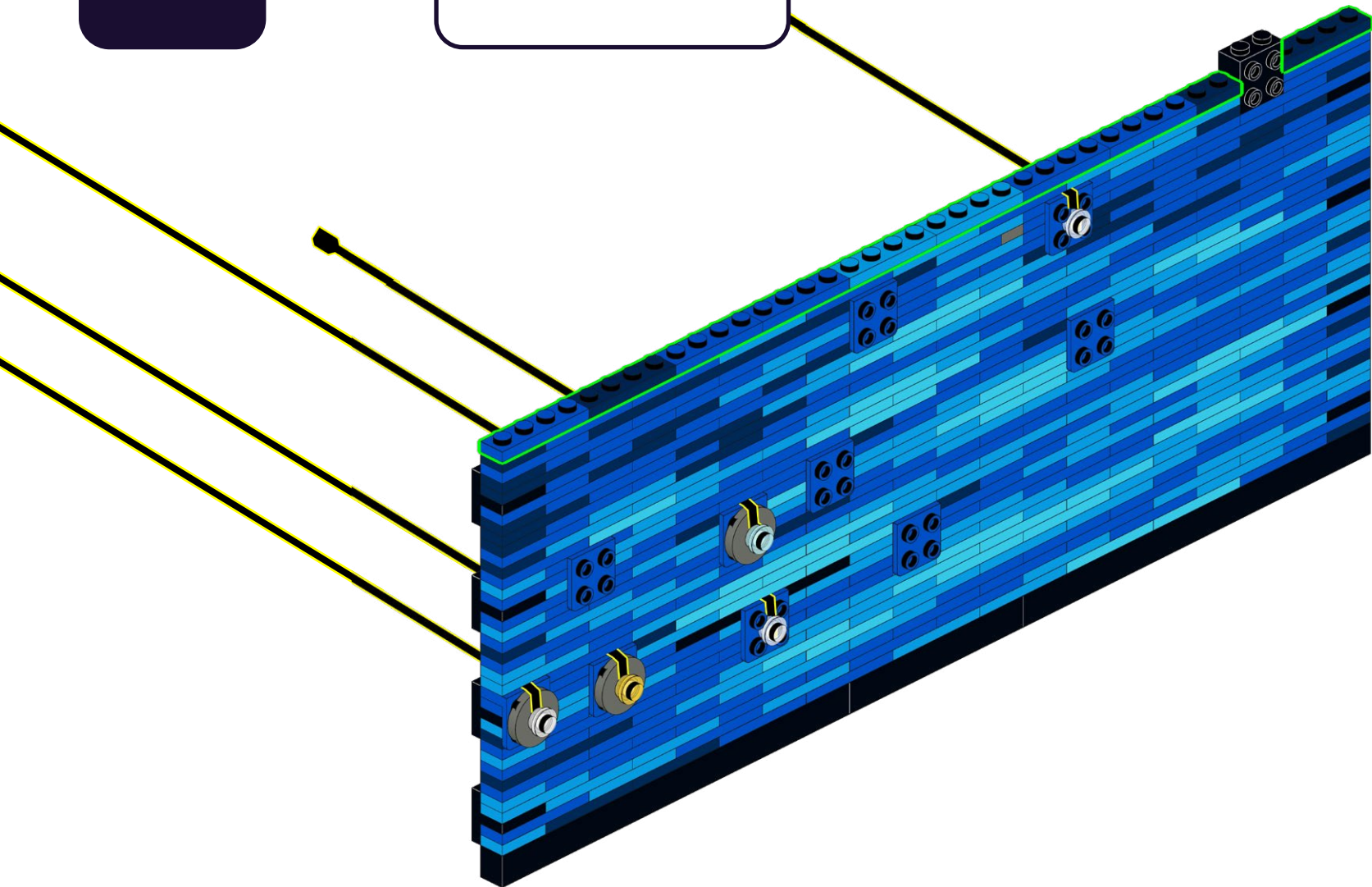
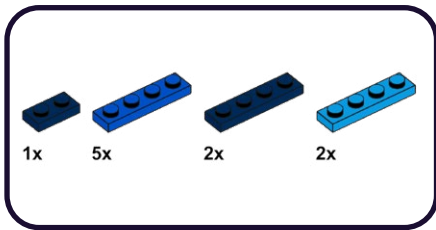



221

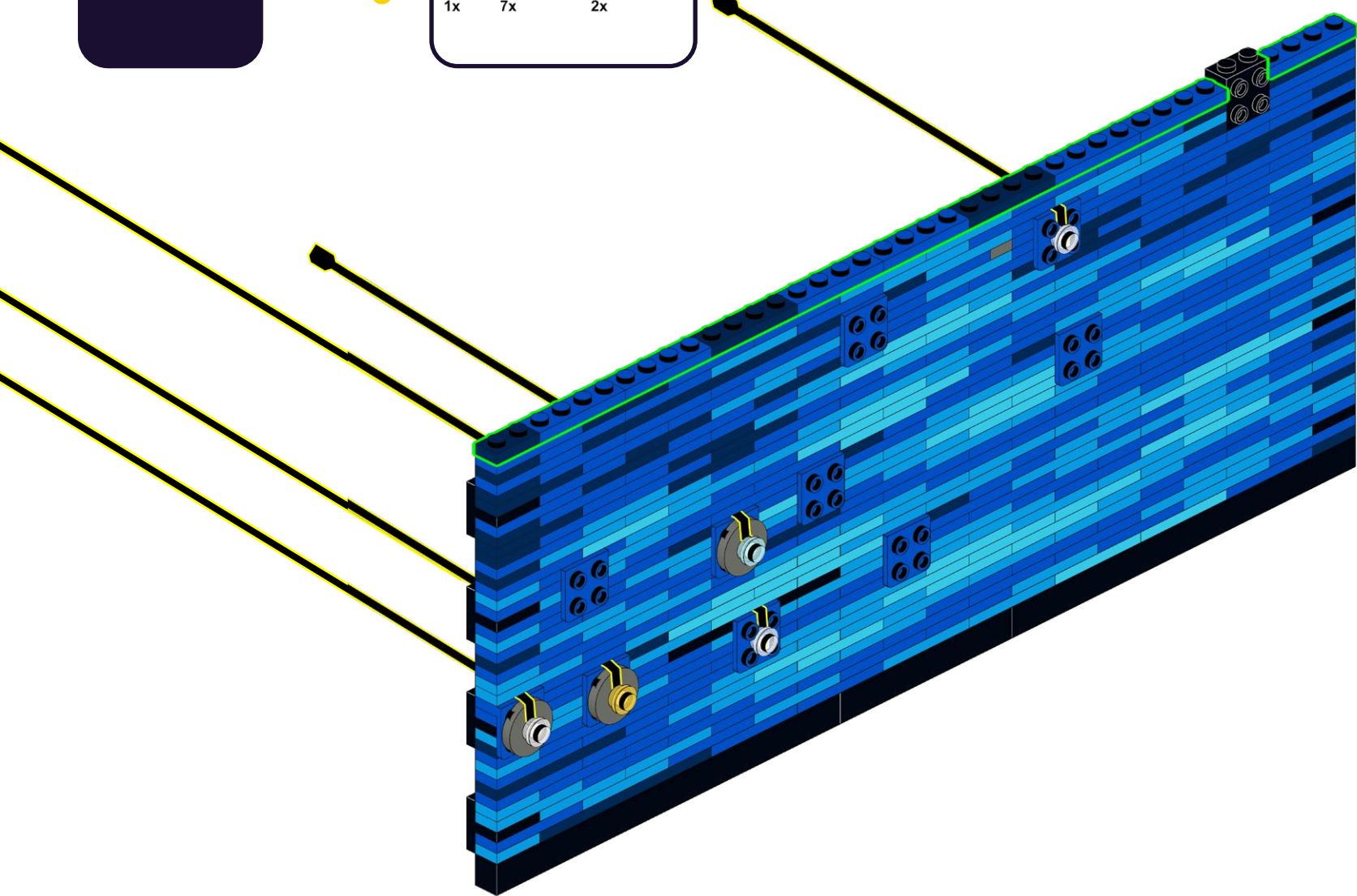
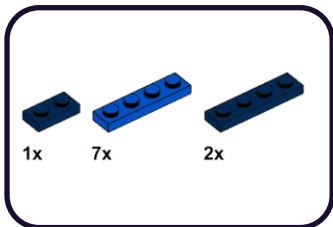

222

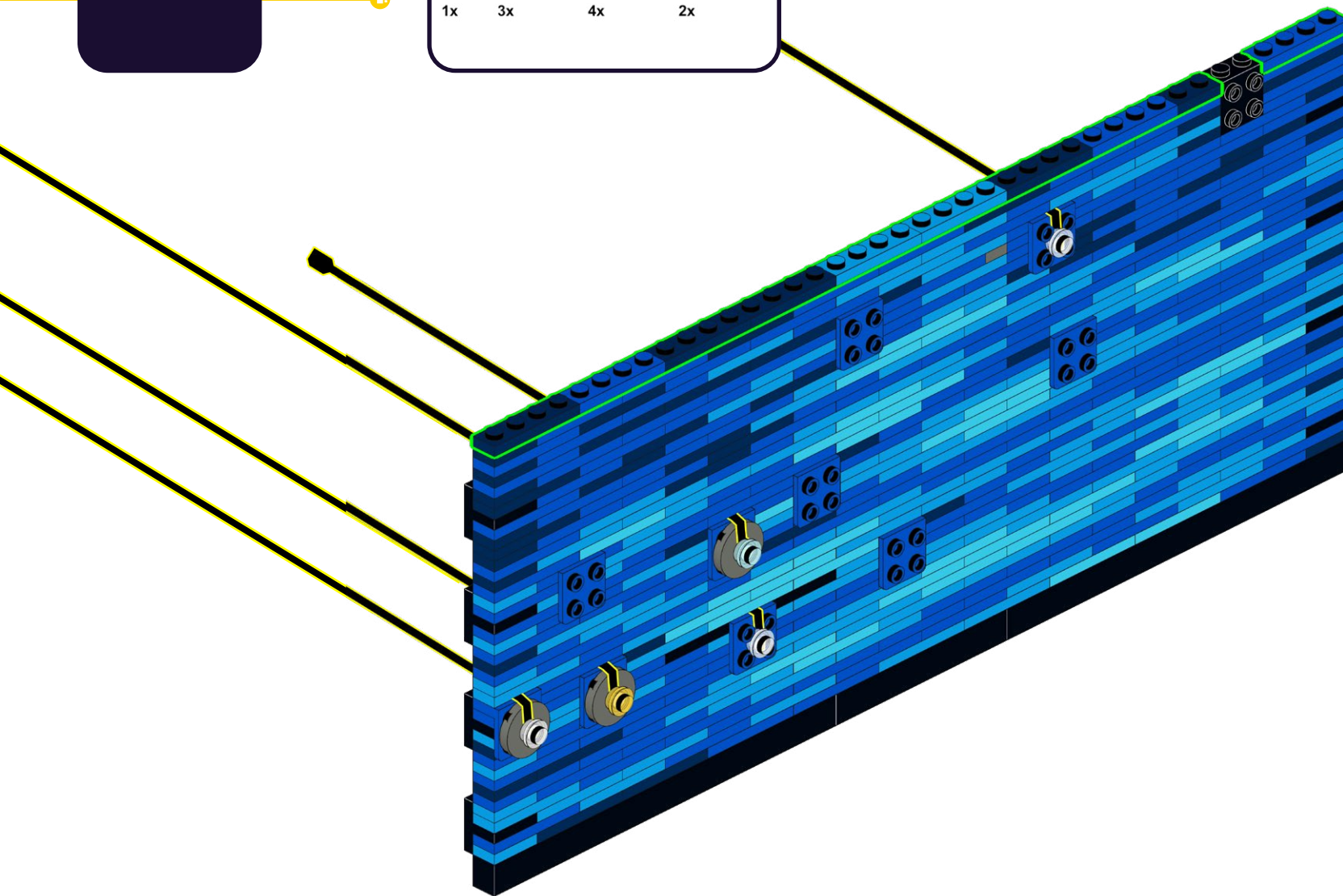
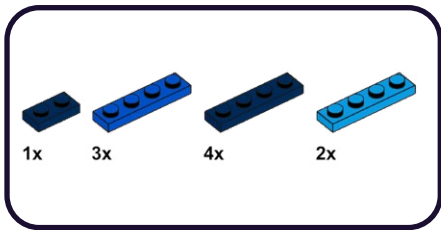

223

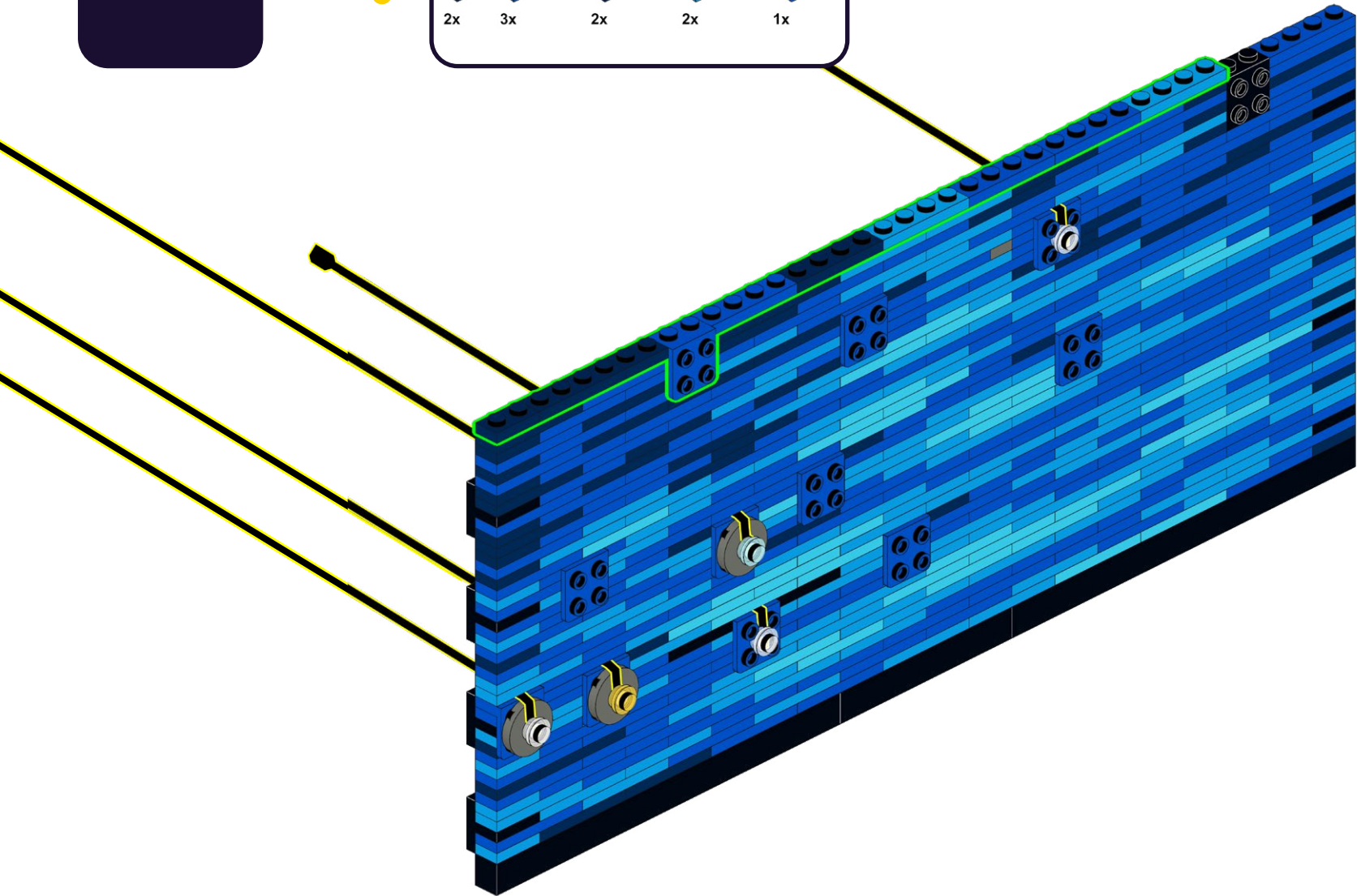
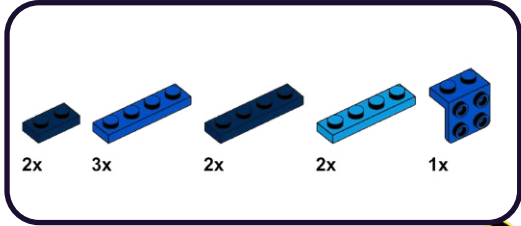



224

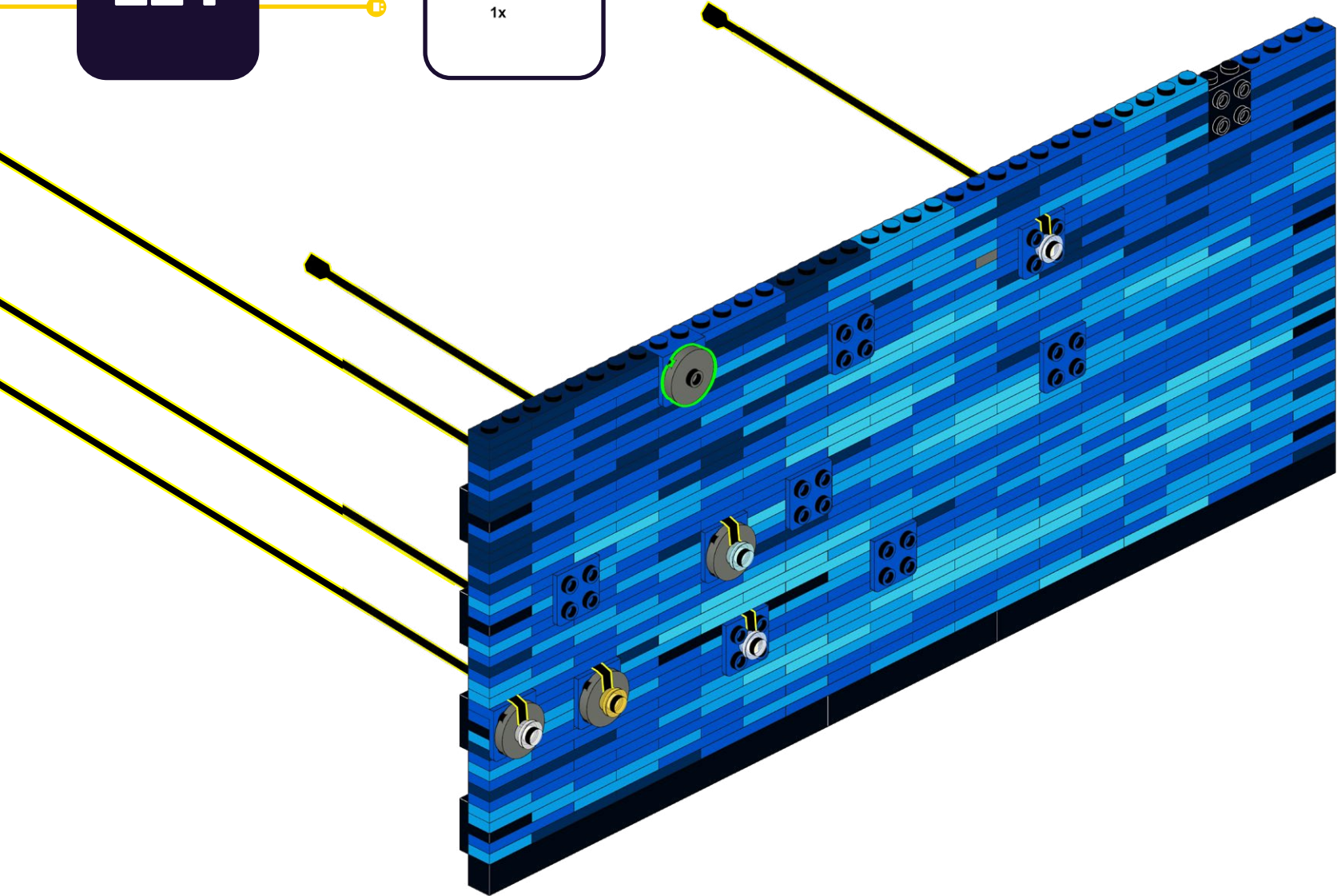
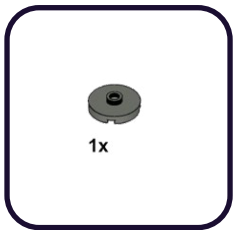

**225**

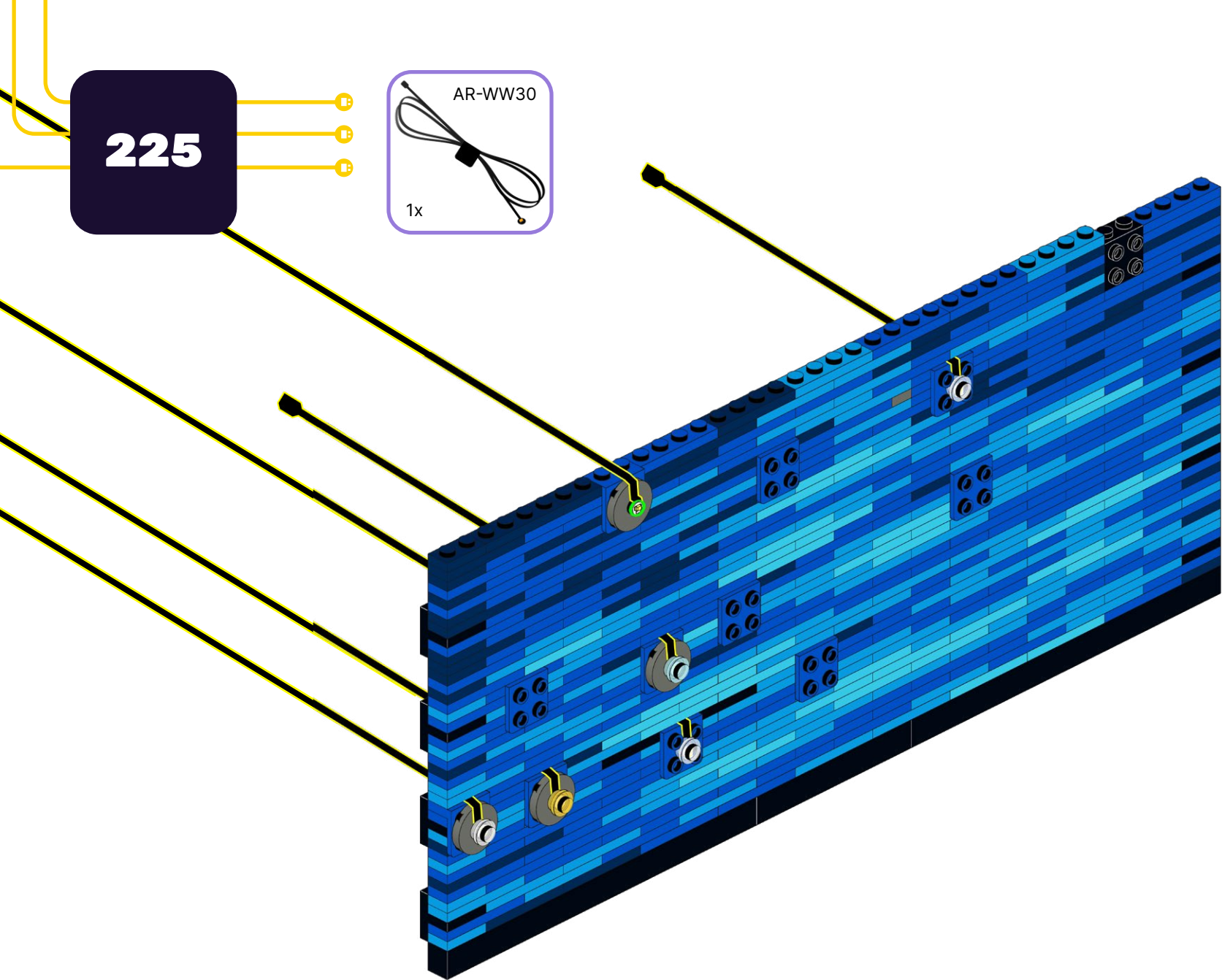
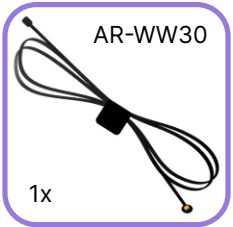

226

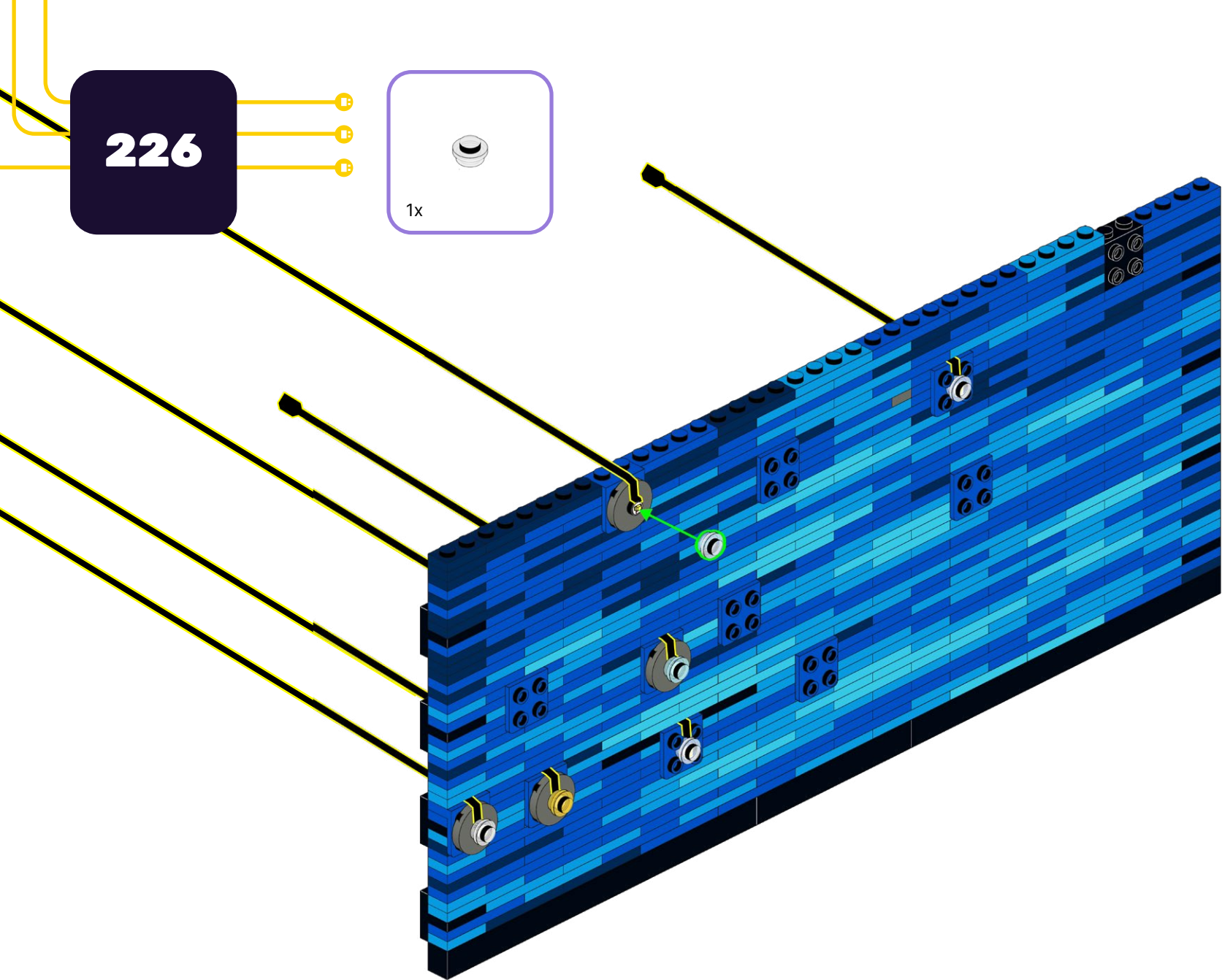
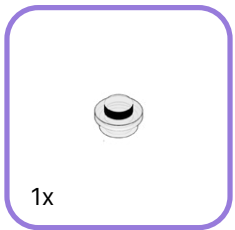





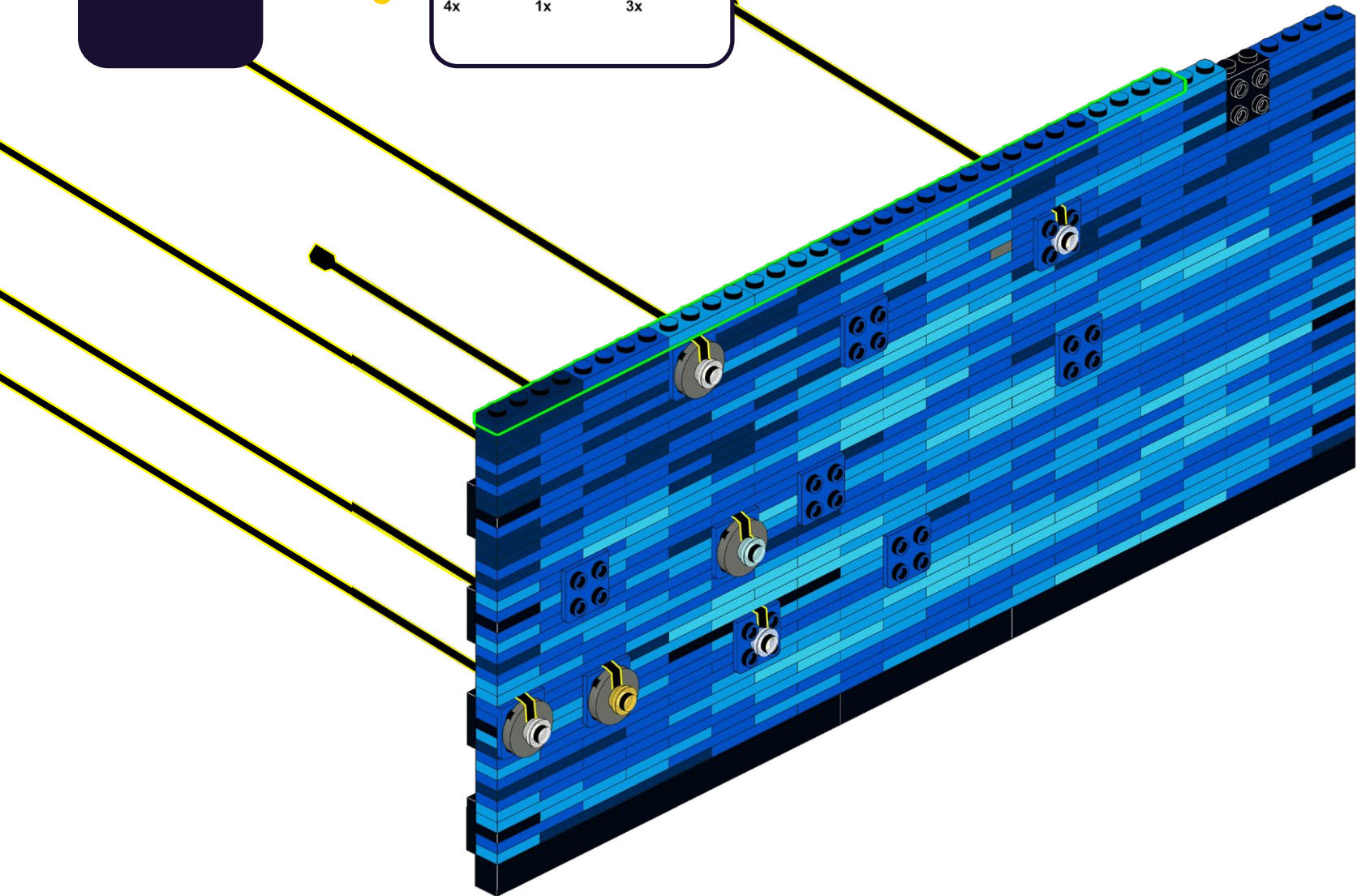
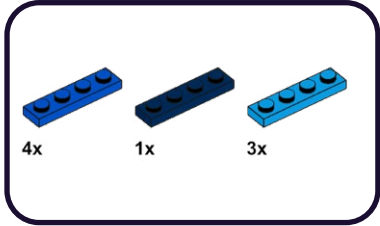

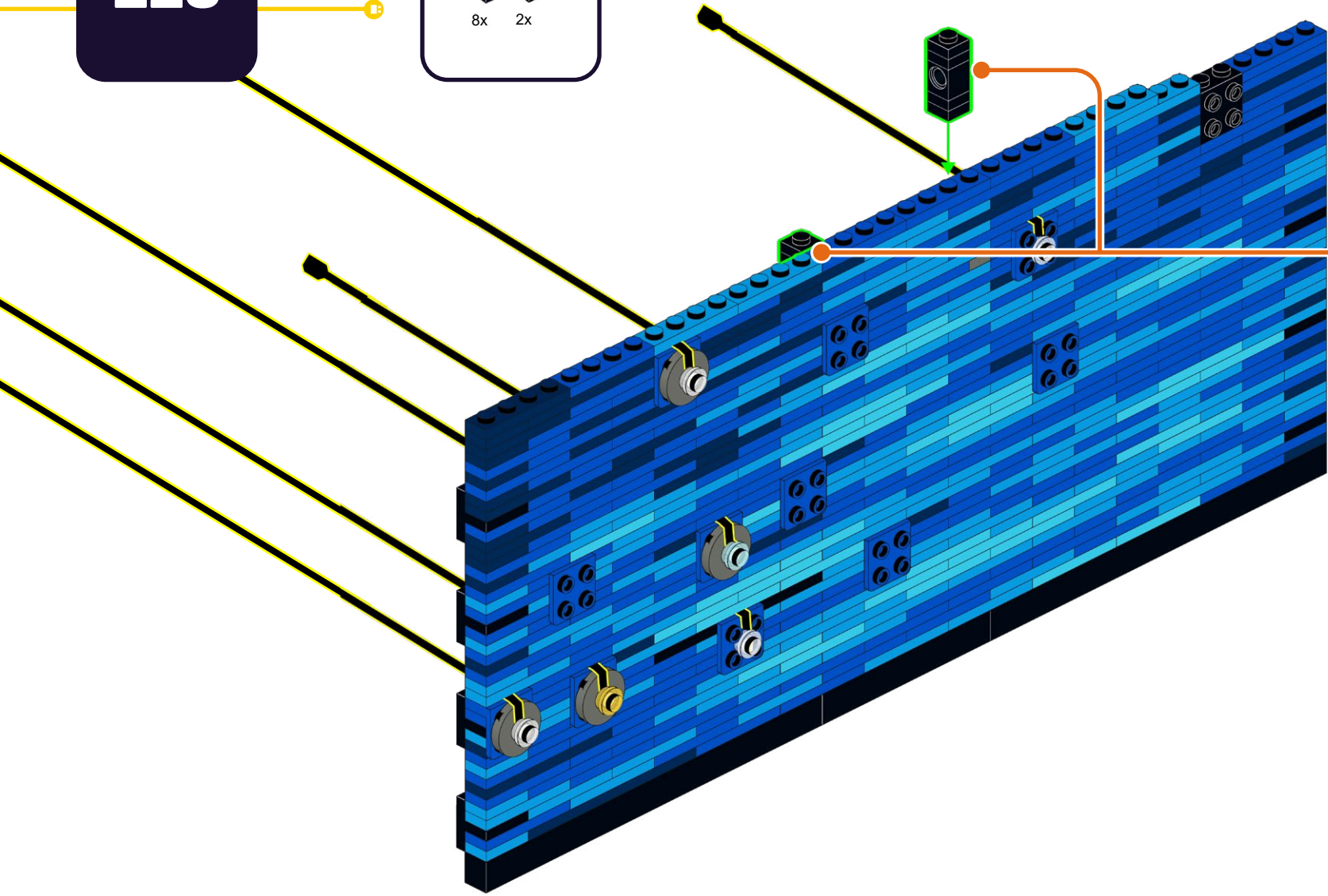
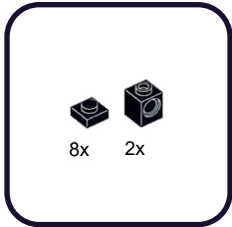

**227**



228



- 1  
- 2 
- 3    x2



229

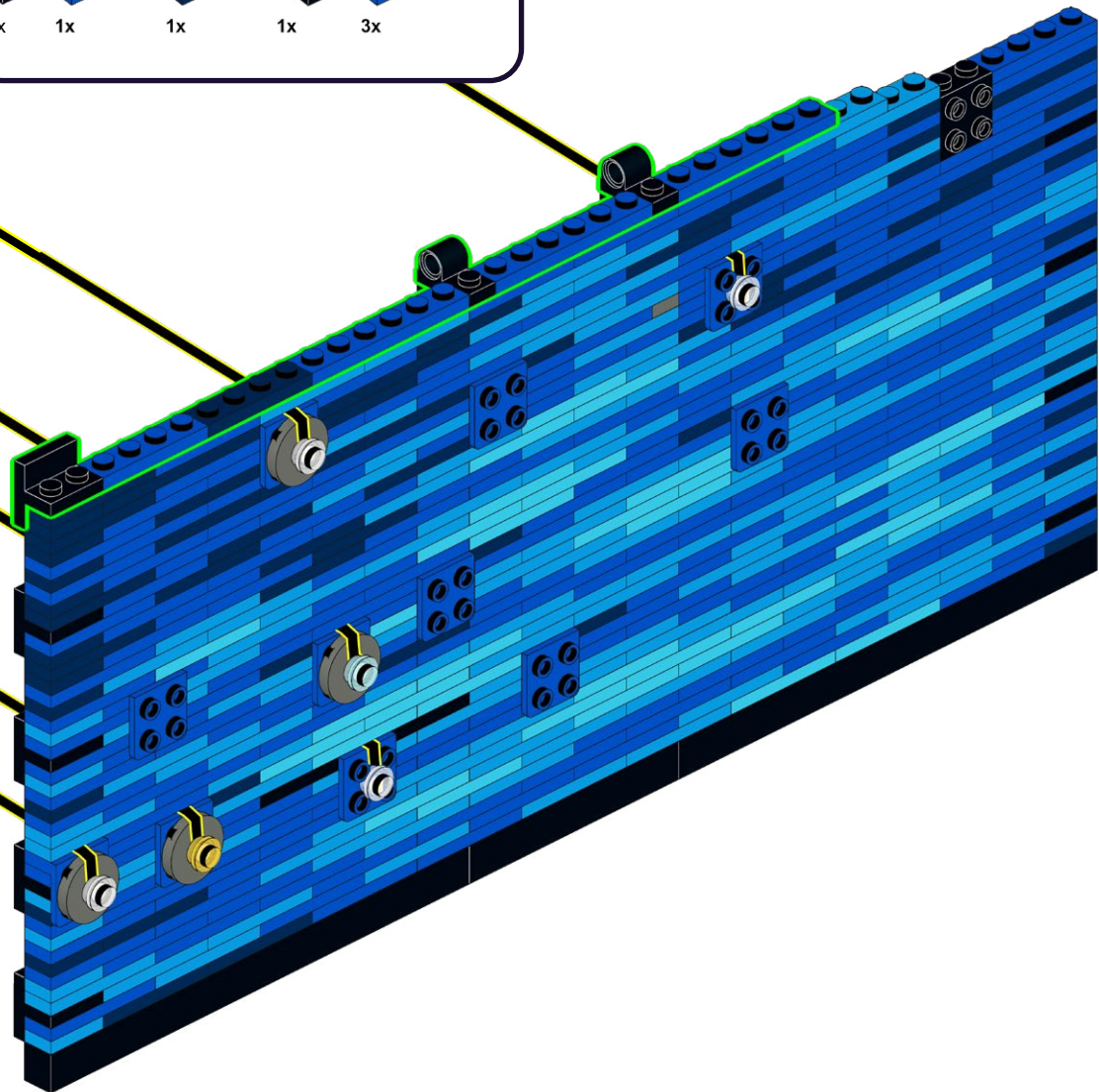
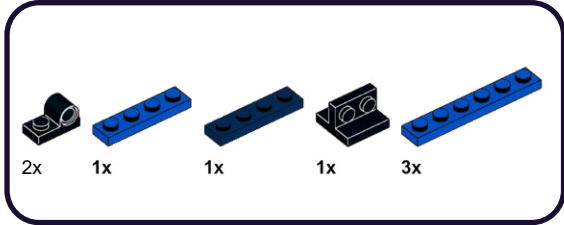



**230**

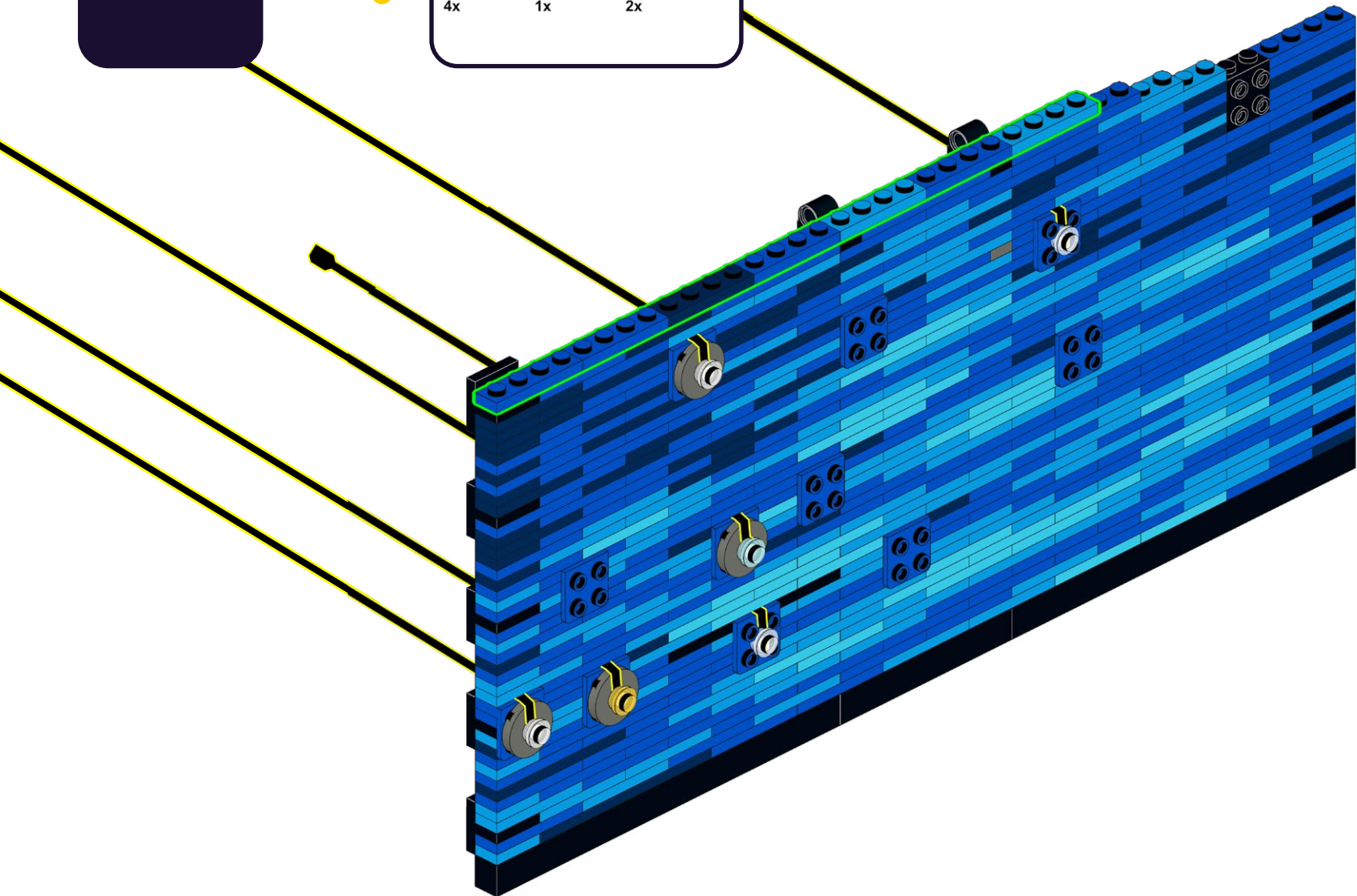
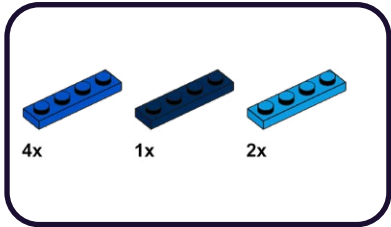

231

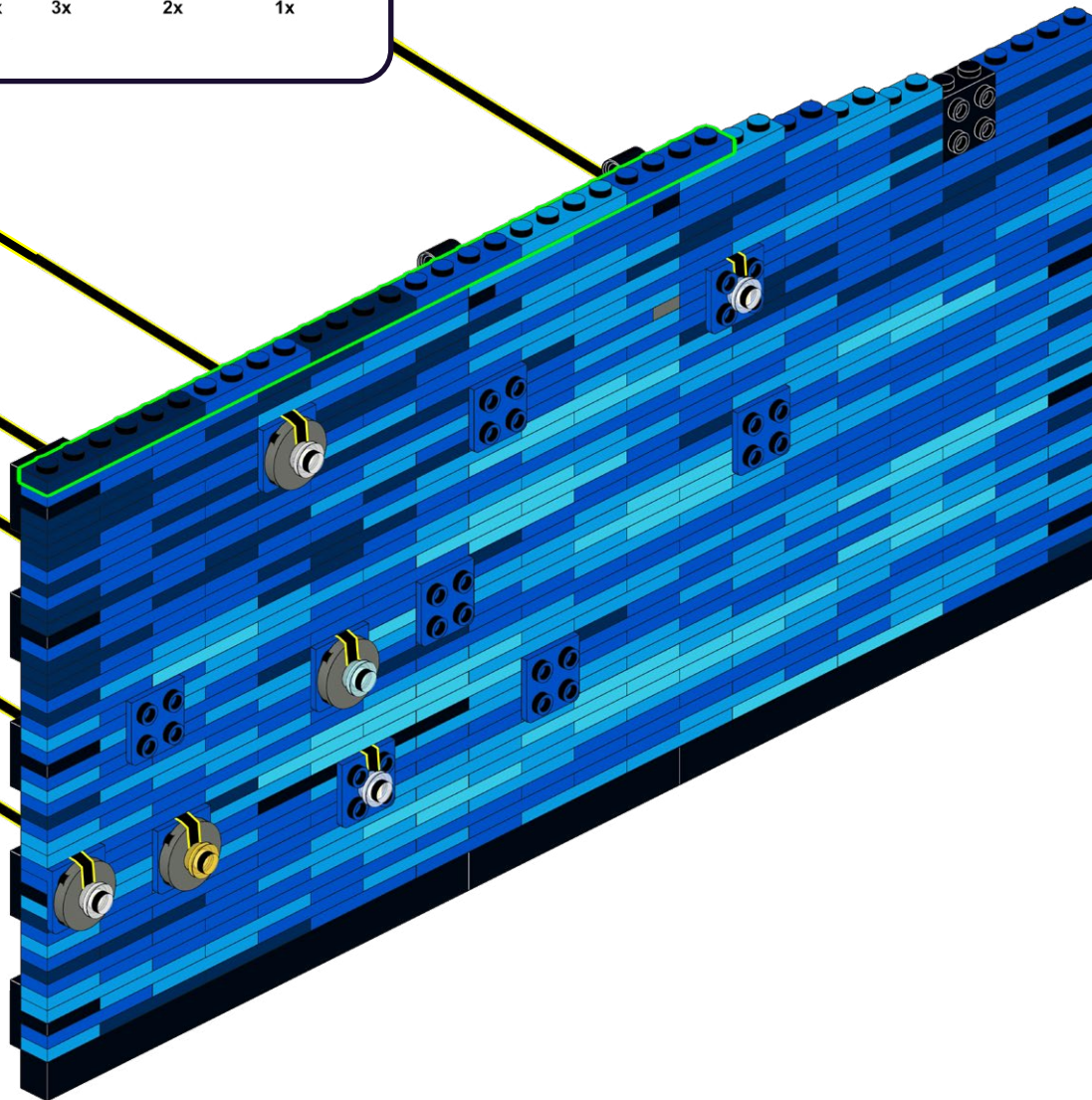
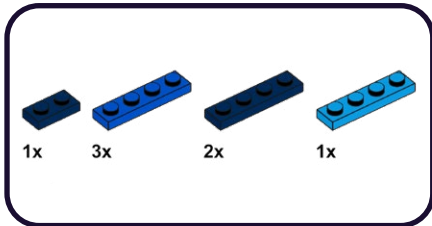



232

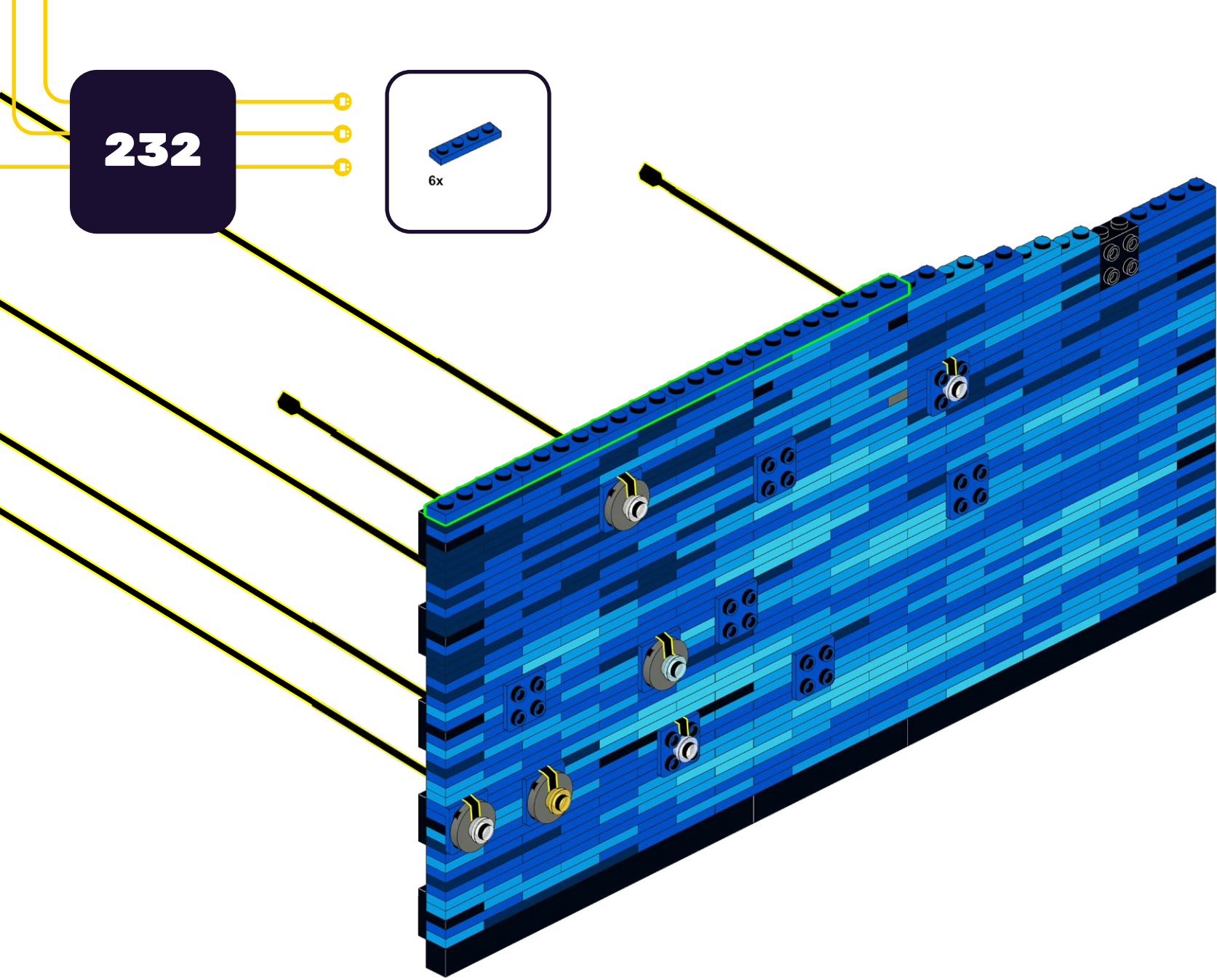
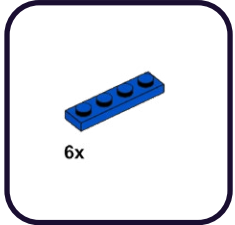

**233**

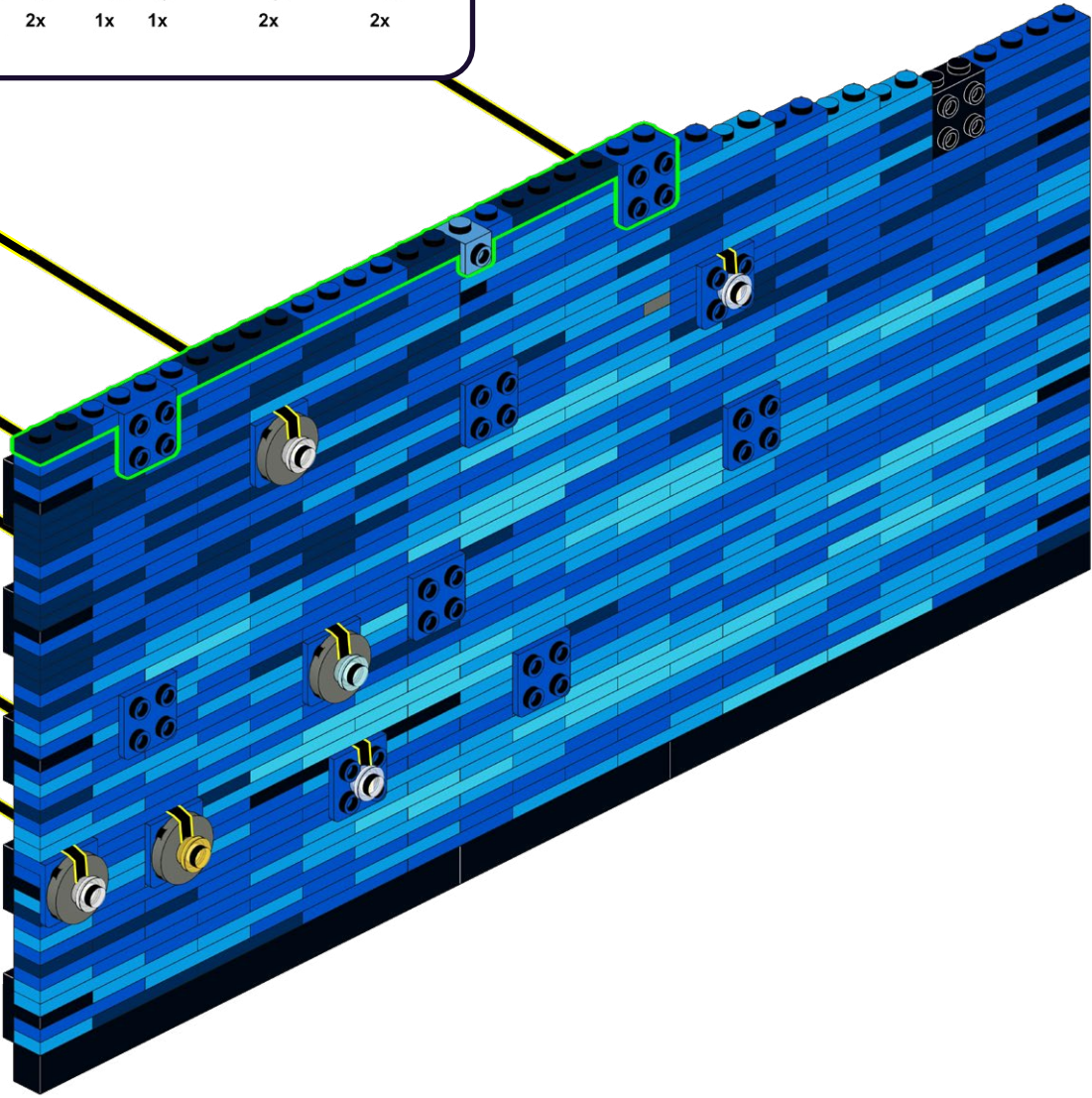
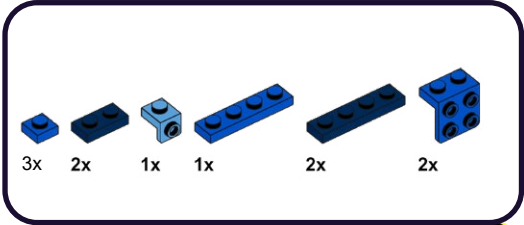



**234**

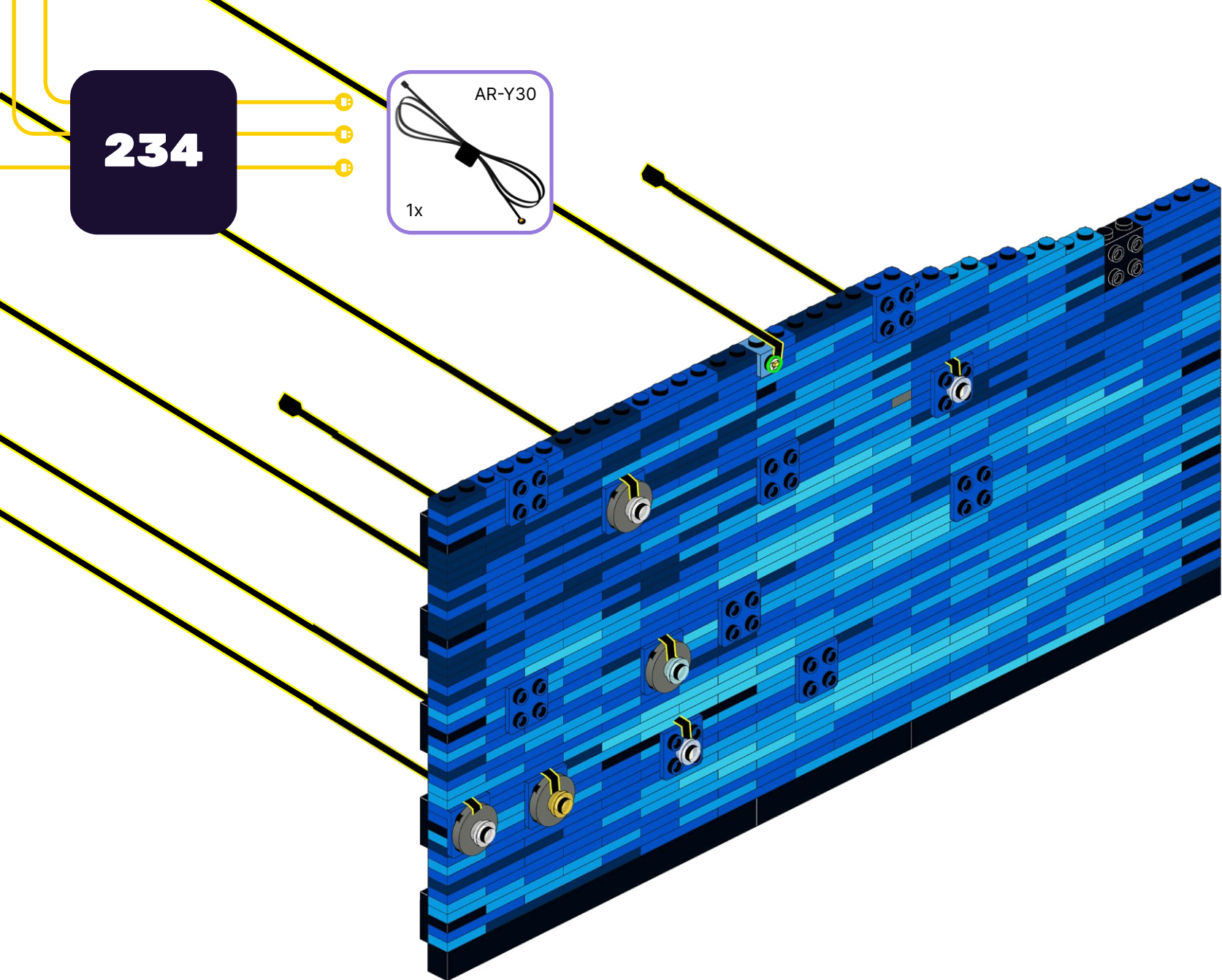
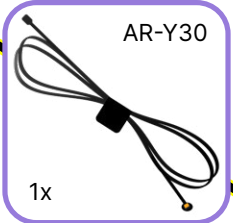

**235**

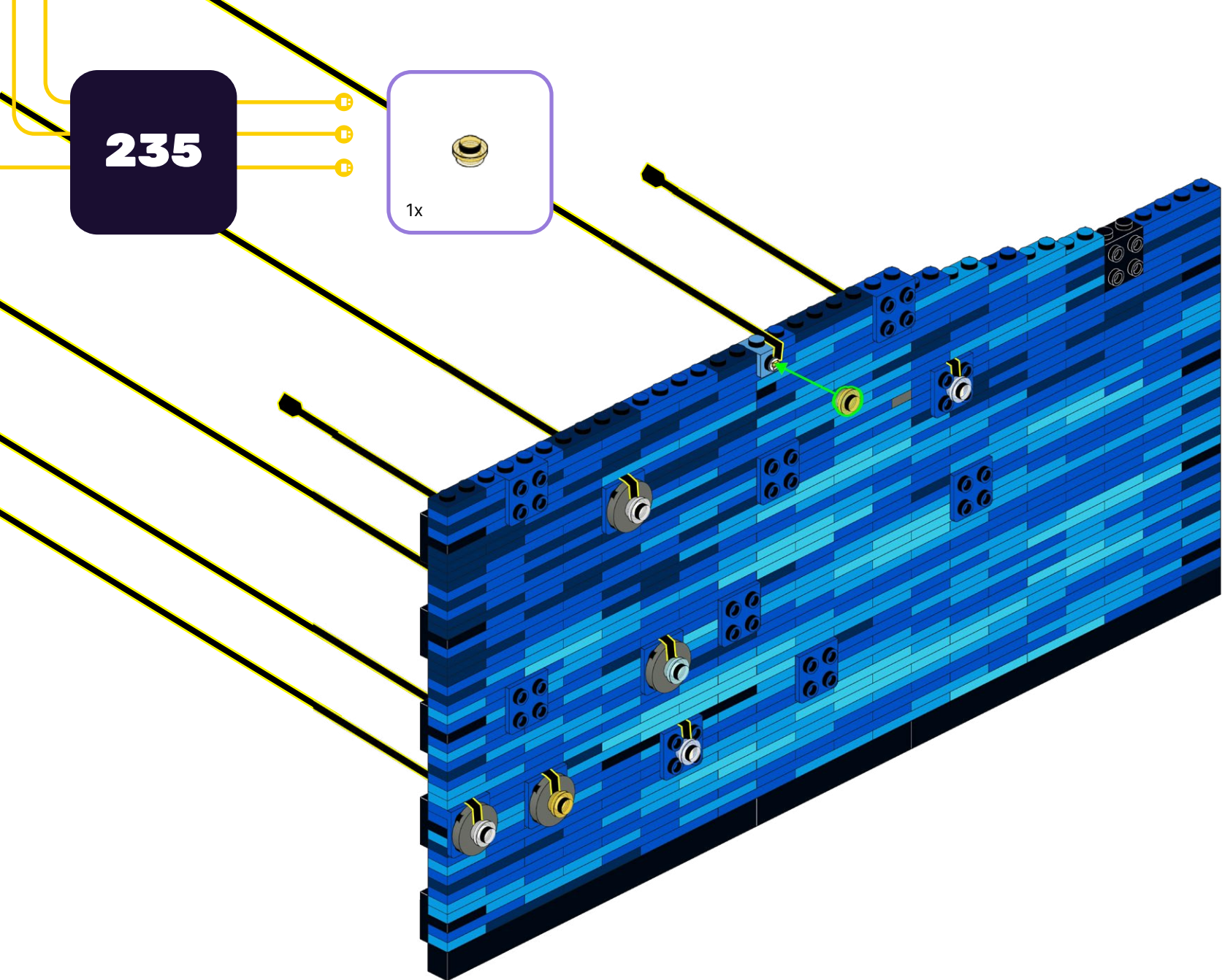
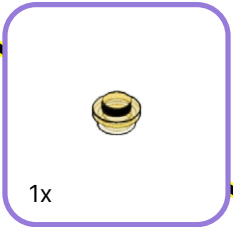



236

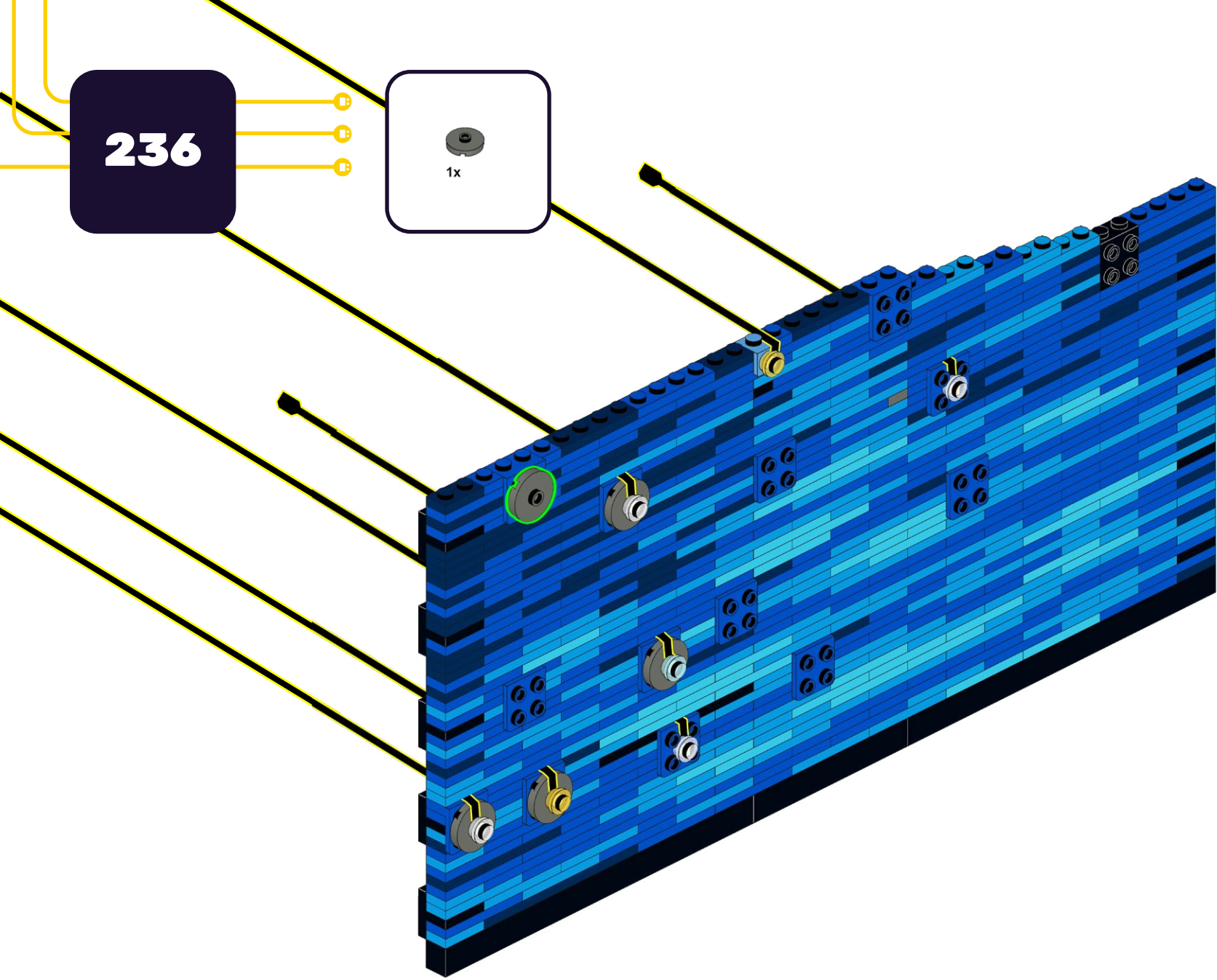

**237**

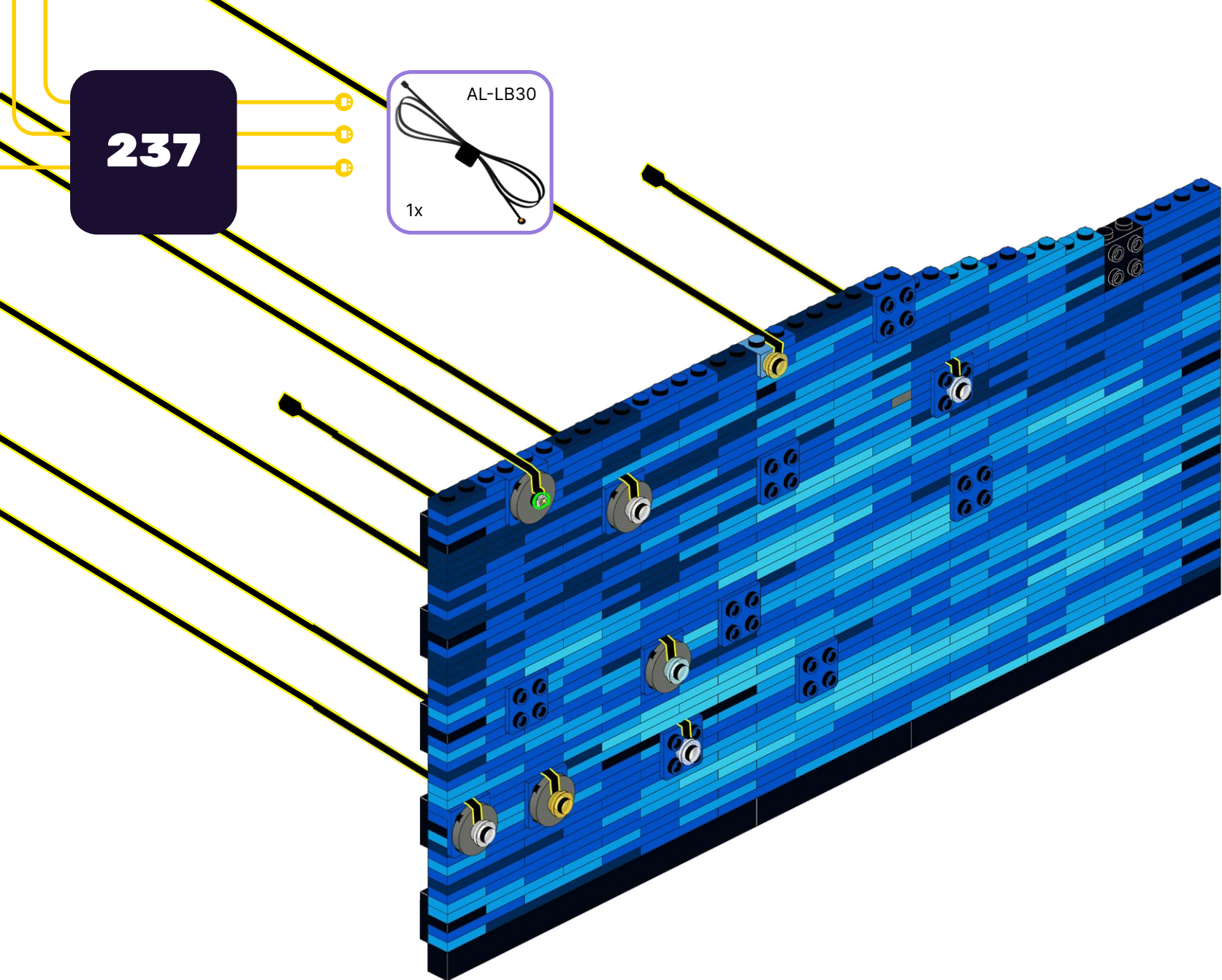
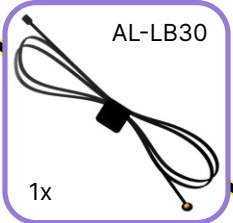



238

1x

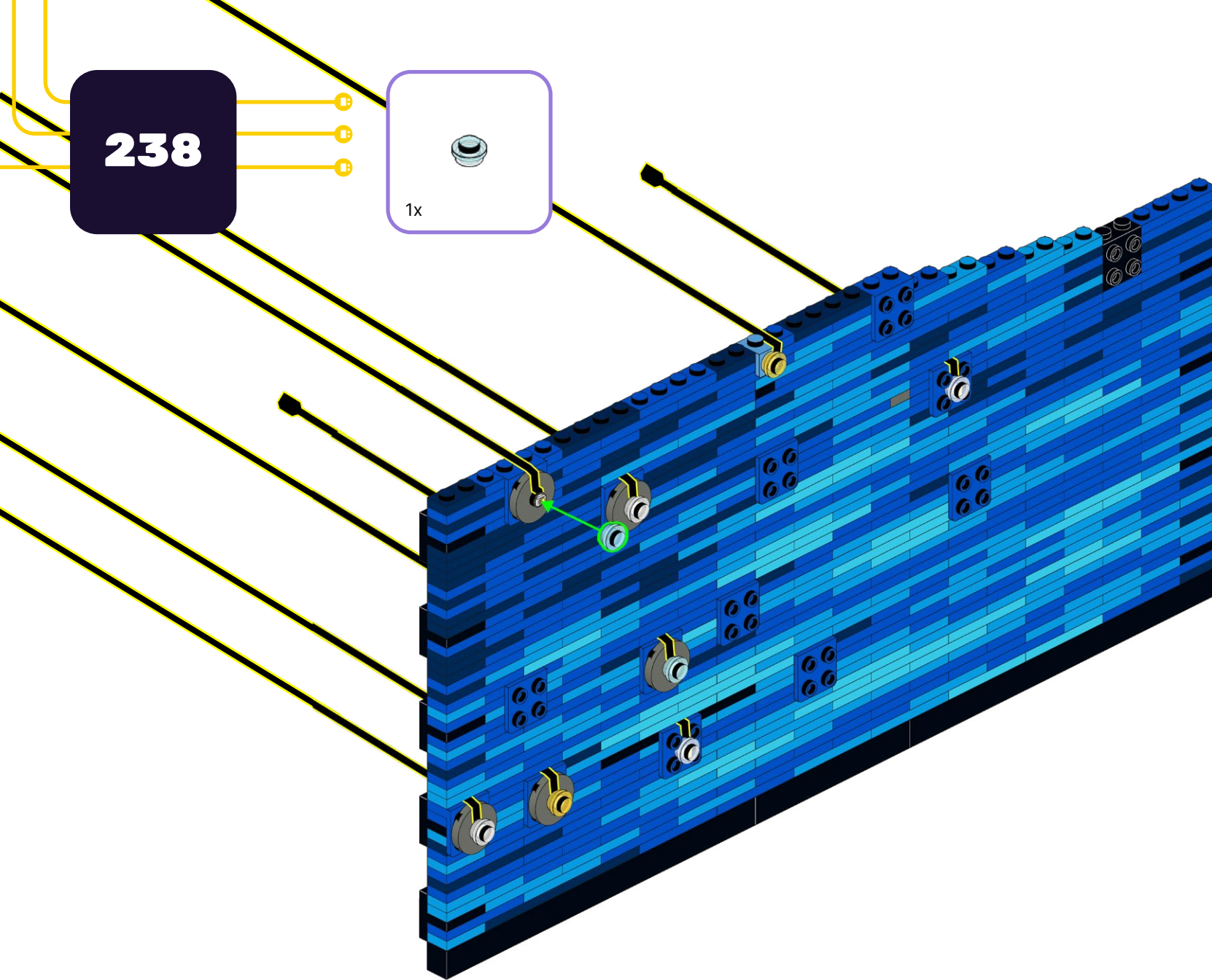

**239**

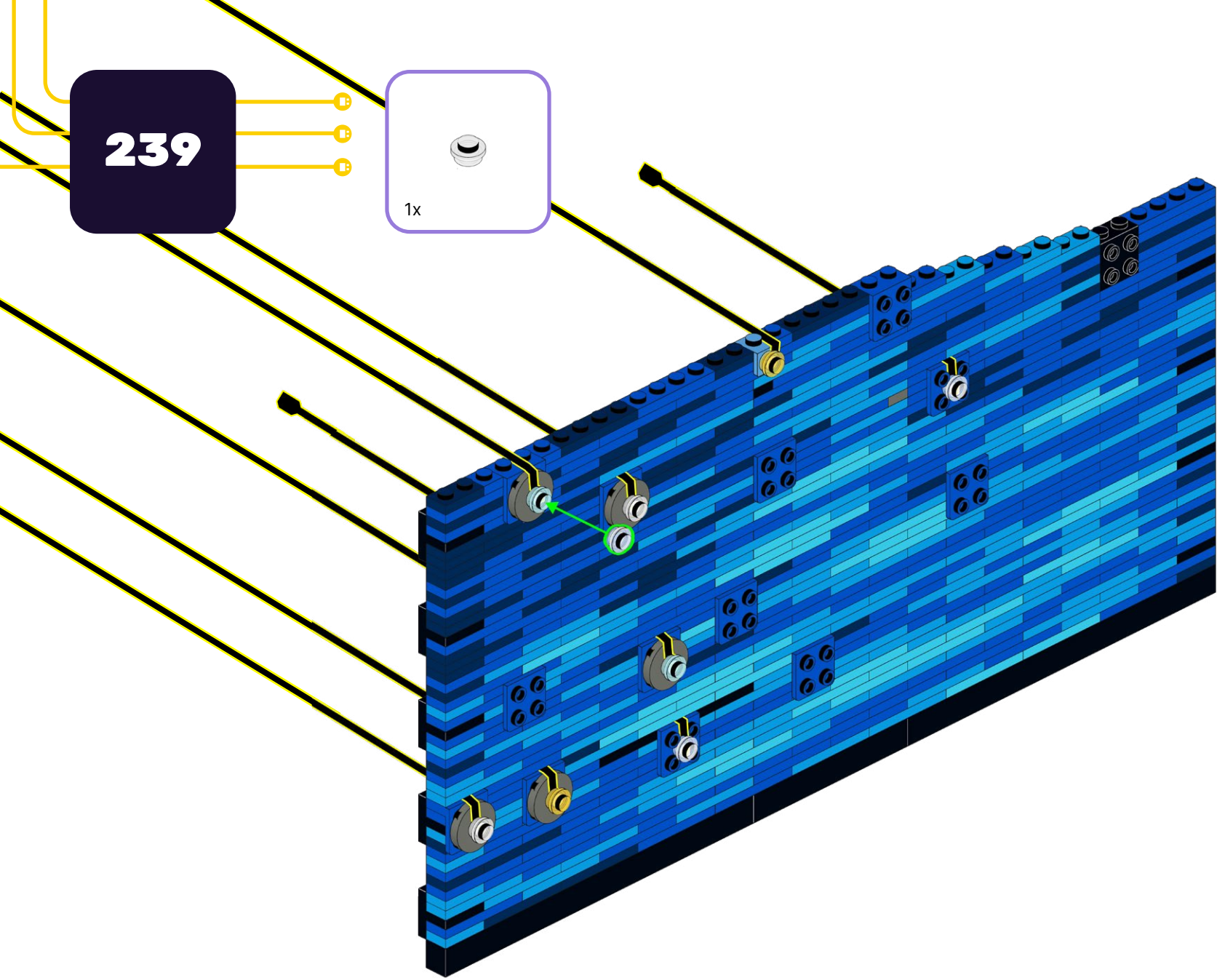
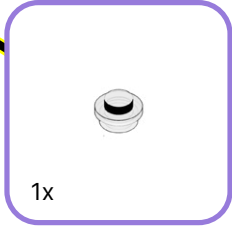



**240**

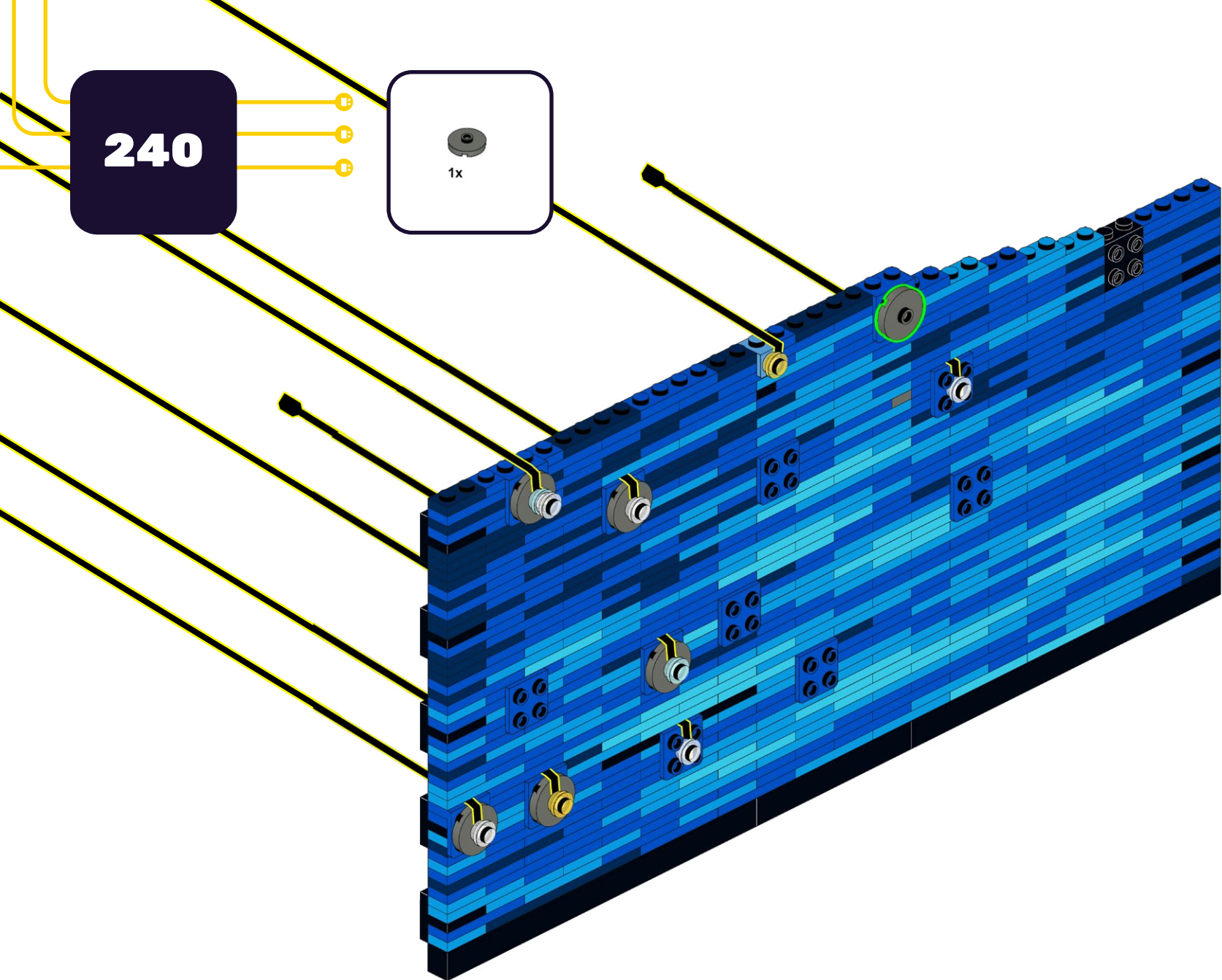

241

AL-LB30

1x

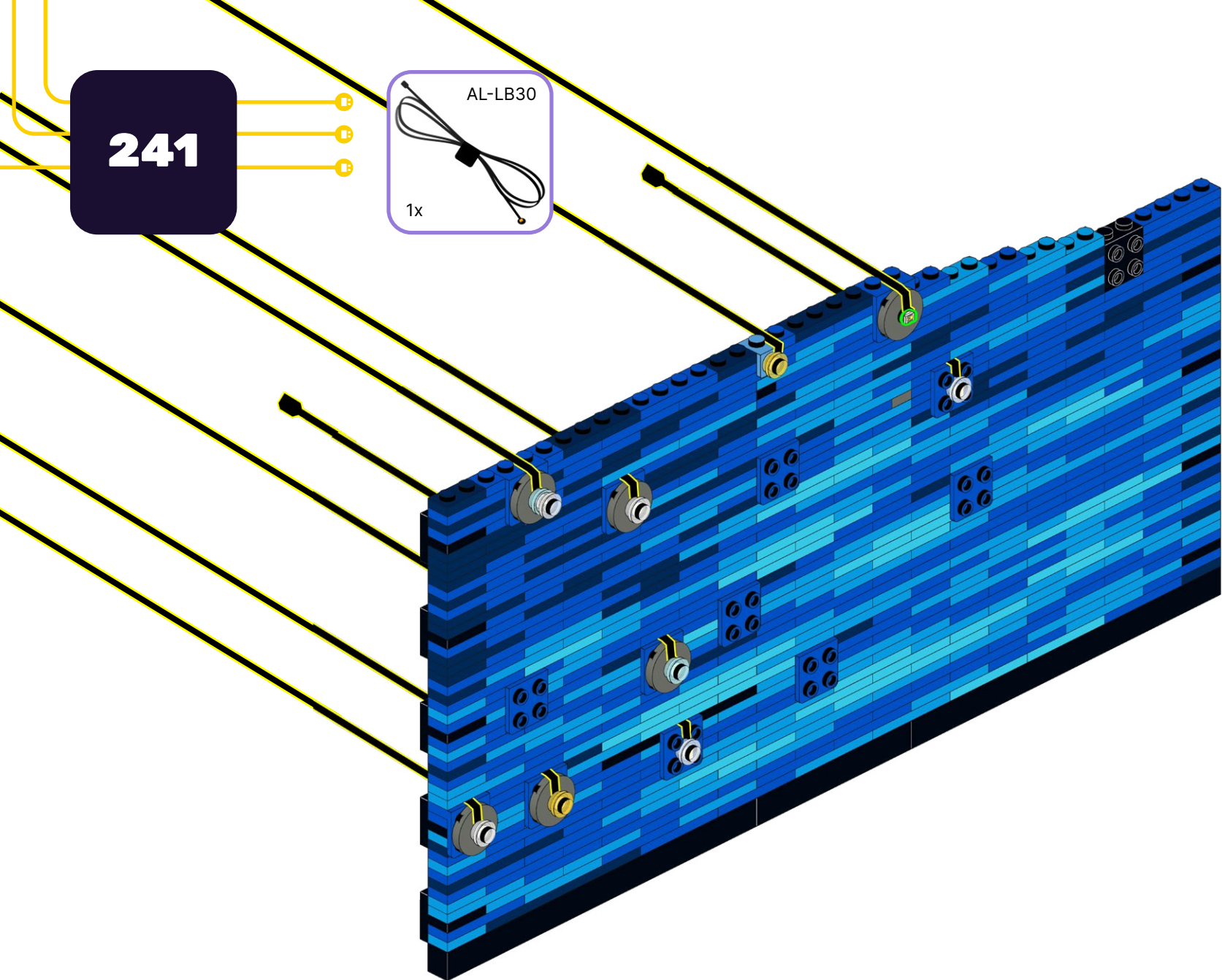
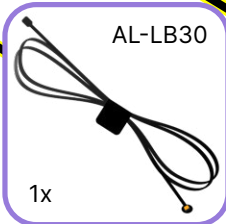



**242**

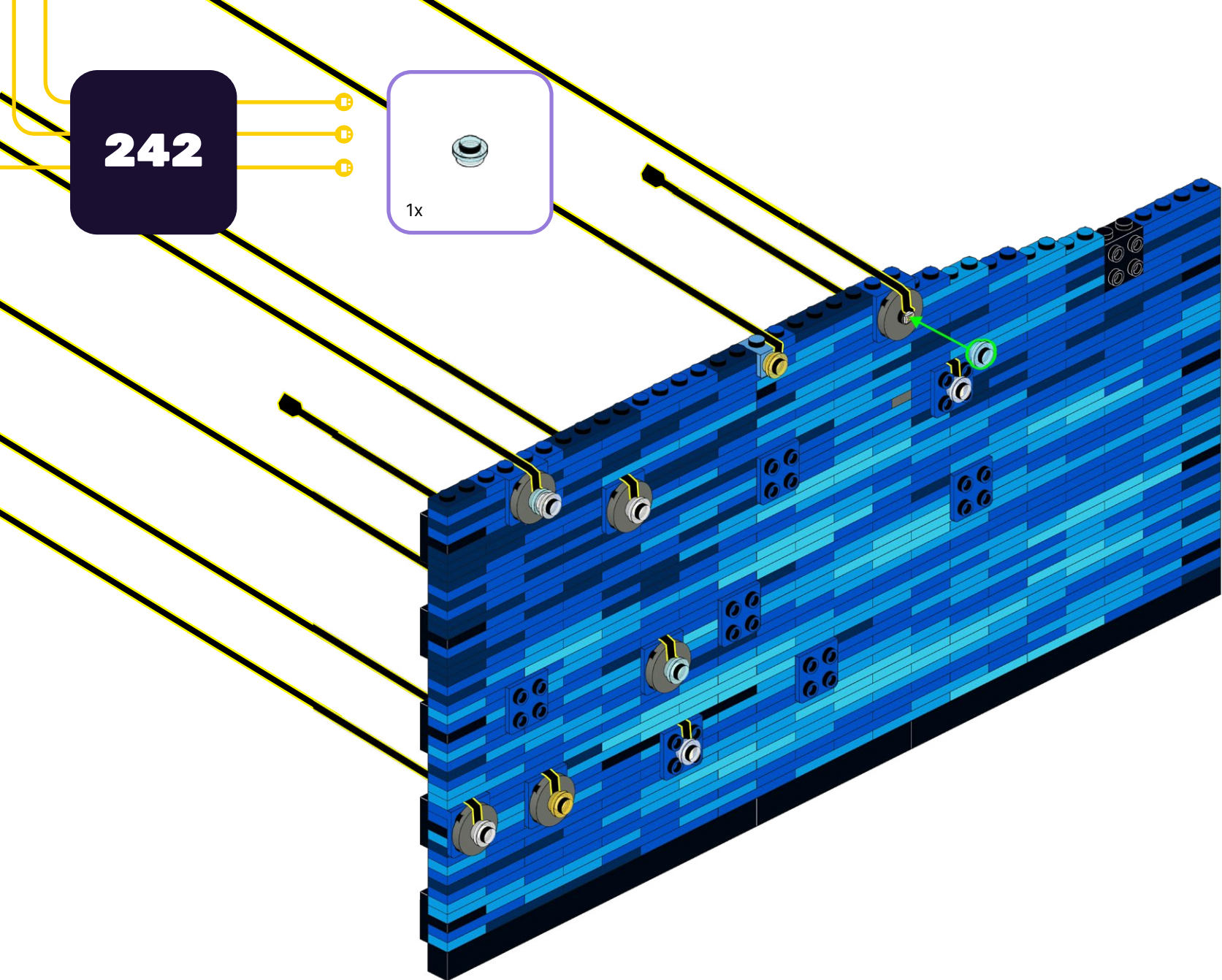

**243**

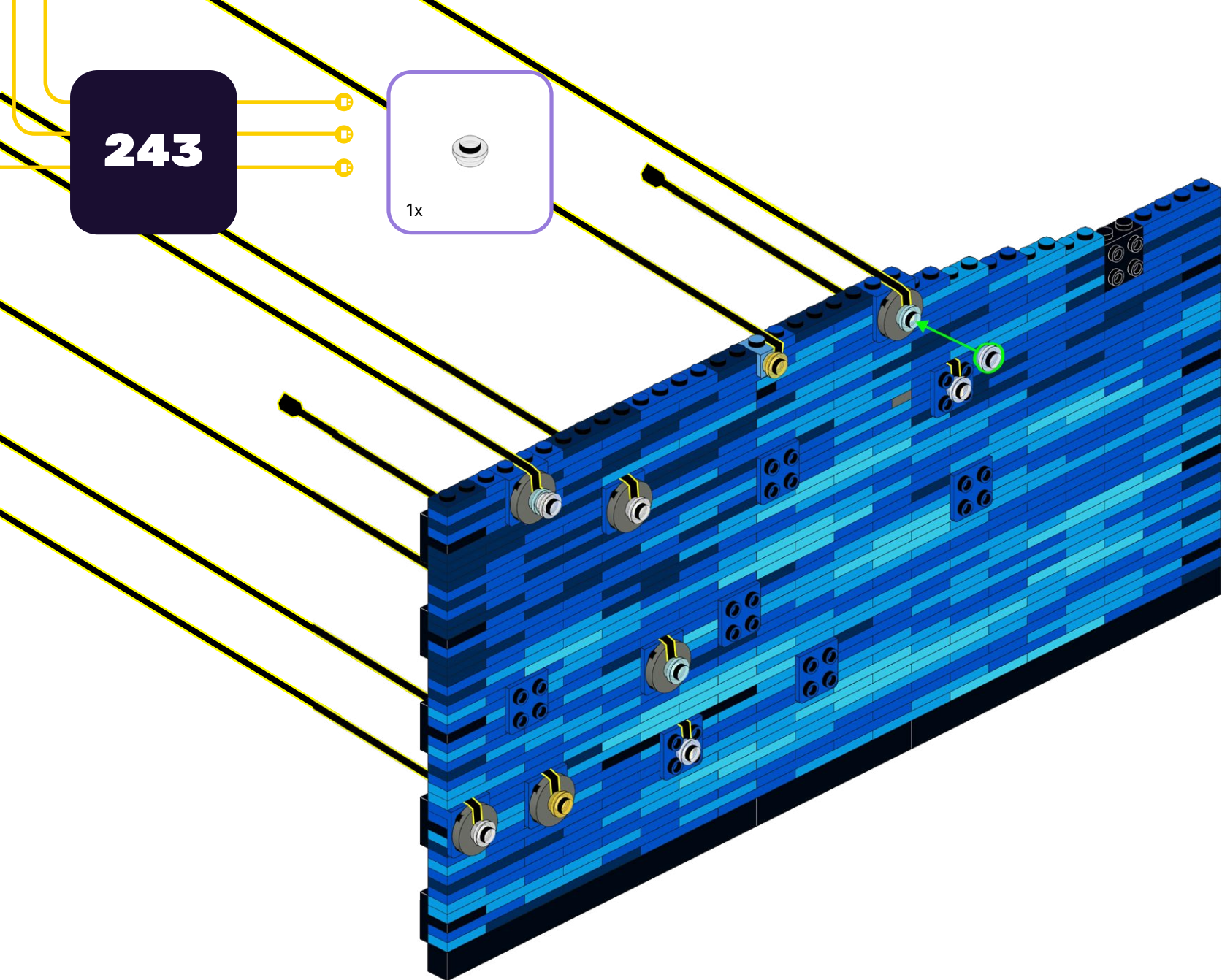
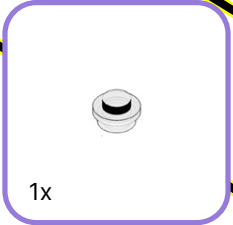



**244**

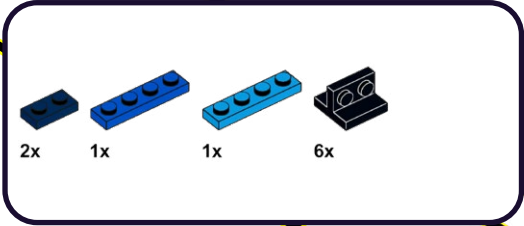

2x 1x 1x 6x

This inset box shows the parts list for step 244. It contains four items: a dark blue 1x2 Technic brick (2x), a dark blue 1x3 Technic brick (1x), a dark blue 1x4 Technic brick (1x), and a dark blue 1x6 Technic brick with a hole (6x).

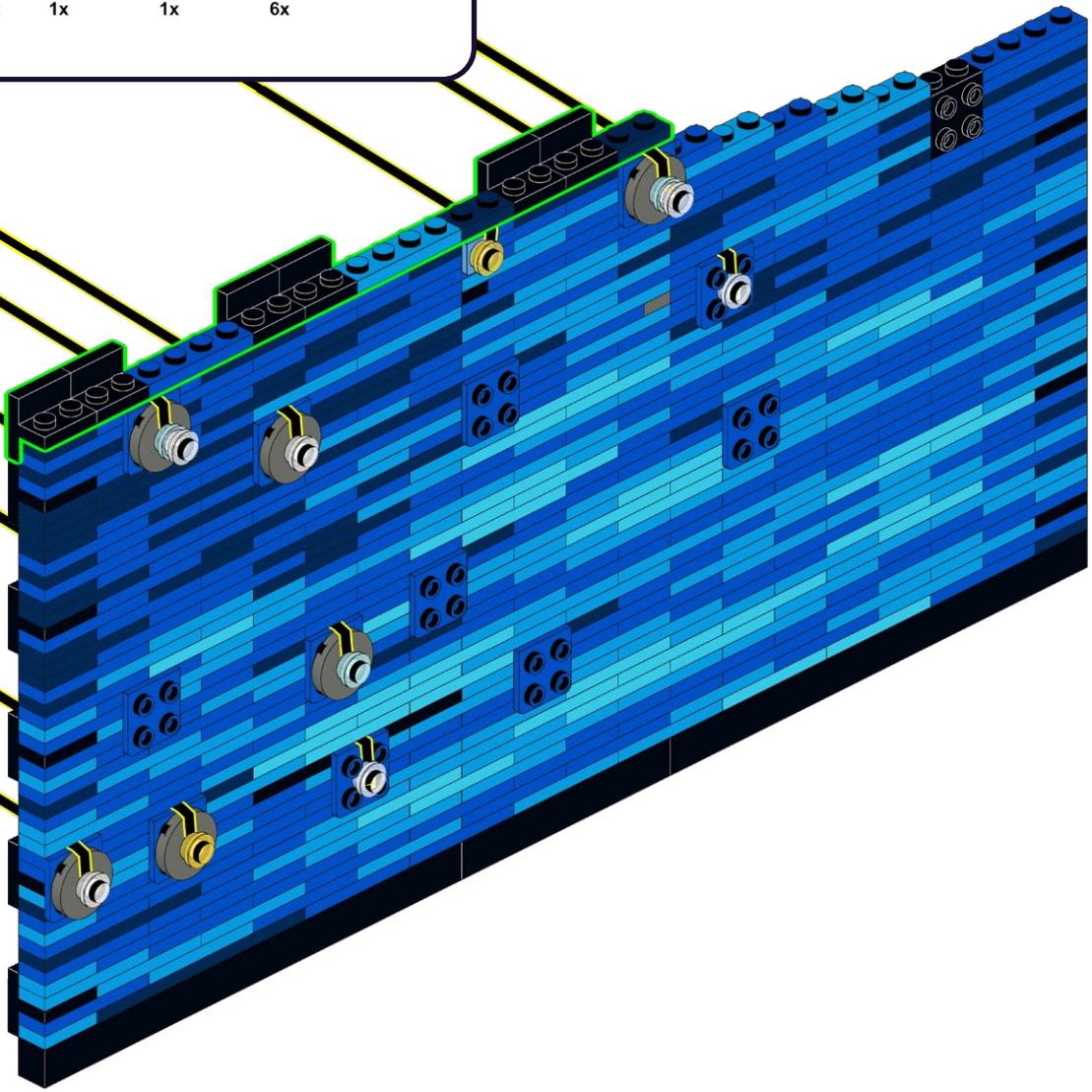

**245**

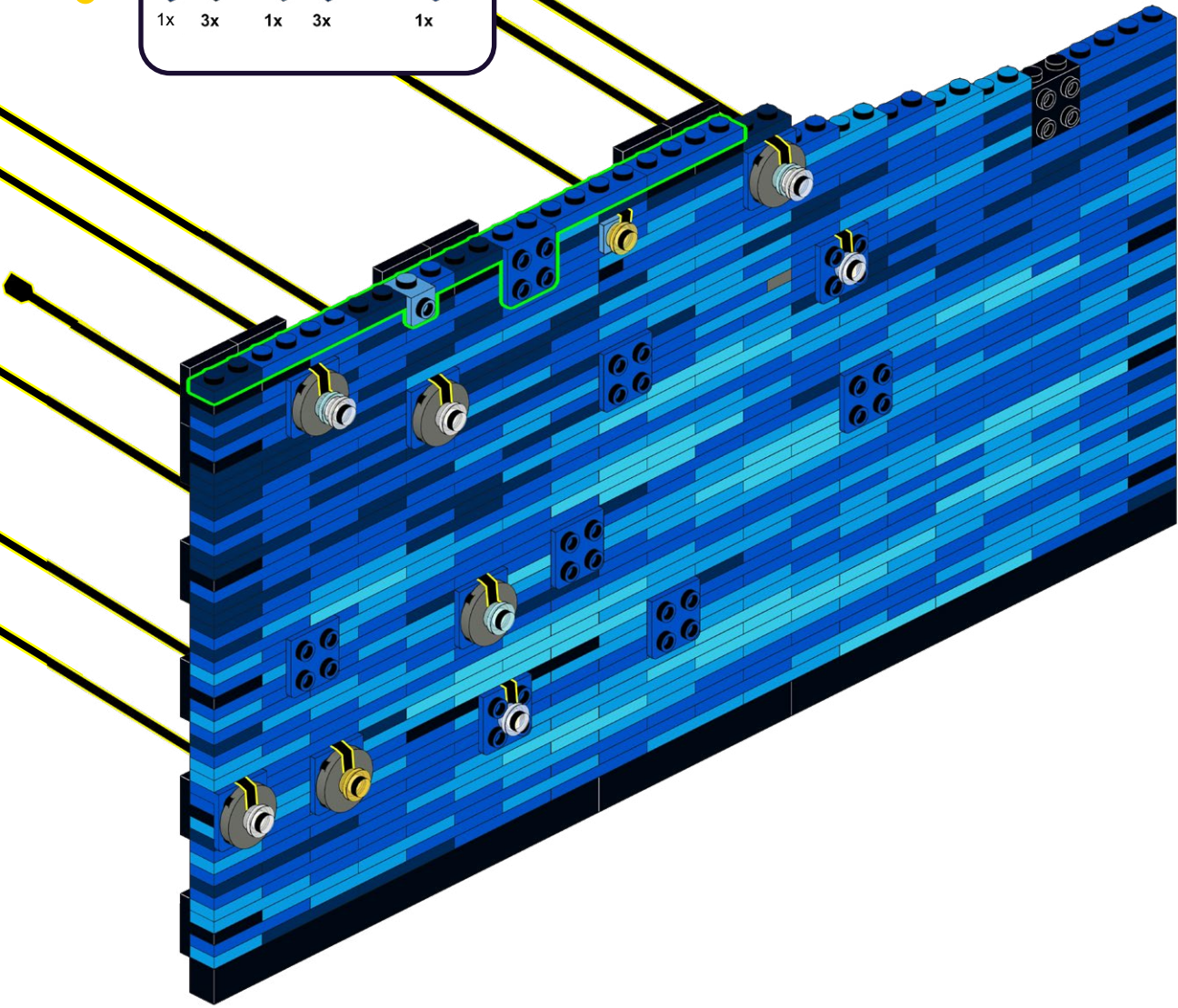
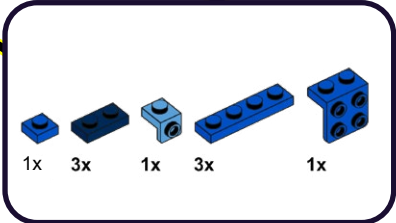



**246**

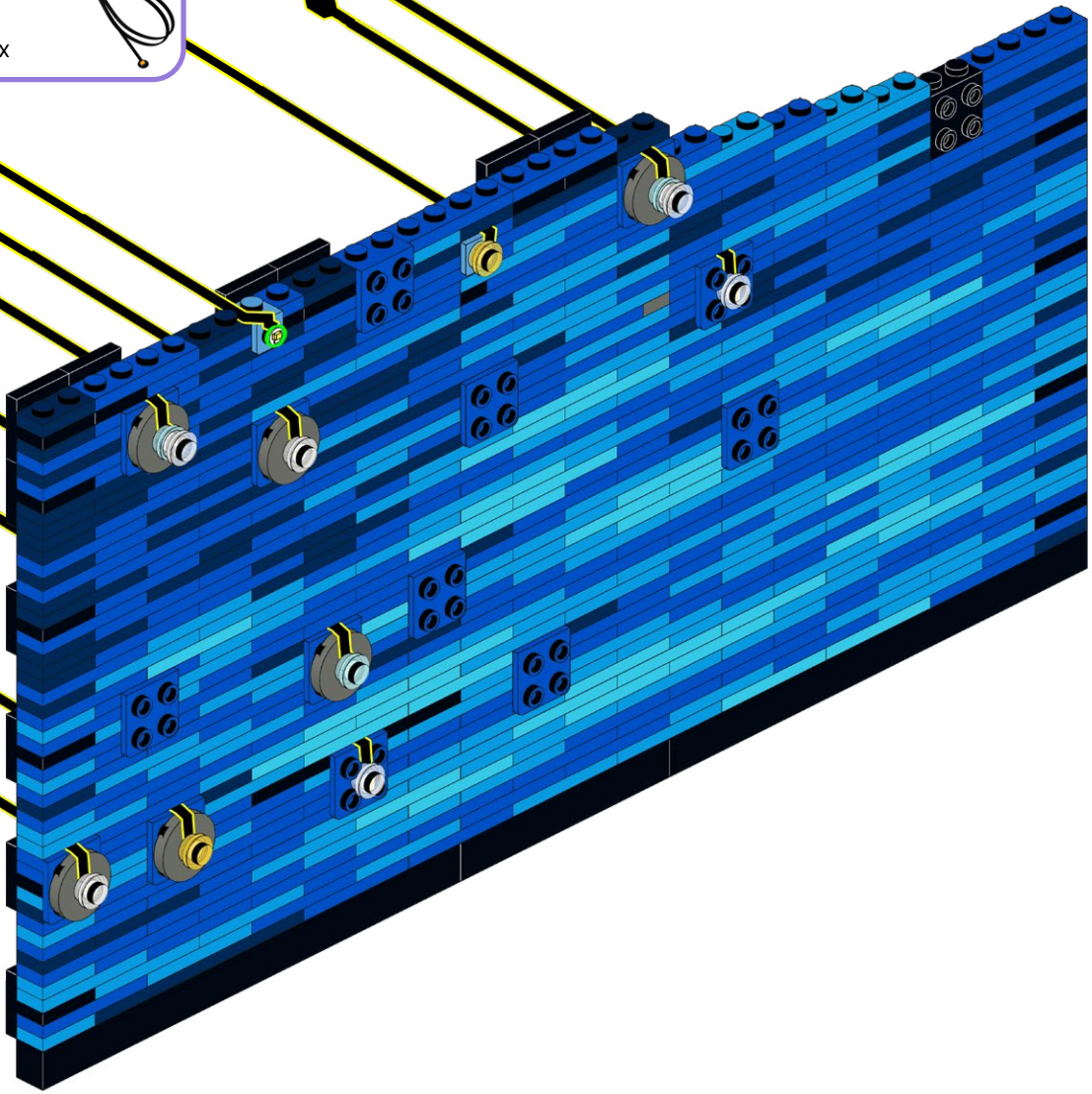
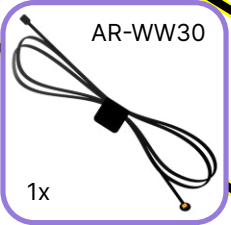



**247**

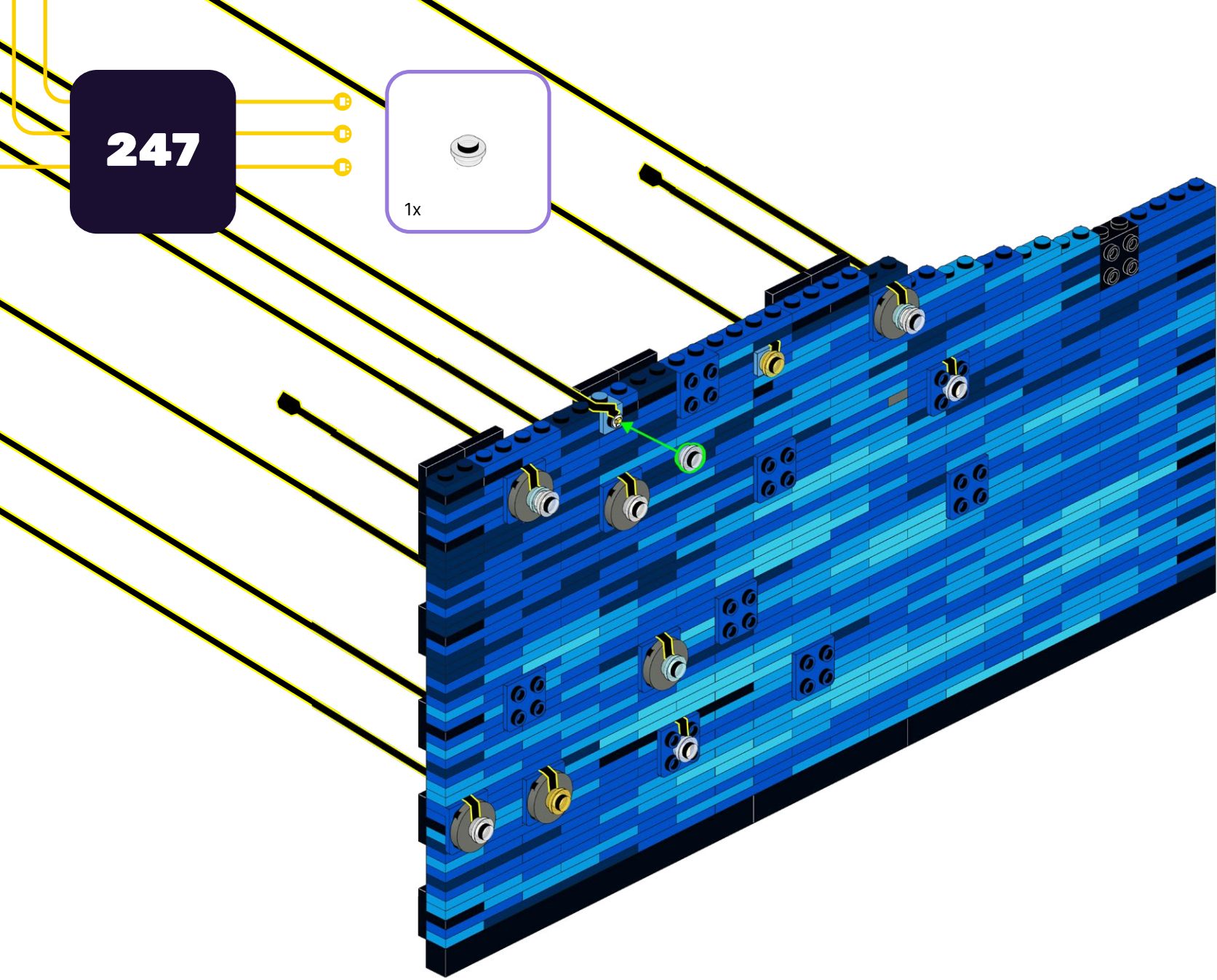
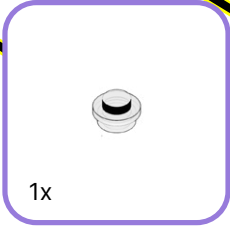

**248**

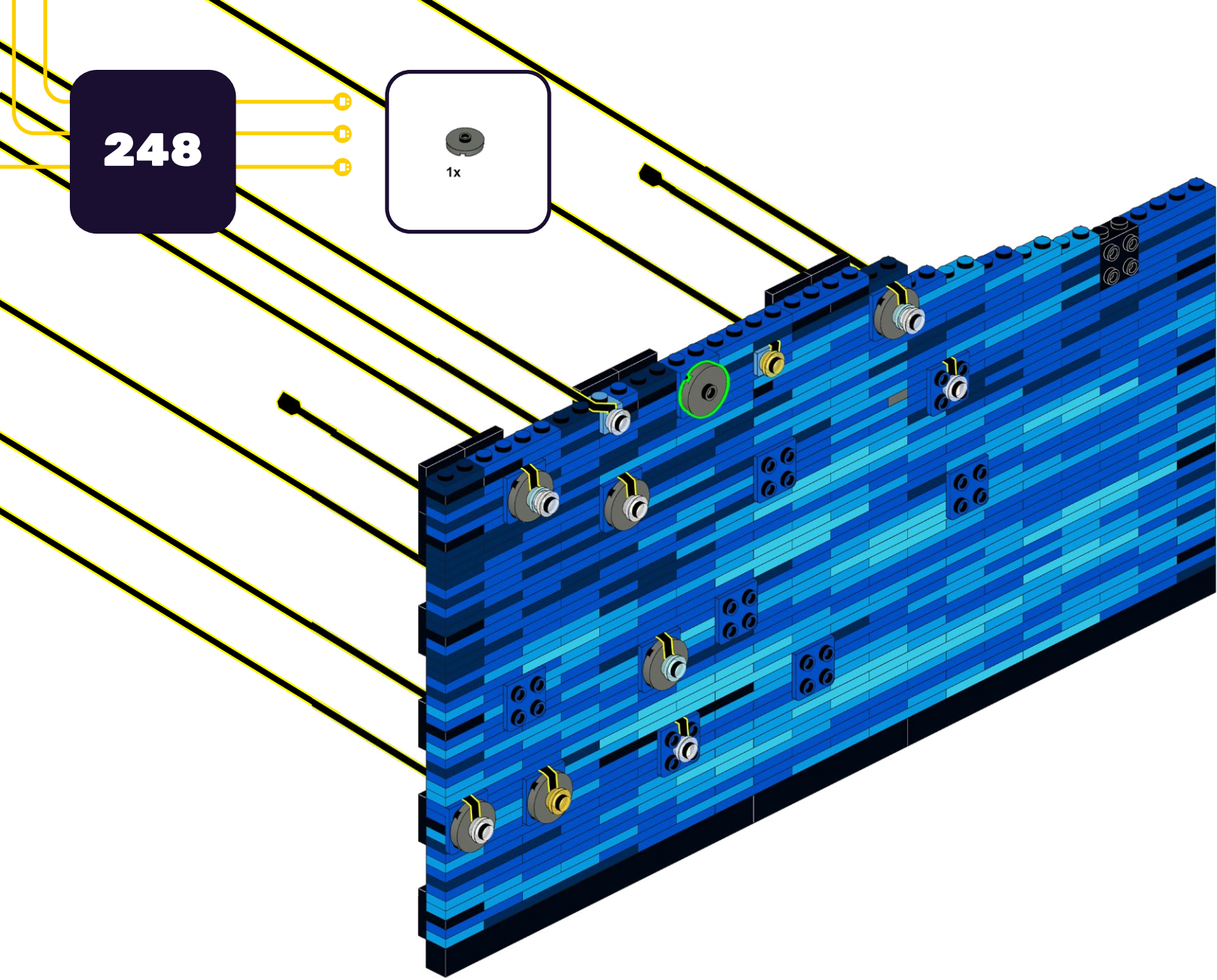



**249**

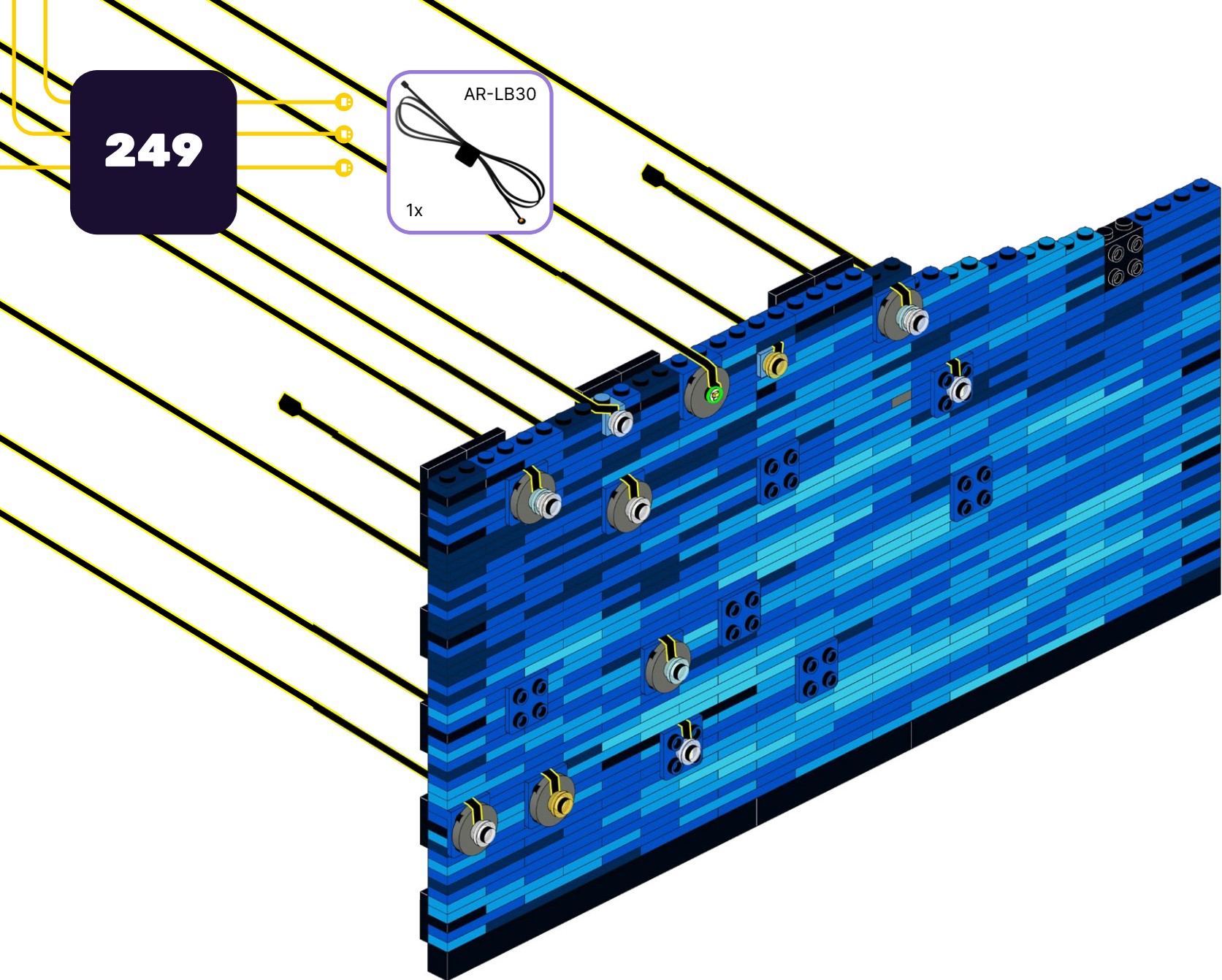
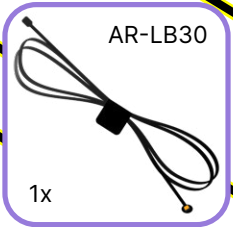

**250**

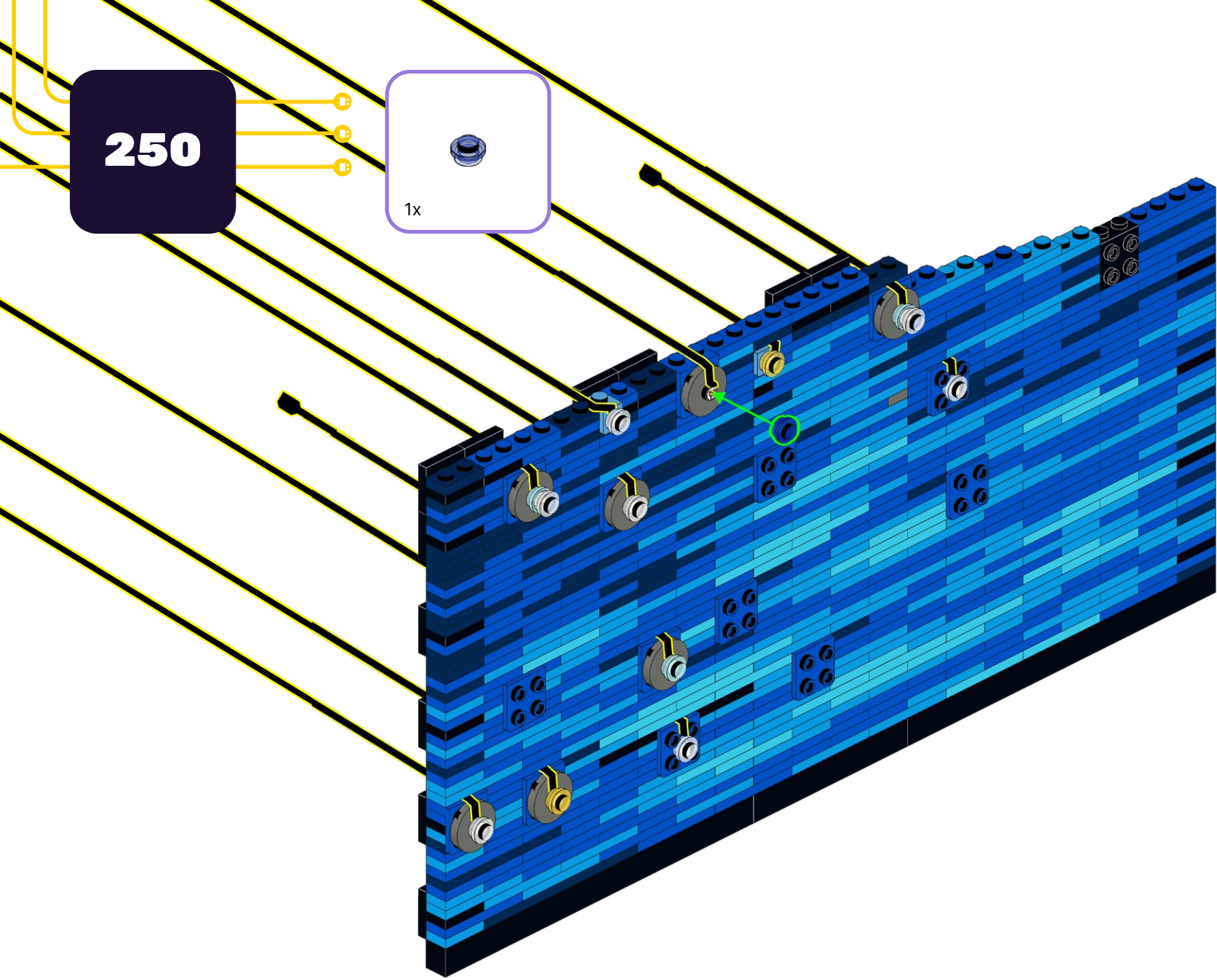



251



1x

1x

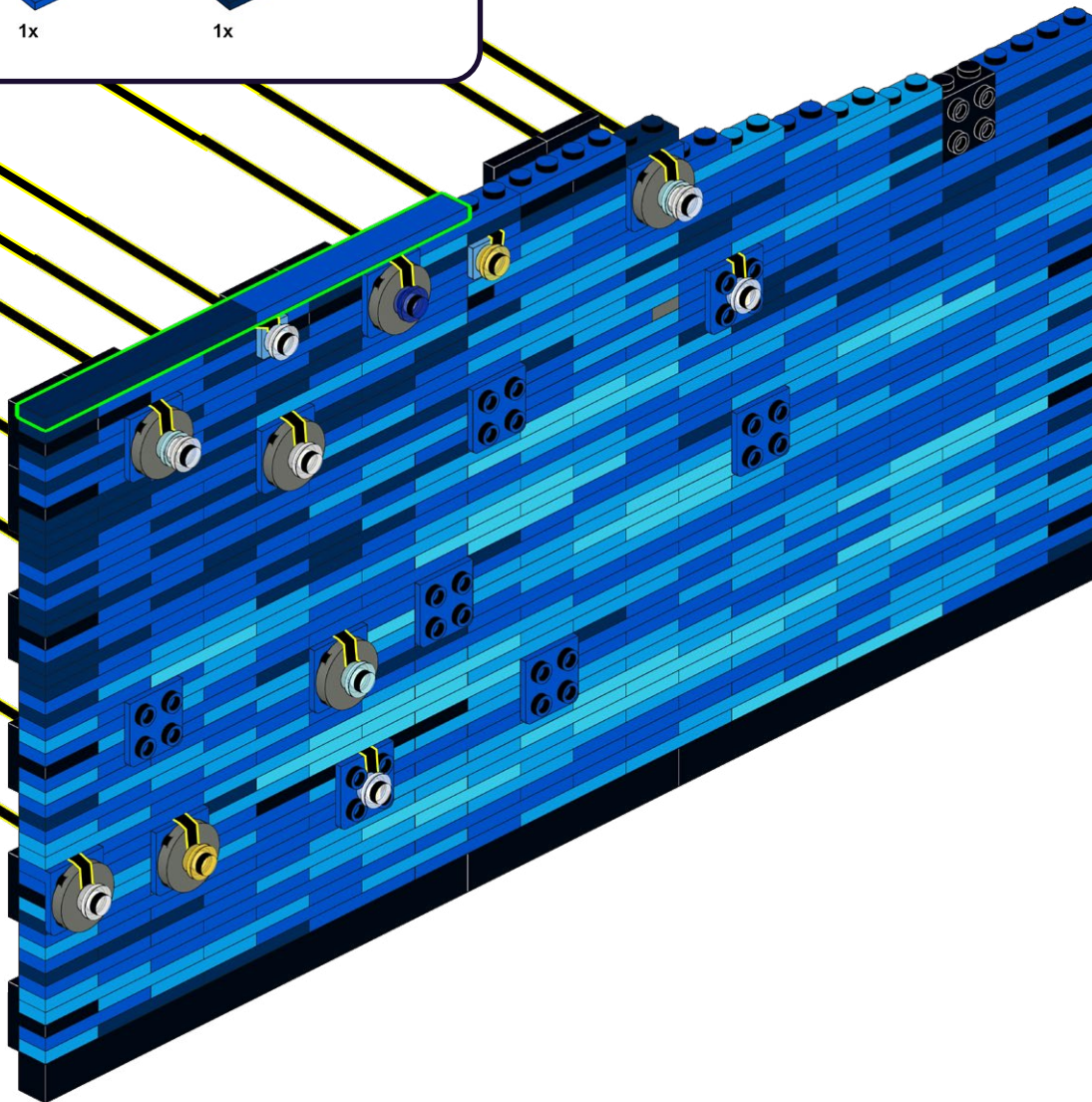



252

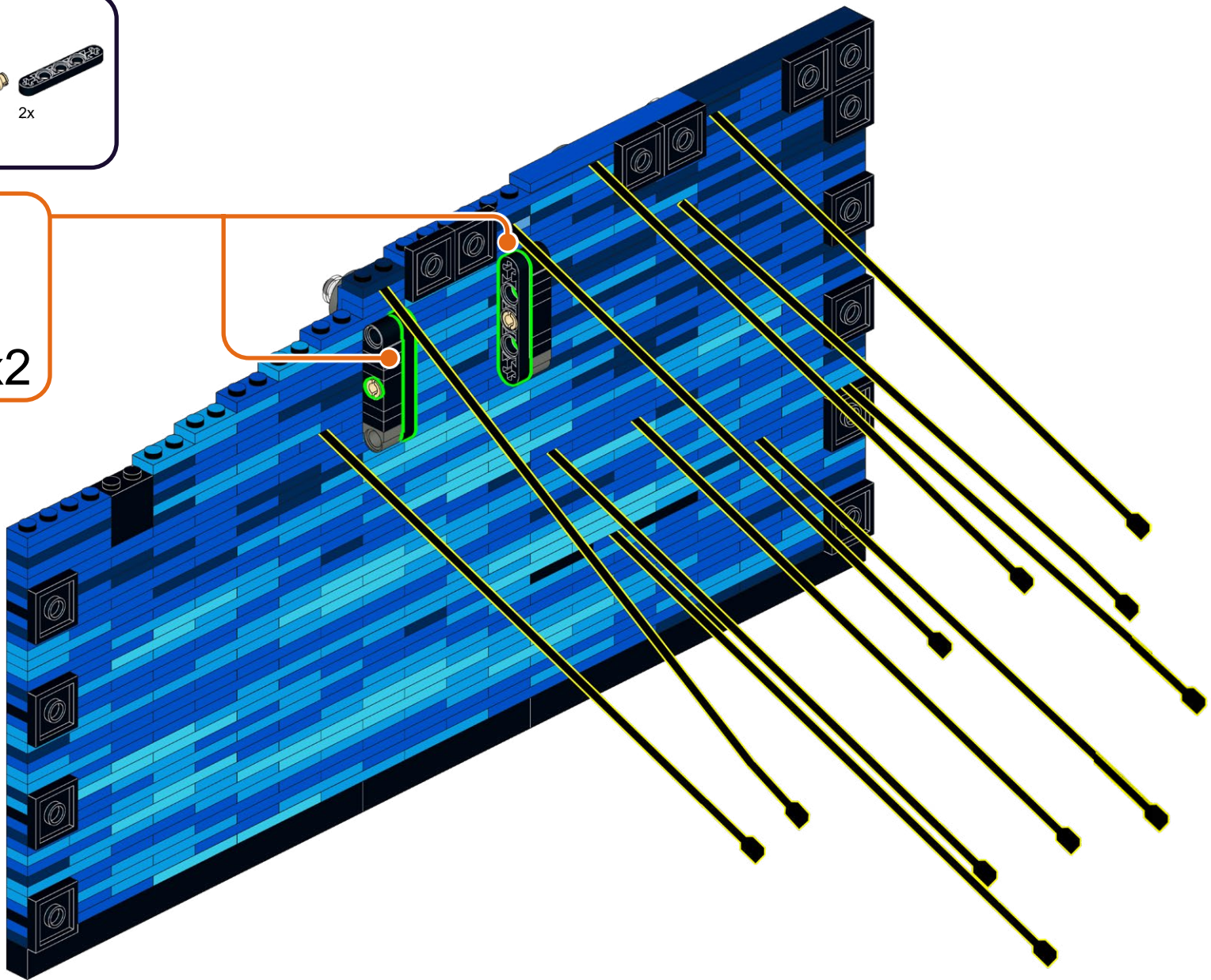
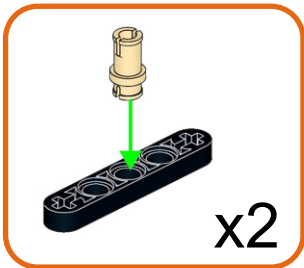
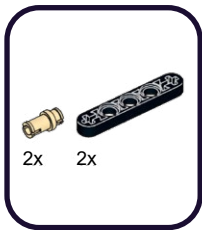
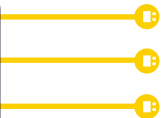

253

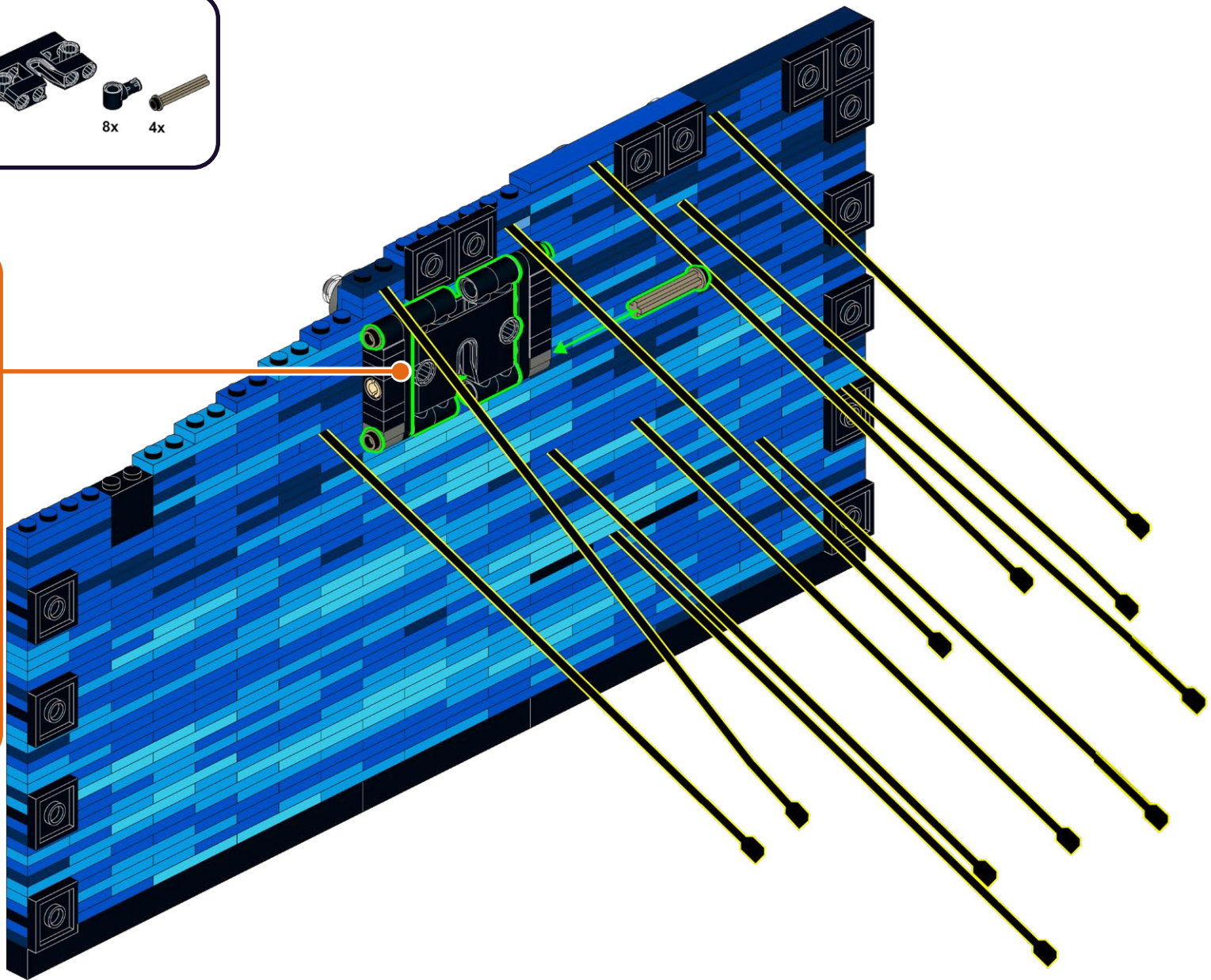
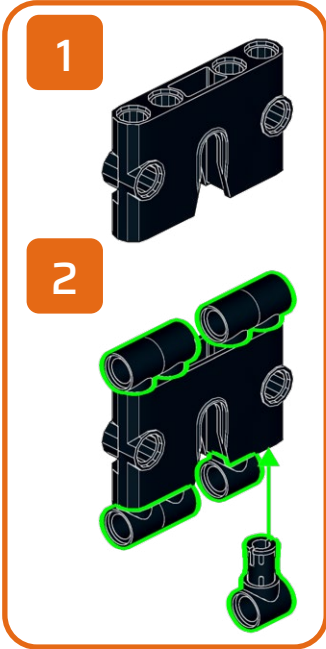
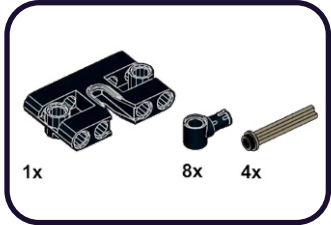



254

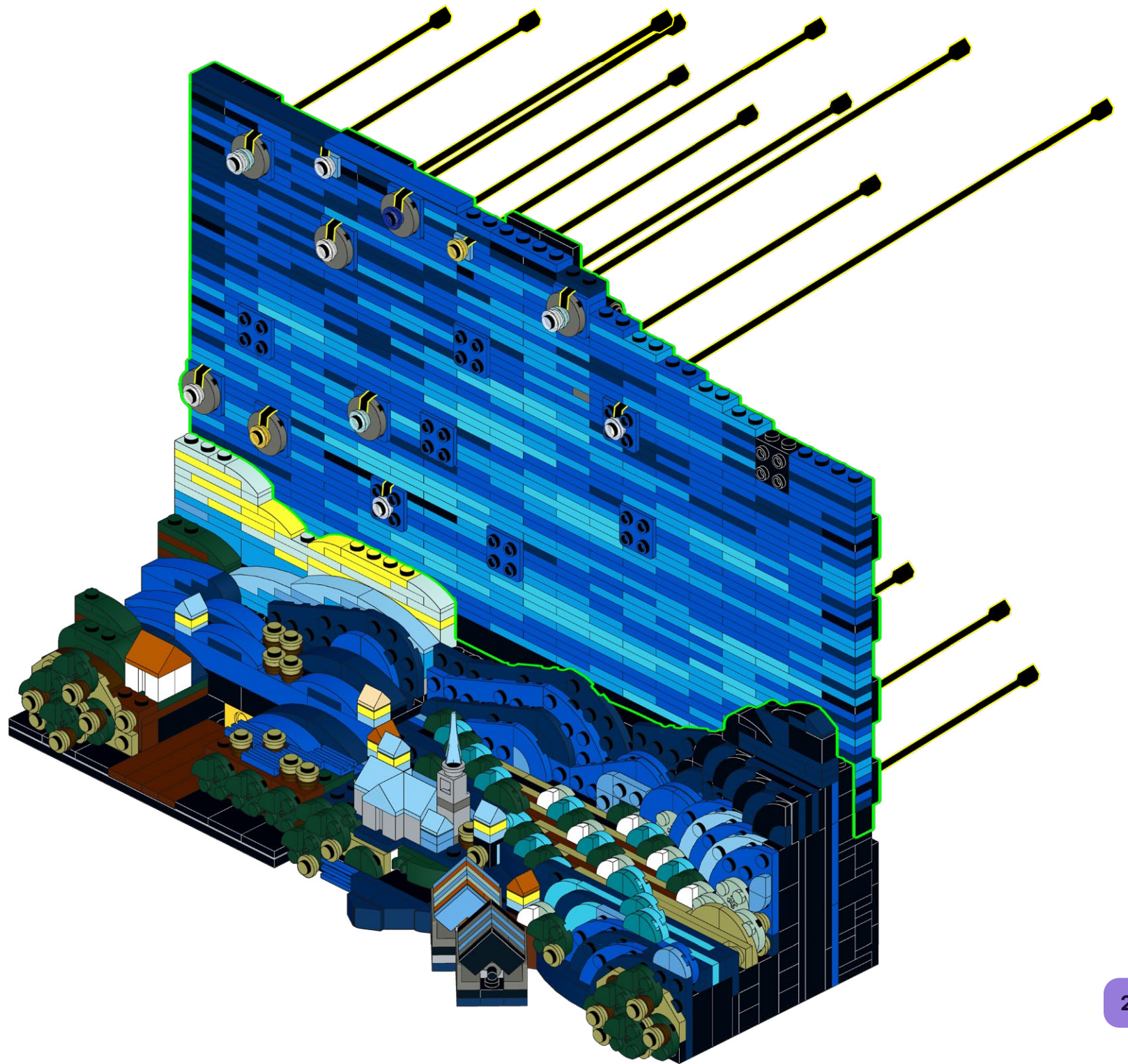

# 255

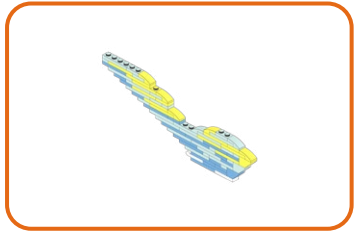

1

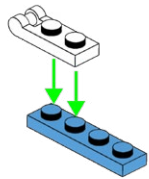
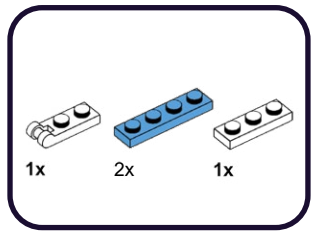

2

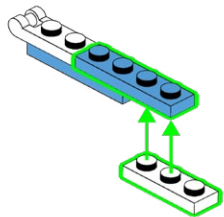

# 256

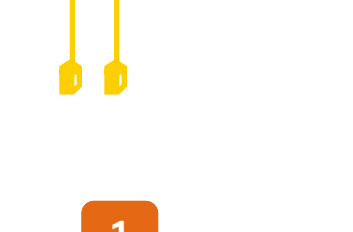

1

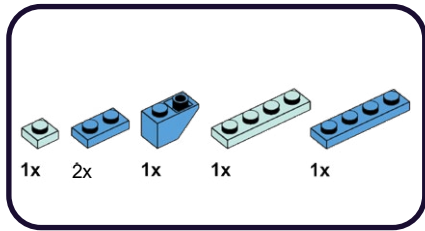

2

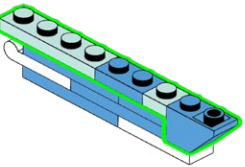
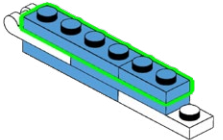

# 257

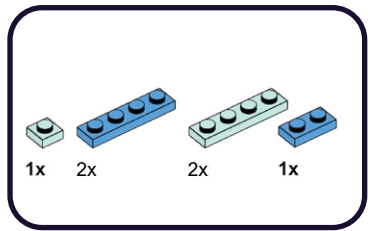

1

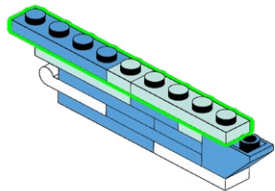

2

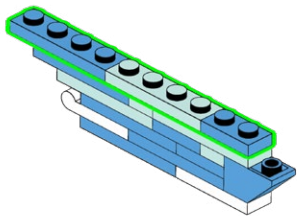

# 258

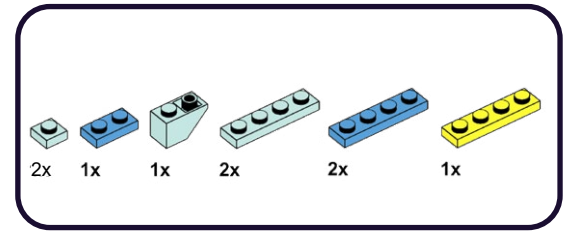

1

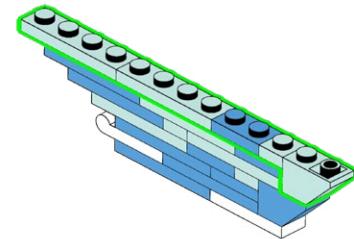

2

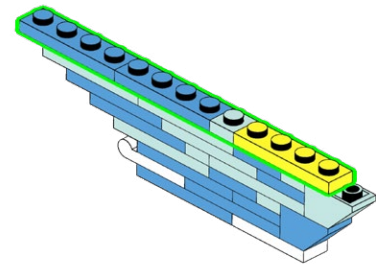



259

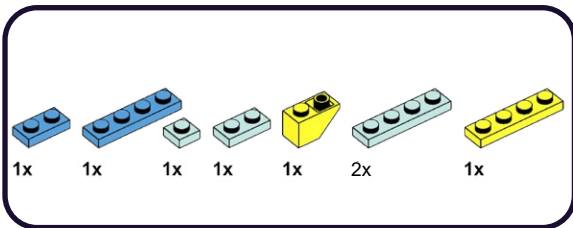

1

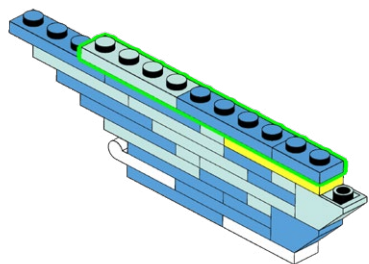

2

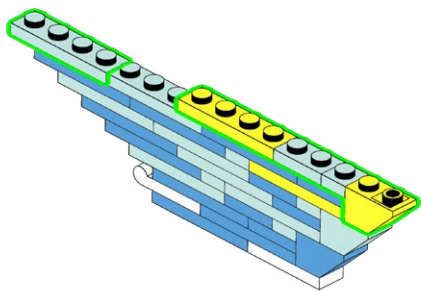

260

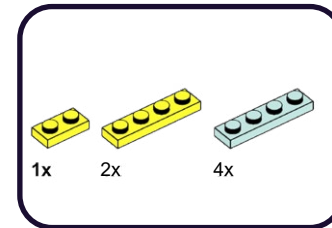

1

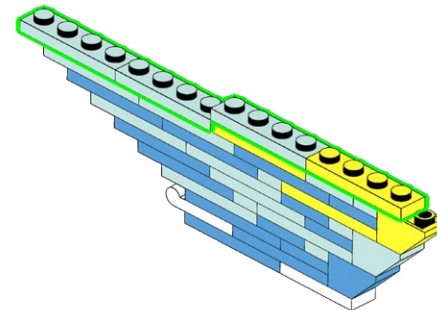

2

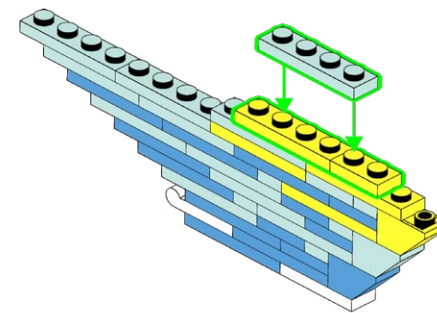

261

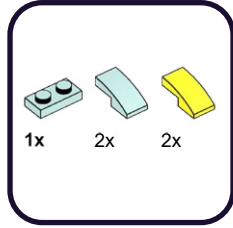

1

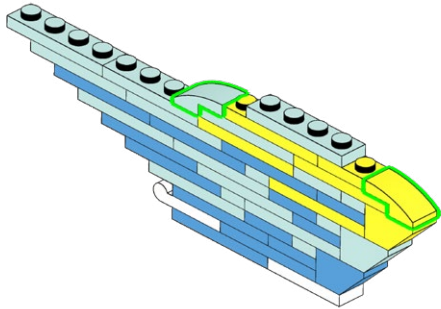

2

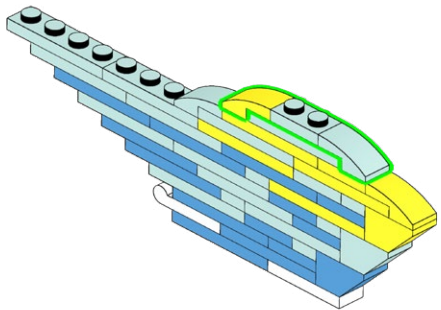

262

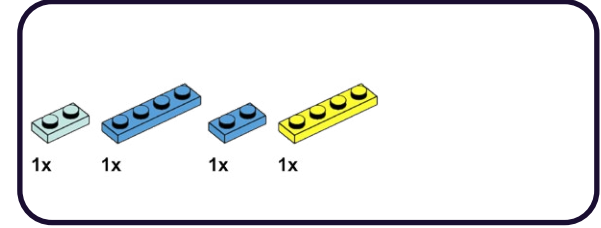

1

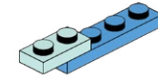

2

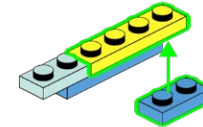

263

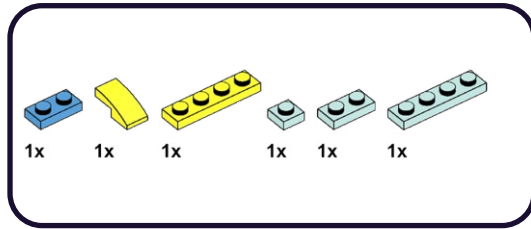

1

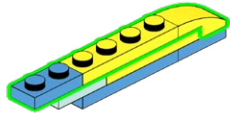

2

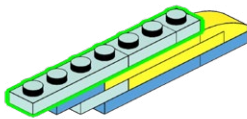

264

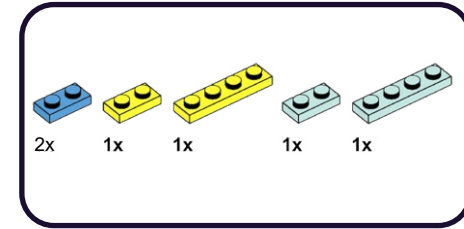

1

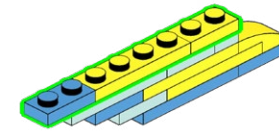

2

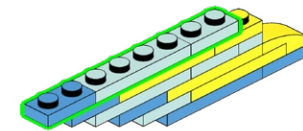

# 265

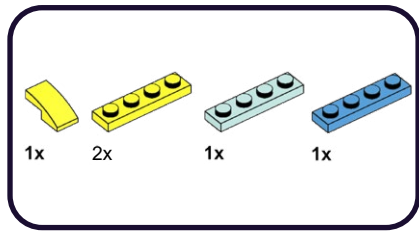

1

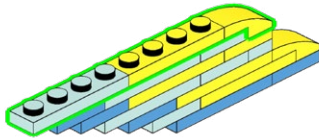

2

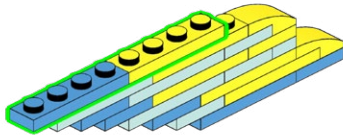

# 266

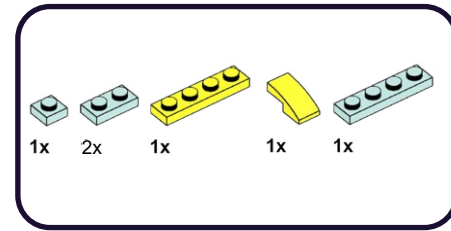

1

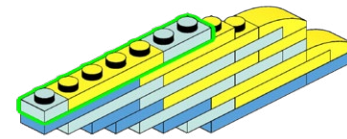

2

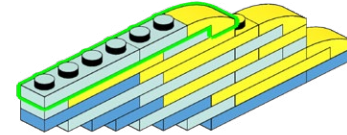

267

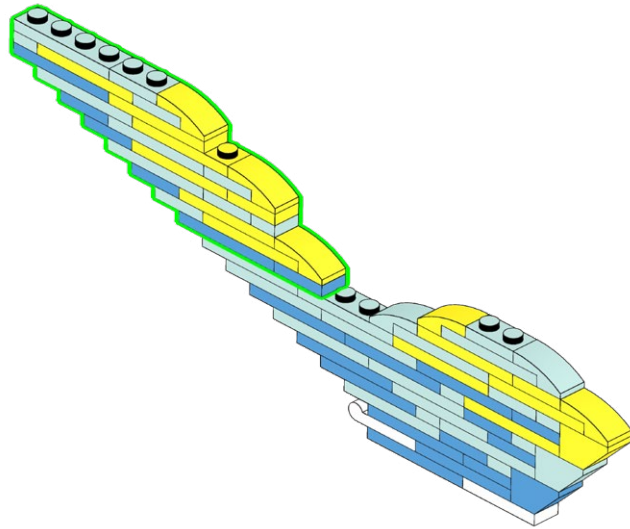



268

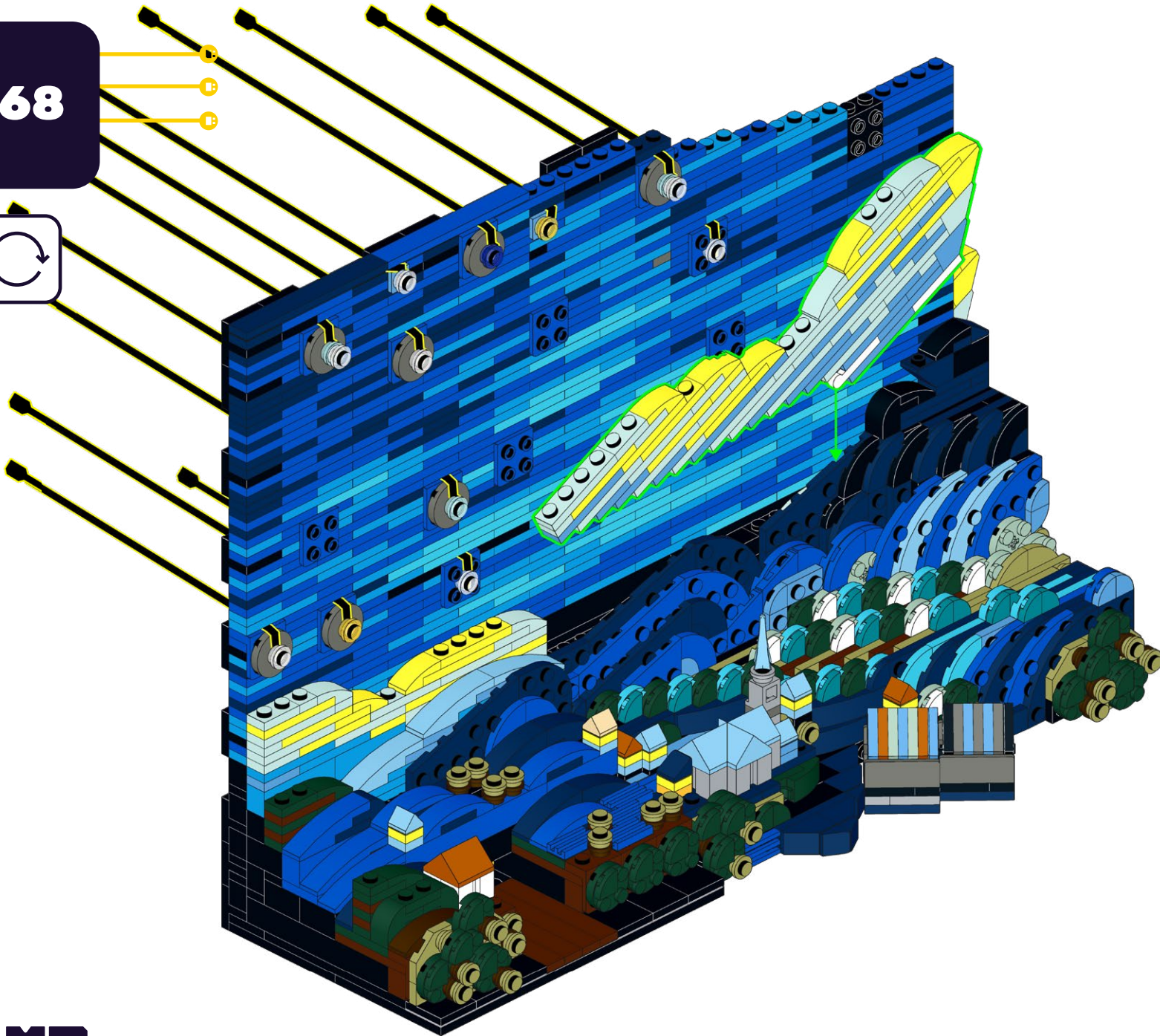



269

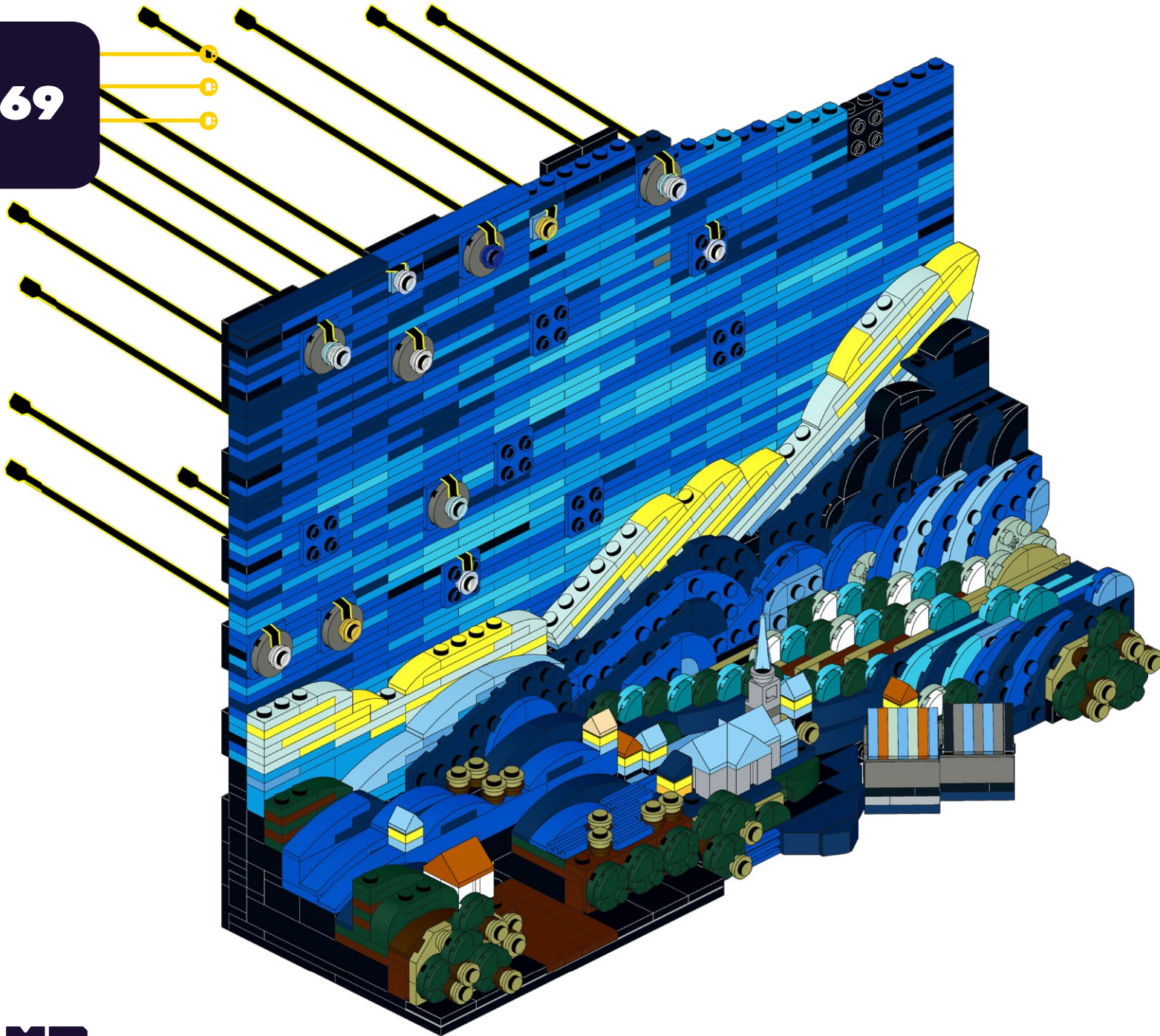

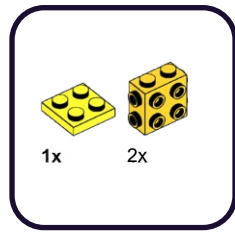
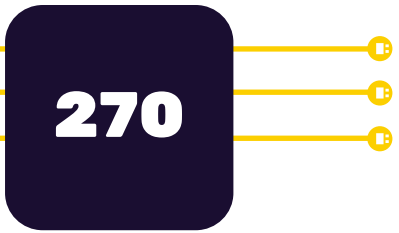

1

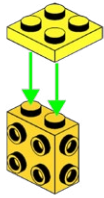

2

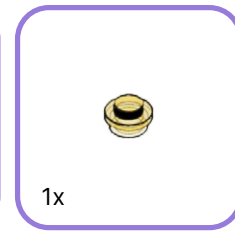
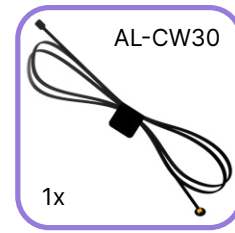

1



2



**272**

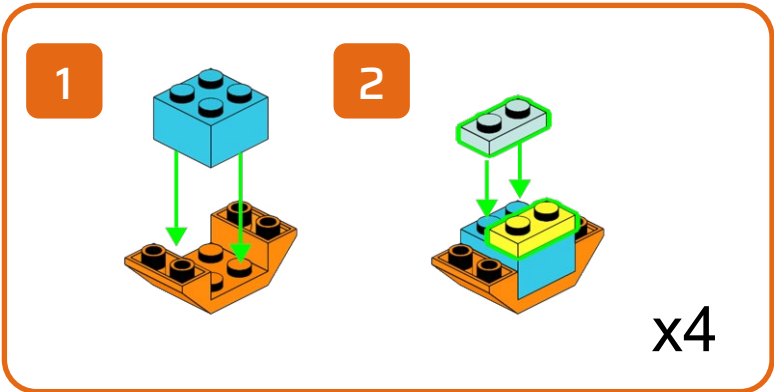
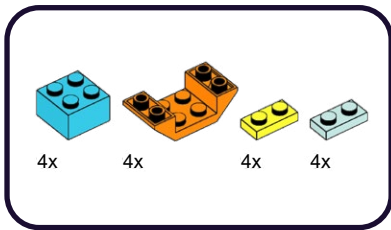

**273**

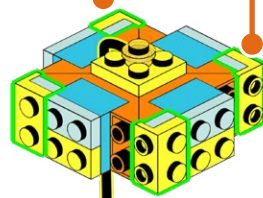
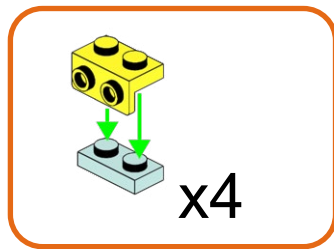
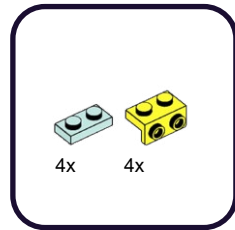

**274**

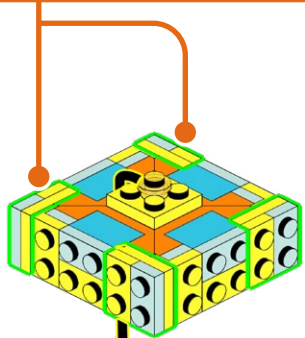
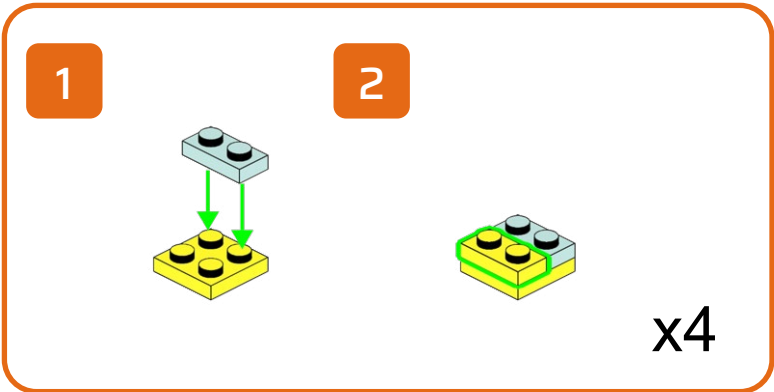
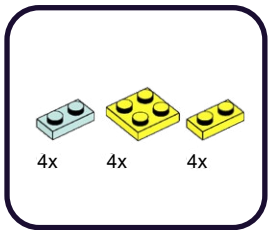

**275**

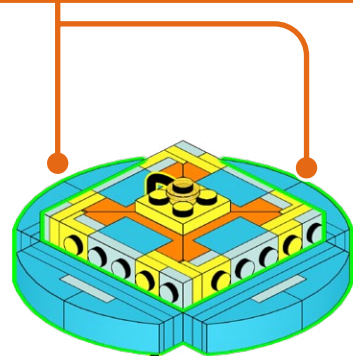
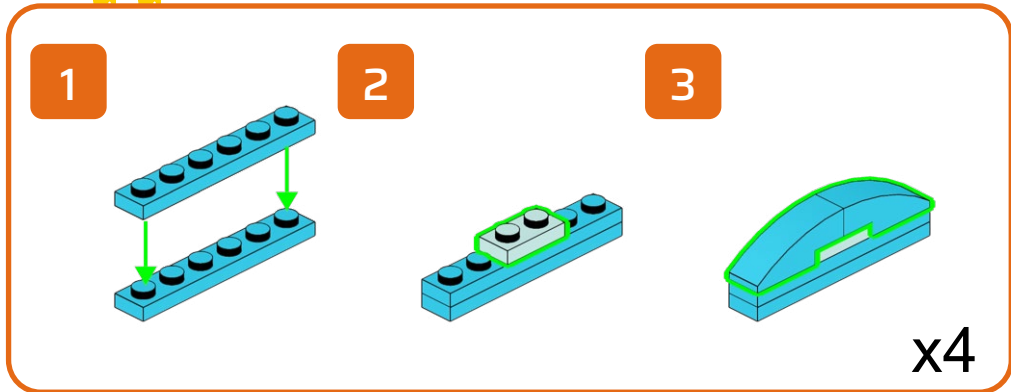
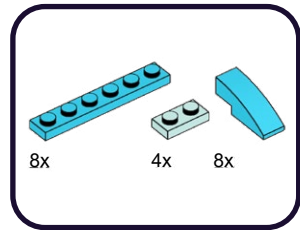



# 276

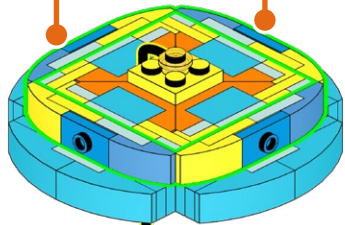
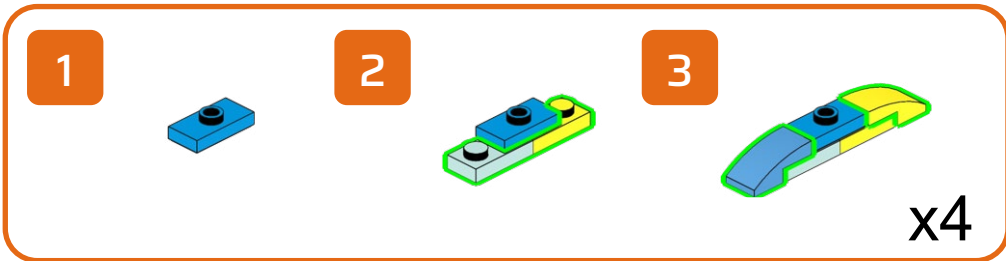
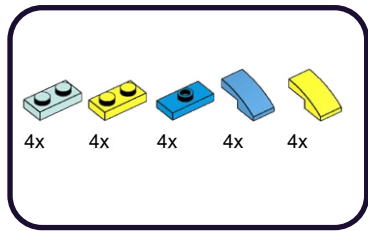

# 277

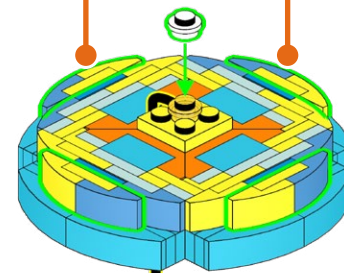
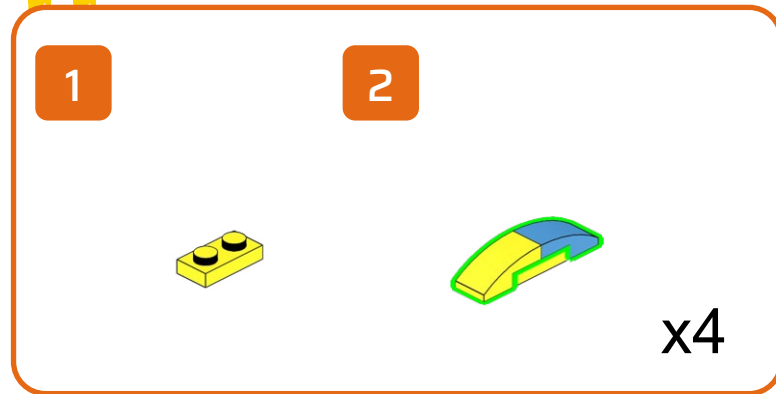
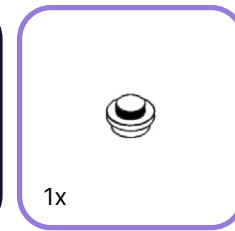
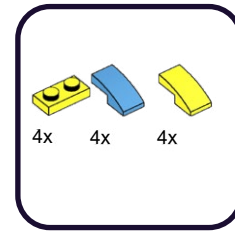

278

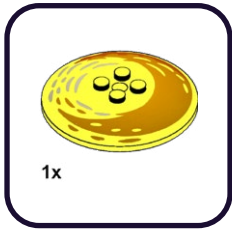

279

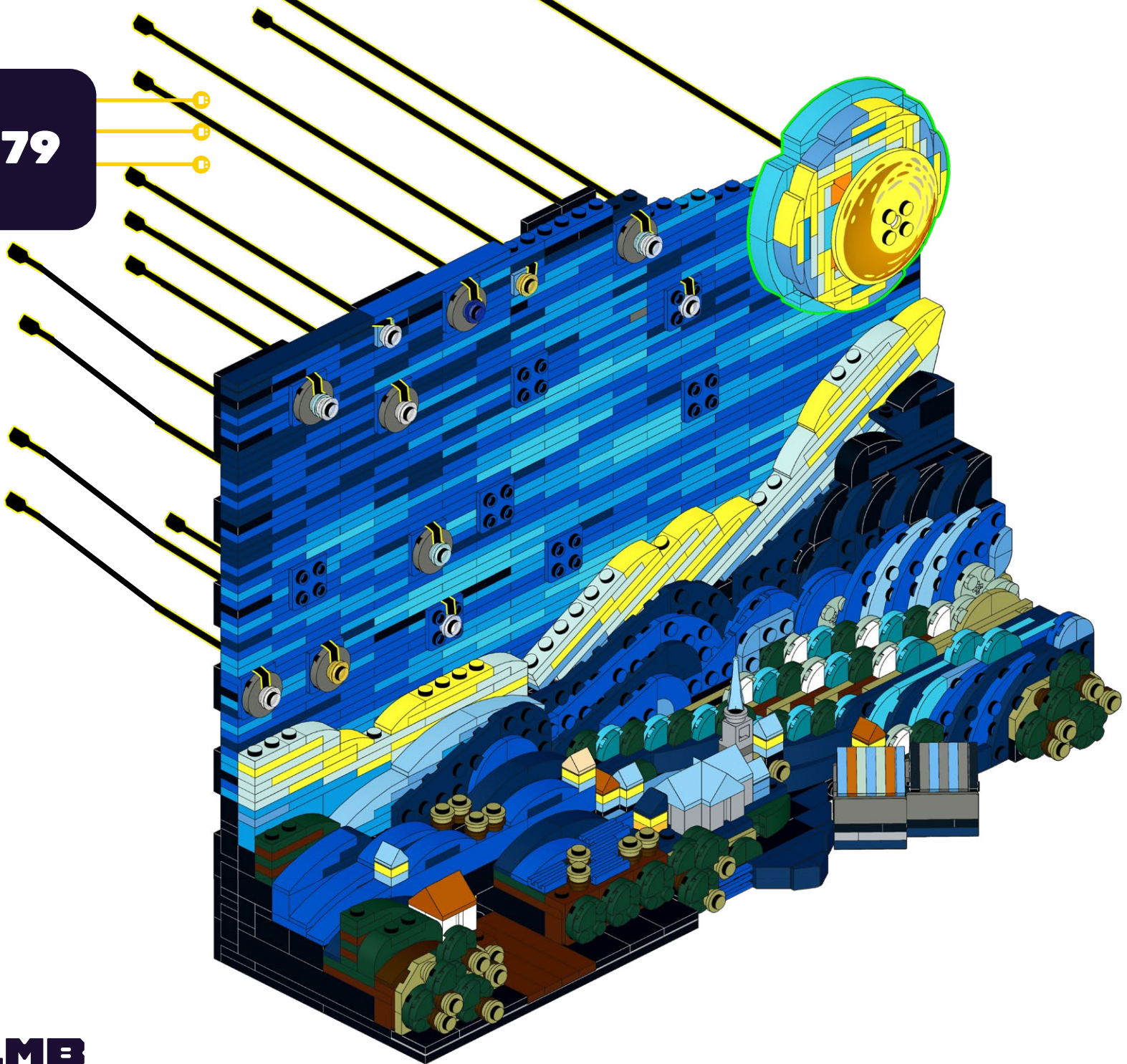



280

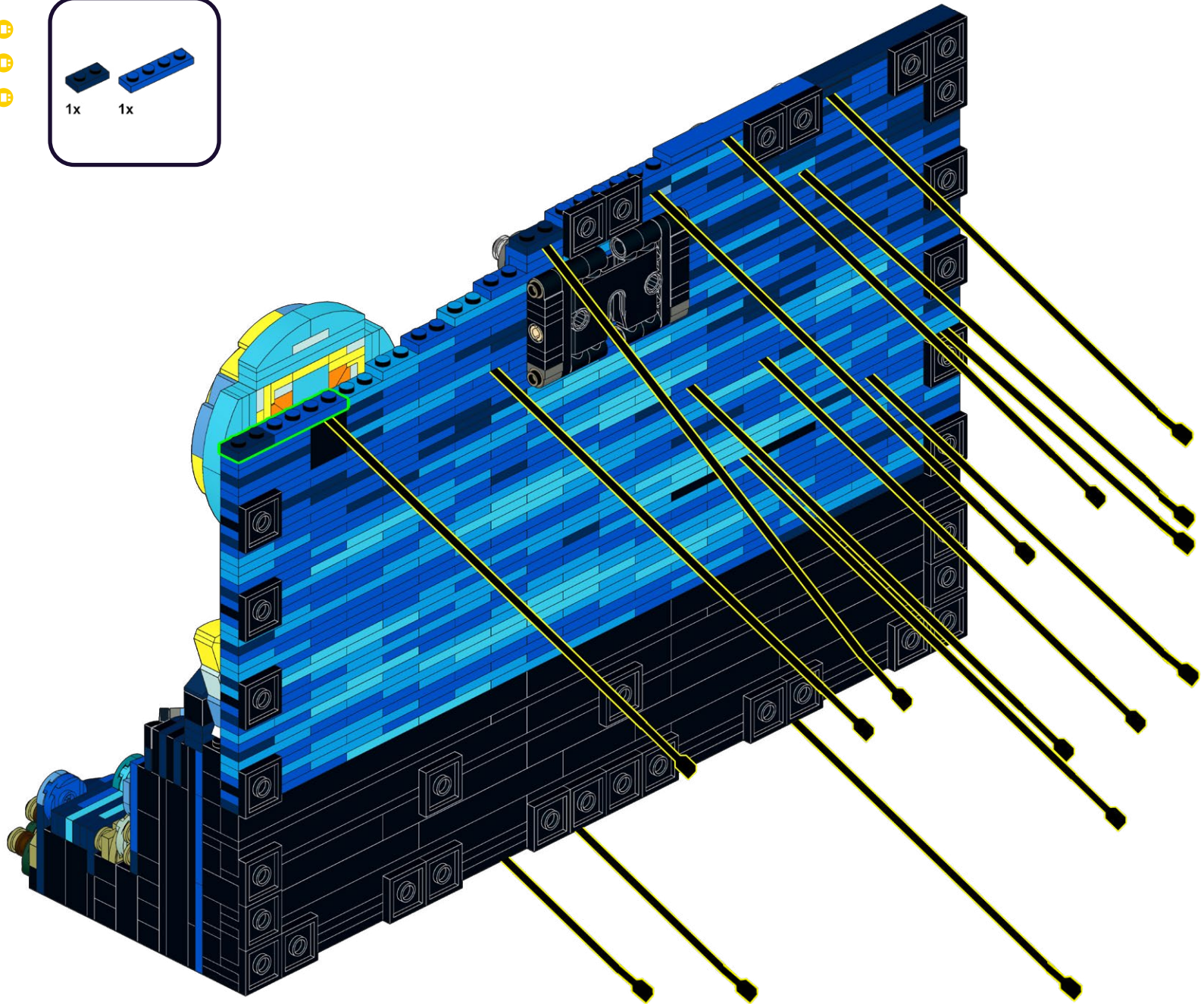
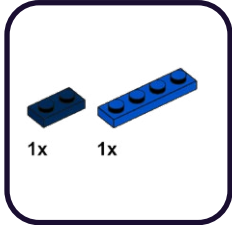

281

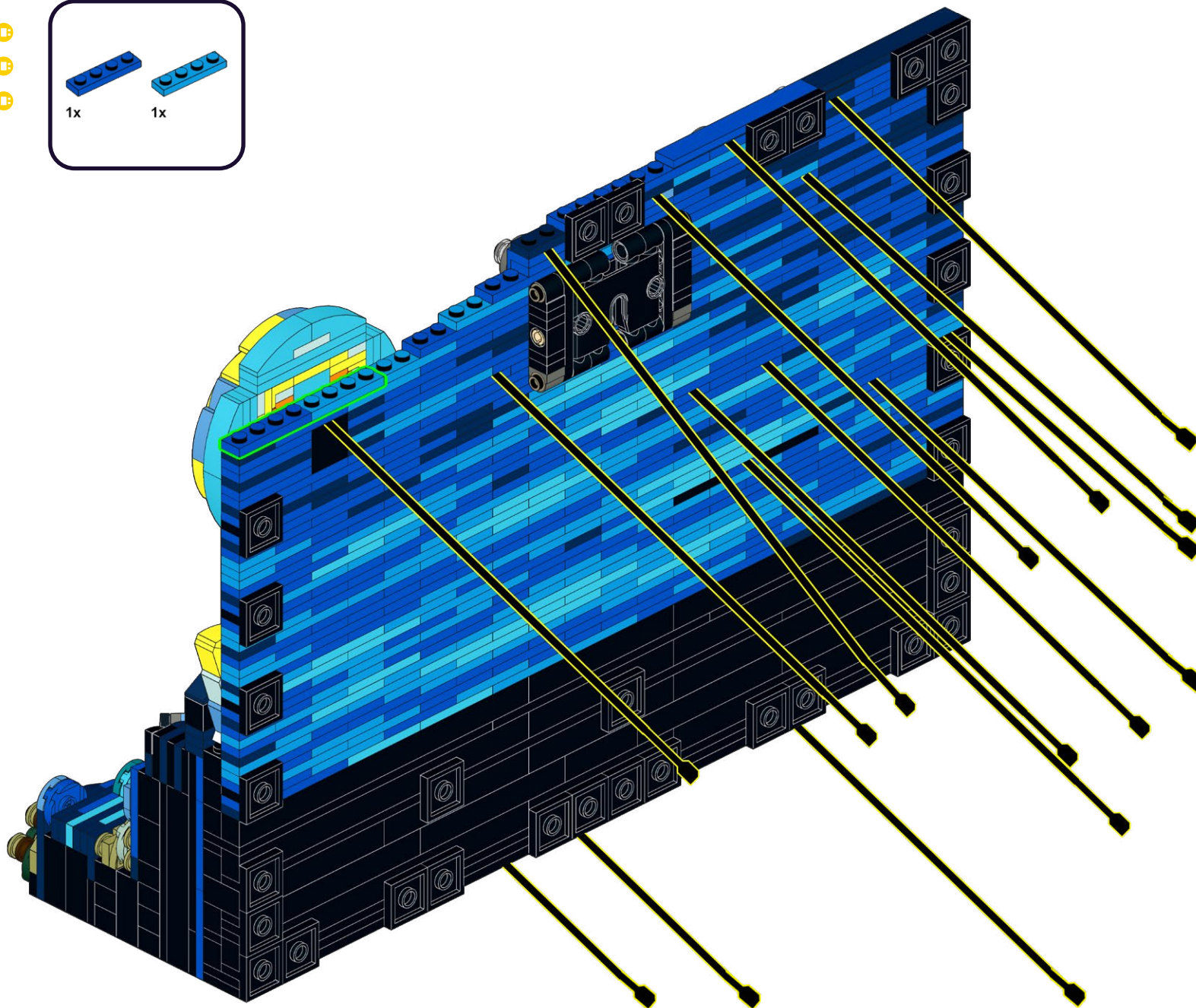
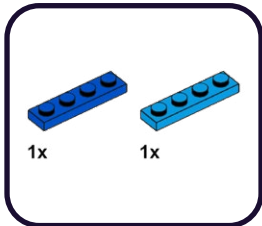



282

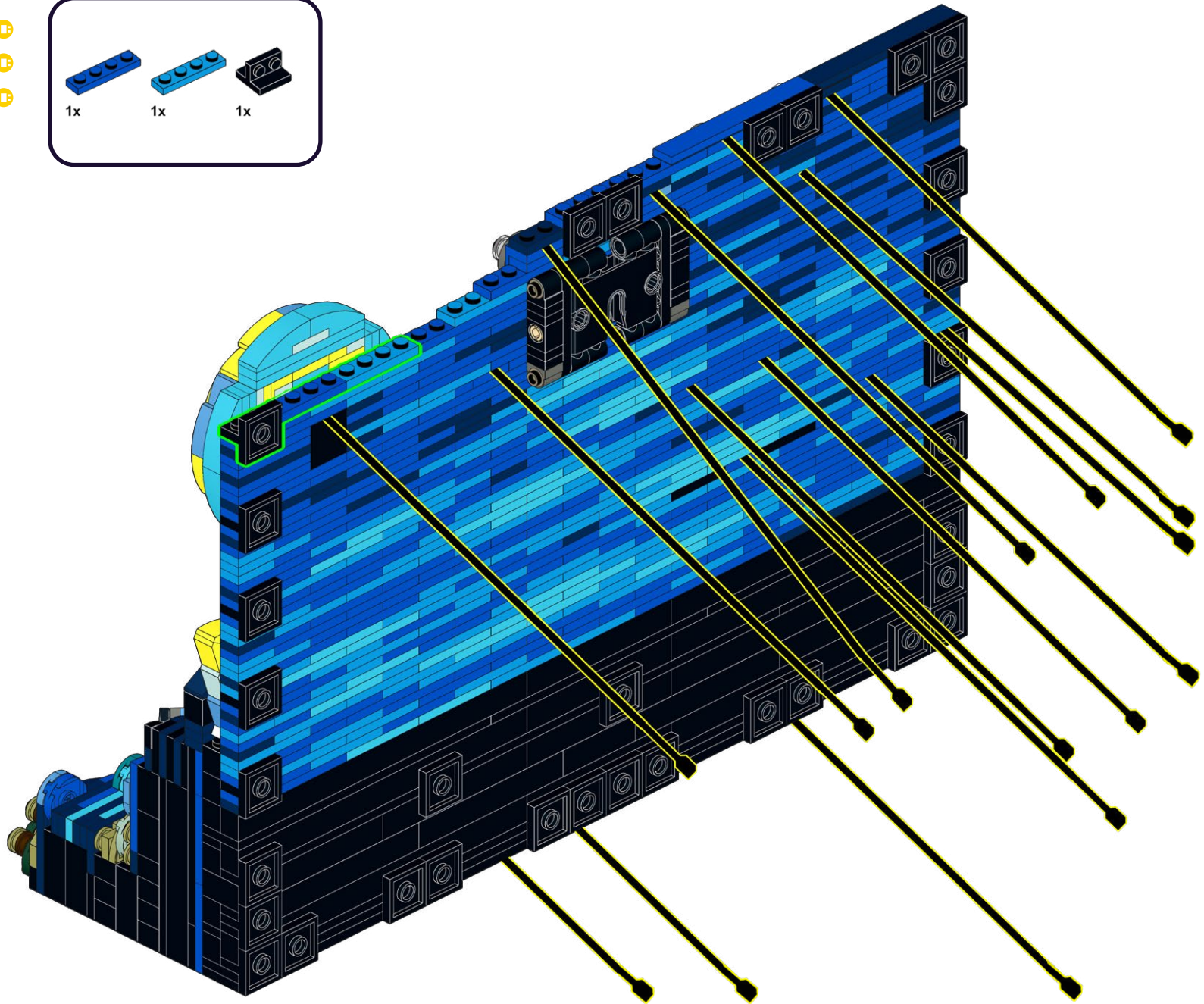
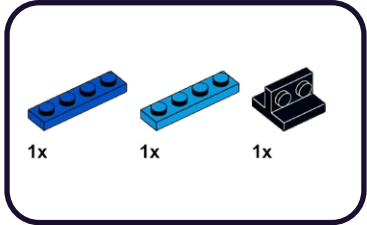

283

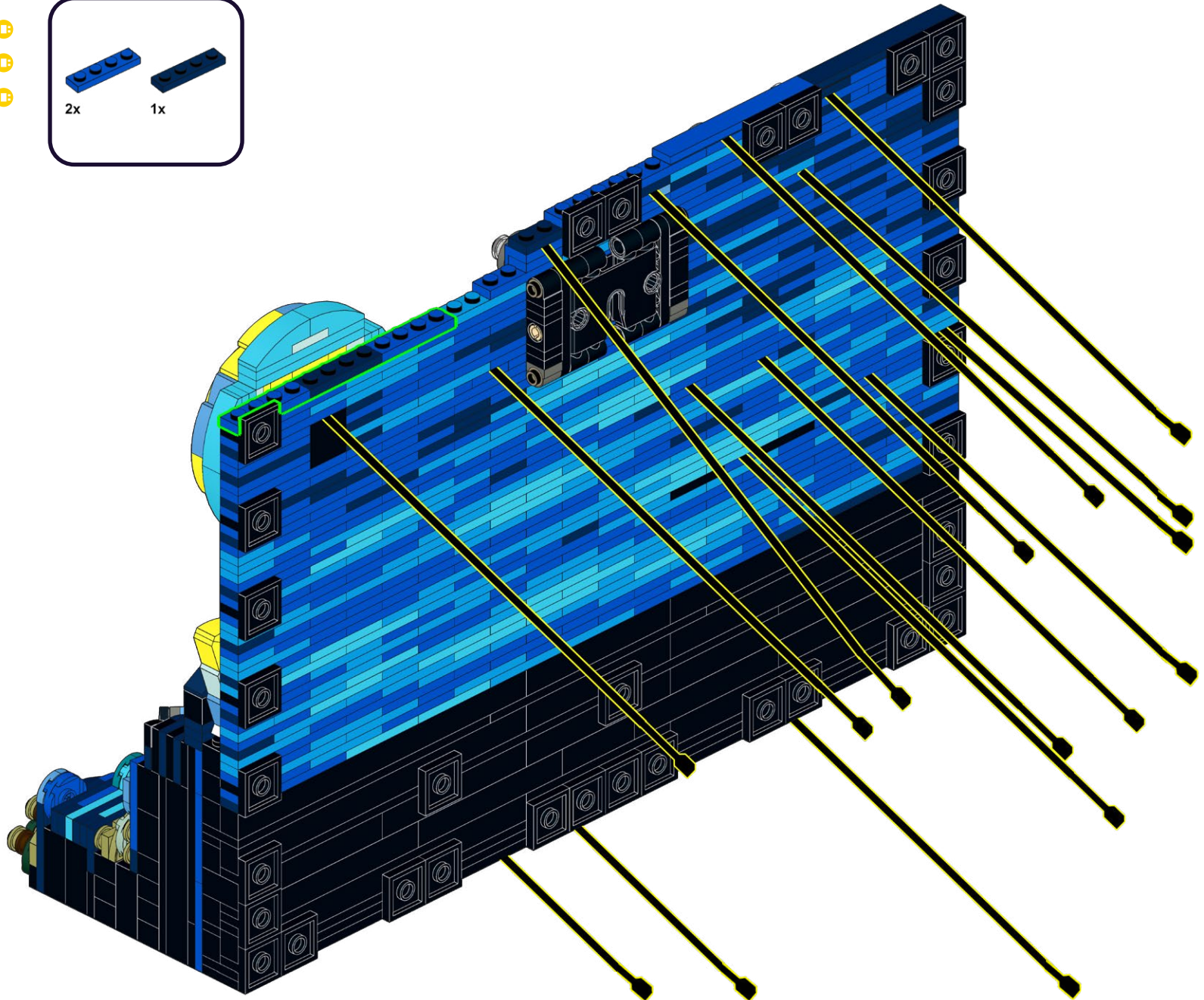
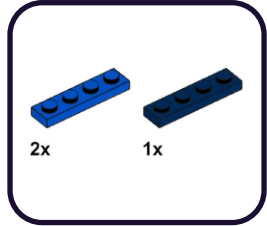



284

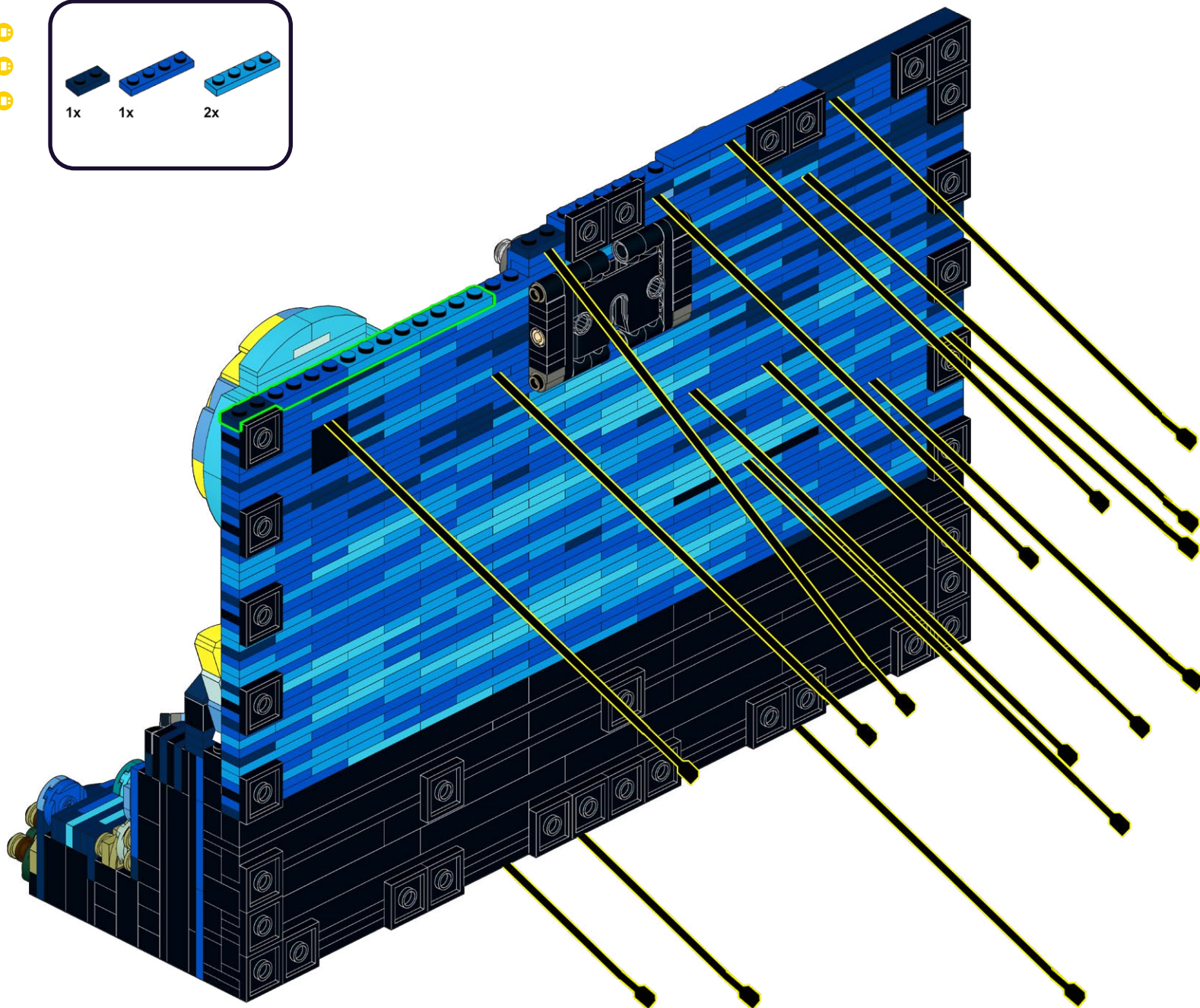
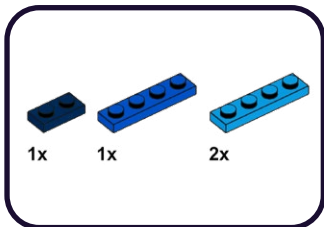

285

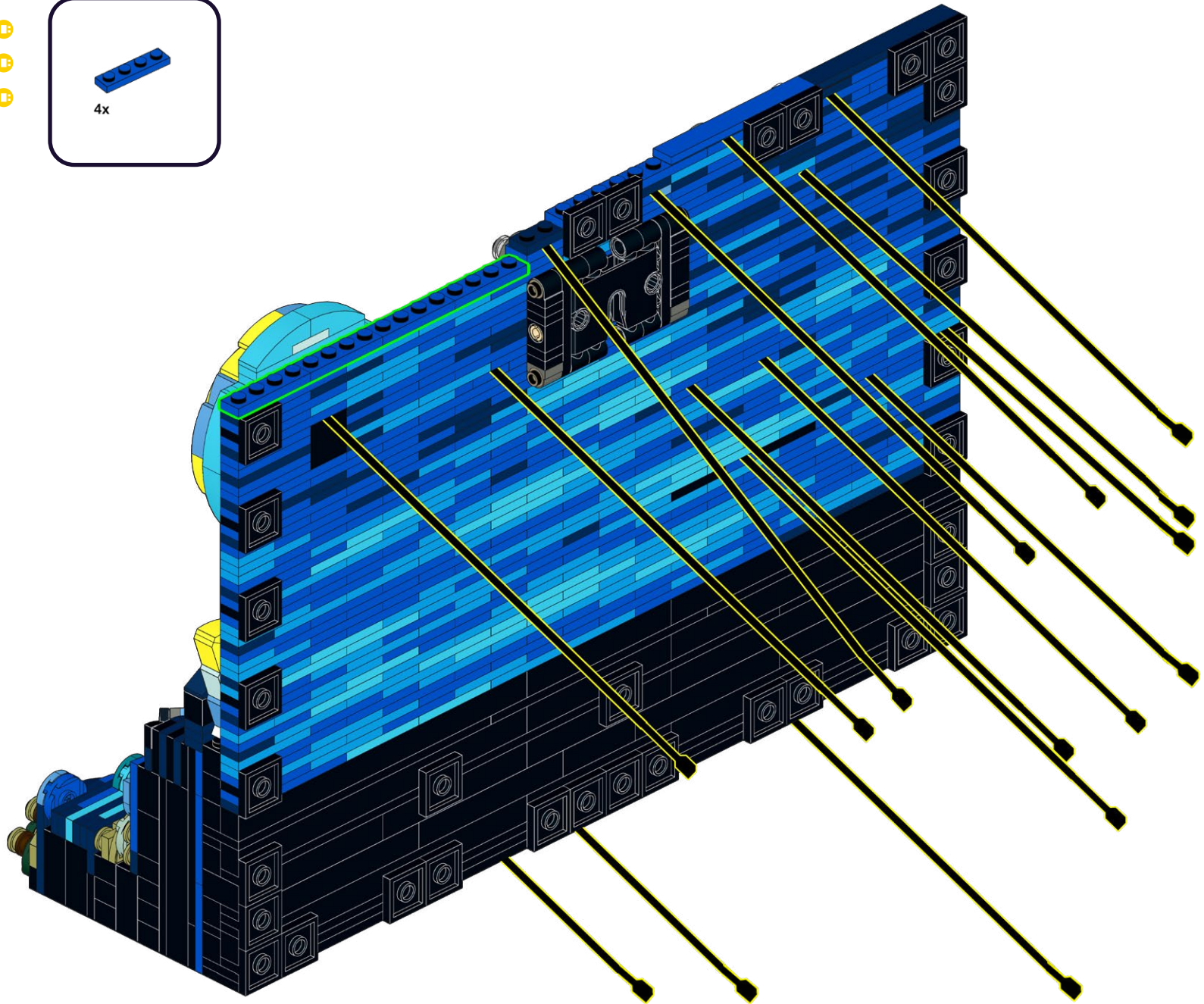
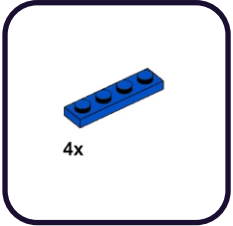



286

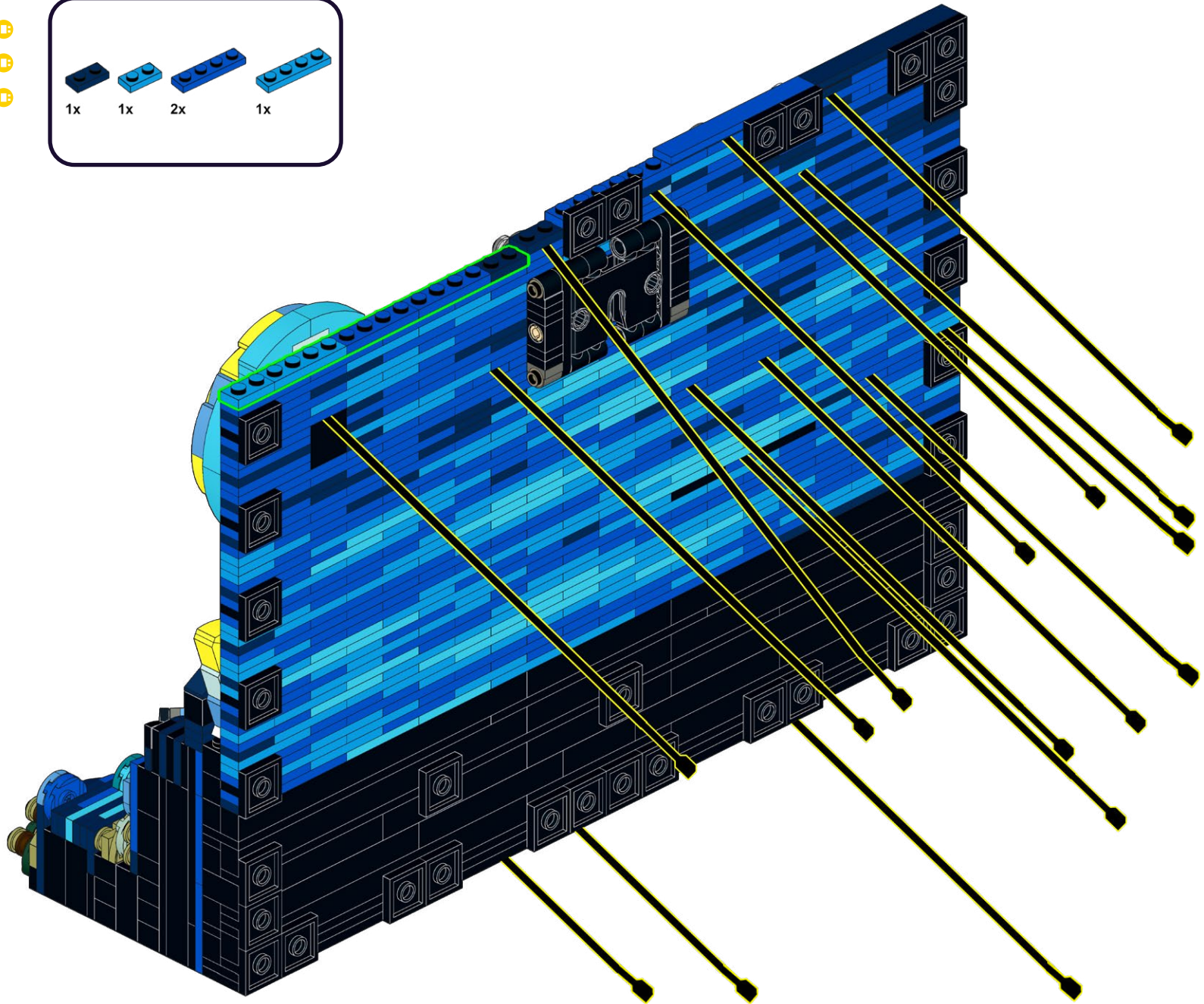
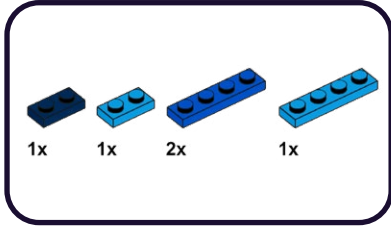



287

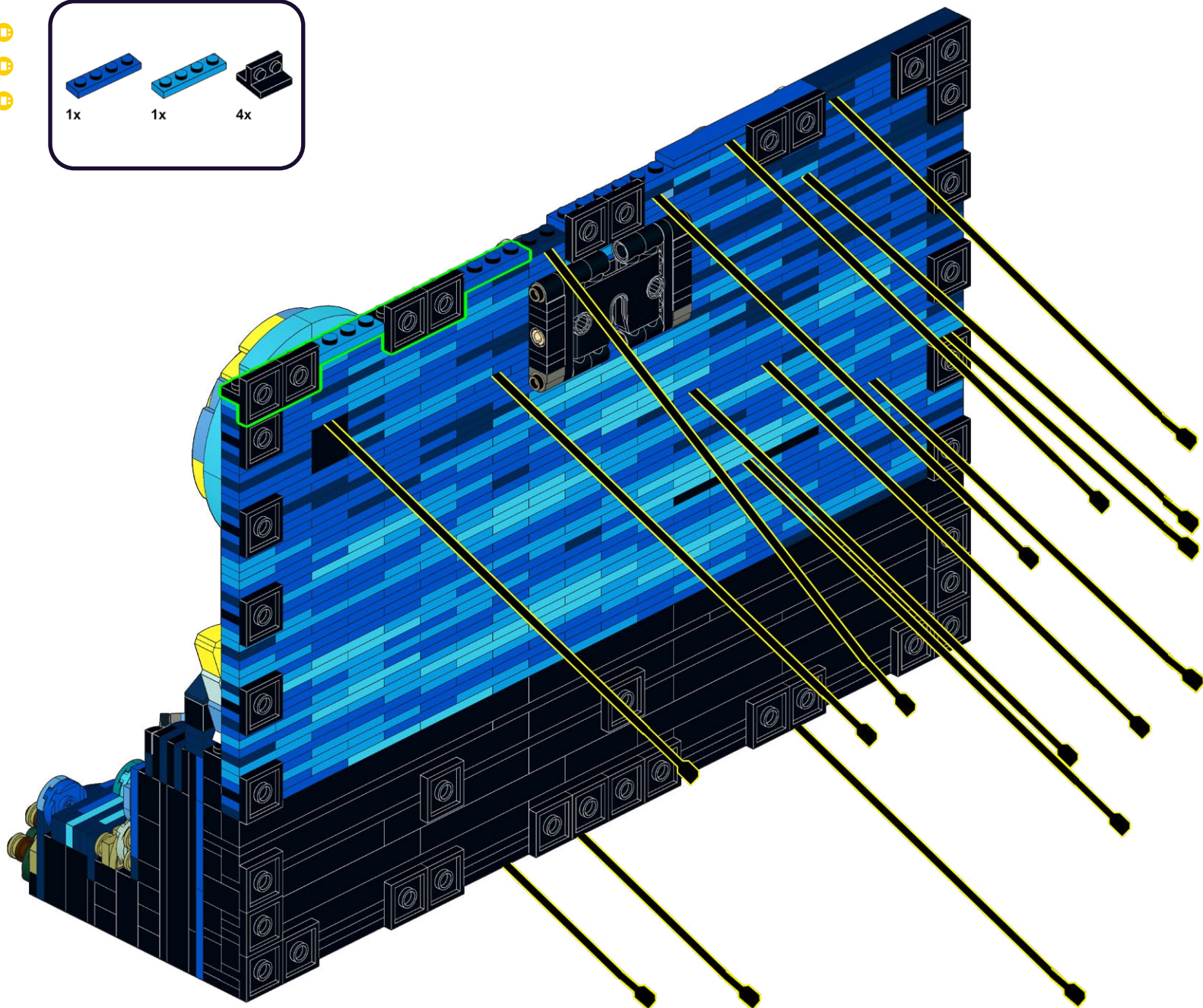
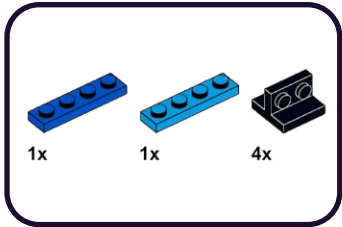

288

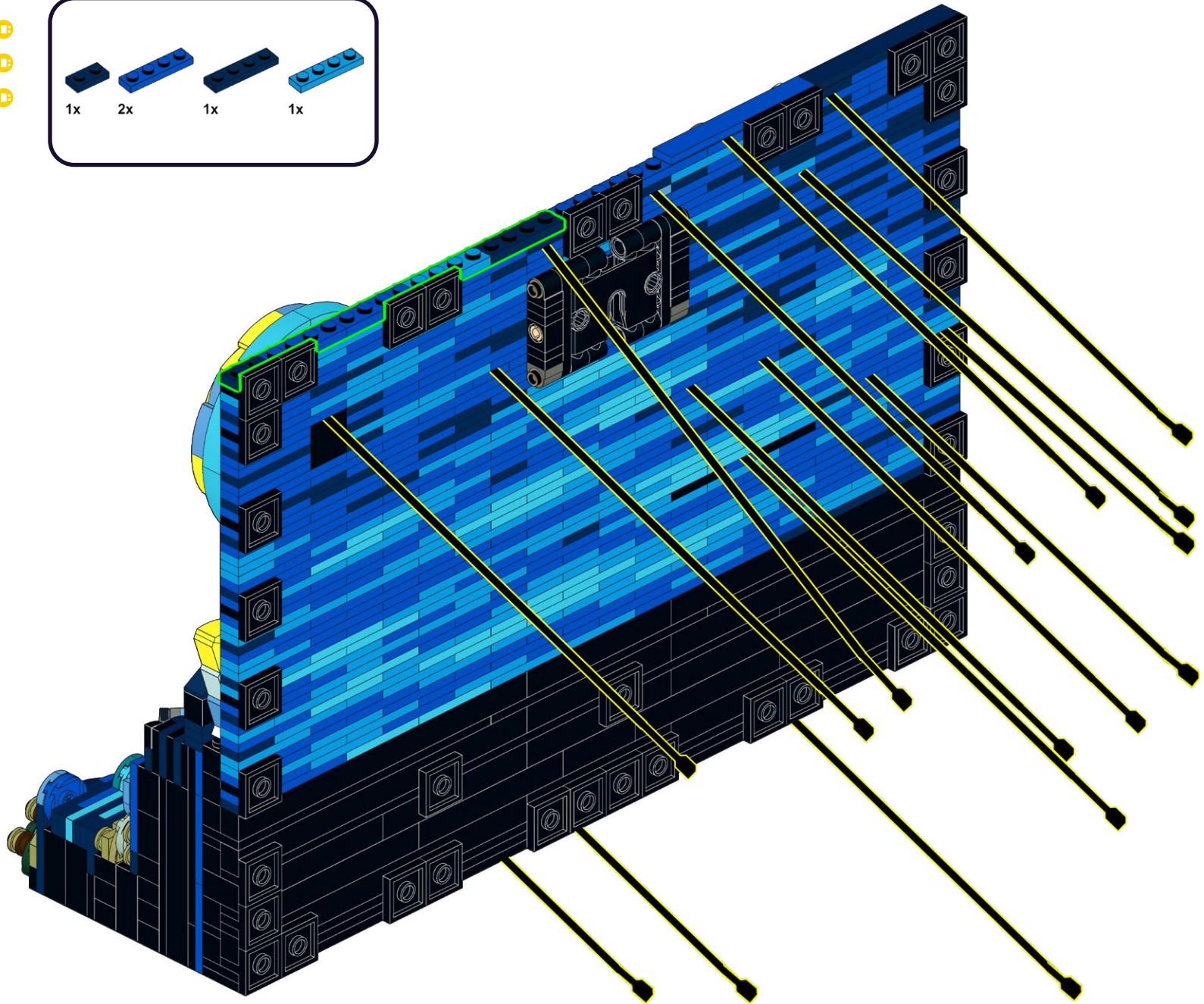
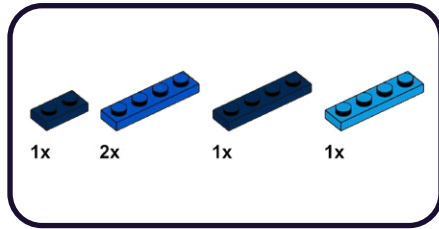



289

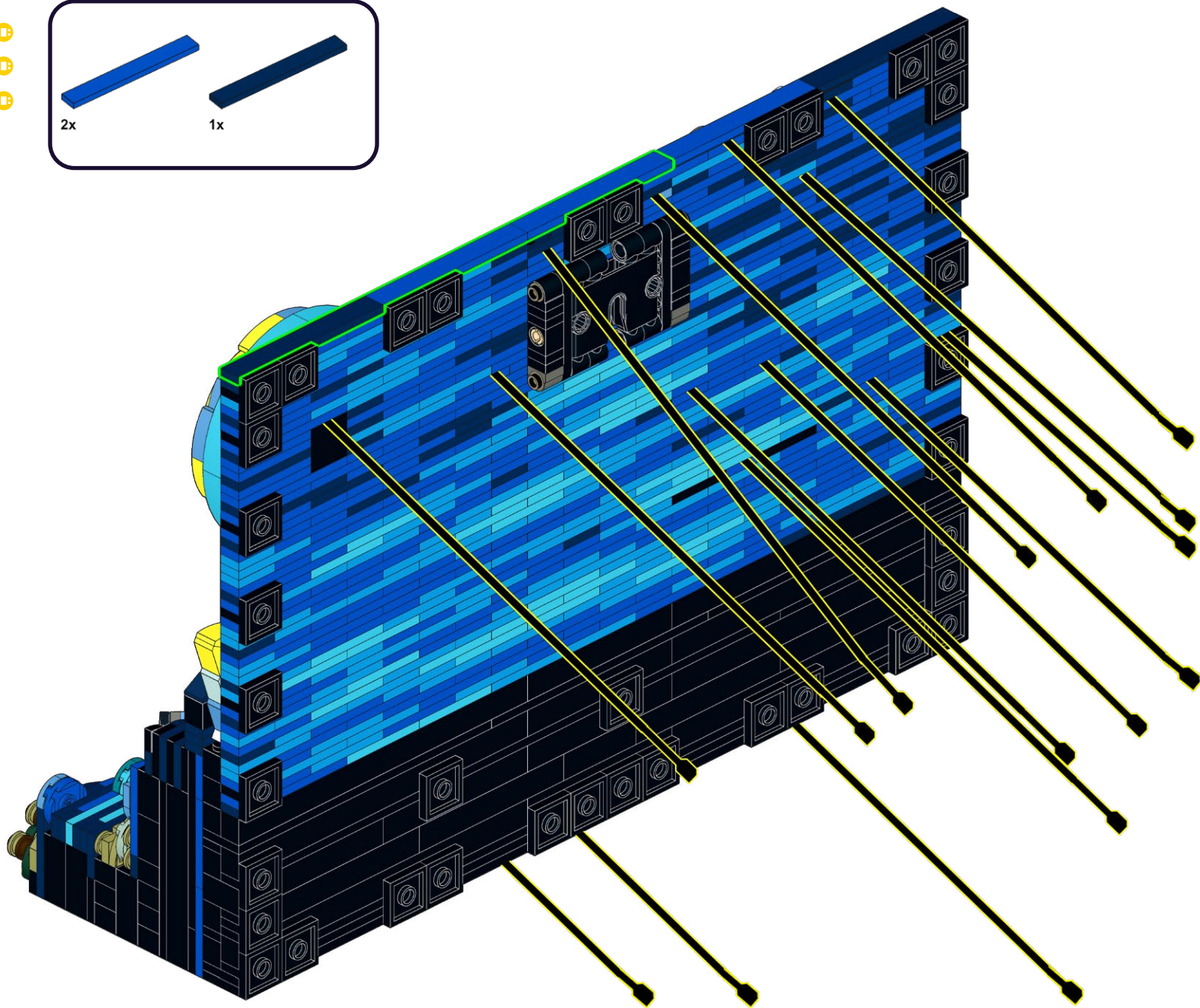
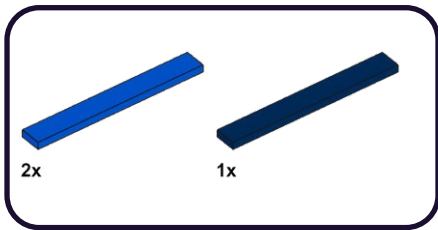



### **HOLD UP!**

You might notice some bags aren't in order, as well as left over pieces, but that's ok! We're changing the way you build LEGO!

### **ATTENDEZ!**

Vous remarquerez peut-être que certains sacs, ainsi que certaines pièces, ne sont pas dans le bon ordre. Mais pas de panique! Nous changeons simplement la façon avec laquelle vous construisez vos LEGO!

### **ASPETTA!**

Potresti notare che alcuni sacchetti non sono in ordine, così come i pezzi avanzati, ma va bene così! Stiamo cambiando il modo in cui costruisci i LEGO!

### **HALT!**

Sie werden möglicherweise bemerken, dass einige tüten durcheinander sind und teile übrig bleiben, aber das ist in Ordnung! Wir ändern die art und weise, wie Sie LEGO bauen!

### **¡ESPERA!**

Es posible que notes que algunas bolsas están fuera de servicio, así como piezas sobrantes, ¡pero está bien! ¡Estamos cambiando la forma en que construyes LEGO!

### **暫停!**

你可能会注意到一些袋子顺序错乱, 以及一些剩余的部件, 但没关系! 我们正在改变你搭建乐高的方式!

#### Open LMB Bag 03

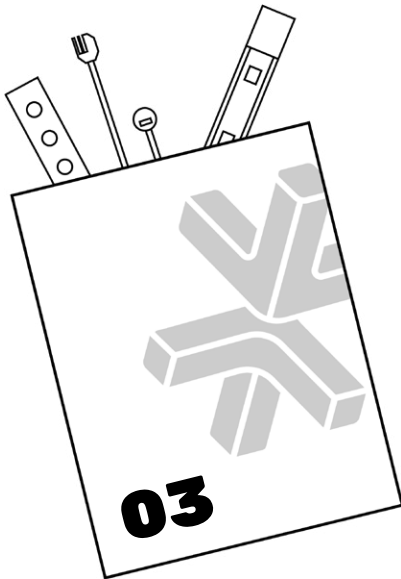



290

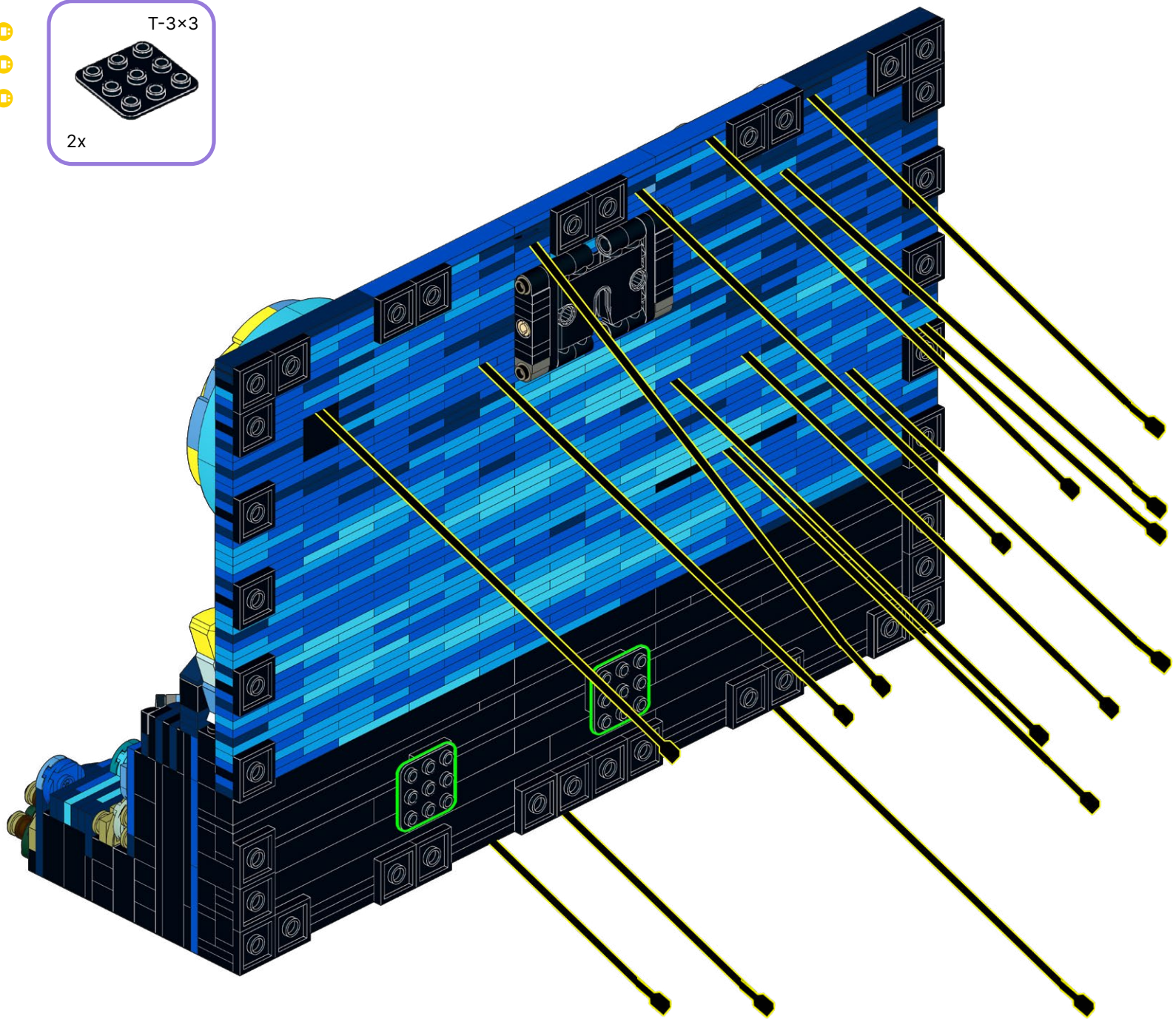



291

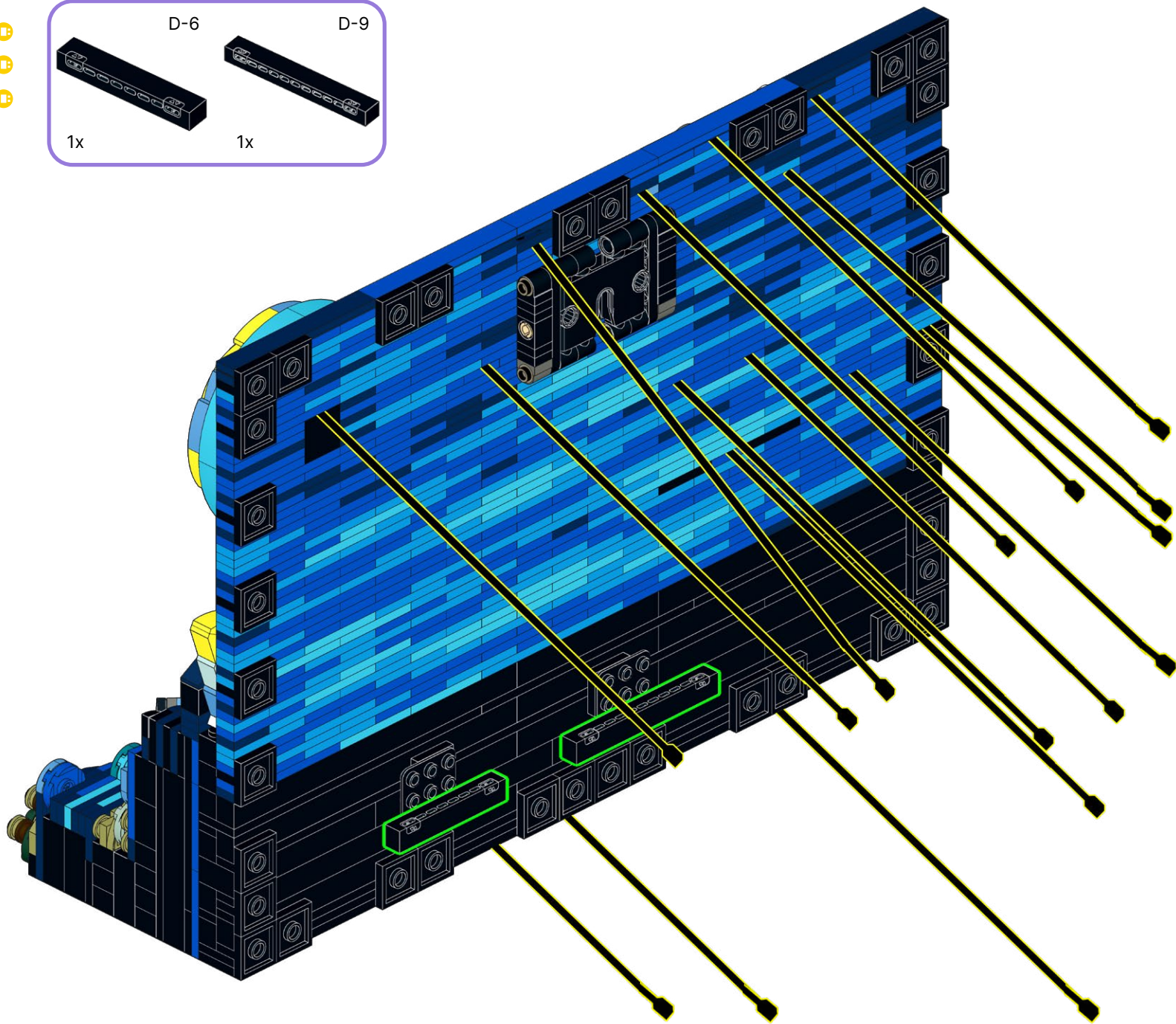
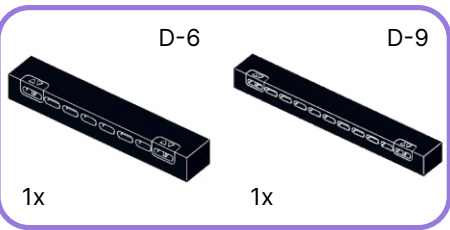

292

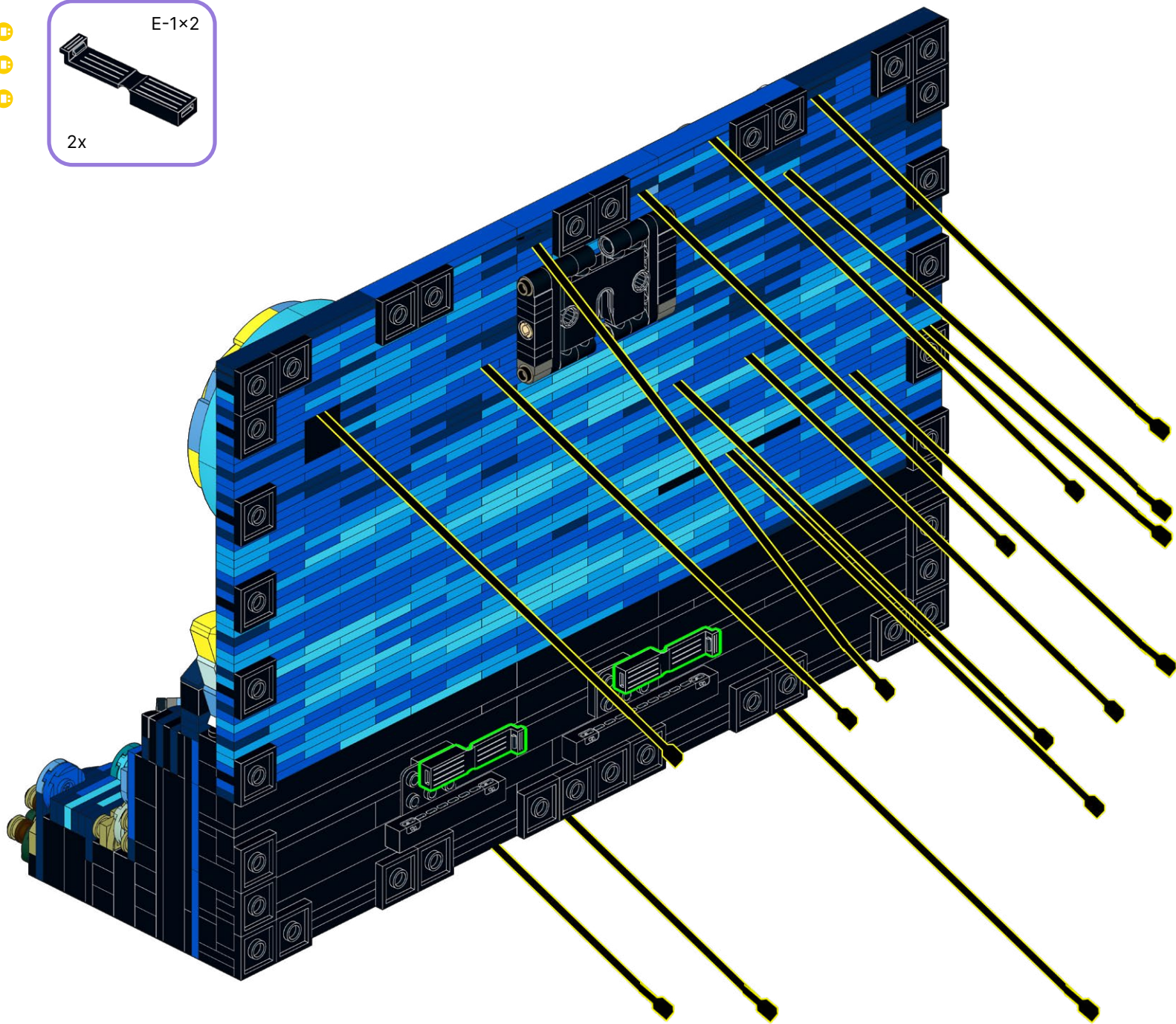
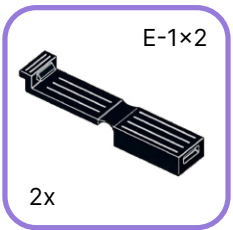



293

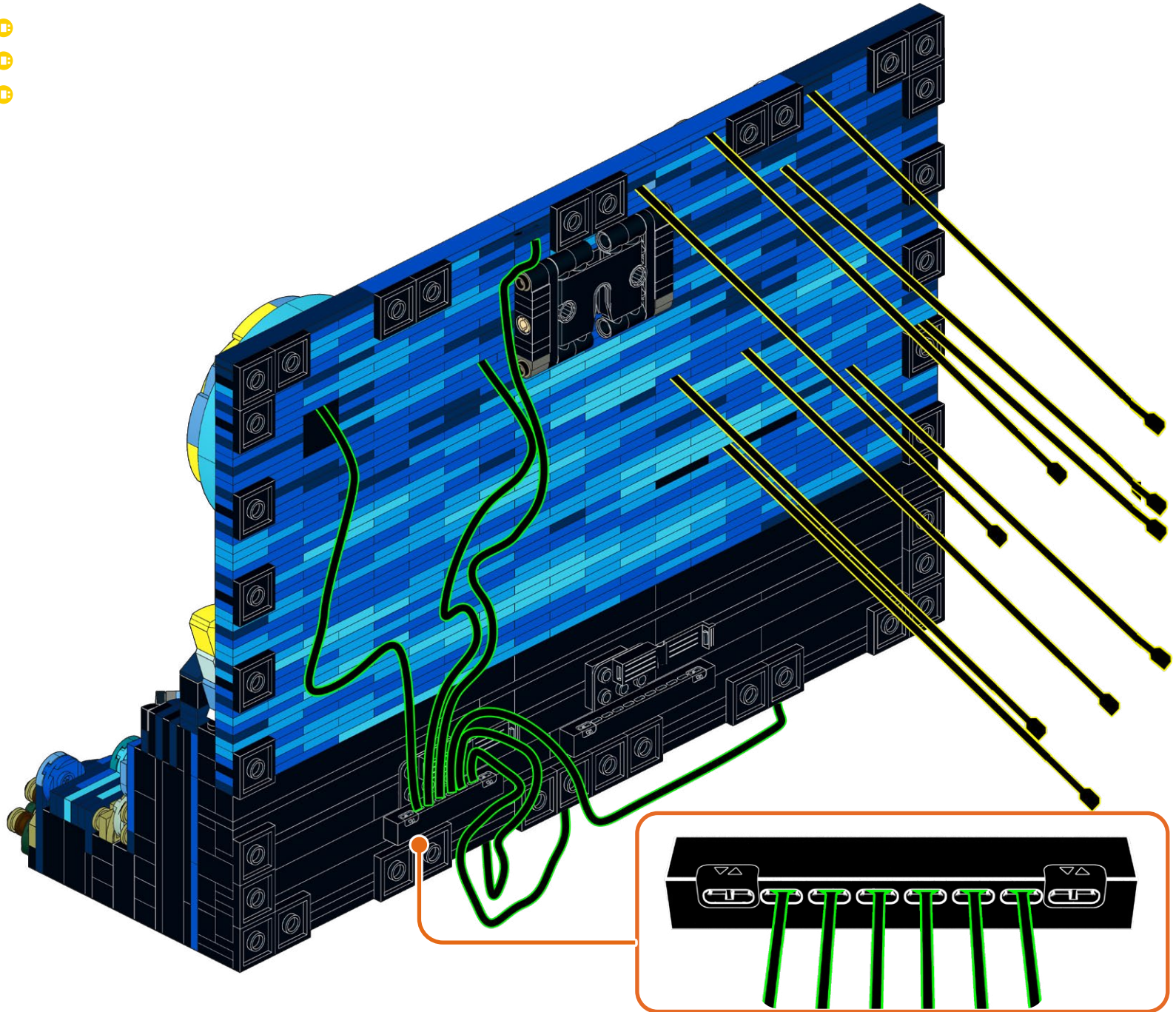

294

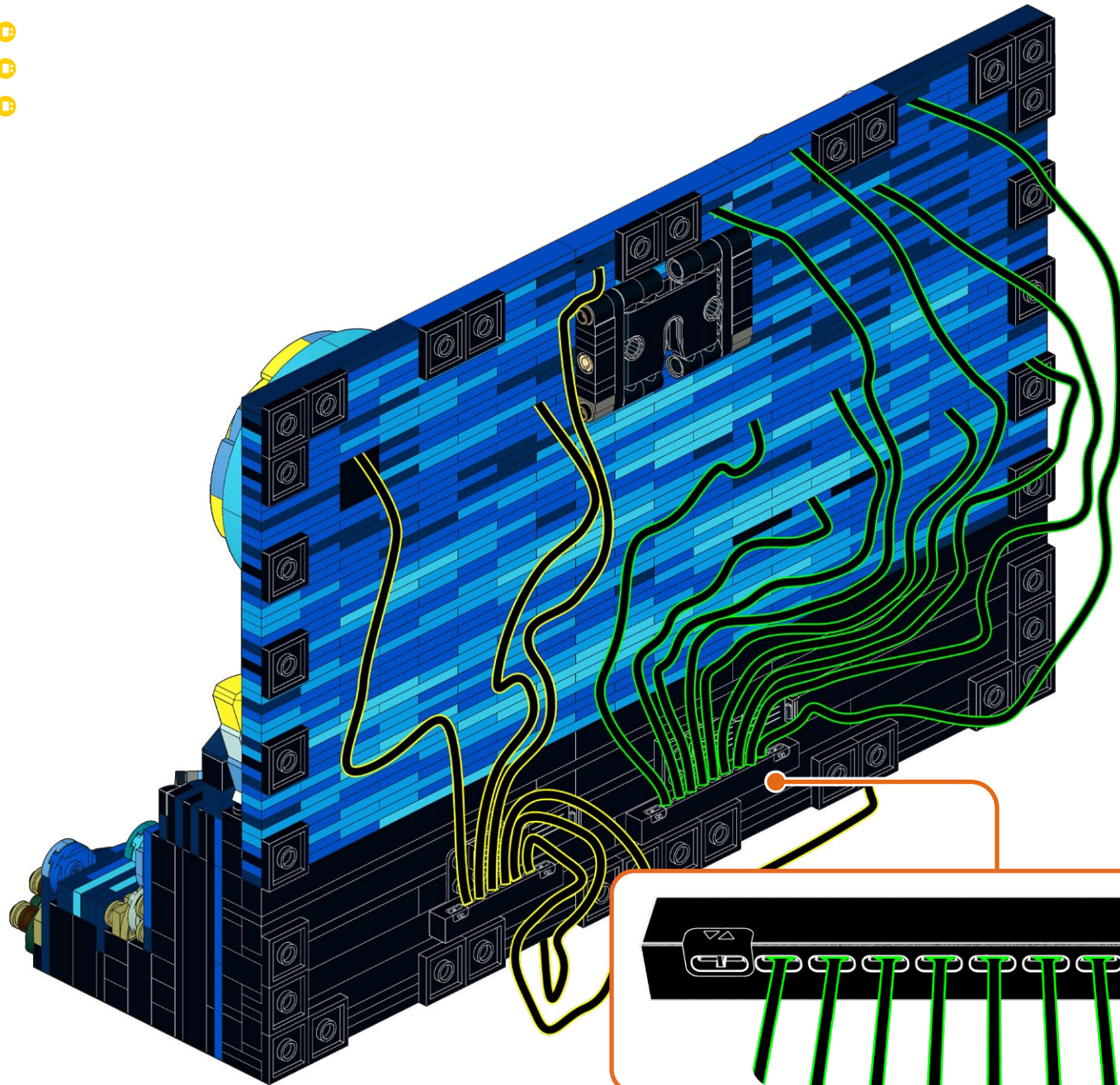



295

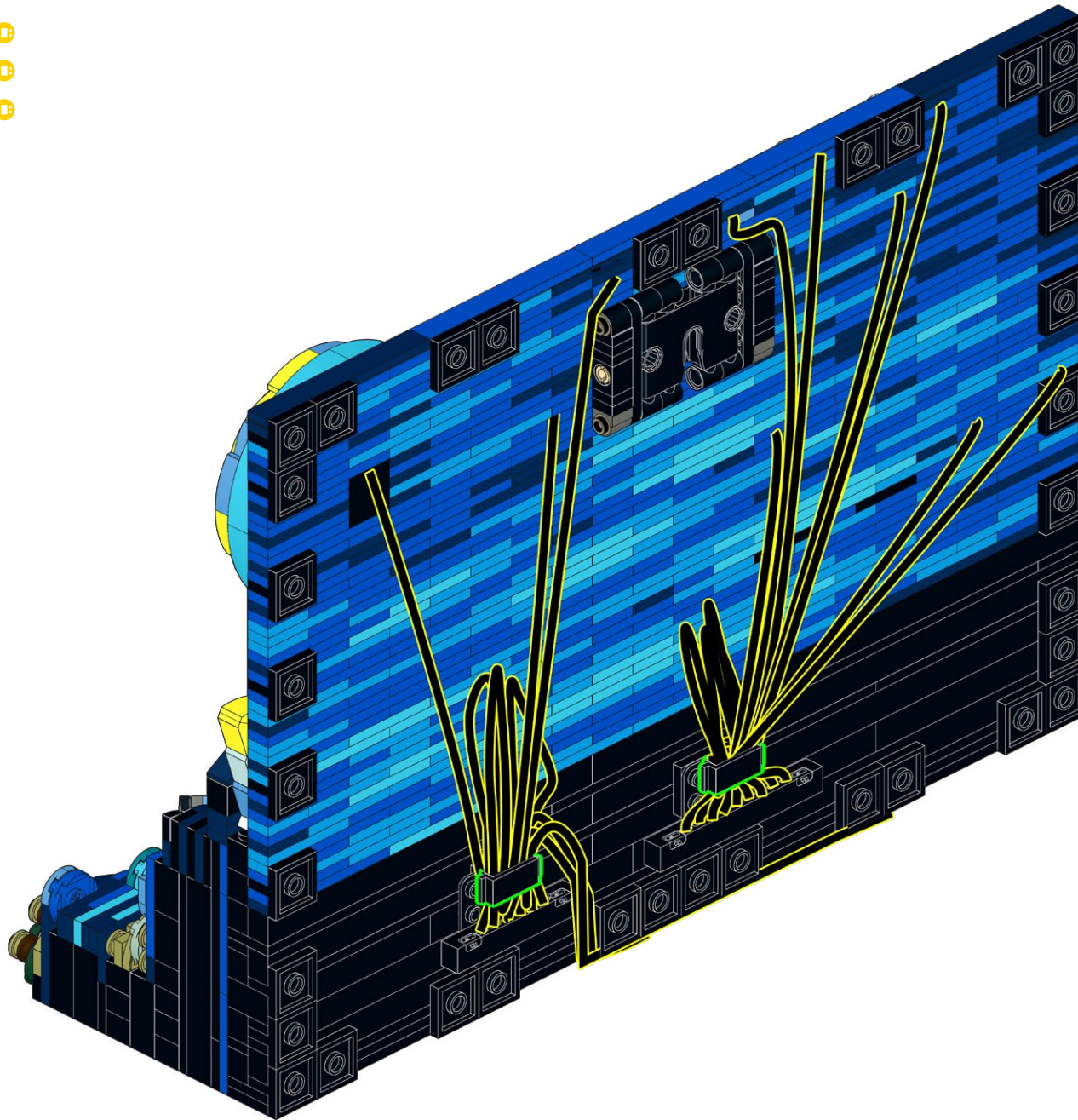



296

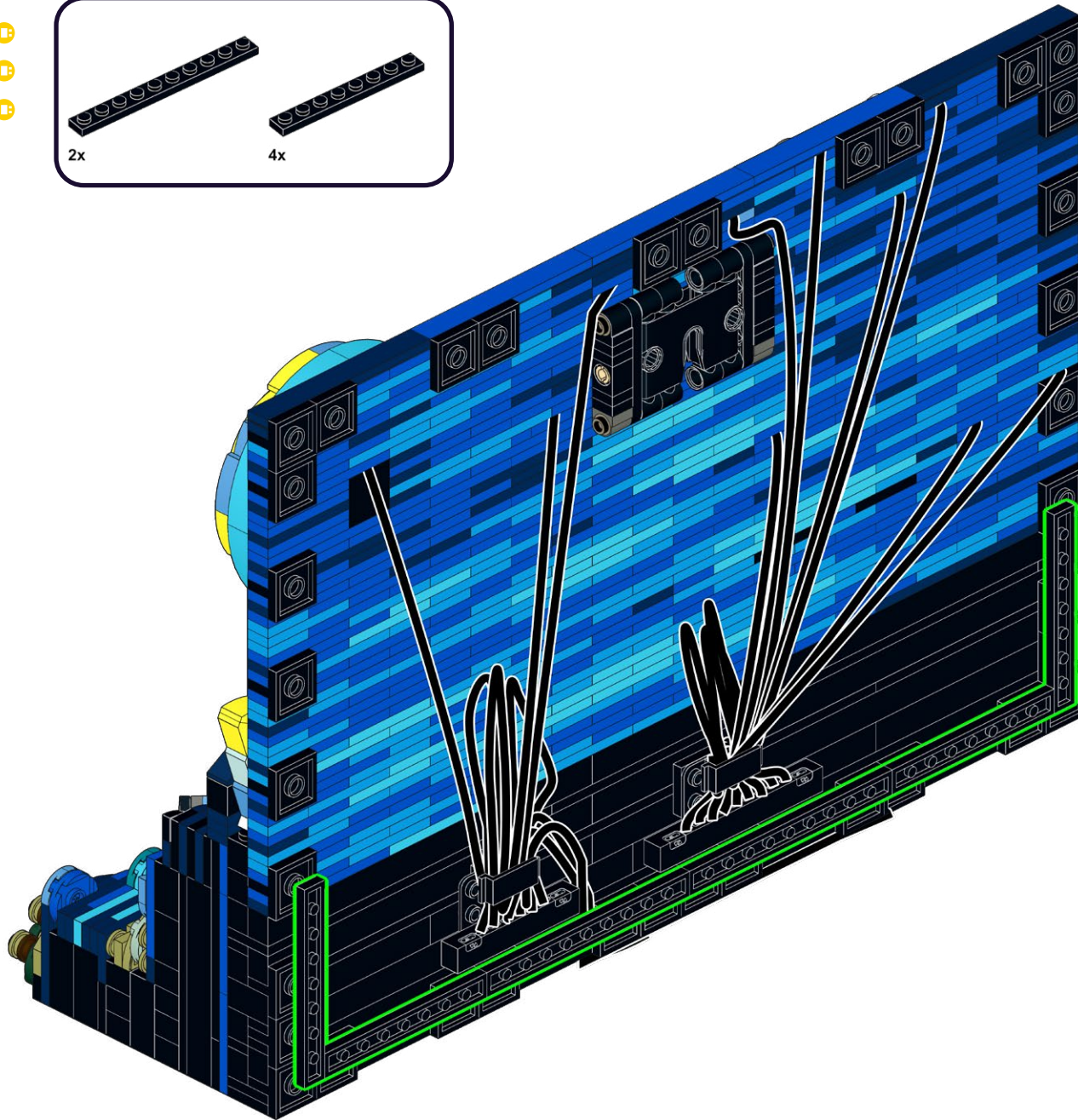
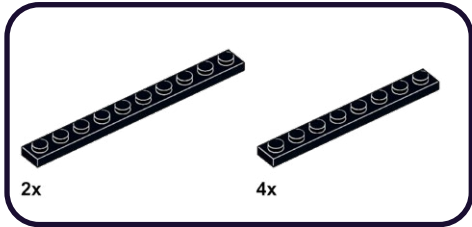

297

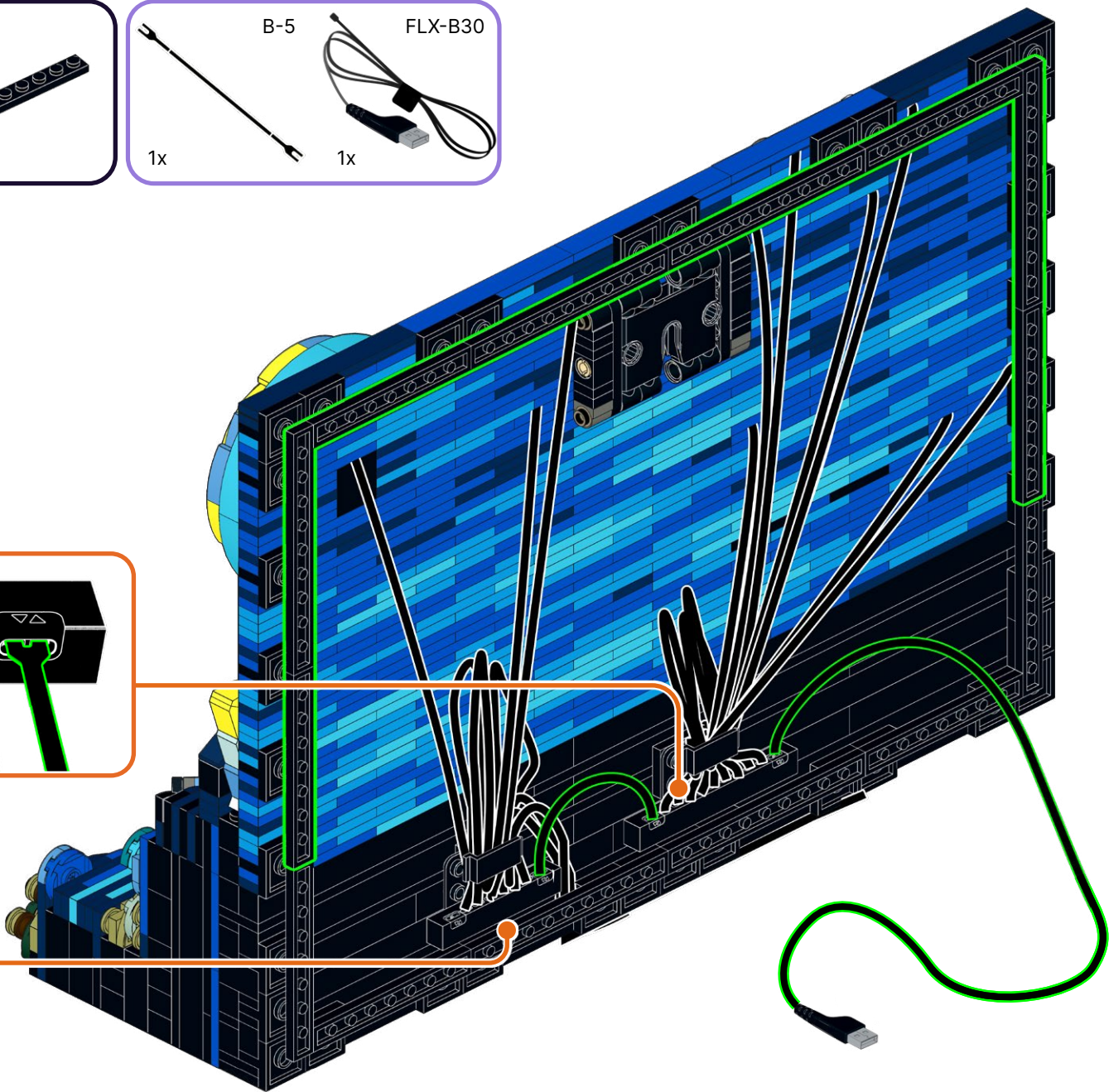
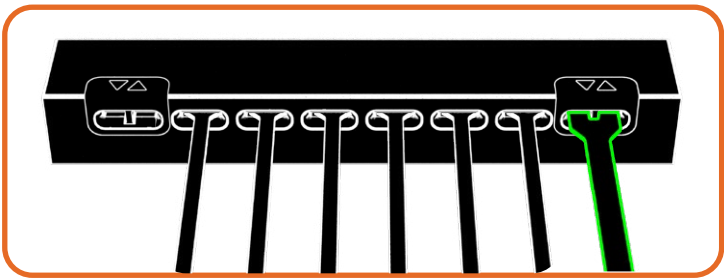
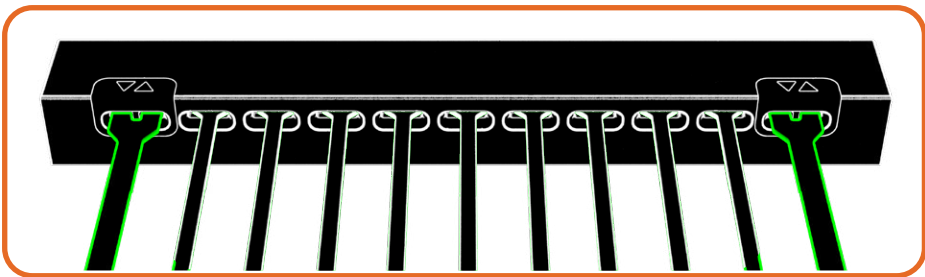
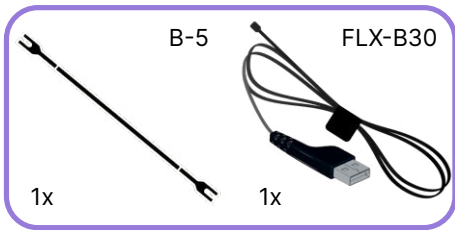
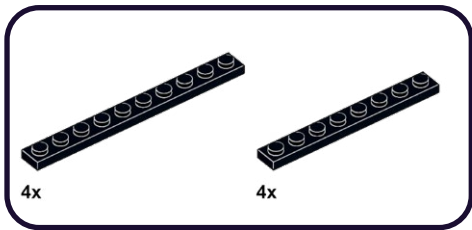



298



Power on Test  
Test de mise sous tension  
Test di Potenza  
Stromtest  
Prueba de Energía  
电源测试

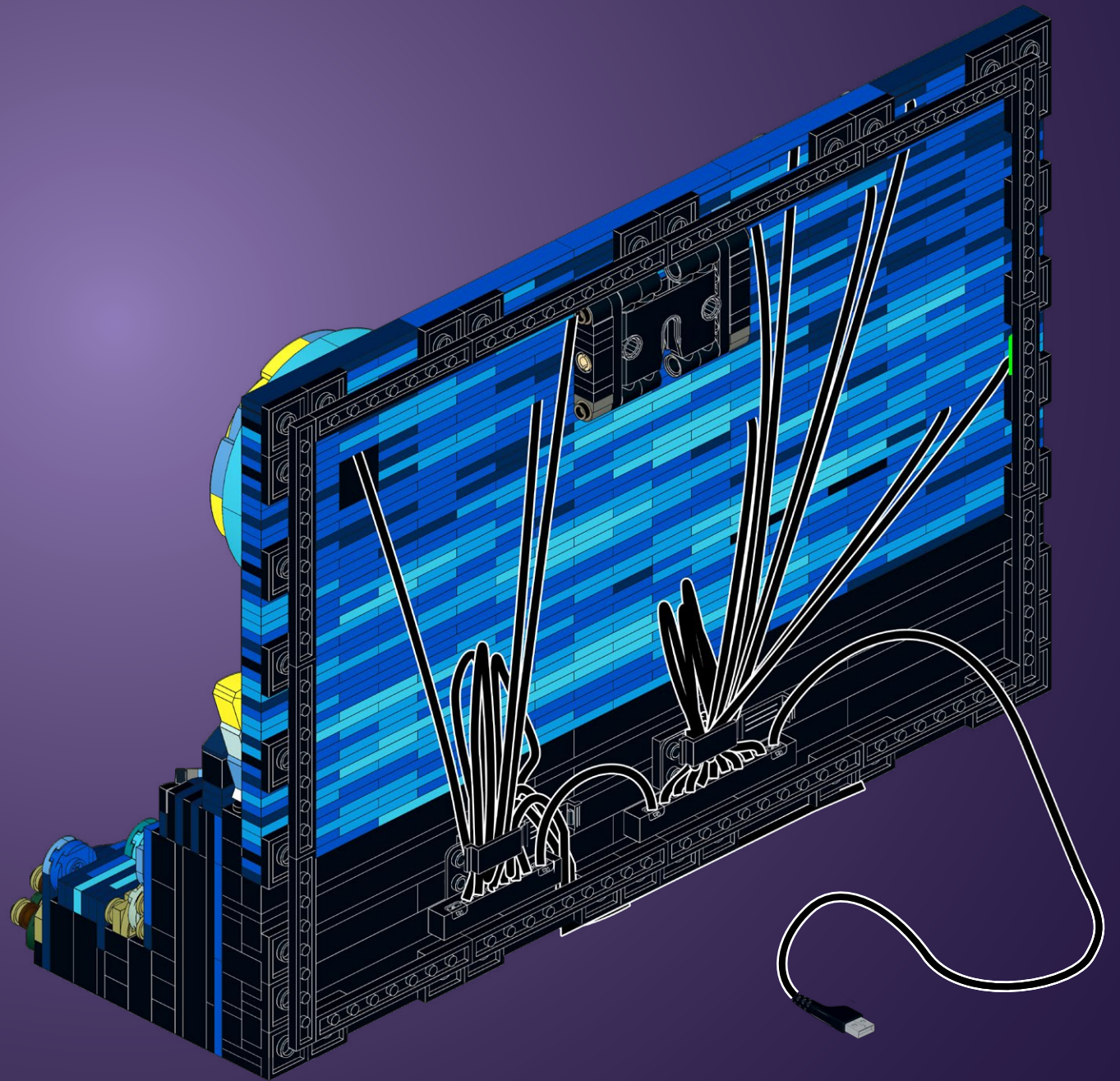

**HOLD UP!**

You might notice some bags aren't in order, as well as left over pieces, but that's ok! We're changing the way you build LEGO!

**ATTENDEZ!**

Vous remarquerez peut-être que certains sacs, ainsi que certaines pièces, ne sont pas dans le bon ordre. Mais pas de panique! Nous changeons simplement la façon avec laquelle vous construisez vos LEGO!

**ASPETTA!**

Potresti notare che alcuni sacchetti non sono in ordine, così come i pezzi avanzati, ma va bene così! Stiamo cambiando il modo in cui costruisci i LEGO!

**HALT!**

Sie werden möglicherweise bemerken, dass einige tüten durcheinander sind und teile übrig bleiben, aber das ist in Ordnung! Wir ändern die art und weise, wie Sie LEGO bauen!

**¡ESPERA!**

Es posible que notes que algunas bolsas están fuera de servicio, así como piezas sobrantes, ¡pero está bien! ¡Estamos cambiando la forma en que construyes LEGO!

**暫停!**

你可能会注意到一些袋子顺序错乱, 以及一些剩余的部件, 但没关系! 我们正在改变你搭建乐高的方式!

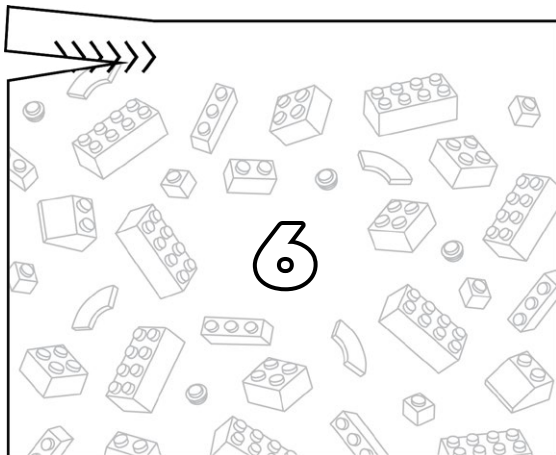
**Open LEGO® Bag 6**



299

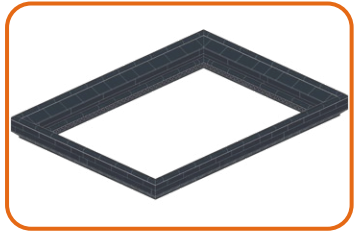
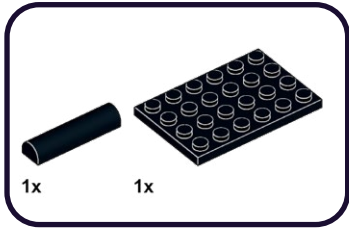

300

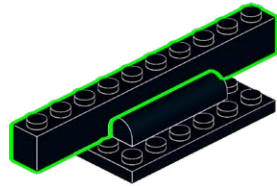
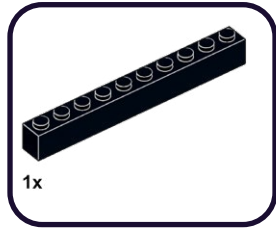

**301**

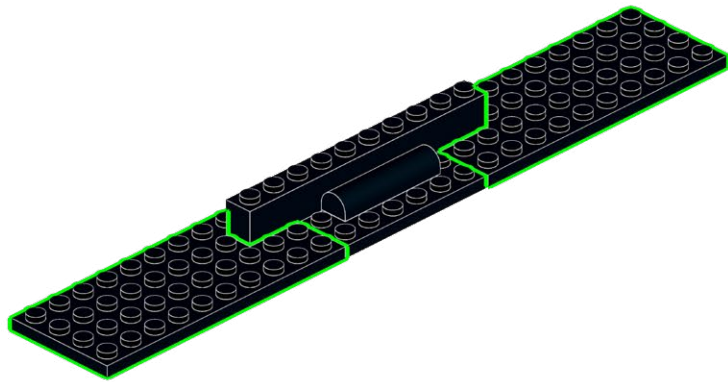

**302**

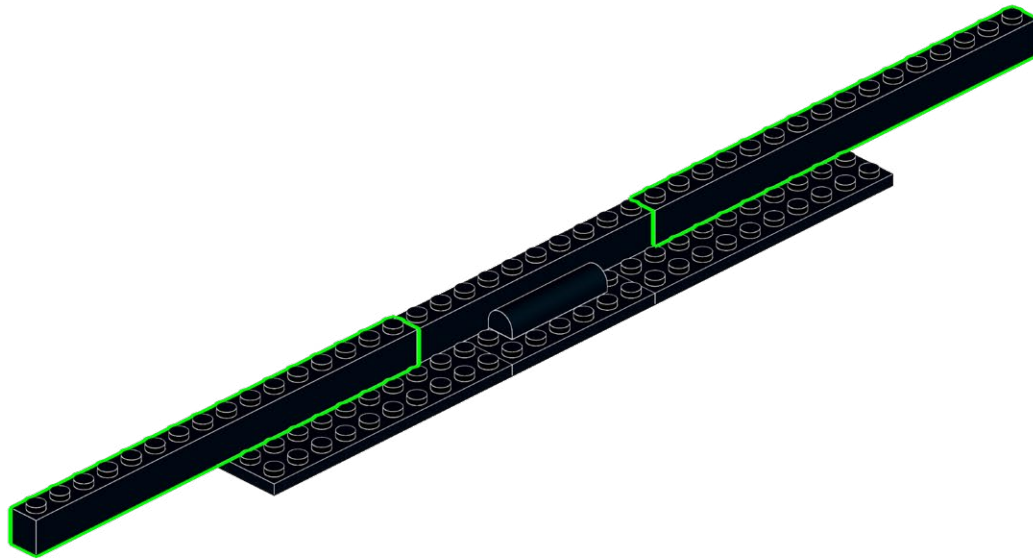
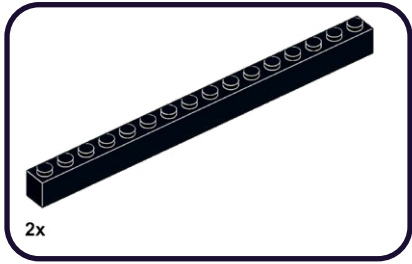



303

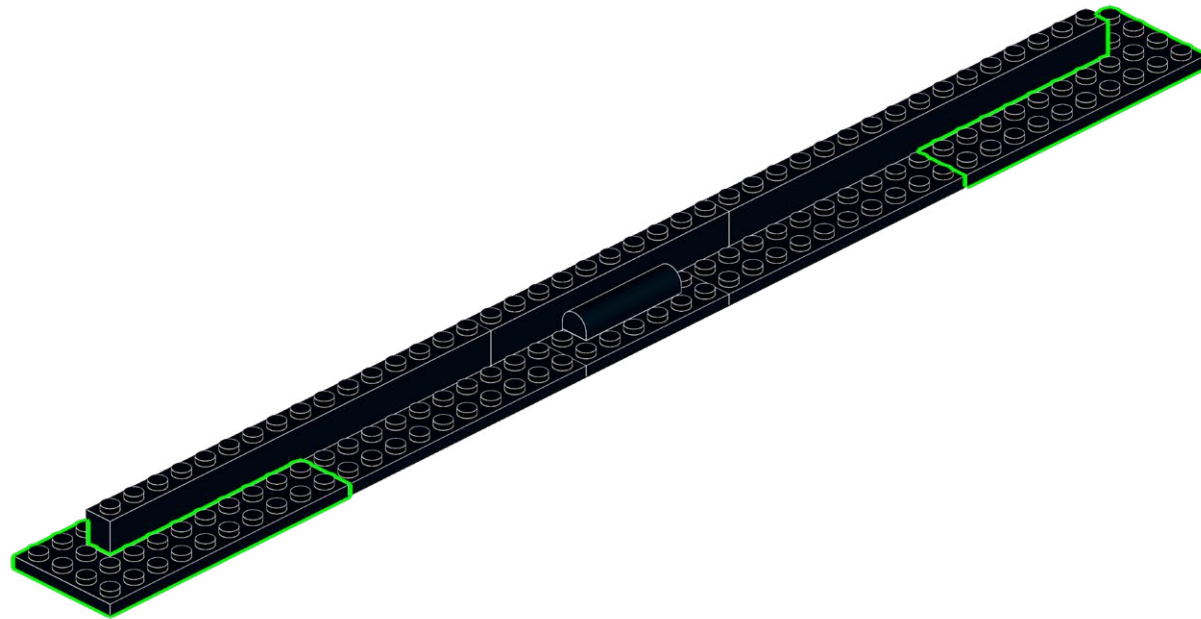
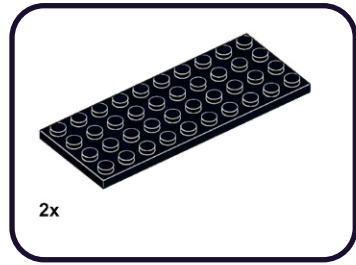

304

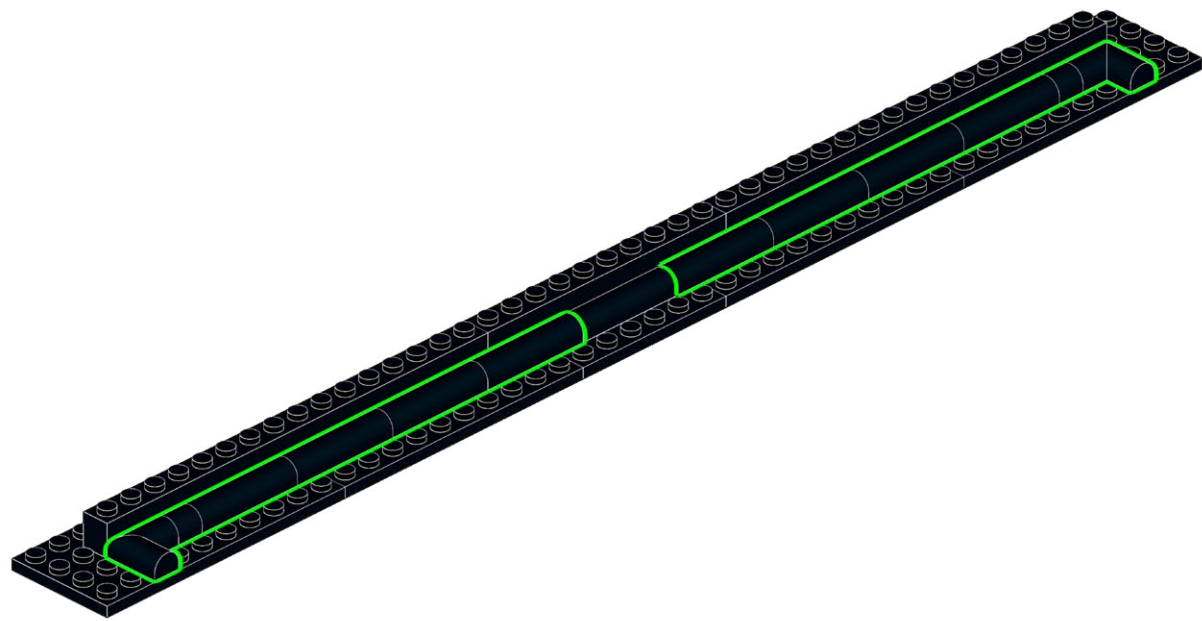
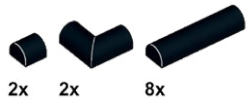

305



24x

2x

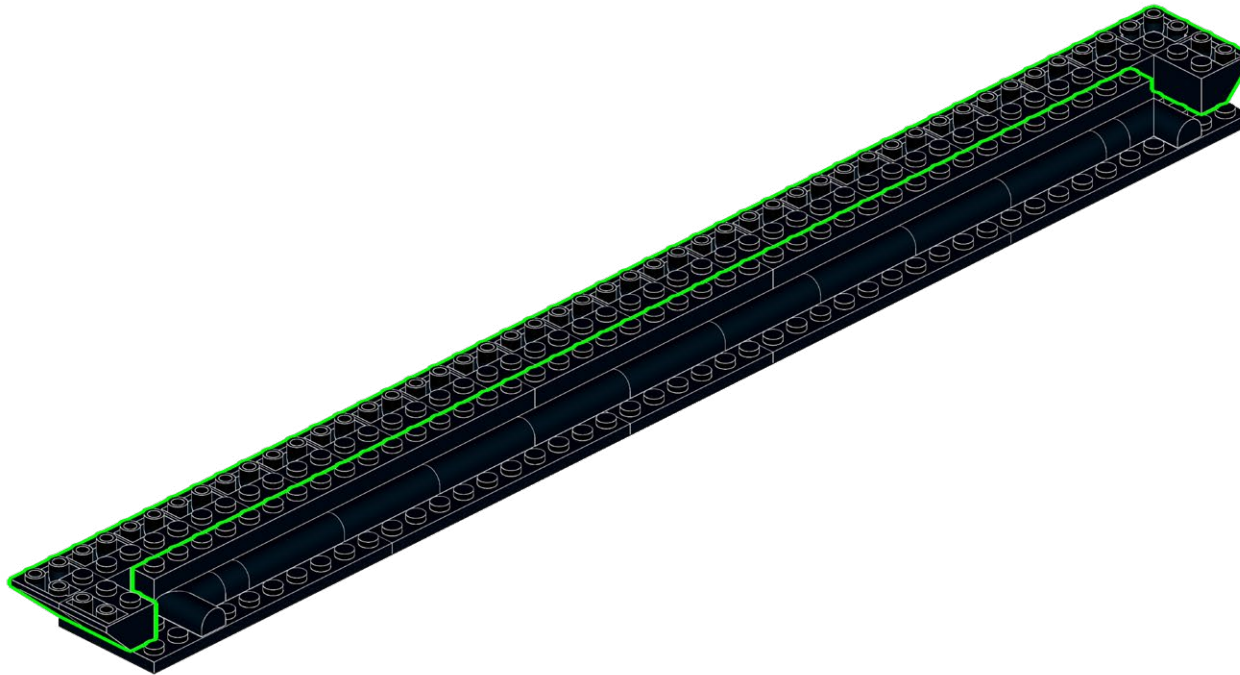

**306**

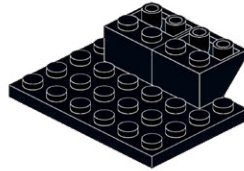
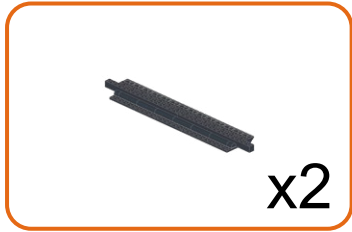
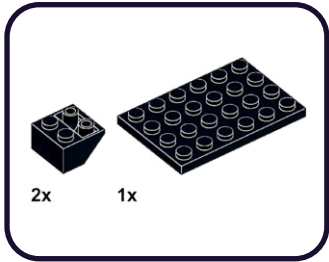



**307**

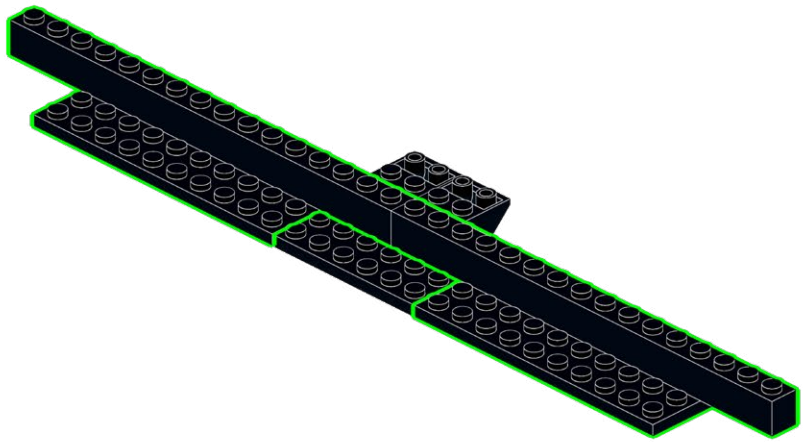
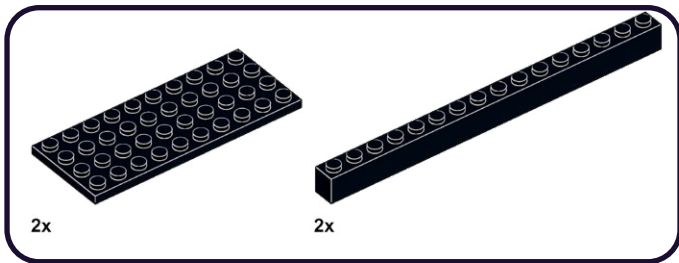

308

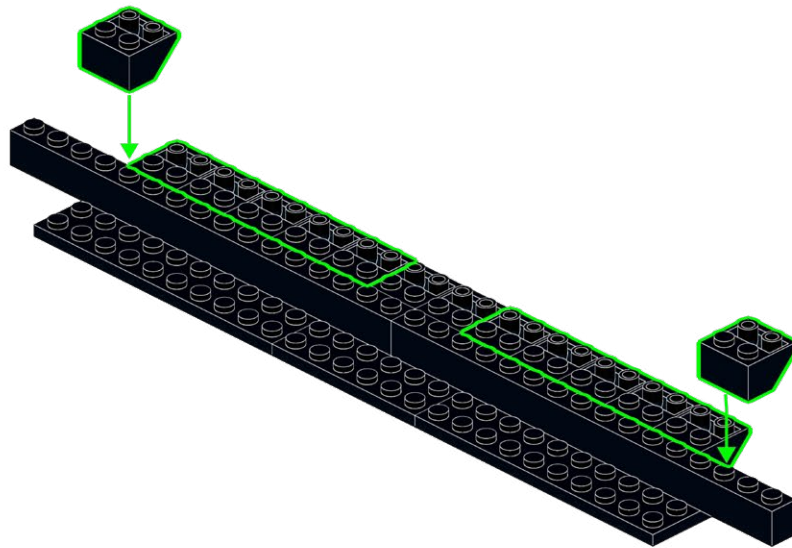
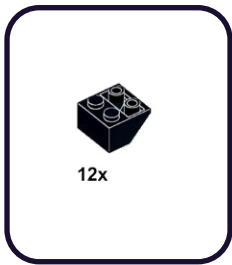

309

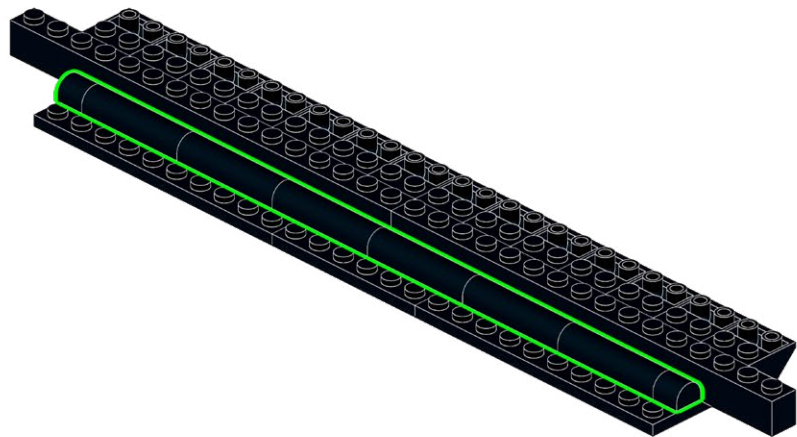
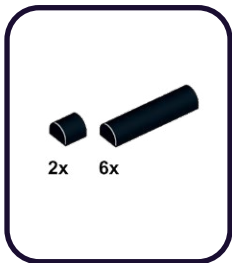

2x

310

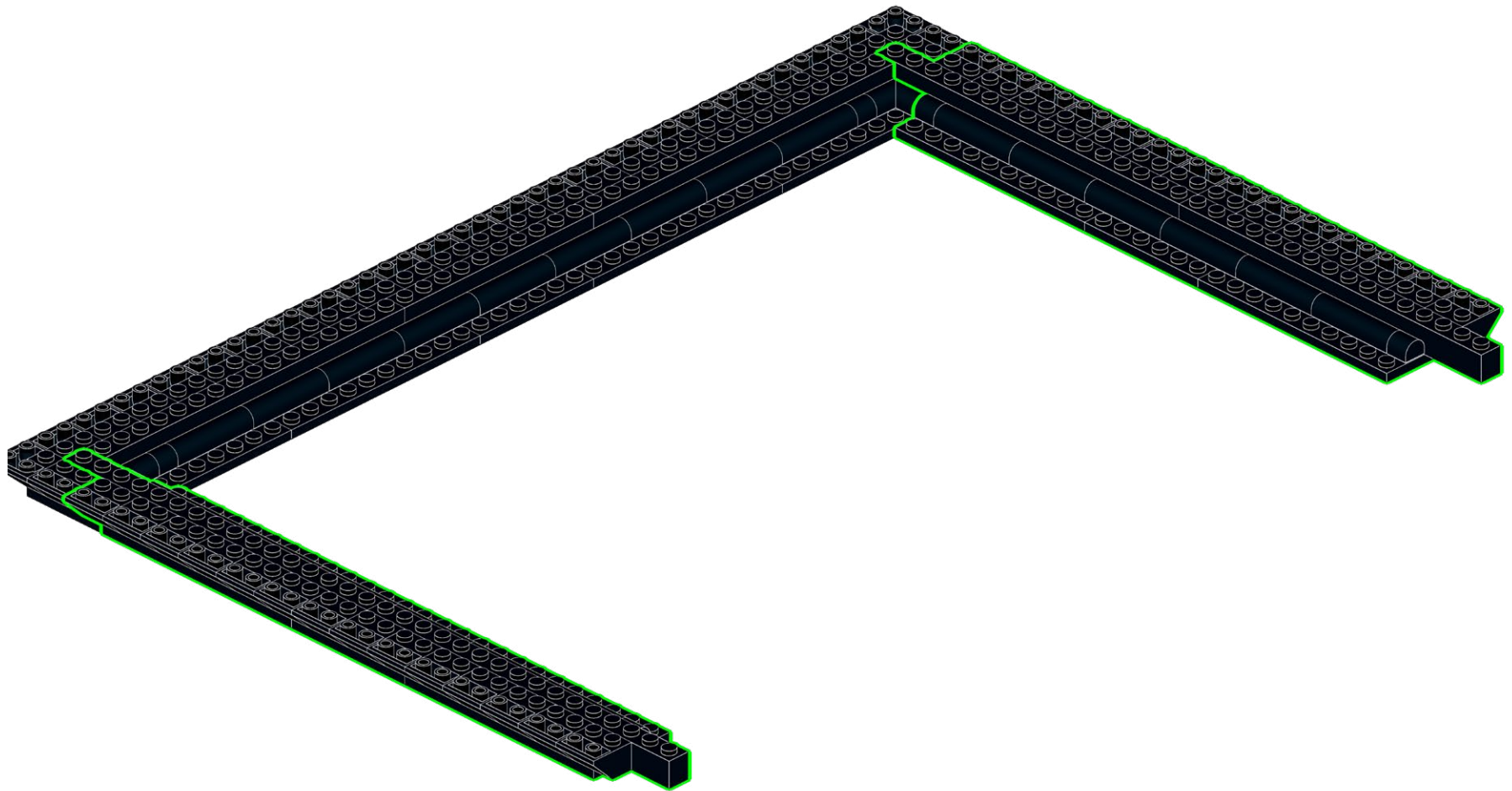

311

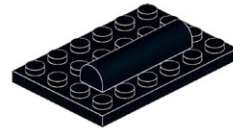
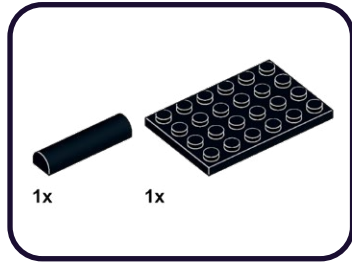



**312**

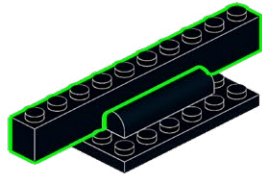
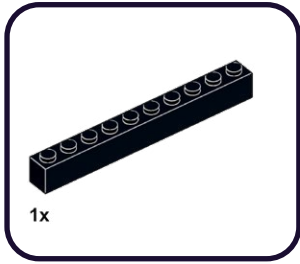

313

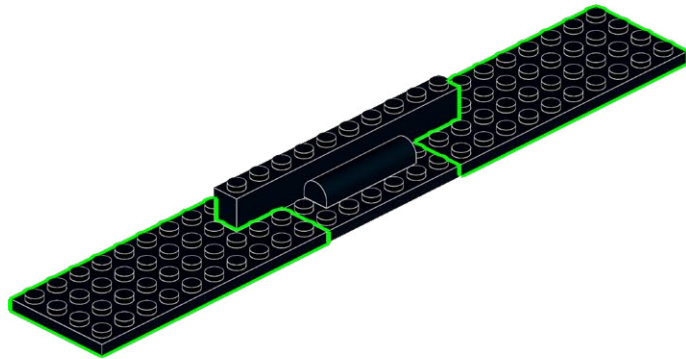
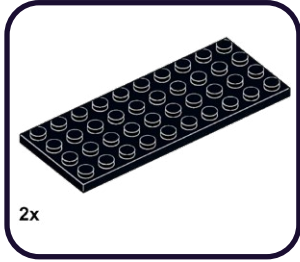

314

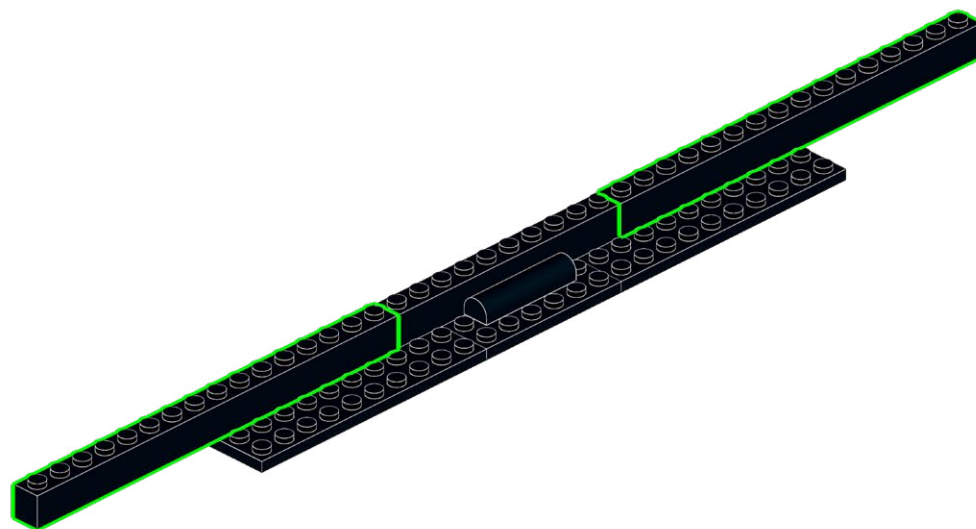
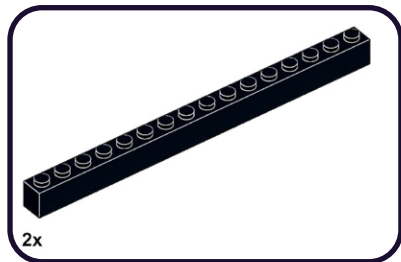

315

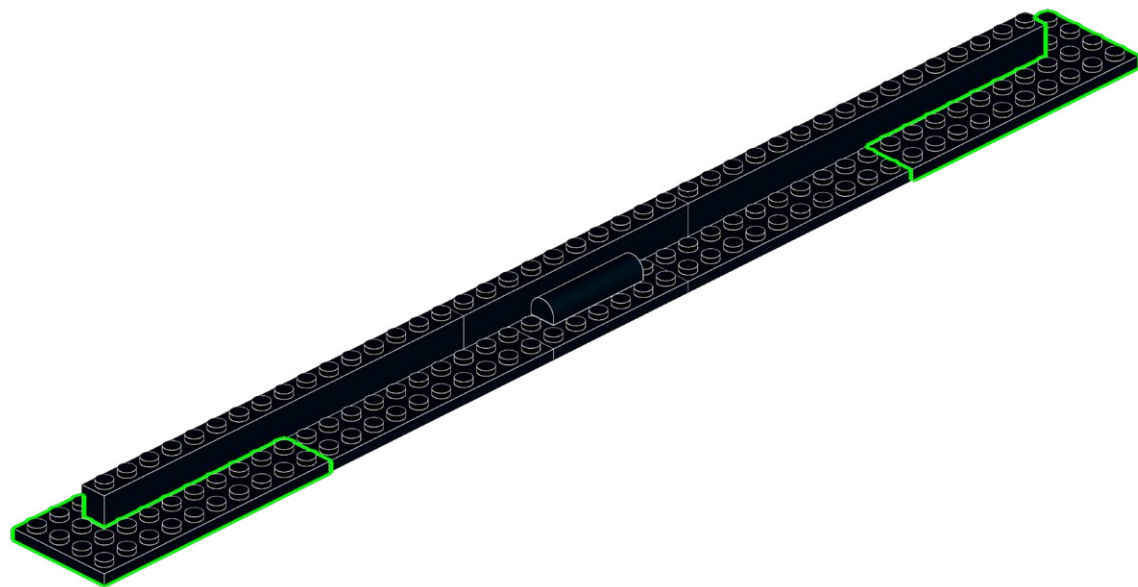
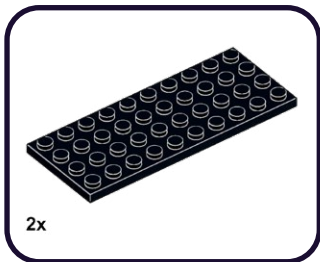

**316**

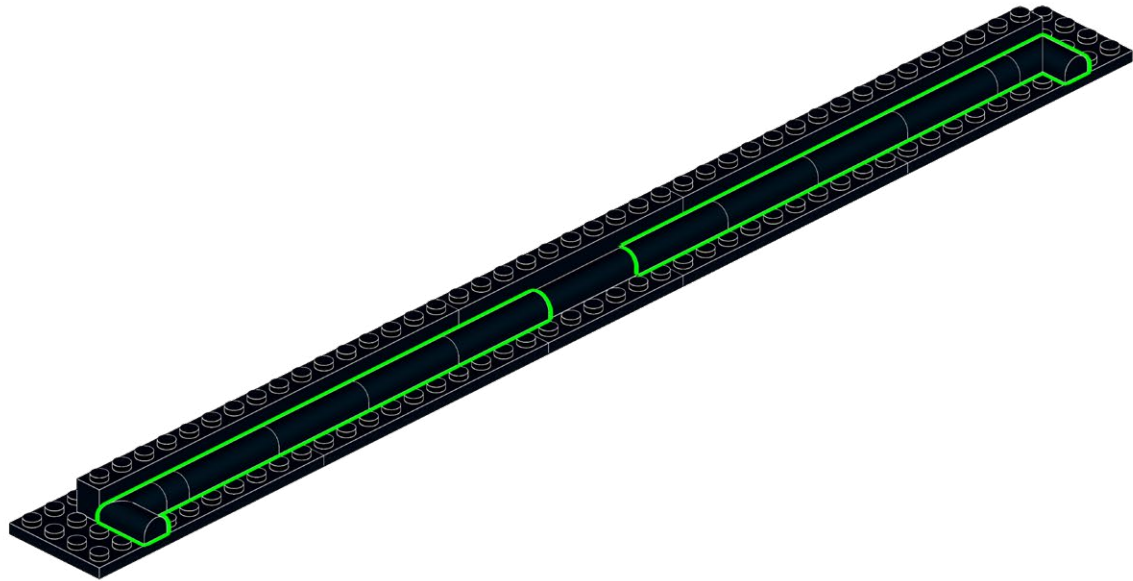
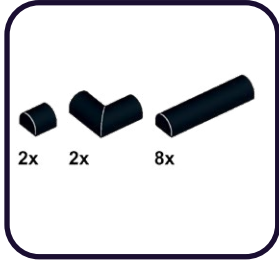



317

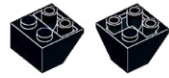

24x

2x

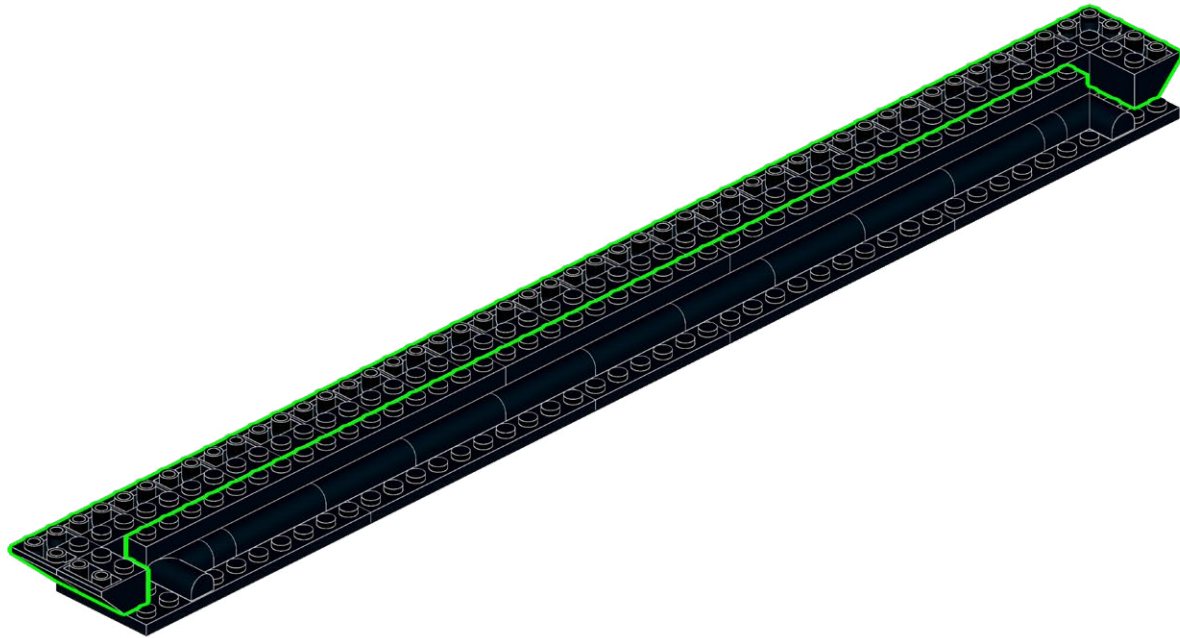

318

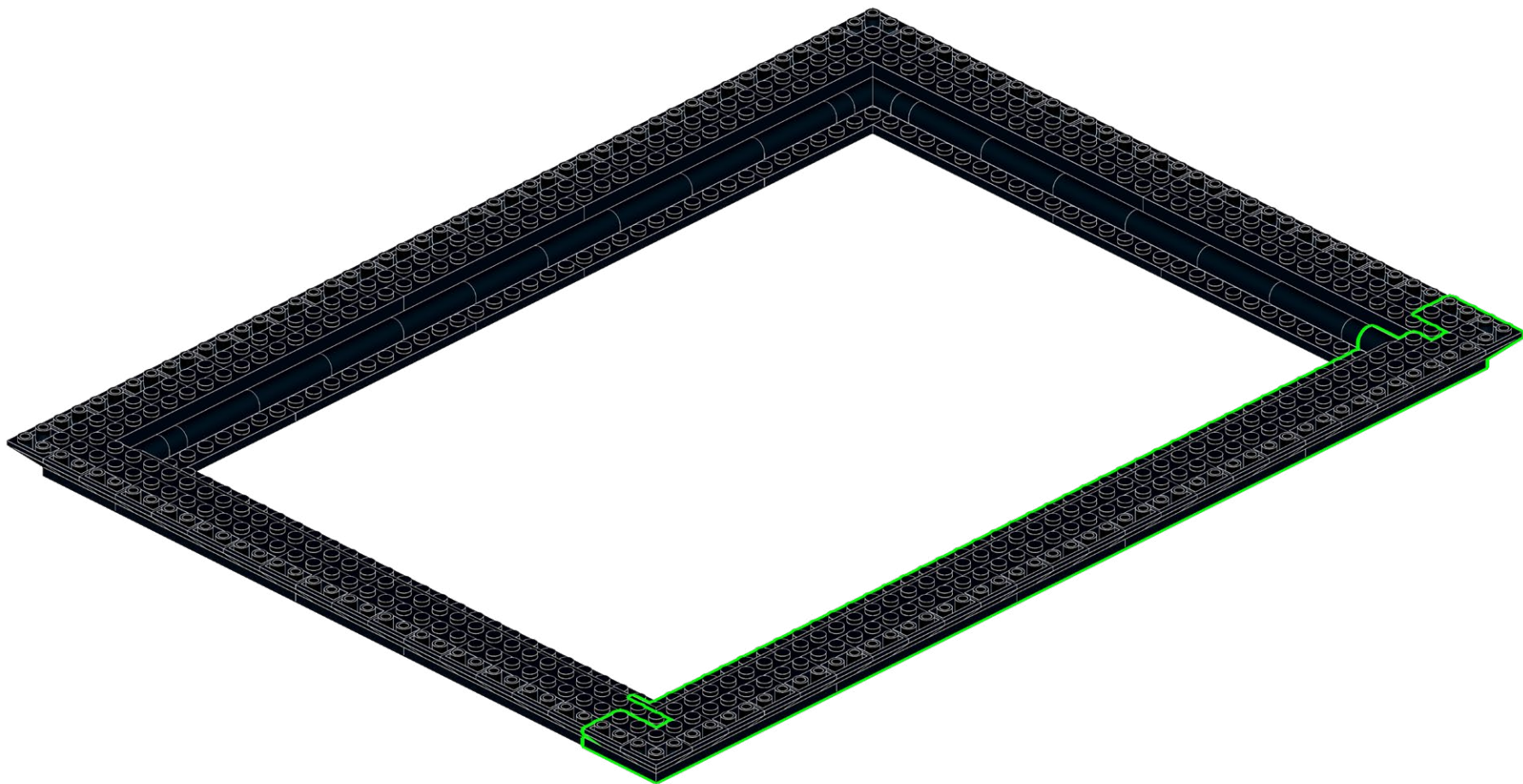

319

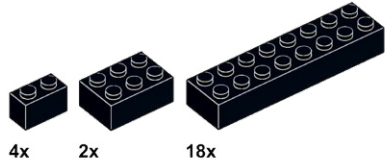

320

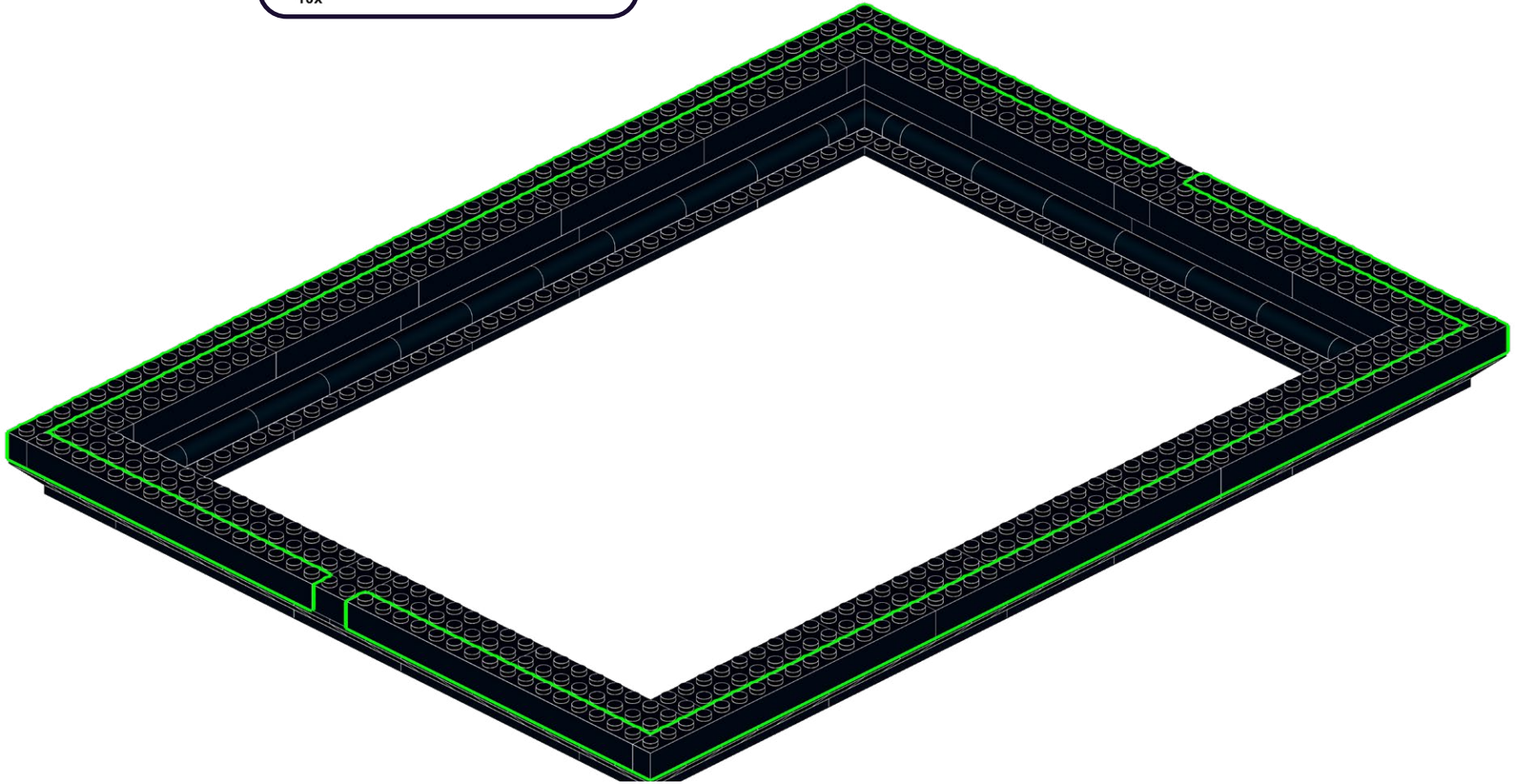
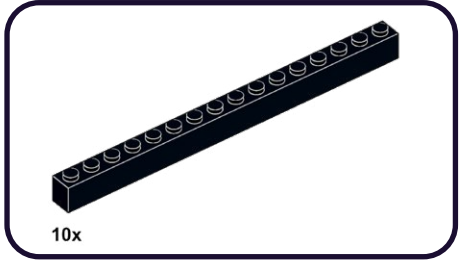



321

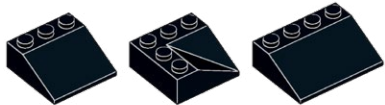

8x

4x

30x

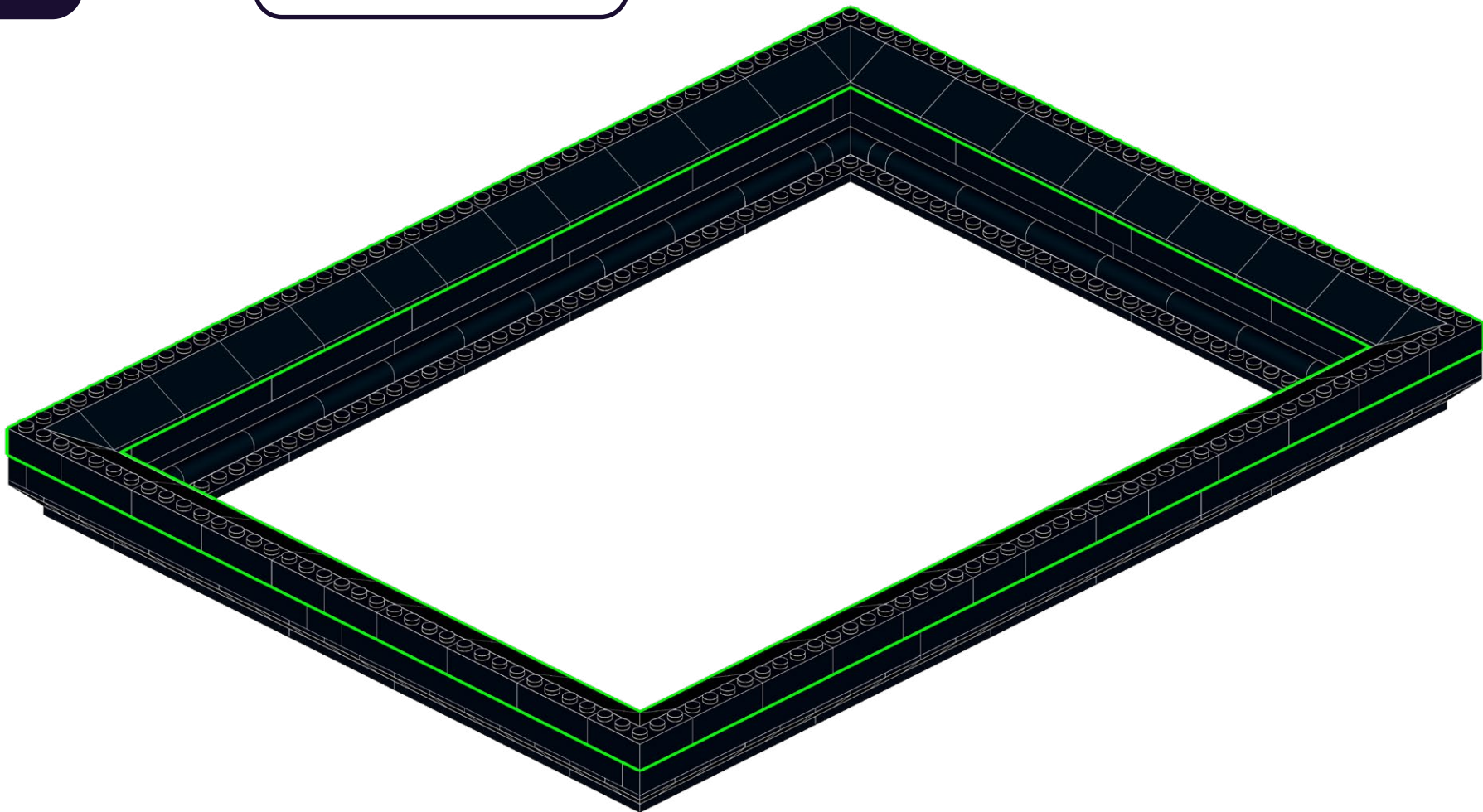



322

4x

38x

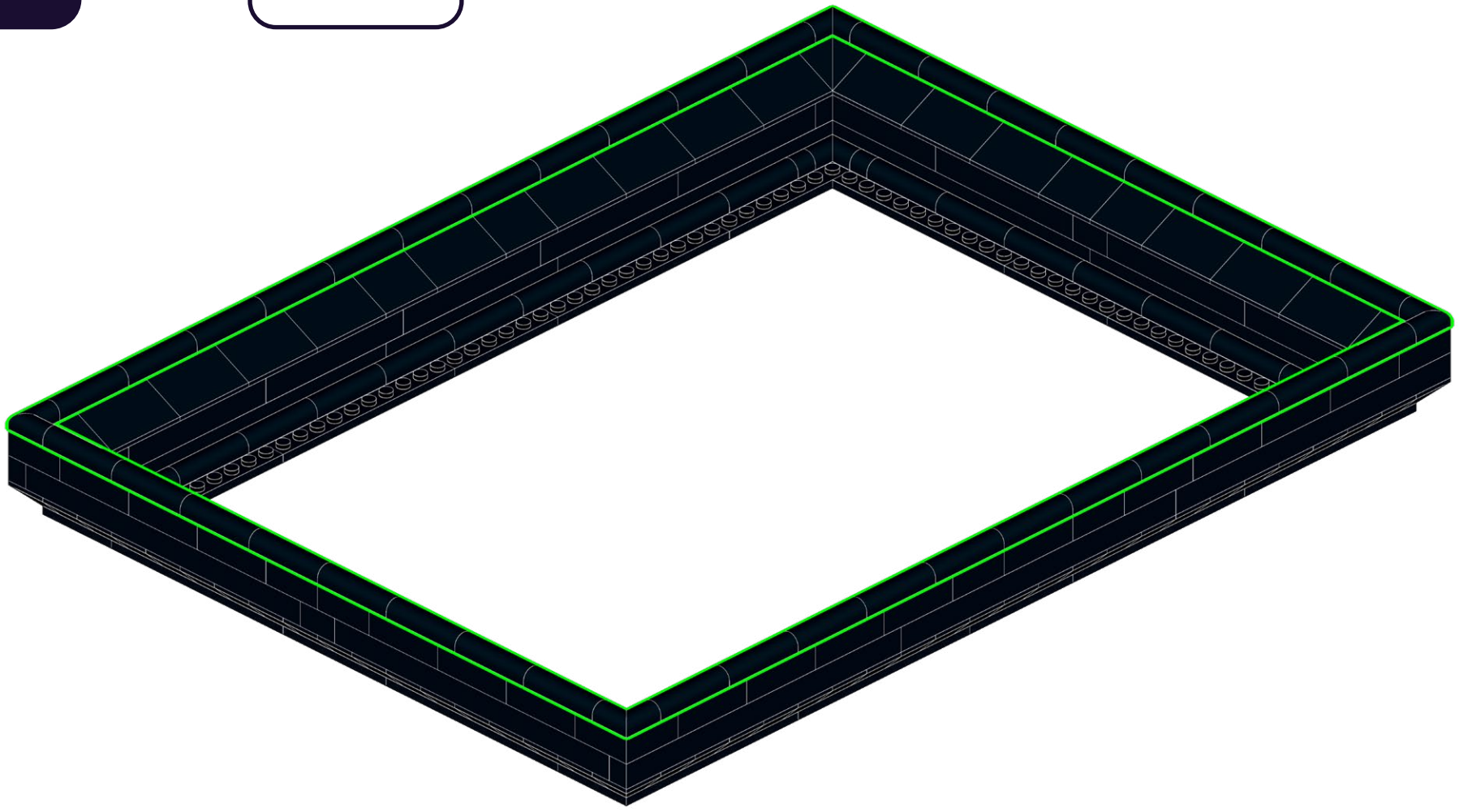

323

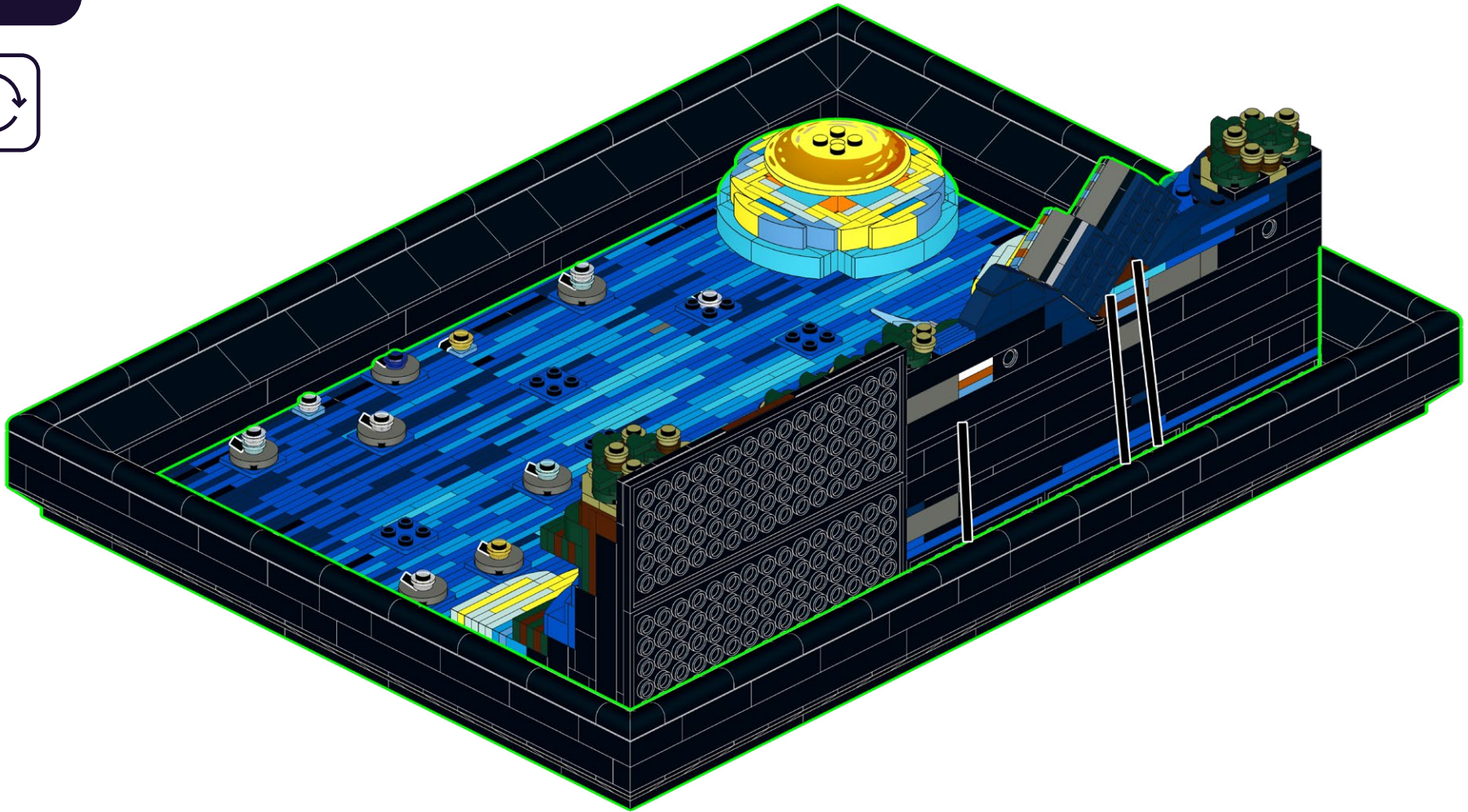



324

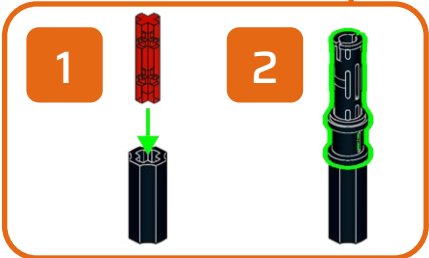
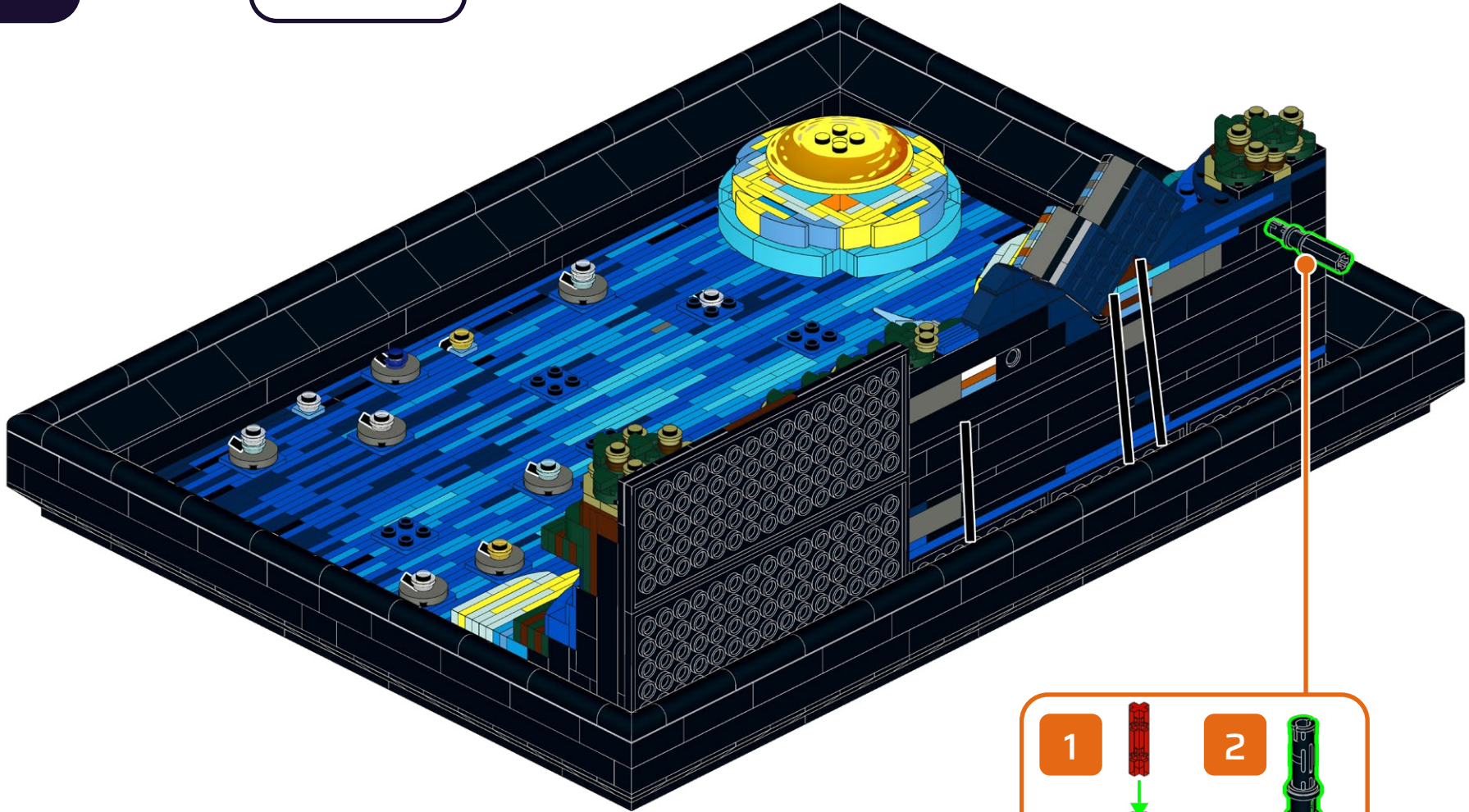

**325**

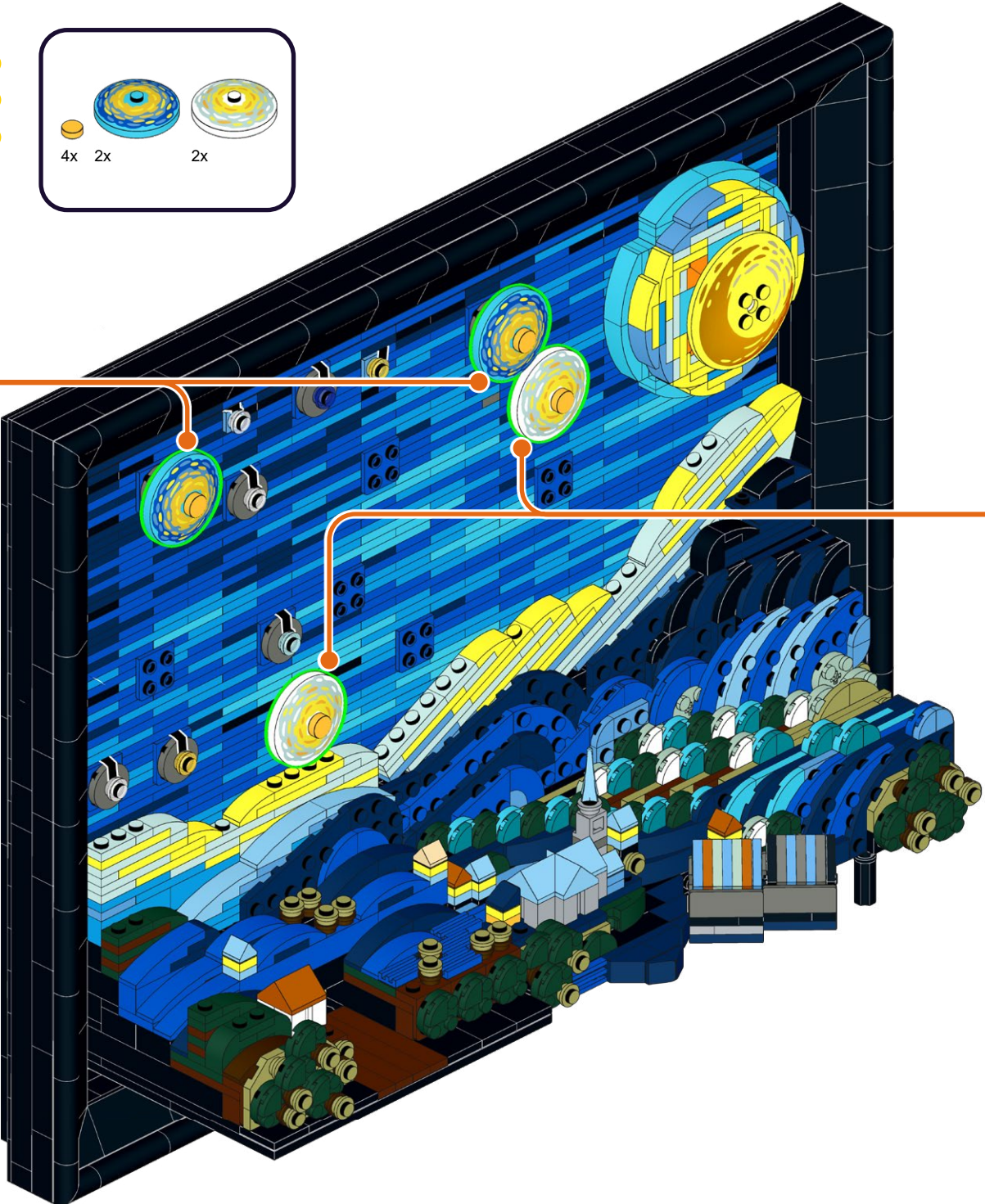
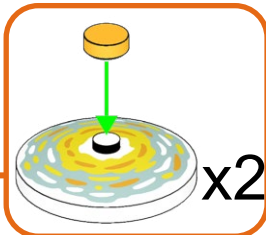
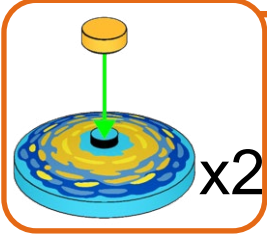
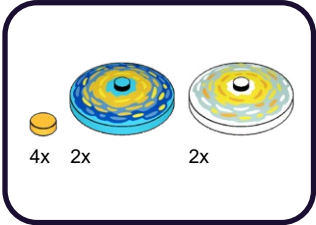



**326**

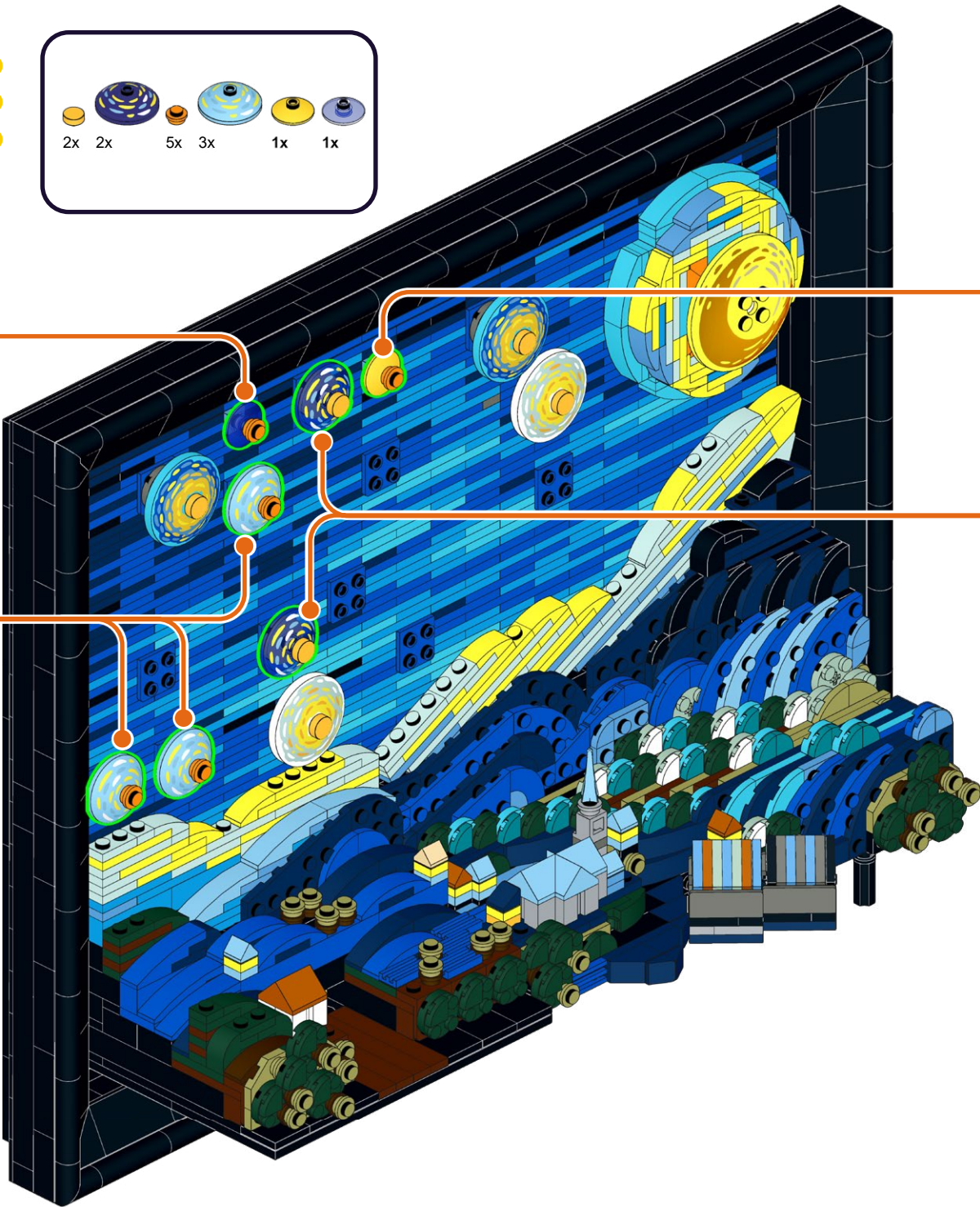
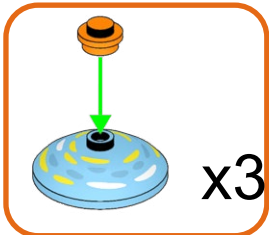
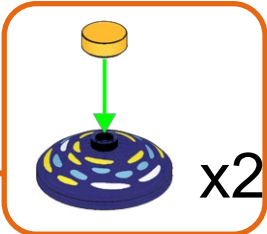
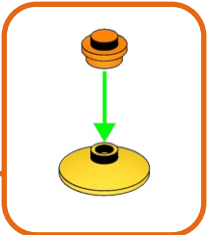
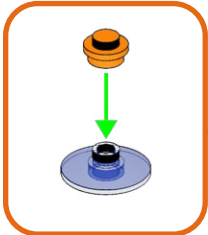
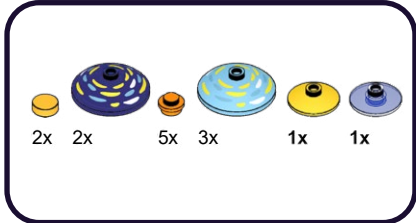

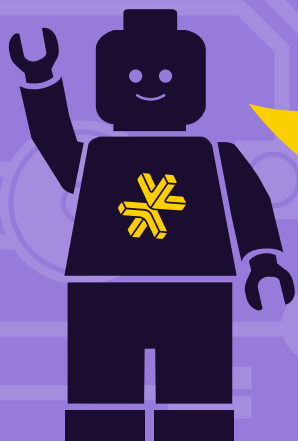

**HOLD UP!**

You might notice some bags aren't in order, as well as left over pieces, but that's ok! We're changing the way you build LEGO!

**ATTENDEZ!**

Vous remarquerez peut-être que certains sacs, ainsi que certaines pièces, ne sont pas dans le bon ordre. Mais pas de panique! Nous changeons simplement la façon avec laquelle vous construisez vos LEGO!

**ASPETTA!**

Potresti notare che alcuni sacchetti non sono in ordine, così come i pezzi avanzati, ma va bene così! Stiamo cambiando il modo in cui costruisci i LEGO!

**HALT!**

Sie werden möglicherweise bemerken, dass einige tüten durcheinander sind und teile übrig bleiben, aber das ist in Ordnung! Wir ändern die art und weise, wie Sie LEGO bauen!

**¡ESPERA!**

Es posible que notes que algunas bolsas están fuera de servicio, así como piezas sobrantes, ¡pero está bien! ¡Estamos cambiando la forma en que construyes LEGO!

**暫停!**

你可能会注意到一些袋子顺序错乱, 以及一些剩余的部件, 但没关系! 我们正在改变你搭建乐高的方式!

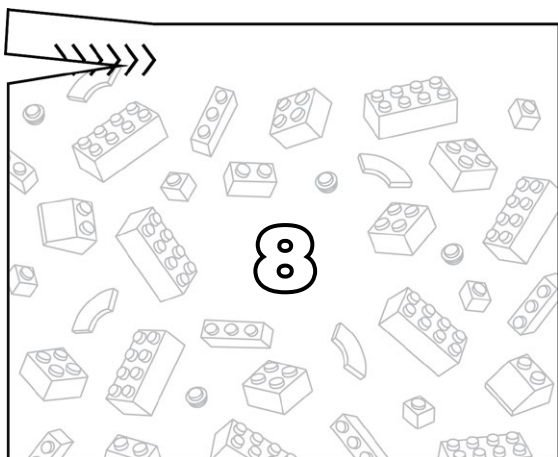
**Open LEGO® Bag 8**

# 327

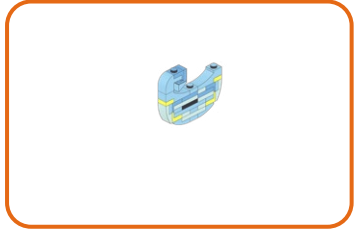
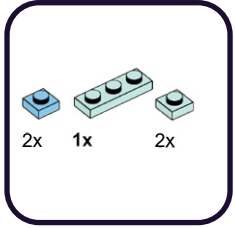

1

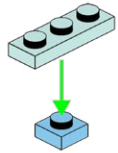

2

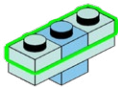

# 328

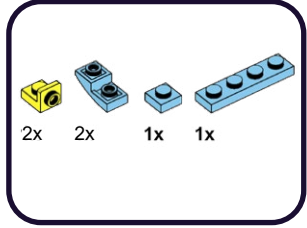

1

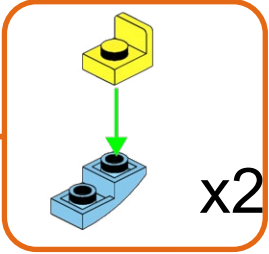

2

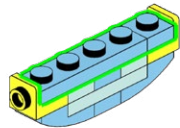

# 329

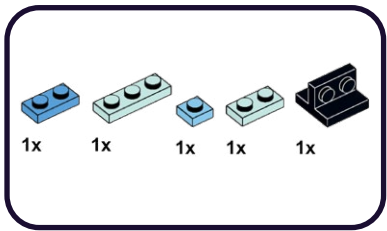

1

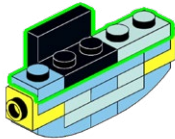

2

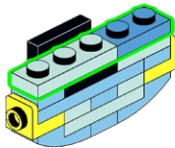

# 330

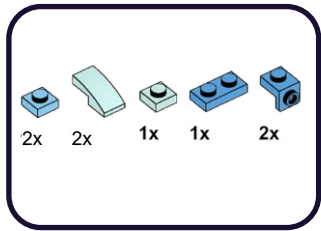

1

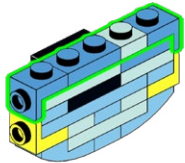

2

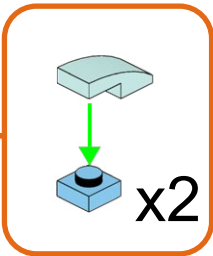
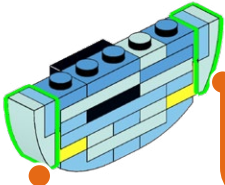

**331**

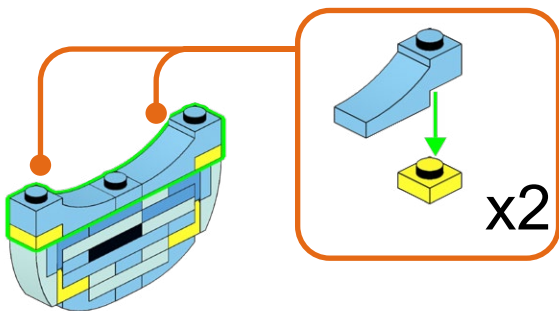
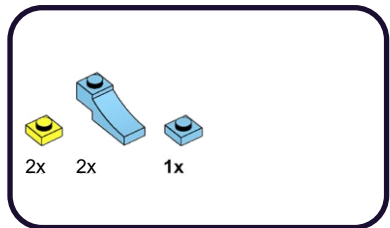

**332**

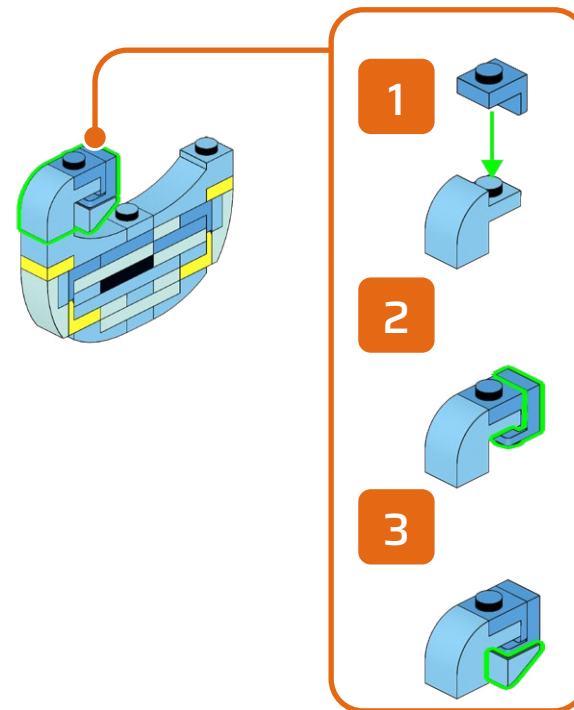
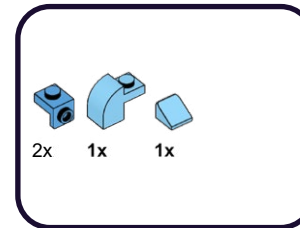

333





# 334

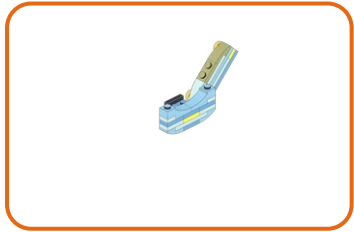
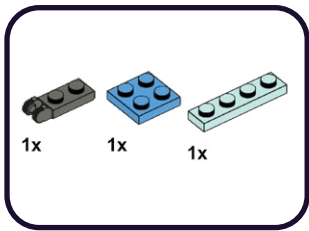

1

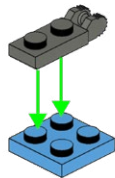

2

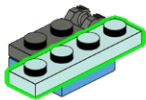

# 335

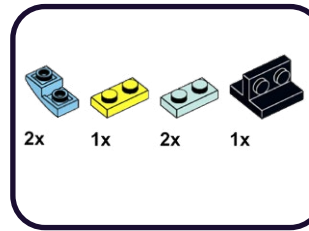

1

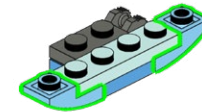

2

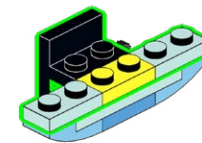

**336**

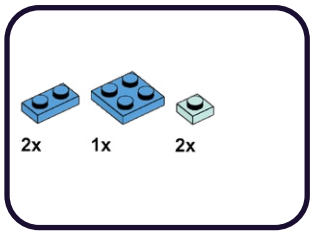

**1**

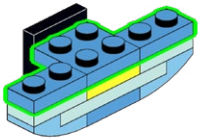

**2**

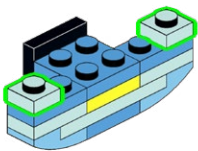

**337**

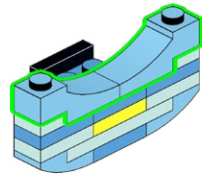
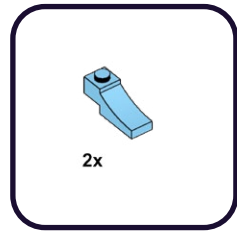

338

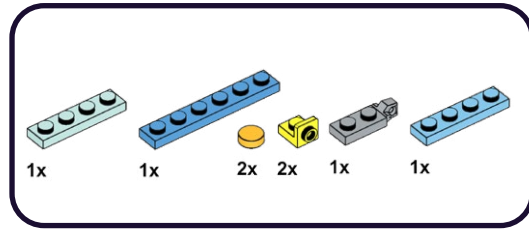

1

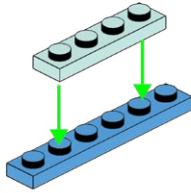

2

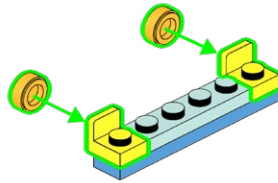

3

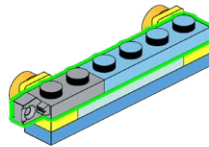

339

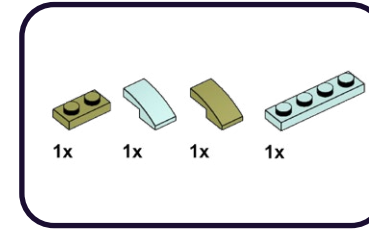

1

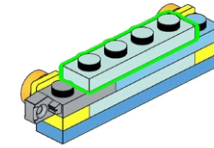

2

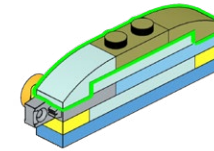

3

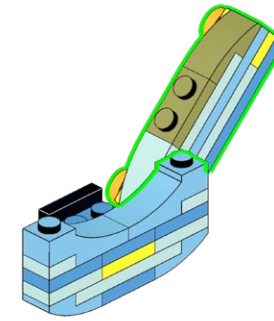

340



# 341

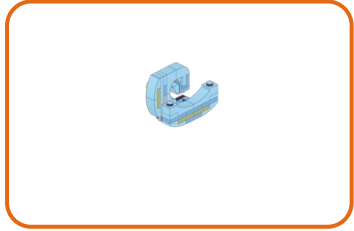
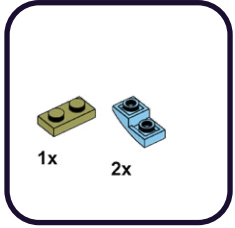

1



2

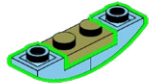

# 342

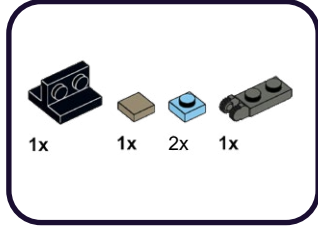

1

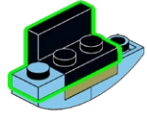

2

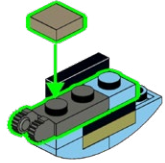



343

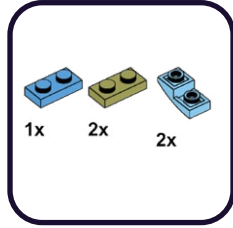

1



2

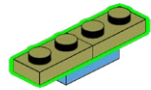

3

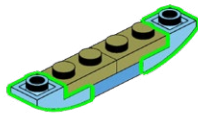

344

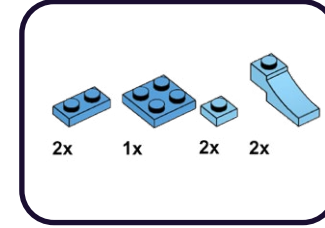

1

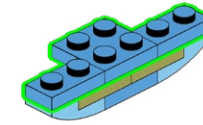

2

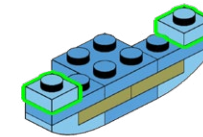

3

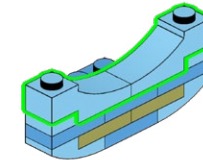

345

1

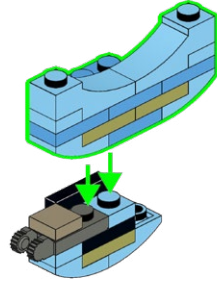

2

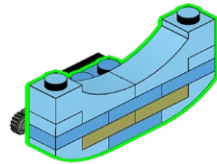

346

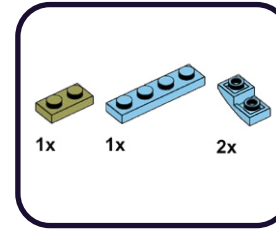

1

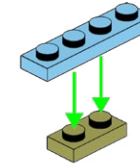

2

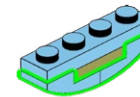

# 347

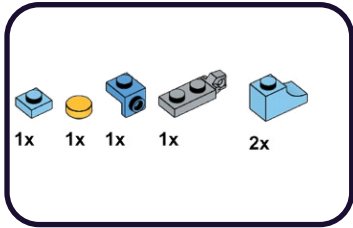

1

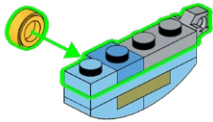

2

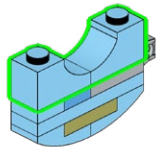

# 348

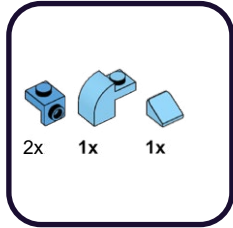

1

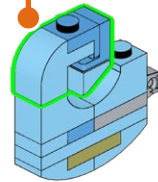

2

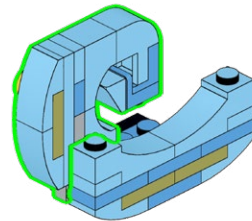

1

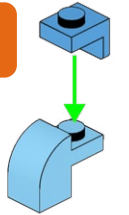

2

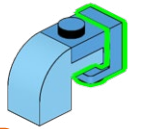

3

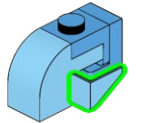

349



# 350



1

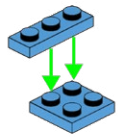
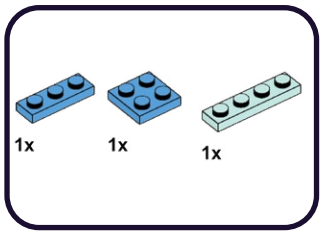

2

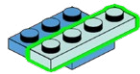

# 351

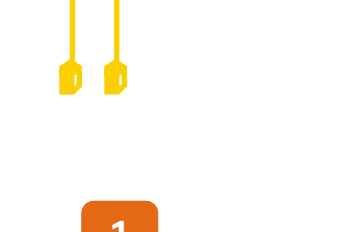

1

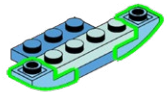
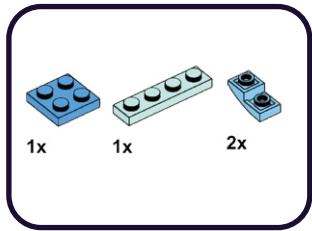

2

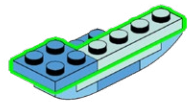



352

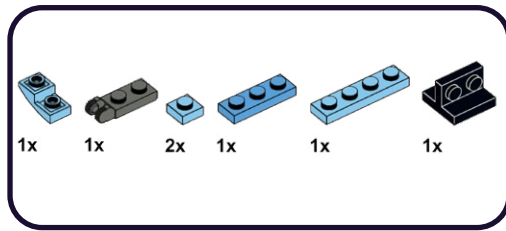

1

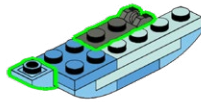

2

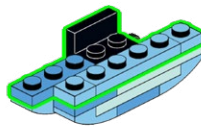

353

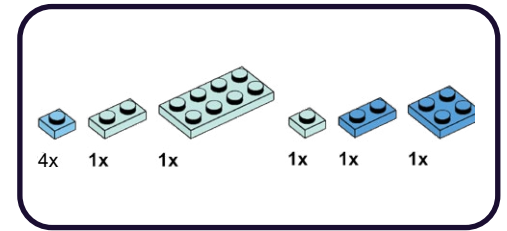

1

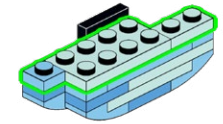

2

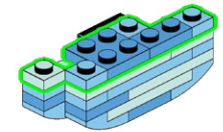

**354**

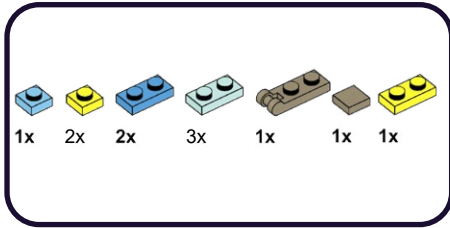

**1**

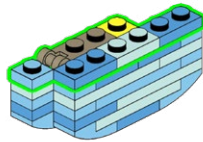

**2**

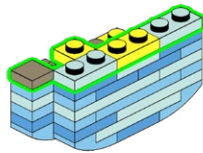

**355**

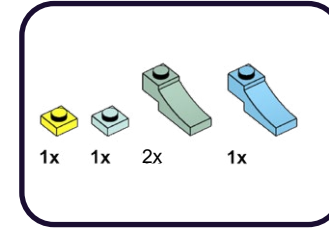

**1**

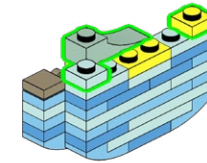

**2**

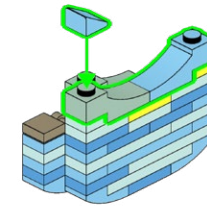

# 356

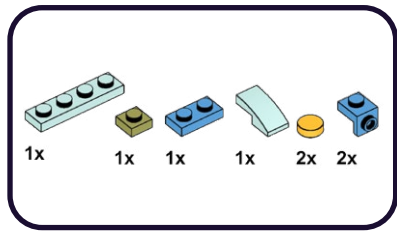

1

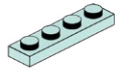

2

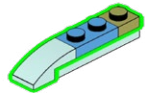

3

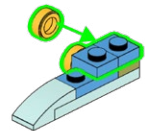

# 357

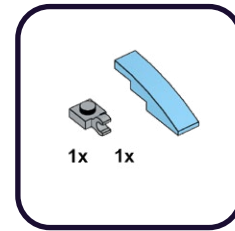

1

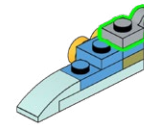

2

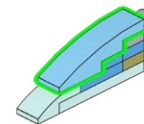

3

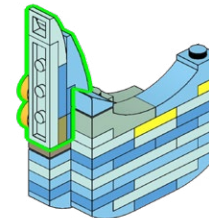

# 358

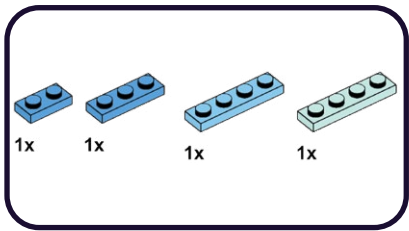

1

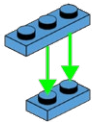

2

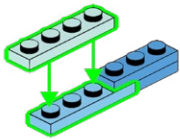

# 359

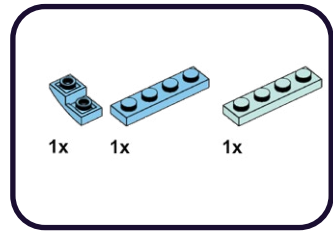

1

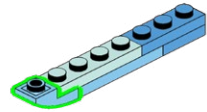

2

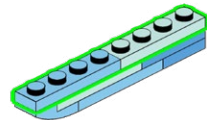

# 360

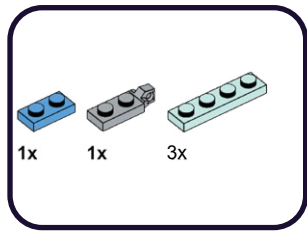

1

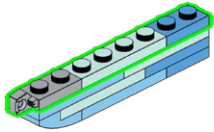

2

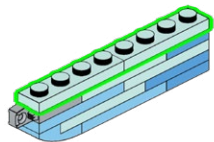

# 361

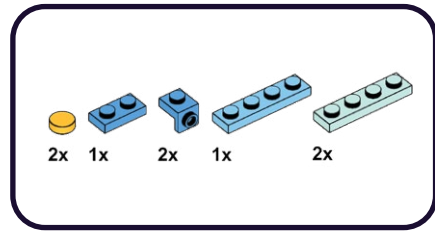

1

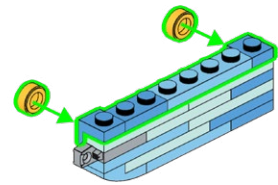

2

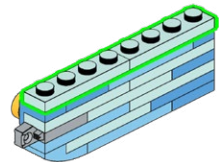



**362**

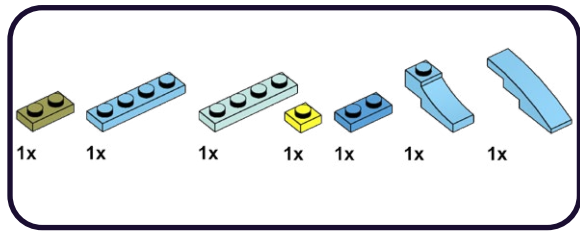

**363**

**1**

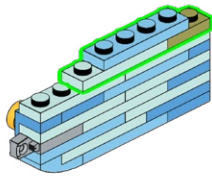

**2**

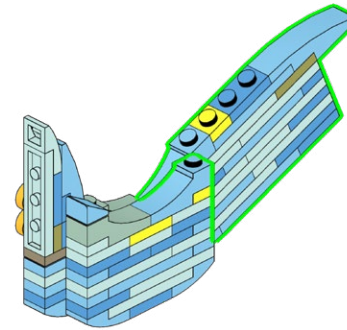
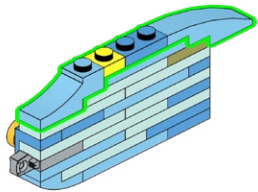

364



# 365

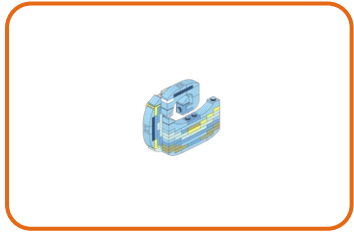
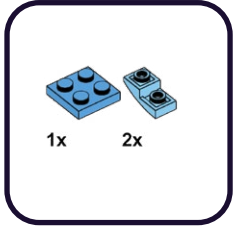

1



2

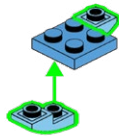

# 366

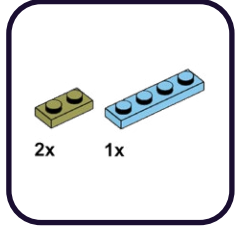

1

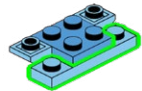

2

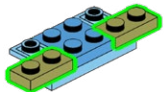

# 367

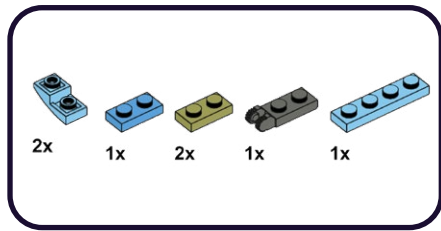

1

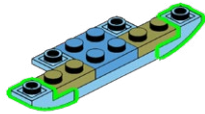

2

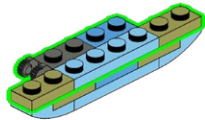

# 368

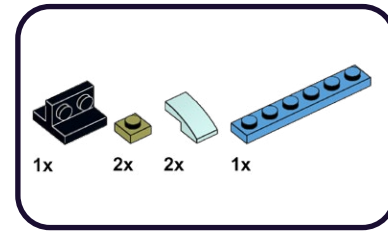

1

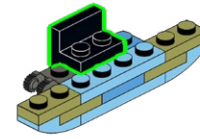

2

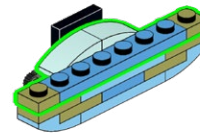

369

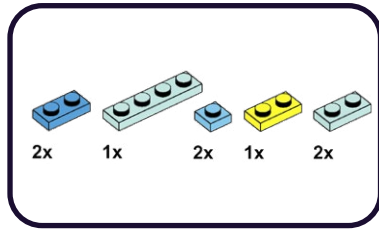

1

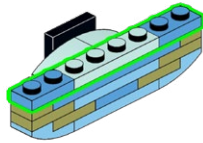

2

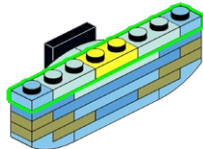

370

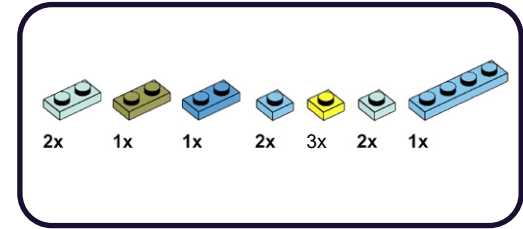

1

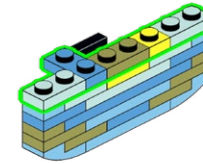

2

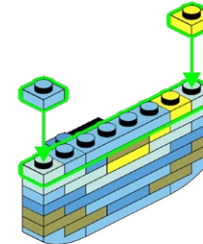



371

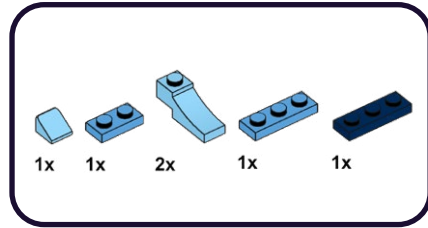

1

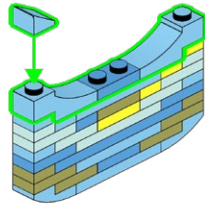

2

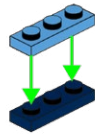

372

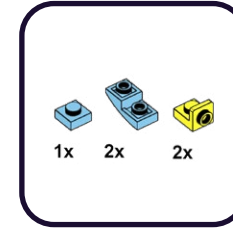

1

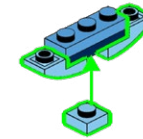

2

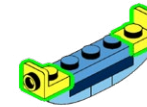

# 373

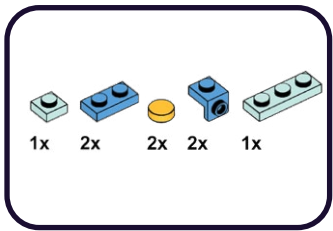

1

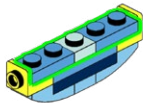

2

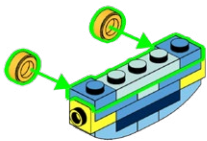

# 374

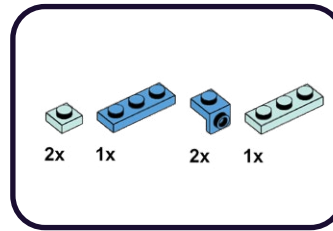

1

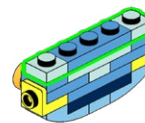

2

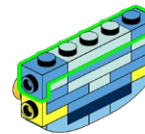

# 375

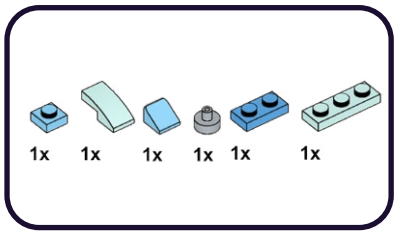

1

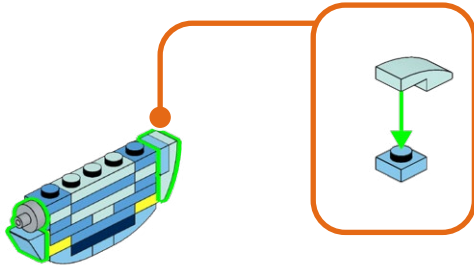

2

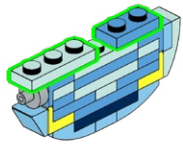

# 376

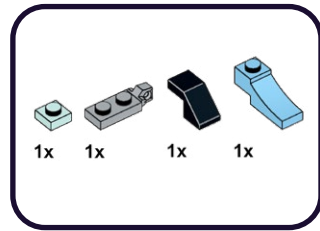

1

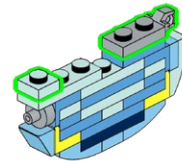

2

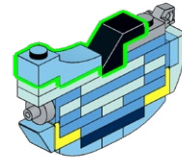

# 377

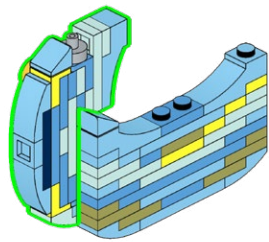

# 378

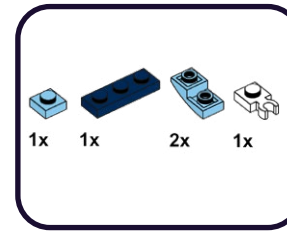

1

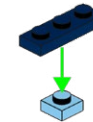

2

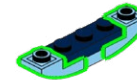

3

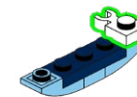

**379**

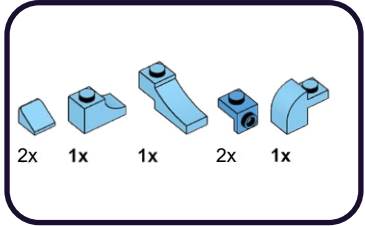

**380**

**1**

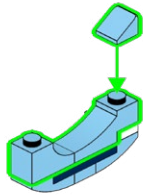

**2**

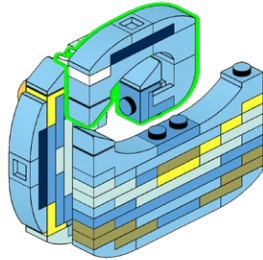
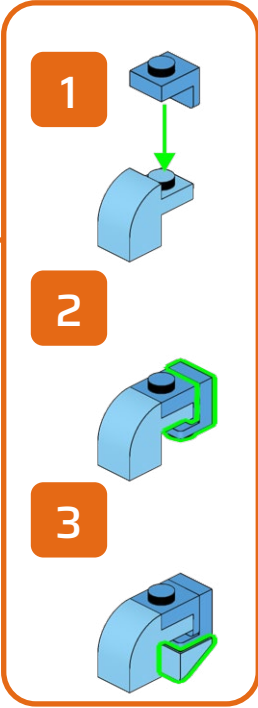
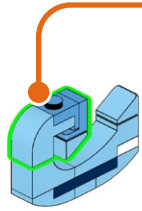



381



382

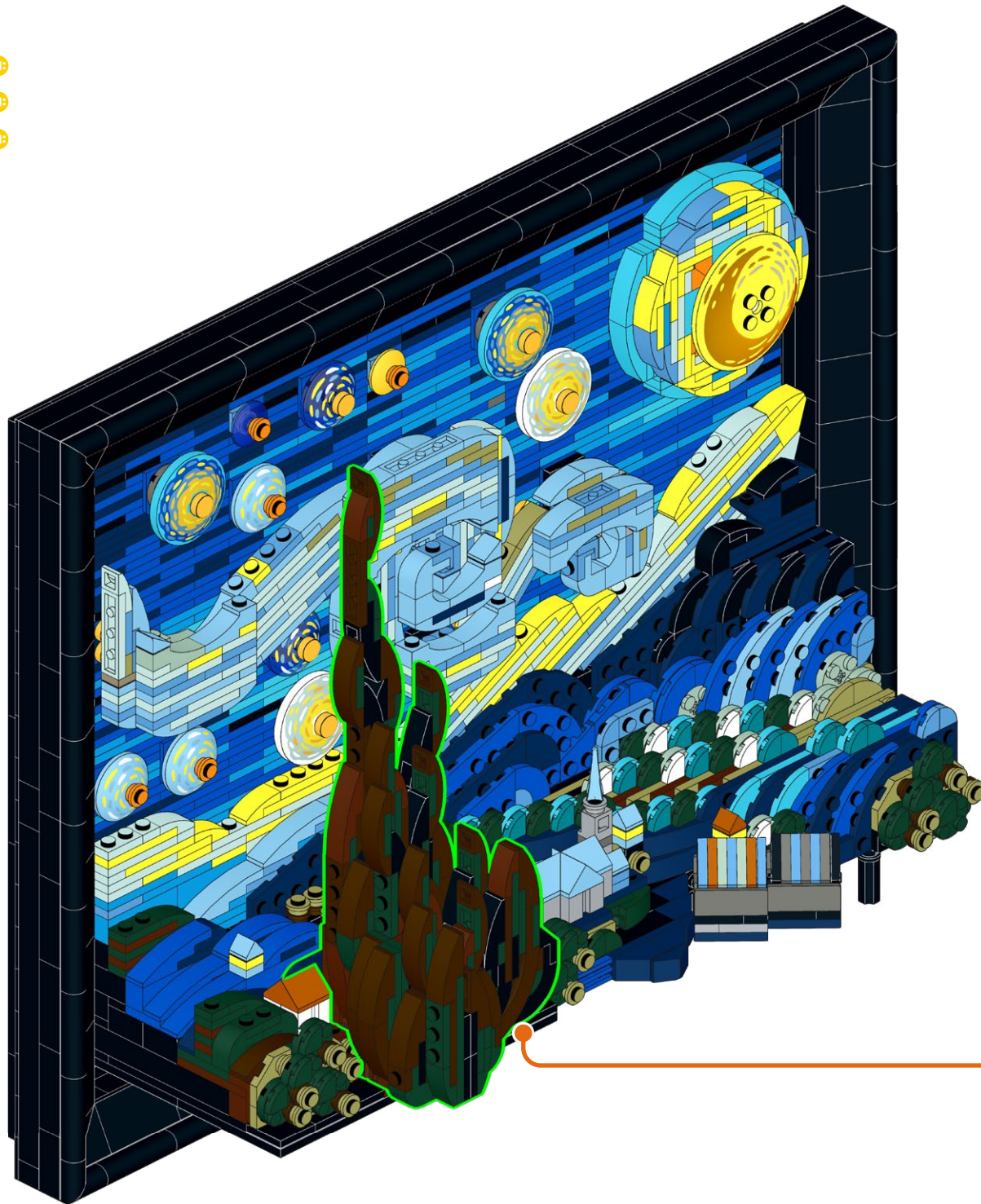



383

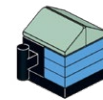
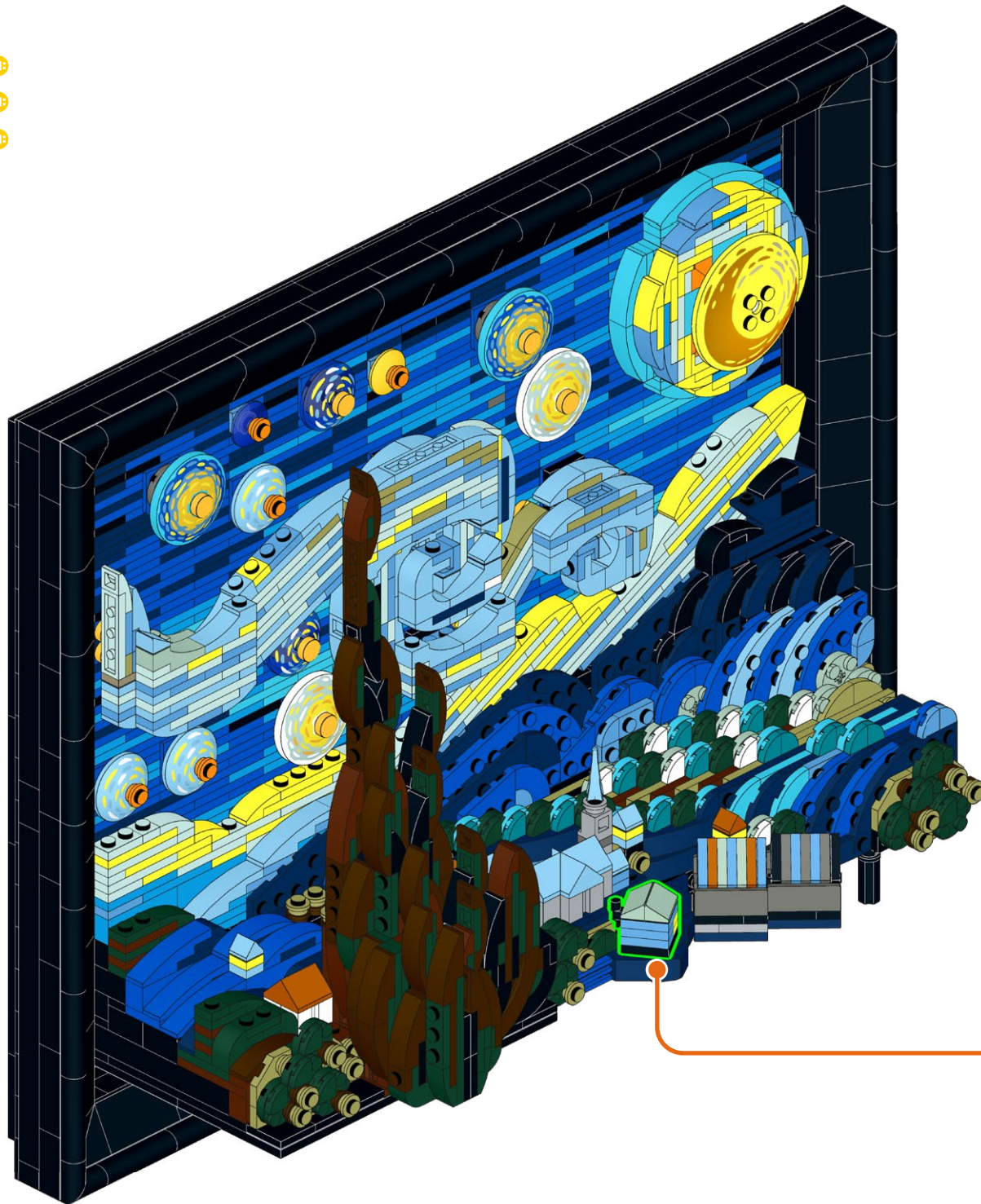

384





385

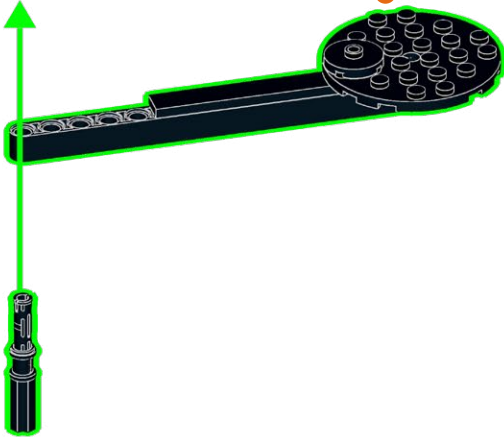
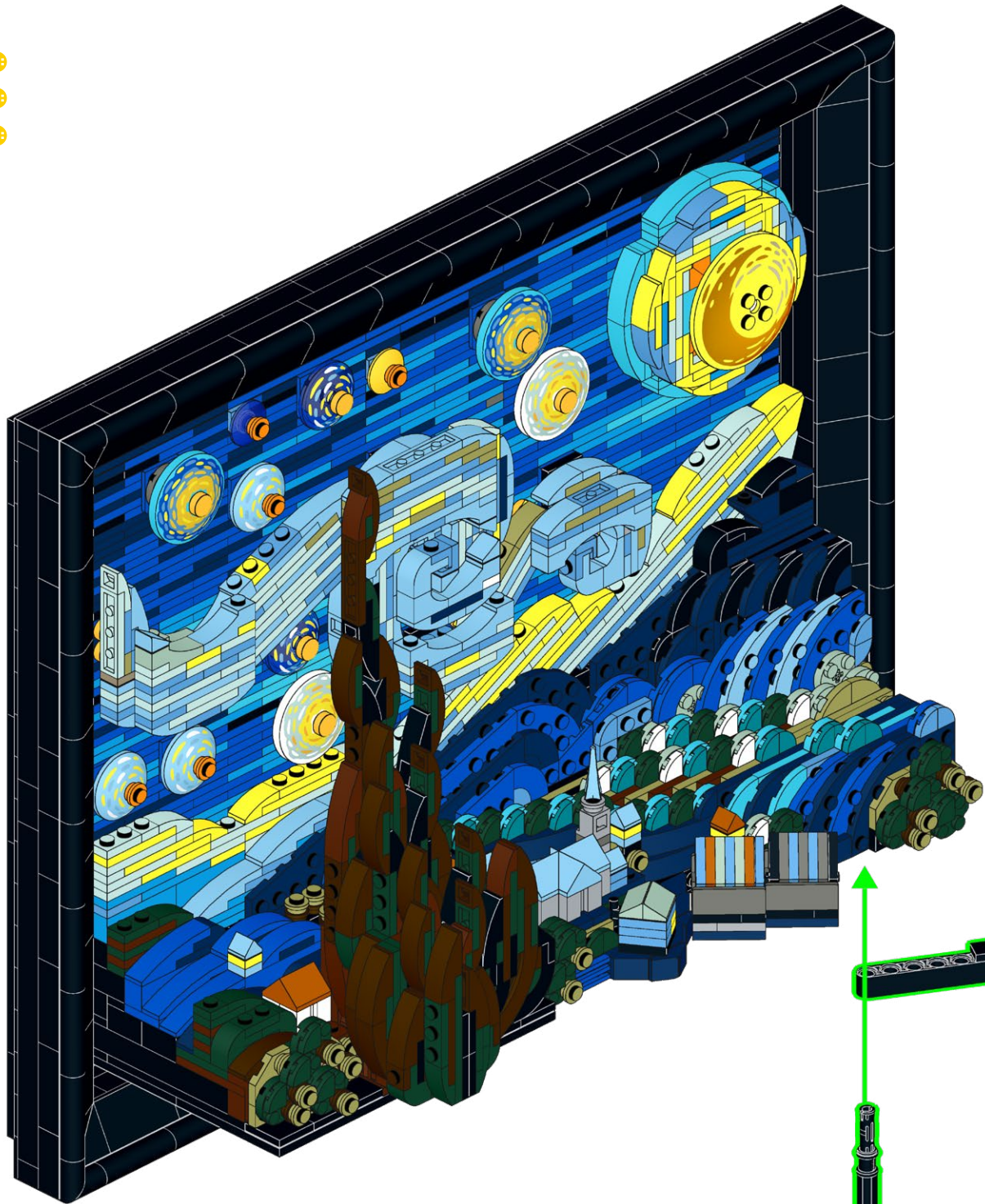



386





**387**



388





# FINAL PRODUCT



# PACKAGE CONTENTS



**2x** AL-LB30  
Astro Light Large  
Light Blue 30cm



**1x** AL-CW30  
Astro Light Large  
Cool White 30cm



**1x** AL-WW30  
Astro Light Large  
Warm White 30cm



**1x** AL-WW15  
Astro Light Large  
Warm White 15cm



**1x** AL-Y30  
Astro Light Large  
Yellow 30cm



**1x** AR-LB30  
Astro Light Regular  
Light Blue 30cm



**1x** AR-LB15  
Astro Light Regular  
Light Blue 15cm



**4x** AR-Y30  
Astro Light Regular  
Yellow 30cm



**3x** AR-WW30  
Astro Light Regular  
Warm White 30cm



**1x** B-5  
Belt 5cm



**1x** FLX-B60  
Flux Belt 60cm



**1x** D-6  
Dock-6



**1x** D-9  
Dock-9

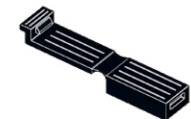

**2x** E-1x2  
Eclipse



**2x** T-3x3  
Tether 3x3



# PACKAGE CONTENTS

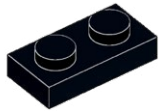

**6x** Plate 1x2 - Black



**2x** Round Plate 1x1 - Trans Light Blue



**4x** Plate 1x1 - Black



**2x** Round Plate 1x1 - Trans Dark Blue



**1x** Round Plate 1x1 - White



**1x** Round Brick 1x1 - Trans Clear



**7x** Round Plate 1x1 - Trans Clear



**5x** Round Plate 1x1 - Trans Yellow

# CONTACT US

Click below for customer support, or general inquiries.

Cliquez ci-dessous pour accéder au support client ou aux renseignements généraux.

Clicca qui sotto per l'assistenza clienti o per richieste generali.

Contact Us



Contactez-nous



Contattaci



Klicken sie unten für kundensupport oder allgemeine anfragen.

Haga clic a continuación para atención al cliente o consultas generales.

点击下方获取客户支持或一般咨询。

Kontaktieren sie uns



Contáctanos



联系我们



## TROUBLESHOOTING

If you're stuck, scan the QR code for troubleshooting.

Se sei bloccato, scansiona il codice QR per la risoluzione dei problemi.

Wenn Sie nicht weiterkommen, scannen Sie den QR-Code zur Fehlerbehebung.

Si vous êtes bloqué, scannez le code QR pour le dépannage

Si está atascado, escanee el código QR para solucionar el problema.

如果遇到问题, 请扫描二维码进行故障排除

