

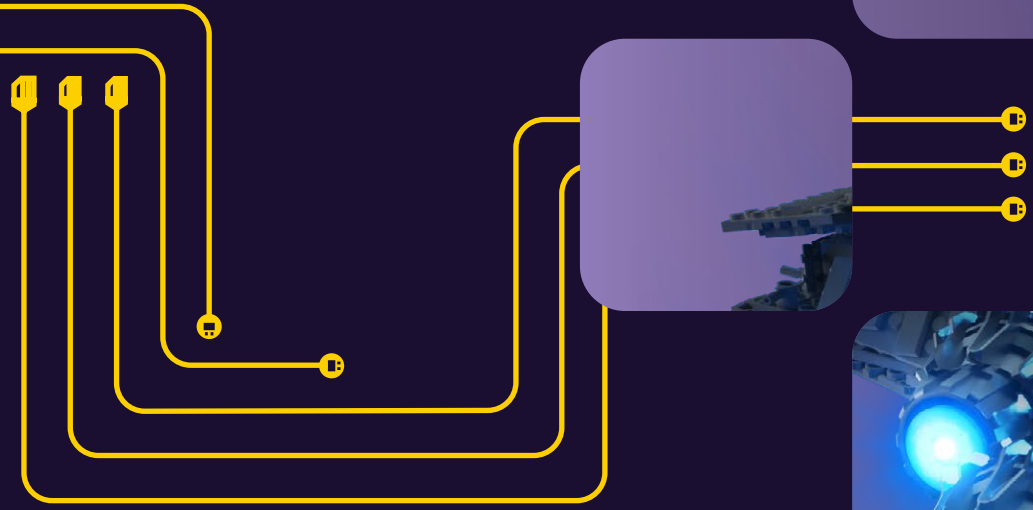

**LIGHT
BRICKS™**



LIGHT KIT INSTALLATION GUIDE

**STAR WARS VENATOR-CLASS
REPUBLIC ATTACK CRUISER**

FOR LEGO
SET
#75367

CONTENTS



03

Getting Started

- 04 Legend
- 05 Component Handling
- 06 Blueprint

07

Instructions

- 07 LEGO Bag 34 - LMB Bag 03
- 49 LEGO Bag 35 - LMB Bag 02
- 88 LEGO Bag 24 - LMB Bag 01
- 128 LEGO Bag 25
- 168 LEGO Bag 26 & 27
- 214 LEGO Bag 28 & 29
- 276 LEGO Bag 30 - LMB Bag 06
- 309 LEGO Bag 31
- 338 LEGO Bag 32
- 351 LEGO Bag 33

000

Final Product

- 000 Package Contents
- 000 Contact & Troubleshooting

GETTING STARTED



Bold, beautiful and bright, Light My Bricks elevates your favourite LEGO set from knick-knack to statement piece. Create a talking point at home or in the office that speaks to your passions with Light My Bricks. To learn more, click below.

[Learn More](#)



Audacieux, beau et lumineux, Light My Bricks élève votre ensemble LEGO préféré du statut de bibelot à celui de pièce maîtresse. Que ce soit à la maison ou au bureau, partagez votre passion des LEGO avec Light My Bricks. Cliquez ci-dessous pour en savoir plus.

[En savoir plus](#)



Audace, bello e luminoso, Light My Bricks eleva il tuo set LEGO preferito da soprammobile a pezzo di tendenza. Crea un punto di discussione a casa o in ufficio che parli alle tue passioni con Light My Bricks. Per saperne di più, clicca qui sotto.

[Ulteriori Informazioni](#)



Mutig, schön und hell – Light My Bricks verwandelt Ihr Lieblings-LEGO-Set von einem schnickschnack in ein statement-stück. Schaffen sie einen gesprächspunkt zu hause oder im büro, der Ihre leidenschaften widerspiegelt, mit Light My Bricks. Um mehr zu erfahren, klicken sie unten.

[Mehr erfahren](#)



Audaz, hermoso y brillante, Light My Bricks eleva tu set LEGO favorito de una chuchería a una pieza llamativa. Crea un tema de conversación en casa o en la oficina que hable de tus pasiones con Light My Bricks. Para obtener más información, haga clic a continuación.

[Más información](#)



大胆、美丽而明亮，Light My Bricks 将你喜爱的乐高套装从小摆件提升为引人注目的装饰品。在家或办公室打造一个能表达你激情的话题，了解更多，请点击下方。

[了解更多](#)



LEGEND

Rotate Set



Retournez L'ensemble
Ruota Set
Set Drehen
Rotar Conjunto
旋转套件

Add Part



Ajoutez une Pièce
Aggiungi Parte
Teil Hinzufügen
Agregar Pieza
添加零件

Click



Cliquez
Clic
Klicken
Clic
点击

Pinch/Fold



Pincez/Pliez
Pizzicare/Piegare
Kneifen/Falten
Pellizcar/Doblar
折叠

Pull Cable



Tirez le Cable
Tirare il Cavo
Kabel Ziehen
Tirar del Cable
拉动电缆

Repeat Step



Répétez
Ripetere
Wiederholen
Repetir
重复

Sticker



Autocollant
Adesivo
Aufkleber
Pegatina
贴纸

Power On Test



Test de mise sous tension
Test di Potenza
Stromtest
Prueba de Energía
电源测试

Disconnect Power

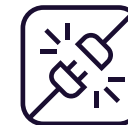

Débranchez L'alimentation
Scollegare L'alimentazione
Strom Trennen
Desconectar la Energía
断开电源

Troubleshoot



Dépanner
Risolvere
Fehlerbehebung
Solución de Problemas
故障排除

COMPONENT HANDLING

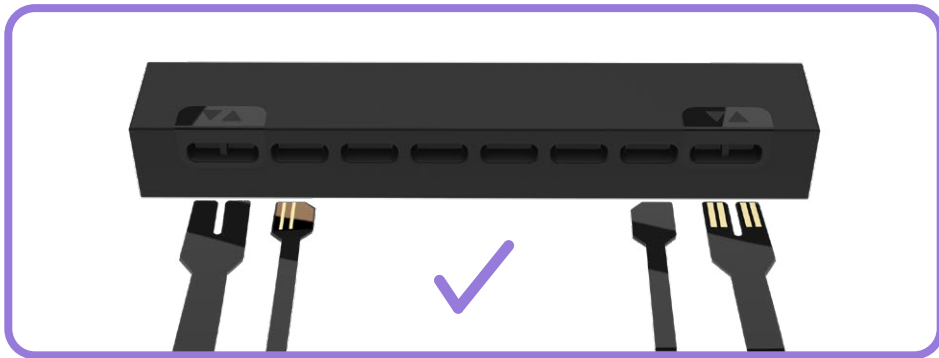
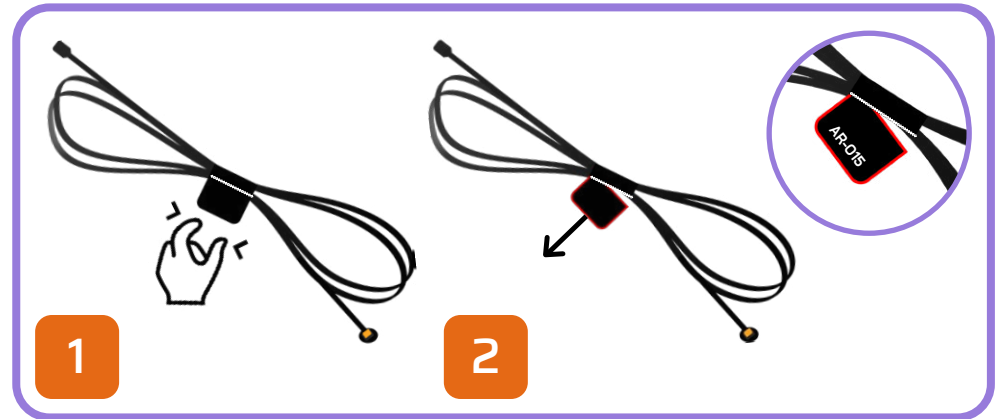
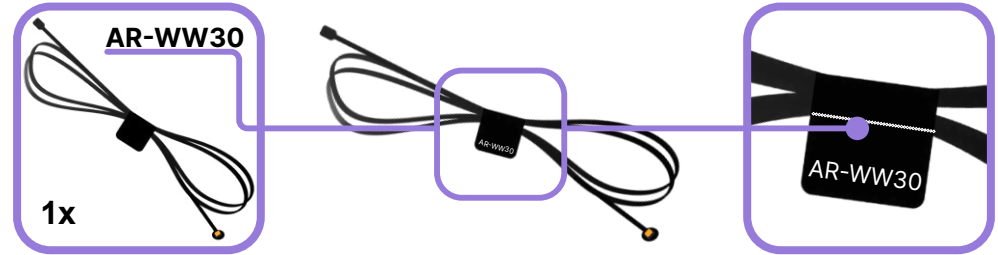
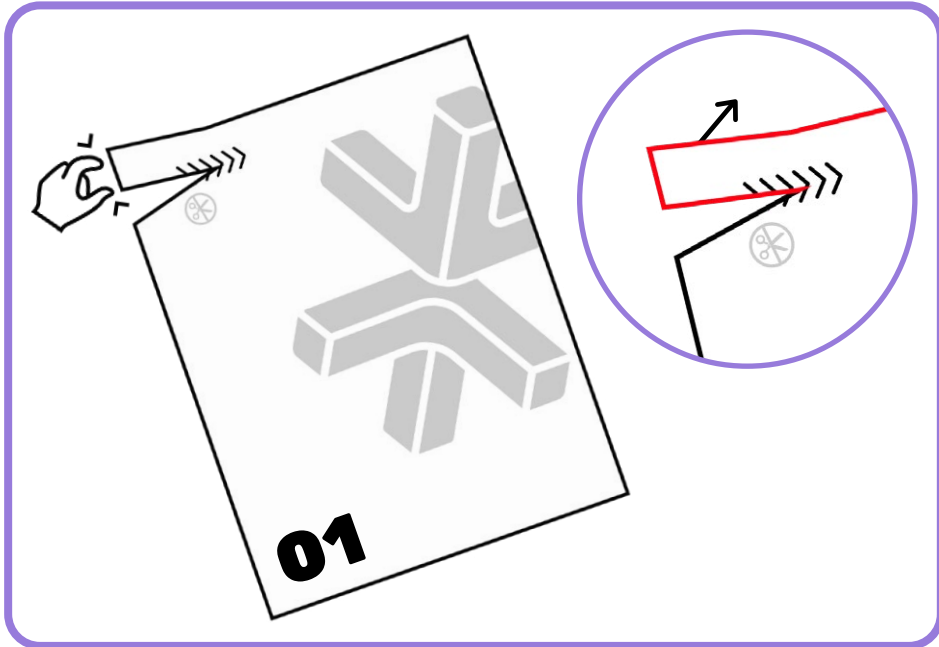

BLUEPRINT

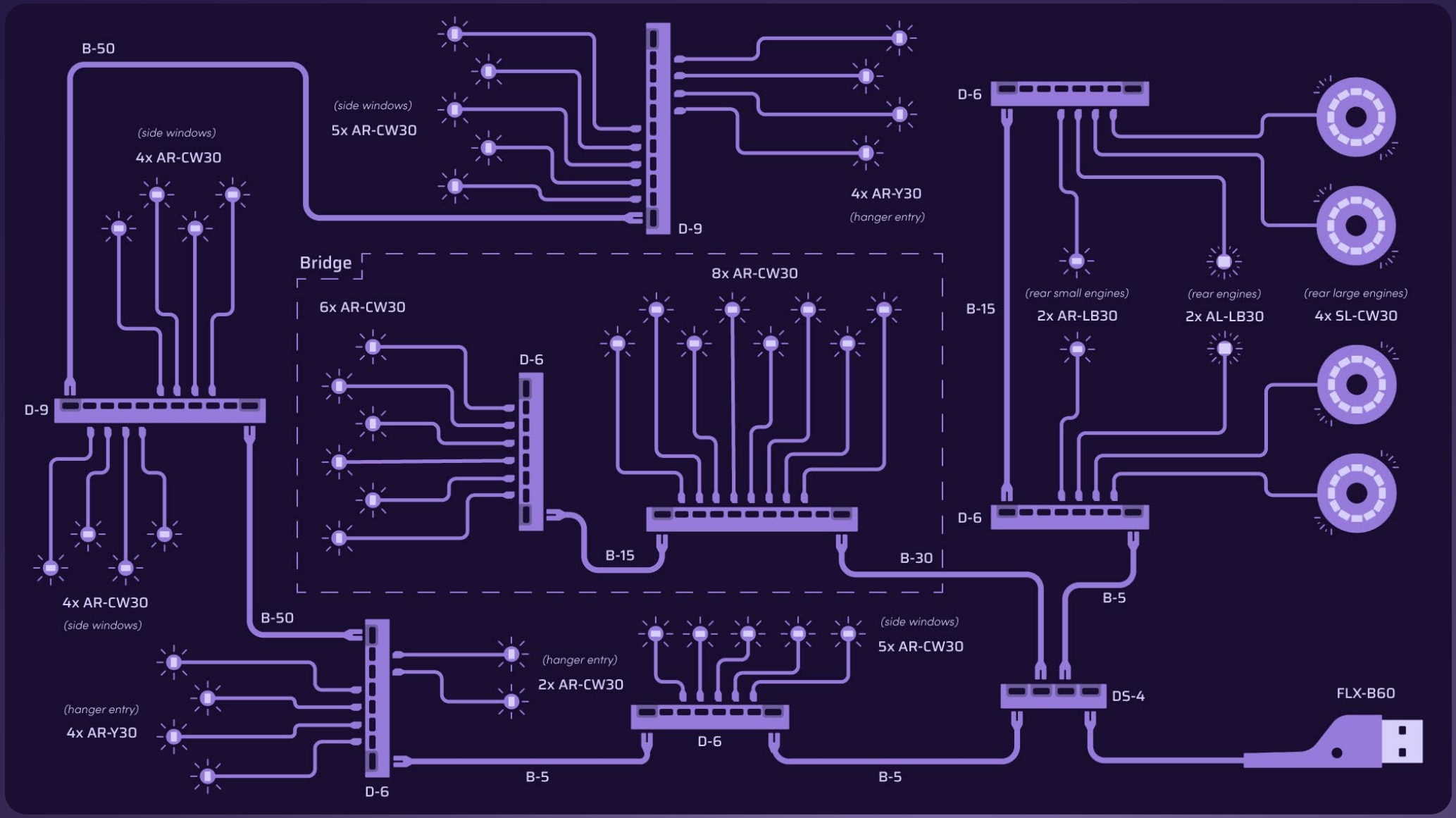

**HOLD UP!**

You might notice some bags aren't in order, as well as left over pieces, but that's ok! We're changing the way you build LEGO!

ATTENDEZ!

Vous remarquerez peut-être que certains sacs, ainsi que certaines pièces, ne sont pas dans le bon ordre. Mais pas de panique! Nous changeons simplement la façon avec laquelle vous construisez vos LEGO!

ASPETTA!

Potresti notare che alcuni sacchetti non sono in ordine, così come i pezzi avanzati, ma va bene così! Stiamo cambiando il modo in cui costruisci i LEGO!

HALT!

Sie werden möglicherweise bemerken, dass einige tüten durcheinander sind und teile übrig bleiben, aber das ist in Ordnung! Wir ändern die art und weise, wie Sie LEGO bauen!

¡ESPERA!

Es posible que notes que algunas bolsas están fuera de servicio, así como piezas sobrantes, ¡pero está bien! ¡Estamos cambiando la forma en que construyes LEGO!

暫停!

你可能会注意到一些袋子顺序错乱, 以及一些剩余的部件, 但没关系! 我们正在改变你搭建乐高的方式!

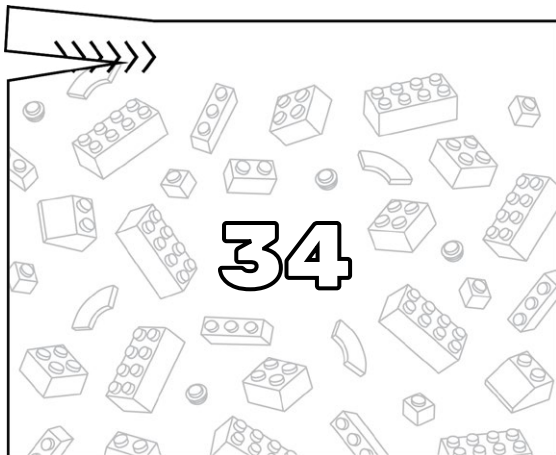
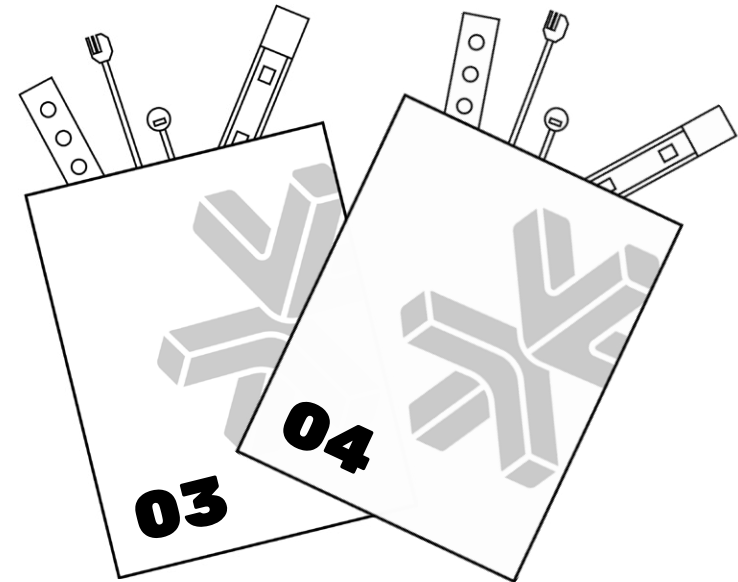
Open LEGO® Bag 34**Open LMB Bags 03 & 04**

1

DS-4 T-1x4

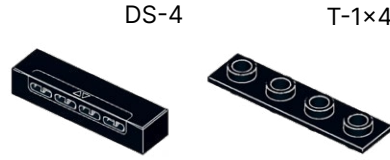

1x 1x

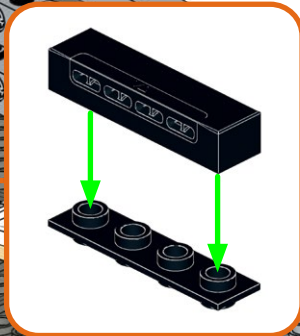

2

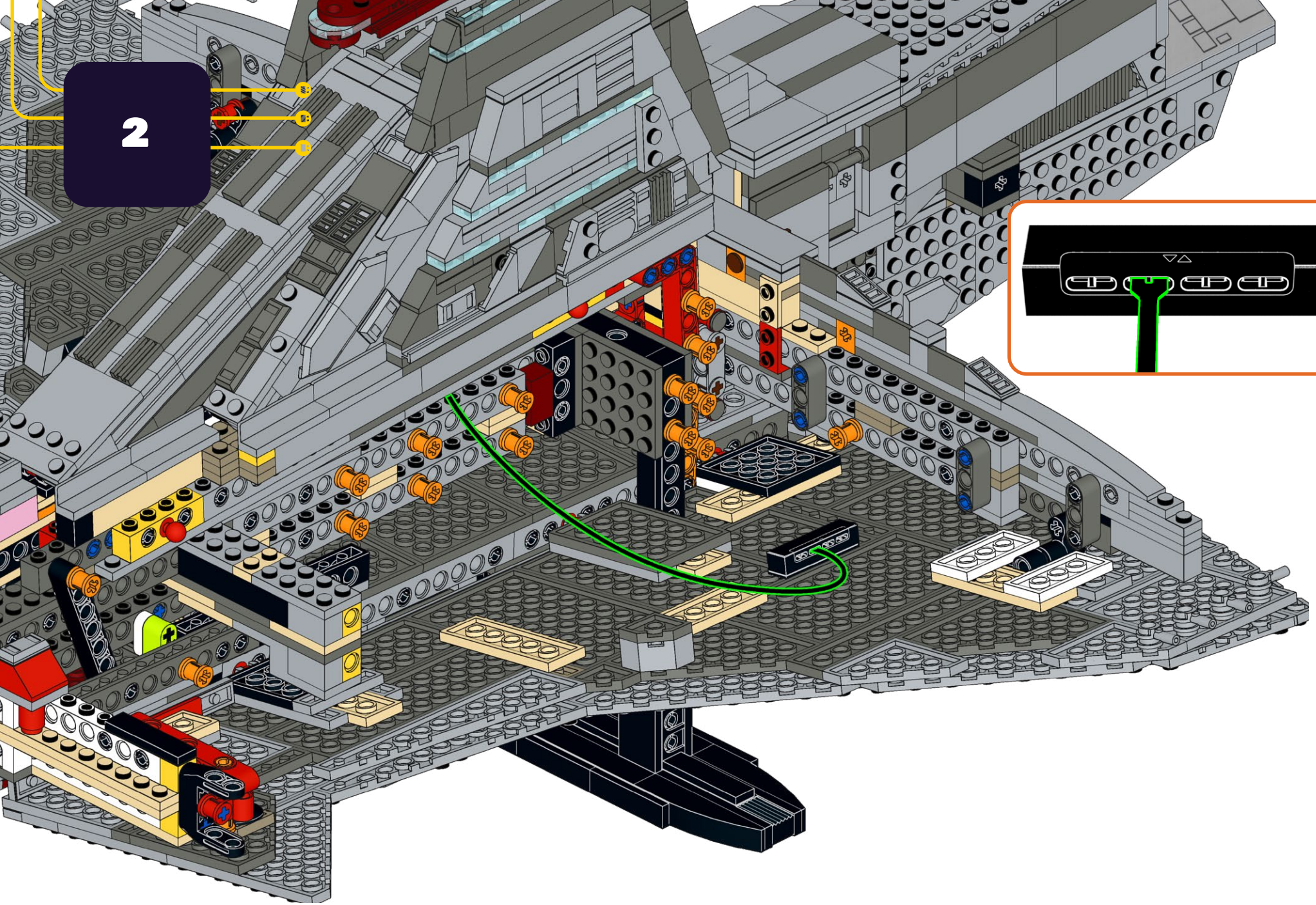

3

FLX-B60

1x

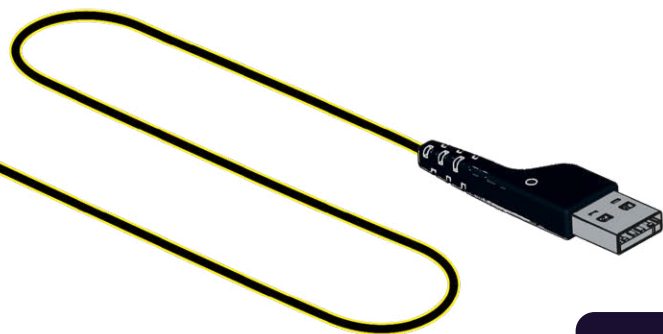
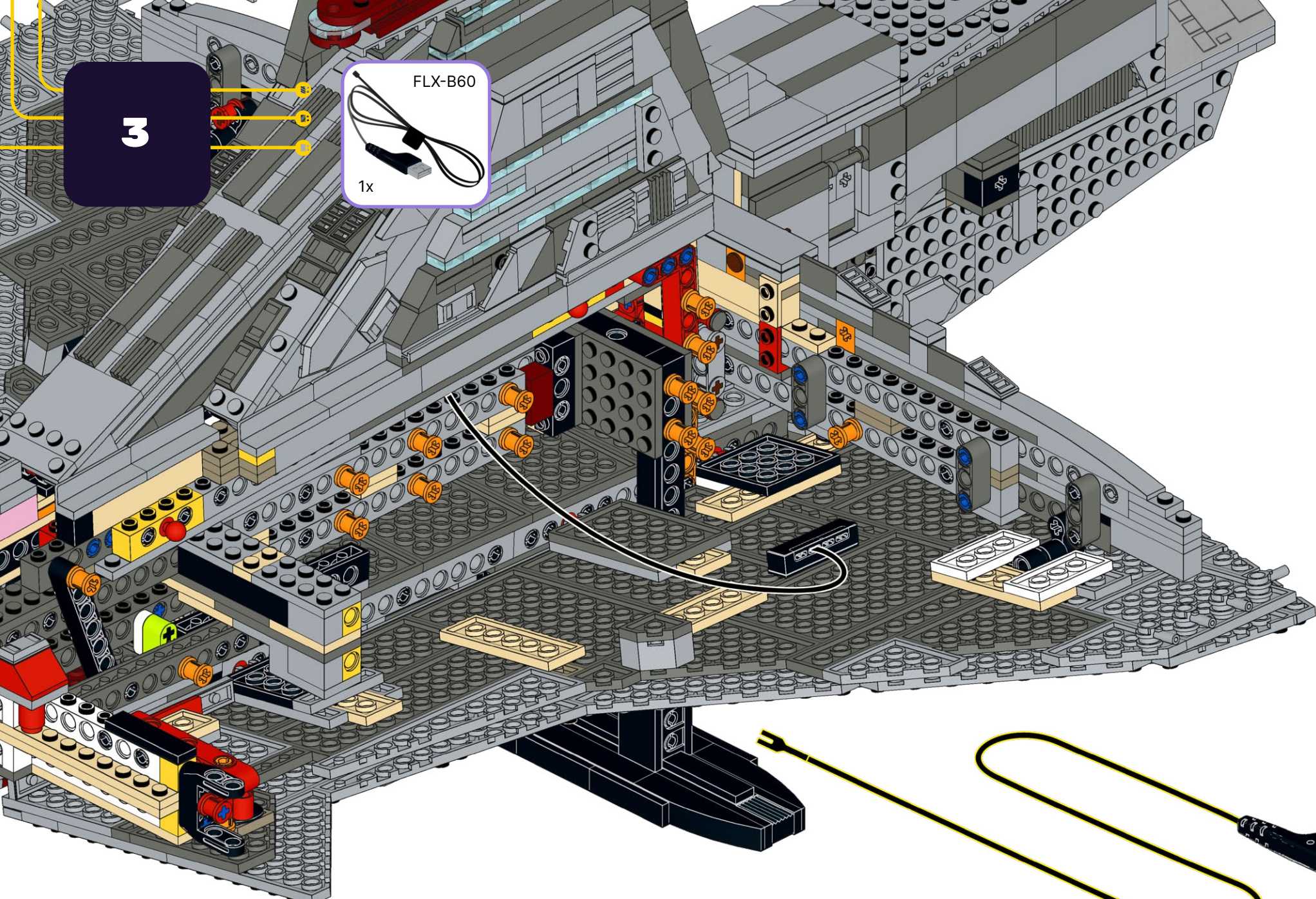

4

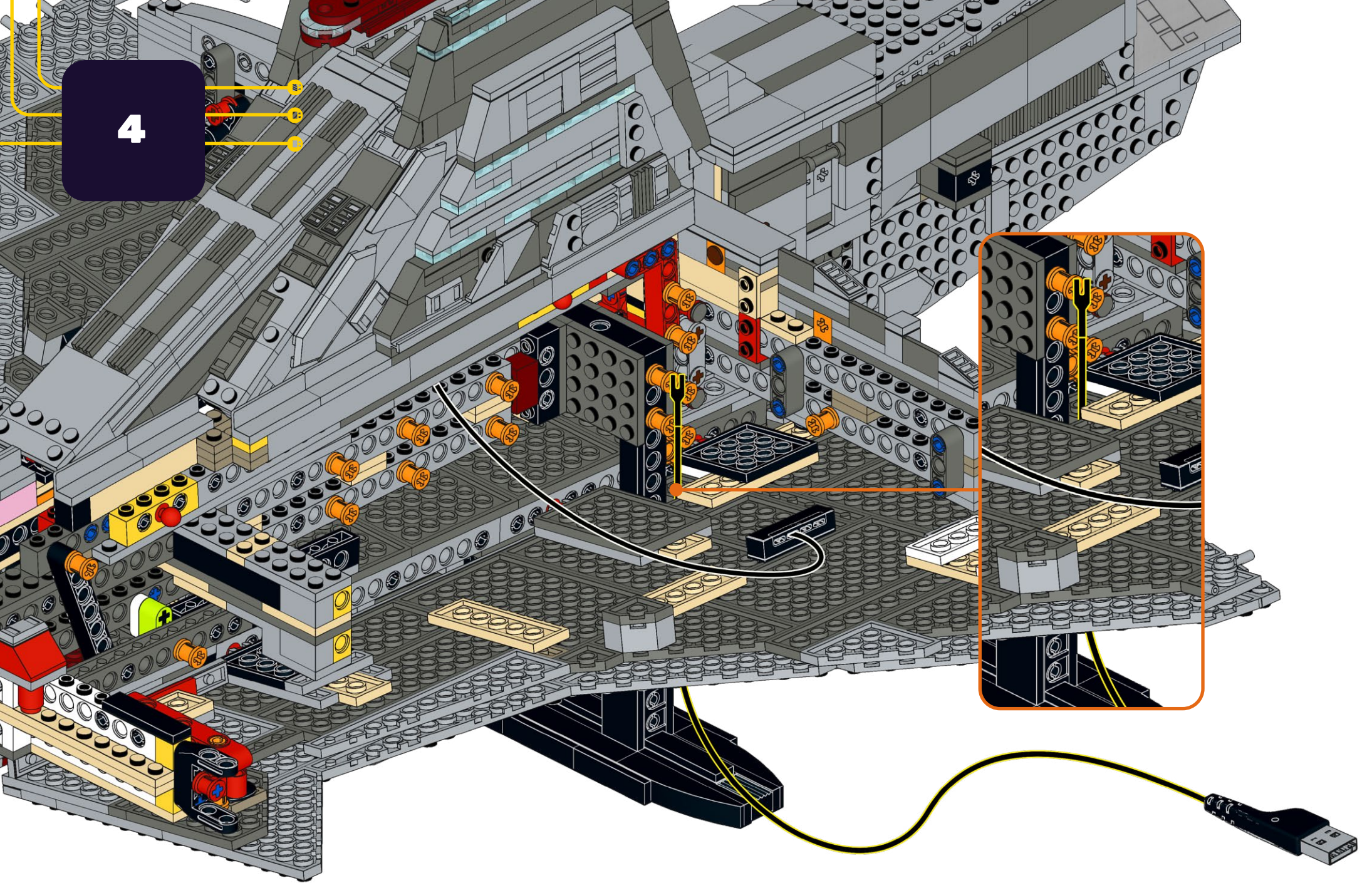

5

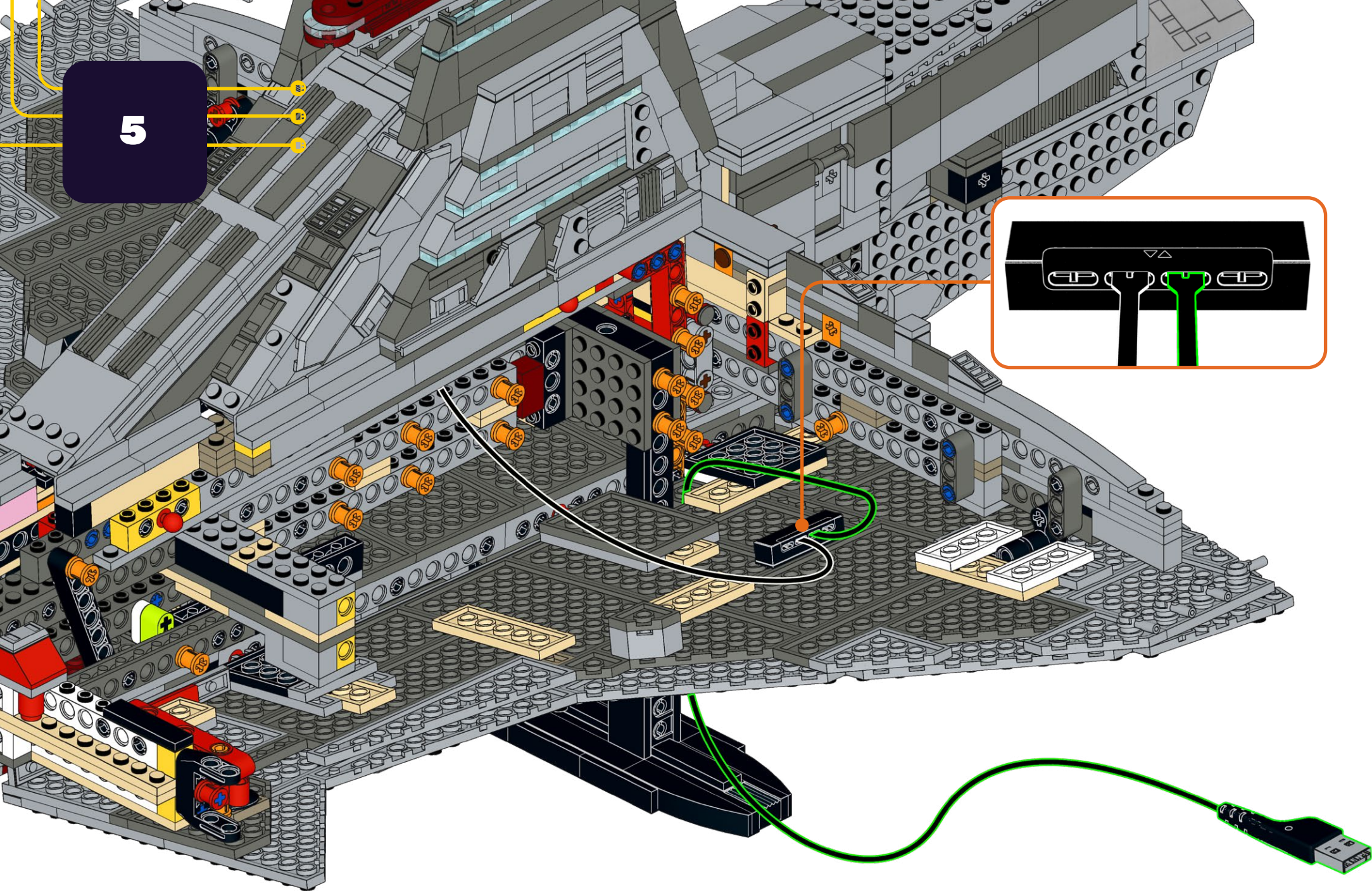

6



Power on Test
Test de mise sous tension
Test di Potenza
Stromtest
Prueba de Energía
电源测试

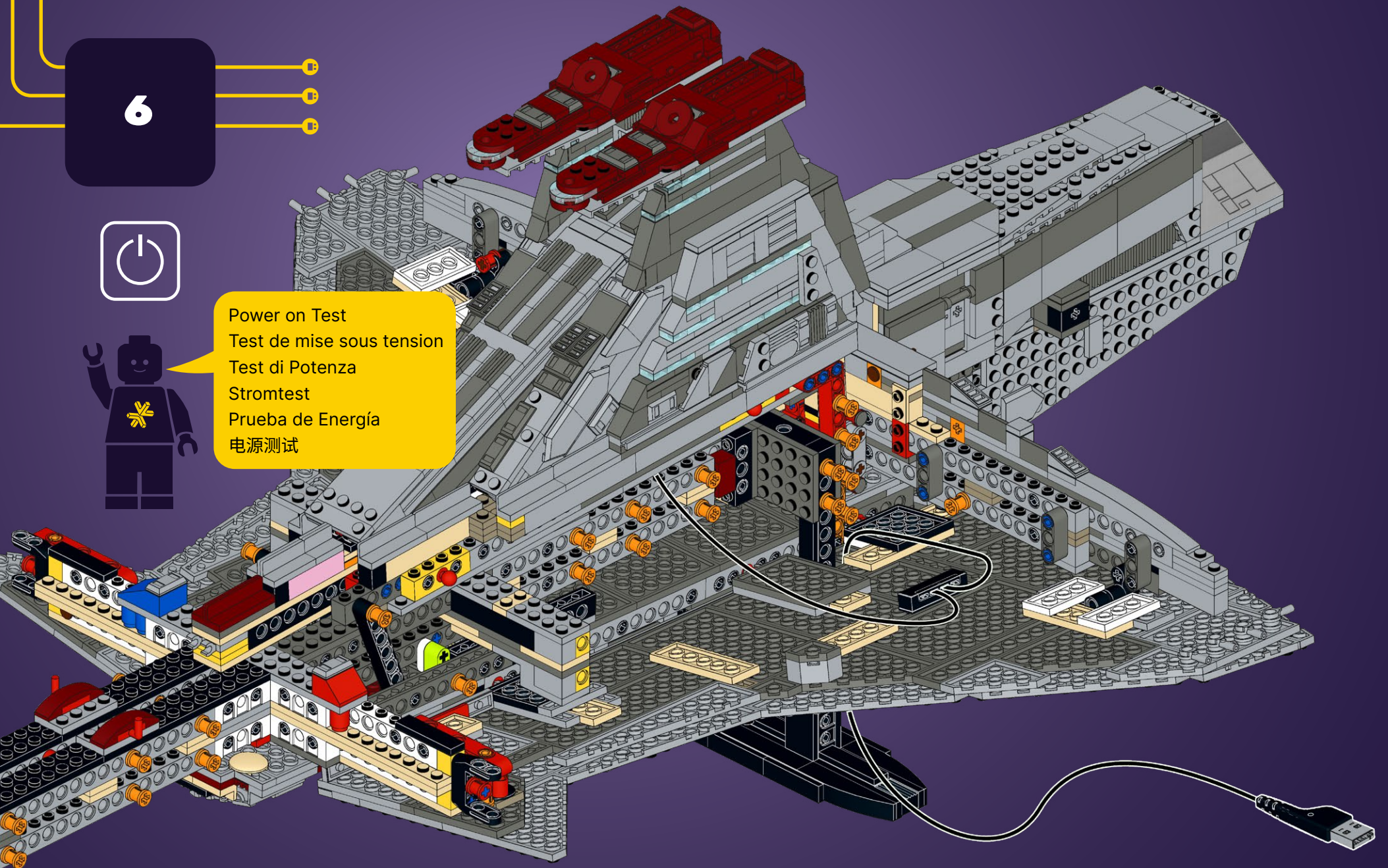

7



2x

2x

2x

1

2

2x

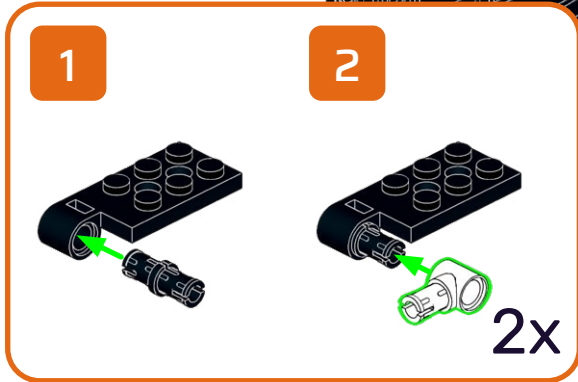

8

1x



9

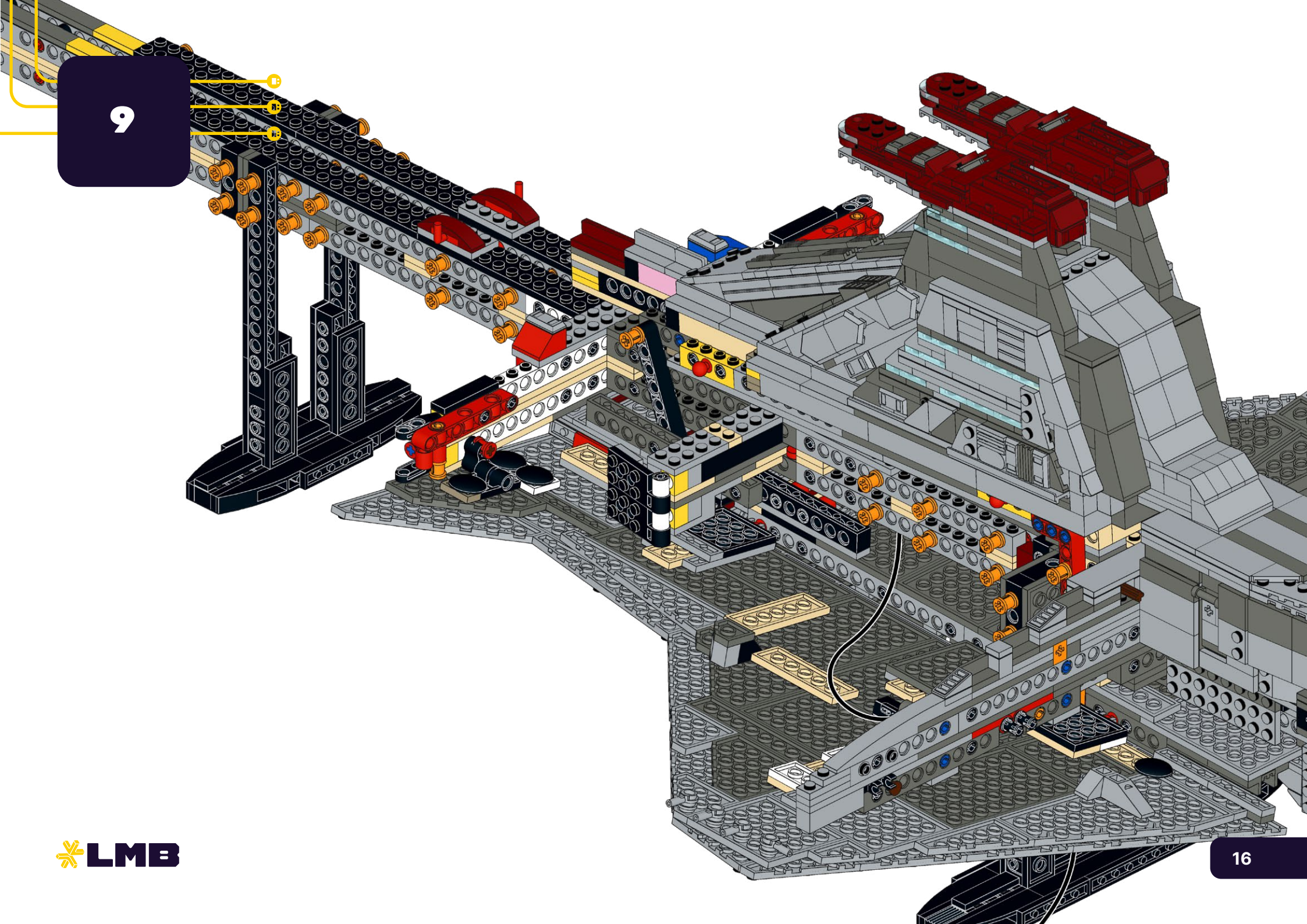

10

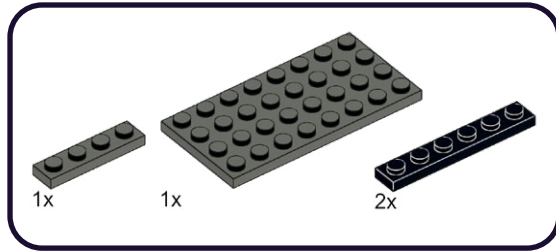

1

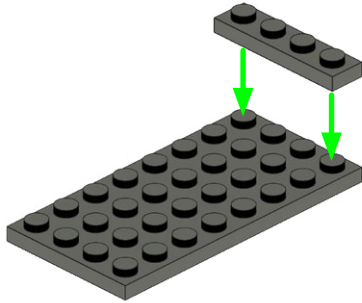

2

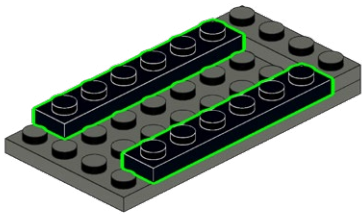

11

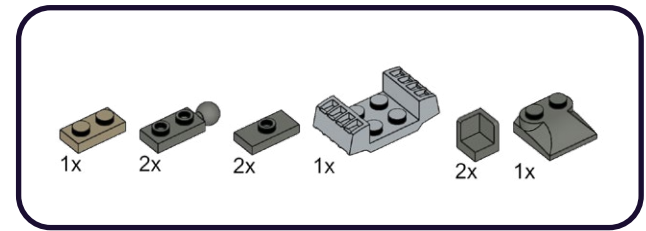

1

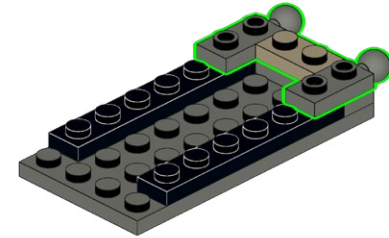

2

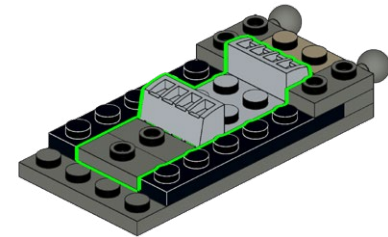

3

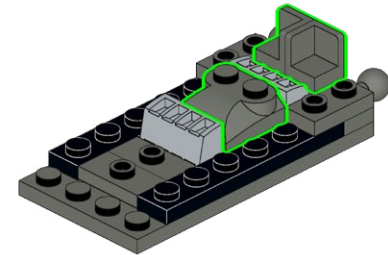

12

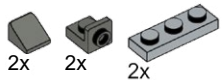

1

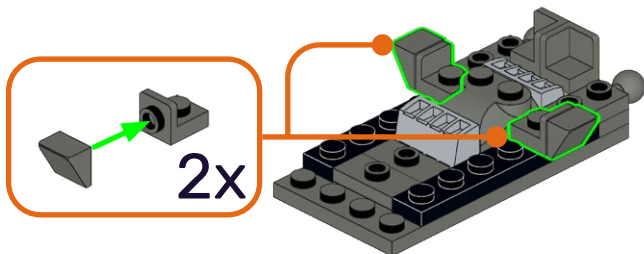

2

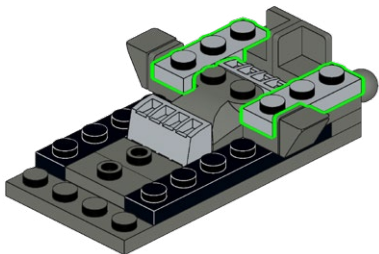

13

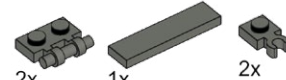

1

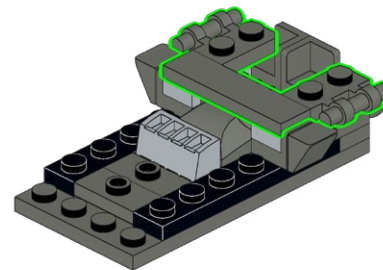

2

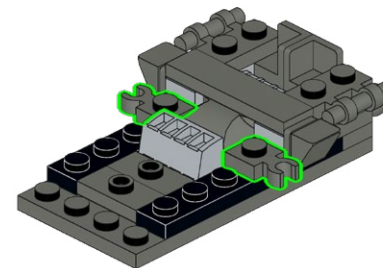

14

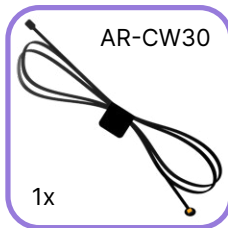
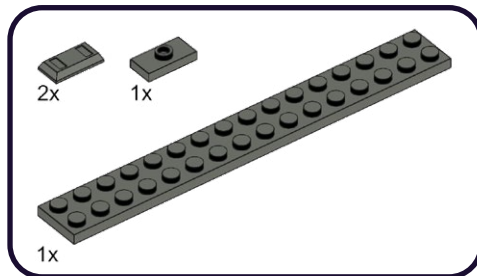

1

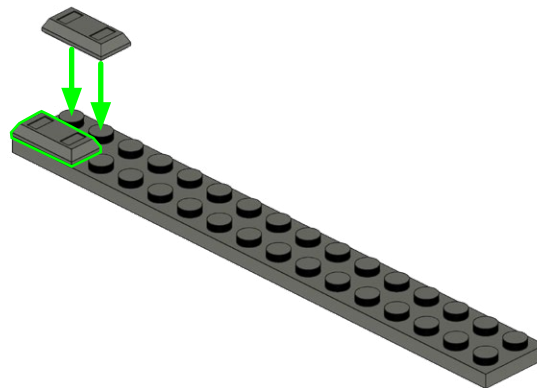

2

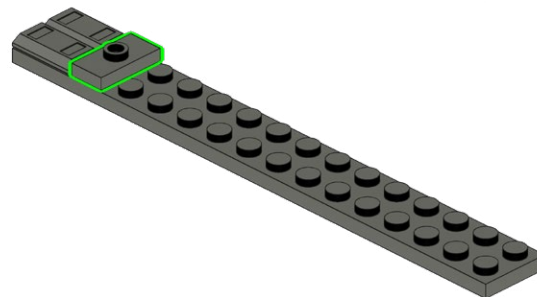

3

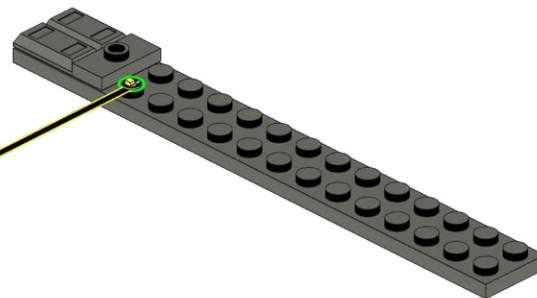

15

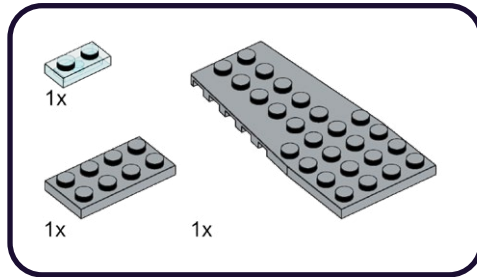

1

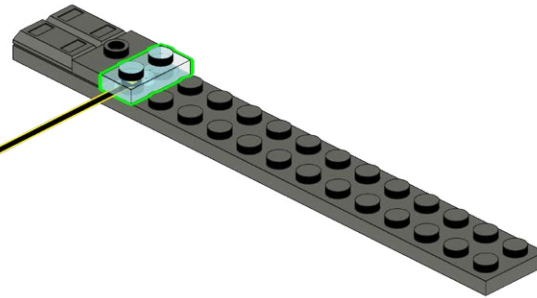

2

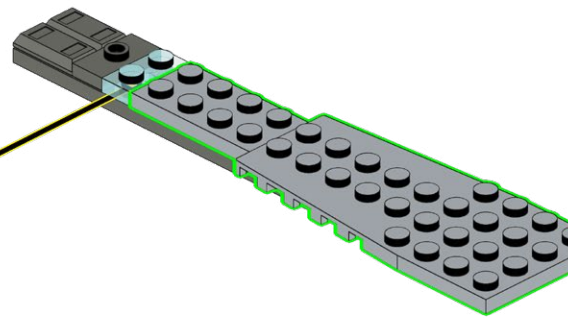

16

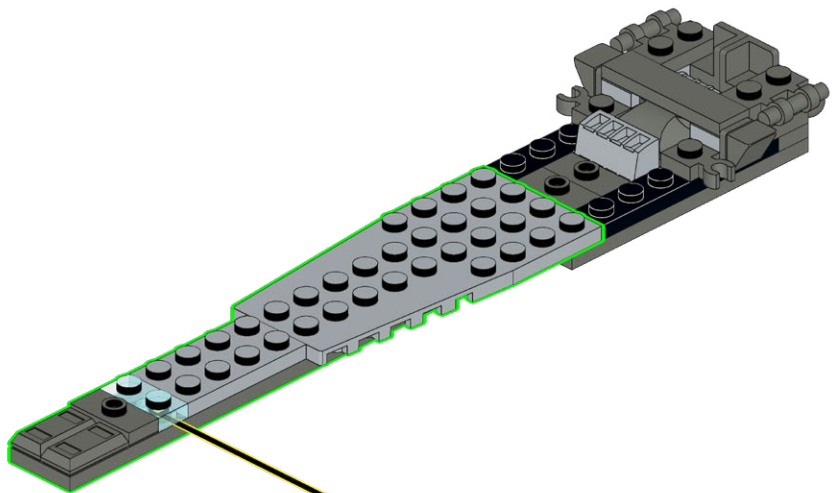

17

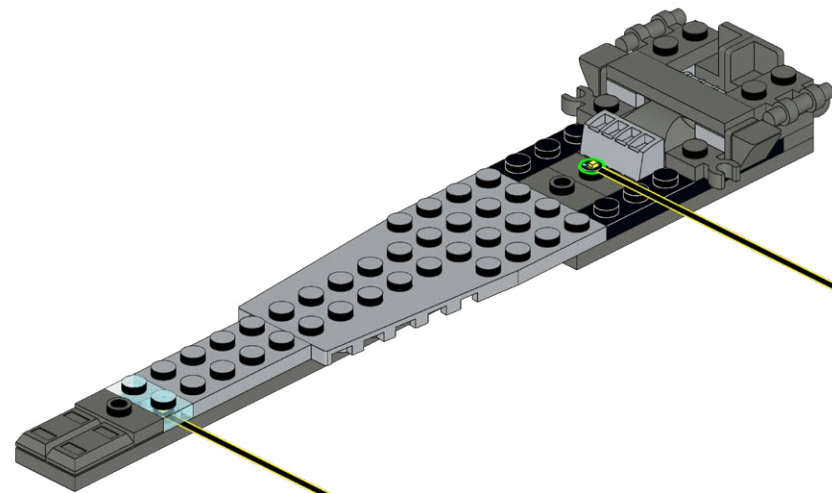
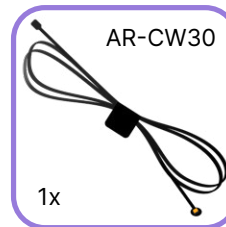

18

1x

19

AR-CW30

1x

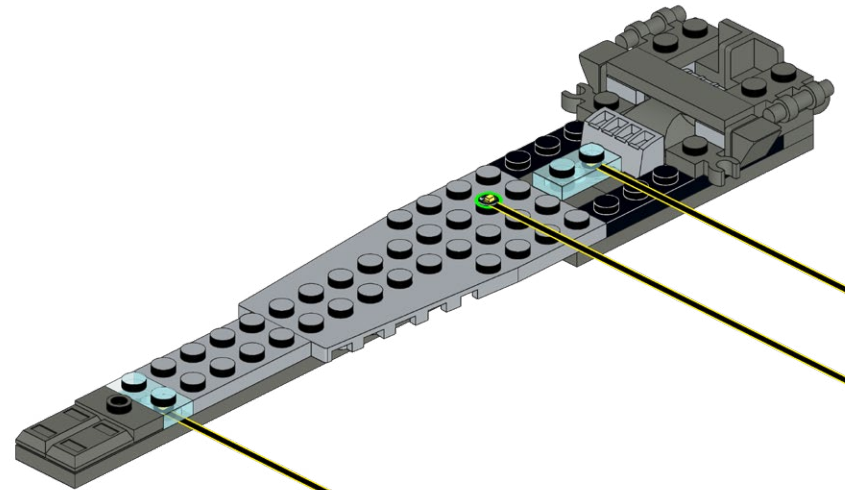
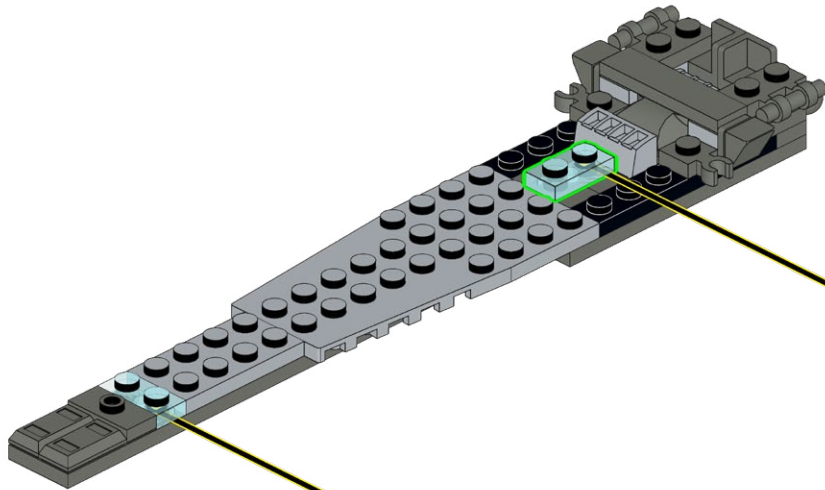

20



1x

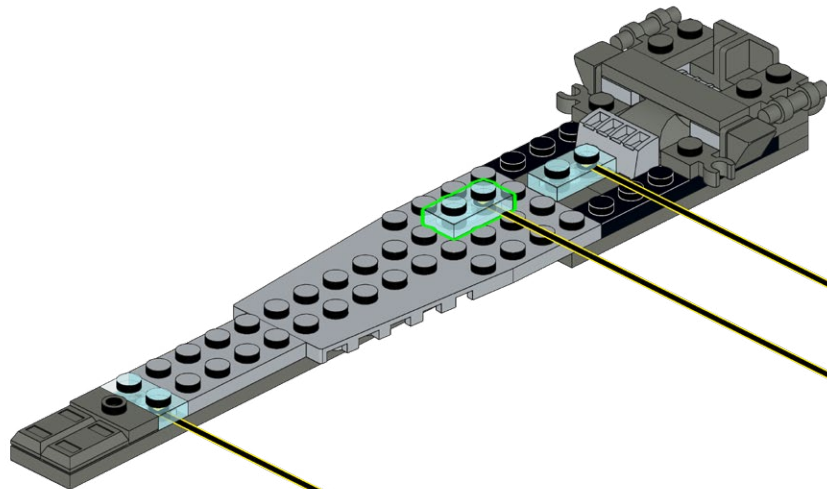

21



1x



1x

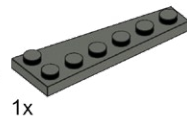

1x



1x

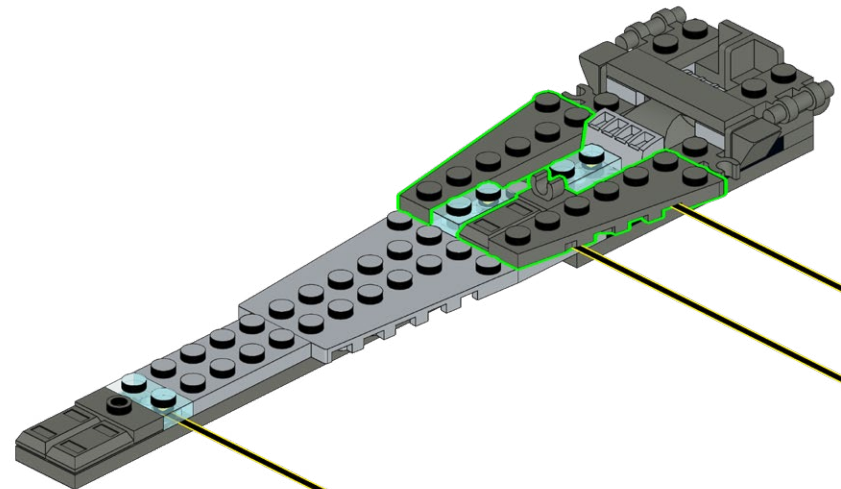

22

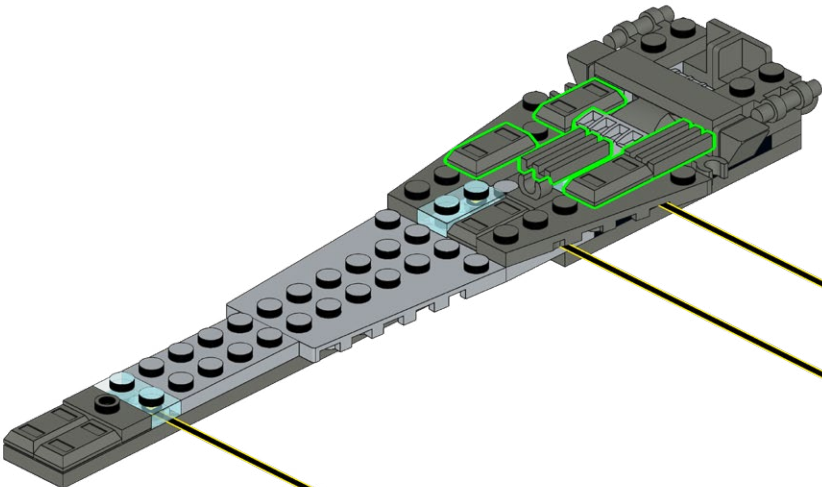
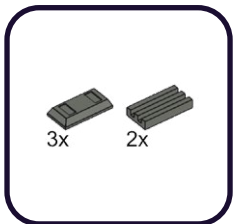

23

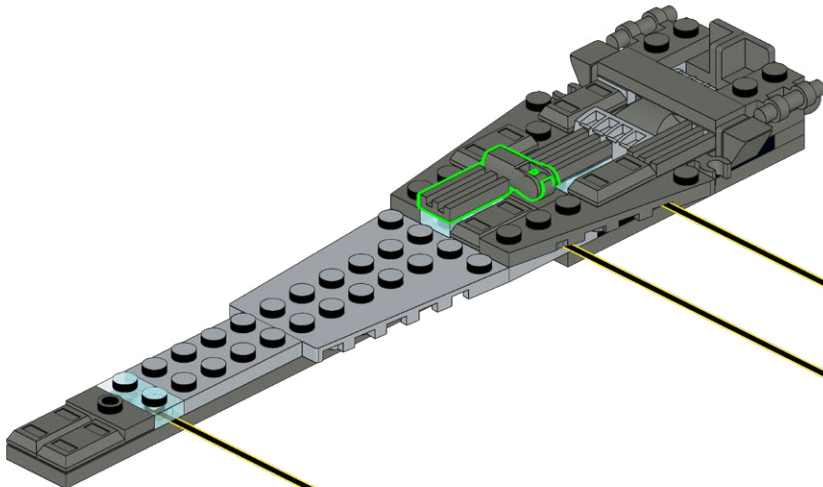
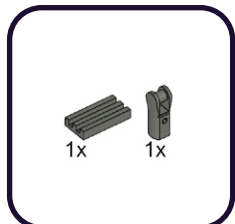

24

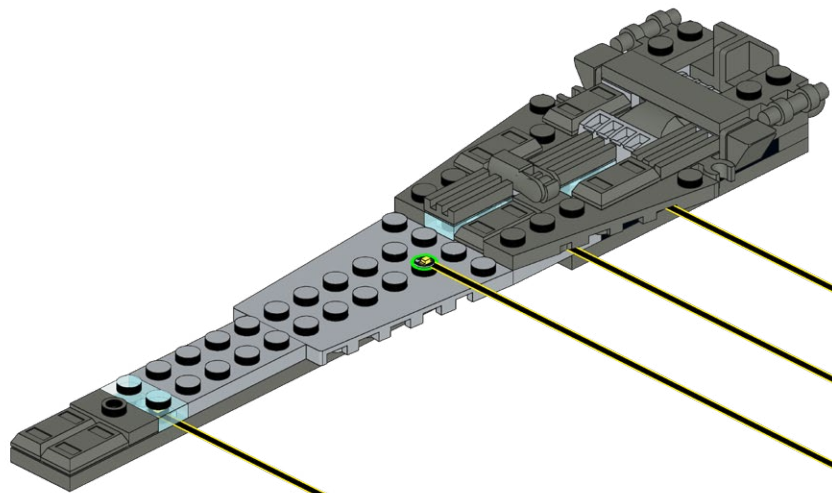
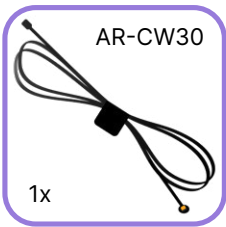

25

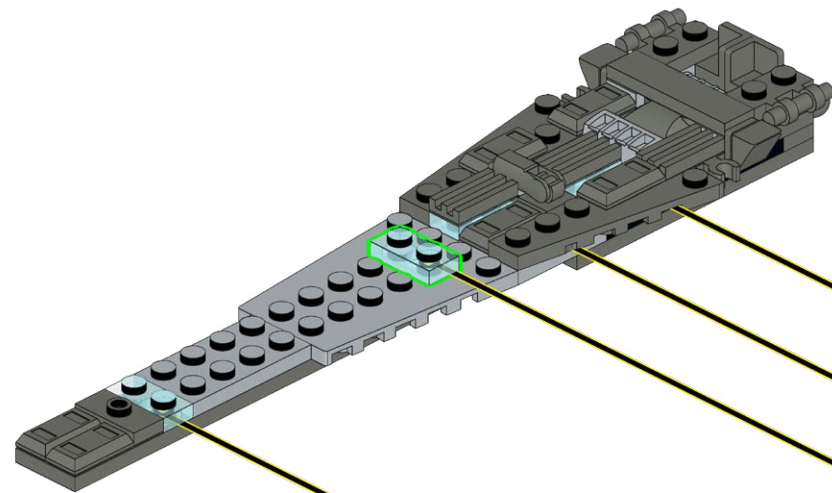
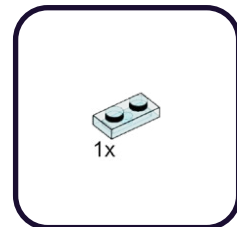

26

2x

1x

27

6x

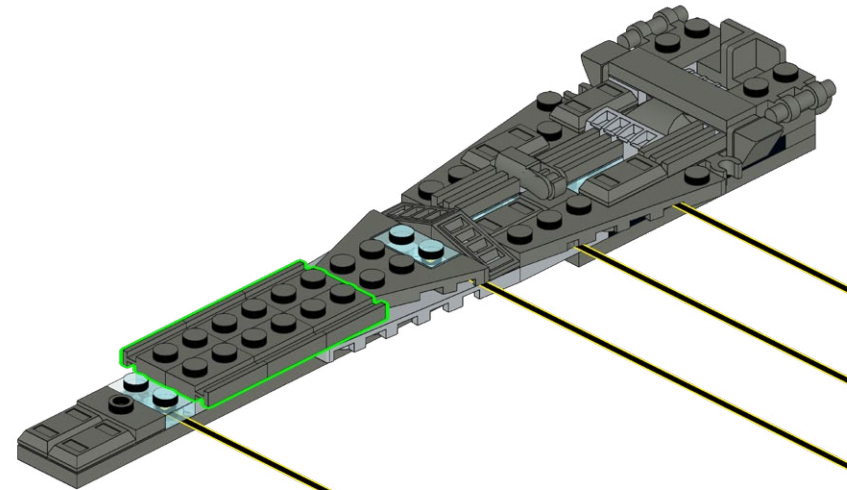
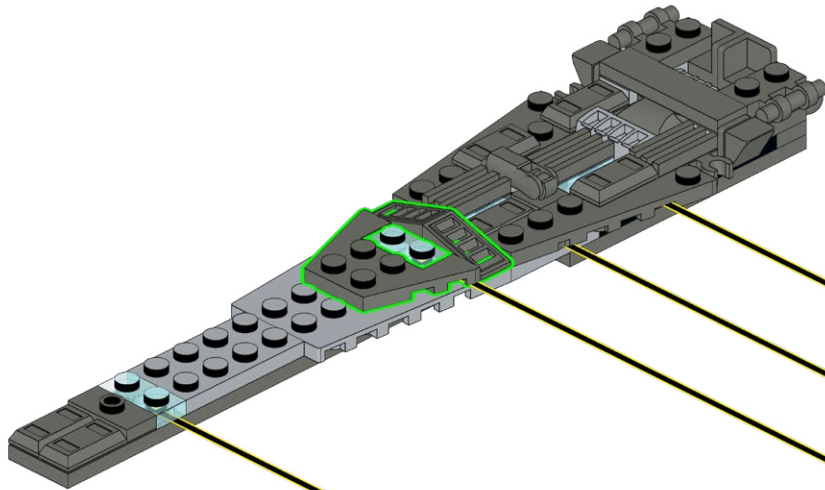

28

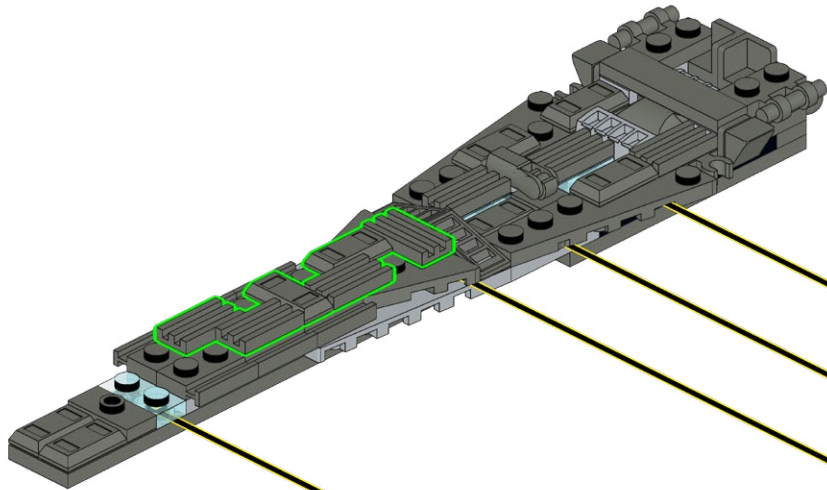
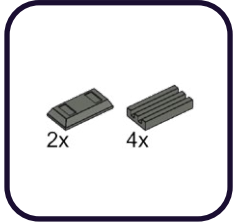

29

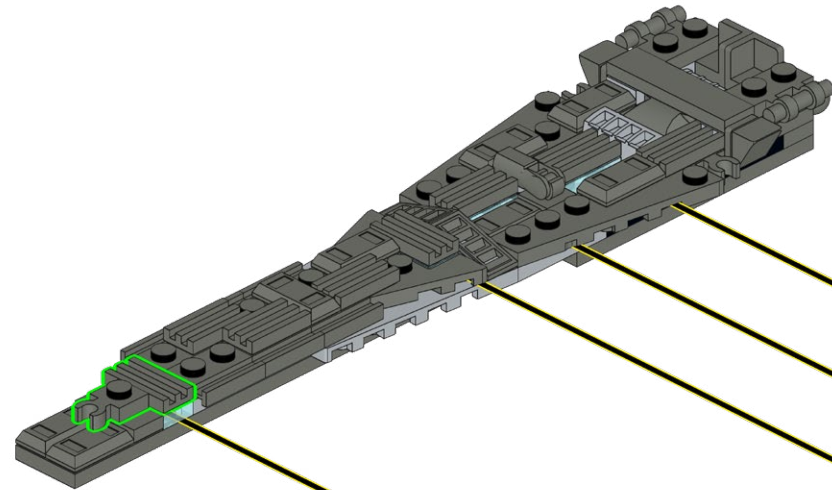
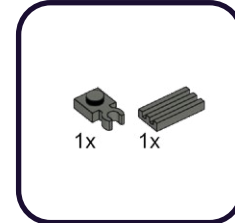

30

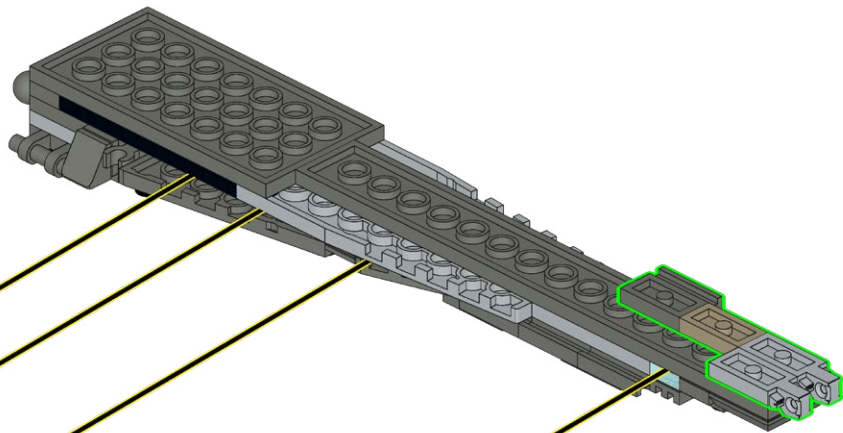
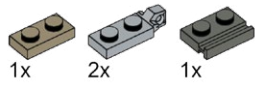

31

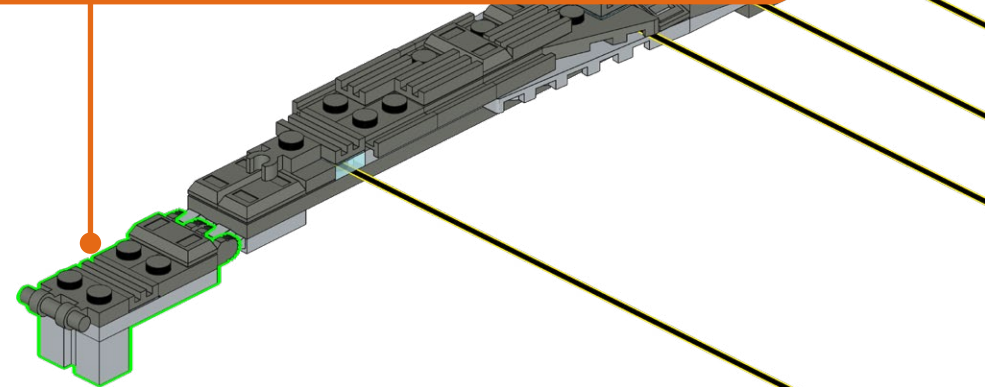
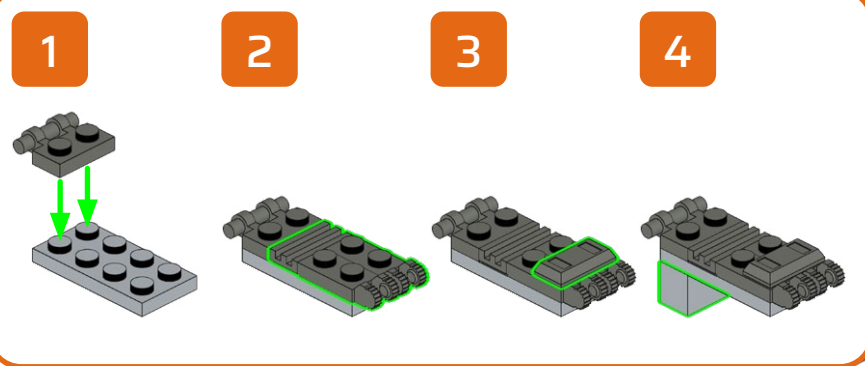
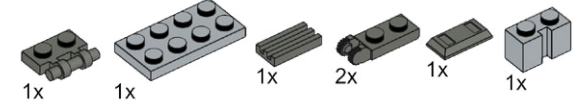

32

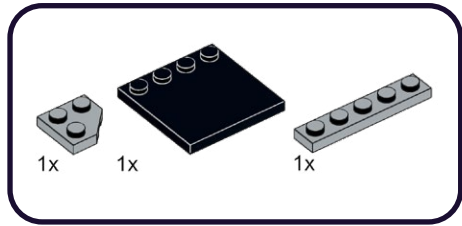

1

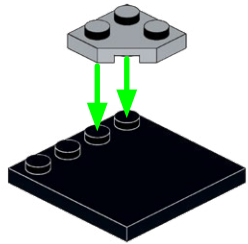

2

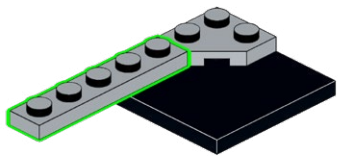

33

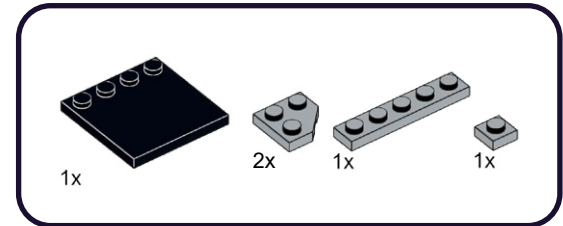

1

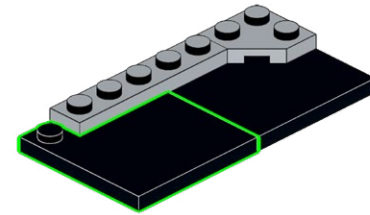

2

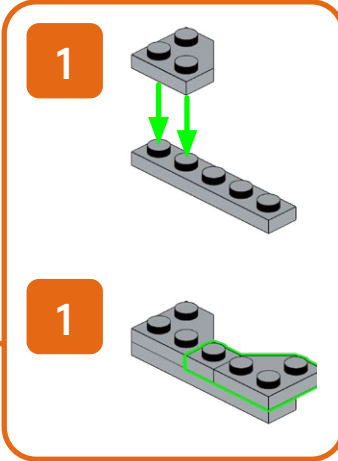
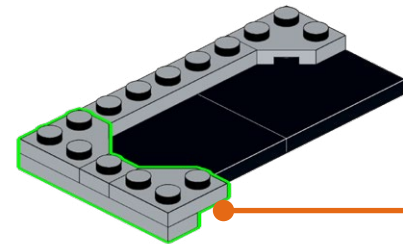

34

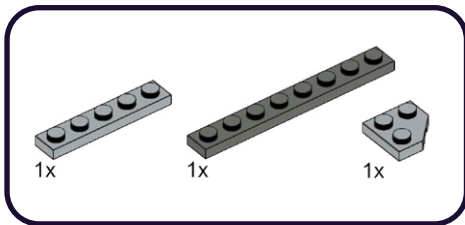

1

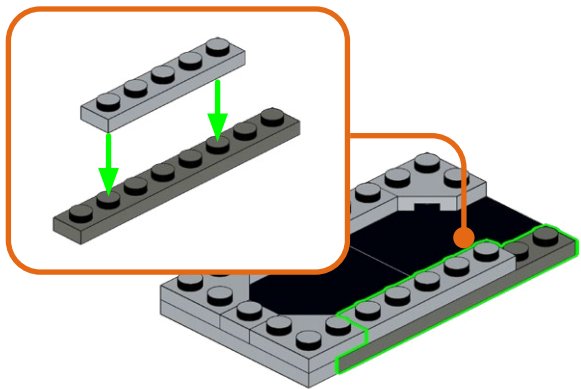

2

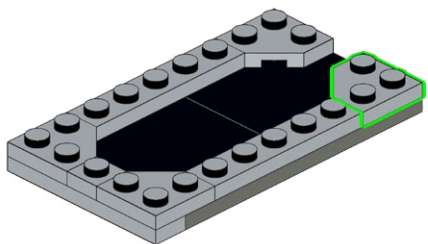

35

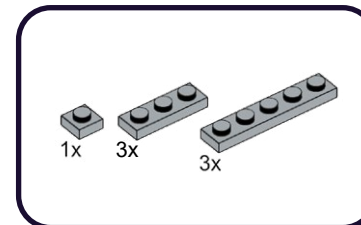

1

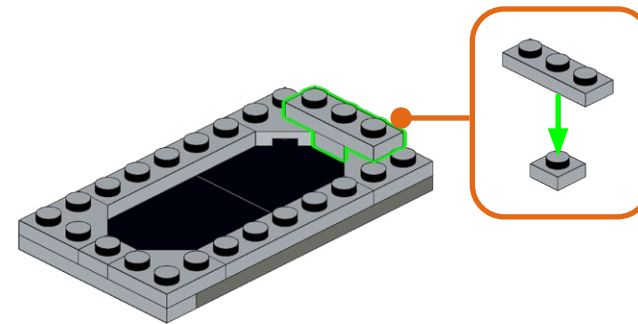

2

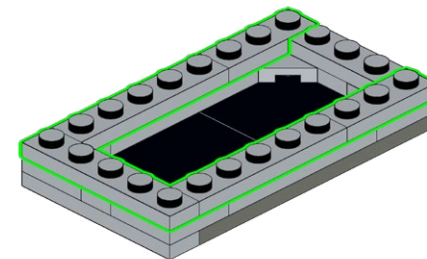

36

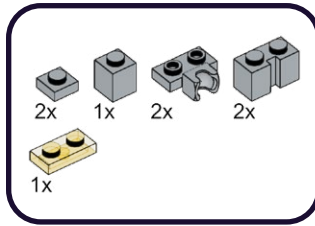
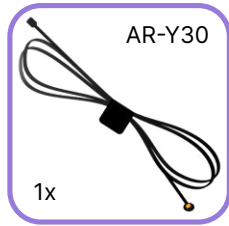

1

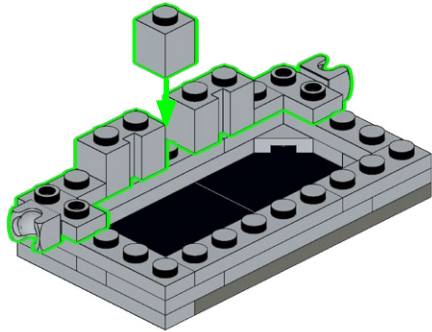

2

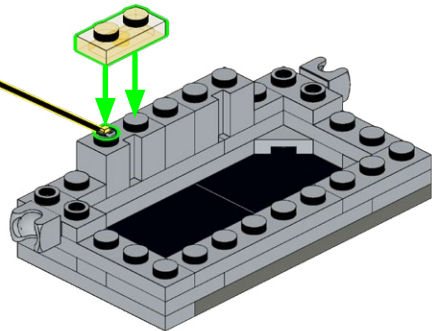

37

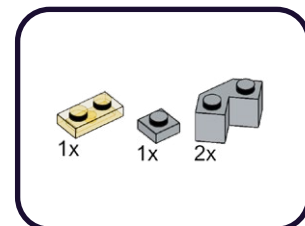
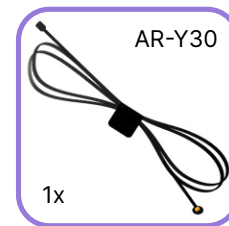

1

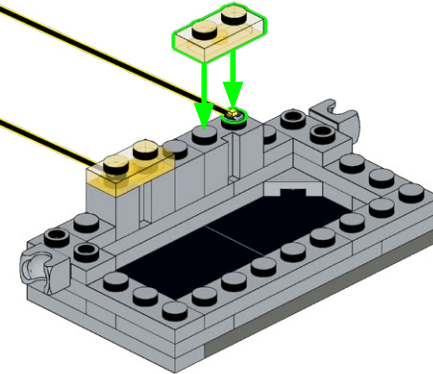

2

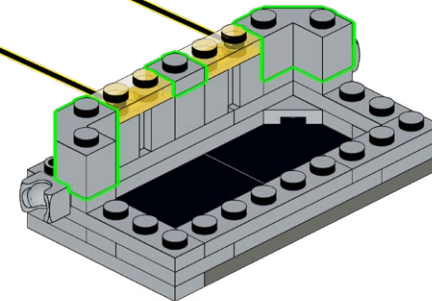

38

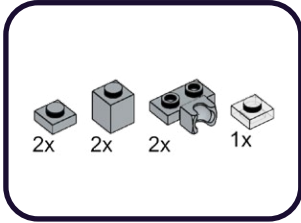
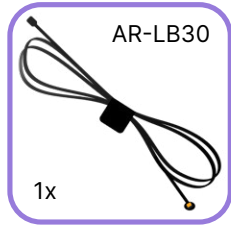

1

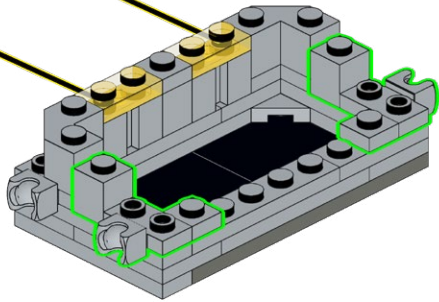

2

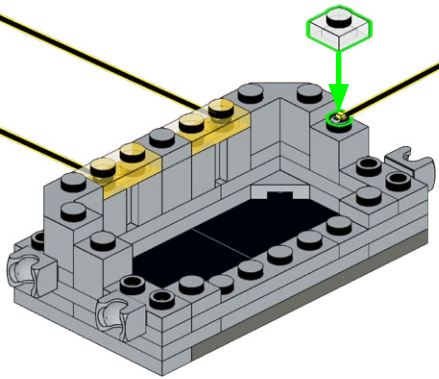

39

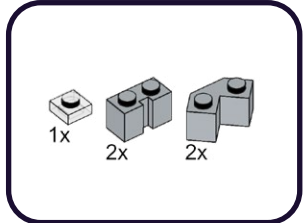
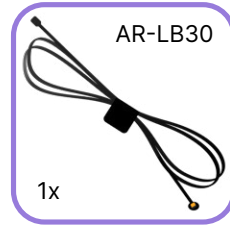

1

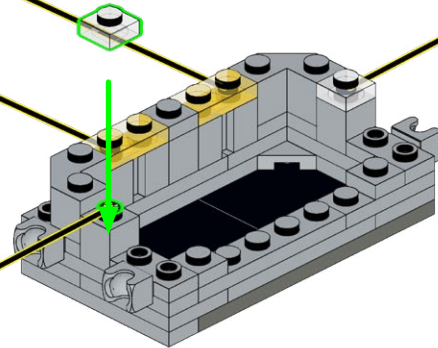

2

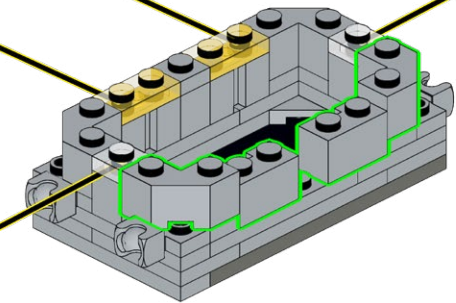

40

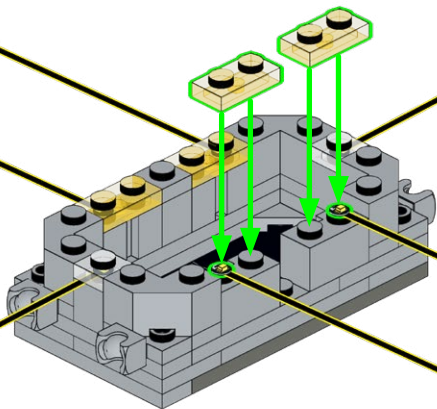
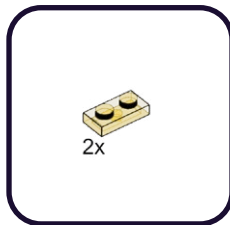
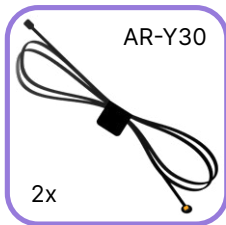

41

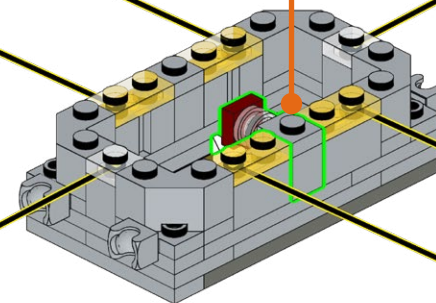
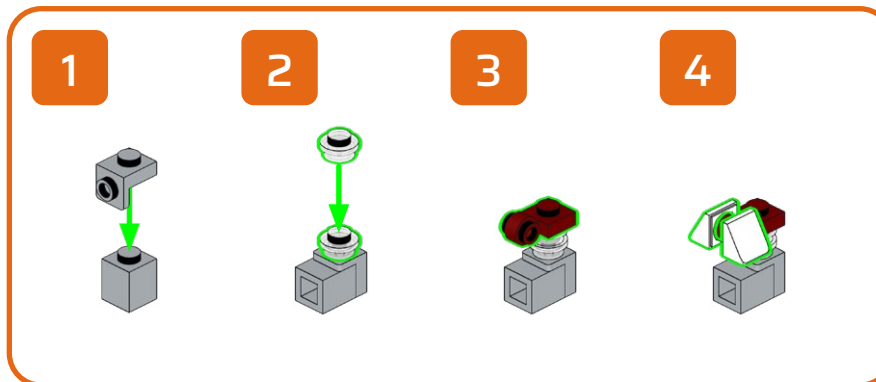
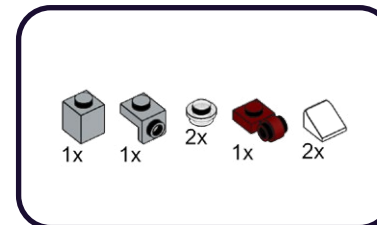

42

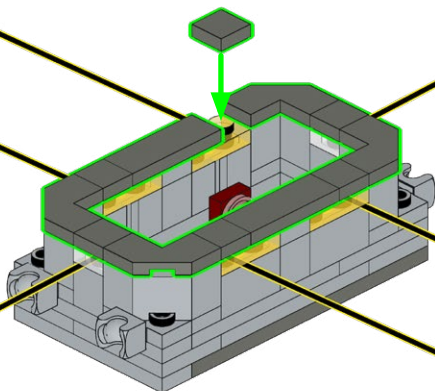
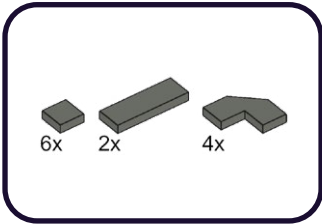

43

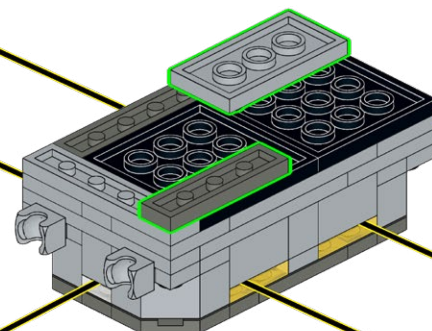
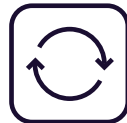
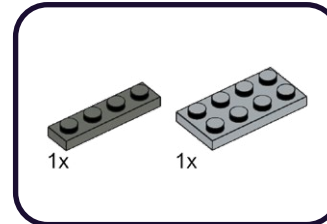

44

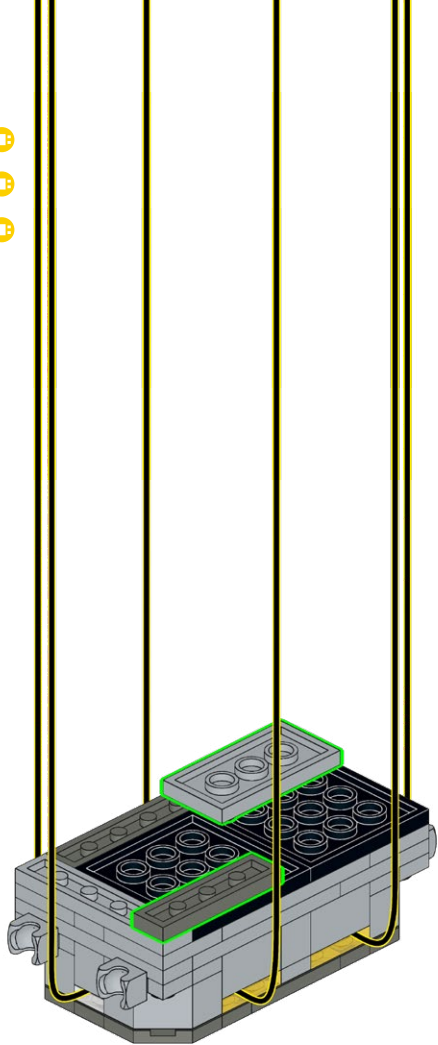

45

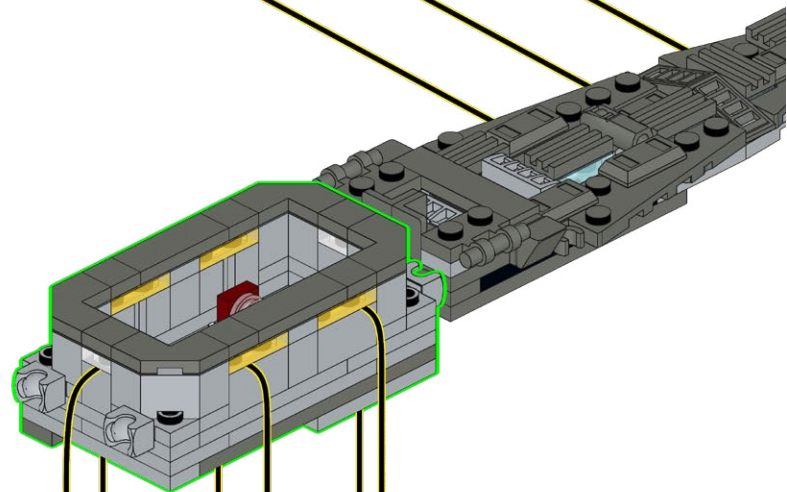

46

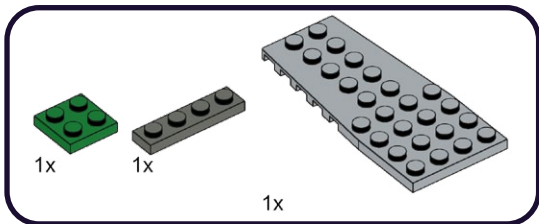

1

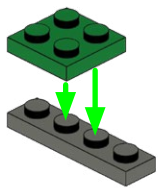

2

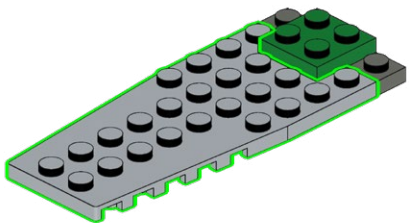

47

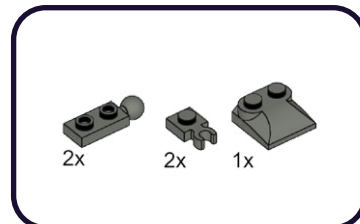

1

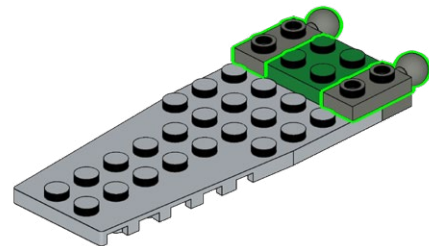

2

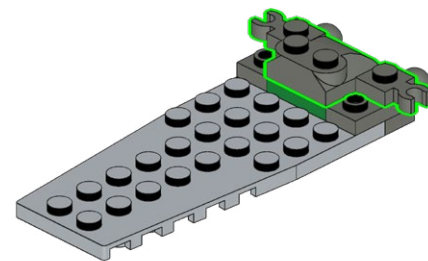

48

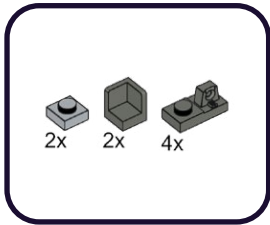

1

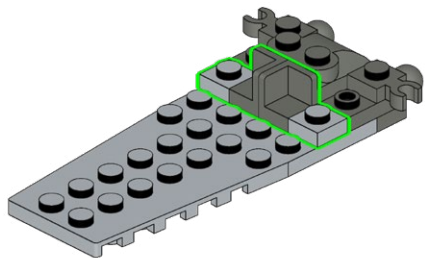

2

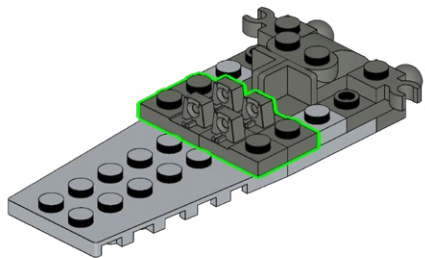

49

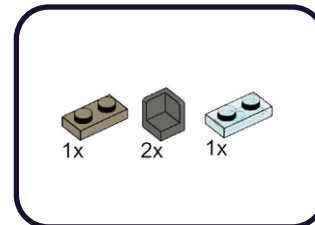
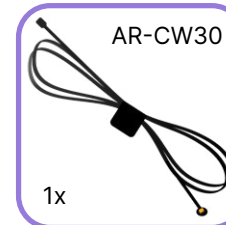

1

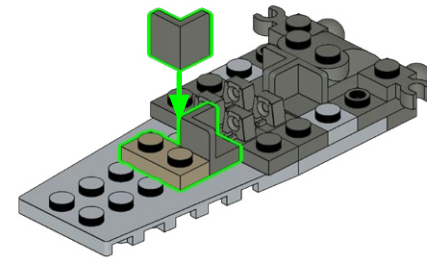

2

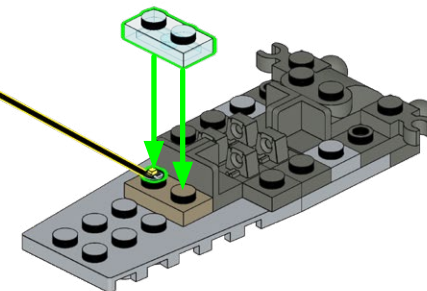

50

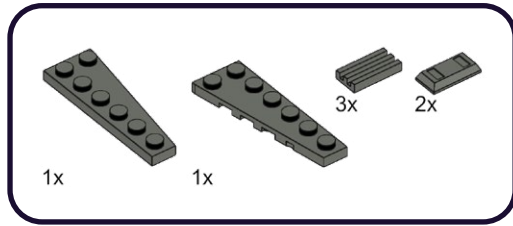

1

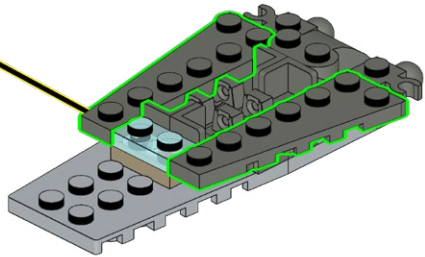

2

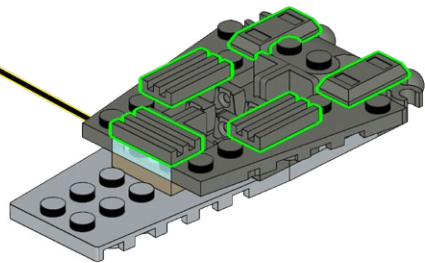

51

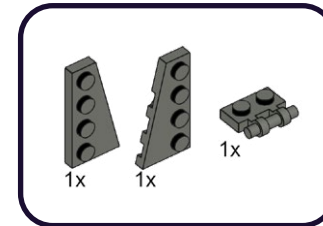

1

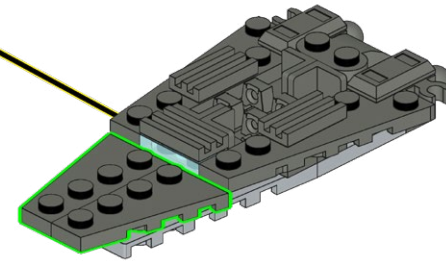

2

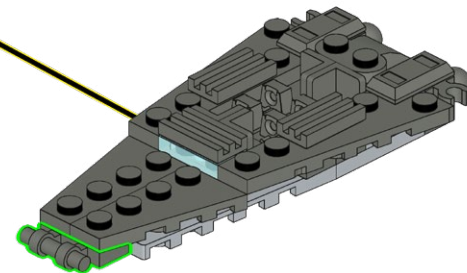

52

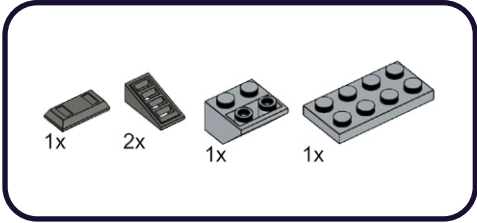

1

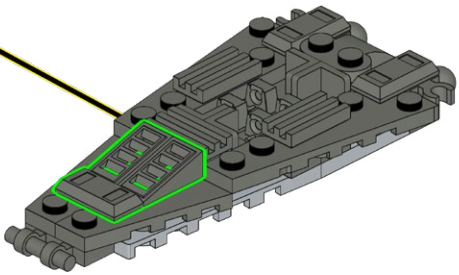

2

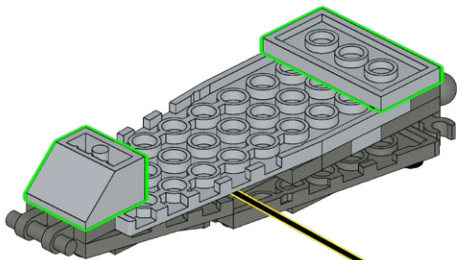

53

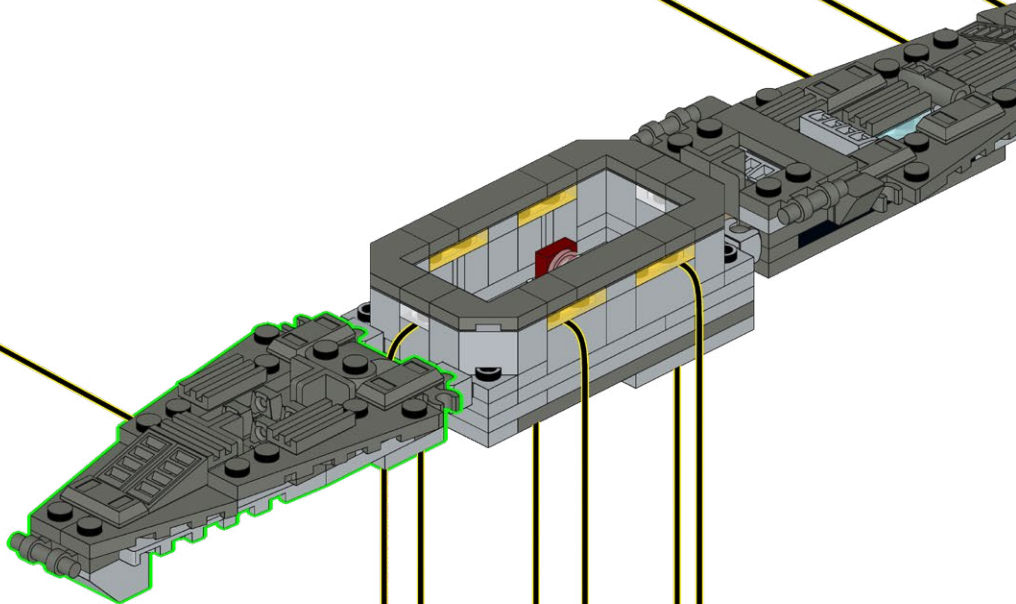

54

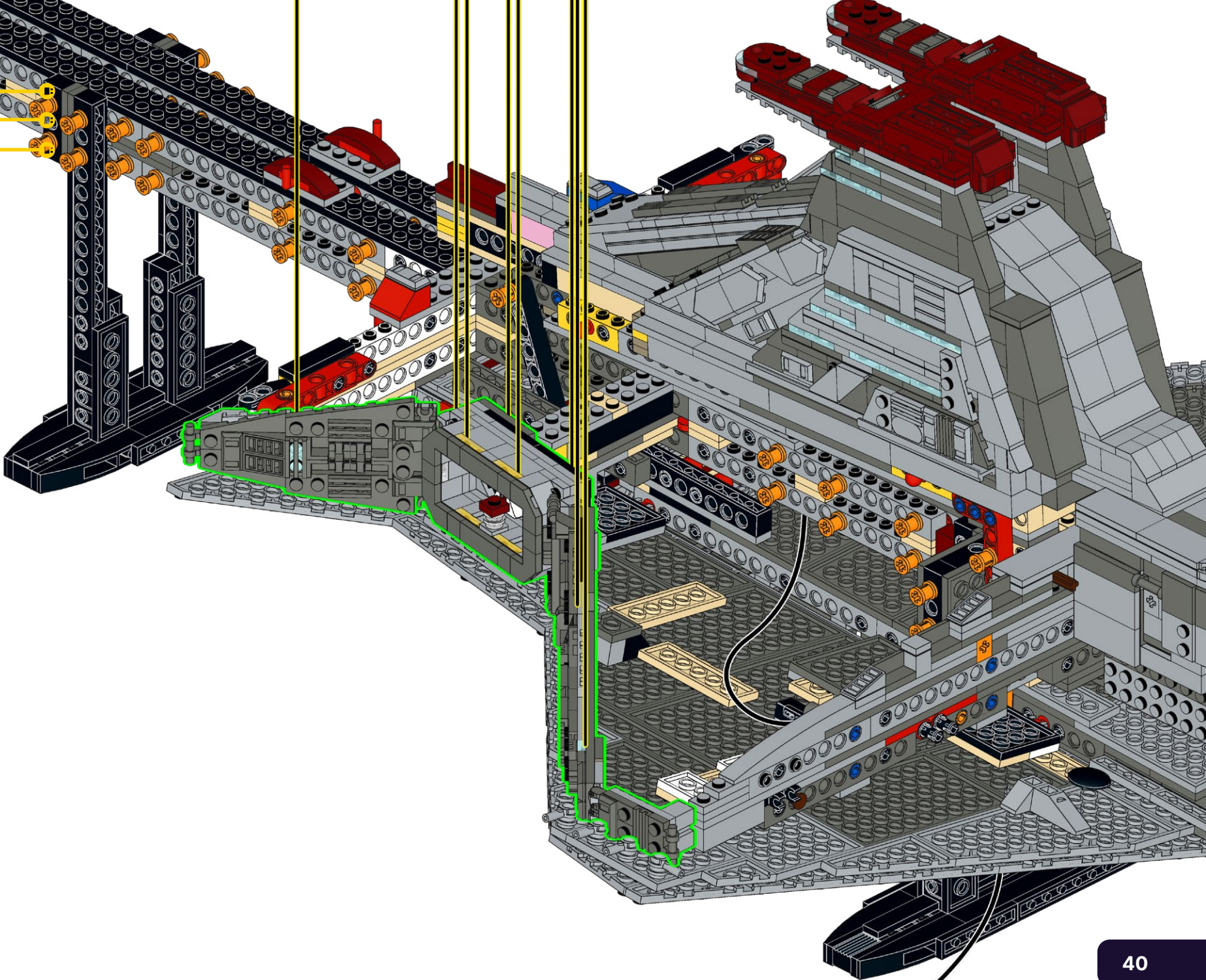

55



D-6 T-1x6

1x 1x

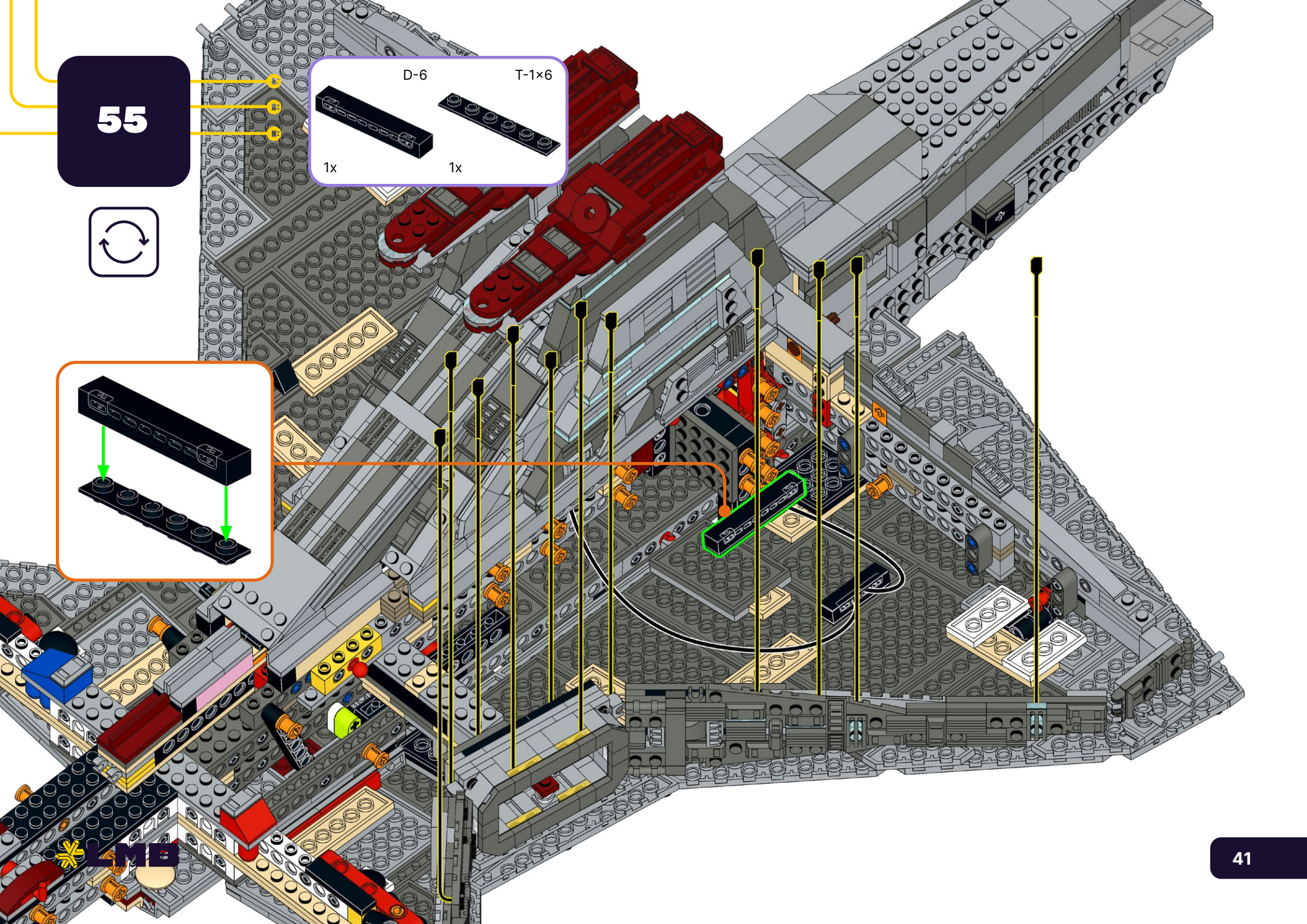
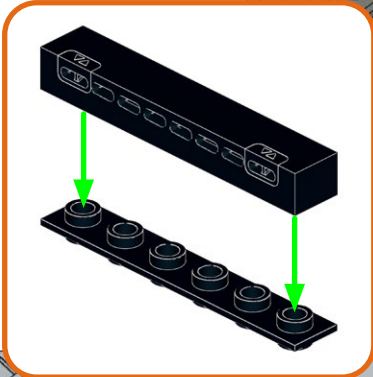

56

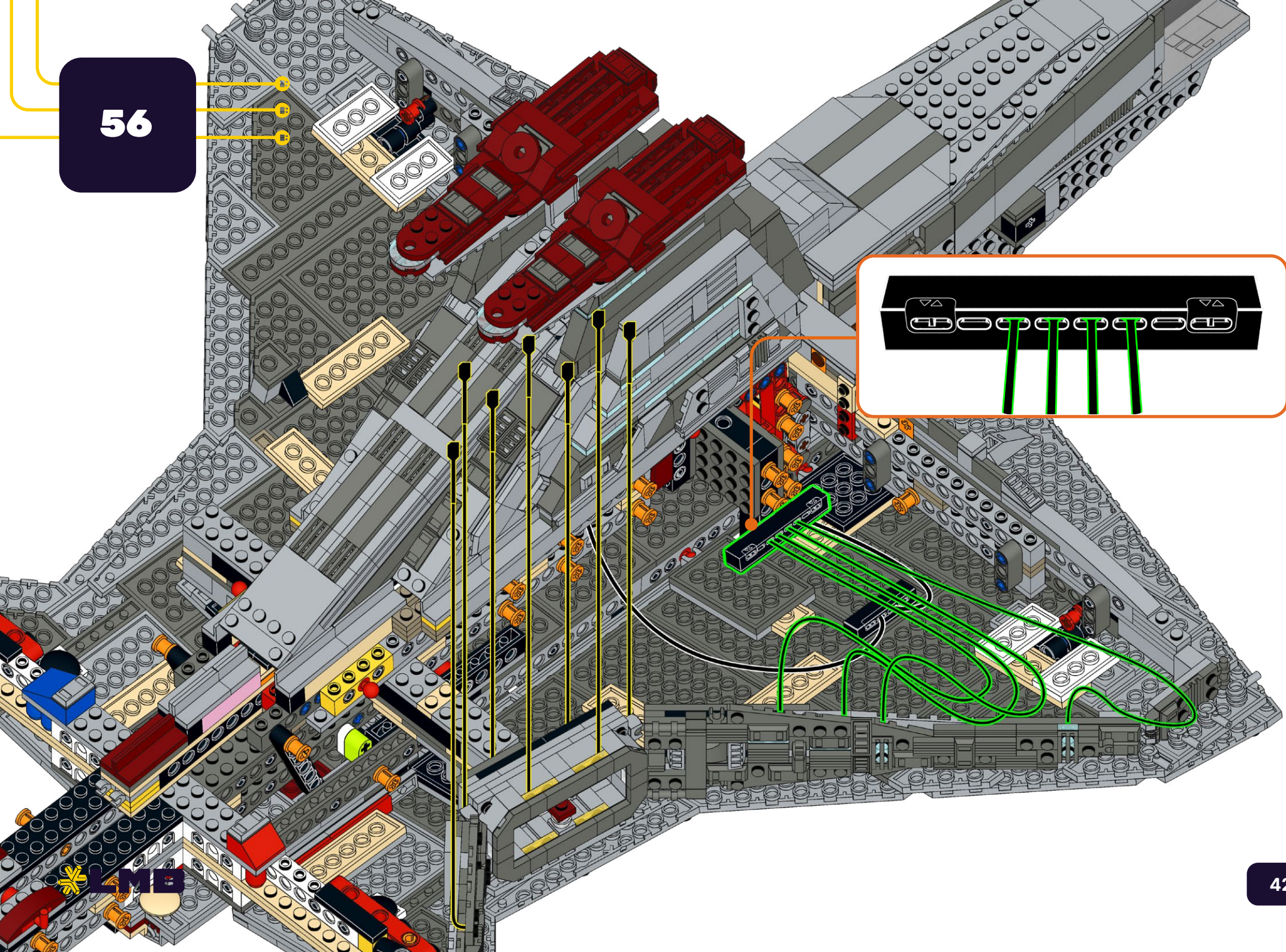

57

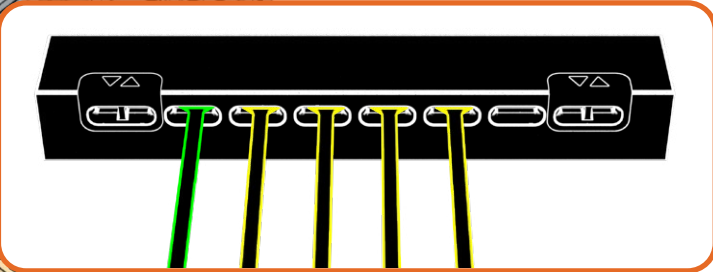
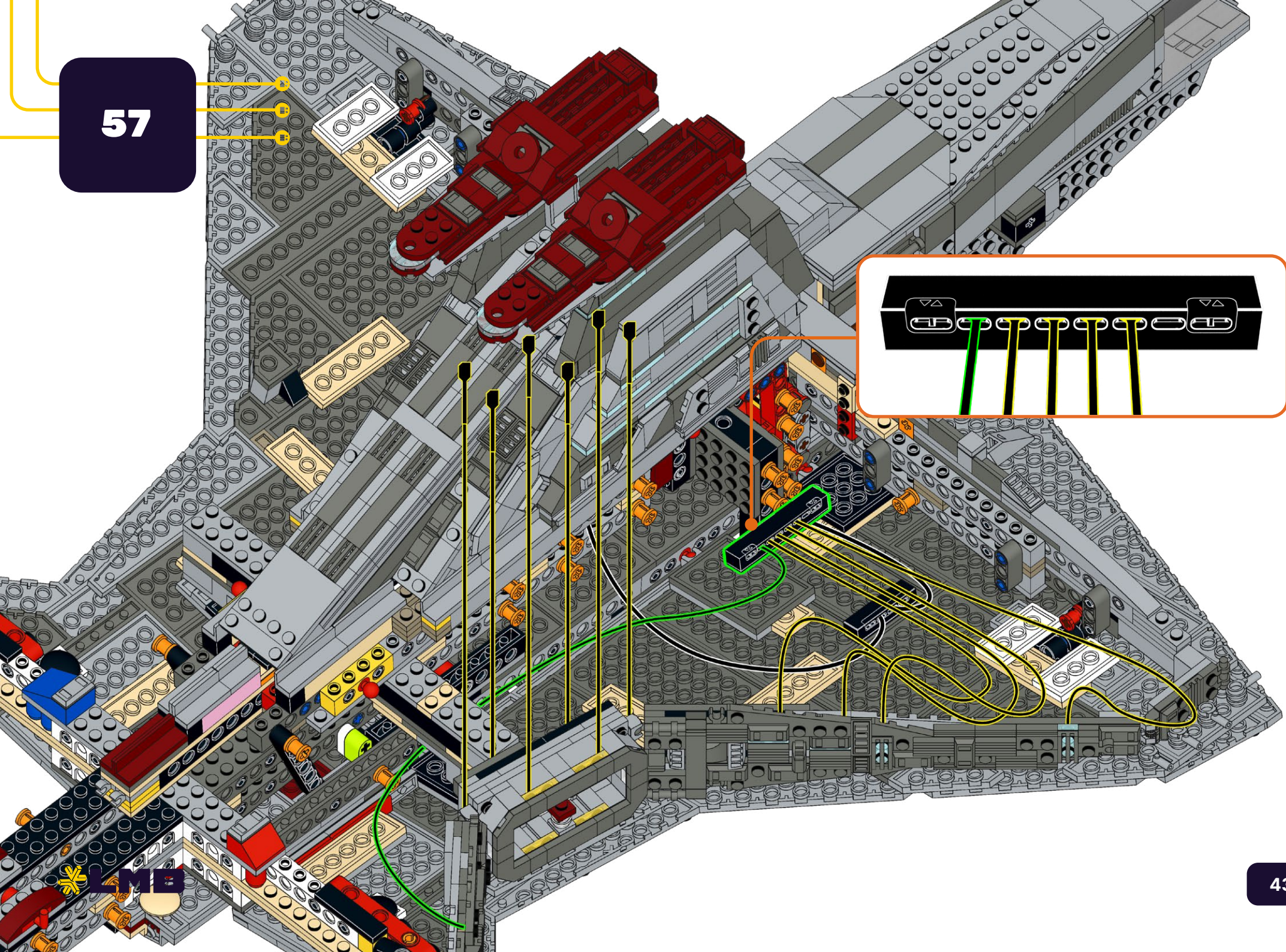

58

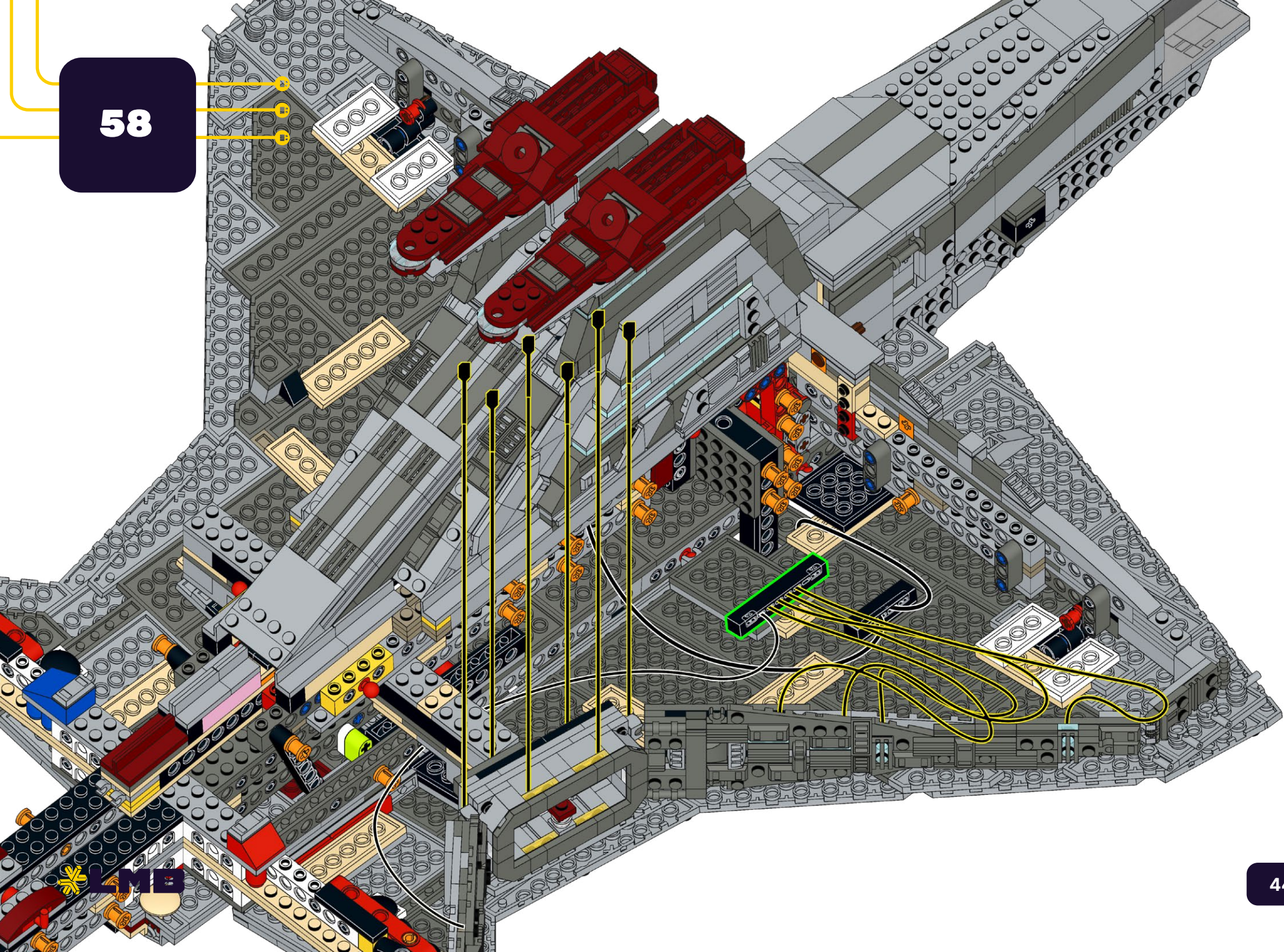

59



E-1x2 T-1x2

1x 1x

1 2

1: A black L-shaped Technic connector with a small black Technic pin on its top surface.
2: A black L-shaped Technic connector with a green Technic pin on its bottom surface.

60

D-6 T-1x6



1x 1x

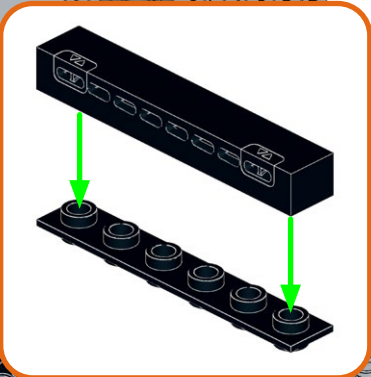

61

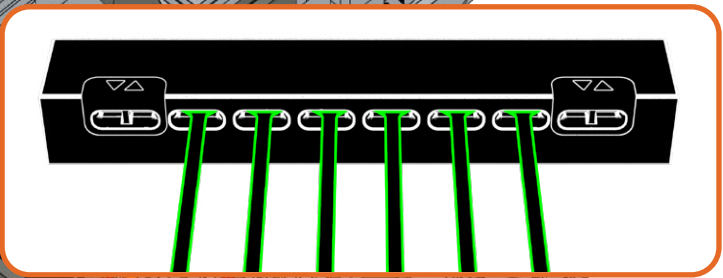

62

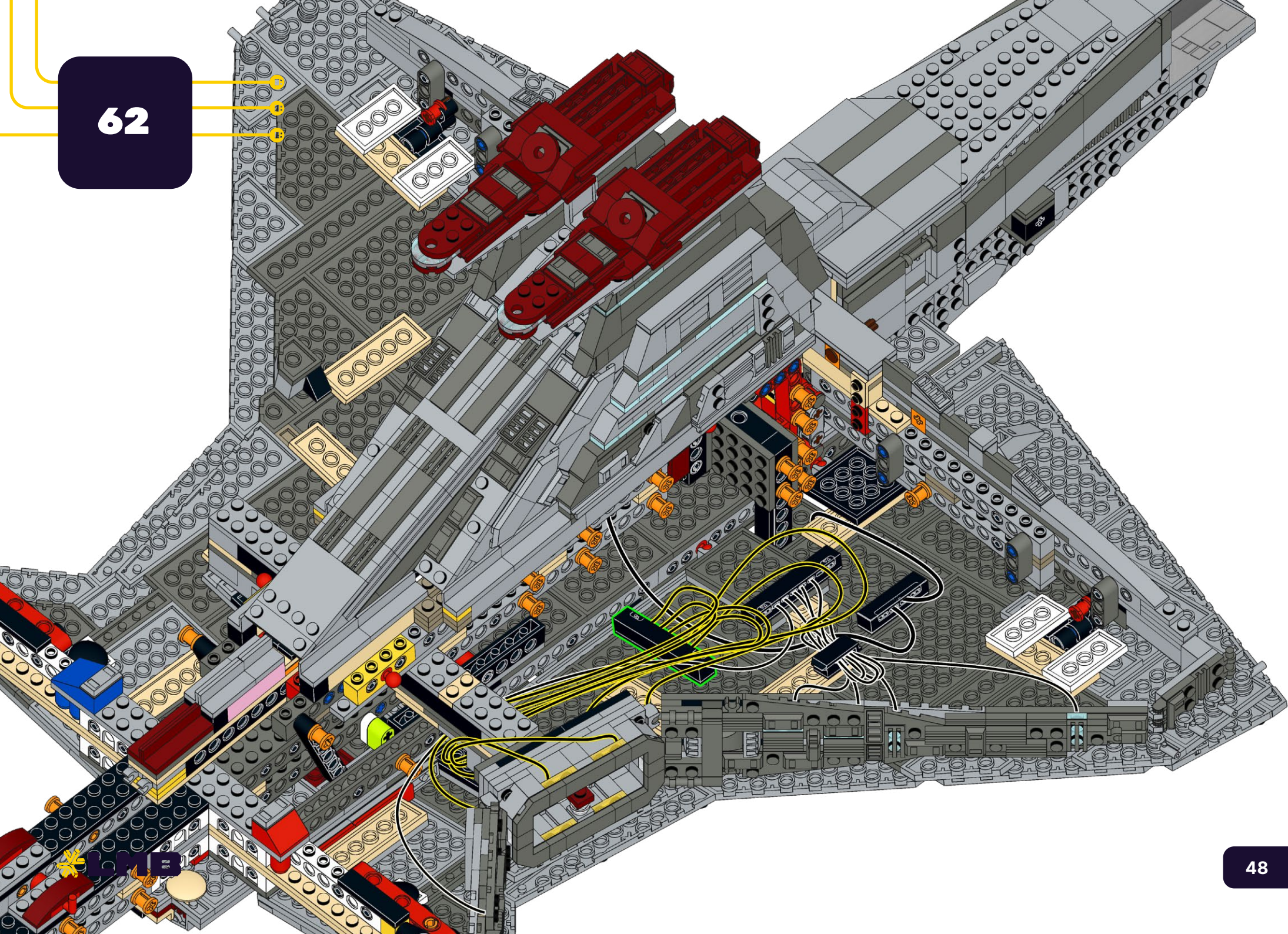

63



E-1x2 T-1x2

1x 1x

This inset shows two parts: a black E-1x2 Technic connector and a black T-1x2 Technic connector. Each is labeled with its quantity, '1x'.

1 2

This inset shows two steps of the assembly process. Step 1 shows the E-1x2 connector being placed over the T-1x2 connector. Step 2 shows the E-1x2 connector fully attached to the T-1x2 connector, with a green LED strip being inserted into the E-1x2 connector.

64

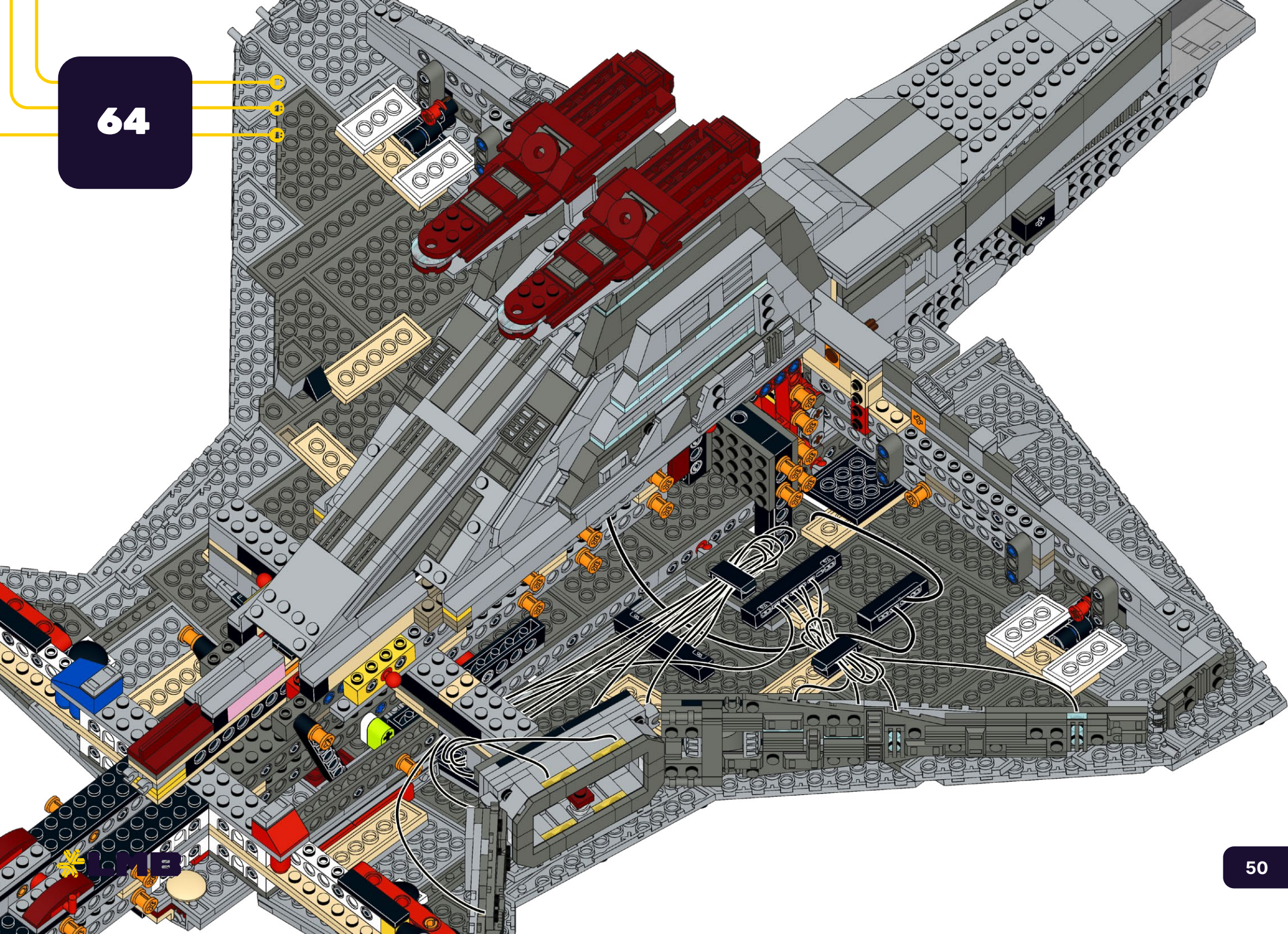

65

B-5

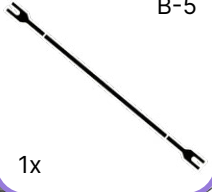

1x

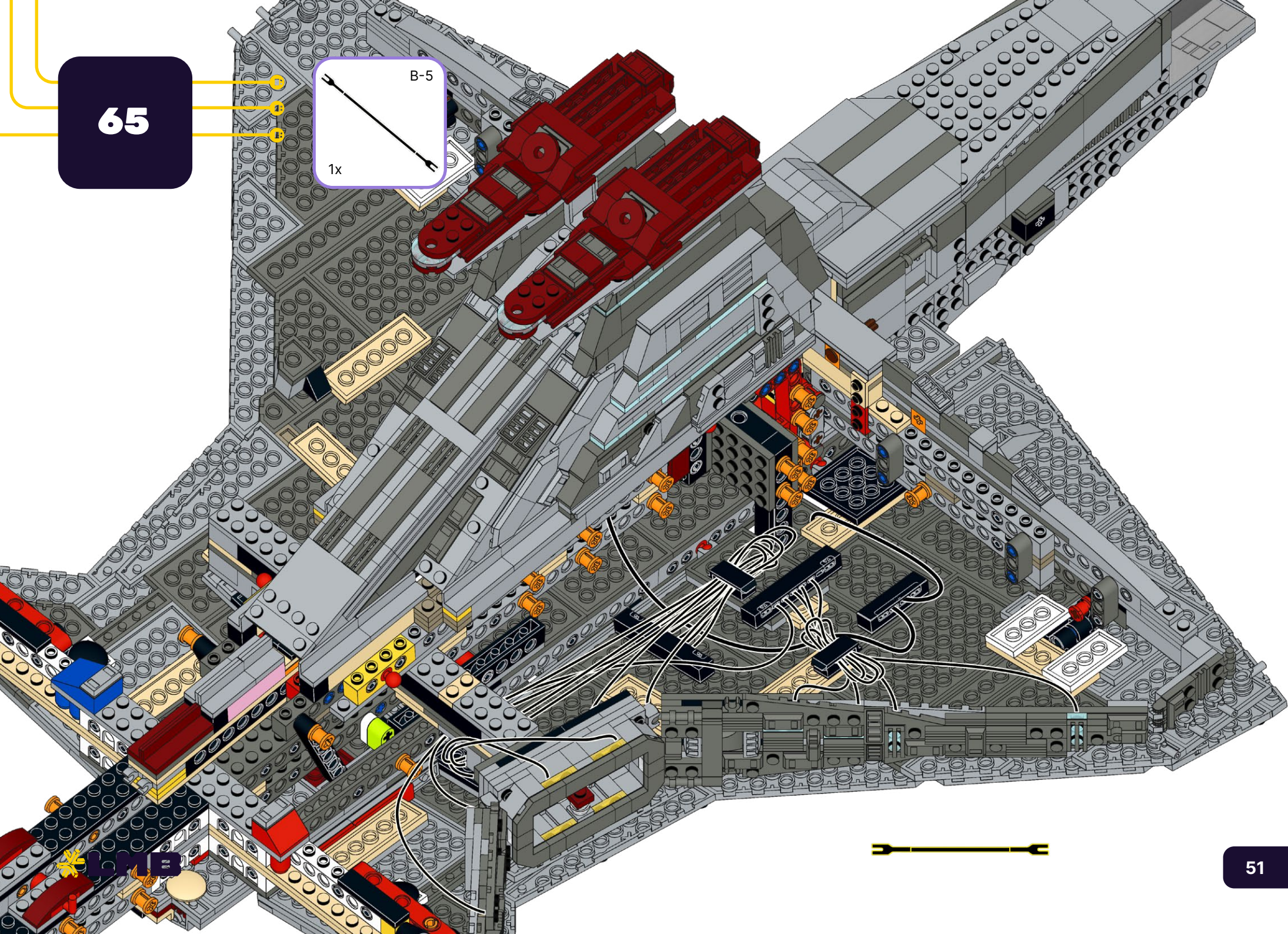

66

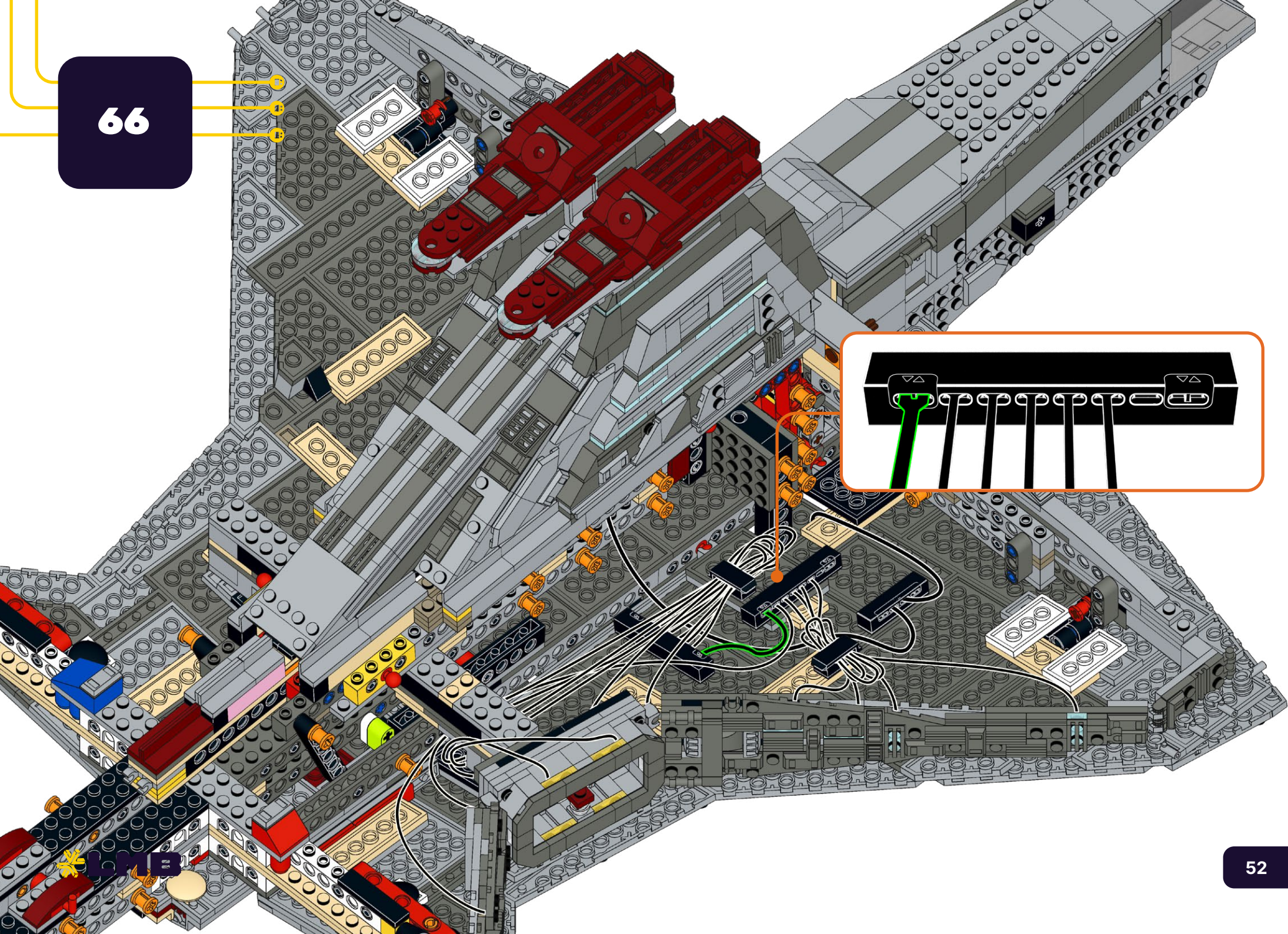

67

B-5
1x

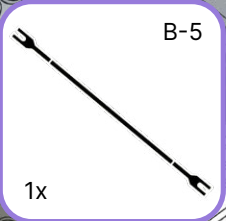

68

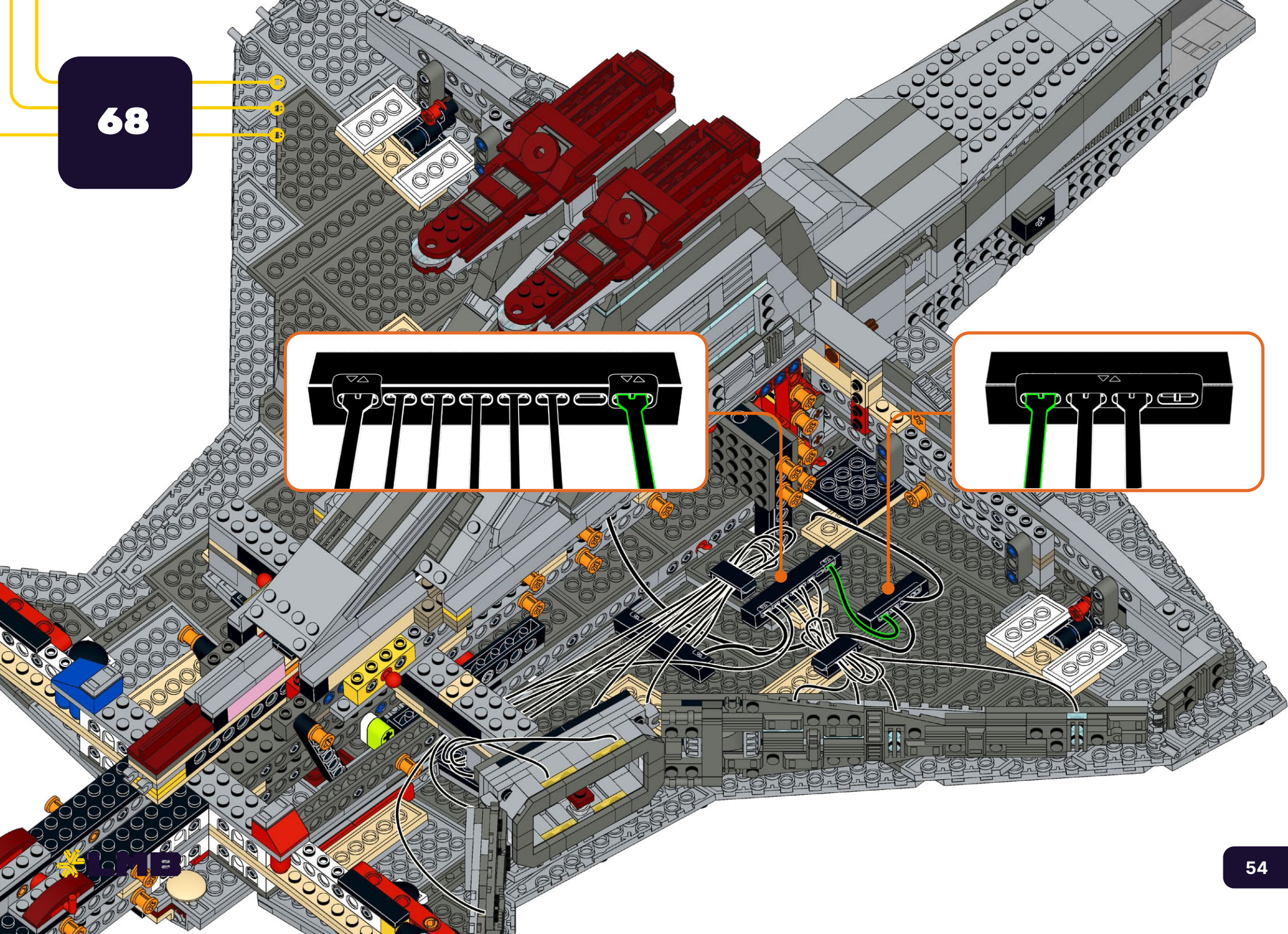

69



Power on Test
Test de mise sous tension
Test di Potenza
Stromtest
Prueba de Energía
电源测试

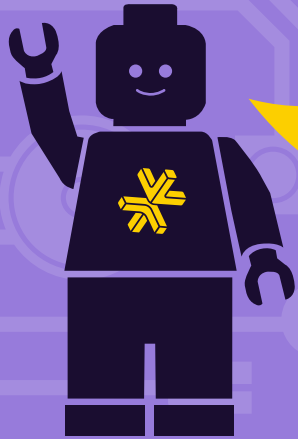

HOLD UP!

You might notice some bags aren't in order, as well as left over pieces, but that's ok! We're changing the way you build LEGO!

ATTENDEZ!

Vous remarquerez peut-être que certains sacs, ainsi que certaines pièces, ne sont pas dans le bon ordre. Mais pas de panique! Nous changeons simplement la façon avec laquelle vous construisez vos LEGO!

ASPETTA!

Potresti notare che alcuni sacchetti non sono in ordine, così come i pezzi avanzati, ma va bene così! Stiamo cambiando il modo in cui costruisci i LEGO!

HALT!

Sie werden möglicherweise bemerken, dass einige tüten durcheinander sind und teile übrig bleiben, aber das ist in Ordnung! Wir ändern die art und weise, wie Sie LEGO bauen!

¡ESPERA!

Es posible que notes que algunas bolsas están fuera de servicio, así como piezas sobrantes, ¡pero está bien! ¡Estamos cambiando la forma en que construyes LEGO!

暫停!

你可能会注意到一些袋子顺序错乱, 以及一些剩余的部件, 但没关系! 我们正在改变你搭建乐高的方式!

Open LEGO® Bag 35

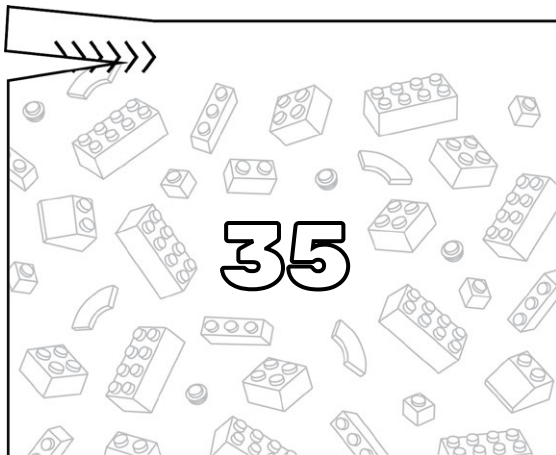

Open LMB Bags 02

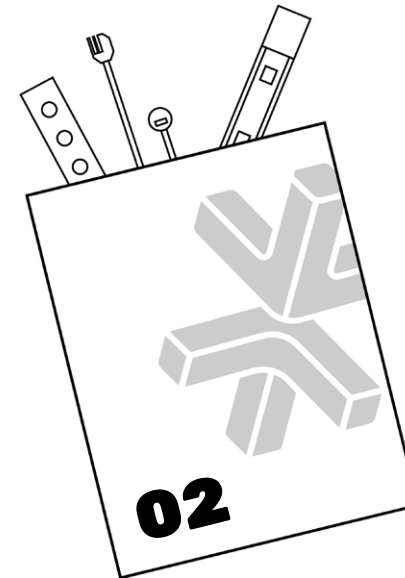

70

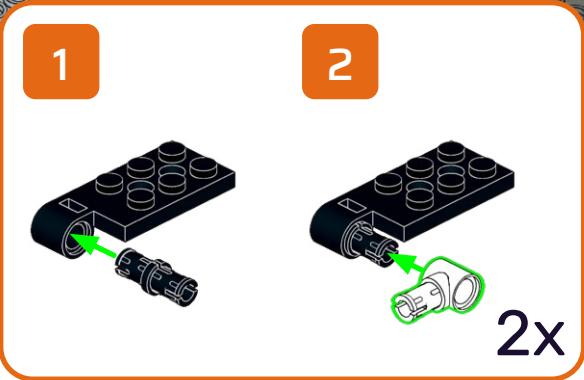

71

1x



72

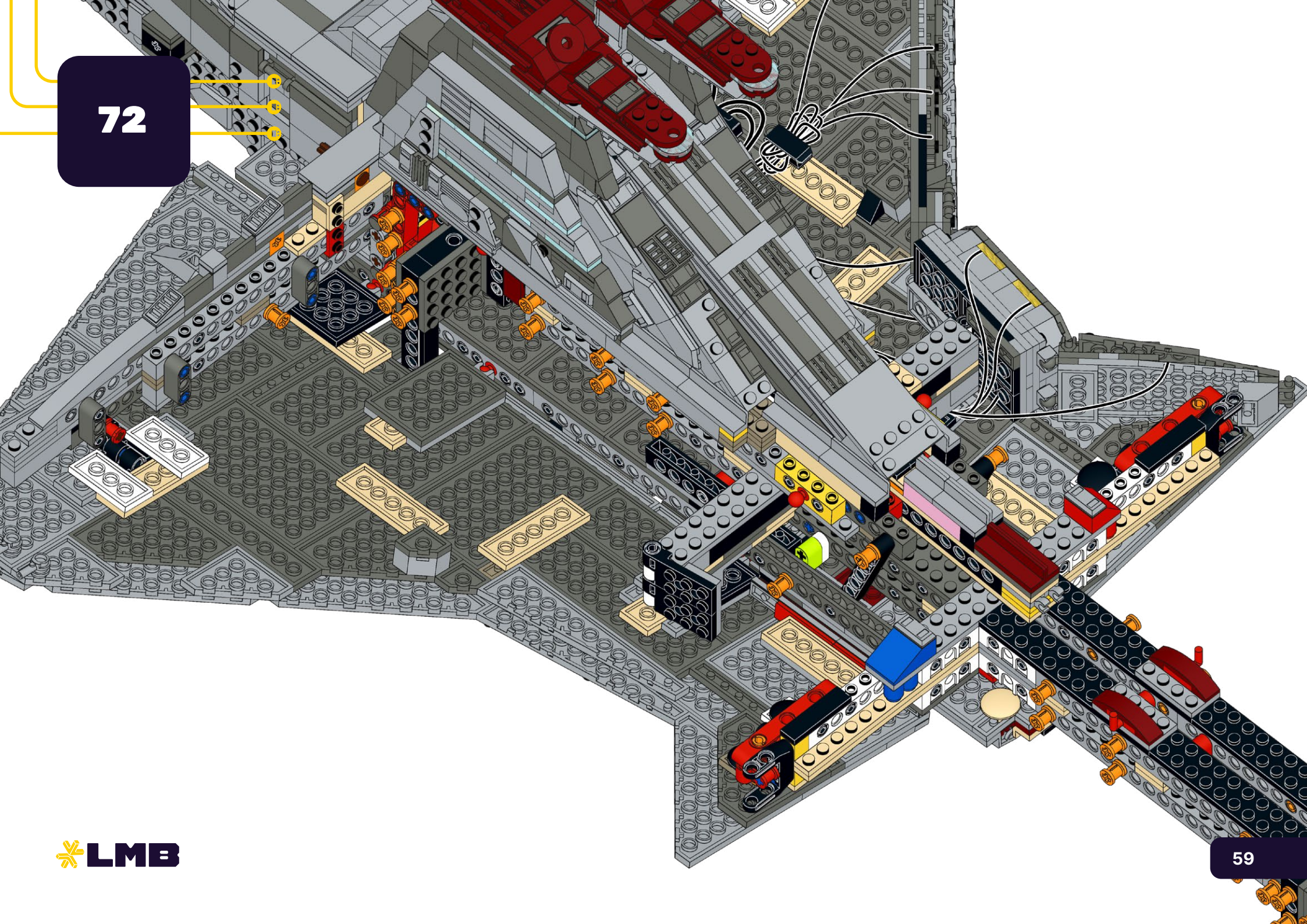

73

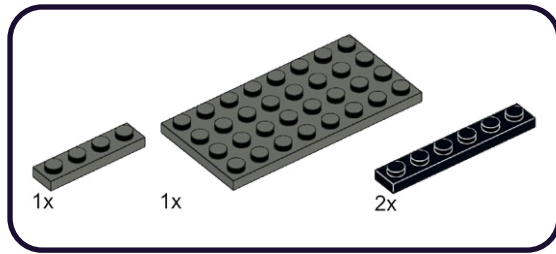

1

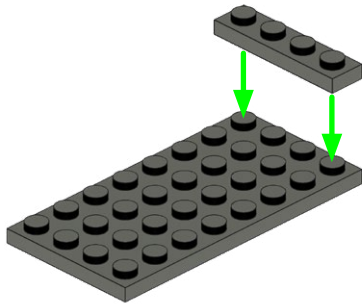

2

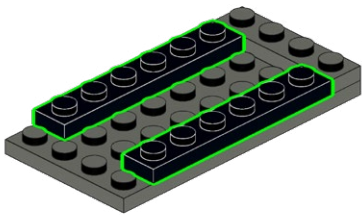

74

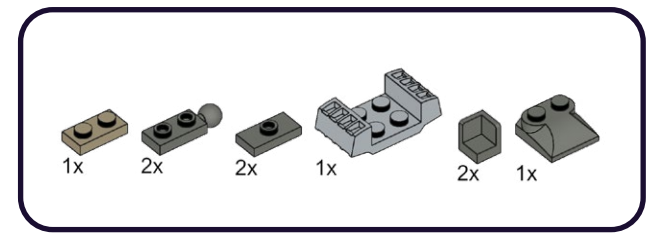

1

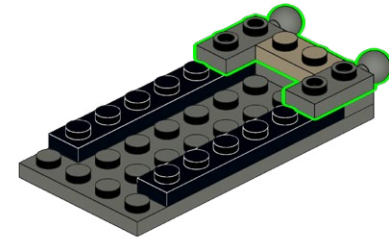

2

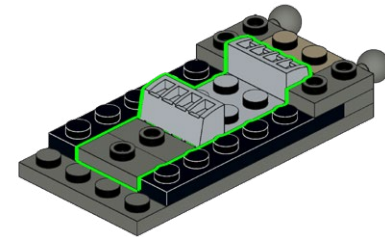

3

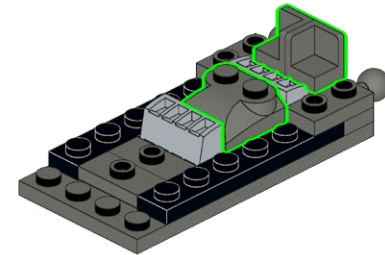

75

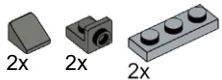

1

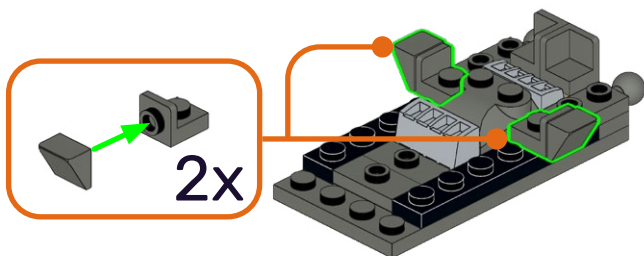

2

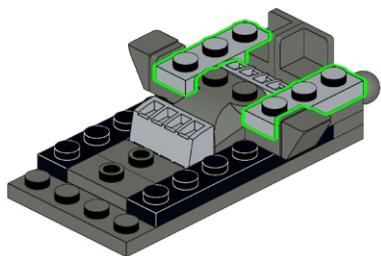

76

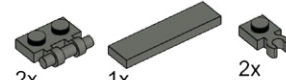

1

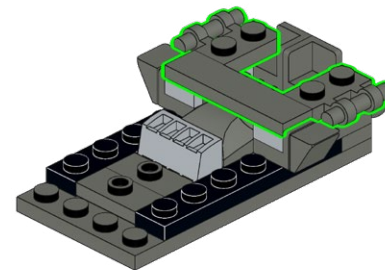

2

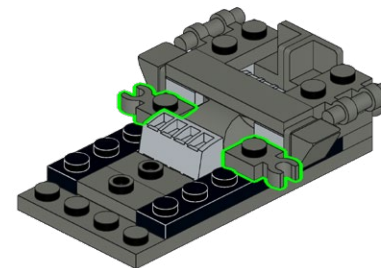

77

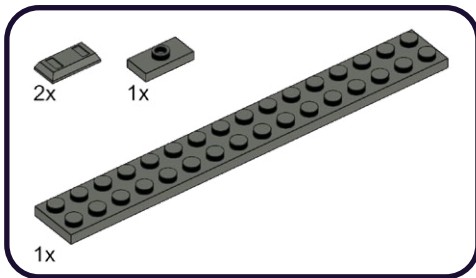
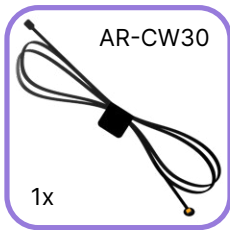

1

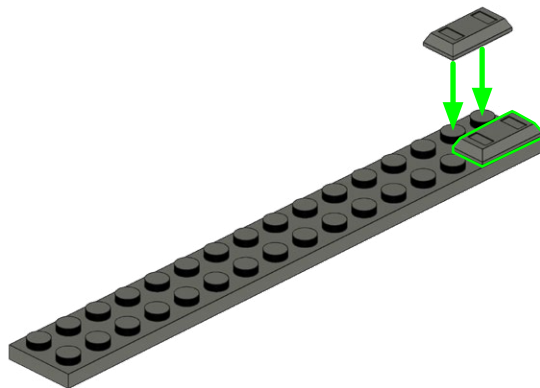

2

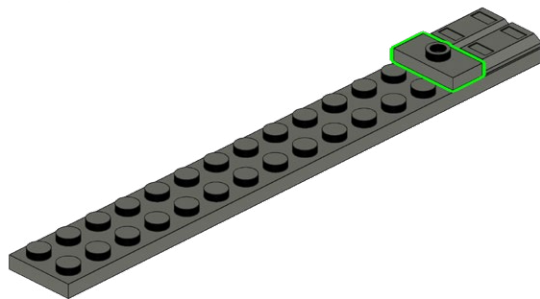

3

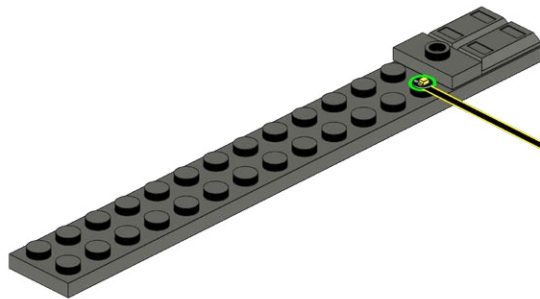

78

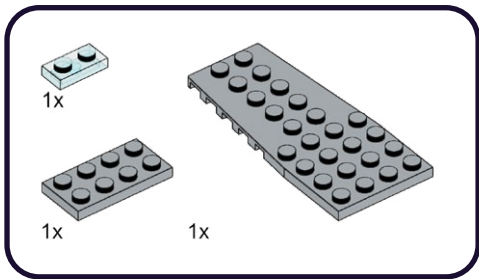

1

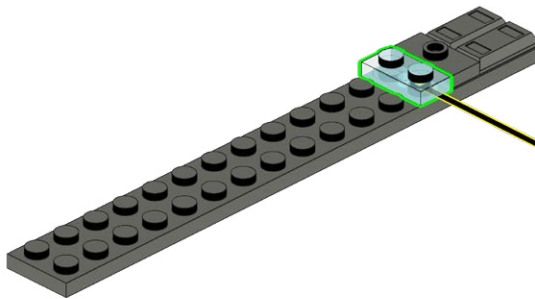

2

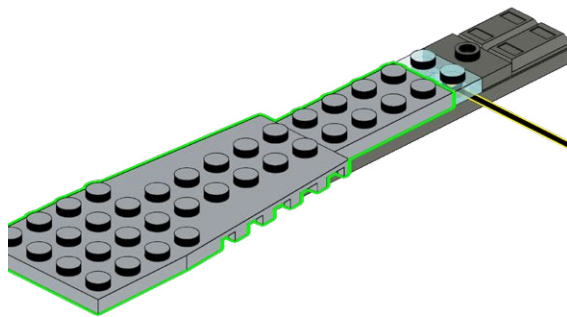

79

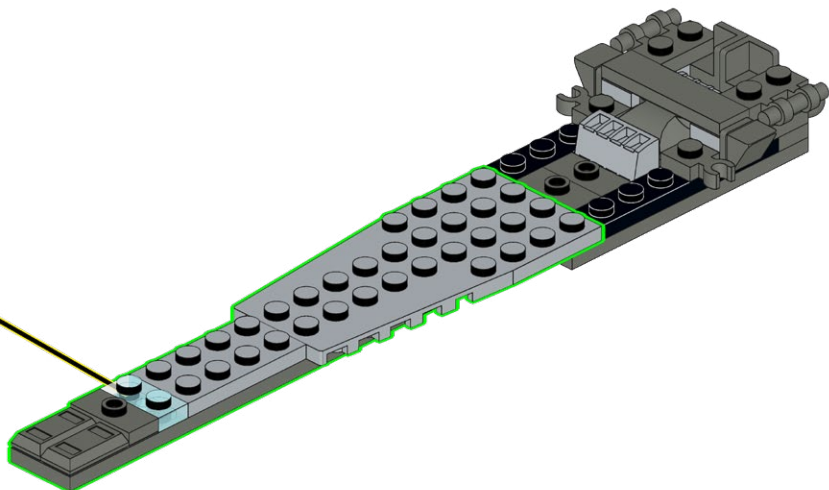

80

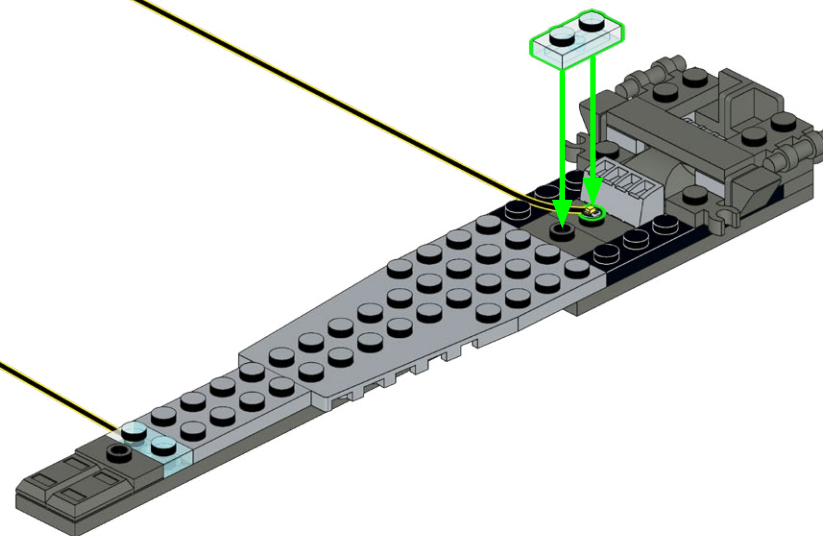
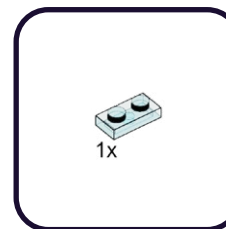
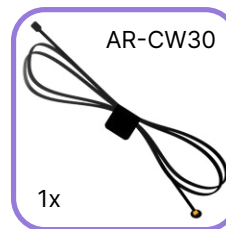

81

AR-CW30

1x

1x

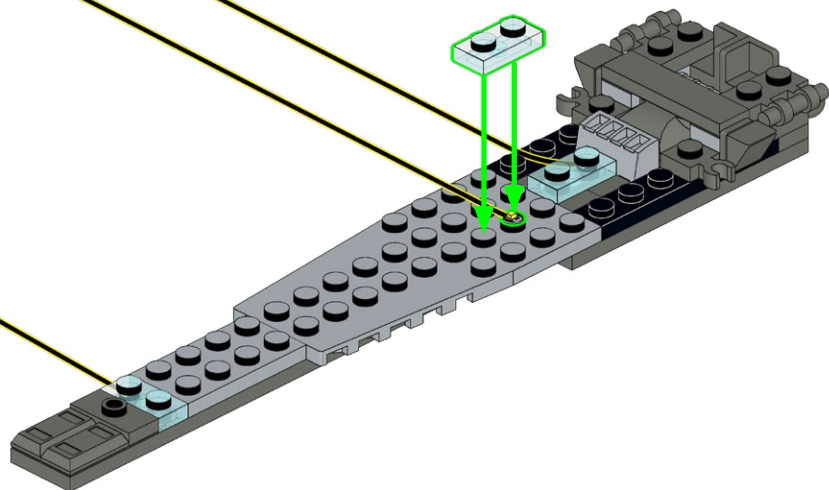

82

1x

1x

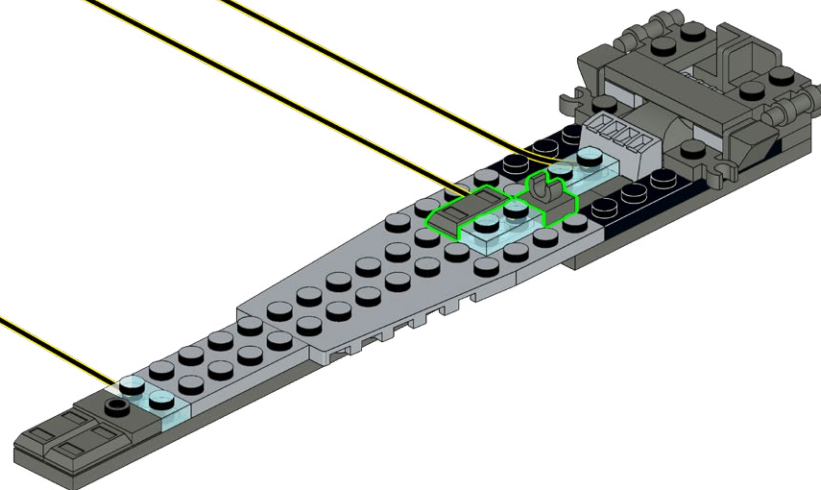

83

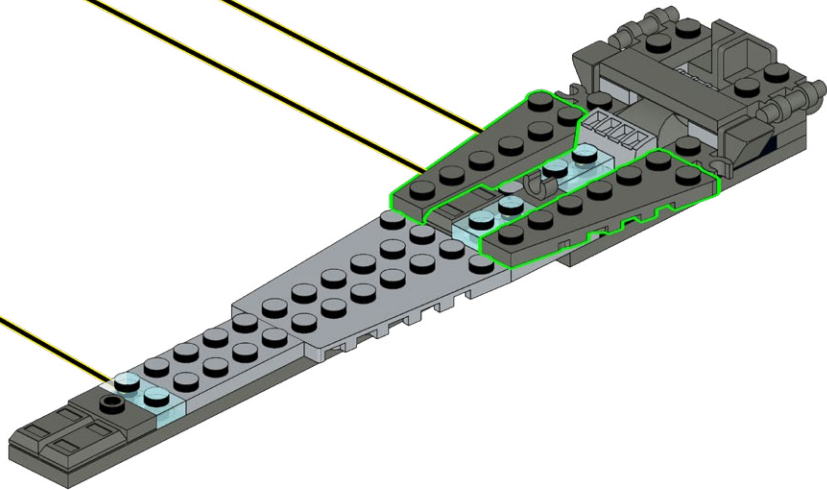
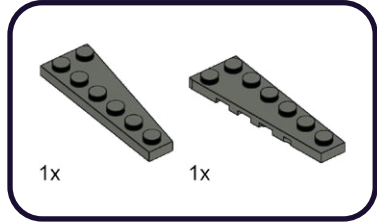

84

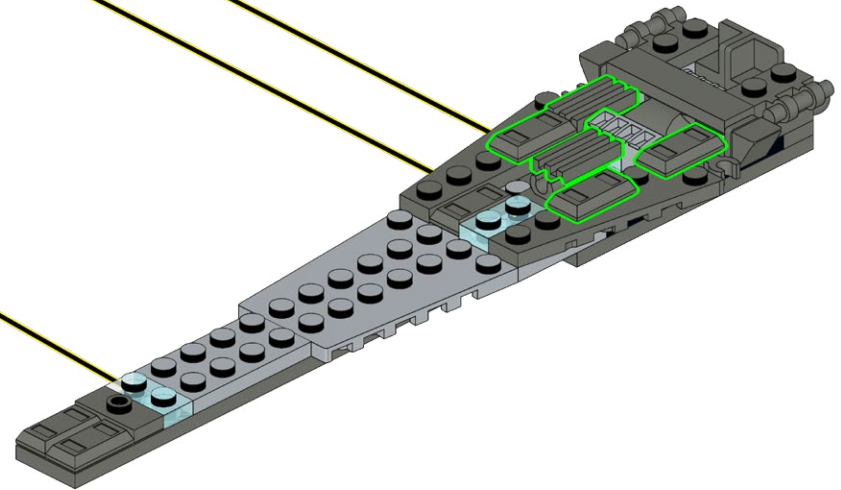
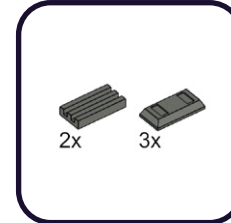

85

1x

1x

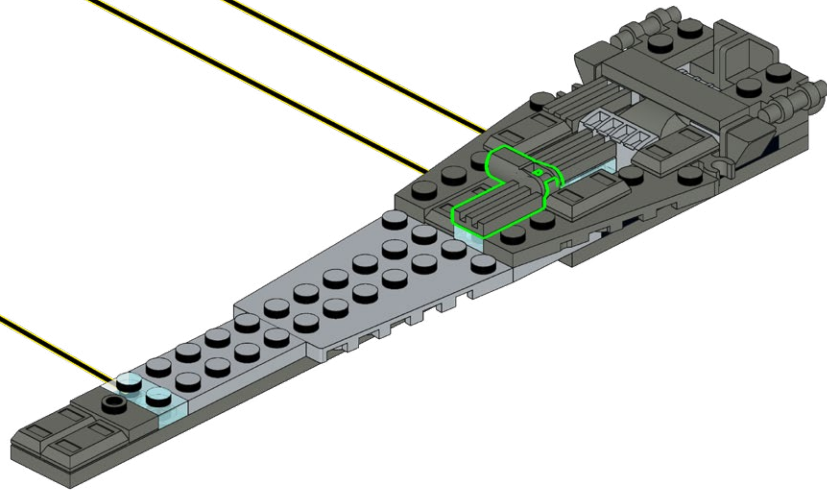

86

1x

AR-CW30

1x

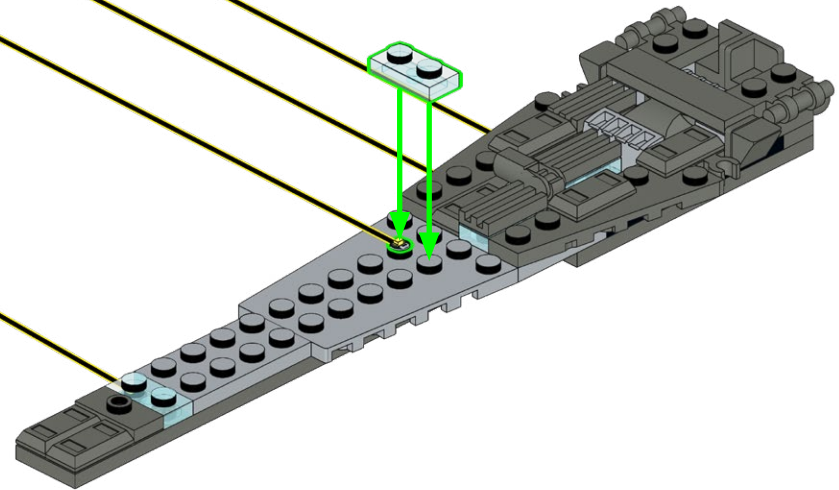

87

2x

1x

88

6x

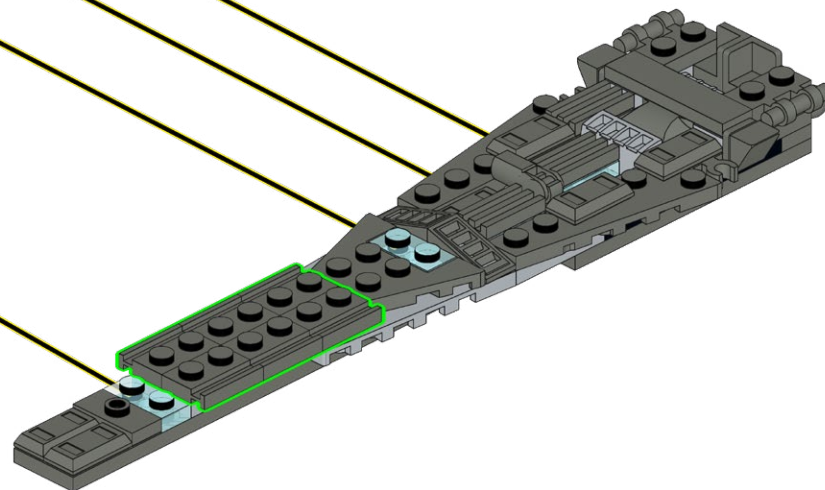
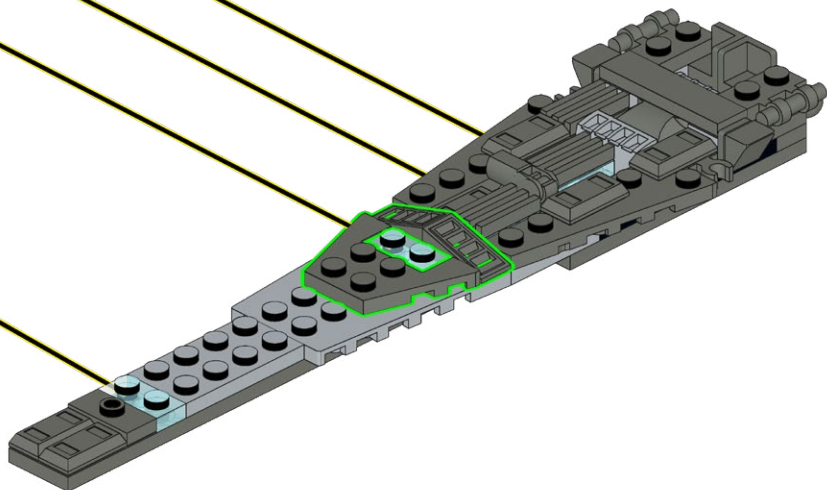

89

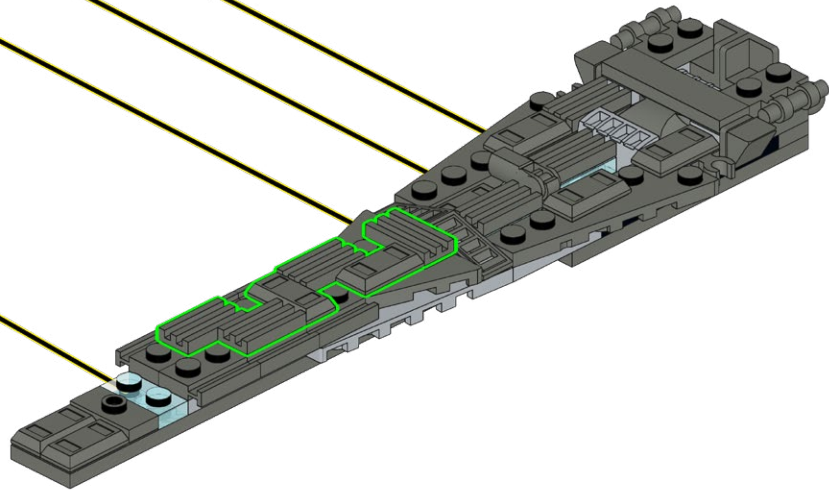
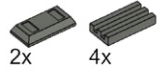

90

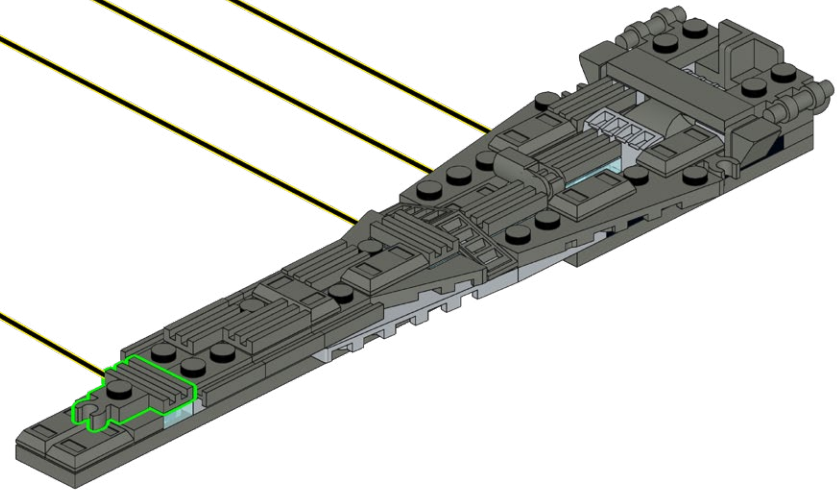
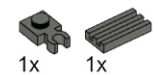

91

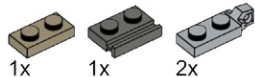

92

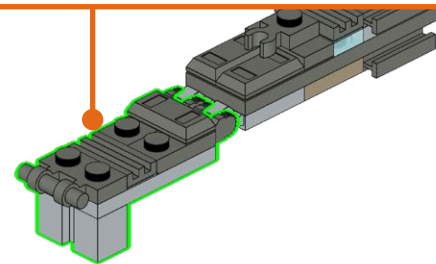
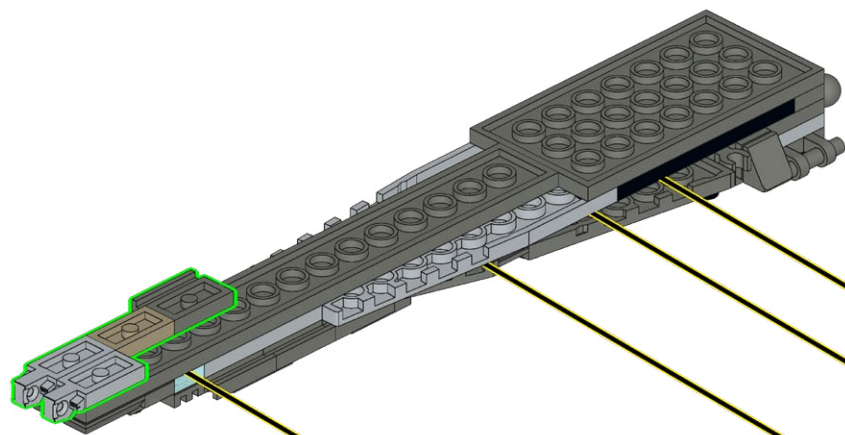
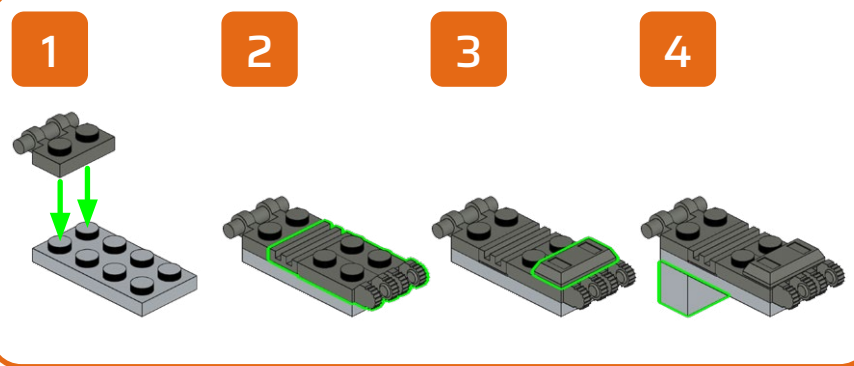
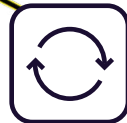
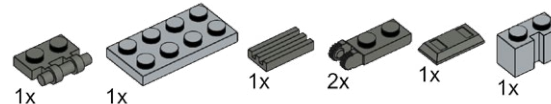

93

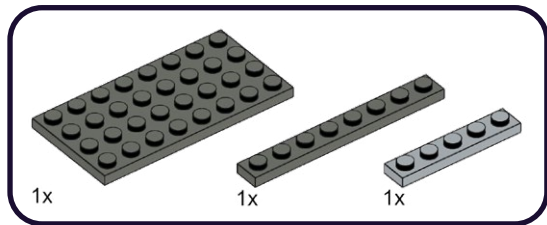

1

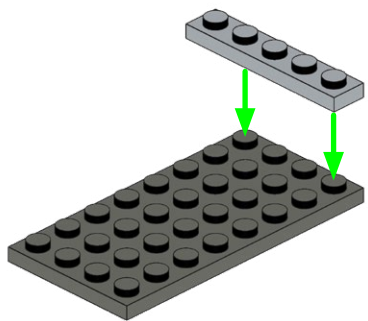

2

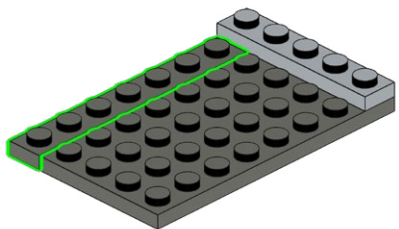

94

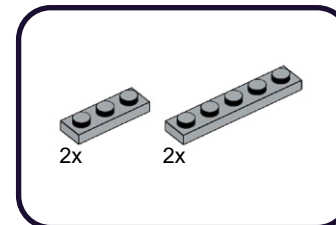

1

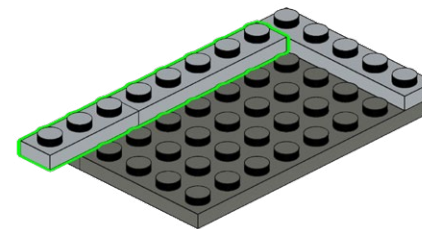

2

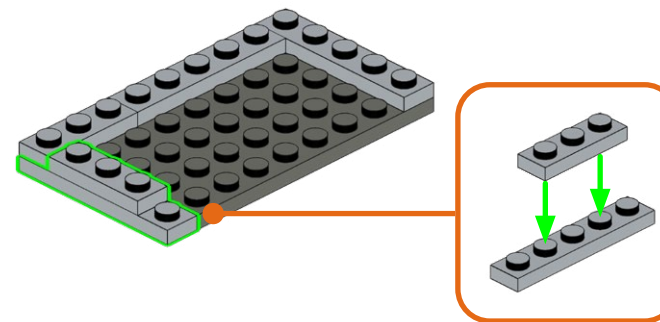

95

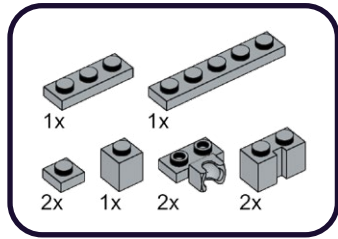

1

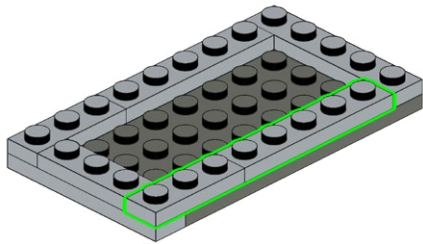

2

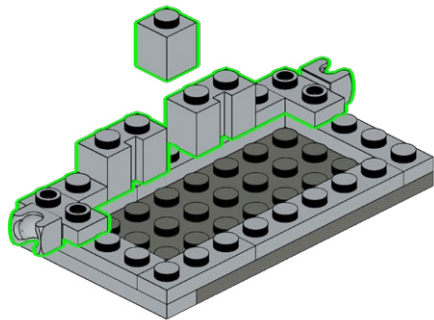

96

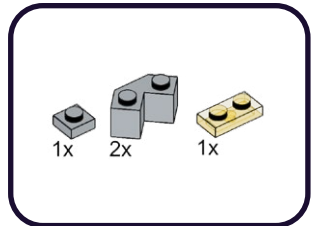
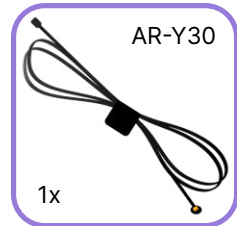

1

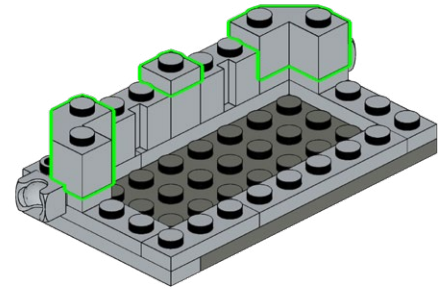

2

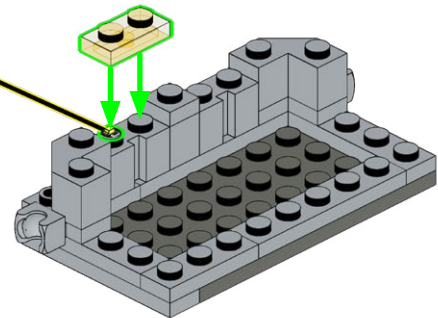

97

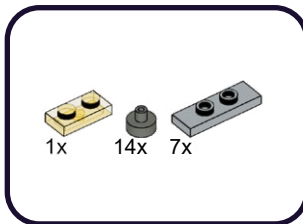
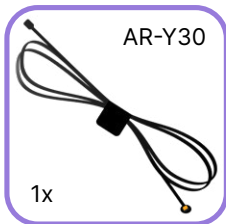

1

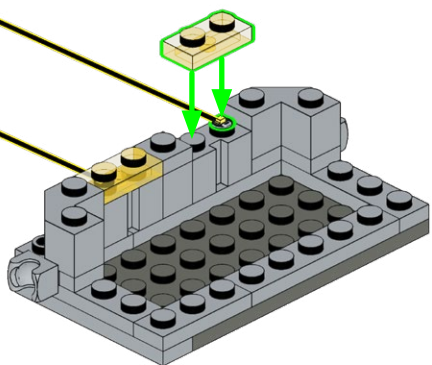

2

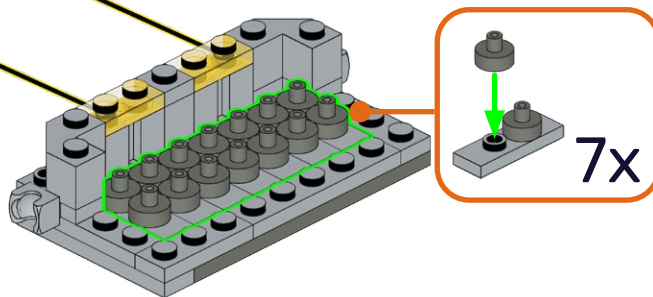

98

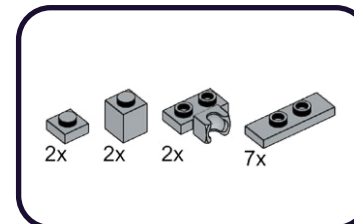

1

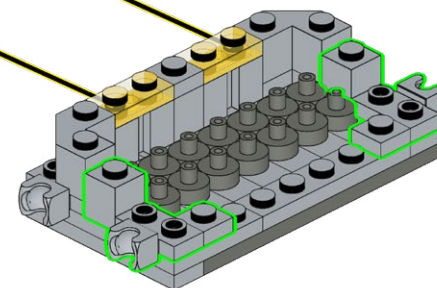

2

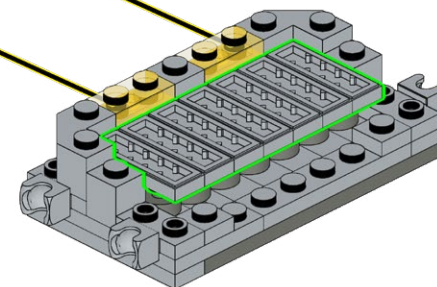

99

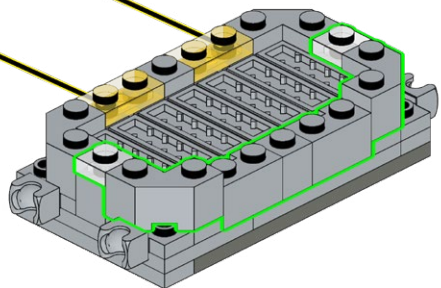
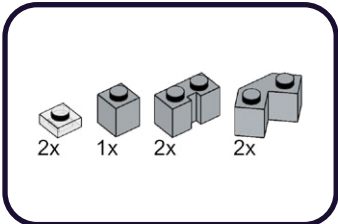

100

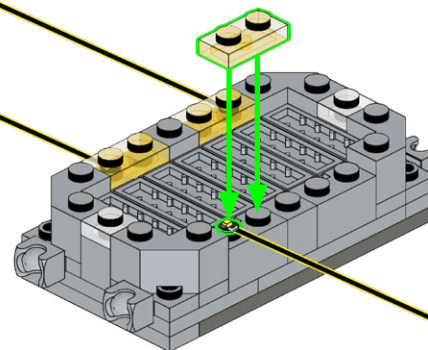
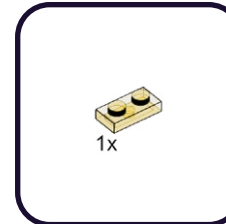
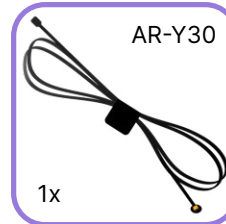

101

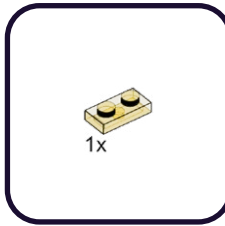
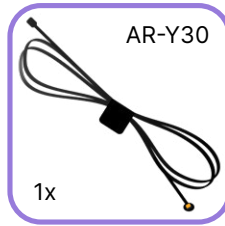

102

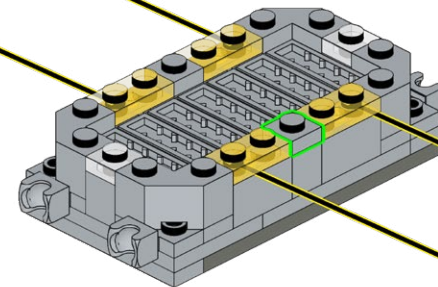
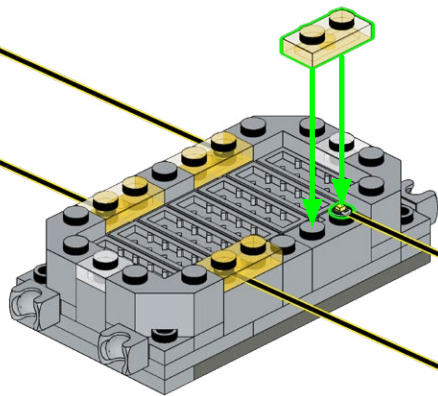
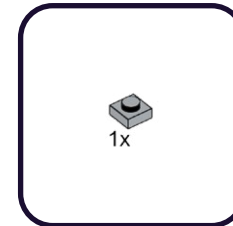

103

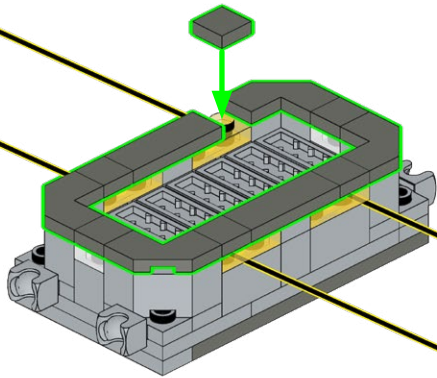
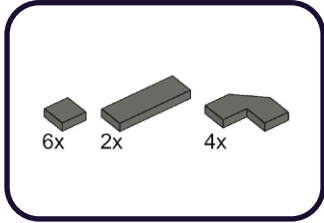

104

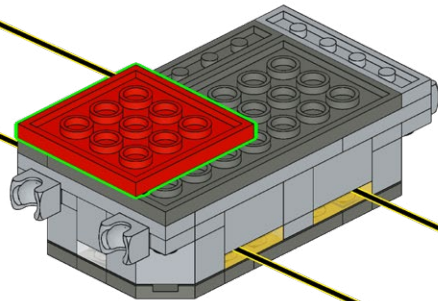
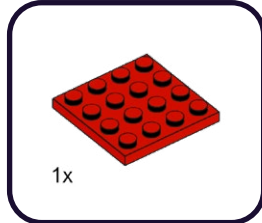

105

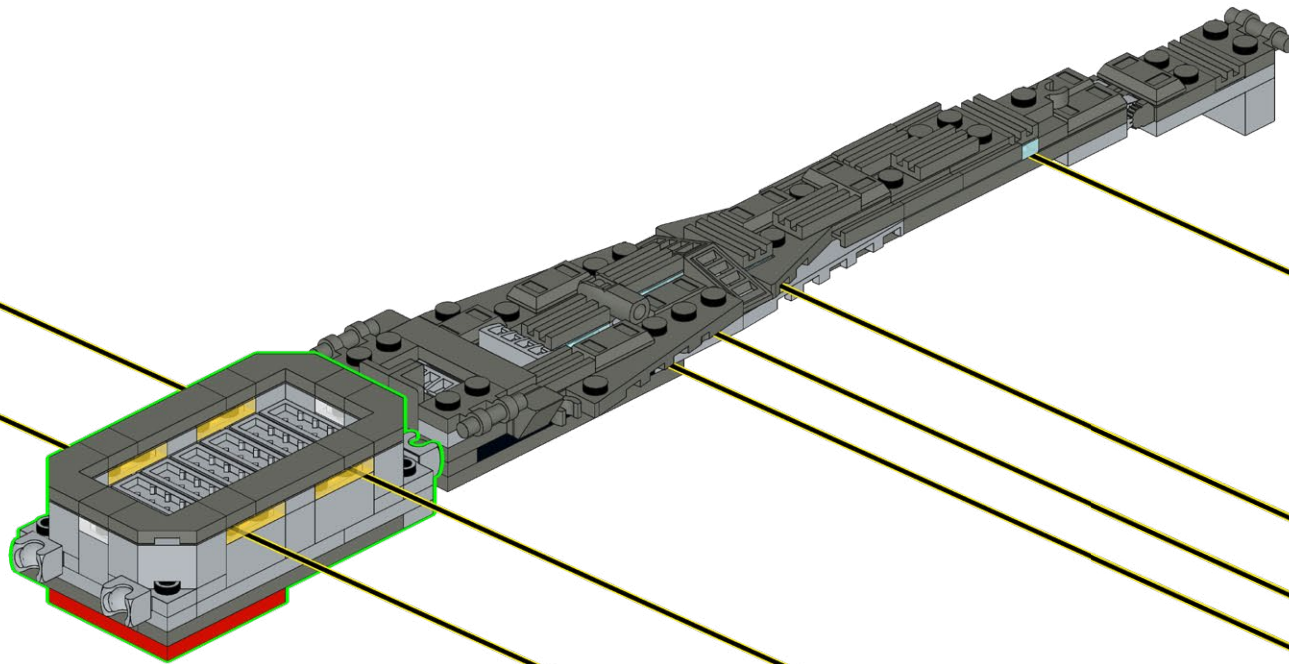

106

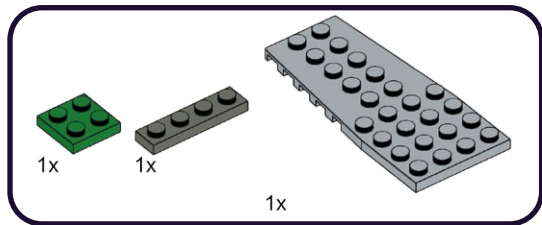

1

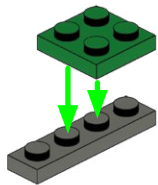

2

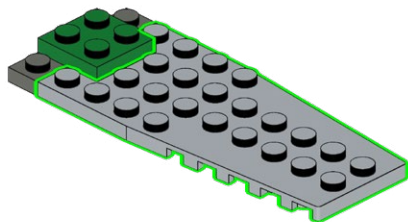

107

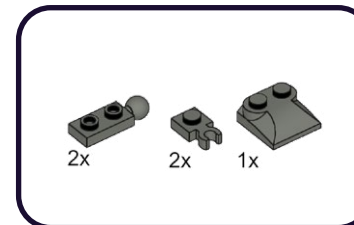

1

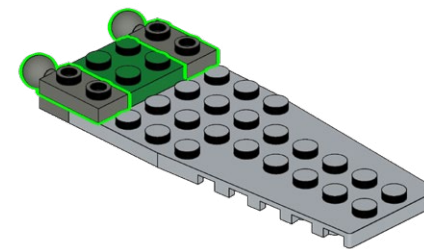

2

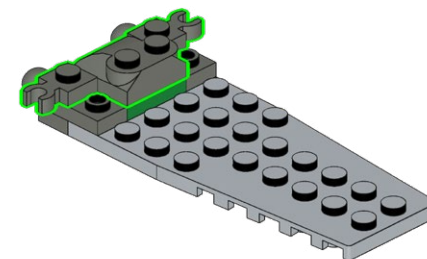

108

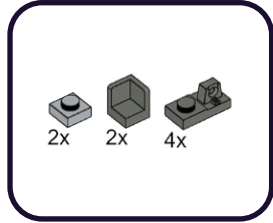

1

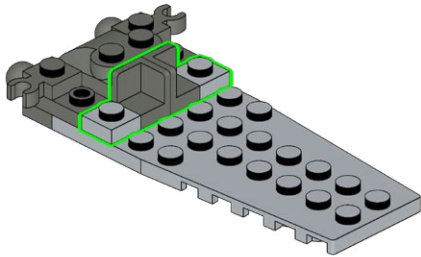

2

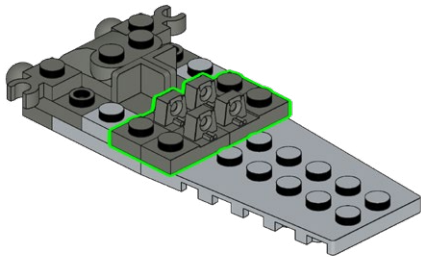

109

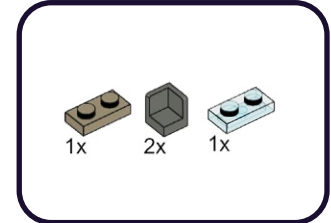
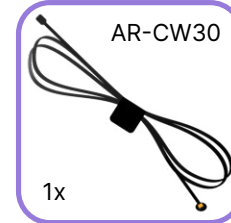

1

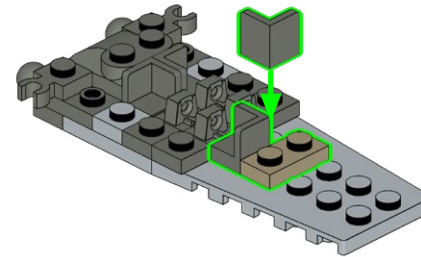

2

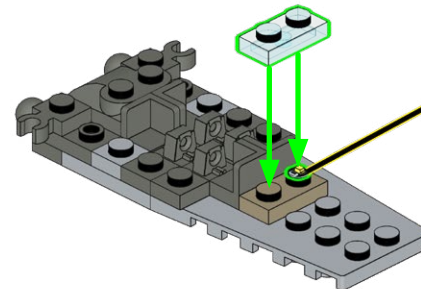

110

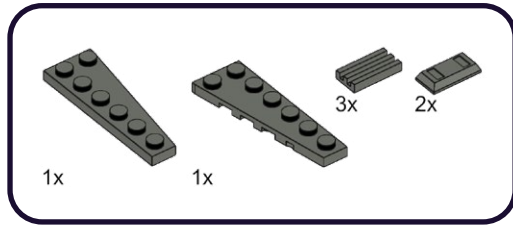

1

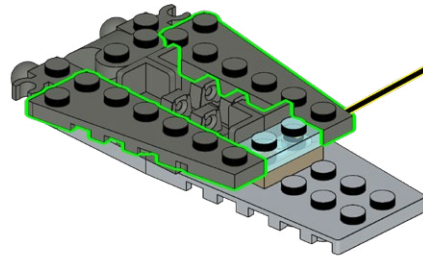

2

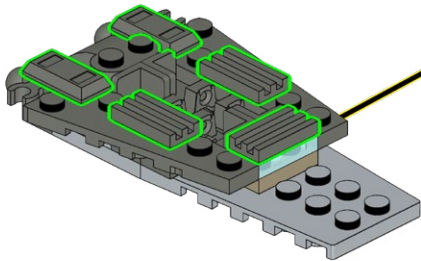

111

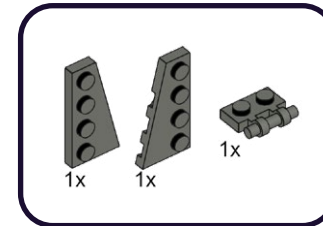

1

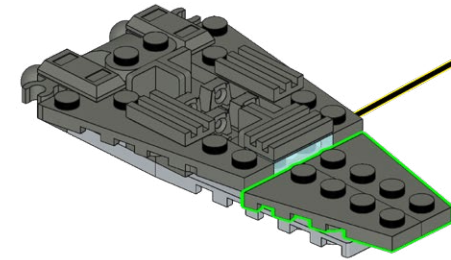

2

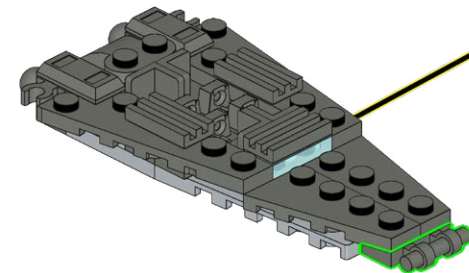

112

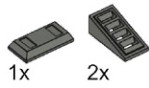

113

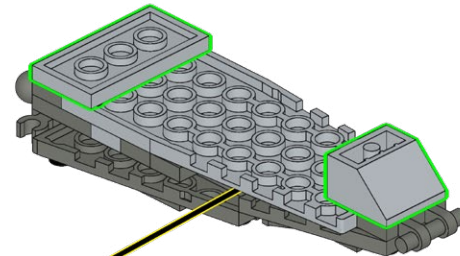
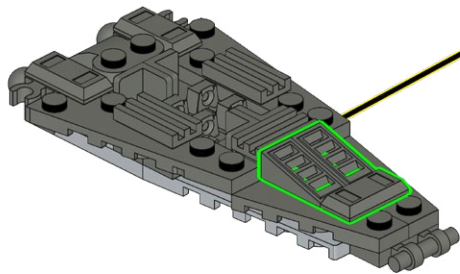
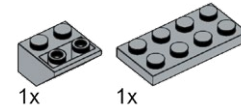

114

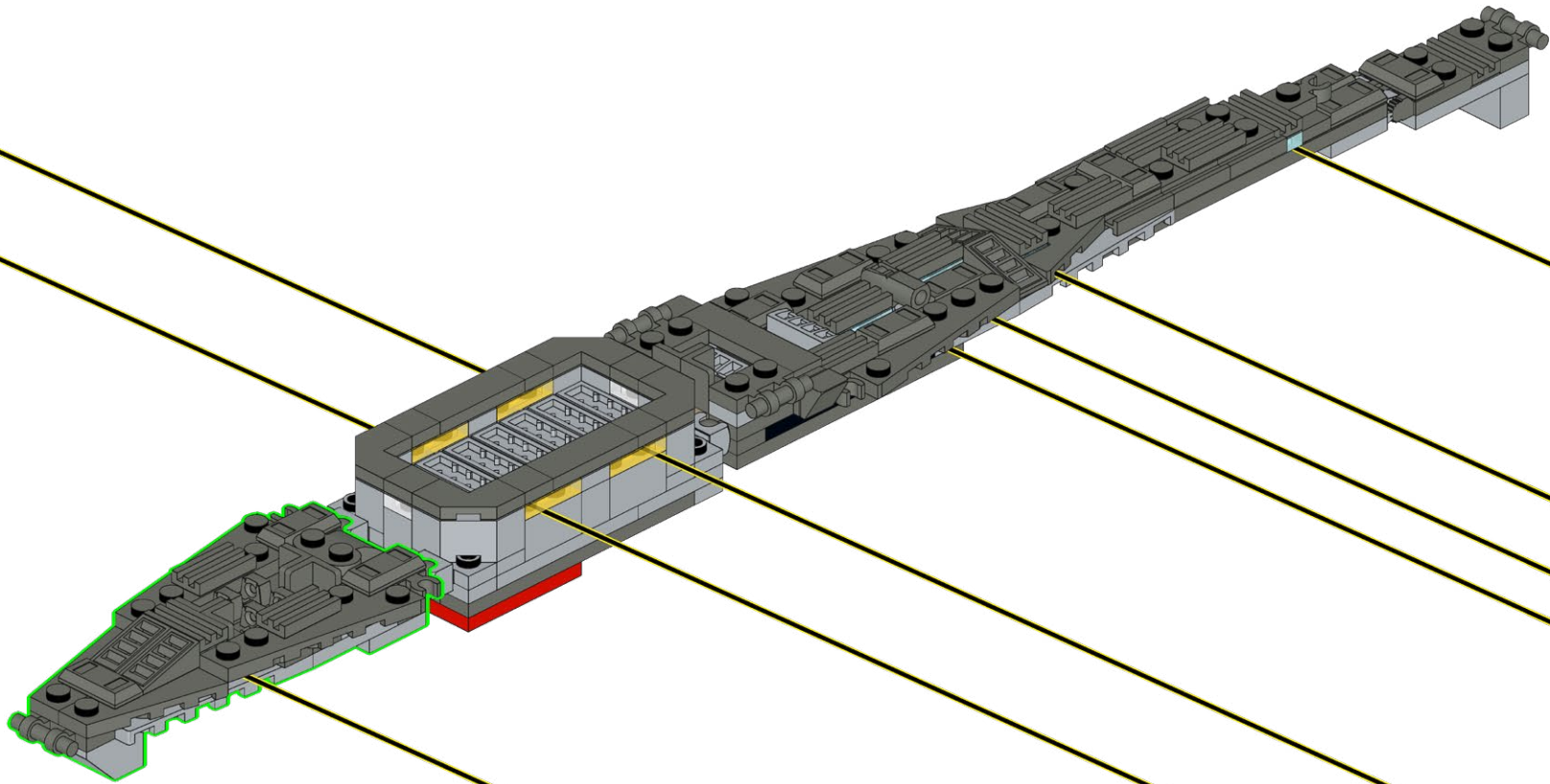

115

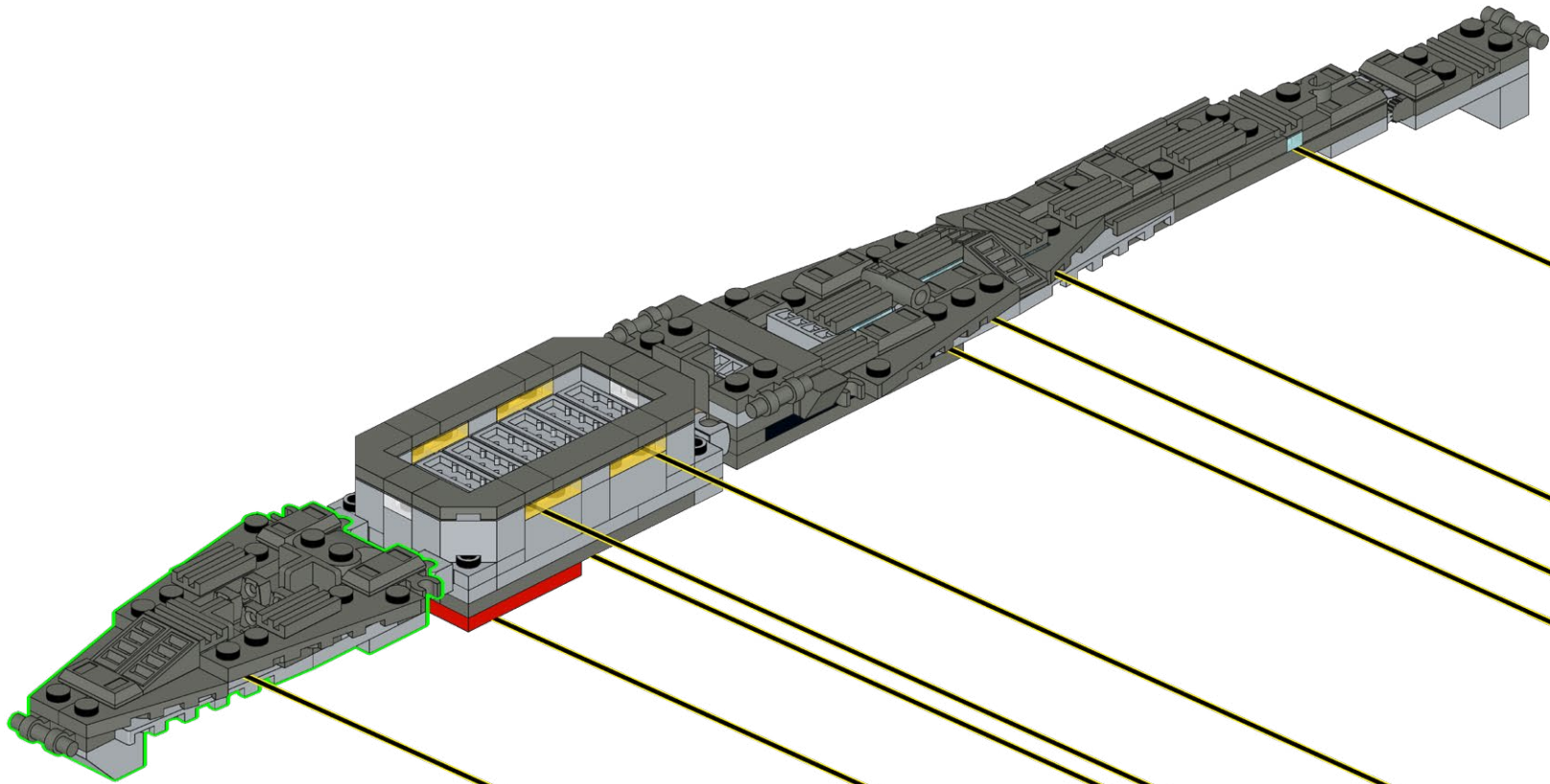

116

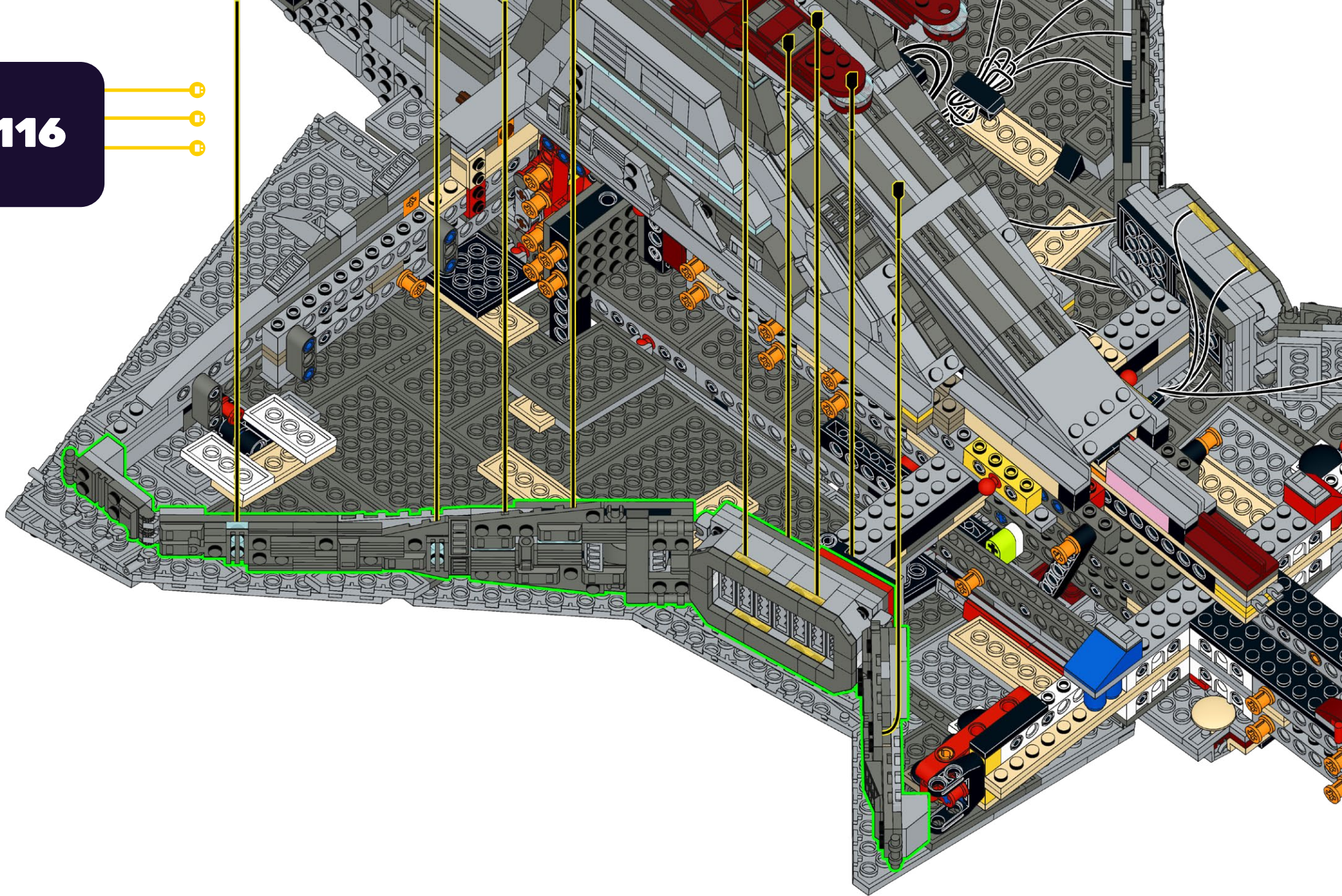

117

D-9

T-1x8

1x

1x

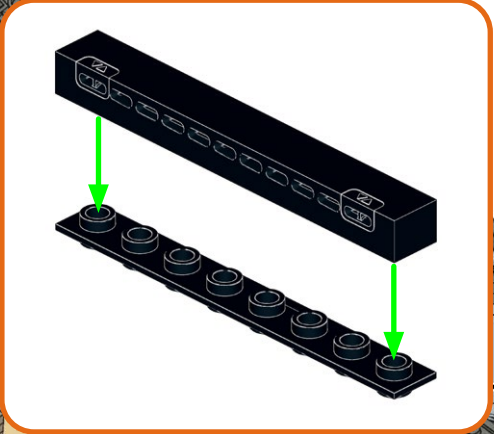
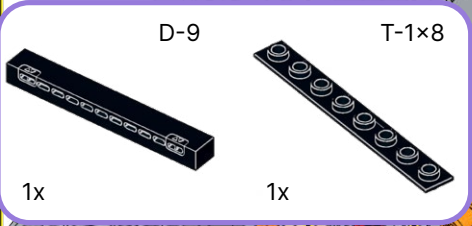

118

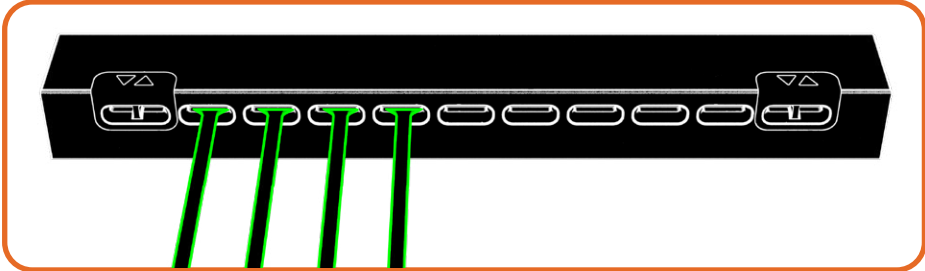
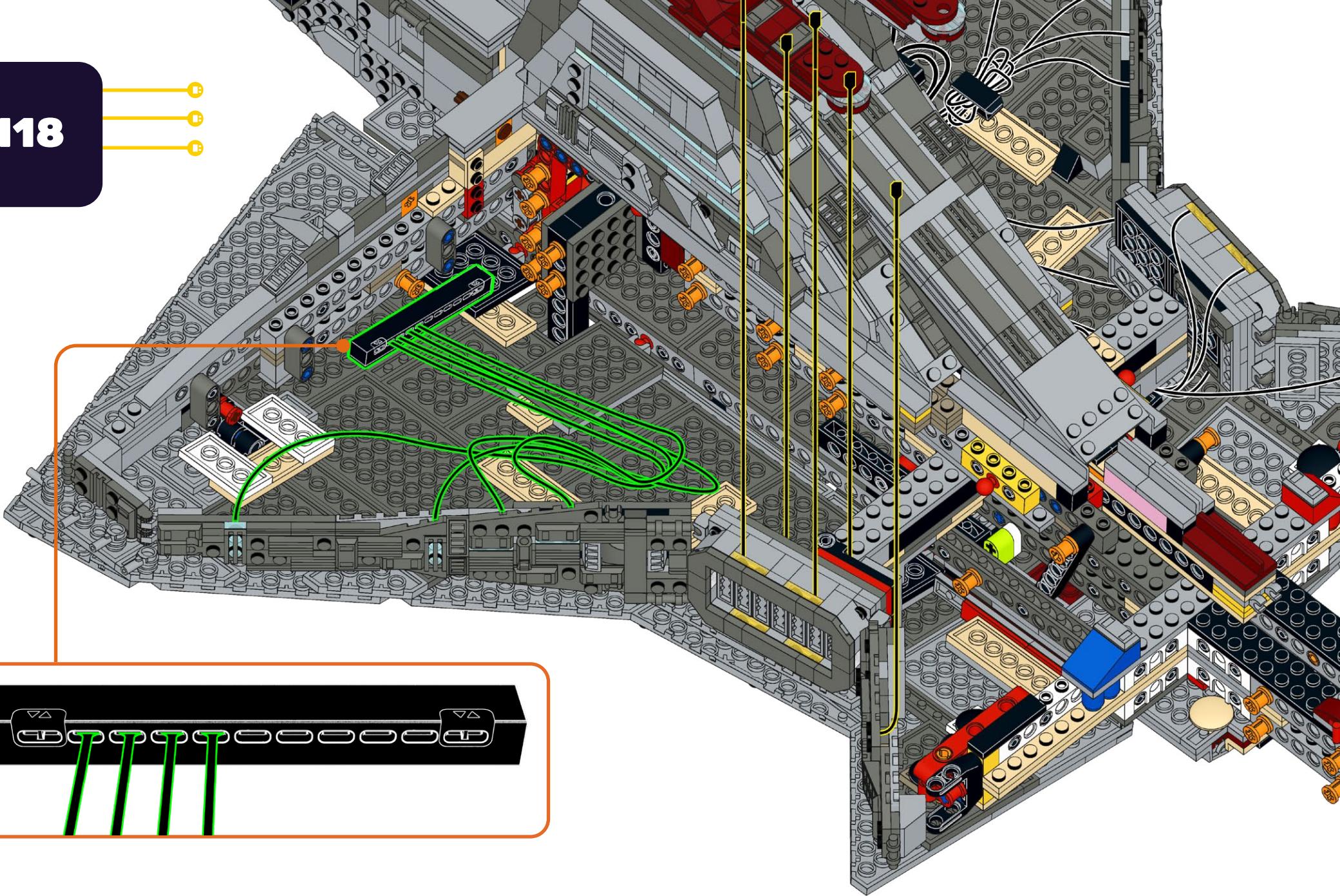

119

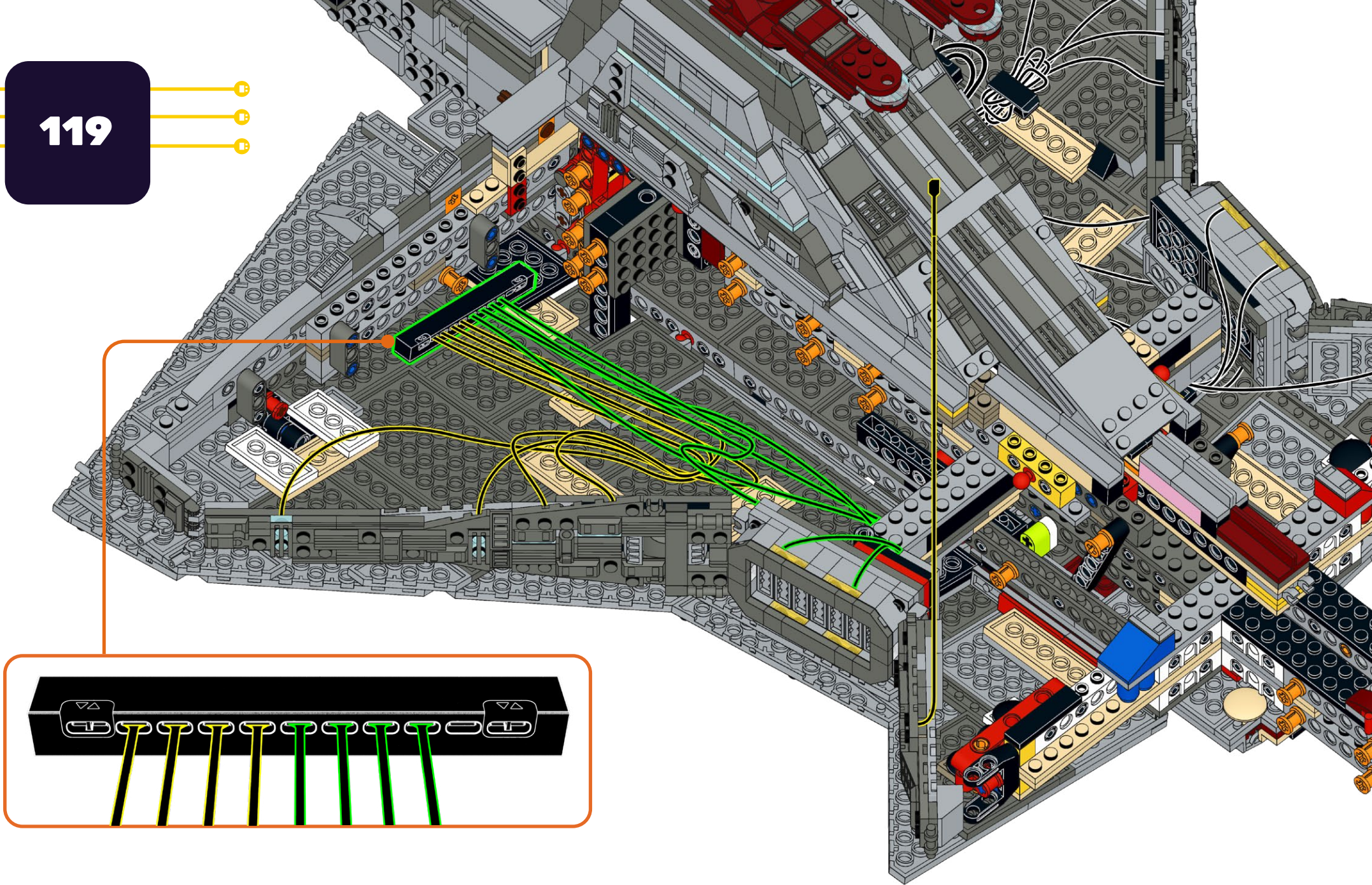

120

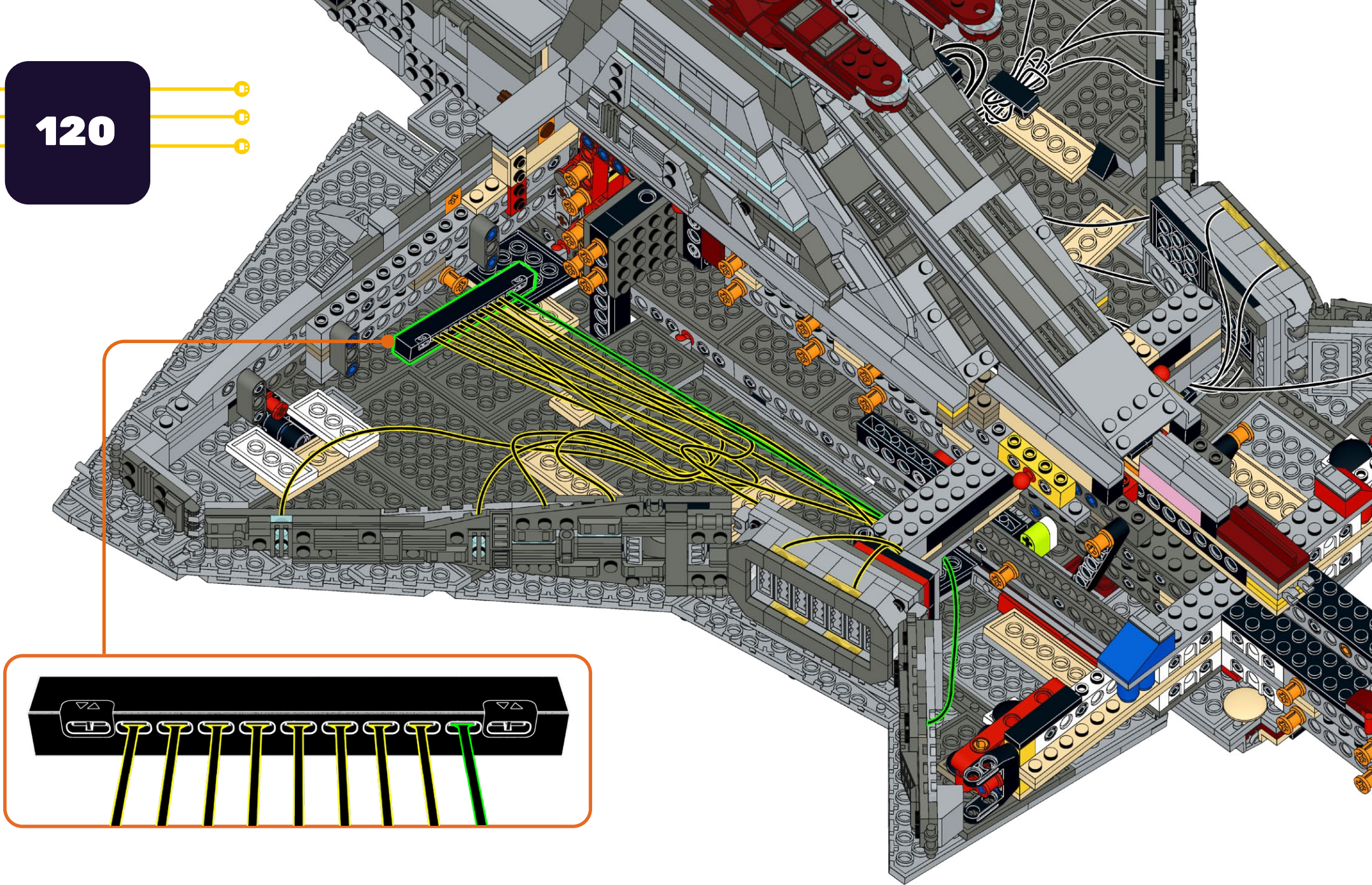

121

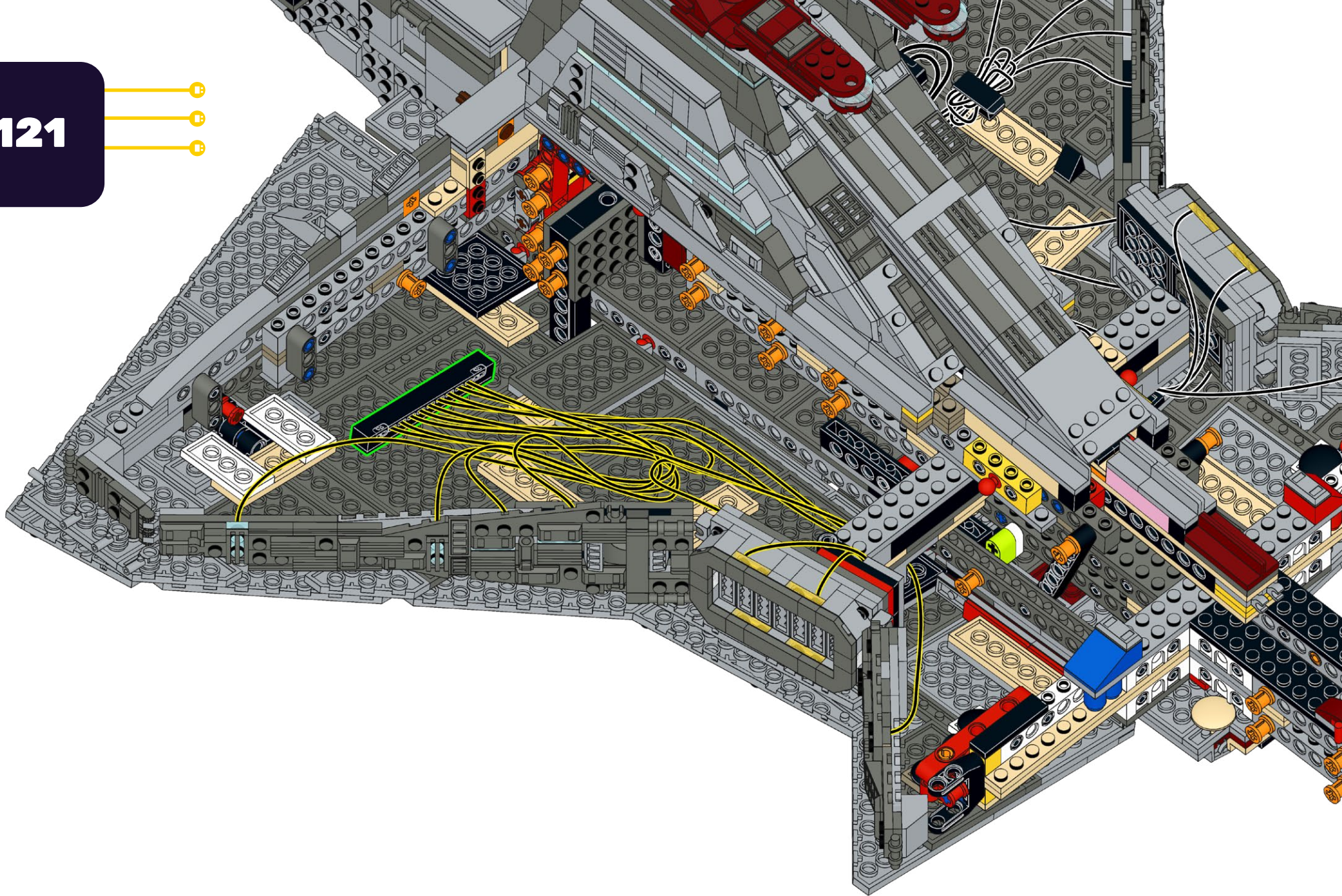

122

E-1x2 T-1x2

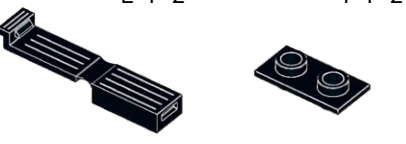

1x 1x

This inset shows two LEGO parts: a black E-1x2 Technic pin and a black T-1x2 Technic Technonut. Each is labeled with '1x' below it.



1 2



This inset shows two steps of the assembly process. Step 1 shows the E-1x2 pin being inserted into the T-1x2 Technonut. Step 2 shows the completed assembly, which is a black Technic pin with a green Technonut attached to its end.

123

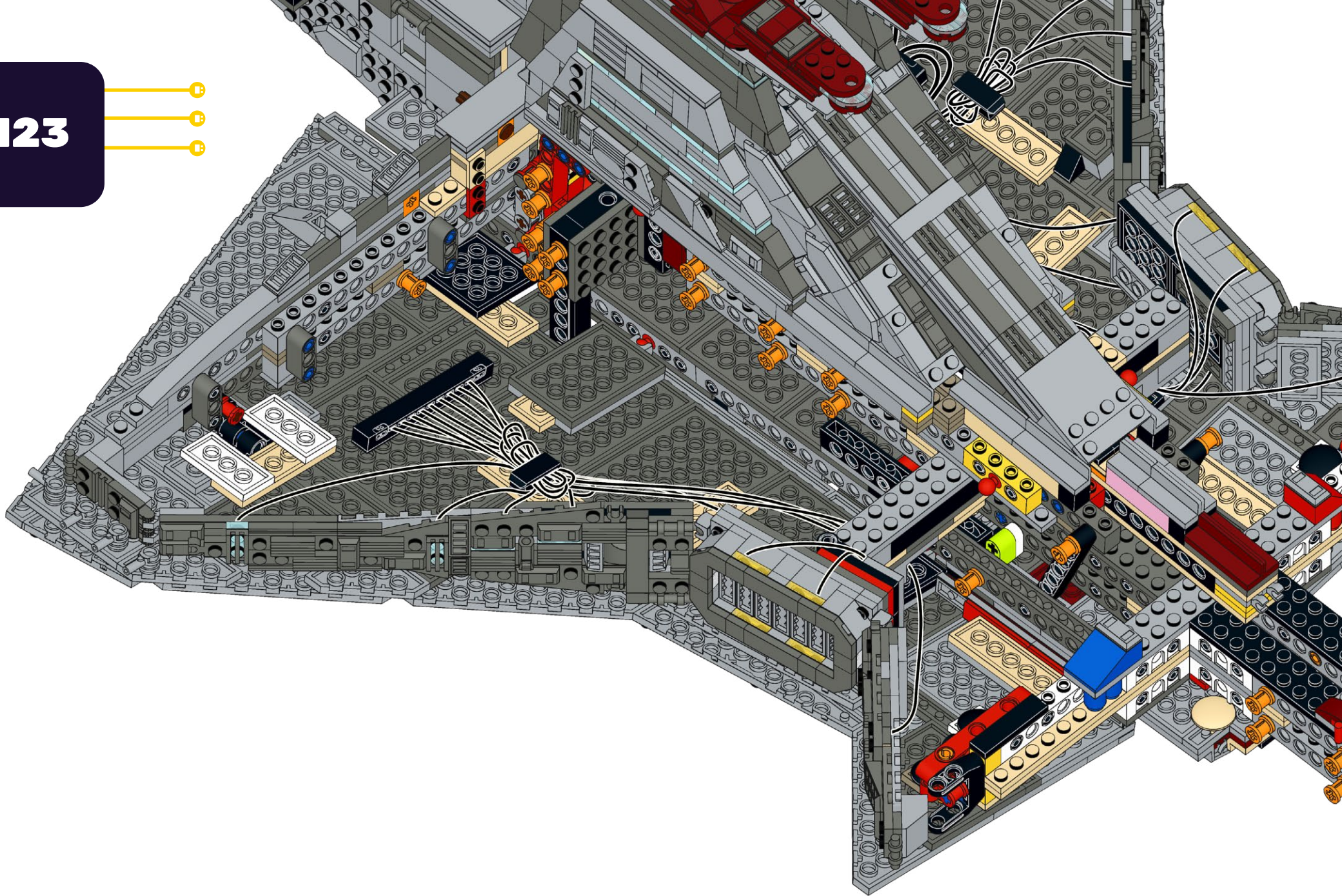

124

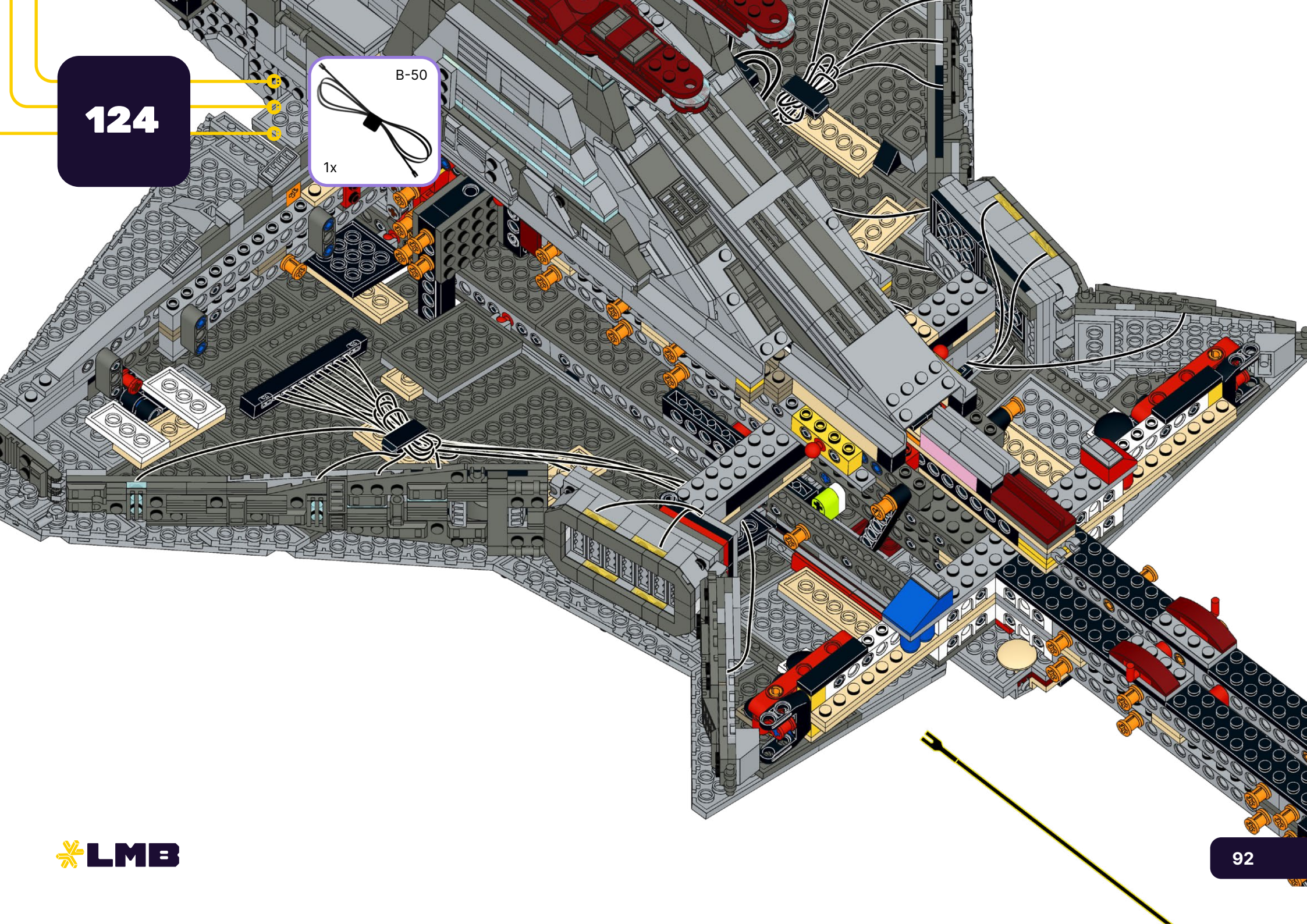
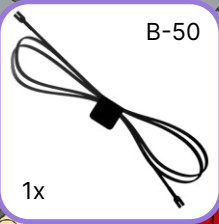

125

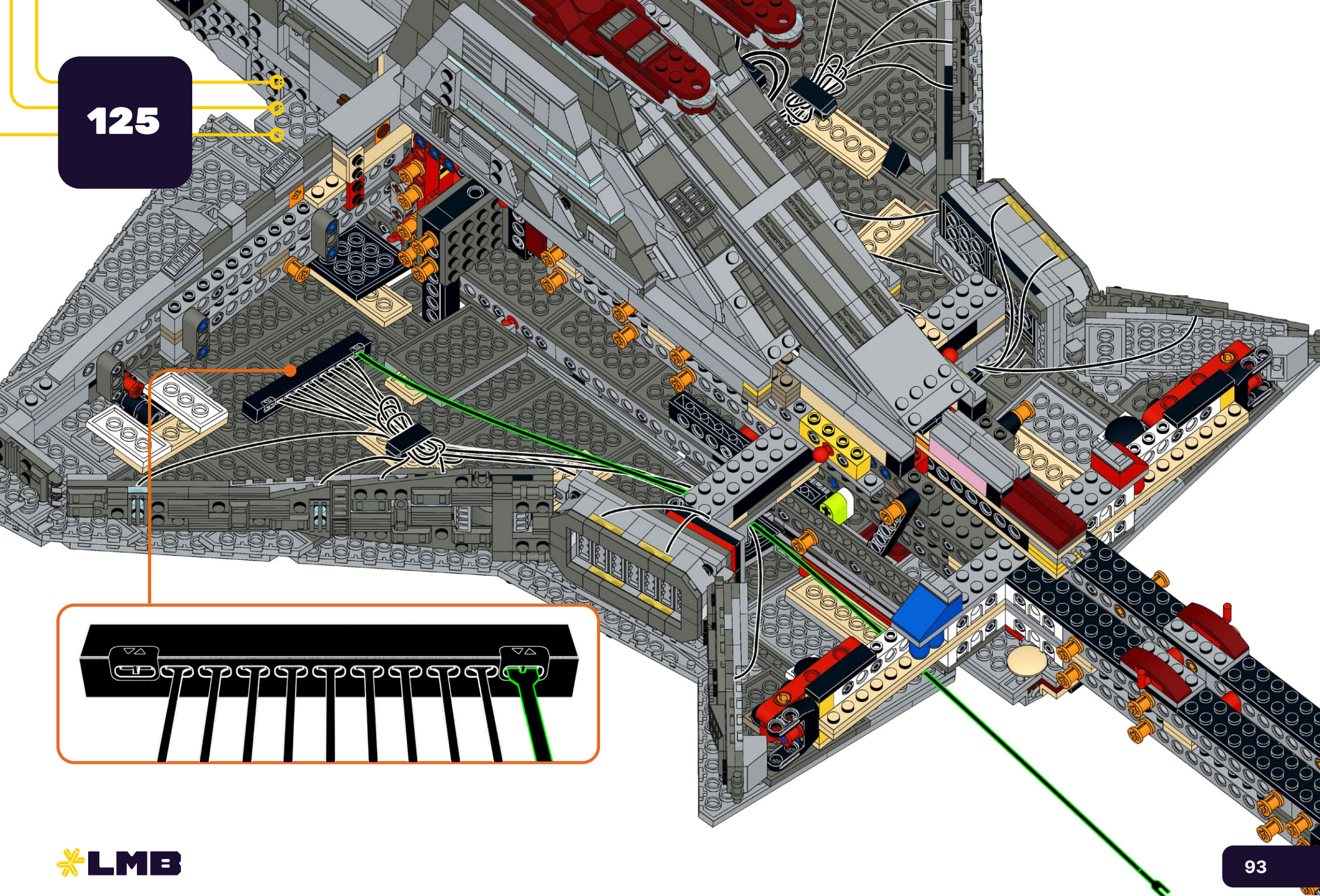

126

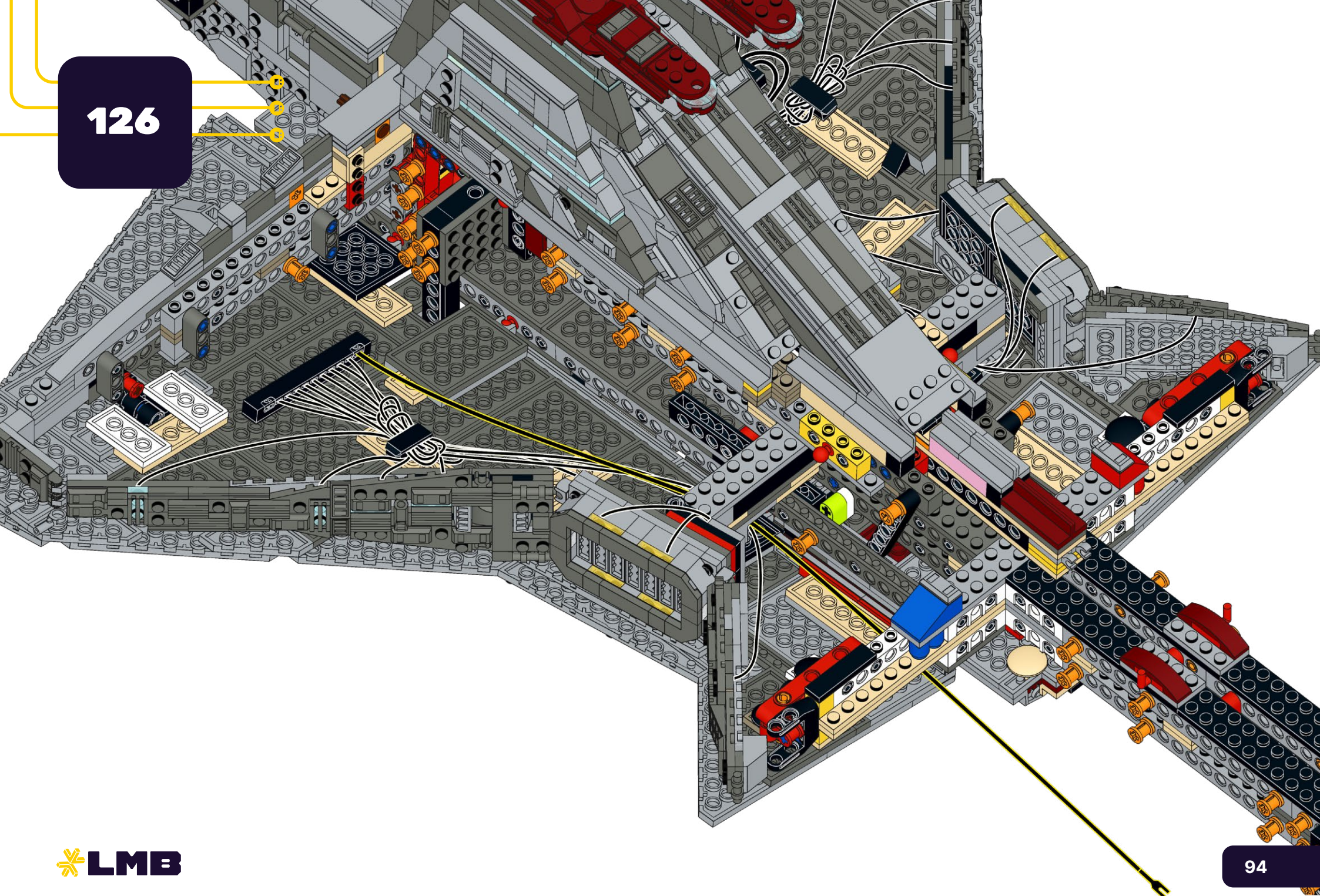



HOLD UP!

You might notice some bags aren't in order, as well as left over pieces, but that's ok! We're changing the way you build LEGO!

ATTENDEZ!

Vous remarquerez peut-être que certains sacs, ainsi que certaines pièces, ne sont pas dans le bon ordre. Mais pas de panique! Nous changeons simplement la façon avec laquelle vous construisez vos LEGO!

ASPETTA!

Potresti notare che alcuni sacchetti non sono in ordine, così come i pezzi avanzati, ma va bene così! Stiamo cambiando il modo in cui costruisci i LEGO!

HALT!

Sie werden möglicherweise bemerken, dass einige tüten durcheinander sind und teile übrig bleiben, aber das ist in Ordnung! Wir ändern die art und weise, wie Sie LEGO bauen!

¡ESPERA!

Es posible que notes que algunas bolsas están fuera de servicio, así como piezas sobrantes, ¡pero está bien! ¡Estamos cambiando la forma en que construyes LEGO!

暫停!

你可能会注意到一些袋子顺序错乱, 以及一些剩余的部件, 但没关系! 我们正在改变你搭建乐高的方式!

Open LEGO® Bag 24

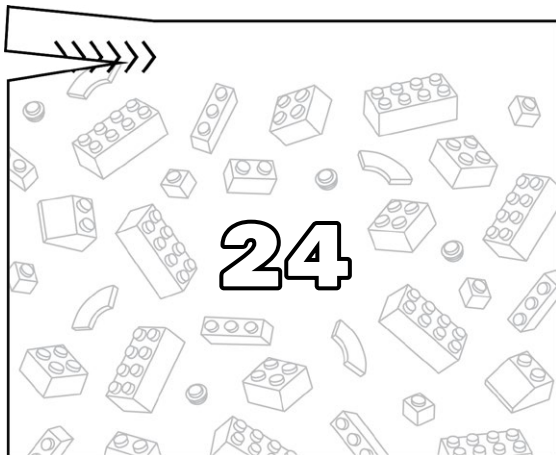

Open LMB Bags 01

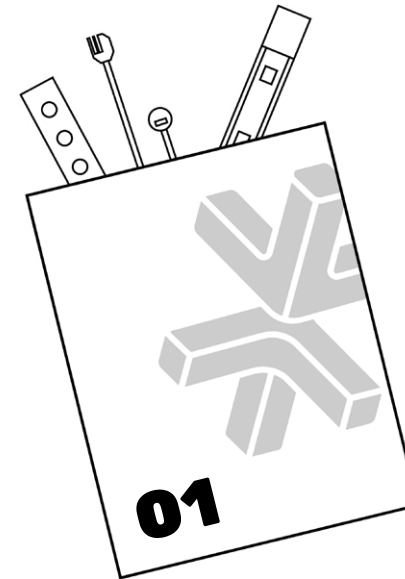

127

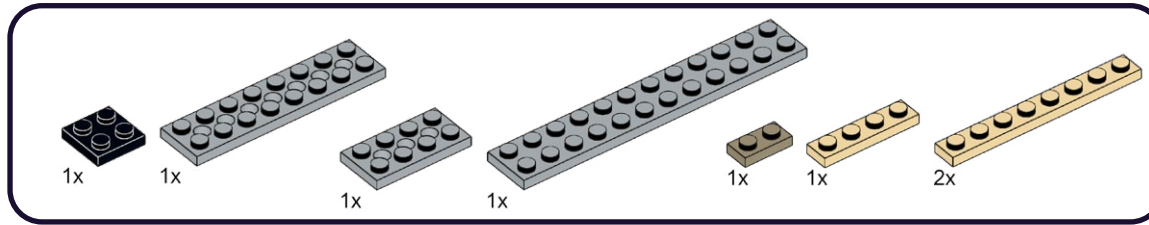

1

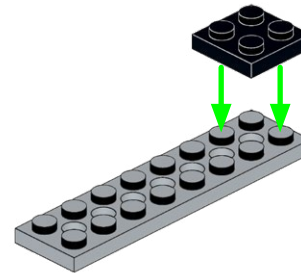

2

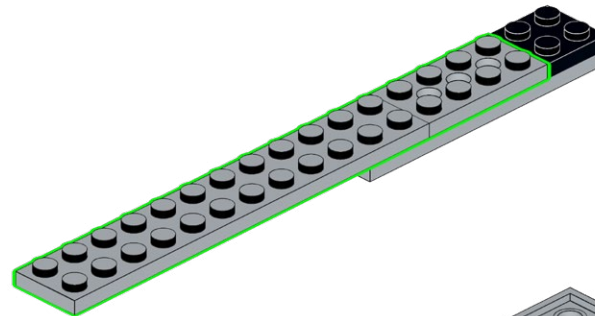

3

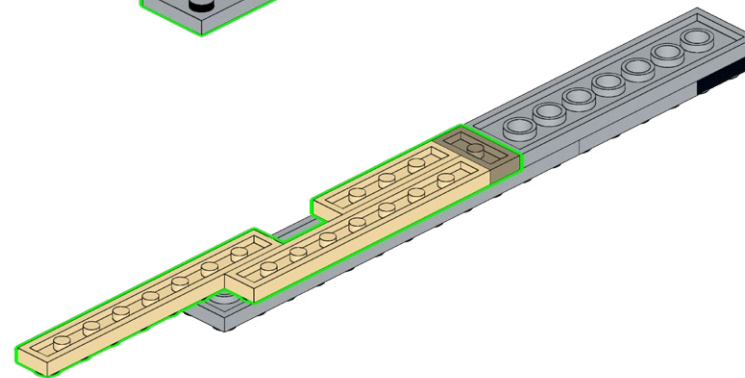

128

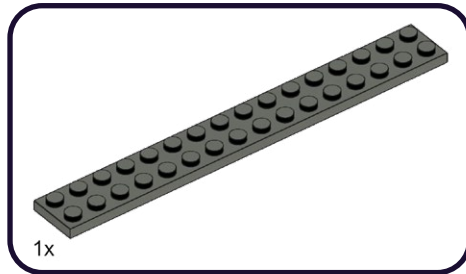

129

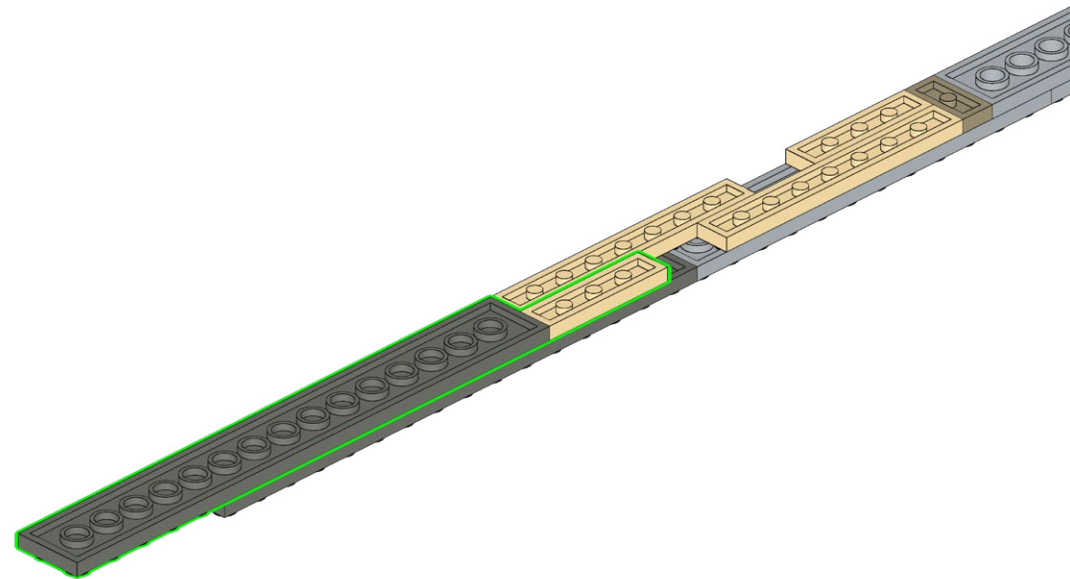
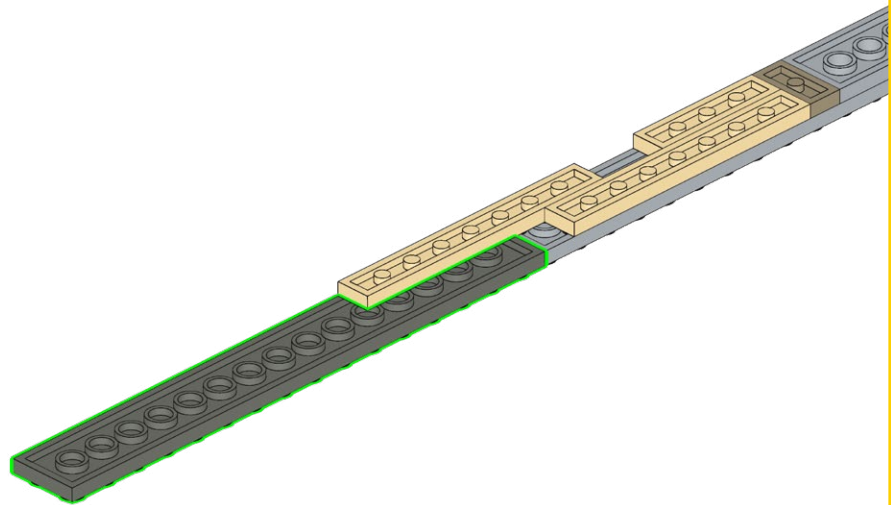
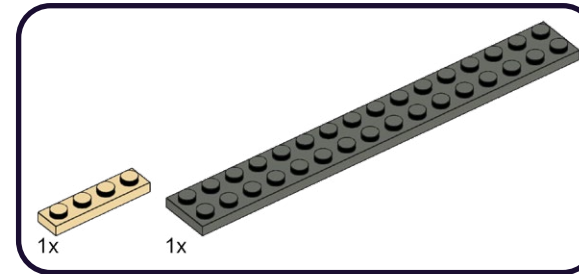

130

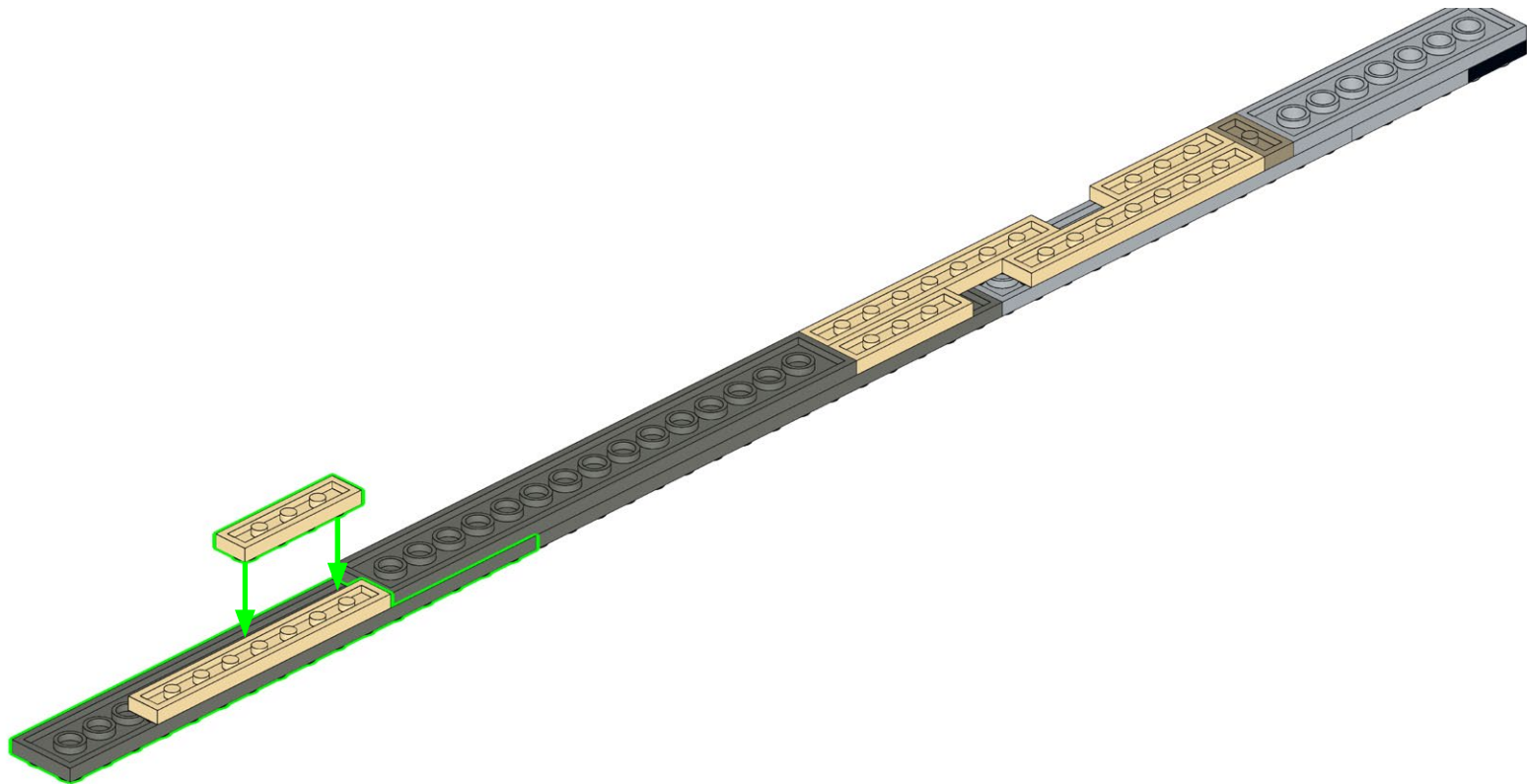
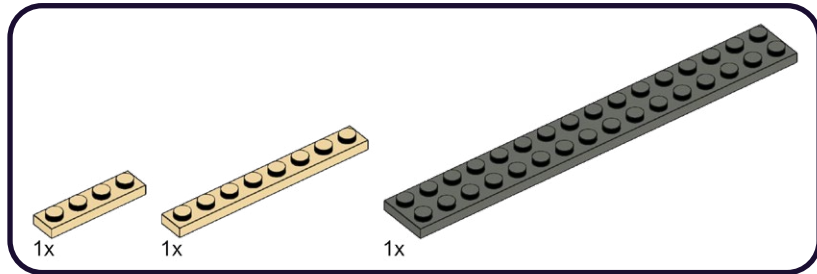

131

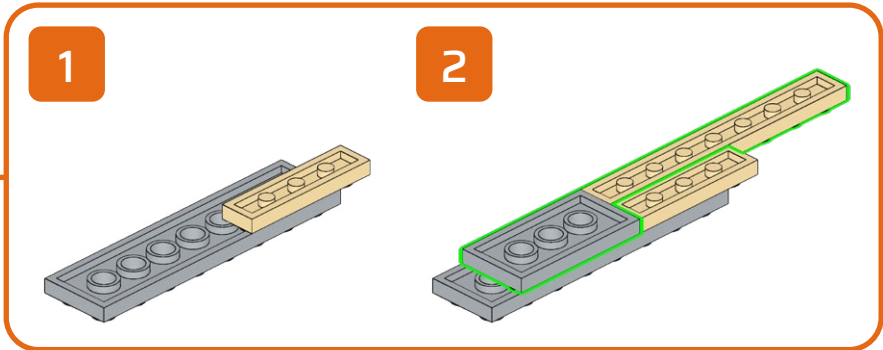
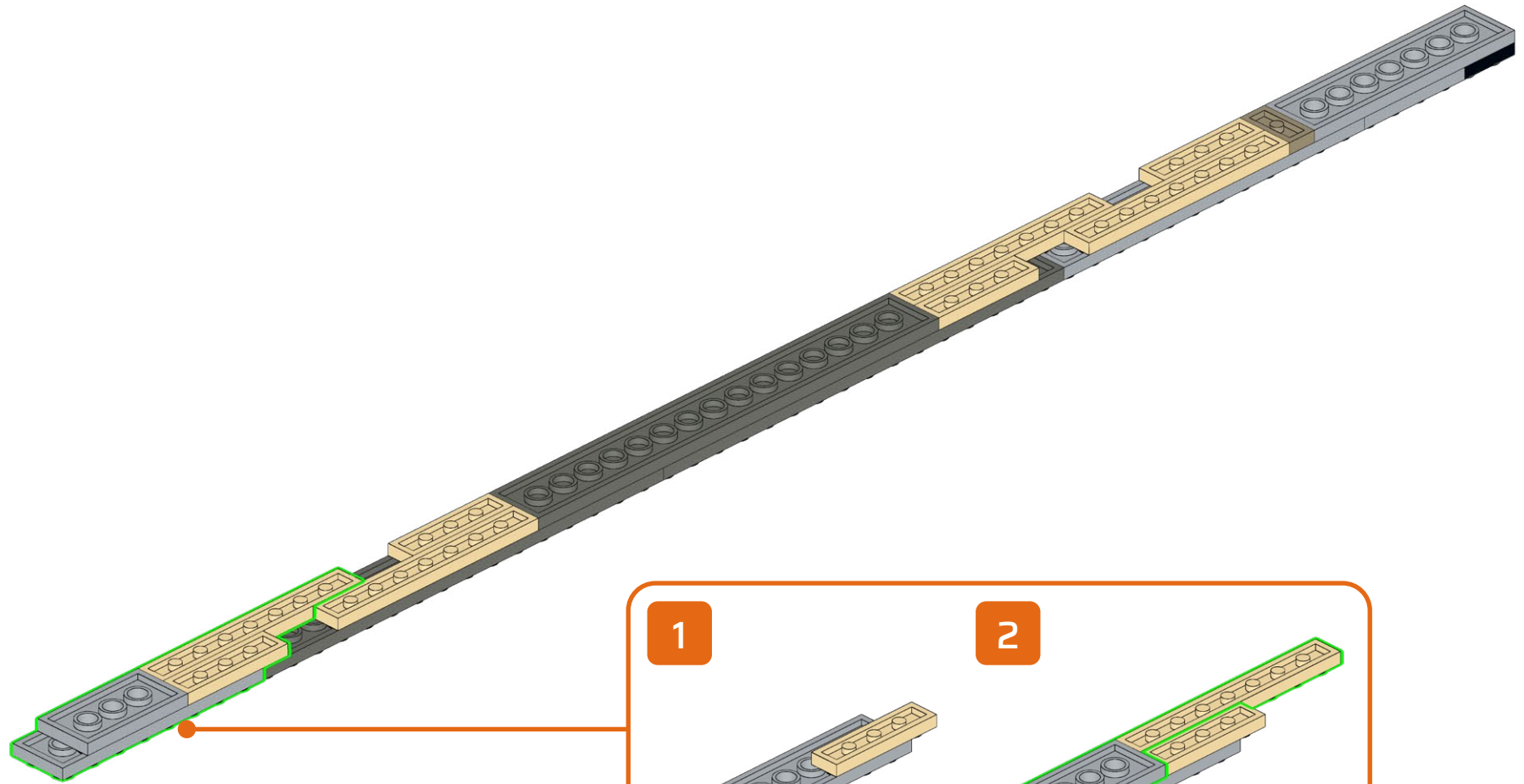
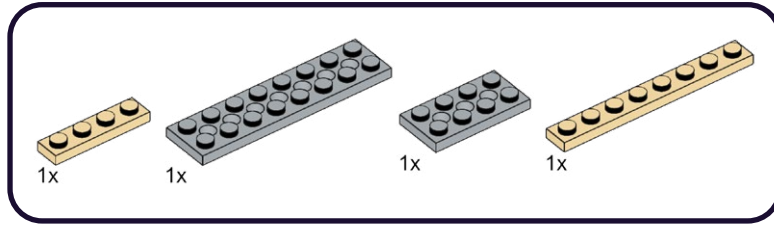

132

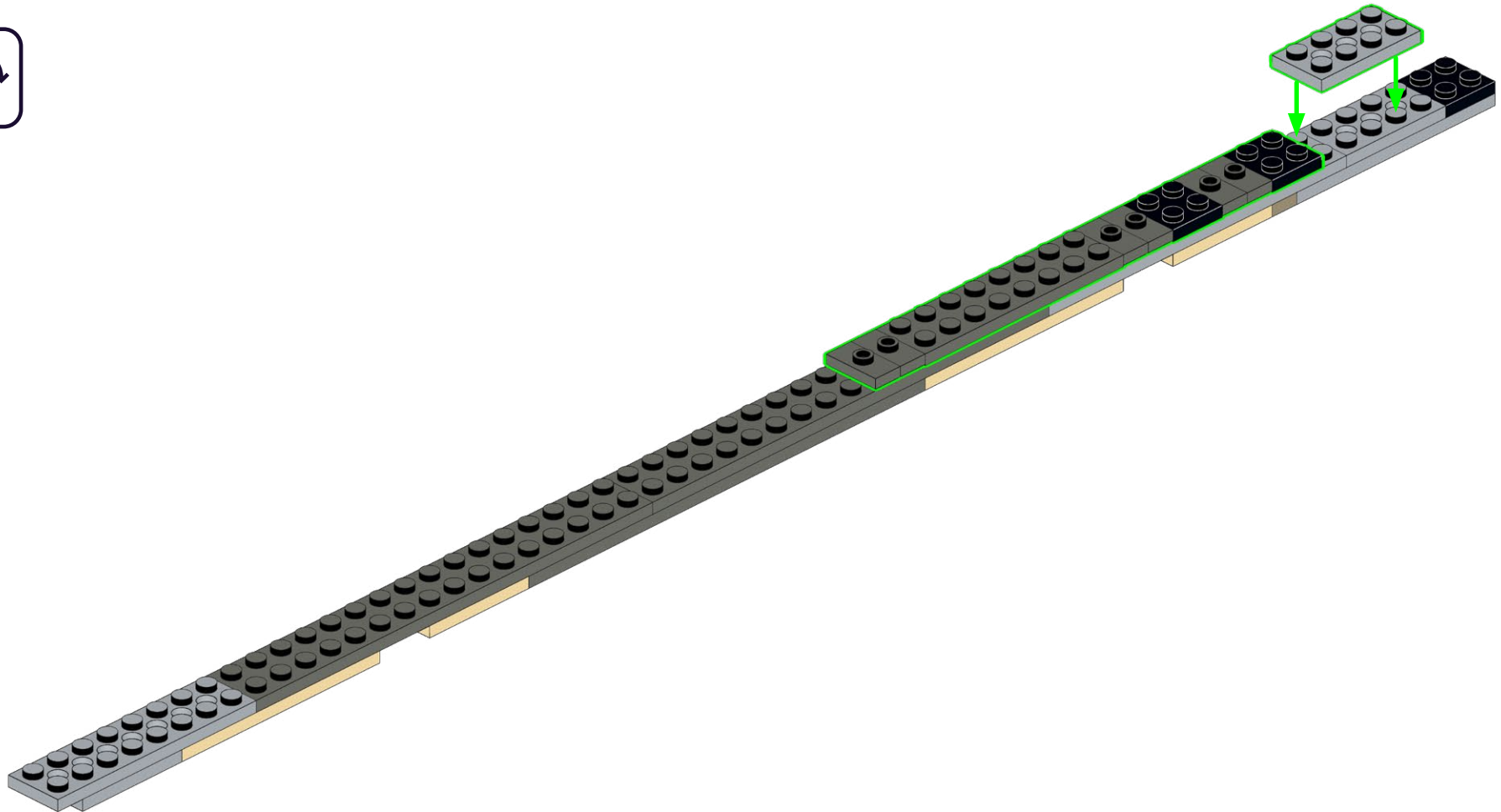
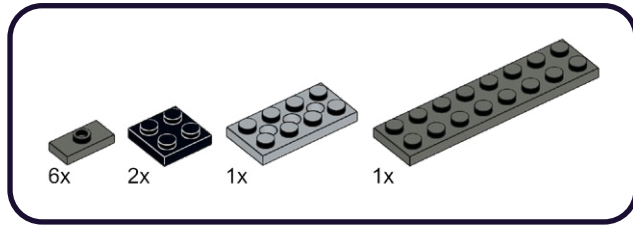

133

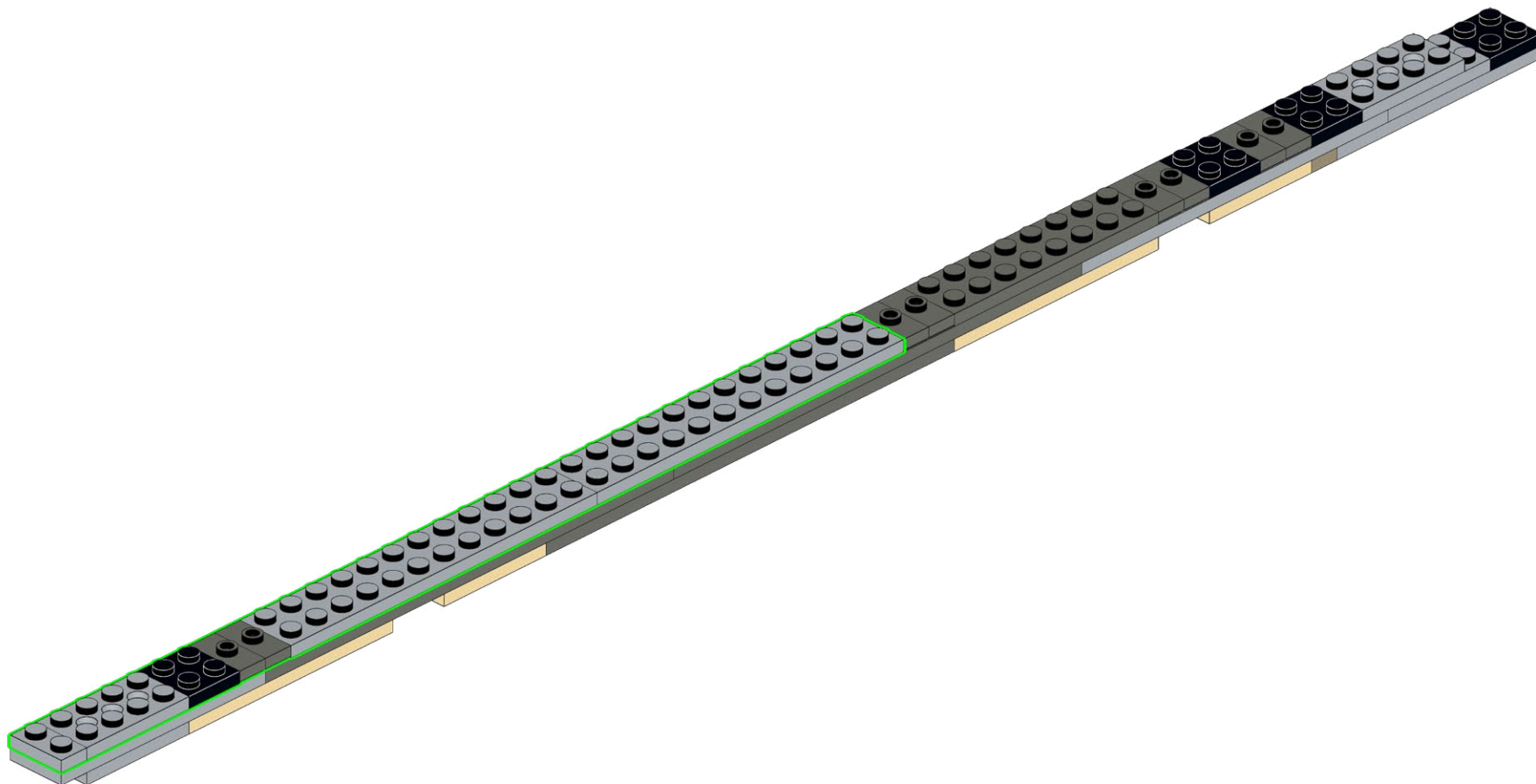
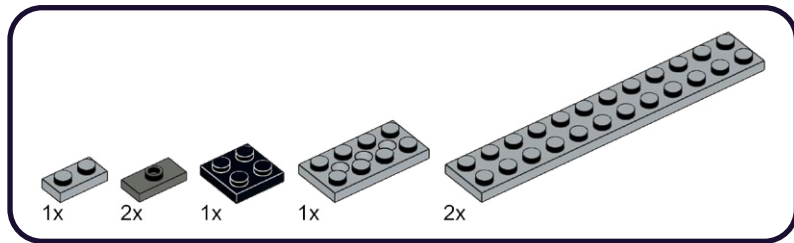

134

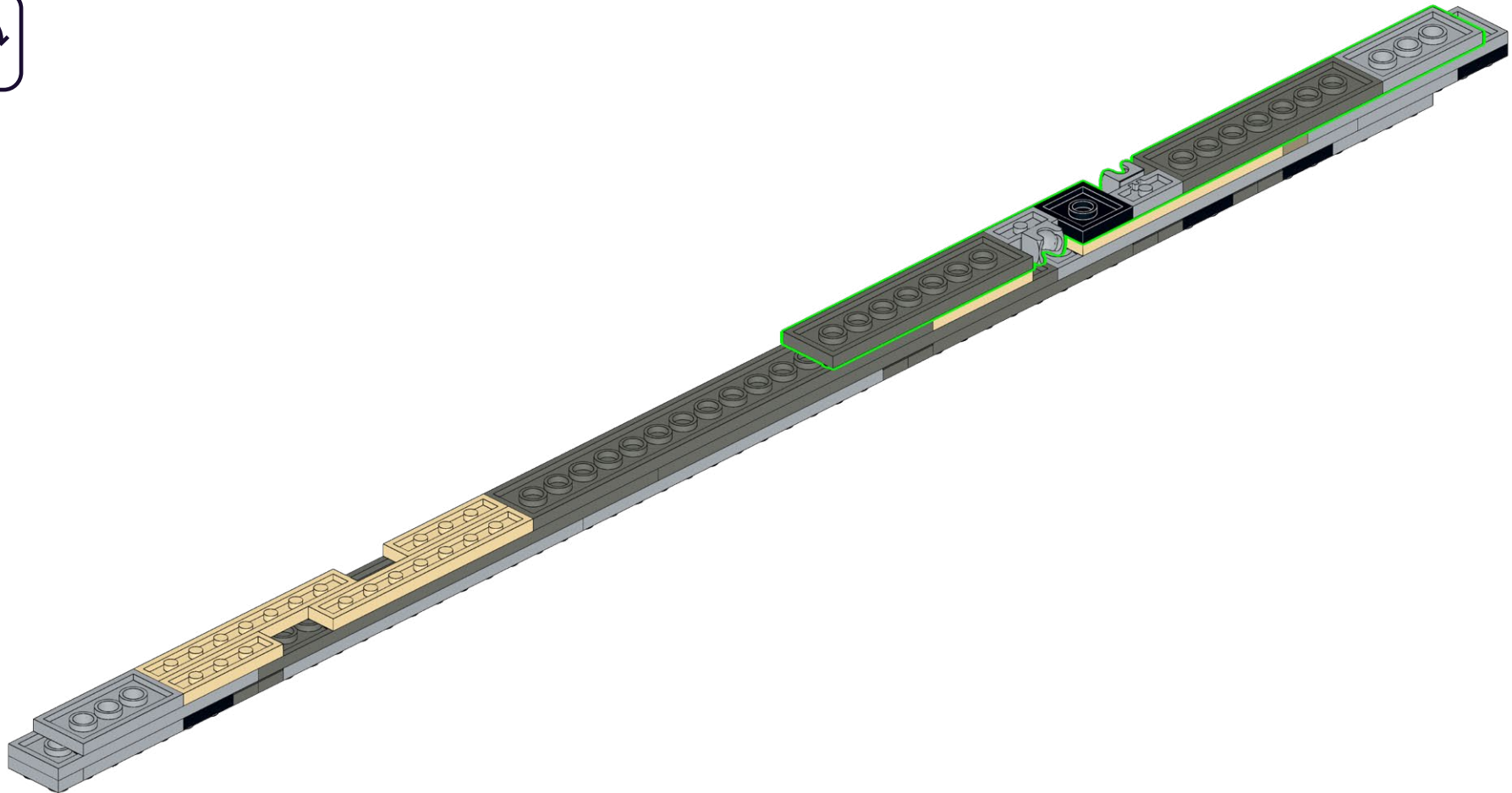
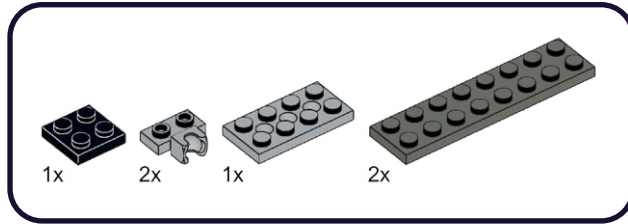

135

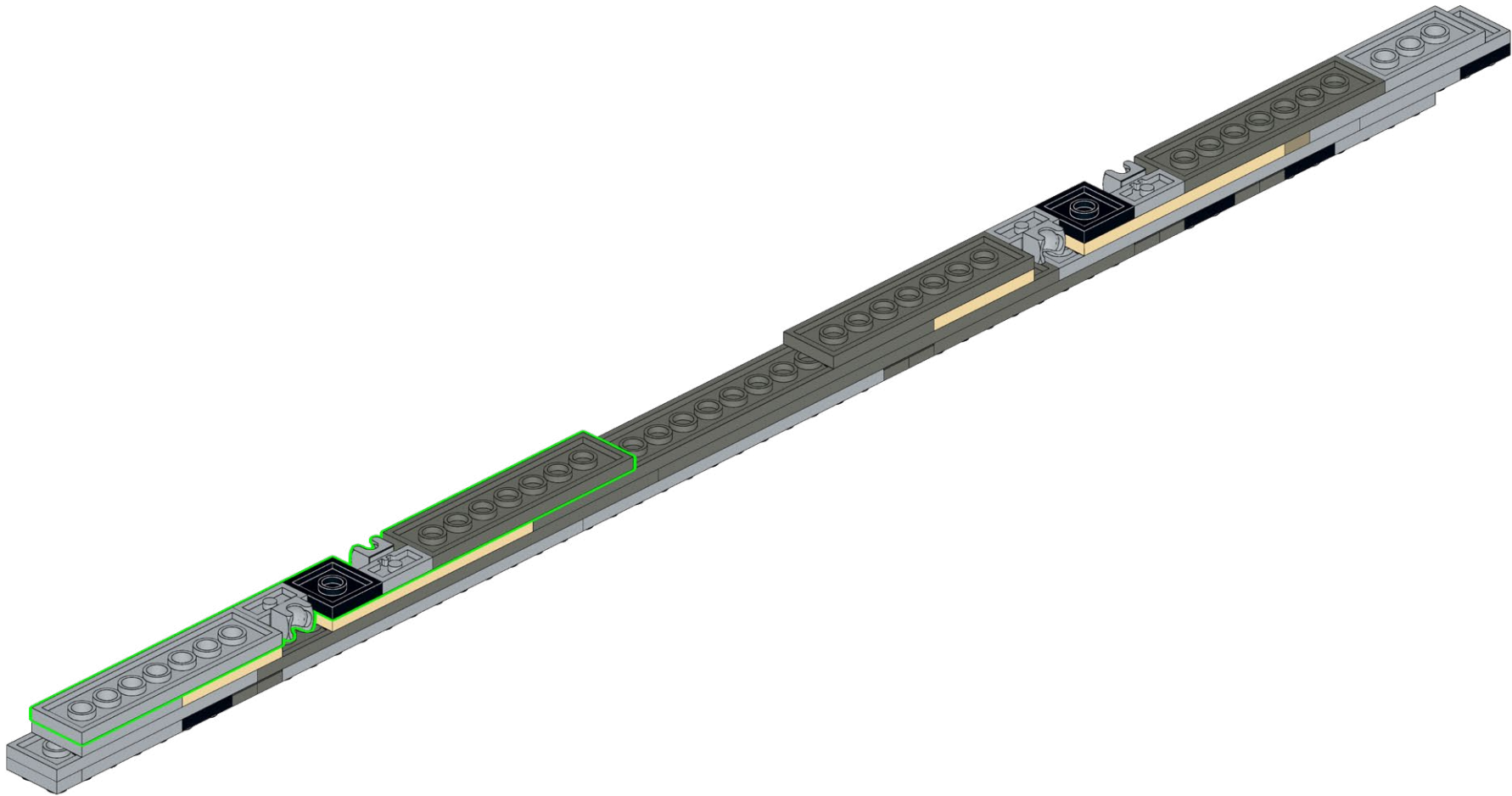
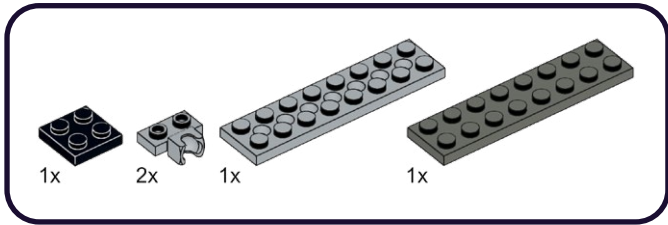

136

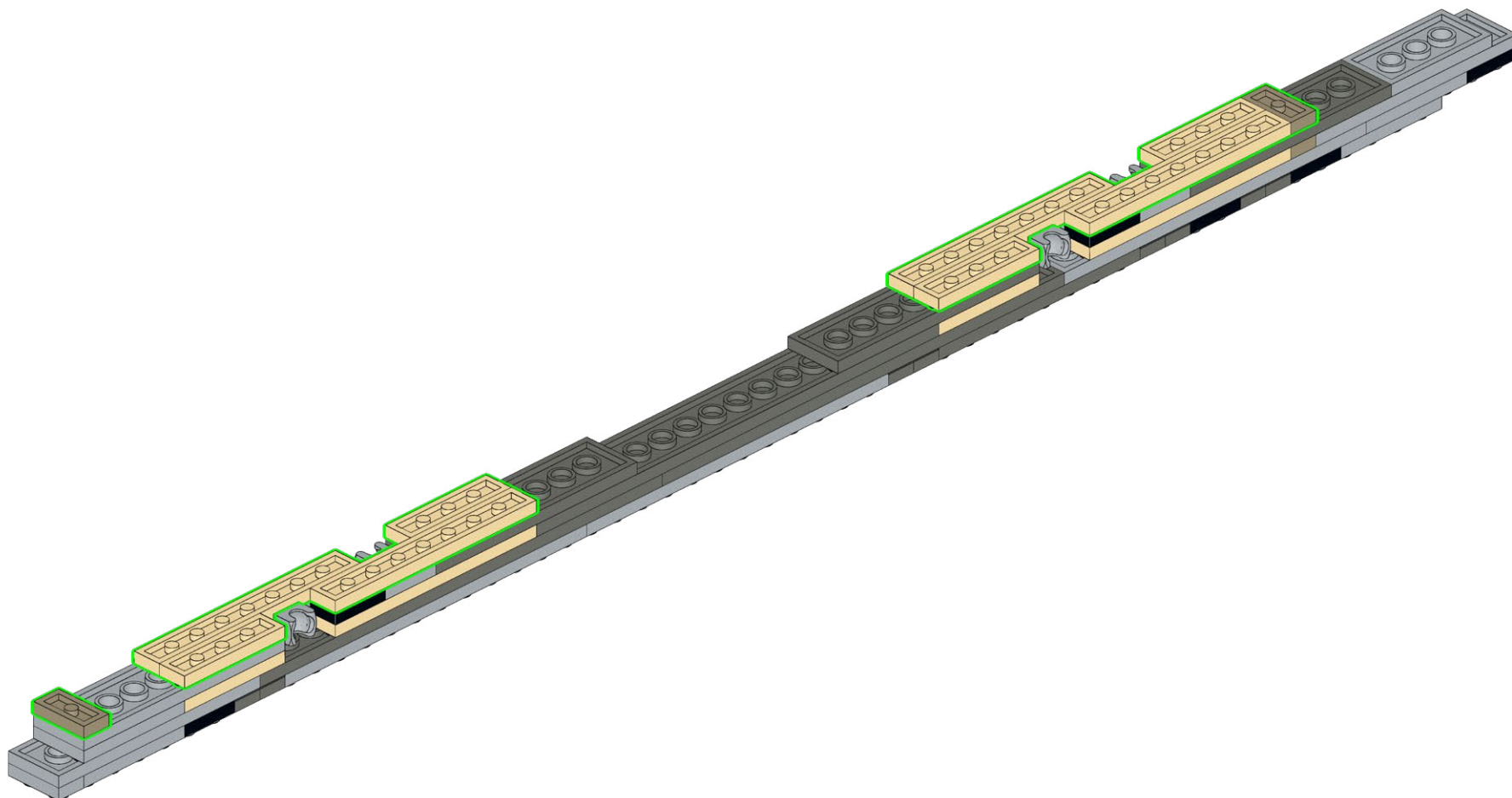
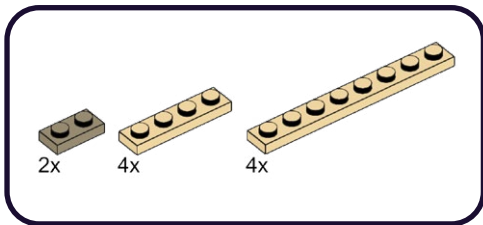

137

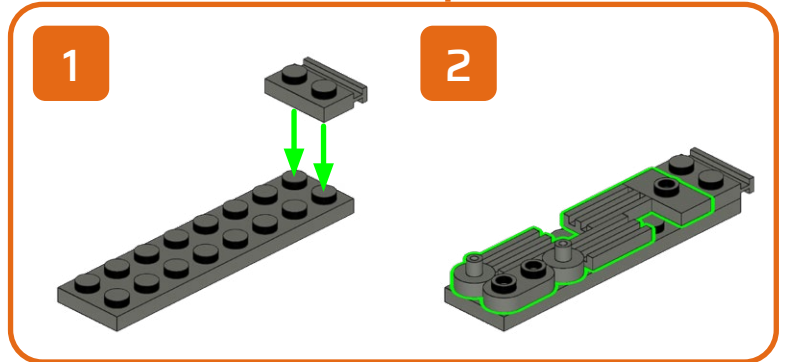
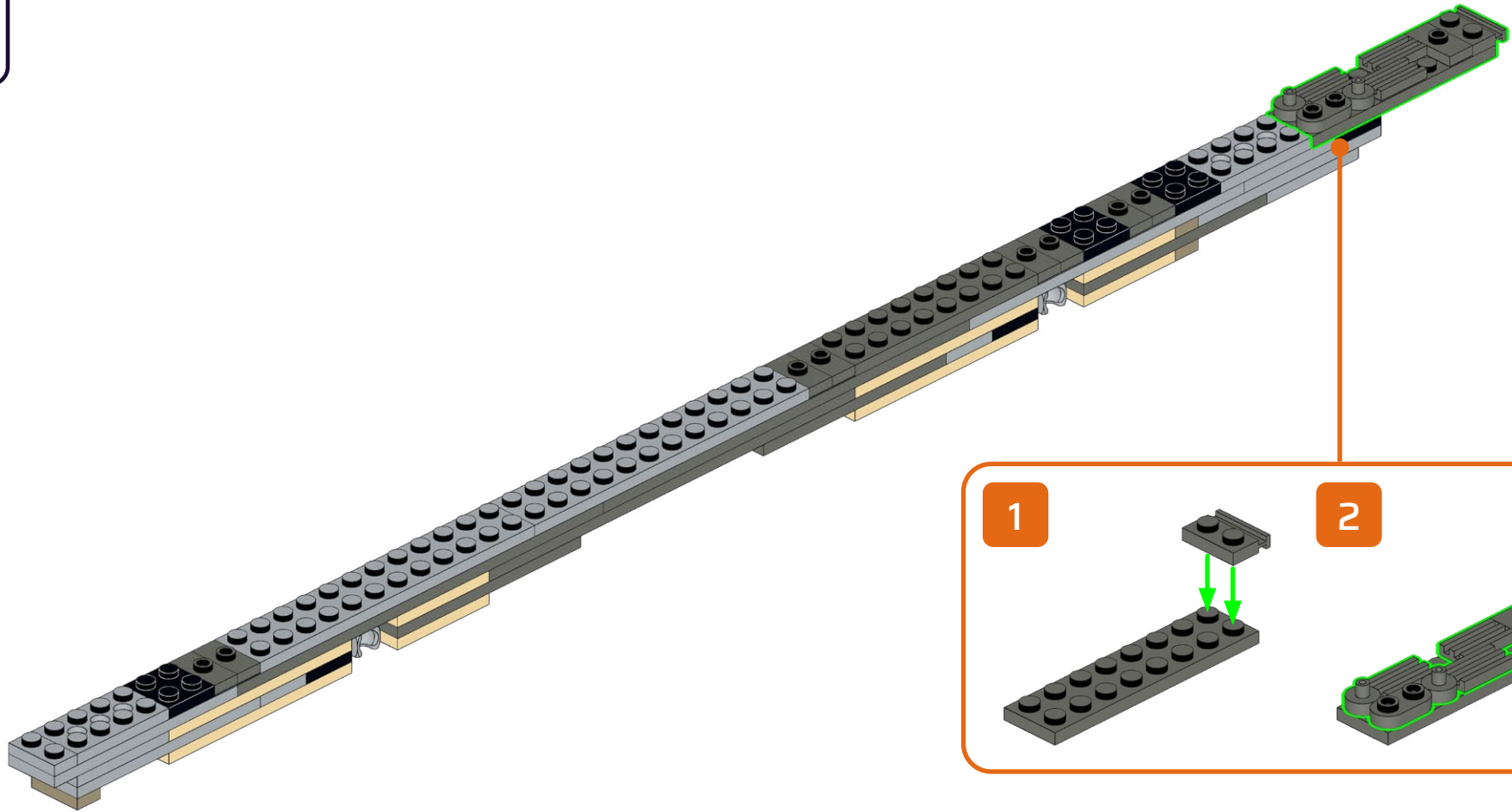
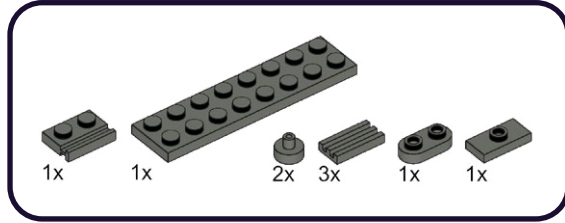

138

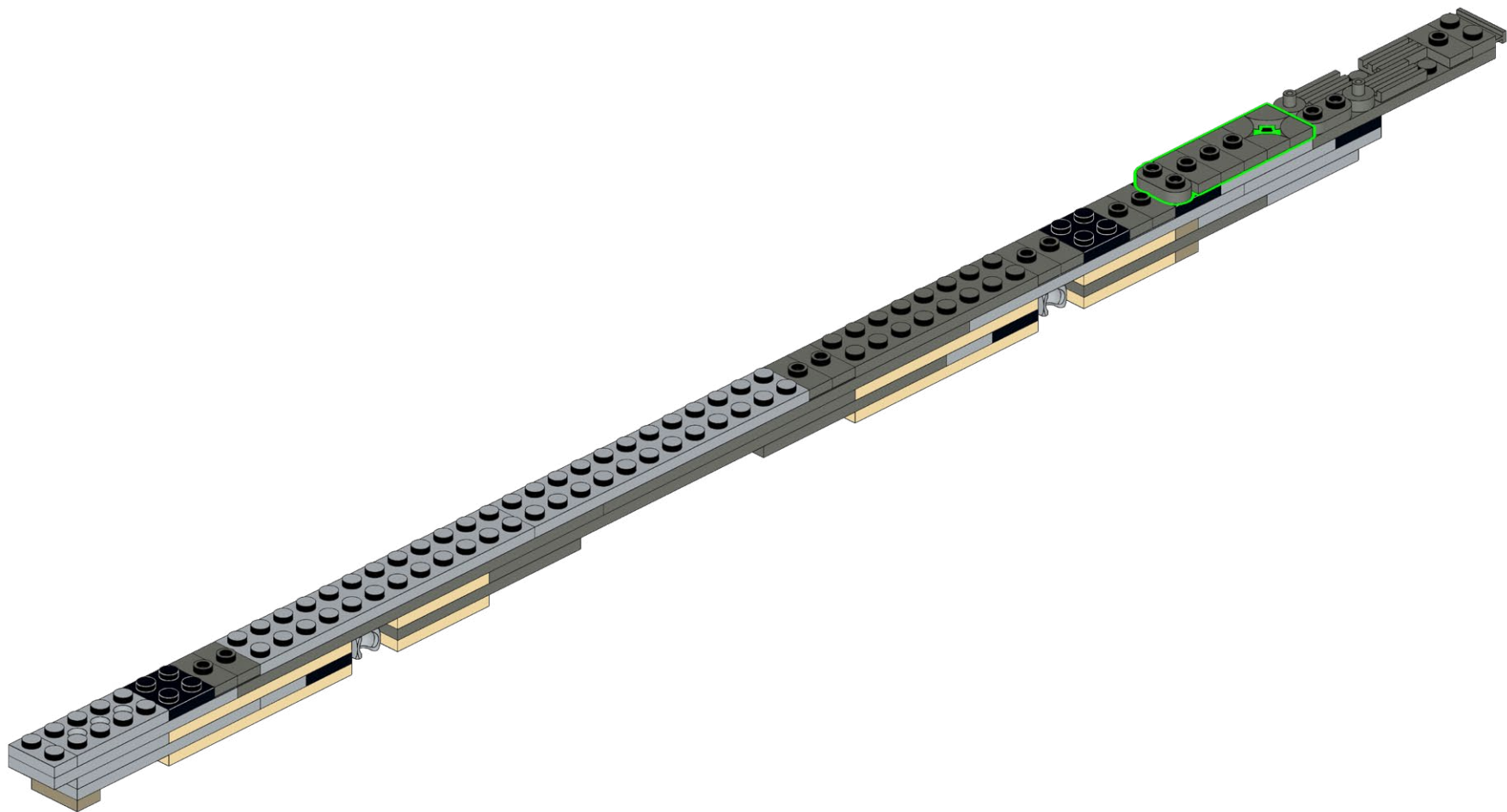
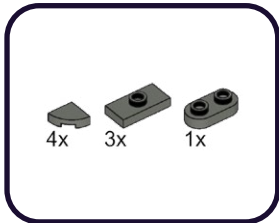

139

AR-CW30

1x

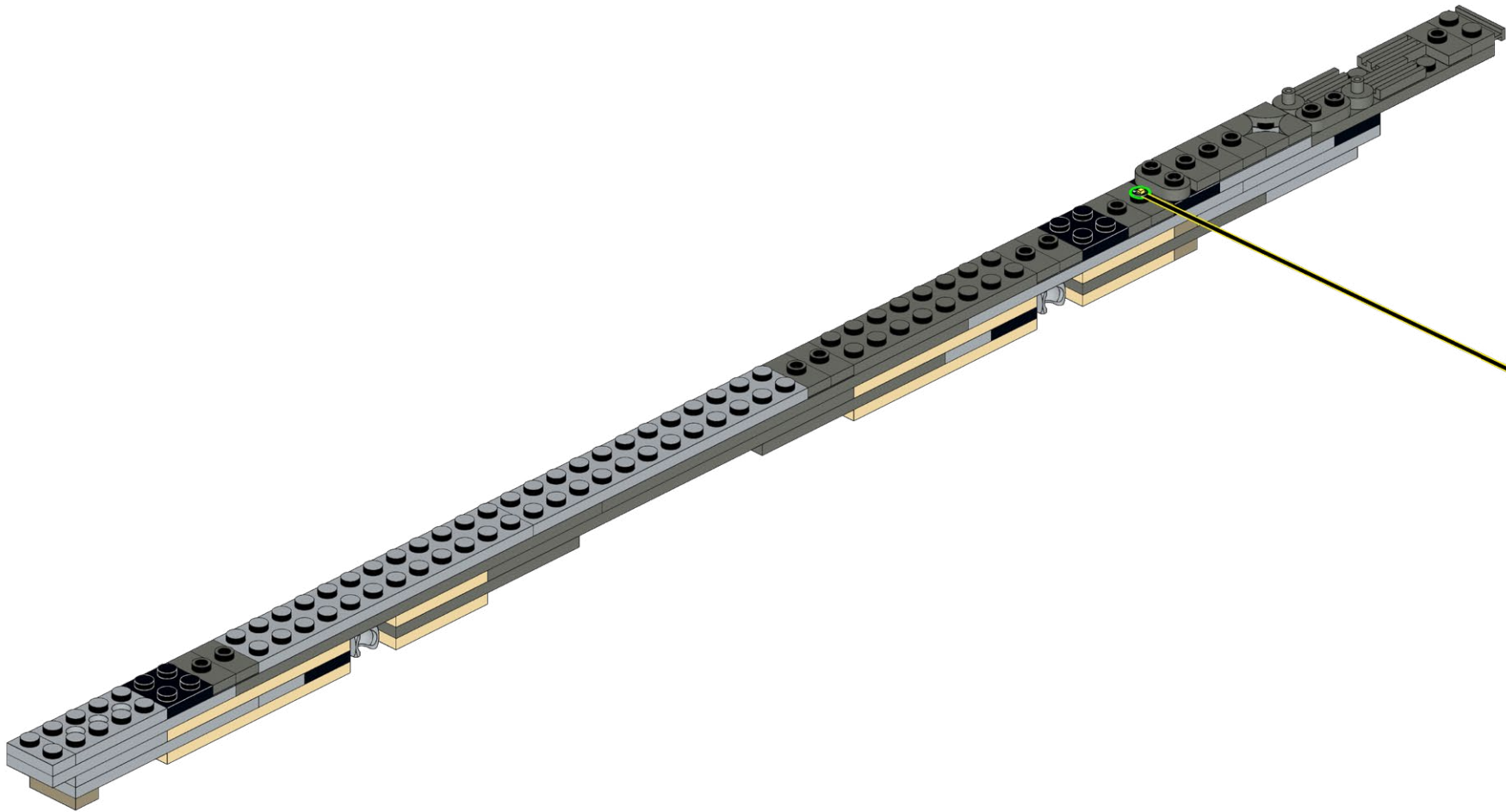

140

1x

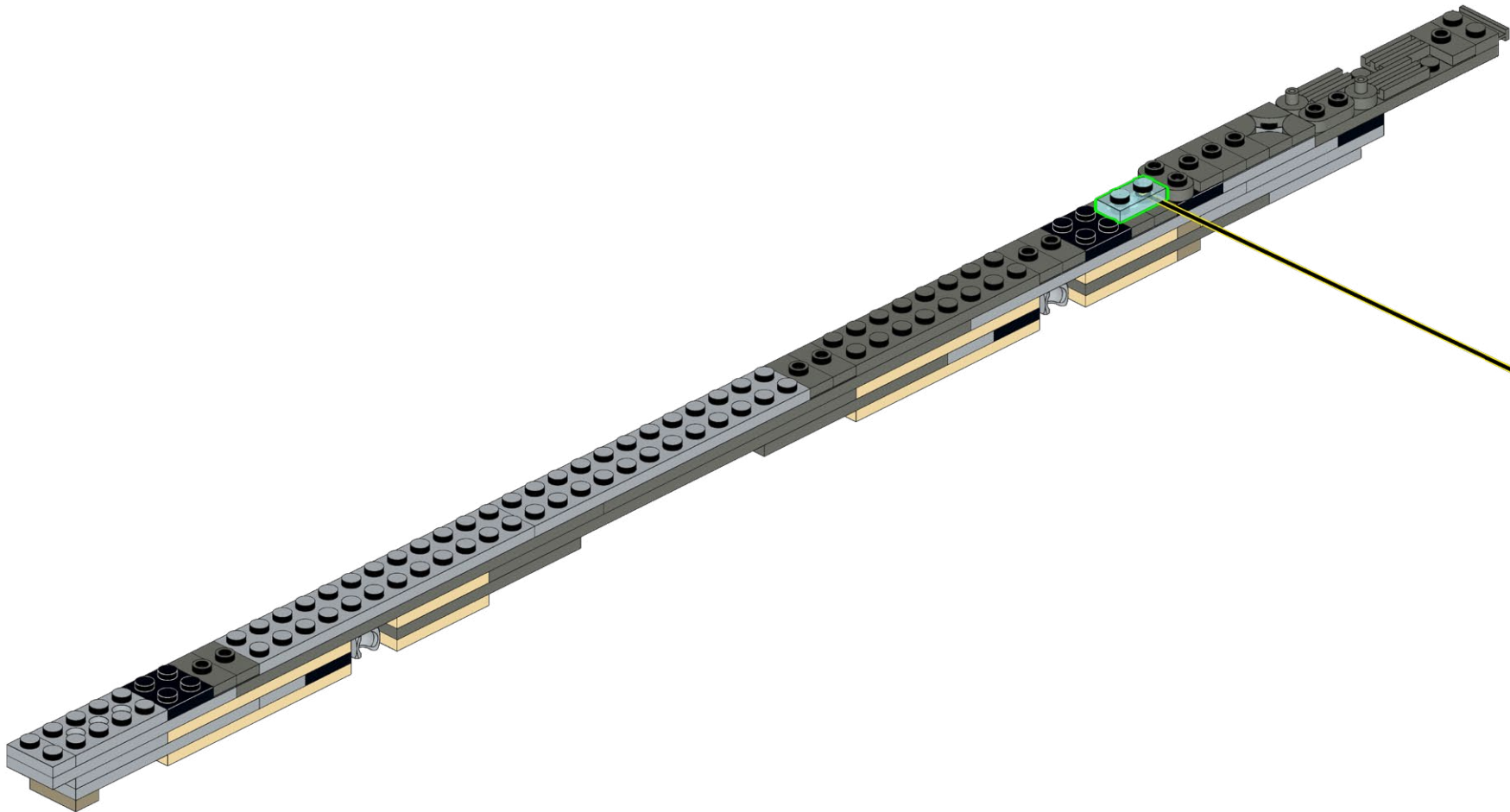

141

AR-CW30

1x

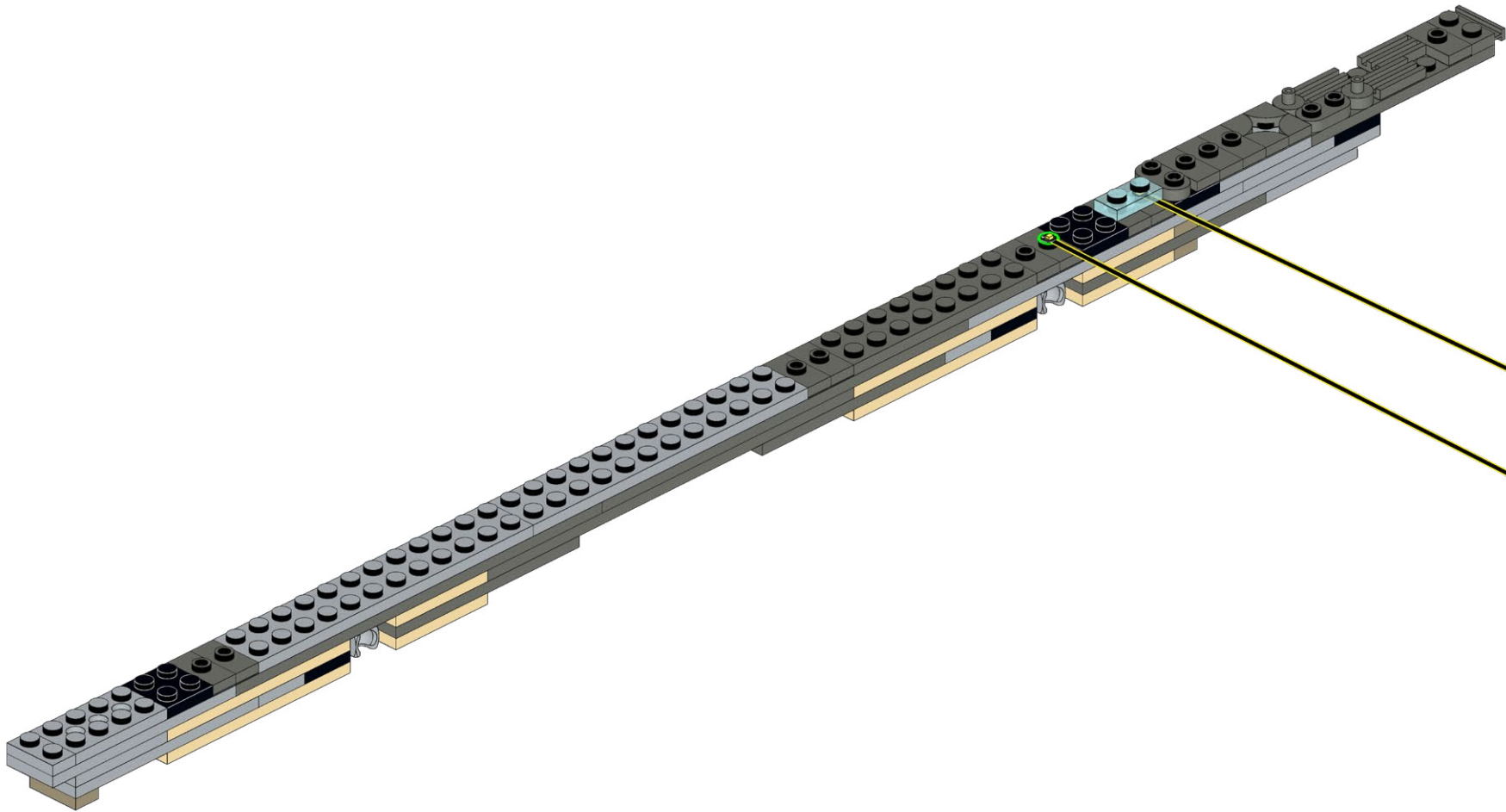

142

1x

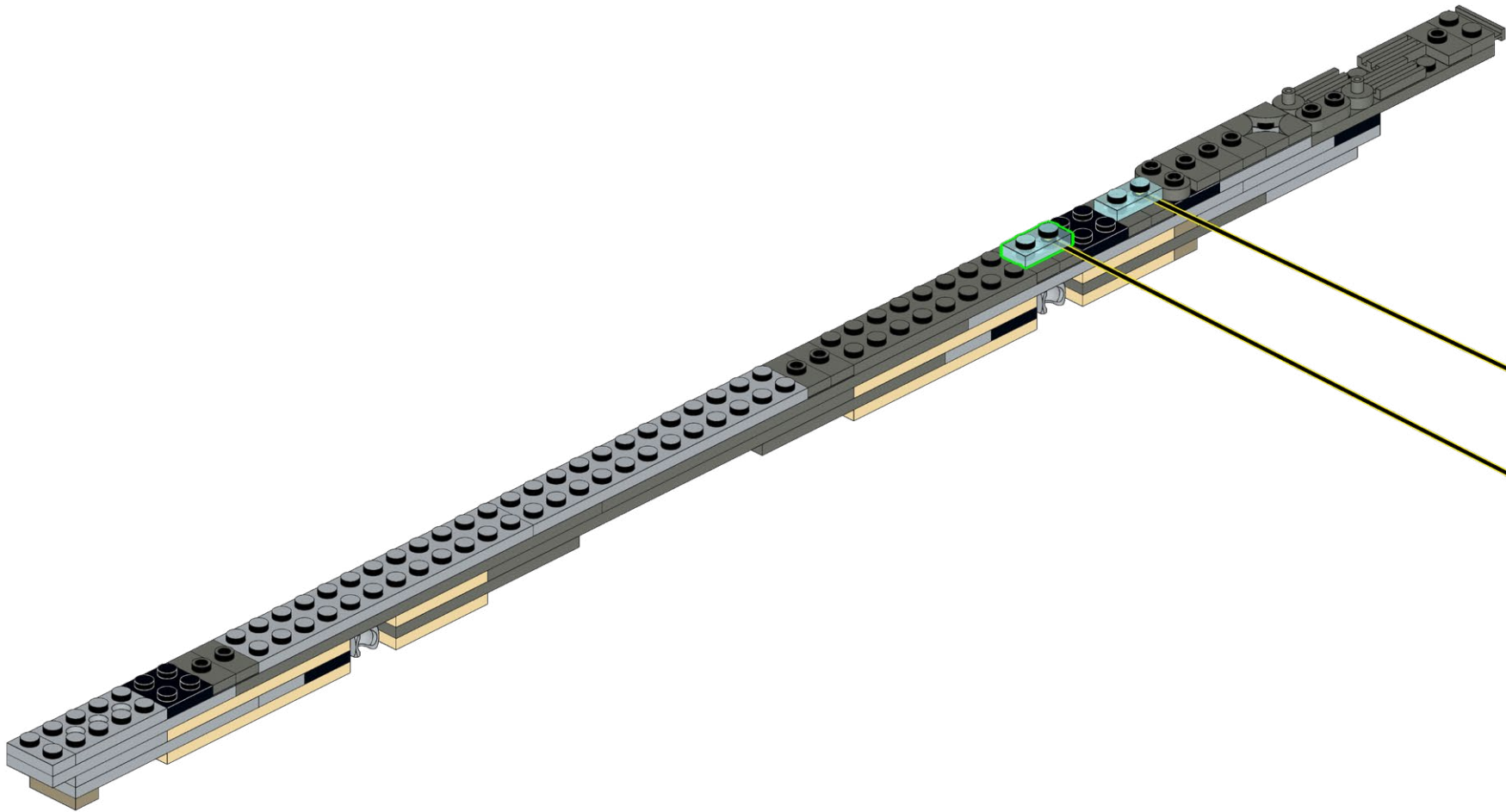

143

- 1x
- 2x
- 1x
- 2x
- 1x

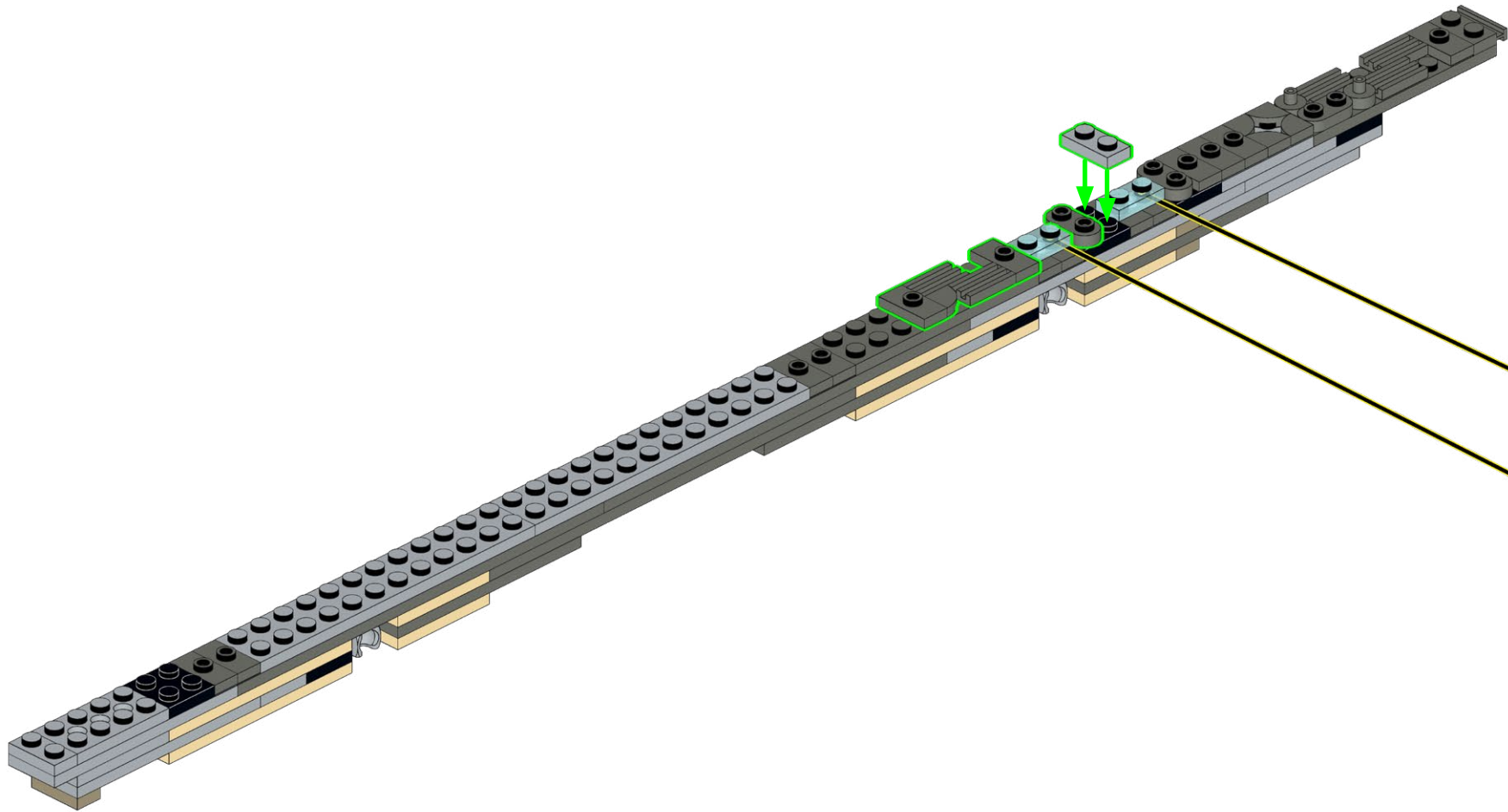

144

- 1x
- 2x
- 2x
- 1x
- 1x

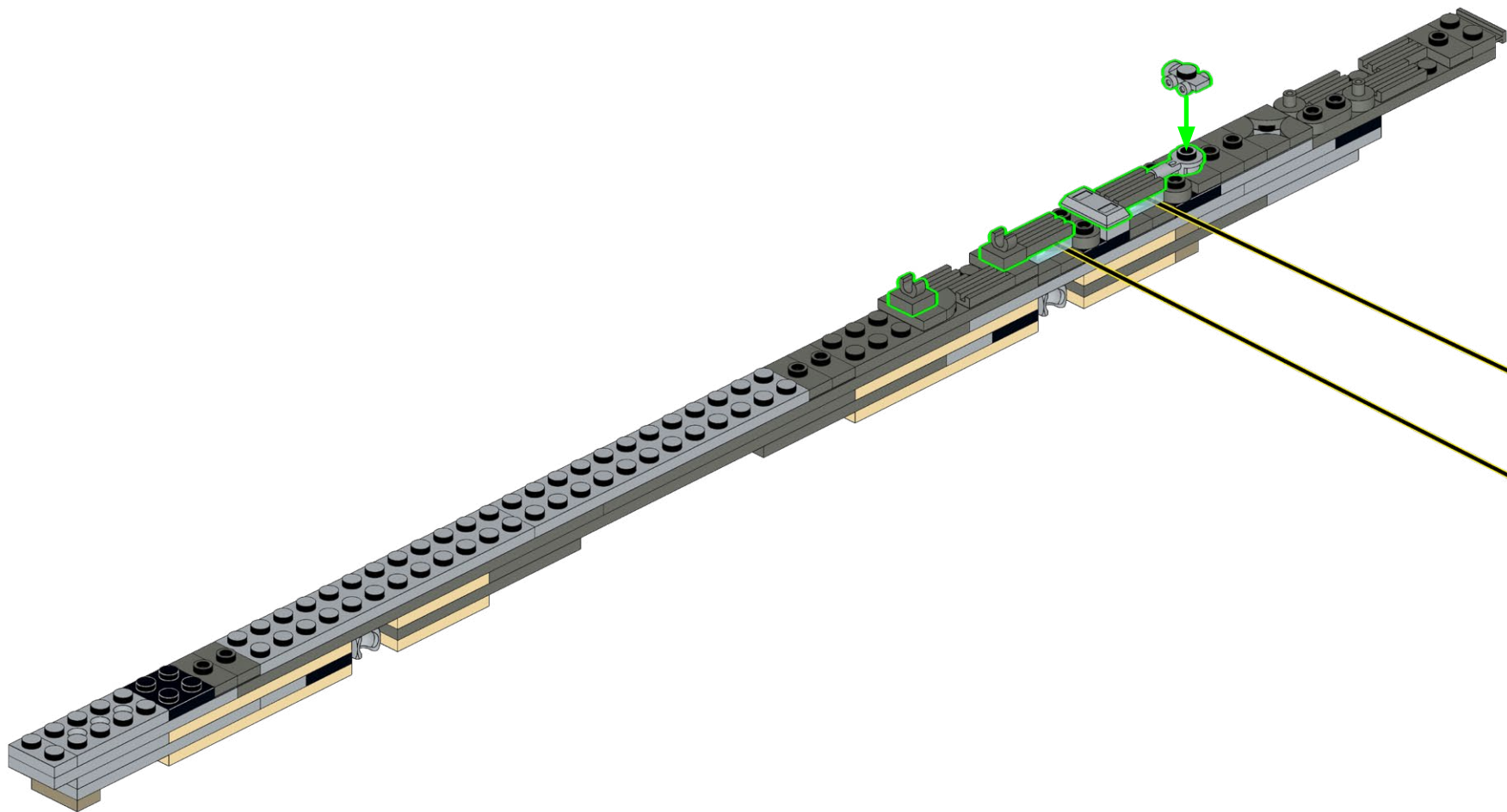

145

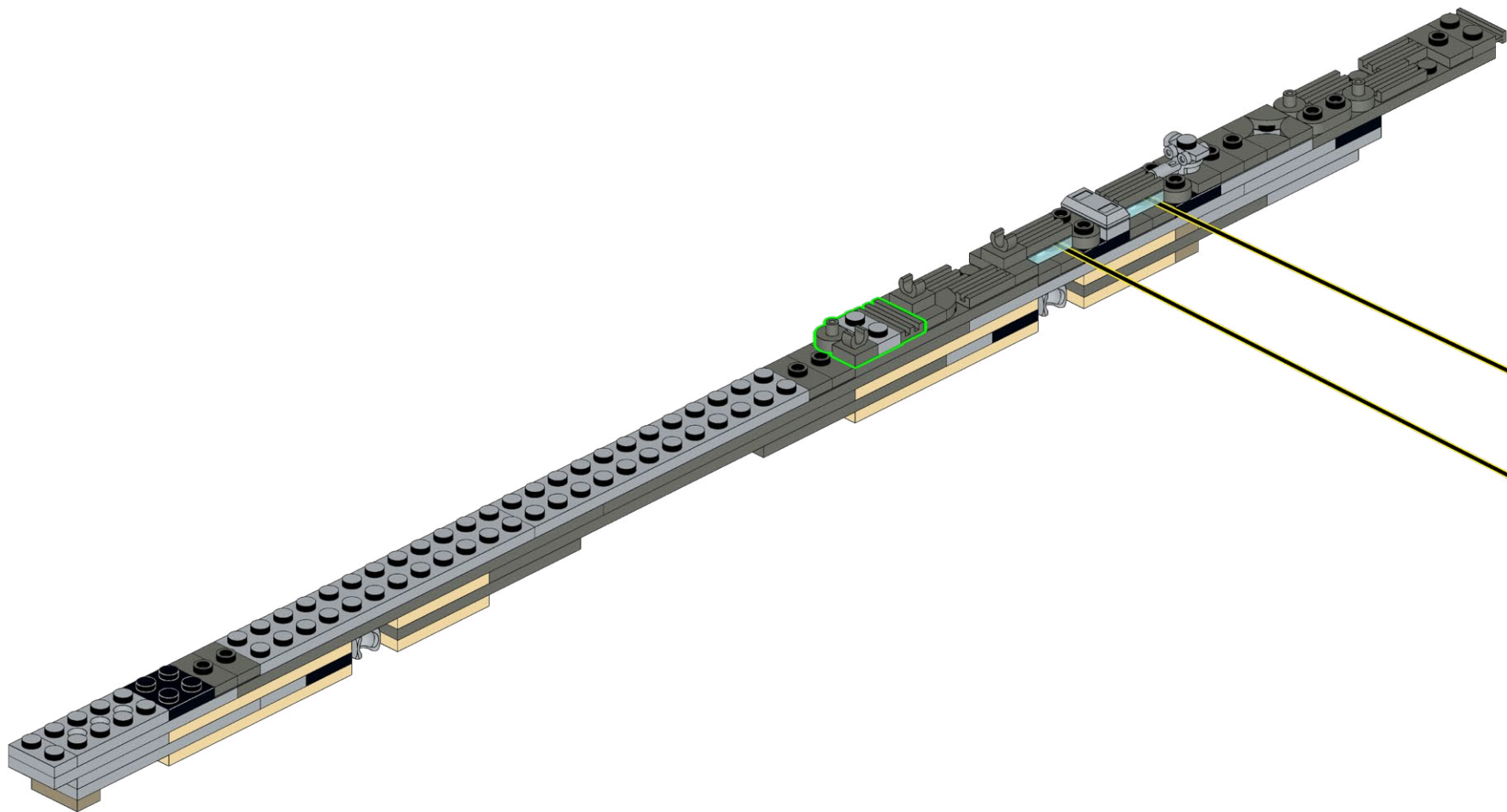
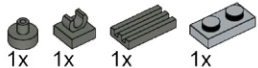

146

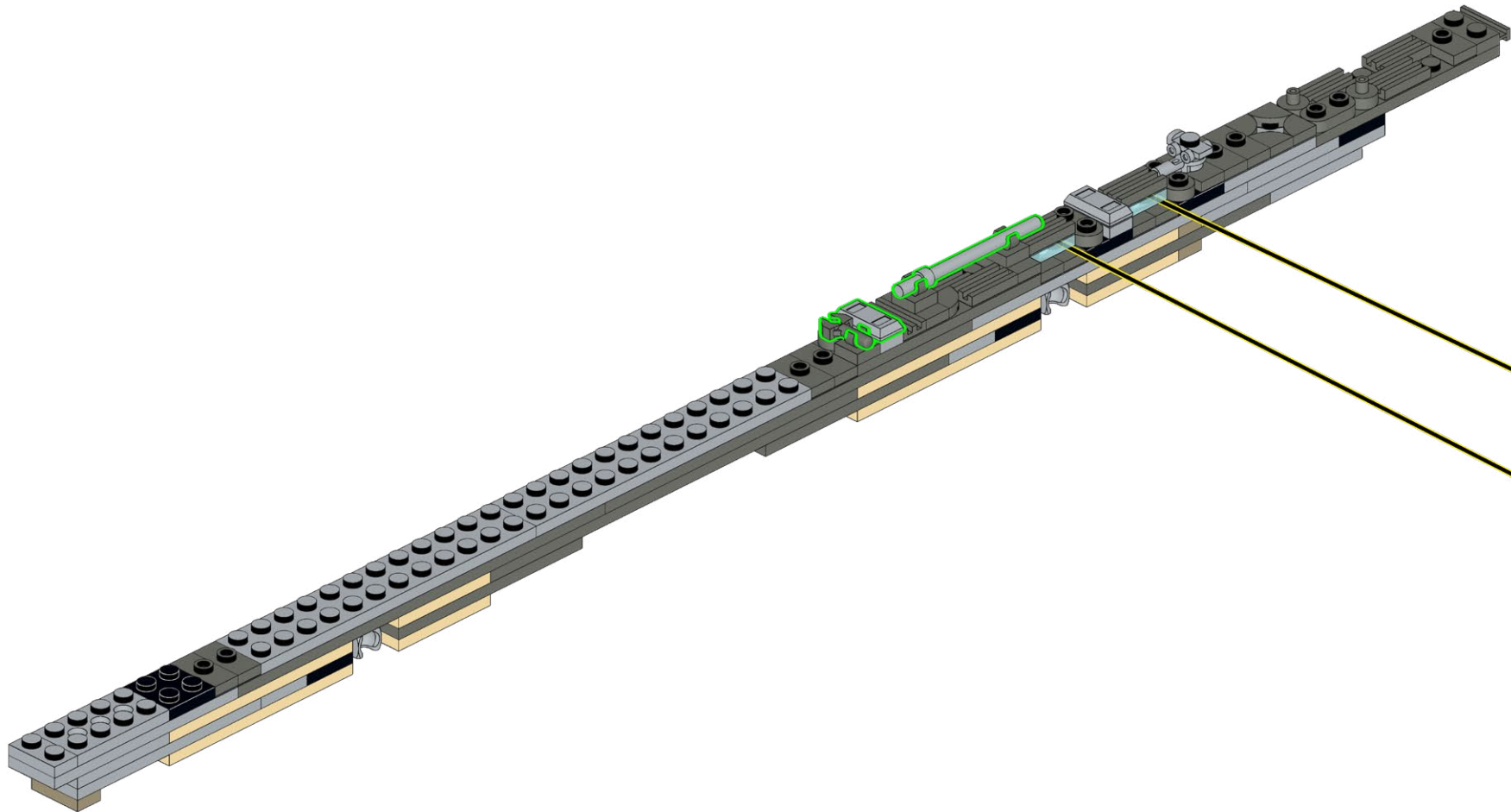
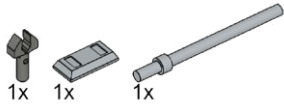

147

AR-CW30

1x

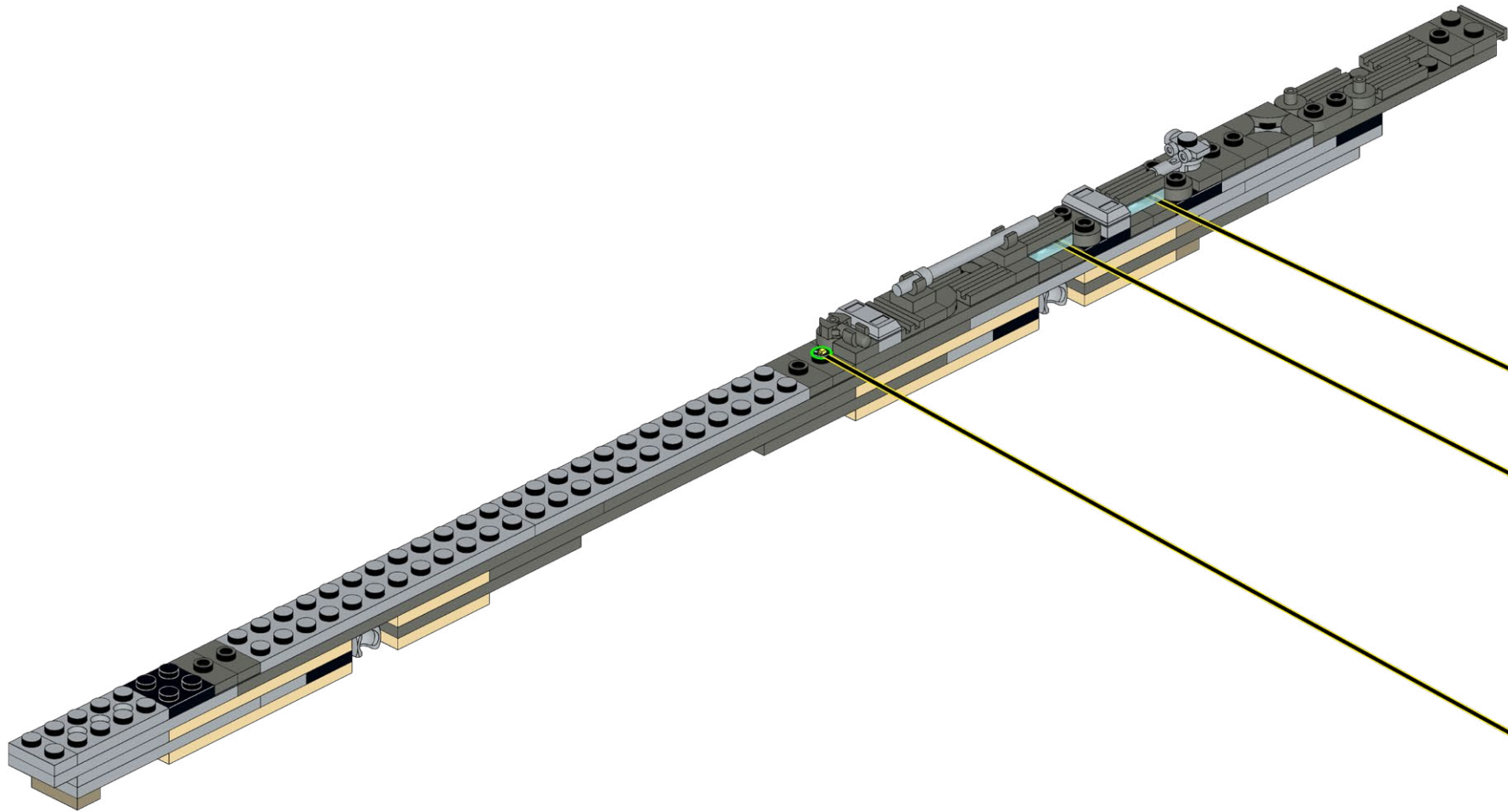

148

1x

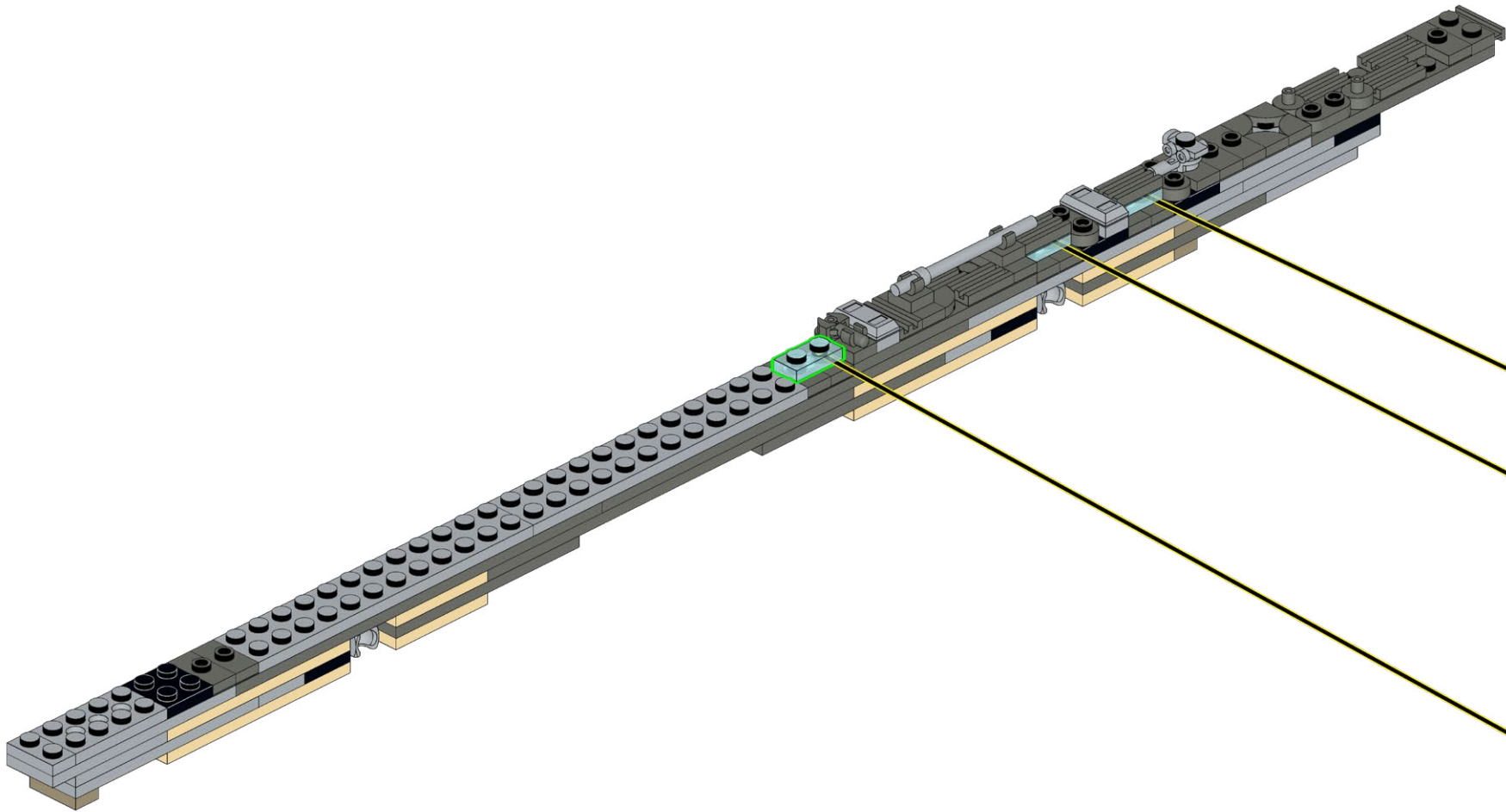

149

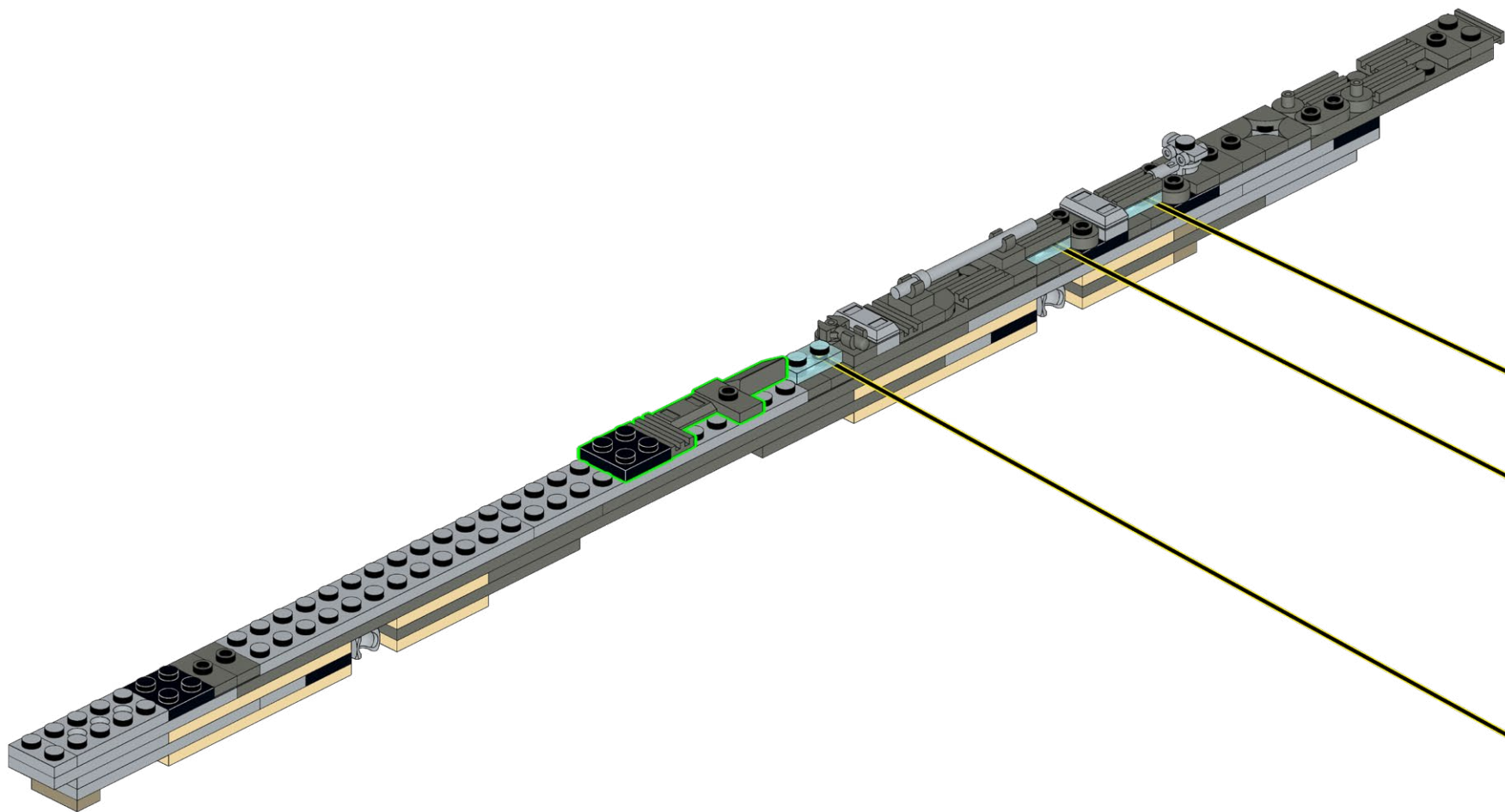
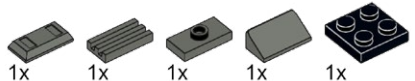

150

- 1x
- 1x
- 1x
- 1x
- 6x
- 1x
- 1x
- 1x

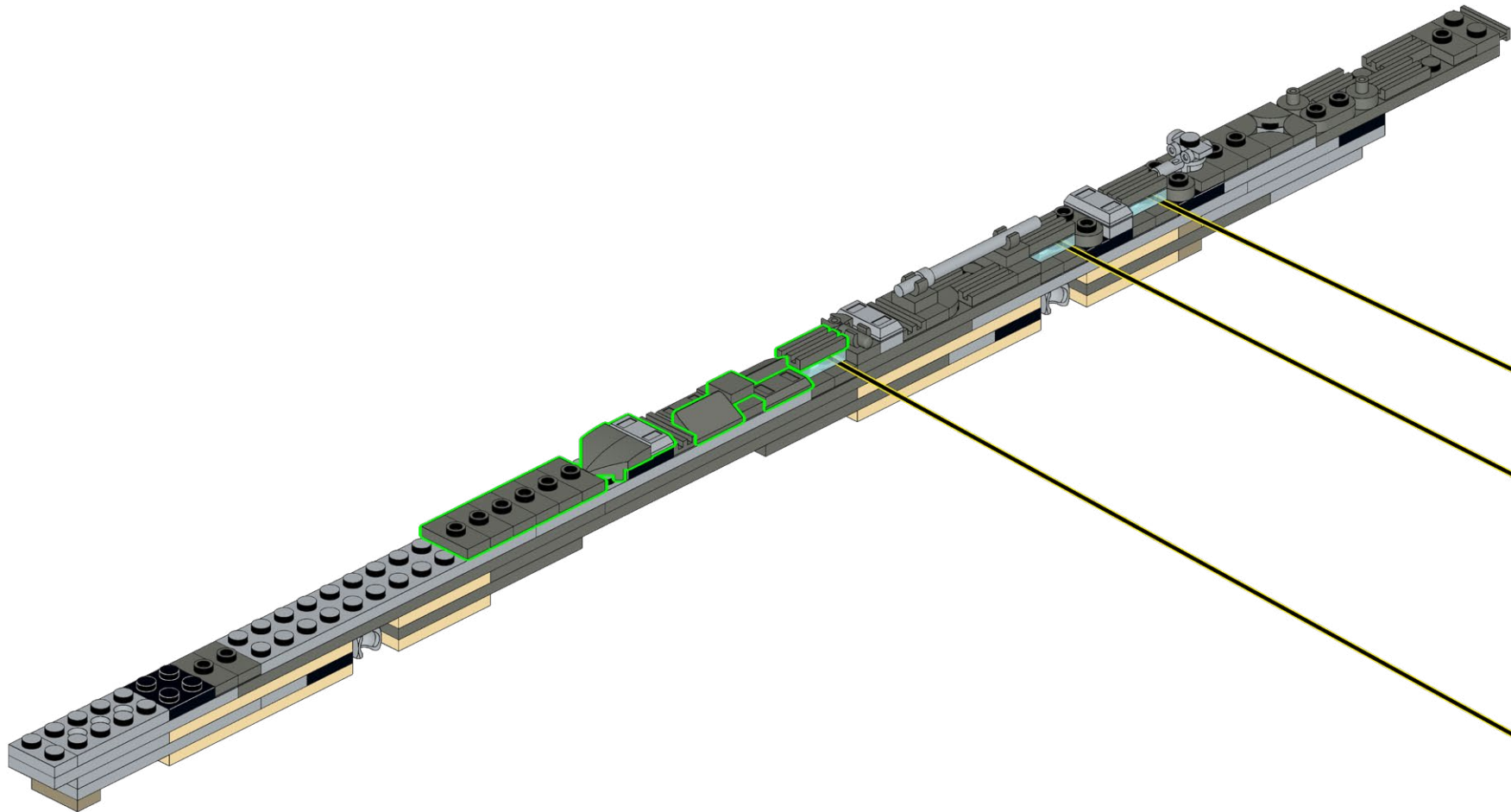

151

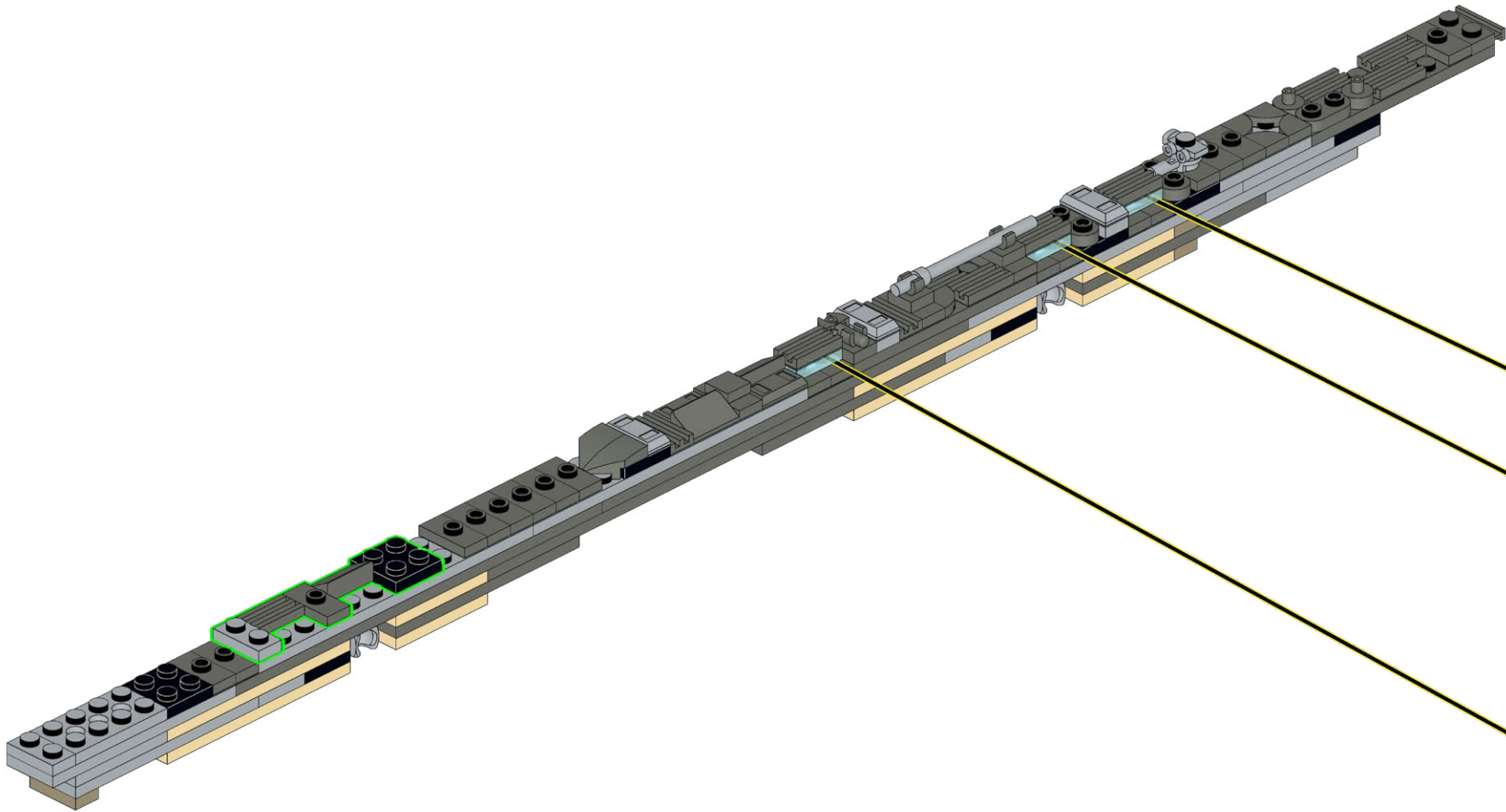
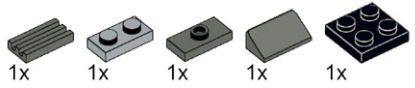

152

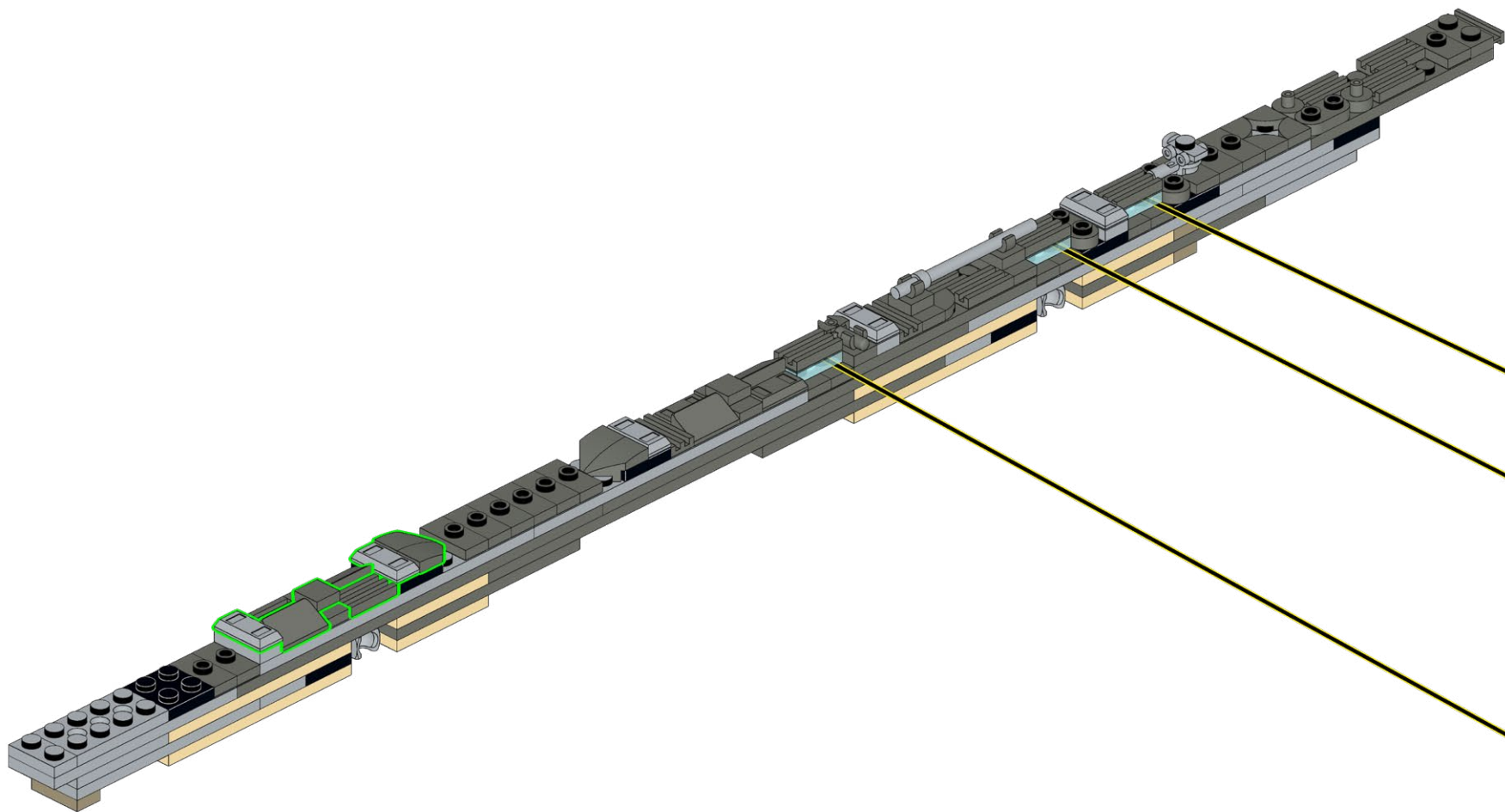
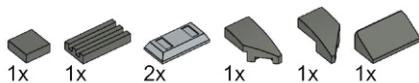

153

AR-CW30

1x

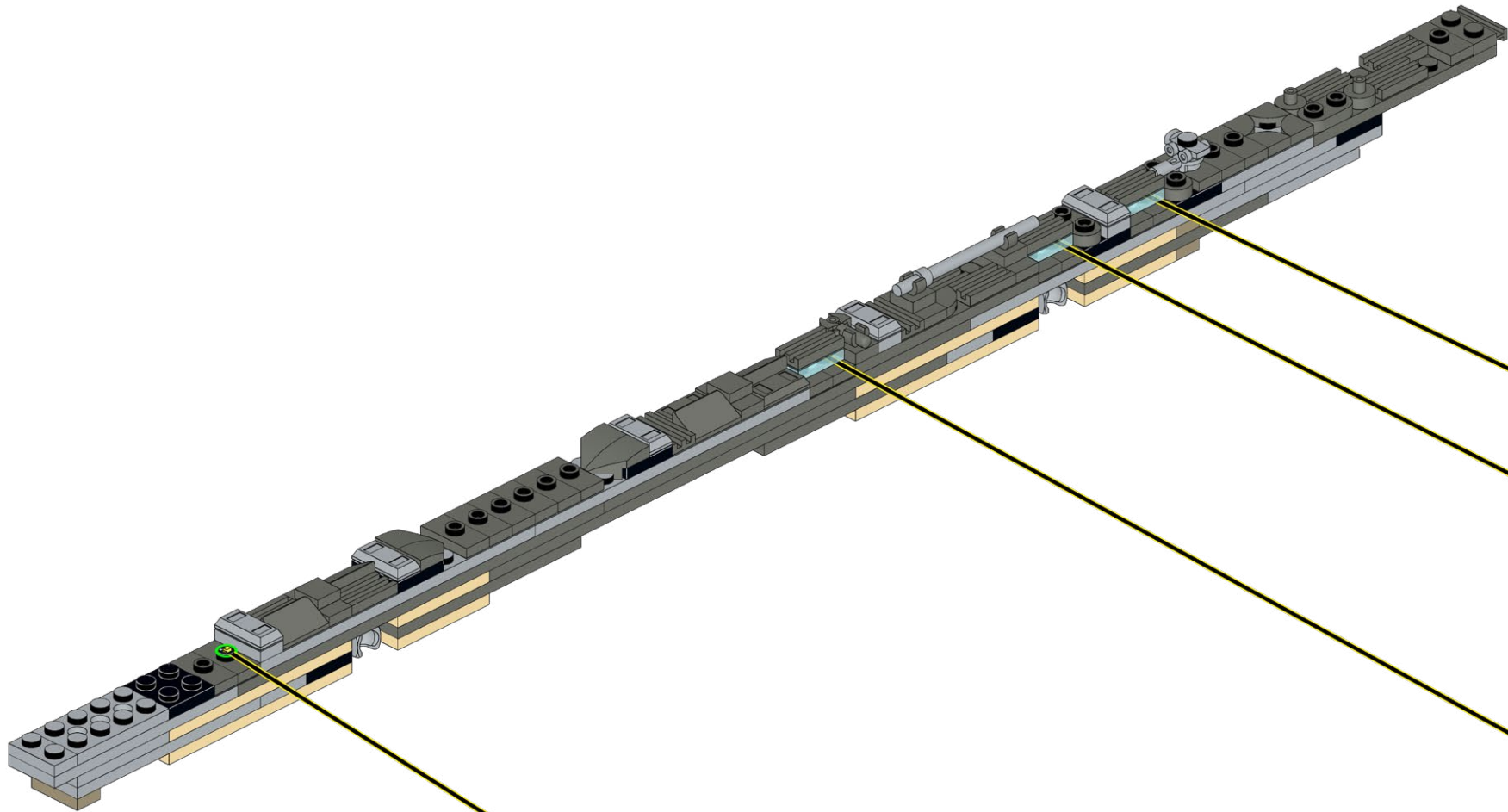

154

1x

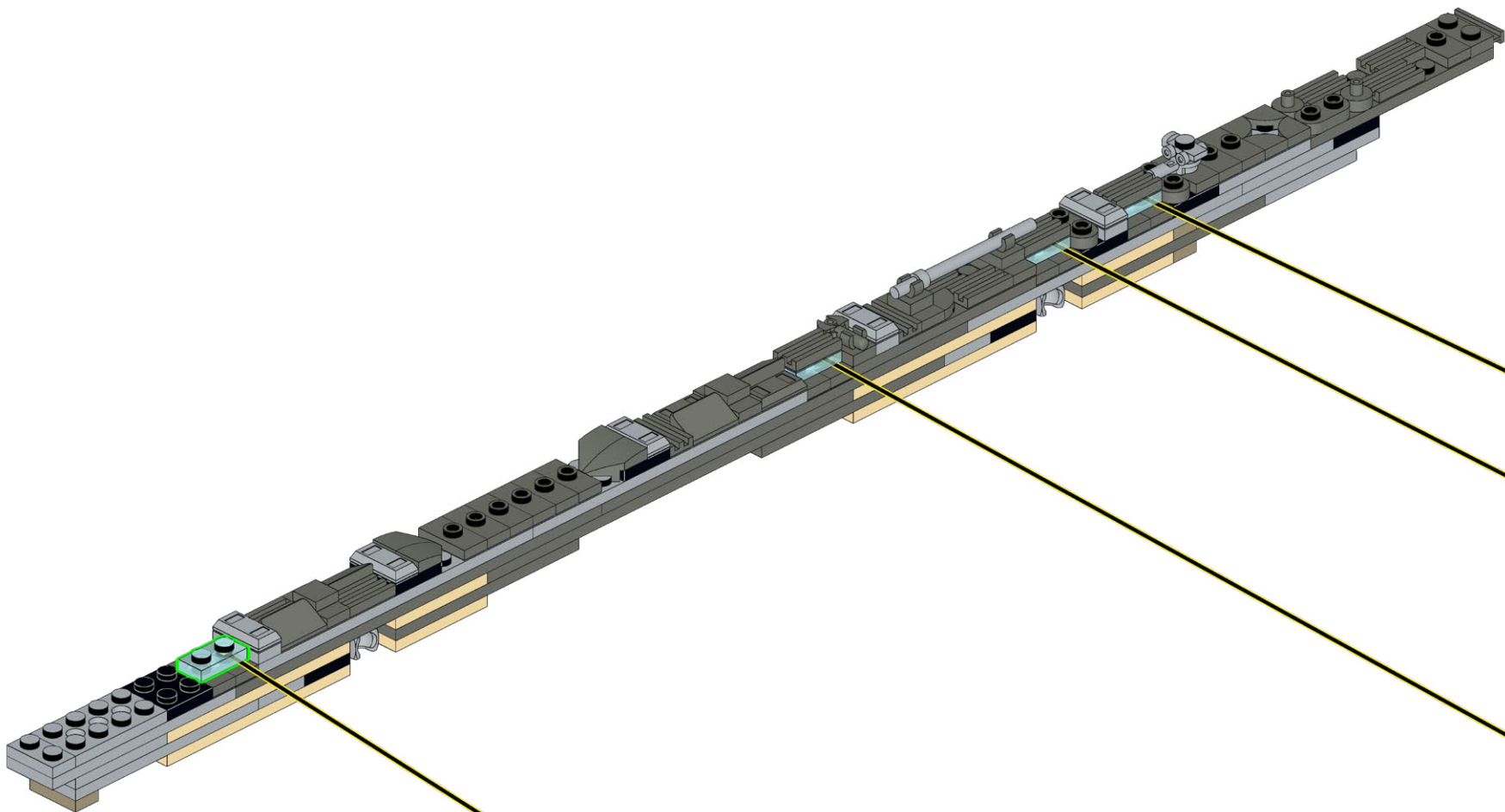

155

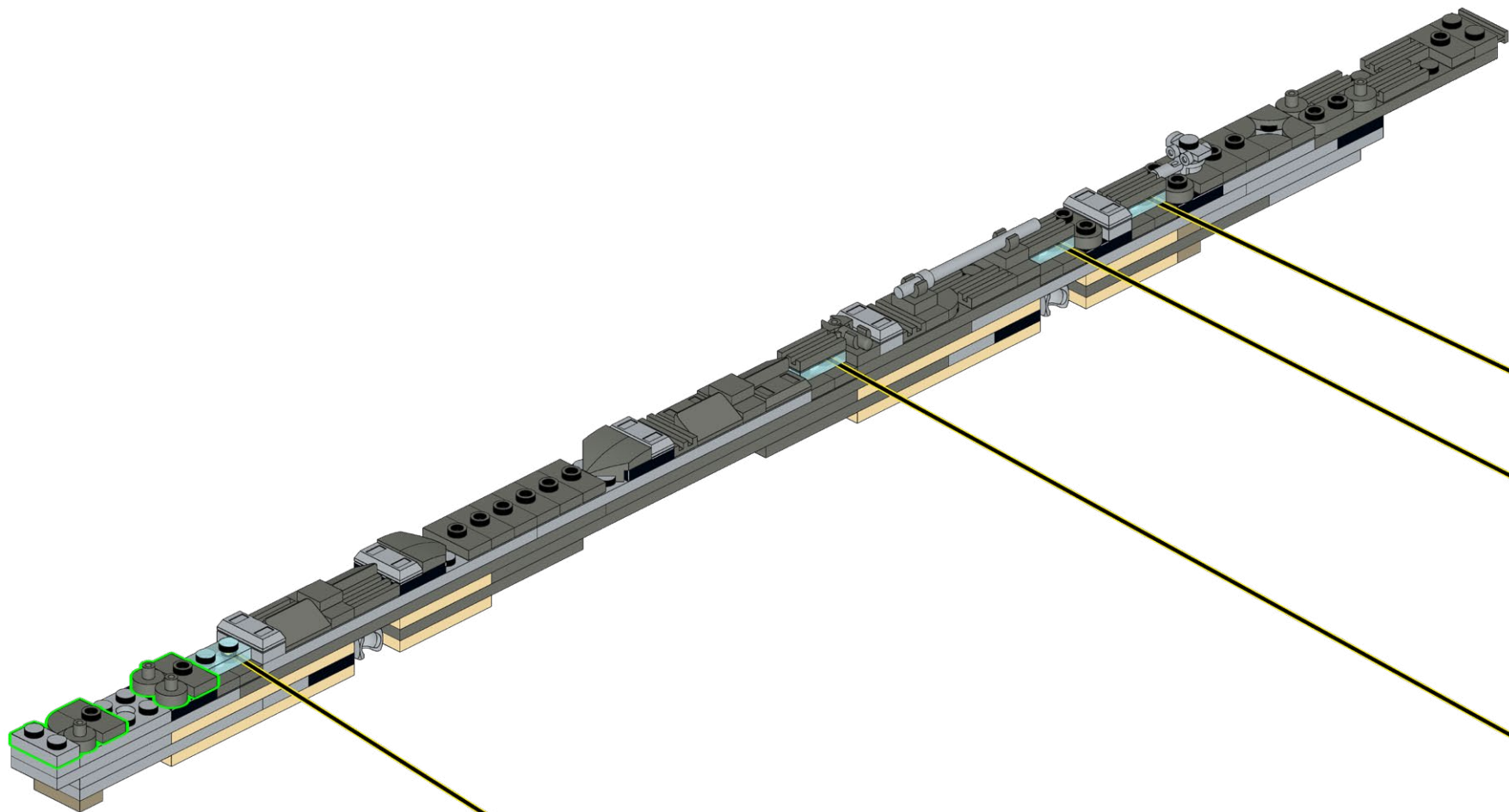
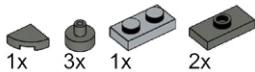

156

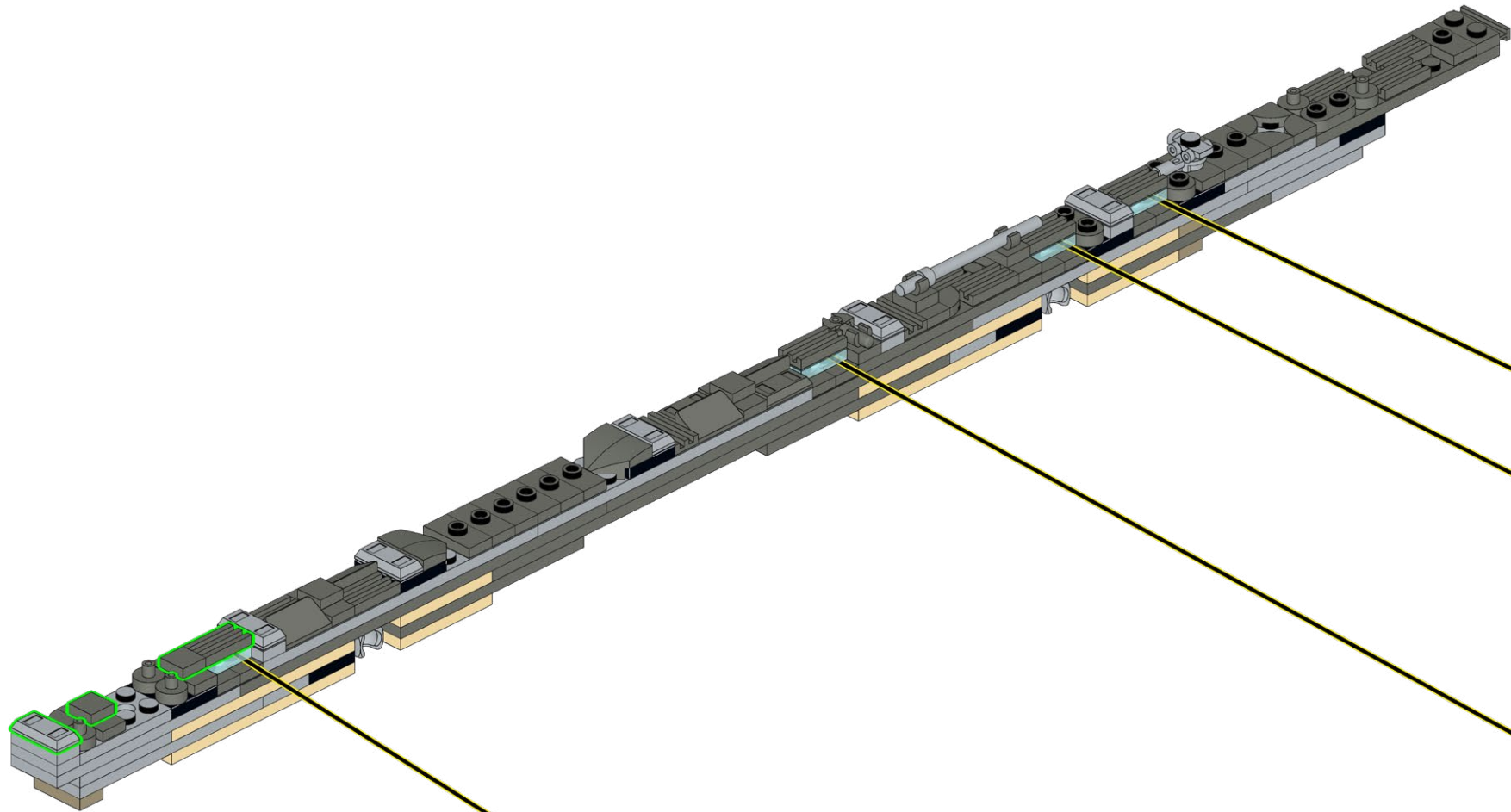
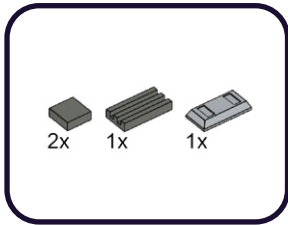

157

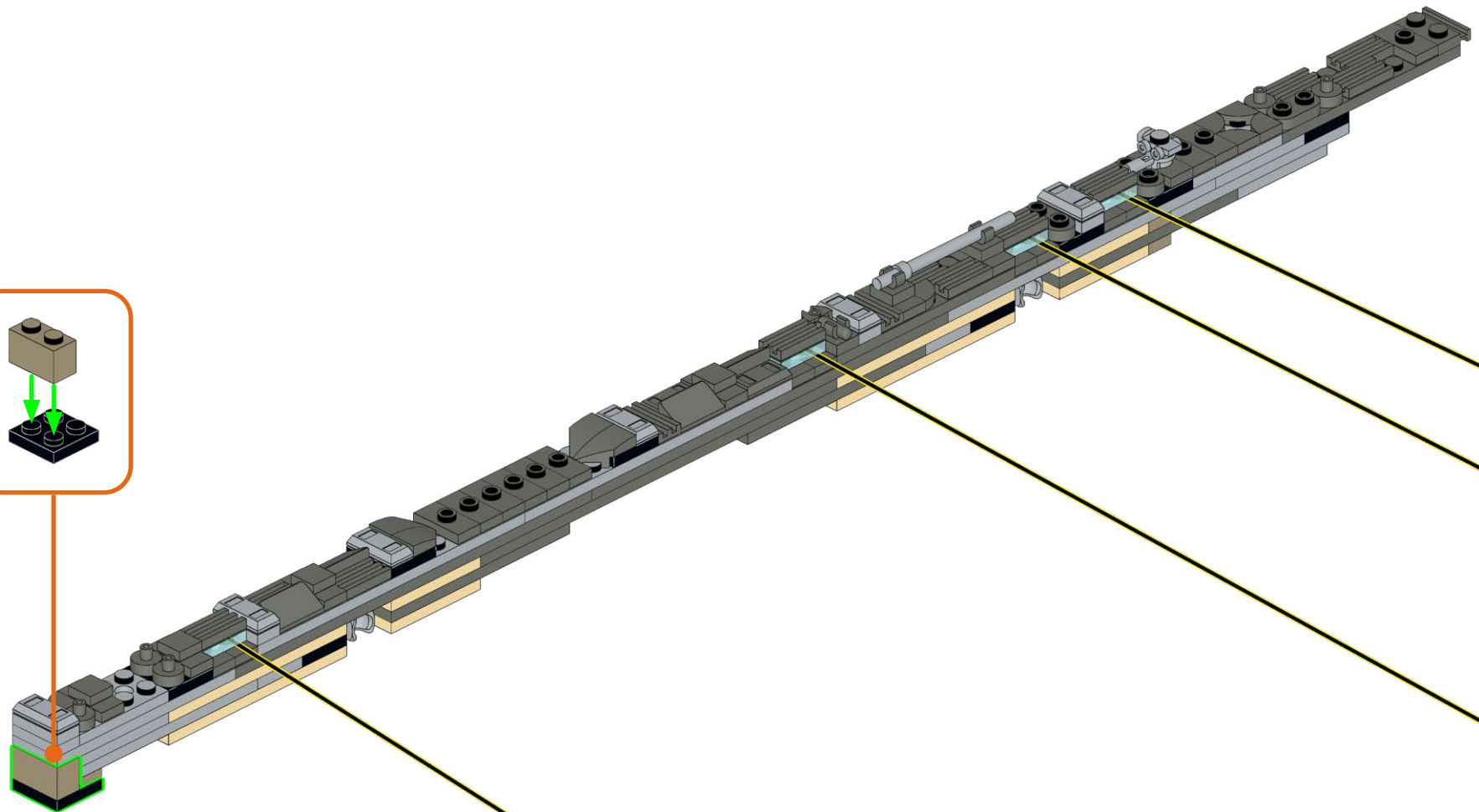
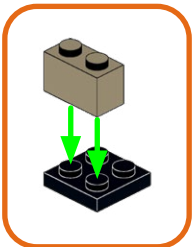
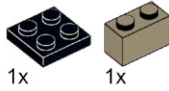

158

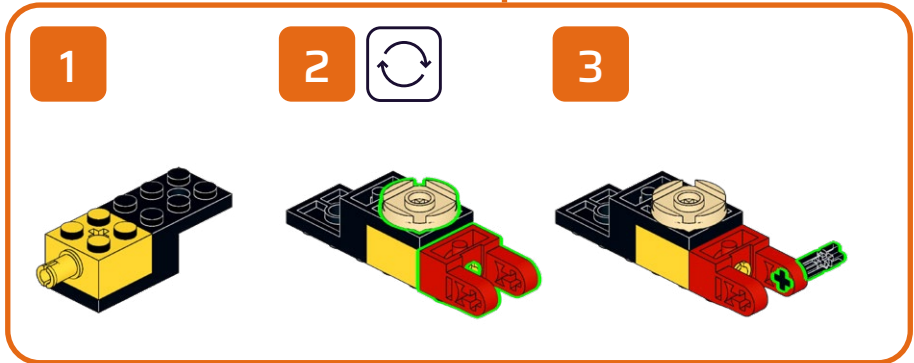
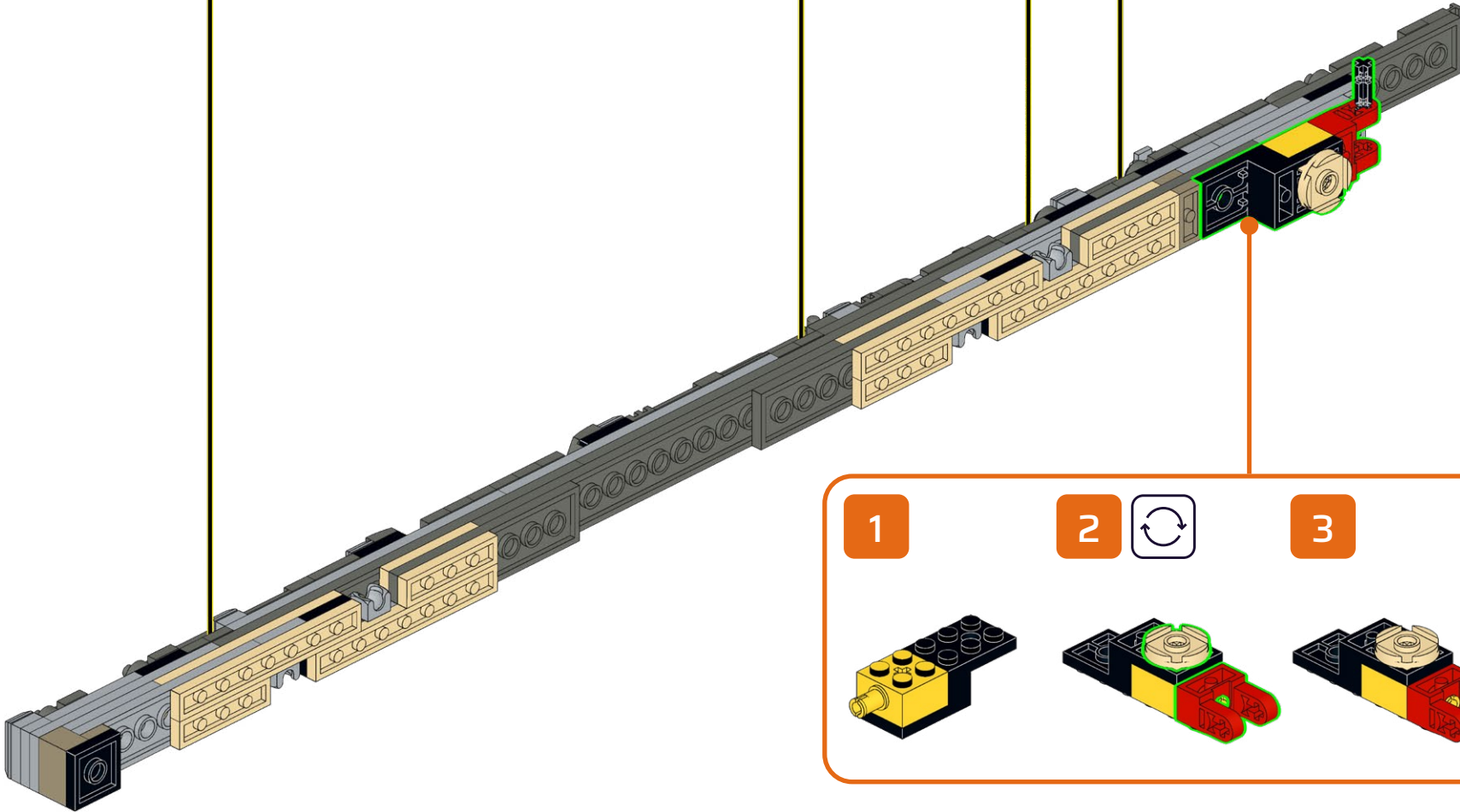
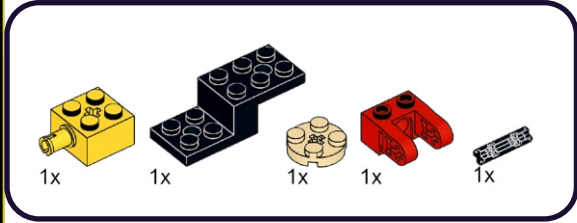

159

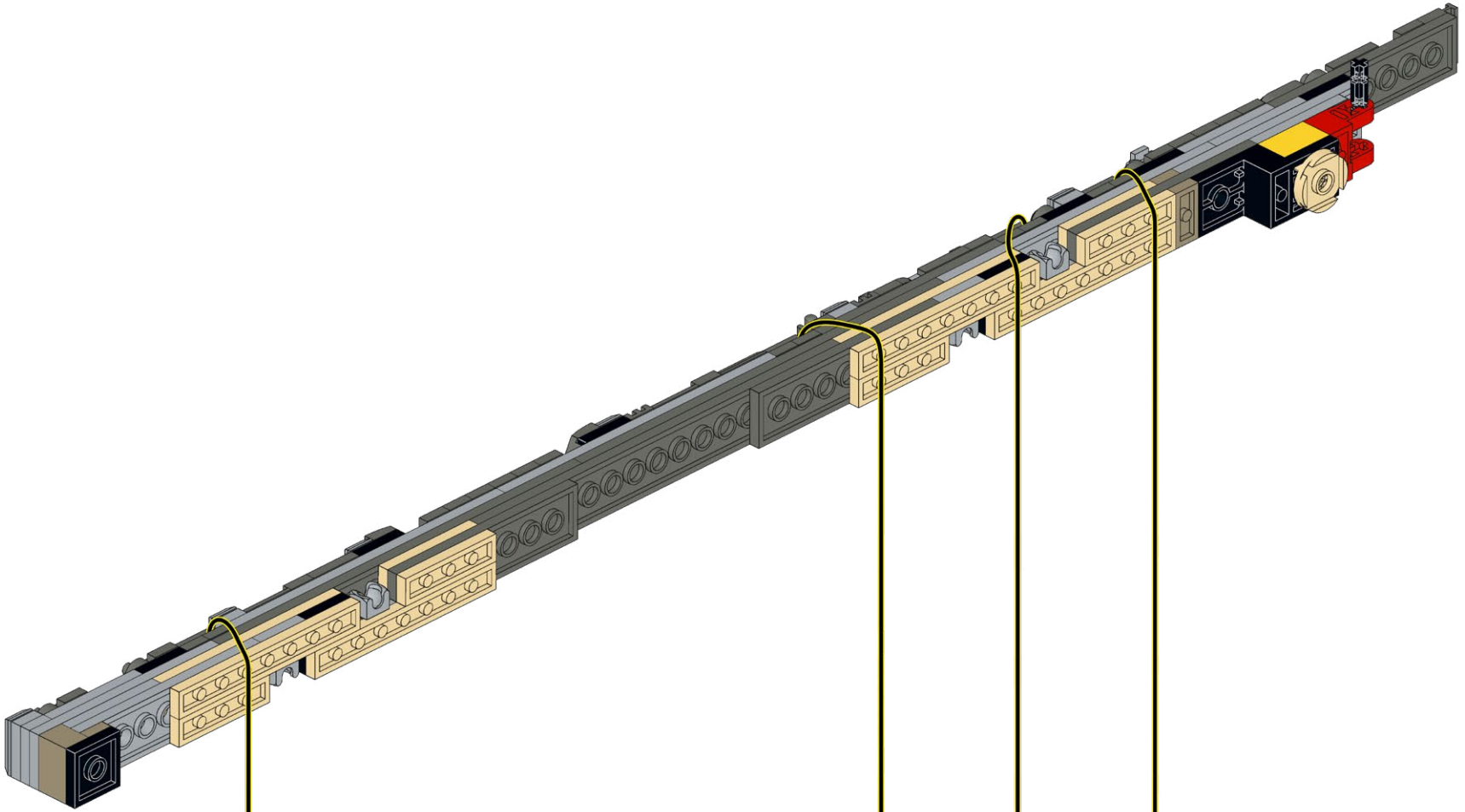

160

4x

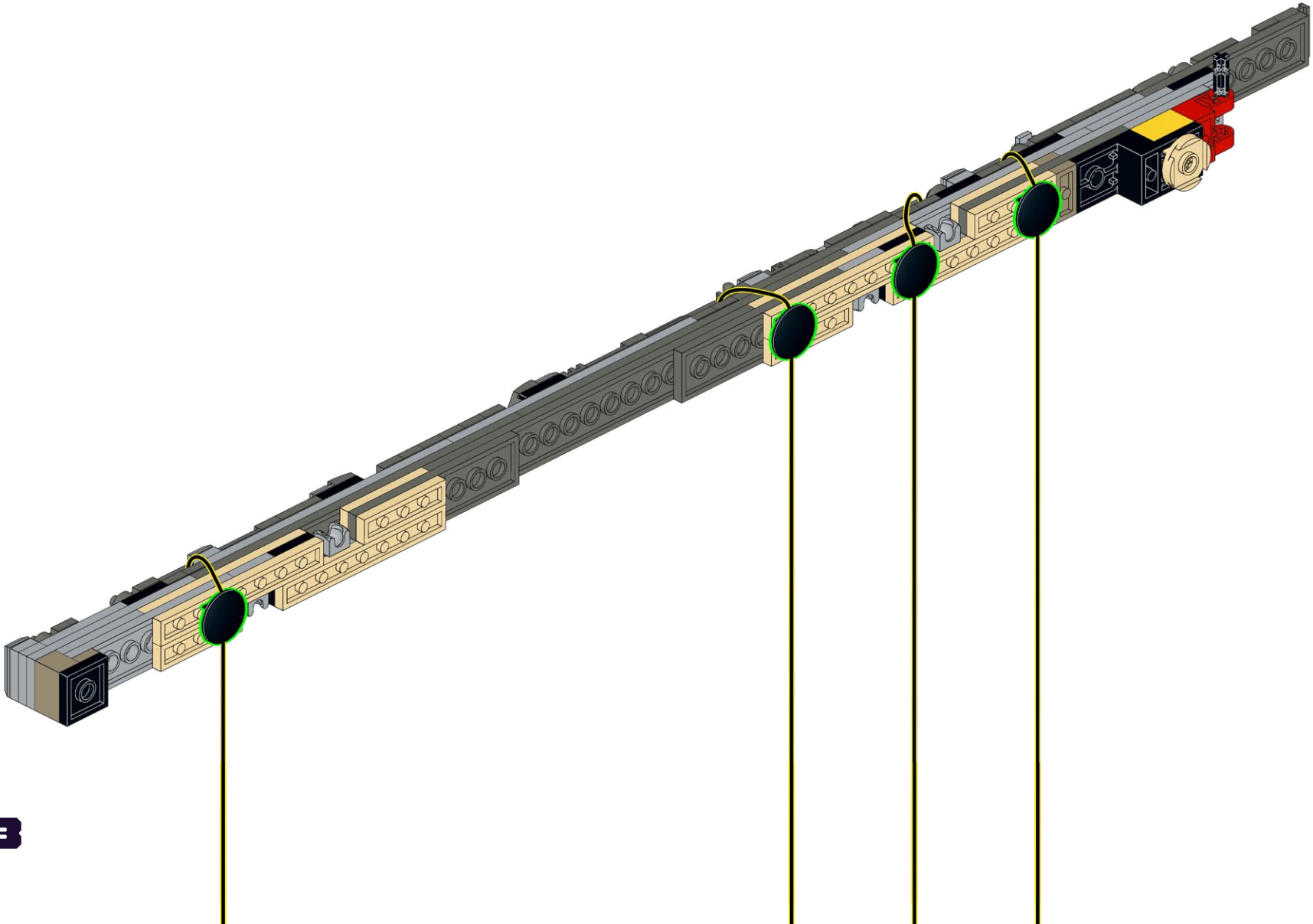

161

6x



162

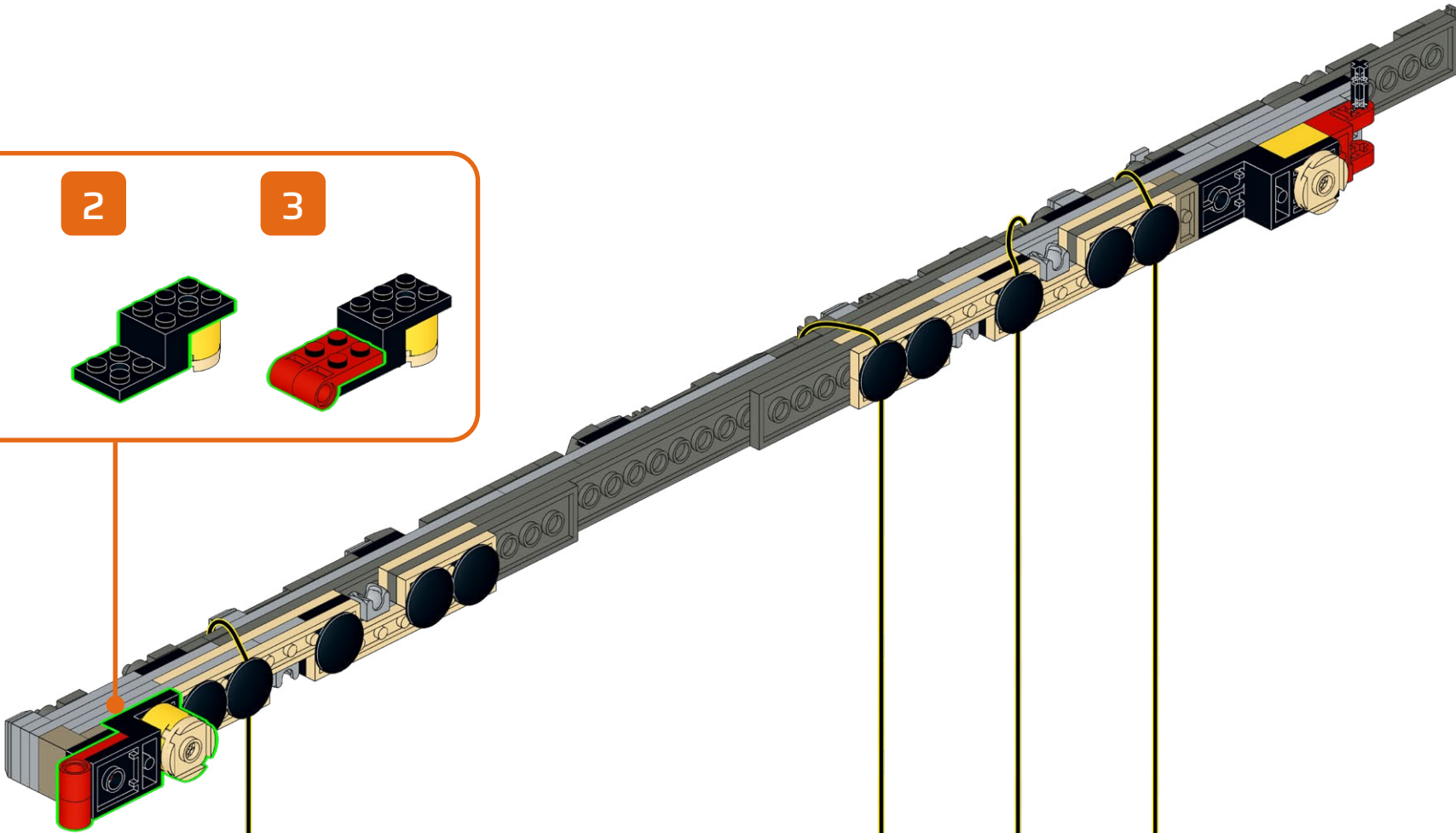
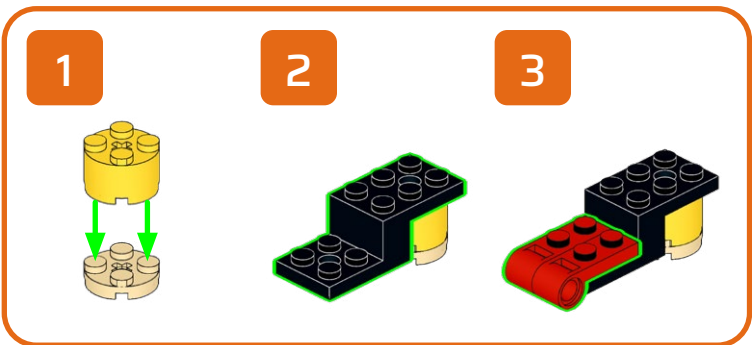
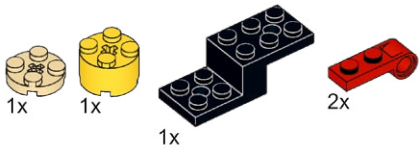

163

2x

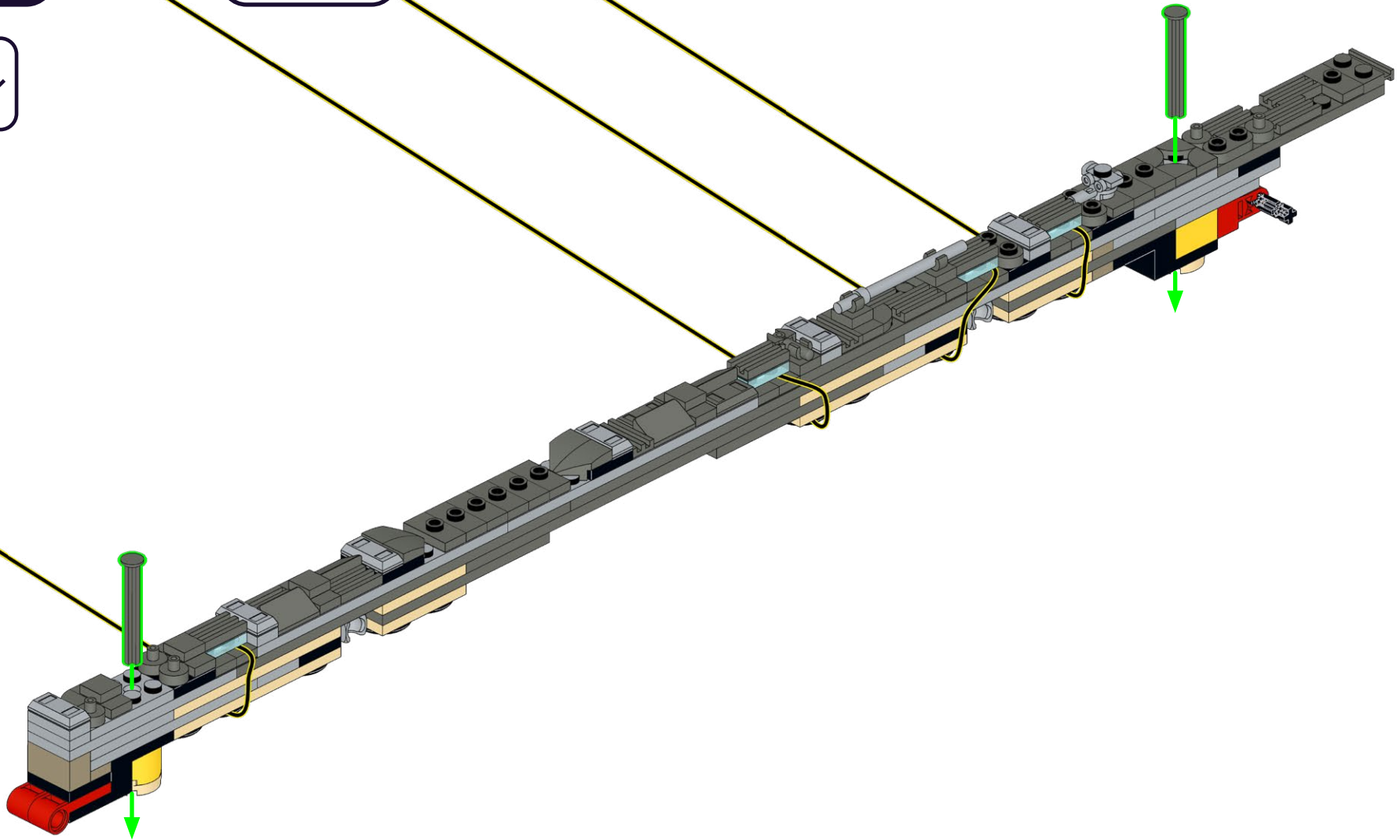

164

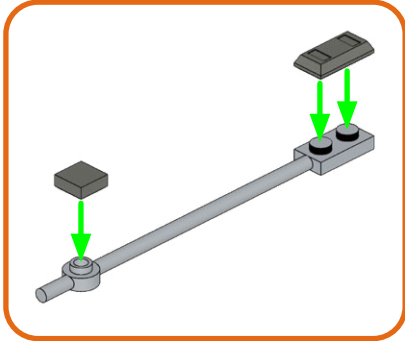
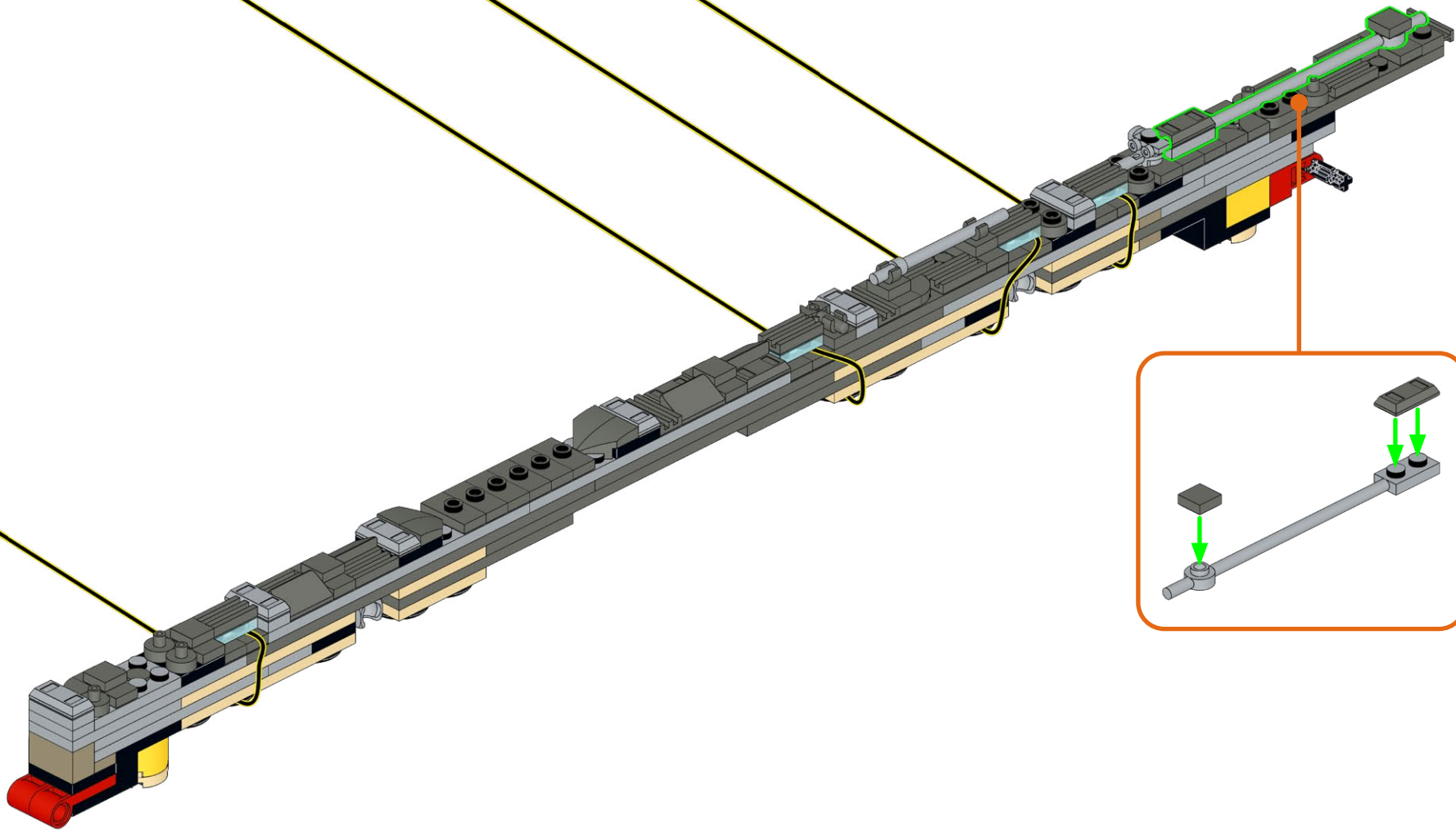
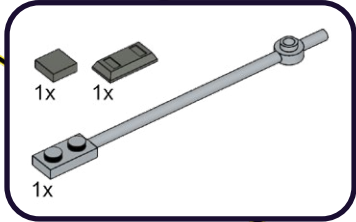

165

1x 2x

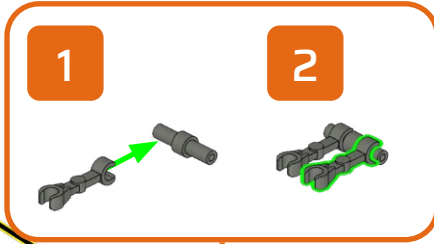

166

1x

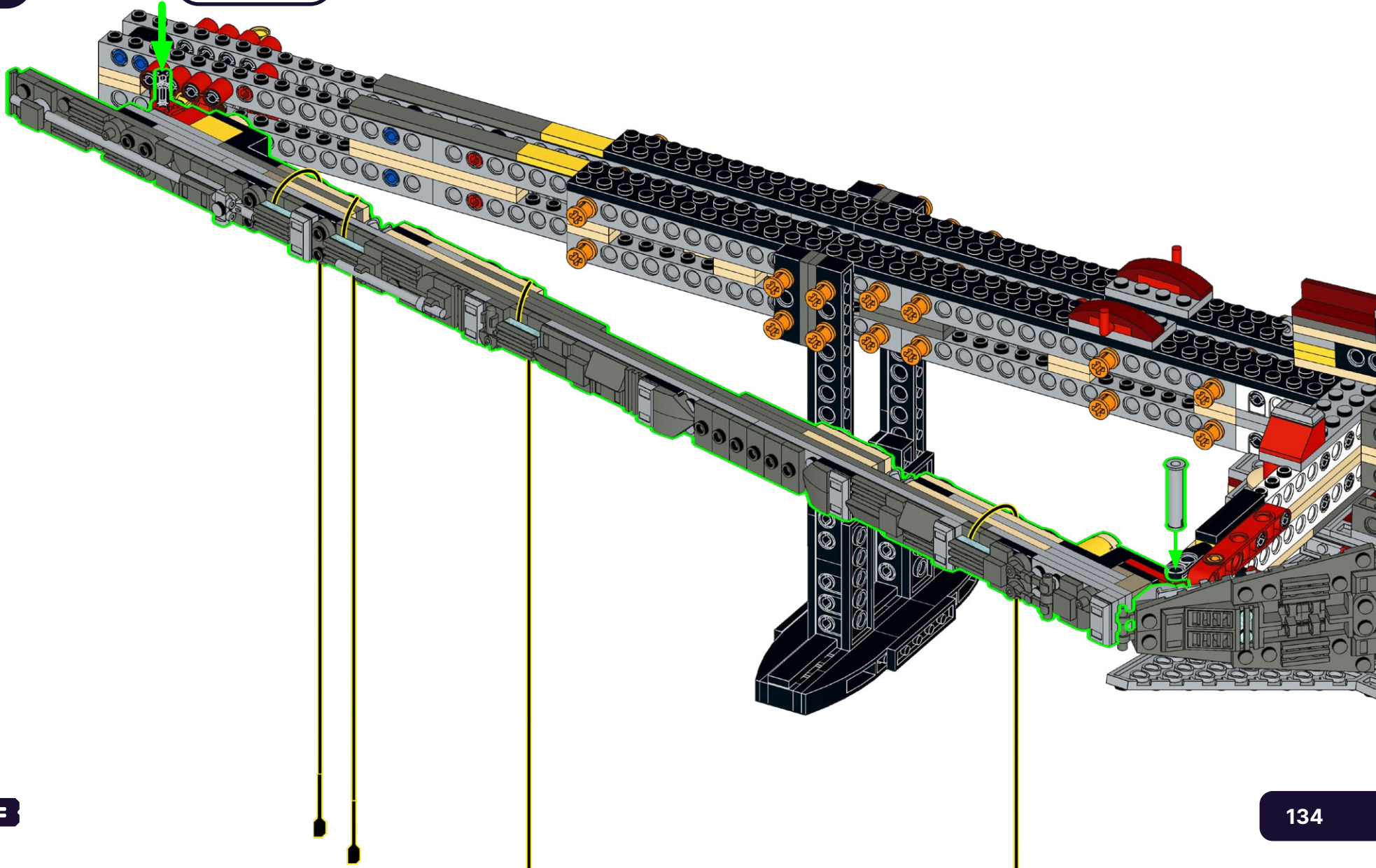

**HOLD UP!**

You might notice some bags aren't in order, as well as left over pieces, but that's ok! We're changing the way you build LEGO!

ATTENDEZ!

Vous remarquerez peut-être que certains sacs, ainsi que certaines pièces, ne sont pas dans le bon ordre. Mais pas de panique! Nous changeons simplement la façon avec laquelle vous construisez vos LEGO!

ASPETTA!

Potresti notare che alcuni sacchetti non sono in ordine, così come i pezzi avanzati, ma va bene così! Stiamo cambiando il modo in cui costruisci i LEGO!

HALT!

Sie werden möglicherweise bemerken, dass einige tüten durcheinander sind und teile übrig bleiben, aber das ist in Ordnung! Wir ändern die art und weise, wie Sie LEGO bauen!

¡ESPERA!

Es posible que notes que algunas bolsas están fuera de servicio, así como piezas sobrantes, ¡pero está bien! ¡Estamos cambiando la forma en que construyes LEGO!

暫停!

你可能会注意到一些袋子顺序错乱, 以及一些剩余的部件, 但没关系! 我们正在改变你搭建乐高的方式!

Open LEGO® Bag 25

167

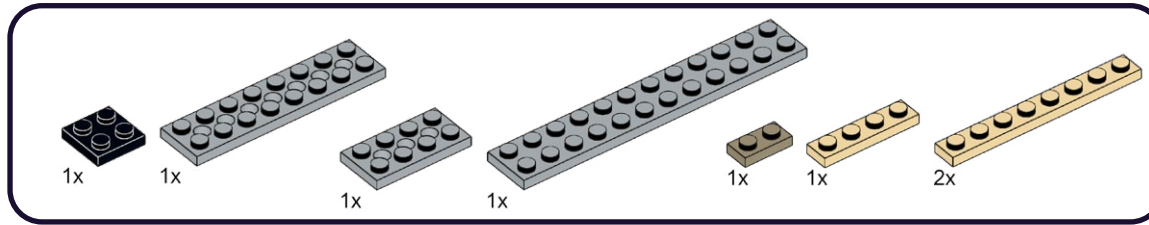

1

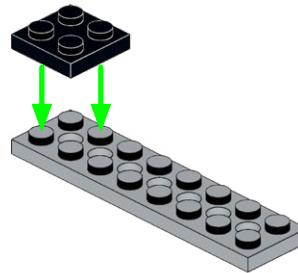

2

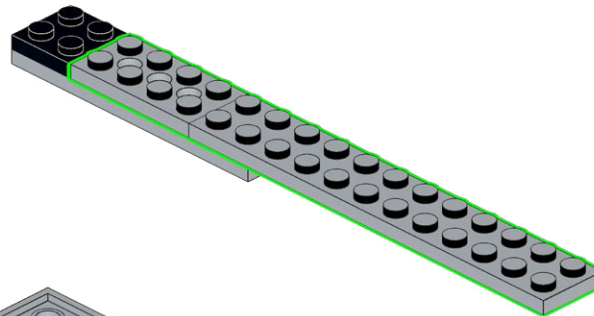

3

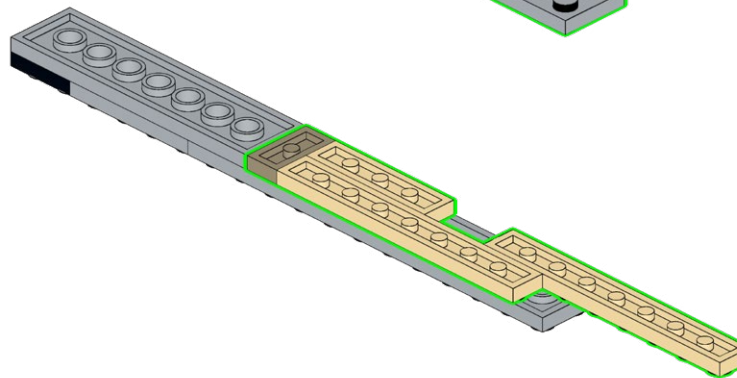

168

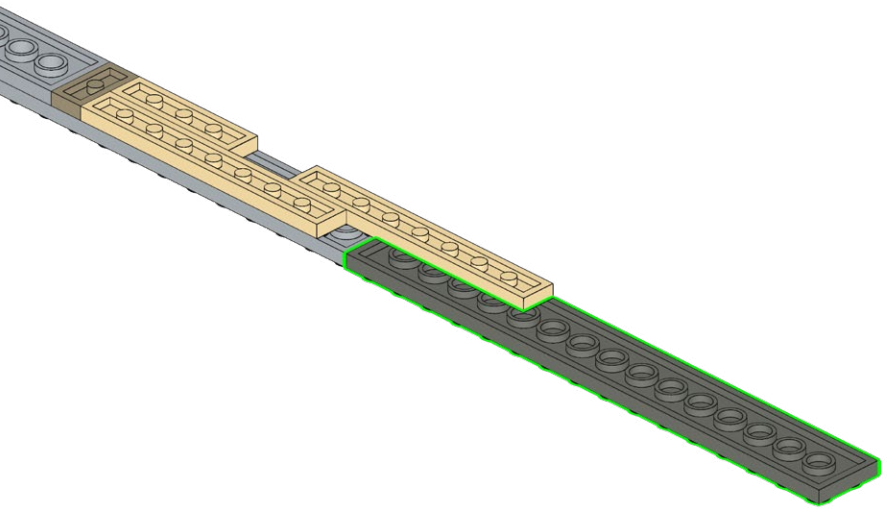
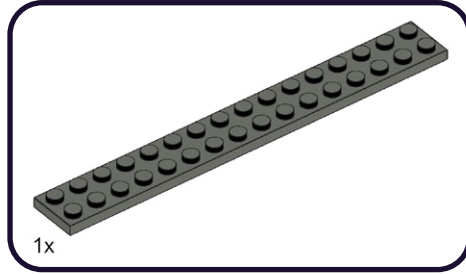

169

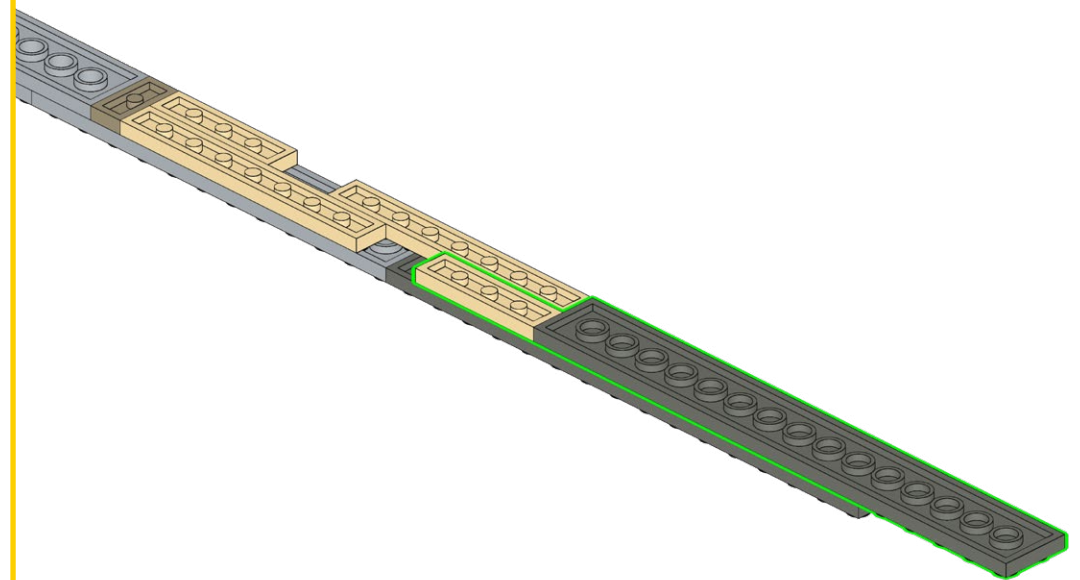
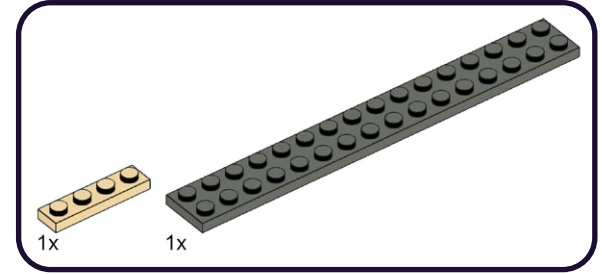

170

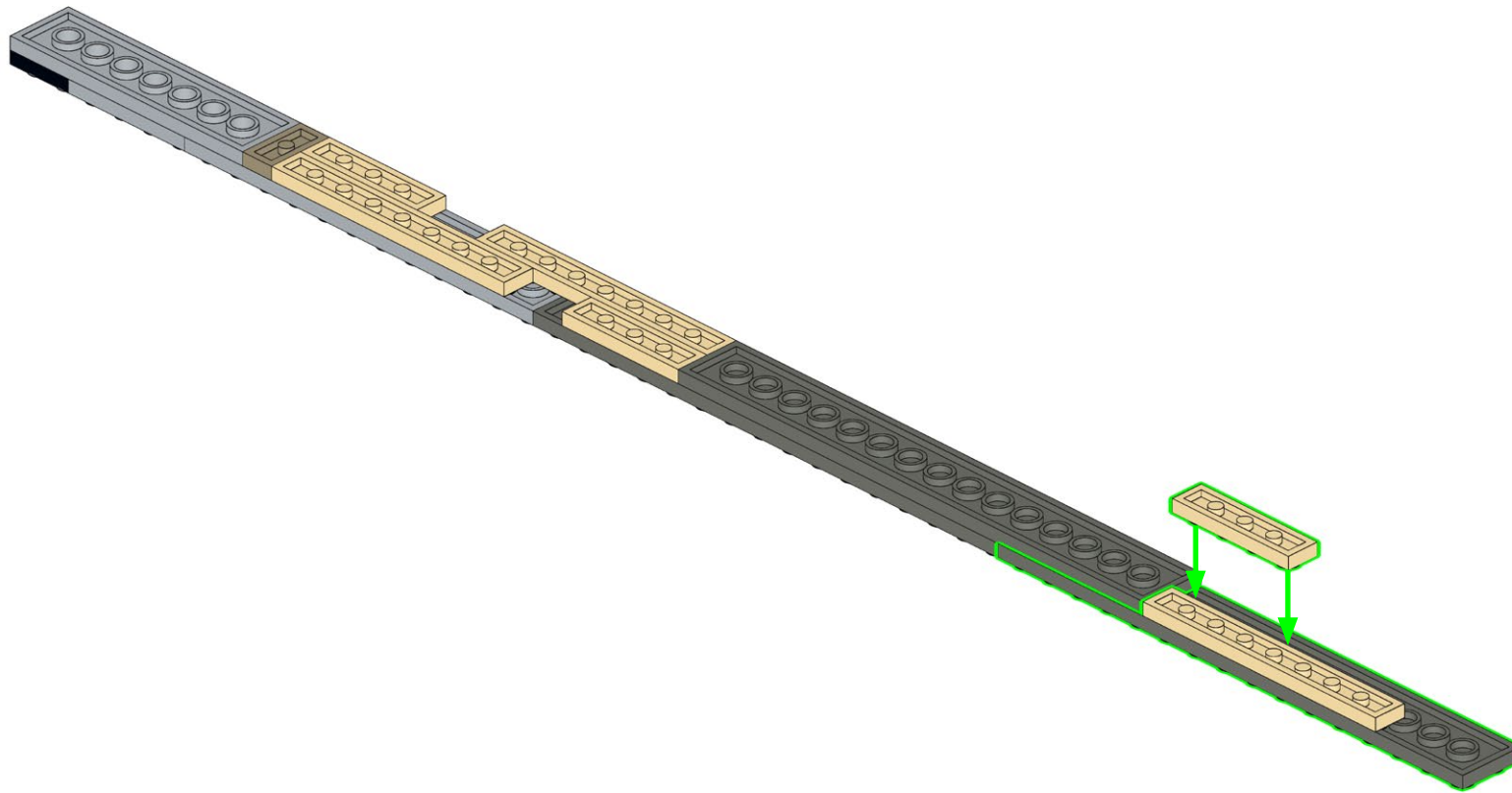
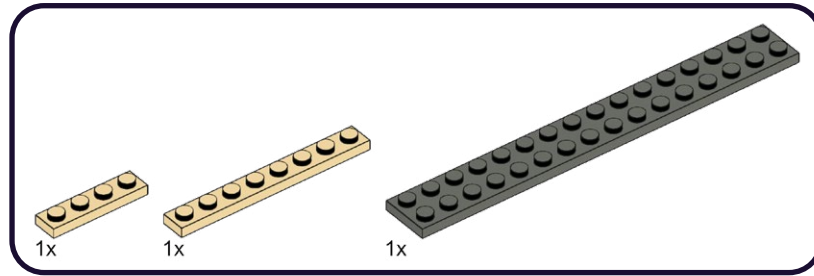

171

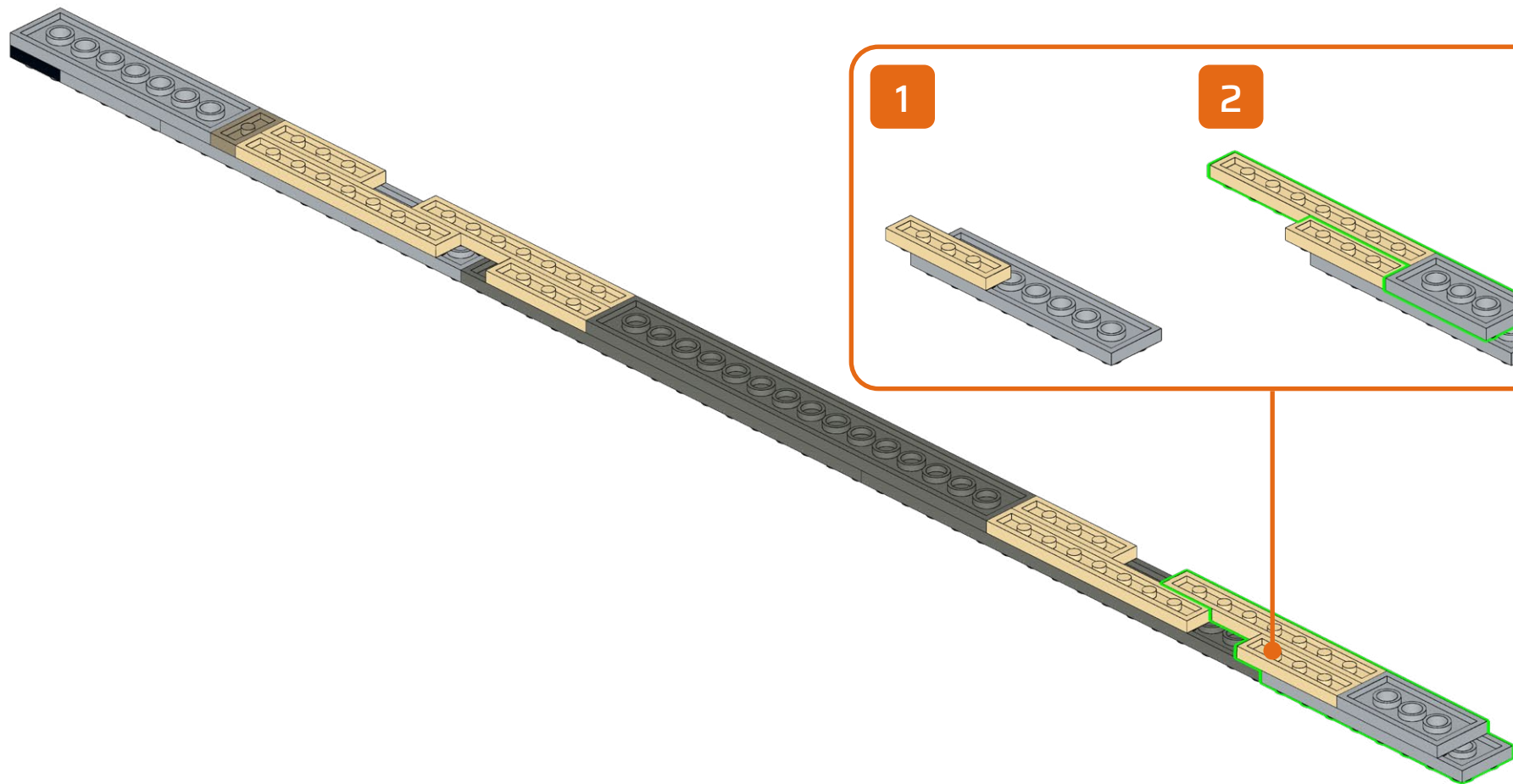
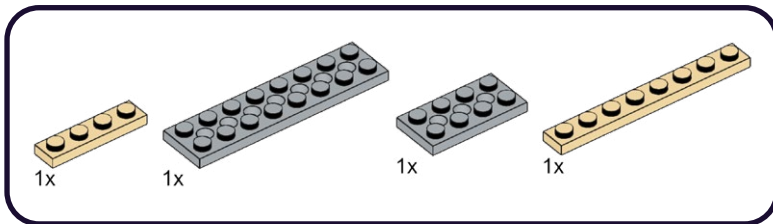

172

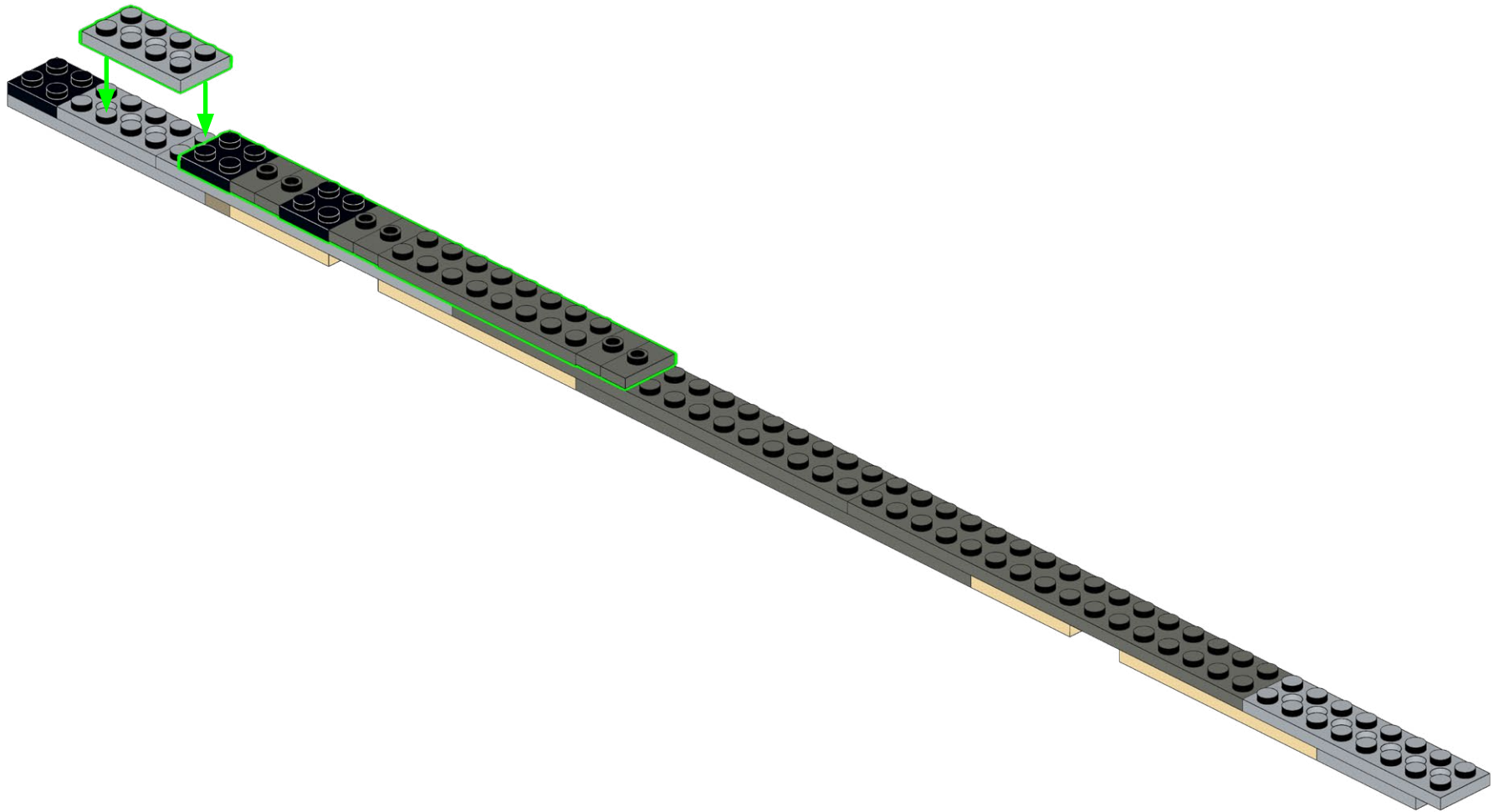
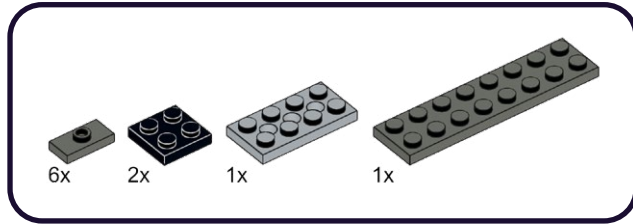

173

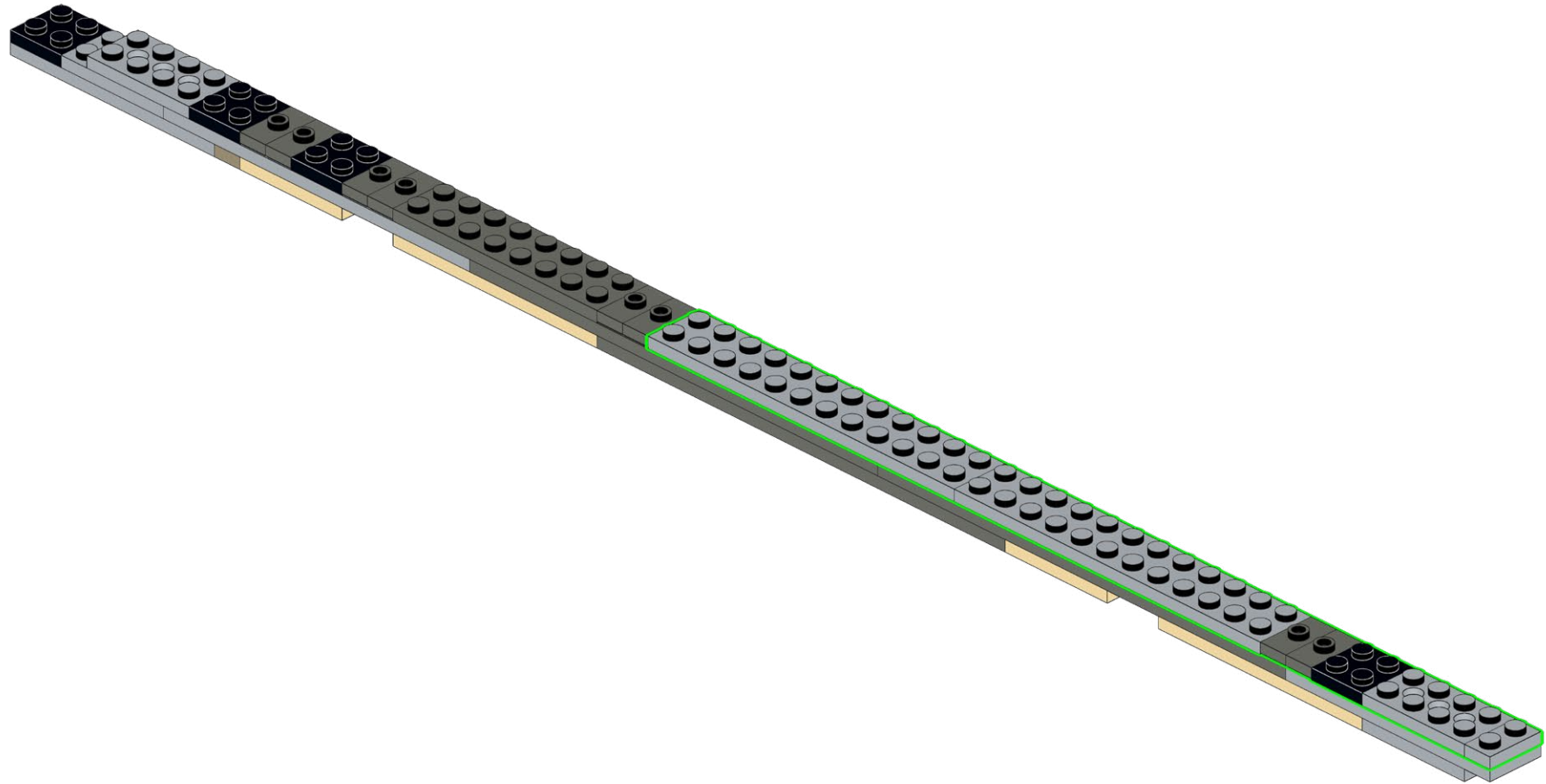
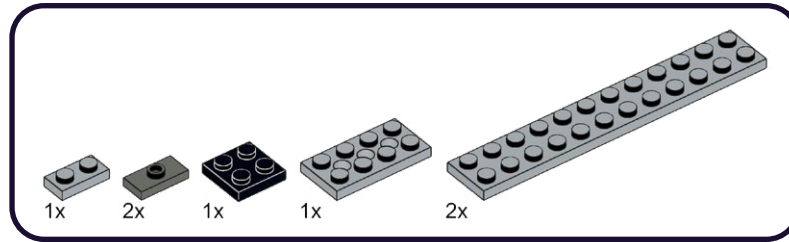

174

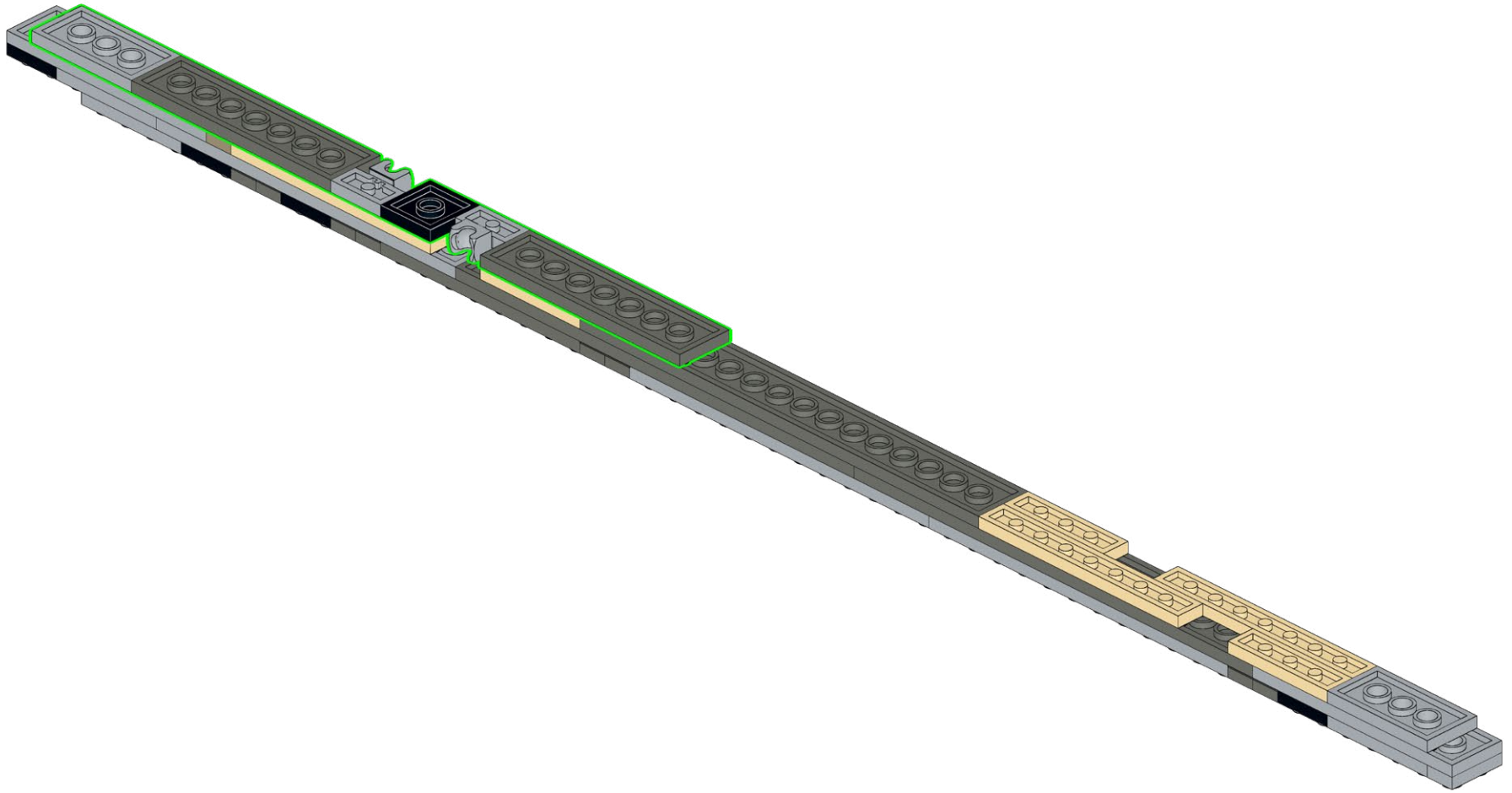
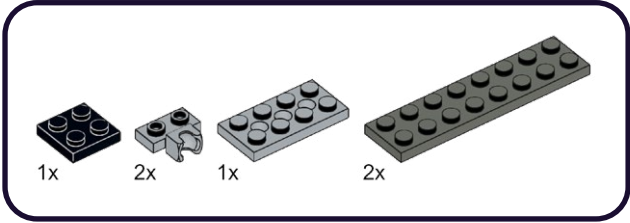

175

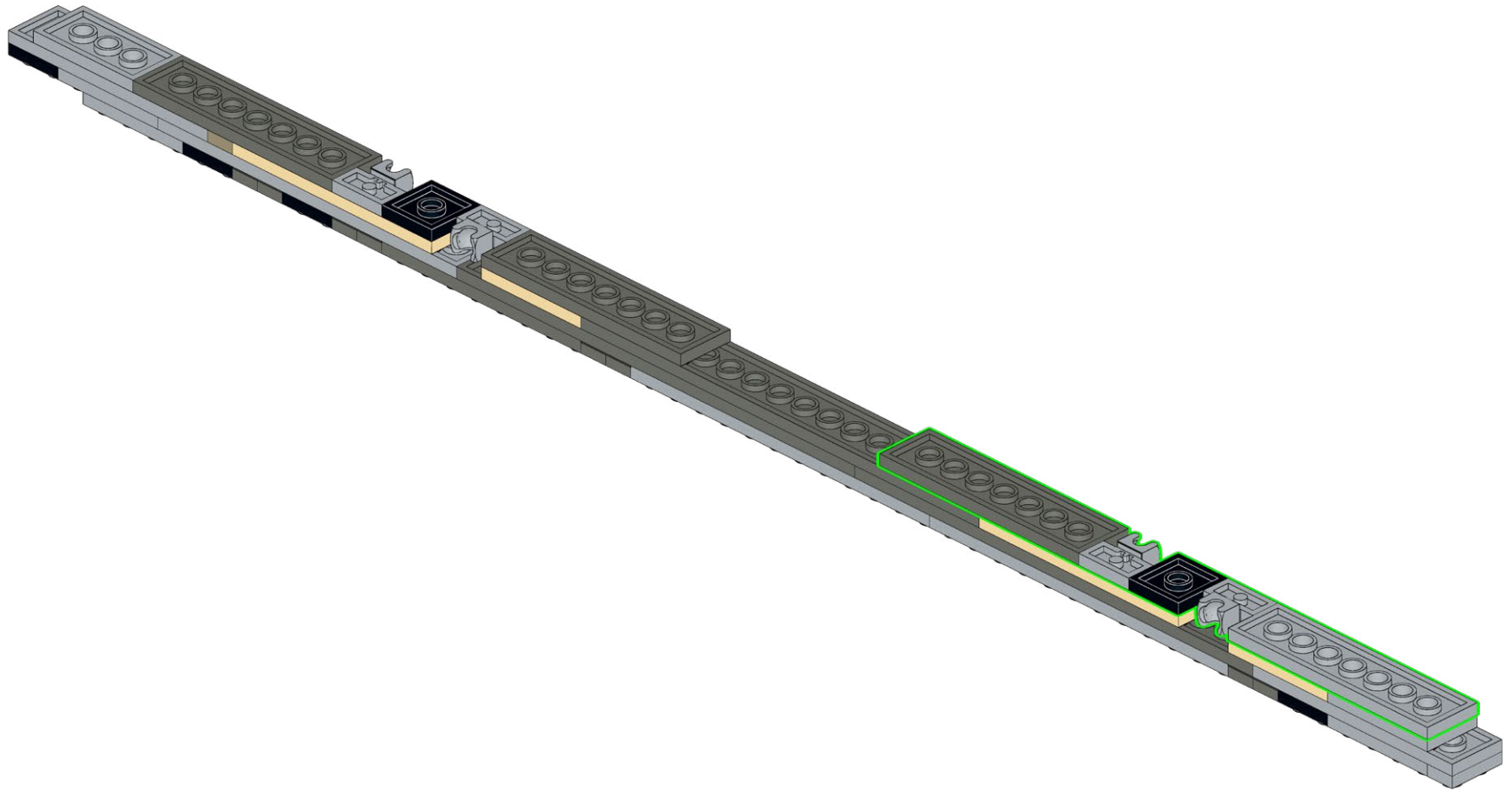
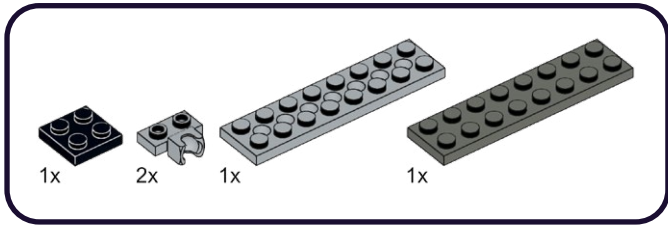

176

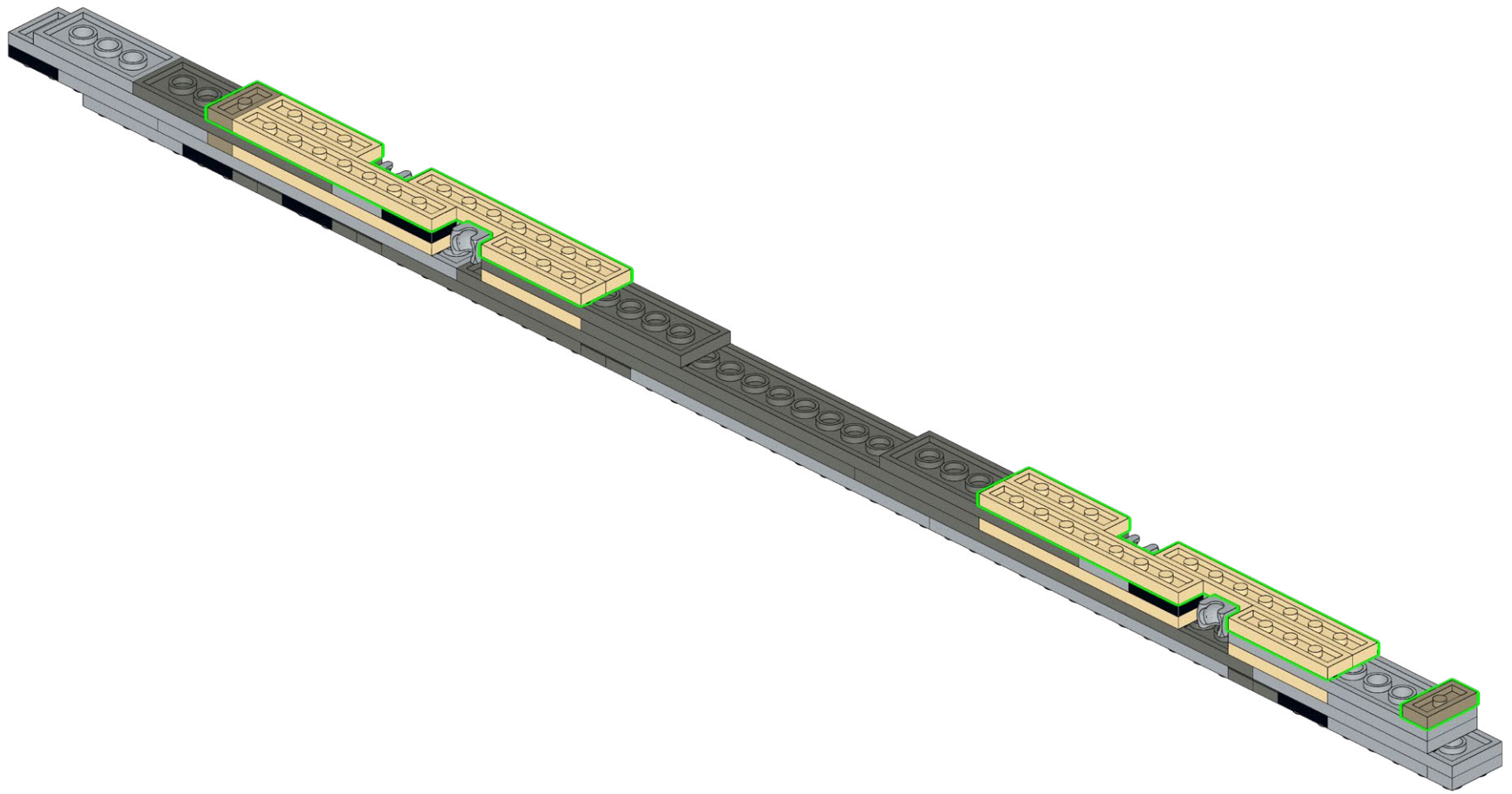
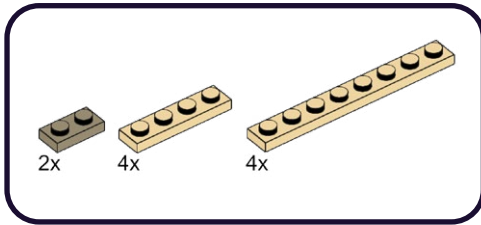

177

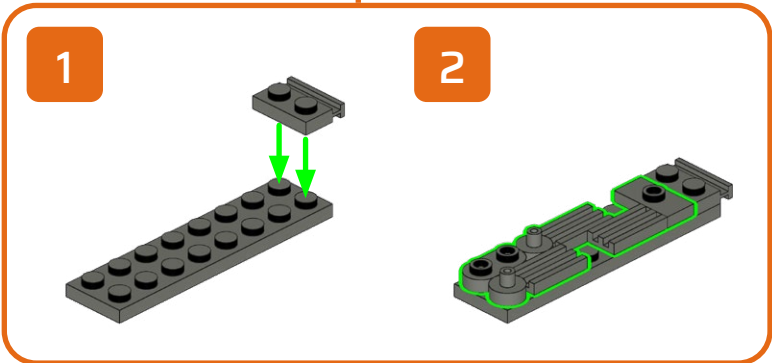
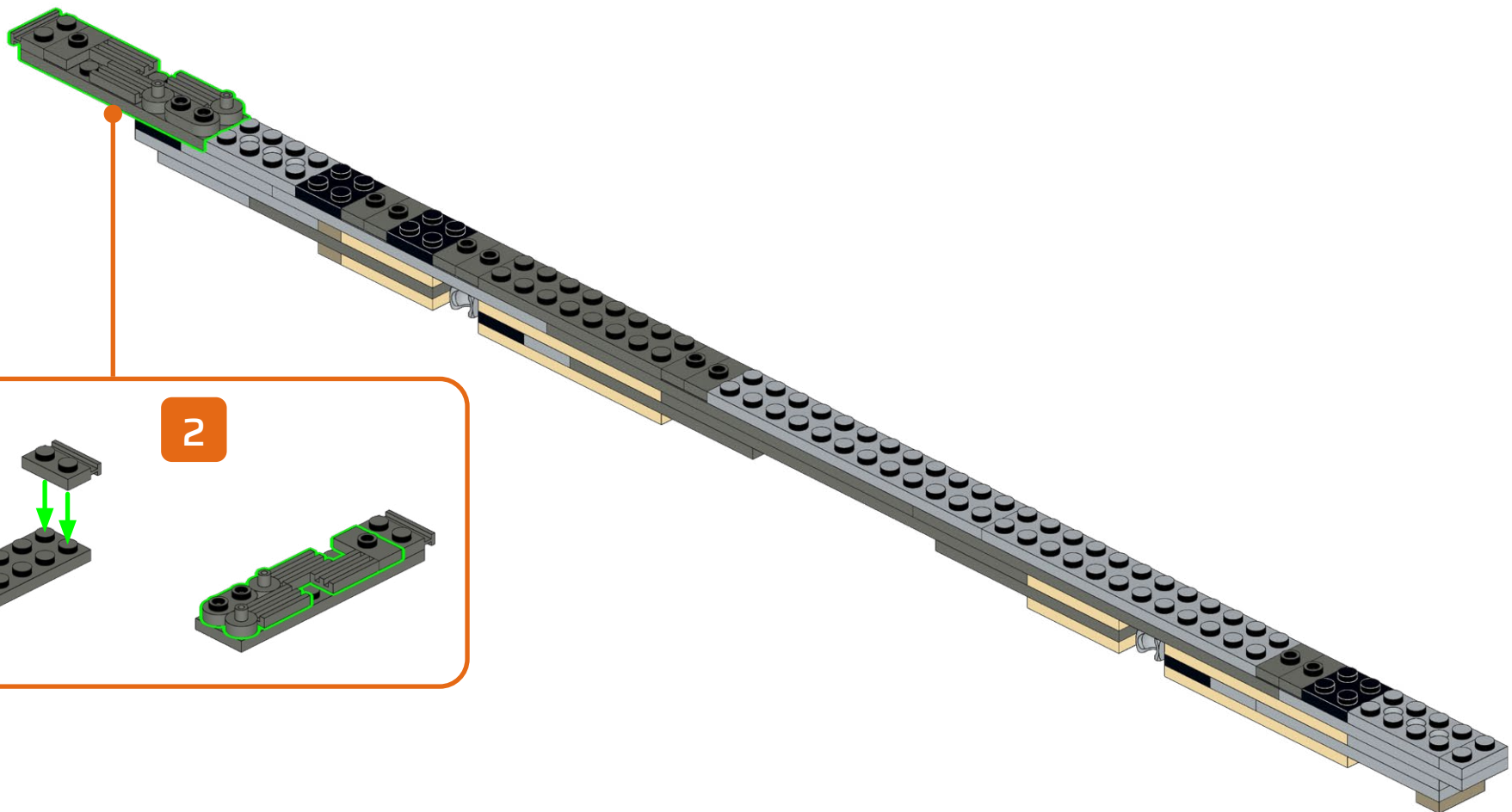
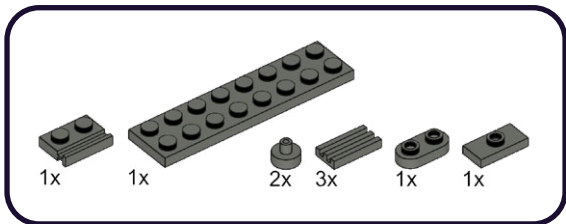

178

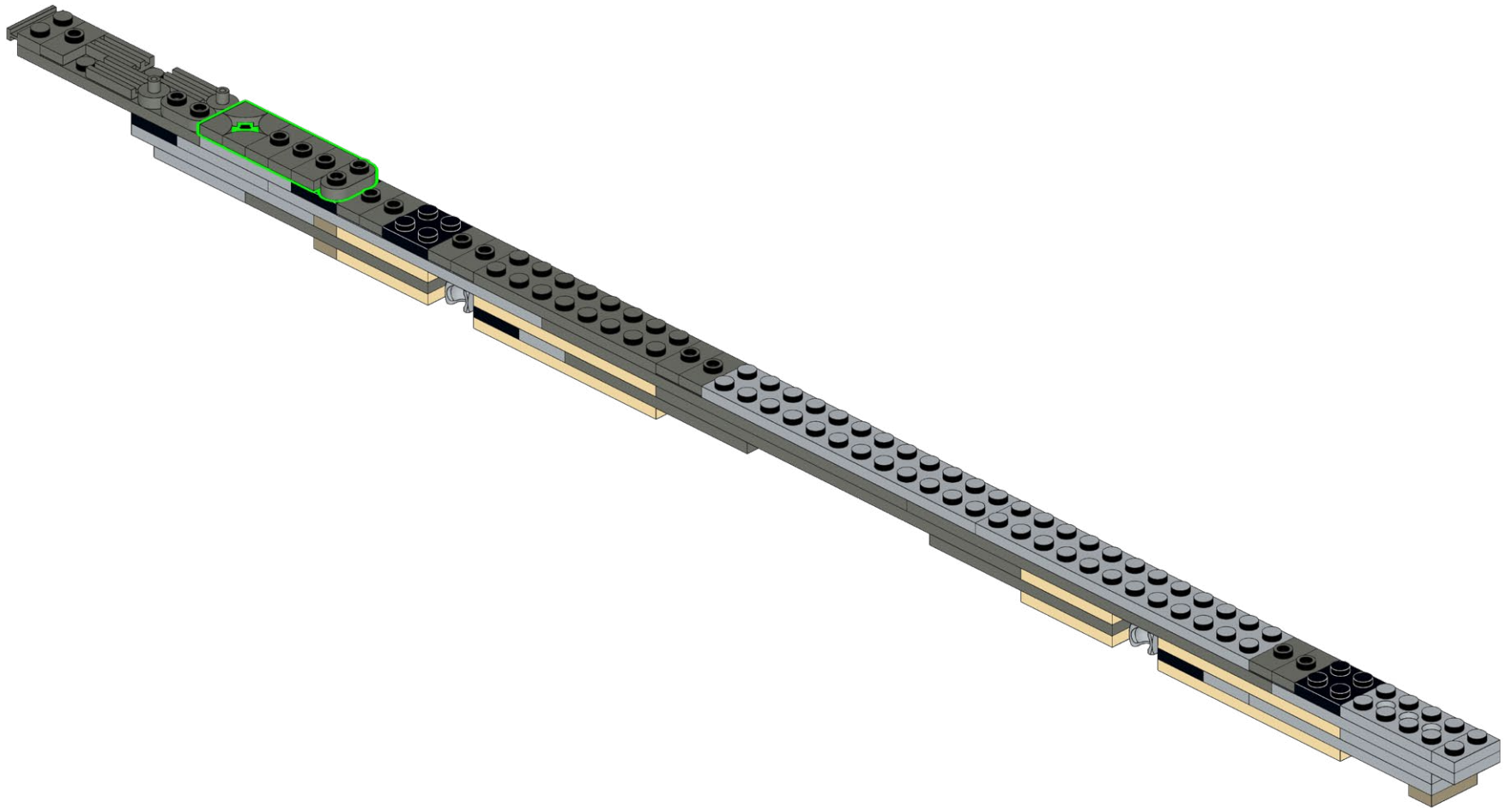
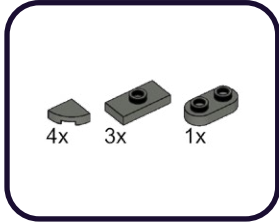

179

AR-CW30

1x

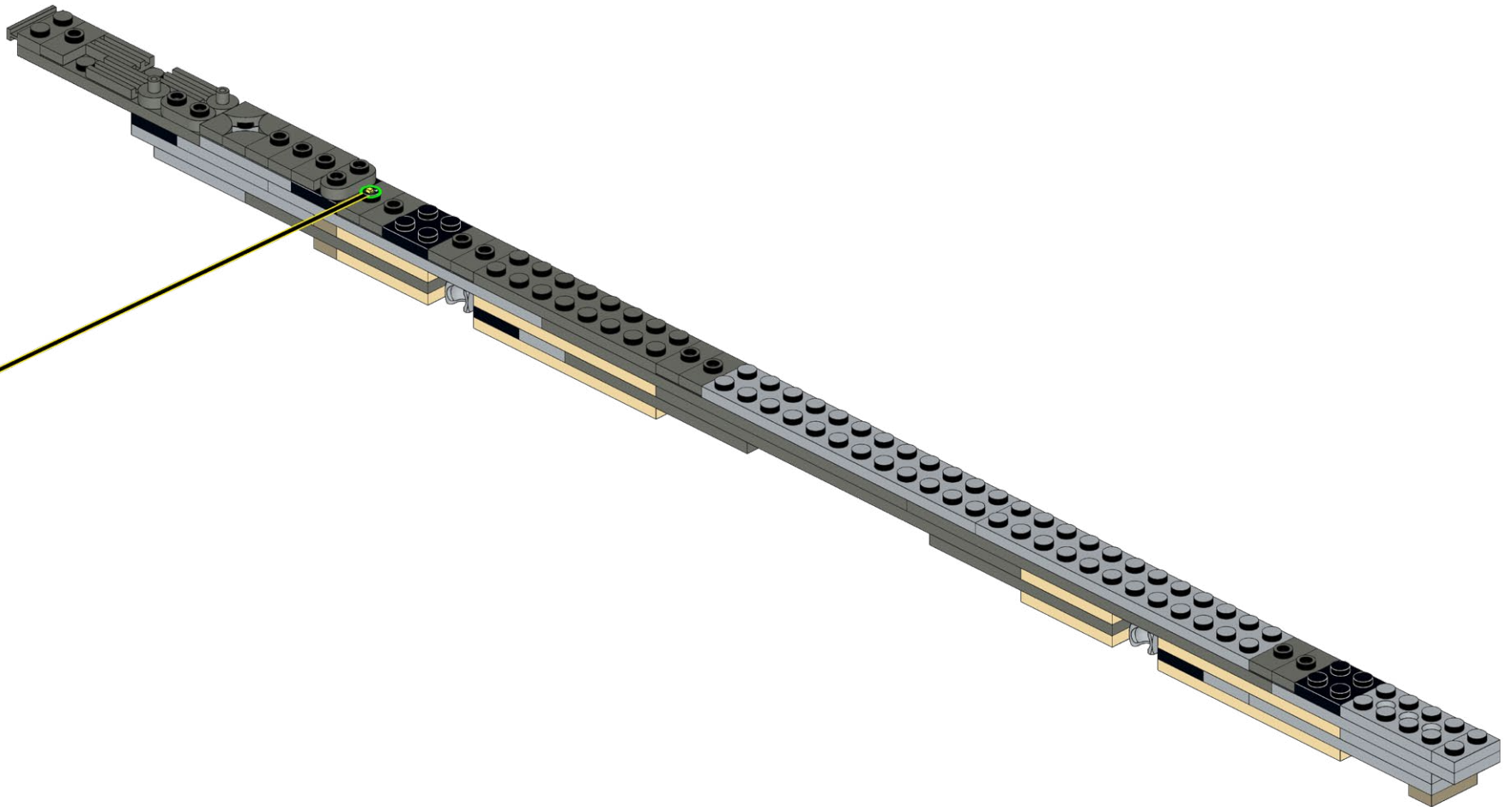
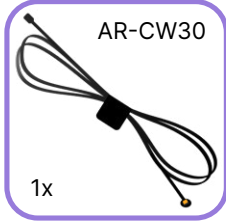

180

1x

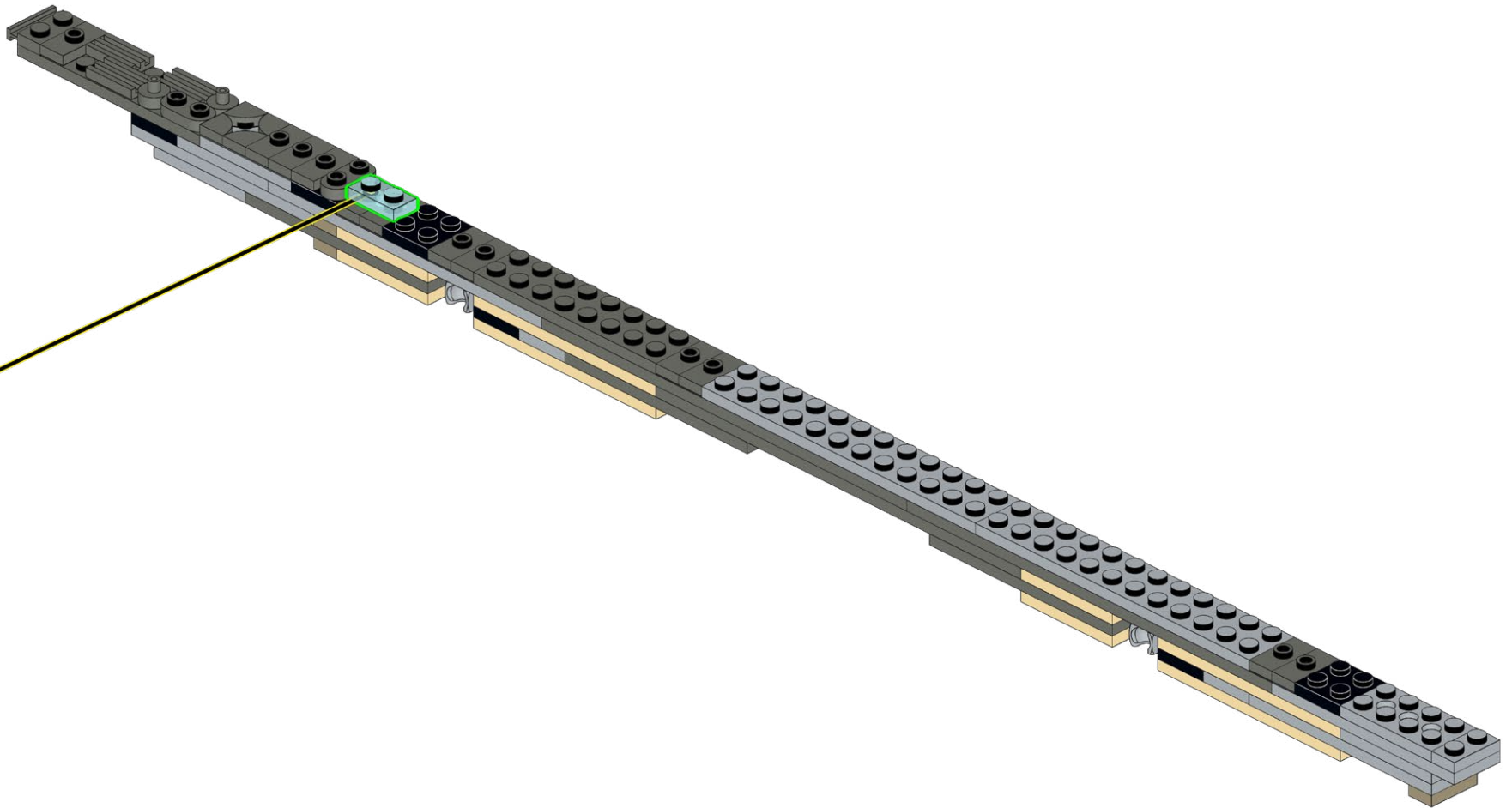

181

AR-CW30

1x

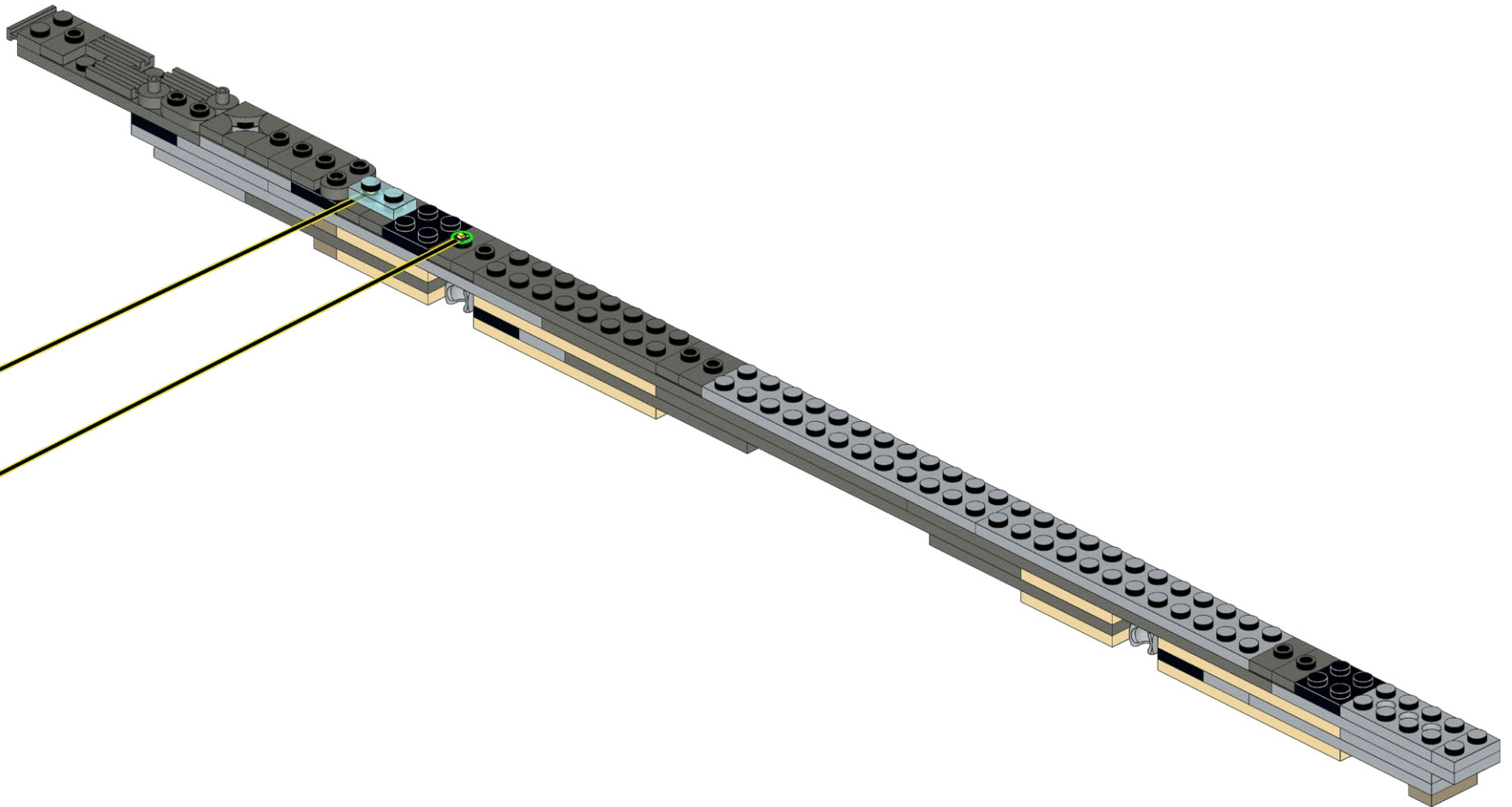
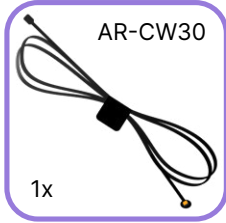

182

1x

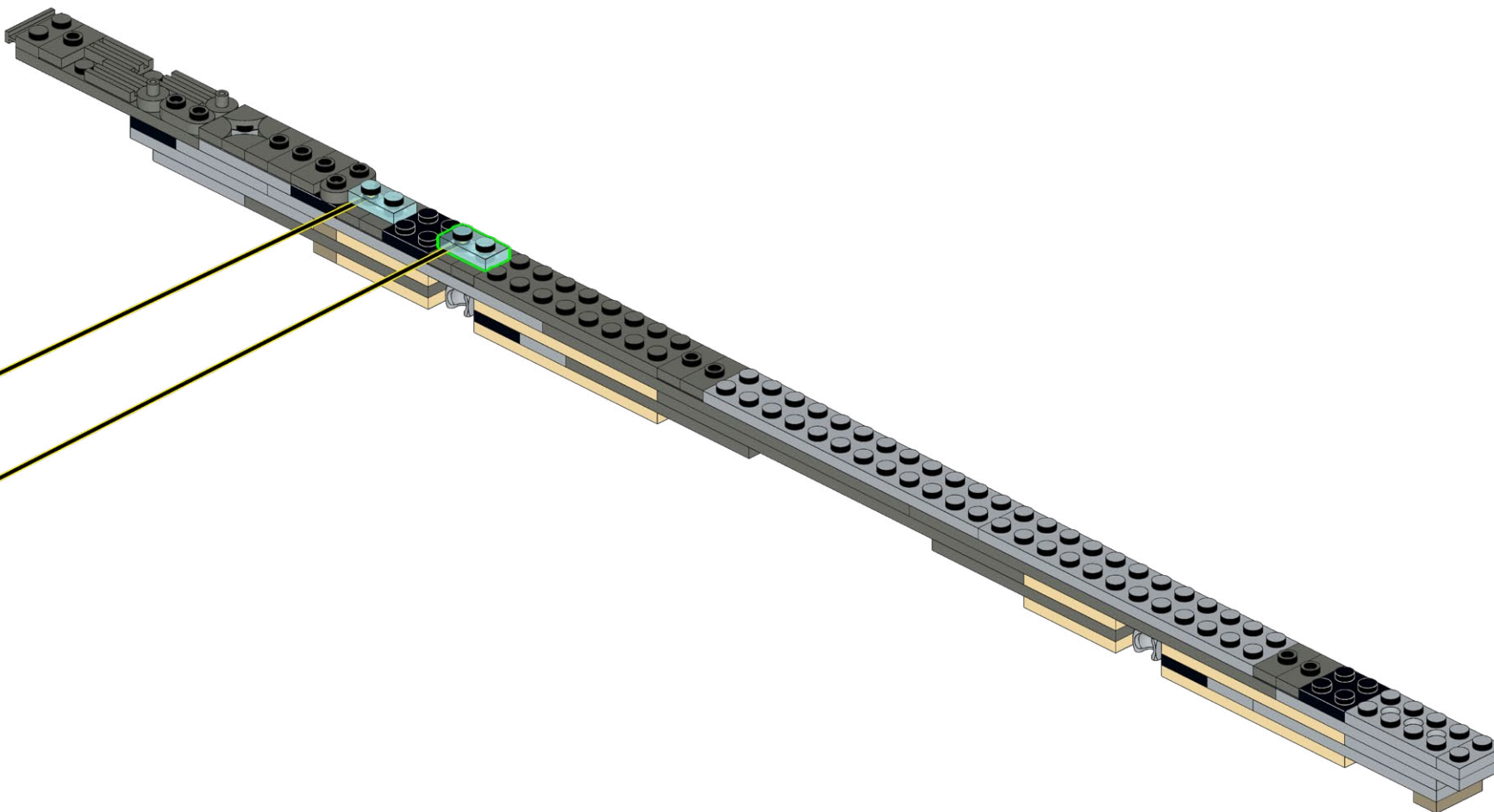

183

- 1x
- 2x
- 1x
- 2x
- 1x

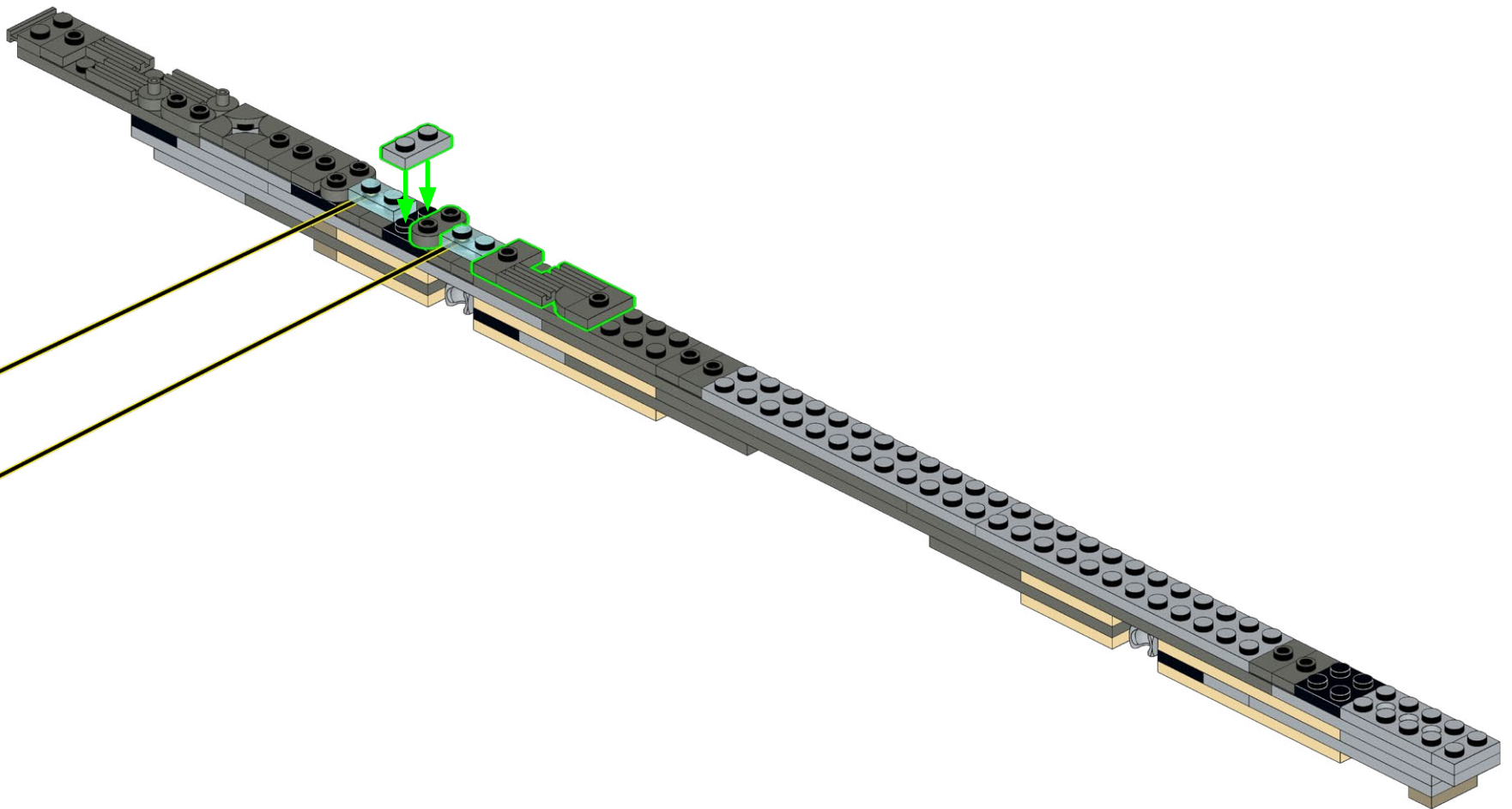

184

- 1x
- 2x
- 2x
- 1x
- 1x

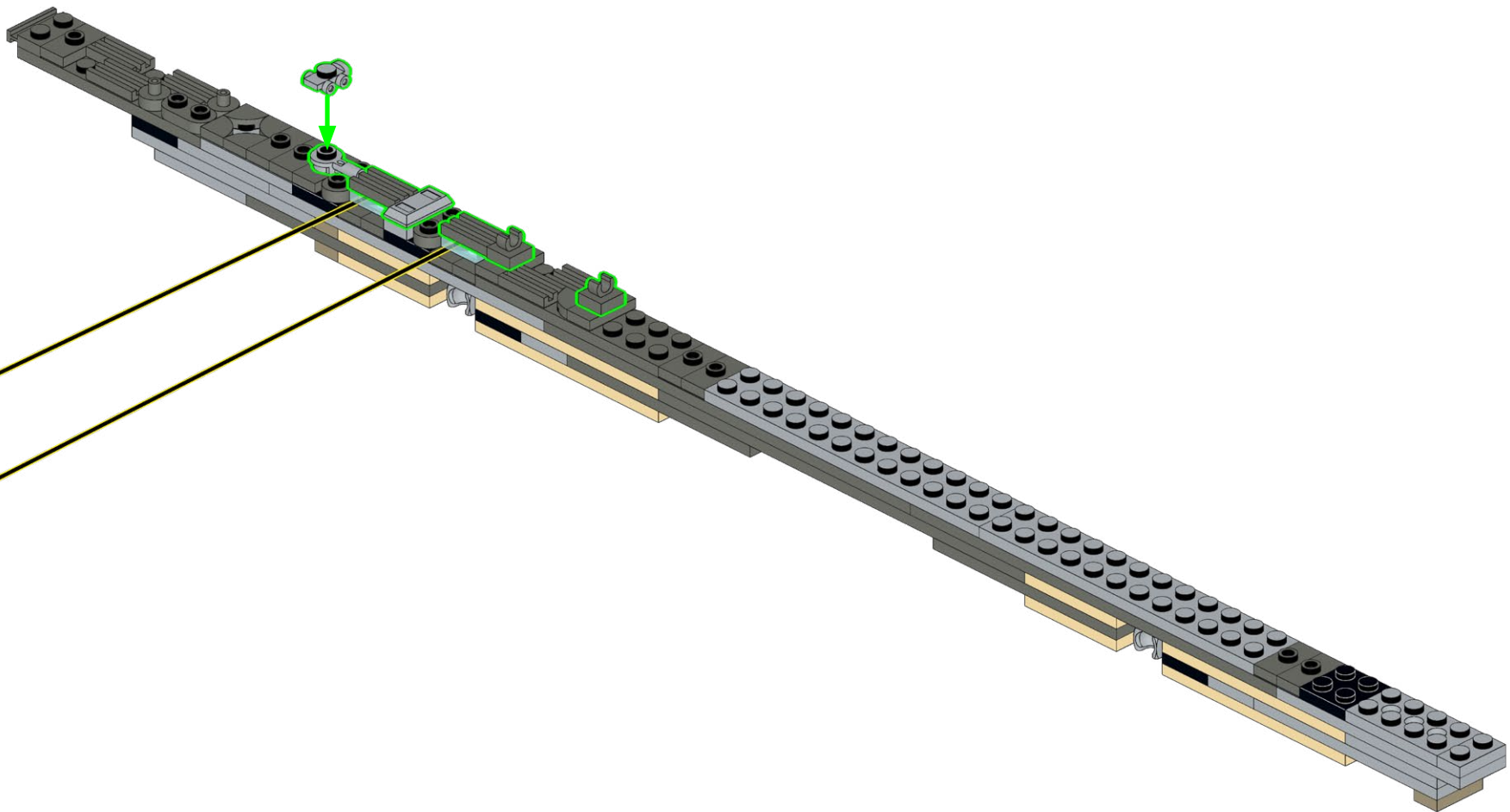

185

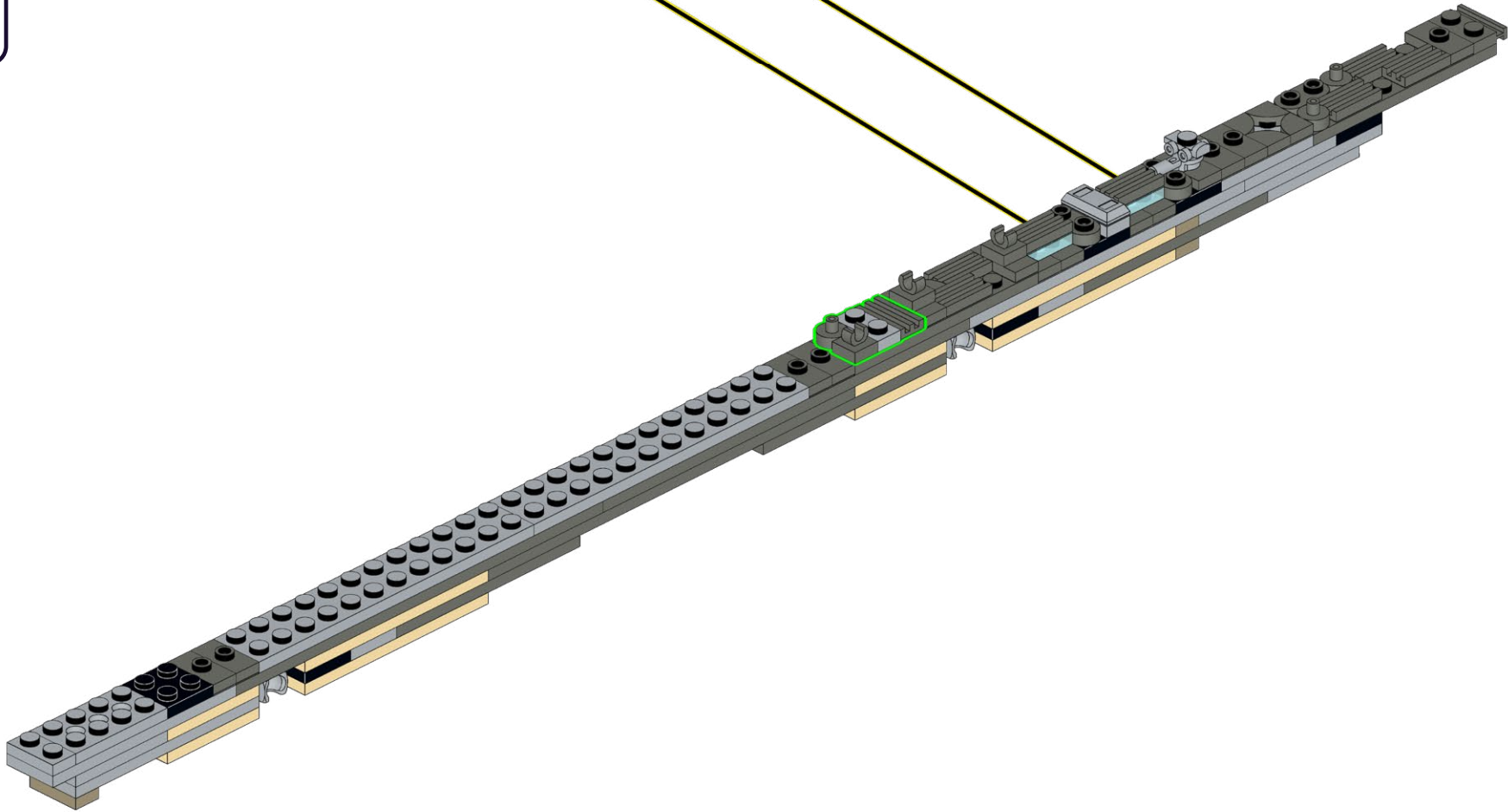
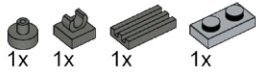

186

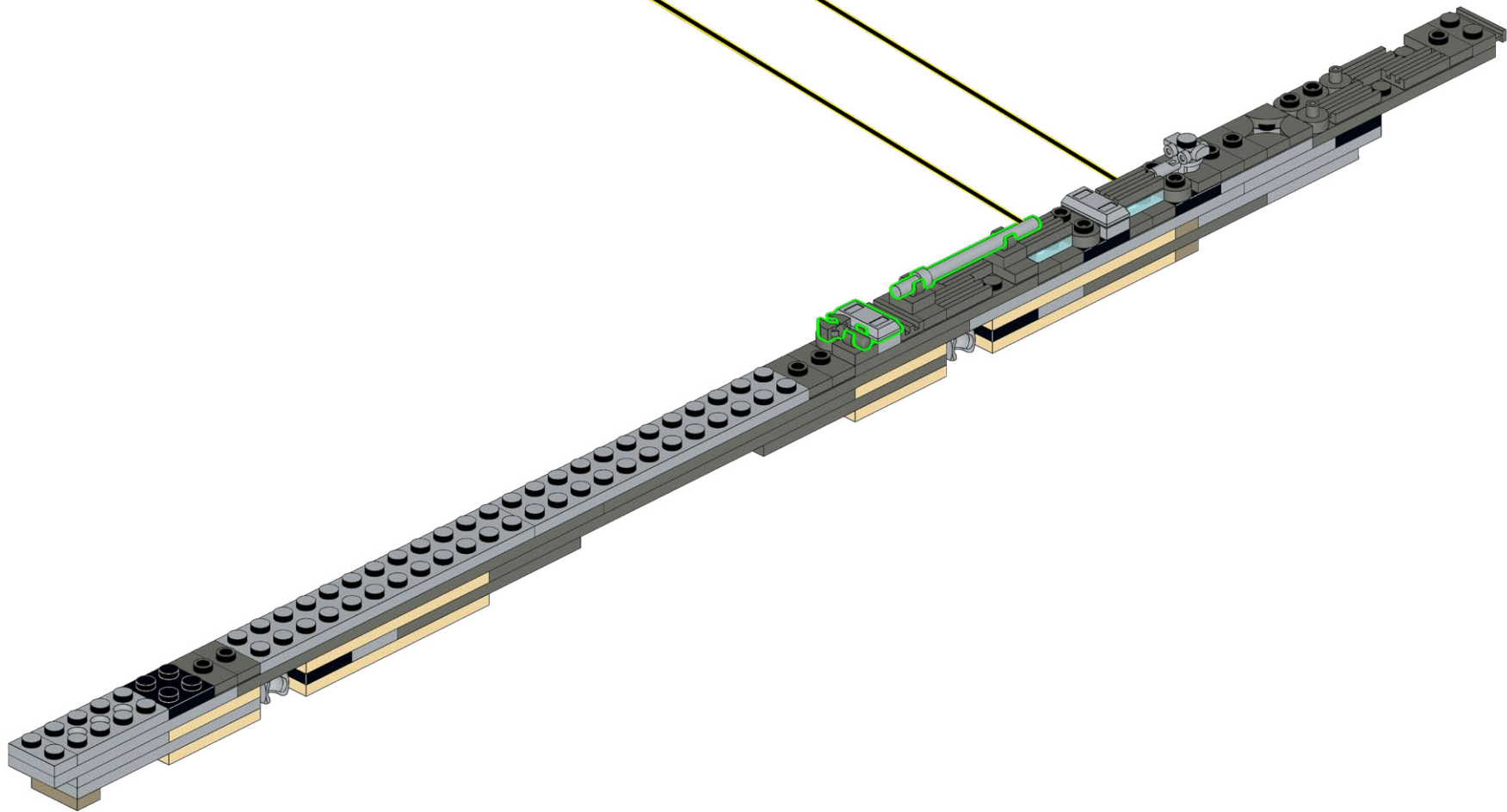
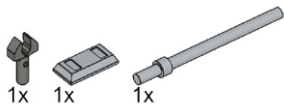

187

AR-CW30

1x

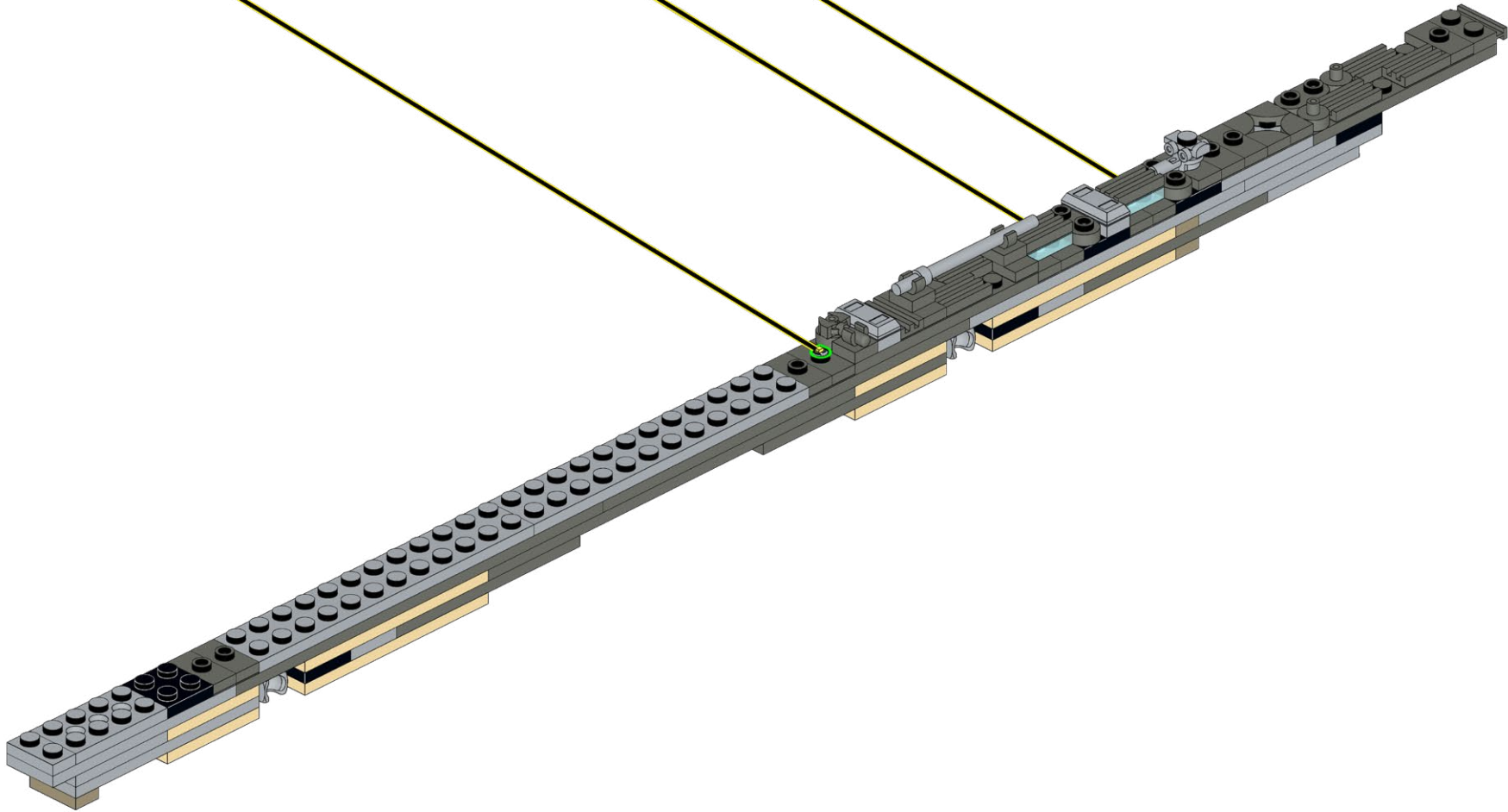

188



1x

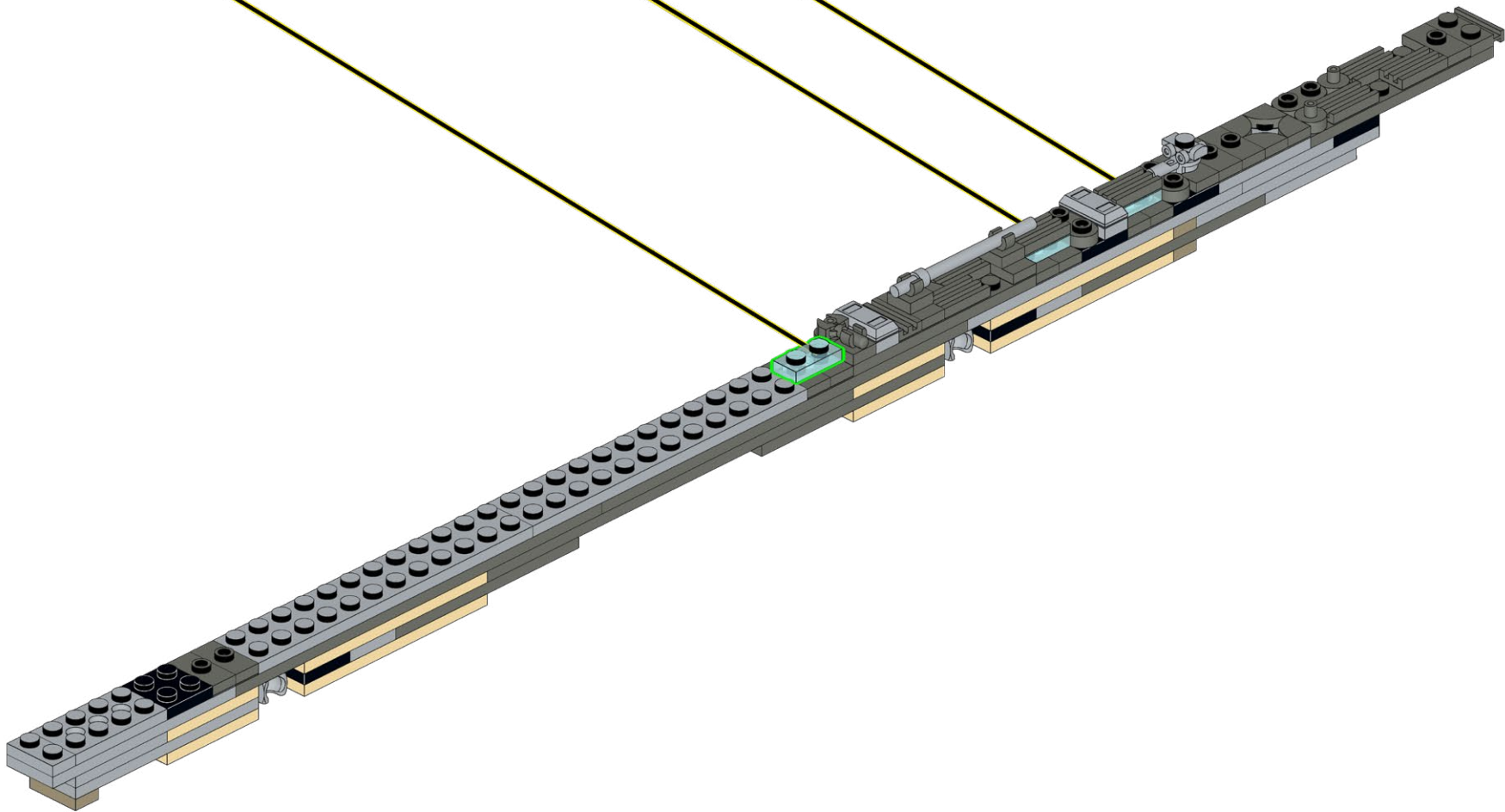

189

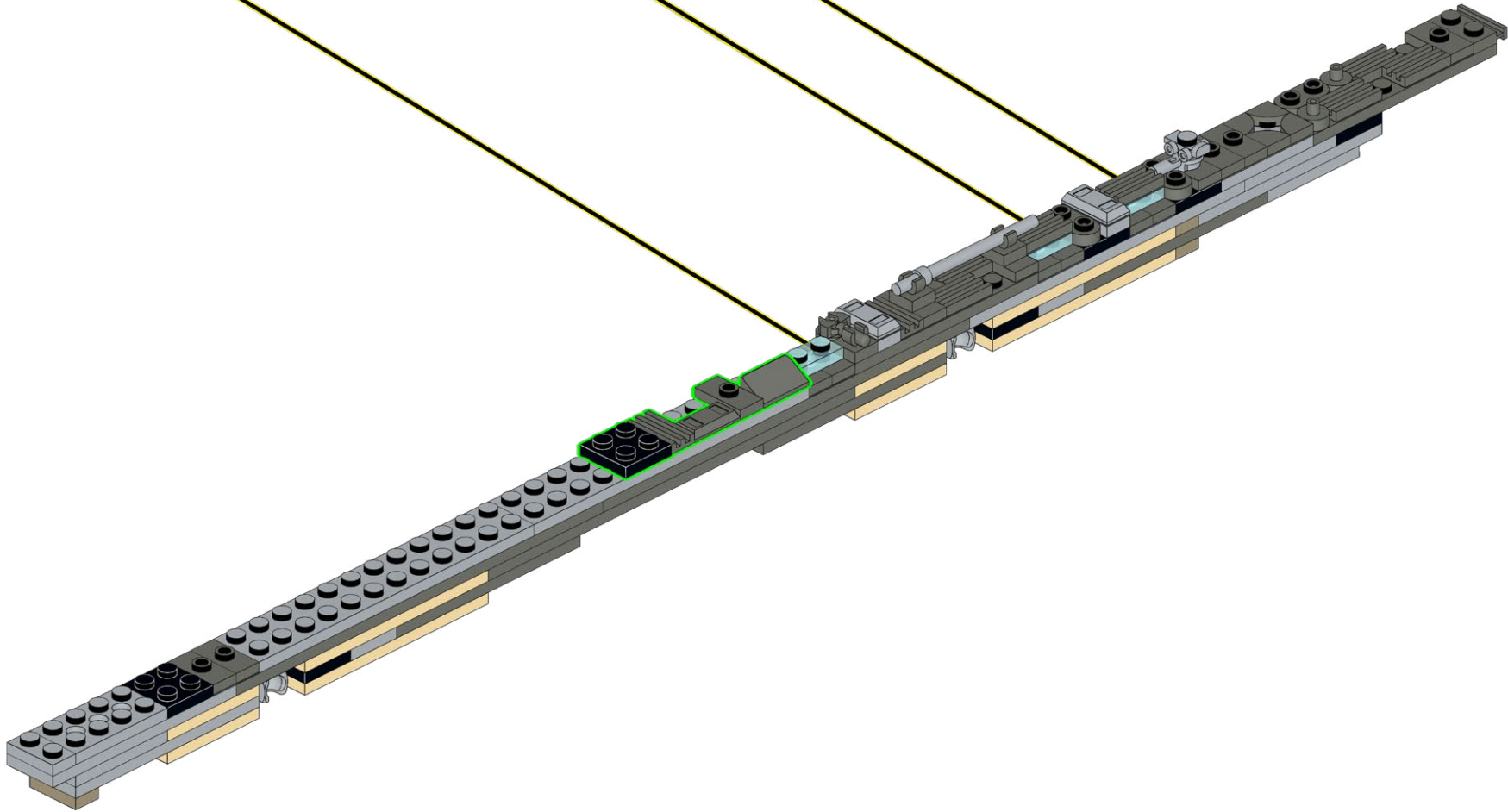
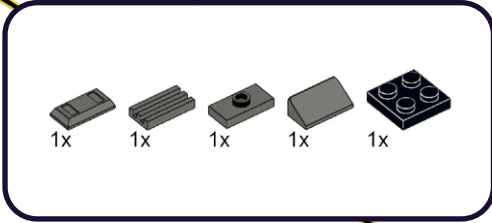

190

- 1x
- 1x
- 1x
- 1x
- 6x
- 1x
- 1x
- 1x

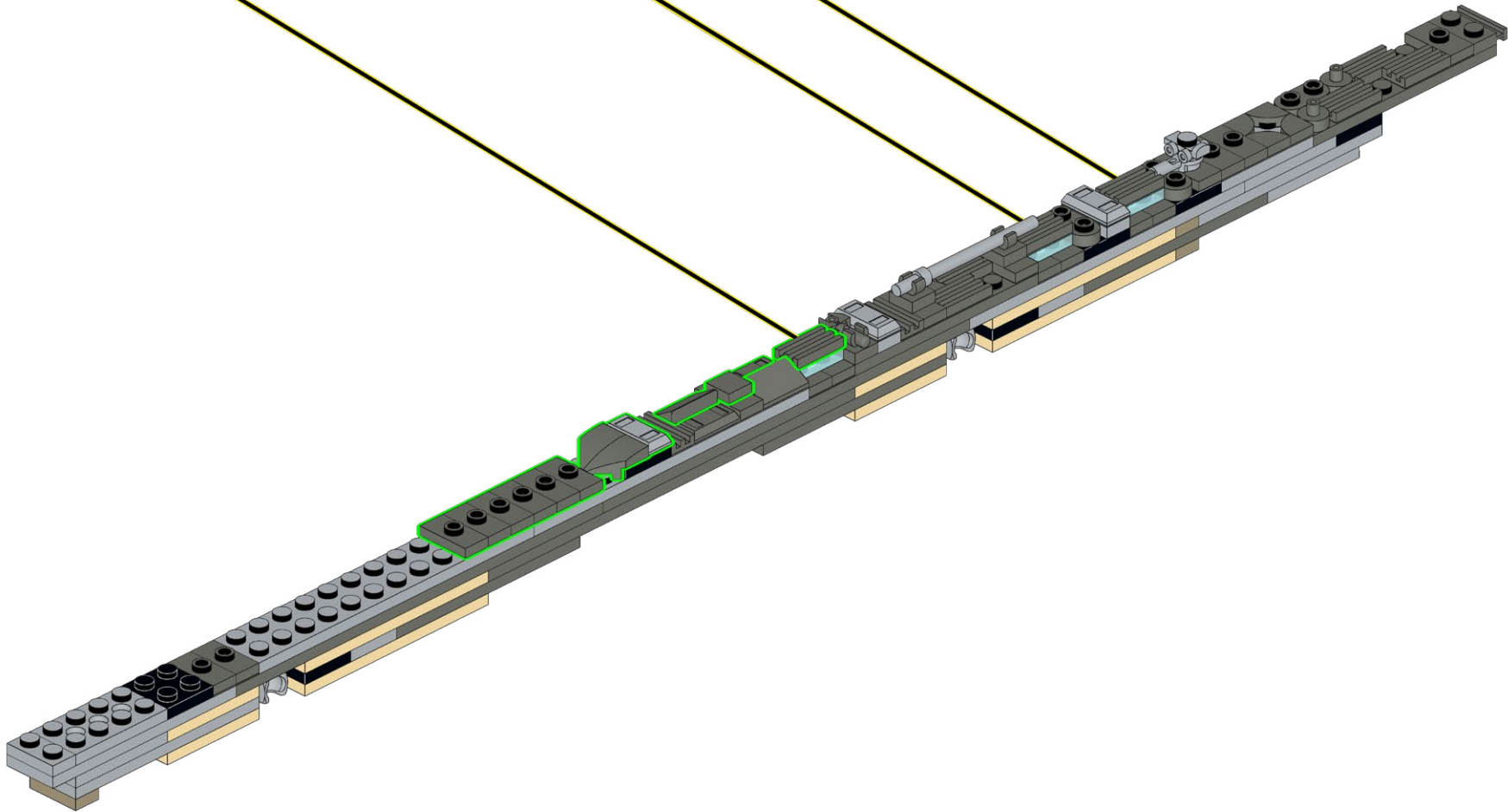

191

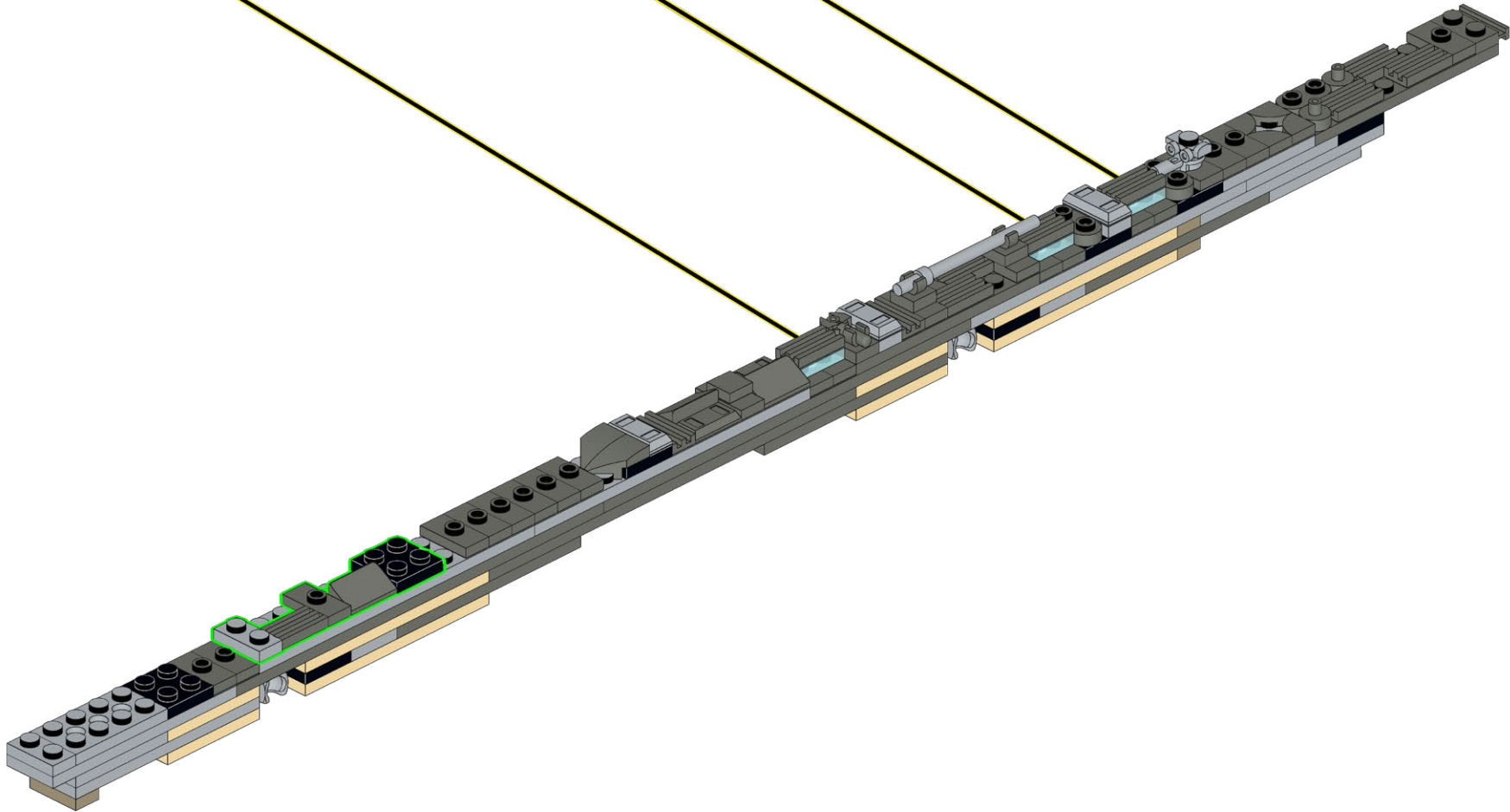
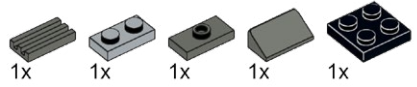

192

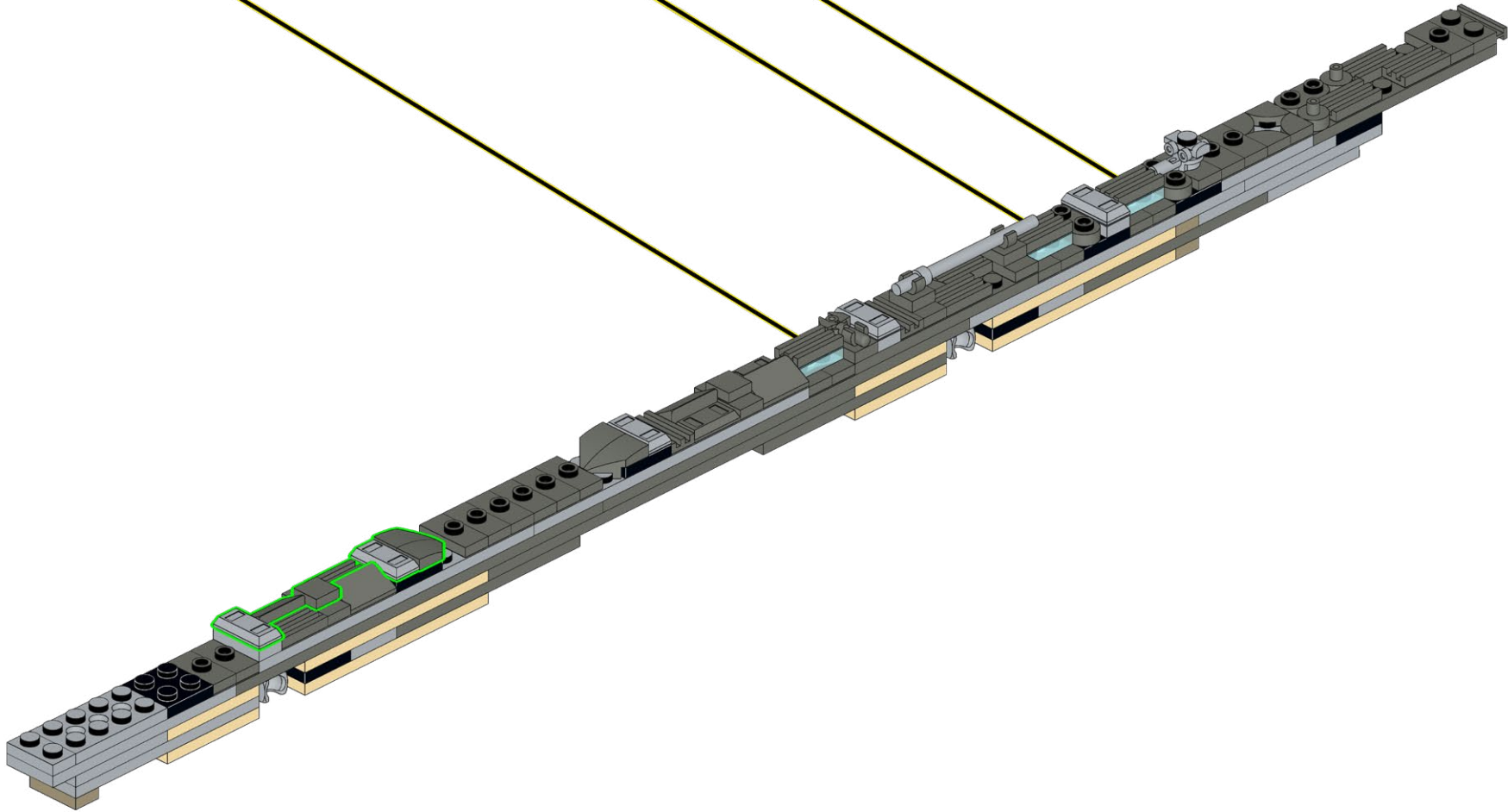
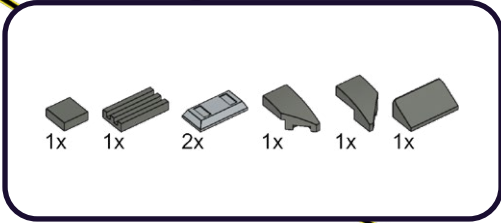

193

AR-CW30

1x

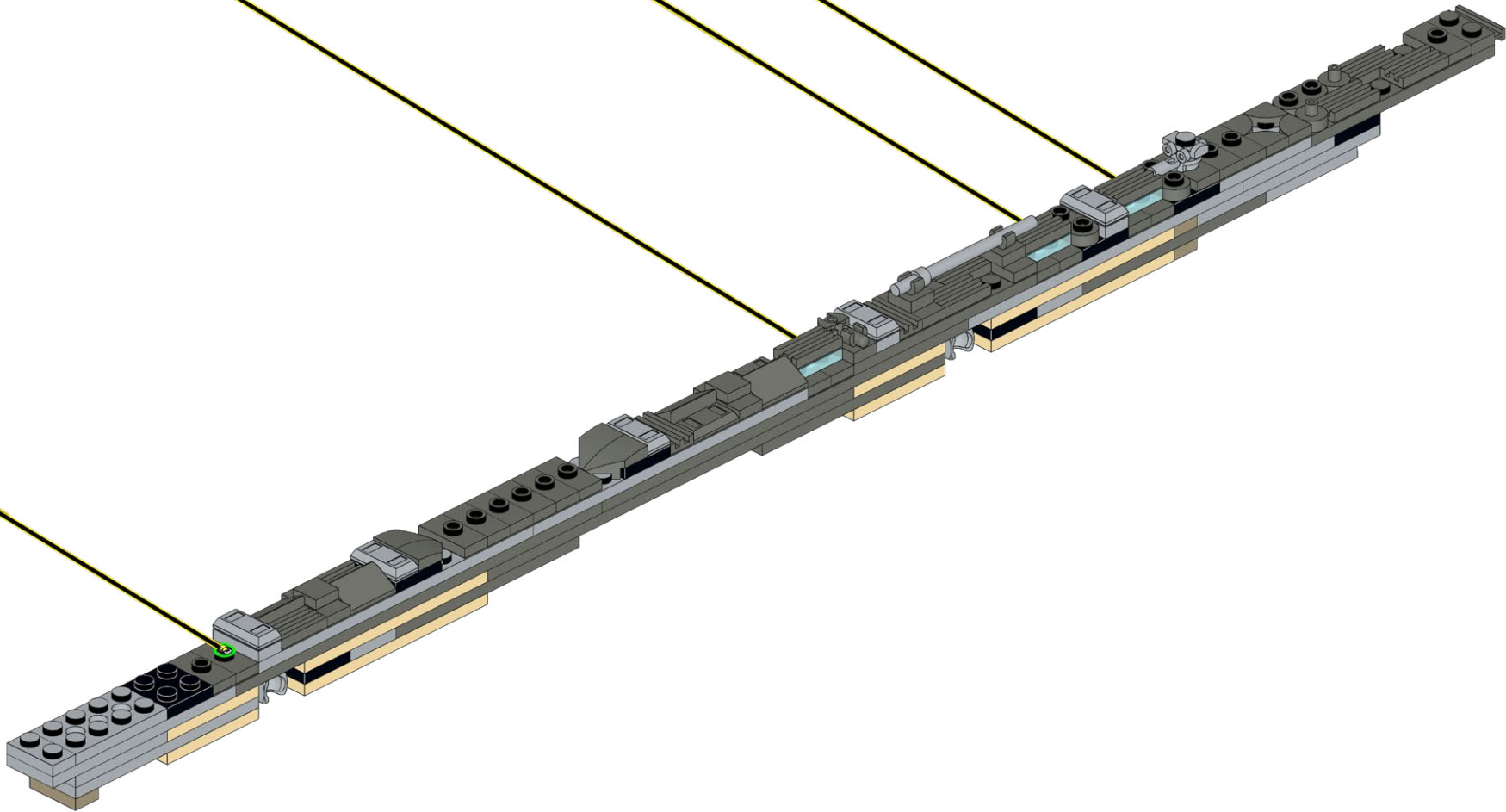
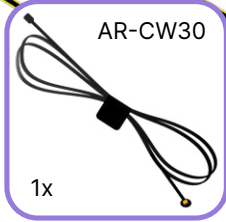

194

1x

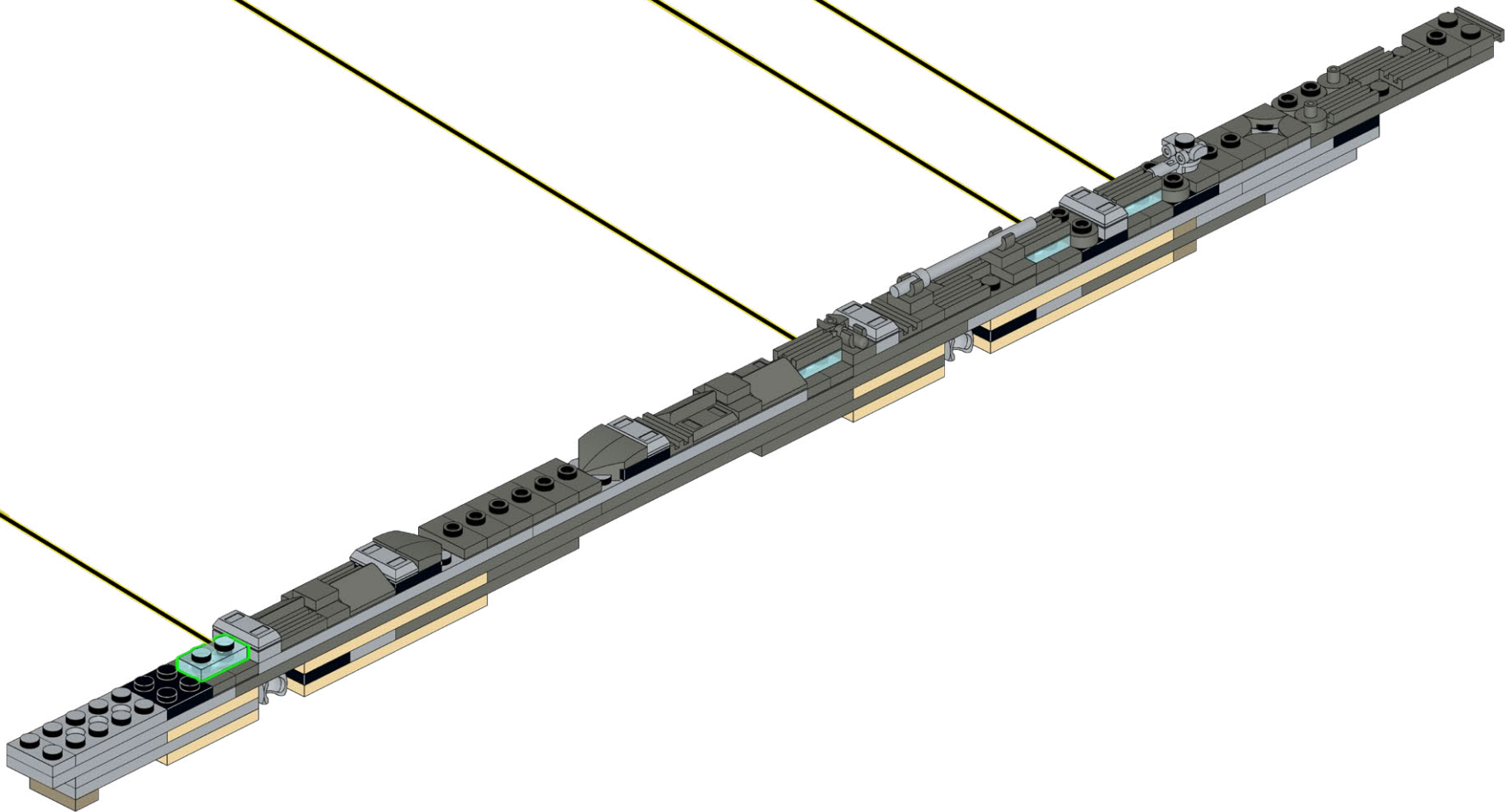

195

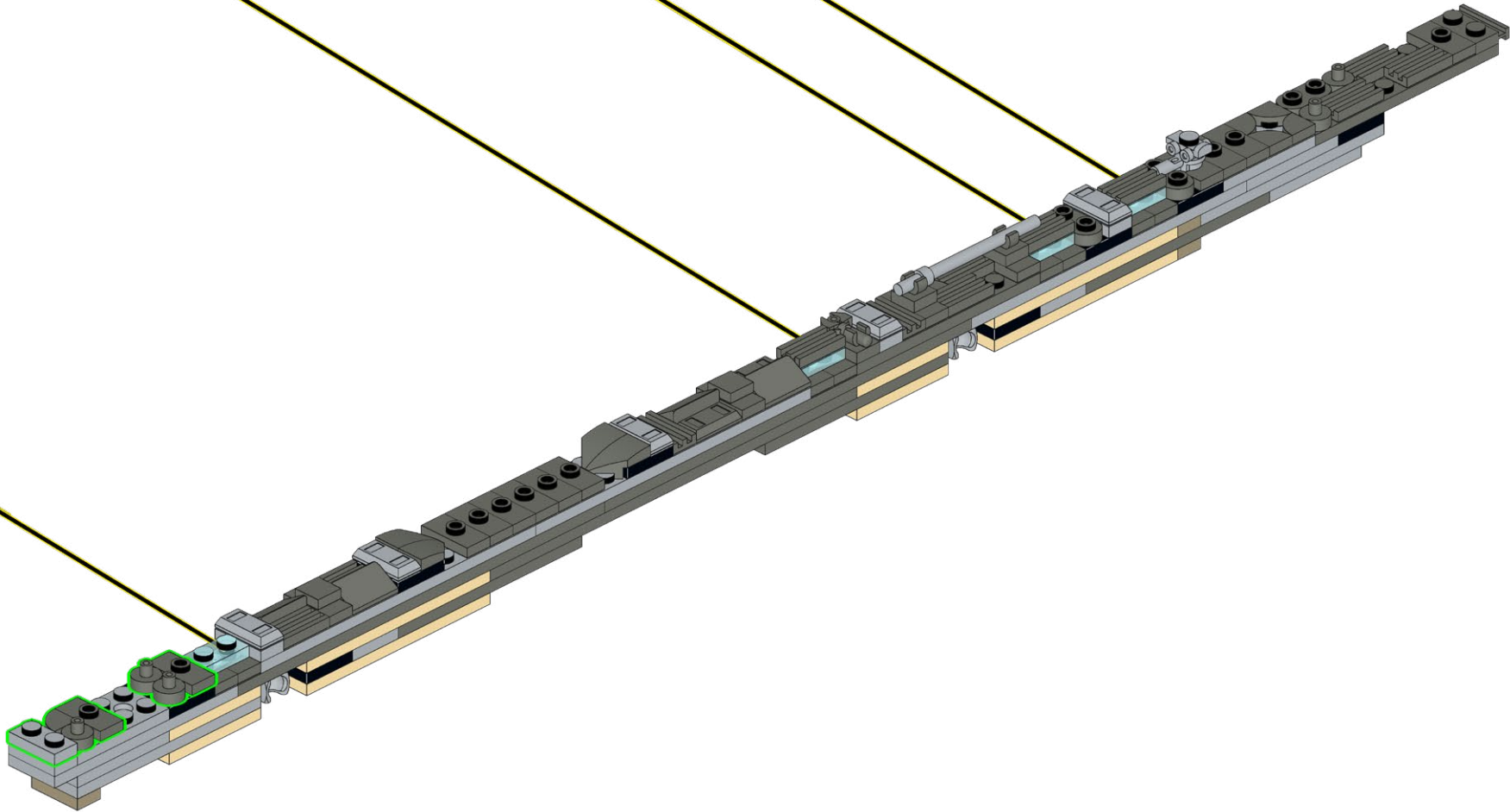
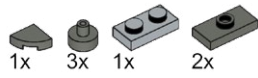

196

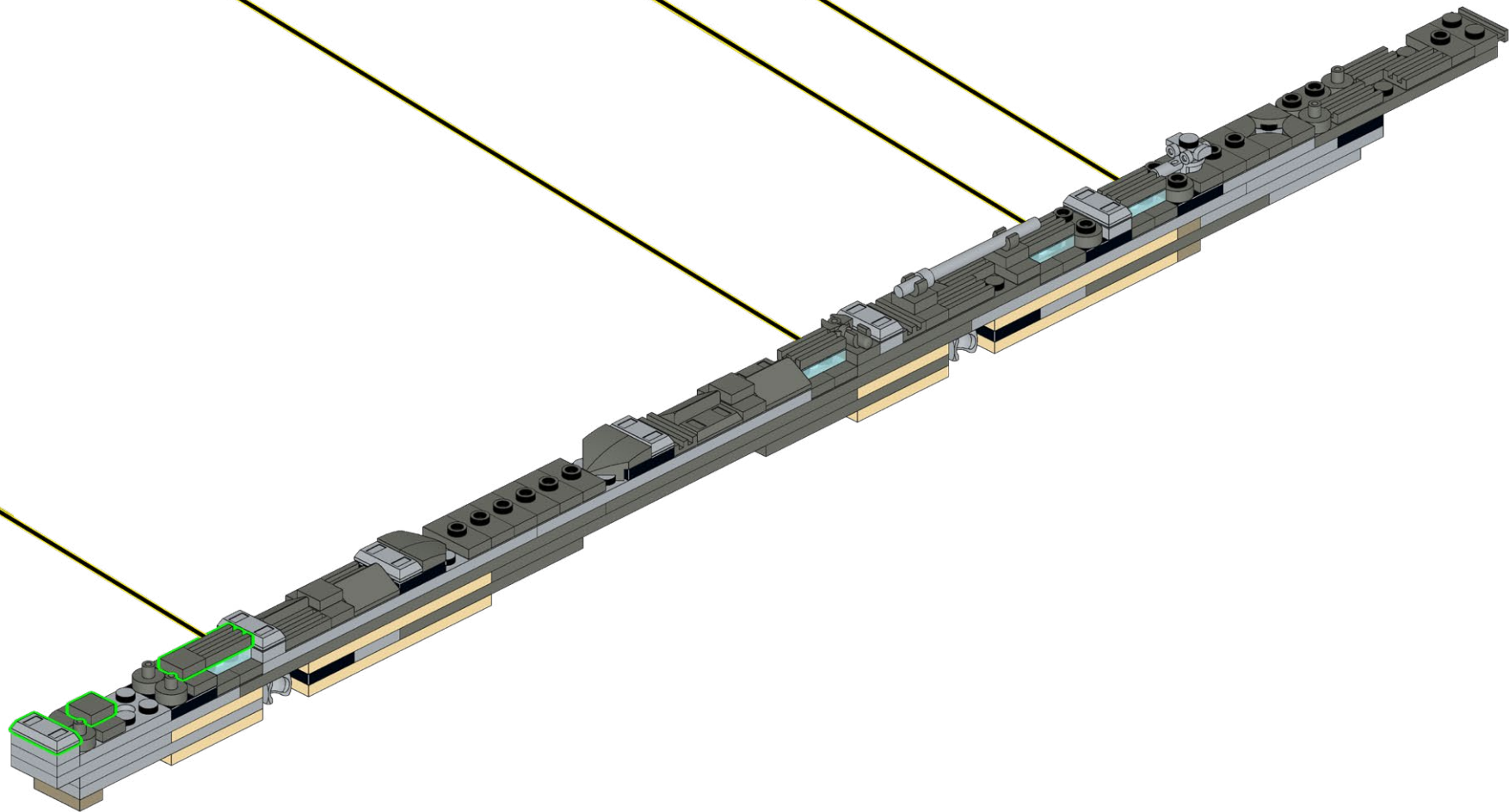
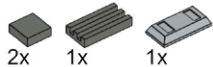

197

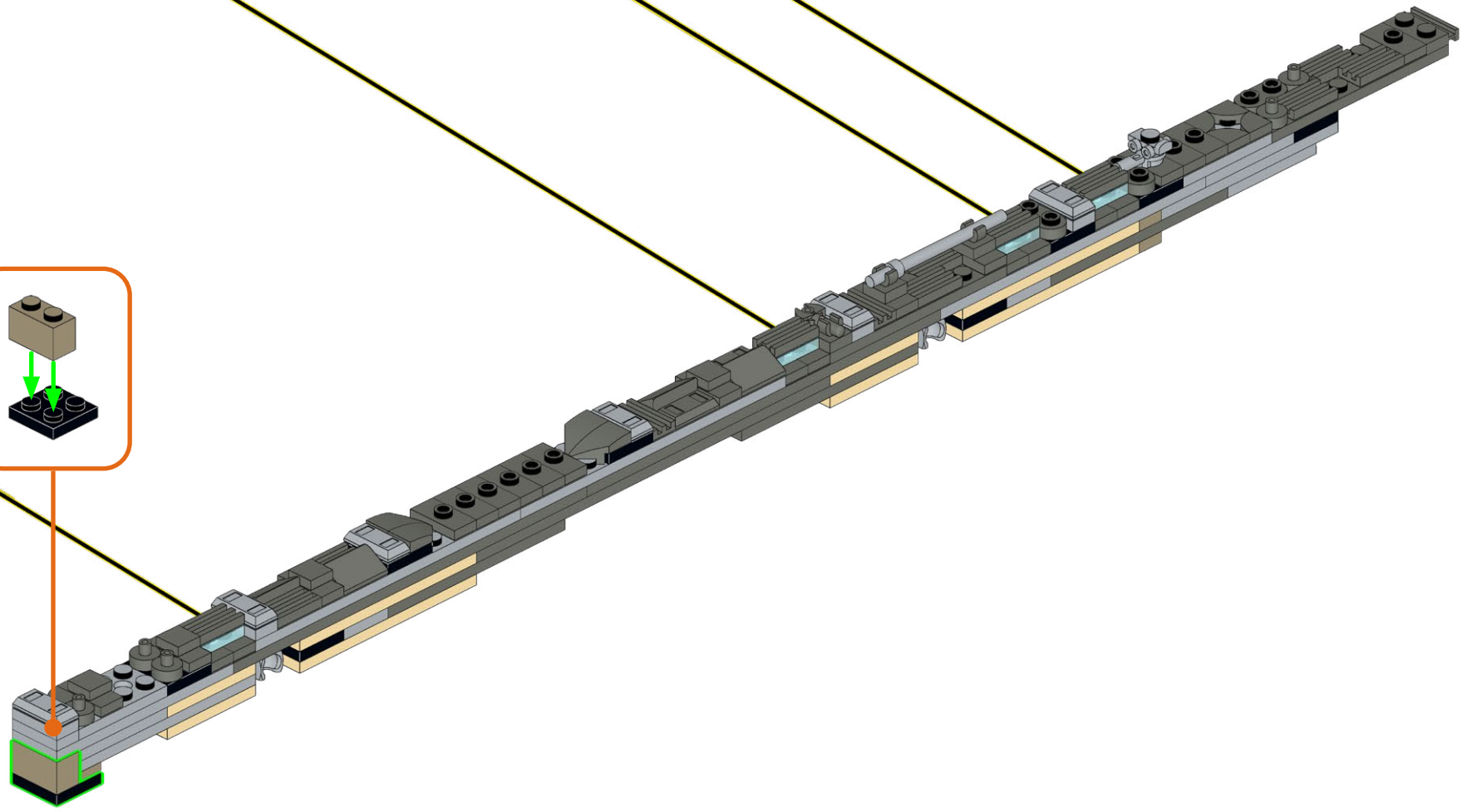
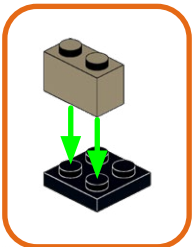
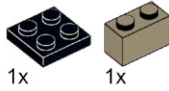

198

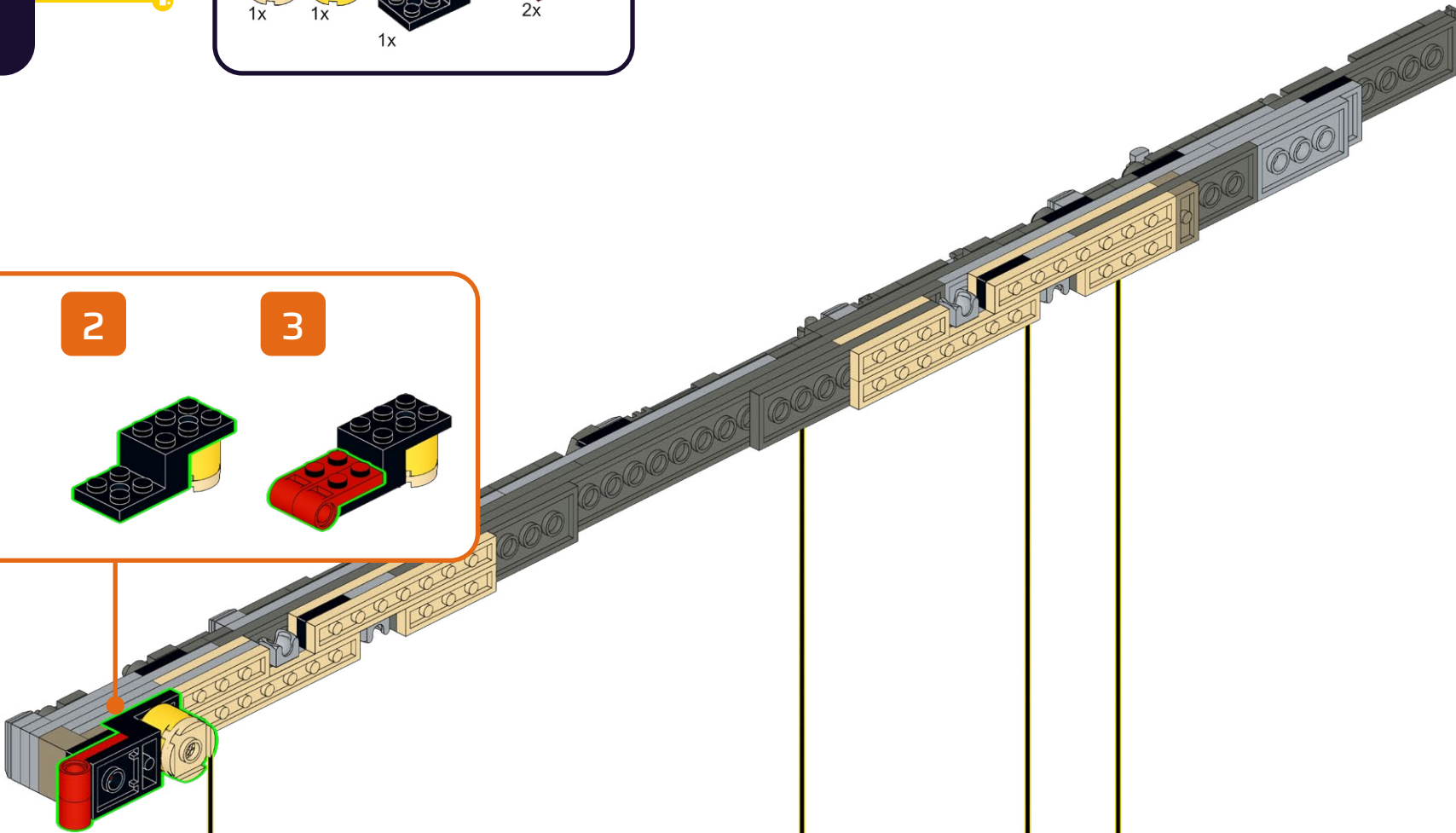
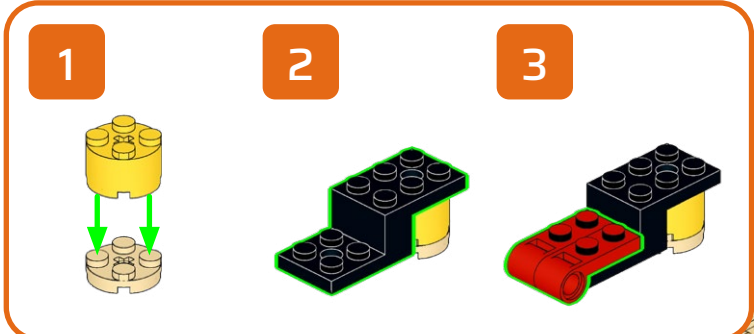
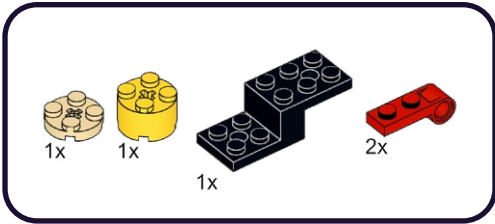

199

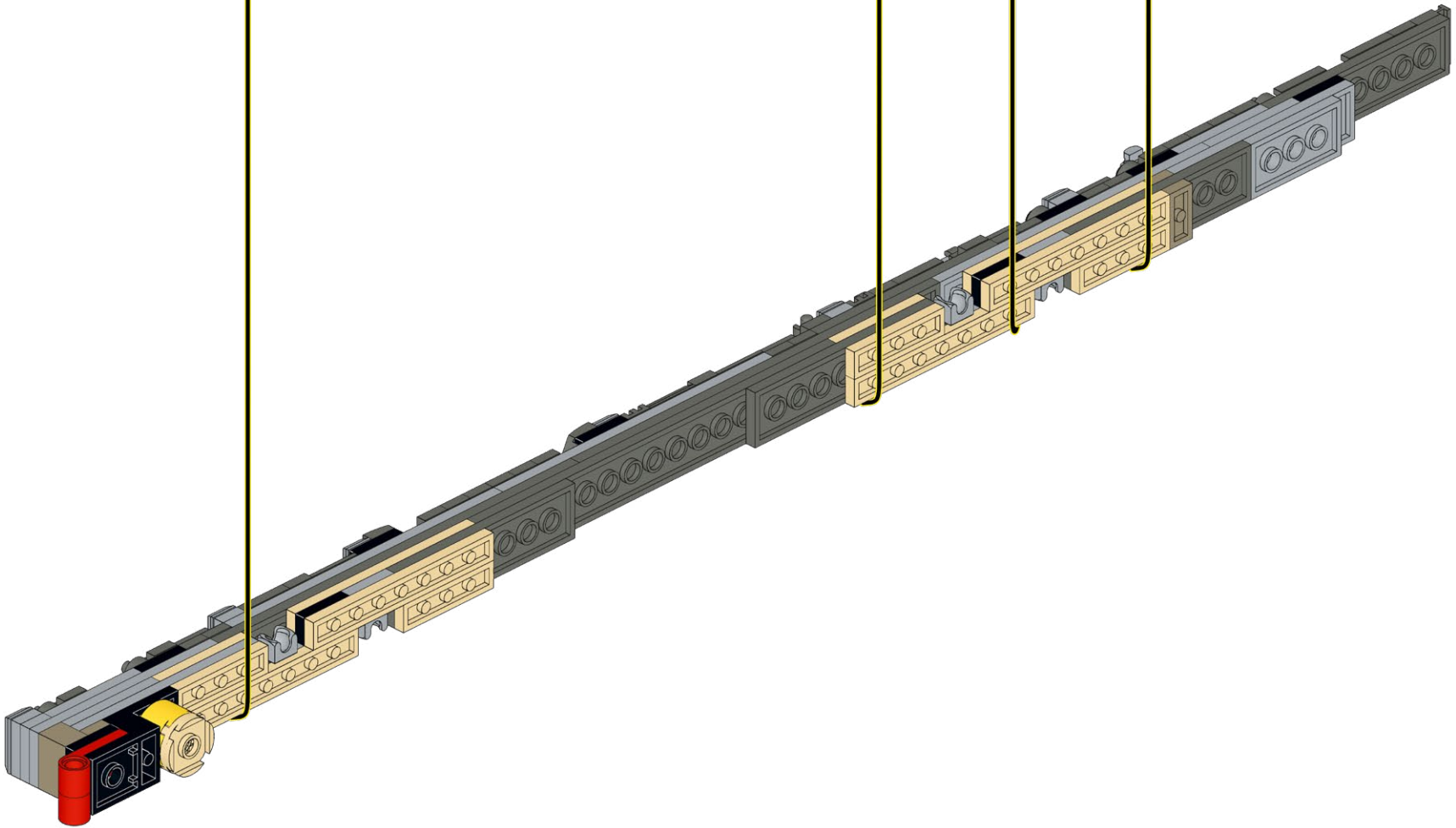

200

4x



201

6x



202

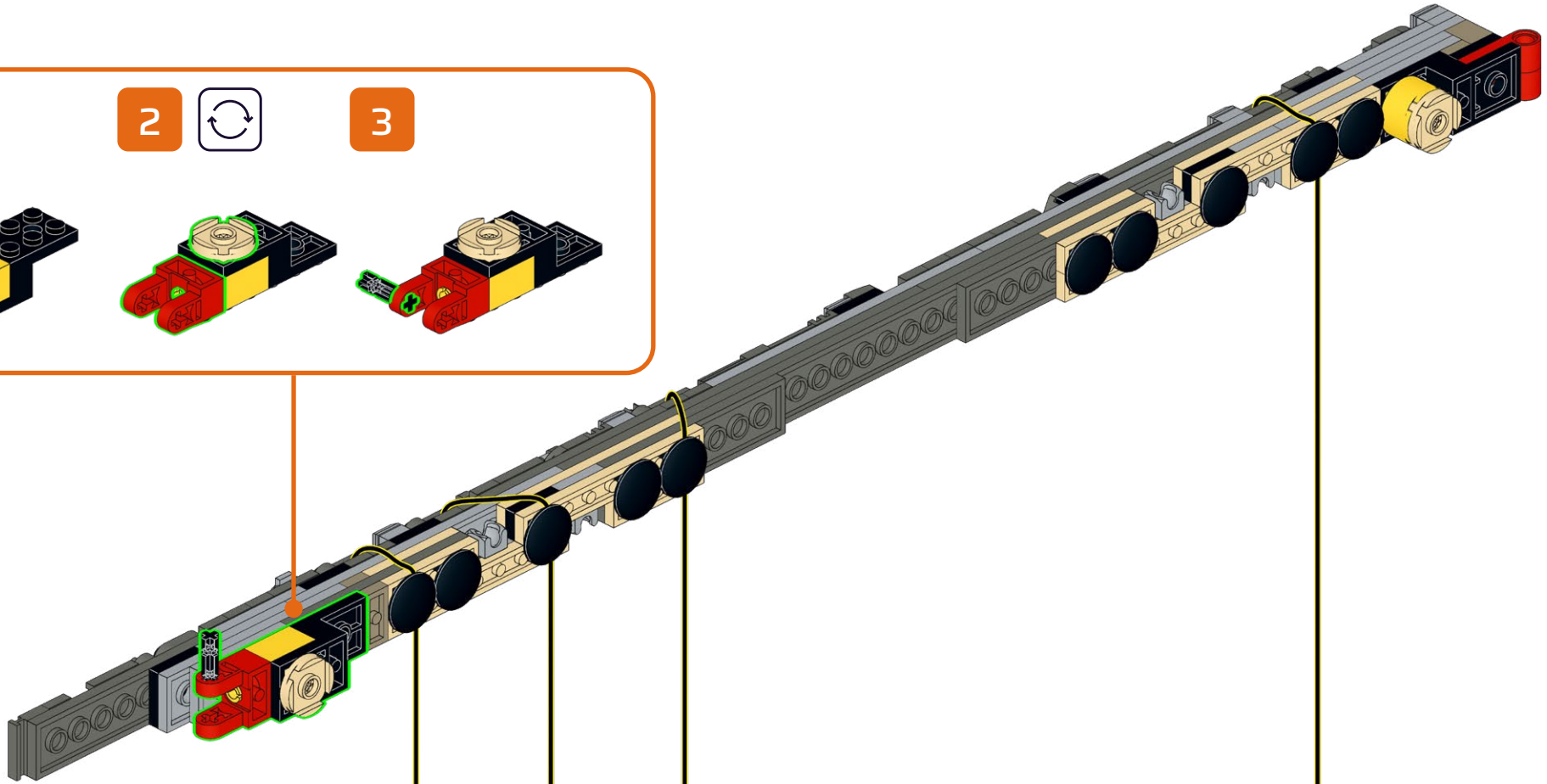
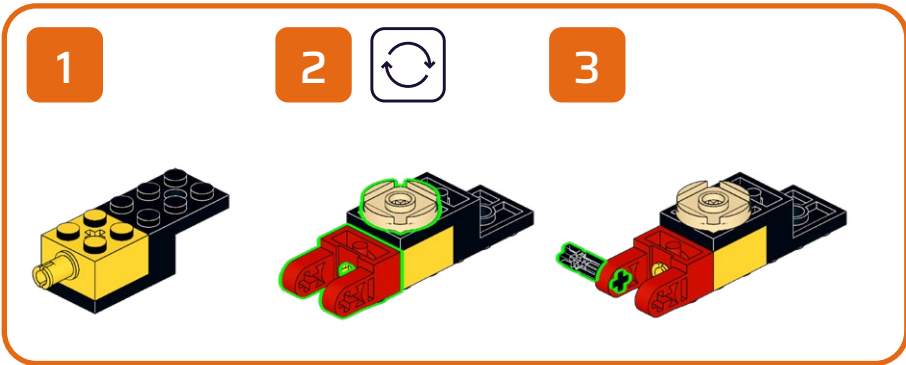
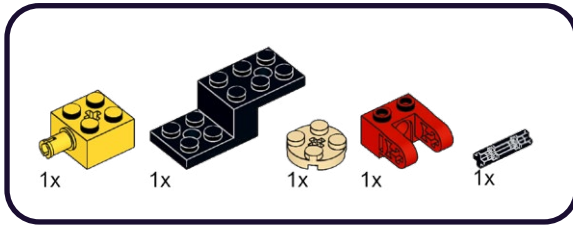

203

2x

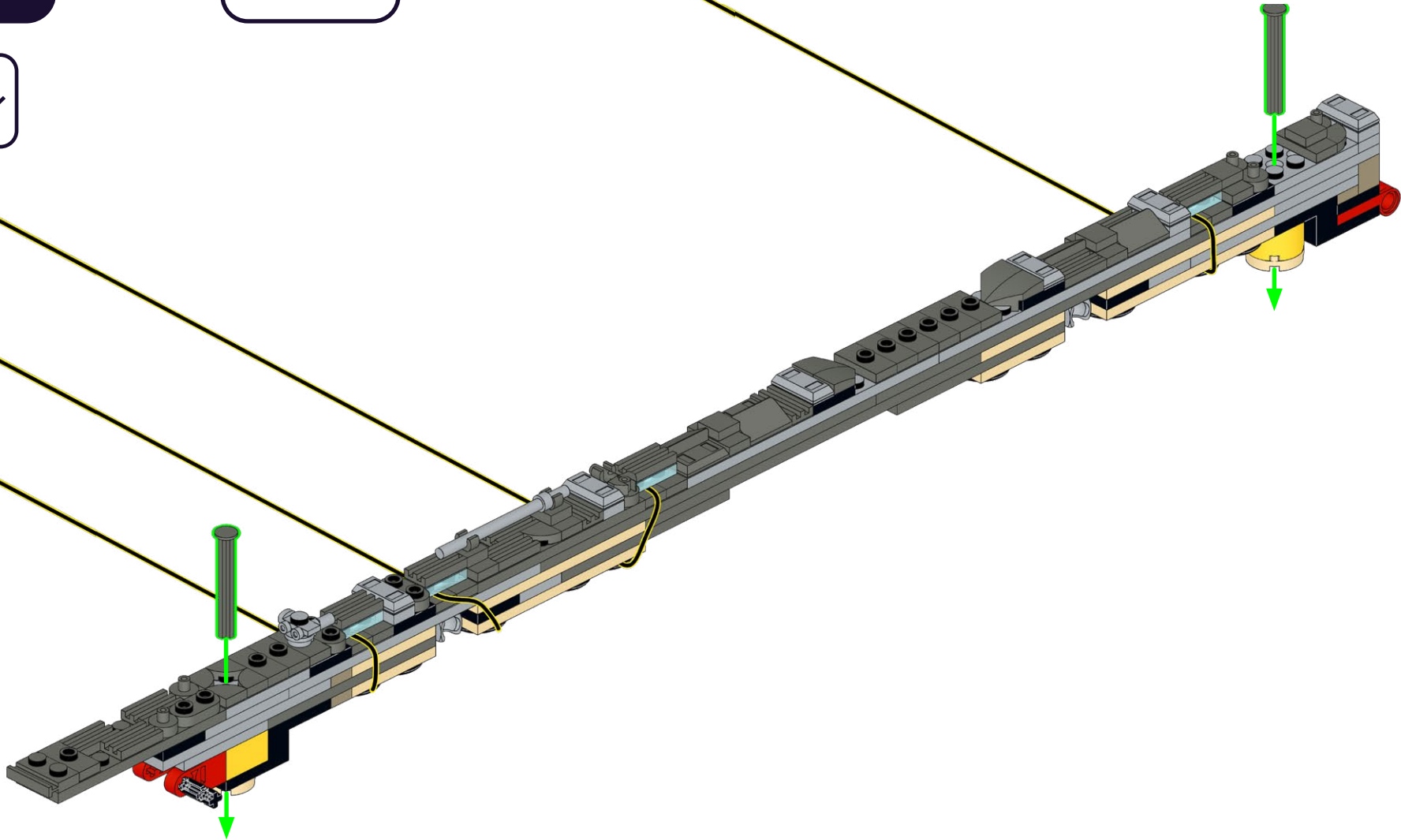

204

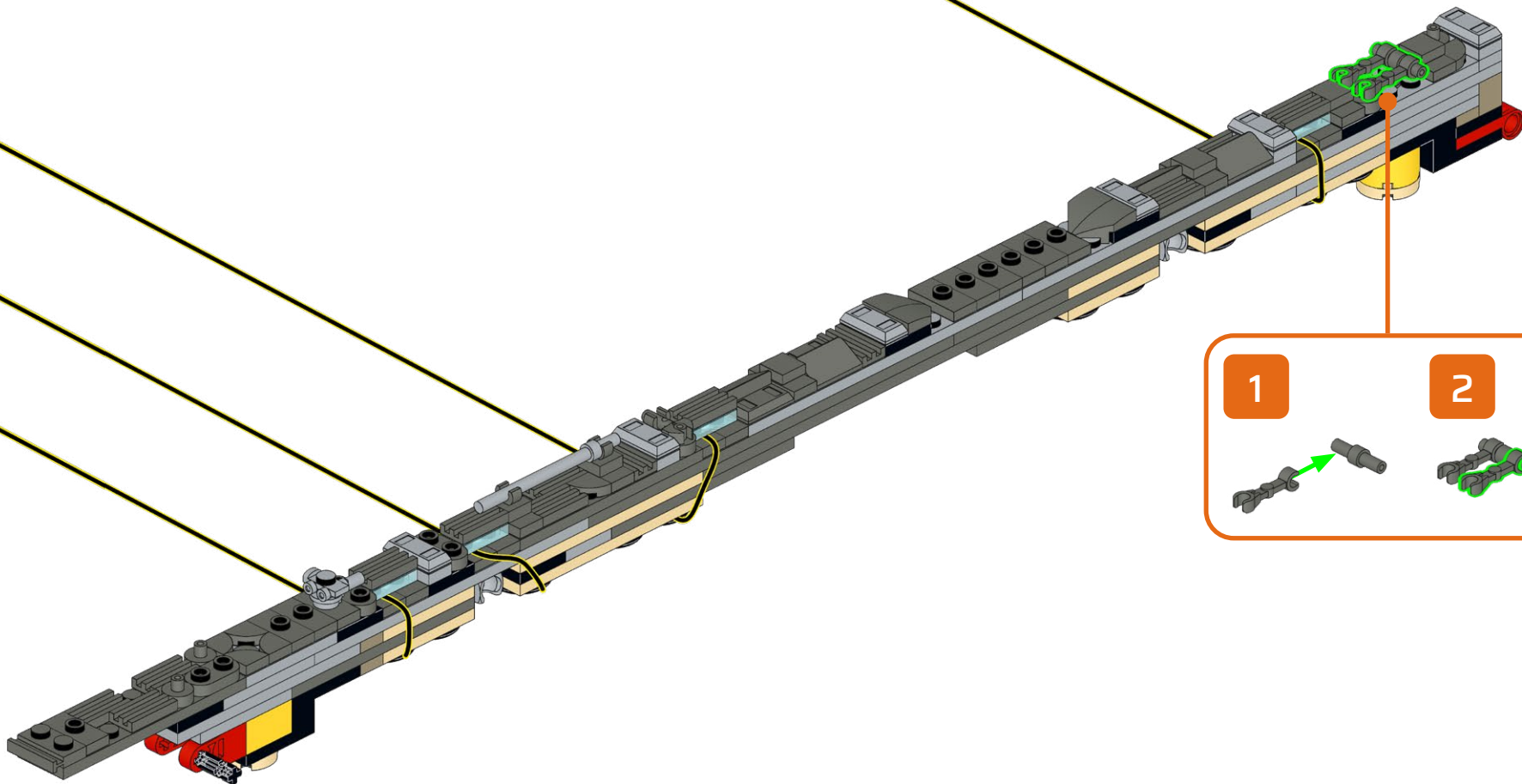
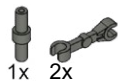

1

2



205

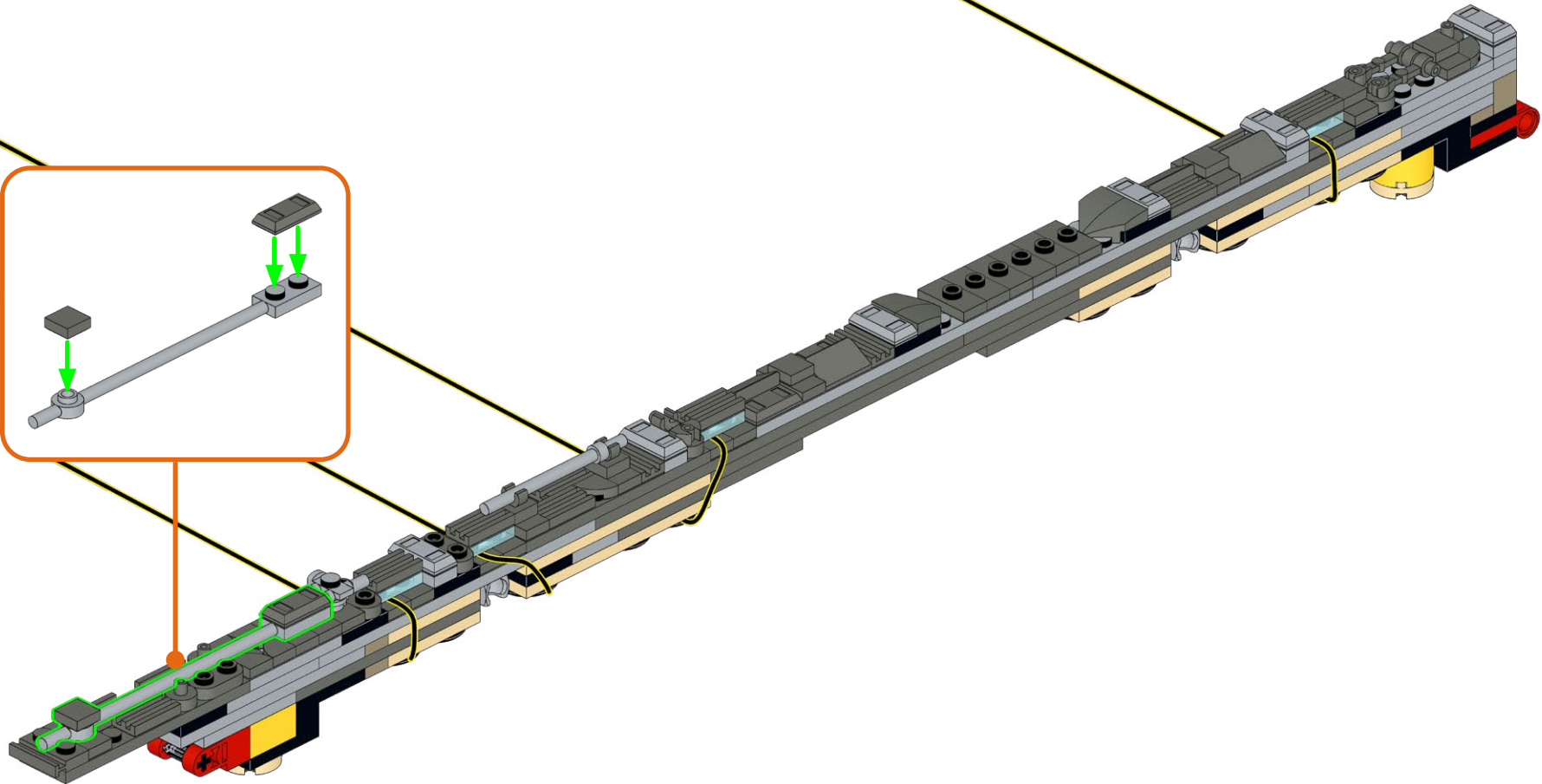
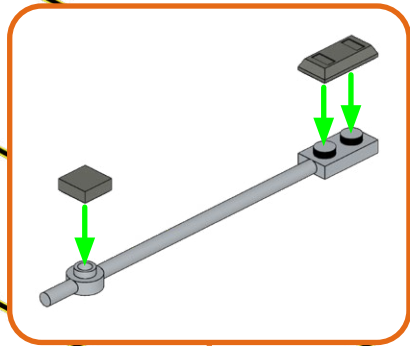
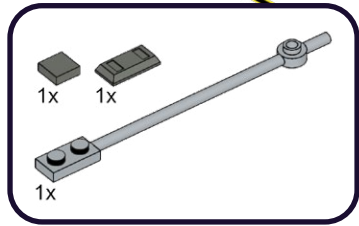

206

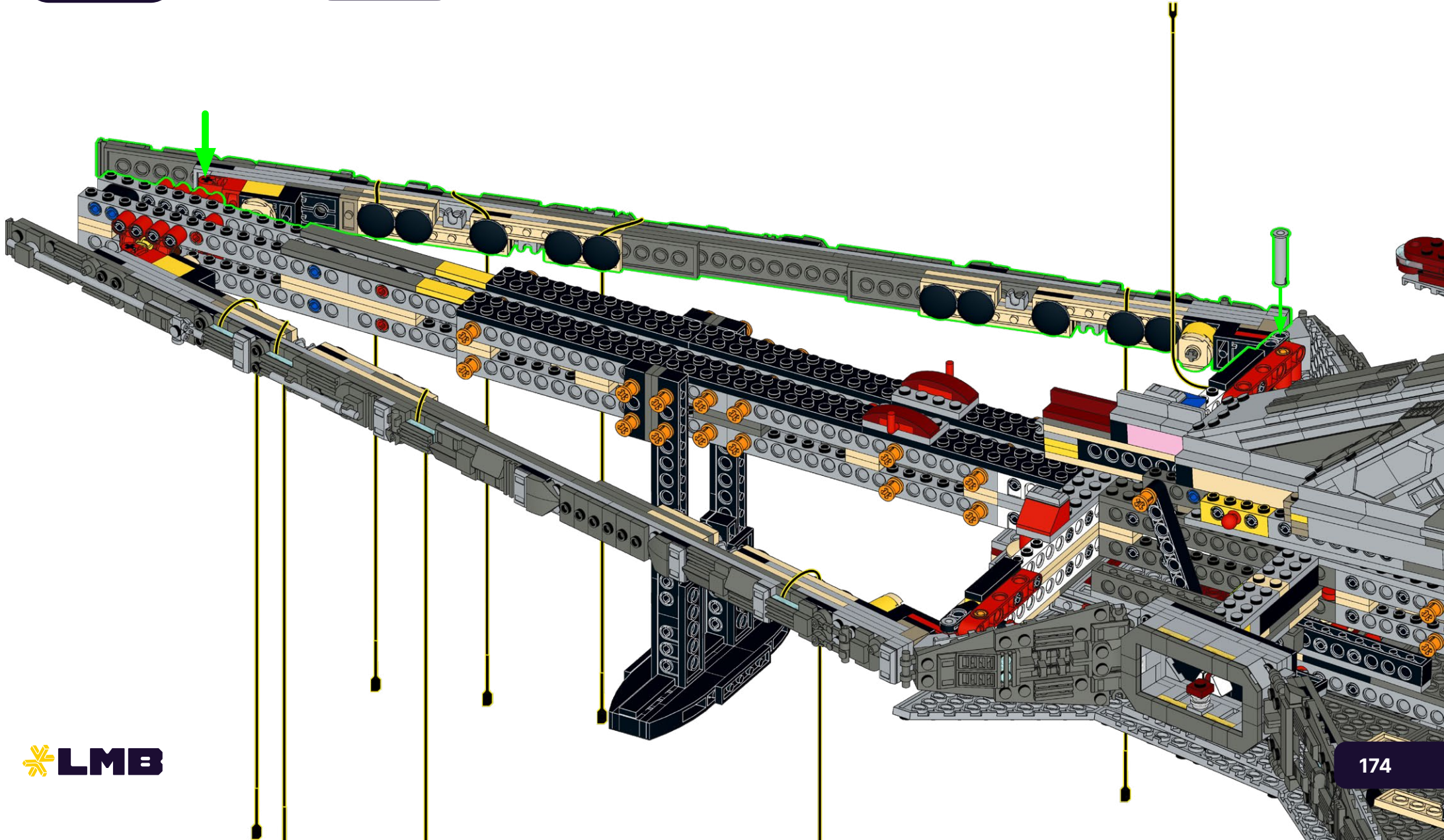
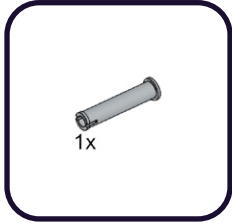

**HOLD UP!**

You might notice some bags aren't in order, as well as left over pieces, but that's ok! We're changing the way you build LEGO!

ATTENDEZ!

Vous remarquerez peut-être que certains sacs, ainsi que certaines pièces, ne sont pas dans le bon ordre. Mais pas de panique! Nous changeons simplement la façon avec laquelle vous construisez vos LEGO!

ASPETTA!

Potresti notare che alcuni sacchetti non sono in ordine, così come i pezzi avanzati, ma va bene così! Stiamo cambiando il modo in cui costruisci i LEGO!

HALT!

Sie werden möglicherweise bemerken, dass einige tüten durcheinander sind und teile übrig bleiben, aber das ist in Ordnung! Wir ändern die art und weise, wie Sie LEGO bauen!

¡ESPERA!

Es posible que notes que algunas bolsas están fuera de servicio, así como piezas sobrantes, ¡pero está bien! ¡Estamos cambiando la forma en que construyes LEGO!

暫停!

你可能会注意到一些袋子顺序错乱, 以及一些剩余的部件, 但没关系! 我们正在改变你搭建乐高的方式!

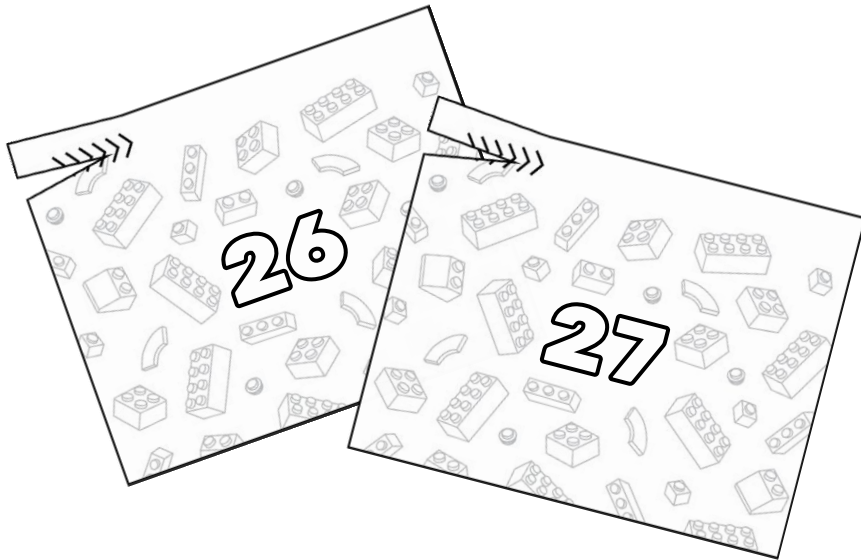
Open LEGO® Bags 26 & 27

207

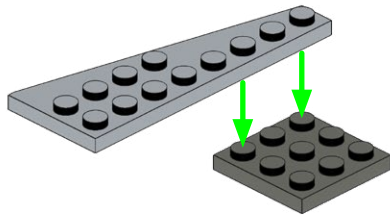
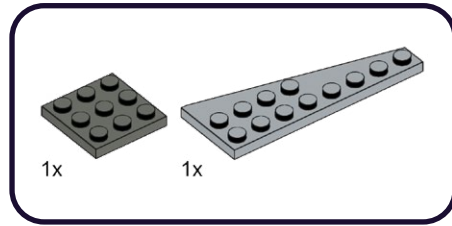

208

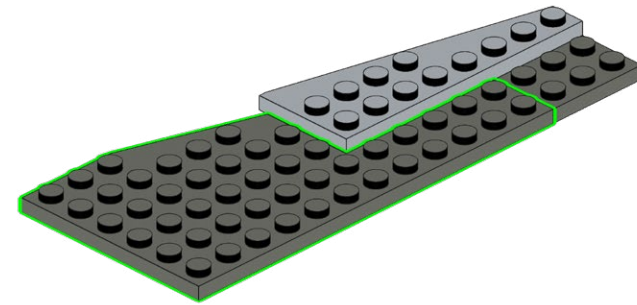
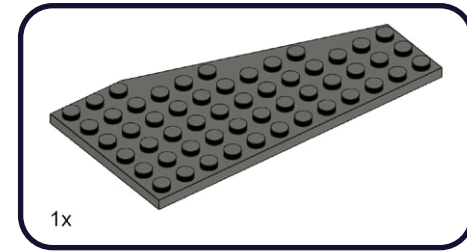

209

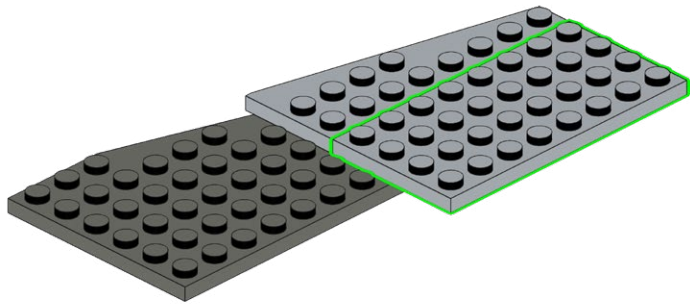
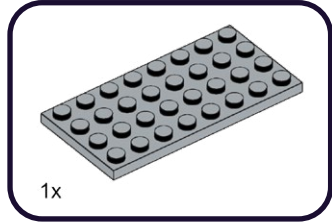

210

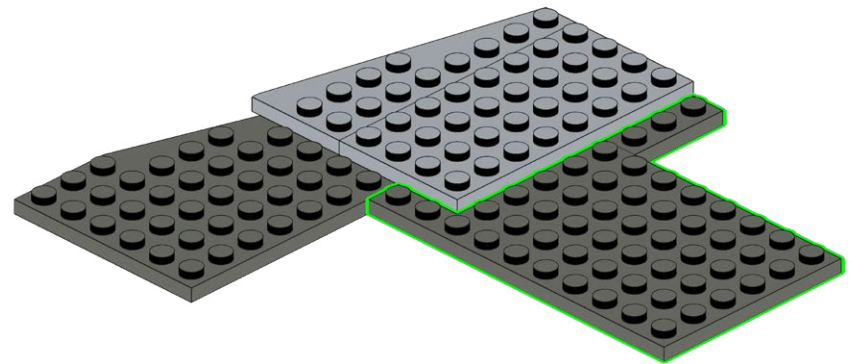
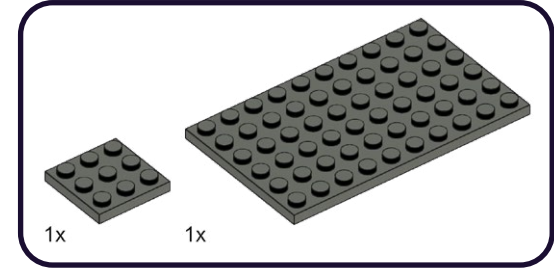

211

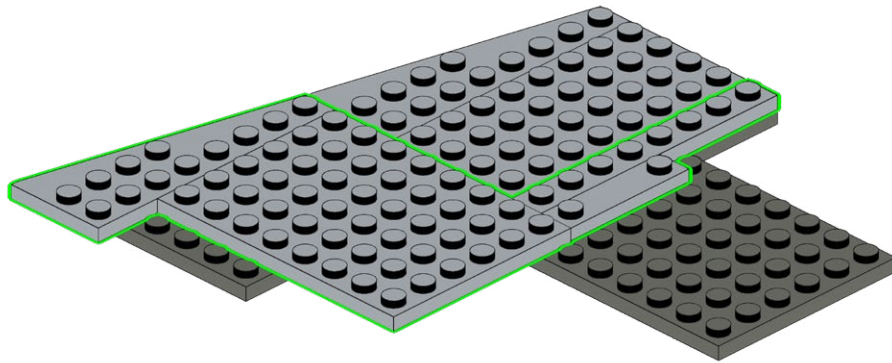
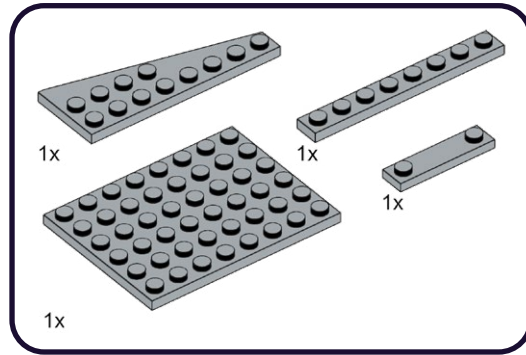

212

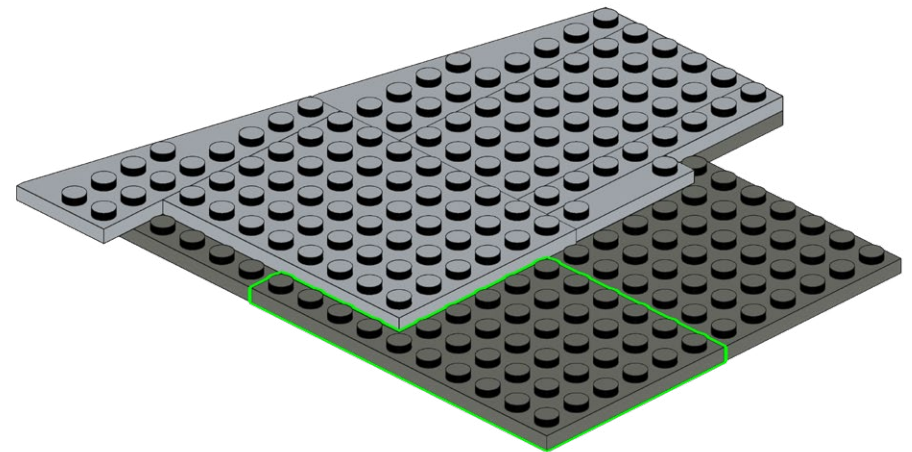
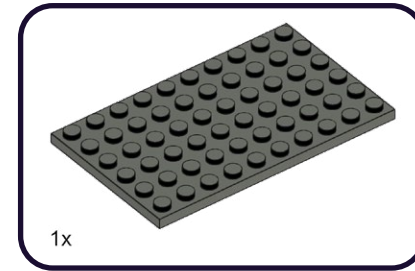

213

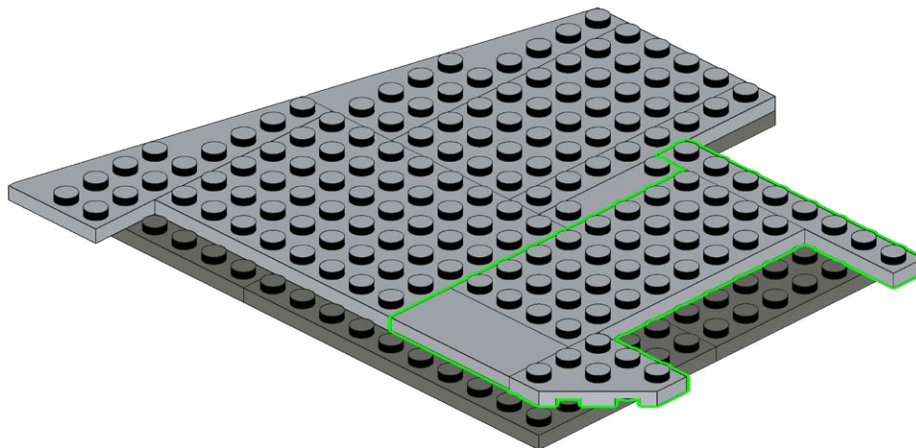
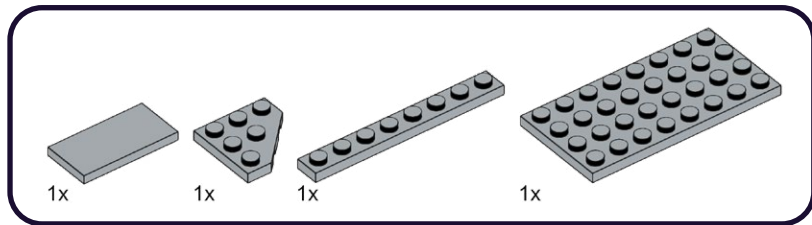

214

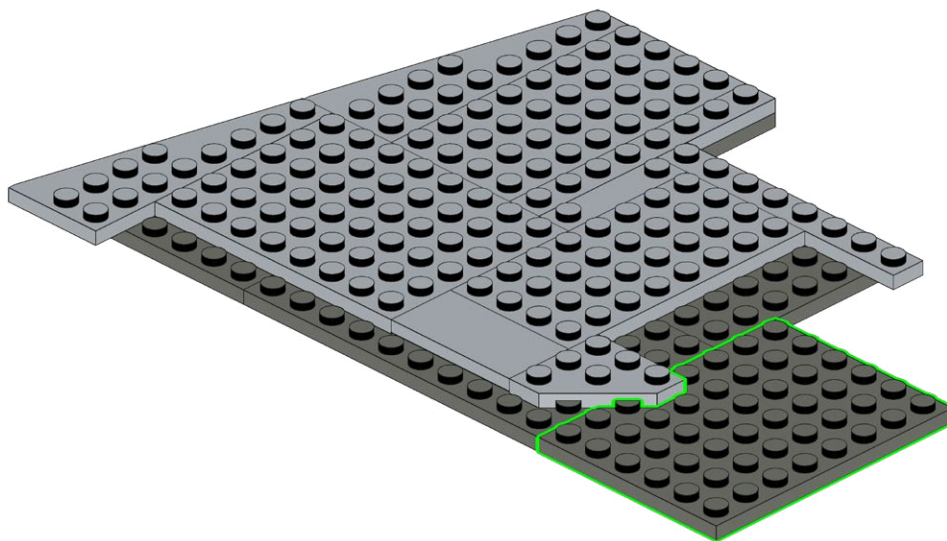
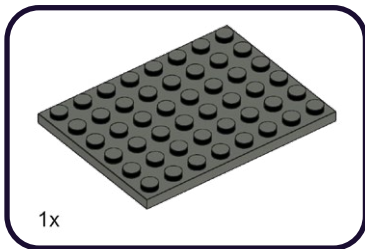

215

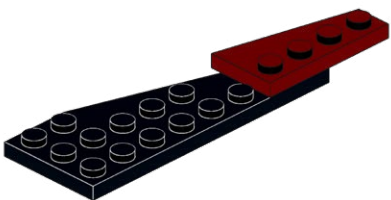
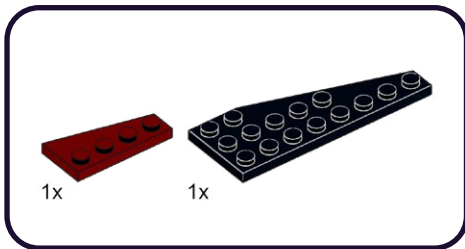

216

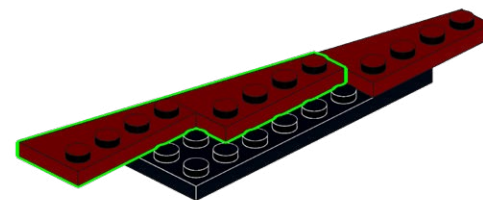
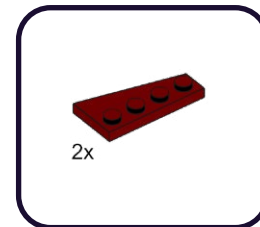

217

1x



218

1x

1x

1x

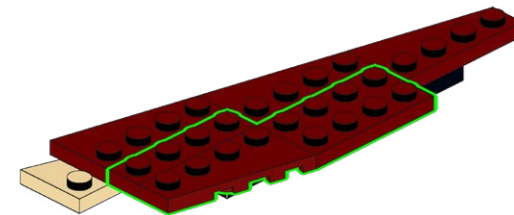
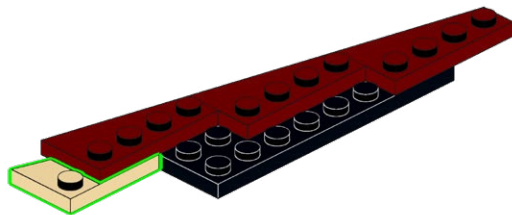

219

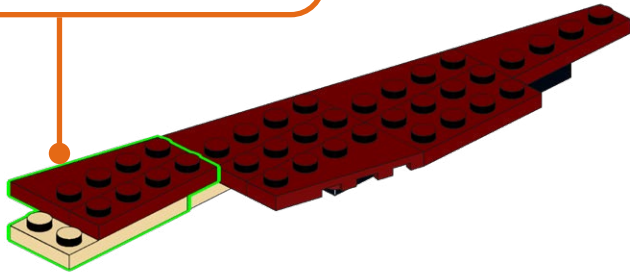
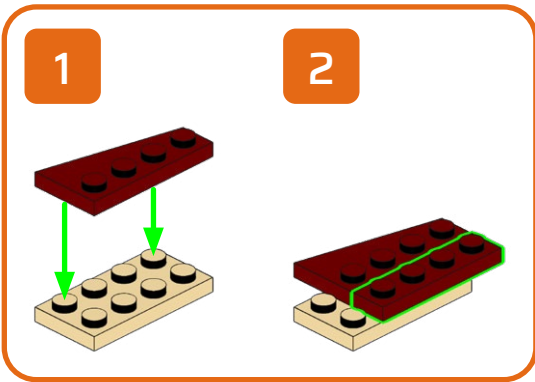
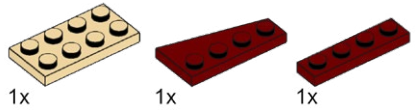

220

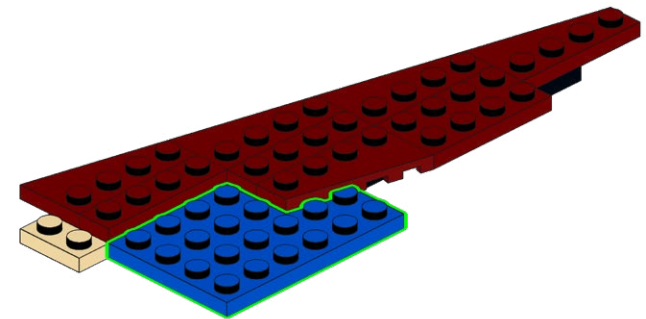
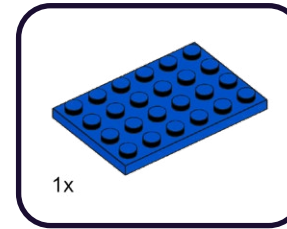

221

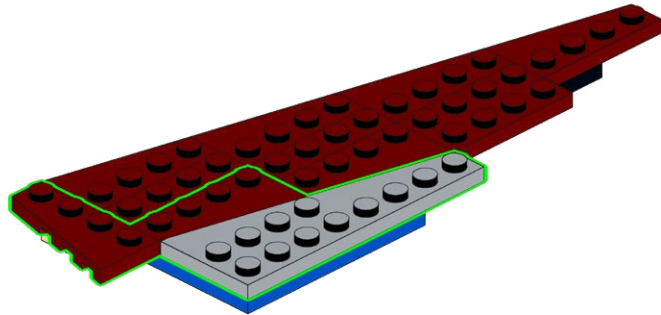
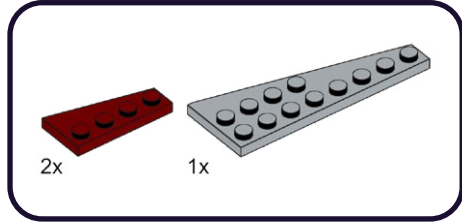

222

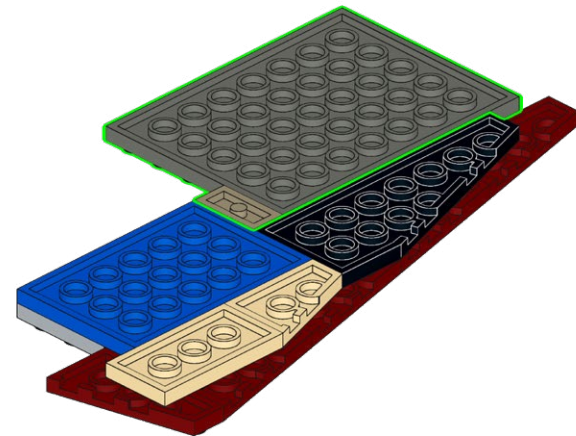
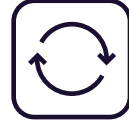
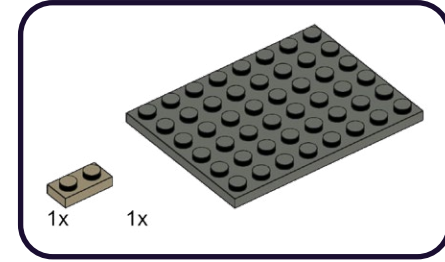

223

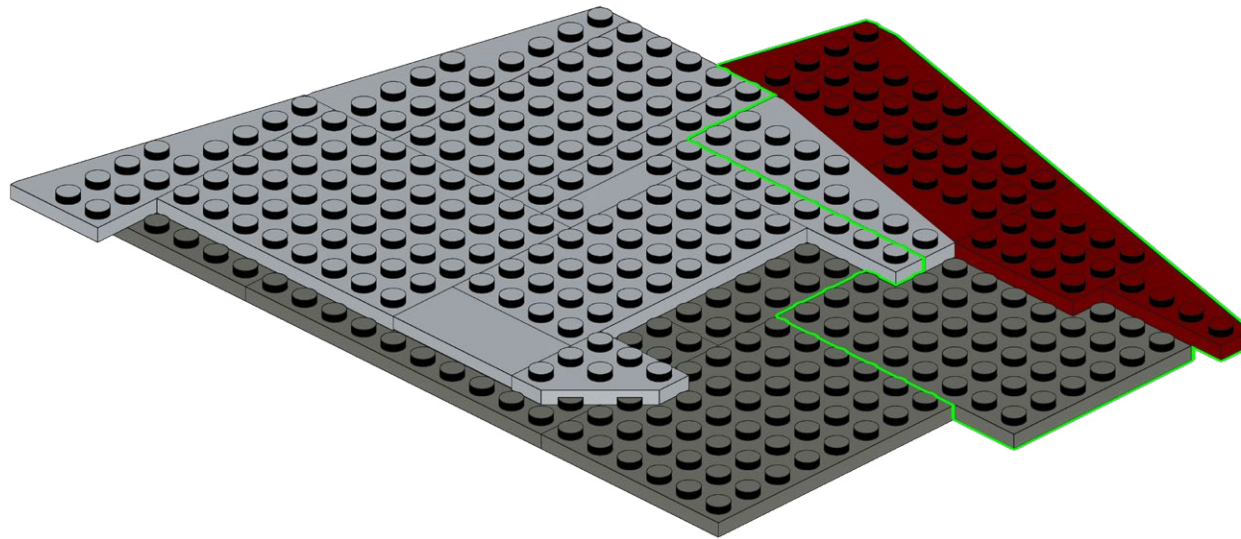

224

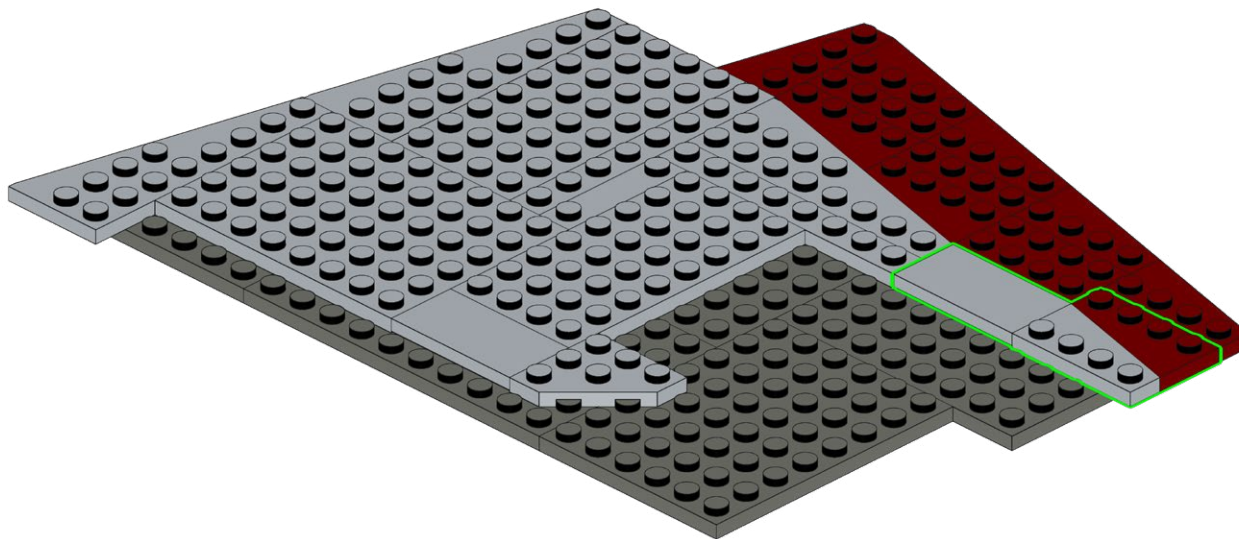
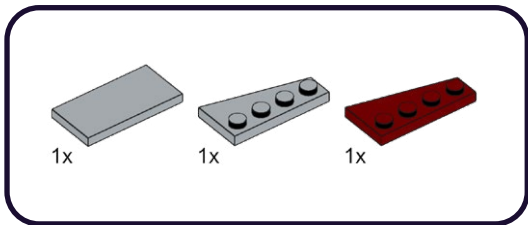

225

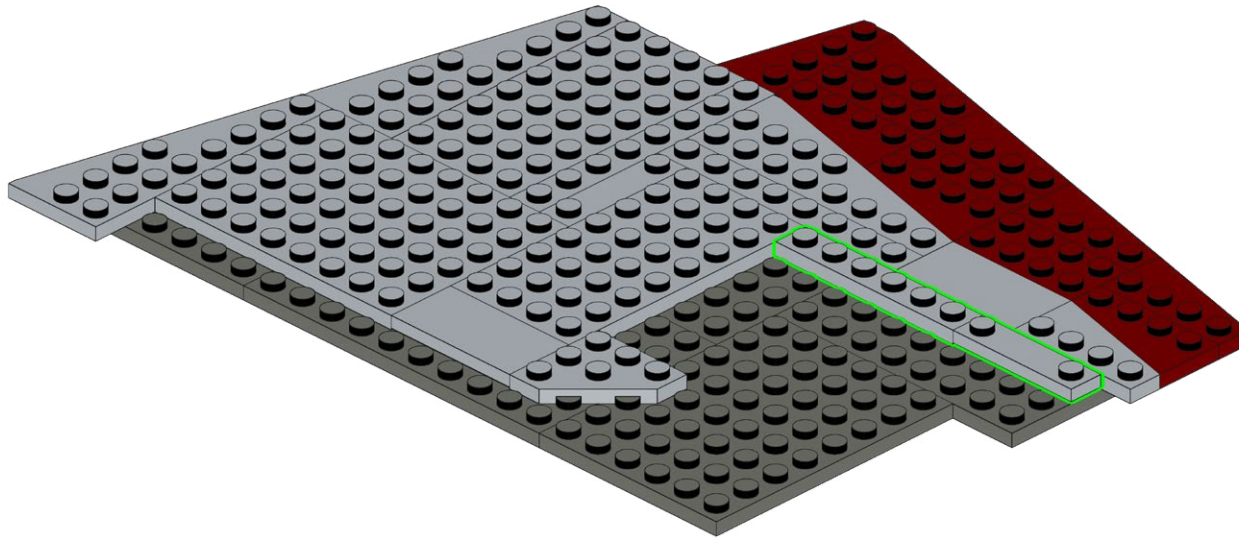
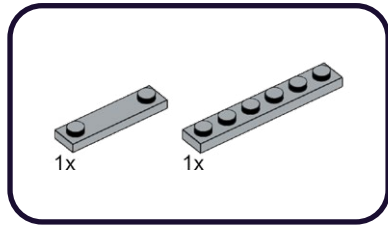

226

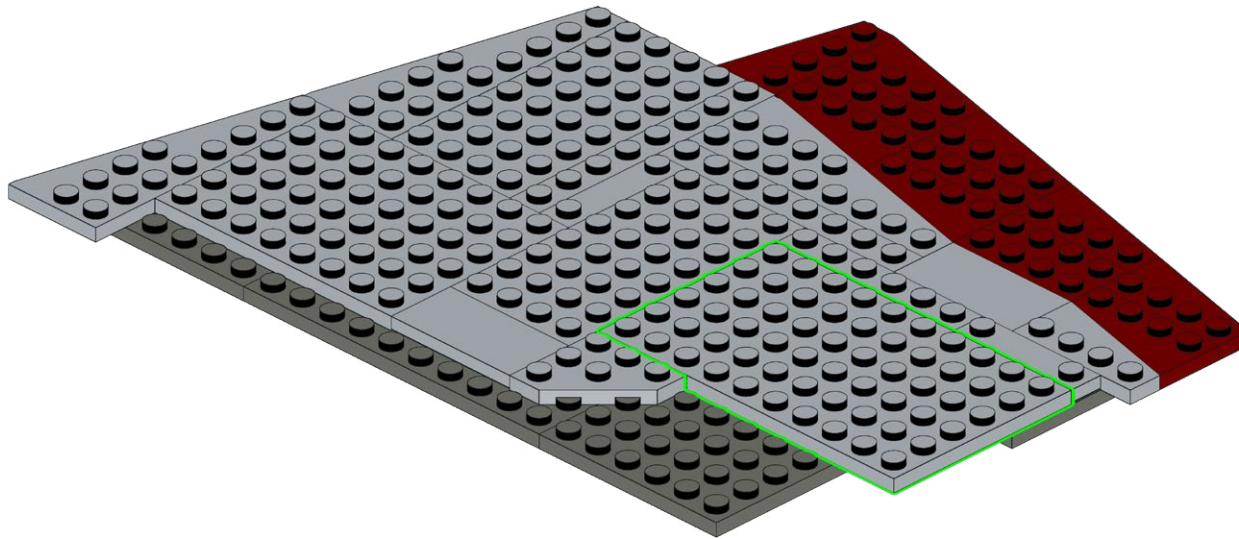
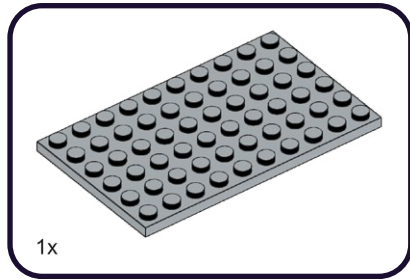

227

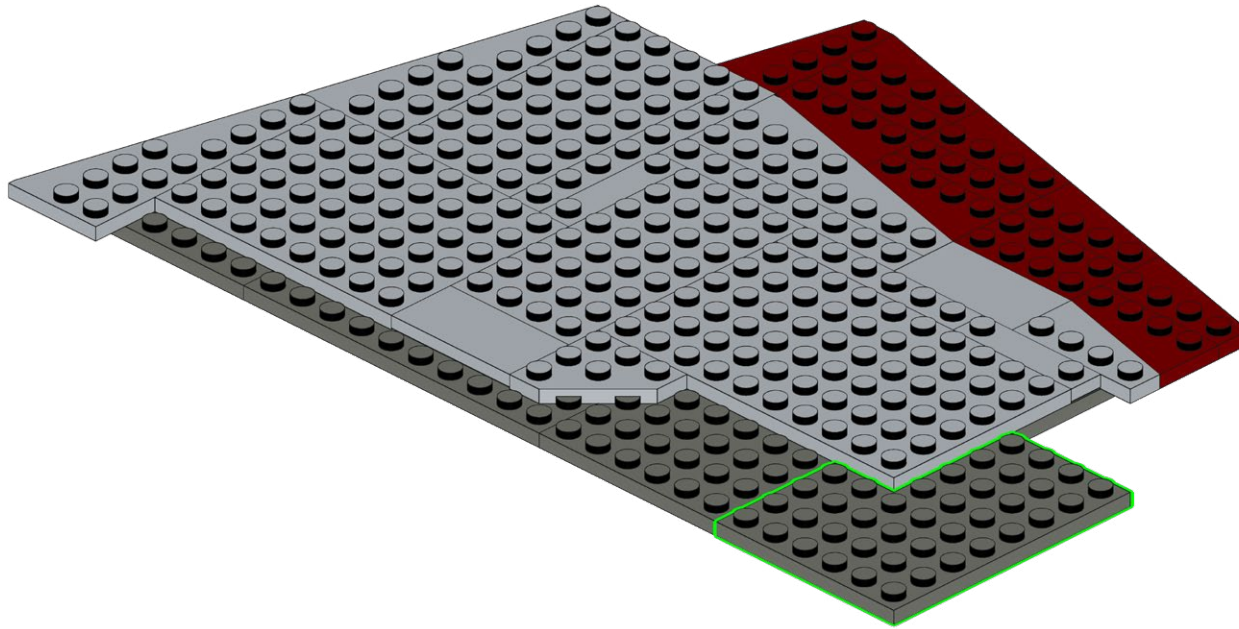
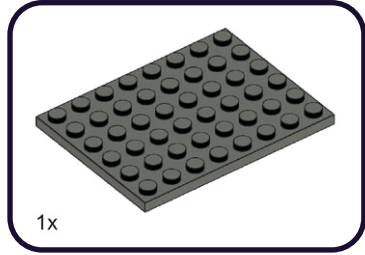

228

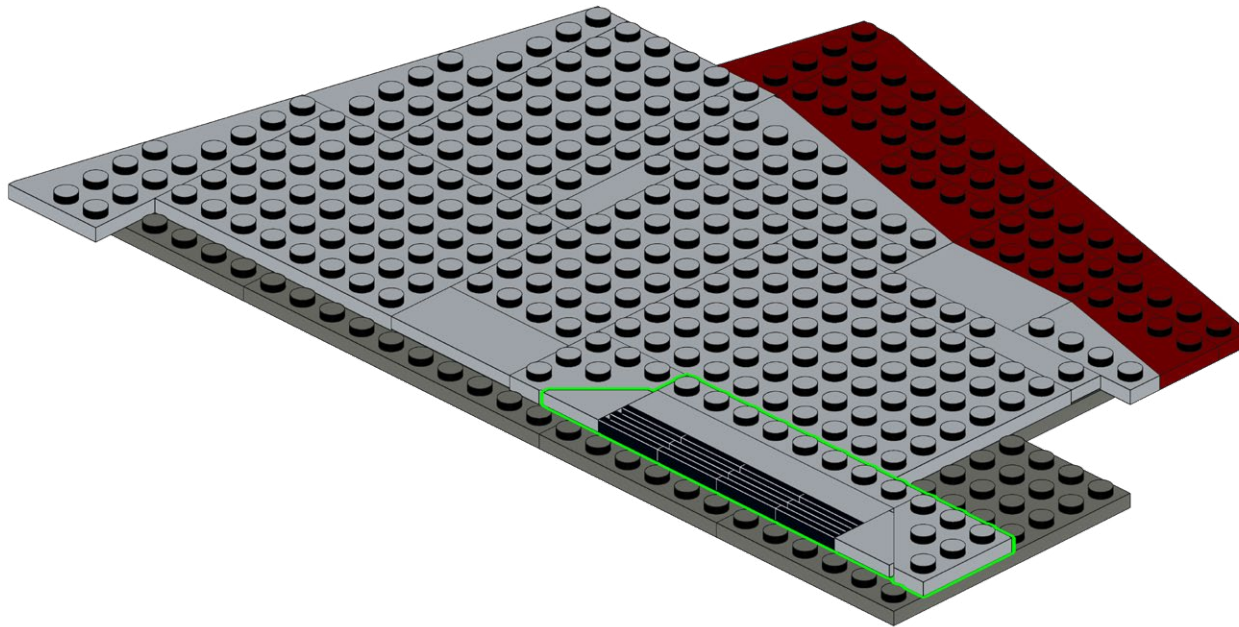
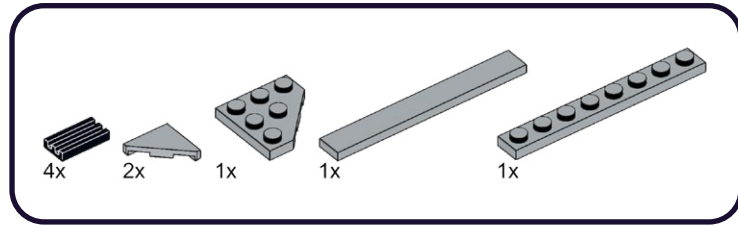

229

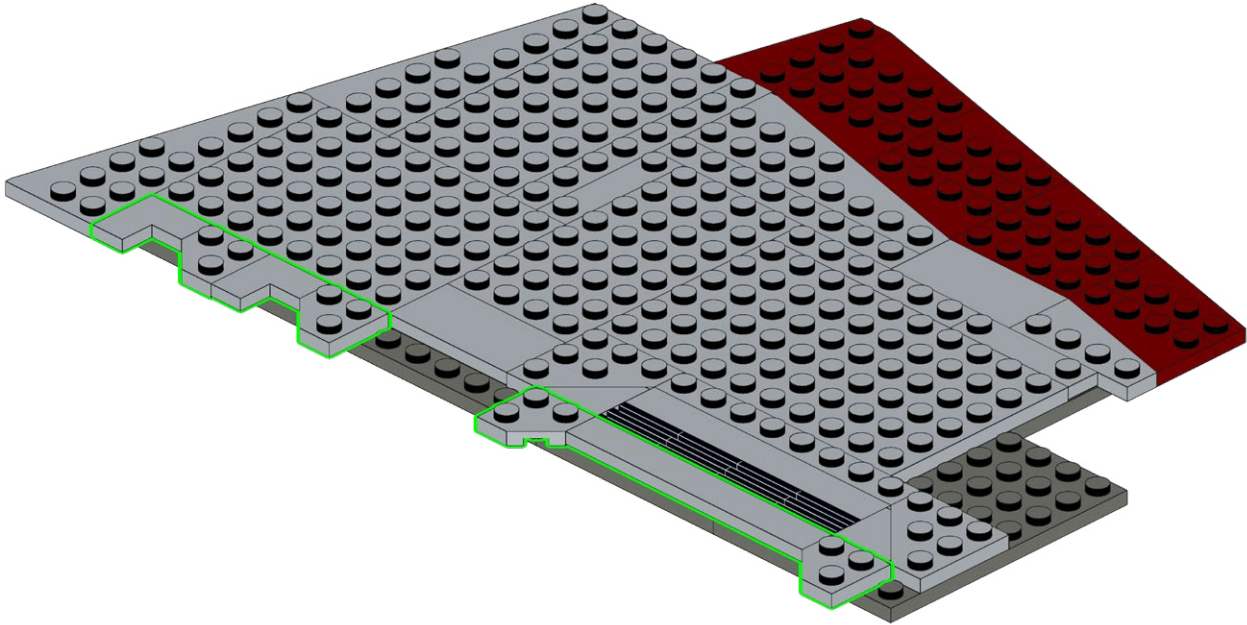
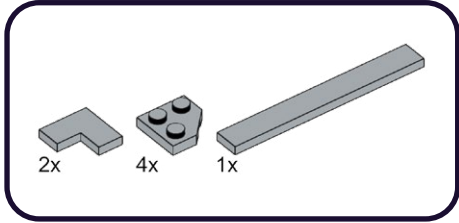

230

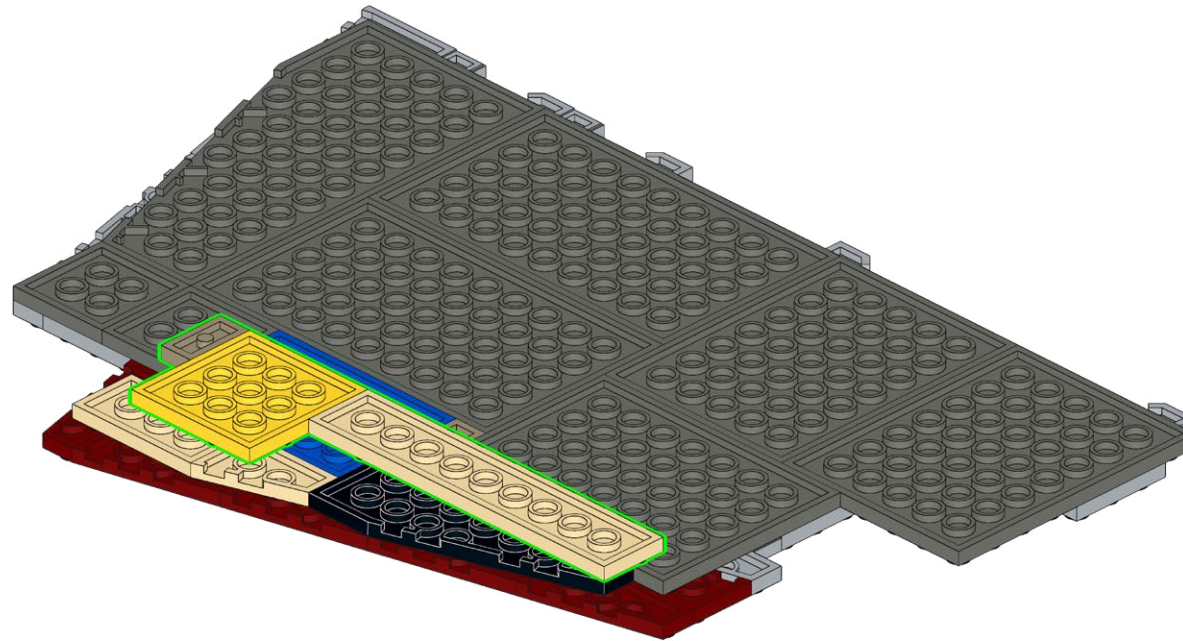
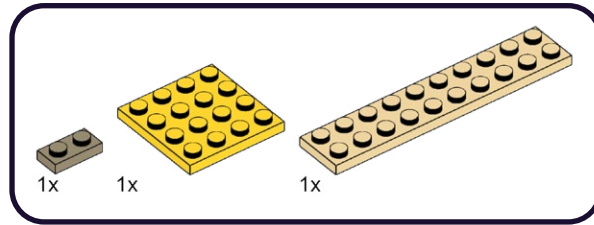

231

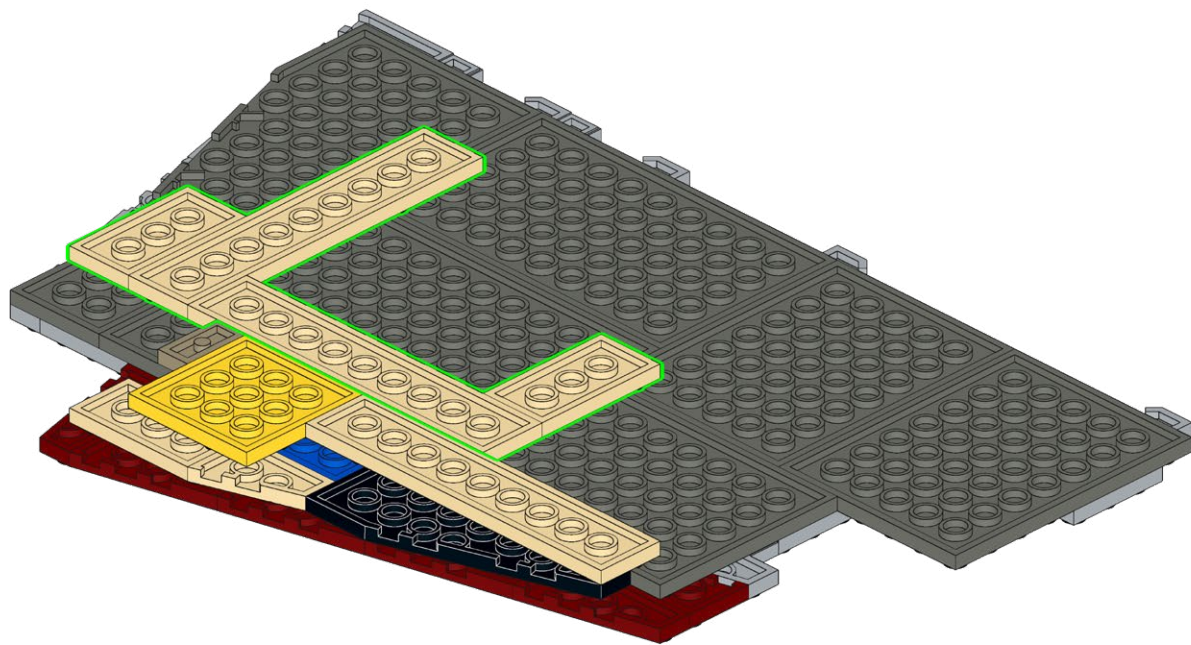
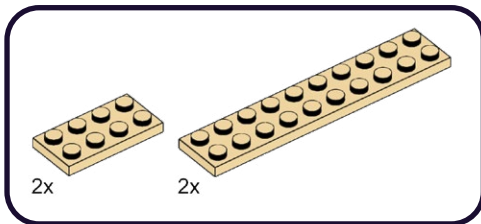

232

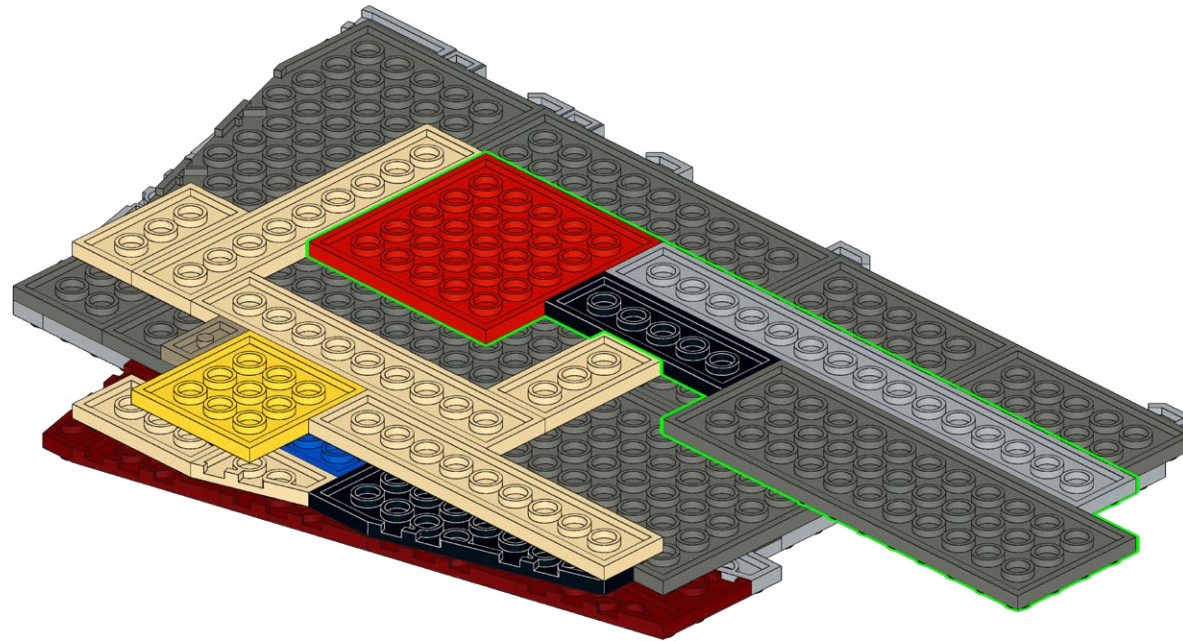
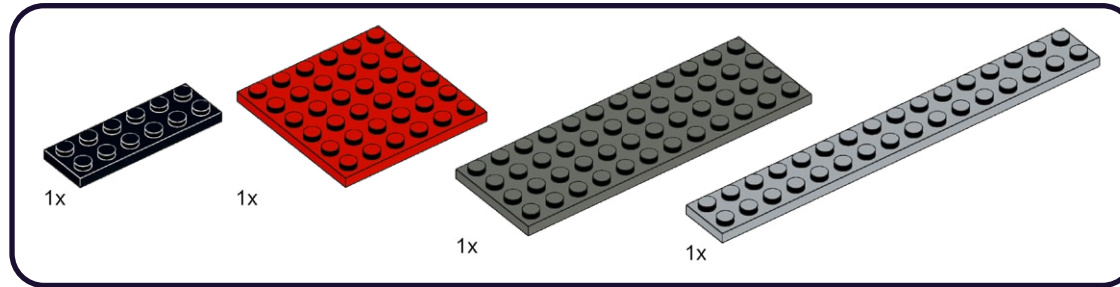

233

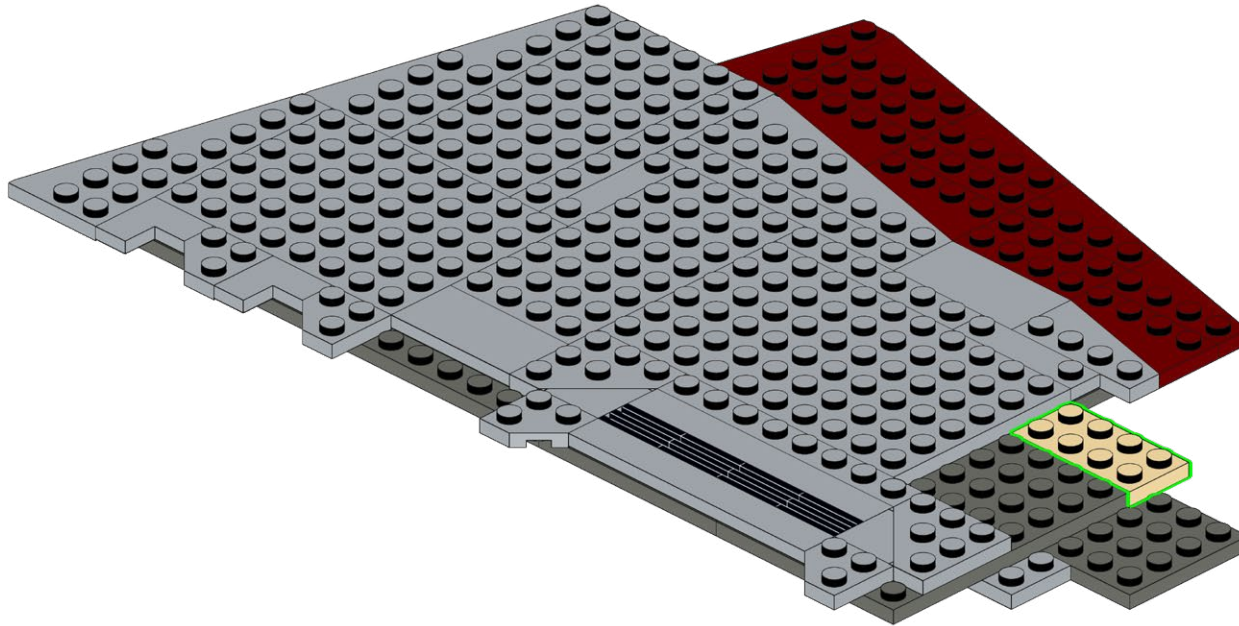
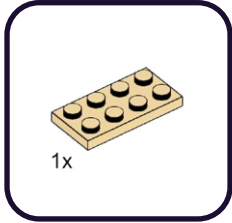

234

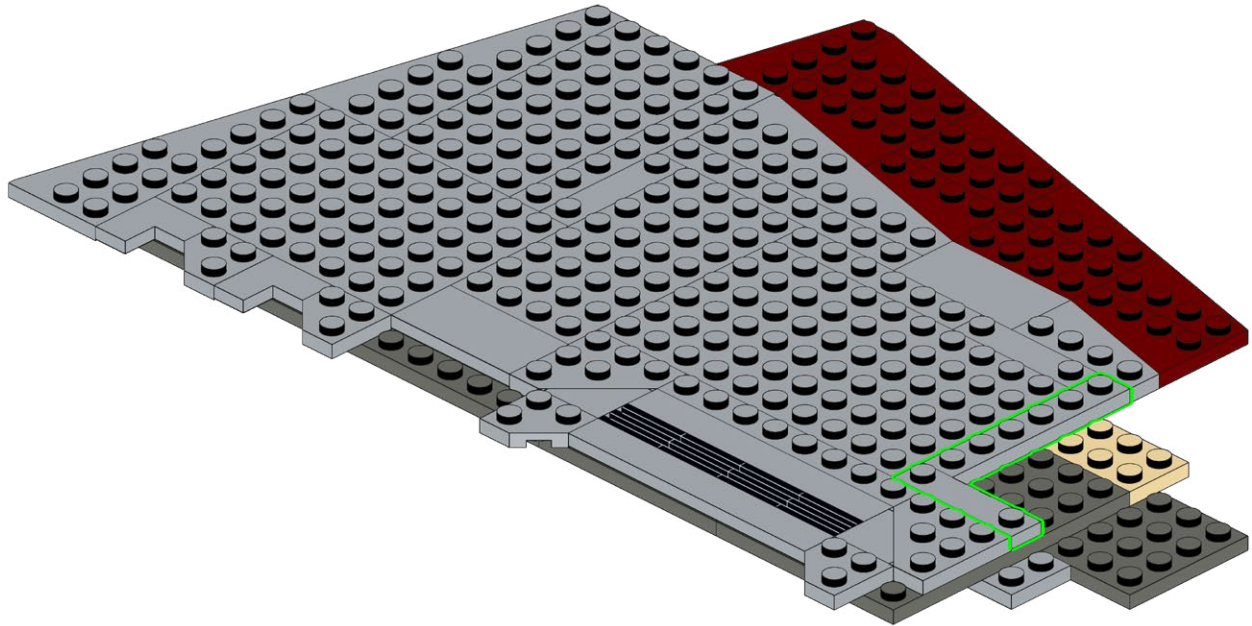
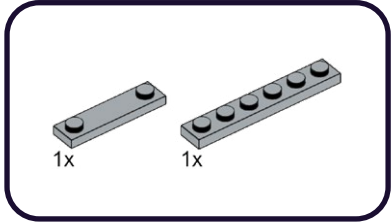

235

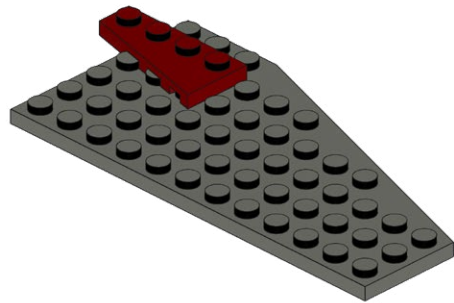
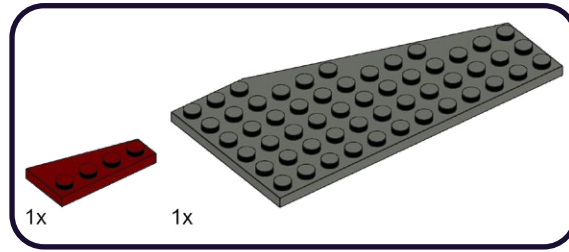

236

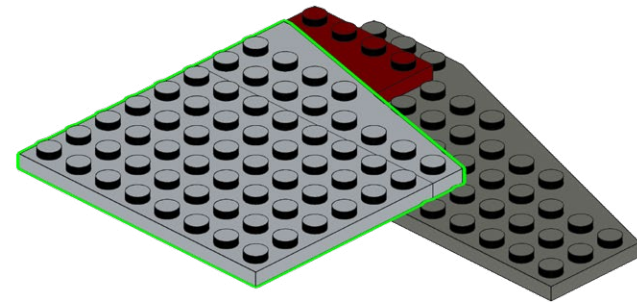
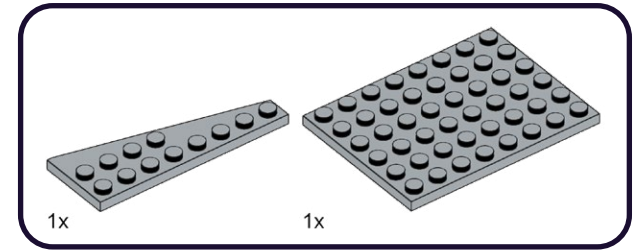

237

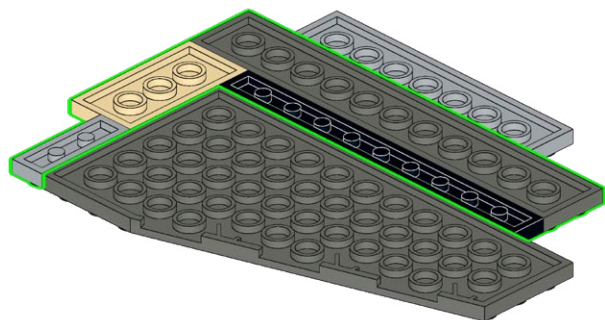
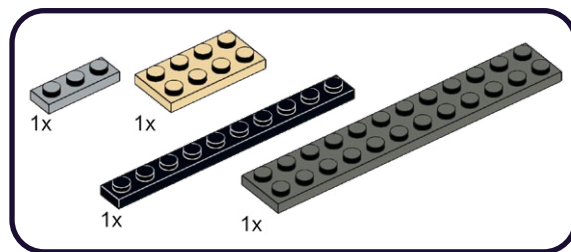

238

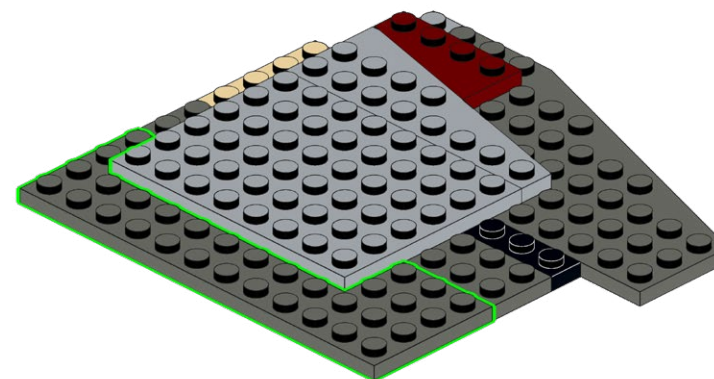
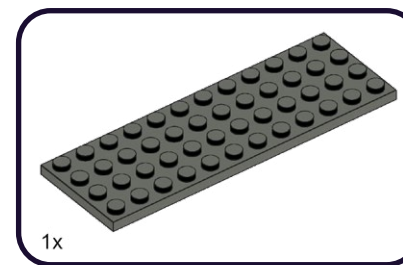
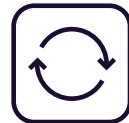

239

5x

1x

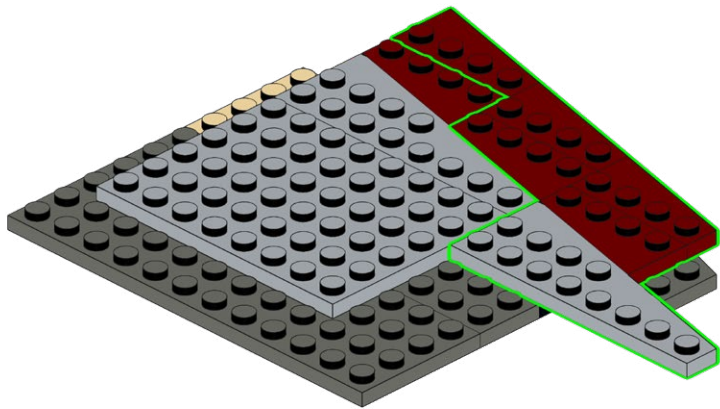
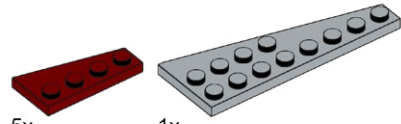

240

1x

1x

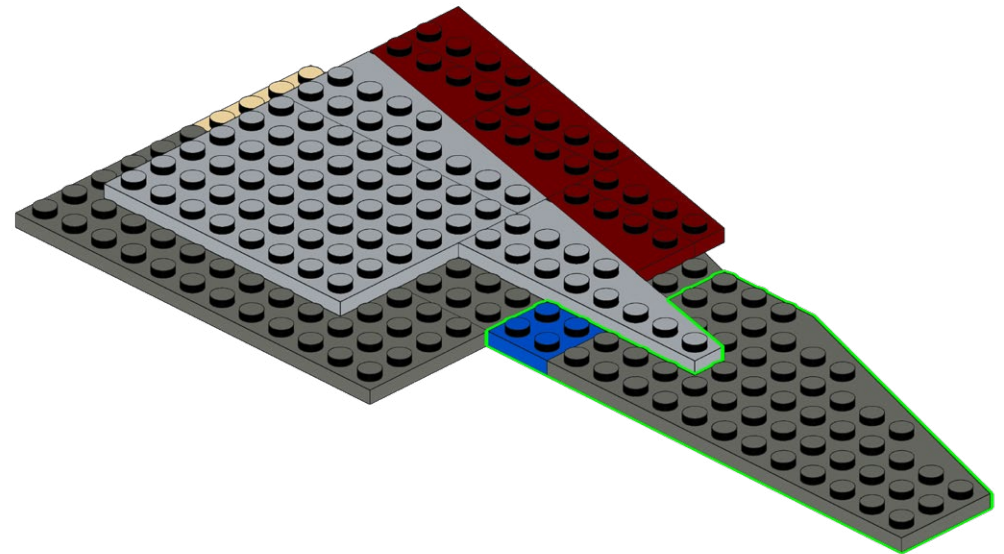

241

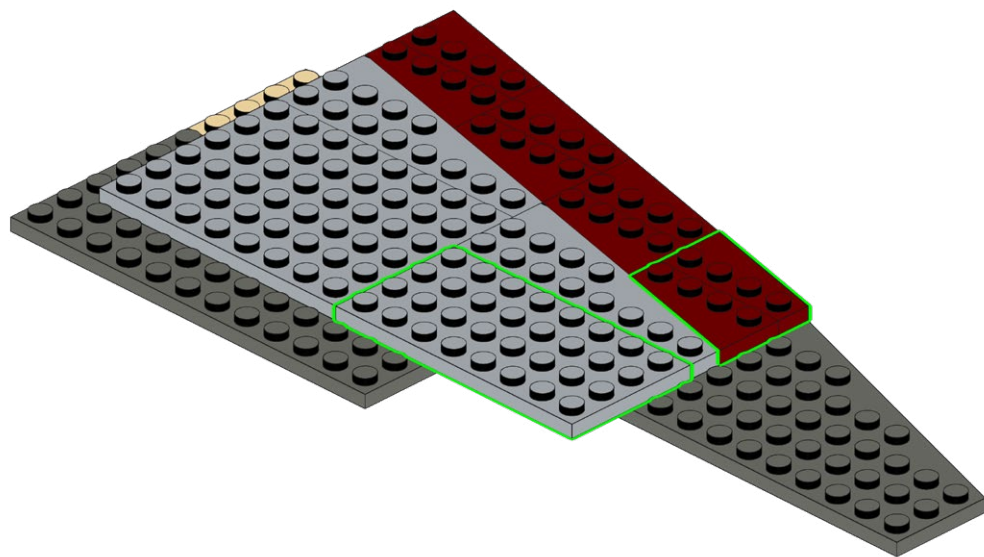
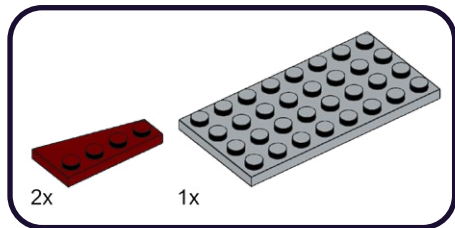

242

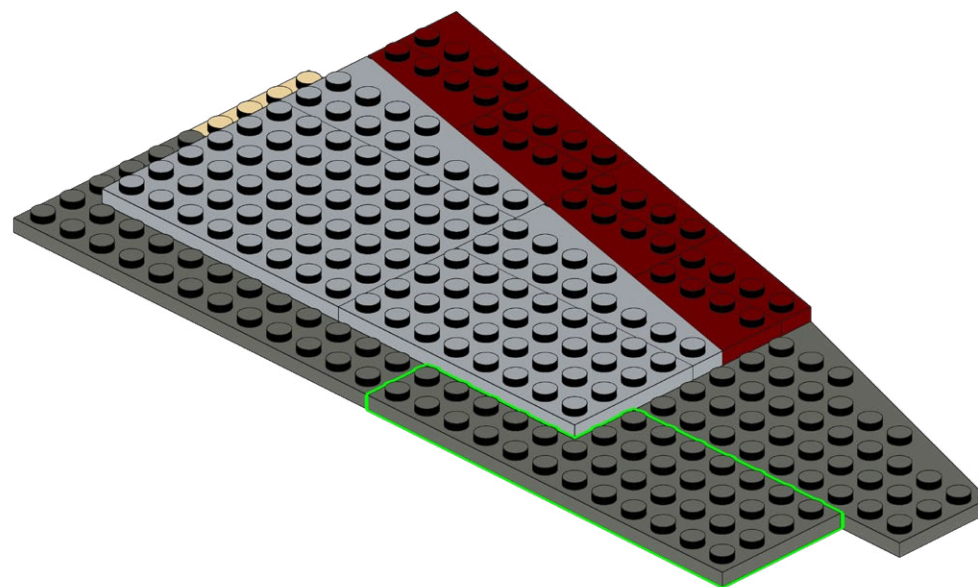
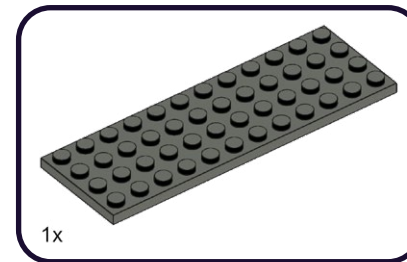

243

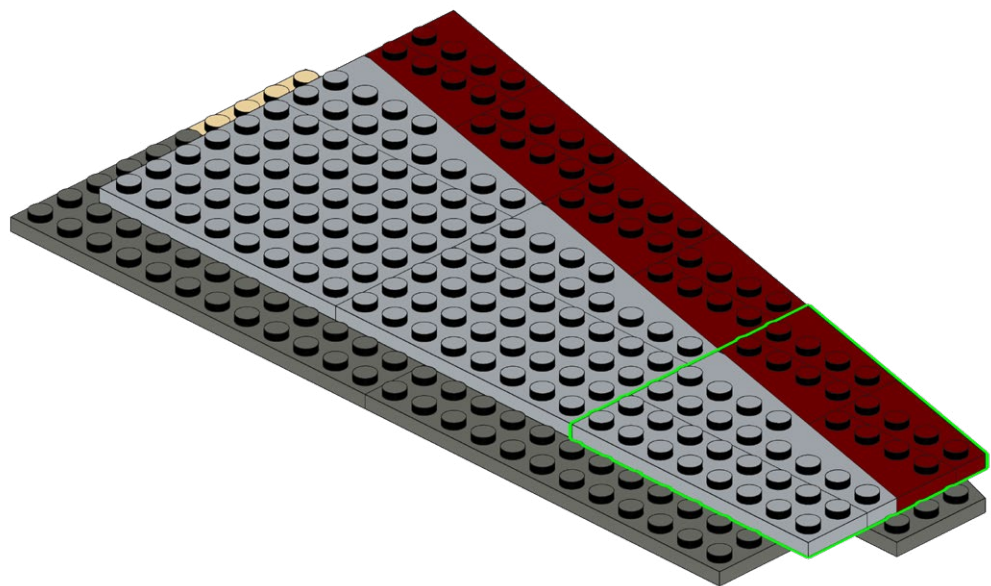
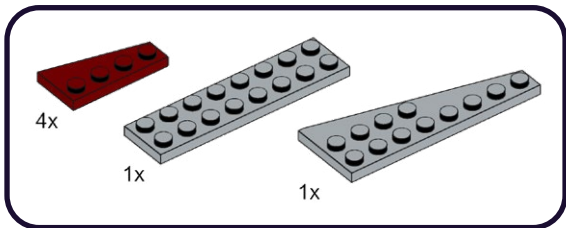

244

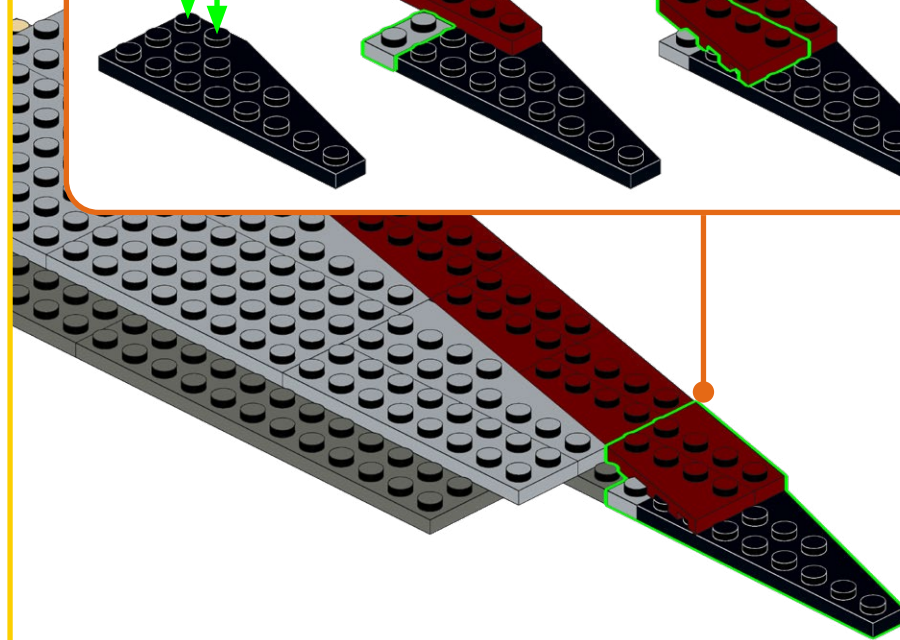
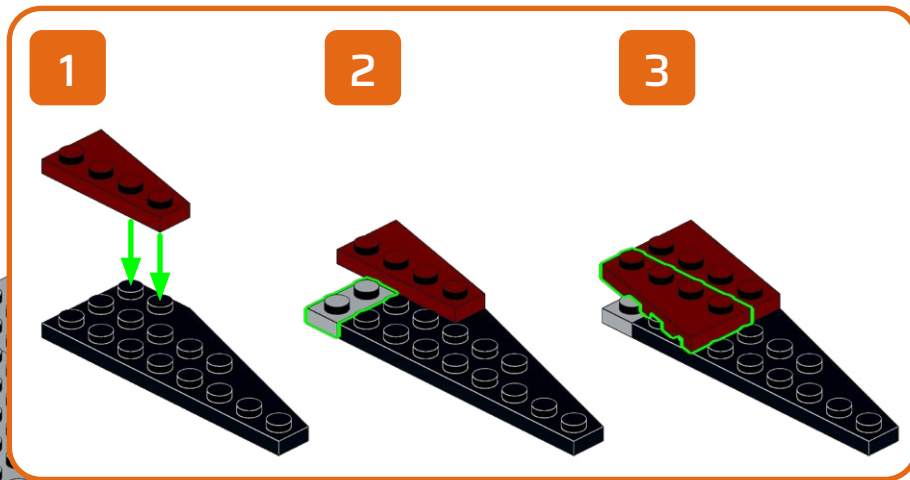
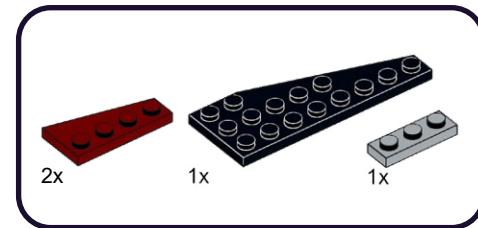

245

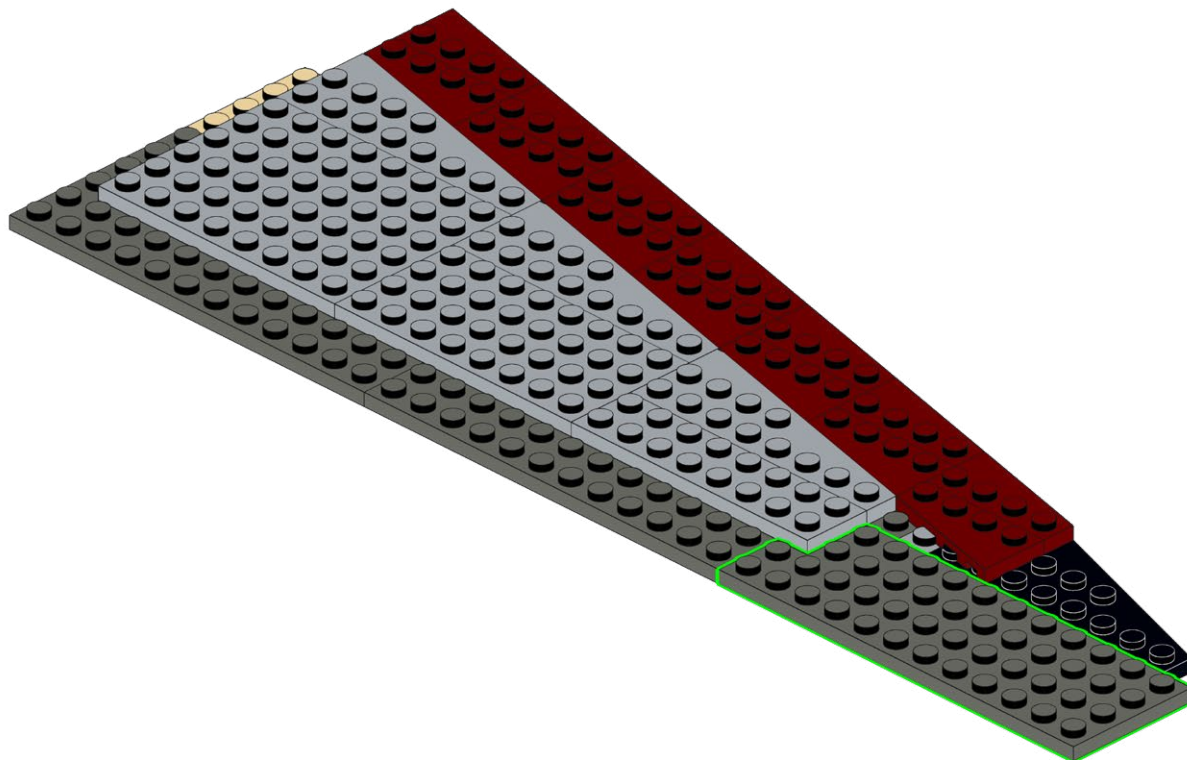
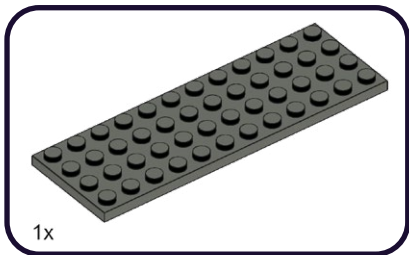

246

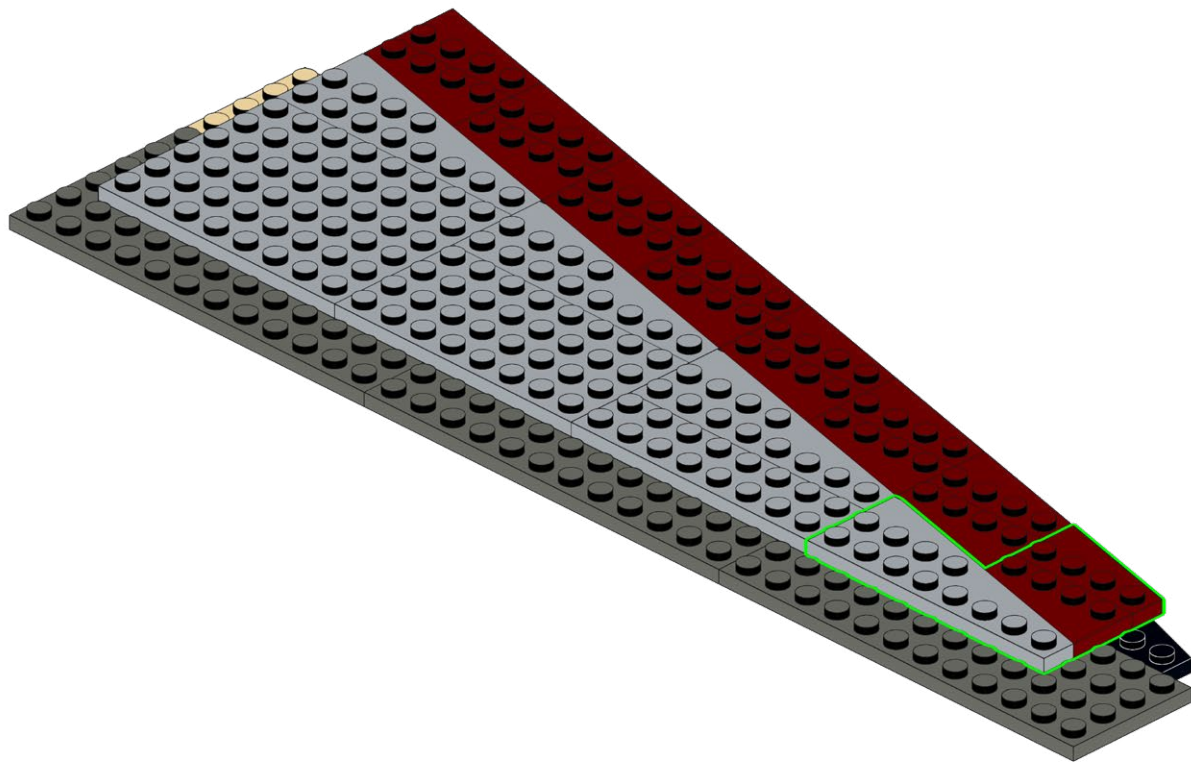
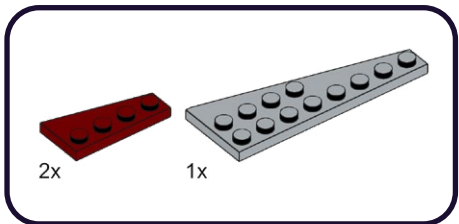

247

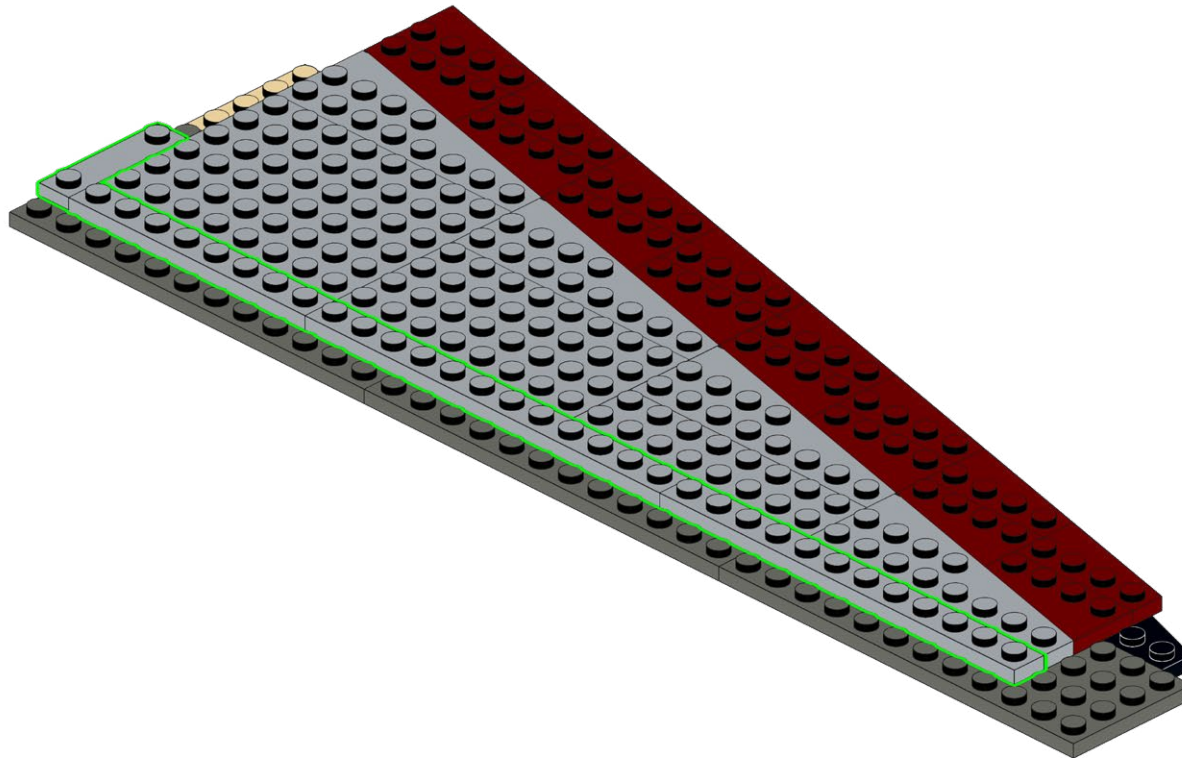
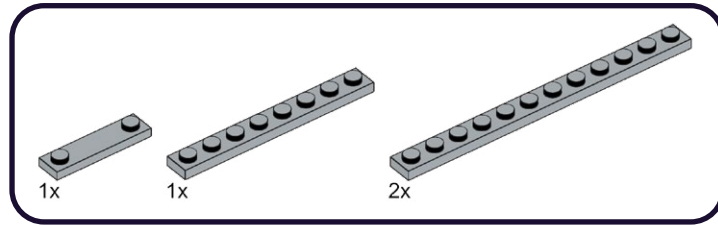

248

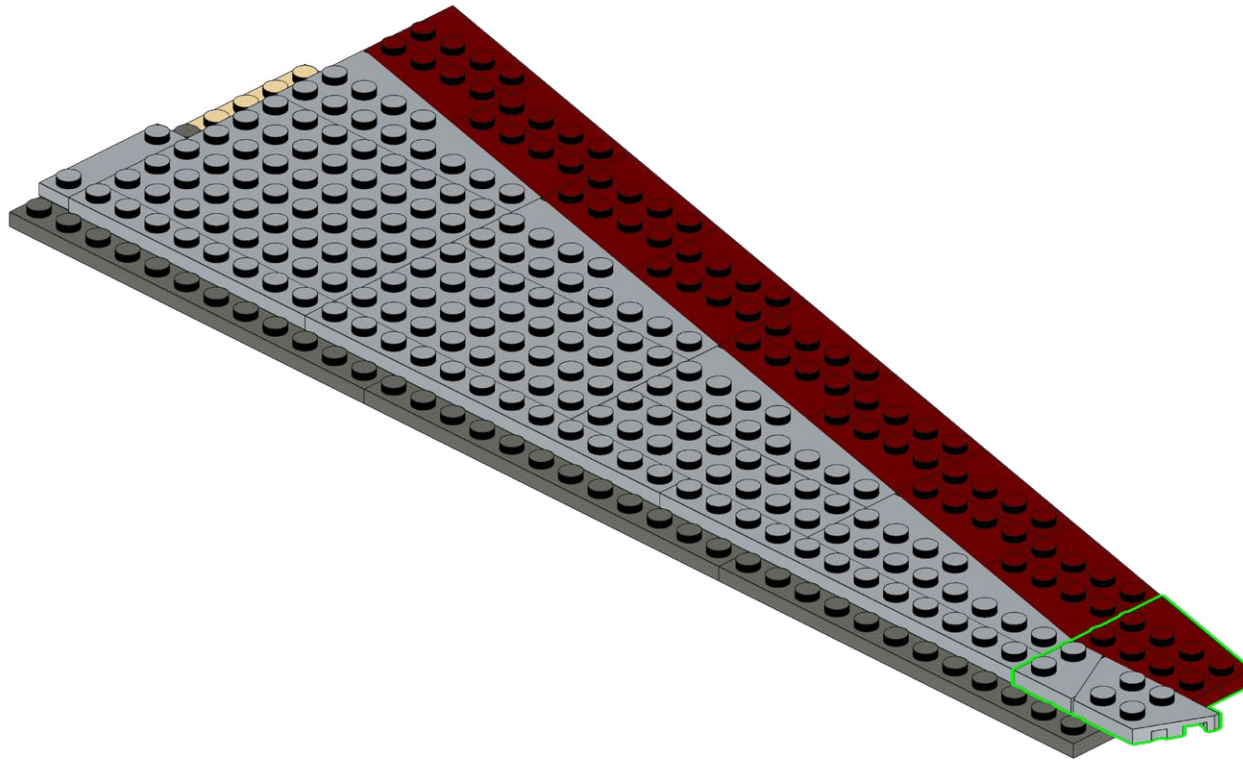
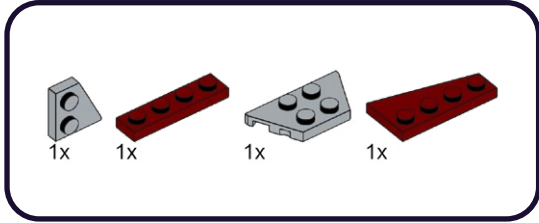

249

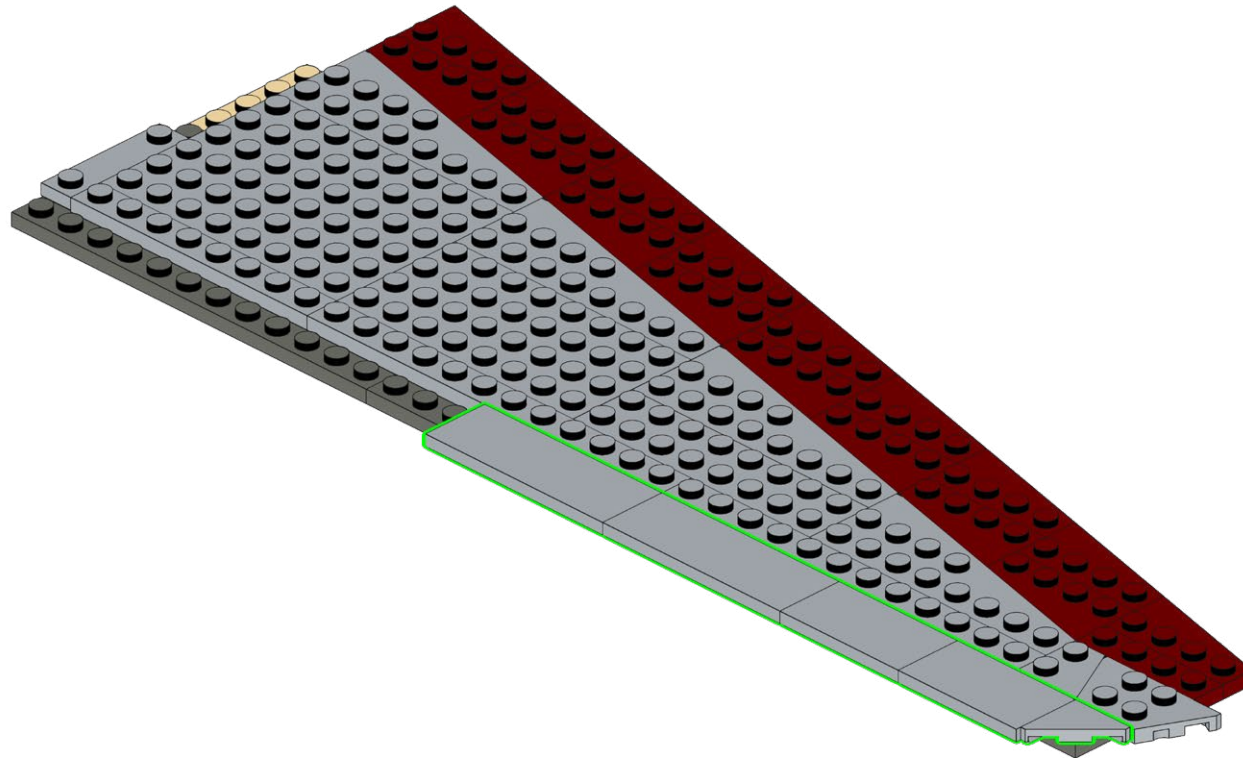
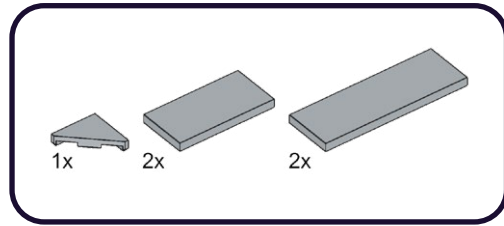

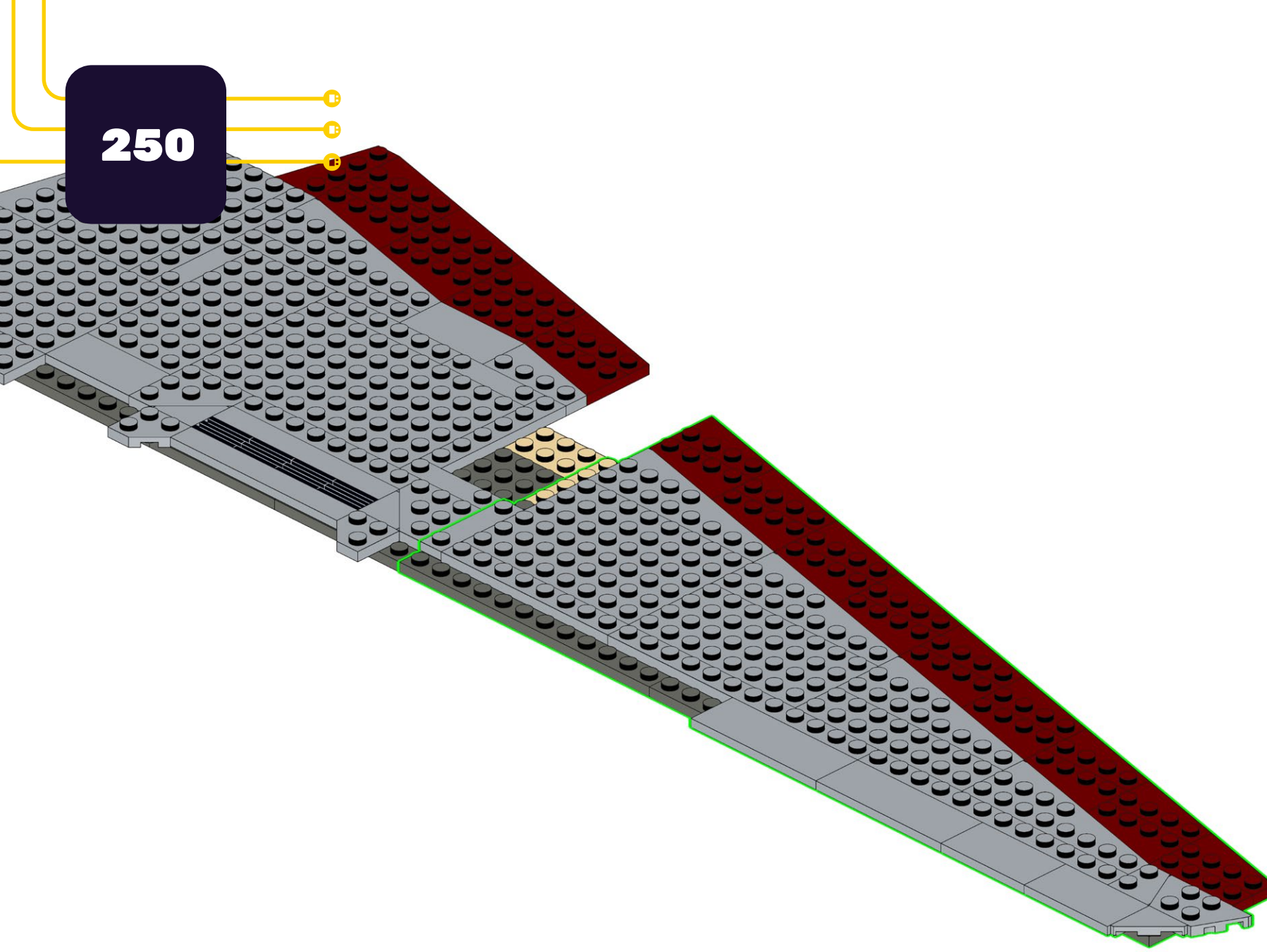

251

1x

1x

1x

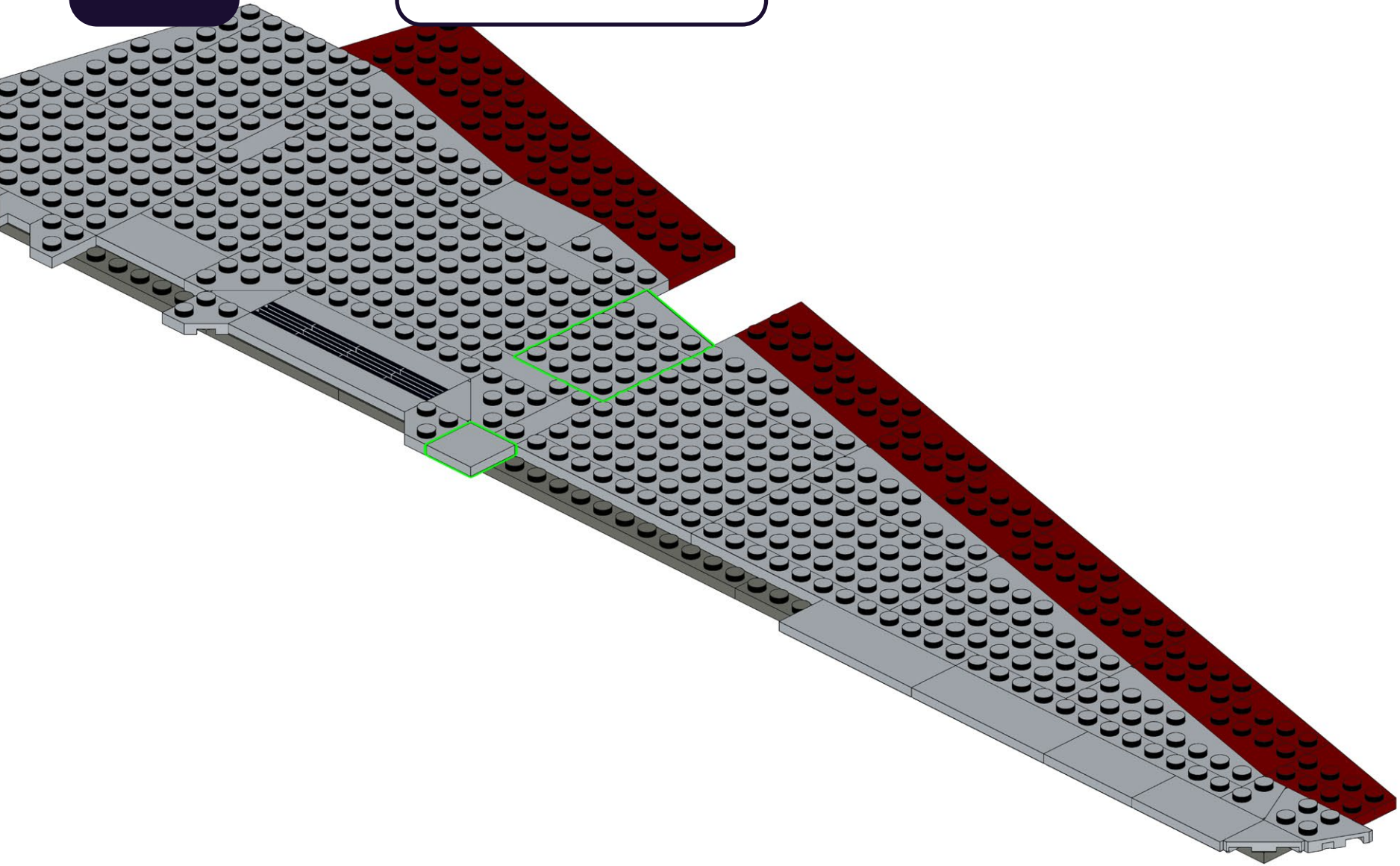

252

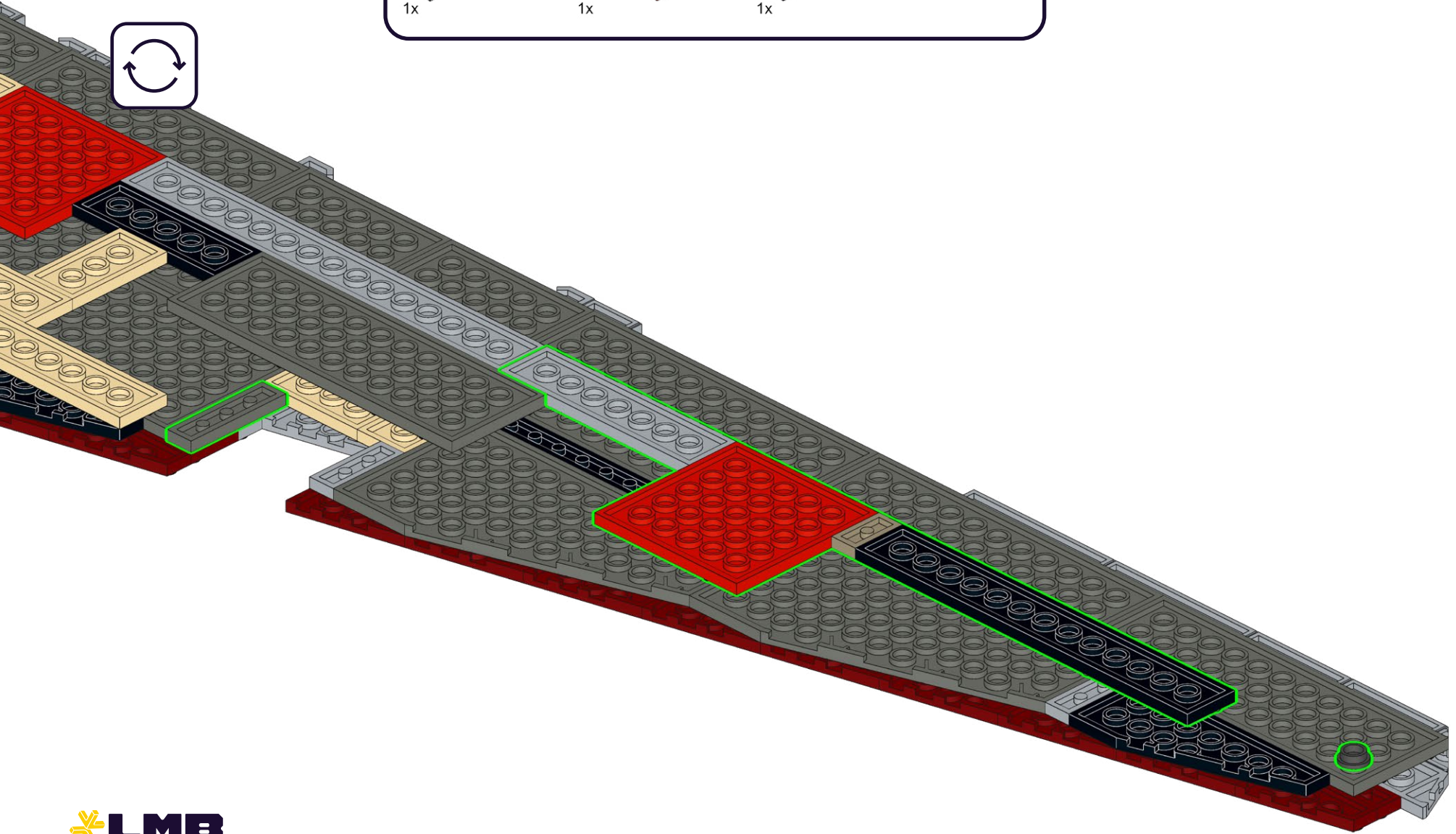
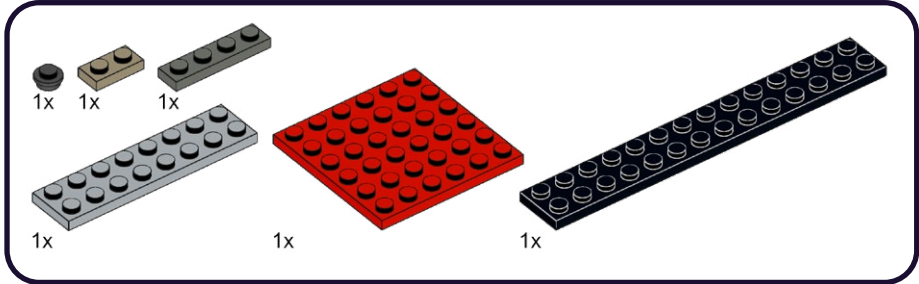

253

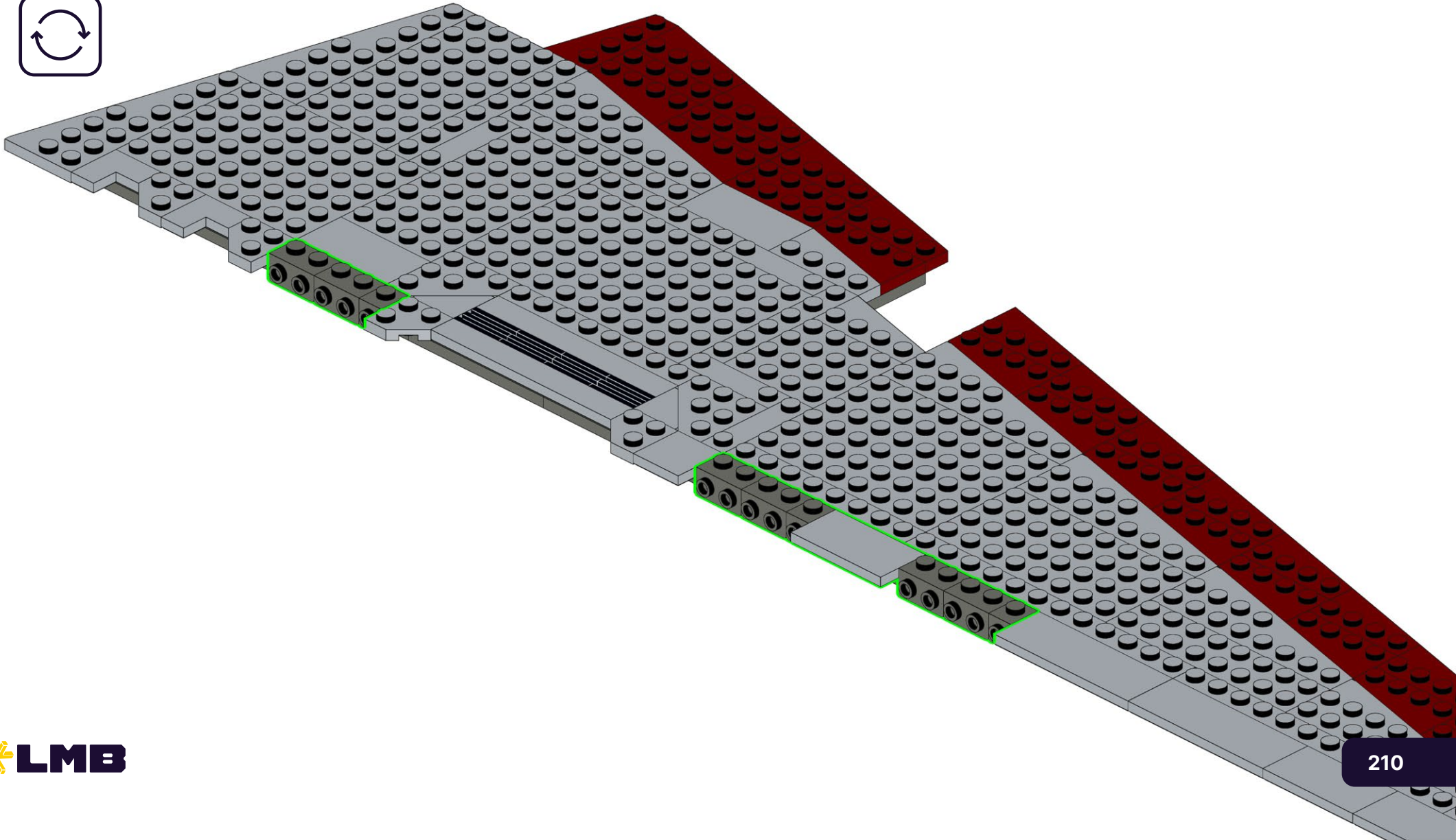
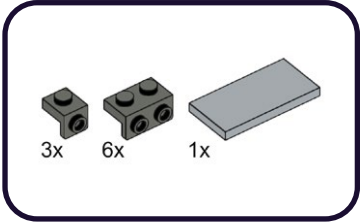

254

3x

3x

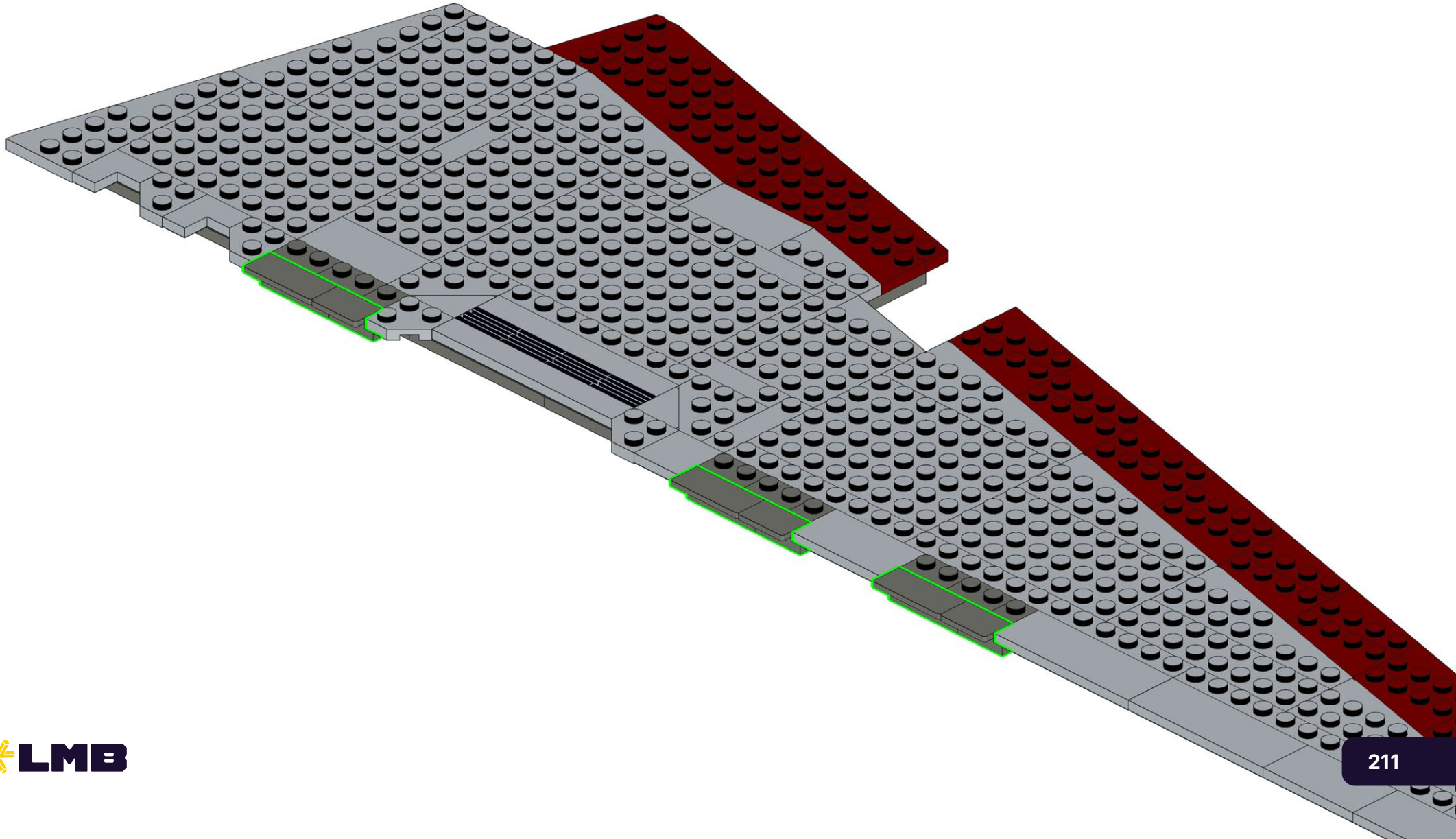

255

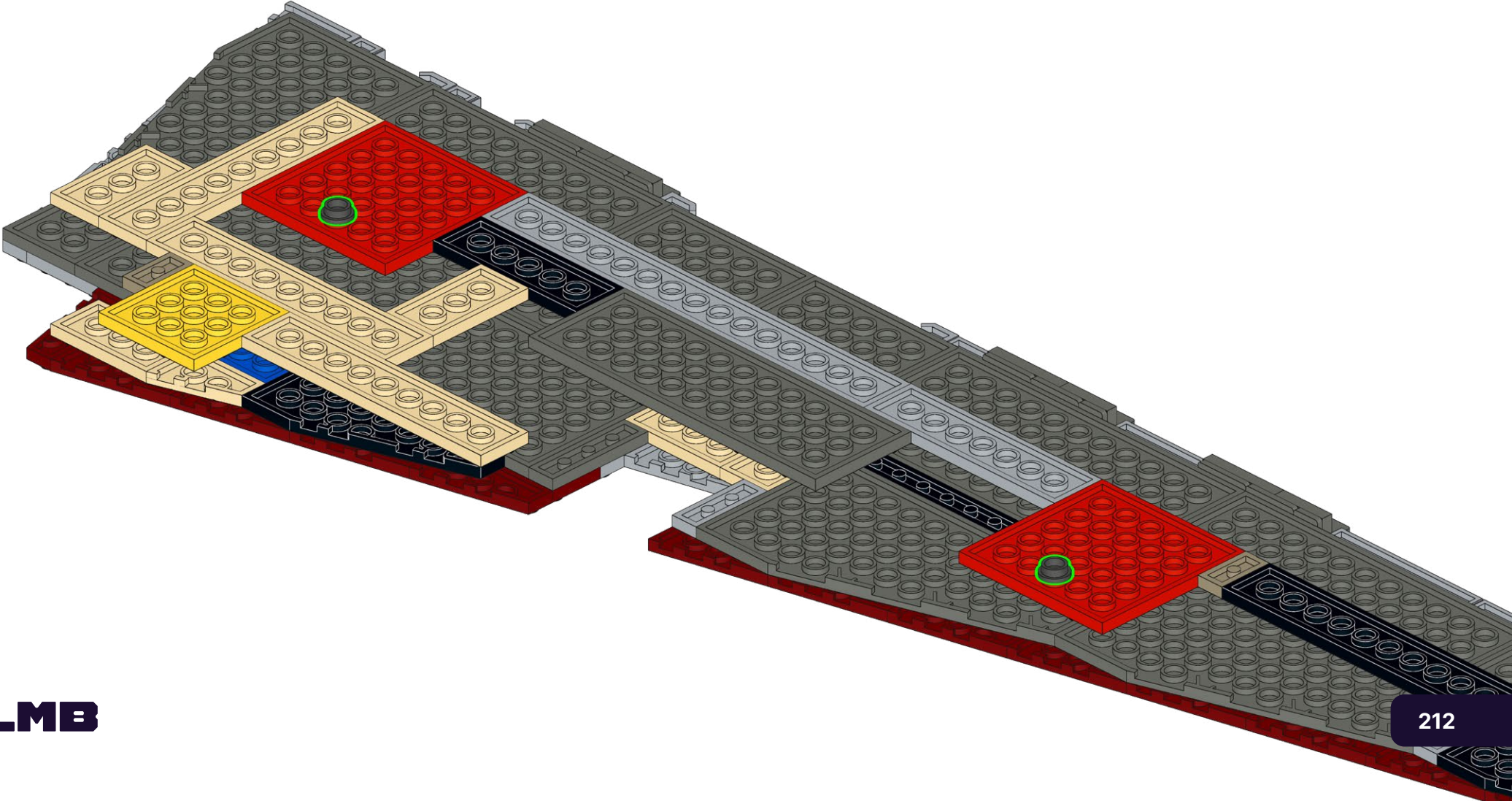

256

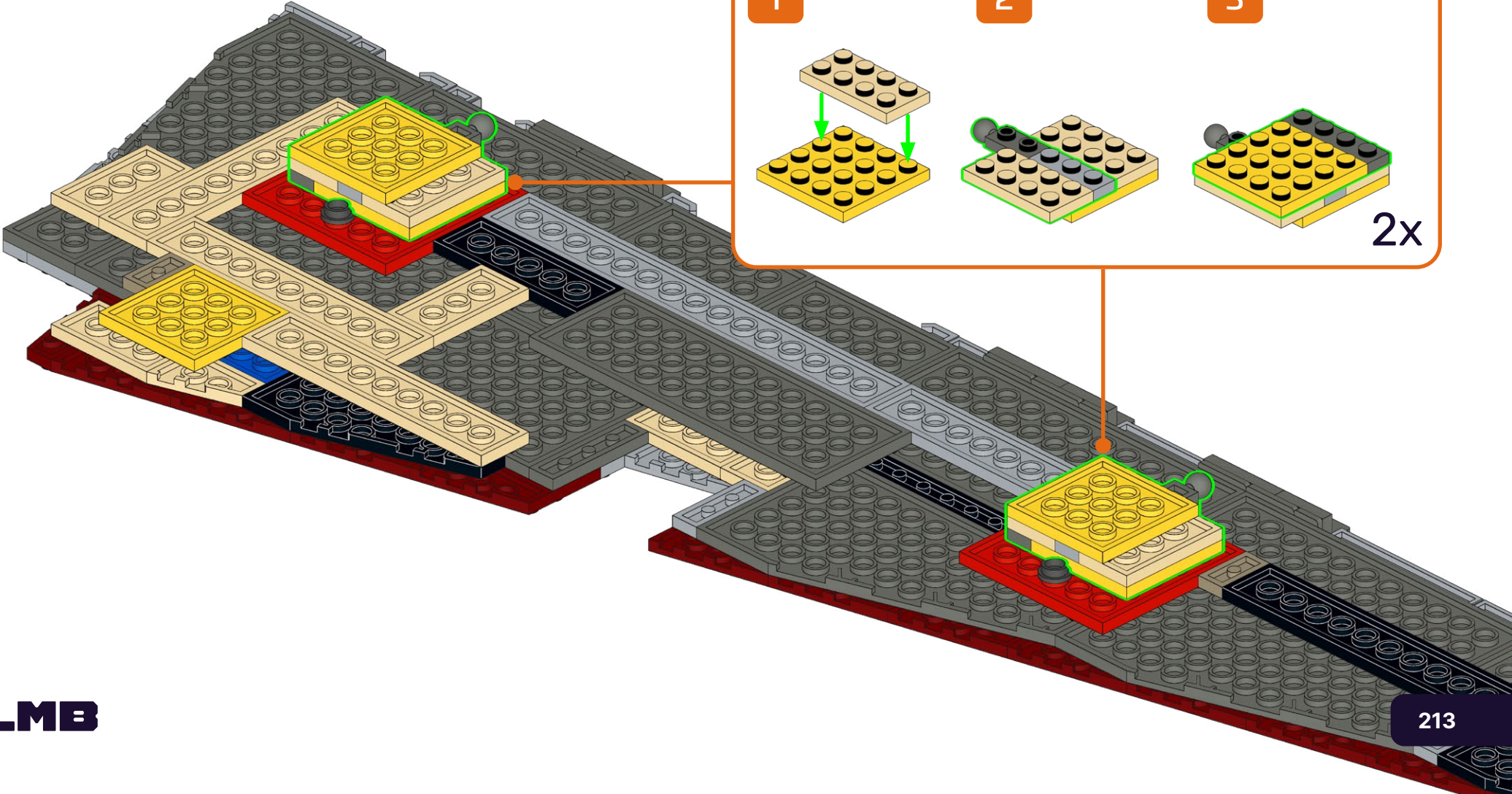
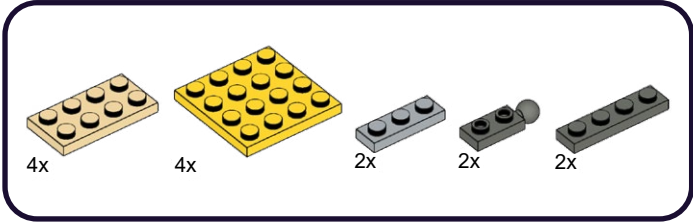

257

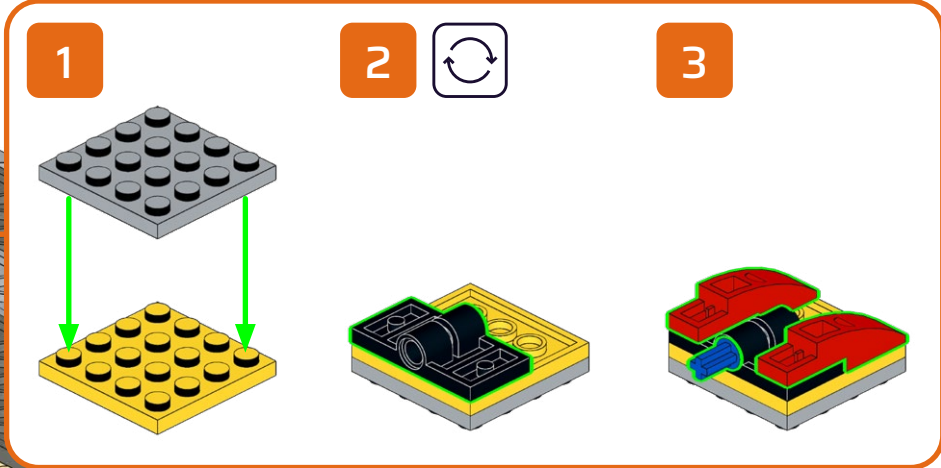
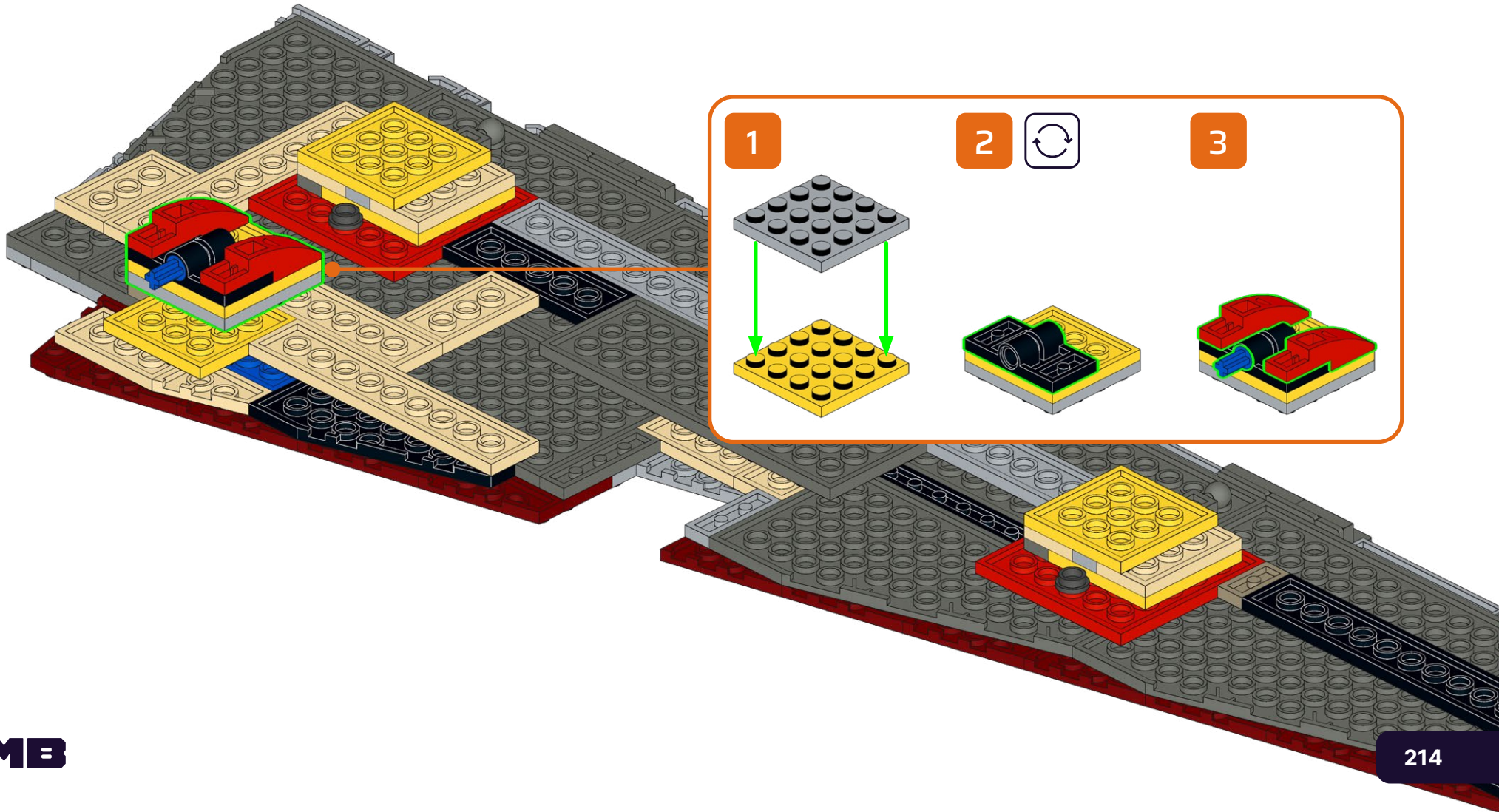
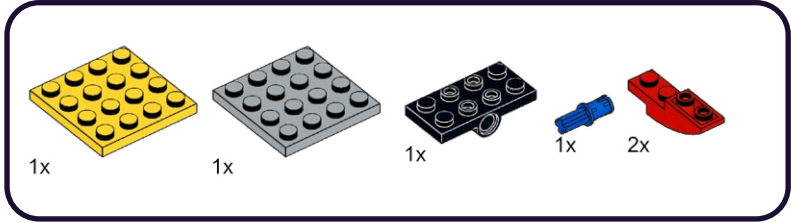

258

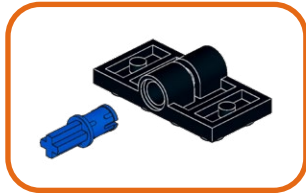
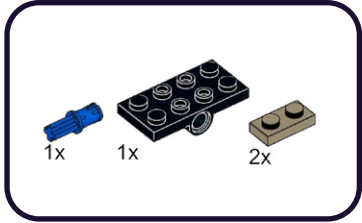

259

3x

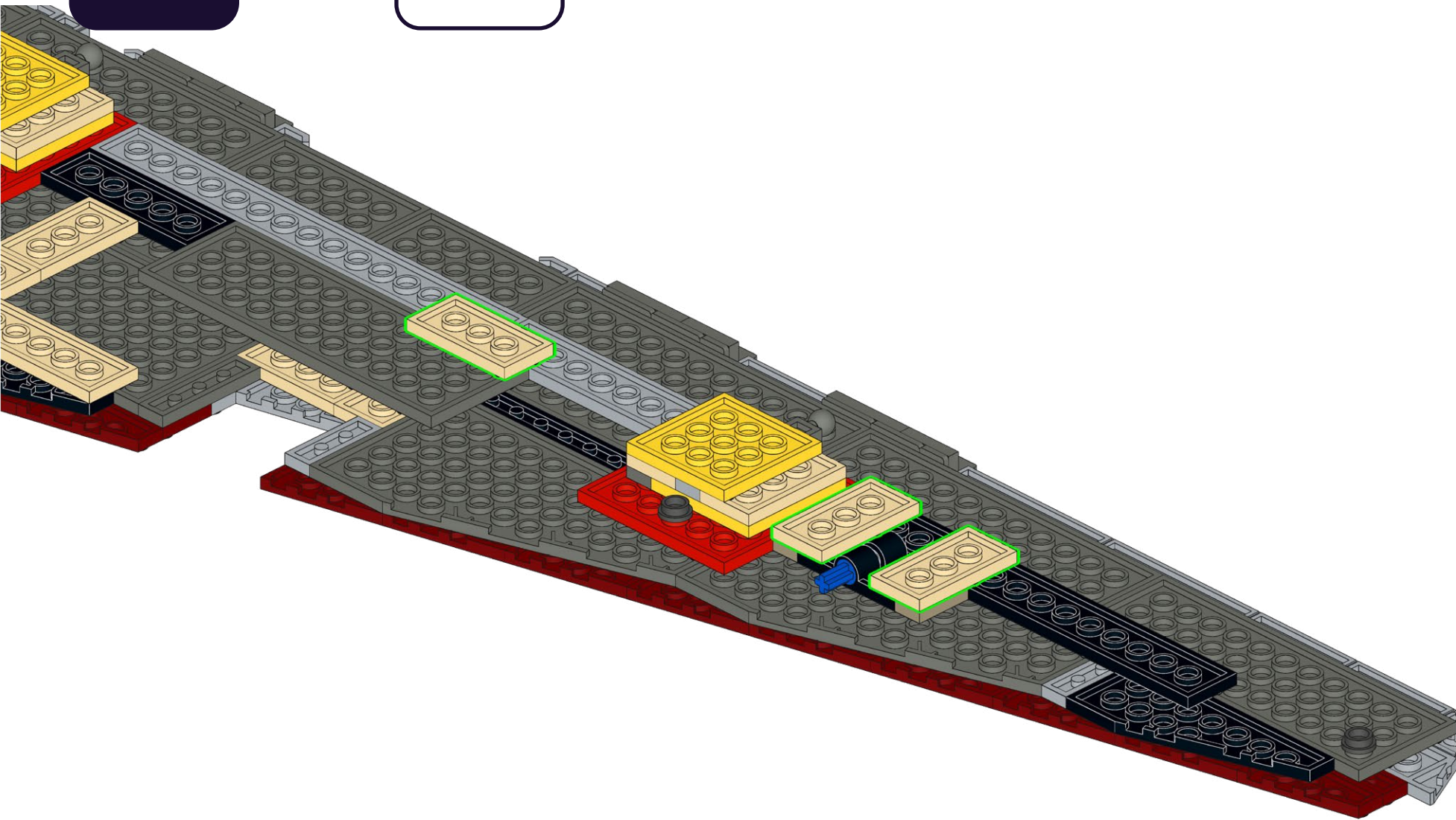

260

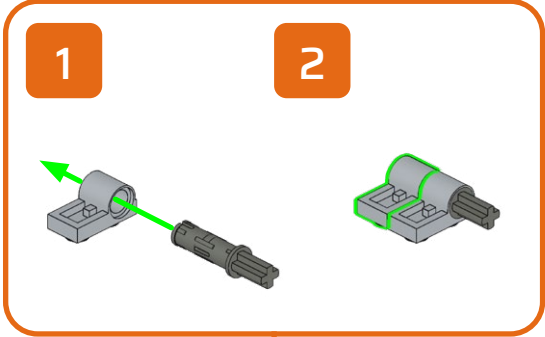
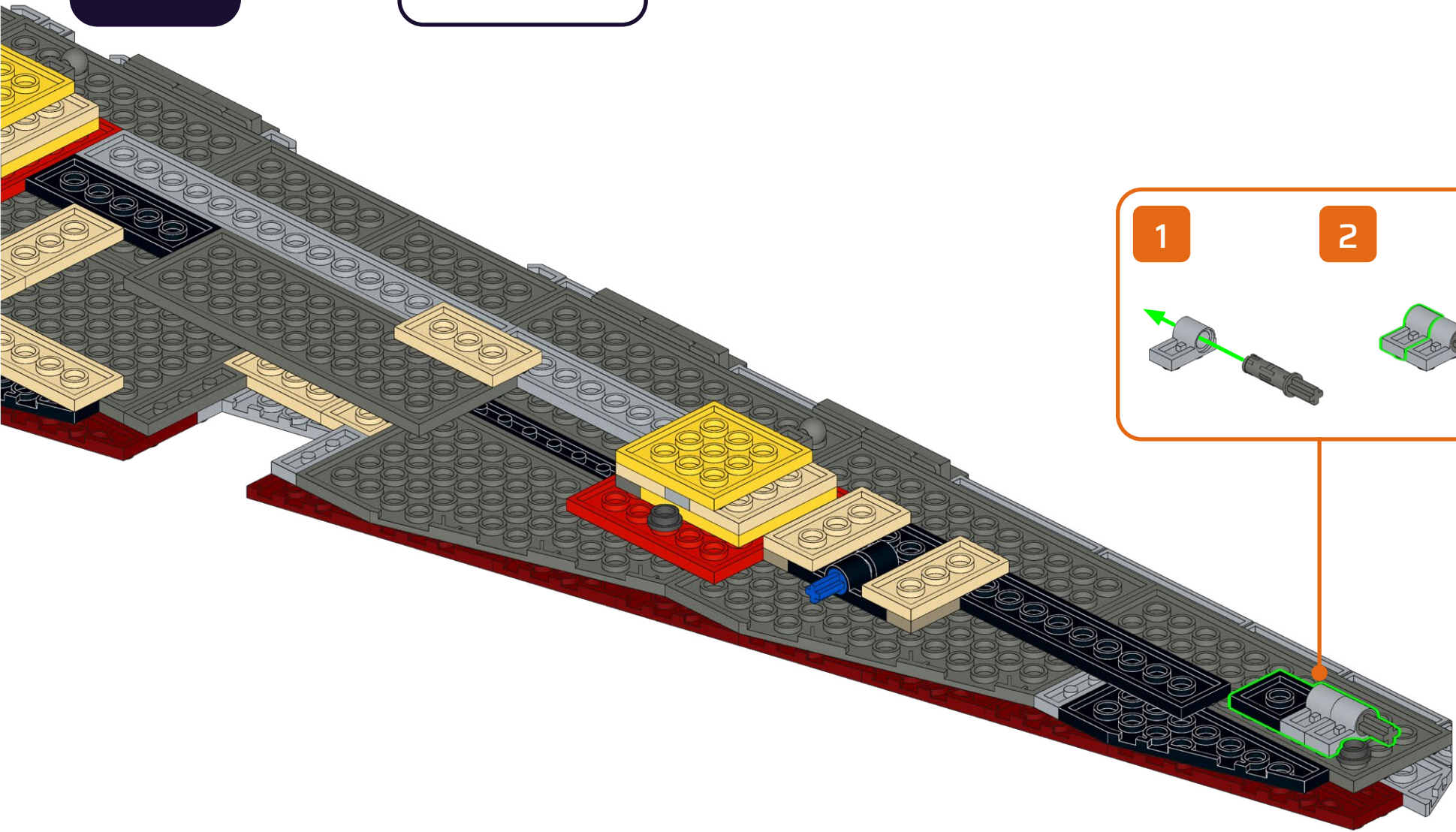
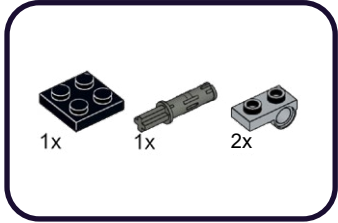

261

1x

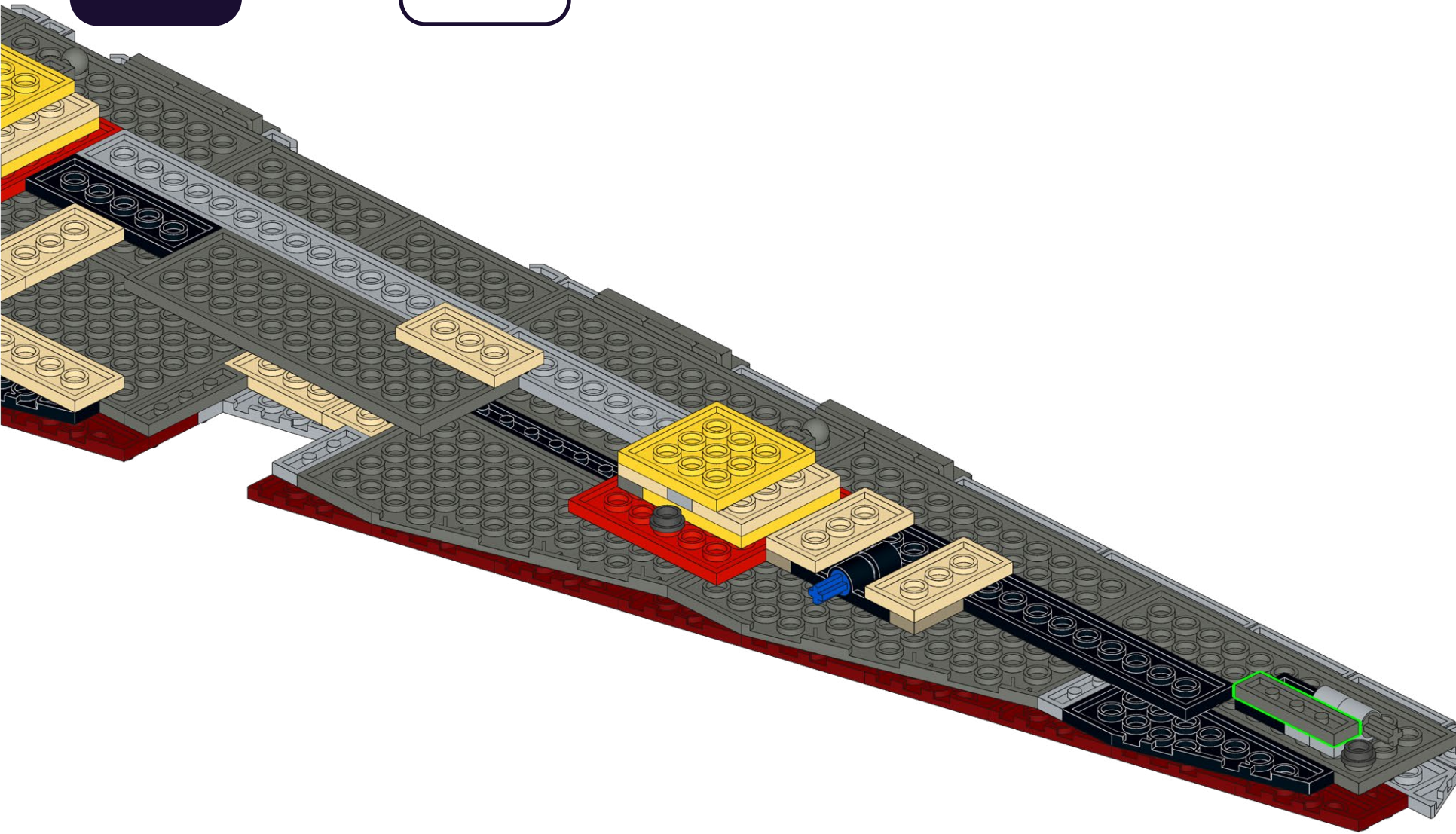

262



263

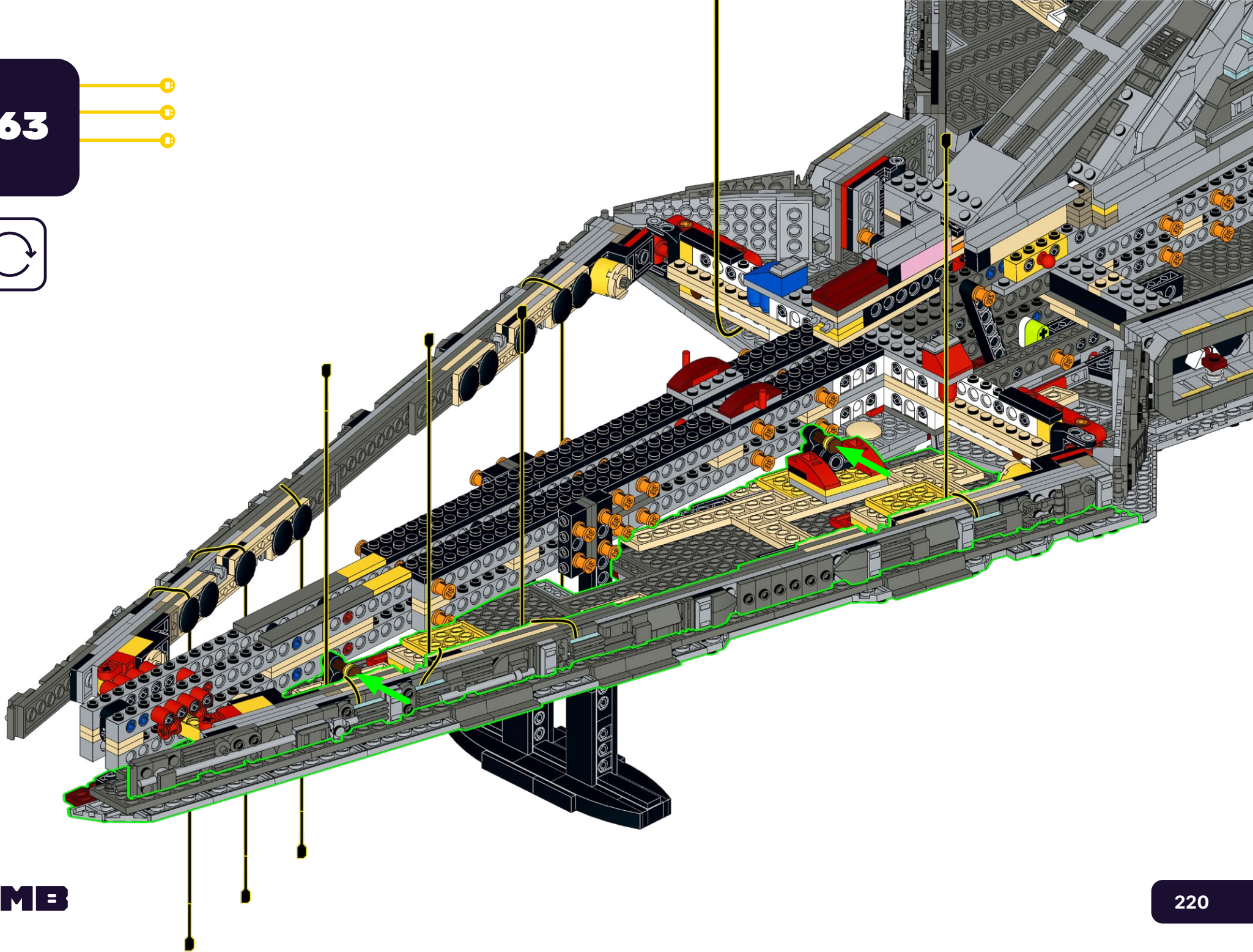

**HOLD UP!**

You might notice some bags aren't in order, as well as left over pieces, but that's ok! We're changing the way you build LEGO!

ATTENDEZ!

Vous remarquerez peut-être que certains sacs, ainsi que certaines pièces, ne sont pas dans le bon ordre. Mais pas de panique! Nous changeons simplement la façon avec laquelle vous construisez vos LEGO!

ASPETTA!

Potresti notare che alcuni sacchetti non sono in ordine, così come i pezzi avanzati, ma va bene così! Stiamo cambiando il modo in cui costruisci i LEGO!

HALT!

Sie werden möglicherweise bemerken, dass einige tüten durcheinander sind und teile übrig bleiben, aber das ist in Ordnung! Wir ändern die art und weise, wie Sie LEGO bauen!

¡ESPERA!

Es posible que notes que algunas bolsas están fuera de servicio, así como piezas sobrantes, ¡pero está bien! ¡Estamos cambiando la forma en que construyes LEGO!

暫停!

你可能会注意到一些袋子顺序错乱, 以及一些剩余的部件, 但没关系! 我们正在改变你搭建乐高的方式!

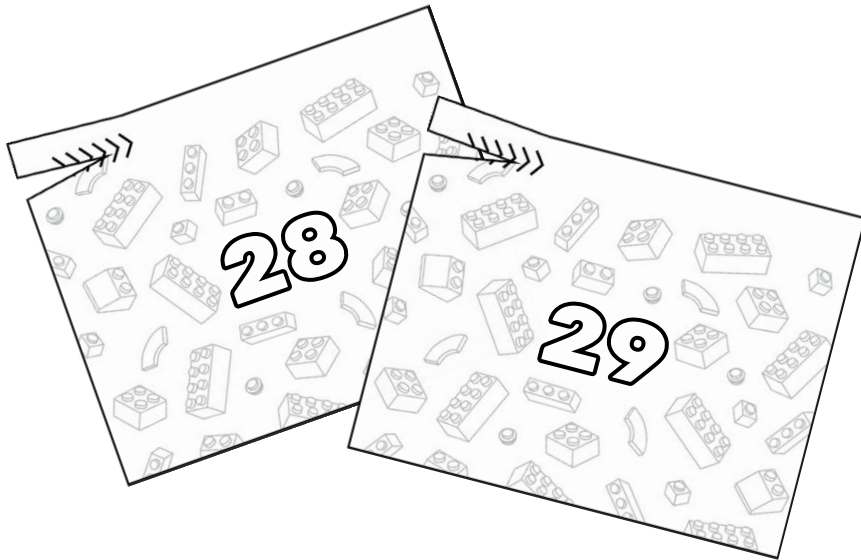
Open LEGO® Bags 28 & 29

264

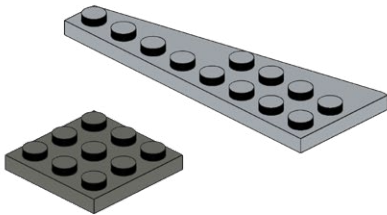
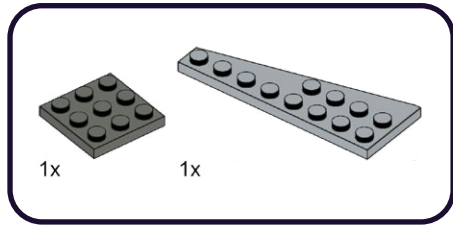

265

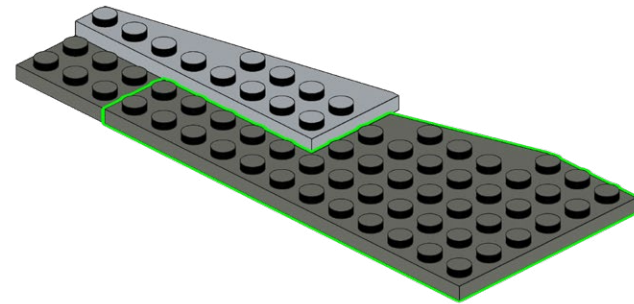
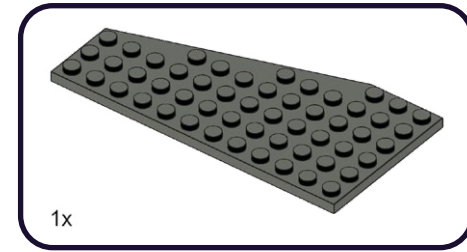

266

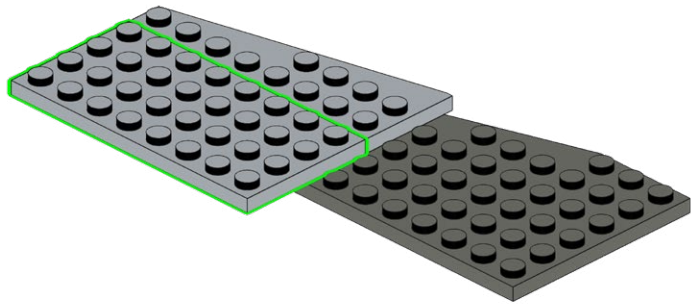
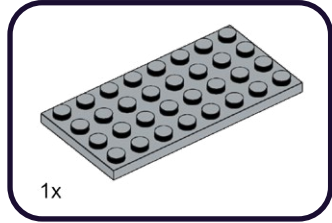

267

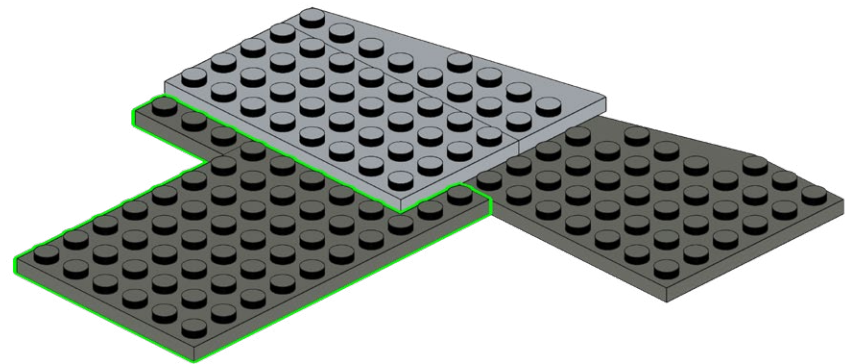
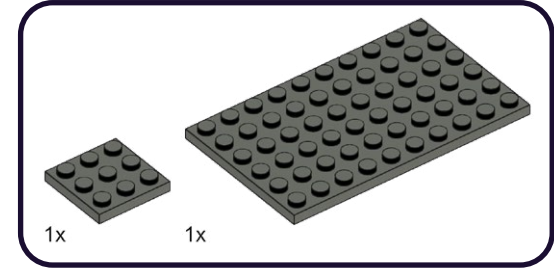

268

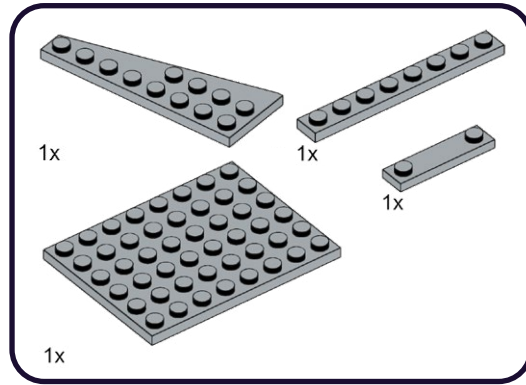

269

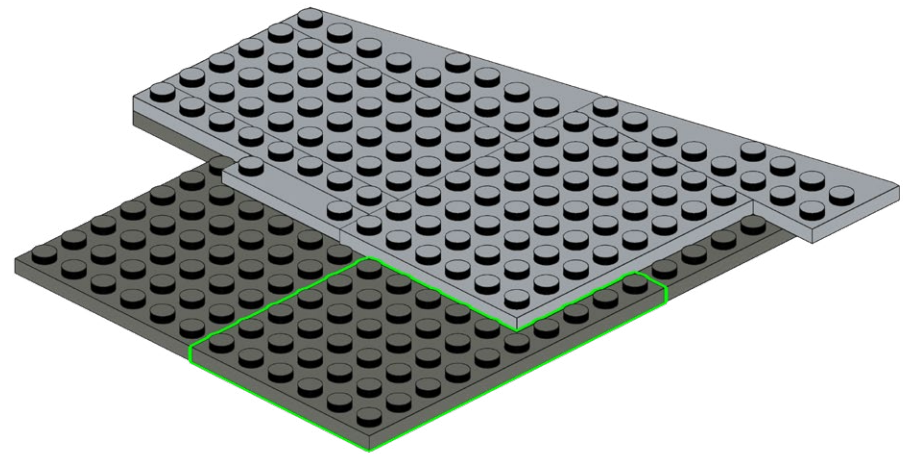
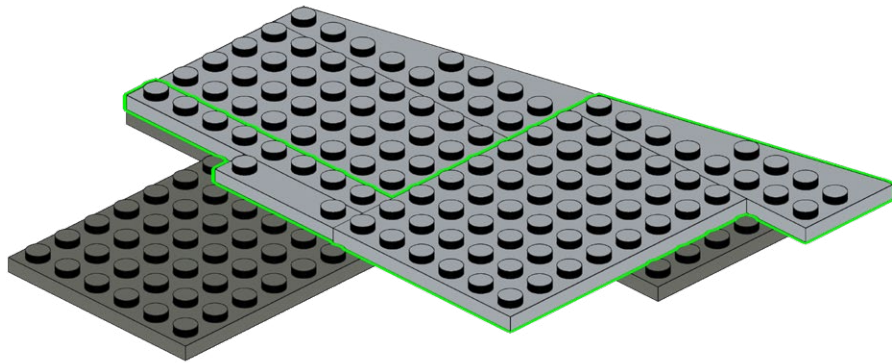
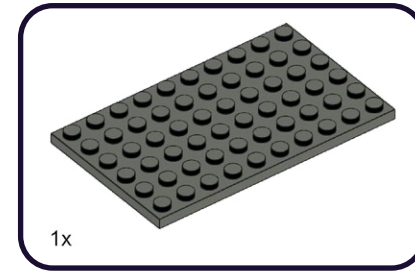

270

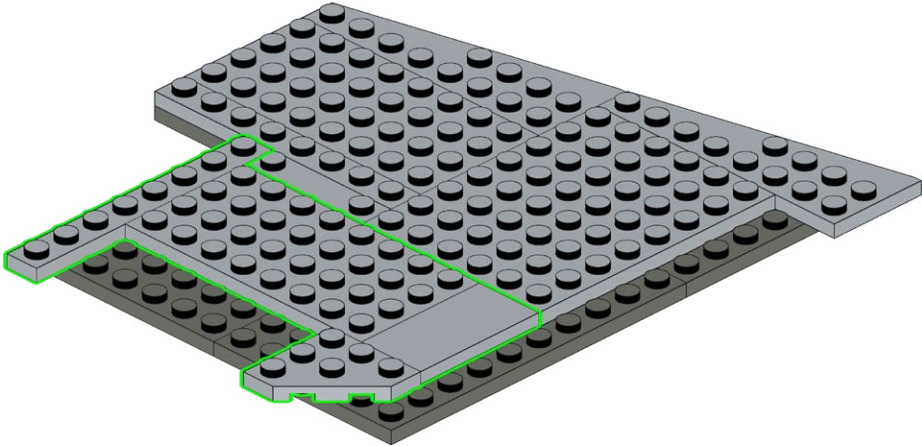
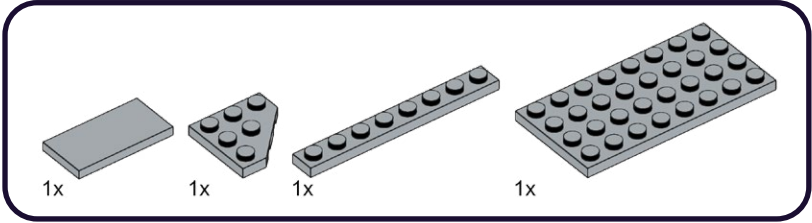

271

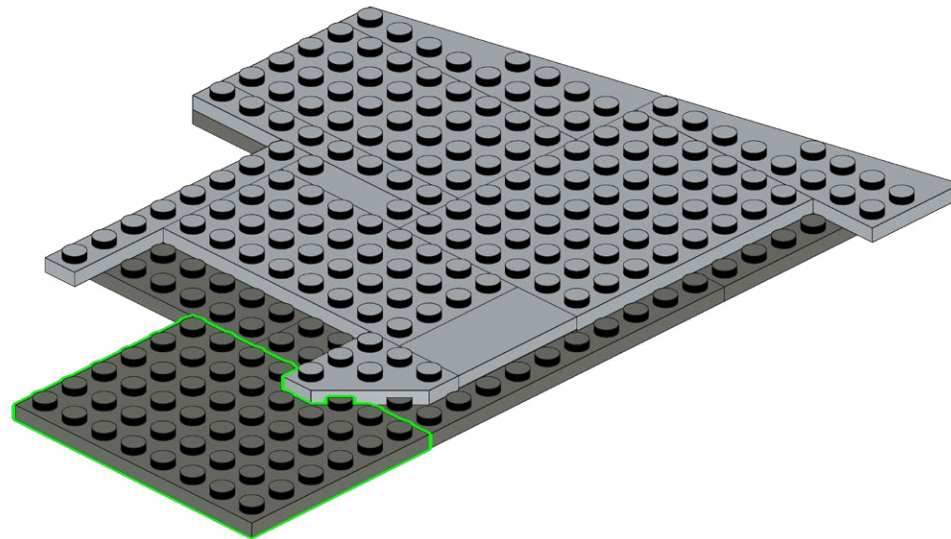
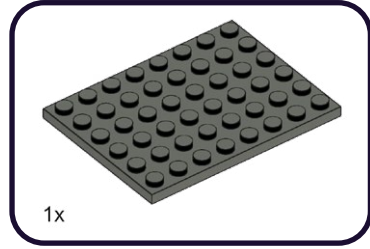

272

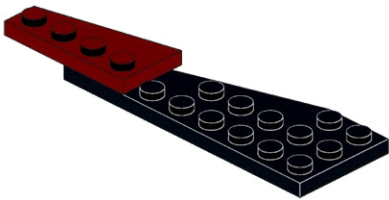
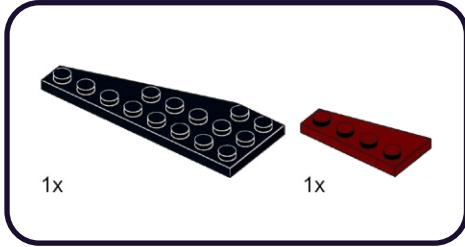

273

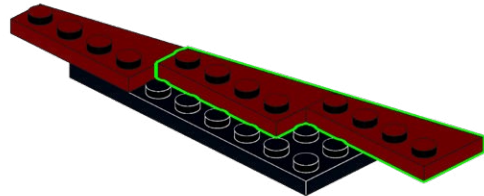
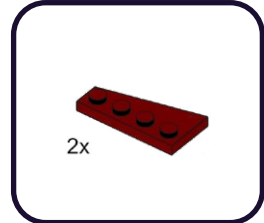

274

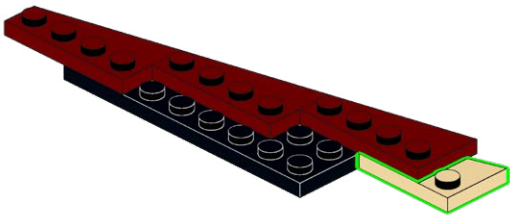
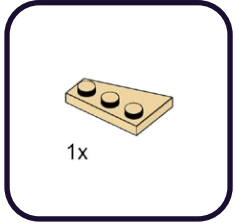

275

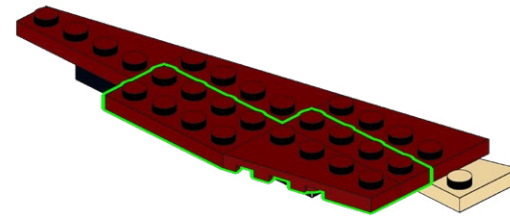
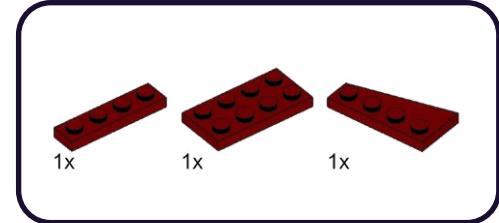

276

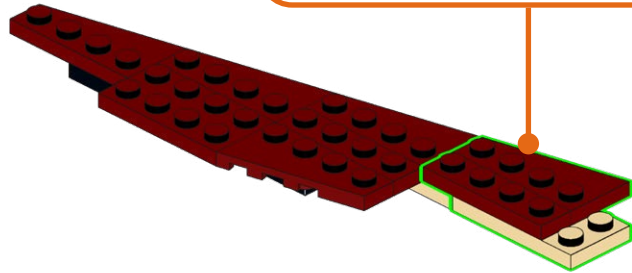
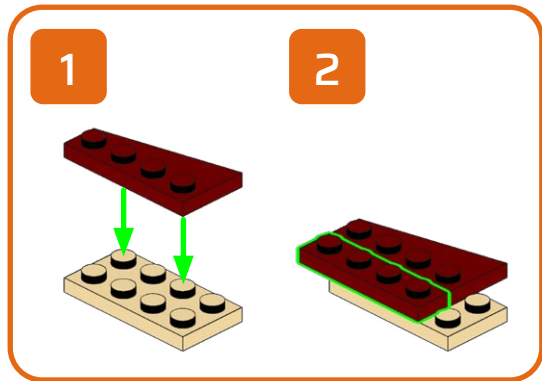
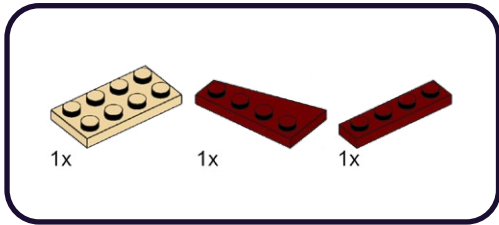

277

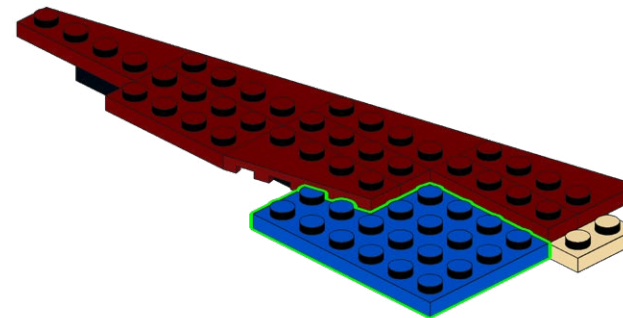
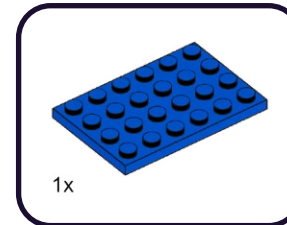

278

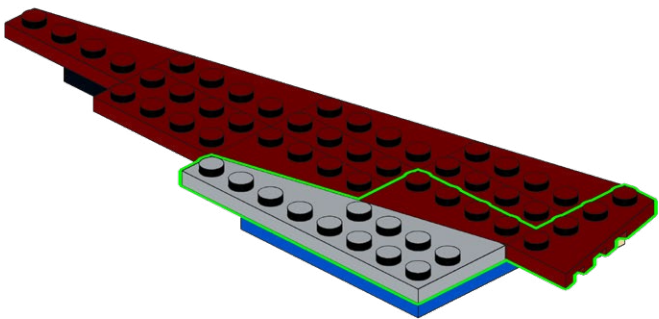
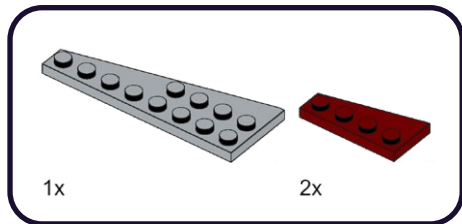

279

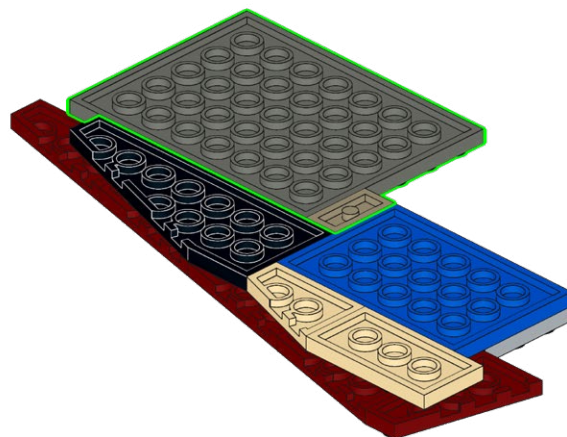
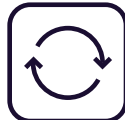
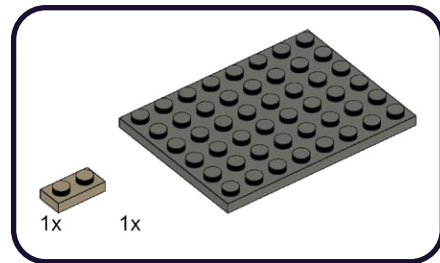

280

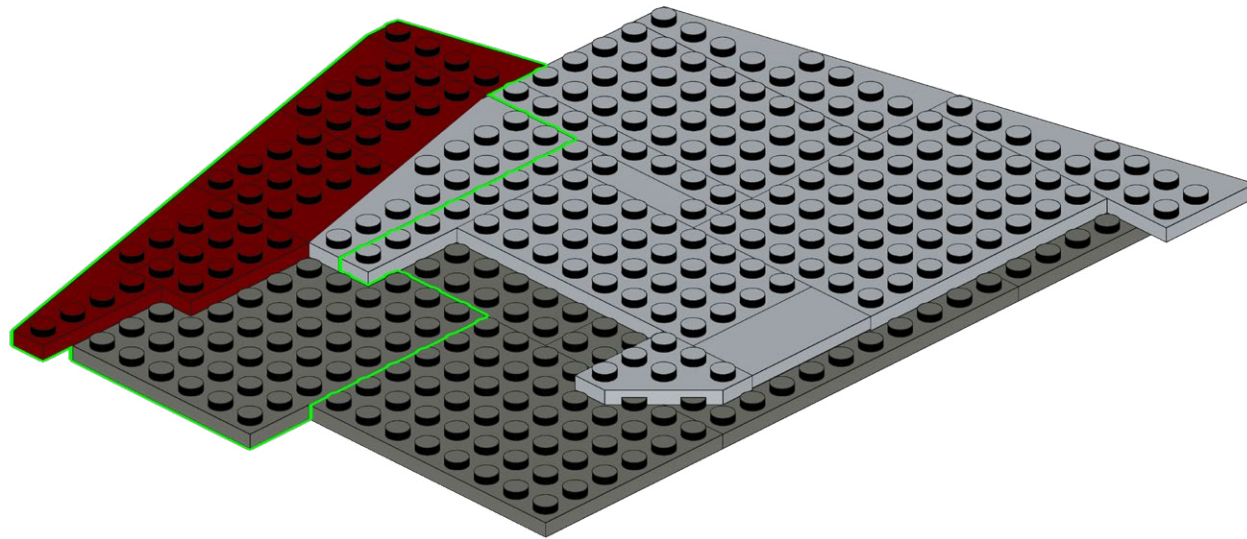

281

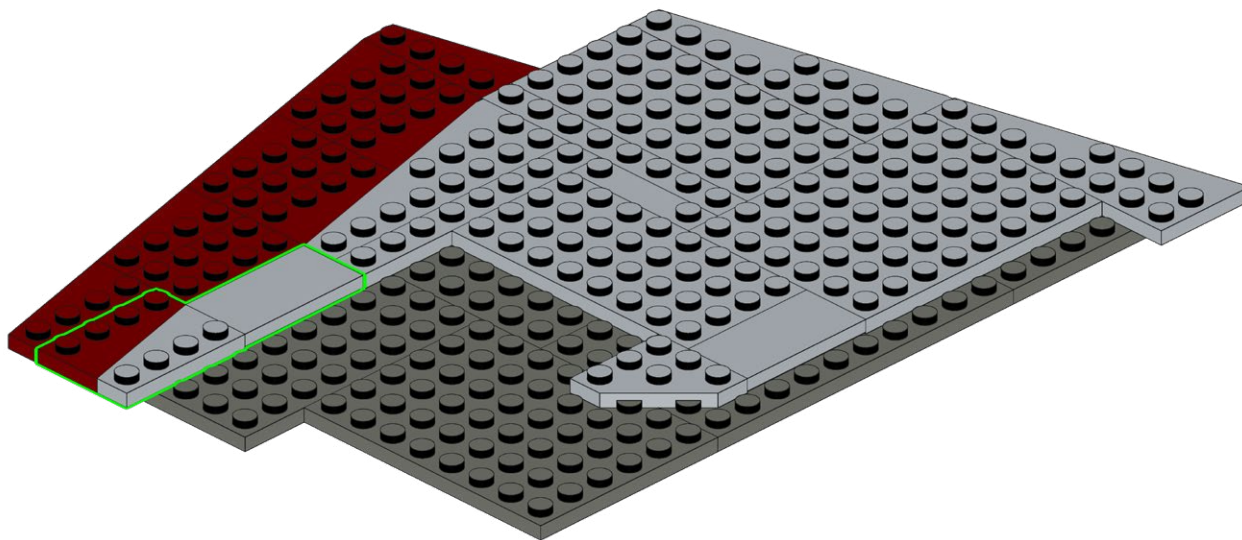
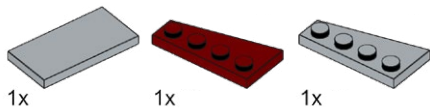

282

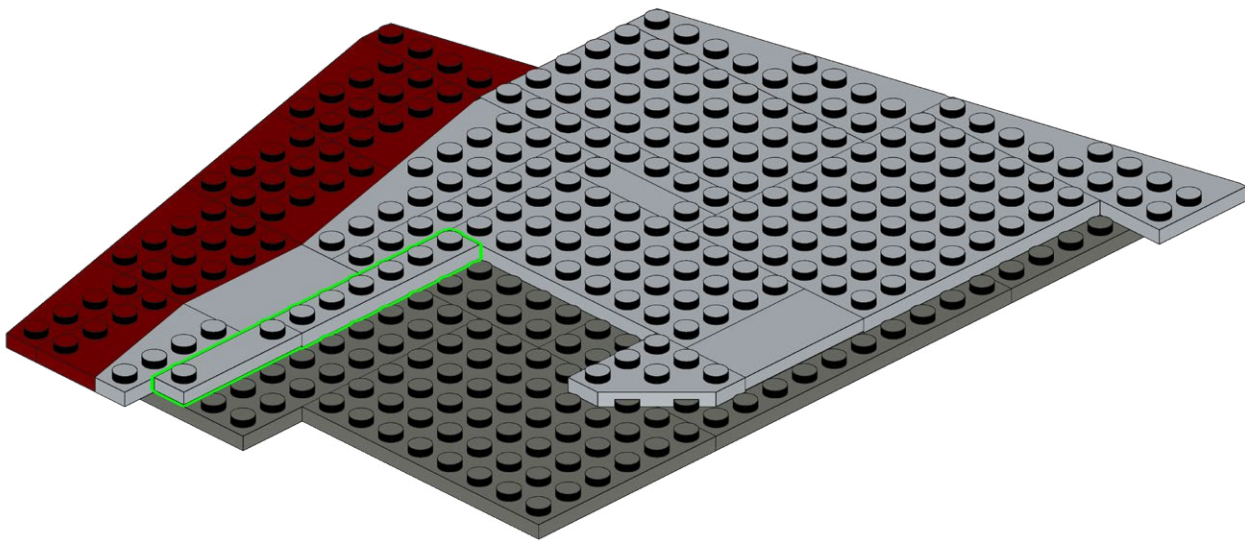
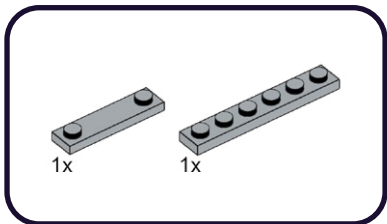

283

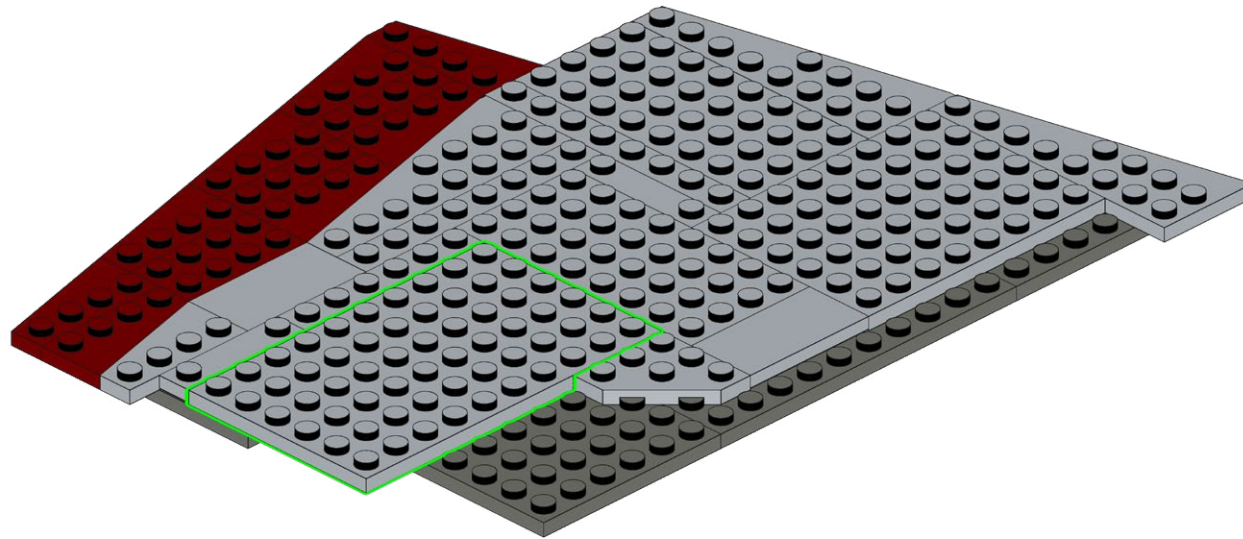
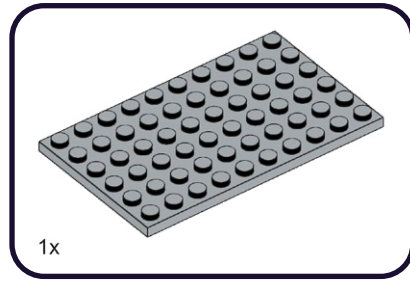

284

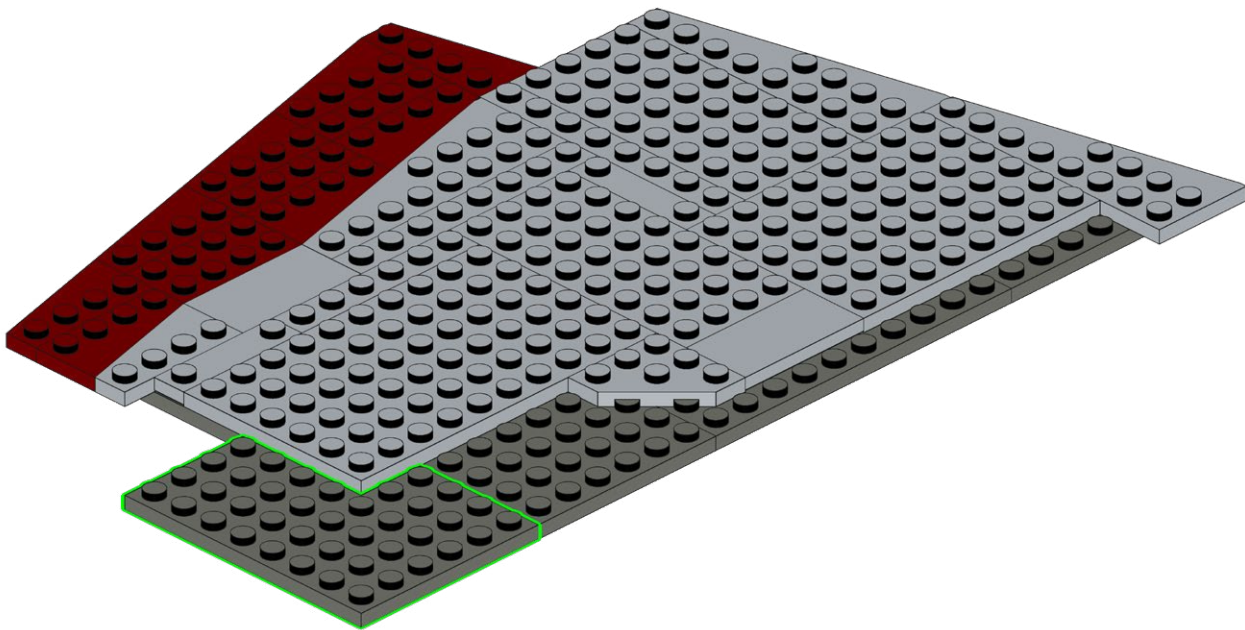
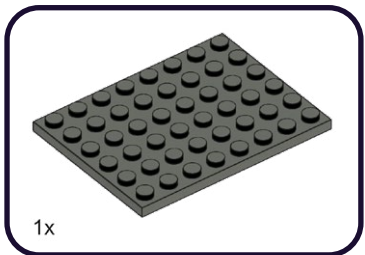

285

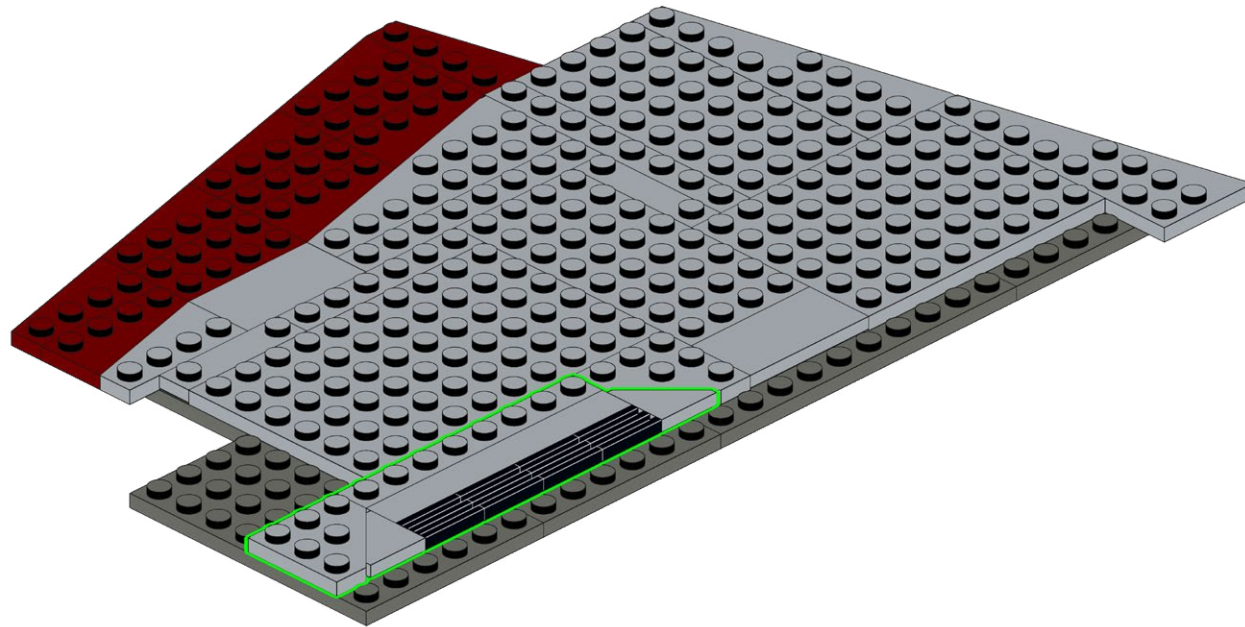
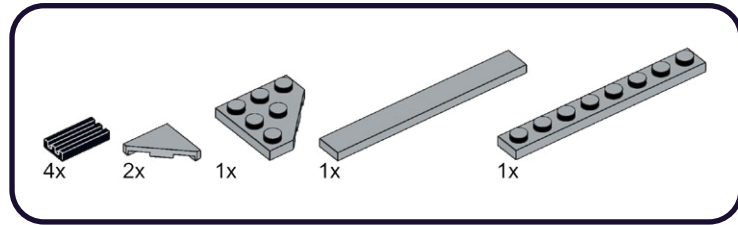

286

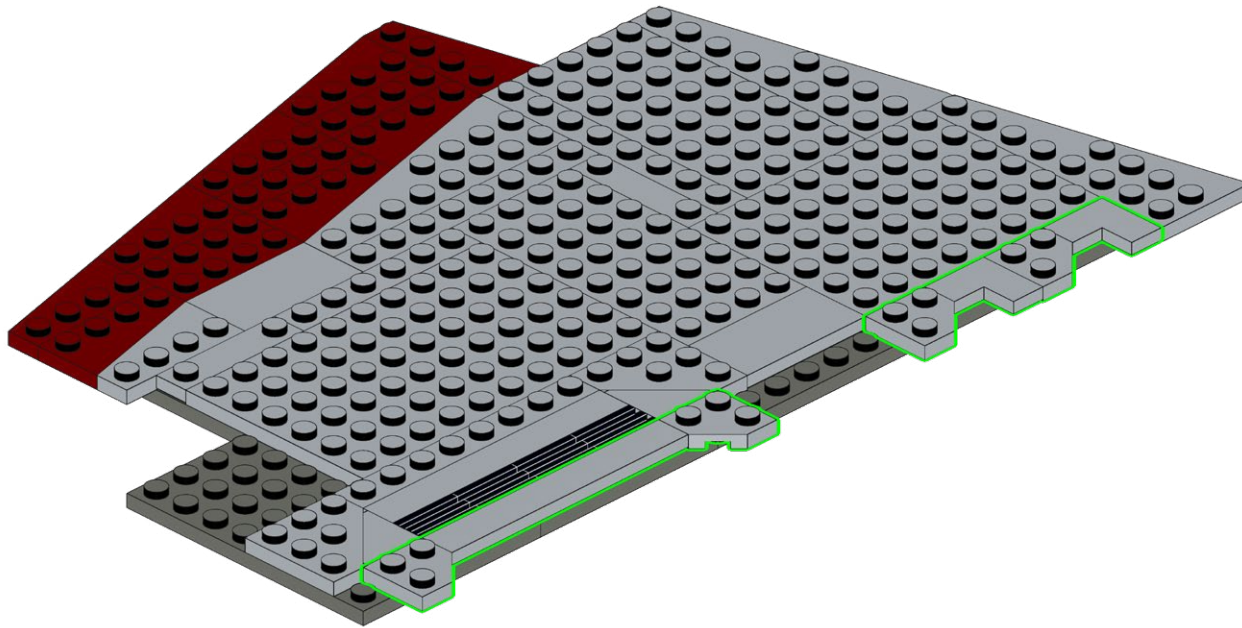
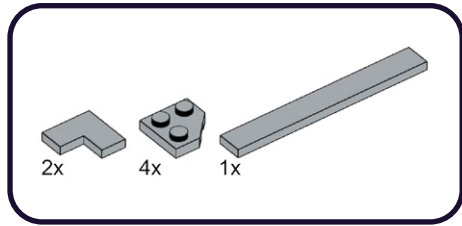

287

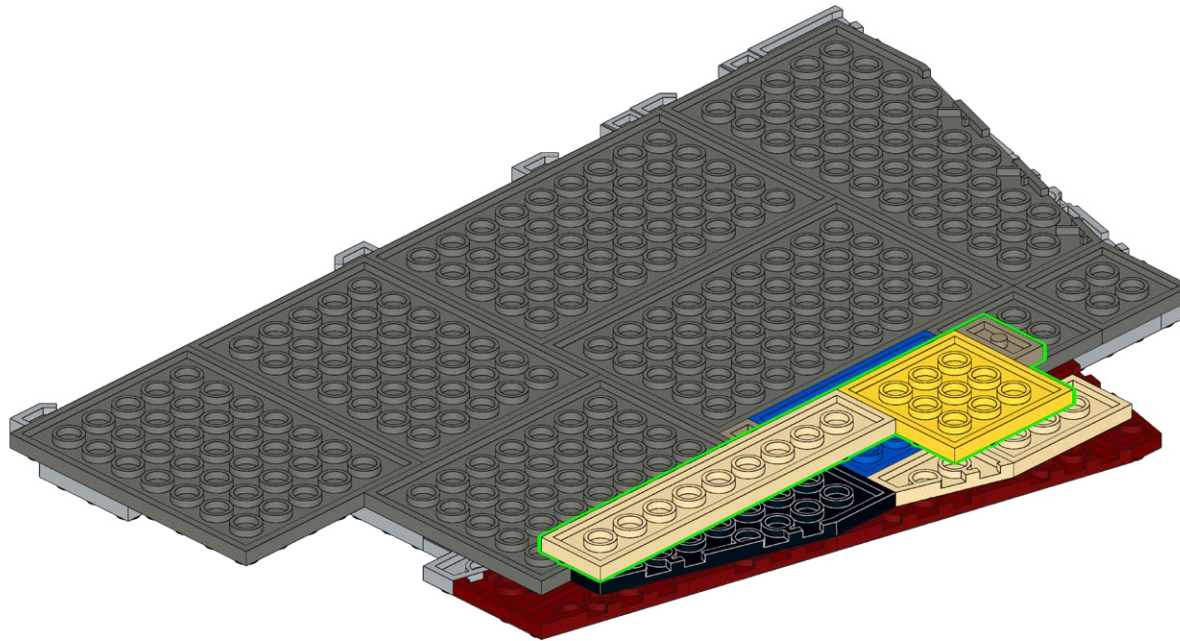
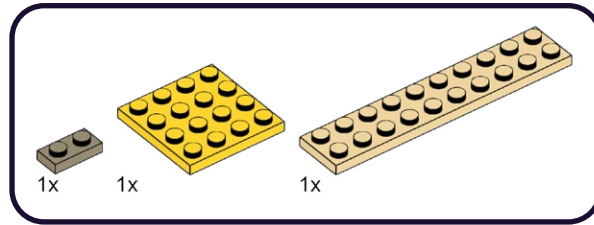

288

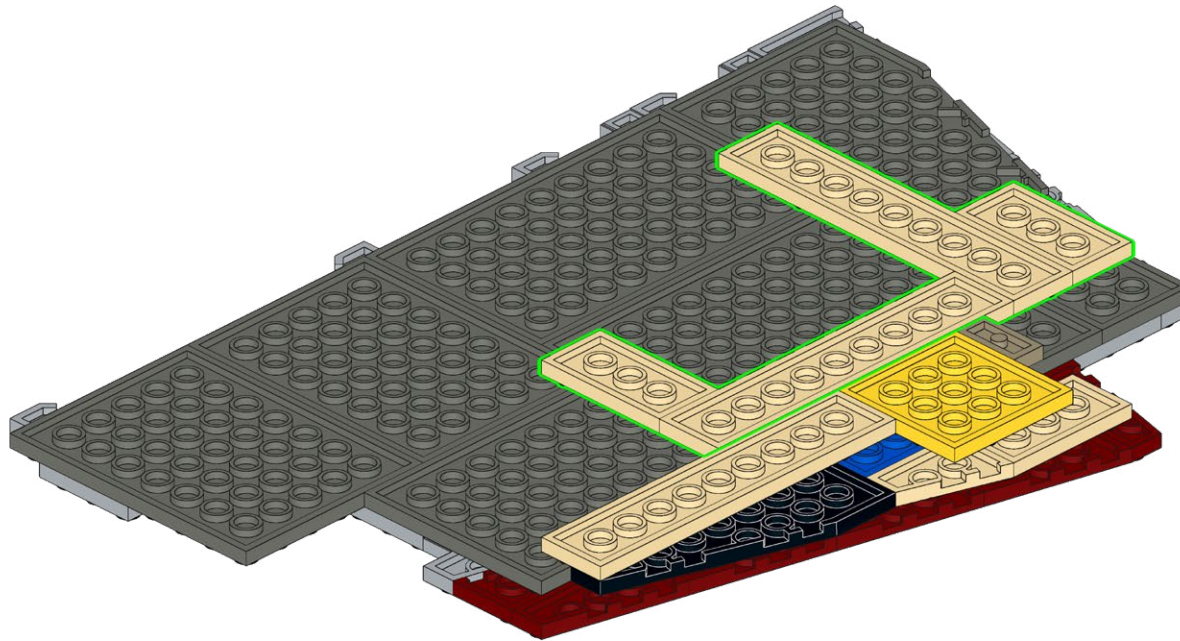
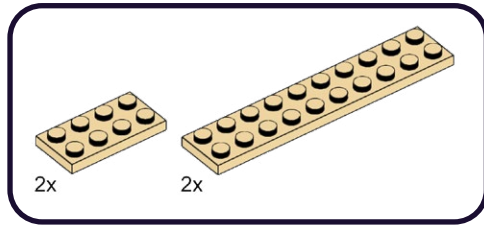

289

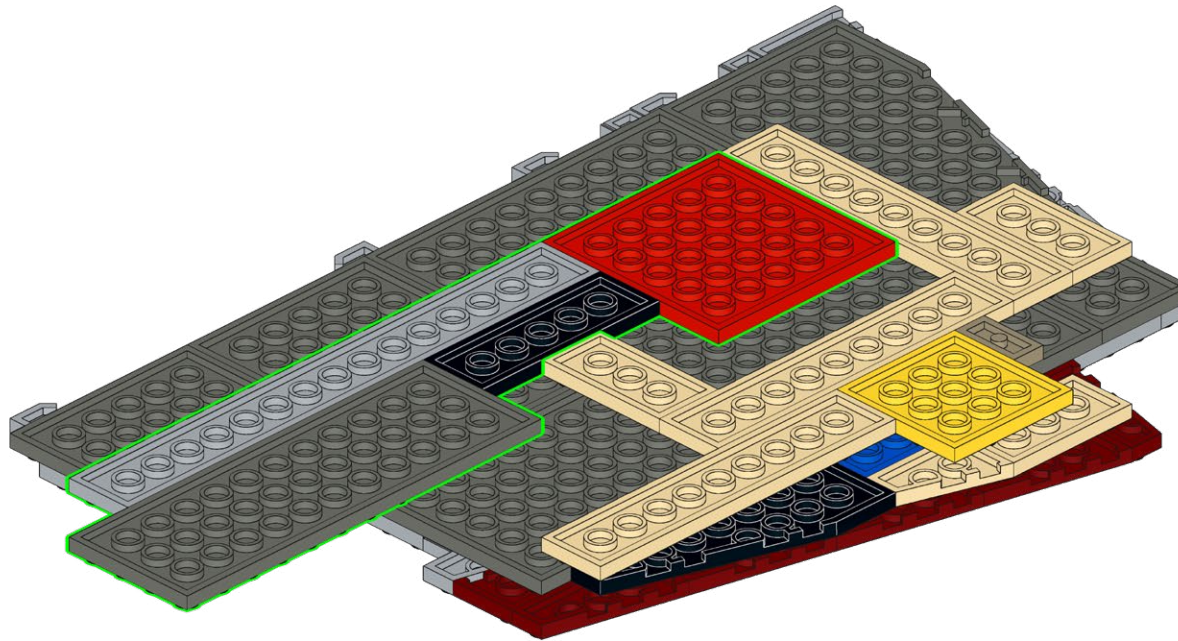
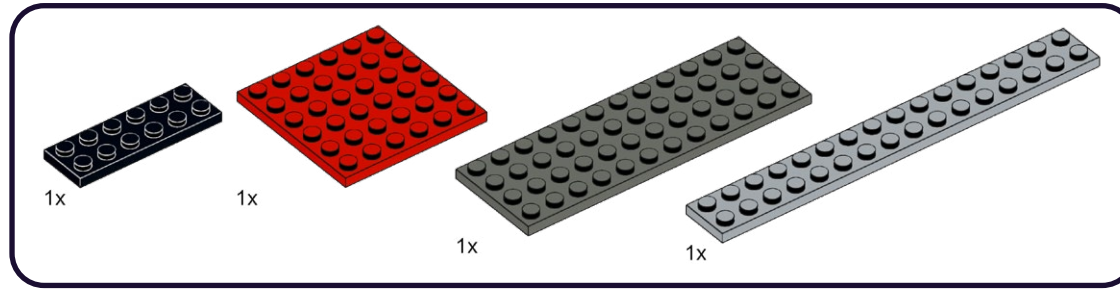

290

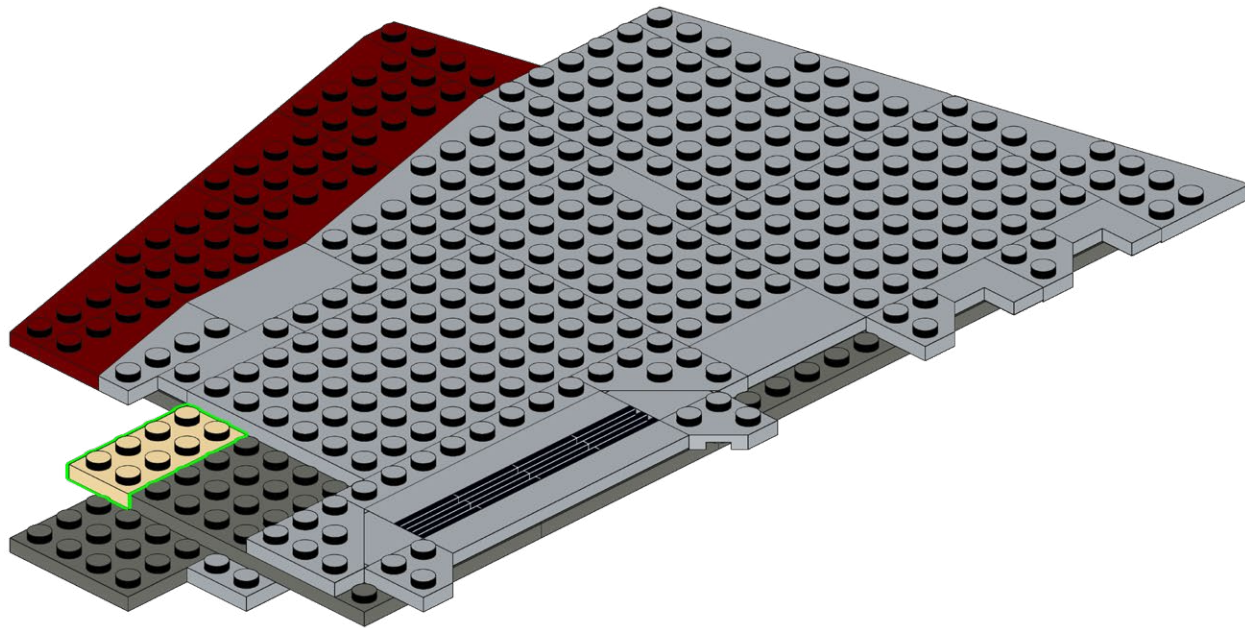
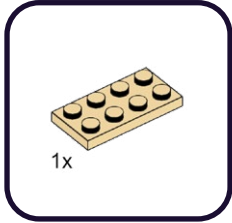

292

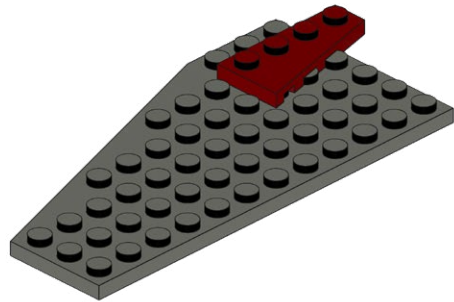
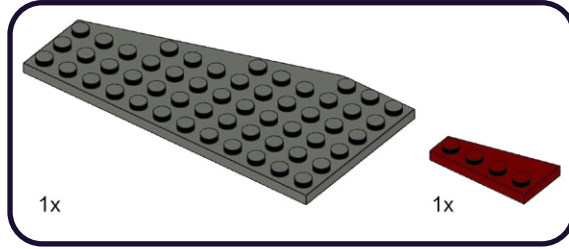

293

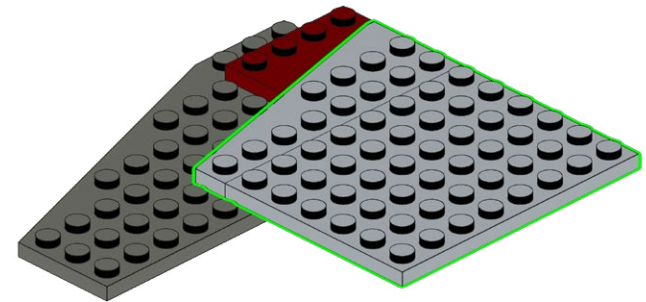
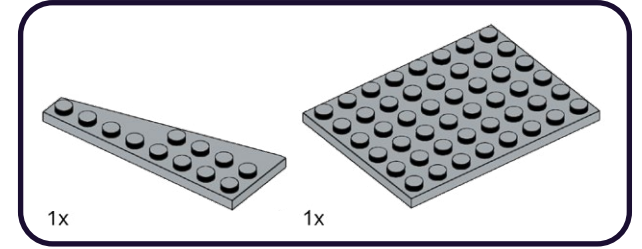

294

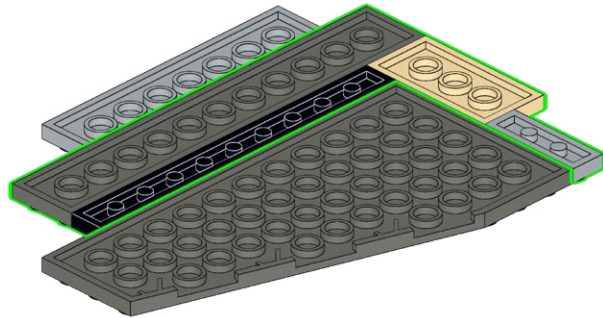
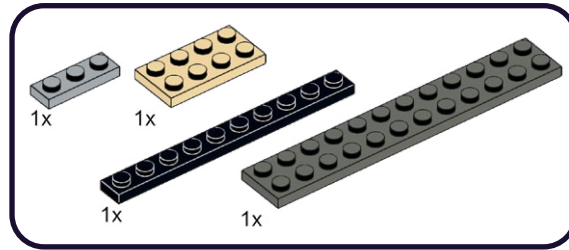

295

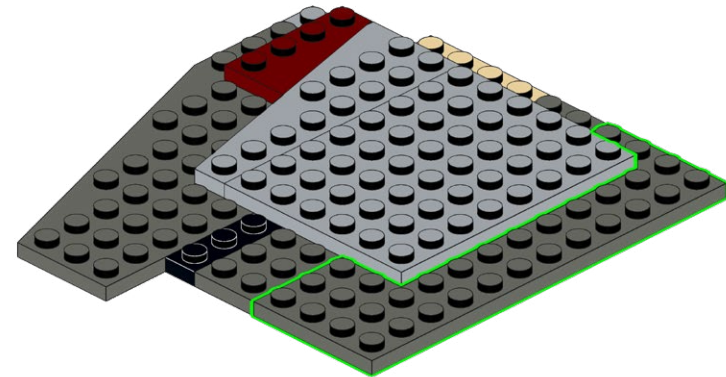
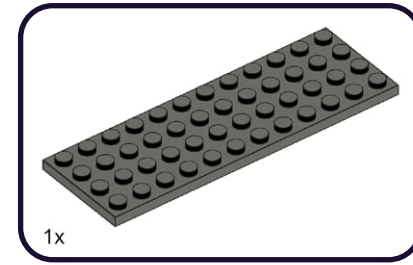

296

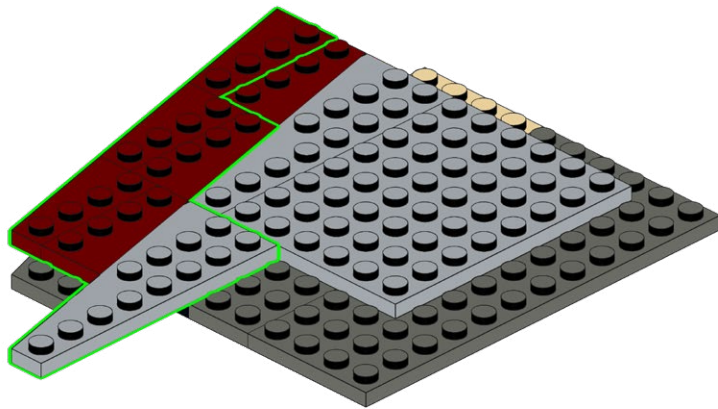
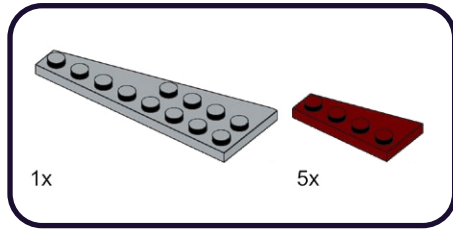

297

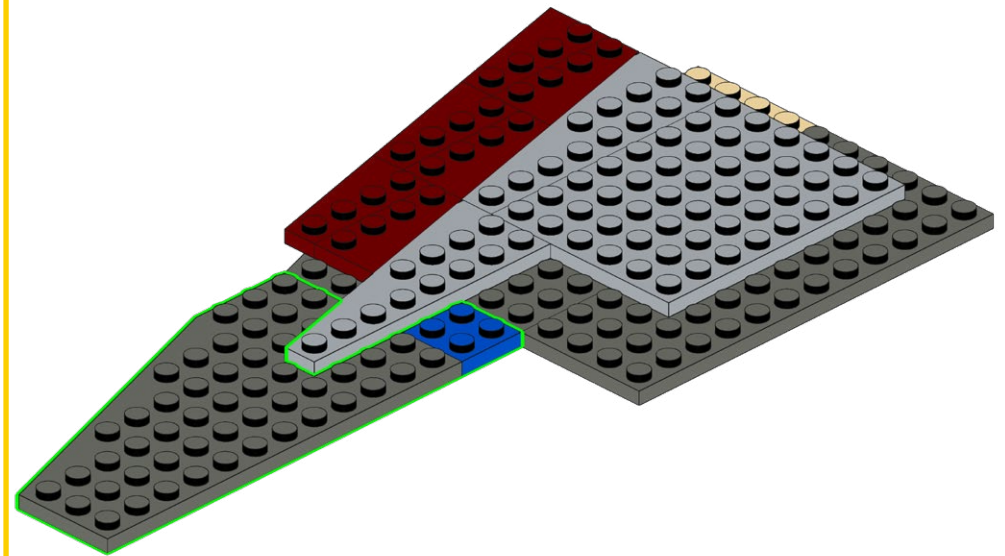
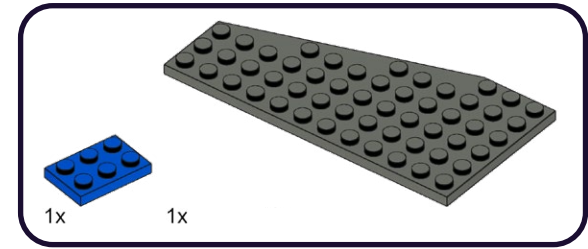

298

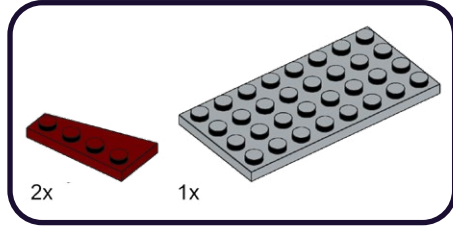

299

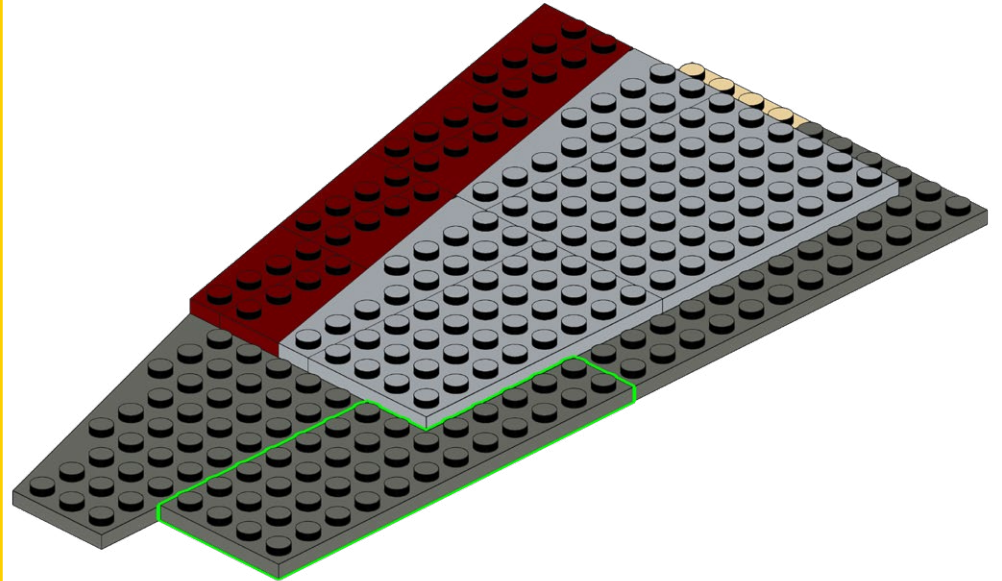
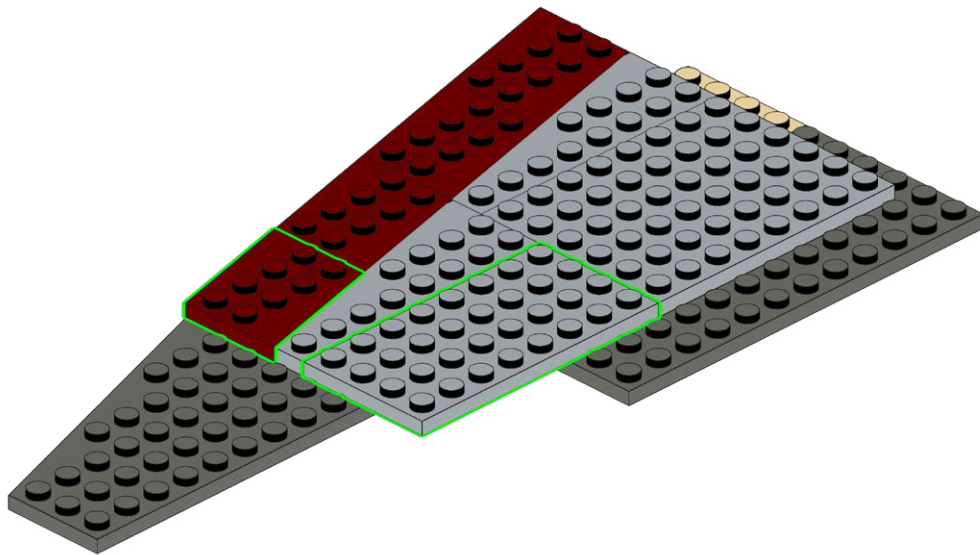
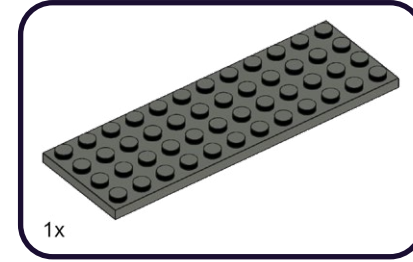

300

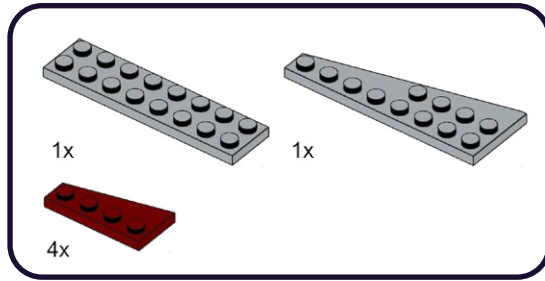

301

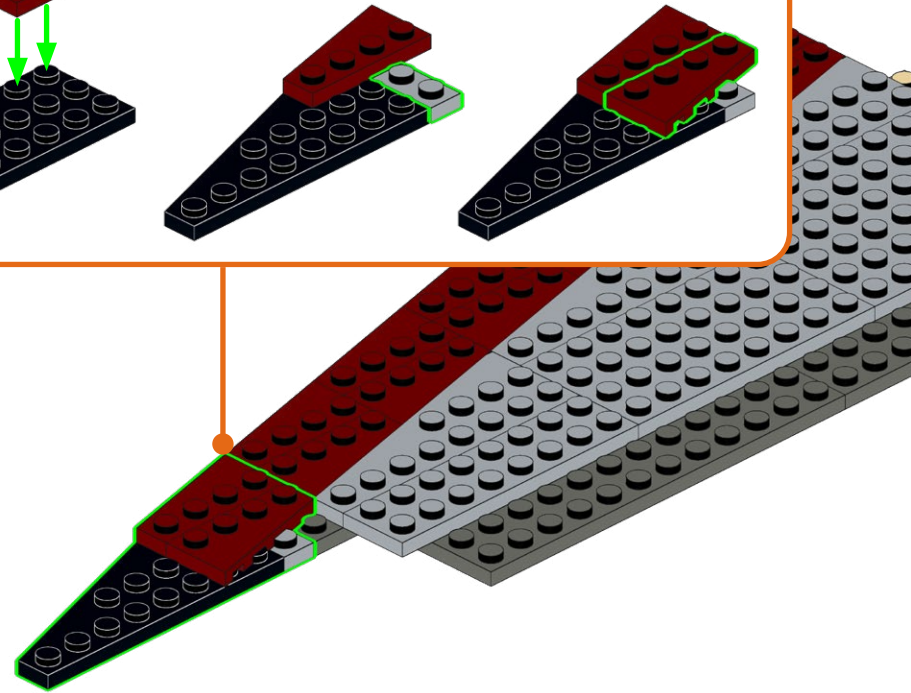
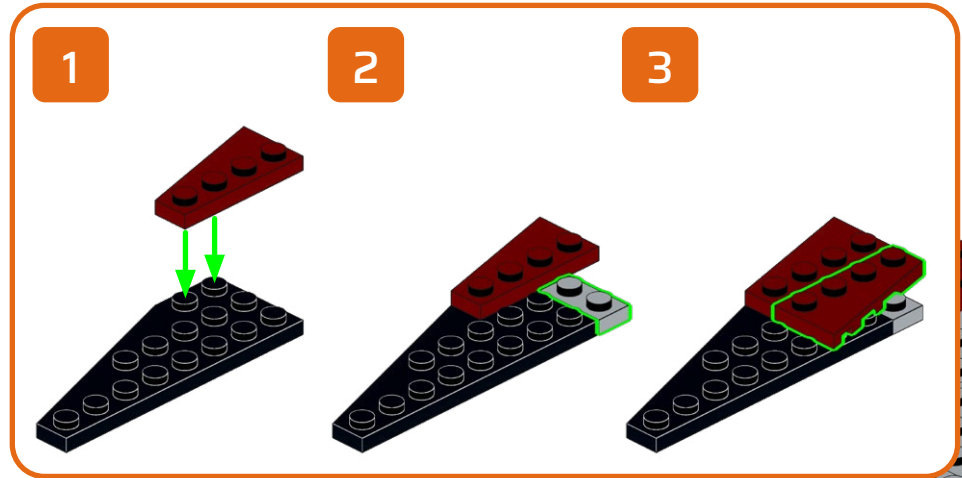
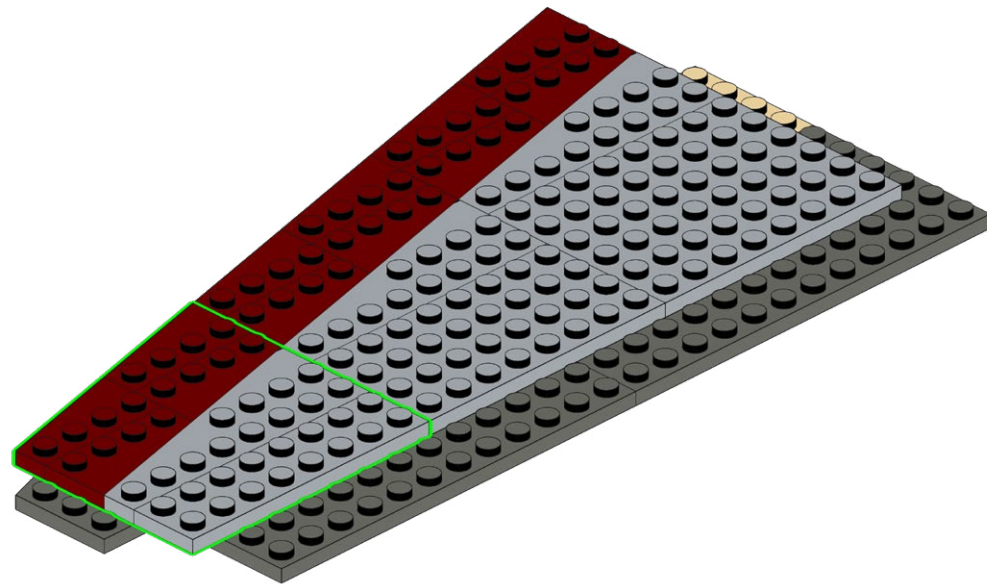
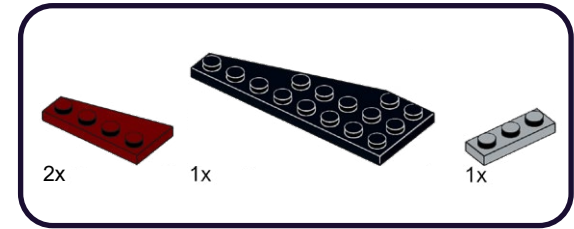

302

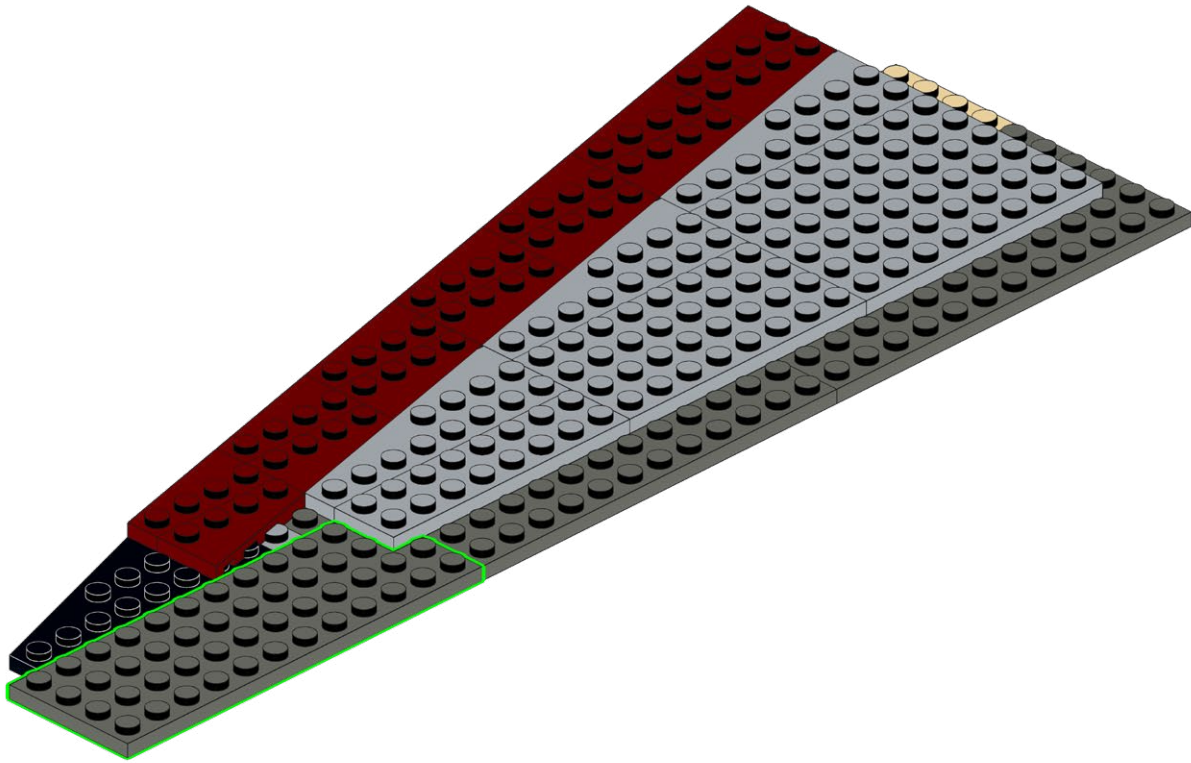
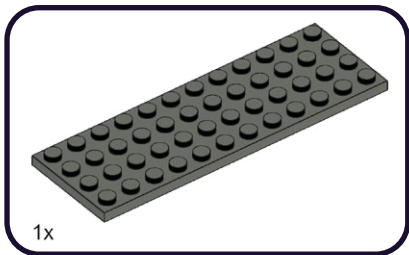

304

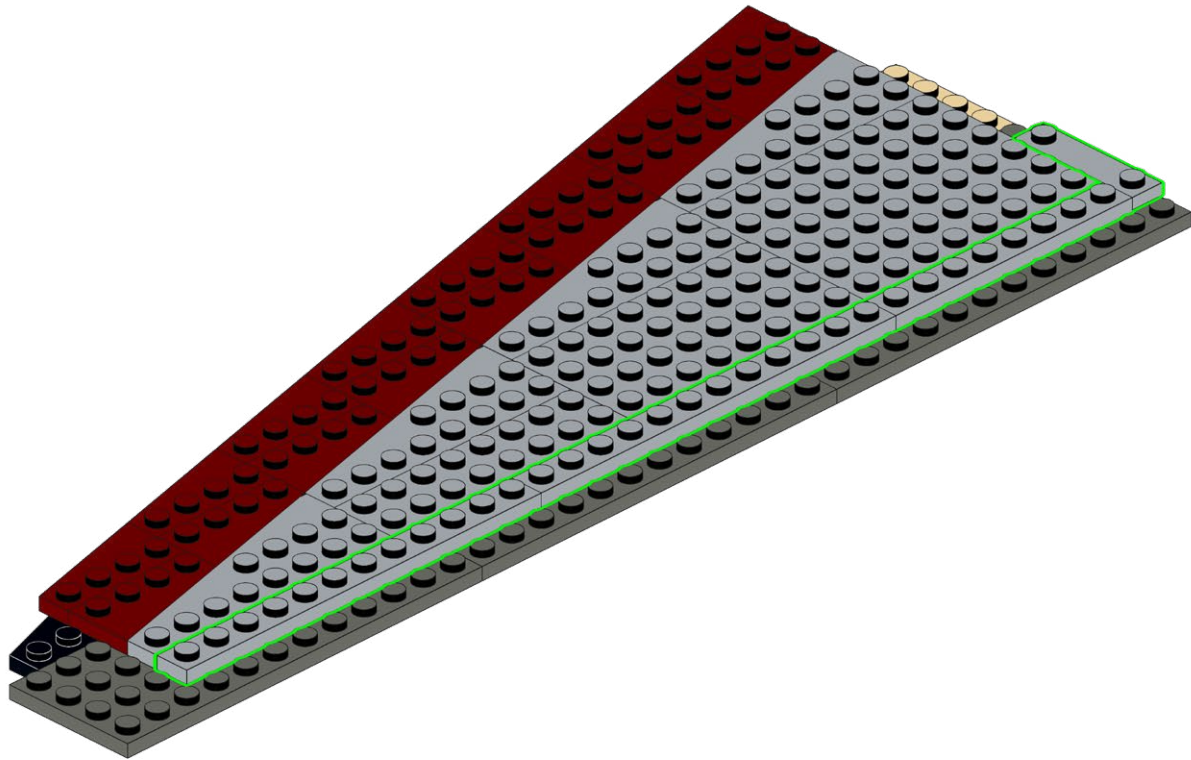
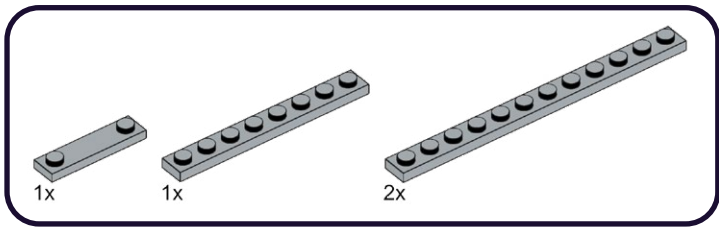

305

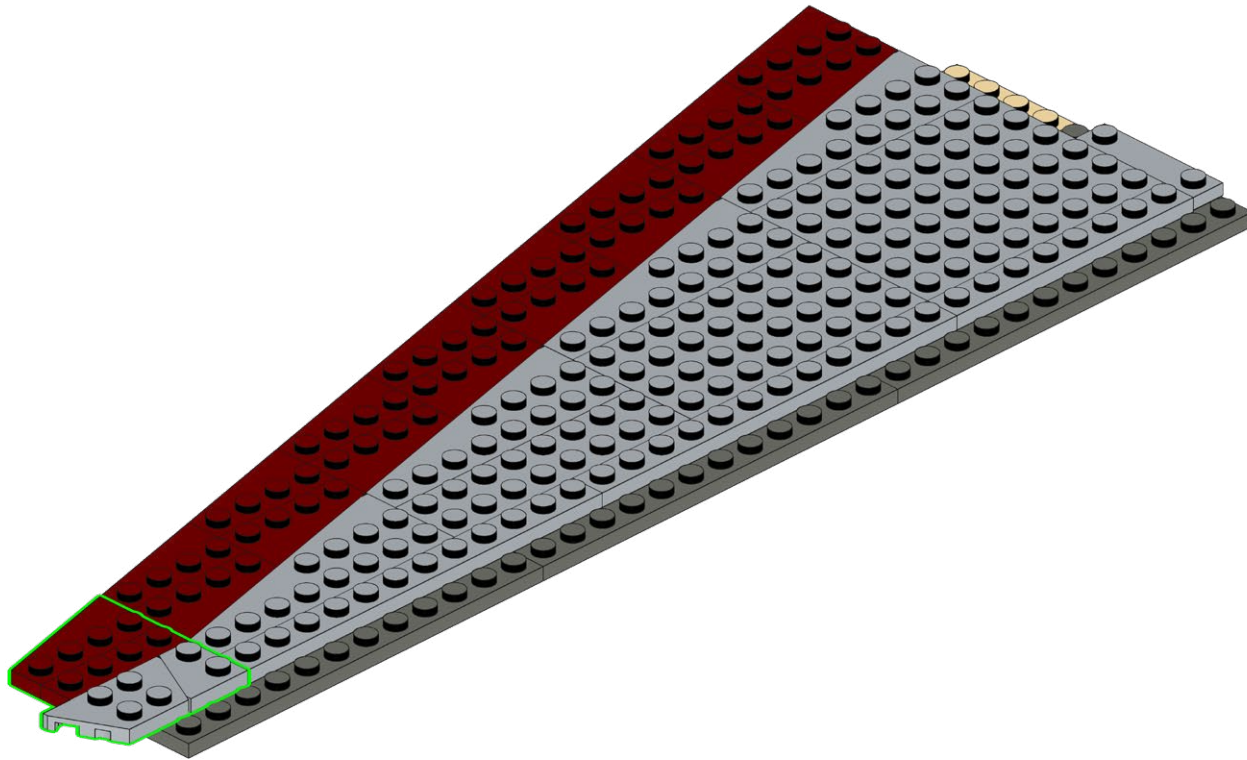
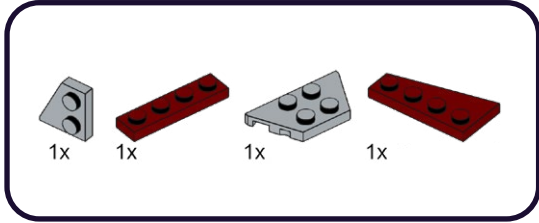

306

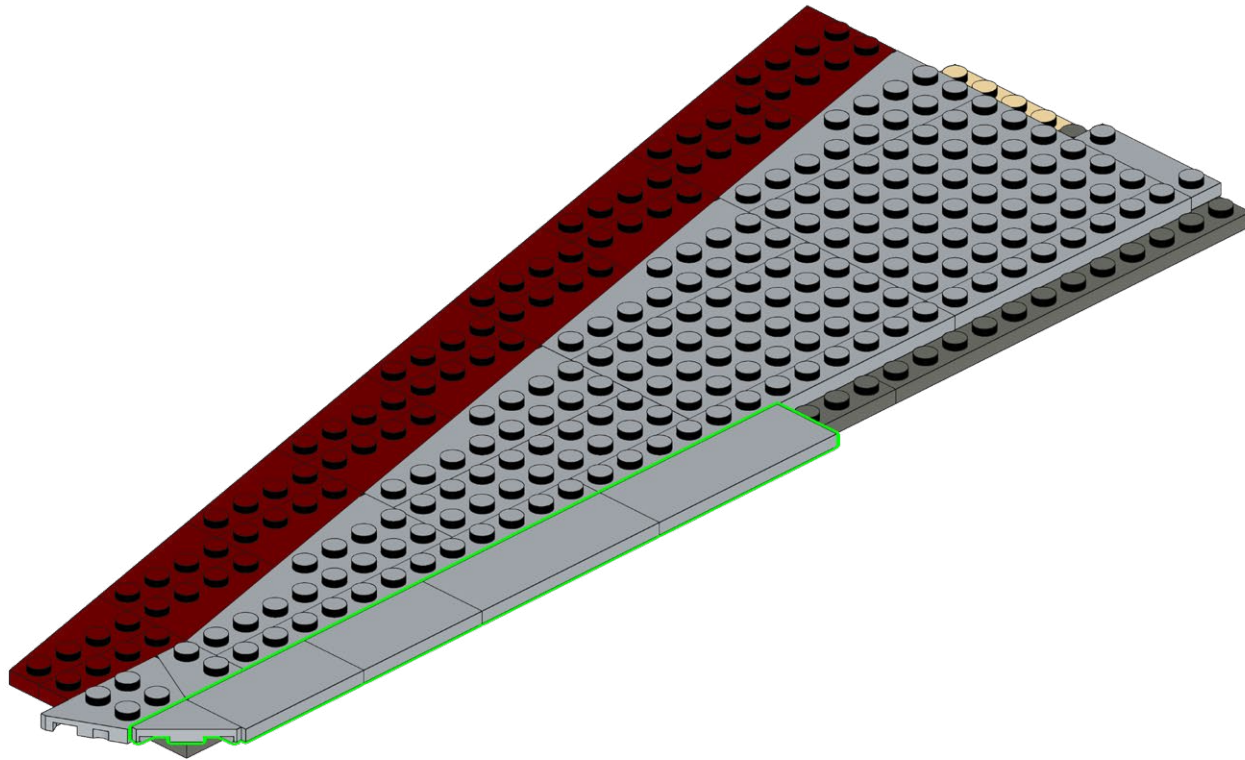
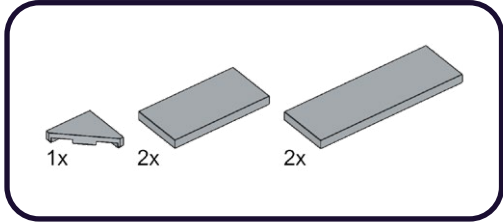

307

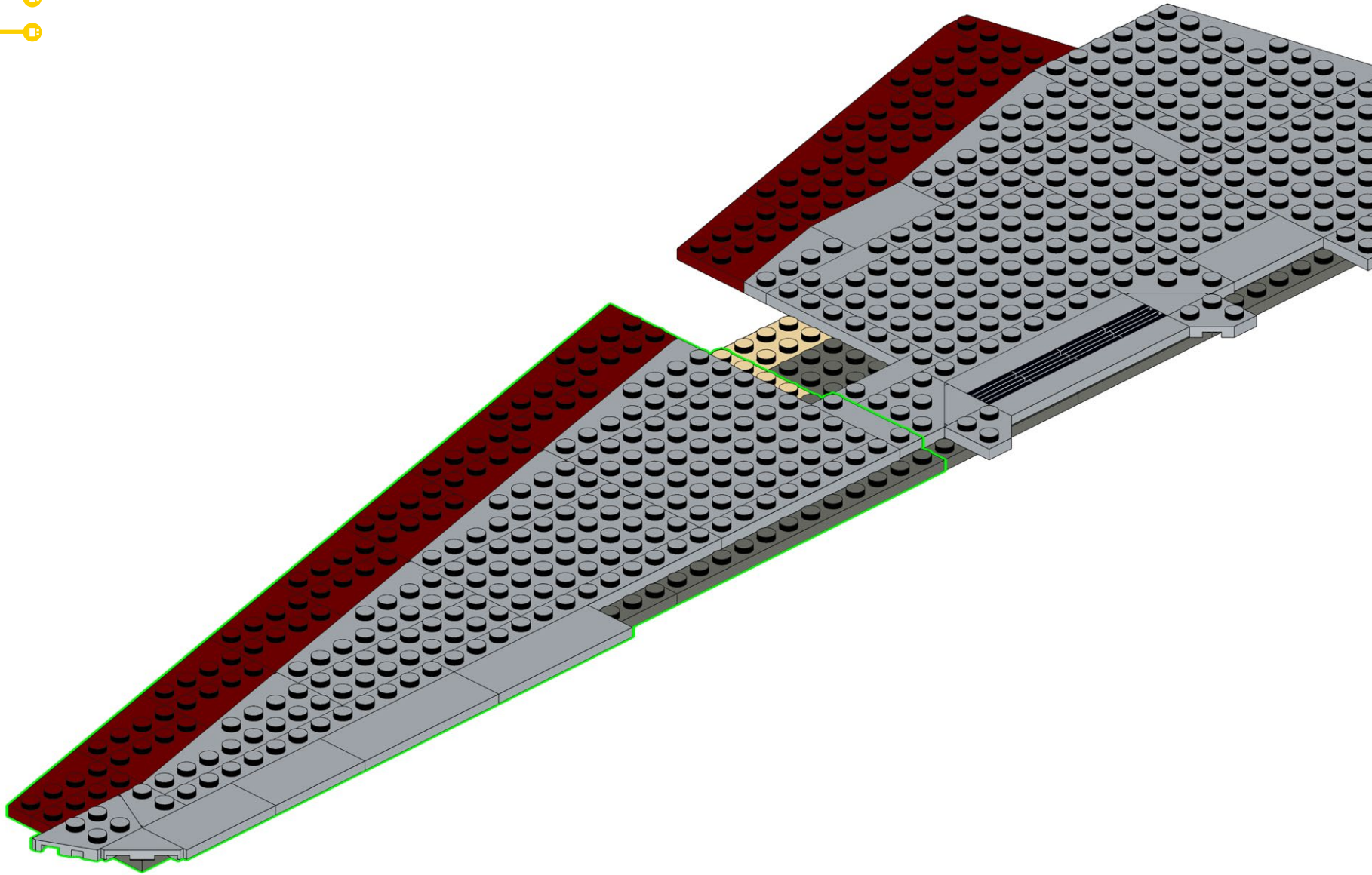

308

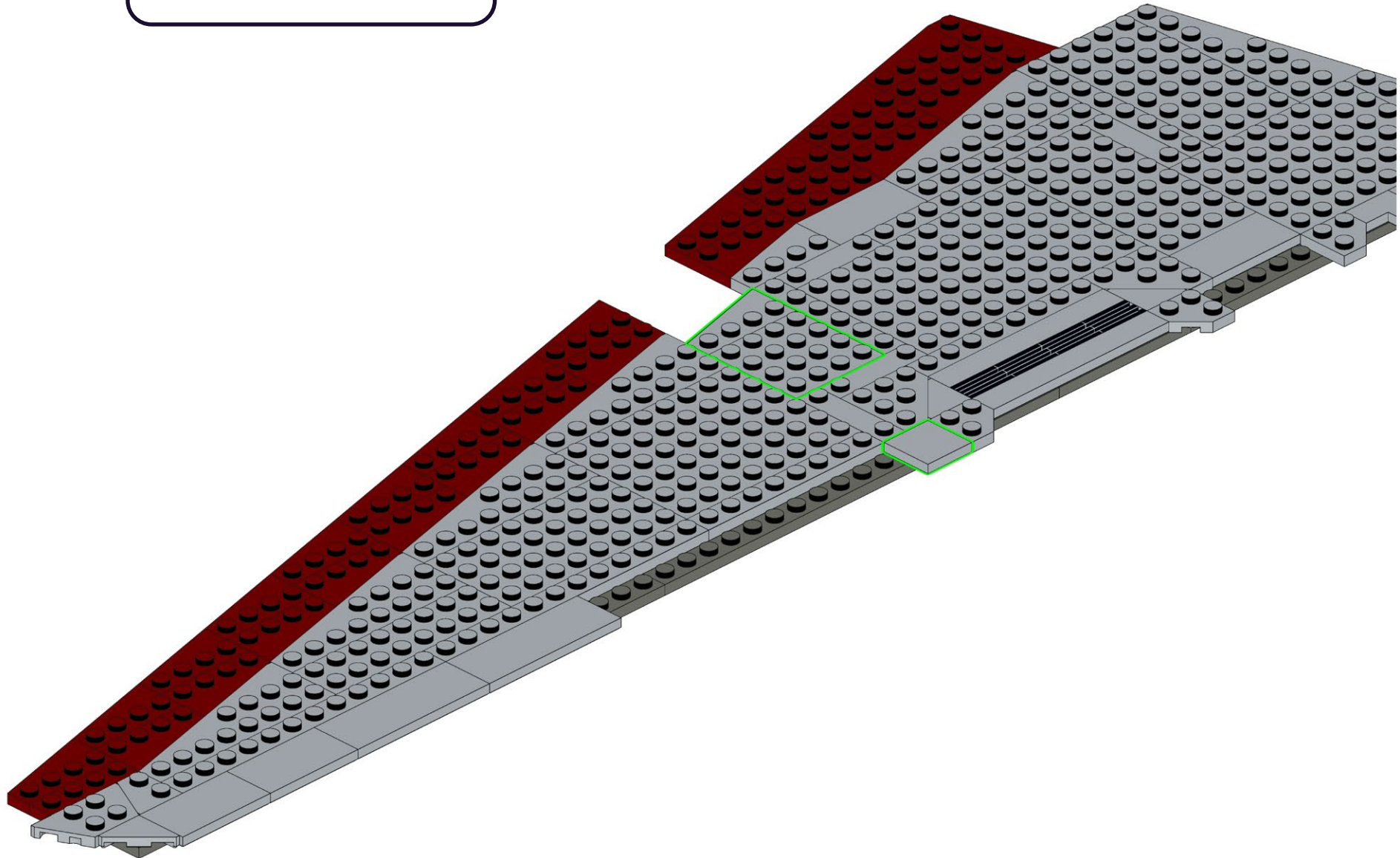
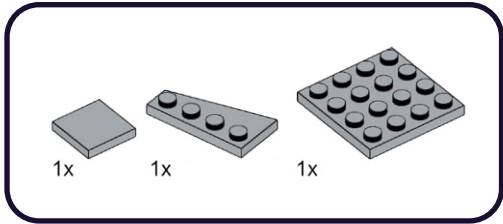

309

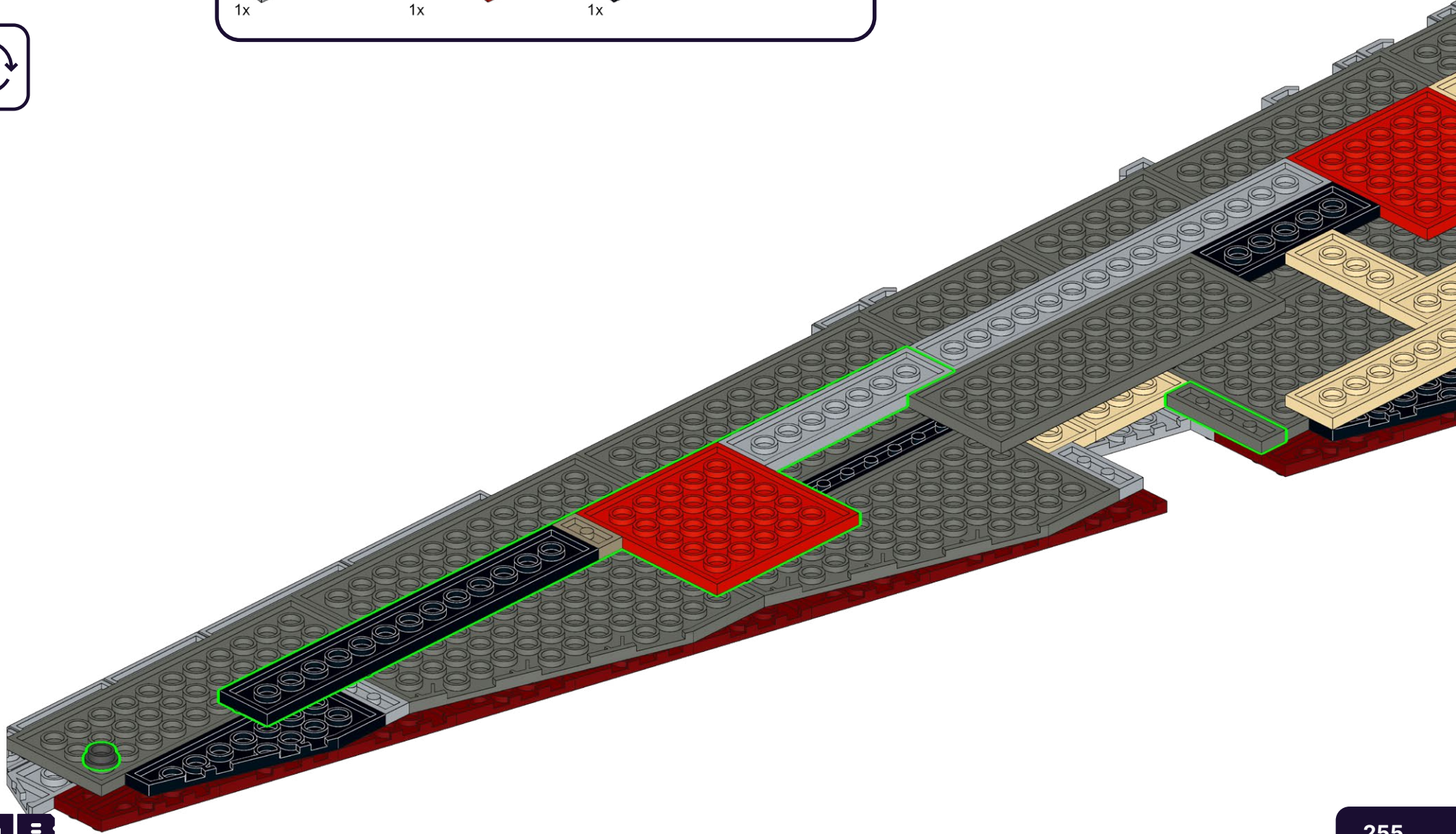
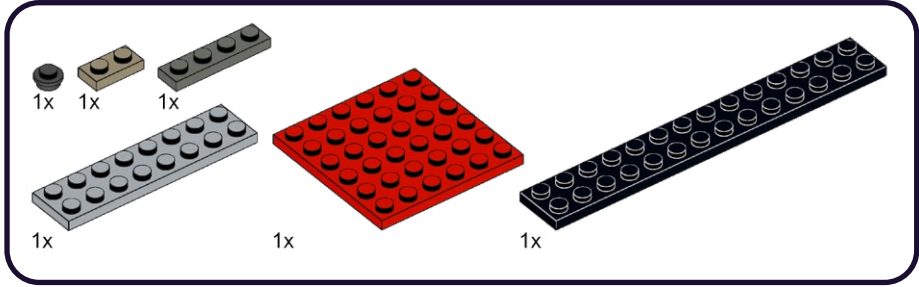

310

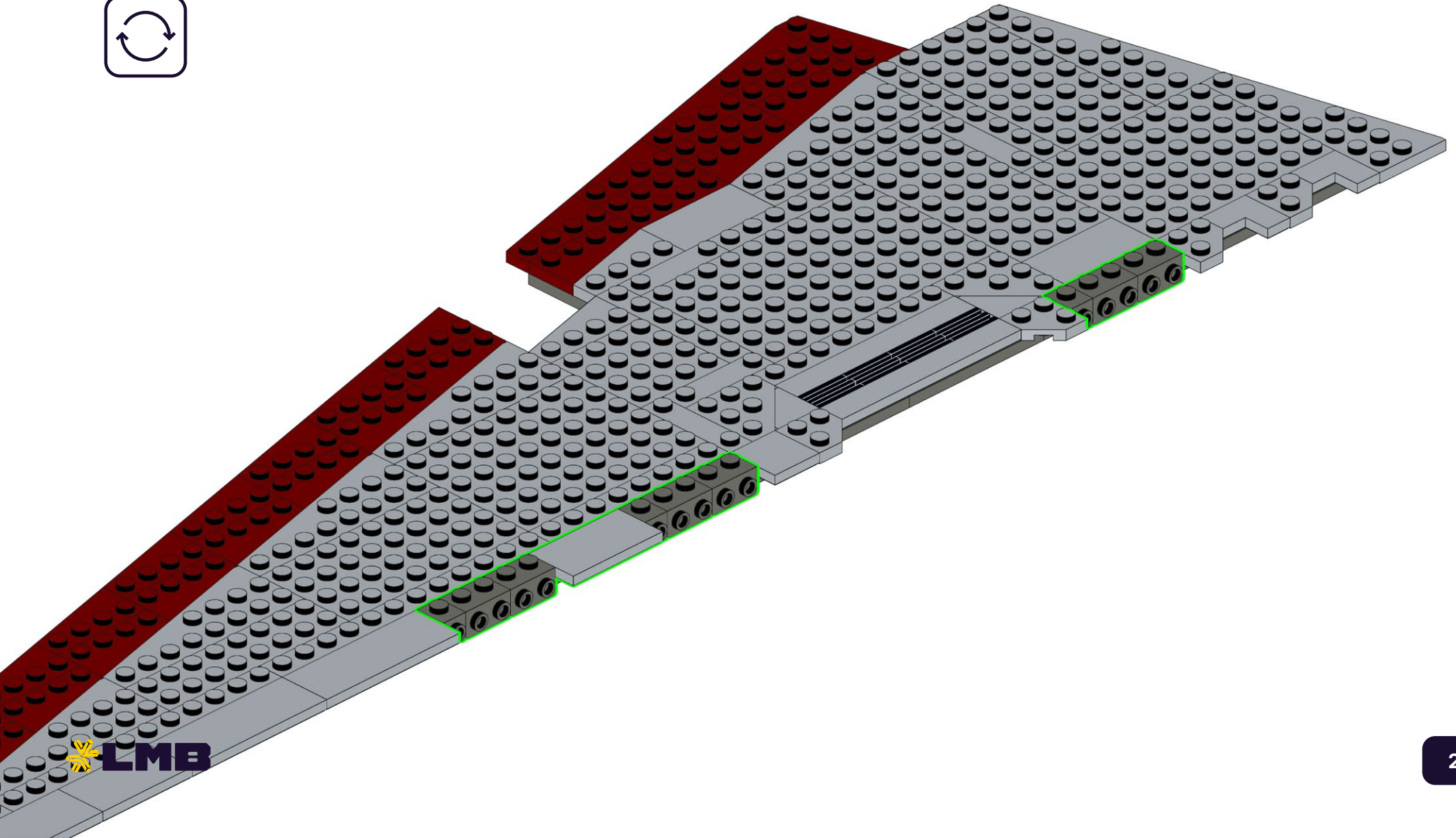
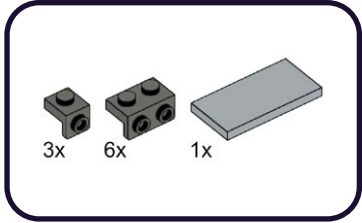

311

3x

3x

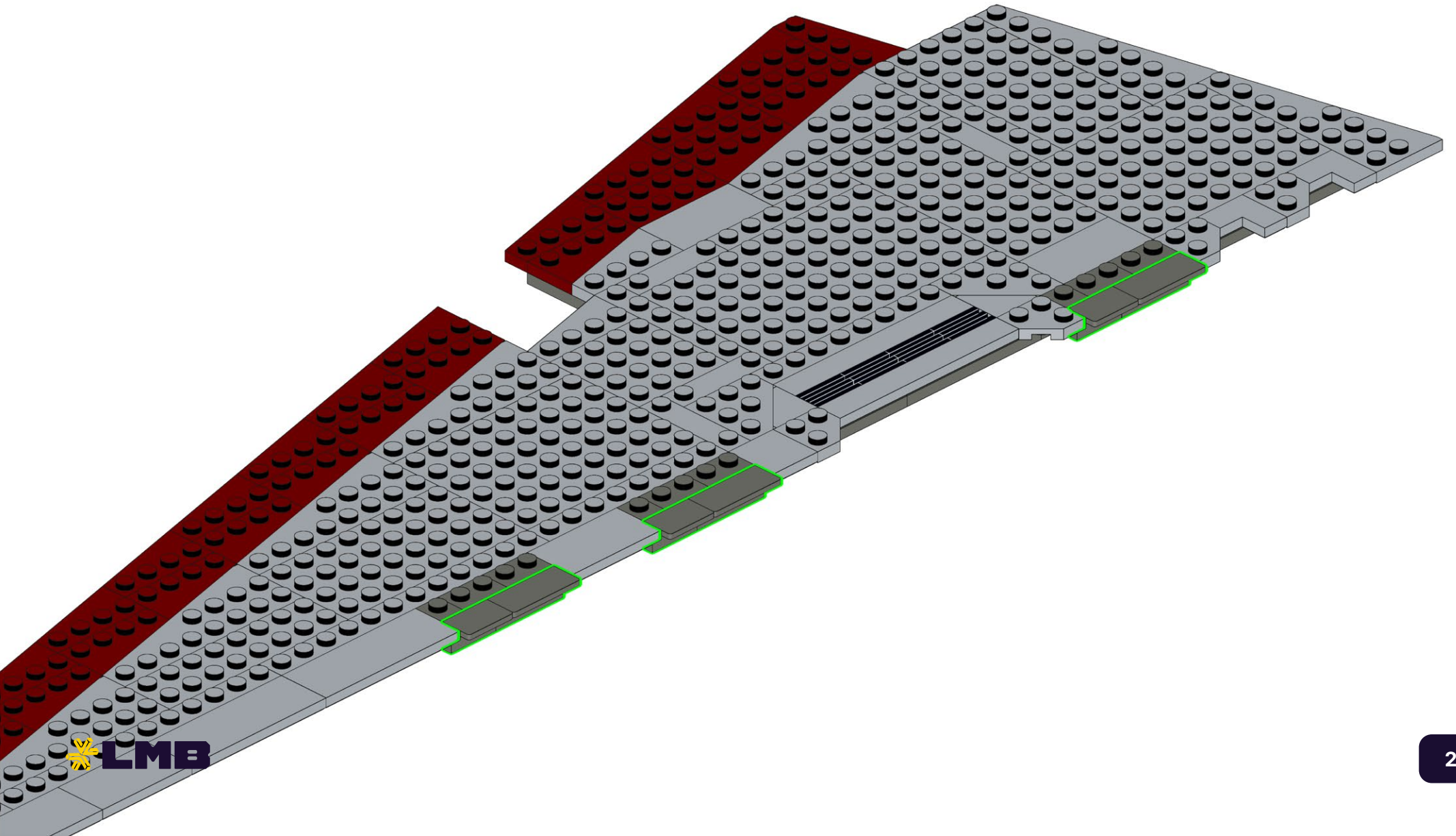

312

2x

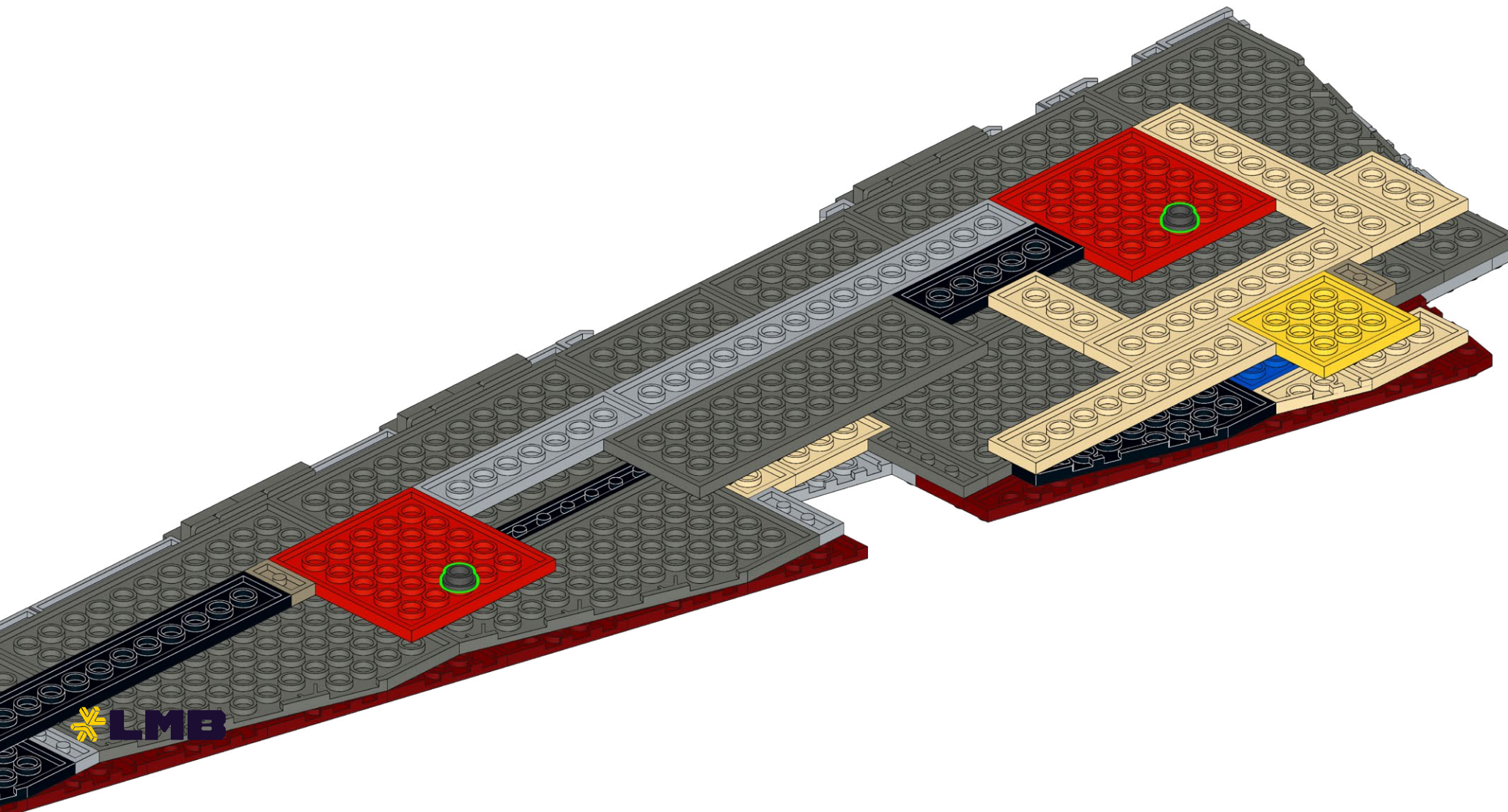

313

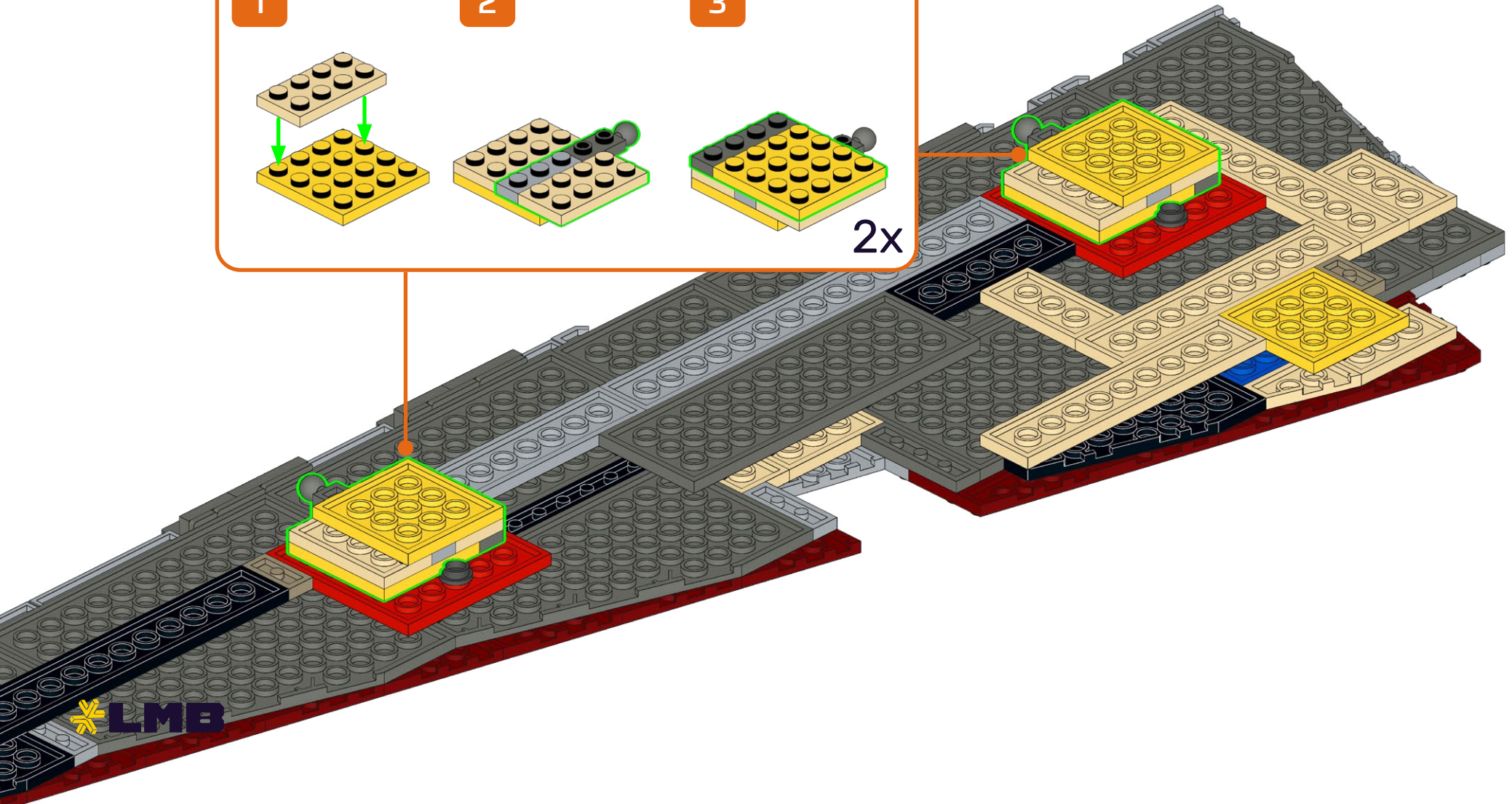
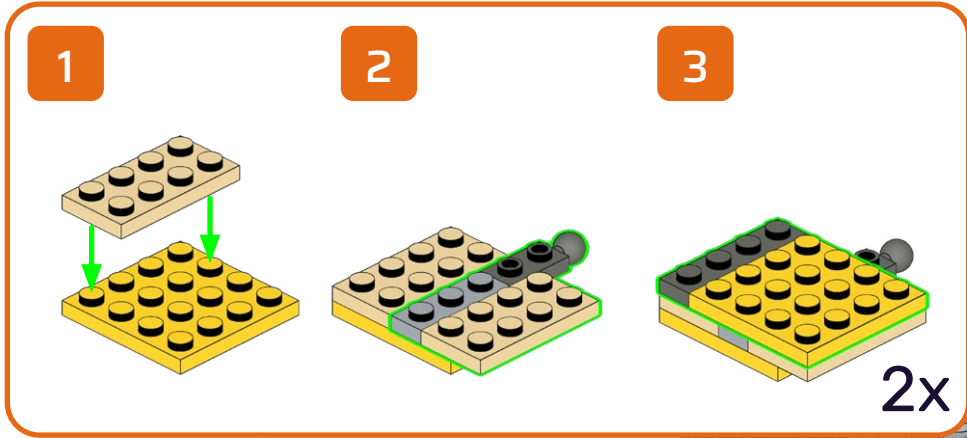
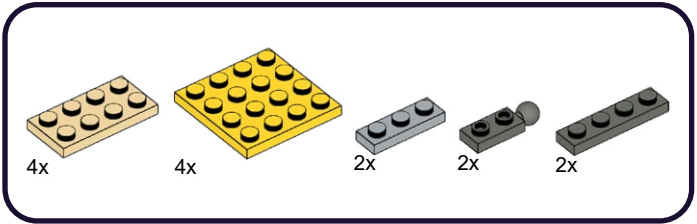

314

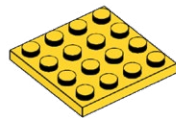

1x



1x



1x



1x

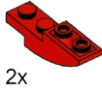

2x

1

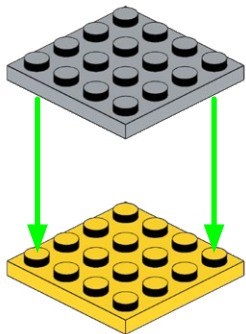

2



3

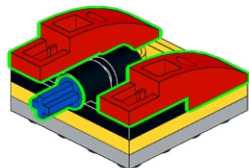
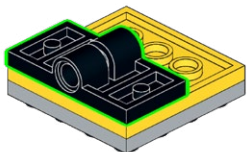

315

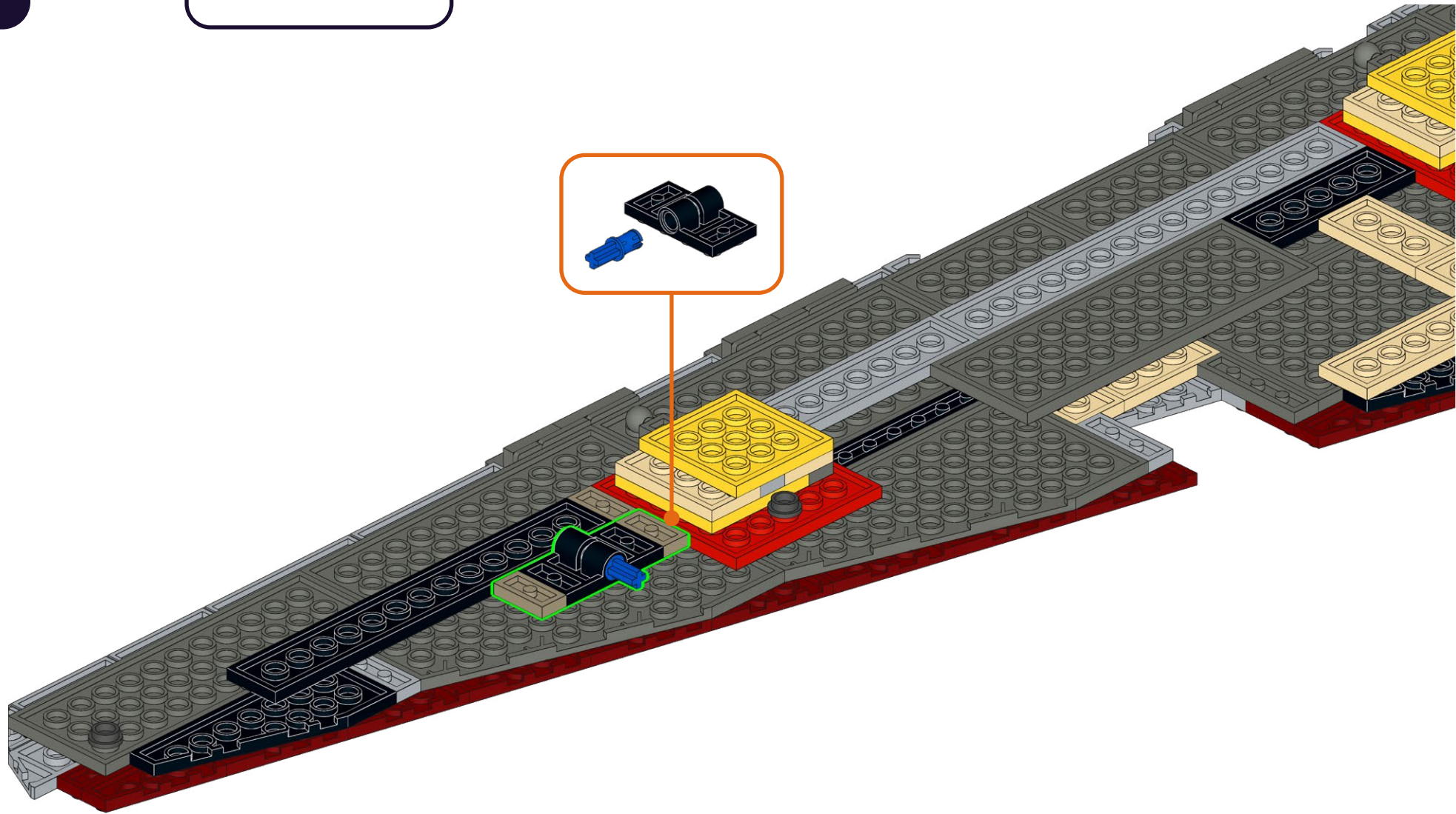
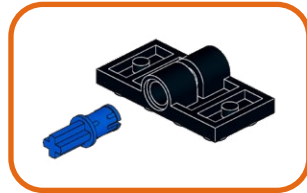
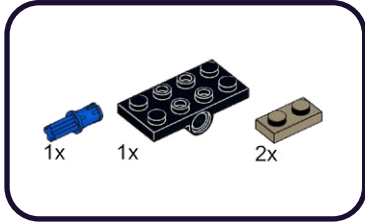

316

3x

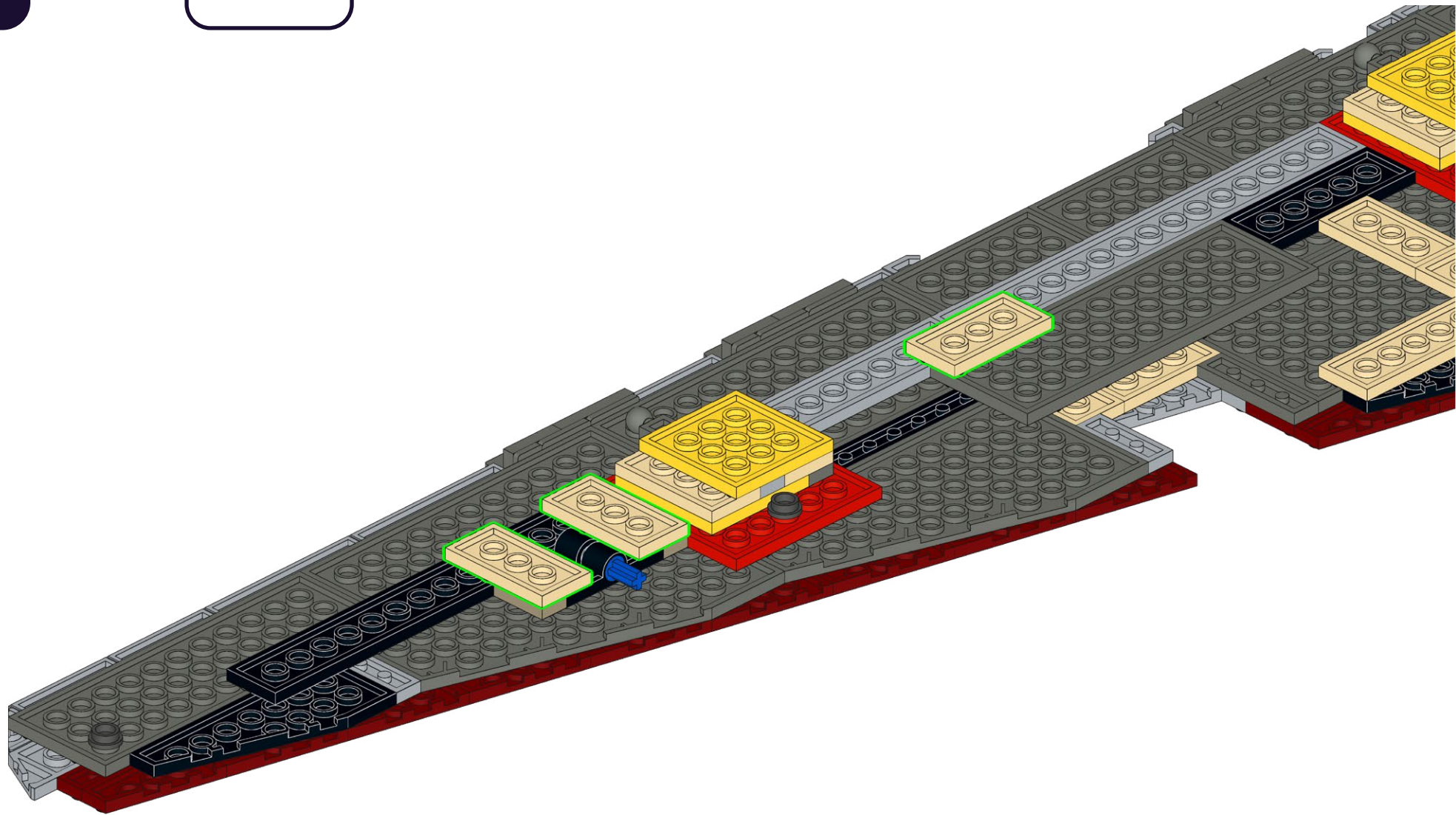

317

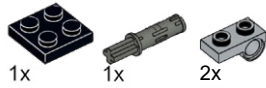

1

2

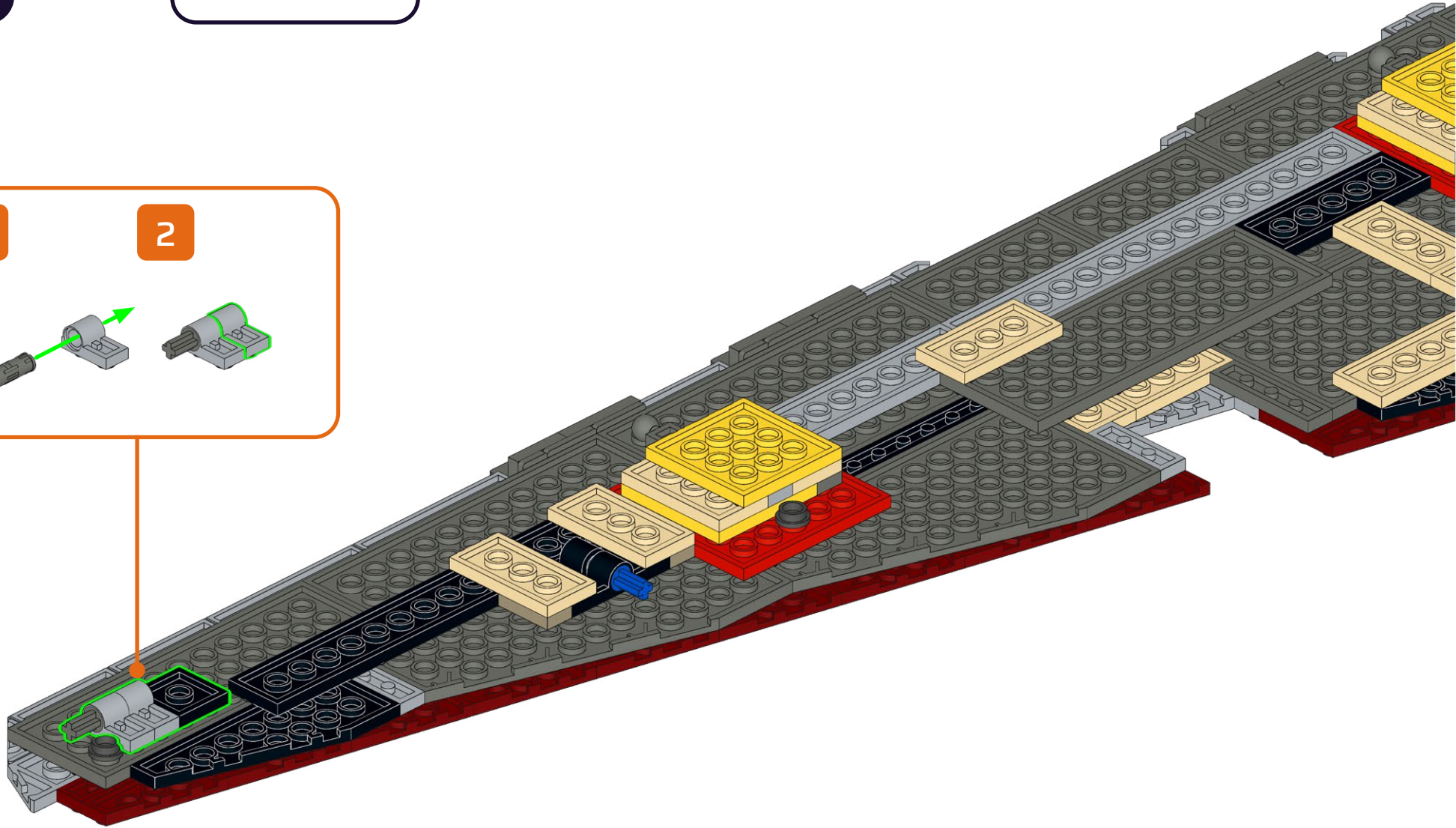
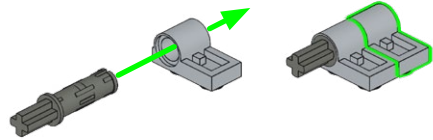

318

1x

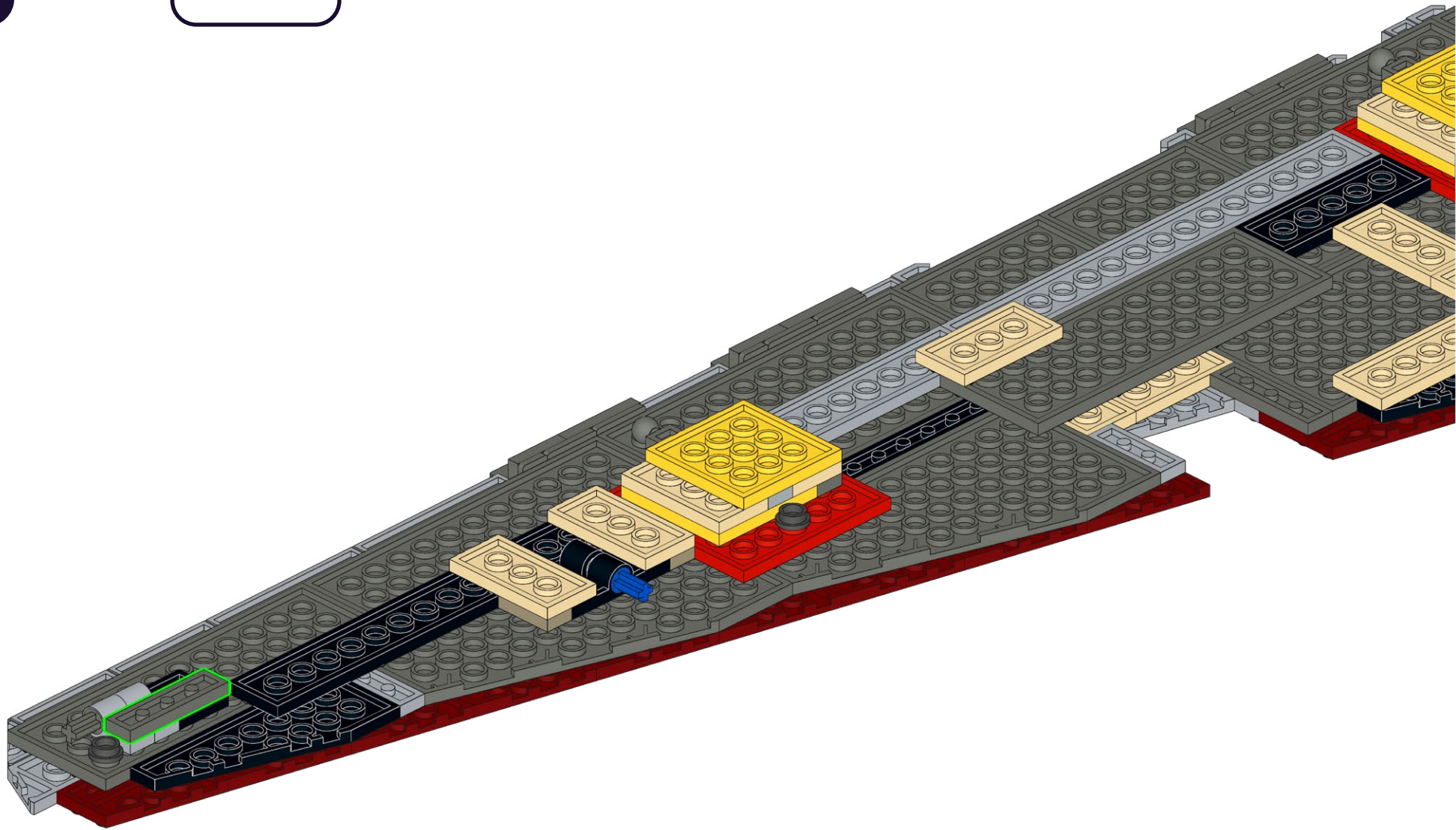

319

2x 2x 2x

1

2

2x

320

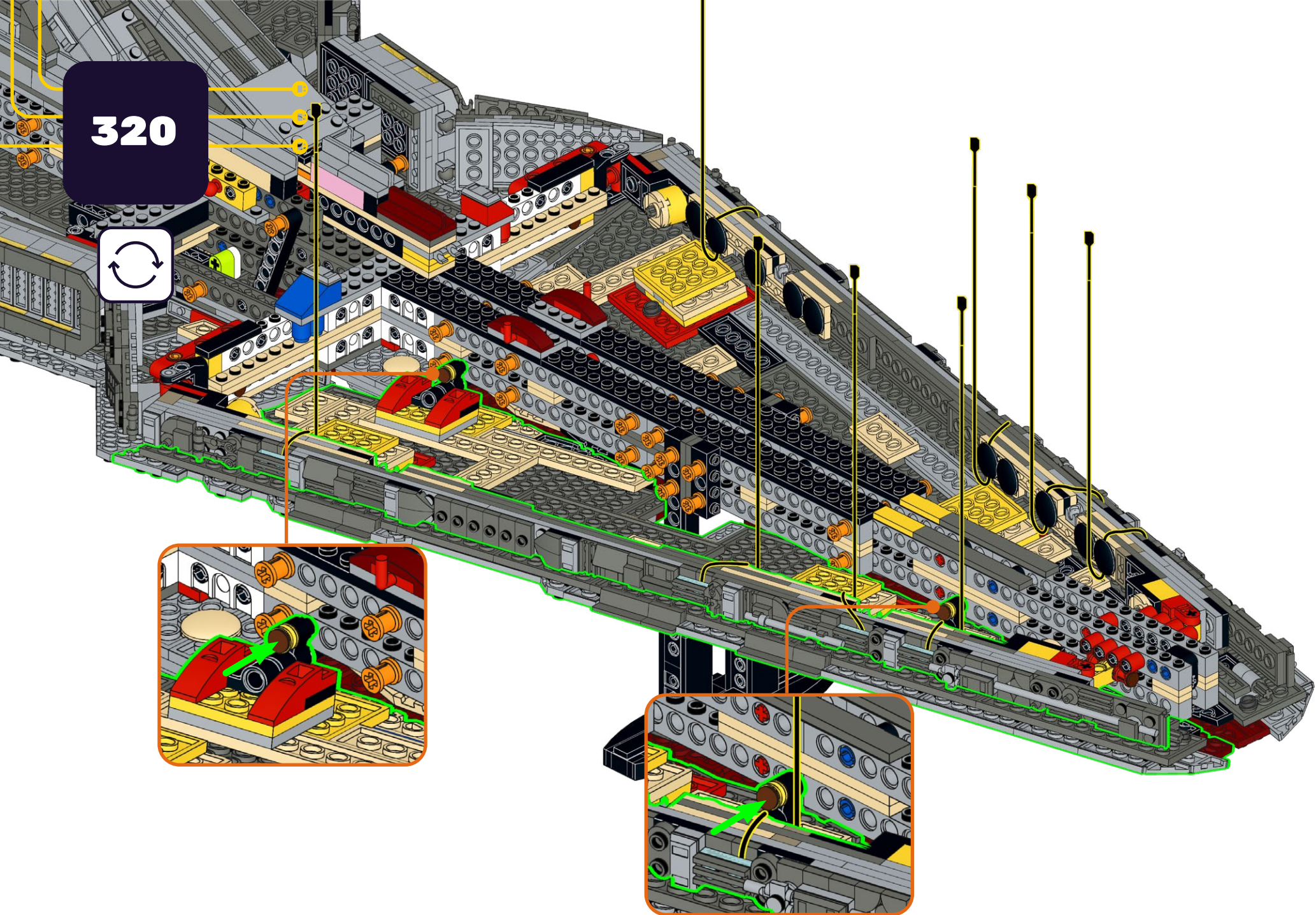

321



322

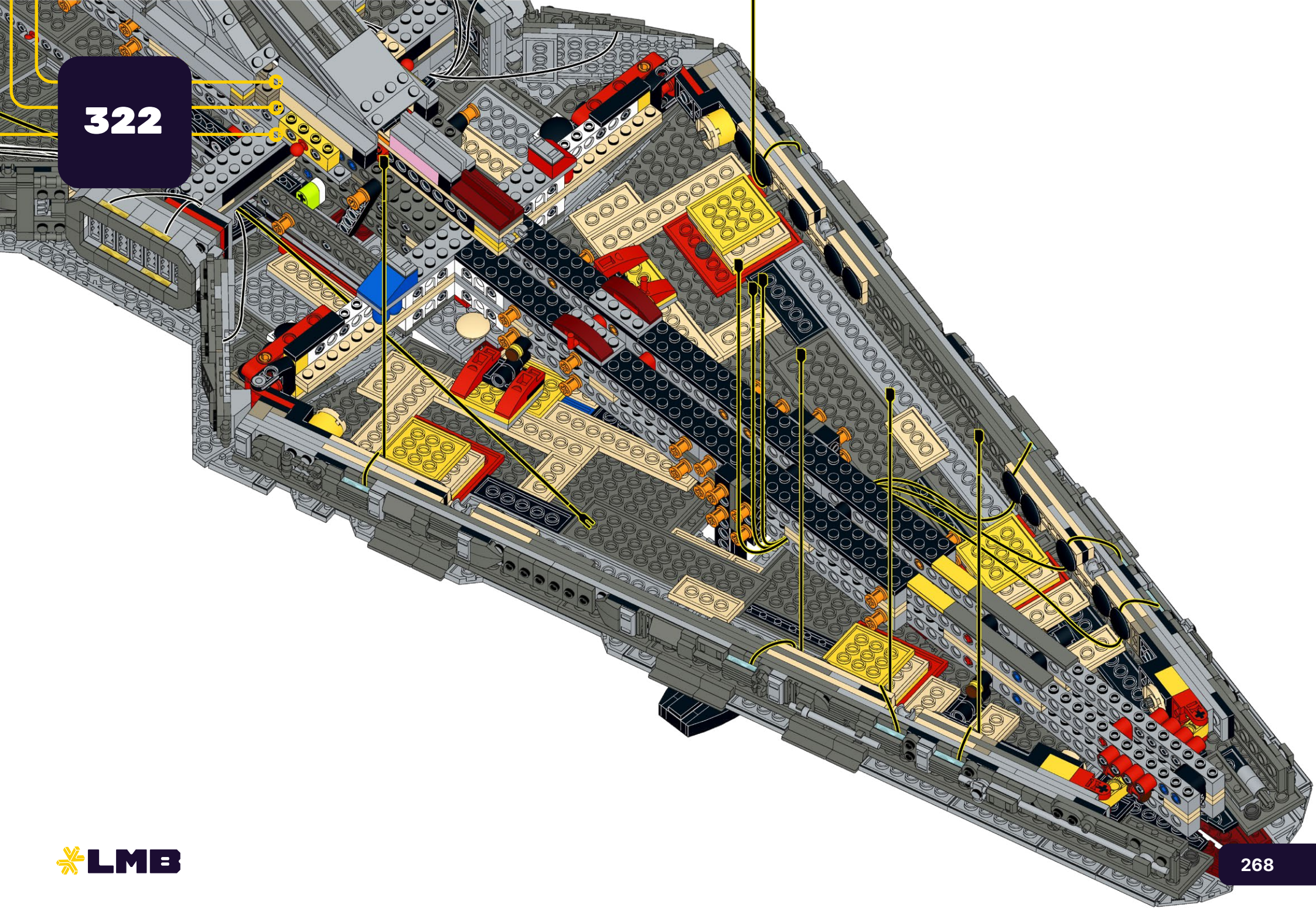

323

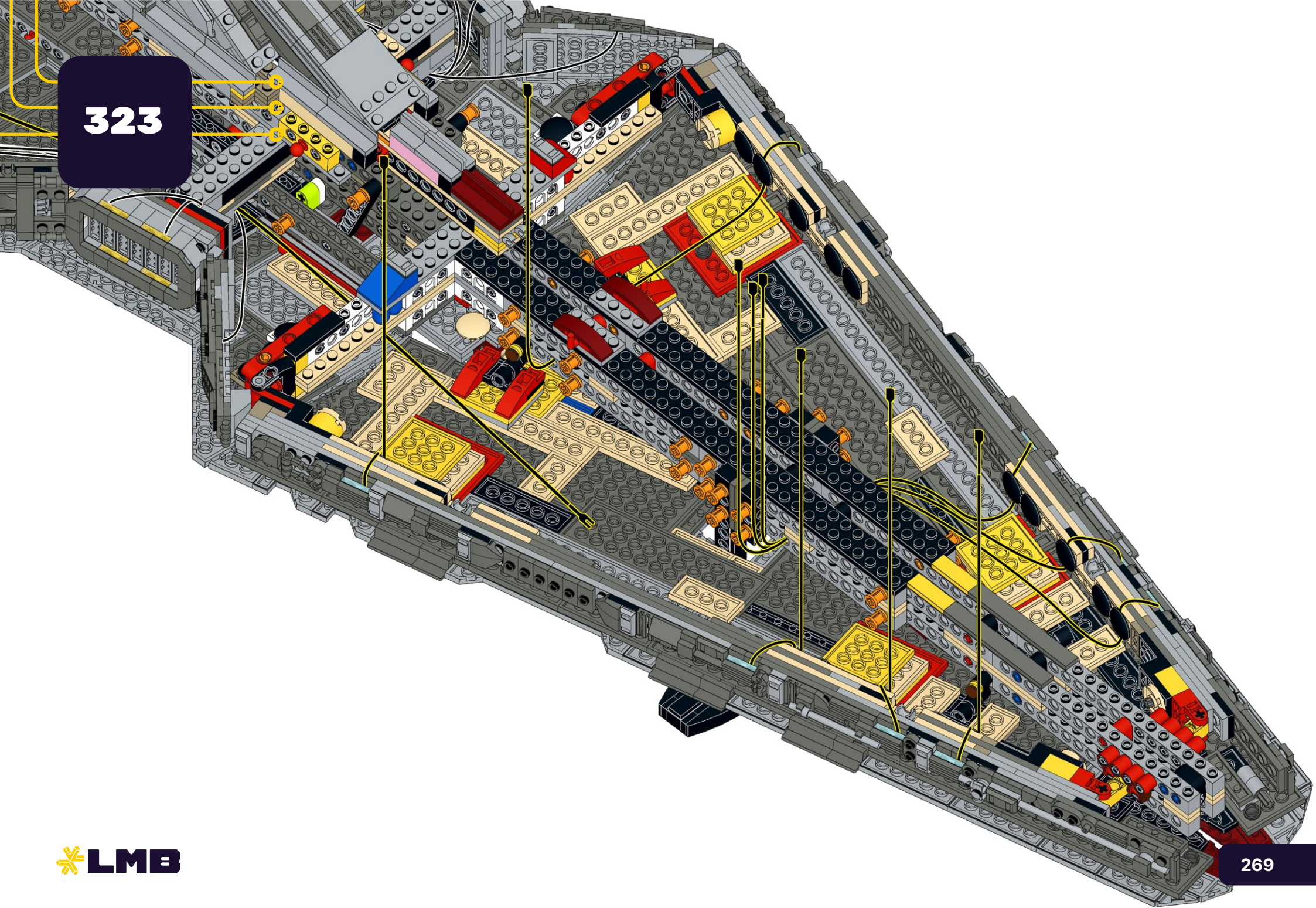

324

D-9 T-1x8

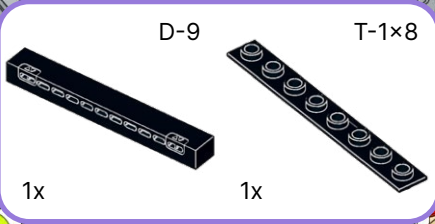

1x 1x

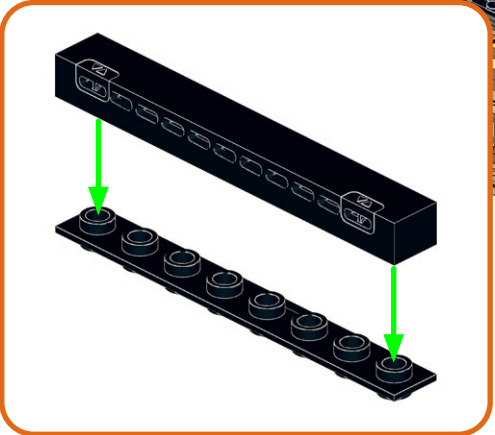

325

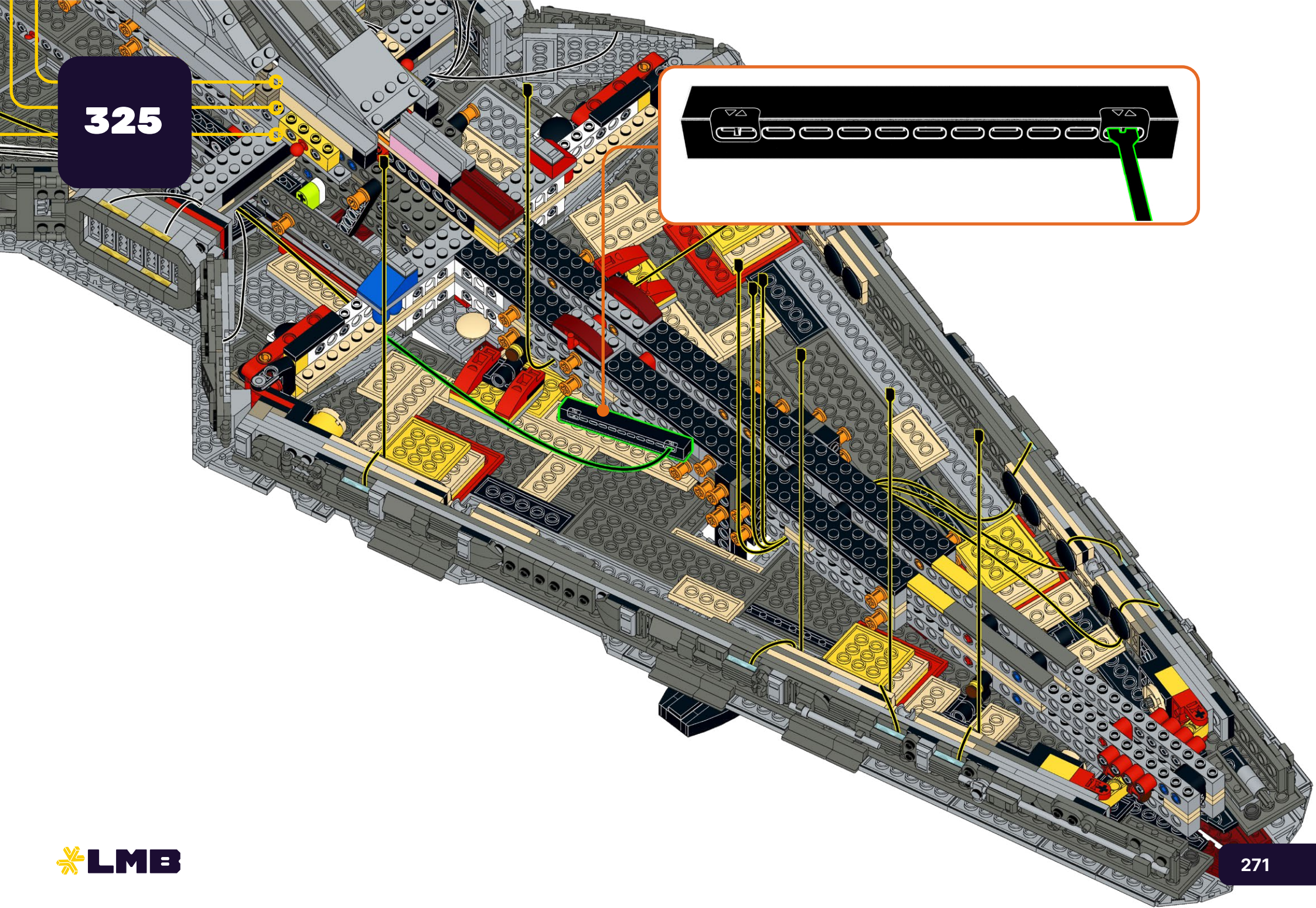
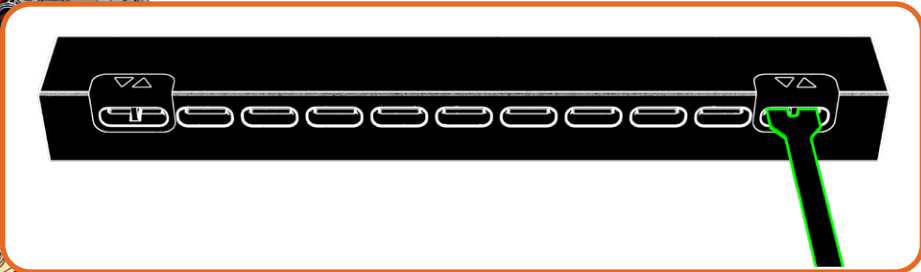

326

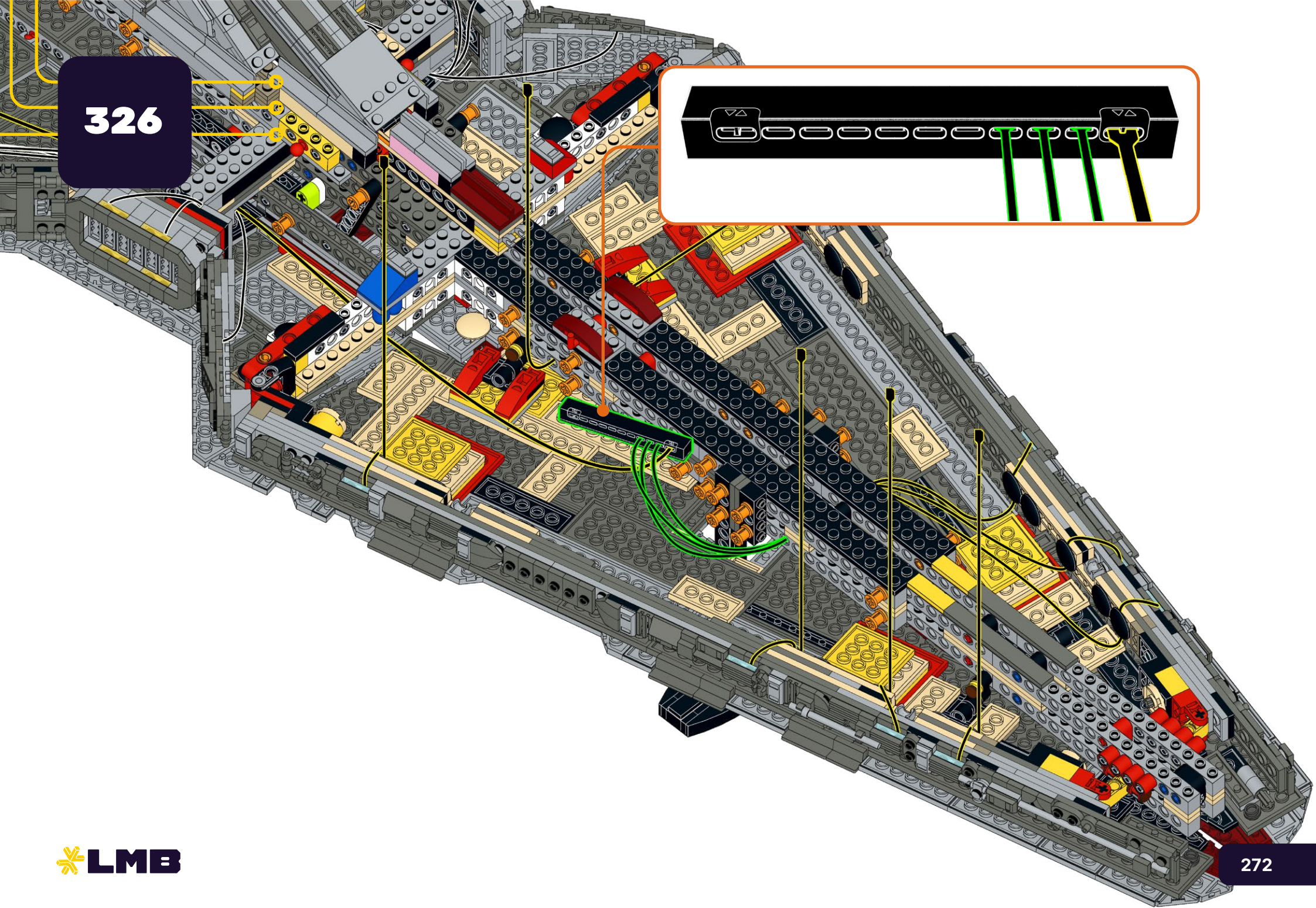
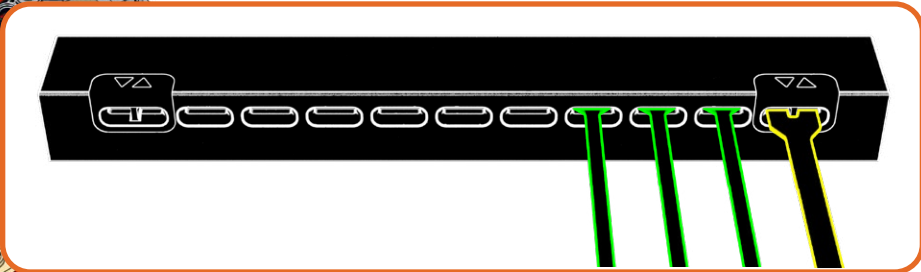

327

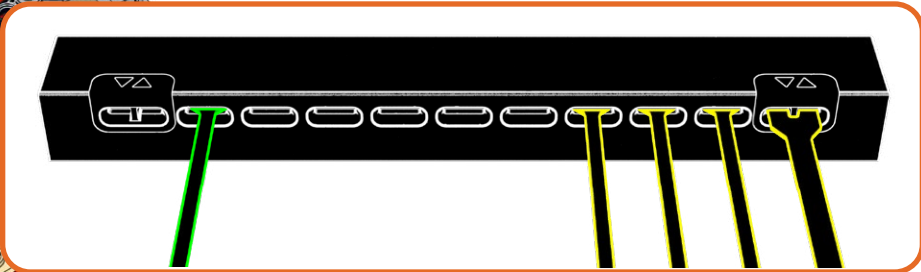

328

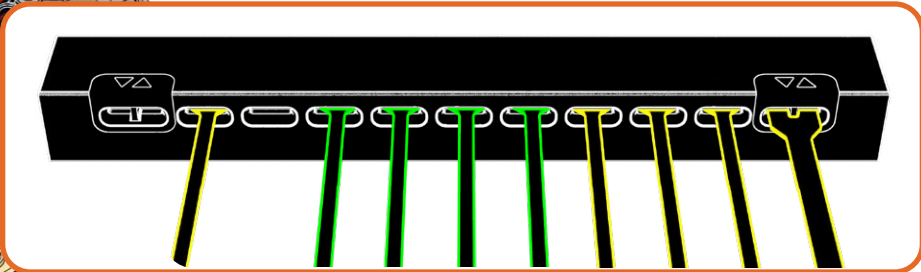

329

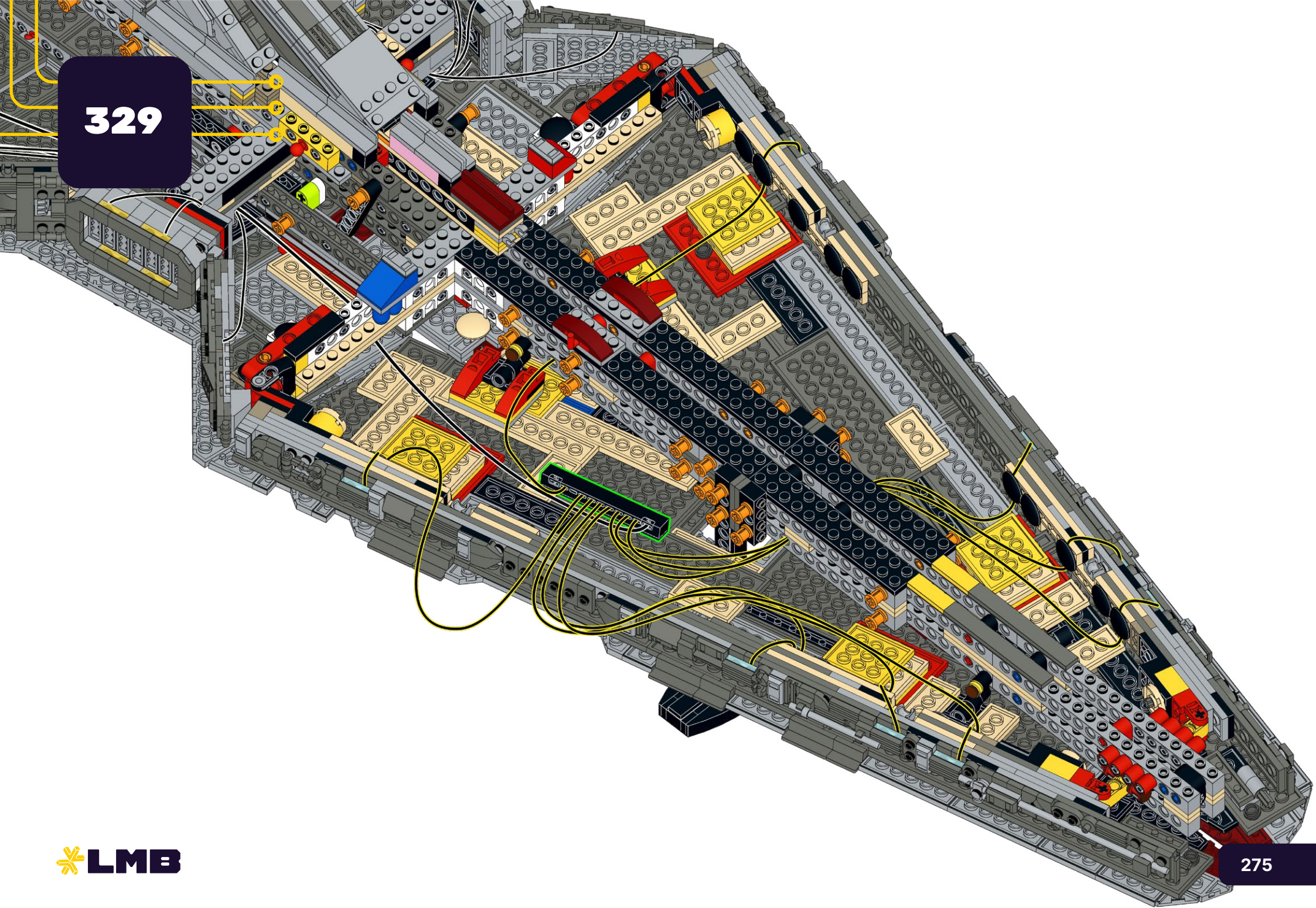

330



E-1x2 T-1x2

1x 1x

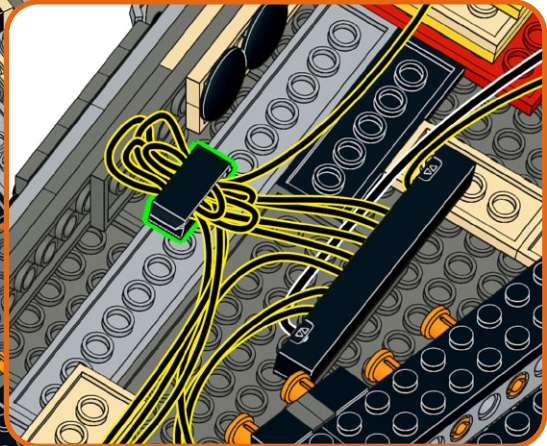

1 2

1 2

331

B-50

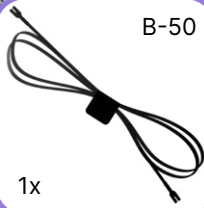

1x

332

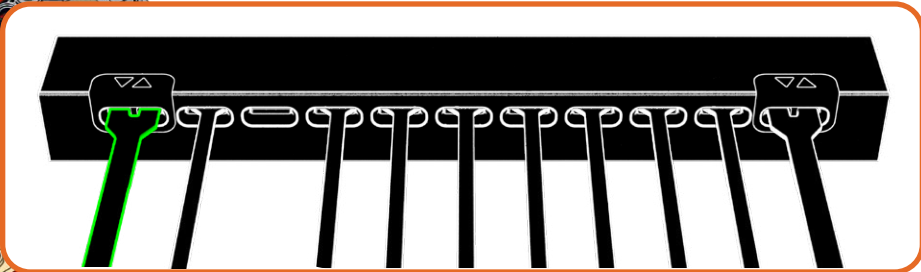

333

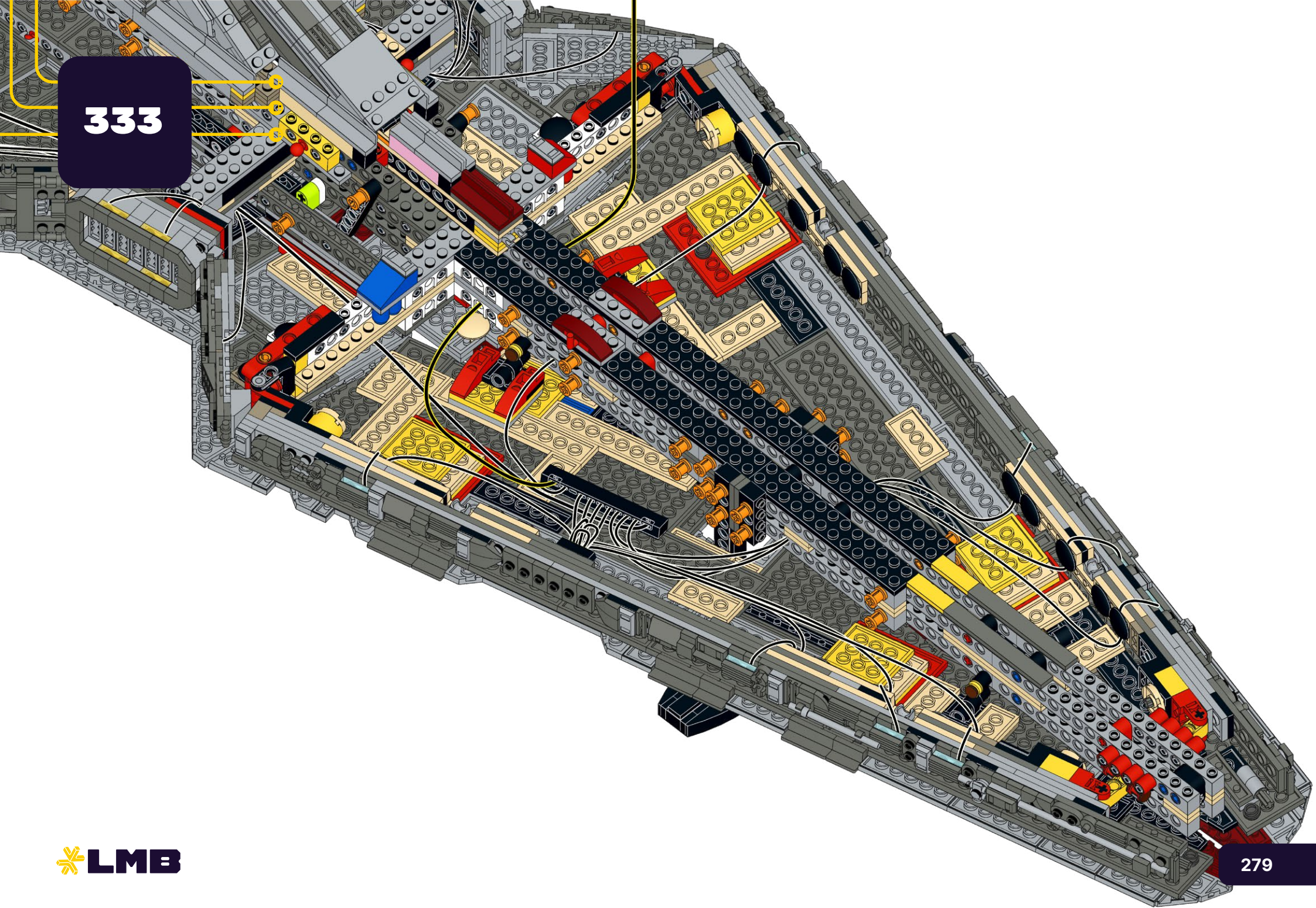

334

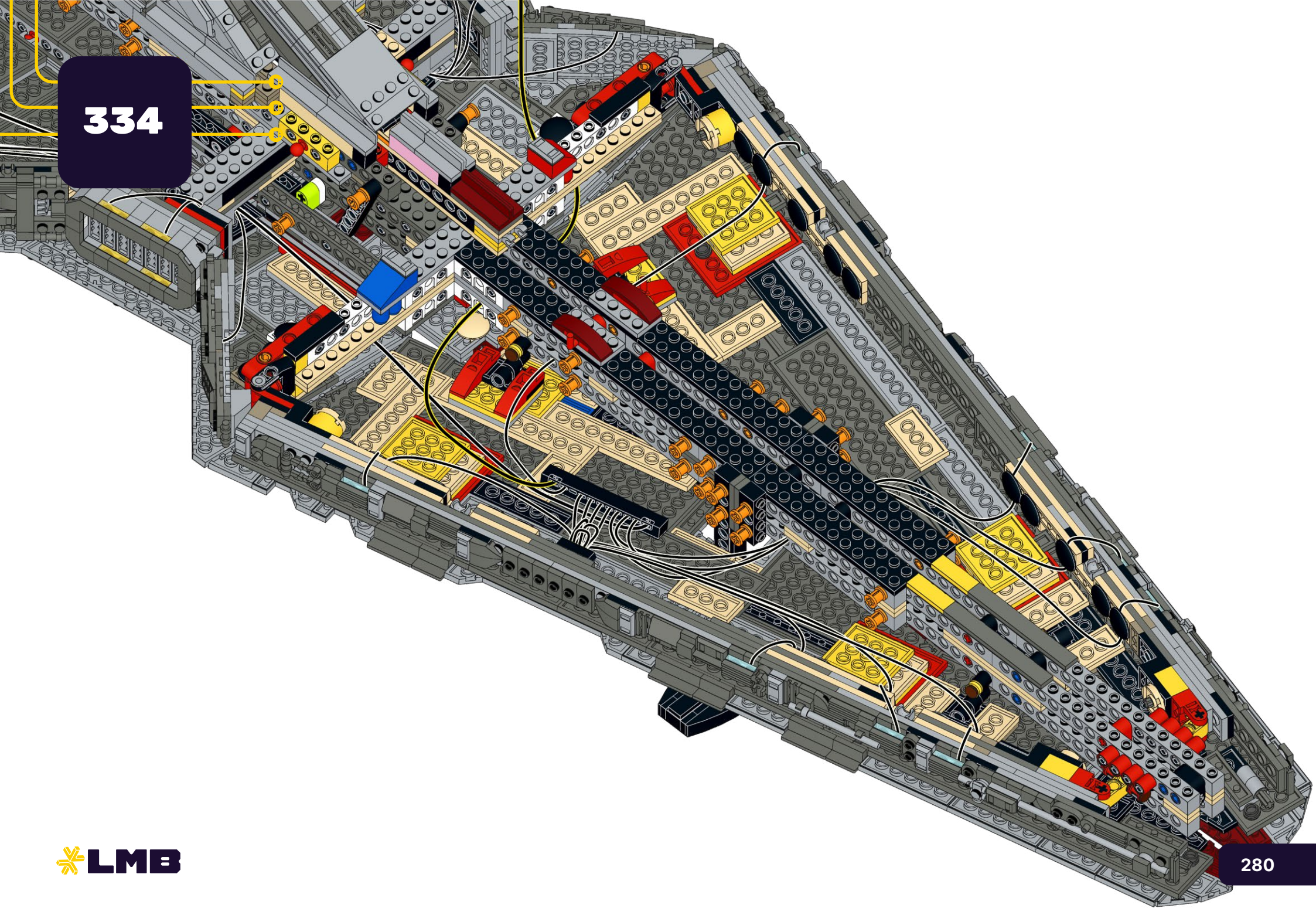

335

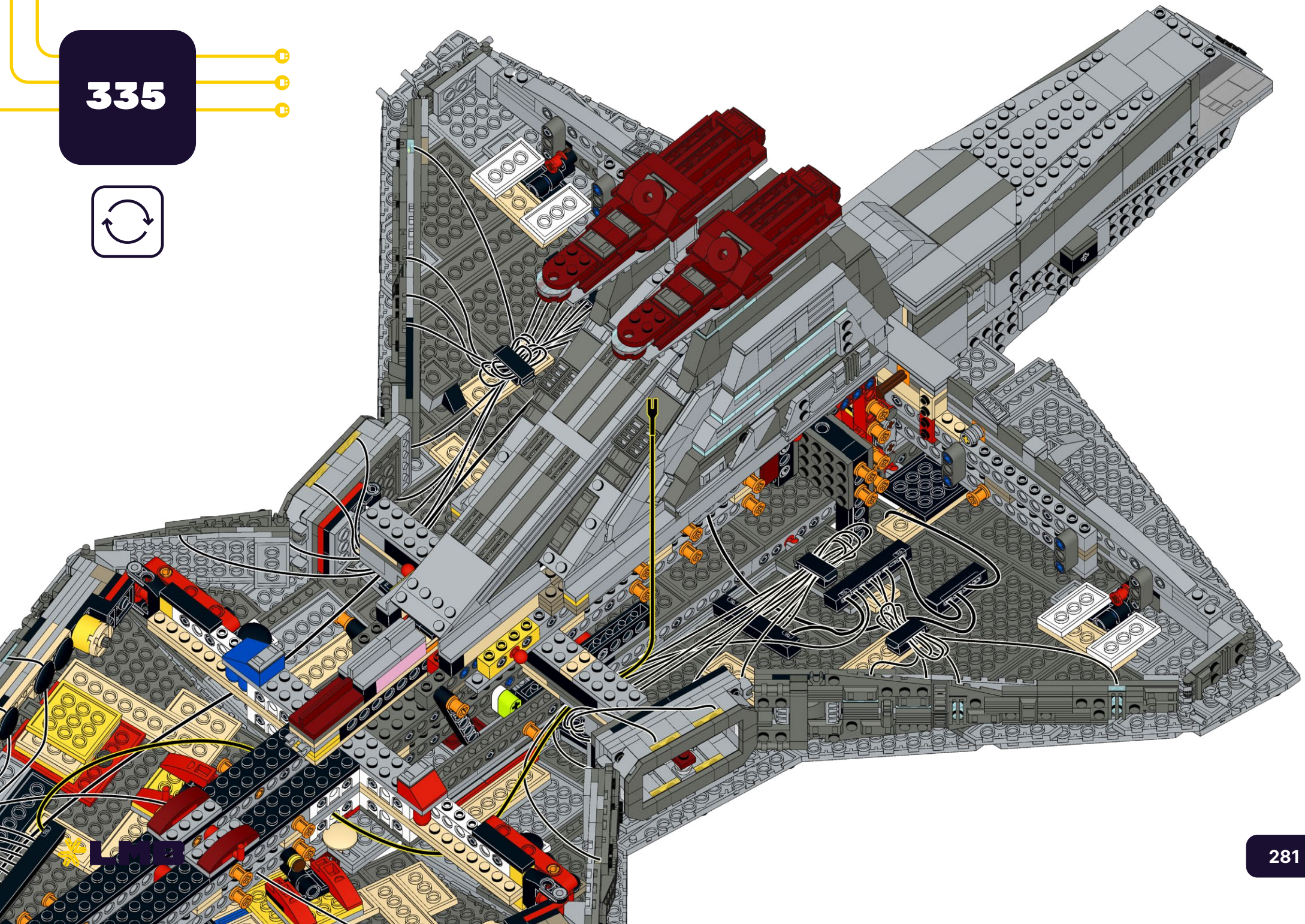

336

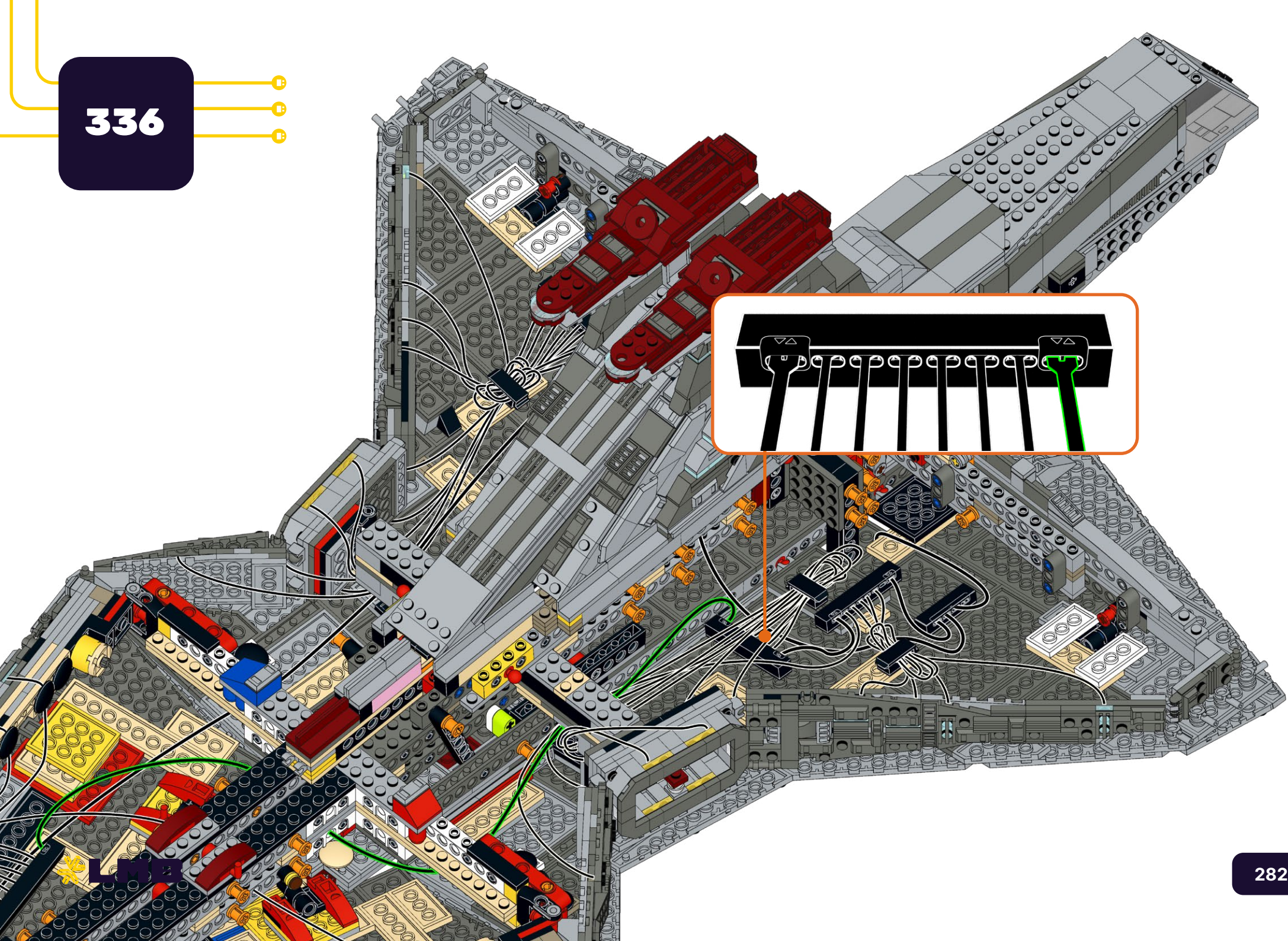

337

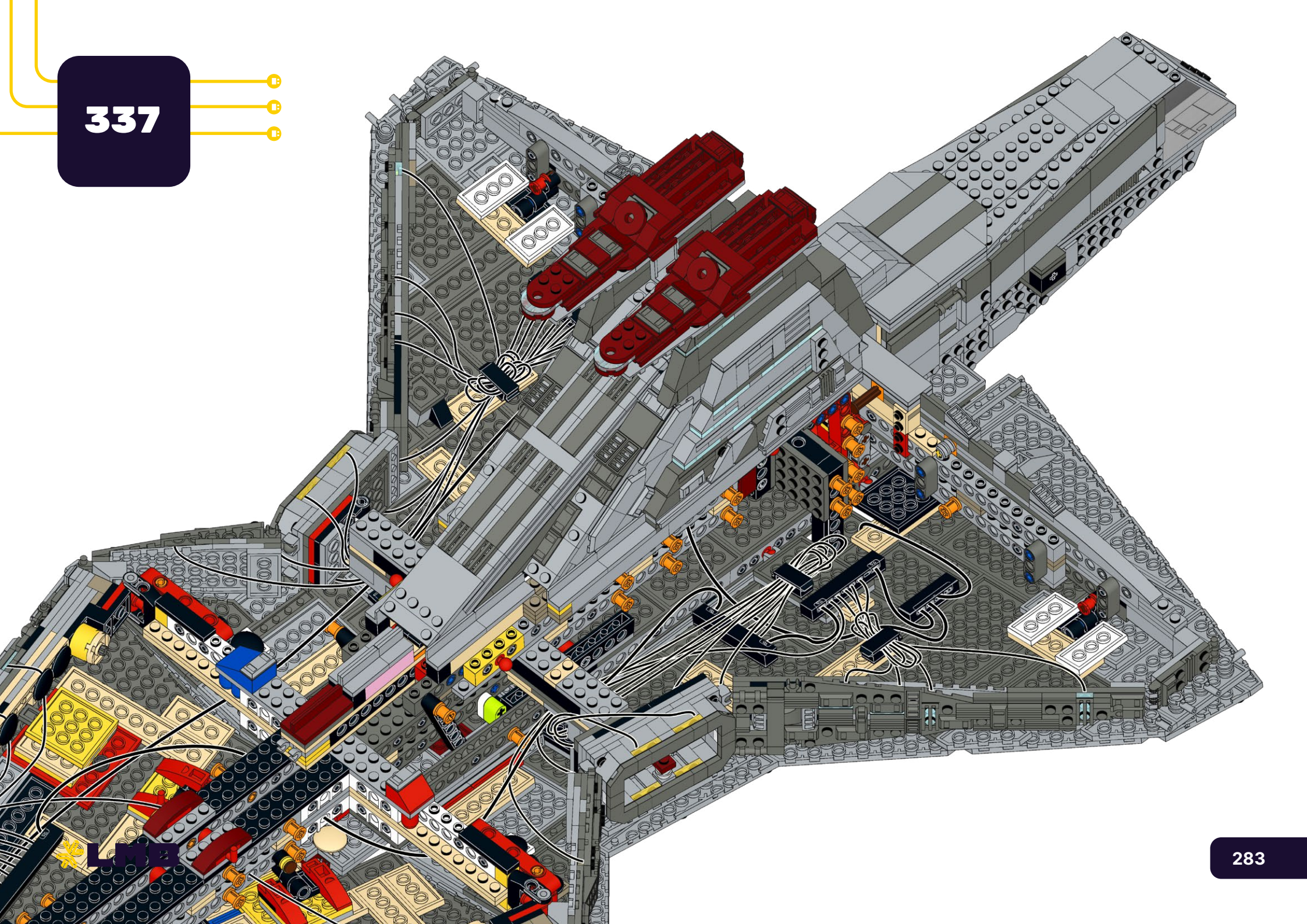

338



Power on Test
Test de mise sous tension
Test di Potenza
Stromtest
Prueba de Energía
电源测试

**HOLD UP!**

You might notice some bags aren't in order, as well as left over pieces, but that's ok! We're changing the way you build LEGO!

ATTENDEZ!

Vous remarquerez peut-être que certains sacs, ainsi que certaines pièces, ne sont pas dans le bon ordre. Mais pas de panique! Nous changeons simplement la façon avec laquelle vous construisez vos LEGO!

ASPETTA!

Potresti notare che alcuni sacchetti non sono in ordine, così come i pezzi avanzati, ma va bene così! Stiamo cambiando il modo in cui costruisci i LEGO!

HALT!

Sie werden möglicherweise bemerken, dass einige tüten durcheinander sind und teile übrig bleiben, aber das ist in Ordnung! Wir ändern die art und weise, wie Sie LEGO bauen!

¡ESPERA!

Es posible que notes que algunas bolsas están fuera de servicio, así como piezas sobrantes, ¡pero está bien! ¡Estamos cambiando la forma en que construyes LEGO!

暫停!

你可能会注意到一些袋子顺序错乱, 以及一些剩余的部件, 但没关系! 我们正在改变你搭建乐高的方式!

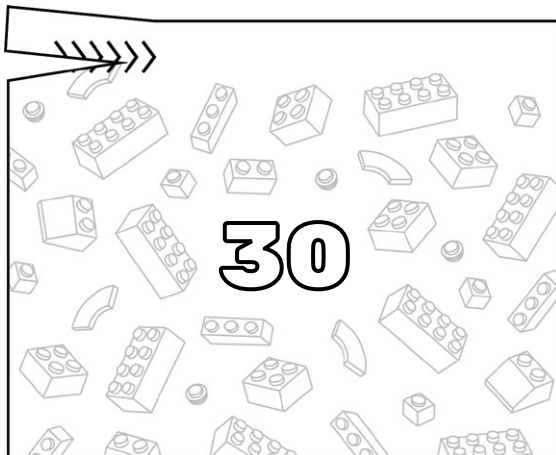
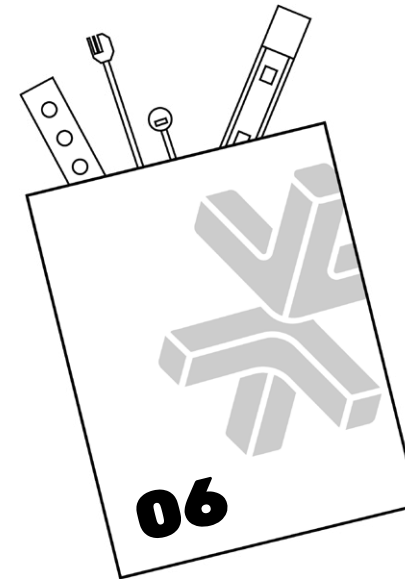
Open LEGO® Bag 30**Open LMB Bags 06**

339

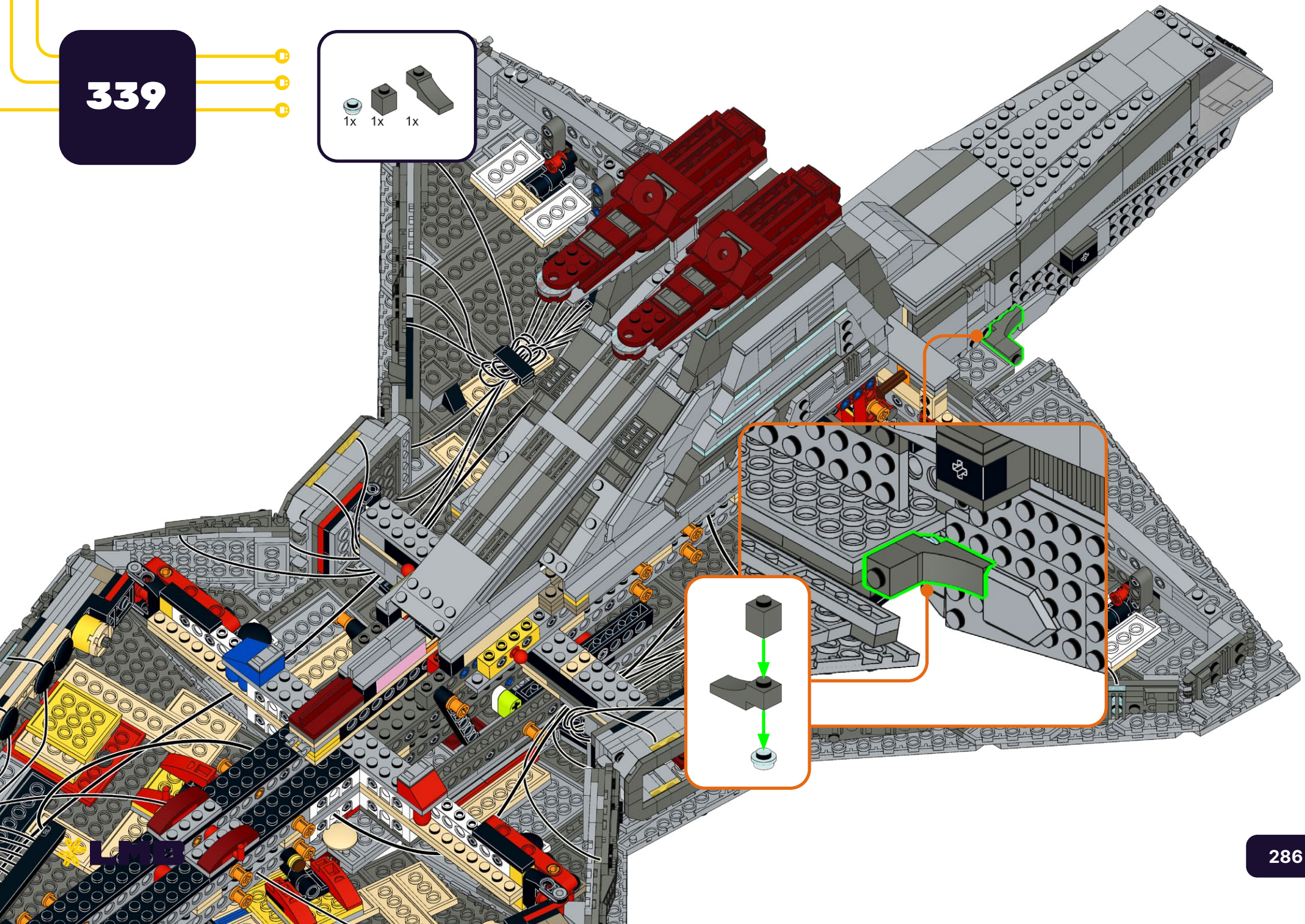
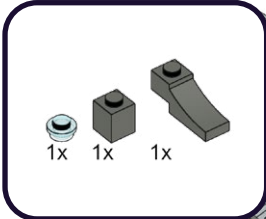

340

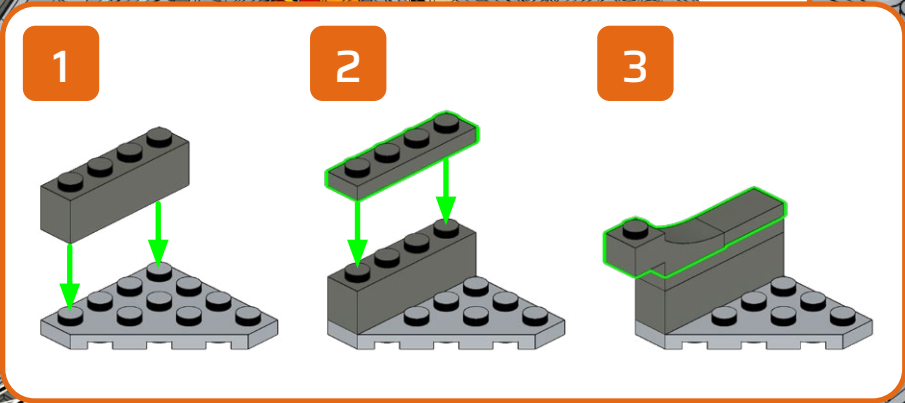
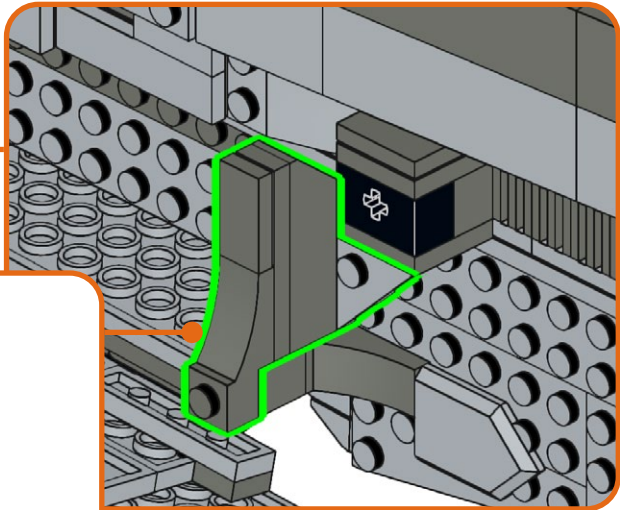
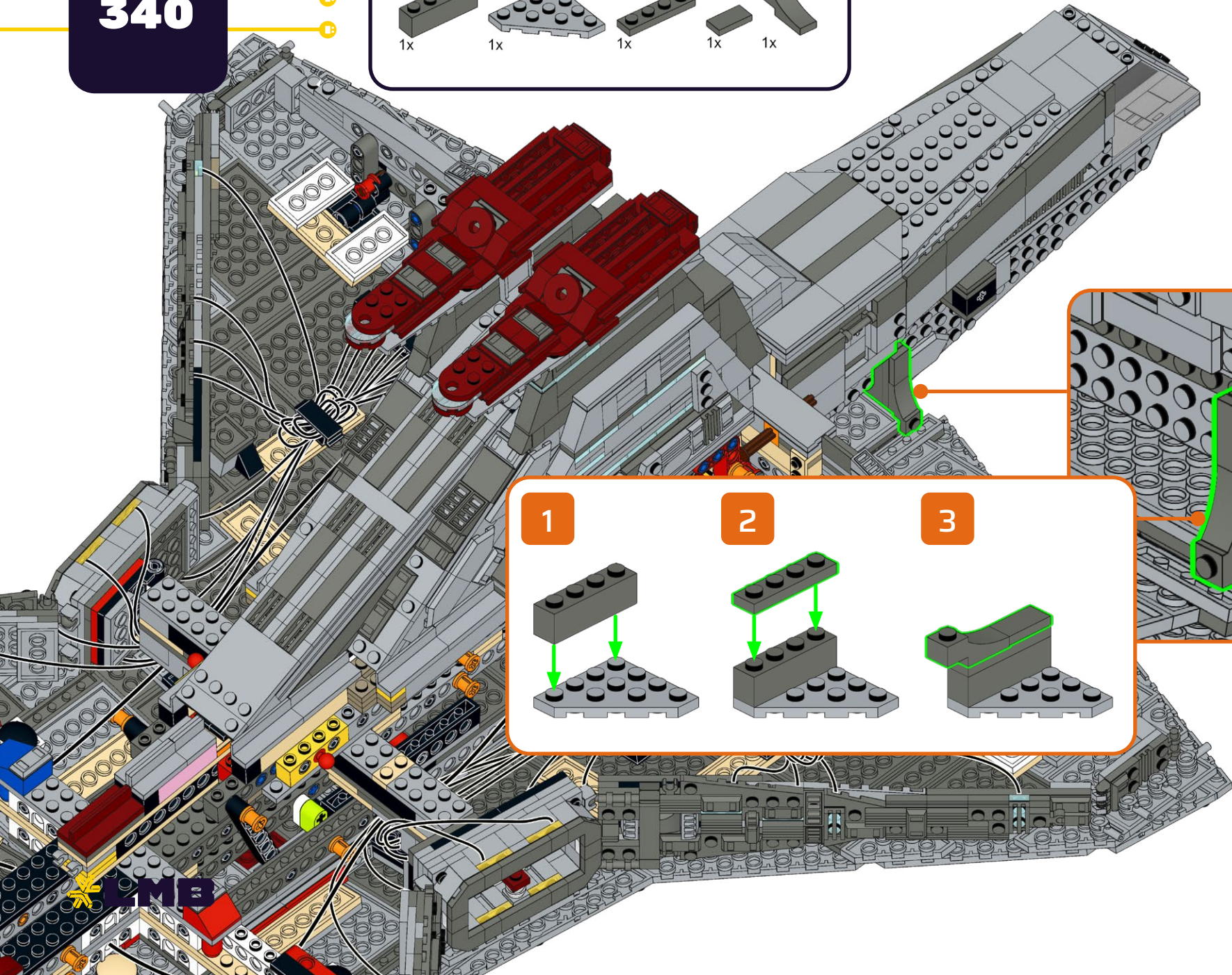
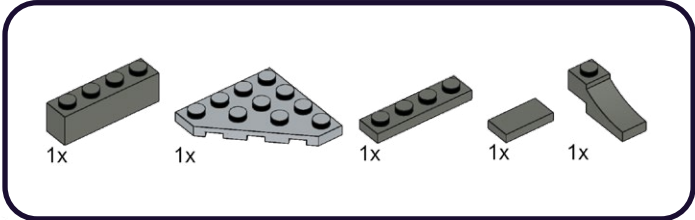

341

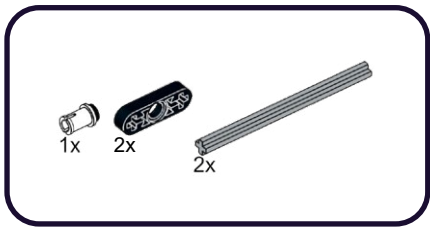

1

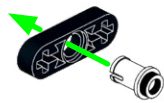

2



3



342

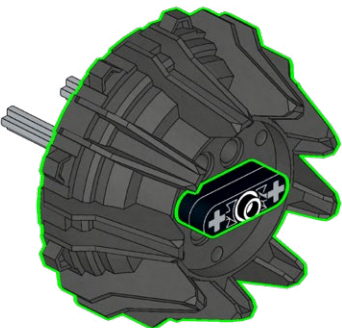

343

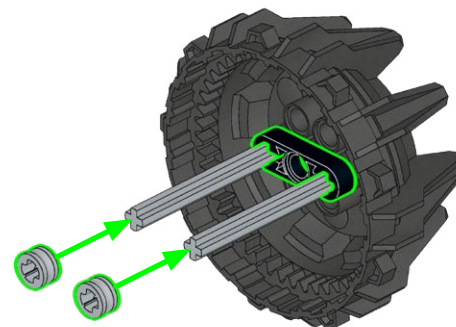
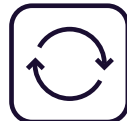
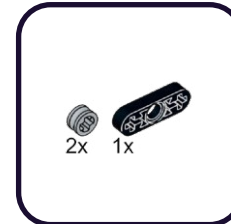

344

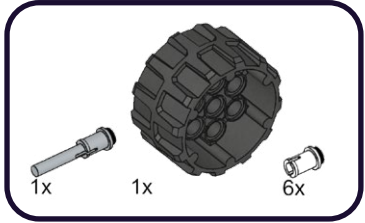

1

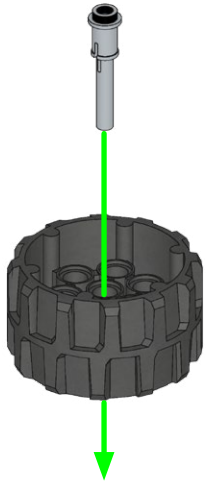

2

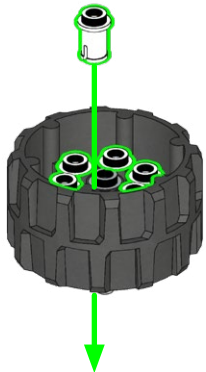

345

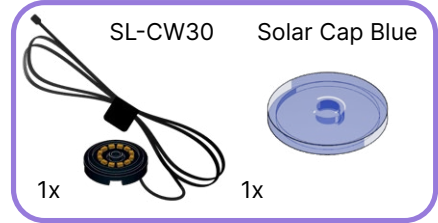

1

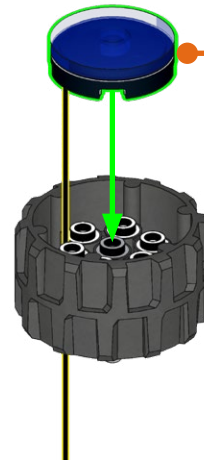

2

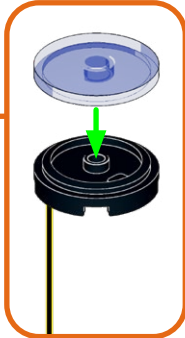

346

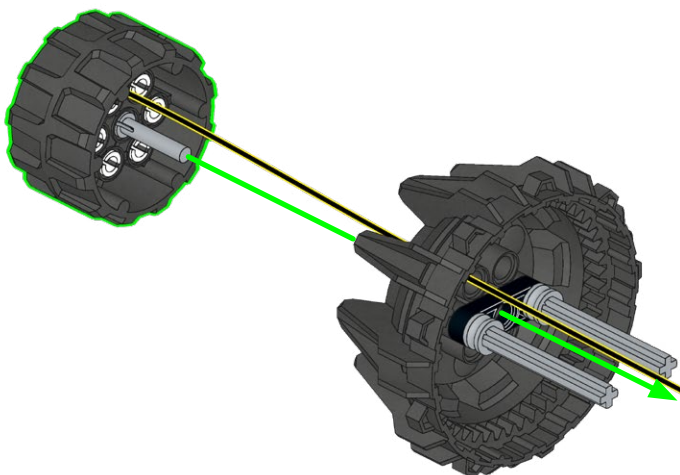

347

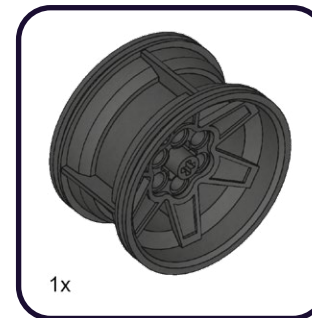

1x

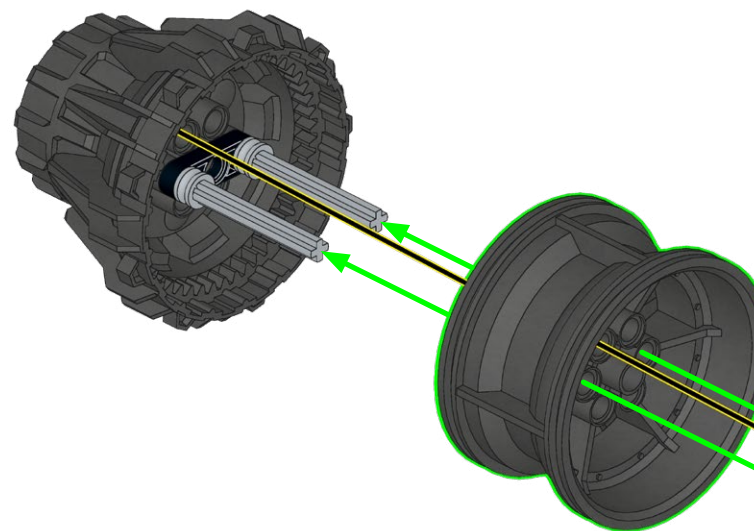

348

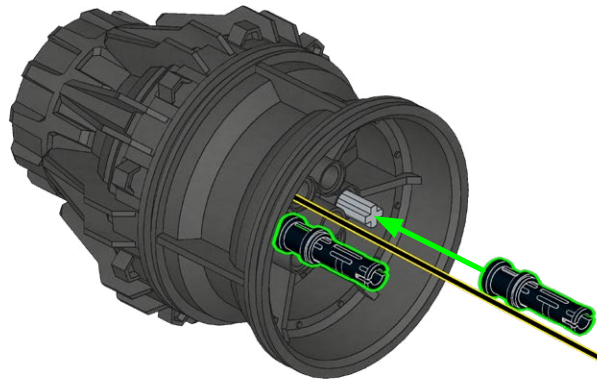

349

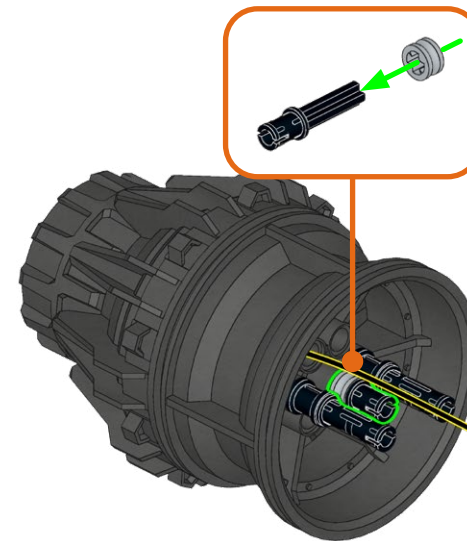
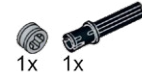

350



1x

351



1x

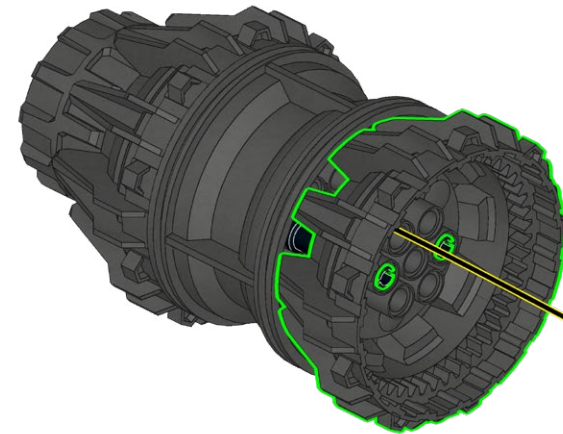
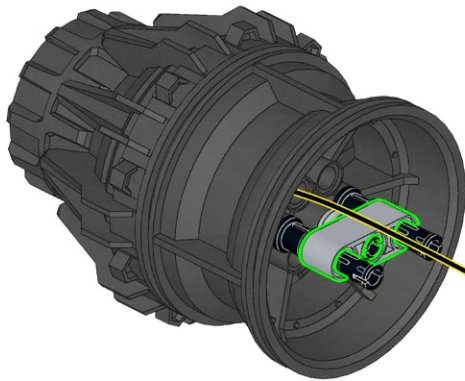

352

2x

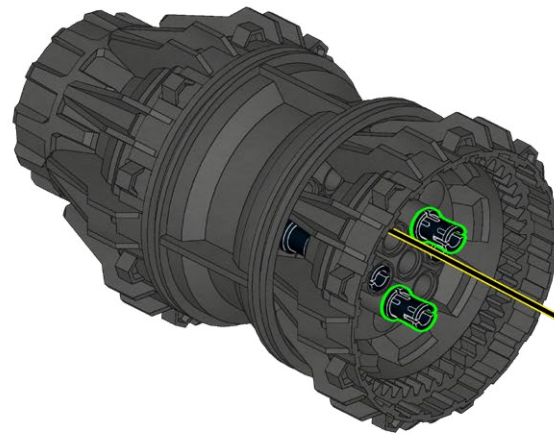

353

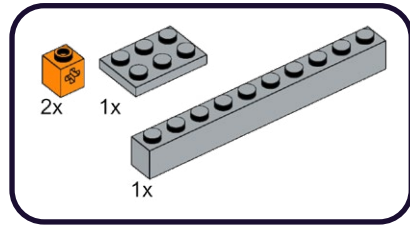

1

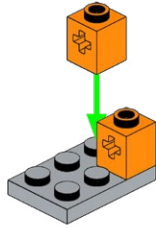

2

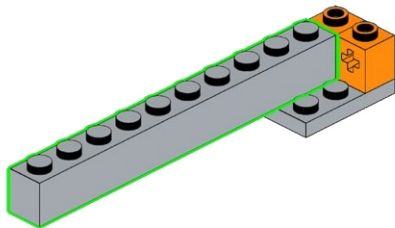

354

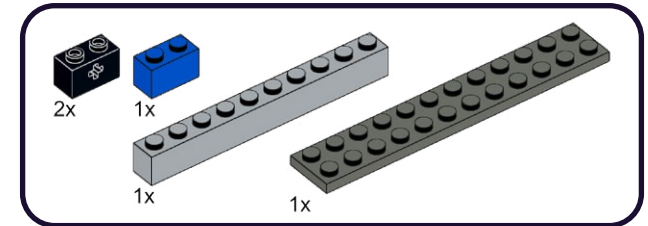

1

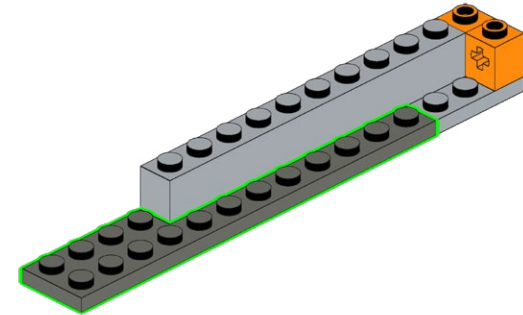

2

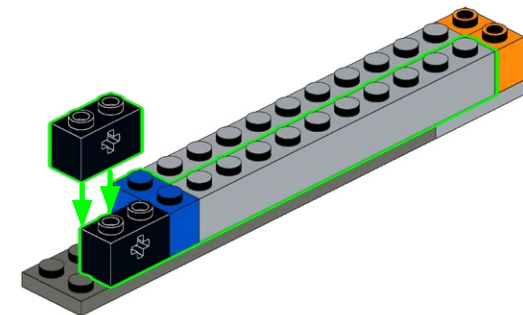

355

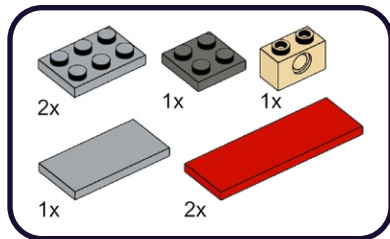

1

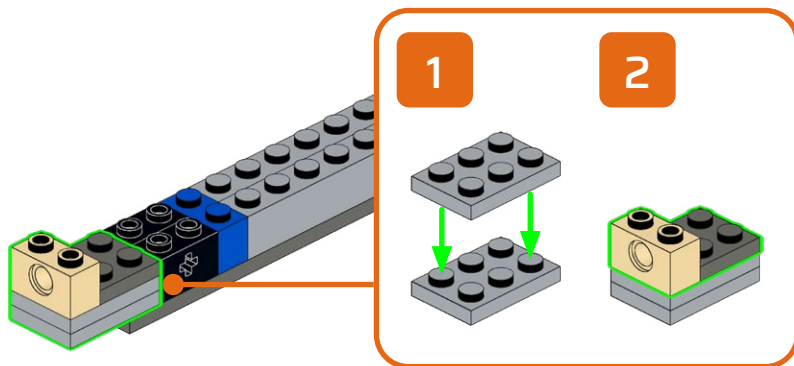

2

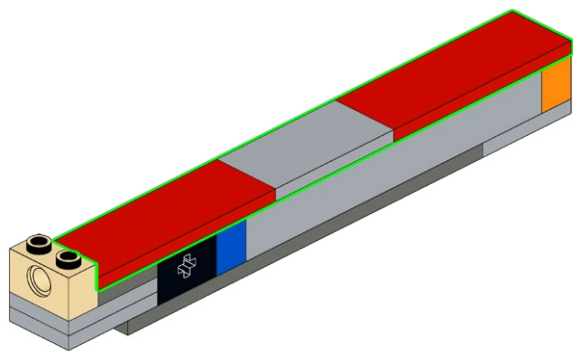

356

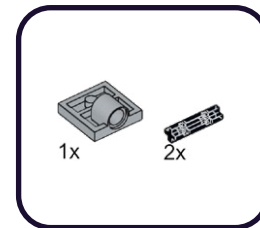

1

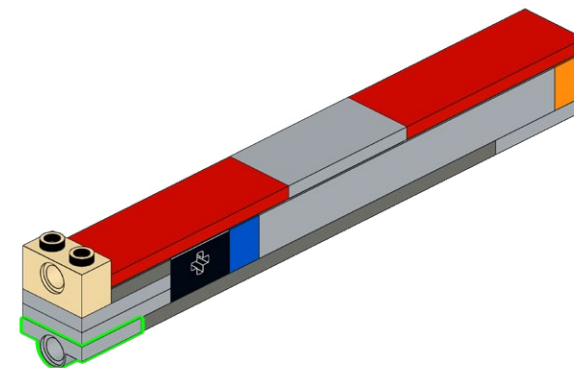

2

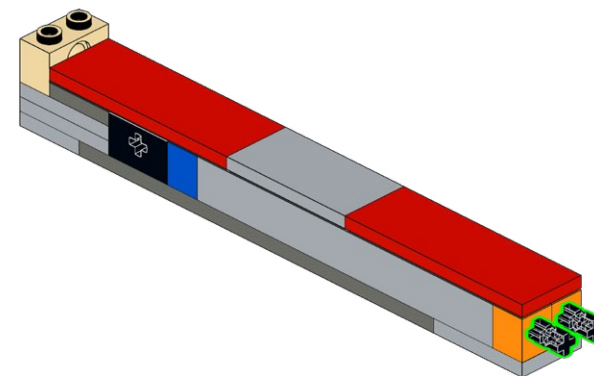
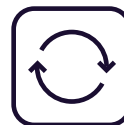

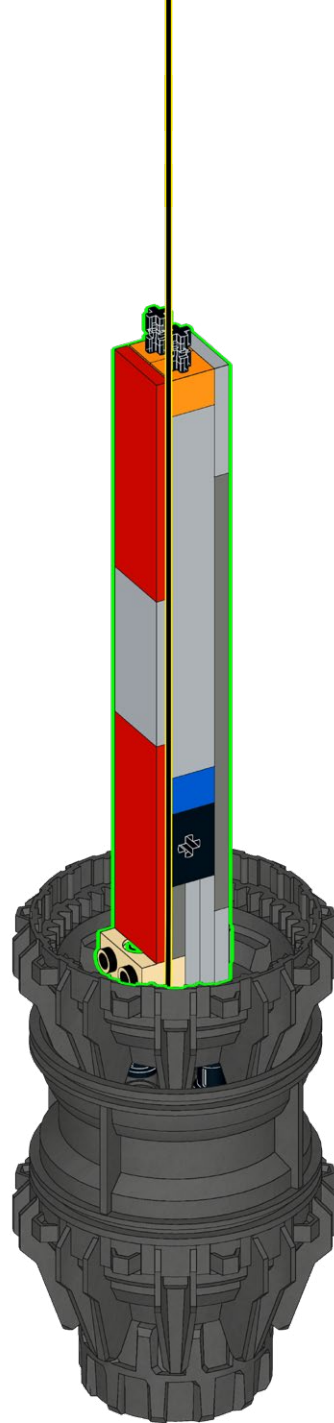
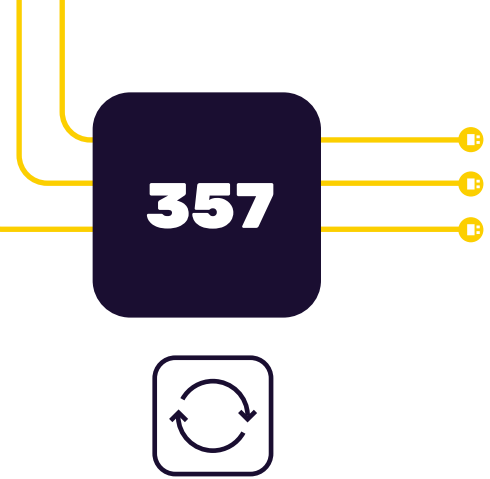

358

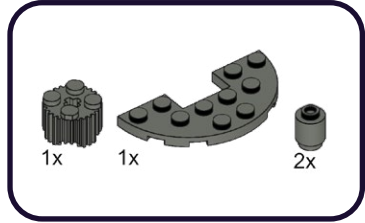

1

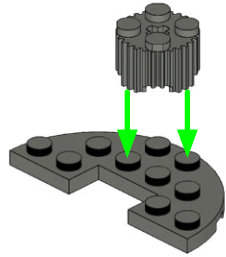

2

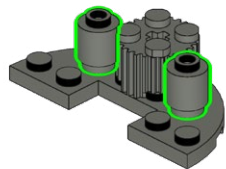

359

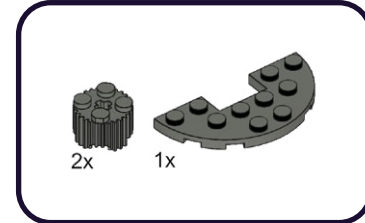

1

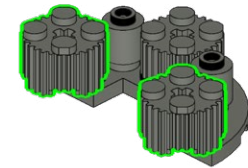

2

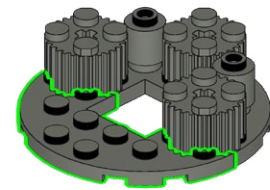

360

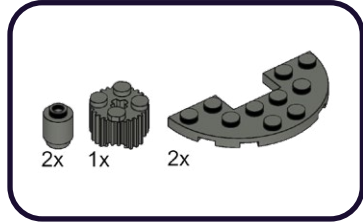

1

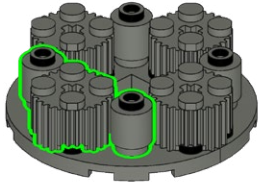

2

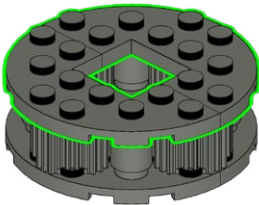

361

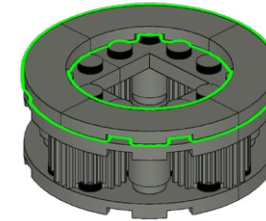
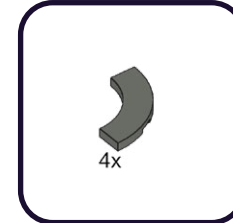

362

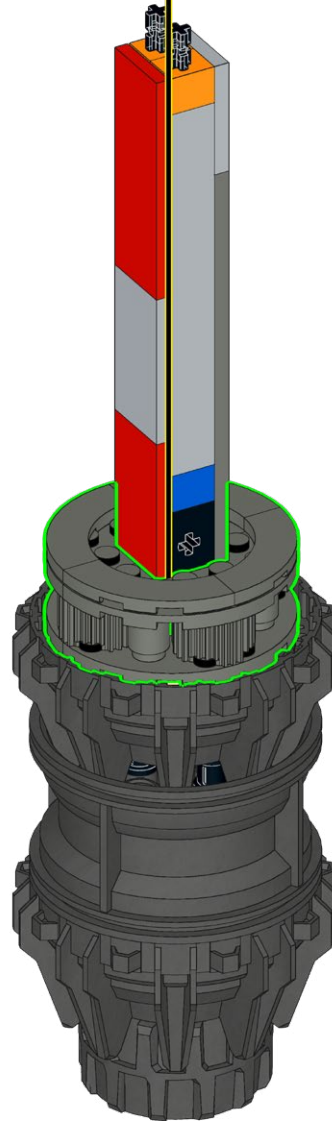

363

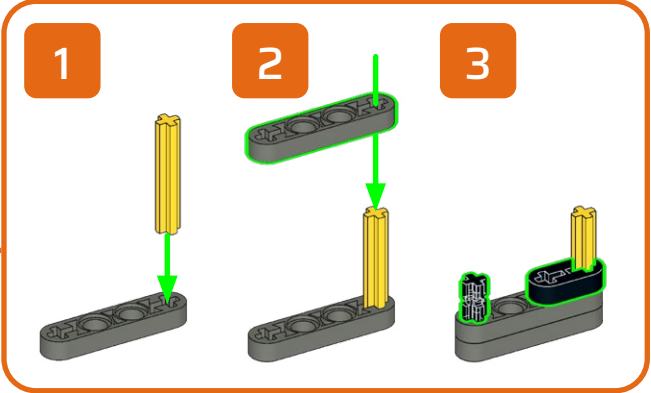
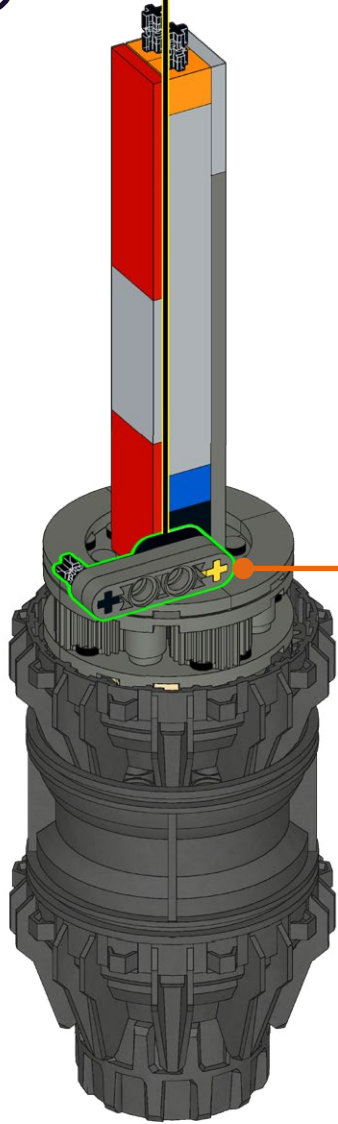
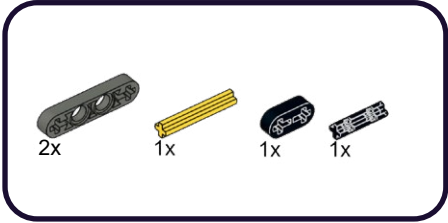

364

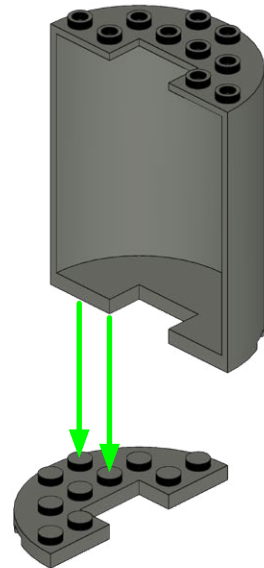
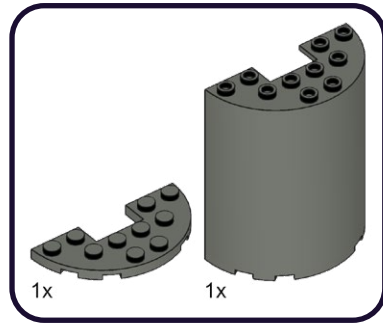

365

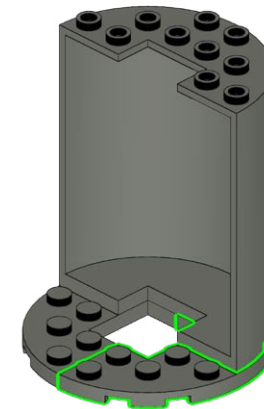
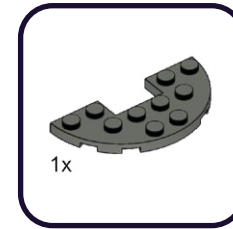

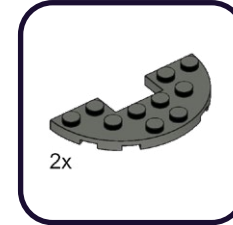
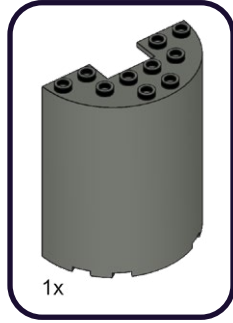

368

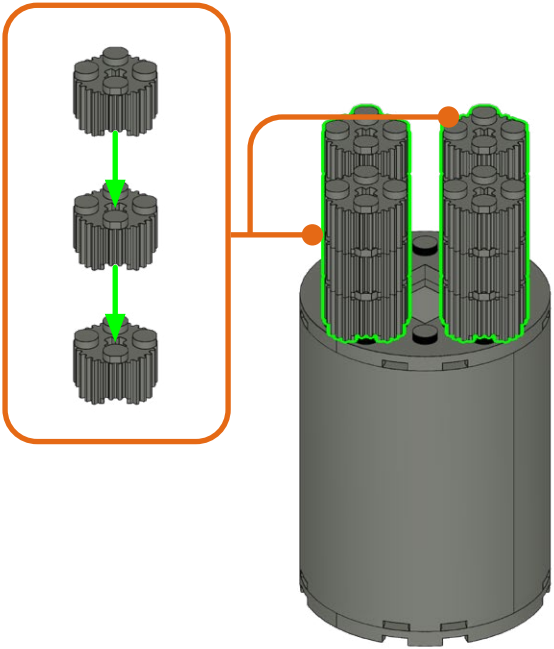

369

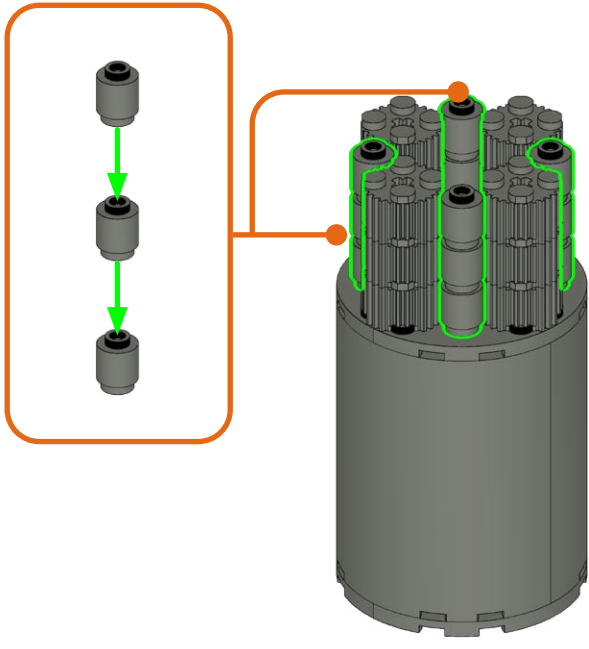
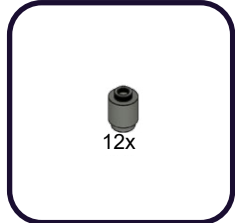

370

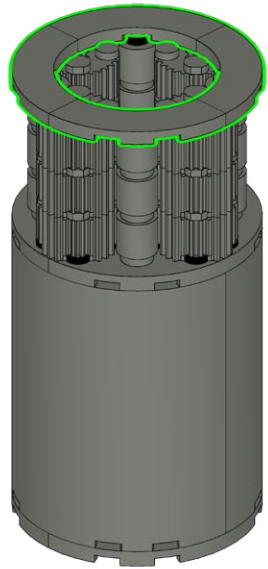

371

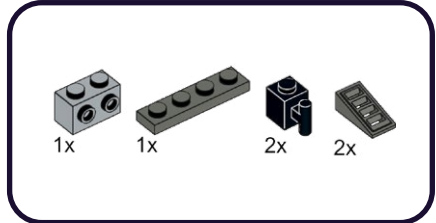

- 1
- 2
- 3



372

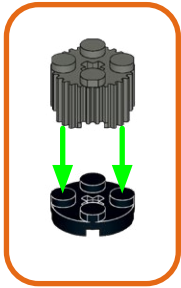
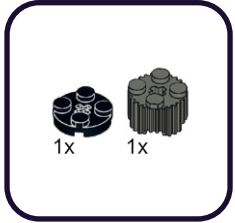

373

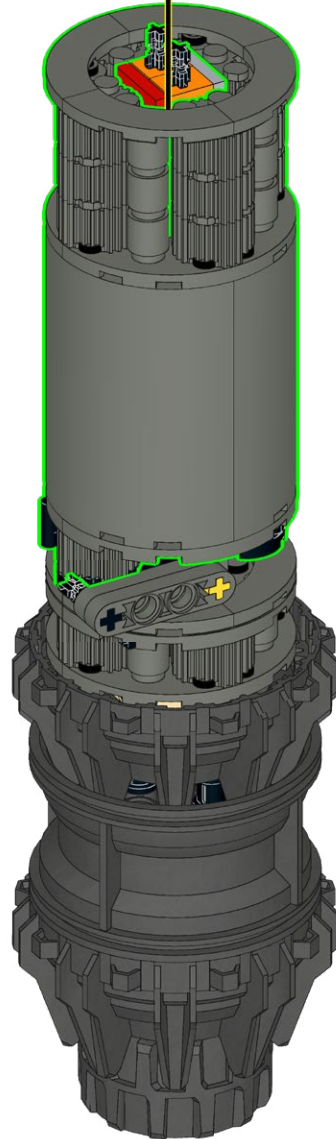

374

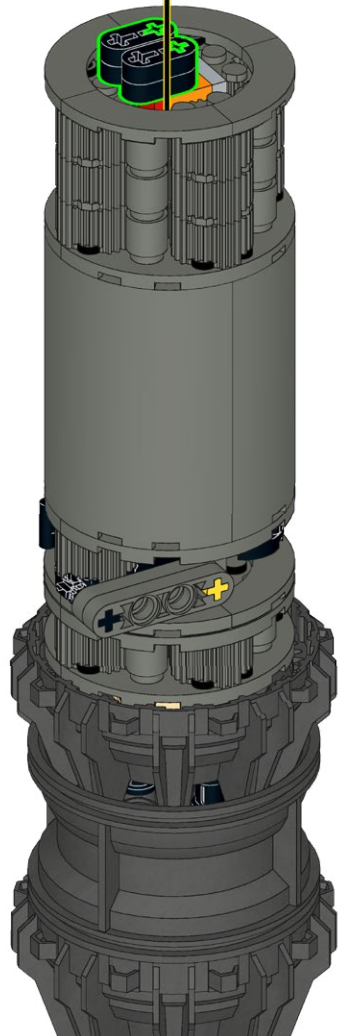

375

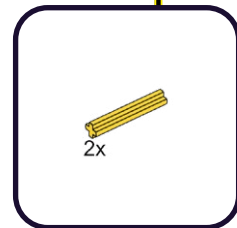

376

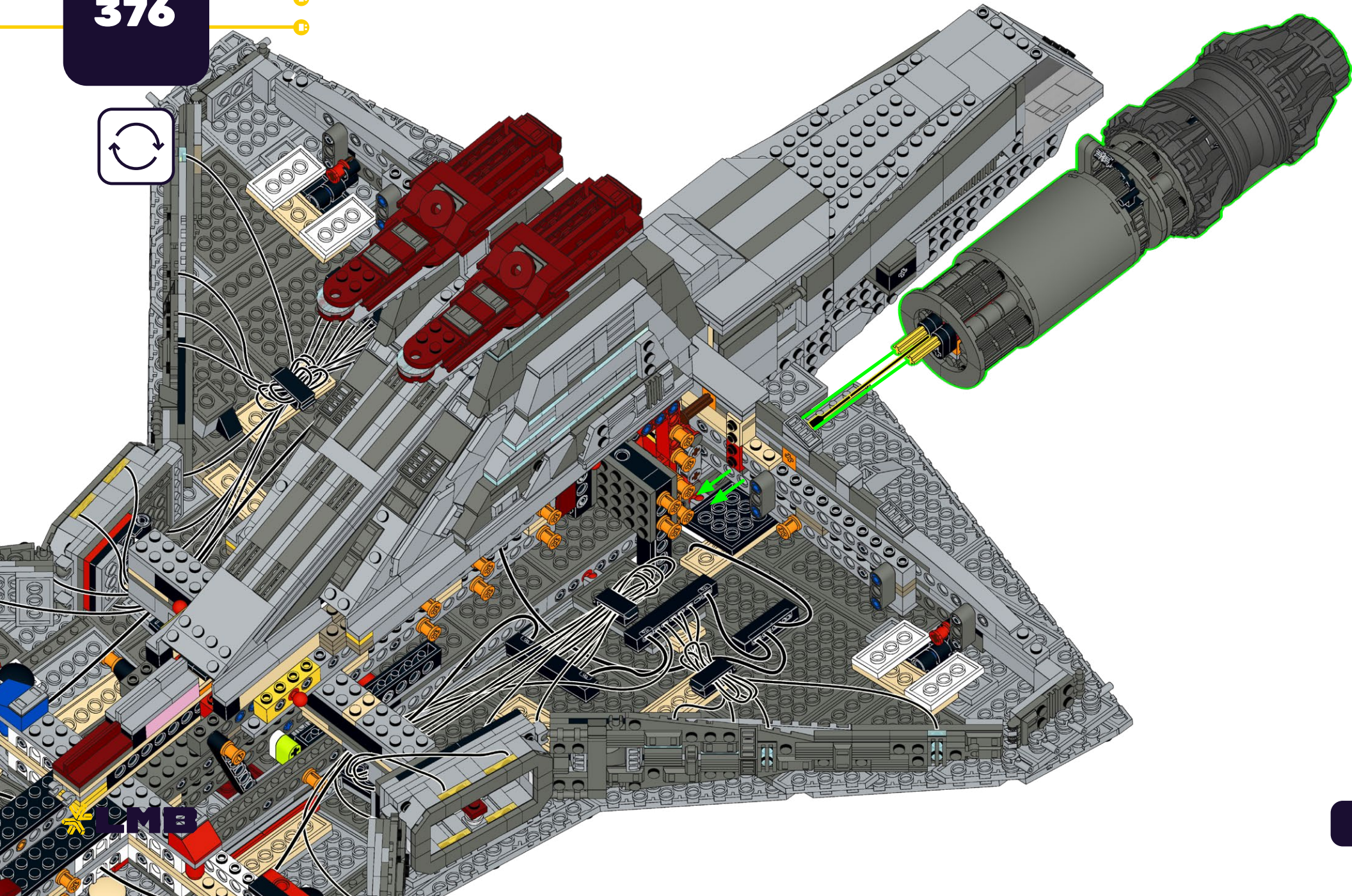

377

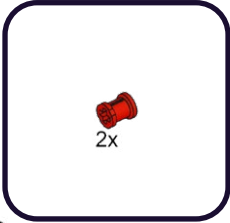

378

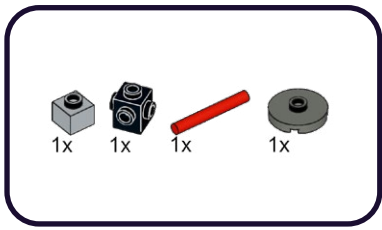

1



2

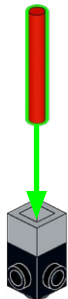

3



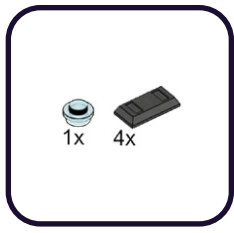
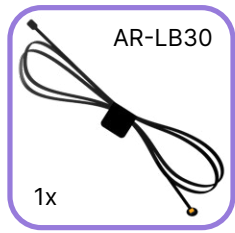

1

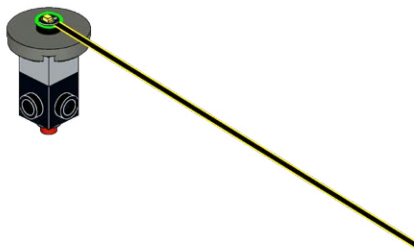

2

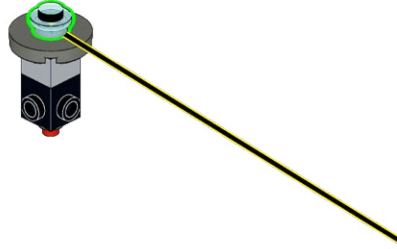

3

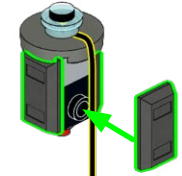

380



1

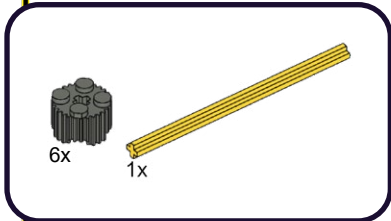
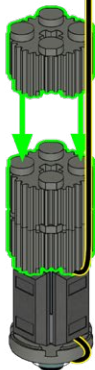

2

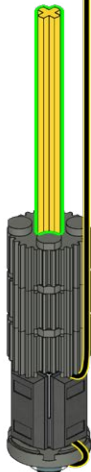

3

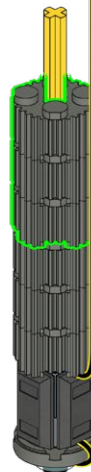



1

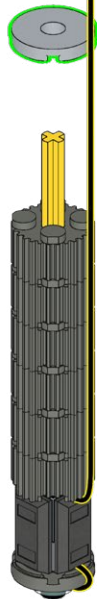

2

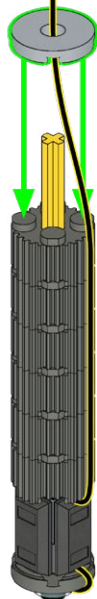

3

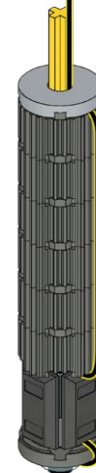

382



383



**HOLD UP!**

You might notice some bags aren't in order, as well as left over pieces, but that's ok! We're changing the way you build LEGO!

ATTENDEZ!

Vous remarquerez peut-être que certains sacs, ainsi que certaines pièces, ne sont pas dans le bon ordre. Mais pas de panique! Nous changeons simplement la façon avec laquelle vous construisez vos LEGO!

ASPETTA!

Potresti notare che alcuni sacchetti non sono in ordine, così come i pezzi avanzati, ma va bene così! Stiamo cambiando il modo in cui costruisci i LEGO!

HALT!

Sie werden möglicherweise bemerken, dass einige tüten durcheinander sind und teile übrig bleiben, aber das ist in Ordnung! Wir ändern die art und weise, wie Sie LEGO bauen!

¡ESPERA!

Es posible que notes que algunas bolsas están fuera de servicio, así como piezas sobrantes, ¡pero está bien! ¡Estamos cambiando la forma en que construyes LEGO!

暫停!

你可能会注意到一些袋子顺序错乱, 以及一些剩余的部件, 但没关系! 我们正在改变你搭建乐高的方式!

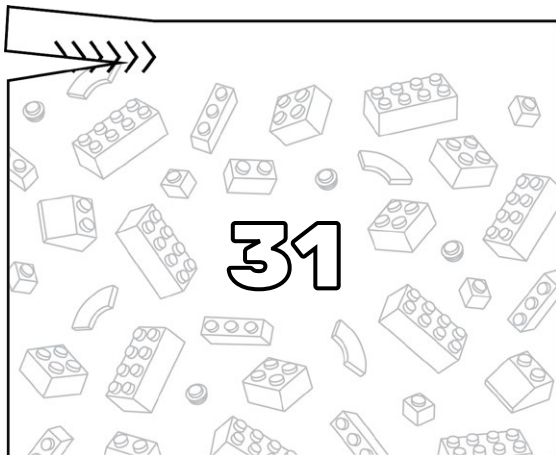
Open LEGO® Bag 31

384

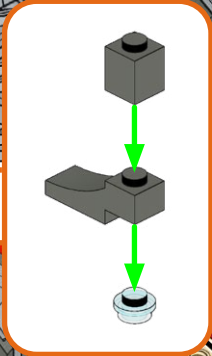
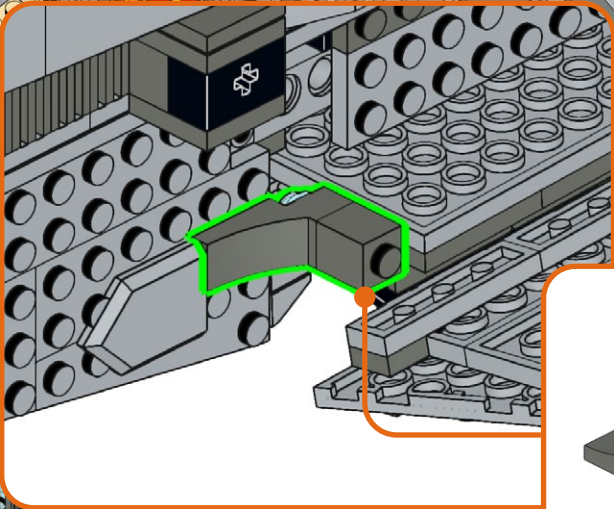
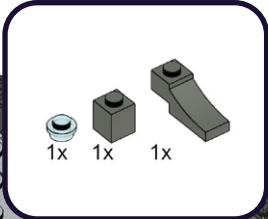

385

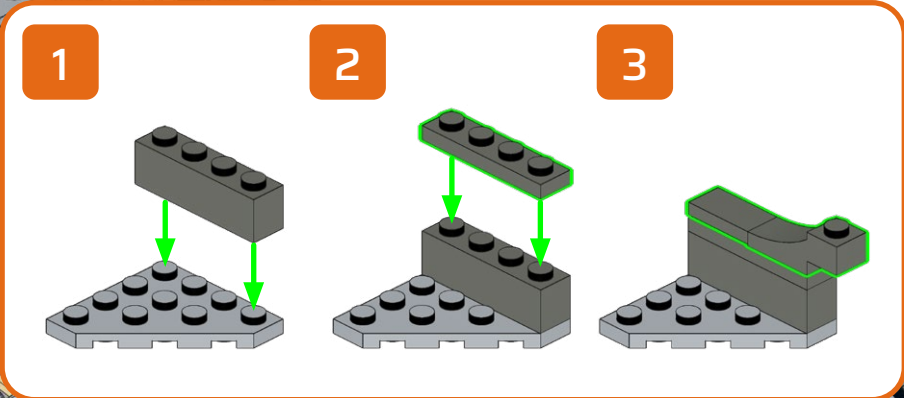
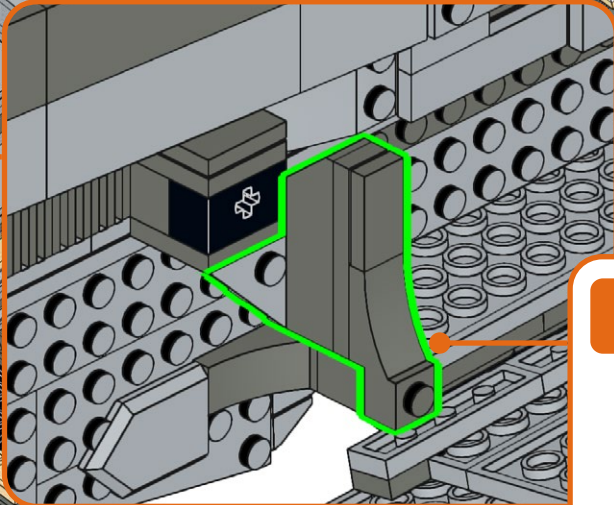
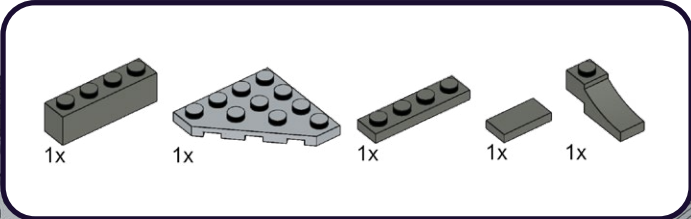

386

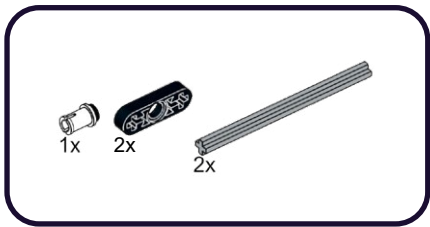

1

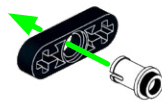

2

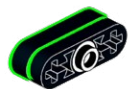

3



387

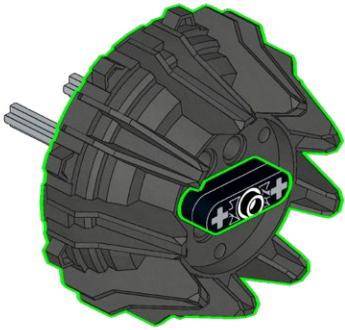

388

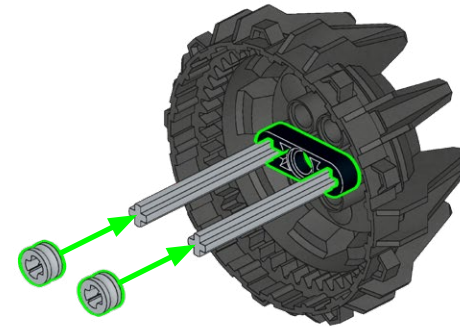
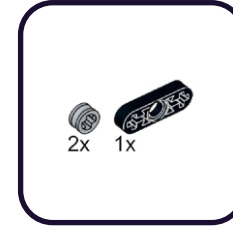

389

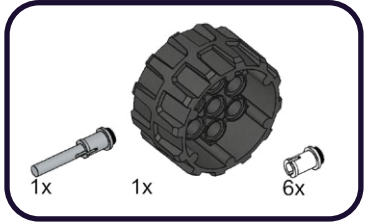

1

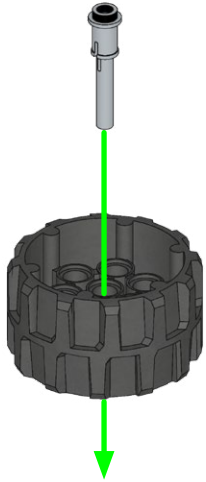

2

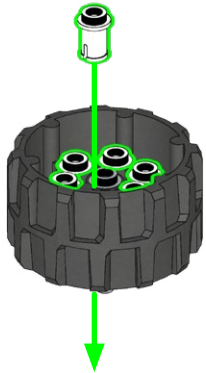

390

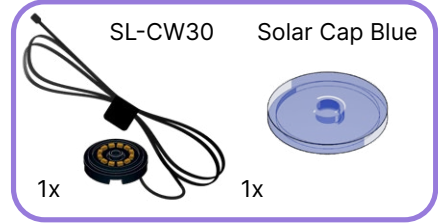

1

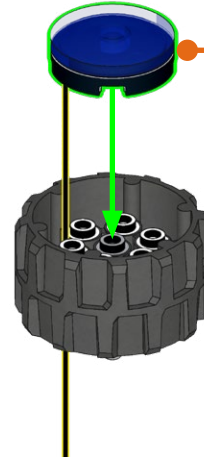

2

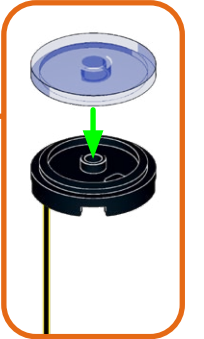

391

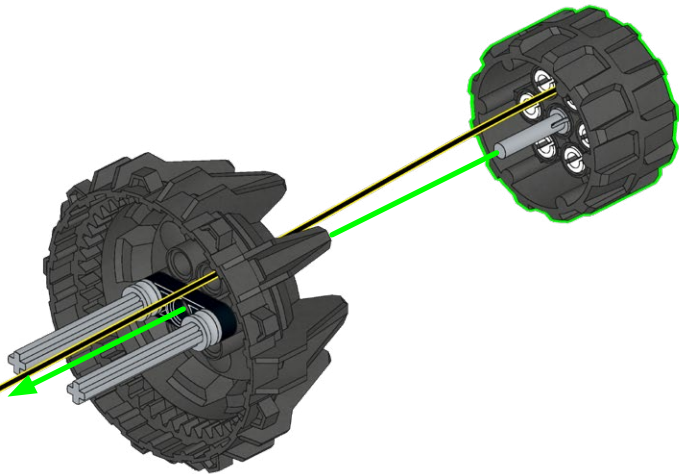

392

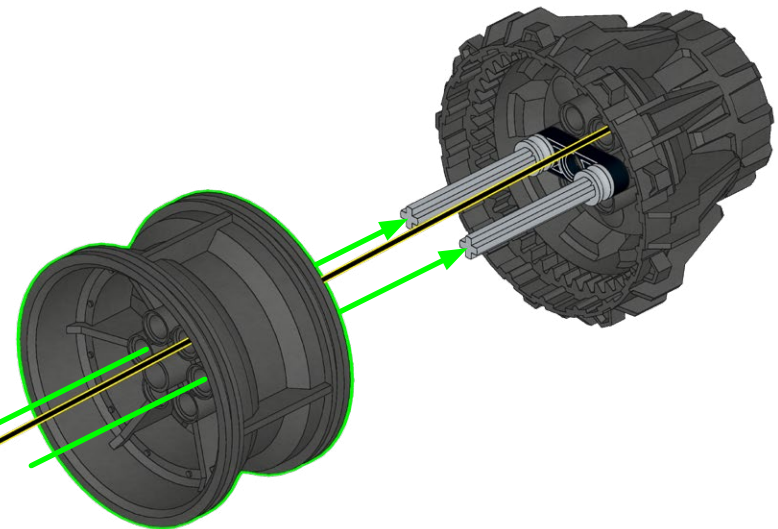
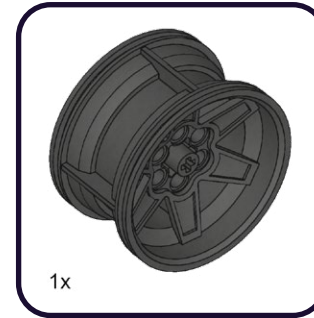

393

2x

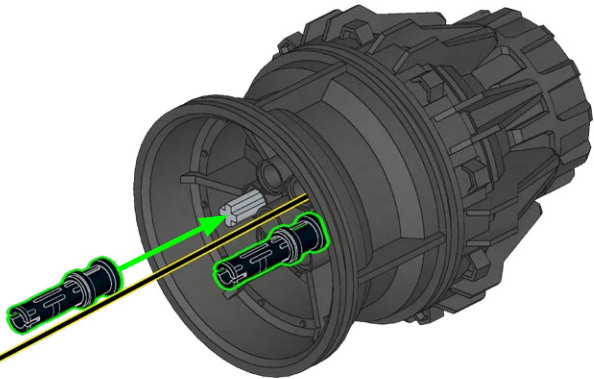

394

1x 1x

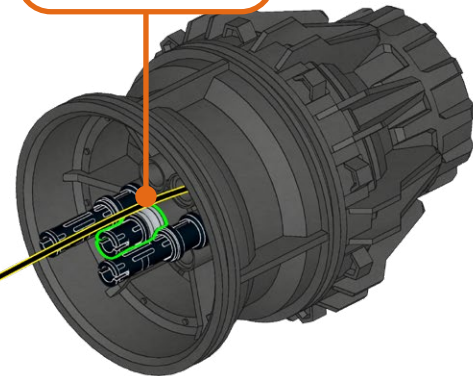
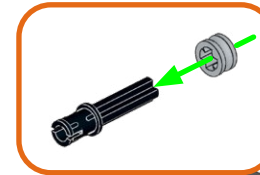

395



1x

396



1x

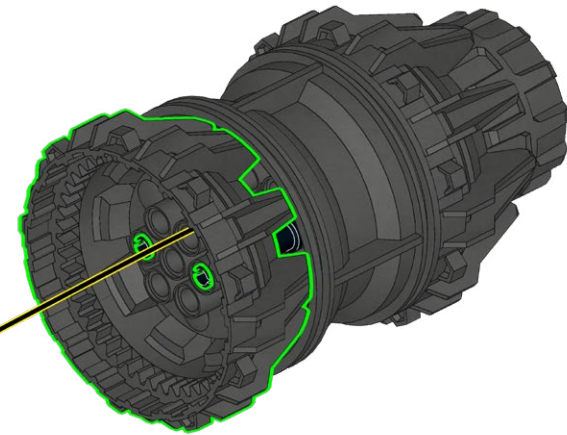
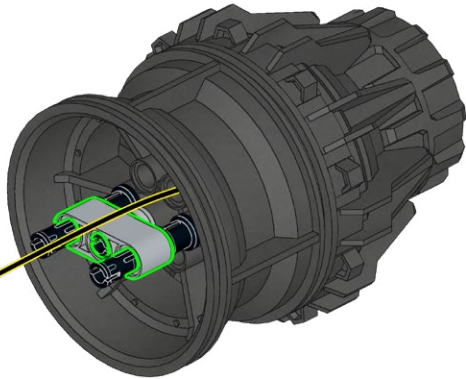

397

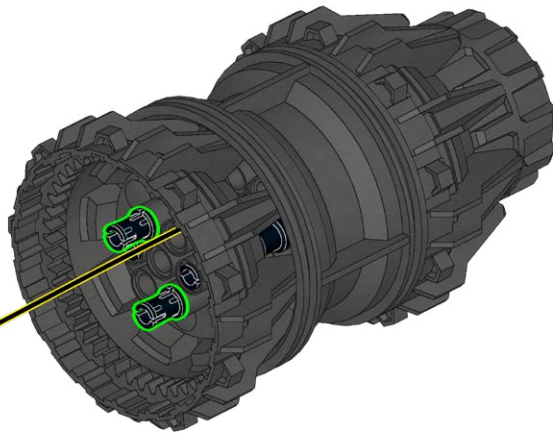

398

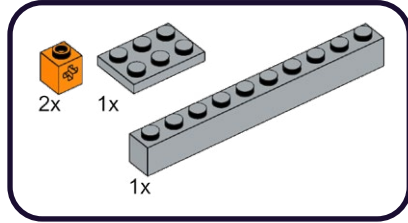

1

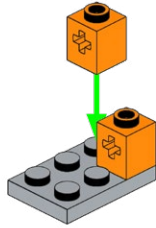

2

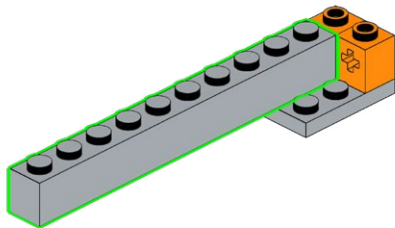

399

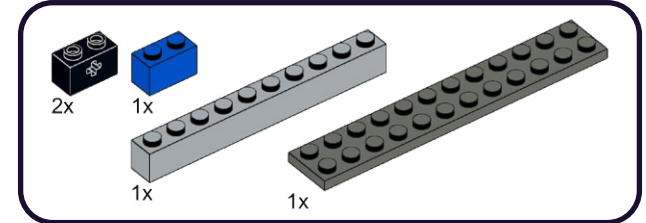

1

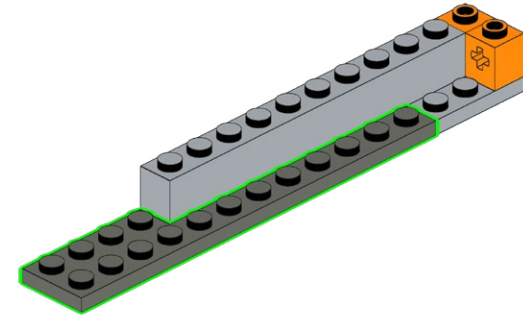

2

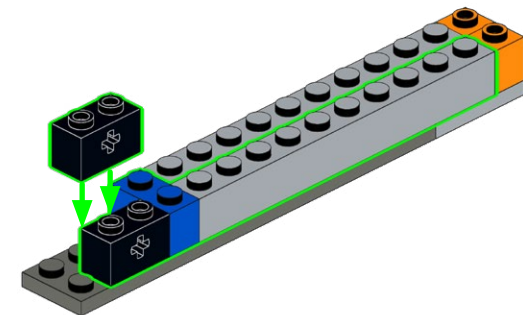

400

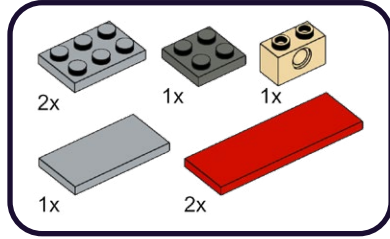

1

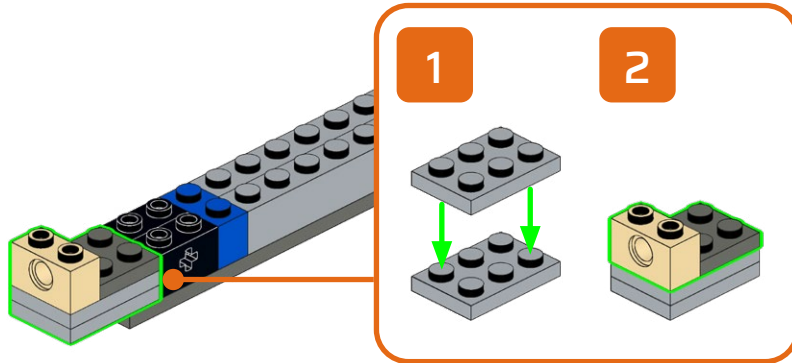

2

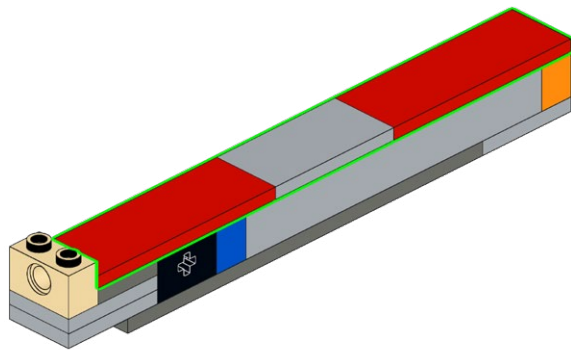

401

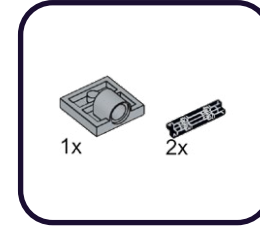

1

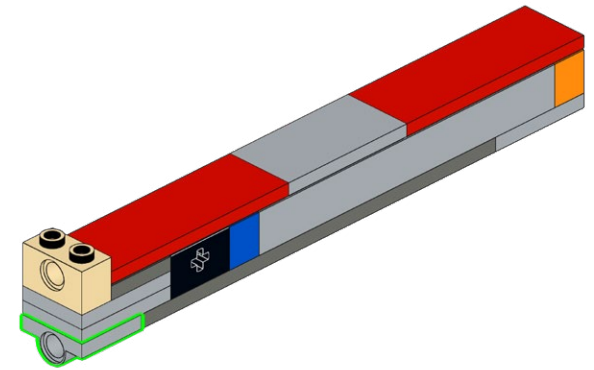

2

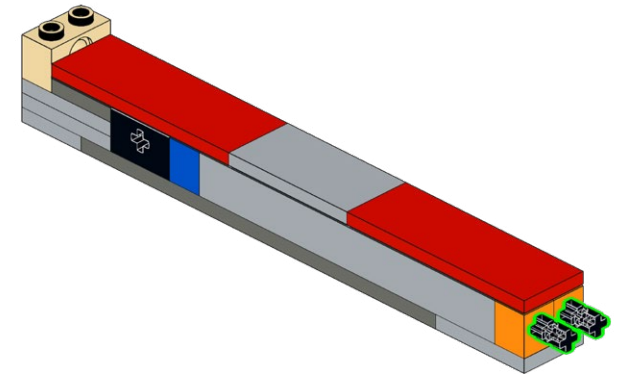
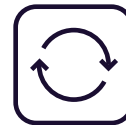

402

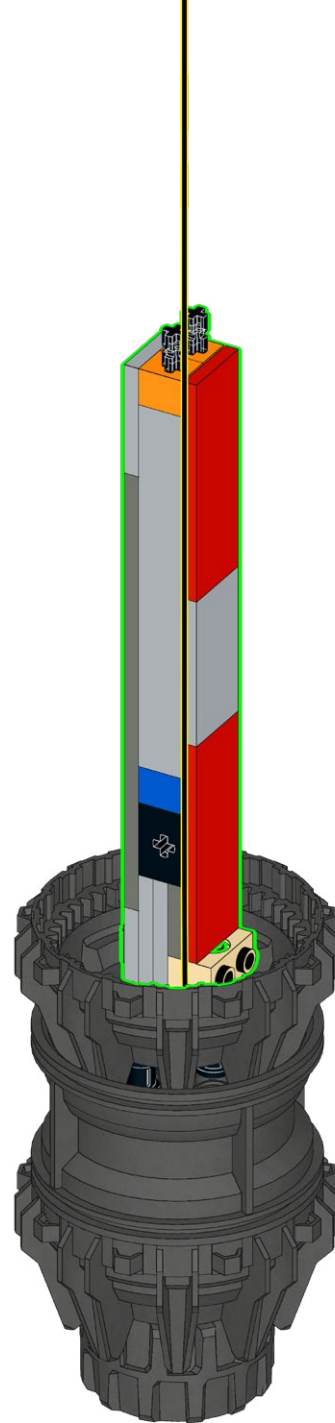

403

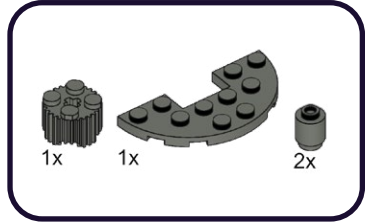

1

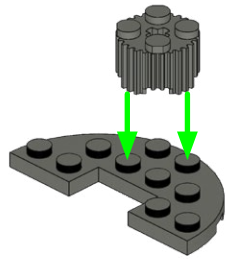

2

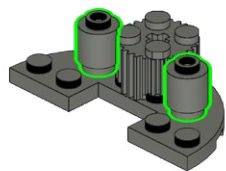

404

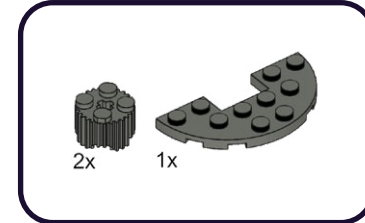

1

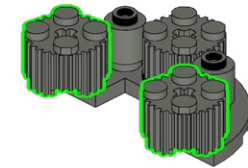

2

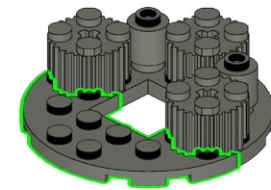

405

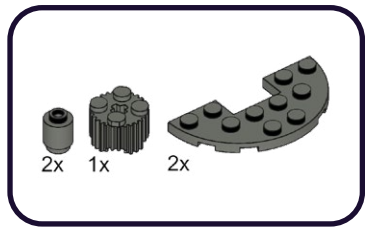

1

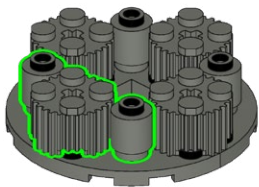

2

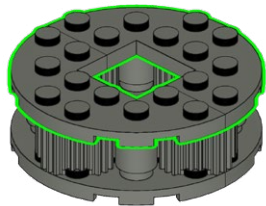

406

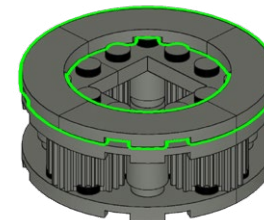
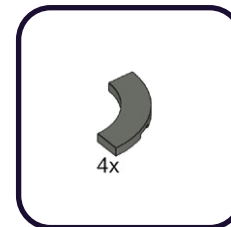

407

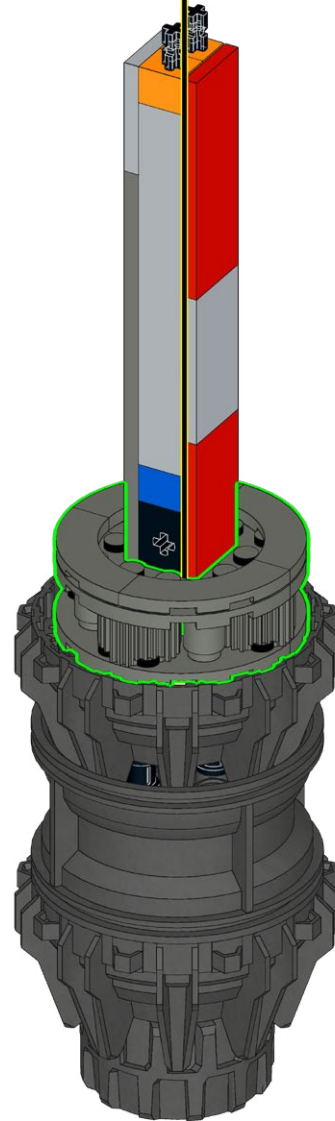

408

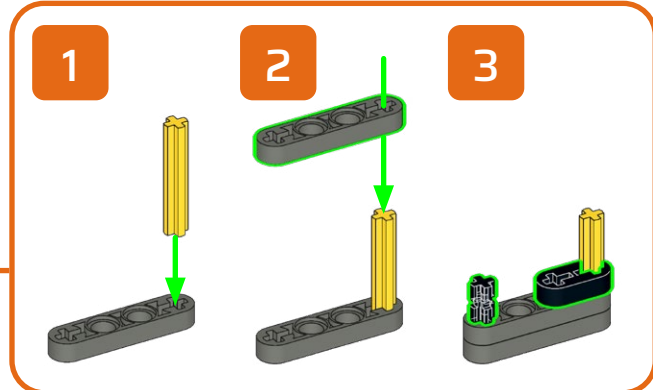
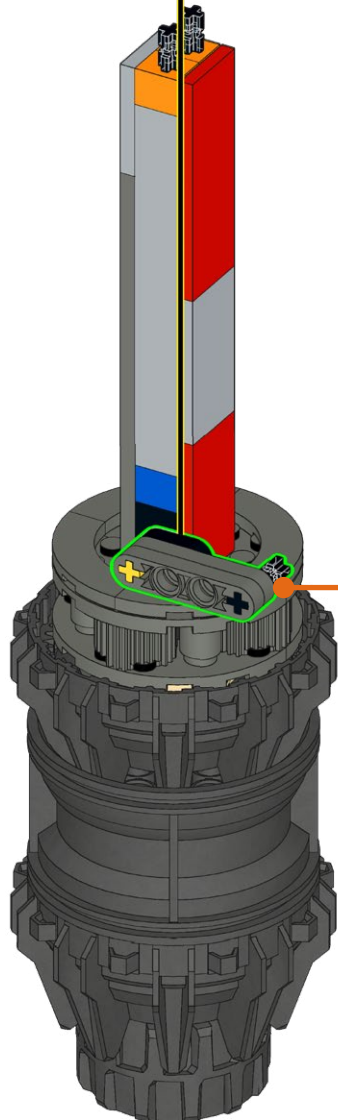
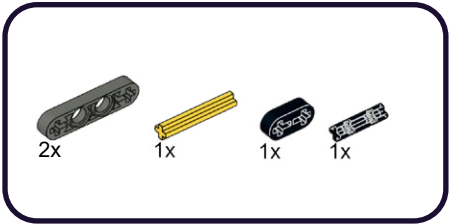

409

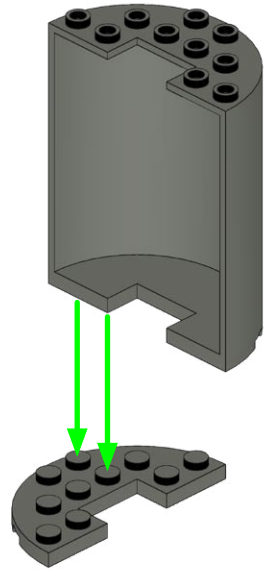
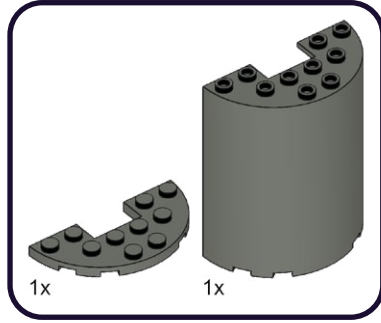

410

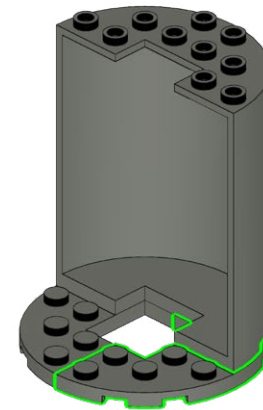
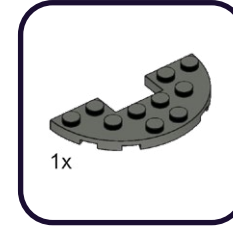

411

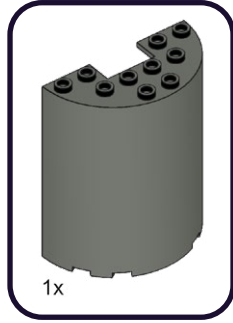

412

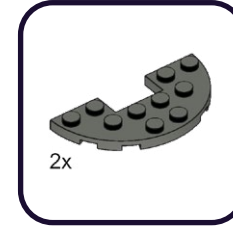

413

12x

414

12x

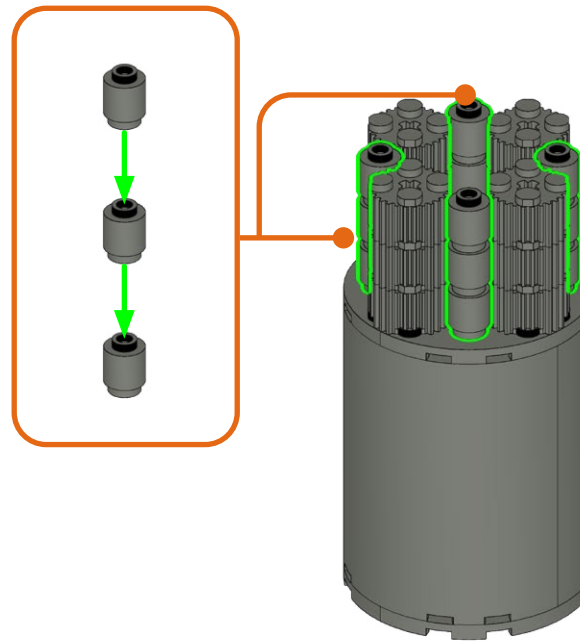
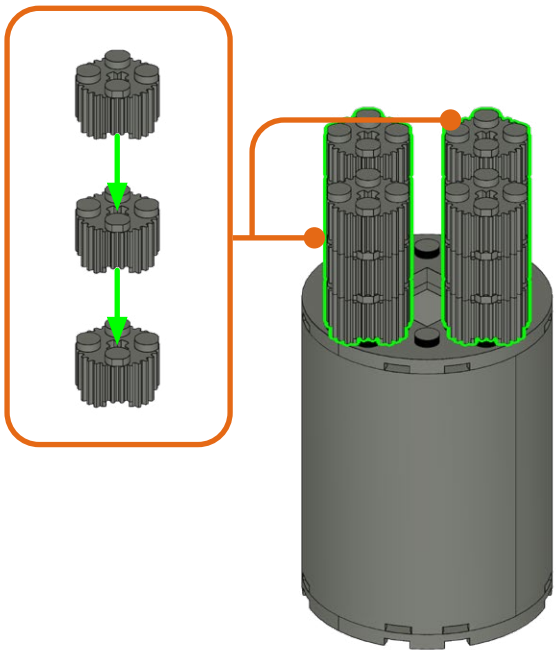

415



4x

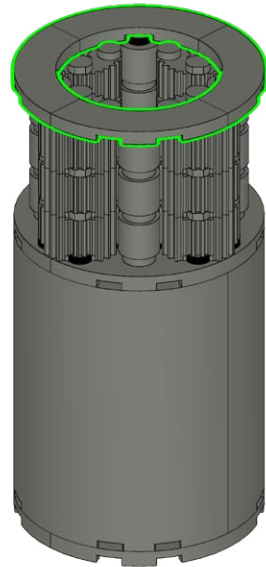

416

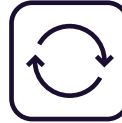

1

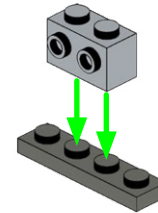

2

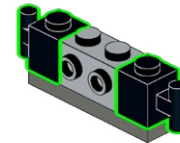

3

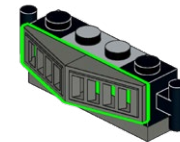

417

2x

2x

418

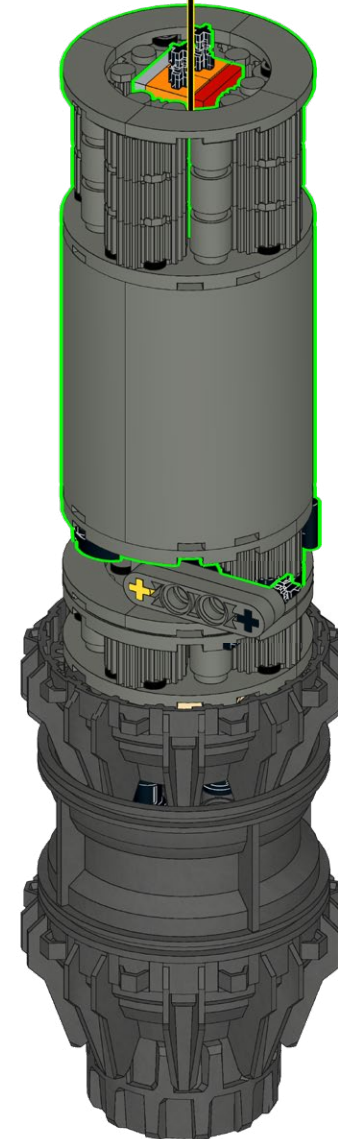
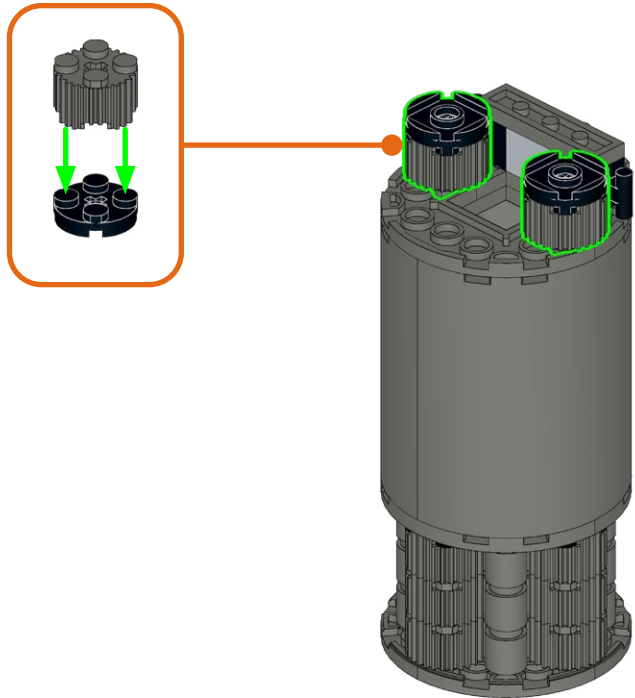

419



4x

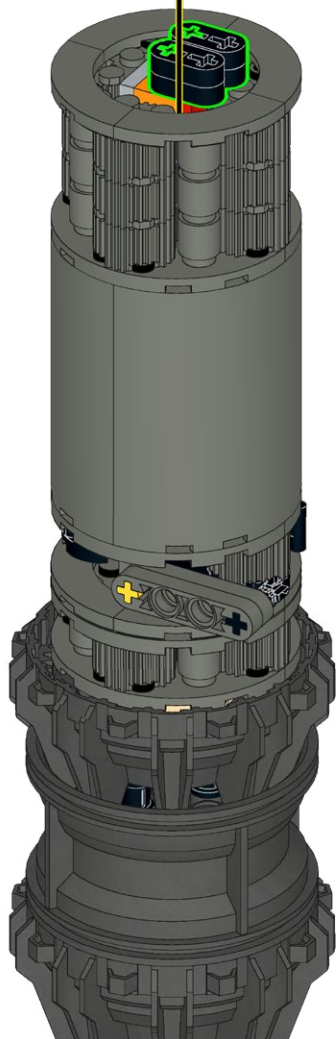

420



2x

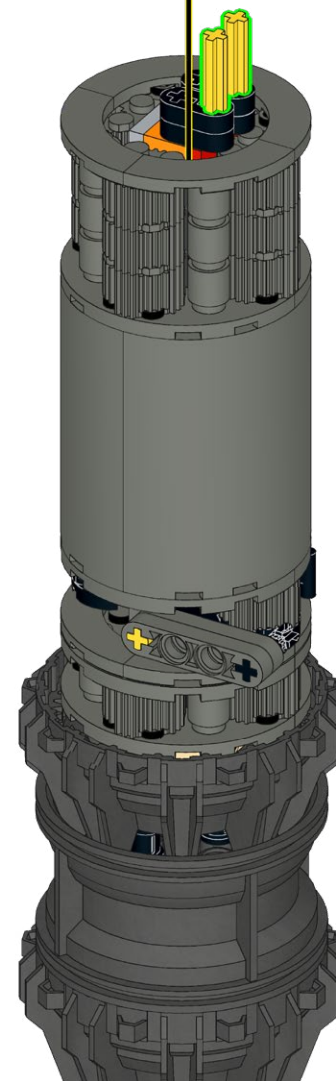

421

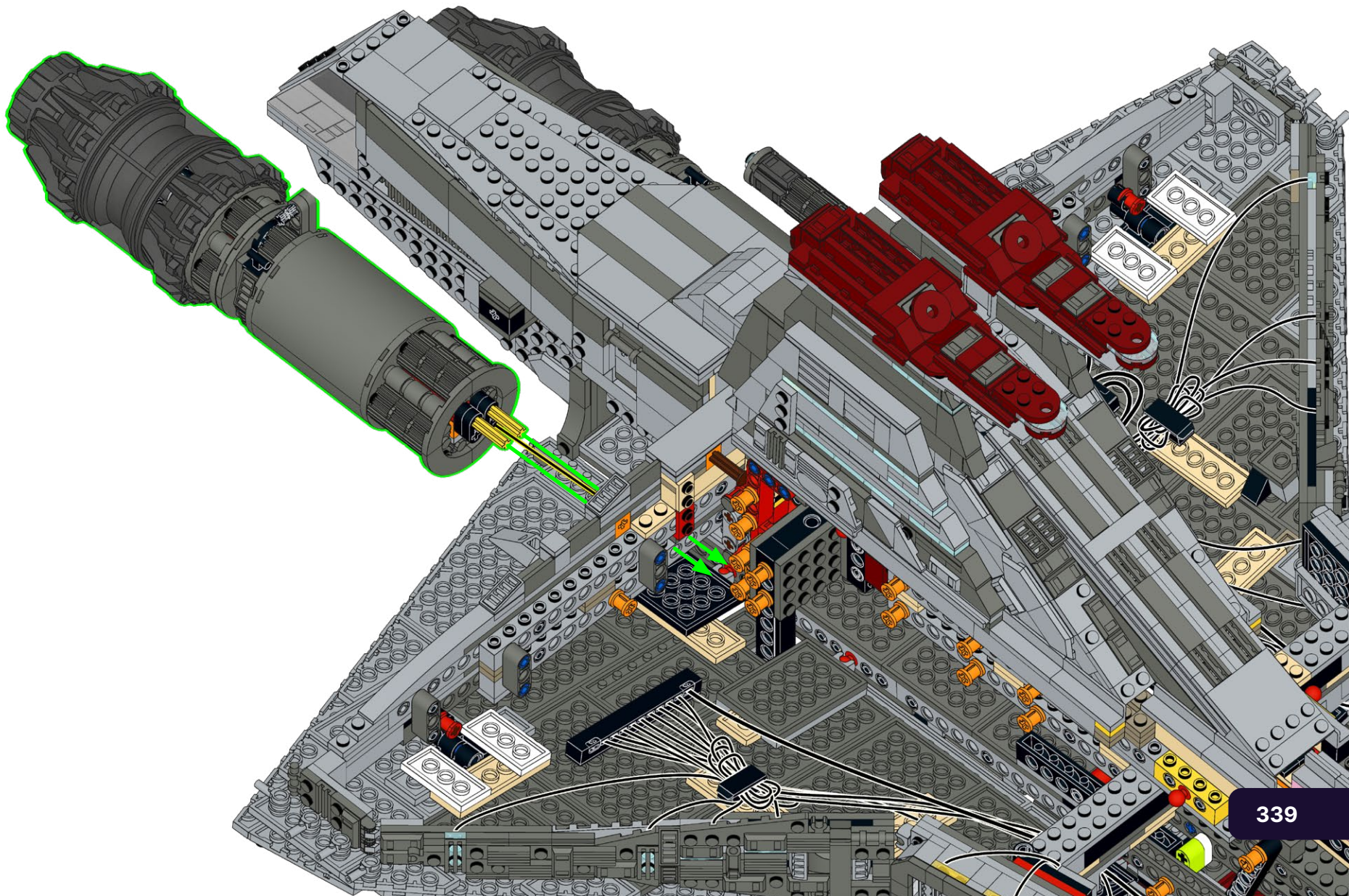

422

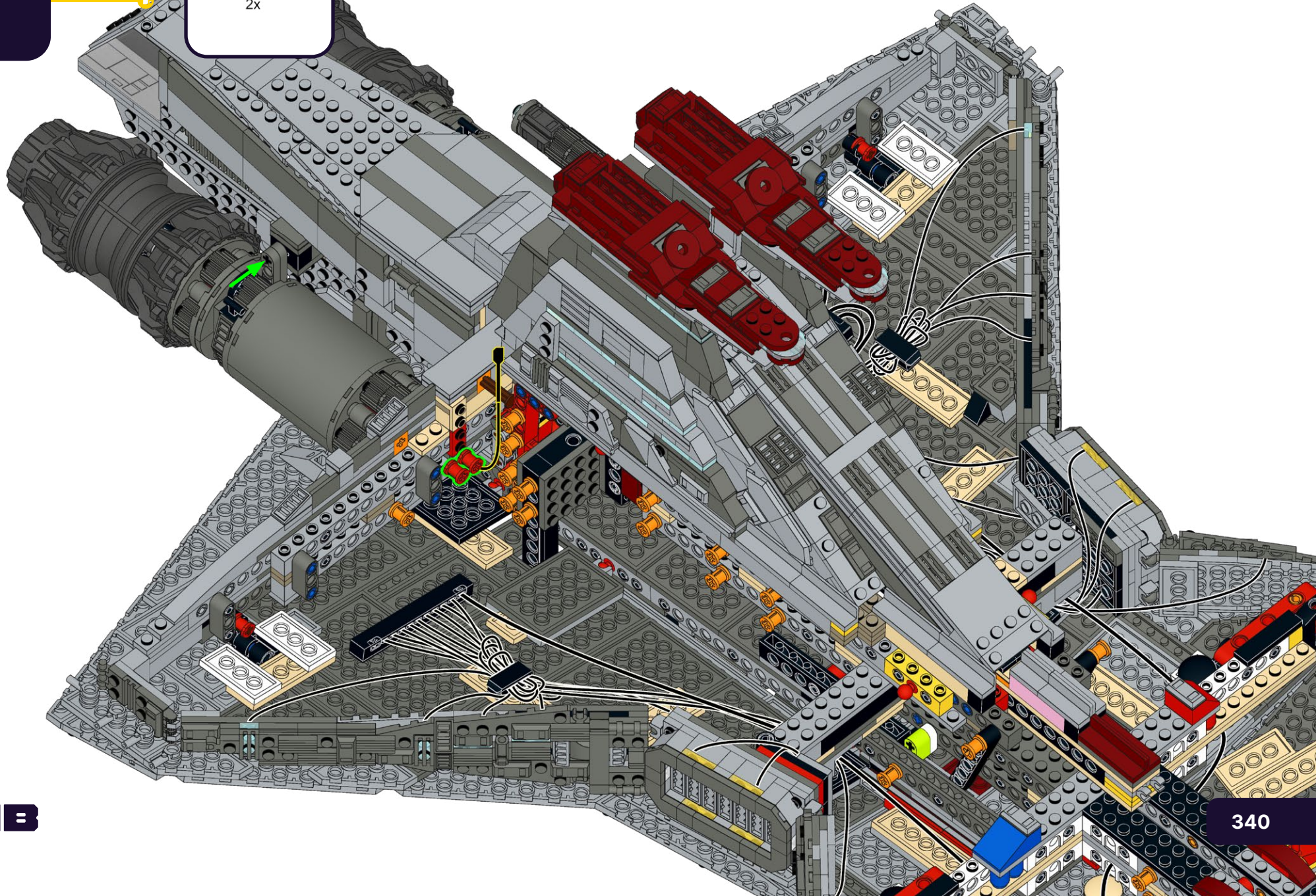
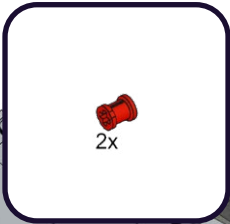

423

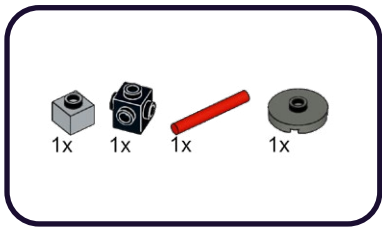

1



2

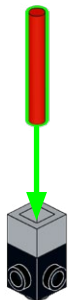

3



424

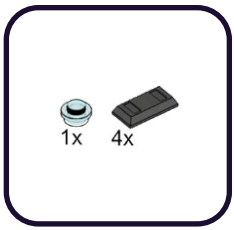
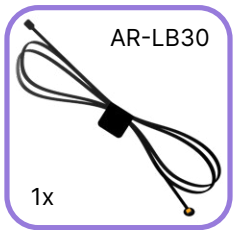

1

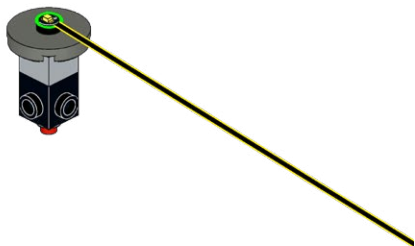

2

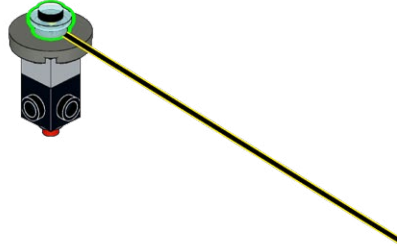

3

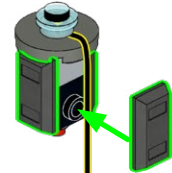

425



1

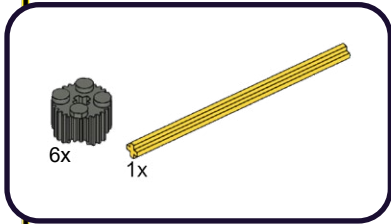
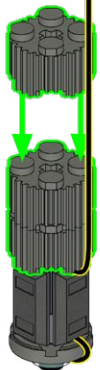

2

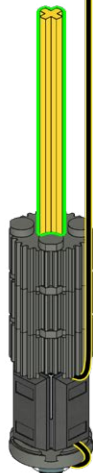

3

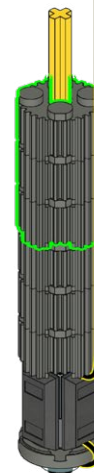

426

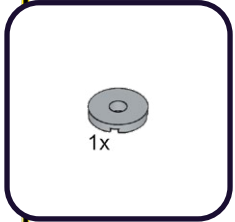

1

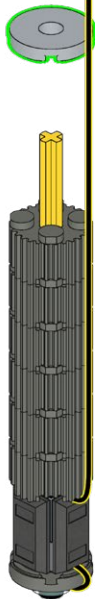

2

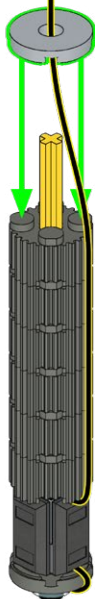

3

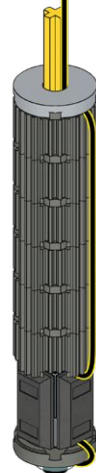

427

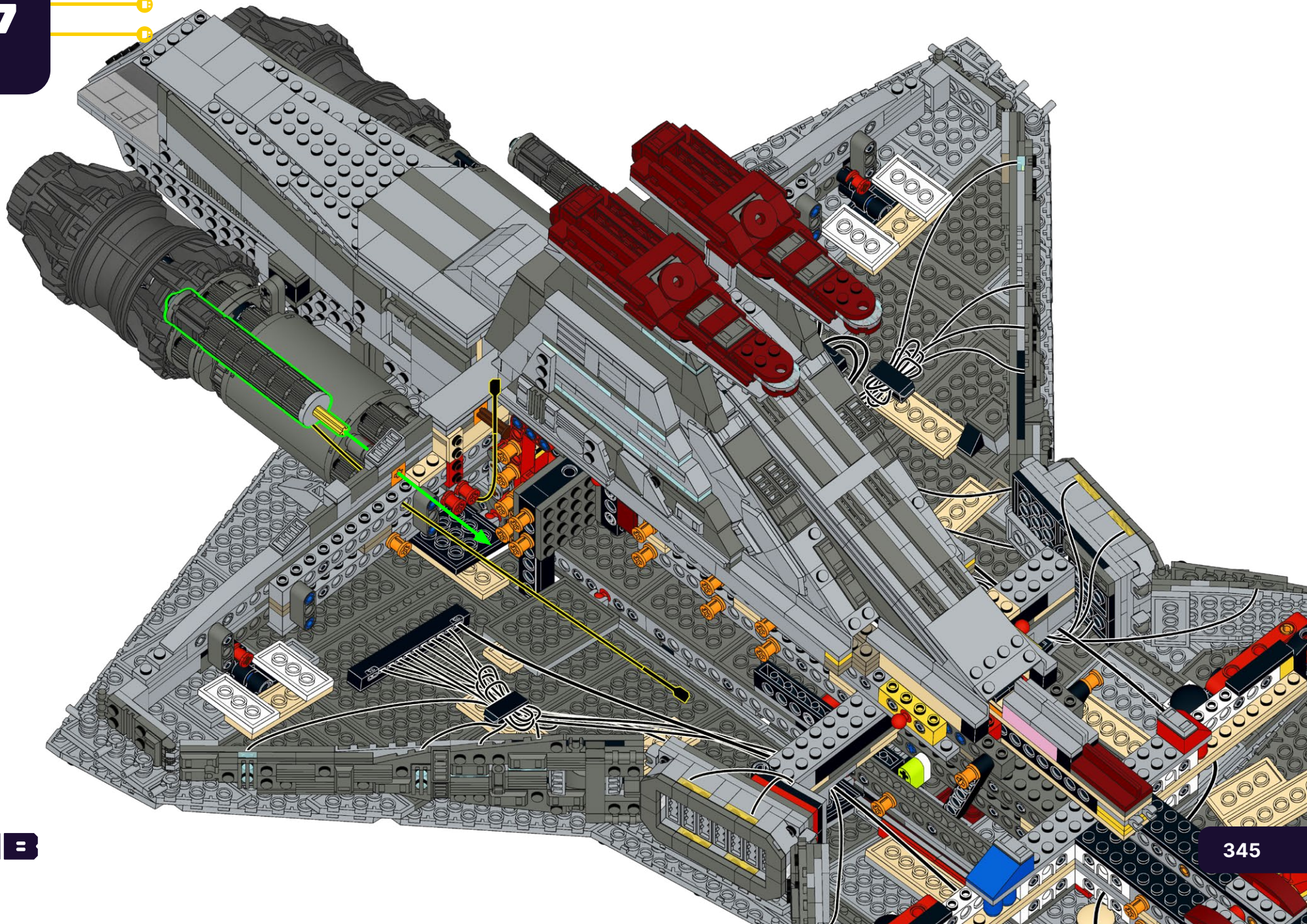

428

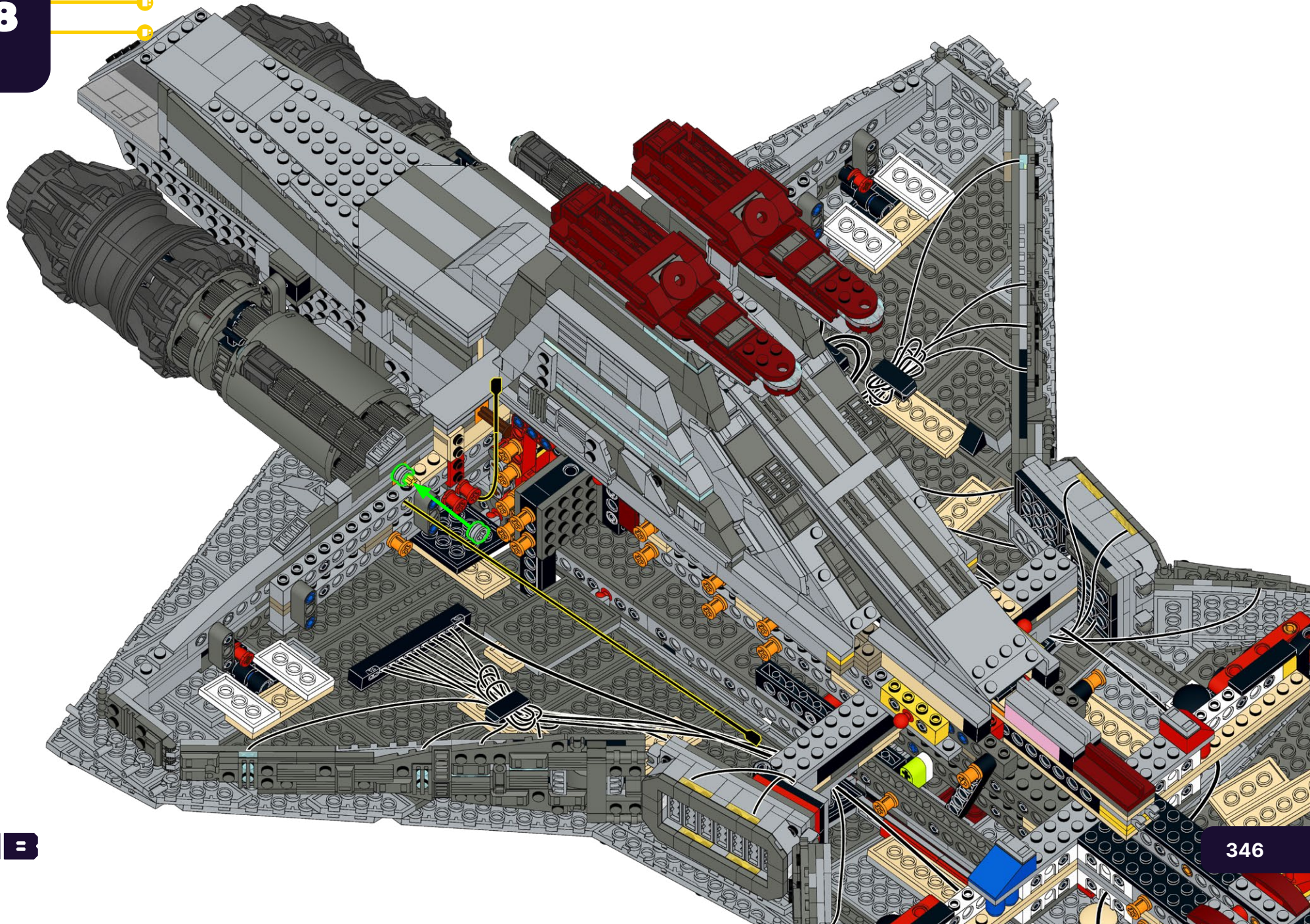

**HOLD UP!**

You might notice some bags aren't in order, as well as left over pieces, but that's ok! We're changing the way you build LEGO!

ATTENDEZ!

Vous remarquerez peut-être que certains sacs, ainsi que certaines pièces, ne sont pas dans le bon ordre. Mais pas de panique! Nous changeons simplement la façon avec laquelle vous construisez vos LEGO!

ASPETTA!

Potresti notare che alcuni sacchetti non sono in ordine, così come i pezzi avanzati, ma va bene così! Stiamo cambiando il modo in cui costruisci i LEGO!

HALT!

Sie werden möglicherweise bemerken, dass einige tüten durcheinander sind und teile übrig bleiben, aber das ist in Ordnung! Wir ändern die art und weise, wie Sie LEGO bauen!

¡ESPERA!

Es posible que notes que algunas bolsas están fuera de servicio, así como piezas sobrantes, ¡pero está bien! ¡Estamos cambiando la forma en que construyes LEGO!

暫停!

你可能会注意到一些袋子顺序错乱, 以及一些剩余的部件, 但没关系! 我们正在改变你搭建乐高的方式!

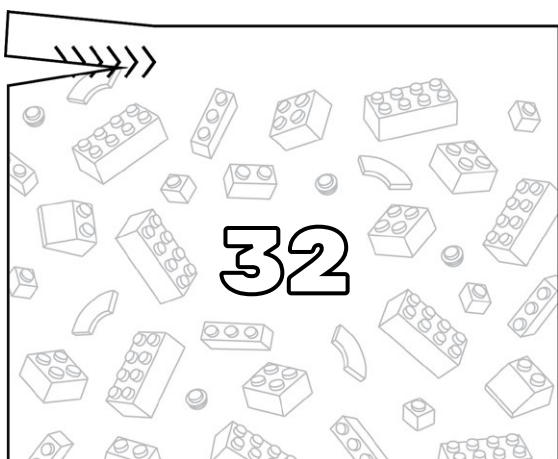
Open LEGO® Bag 32

429

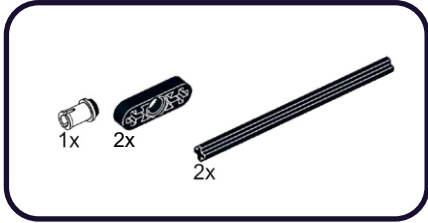
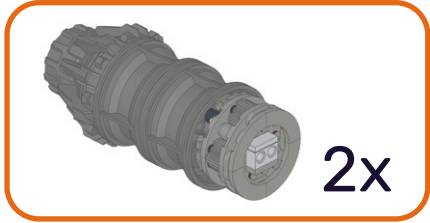

1

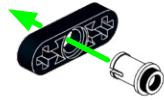

2

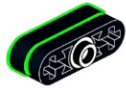

3



430

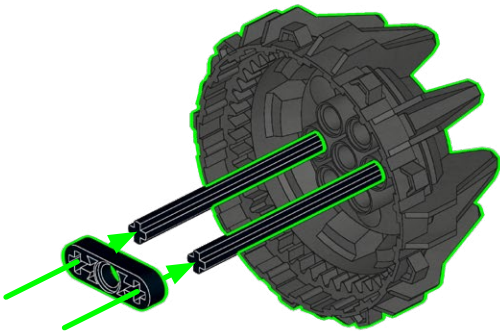
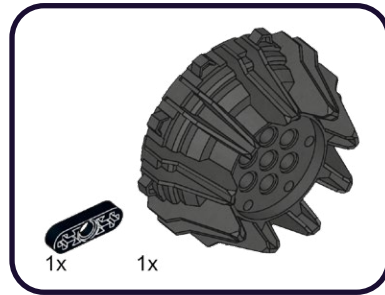

431

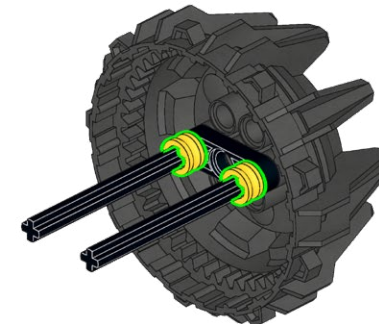

432

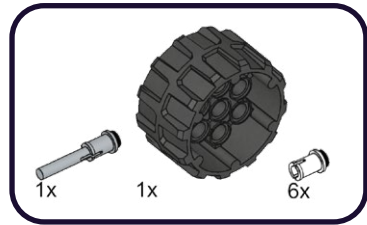

1

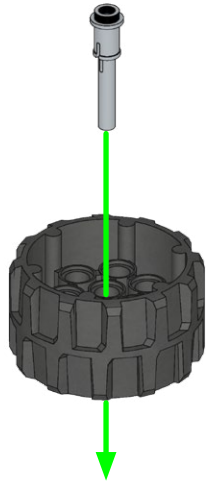

2

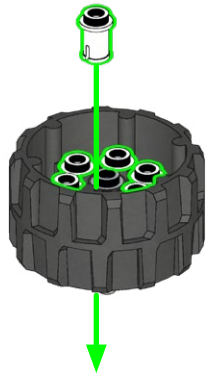

433

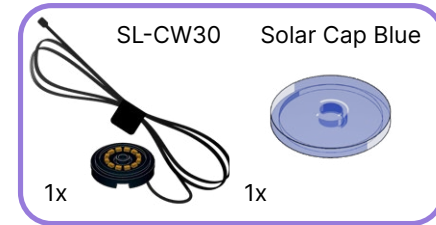

1

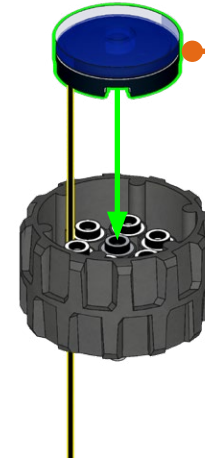

2

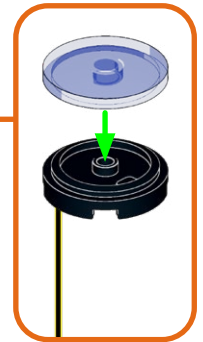

434

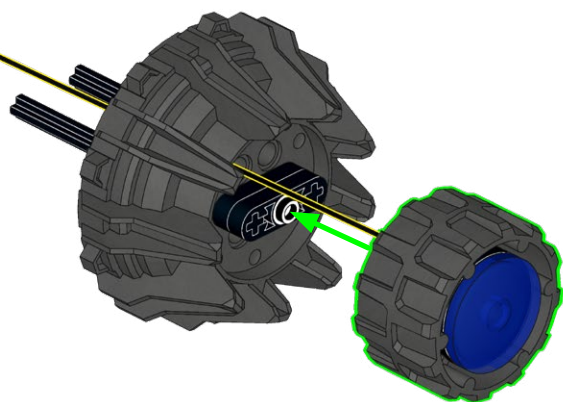

435

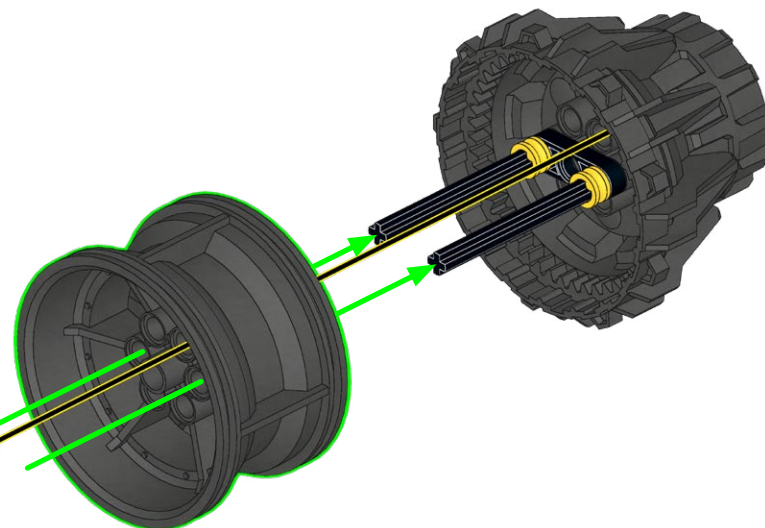
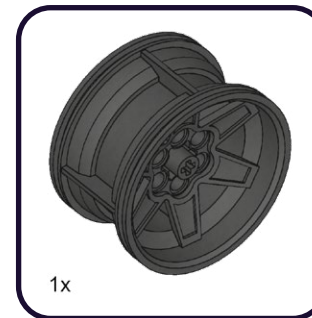
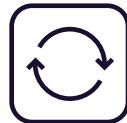

436

2x

437

1x

1x

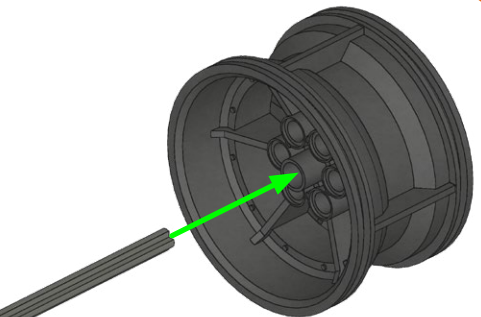
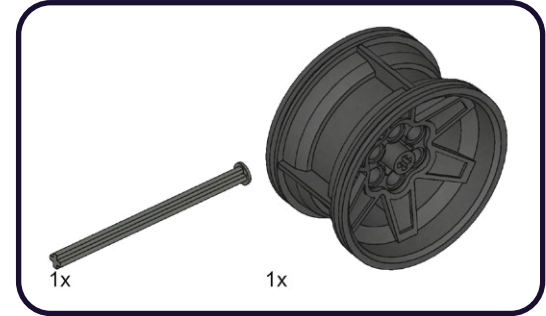
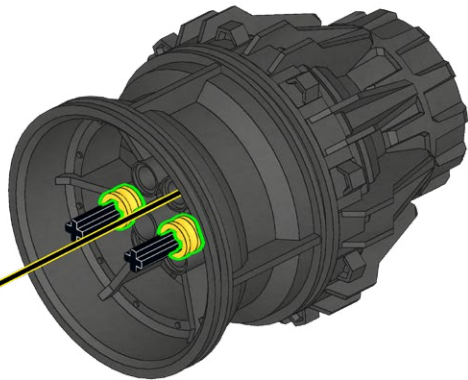

438

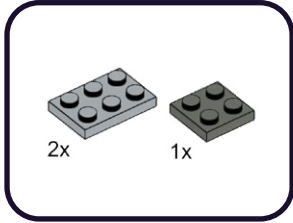

1

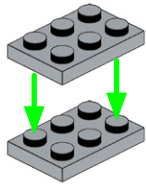

2

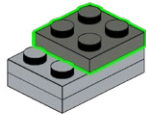

439

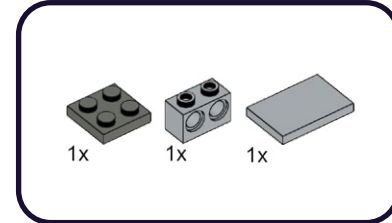

1

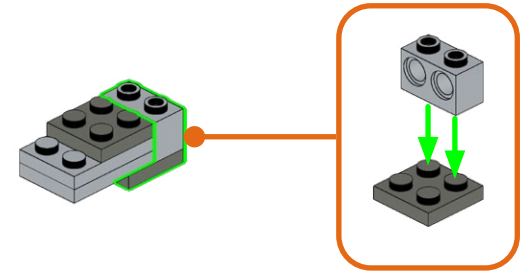

2

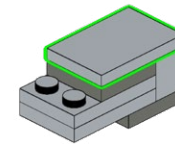

440

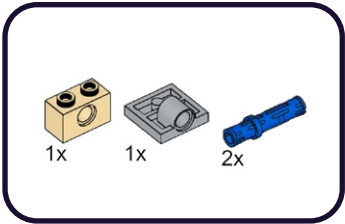

1

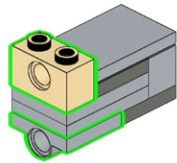

2

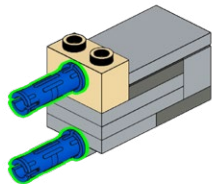

441

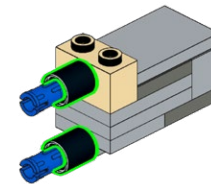
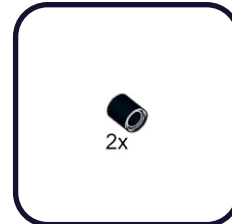

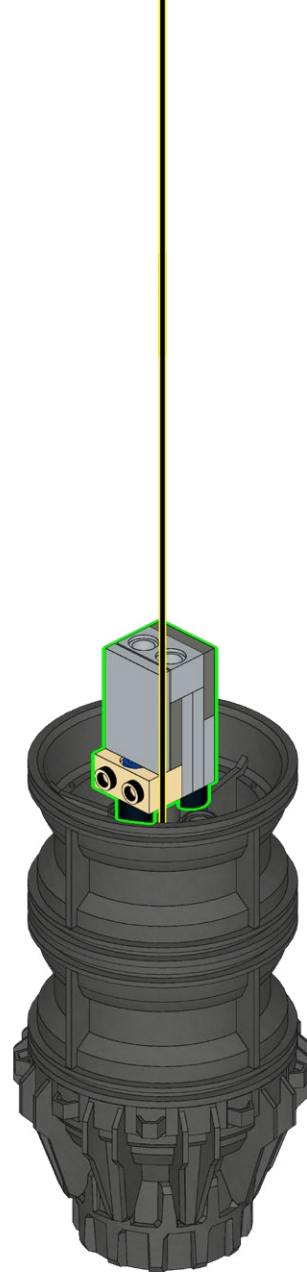
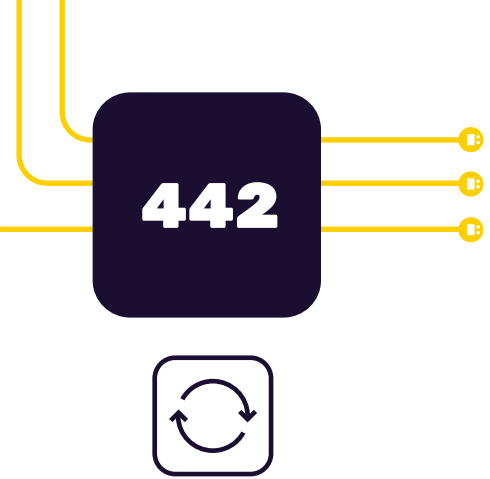

443

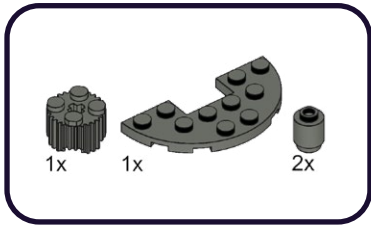

1

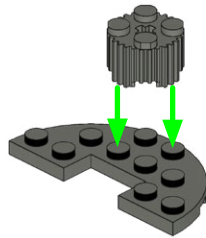

2

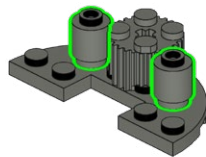

444

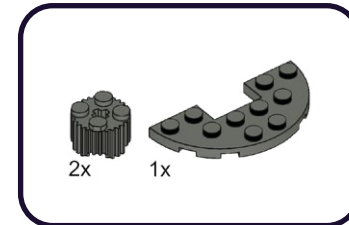

1

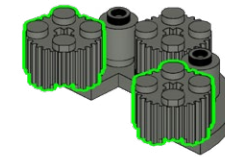

2

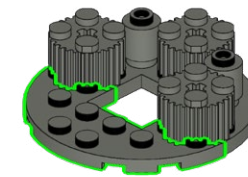

445

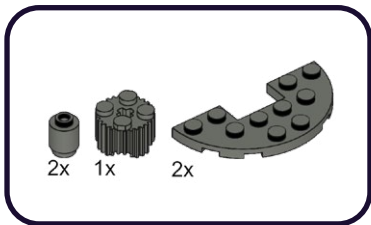

1

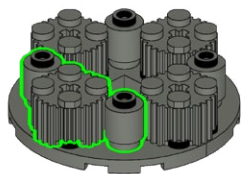

2

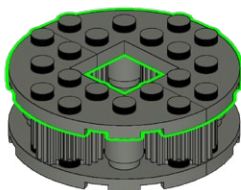

446

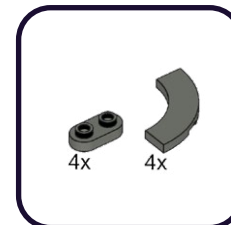

1

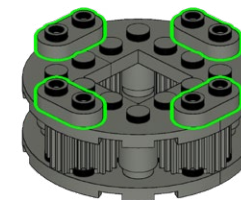

2

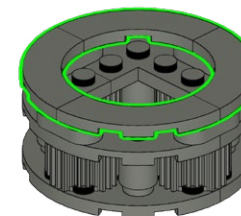

447

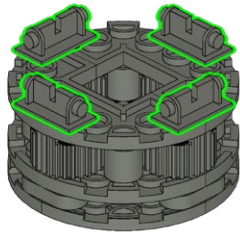
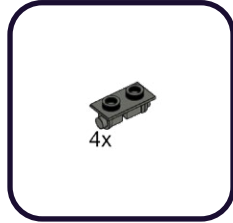

448

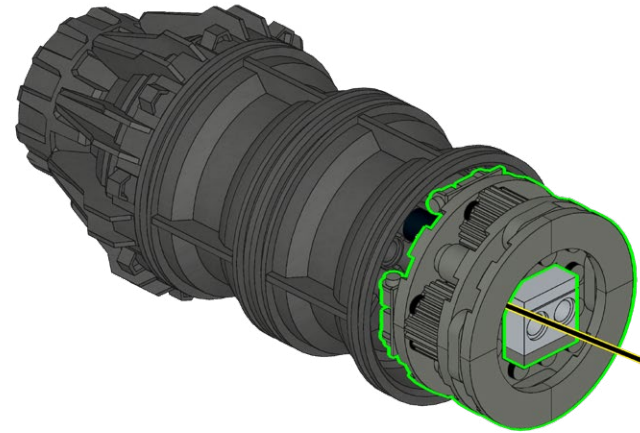
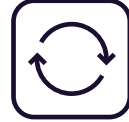

2x

449

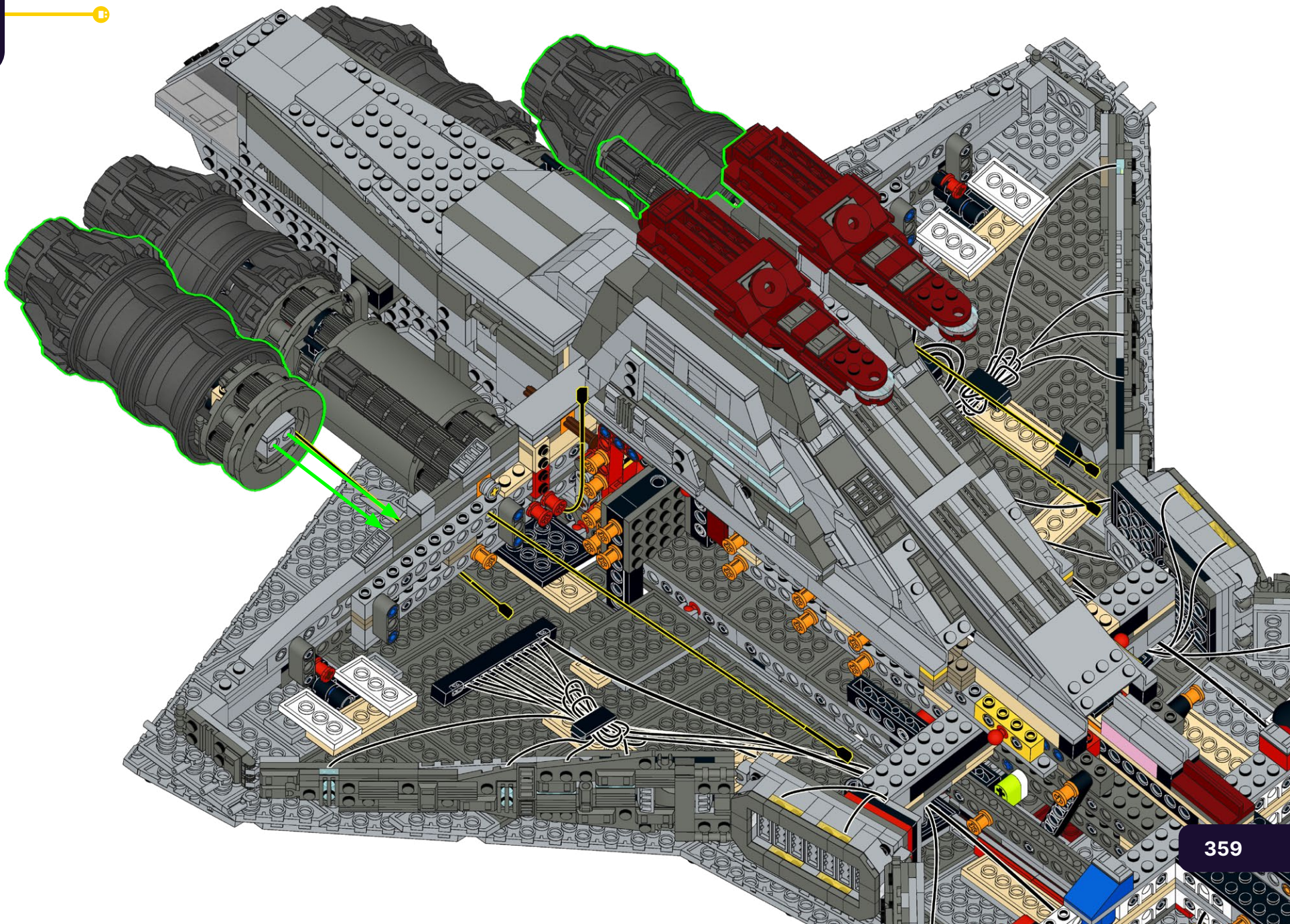

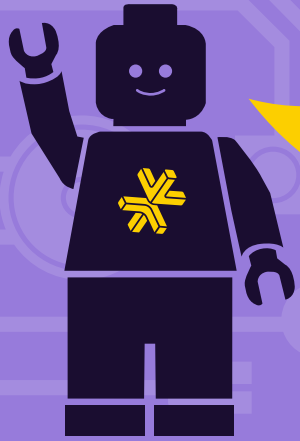
**HOLD UP!**

You might notice some bags aren't in order, as well as left over pieces, but that's ok! We're changing the way you build LEGO!

ATTENDEZ!

Vous remarquerez peut-être que certains sacs, ainsi que certaines pièces, ne sont pas dans le bon ordre. Mais pas de panique! Nous changeons simplement la façon avec laquelle vous construisez vos LEGO!

ASPETTA!

Potresti notare che alcuni sacchetti non sono in ordine, così come i pezzi avanzati, ma va bene così! Stiamo cambiando il modo in cui costruisci i LEGO!

HALT!

Sie werden möglicherweise bemerken, dass einige tüten durcheinander sind und teile übrig bleiben, aber das ist in Ordnung! Wir ändern die art und weise, wie Sie LEGO bauen!

¡ESPERA!

Es posible que notes que algunas bolsas están fuera de servicio, así como piezas sobrantes, ¡pero está bien! ¡Estamos cambiando la forma en que construyes LEGO!

暫停!

你可能会注意到一些袋子顺序错乱, 以及一些剩余的部件, 但没关系! 我们正在改变你搭建乐高的方式!

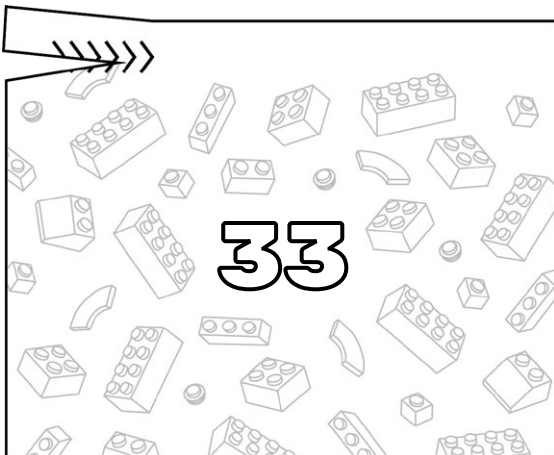
Open LEGO® Bag 33

450

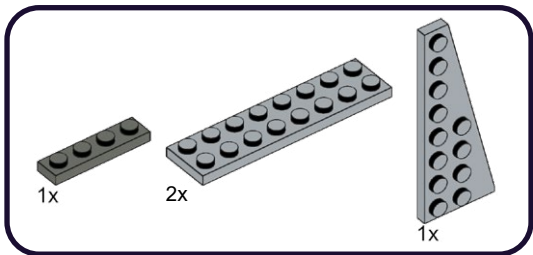

1

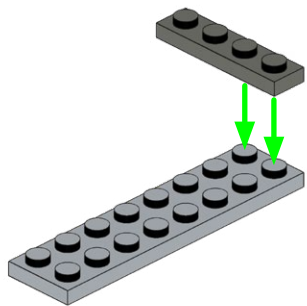

2

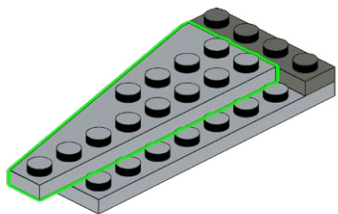

3

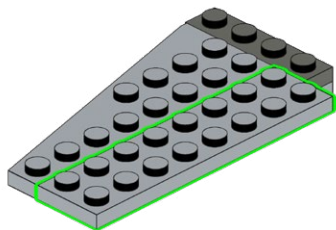

451

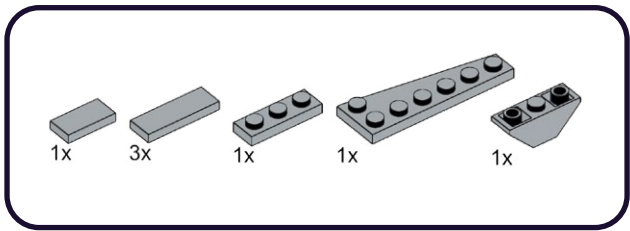

1

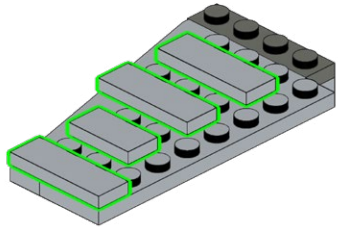

2

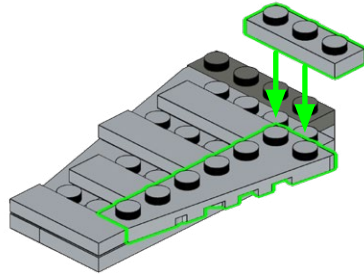

3

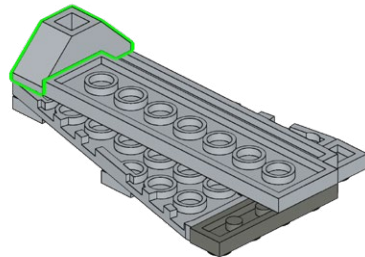

452

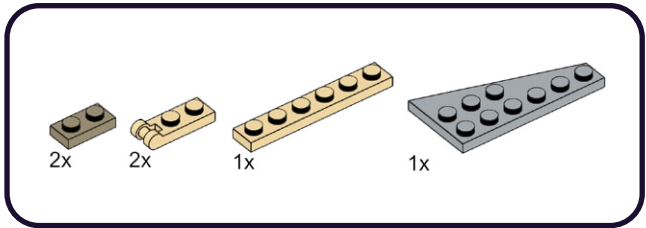

1

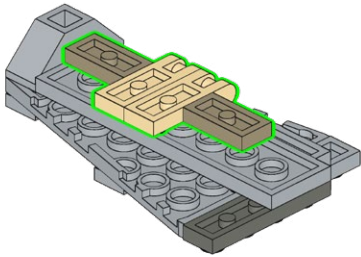

2

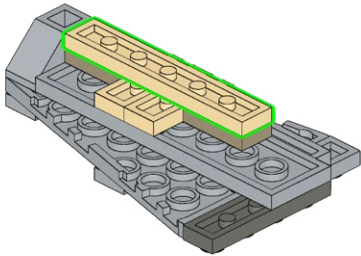

3

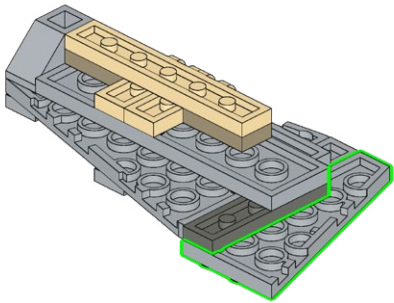

453

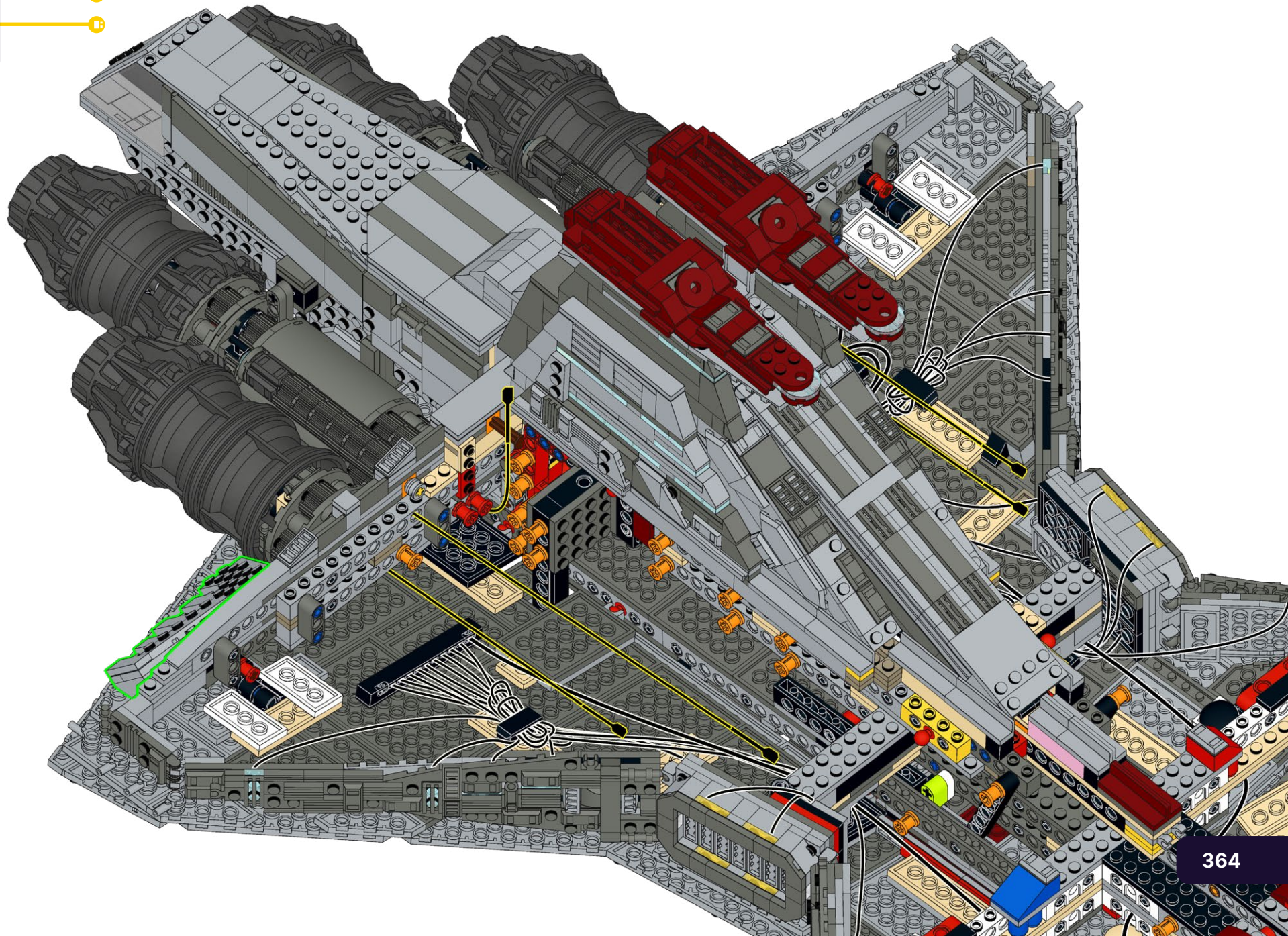
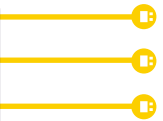

454

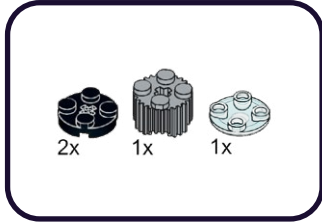
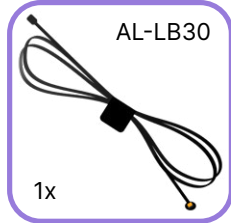

1

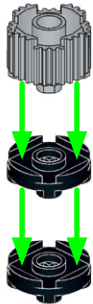

2



3



455



1

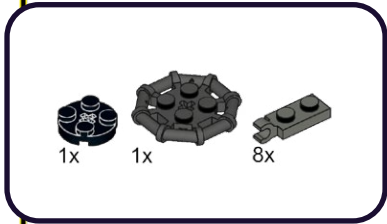
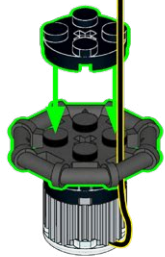

2

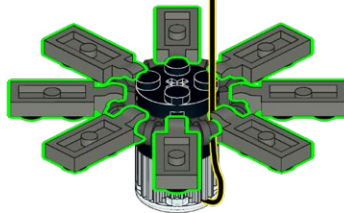

3



456

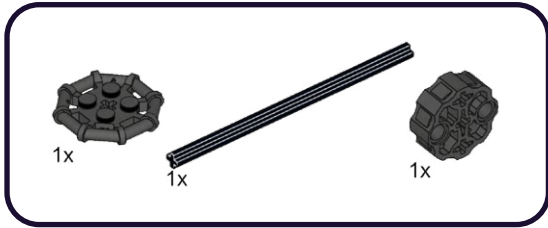

1



2

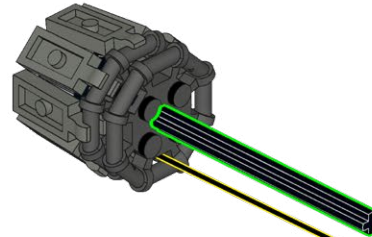

3

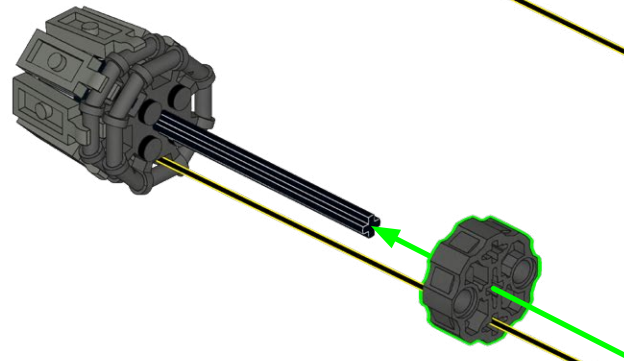

457

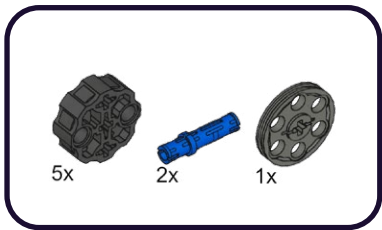

1

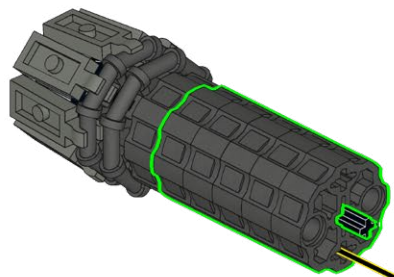

2

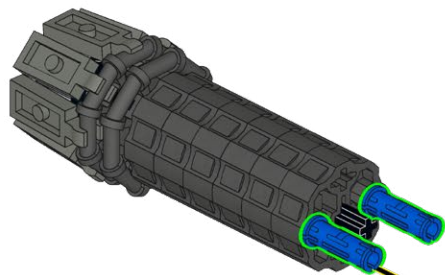

3

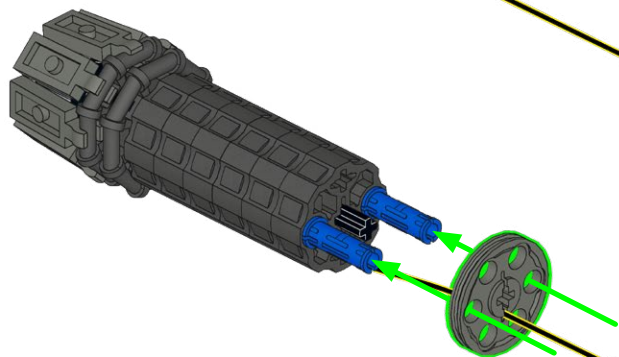

458

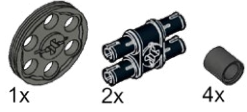

1

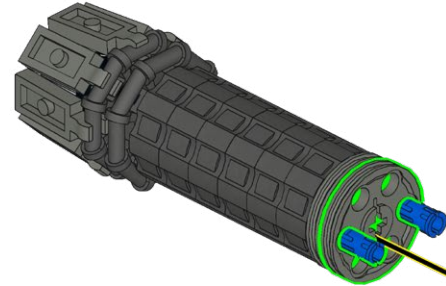

2

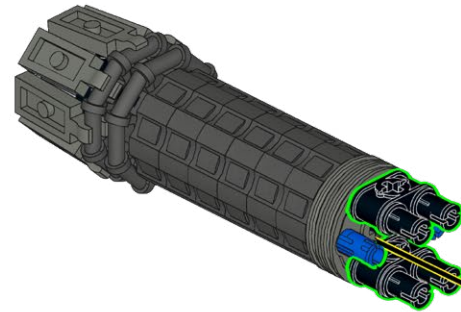

3

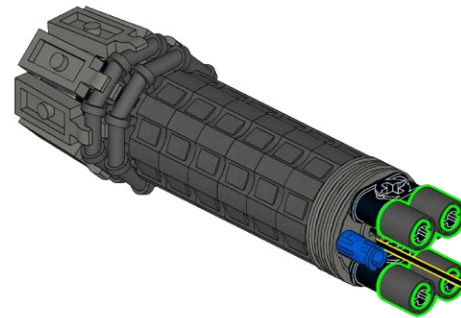

459

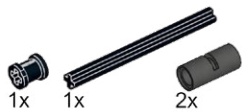

1

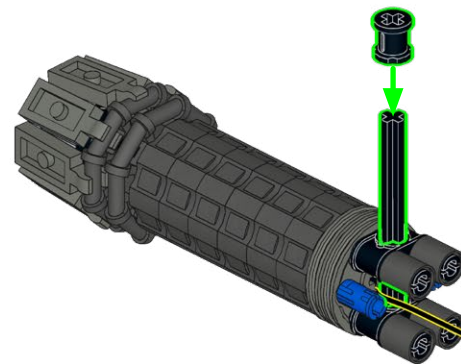

2

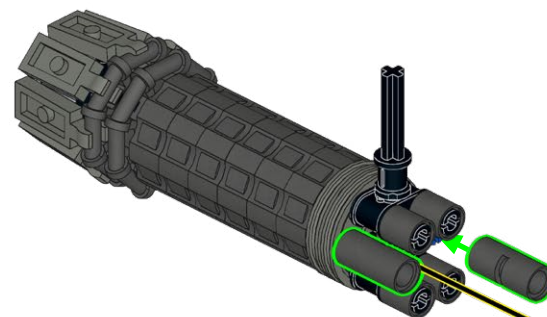

460

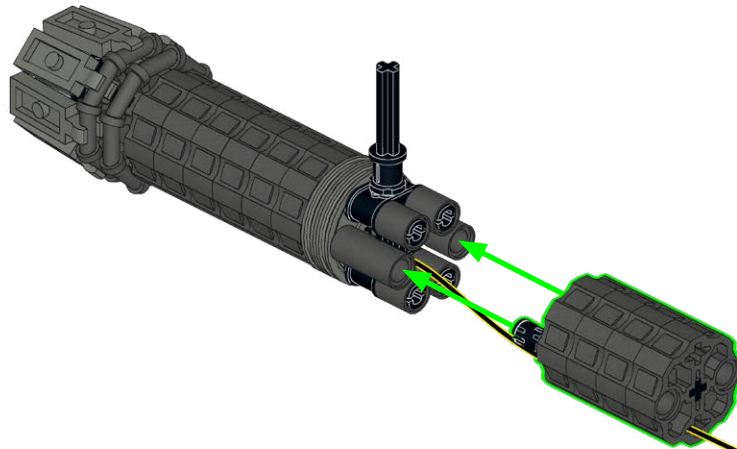
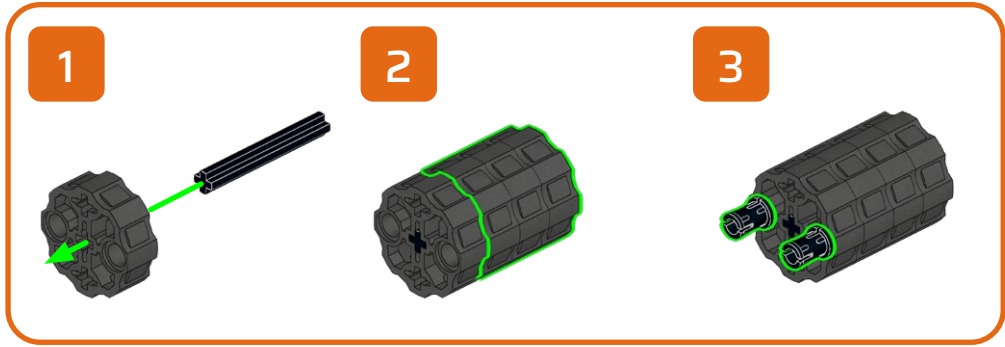
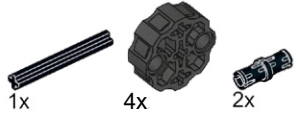

2x

461

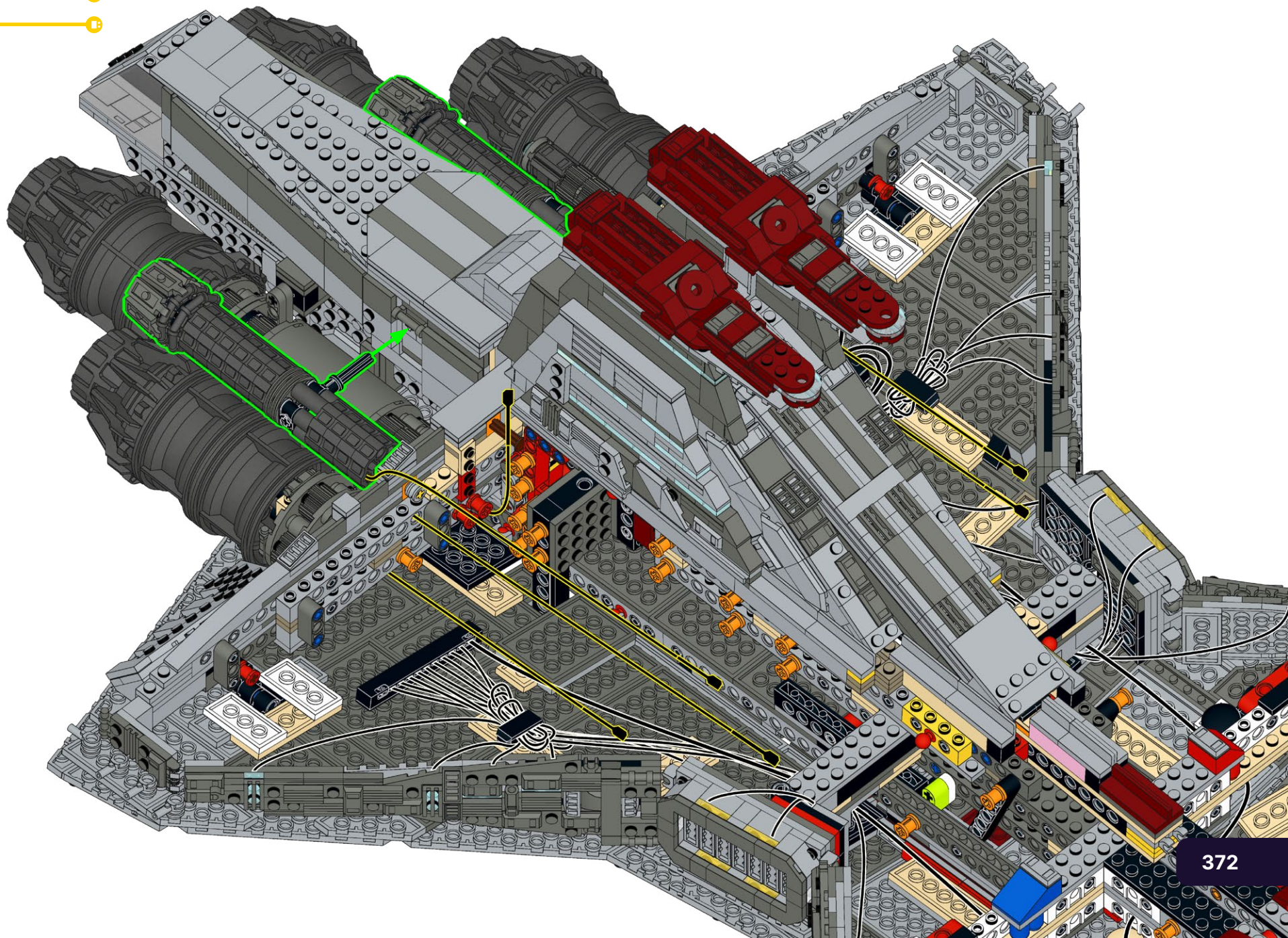

462

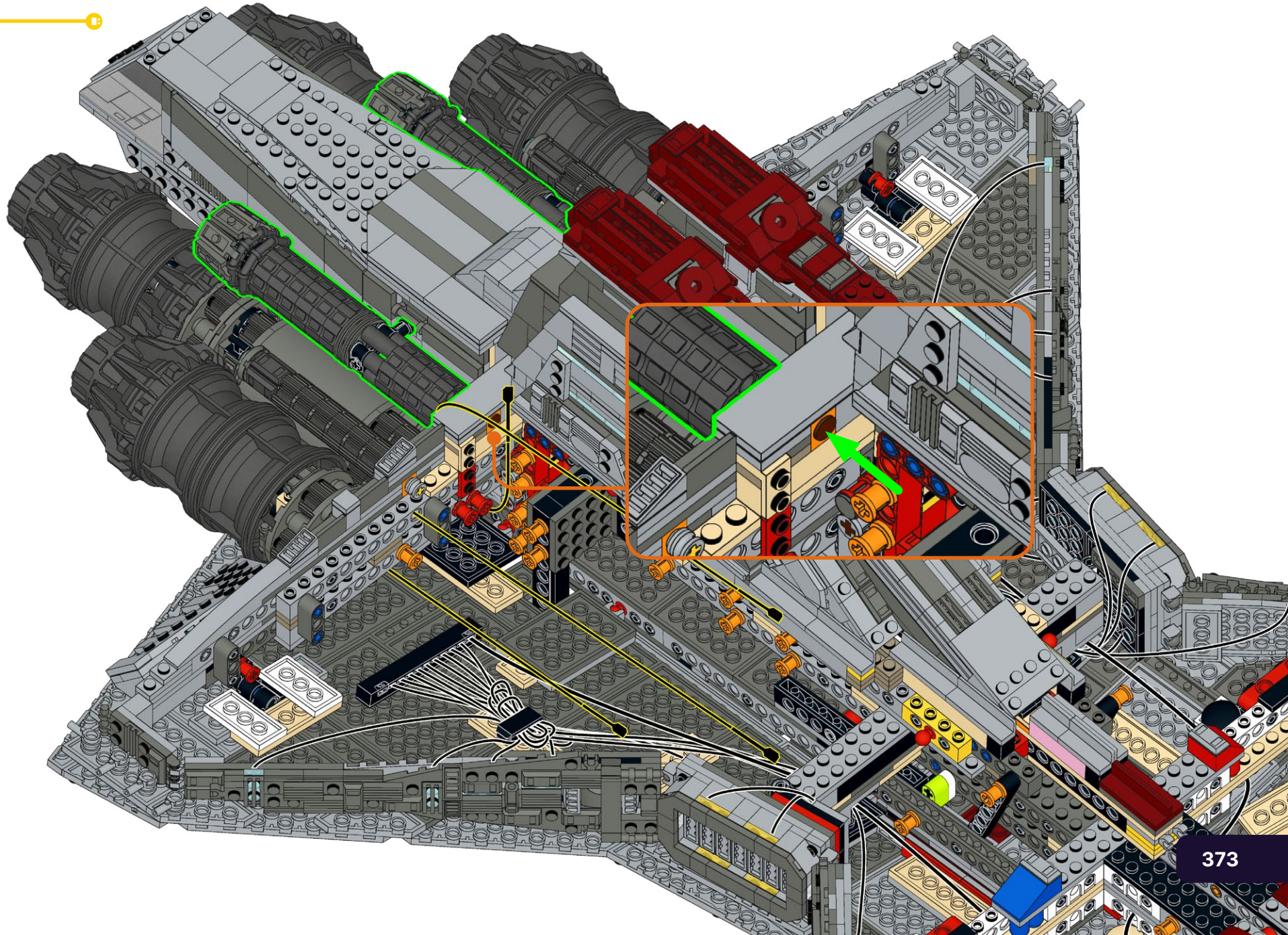
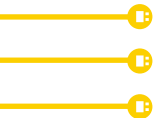

463

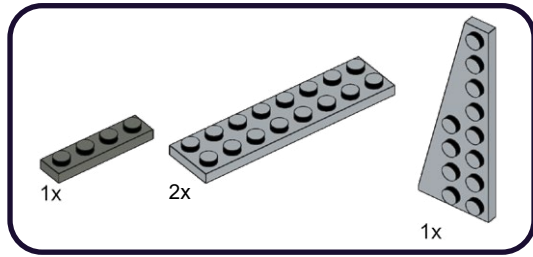

1

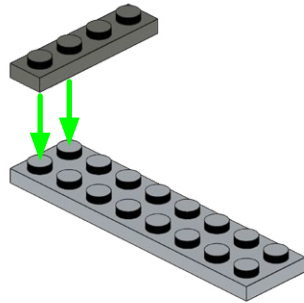

2

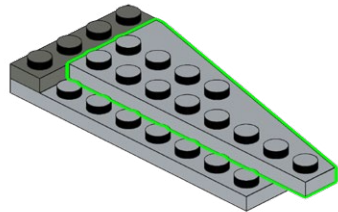

3

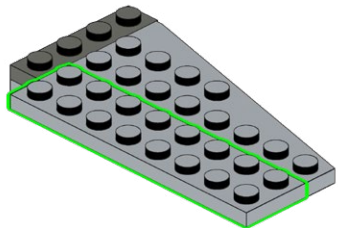

464

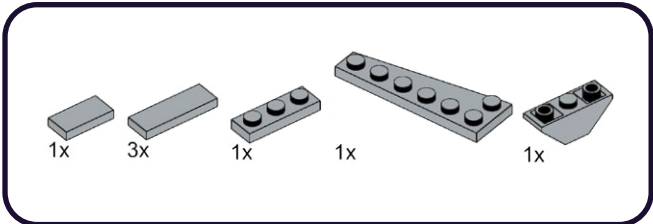

1

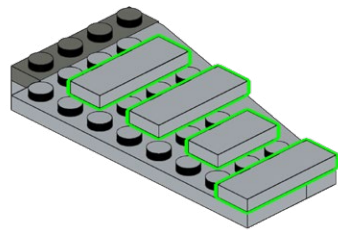

2

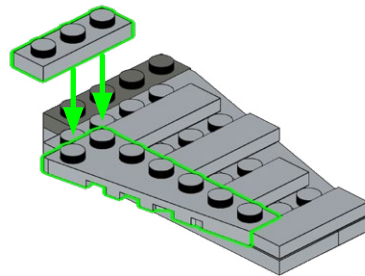

3

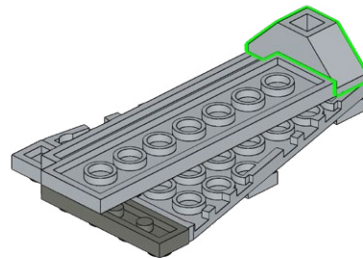

465

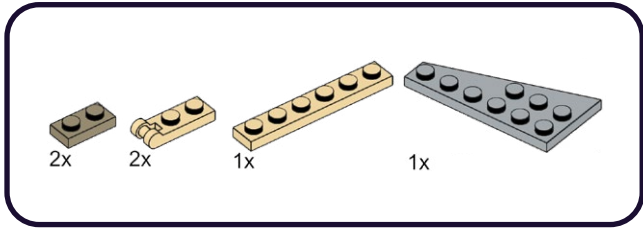

1

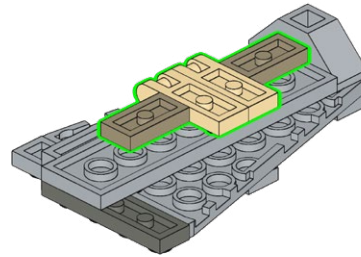

2

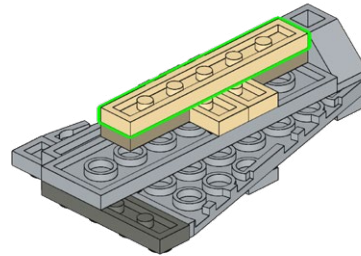

3

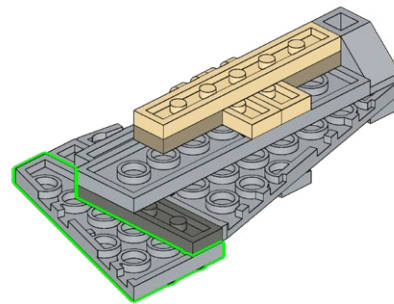

466

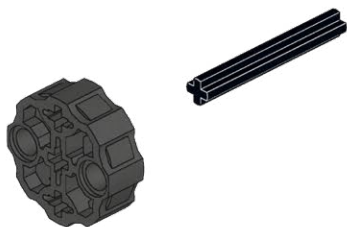

467

D-6



1x

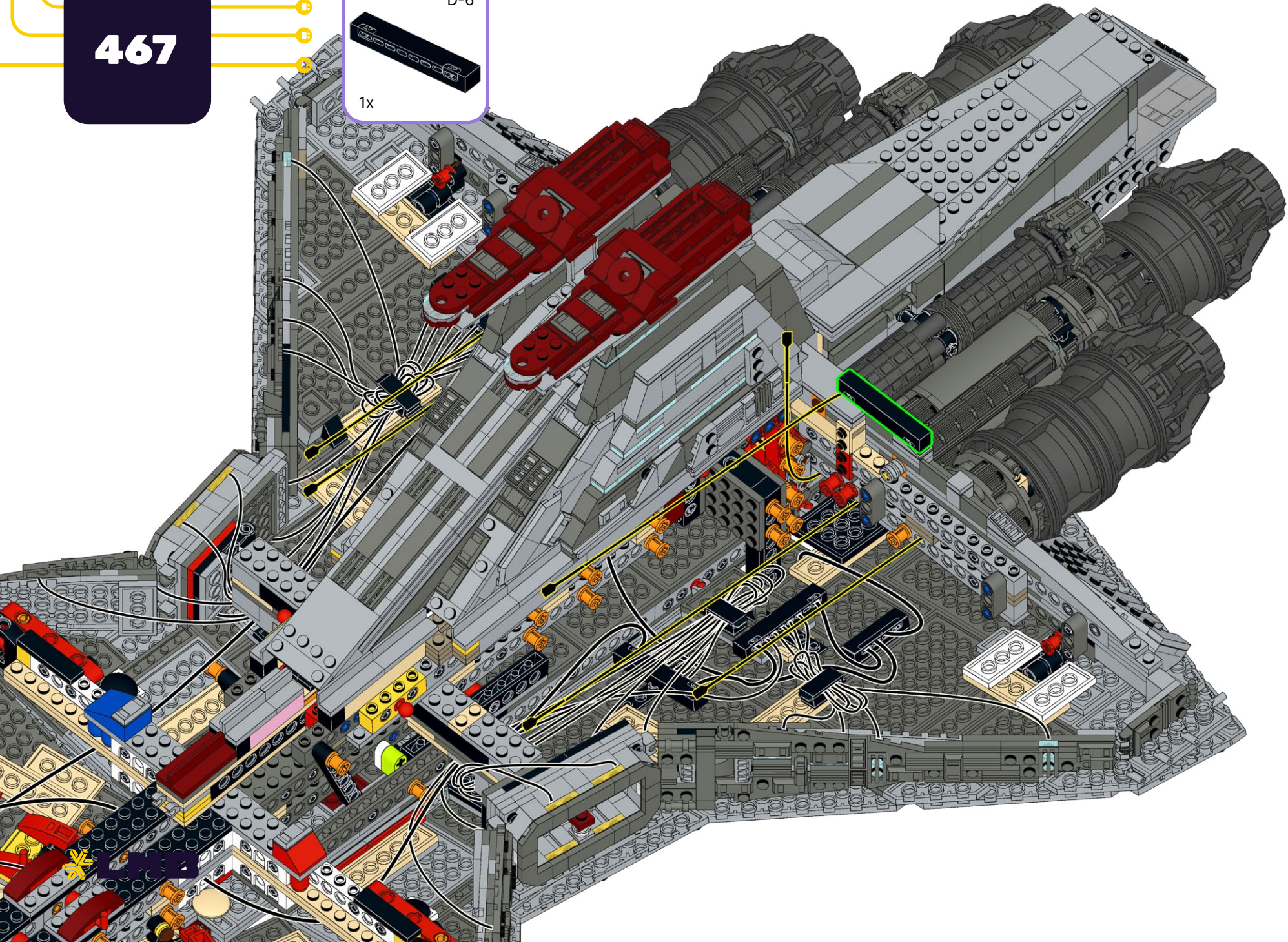

468

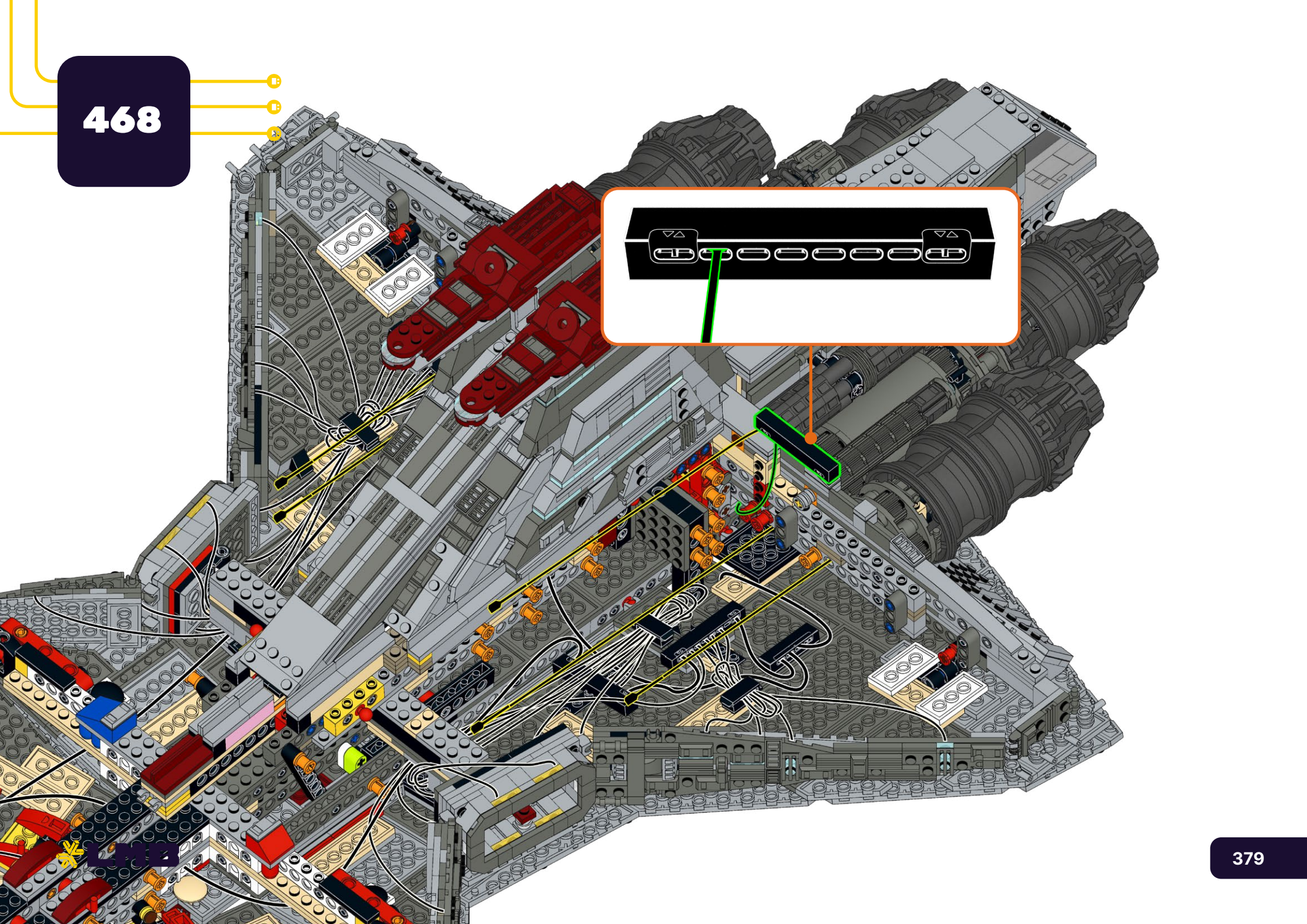

469

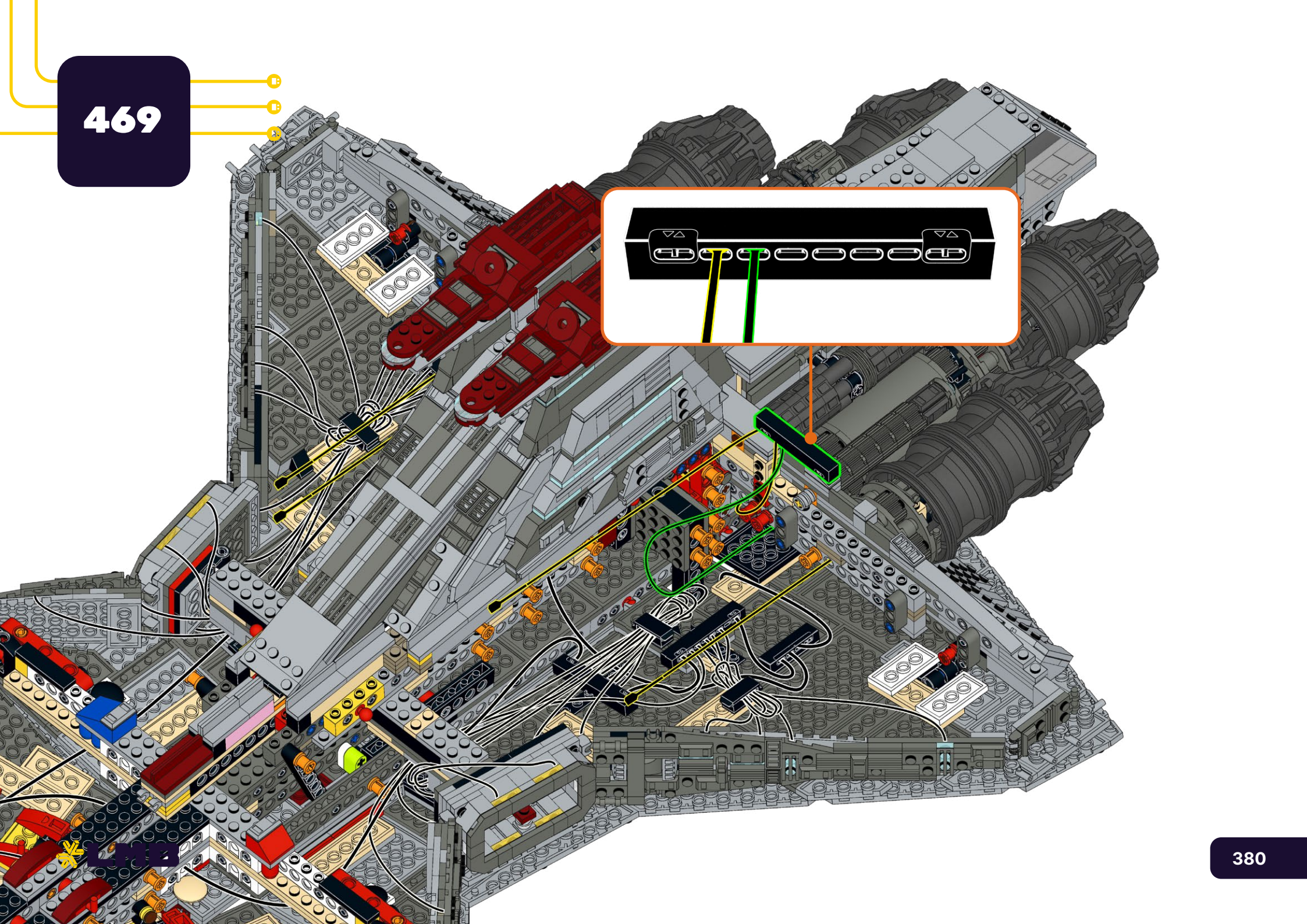

470

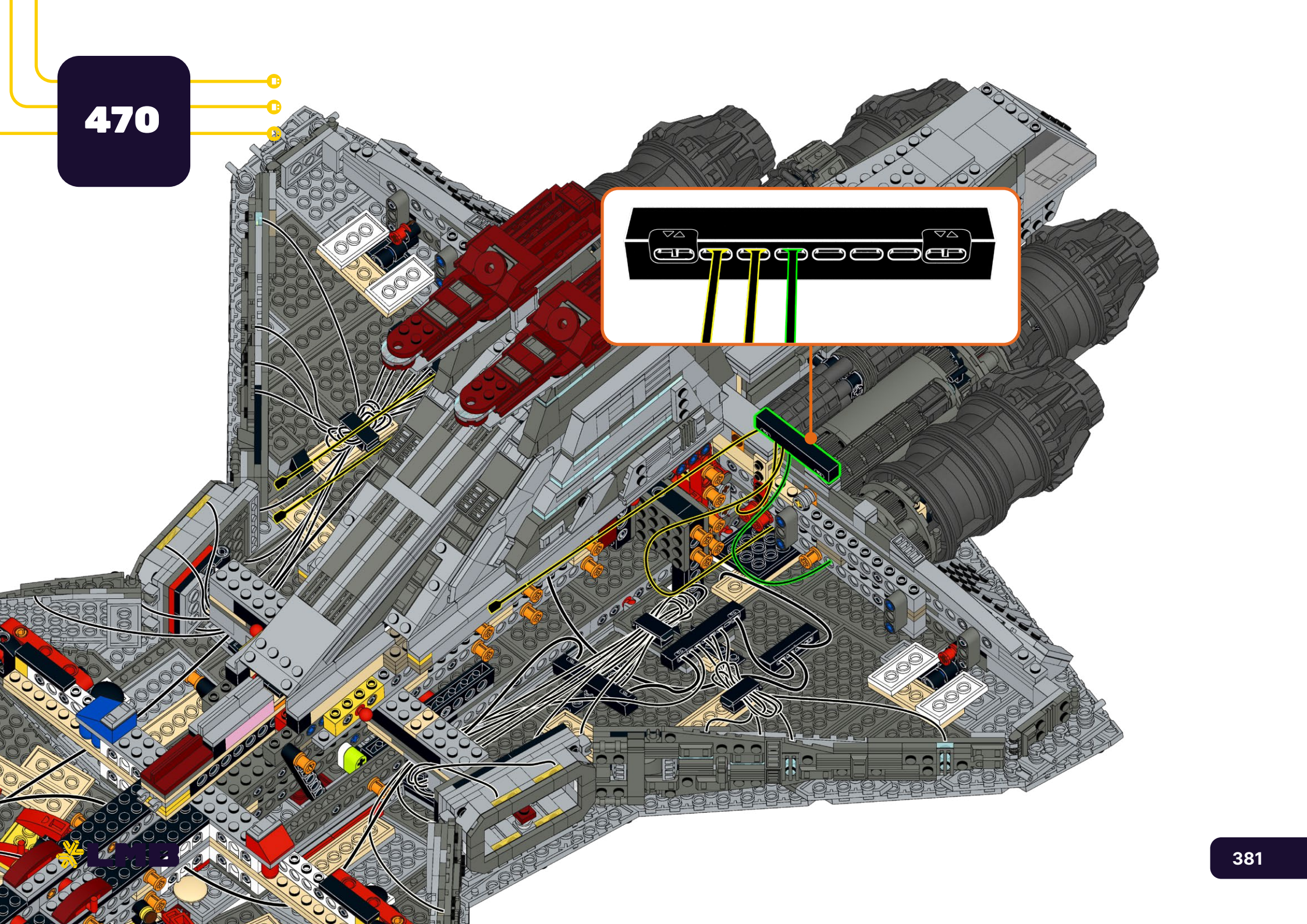

471

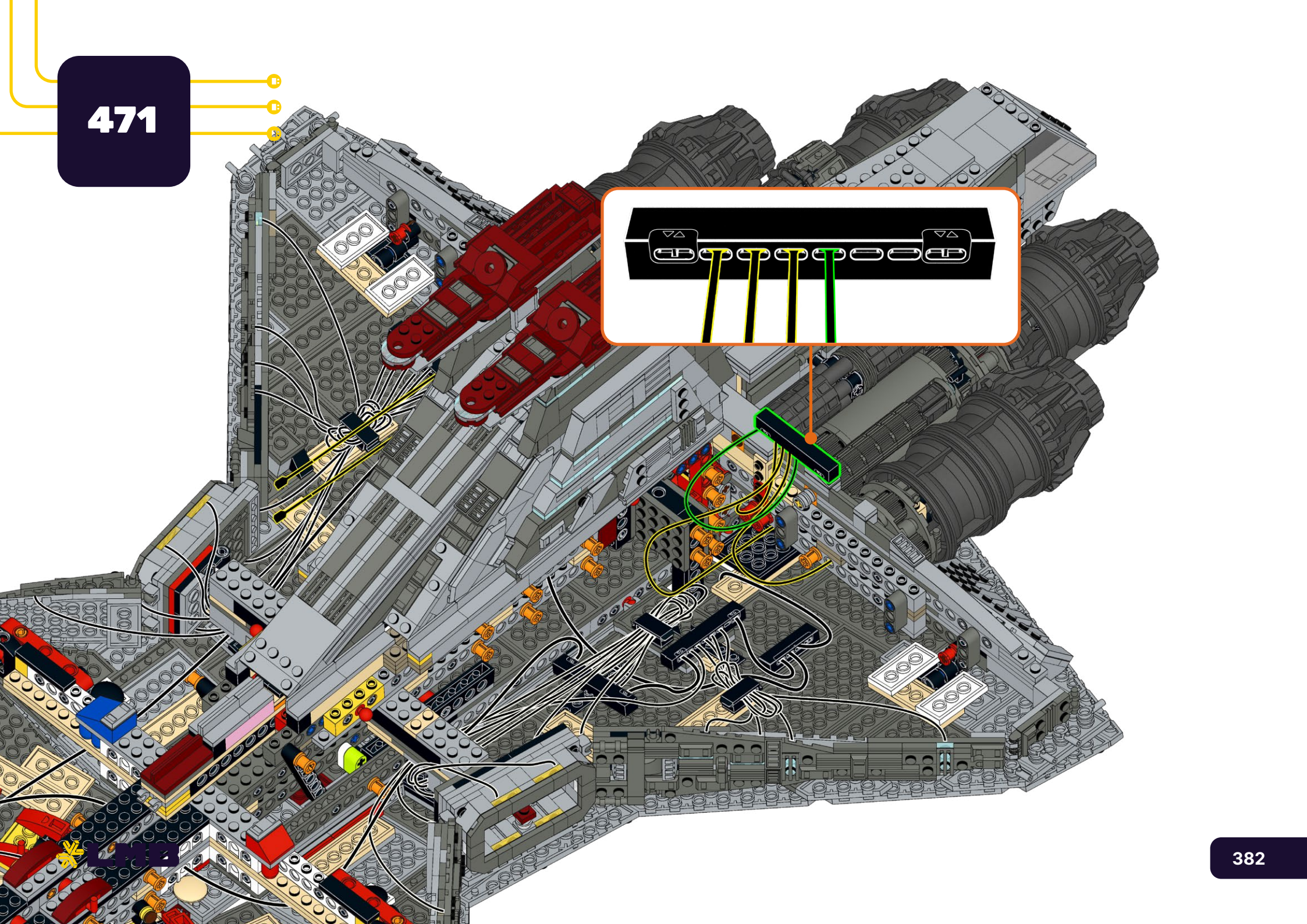

472

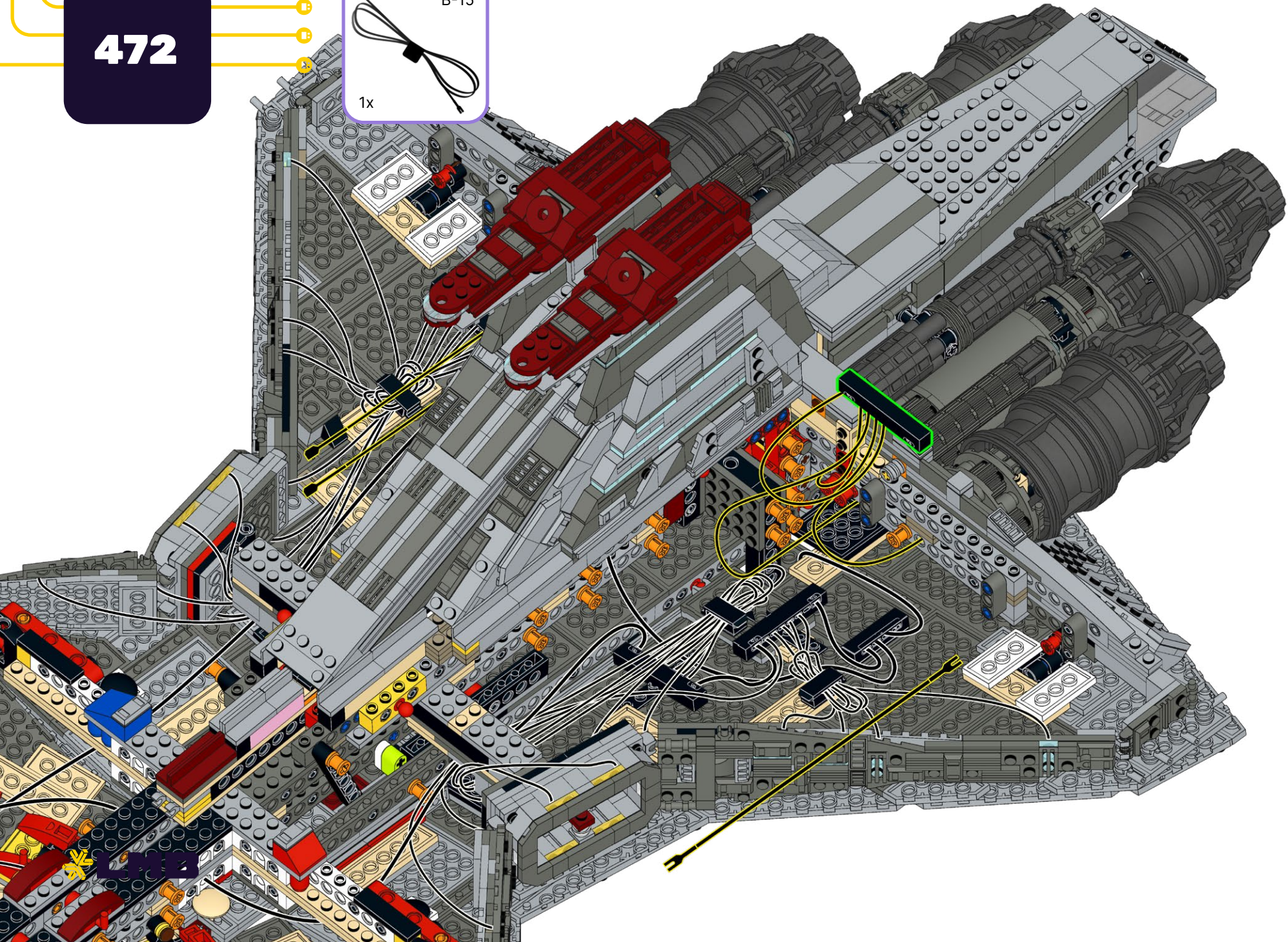
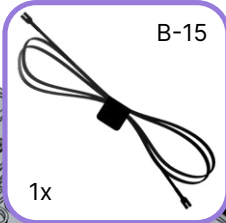

473

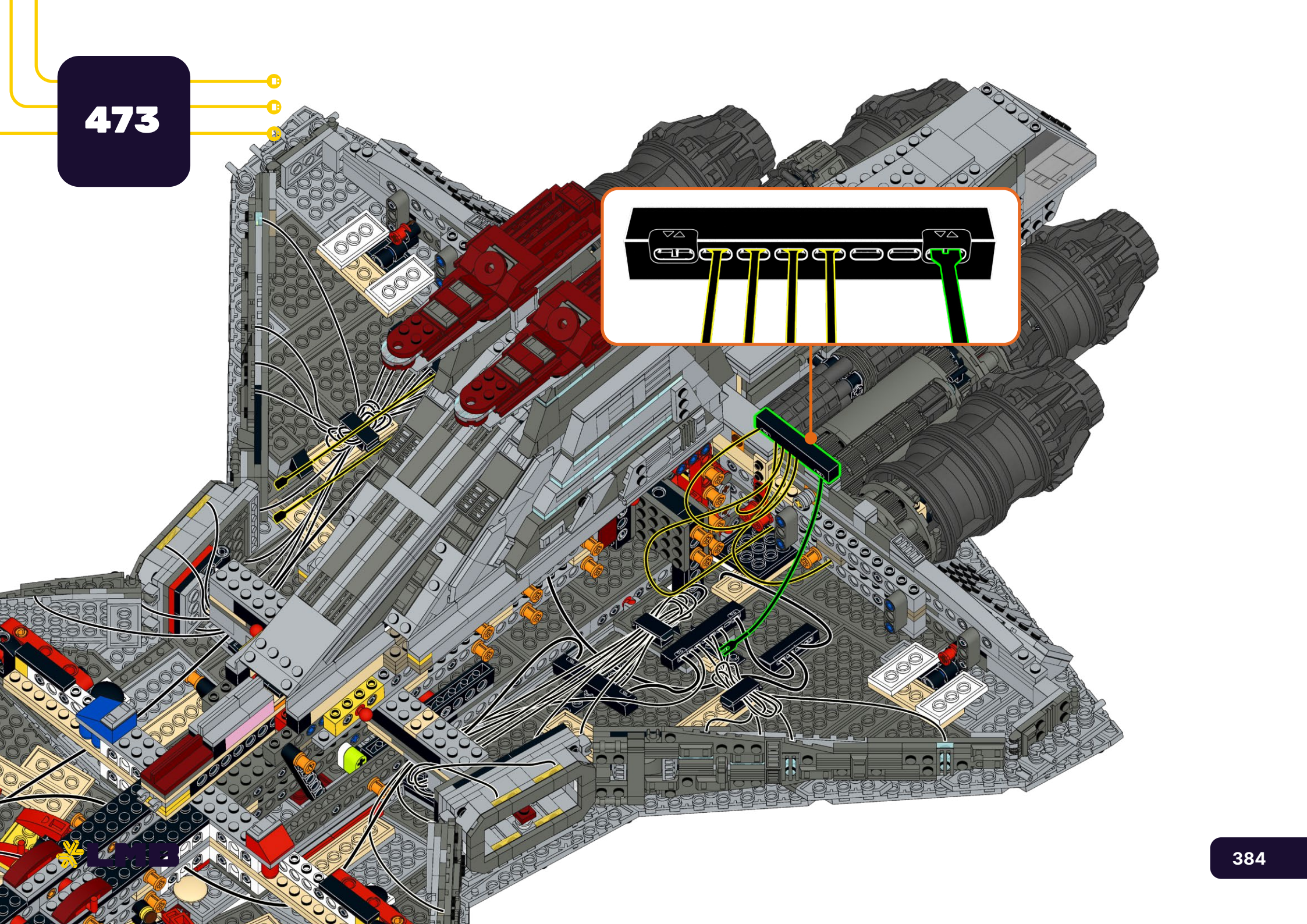

474

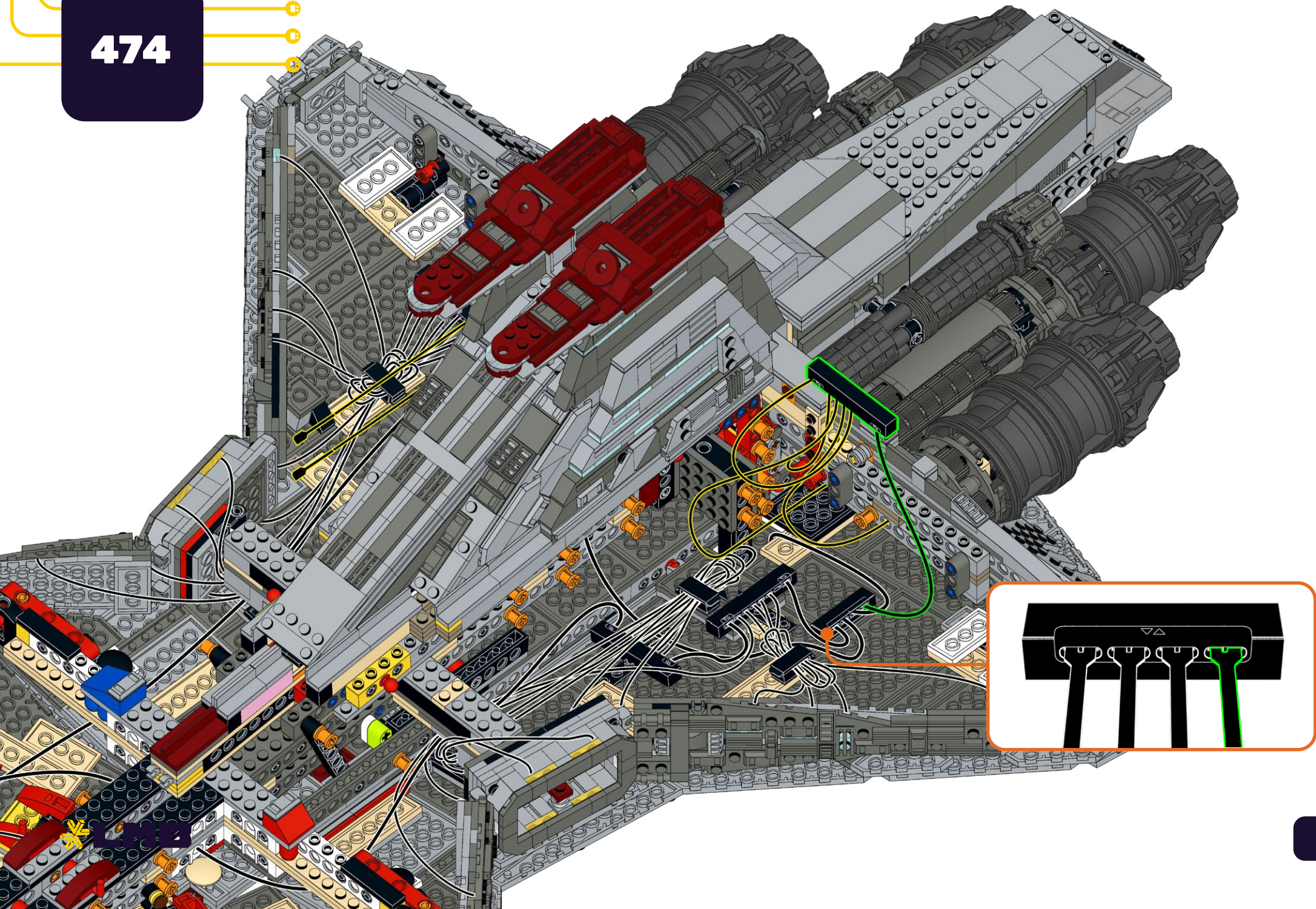

475

E-1x2
1x

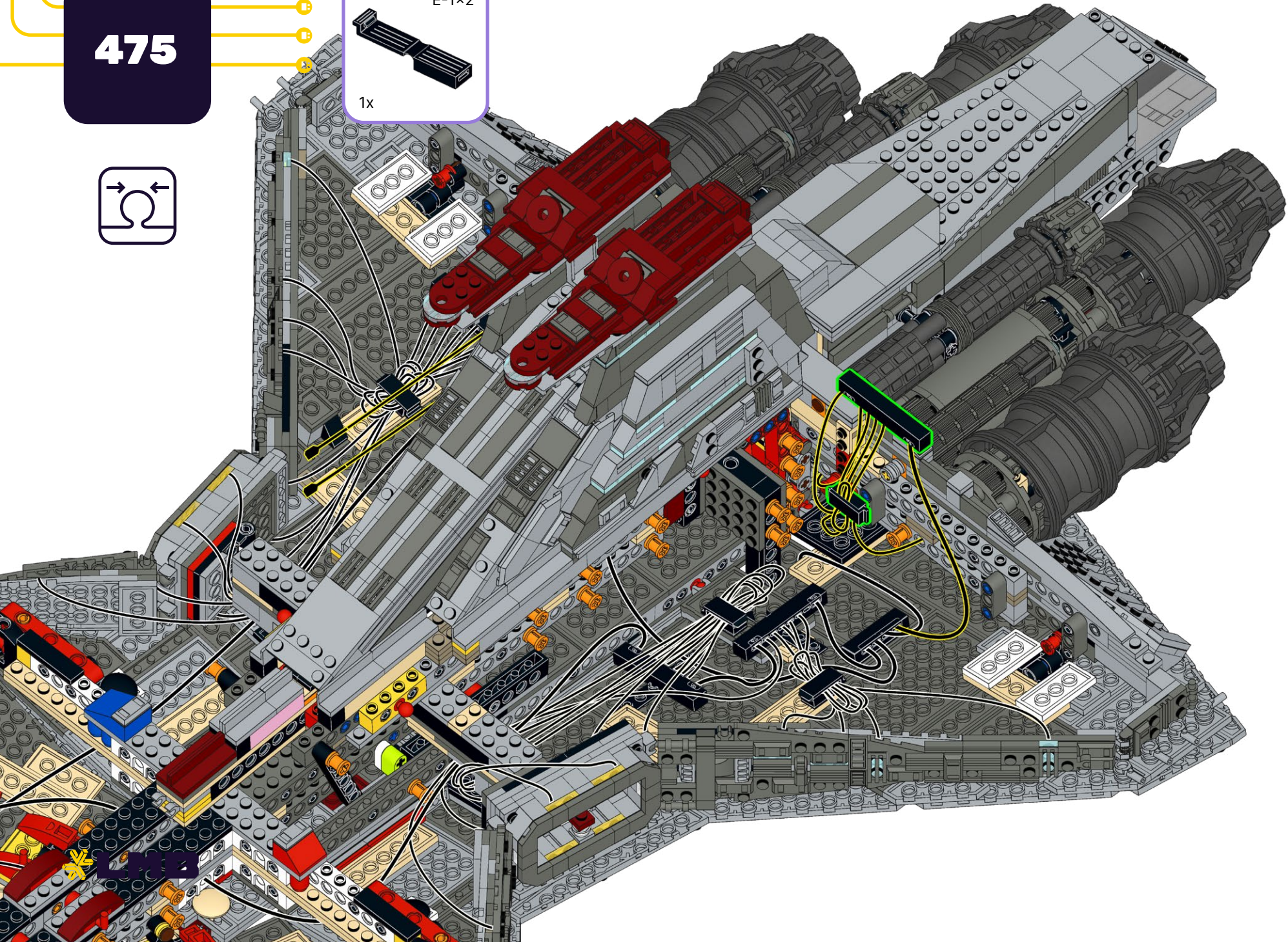

476

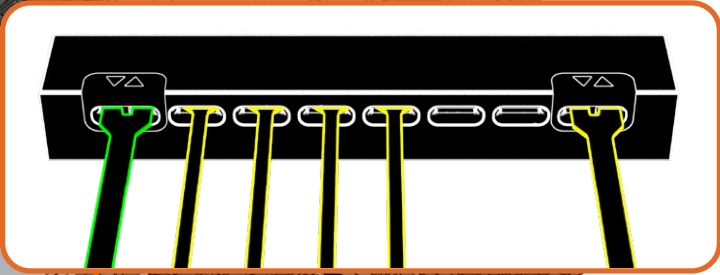
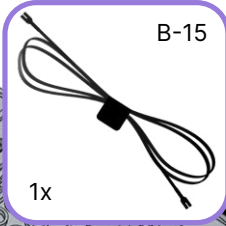

477

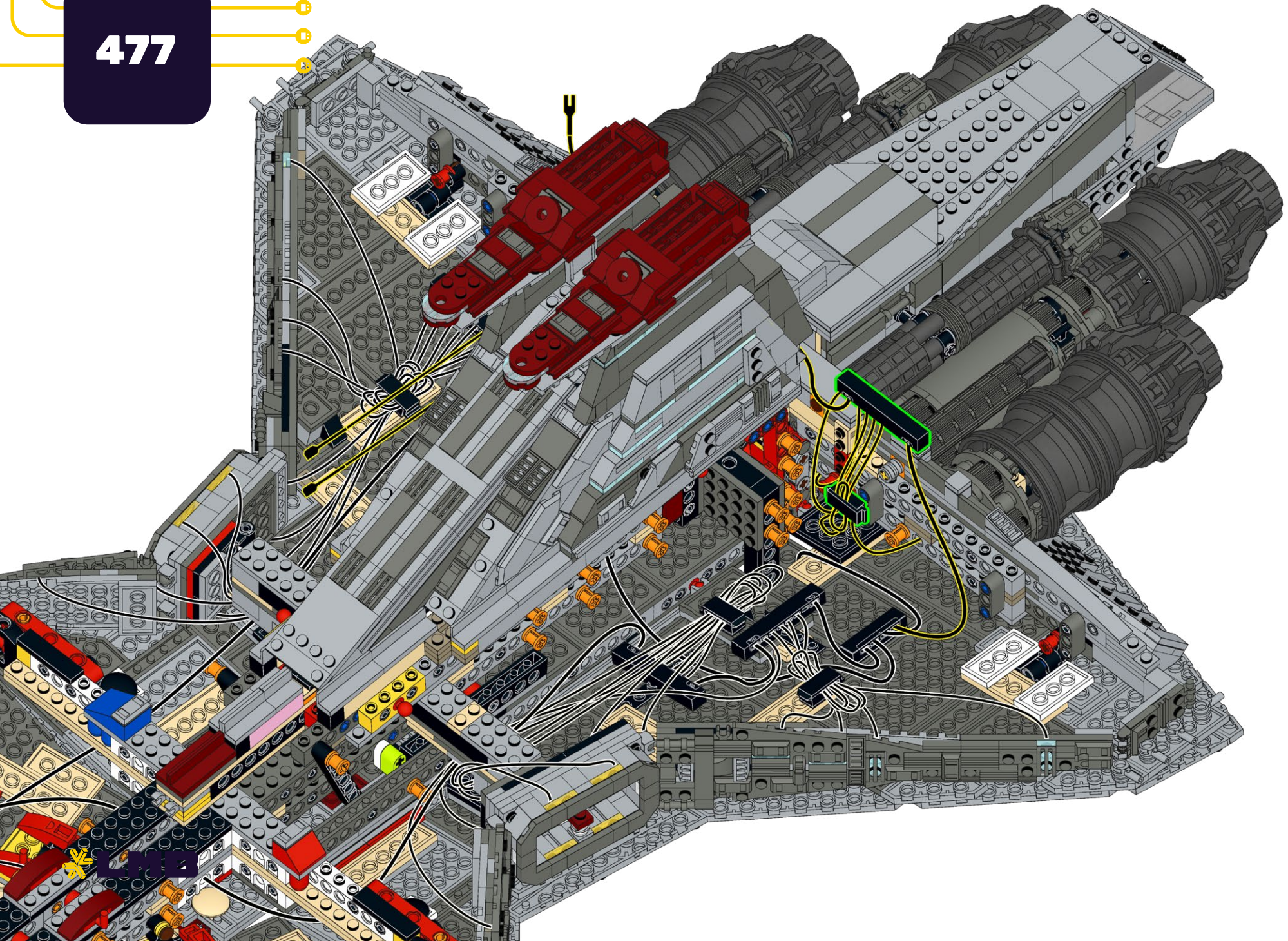

478

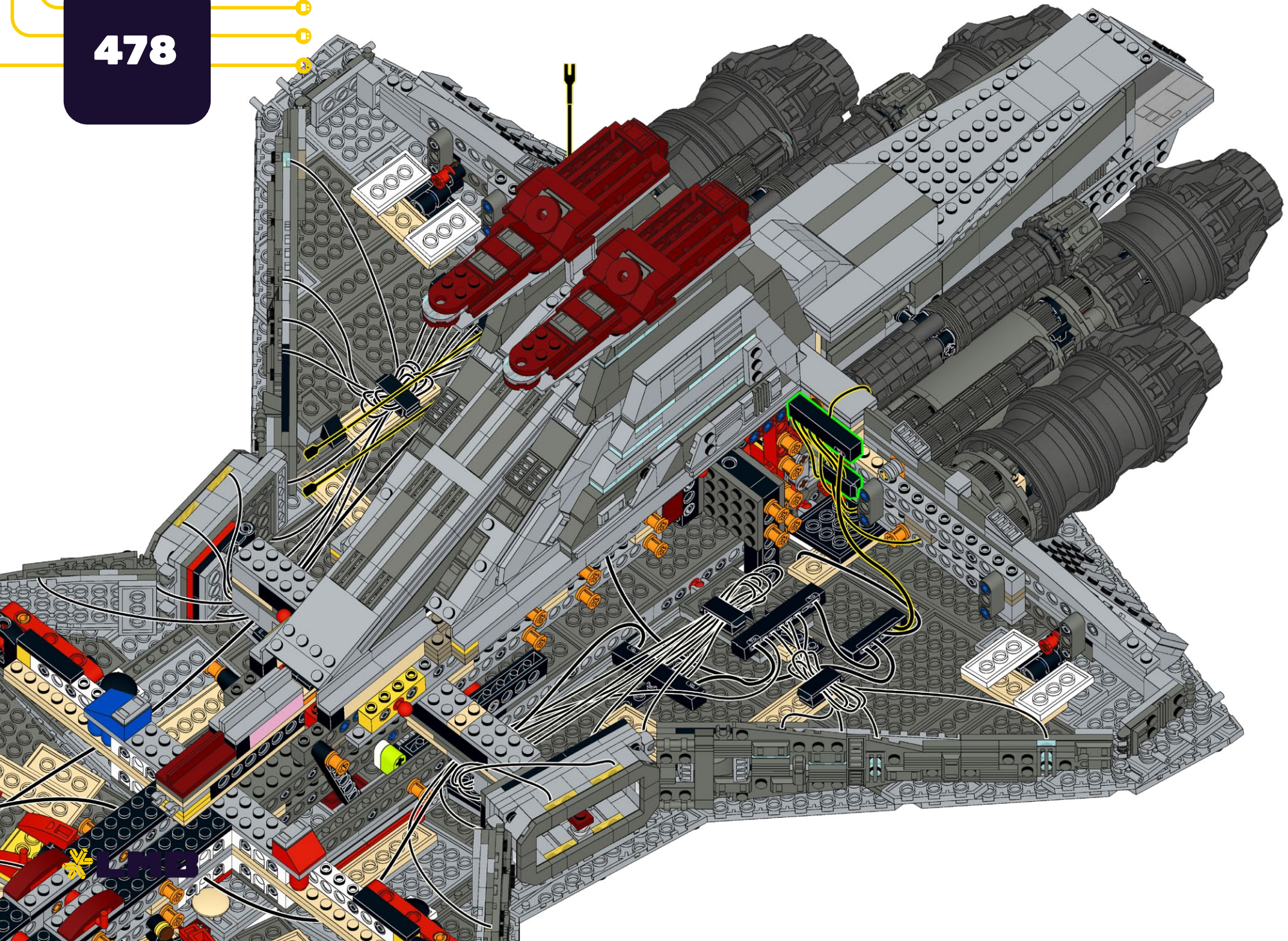

479

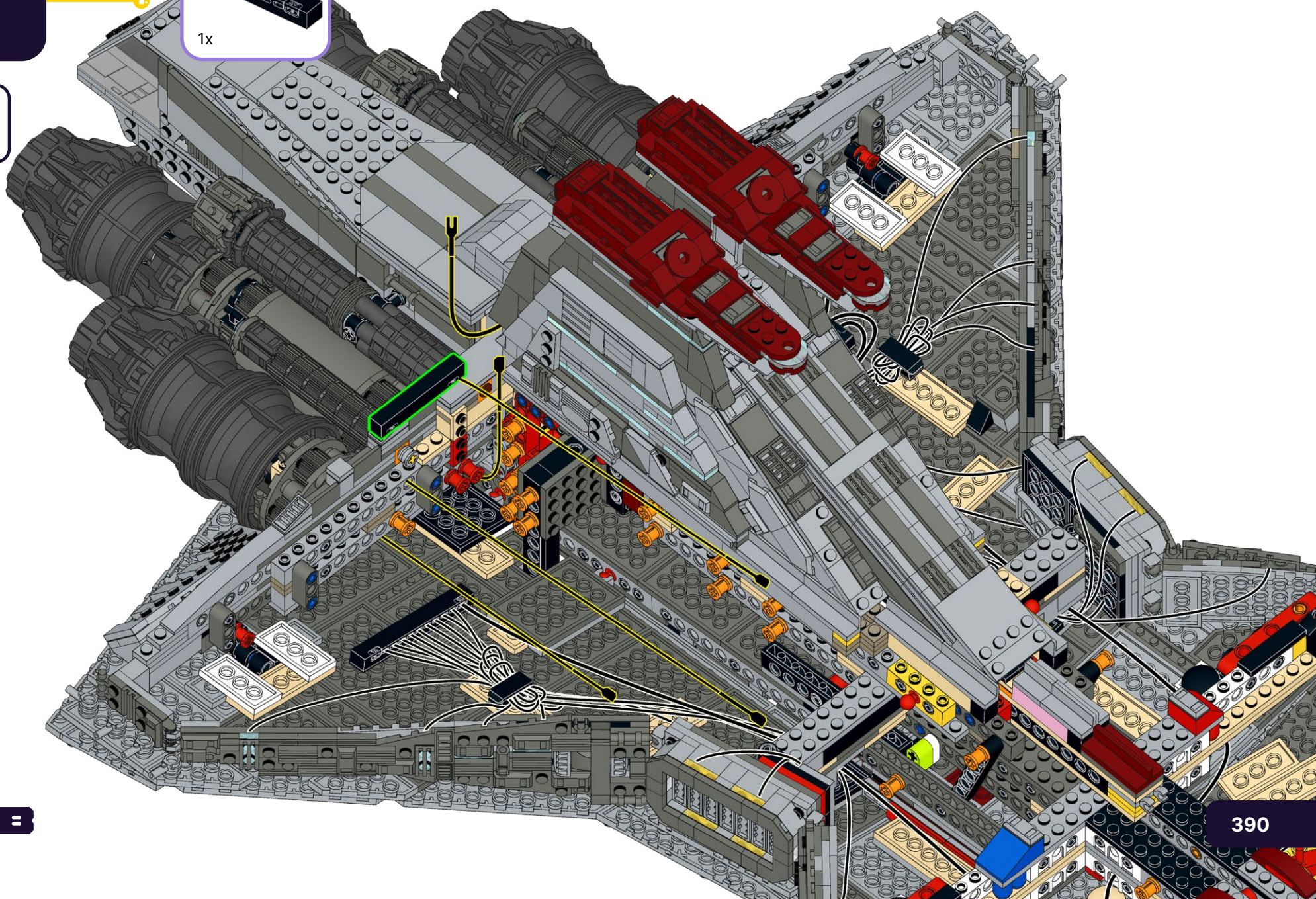
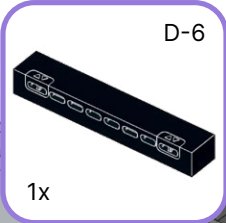

480

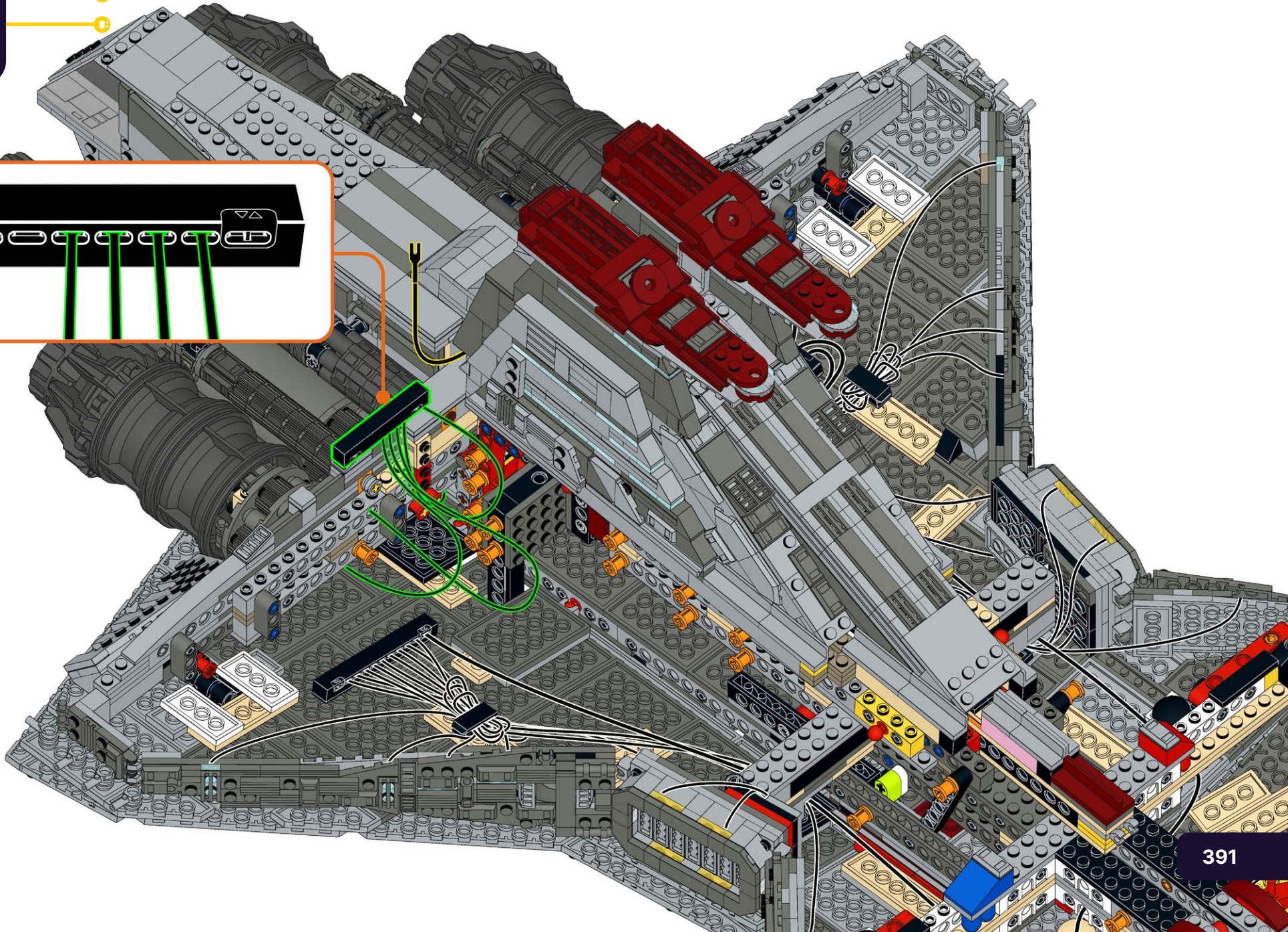
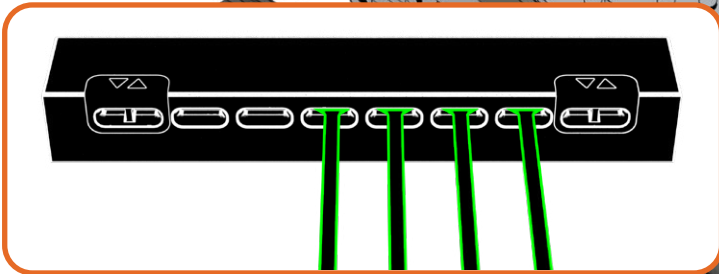

481

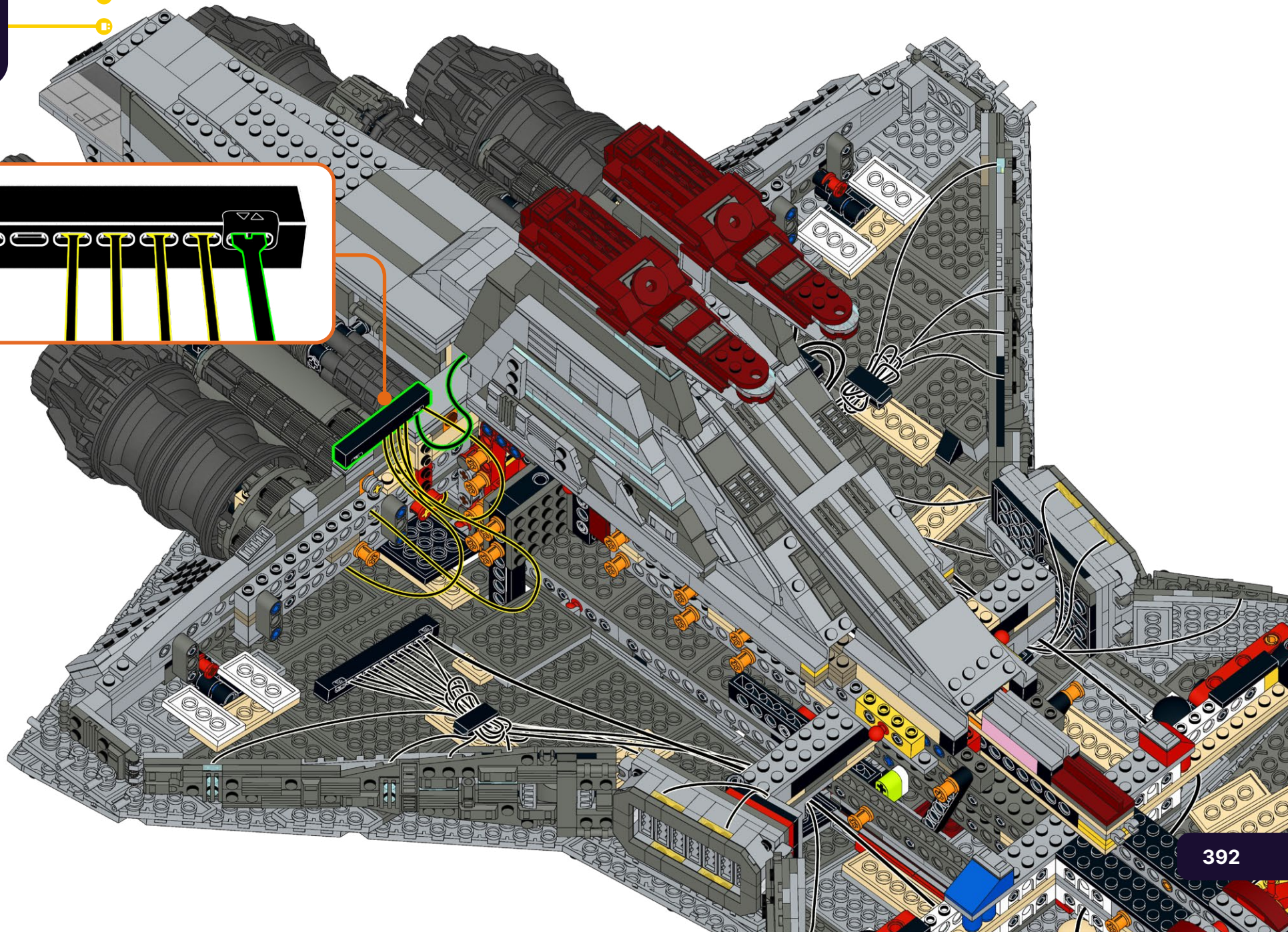
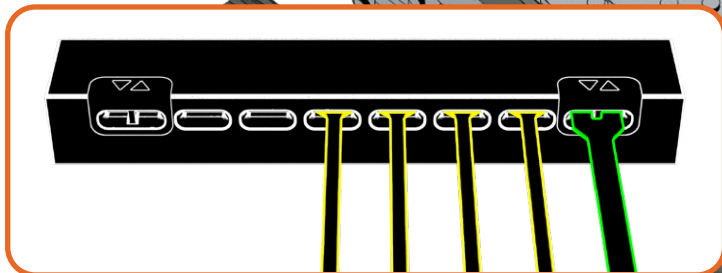

482

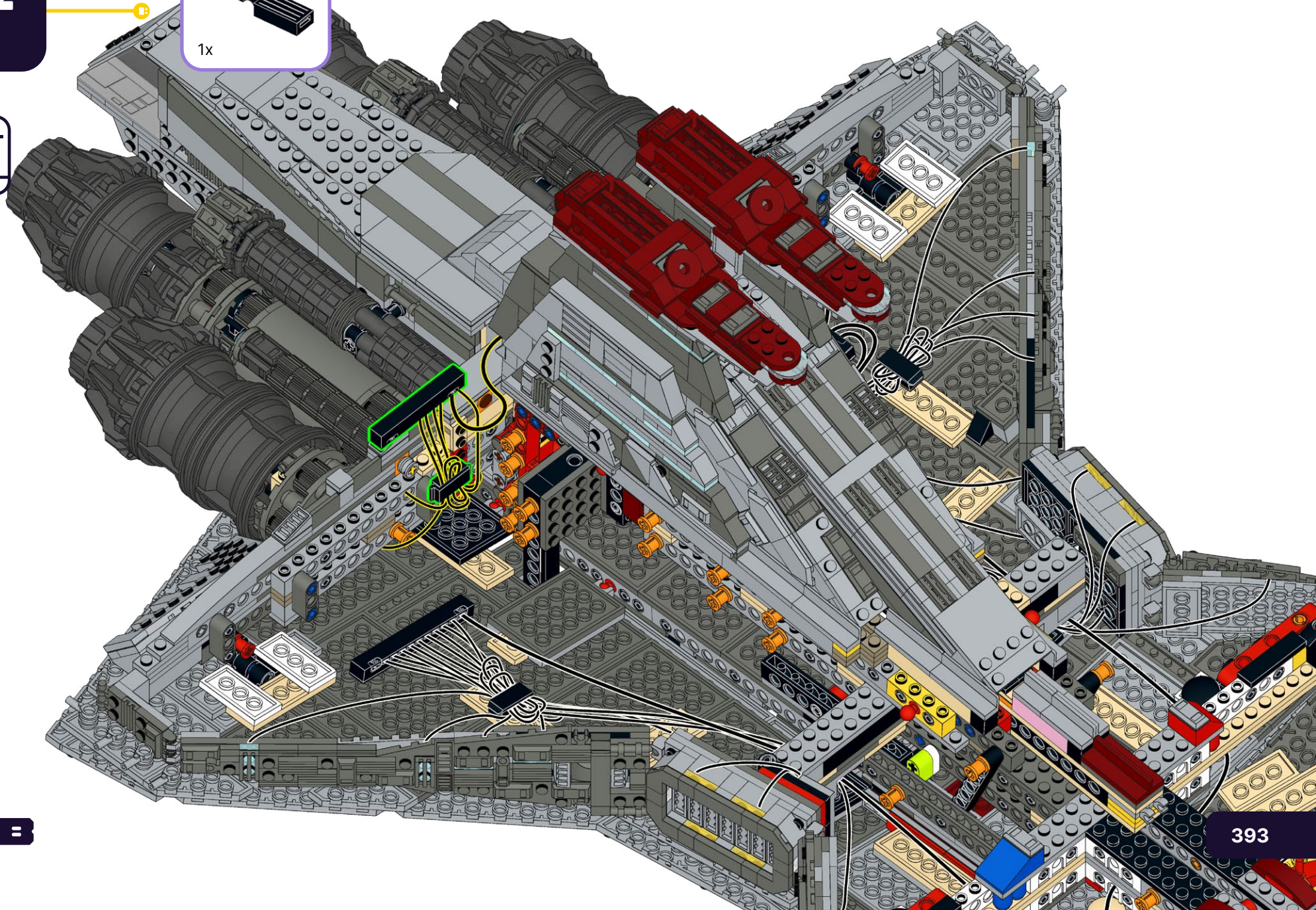
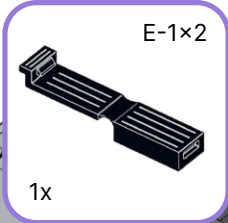

483

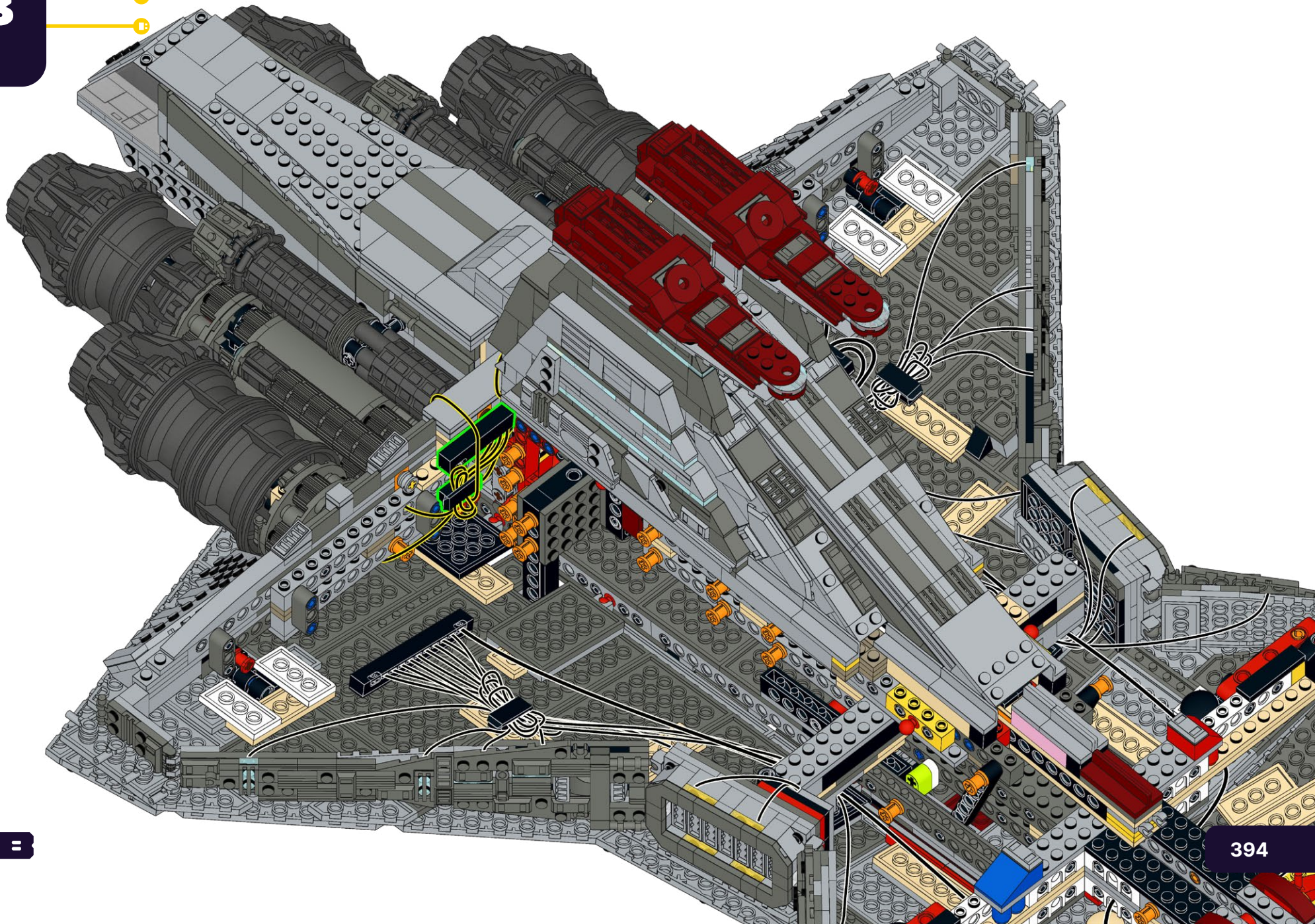

484



Power on Test
Test de mise sous tension
Test di Potenza
Stromtest
Prueba de Energía
电源测试



FINAL PRODUCT



PACKAGE CONTENTS



32x AR-CW30
Astro Light Regular
Cool White 30cm



5x D-6
Dock-6



2x B-30
Belt 30cm



4x AR-LB30
Astro Light Regular
Light Blue 30cm



3x D-9
Dock-9



2x B-50
Belt 50cm



8x AR-Y30
Astro Light Regular
Yellow 30cm



1x D-S
Split Dock



1x FLX-B60
Flux Belt 60cm



2x AL-LB30
Astro Light Large
Light Blue 30cm



2x B-5
Belt 5cm



4x SL-CW30
Solar Light Cool White
30cm



2x B-15
Belt 15cm

PACKAGE CONTENTS



4x T-1x2
Tether 1x2

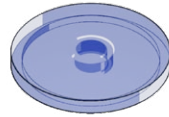

4x S-CAP-B
Solar Light Cap - Blue



1x T-1x4
Tether 1x4



2x T-1x6
Tether 1x6



2x T-1x8
Tether 1x8

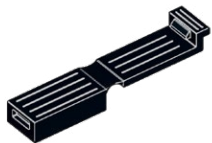

8x E-1x2
Eclipse 1x2

CONTACT US

Click below for customer support, or general inquiries.

Cliquez ci-dessous pour accéder au support client ou aux renseignements généraux.

Clicca qui sotto per l'assistenza clienti o per richieste generali.

Contact Us



Contactez-nous



Contattaci



Klicken sie unten für kundensupport oder allgemeine anfragen.

Haga clic a continuación para atención al cliente o consultas generales.

点击下方获取客户支持或一般咨询。

Kontaktieren sie uns



Contáctanos



联系我们



TROUBLESHOOTING

If you're stuck, scan the QR code for troubleshooting.

Se sei bloccato, scansiona il codice QR per la risoluzione dei problemi.

Wenn Sie nicht weiterkommen, scannen Sie den QR-Code zur Fehlerbehebung.

Si vous êtes bloqué, scannez le code QR pour le dépannage

Si está atascado, escanee el código QR para solucionar el problema.

如果遇到问题, 请扫描二维码进行故障排除

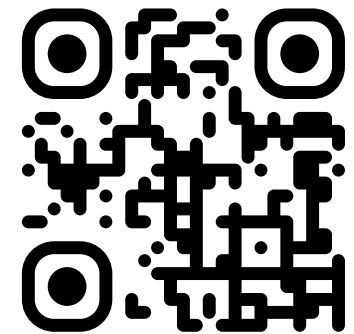



LIGHTMYBRICKS

lightmybricks.com



LEGO® is a trademark of the LEGO Group of companies, which does not sponsor, authorize or endorse this product. All LEGO® sets featured in images are sold separately. This is not a LEGO® product. The LEGO Group is not liable for any loss, injury or damage arising from the use or misuse of this product. ©2024 Light My Bricks Pty Ltd. All rights reserved. www.lightmybricks.com

Our components are designed and packaged in Australia by Light My Bricks Pty Ltd. Components are manufactured in China. 3fl bldg C, Shuanghuan Quanxin Technology Information Industry Park Baolong Street, Longgang District, Shenzhen, China. Imported in Australia by Light My Bricks Pty Ltd, 5/26 Rushdale St, Knoxfield, VIC, 3180, Australia.

WARNING: CHOKING HAZARD - Small parts. Not for children under 3 years.

AVERTISSEMENT : RISQUE D'ÉTOUFFEMENT - Petites pièces. Ne convient pas aux enfants de moins de 3 ans.

ATTENZIONE: PERICOLO DI SOFFOCAMENTO - Piccole parti. Non adatto a bambini di età inferiore a 3 anni.

WARNUNG: ERSTICKUNGSGEFAHR - Kleine Teile. Nicht für Kinder unter 3 Jahren geeignet.

ADVERTENCIA: PELIGRO DE ASFIXIA - Piezas pequeñas. No son apto para niños menores de 3 años.

警告：窒息危险 - 小零件。不适合3岁以下儿童。