

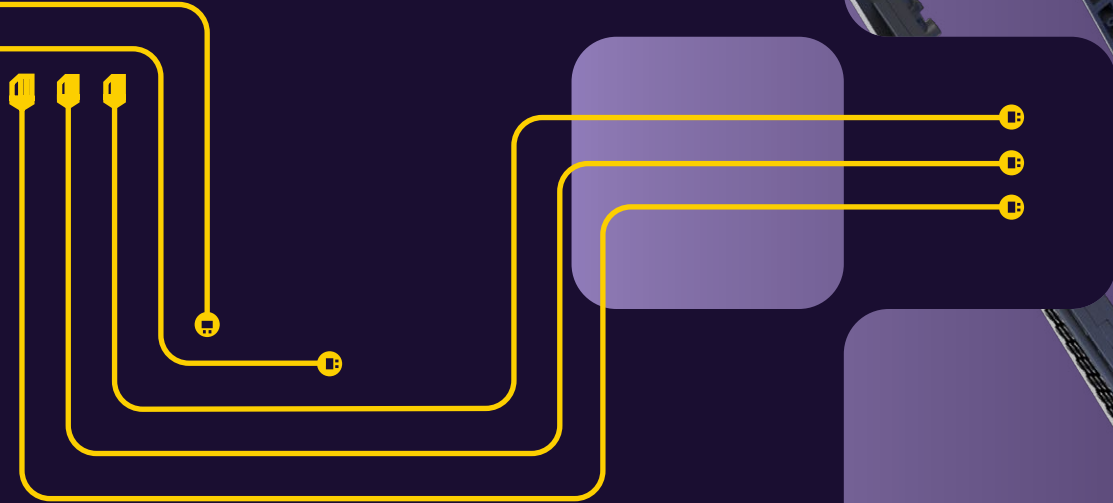

**LIGHT  
BRICKS™**



# LIGHT KIT INSTALLATION GUIDE

**STAR WARS™  
TIE INTERCEPTOR™**

FOR  
LEGO SET  
#75382



# CONTENTS



## 03

### Getting Started

- 04 Legend
- 05 Blueprint

## 05

### Instructions

- 7 Bag 1
- 25 Bag 2
- 37 Bag 3
- 52 Bag 4 - LMB Bag 1
- 82 Bag 5
- 109 Bag 6
- 138 Bag 7
- 165 Bag 8
- 188 Bag 9
- 203 LMB Bag 2
- 220 Bag 10
- 267 Bag 11
- 304 Bag 12
- 320 Bag 13
- 350 Bag 14
- 366 Bag 15
- 387 Bag 16
- 415 Bag 17
- 436 Bag 18
- 466 Bag 19
- 487 Bag 20
- 523 Bag 21
- 544 Bag 22

## 348

### Final Product

- 580 Contents & Glossary
- 582 Contact & Troubleshooting



# GETTING STARTED

Bold, beautiful and bright, Light My Bricks elevates your favourite LEGO set from knick-knack to statement piece. Create a talking point at home or in the office that speaks to your passions with Light My Bricks. To learn more, click below.

[Learn More](#)



Audacieux, beau et lumineux, Light My Bricks élève votre ensemble LEGO préféré du statut de bibelot à celui de pièce maîtresse. Que ce soit à la maison ou au bureau, partagez votre passion des LEGO avec Light My Bricks. Cliquez ci-dessous pour en savoir plus.

[En savoir plus](#)



Audace, bello e luminoso, Light My Bricks eleva il tuo set LEGO preferito da soprammobile a pezzo di tendenza. Crea un punto di discussione a casa o in ufficio che parli alle tue passioni con Light My Bricks. Per saperne di più, clicca qui sotto.

[Ulteriori Informazioni](#)



Mutig, schön und hell – Light My Bricks verwandelt Ihr Lieblings-LEGO-Set von einem schnickschnack in ein statement-stück. Schaffen sie einen gesprächspunkt zu hause oder im büro, der Ihre leidenschaften widerspiegelt, mit Light My Bricks. Um mehr zu erfahren, klicken sie unten.

[Mehr erfahren](#)



Audaz, hermoso y brillante, Light My Bricks eleva tu set LEGO favorito de una chuchería a una pieza llamativa. Crea un tema de conversación en casa o en la oficina que hable de tus pasiones con Light My Bricks. Para obtener más información, haga clic a continuación.

[Más información](#)



大胆、美丽而明亮，Light My Bricks 将你喜爱的乐高套装从小摆件提升为引人注目的装饰品。在家或办公室打造一个能表达你激情的话题，了解更多，请点击下方。

[了解更多](#)



# LEGEND

## Rotate Set



Girar  
Drehen  
Tourner  
Ruotare  
Вращать  
旋转  
回転する  
دوراتسا

## Add Part



Voltear  
Umkippen  
Basculer  
Ribaltarsi  
Опрокидываться  
翻倒  
転がる  
نارود

## Click



Clic  
Klick  
Cliquer  
Clic  
Нажмите  
点击  
クリック  
انقر

## Pinch/Fold



Pliegue  
Falte  
Pli  
Piega  
Отключить  
折痕  
折り目  
دعجت

## Pull Cable



Tire del Cable  
Kabel Ziehen  
Câble de Traction  
Tirare il Cavo  
Тяговый Кабель  
拉线  
ケーブルを引く  
لباك دش

## Repeat Step



Repetir  
Wiederholen  
Répéter  
Ripetere  
Повторить  
重复  
繰り返す  
ررركي

## Sticker



Pegatina  
Aufkleber  
Autocollant  
Etichetta  
Наклейка  
贴纸  
ステッカー  
ملصق

## Power On Test



Encender  
Einschalten  
Allumer  
Accendere  
Включить  
打开  
電源オン  
عوض ل لايغش ت ب مق

## Disconnect Power

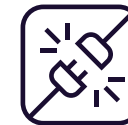

Desconectar  
Trennen  
Déconnecter  
Disconnetti  
Отключить  
断开  
電気を切る  
ءابرهكك ل لصف

## Troubleshoot



Resolución de Problemas  
Probleme Lösen  
Résolution De Problème  
Risoluzione Dei Problemi  
Решение проблем  
解决问题  
問題解決  
لك اشمل ل ح

# COMPONENT HANDLING

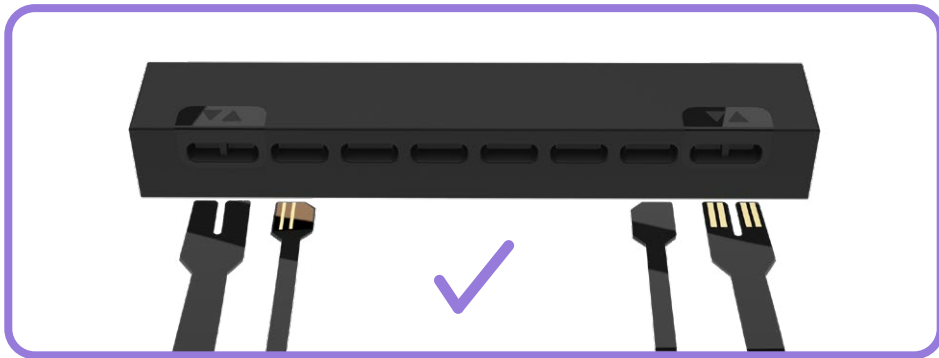
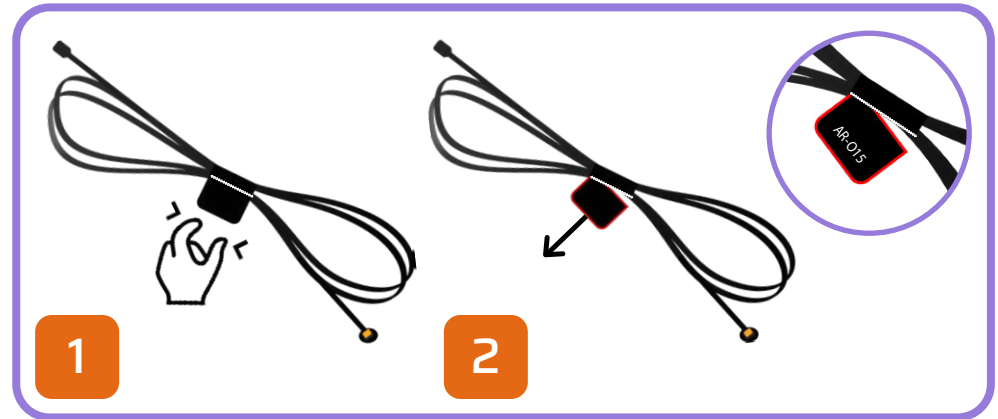
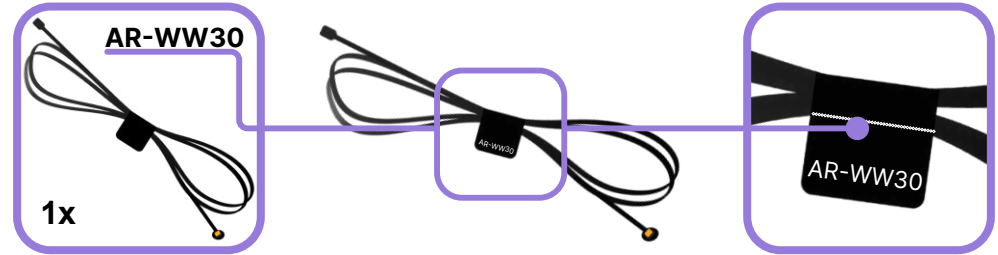
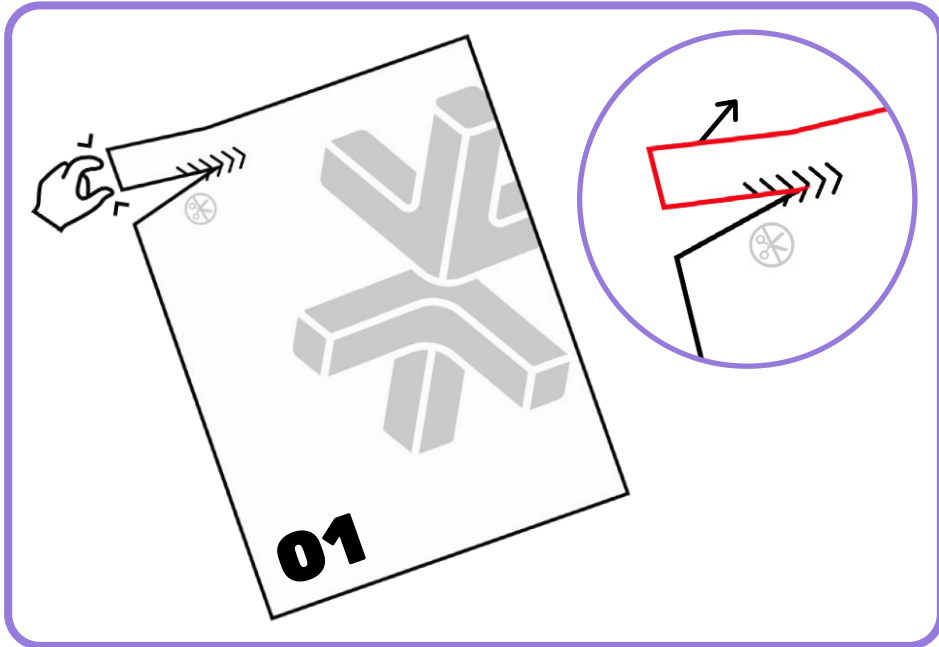

# BLUEPRINT

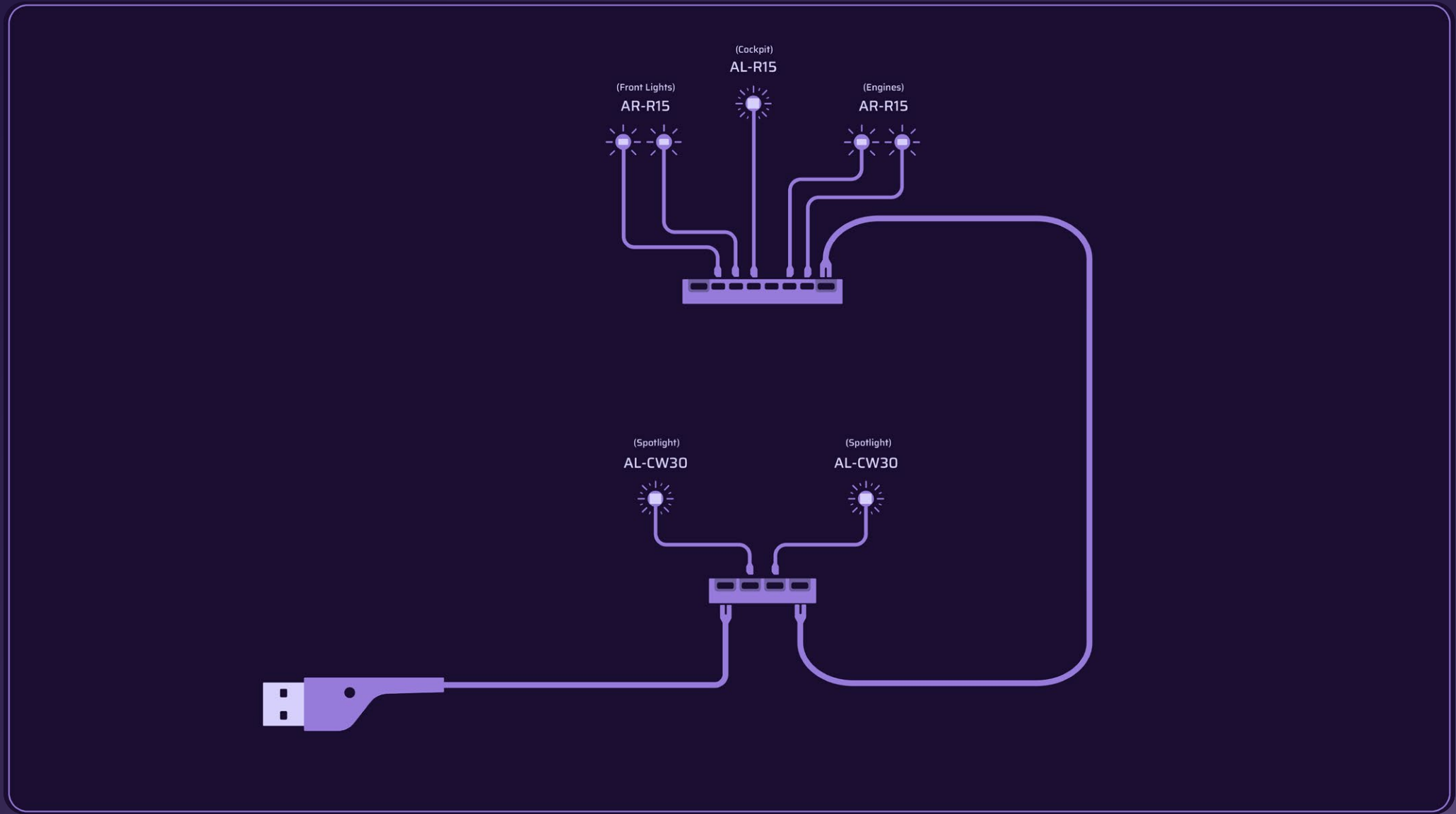

**HOLD UP!**

You might notice some bags are out of order, as well as left over pieces, but that's ok! We're changing the way you build LEGO!

**HALTEN!**

Möglicherweise stellen Sie fest, dass einige Beutel nicht in Ordnung sind und auch Teile übrig bleiben, aber das ist in Ordnung! Wir verändern die Art und Weise, wie Sie LEGO bauen!

**TENIR BON!**

Vous remarquerez peut-être que certains sacs sont en panne, ainsi que des morceaux restants, mais ce n'est pas grave ! Nous changeons la façon dont vous construisez LEGO !

**SOSTENERE!**

Potresti notare che alcune borse sono fuori uso, così come alcuni pezzi avanzati, ma va bene! Stiamo cambiando il modo in cui costruisci i LEGO!

**¡SOSTENER!**

Puede que notes que algunas bolsas están fuera de orden, así como piezas sobrantes, ¡pero está bien! ¡Estamos cambiando la forma de construir LEGO!

**耽误!**

您可能会注意到有些袋子坏了, 还有剩余的碎片, 但这没关系! 我们正在改变您搭建乐高的方式!

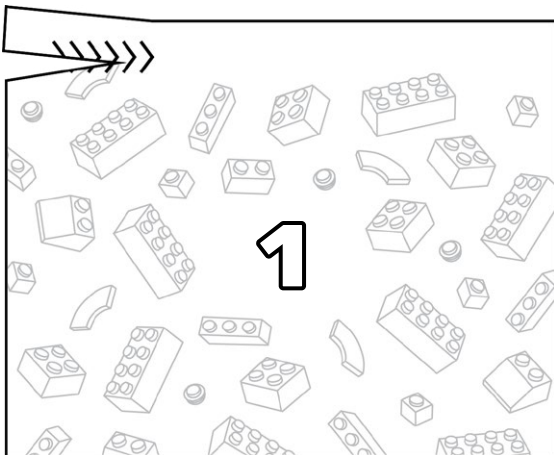
**Open LEGO® Bag 1**



# 1

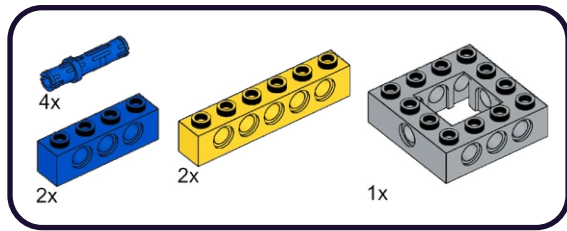

# 2

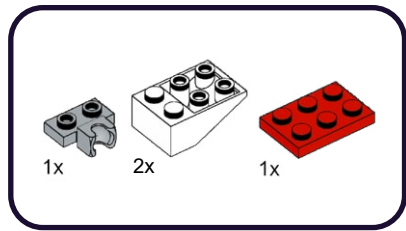

# 1

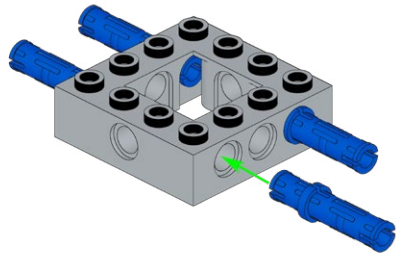

# 2

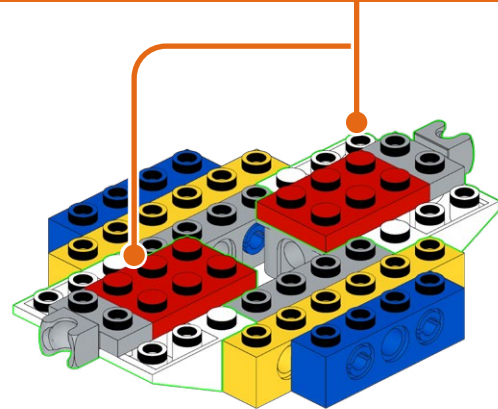
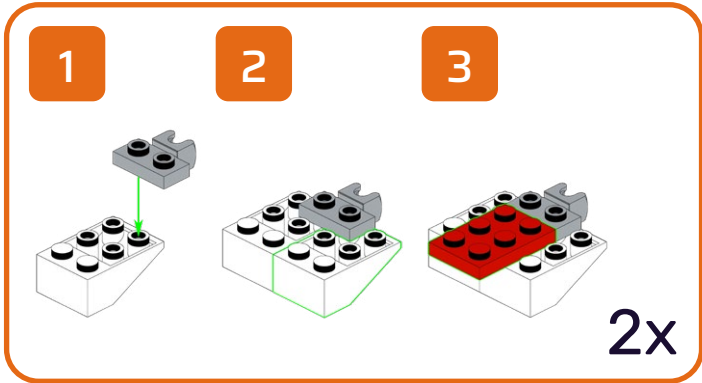
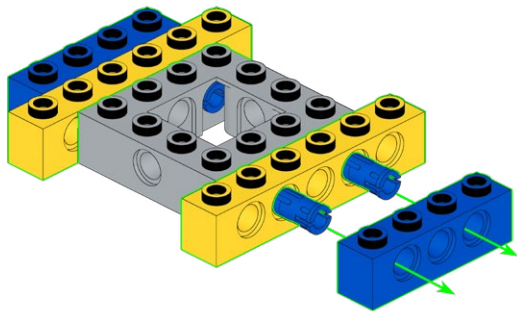

3

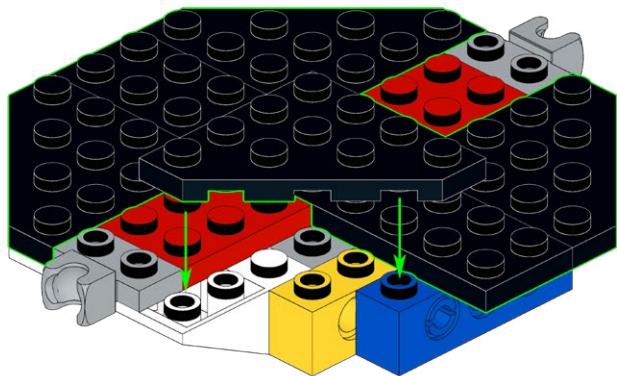
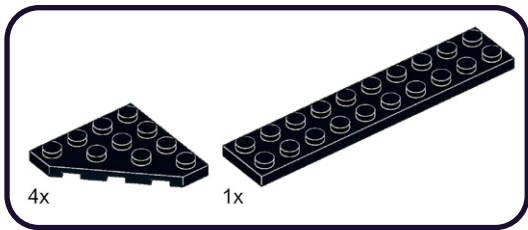

4

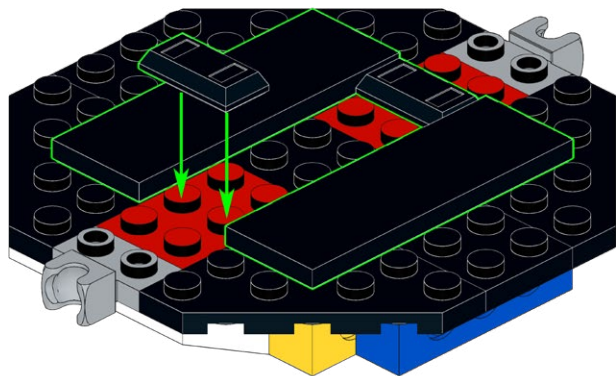
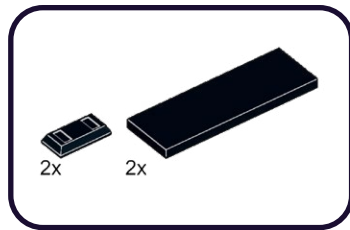

5

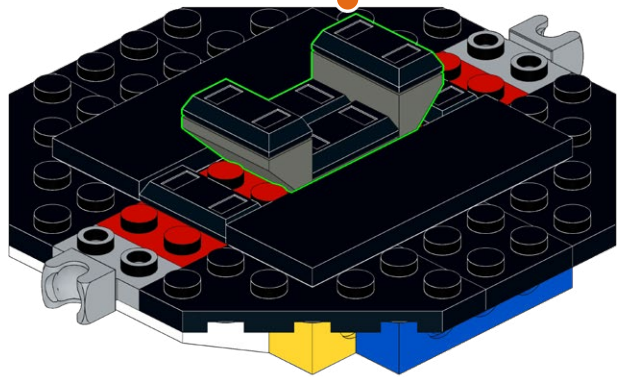
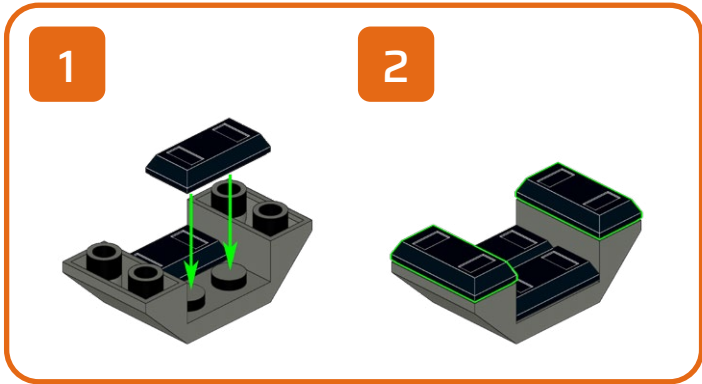
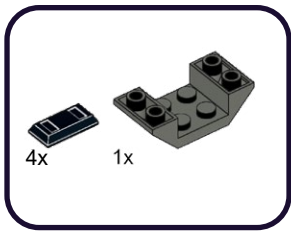

6

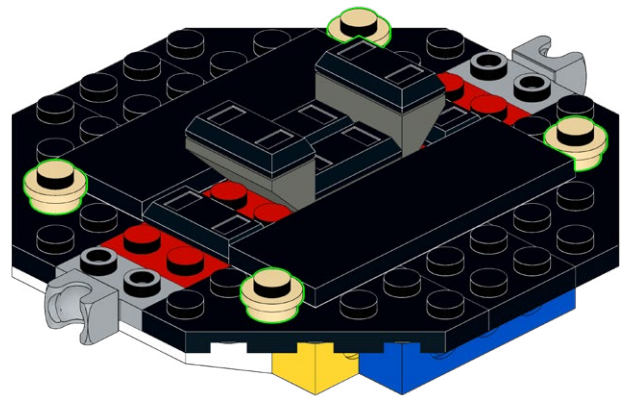
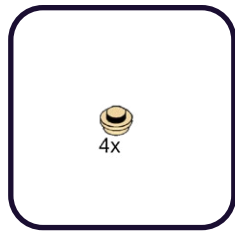

7

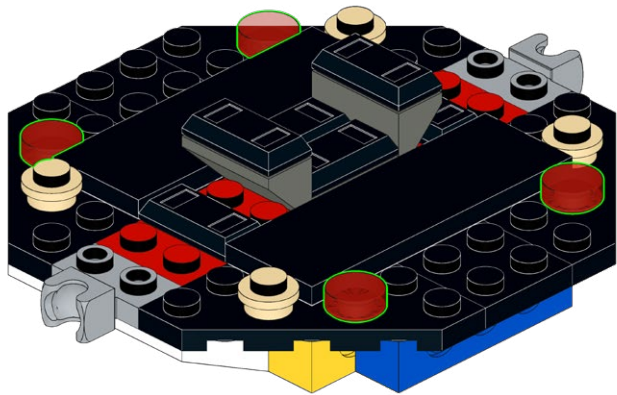
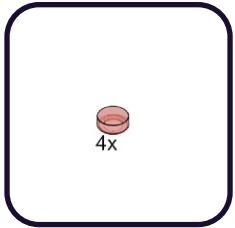

8

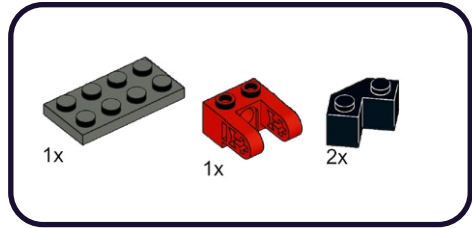

1

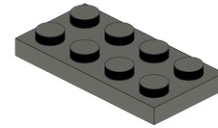

2

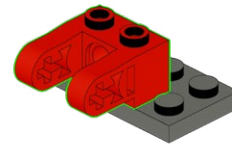

3

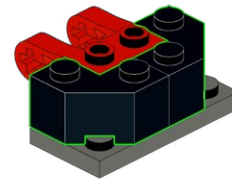

# 9

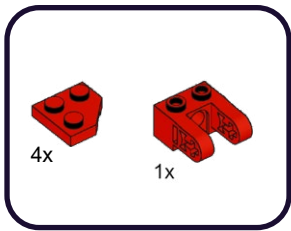

1

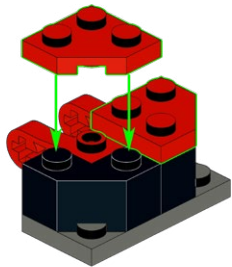

2

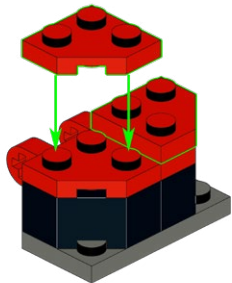

3

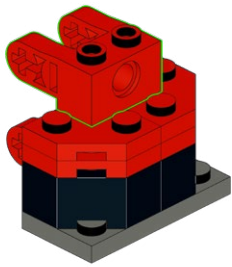

# 10

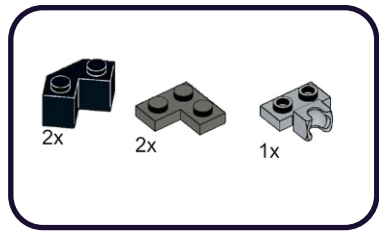

1

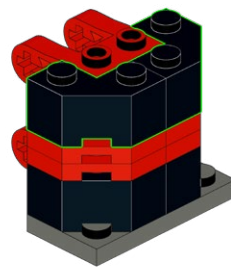

2

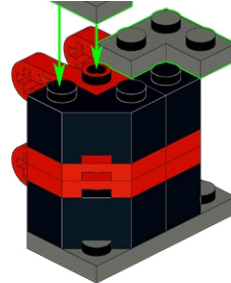

3

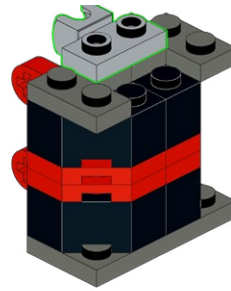



11

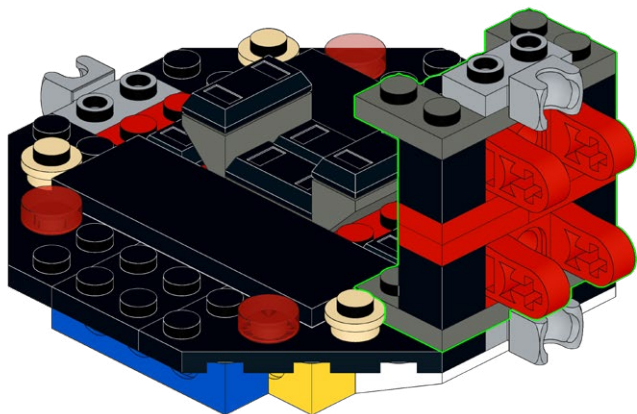

12

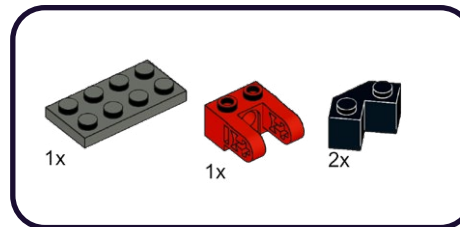

1

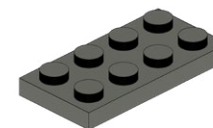

2

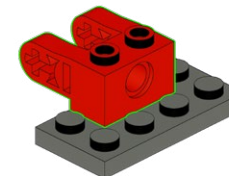

3

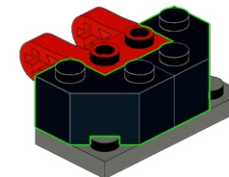

13

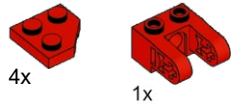

1

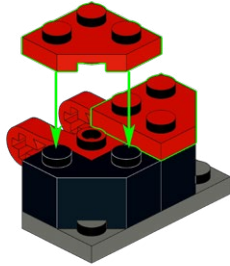

2

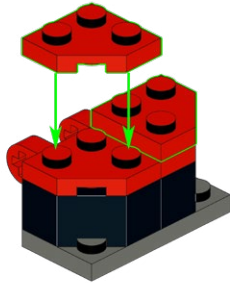

3

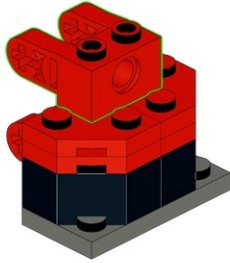

14

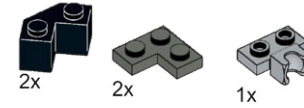

1

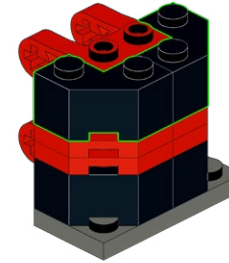

2

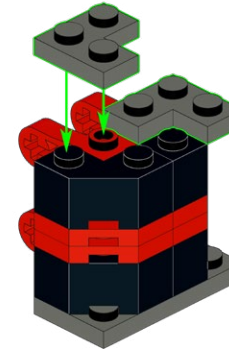

3

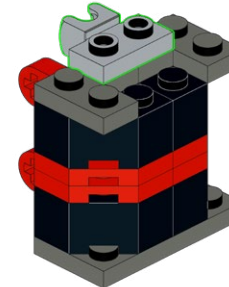

15

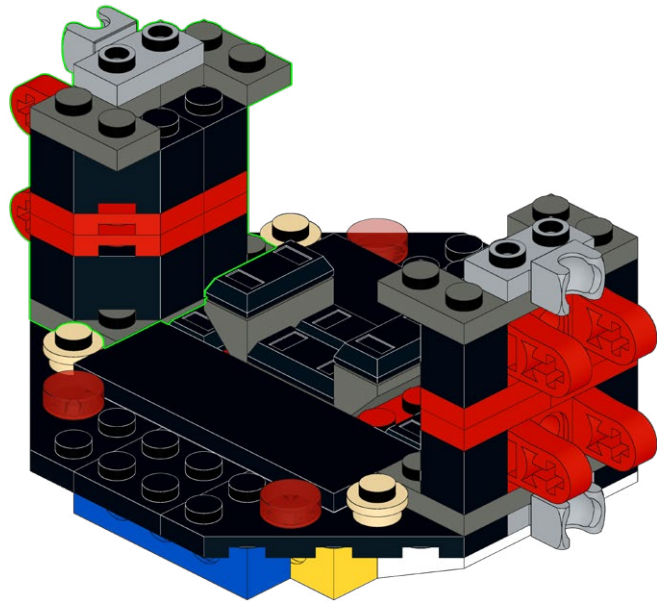

16

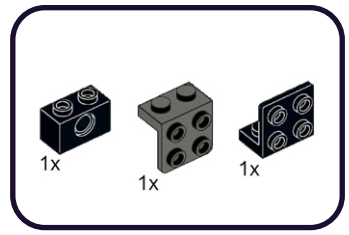

1

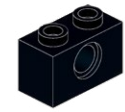

2

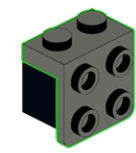

3

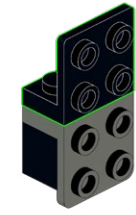

# 17

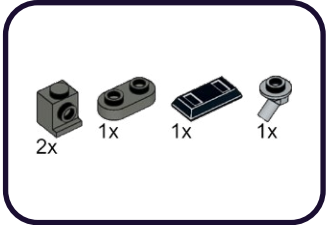

1

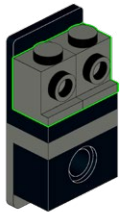

2

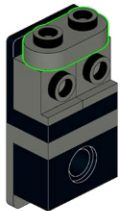

3

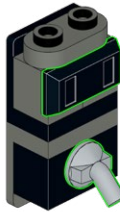

# 18



1

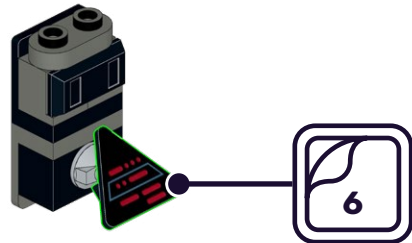

19

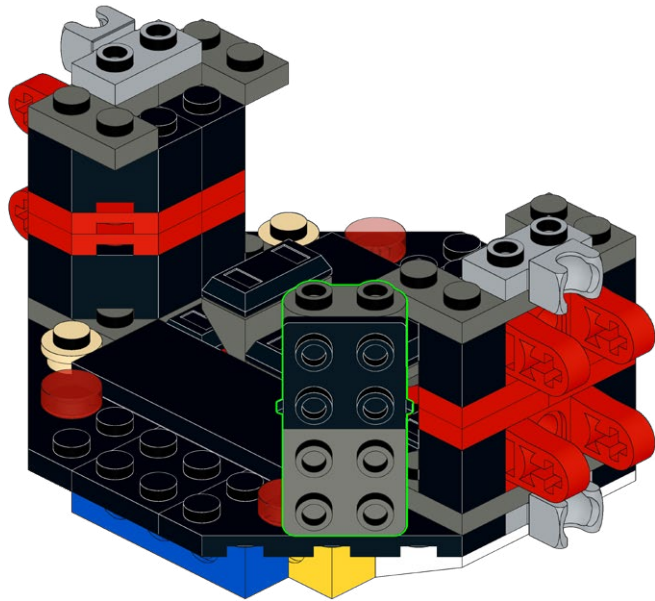

20

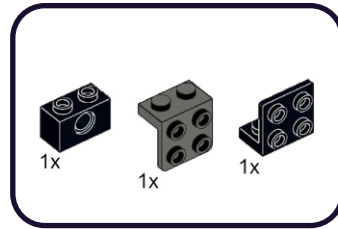

1

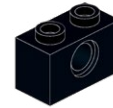

2

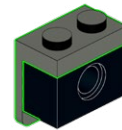

3

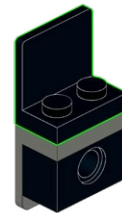



# 21

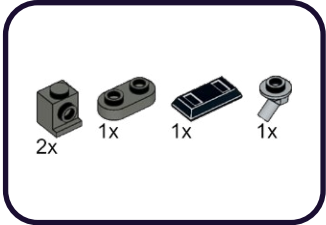

1

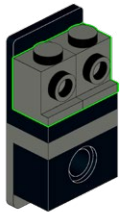

2

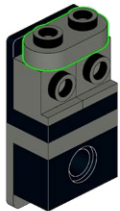

3

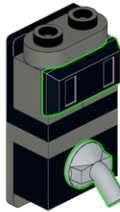

# 22



1

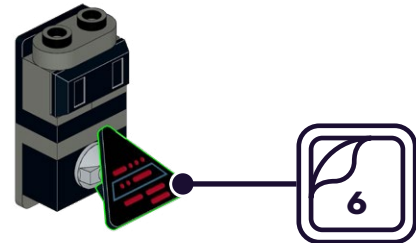

23

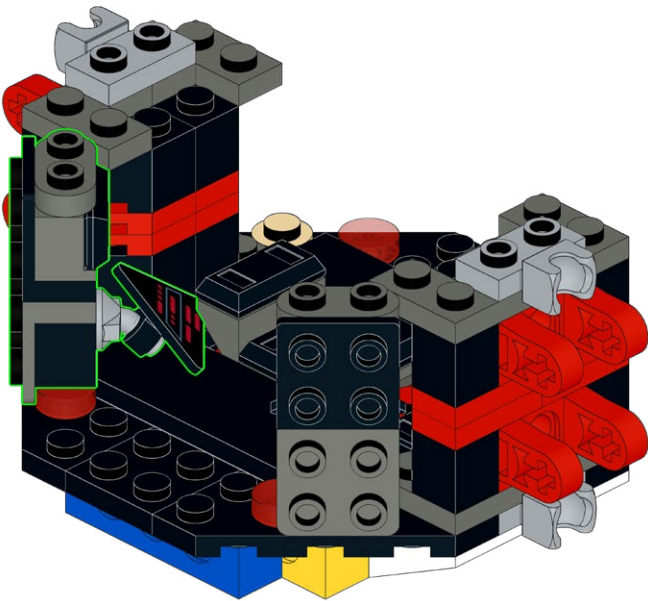

24

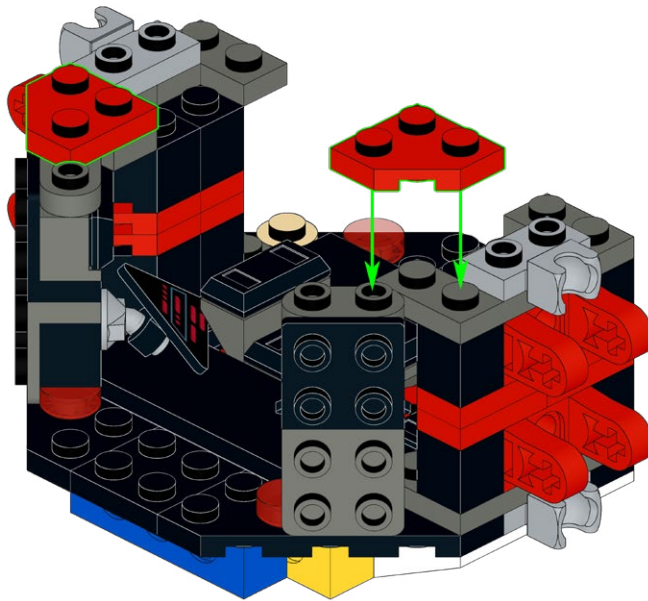
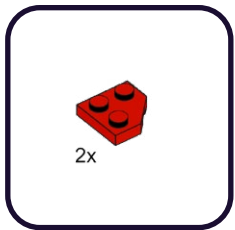

# 25

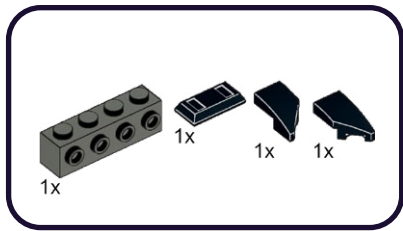

1

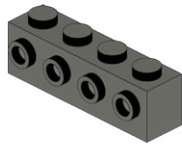

2

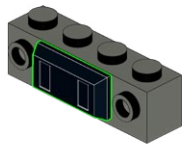

3

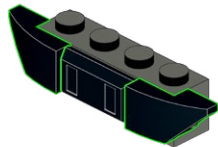

# 26

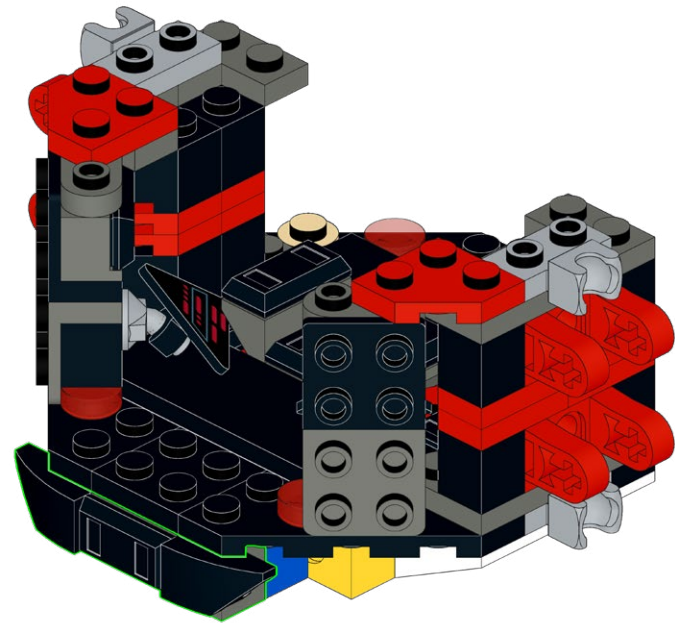

# 27

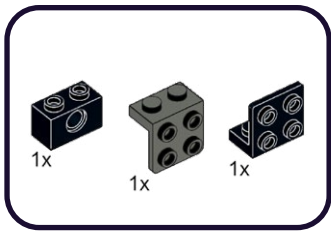

1



2

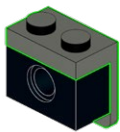

3

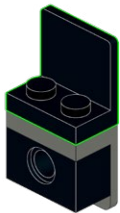

# 28

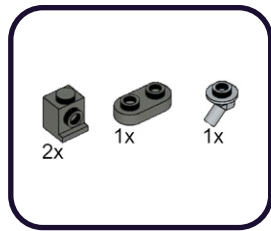

1

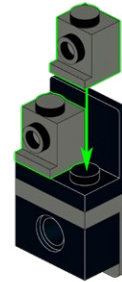

2

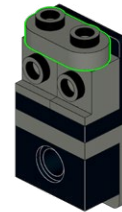

3

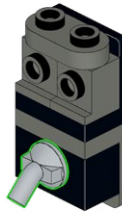

29



1

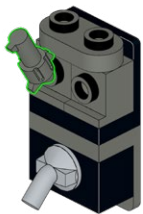

2

5

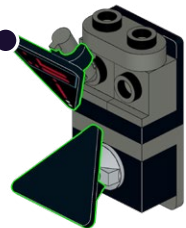

30

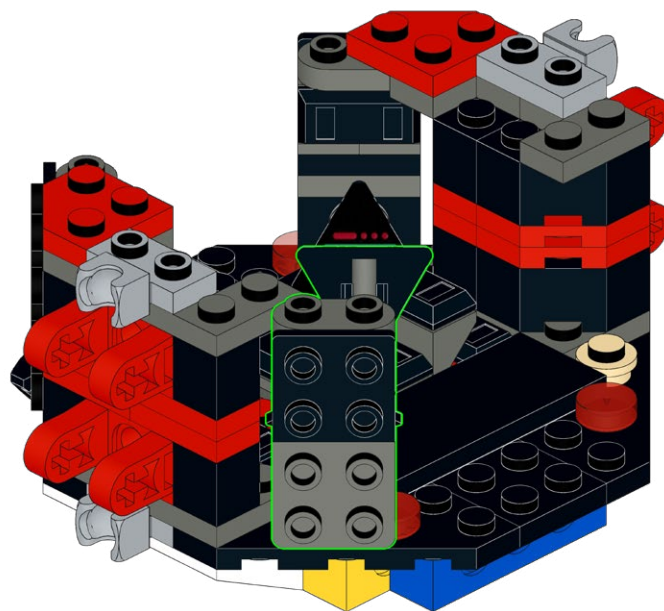



31

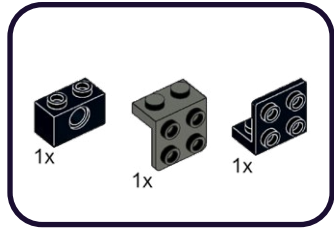

1



2

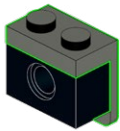

3

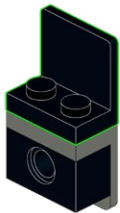

32

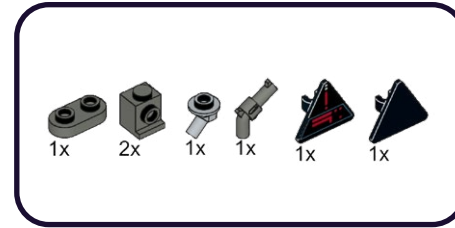

1

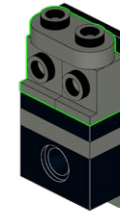

2

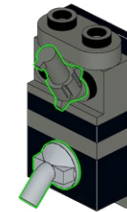

3

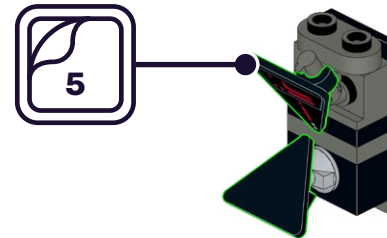

33

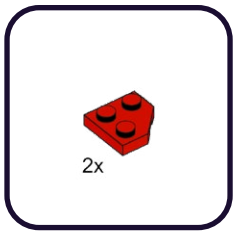

1

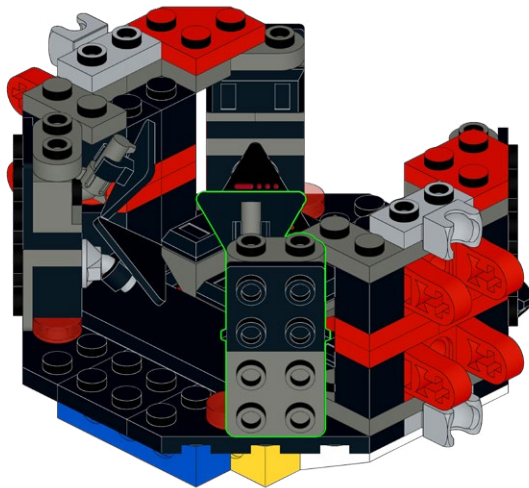

2

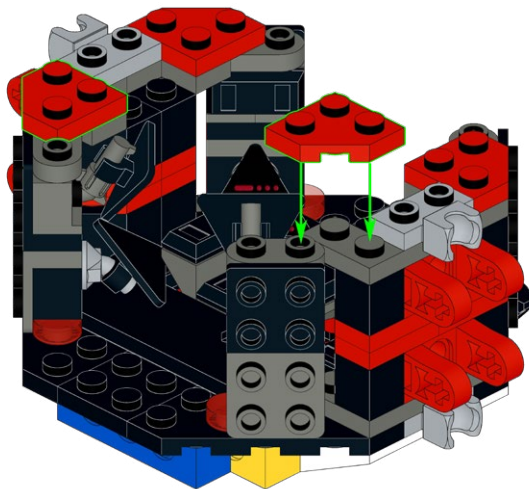

**HOLD UP!**

You might notice some bags are out of order, as well as left over pieces, but that's ok! We're changing the way you build LEGO!

**HALTEN!**

Möglicherweise stellen Sie fest, dass einige Beutel nicht in Ordnung sind und auch Teile übrig bleiben, aber das ist in Ordnung! Wir verändern die Art und Weise, wie Sie LEGO bauen!

**TENIR BON!**

Vous remarquerez peut-être que certains sacs sont en panne, ainsi que des morceaux restants, mais ce n'est pas grave ! Nous changeons la façon dont vous construisez LEGO !

**SOSTENERE!**

Potresti notare che alcune borse sono fuori uso, così come alcuni pezzi avanzati, ma va bene! Stiamo cambiando il modo in cui costruisci i LEGO!

**¡SOSTENER!**

Puede que notes que algunas bolsas están fuera de orden, así como piezas sobrantes, ¡pero está bien! ¡Estamos cambiando la forma de construir LEGO!

**耽误!**

您可能会注意到有些袋子坏了, 还有剩余的碎片, 但这没关系! 我们正在改变您搭建乐高的方式!

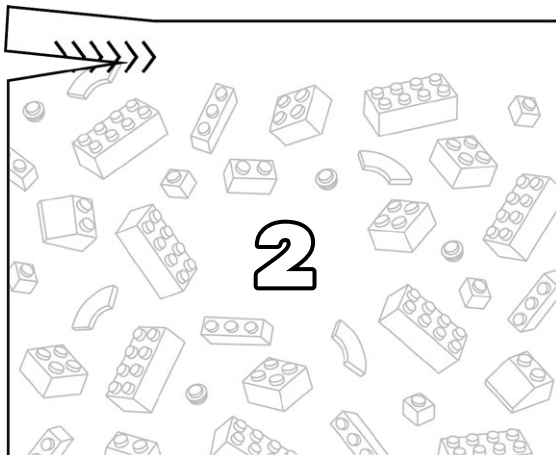
**Open LEGO® Bag 1**

34

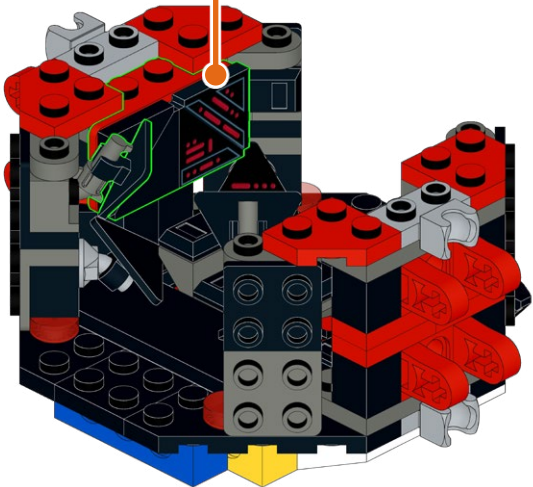
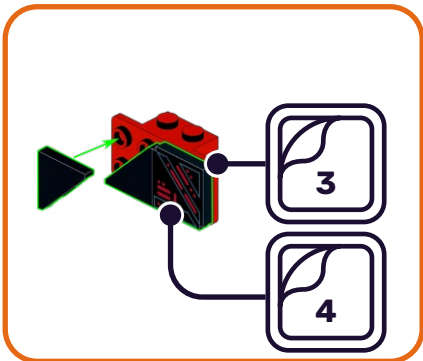
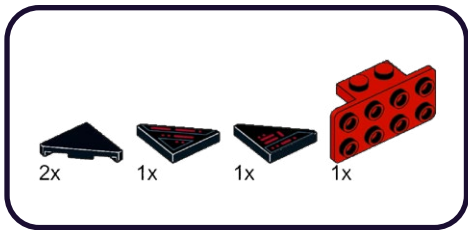

# 35



1

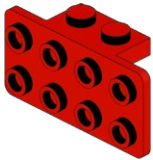

2

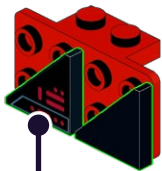

3

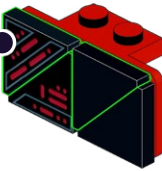

# 36

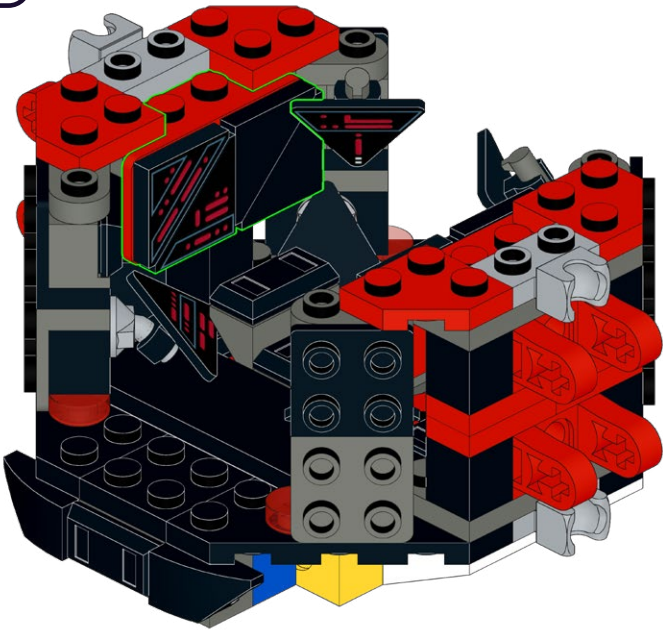

# 37

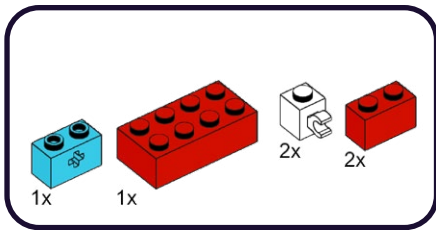

1

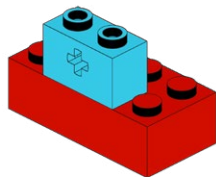

2

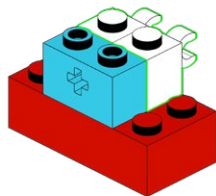

3

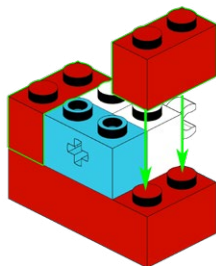

# 38

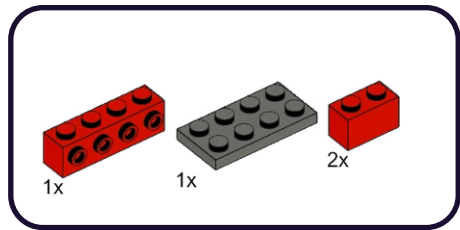

1

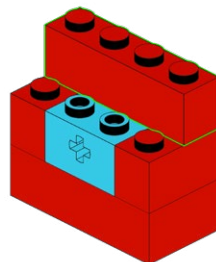

2

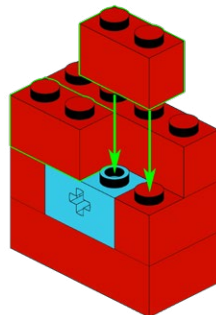

3

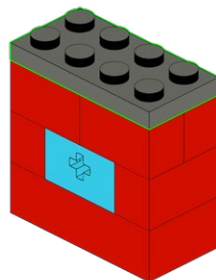

# 39

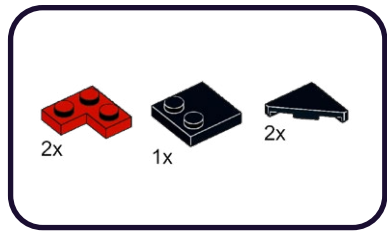

1

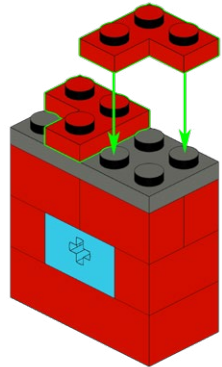

2

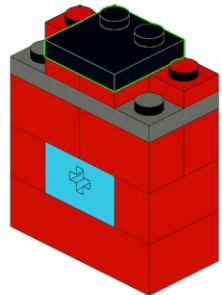

3

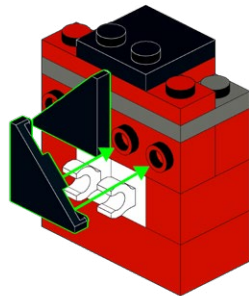

# 40

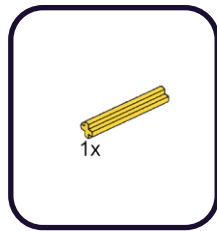

1

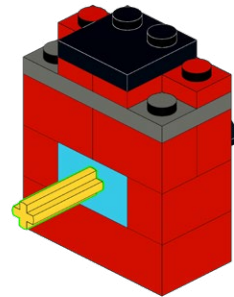
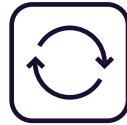



41

2x

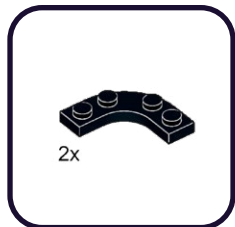

1

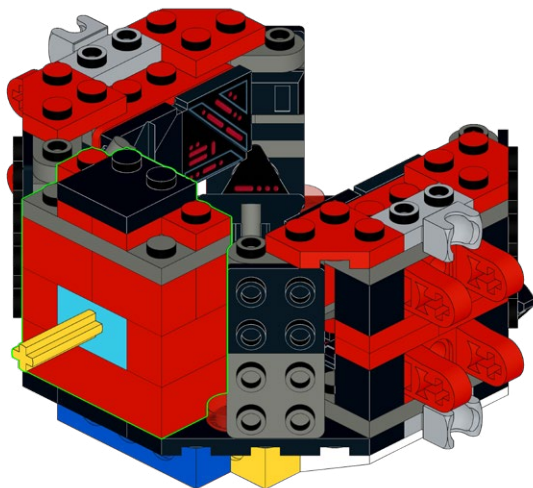

2

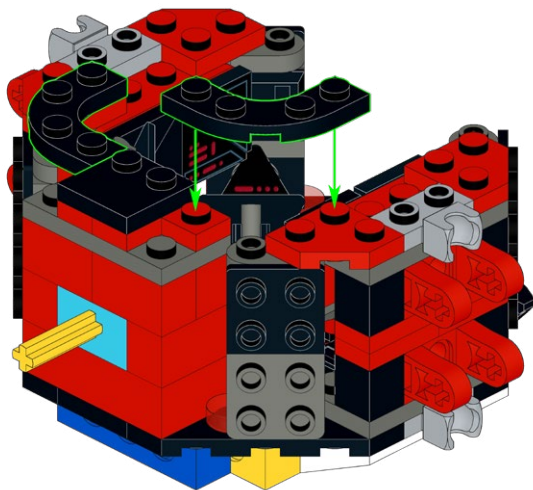

42

1x

1x

1x

2x

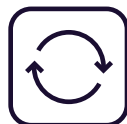
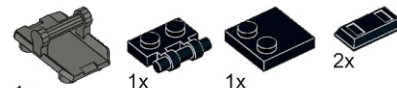

1

2

3

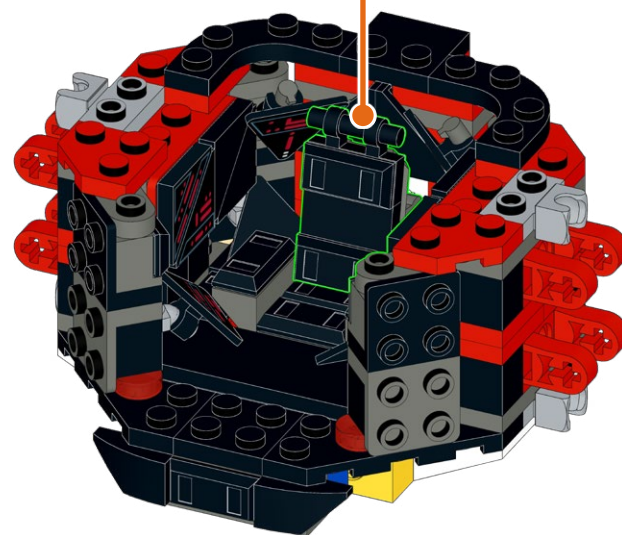
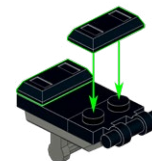
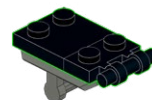
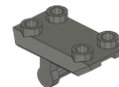



43

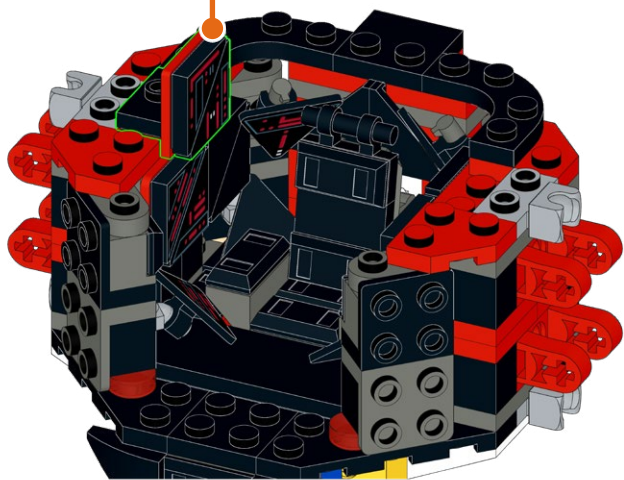
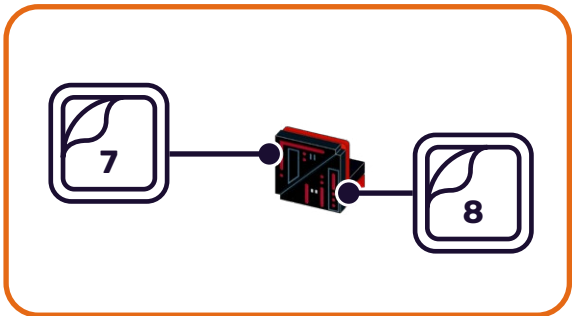
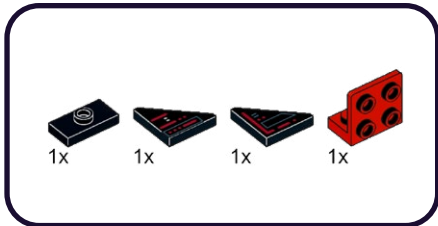

44

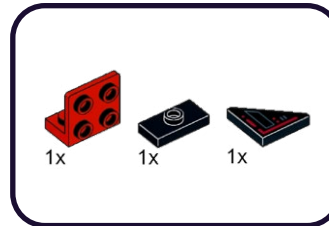

1



2

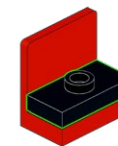

3



45

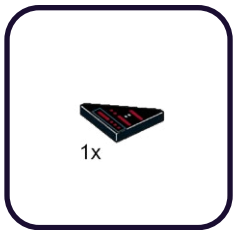

2

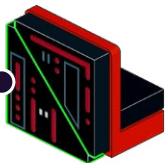

46

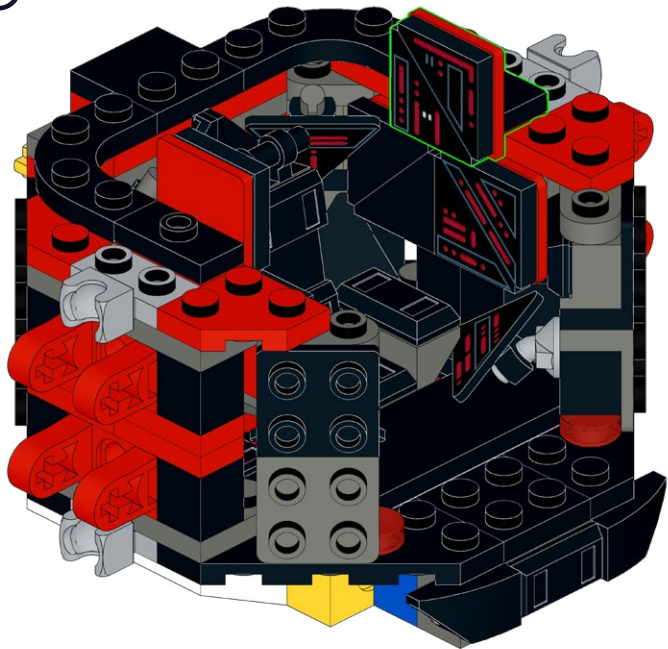

47

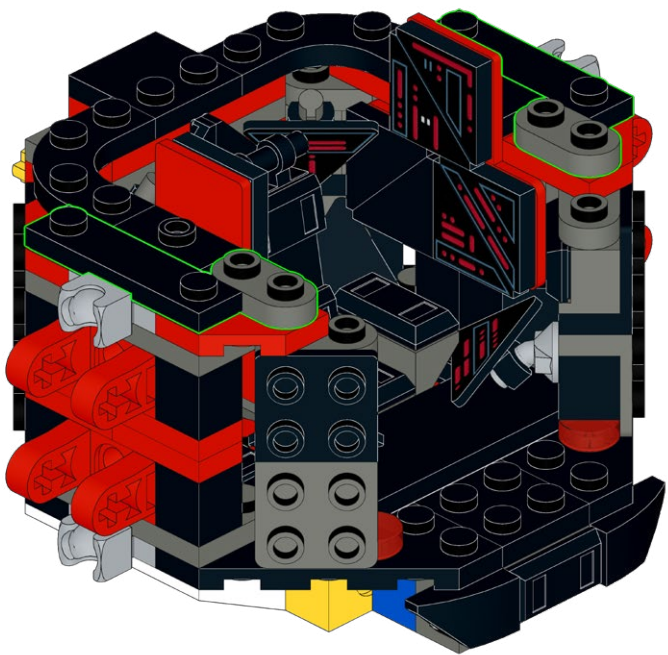
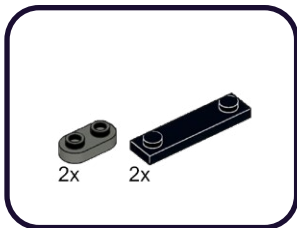

48

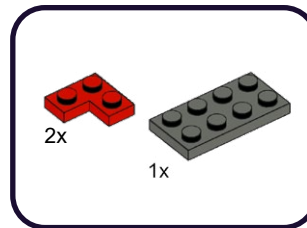

1

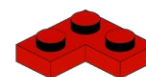

2

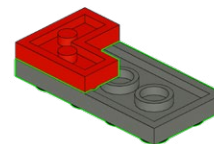
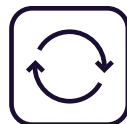

3

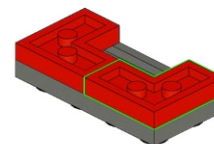

# 49

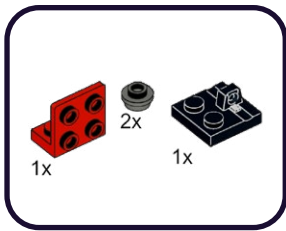

1

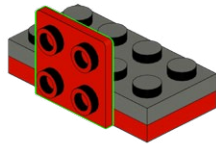

2

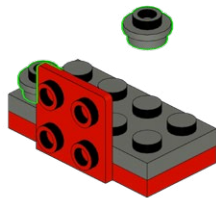

3

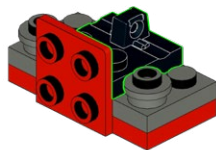

# 50

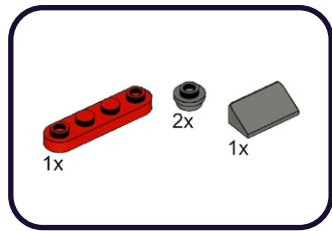

1

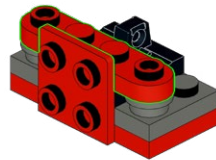

2

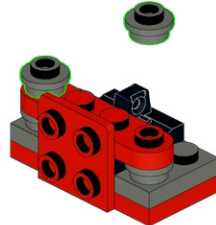

3

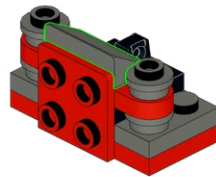

# 51

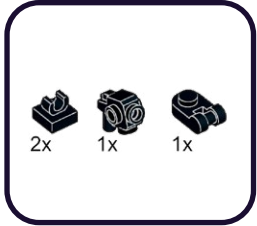

1

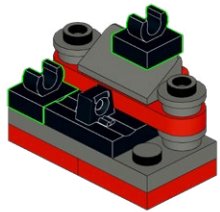

2

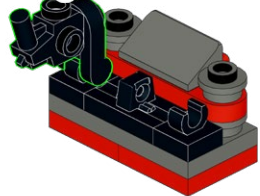

# 52

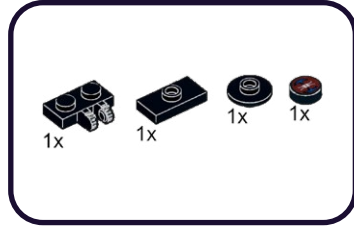

1

2

3

4



3

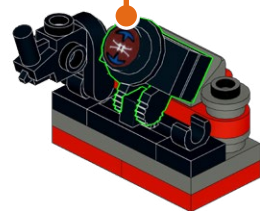

**53**

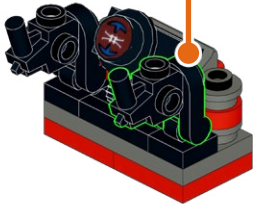

**54**

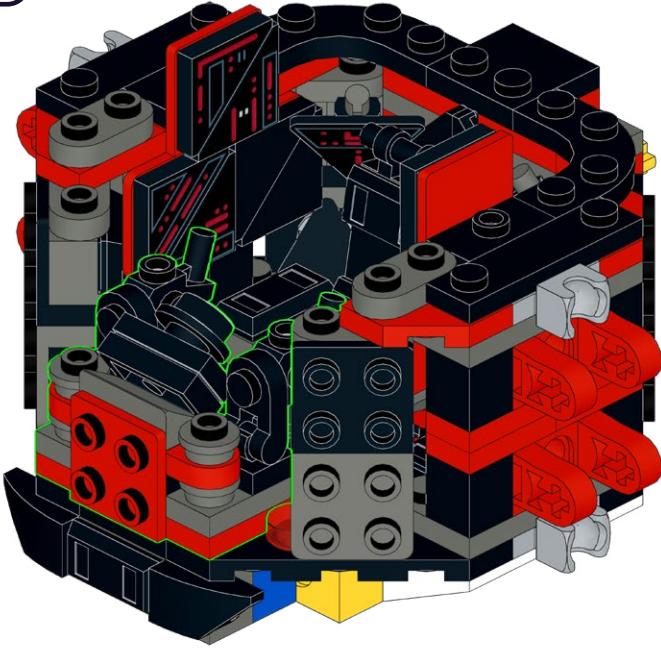

**HOLD UP!**

You might notice some bags are out of order, as well as left over pieces, but that's ok! We're changing the way you build LEGO!

**HALTEN!**

Möglicherweise stellen Sie fest, dass einige Beutel nicht in Ordnung sind und auch Teile übrig bleiben, aber das ist in Ordnung! Wir verändern die Art und Weise, wie Sie LEGO bauen!

**TENIR BON!**

Vous remarquerez peut-être que certains sacs sont en panne, ainsi que des morceaux restants, mais ce n'est pas grave ! Nous changeons la façon dont vous construisez LEGO !

**SOSTENERE!**

Potresti notare che alcune borse sono fuori uso, così come alcuni pezzi avanzati, ma va bene! Stiamo cambiando il modo in cui costruisci i LEGO!

**¡SOSTENER!**

Puede que notes que algunas bolsas están fuera de orden, así como piezas sobrantes, ¡pero está bien! ¡Estamos cambiando la forma de construir LEGO!

**耽误!**

您可能会注意到有些袋子坏了, 还有剩余的碎片, 但这没关系! 我们正在改变您搭建乐高的方式!

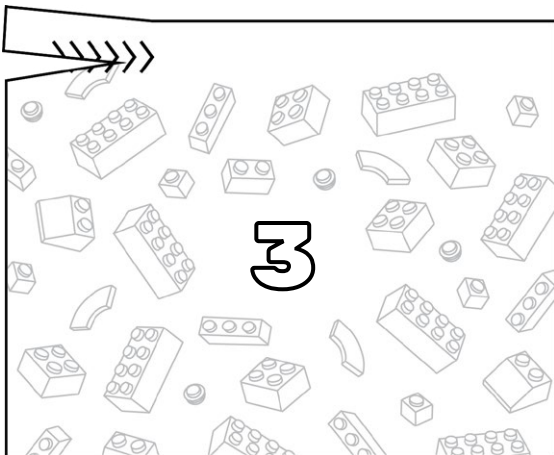
**Open LEGO® Bag 1**



# 55

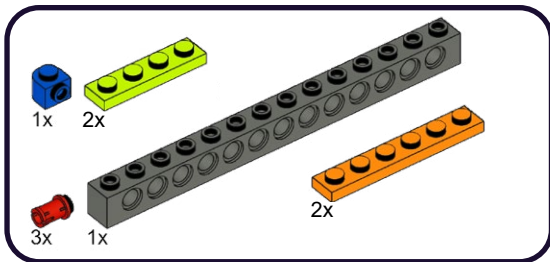

1

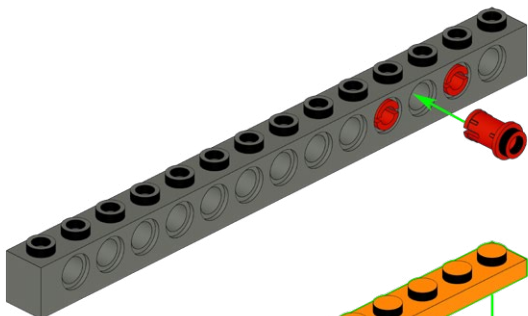

2

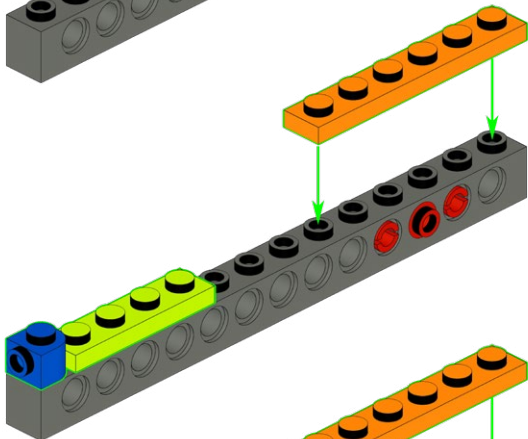

3

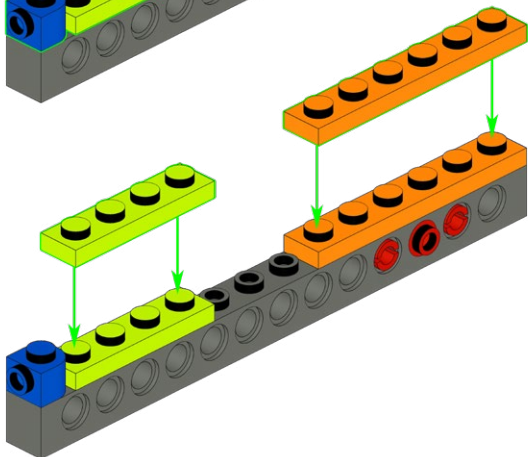

# 56

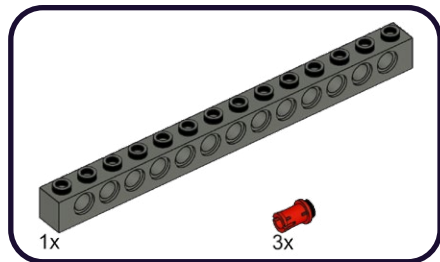

1

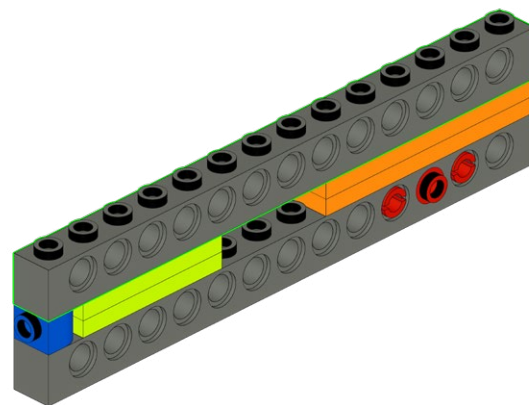

2

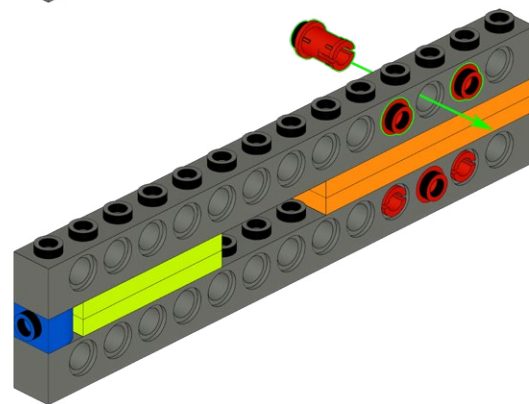



# 57

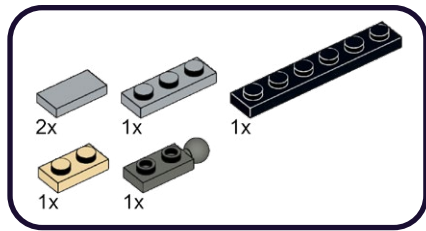

1

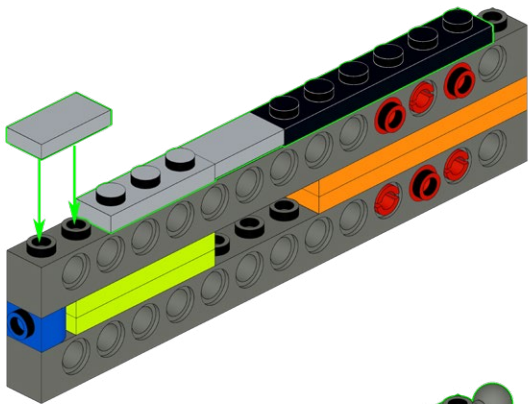

2

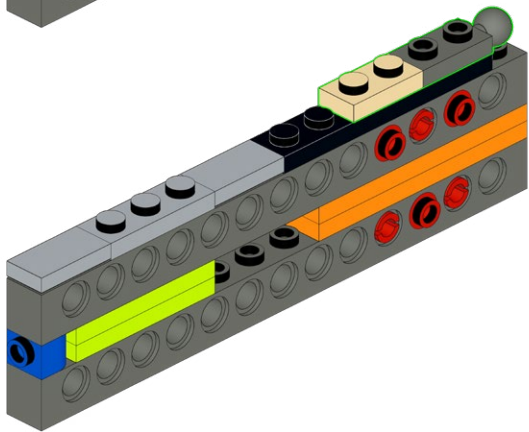

# 58

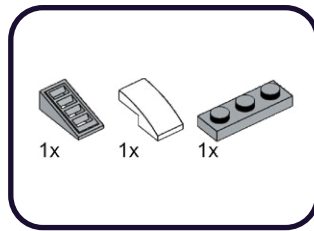

1

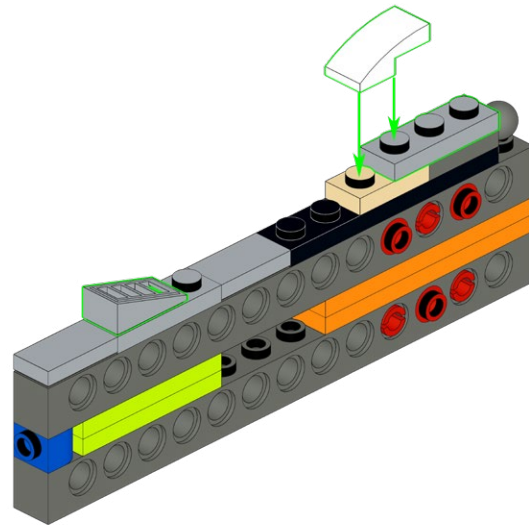

# 59

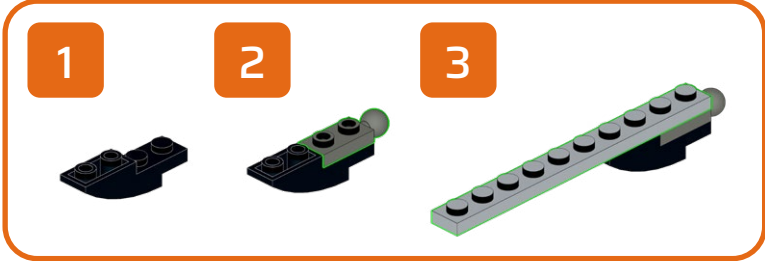
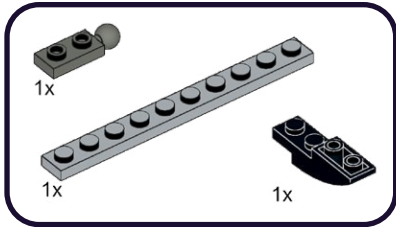

1

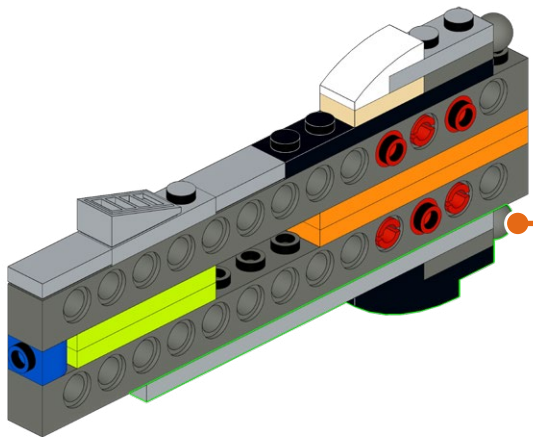

# 60

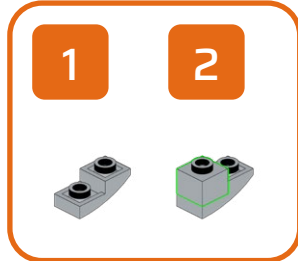
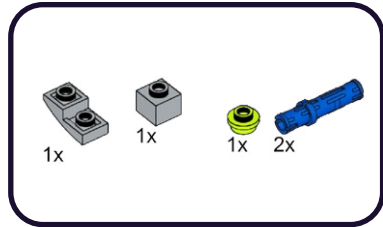

1

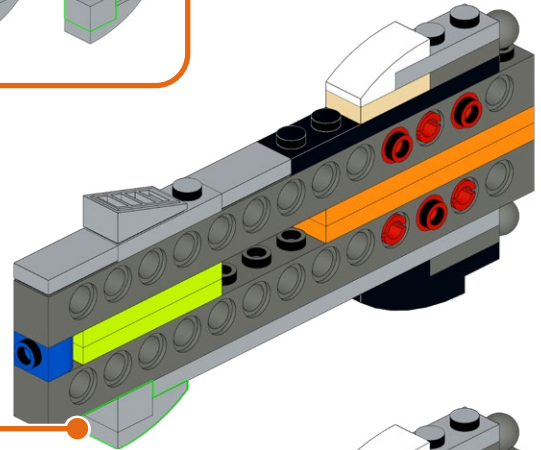

2

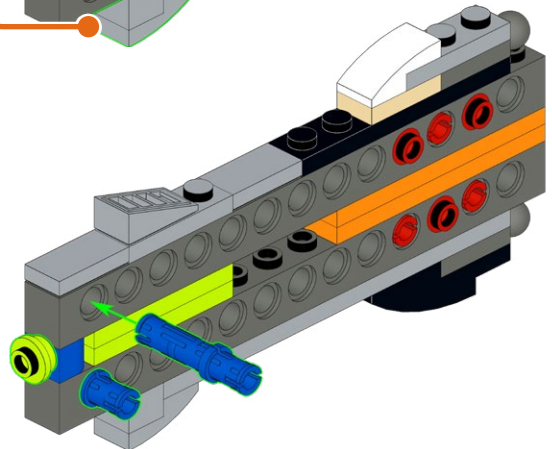

61

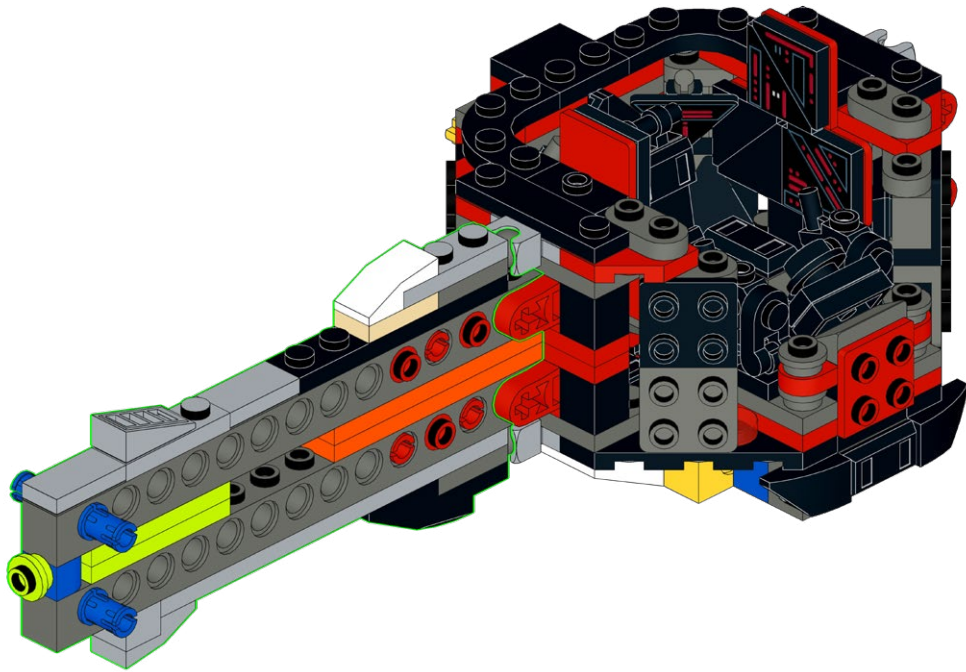

62

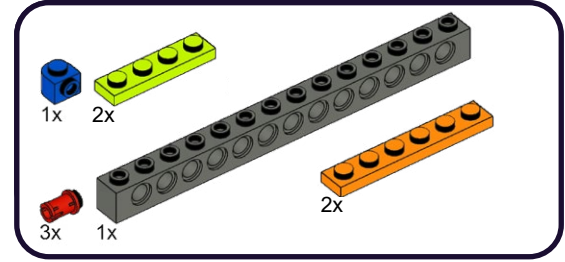

1

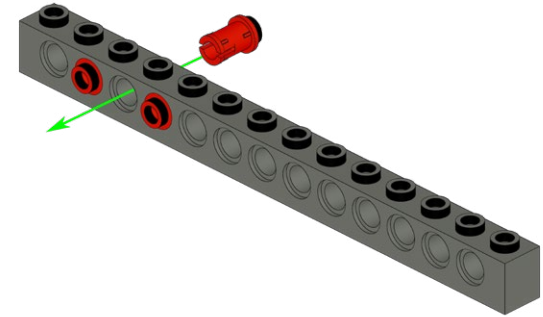

2

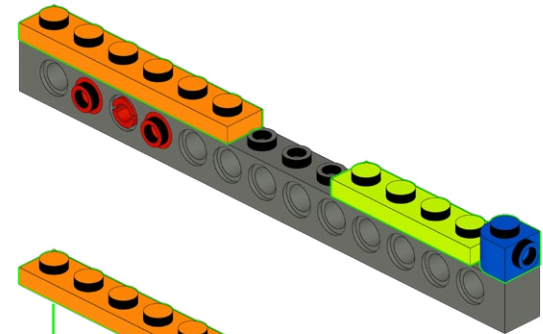

3

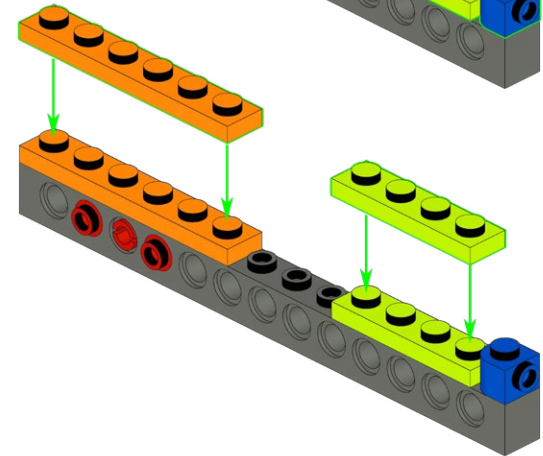

# 63

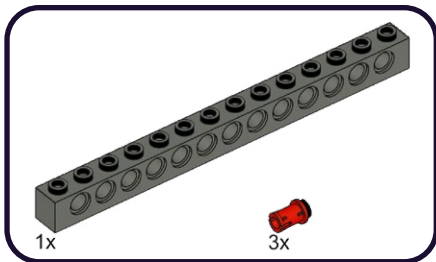

1

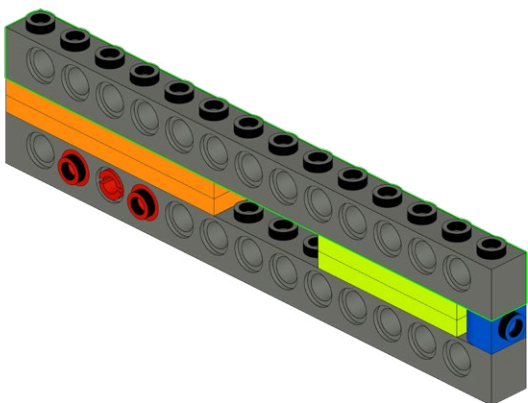

2

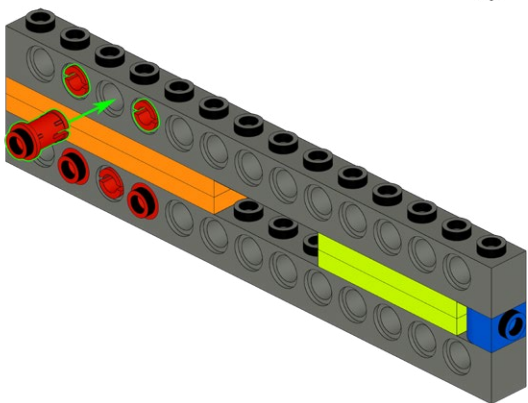

# 64

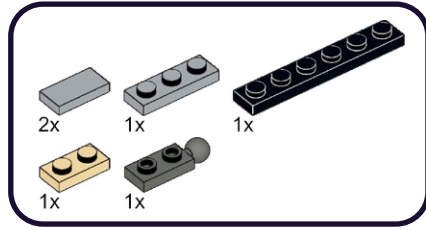

1

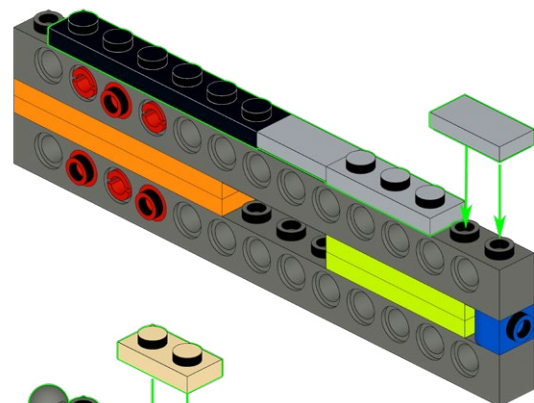

2

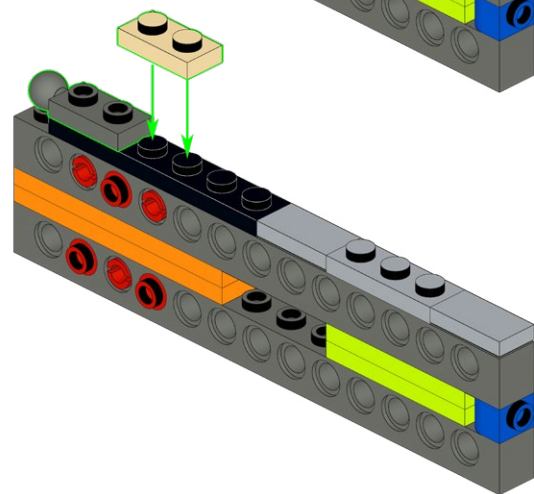

# 65

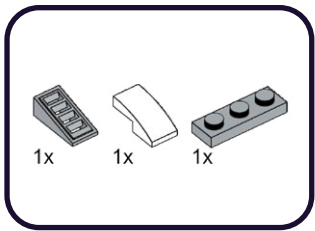

1

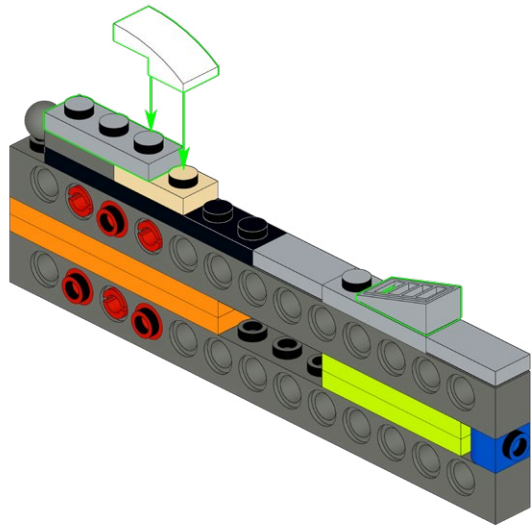

# 66

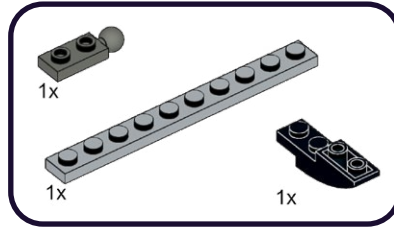

1

2

3

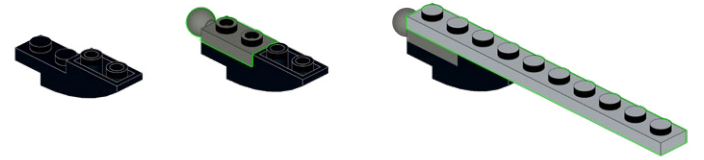

1

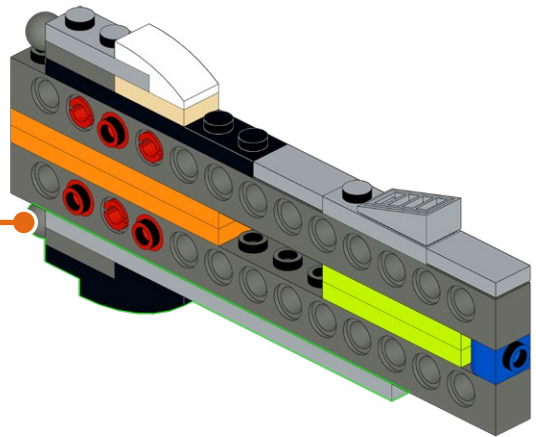



# 67

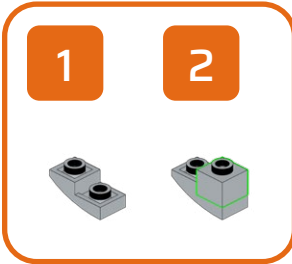
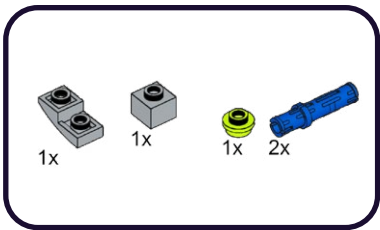

1

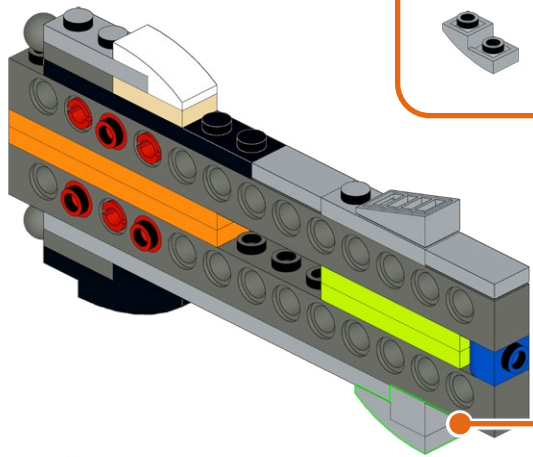

2

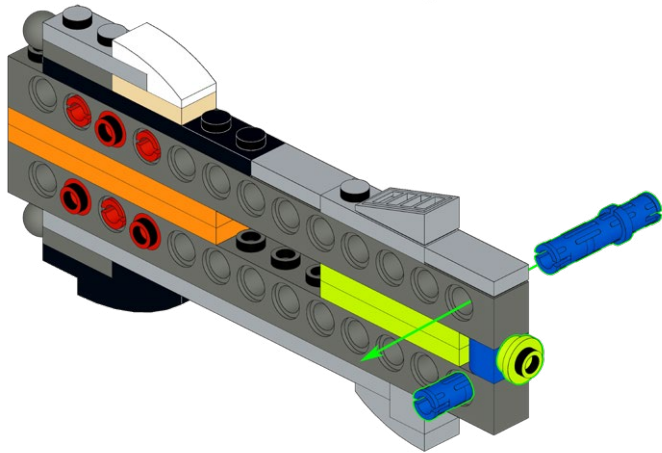

# 68

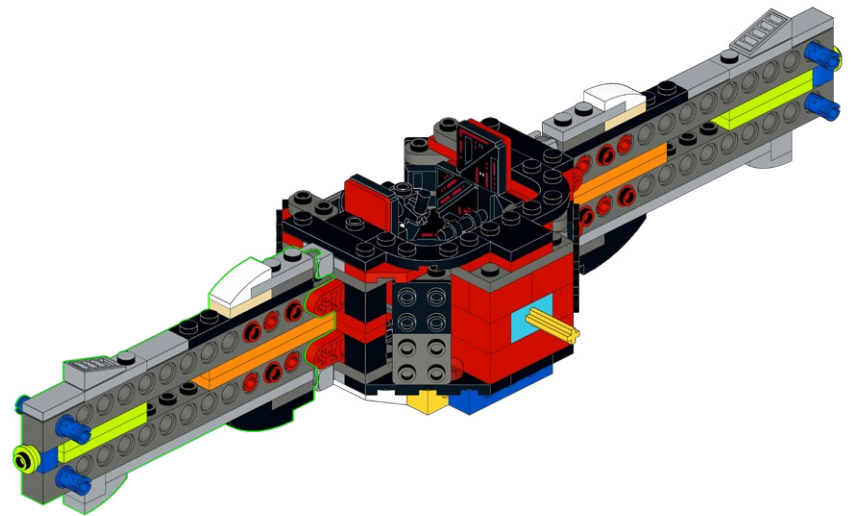
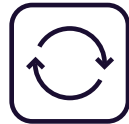

69

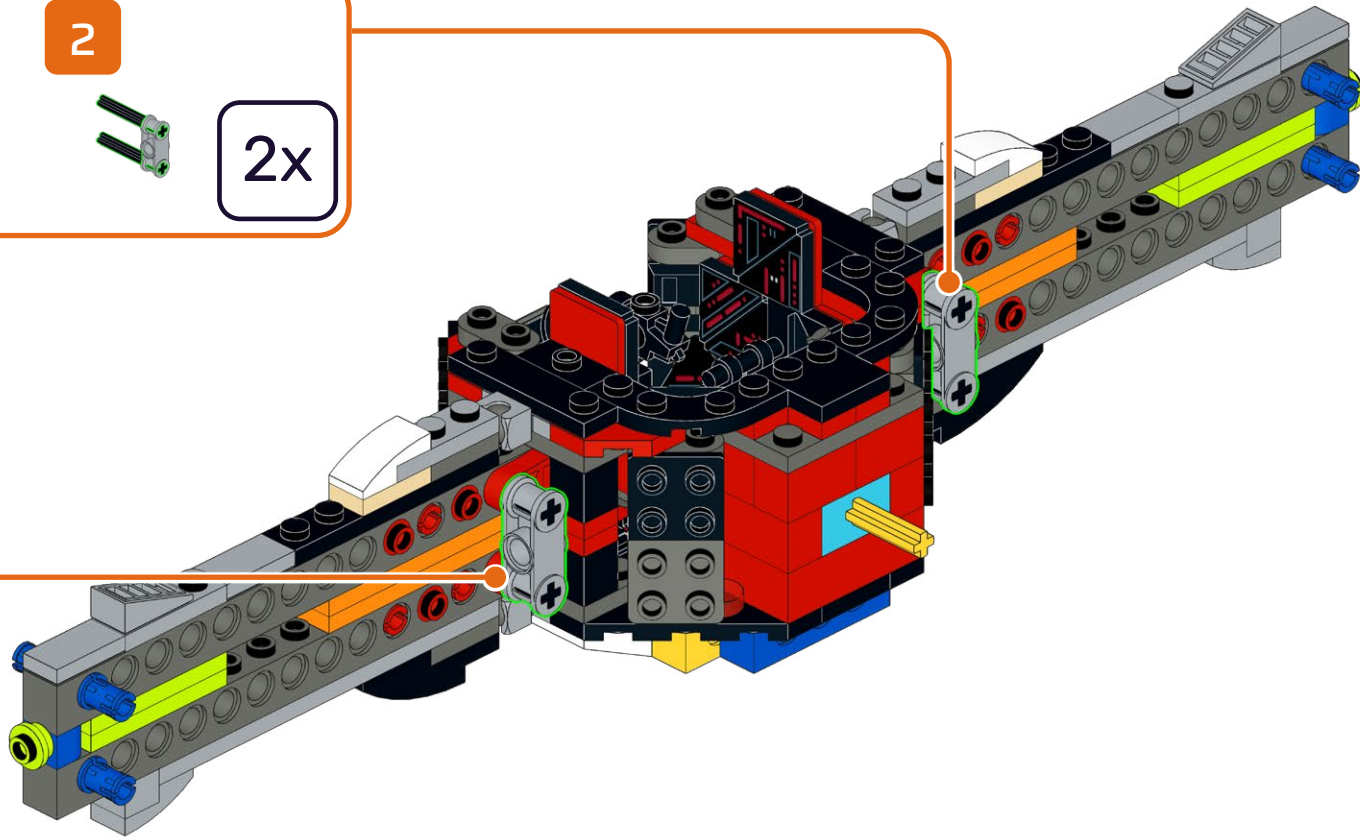
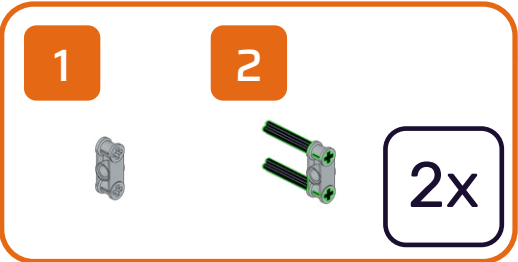
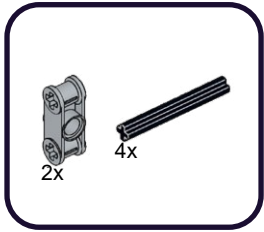

70

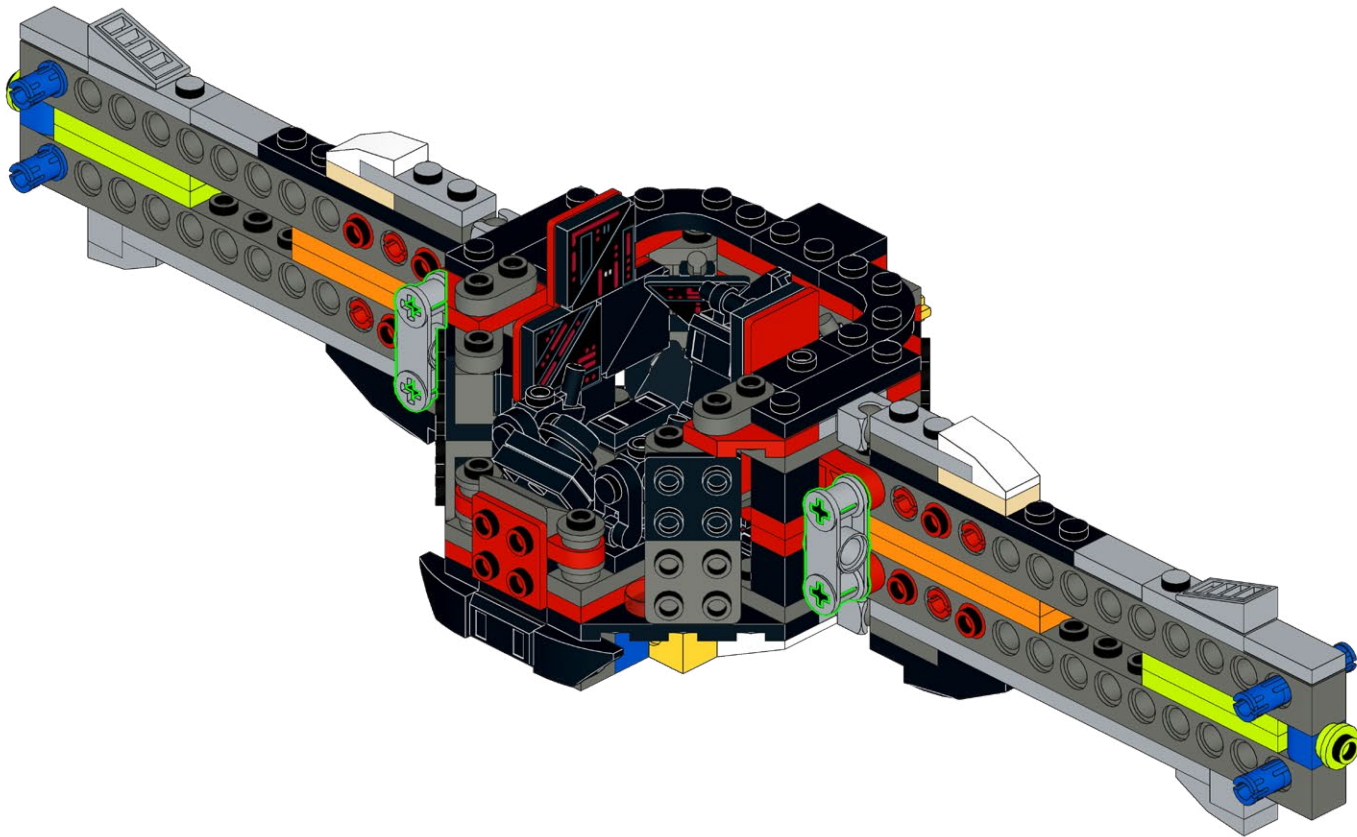
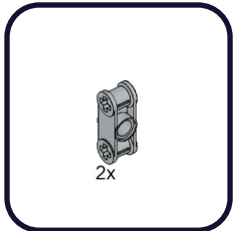



71

1x

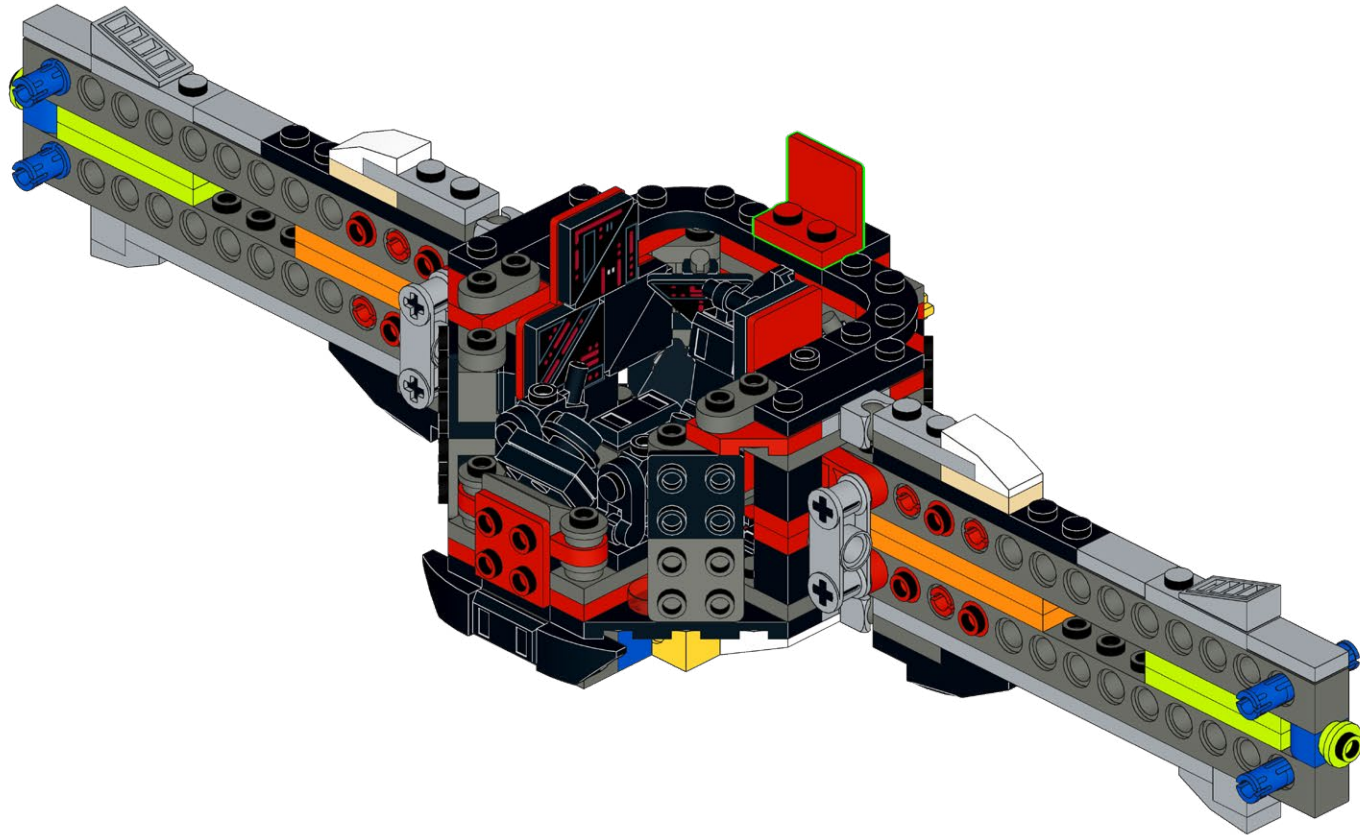

72

2x

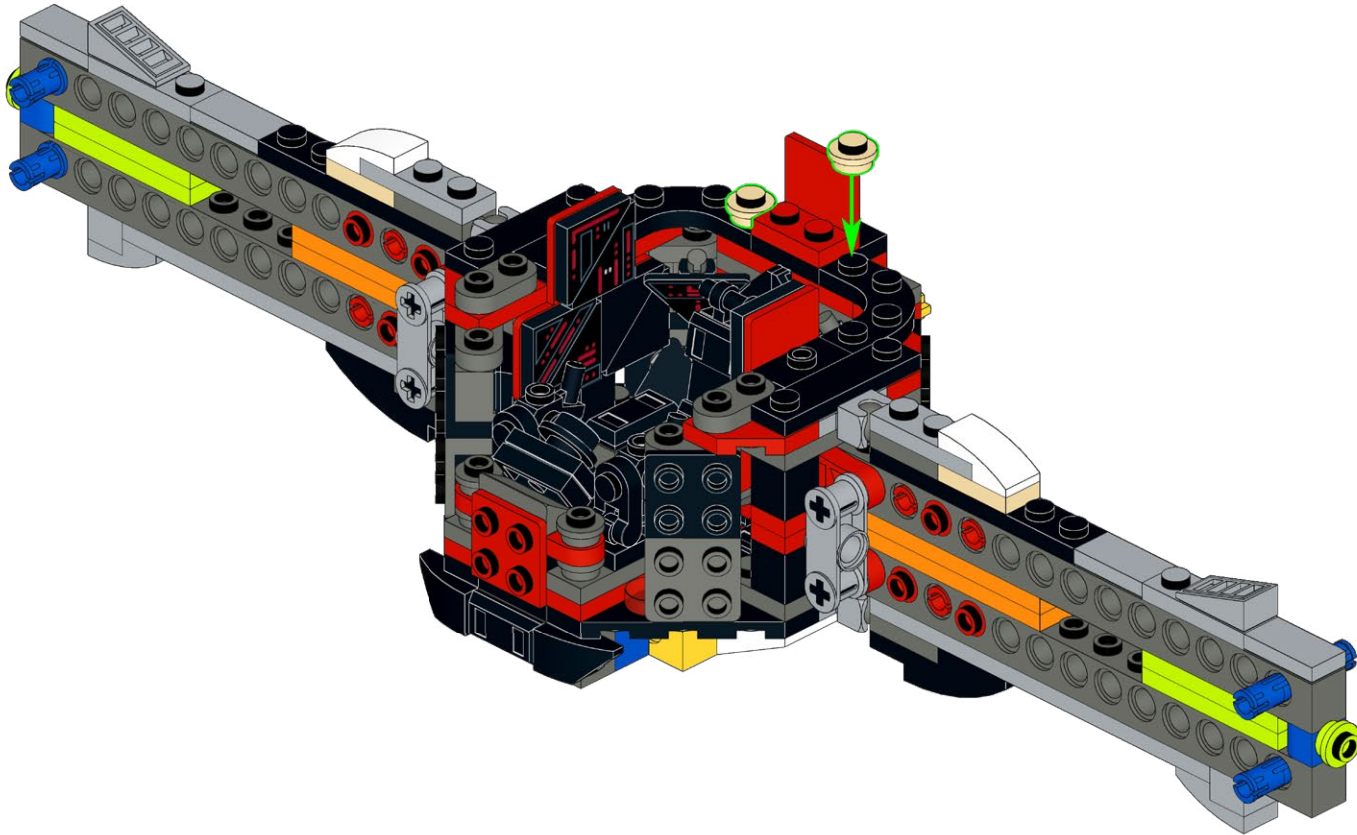

73

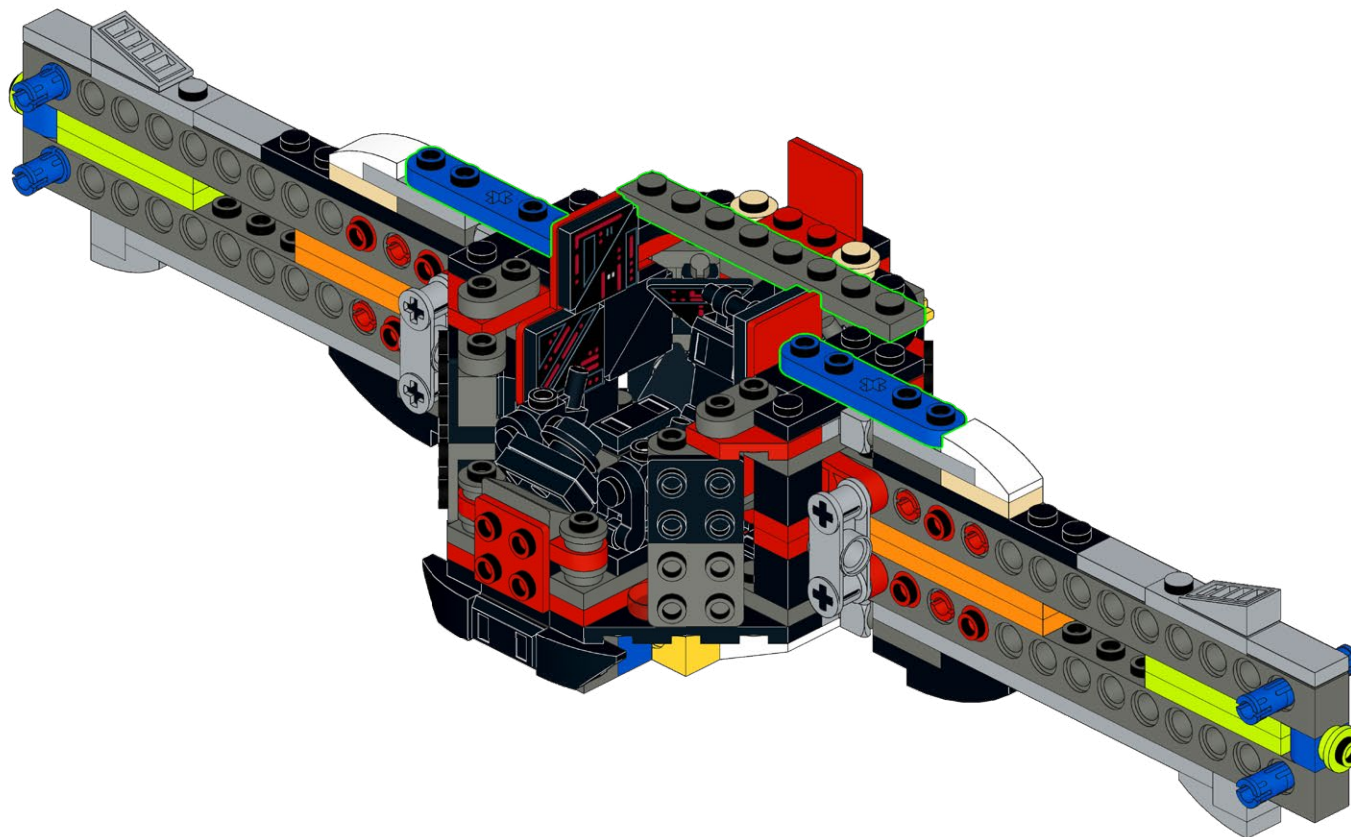
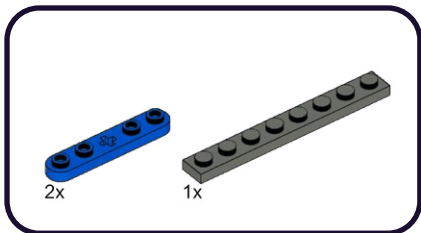

74

4x

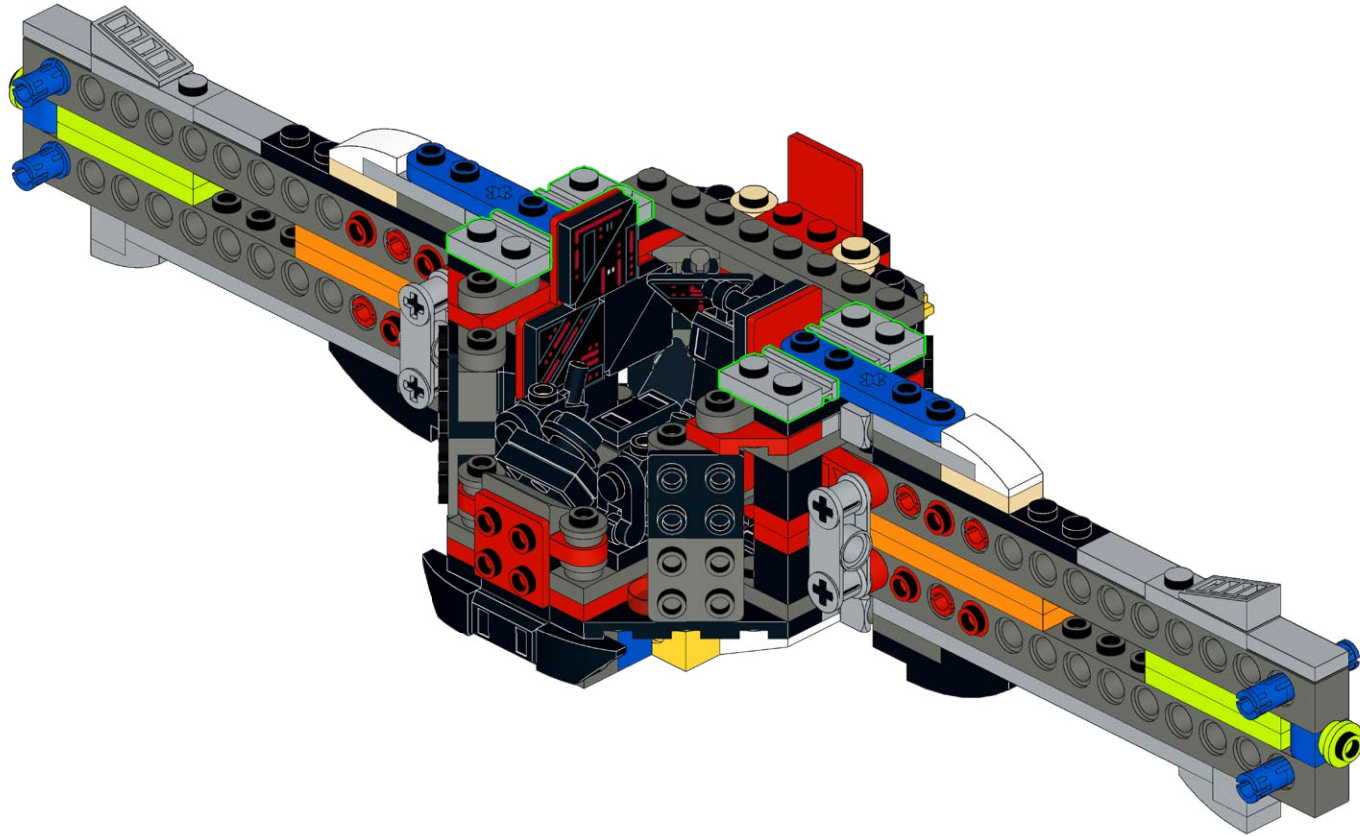



75

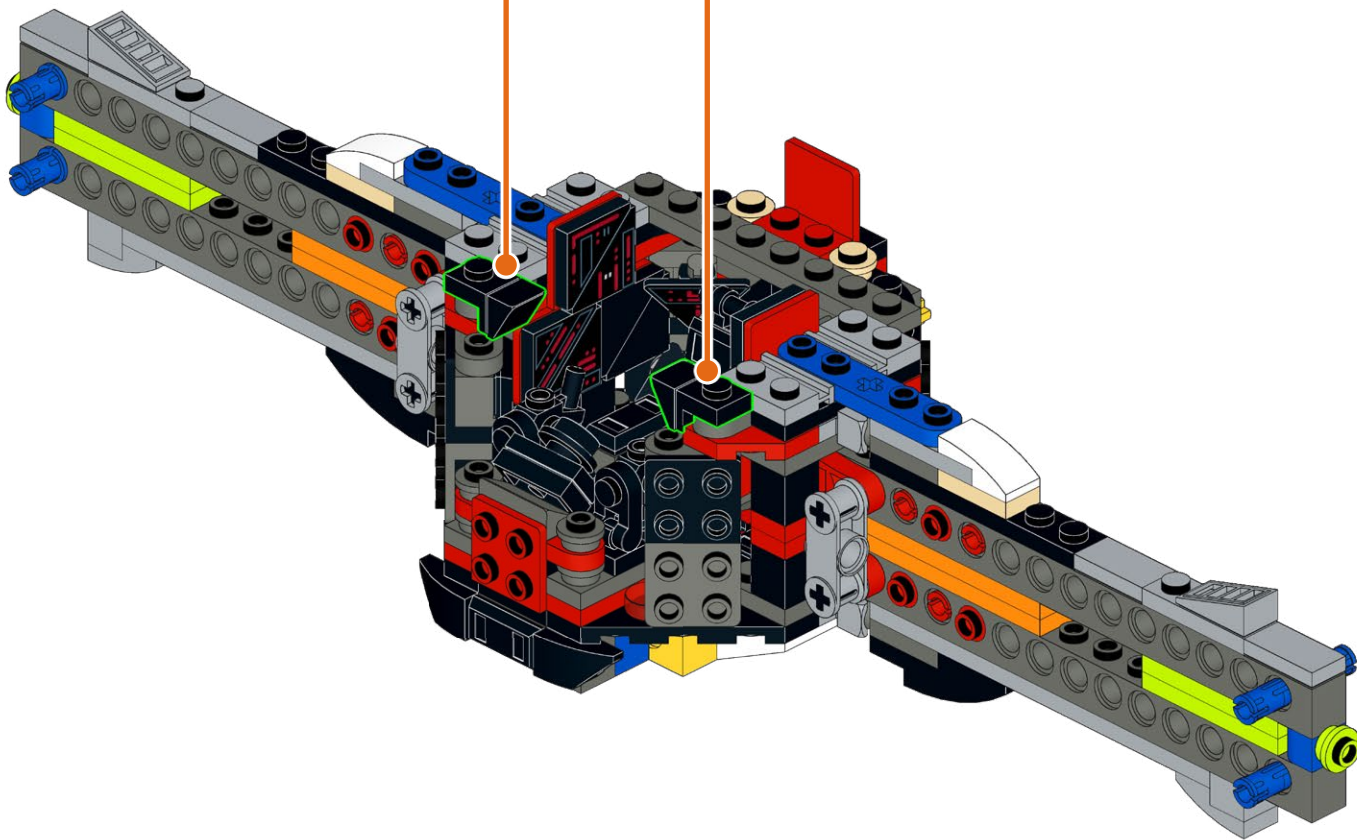
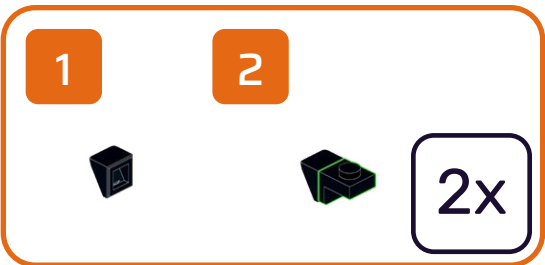
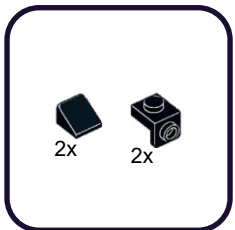



### **HOLD UP!**

You might notice some bags are out of order, as well as left over pieces, but that's ok! We're changing the way you build LEGO!

### **HALTEN!**

Möglicherweise stellen Sie fest, dass einige Beutel nicht in Ordnung sind und auch Teile übrig bleiben, aber das ist in Ordnung! Wir verändern die Art und Weise, wie Sie LEGO bauen!

### **TENIR BON!**

Vous remarquerez peut-être que certains sacs sont en panne, ainsi que des morceaux restants, mais ce n'est pas grave ! Nous changeons la façon dont vous construisez LEGO !

### **SOSTENERE!**

Potresti notare che alcune borse sono fuori uso, così come alcuni pezzi avanzati, ma va bene! Stiamo cambiando il modo in cui costruisci i LEGO!

### **¡SOSTENER!**

Puede que notes que algunas bolsas están fuera de orden, así como piezas sobrantes, ¡pero está bien! ¡Estamos cambiando la forma de construir LEGO!

### **耽误!**

您可能会注意到有些袋子坏了, 还有剩余的碎片, 但这没关系! 我们正在改变您搭建乐高的方式!

#### Open LEGO® Bag 1

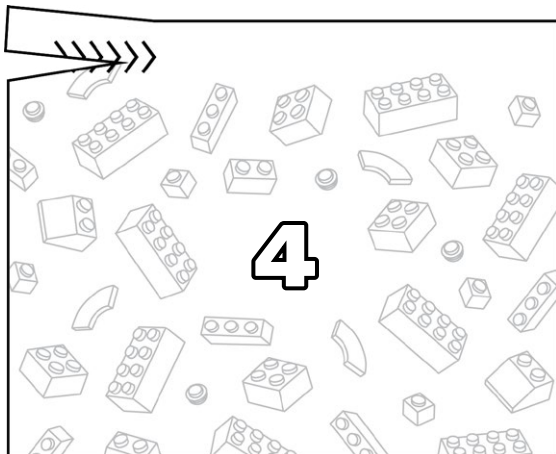

#### Open LMB Bag 01

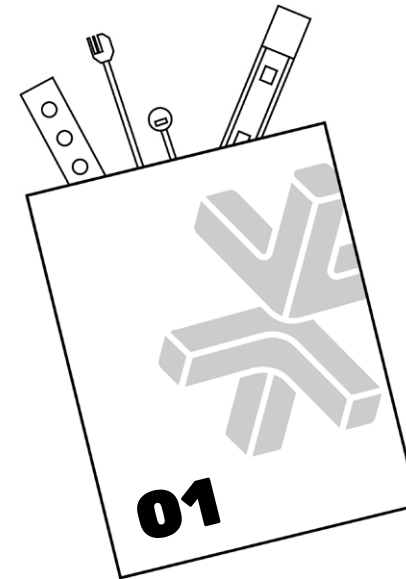

76

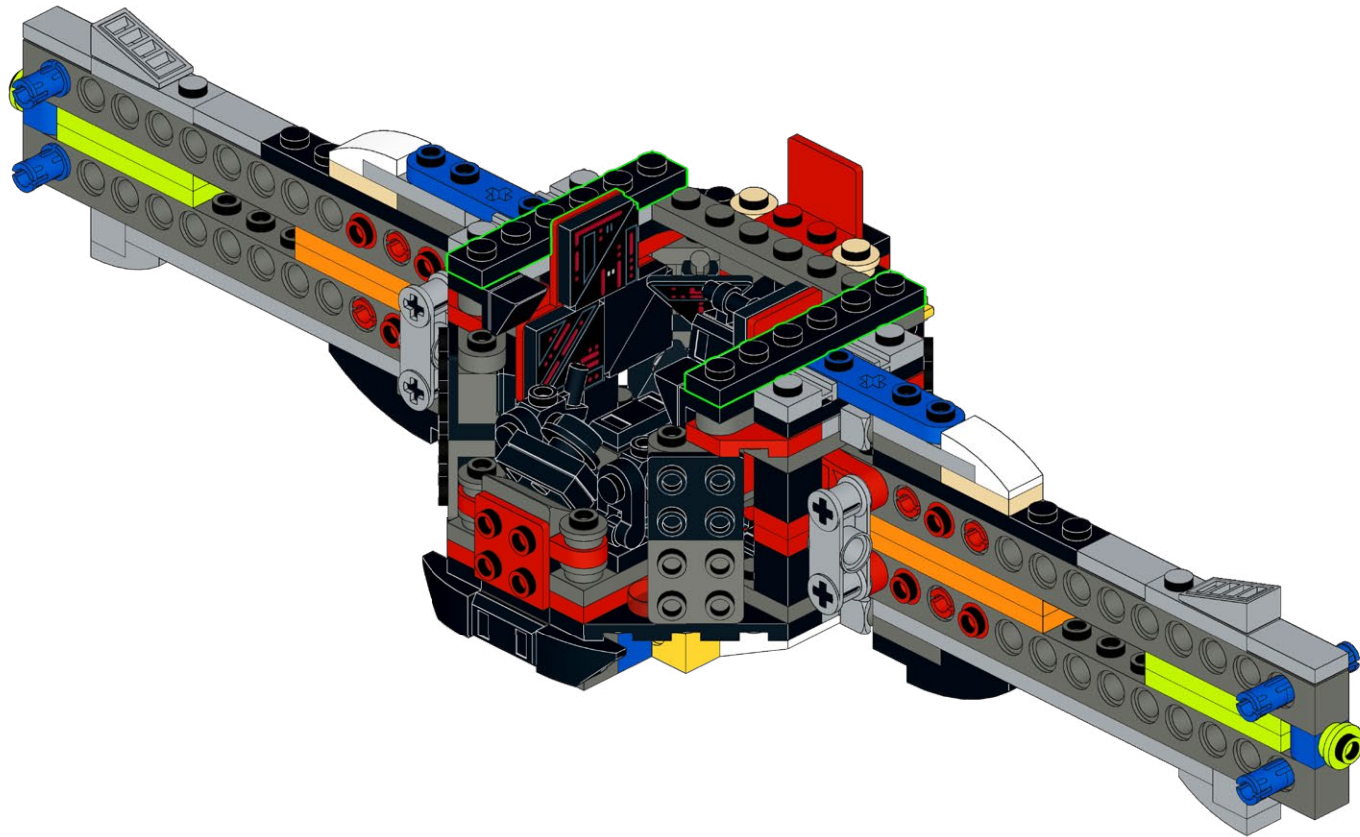
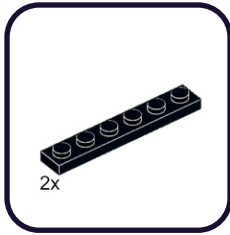

77

2x

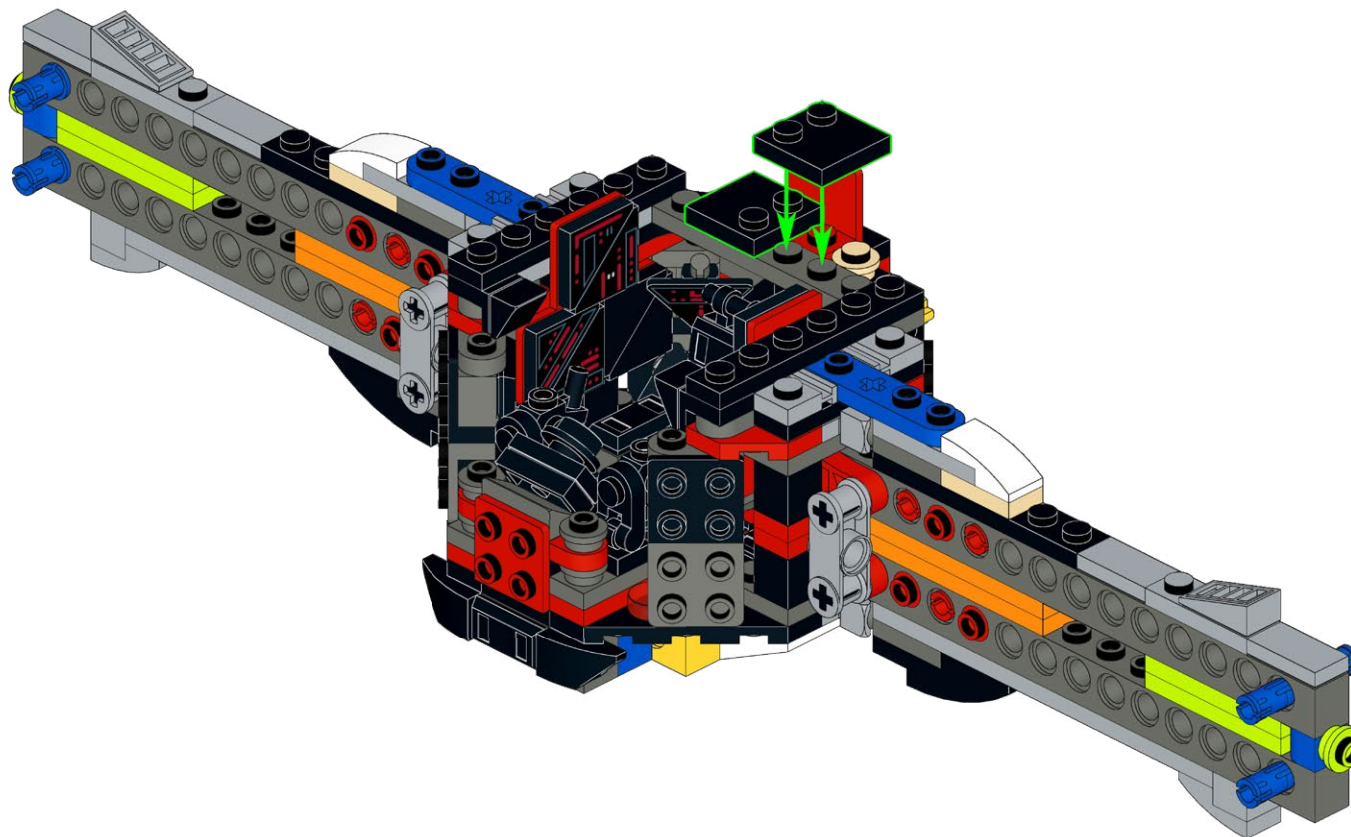



78

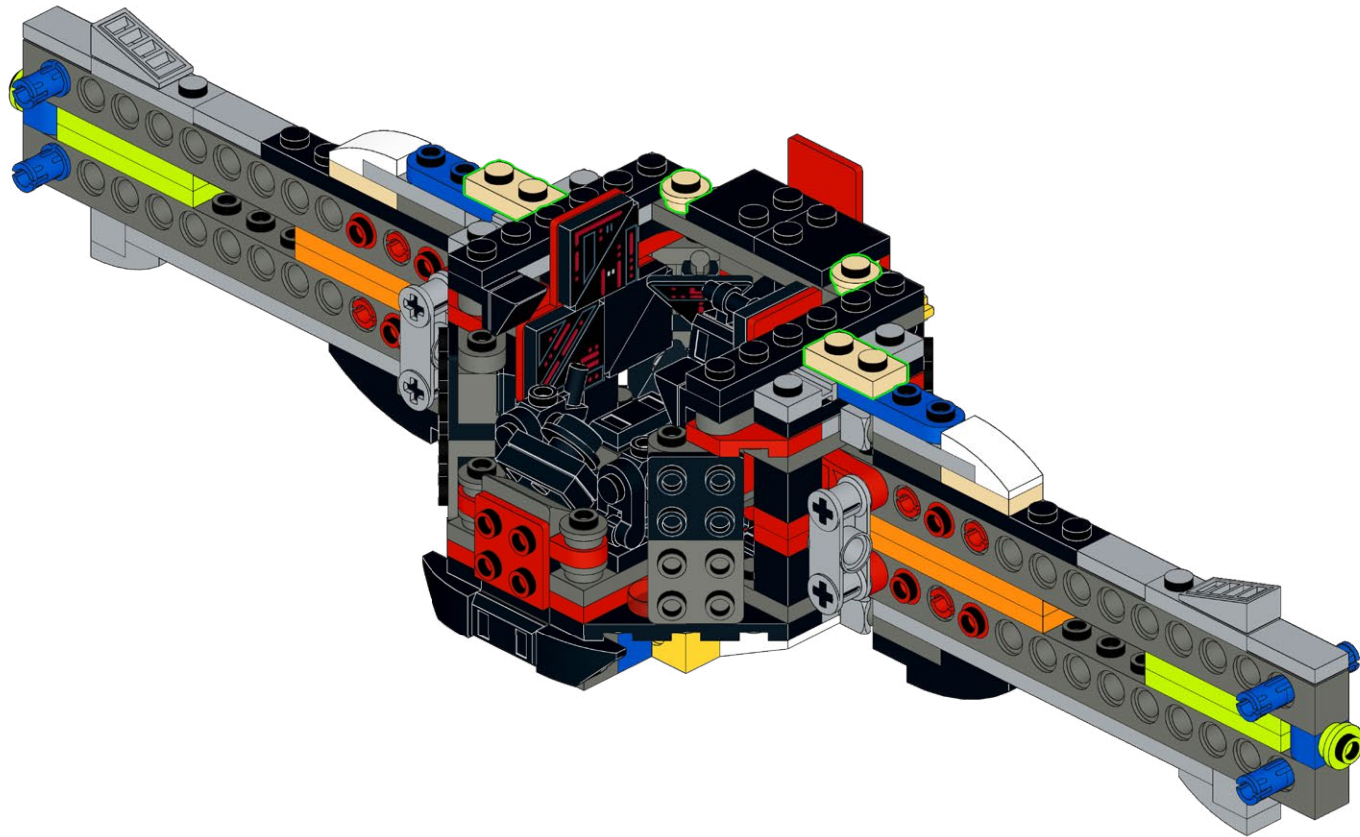
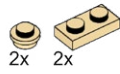

79

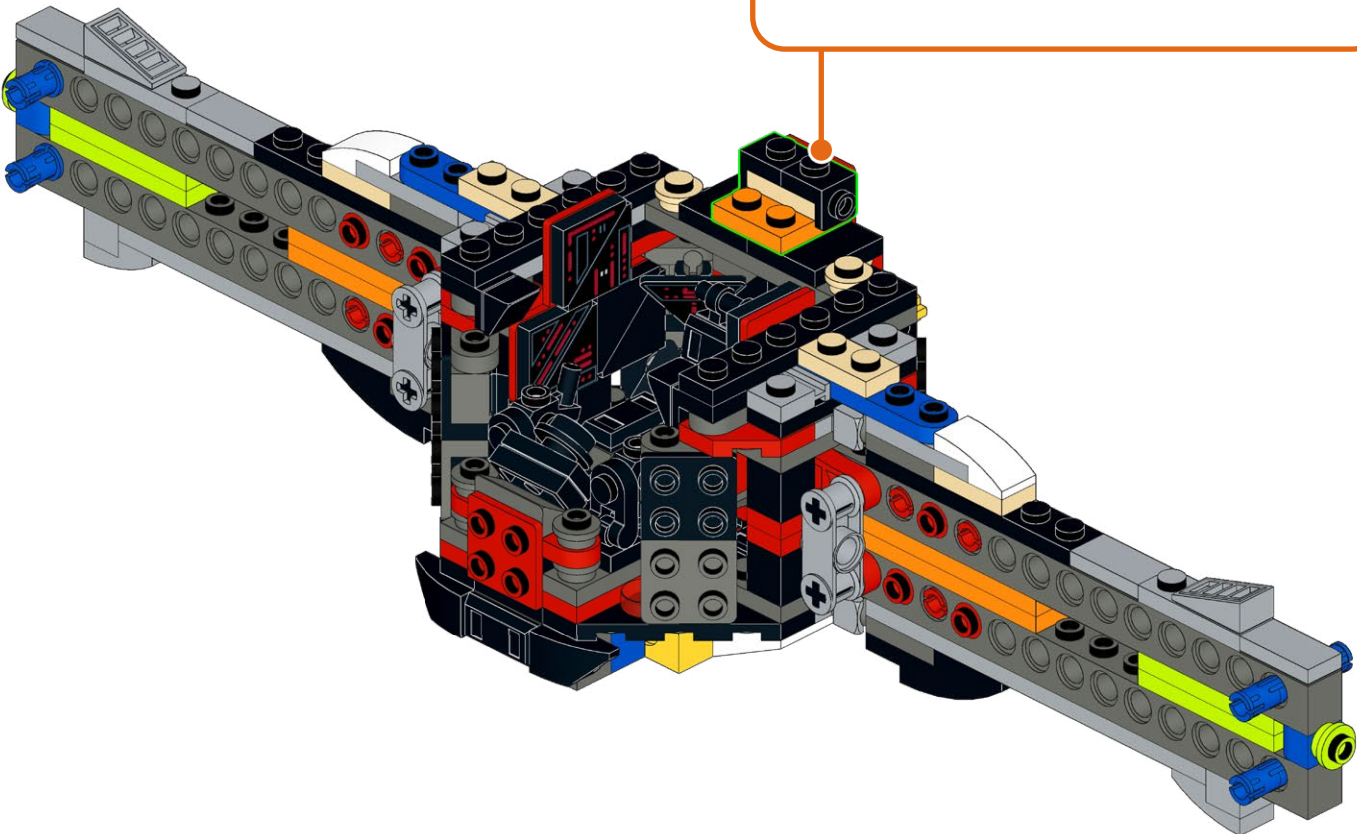
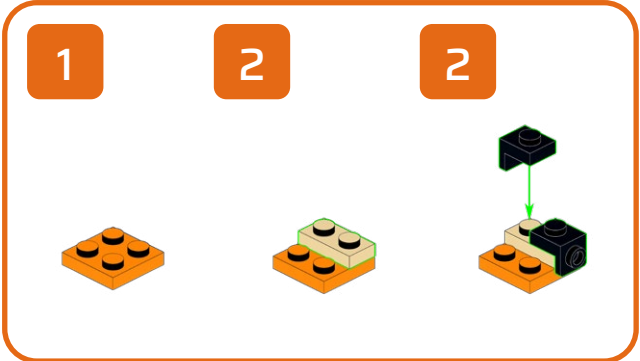
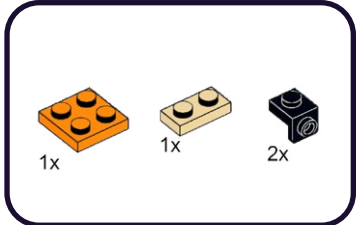

80

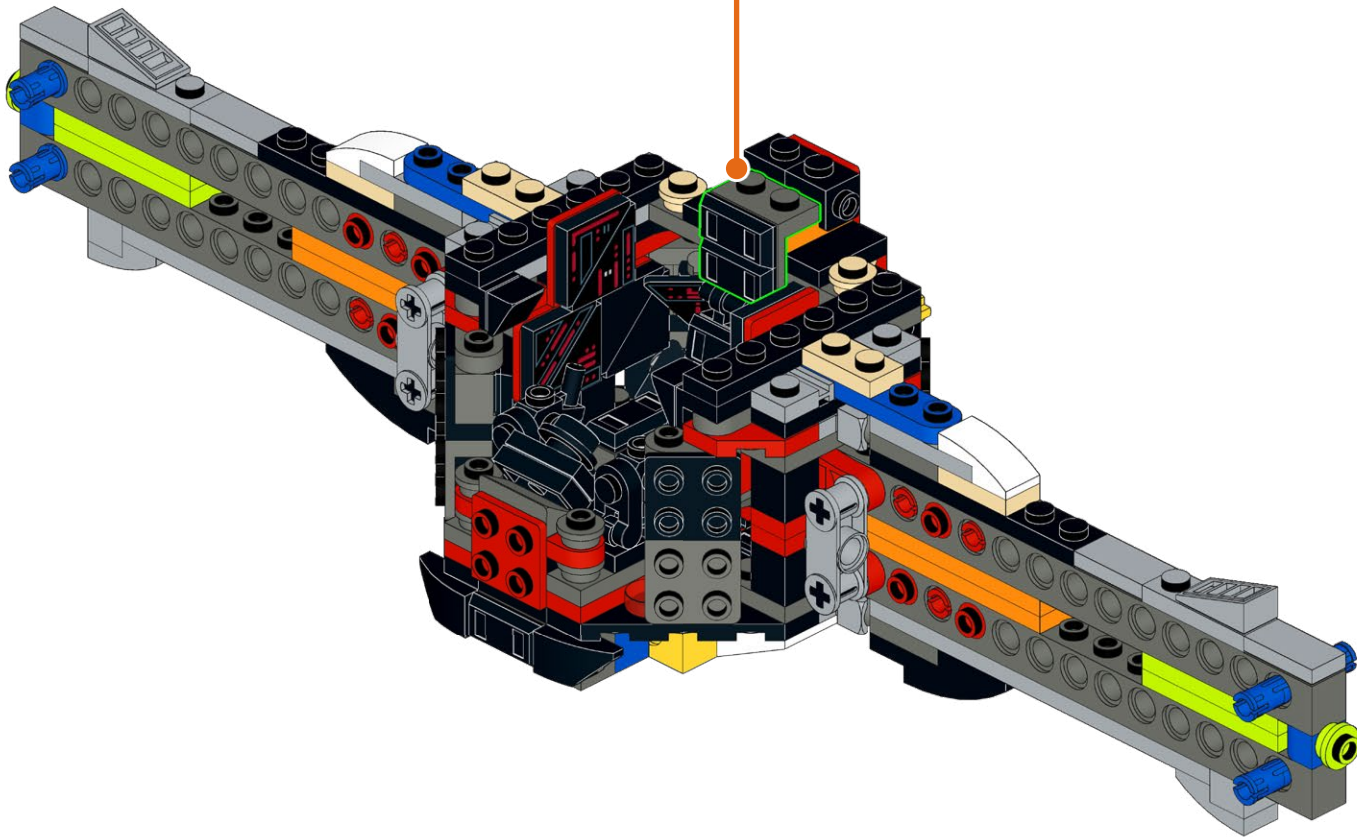
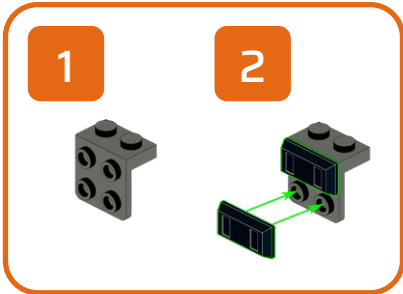
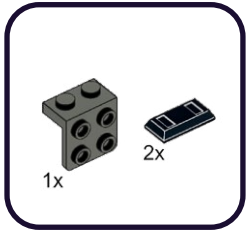

81

2x

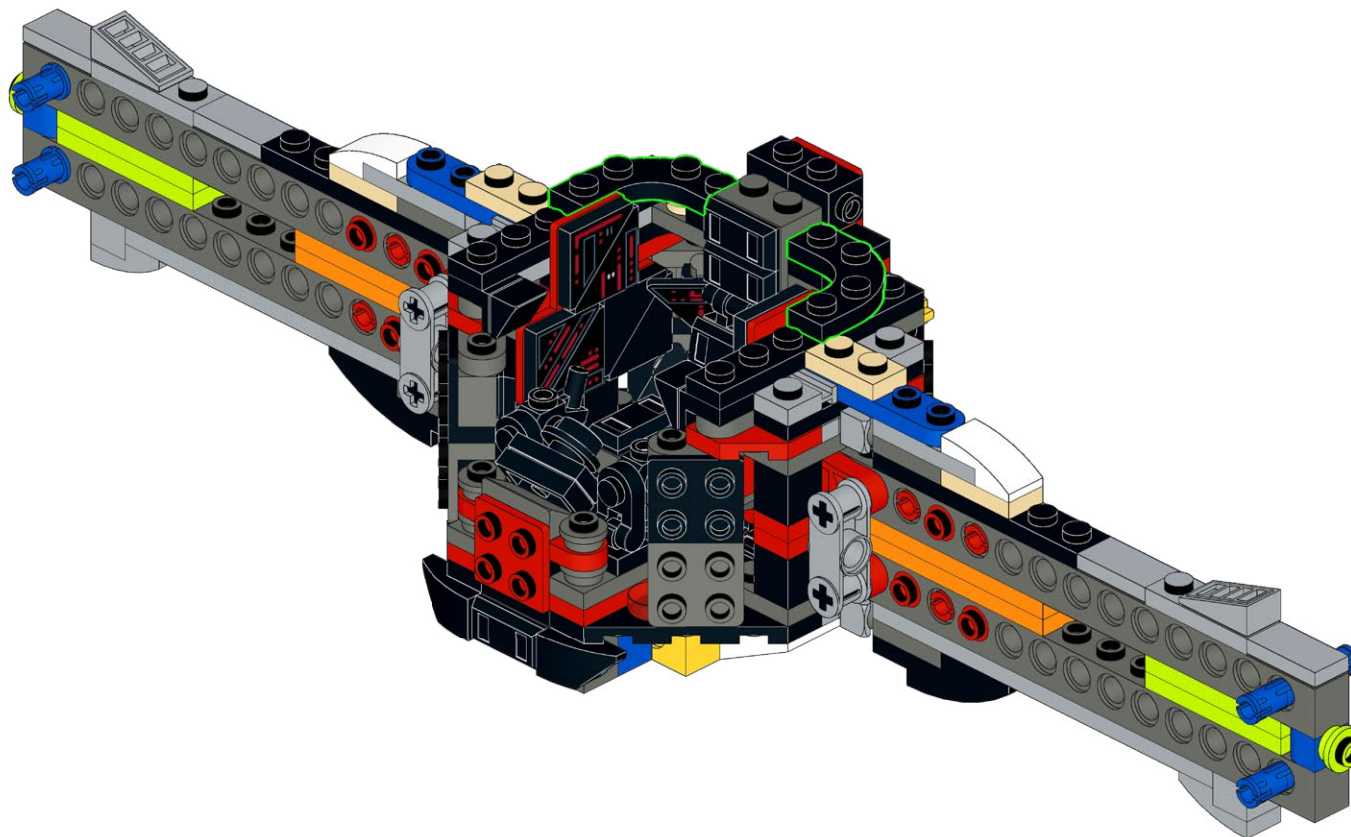



82



2x

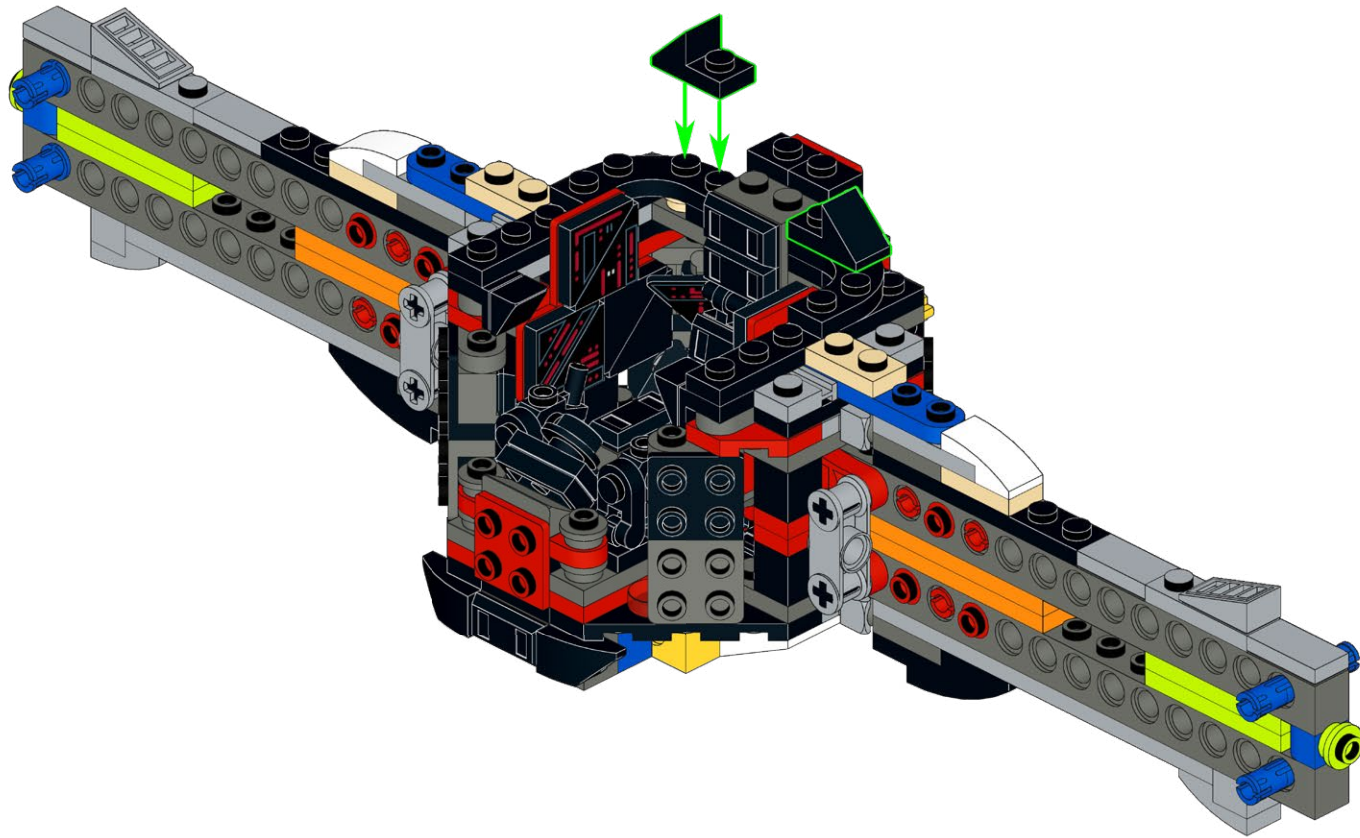

83

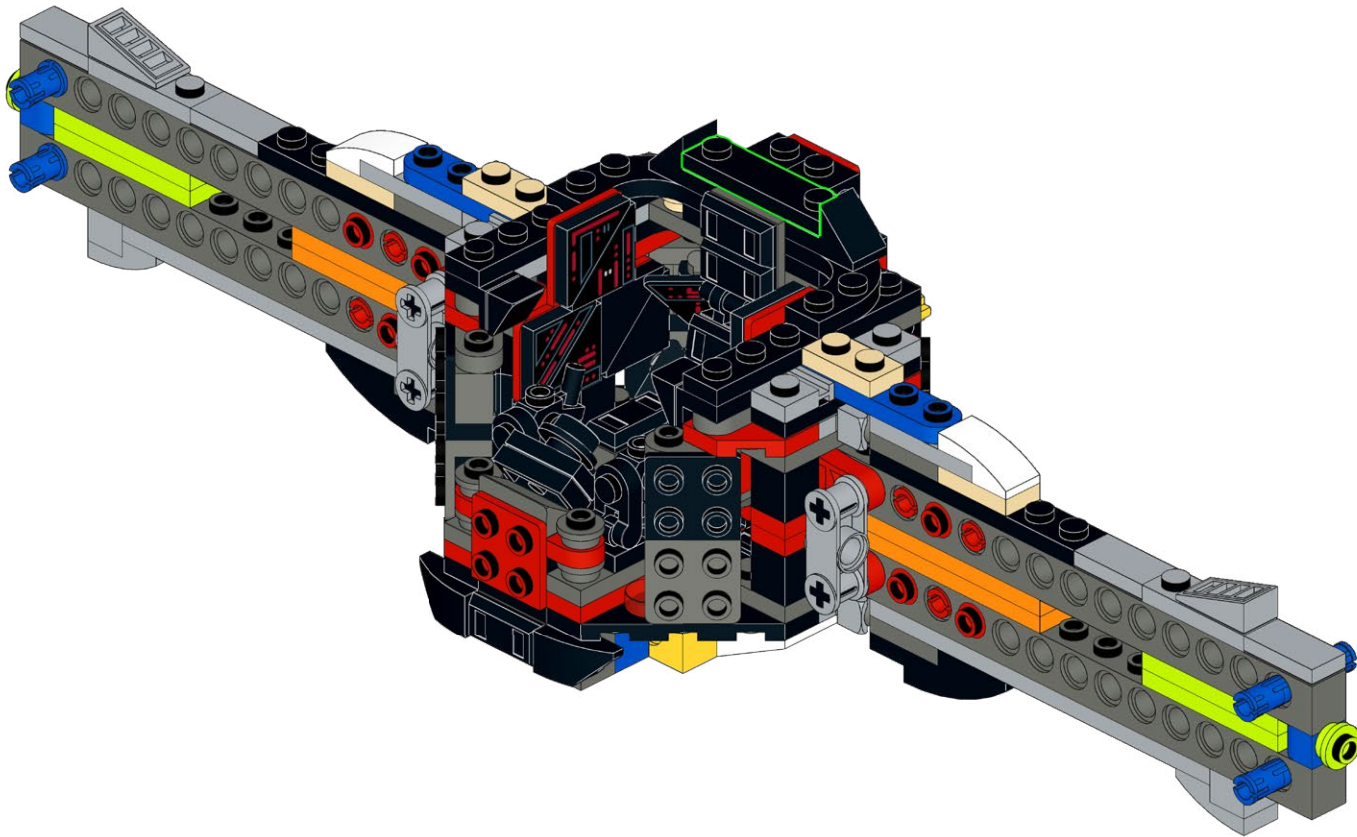
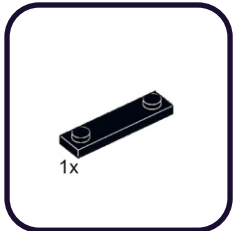



84

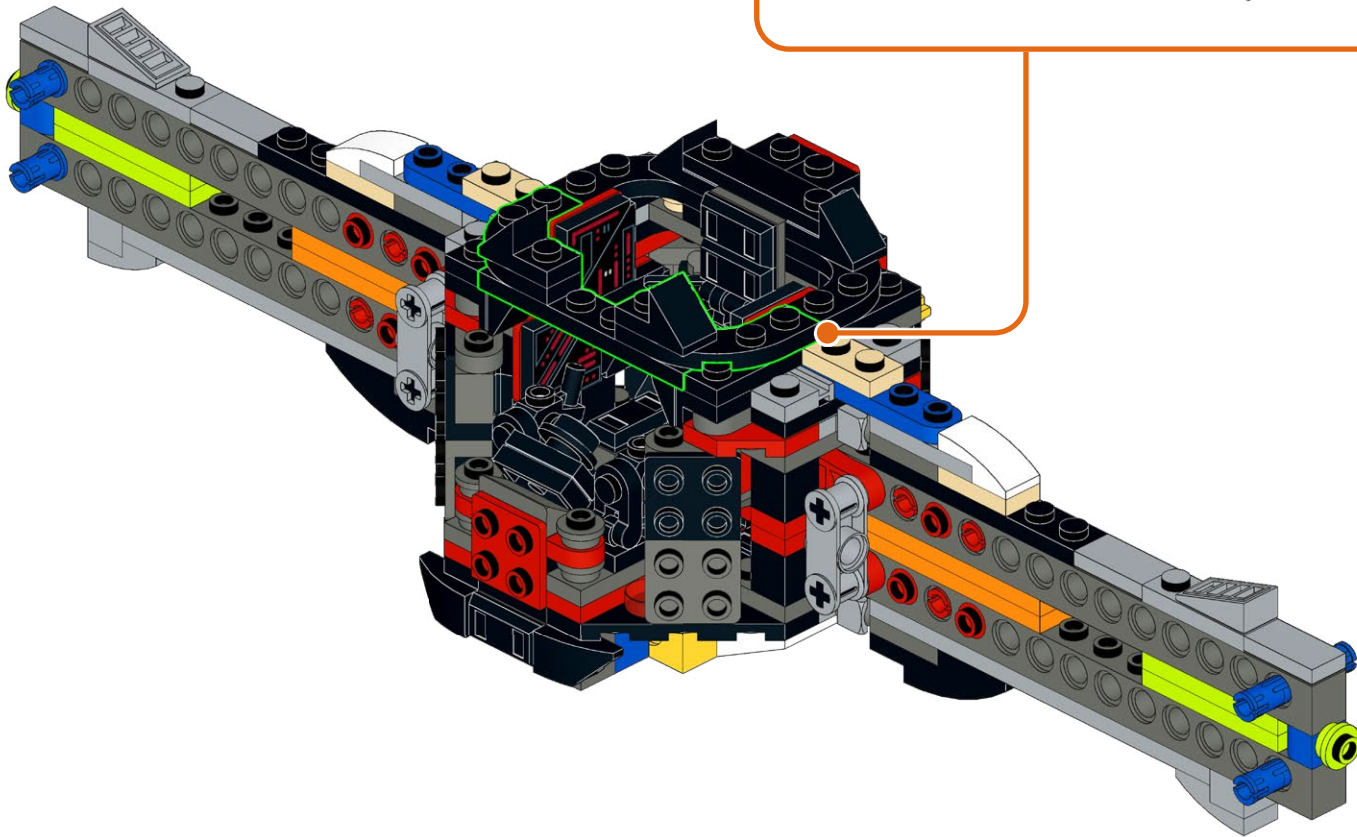
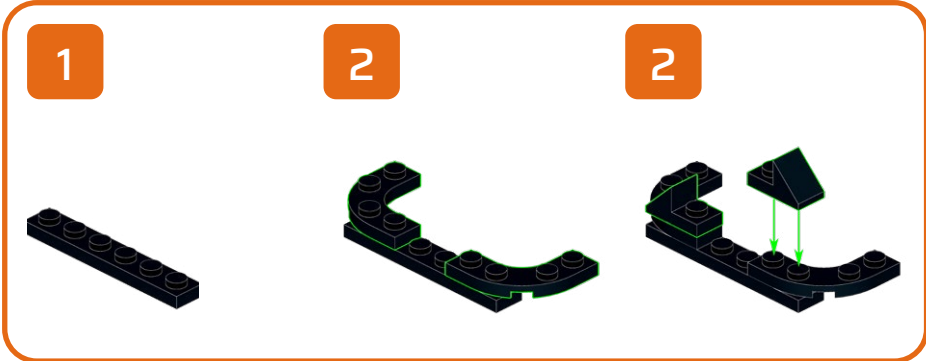

85

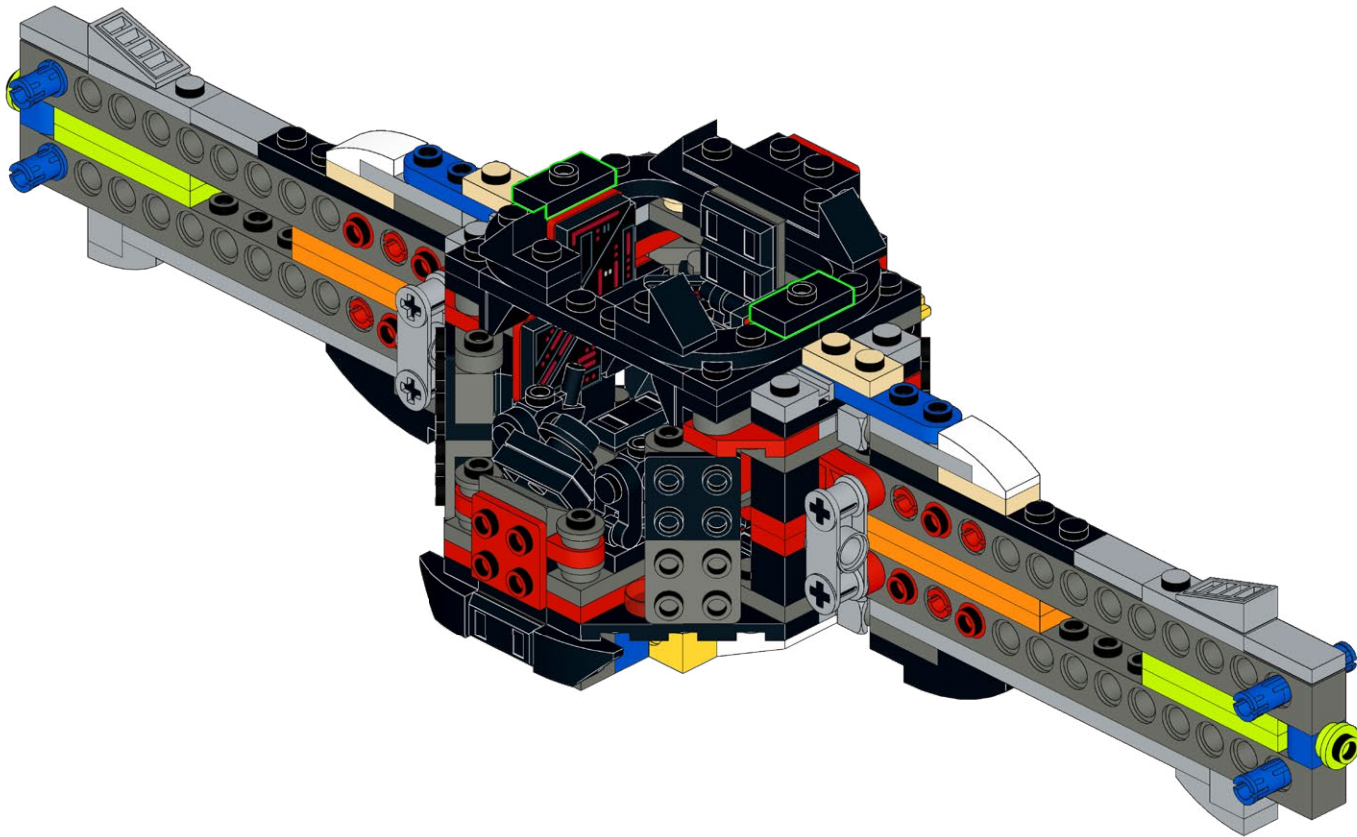

86

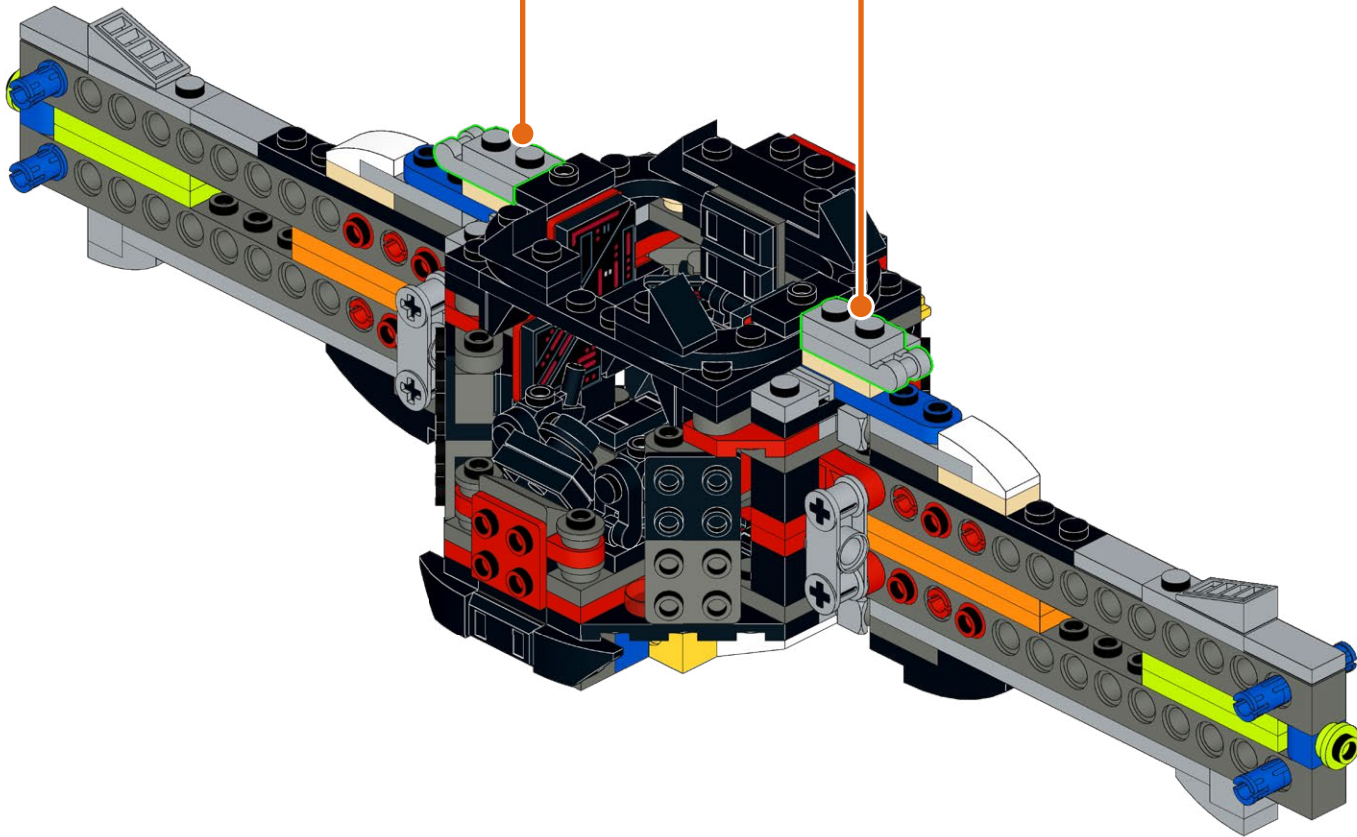
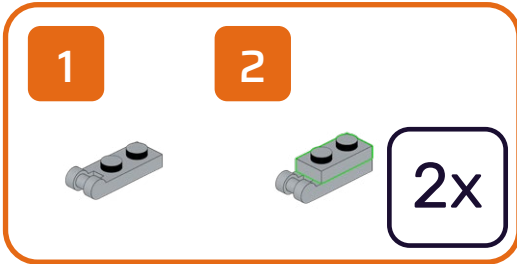
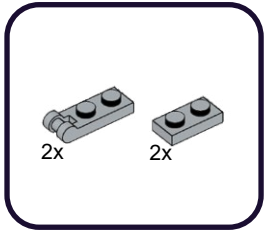

# 87

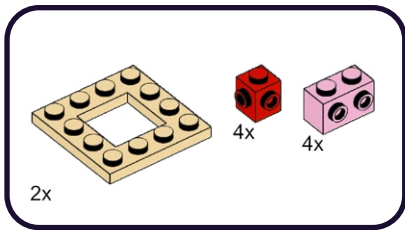

1

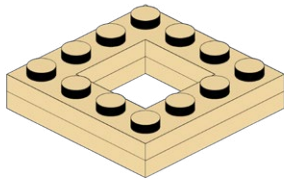

2

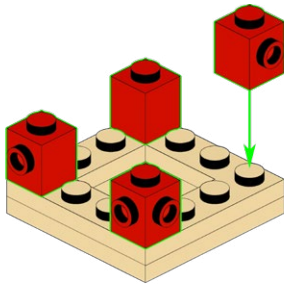

3

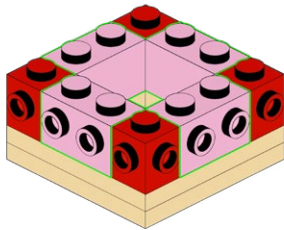

# 88

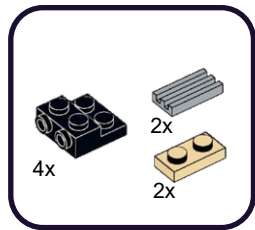

1

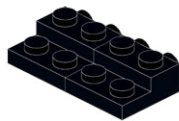

2

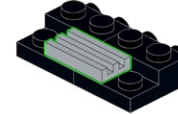

3

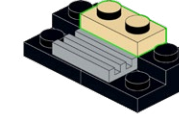

2x

1

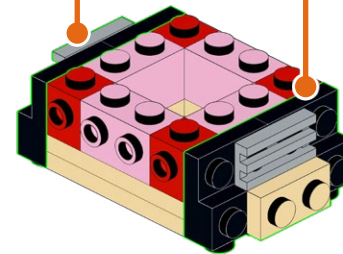

89

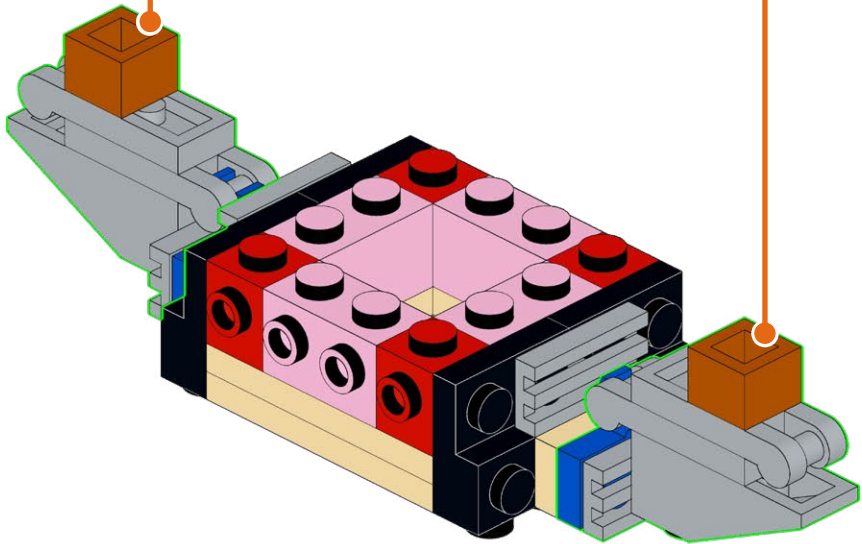
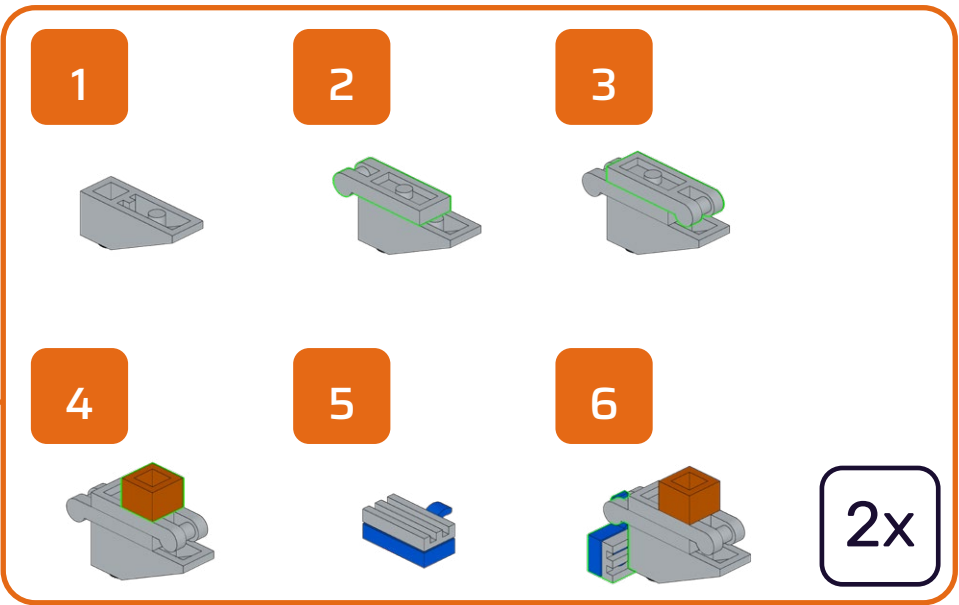
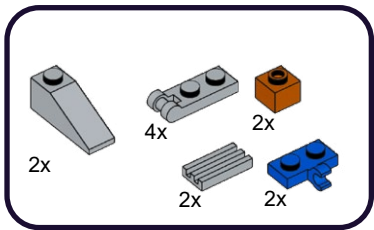



90

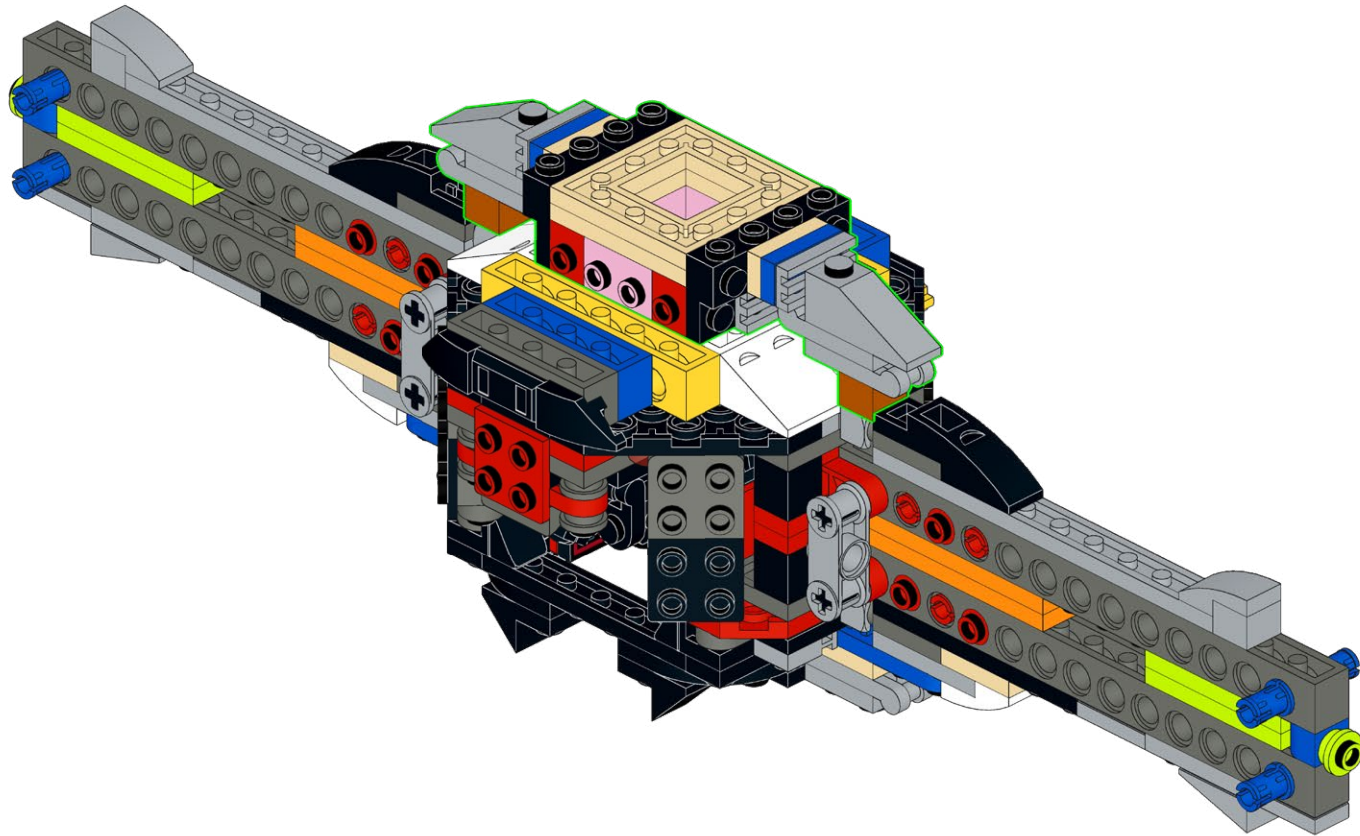



91

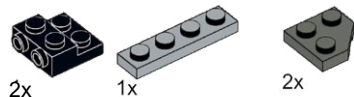

1

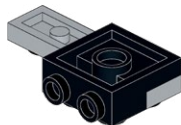

2

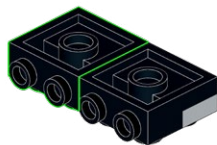

3

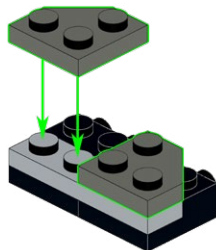

92

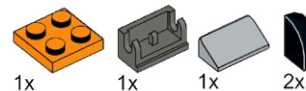

1

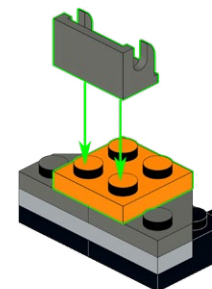

2

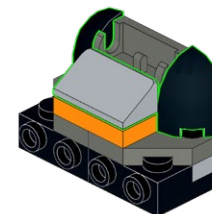
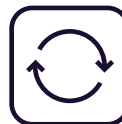

93

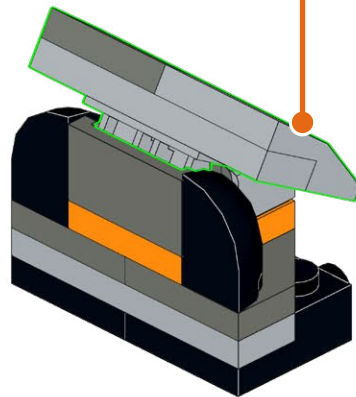
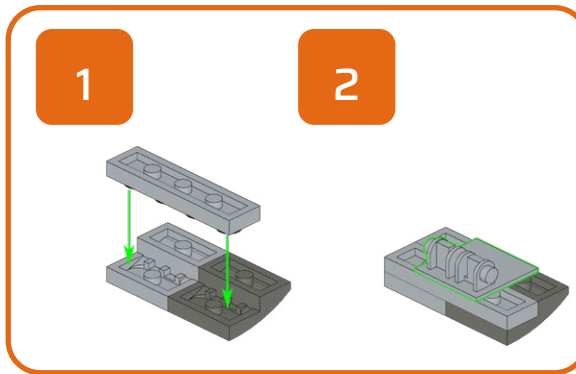
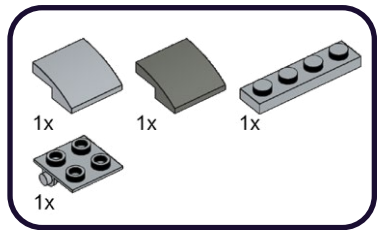

94

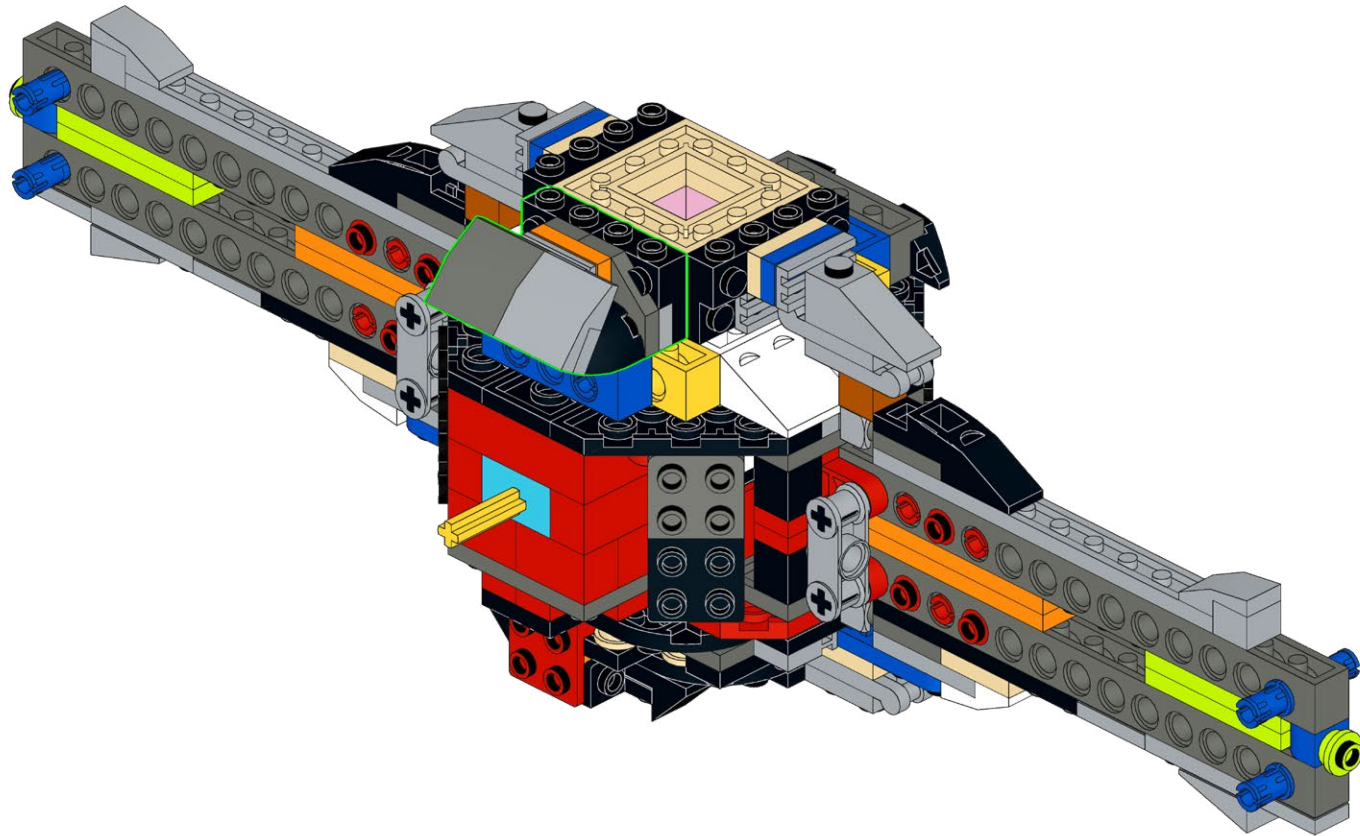

95

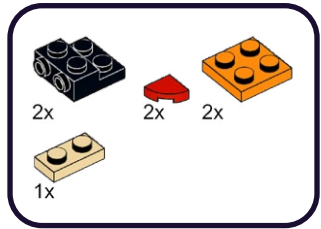

1

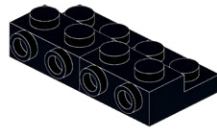

2

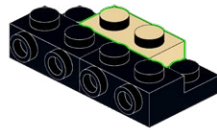

3

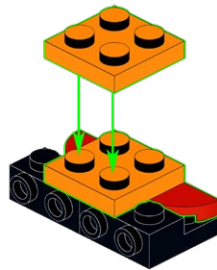

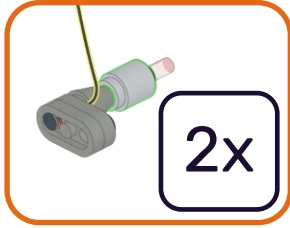

1



2

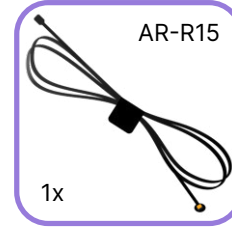
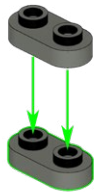

1

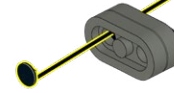

2

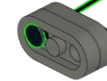

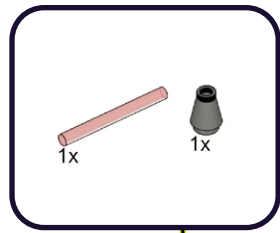
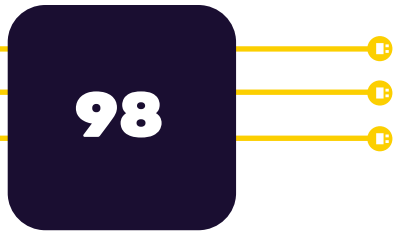

1

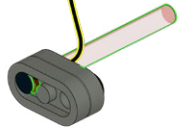

2

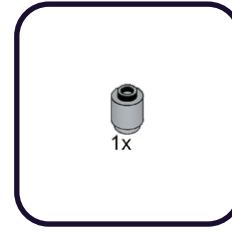
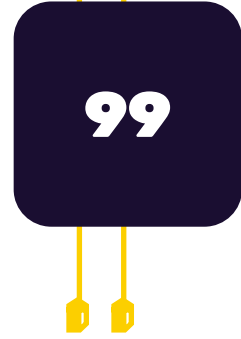
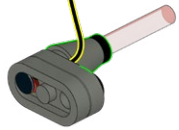

1





**100**

**1**

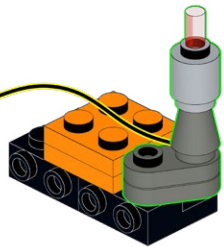

**2**

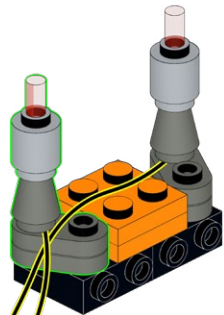

**101**

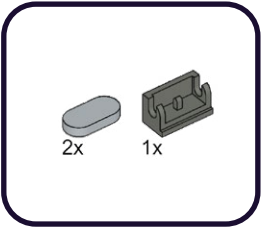

**1**

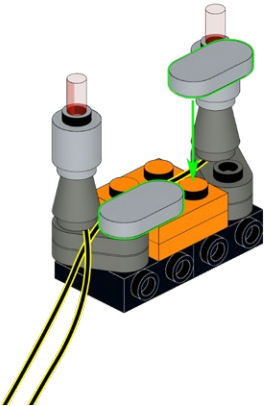

**2**

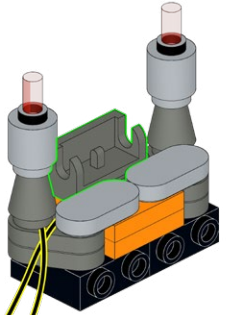

102

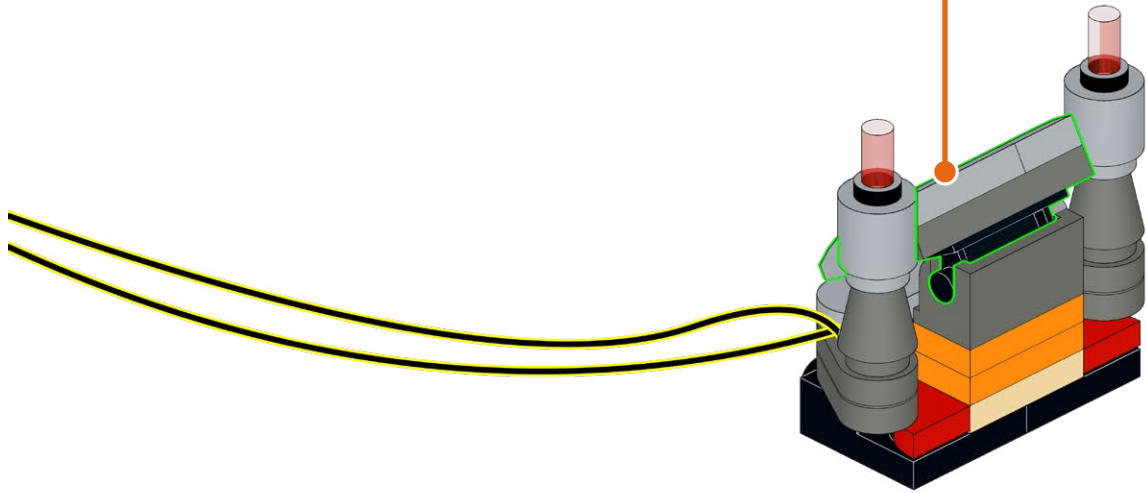
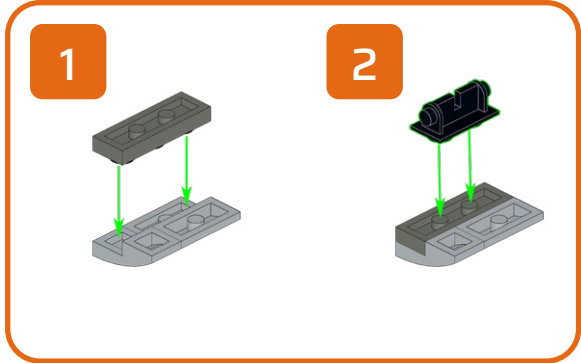
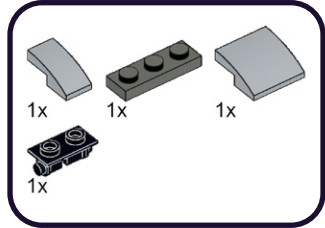
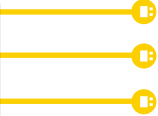

103

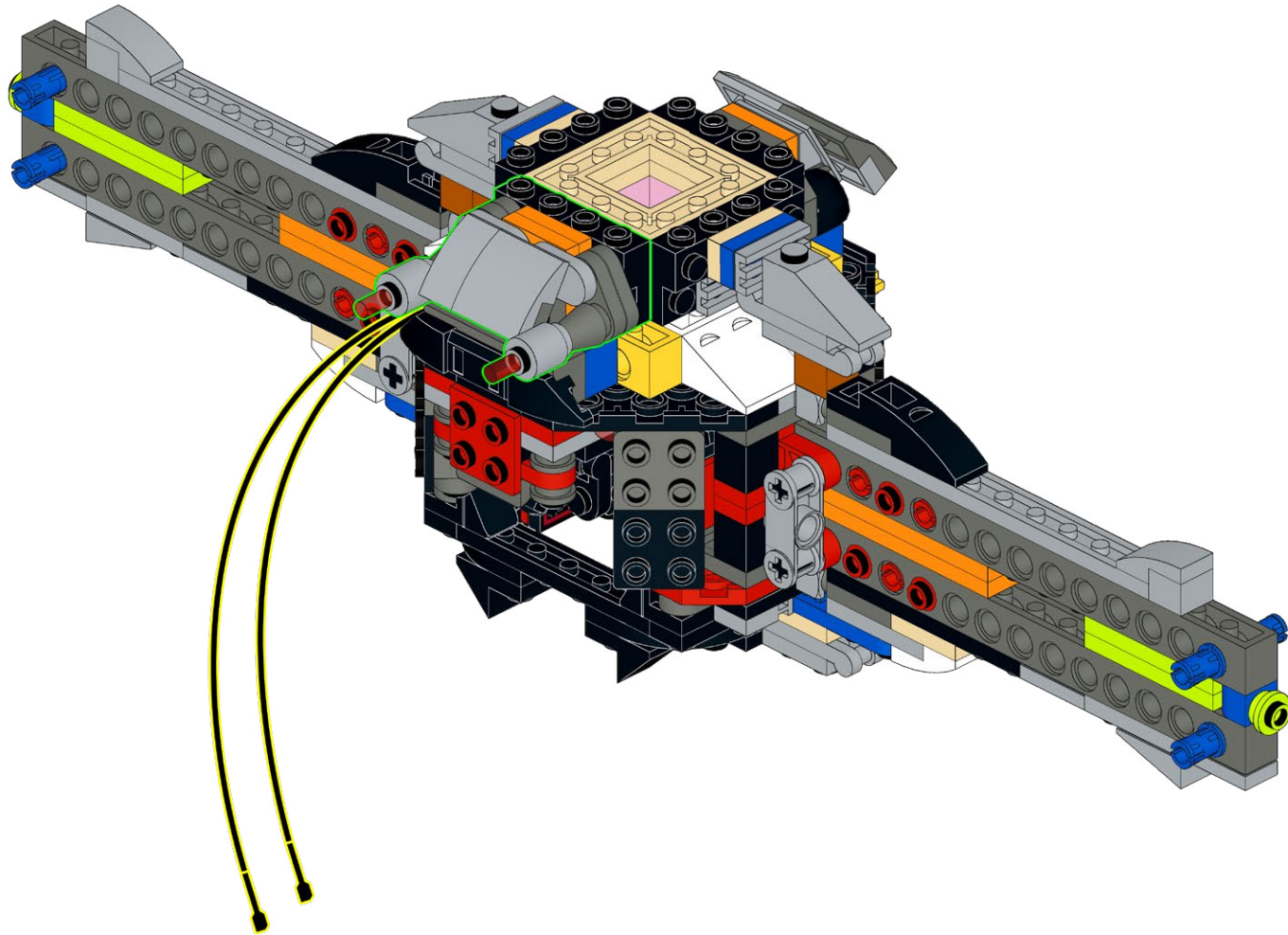

**104**

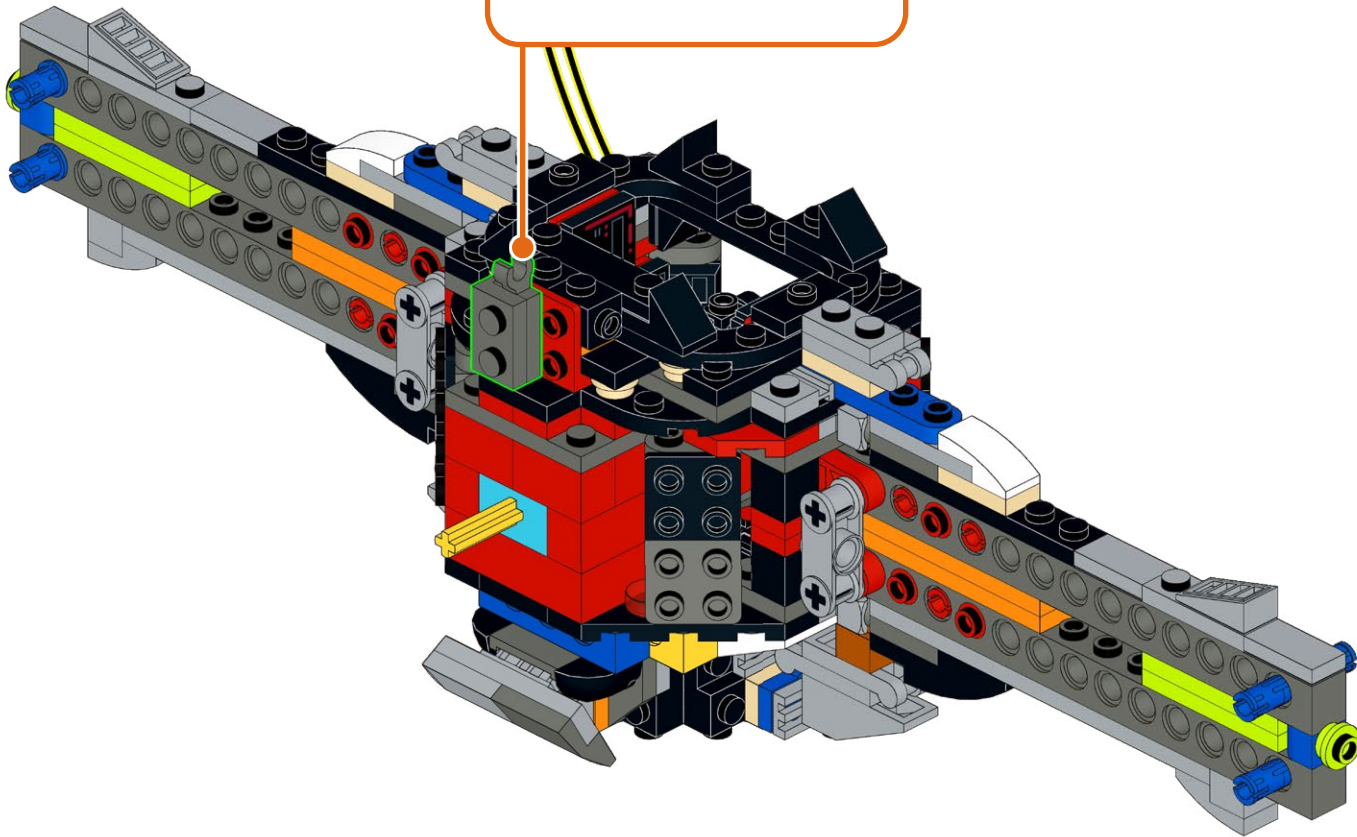
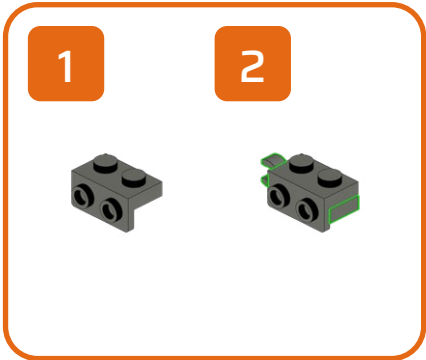
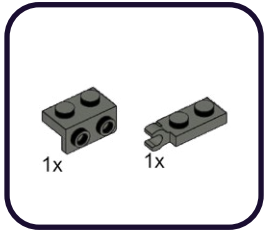

**105**

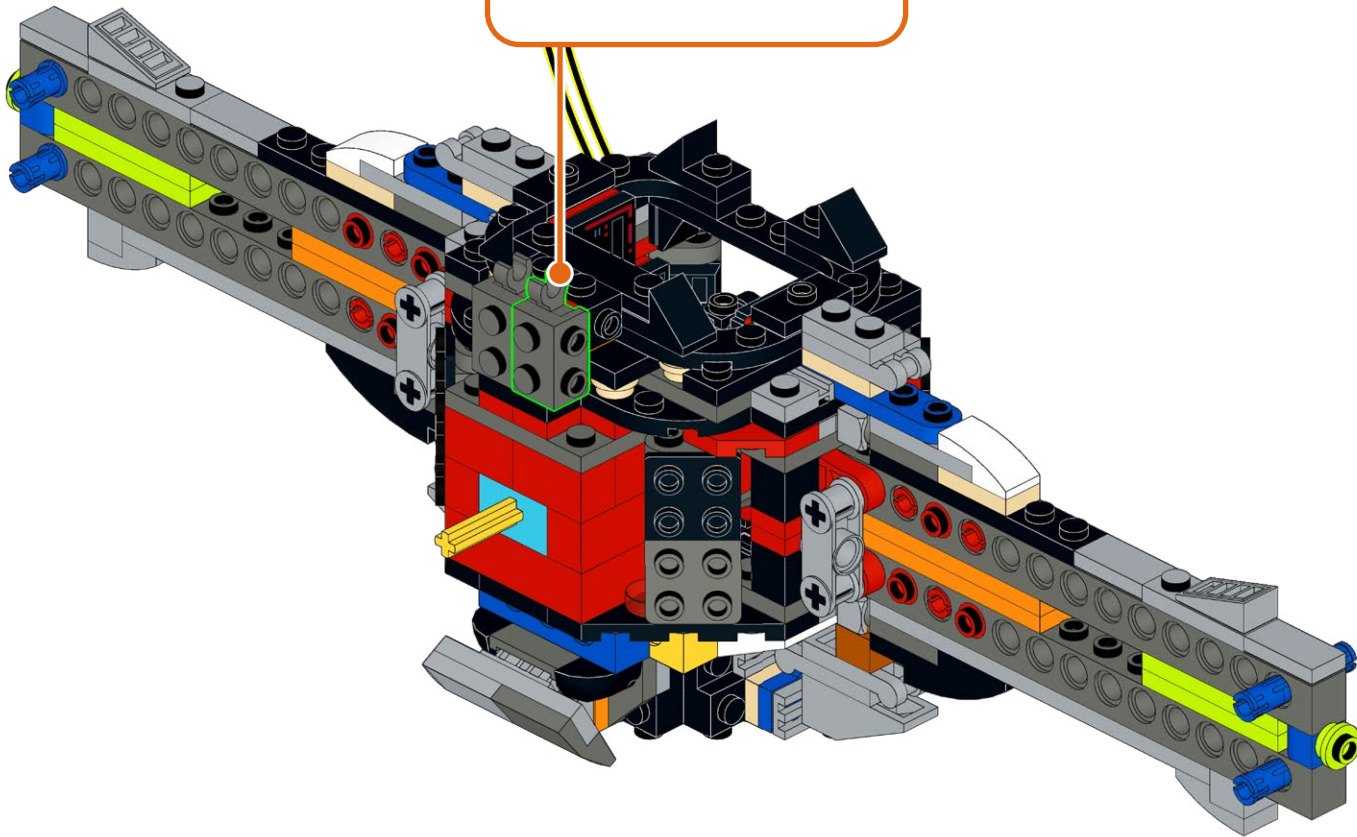
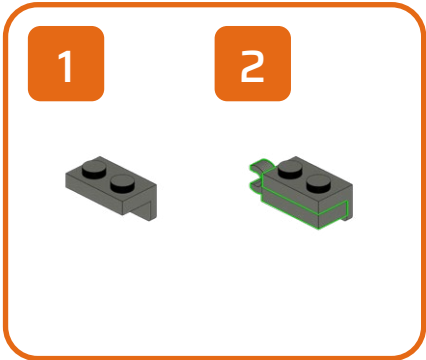
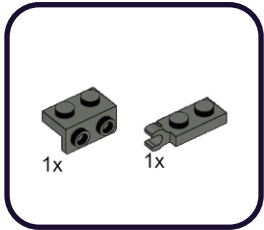



106

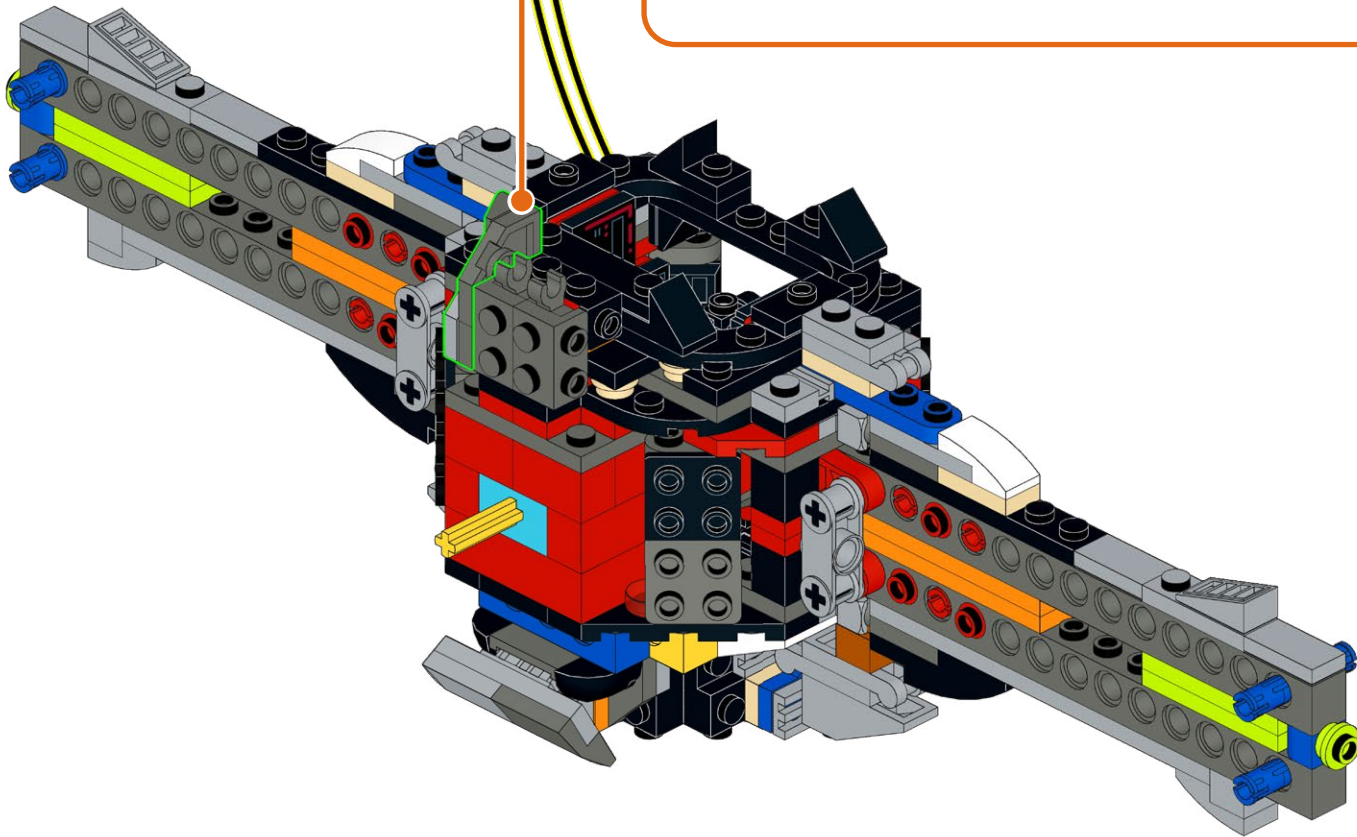
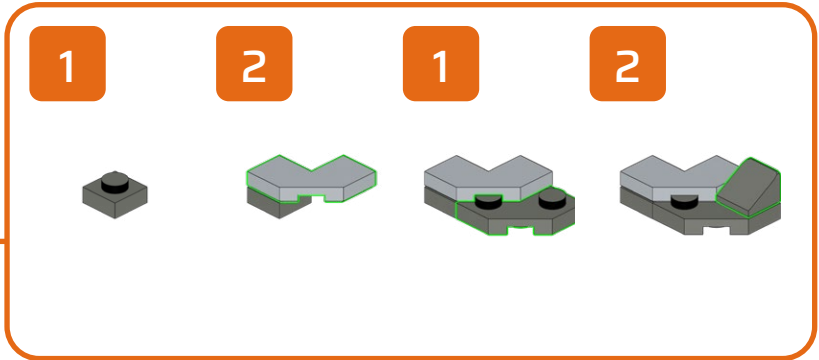
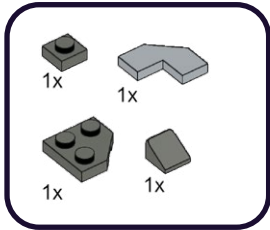



107

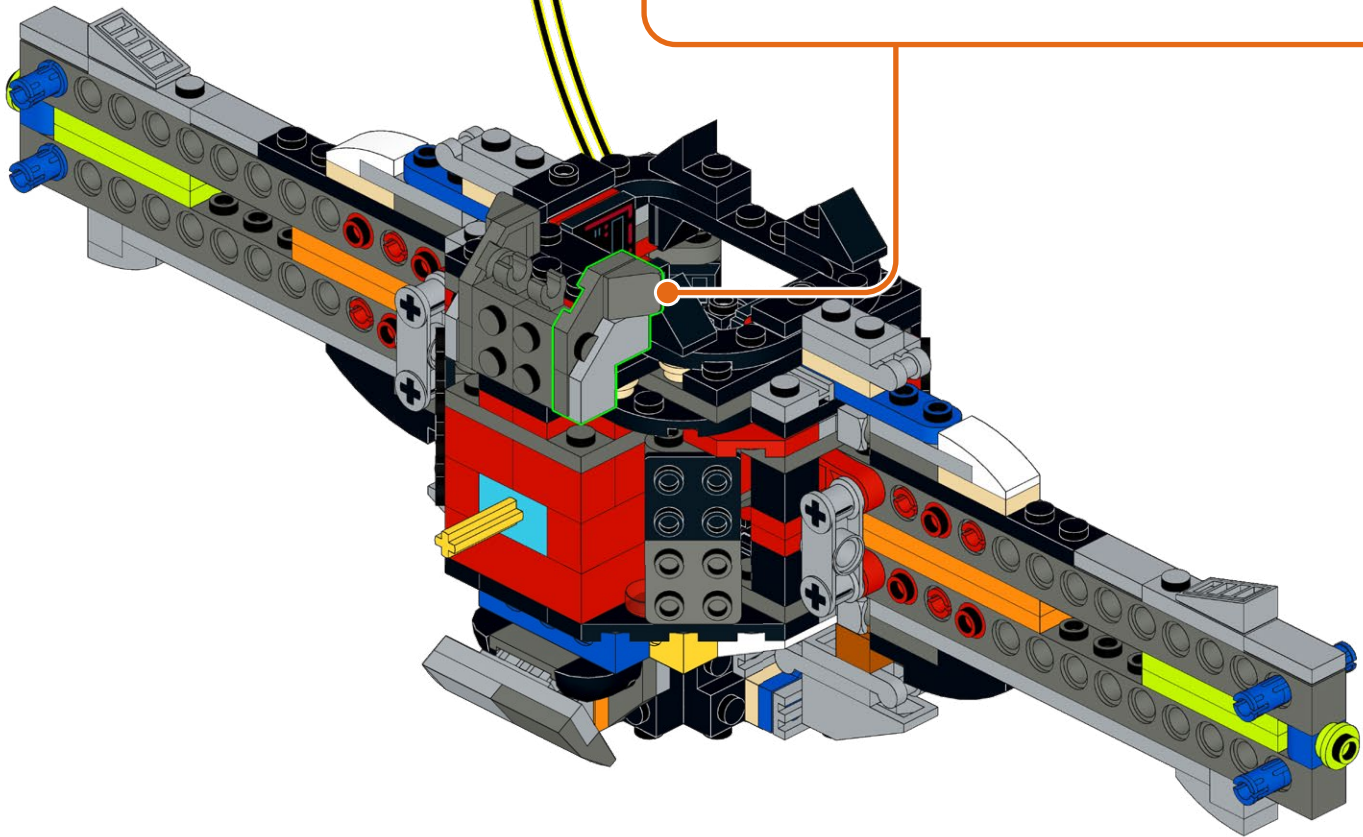
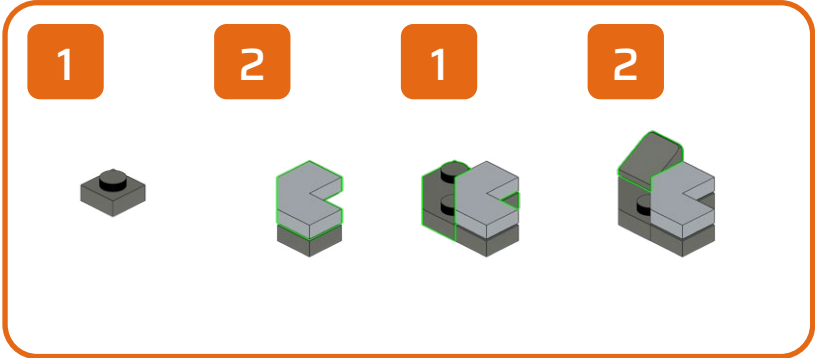
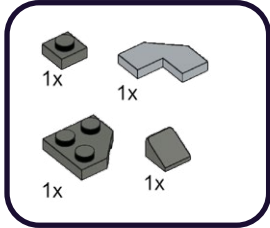

108

2x

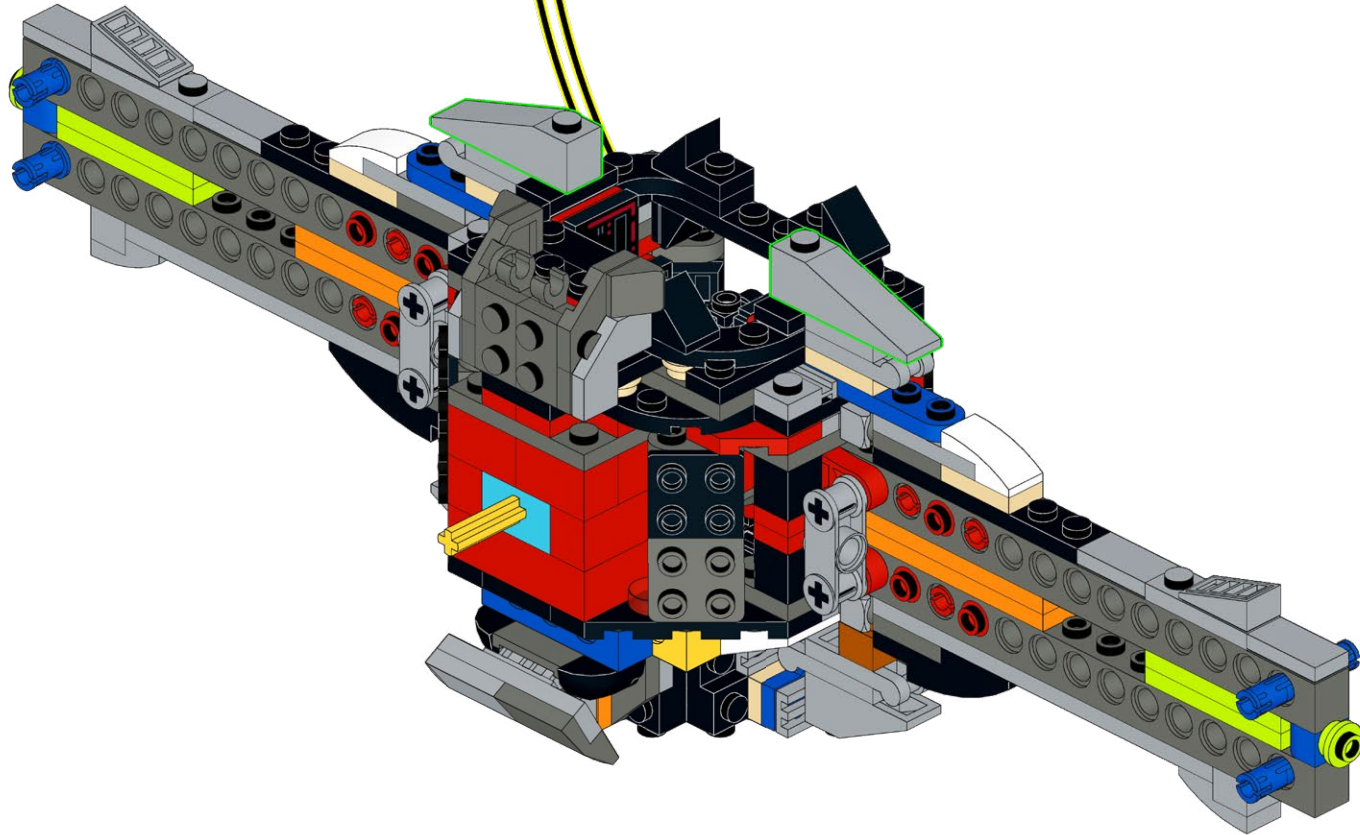

109

2x

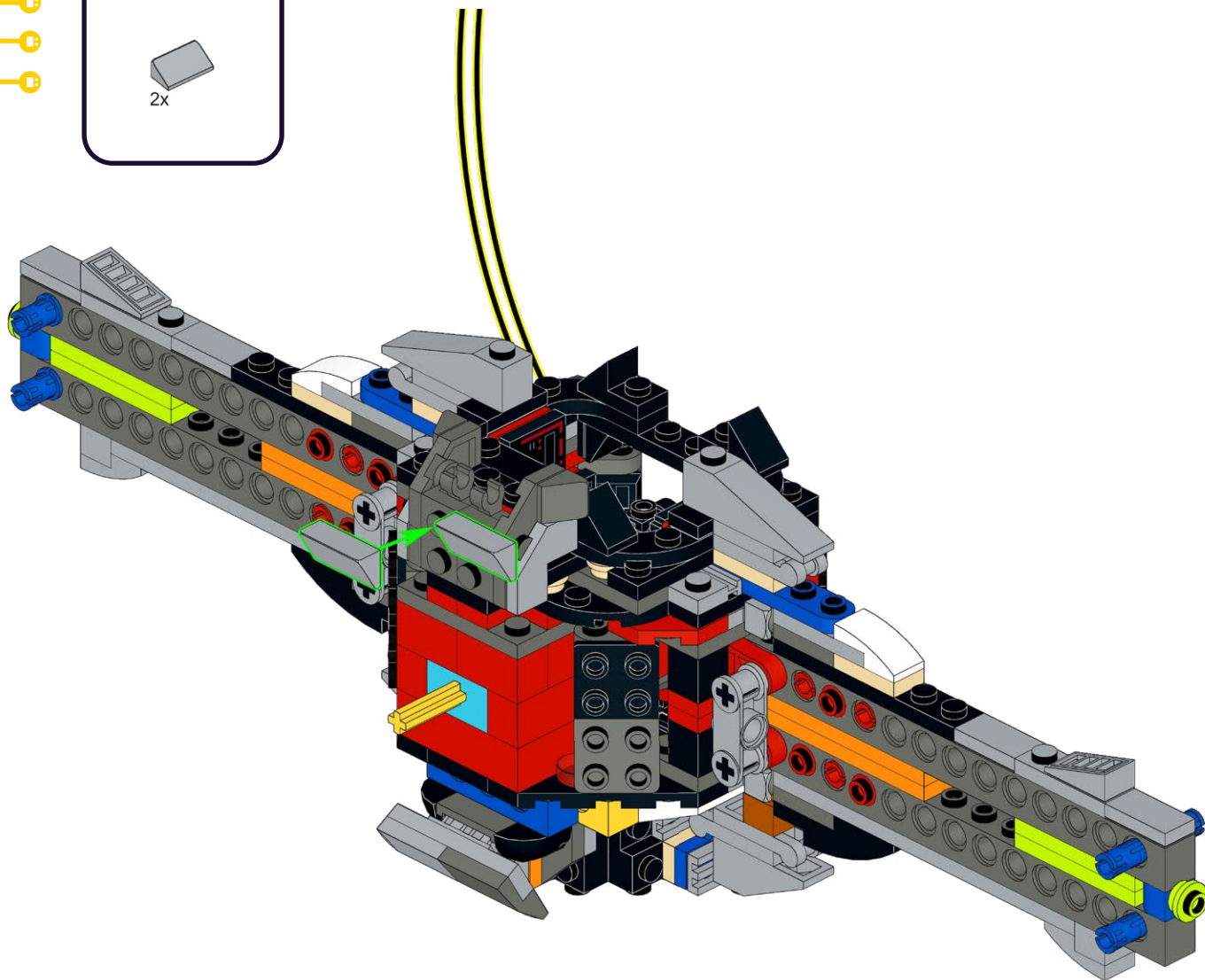

**HOLD UP!**

You might notice some bags are out of order, as well as left over pieces, but that's ok! We're changing the way you build LEGO!

**HALTEN!**

Möglicherweise stellen Sie fest, dass einige Beutel nicht in Ordnung sind und auch Teile übrig bleiben, aber das ist in Ordnung! Wir verändern die Art und Weise, wie Sie LEGO bauen!

**TENIR BON!**

Vous remarquerez peut-être que certains sacs sont en panne, ainsi que des morceaux restants, mais ce n'est pas grave ! Nous changeons la façon dont vous construisez LEGO !

**SOSTENERE!**

Potresti notare che alcune borse sono fuori uso, così come alcuni pezzi avanzati, ma va bene! Stiamo cambiando il modo in cui costruisci i LEGO!

**¡SOSTENER!**

Puede que notes que algunas bolsas están fuera de orden, así como piezas sobrantes, ¡pero está bien! ¡Estamos cambiando la forma de construir LEGO!

**耽误!**

您可能会注意到有些袋子坏了, 还有剩余的碎片, 但这没关系! 我们正在改变您搭建乐高的方式!

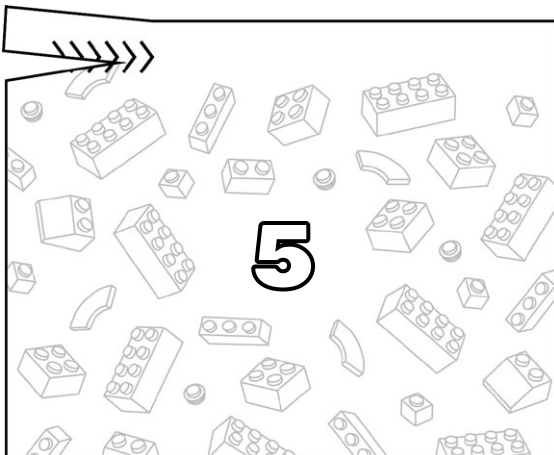
**Open LEGO® Bag 1**

# 110

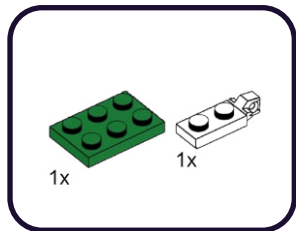

1

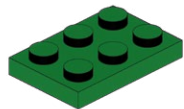

2

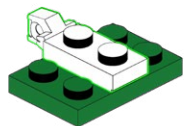

# 111

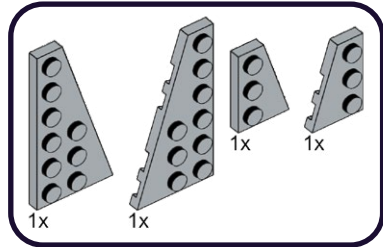

1

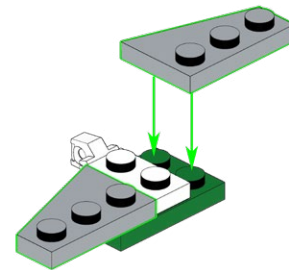

2

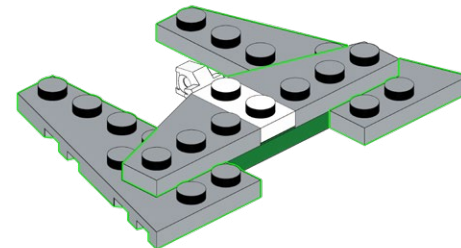

112

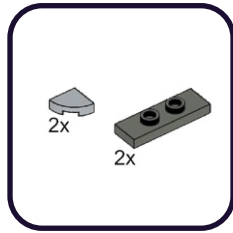

1

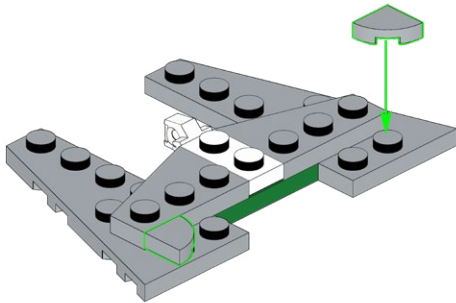

2

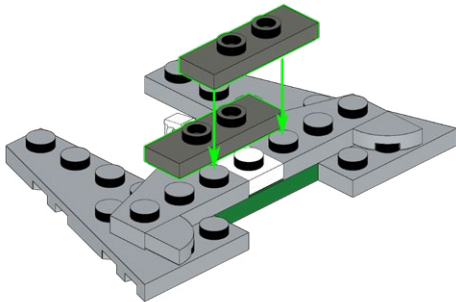

113

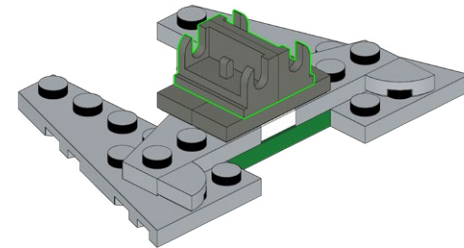
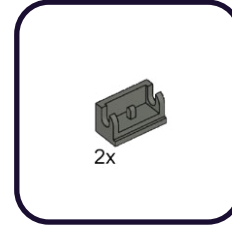



114

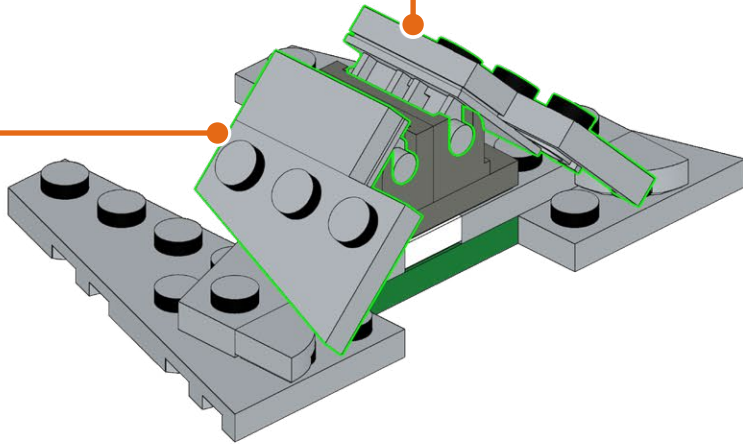
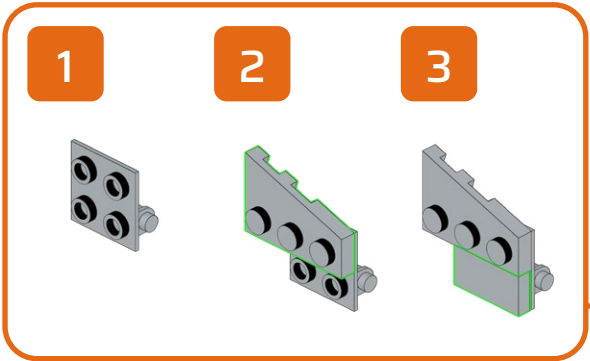
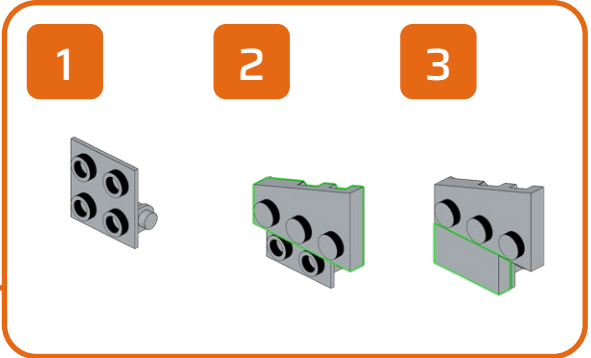
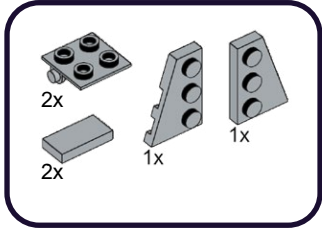

115

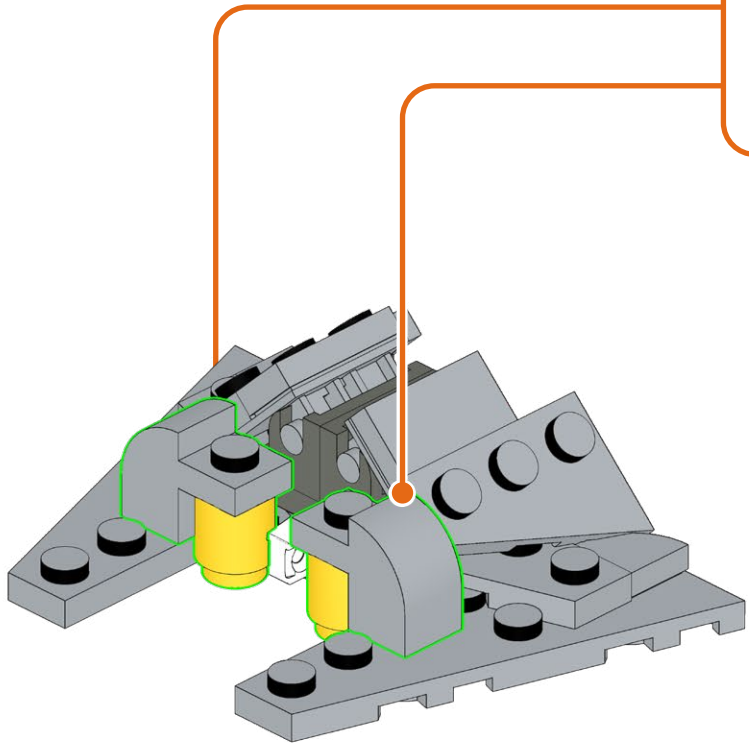
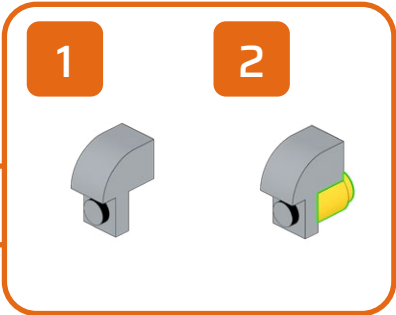
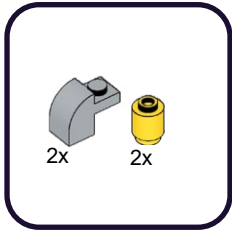

116

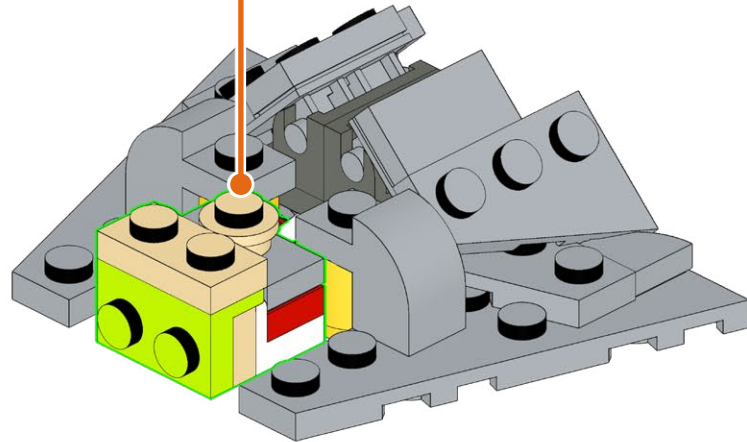
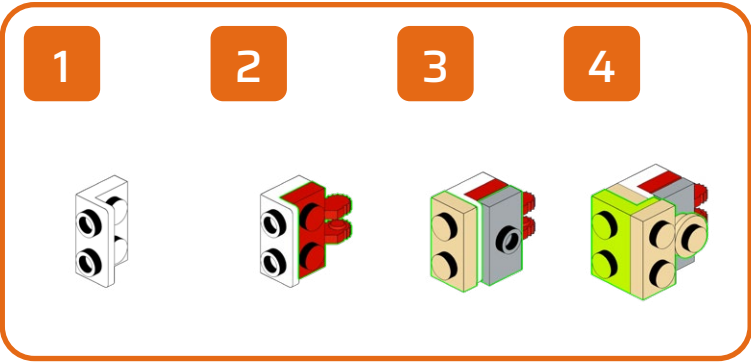
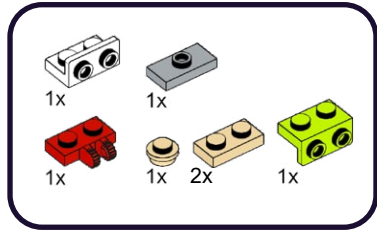

117



2x

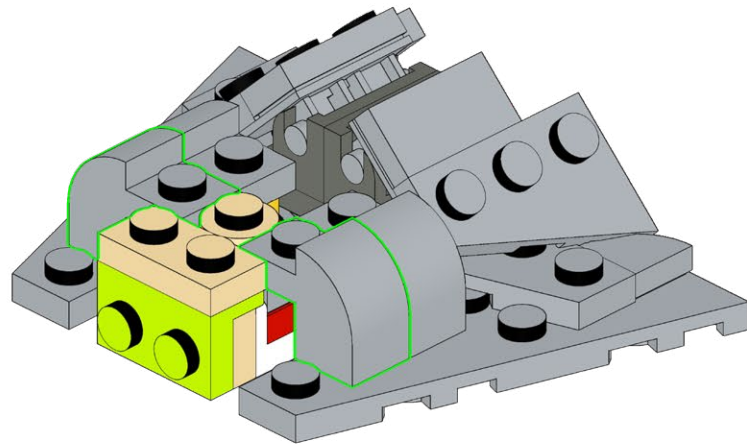

118

2x

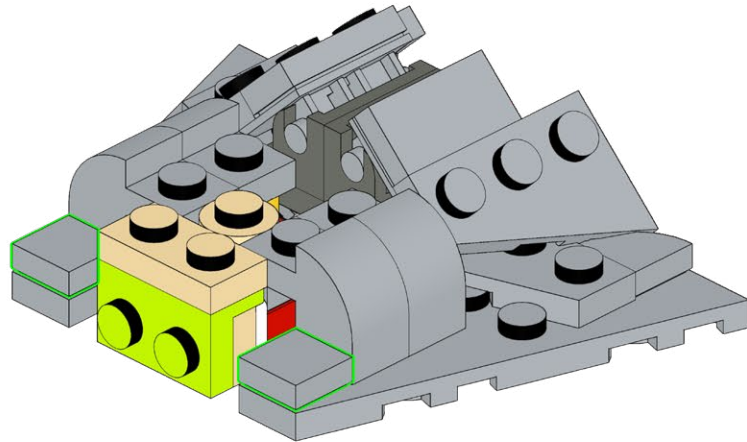

119

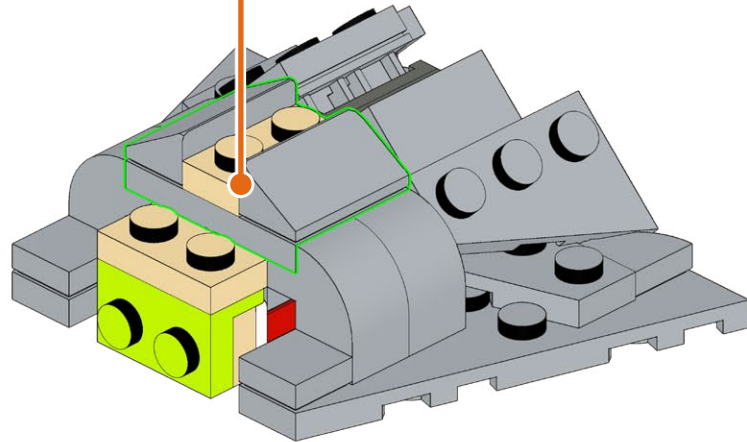
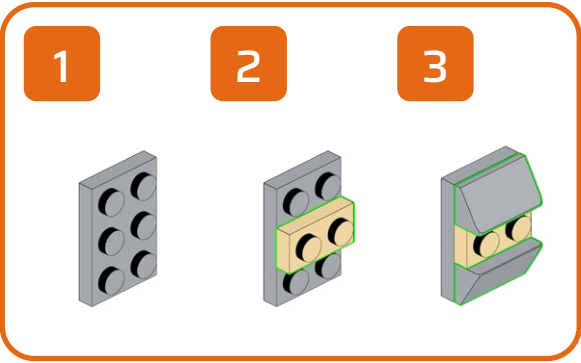
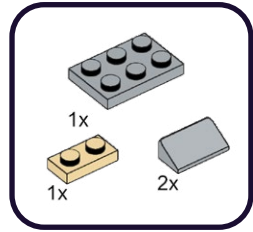



# 120

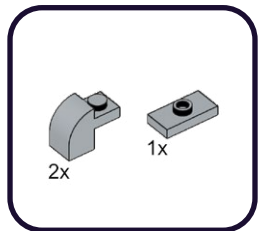

1

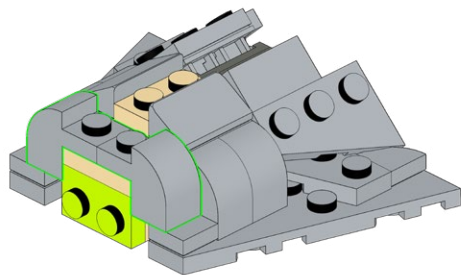

2

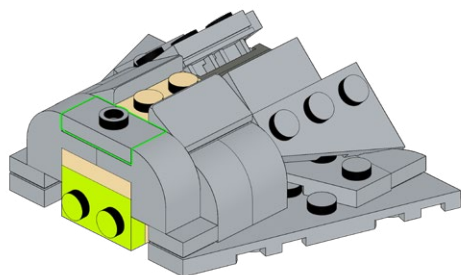

# 121

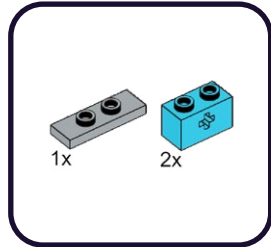

1

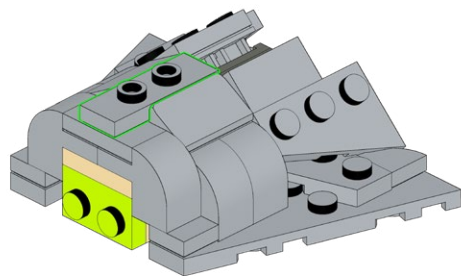

2

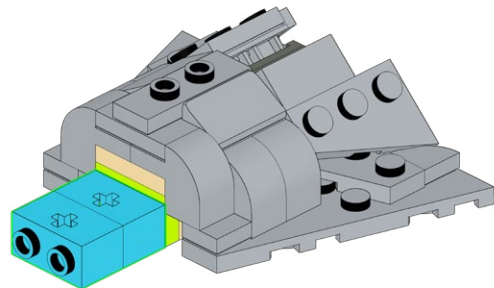

122

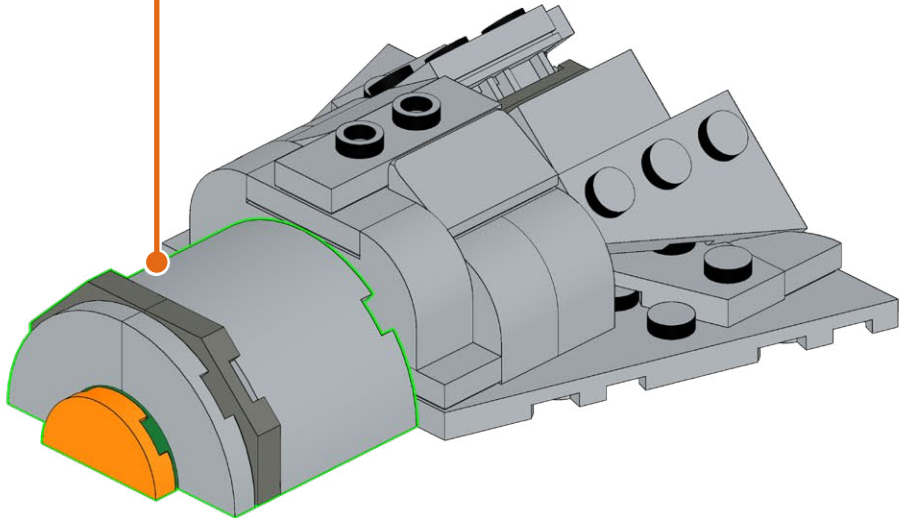
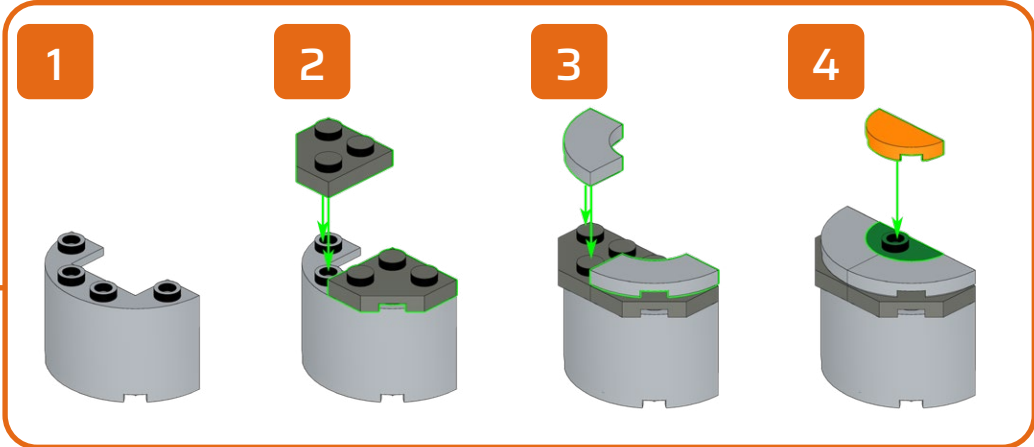
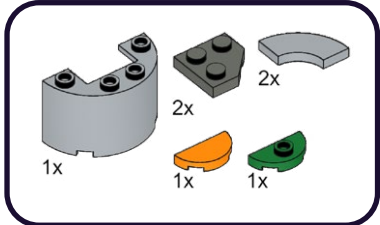

123

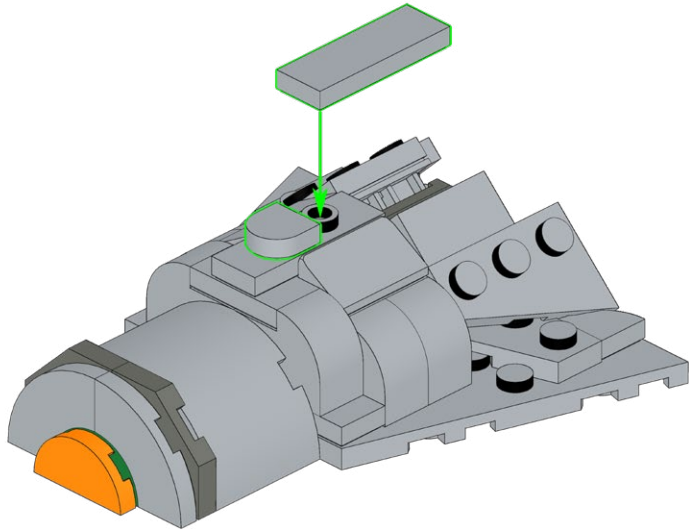
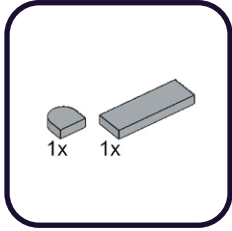

124

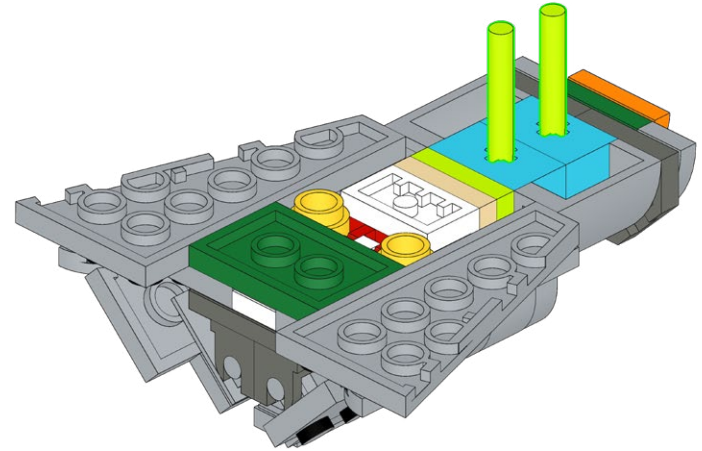
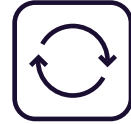
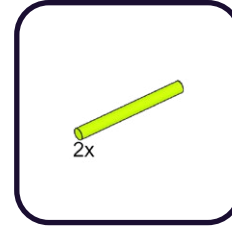

125

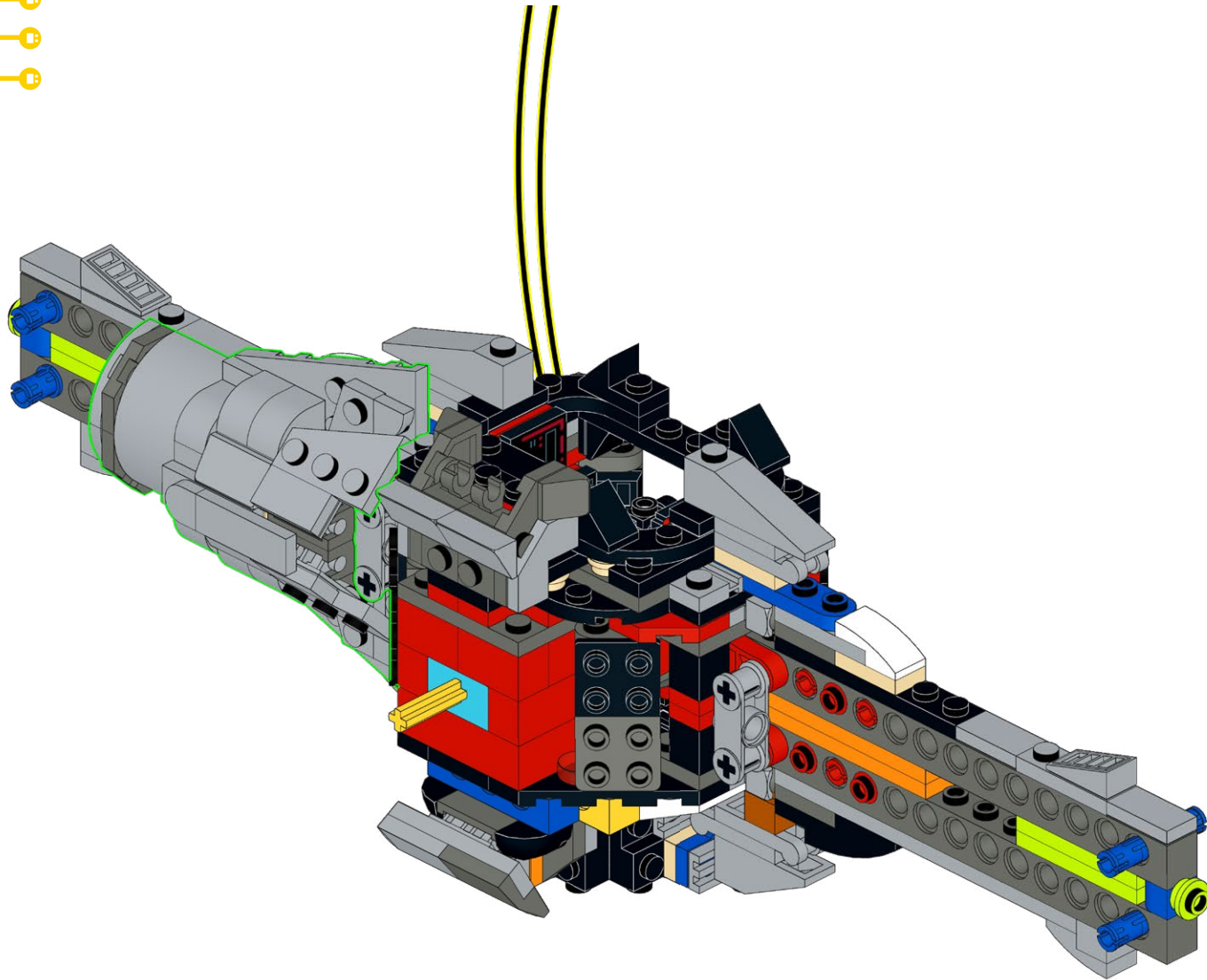

126

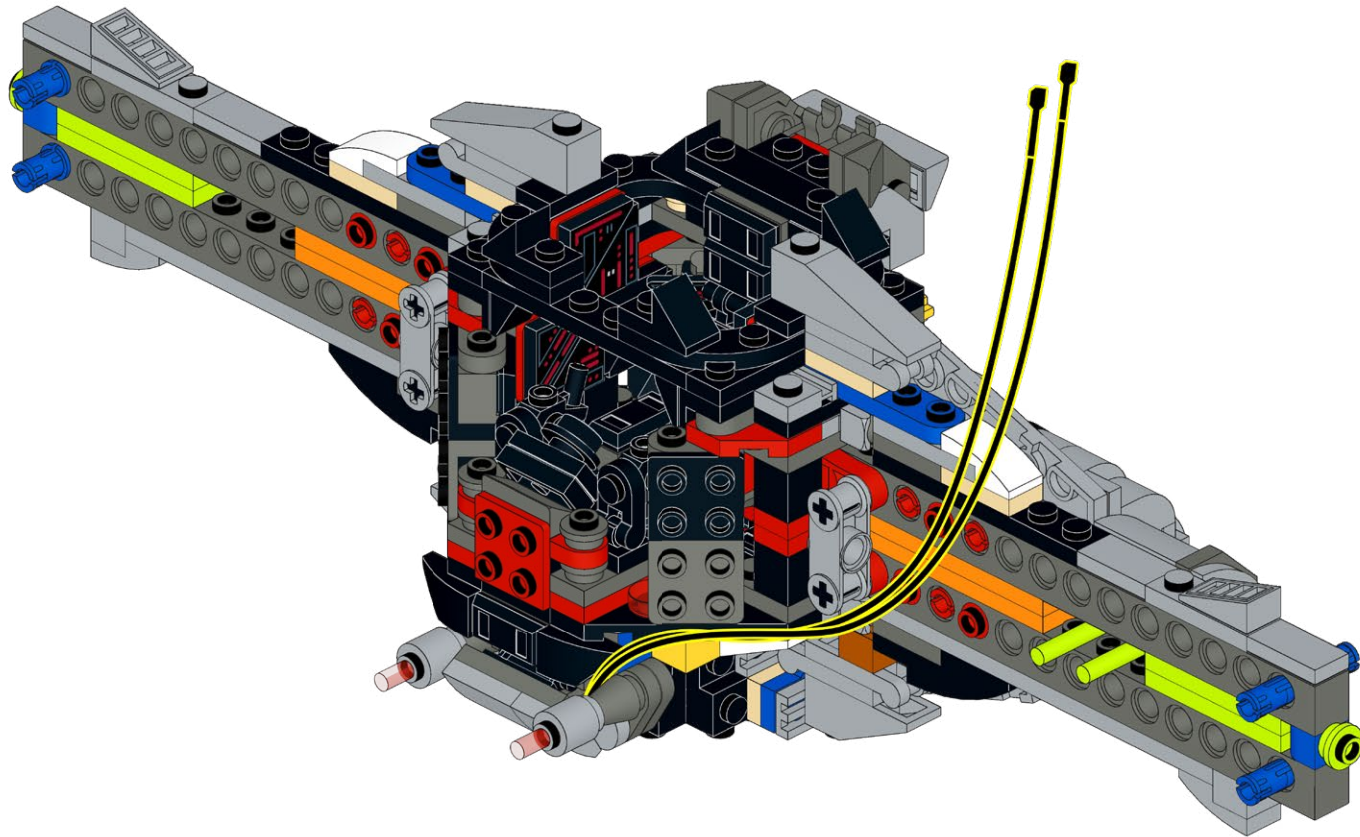

# 127

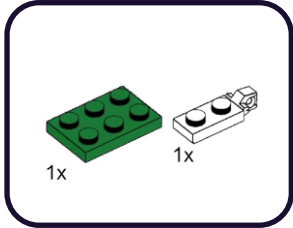

1

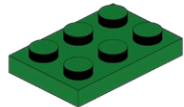

2

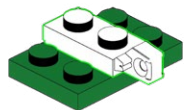

# 128

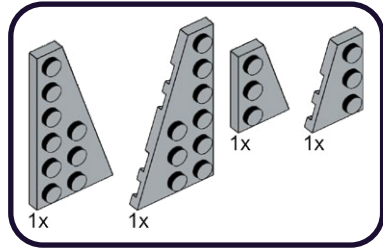

1

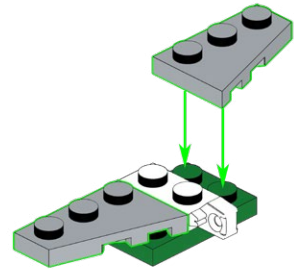

2

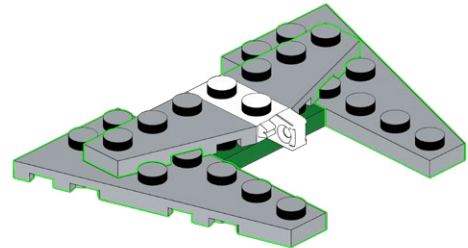



# 129

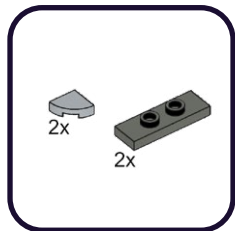

1

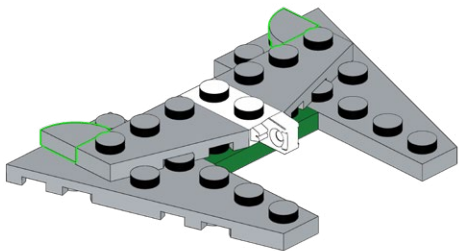

2

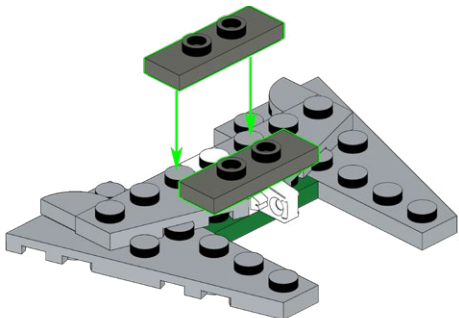

# 130

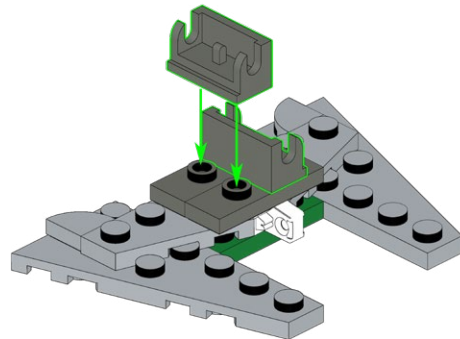
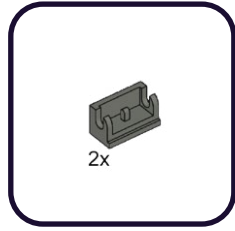

131

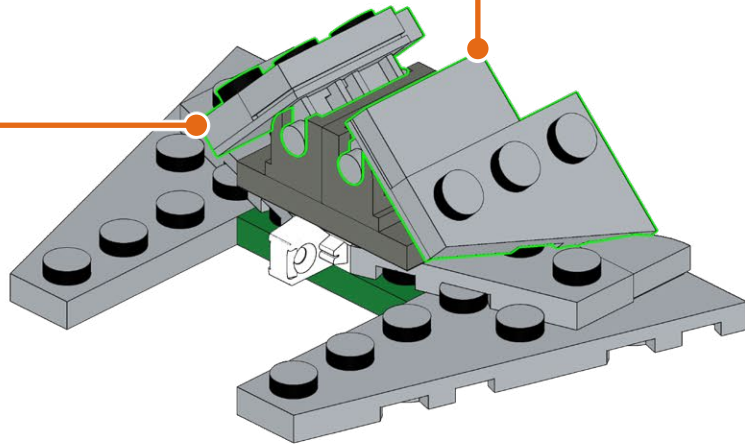
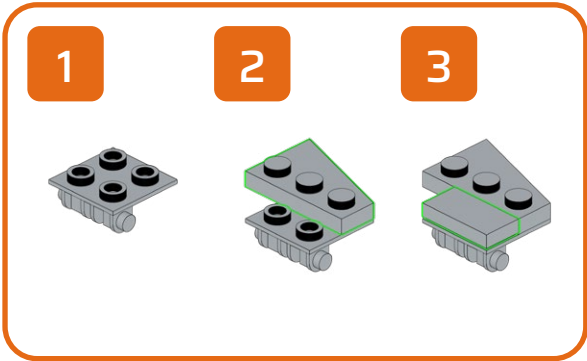
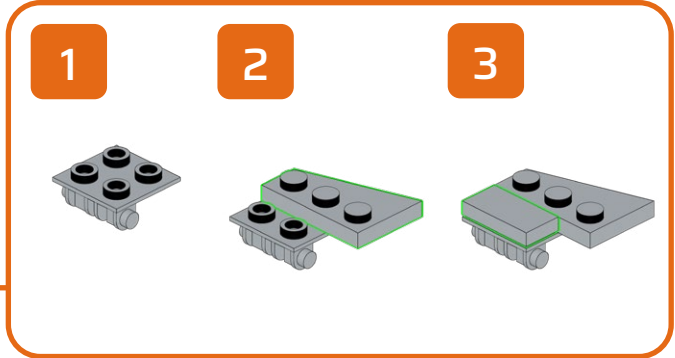
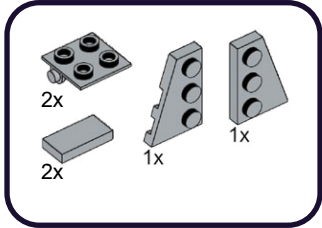

132

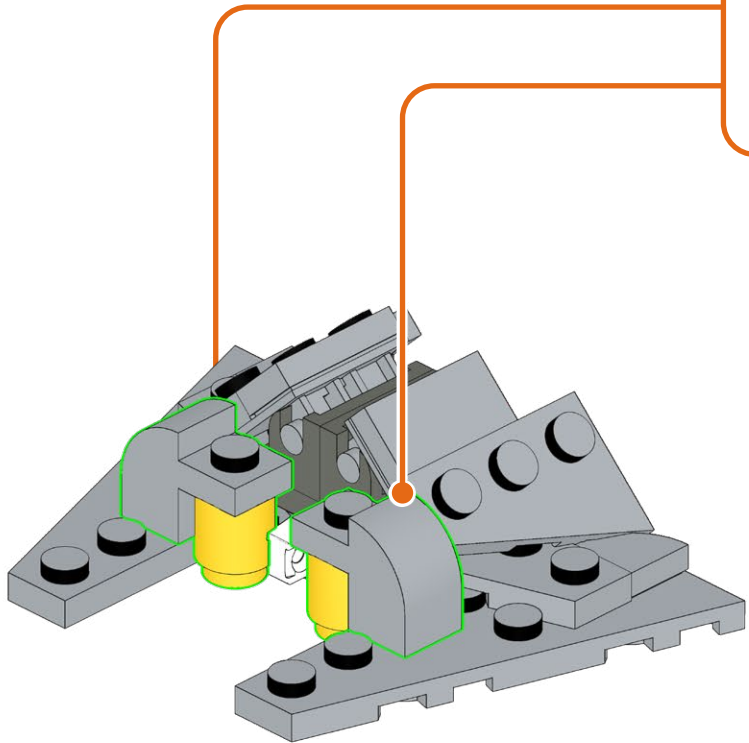
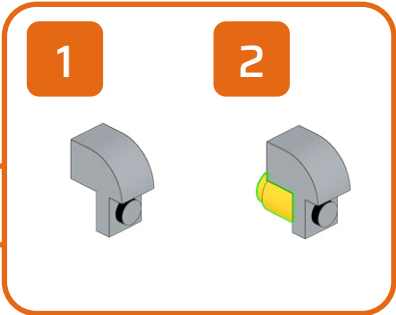
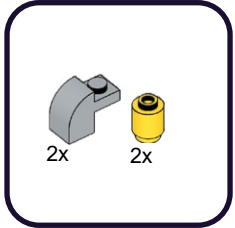

133

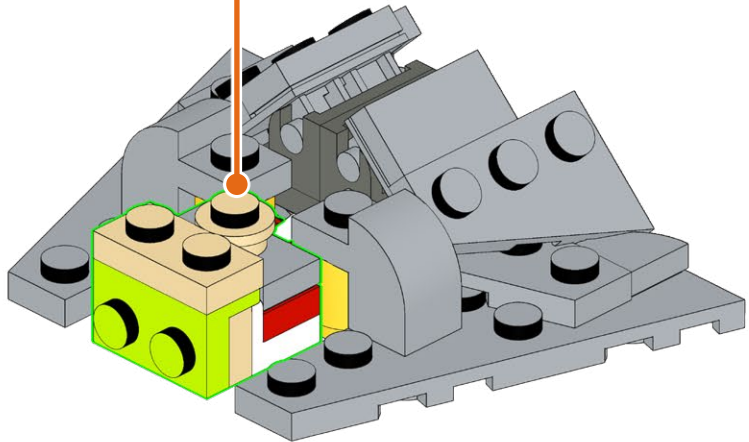
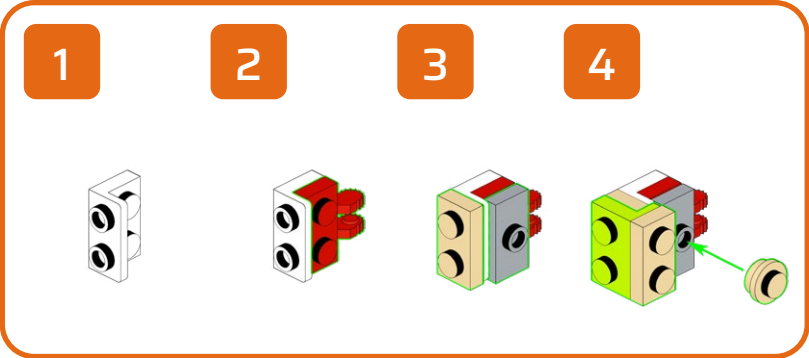
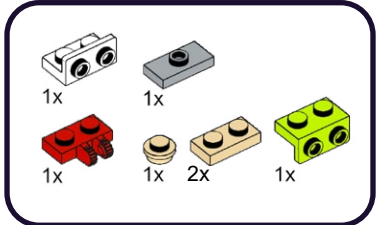

134

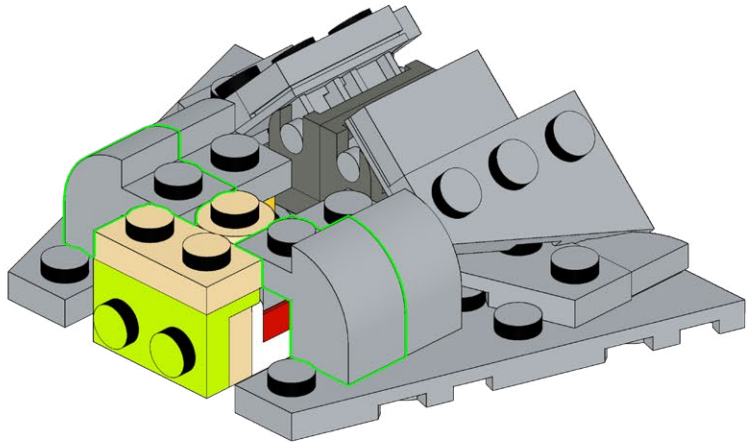
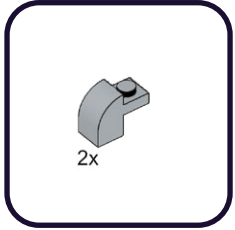

135

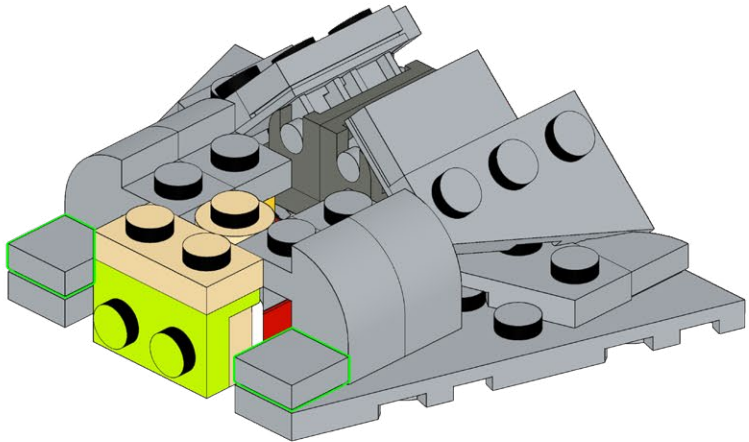
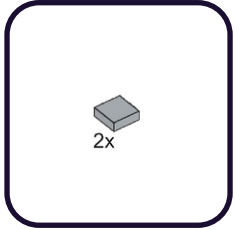



136

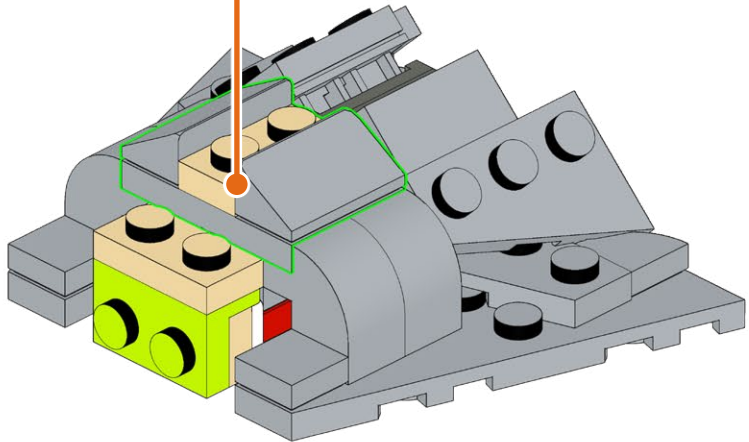
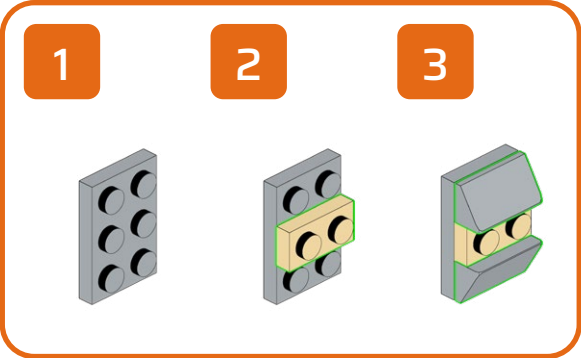
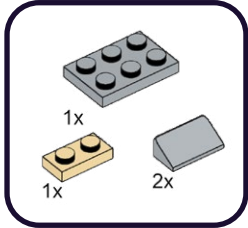

137

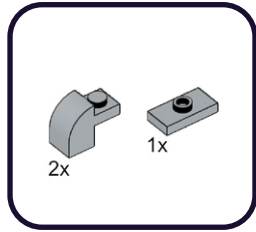

1

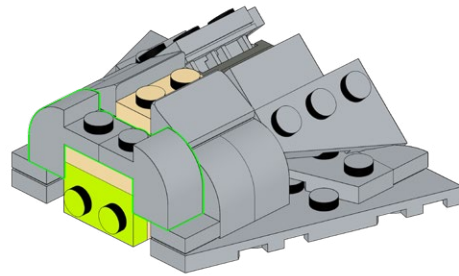

2

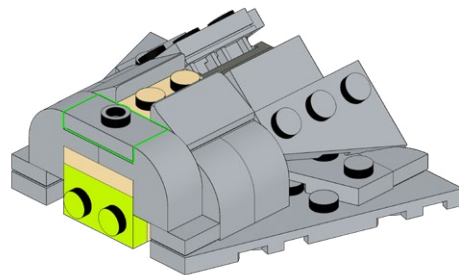

138

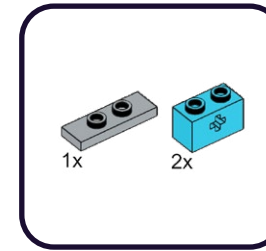

1

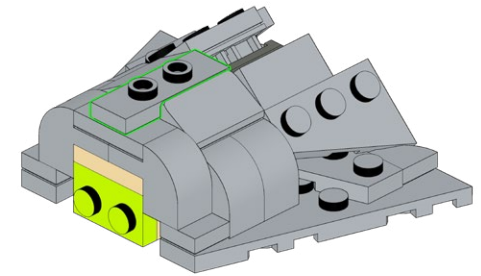

2

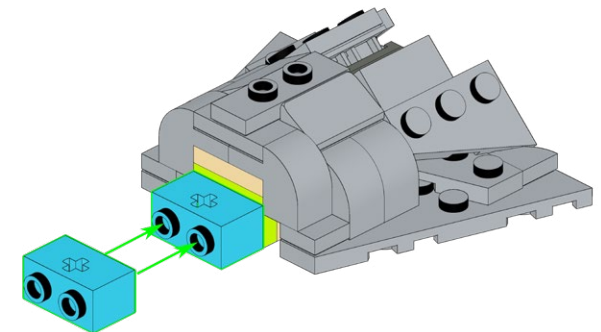

139

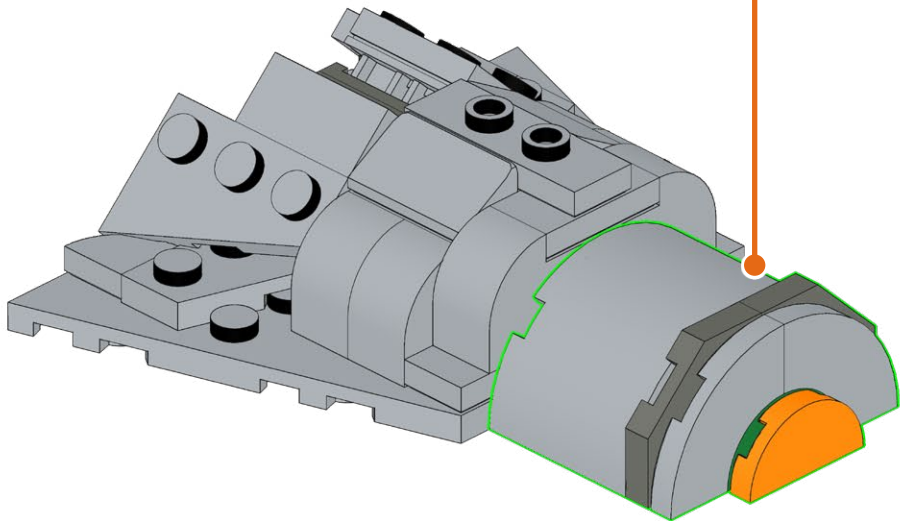
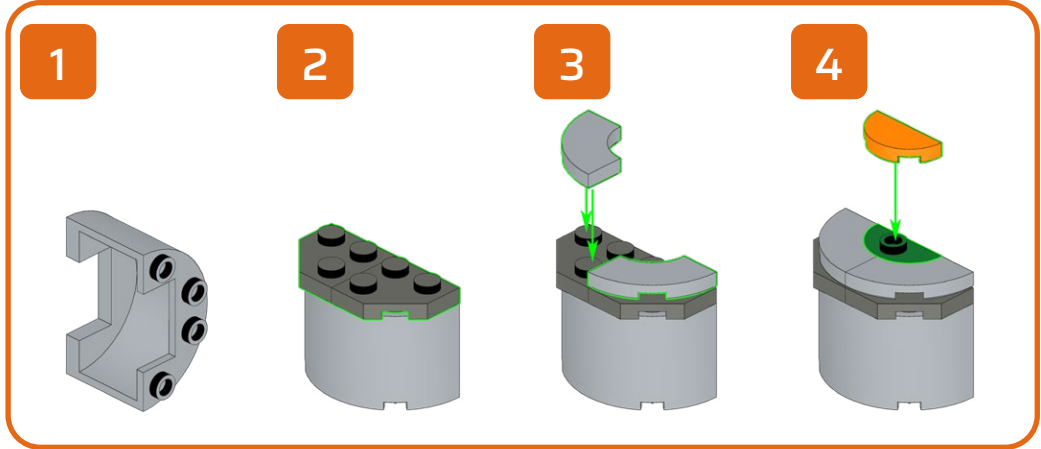
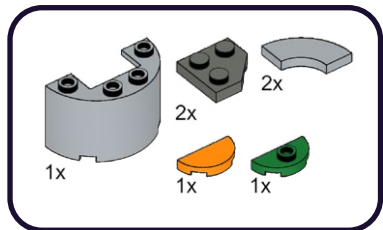

**140**

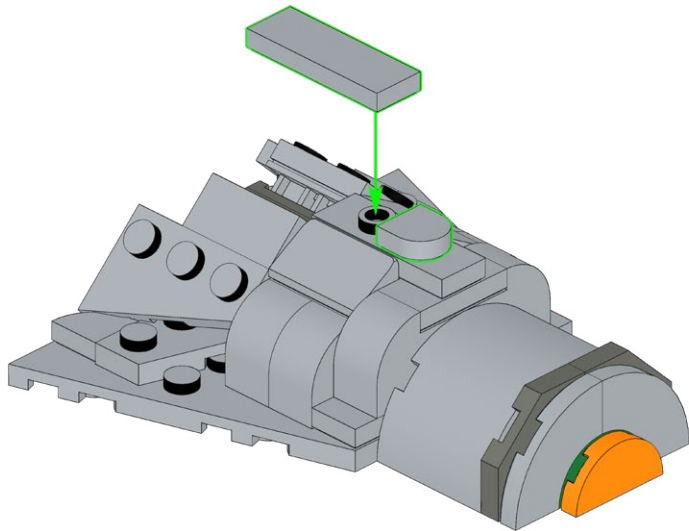
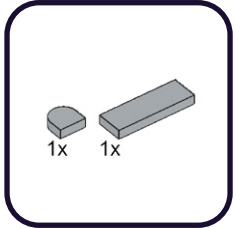

**141**

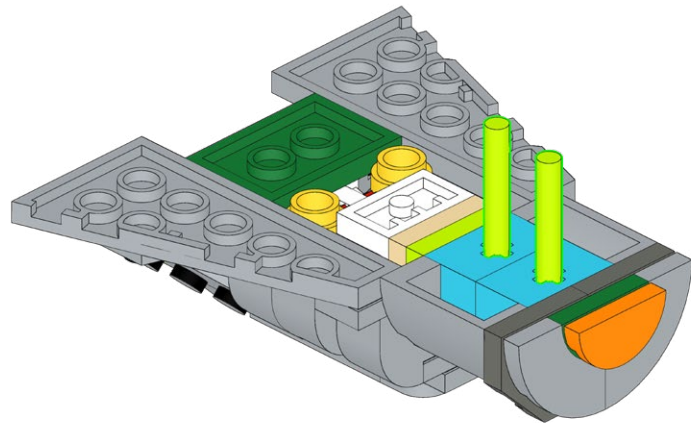
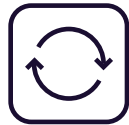
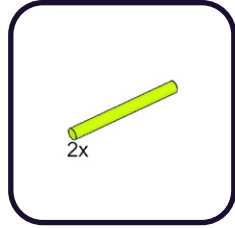

142

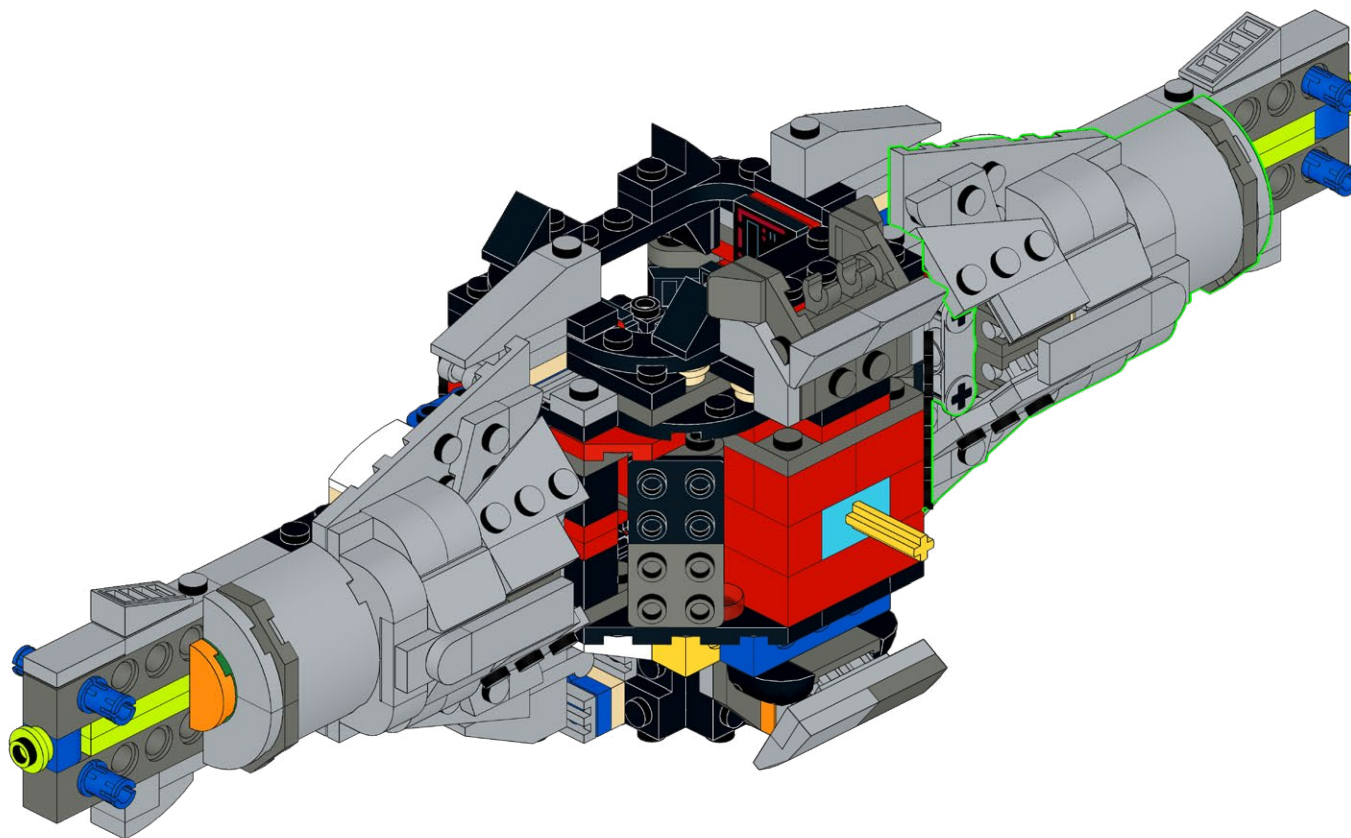

143

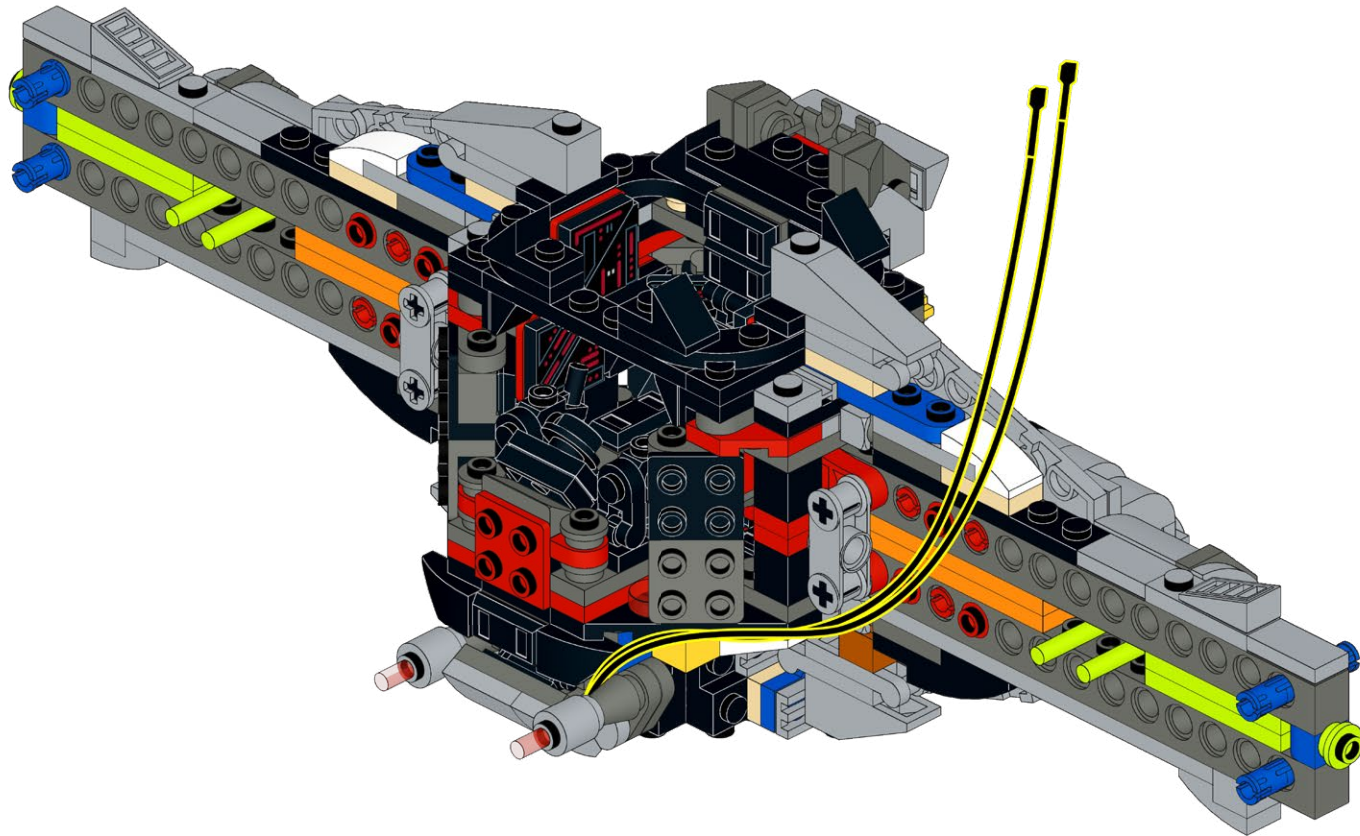



**HOLD UP!**

You might notice some bags are out of order, as well as left over pieces, but that's ok! We're changing the way you build LEGO!

**HALTEN!**

Möglicherweise stellen Sie fest, dass einige Beutel nicht in Ordnung sind und auch Teile übrig bleiben, aber das ist in Ordnung! Wir verändern die Art und Weise, wie Sie LEGO bauen!

**TENIR BON!**

Vous remarquerez peut-être que certains sacs sont en panne, ainsi que des morceaux restants, mais ce n'est pas grave ! Nous changeons la façon dont vous construisez LEGO !

**SOSTENERE!**

Potresti notare che alcune borse sono fuori uso, così come alcuni pezzi avanzati, ma va bene! Stiamo cambiando il modo in cui costruisci i LEGO!

**¡SOSTENER!**

Puede que notes que algunas bolsas están fuera de orden, así como piezas sobrantes, ¡pero está bien! ¡Estamos cambiando la forma de construir LEGO!

**耽误!**

您可能会注意到有些袋子坏了, 还有剩余的碎片, 但这没关系! 我们正在改变您搭建乐高的方式!

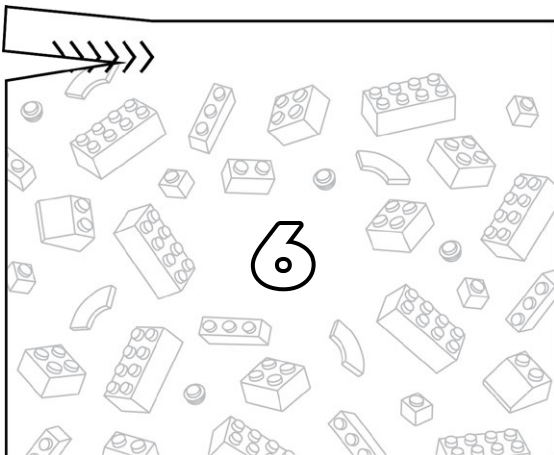
**Open LEGO® Bag 1**

# 144

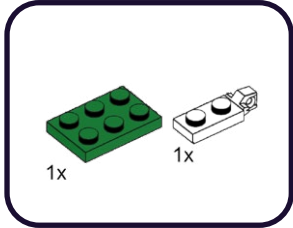

1

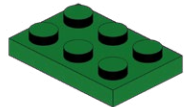

2

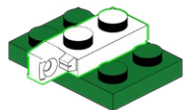

# 145

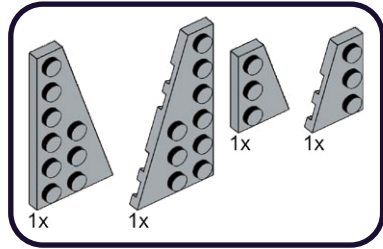

1

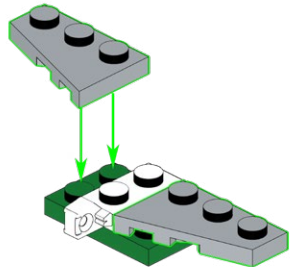

2

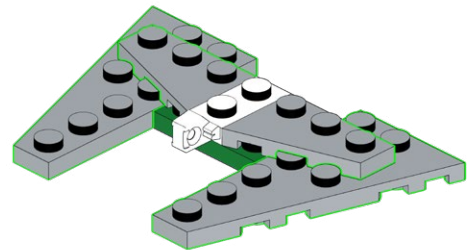

# 146

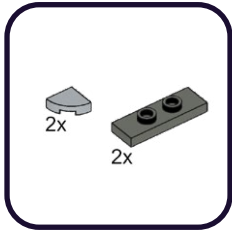

1

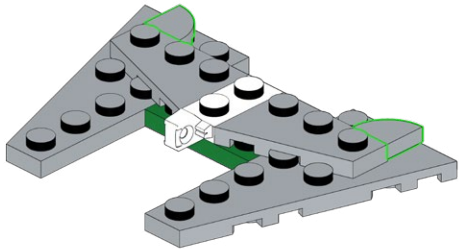

2

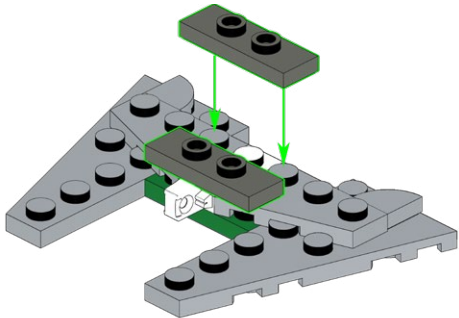

# 147

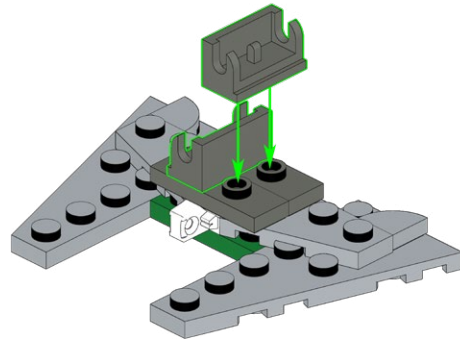
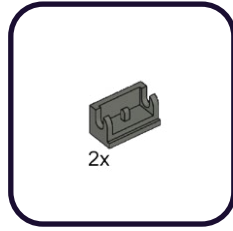

148

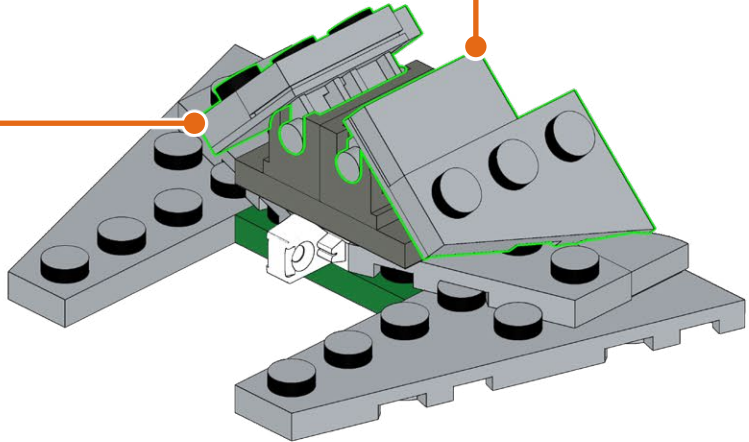
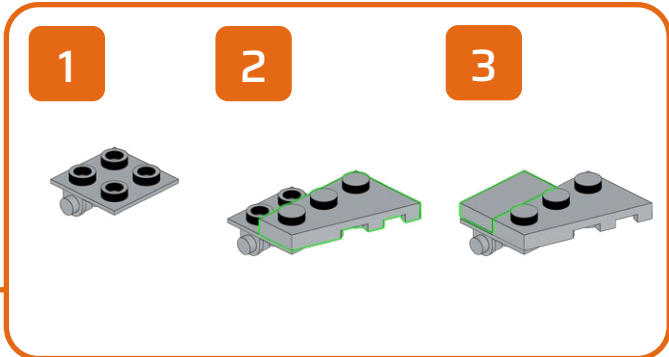
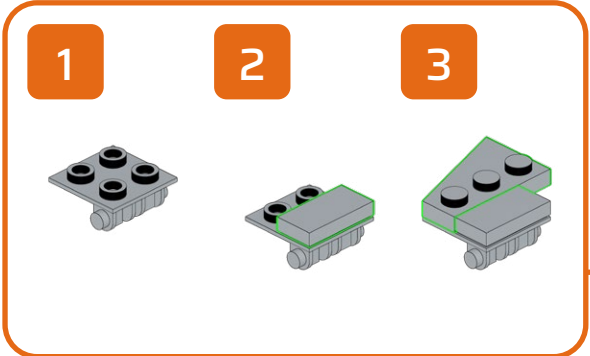
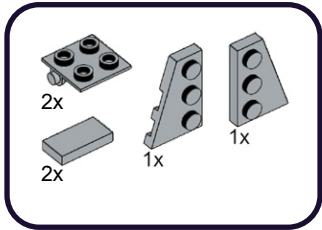

149

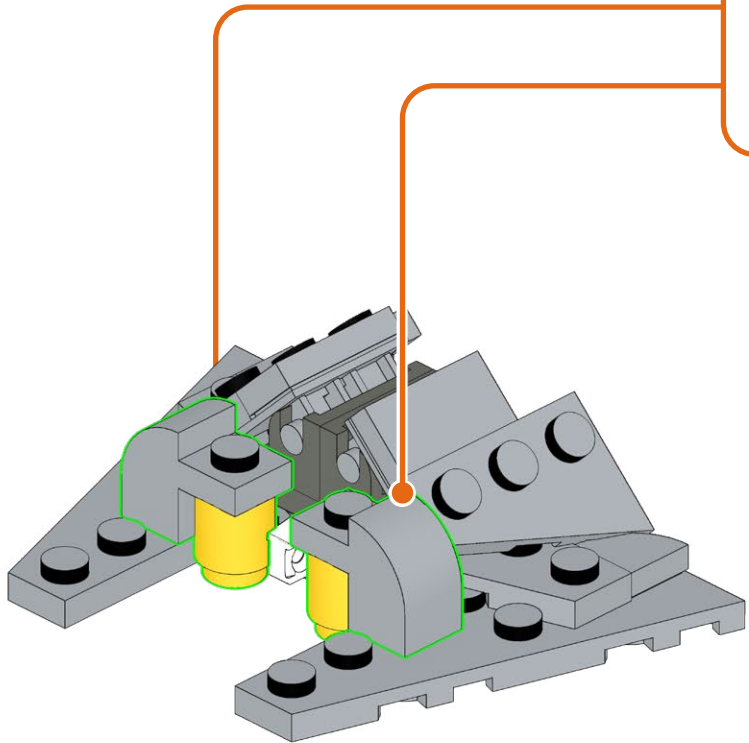
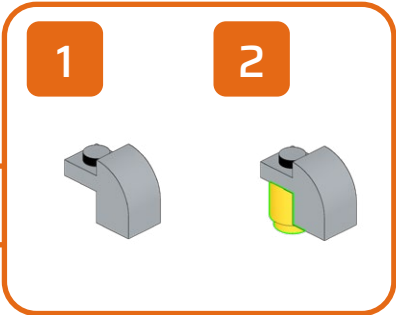
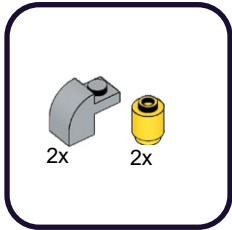

150

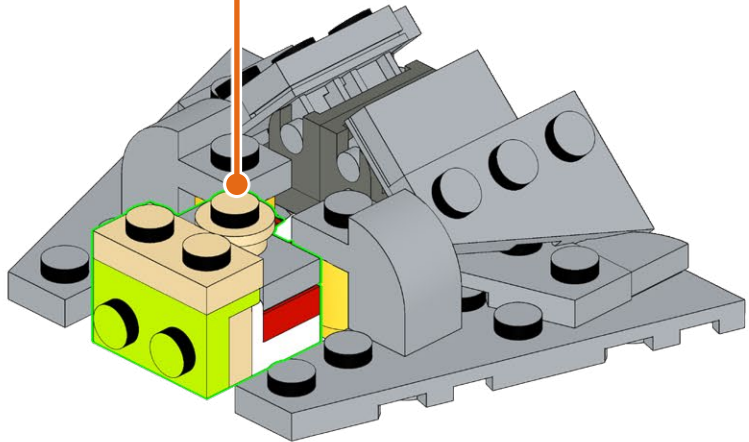
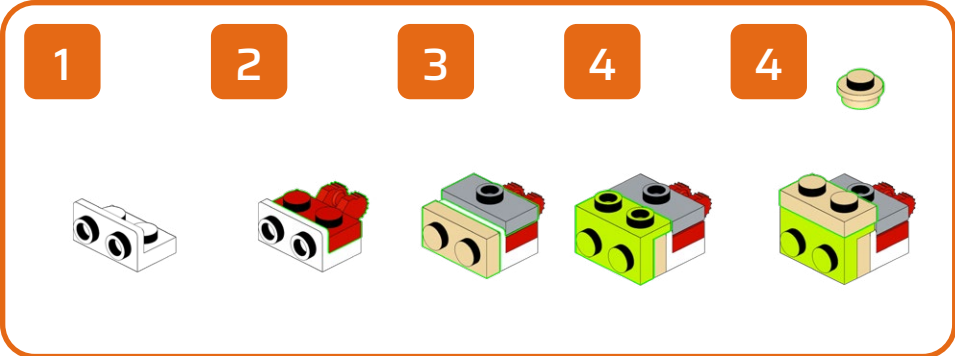
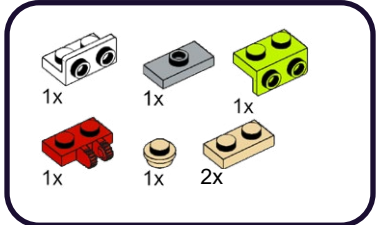



151



2x

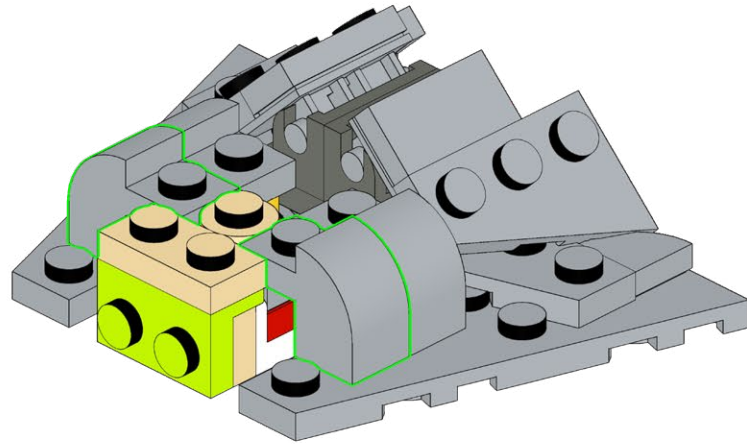



153

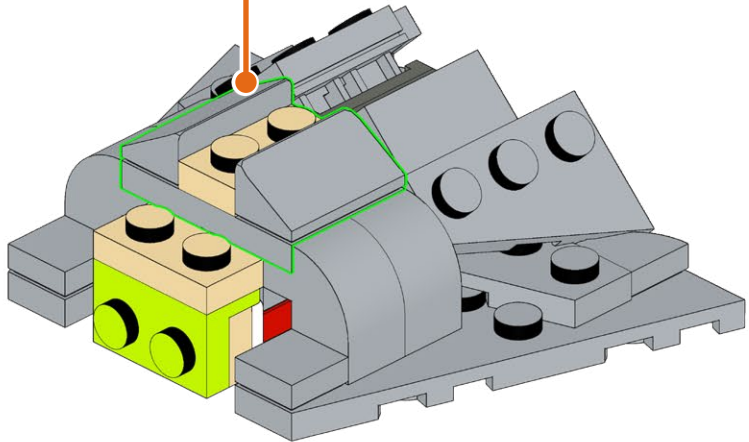
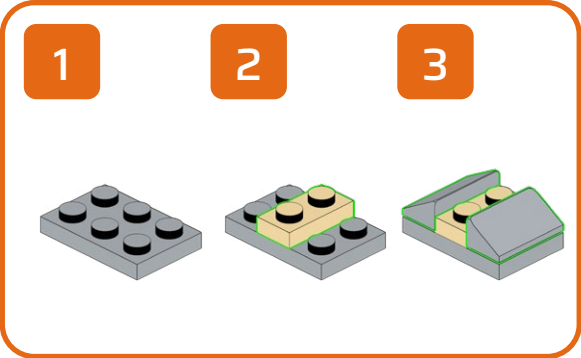
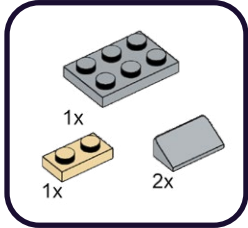

# 154

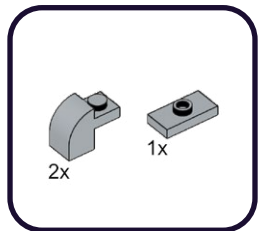

1

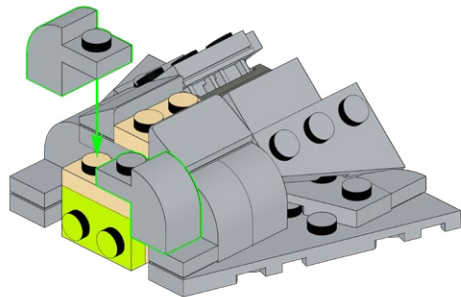

2

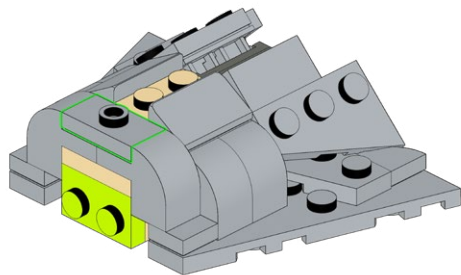

# 155

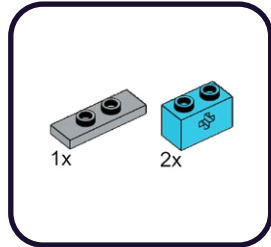

1

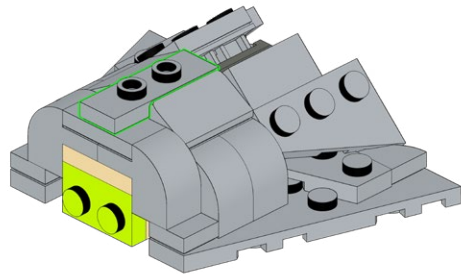

2

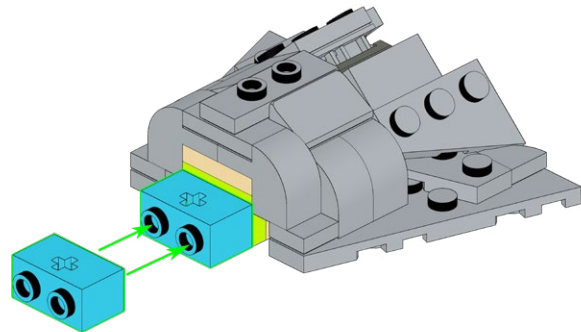

**156**

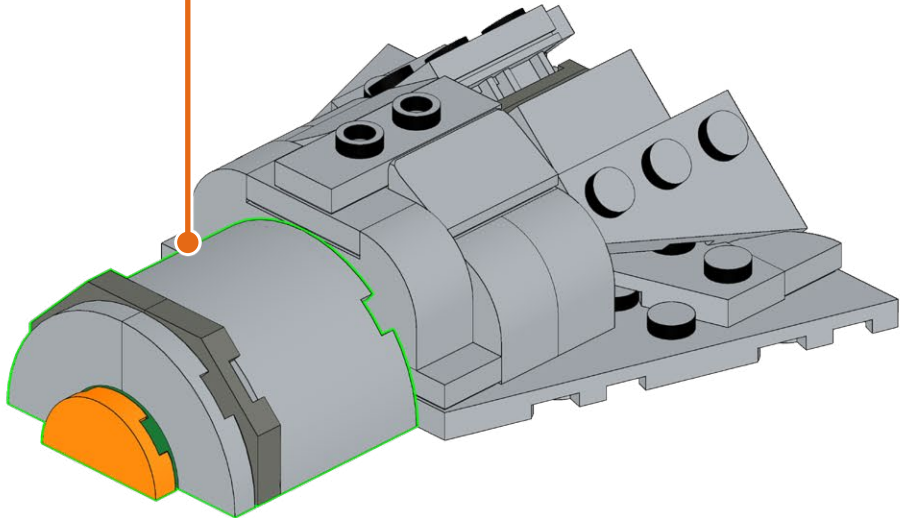
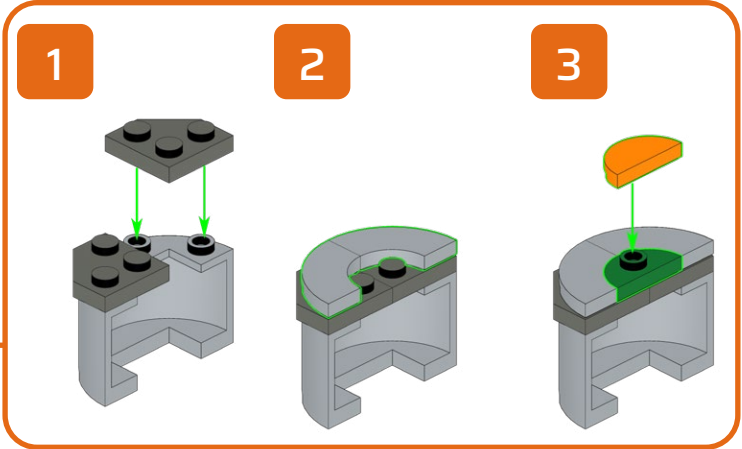
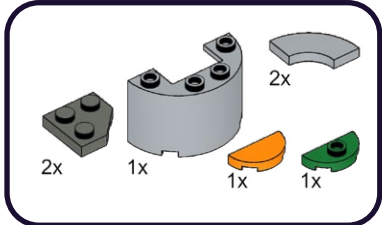

**157**

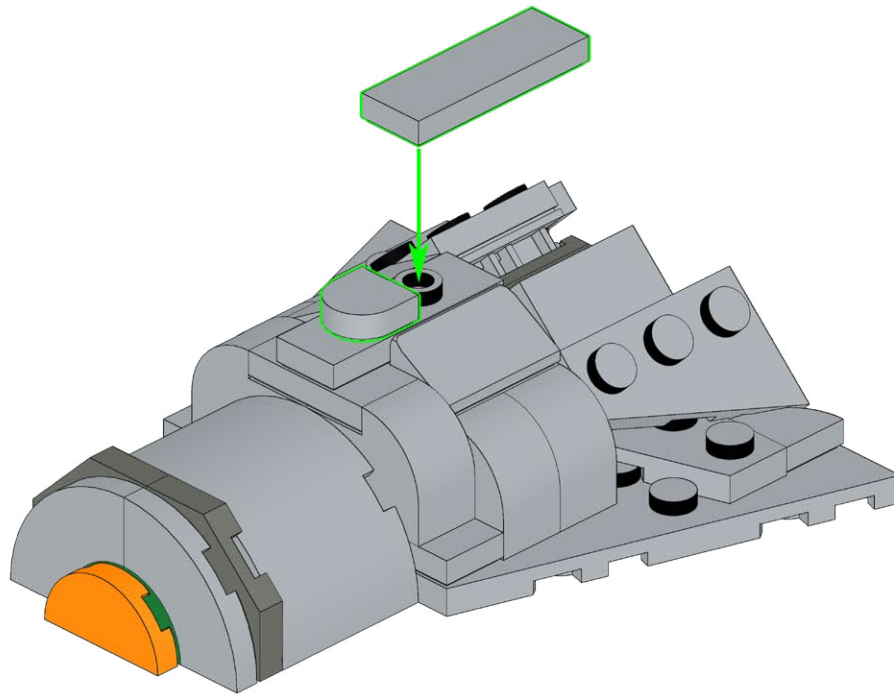
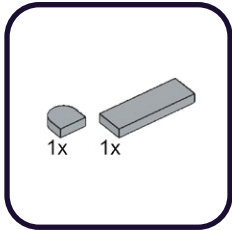



158

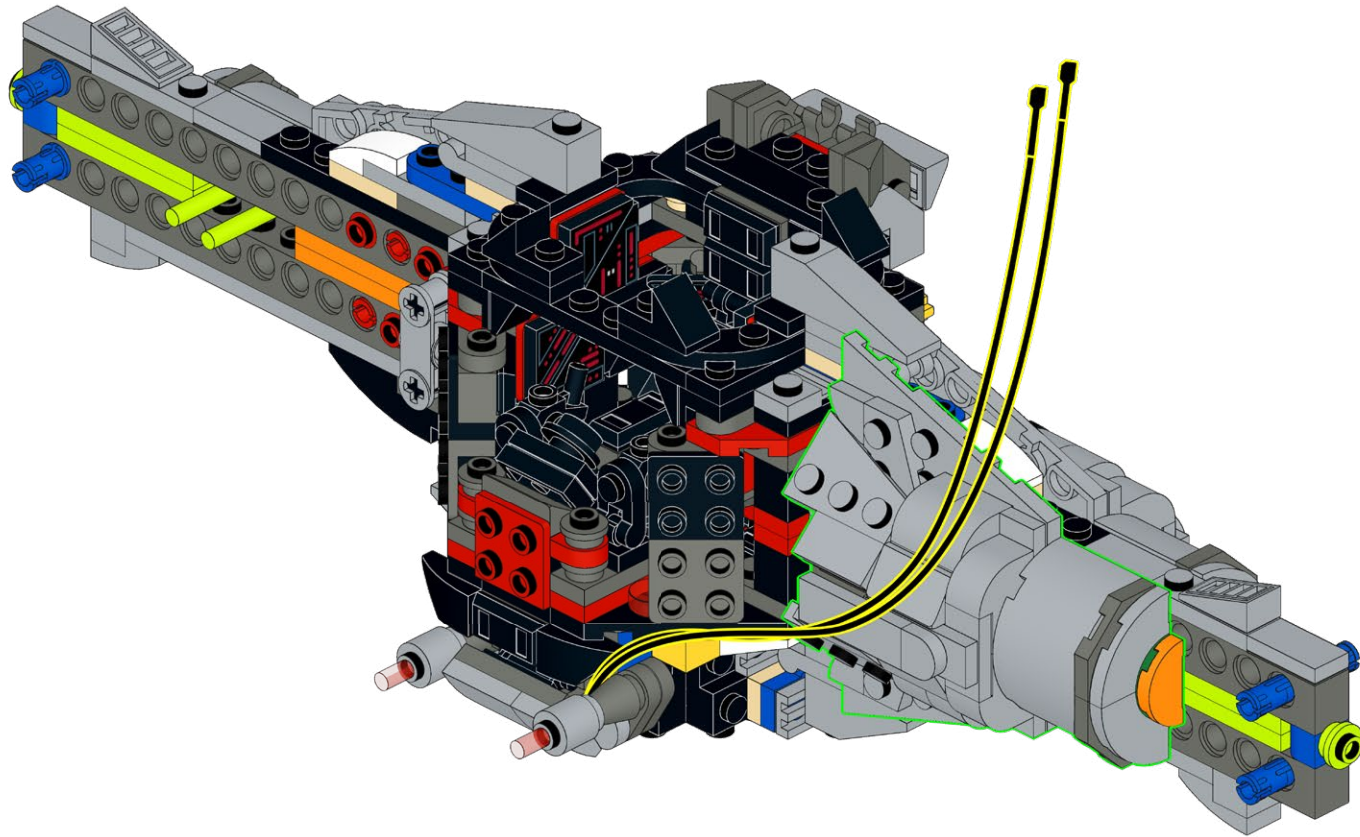

# 159

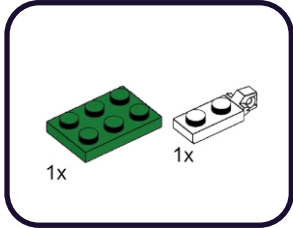

1

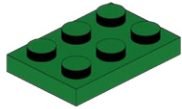

2

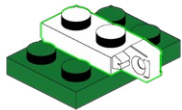

# 160

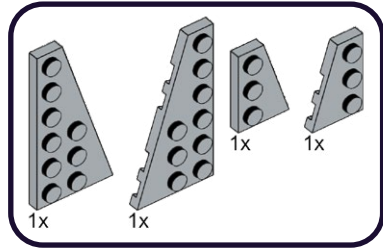

1

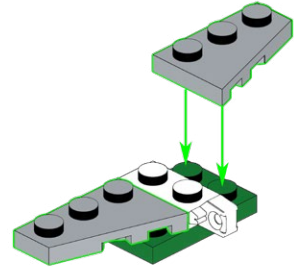

2

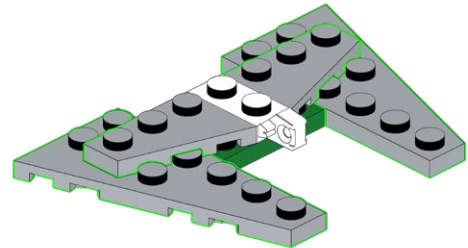

161

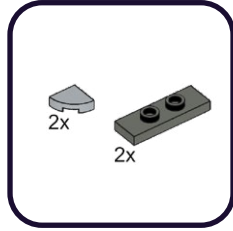

1

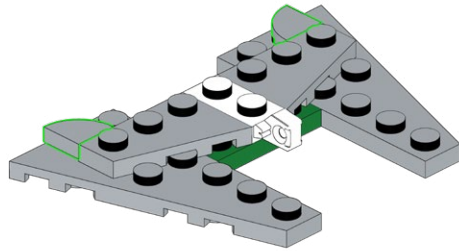

2

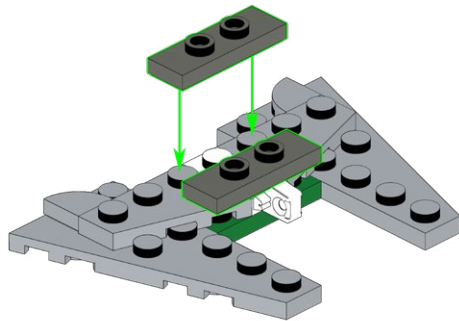

162

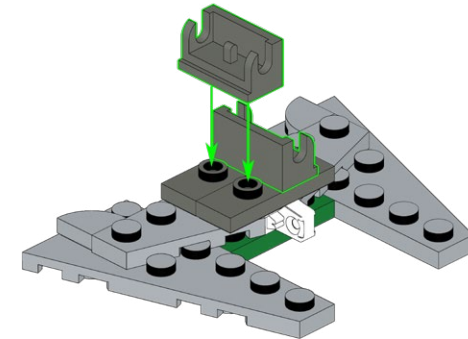
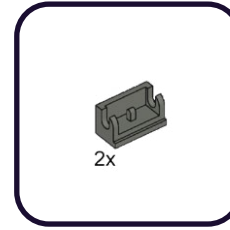

163

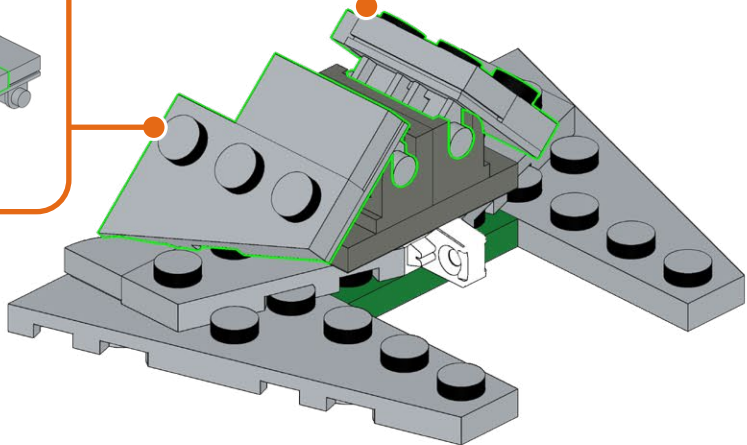
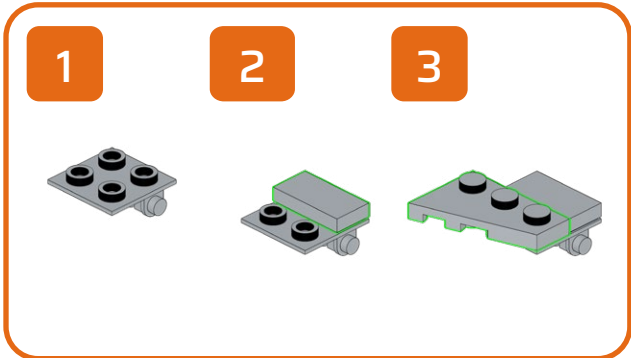
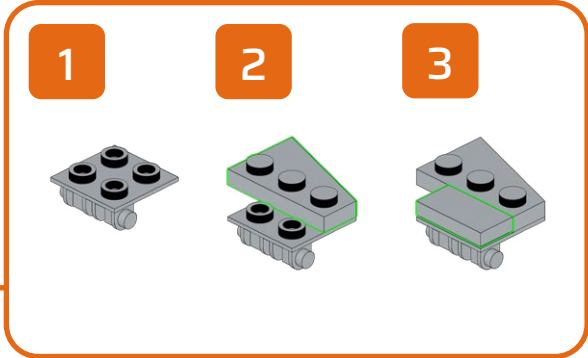
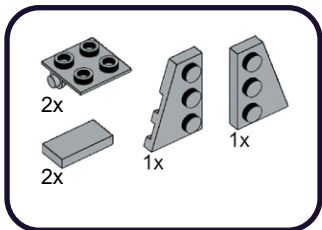

164

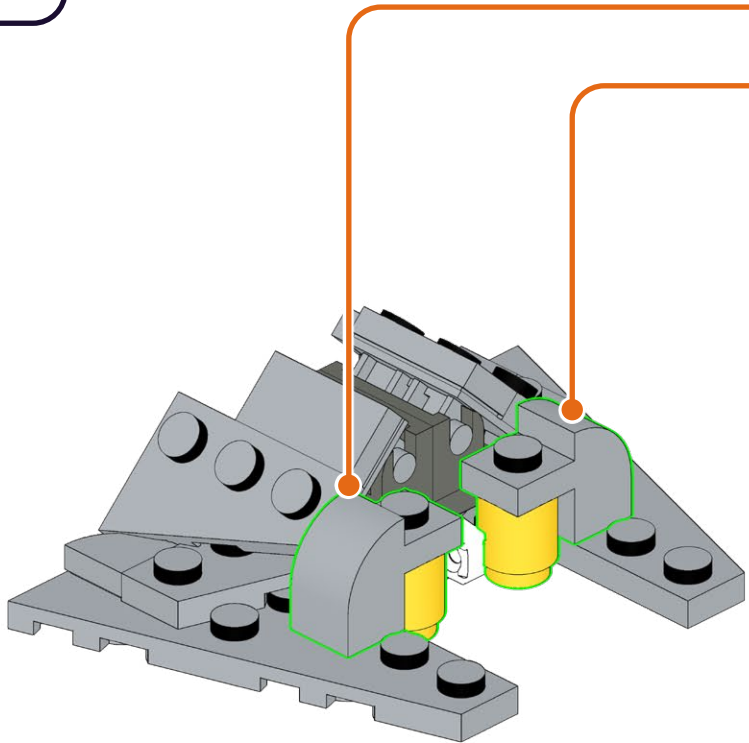
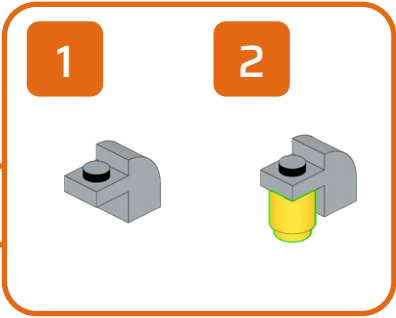
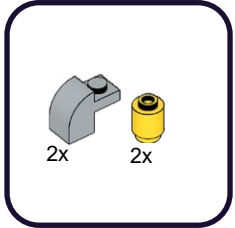

165

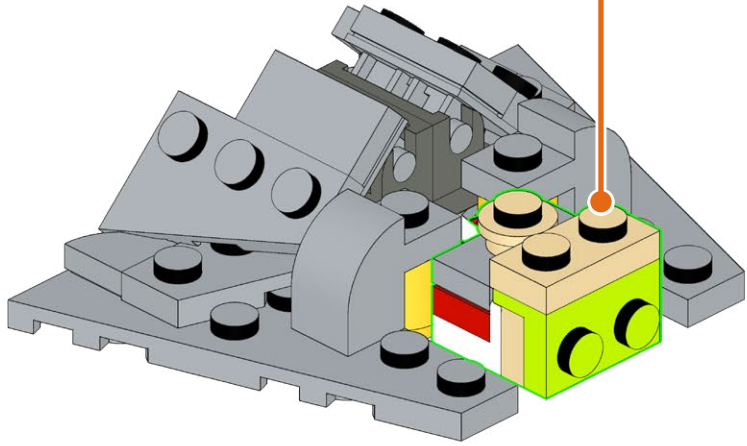
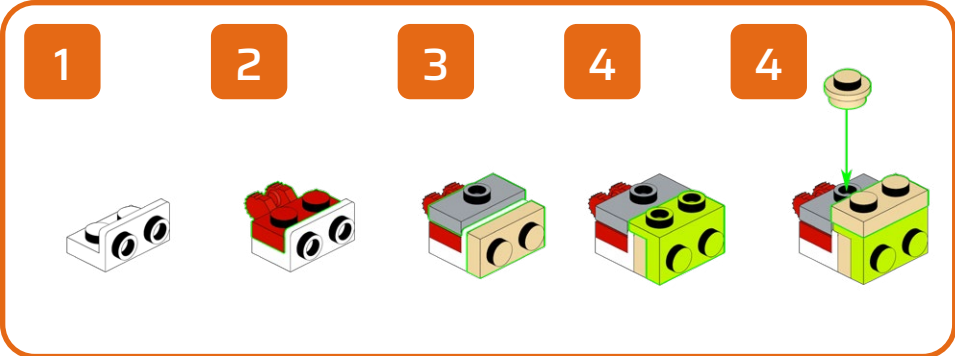
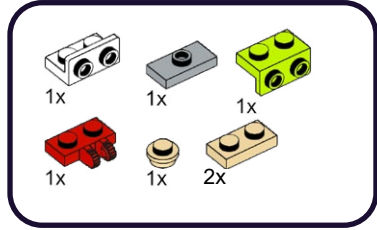



166

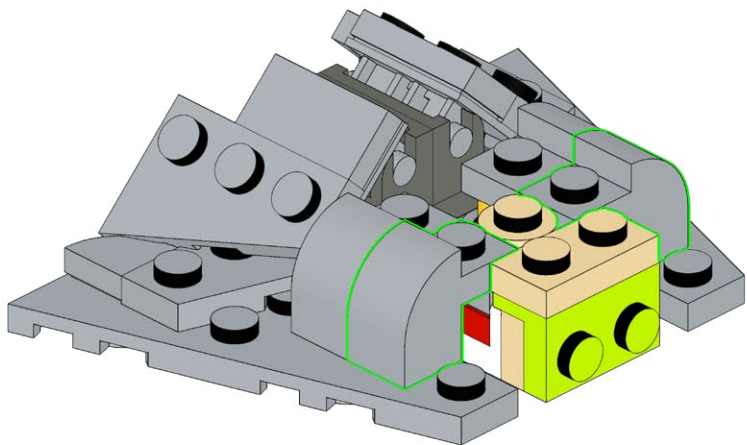
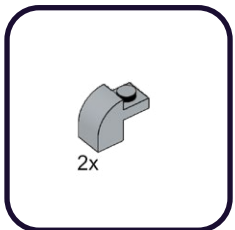

167

2x

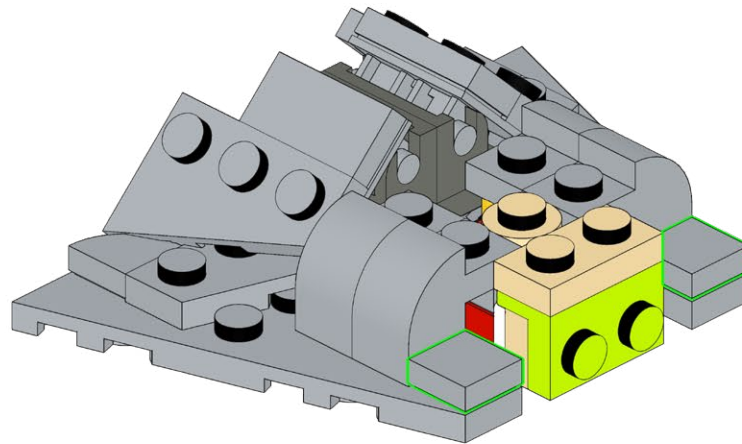

168

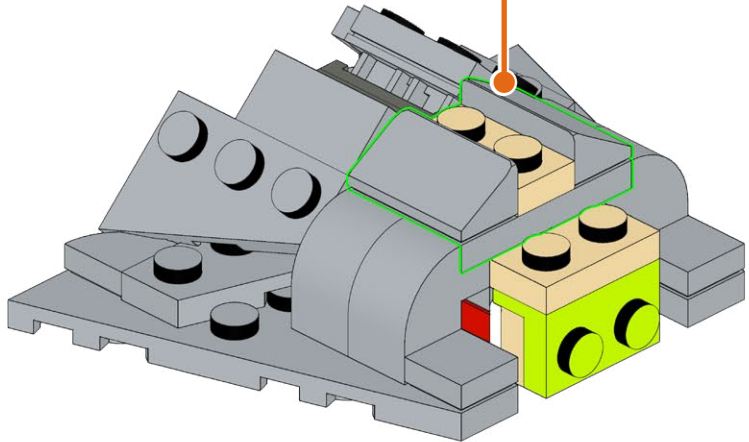
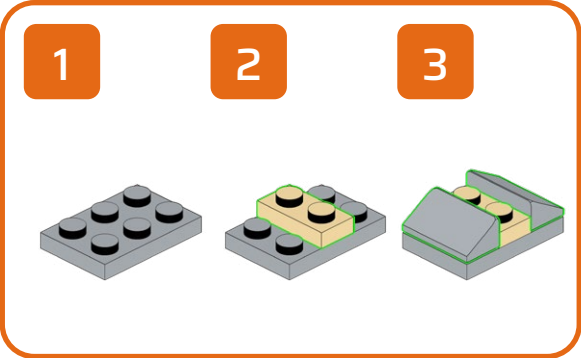
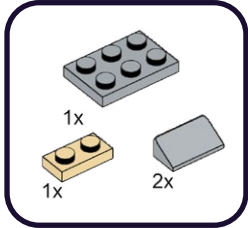

169

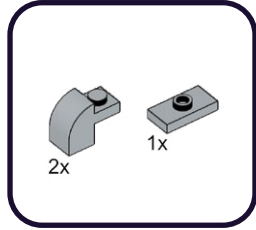

1

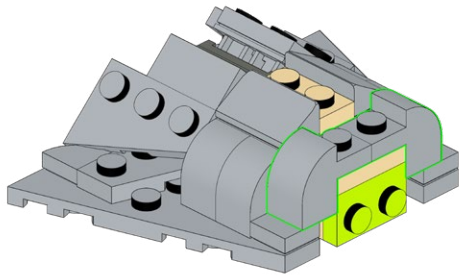

2

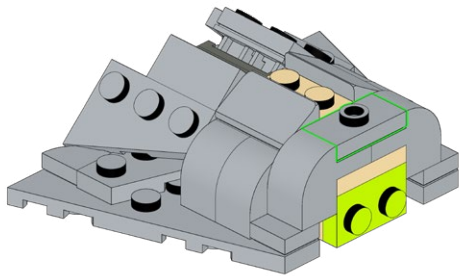

170

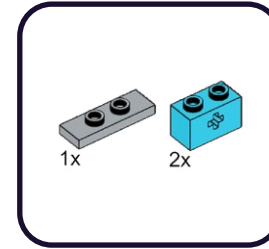

1

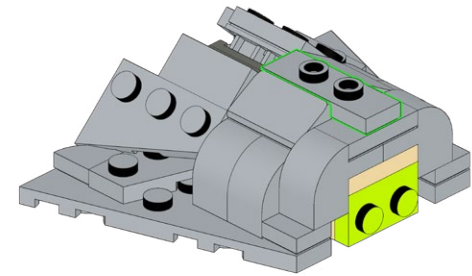

2

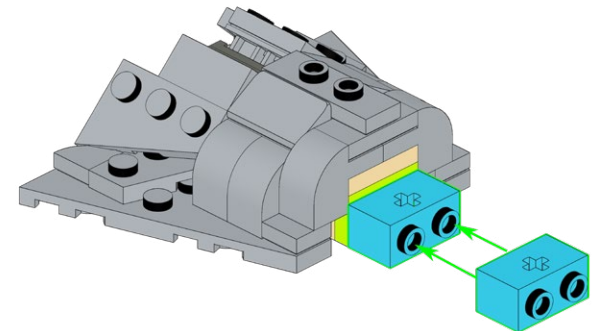

171

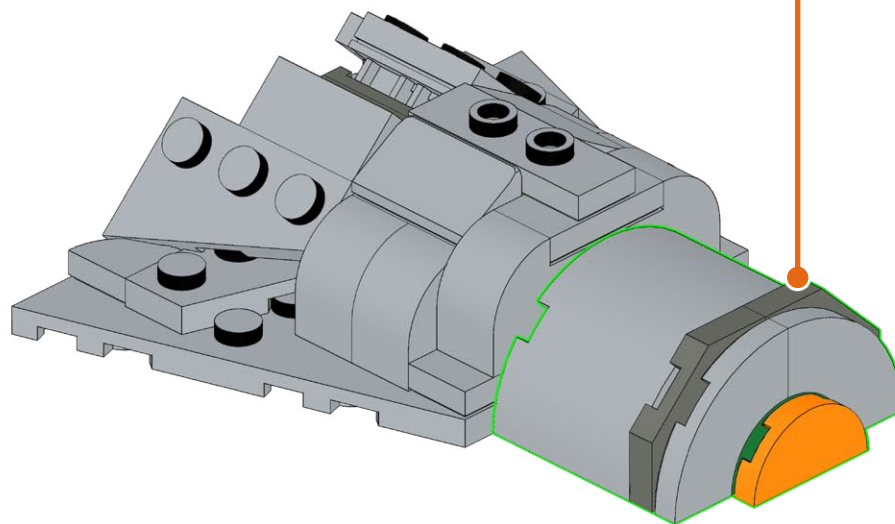
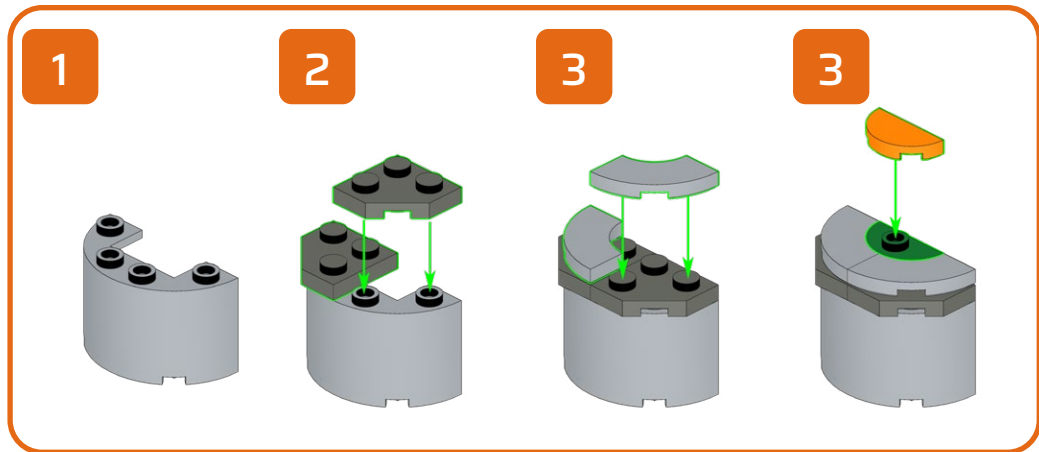
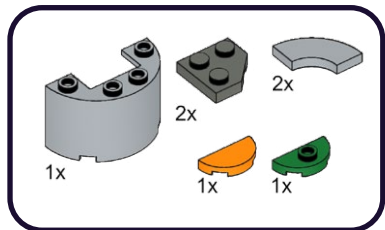

172

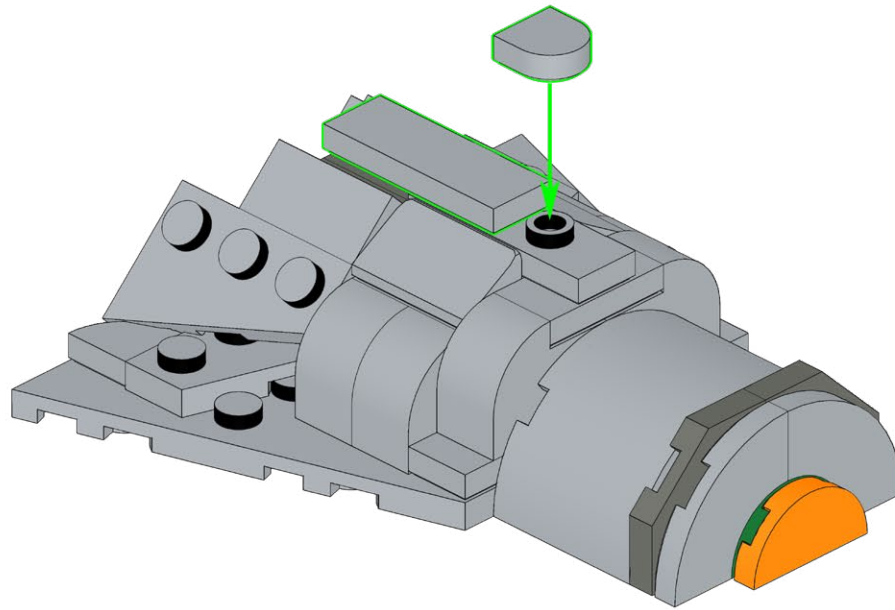
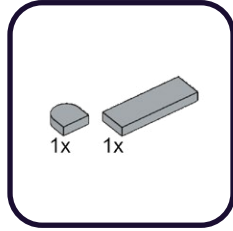

173

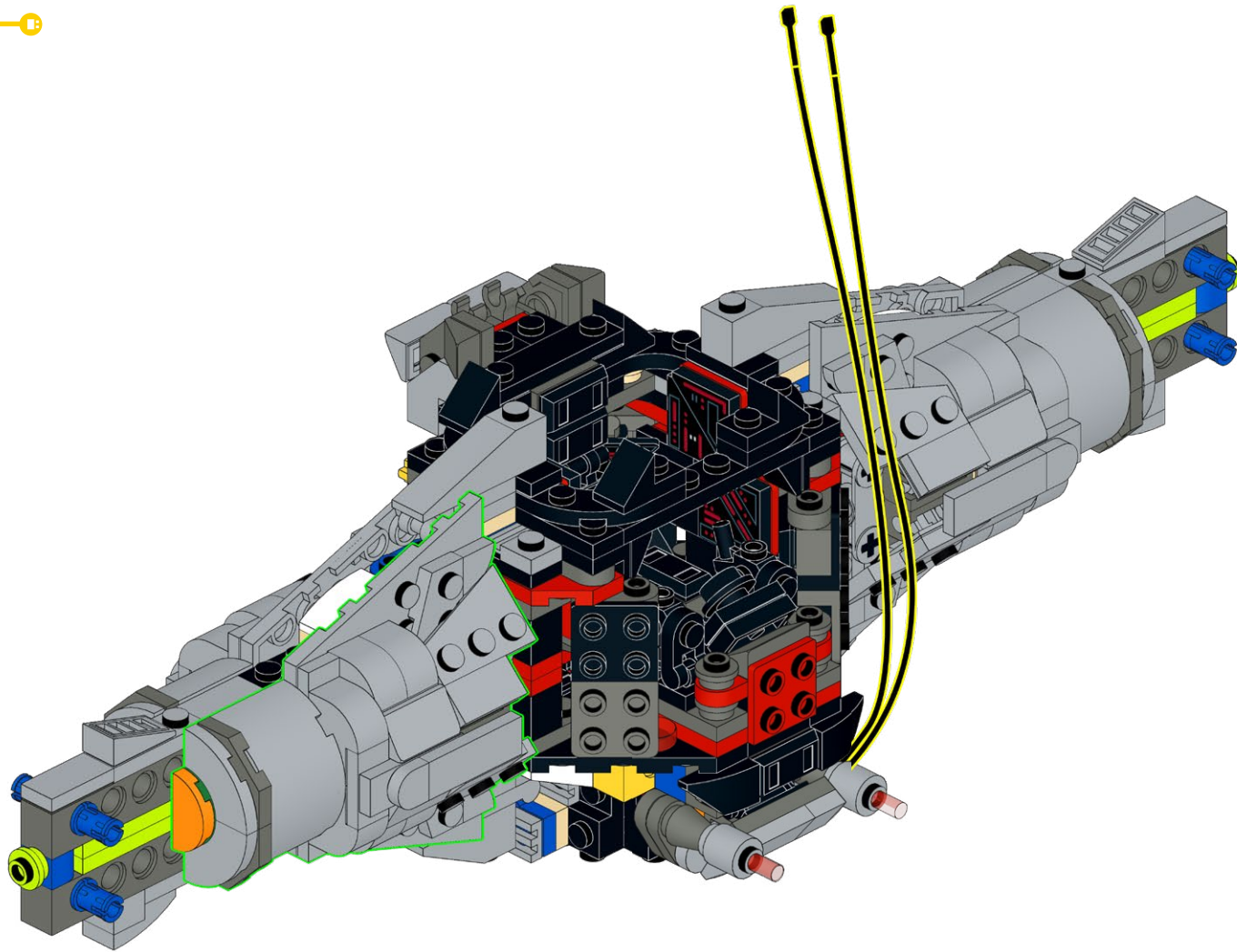



174

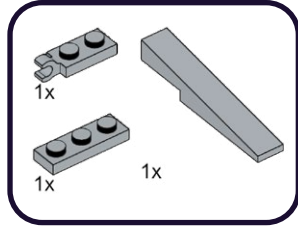

1

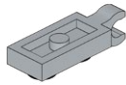

2

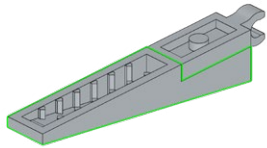

3

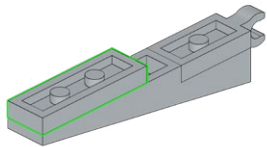

175

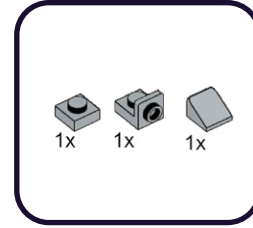

1

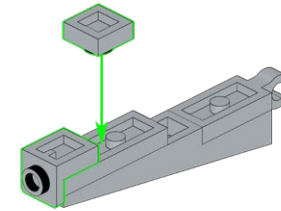

2

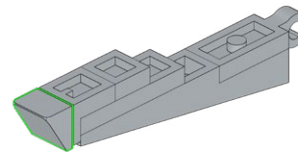

176

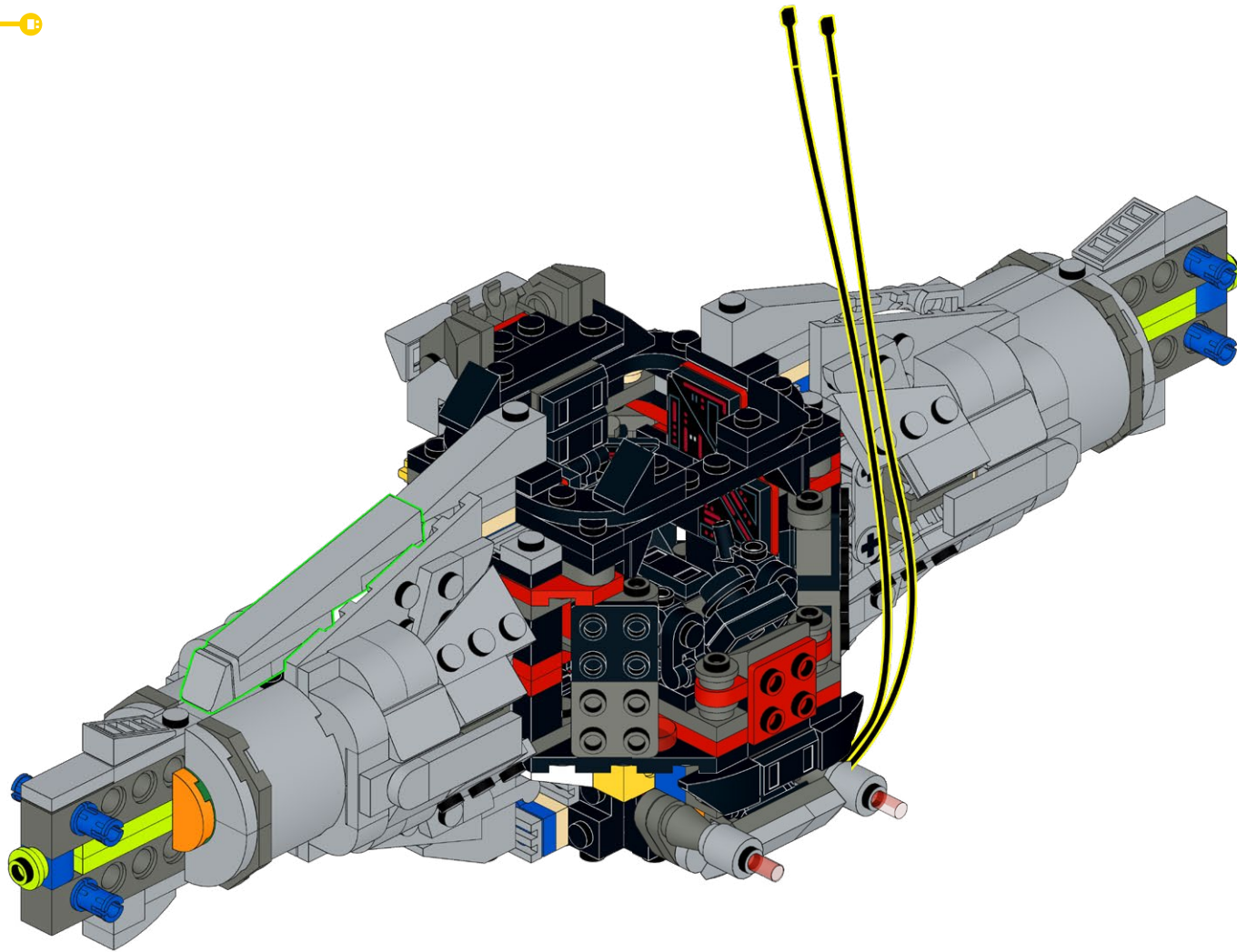

# 177

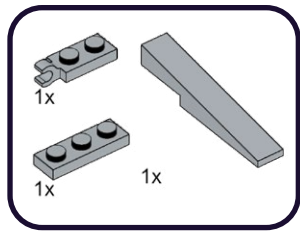

1

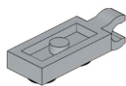

2

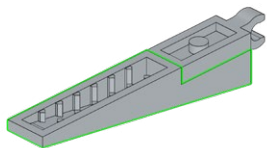

3

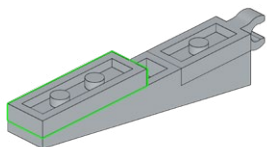

# 178

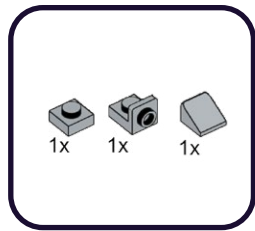

1

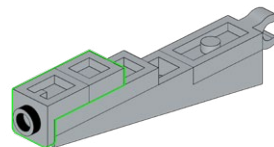

2

3x

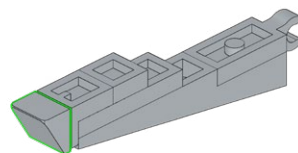

179

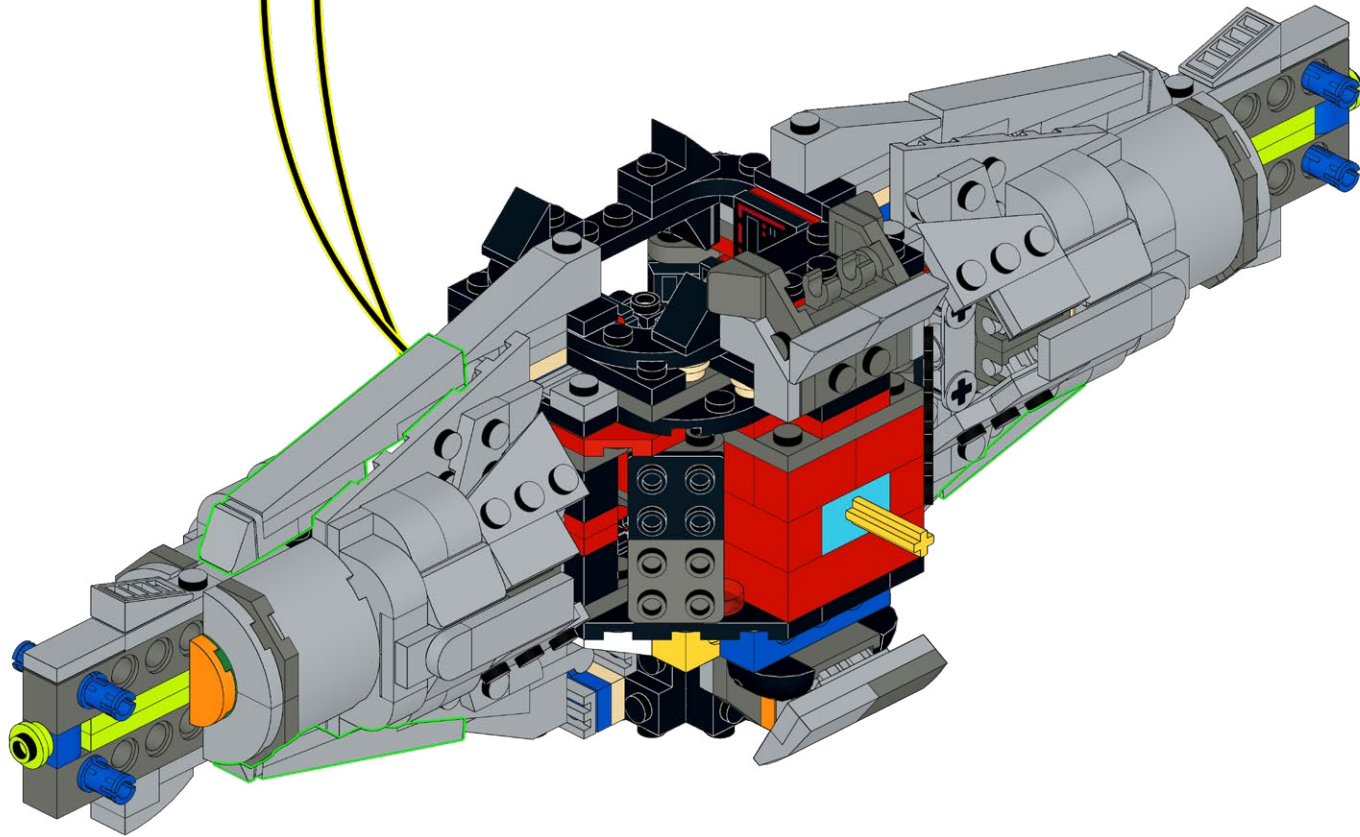

**HOLD UP!**

You might notice some bags are out of order, as well as left over pieces, but that's ok! We're changing the way you build LEGO!

**HALTEN!**

Möglicherweise stellen Sie fest, dass einige Beutel nicht in Ordnung sind und auch Teile übrig bleiben, aber das ist in Ordnung! Wir verändern die Art und Weise, wie Sie LEGO bauen!

**TENIR BON!**

Vous remarquerez peut-être que certains sacs sont en panne, ainsi que des morceaux restants, mais ce n'est pas grave ! Nous changeons la façon dont vous construisez LEGO !

**SOSTENERE!**

Potresti notare che alcune borse sono fuori uso, così come alcuni pezzi avanzati, ma va bene! Stiamo cambiando il modo in cui costruisci i LEGO!

**¡SOSTENER!**

Puede que notes que algunas bolsas están fuera de orden, así como piezas sobrantes, ¡pero está bien! ¡Estamos cambiando la forma de construir LEGO!

**耽误!**

您可能会注意到有些袋子坏了, 还有剩余的碎片, 但这没关系! 我们正在改变您搭建乐高的方式!

**Open LEGO® Bag 1**

# 180

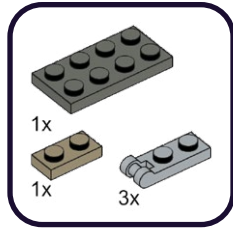

1

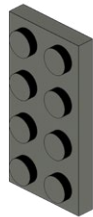

2

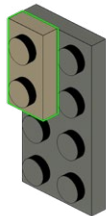

3

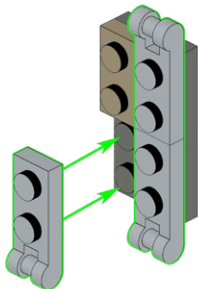

# 181

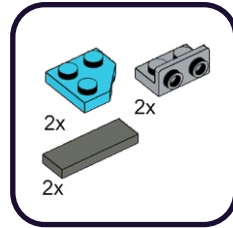

1

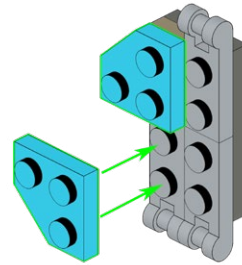

2

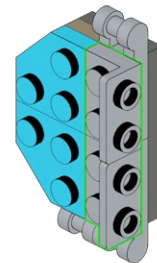

3

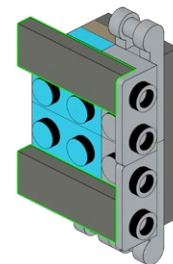

182

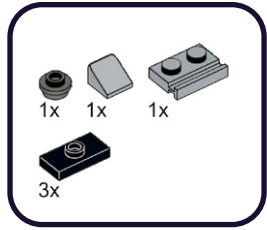

1

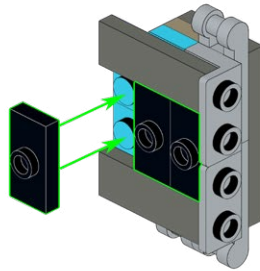

2

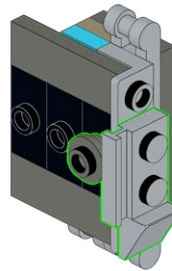



183

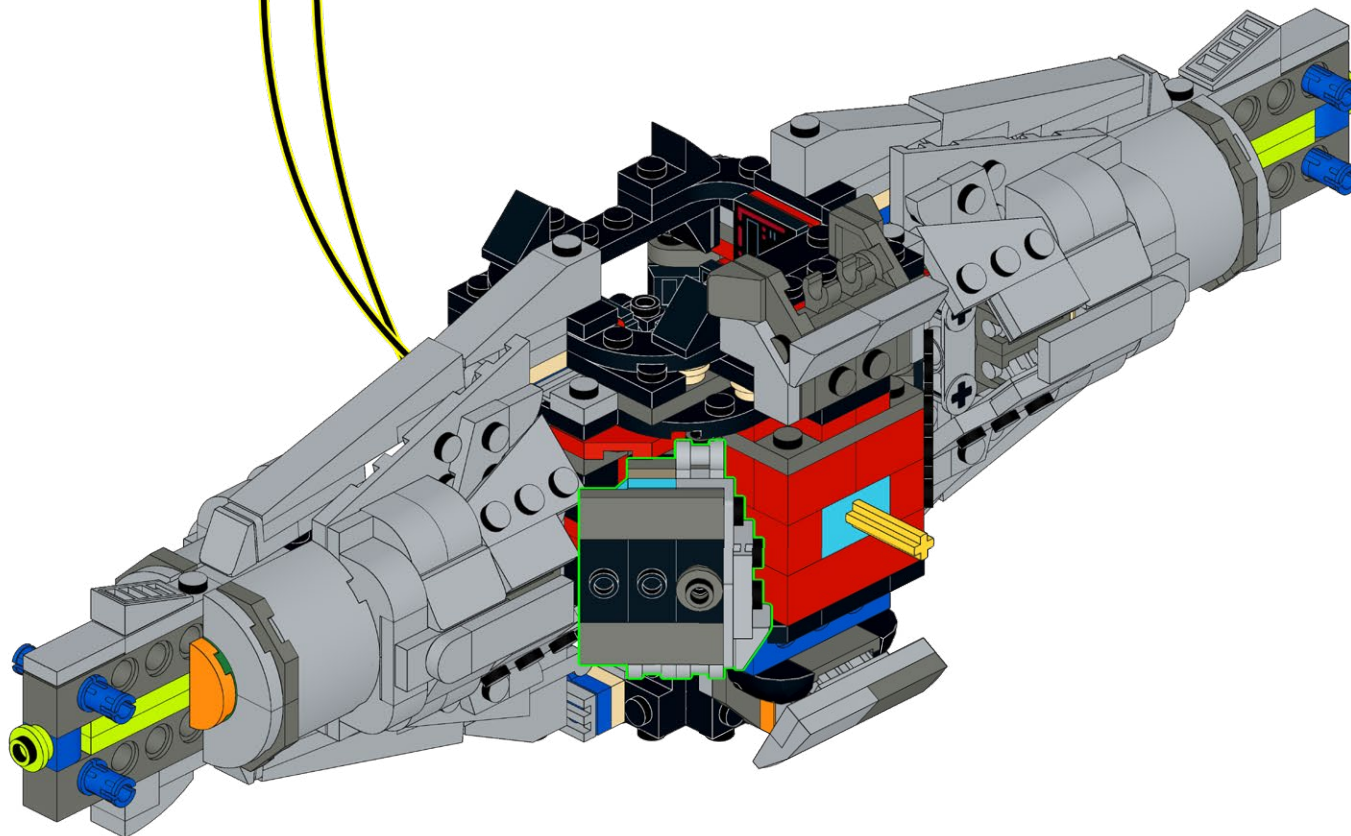

# 184

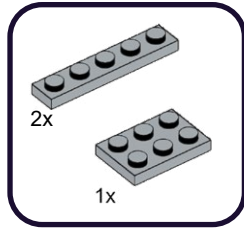

1

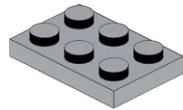

2

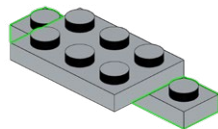

3

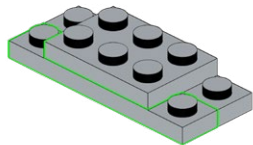

# 185

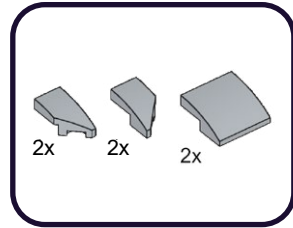

1

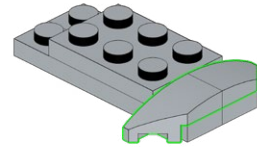

2

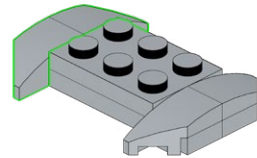

3

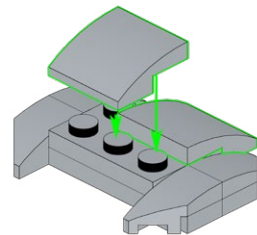

186

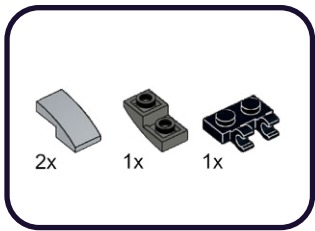

1

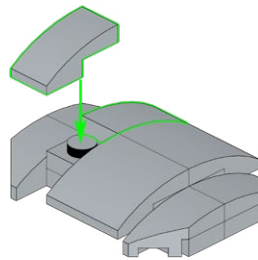

2

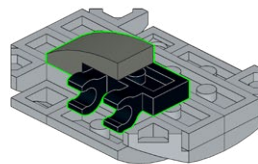

187

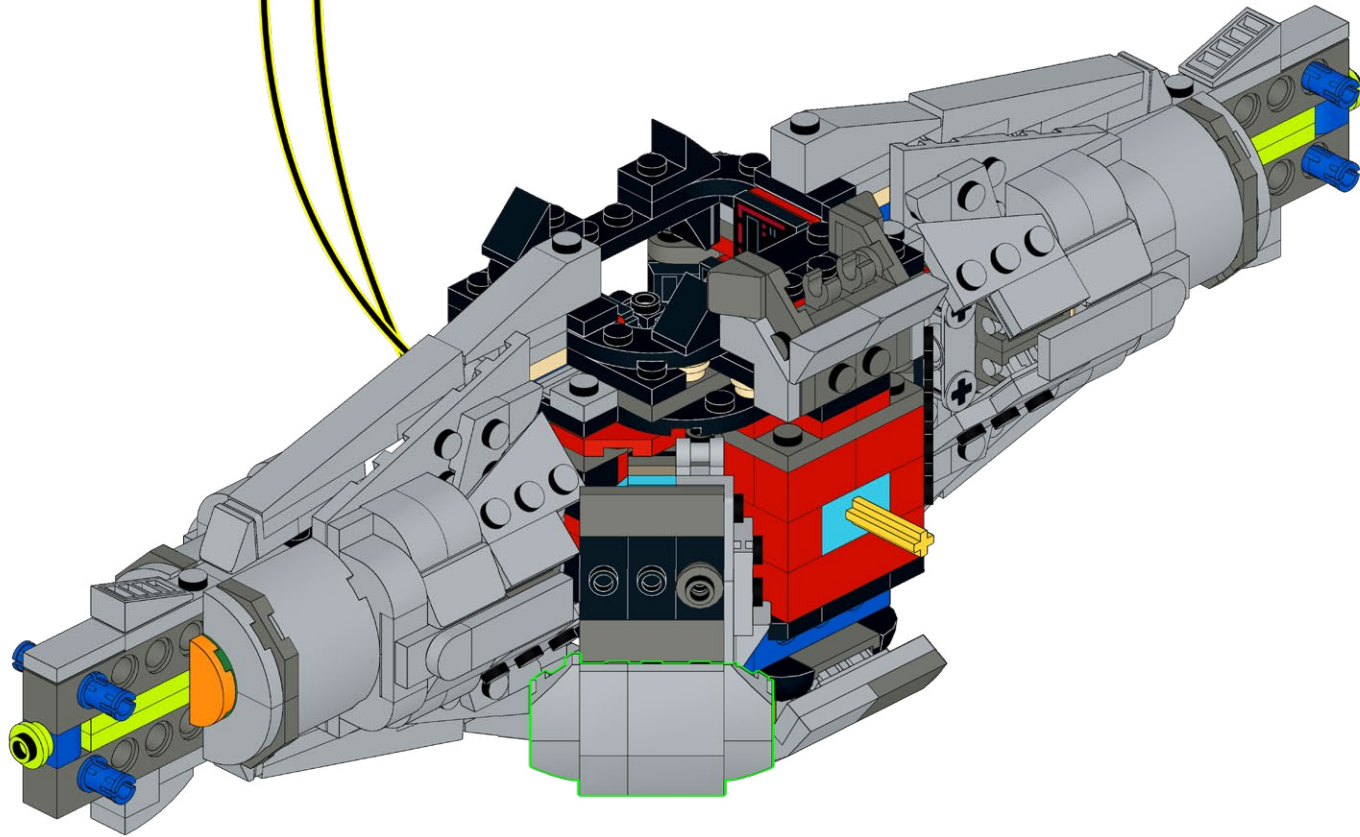

# 188

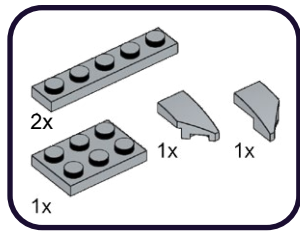

1

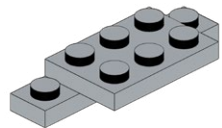

2

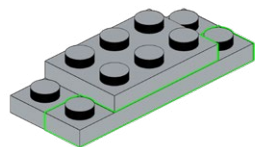

3

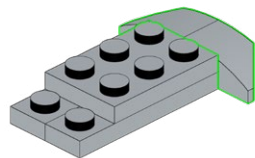

# 189

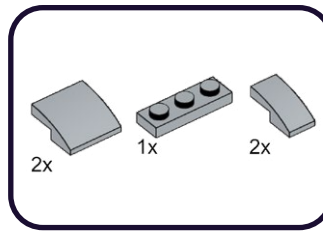

1

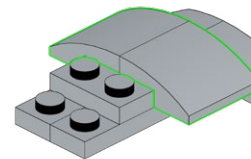

2

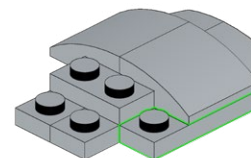

3

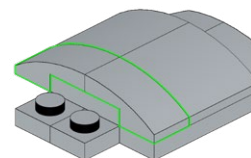

190

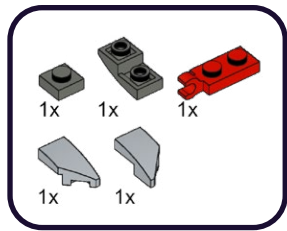

1

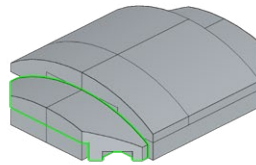

2

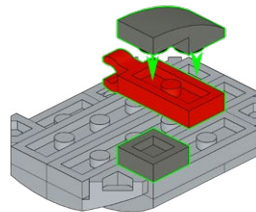

191

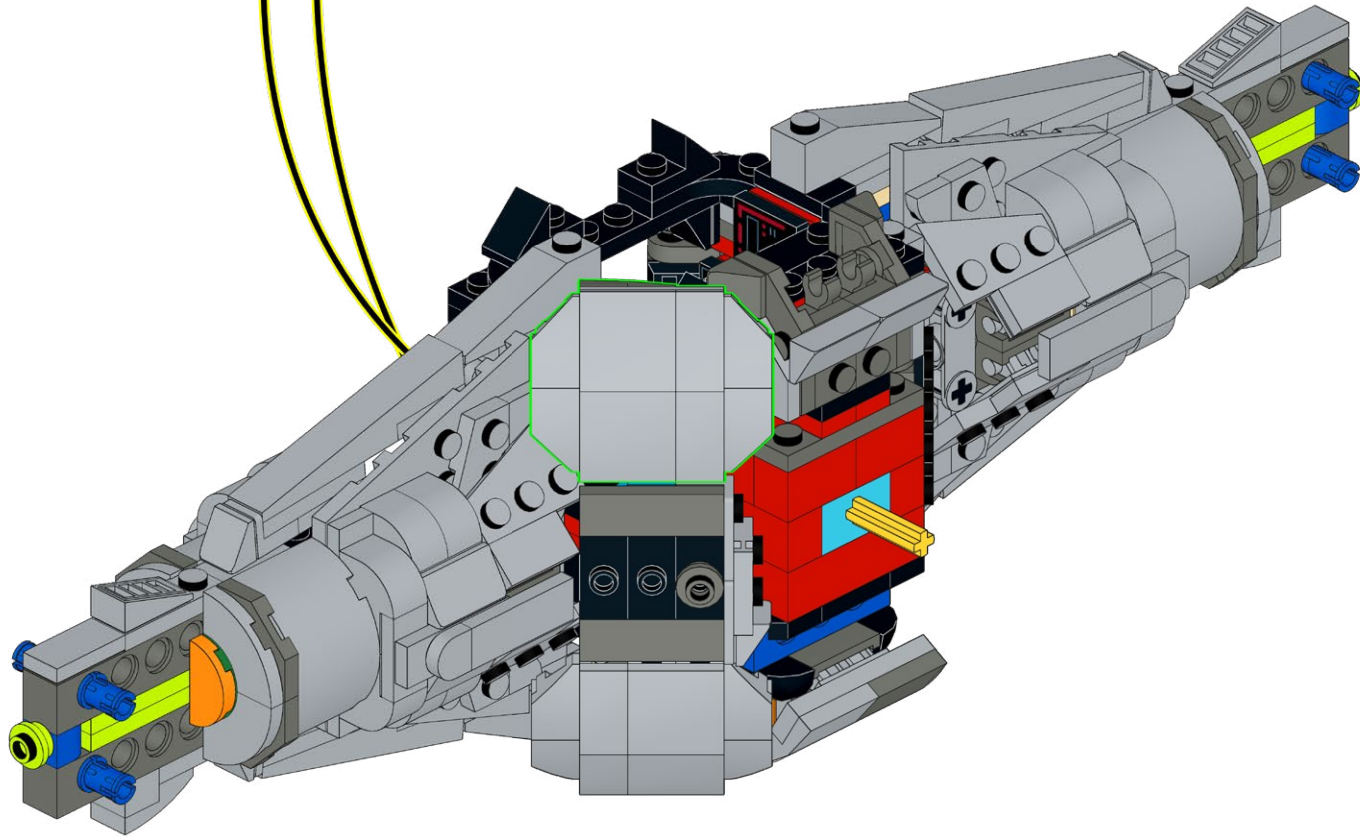



# 192

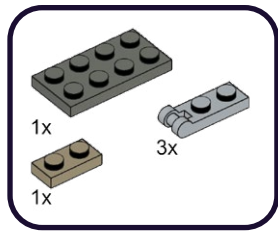

1

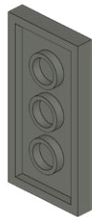

2

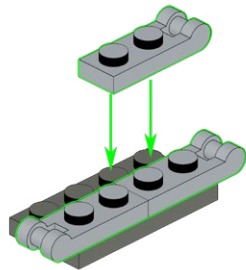

3

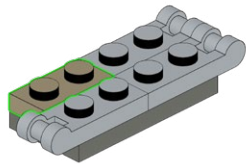

# 193

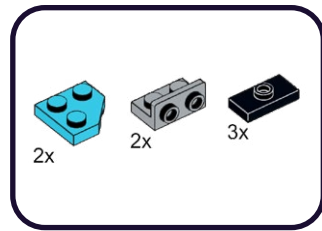

1

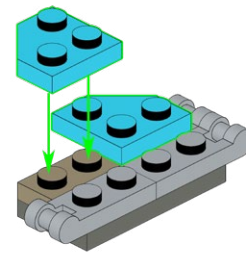

2

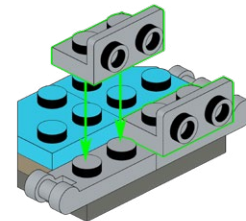

3

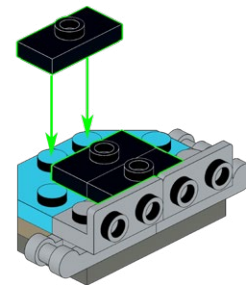

194

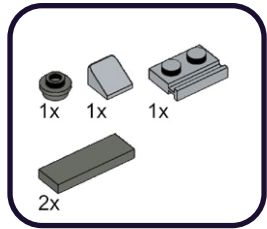

1

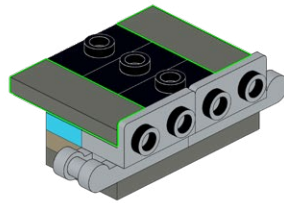

2

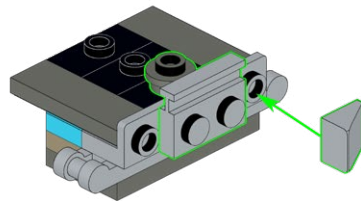

195

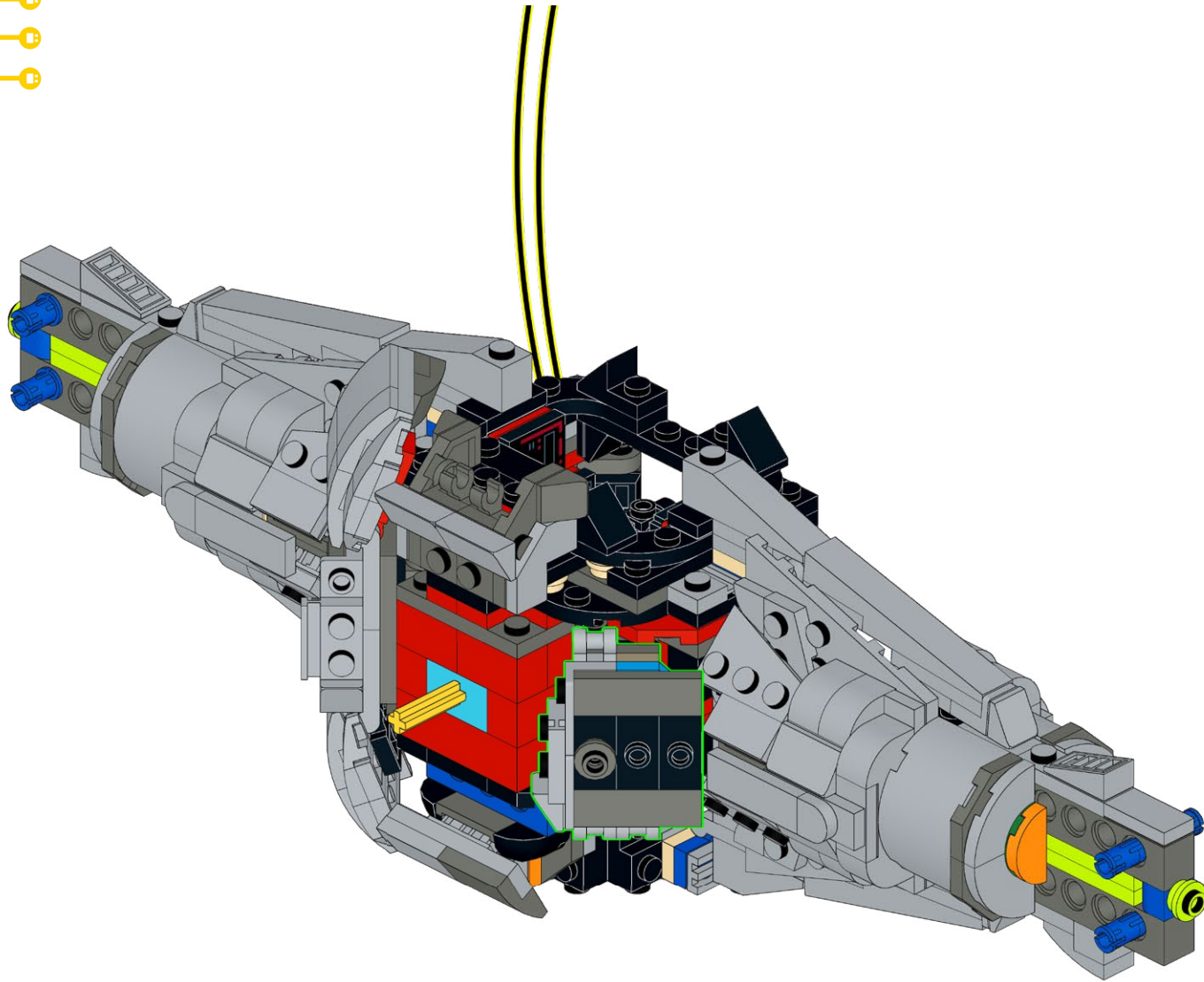

# 196

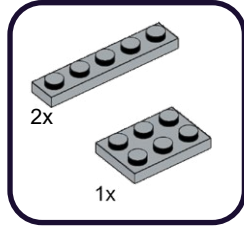

1

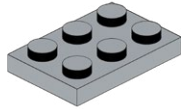

2

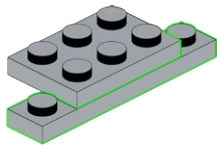

3

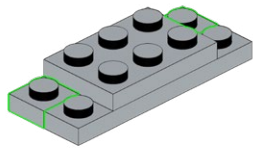

# 197

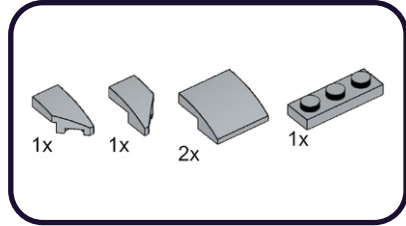

1

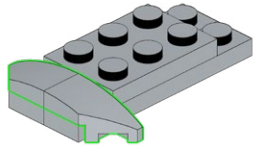

2

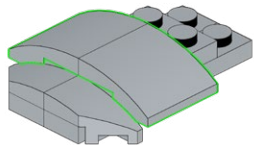

3

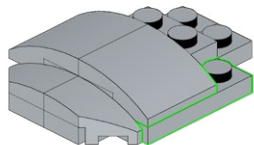

# 198

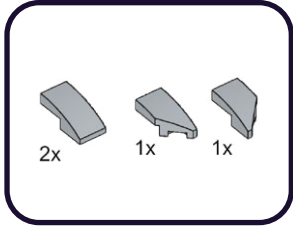

1

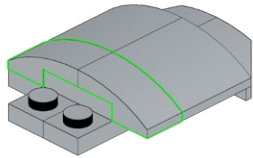

2

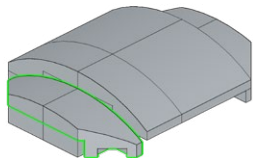

# 199

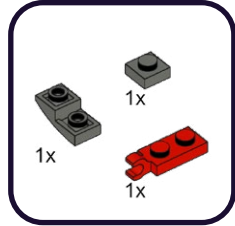

1

2



1

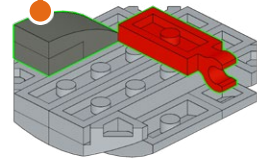

200

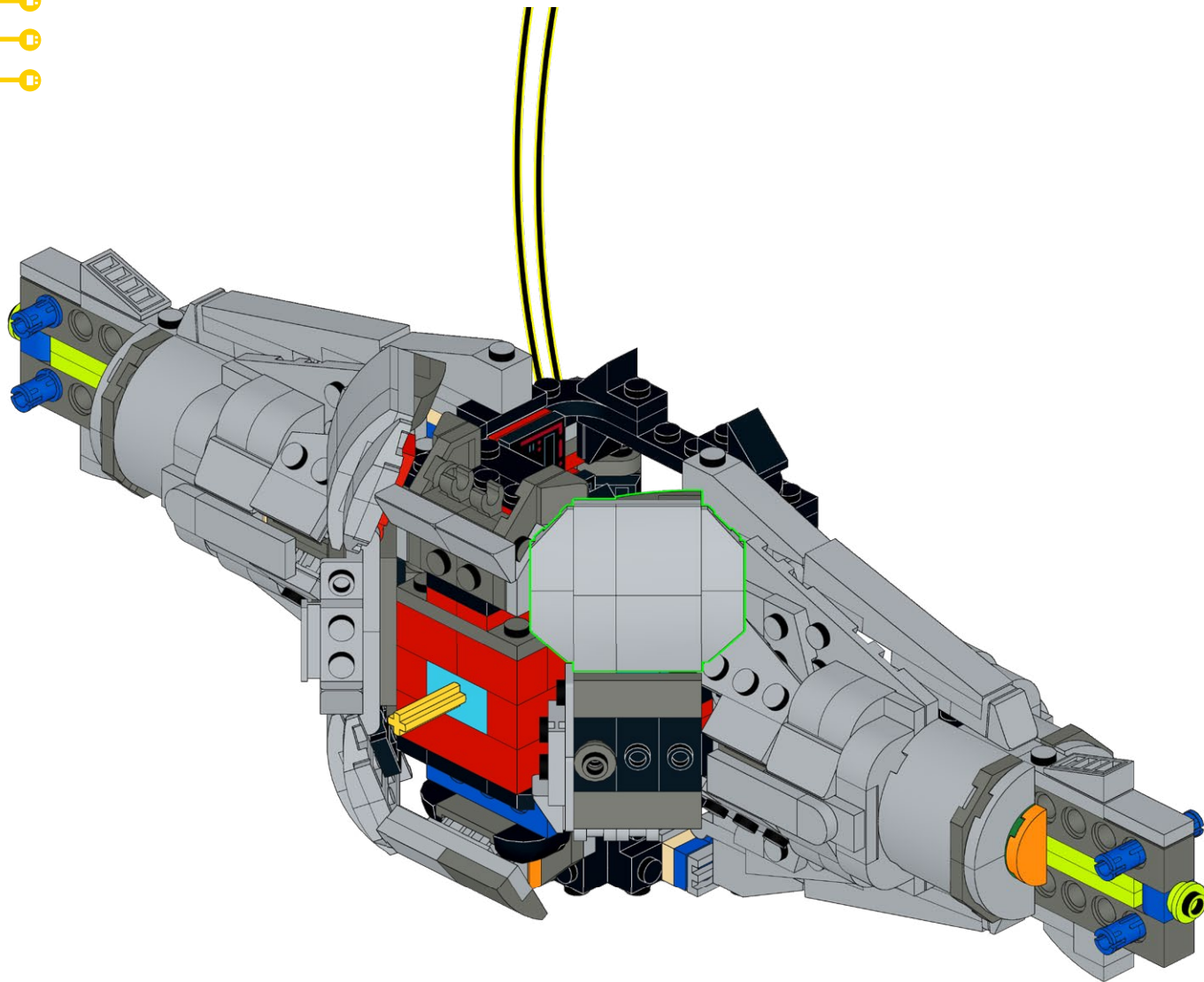

# 201

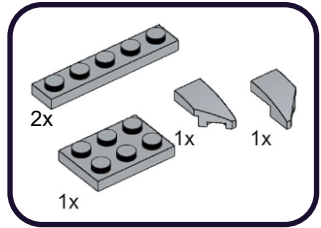

1

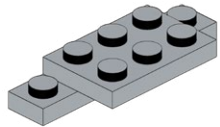

2

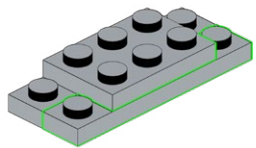

3

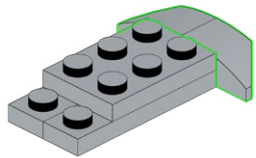

# 202

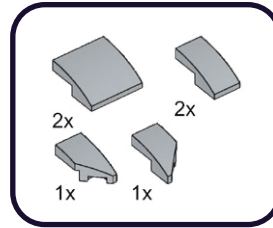

1

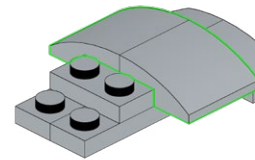

2

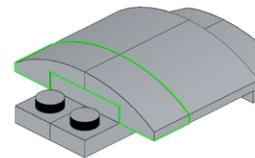

3

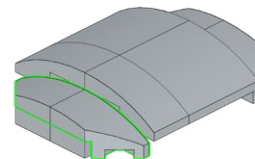



**203**

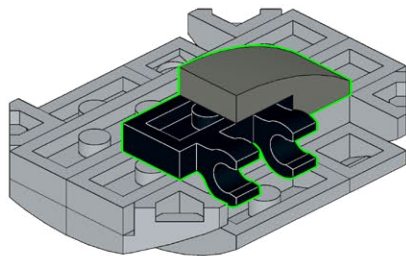
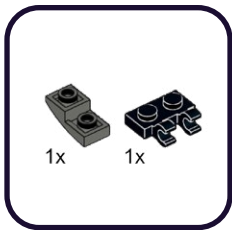

204

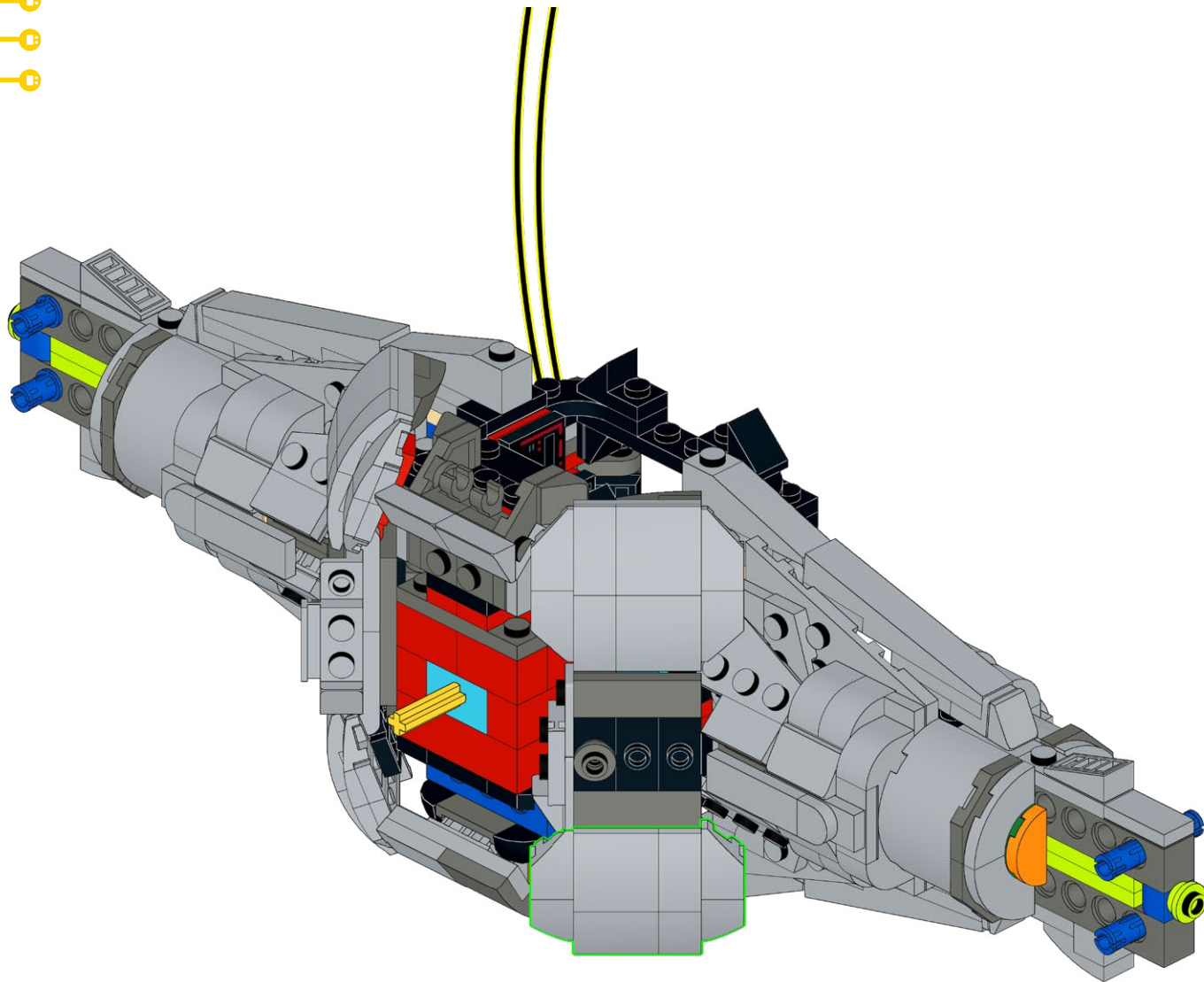

# 205

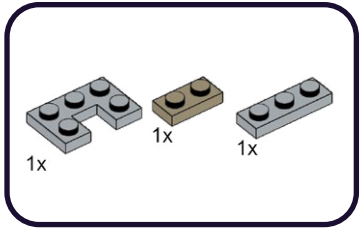

1

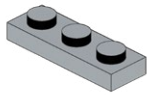

2

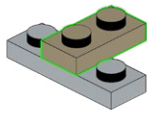

3

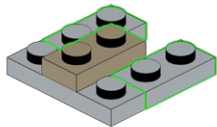

# 206

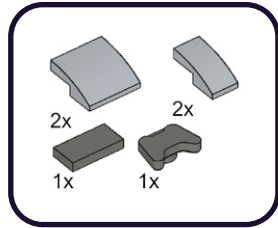

1

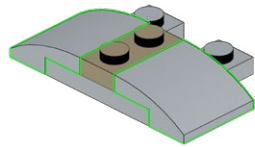

2

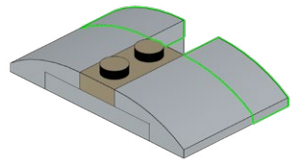

3

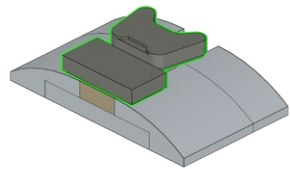

207

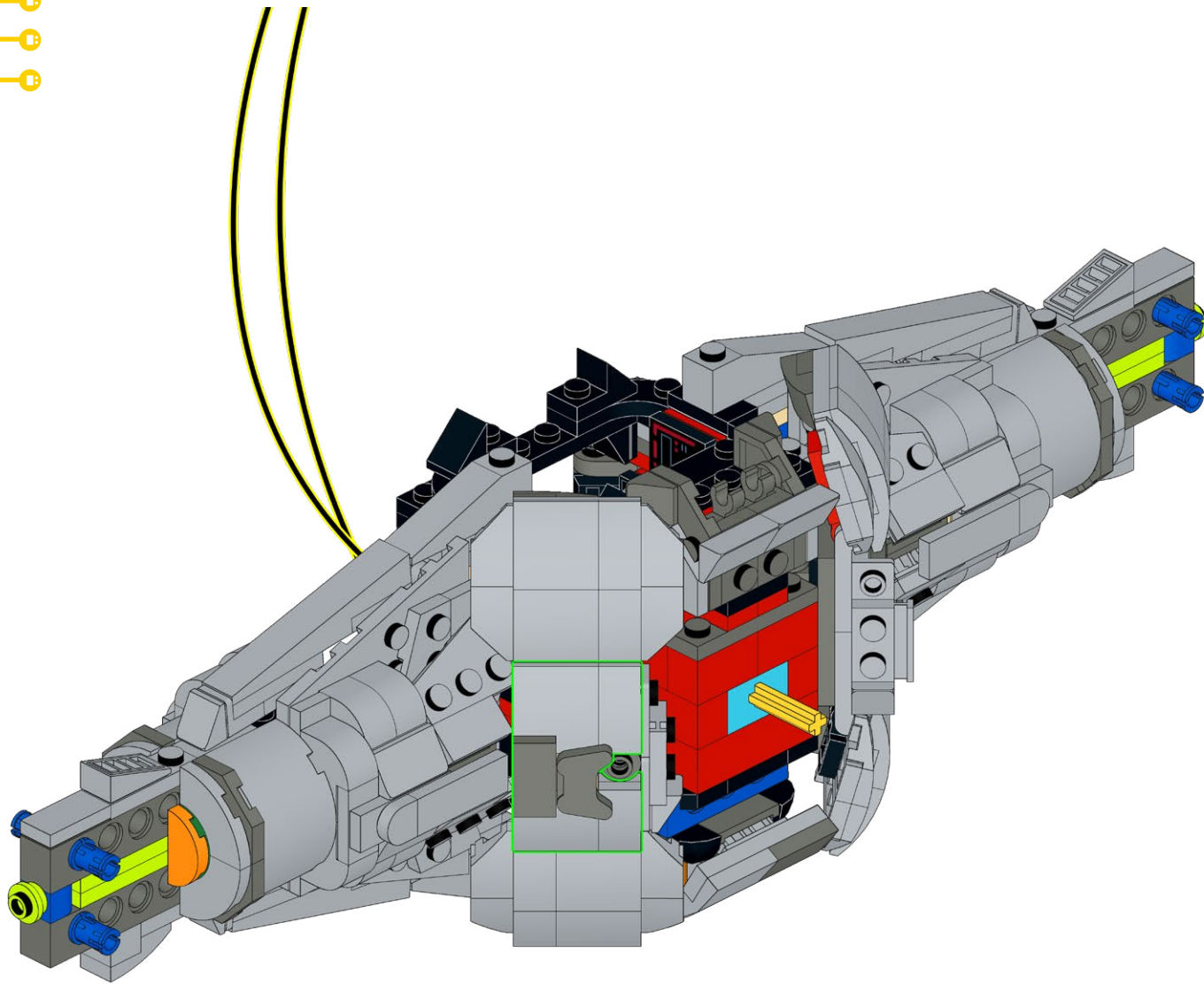

208

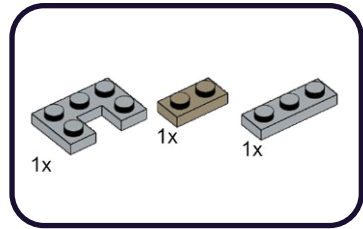

1

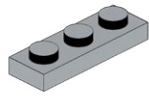

2

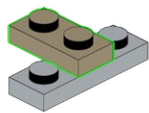

3

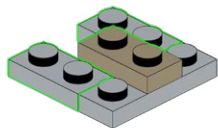

209

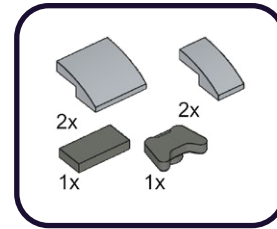

1

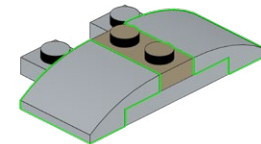

2

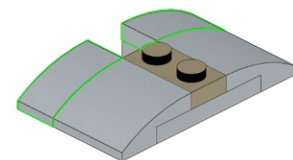

3

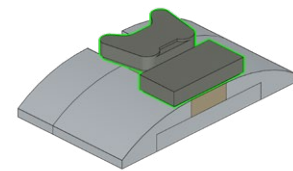

210

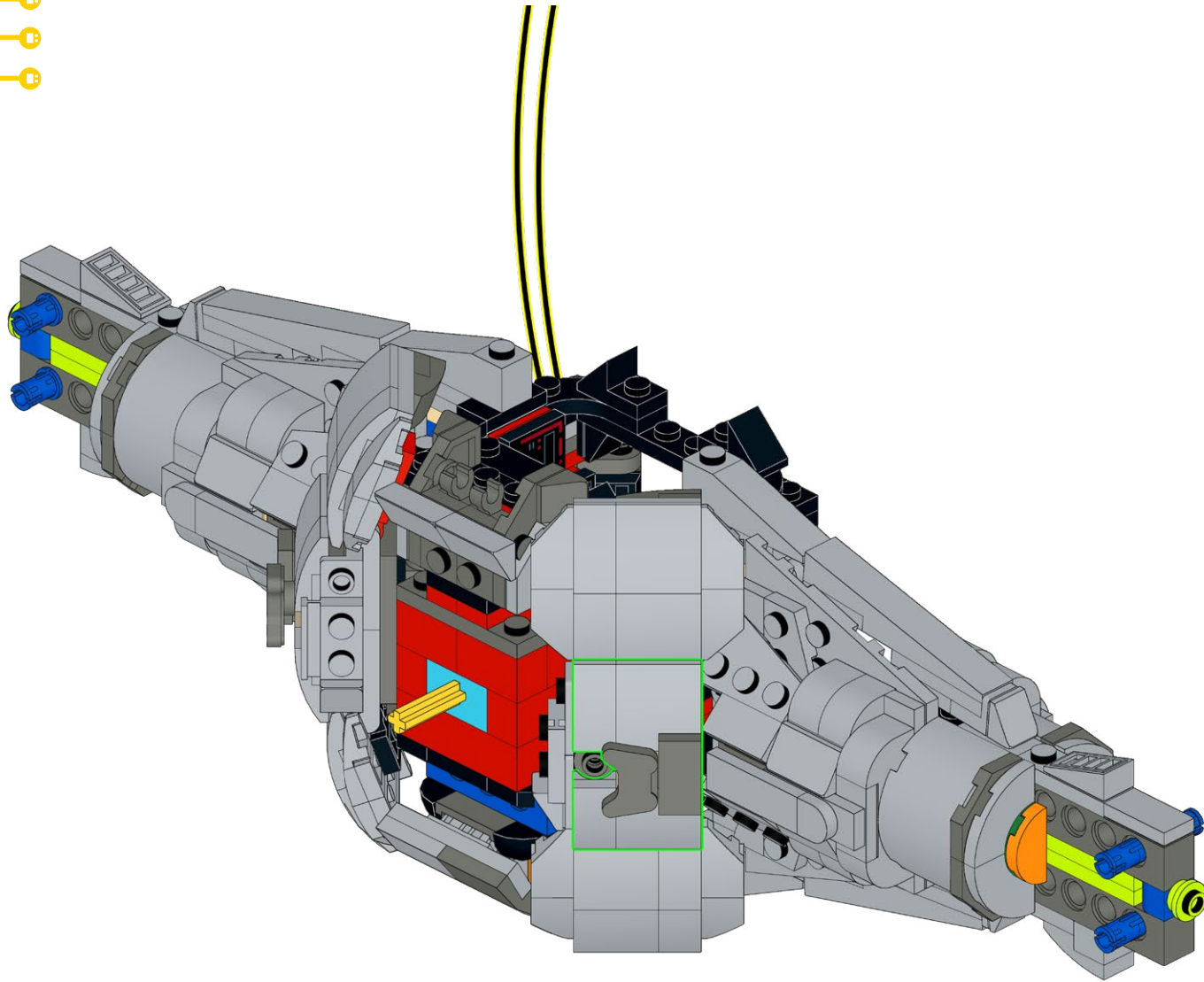

211

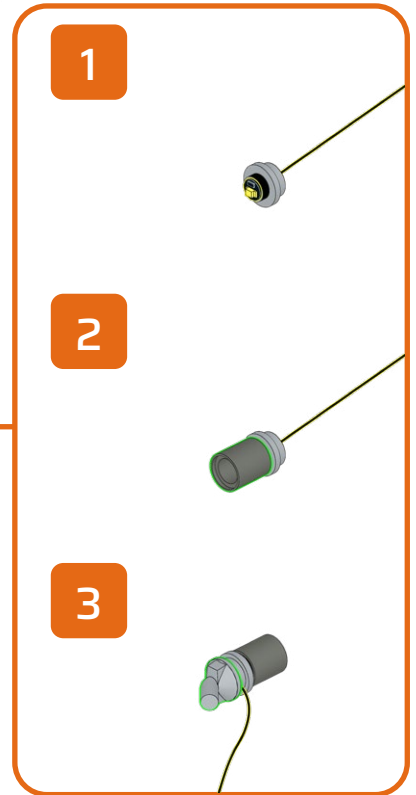
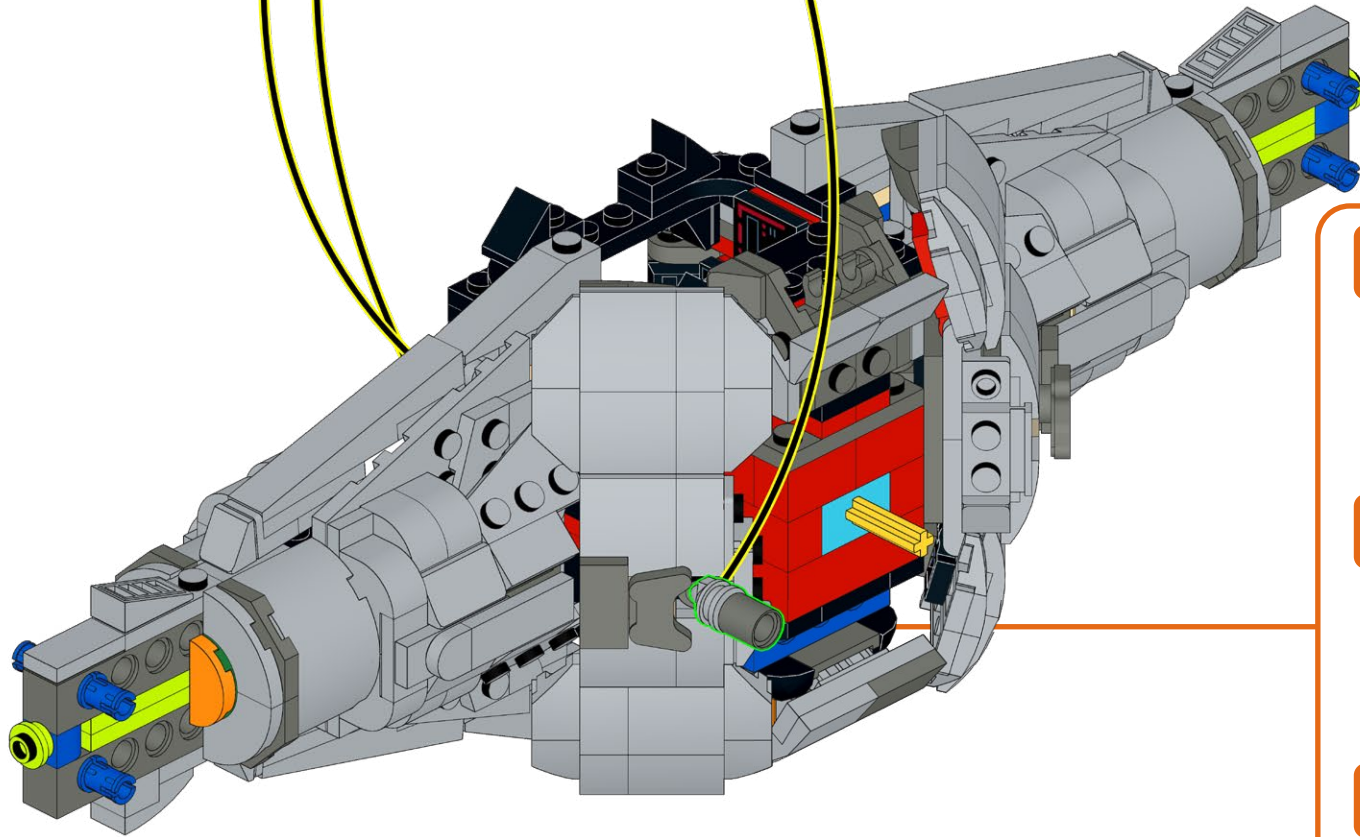
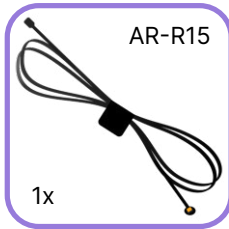
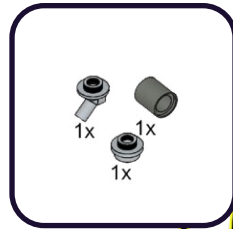



212

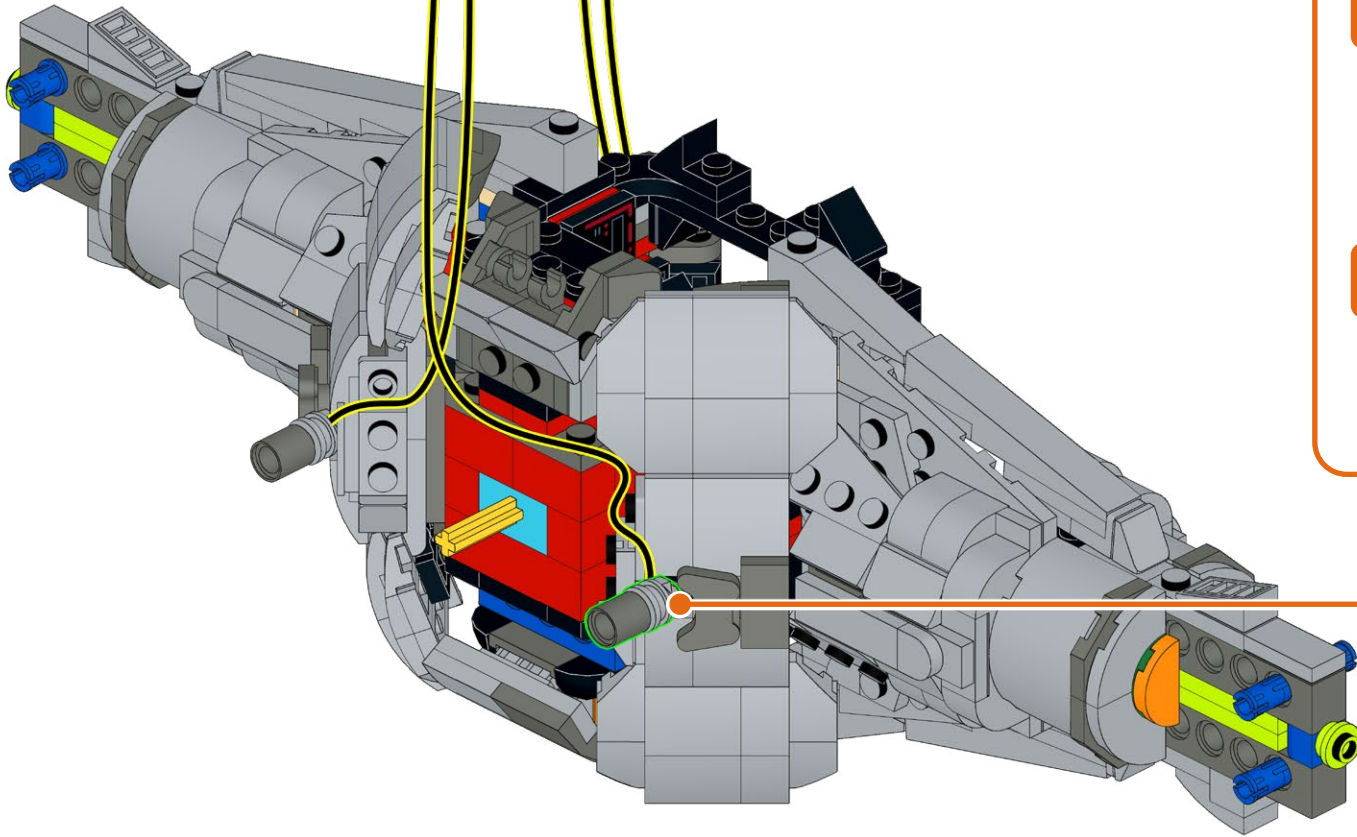
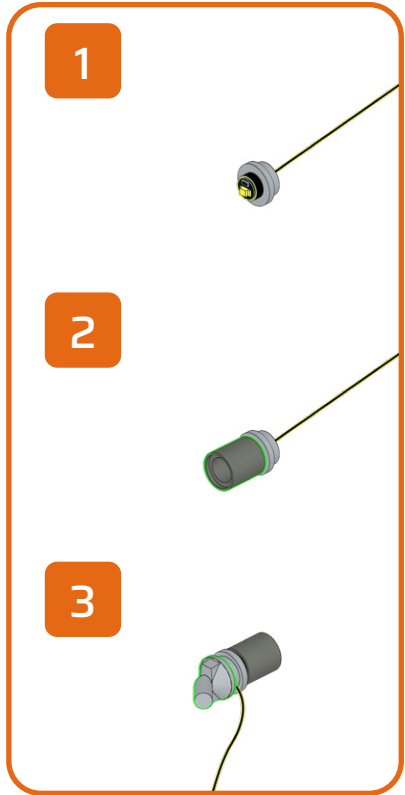
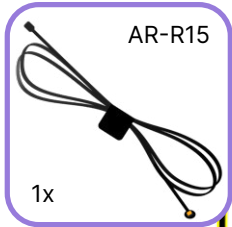
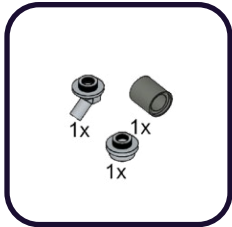

213

2x

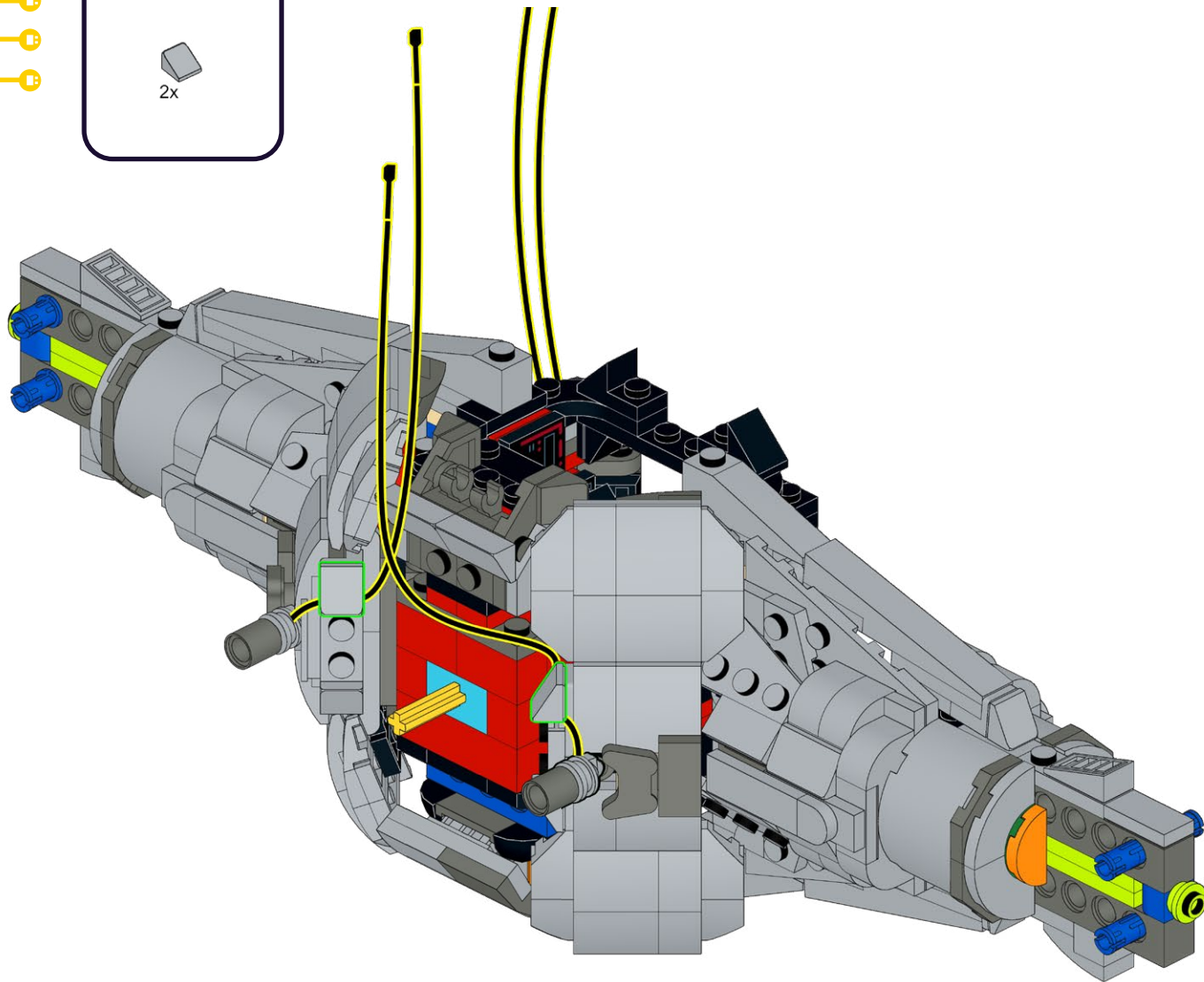

214

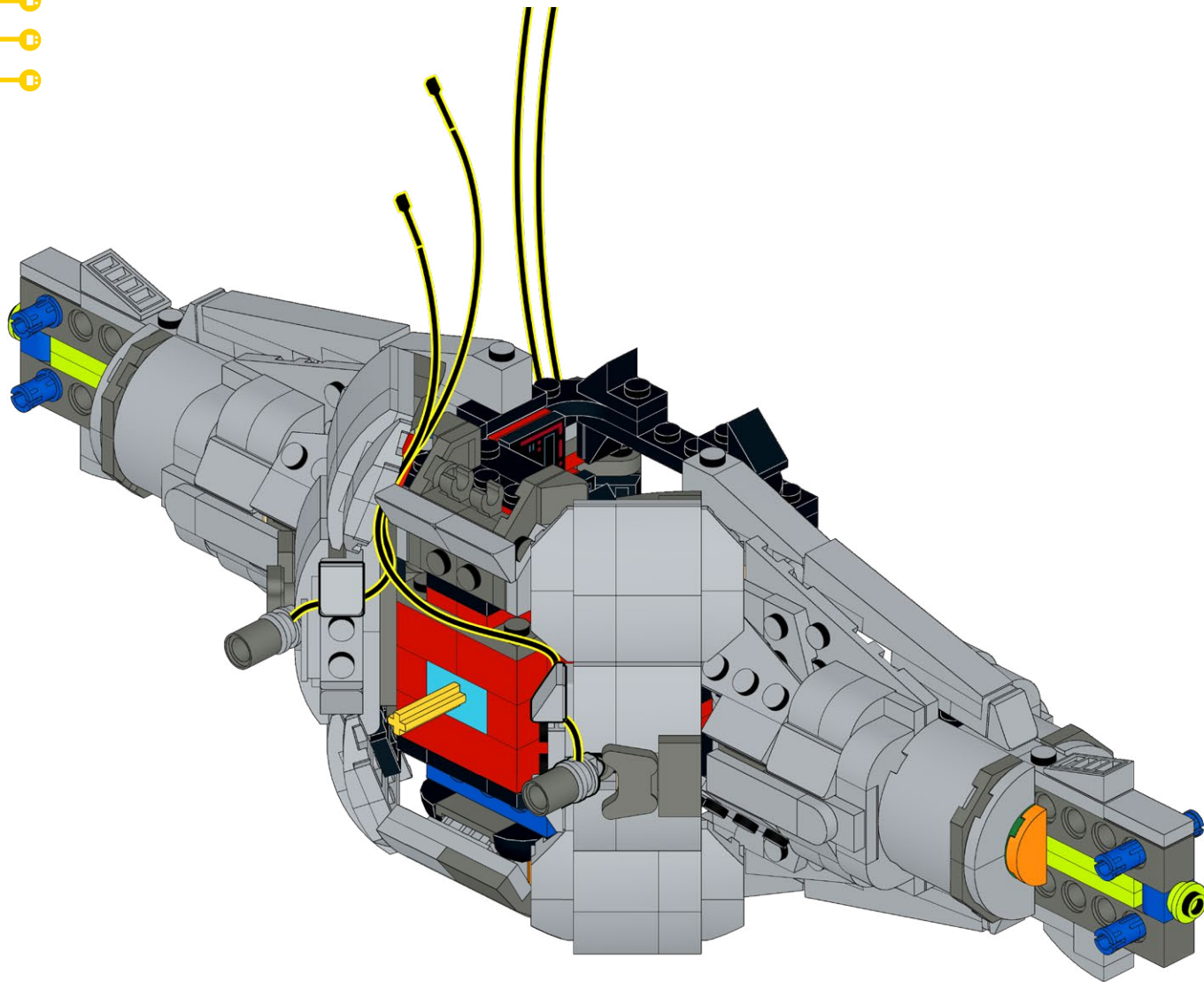

**HOLD UP!**

You might notice some bags are out of order, as well as left over pieces, but that's ok! We're changing the way you build LEGO!

**HALTEN!**

Möglicherweise stellen Sie fest, dass einige Beutel nicht in Ordnung sind und auch Teile übrig bleiben, aber das ist in Ordnung! Wir verändern die Art und Weise, wie Sie LEGO bauen!

**TENIR BON!**

Vous remarquerez peut-être que certains sacs sont en panne, ainsi que des morceaux restants, mais ce n'est pas grave ! Nous changeons la façon dont vous construisez LEGO !

**SOSTENERE!**

Potresti notare che alcune borse sono fuori uso, così come alcuni pezzi avanzati, ma va bene! Stiamo cambiando il modo in cui costruisci i LEGO!

**¡SOSTENER!**

Puede que notes que algunas bolsas están fuera de orden, así como piezas sobrantes, ¡pero está bien! ¡Estamos cambiando la forma de construir LEGO!

**耽误!**

您可能会注意到有些袋子坏了, 还有剩余的碎片, 但这没关系! 我们正在改变您搭建乐高的方式!

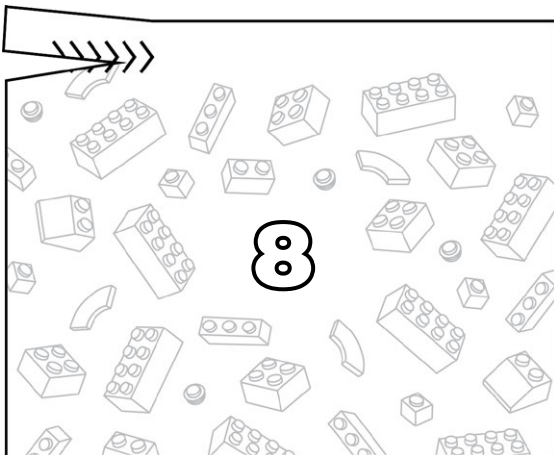
**Open LEGO® Bag 1**

# 215

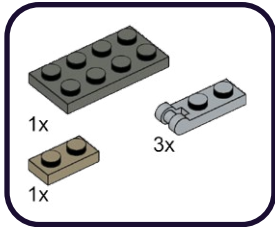

1



2

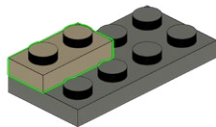

3

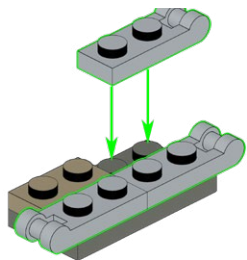

# 216

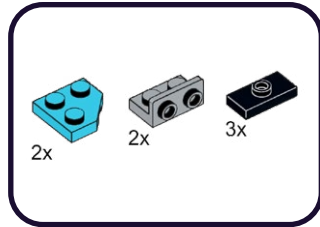

1

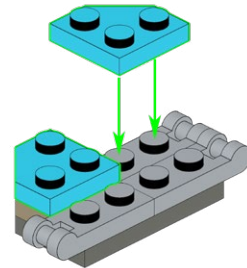

2

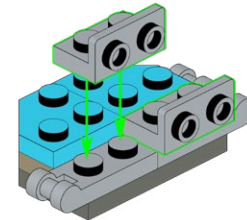

3

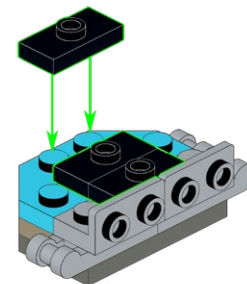

217

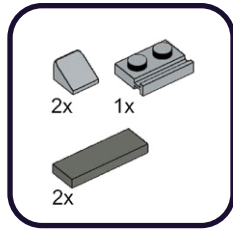

1

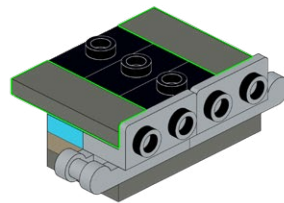

2

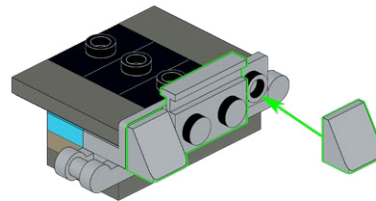



218

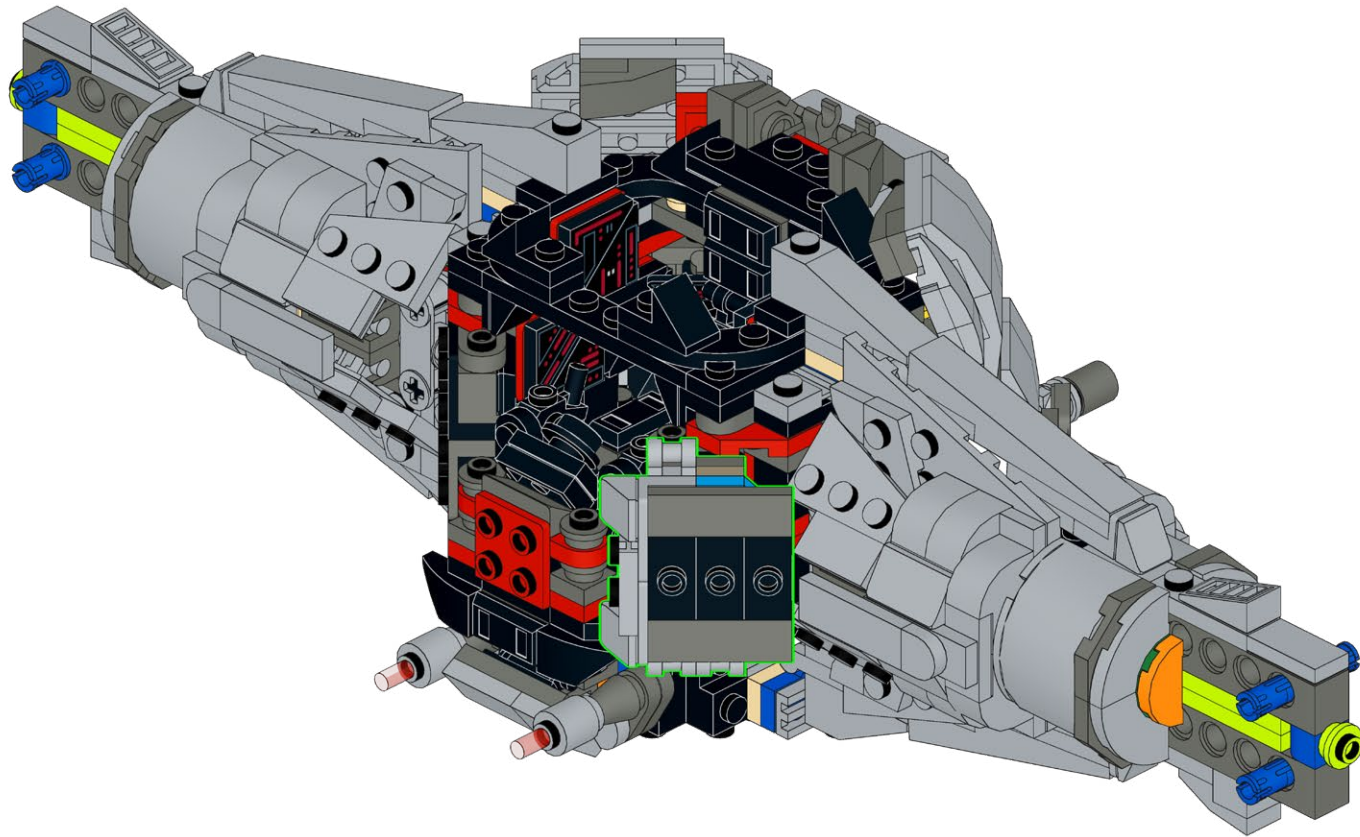



# 219

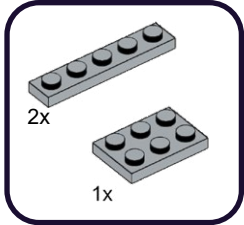

1

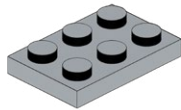

2

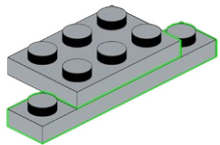

3

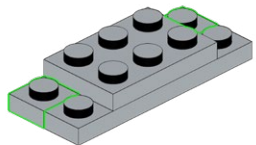

# 220

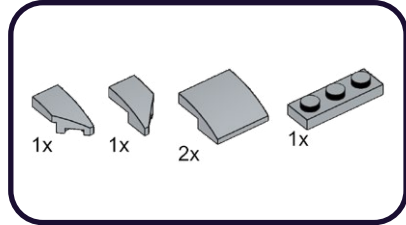

1

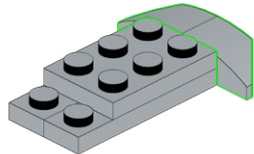

2

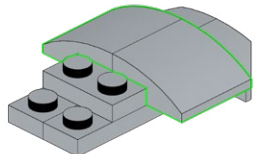

3

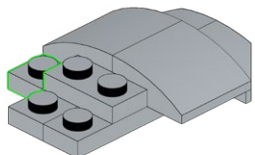

# 221

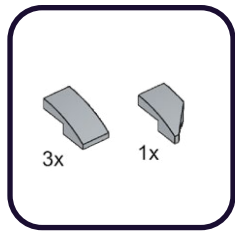

1

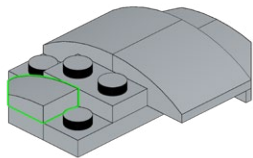

2

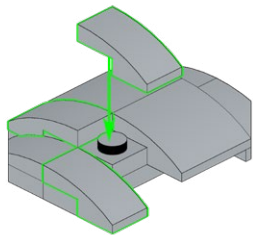

# 222

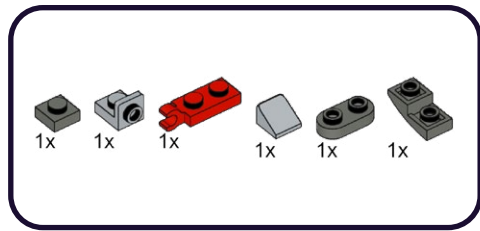

1

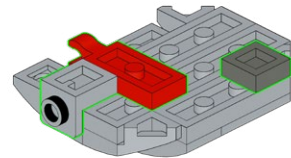
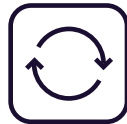

1

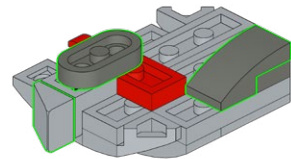

223

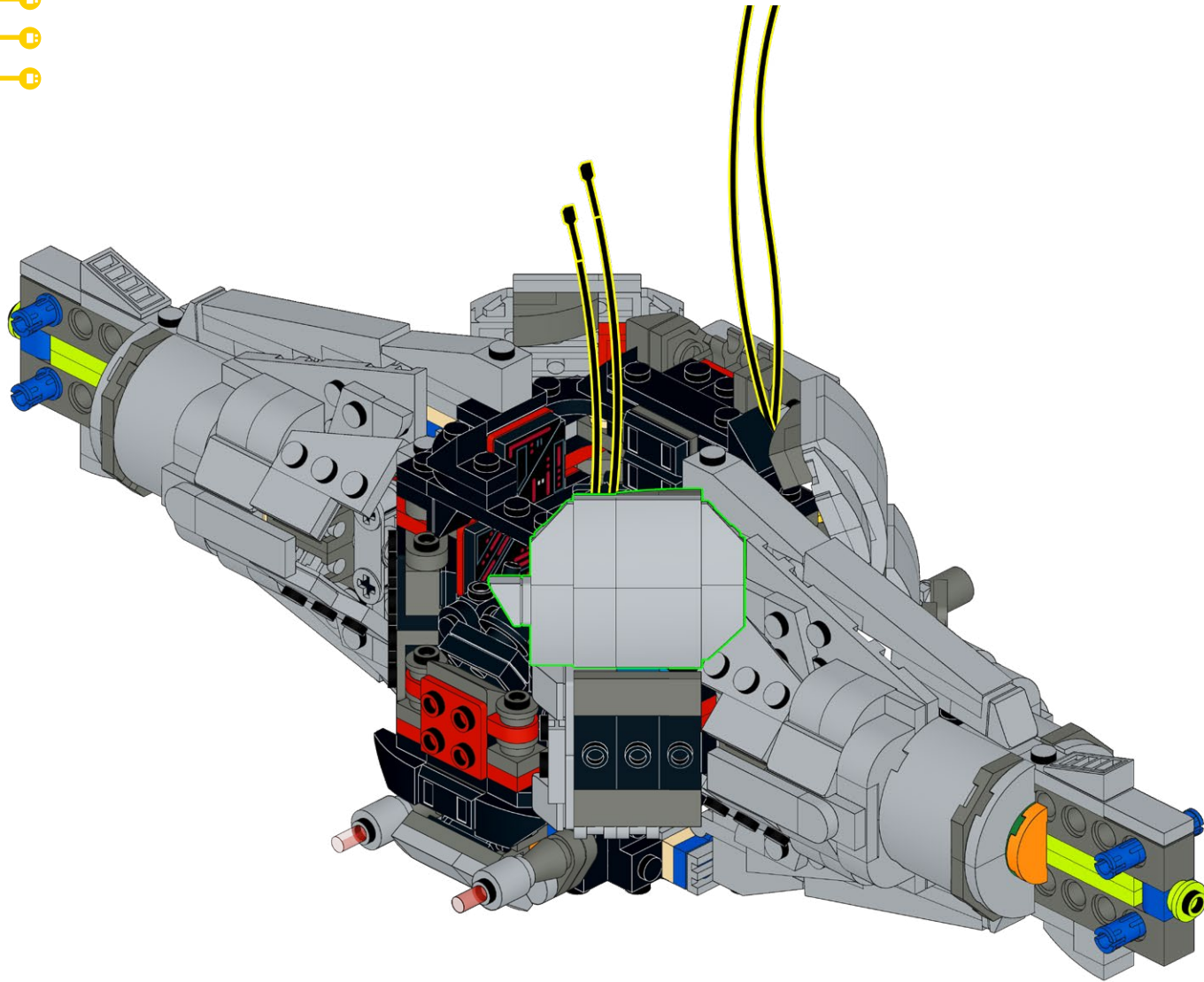

# 224

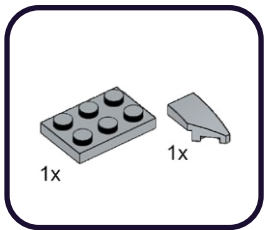

1

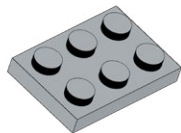

2

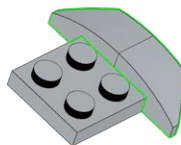

# 225

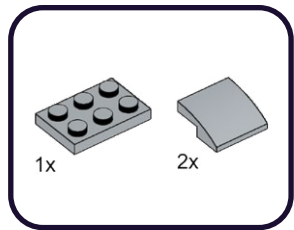

1

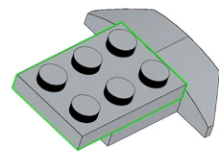

1

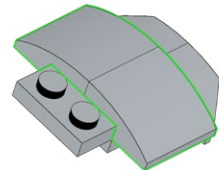

**226**

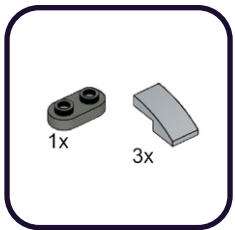

**1**

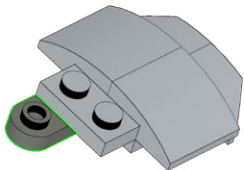

**2**

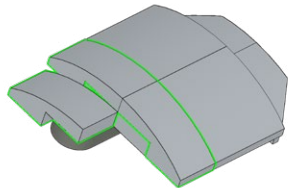

**227**

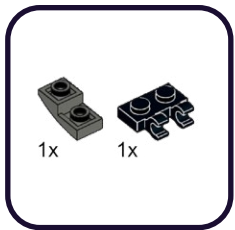

**1**

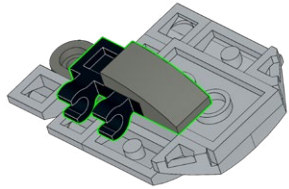

228

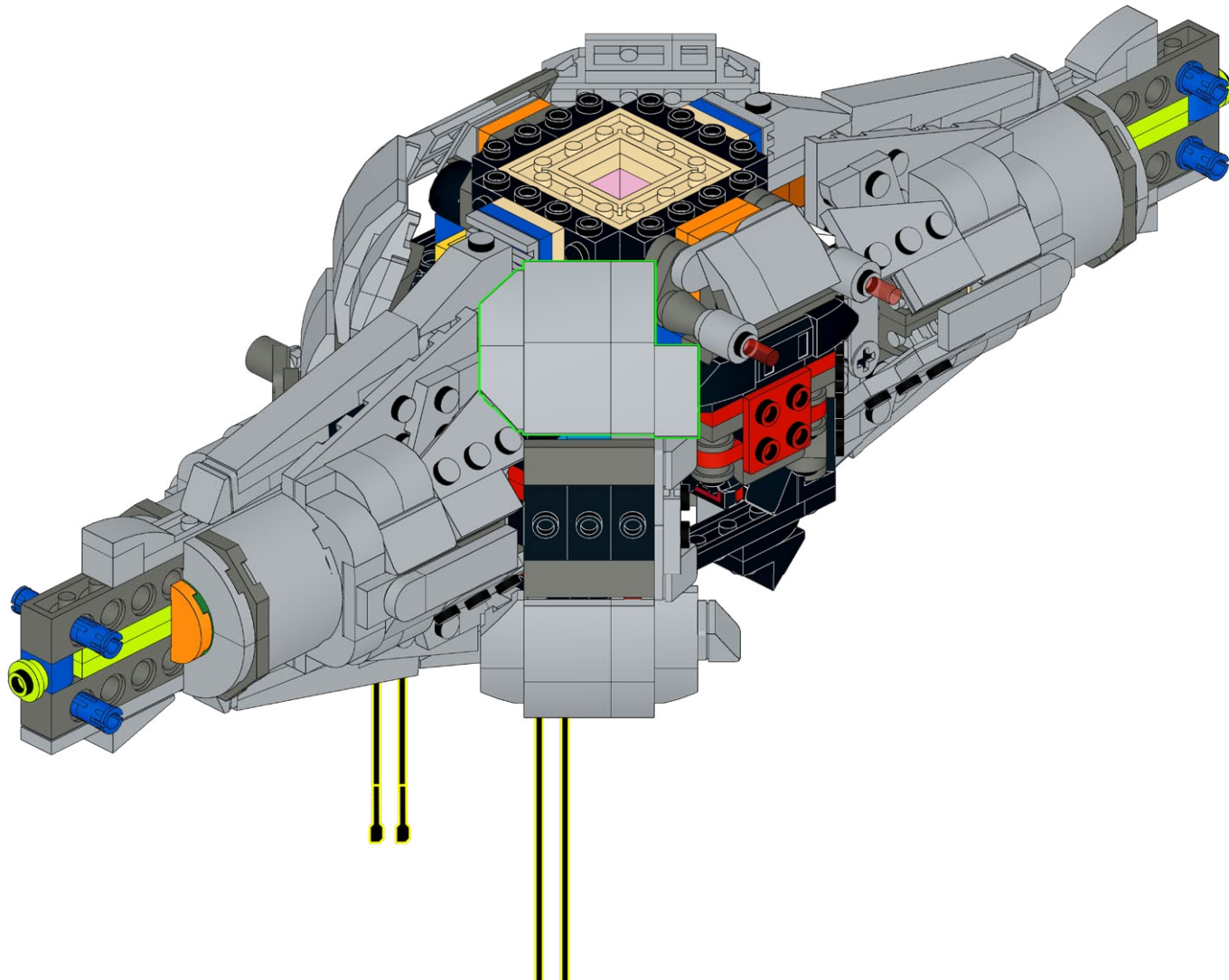

# 229

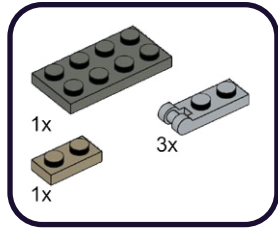

1



2

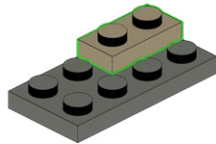

3

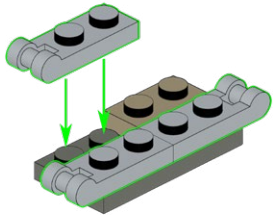

# 230

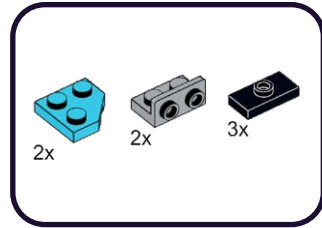

1

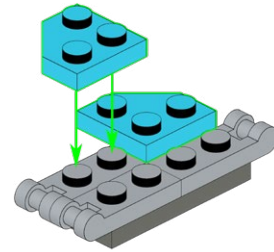

2

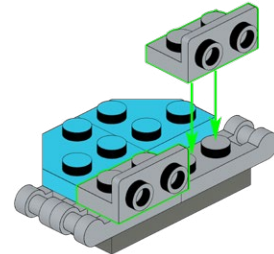

3

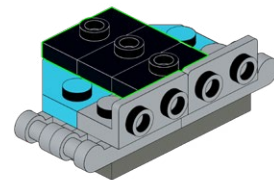



231

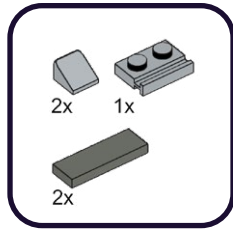

1

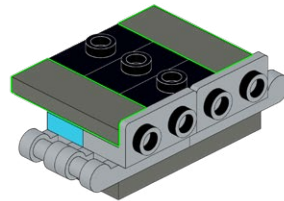

2

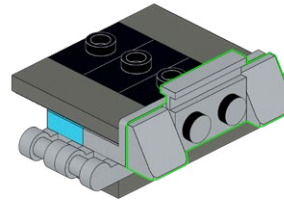

232

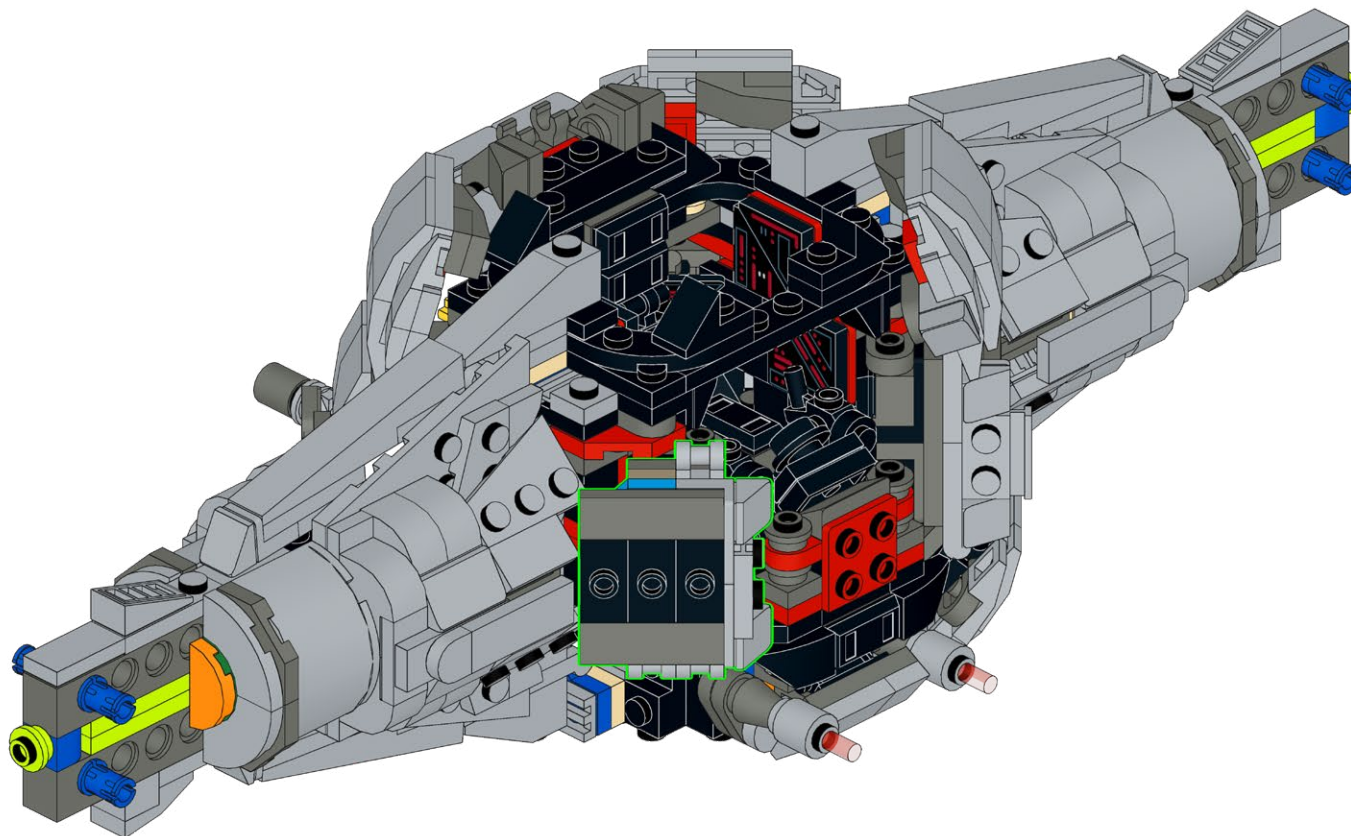

# 233

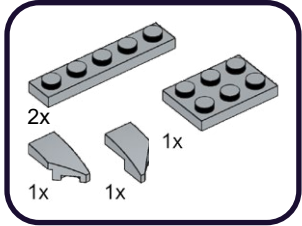

1

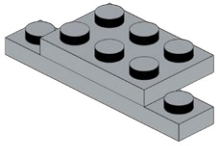

2

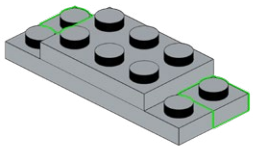

3

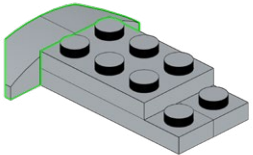

# 234

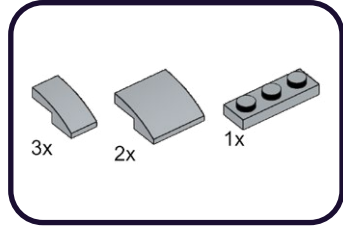

1

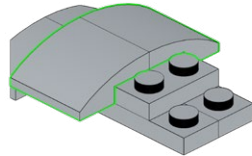

2

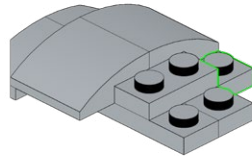

3

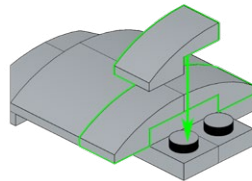

# 235

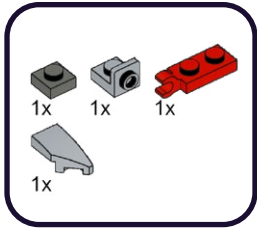

1

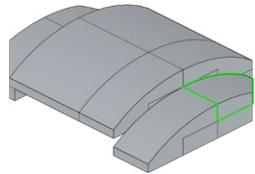

2

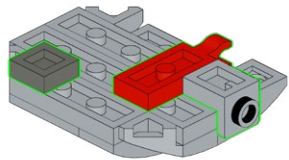

# 236

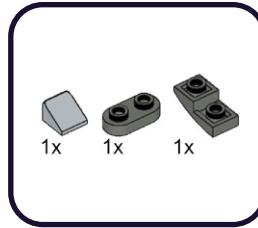

1

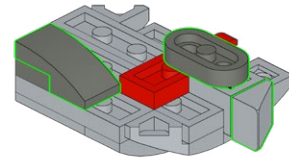

237

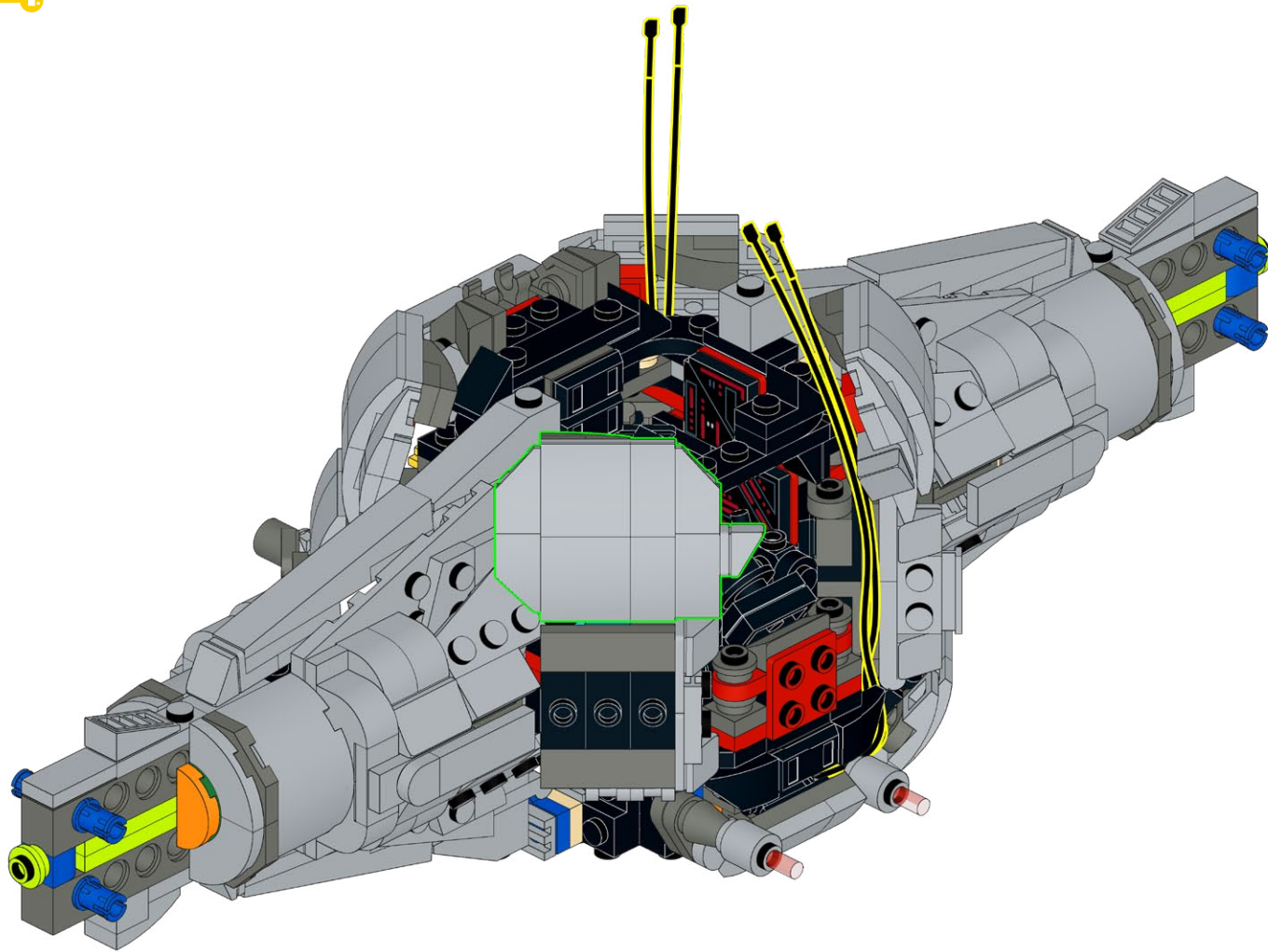

238

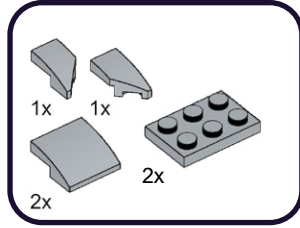

1

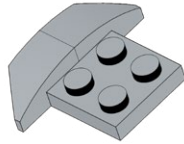

2

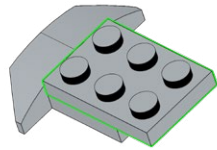

3

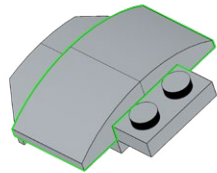

239

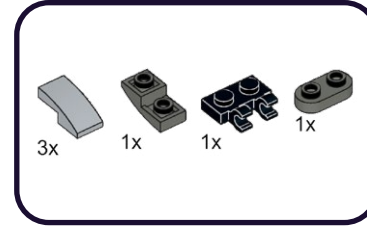

1

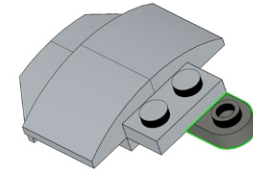

2

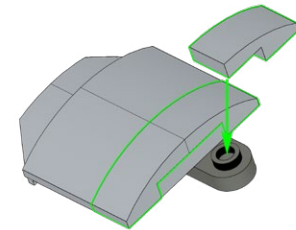

3

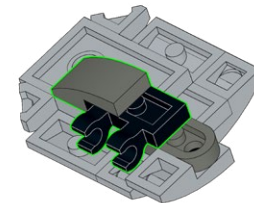
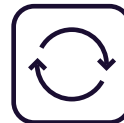

240

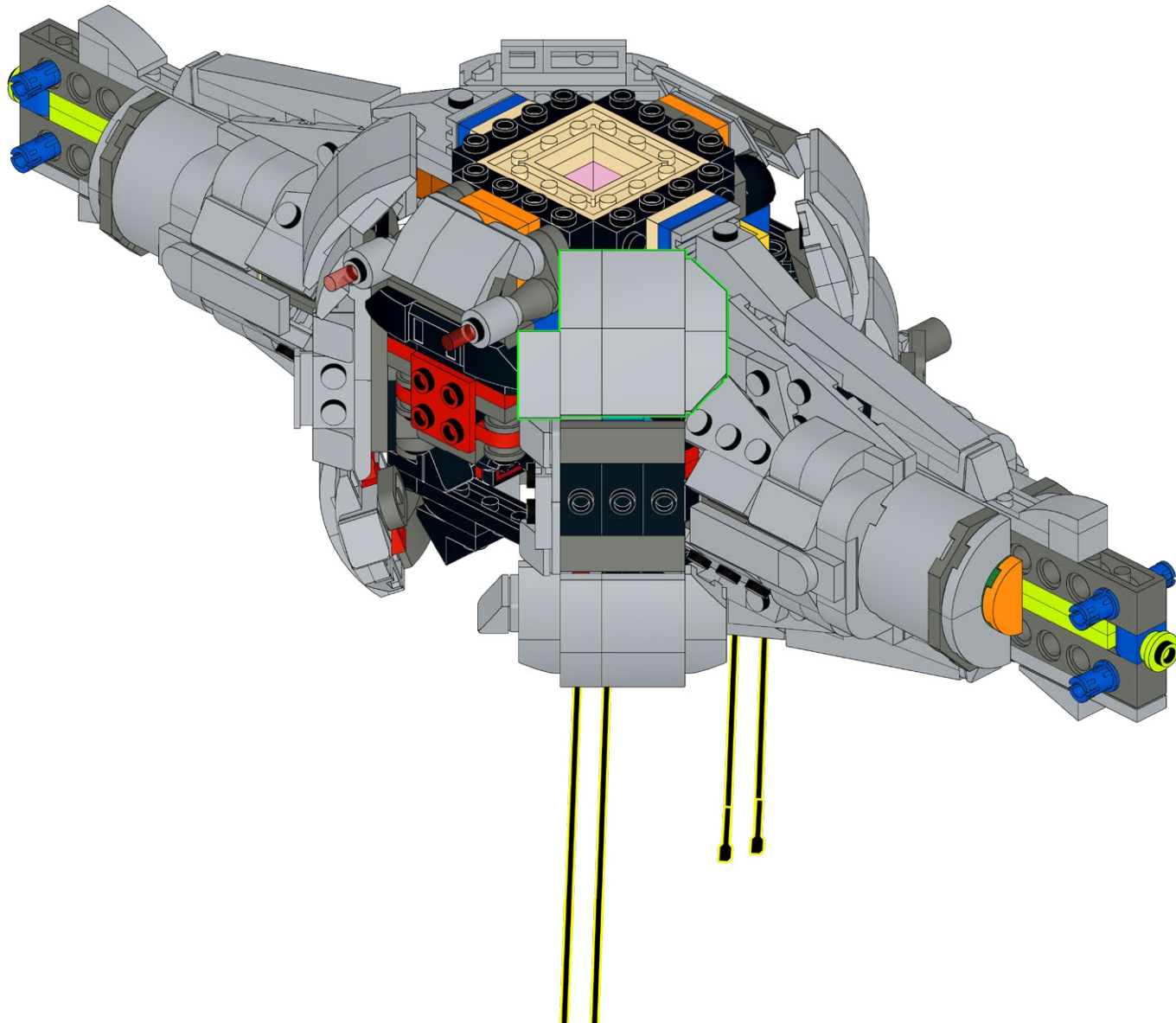



# 241

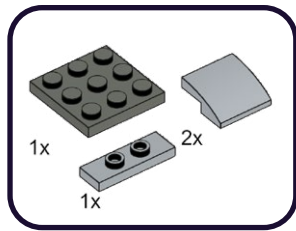

1

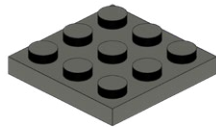

2

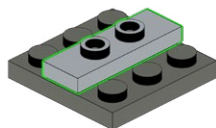

3

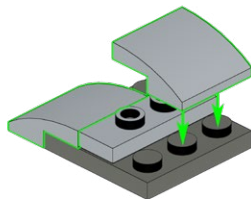

# 242

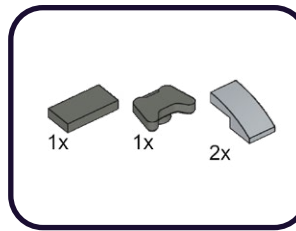

1

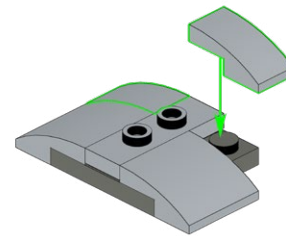

2

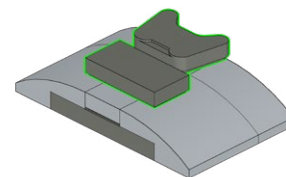

243

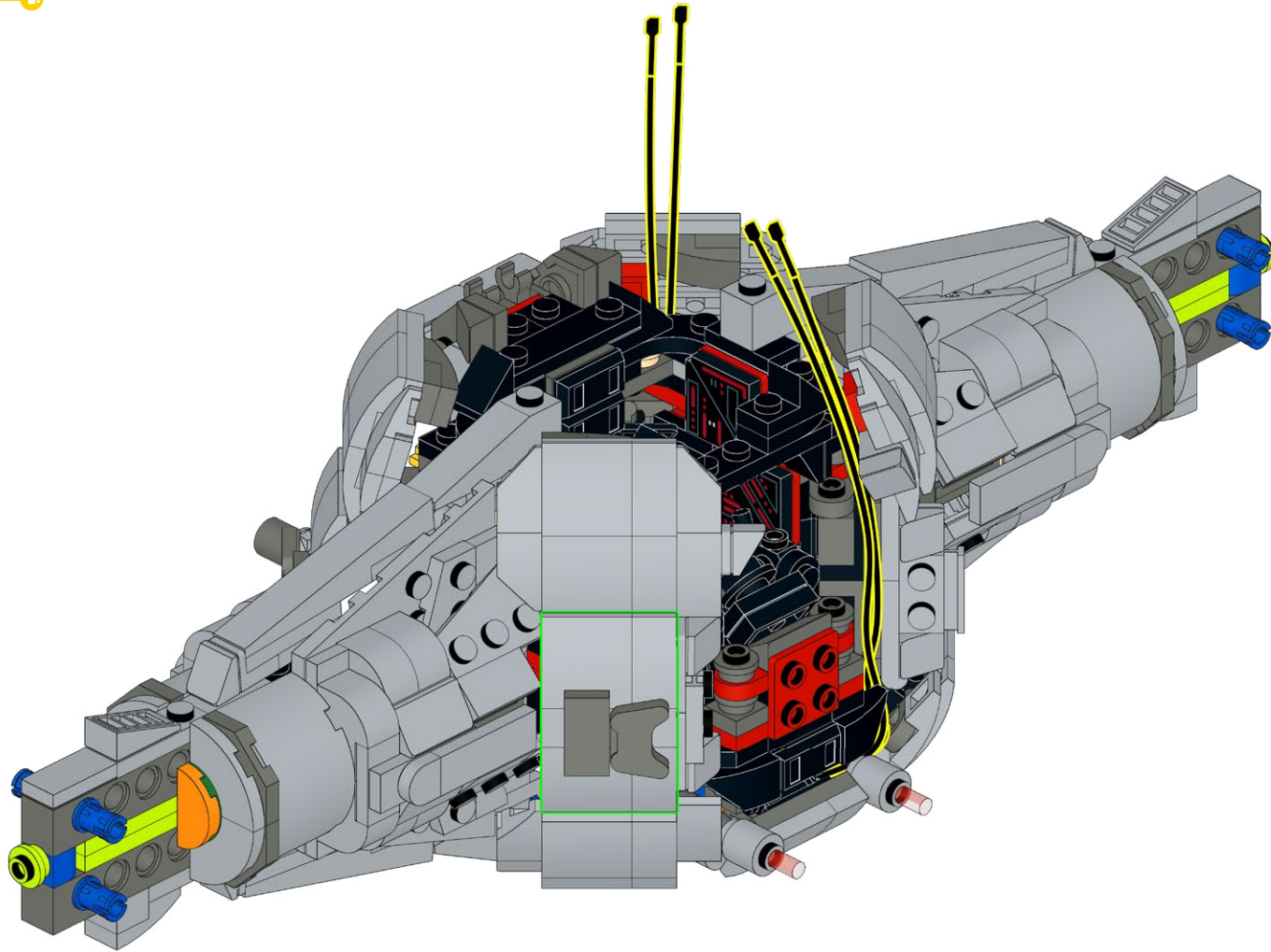

244

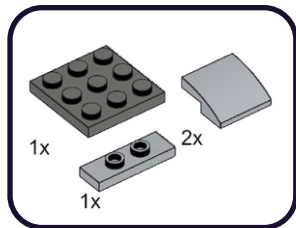

1

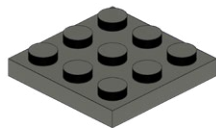

2

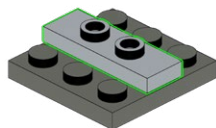

3

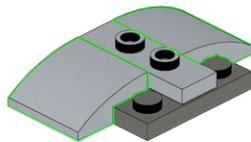

245

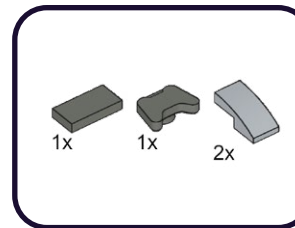

1

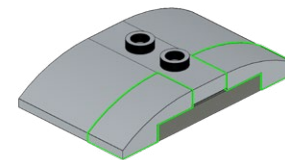

2

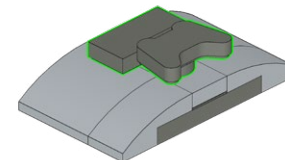

246

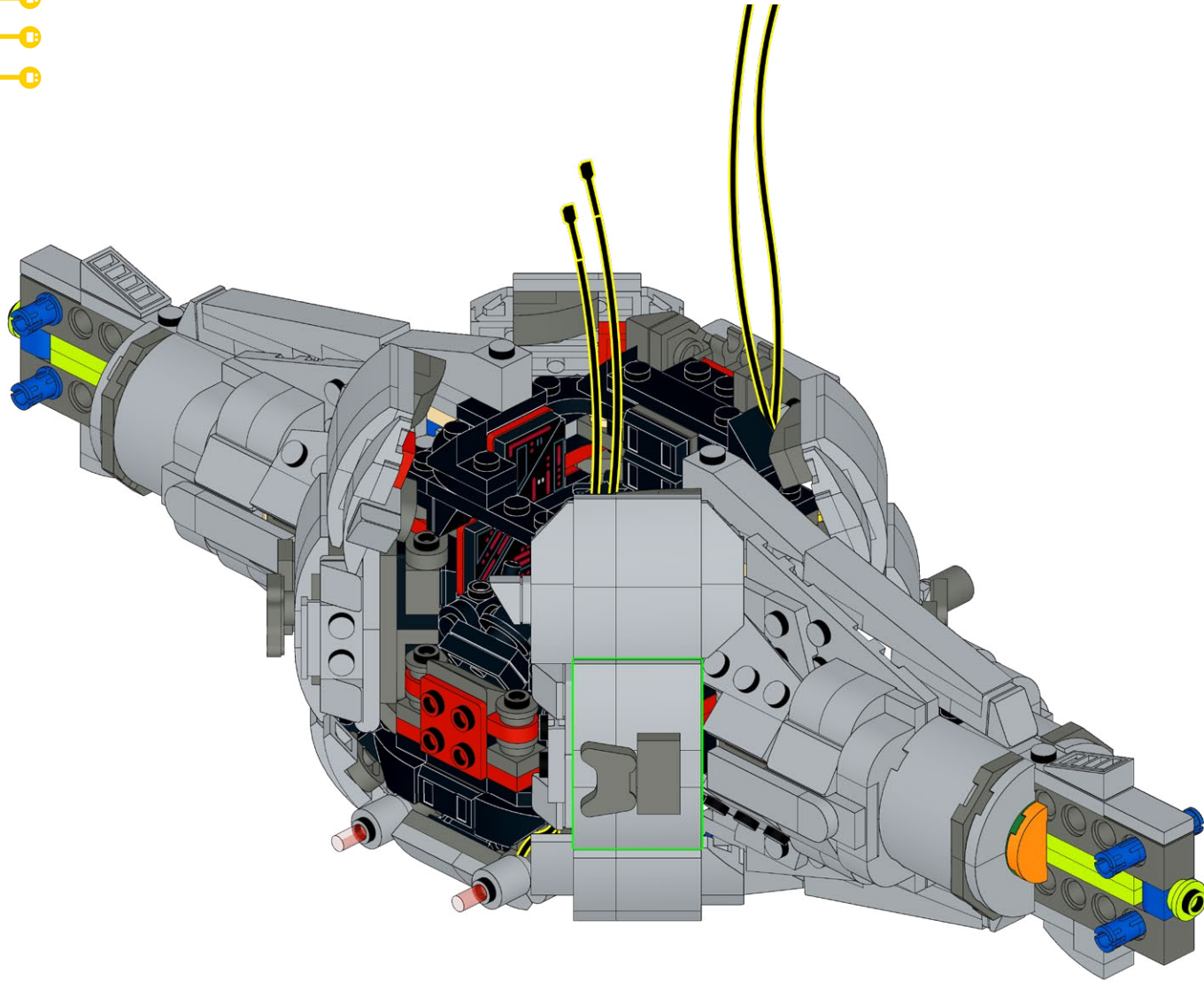

247

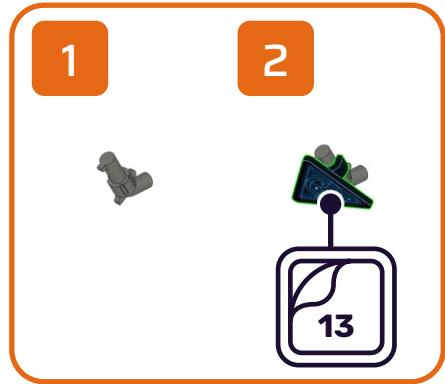
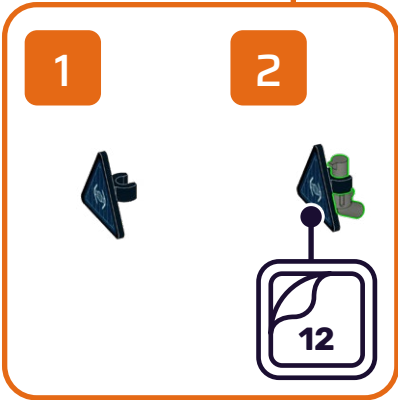
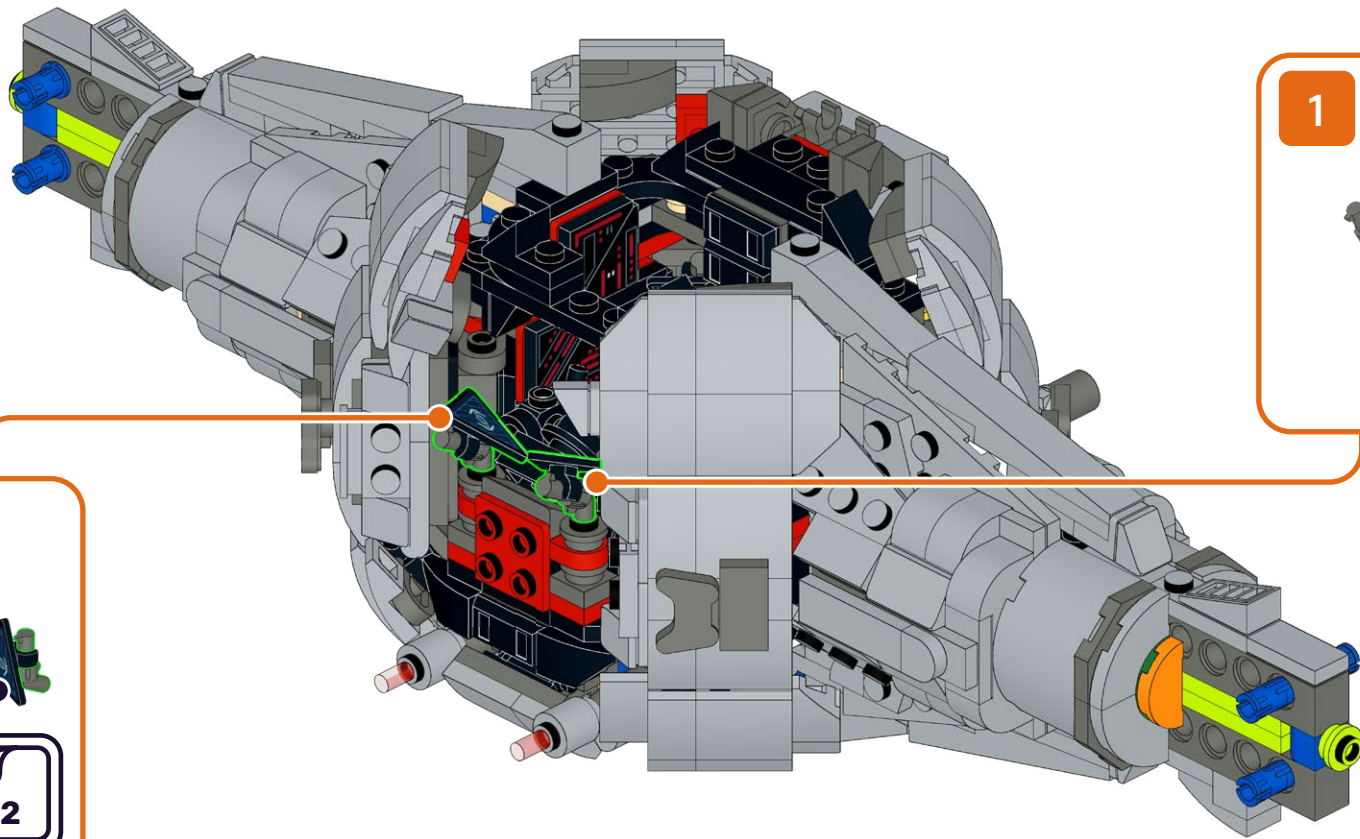
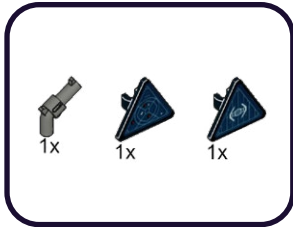

**HOLD UP!**

You might notice some bags are out of order, as well as left over pieces, but that's ok! We're changing the way you build LEGO!

**HALTEN!**

Möglicherweise stellen Sie fest, dass einige Beutel nicht in Ordnung sind und auch Teile übrig bleiben, aber das ist in Ordnung! Wir verändern die Art und Weise, wie Sie LEGO bauen!

**TENIR BON!**

Vous remarquerez peut-être que certains sacs sont en panne, ainsi que des morceaux restants, mais ce n'est pas grave ! Nous changeons la façon dont vous construisez LEGO !

**SOSTENERE!**

Potresti notare che alcune borse sono fuori uso, così come alcuni pezzi avanzati, ma va bene! Stiamo cambiando il modo in cui costruisci i LEGO!

**¡SOSTENER!**

Puede que notes que algunas bolsas están fuera de orden, así como piezas sobrantes, ¡pero está bien! ¡Estamos cambiando la forma de construir LEGO!

**耽误!**

您可能会注意到有些袋子坏了, 还有剩余的碎片, 但这没关系! 我们正在改变您搭建乐高的方式!

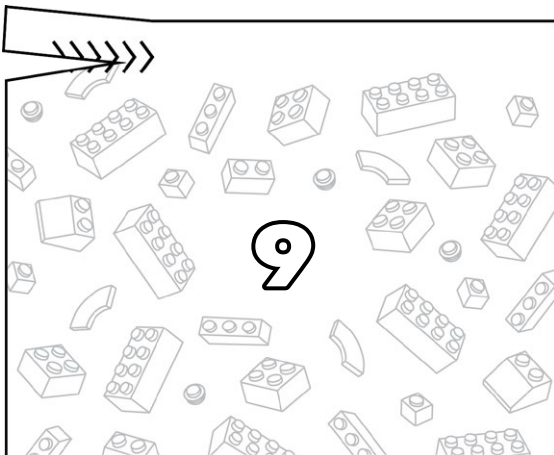
**Open LEGO® Bag 1**



248

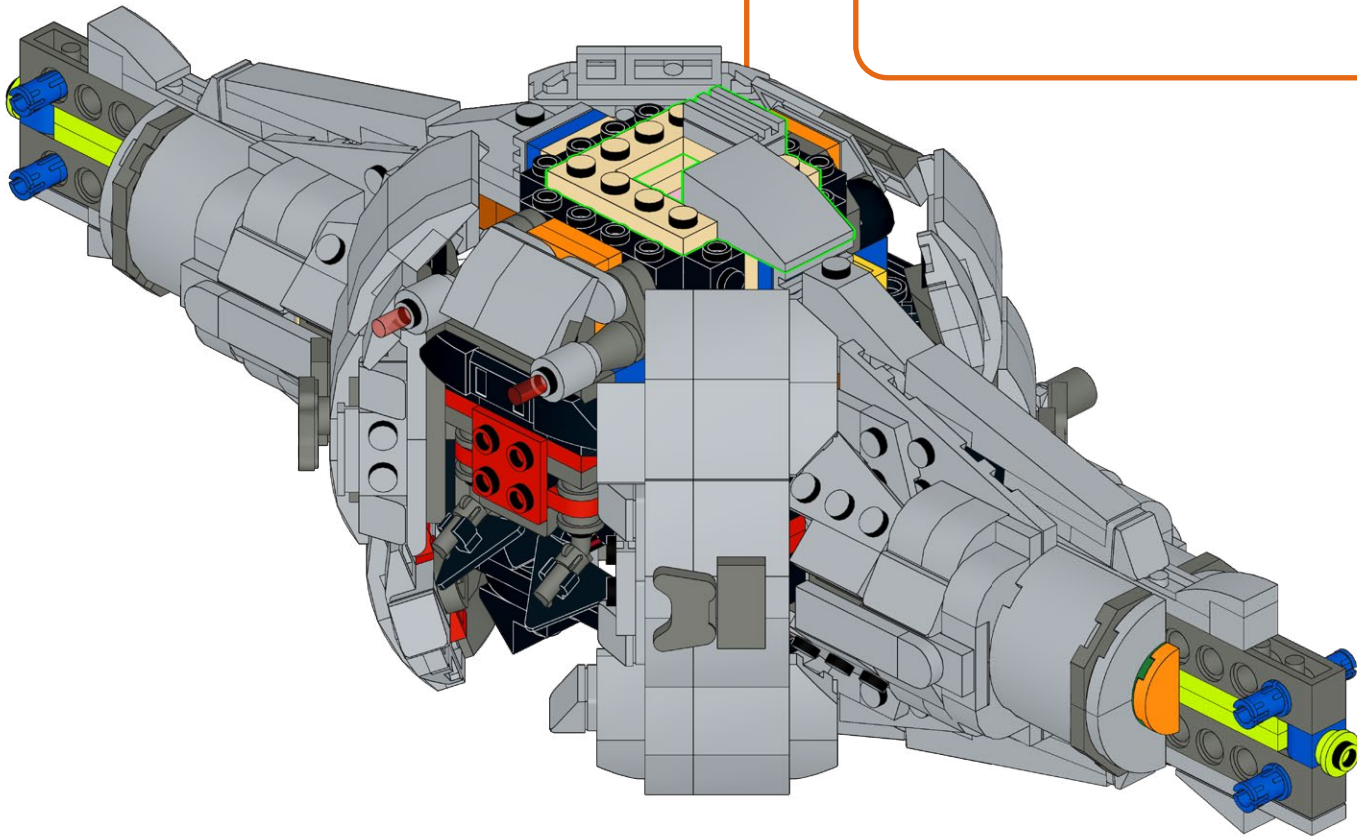
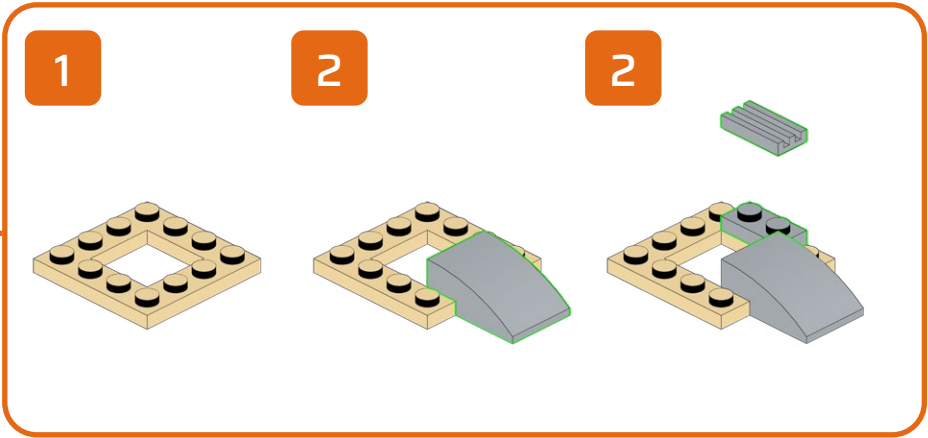
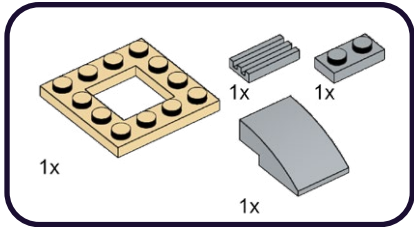



249

4x

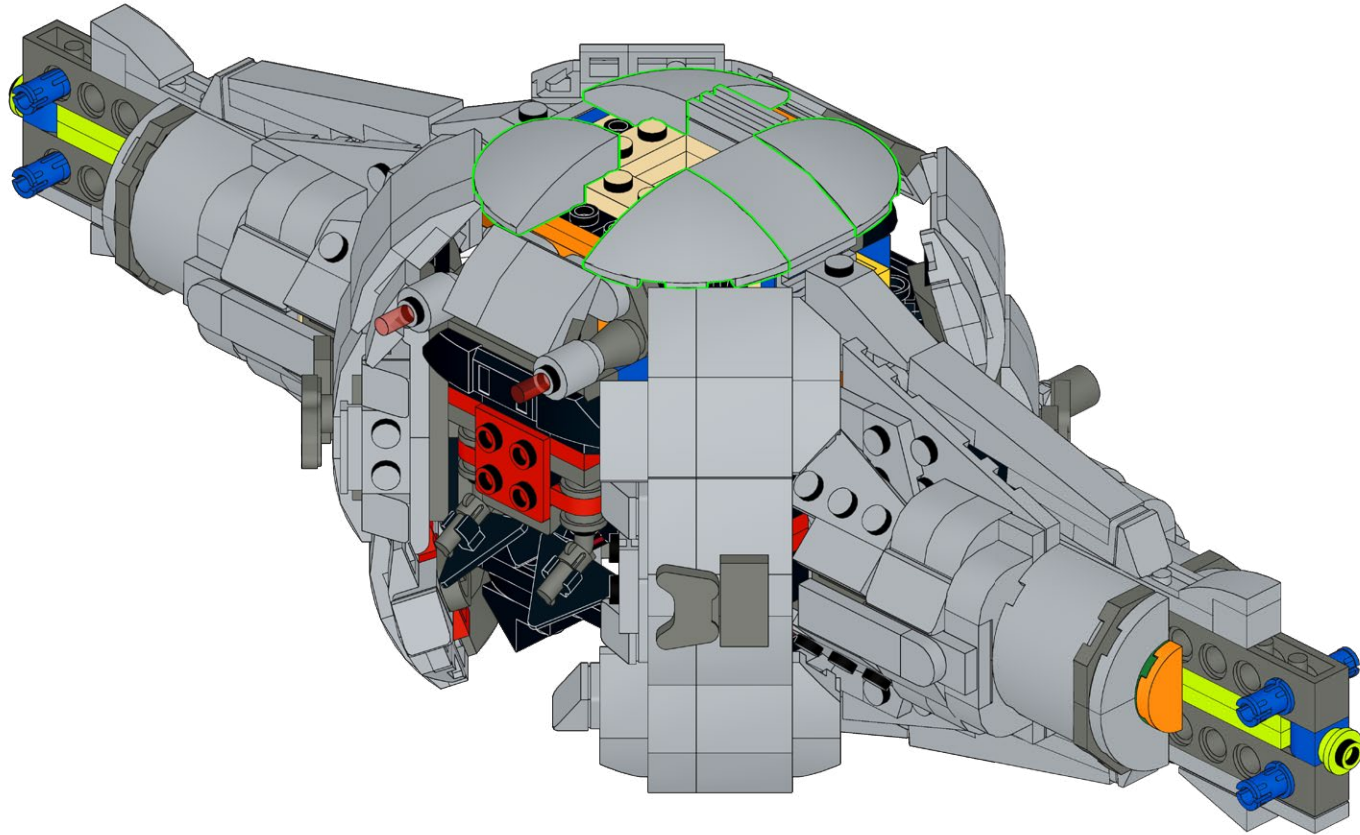

250

2x

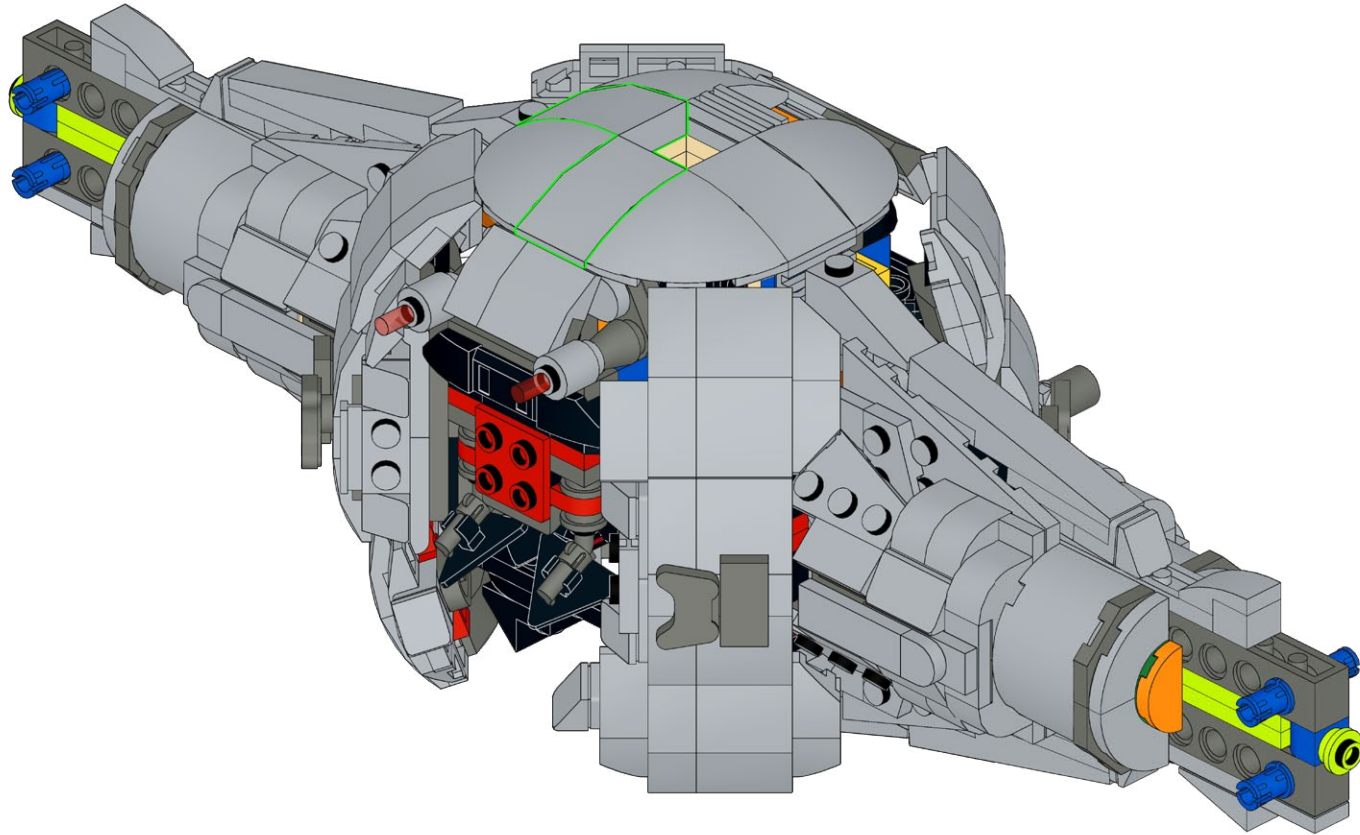

251

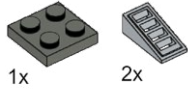

1x

2x

1

2

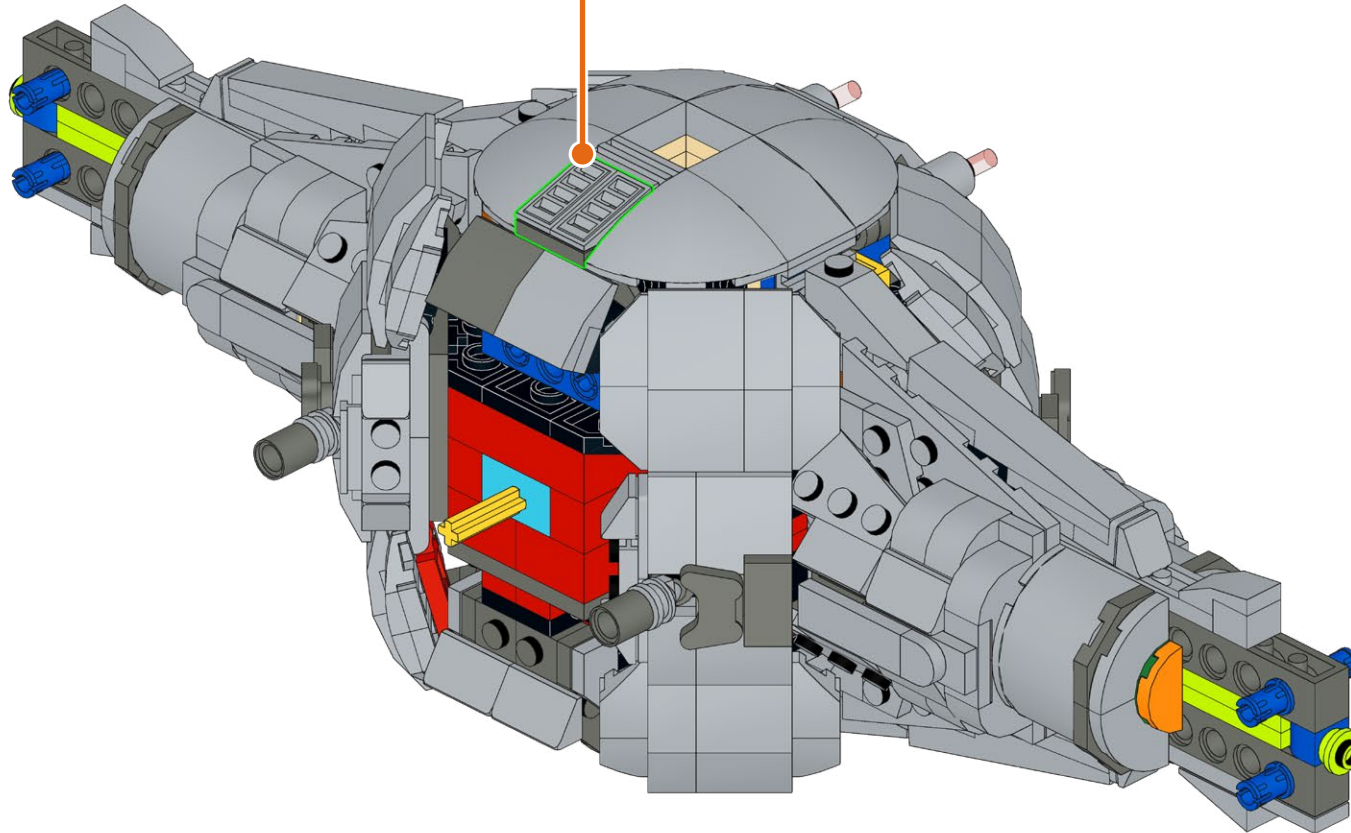
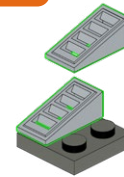
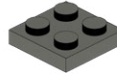

# 252

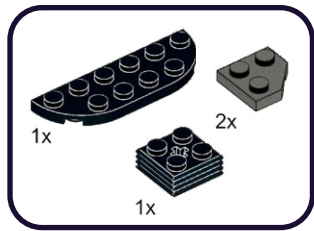

1

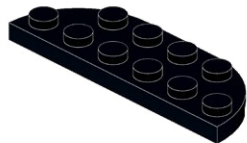

2

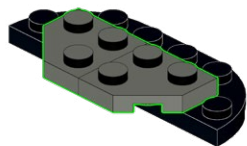

3

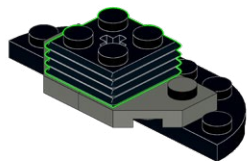

# 253

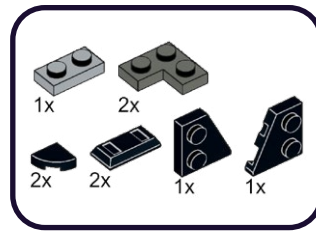

1

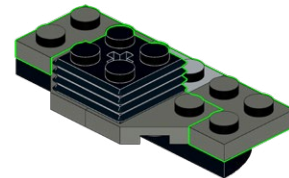

2

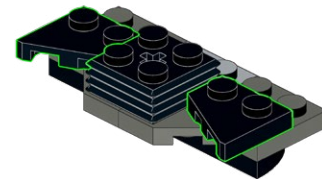

3

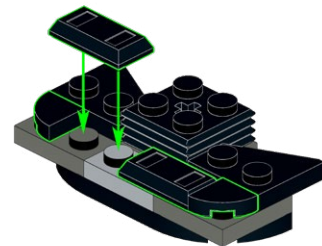

254



1

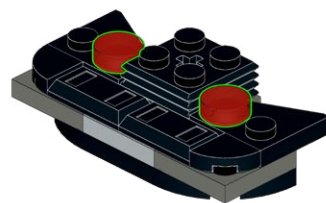

2

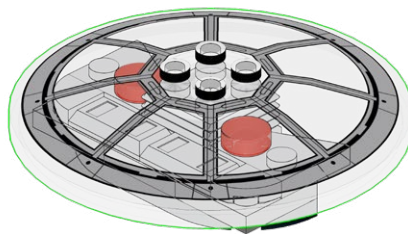



255

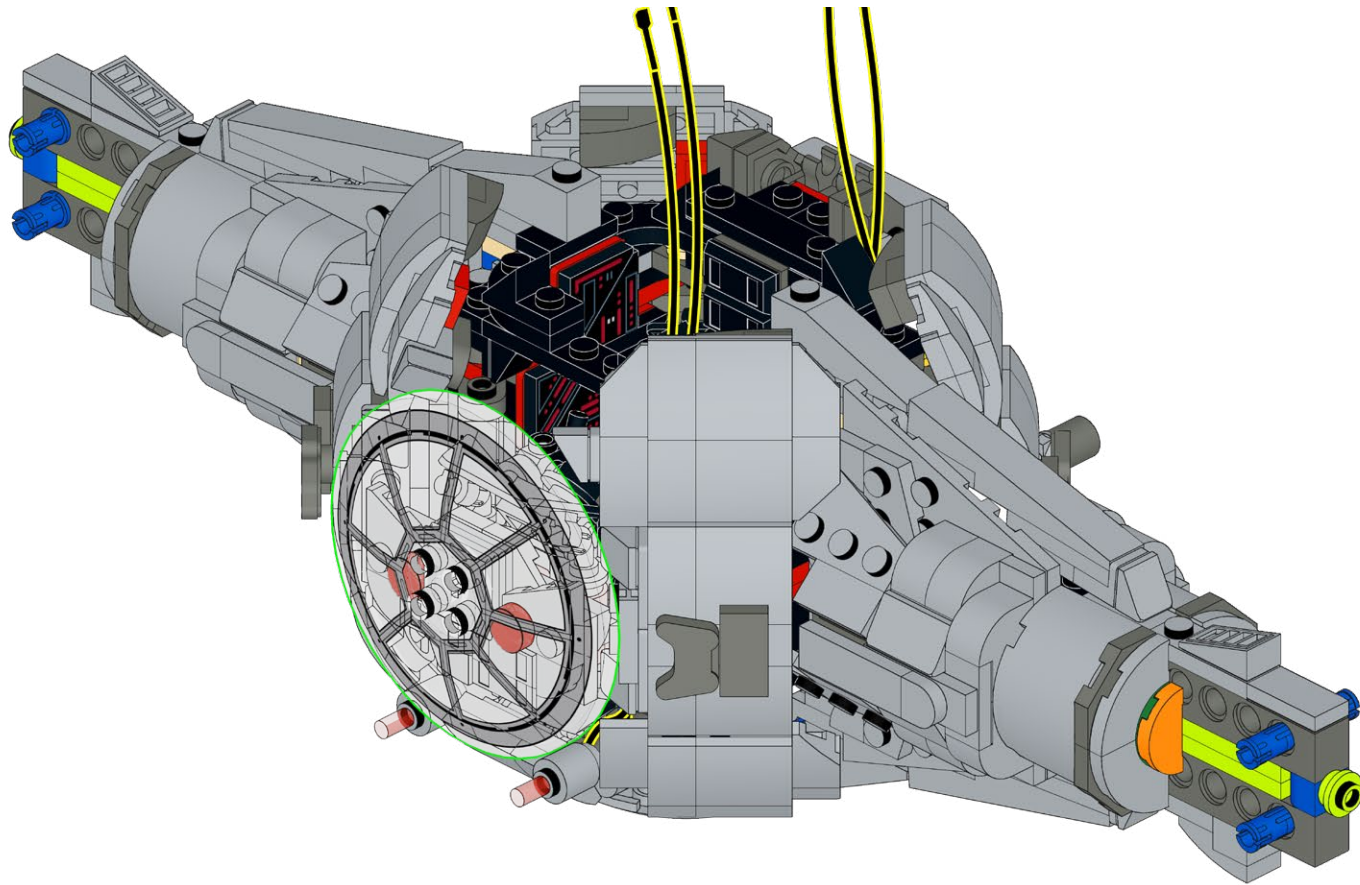

# 256

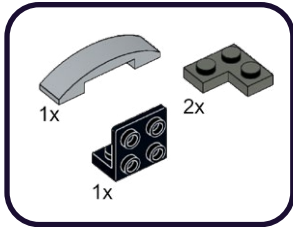

1

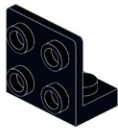

2

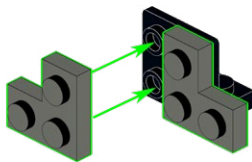

3

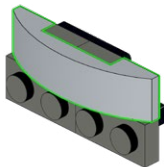

# 257

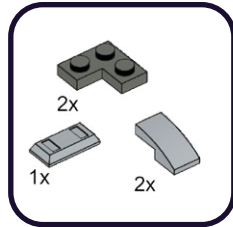

1

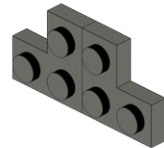

2

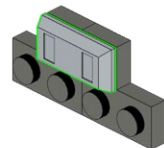

3

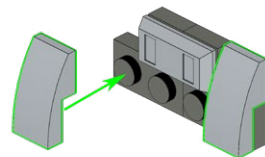



# 258

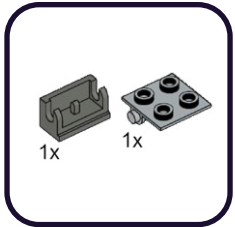

1

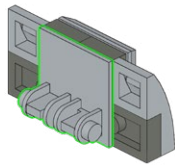

2

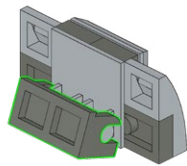

3

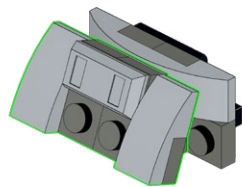

# 259

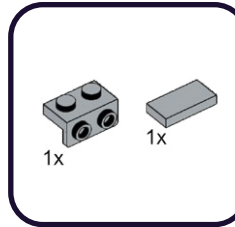

1

2

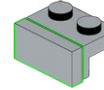
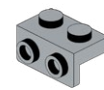

1

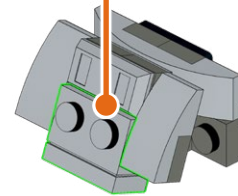

# 260

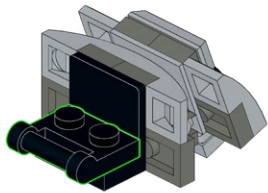
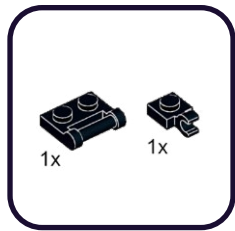

2

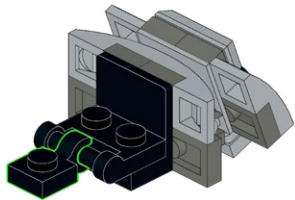

# 261

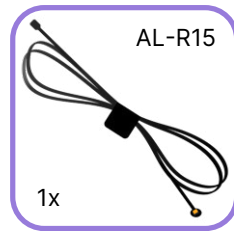
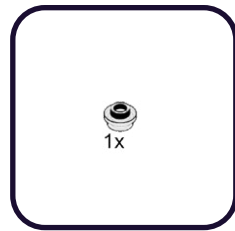

1

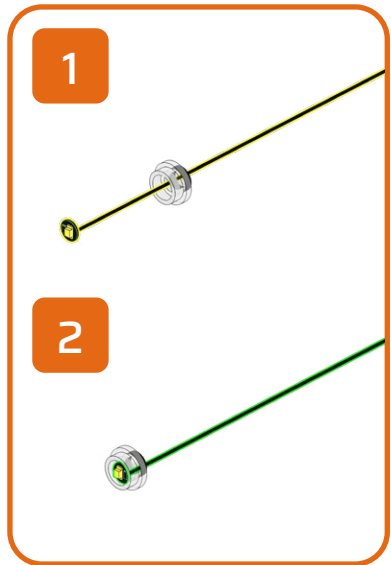
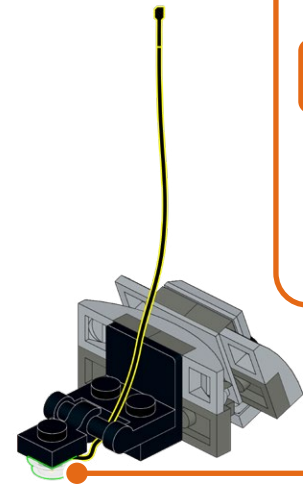

262

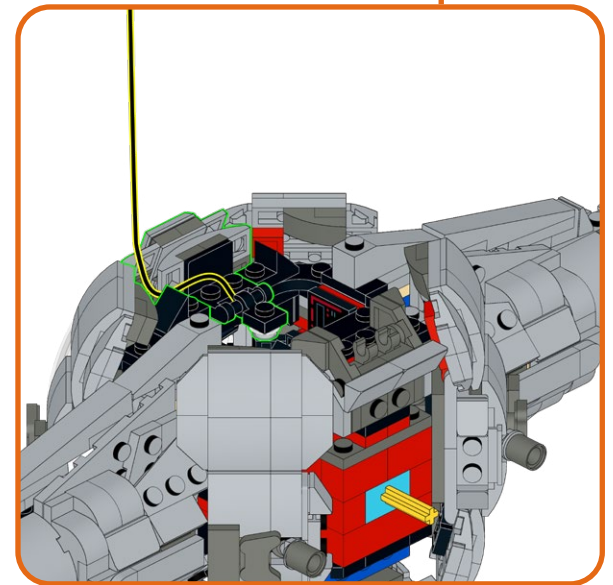
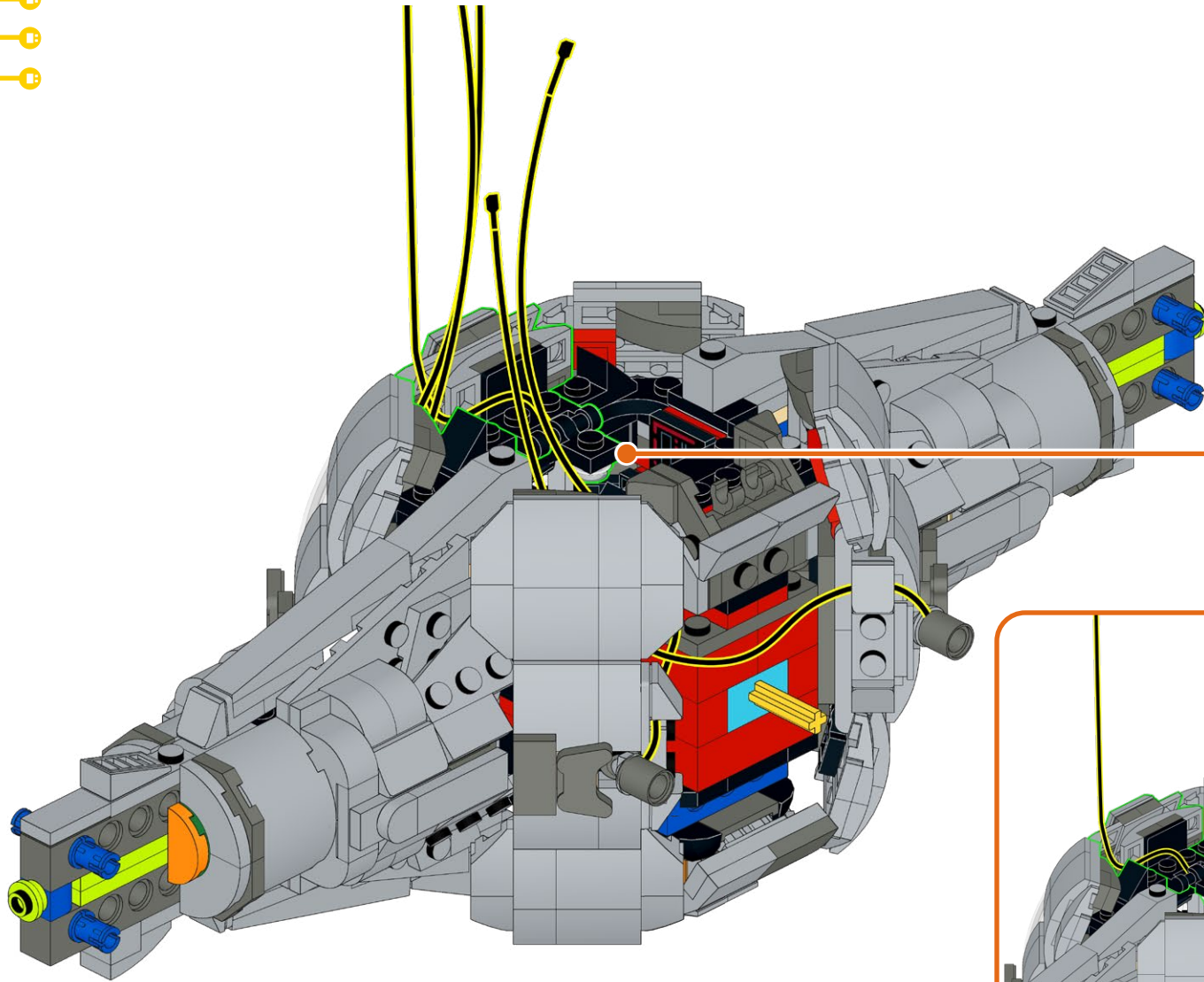

263

1x

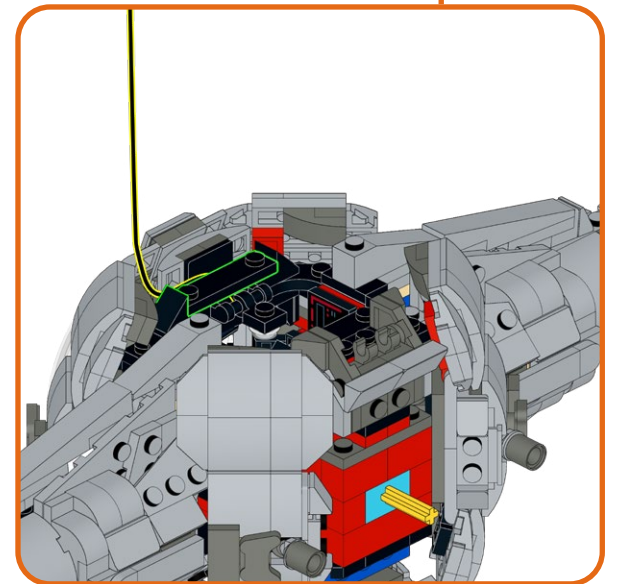
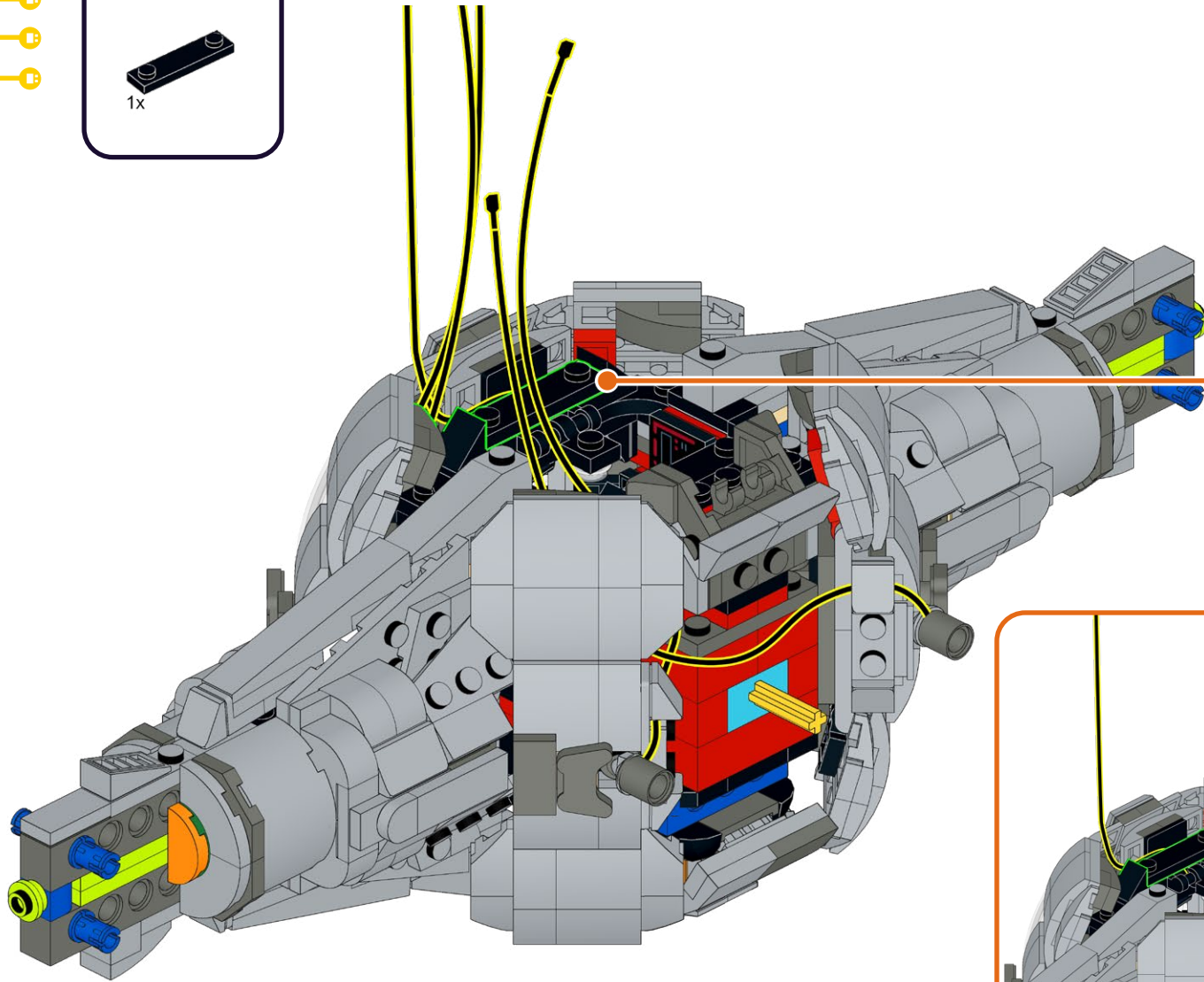

264

D-6



1x

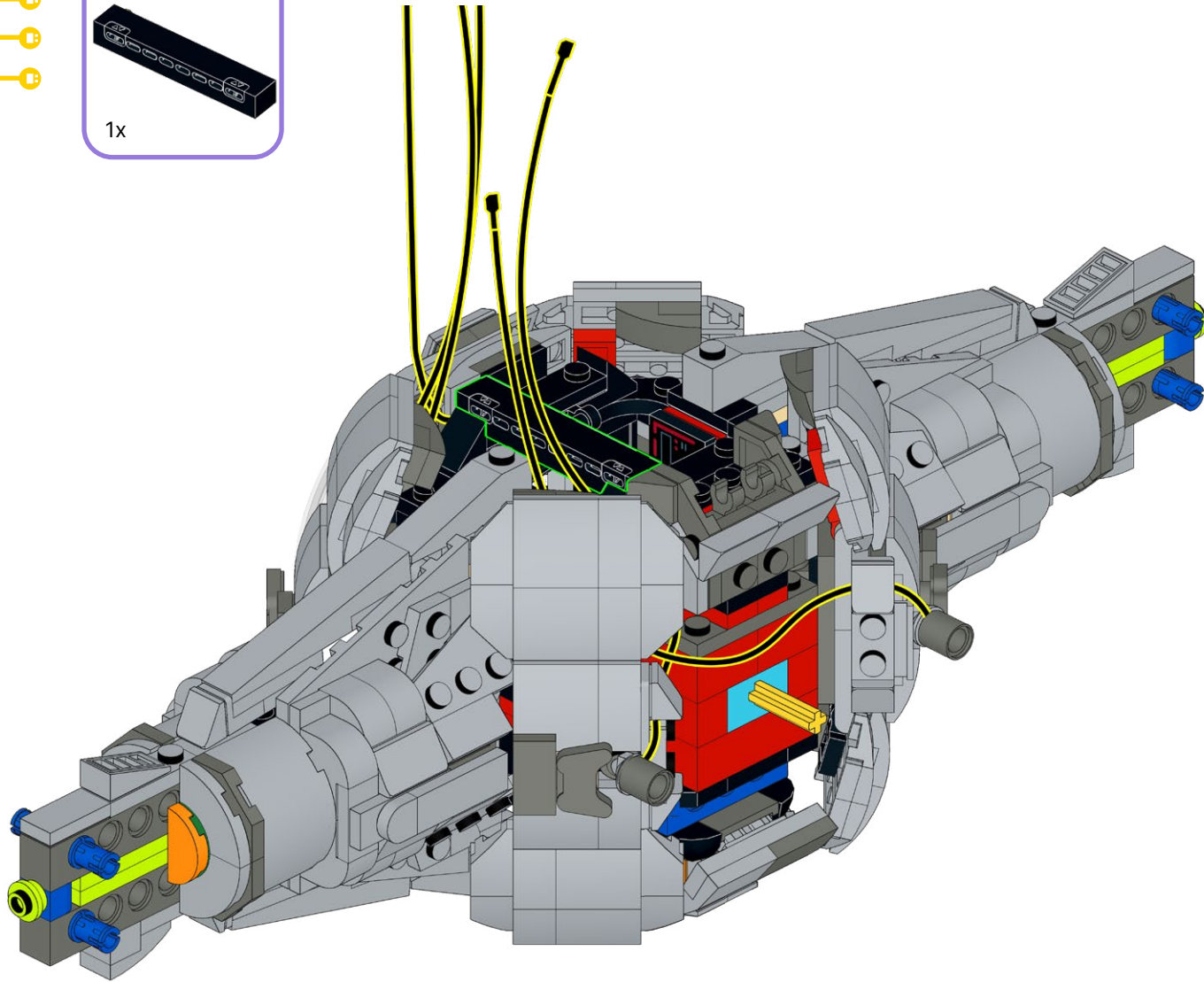



265

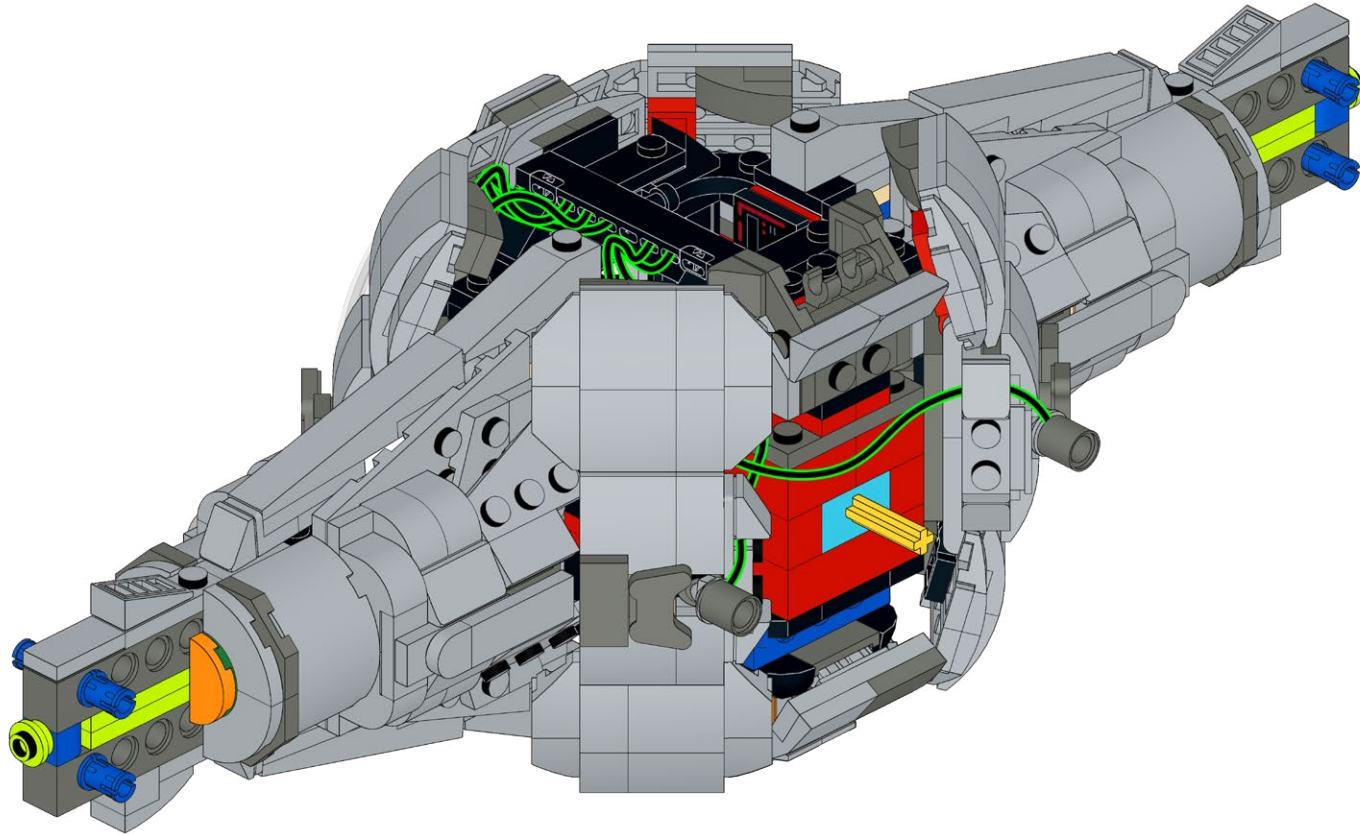
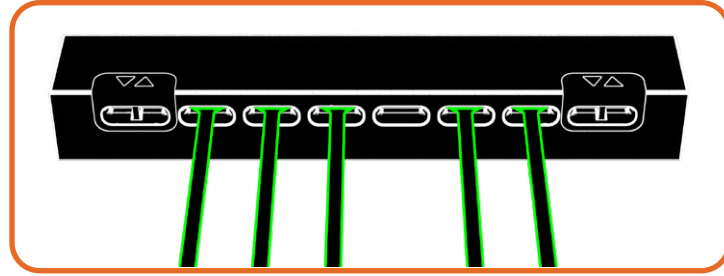



### **HOLD UP!**

You might notice some bags are out of order, as well as left over pieces, but that's ok! We're changing the way you build LEGO!

### **HALTEN!**

Möglicherweise stellen Sie fest, dass einige Beutel nicht in Ordnung sind und auch Teile übrig bleiben, aber das ist in Ordnung! Wir verändern die Art und Weise, wie Sie LEGO bauen!

### **TENIR BON!**

Vous remarquerez peut-être que certains sacs sont en panne, ainsi que des morceaux restants, mais ce n'est pas grave ! Nous changeons la façon dont vous construisez LEGO !

### **SOSTENERE!**

Potresti notare che alcune borse sono fuori uso, così come alcuni pezzi avanzati, ma va bene! Stiamo cambiando il modo in cui costruisci i LEGO!

### **¡SOSTENER!**

Puede que notes que algunas bolsas están fuera de orden, así como piezas sobrantes, ¡pero está bien! ¡Estamos cambiando la forma de construir LEGO!

### **耽误!**

您可能会注意到有些袋子坏了, 还有剩余的碎片, 但这没关系! 我们正在改变您搭建乐高的方式!

#### Open LMB Bag 02

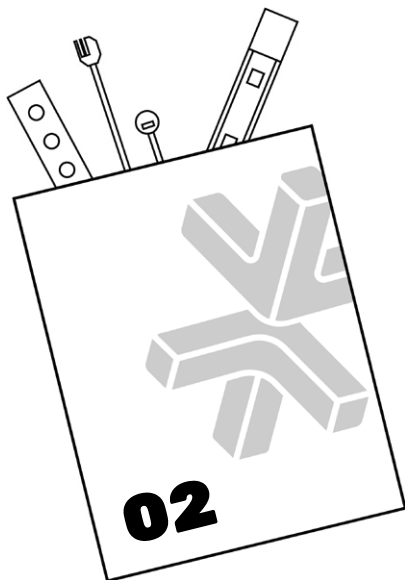



266

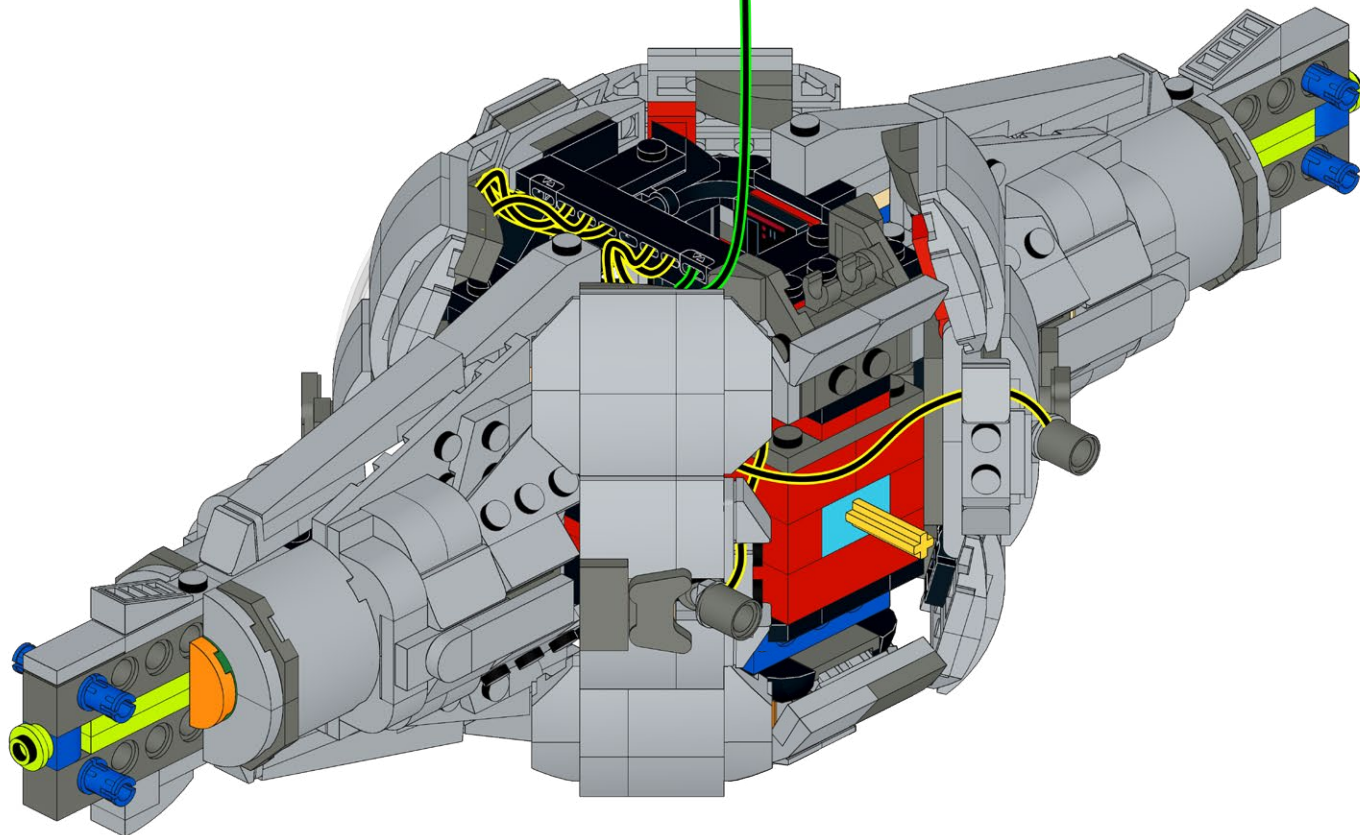
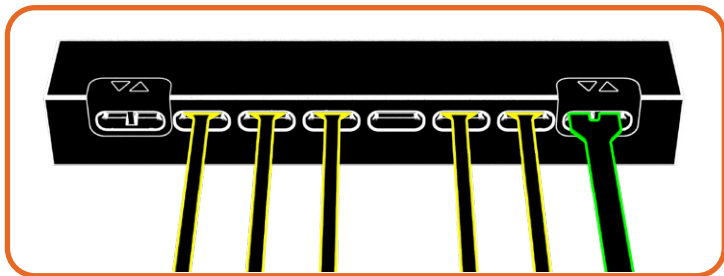
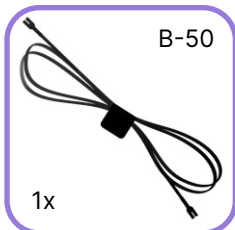

267

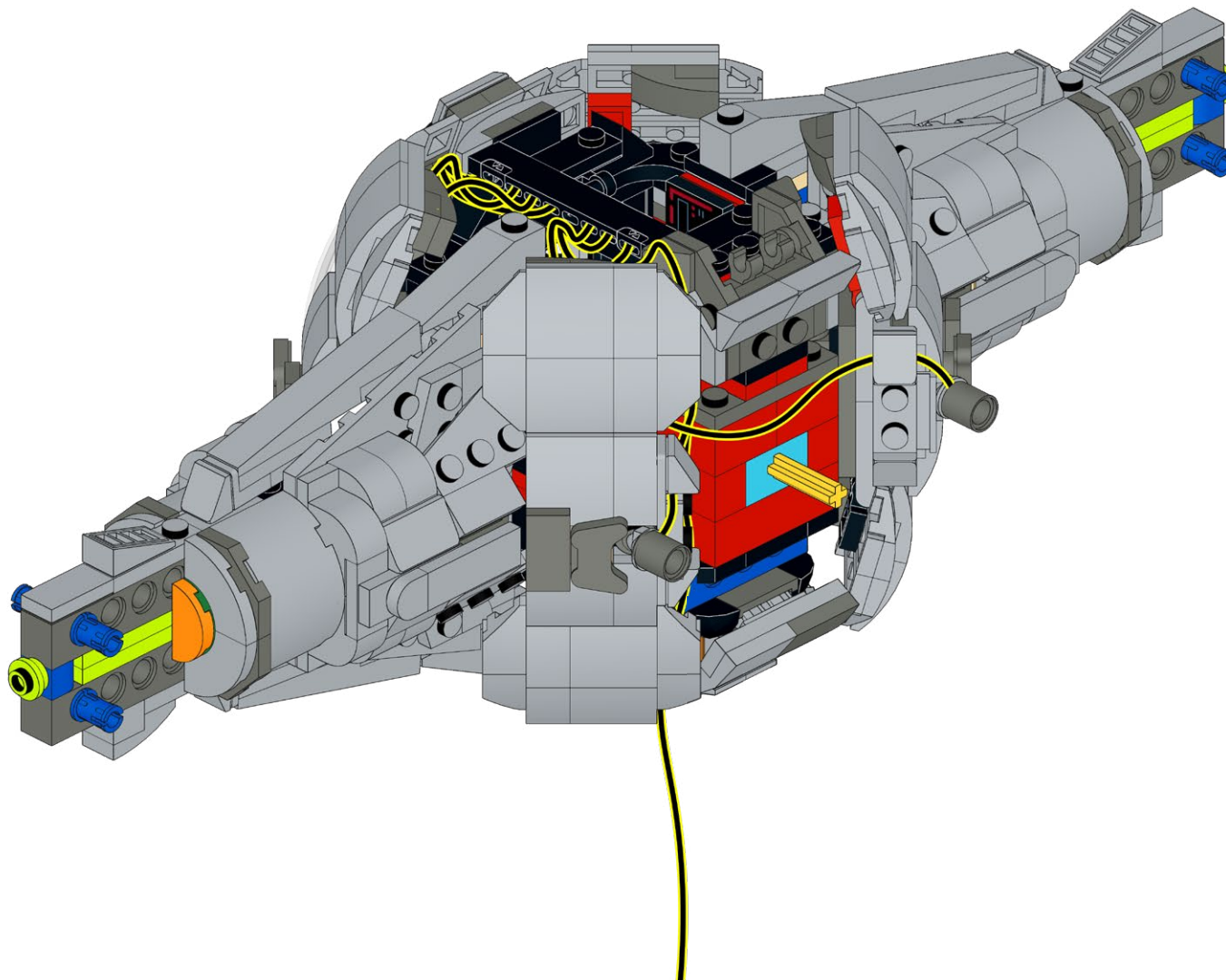

268

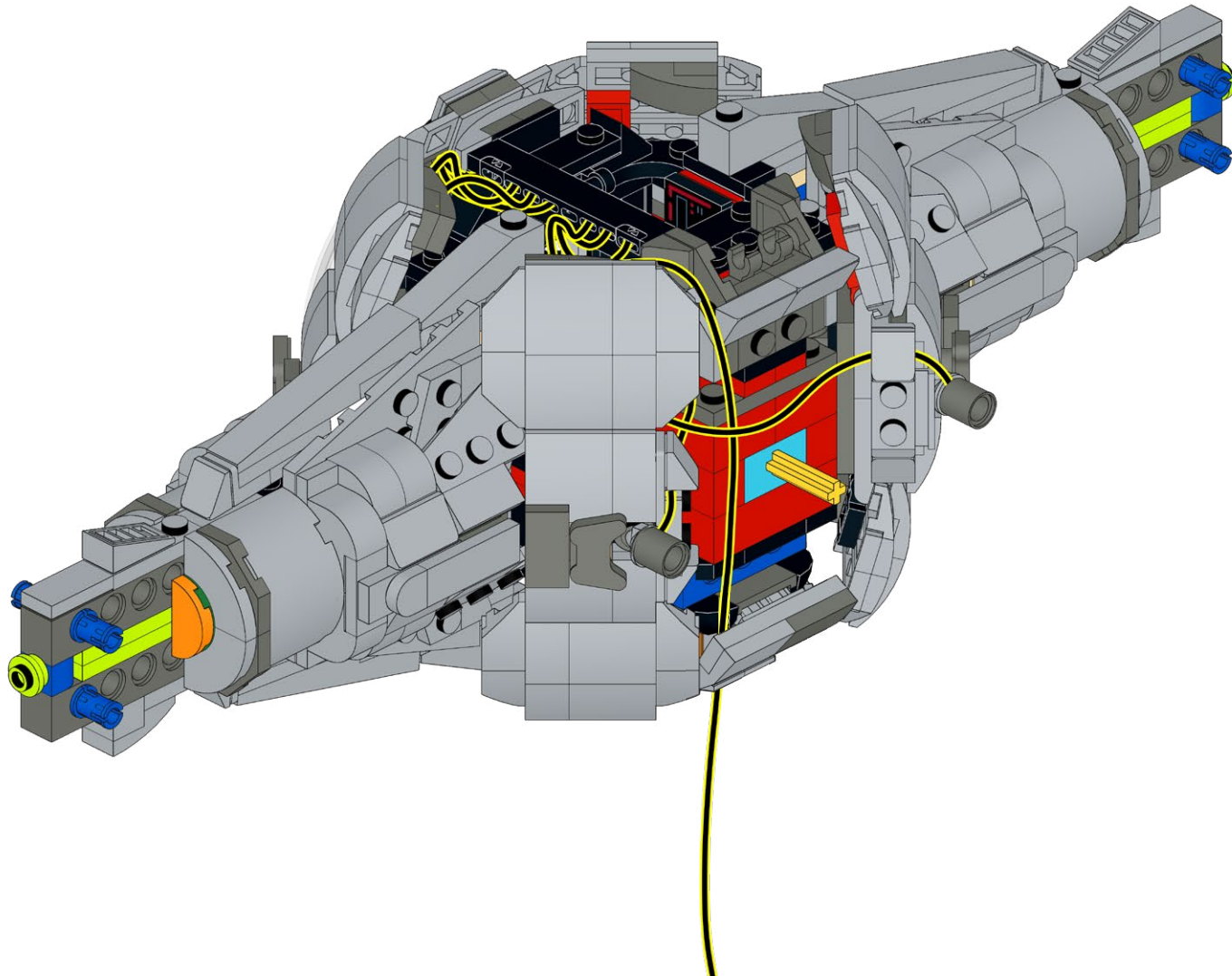

# 269

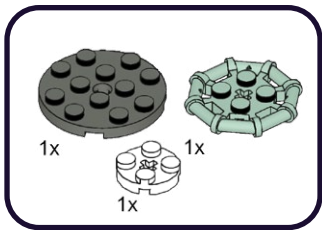

1 1

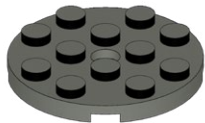

2



3

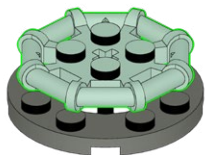

# 270

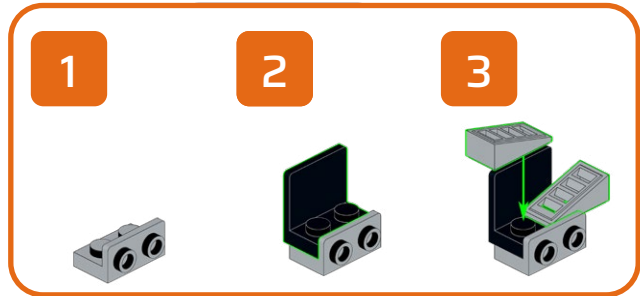
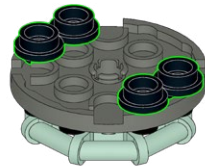
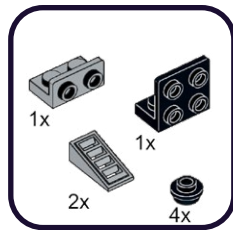

2

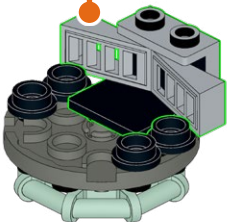

# 271

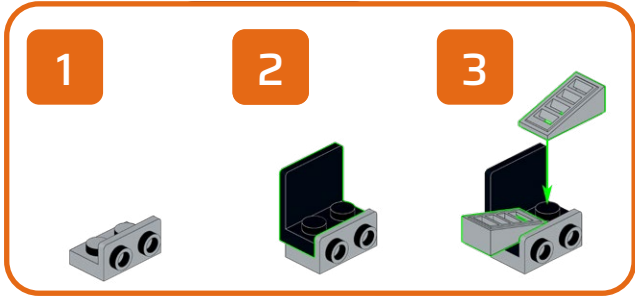
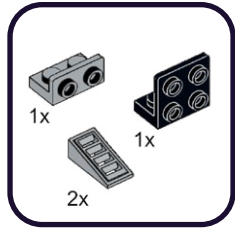

1

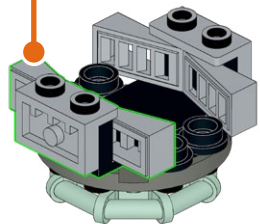

# 272

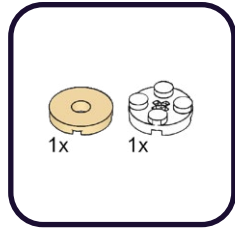

1

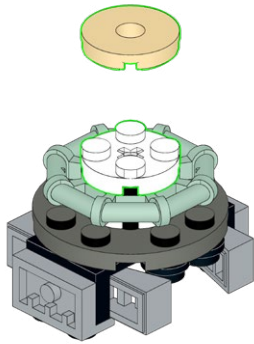

# 273

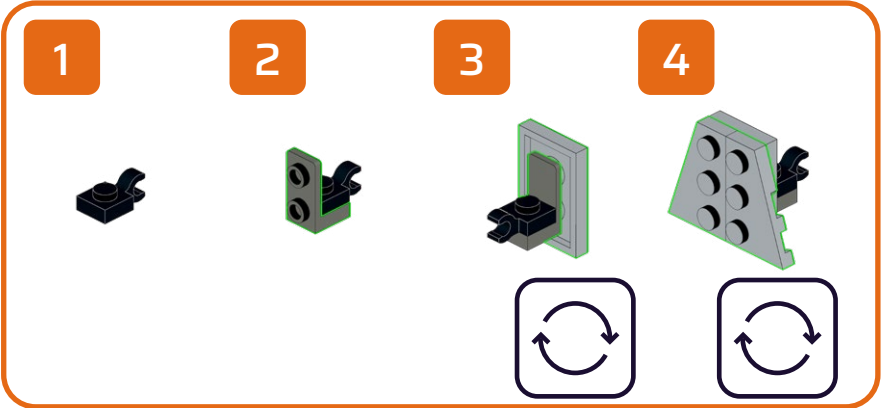
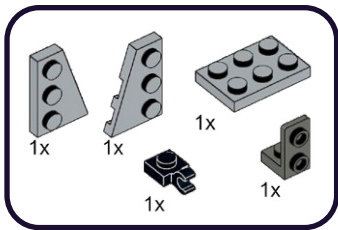

1

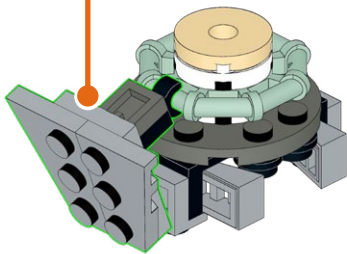

# 274

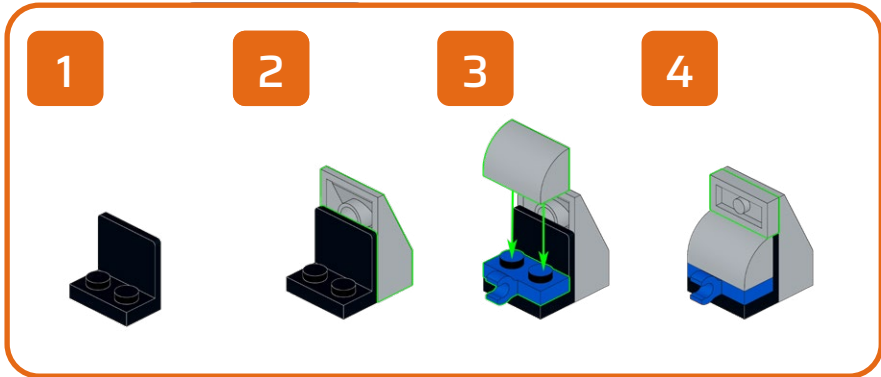
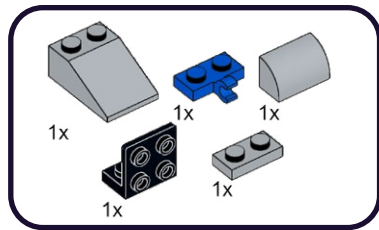

1

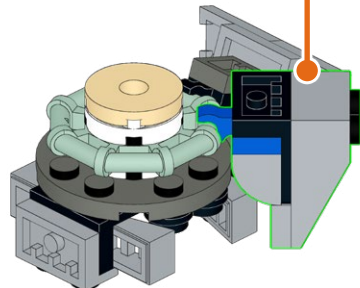



# 275

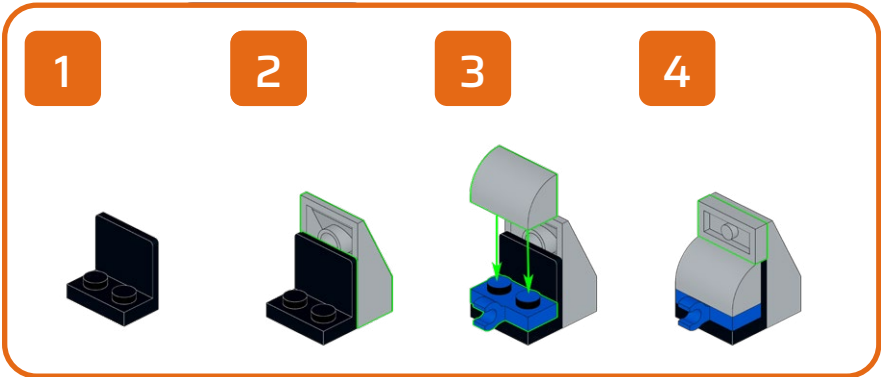
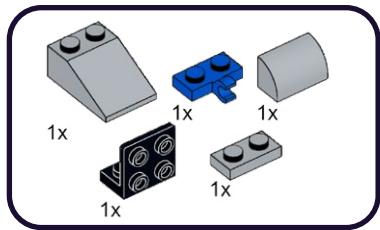

1

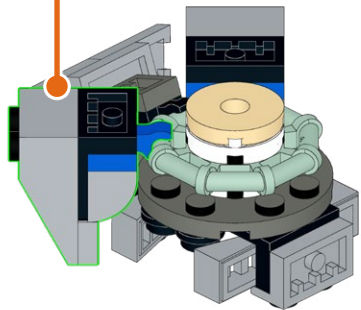

# 276

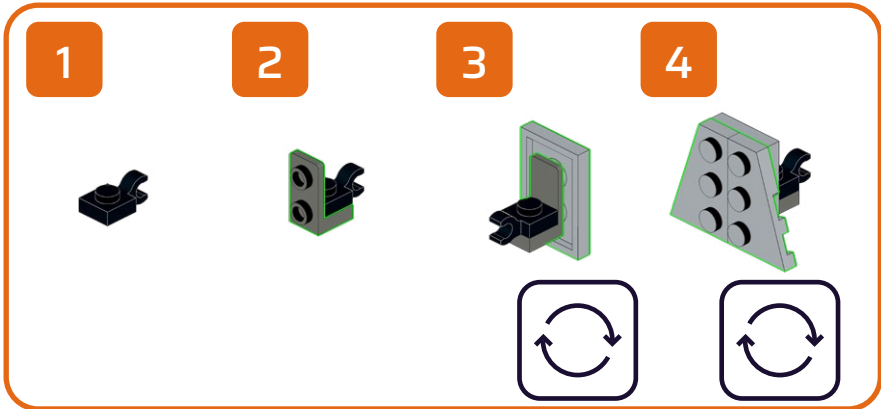
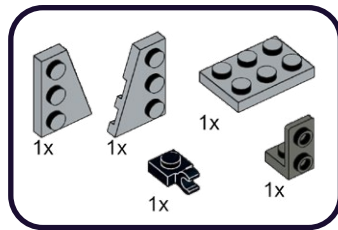

1

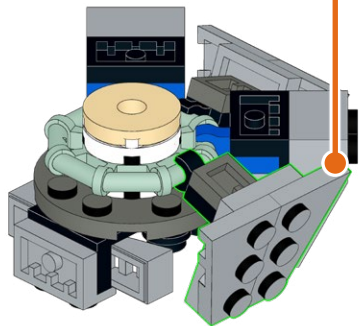



277

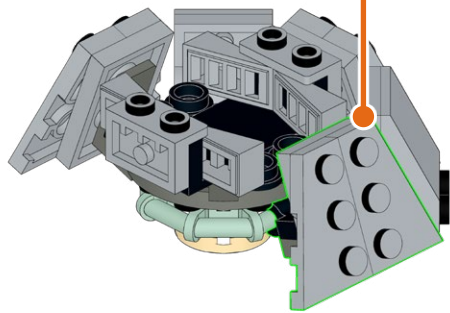
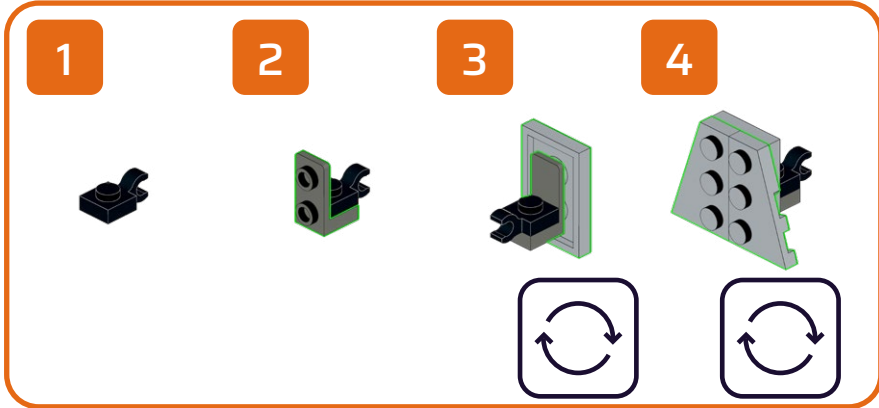
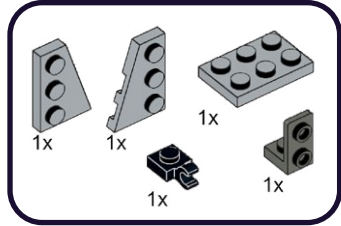

278

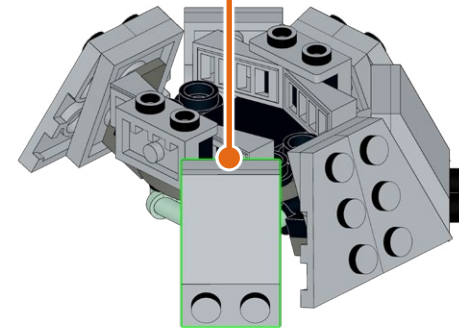
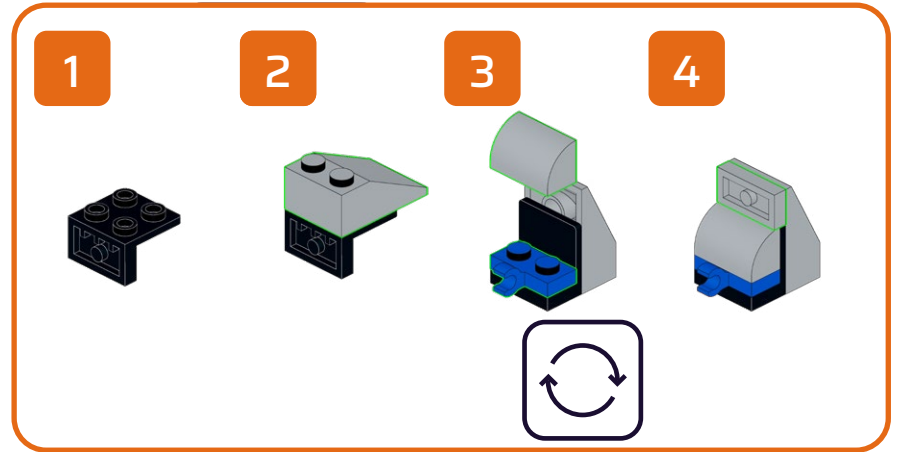
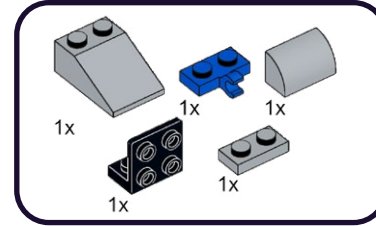

# 279

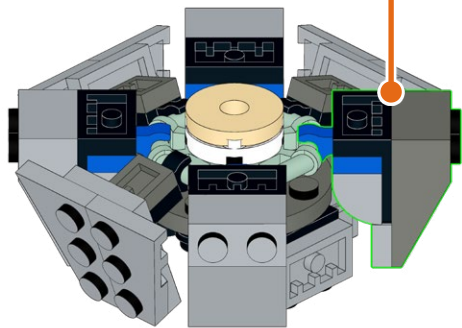
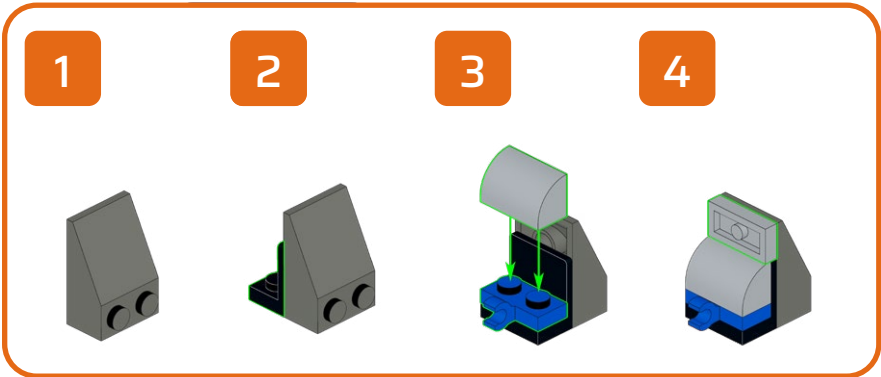
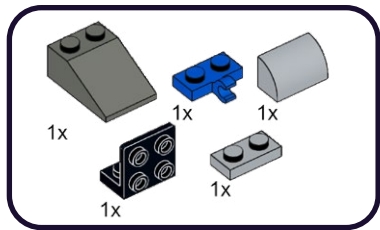

# 280

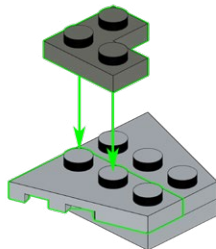
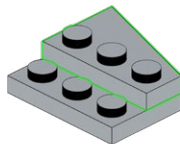
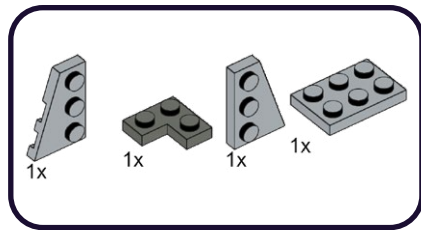

# 281

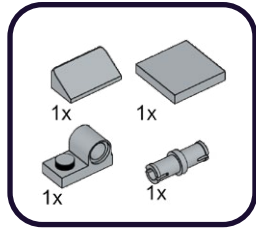

1

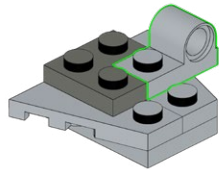

2

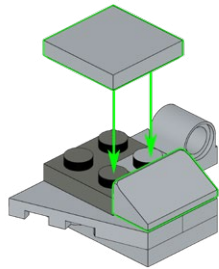

3

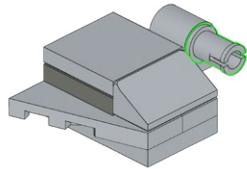

# 282

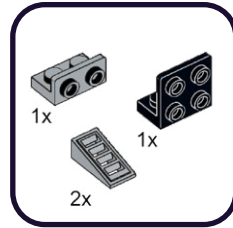

1

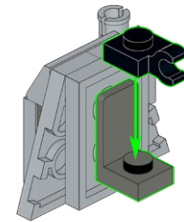
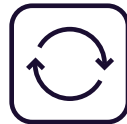

283

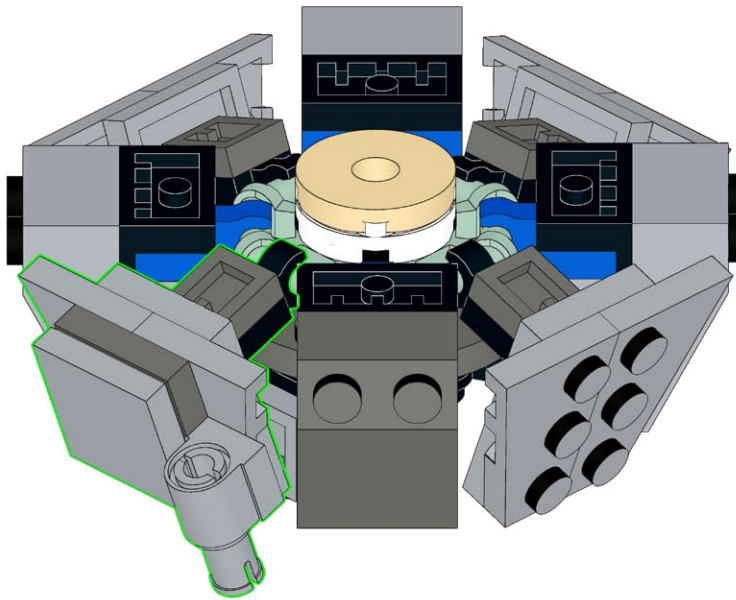

284

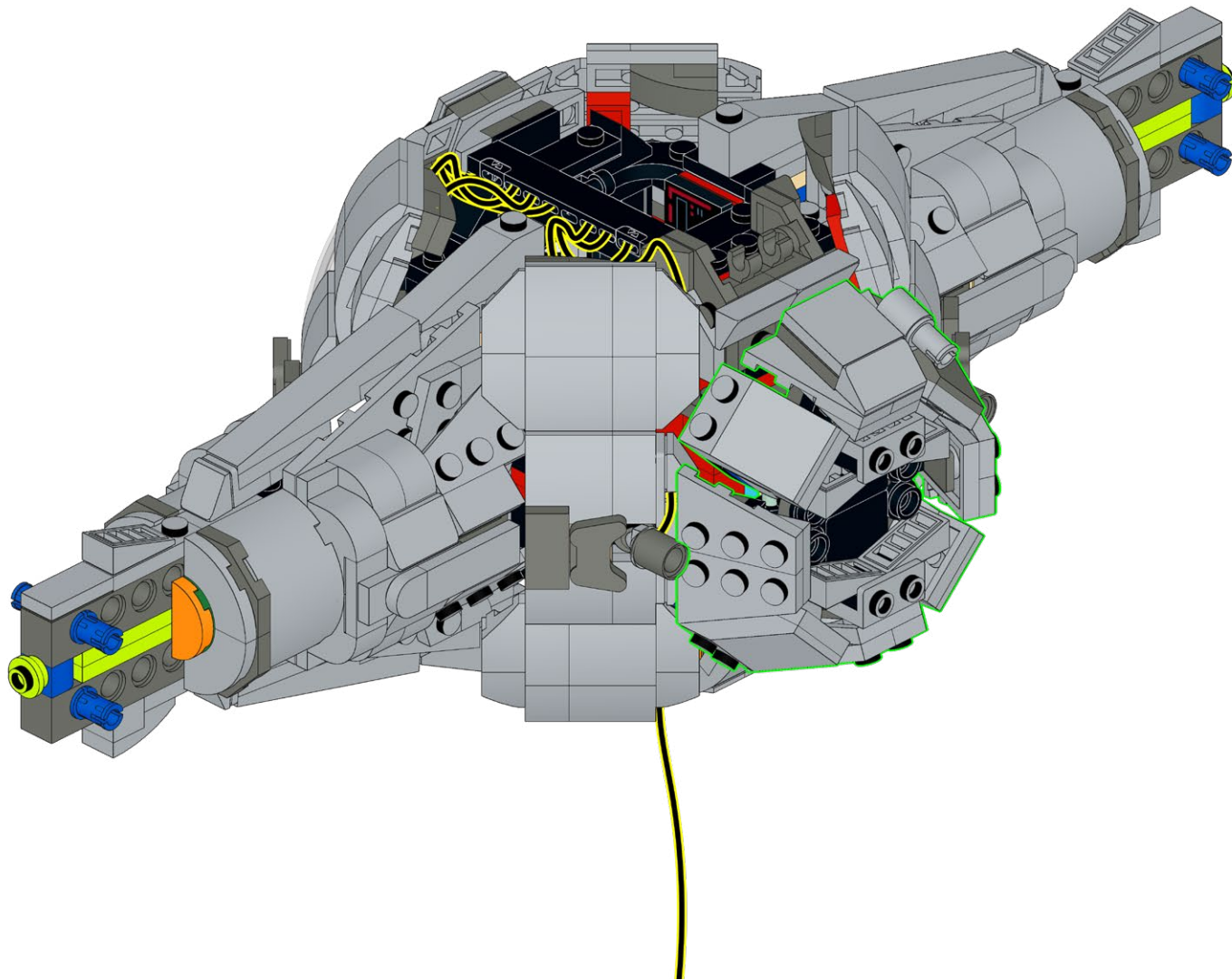

# 285

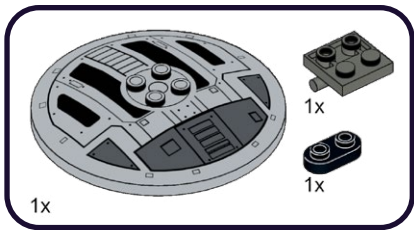

1

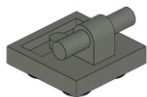

2

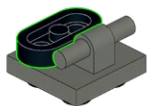

3

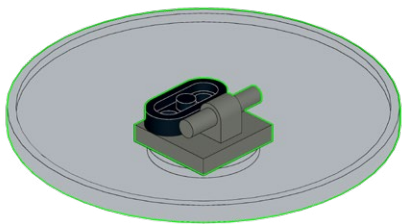

# 286

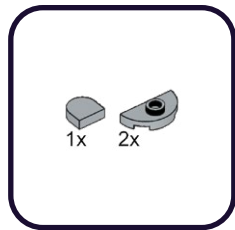

1

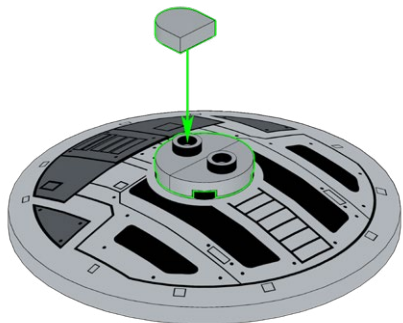

2

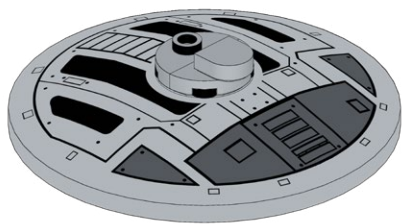

# 287

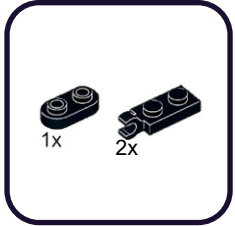

1



2

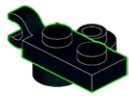

3

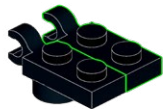

# 288

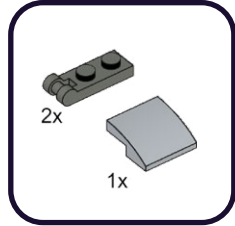

1

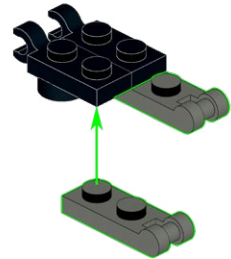

2

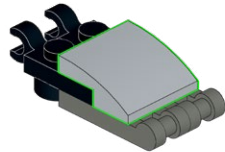

3

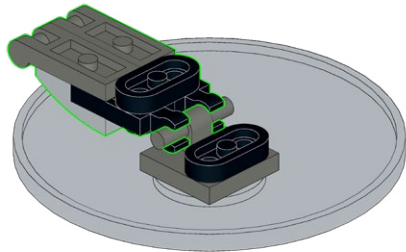



289

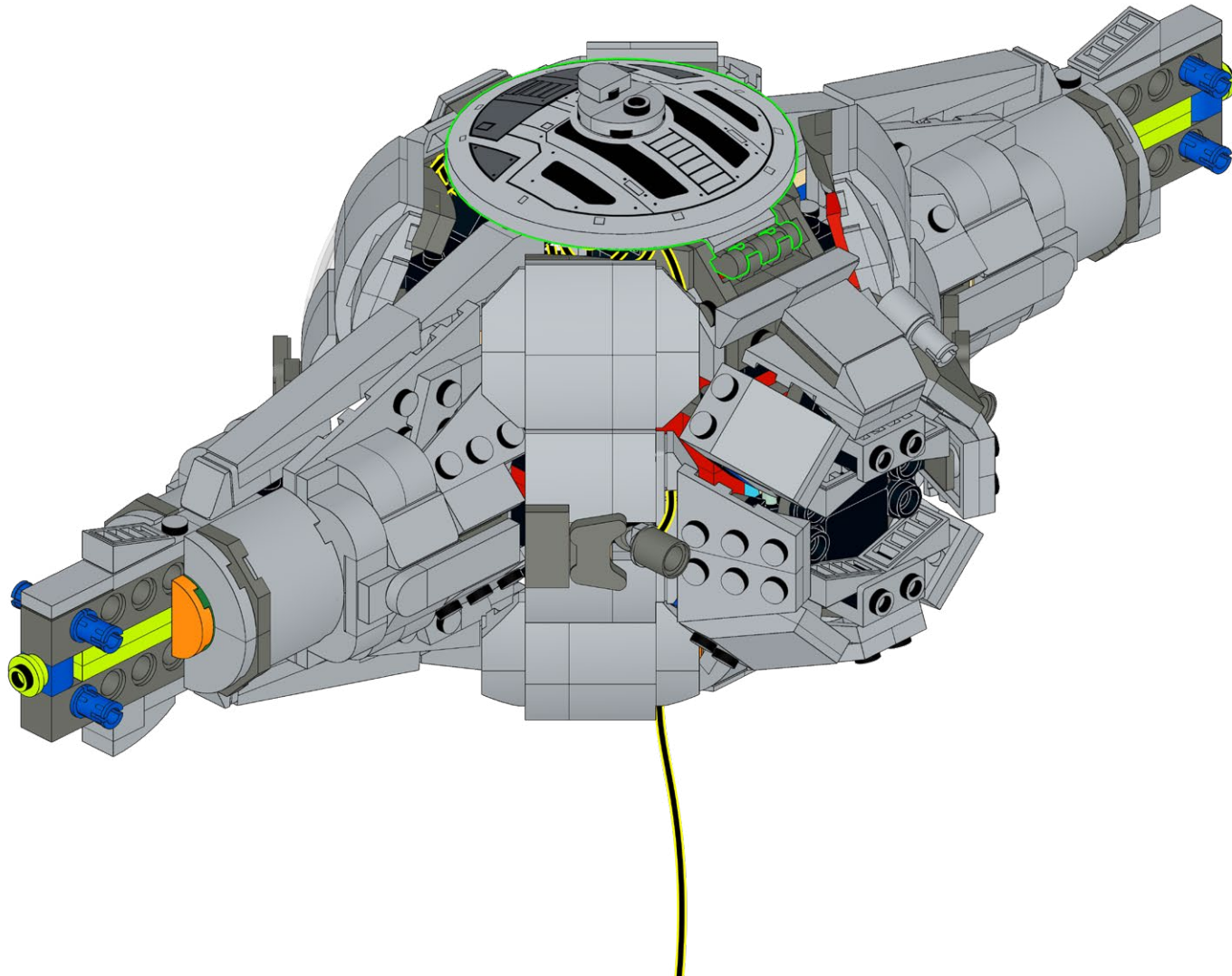

290

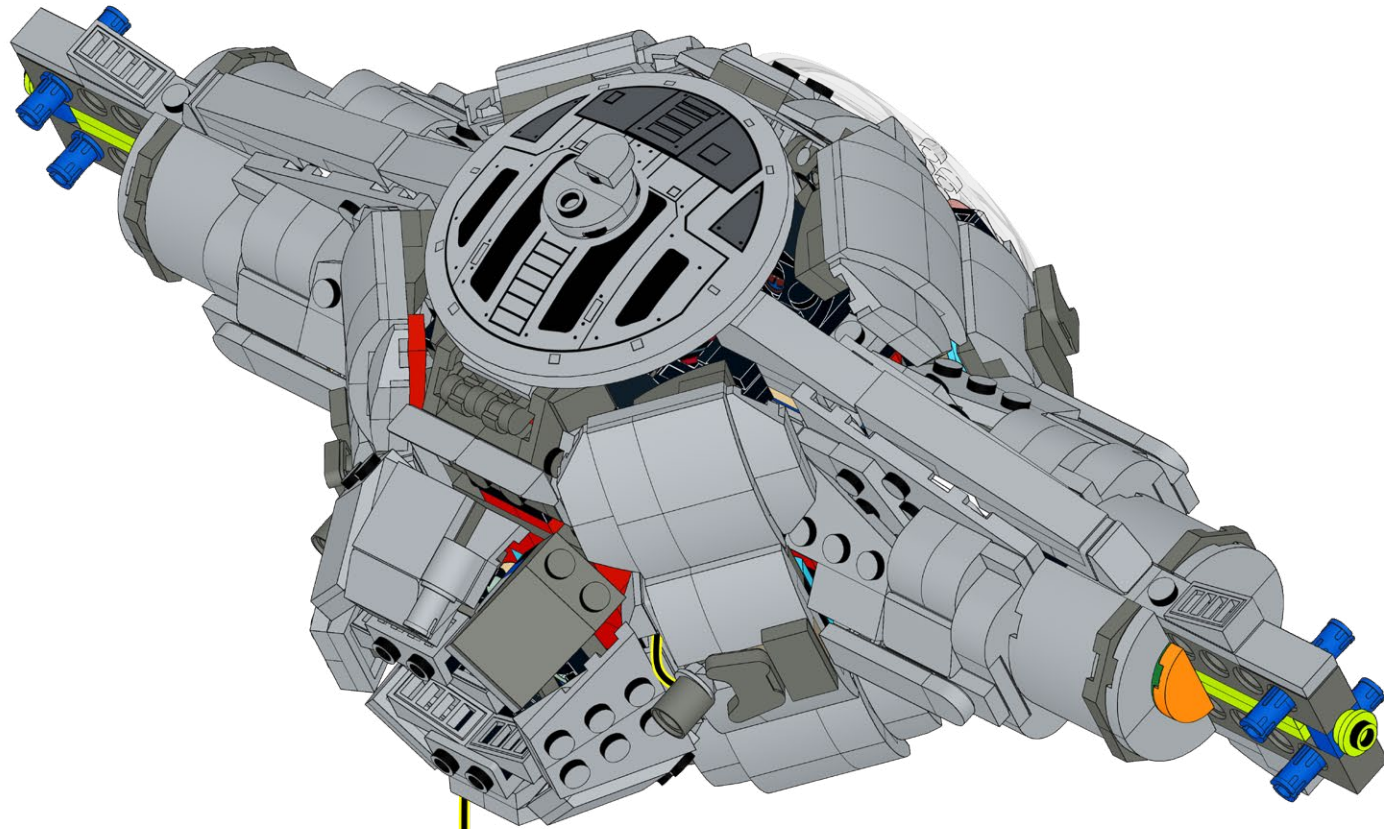

**HOLD UP!**

You might notice some bags are out of order, as well as left over pieces, but that's ok! We're changing the way you build LEGO!

**HALTEN!**

Möglicherweise stellen Sie fest, dass einige Beutel nicht in Ordnung sind und auch Teile übrig bleiben, aber das ist in Ordnung! Wir verändern die Art und Weise, wie Sie LEGO bauen!

**TENIR BON!**

Vous remarquerez peut-être que certains sacs sont en panne, ainsi que des morceaux restants, mais ce n'est pas grave ! Nous changeons la façon dont vous construisez LEGO !

**SOSTENERE!**

Potresti notare che alcune borse sono fuori uso, così come alcuni pezzi avanzati, ma va bene! Stiamo cambiando il modo in cui costruisci i LEGO!

**¡SOSTENER!**

Puede que notes que algunas bolsas están fuera de orden, así como piezas sobrantes, ¡pero está bien! ¡Estamos cambiando la forma de construir LEGO!

**耽误!**

您可能会注意到有些袋子坏了, 还有剩余的碎片, 但这没关系! 我们正在改变您搭建乐高的方式!

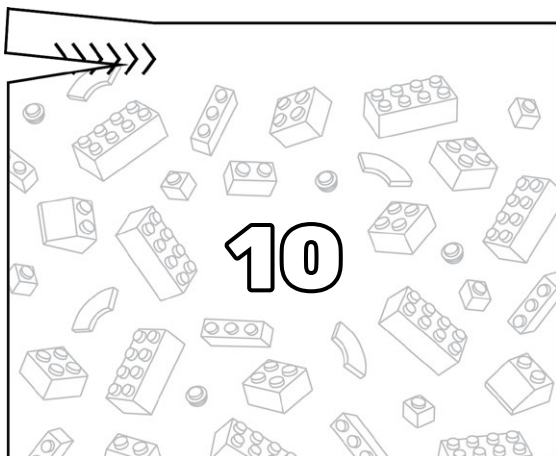
**Open LEGO® Bag 1**

291

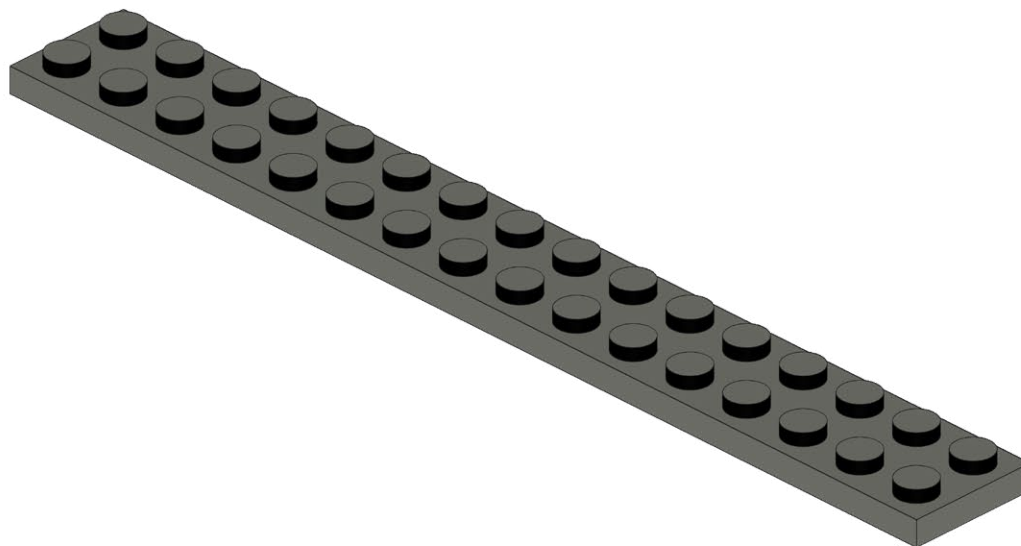
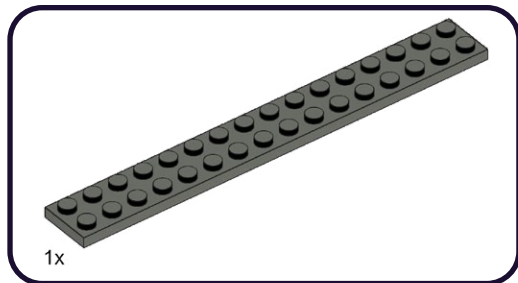

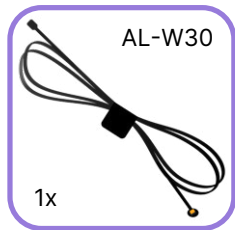
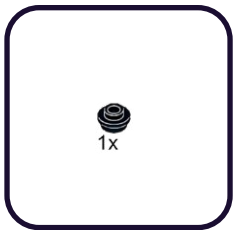

1



1



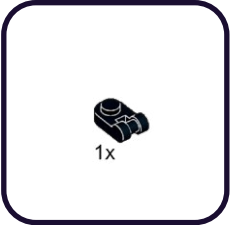

1



1



**296**



**297**

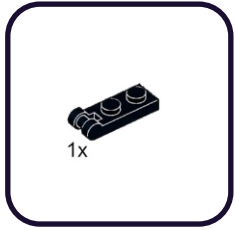

**1**



**1**





298

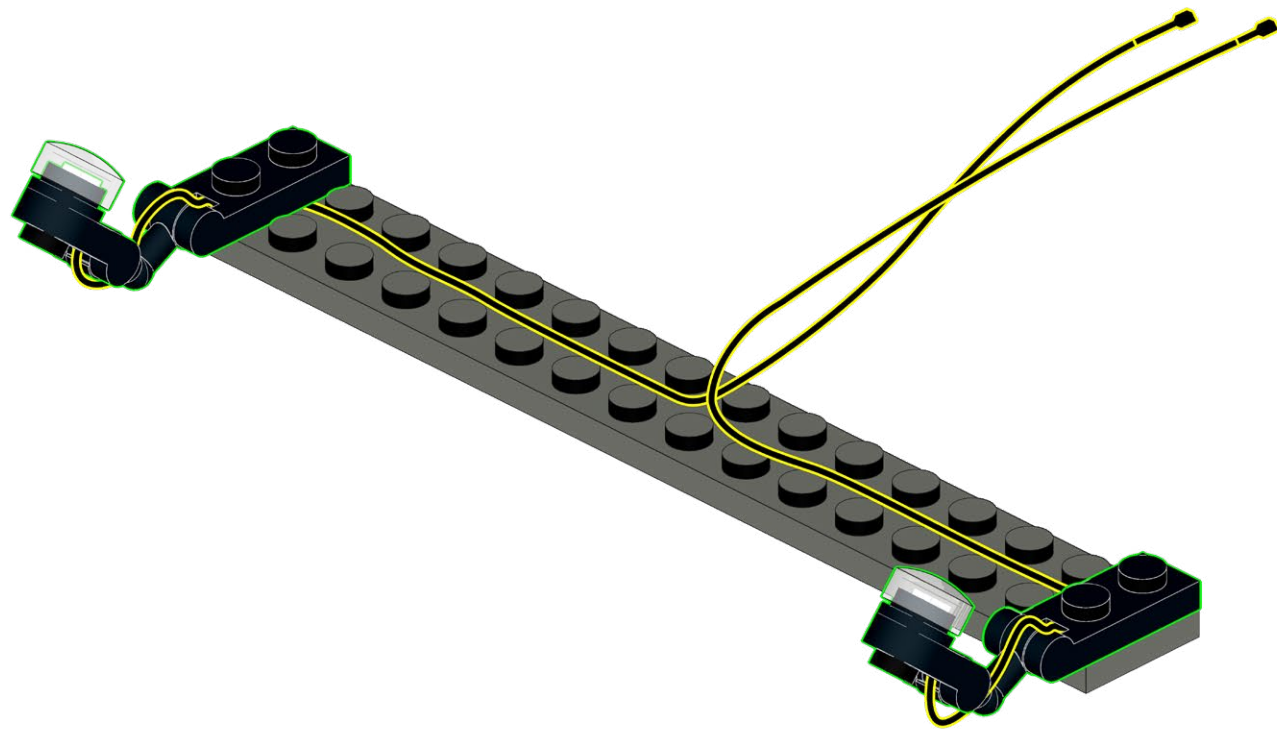

299

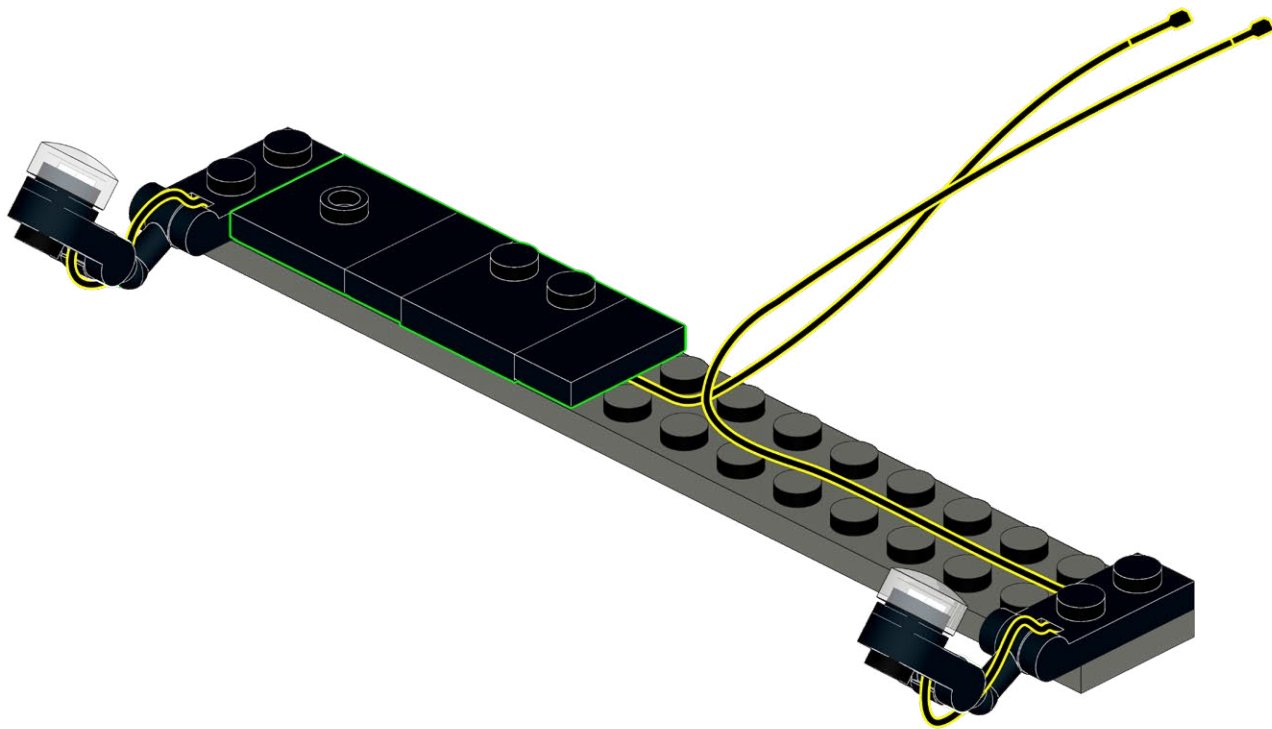
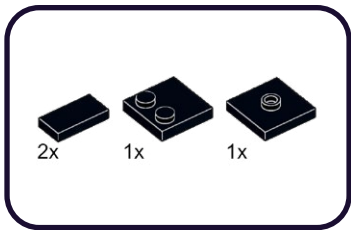

**300**

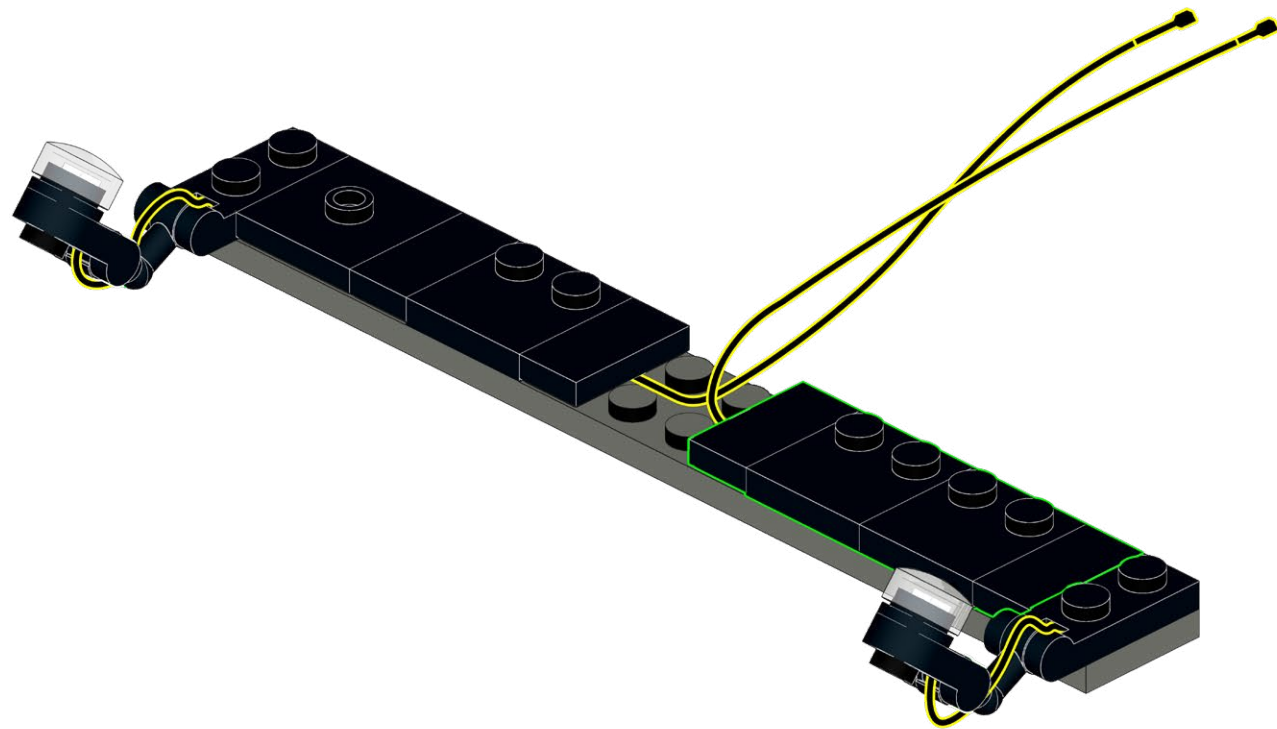
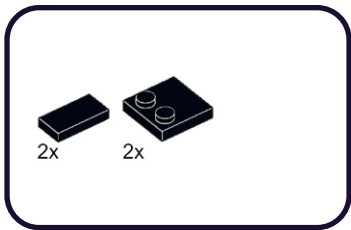

301

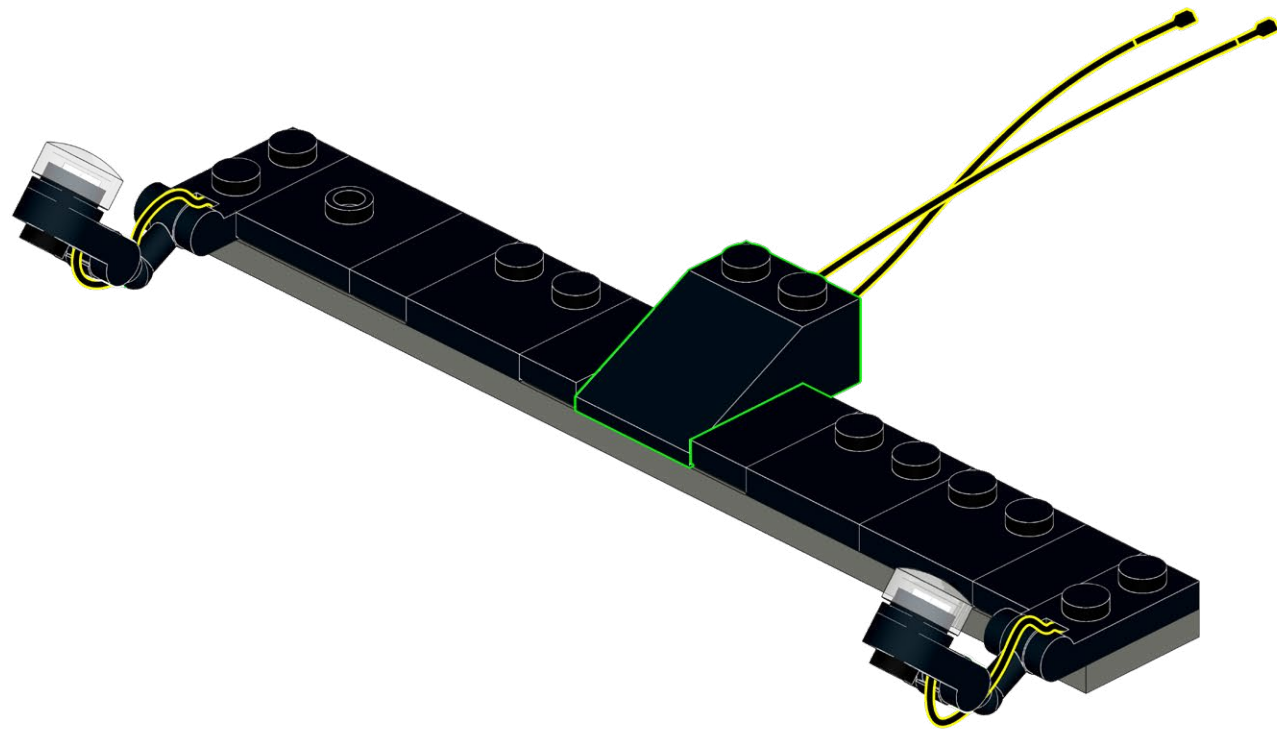
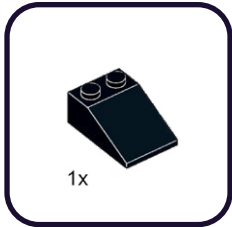

**302**

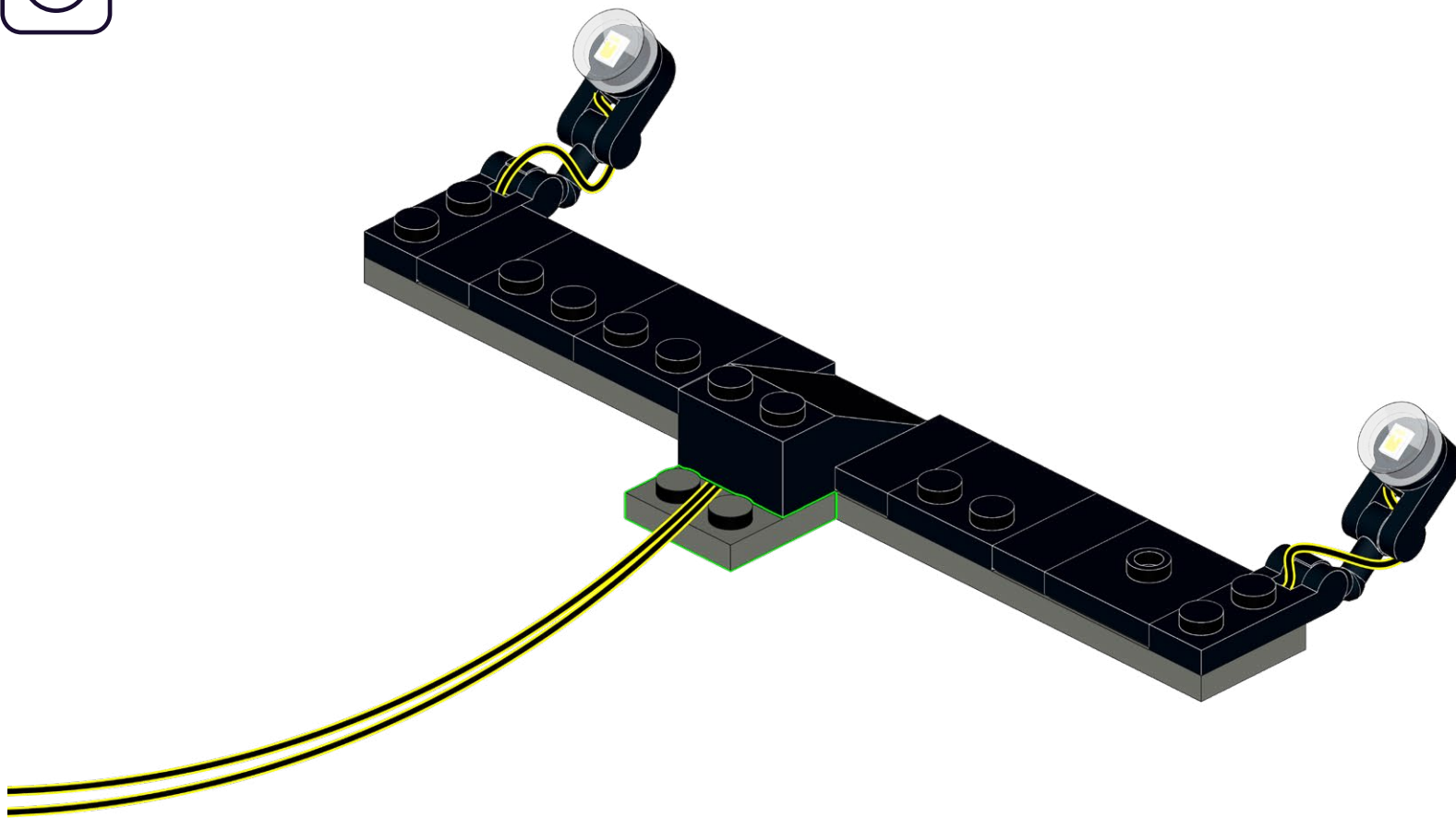
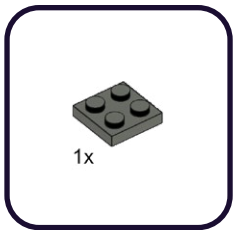

**303**

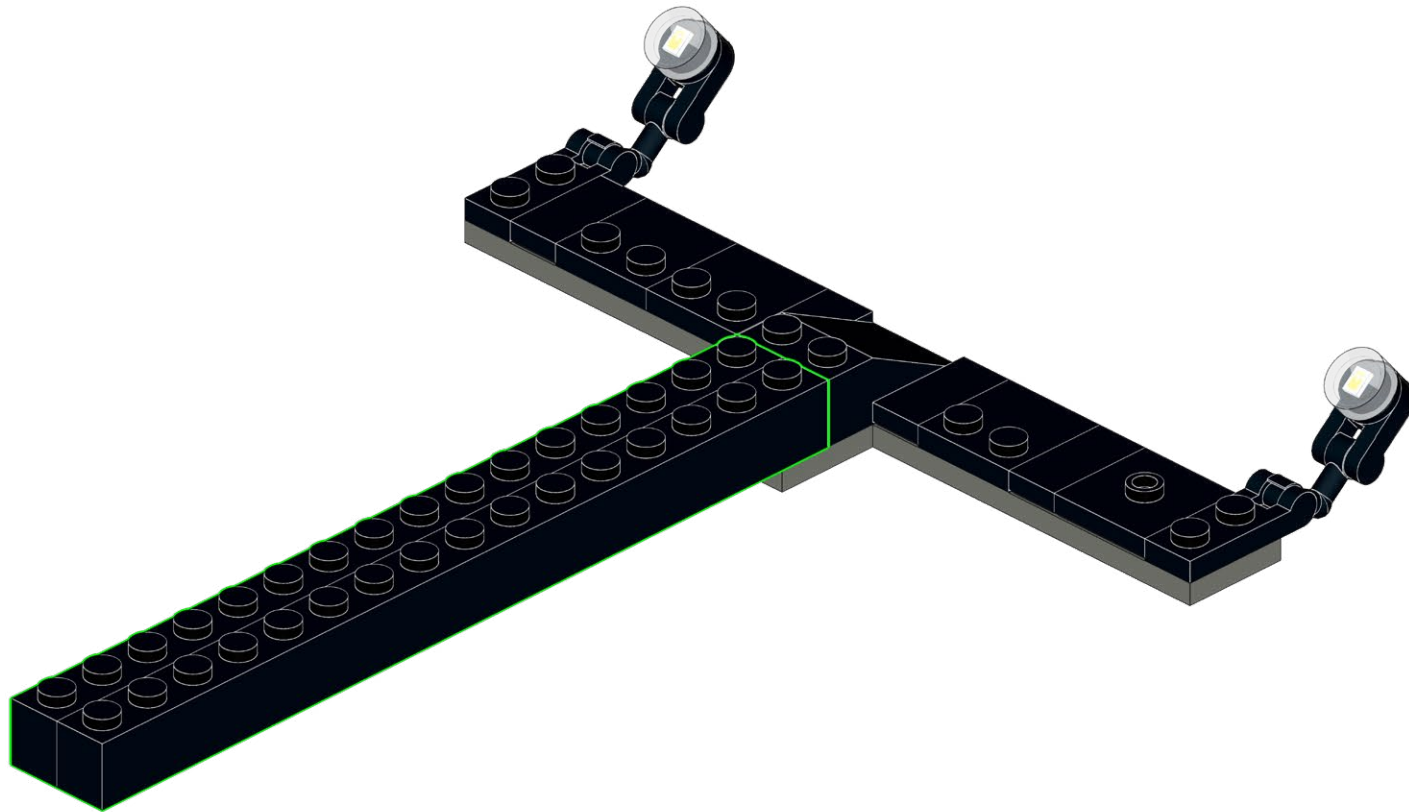
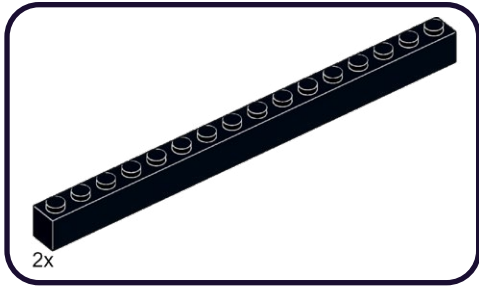

304

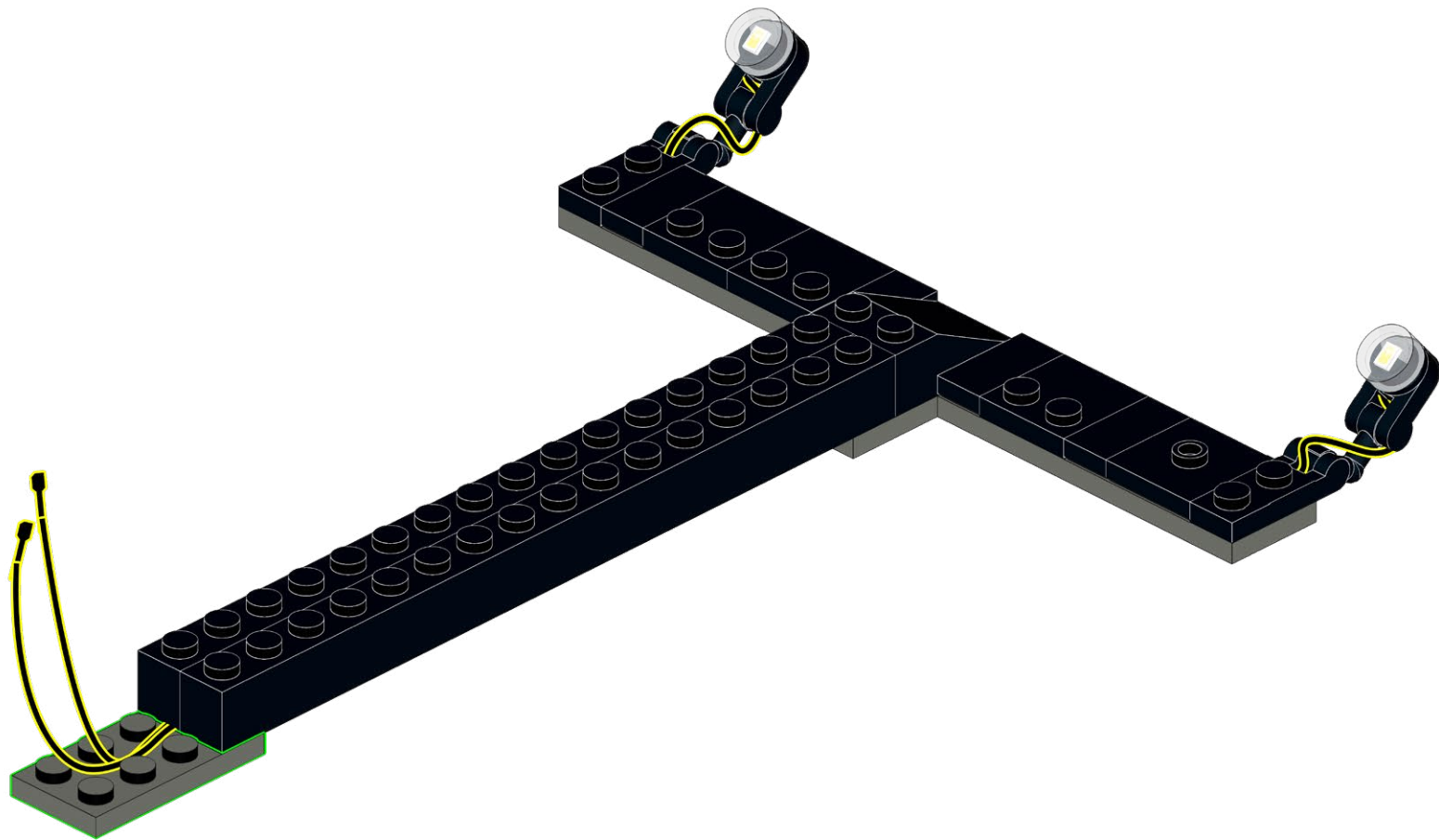
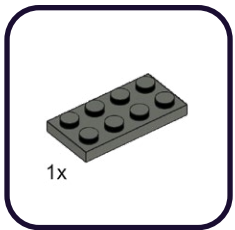



**305**

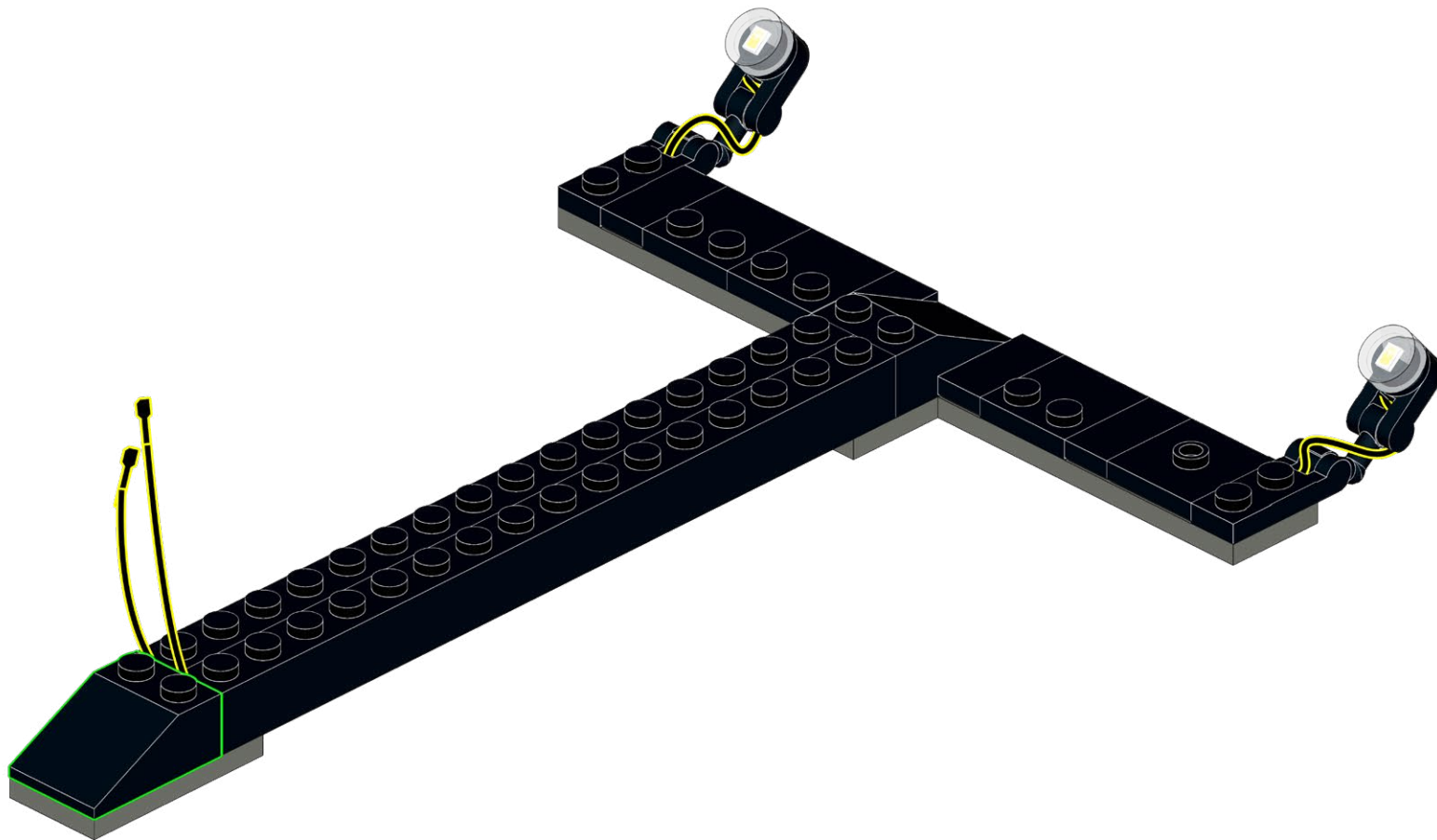
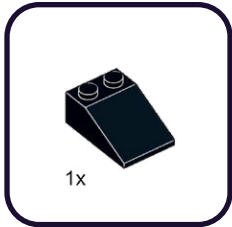

306

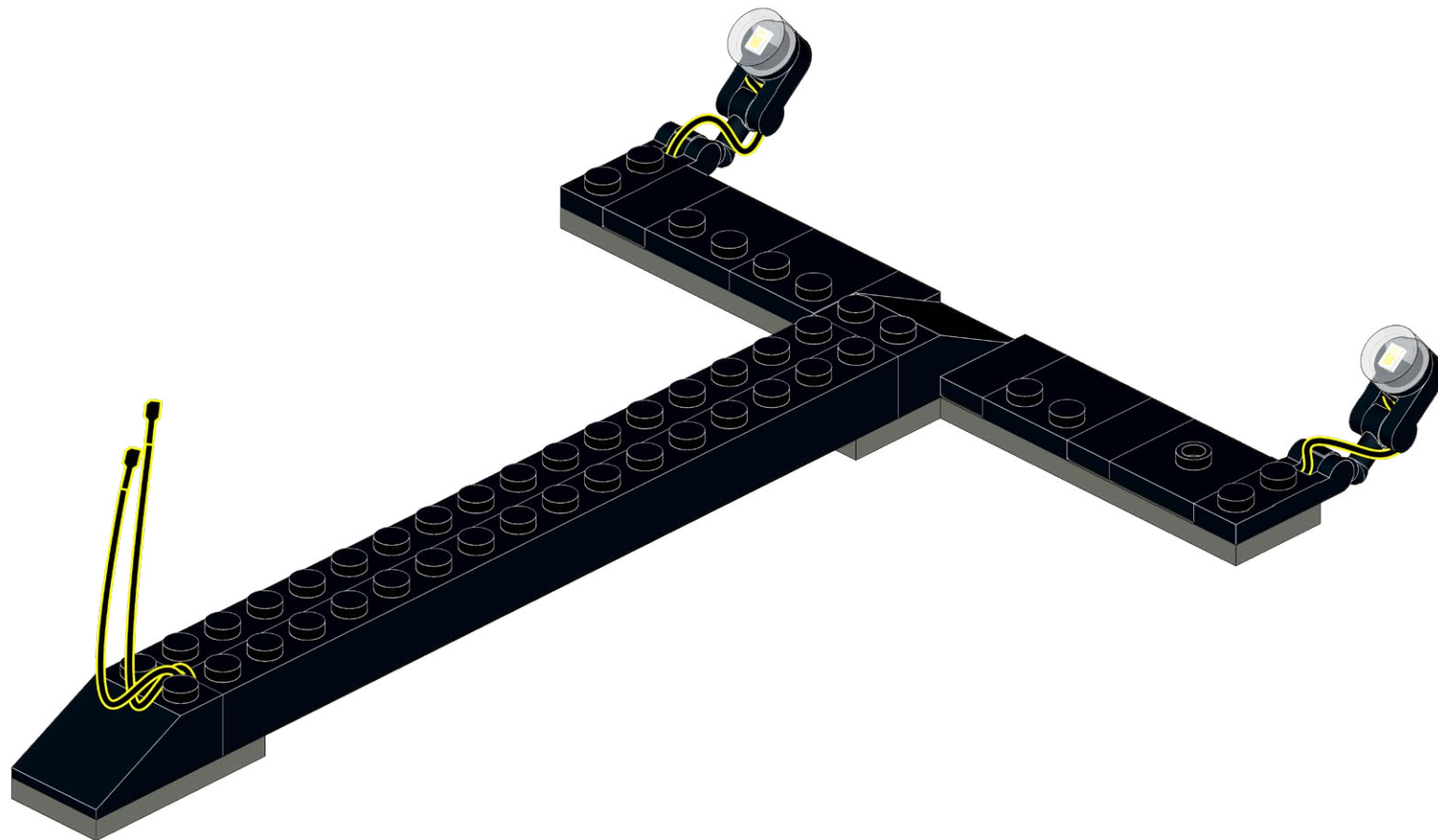

307

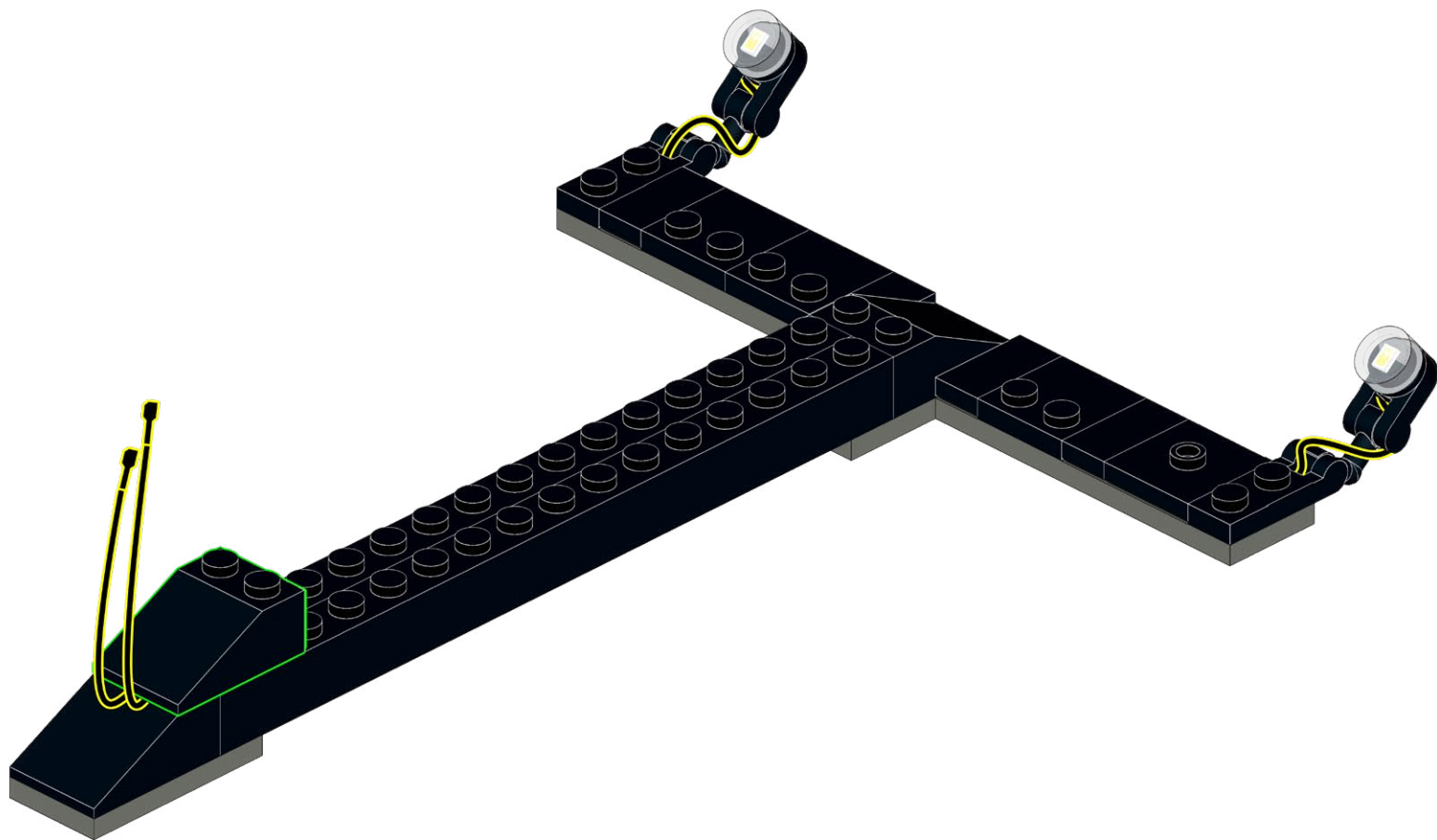
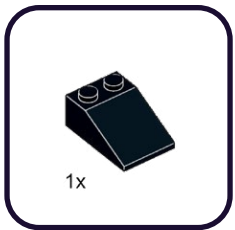

308

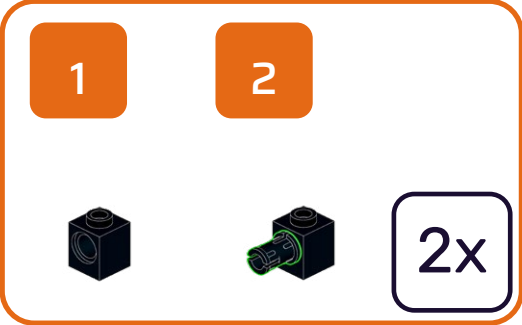
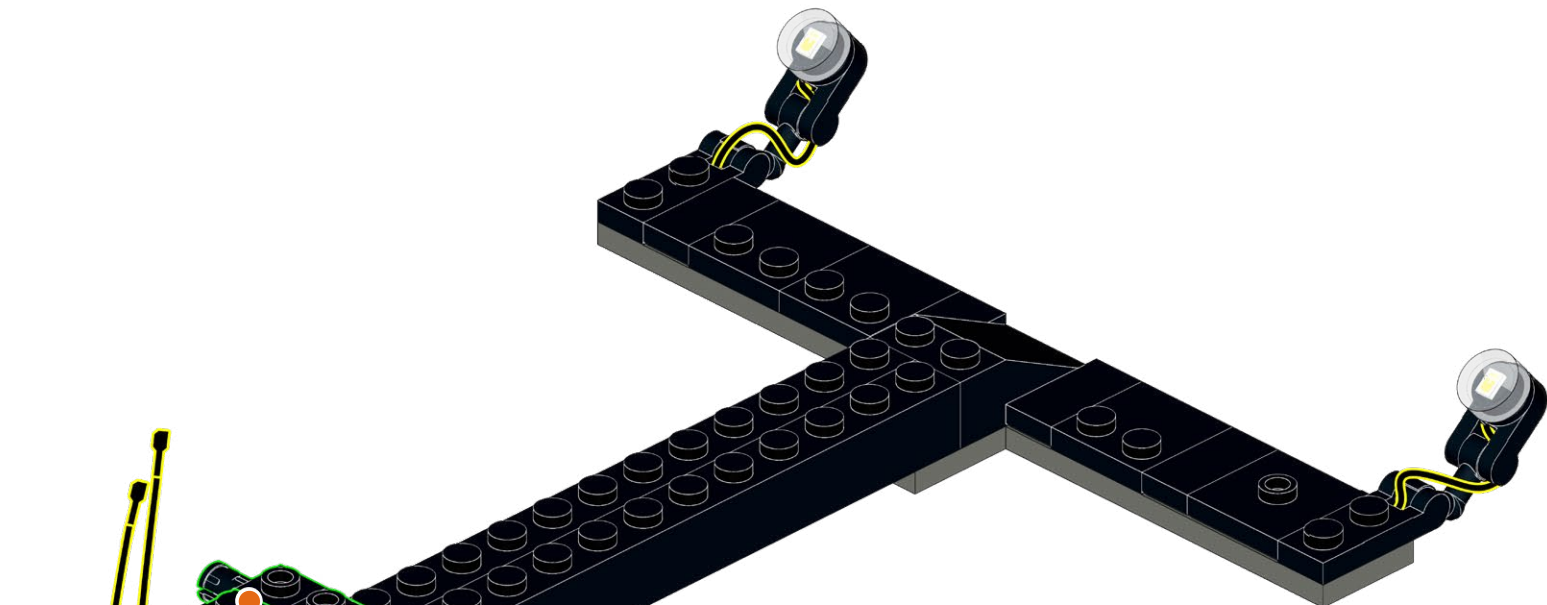
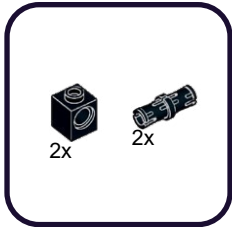

309

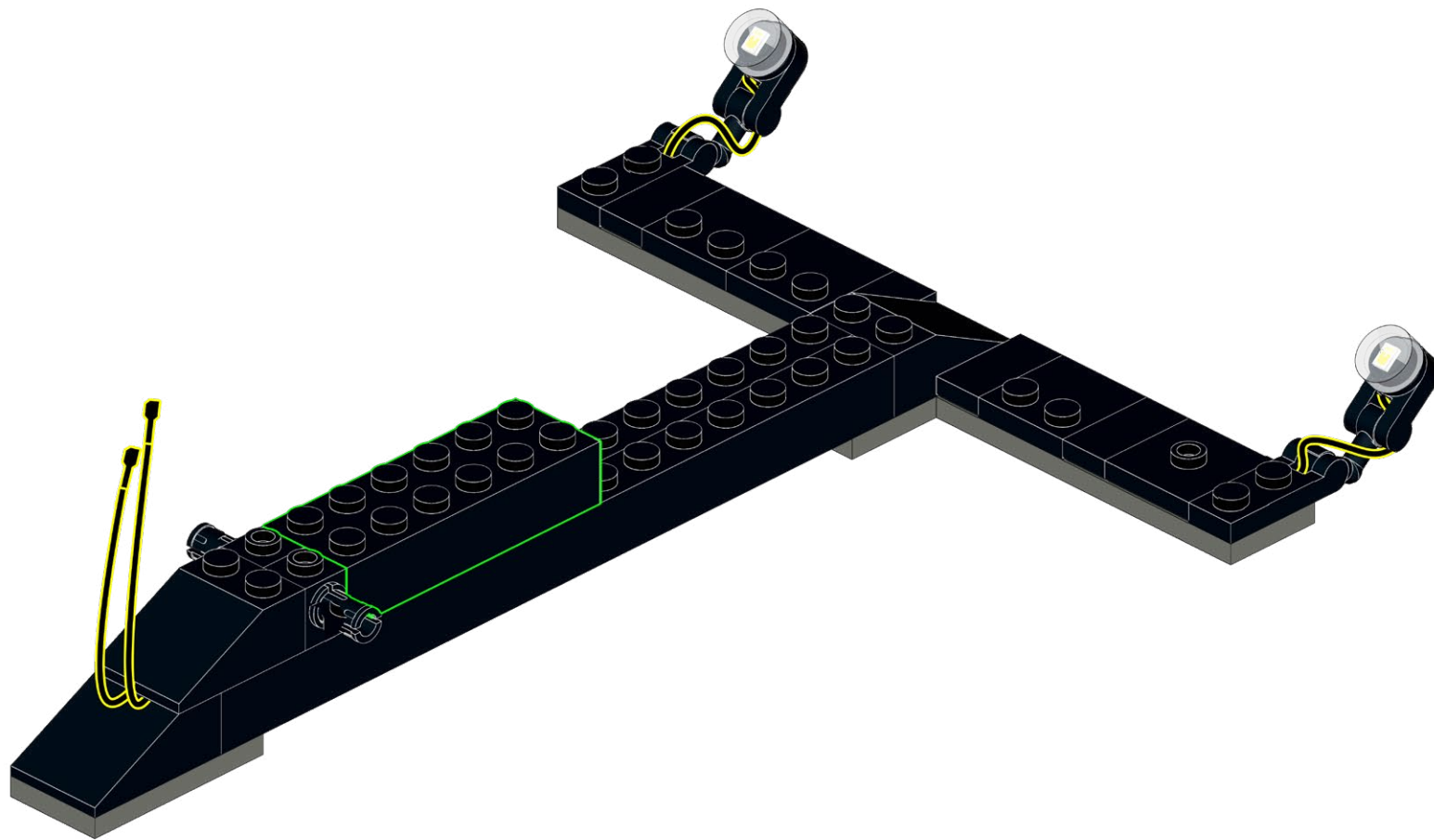
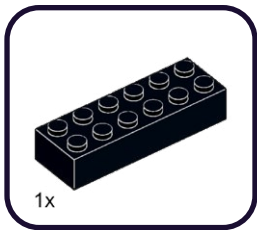

**310**

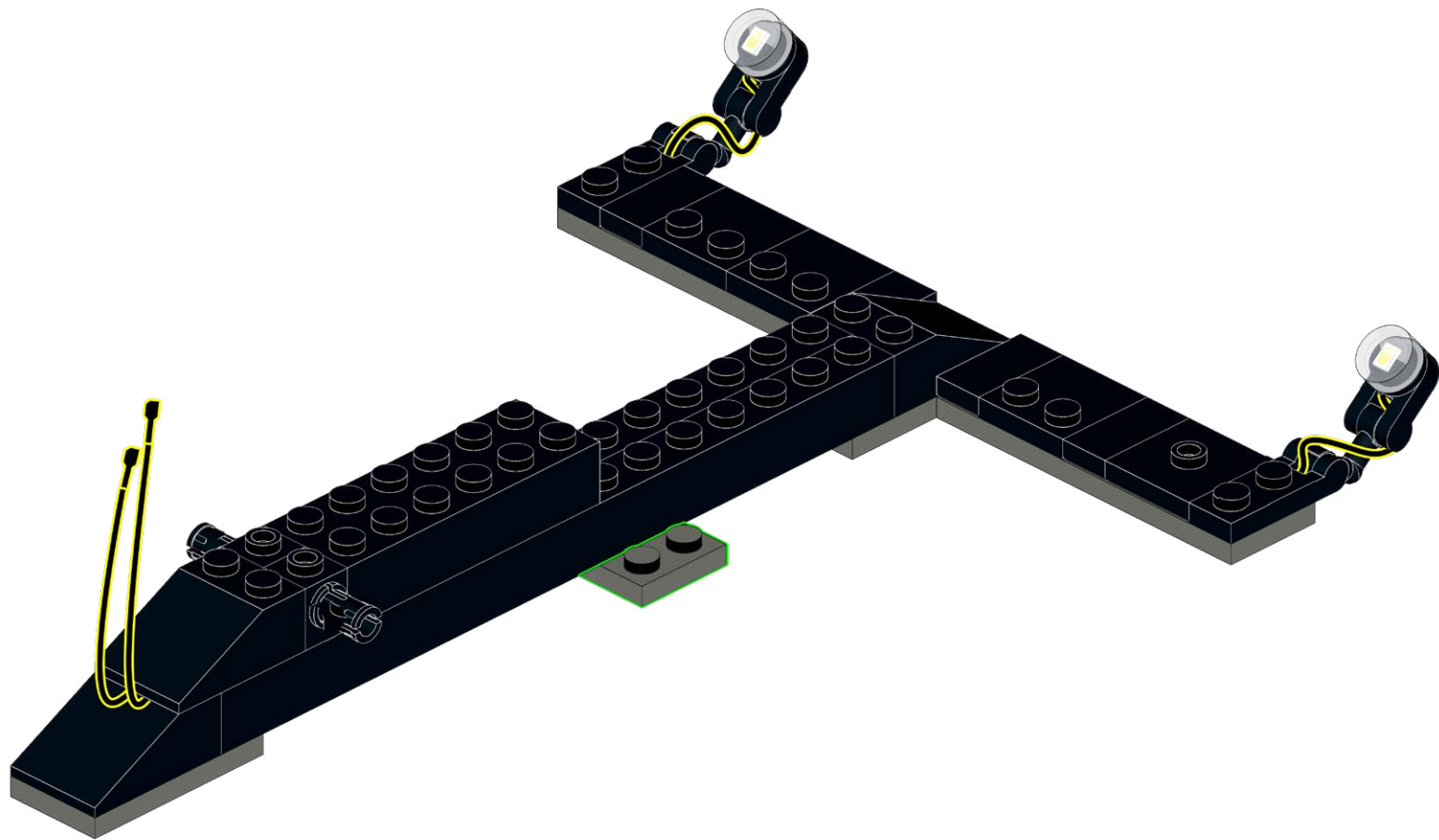
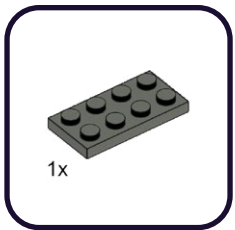

311

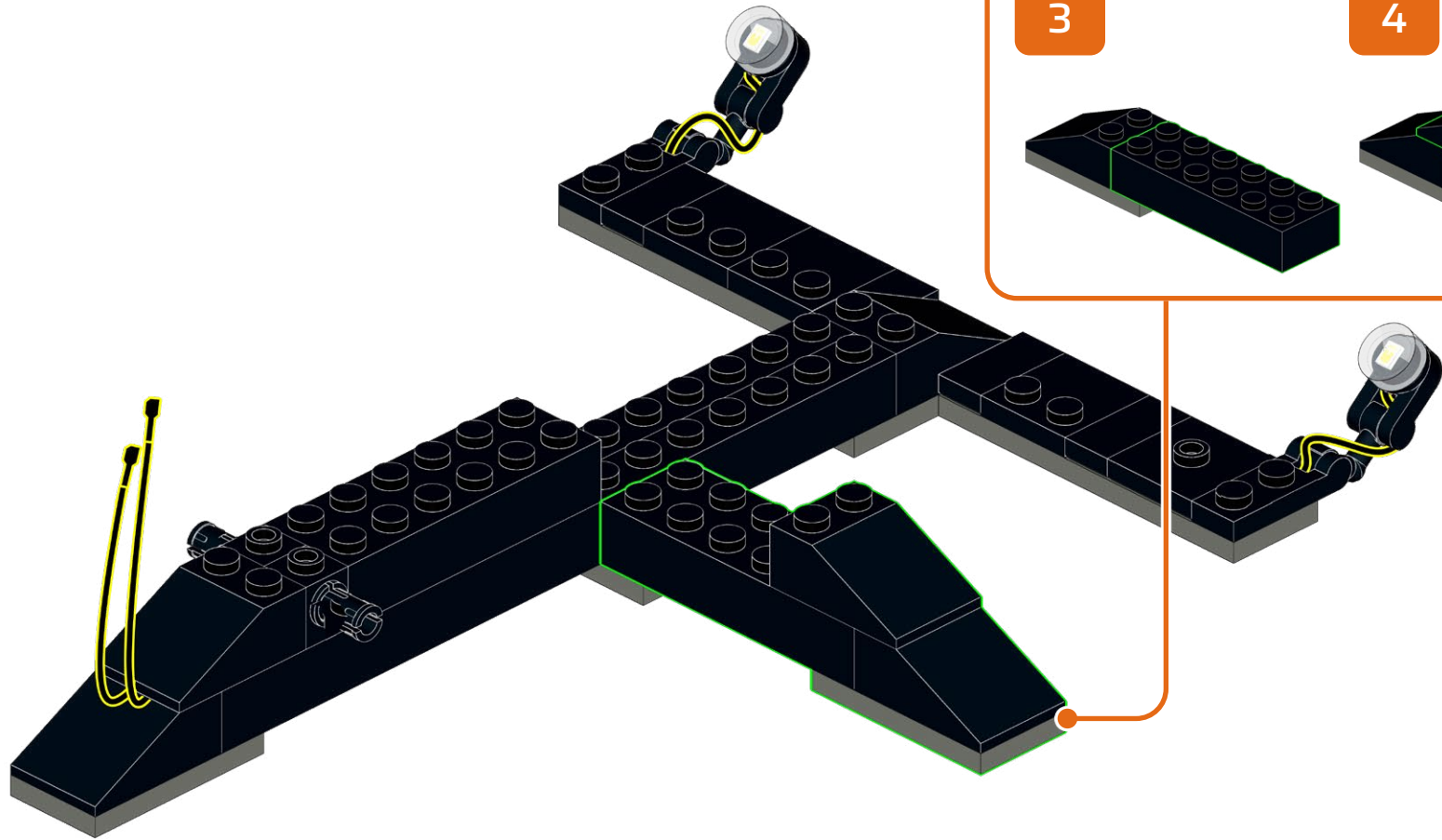
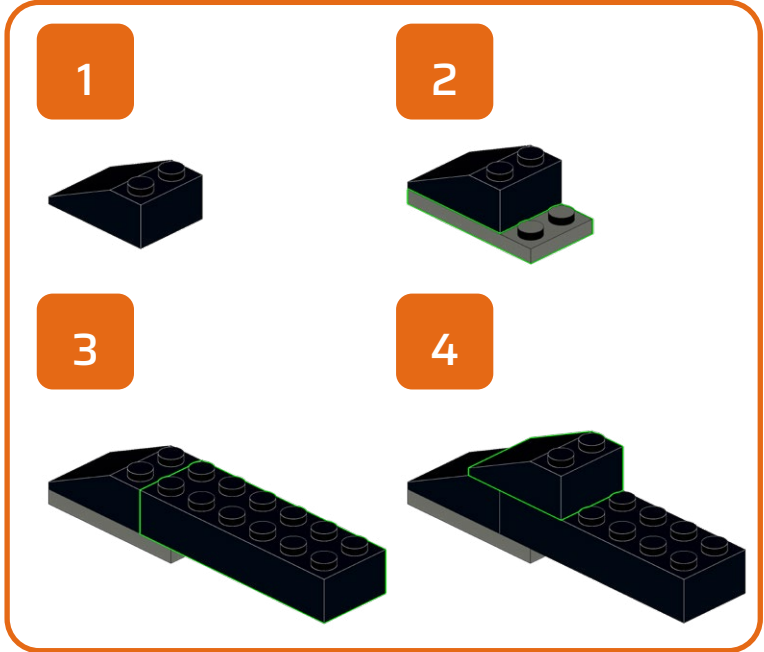
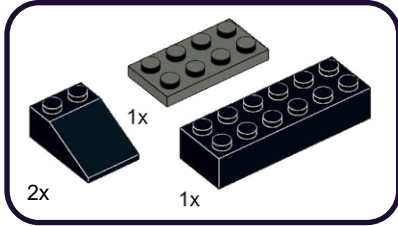



312

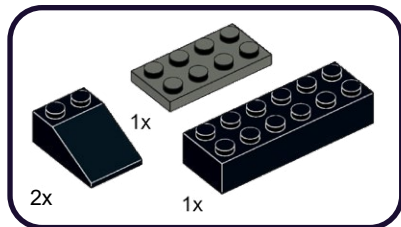

1

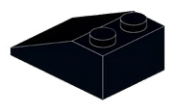

2

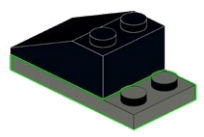

3

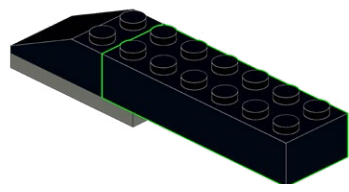

4

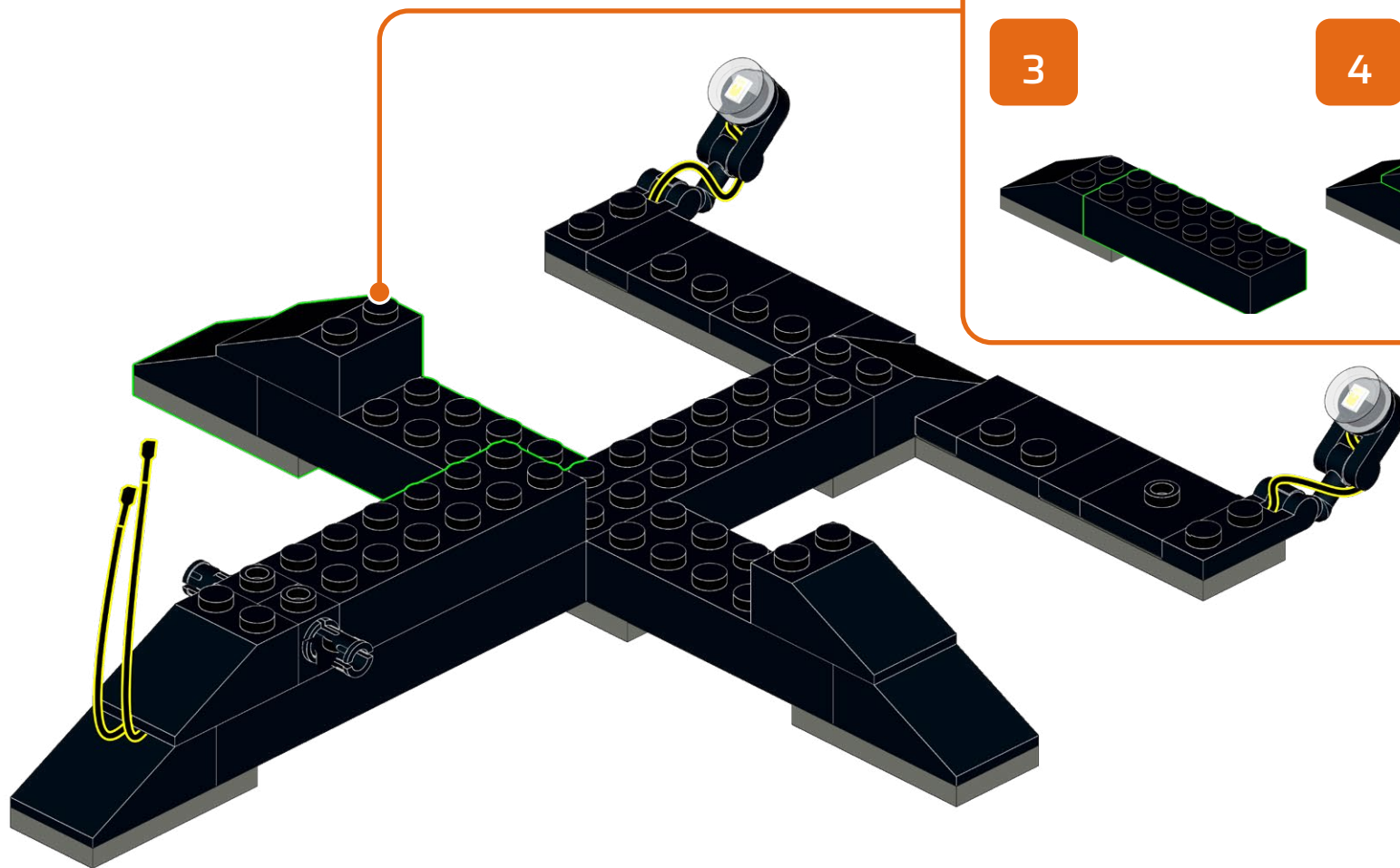
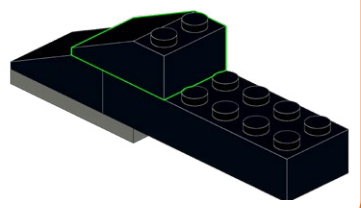

313

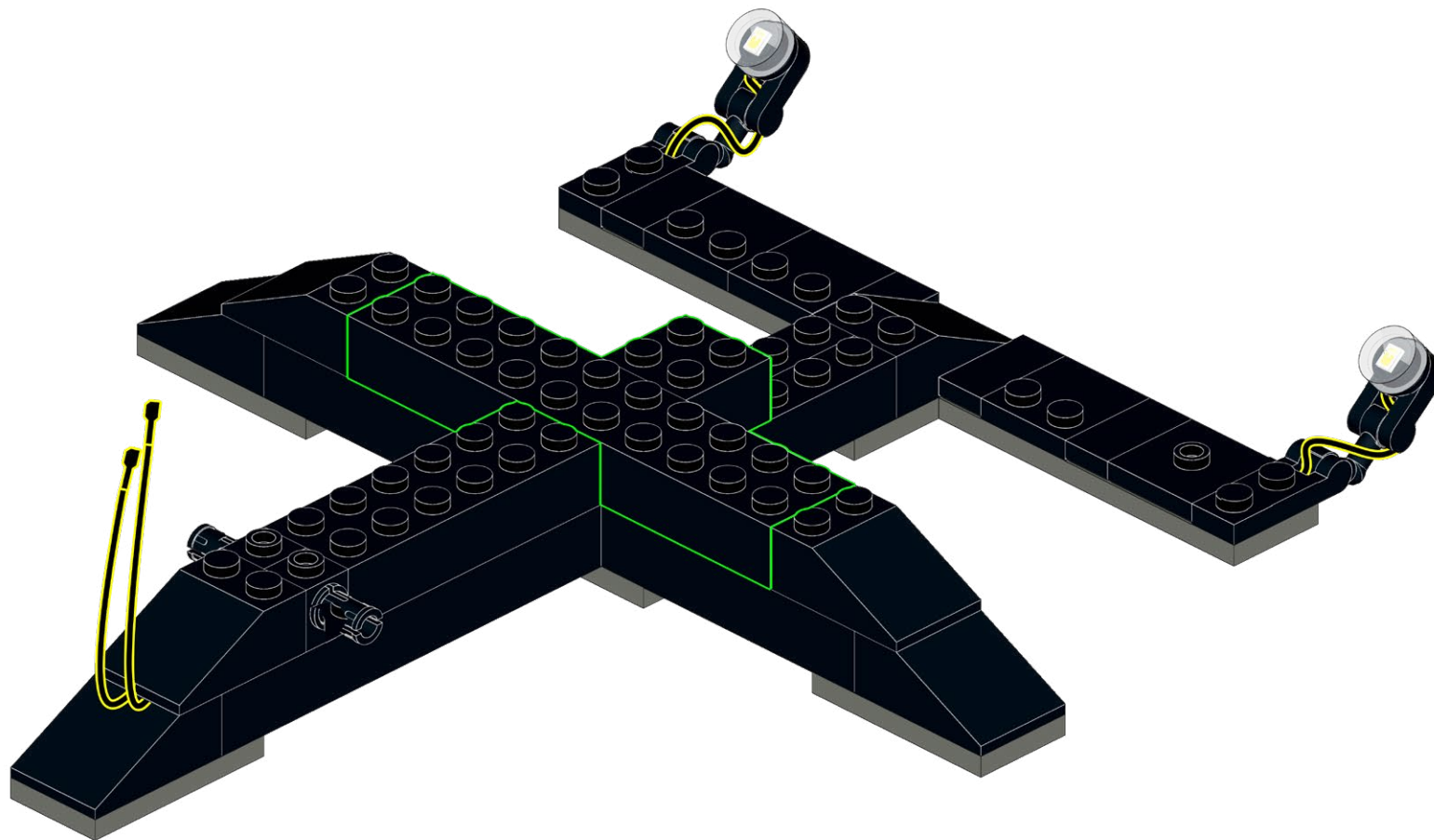
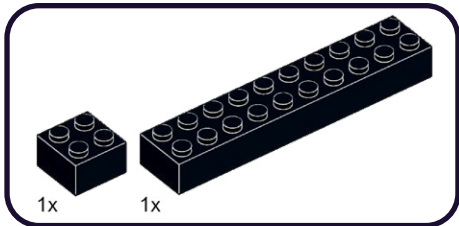

314

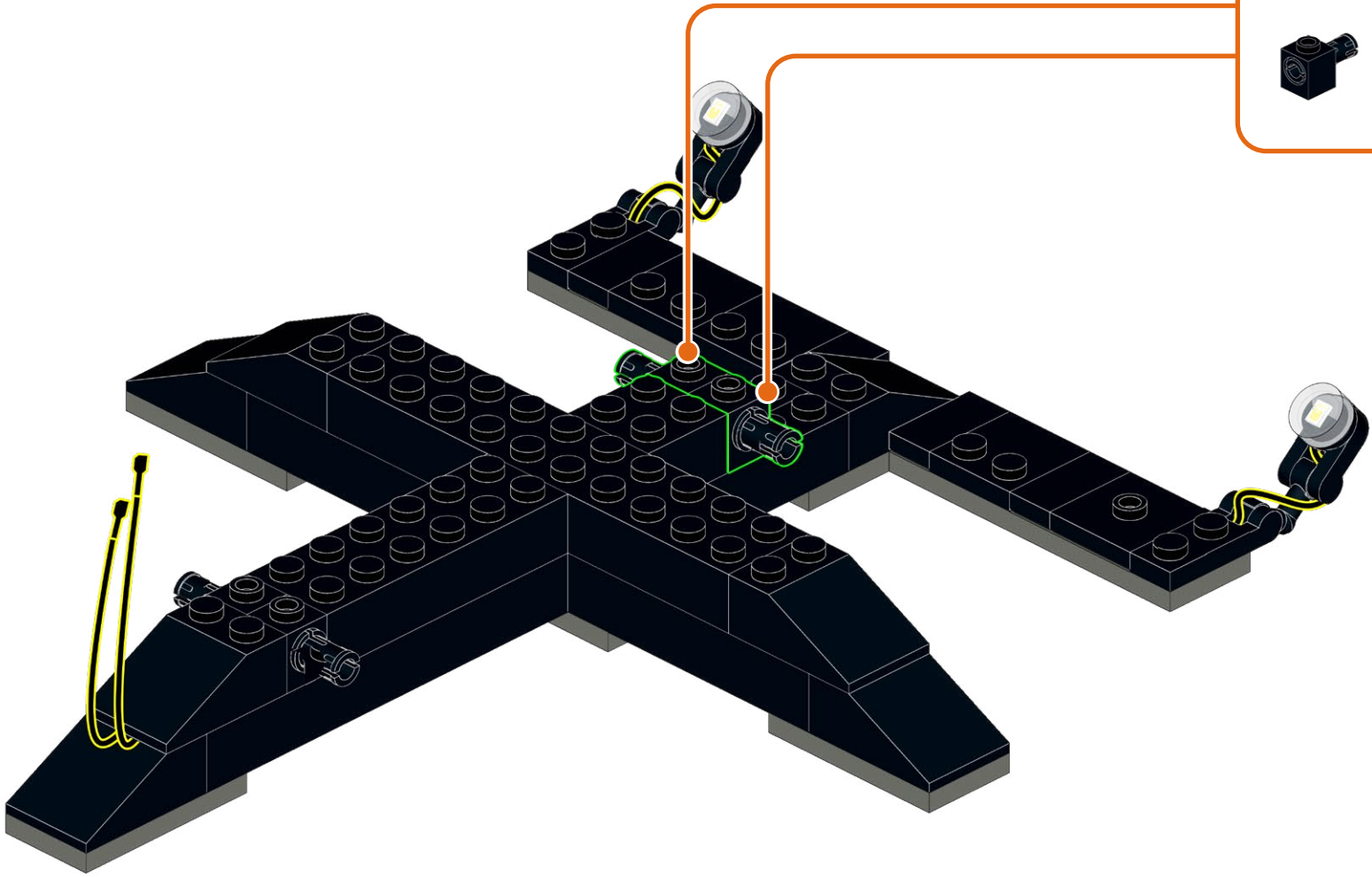

315

1x

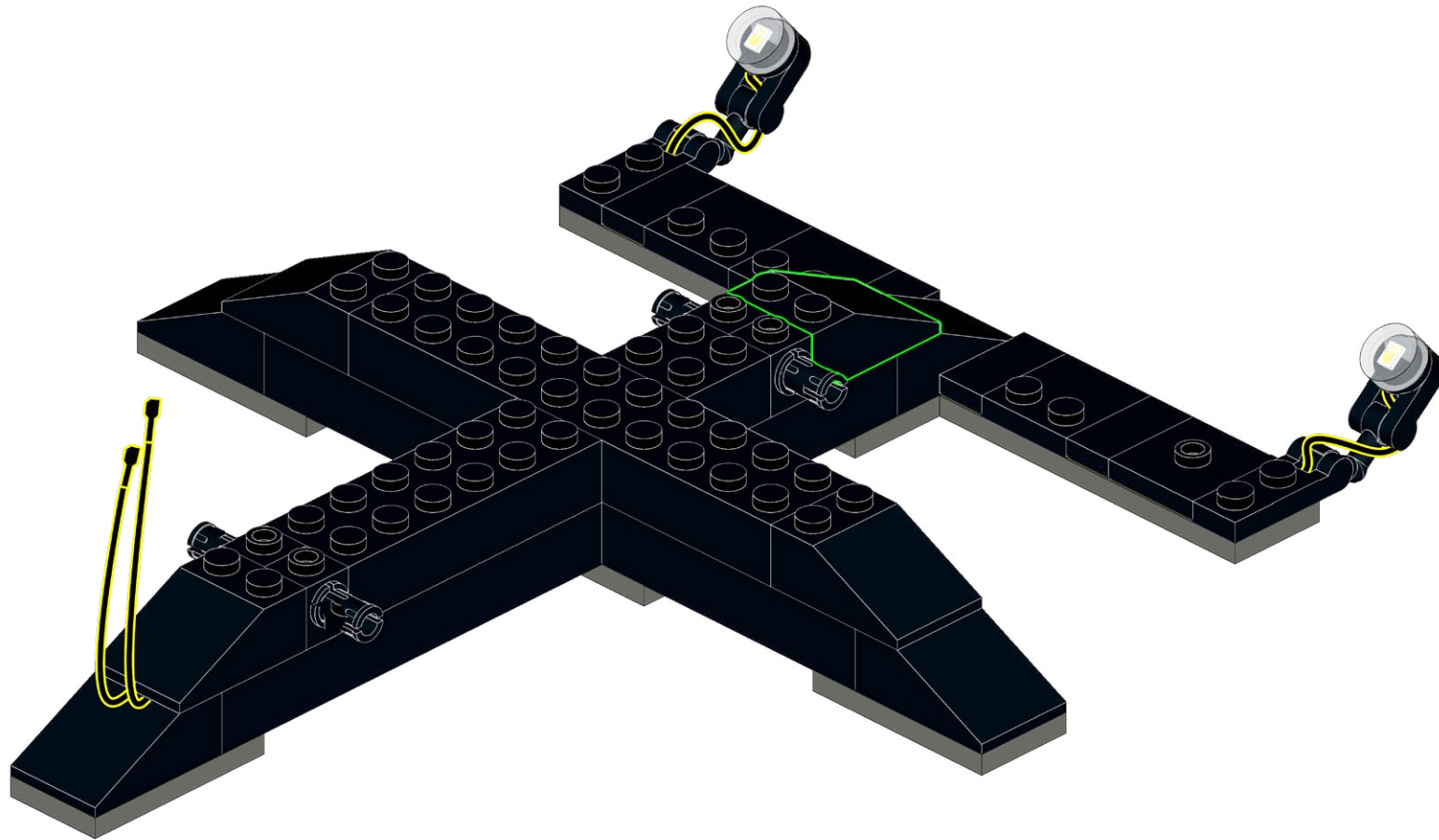

316

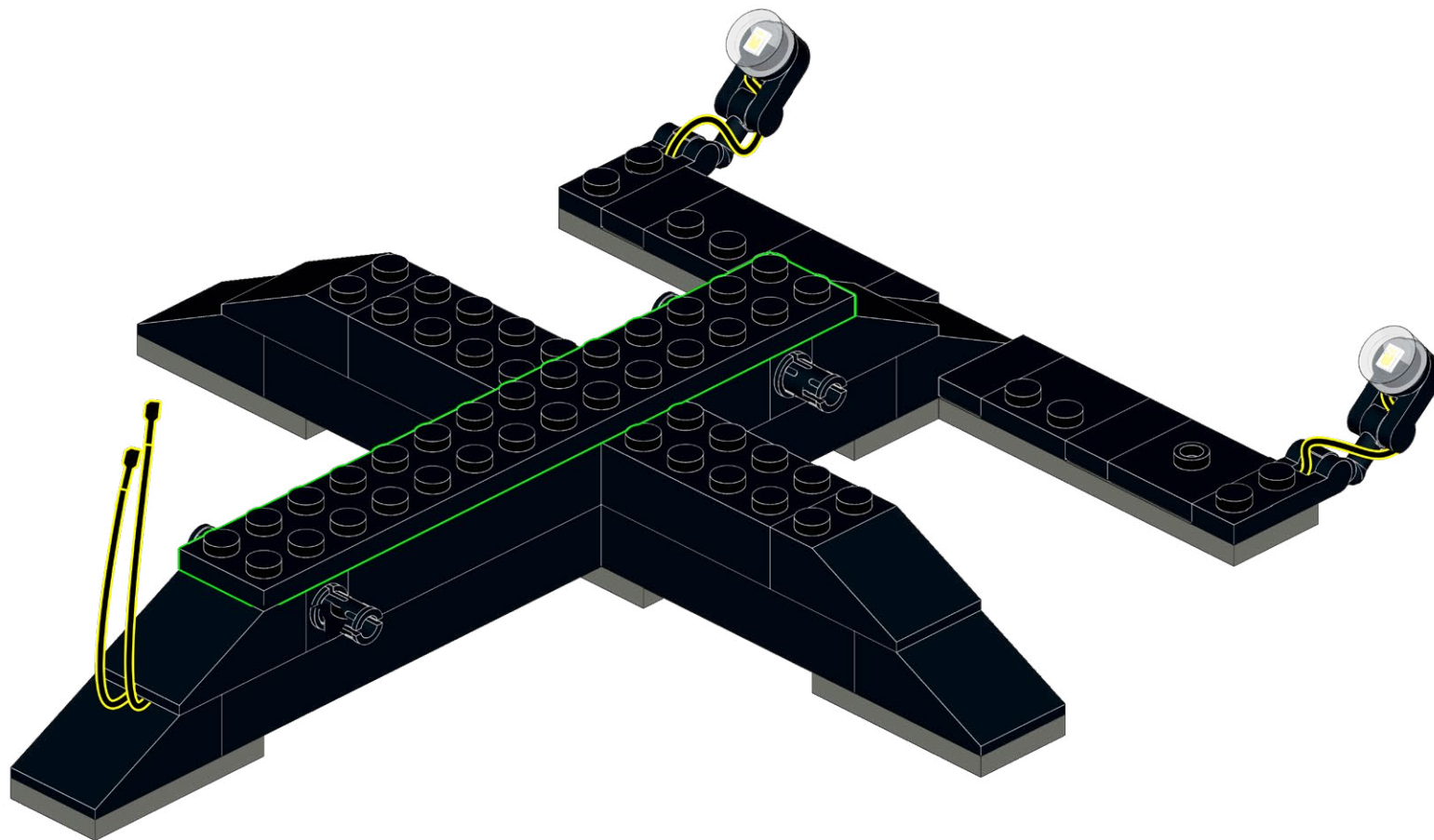
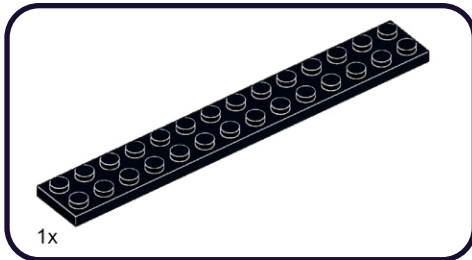



317

2x

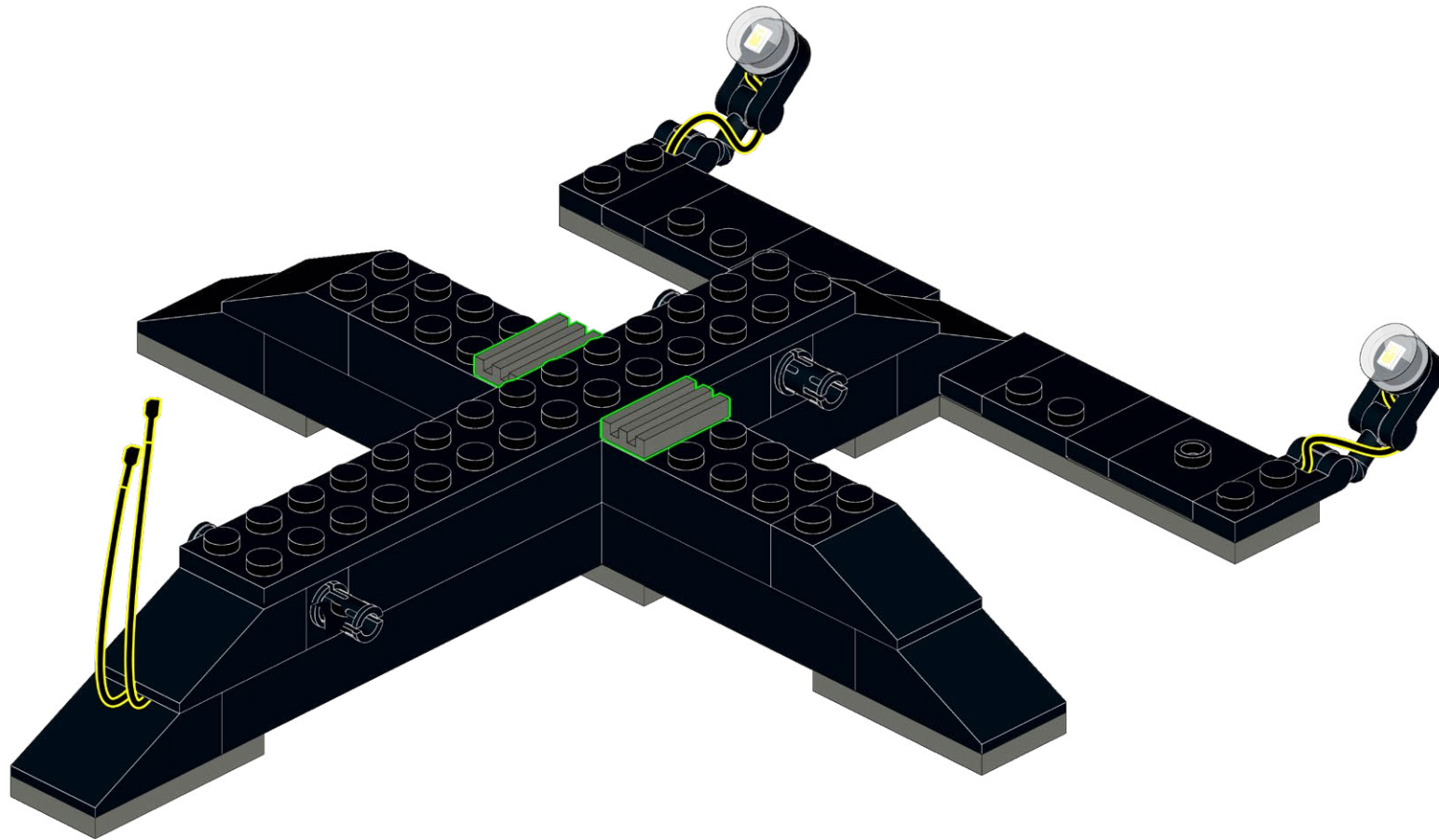

318

2x

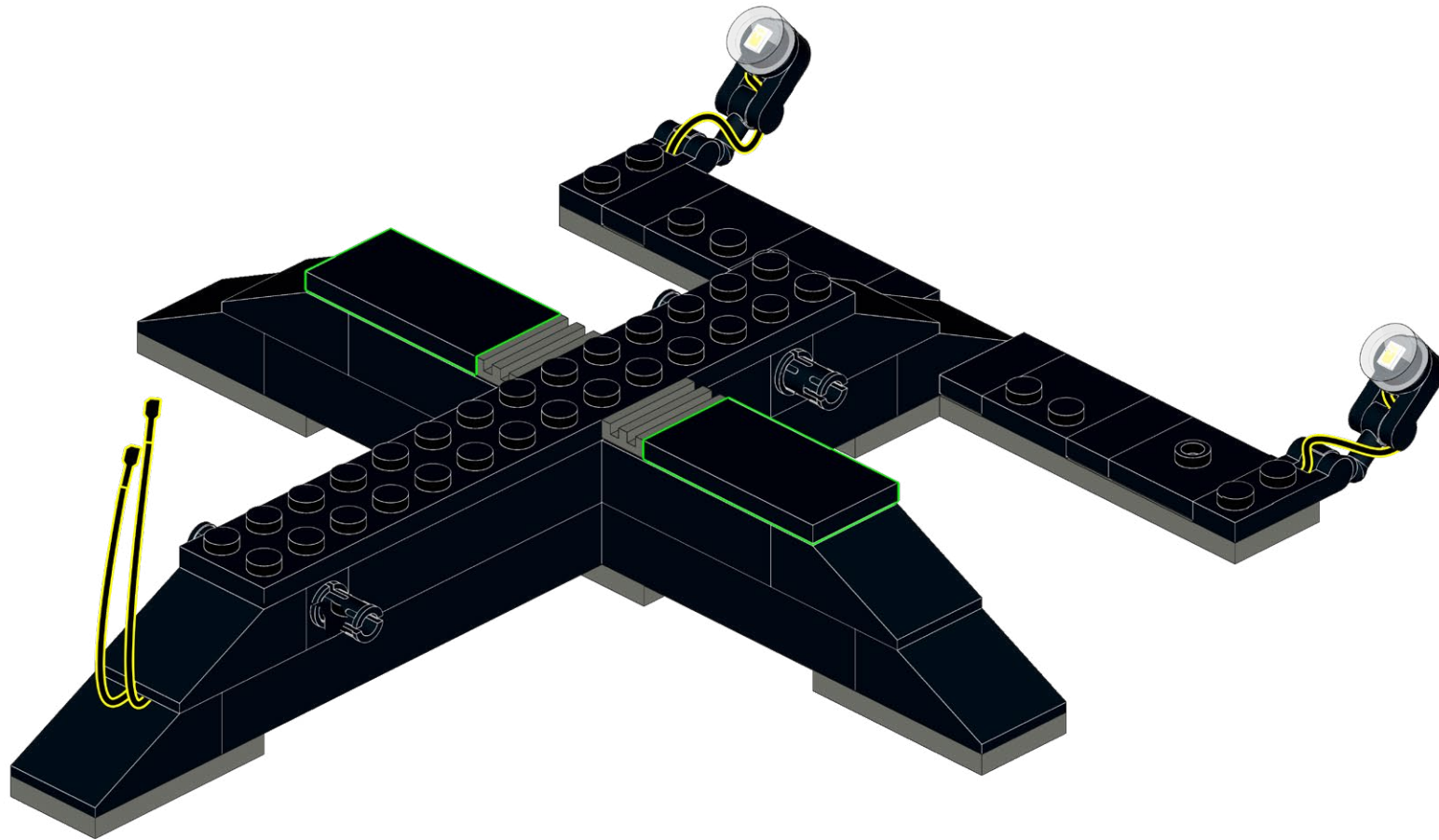



319

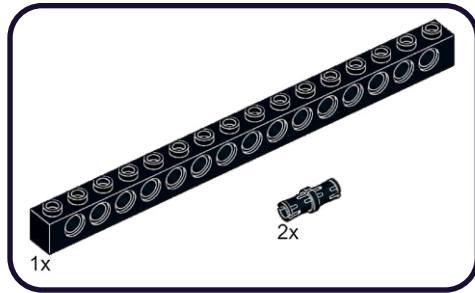

1

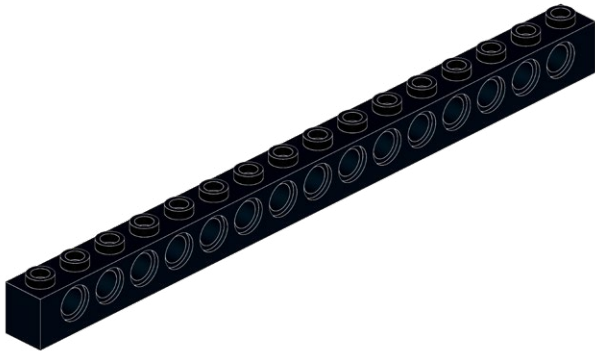

2

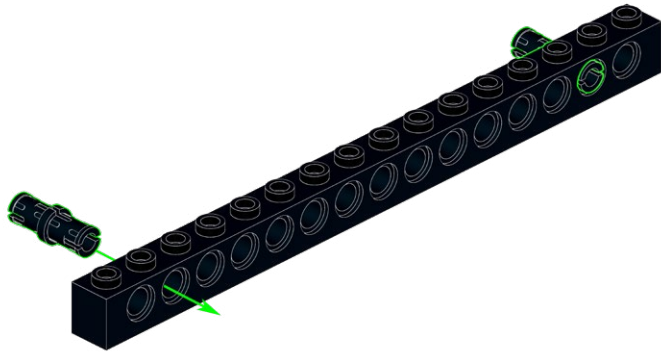

320

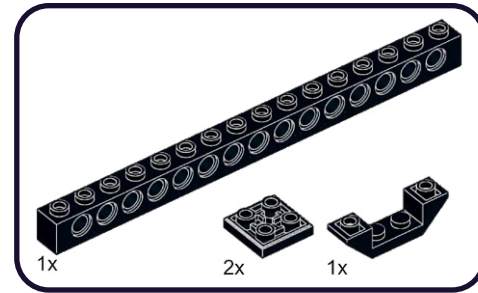

1

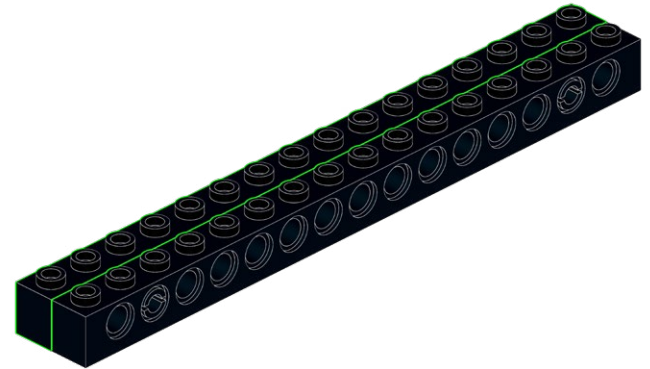

2

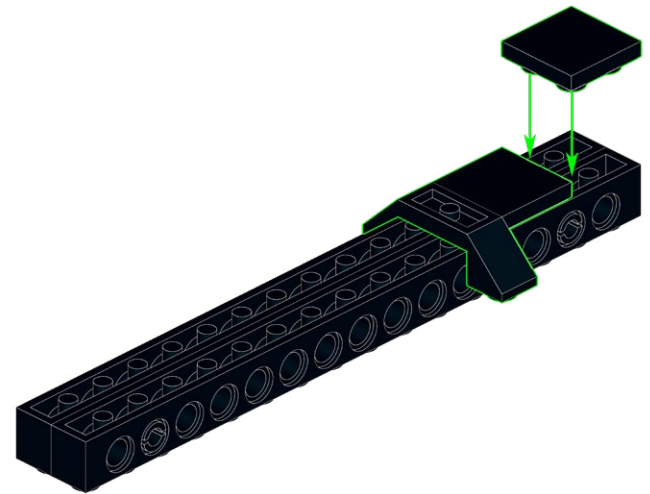
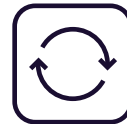

321

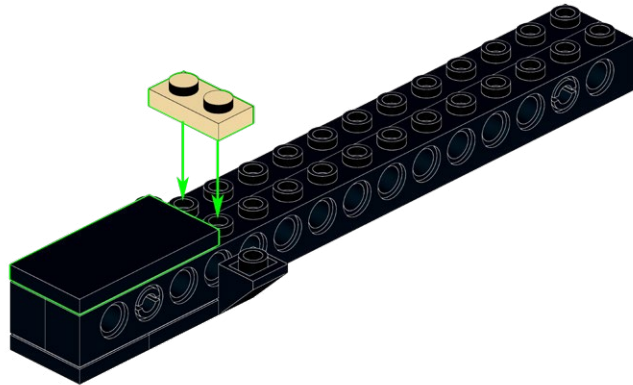
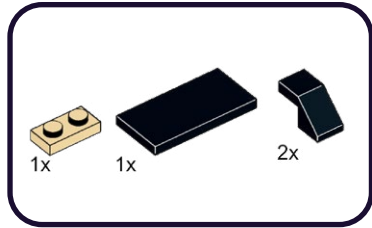

2

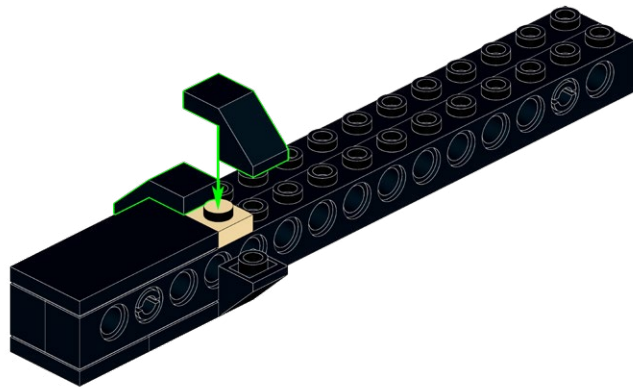

322



1

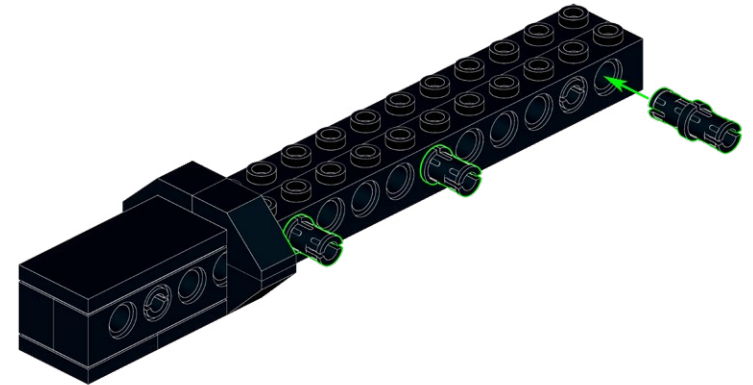

2

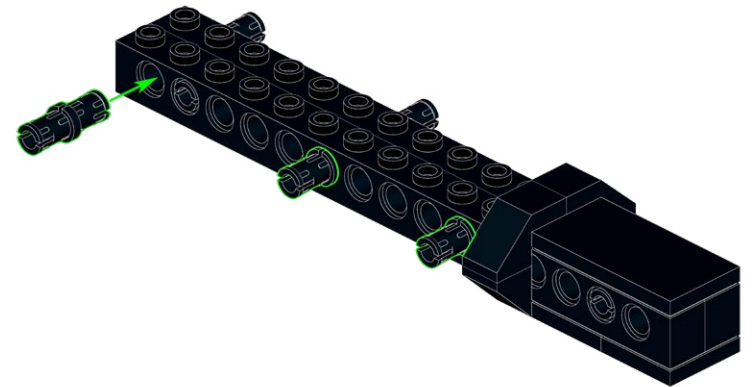

**323**

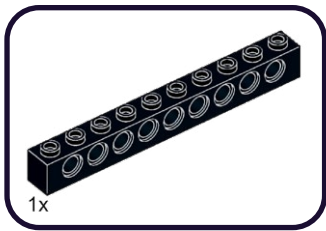

**324**

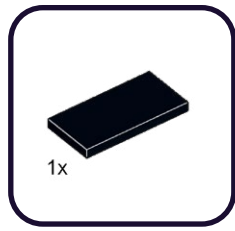

**1**

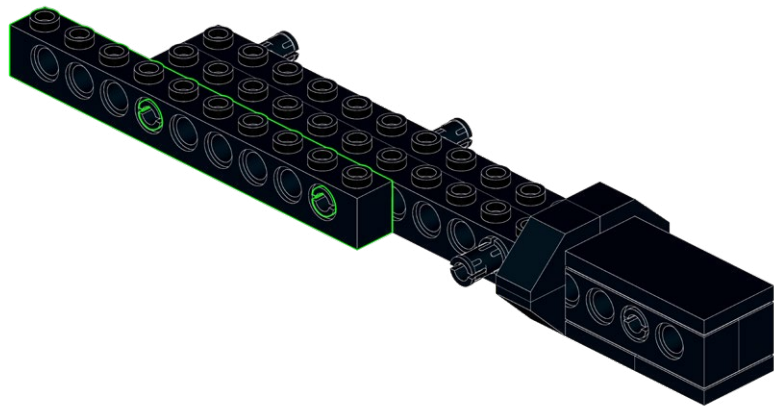

**1**

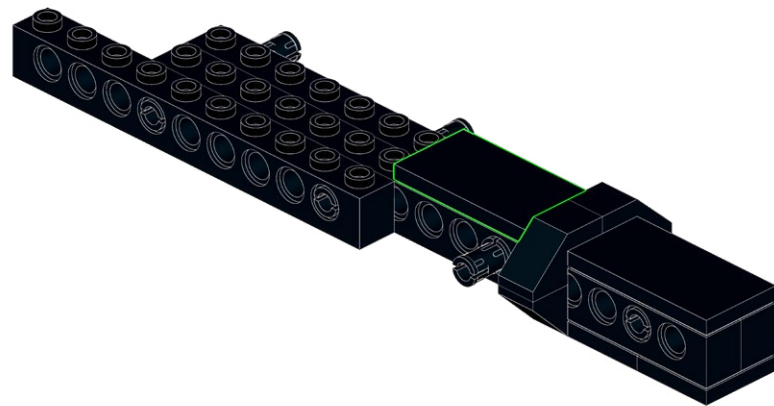

325

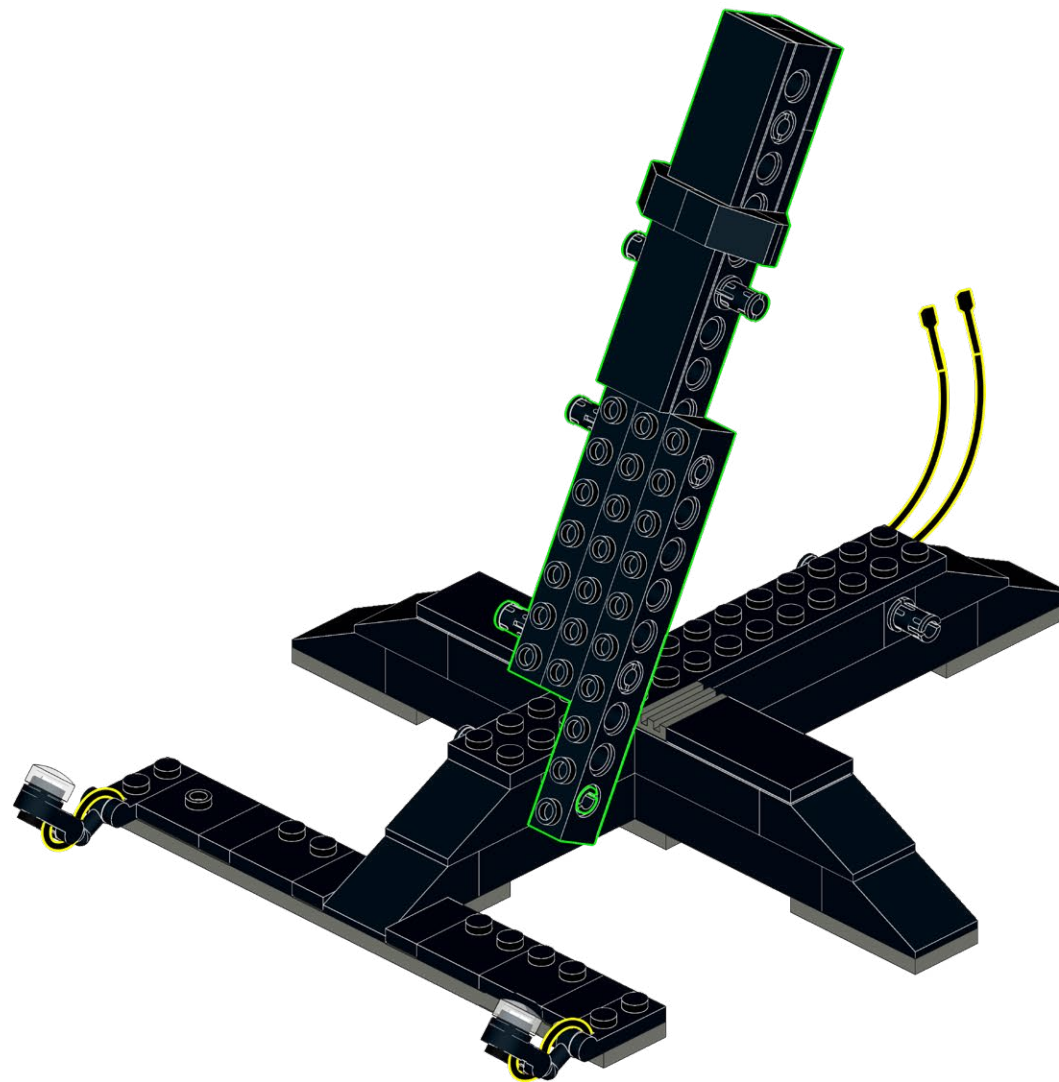

326

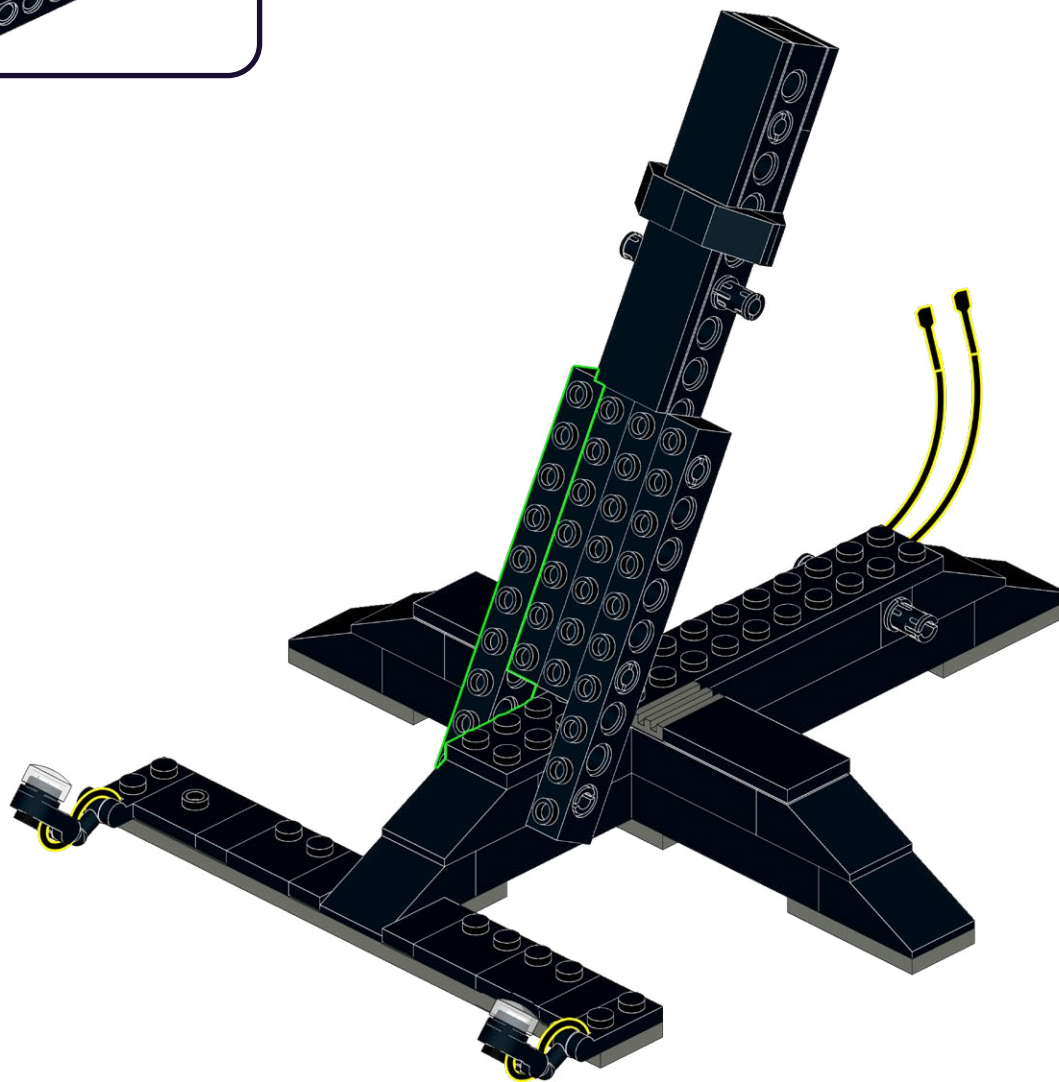
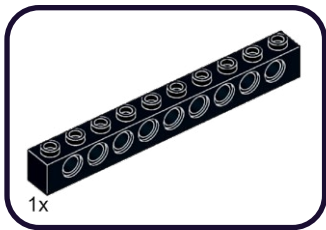

327

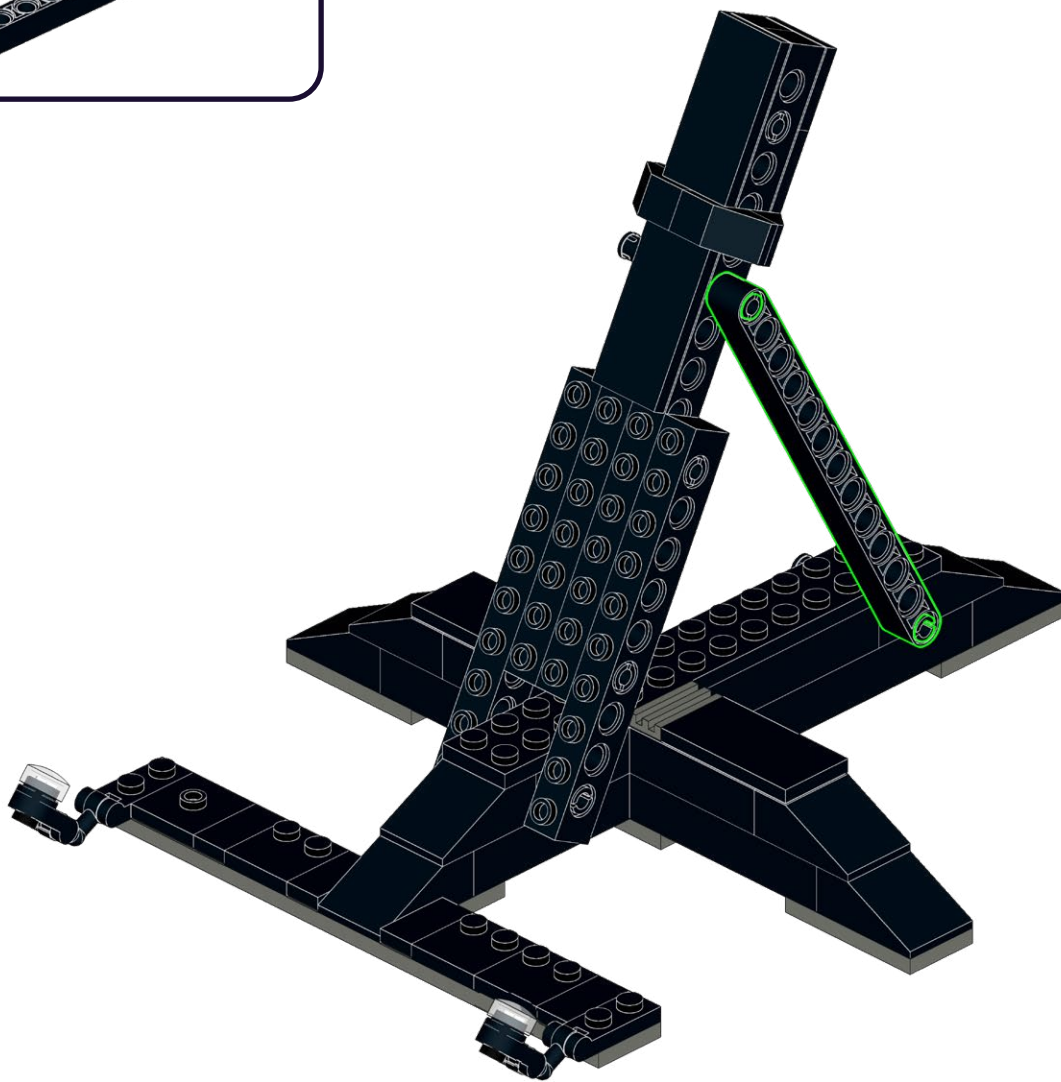



328

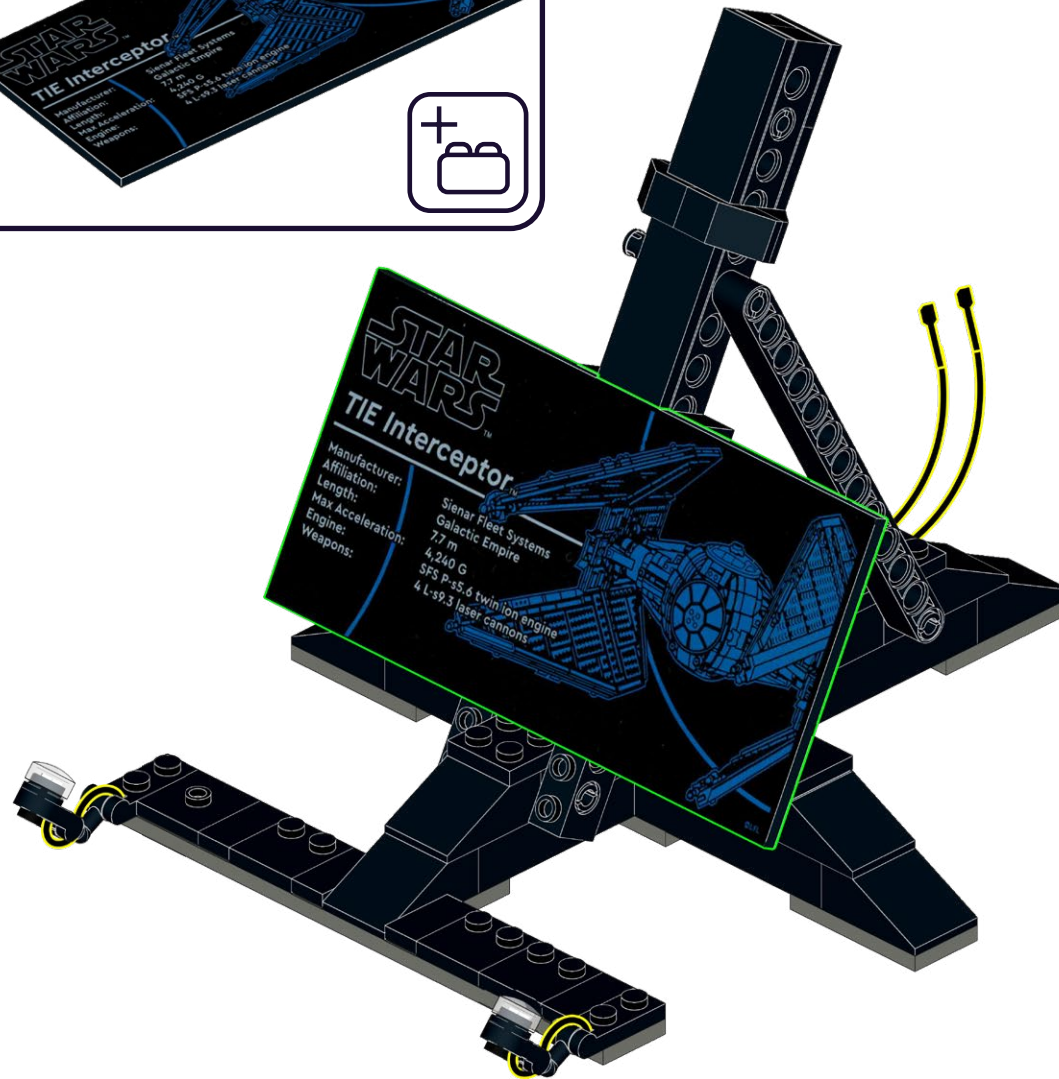



329

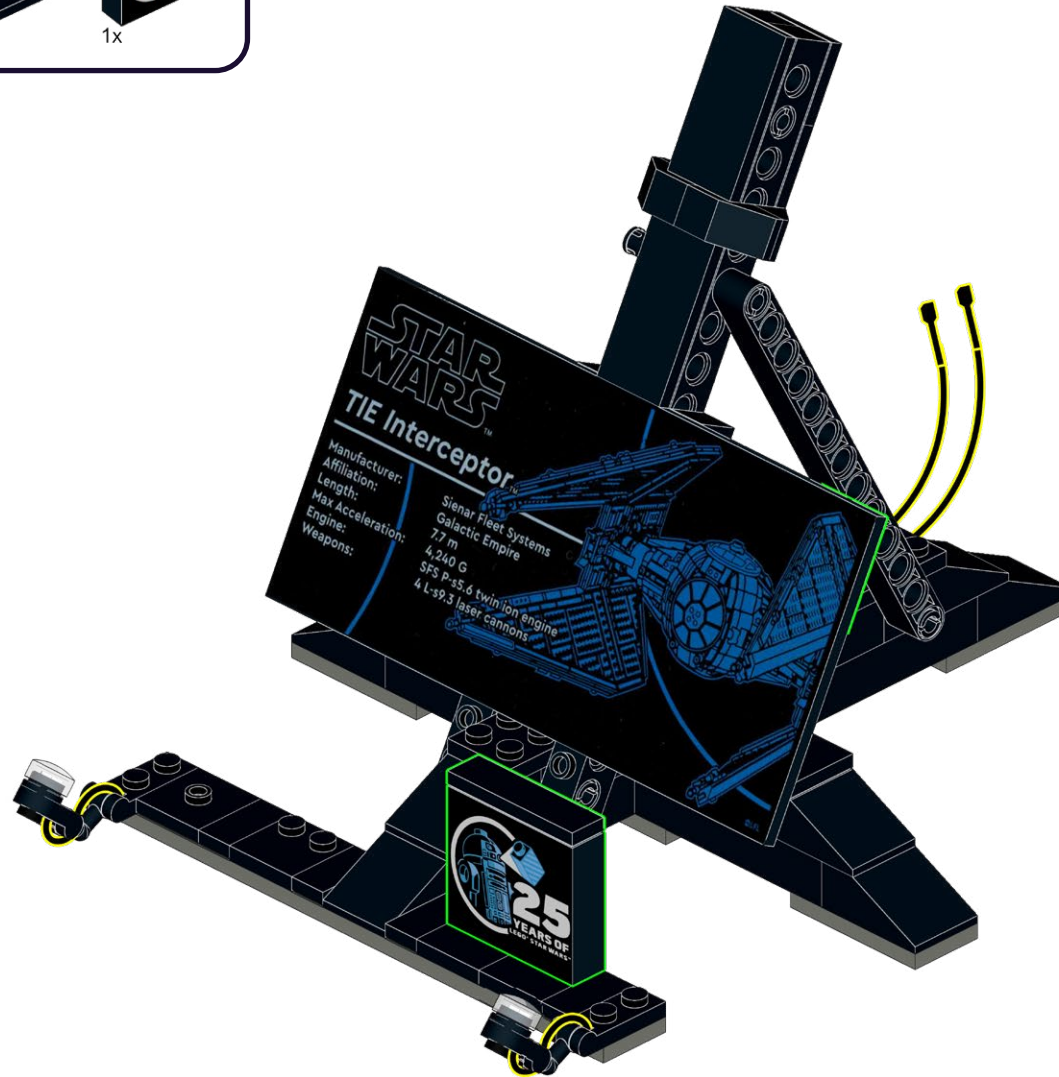
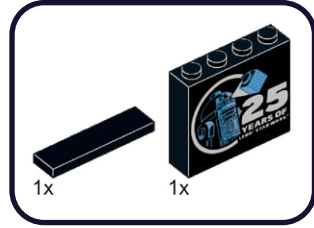

**330**

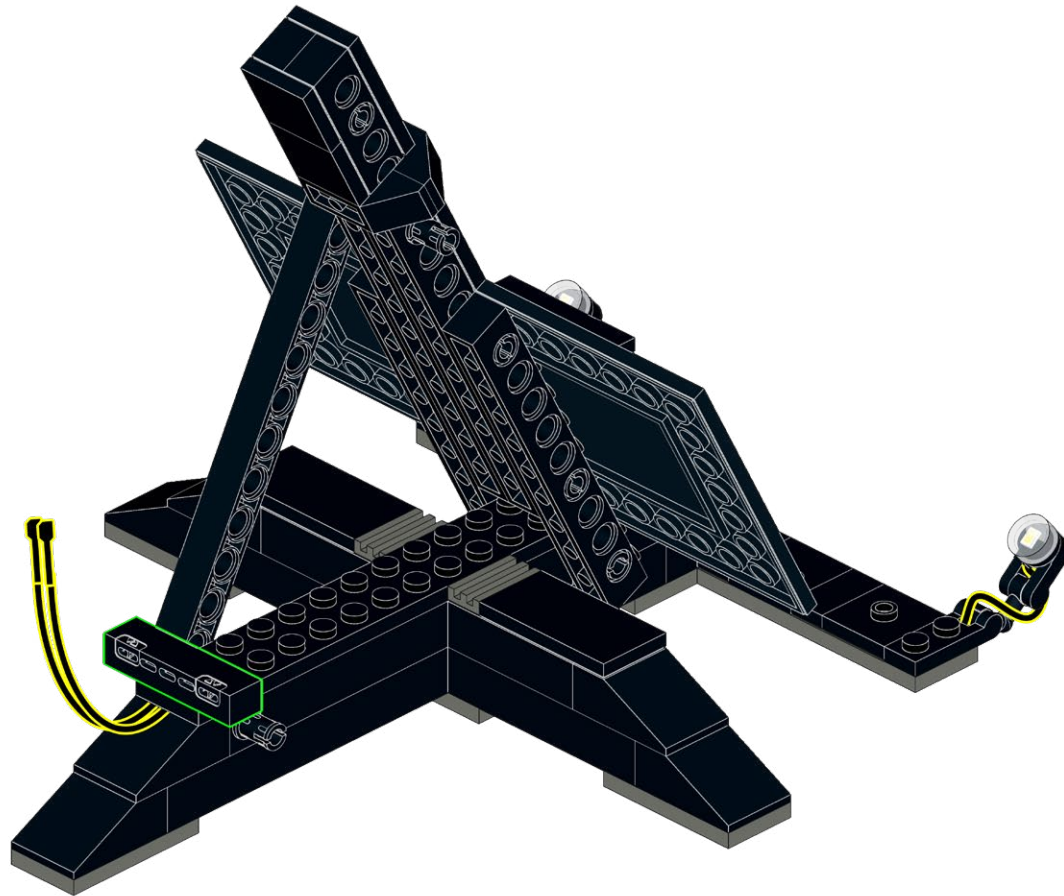
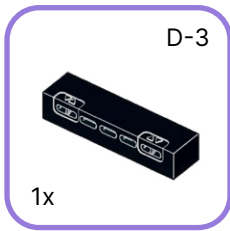

331

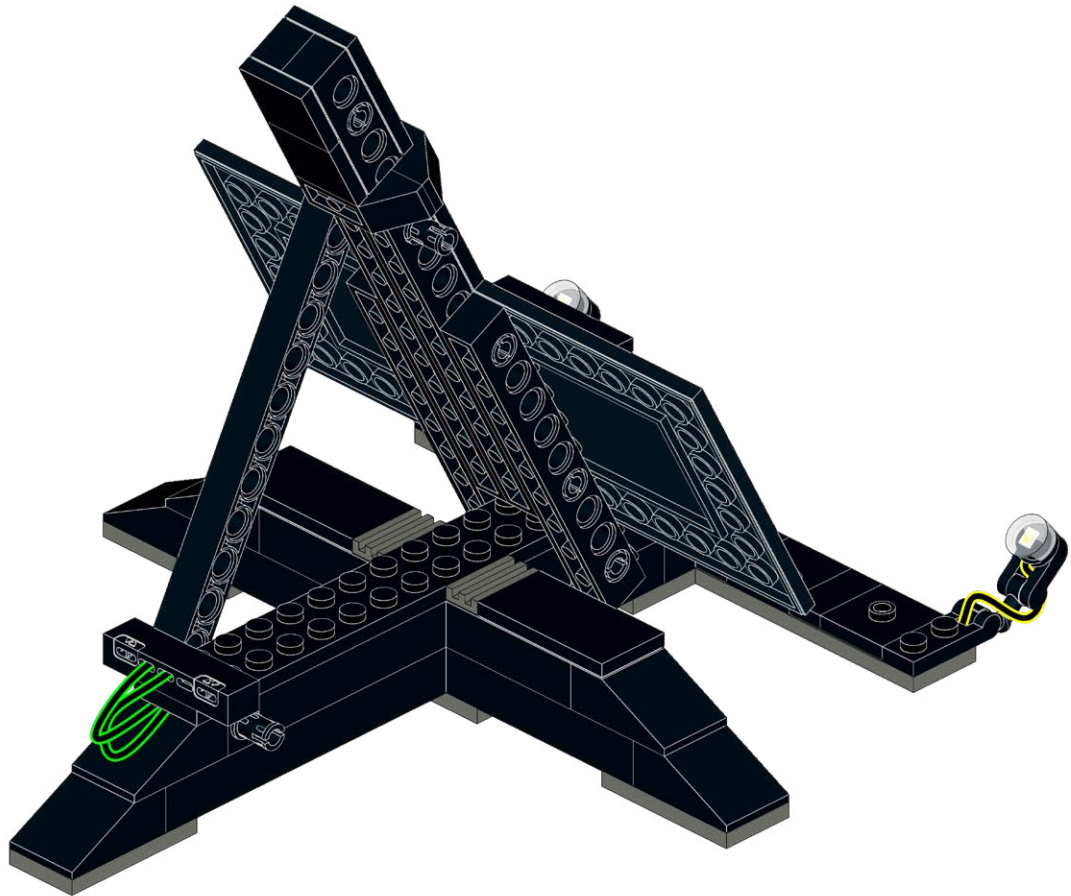
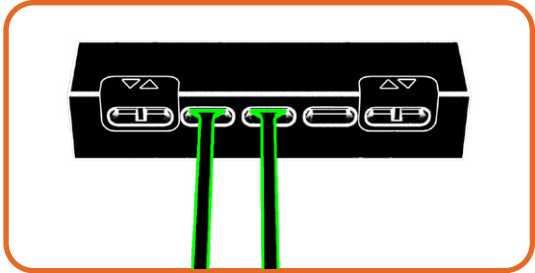

# 332

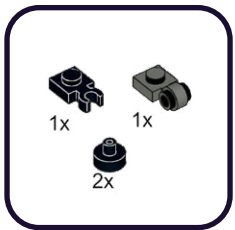

1



2

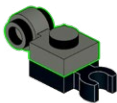

3

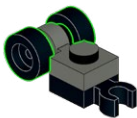

# 333

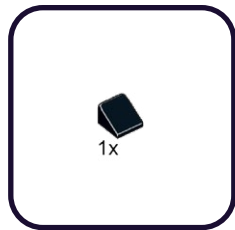

1

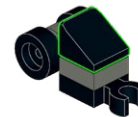

2



# 334

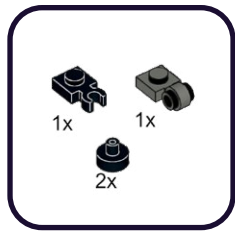

1



2

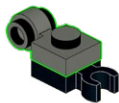

3

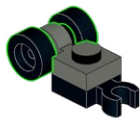

# 335

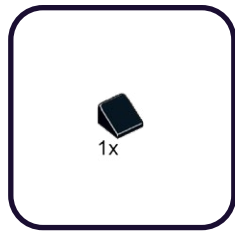

1

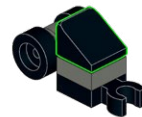

2

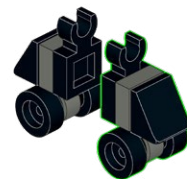

# 336

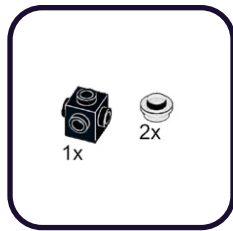

1



2



# 337

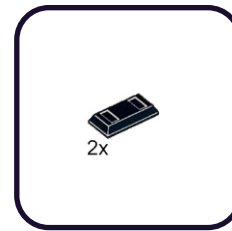

1

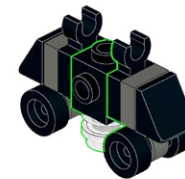

2

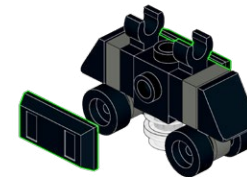

338

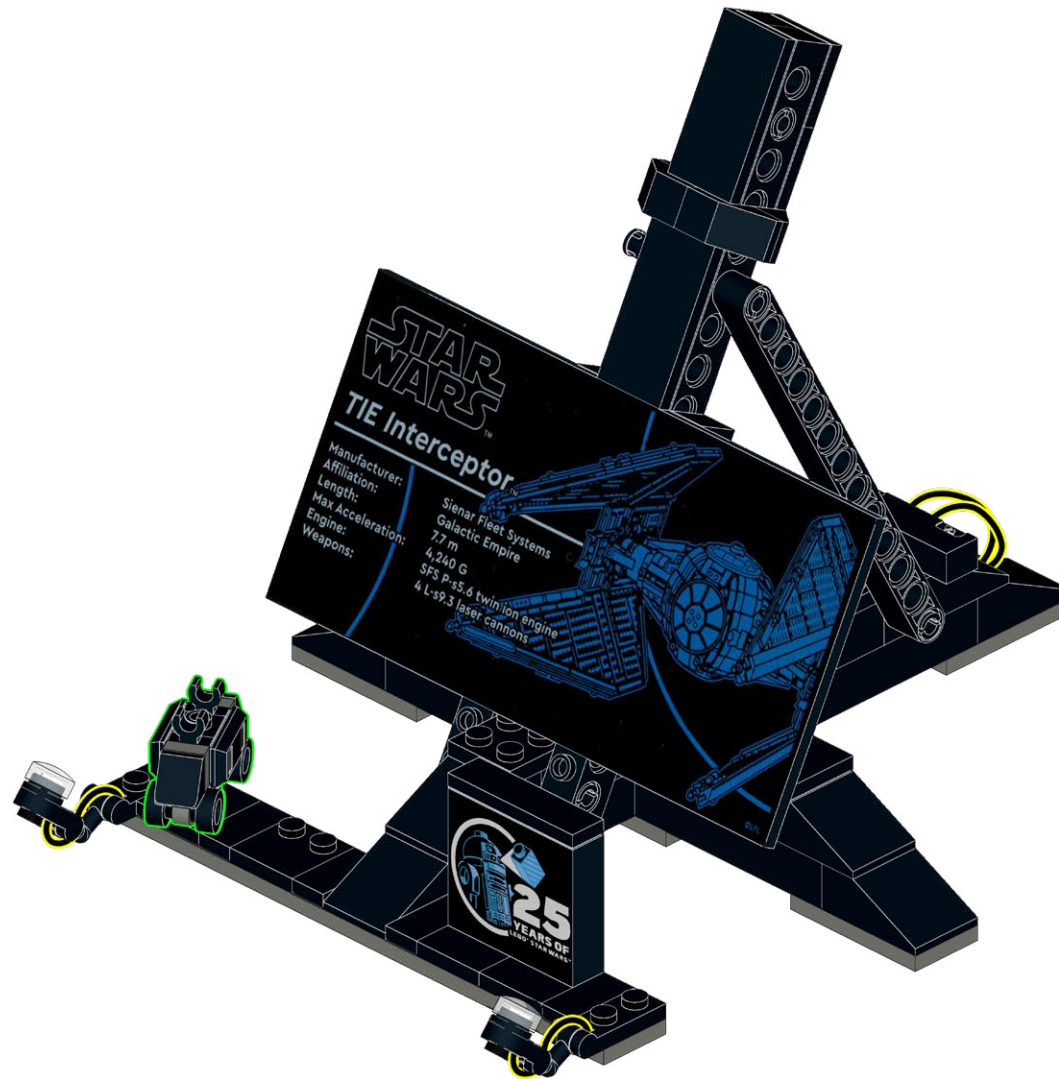



339

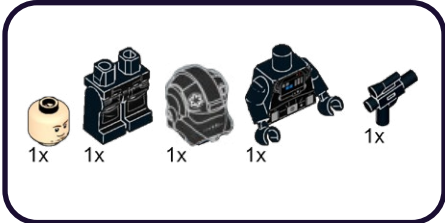

1

2

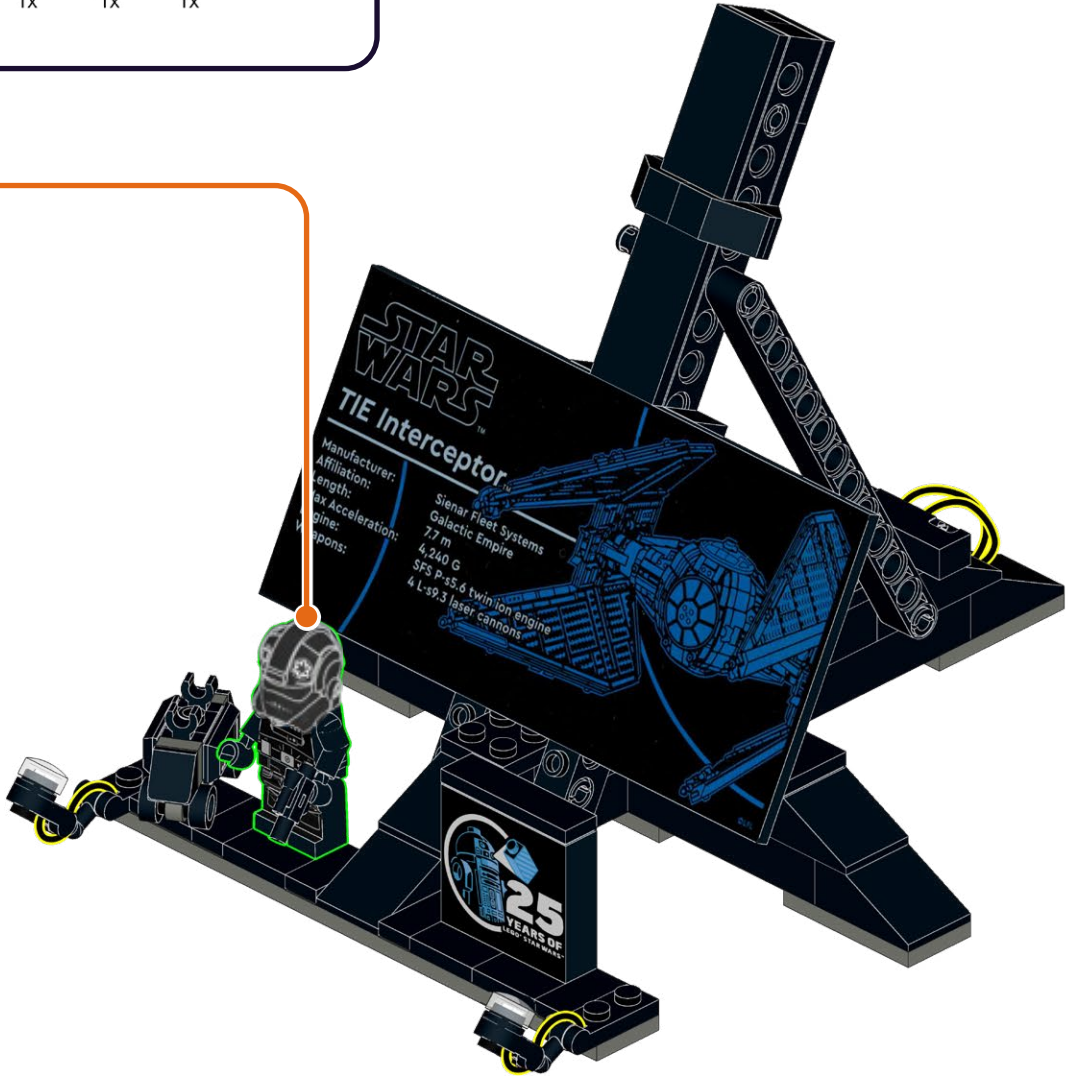

340

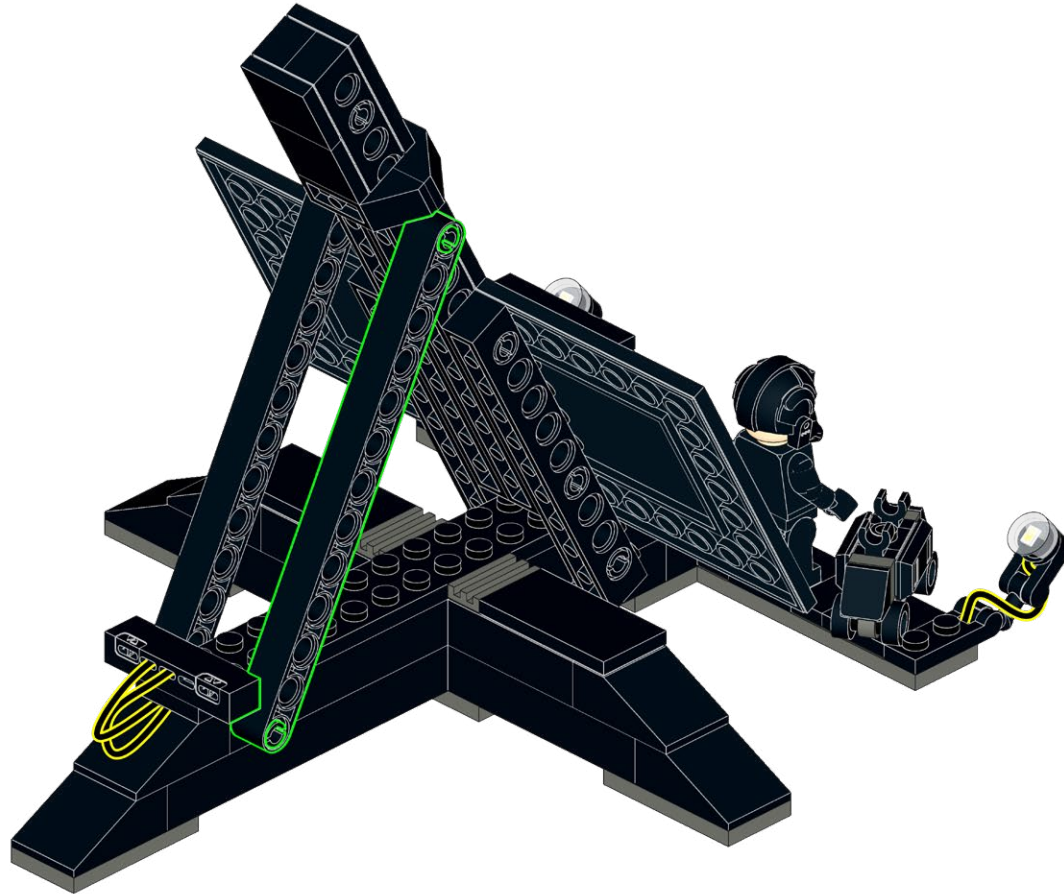

341

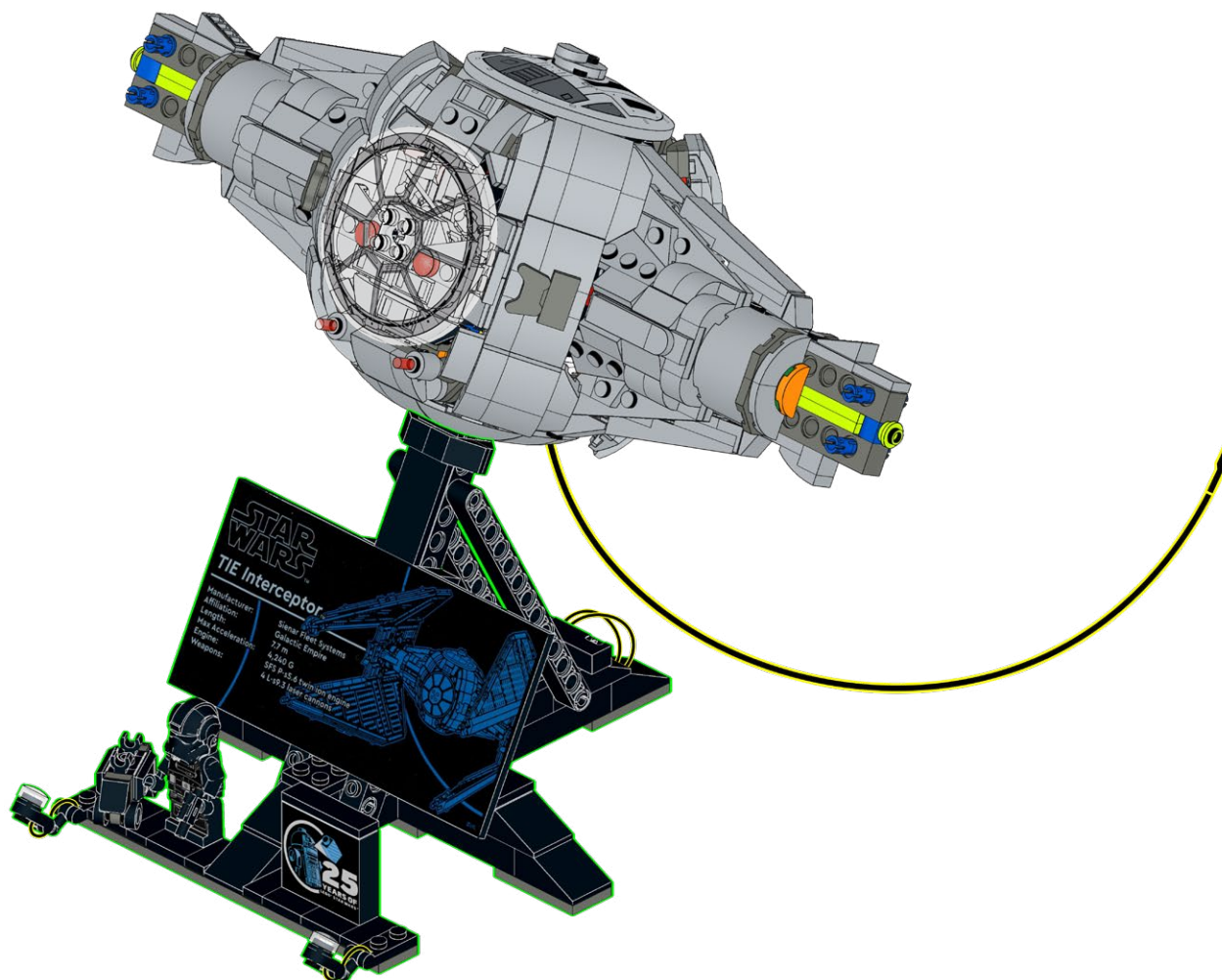

342

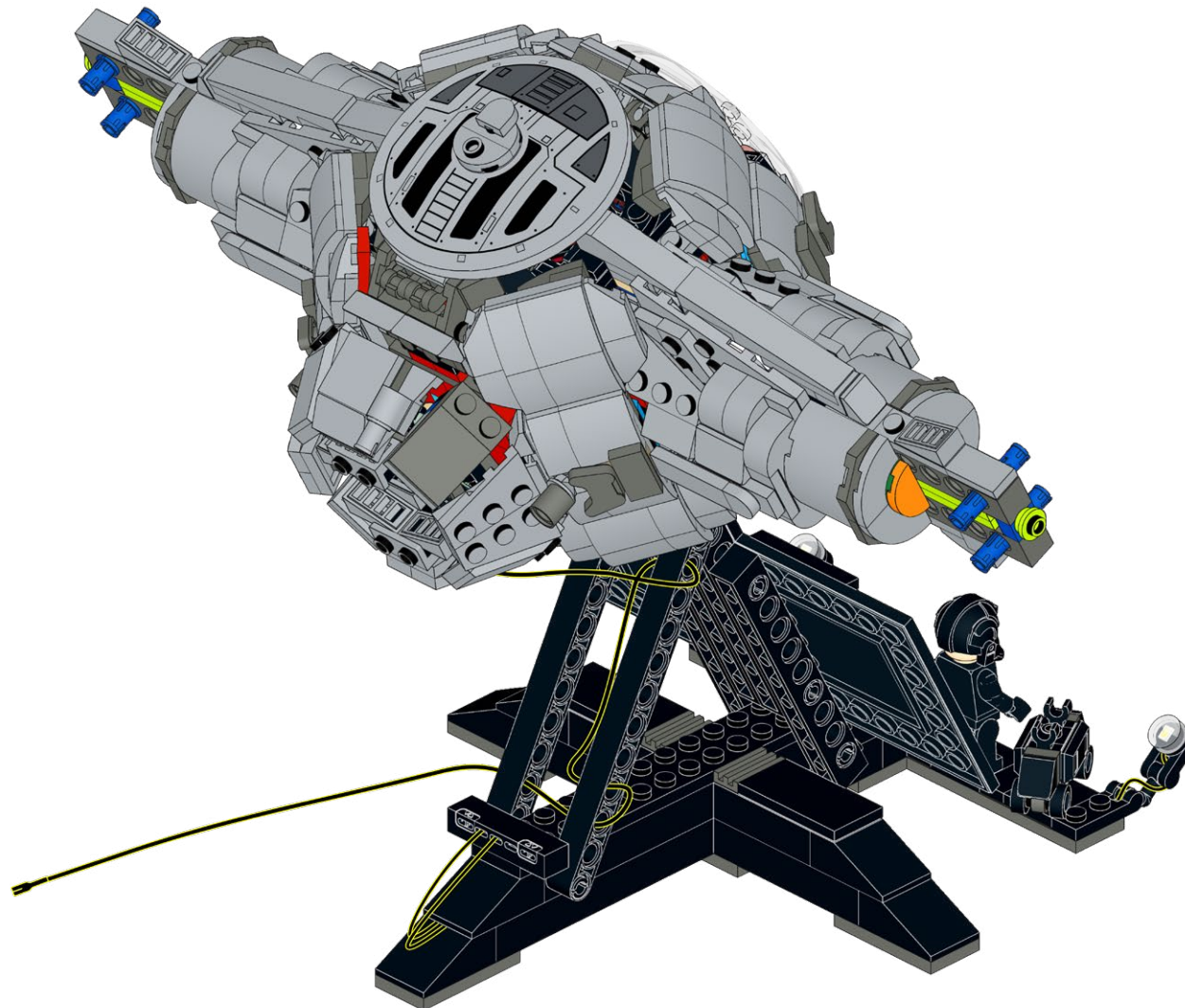



343

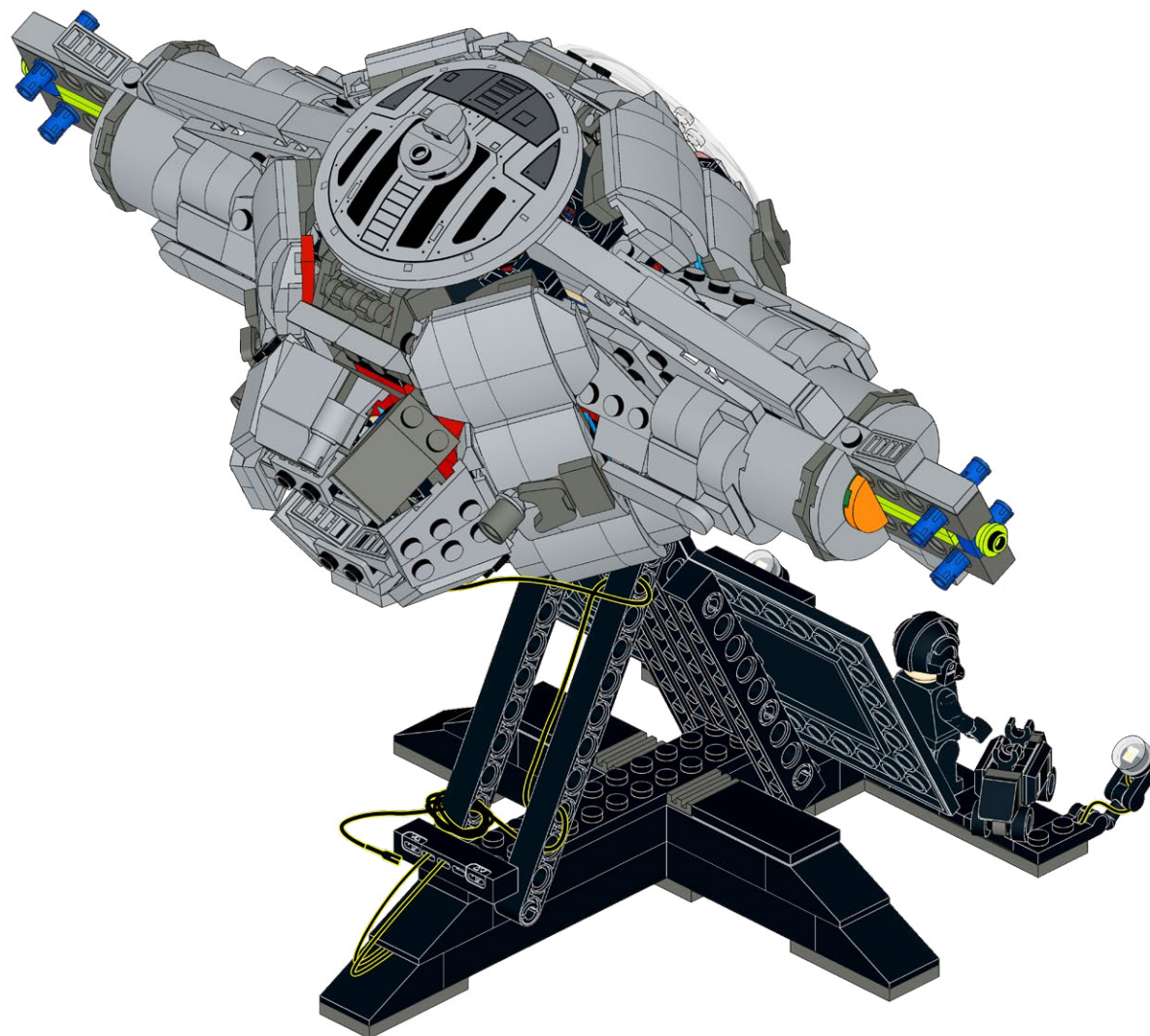

344



345

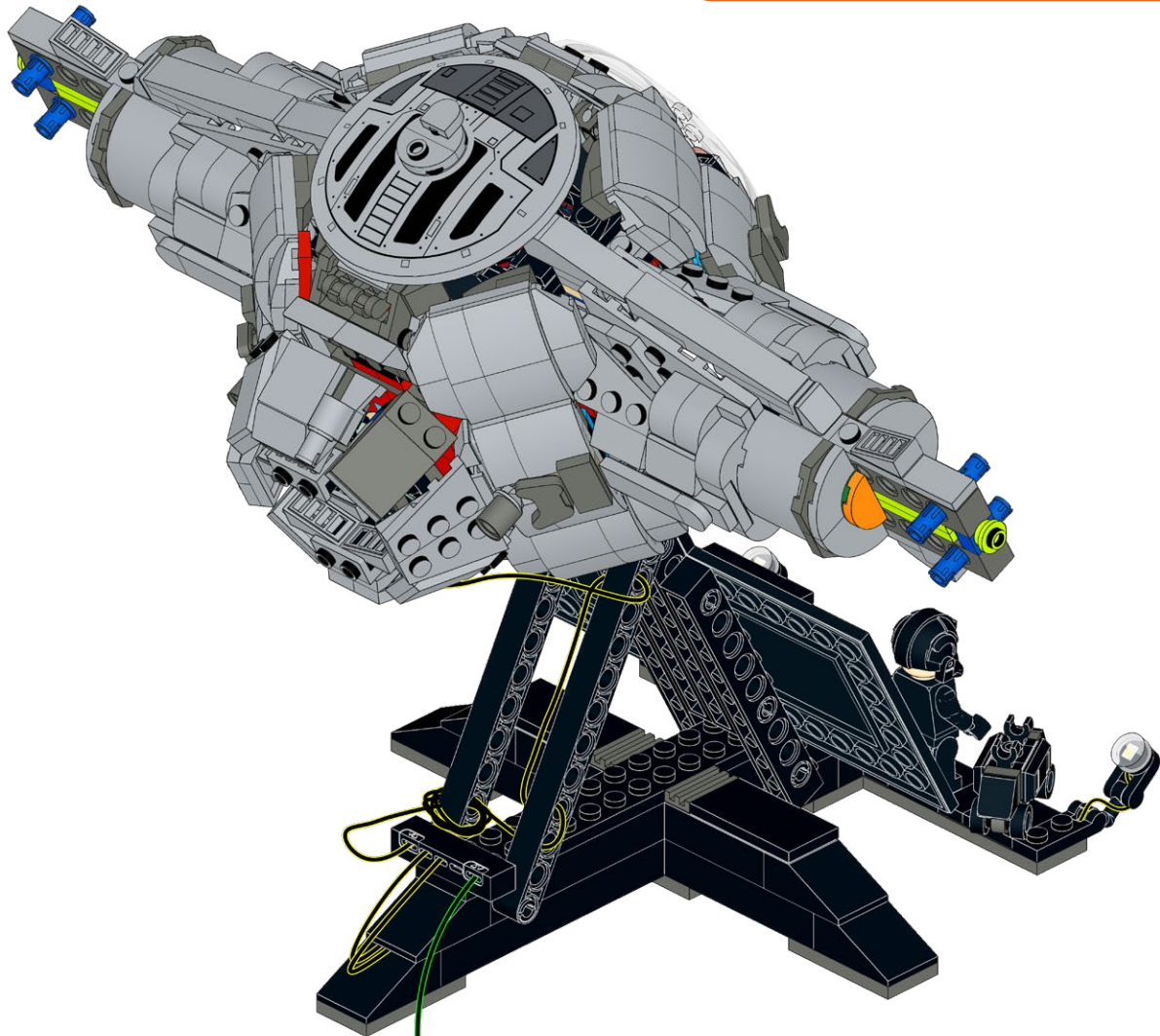
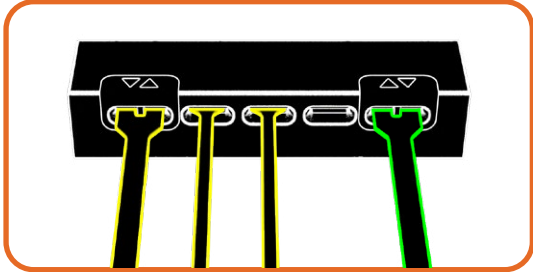



**HOLD UP!**

You might notice some bags are out of order, as well as left over pieces, but that's ok! We're changing the way you build LEGO!

**HALTEN!**

Möglicherweise stellen Sie fest, dass einige Beutel nicht in Ordnung sind und auch Teile übrig bleiben, aber das ist in Ordnung! Wir verändern die Art und Weise, wie Sie LEGO bauen!

**TENIR BON!**

Vous remarquerez peut-être que certains sacs sont en panne, ainsi que des morceaux restants, mais ce n'est pas grave ! Nous changeons la façon dont vous construisez LEGO !

**SOSTENERE!**

Potresti notare che alcune borse sono fuori uso, così come alcuni pezzi avanzati, ma va bene! Stiamo cambiando il modo in cui costruisci i LEGO!

**¡SOSTENER!**

Puede que notes que algunas bolsas están fuera de orden, así como piezas sobrantes, ¡pero está bien! ¡Estamos cambiando la forma de construir LEGO!

**耽误!**

您可能会注意到有些袋子坏了, 还有剩余的碎片, 但这没关系! 我们正在改变您搭建乐高的方式!

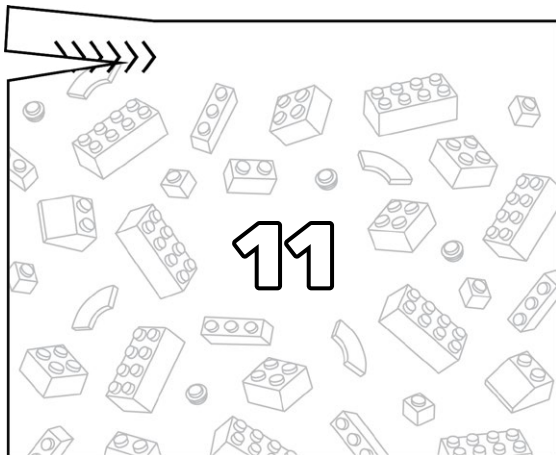
**Open LEGO® Bag 1**

346

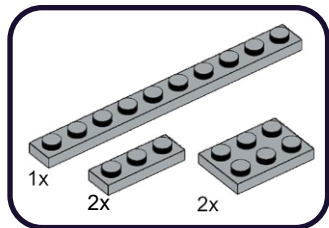

1

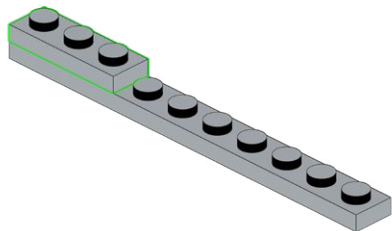

2

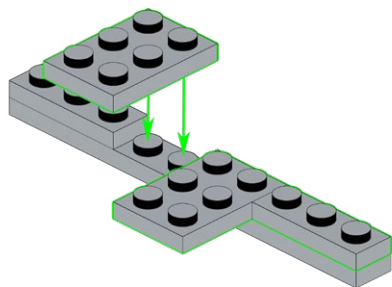

347

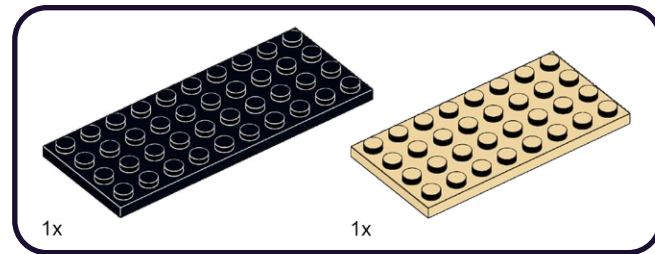

1

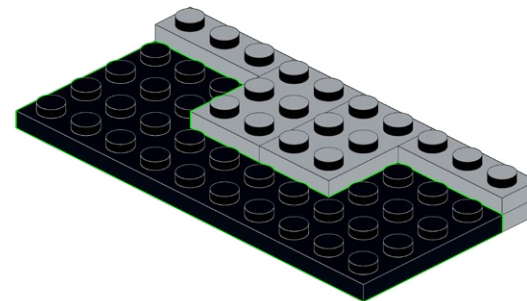

2

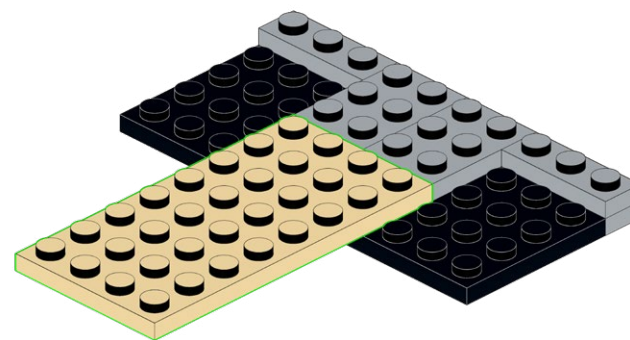

348

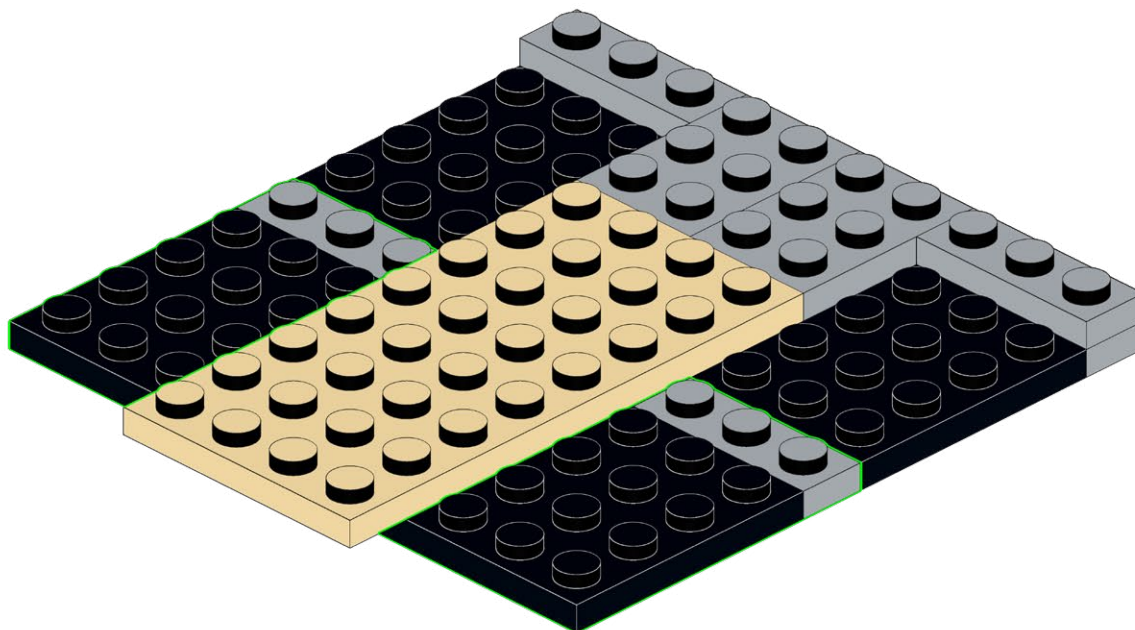
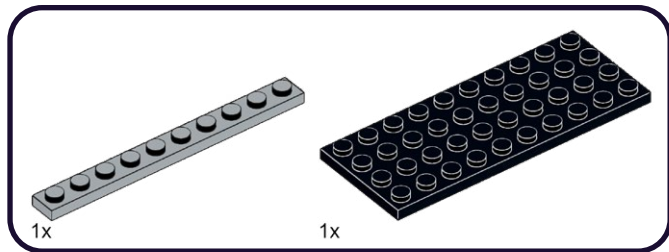

349

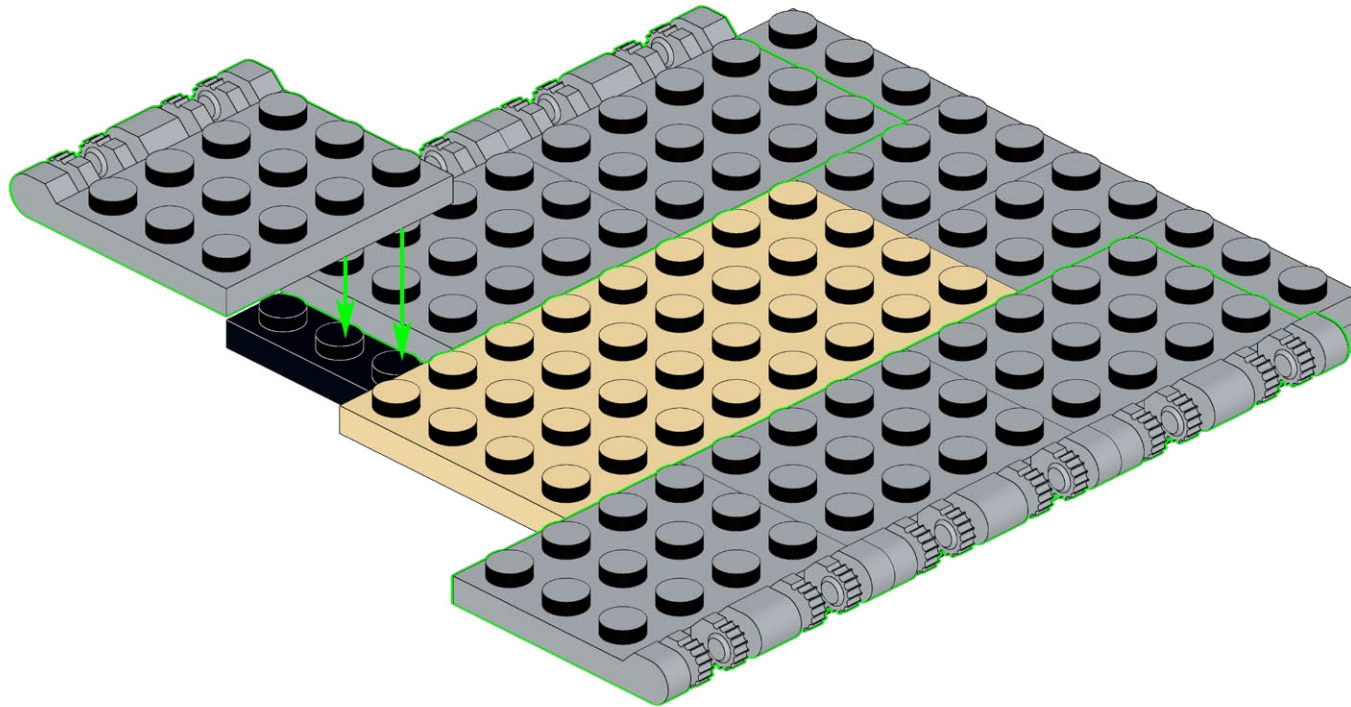
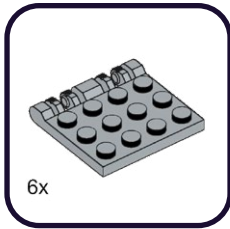

350

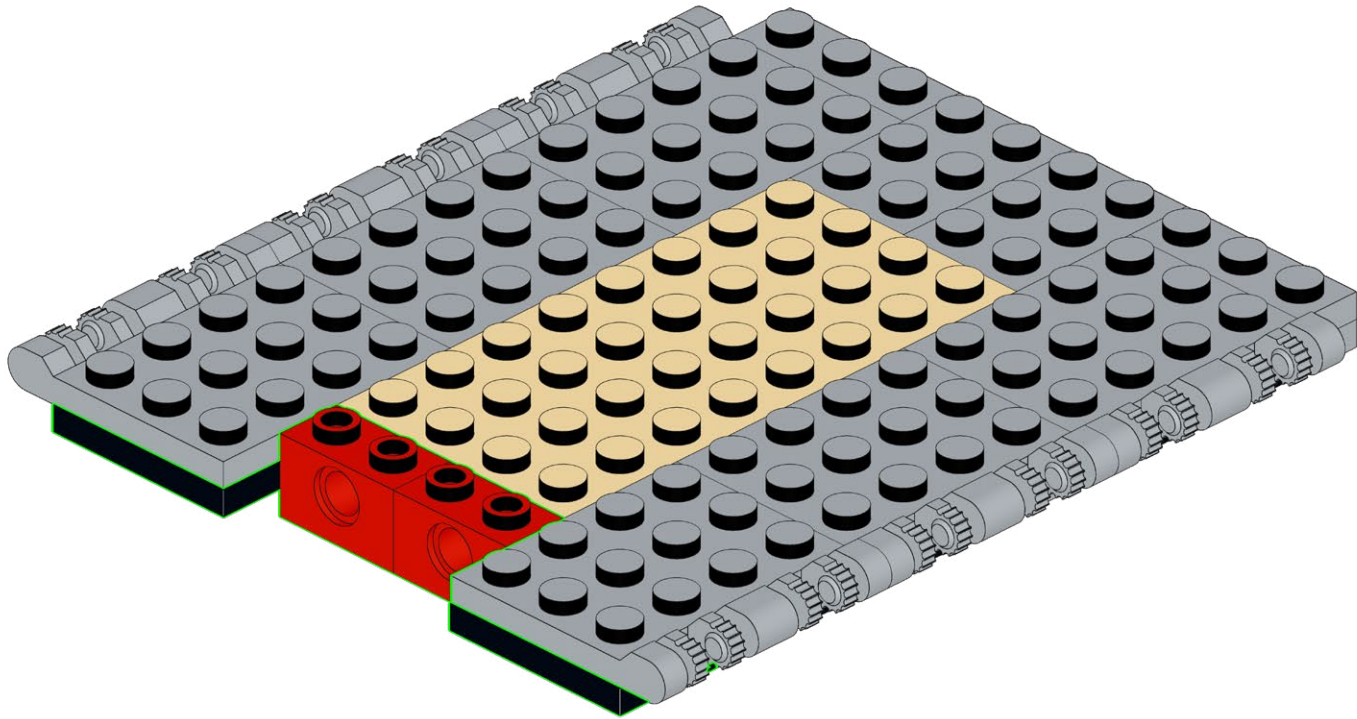
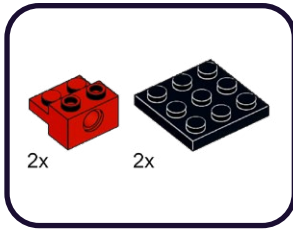



351

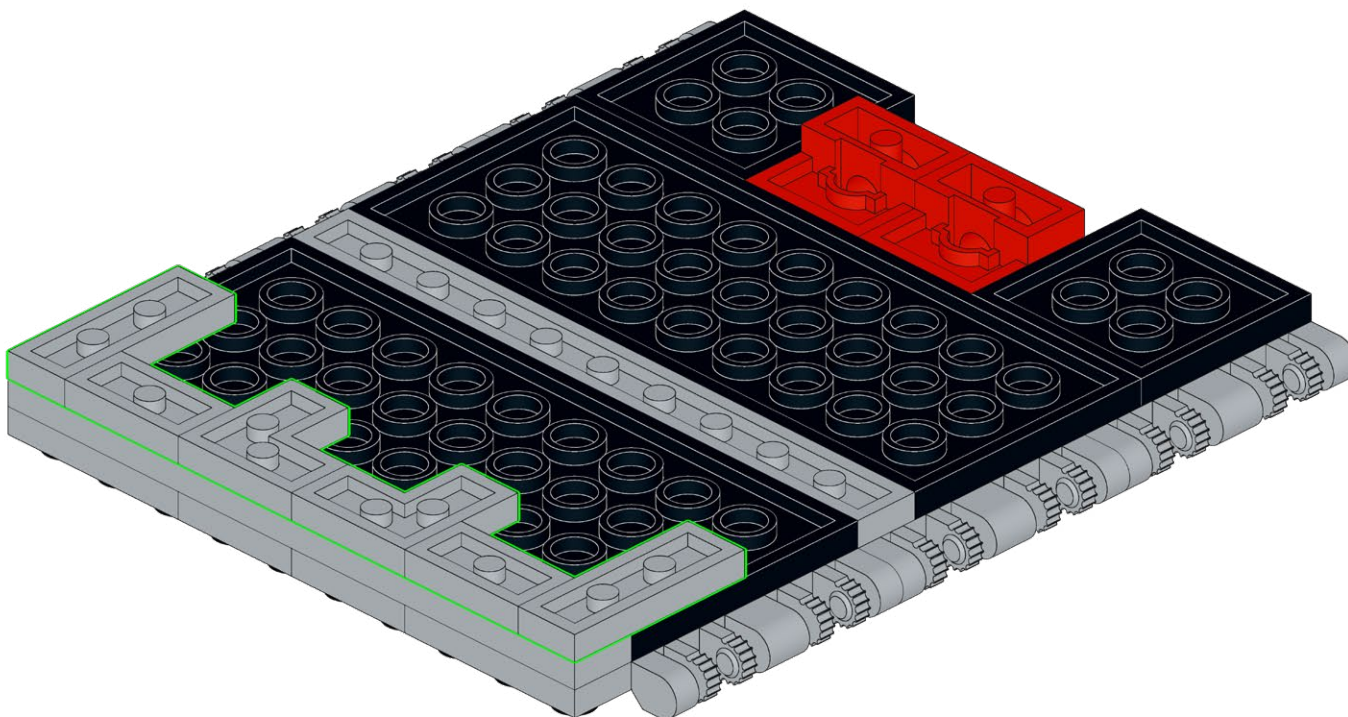
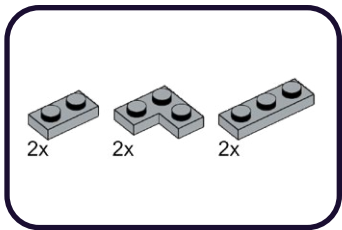

352

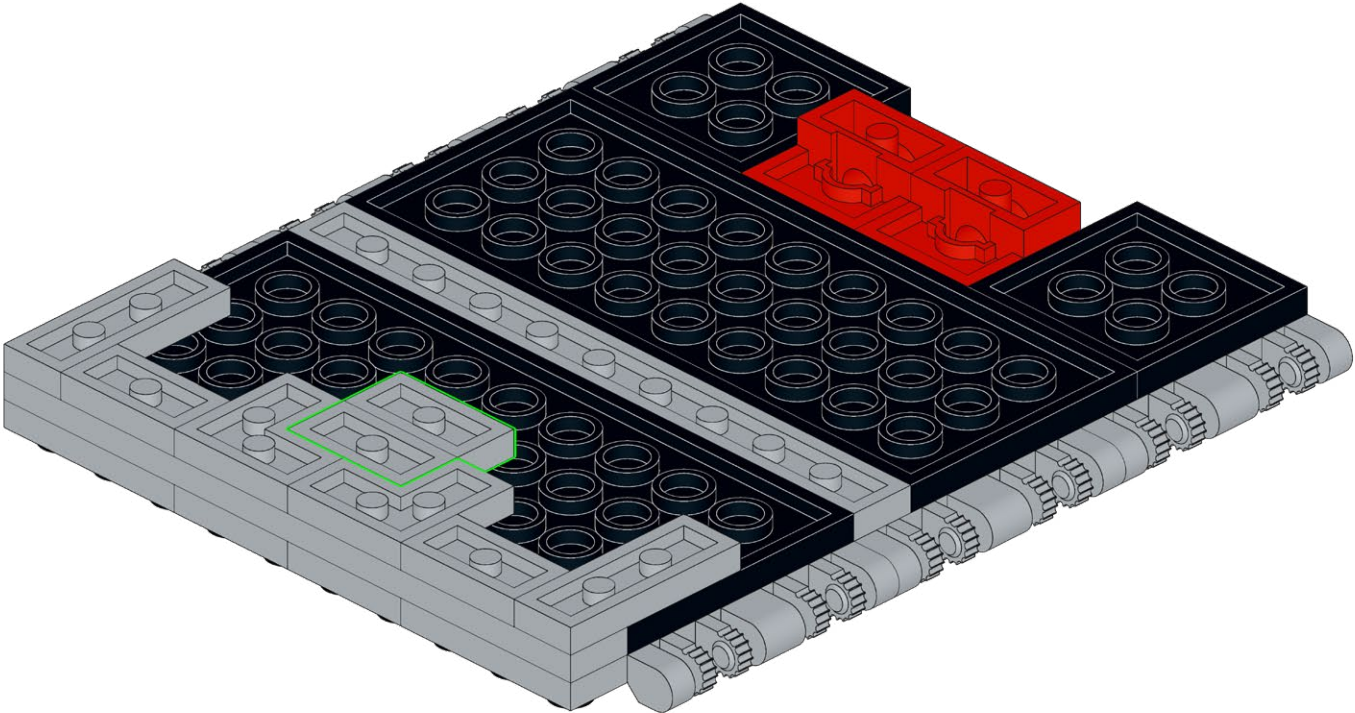
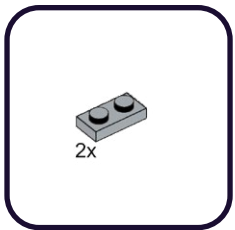



**353**

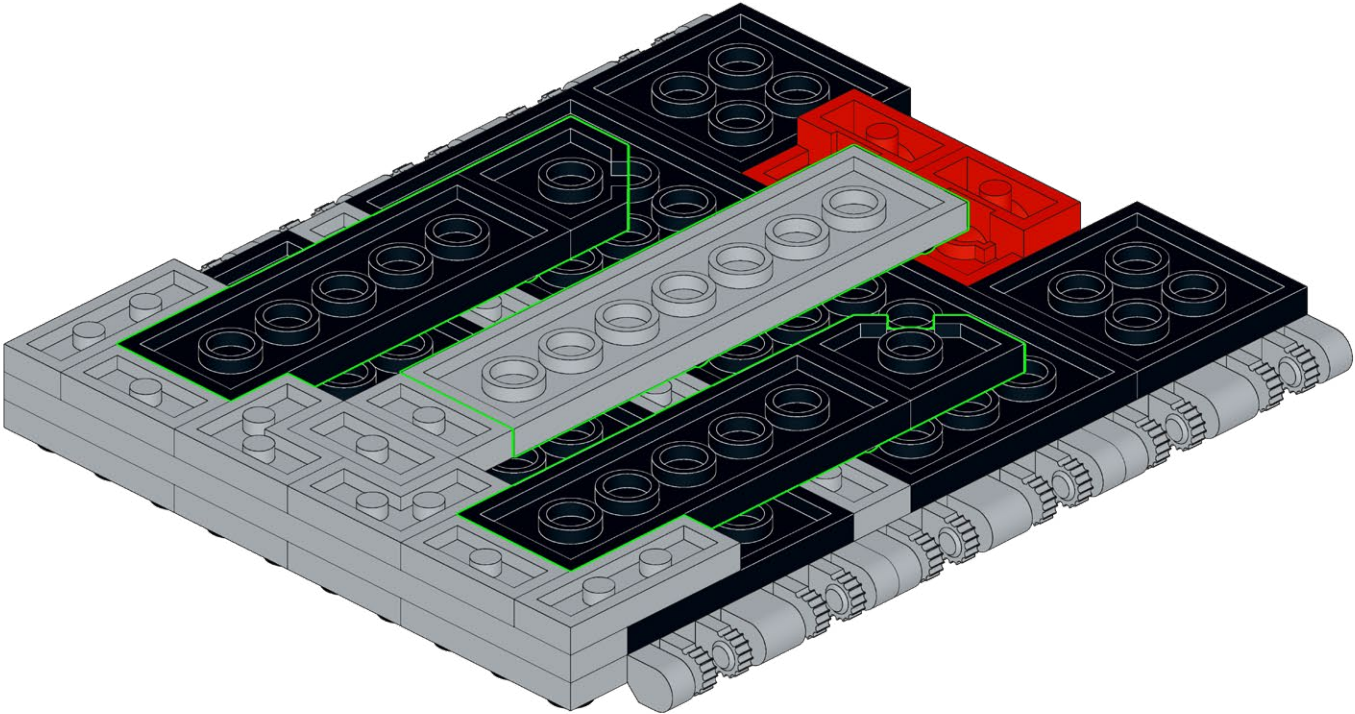
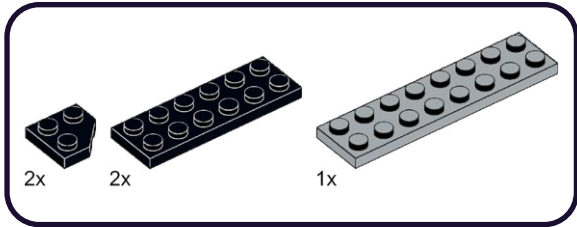

354

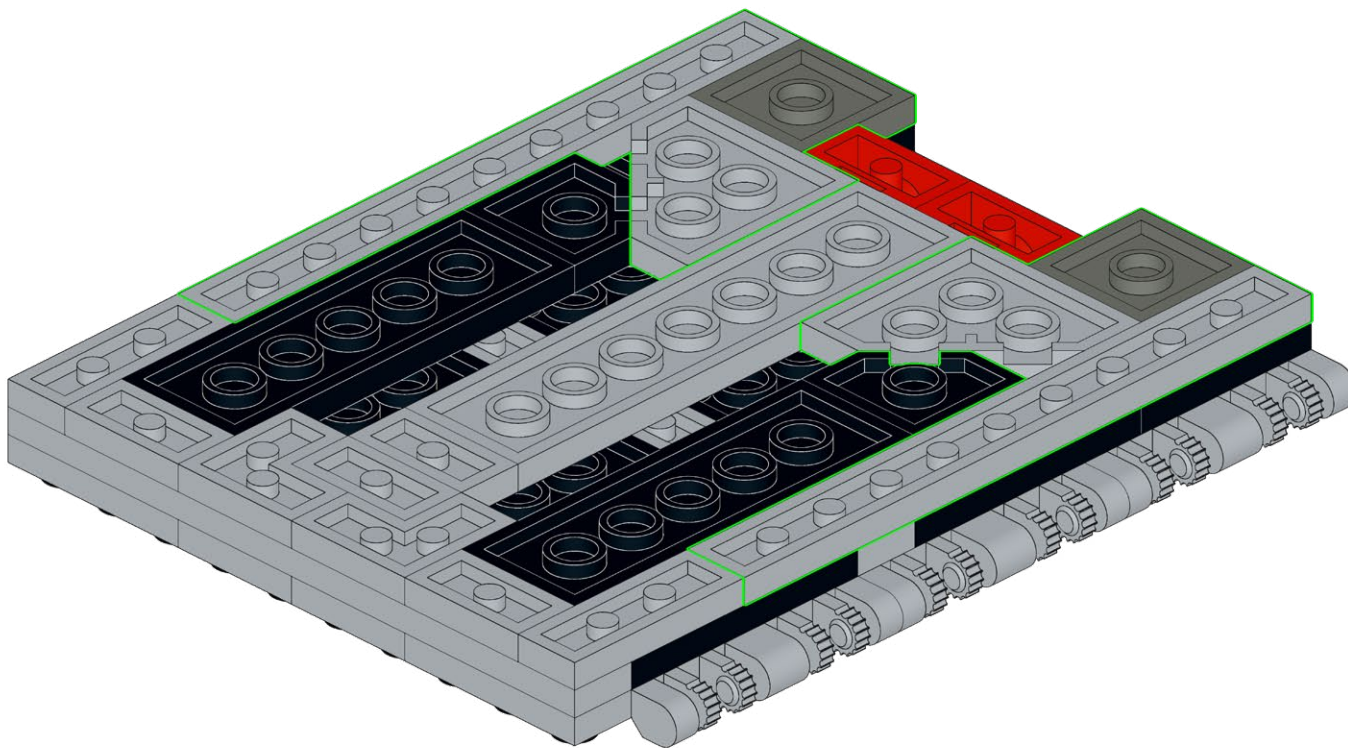
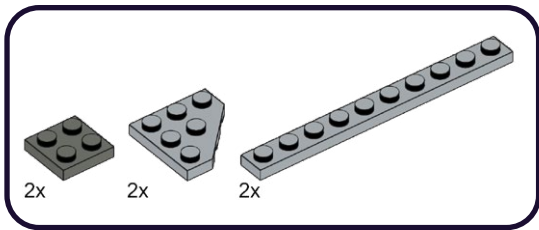

355

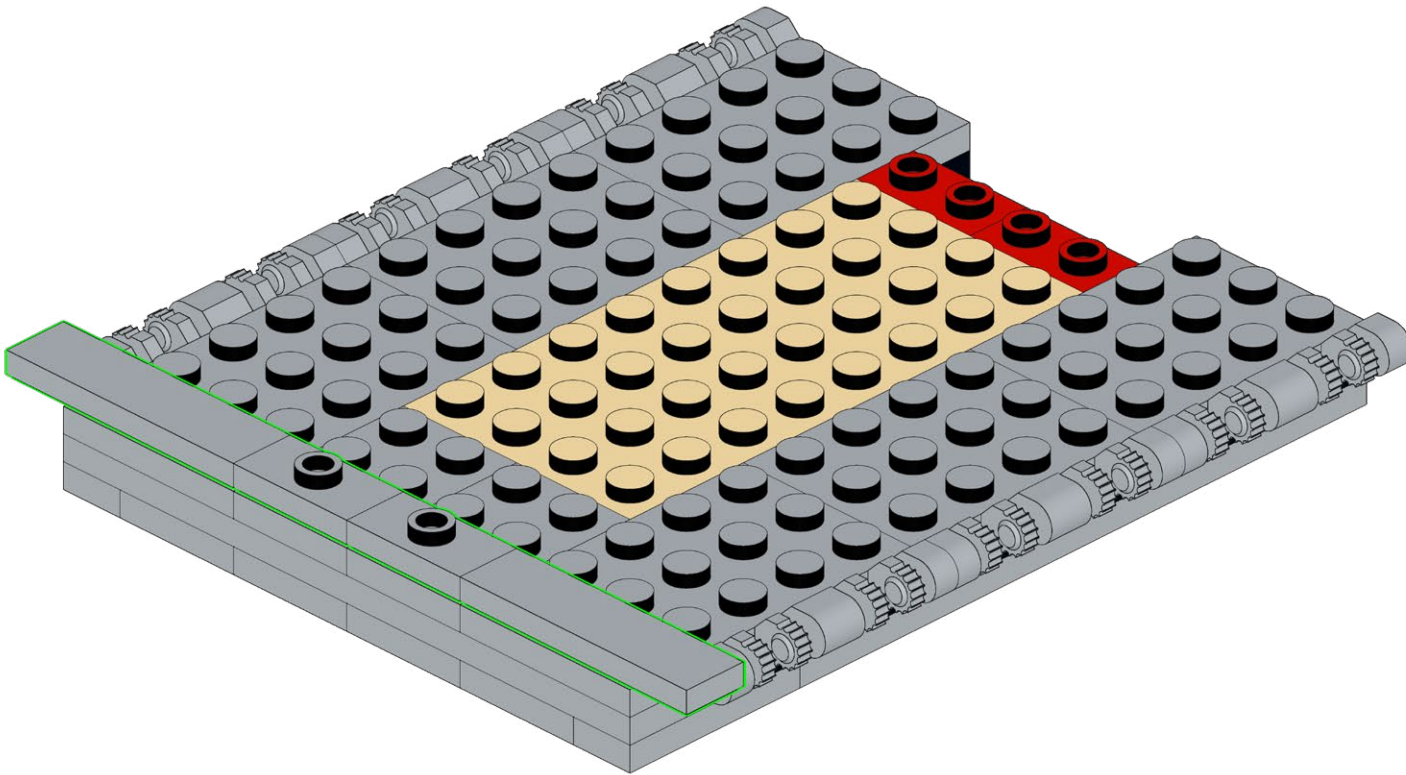
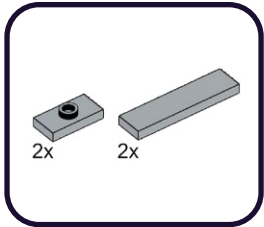

356

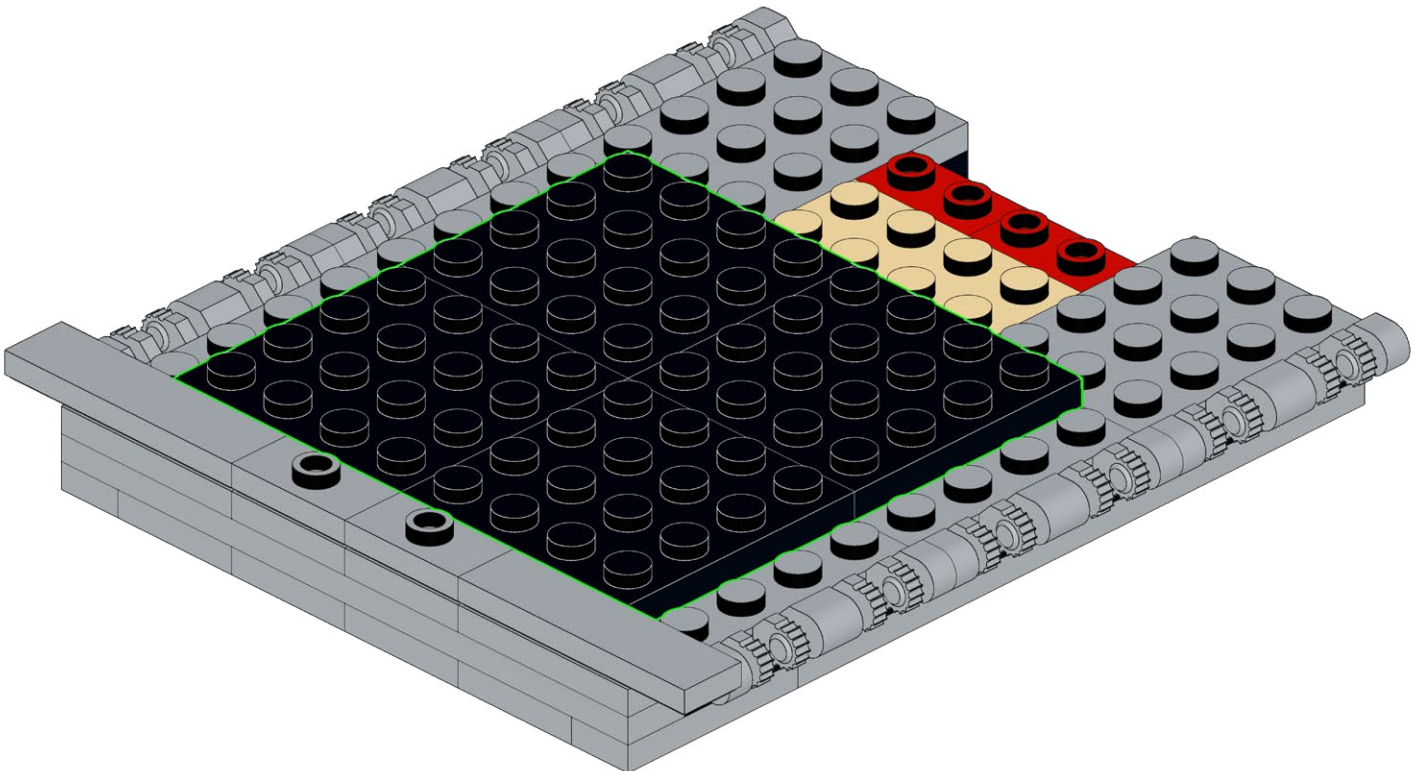
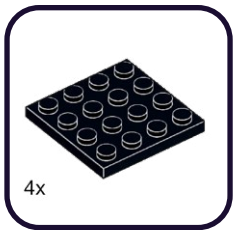



**357**

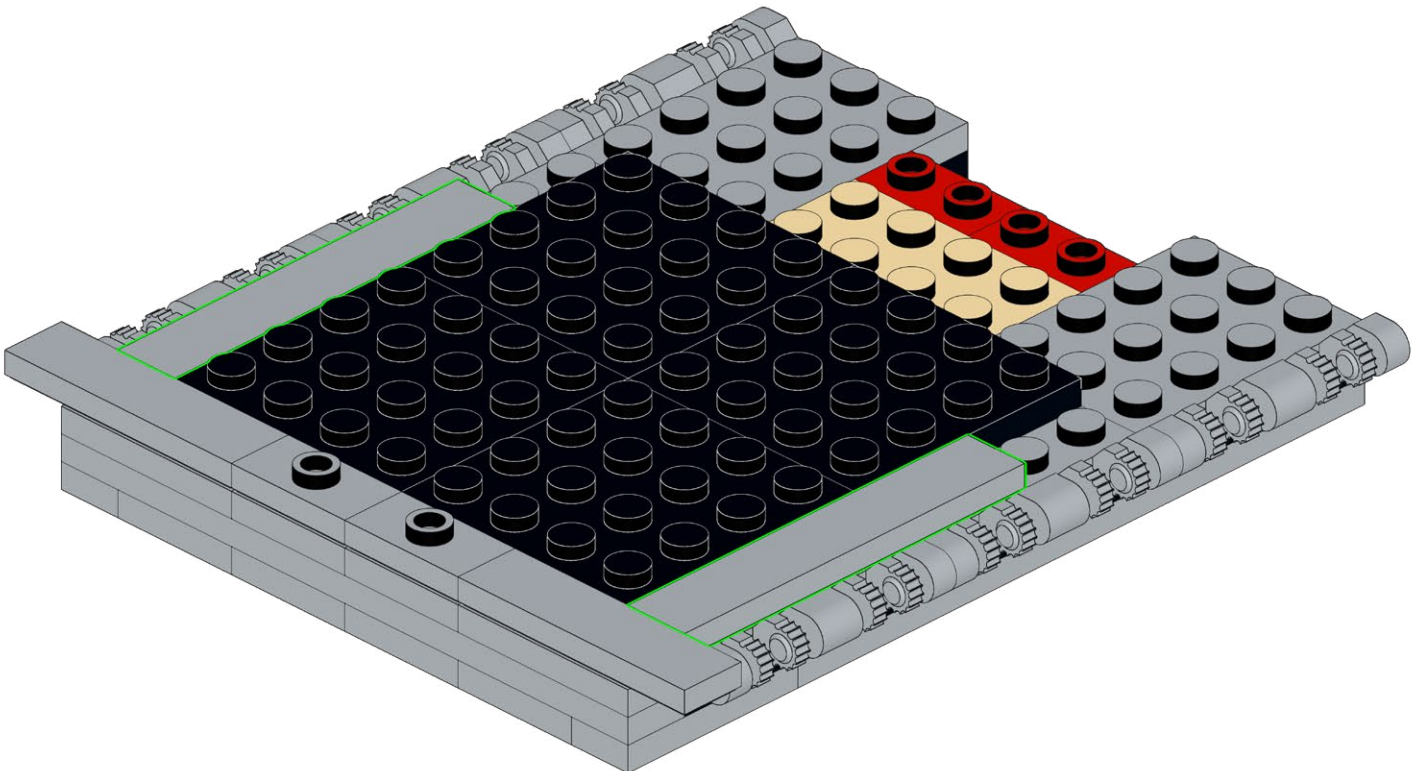
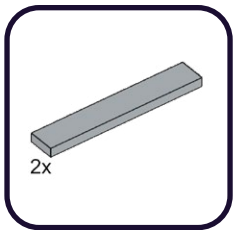

358

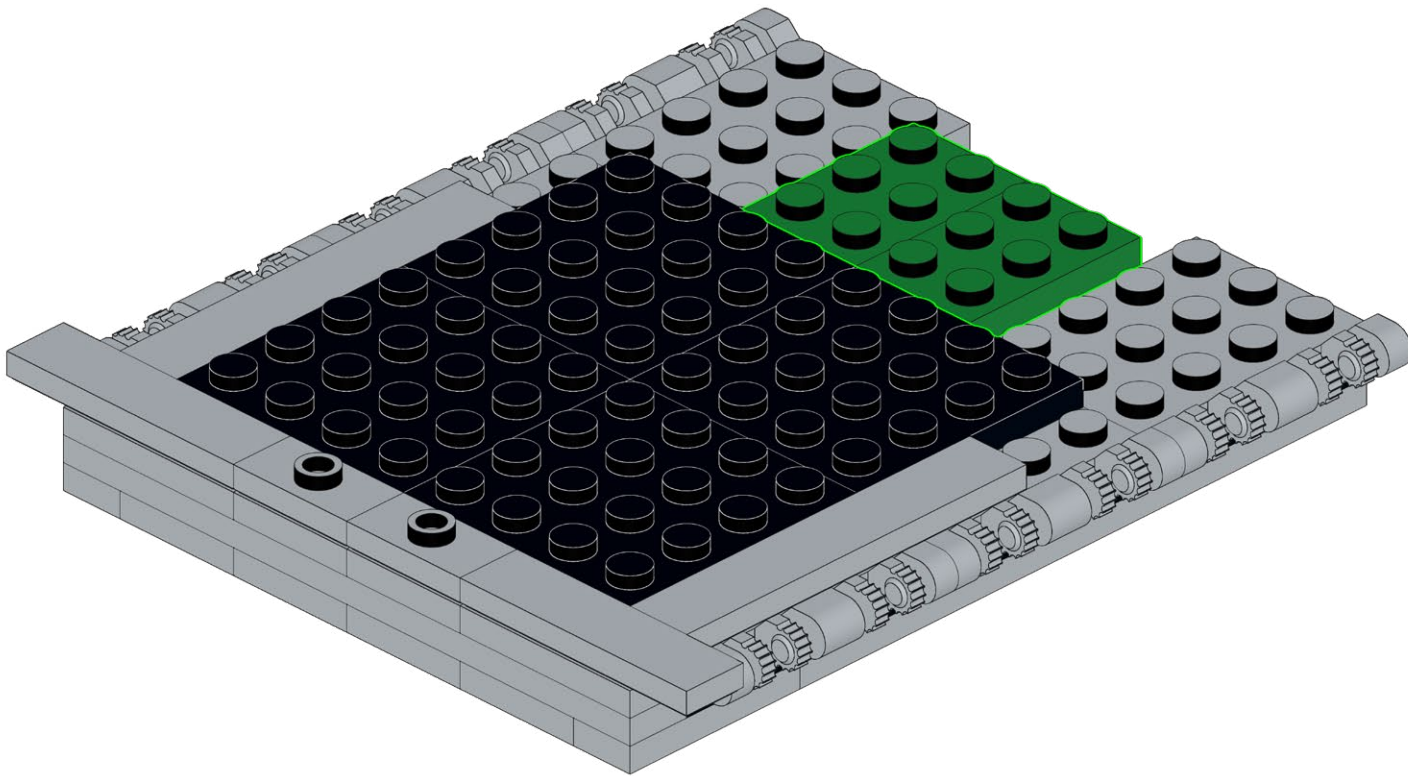
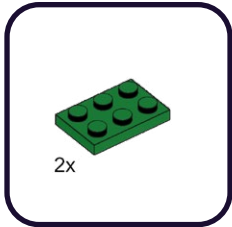

359

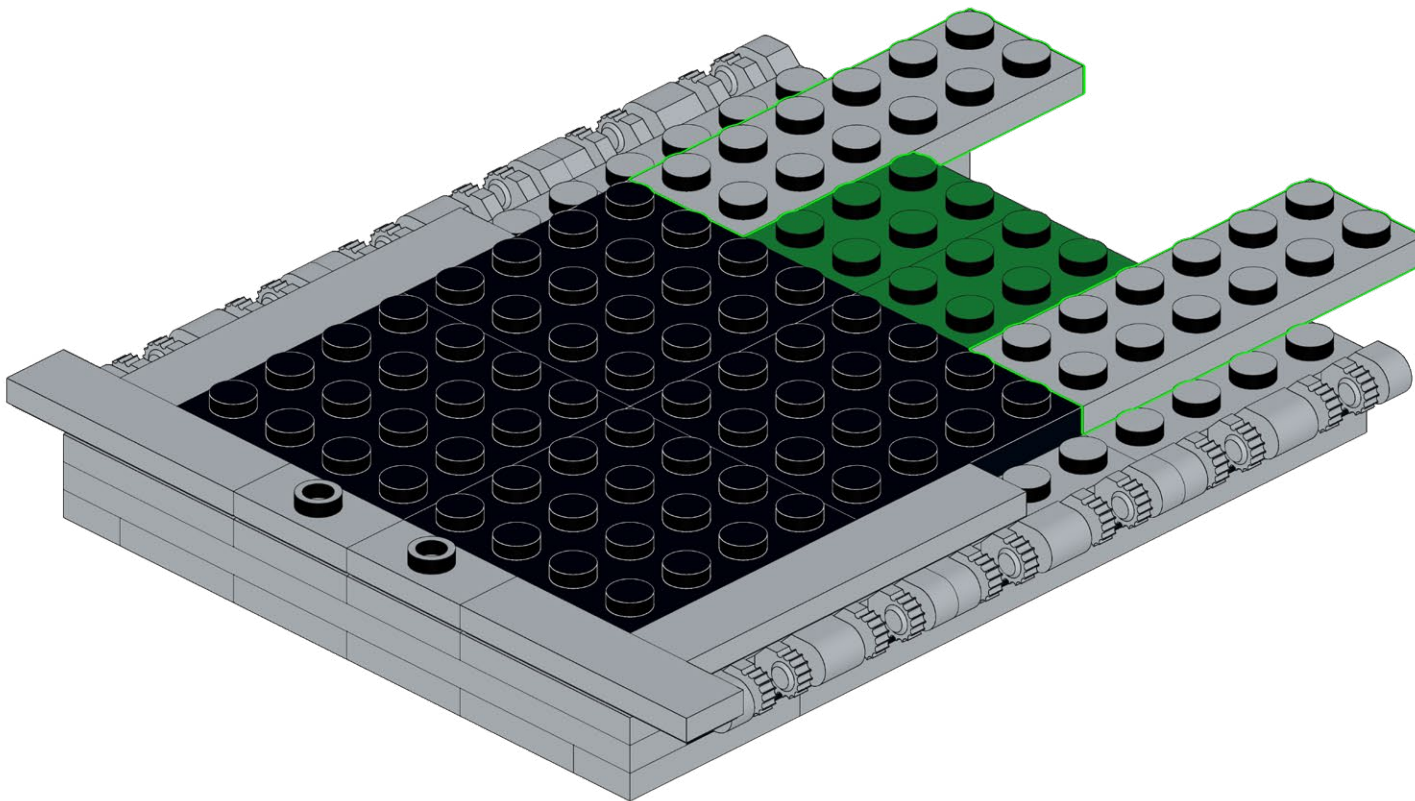
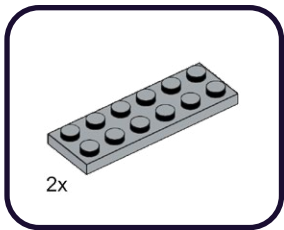



360

2x

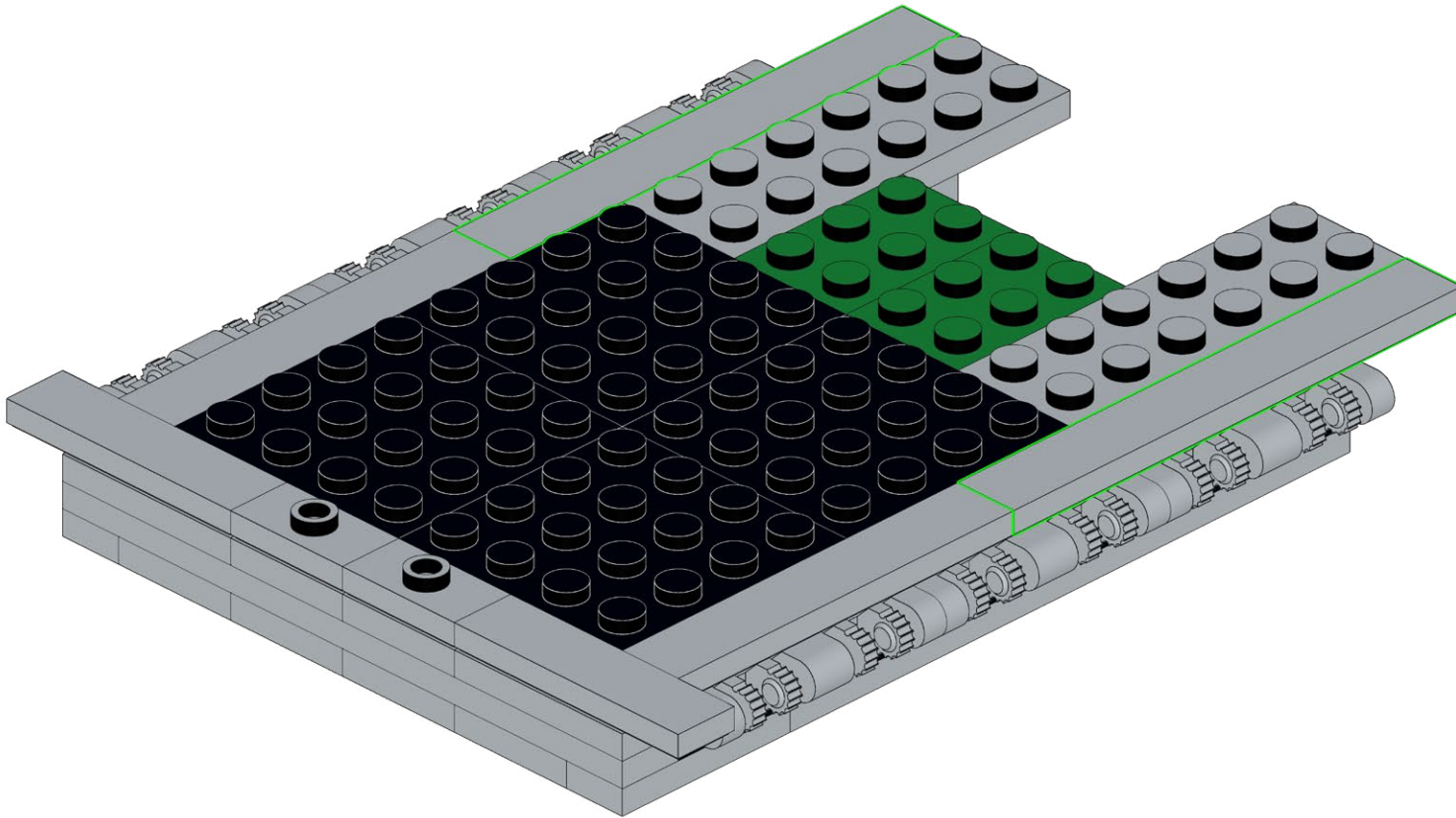

361

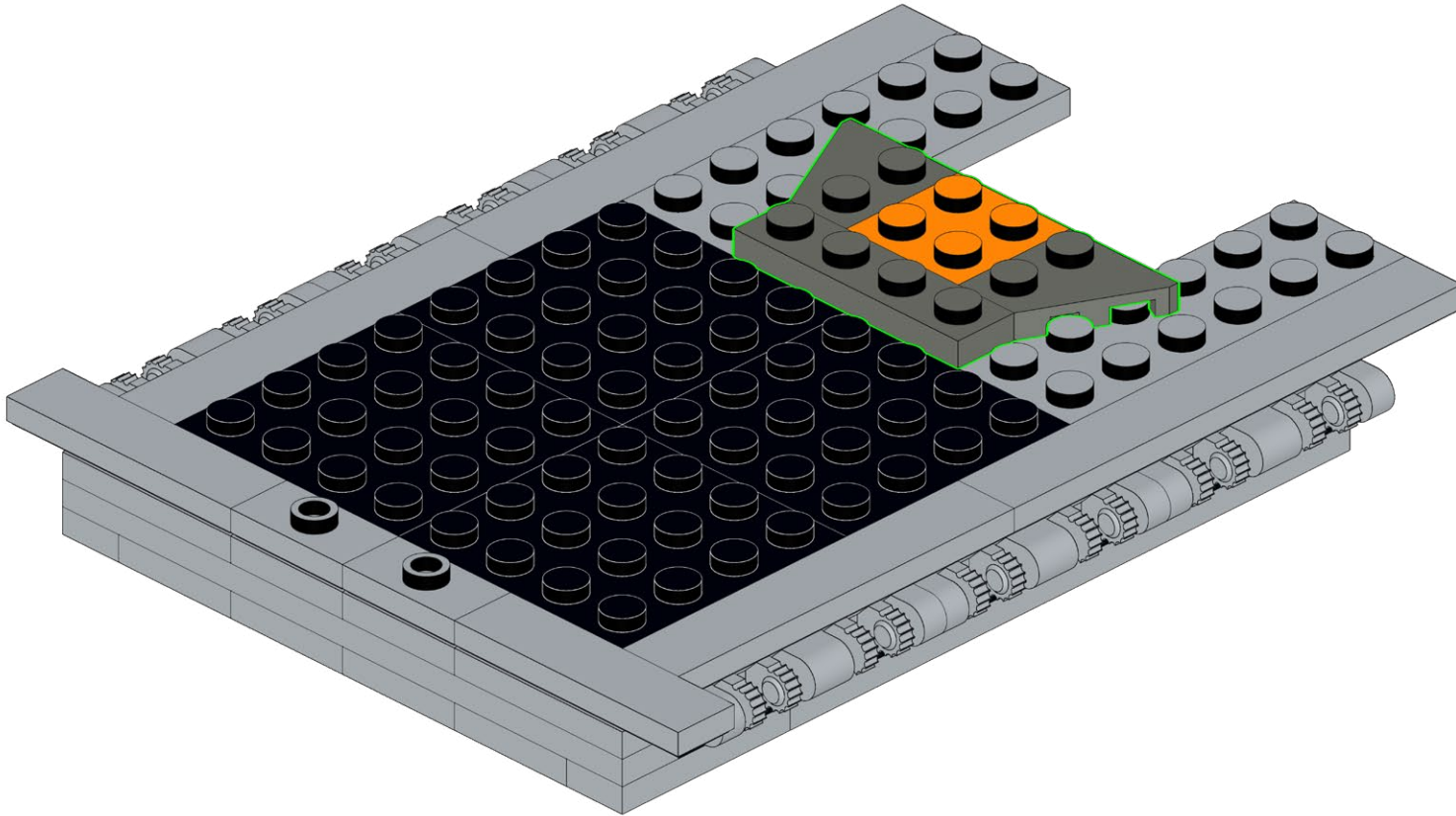
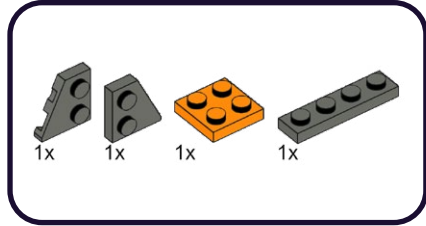

362

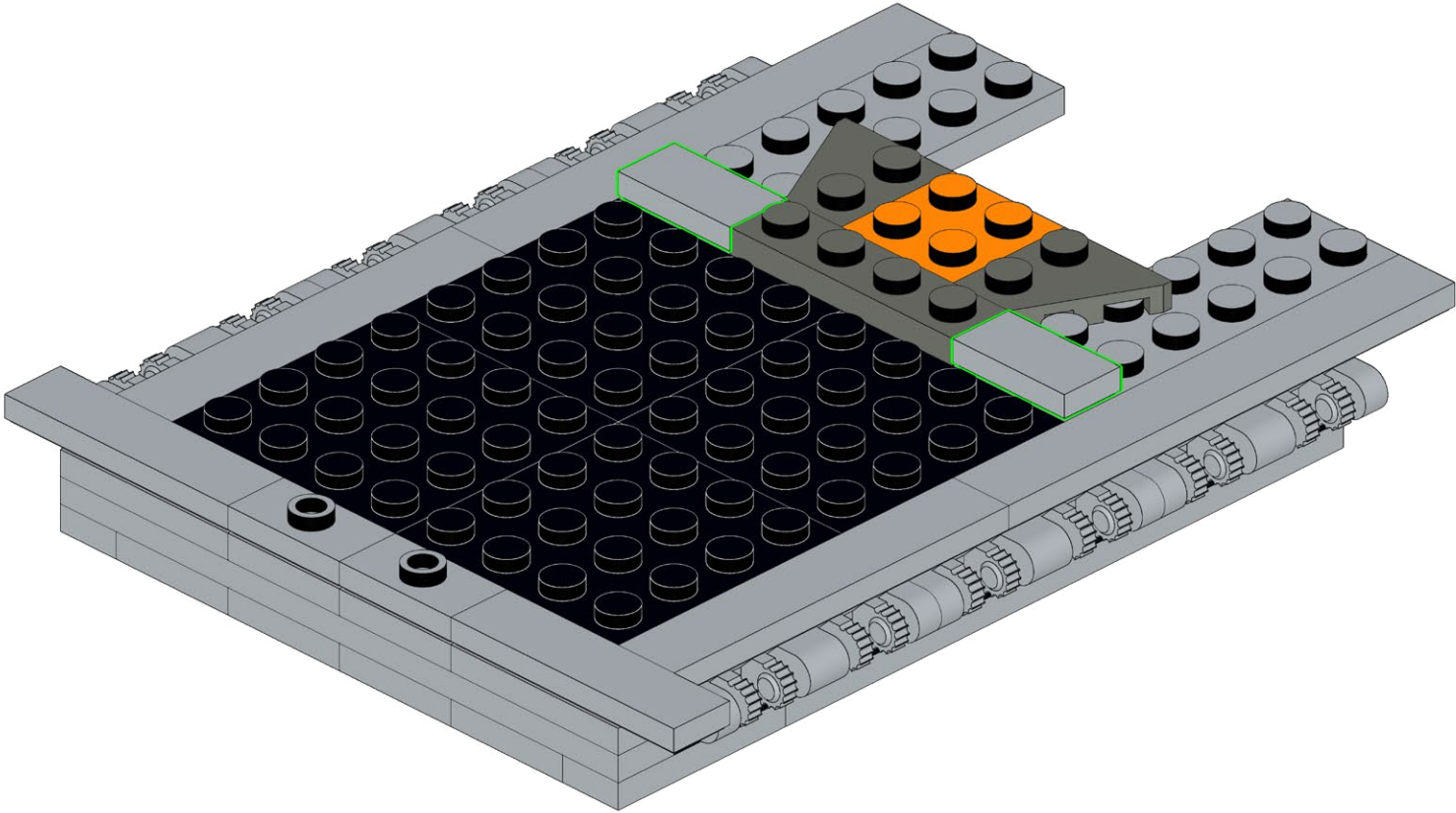
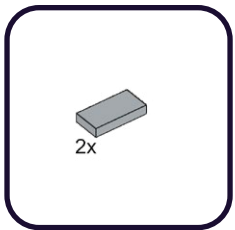

363

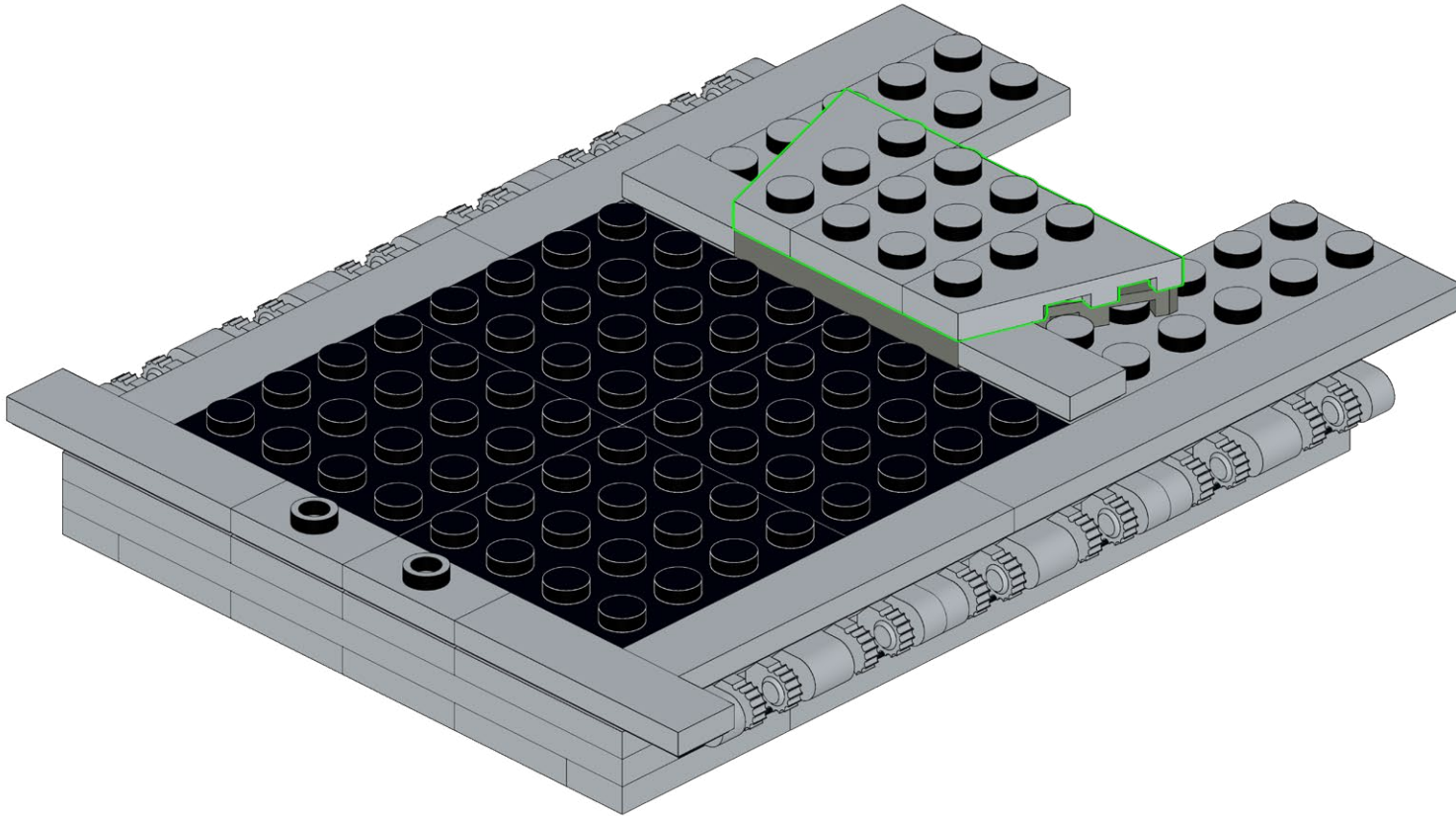
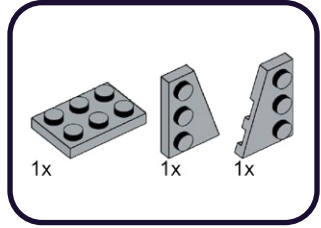



364

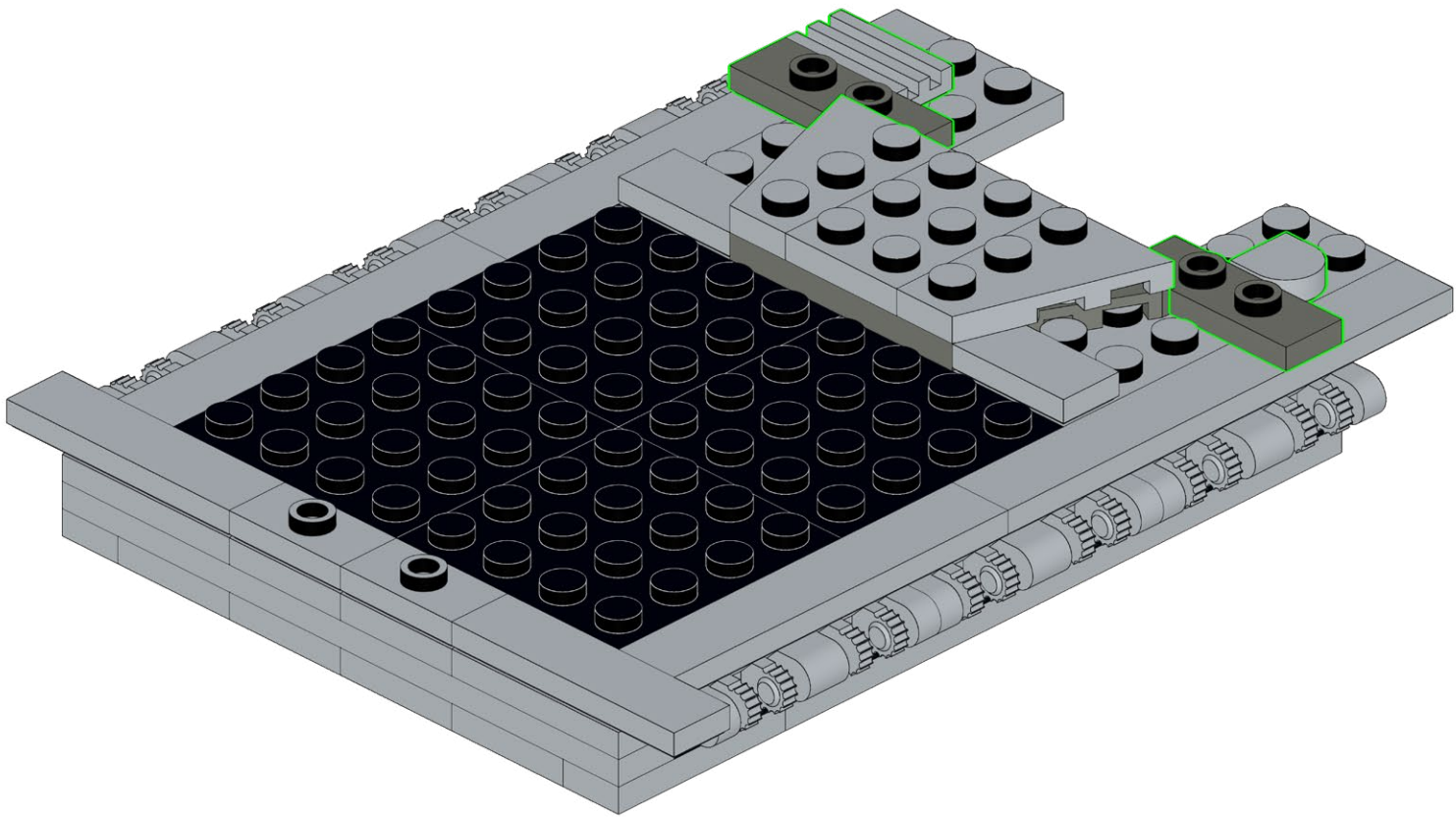
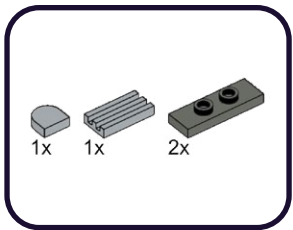

**365**

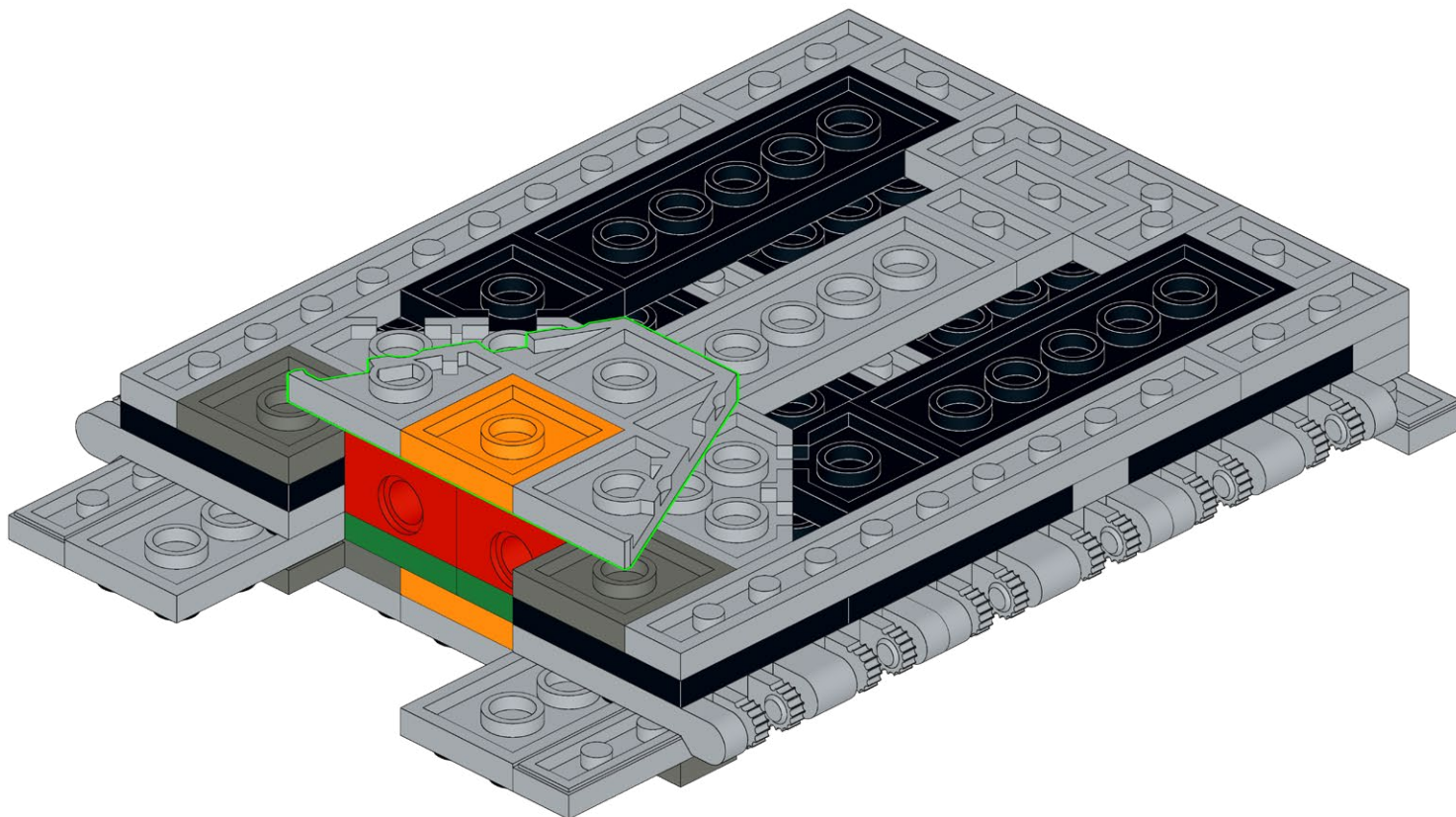
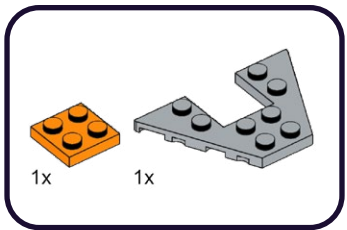
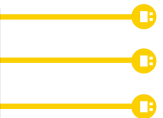



366

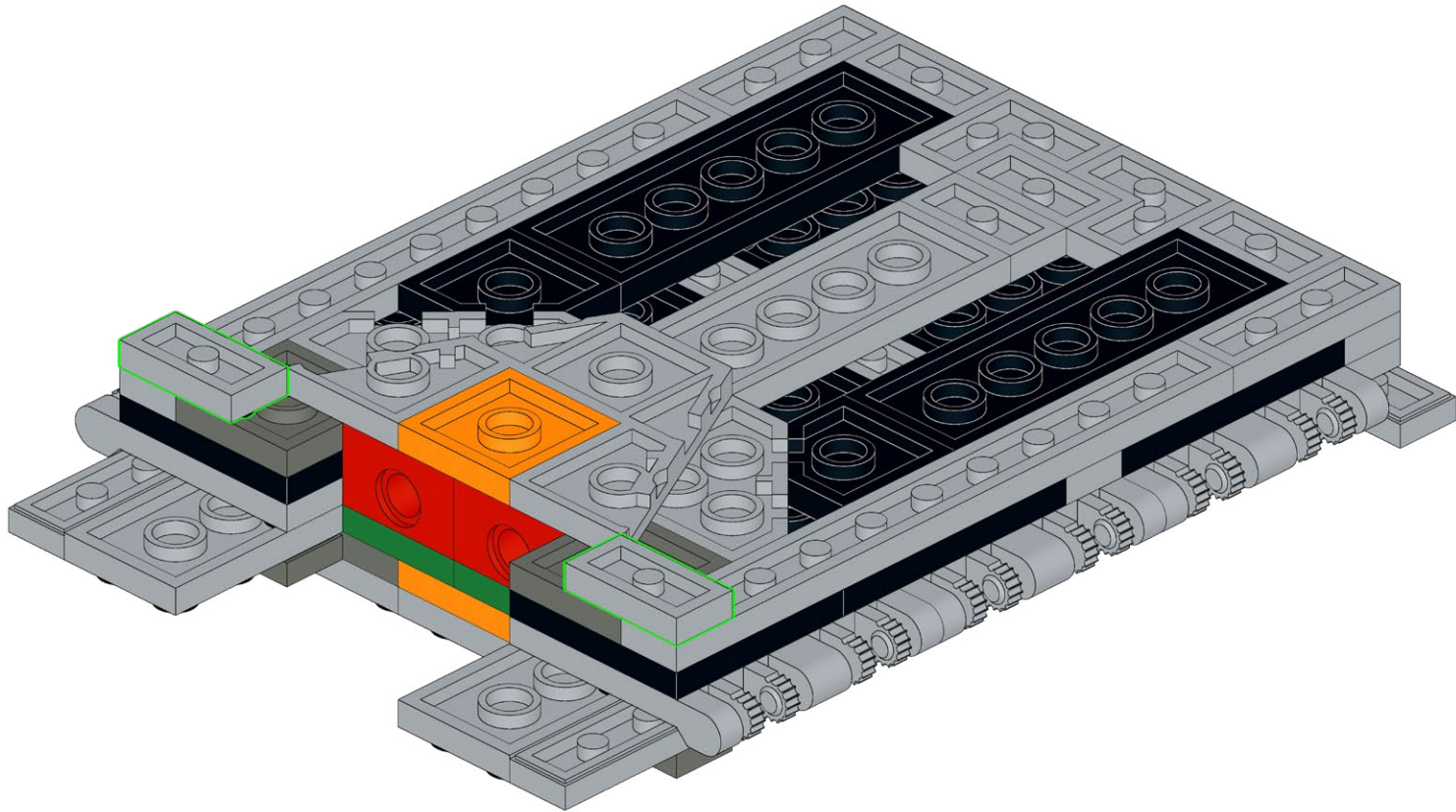
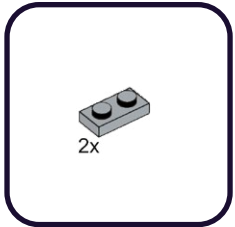

367

1x 1x

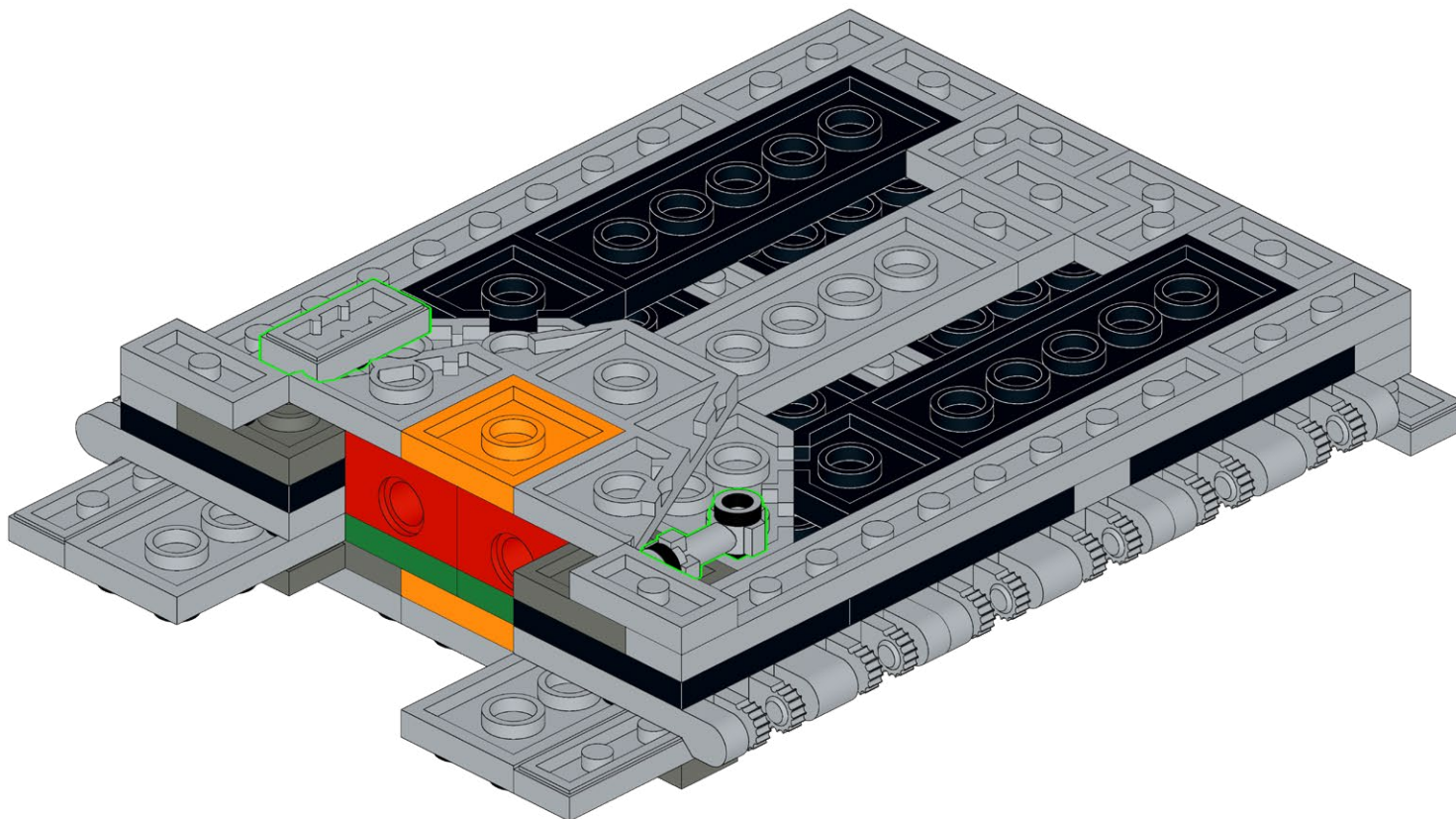

368

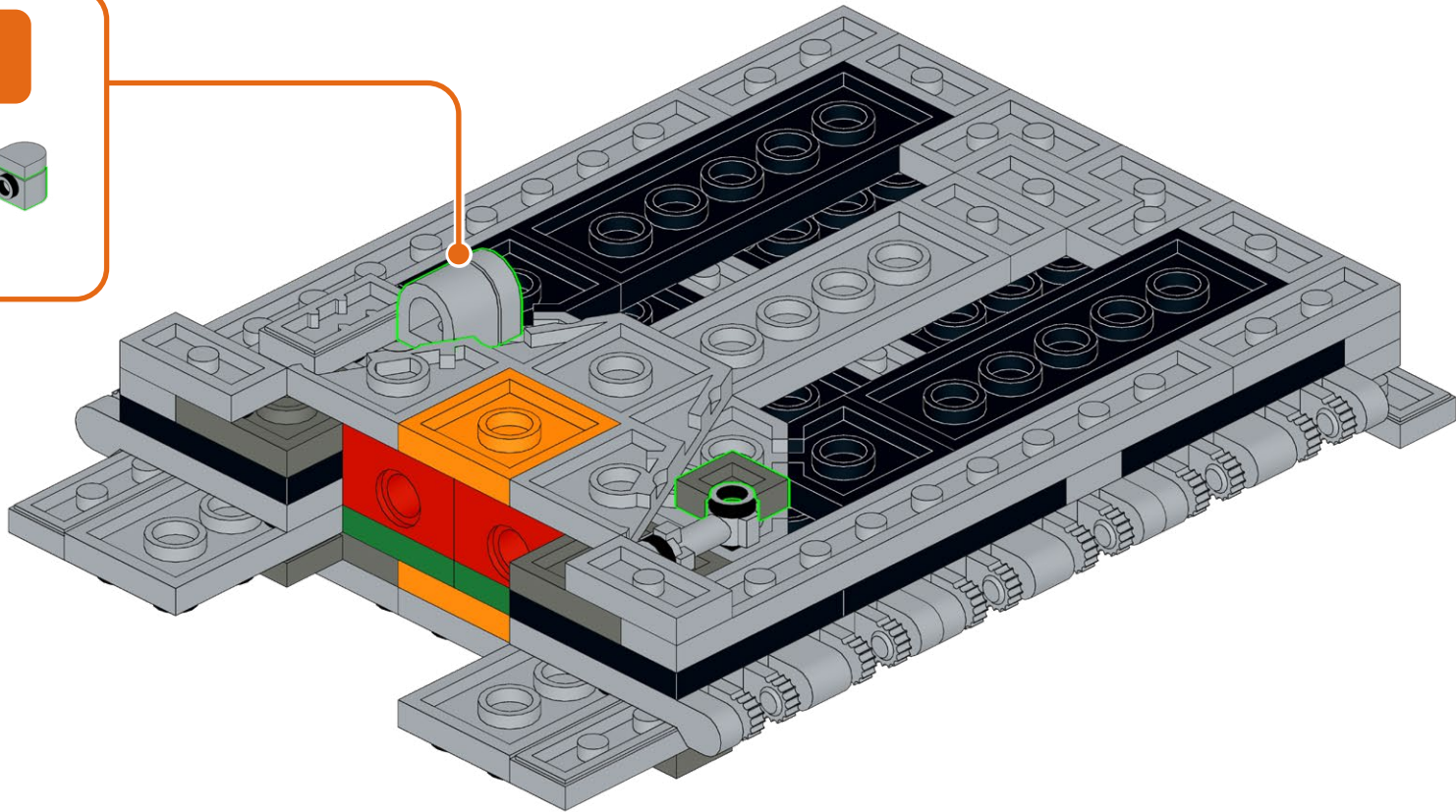
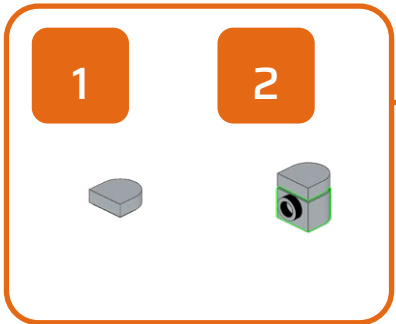
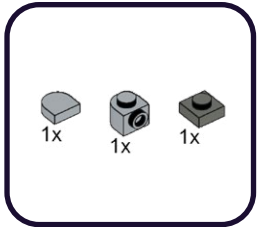



369

6x

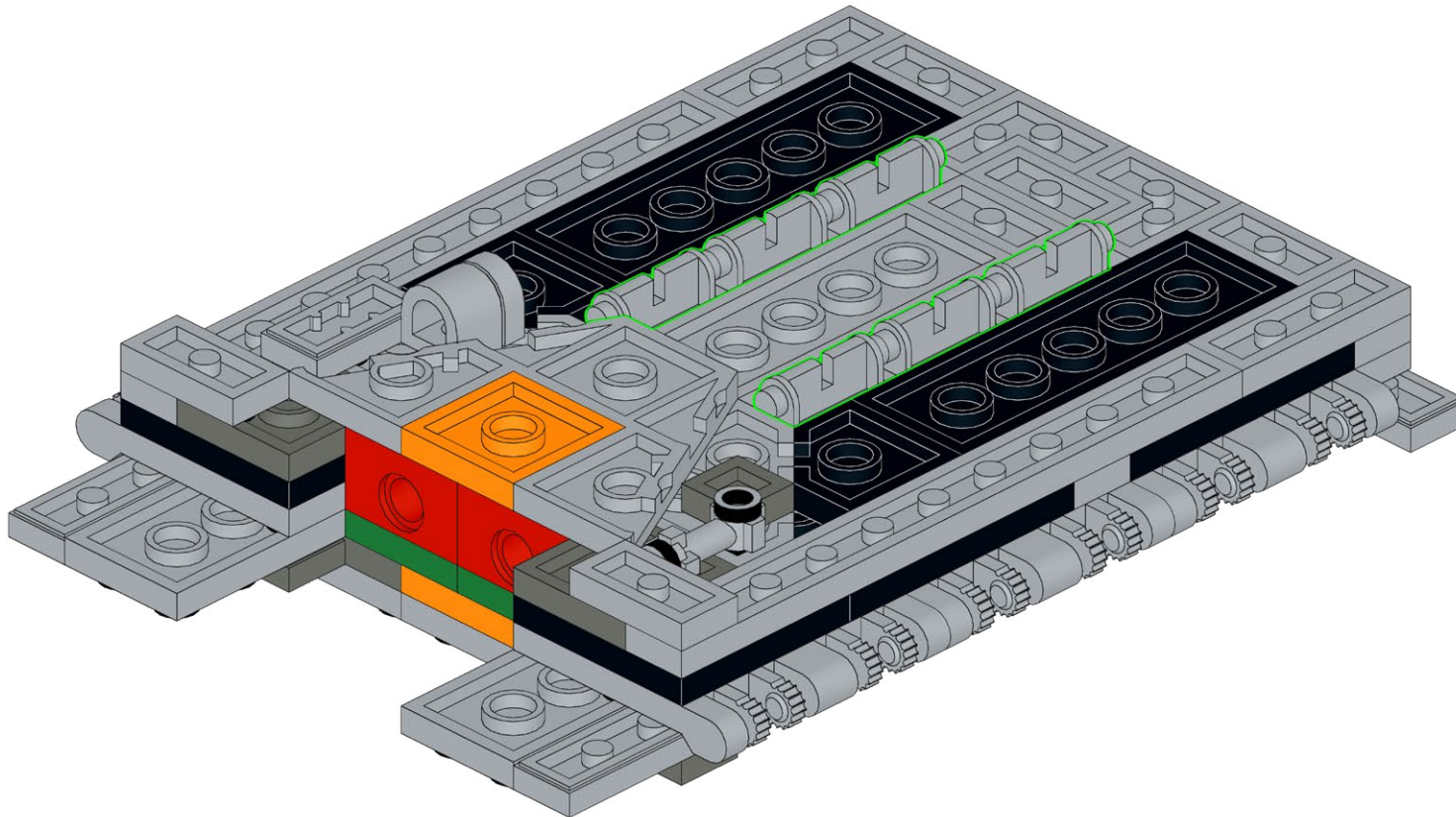

**370**

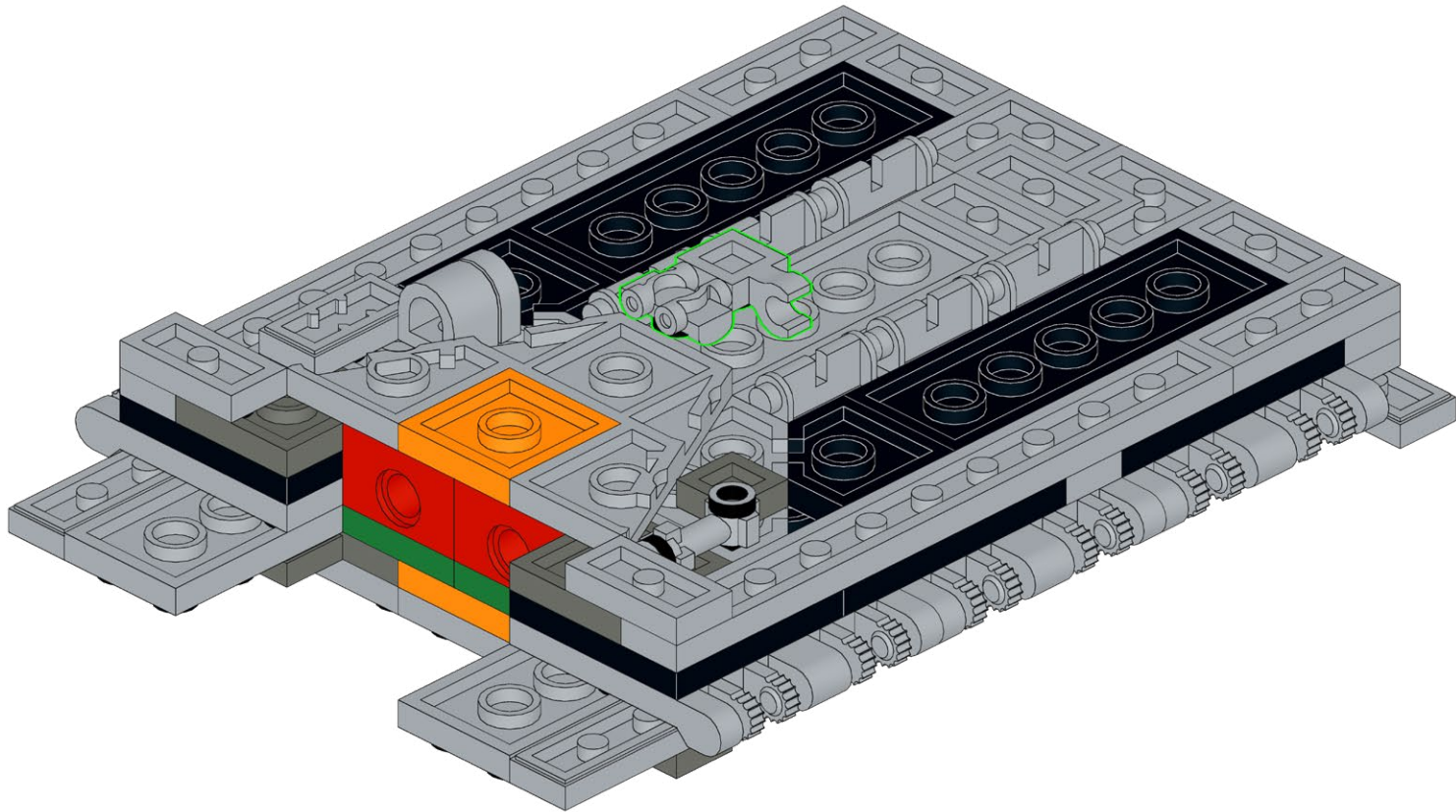
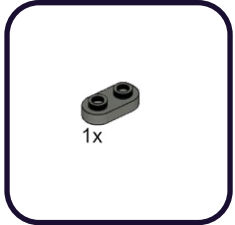

371

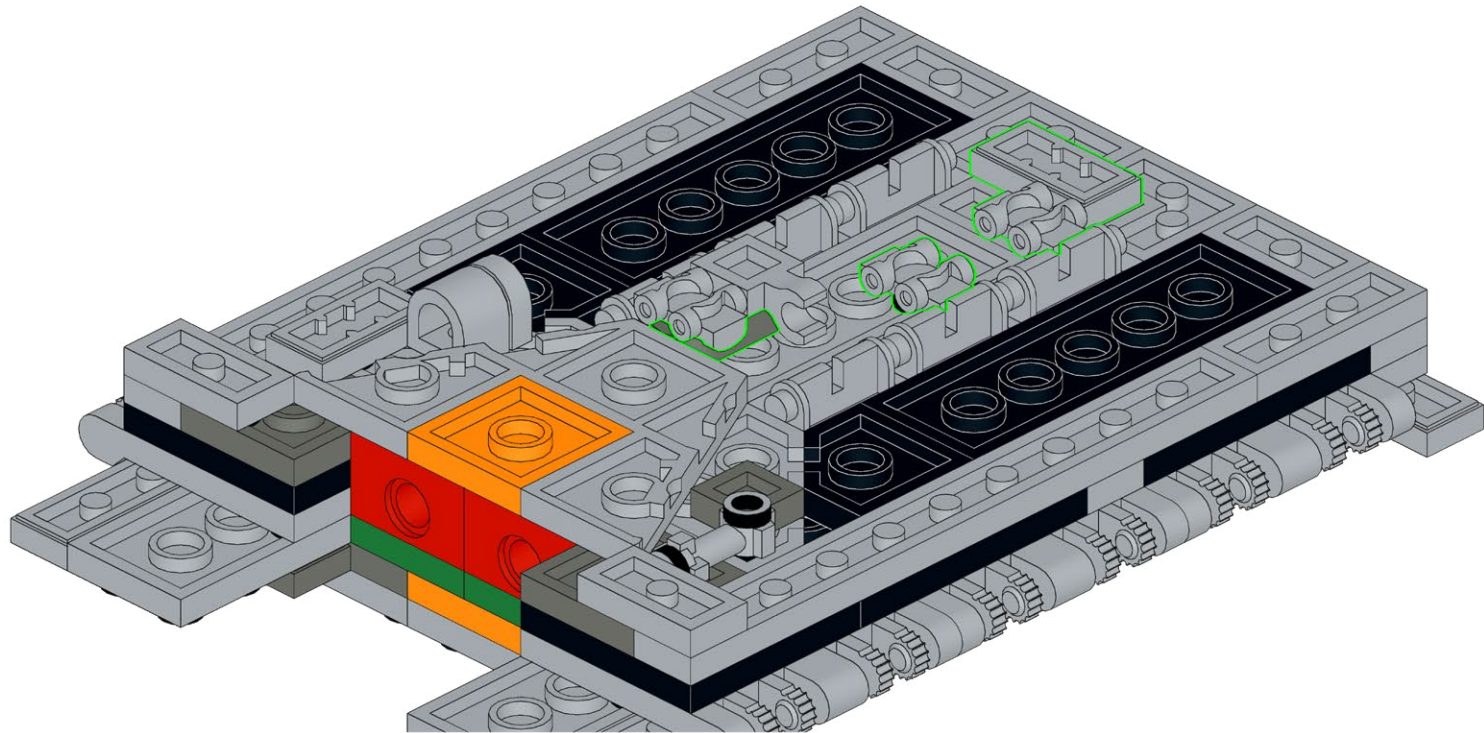
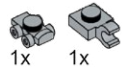



**372**

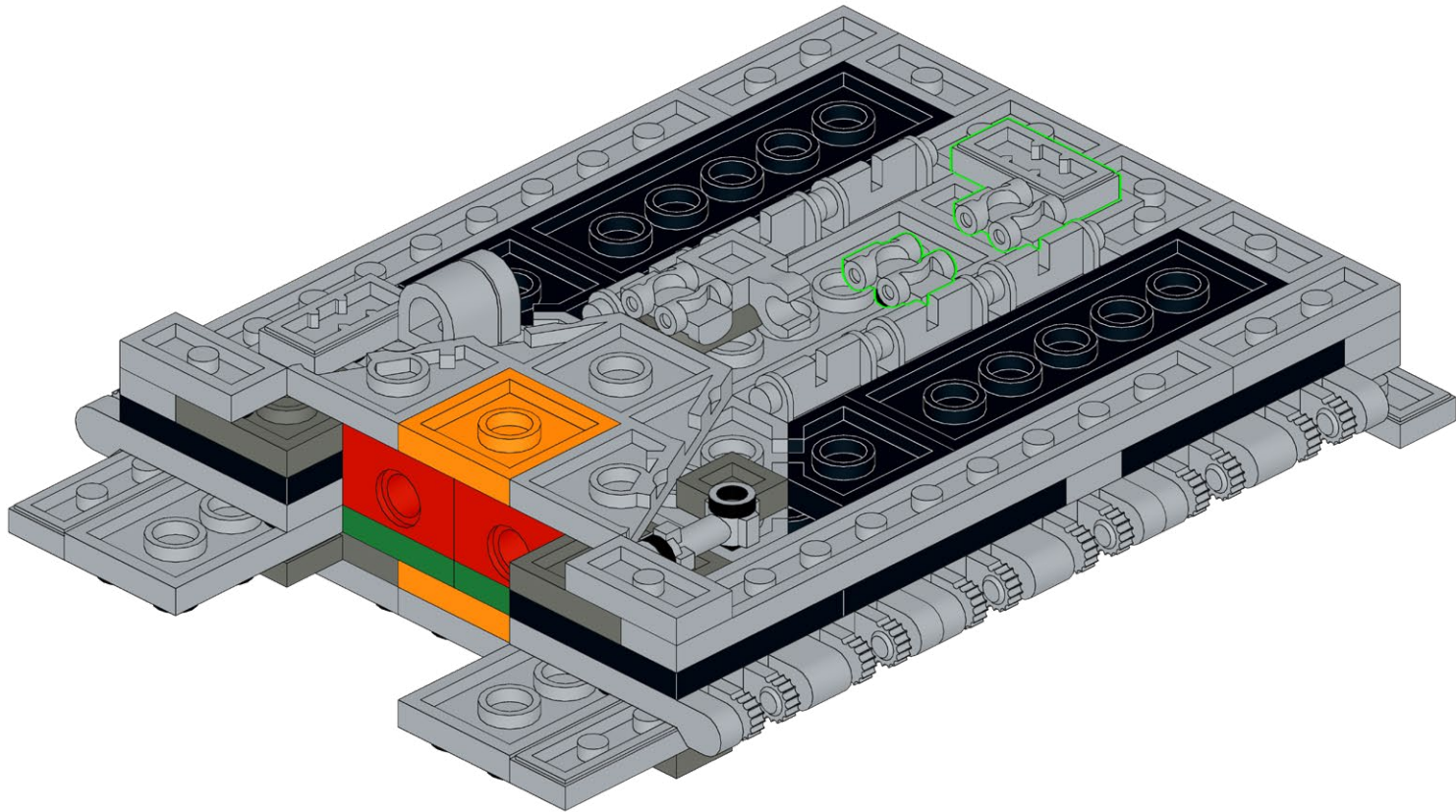
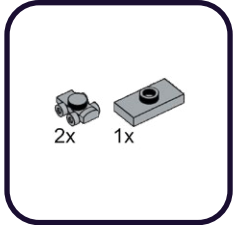

**373**

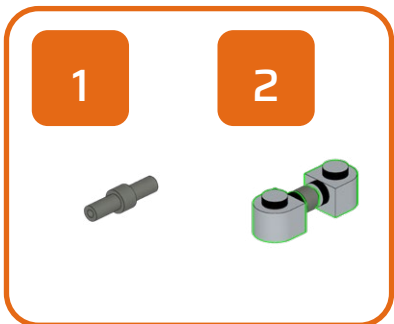
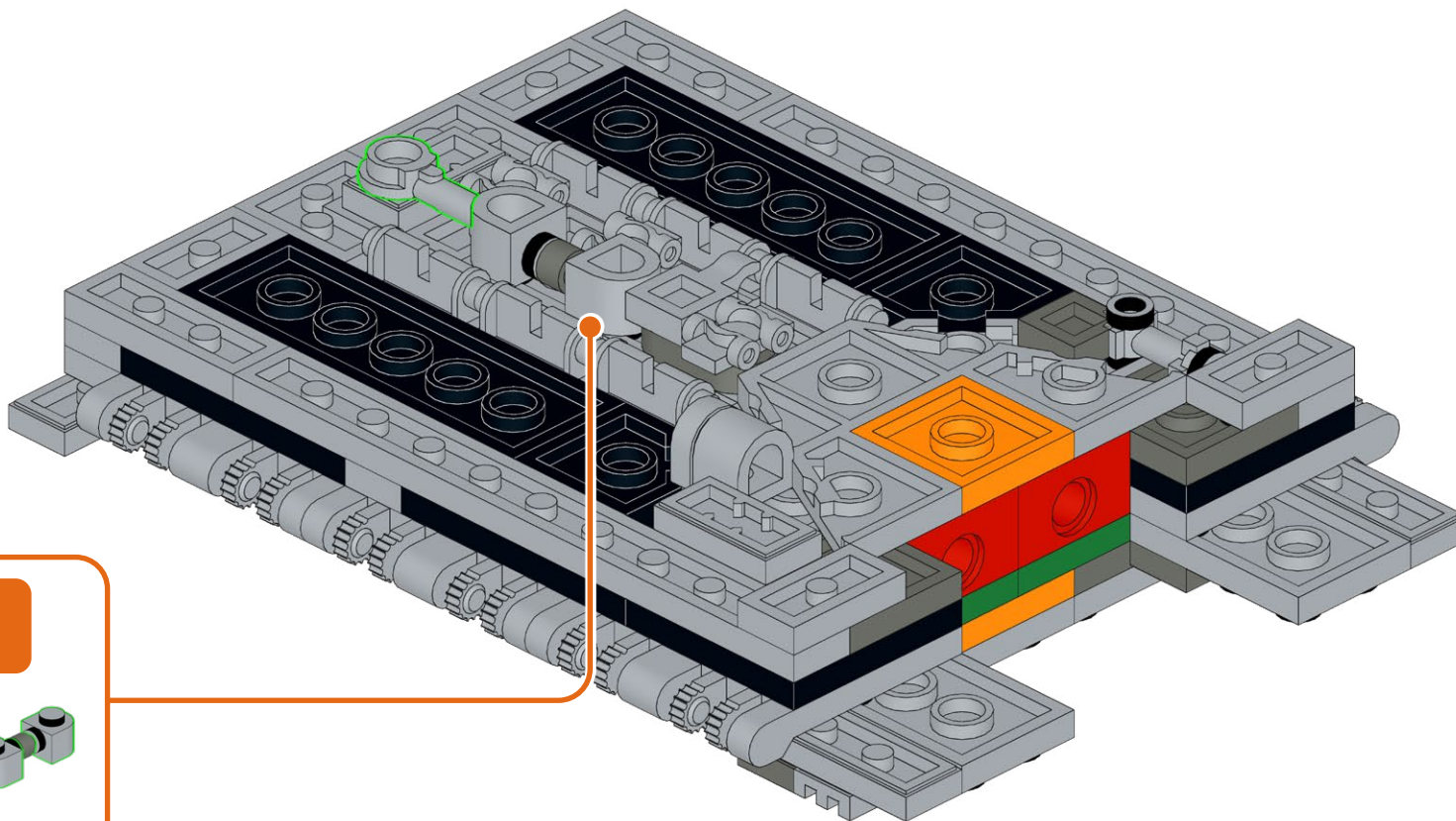
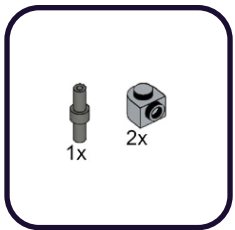

**374**

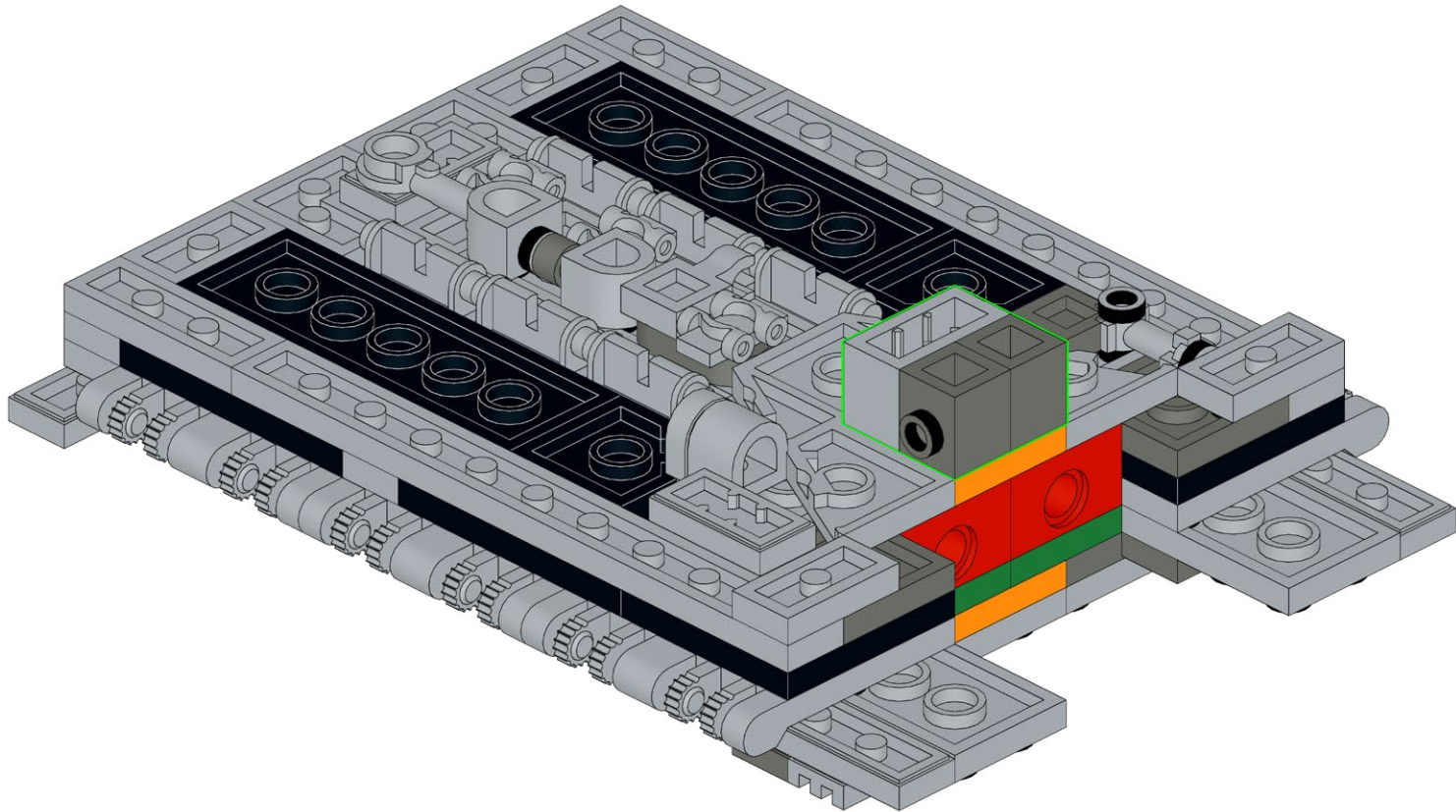
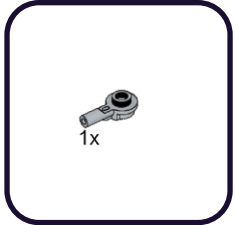



**375**

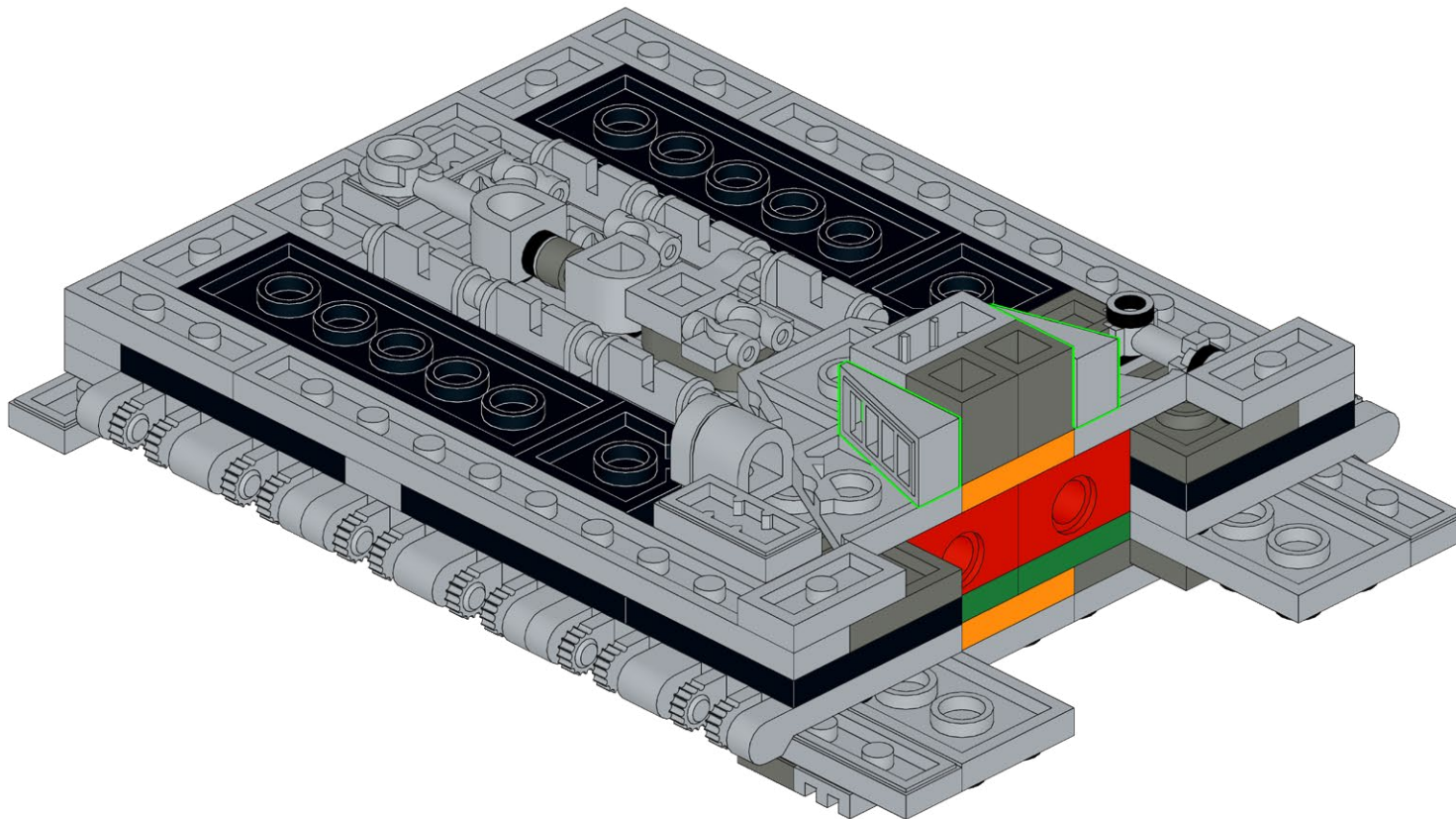
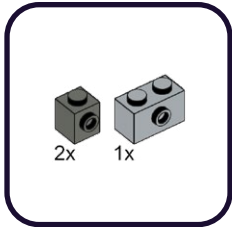

376

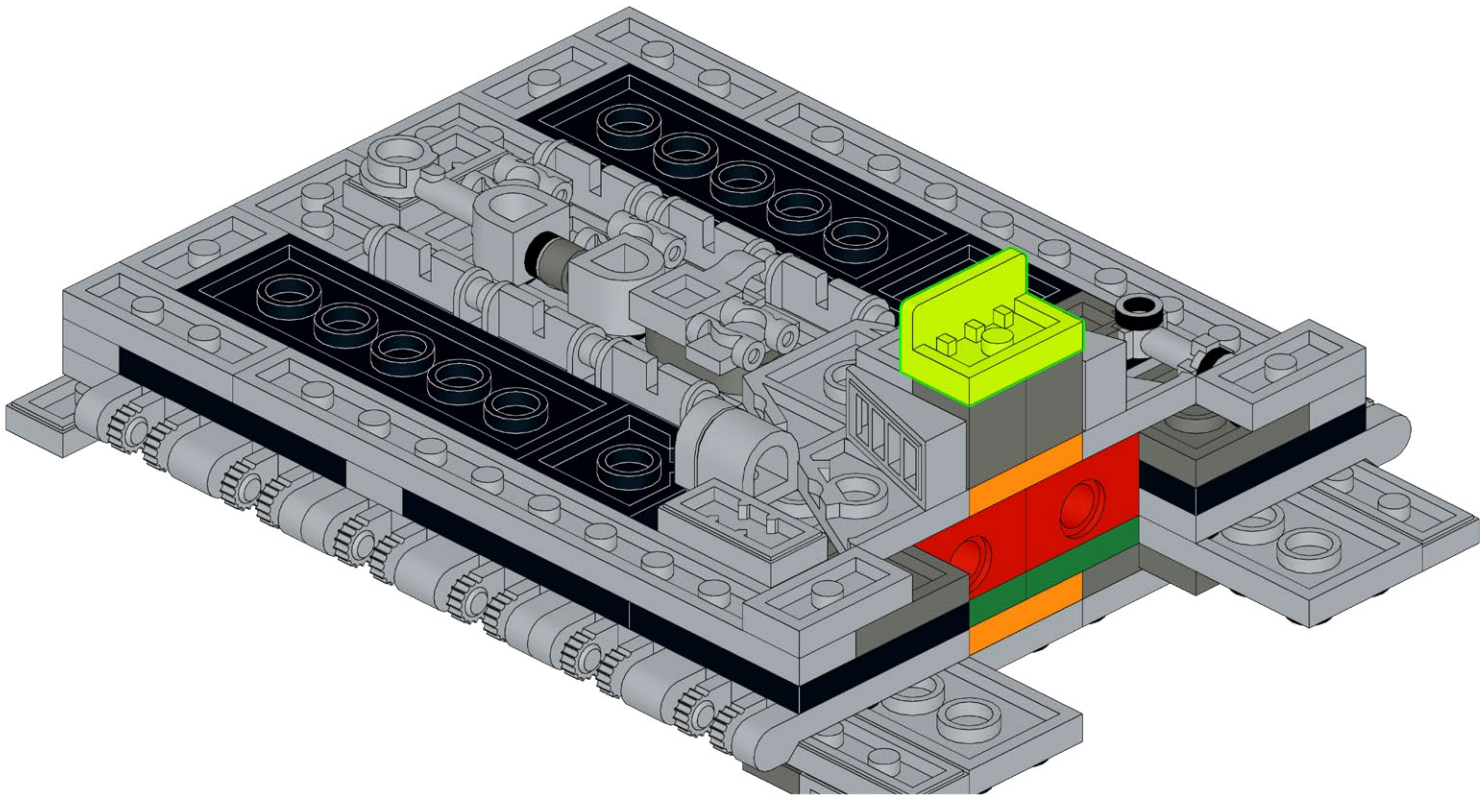
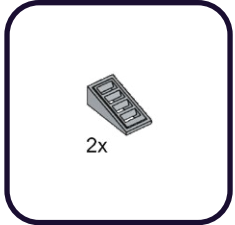

377



1x

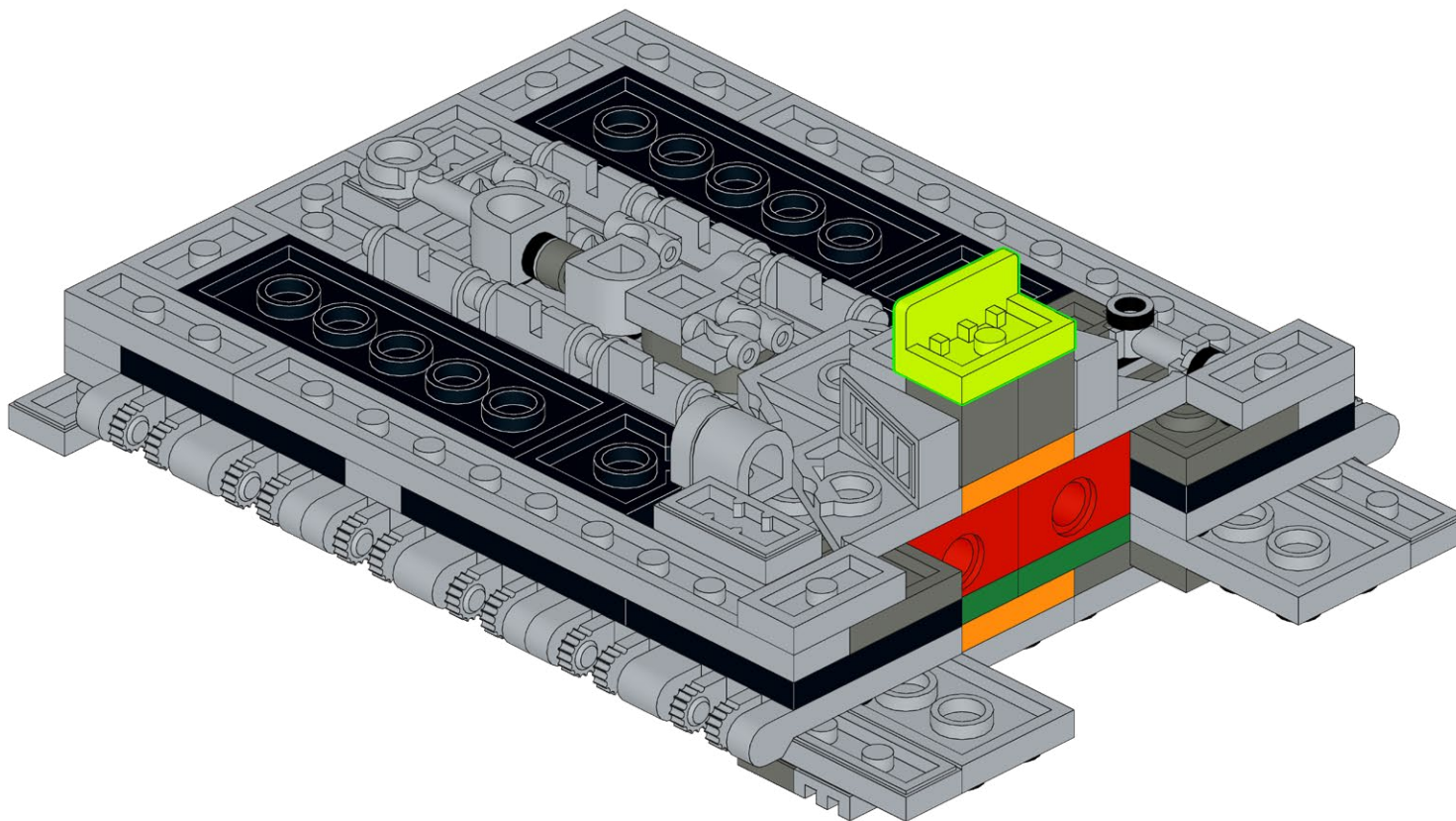



**378**

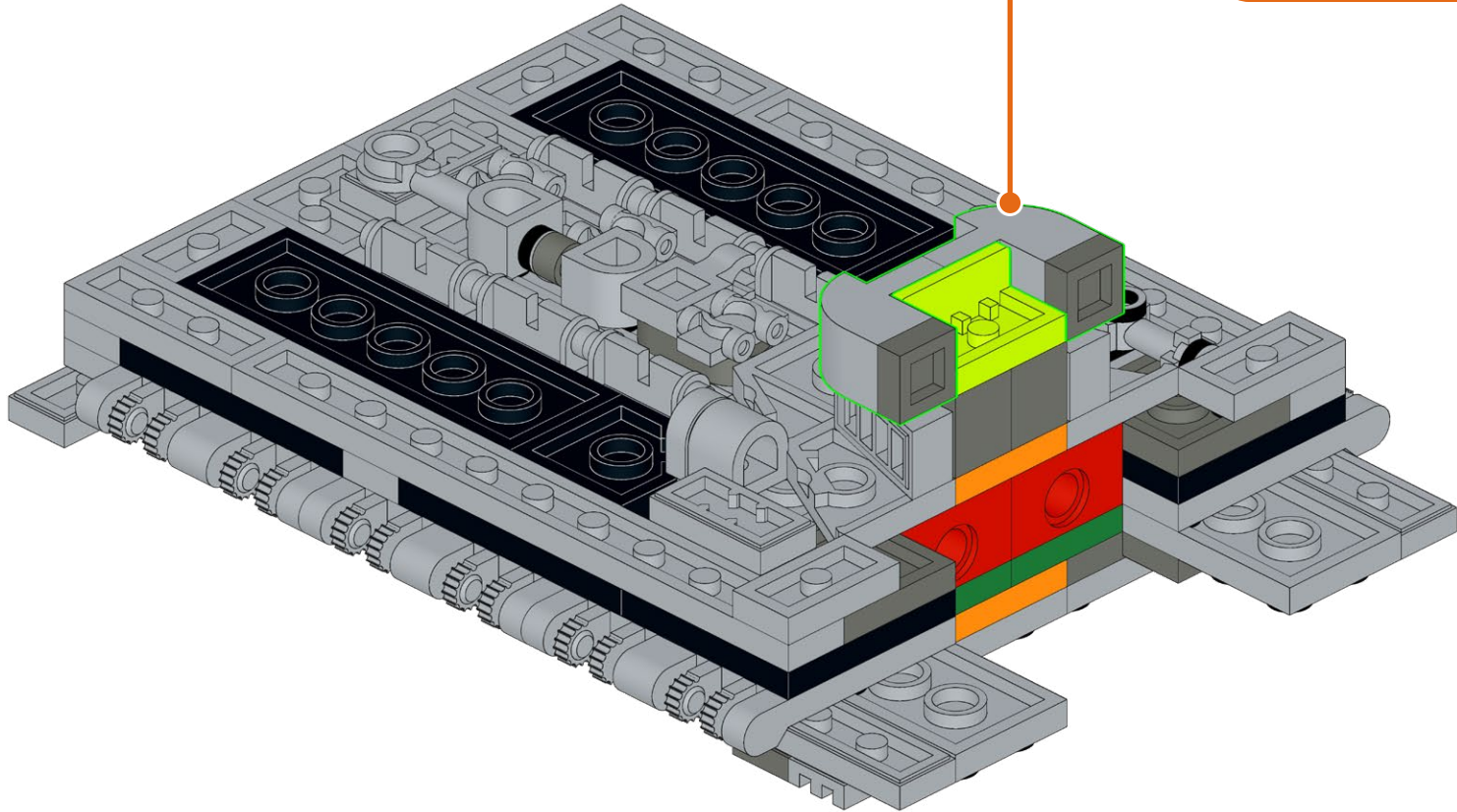
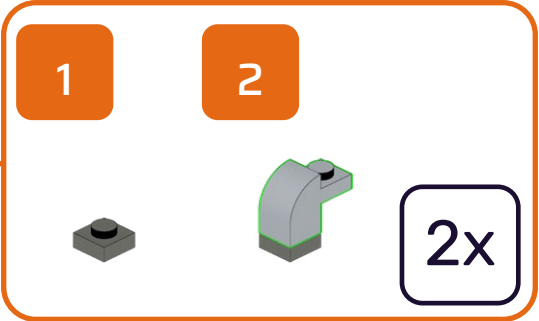
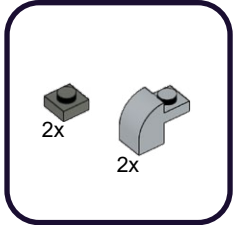

379

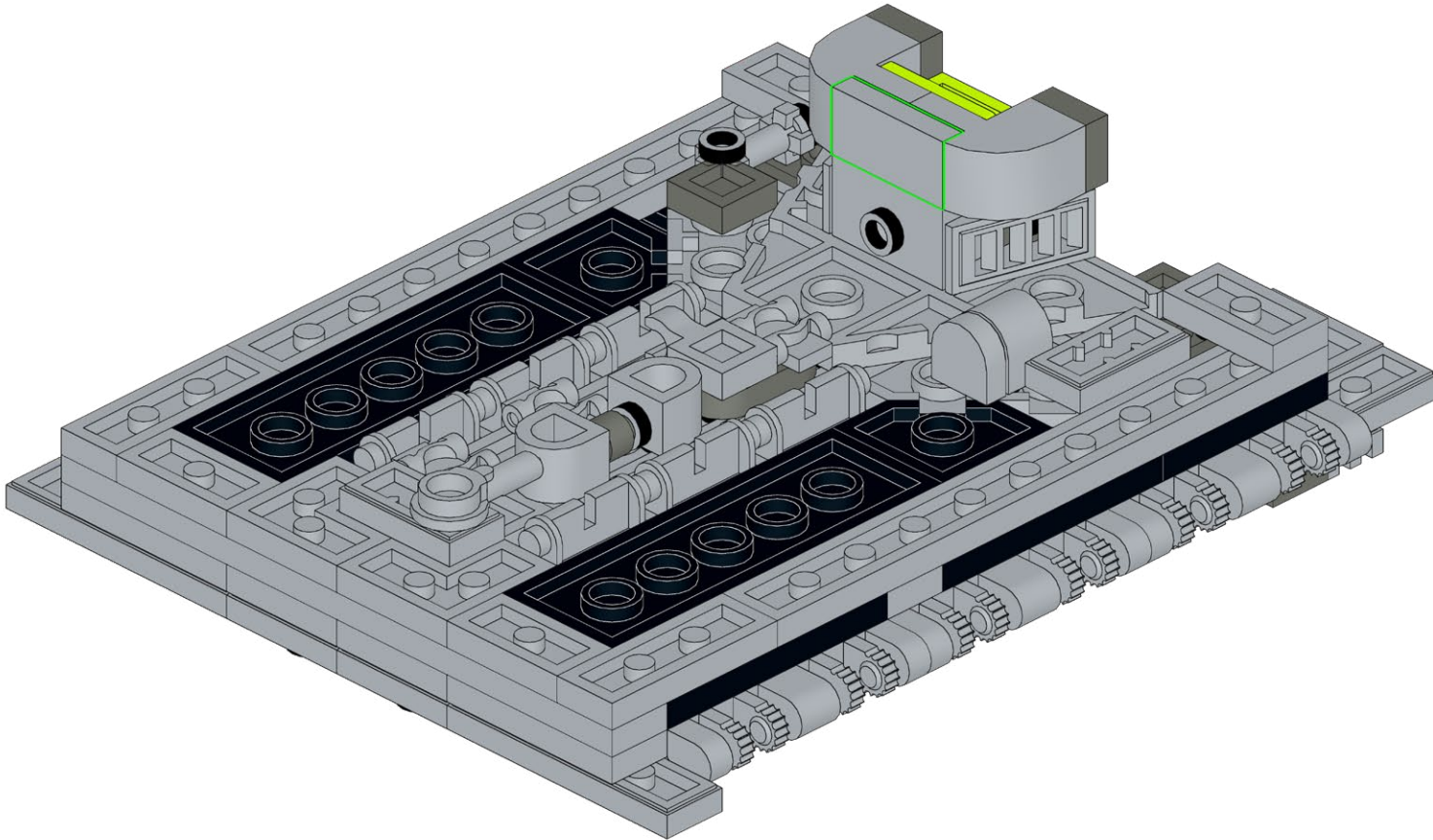
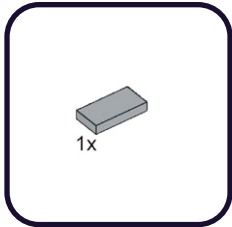

**380**

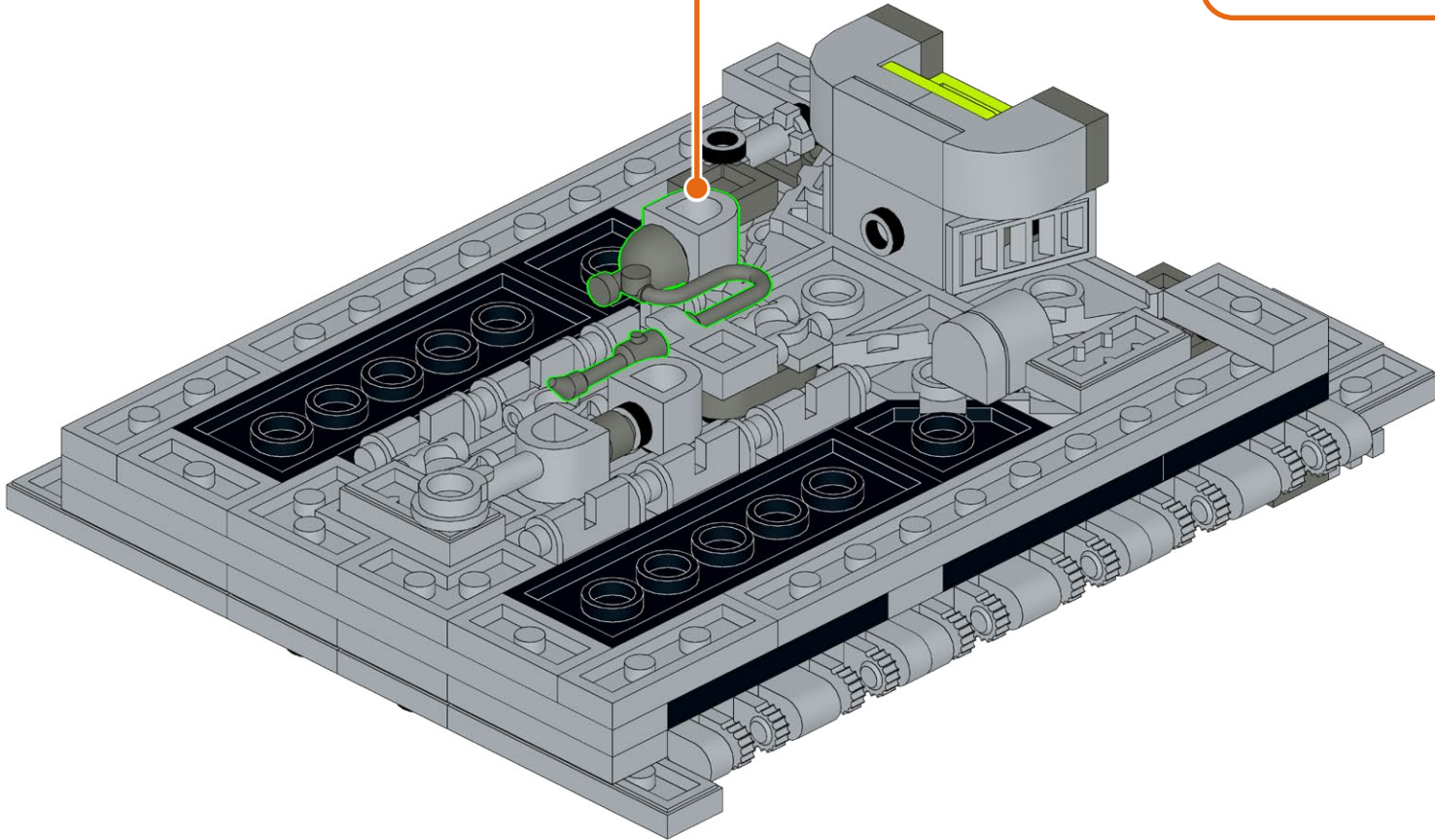
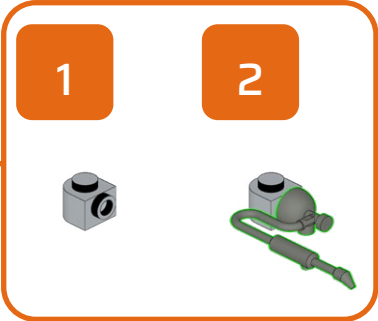
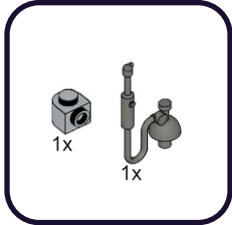

381

1x

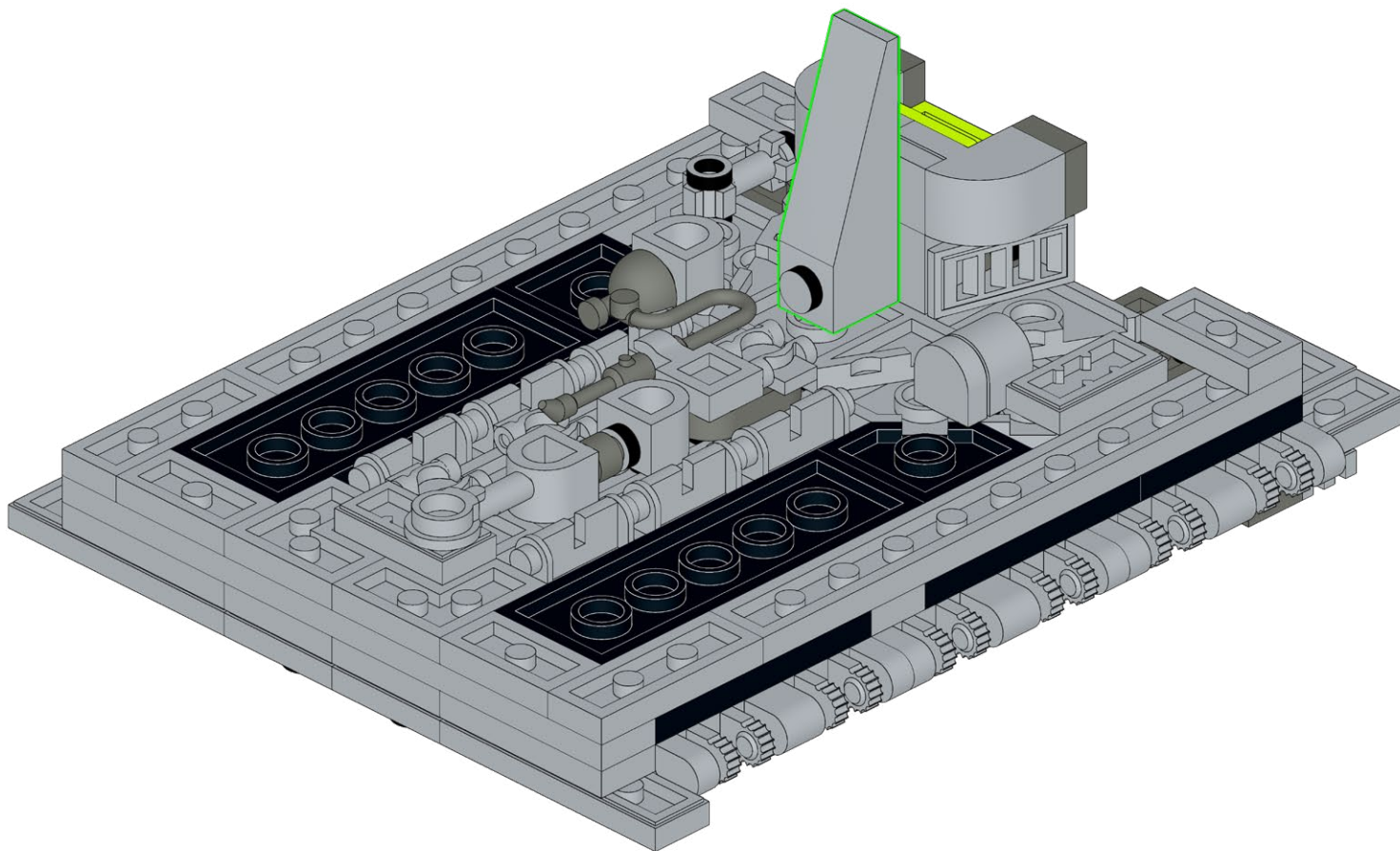



382

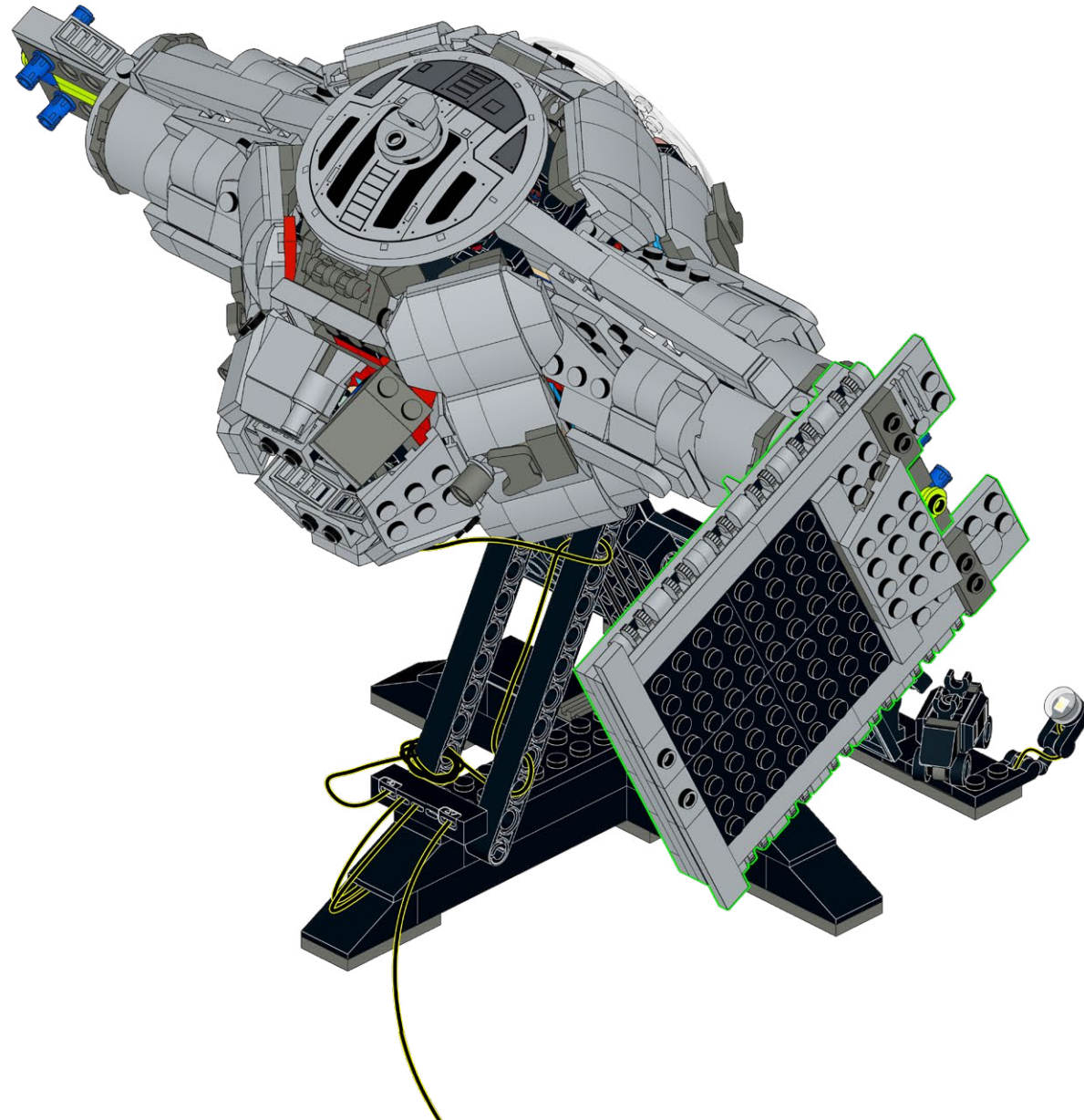

**HOLD UP!**

You might notice some bags are out of order, as well as left over pieces, but that's ok! We're changing the way you build LEGO!

**HALTEN!**

Möglicherweise stellen Sie fest, dass einige Beutel nicht in Ordnung sind und auch Teile übrig bleiben, aber das ist in Ordnung! Wir verändern die Art und Weise, wie Sie LEGO bauen!

**TENIR BON!**

Vous remarquerez peut-être que certains sacs sont en panne, ainsi que des morceaux restants, mais ce n'est pas grave ! Nous changeons la façon dont vous construisez LEGO !

**SOSTENERE!**

Potresti notare che alcune borse sono fuori uso, così come alcuni pezzi avanzati, ma va bene! Stiamo cambiando il modo in cui costruisci i LEGO!

**¡SOSTENER!**

Puede que notes que algunas bolsas están fuera de orden, así como piezas sobrantes, ¡pero está bien! ¡Estamos cambiando la forma de construir LEGO!

**耽误!**

您可能会注意到有些袋子坏了, 还有剩余的碎片, 但这没关系! 我们正在改变您搭建乐高的方式!

**Open LEGO® Bag 1**



# 383

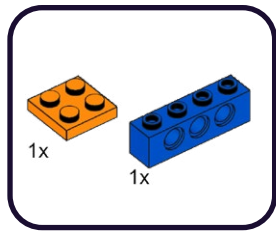

1



2

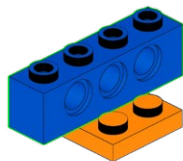

# 384

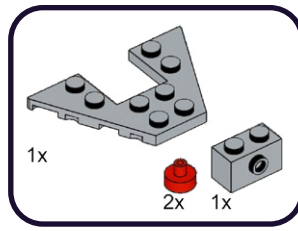

1

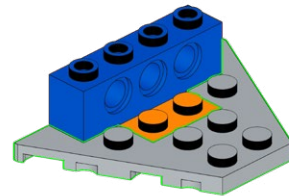

2

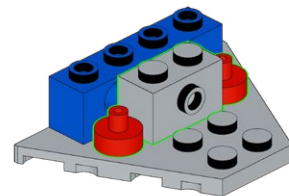

385

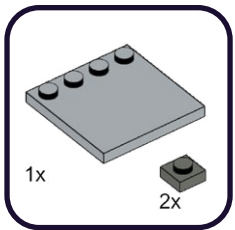

1

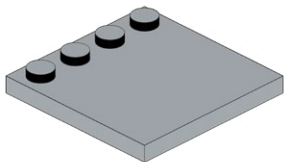

2

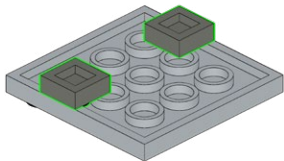

386

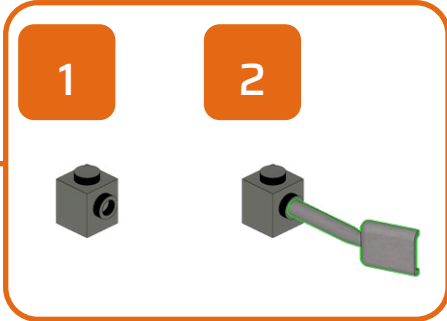
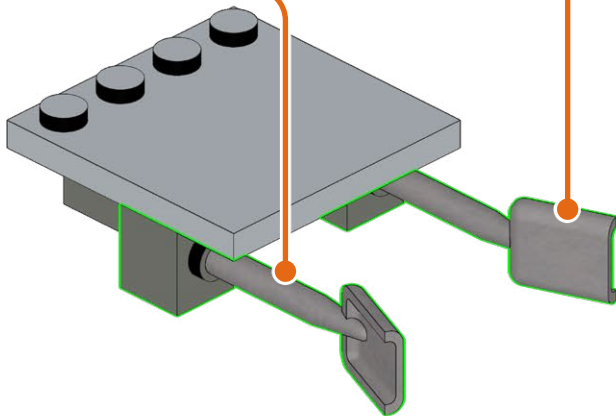
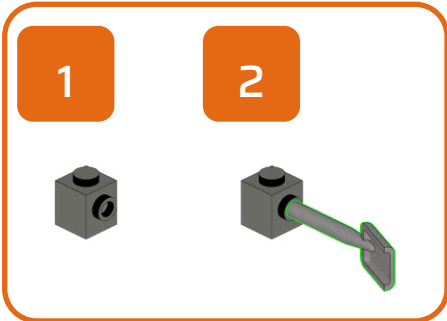
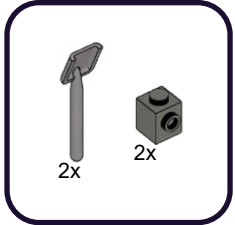

# 387

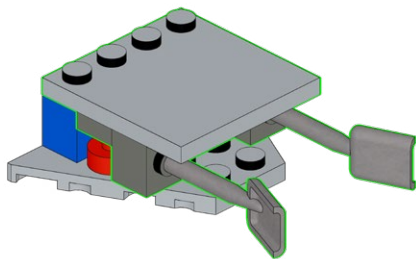
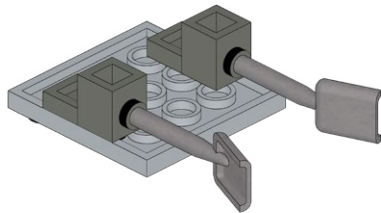

# 388

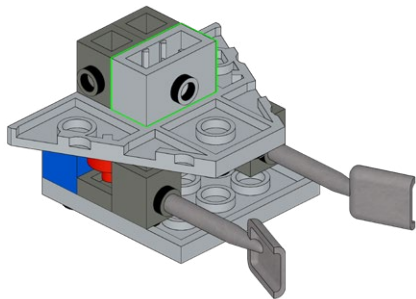
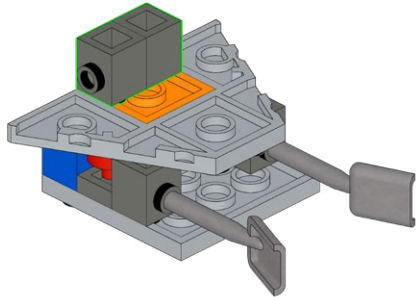
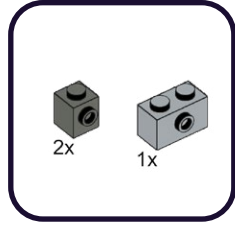

**389**

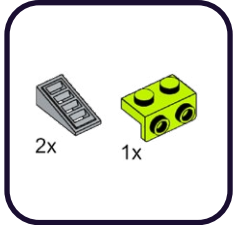

1

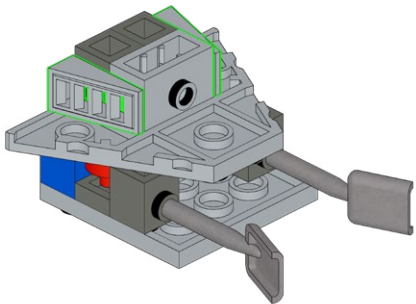

2

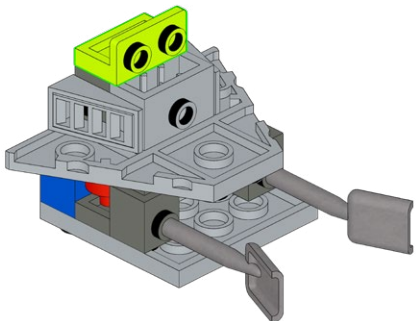

**390**

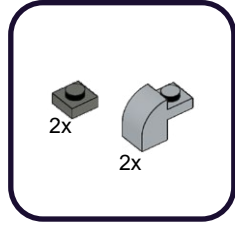

1

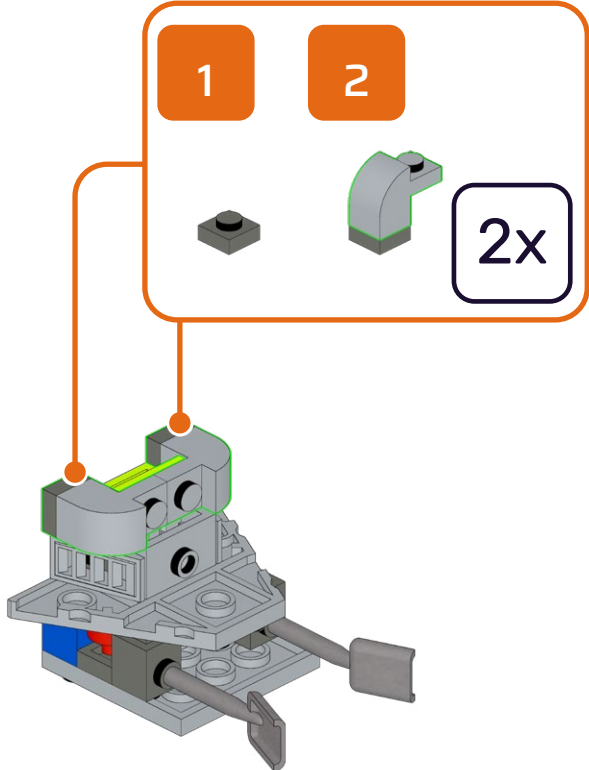

**391**

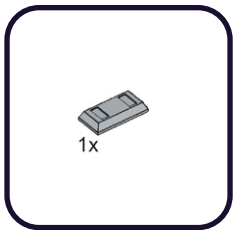

**1**

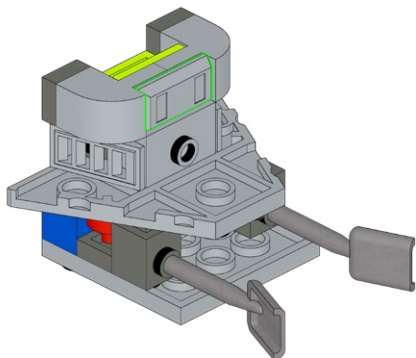

**392**

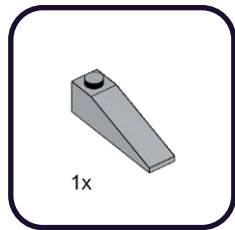

**1**

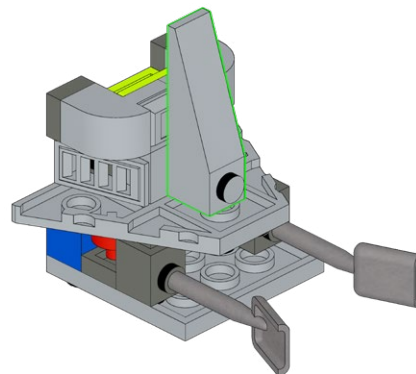



393

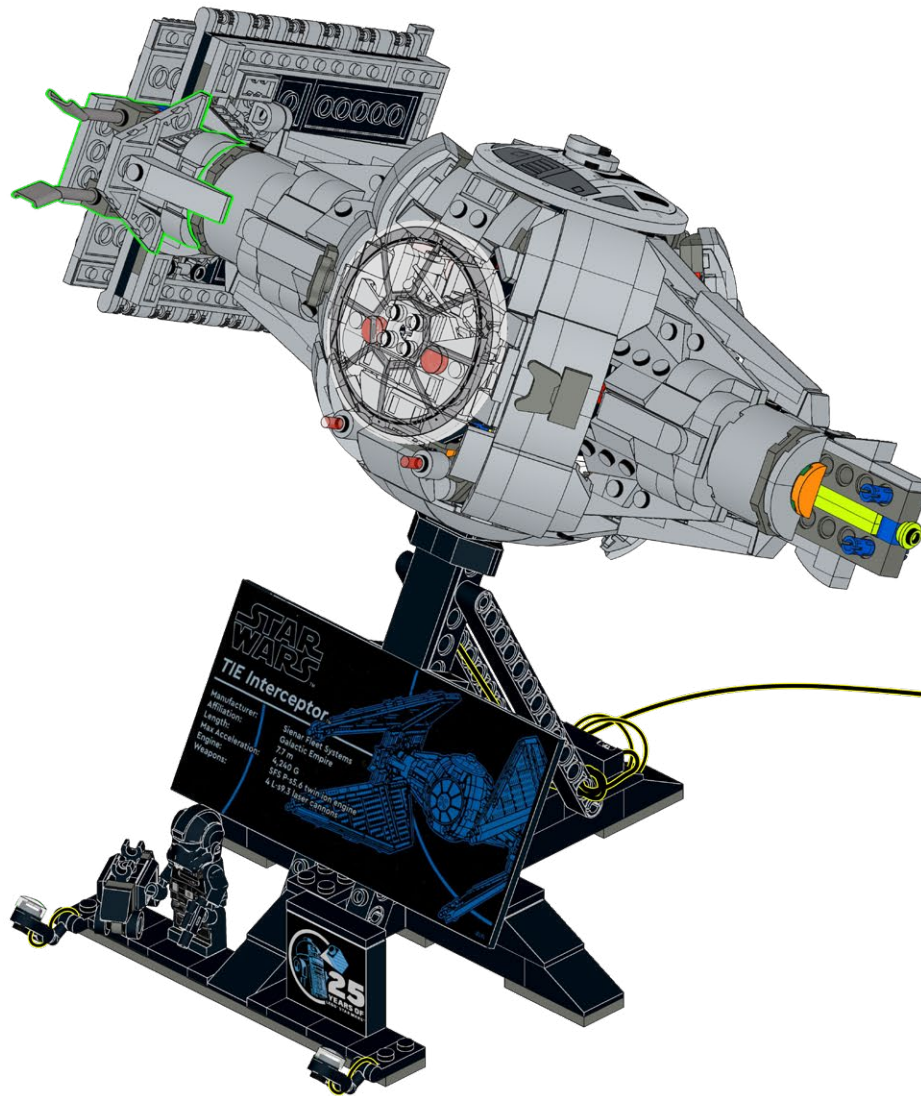

394

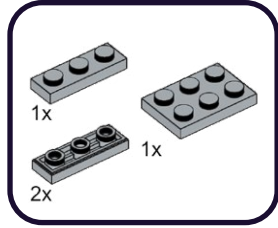

1

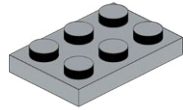

2

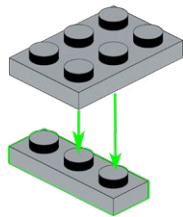

3

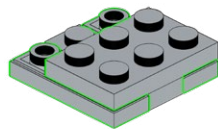

395

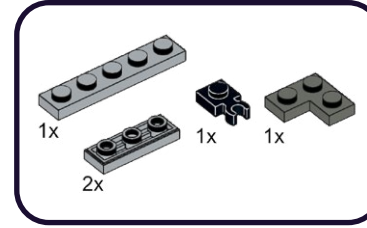

1

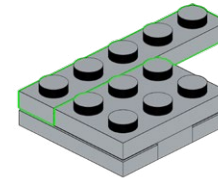

2

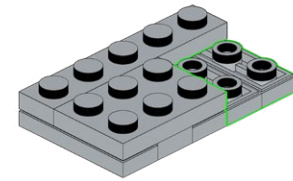

3

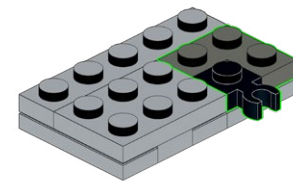

396

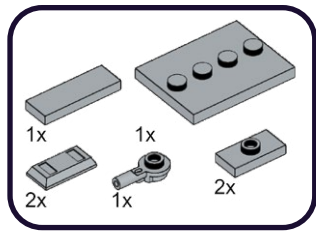

1

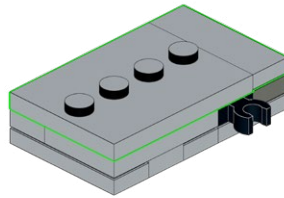

2

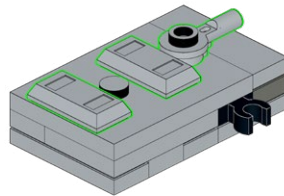

3

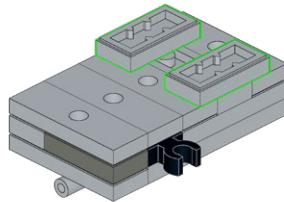

397



# 398

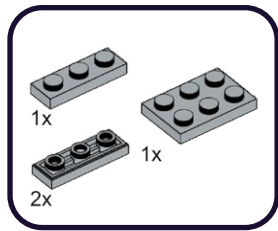

1

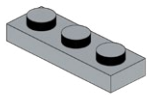

2

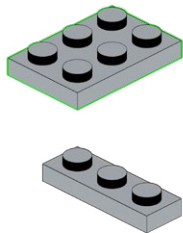

3

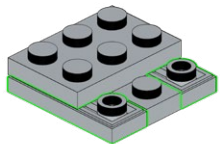

# 399

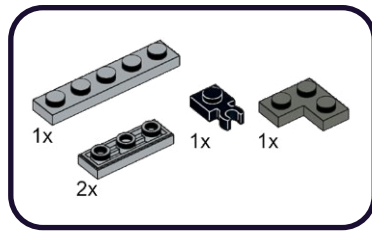

1

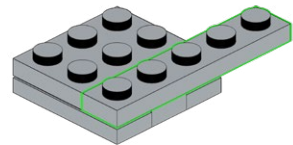

2

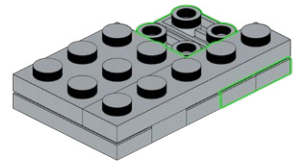

3

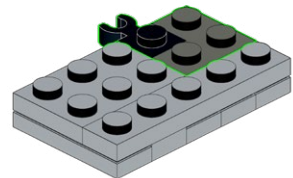

**400**

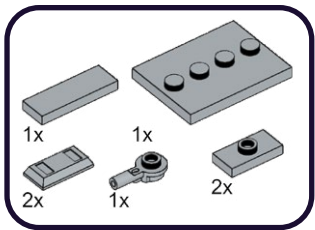

**1**

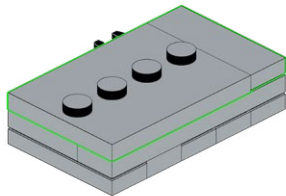

**2**

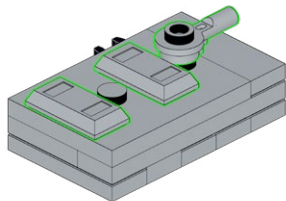

**3**

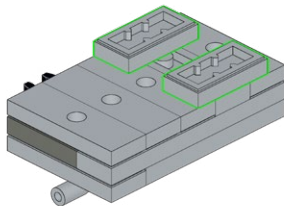



401

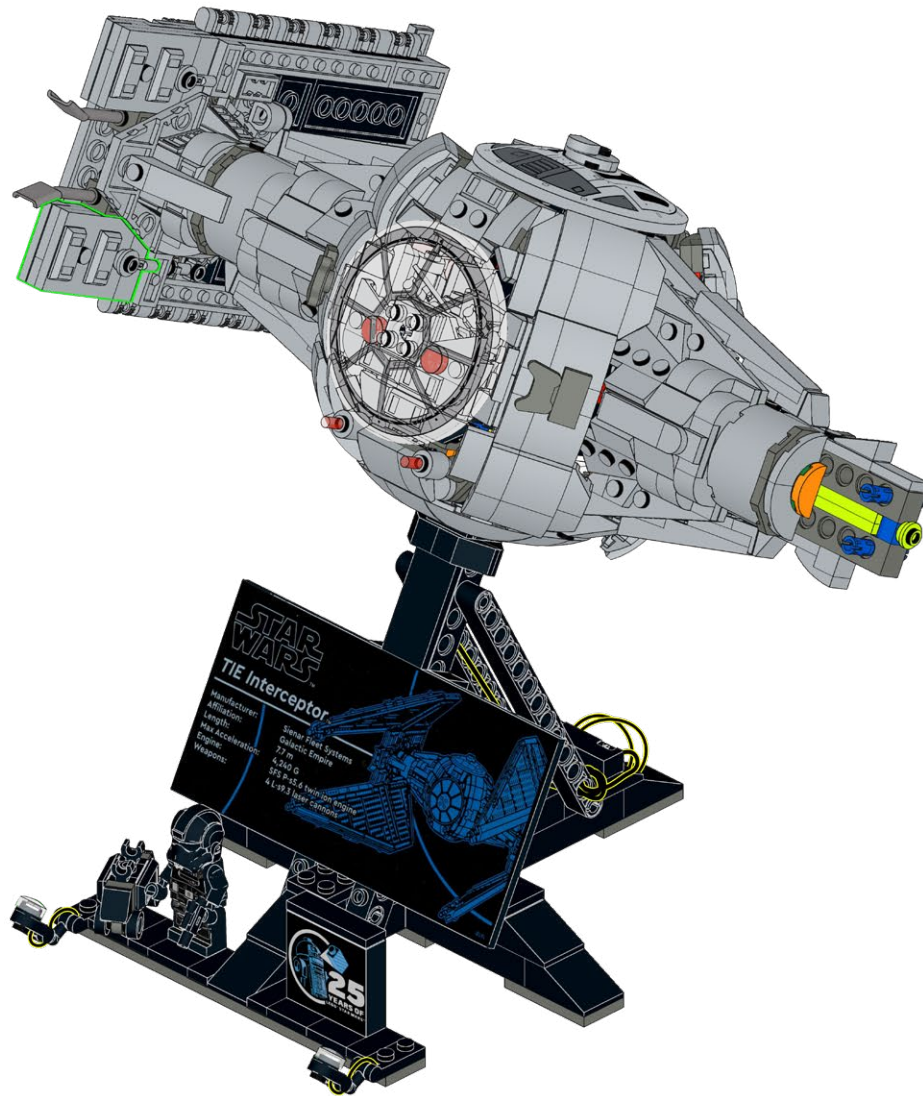

402

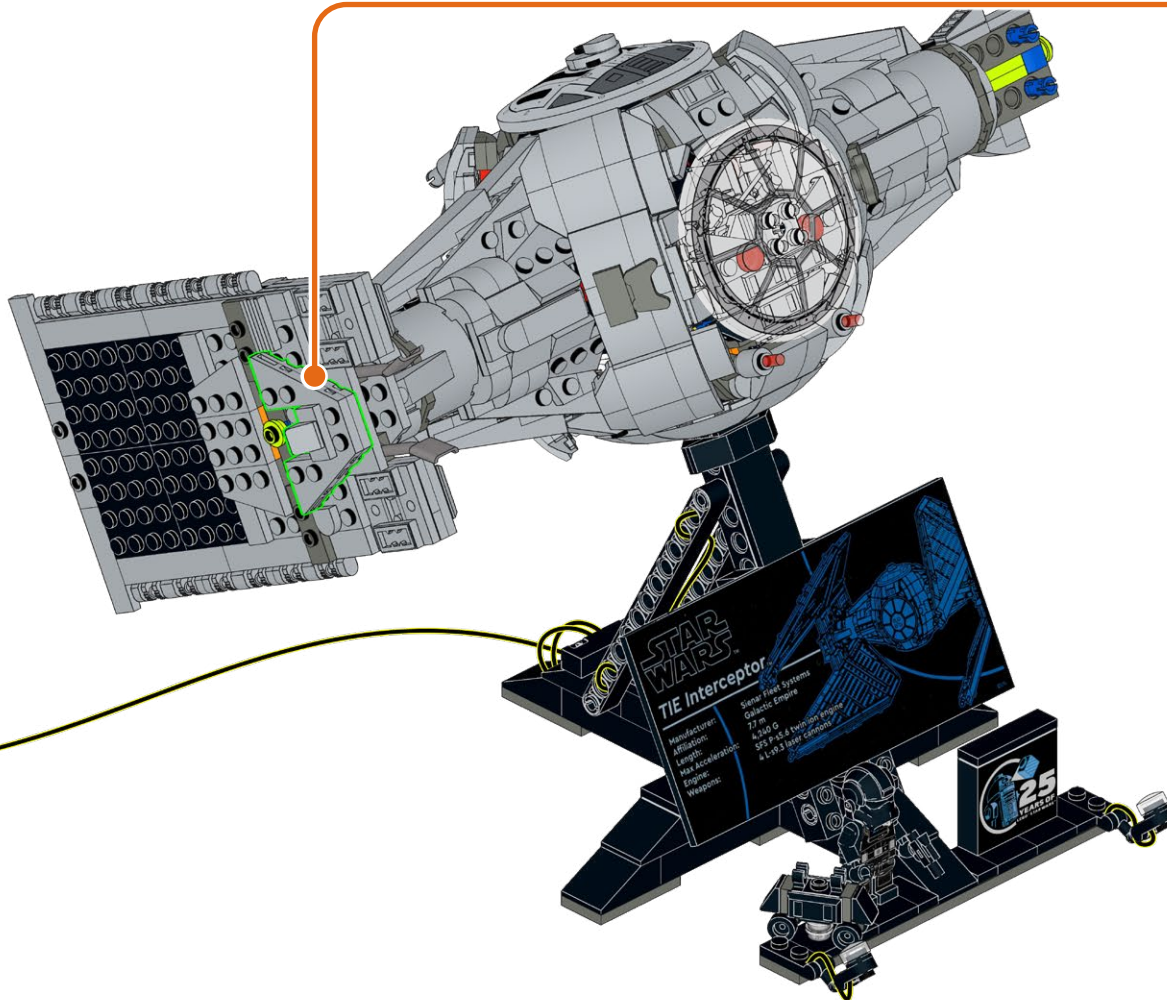
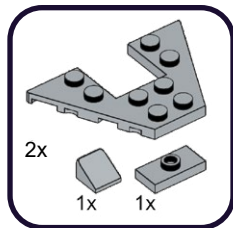

1

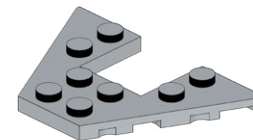

2

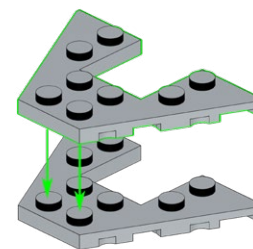

3

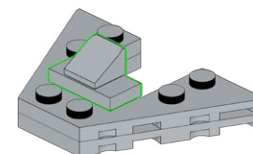

403

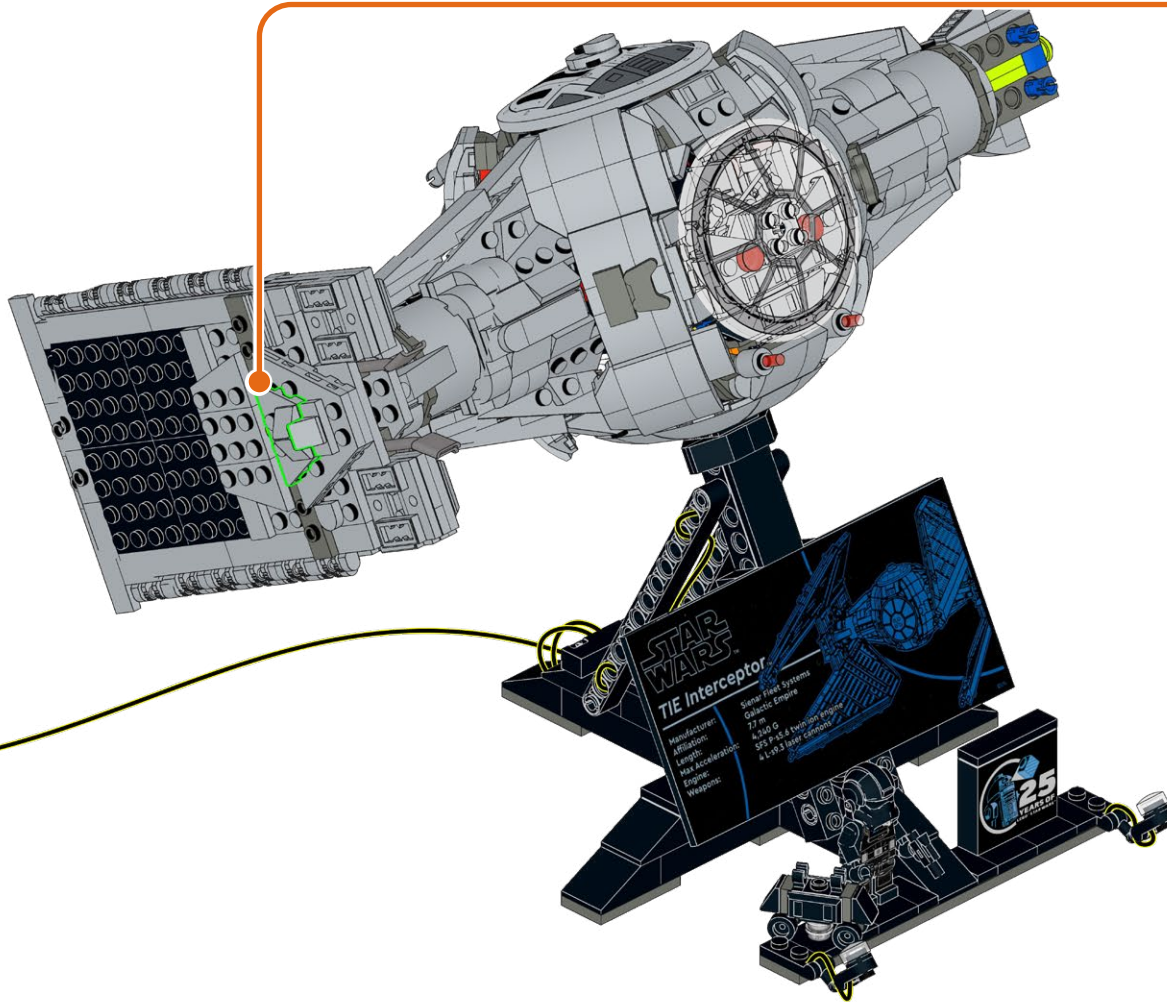
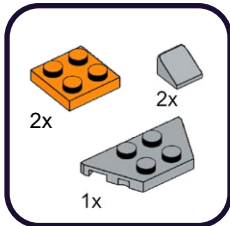

1

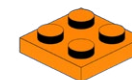

1

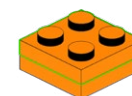

1

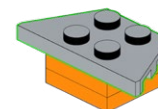

1

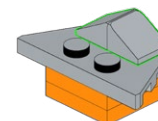

**HOLD UP!**

You might notice some bags are out of order, as well as left over pieces, but that's ok! We're changing the way you build LEGO!

**HALTEN!**

Möglicherweise stellen Sie fest, dass einige Beutel nicht in Ordnung sind und auch Teile übrig bleiben, aber das ist in Ordnung! Wir verändern die Art und Weise, wie Sie LEGO bauen!

**TENIR BON!**

Vous remarquerez peut-être que certains sacs sont en panne, ainsi que des morceaux restants, mais ce n'est pas grave ! Nous changeons la façon dont vous construisez LEGO !

**SOSTENERE!**

Potresti notare che alcune borse sono fuori uso, così come alcuni pezzi avanzati, ma va bene! Stiamo cambiando il modo in cui costruisci i LEGO!

**¡SOSTENER!**

Puede que notes que algunas bolsas están fuera de orden, así como piezas sobrantes, ¡pero está bien! ¡Estamos cambiando la forma de construir LEGO!

**耽误!**

您可能会注意到有些袋子坏了, 还有剩余的碎片, 但这没关系! 我们正在改变您搭建乐高的方式!

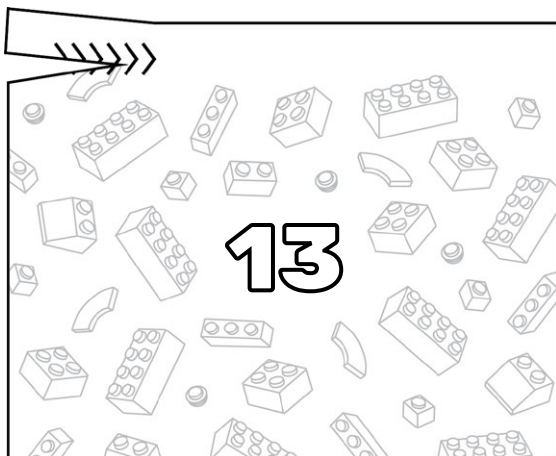
**Open LEGO® Bag 1**



404

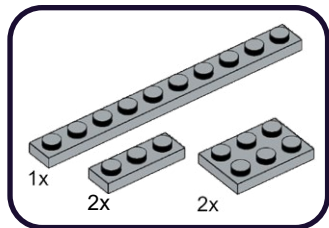

1

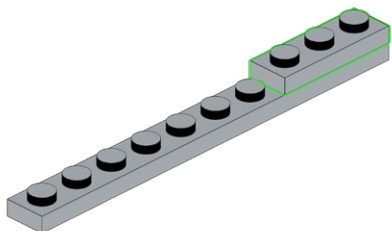

2

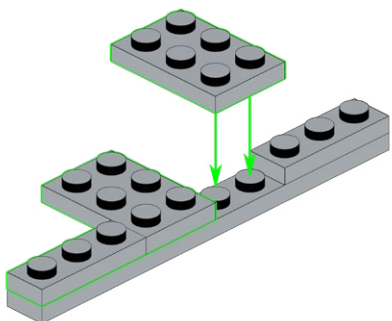

405

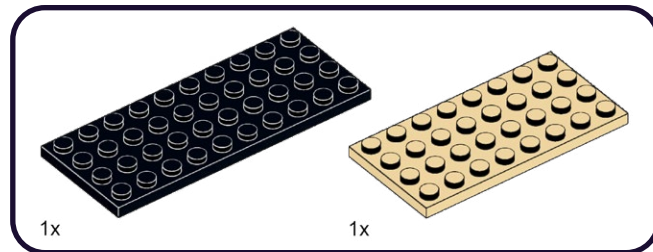

1

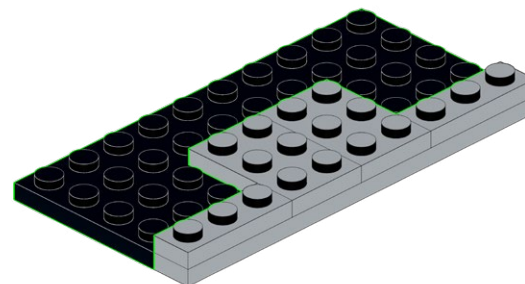

2

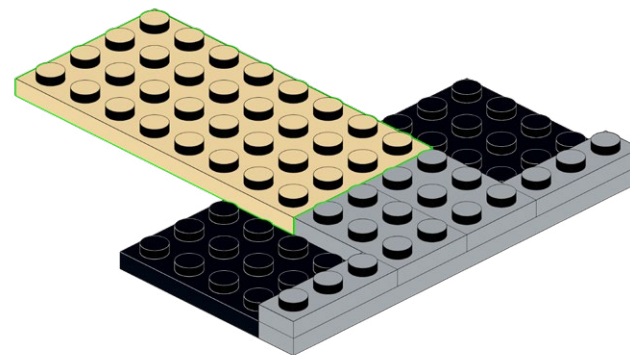

406

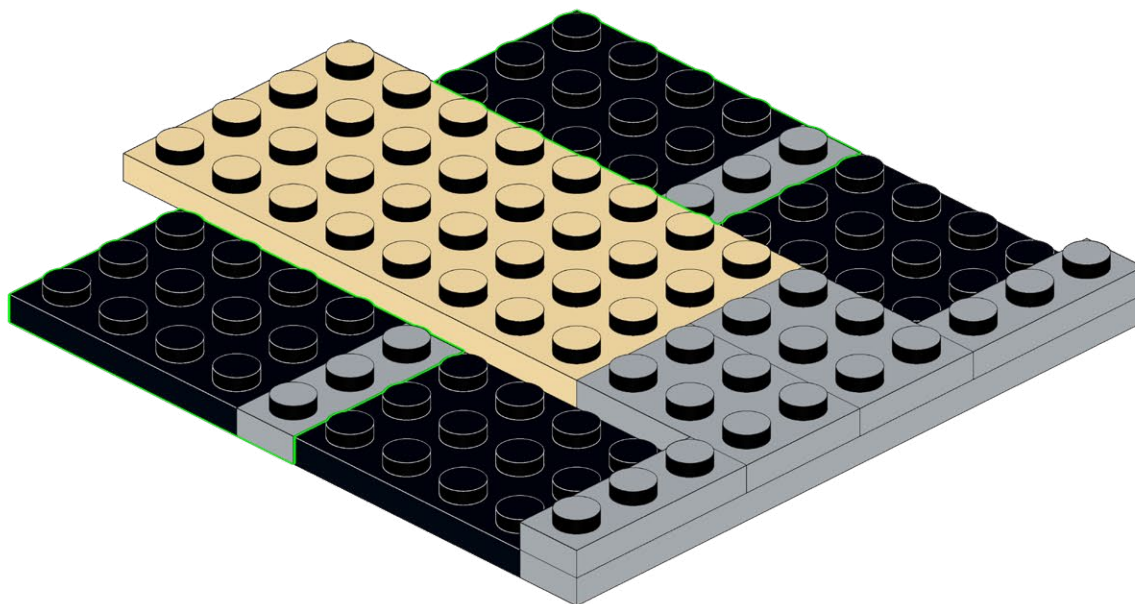
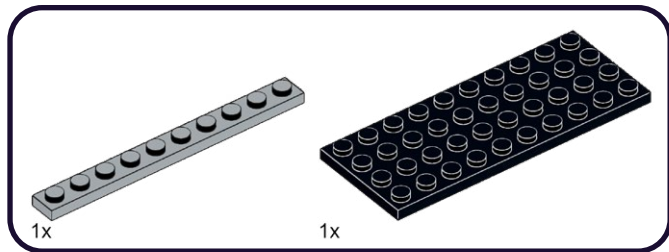



407

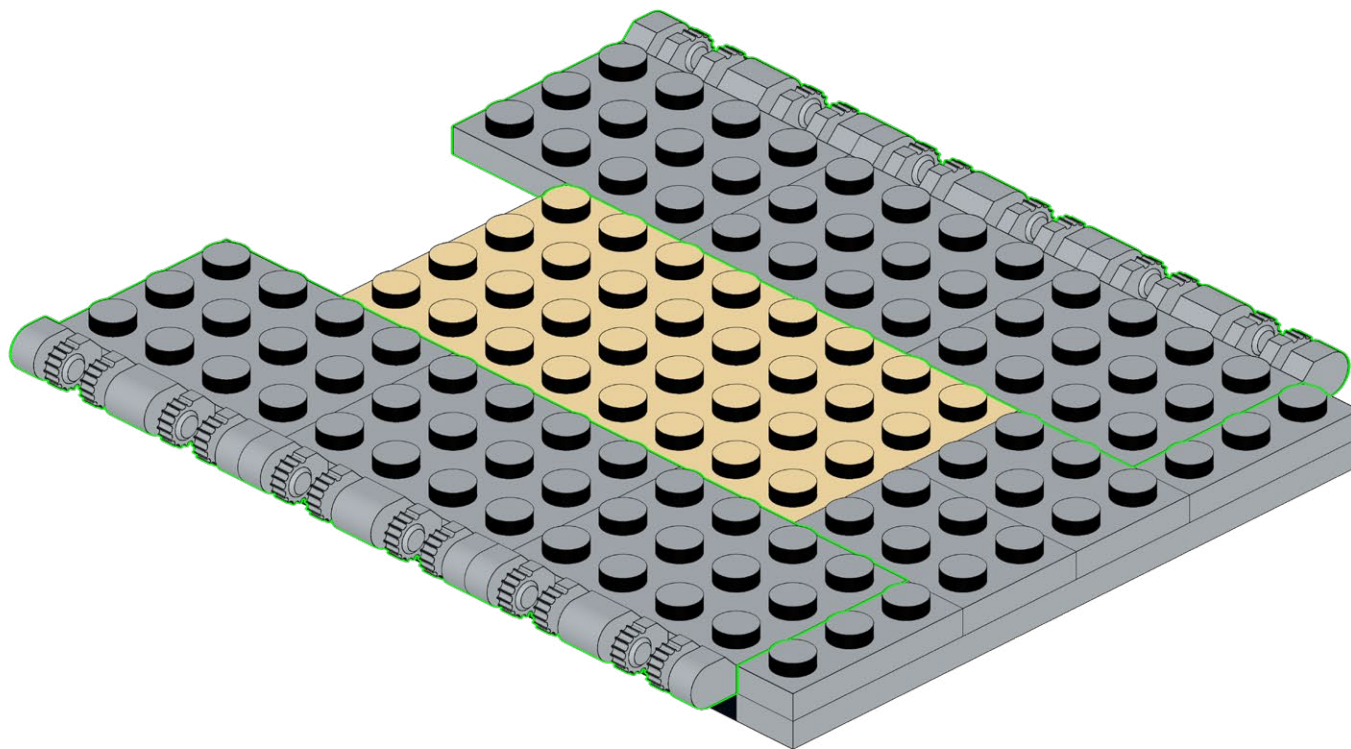
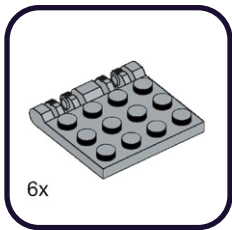

408

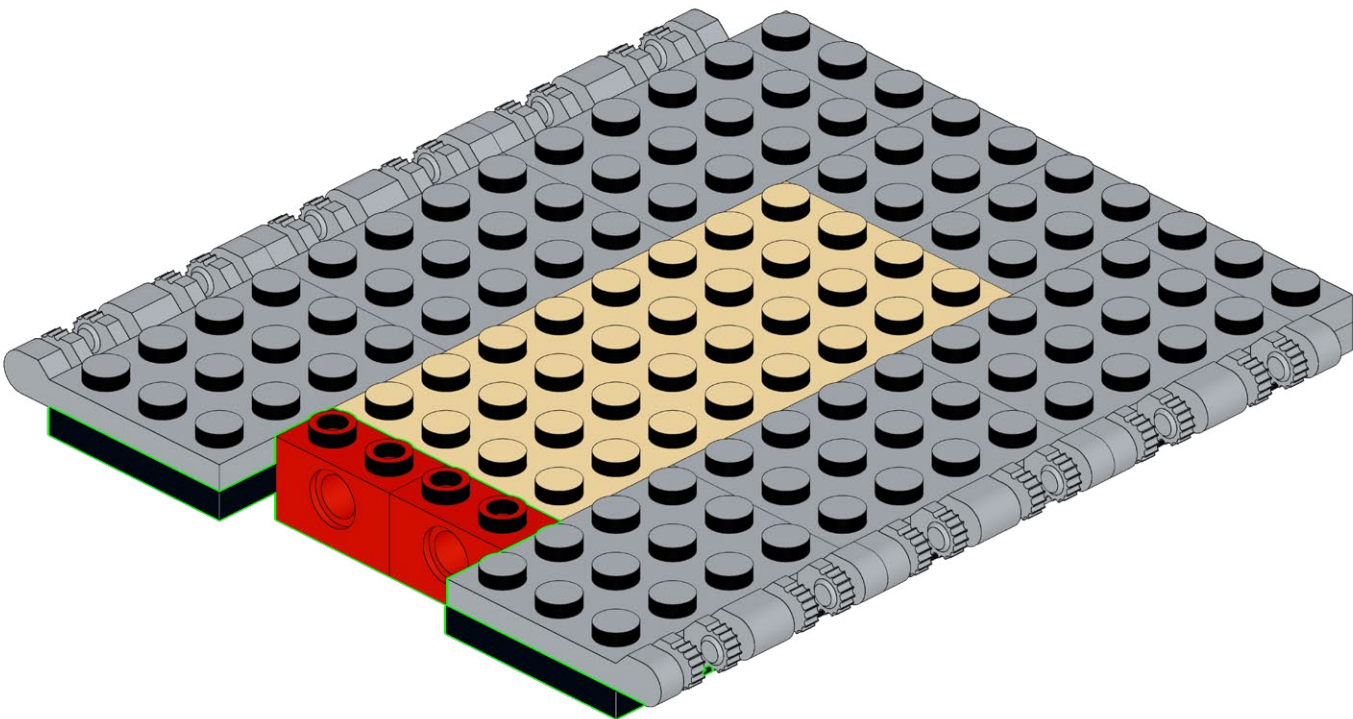
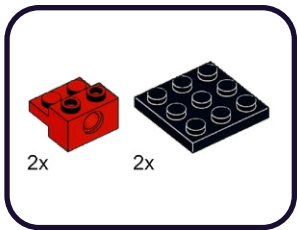
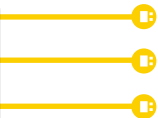

409

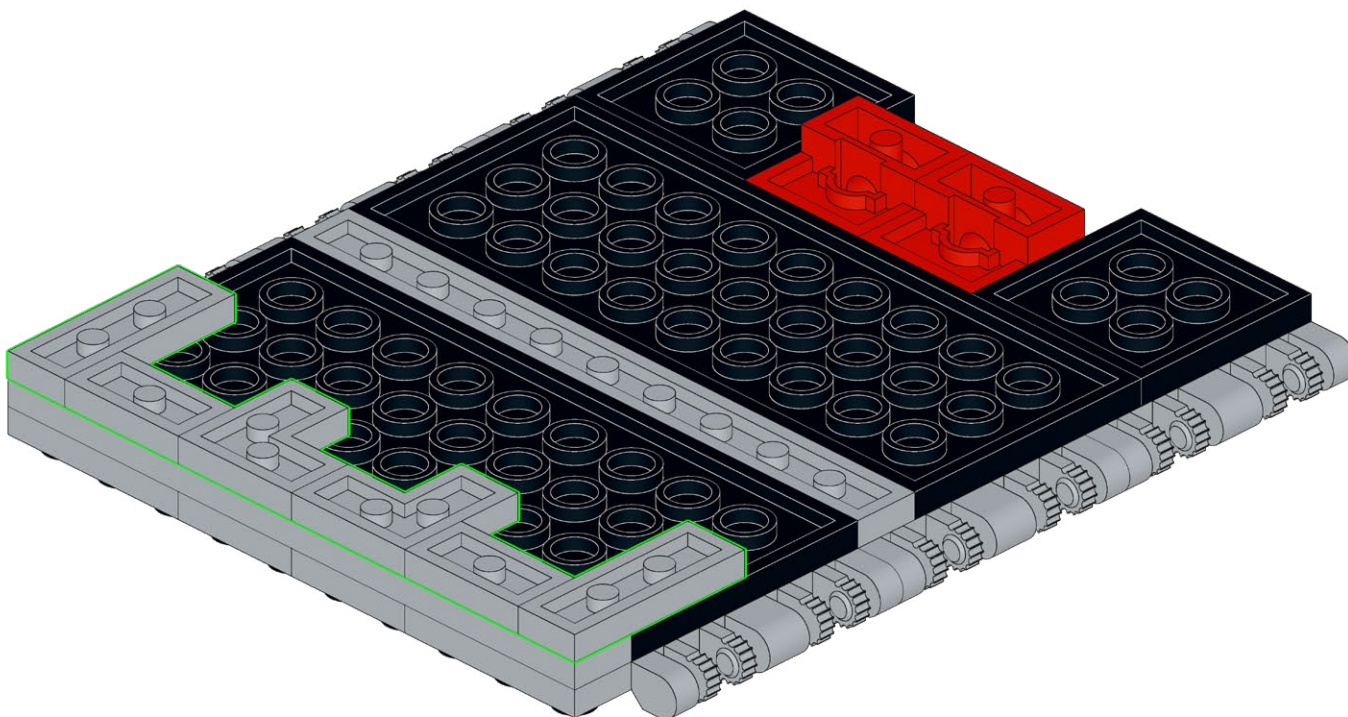
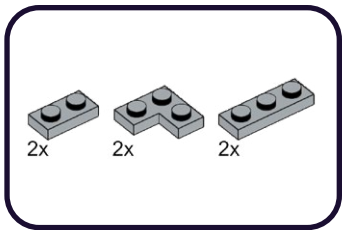

410

2x

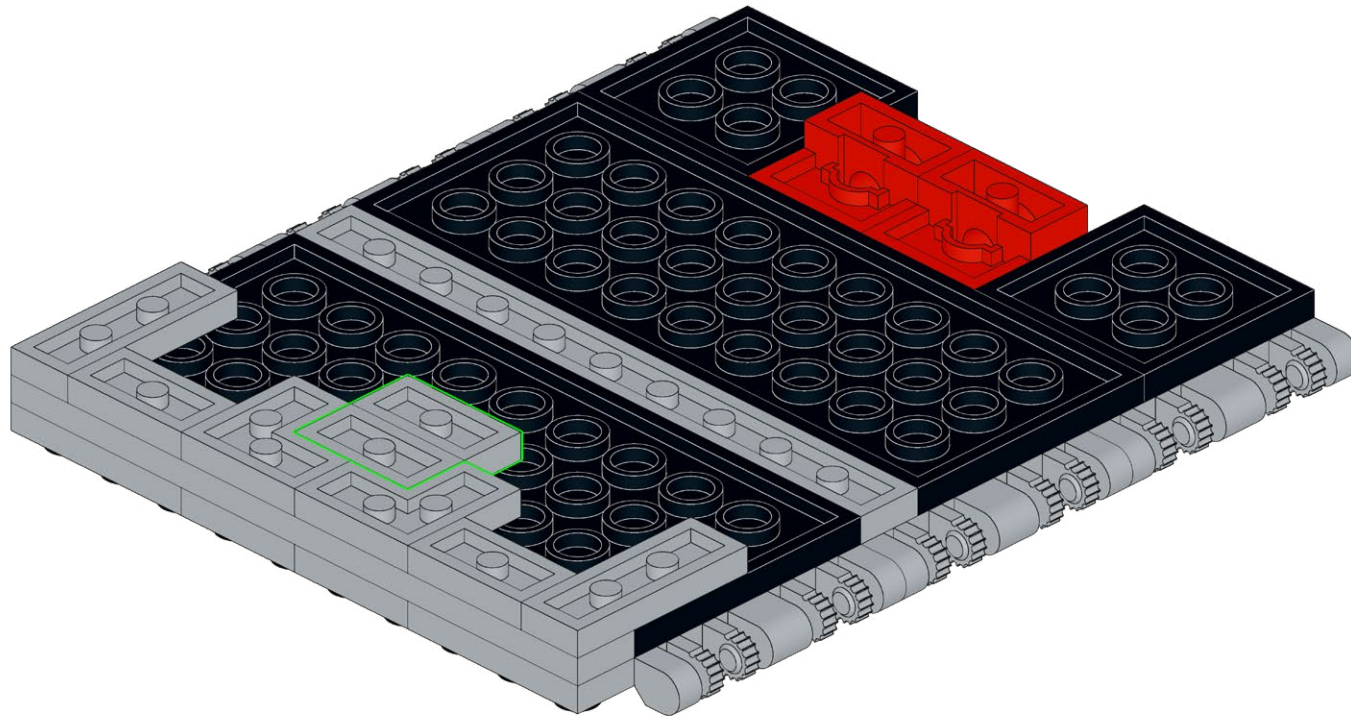



411

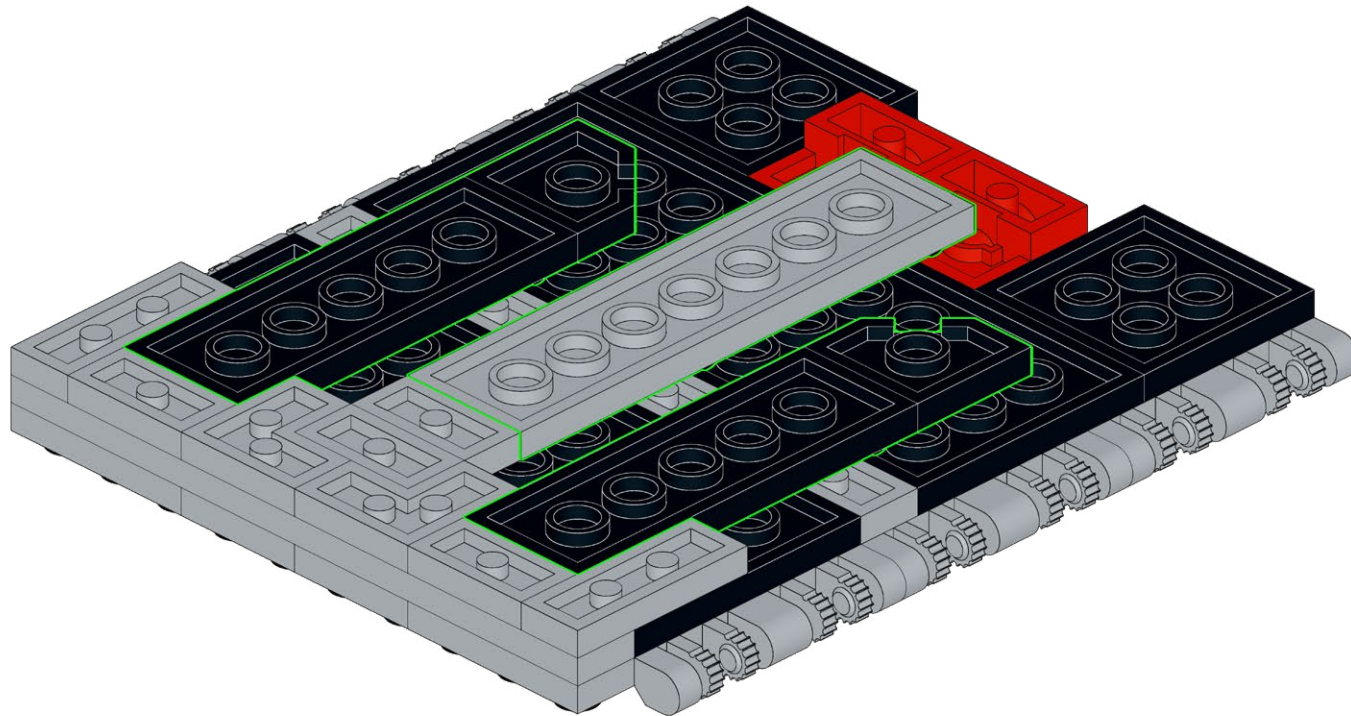
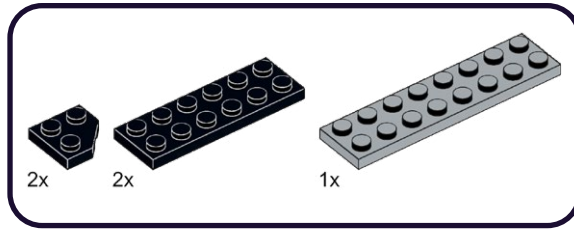

412

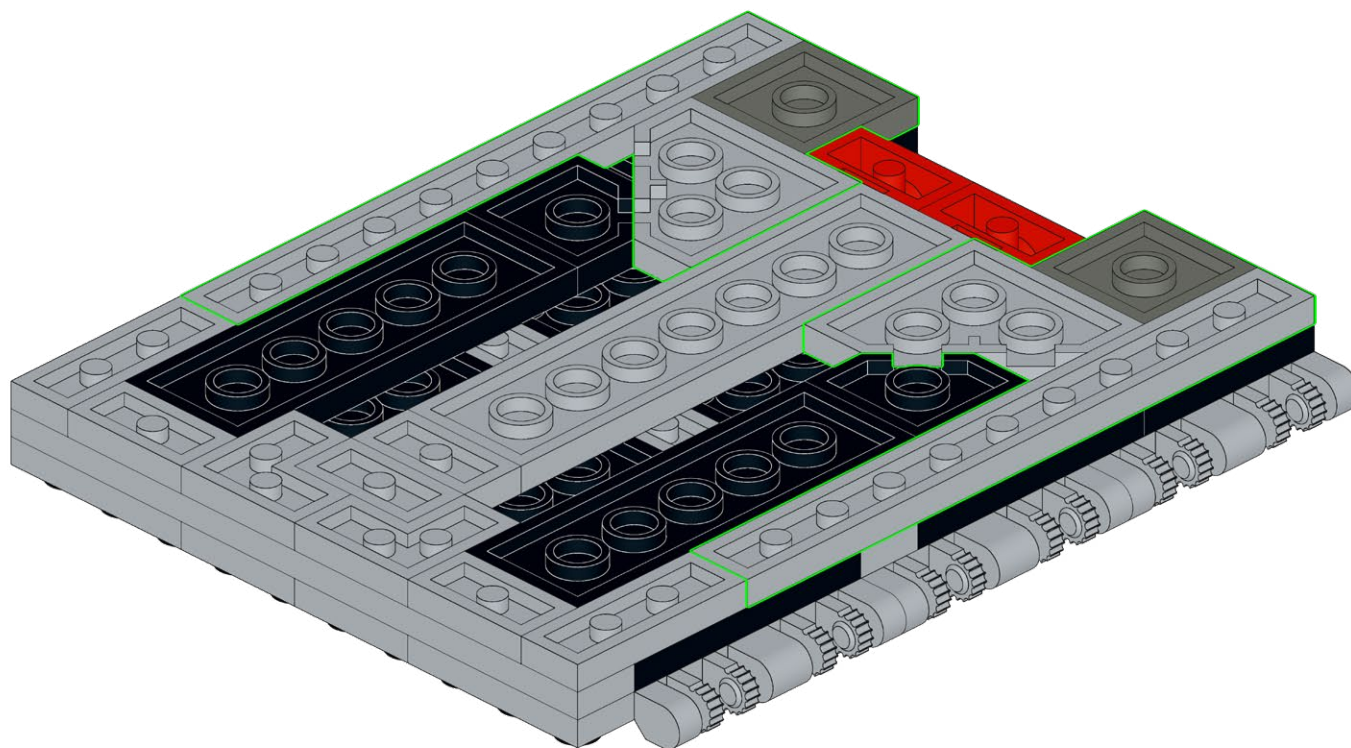
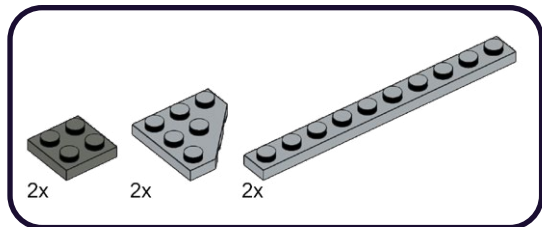



413

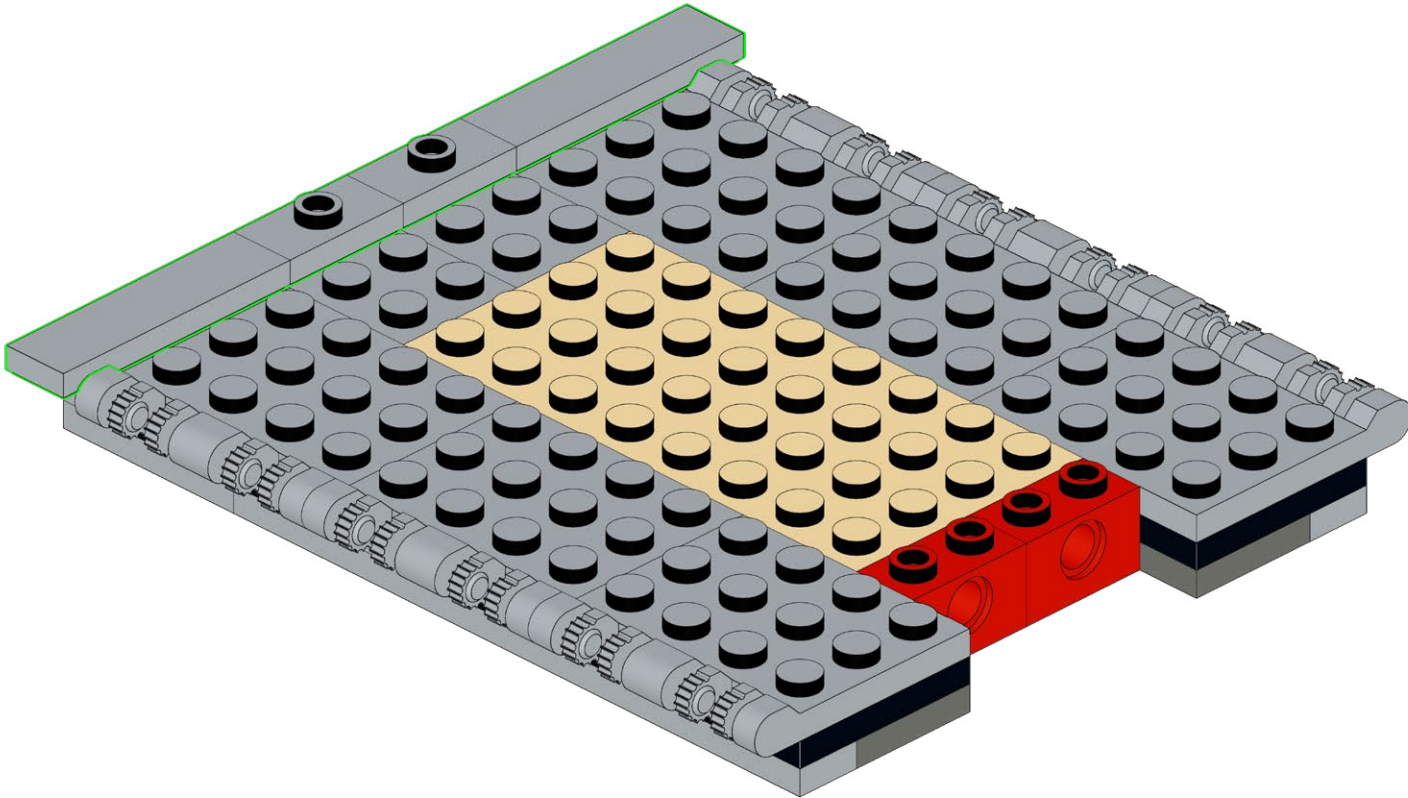
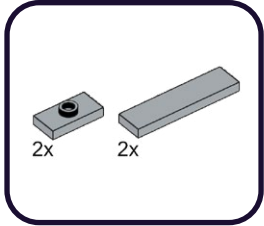

414

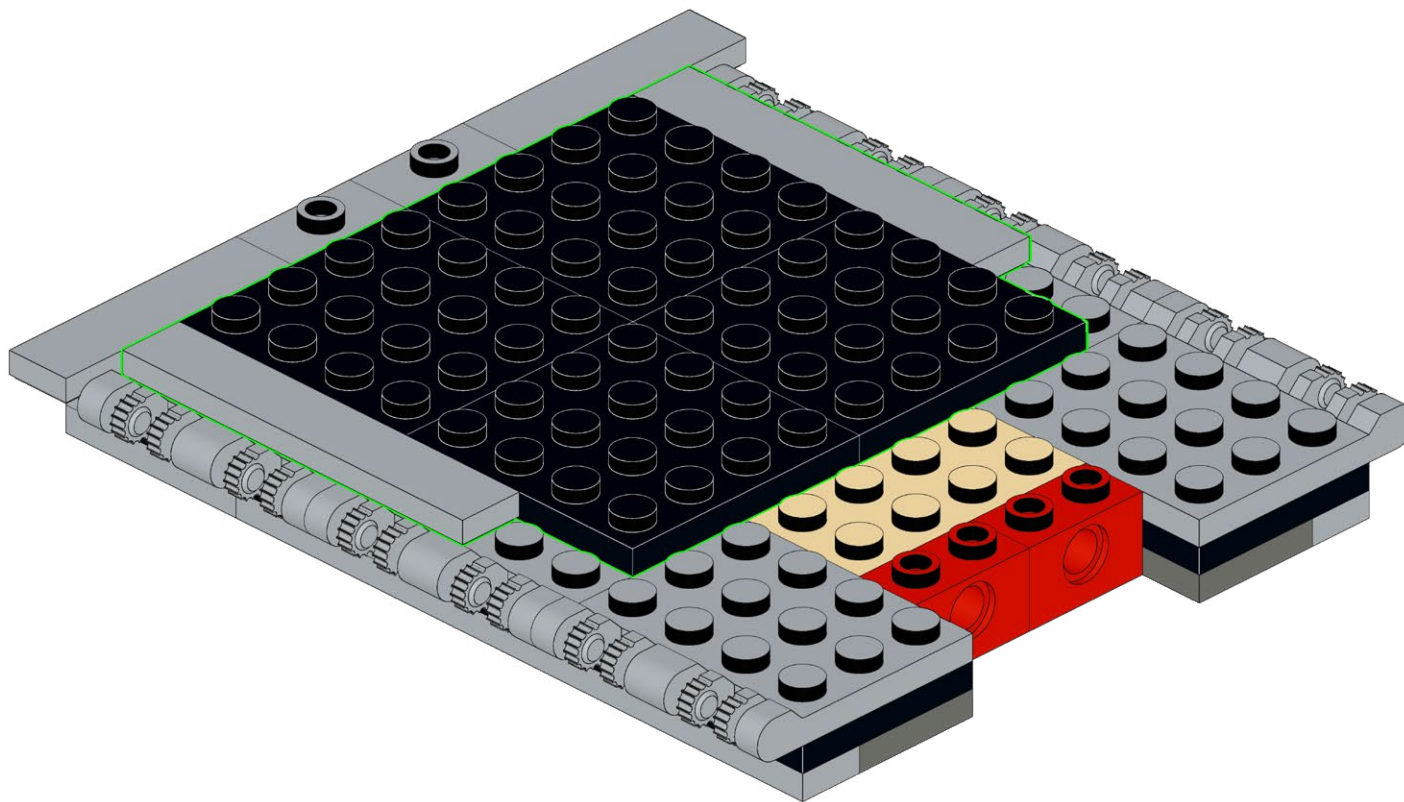
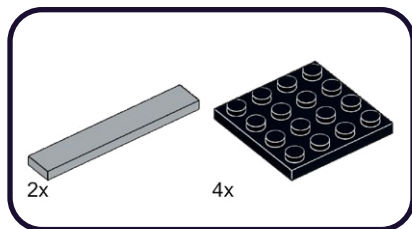

415

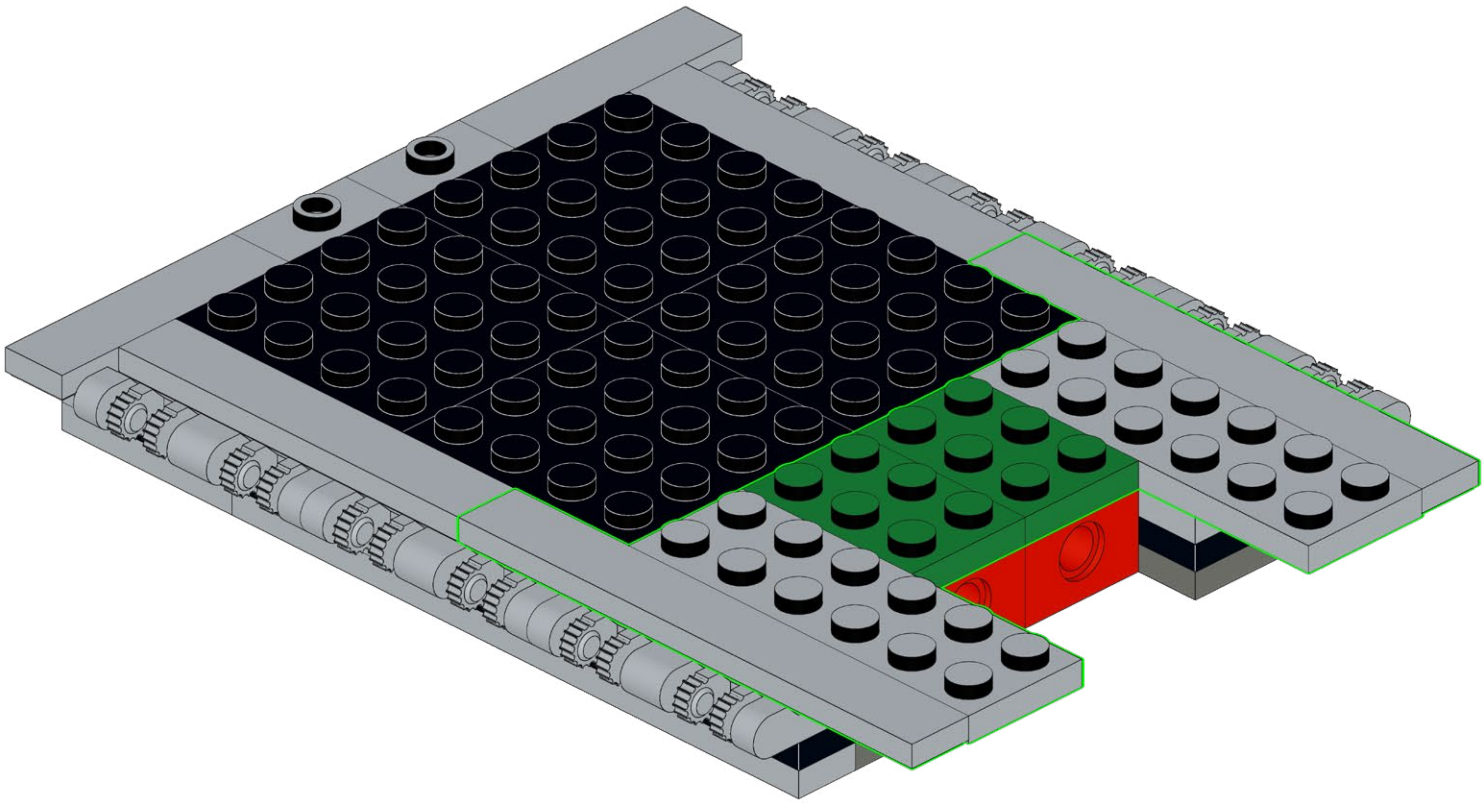
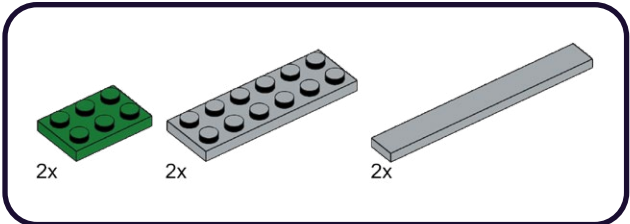

416

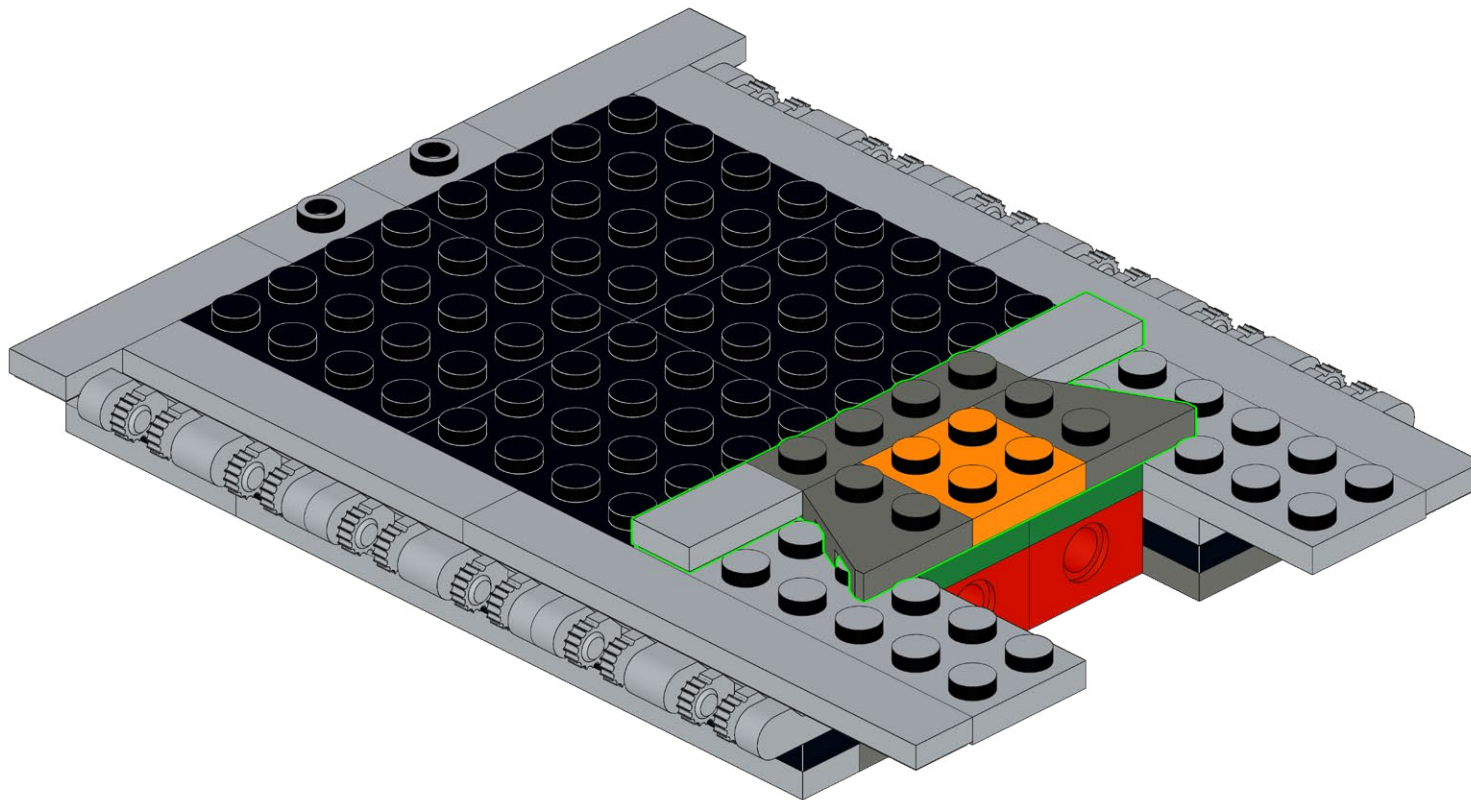
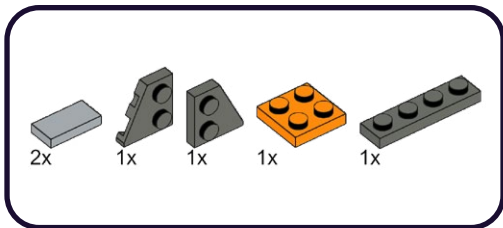



417

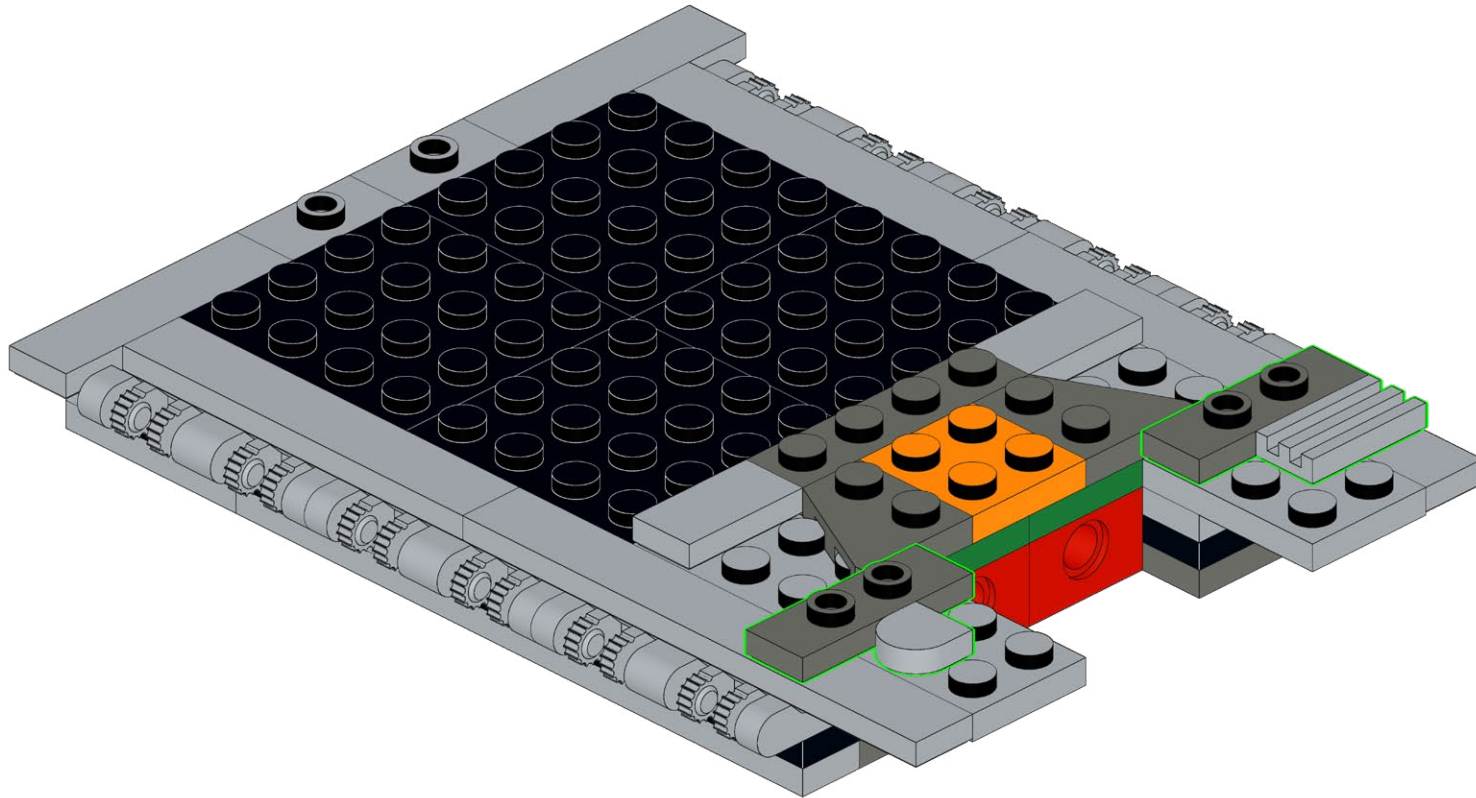
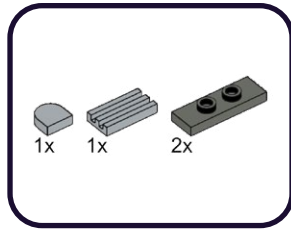

418

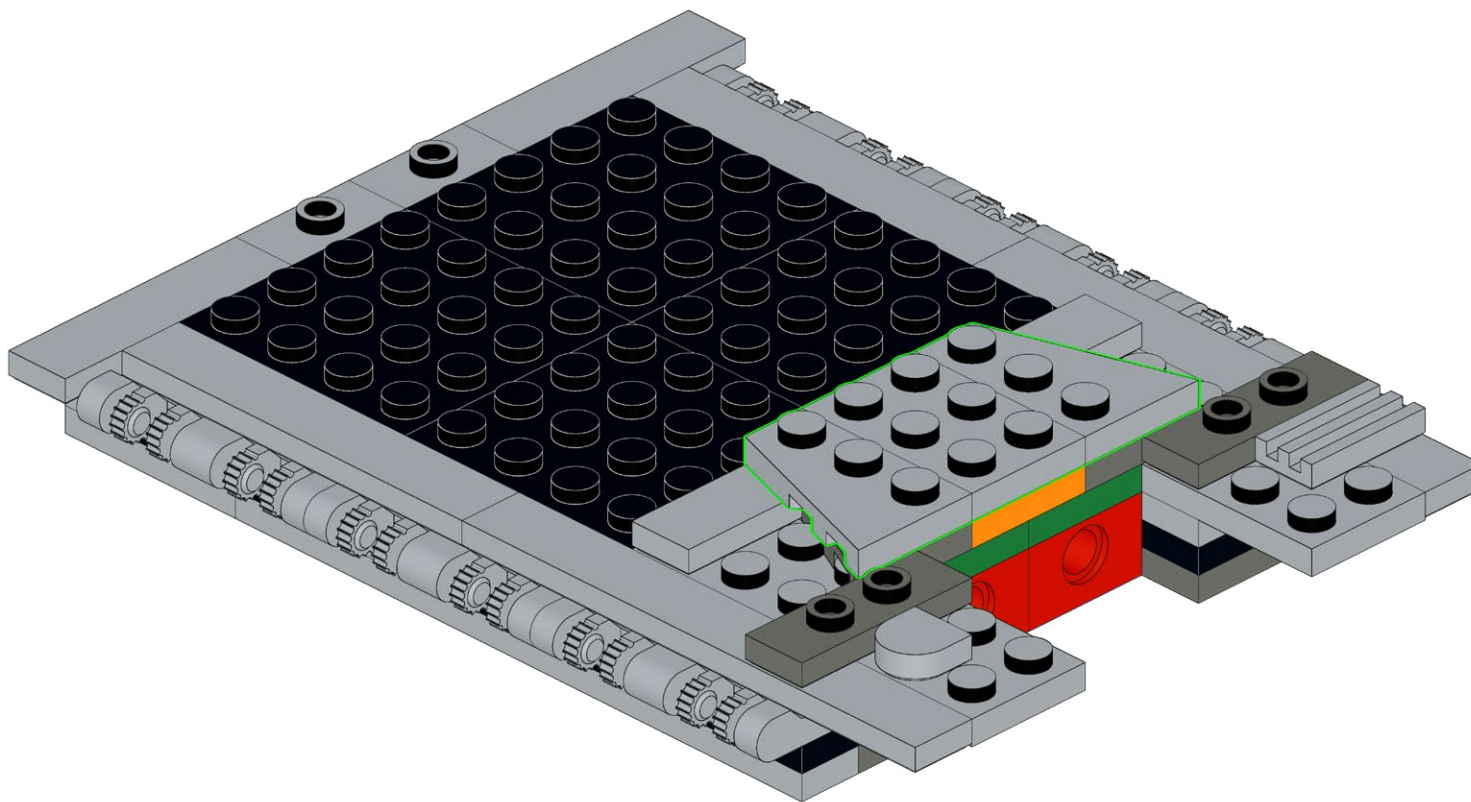
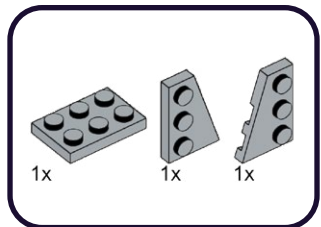



419

2x

1x

1x

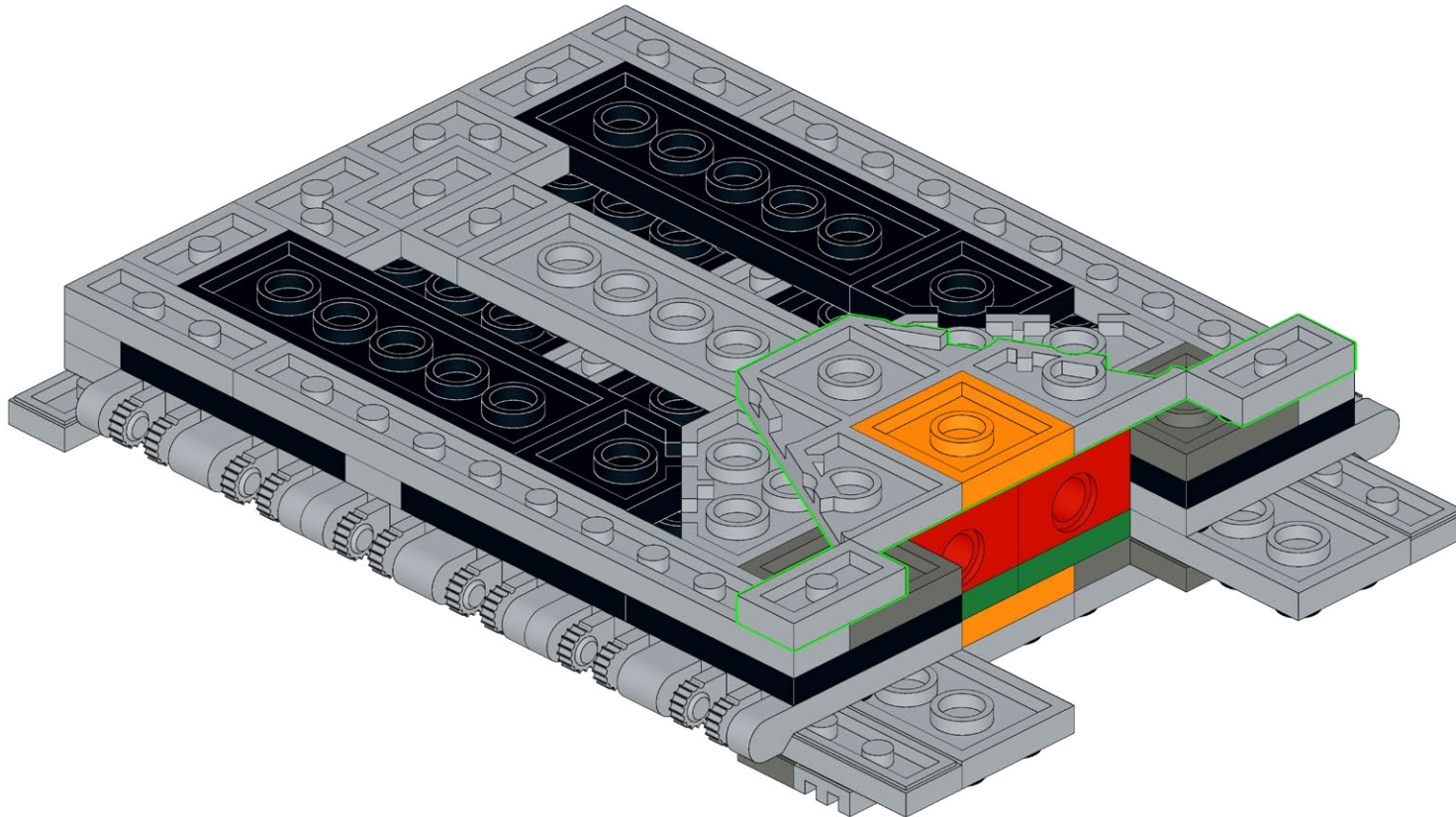

420

1x

1x

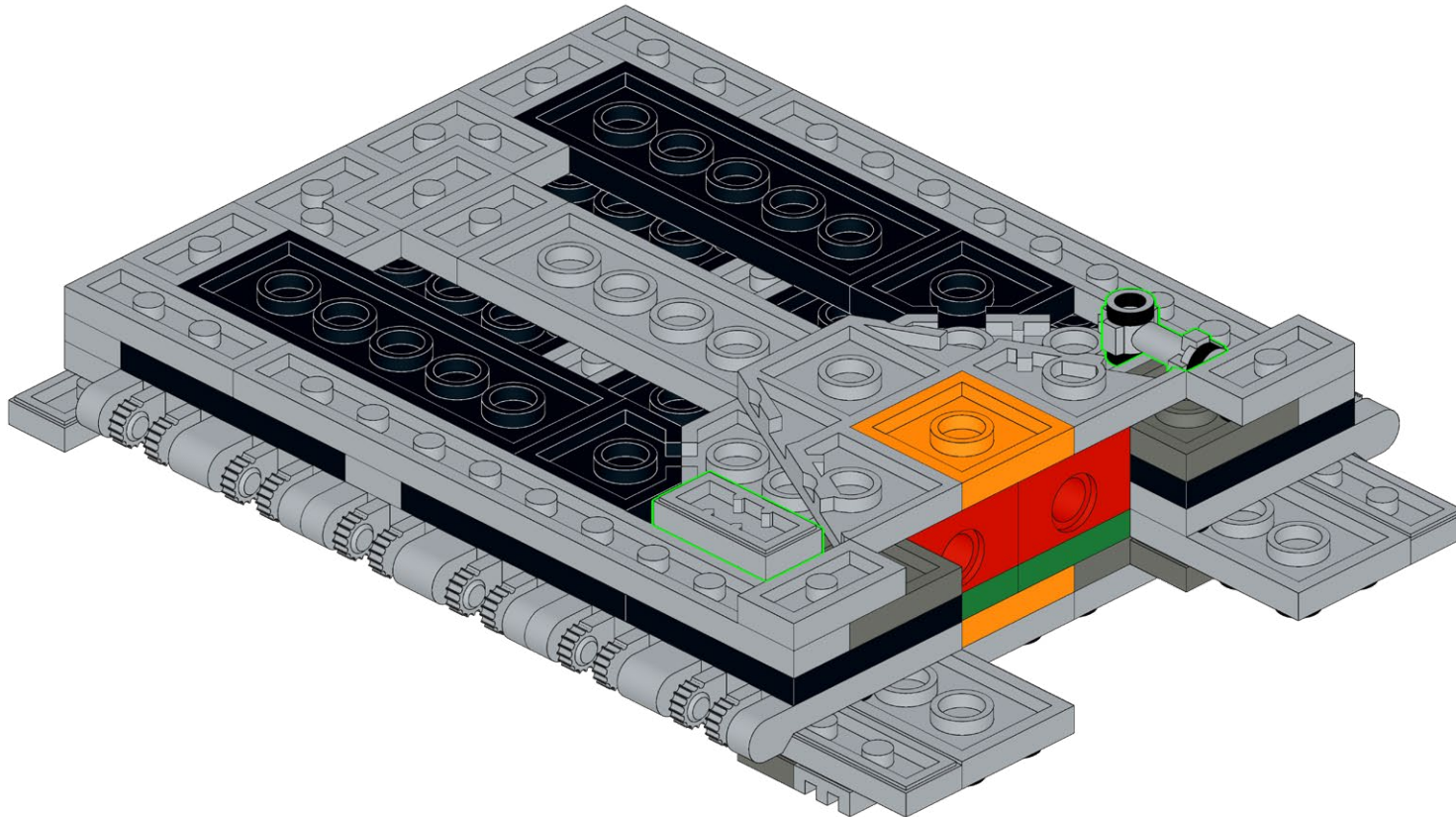

421

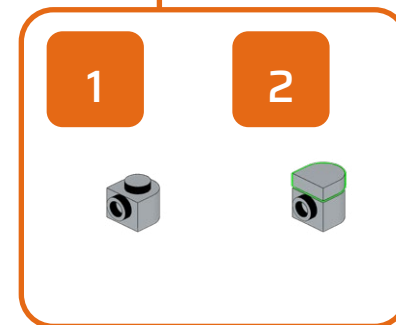
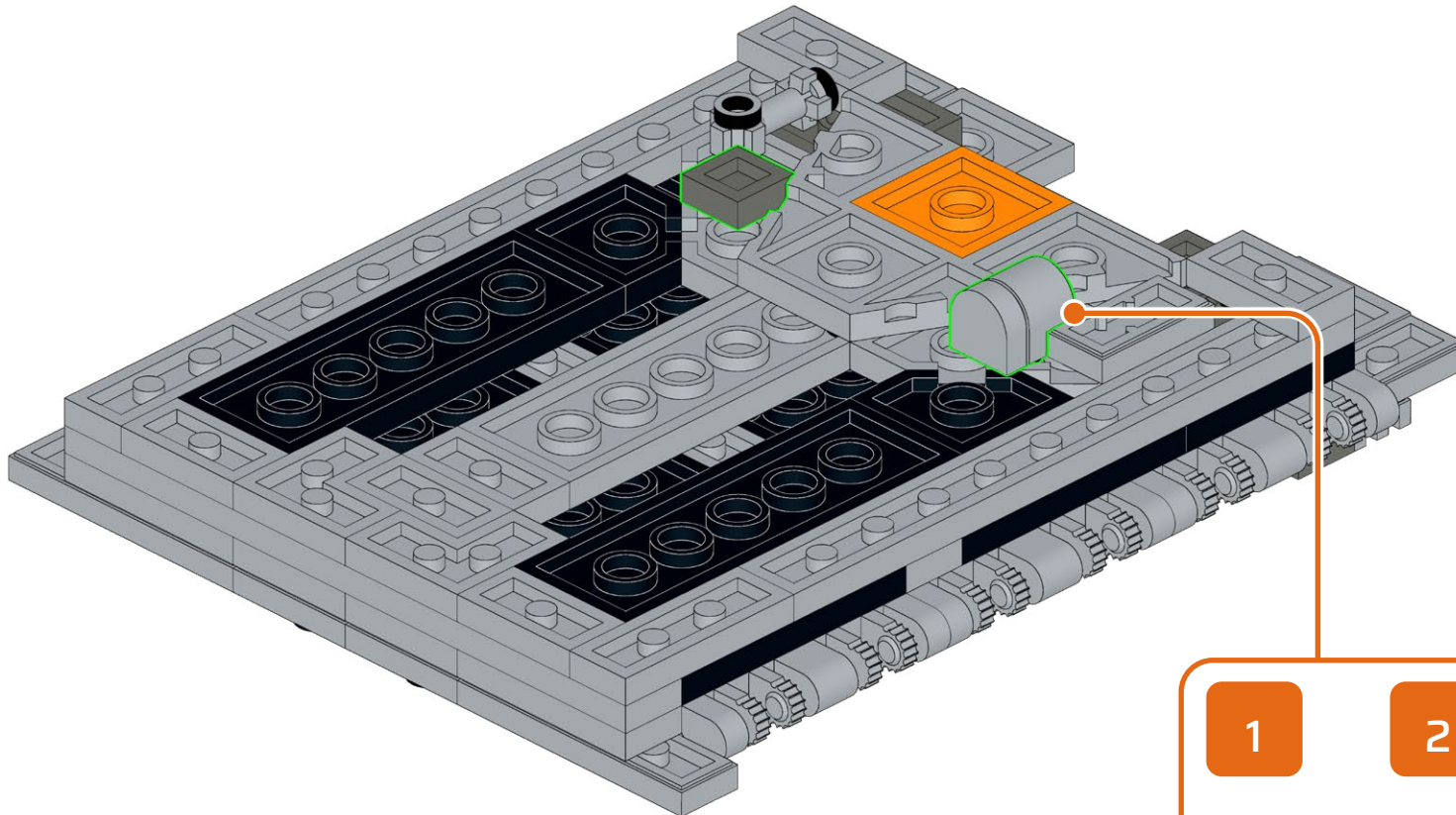
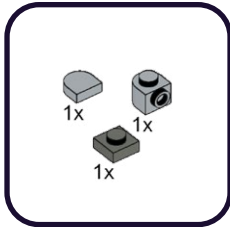



422

6x

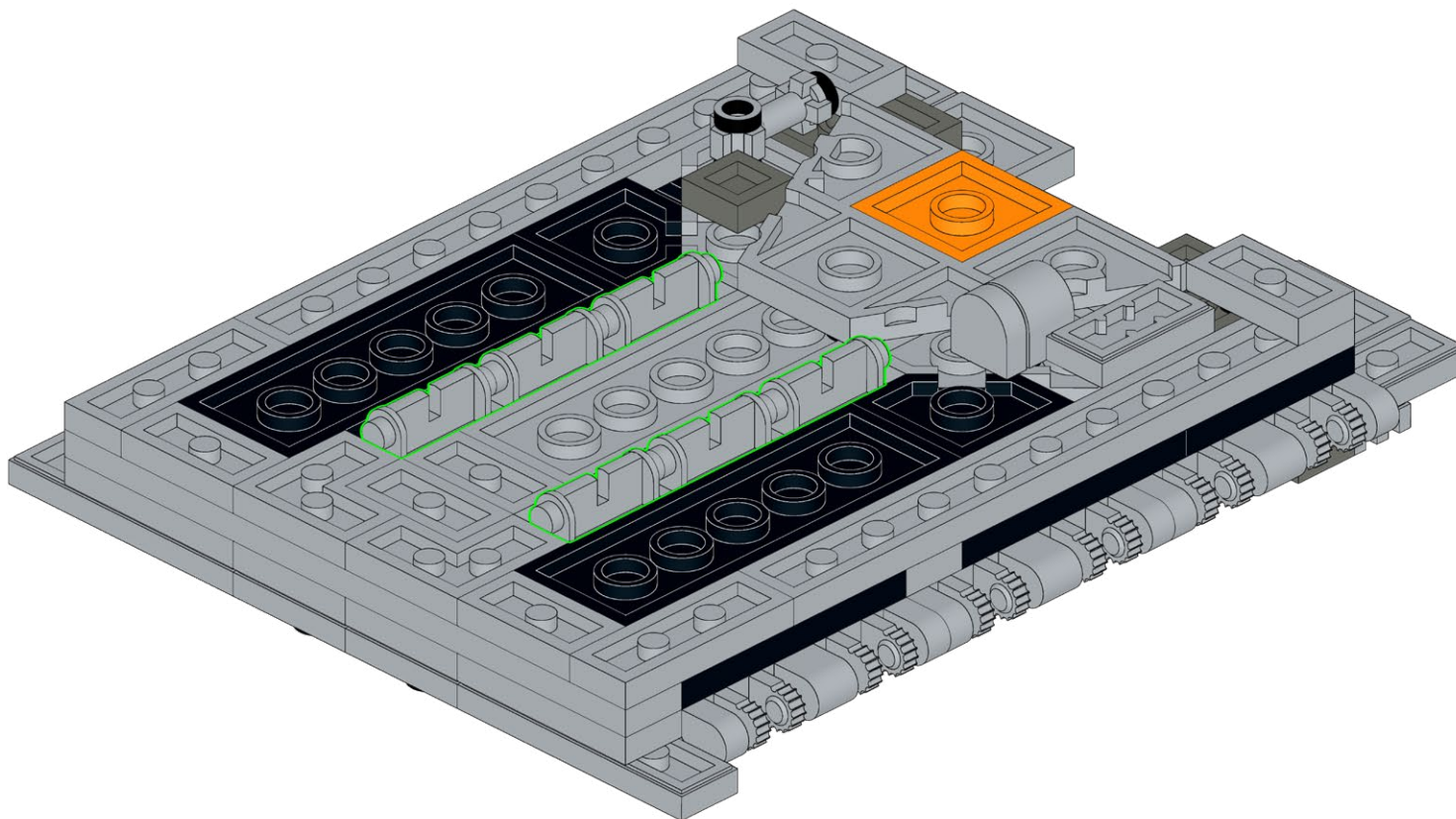



424

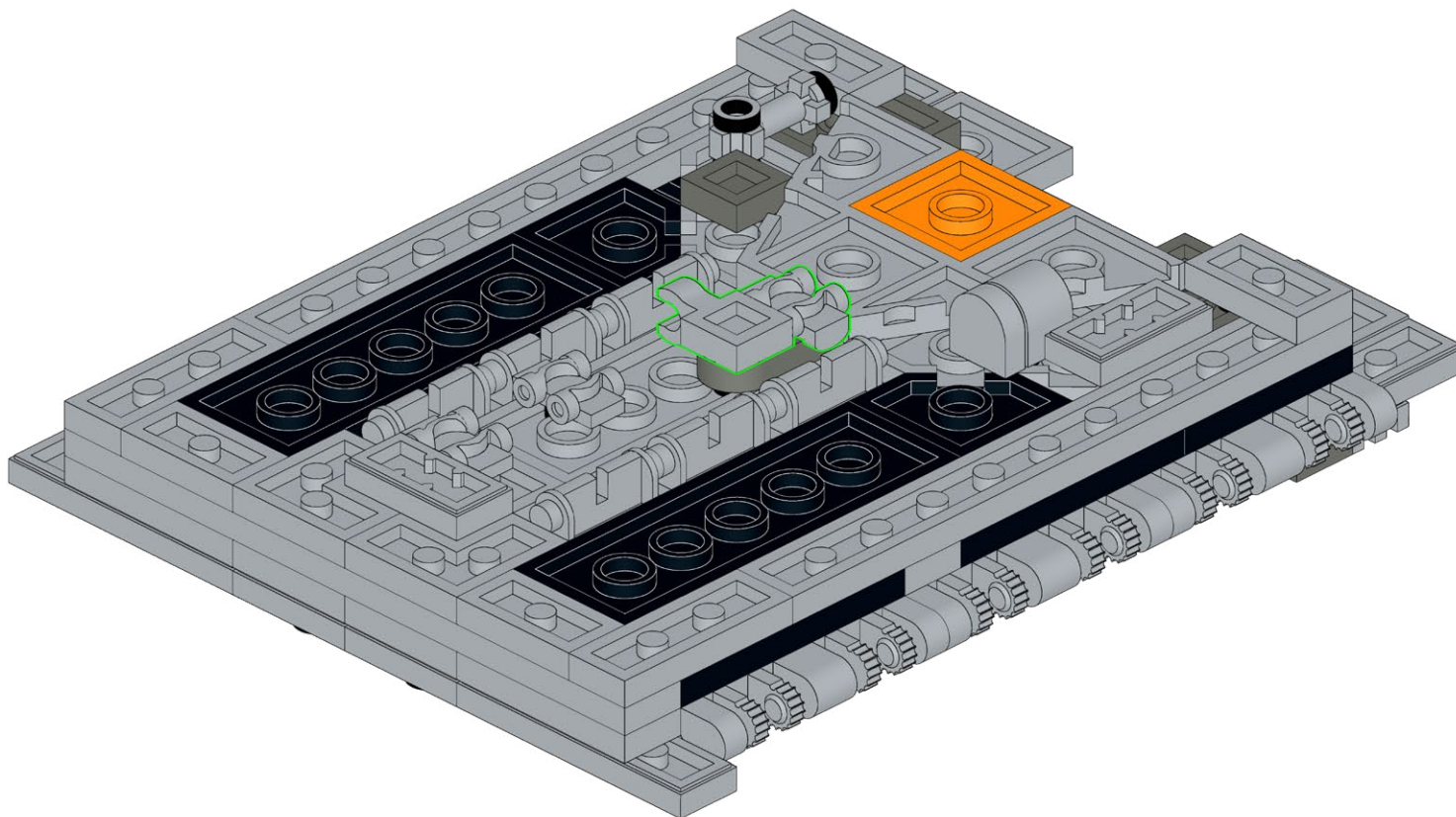
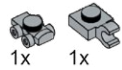



425

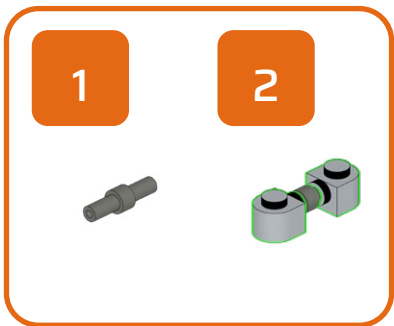
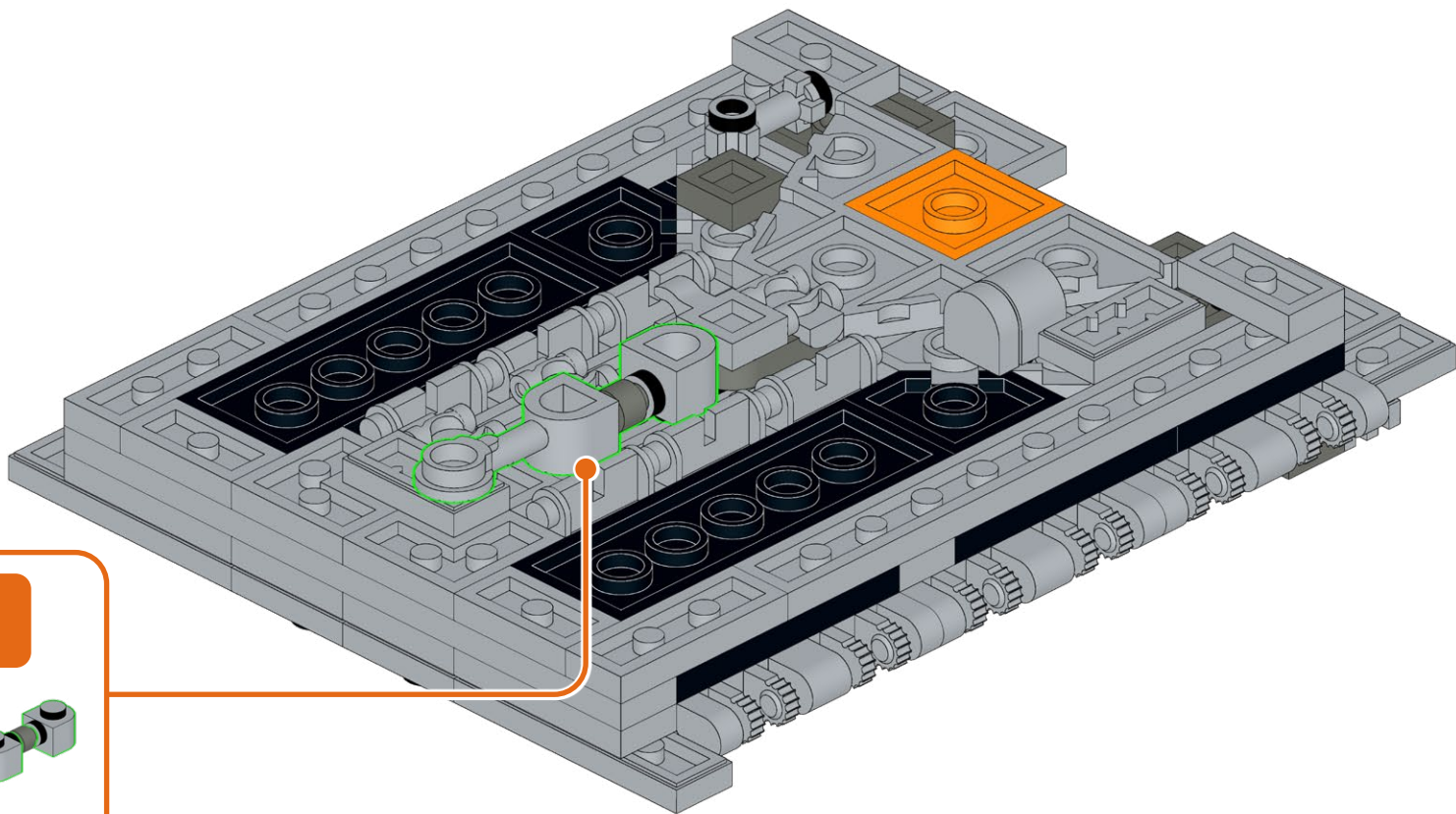
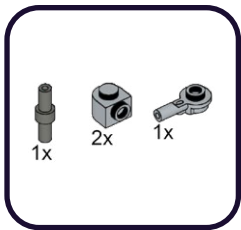

426

2x

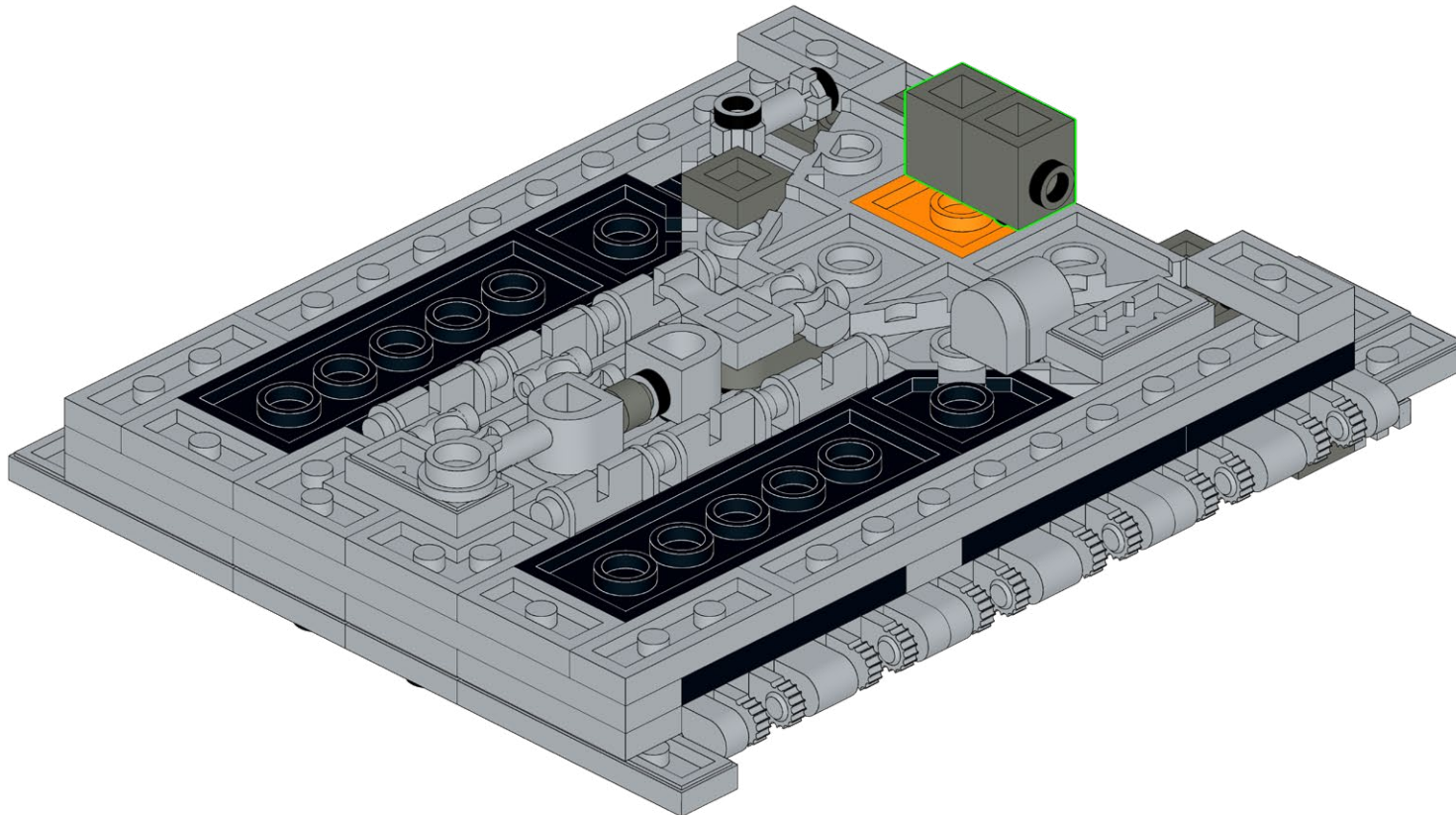

427

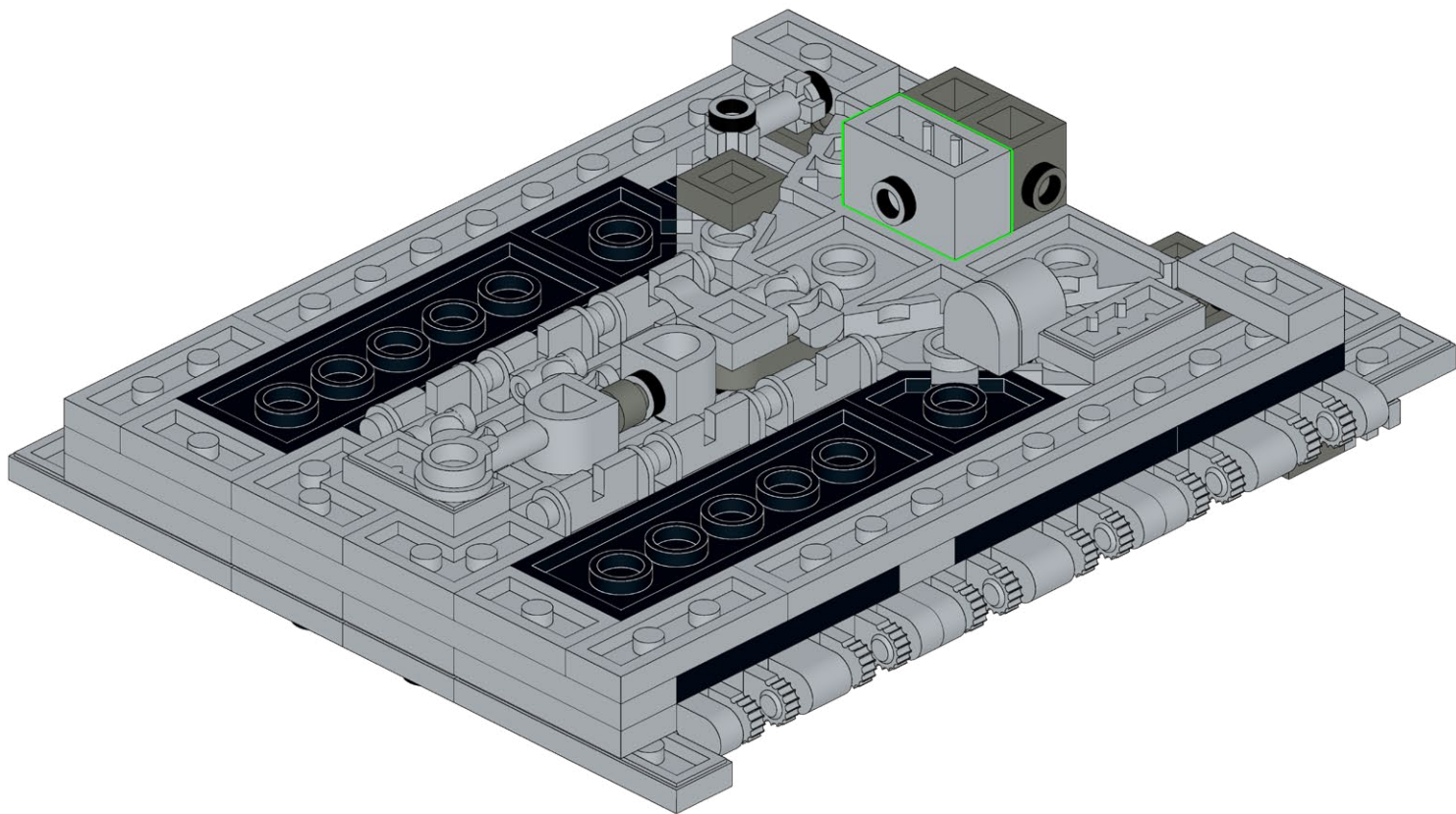
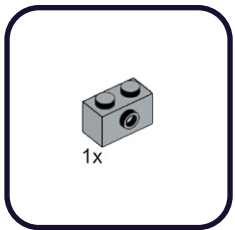

428

2x

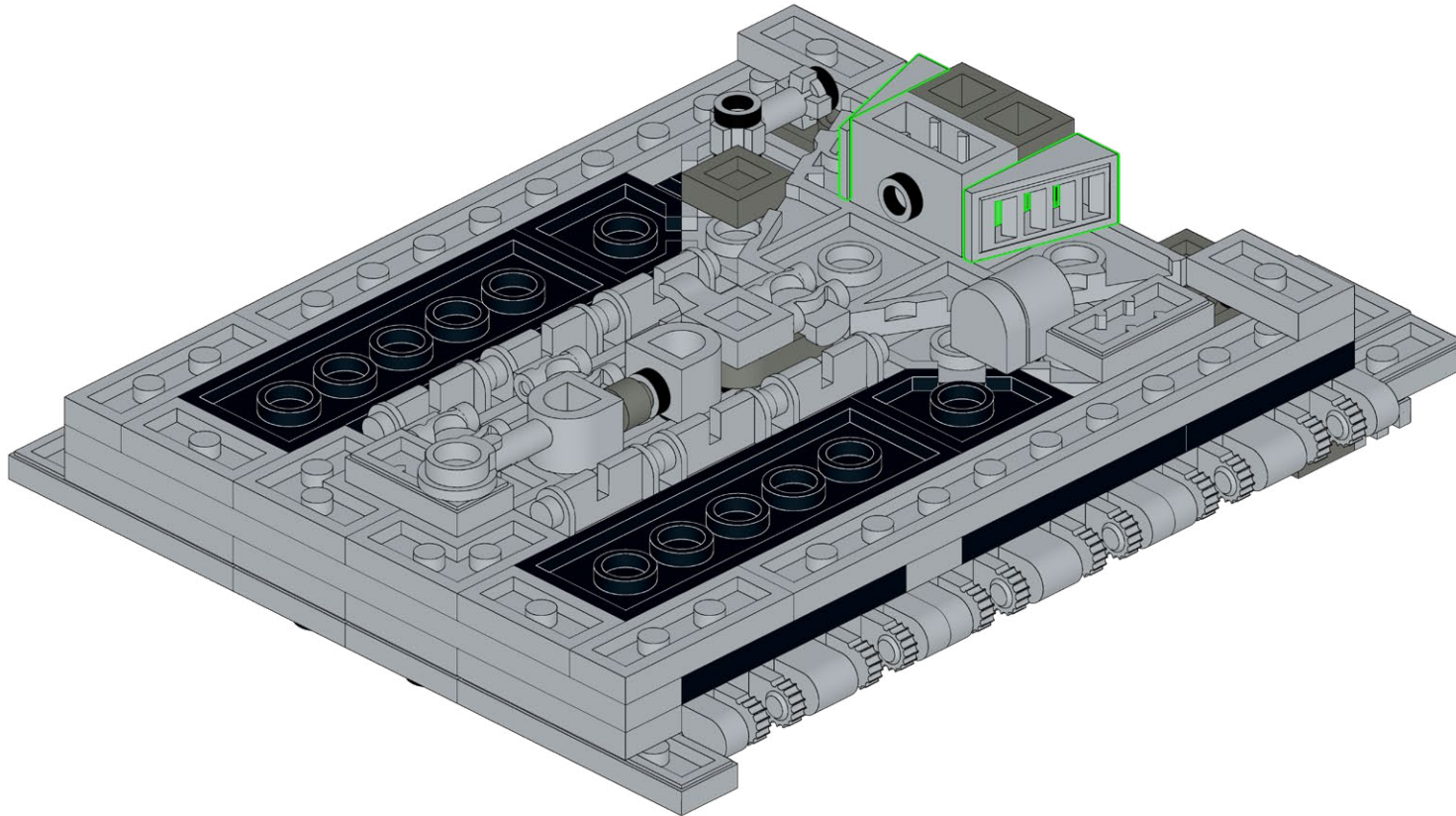



429



1x

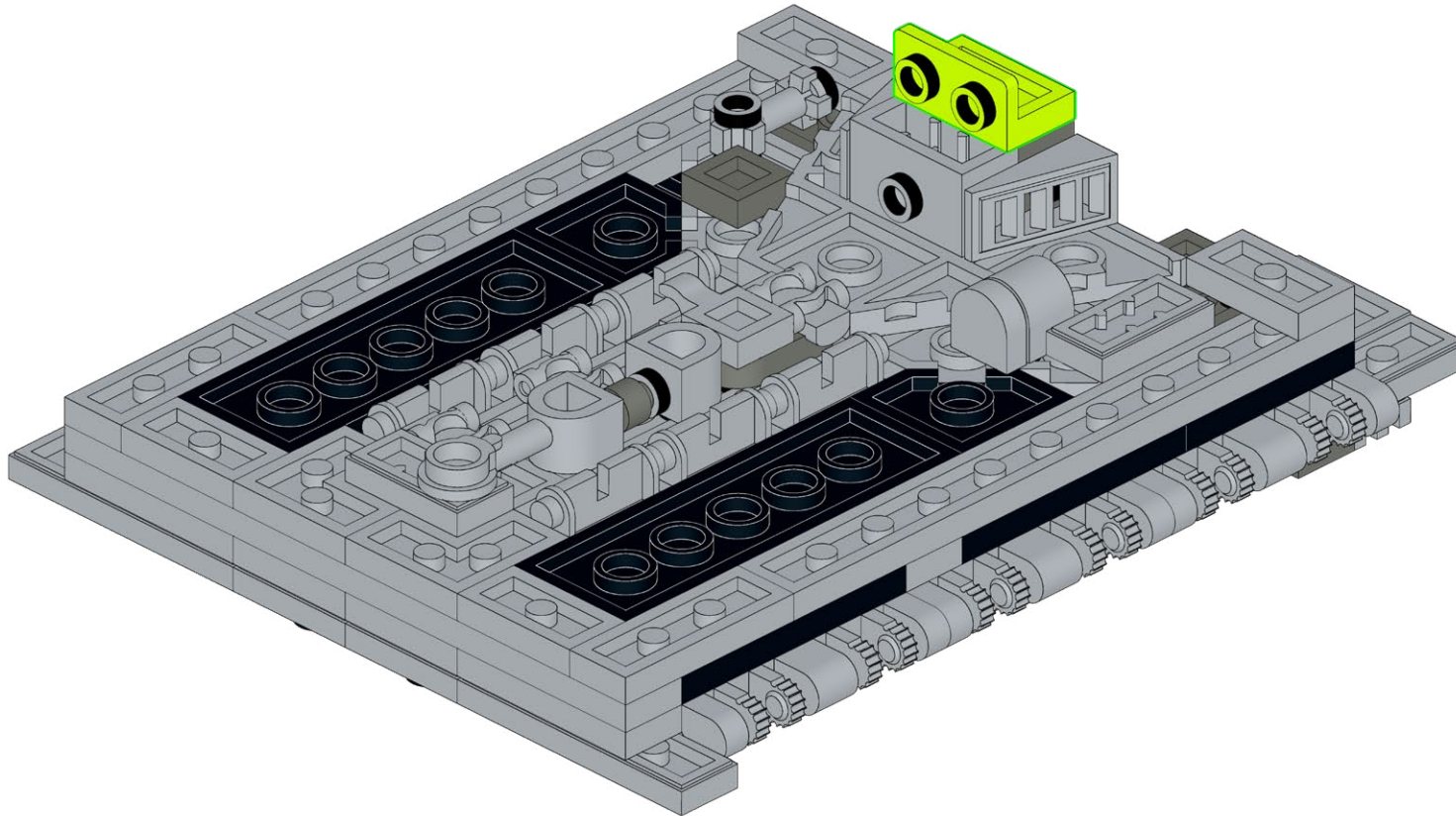





431

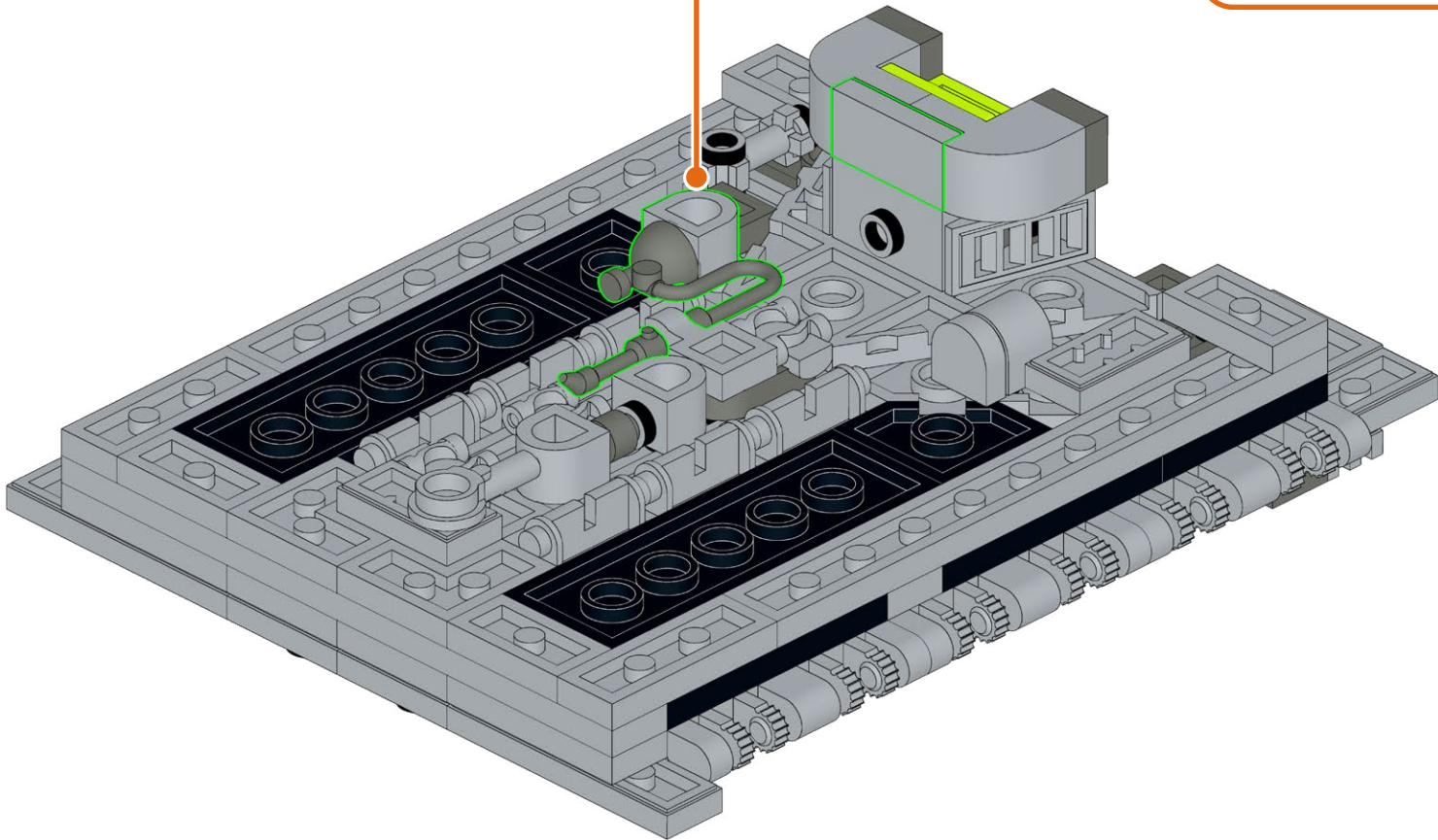
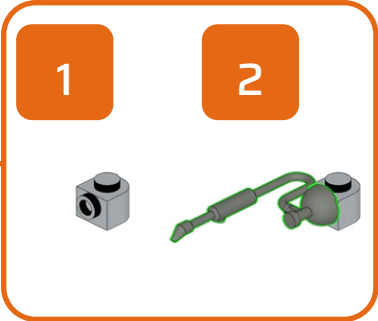
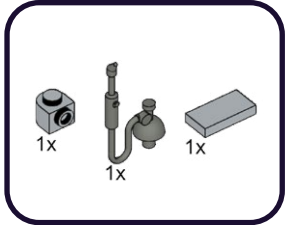

432

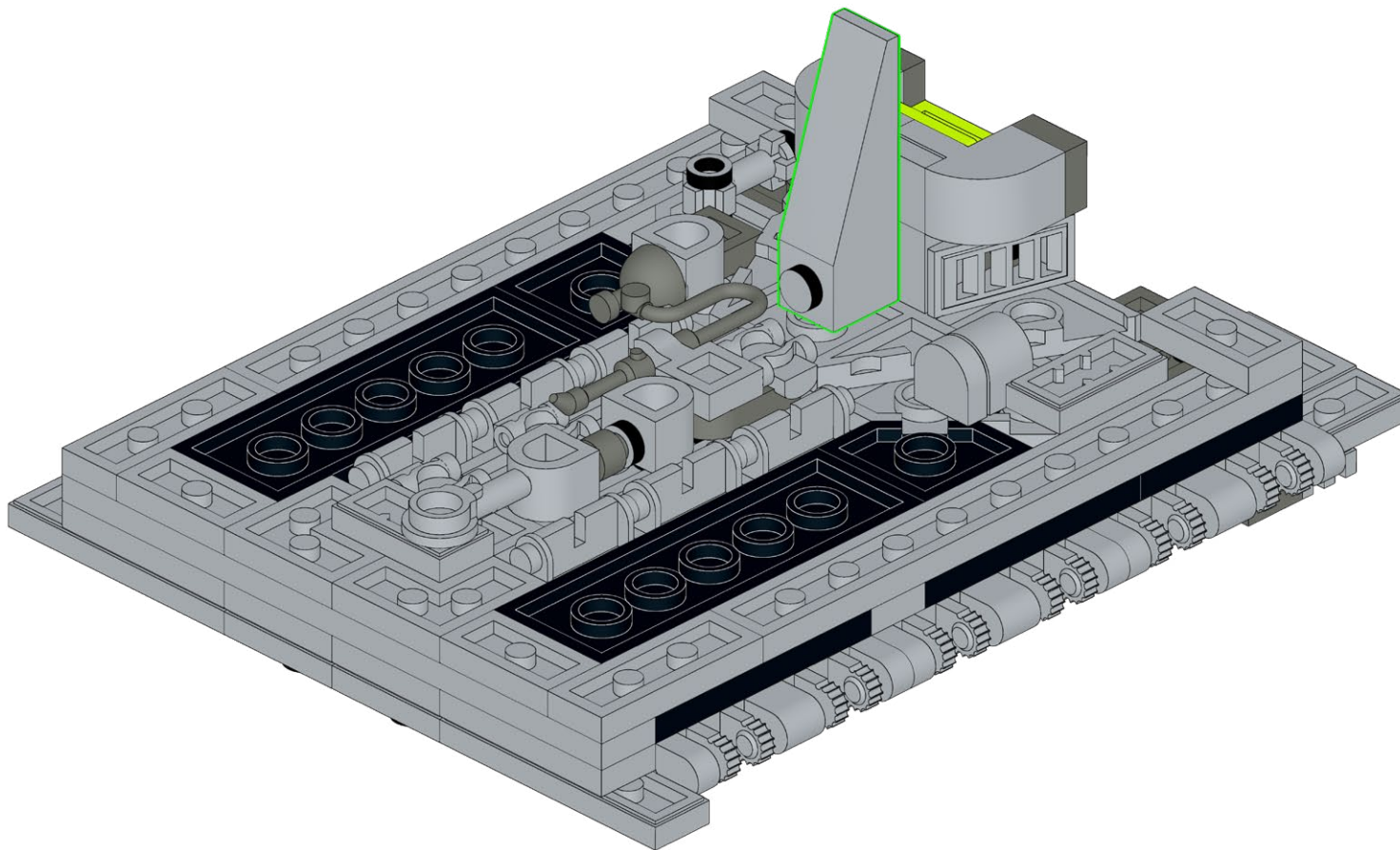
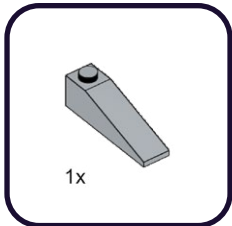

433

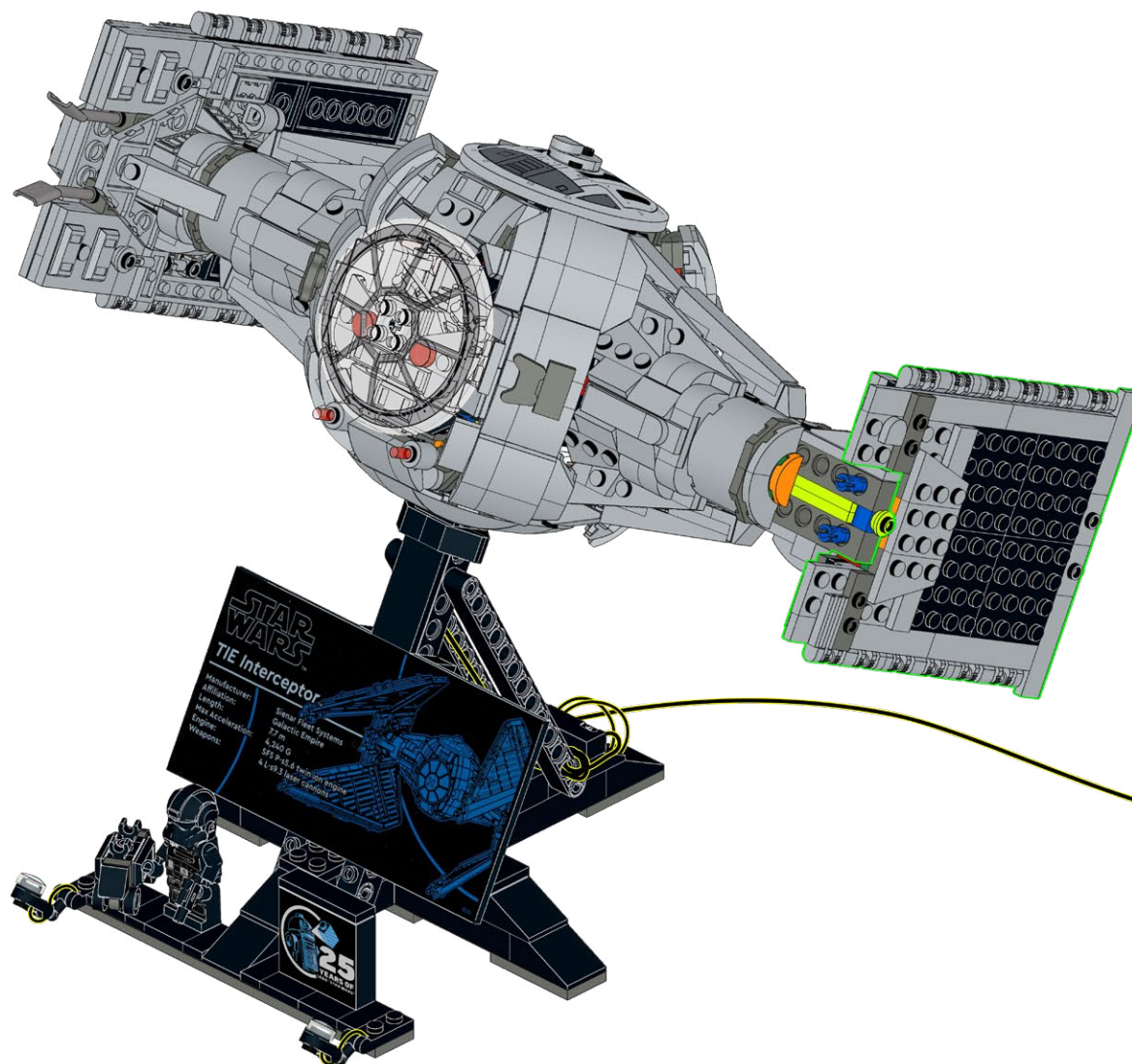

**HOLD UP!**

You might notice some bags are out of order, as well as left over pieces, but that's ok! We're changing the way you build LEGO!

**HALTEN!**

Möglicherweise stellen Sie fest, dass einige Beutel nicht in Ordnung sind und auch Teile übrig bleiben, aber das ist in Ordnung! Wir verändern die Art und Weise, wie Sie LEGO bauen!

**TENIR BON!**

Vous remarquerez peut-être que certains sacs sont en panne, ainsi que des morceaux restants, mais ce n'est pas grave ! Nous changeons la façon dont vous construisez LEGO !

**SOSTENERE!**

Potresti notare che alcune borse sono fuori uso, così come alcuni pezzi avanzati, ma va bene! Stiamo cambiando il modo in cui costruisci i LEGO!

**¡SOSTENER!**

Puede que notes que algunas bolsas están fuera de orden, así como piezas sobrantes, ¡pero está bien! ¡Estamos cambiando la forma de construir LEGO!

**耽误!**

您可能会注意到有些袋子坏了, 还有剩余的碎片, 但这没关系! 我们正在改变您搭建乐高的方式!

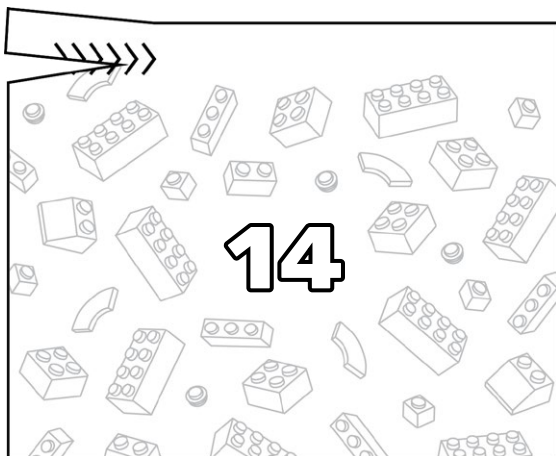
**Open LEGO® Bag 1**

434

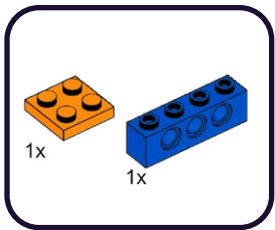

1



2

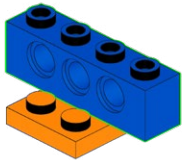

435

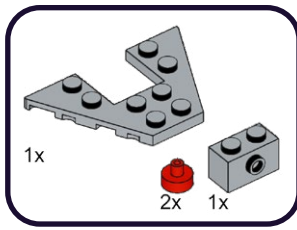

1

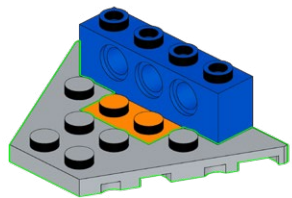

2

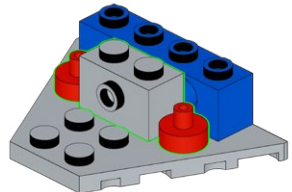



**436**

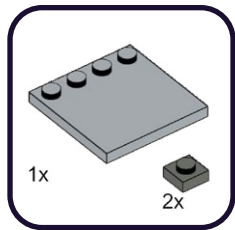

**1**

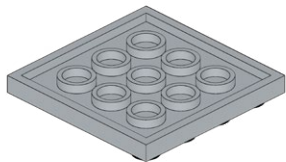

**2**

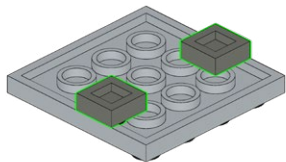

**437**



**1**

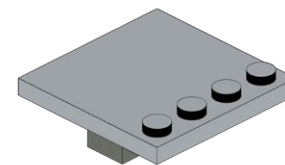
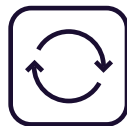



438

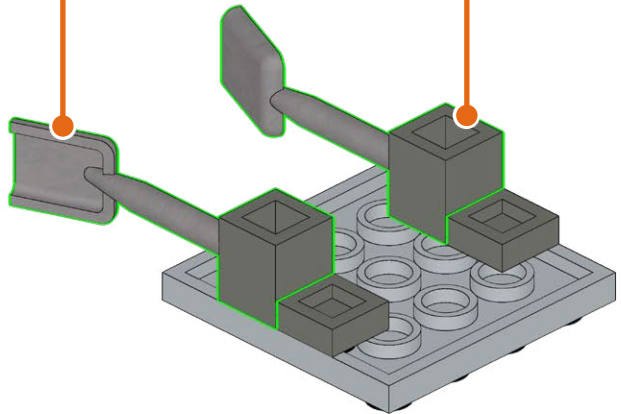
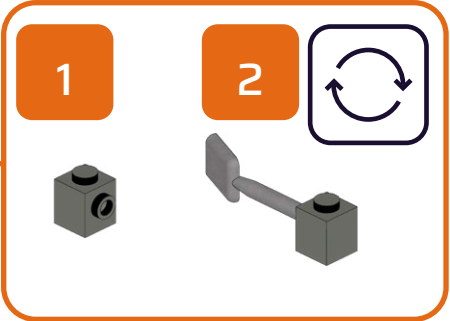
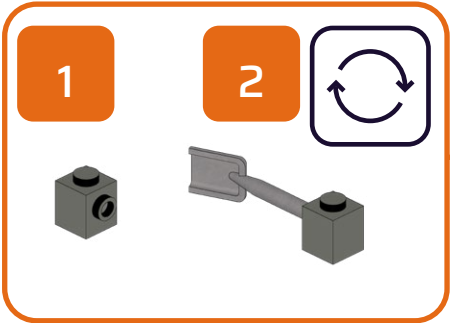
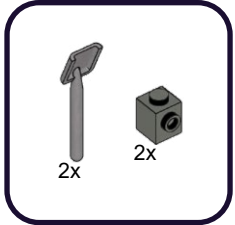

439

1

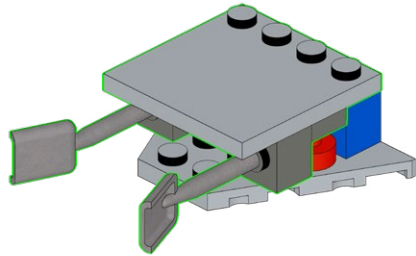

2

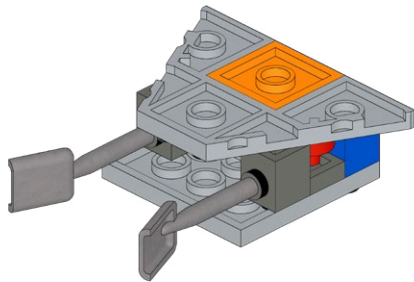

440

2x

1x

1

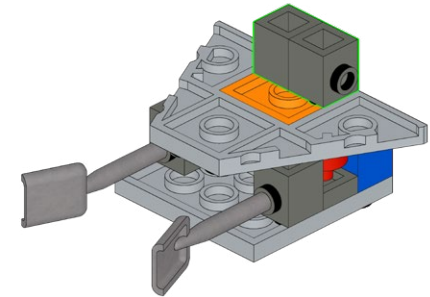

2

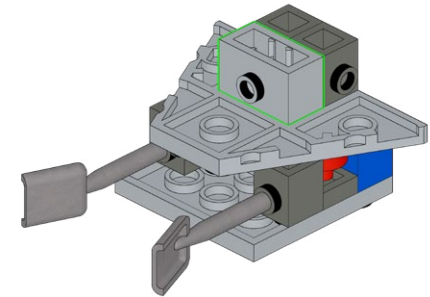

# 441

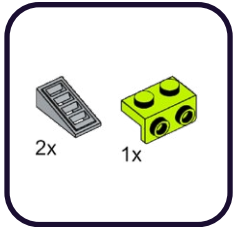

1

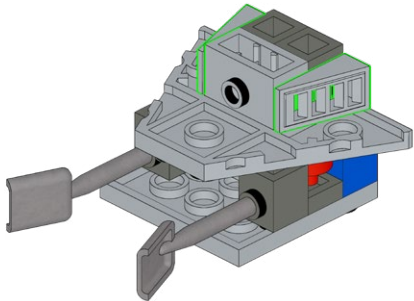

2

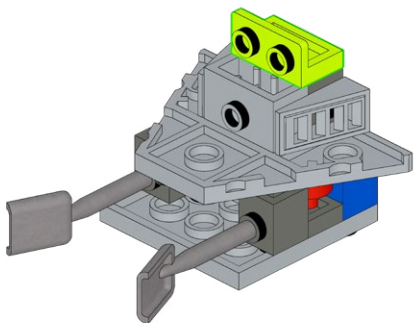

# 442

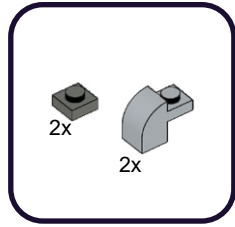

1

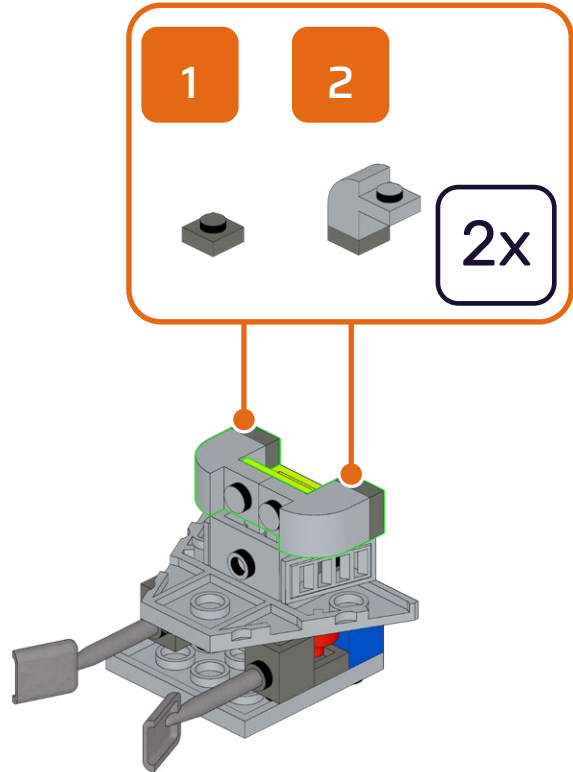

443

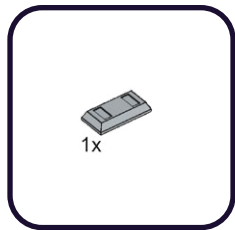

1

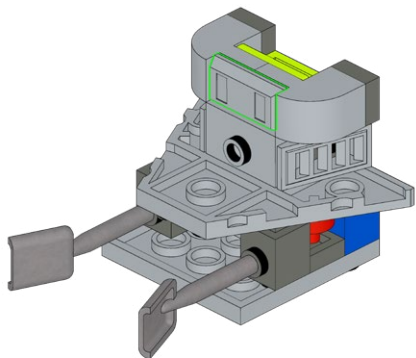

444

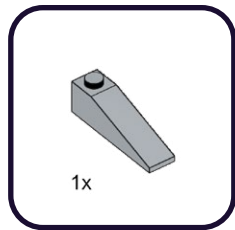

1

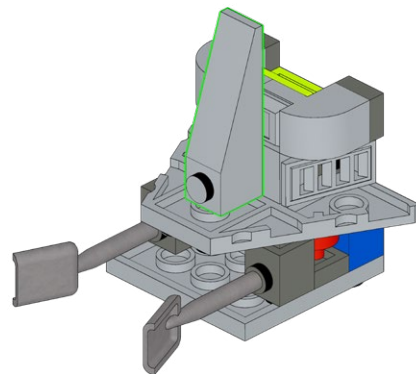

445

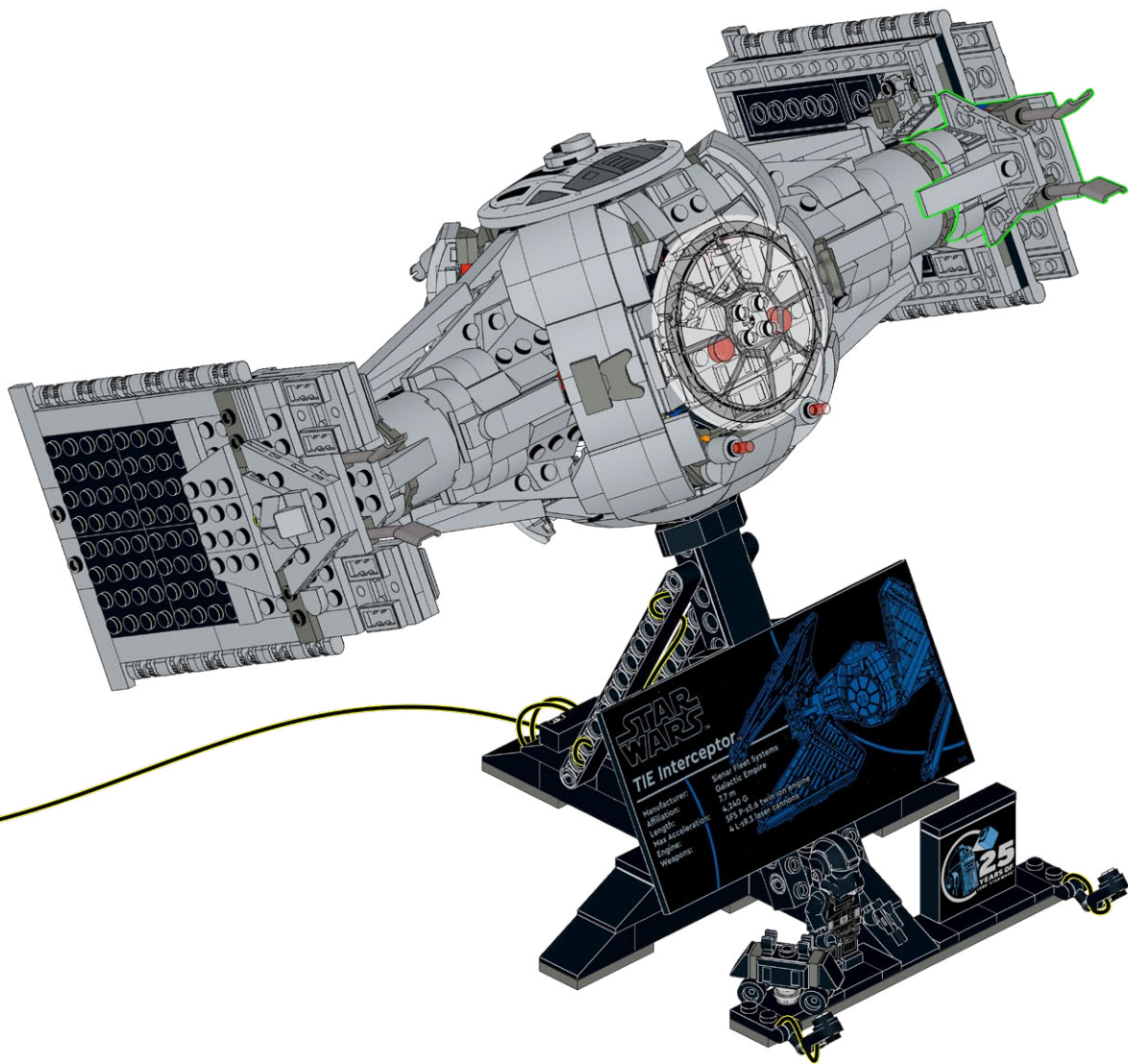

446

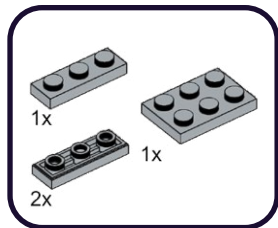

1

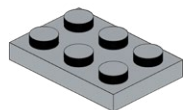

2

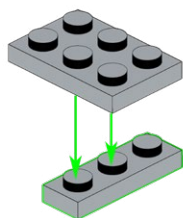

3

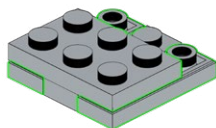

447

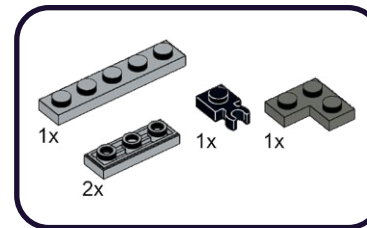

1

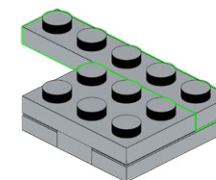

2

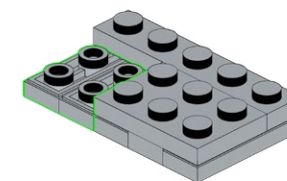

3

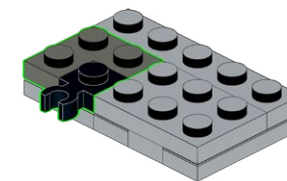



448

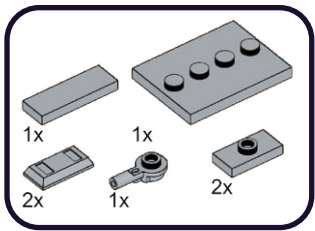

1

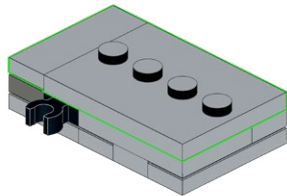

2

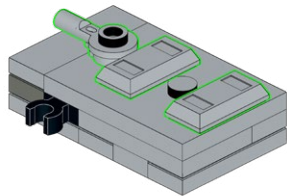

3

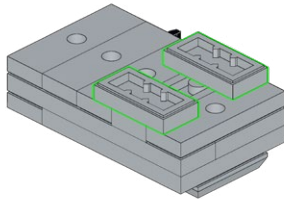

449

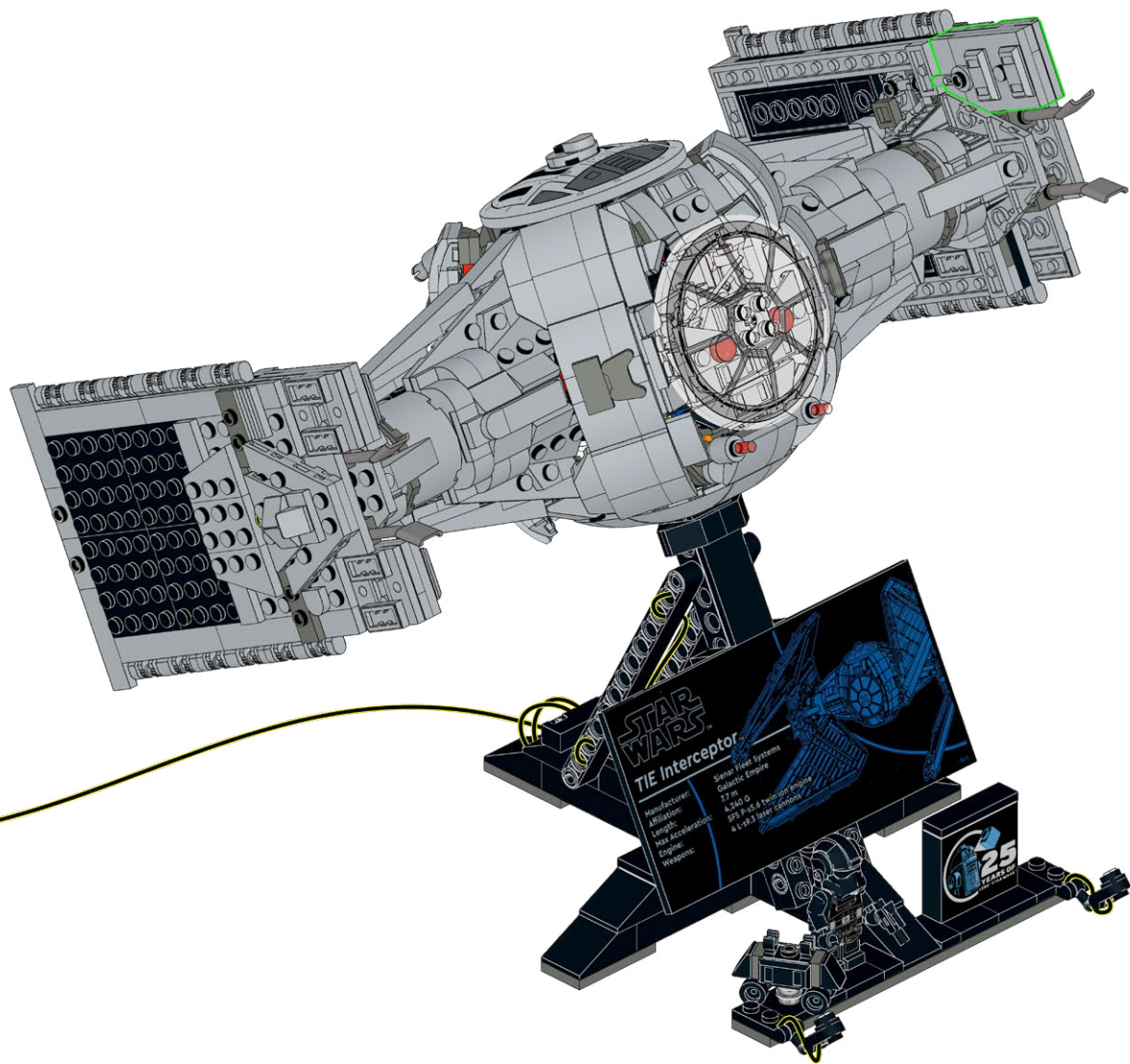

450

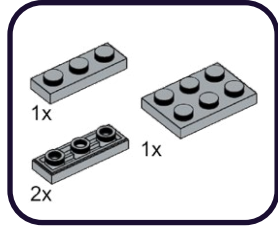

1

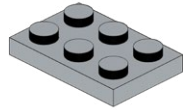

2

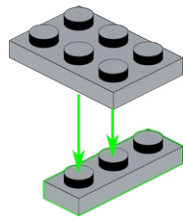

3

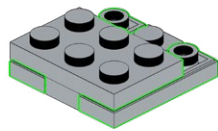

451

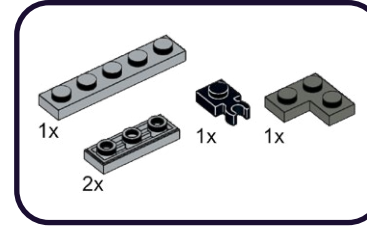

1

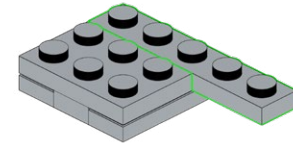

2

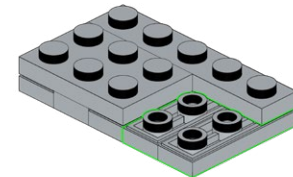

3

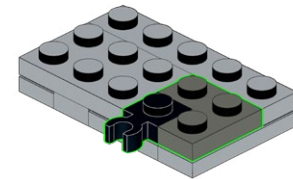

452

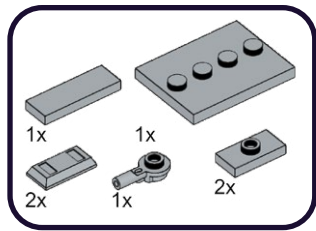

1

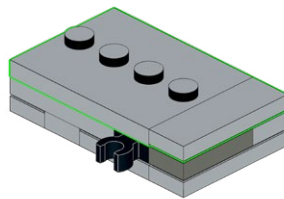

2

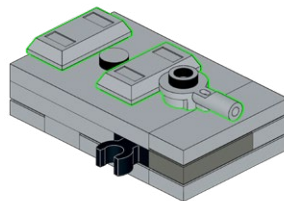

3

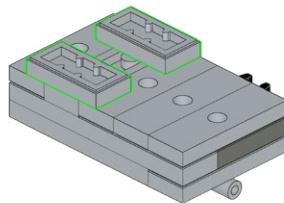

453

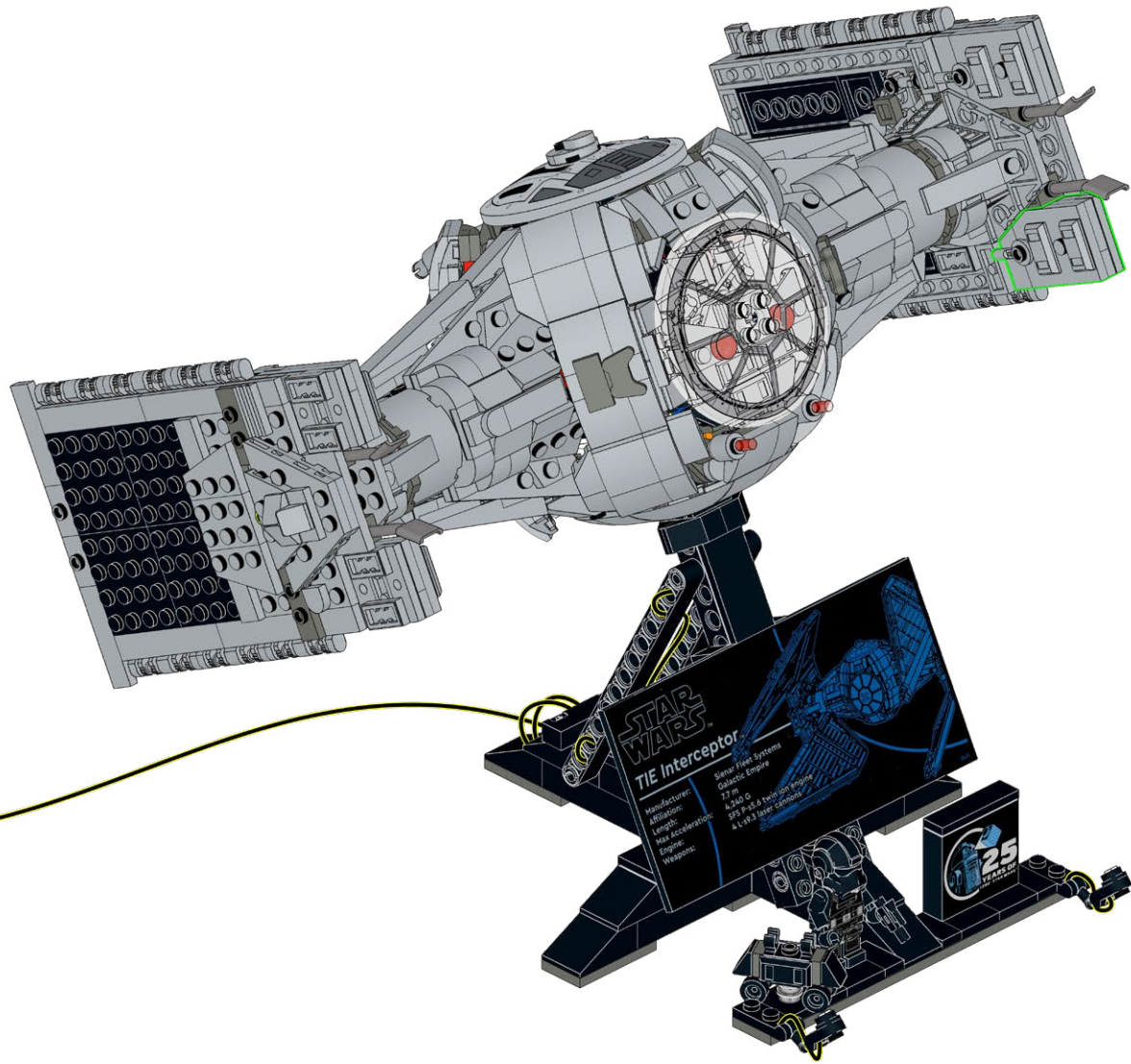



454

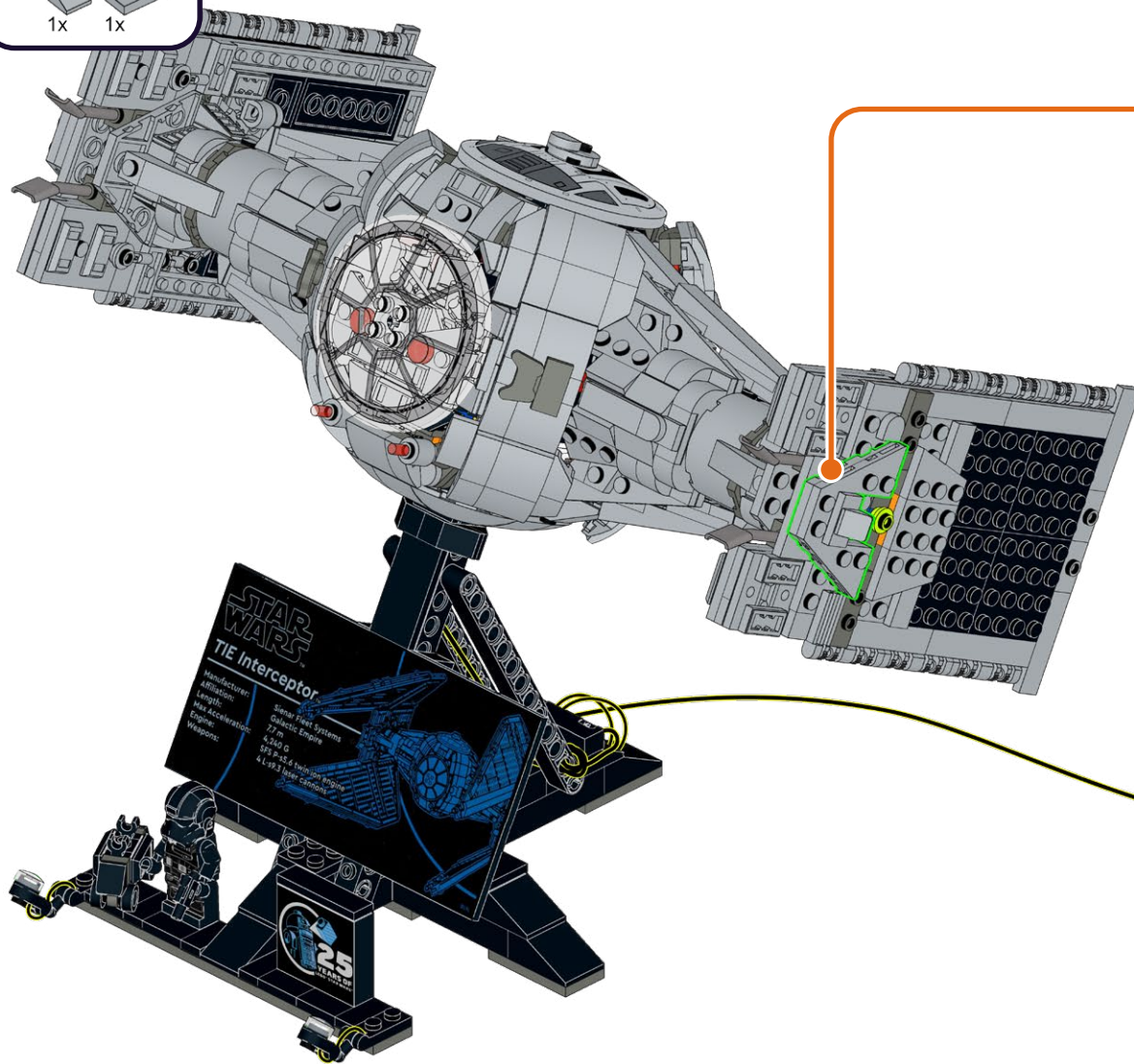
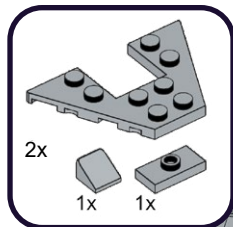

1

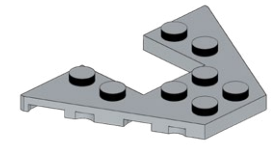

2

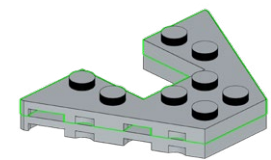

3

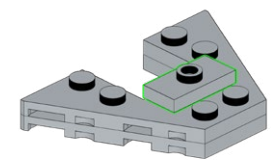

4

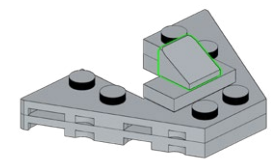



455

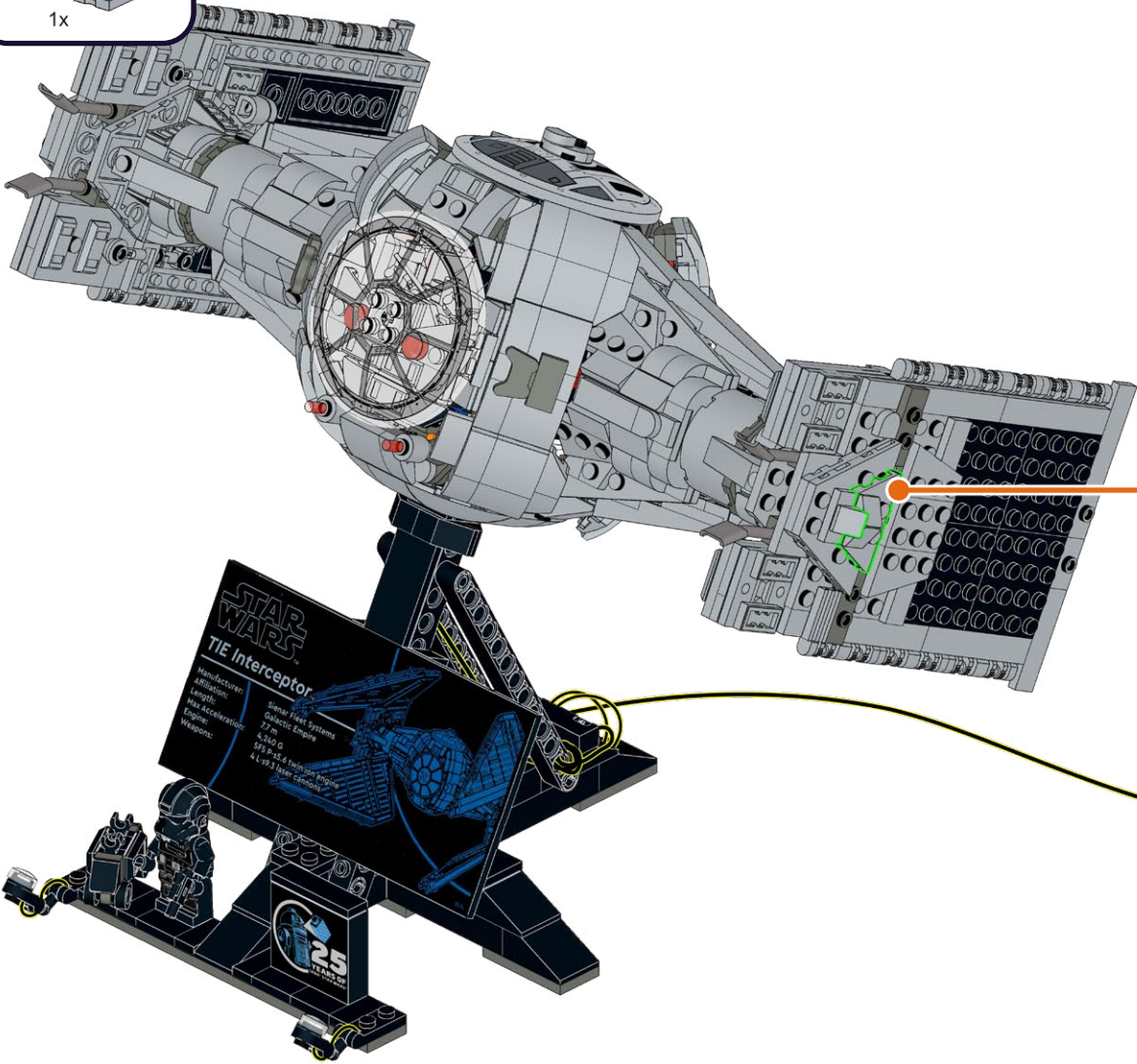
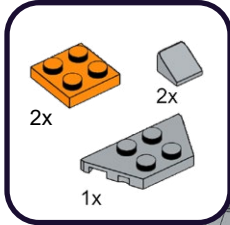

- 1
- 2
- 3
- 4

**HOLD UP!**

You might notice some bags are out of order, as well as left over pieces, but that's ok! We're changing the way you build LEGO!

**HALTEN!**

Möglicherweise stellen Sie fest, dass einige Beutel nicht in Ordnung sind und auch Teile übrig bleiben, aber das ist in Ordnung! Wir verändern die Art und Weise, wie Sie LEGO bauen!

**TENIR BON!**

Vous remarquerez peut-être que certains sacs sont en panne, ainsi que des morceaux restants, mais ce n'est pas grave ! Nous changeons la façon dont vous construisez LEGO !

**SOSTENERE!**

Potresti notare che alcune borse sono fuori uso, così come alcuni pezzi avanzati, ma va bene! Stiamo cambiando il modo in cui costruisci i LEGO!

**¡SOSTENER!**

Puede que notes que algunas bolsas están fuera de orden, así como piezas sobrantes, ¡pero está bien! ¡Estamos cambiando la forma de construir LEGO!

**耽误!**

您可能会注意到有些袋子坏了, 还有剩余的碎片, 但这没关系! 我们正在改变您搭建乐高的方式!

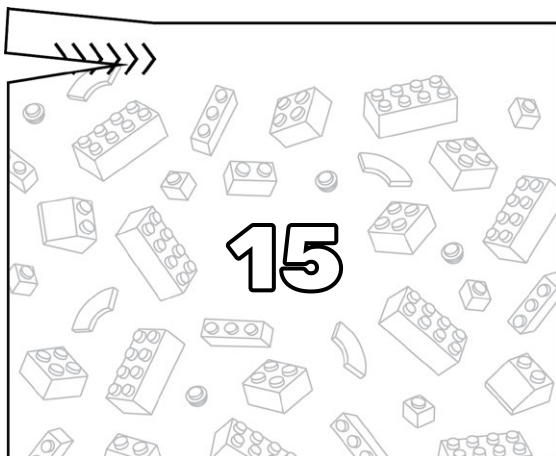
**Open LEGO® Bag 1**

456

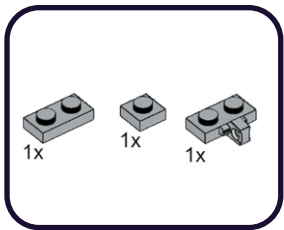

1



2

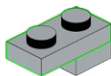

3

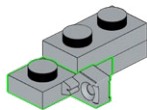

# 457

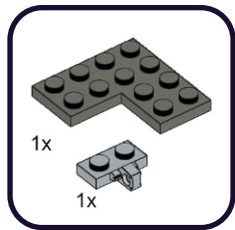

1

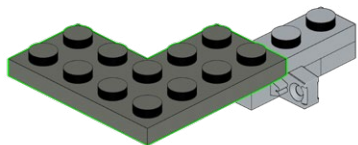

2

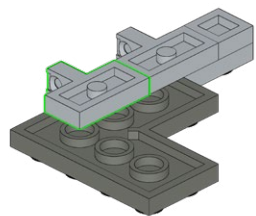

# 458

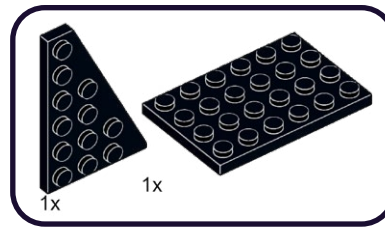

1

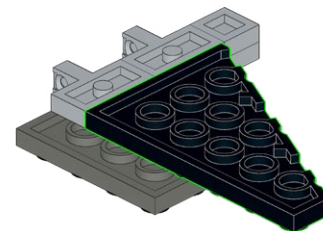

2

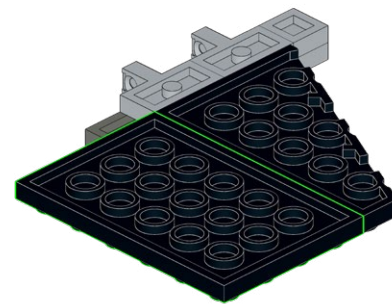

459

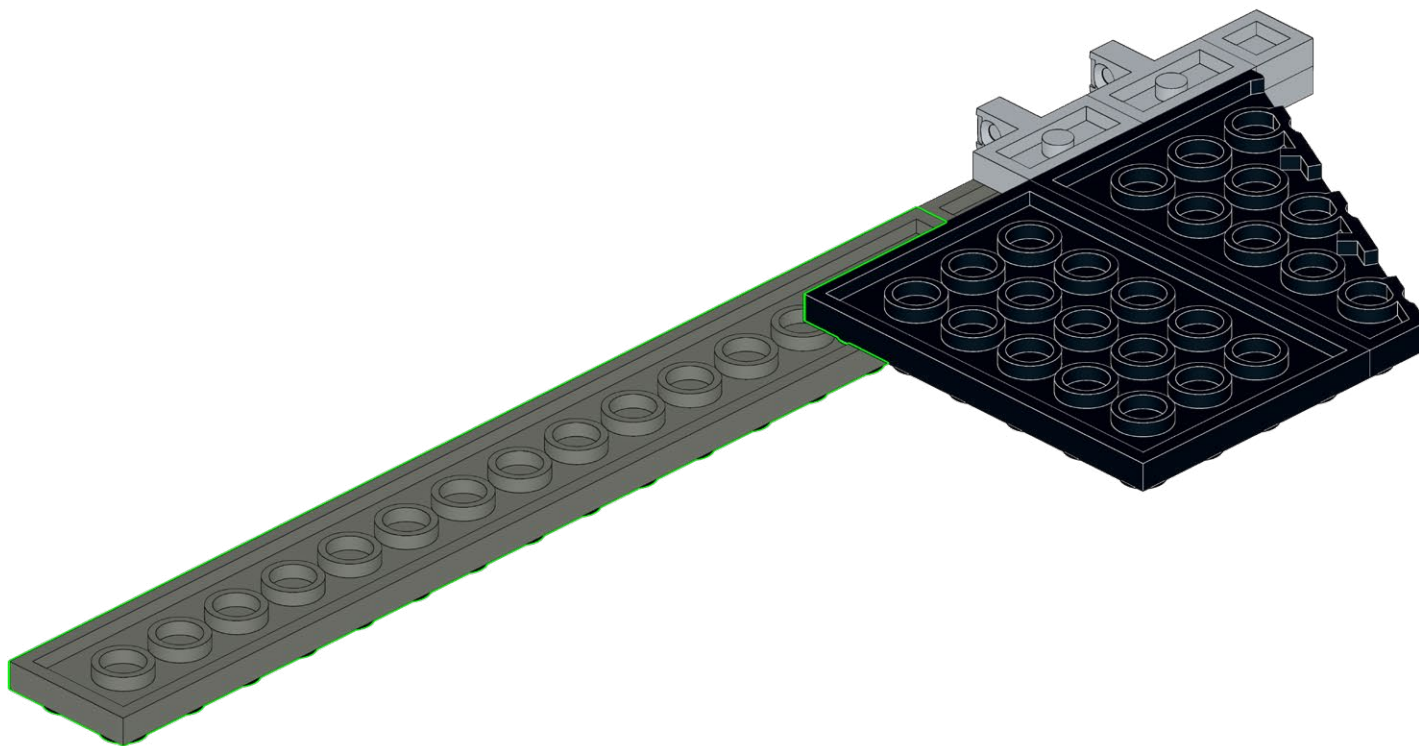
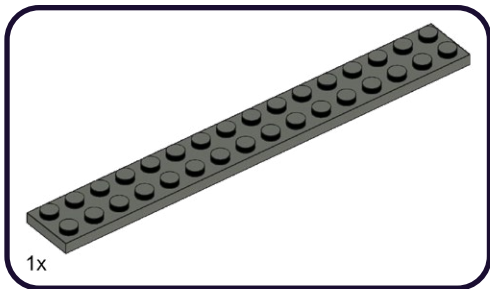

460

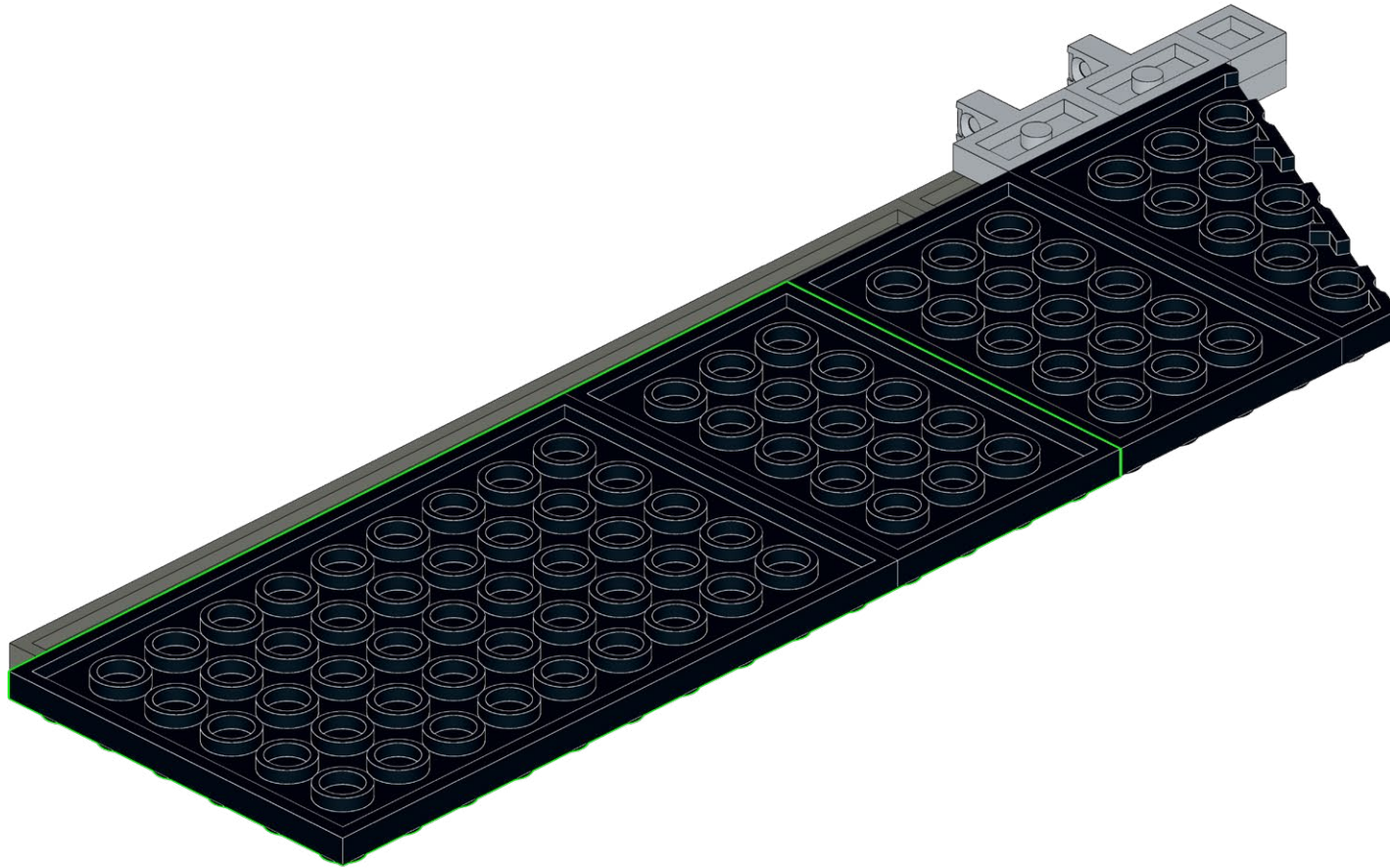
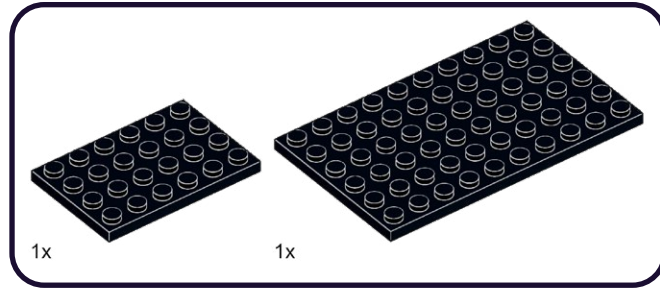



461

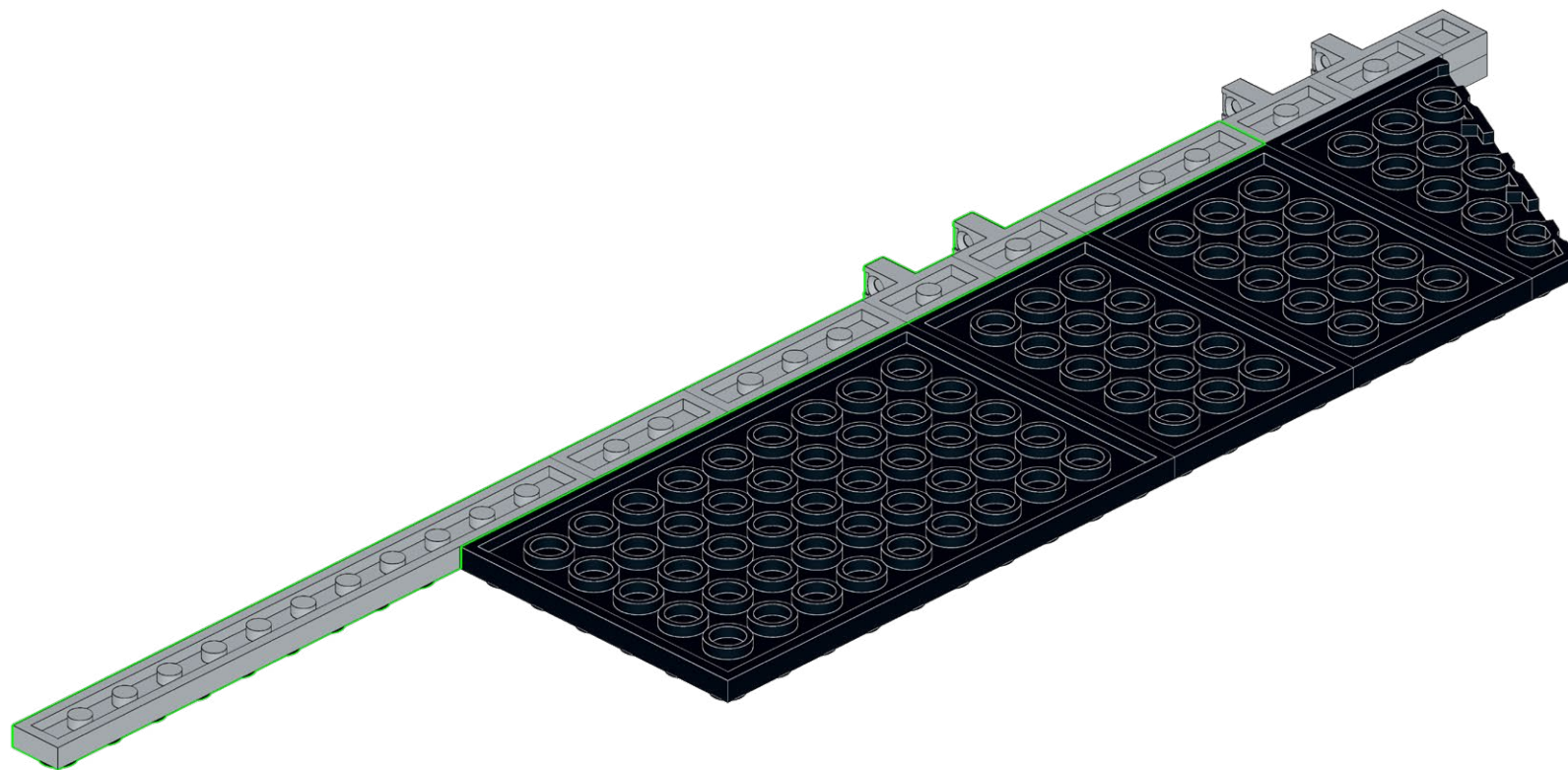
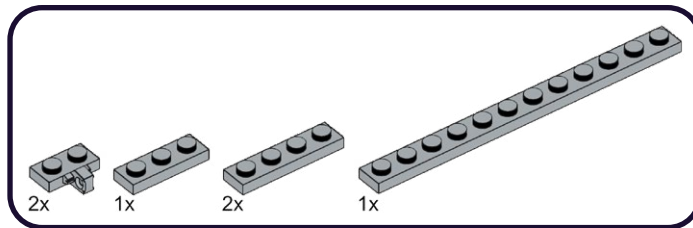

462

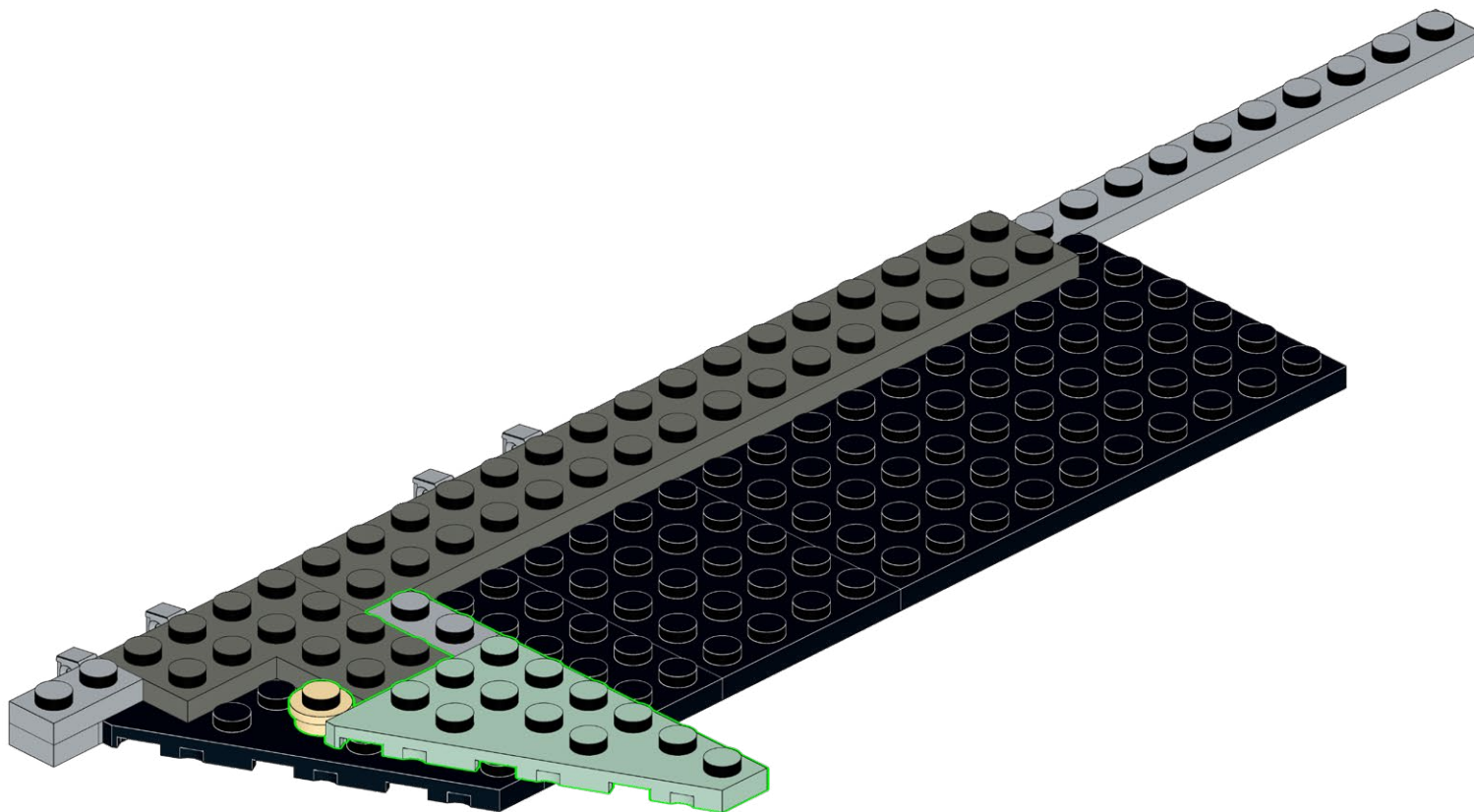
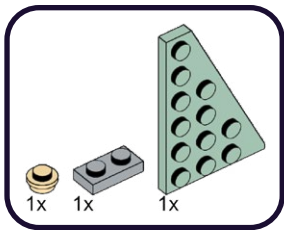

463

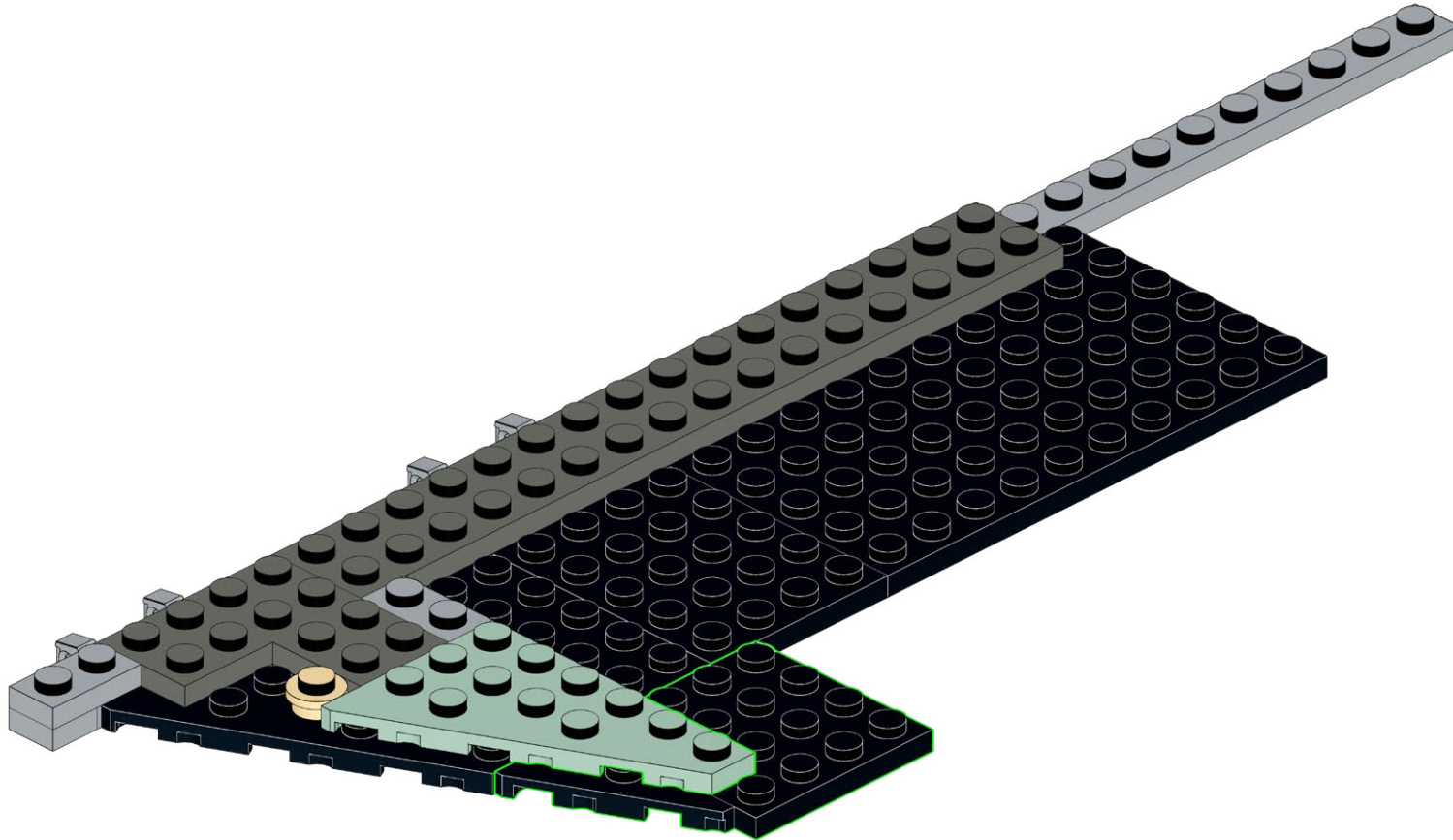
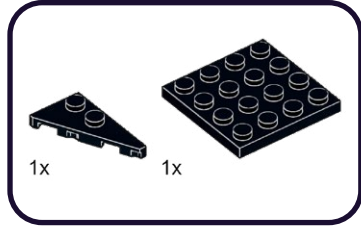

464

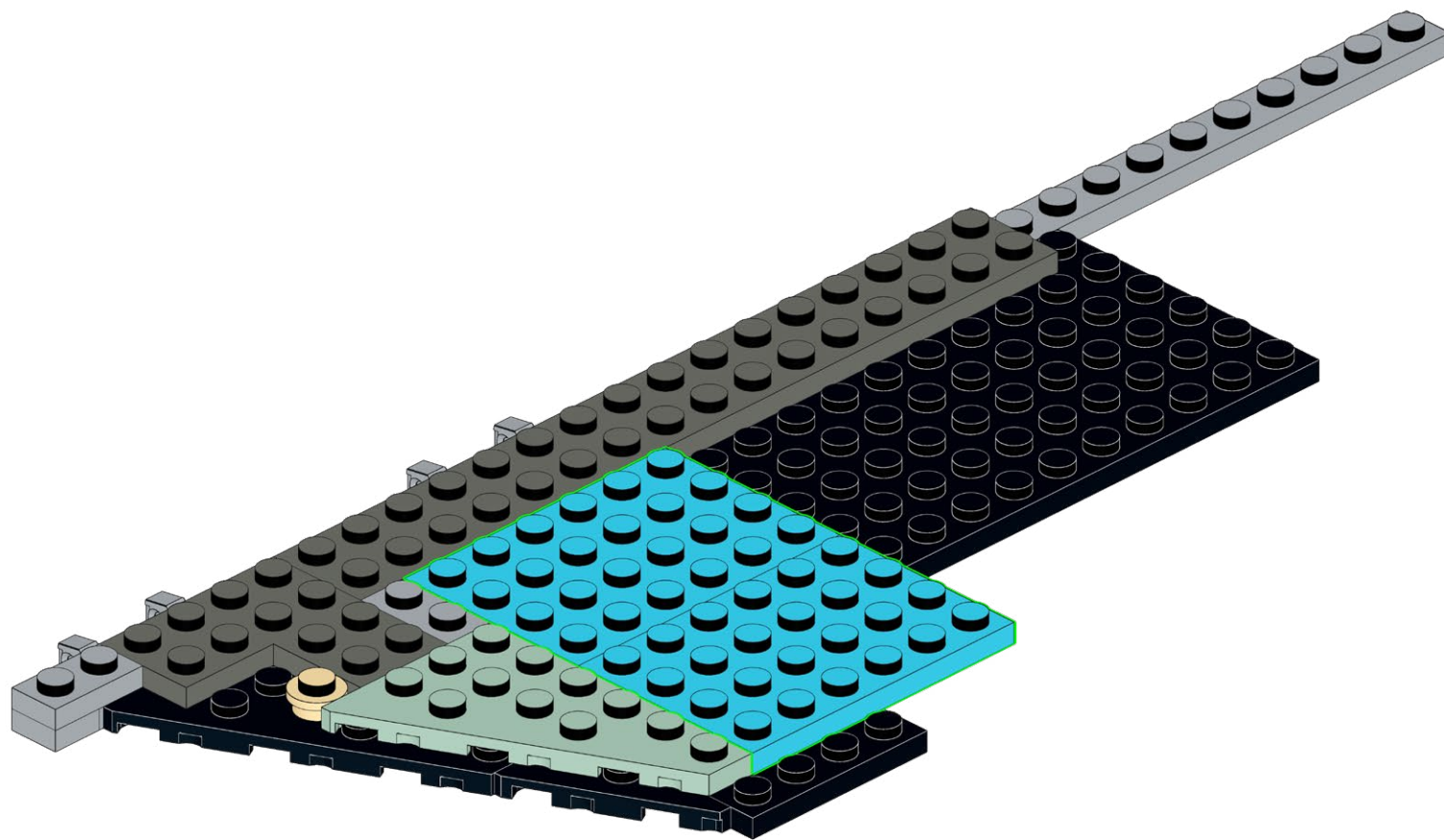
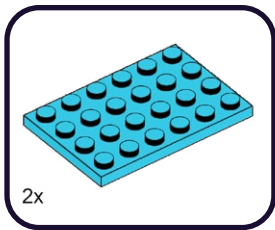

465

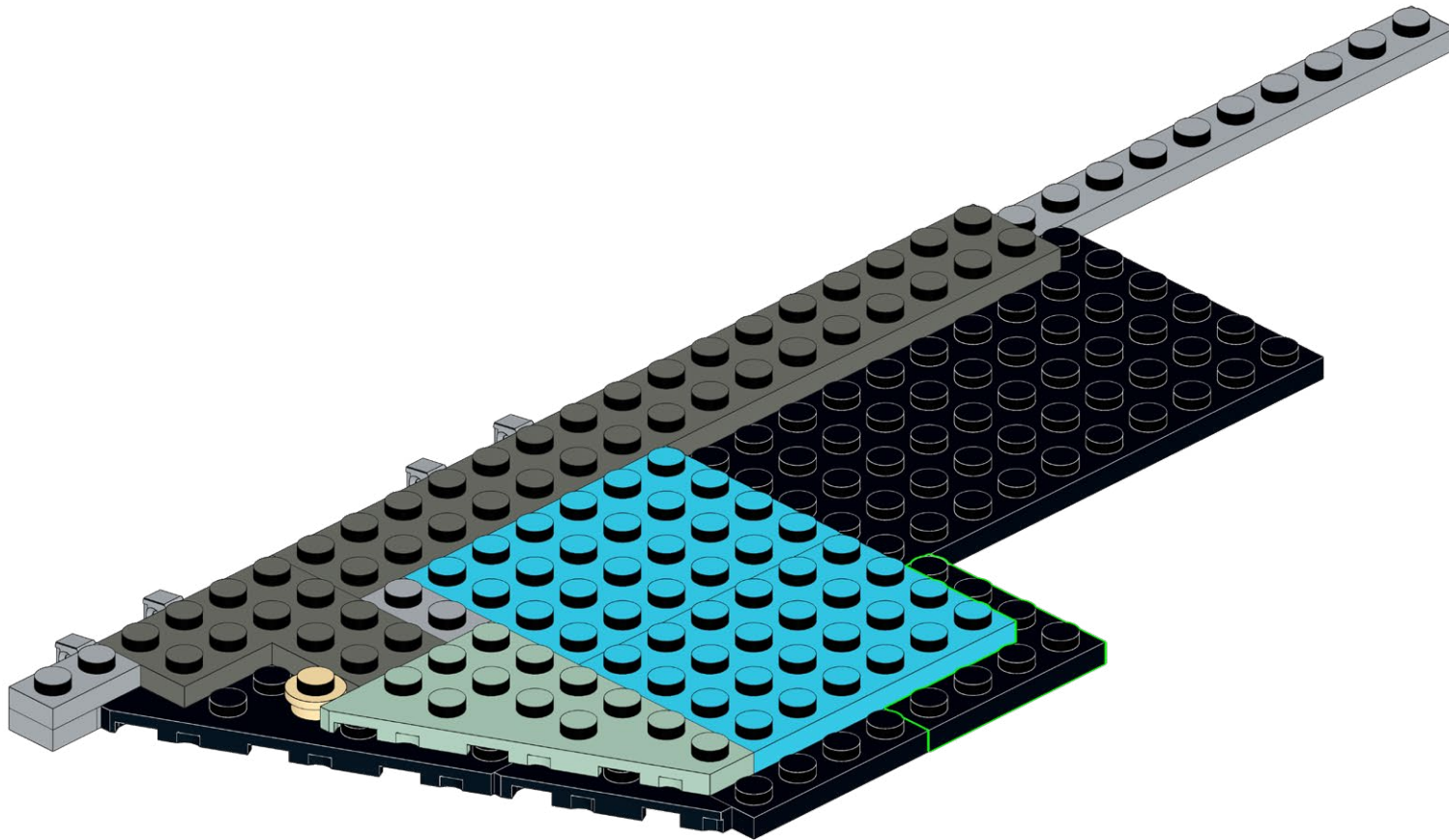
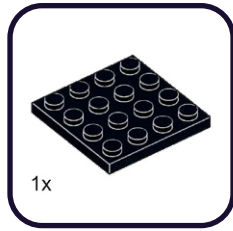



466

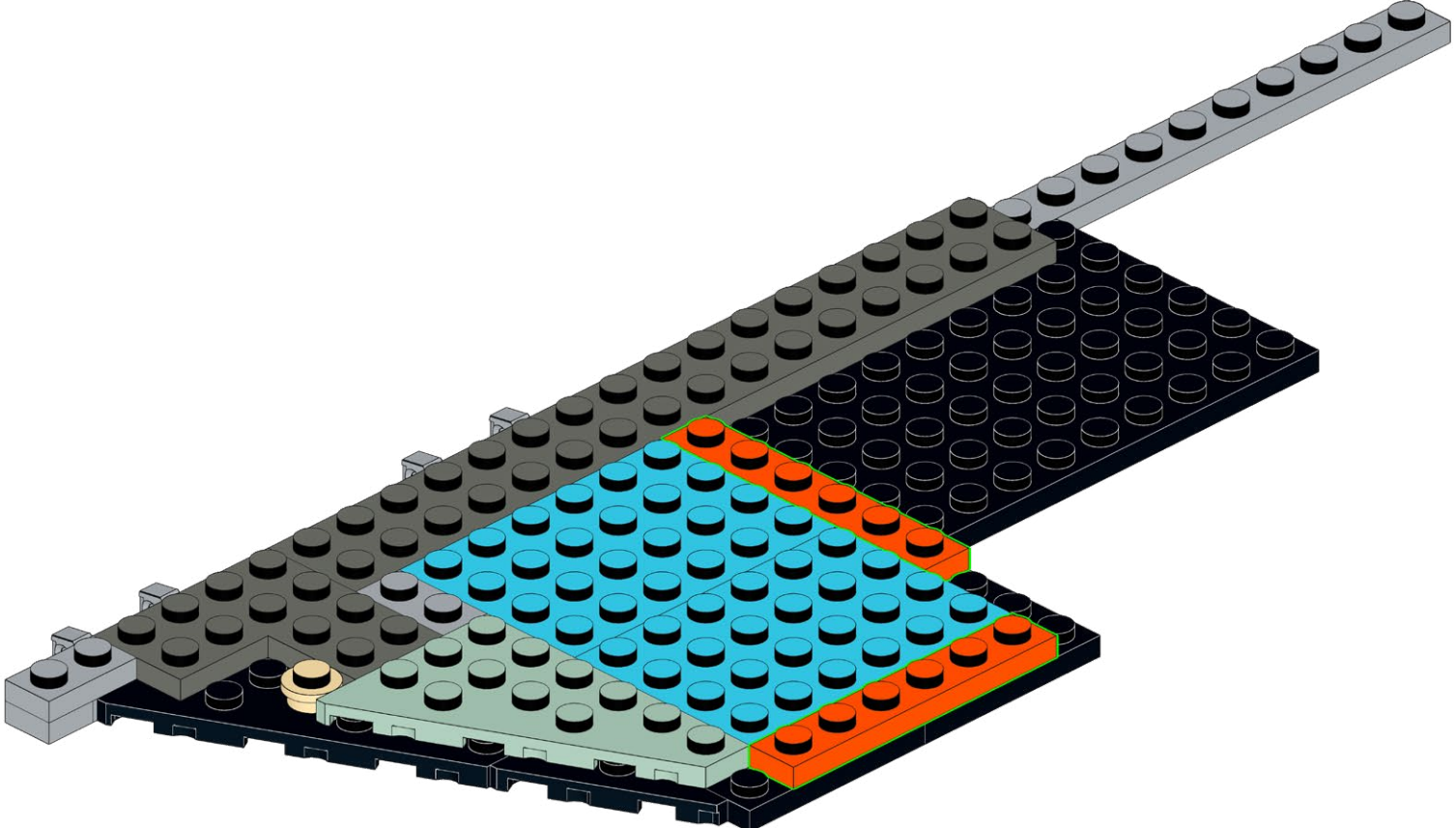
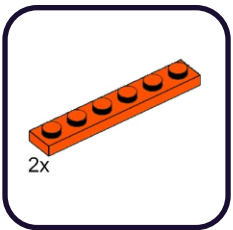



467

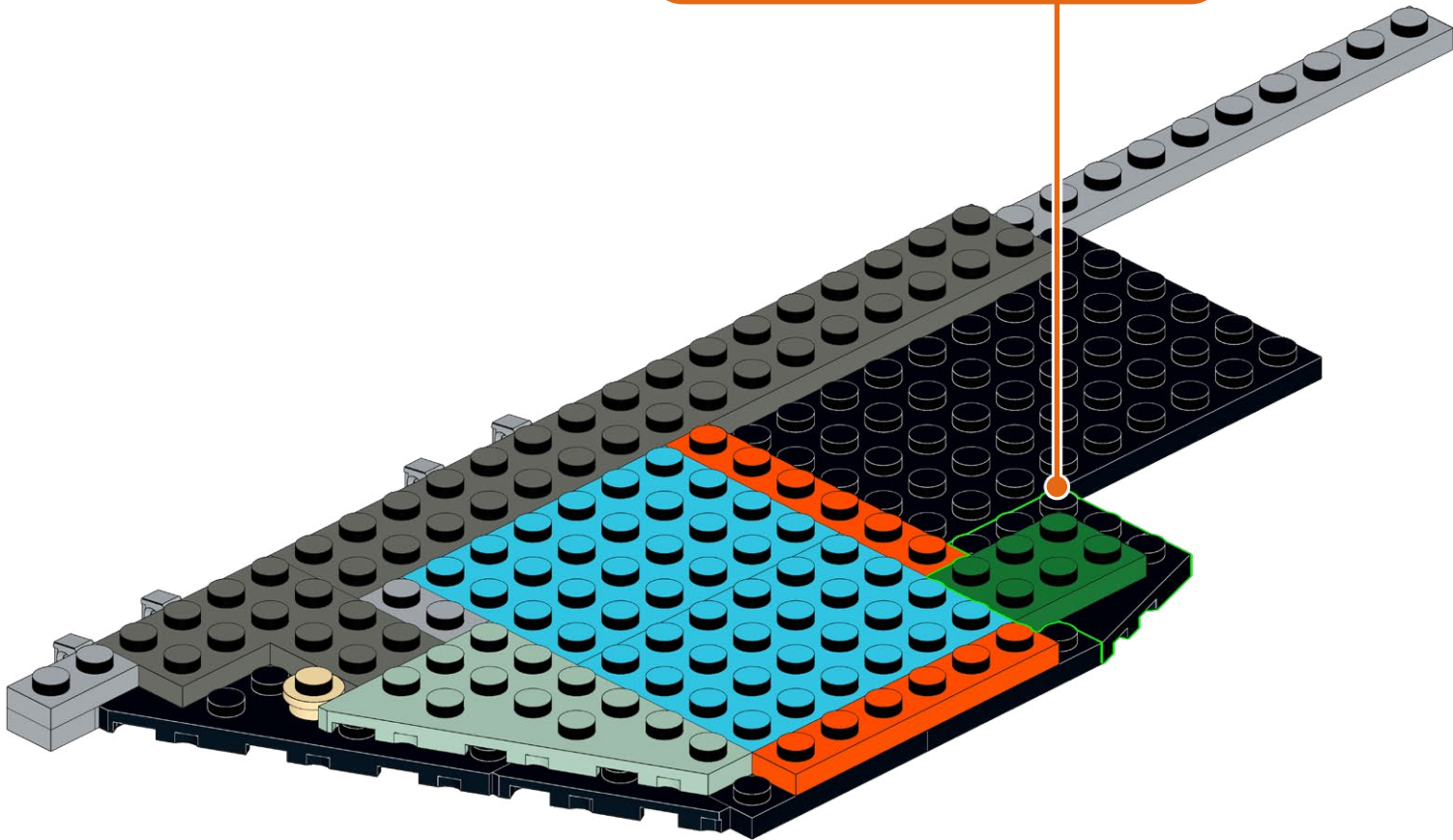
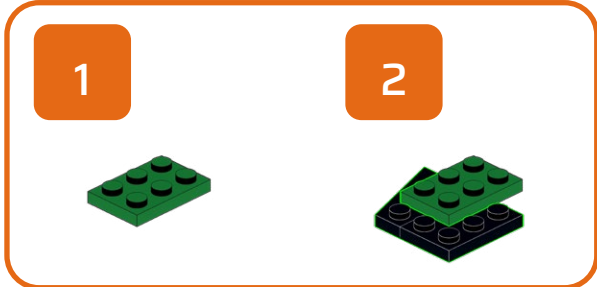
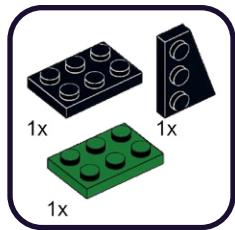

468

1x

2x

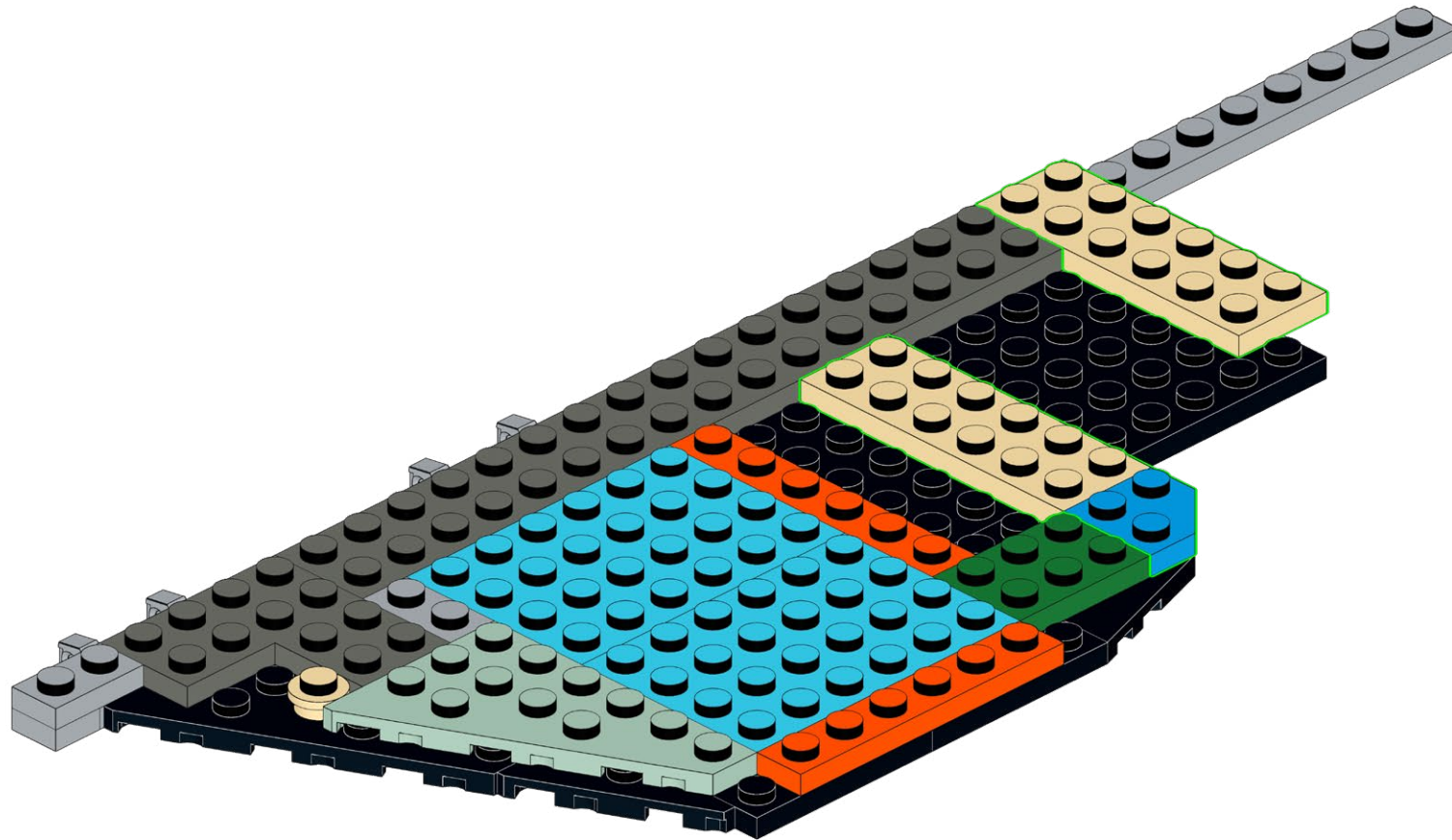



470

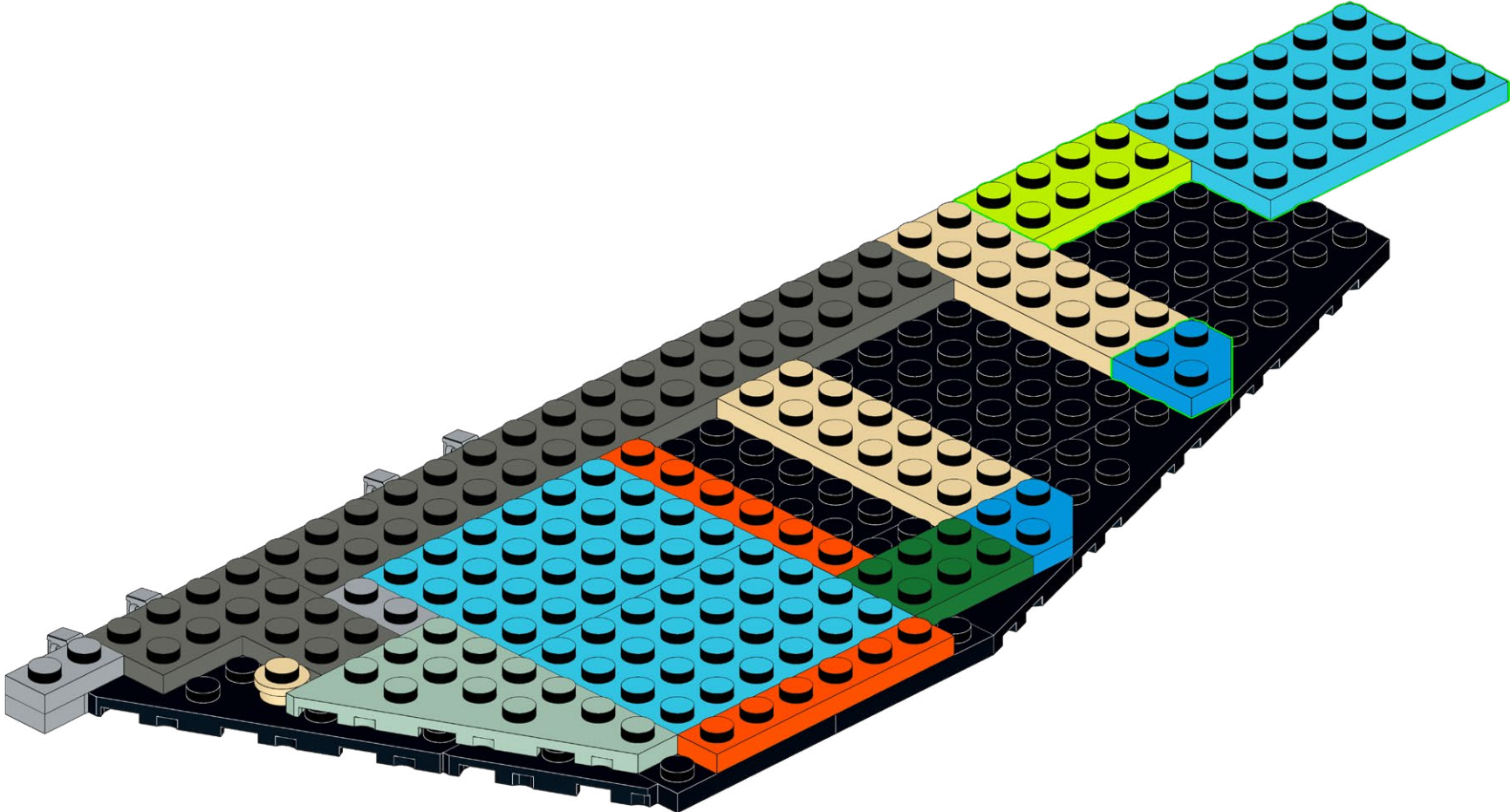
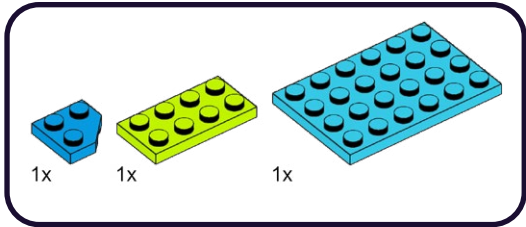



471

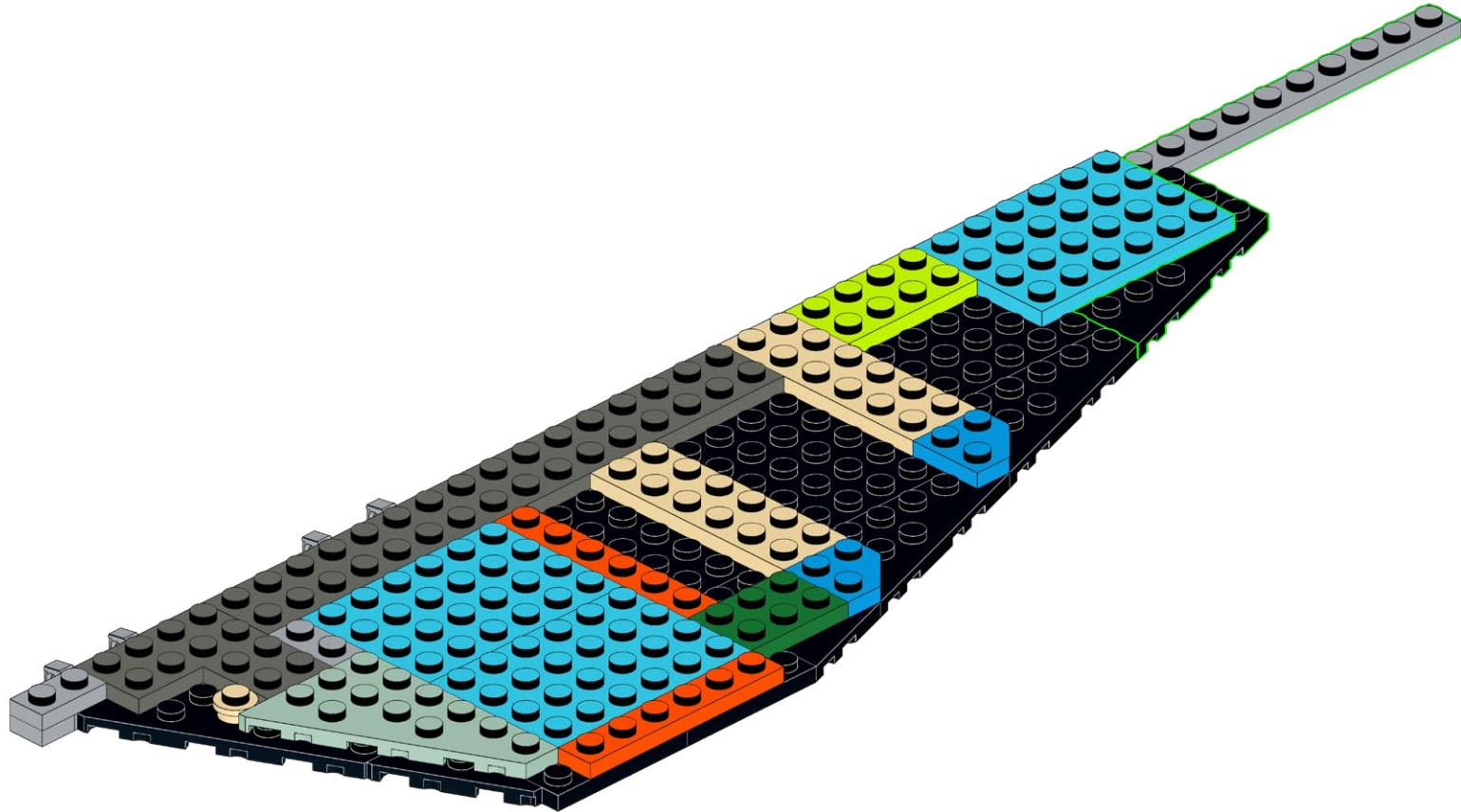
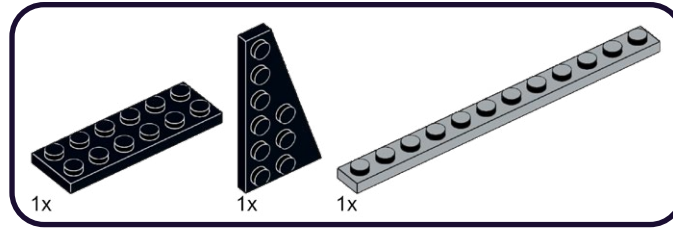

472

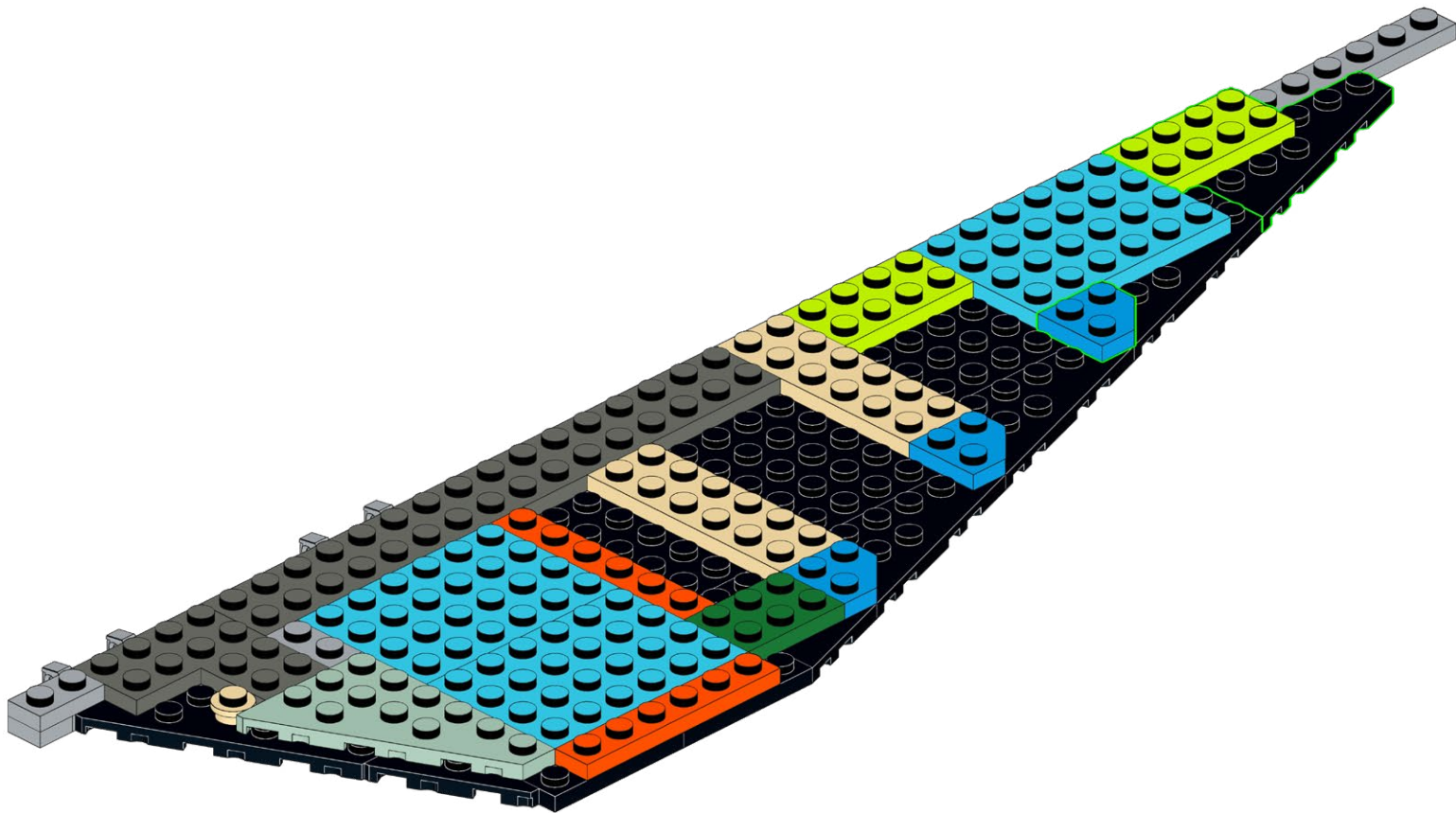
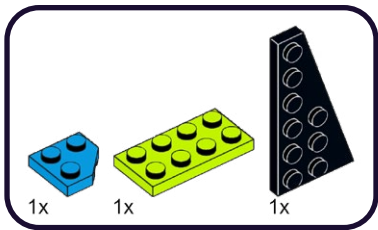



473

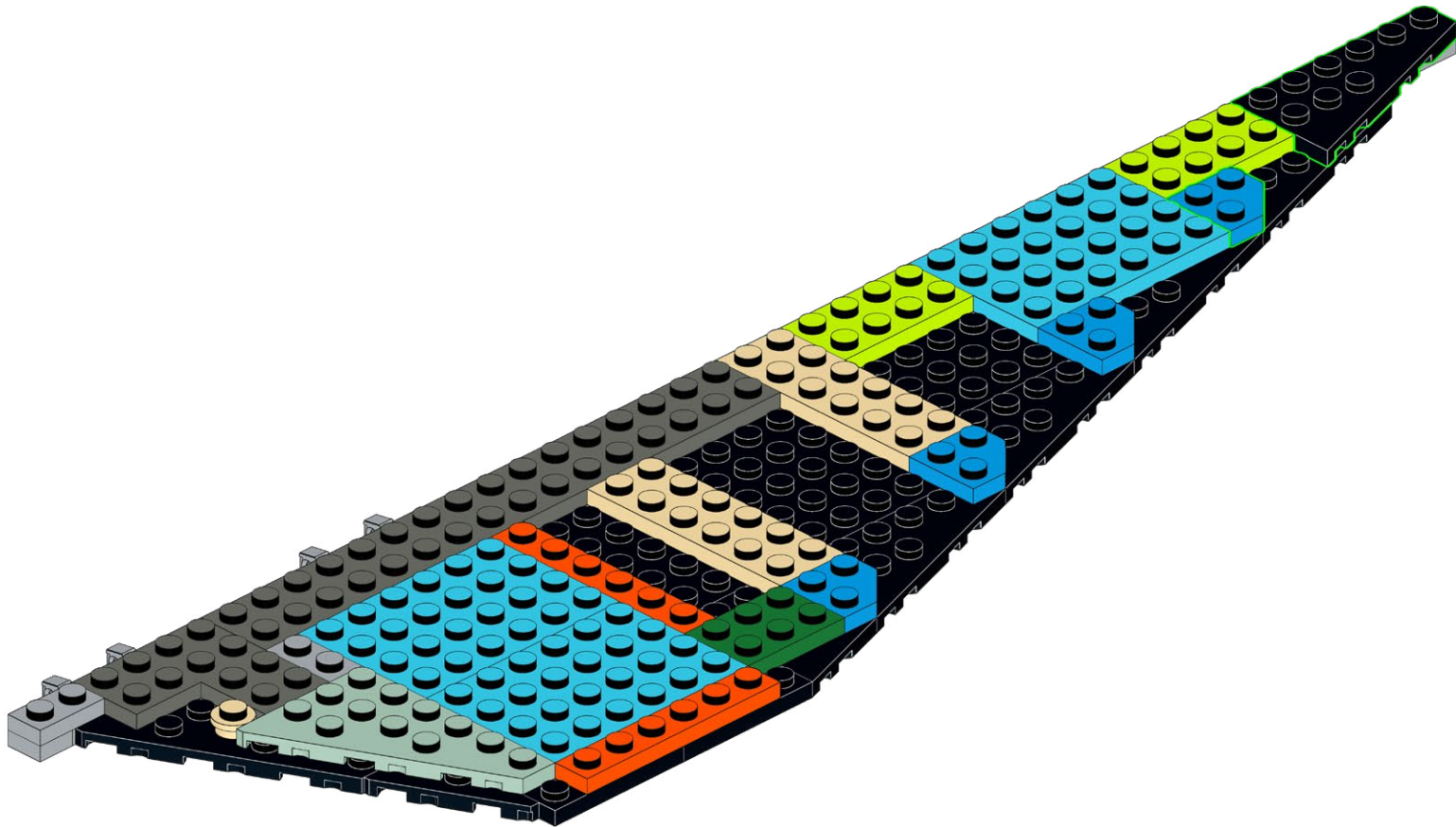
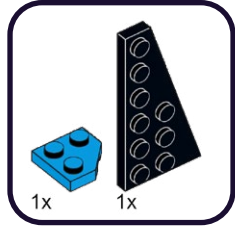

474

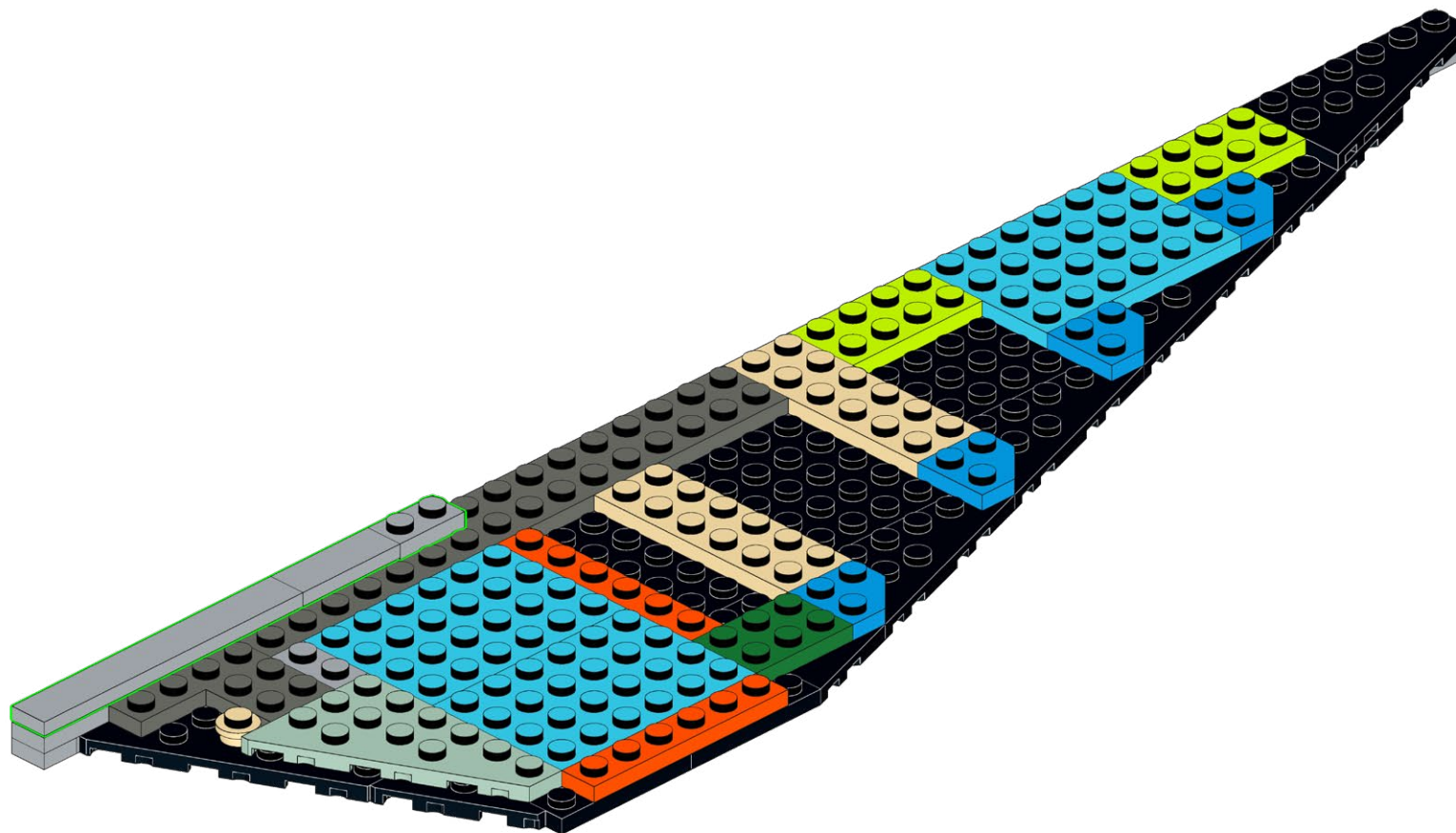
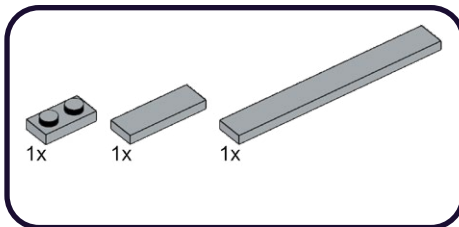

475

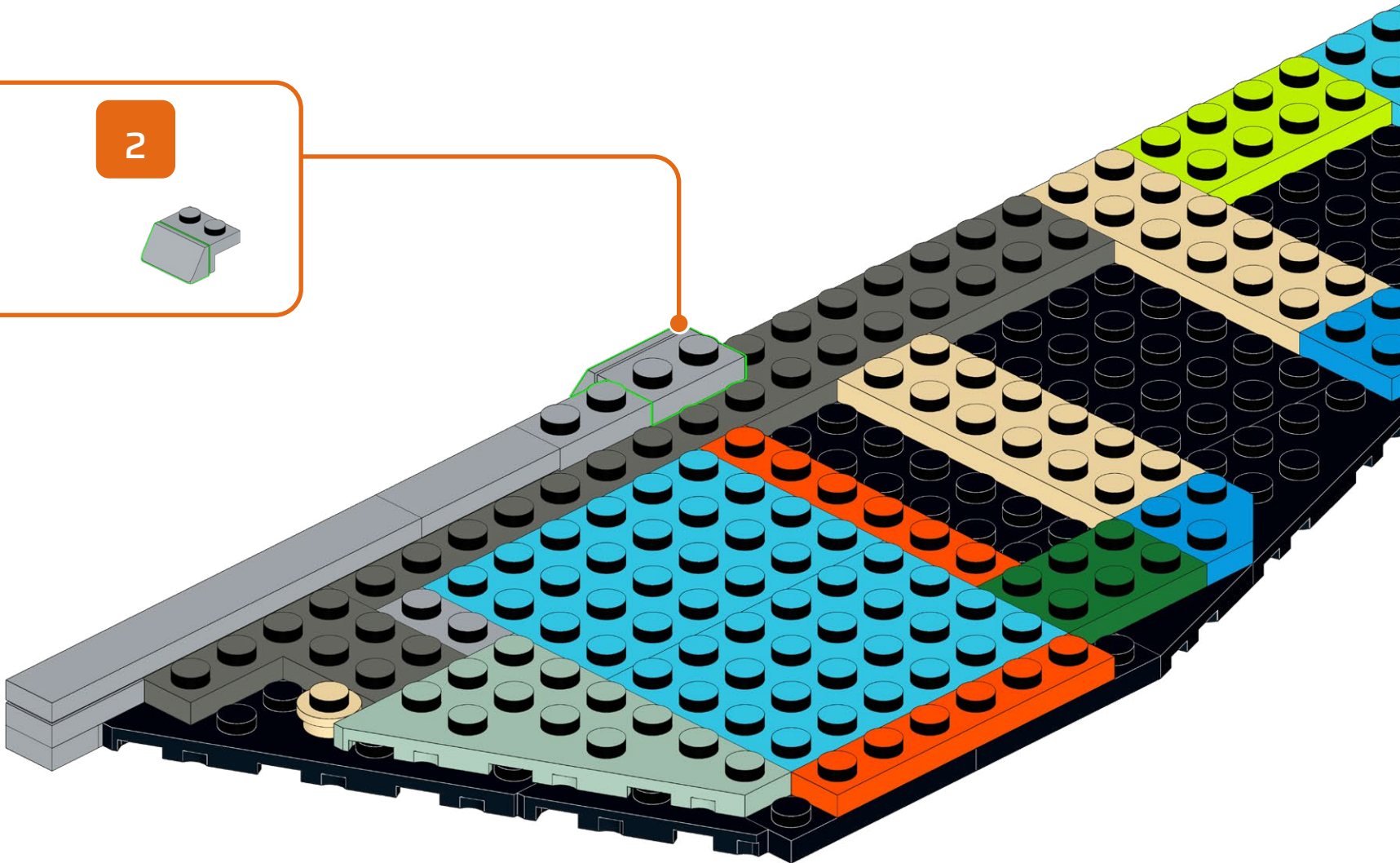
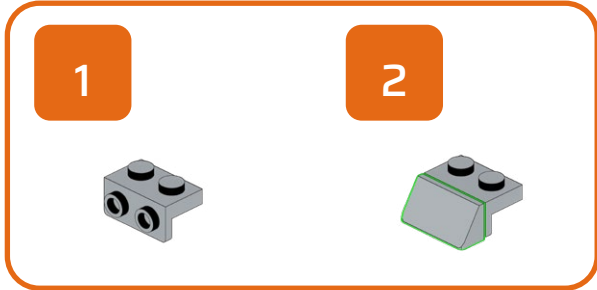
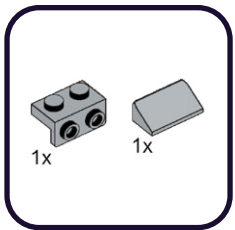

476

6x

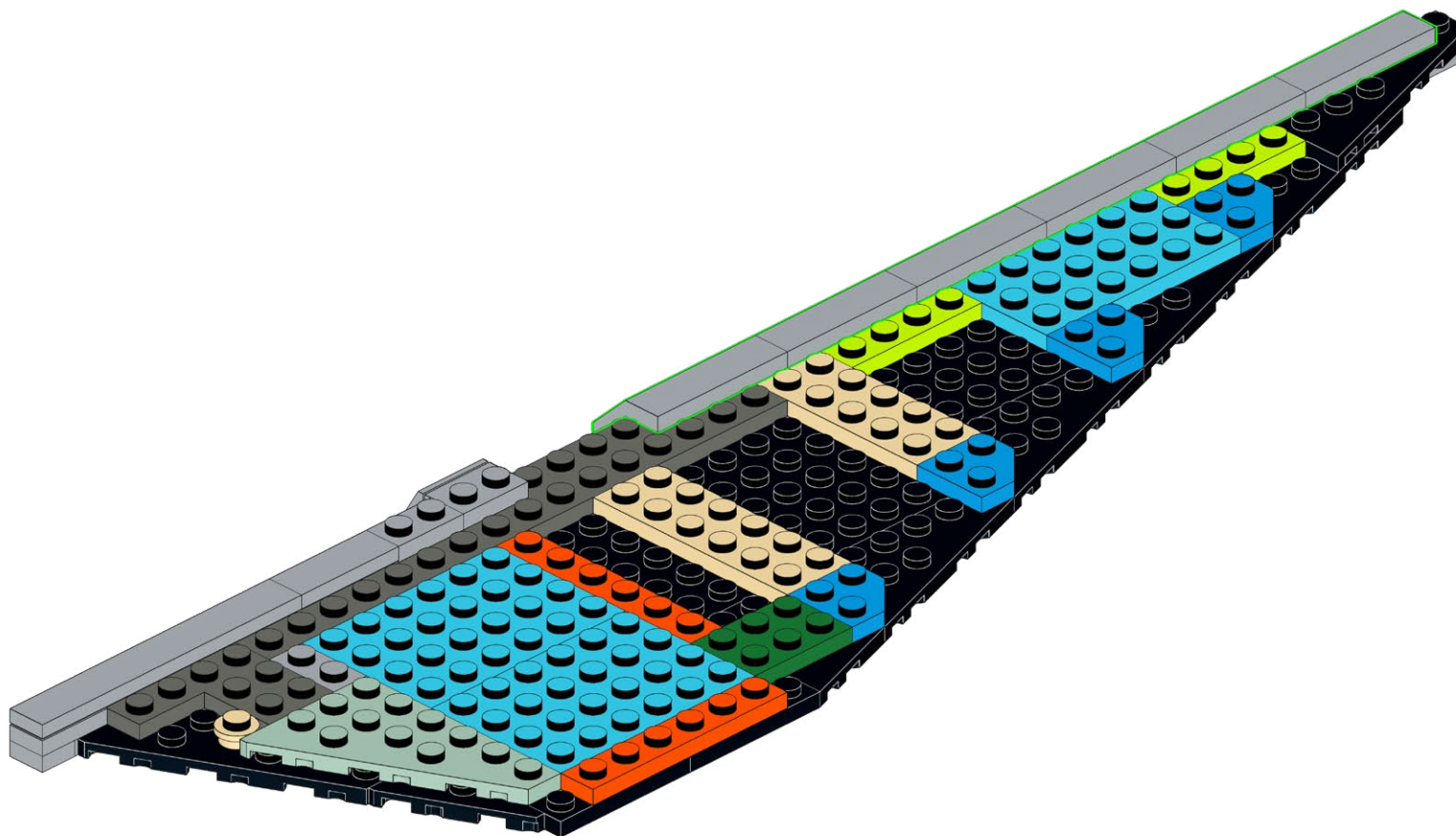



**HOLD UP!**

You might notice some bags are out of order, as well as left over pieces, but that's ok! We're changing the way you build LEGO!

**HALTEN!**

Möglicherweise stellen Sie fest, dass einige Beutel nicht in Ordnung sind und auch Teile übrig bleiben, aber das ist in Ordnung! Wir verändern die Art und Weise, wie Sie LEGO bauen!

**TENIR BON!**

Vous remarquerez peut-être que certains sacs sont en panne, ainsi que des morceaux restants, mais ce n'est pas grave ! Nous changeons la façon dont vous construisez LEGO !

**SOSTENERE!**

Potresti notare che alcune borse sono fuori uso, così come alcuni pezzi avanzati, ma va bene! Stiamo cambiando il modo in cui costruisci i LEGO!

**¡SOSTENER!**

Puede que notes que algunas bolsas están fuera de orden, así como piezas sobrantes, ¡pero está bien! ¡Estamos cambiando la forma de construir LEGO!

**耽误!**

您可能会注意到有些袋子坏了, 还有剩余的碎片, 但这没关系! 我们正在改变您搭建乐高的方式!

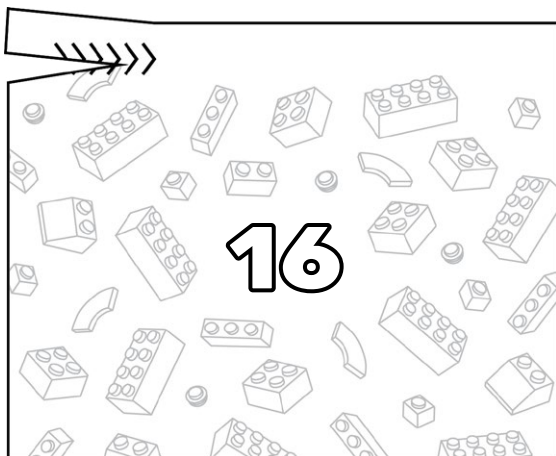
**Open LEGO® Bag 1**

477

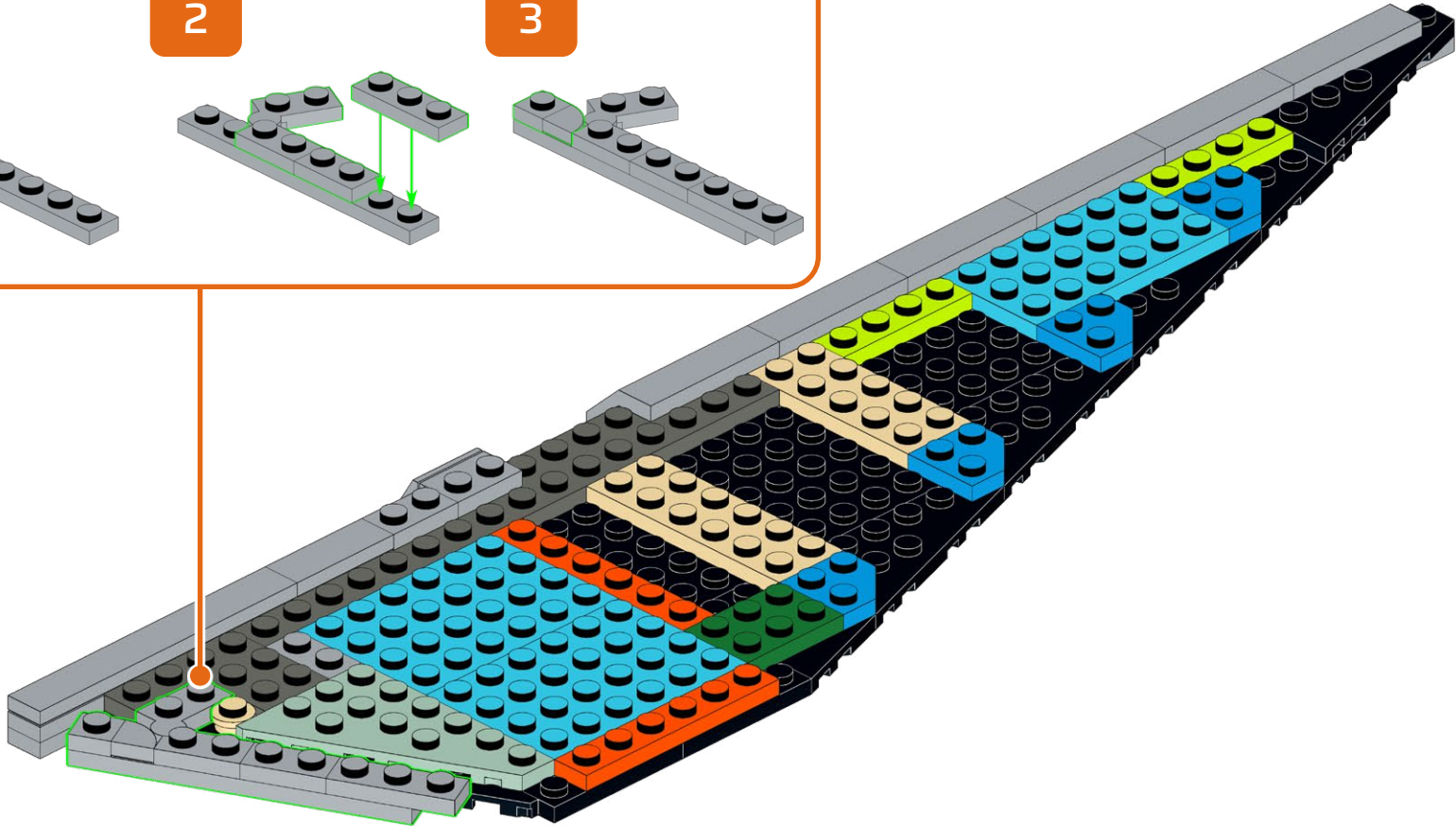
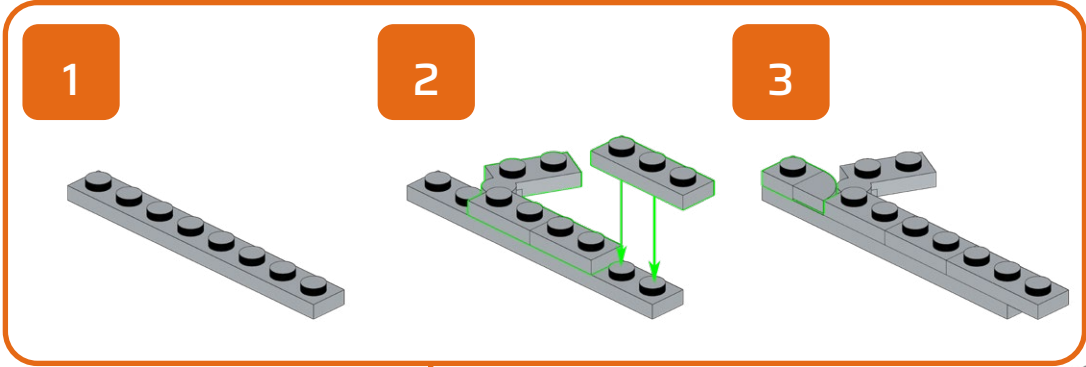
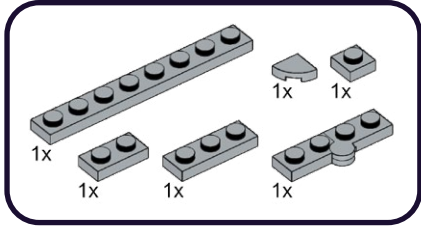



478

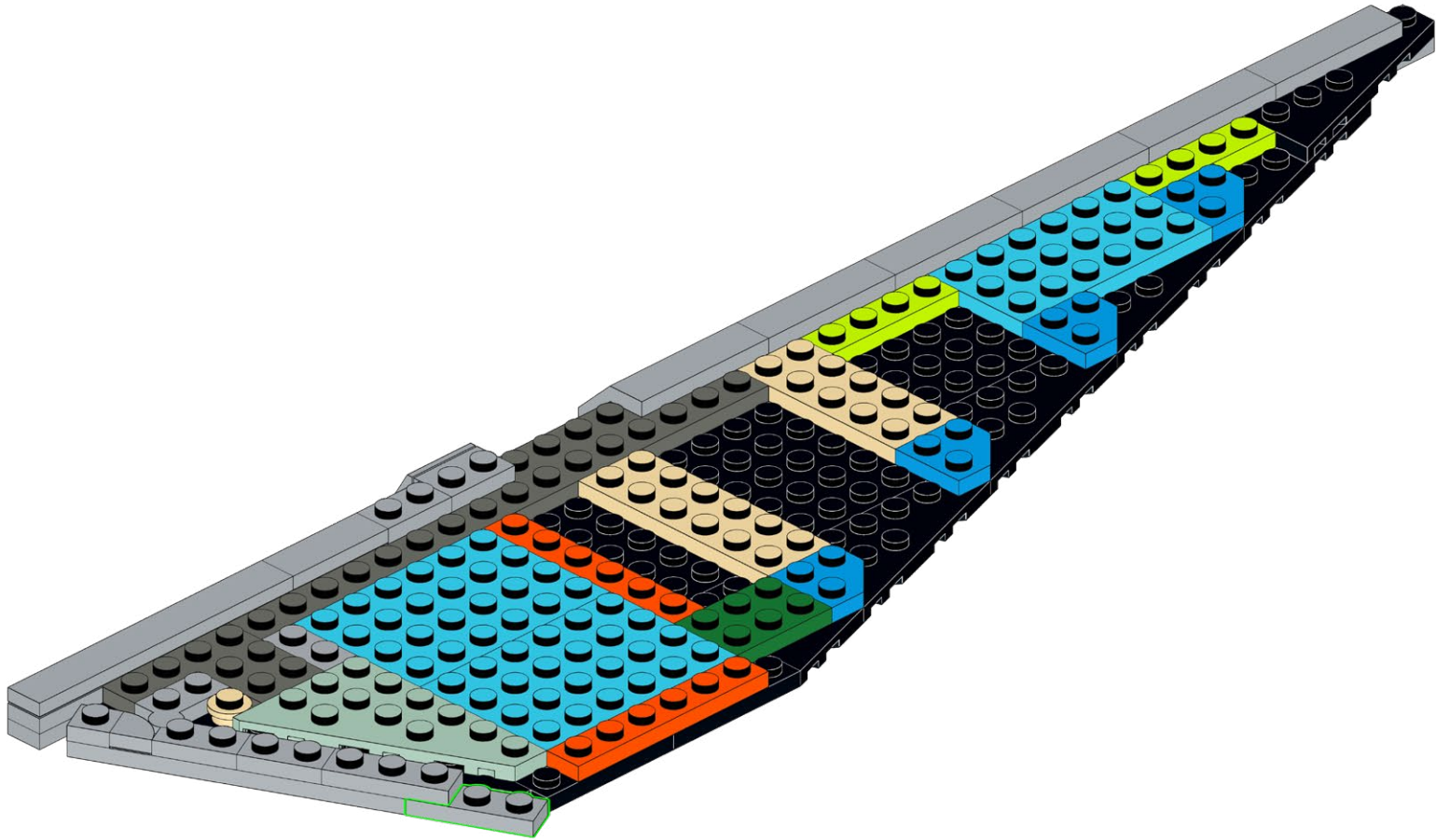
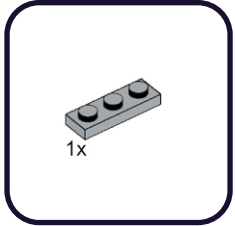

479

1x

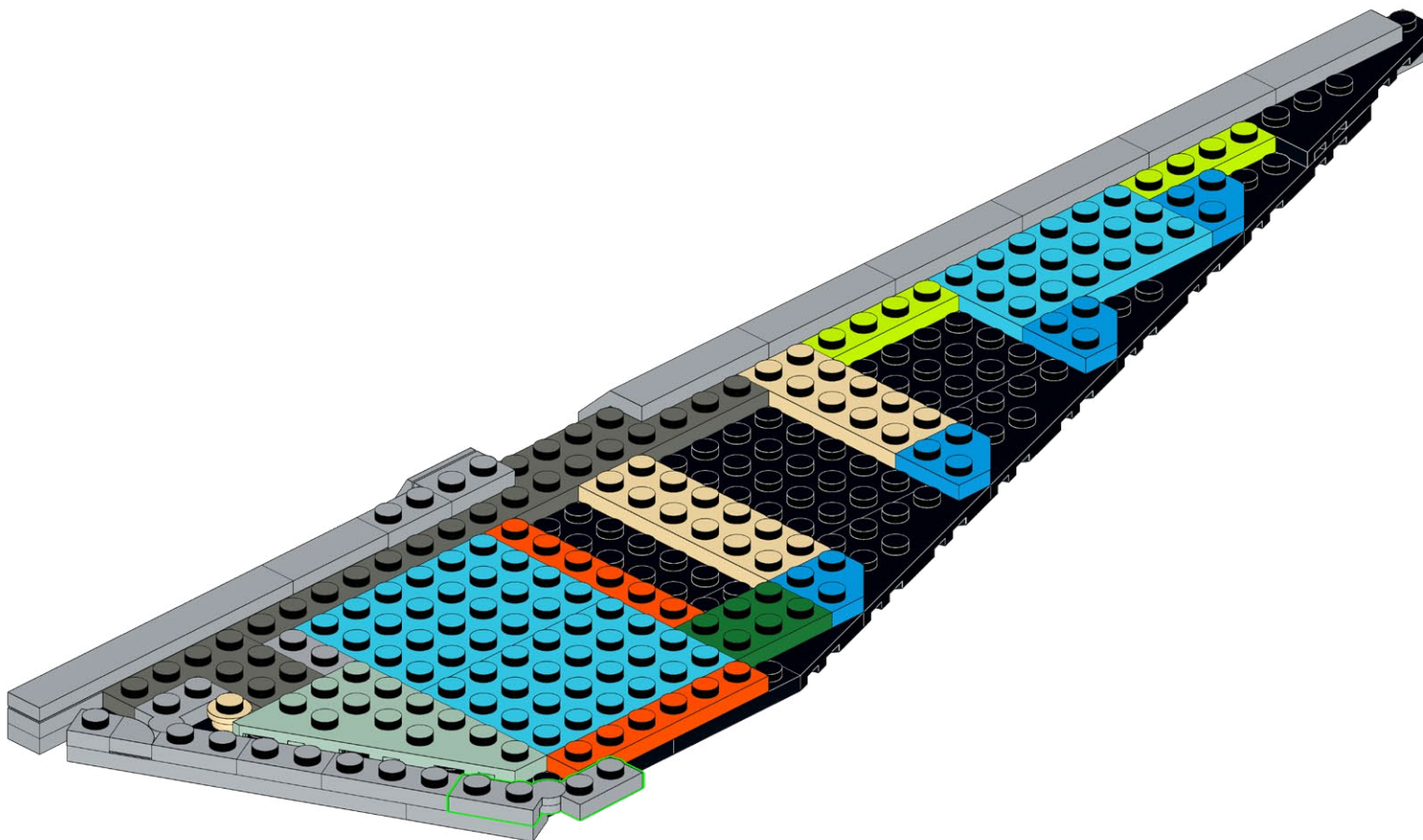



481

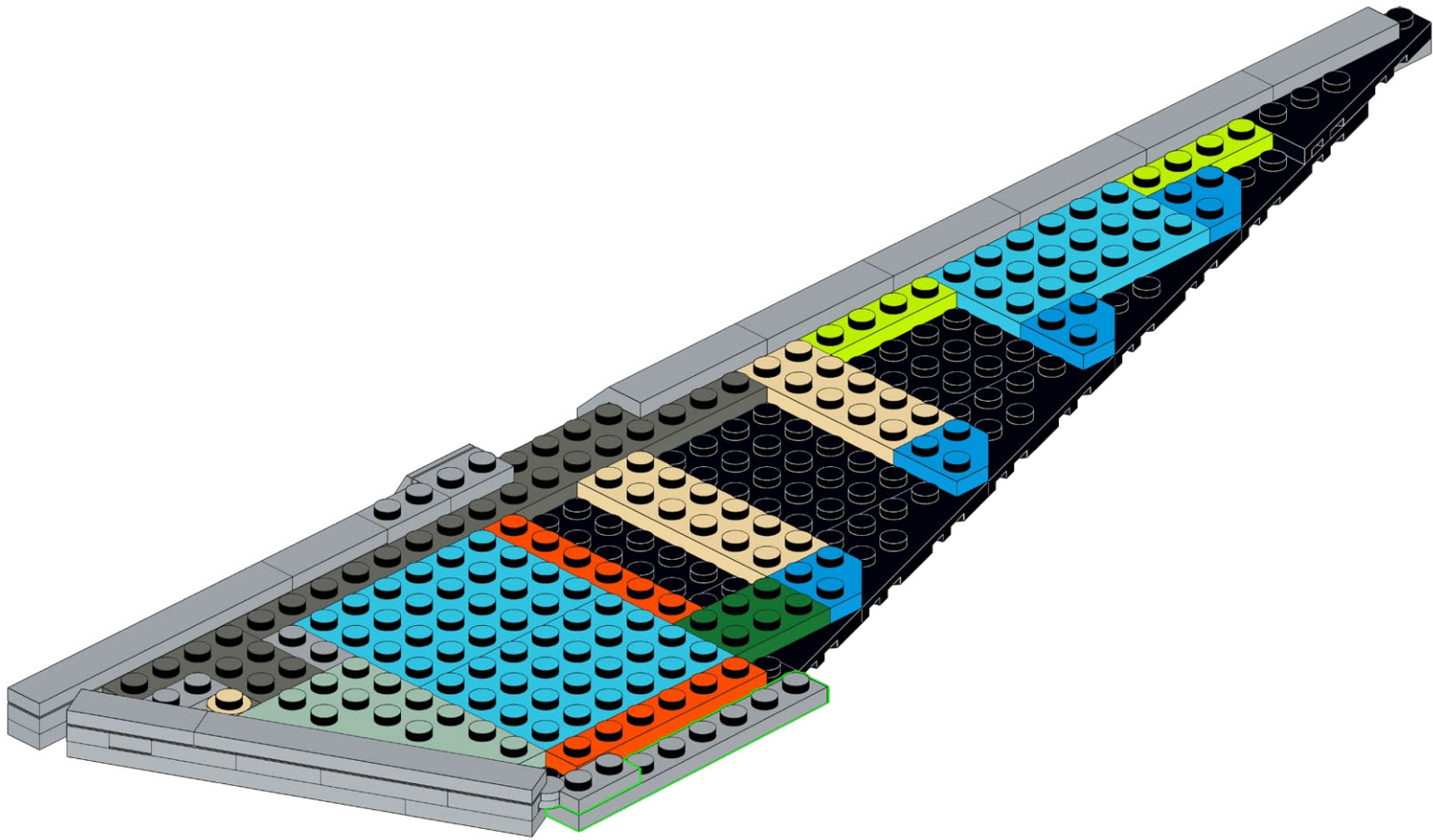
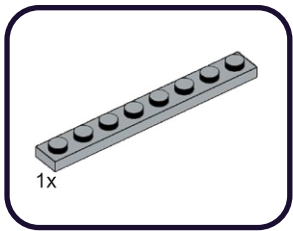





483

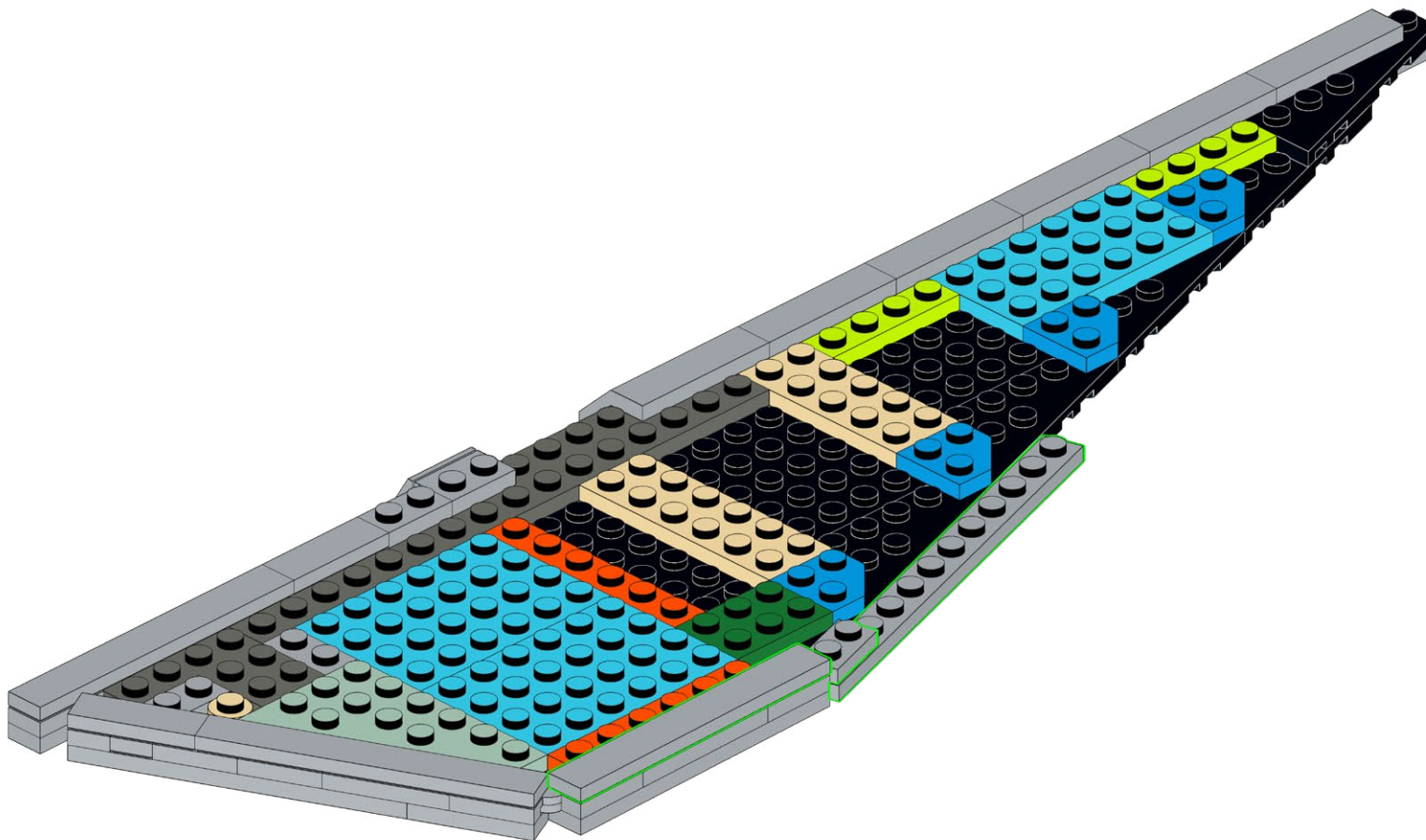
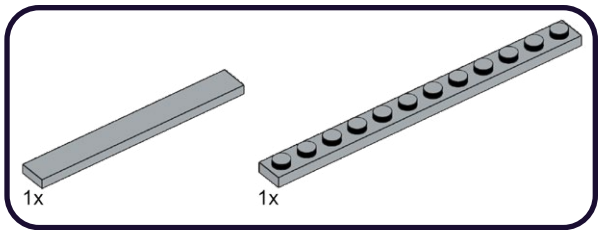



484

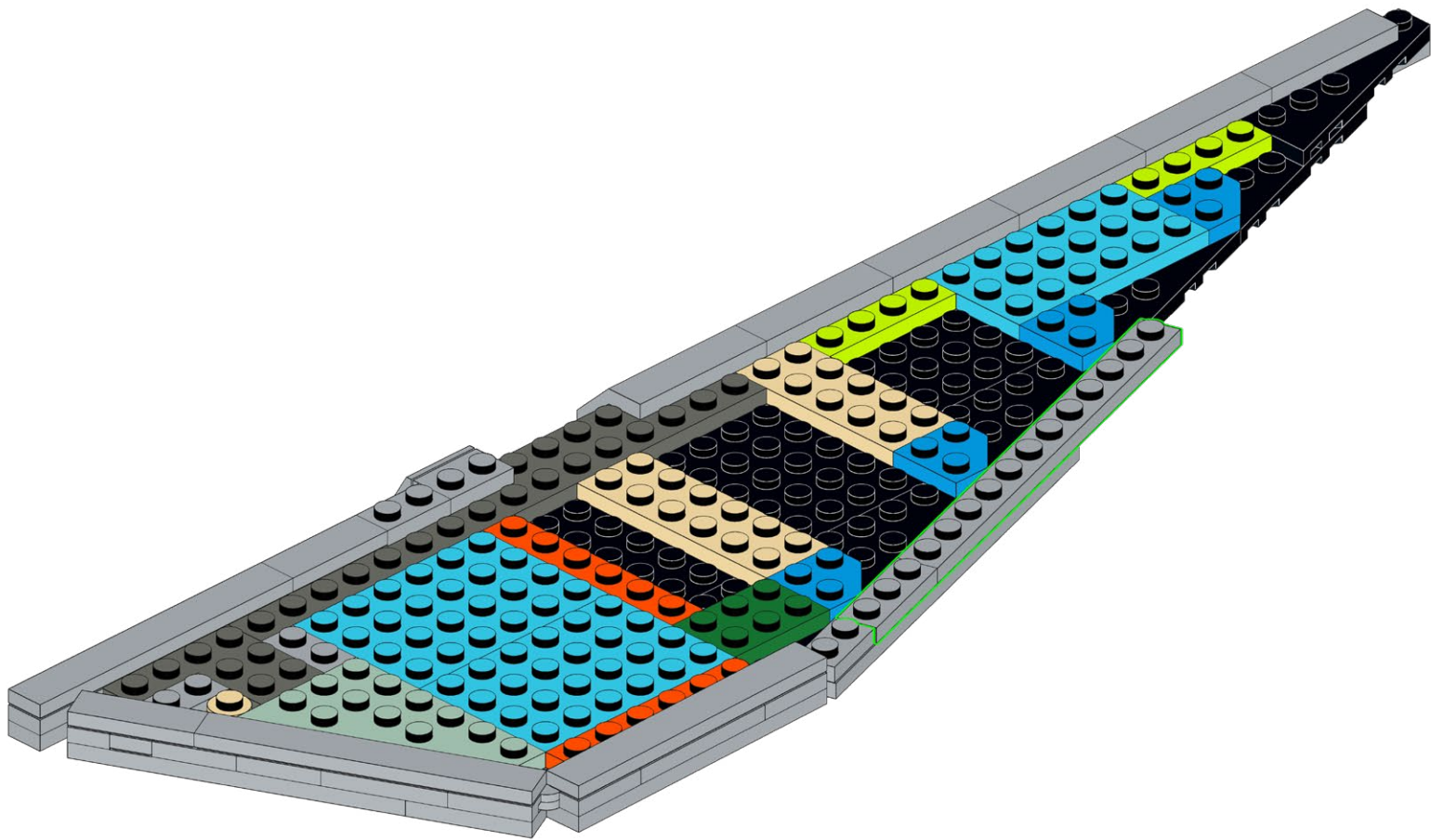
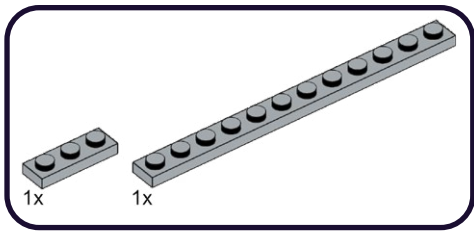

485

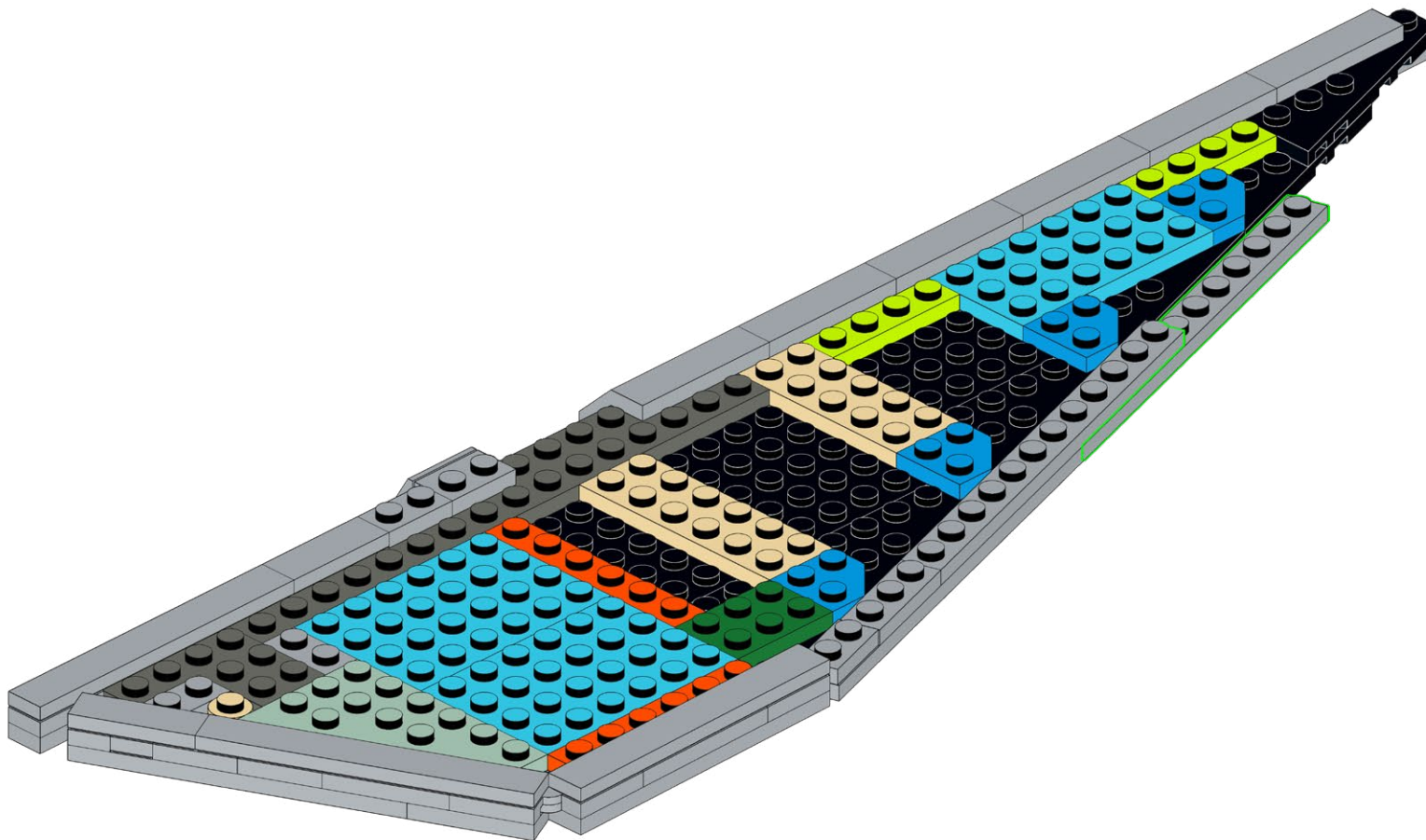
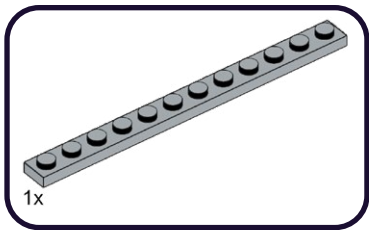

486

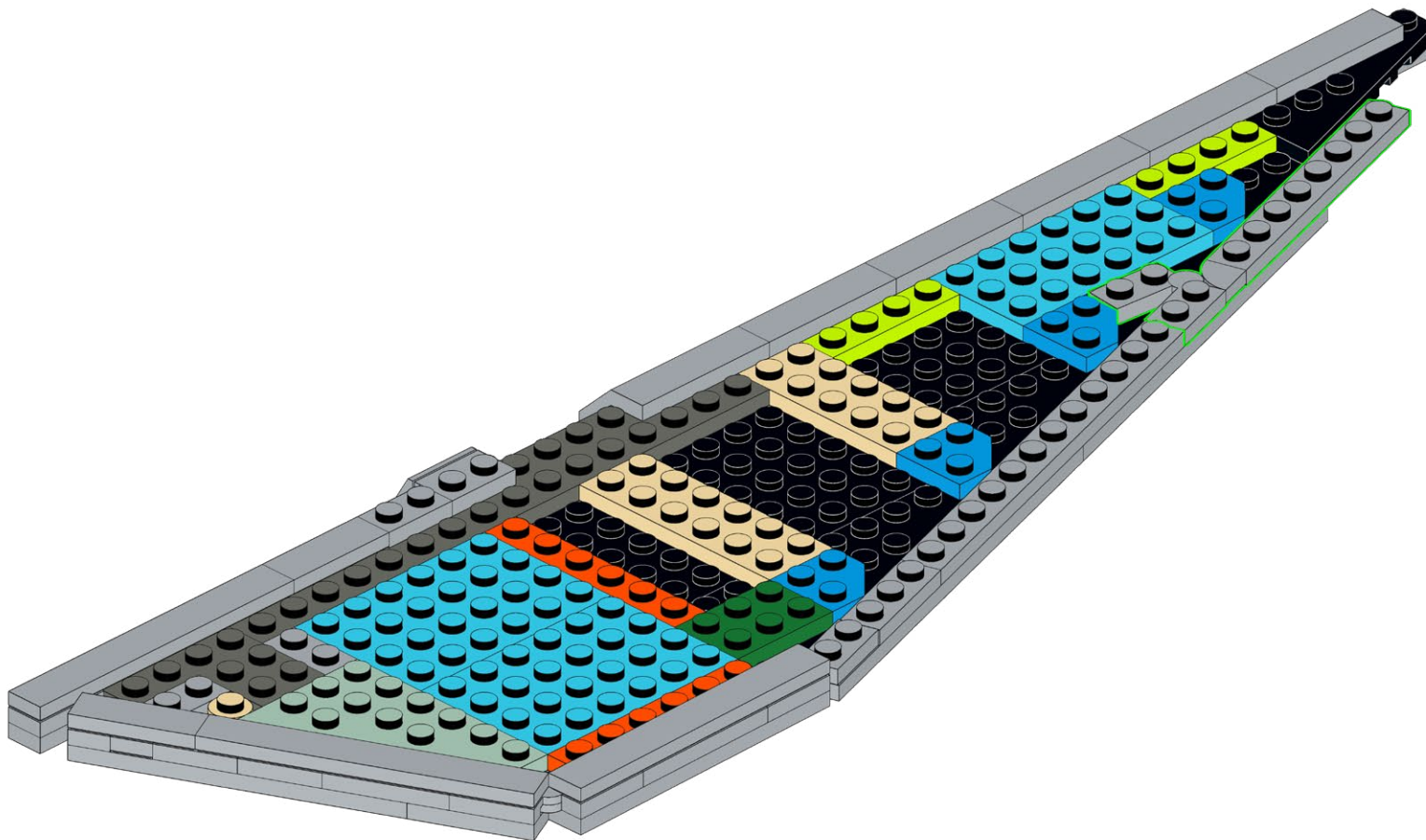
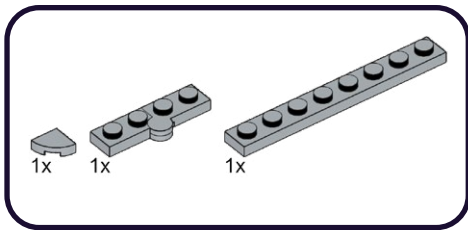

487

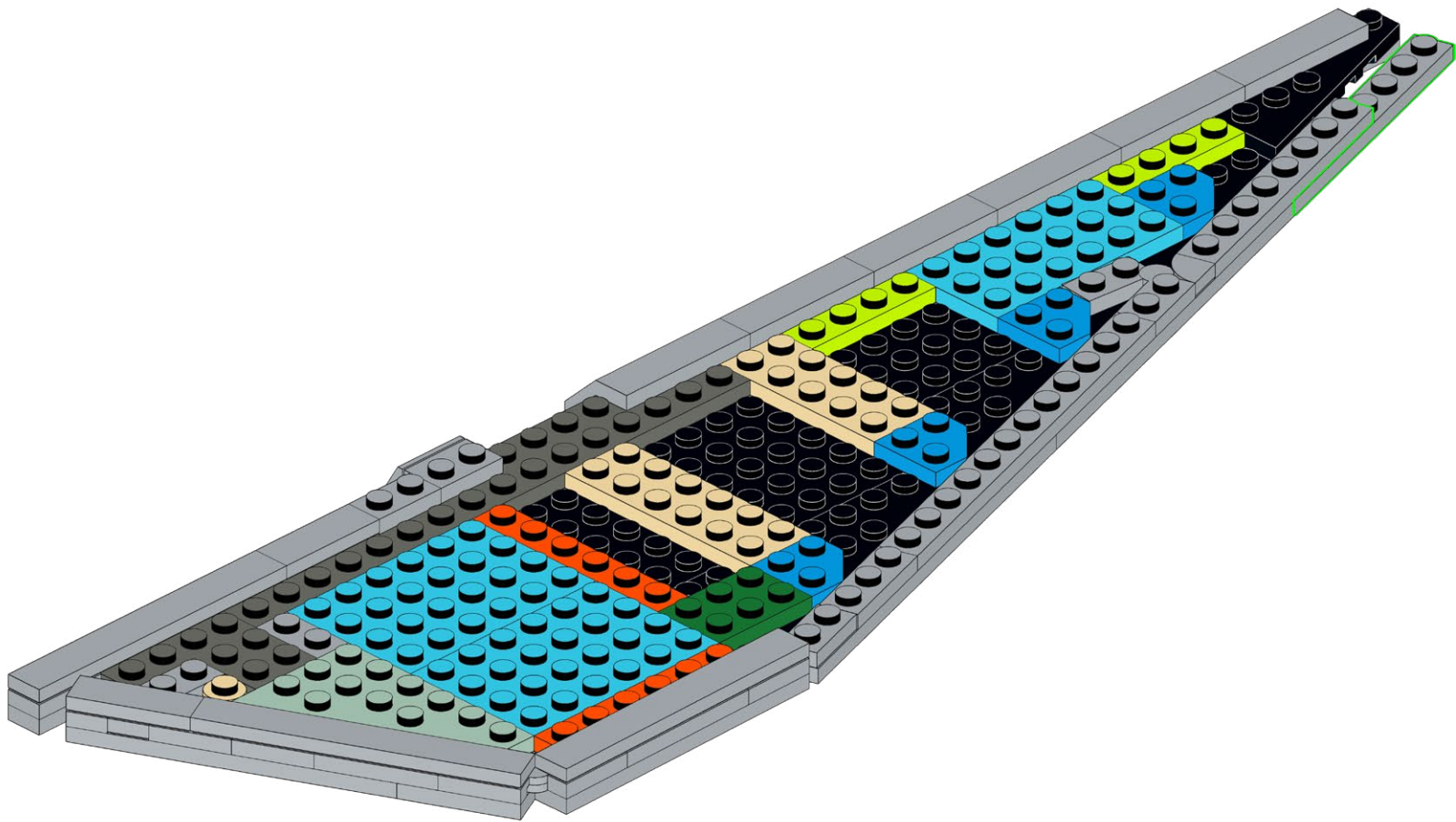
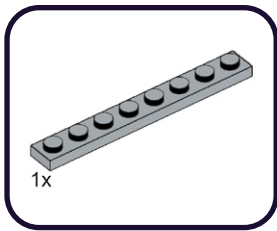



488

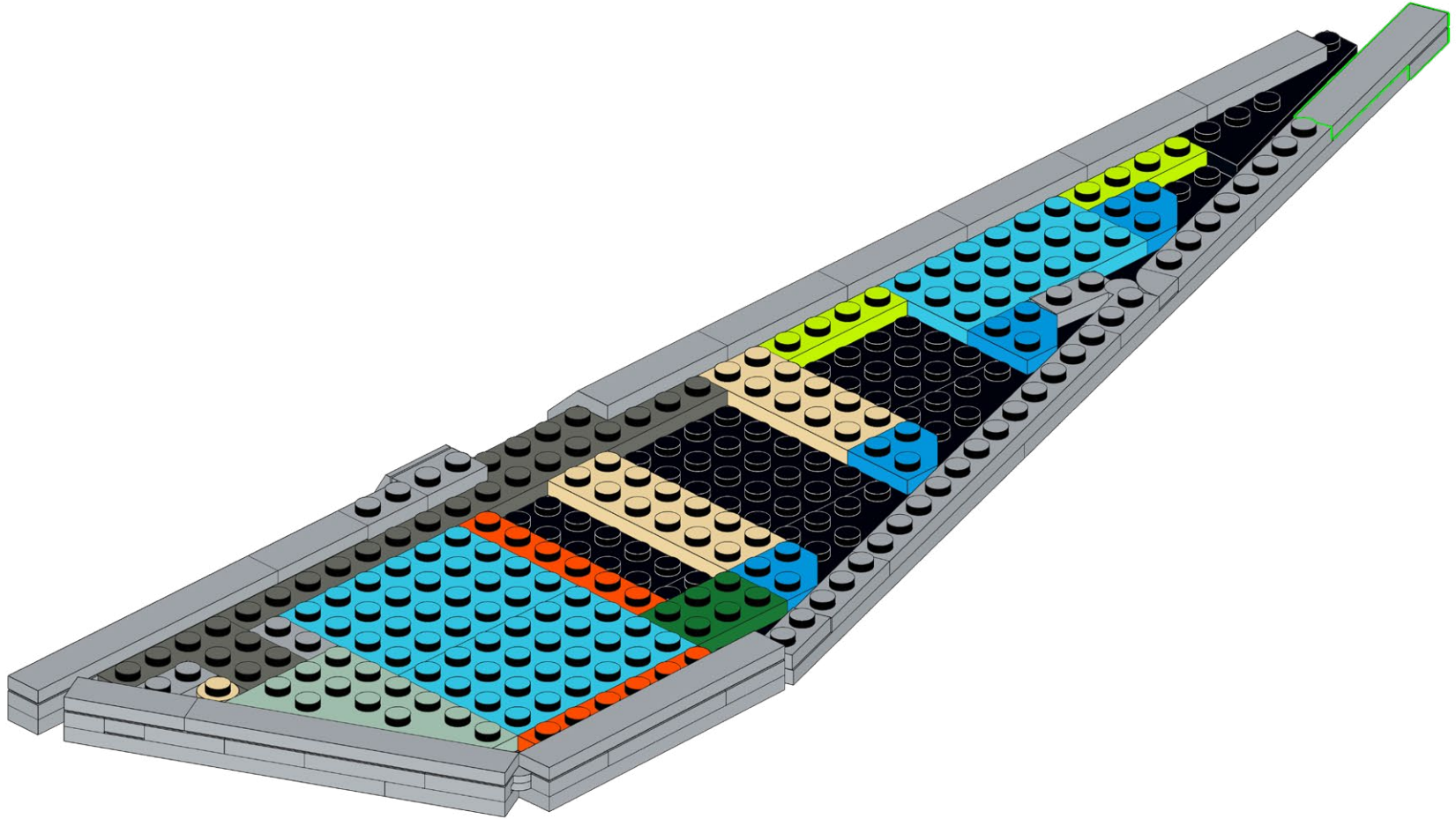
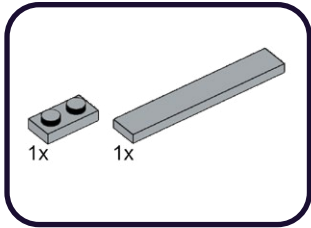

489

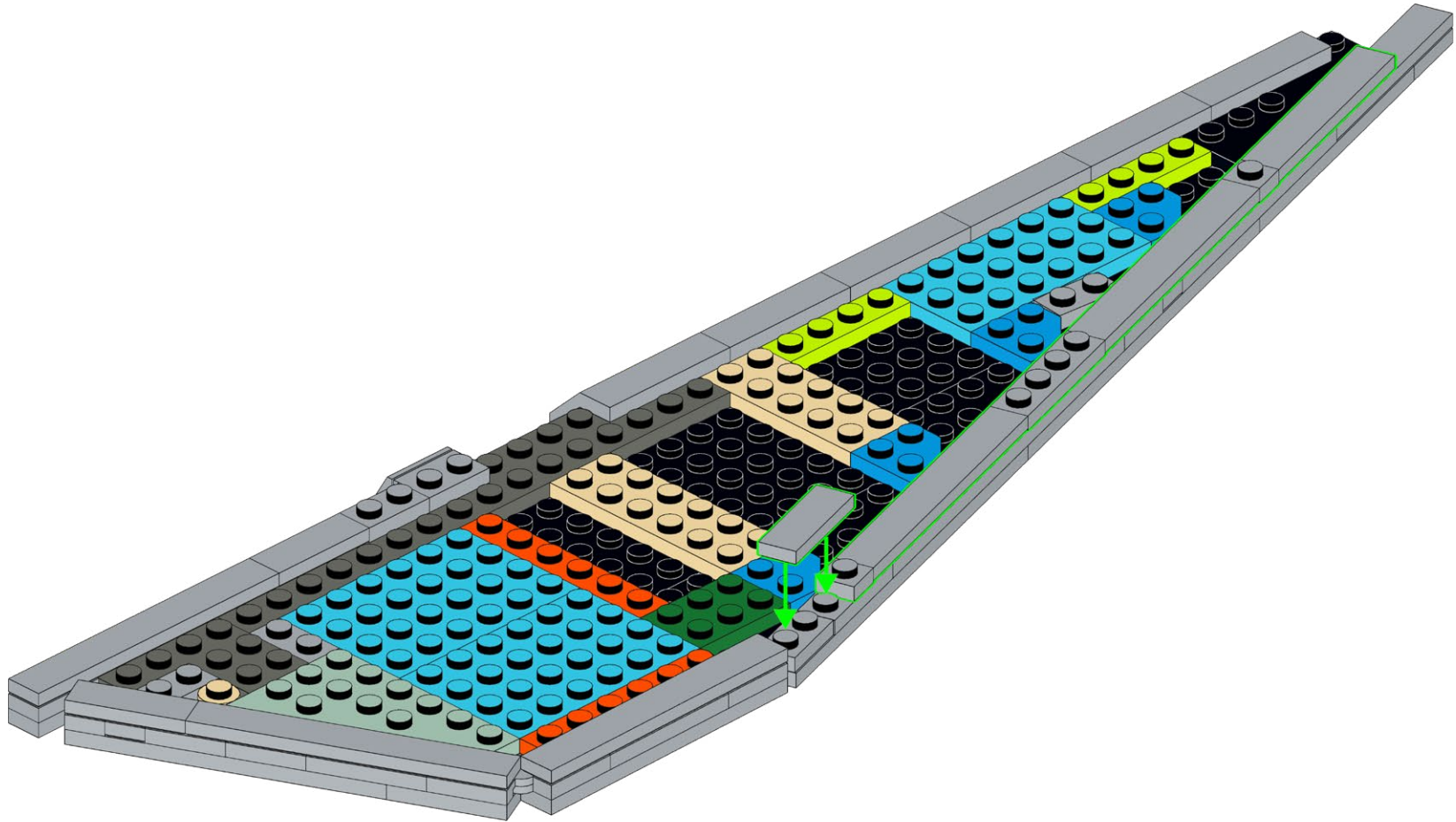
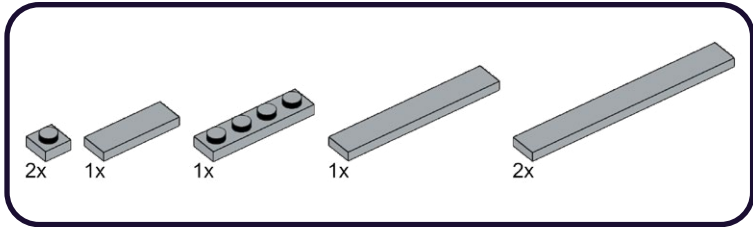



490

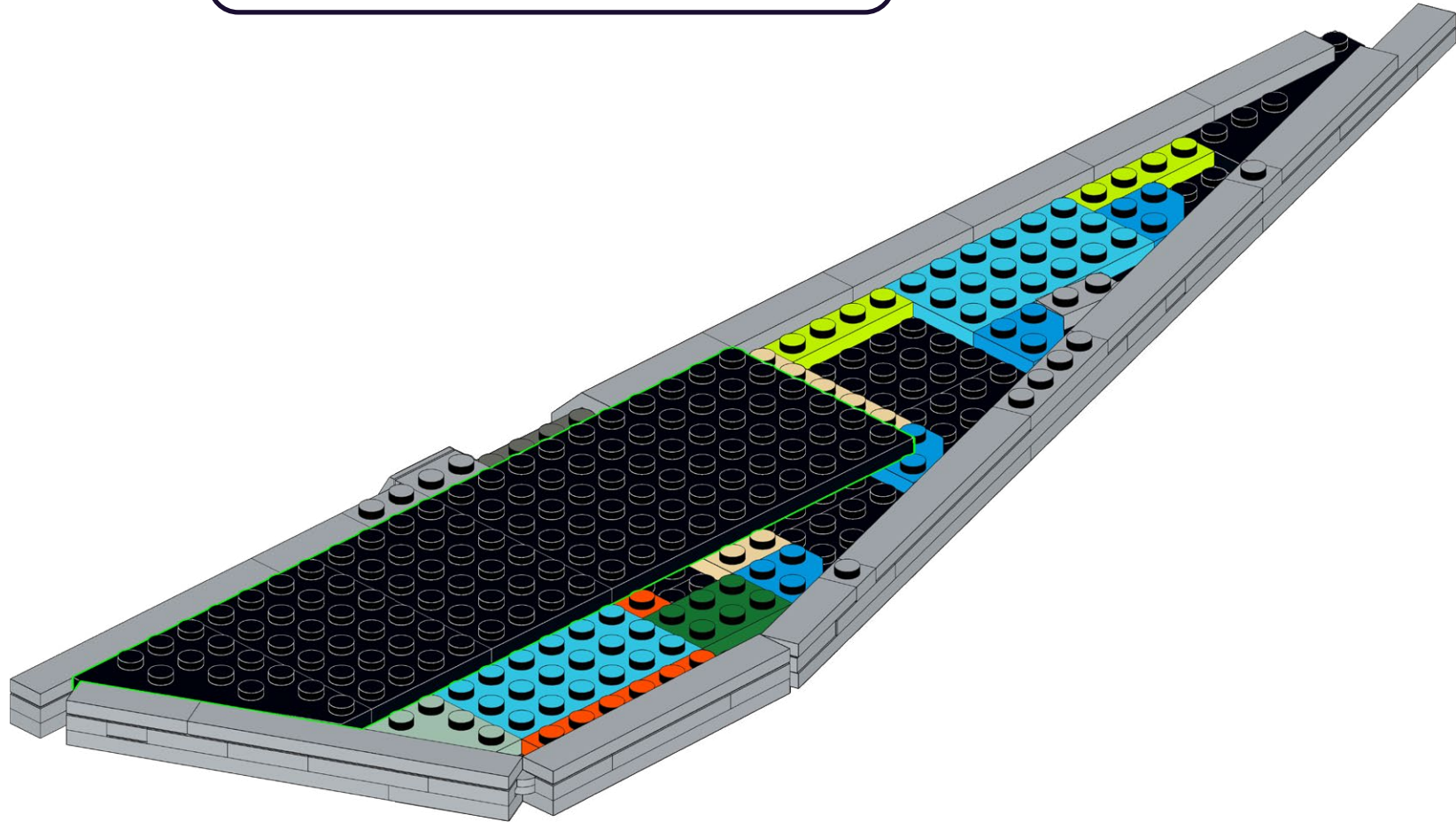
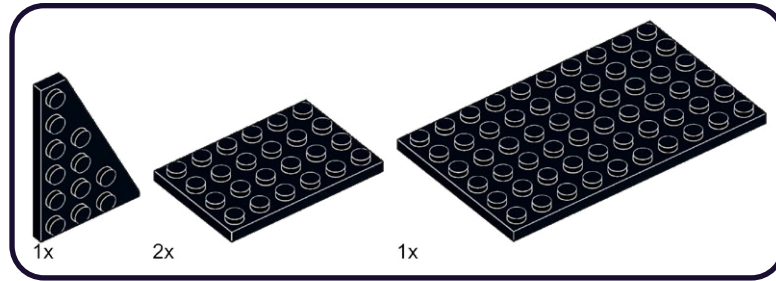

491

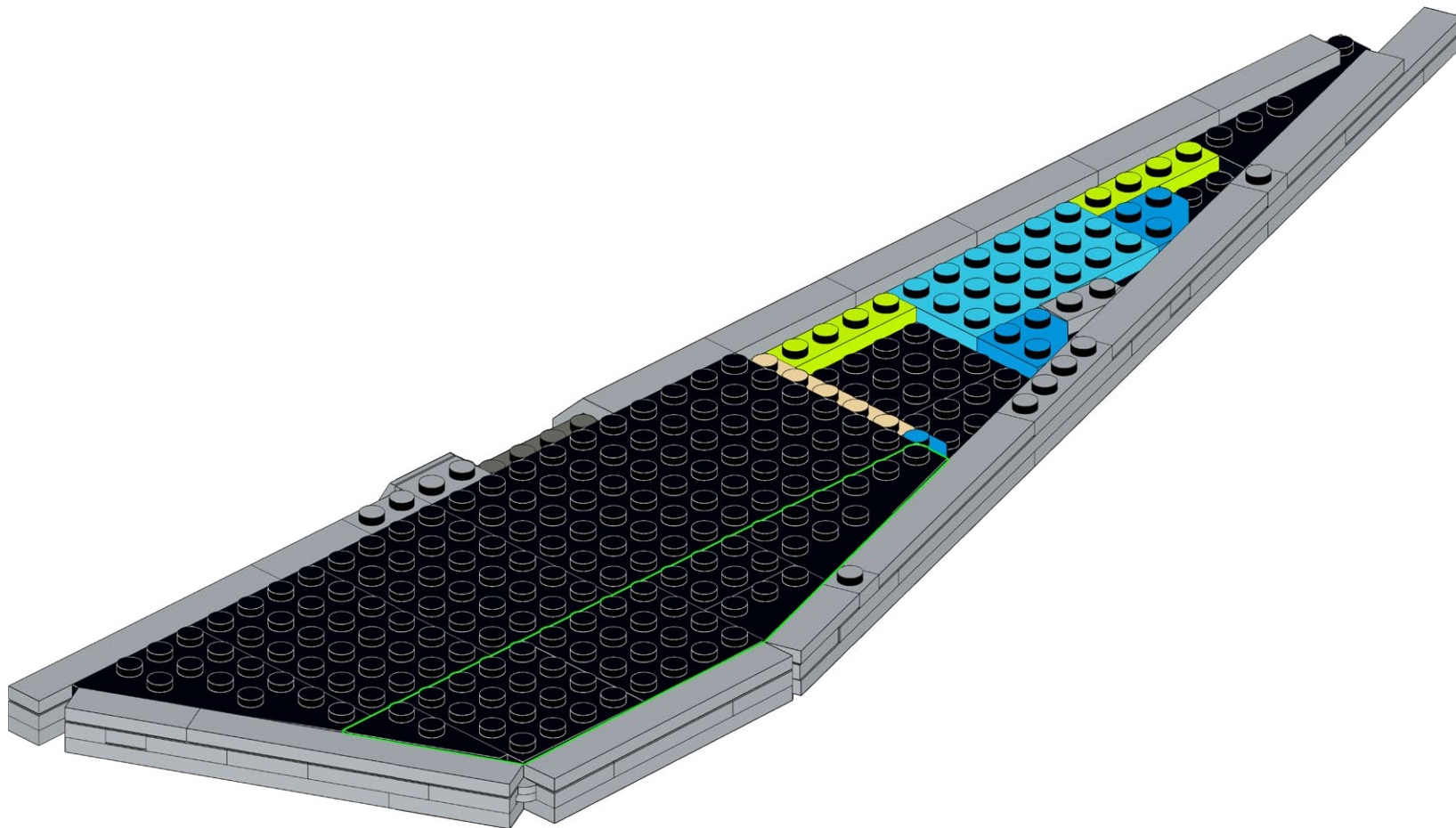
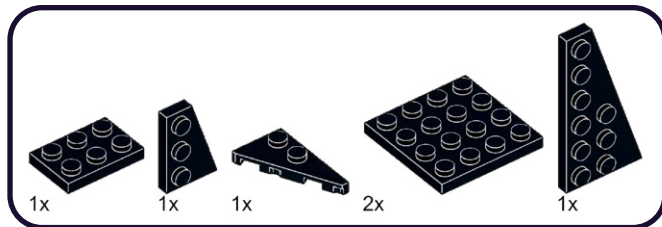

492

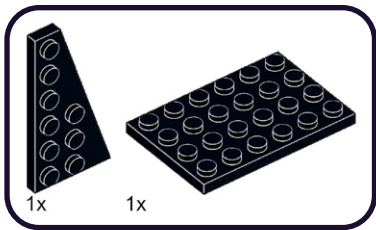

493

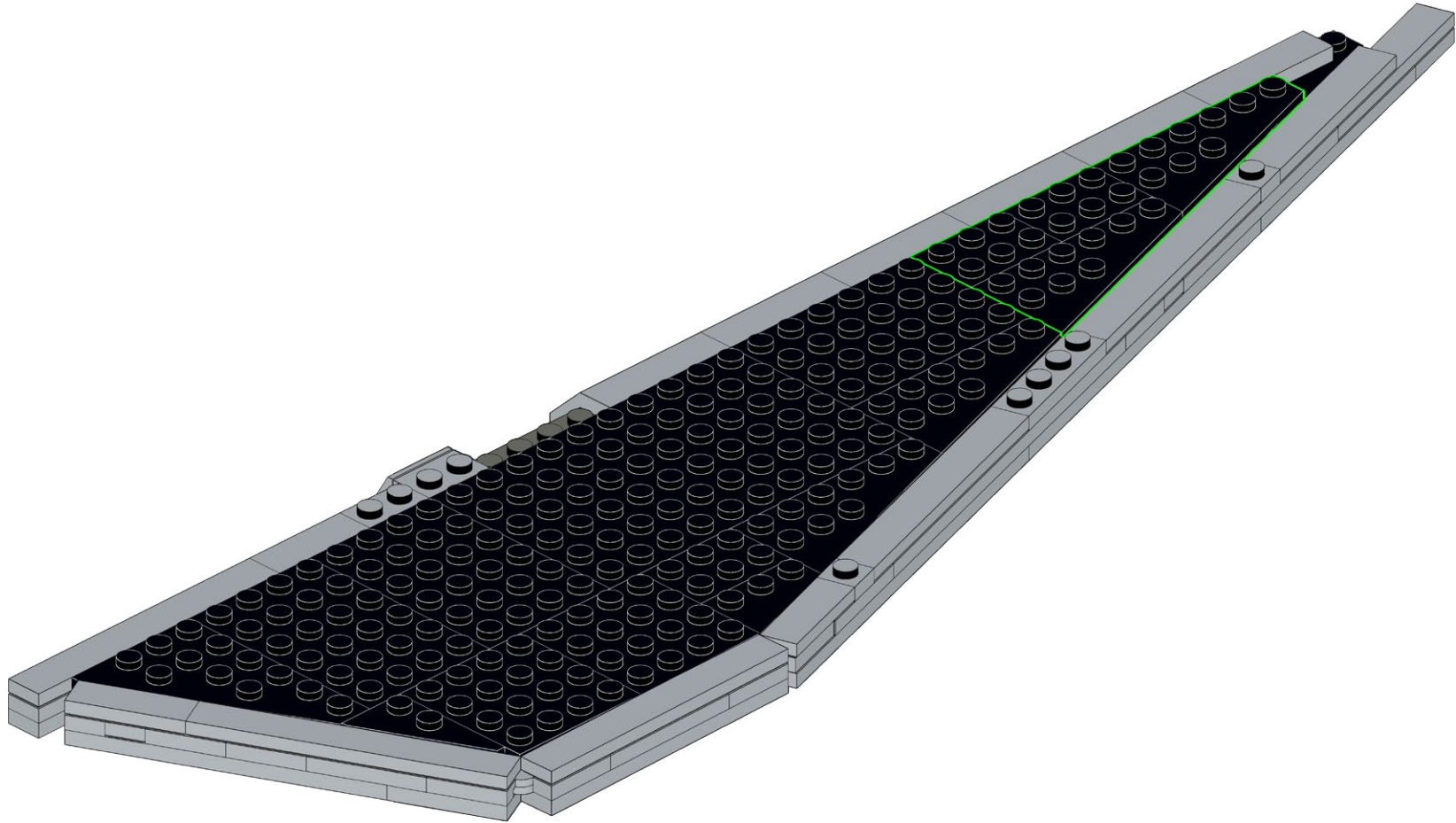
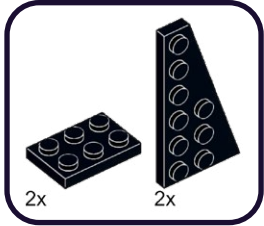



494

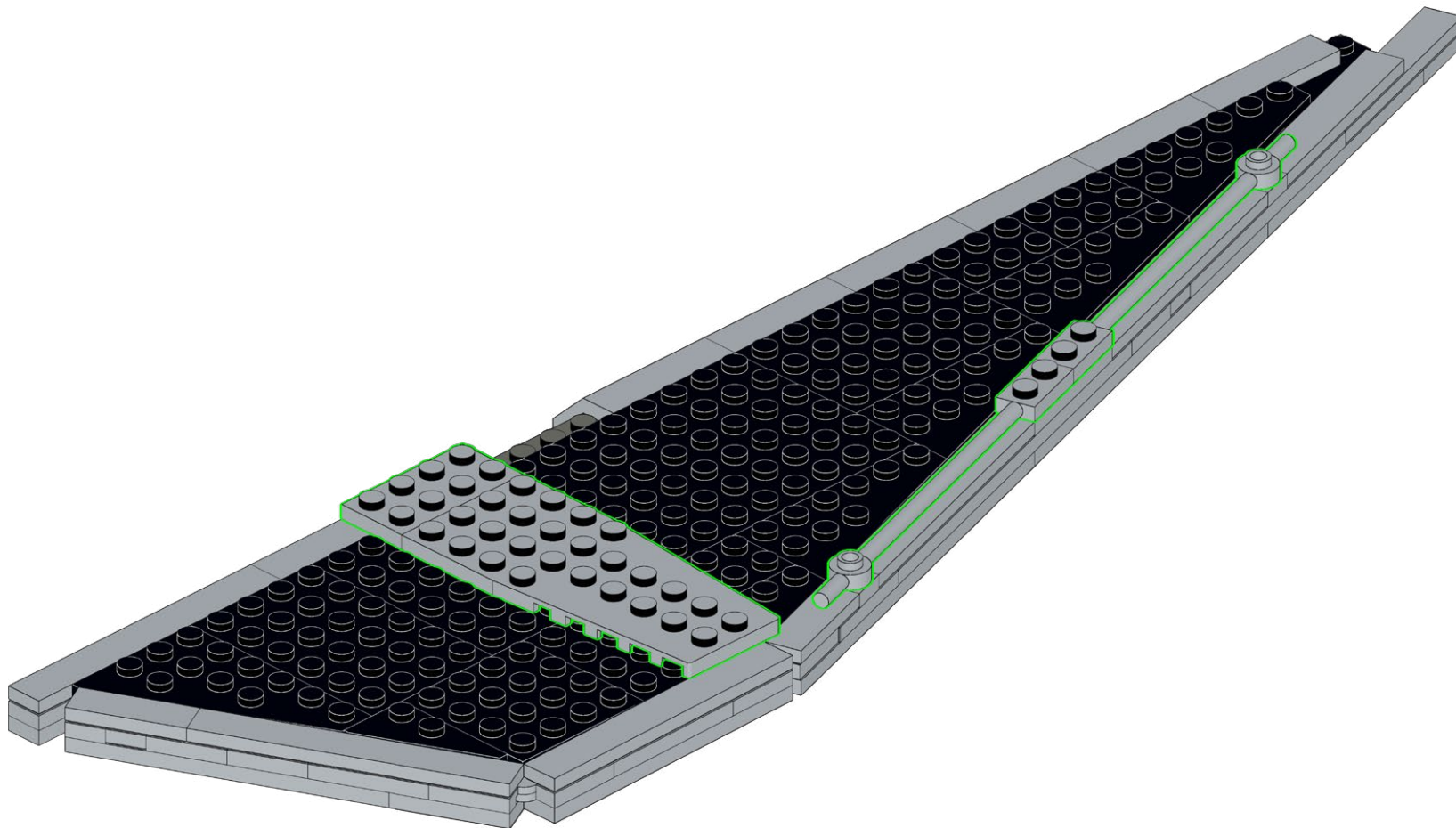
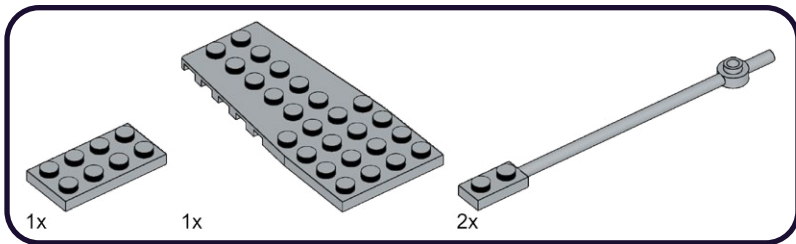

**495**

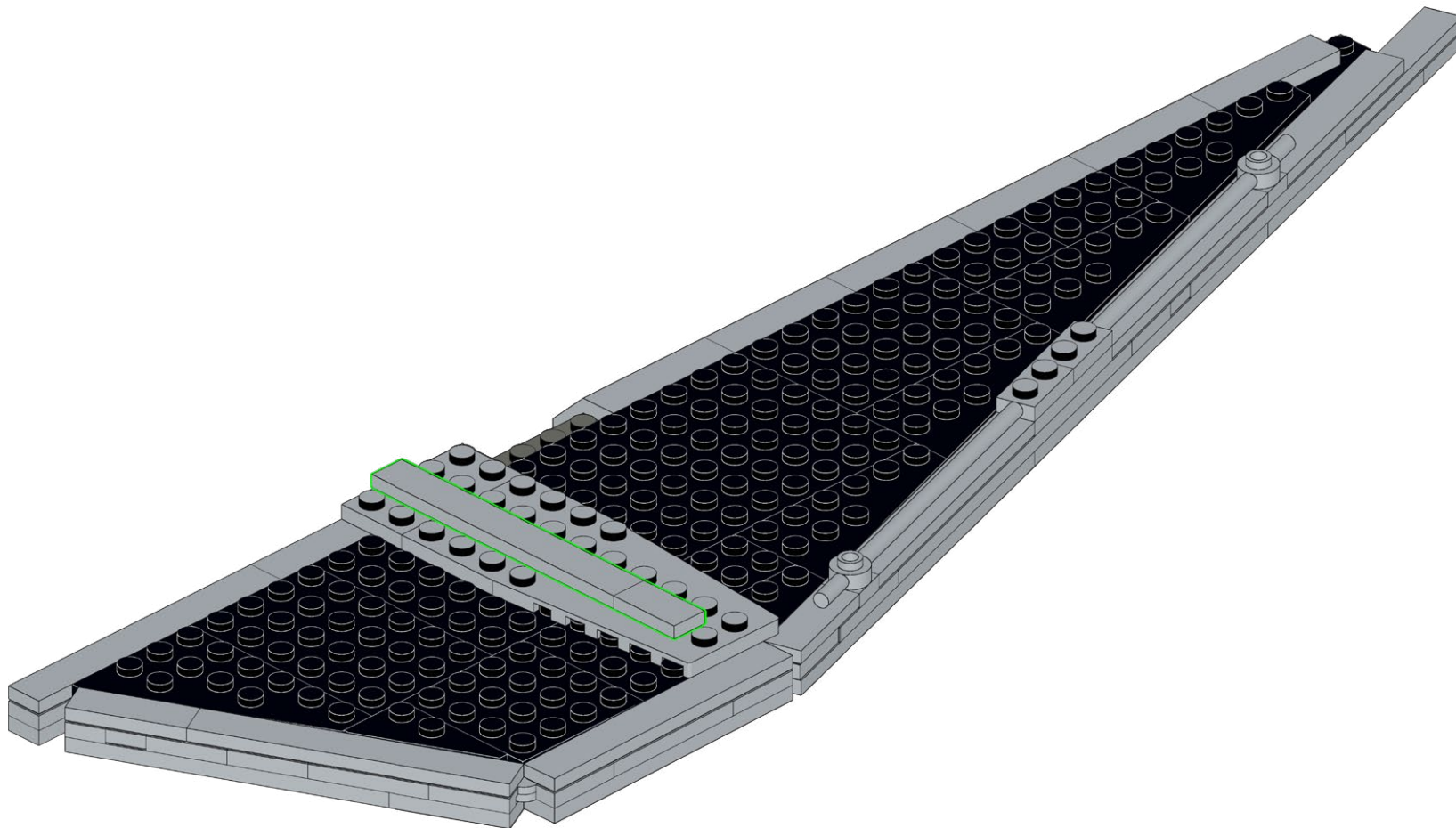
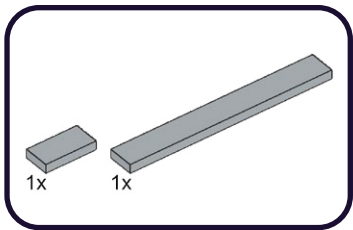



496

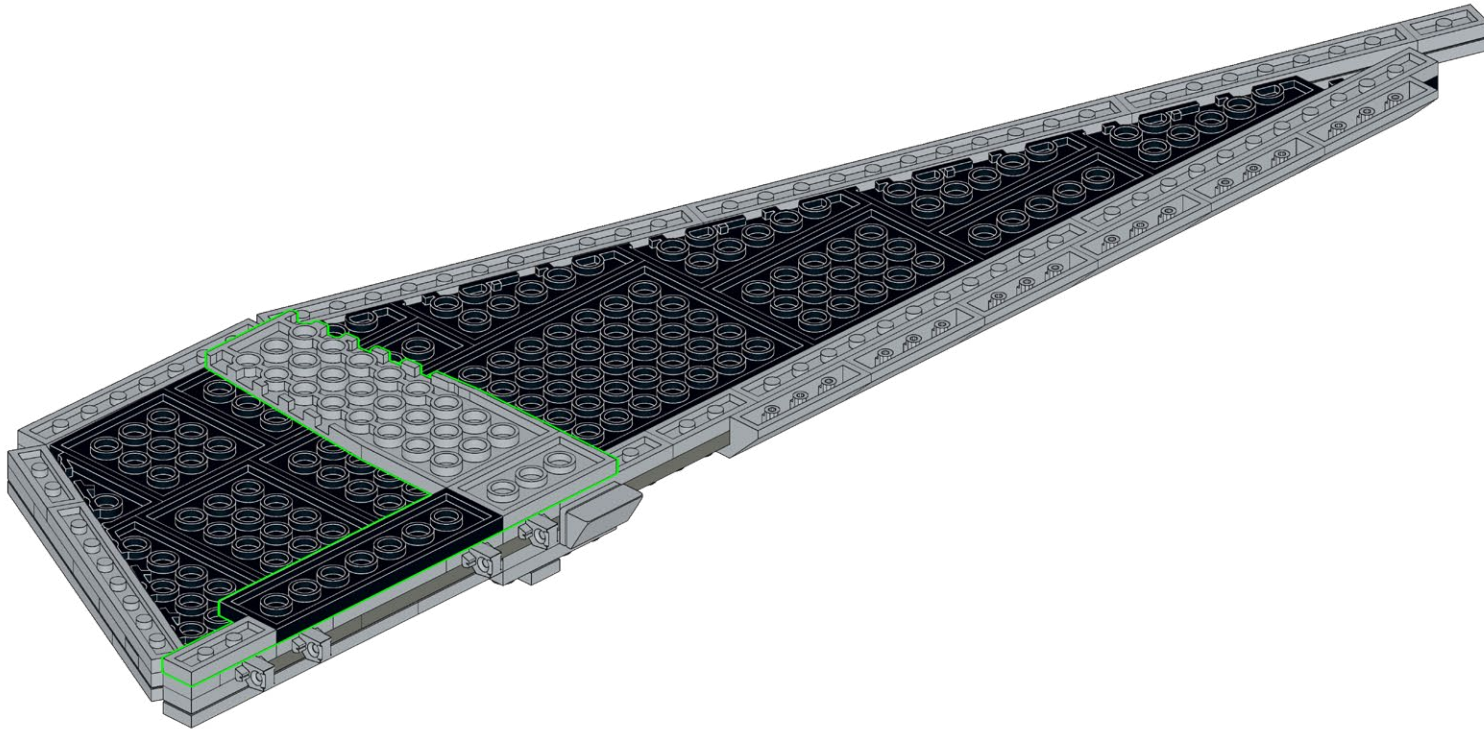
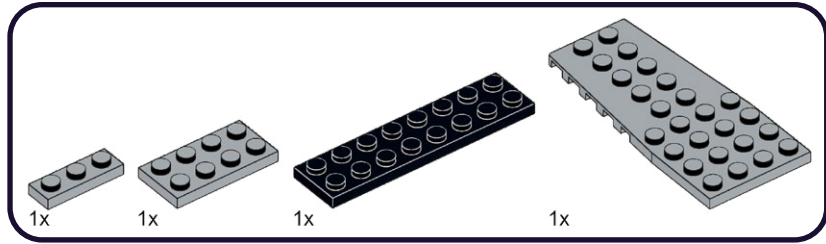

497

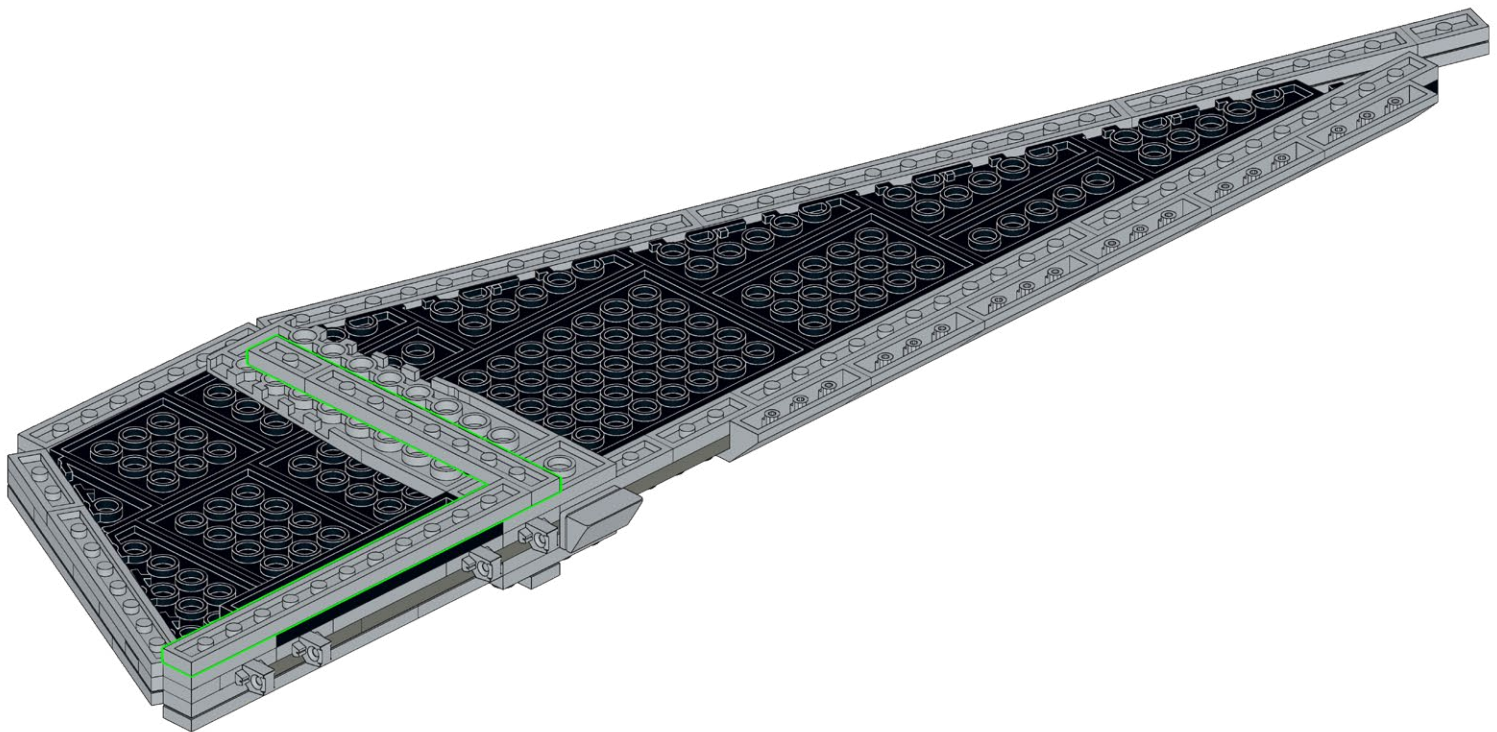
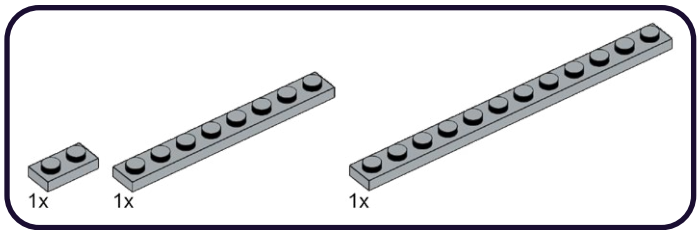

498

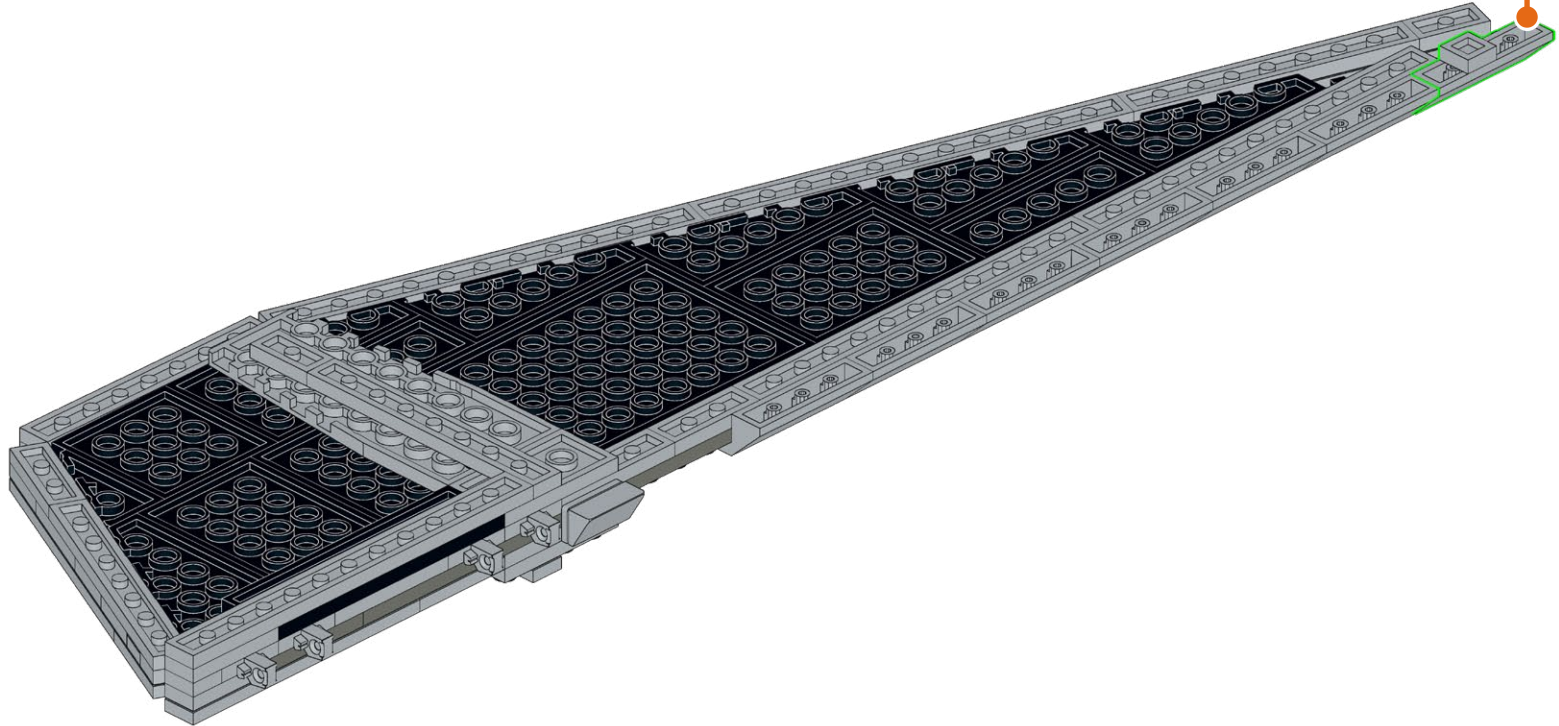
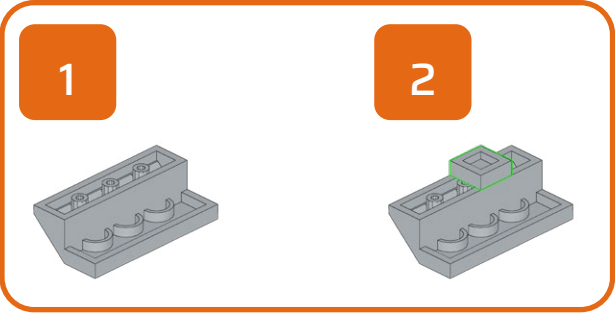
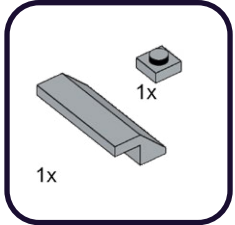

499

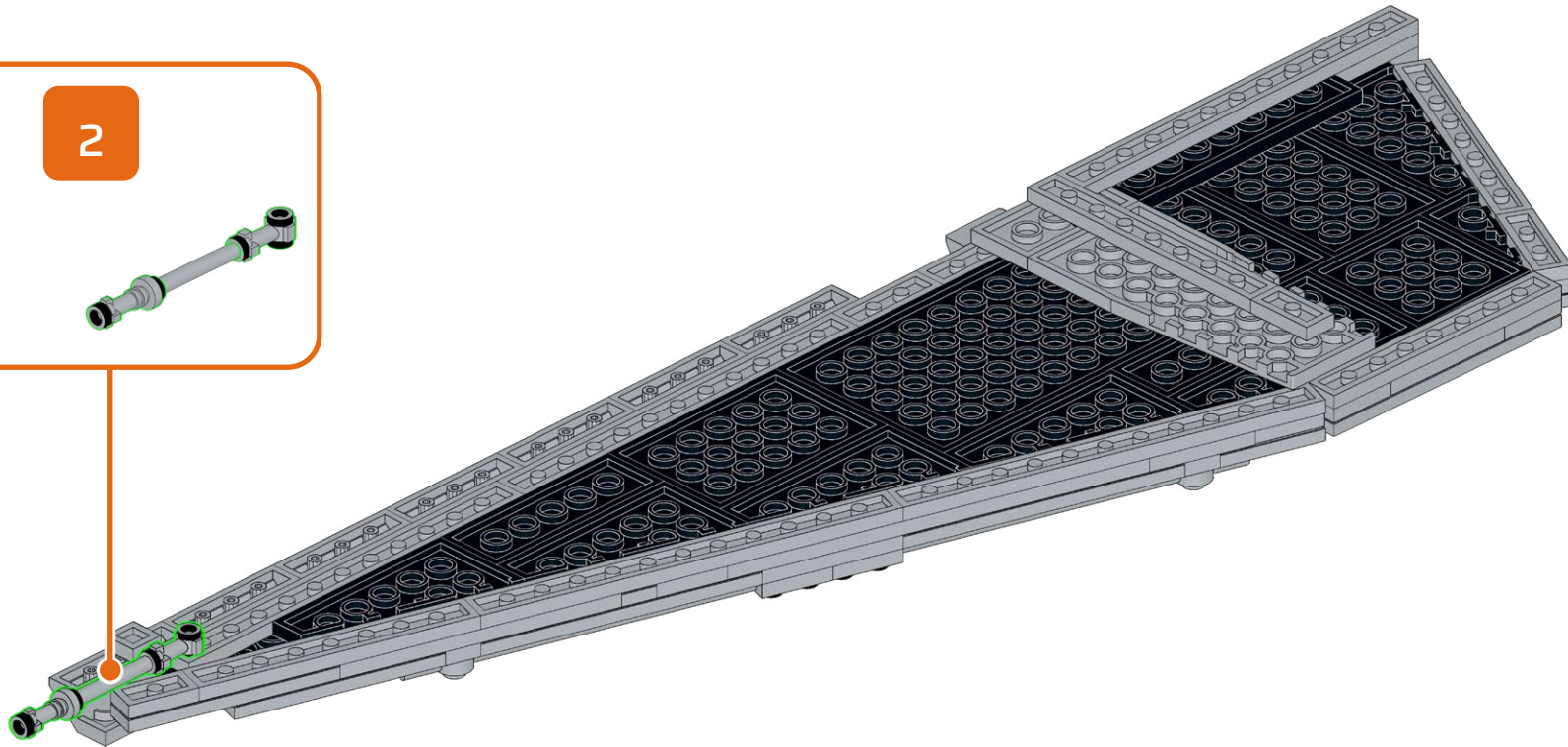
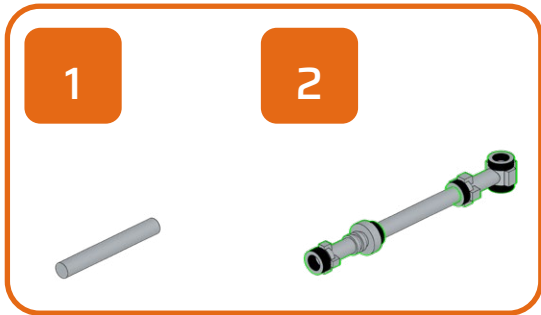
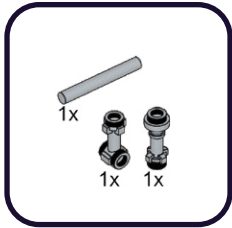



500

1x

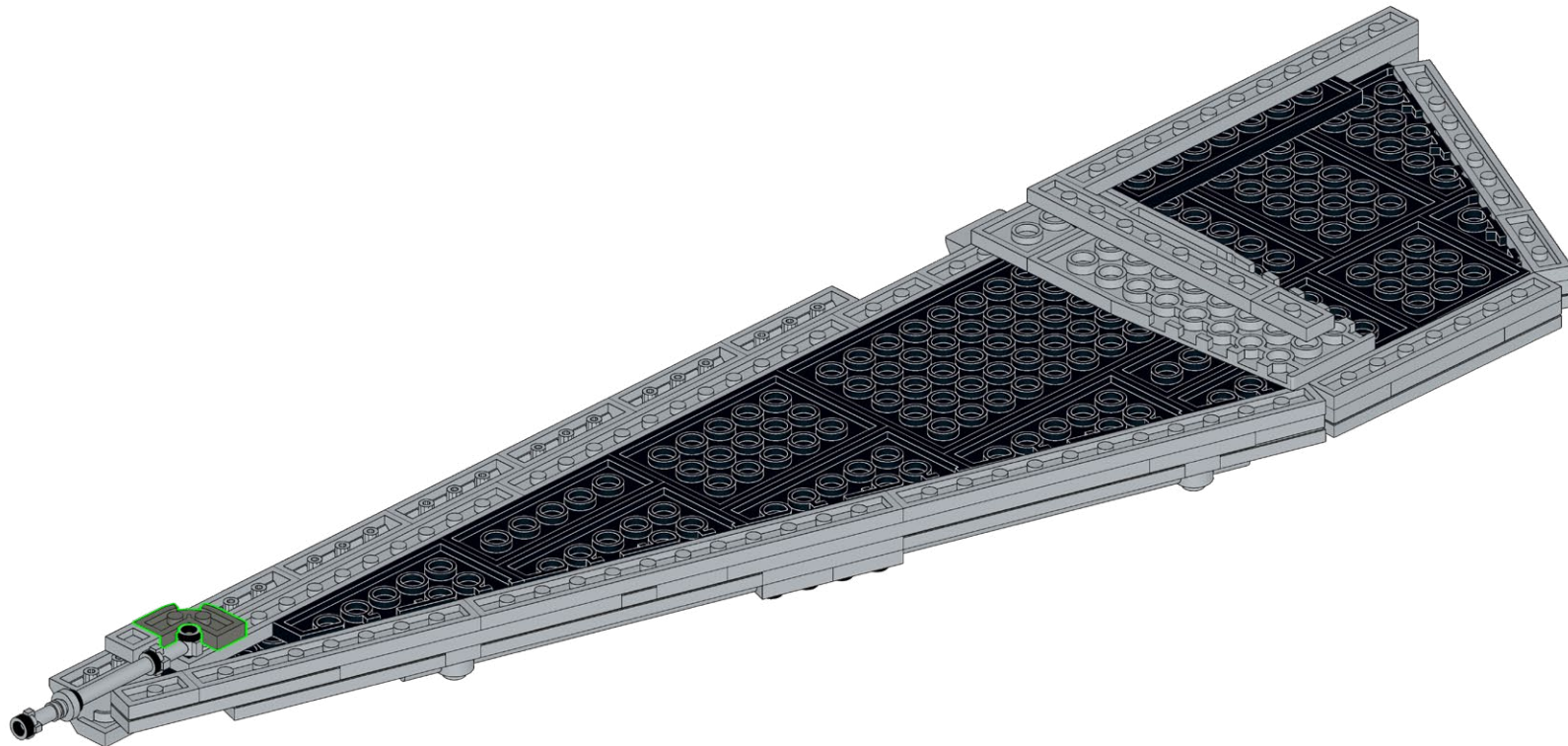

501

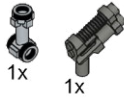

1

2

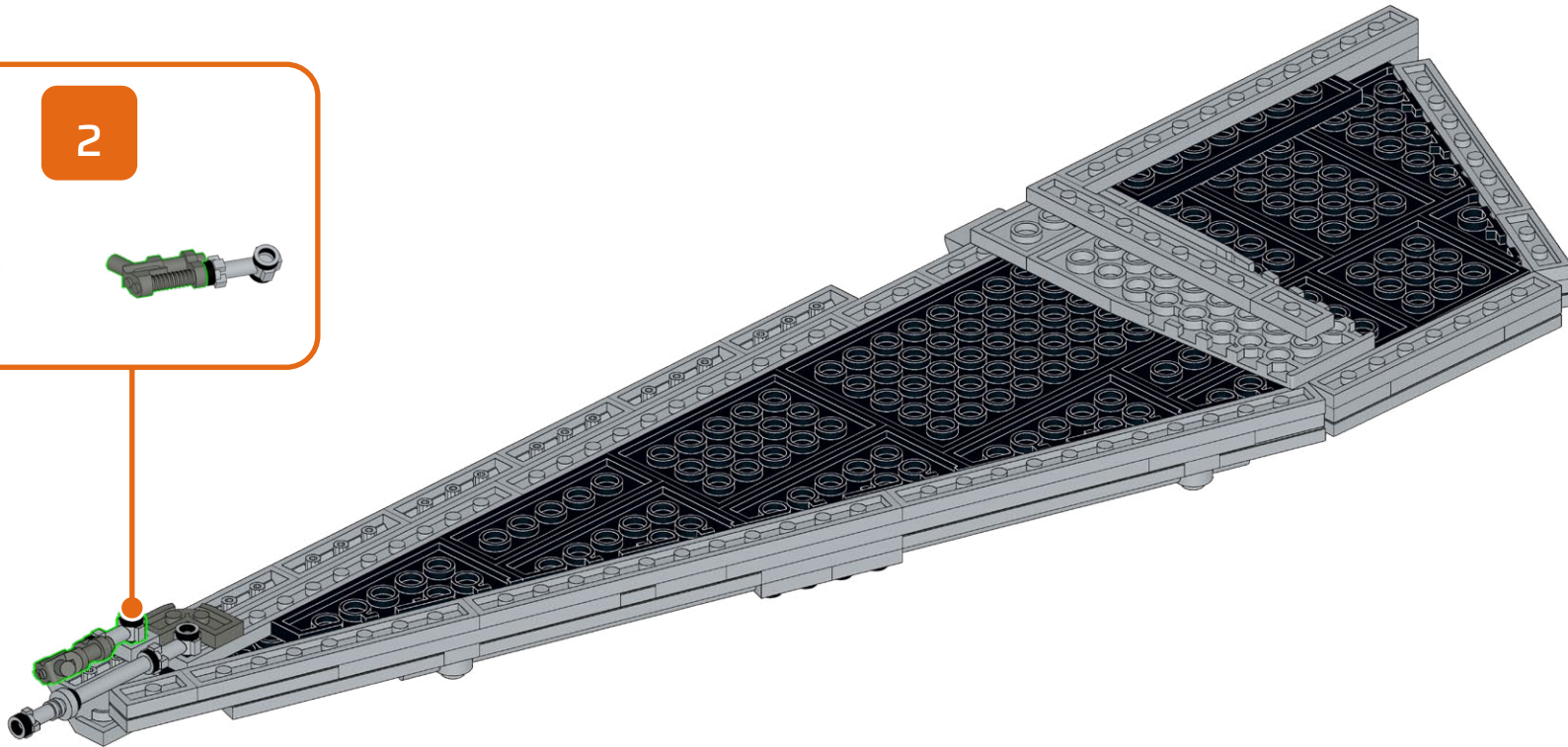



502

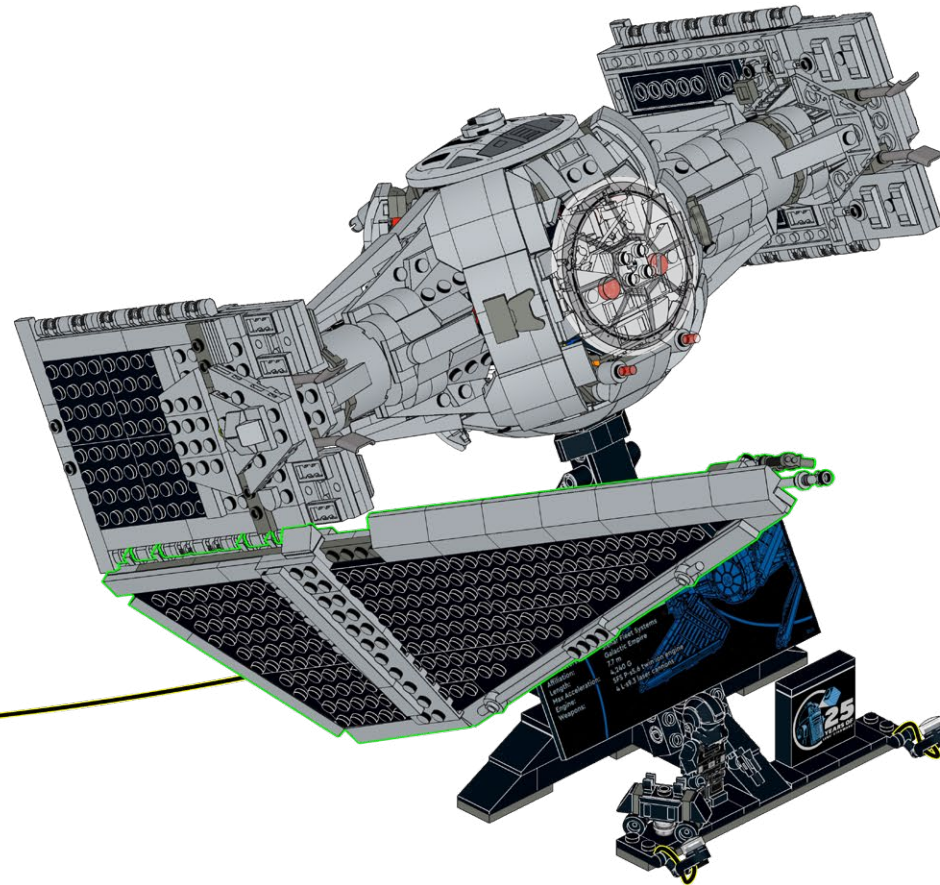

503

1x

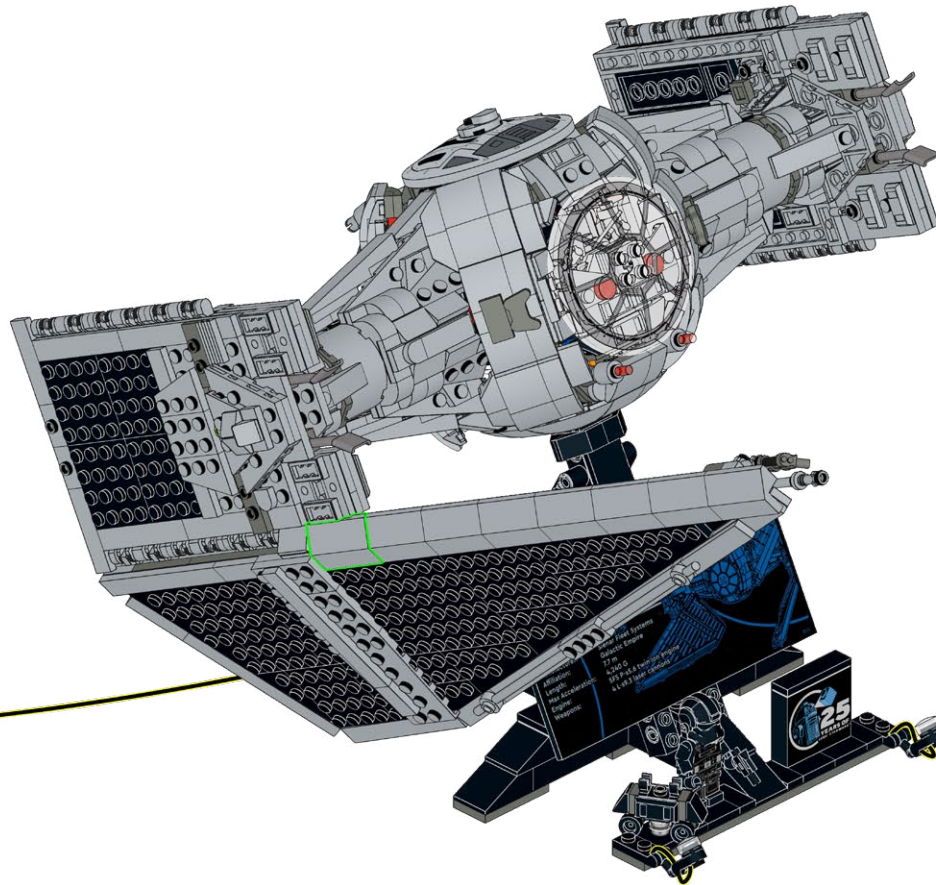

**HOLD UP!**

You might notice some bags are out of order, as well as left over pieces, but that's ok! We're changing the way you build LEGO!

**HALTEN!**

Möglicherweise stellen Sie fest, dass einige Beutel nicht in Ordnung sind und auch Teile übrig bleiben, aber das ist in Ordnung! Wir verändern die Art und Weise, wie Sie LEGO bauen!

**TENIR BON!**

Vous remarquerez peut-être que certains sacs sont en panne, ainsi que des morceaux restants, mais ce n'est pas grave ! Nous changeons la façon dont vous construisez LEGO !

**SOSTENERE!**

Potresti notare che alcune borse sono fuori uso, così come alcuni pezzi avanzati, ma va bene! Stiamo cambiando il modo in cui costruisci i LEGO!

**¡SOSTENER!**

Puede que notes que algunas bolsas están fuera de orden, así como piezas sobrantes, ¡pero está bien! ¡Estamos cambiando la forma de construir LEGO!

**耽误!**

您可能会注意到有些袋子坏了, 还有剩余的碎片, 但这没关系! 我们正在改变您搭建乐高的方式!

**Open LEGO® Bag 1**

504

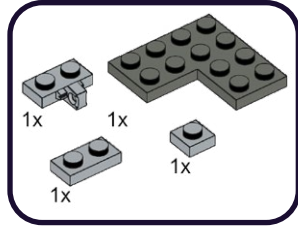

1

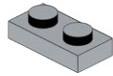

2

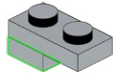

3

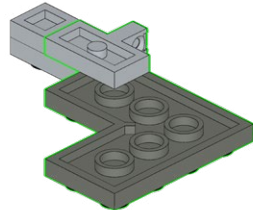

505

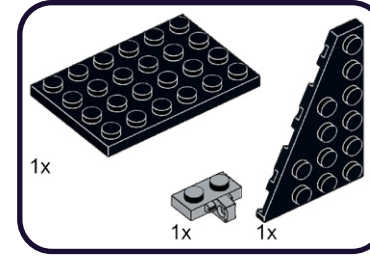

1

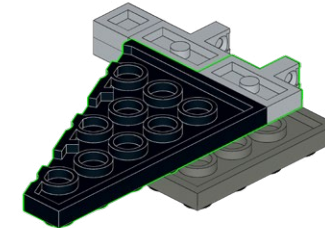

2

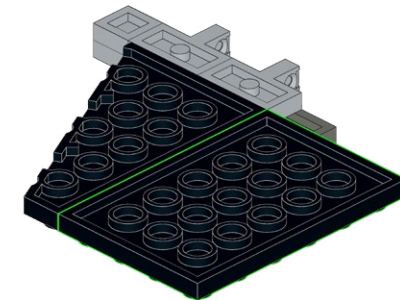

**506**

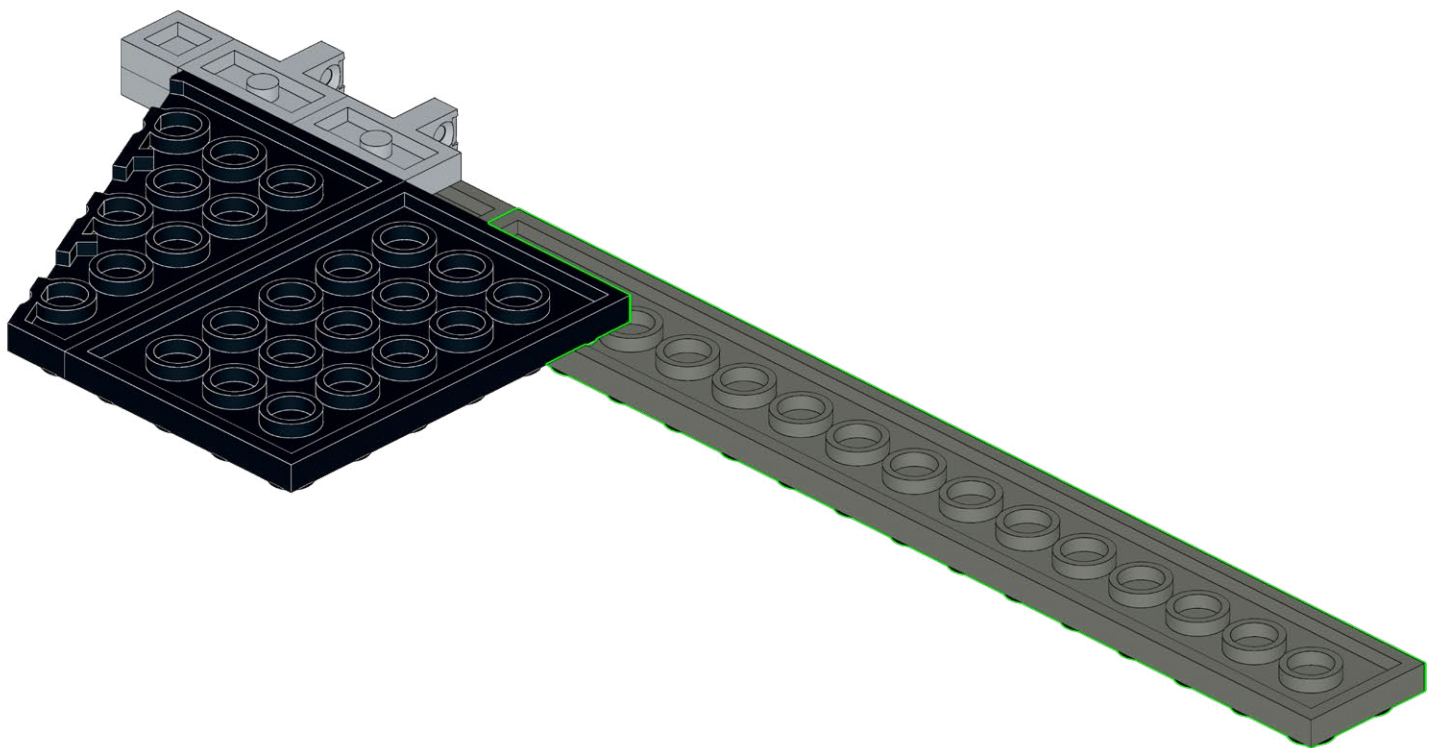
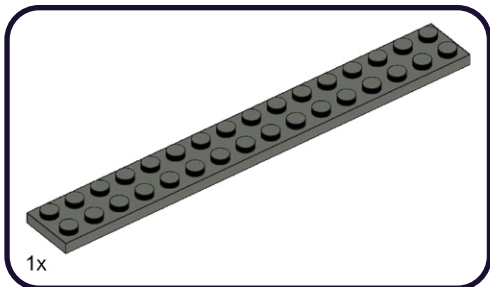



**507**

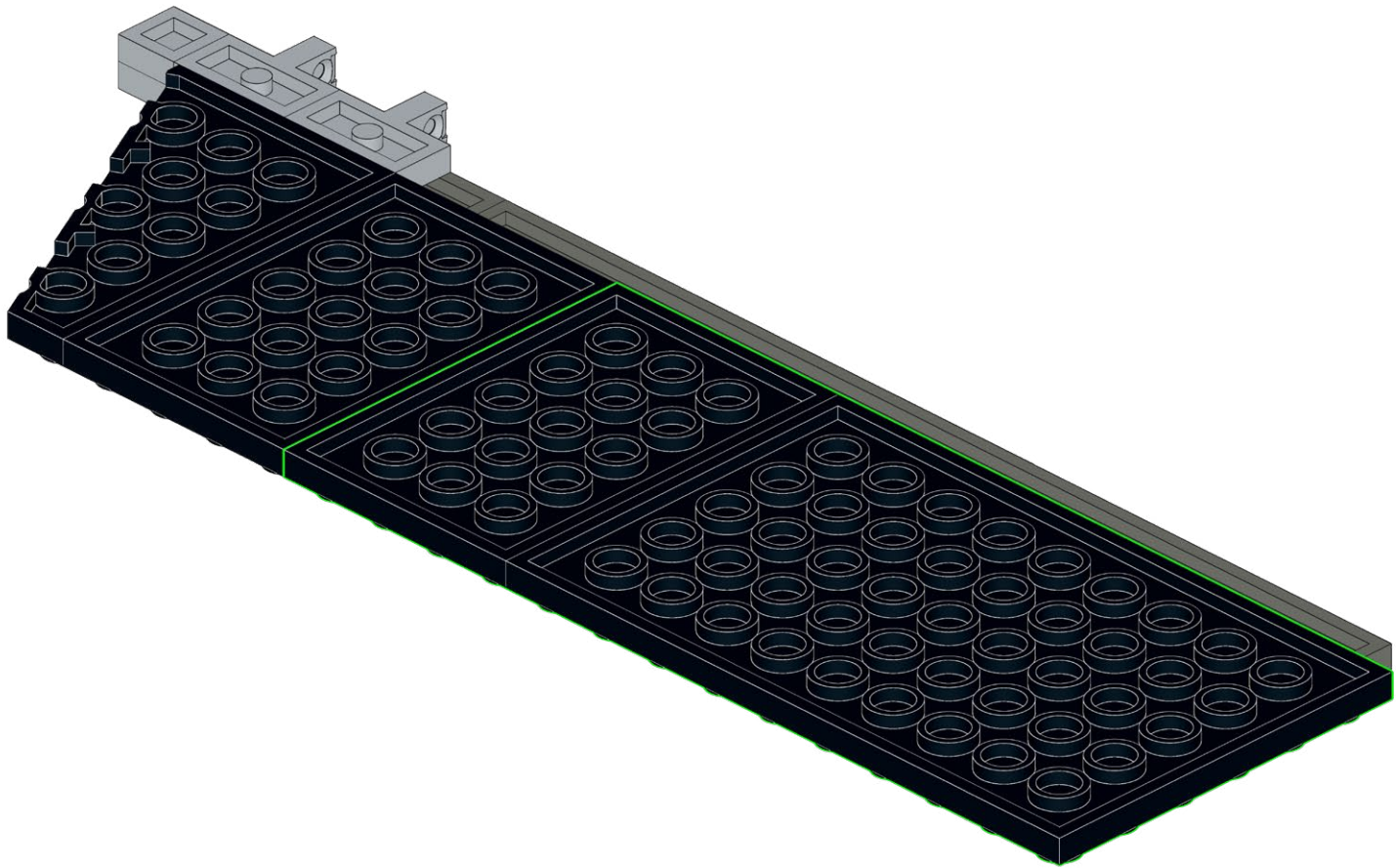
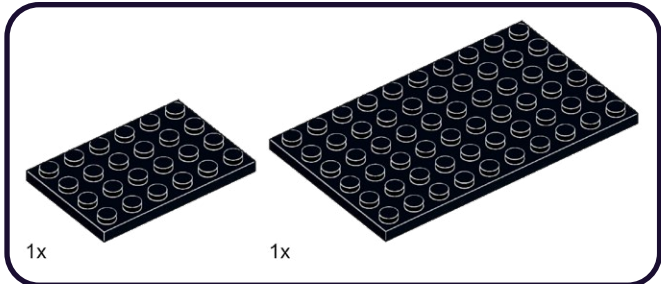



**508**

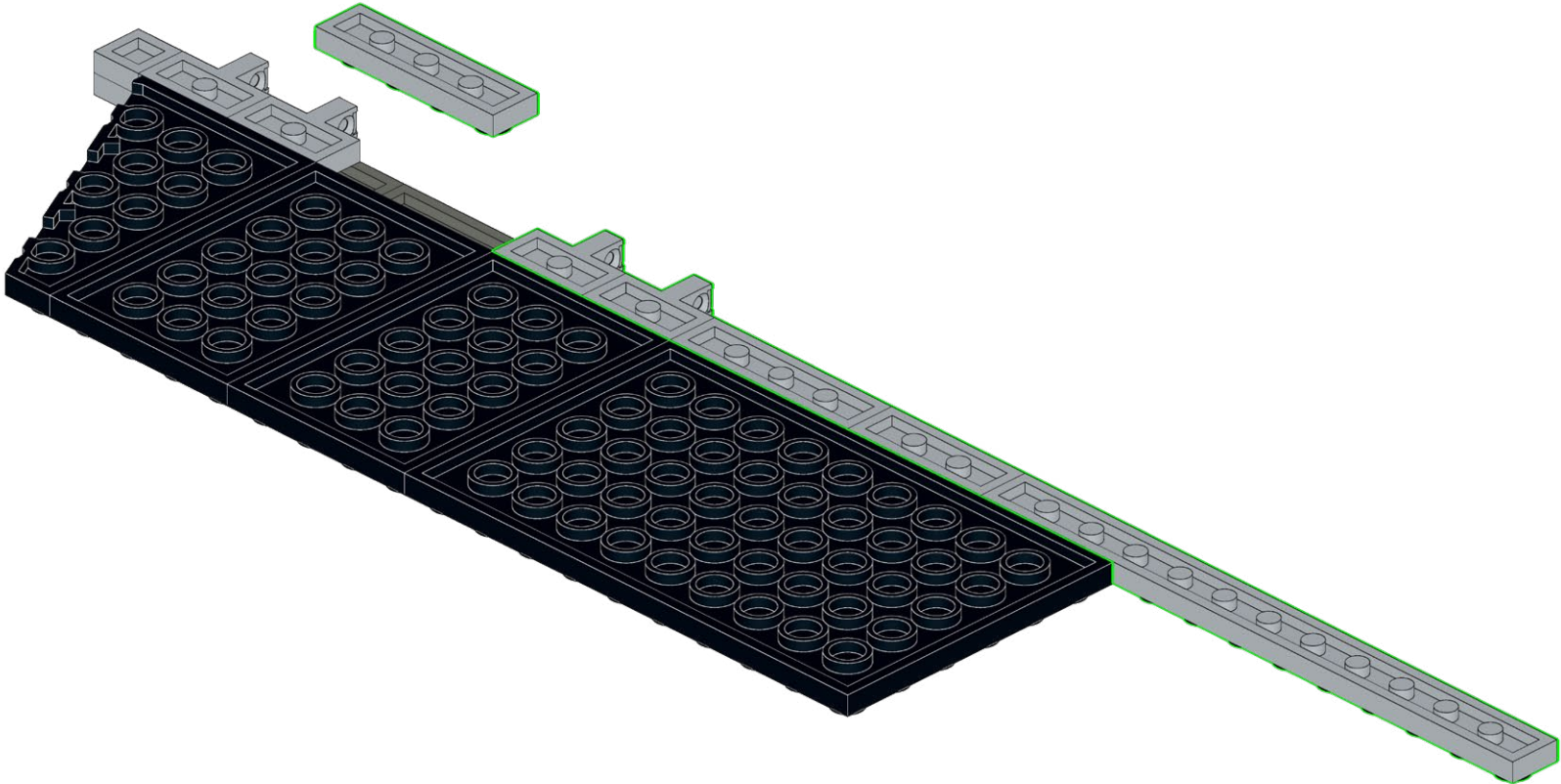
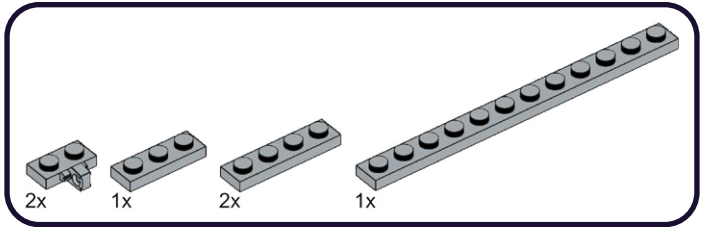

509

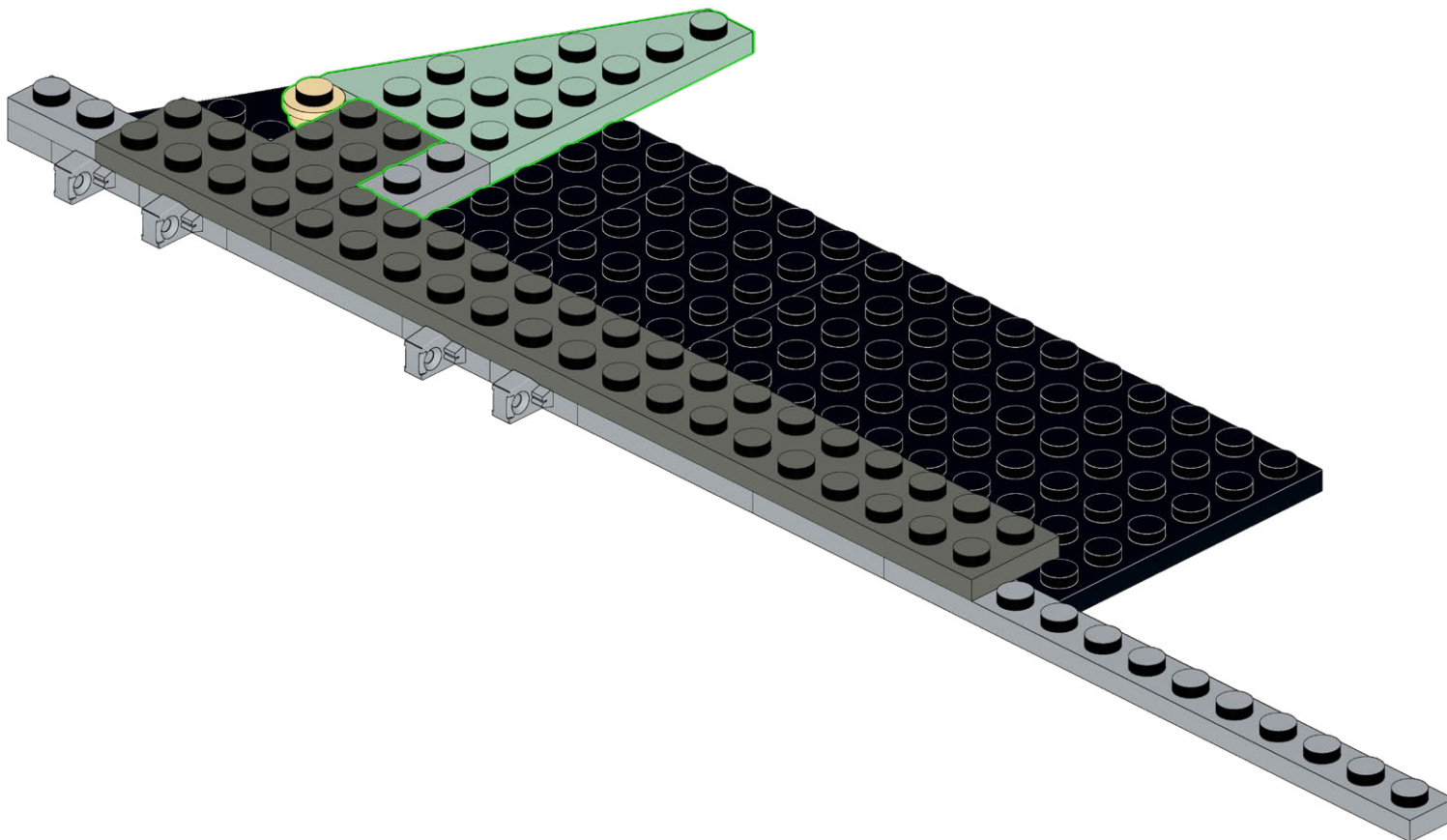
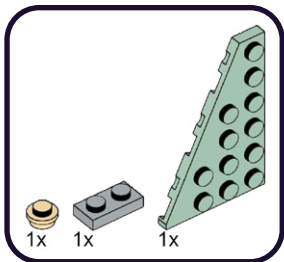

**510**

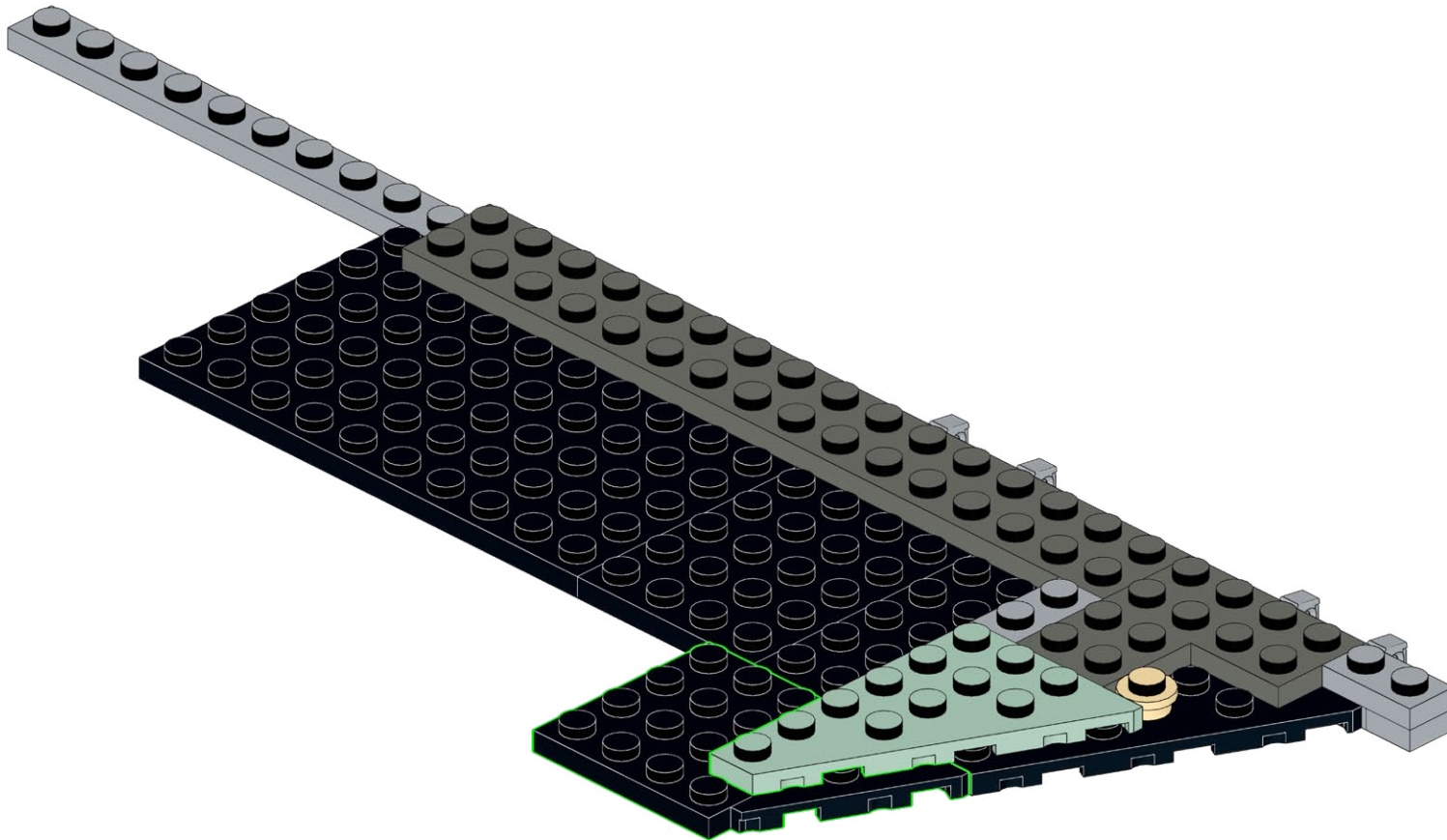
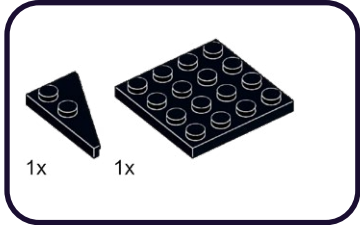

511

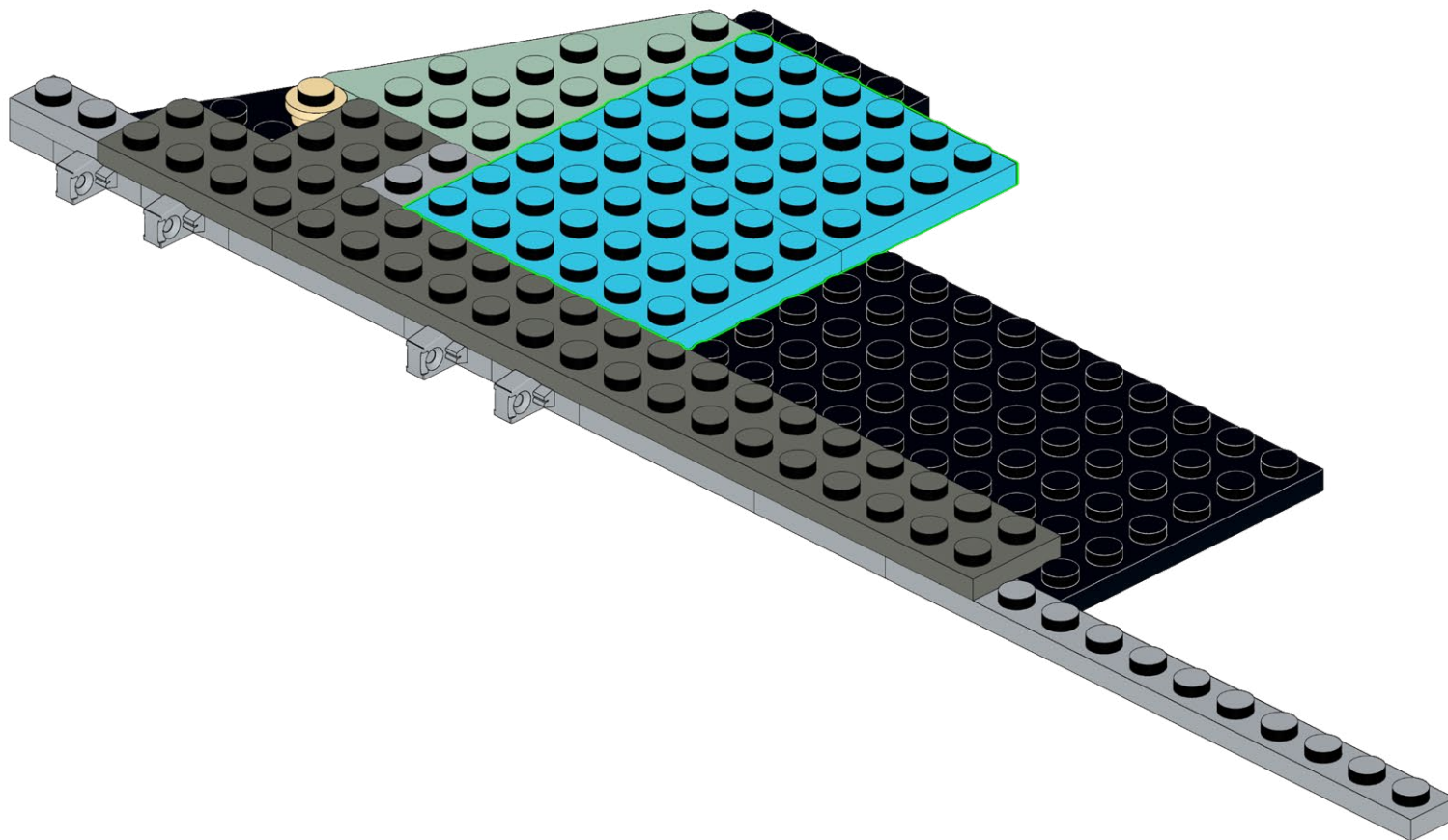
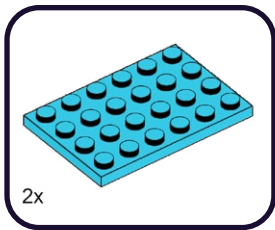

512

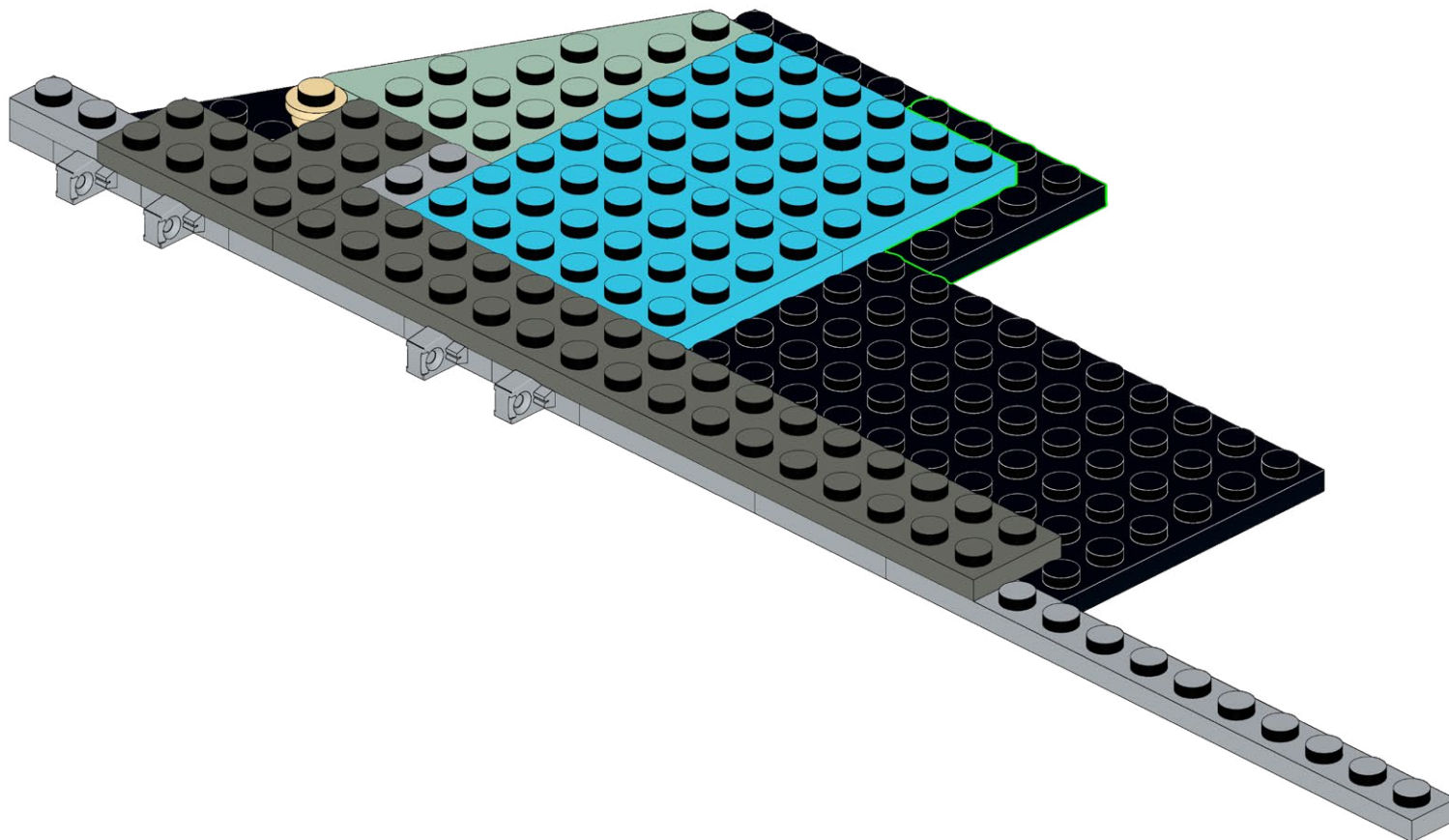
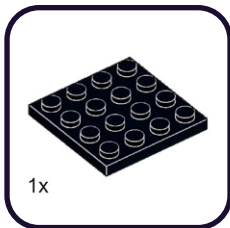



513

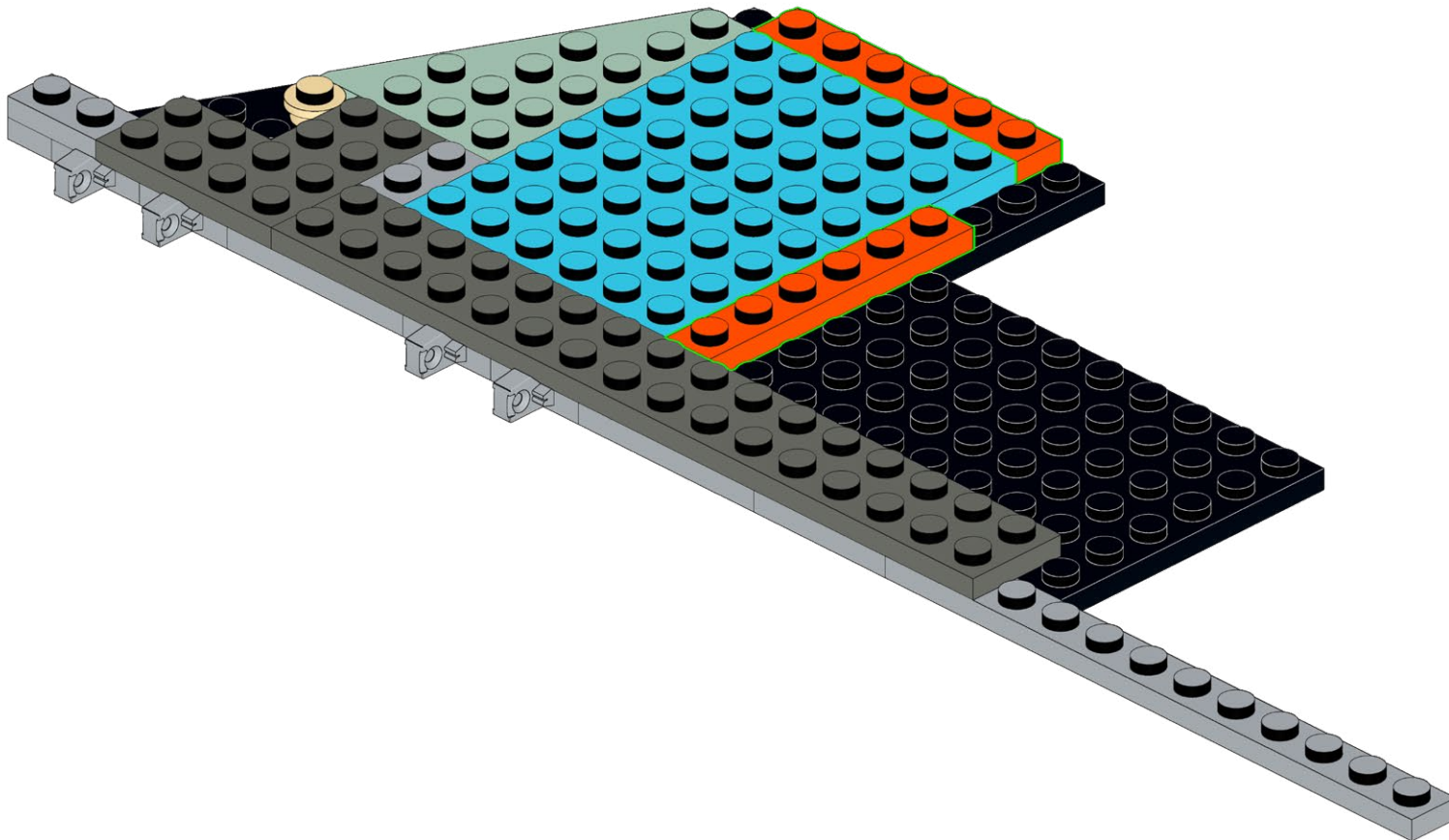
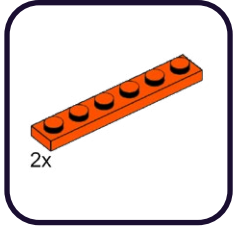



514

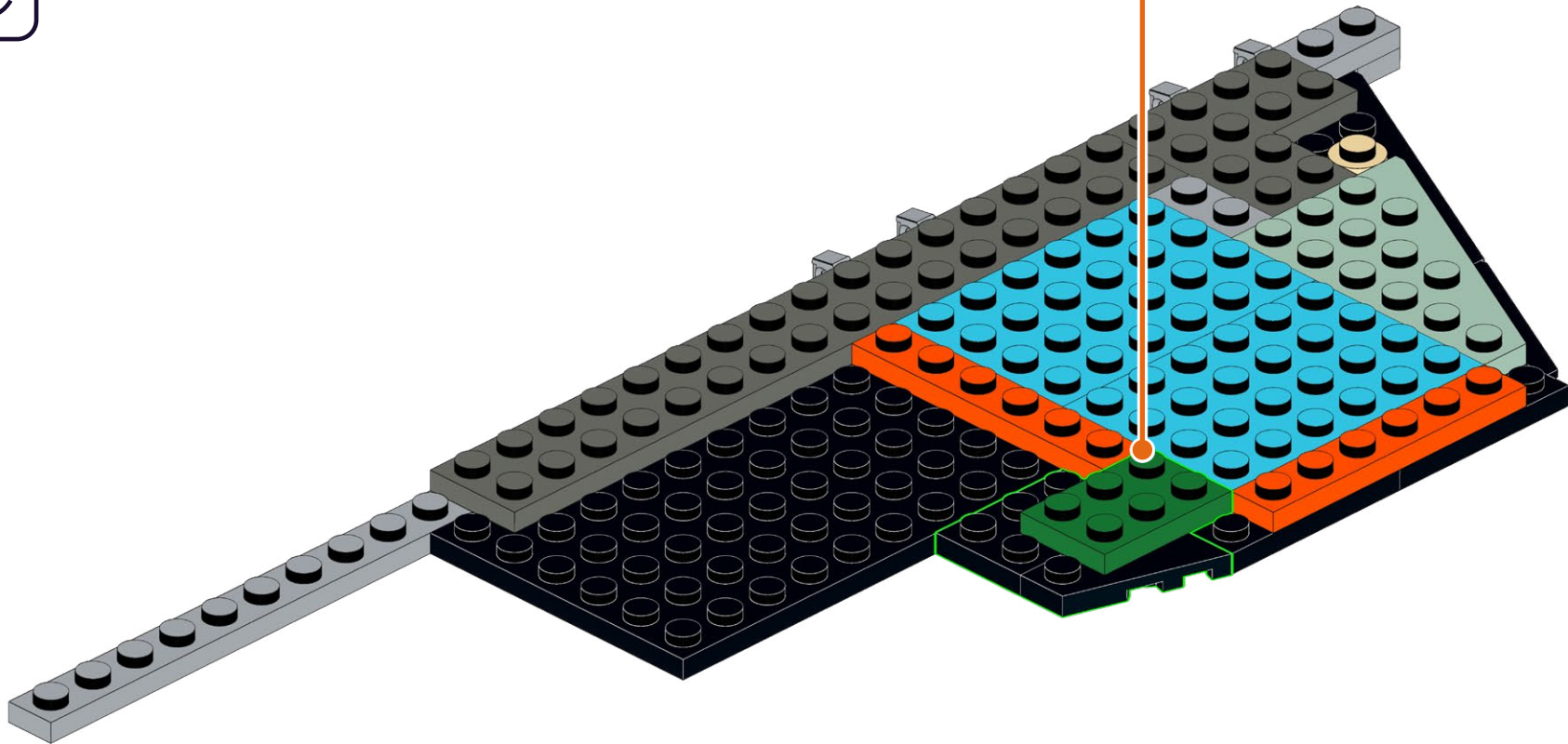
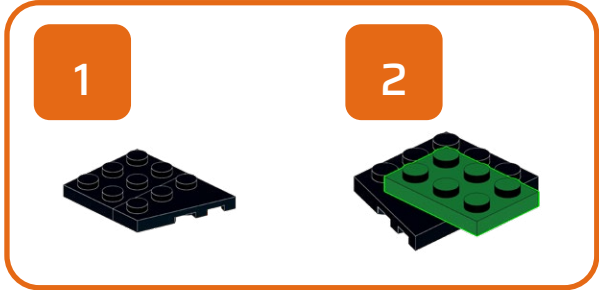
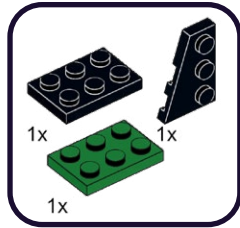

515

1x

2x

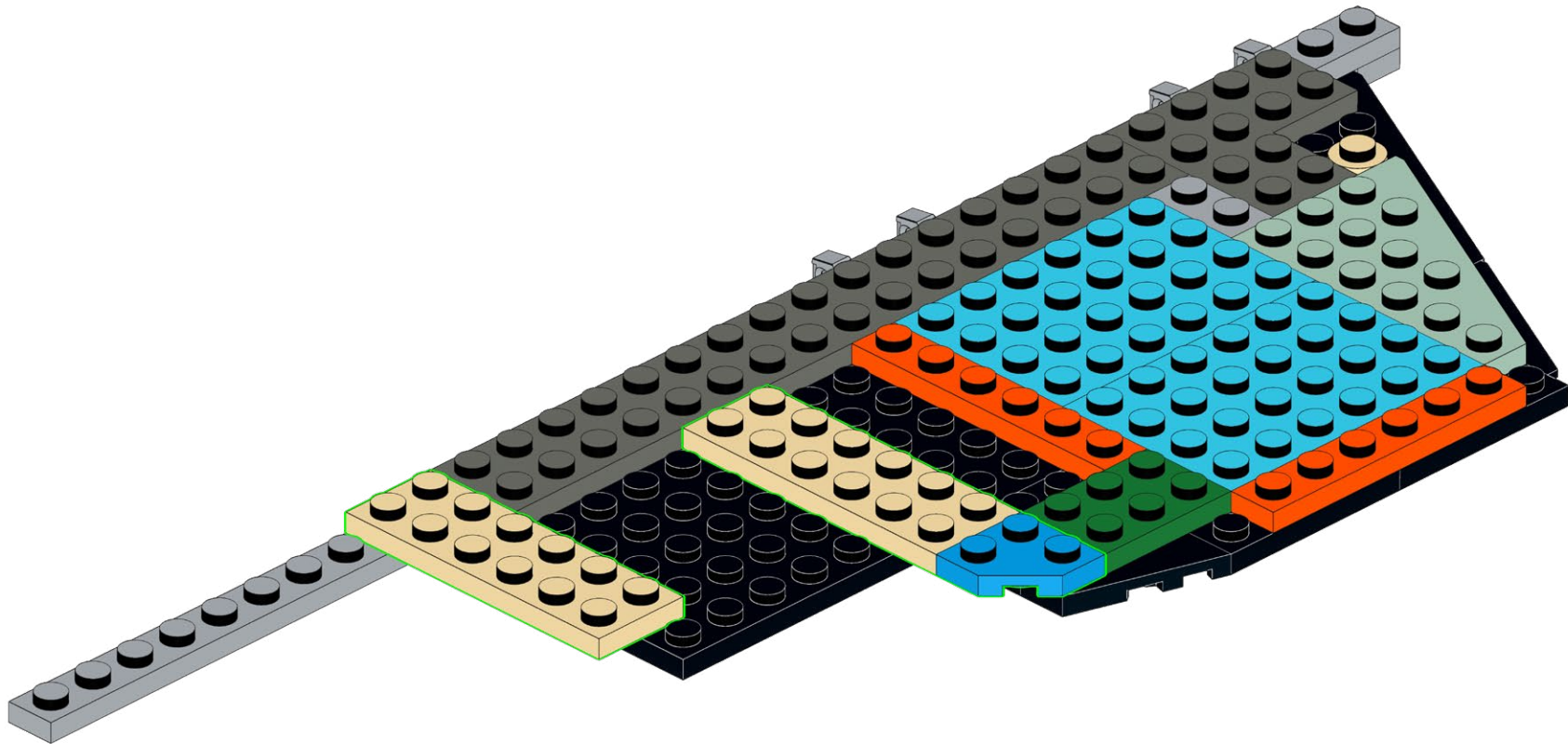

516

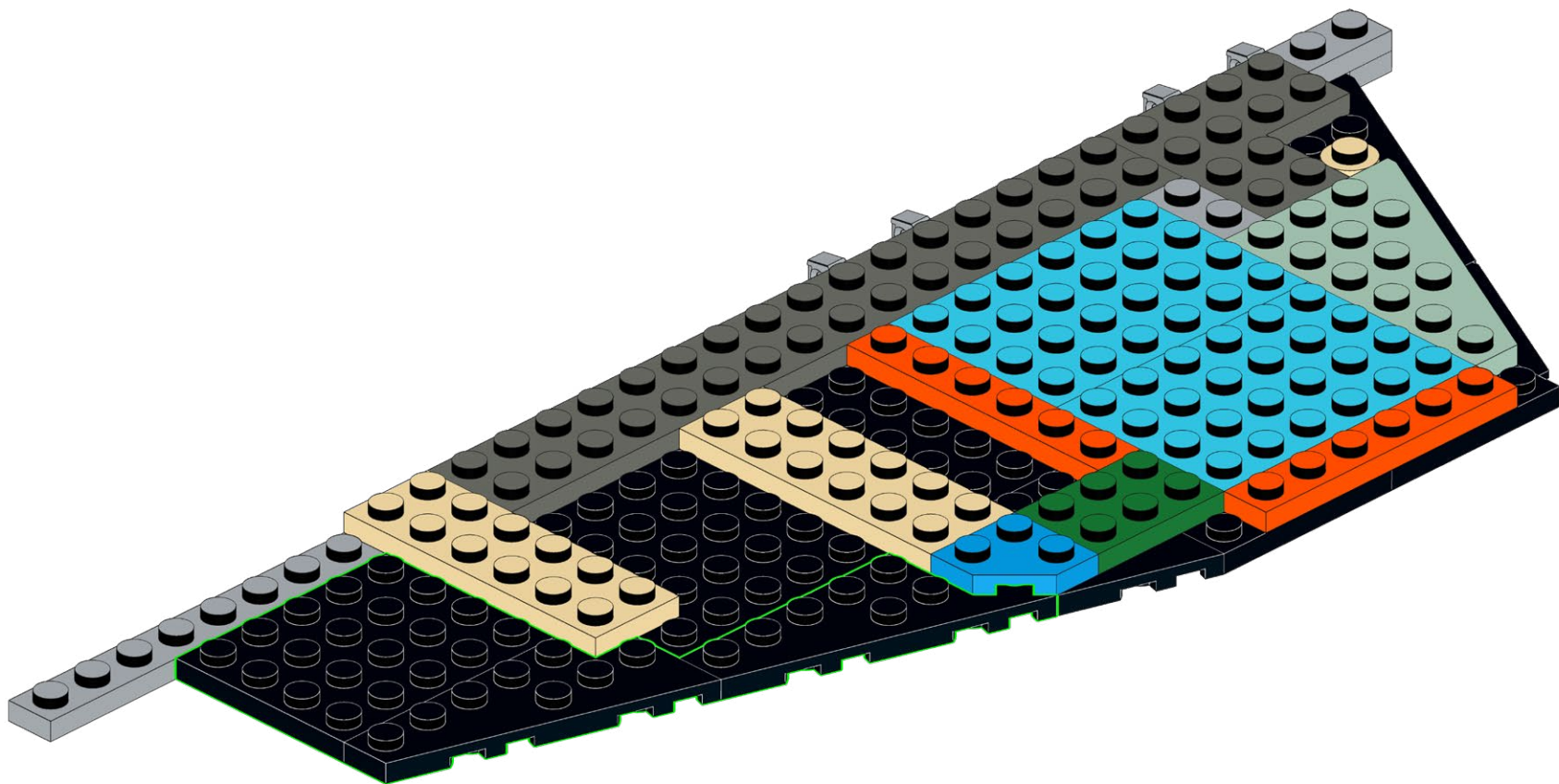
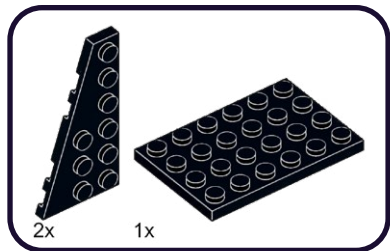

517

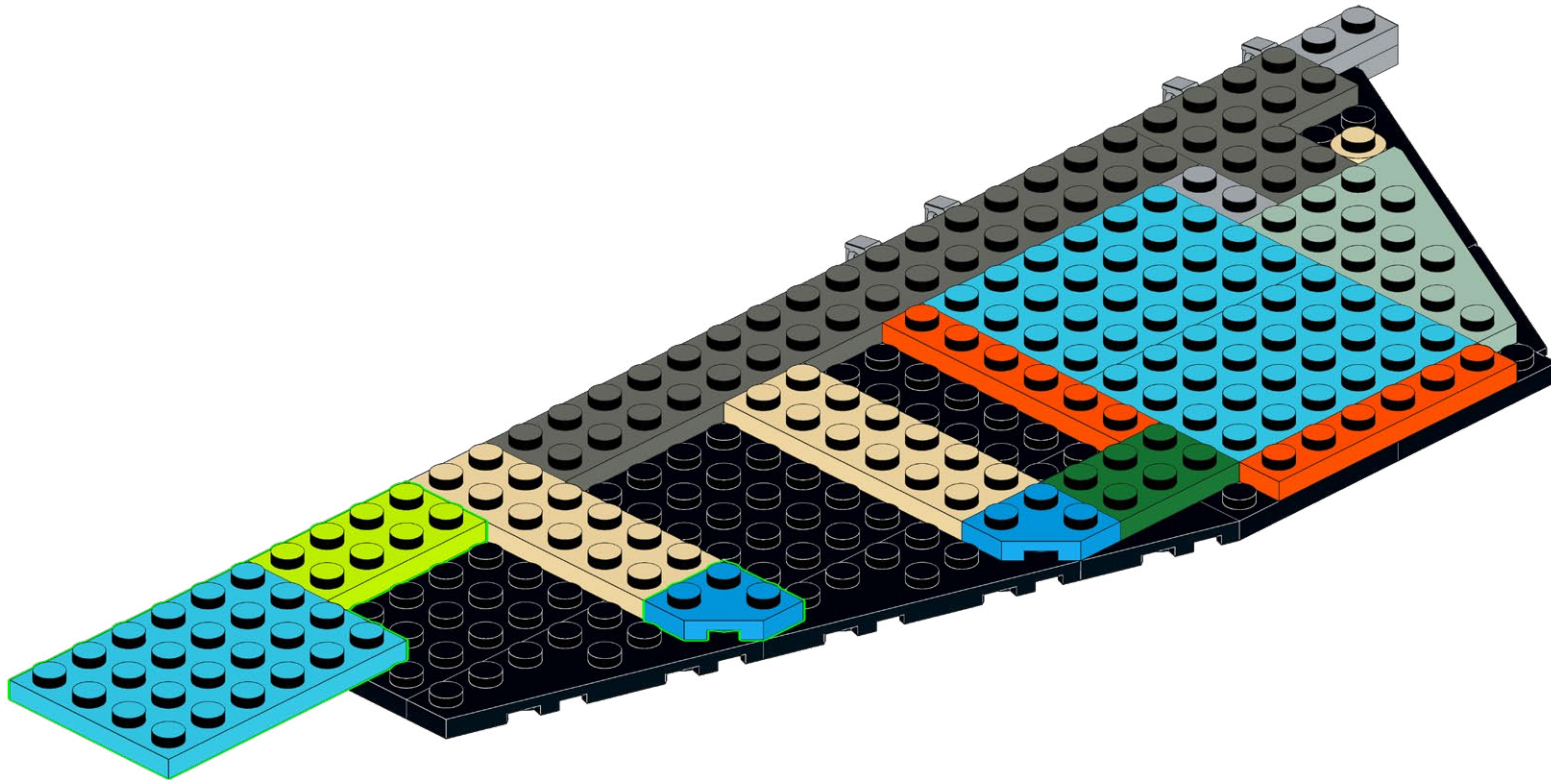
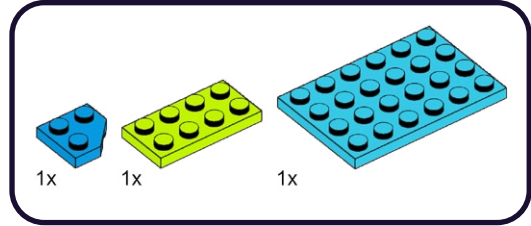



518

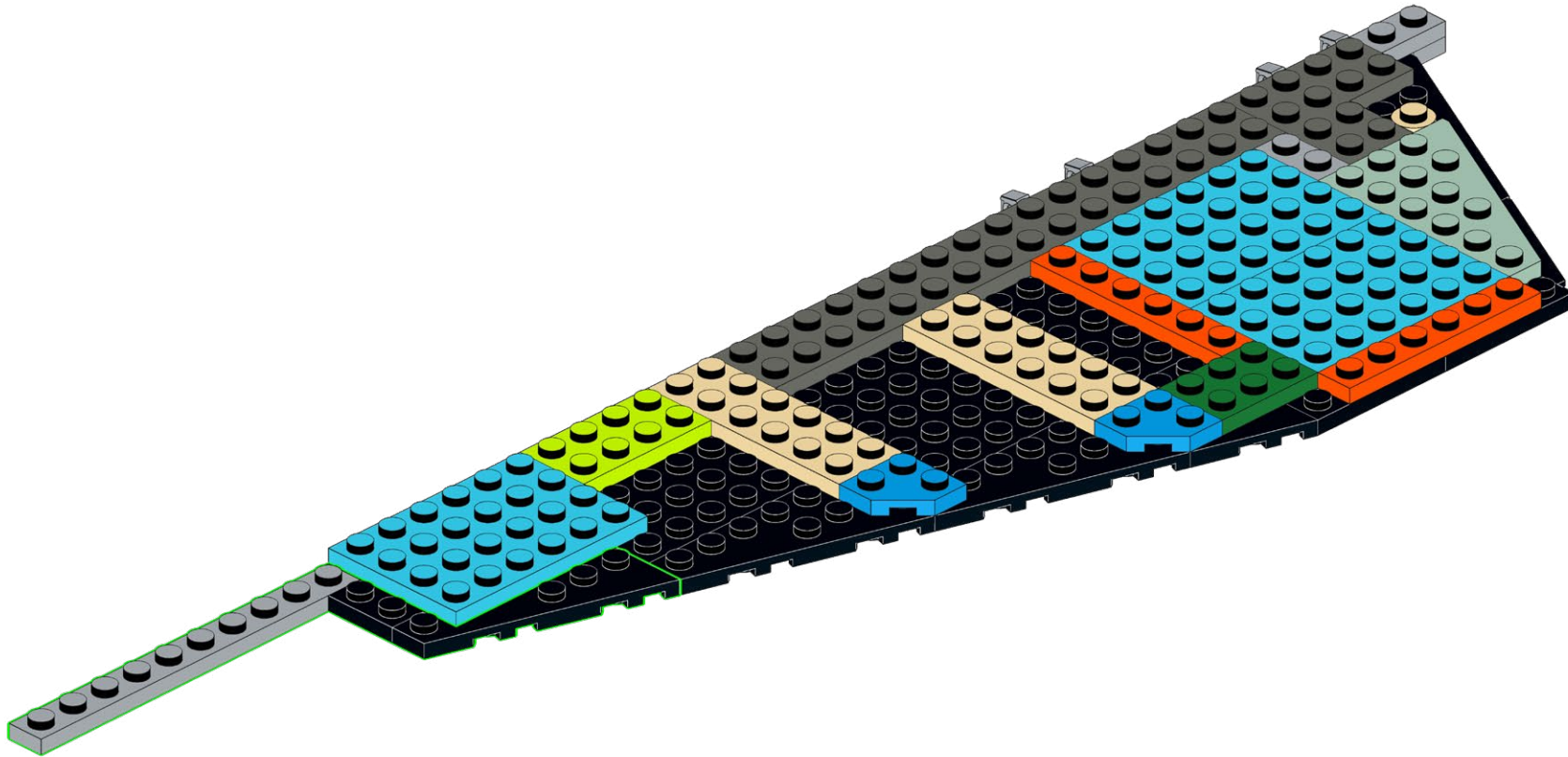
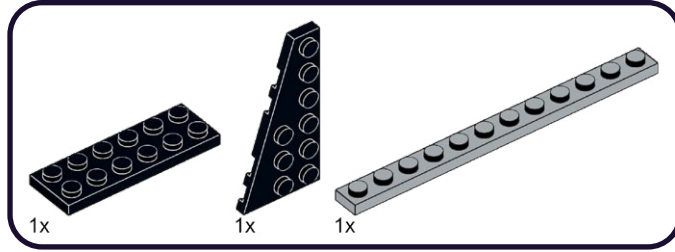

519

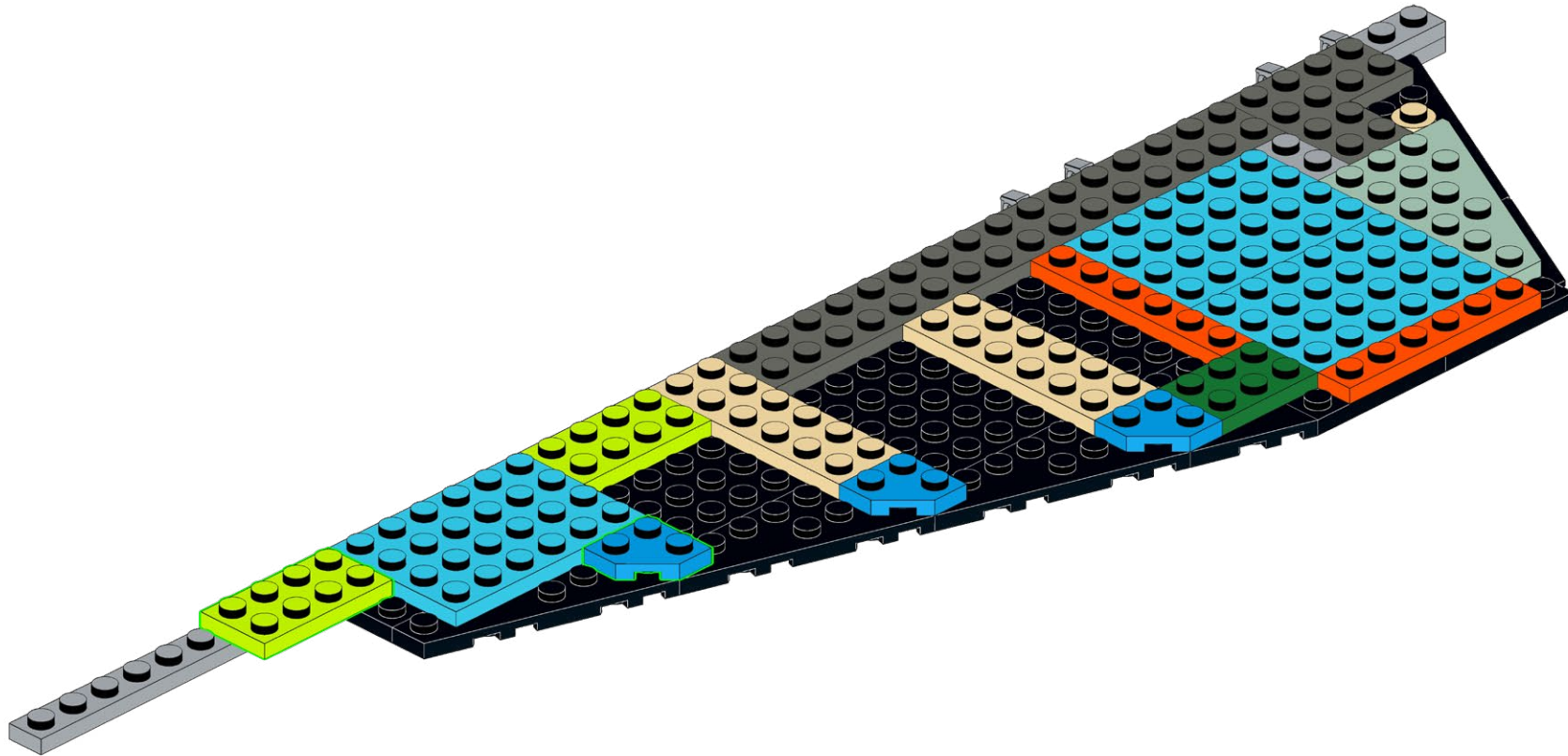
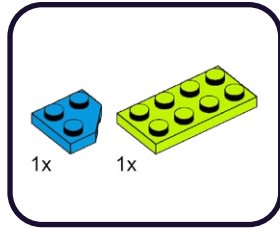



520

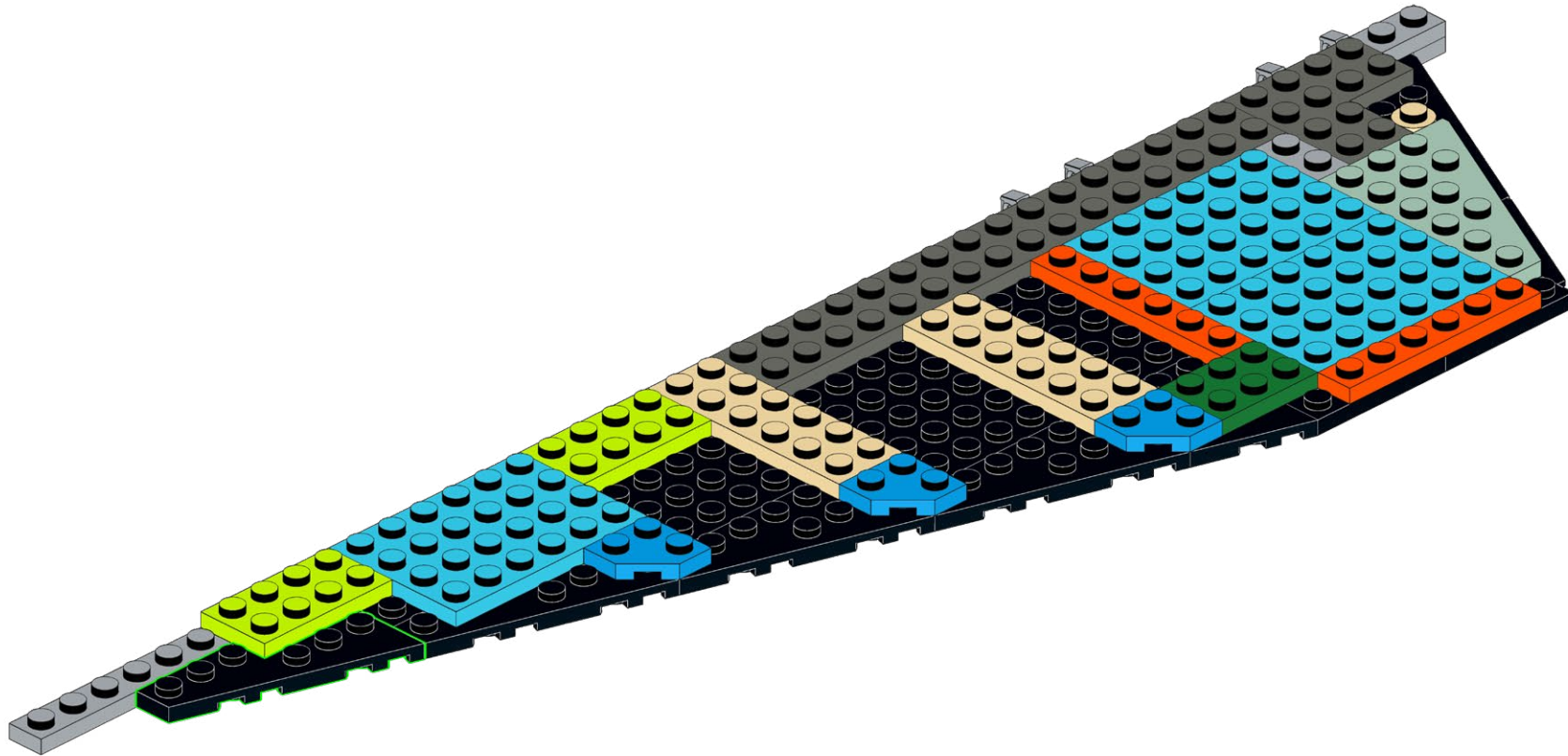
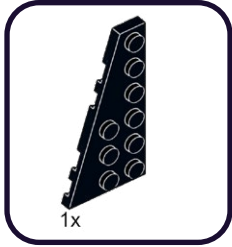

521

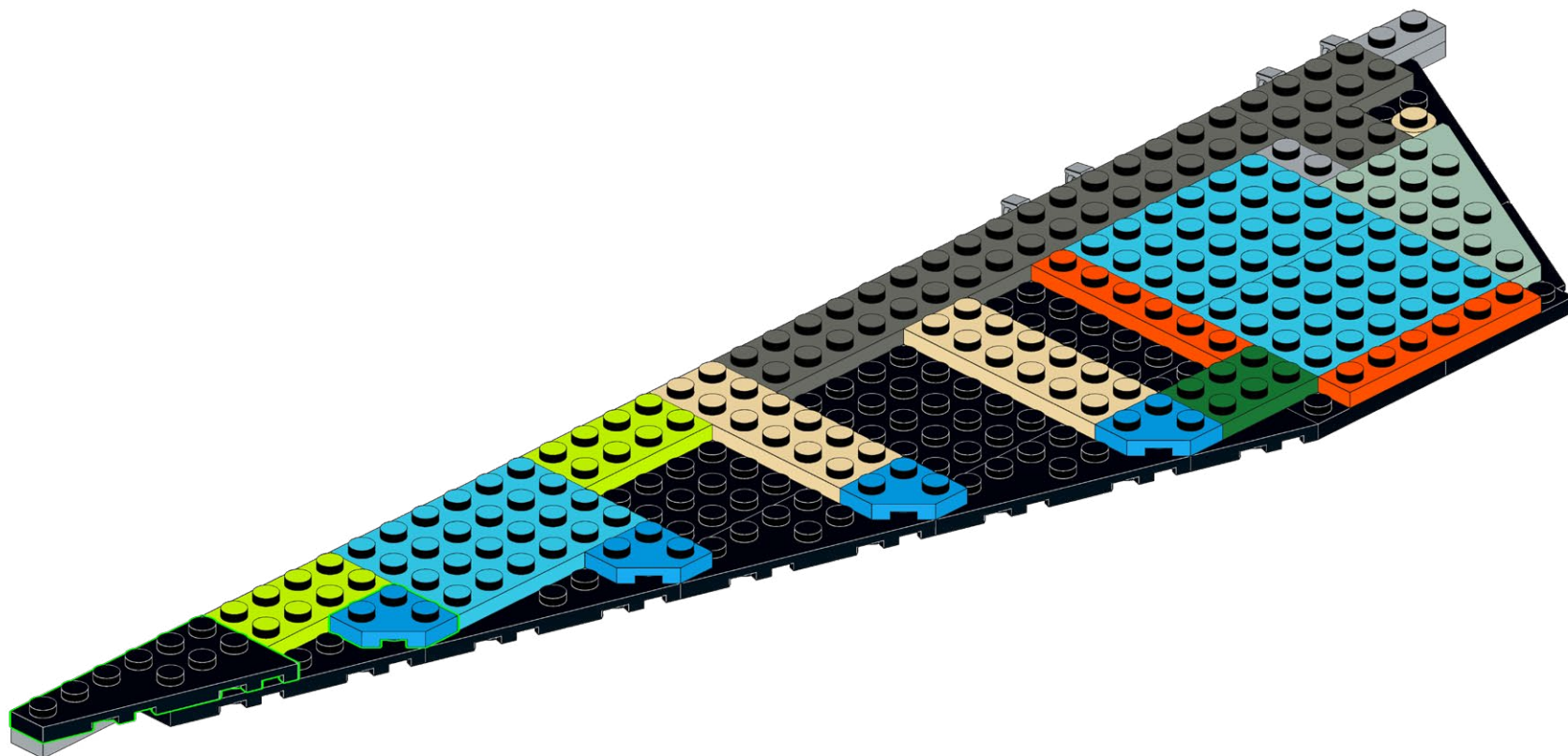
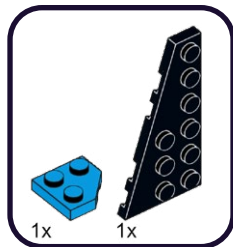

522

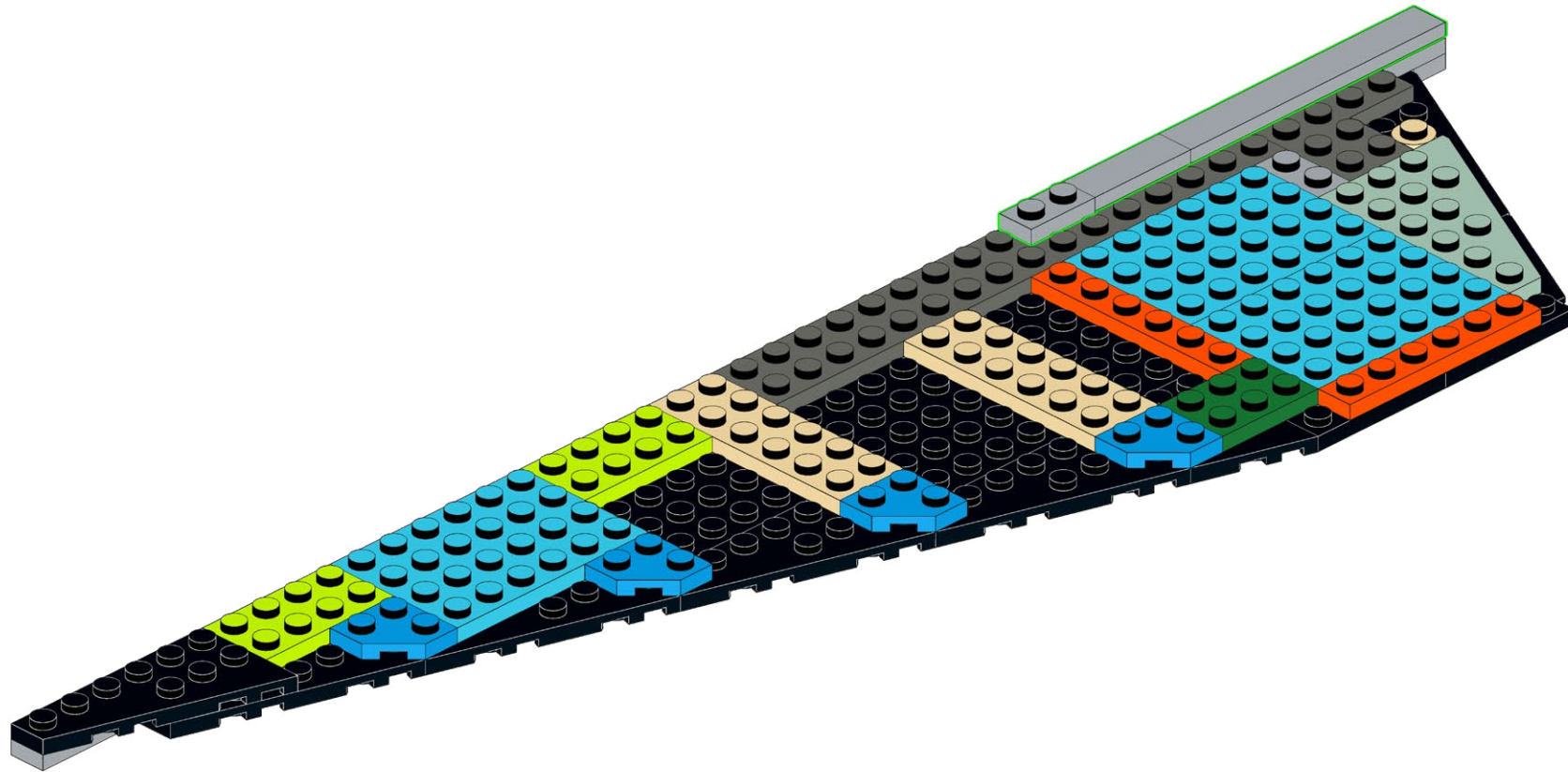
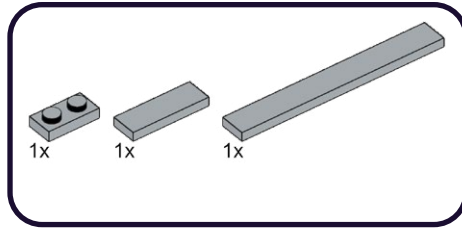

523

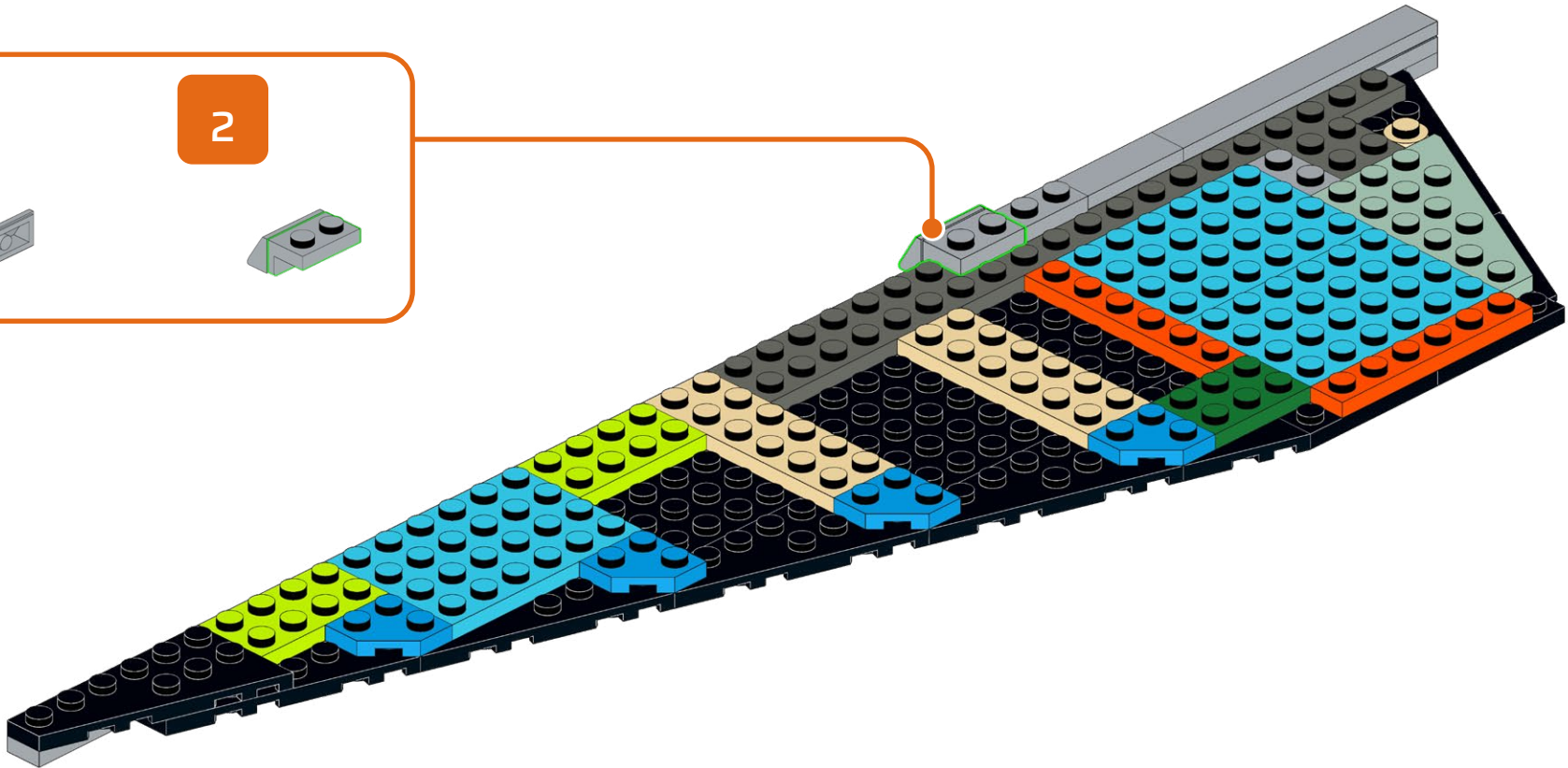
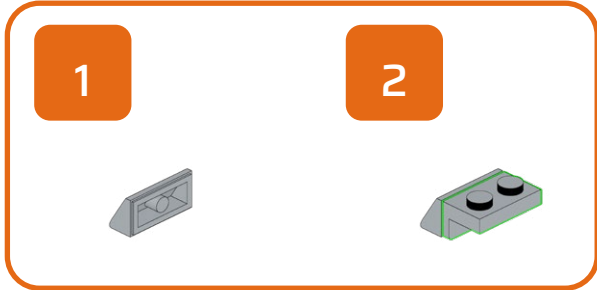
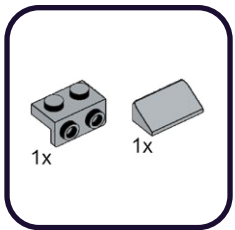



524

6x

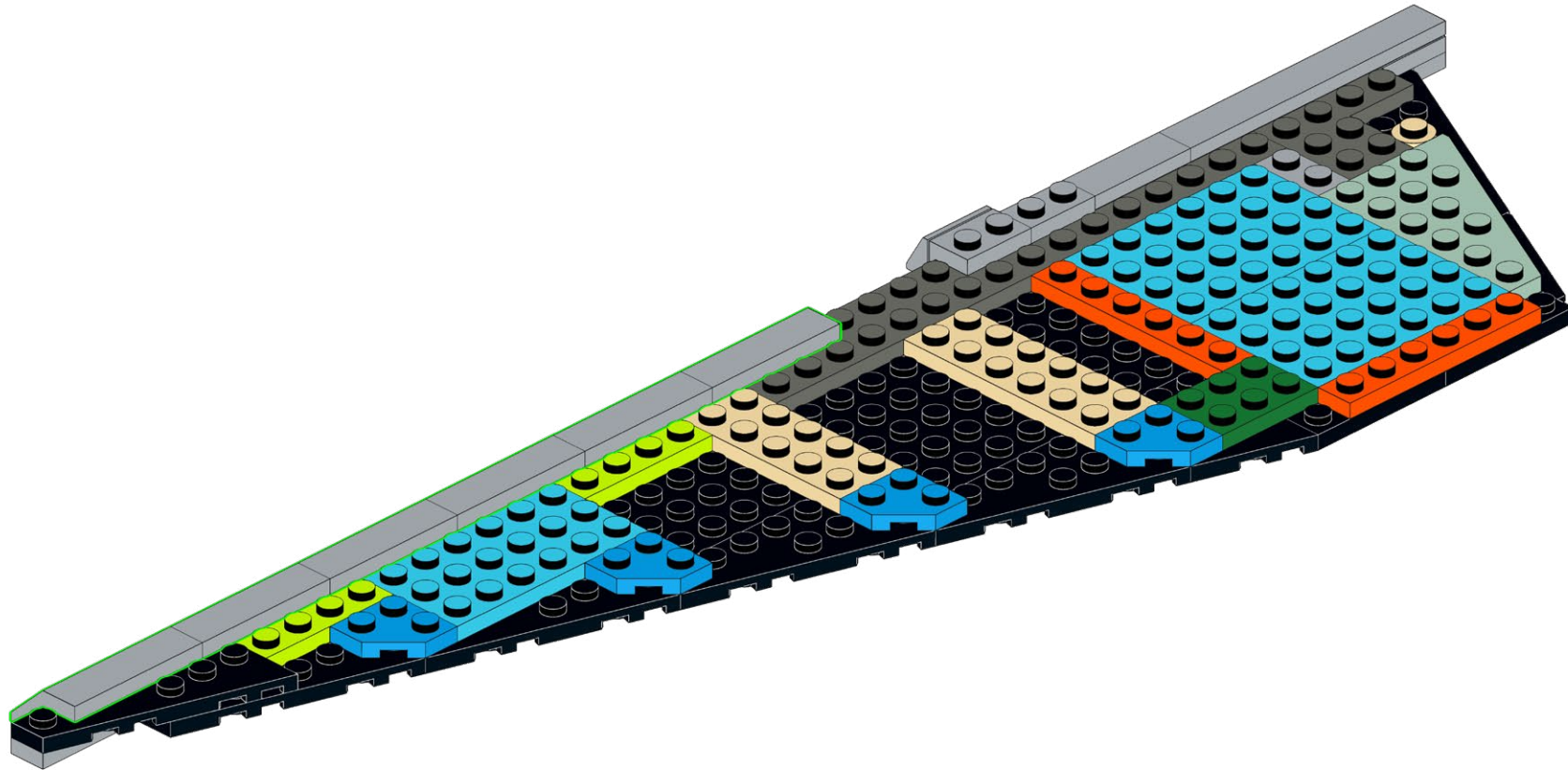

**HOLD UP!**

You might notice some bags are out of order, as well as left over pieces, but that's ok! We're changing the way you build LEGO!

**HALTEN!**

Möglicherweise stellen Sie fest, dass einige Beutel nicht in Ordnung sind und auch Teile übrig bleiben, aber das ist in Ordnung! Wir verändern die Art und Weise, wie Sie LEGO bauen!

**TENIR BON!**

Vous remarquerez peut-être que certains sacs sont en panne, ainsi que des morceaux restants, mais ce n'est pas grave ! Nous changeons la façon dont vous construisez LEGO !

**SOSTENERE!**

Potresti notare che alcune borse sono fuori uso, così come alcuni pezzi avanzati, ma va bene! Stiamo cambiando il modo in cui costruisci i LEGO!

**¡SOSTENER!**

Puede que notes que algunas bolsas están fuera de orden, así como piezas sobrantes, ¡pero está bien! ¡Estamos cambiando la forma de construir LEGO!

**耽误!**

您可能会注意到有些袋子坏了, 还有剩余的碎片, 但这没关系! 我们正在改变您搭建乐高的方式!

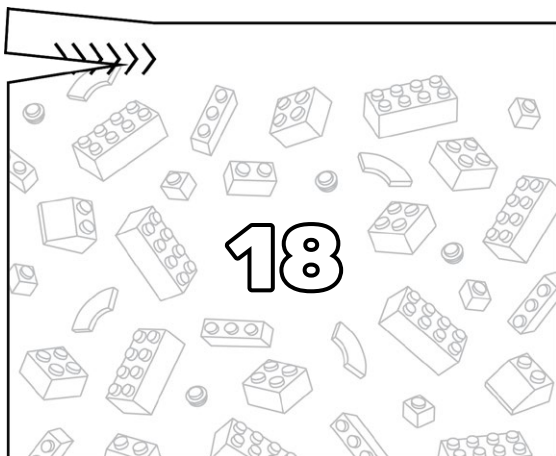
**Open LEGO® Bag 1**



525

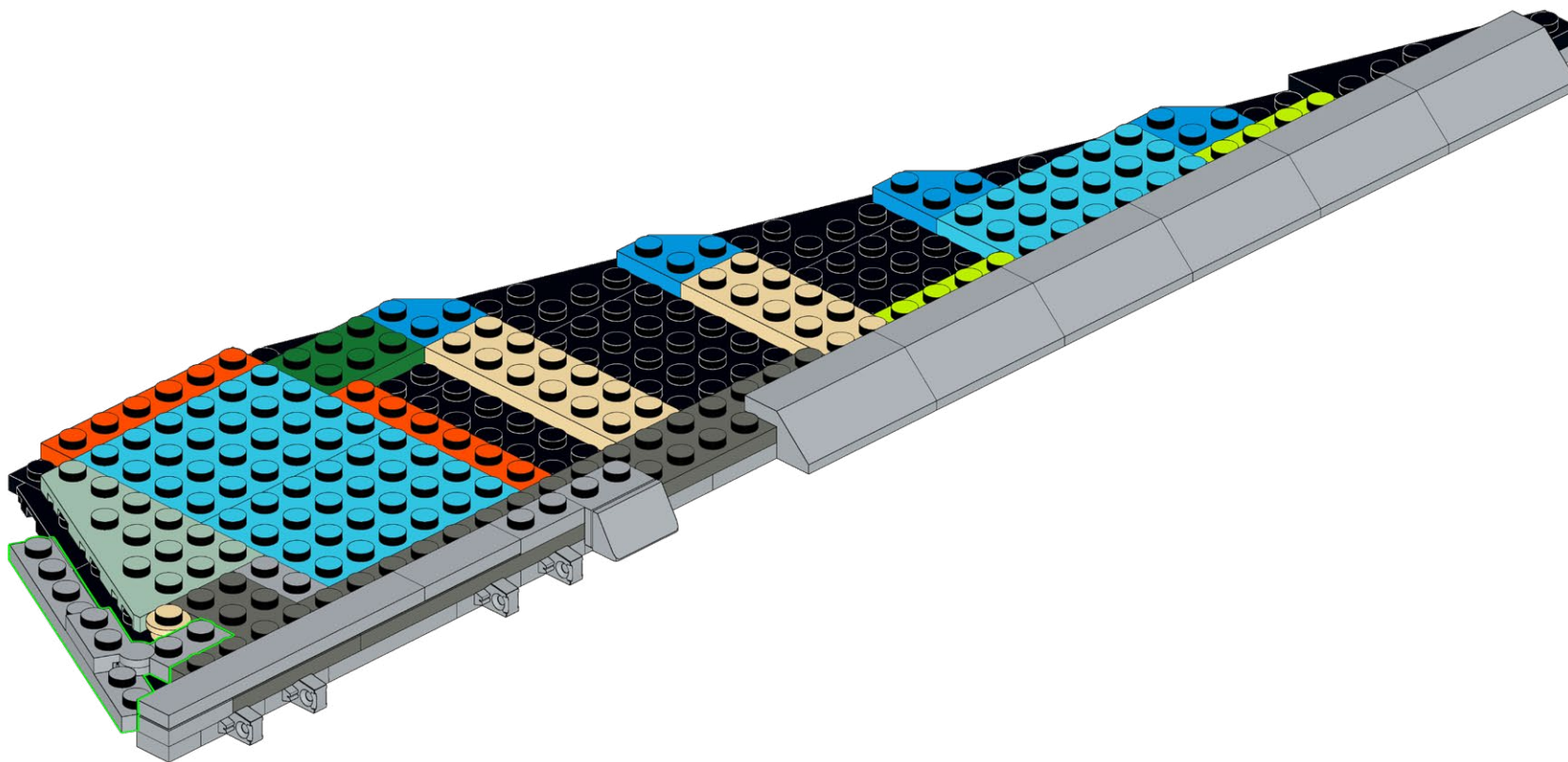
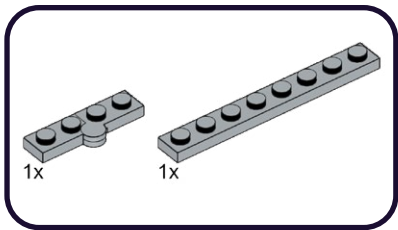

526

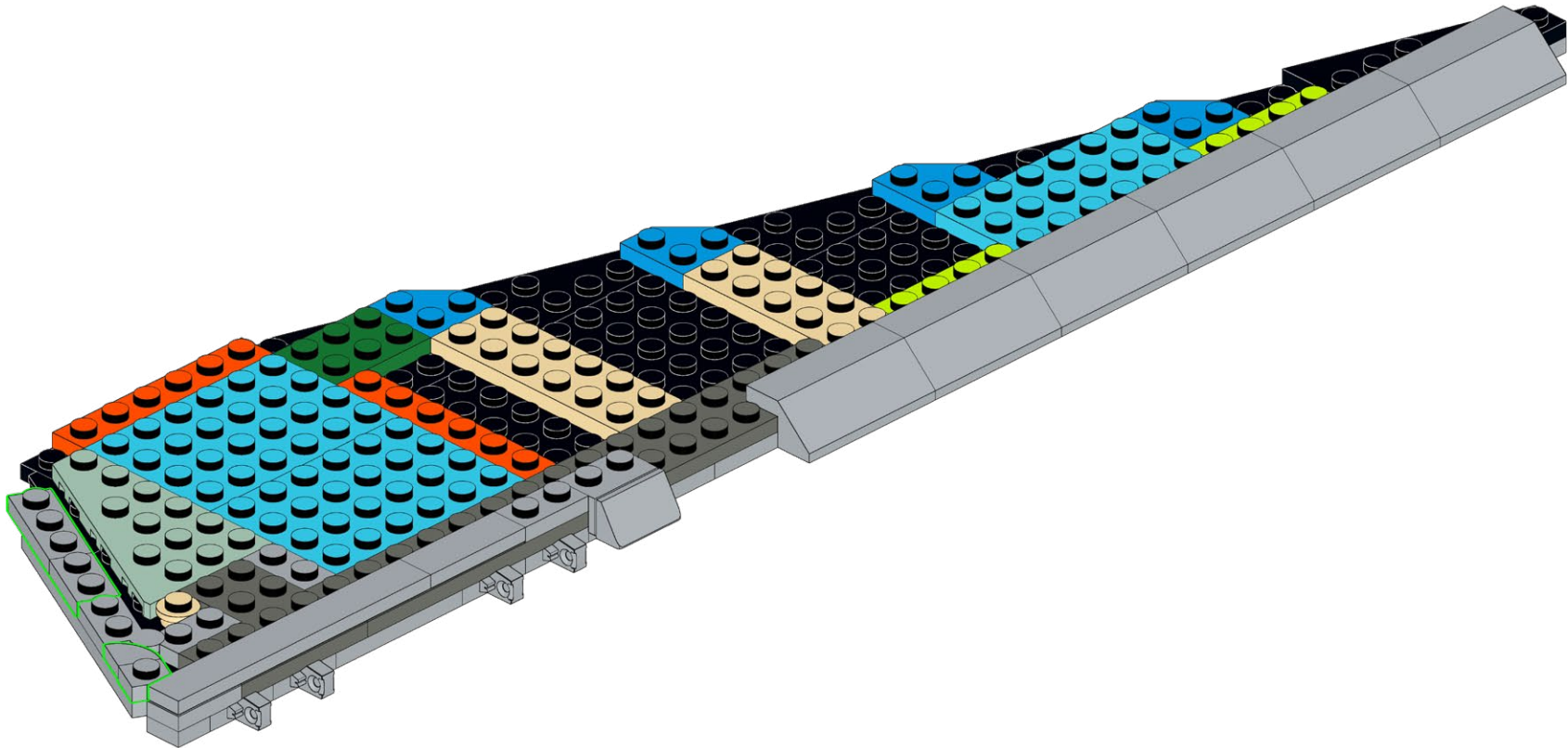
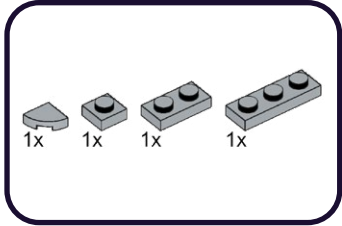

527

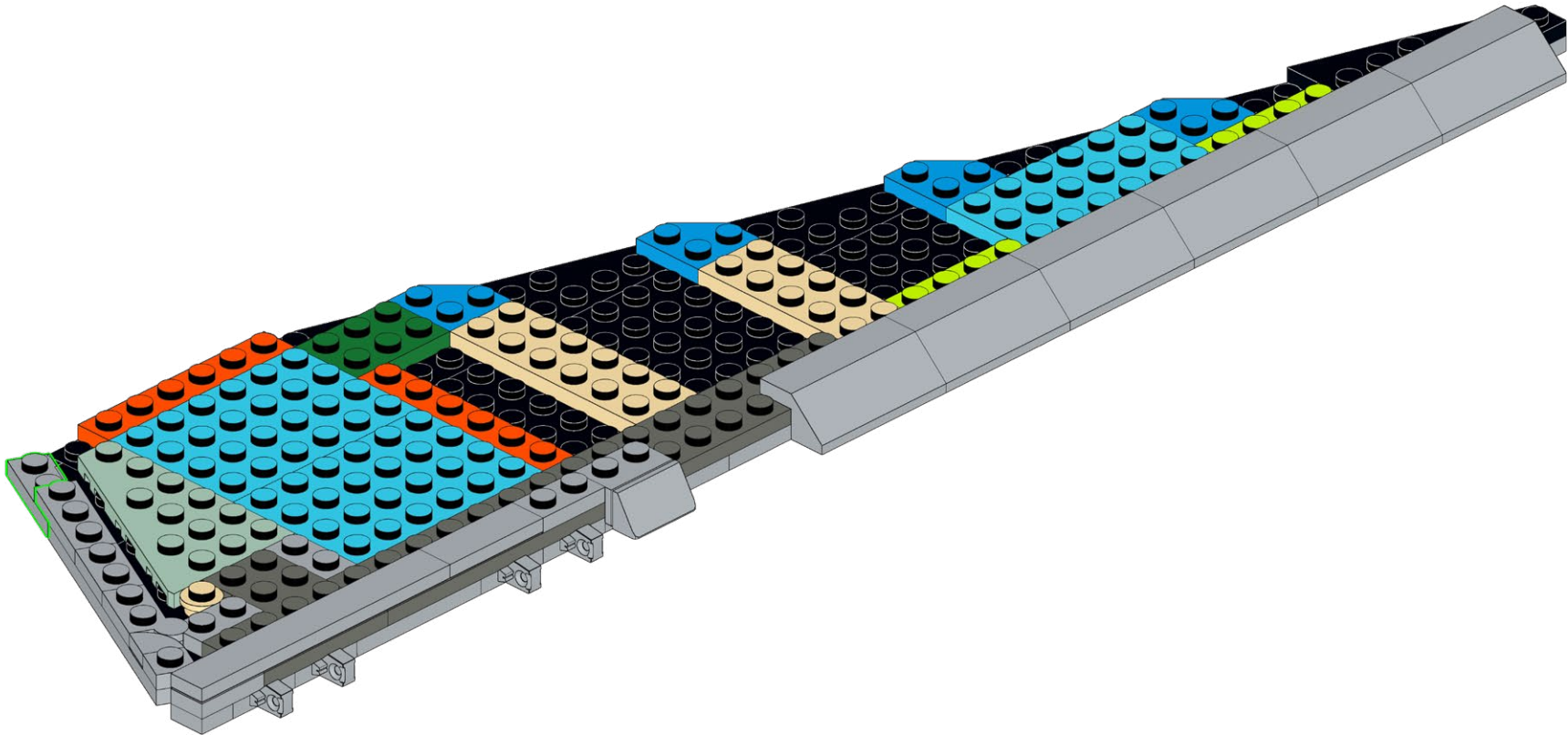
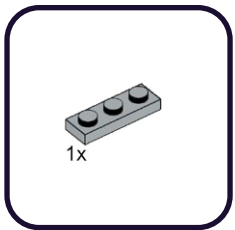

528

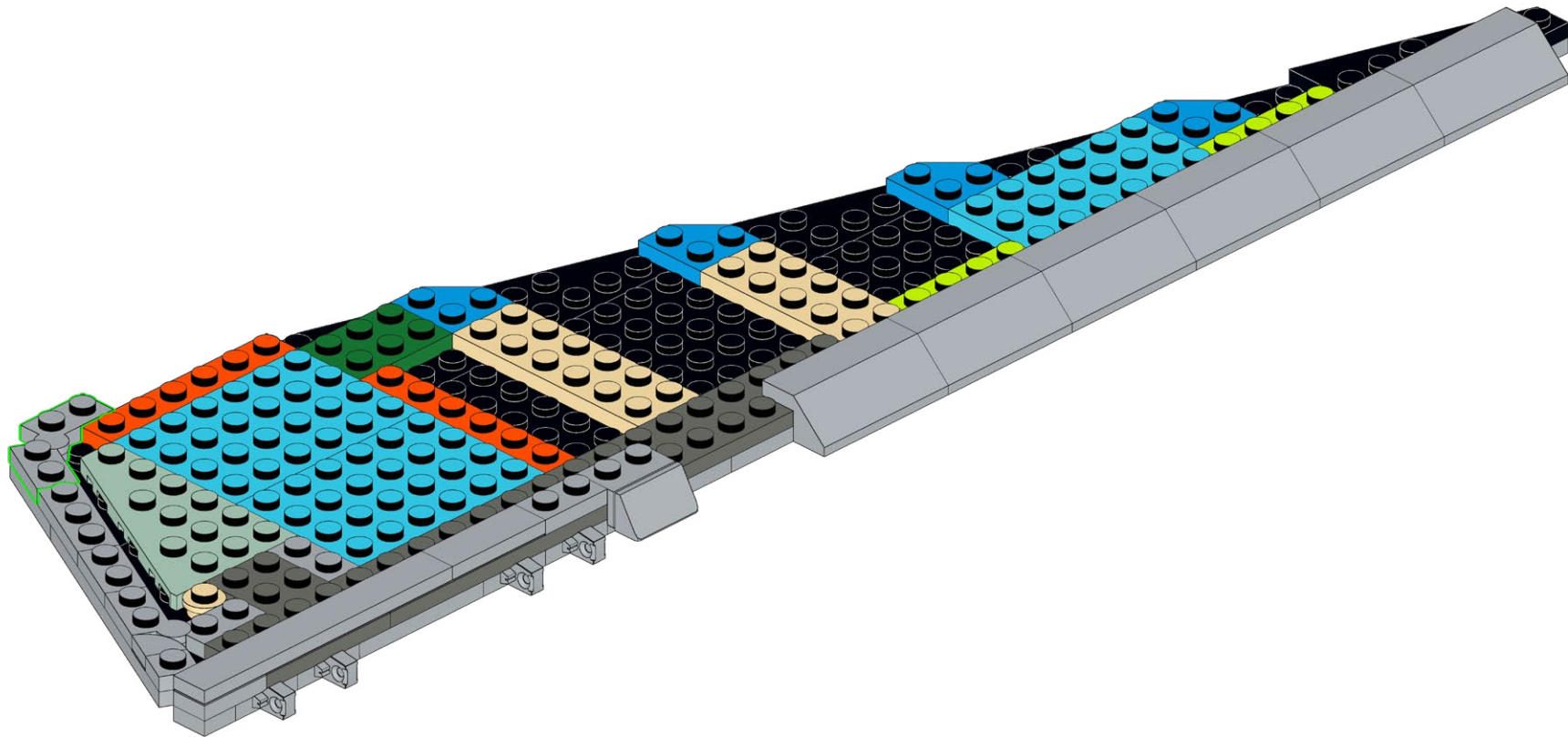
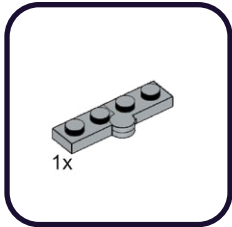

529

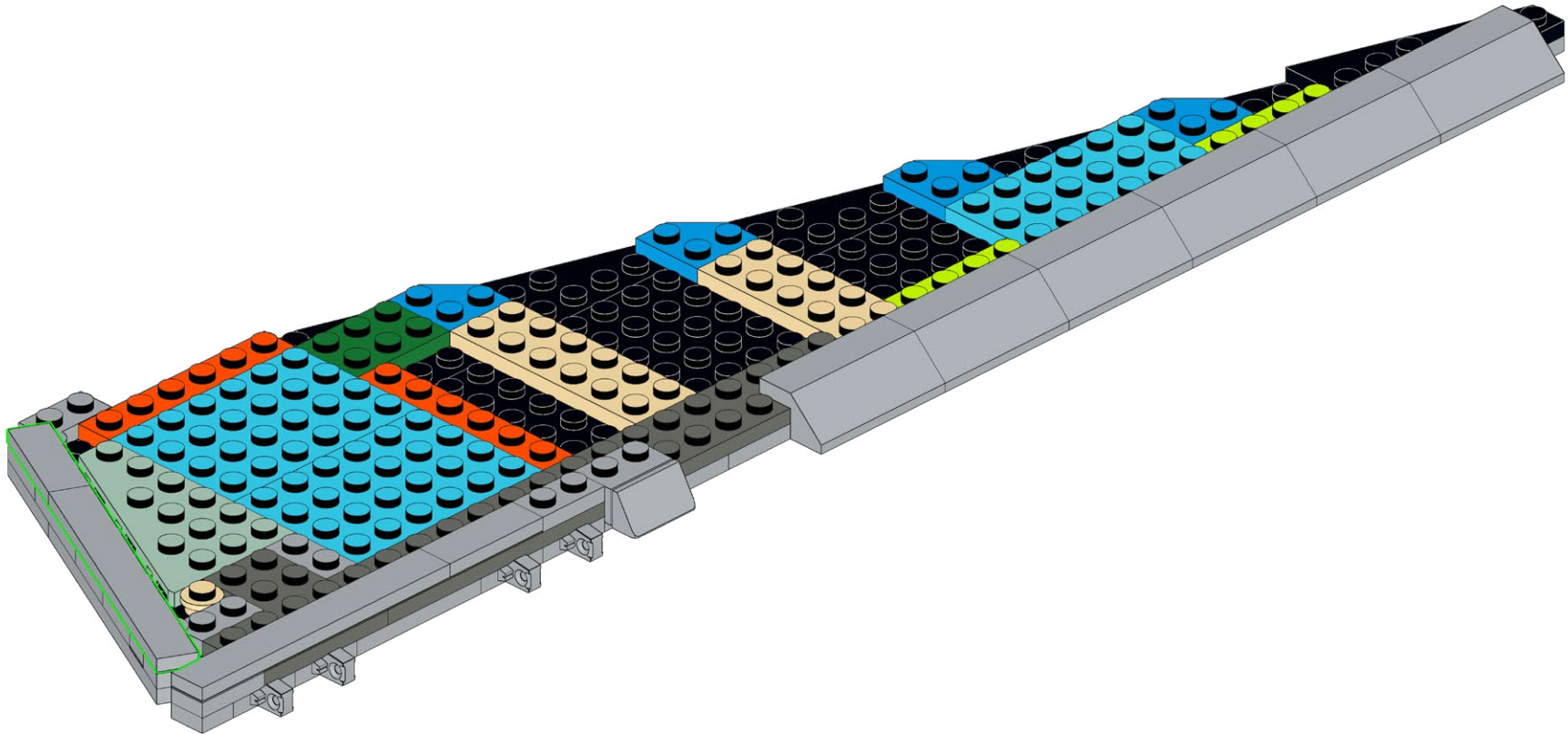
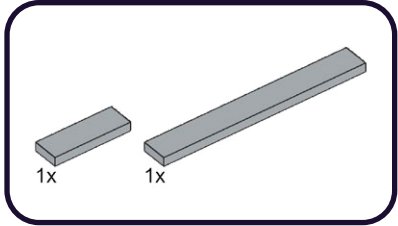



530

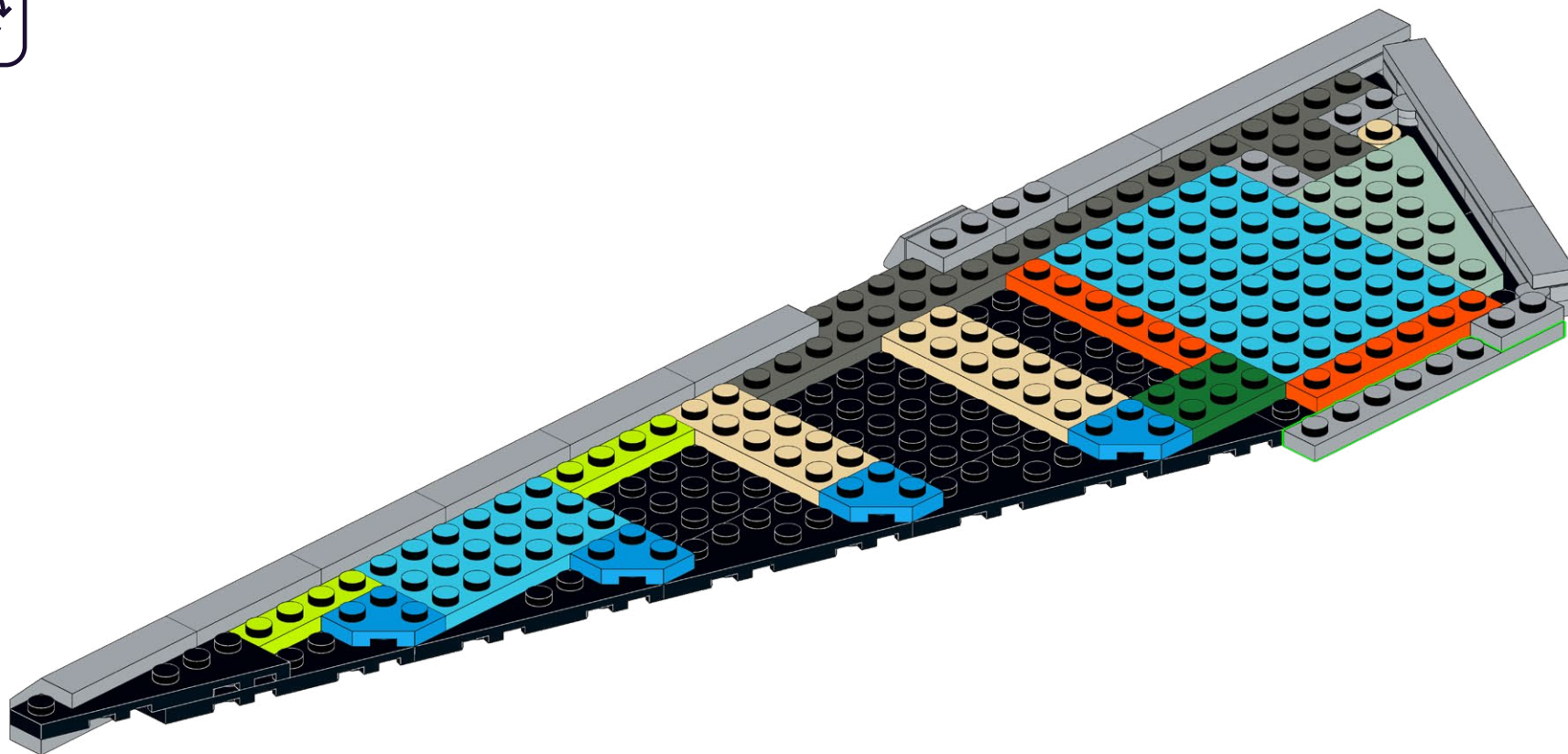
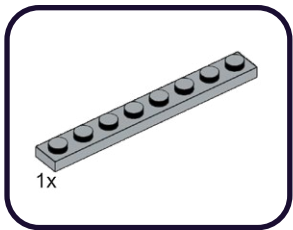



531

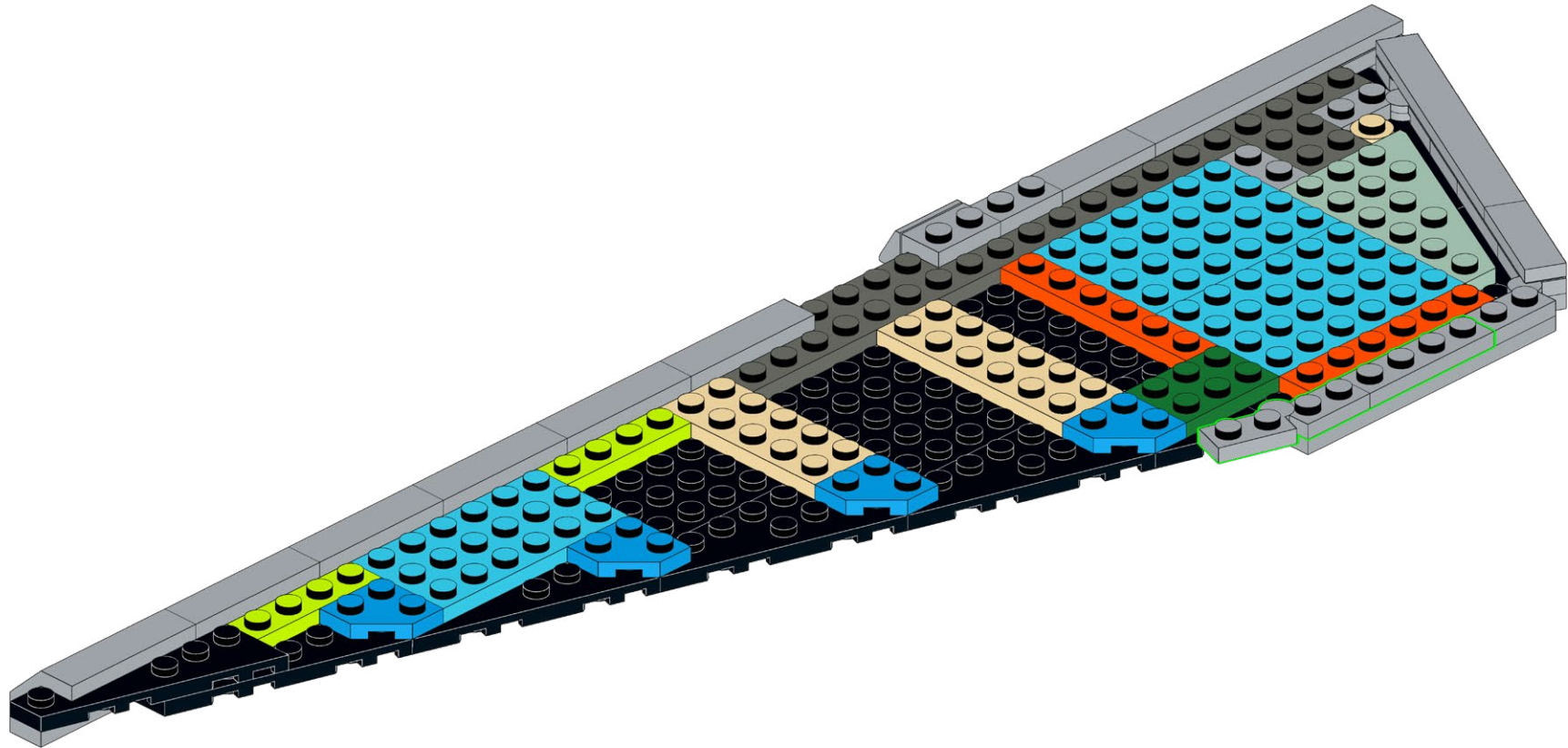
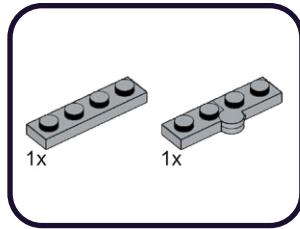

532

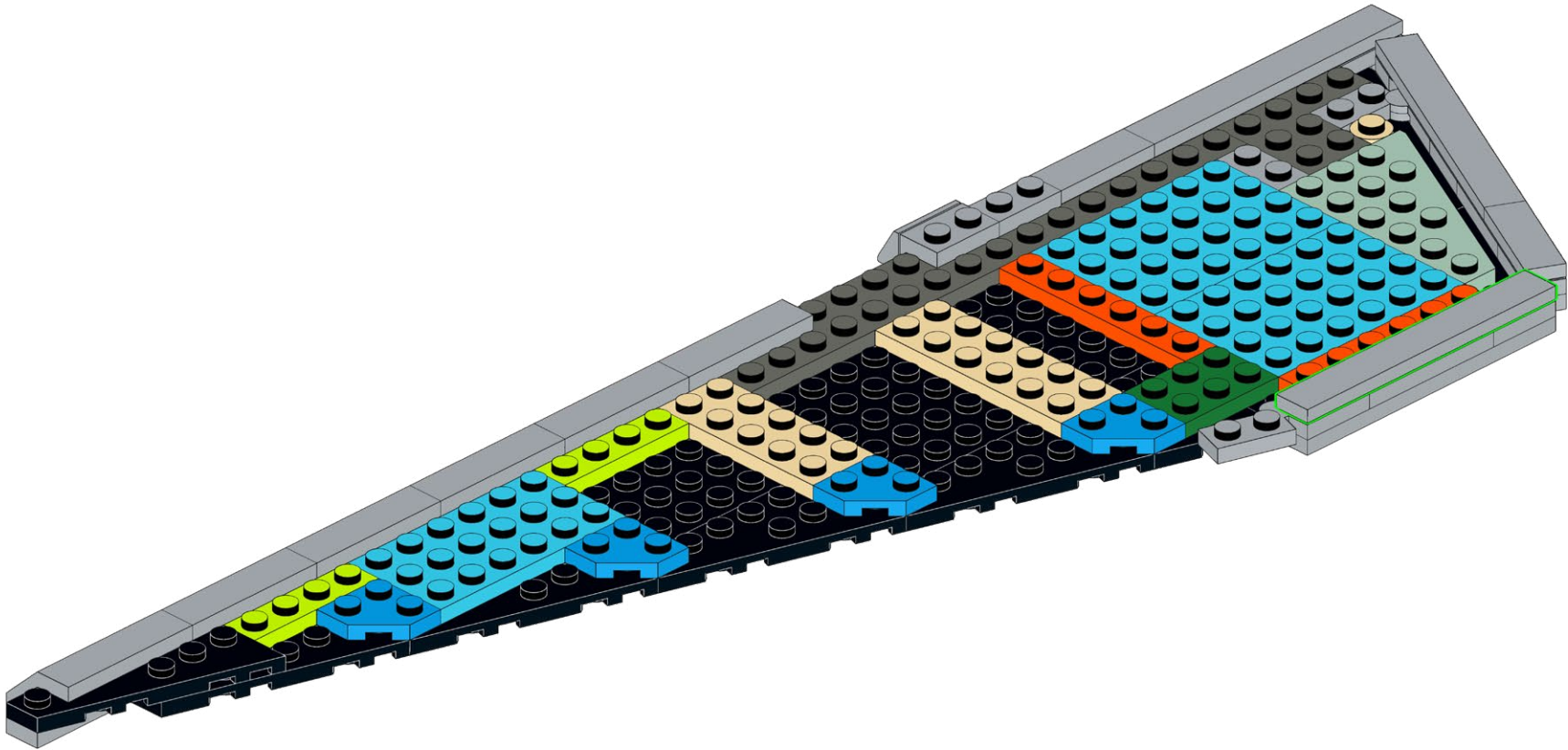
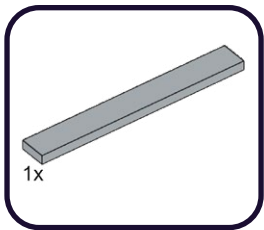

533

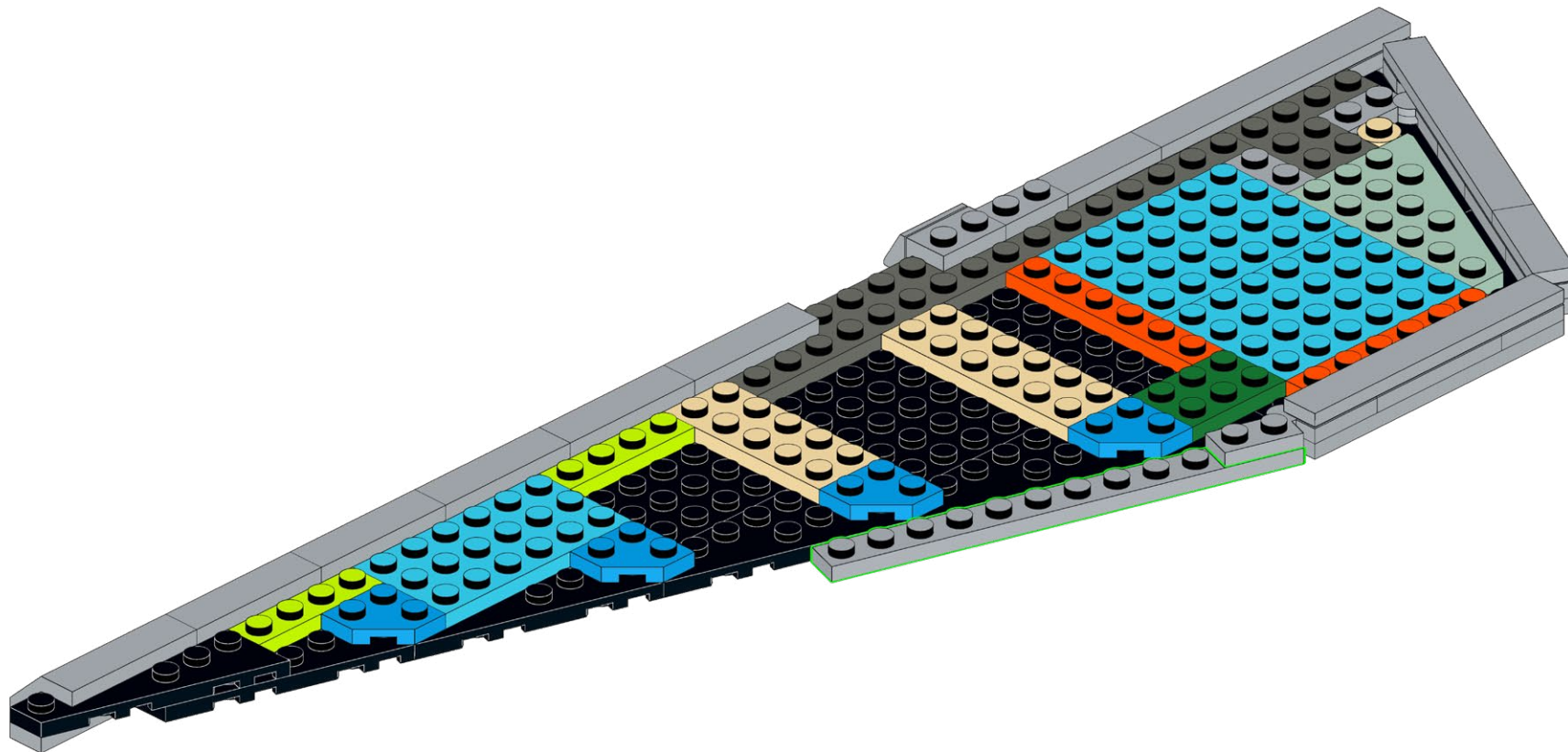
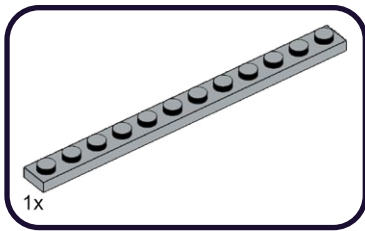

534

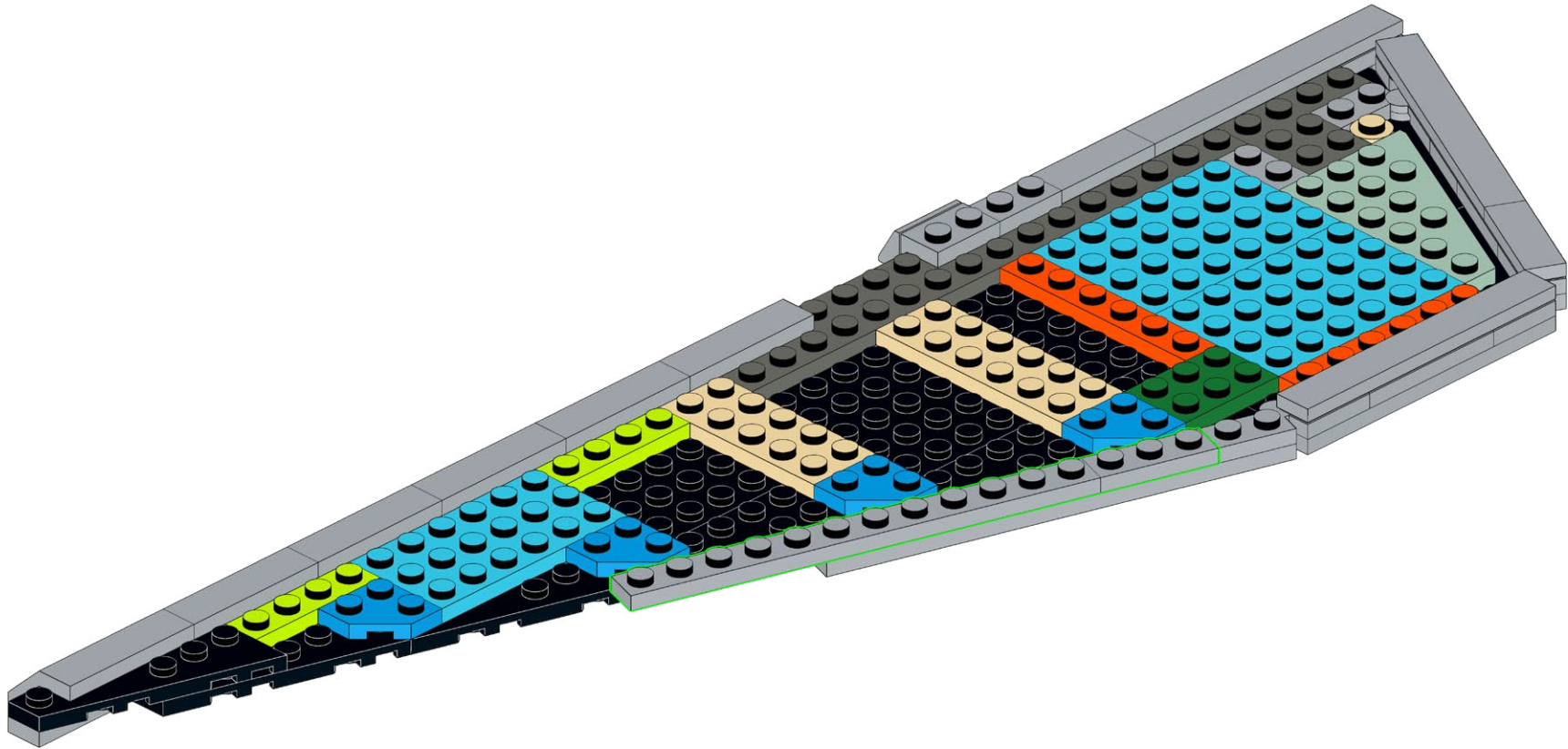
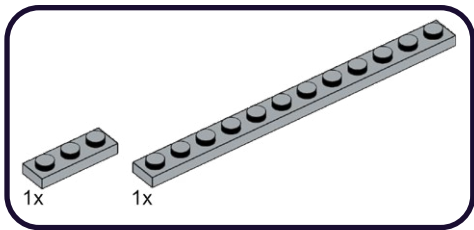



535

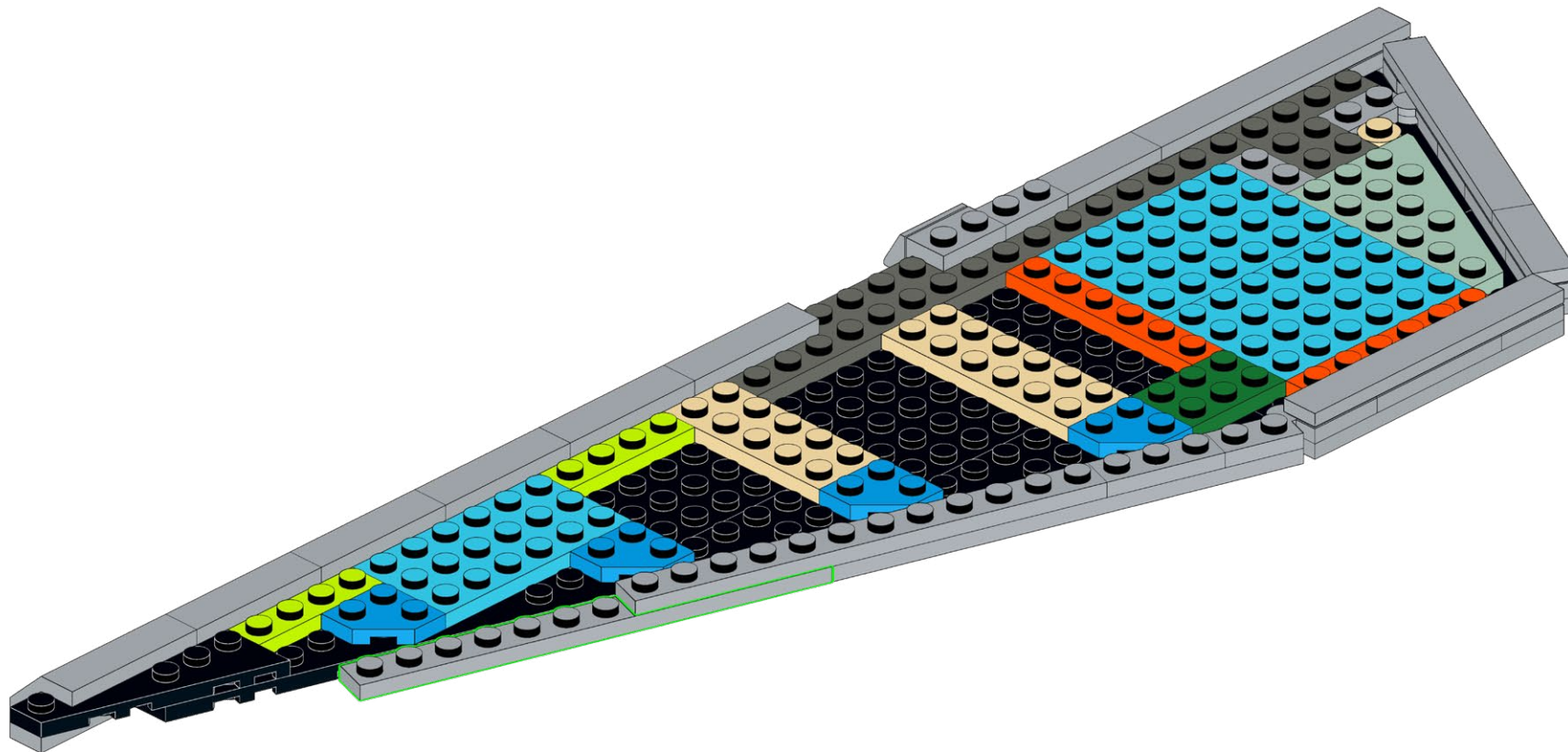
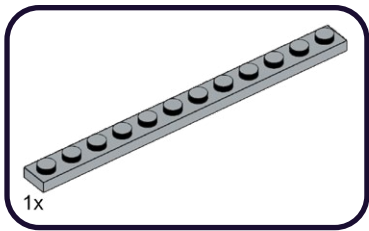

536

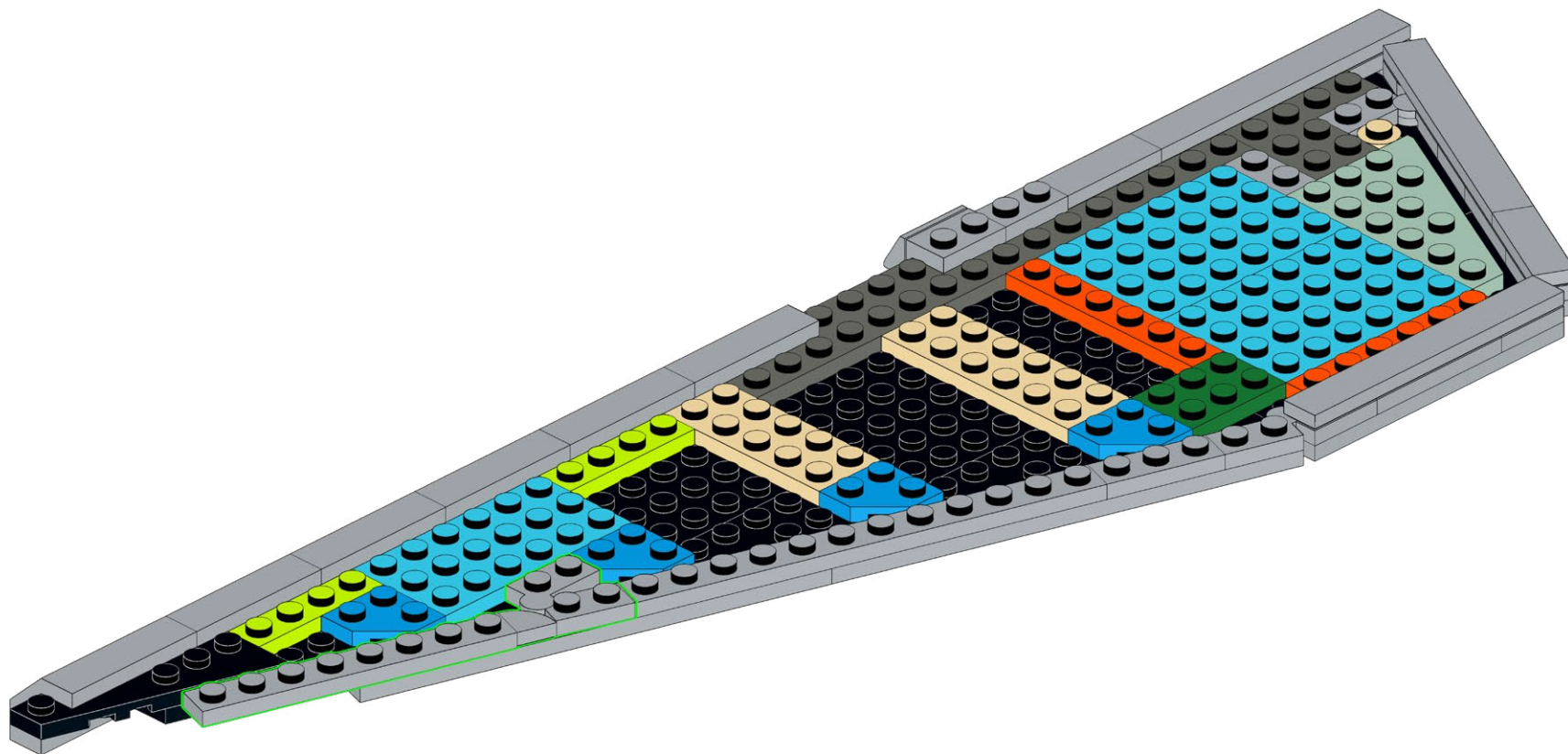
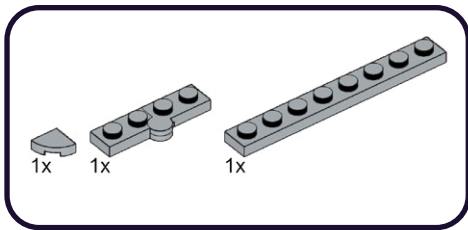



537

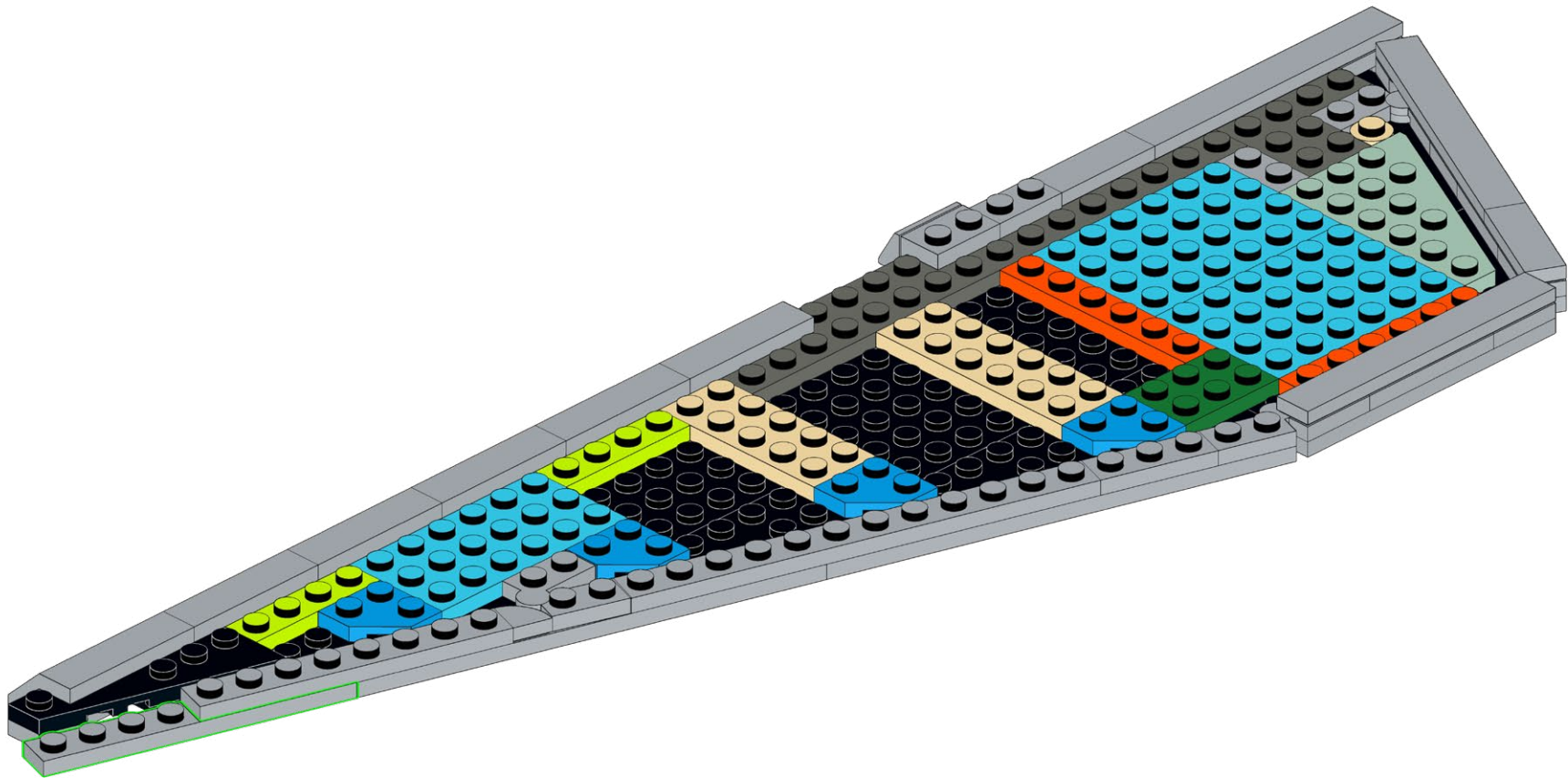
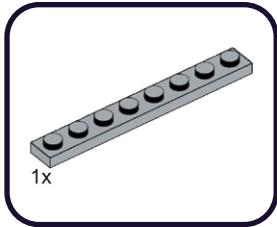

538

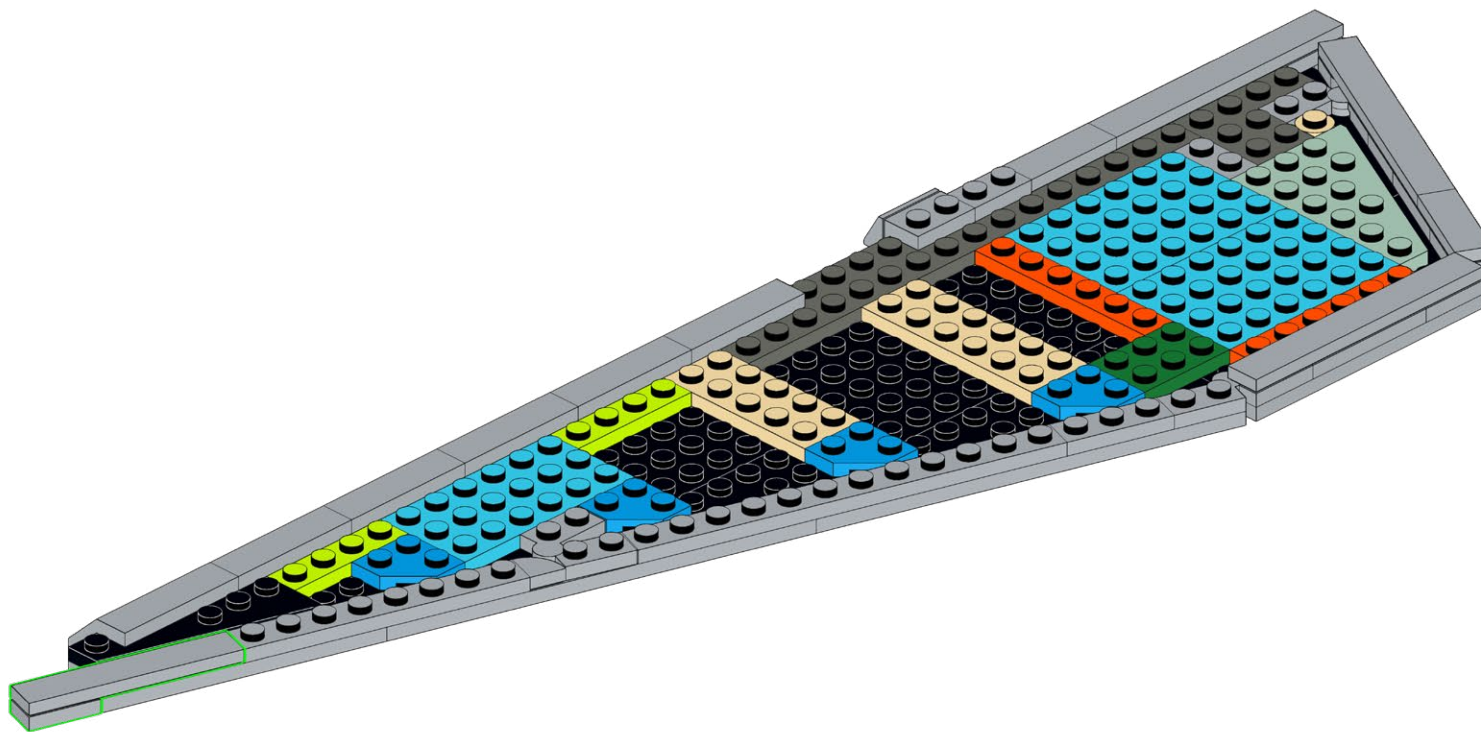
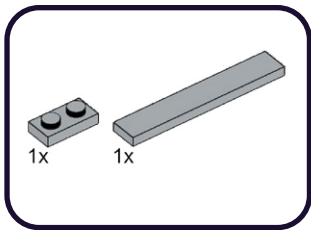

539

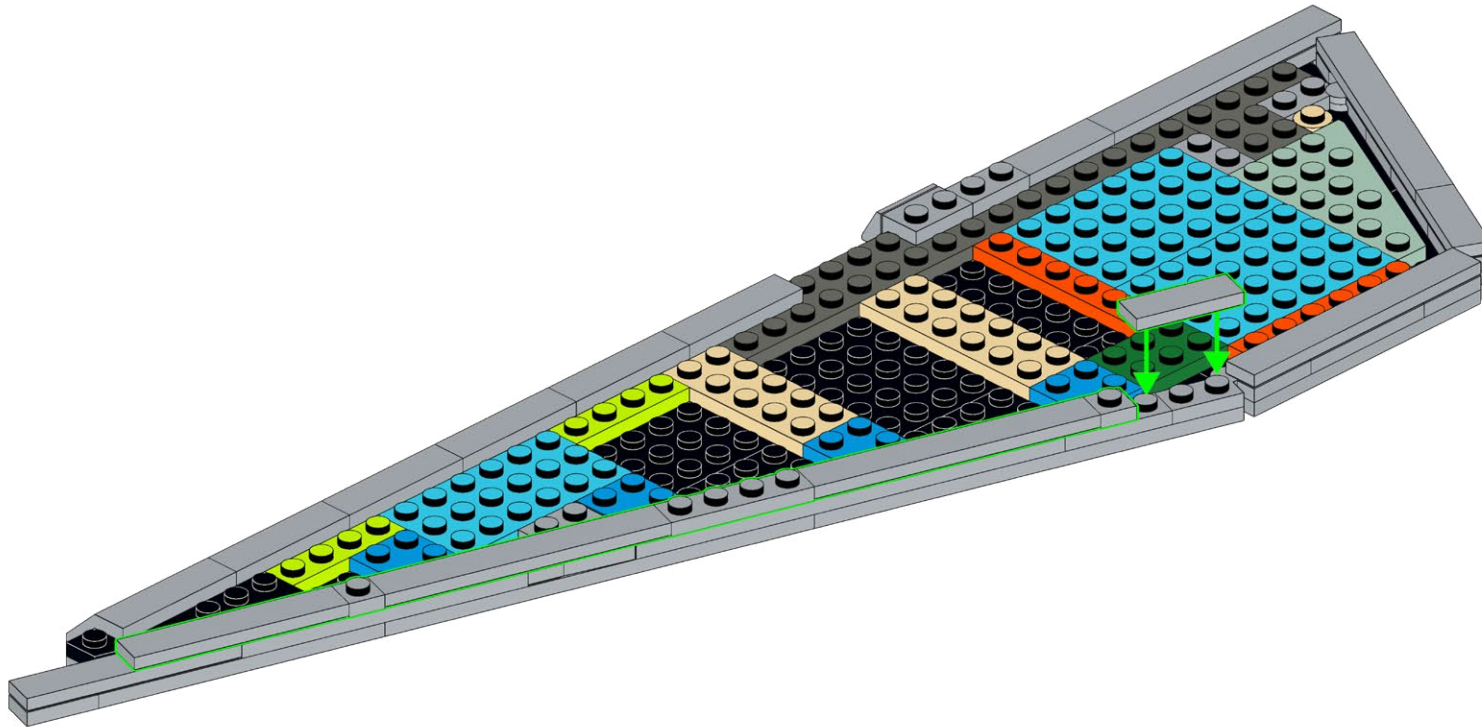
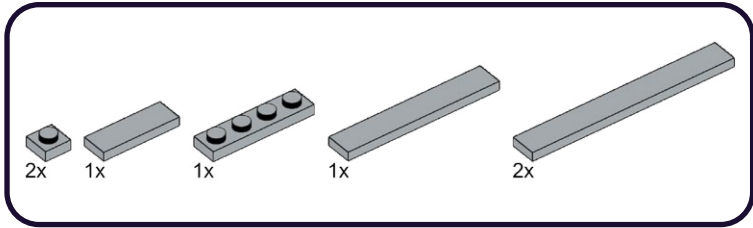

540

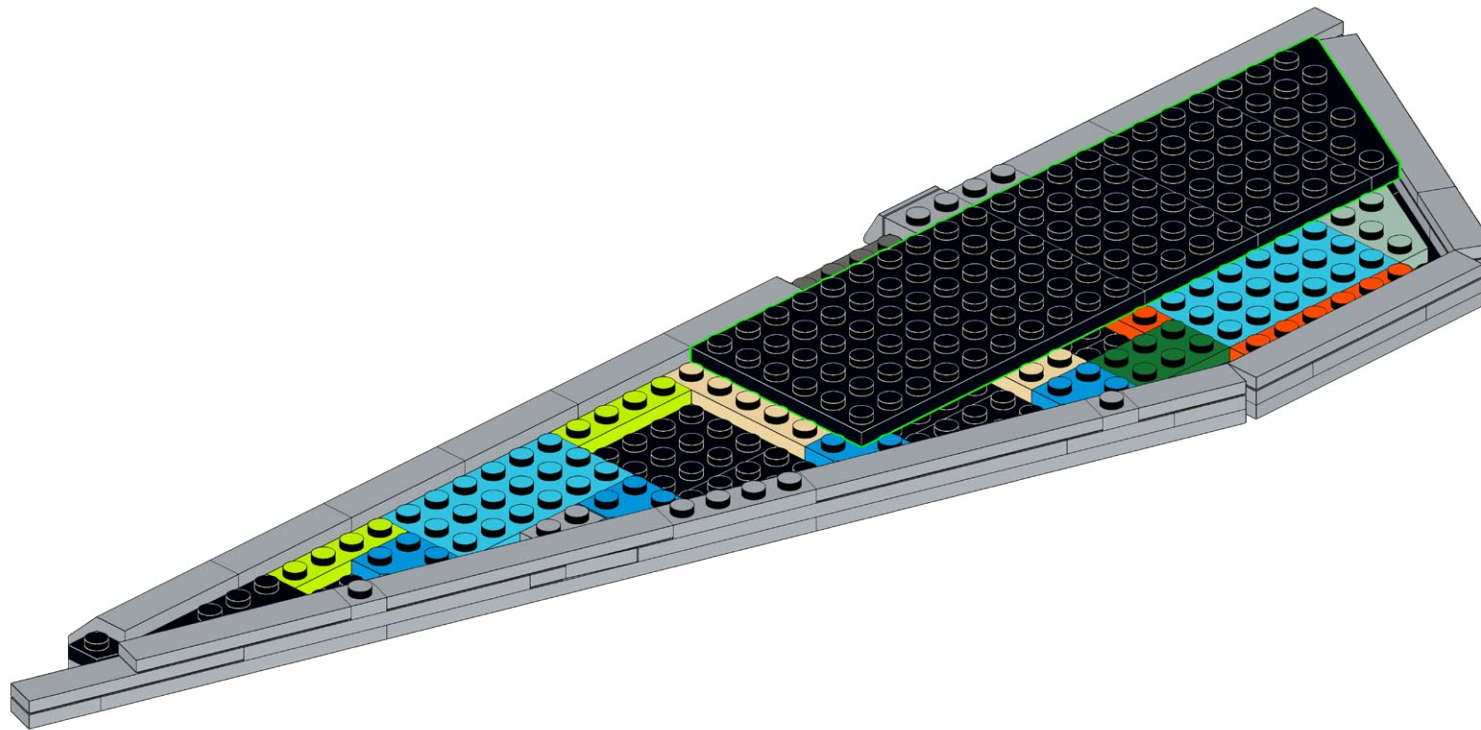
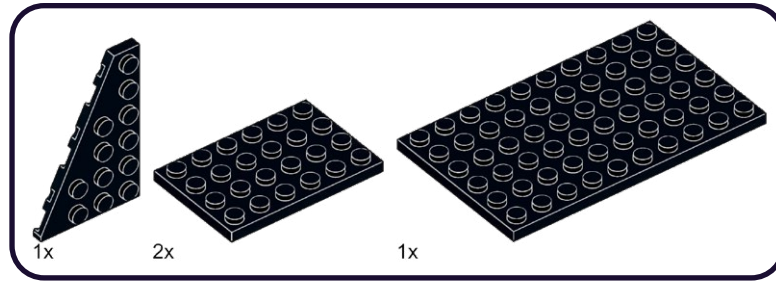

541

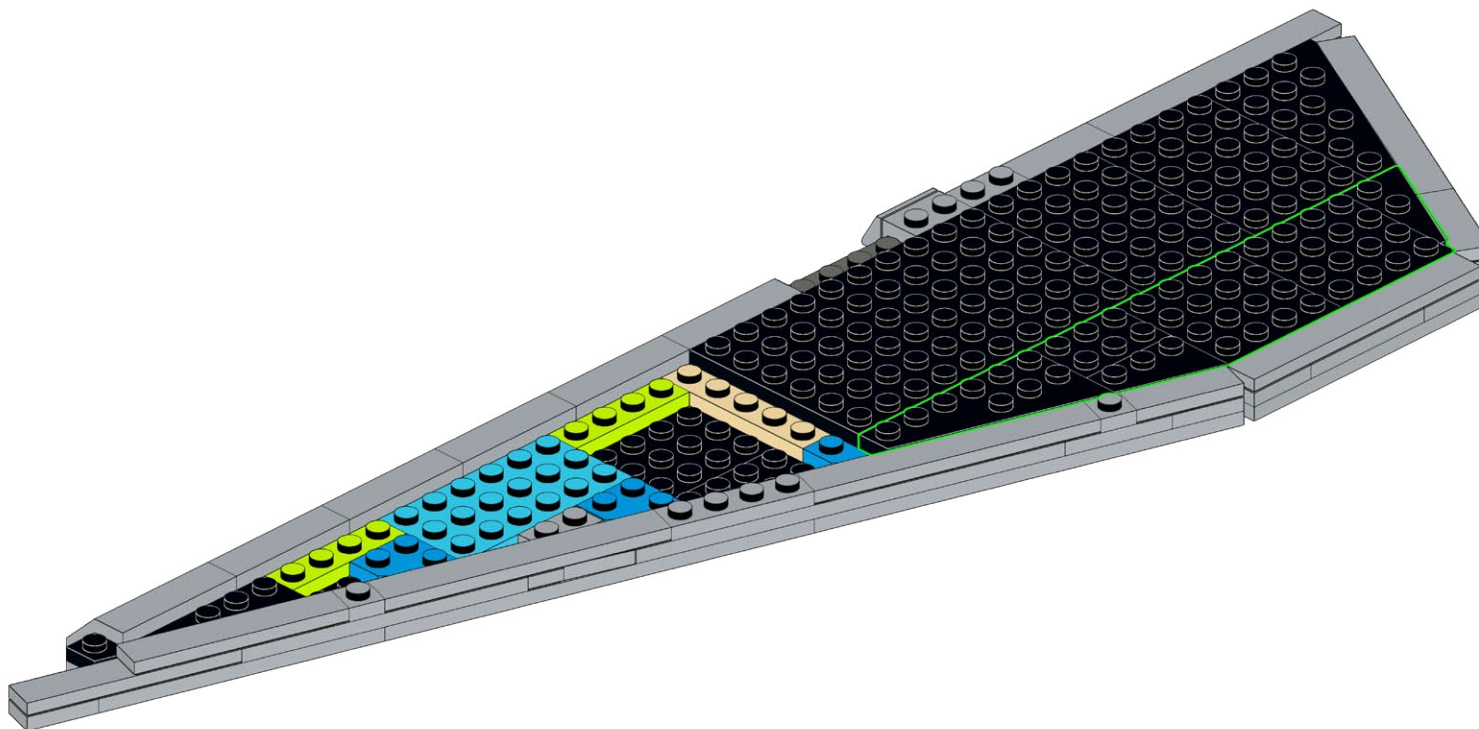
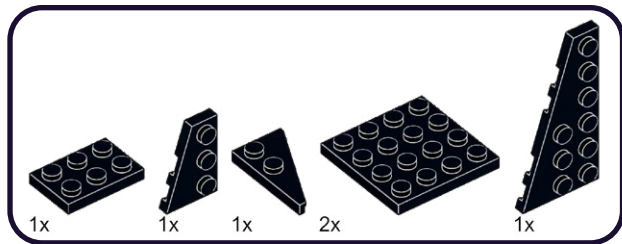



542

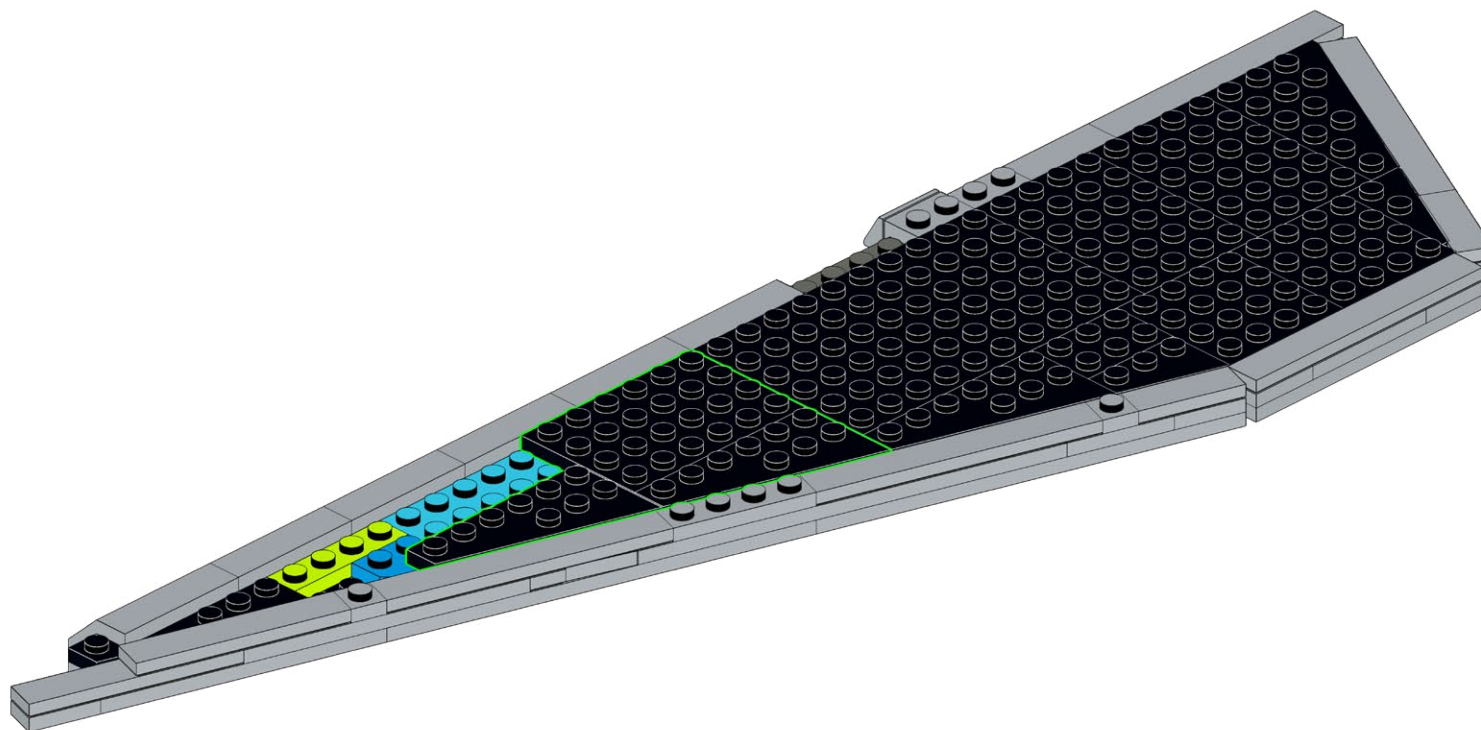
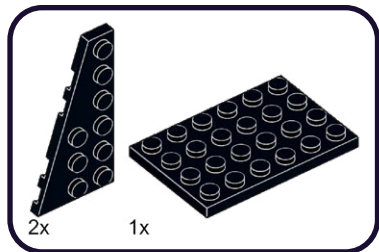



543

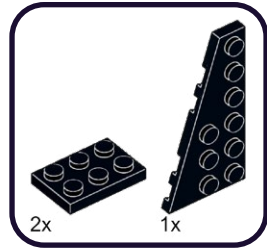

544

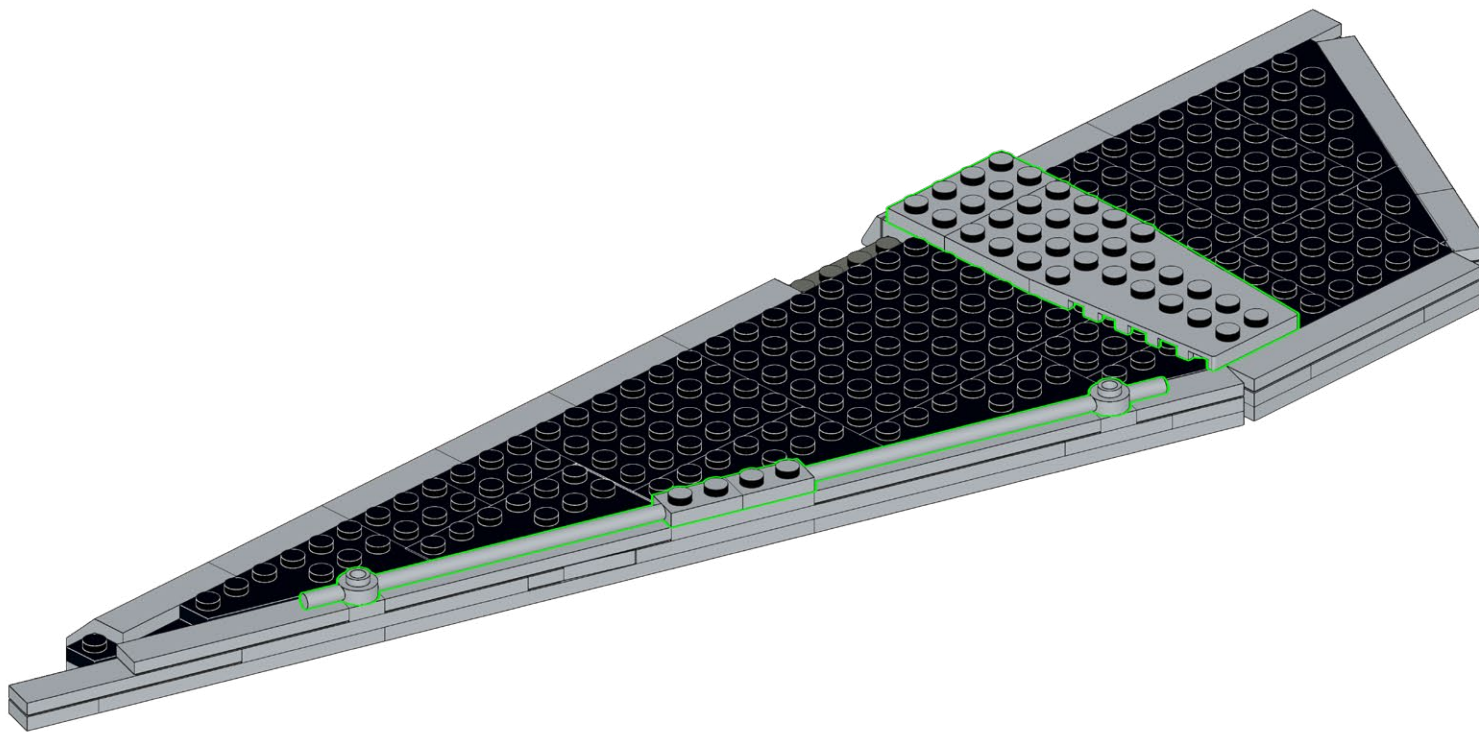
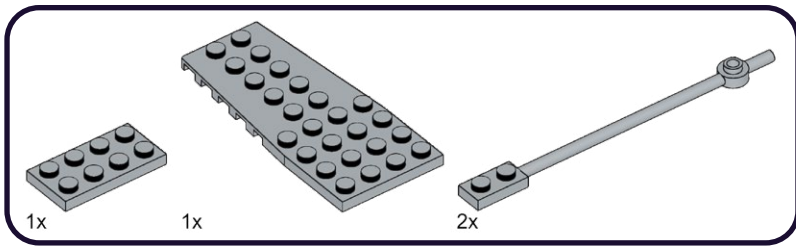

545

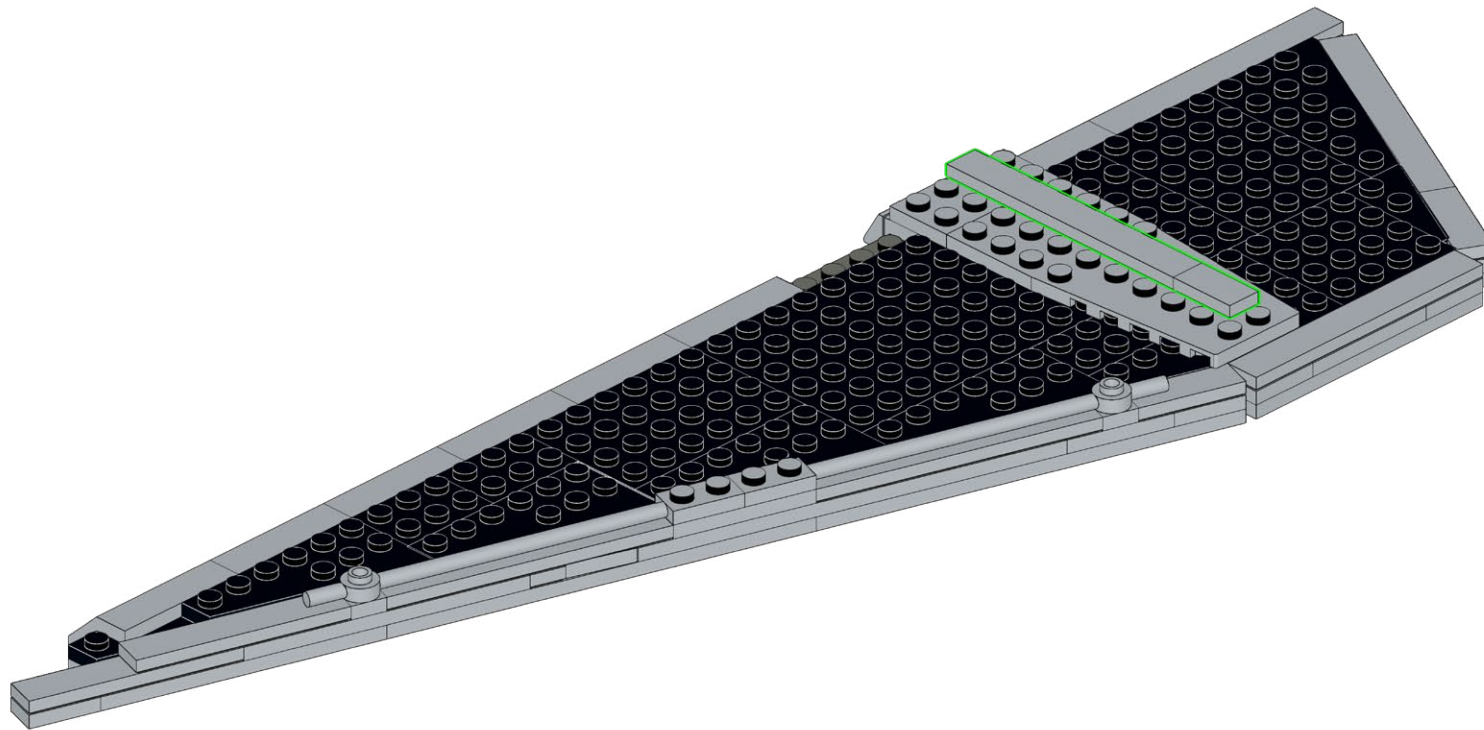
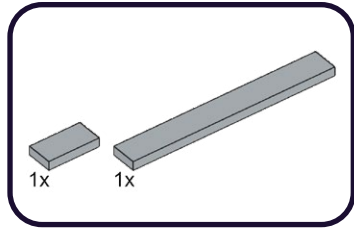

**546**

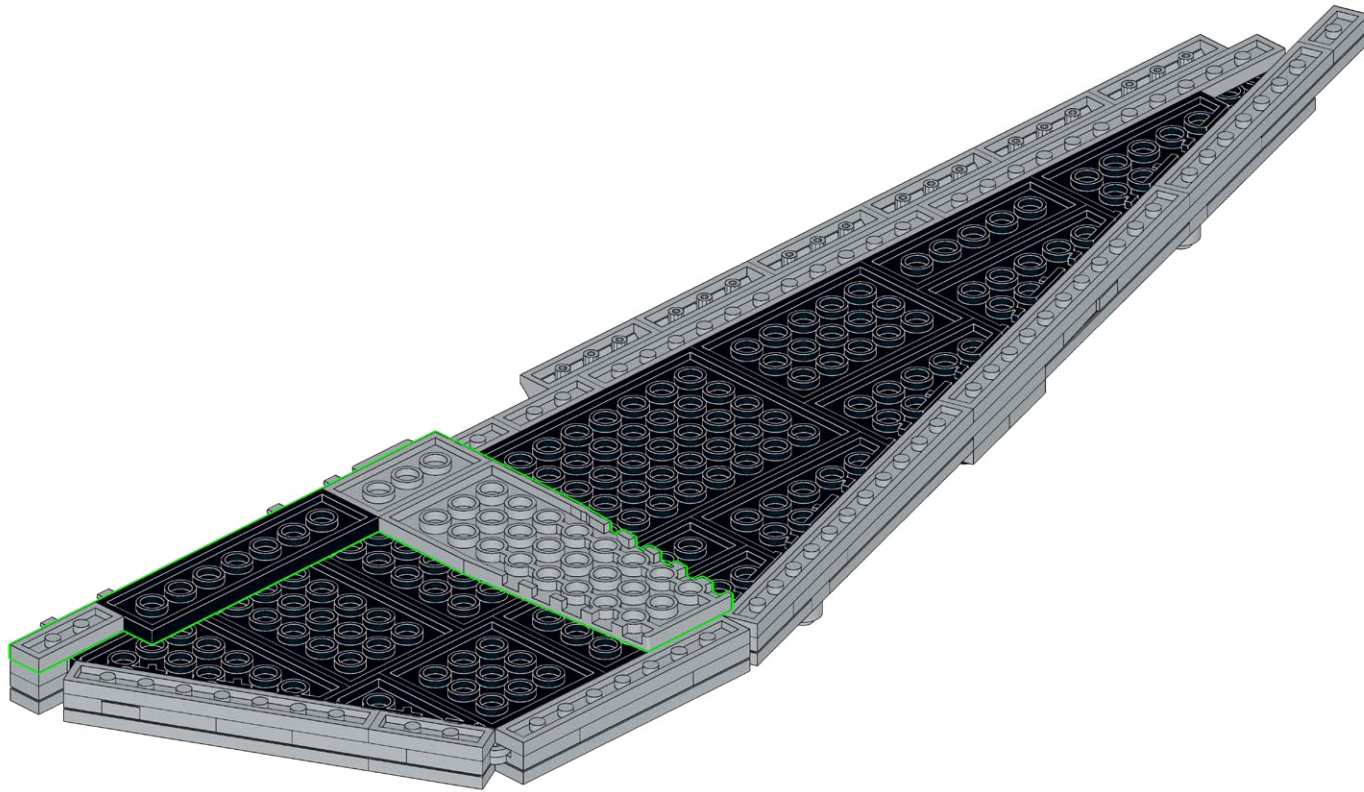
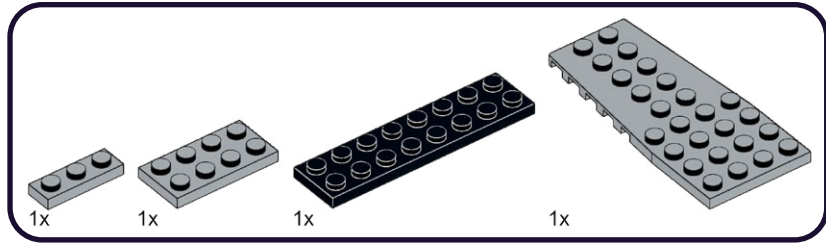

**547**

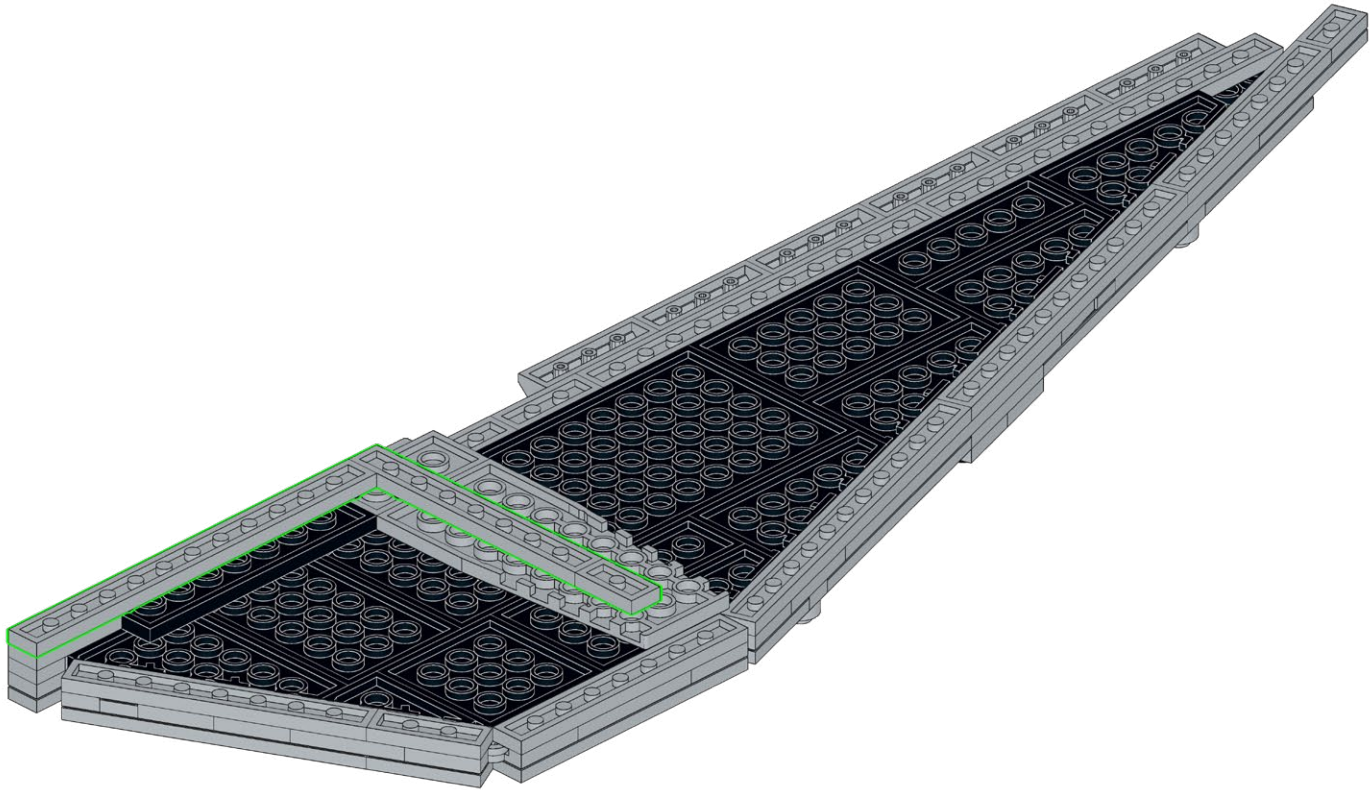
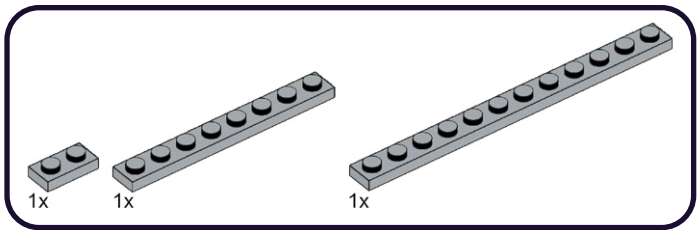



**548**

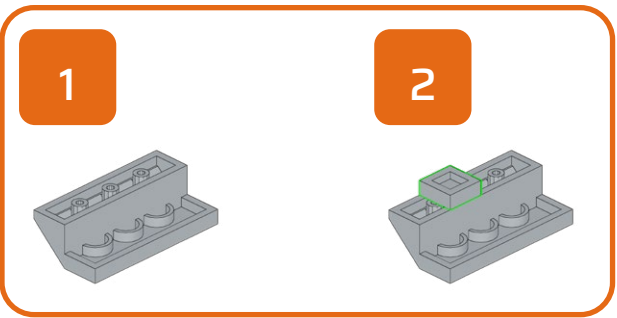
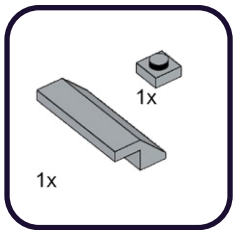
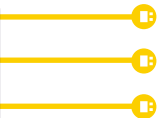



549

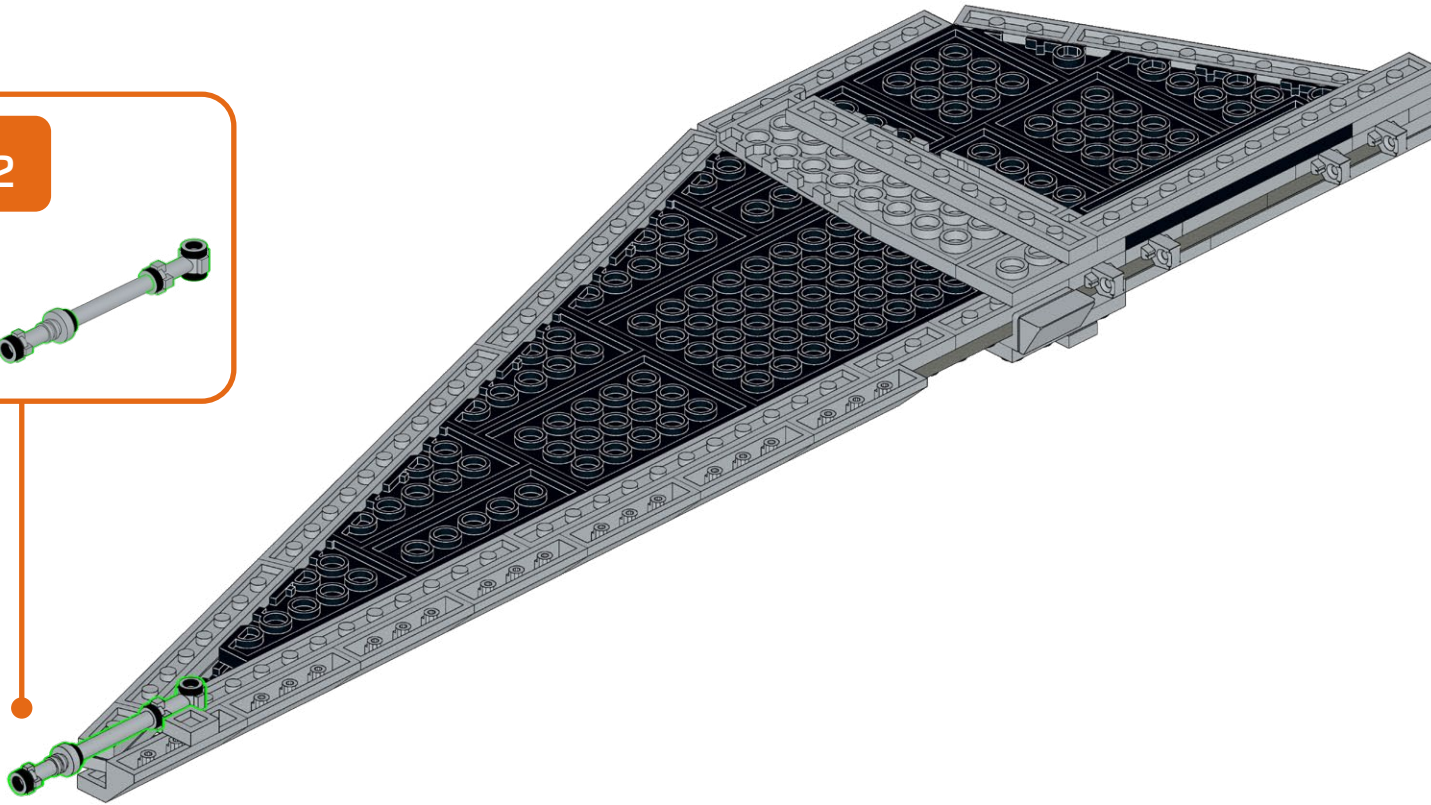
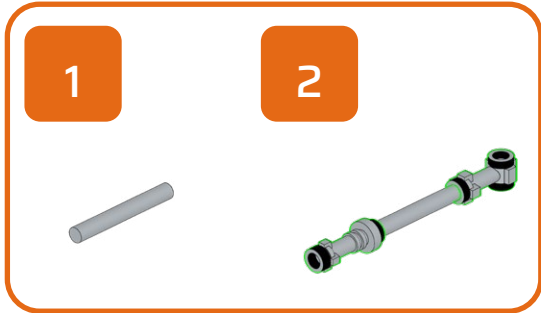
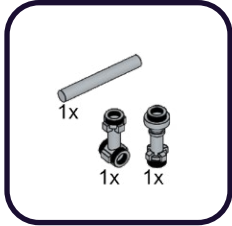

550

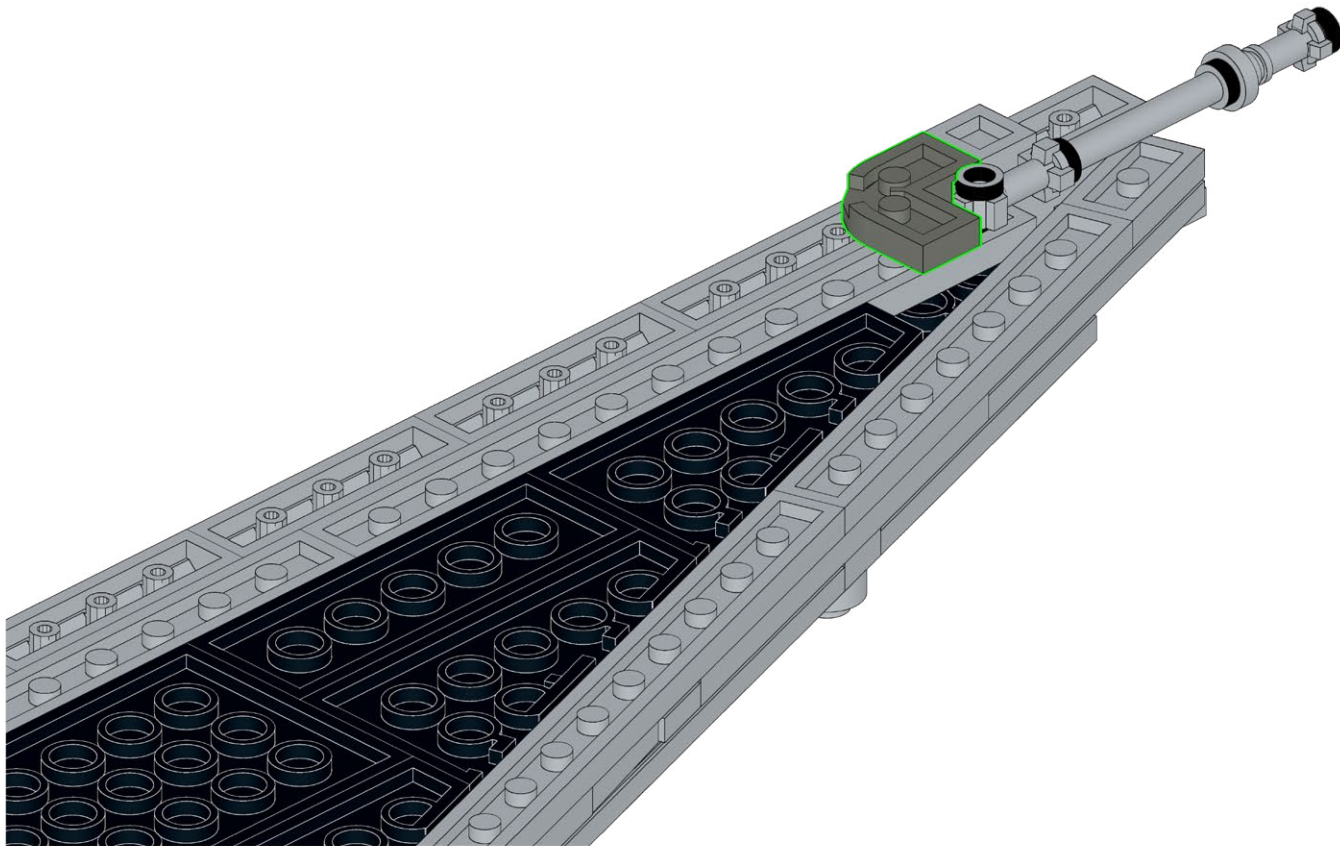
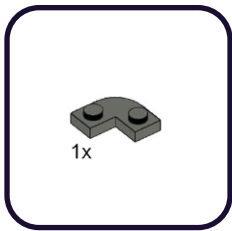

551

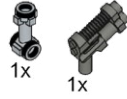

1

2

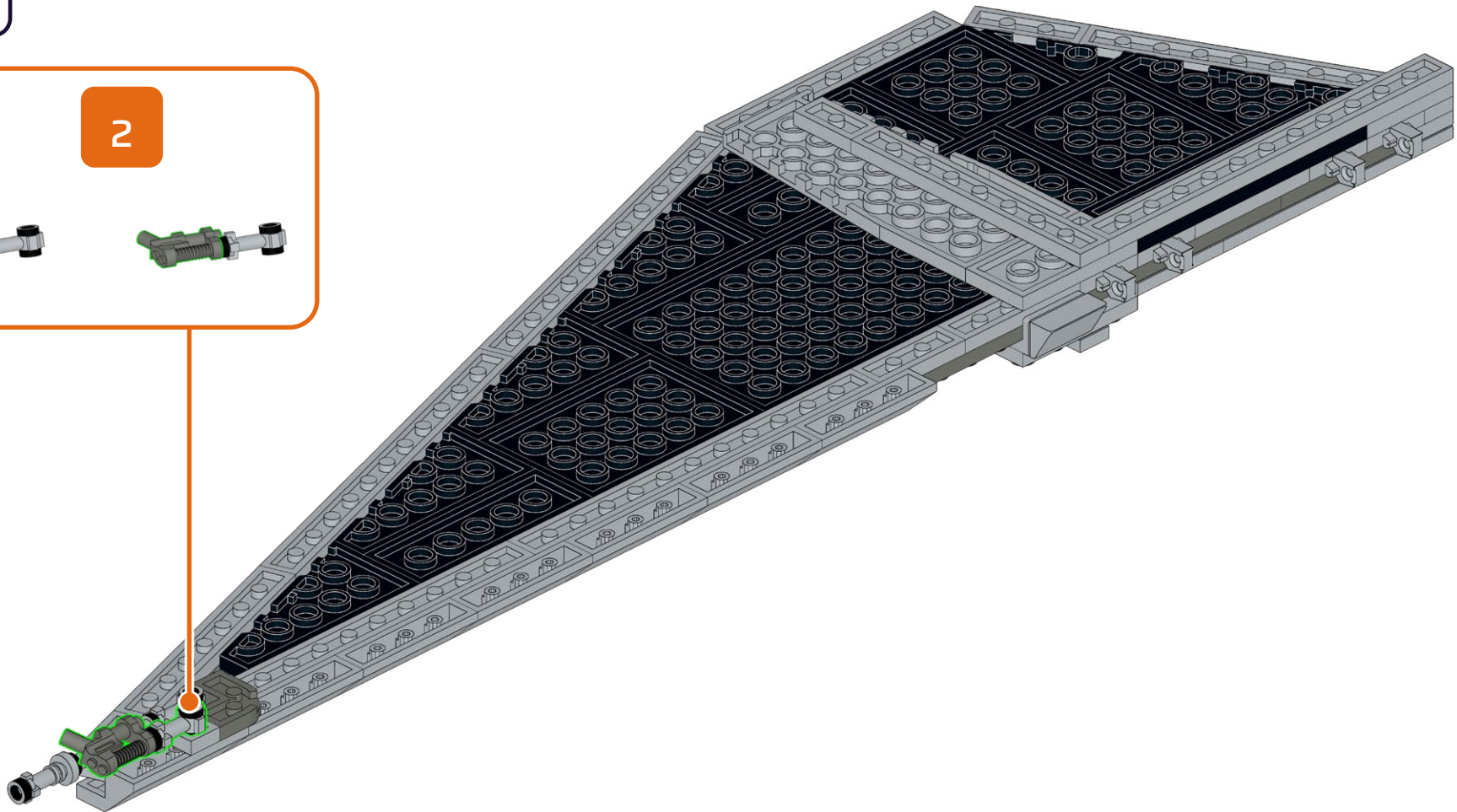



552

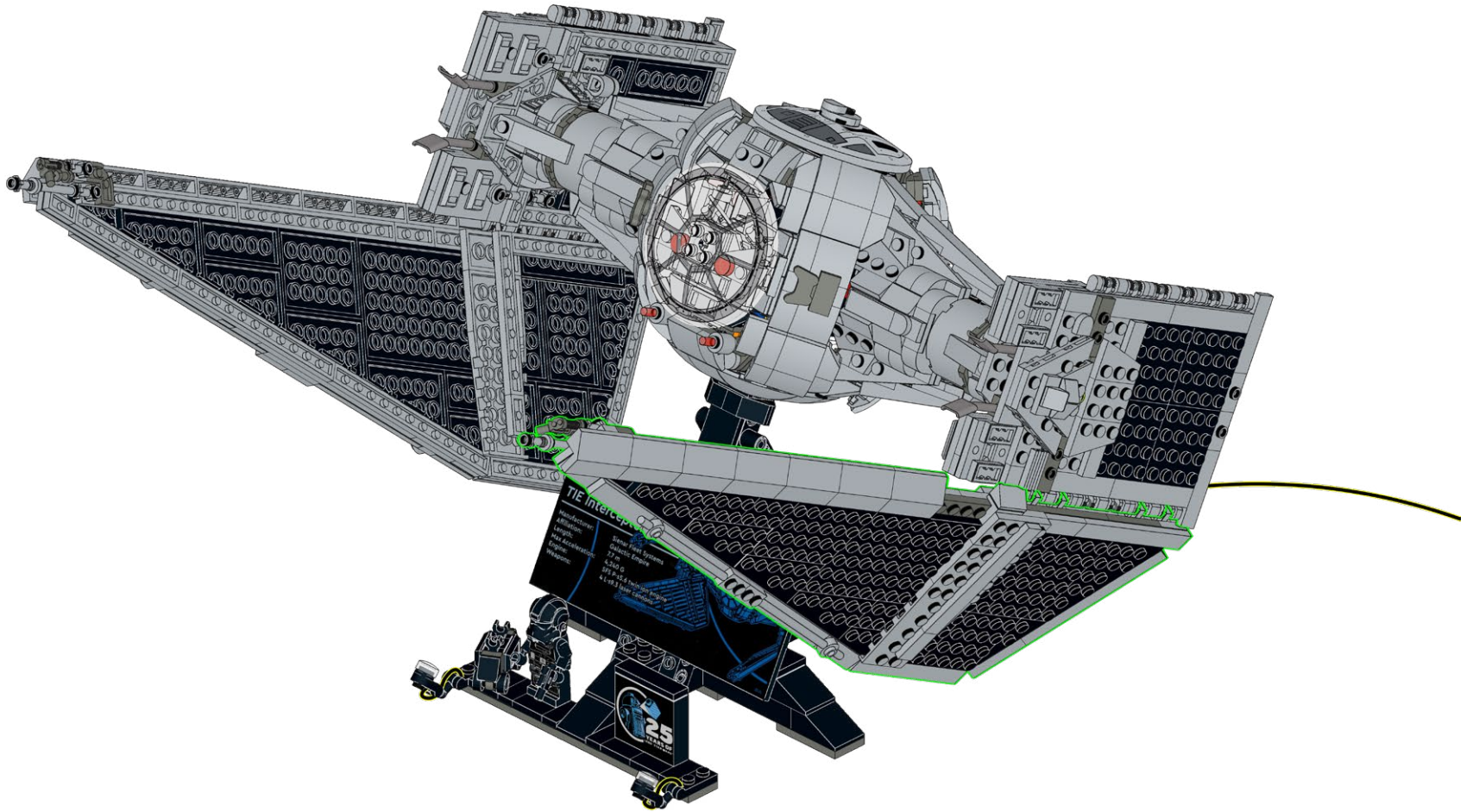

553

1x

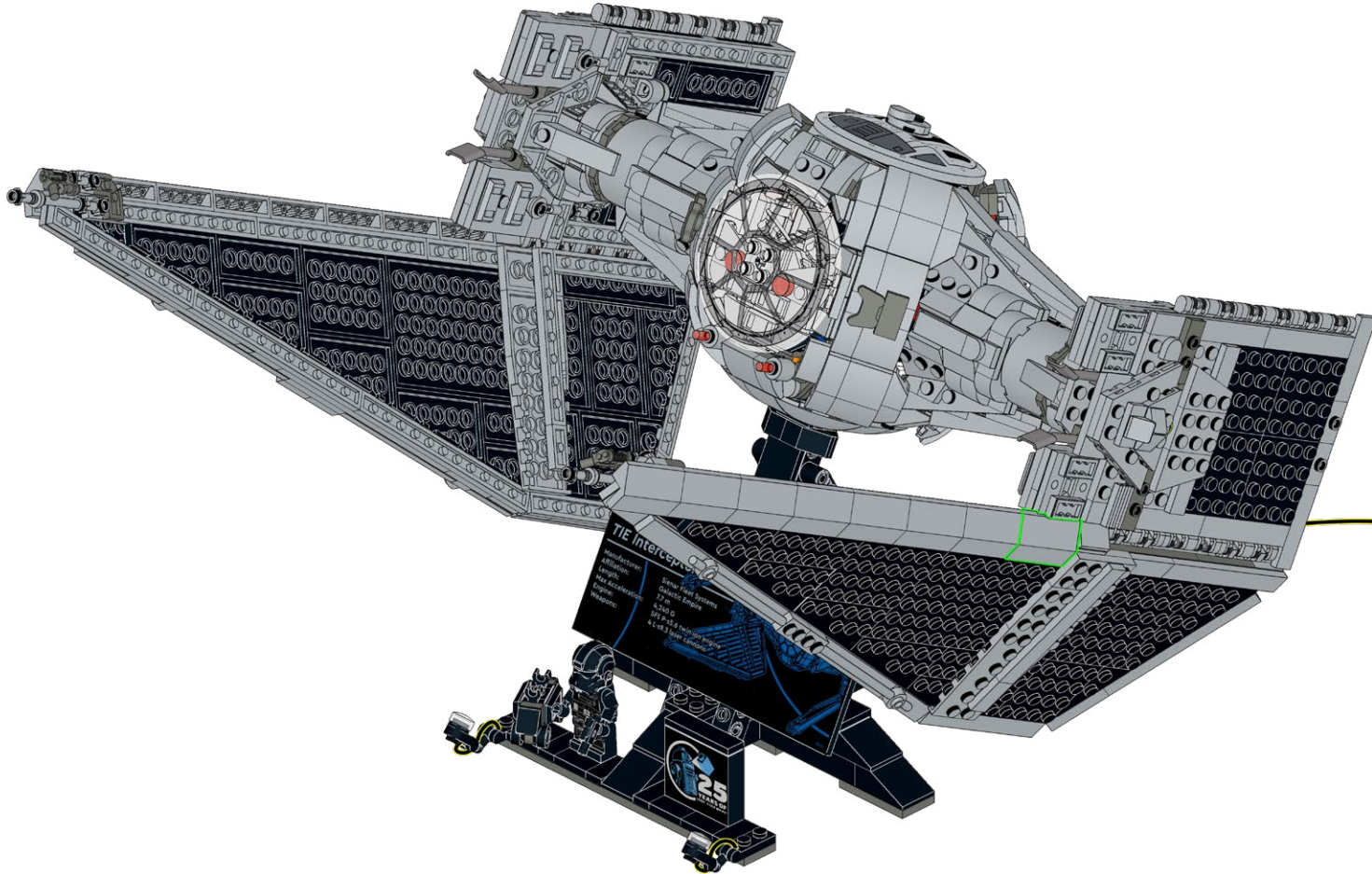



**HOLD UP!**

You might notice some bags are out of order, as well as left over pieces, but that's ok! We're changing the way you build LEGO!

**HALTEN!**

Möglicherweise stellen Sie fest, dass einige Beutel nicht in Ordnung sind und auch Teile übrig bleiben, aber das ist in Ordnung! Wir verändern die Art und Weise, wie Sie LEGO bauen!

**TENIR BON!**

Vous remarquerez peut-être que certains sacs sont en panne, ainsi que des morceaux restants, mais ce n'est pas grave ! Nous changeons la façon dont vous construisez LEGO !

**SOSTENERE!**

Potresti notare che alcune borse sono fuori uso, così come alcuni pezzi avanzati, ma va bene! Stiamo cambiando il modo in cui costruisci i LEGO!

**¡SOSTENER!**

Puede que notes que algunas bolsas están fuera de orden, así como piezas sobrantes, ¡pero está bien! ¡Estamos cambiando la forma de construir LEGO!

**耽误!**

您可能会注意到有些袋子坏了, 还有剩余的碎片, 但这没关系! 我们正在改变您搭建乐高的方式!

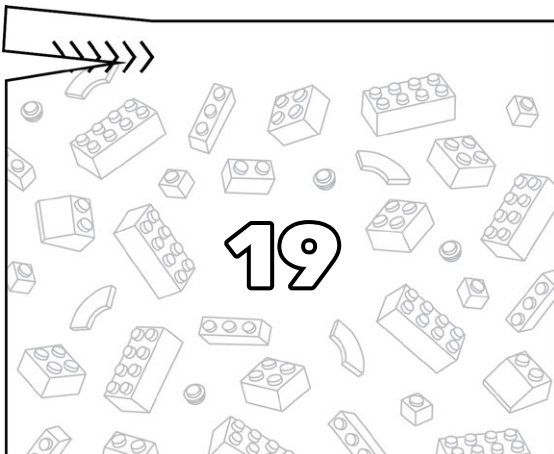
**Open LEGO® Bag 1**

# 554

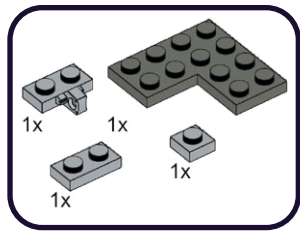

1

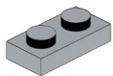

2

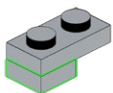

3

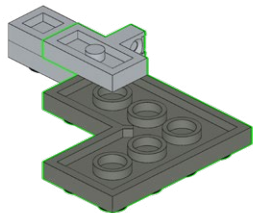

# 555

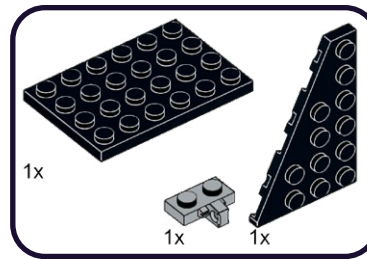

1

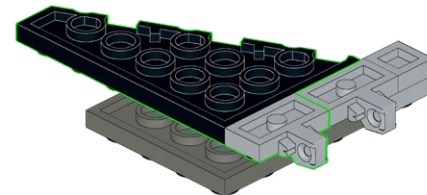

2

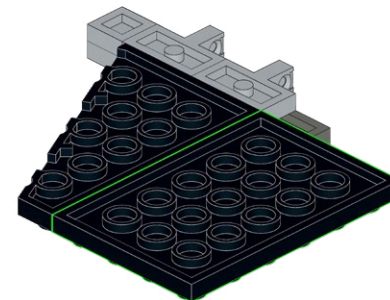

556

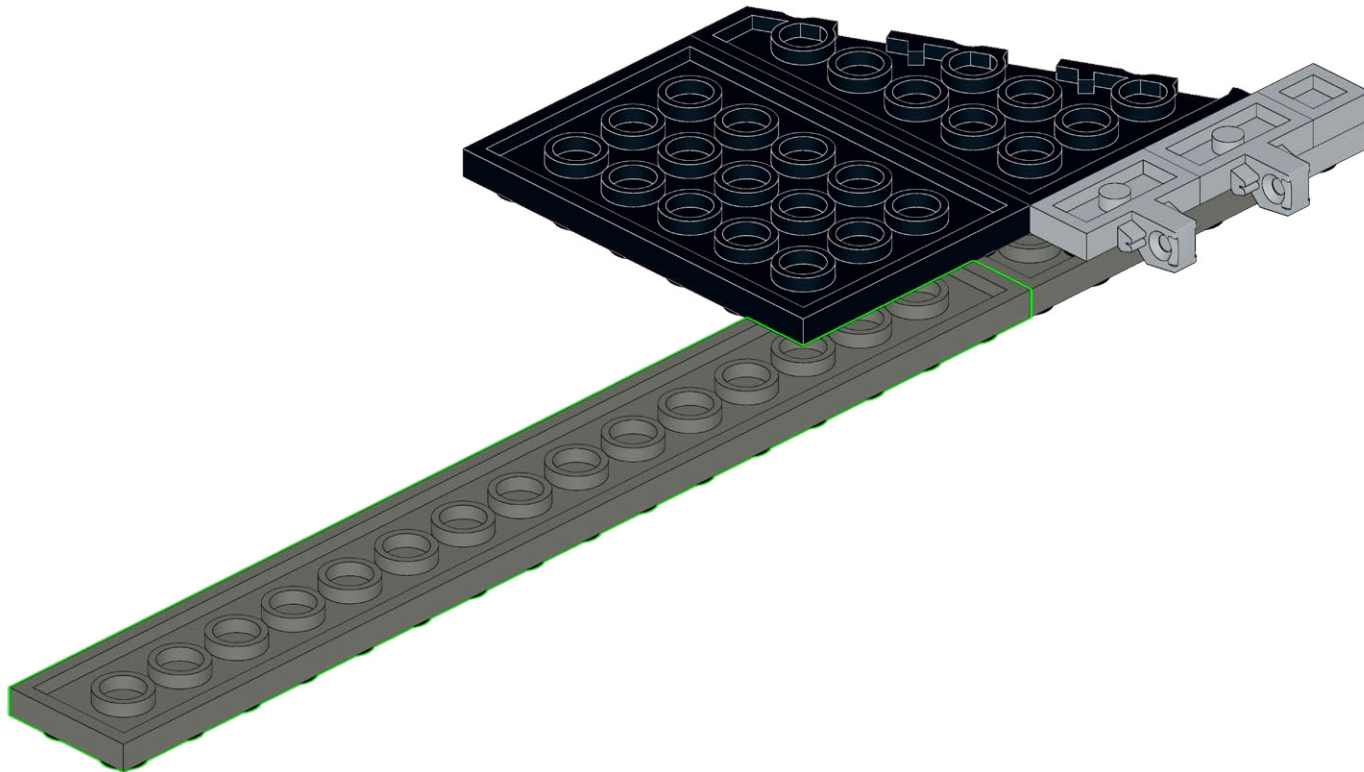
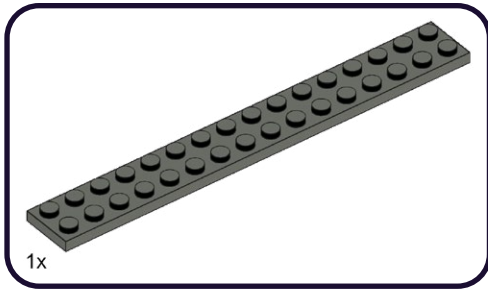

557

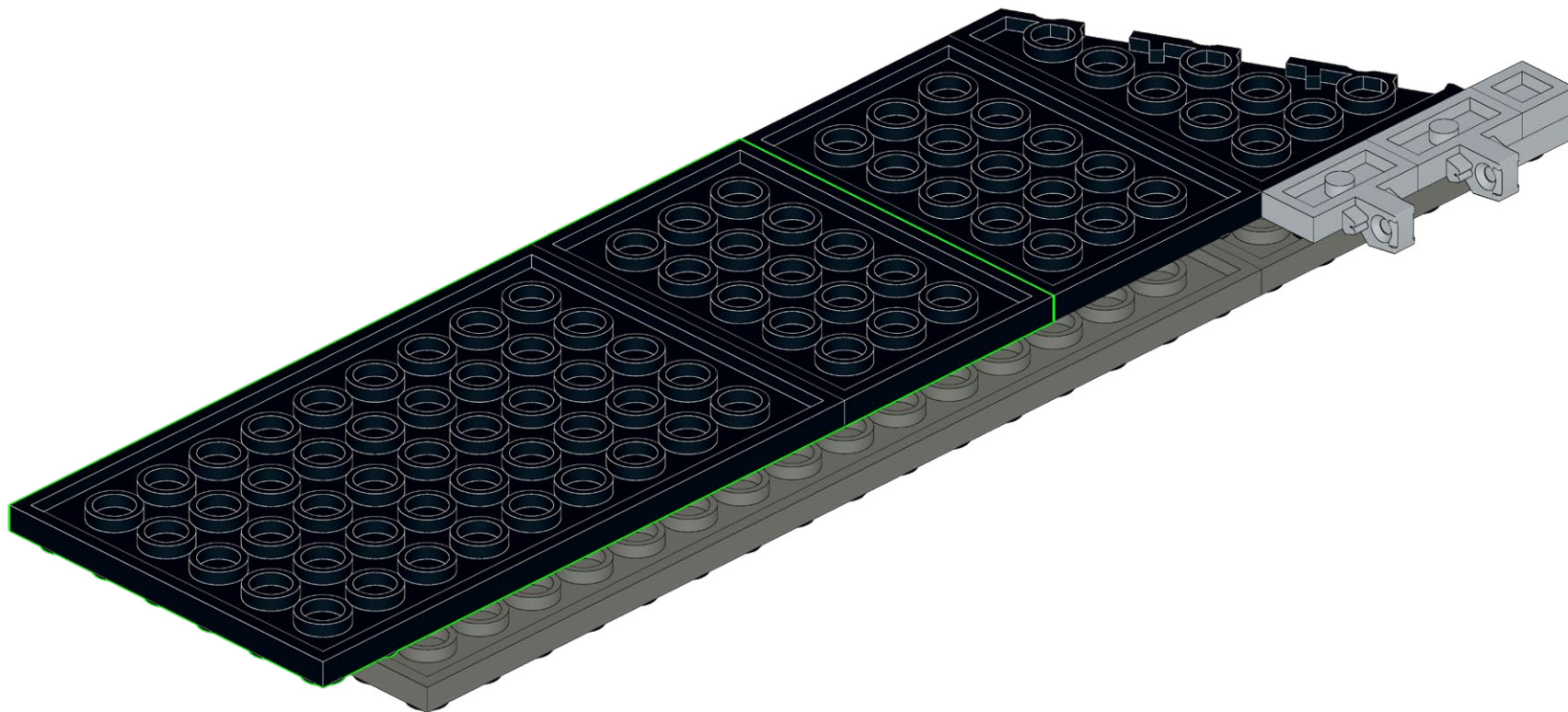
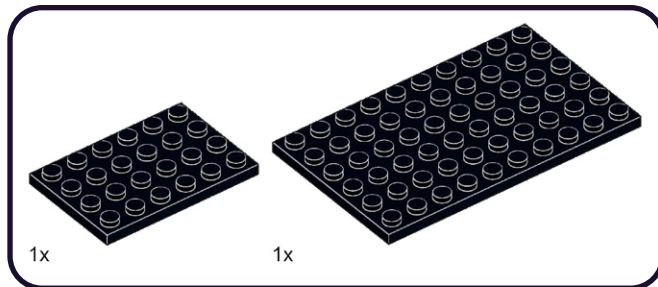

558

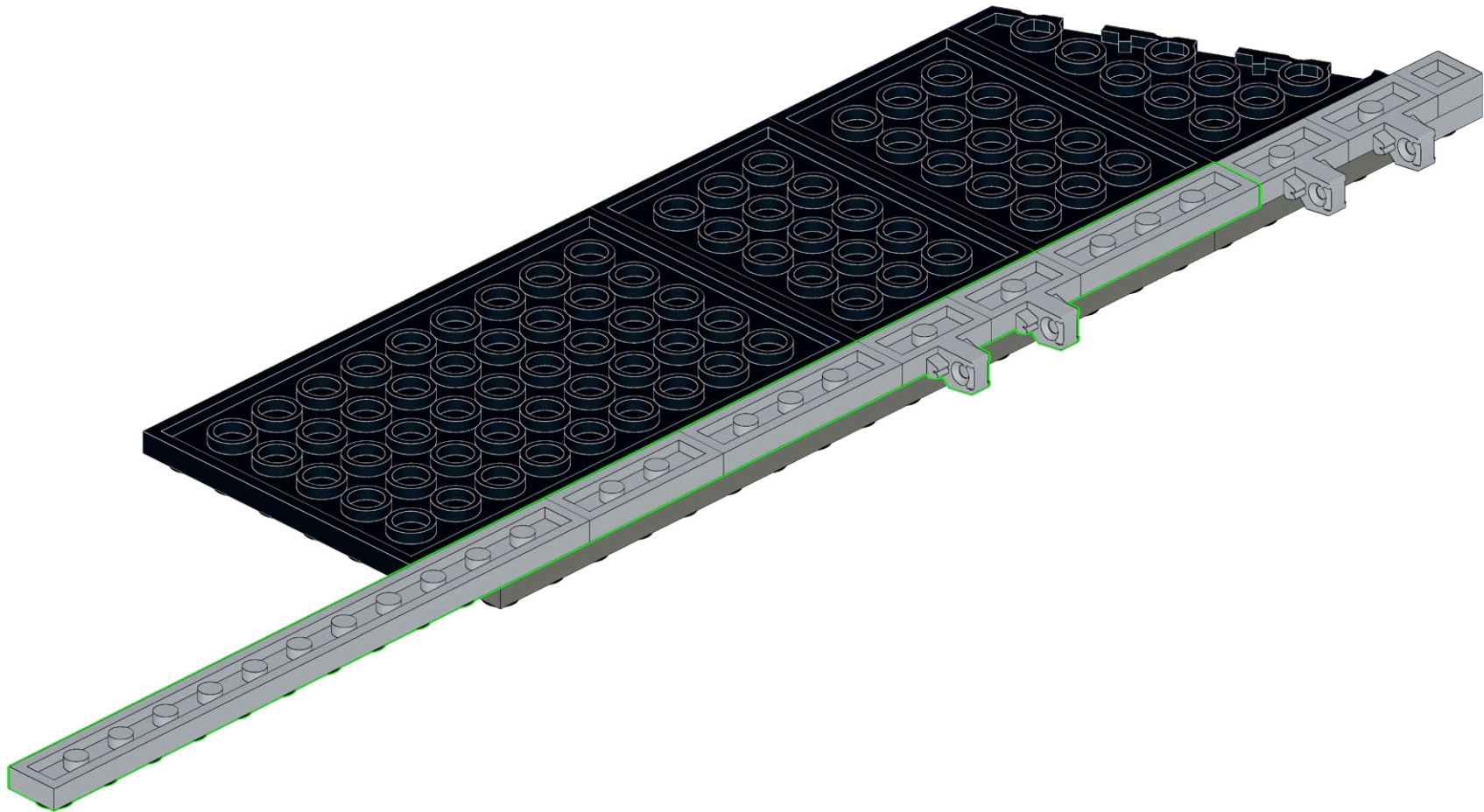
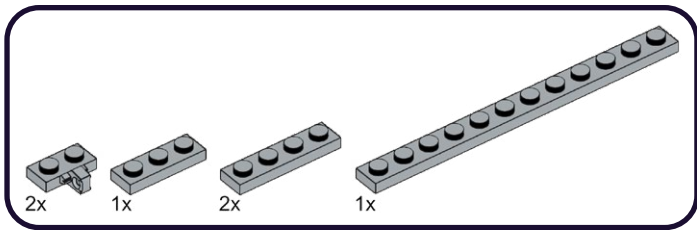



559

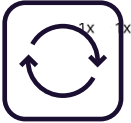
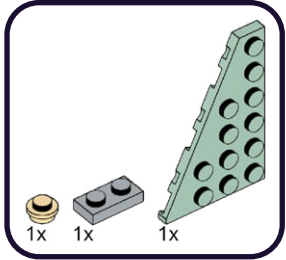

1x

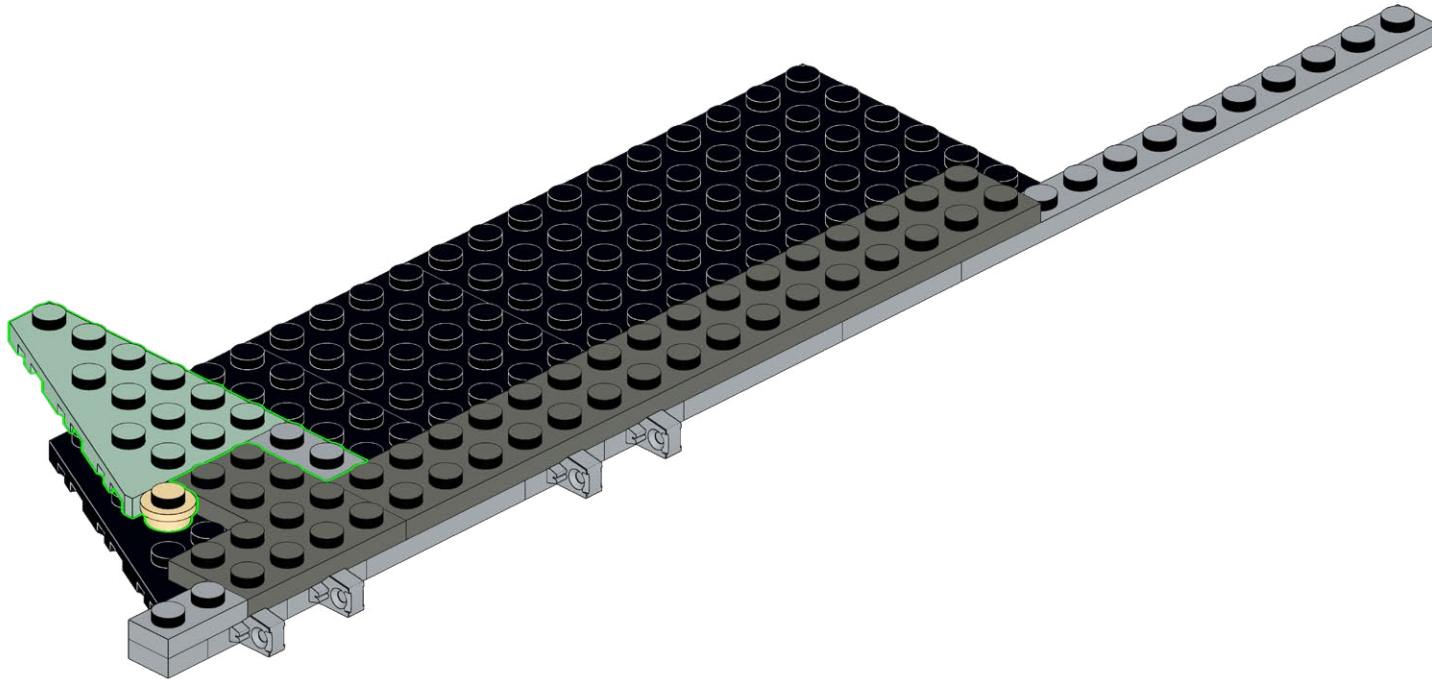

560

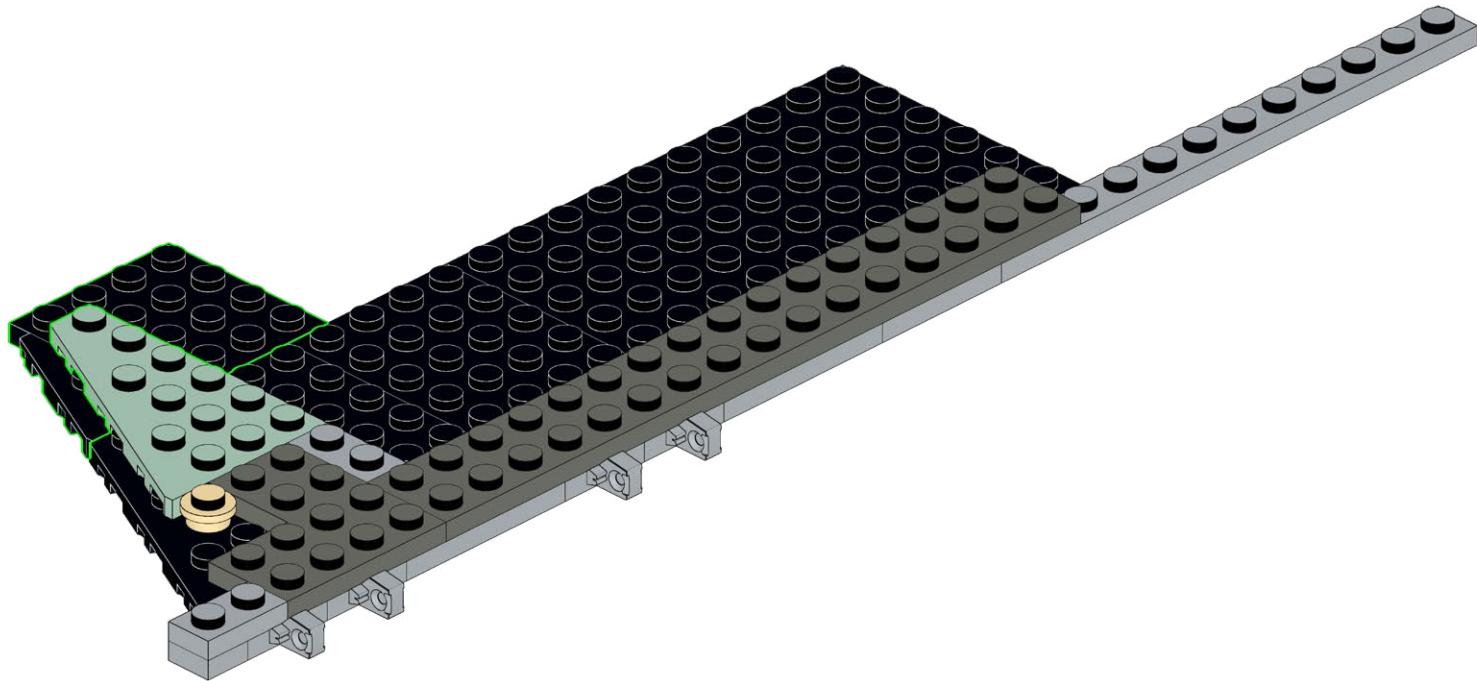
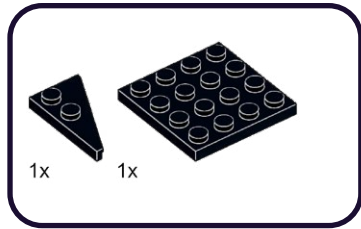

561

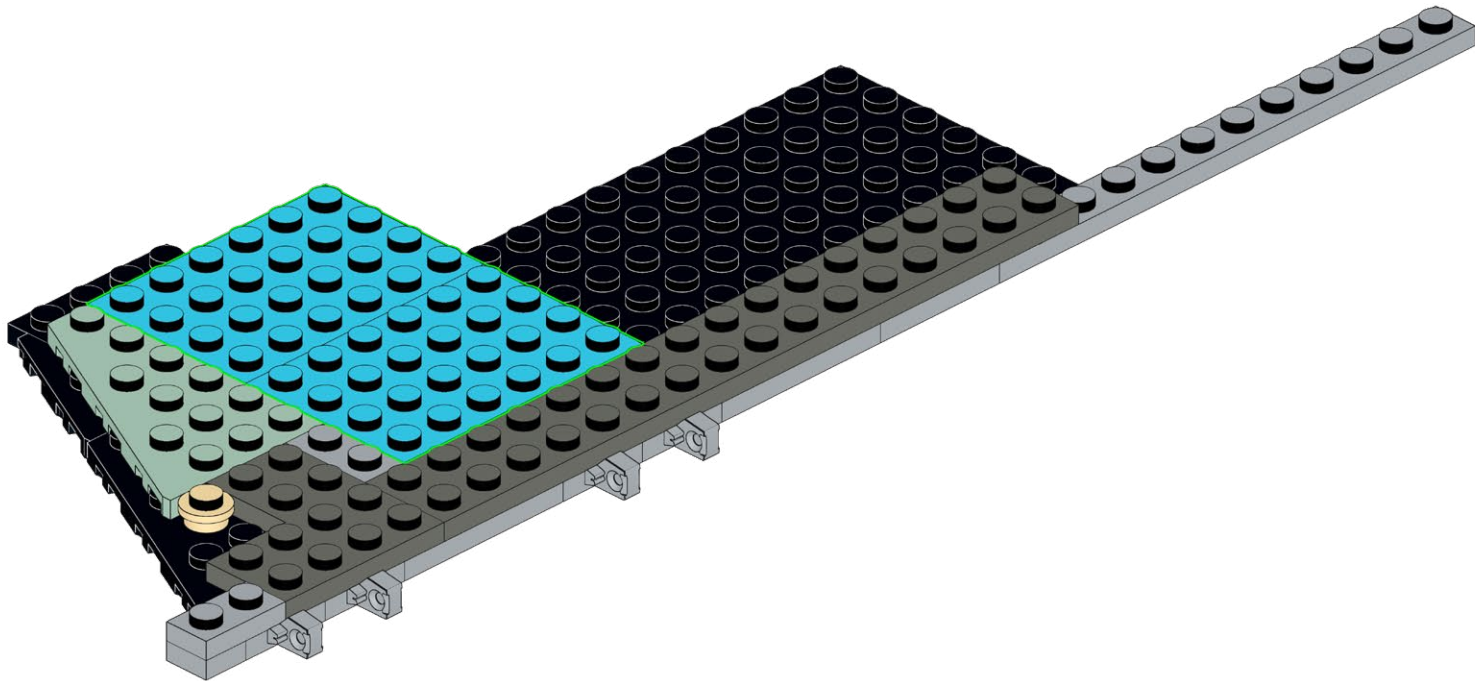
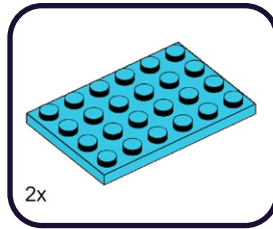

562

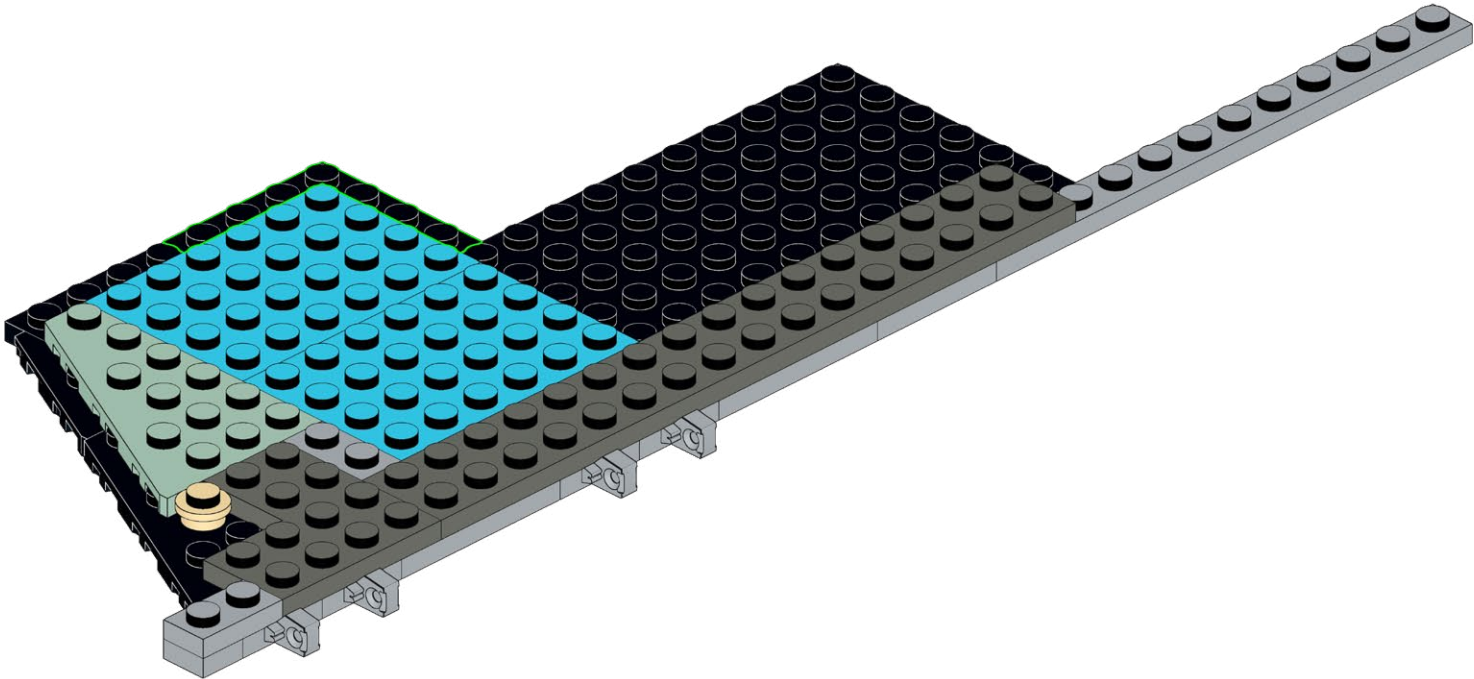

563

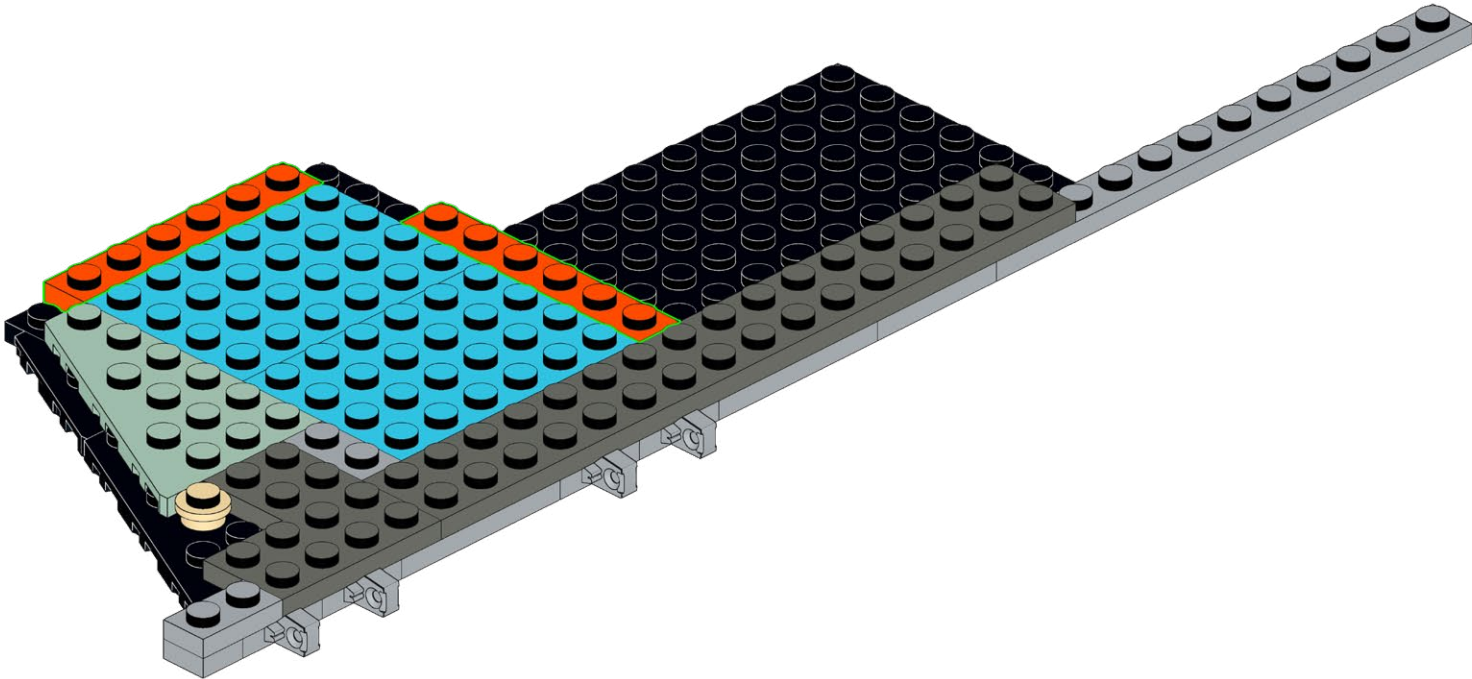
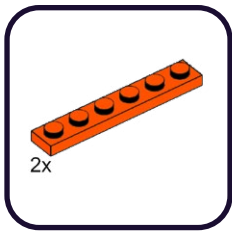



564

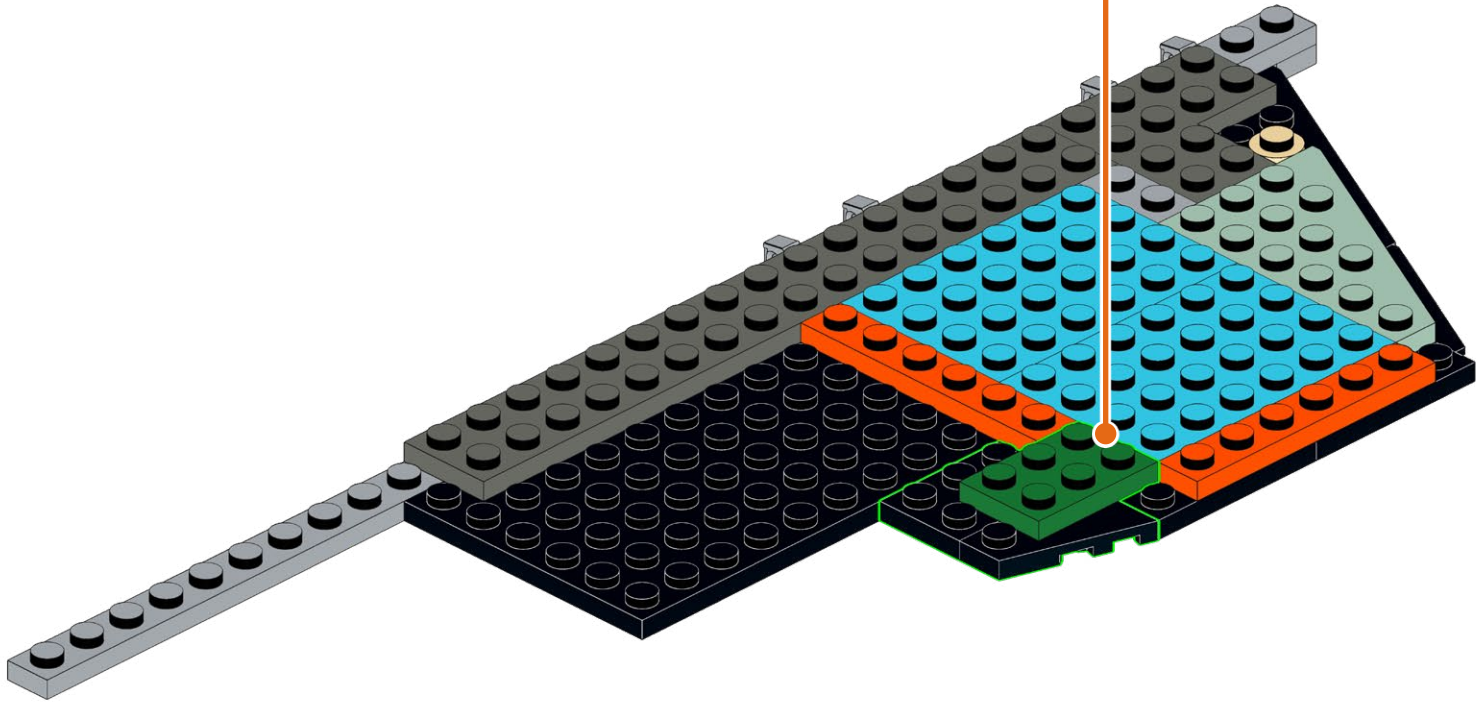
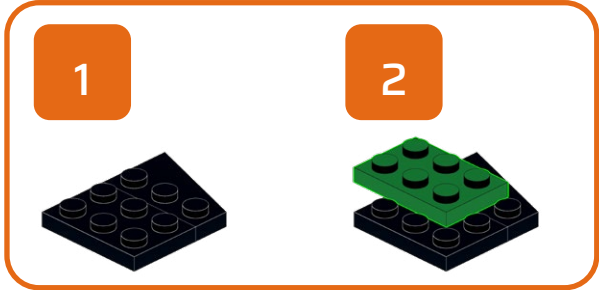
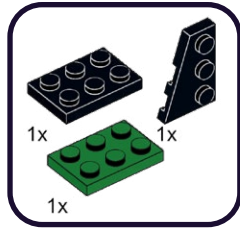

565

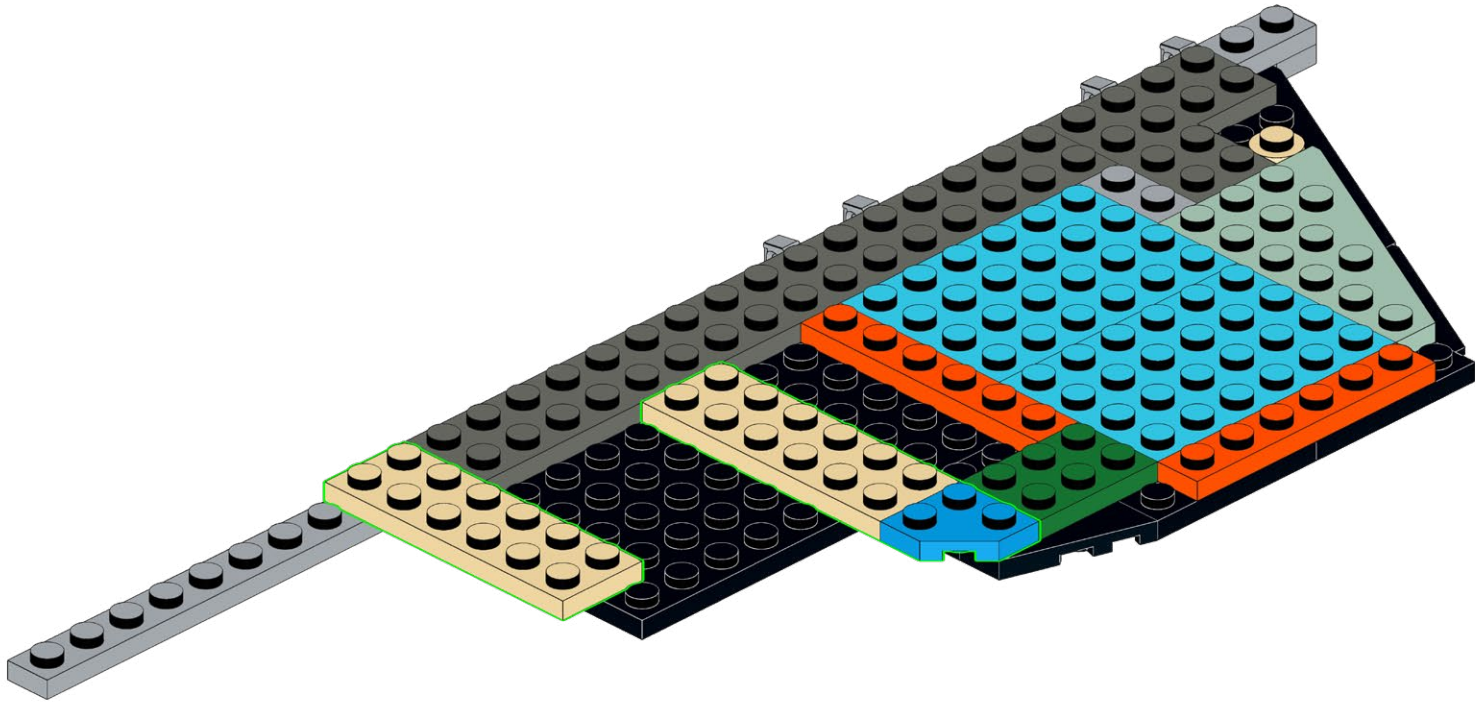
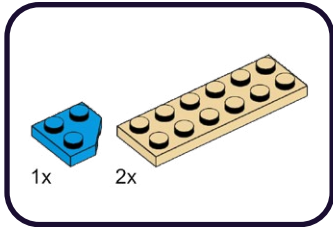

566

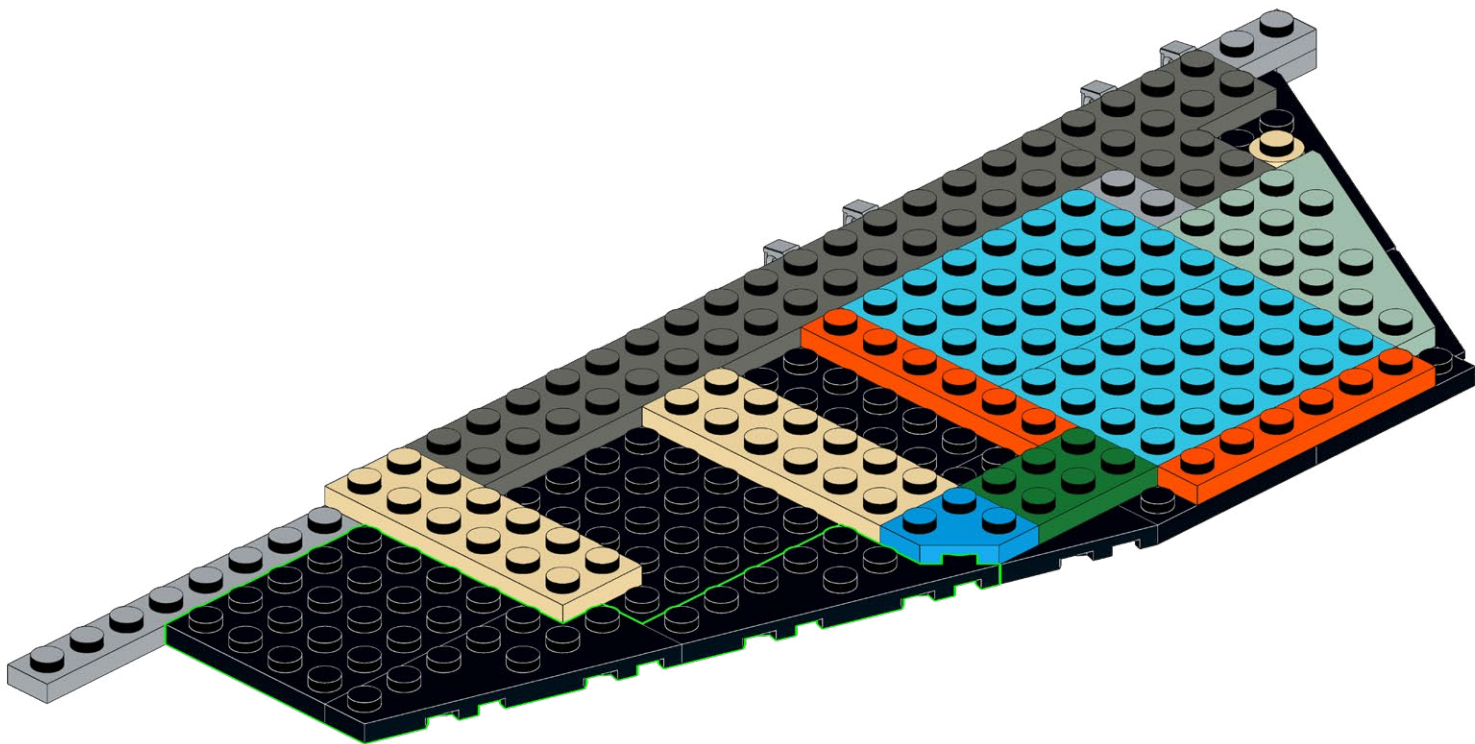
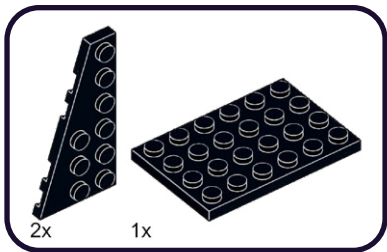

567

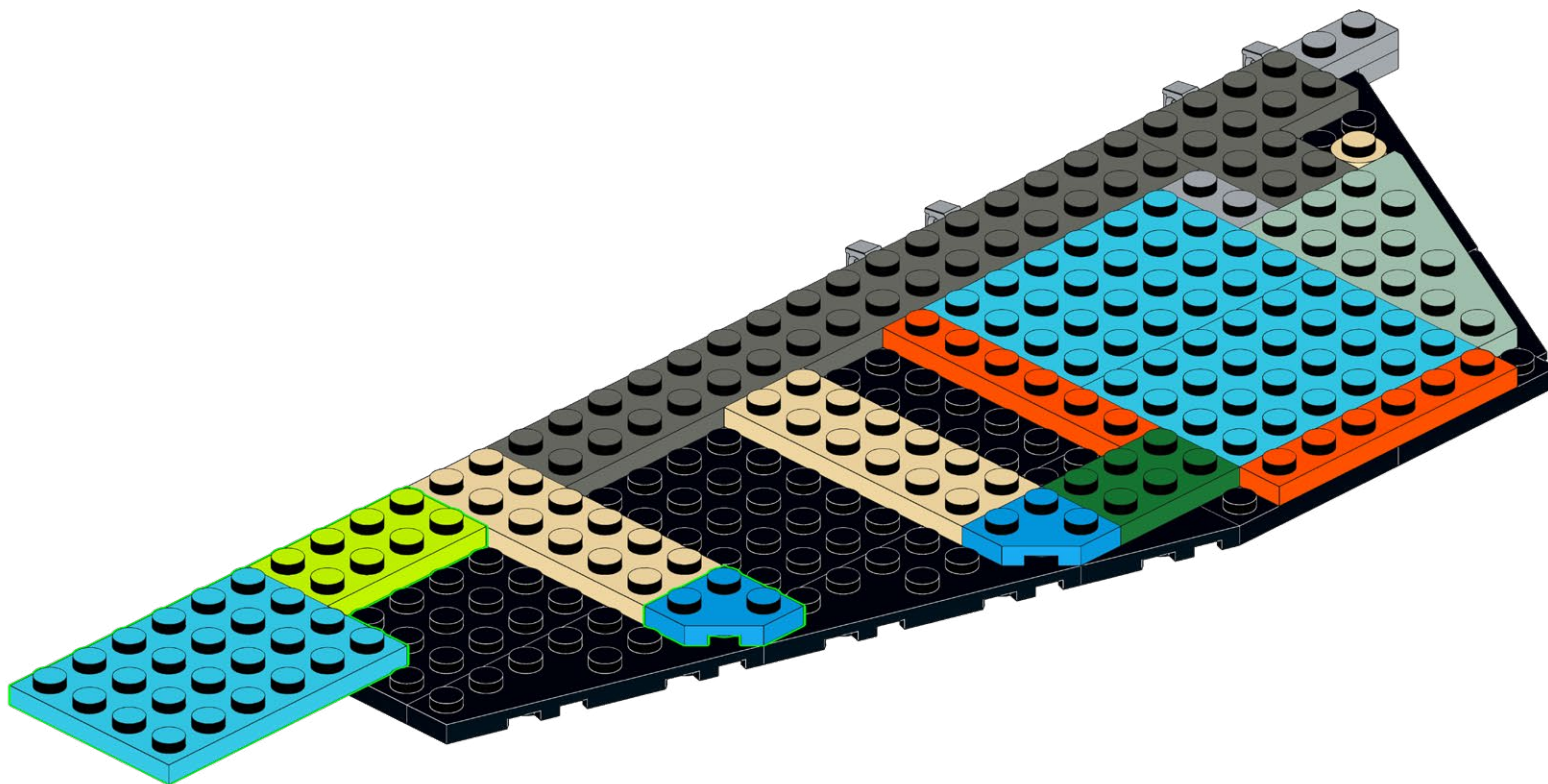
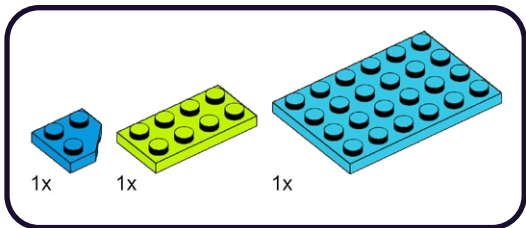



568

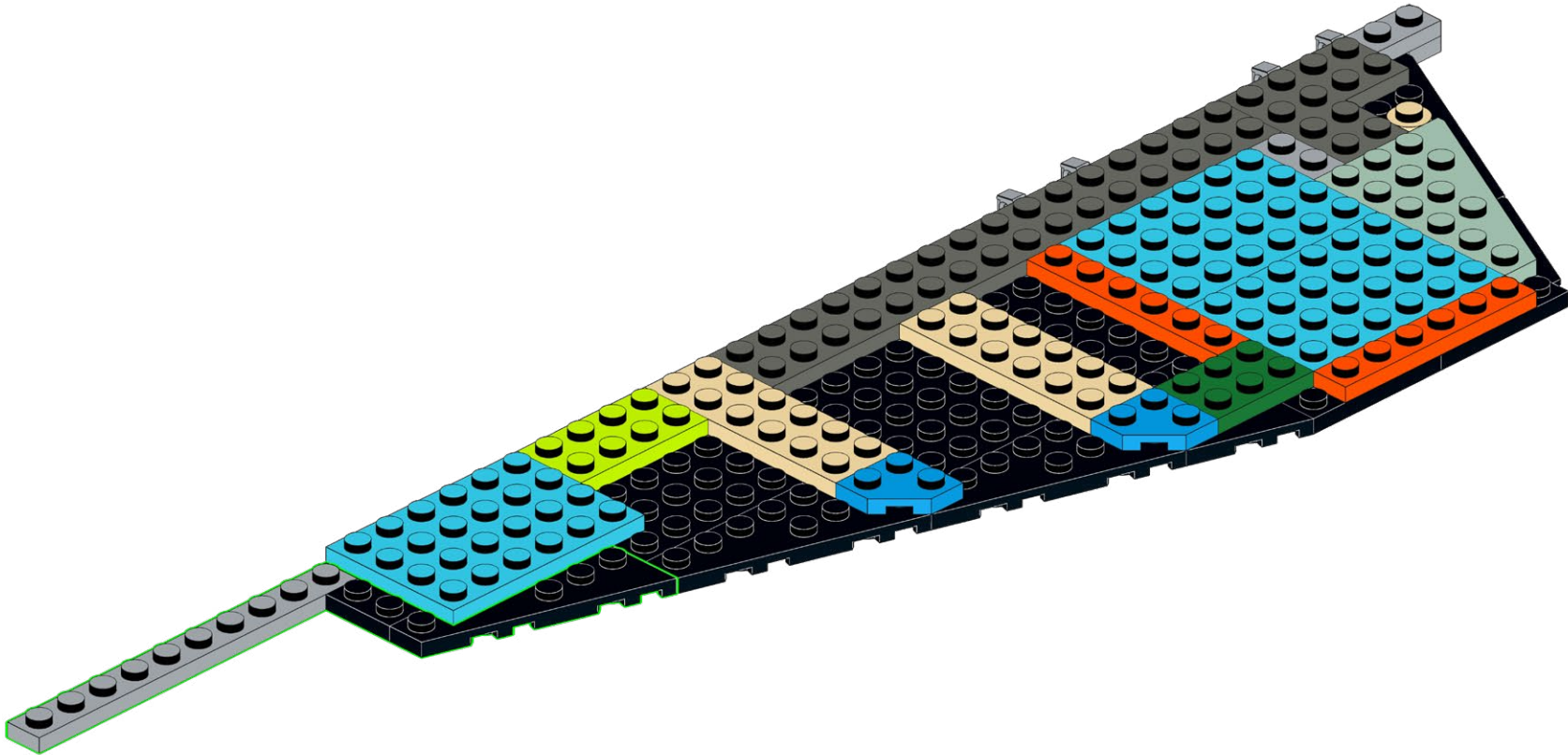
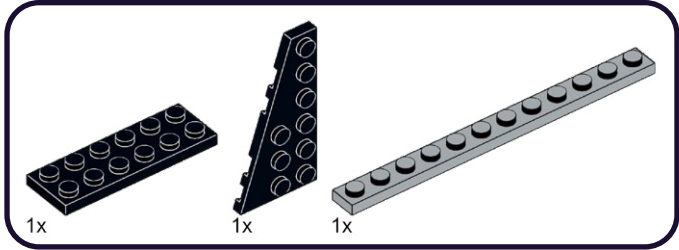



569

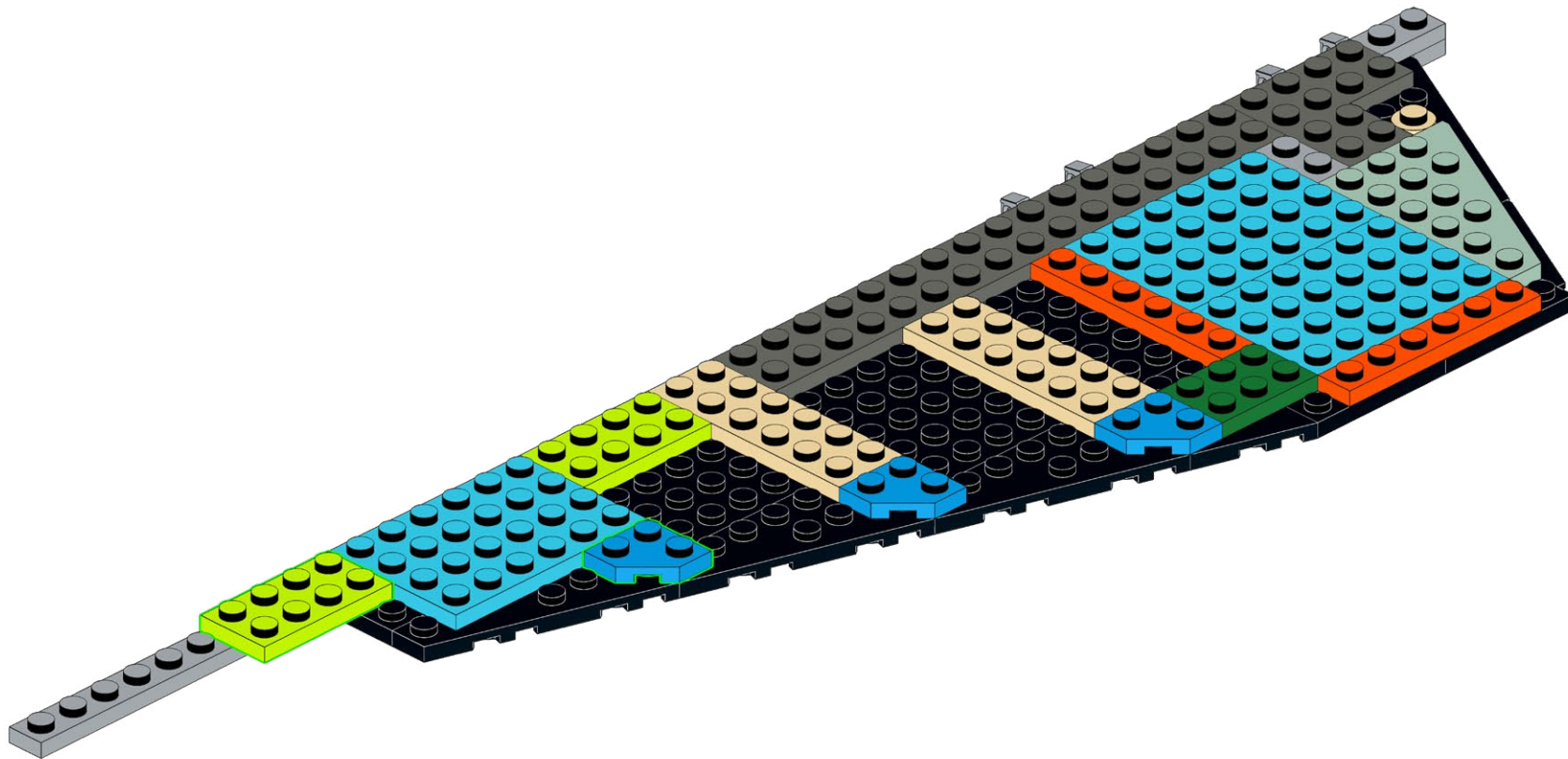
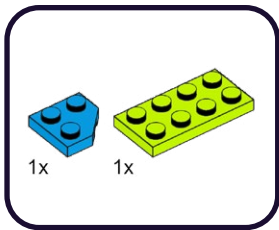

570

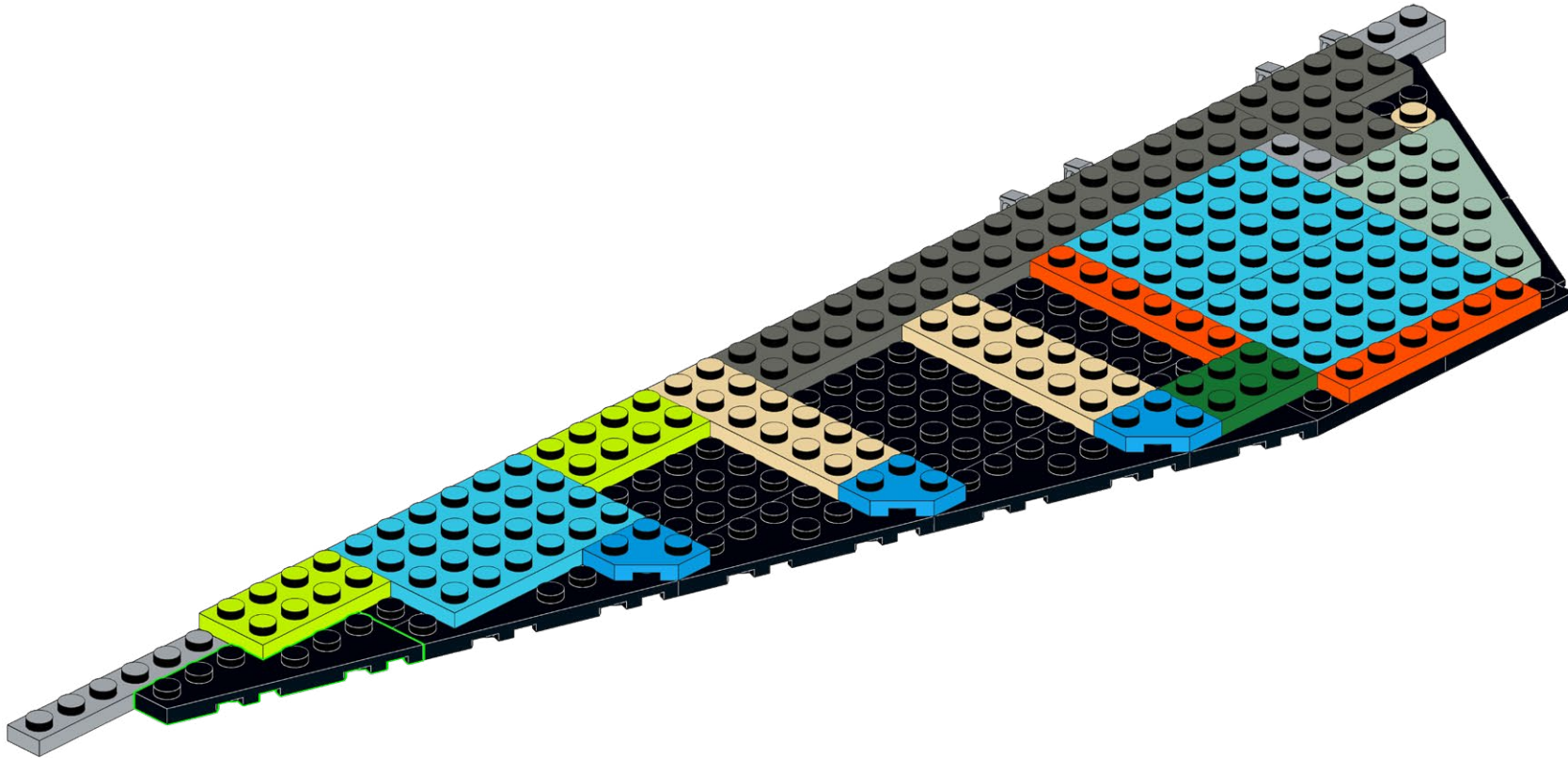
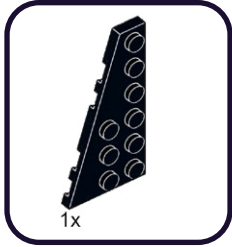

571

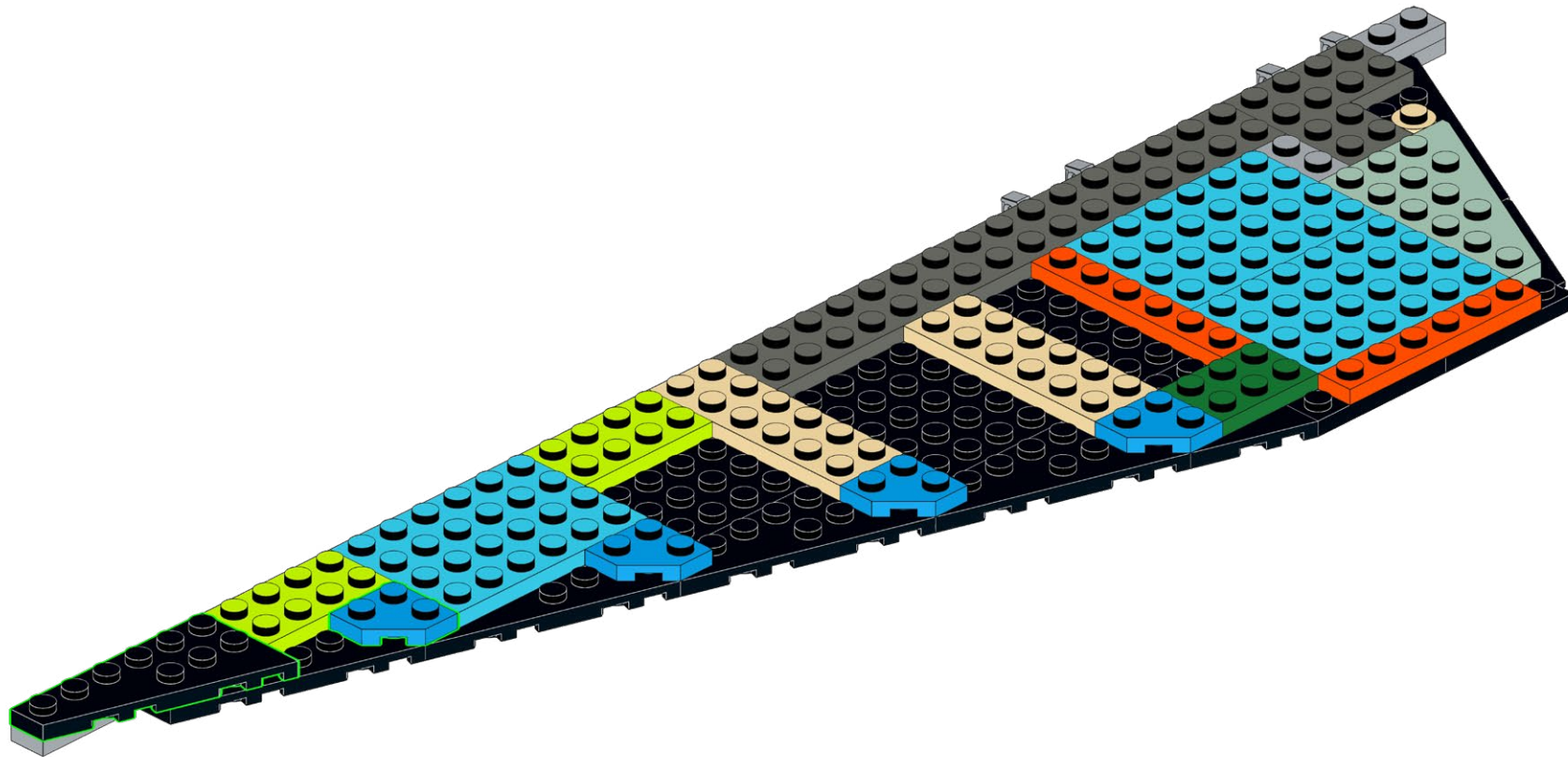
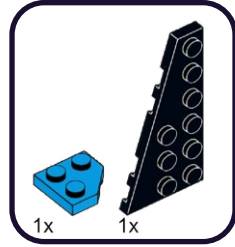

**572**

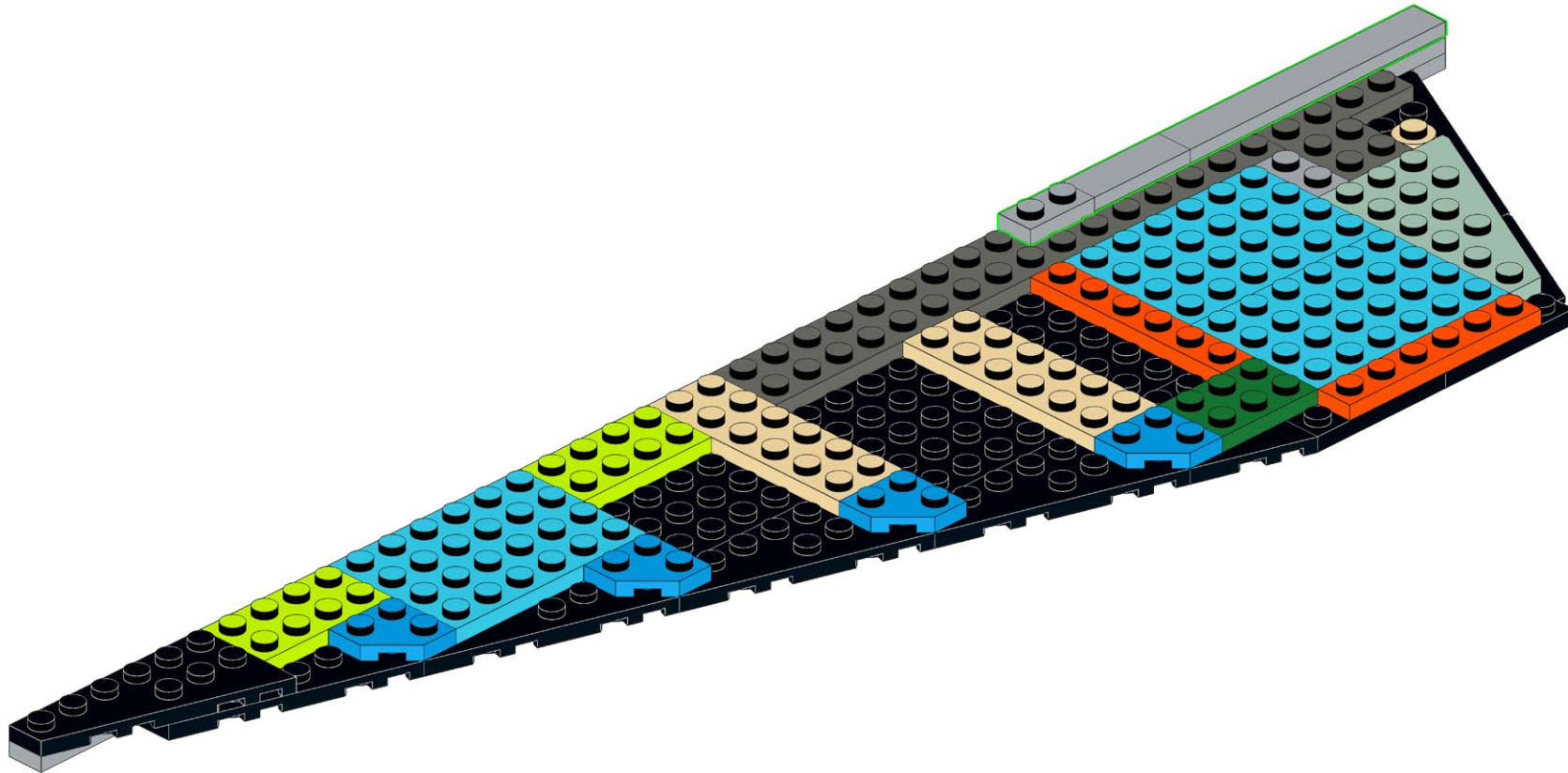
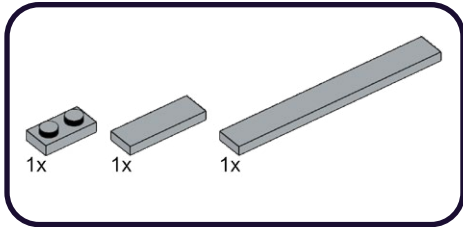



**573**

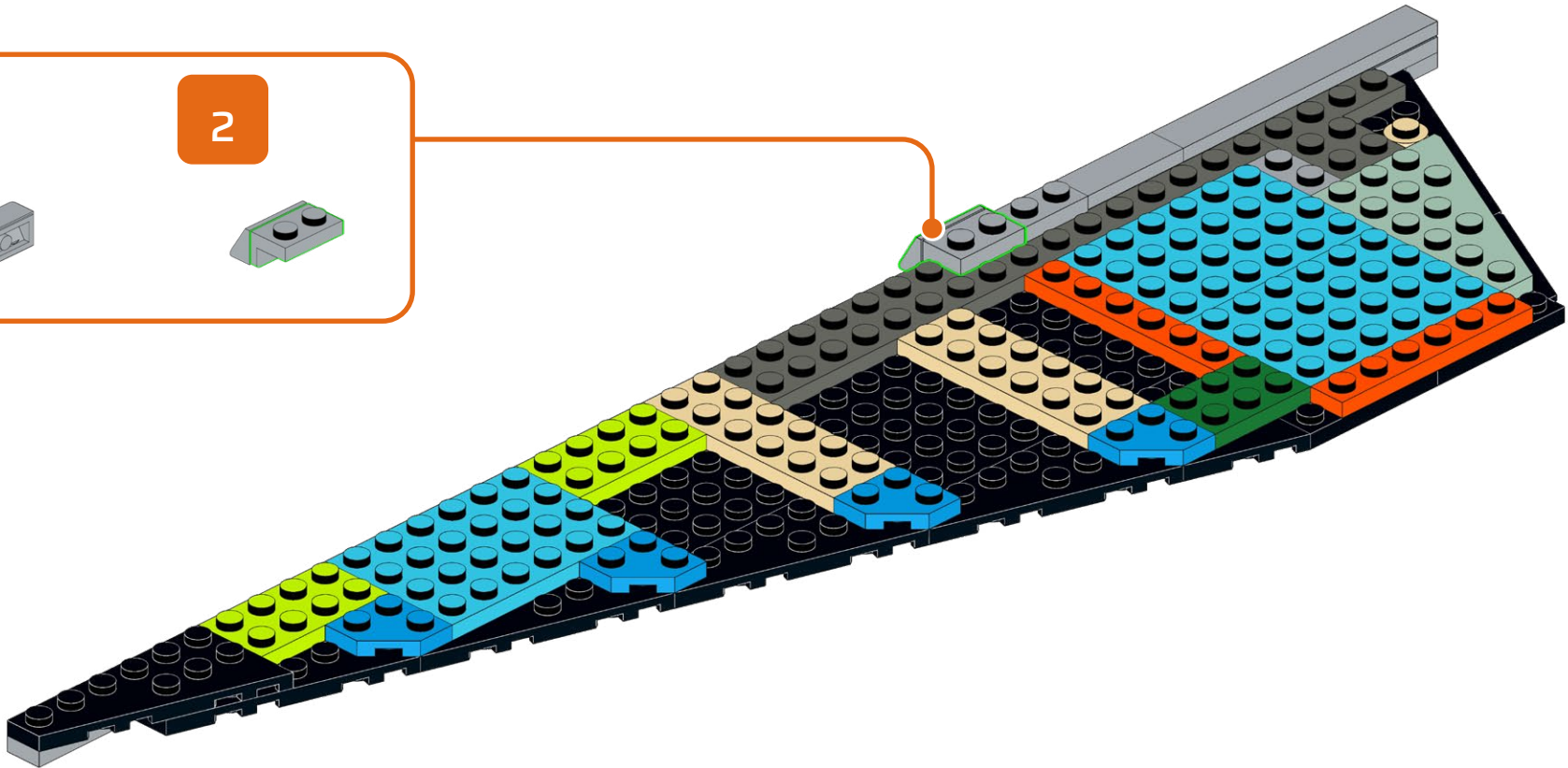
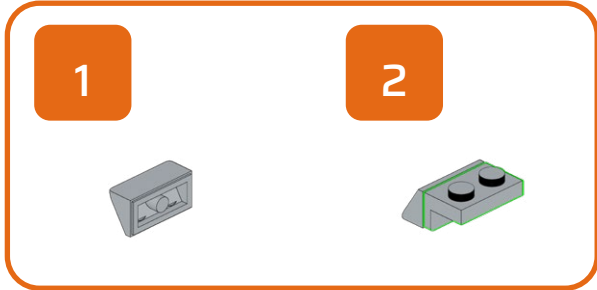
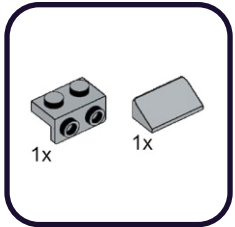



574

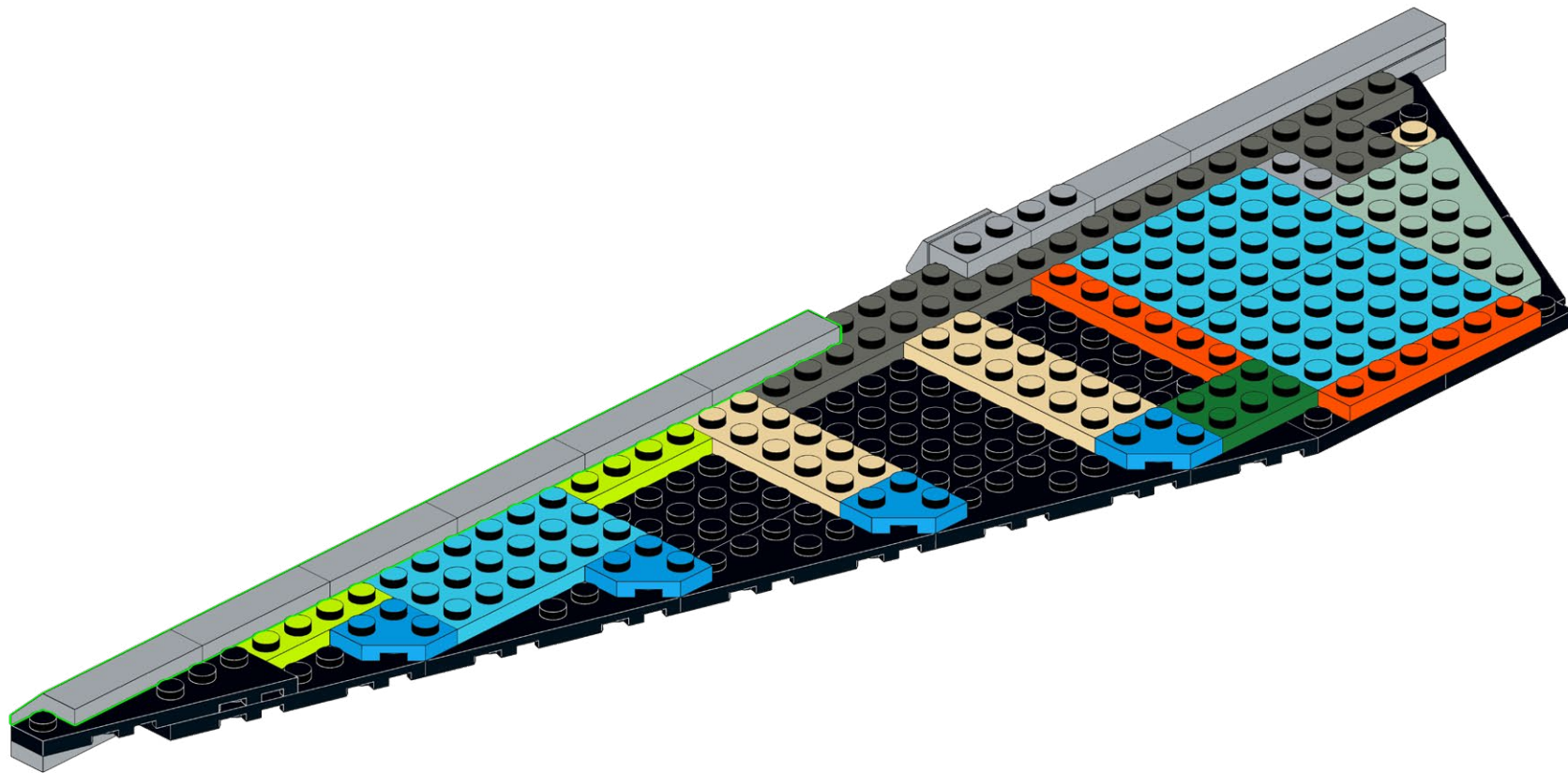
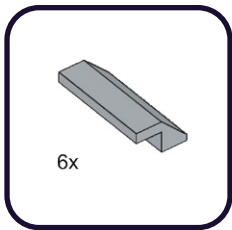

**HOLD UP!**

You might notice some bags are out of order, as well as left over pieces, but that's ok! We're changing the way you build LEGO!

**HALTEN!**

Möglicherweise stellen Sie fest, dass einige Beutel nicht in Ordnung sind und auch Teile übrig bleiben, aber das ist in Ordnung! Wir verändern die Art und Weise, wie Sie LEGO bauen!

**TENIR BON!**

Vous remarquerez peut-être que certains sacs sont en panne, ainsi que des morceaux restants, mais ce n'est pas grave ! Nous changeons la façon dont vous construisez LEGO !

**SOSTENERE!**

Potresti notare che alcune borse sono fuori uso, così come alcuni pezzi avanzati, ma va bene! Stiamo cambiando il modo in cui costruisci i LEGO!

**¡SOSTENER!**

Puede que notes que algunas bolsas están fuera de orden, así como piezas sobrantes, ¡pero está bien! ¡Estamos cambiando la forma de construir LEGO!

**耽误!**

您可能会注意到有些袋子坏了, 还有剩余的碎片, 但这没关系! 我们正在改变您搭建乐高的方式!

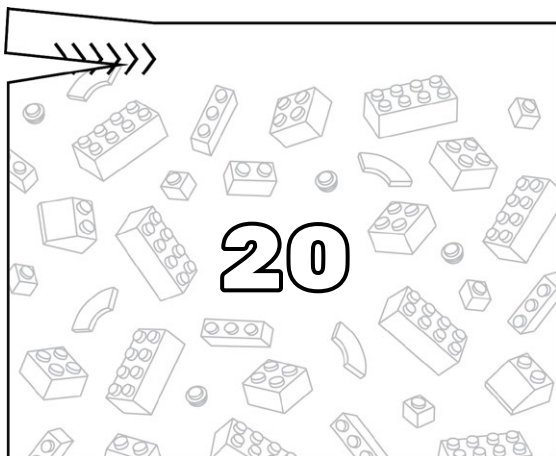
**Open LEGO® Bag 1**

575

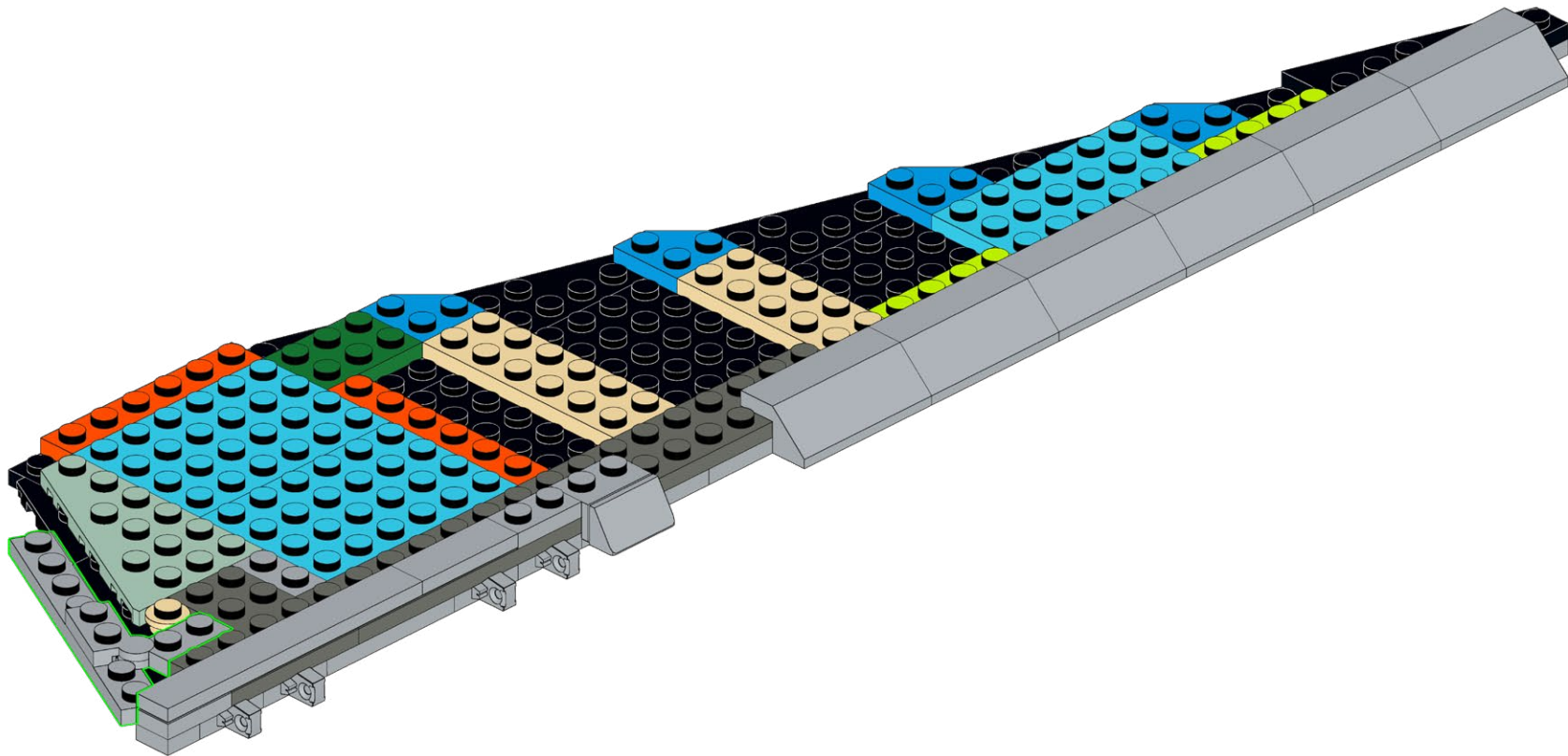
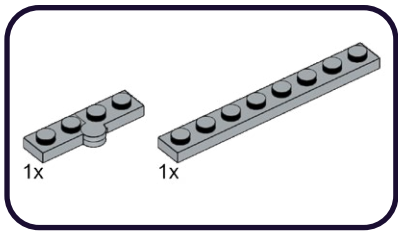

576

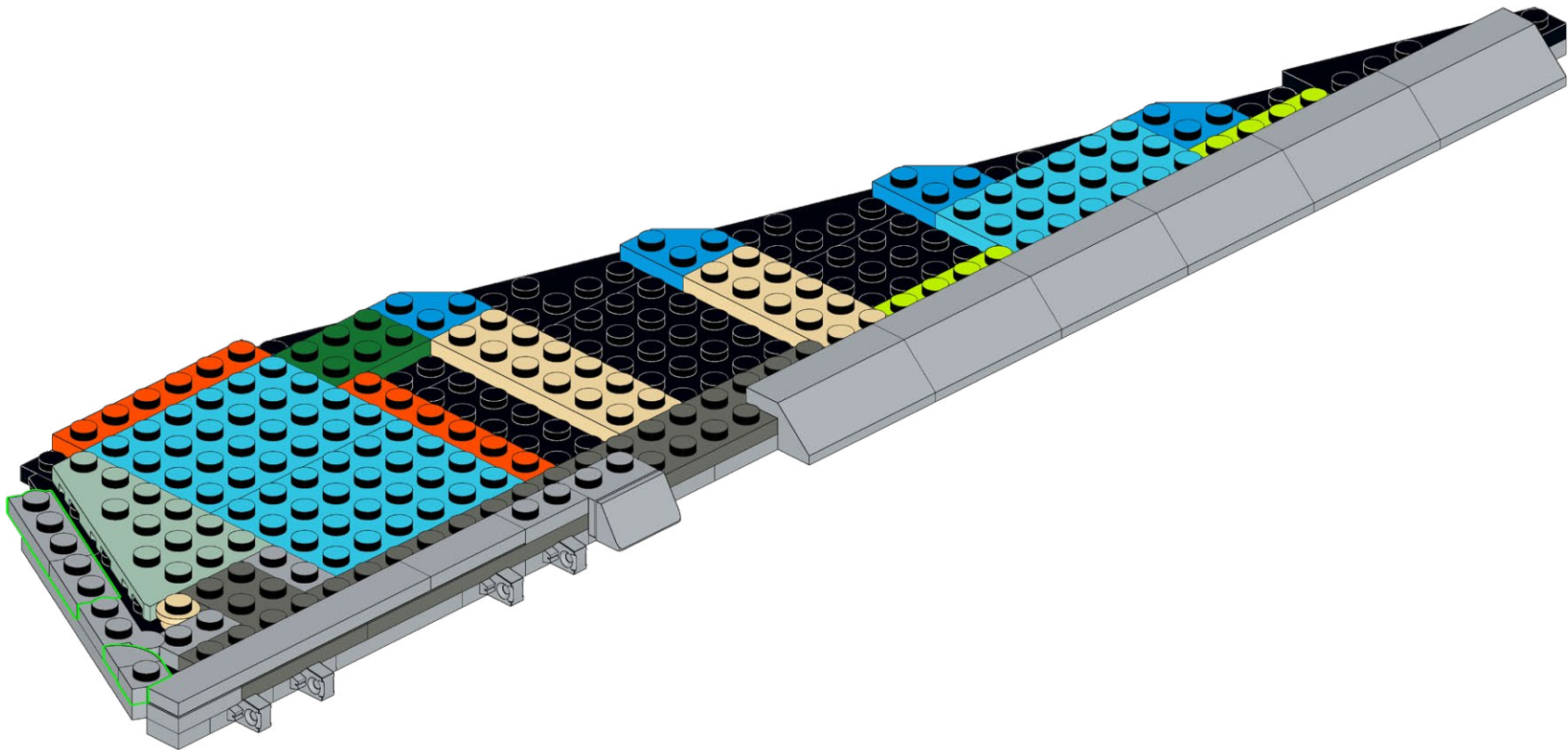
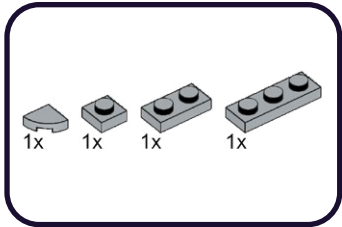

577

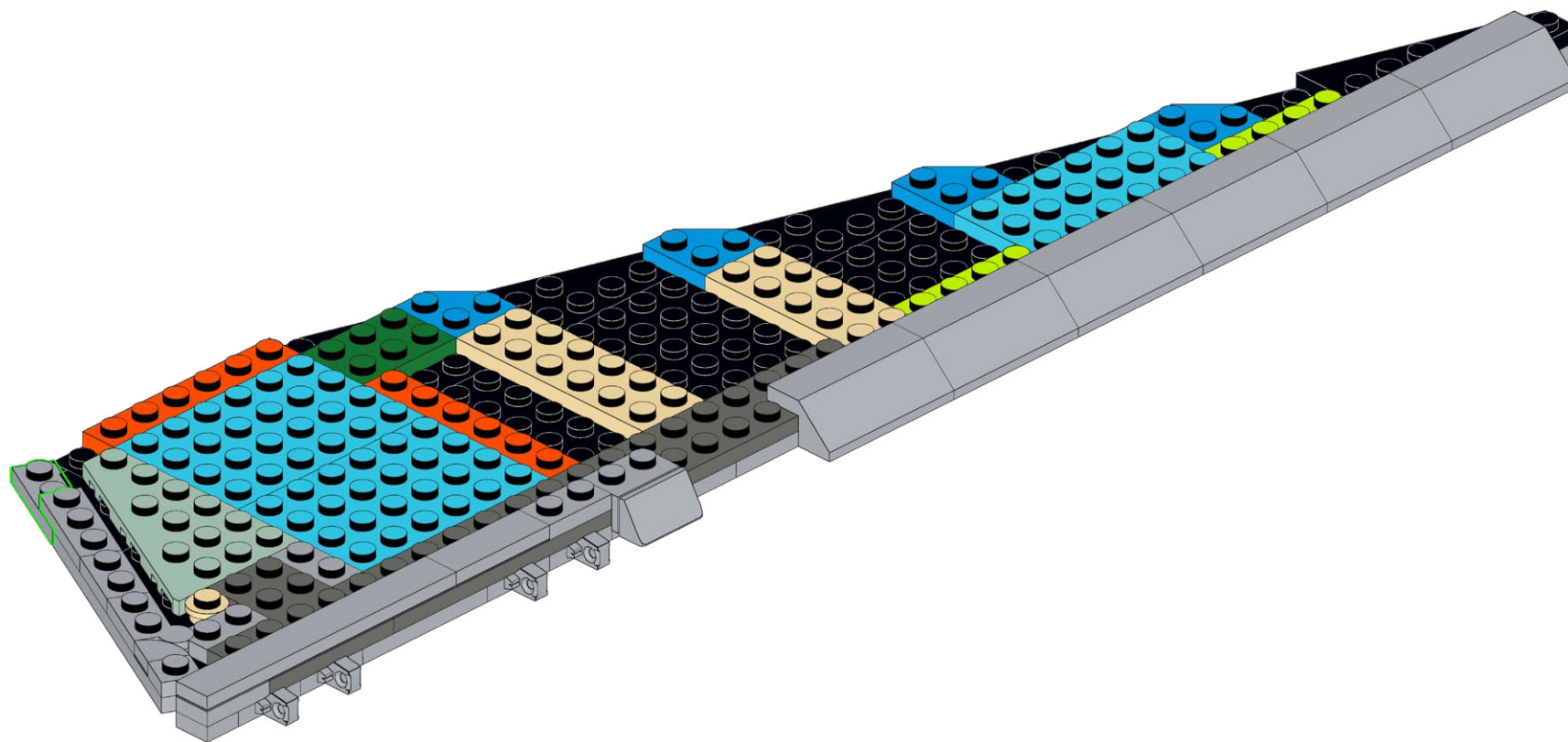
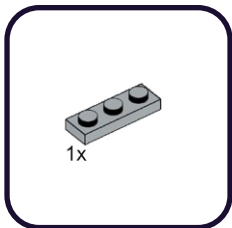



578

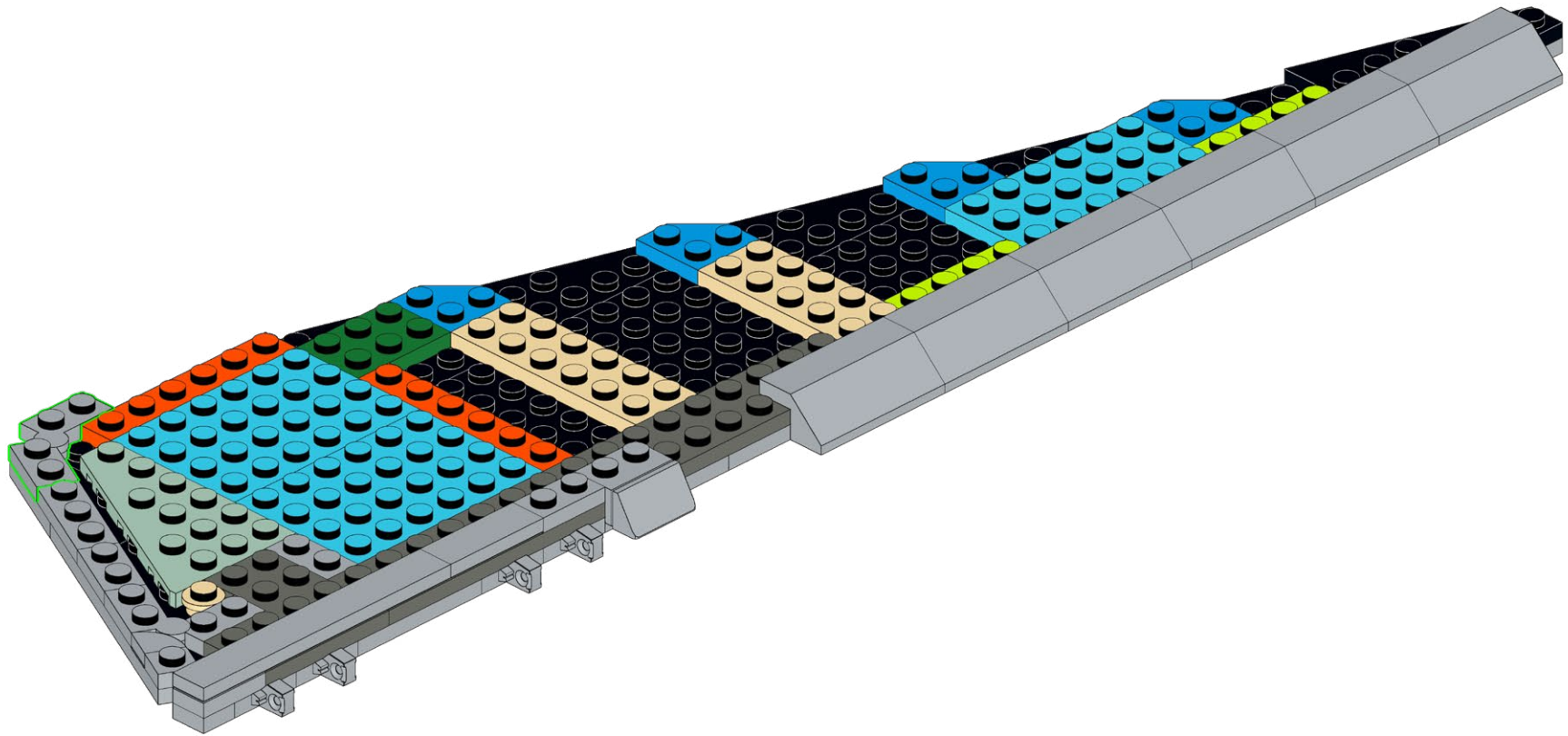
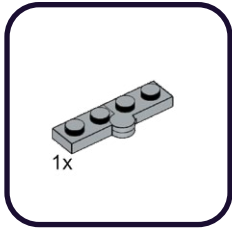

**579**

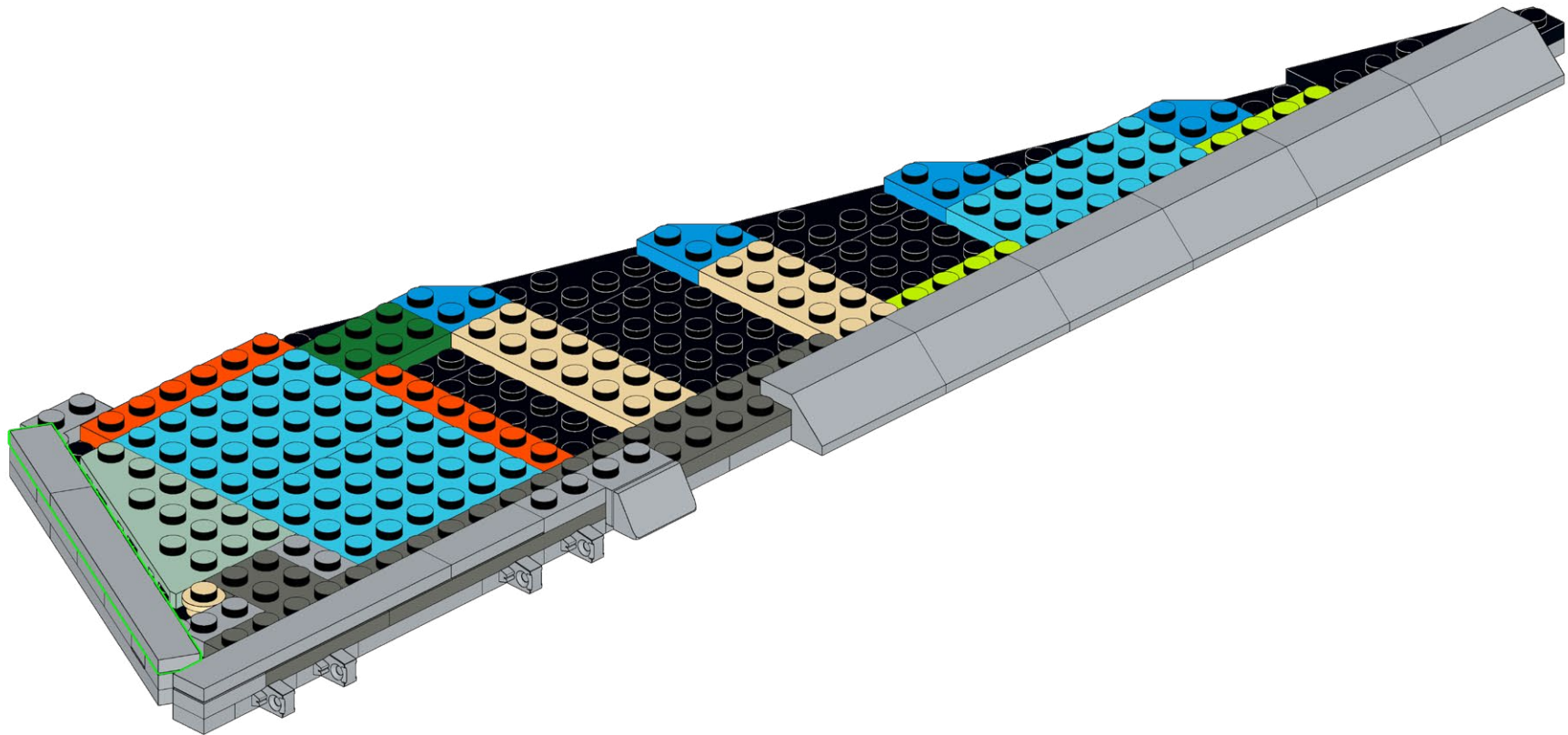
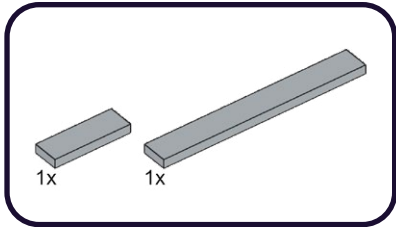

580

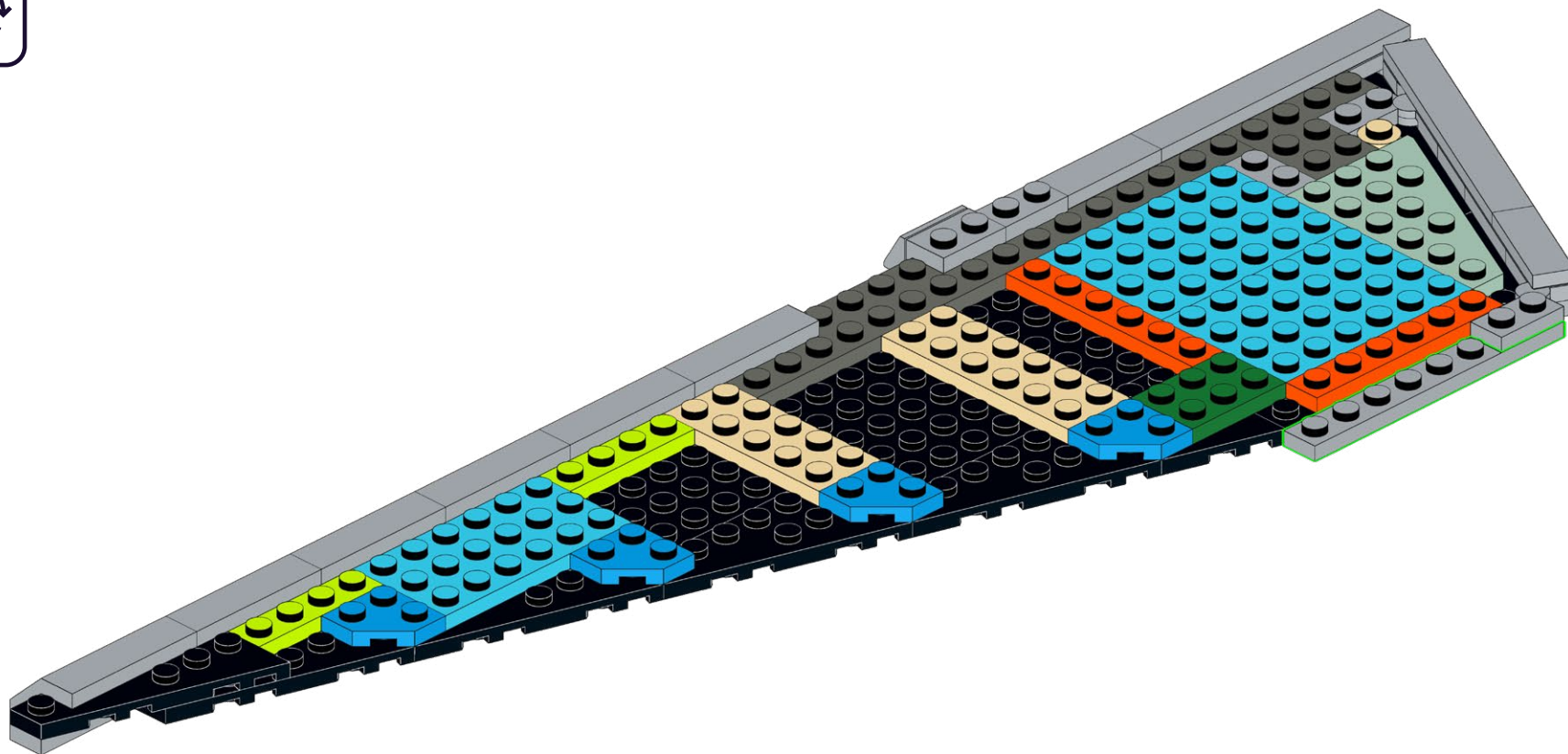
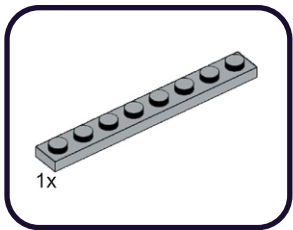

581

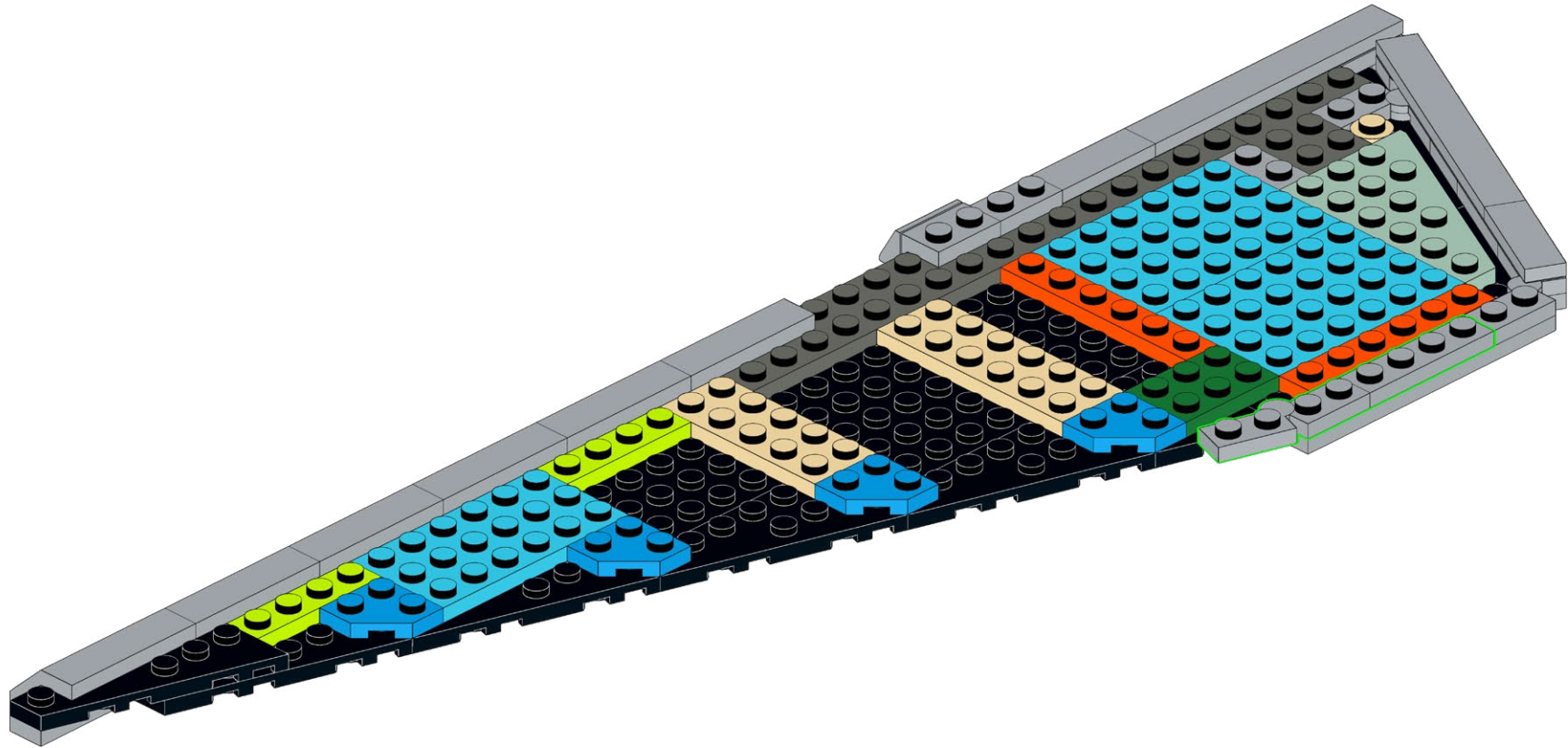
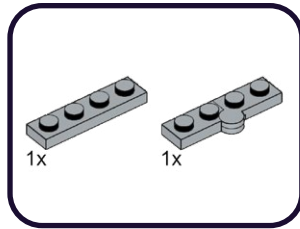



582

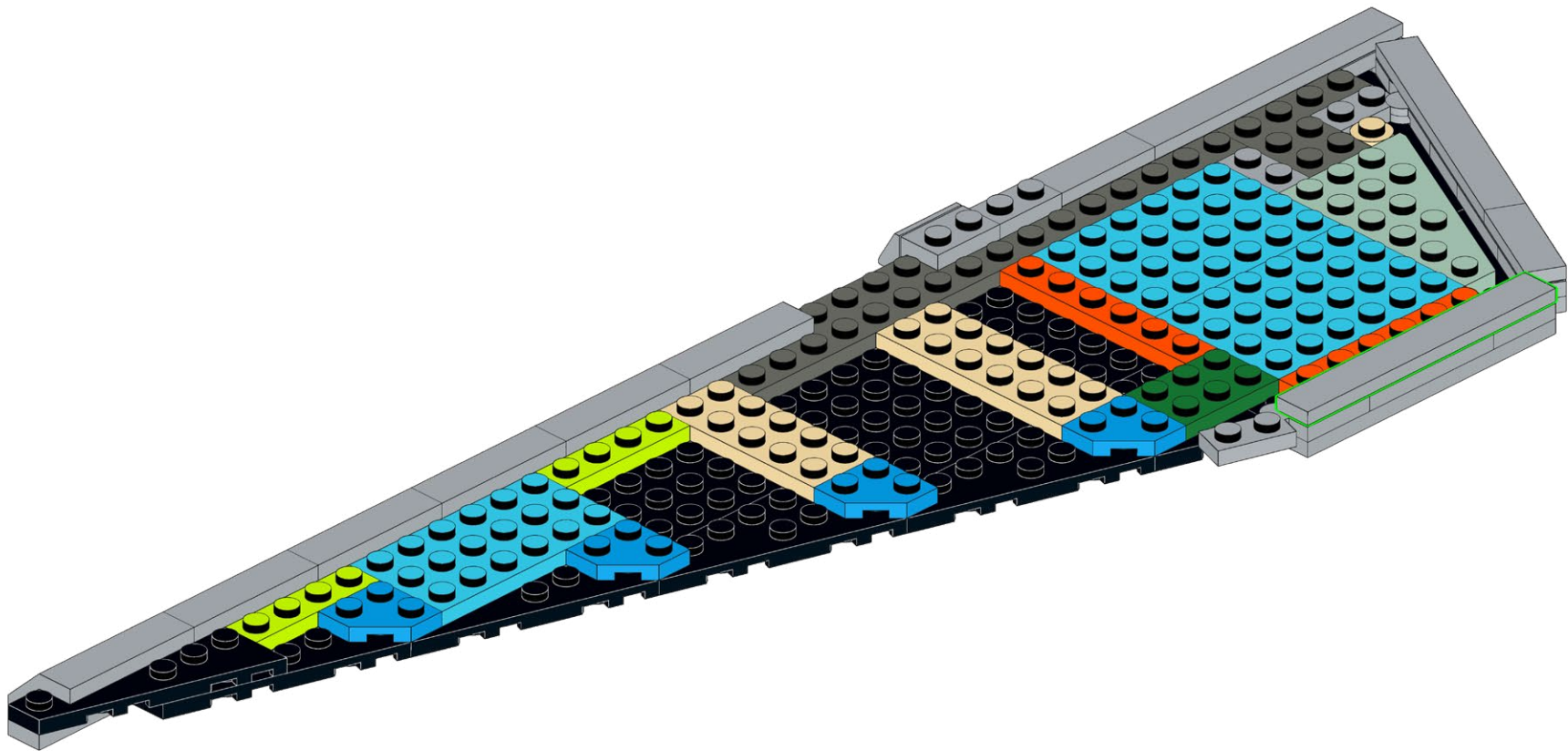
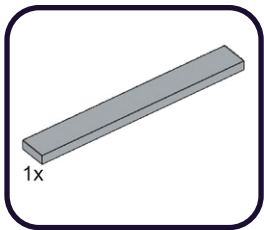



583

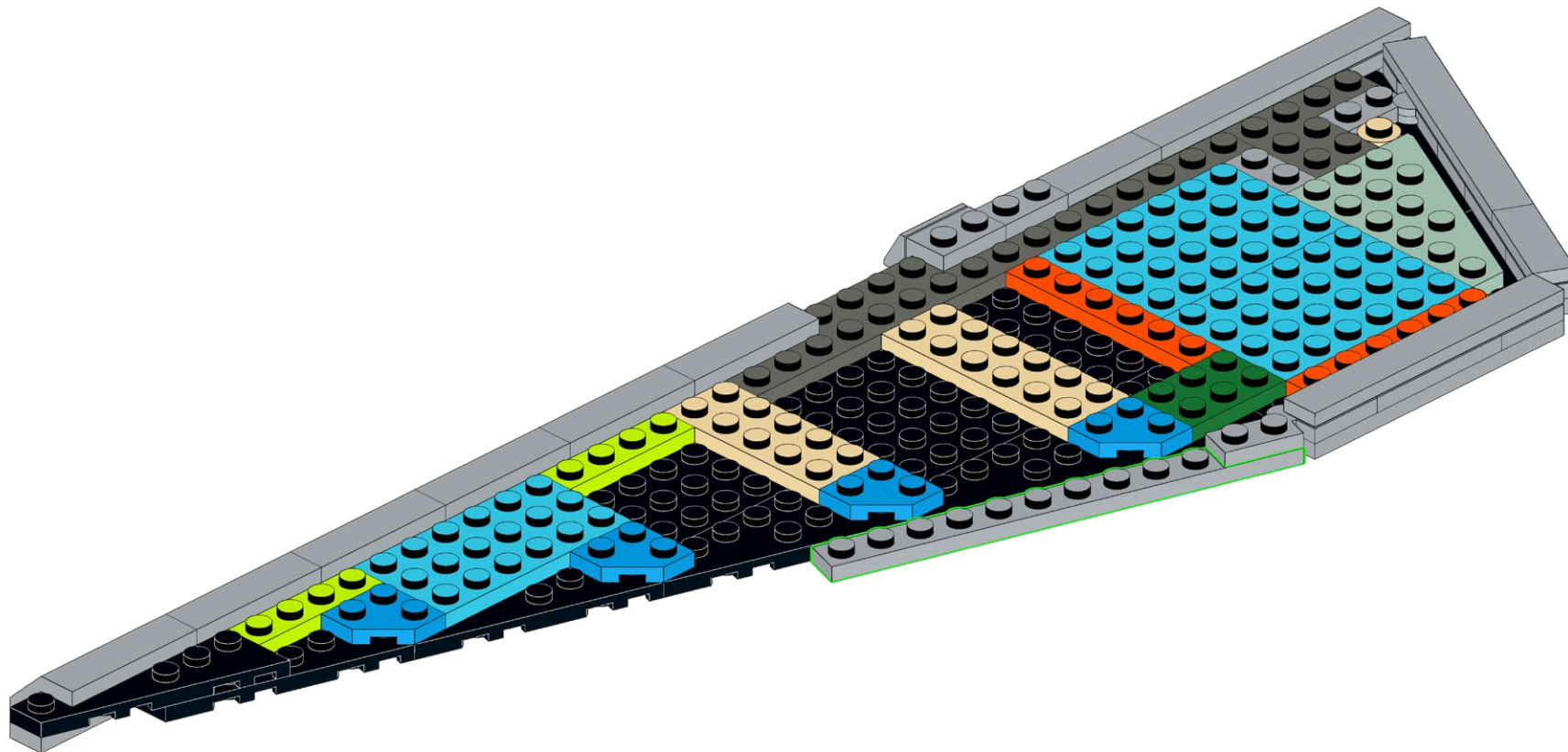
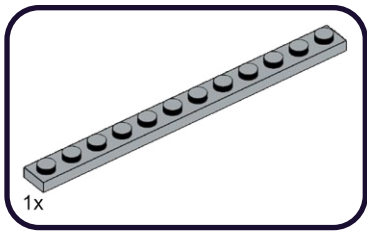

584

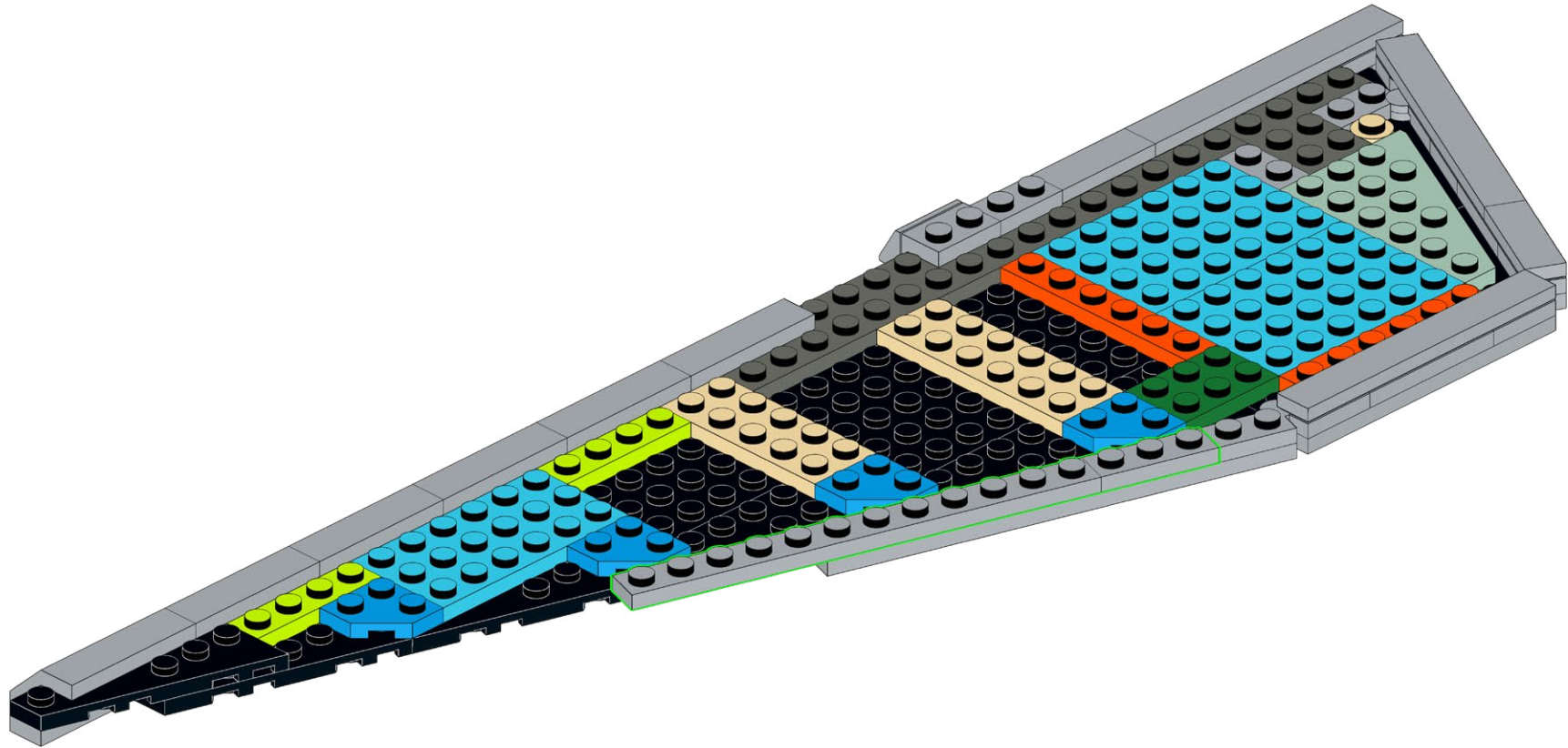
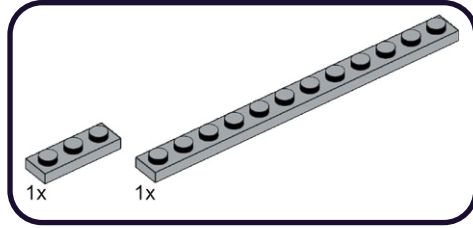

585

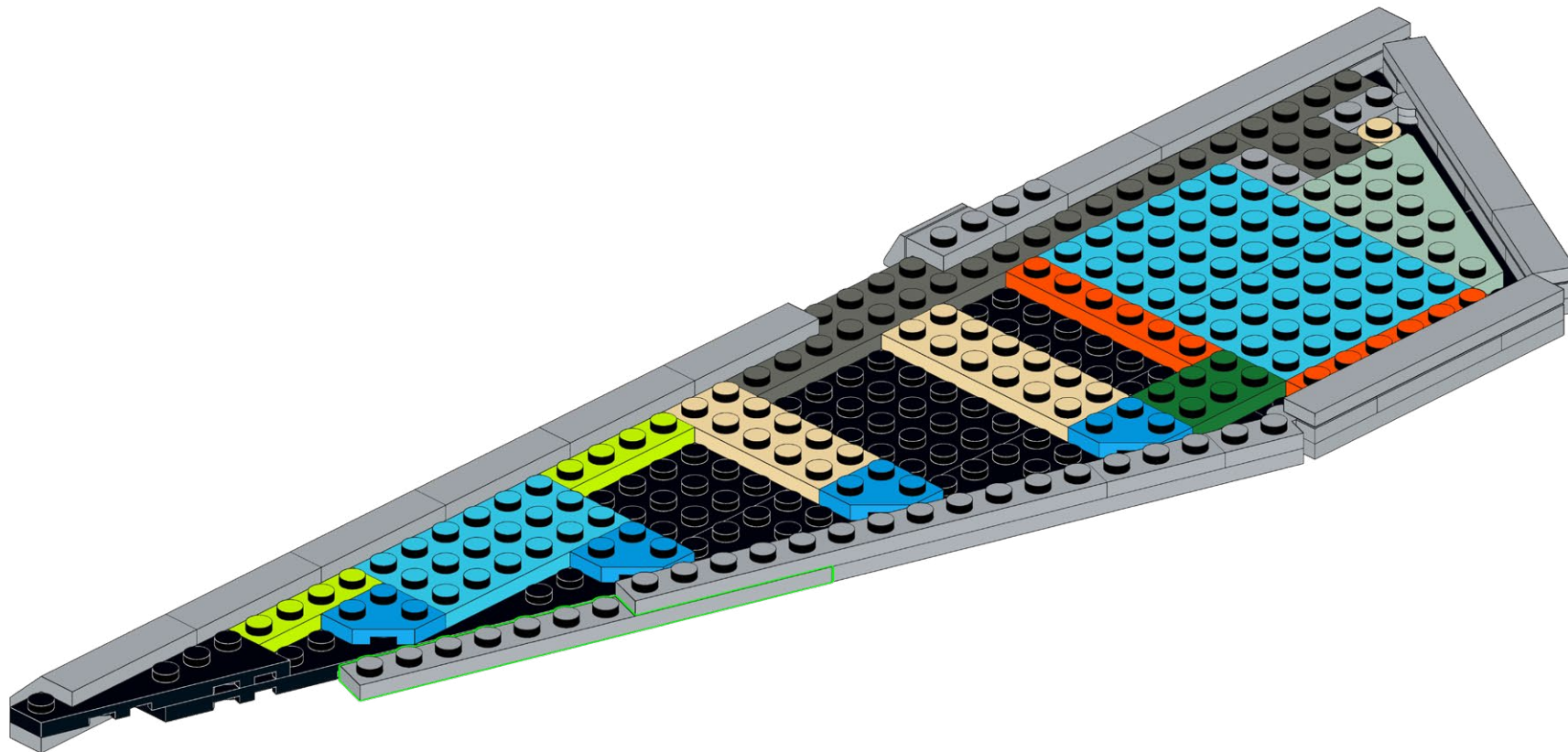
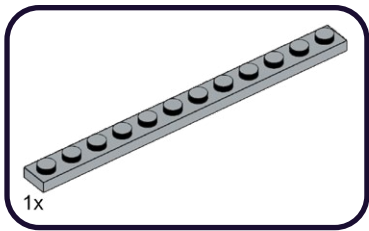

586

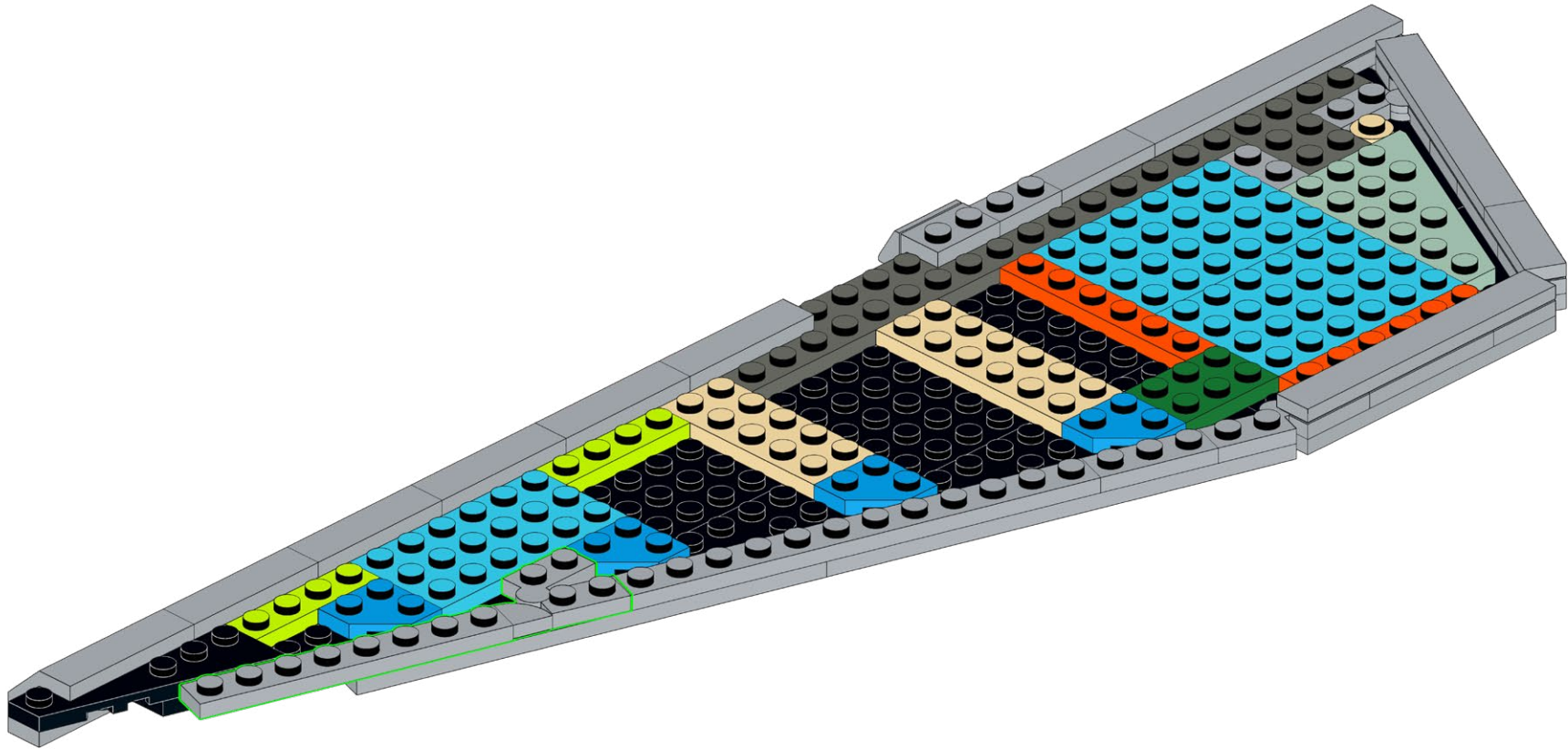
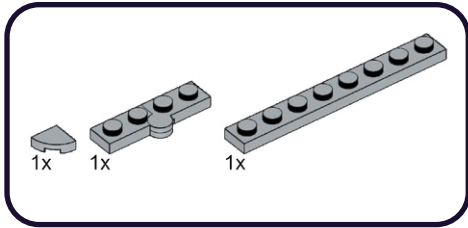



587

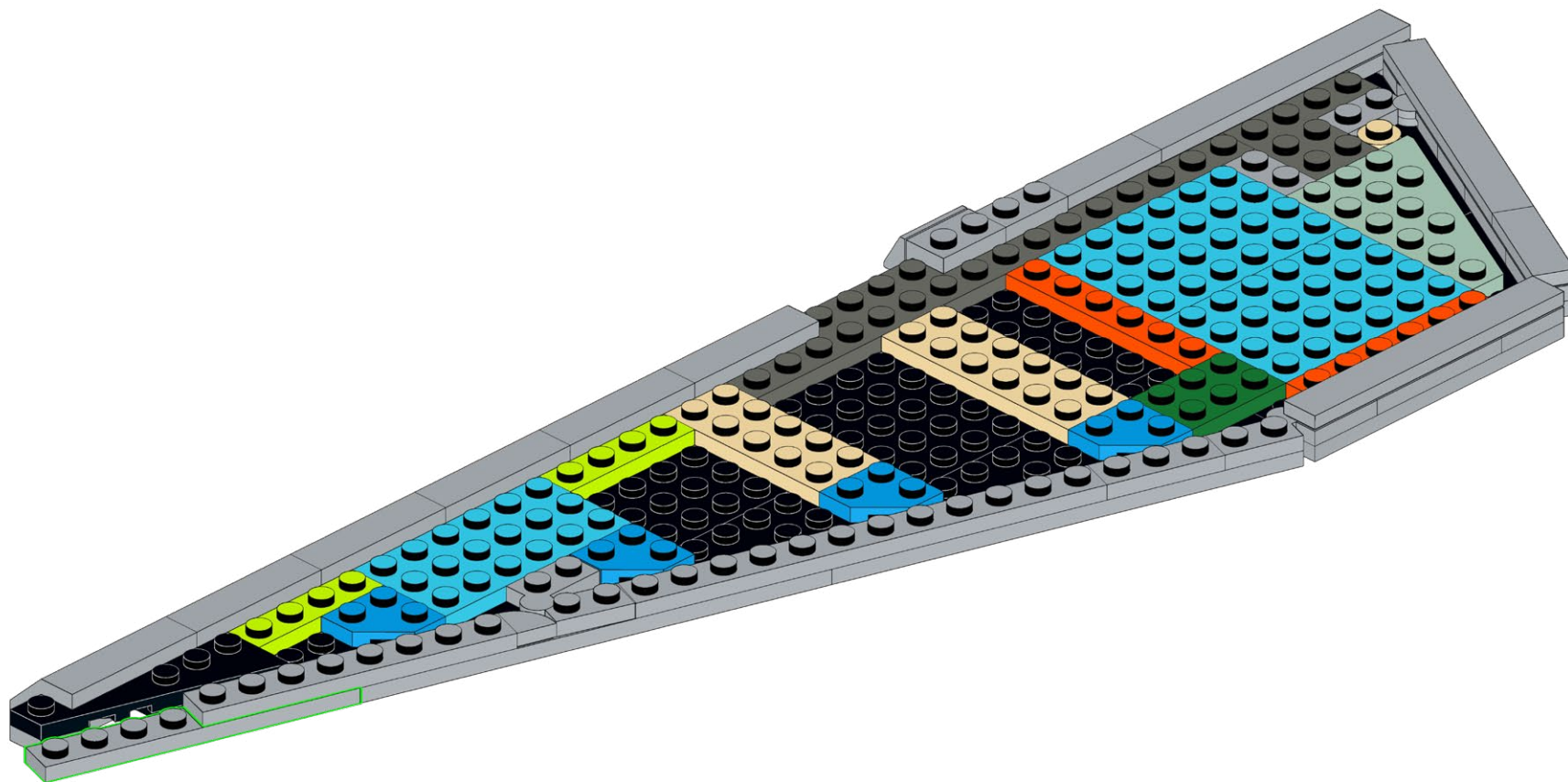
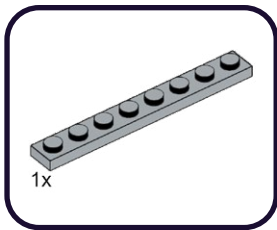



588

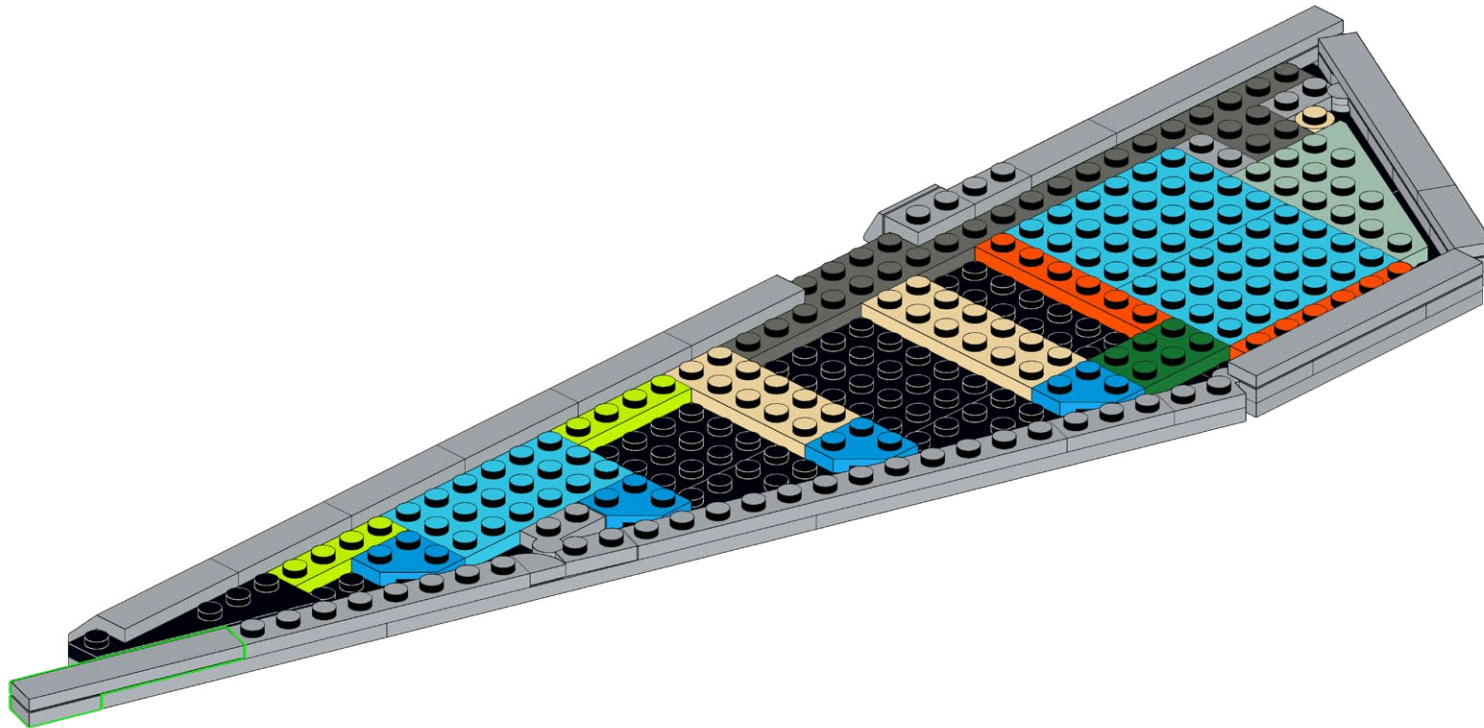
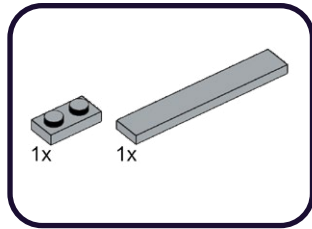

589

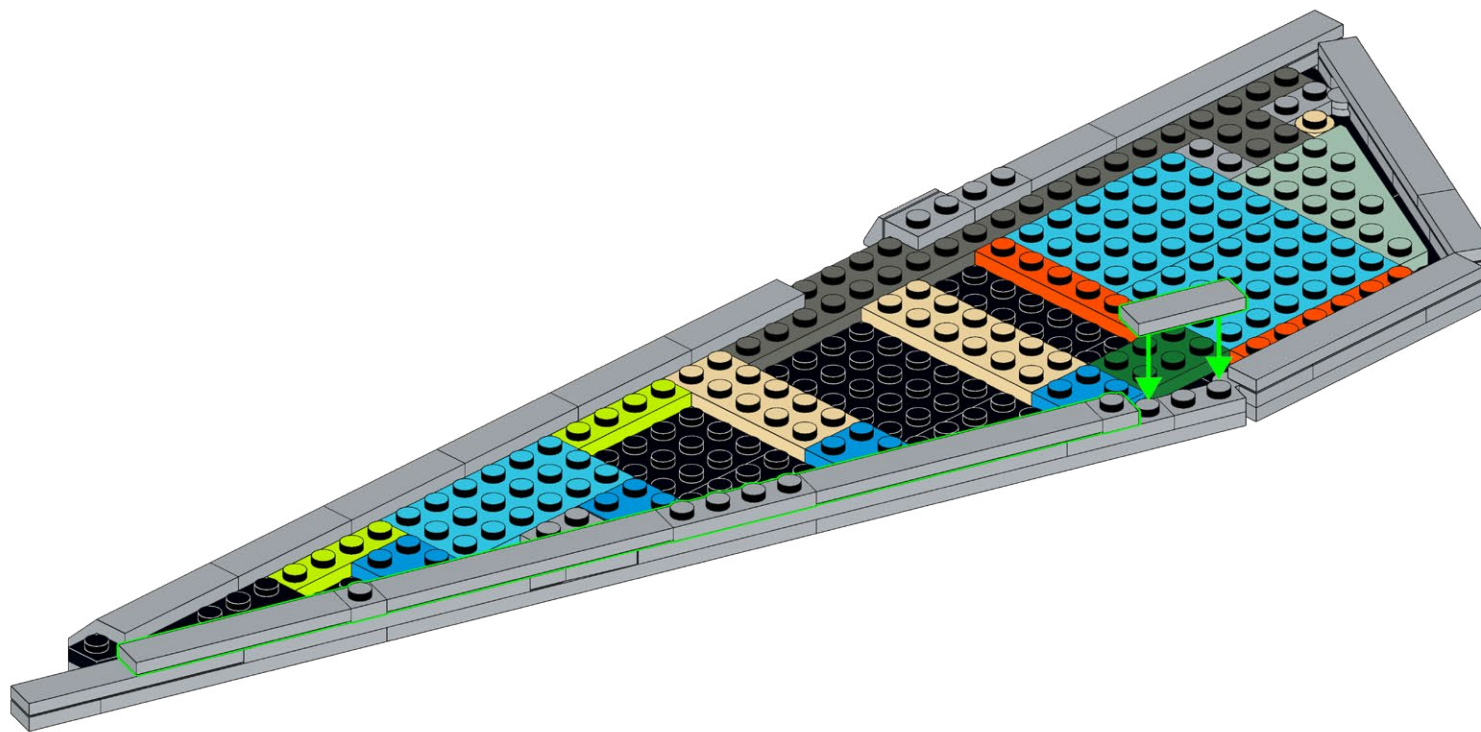
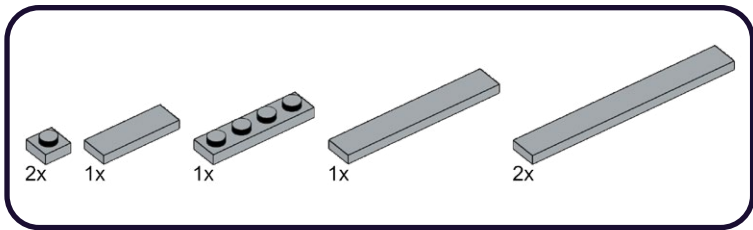

590

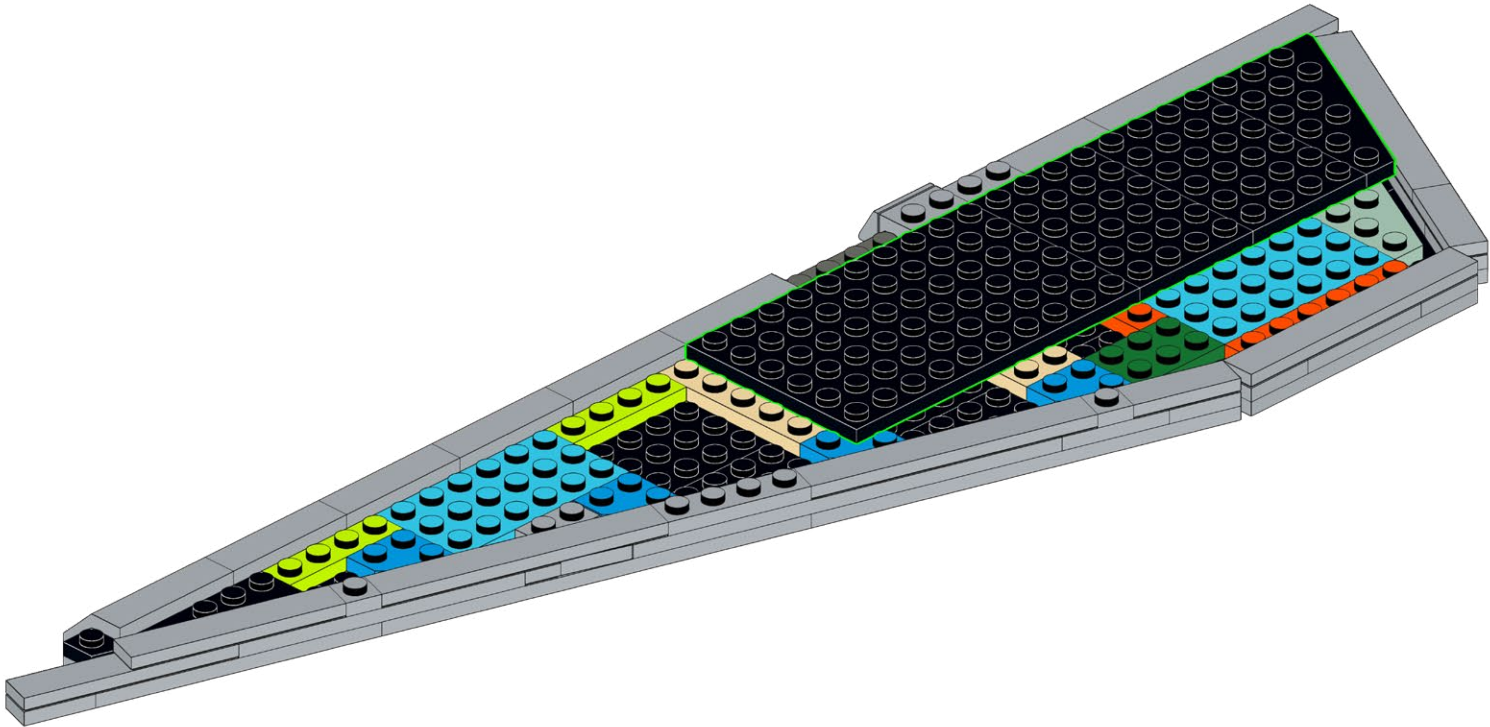
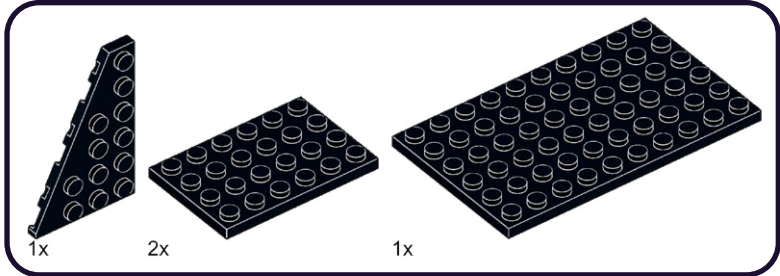

591

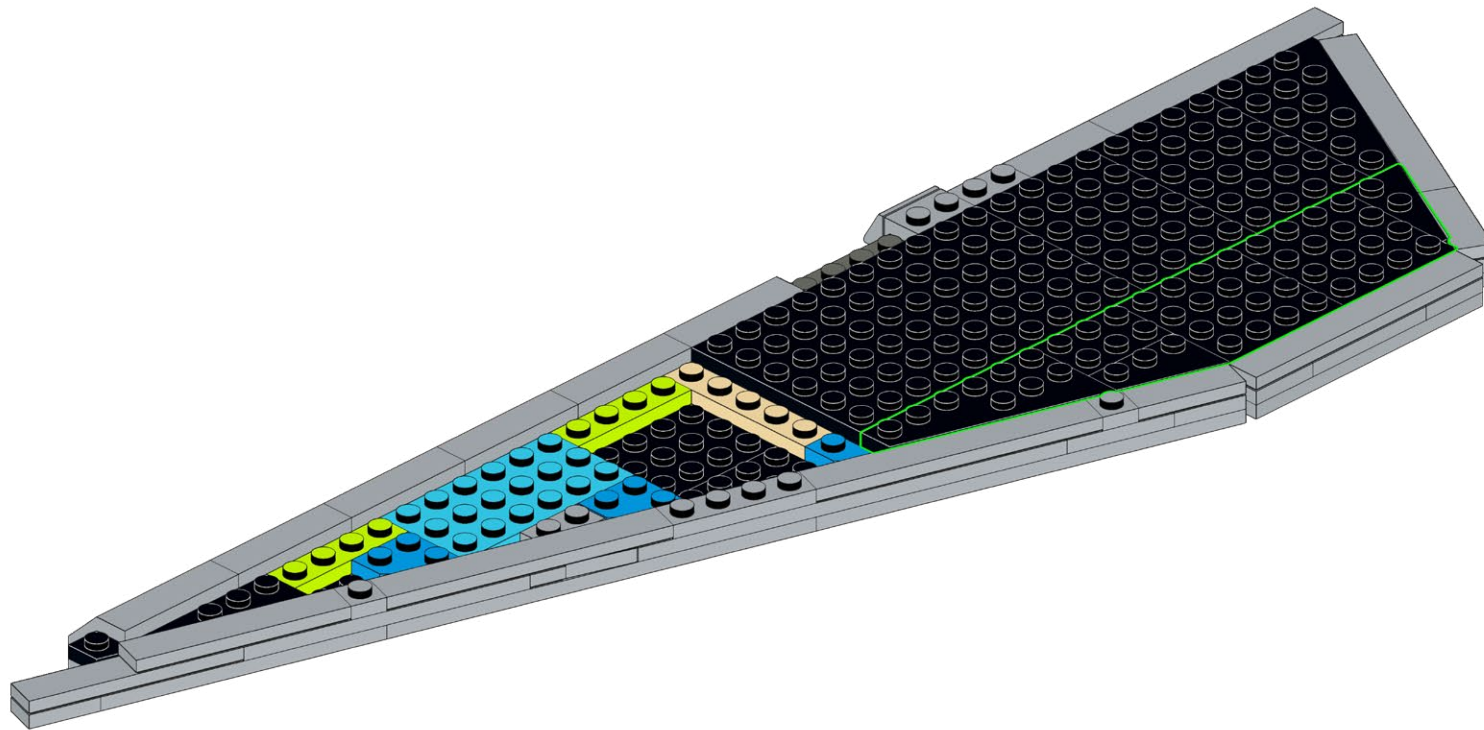
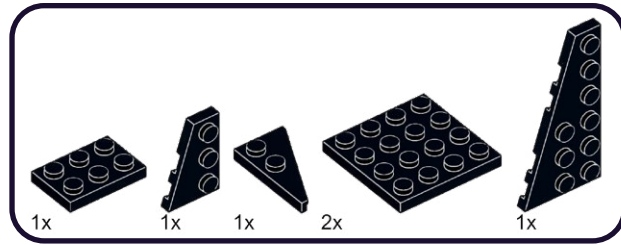

592

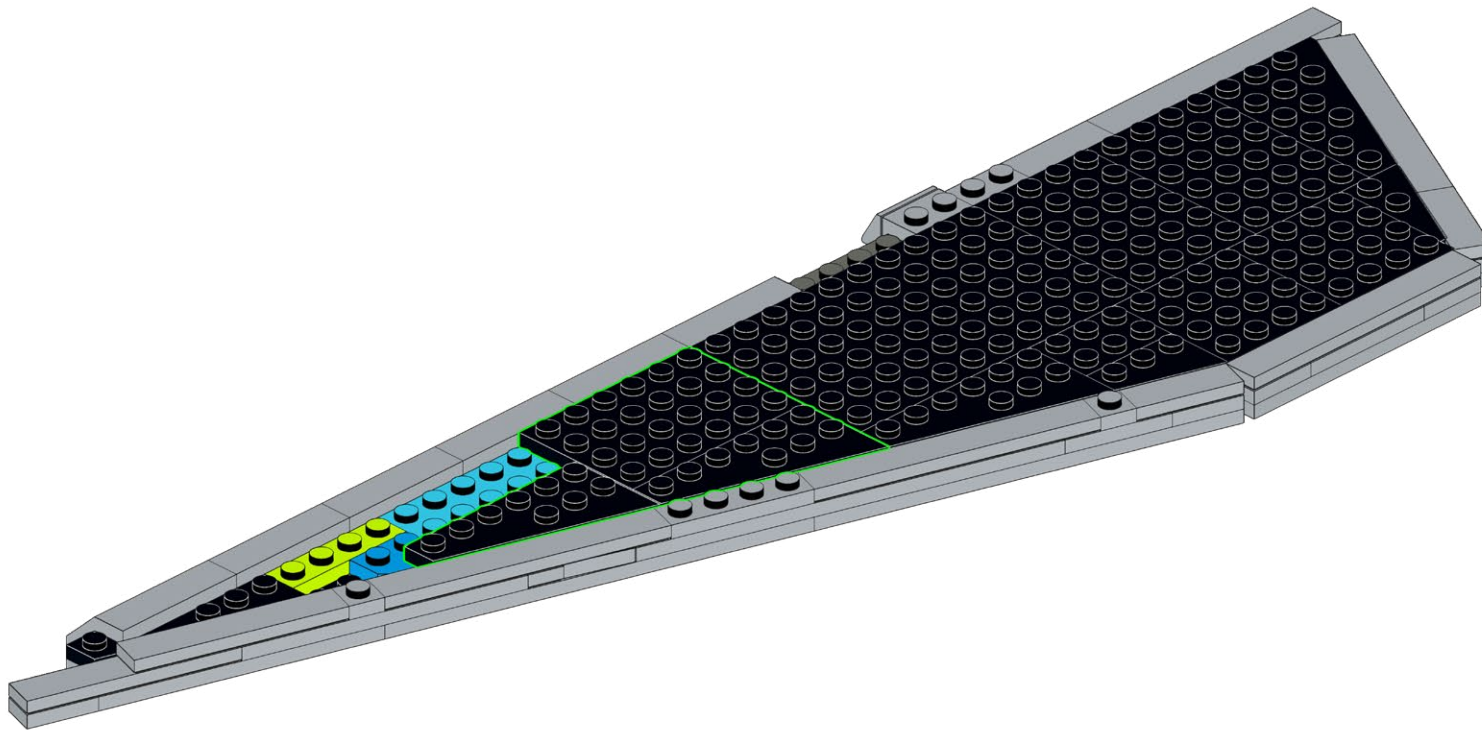
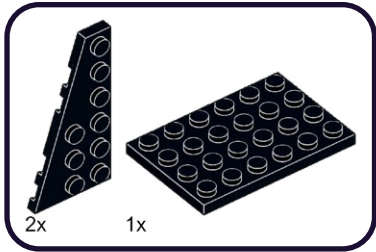



593

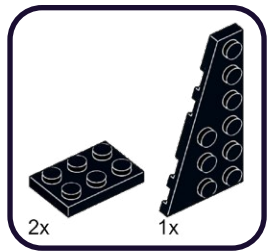

594

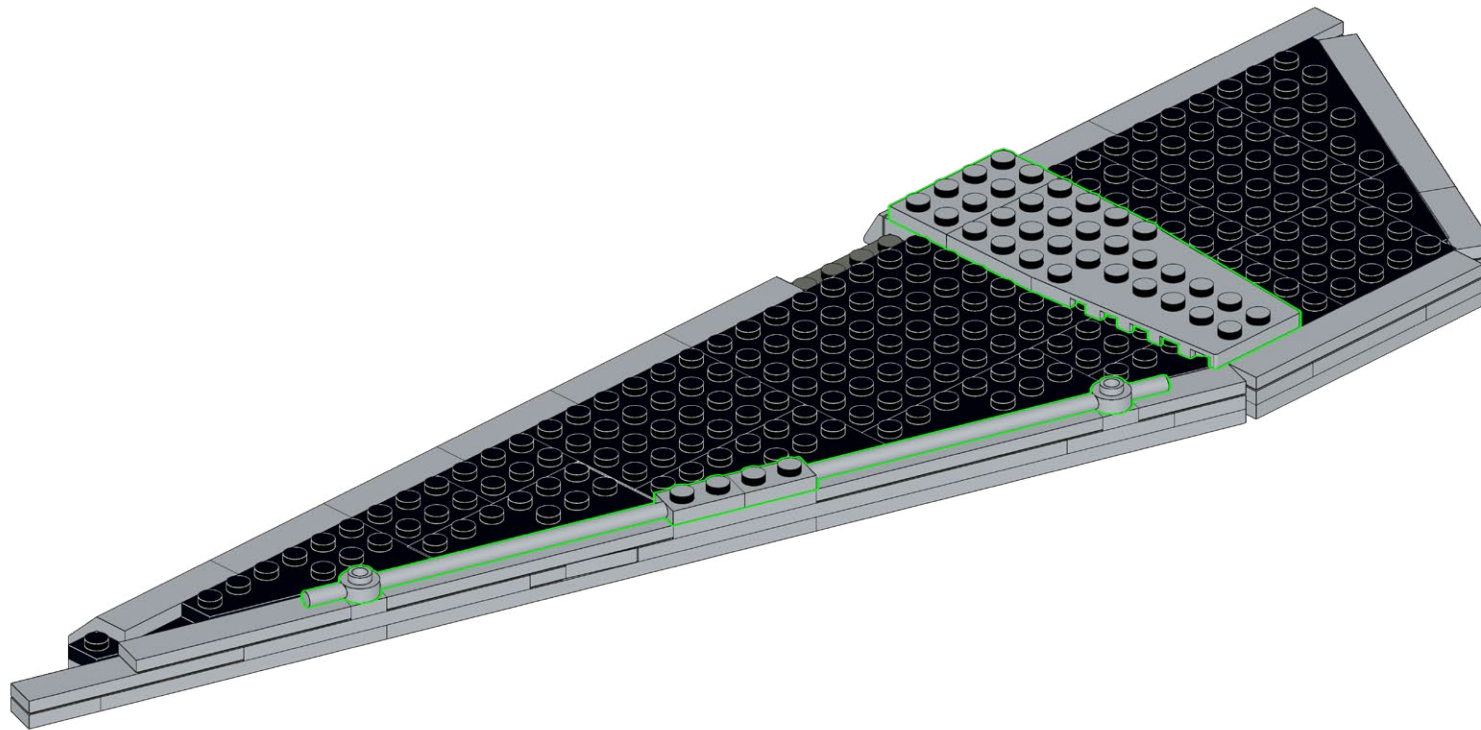
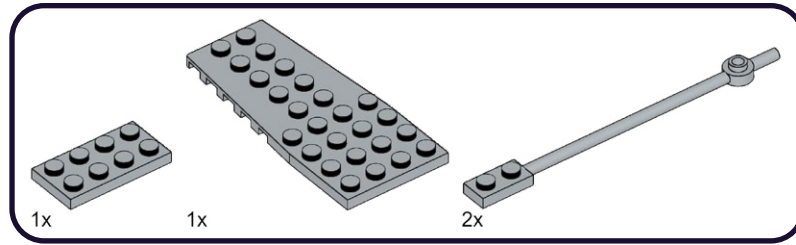

**595**

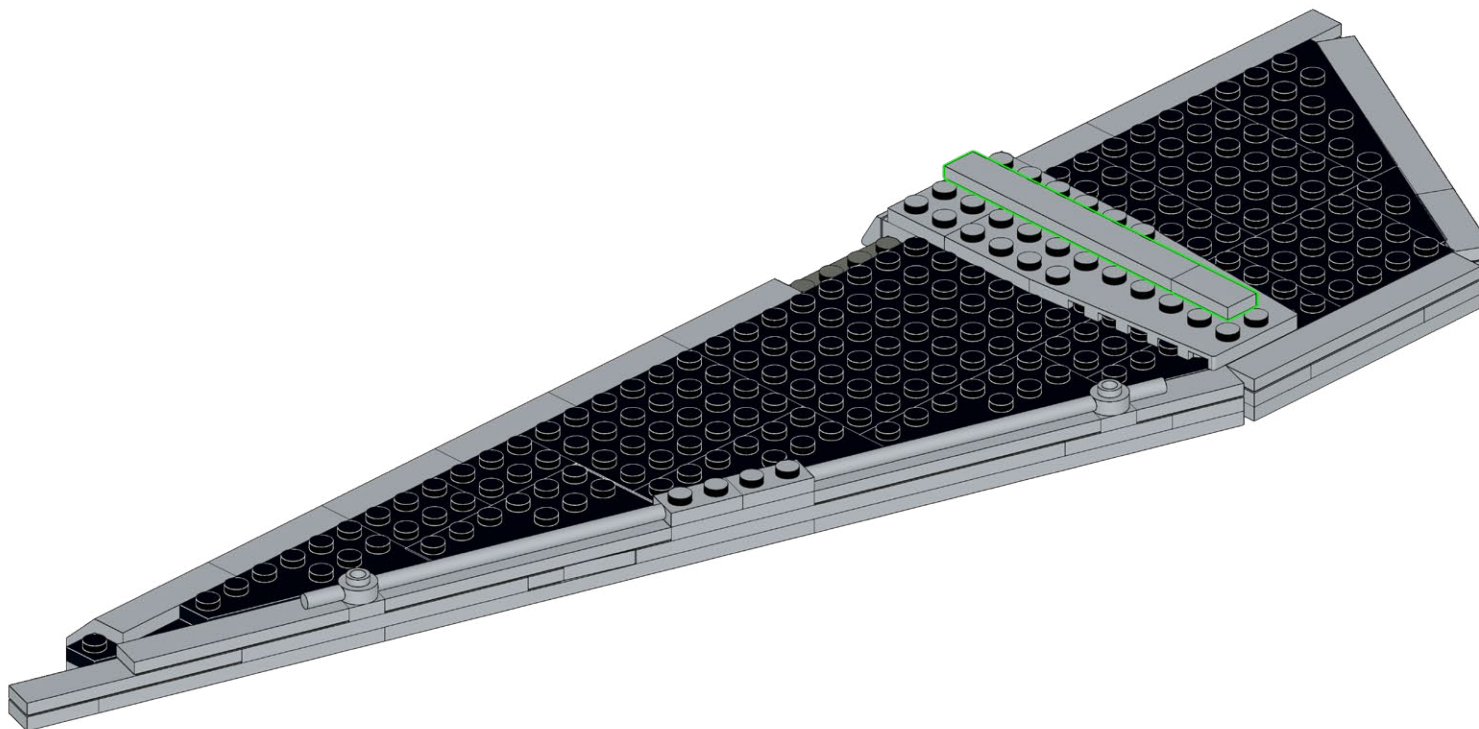
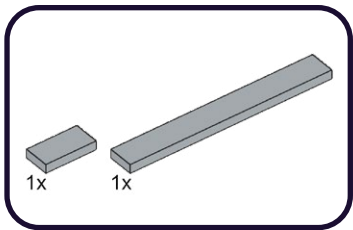

596

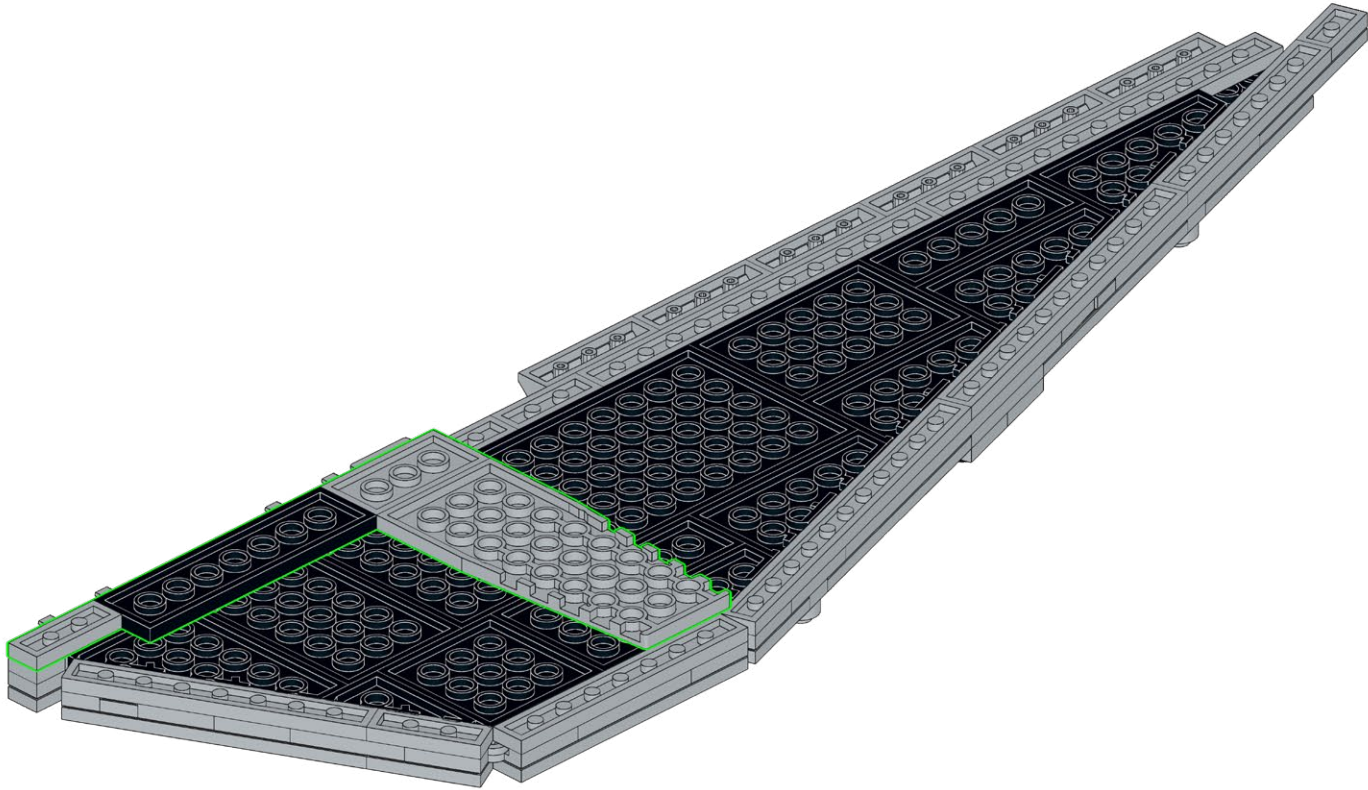
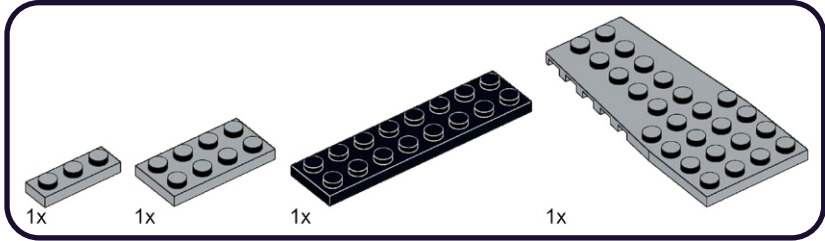

597

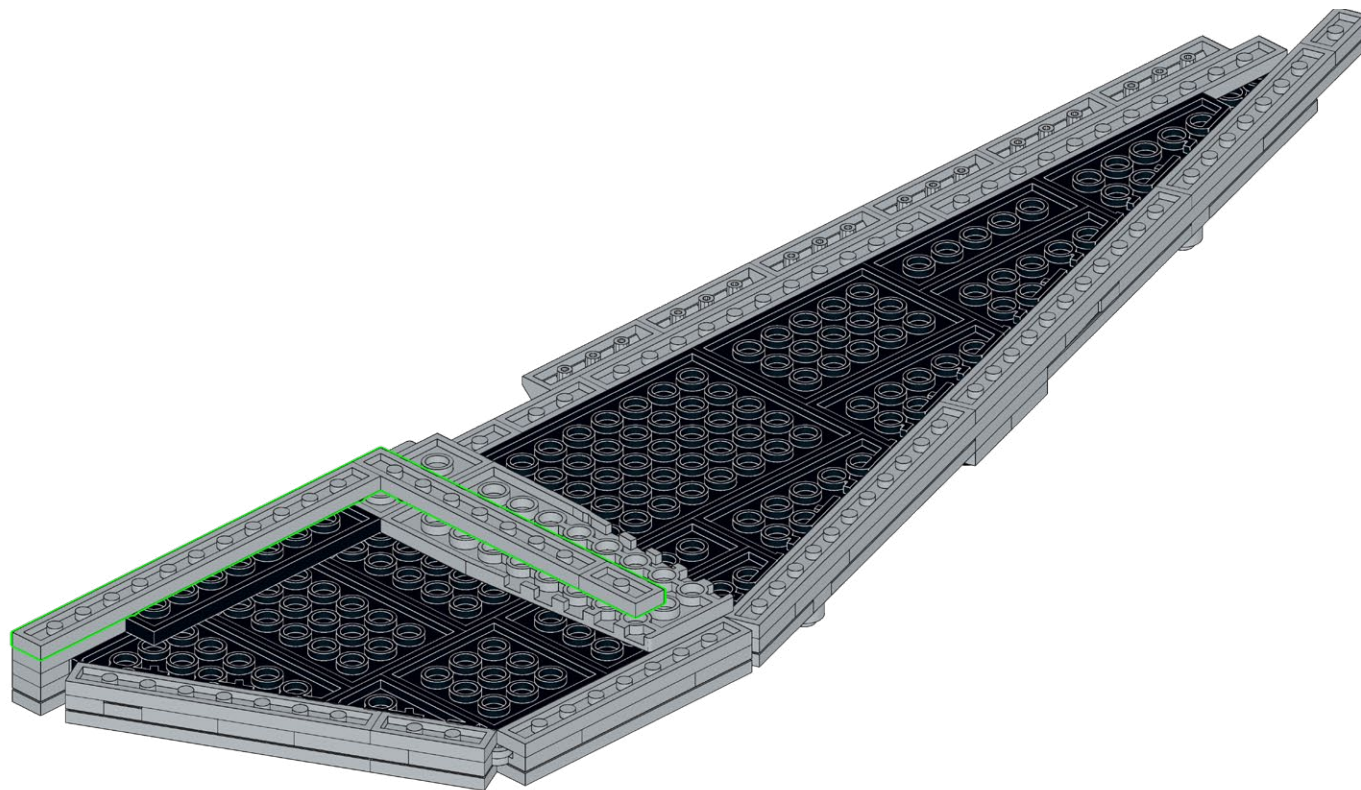
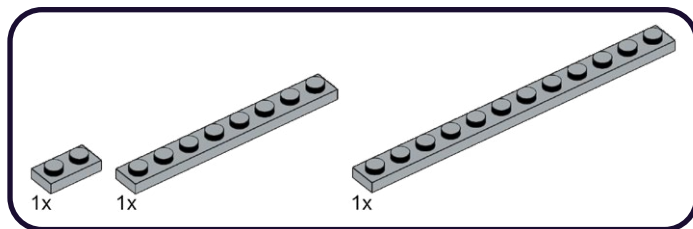



598

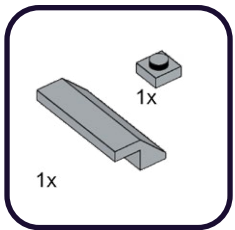
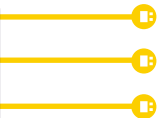

1

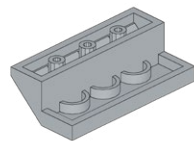

2

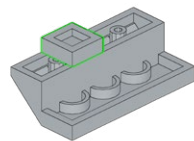

599

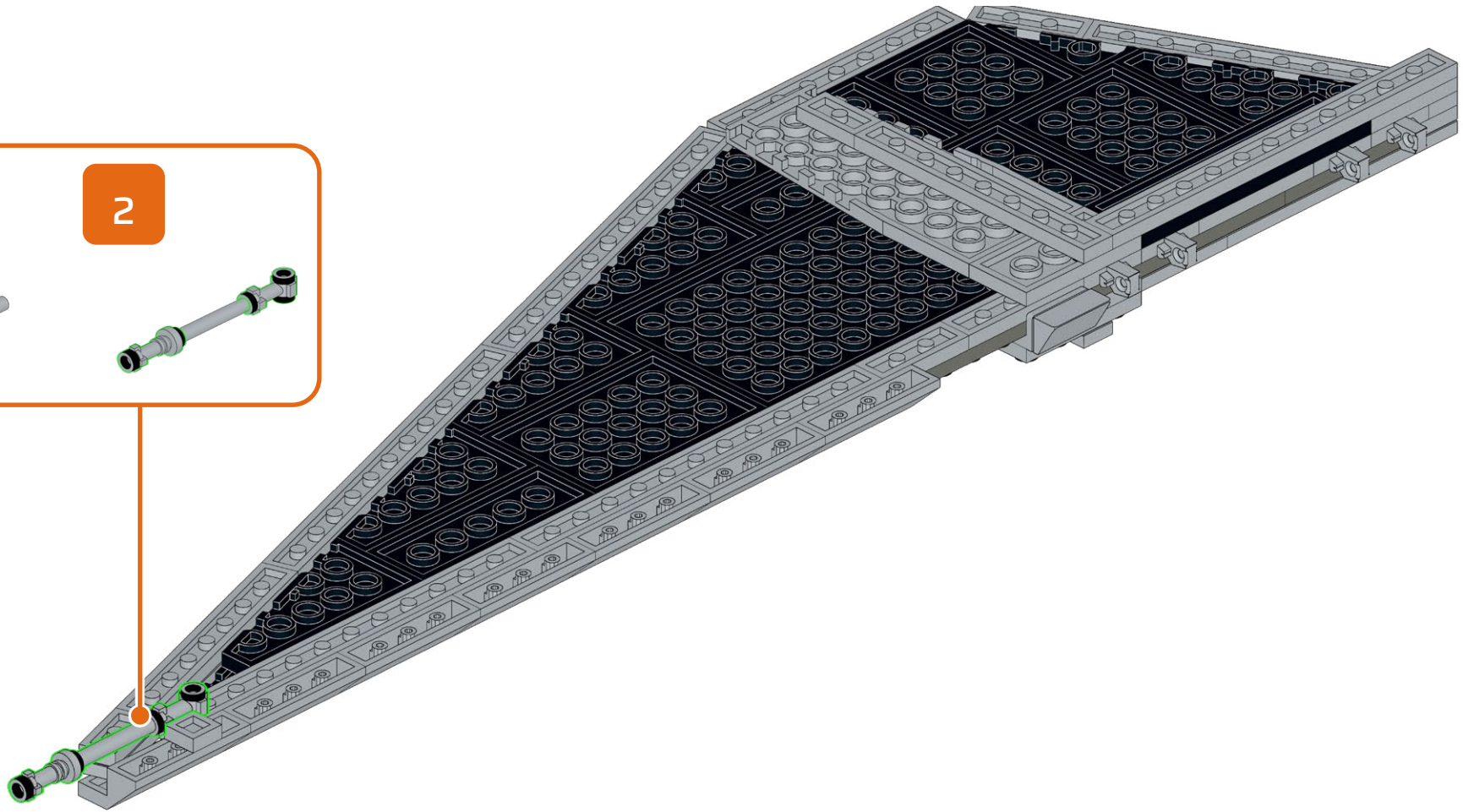
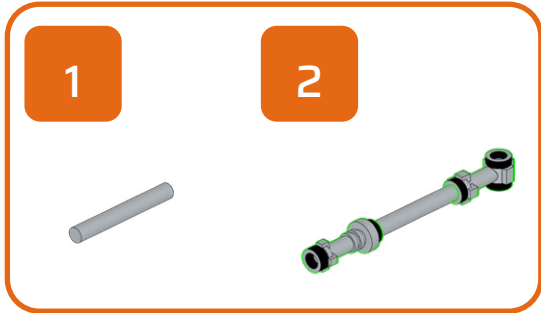
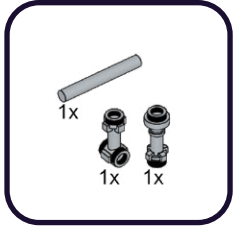

600

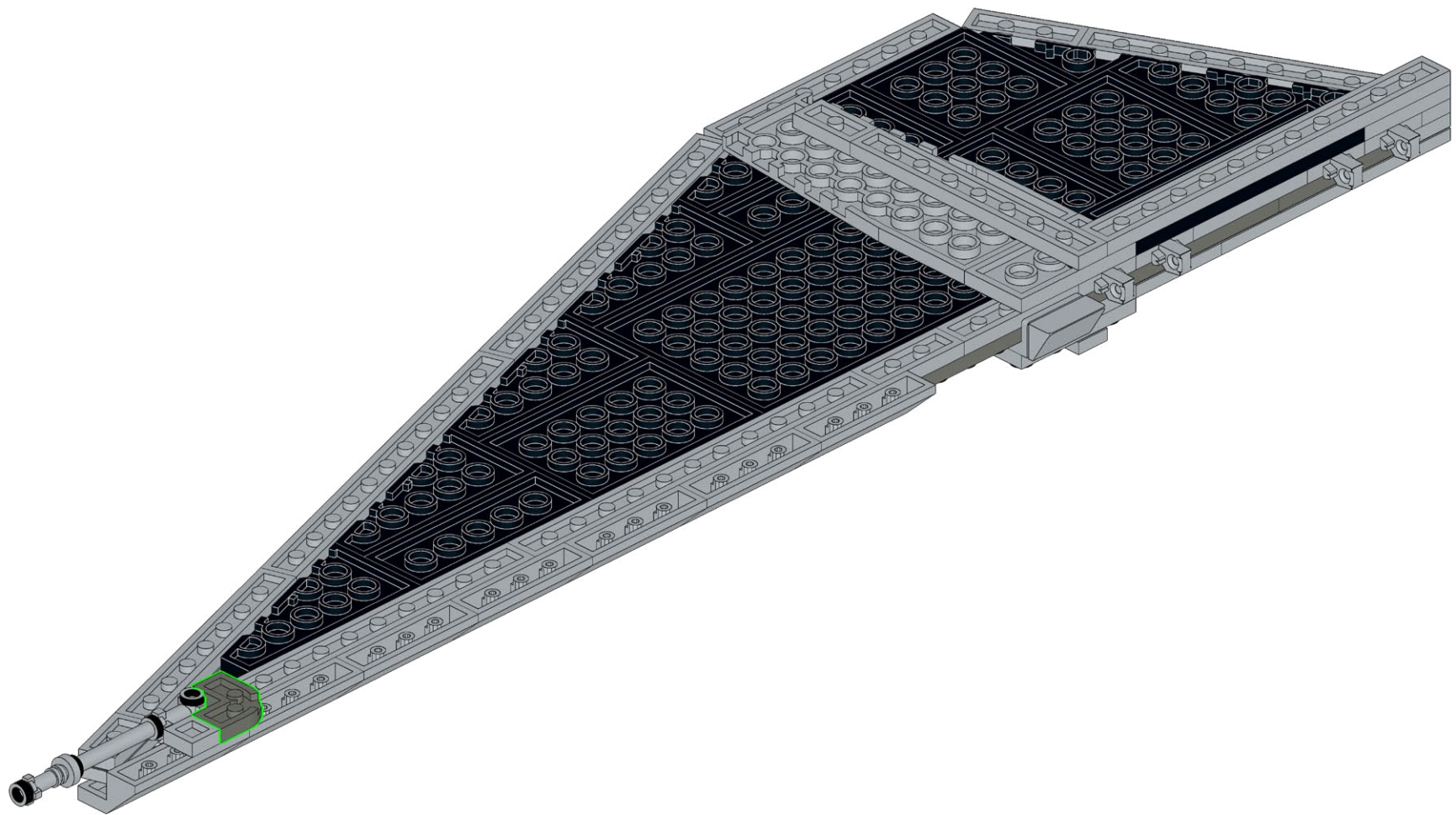
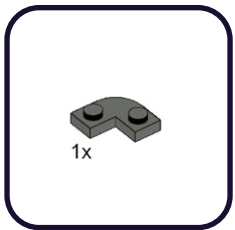



601

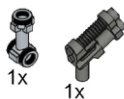

1

2

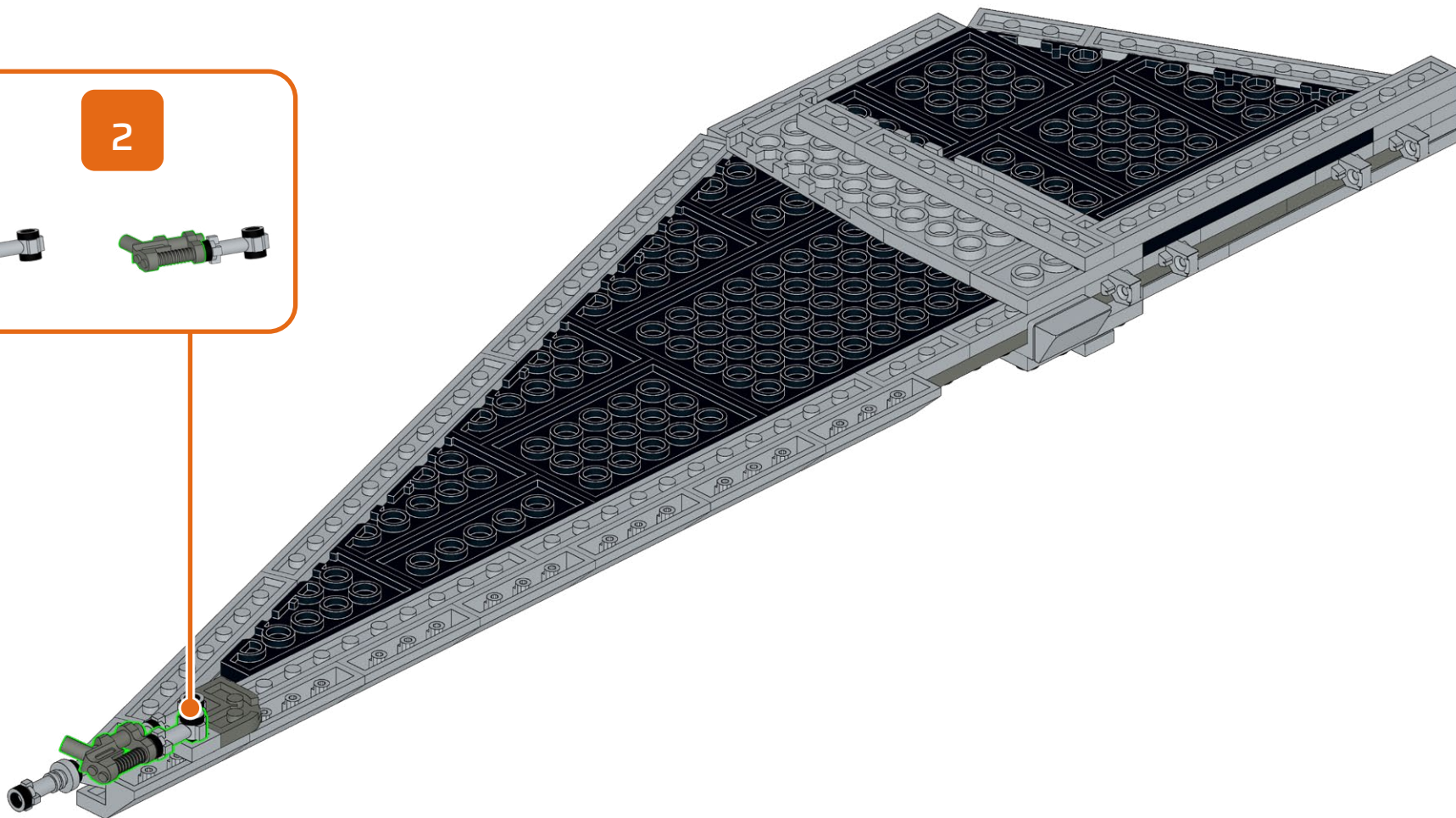

602

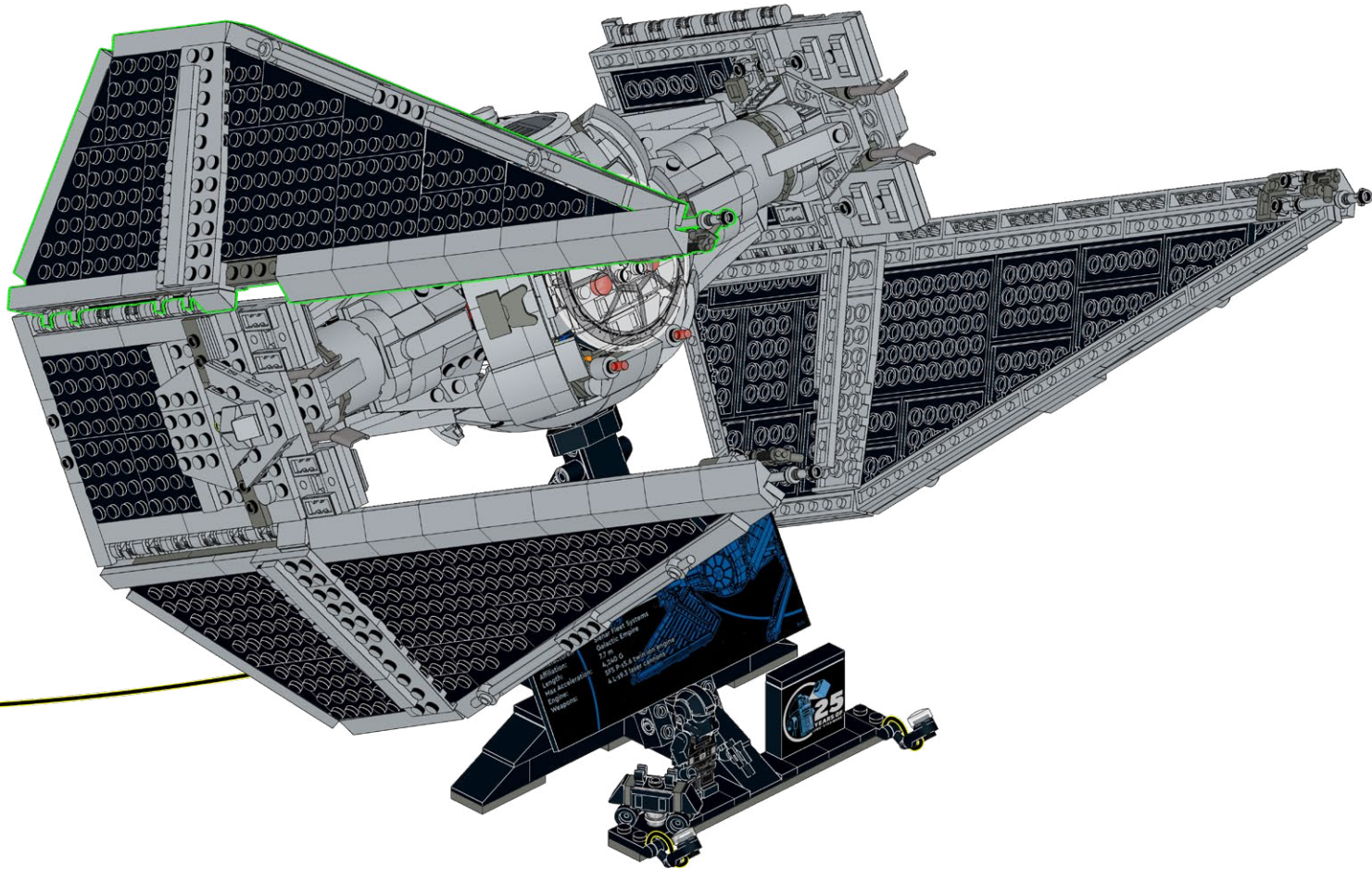



603

1x

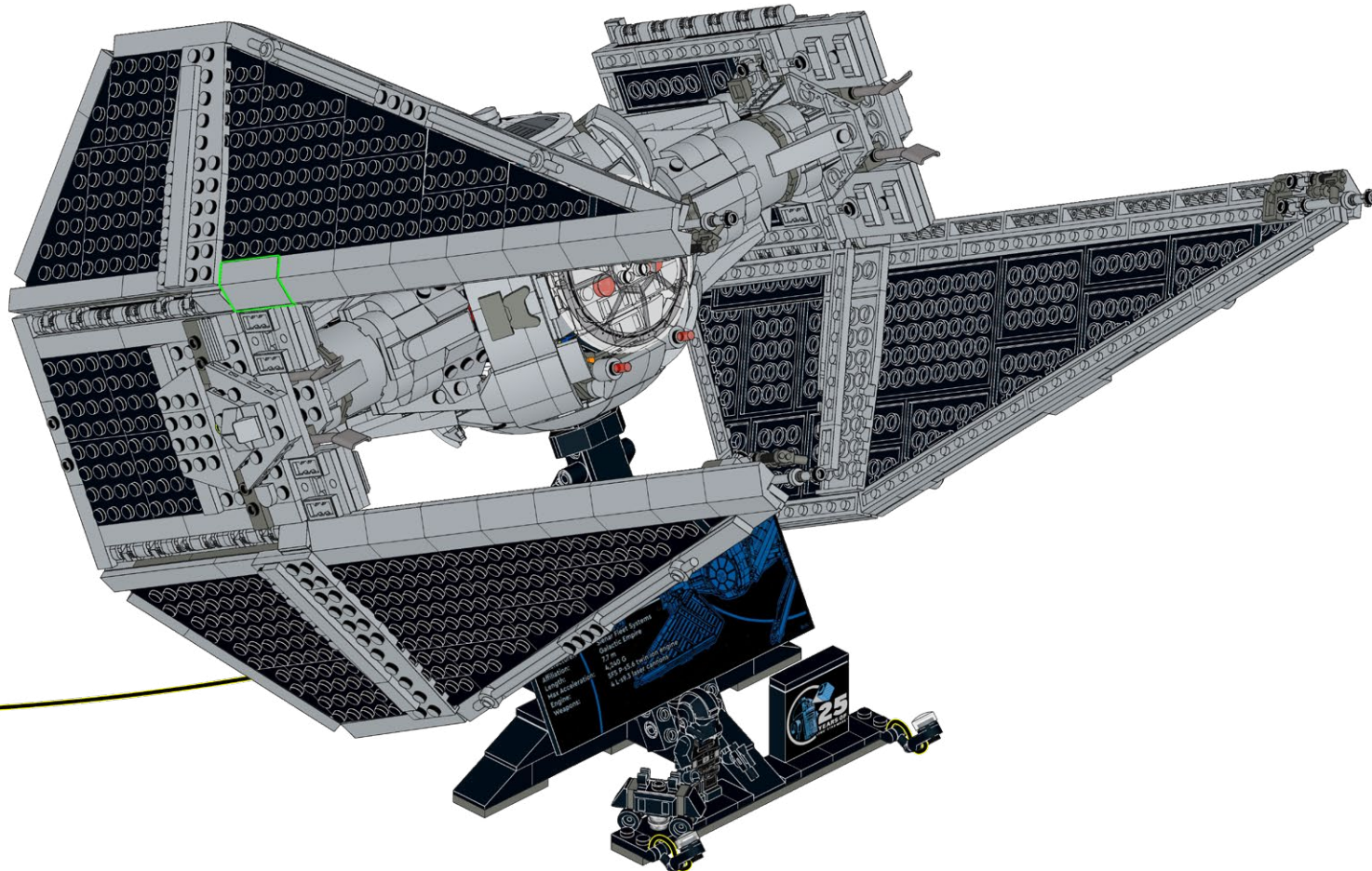

# 604

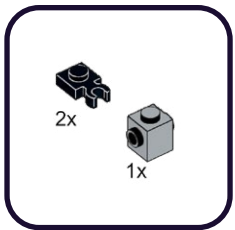

1



2



# 605

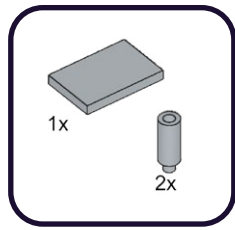

1

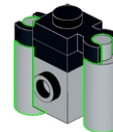

2

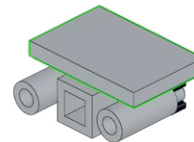
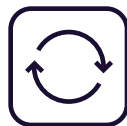

# 606

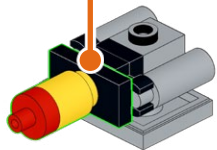
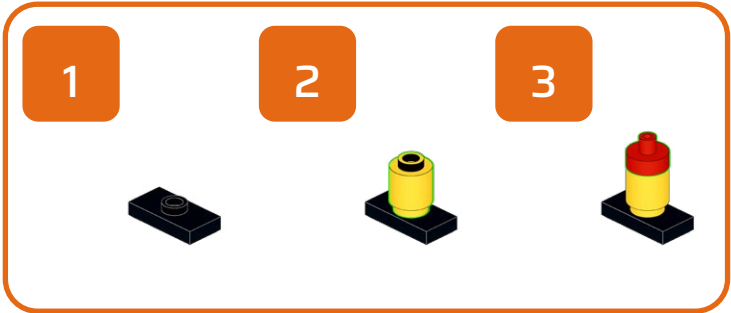
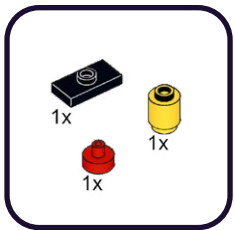

# 607

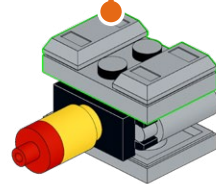
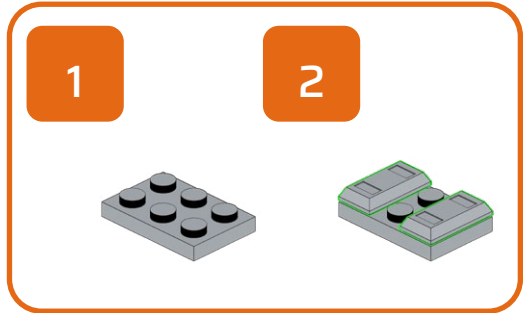
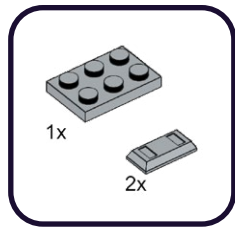

608

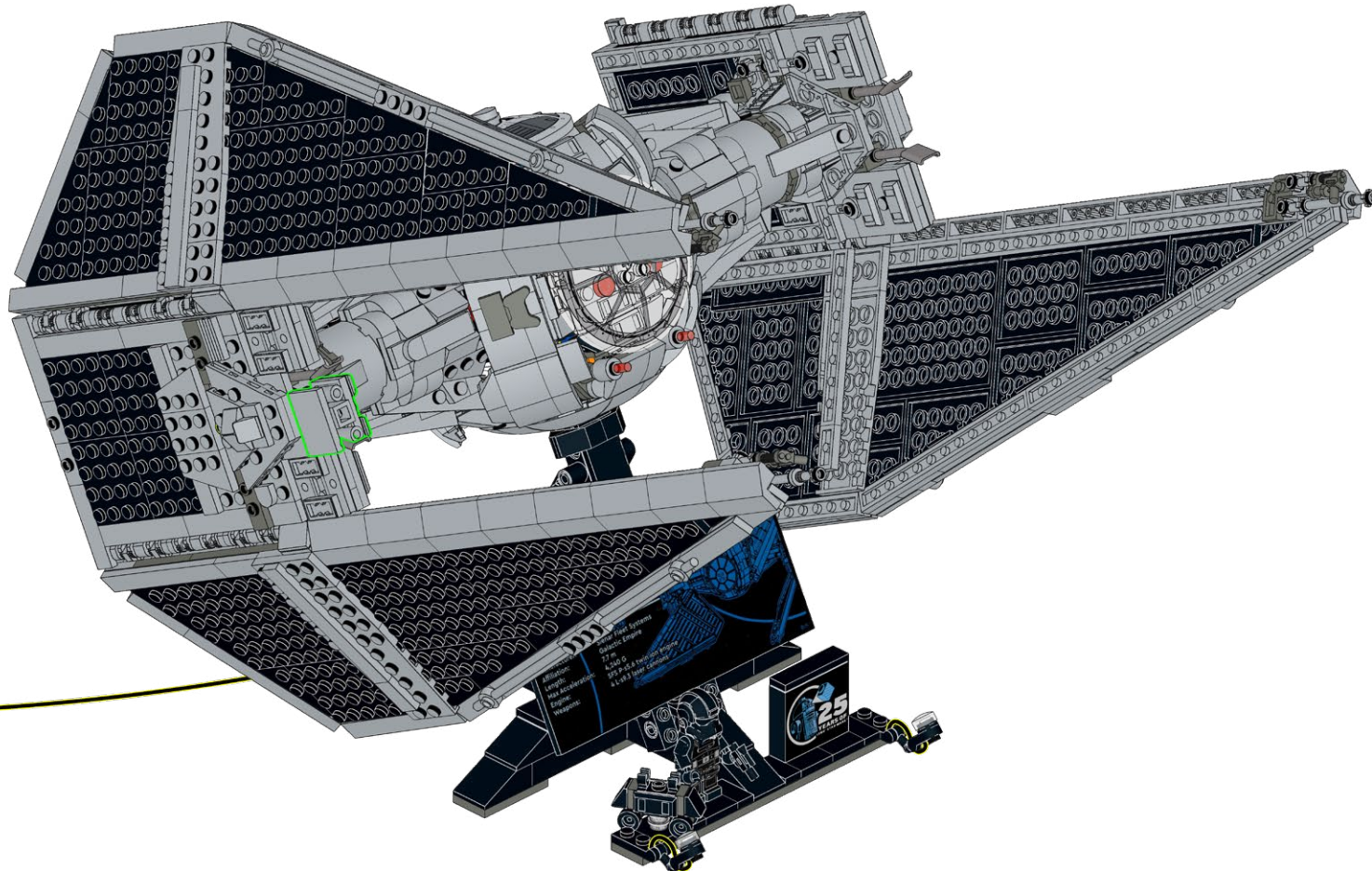



609

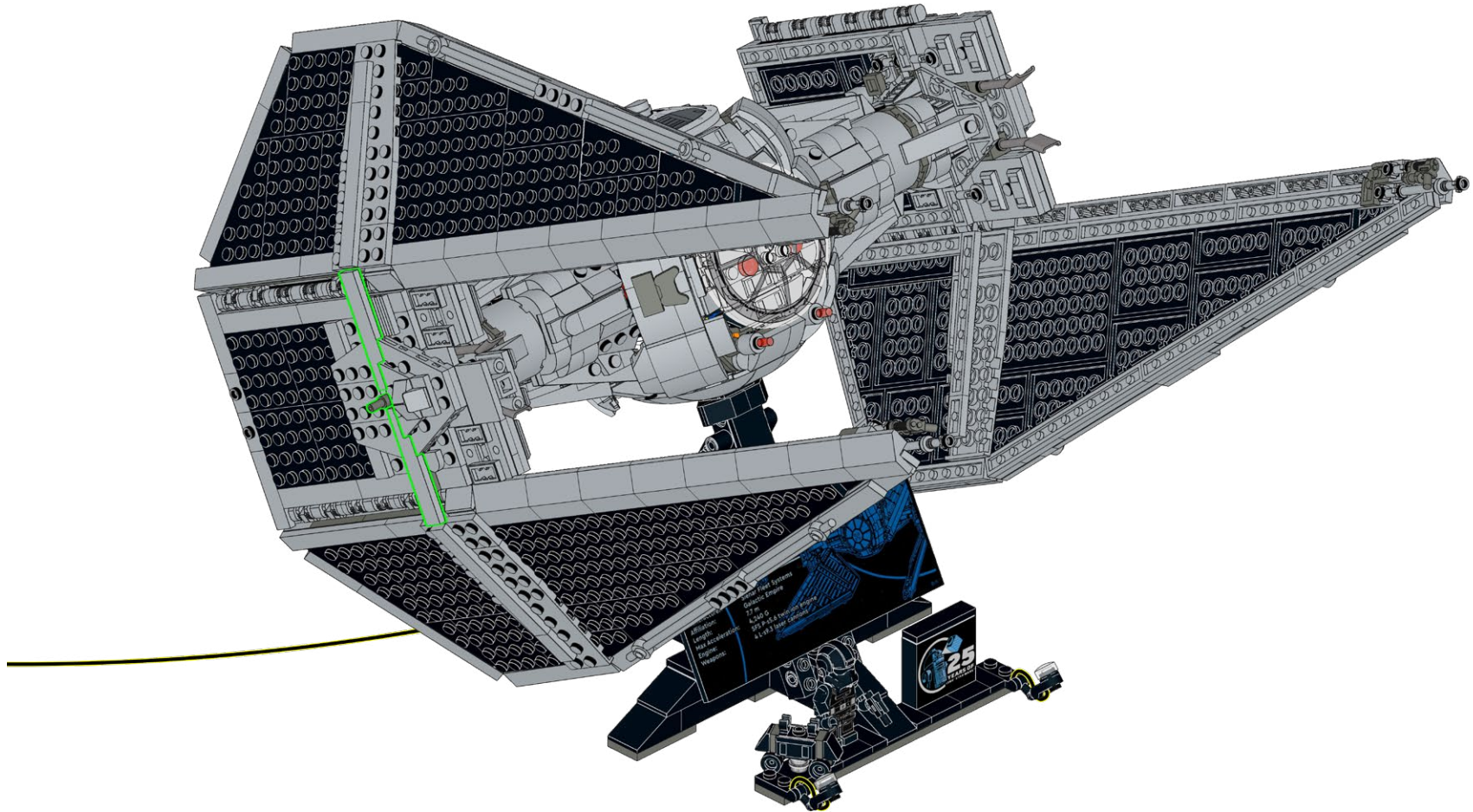
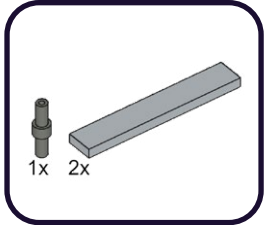



610

1x



611



1x



**HOLD UP!**

You might notice some bags are out of order, as well as left over pieces, but that's ok! We're changing the way you build LEGO!

**HALTEN!**

Möglicherweise stellen Sie fest, dass einige Beutel nicht in Ordnung sind und auch Teile übrig bleiben, aber das ist in Ordnung! Wir verändern die Art und Weise, wie Sie LEGO bauen!

**TENIR BON!**

Vous remarquerez peut-être que certains sacs sont en panne, ainsi que des morceaux restants, mais ce n'est pas grave ! Nous changeons la façon dont vous construisez LEGO !

**SOSTENERE!**

Potresti notare che alcune borse sono fuori uso, così come alcuni pezzi avanzati, ma va bene! Stiamo cambiando il modo in cui costruisci i LEGO!

**¡SOSTENER!**

Puede que notes que algunas bolsas están fuera de orden, así como piezas sobrantes, ¡pero está bien! ¡Estamos cambiando la forma de construir LEGO!

**耽误!**

您可能会注意到有些袋子坏了, 还有剩余的碎片, 但这没关系! 我们正在改变您搭建乐高的方式!

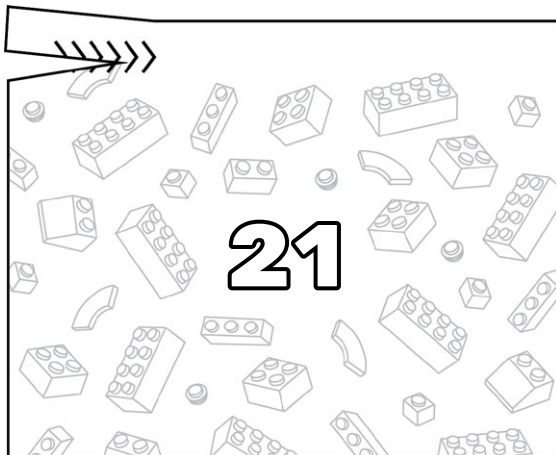
**Open LEGO® Bag 1**

612

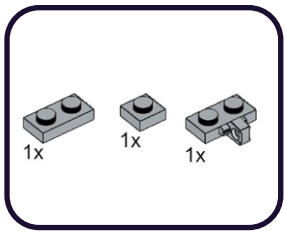

1



2

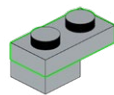

3

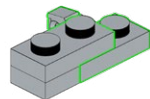



613

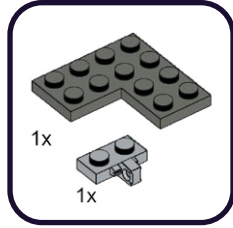

1

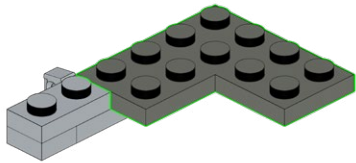

2

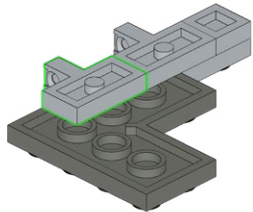

614

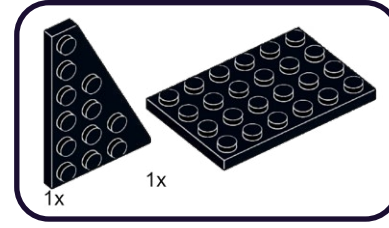

1

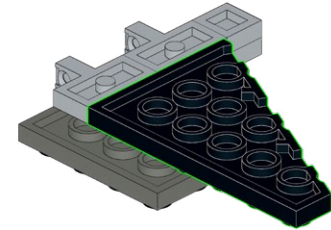

2

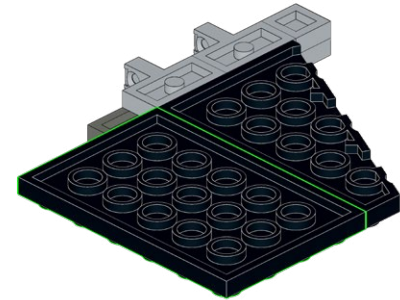



615

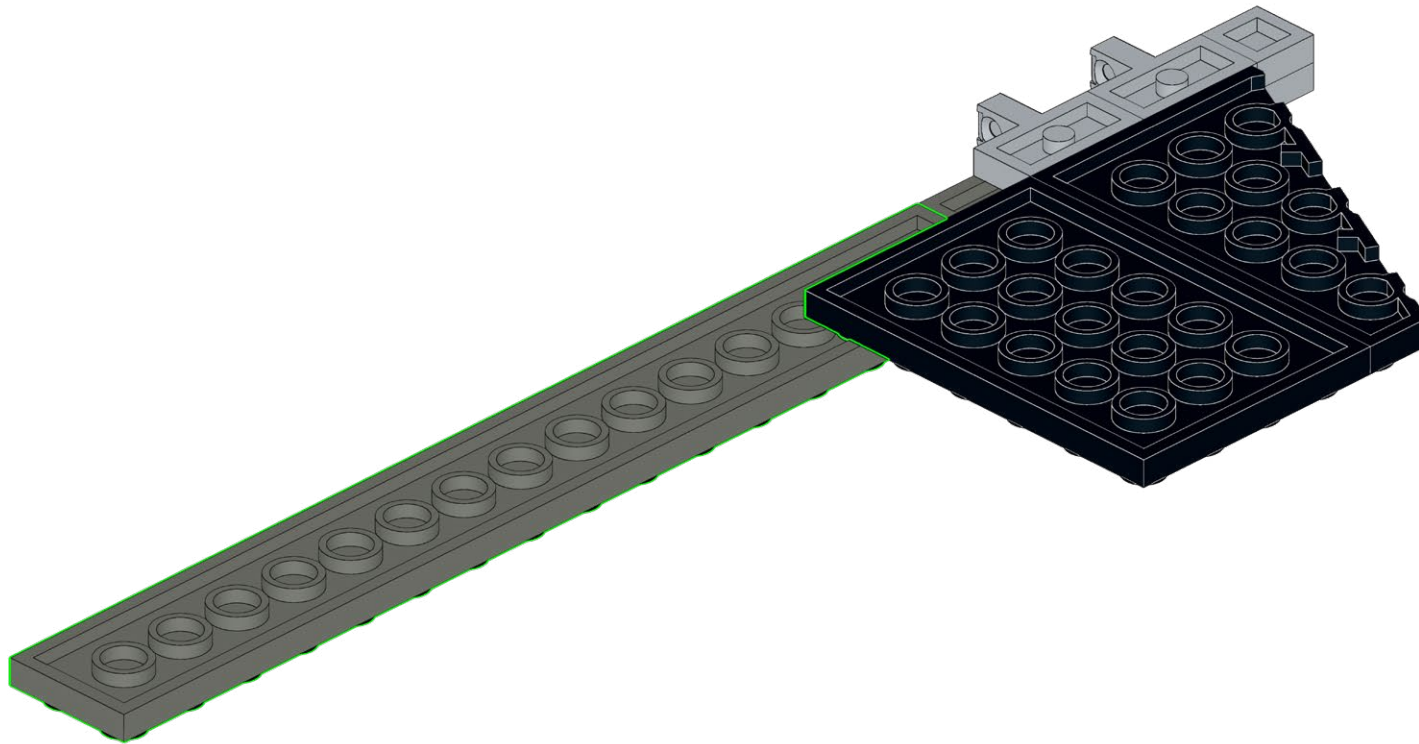
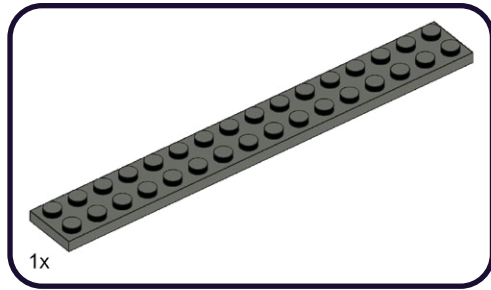

616

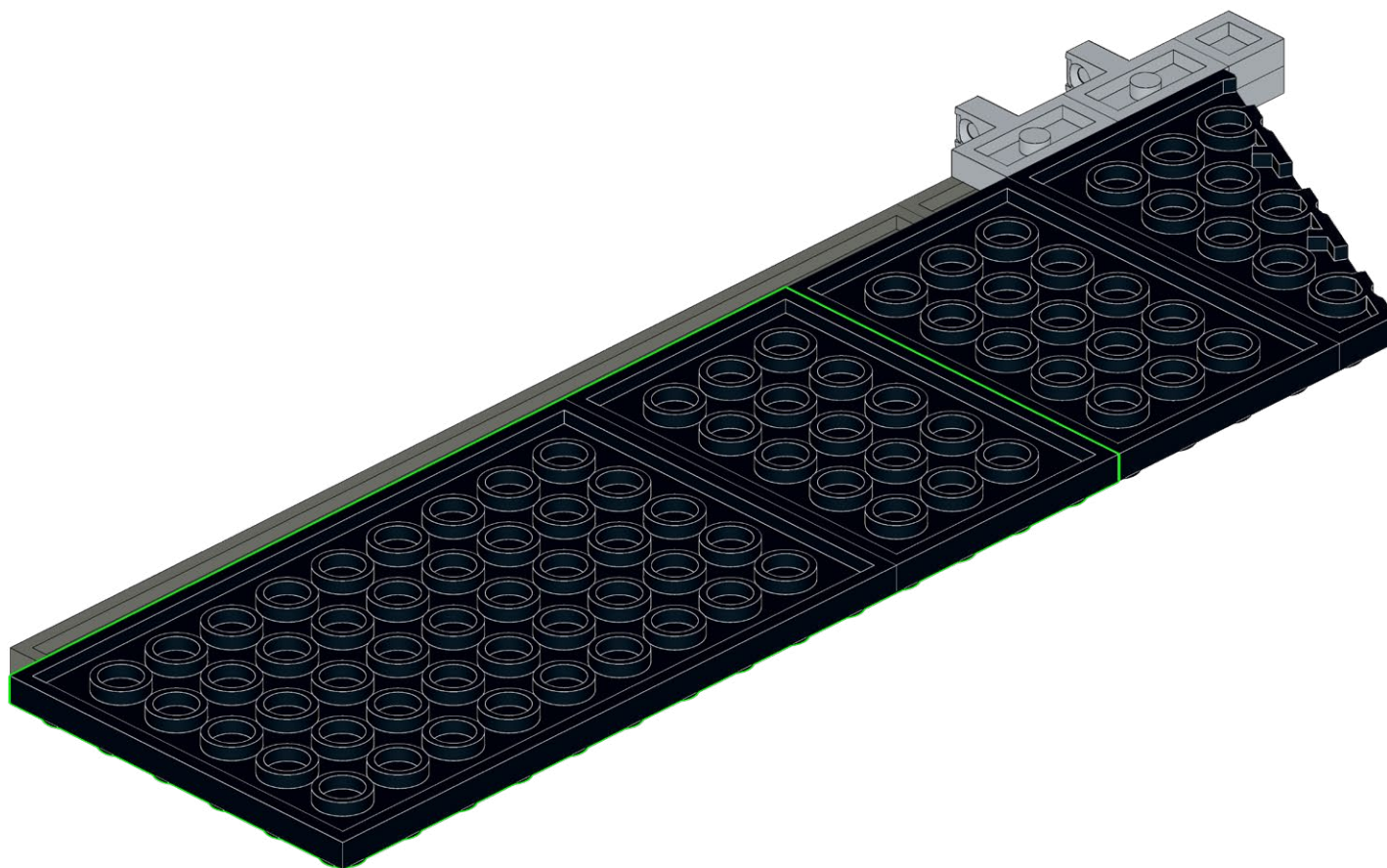
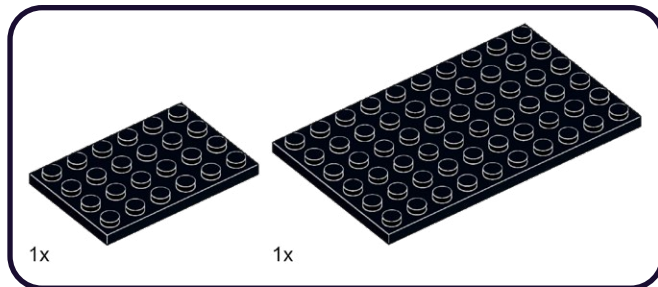

617

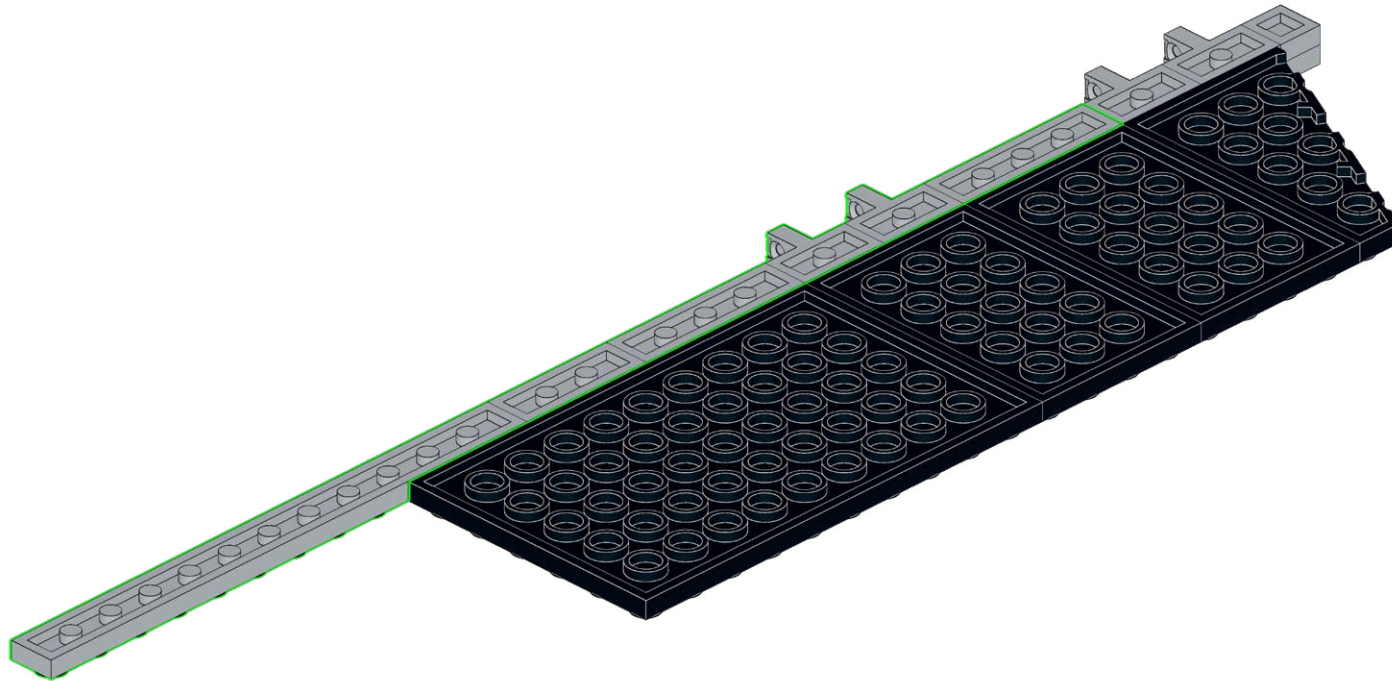
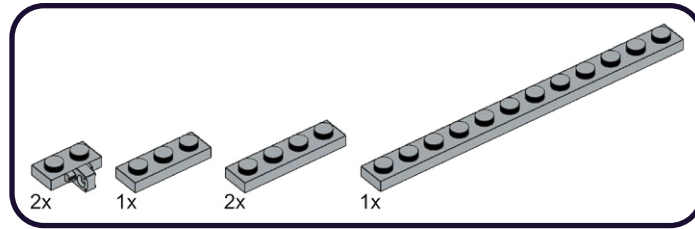

618

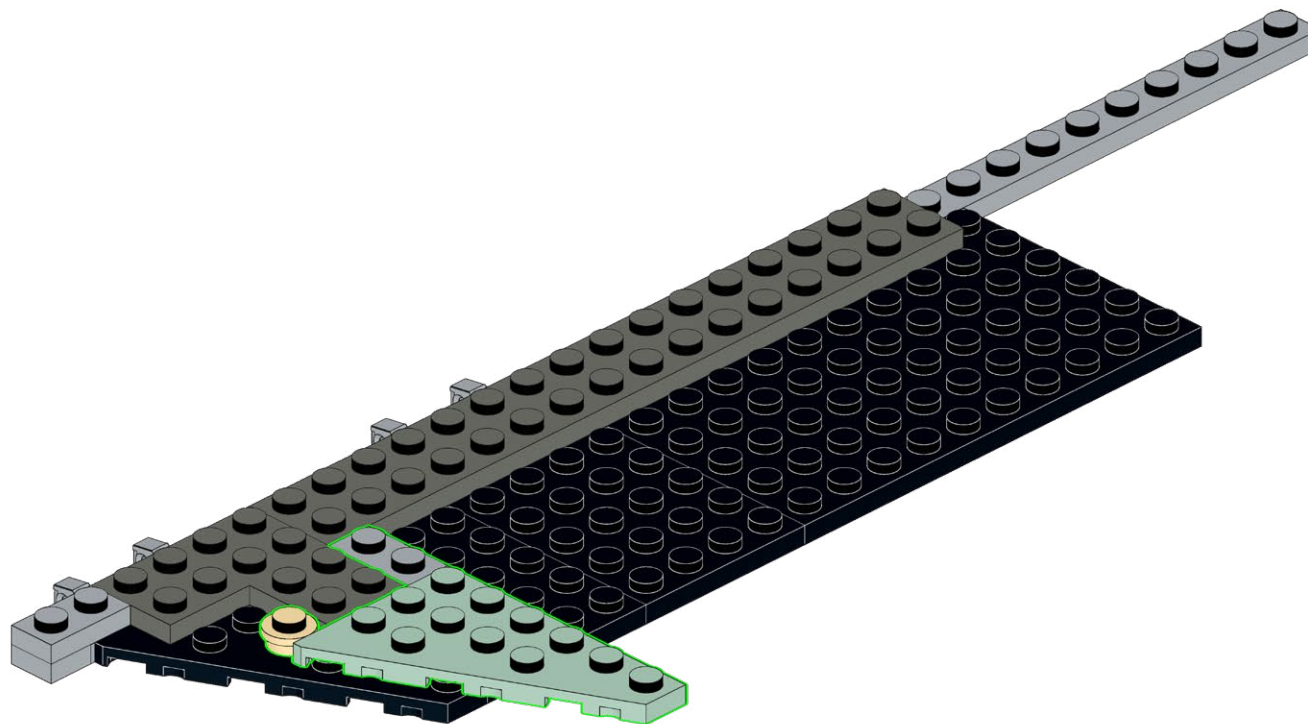
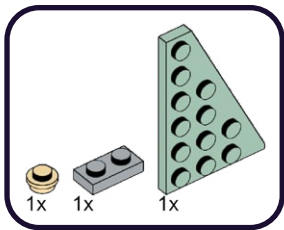

619

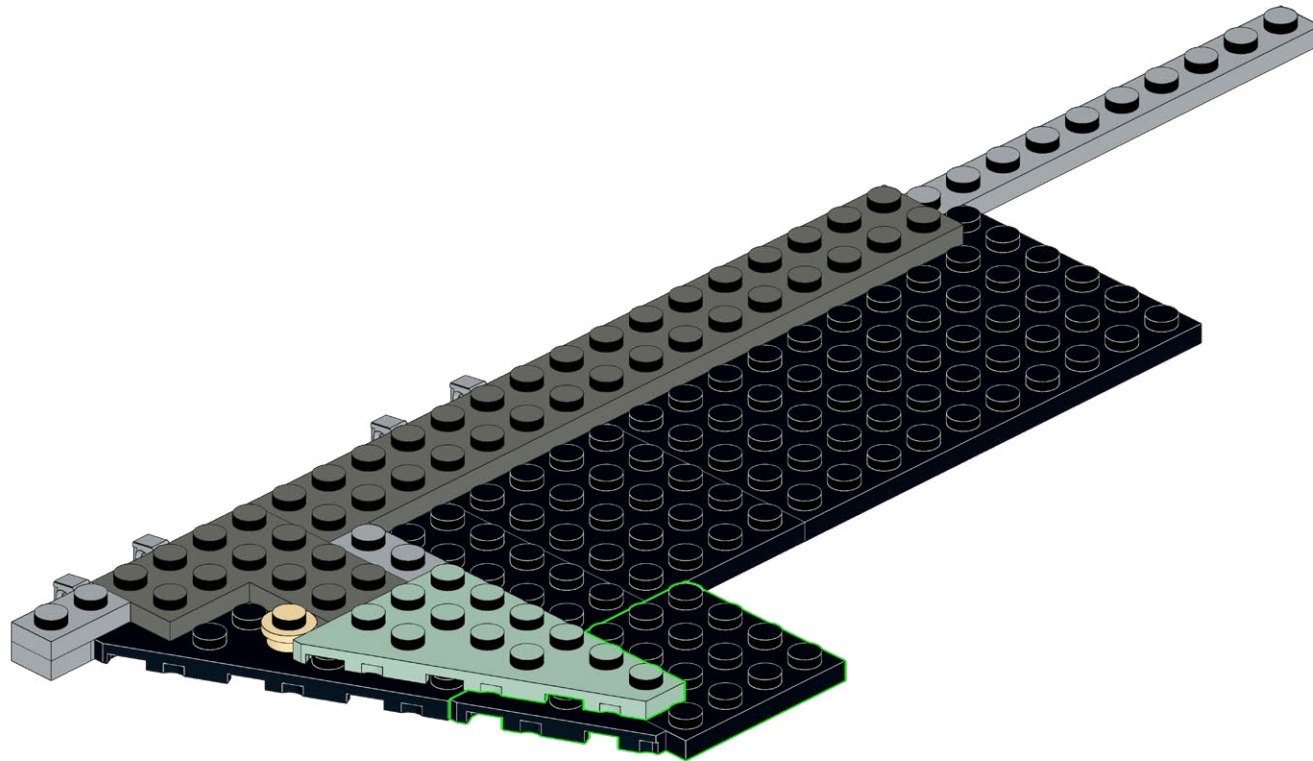
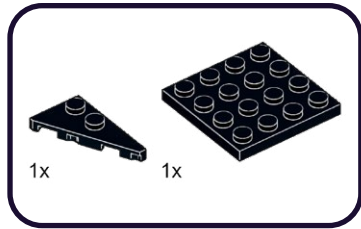



620

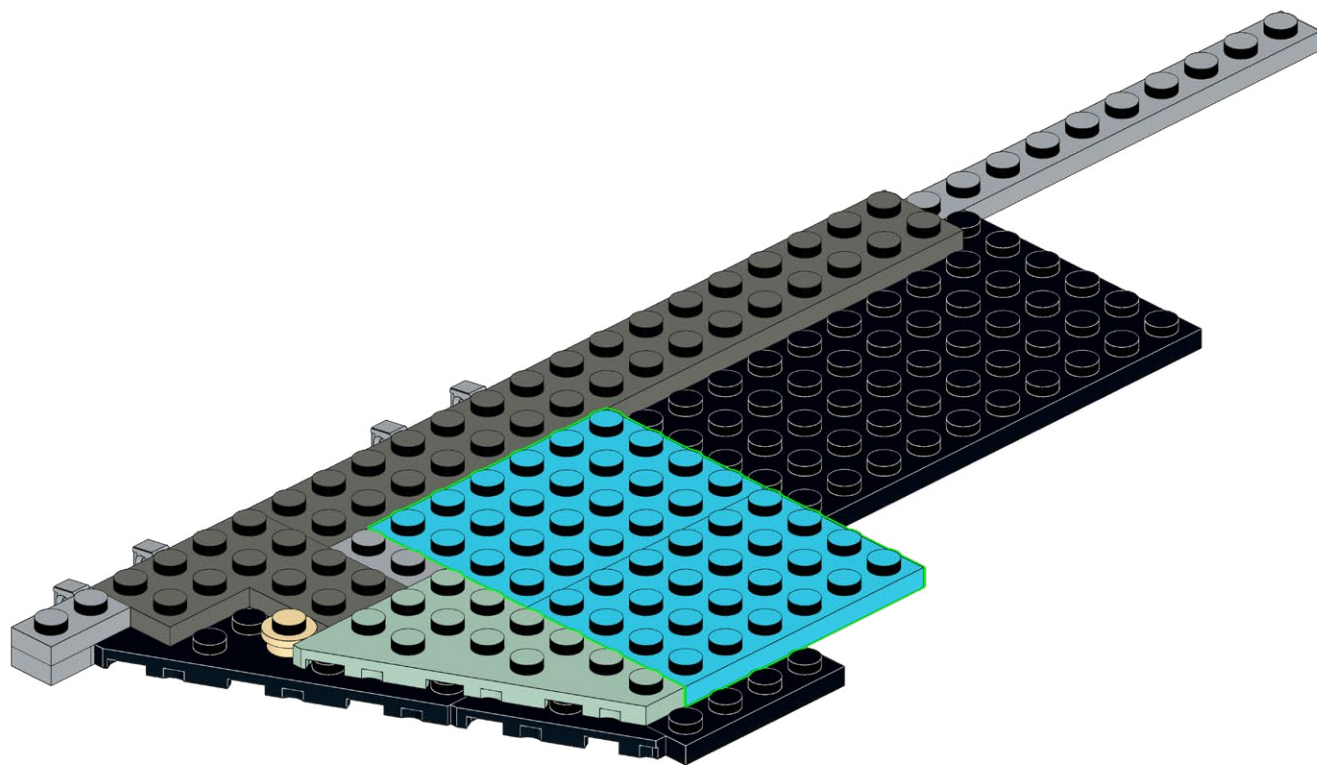
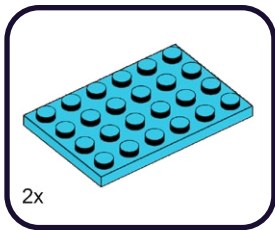

621

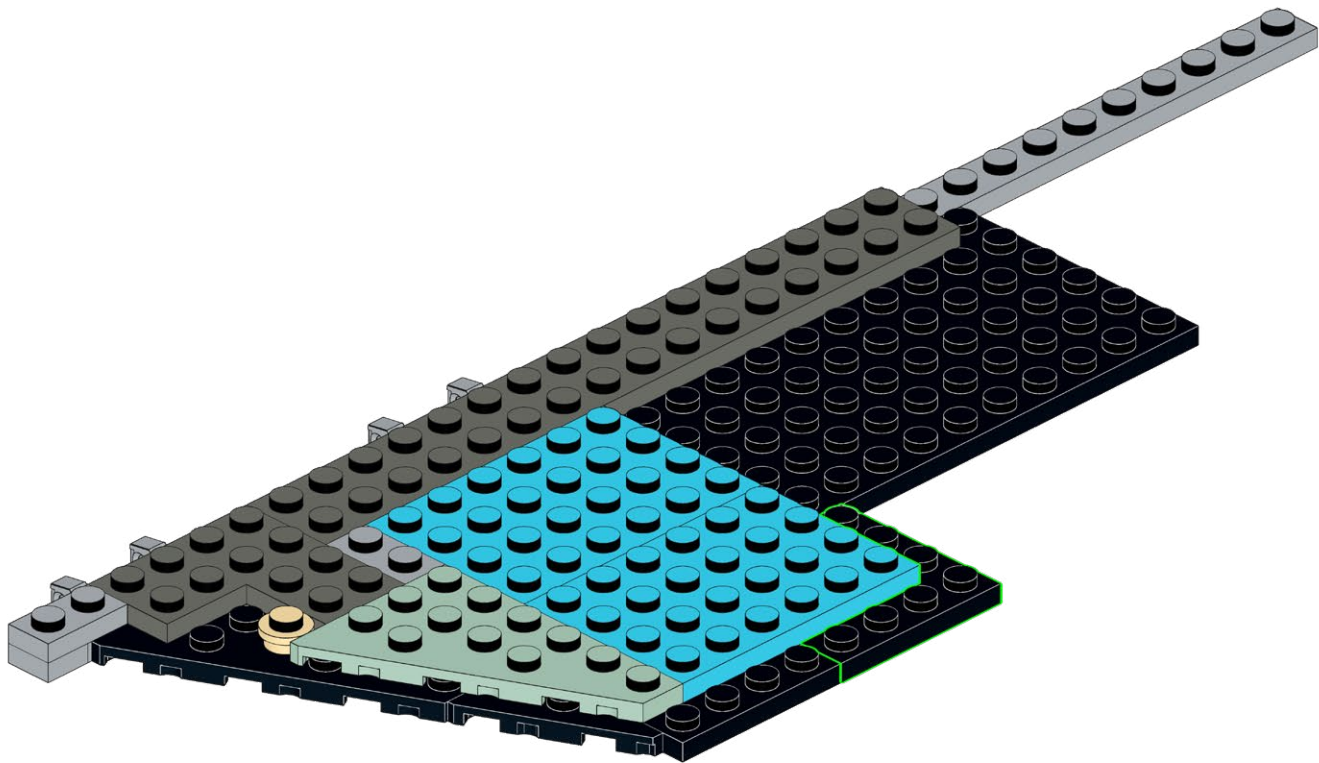

622

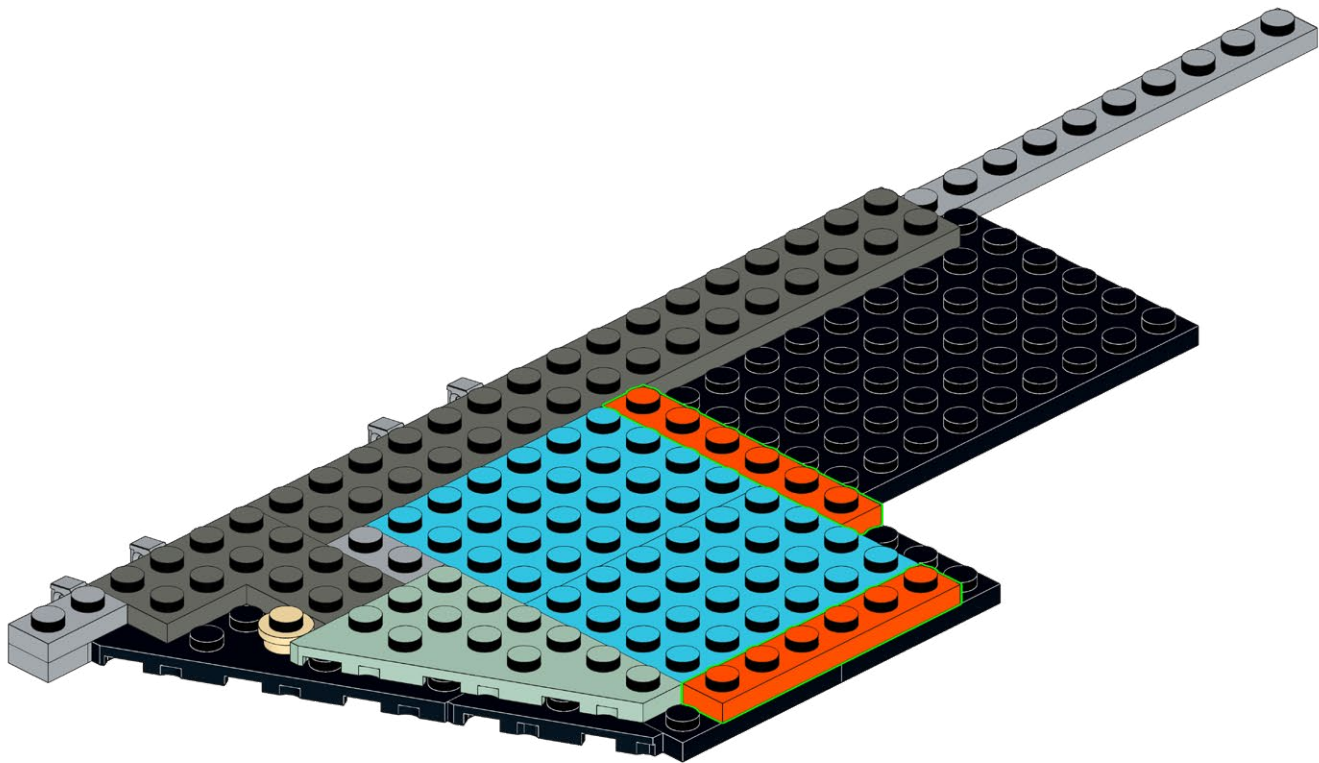
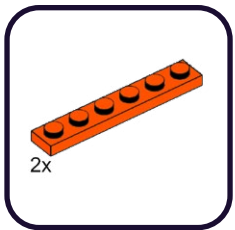

623

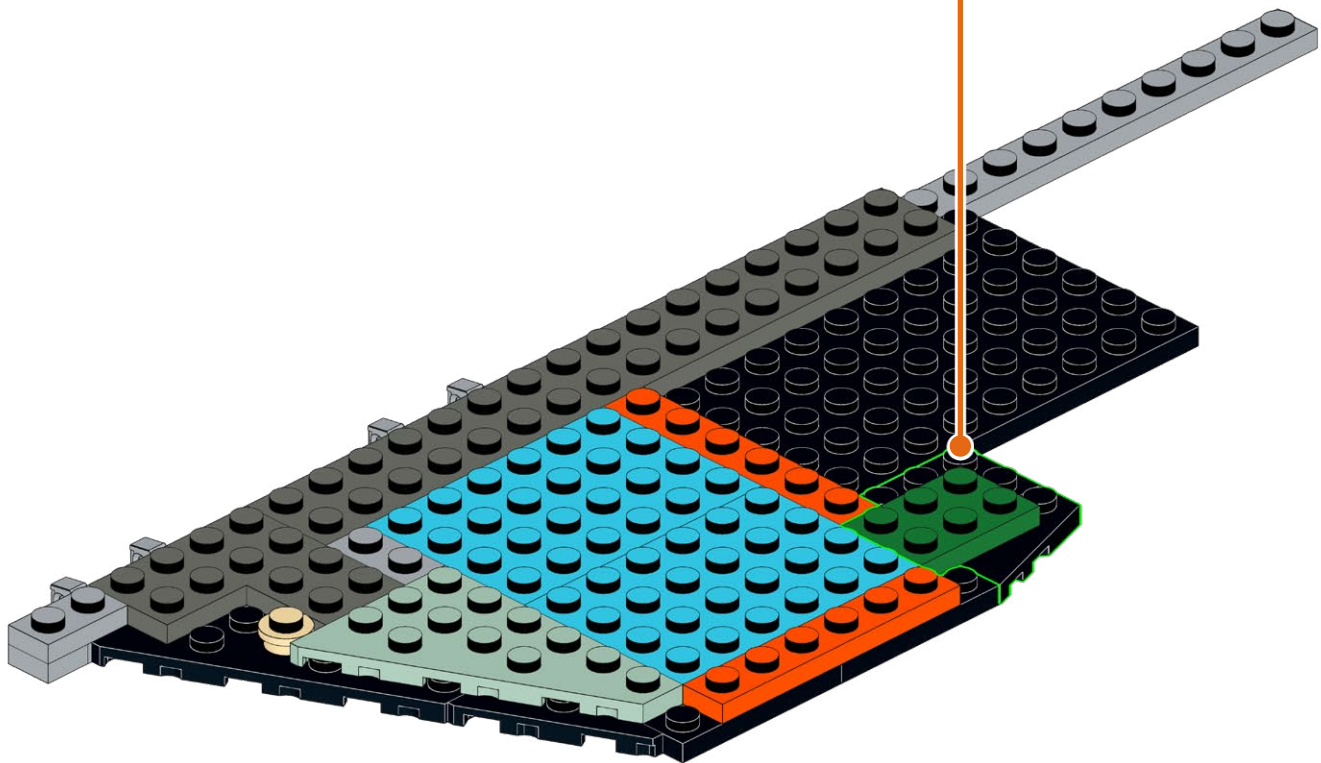
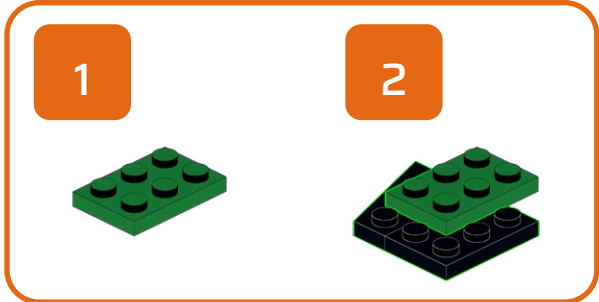

624

1x

2x





625

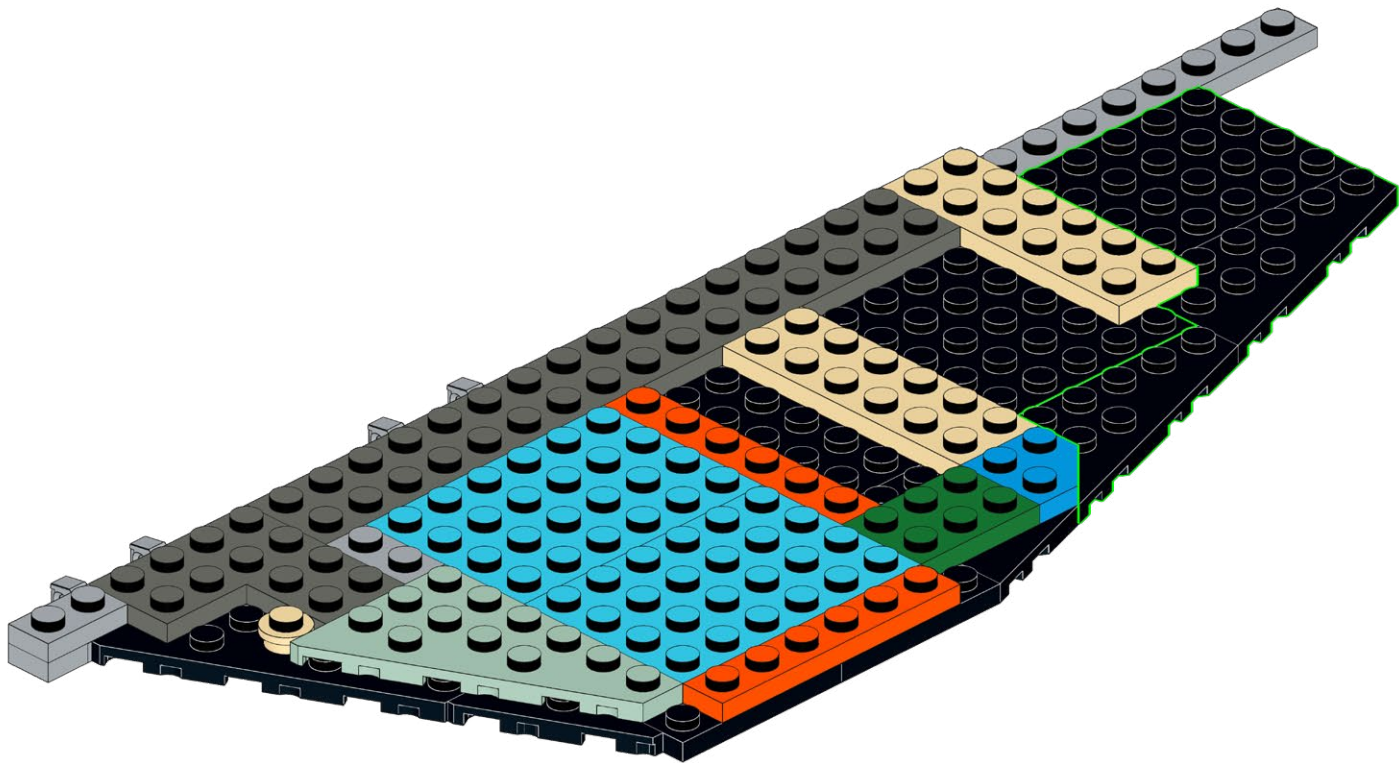
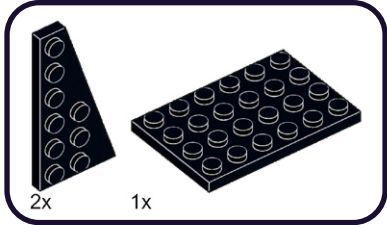

626

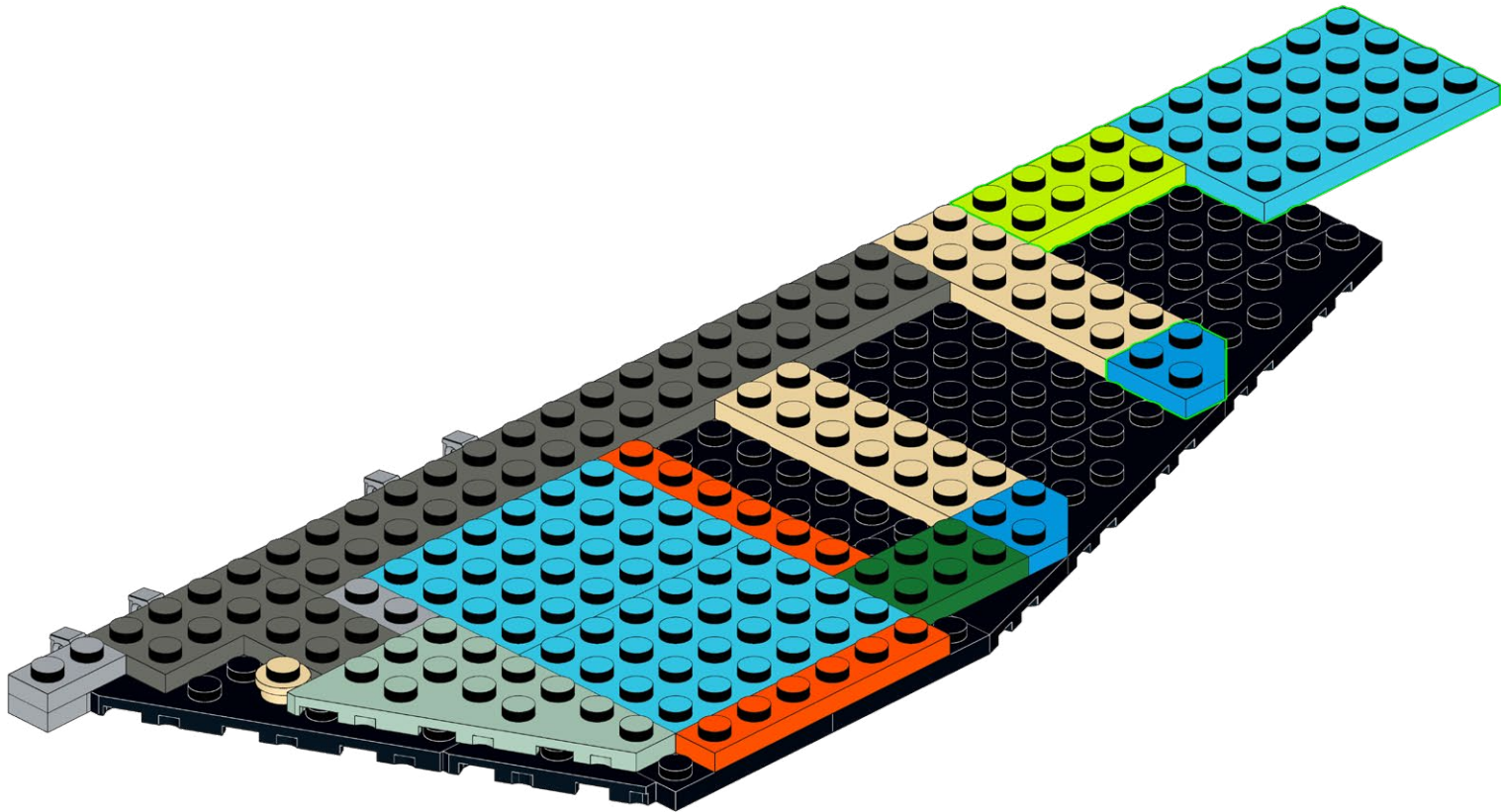
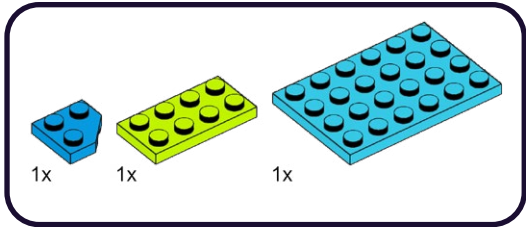

627

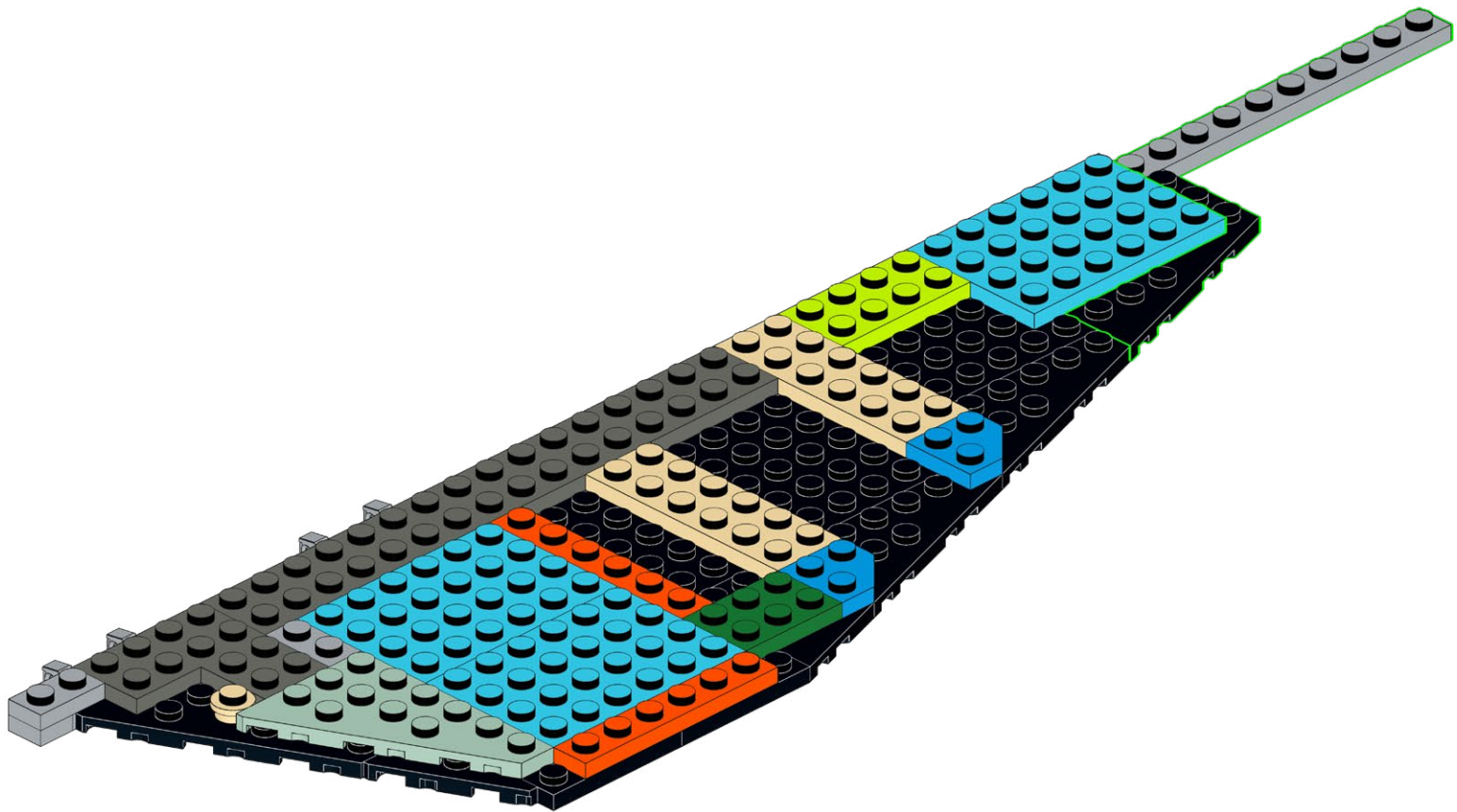
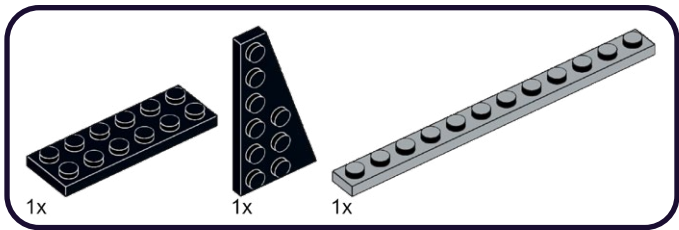

628

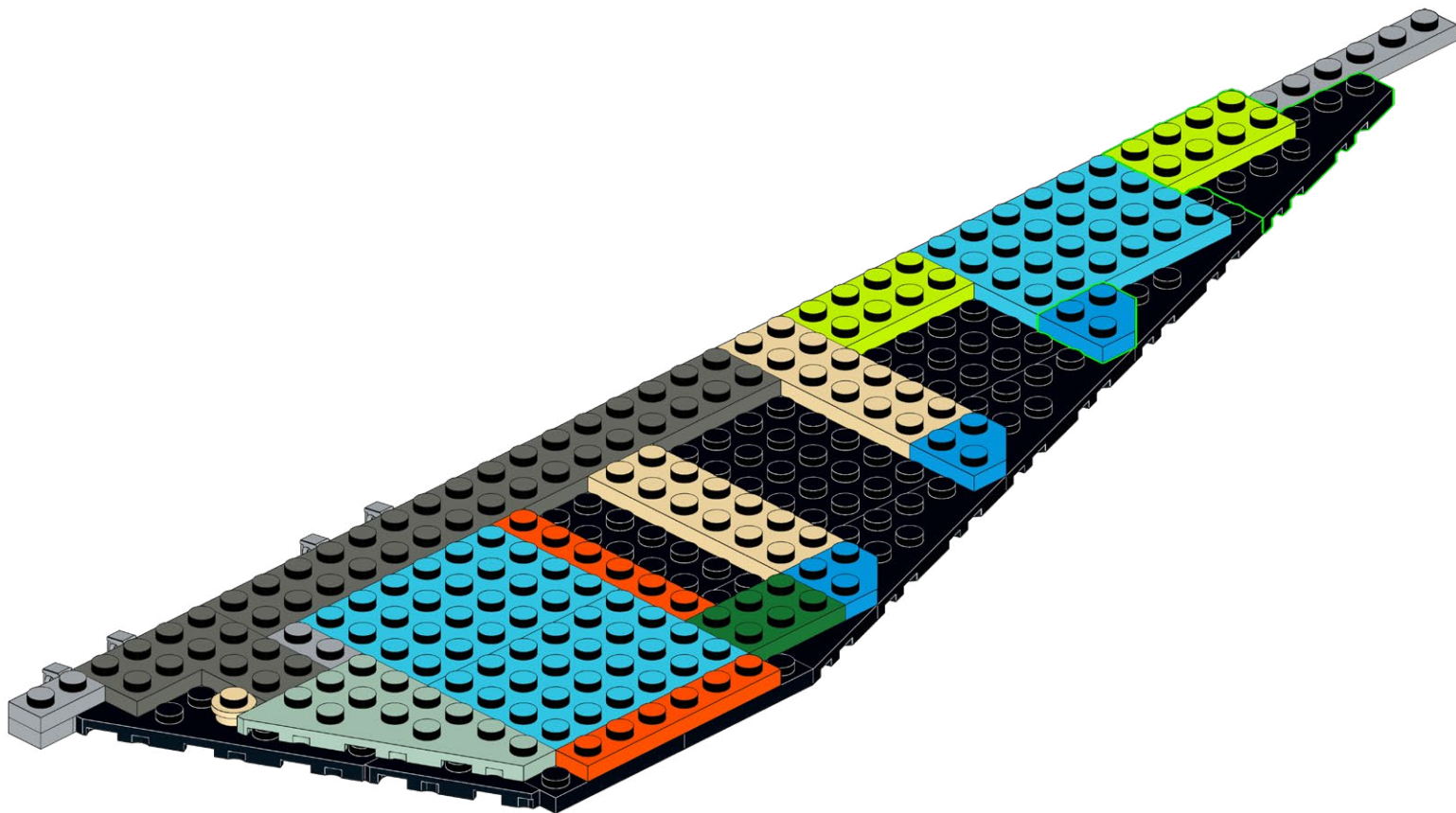
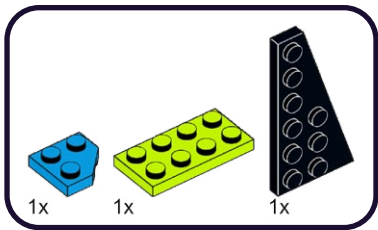



629

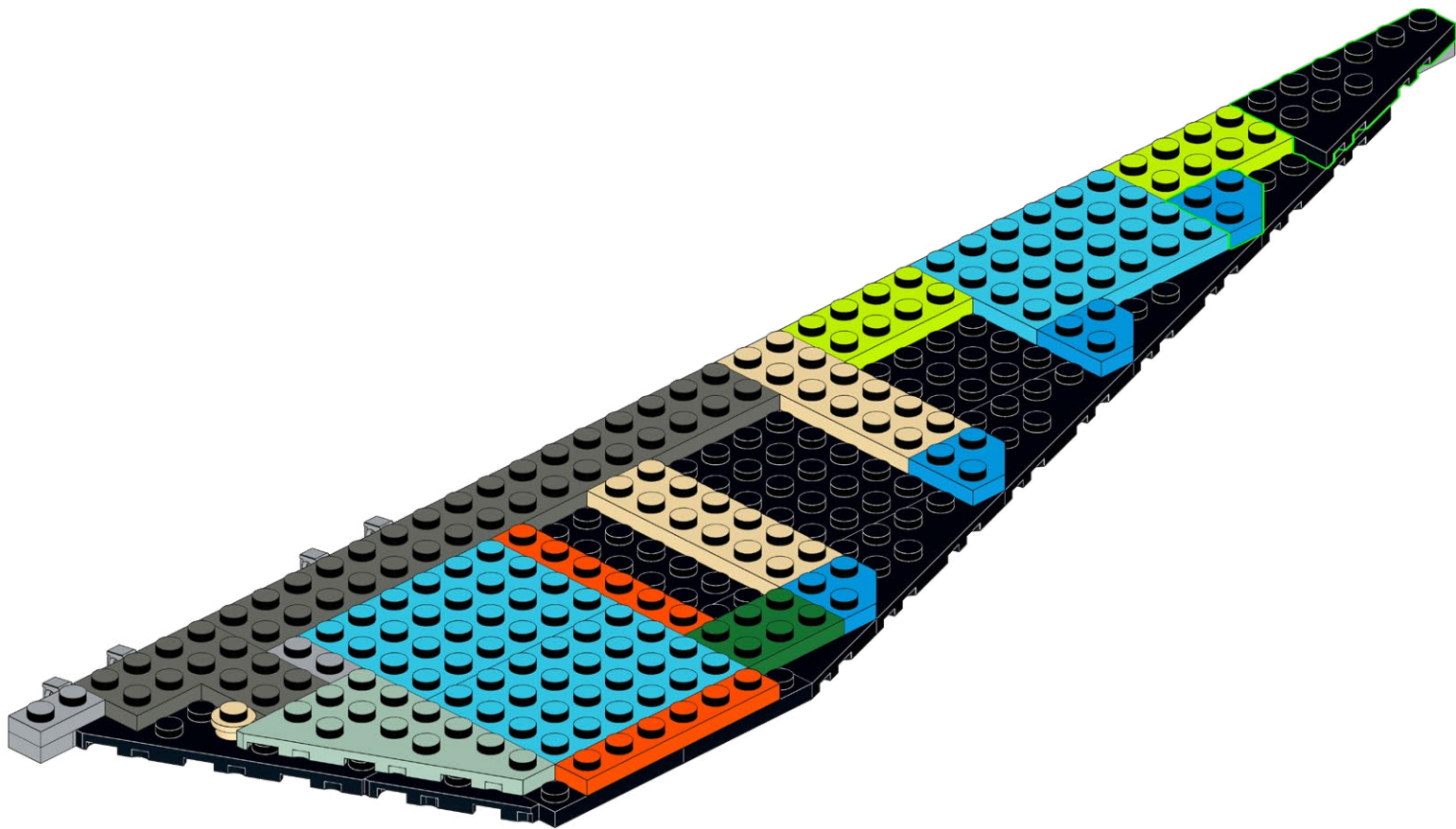
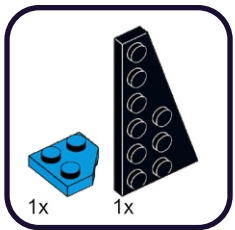



630

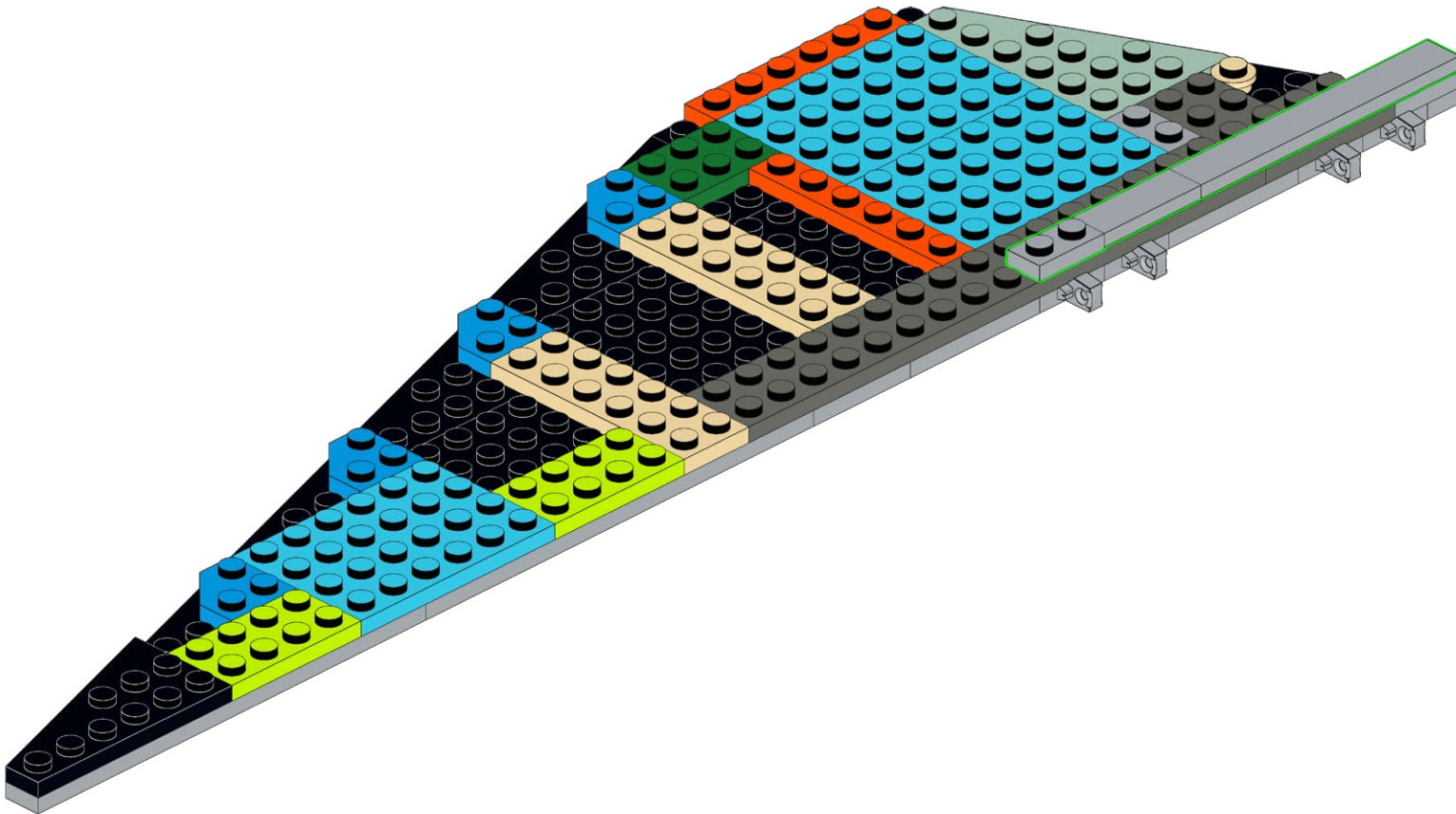
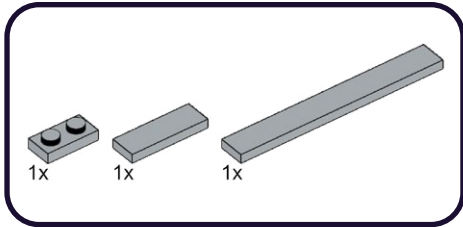

631

1x

1x

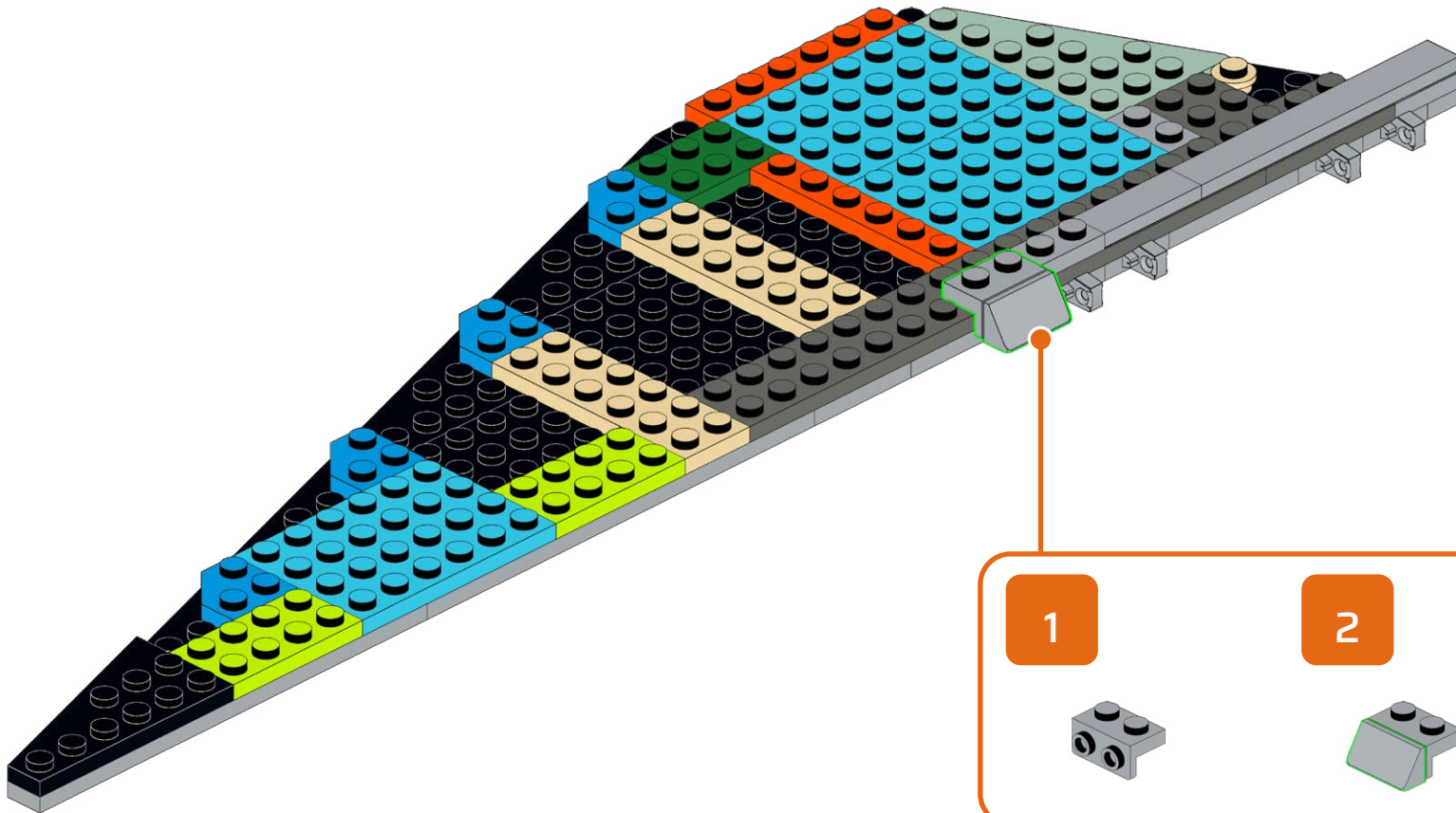

1

2

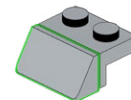
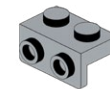

632

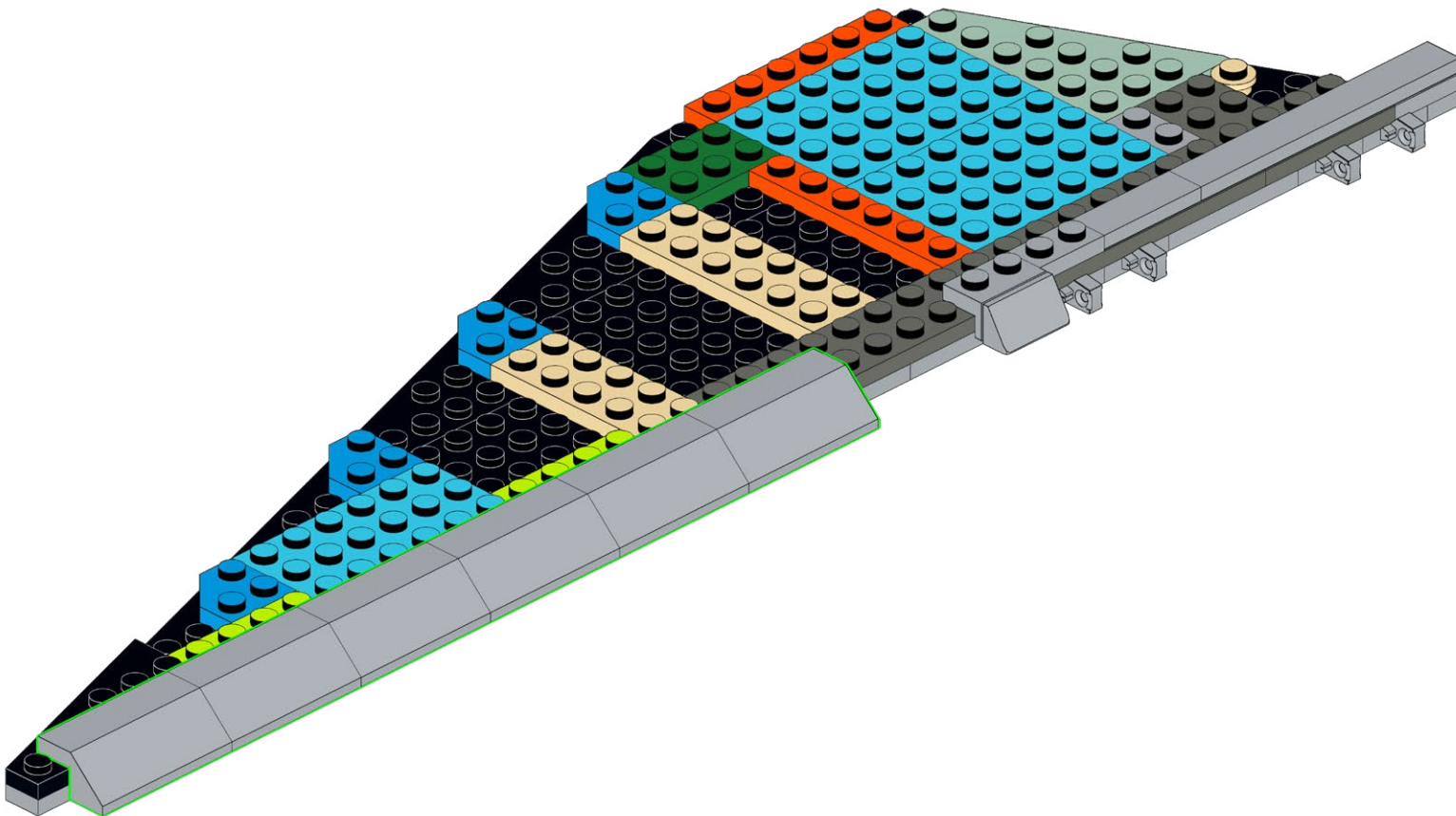
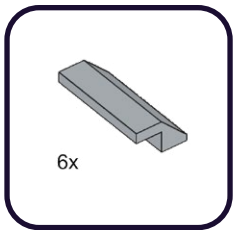

**HOLD UP!**

You might notice some bags are out of order, as well as left over pieces, but that's ok! We're changing the way you build LEGO!

**HALTEN!**

Möglicherweise stellen Sie fest, dass einige Beutel nicht in Ordnung sind und auch Teile übrig bleiben, aber das ist in Ordnung! Wir verändern die Art und Weise, wie Sie LEGO bauen!

**TENIR BON!**

Vous remarquerez peut-être que certains sacs sont en panne, ainsi que des morceaux restants, mais ce n'est pas grave ! Nous changeons la façon dont vous construisez LEGO !

**SOSTENERE!**

Potresti notare che alcune borse sono fuori uso, così come alcuni pezzi avanzati, ma va bene! Stiamo cambiando il modo in cui costruisci i LEGO!

**¡SOSTENER!**

Puede que notes que algunas bolsas están fuera de orden, así como piezas sobrantes, ¡pero está bien! ¡Estamos cambiando la forma de construir LEGO!

**耽误!**

您可能会注意到有些袋子坏了, 还有剩余的碎片, 但这没关系! 我们正在改变您搭建乐高的方式!

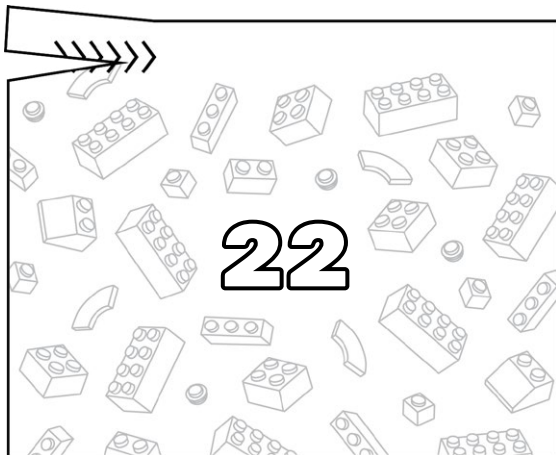
**Open LEGO® Bag 1**

633

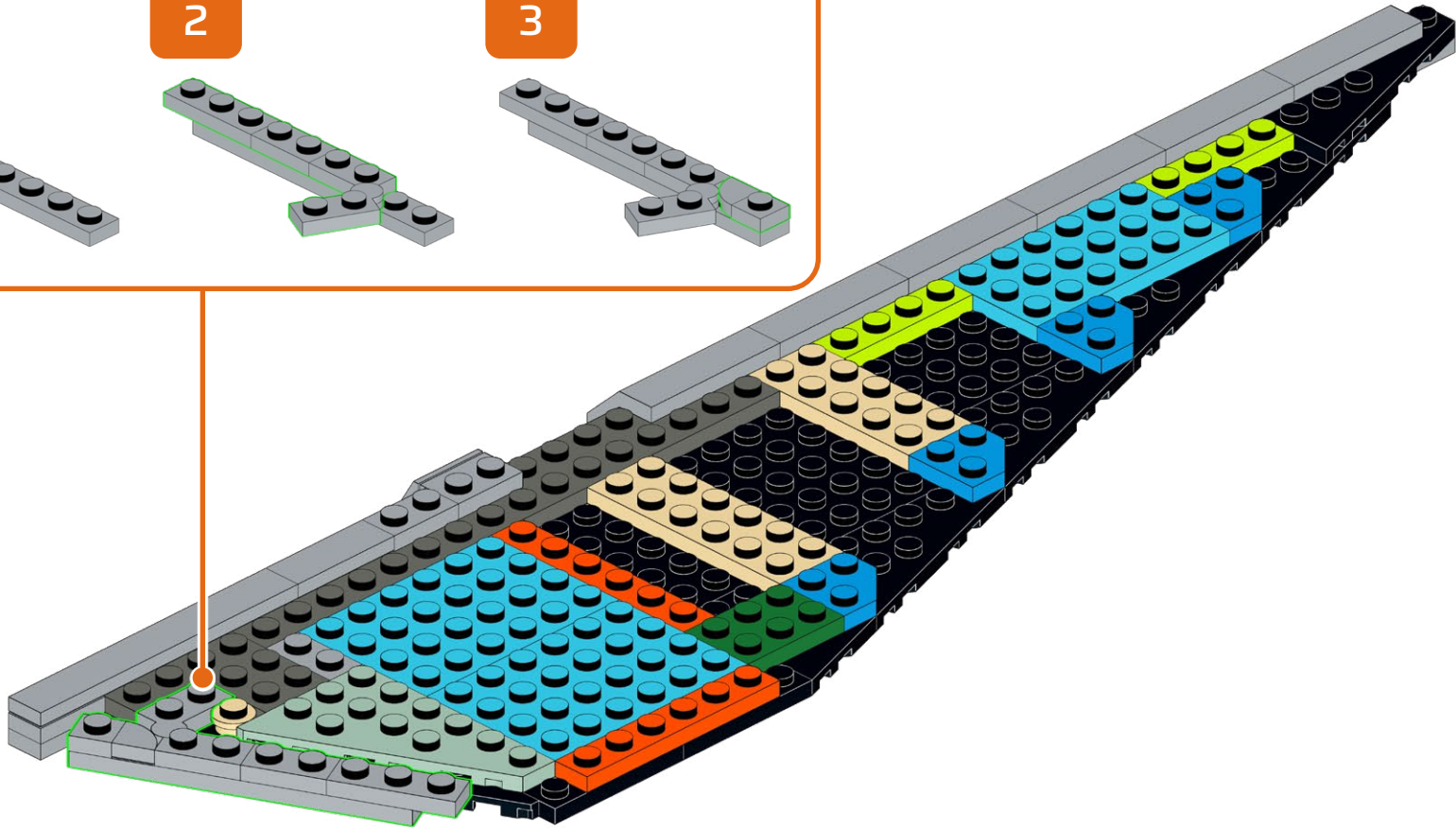
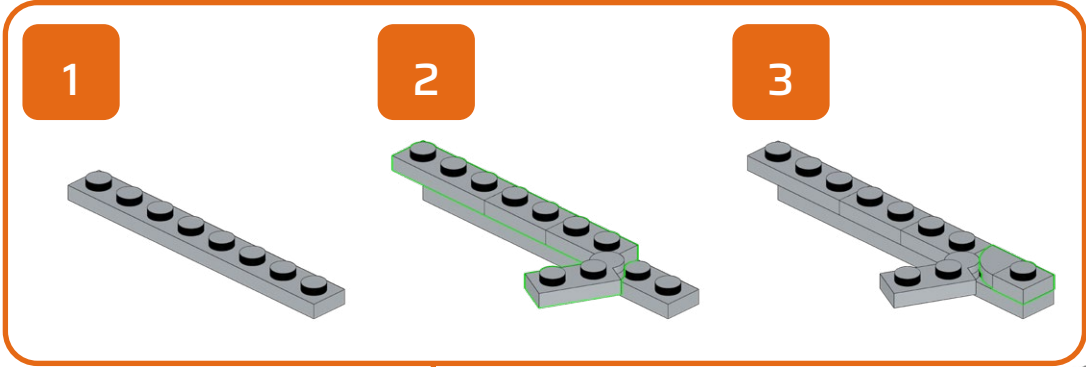
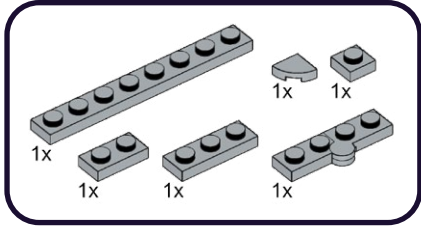



634

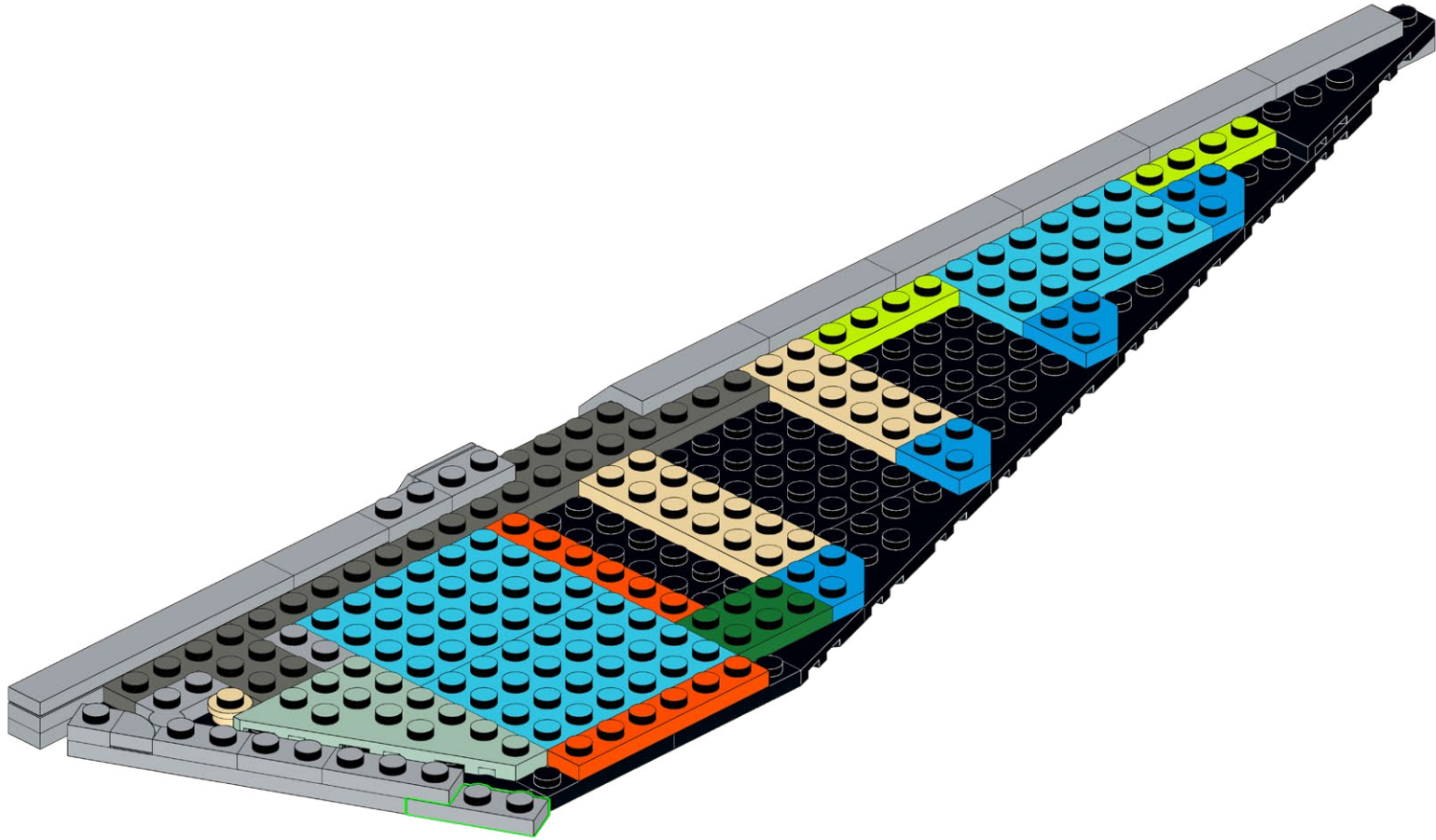
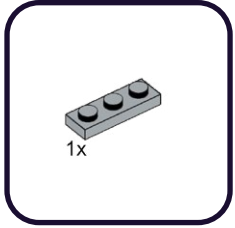

635

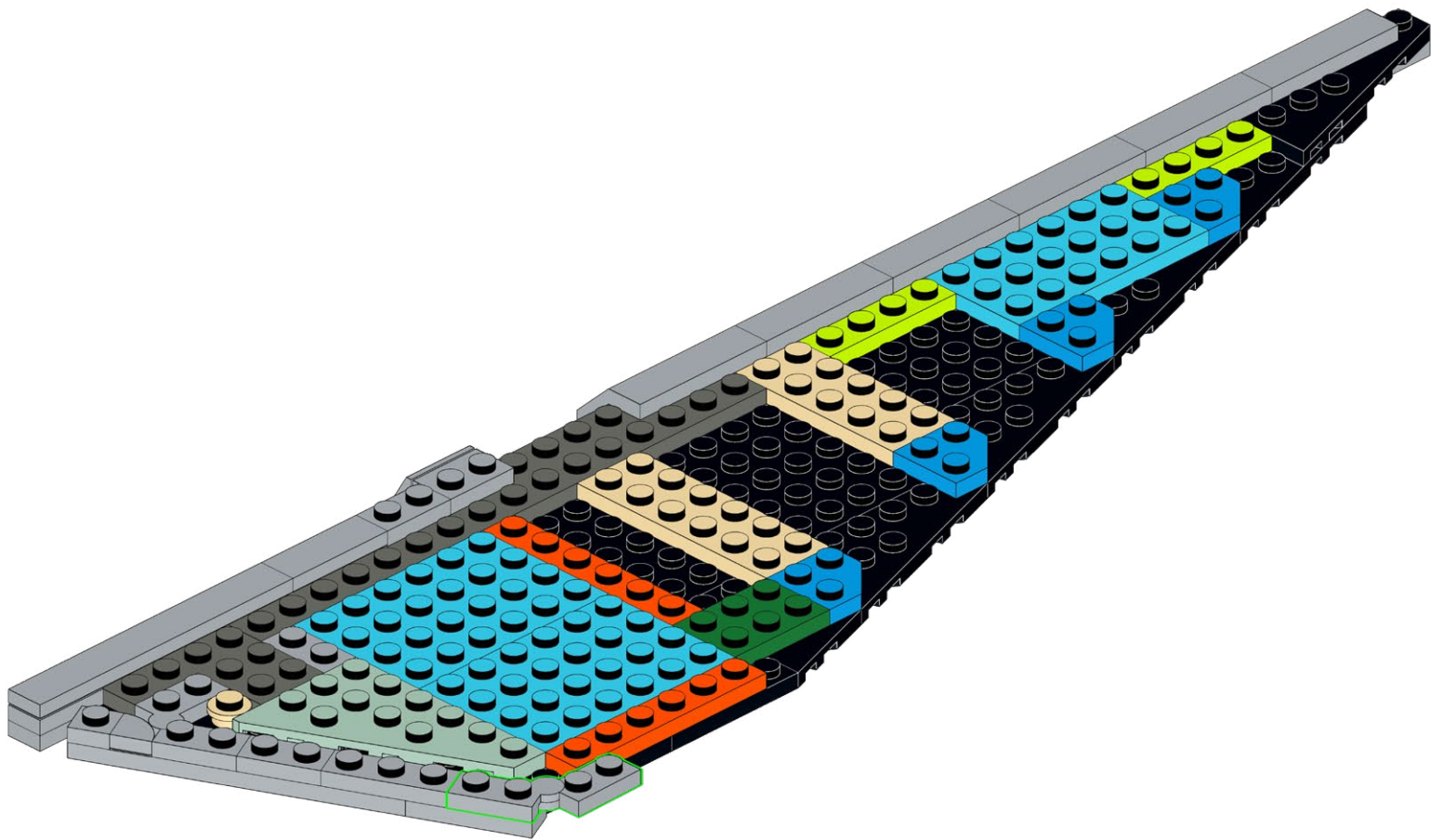
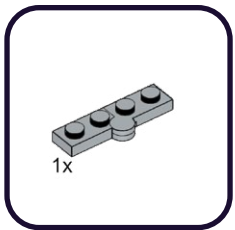



637

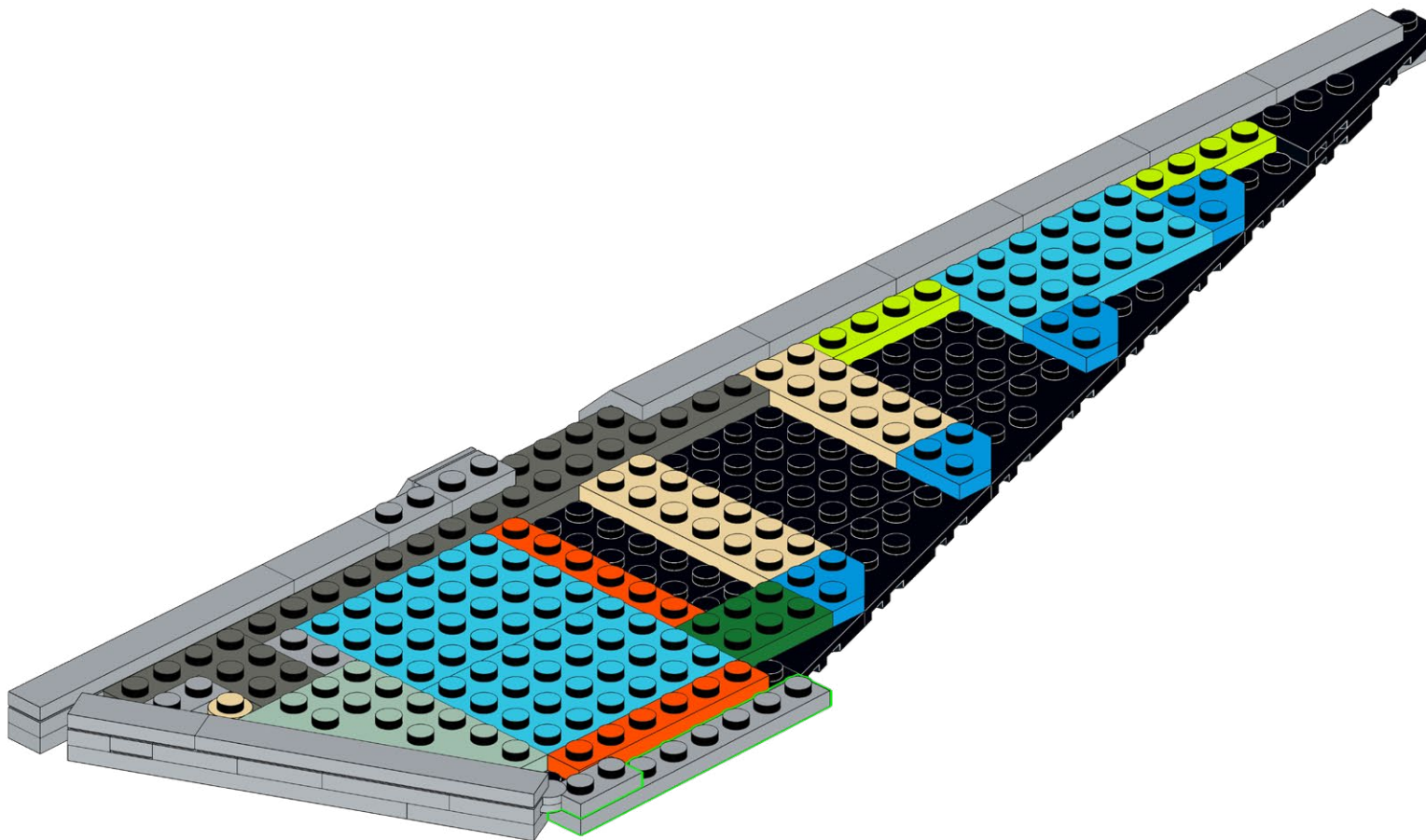
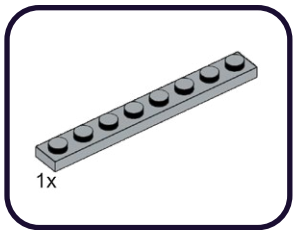



638

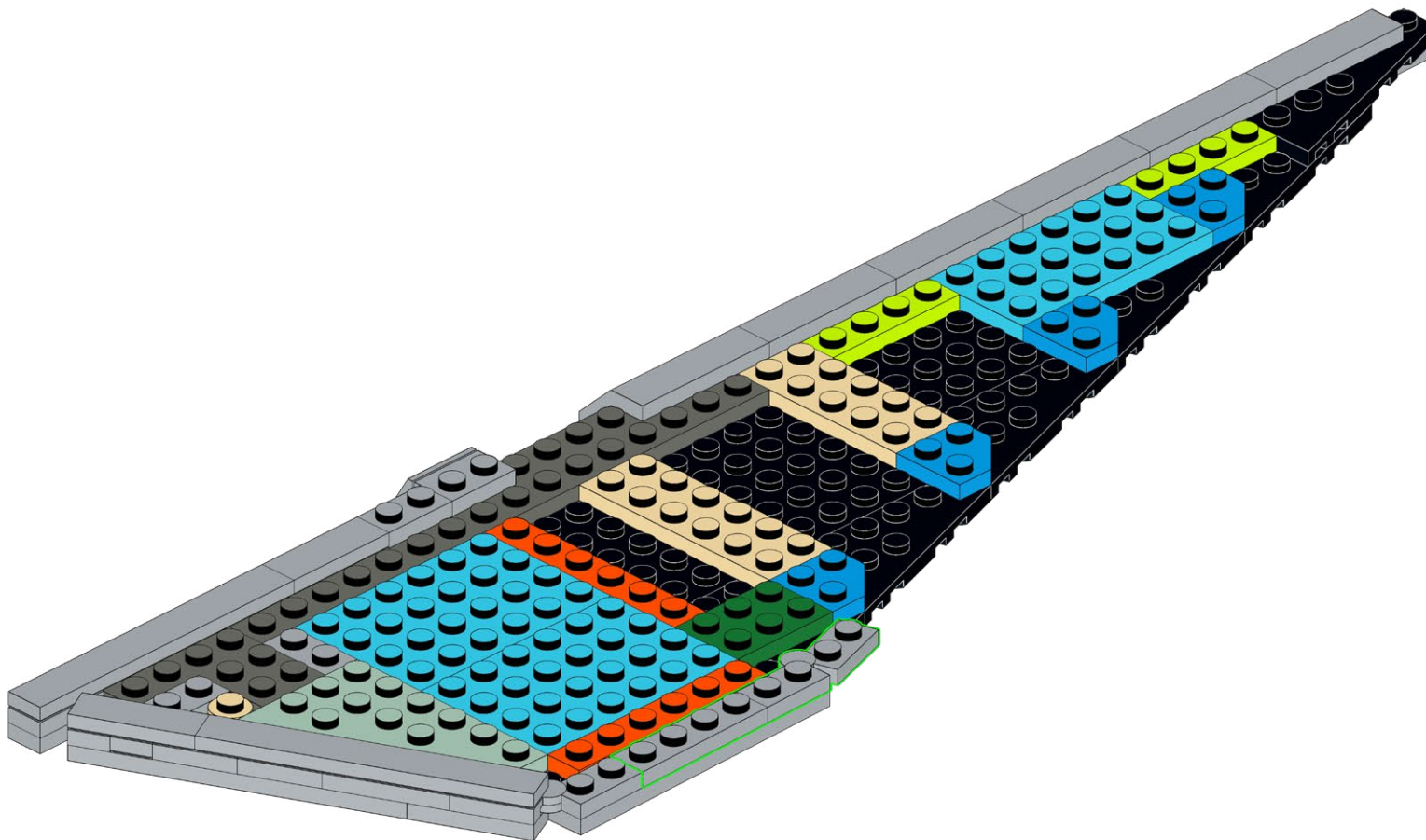
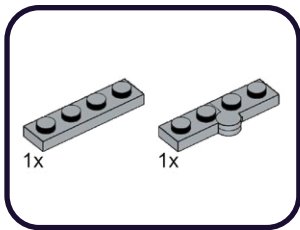



639

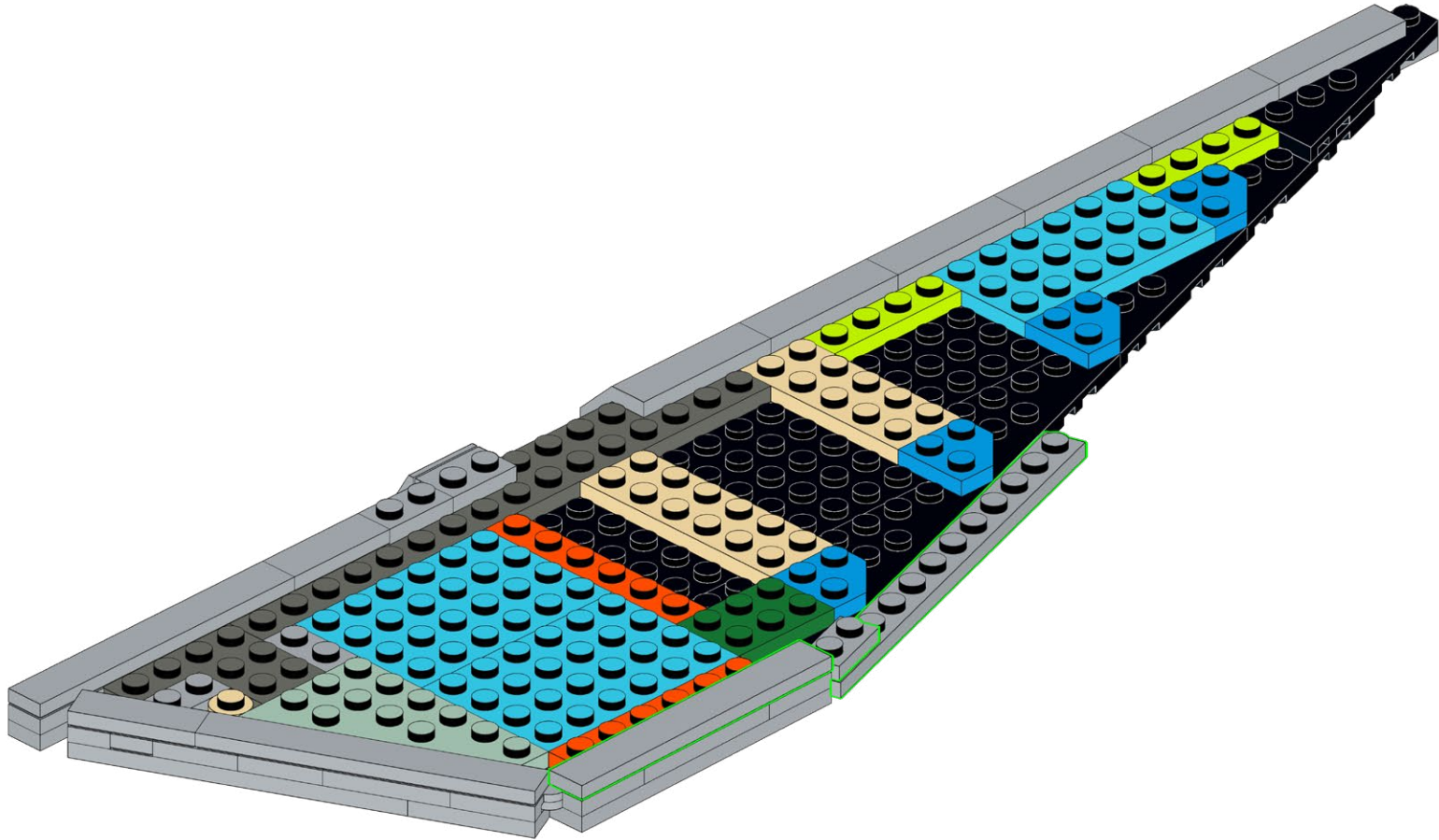
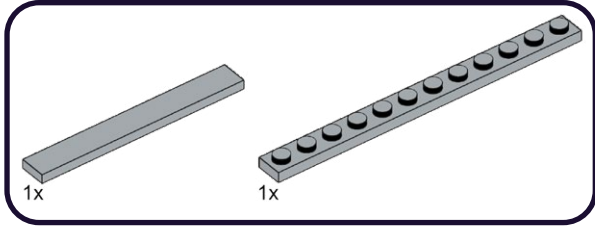

640

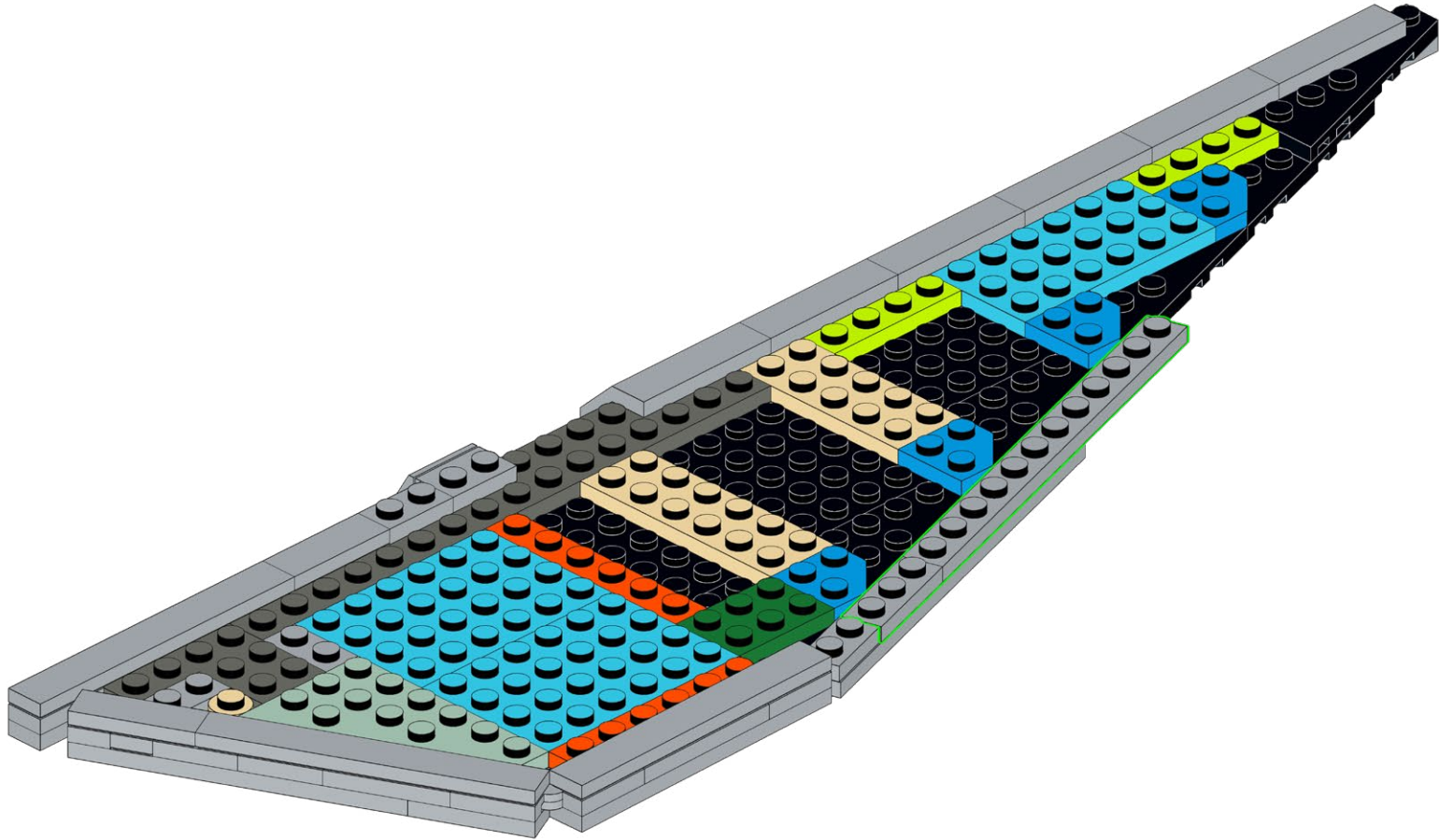
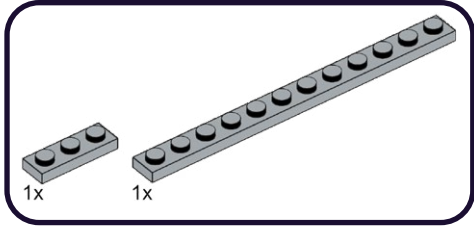

641

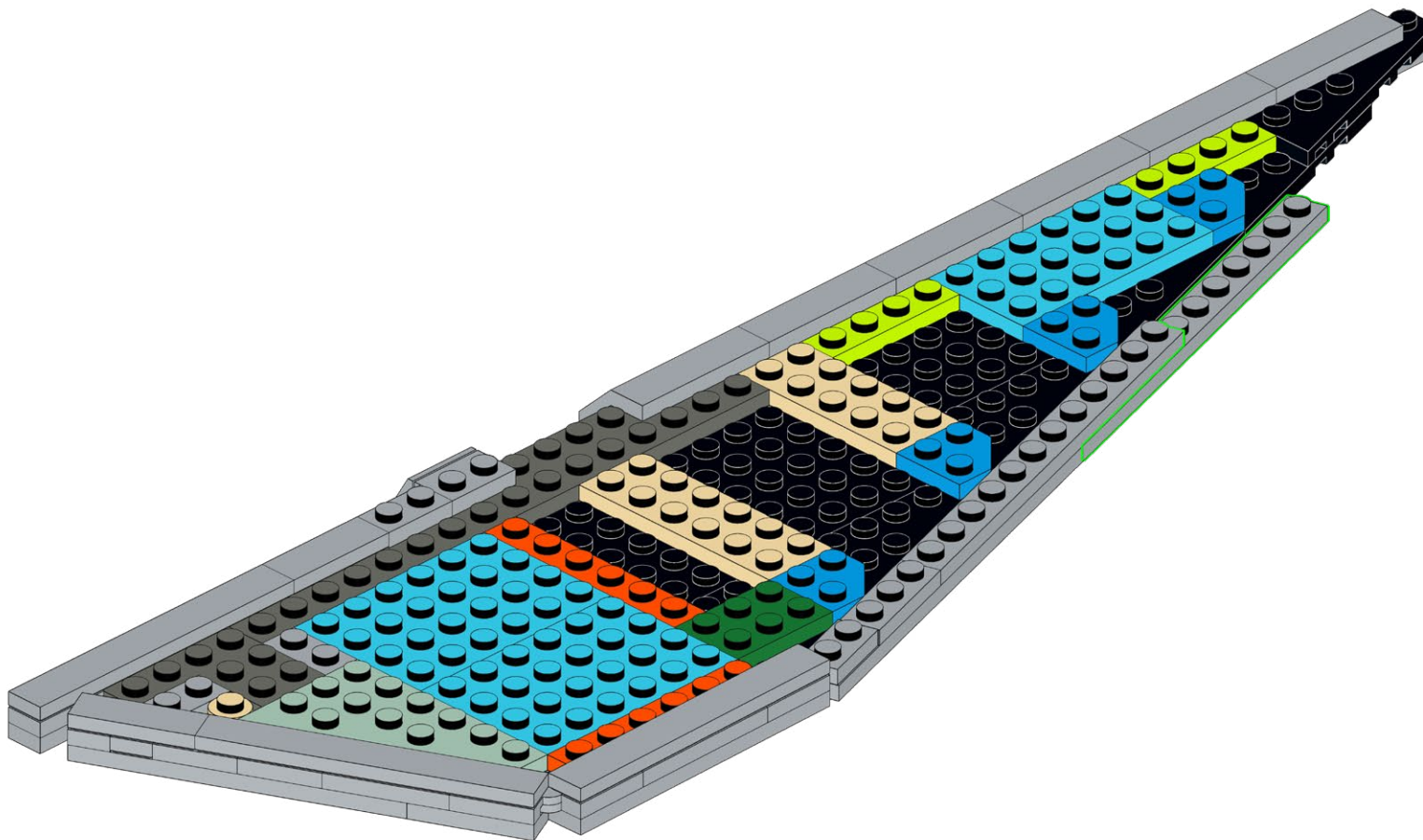
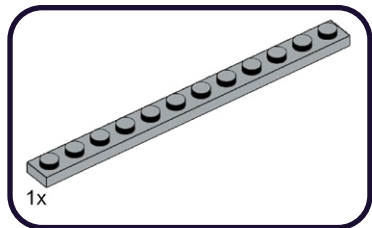

642

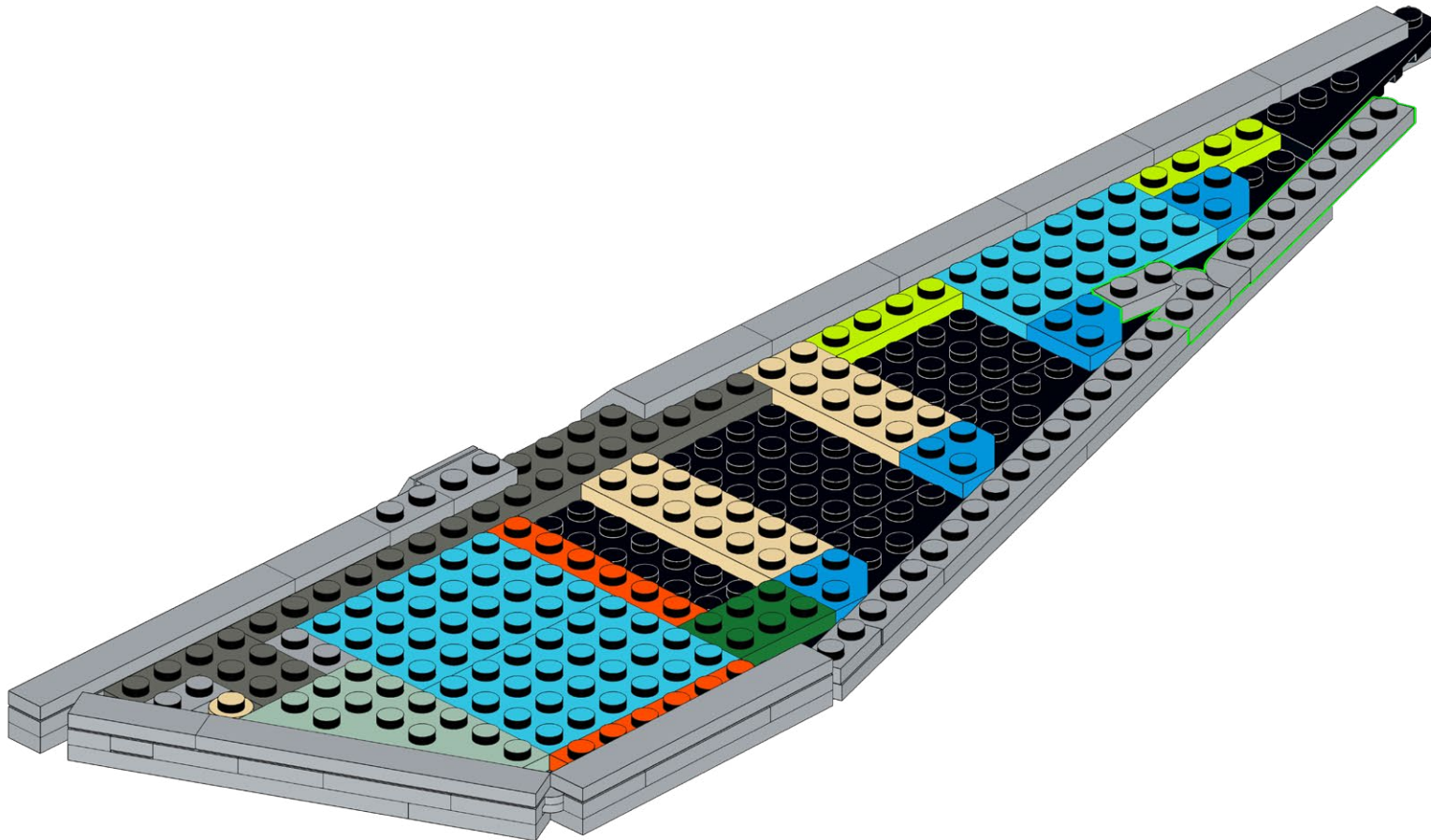
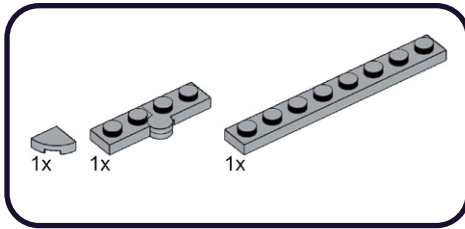



643

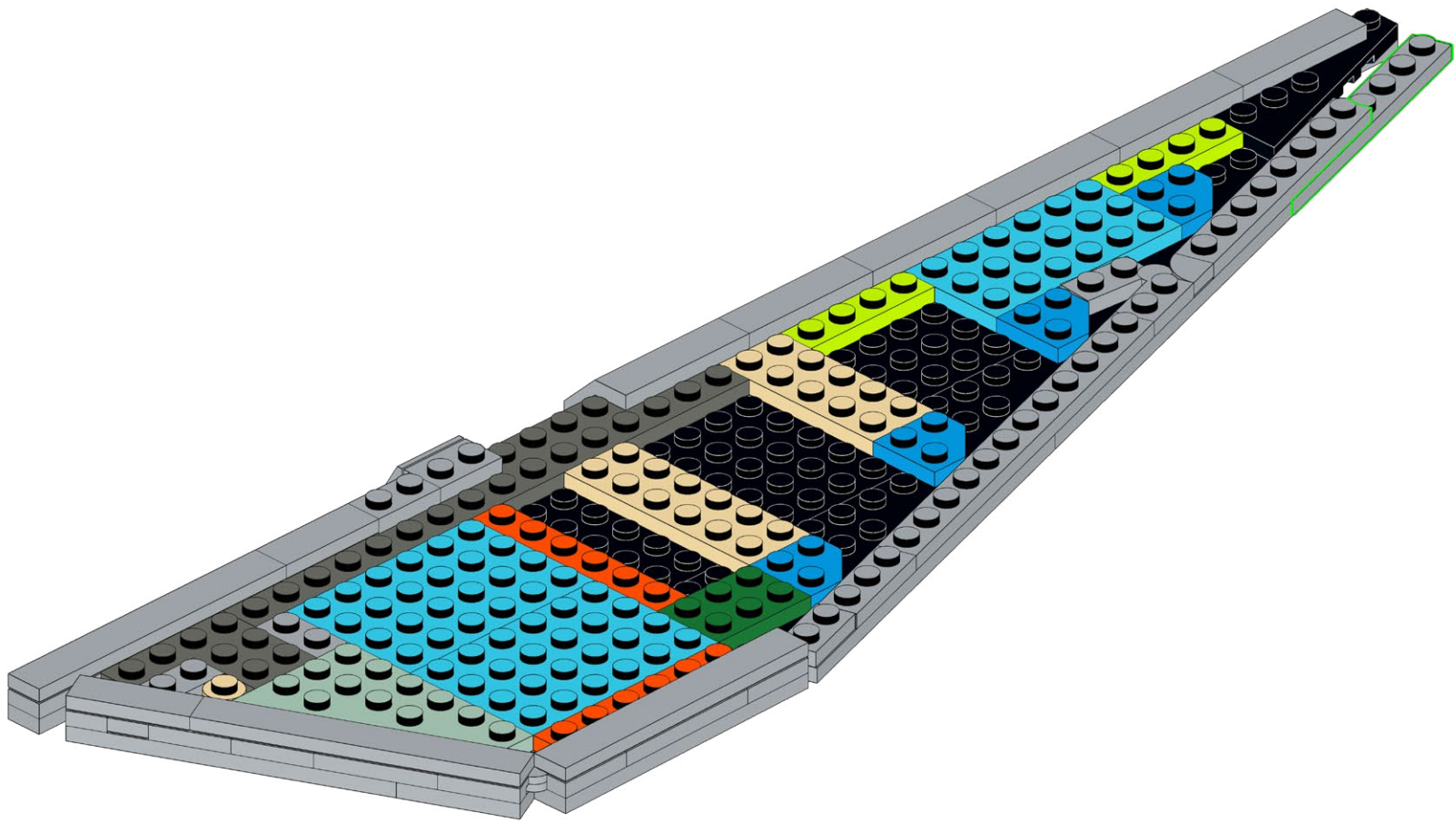
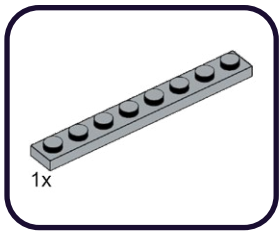



644

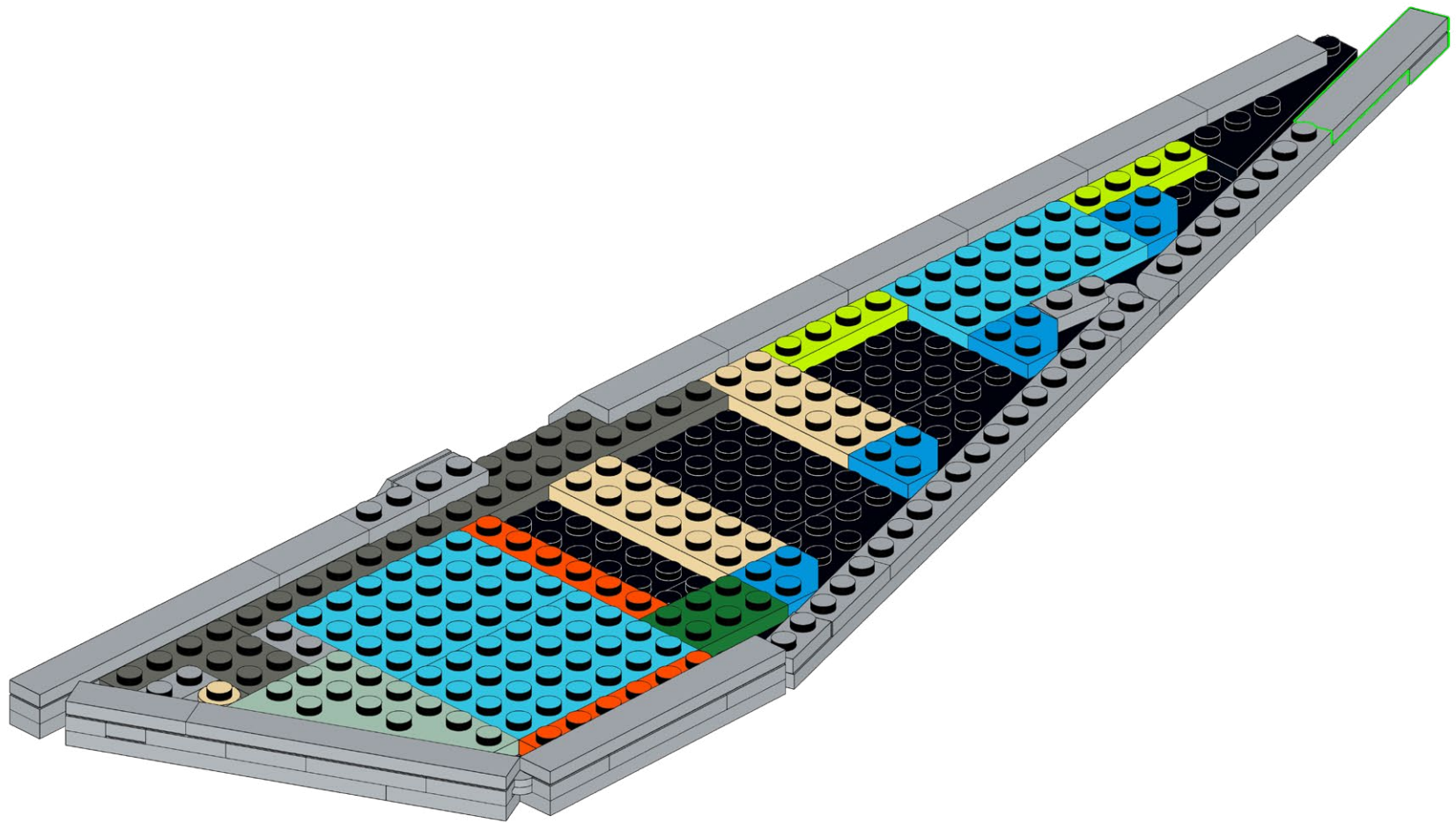
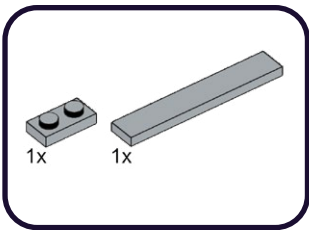

645

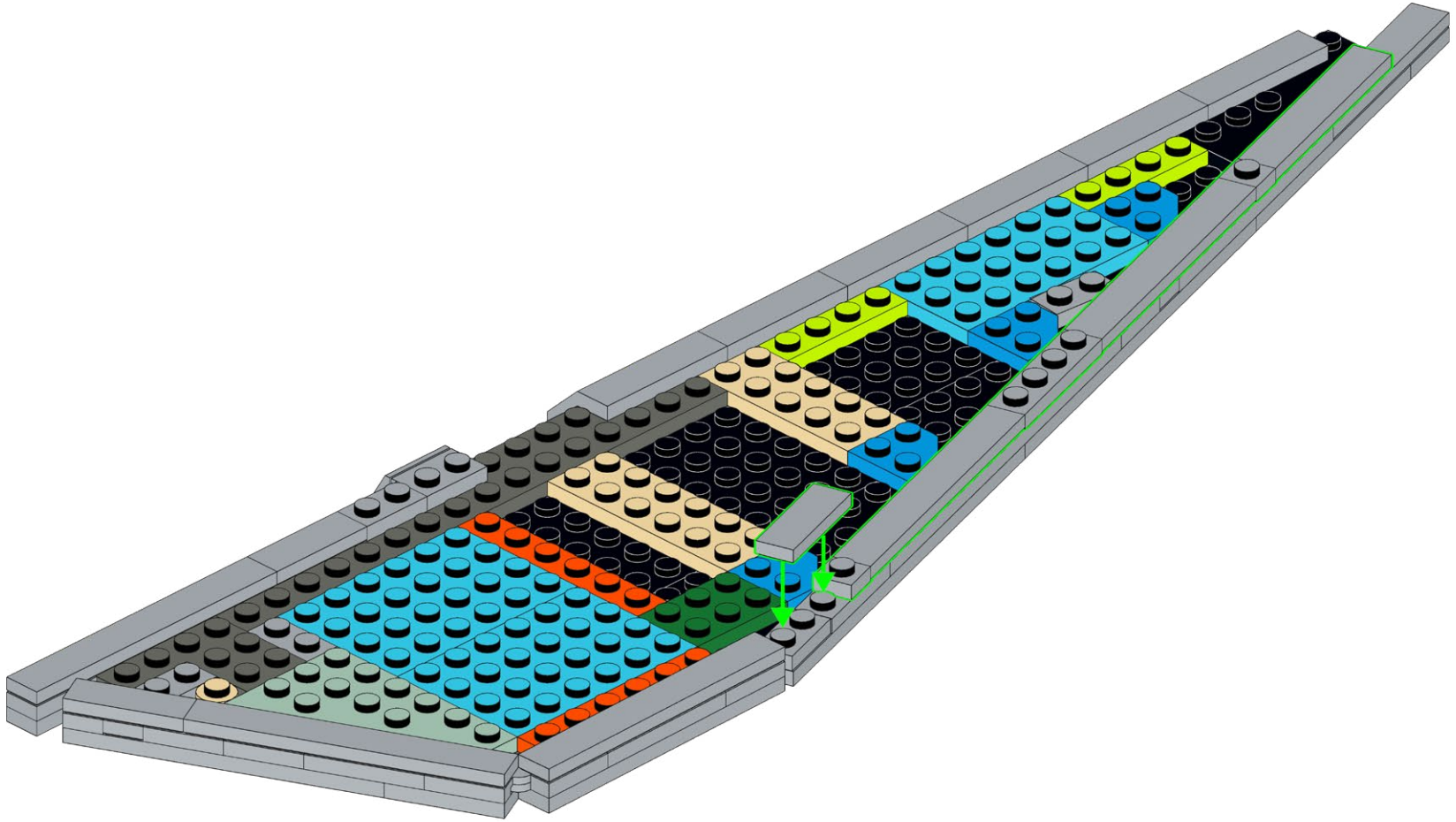
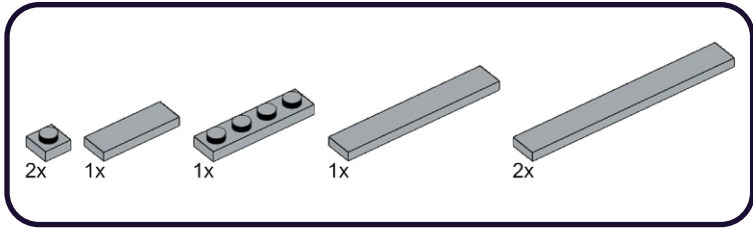

646

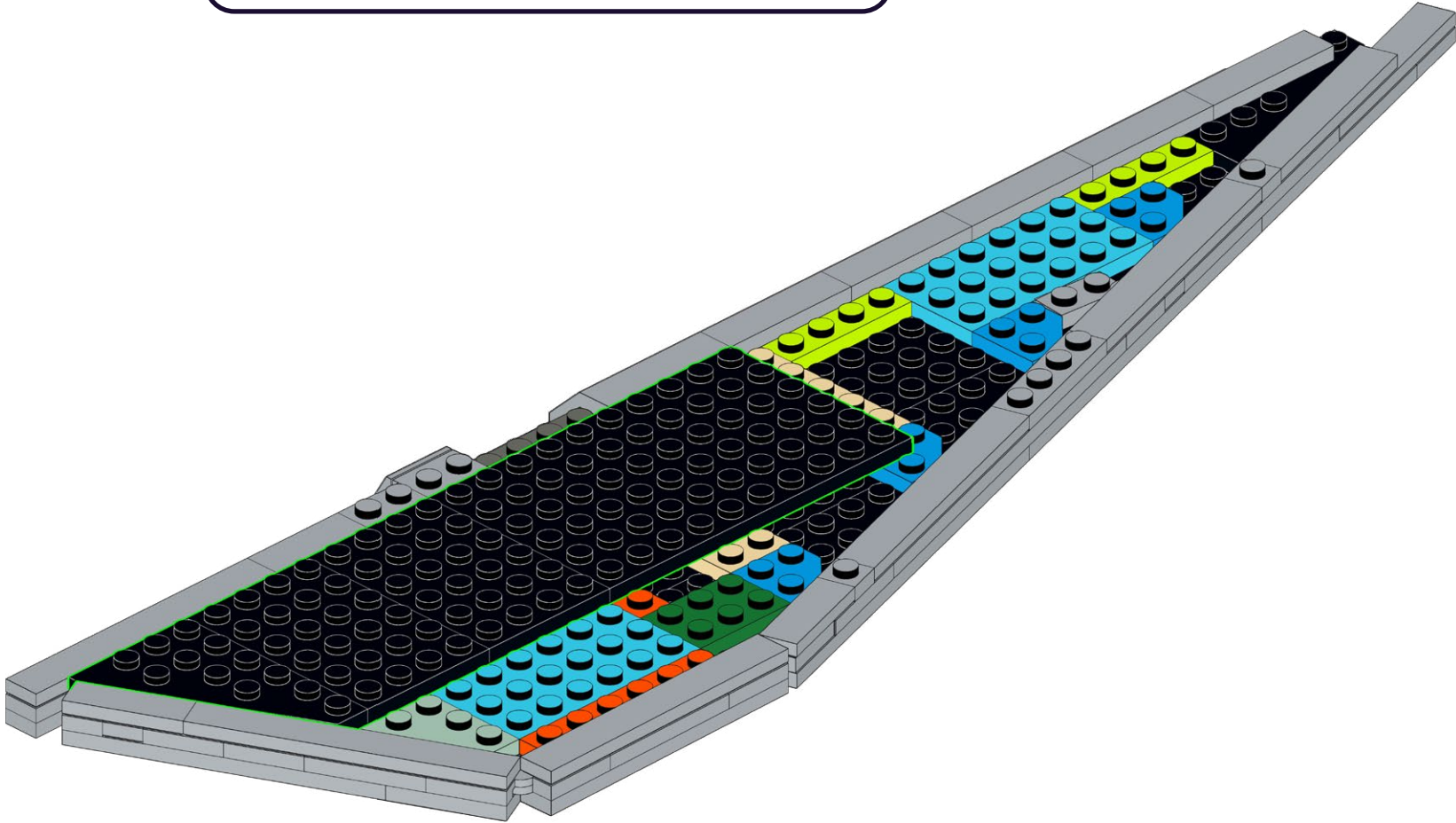
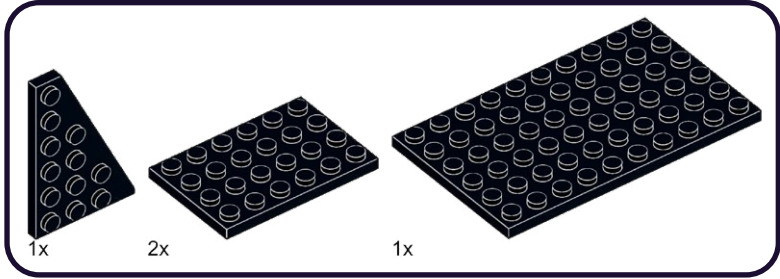





648

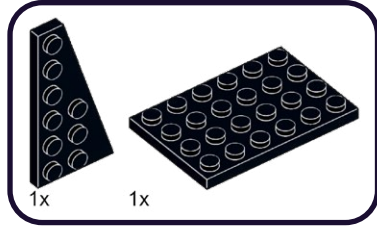



649

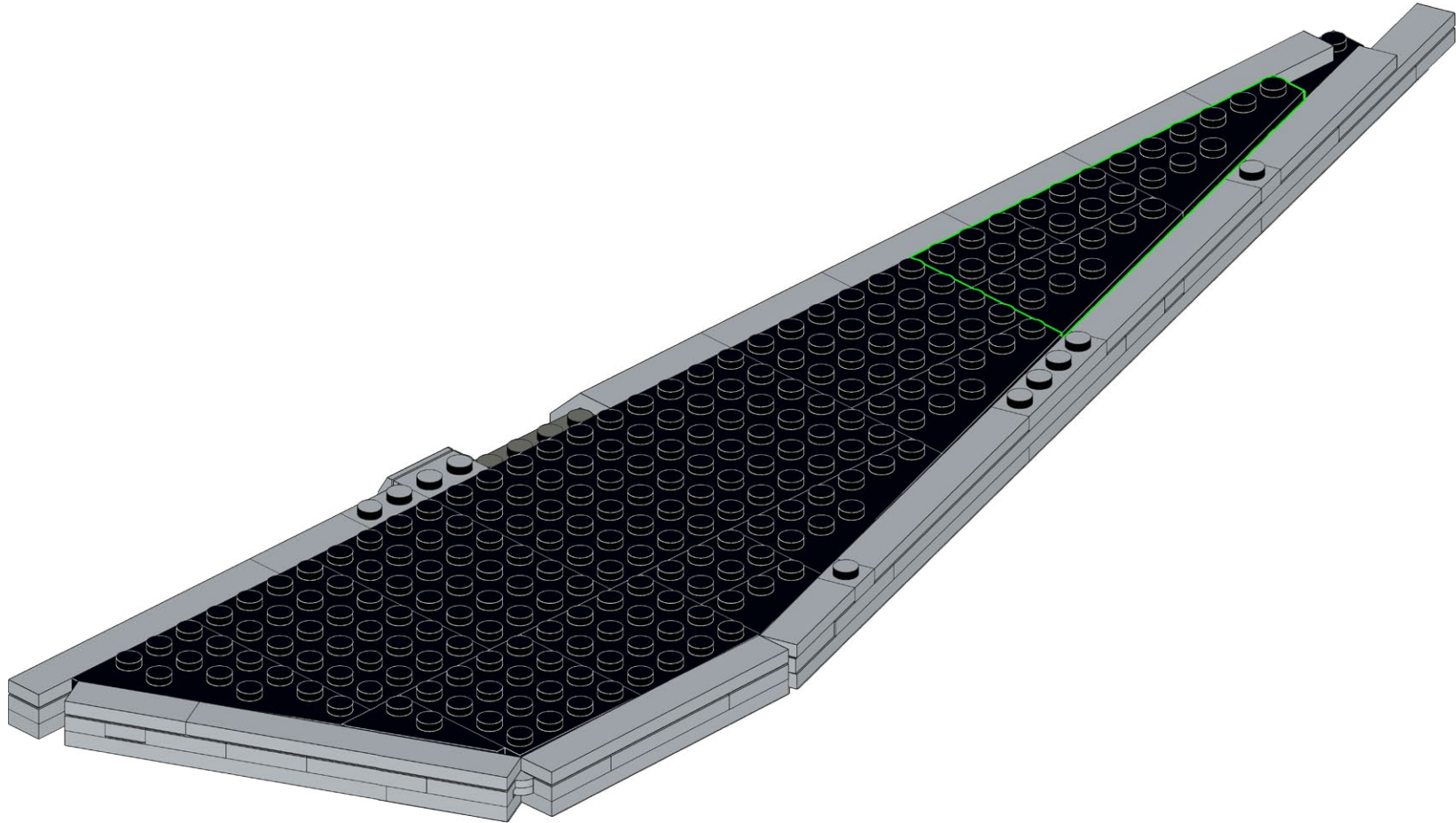
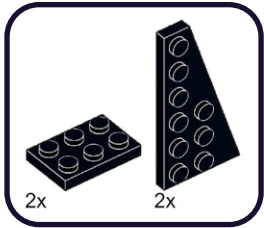

650

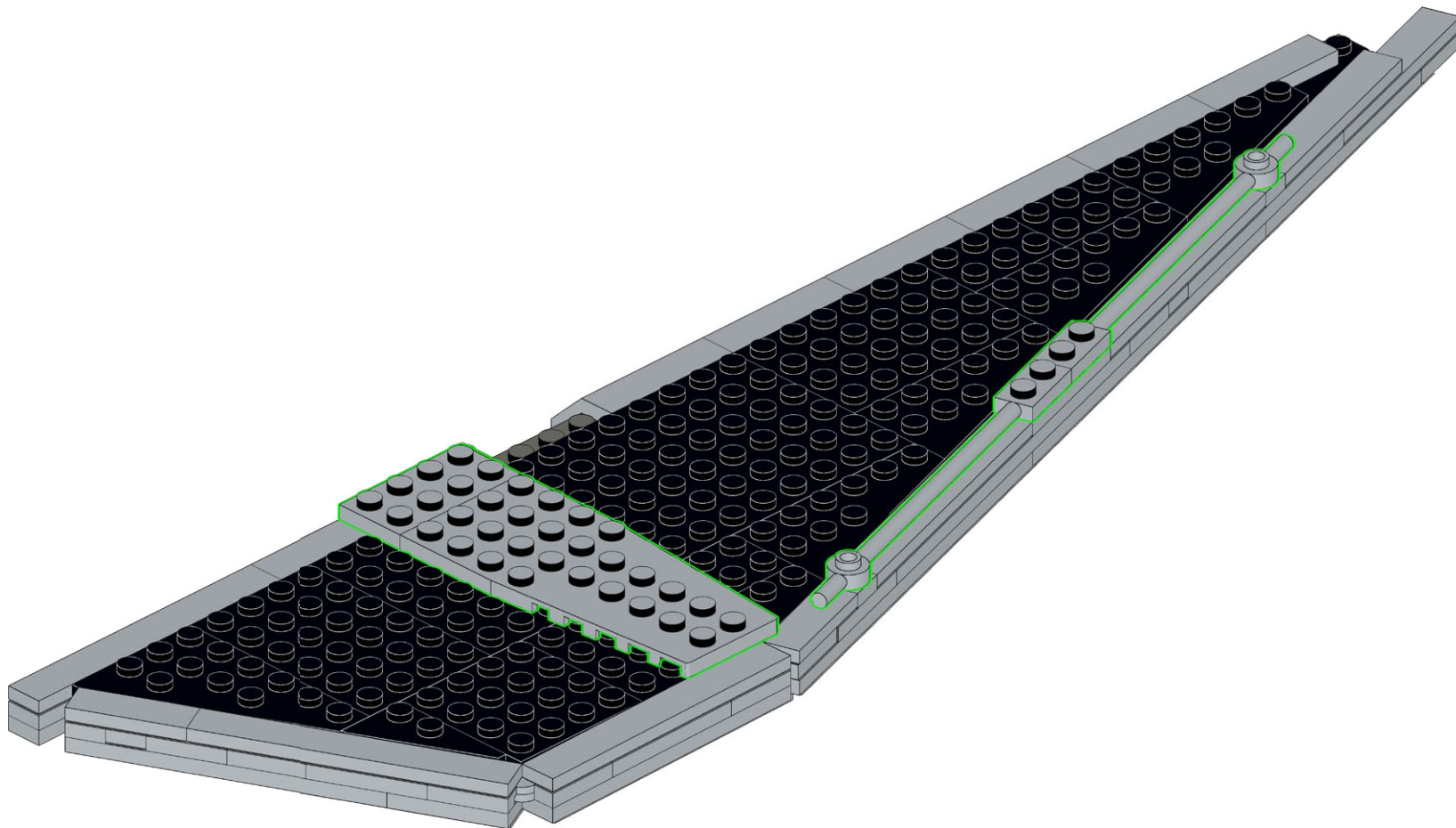
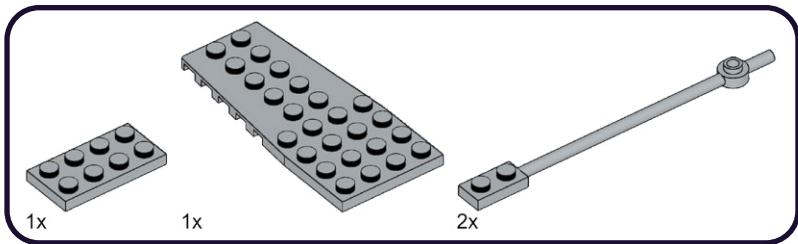

651

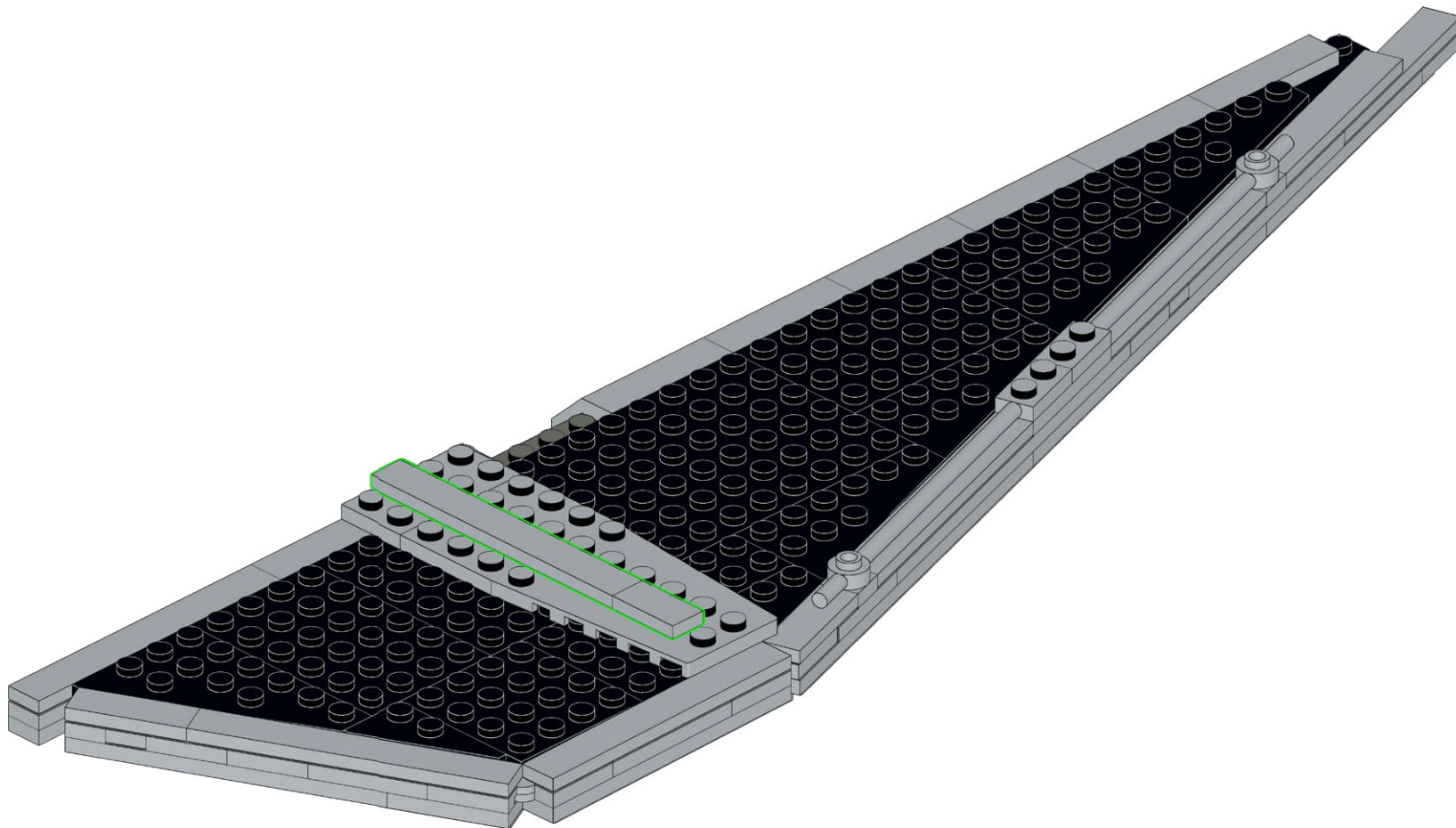
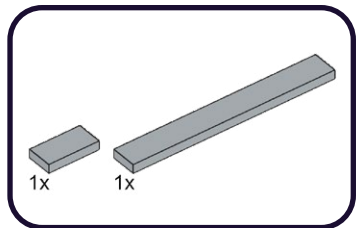

652

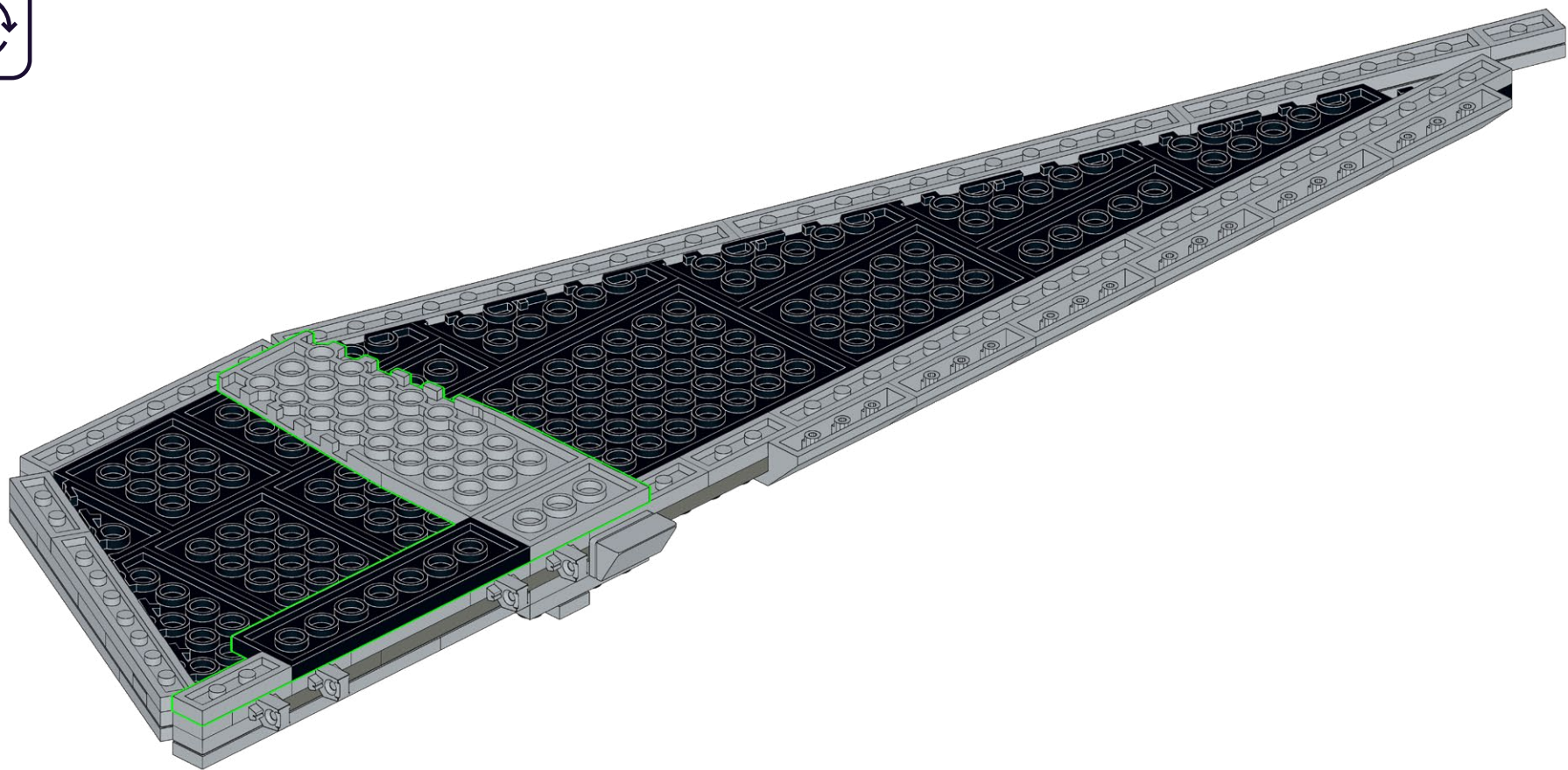
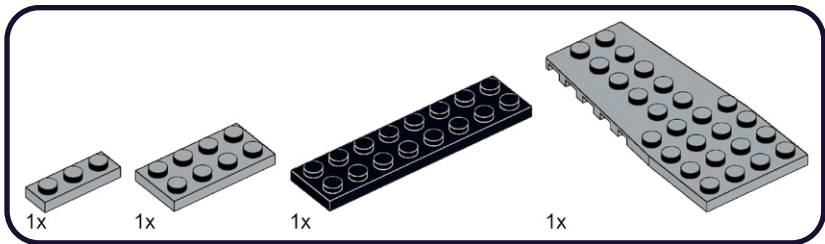



653

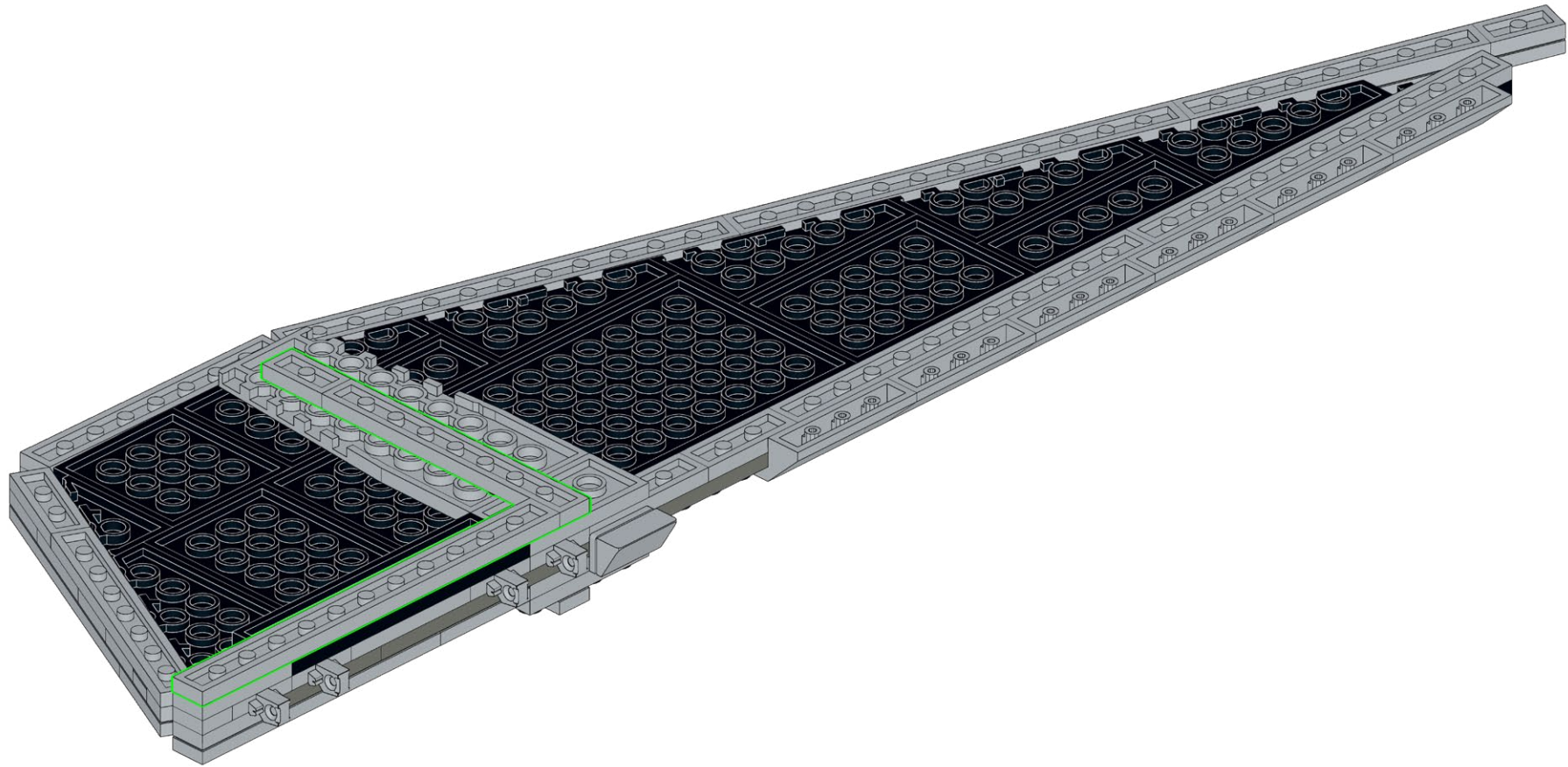
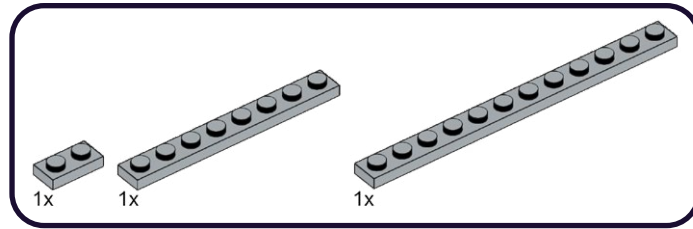



654

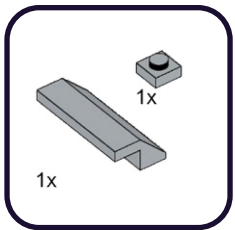

1

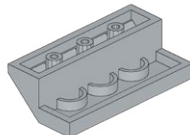

2

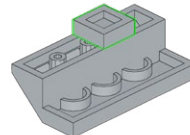

655

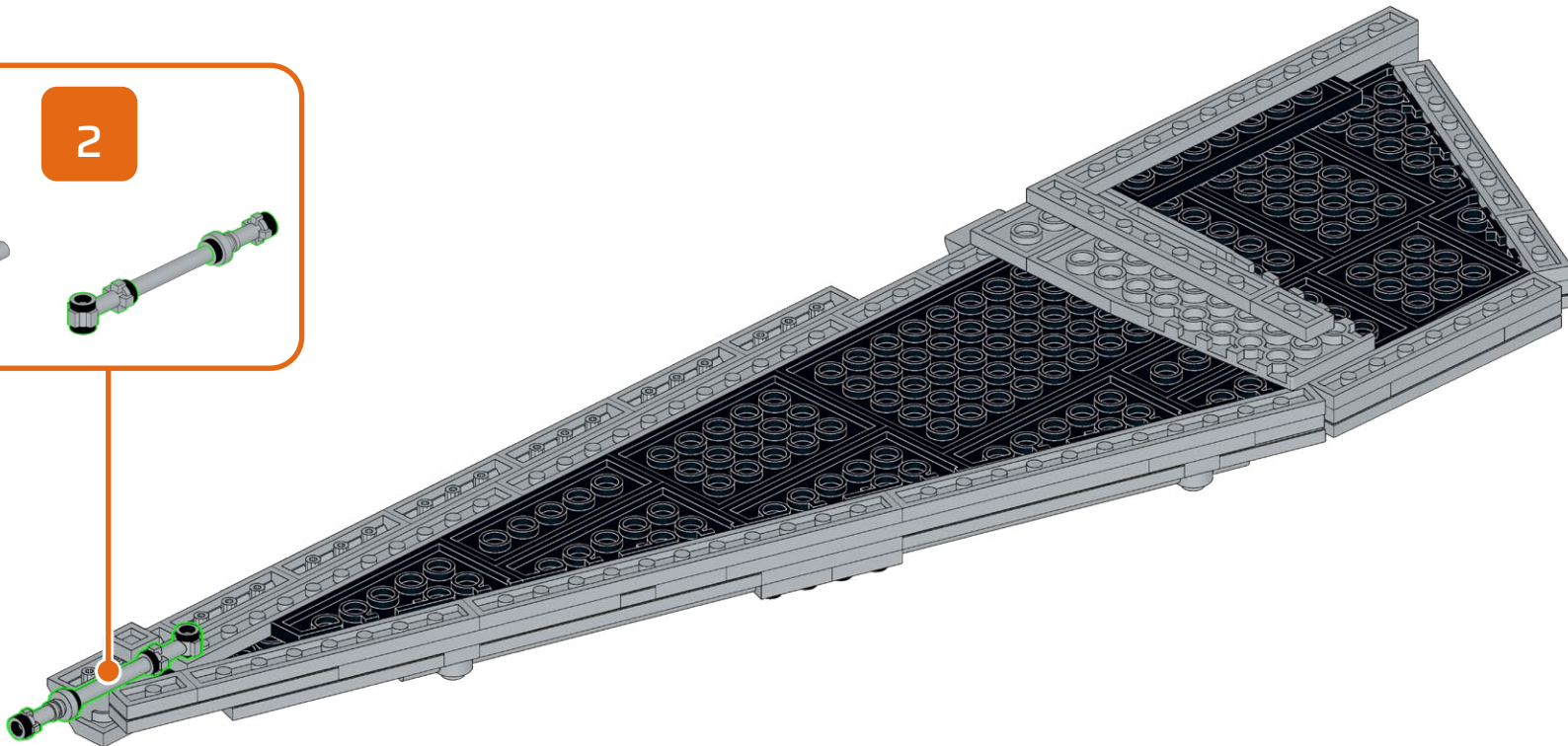
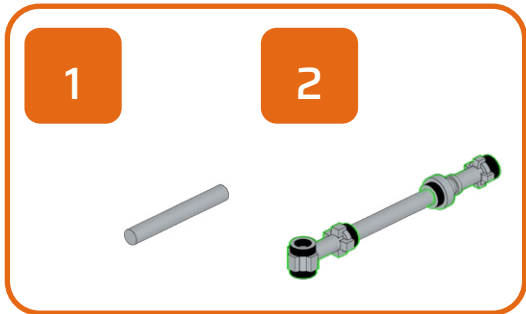
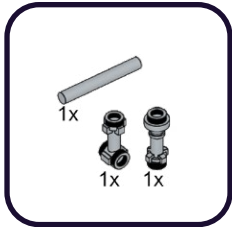

656

1x

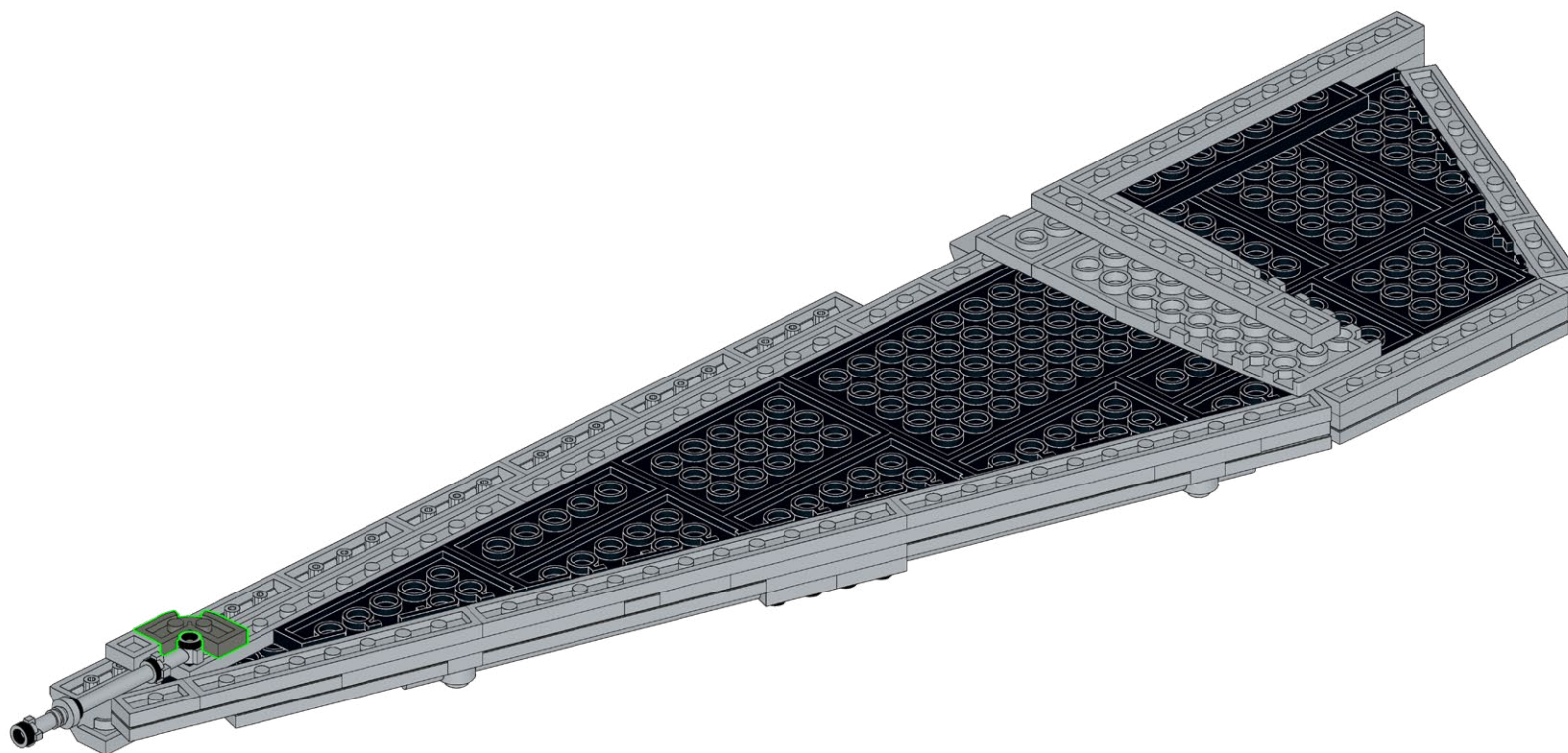

**657**

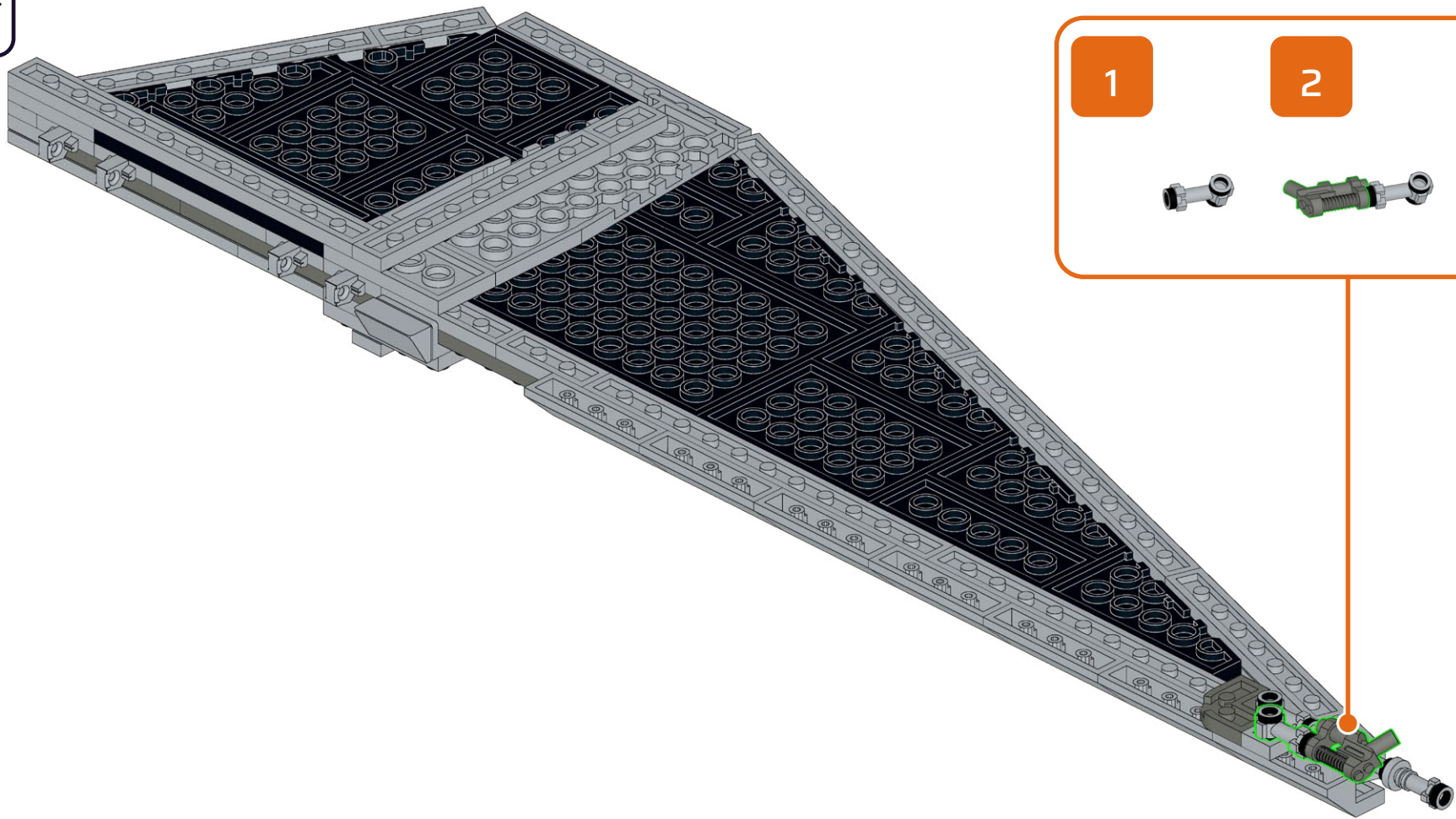
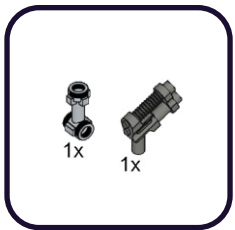

1

2





658

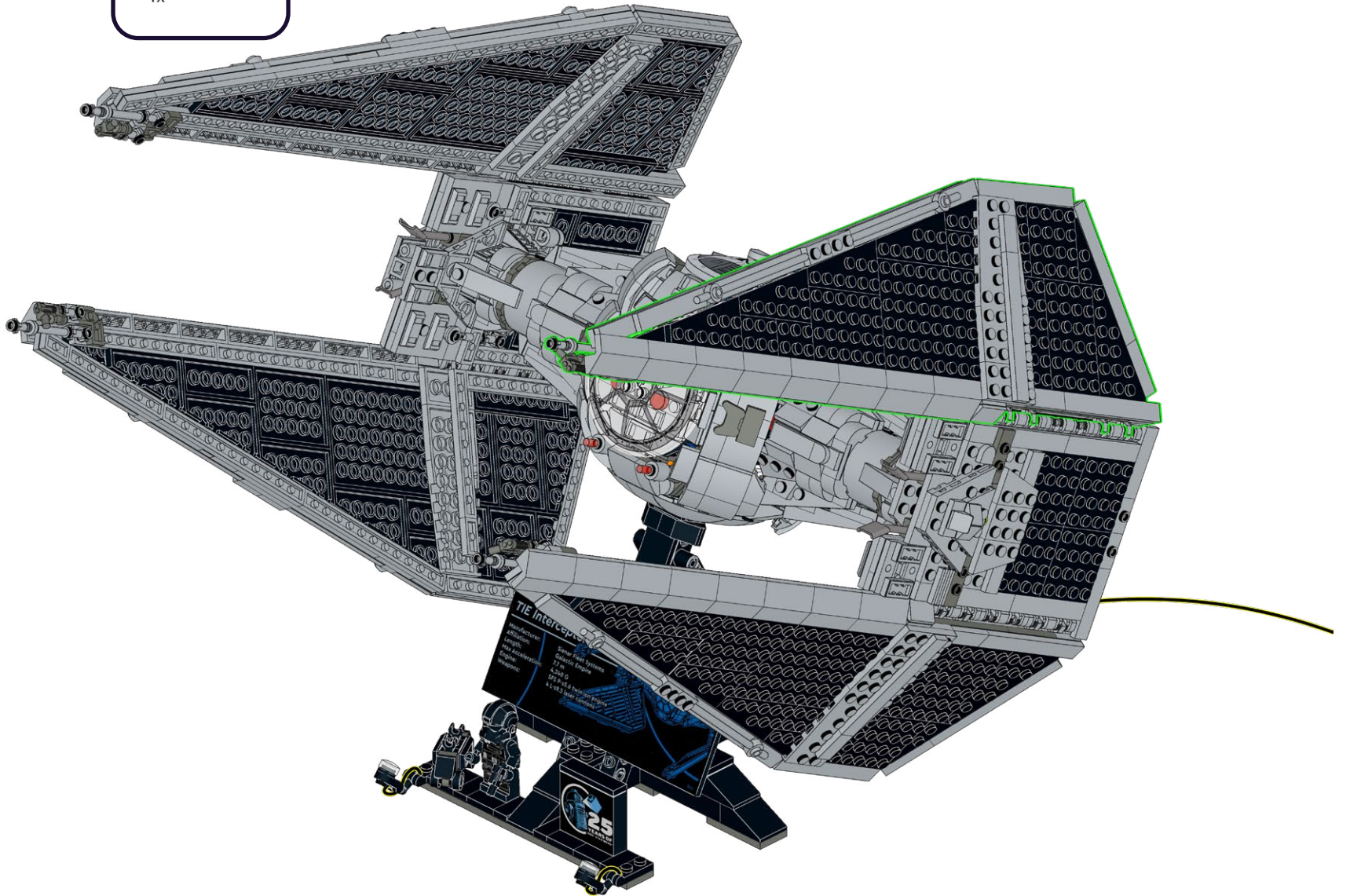
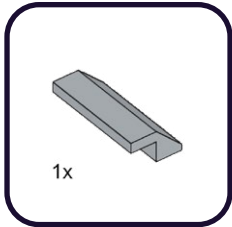



# 659

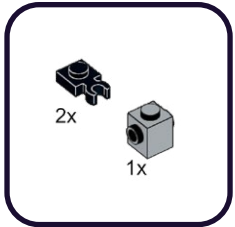

1



2



# 660

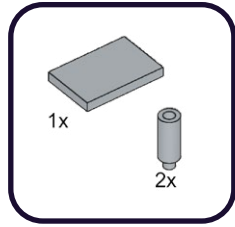

1

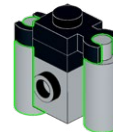

2

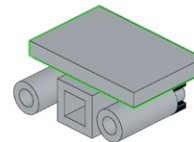
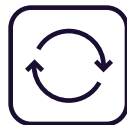

# 661

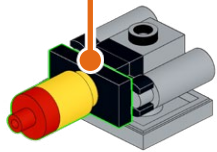
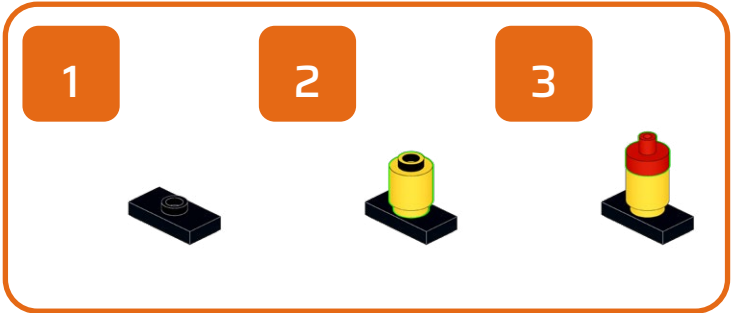
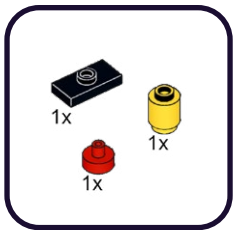

# 662

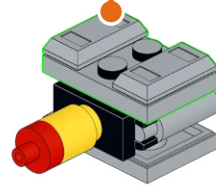
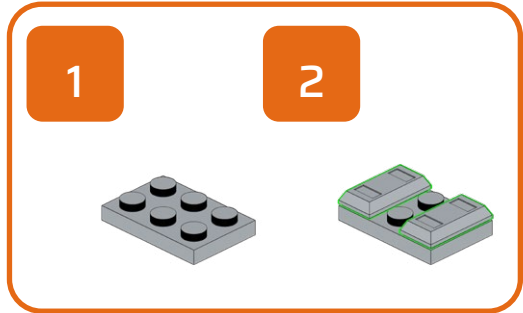
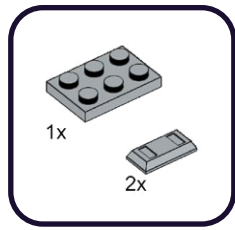

663





664

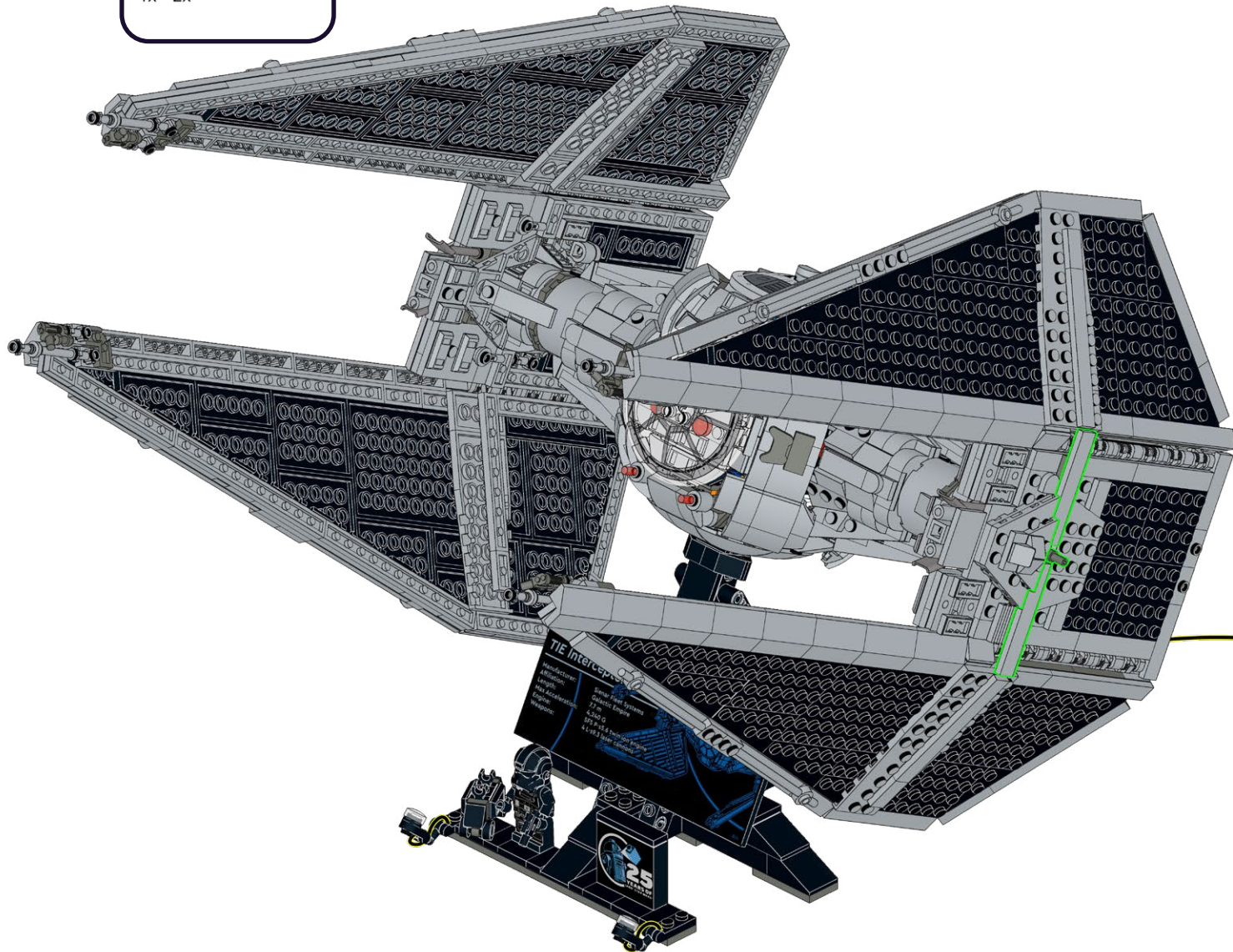
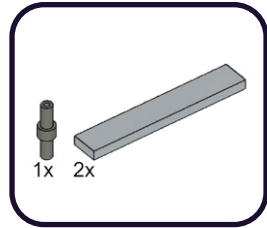

665

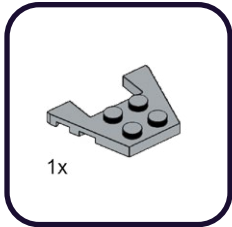



666

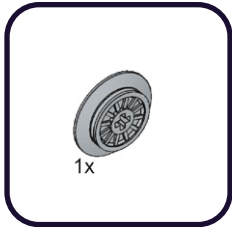

667





668



# FINAL PRODUCT



# CONTENTS & GLOSSARY



**4x** AR-R15  
Astro Light Regular  
Red 15cm



**1x** B-50  
Belt 50cm



**1x** AL-R15  
Astro Light Large  
Red 15cm



**2x** Astro Cap Clear



**2x** AL-W30  
Astro Light Large  
Cool White 30cm



**1x** FLX-B  
Flux Belt



**1x** D-3  
Dock-3



**1x** D-6  
Dock-6



# CONTENTS & GLOSSARY



**2x** Plate, Round 1x1 with Open Stud - Black



**2x** Arm Skeleton, Bent with Clips (Horizontal Grip) - Black



**2x** Plate, Round 1x1 with Open Stud - Light Bluish Grey



**1x** Plate, Modified 1x1 with Open O Clip (Horizontal Grip) - Black



**1x** Plate, Round 1x1 with Open Stud - Trans Clear



**1x** Plate, Modified 1x2 with Bar Handle on Side Closed Ends - Black



**2x** Plate, Round 1x1 with Bar Handle - Black



**2x** Plate, Modified 1x2 with Bar Handle on End - Black

# CONTACT US

Click below for customer support, or general inquiries.

Cliquez ci-dessous pour accéder au support client ou aux renseignements généraux.

Clicca qui sotto per l'assistenza clienti o per richieste generali.

Contact Us



Contactez-nous



Contattaci



Klicken sie unten für kundensupport oder allgemeine anfragen.

Haga clic a continuación para atención al cliente o consultas generales.

点击下方获取客户支持或一般咨询。

Kontaktieren sie uns



Contáctanos



联系我们



## TROUBLESHOOTING

If you're stuck, scan the QR code for troubleshooting.

Se sei bloccato, scansiona il codice QR per la risoluzione dei problemi.

Wenn Sie nicht weiterkommen, scannen Sie den QR-Code zur Fehlerbehebung.

Si vous êtes bloqué, scannez le code QR pour le dépannage

Si está atascado, escanee el código QR para solucionar el problema.

如果遇到问题, 请扫描二维码进行故障排除

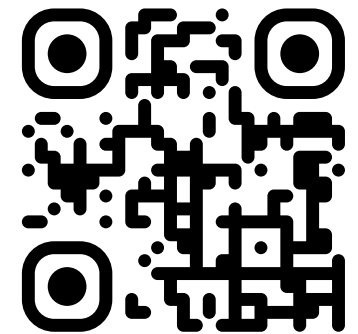



# LIGHTMYBRICKS

[lightmybricks.com](http://lightmybricks.com)



LEGO® is a trademark of the LEGO Group of companies, which does not sponsor, authorize or endorse this product. All LEGO® sets featured in images are sold separately. This is not a LEGO® product. The LEGO Group is not liable for any loss, injury or damage arising from the use or misuse of this product. ©2024 Light My Bricks Pty Ltd. All rights reserved. [www.lightmybricks.com](http://www.lightmybricks.com)

Our components are designed and packaged in Australia by Light My Bricks Pty Ltd. Components are manufactured in China. 3fl bldg C, Shuanghuan Quanxin Technology Information Industry Park Baolong Street, Longgang District, Shenzhen, China. Imported in Australia by Light My Bricks Pty Ltd, 5/26 Rushdale St, Knoxfield, VIC, 3180, Australia.

WARNING: CHOKING HAZARD - Small parts. Not for children under 3 years.

AVERTISSEMENT : RISQUE D'ÉTOUFFEMENT - Petites pièces. Ne convient pas aux enfants de moins de 3 ans.

ATTENZIONE: PERICOLO DI SOFFOCAMENTO - Piccole parti. Non adatto a bambini di età inferiore a 3 anni.

WARNUNG: ERSTICKUNGSGEFAHR - Kleine Teile. Nicht für Kinder unter 3 Jahren geeignet.

ADVERTENCIA: PELIGRO DE ASFIXIA - Piezas pequeñas. No son apto para niños menores de 3 años.

警告：窒息危险 - 小零件。不适合3岁以下儿童。