

# LIGHT KIT INSTALLATION GUIDE

**STAR WARS  
MOS ESPA PODRACE™ DIORAMA**

**FOR  
LEGO SET  
#75380**

# CONTENTS



**03**

Getting Started

- 04** Legend
- 05** Component Handling
- 06** Blueprint

**07**

Instructions

- 07** LMB Bag 01
- 79** LMB Bag 02
- 129** LMB Bag 03

**197**

Final Product

- 198** Package Contents
- 200** Contact & Troubleshooting

# GETTING STARTED



Bold, beautiful and bright, Light My Bricks elevates your favourite LEGO set from knick-knack to statement piece. Create a talking point at home or in the office that speaks to your passions with Light My Bricks. To learn more, click below.

**Learn More**



Audacieux, beau et lumineux, Light My Bricks élève votre ensemble LEGO préféré du statut de bibelot à celui de pièce maîtresse. Que ce soit à la maison ou au bureau, partagez votre passion des LEGO avec Light My Bricks. Cliquez ci-dessous pour en savoir plus.

**En savoir plus**



Audace, bello e luminoso, Light My Bricks eleva il tuo set LEGO preferito da soprammobile a pezzo di tendenza. Crea un punto di discussione a casa o in ufficio che parli alle tue passioni con Light My Bricks. Per saperne di più, clicca qui sotto.

**Ulteriori Informazioni**



Mutig, schön und hell – Light My Bricks verwandelt Ihr Lieblings-LEGO-Set von einem schnickschnack in ein statement-stück. Schaffen sie einen gesprächspunkt zu hause oder im büro, der Ihre leidenschaften widerspiegelt, mit Light My Bricks. Um mehr zu erfahren, klicken sie unten.

**Mehr erfahren**



Audaz, hermoso y brillante, Light My Bricks eleva tu set LEGO favorito de una chuchería a una pieza llamativa. Crea un tema de conversación en casa o en la oficina que hable de tus pasiones con Light My Bricks. Para obtener más información, haga clic a continuación.

**Más información**



大胆、美丽而明亮，Light My Bricks 将你喜爱的乐高套装从小摆件提升为引人注目的装饰品。在家或办公室打造一个能表达你激情的话题，了解更多，请点击下方。

**了解更多**



# LEGEND

## Rotate Set



Retournez L'ensemble  
Ruota Set  
Set Drehen  
Rotar Conjunto  
旋转套件

## Add Part



Ajoutez une Pièce  
Aggiungi Parte  
Teil Hinzufügen  
Agregar Pieza  
添加零件

## Click



Cliquez  
Clic  
Klicken  
Clic  
点击

## Pinch/Fold



Pincez/Pliez  
Pizzicare/Piegare  
Kneifen/Falten  
Pellizcar/Doblar  
折叠

## Pull Cable



Tirez le Cable  
Tirare il Cavo  
Kabel Ziehen  
Tirar del Cable  
拉动电缆

## Repeat Step



Répétez  
Ripetere  
Wiederholen  
Repetir  
重复

## Sticker



Autocollant  
Adesivo  
Aufkleber  
Pegatina  
贴纸

## Power On Test



Test de mise sous tension  
Test di Potenza  
Stromtest  
Prueba de Energía  
电源测试

## Disconnect Power

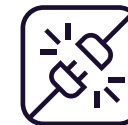

Débranchez L'alimentation  
Scollegare L'alimentazione  
Strom Trennen  
Desconectar la Energía  
断开电源

## Troubleshoot



Dépanner  
Risolvere  
Fehlerbehebung  
Solución de Problemas  
故障排除

# COMPONENT HANDLING

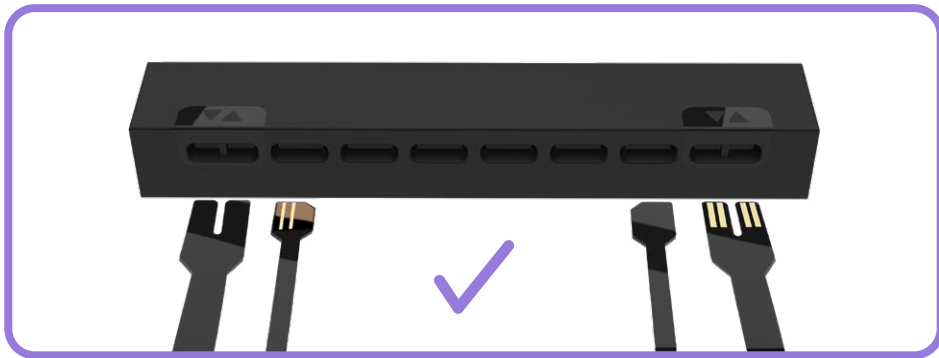
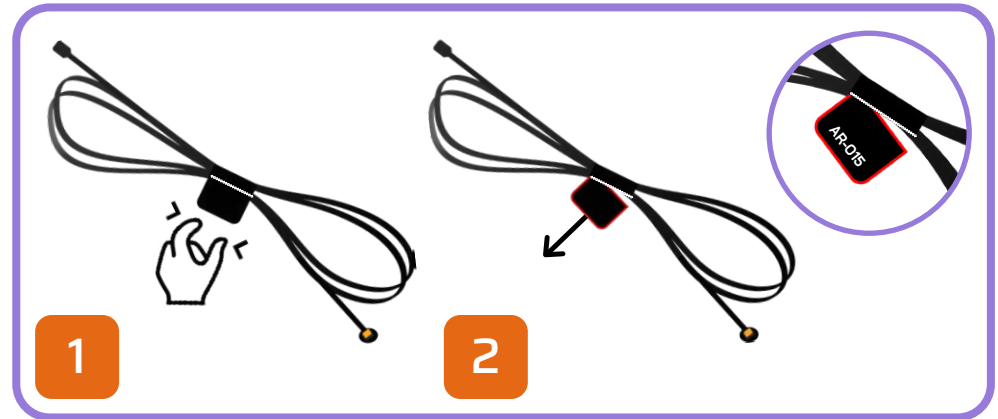
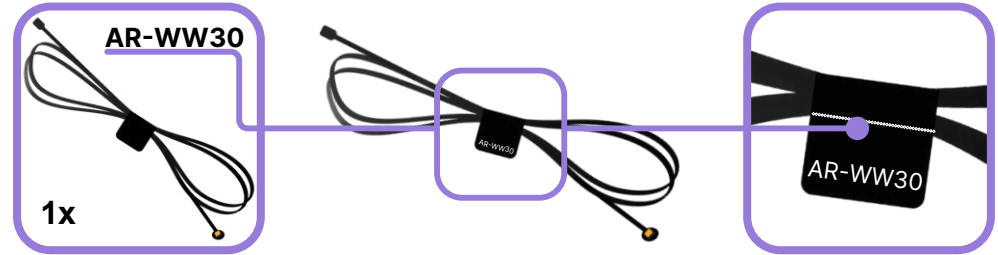
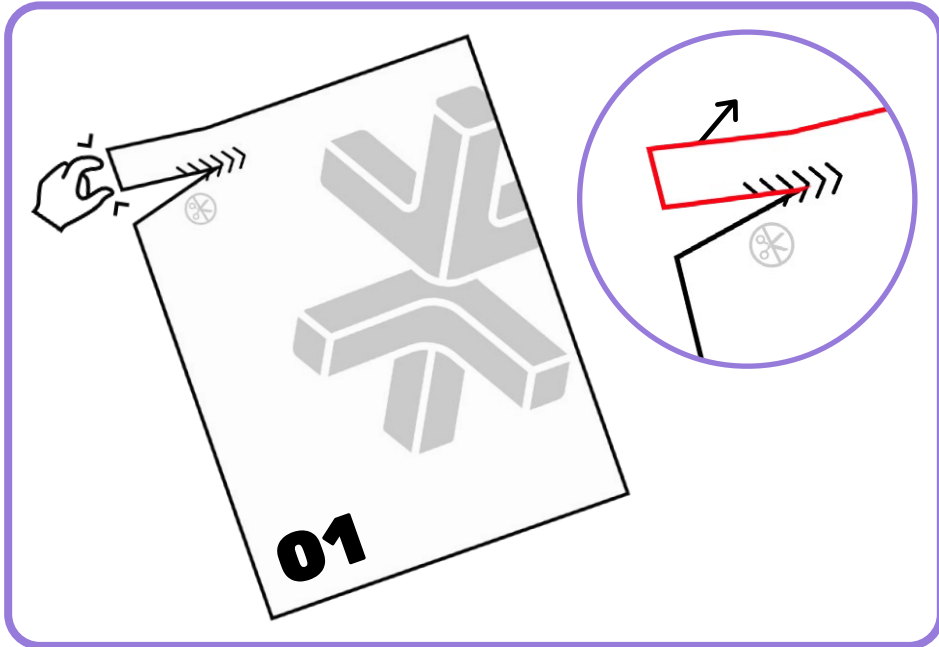

# BLUEPRINT

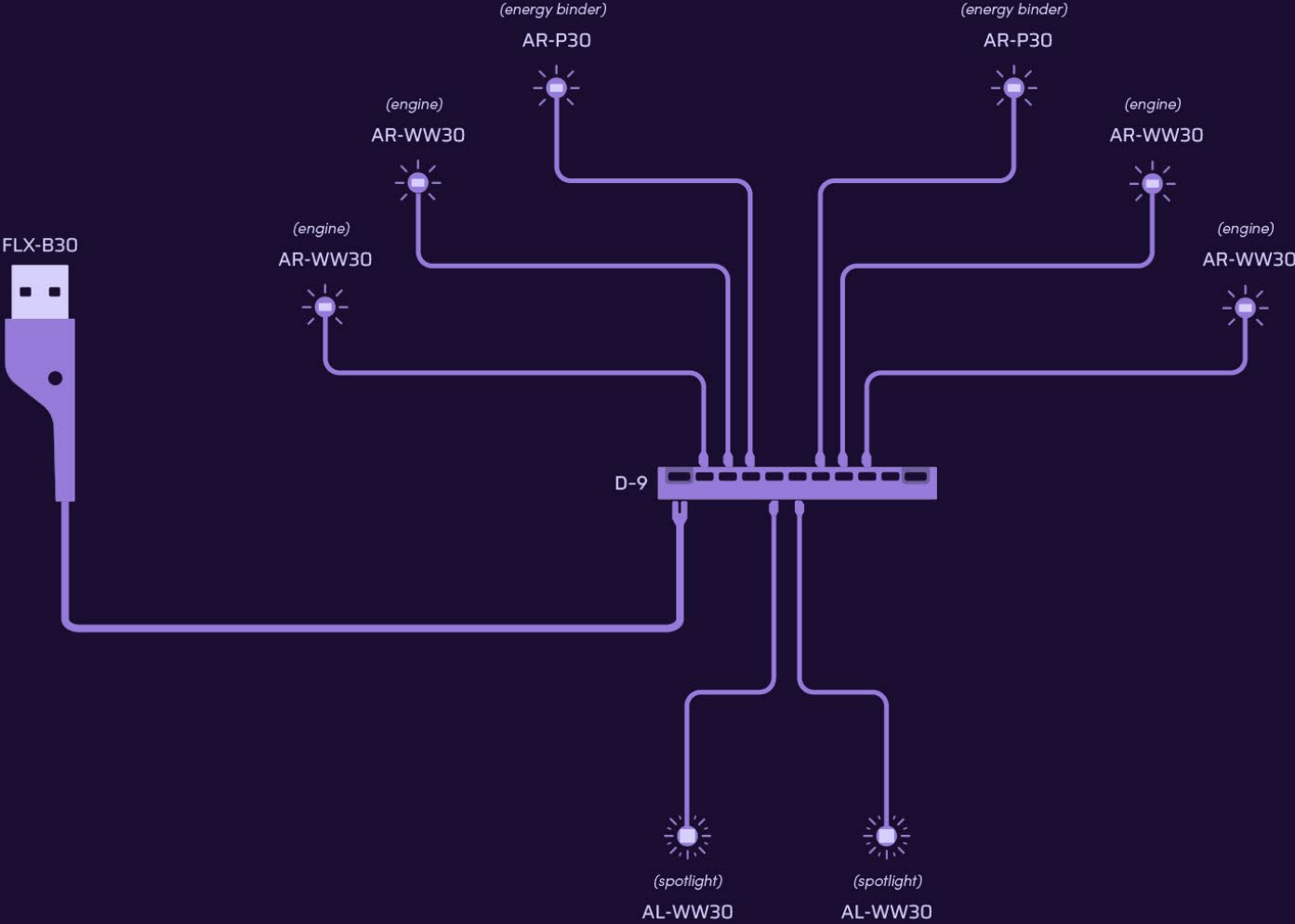



### **HOLD UP!**

You might notice some bags aren't in order, as well as left over pieces, but that's ok! We're changing the way you build LEGO!

### **HALTEN!**

Möglicherweise stellen Sie fest, dass einige Beutel nicht in Ordnung sind und auch Teile übrig bleiben, aber das ist in Ordnung! Wir verändern die Art und Weise, wie Sie LEGO bauen!

### **TENIR BON!**

Vous remarquerez peut-être que certains sacs sont en panne, ainsi que des morceaux restants, mais ce n'est pas grave ! Nous changeons la façon dont vous construisez LEGO !

### **HALT!**

Sie werden möglicherweise bemerken, dass einige tüten durcheinander sind und teile übrig bleiben, aber das ist in Ordnung! Wir ändern die art und weise, wie Sie LEGO bauen!

### **¡ESPERA!**

Es posible que notes que algunas bolsas están fuera de servicio, así como piezas sobrantes, ¡pero está bien! ¡Estamos cambiando la forma en que construyes LEGO!

### **暫停!**

你可能会注意到一些袋子顺序错乱, 以及一些剩余的部件, 但没关系! 我们正在改变你搭建乐高的方式!

#### Open LMB Bag 01

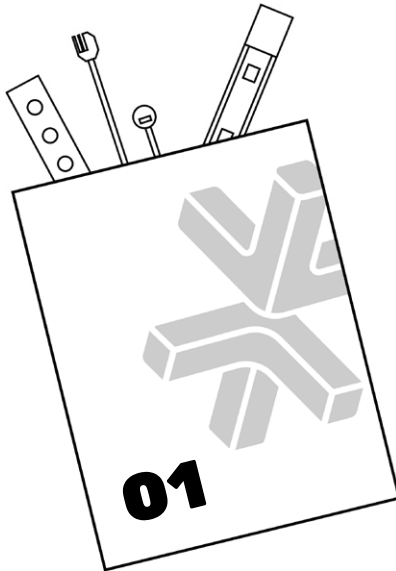

1

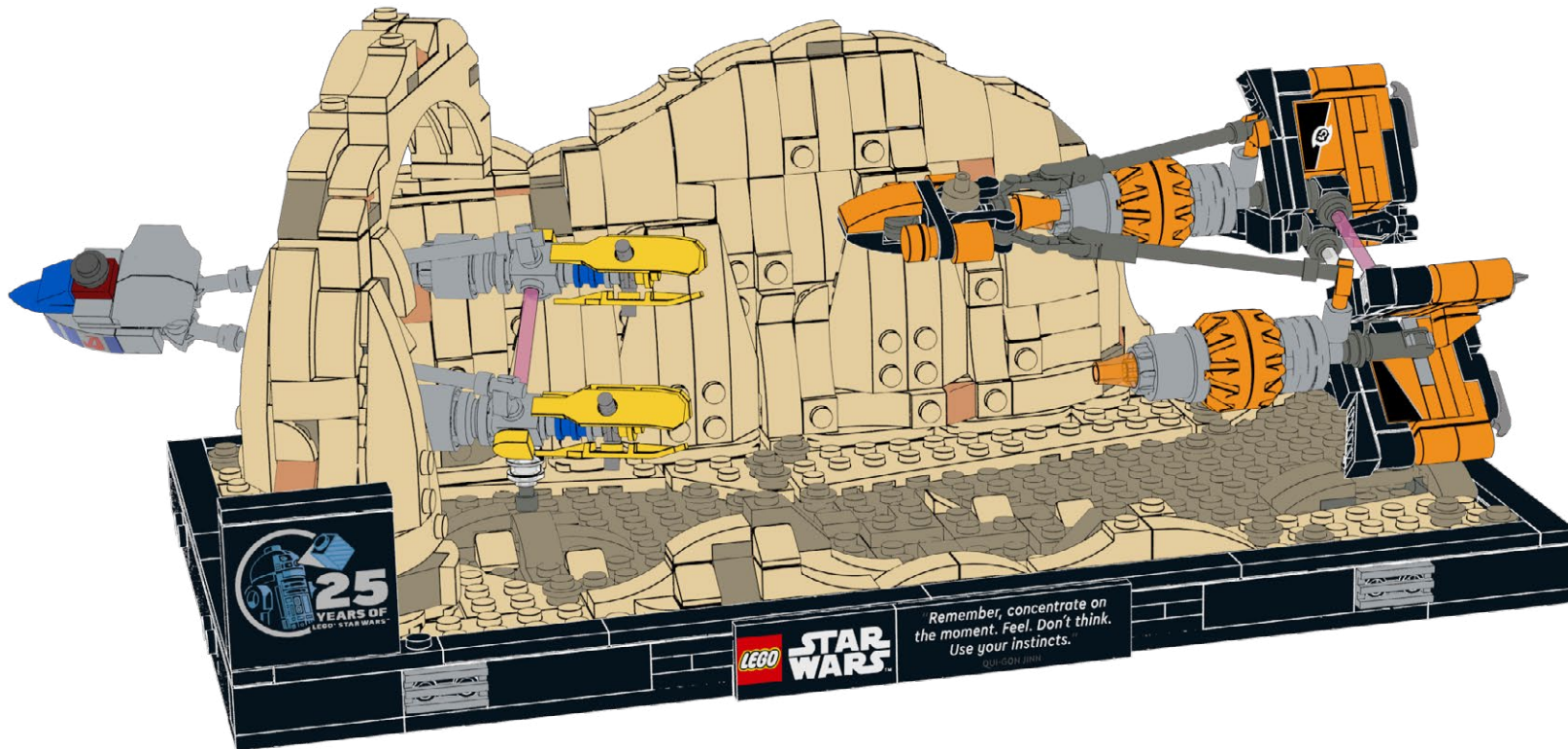



2

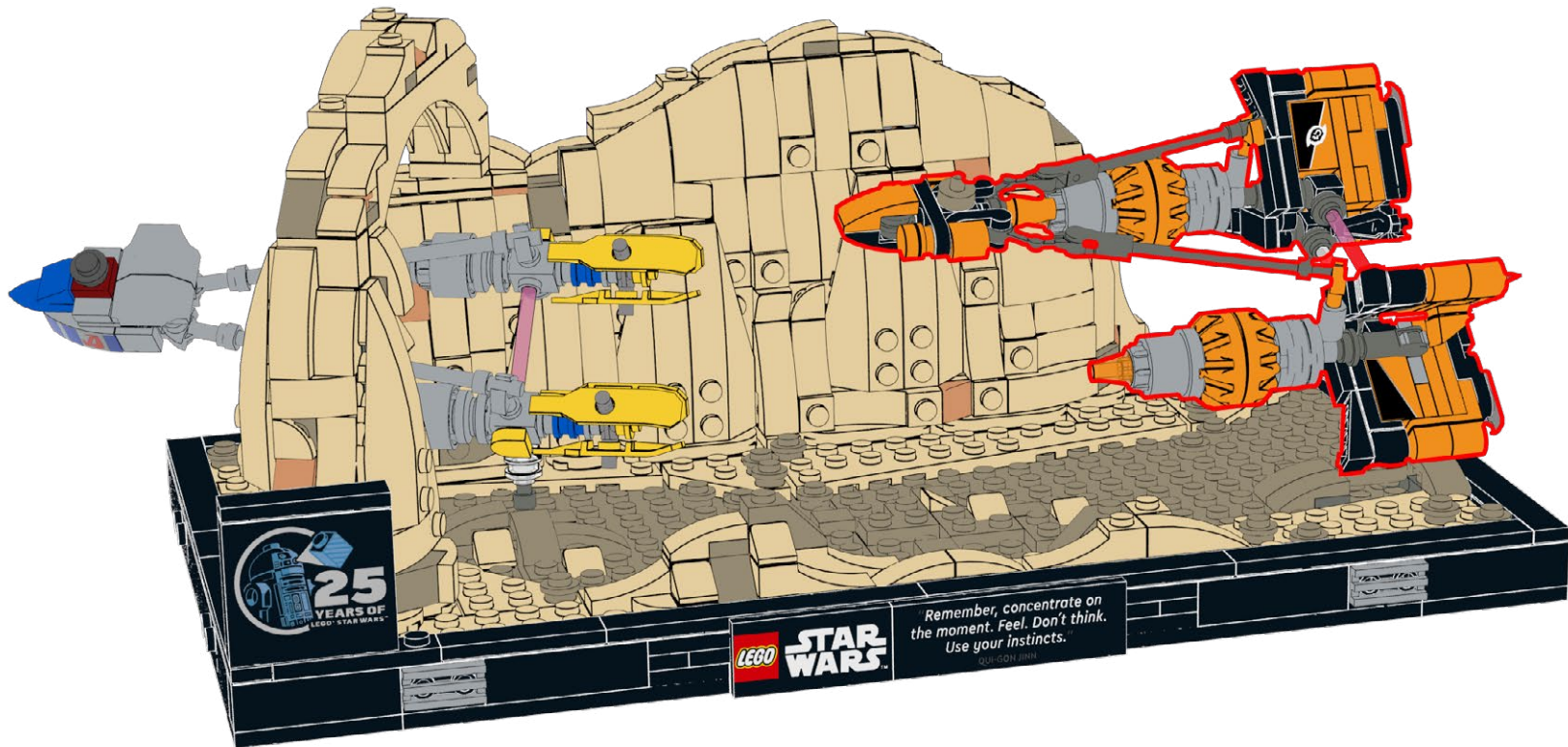

3

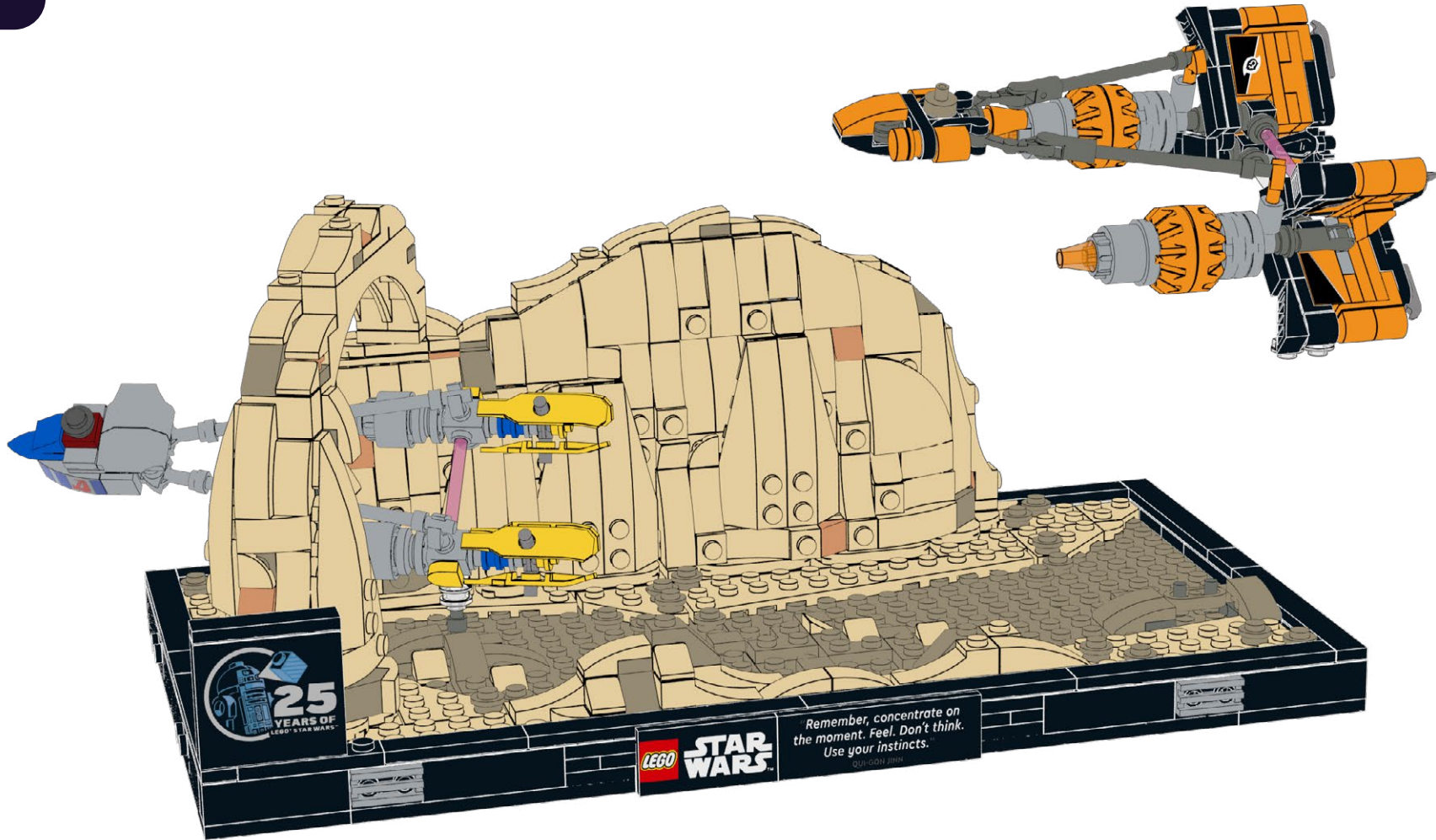

4

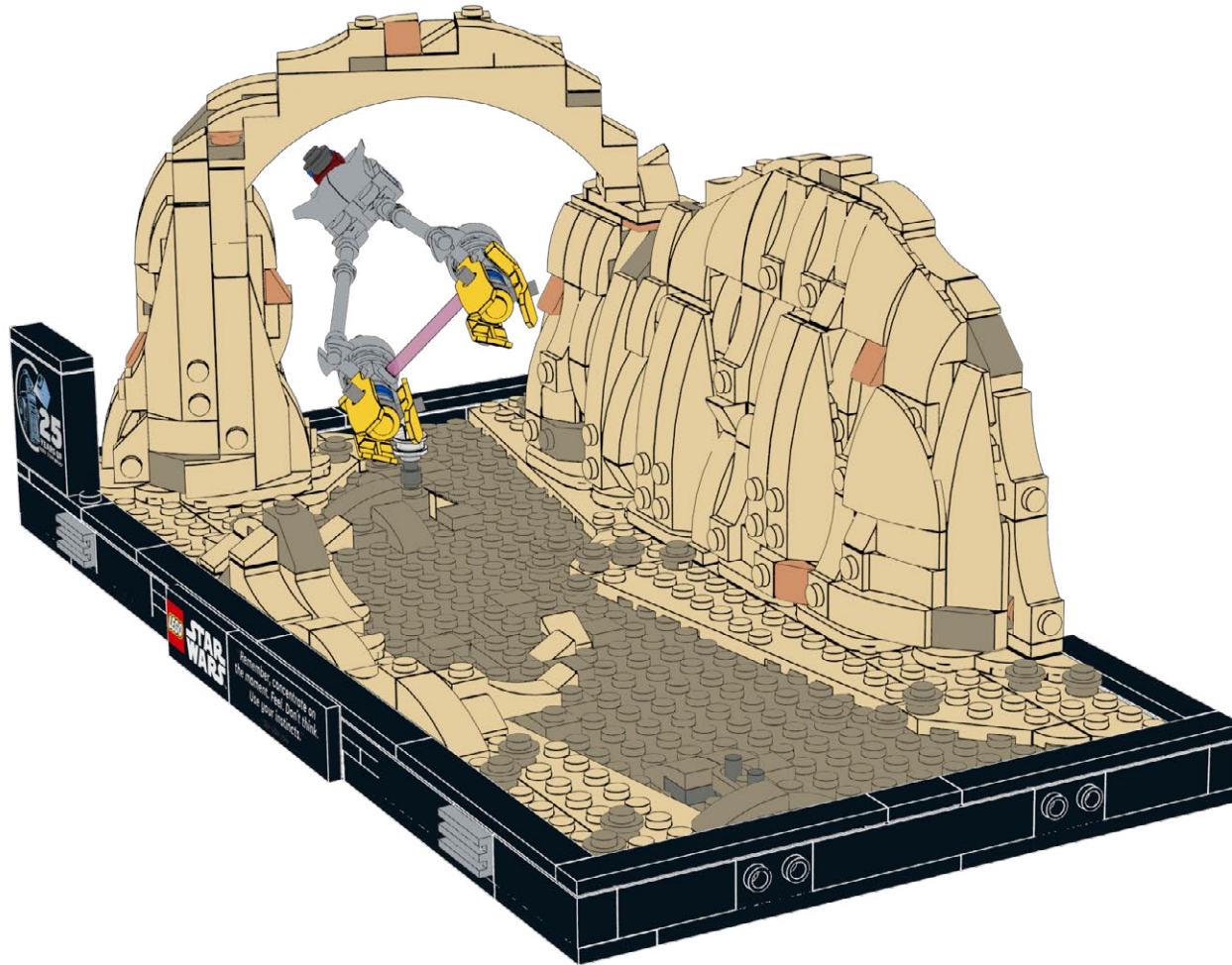

5

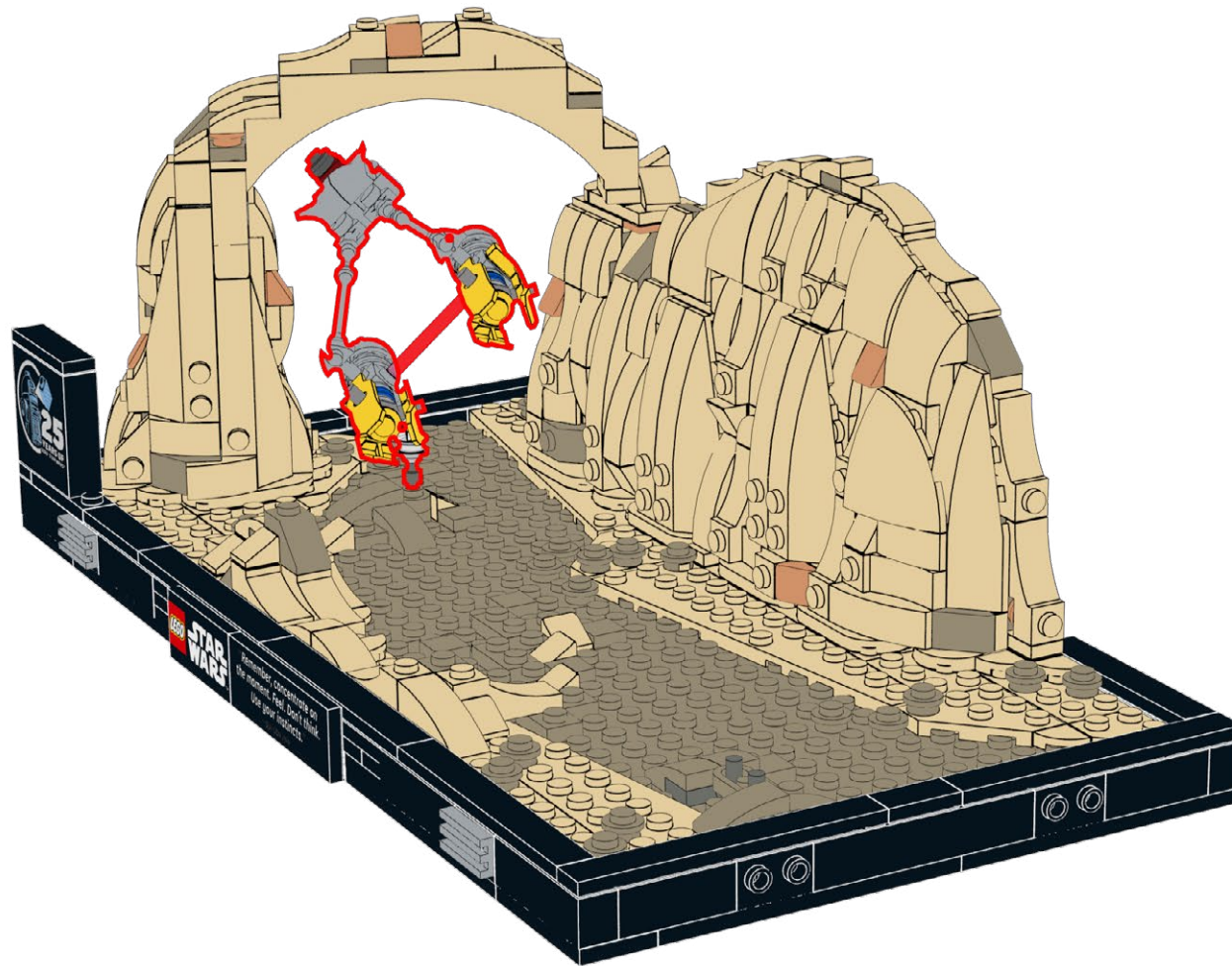

6

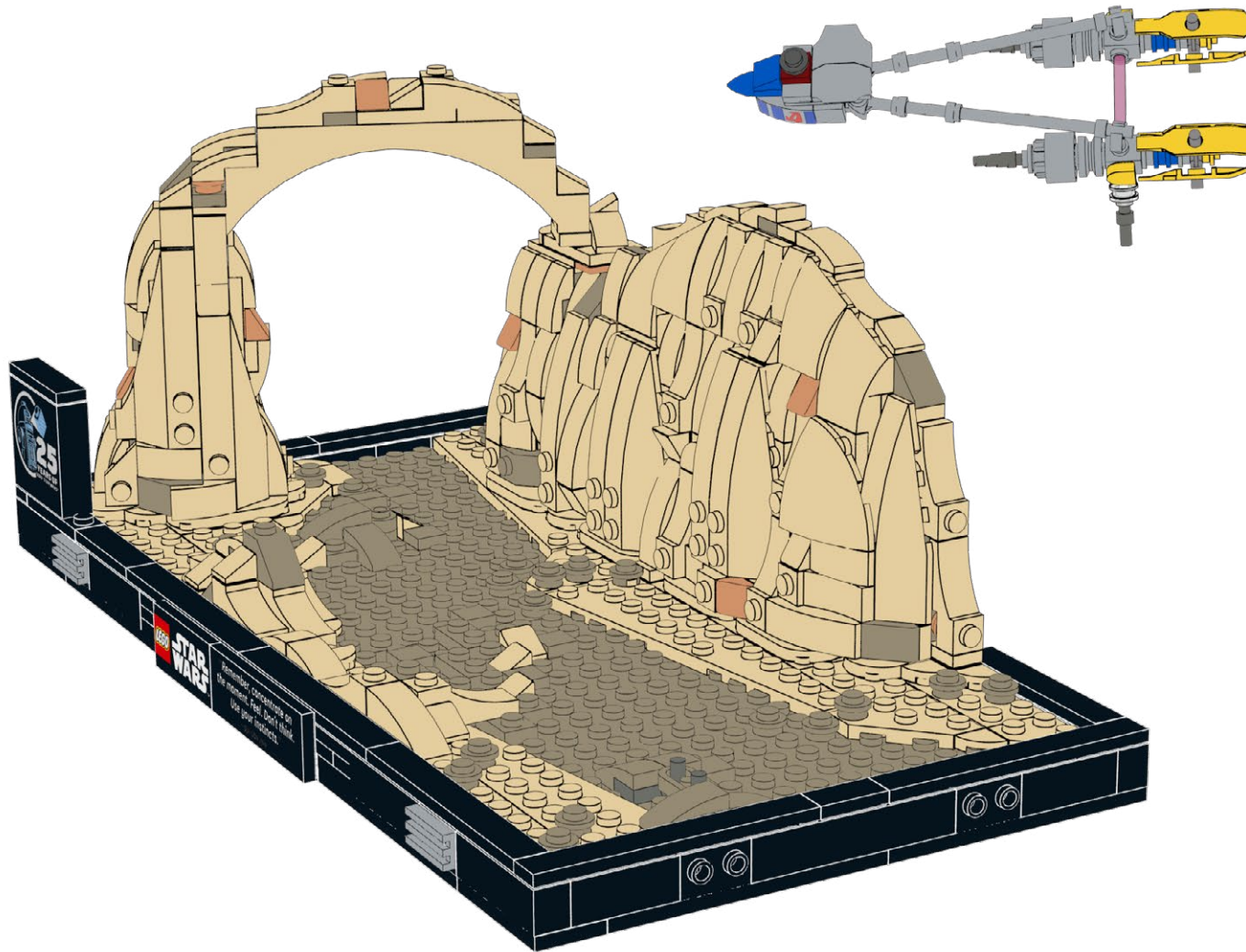

7

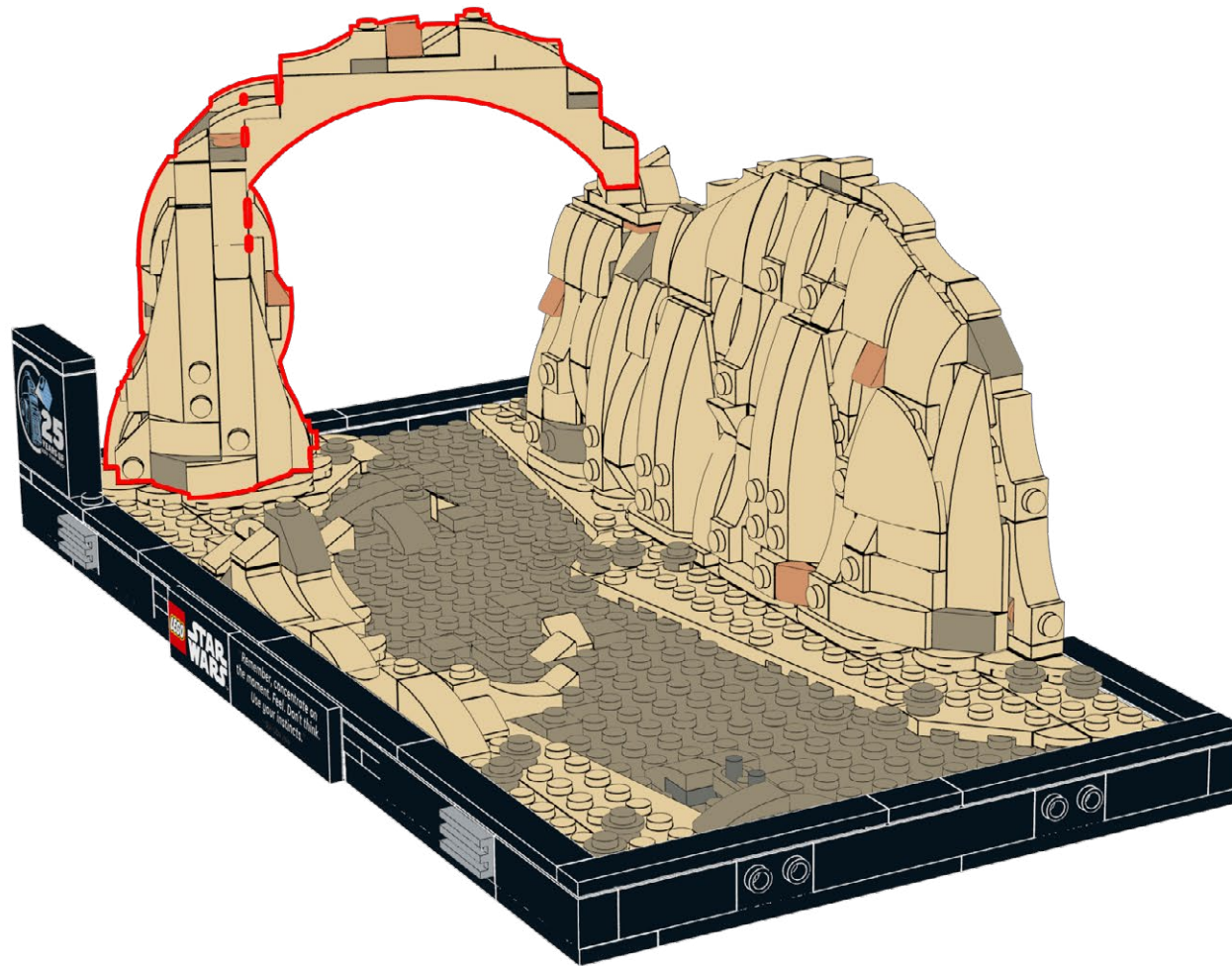

8

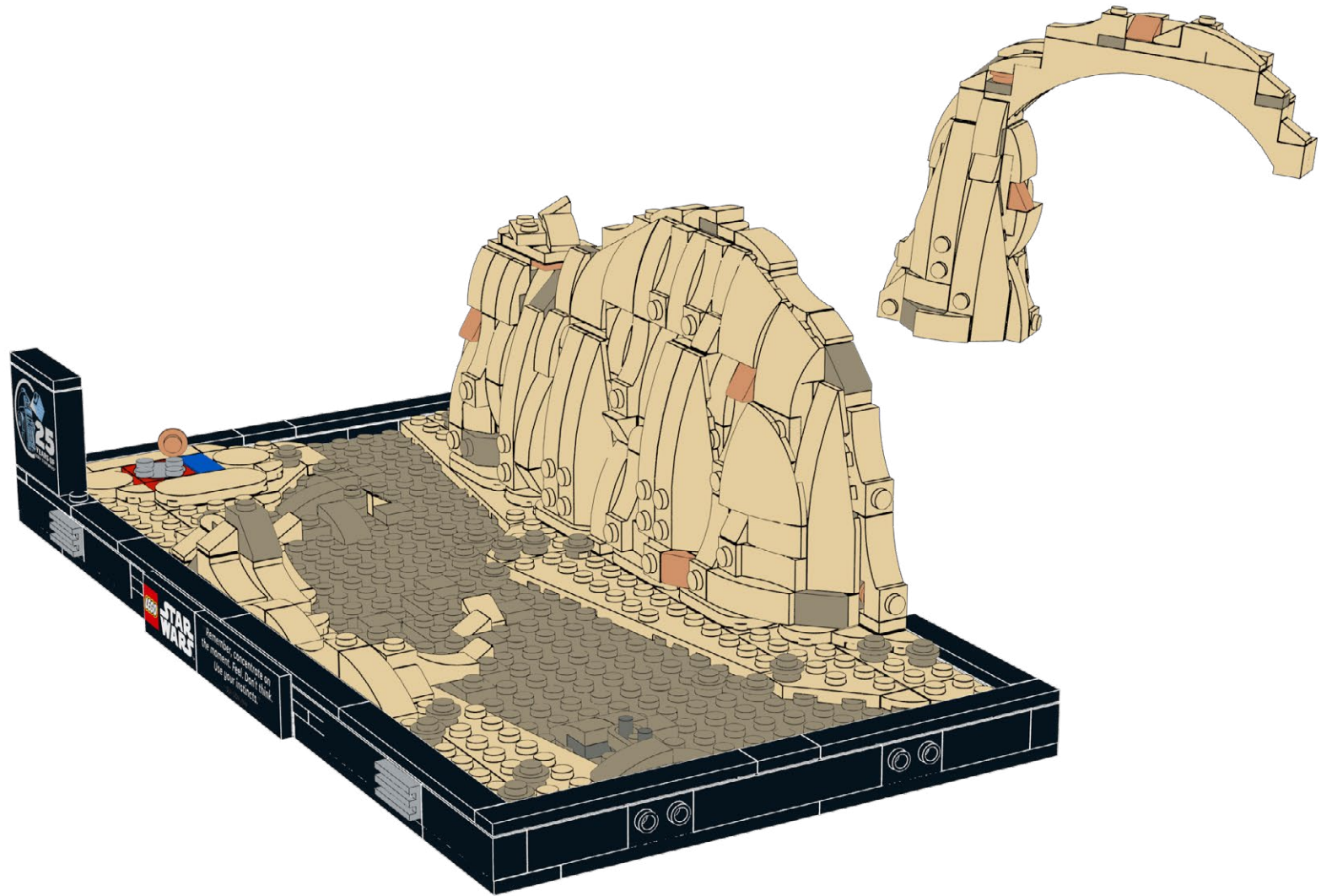

9

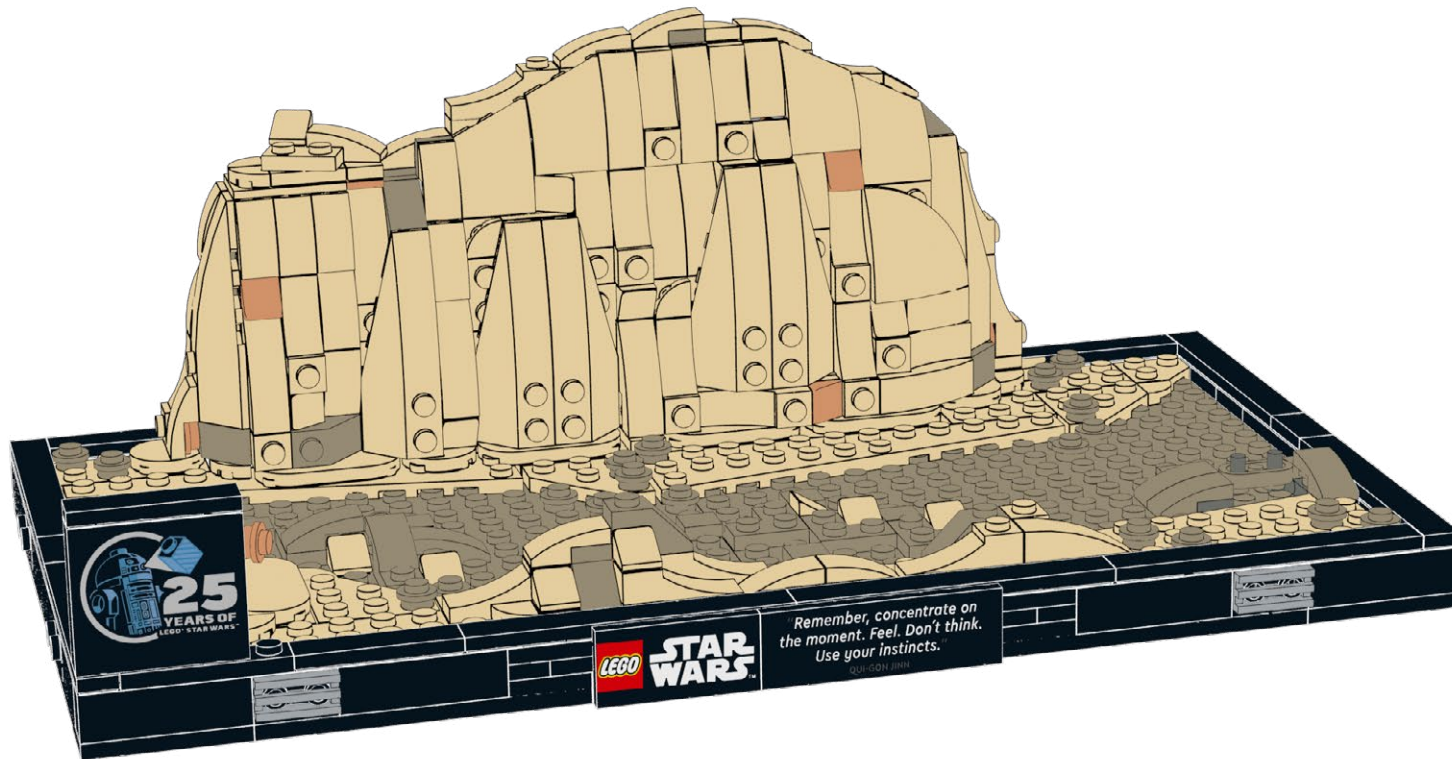



10

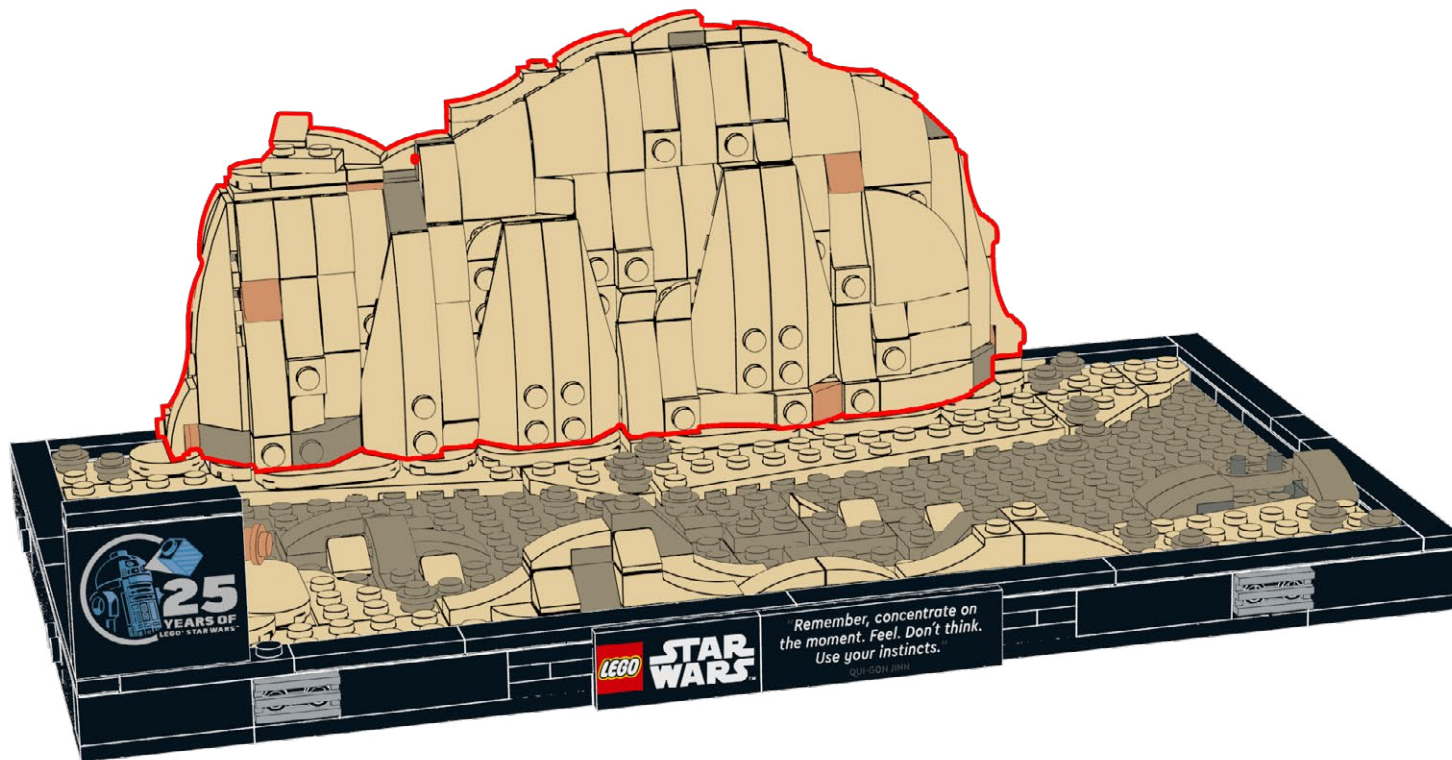

11

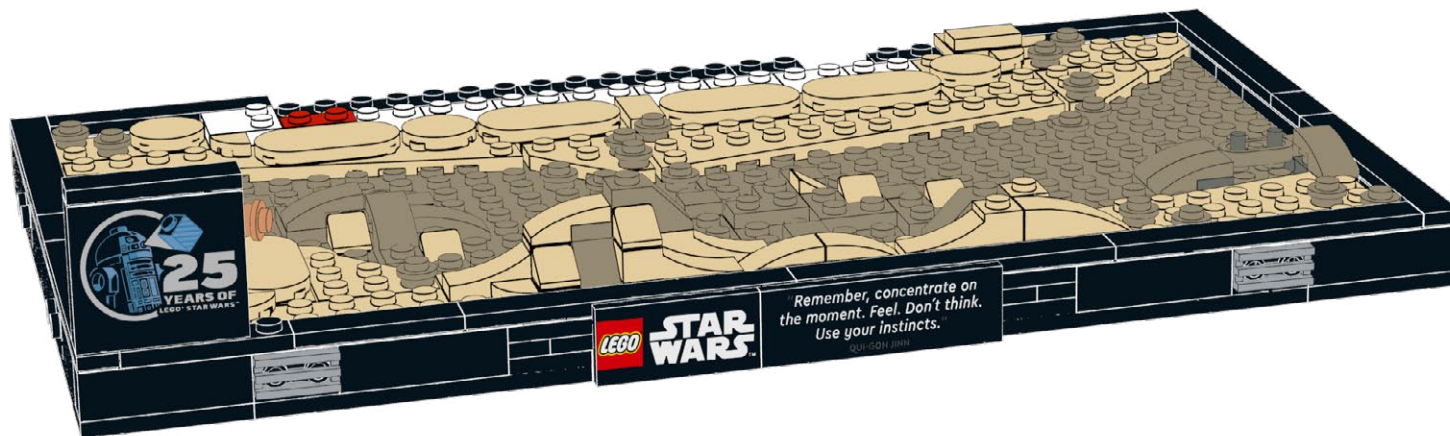
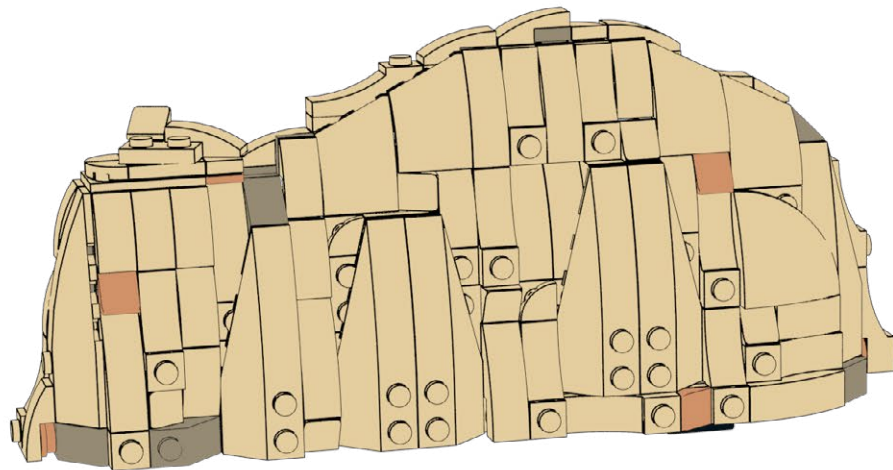

12

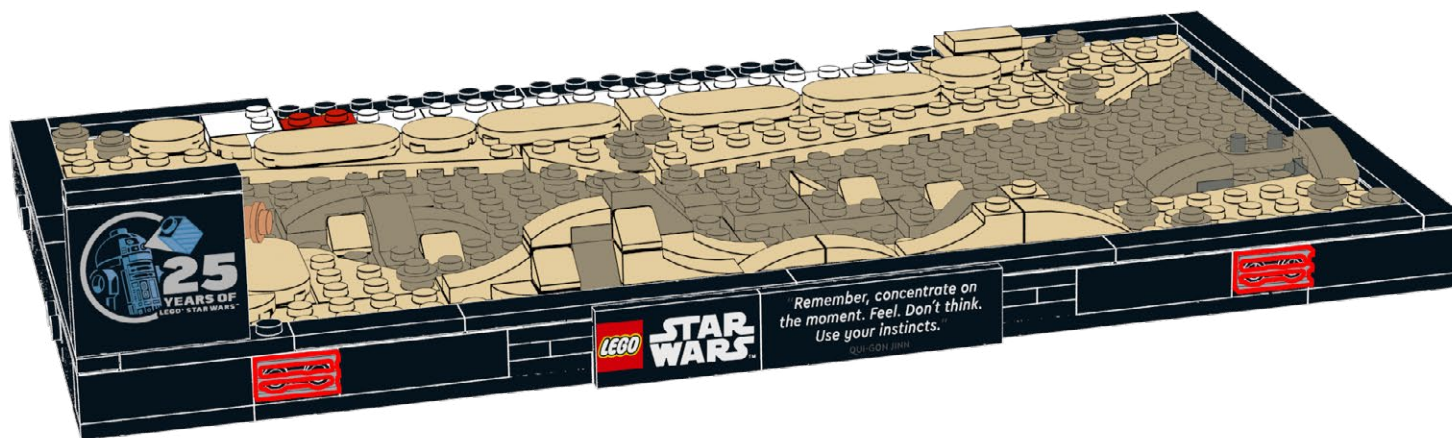

13

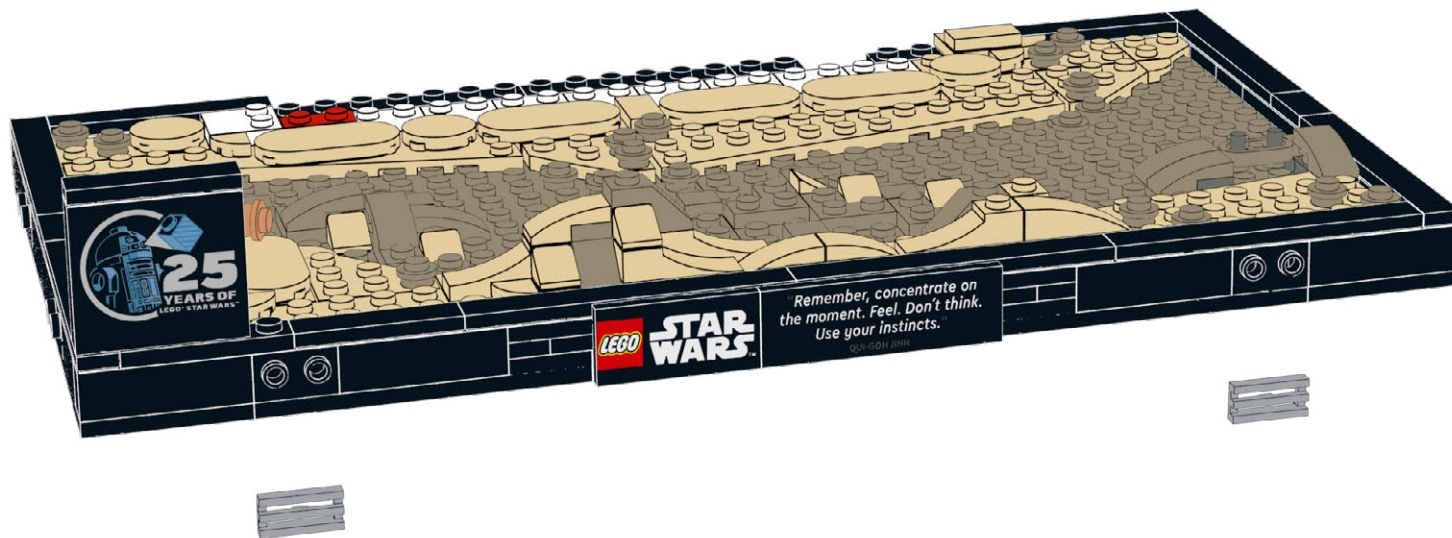

14

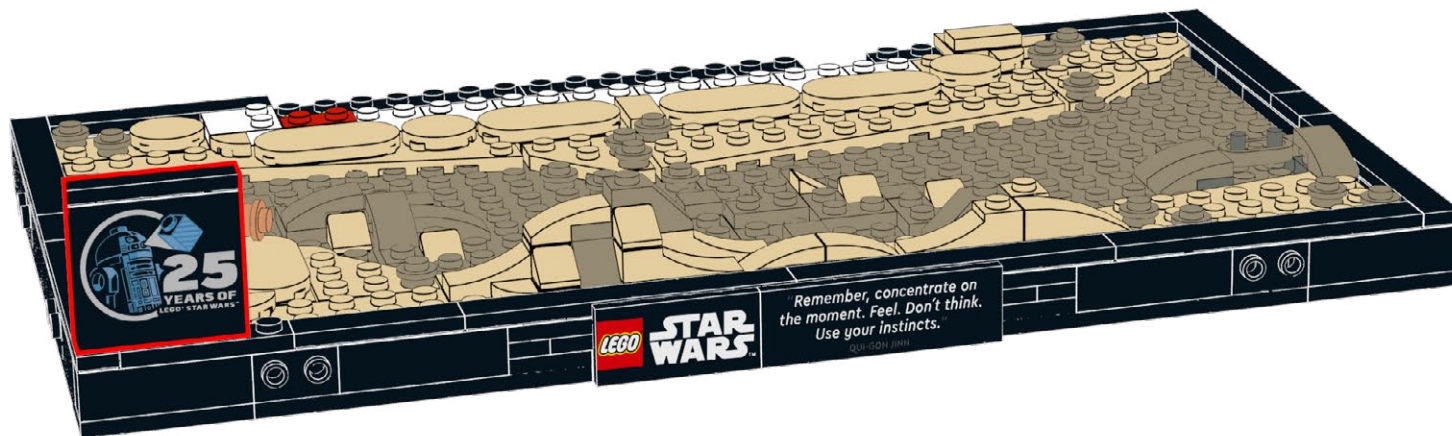

15

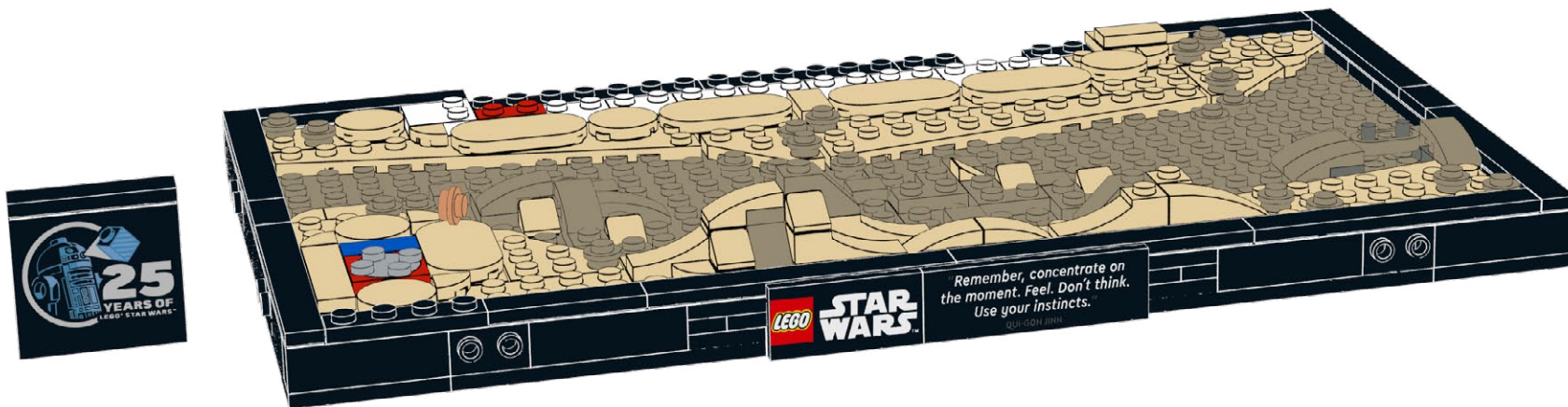

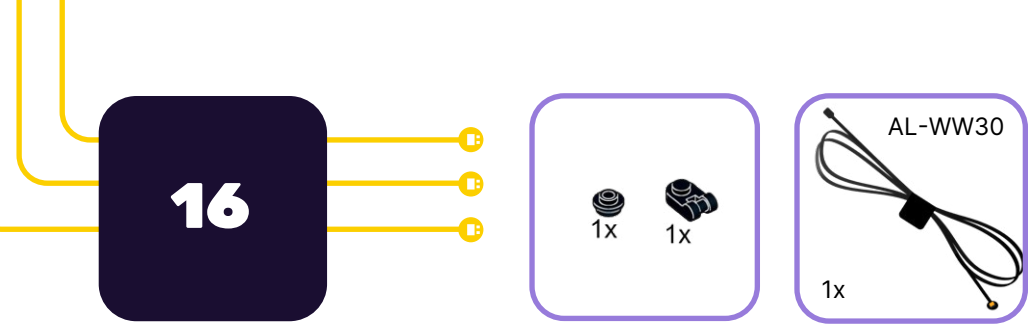

1



2

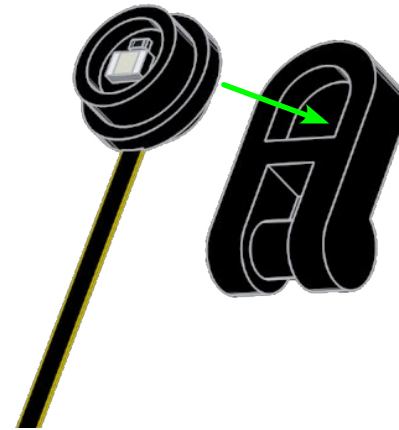

17

1x

1x

Astro Cap Clear

1x

1

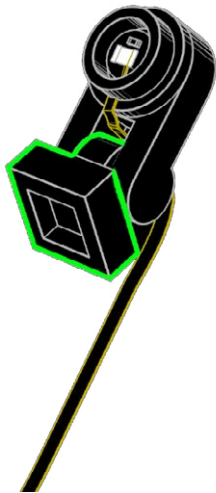

2

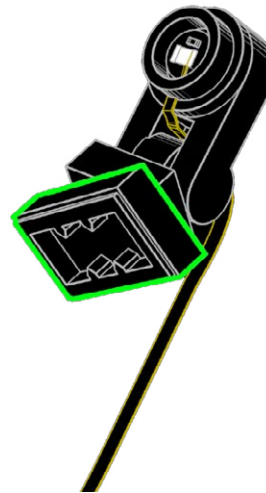

3

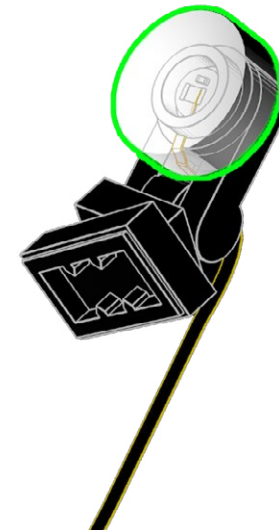

2x



18

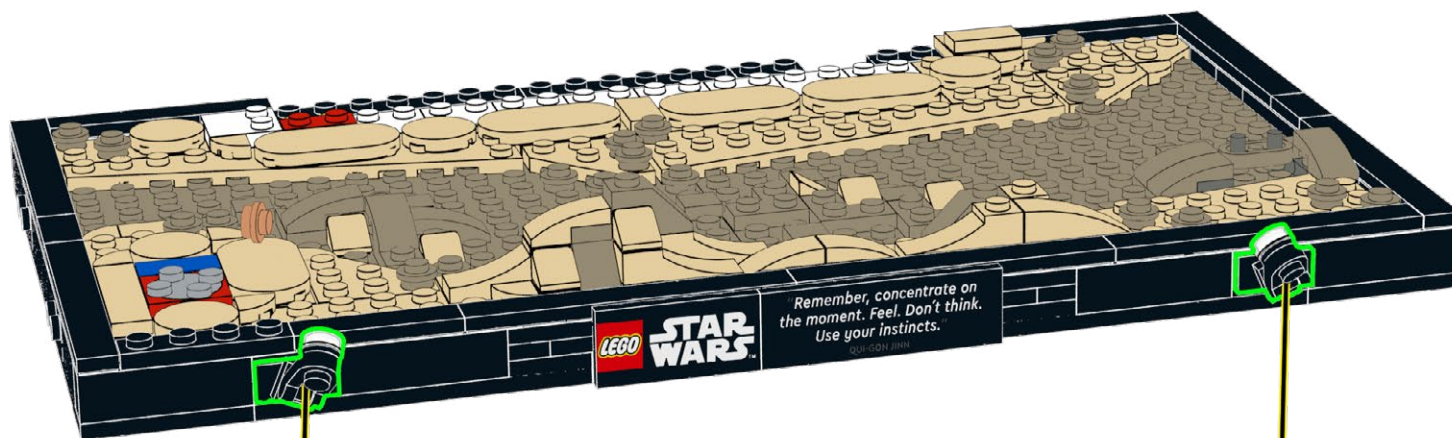

19

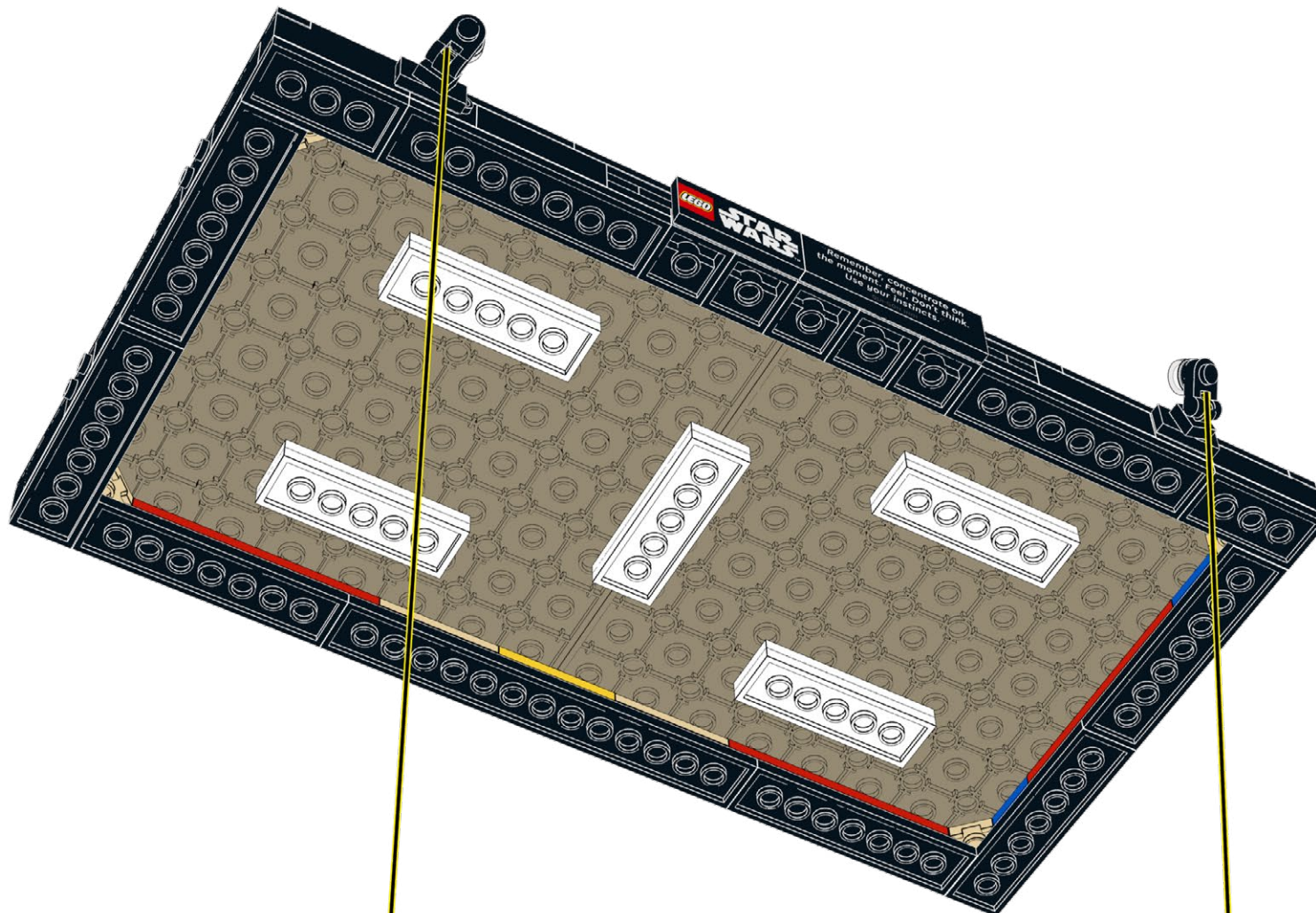

# 20

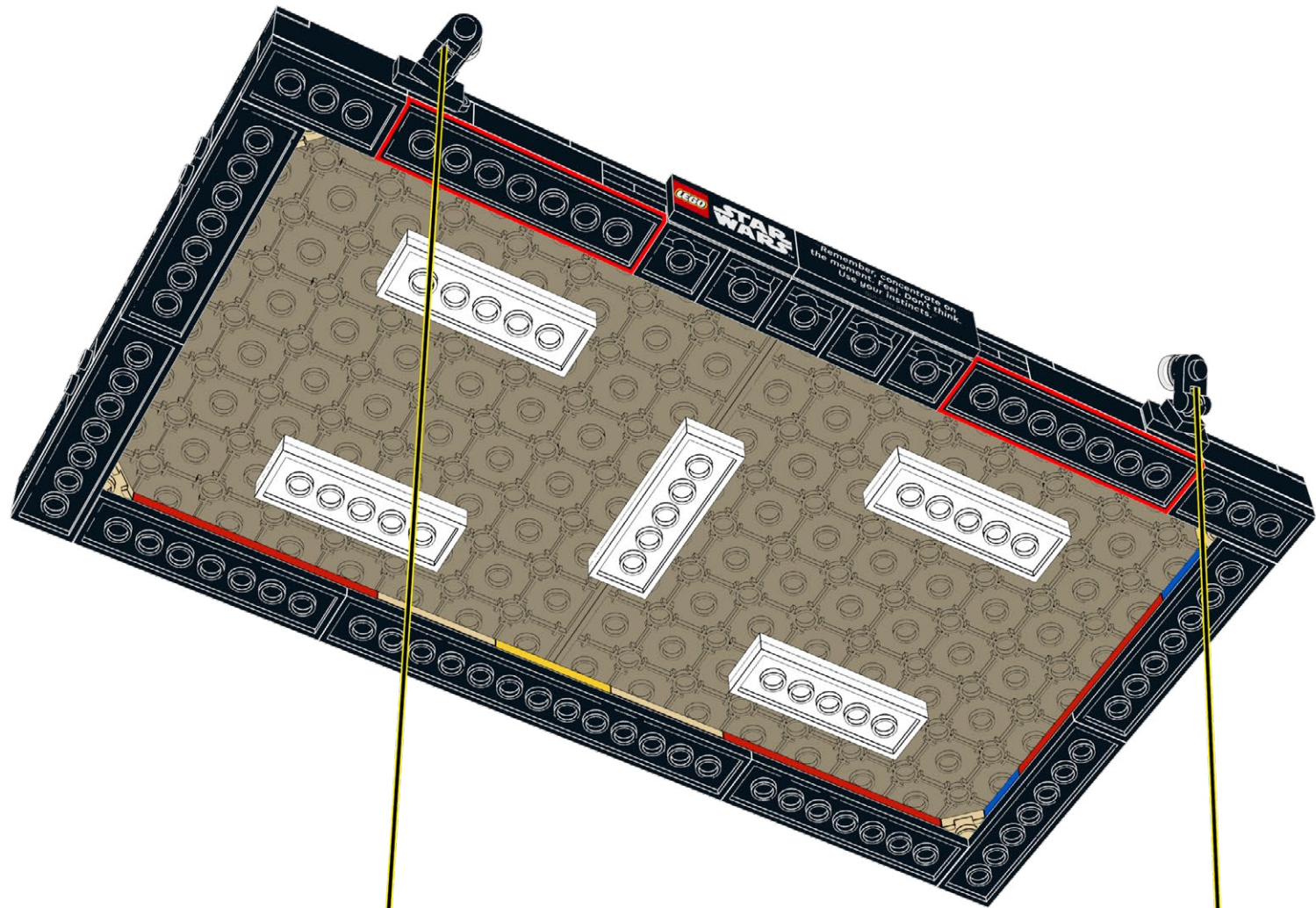

21

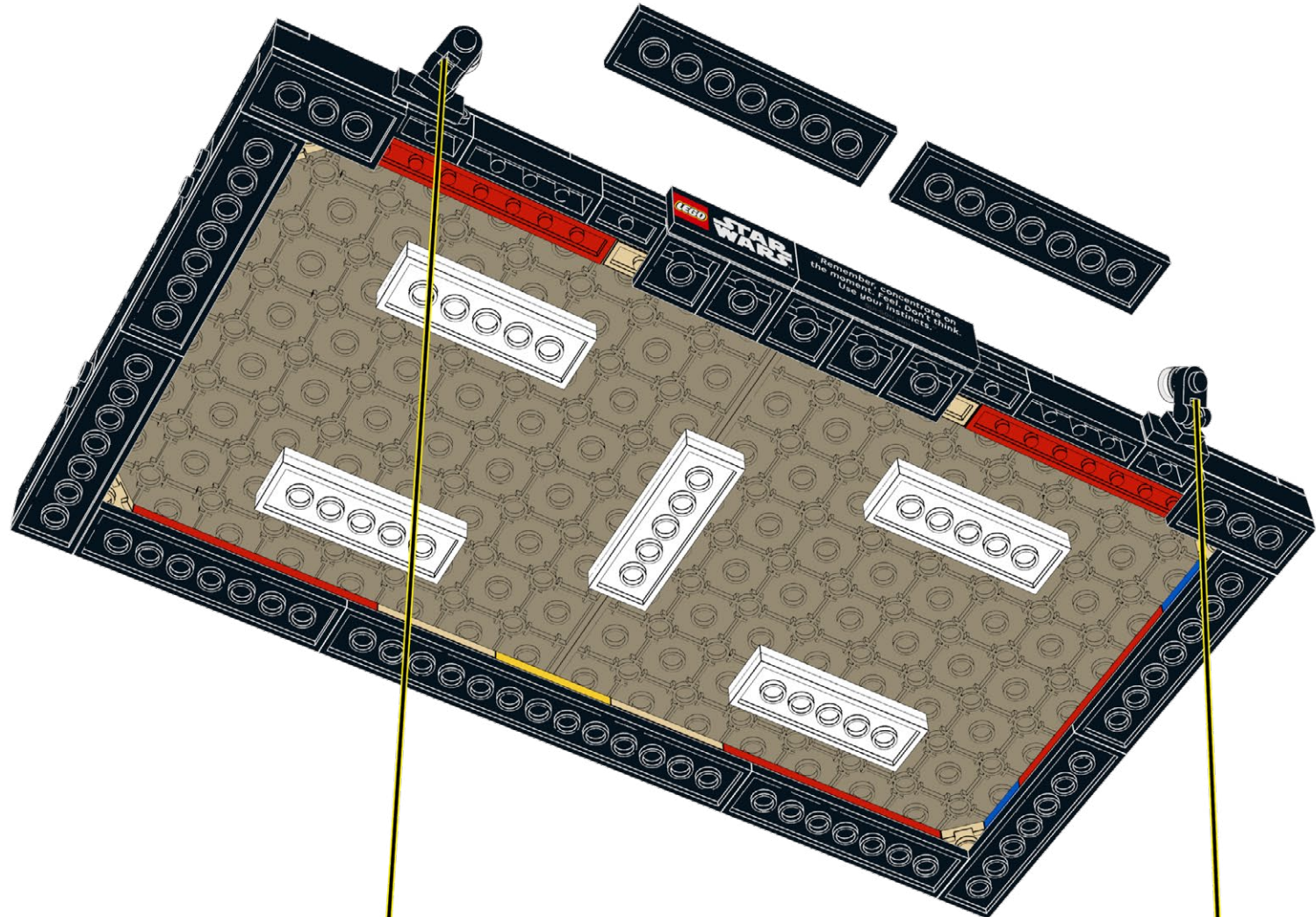

22

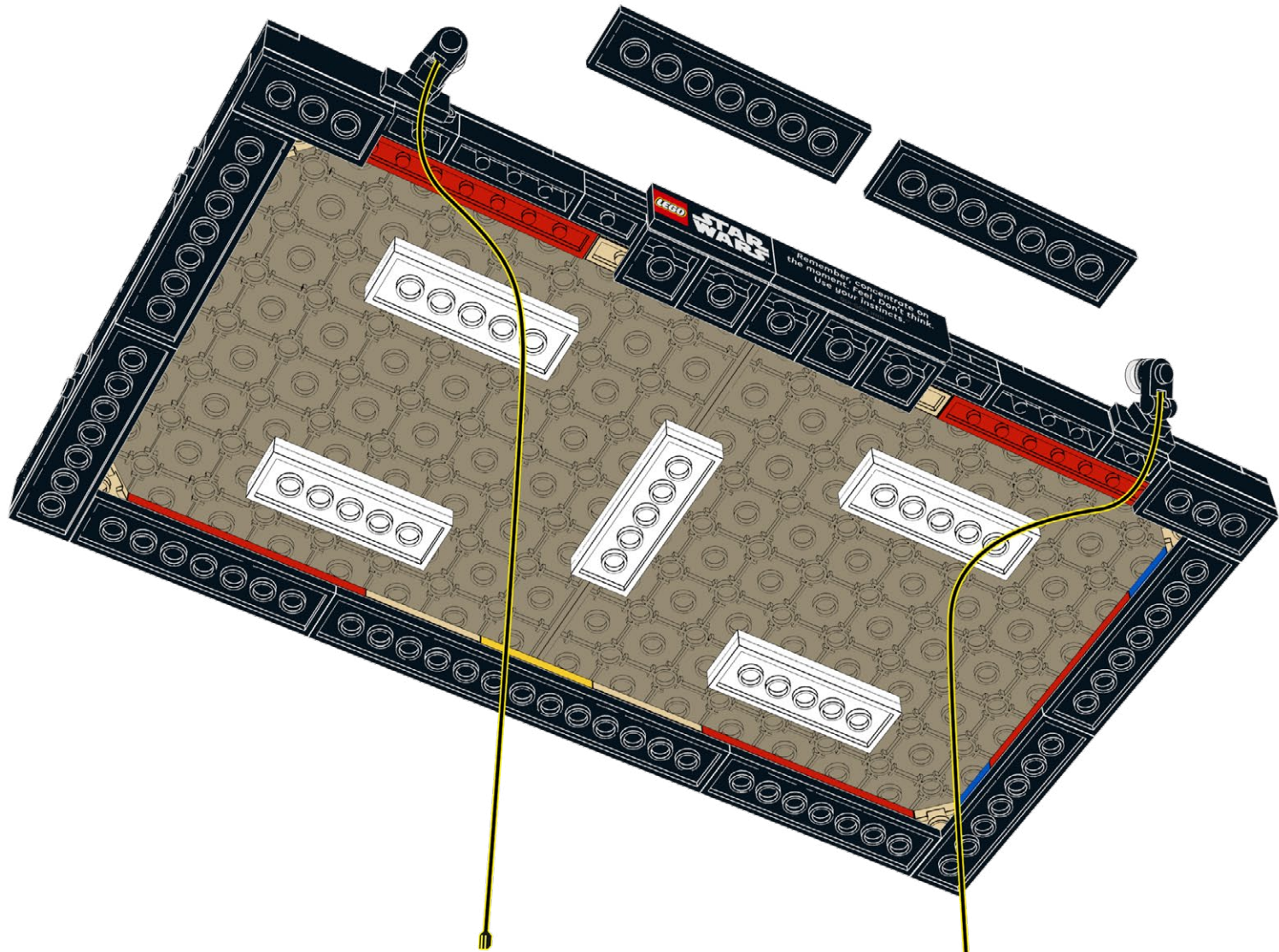

23

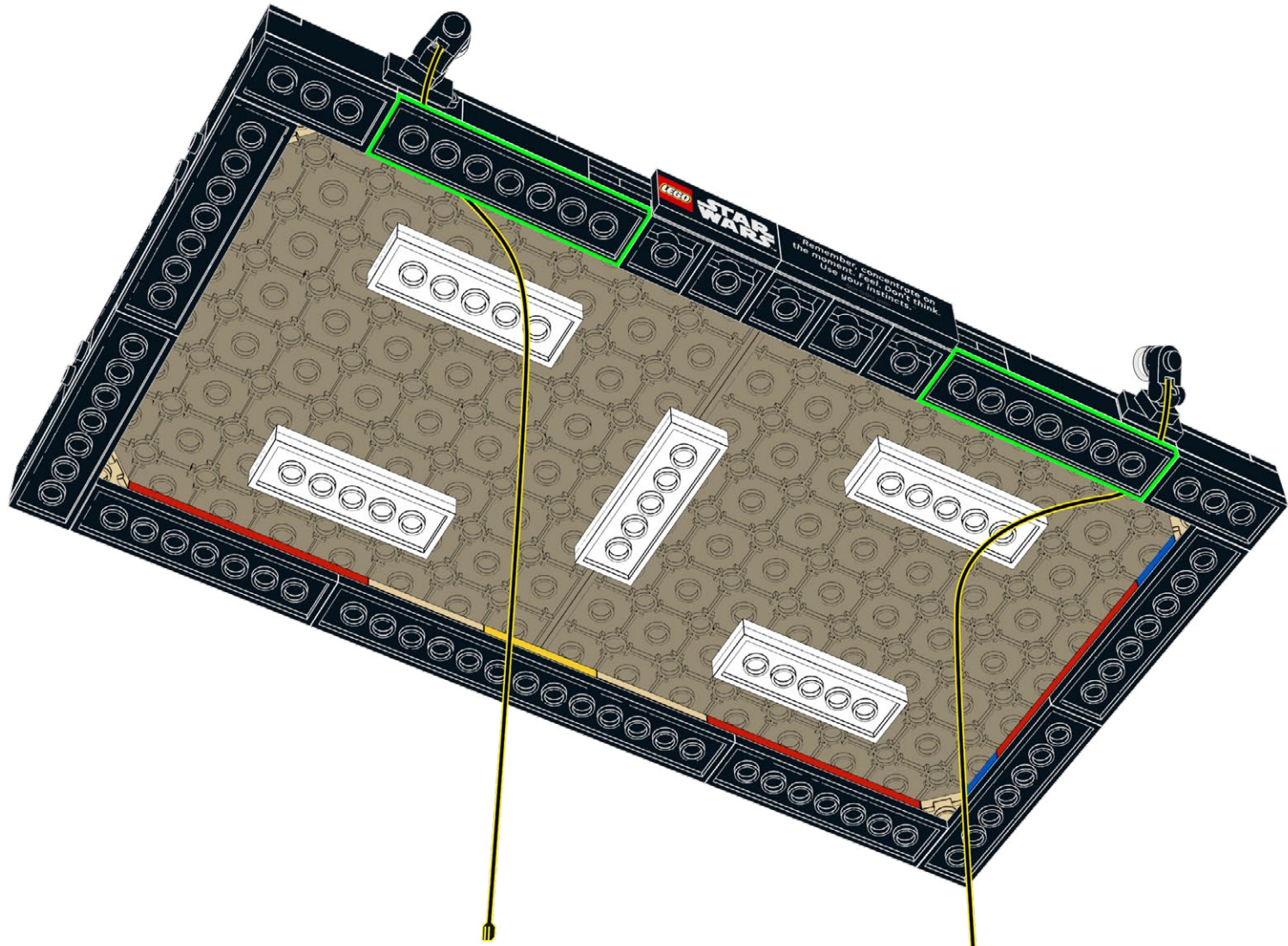

24

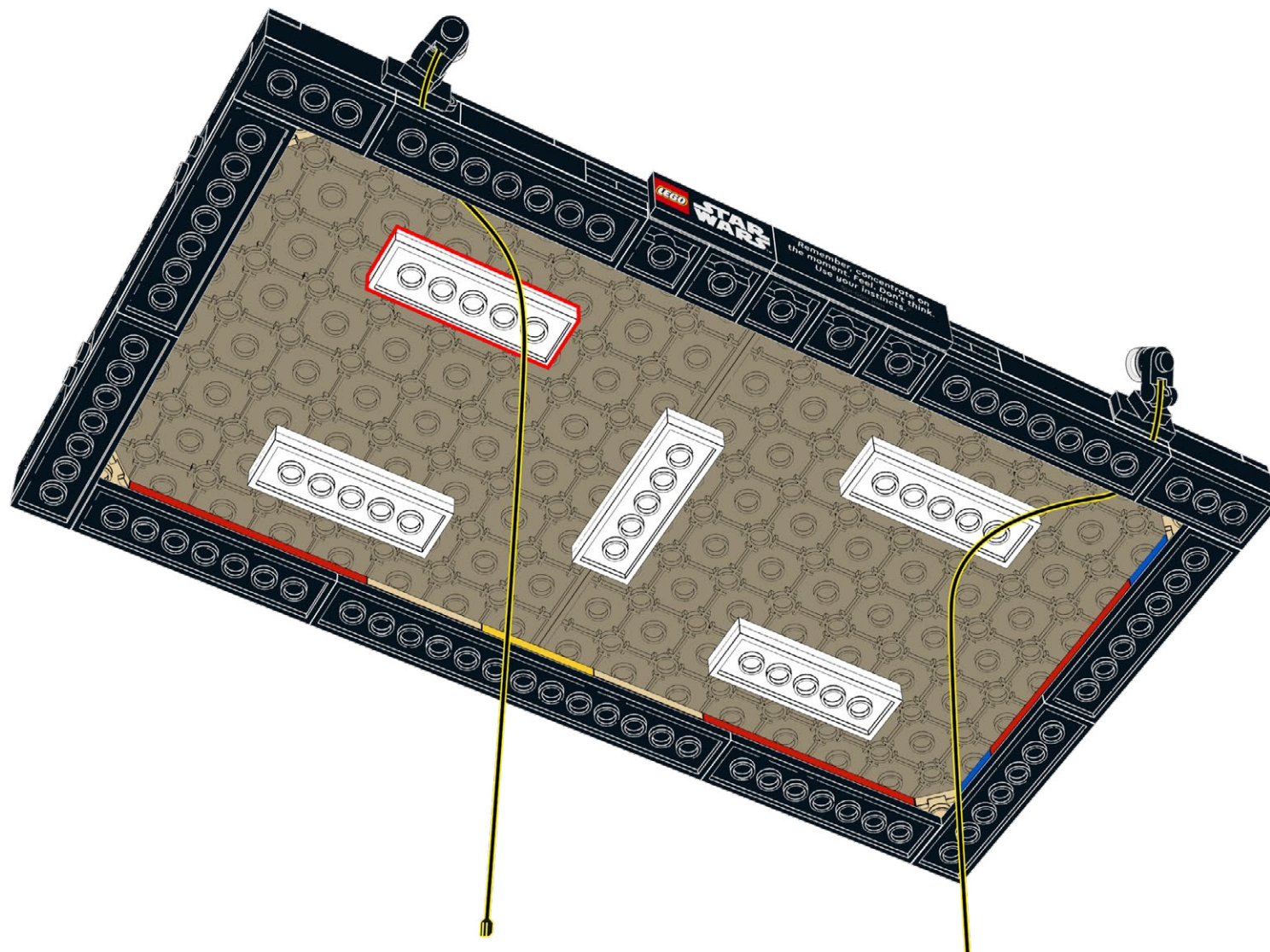

25

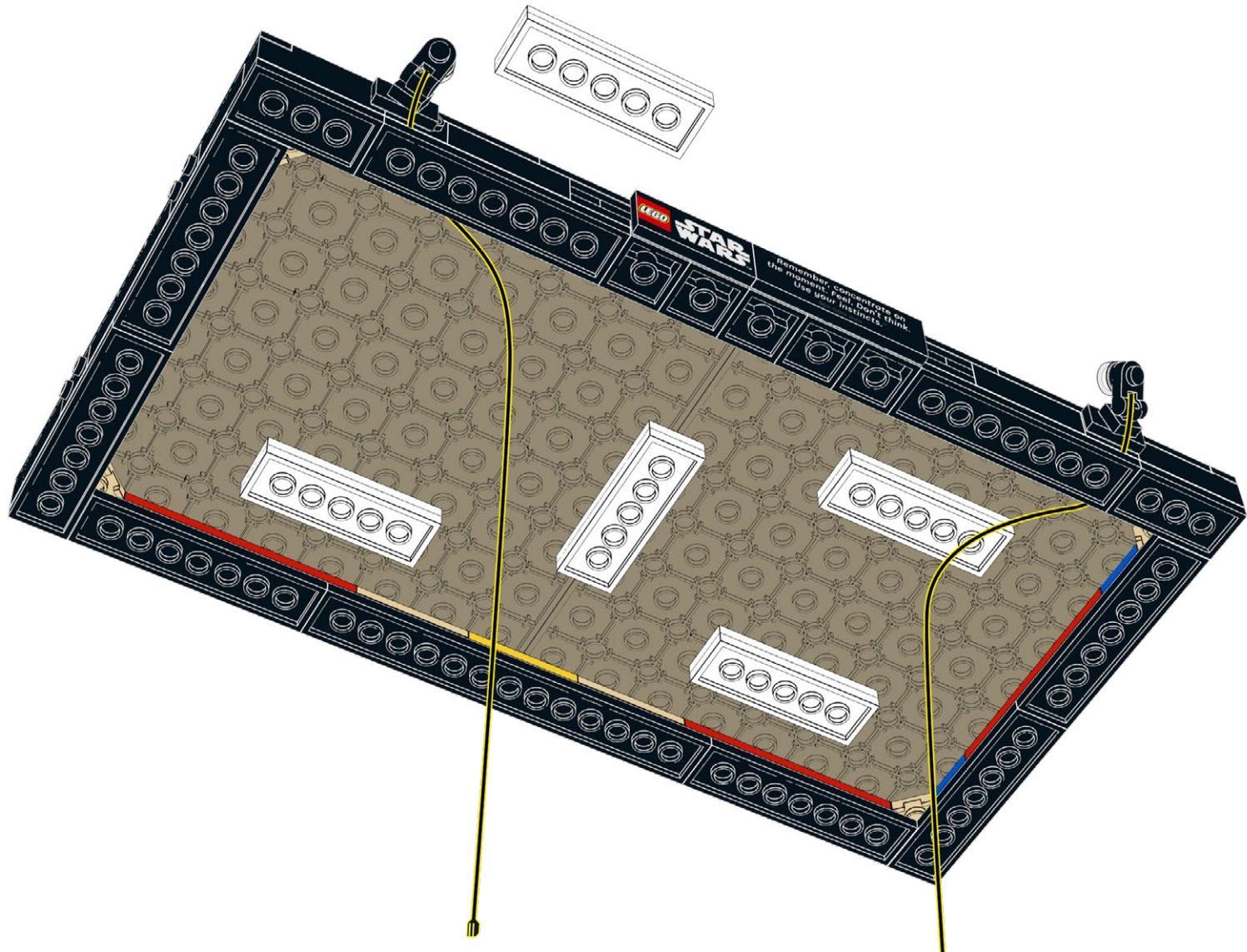



26

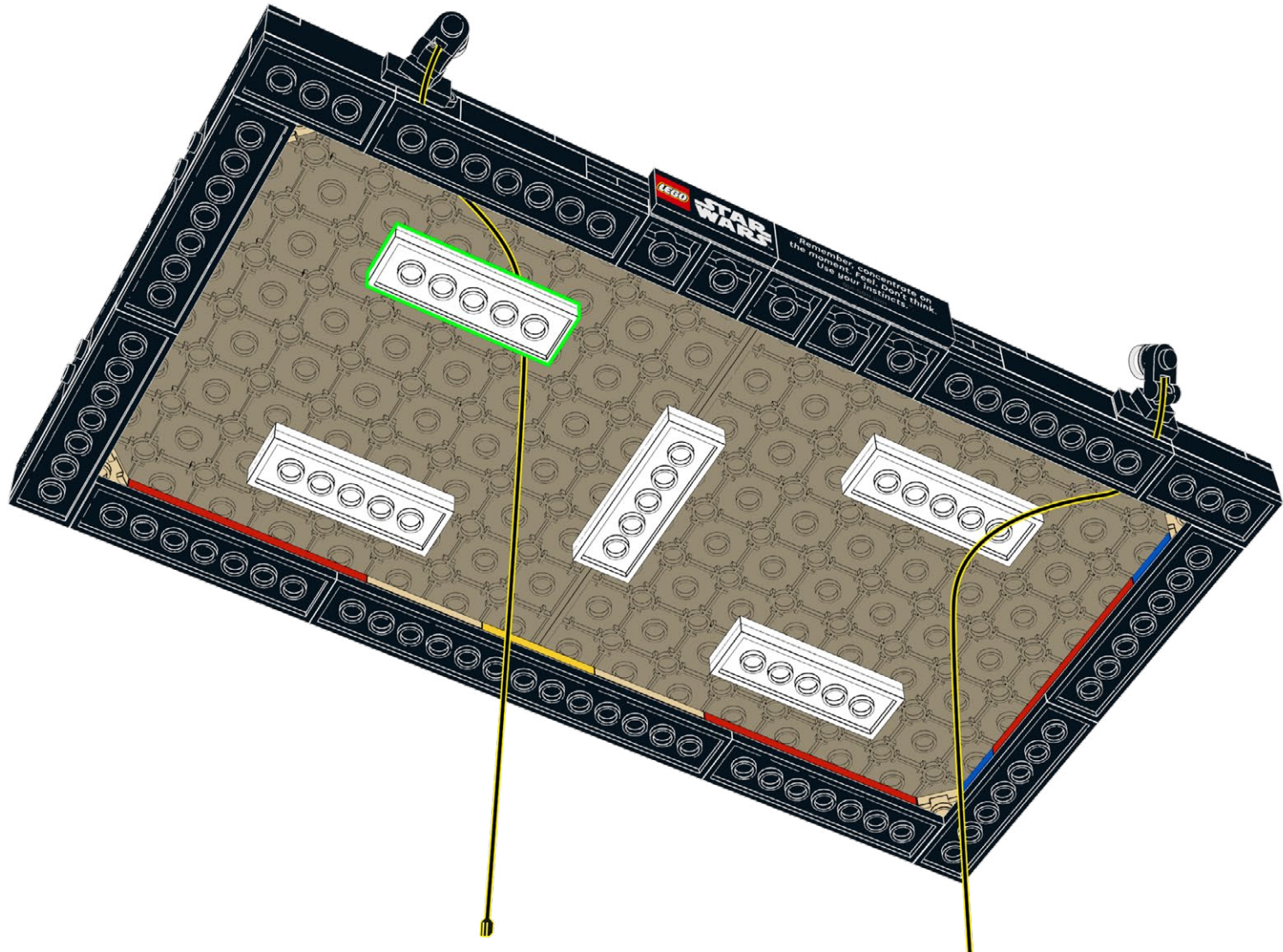

27

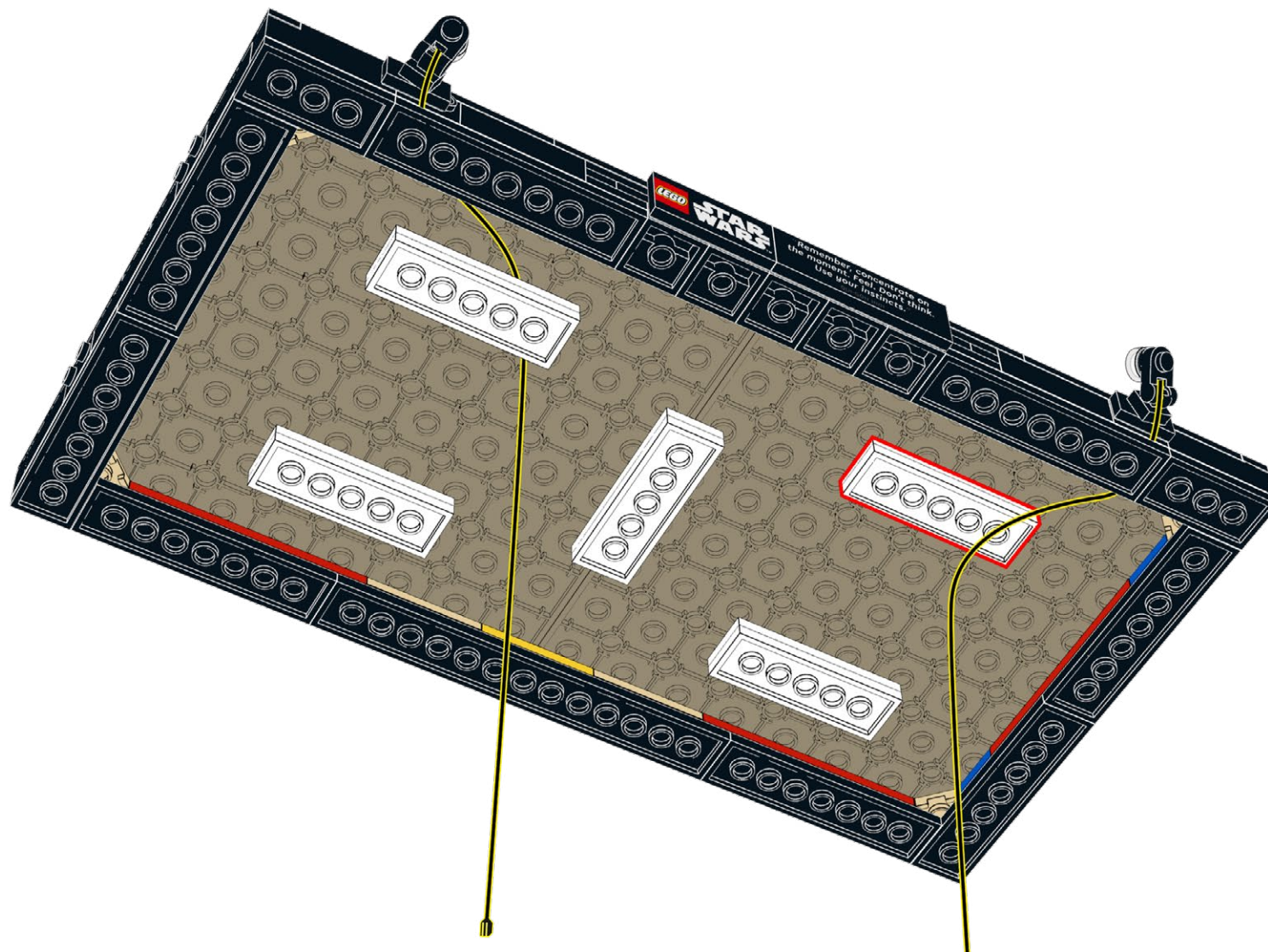

28

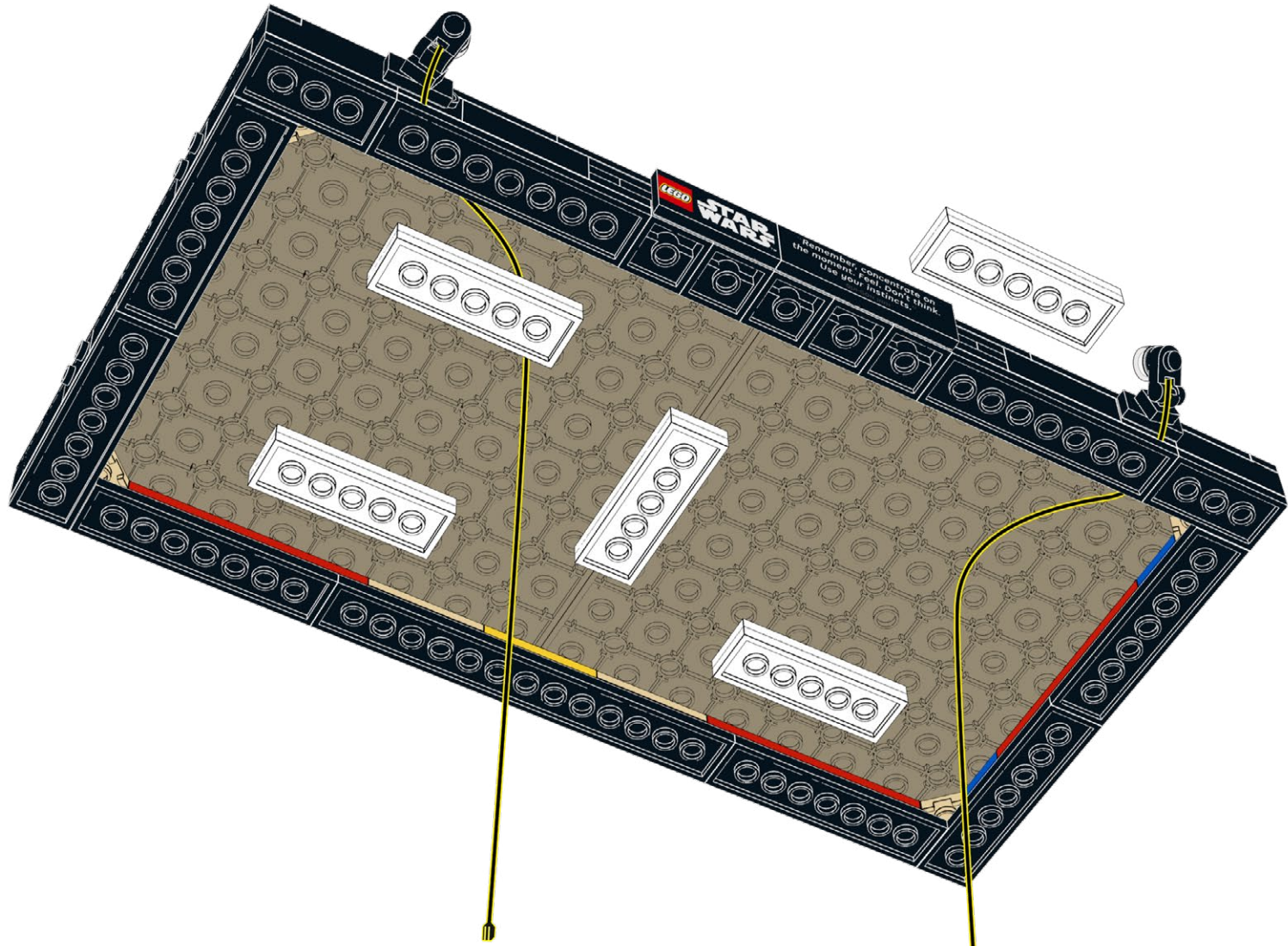

29

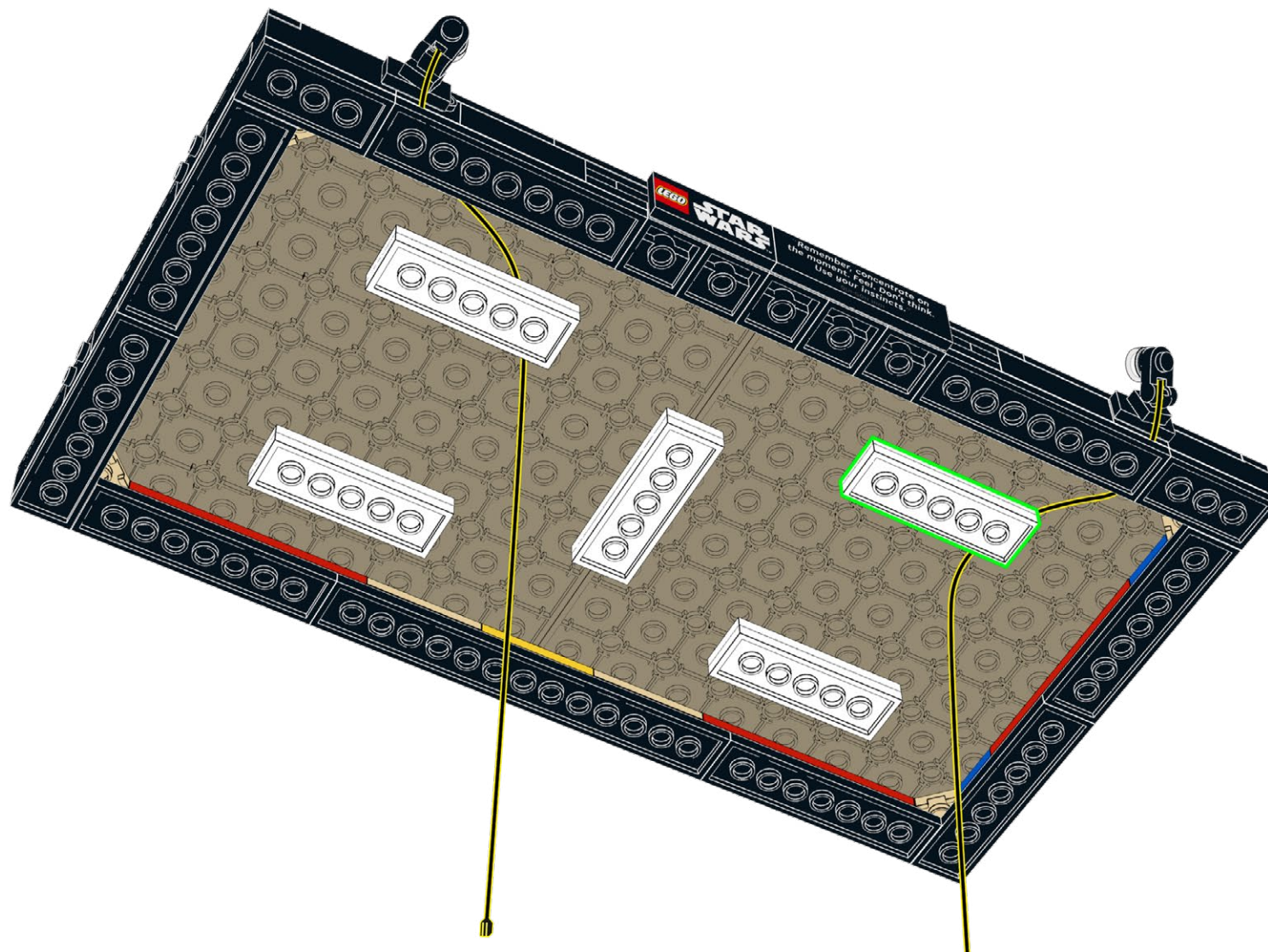

30

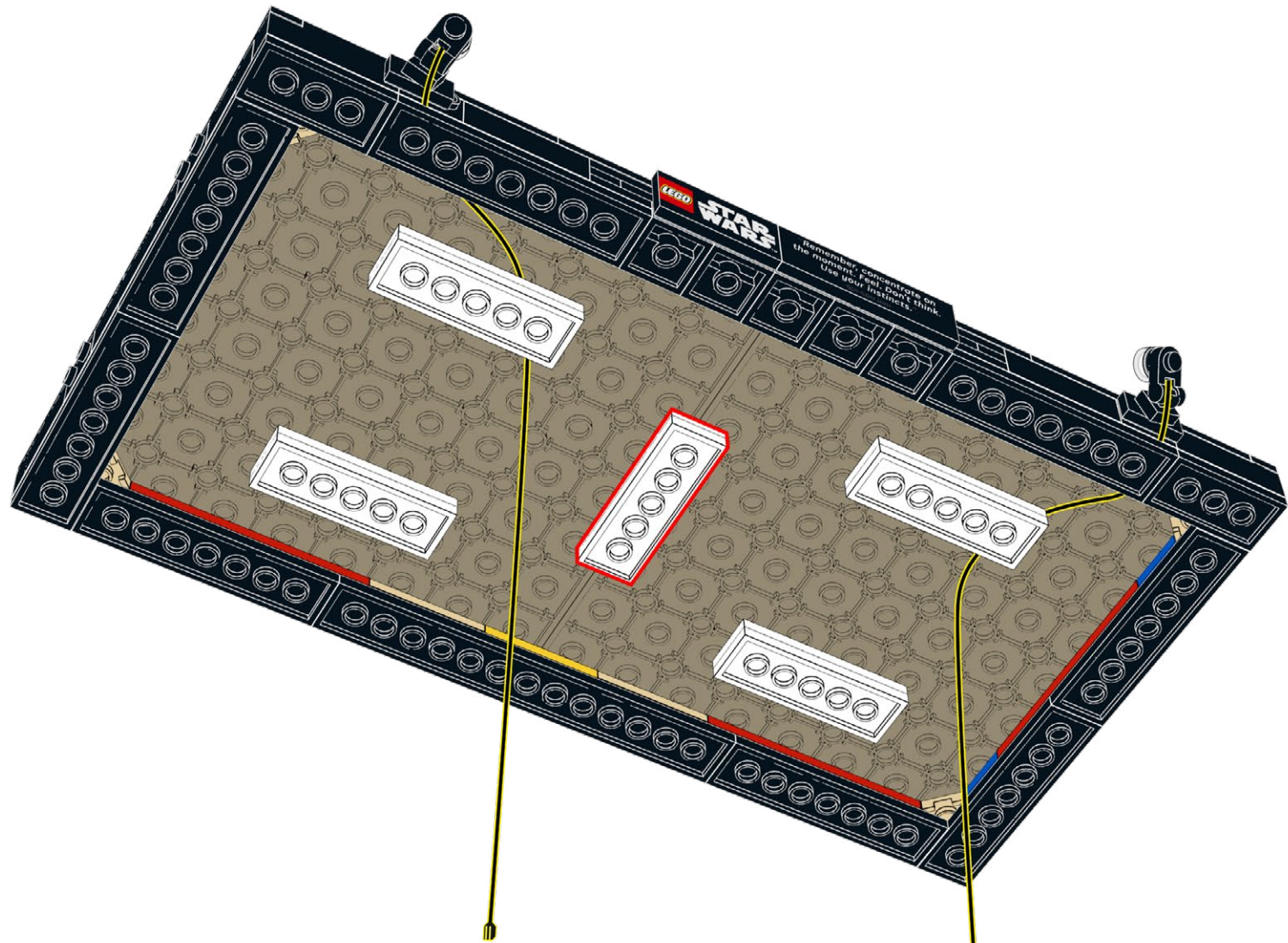

31

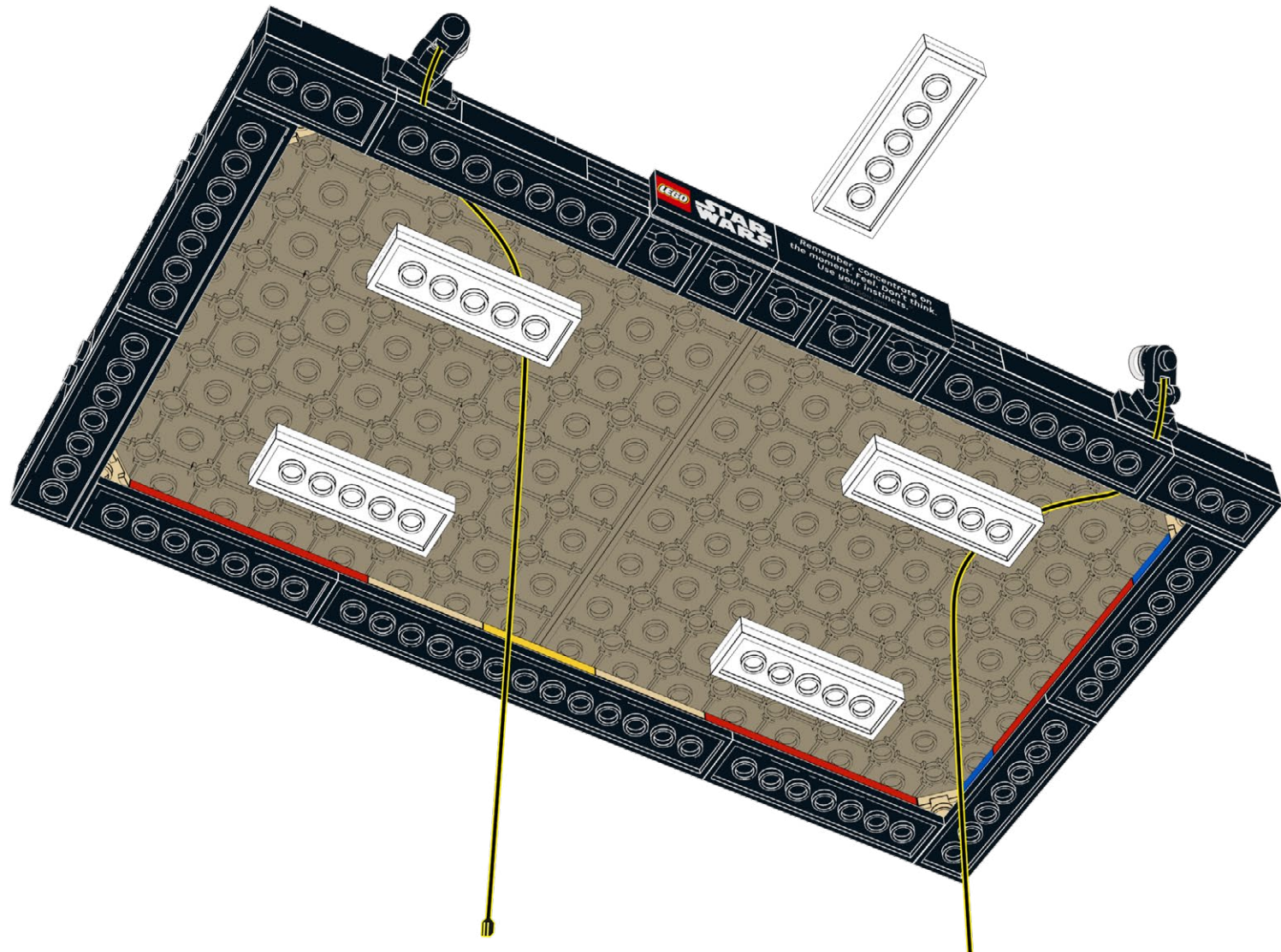

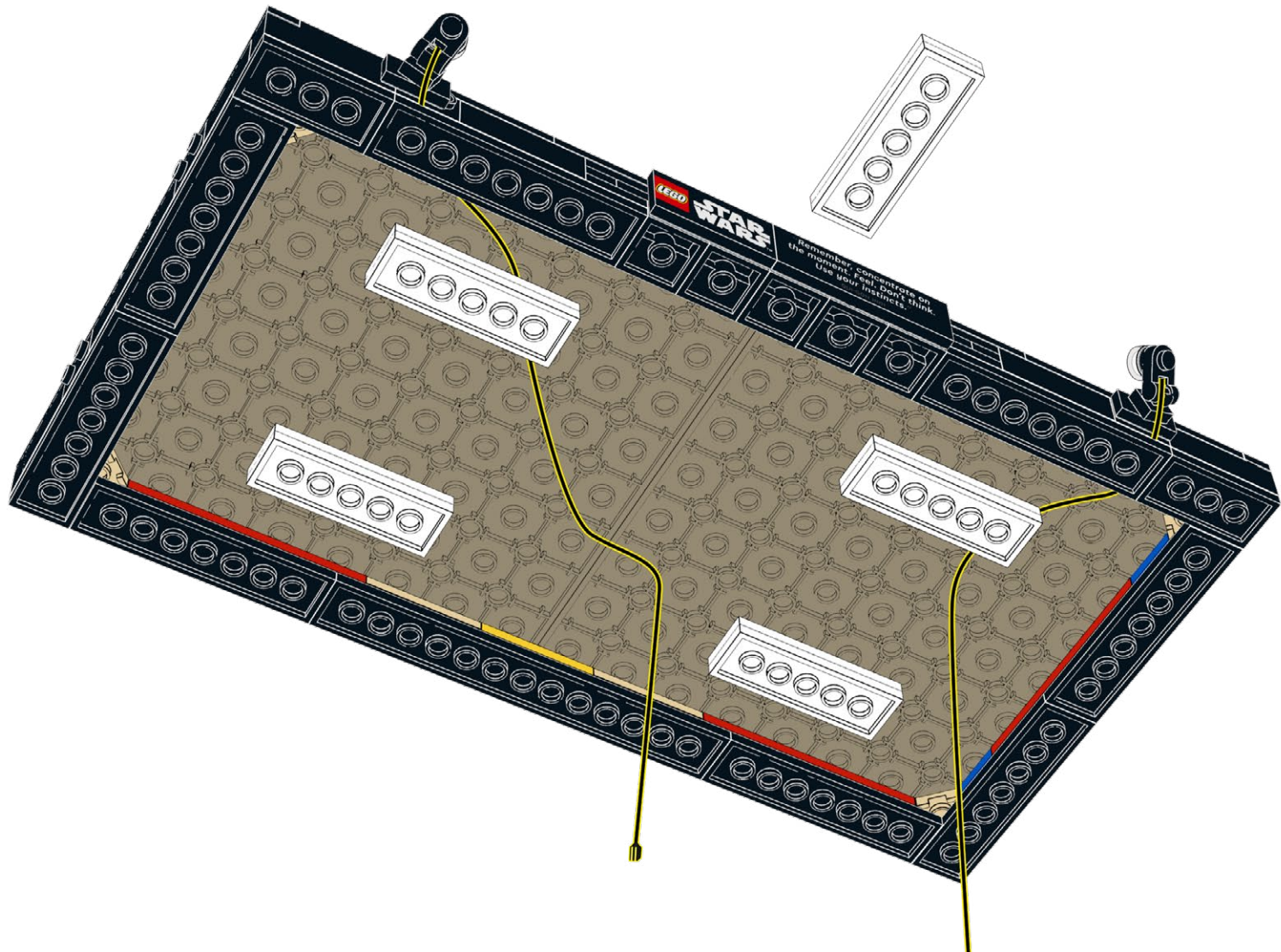

33

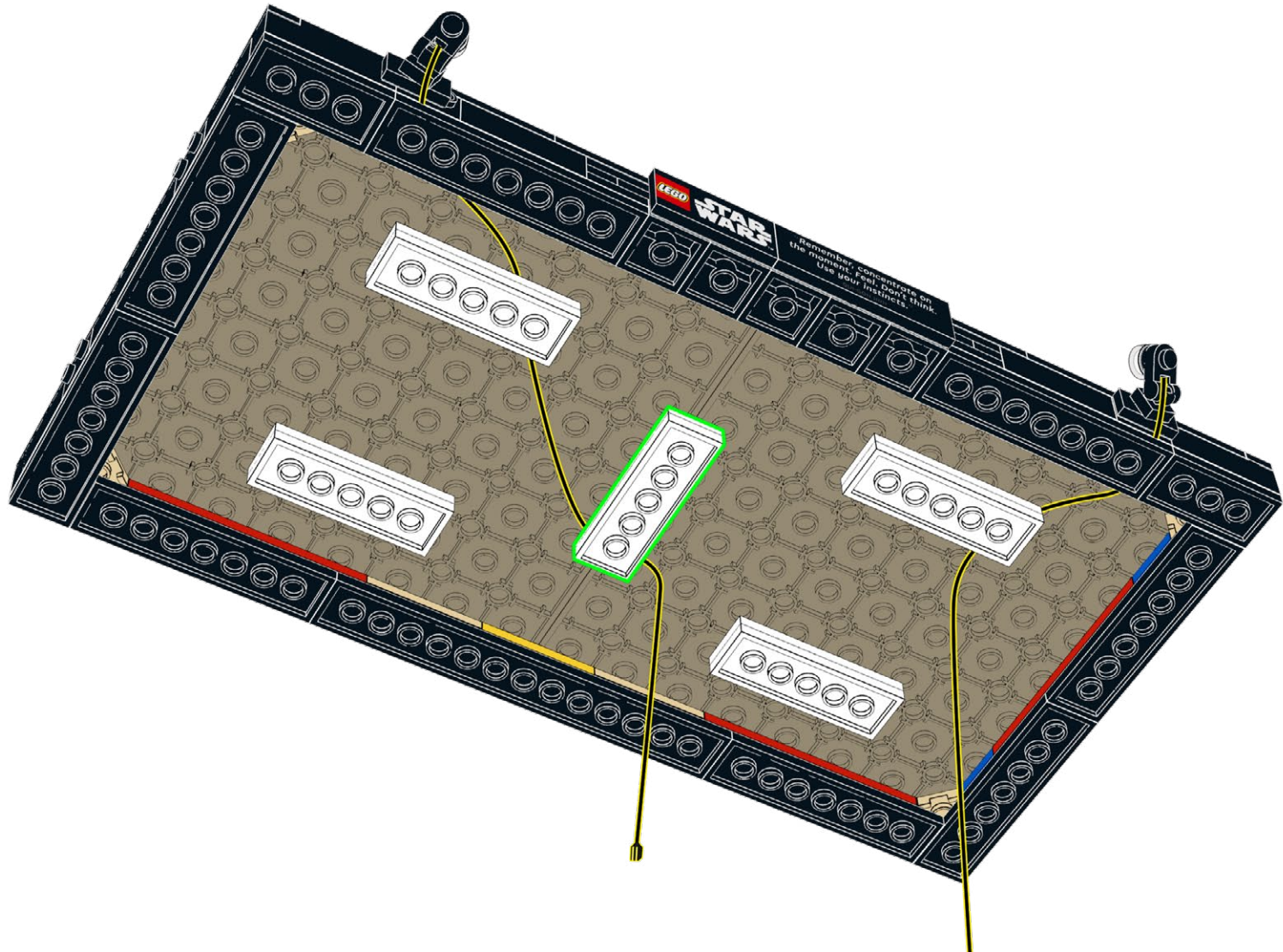



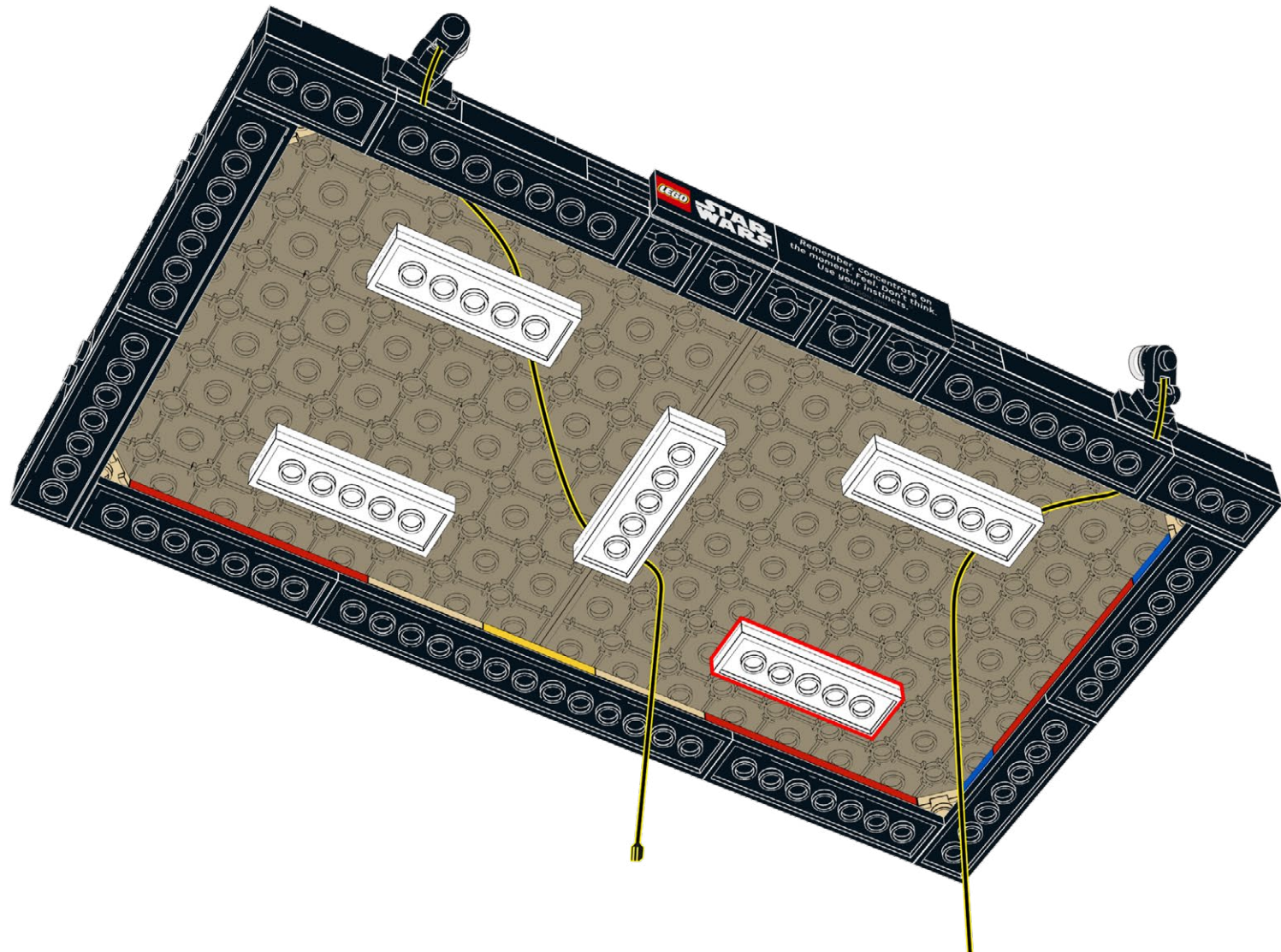

35

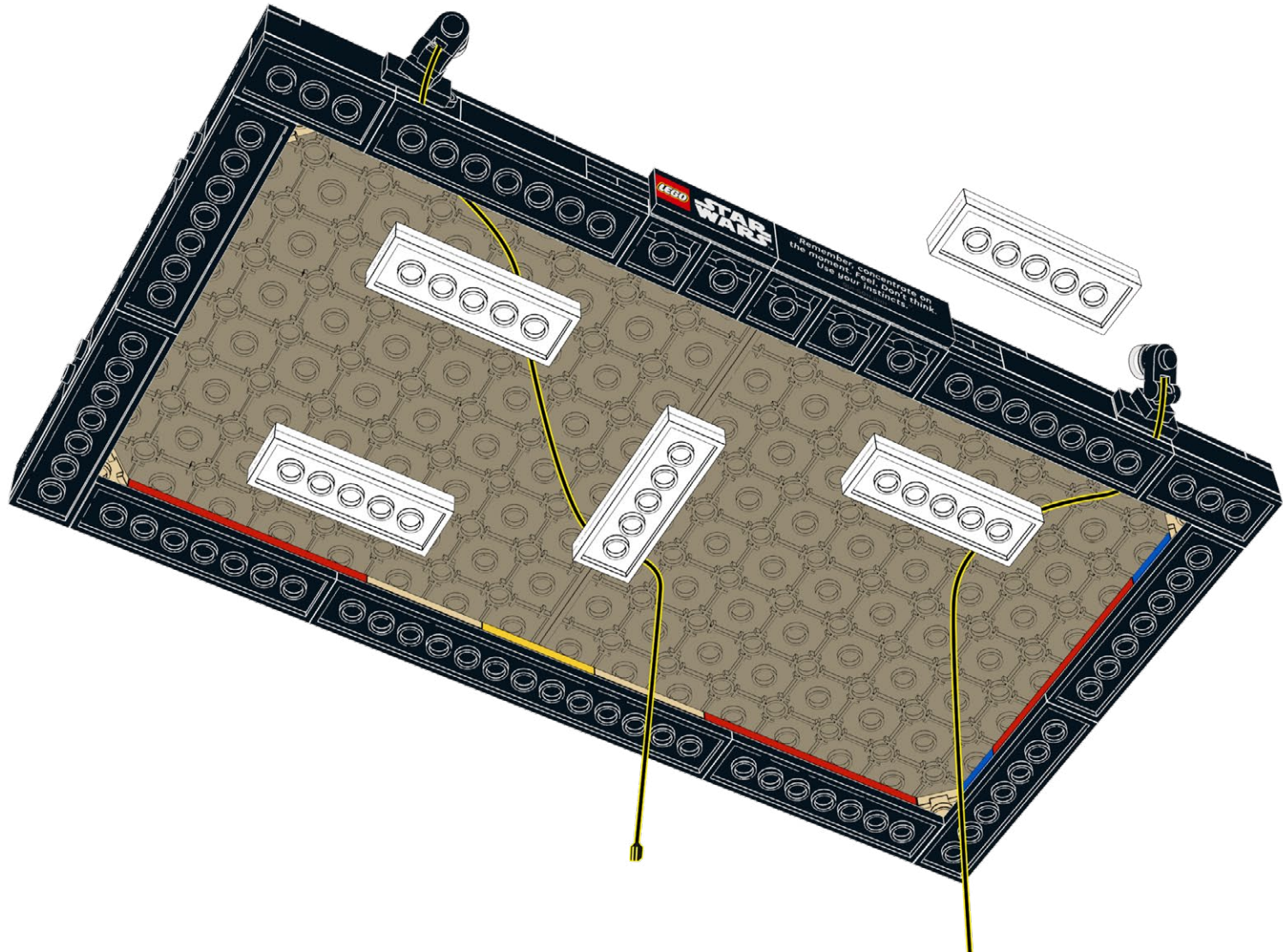

# 36

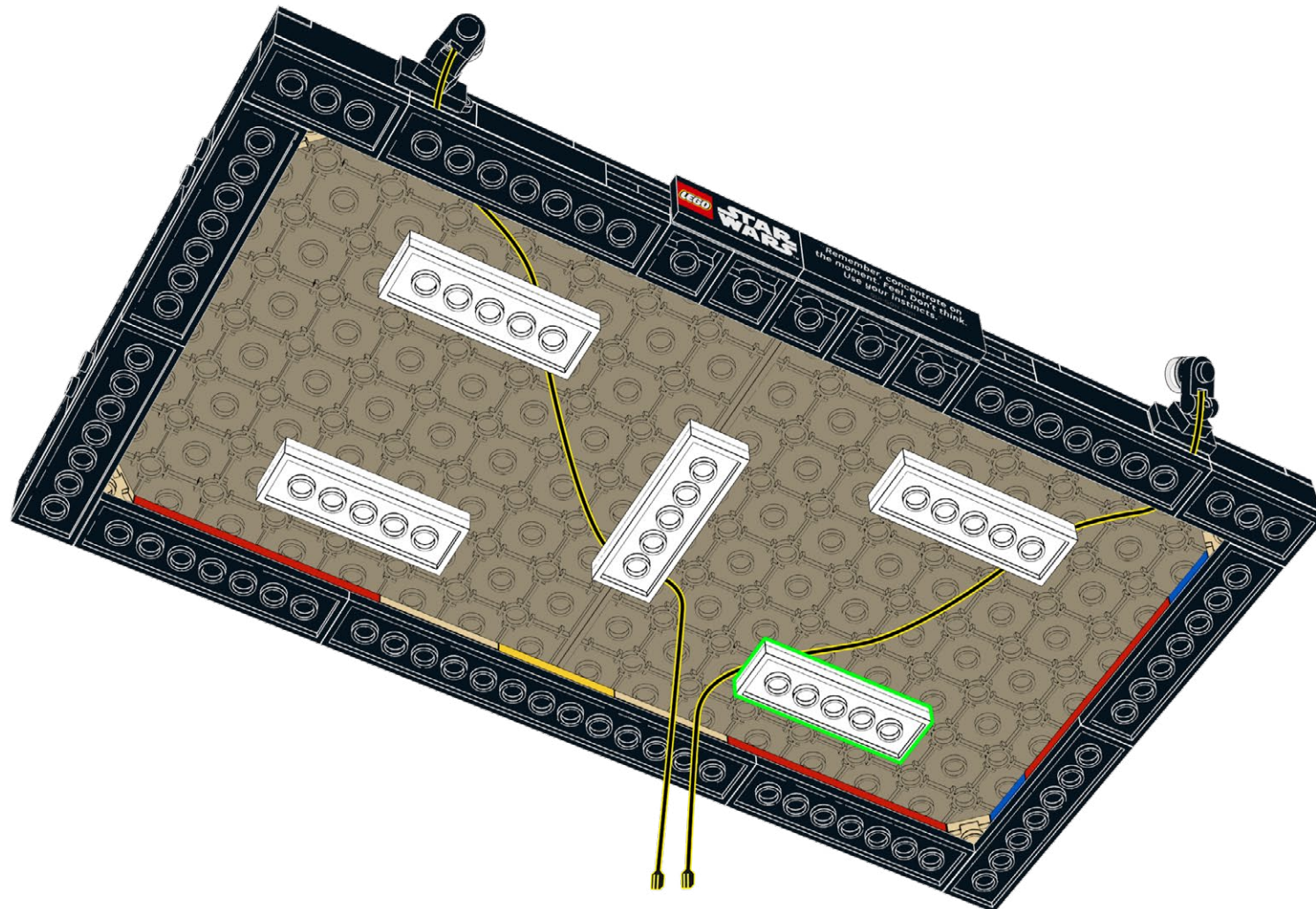

37

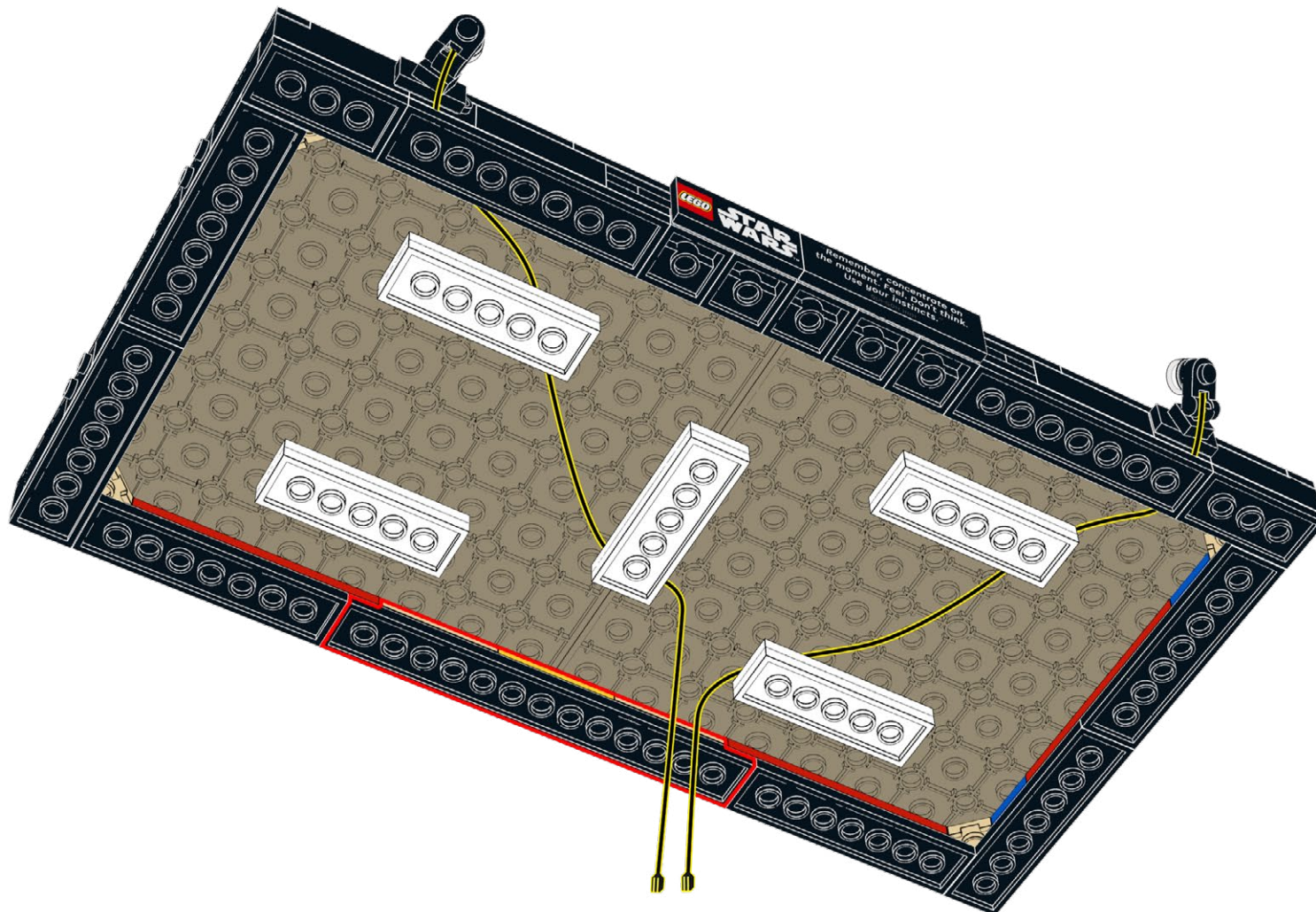

38

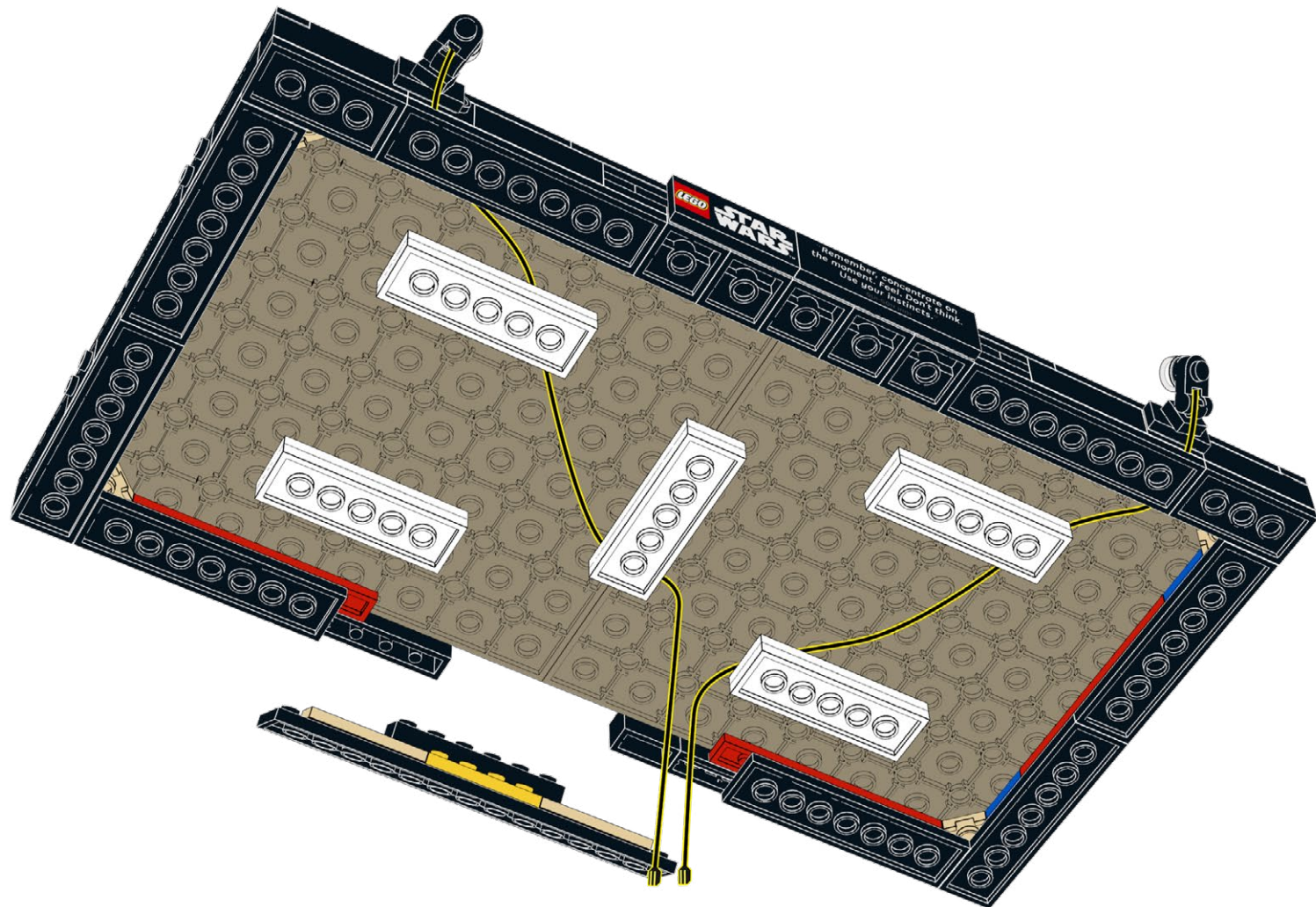

39

1

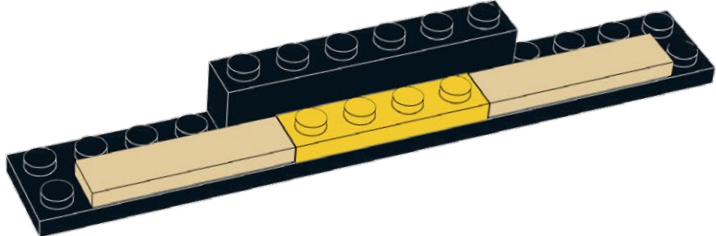

2

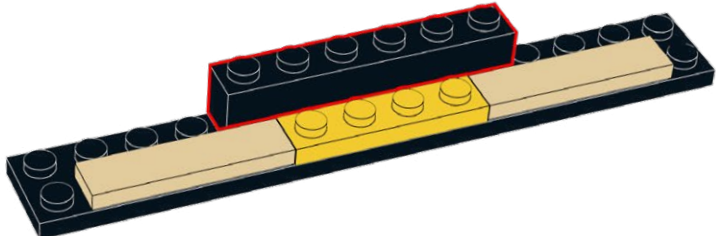

3

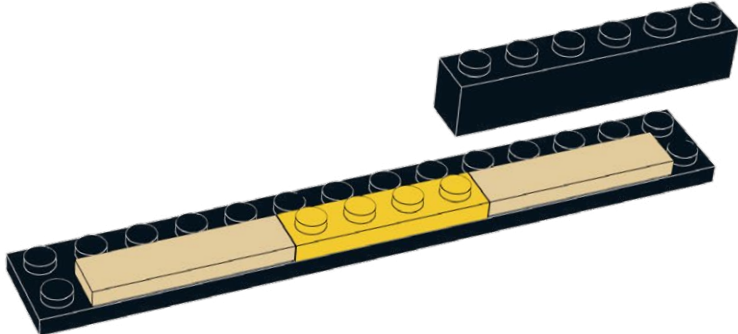

40

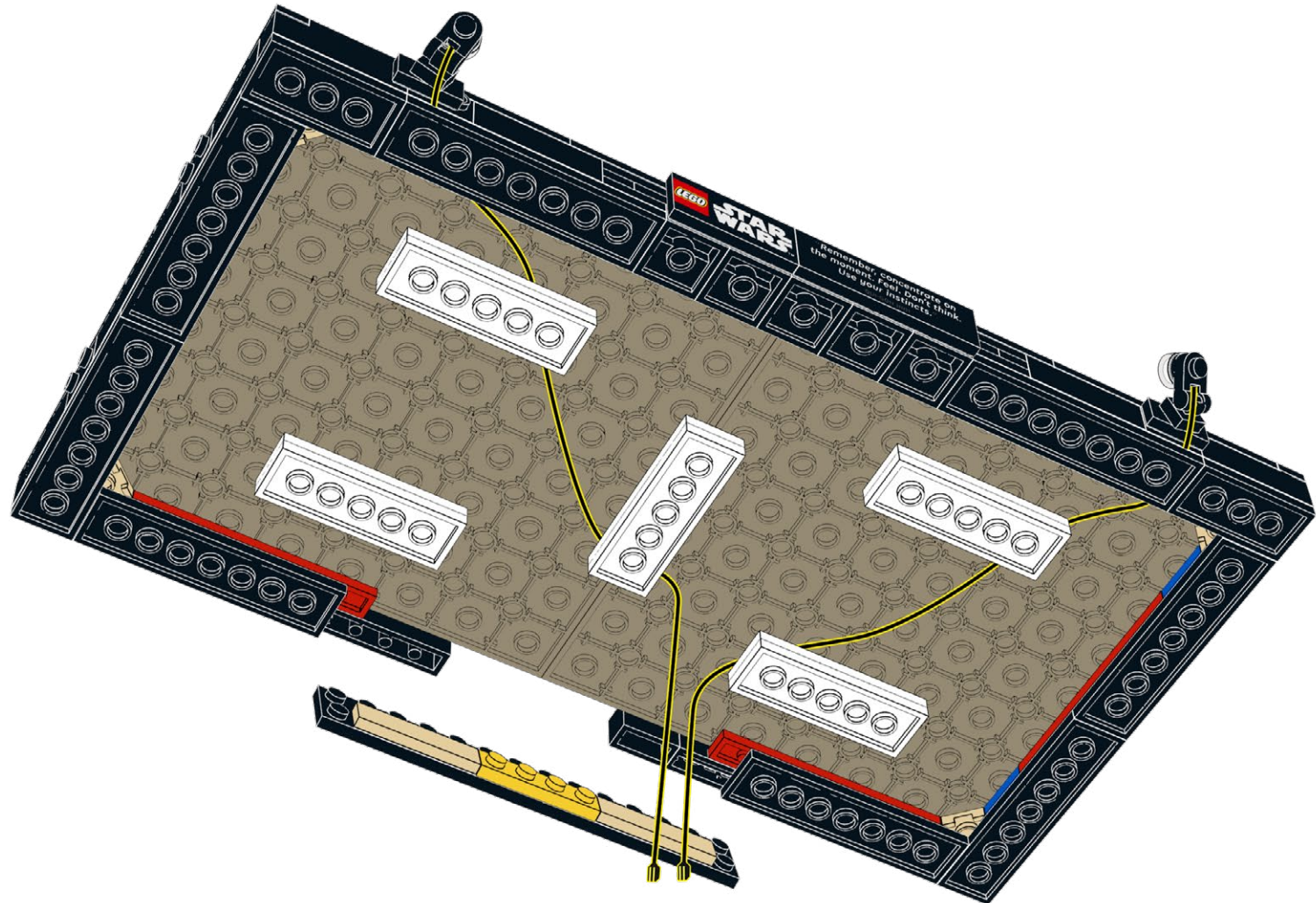

41

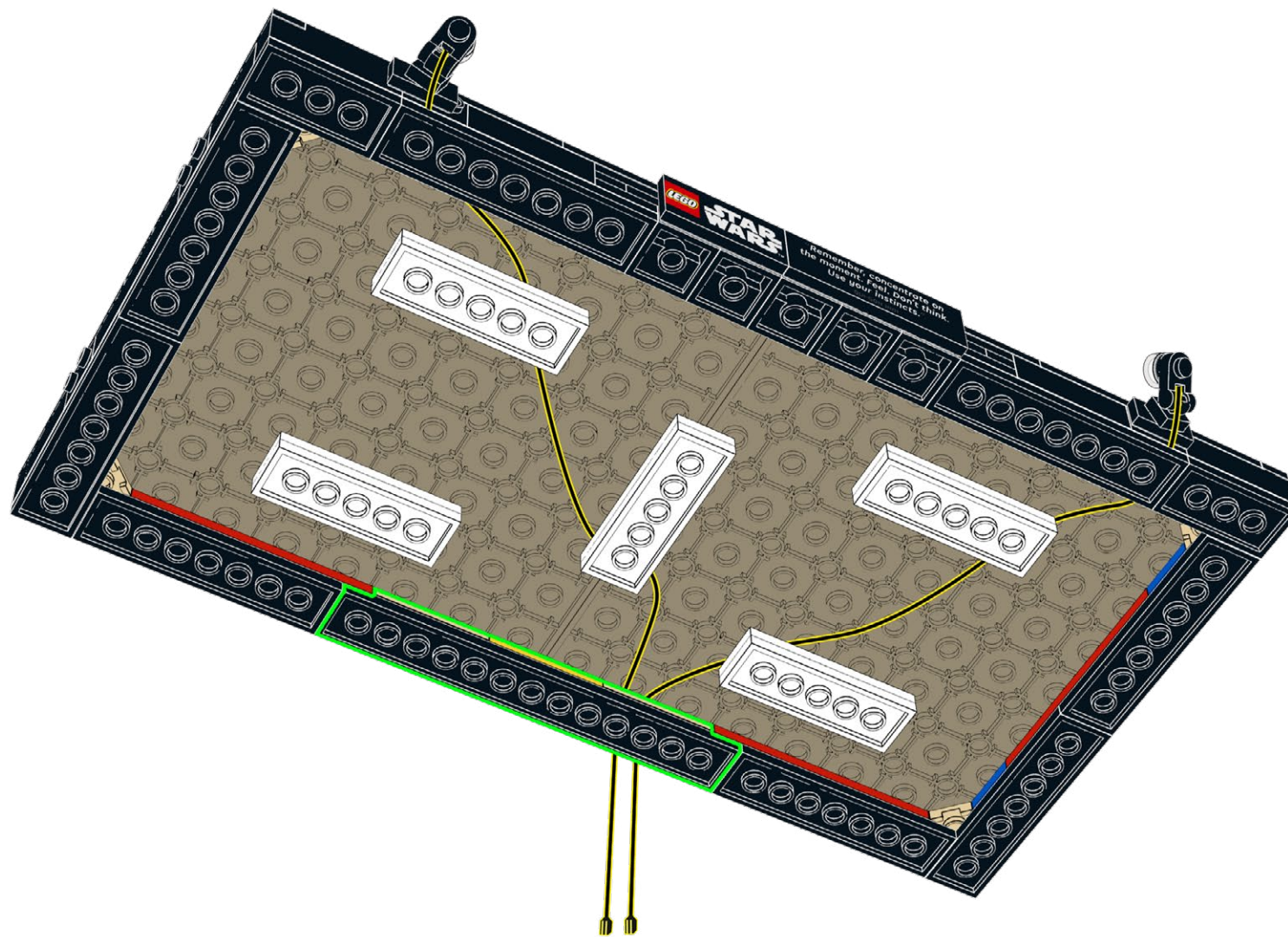



42

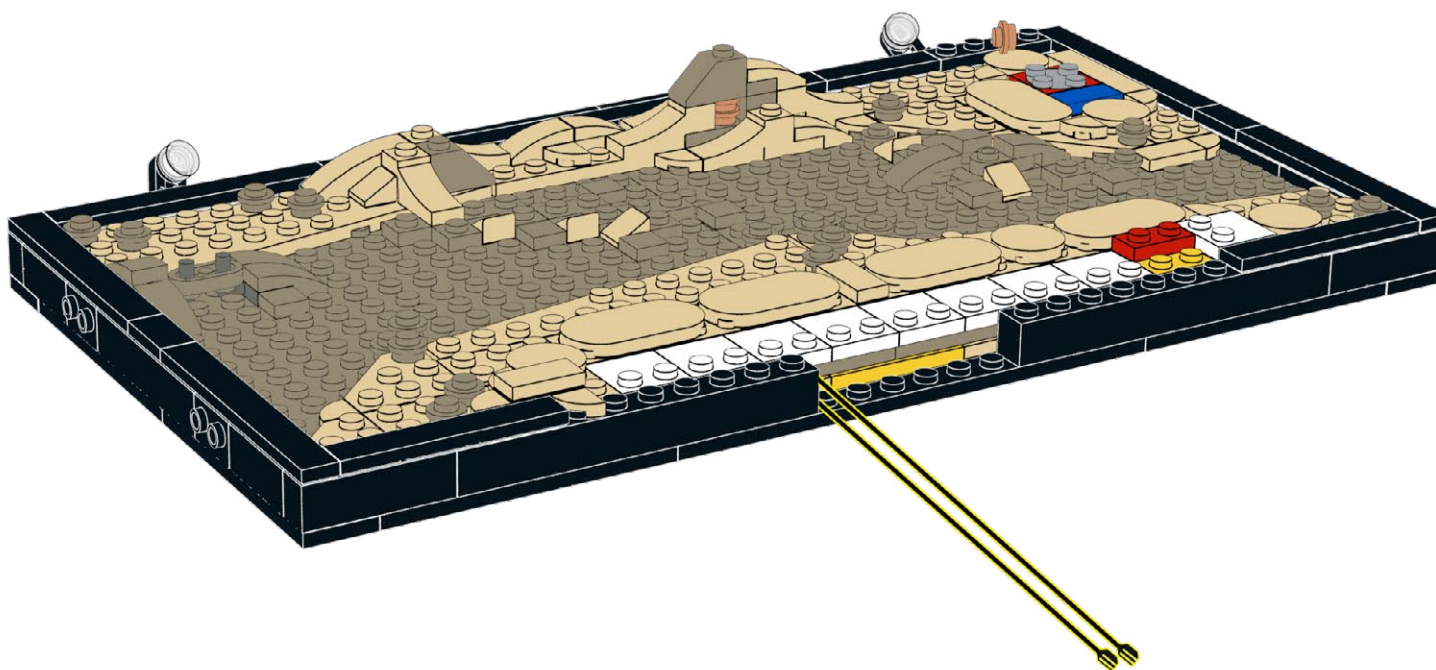

43

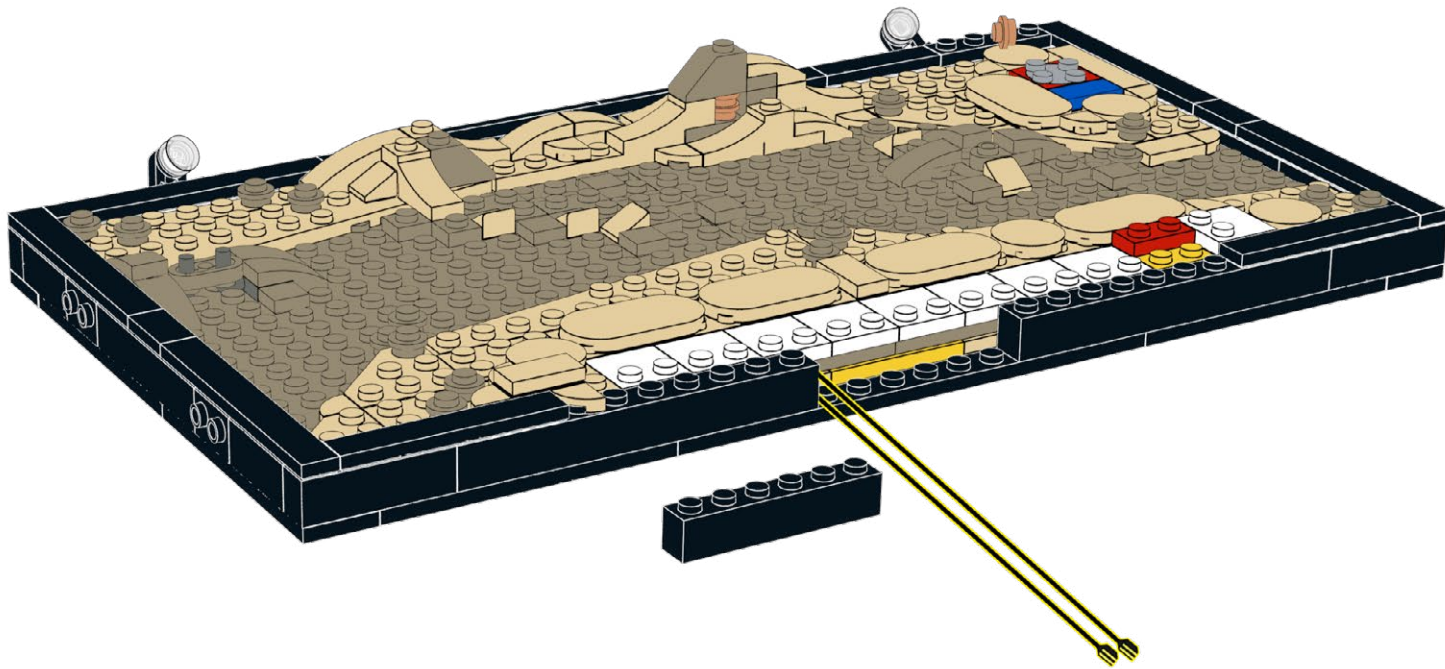

44

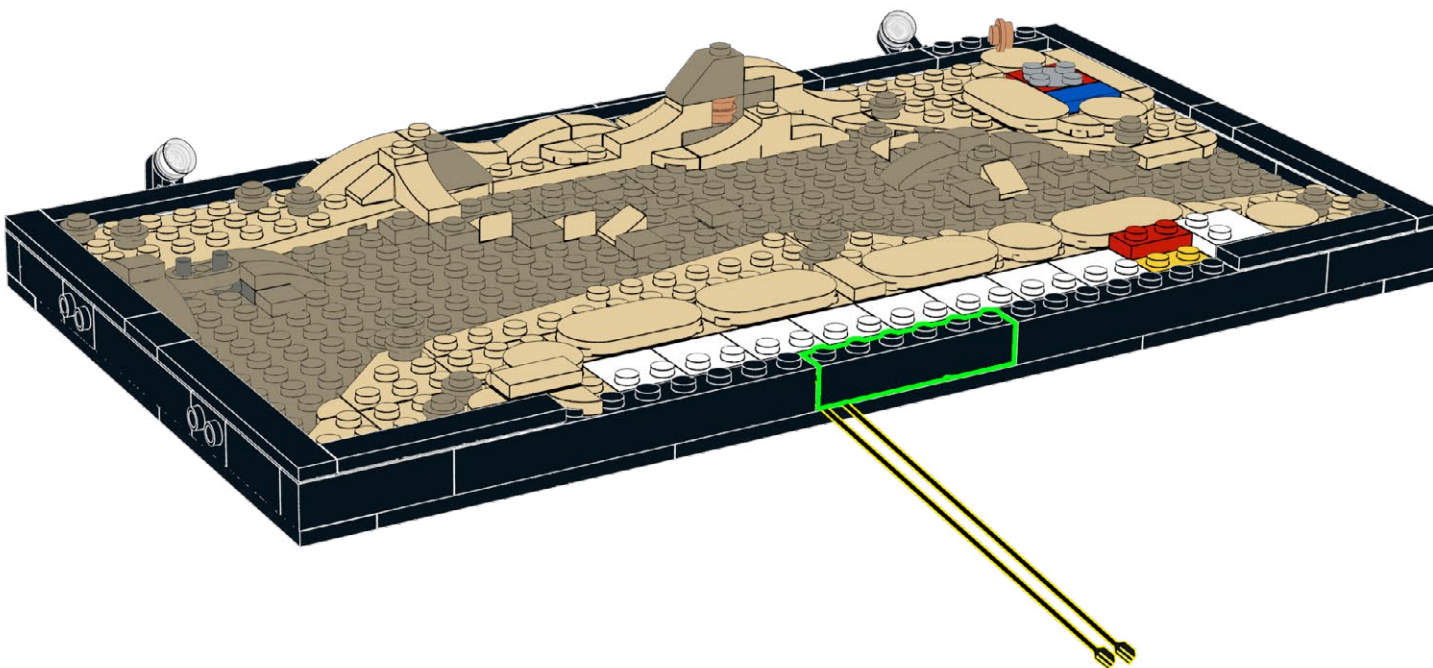

45

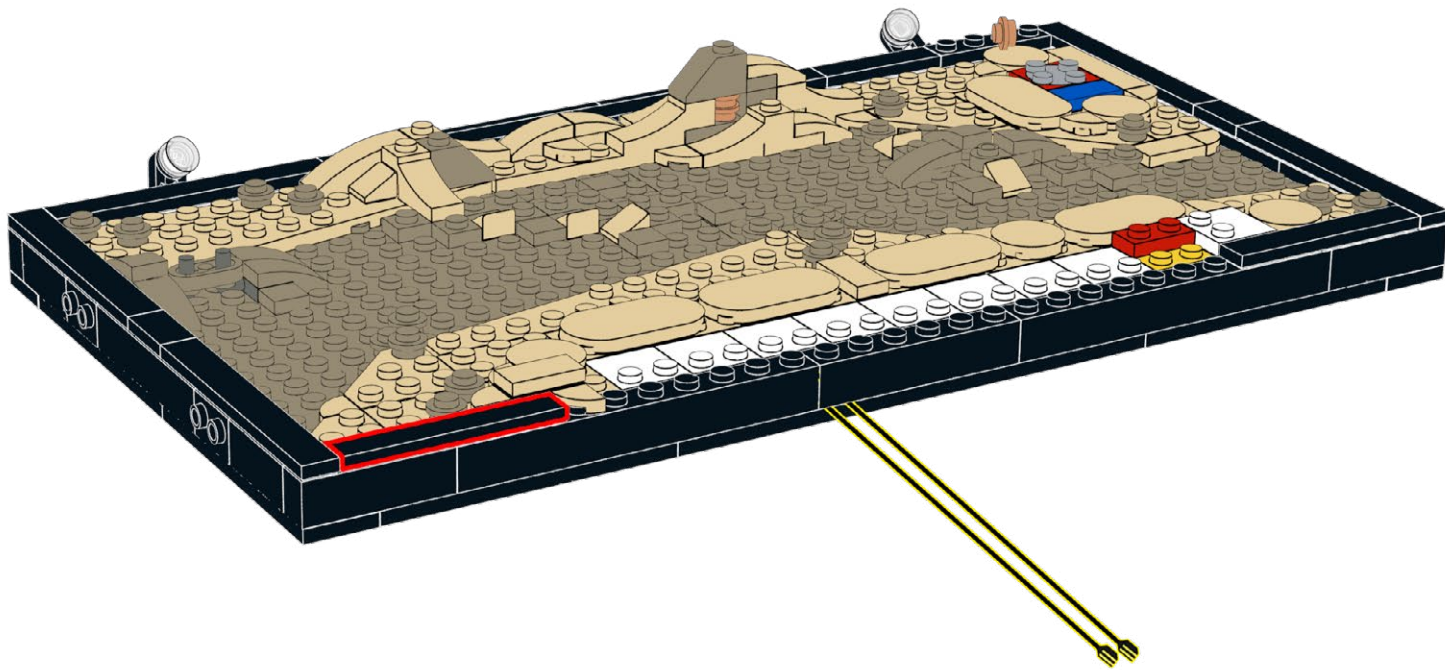

46

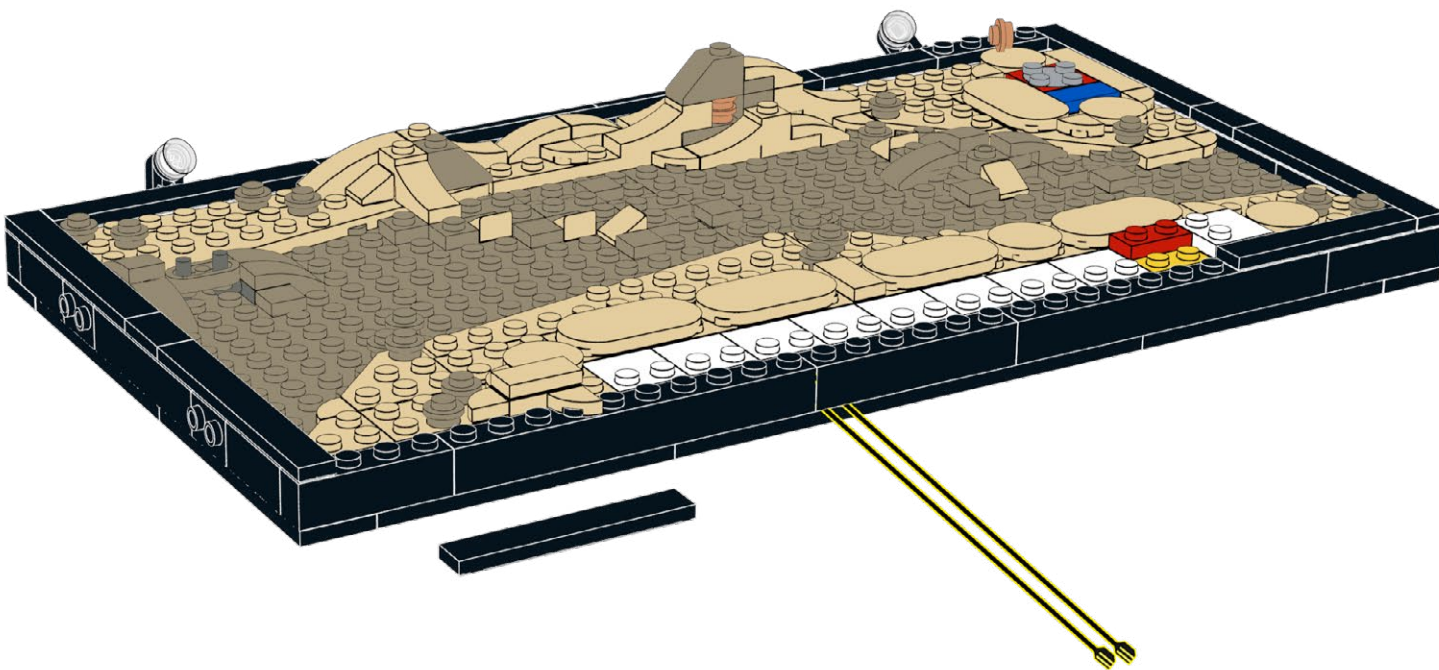

47

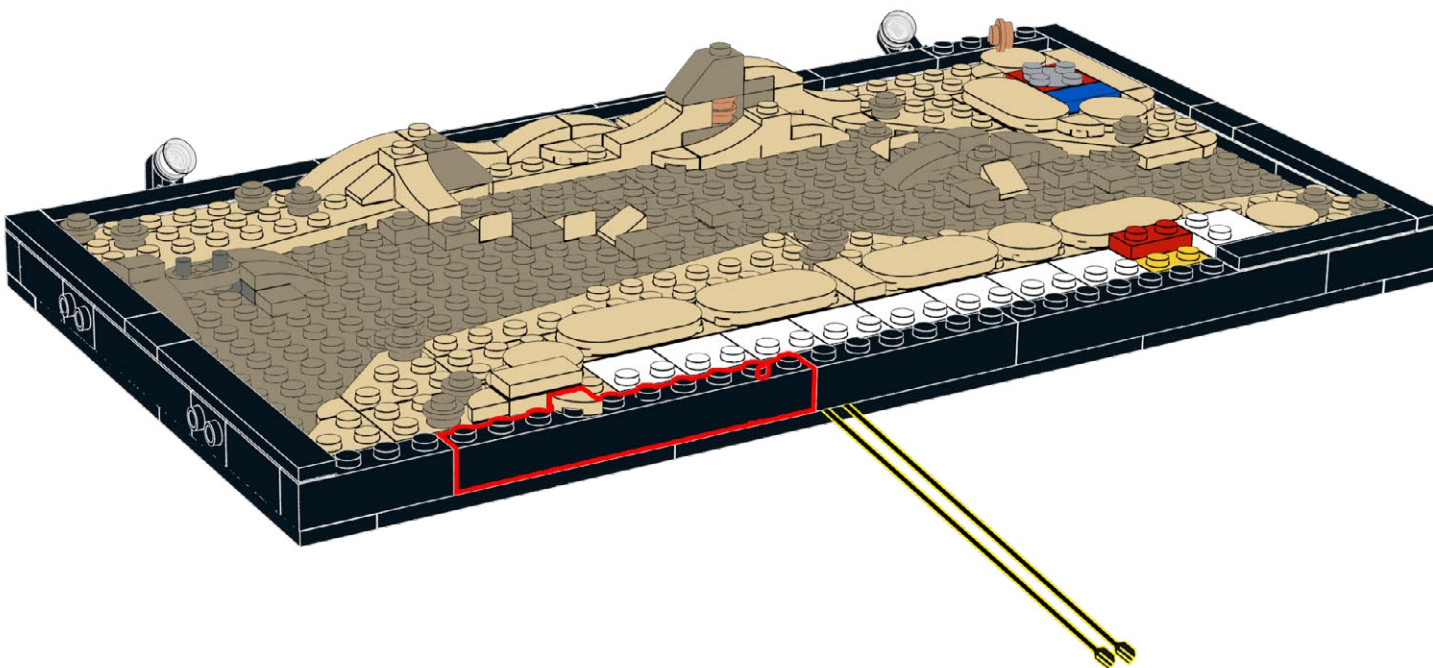

48

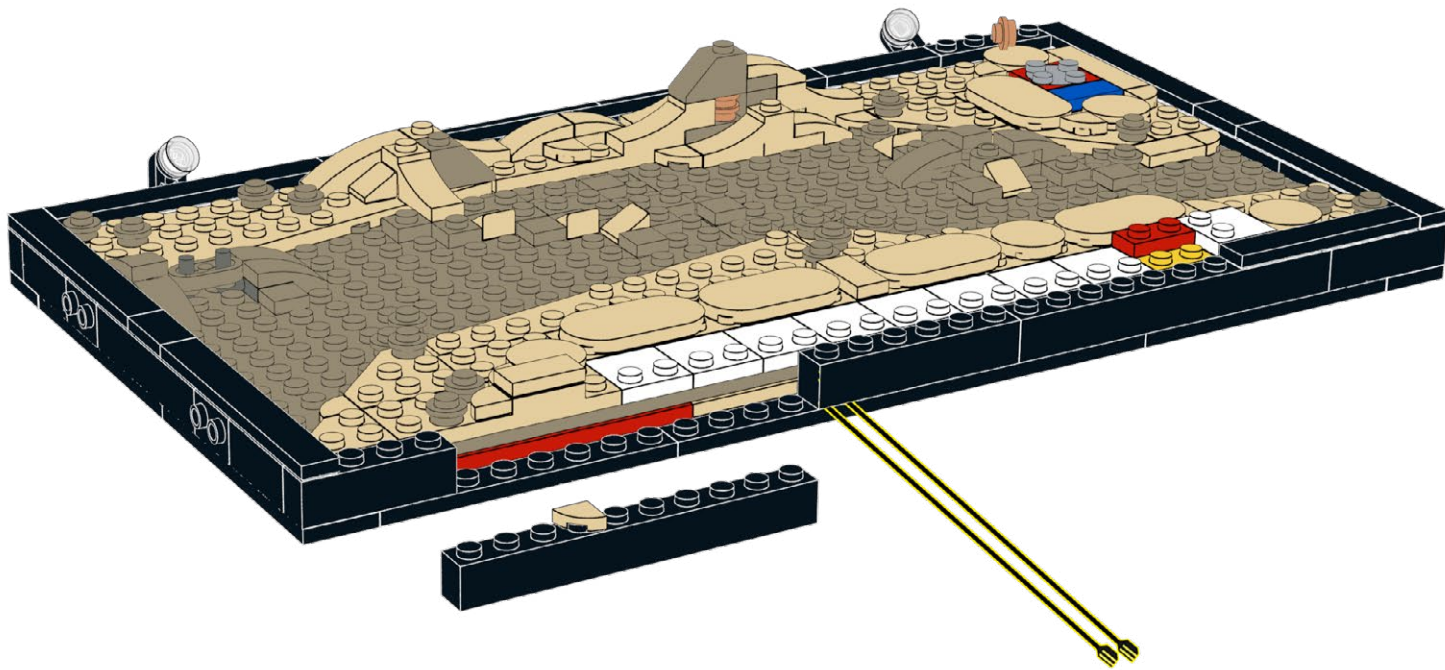

49

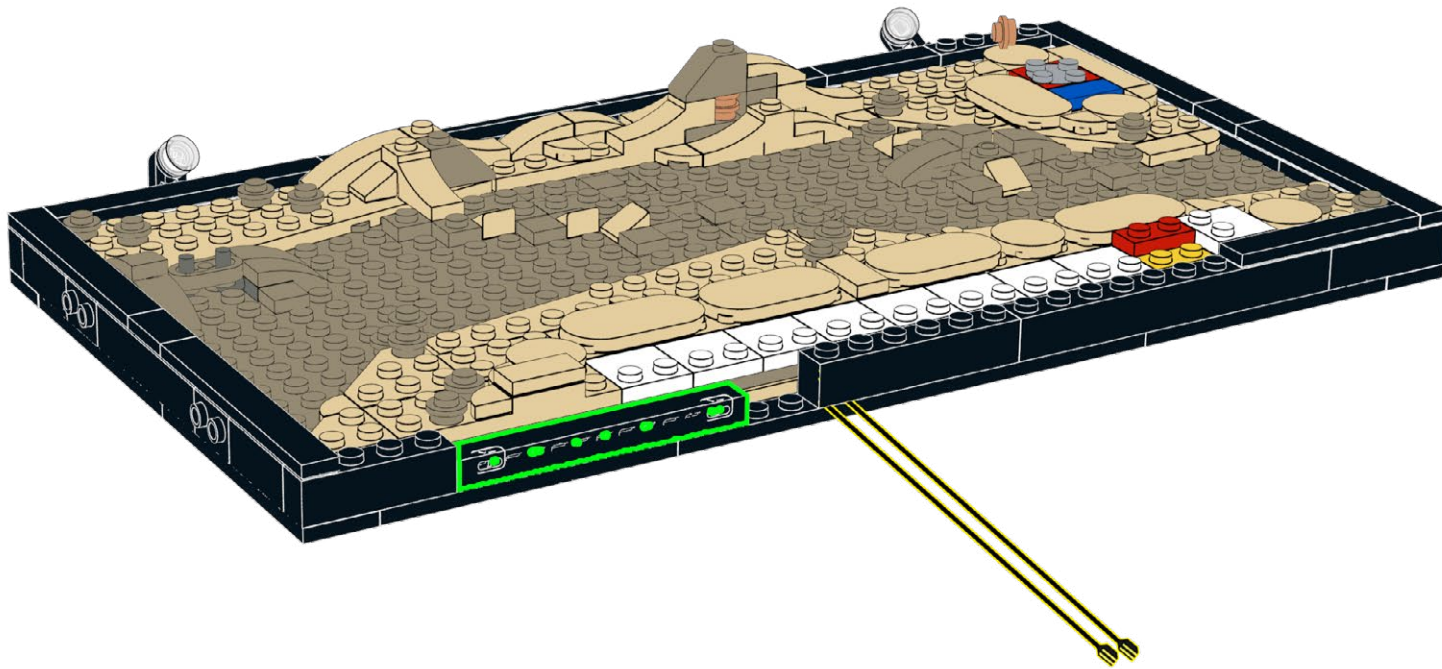
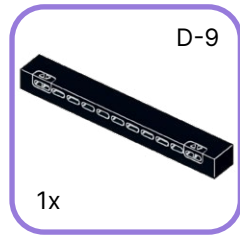



50

1x

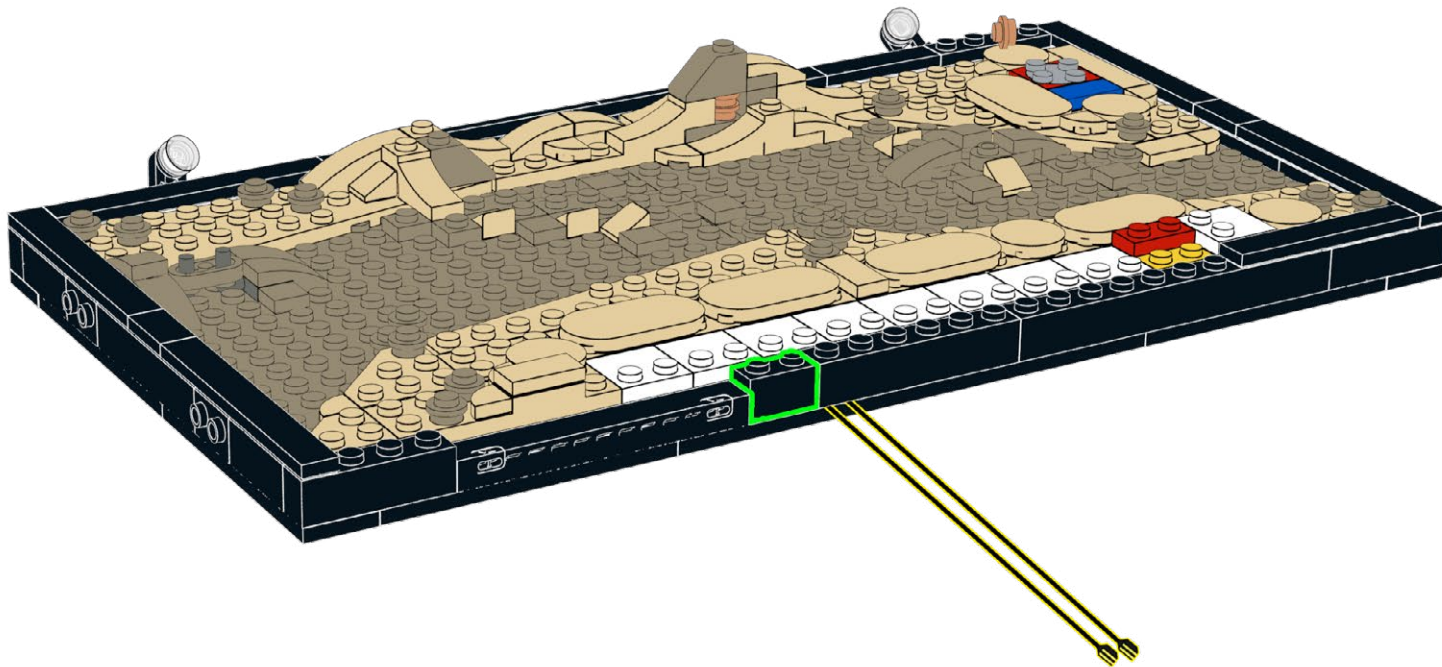

51

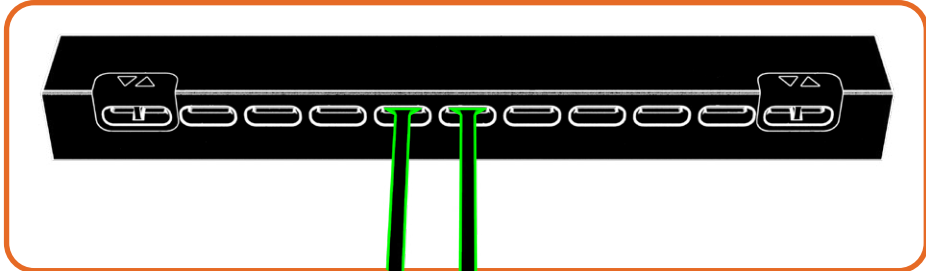
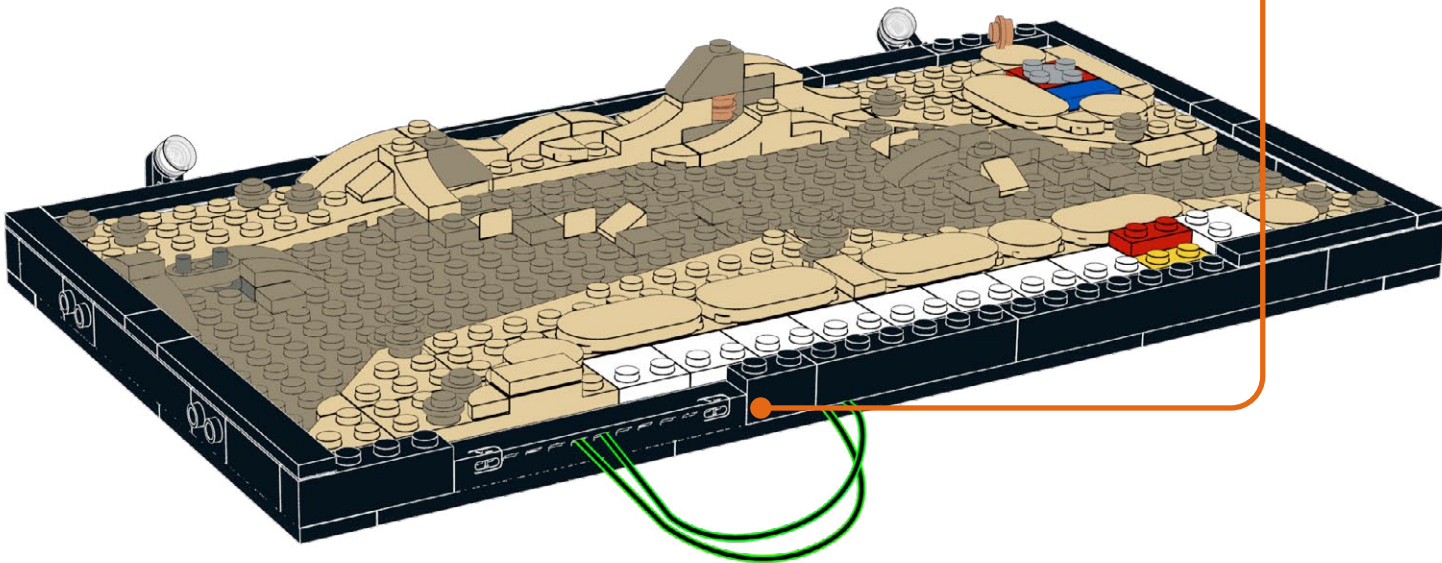

52

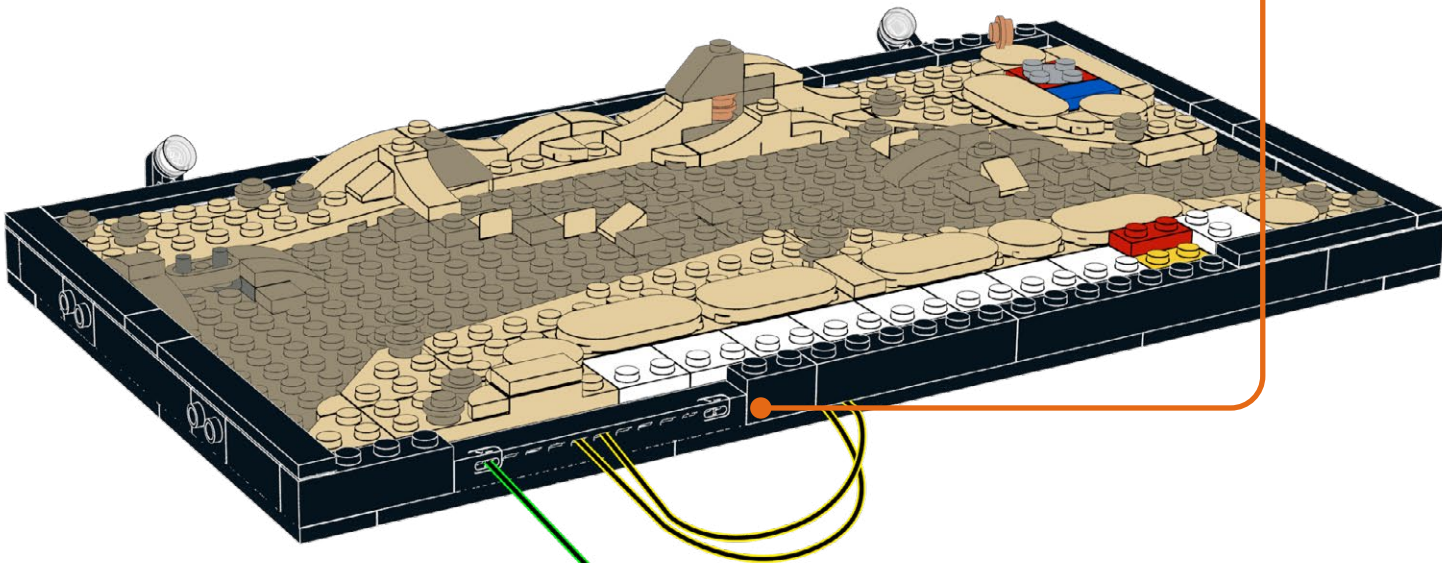
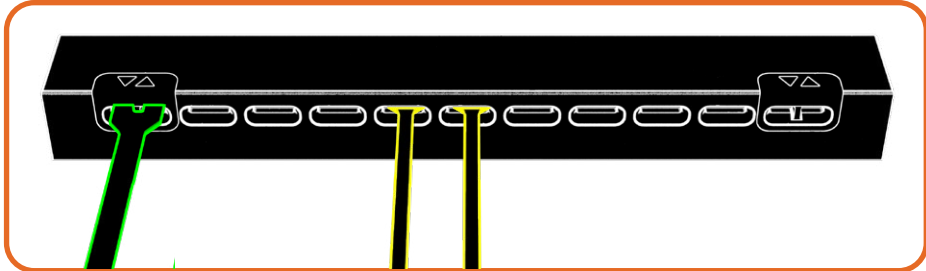

53

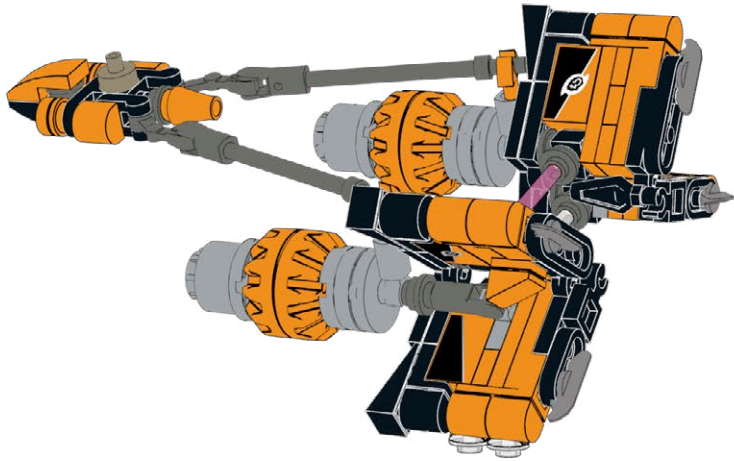

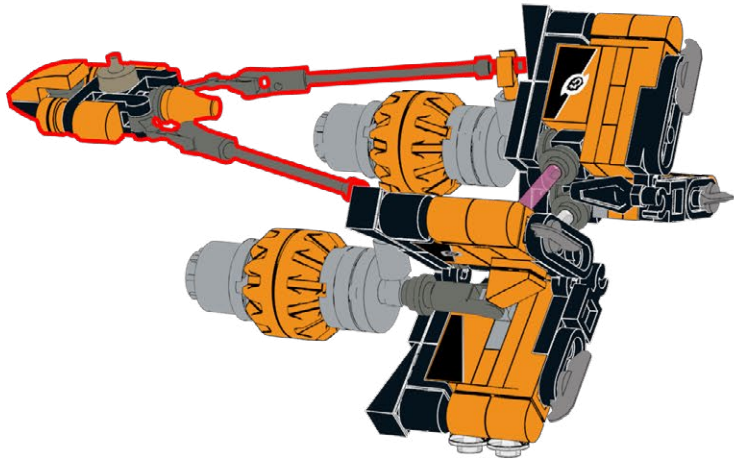

55

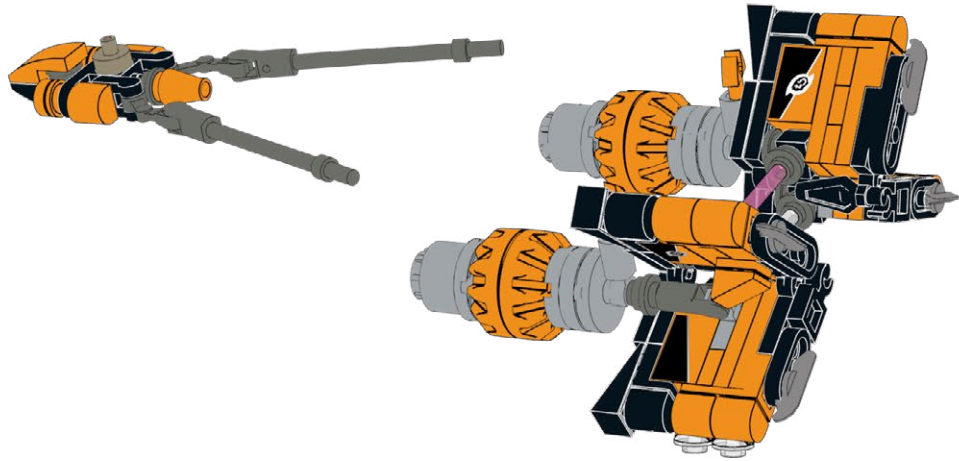

56

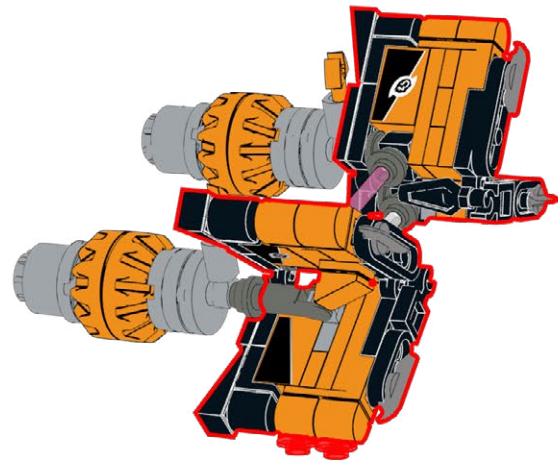

57

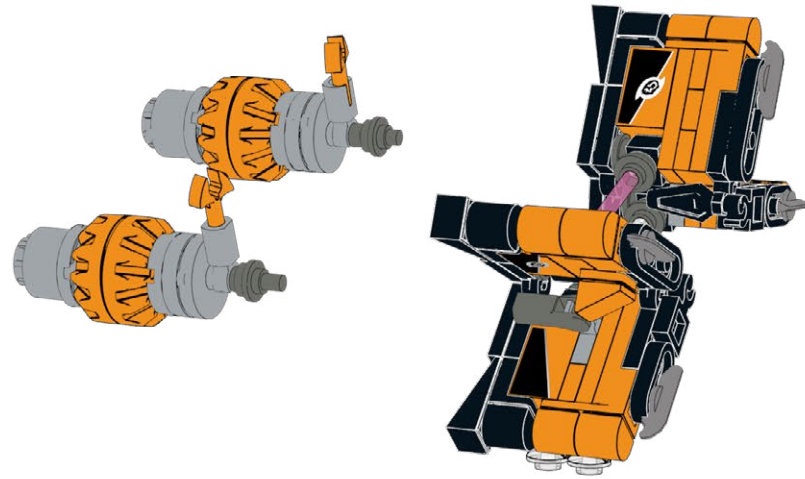



# 58

1

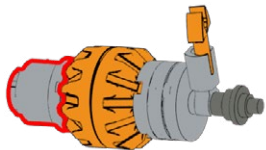

2

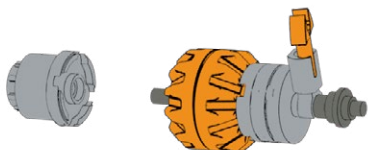

# 59

1

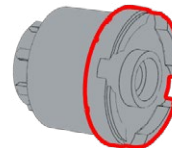

2

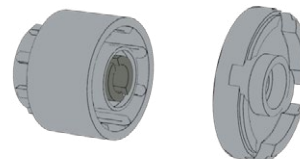



60



61

1

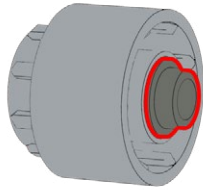

1

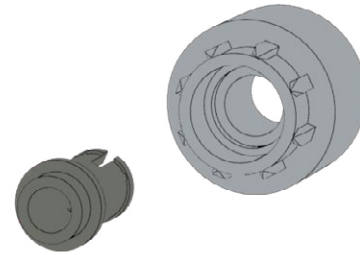

2

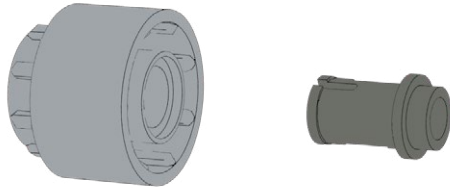

2

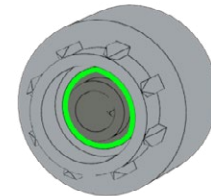

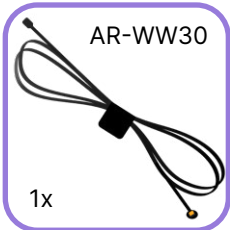

1

1

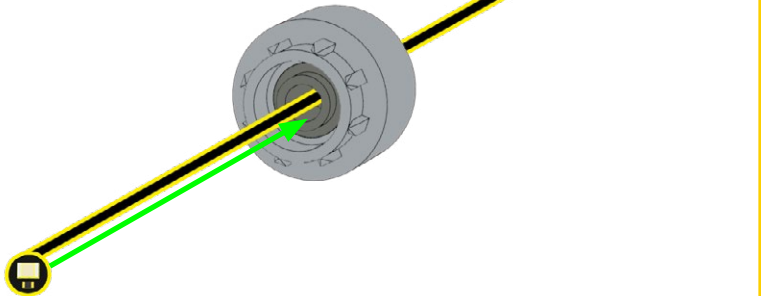

2

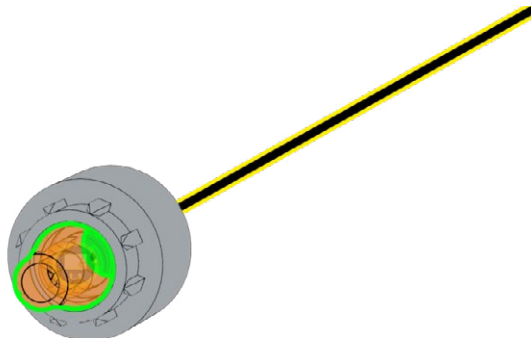
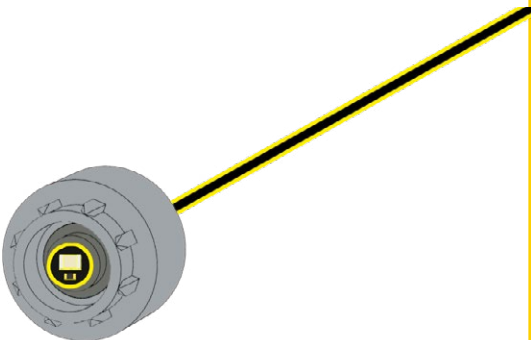

64

65

1

1

2

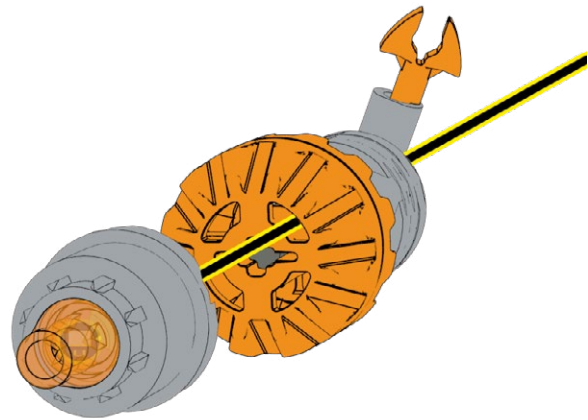
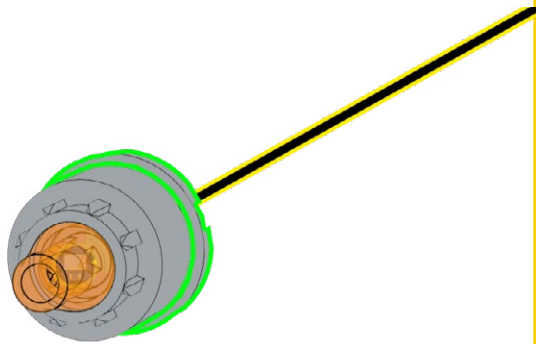
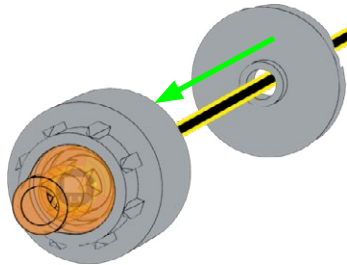



1

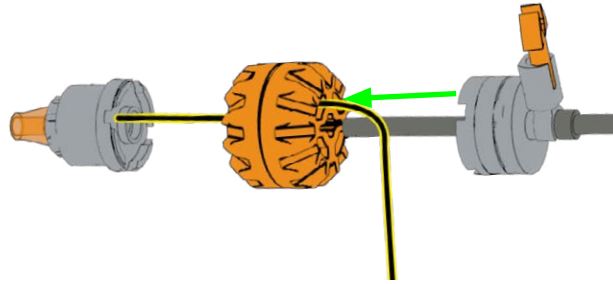

2

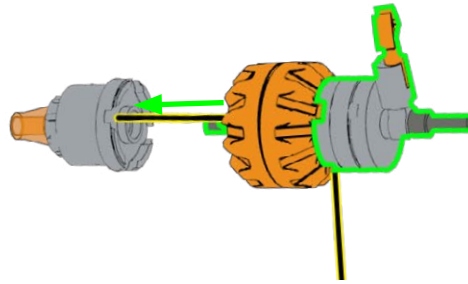

3

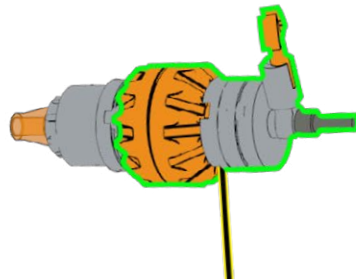

2x

67

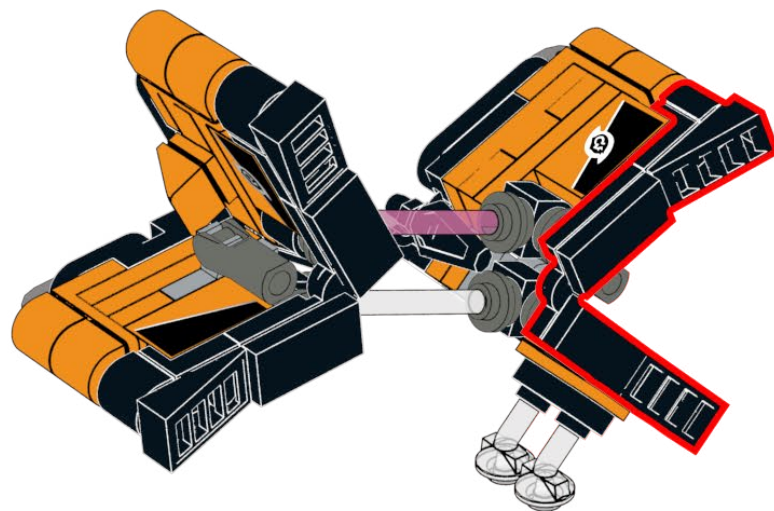

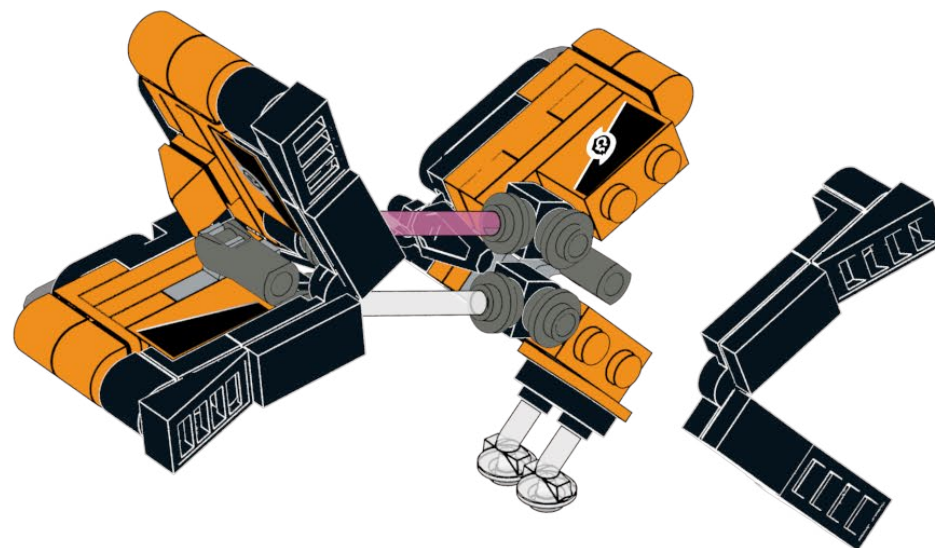

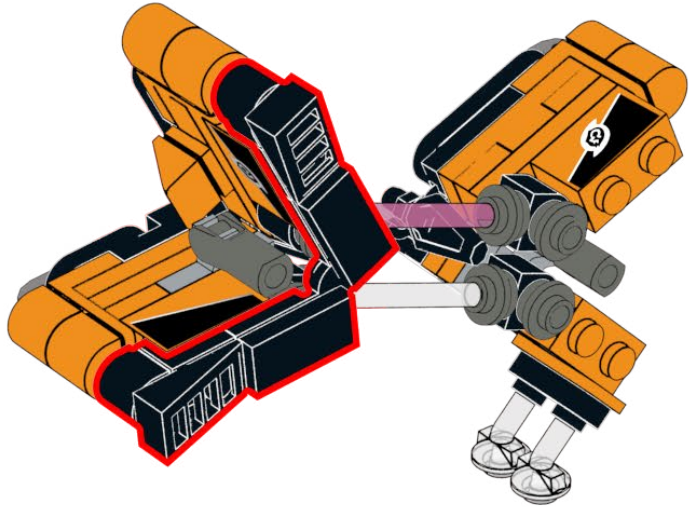



70

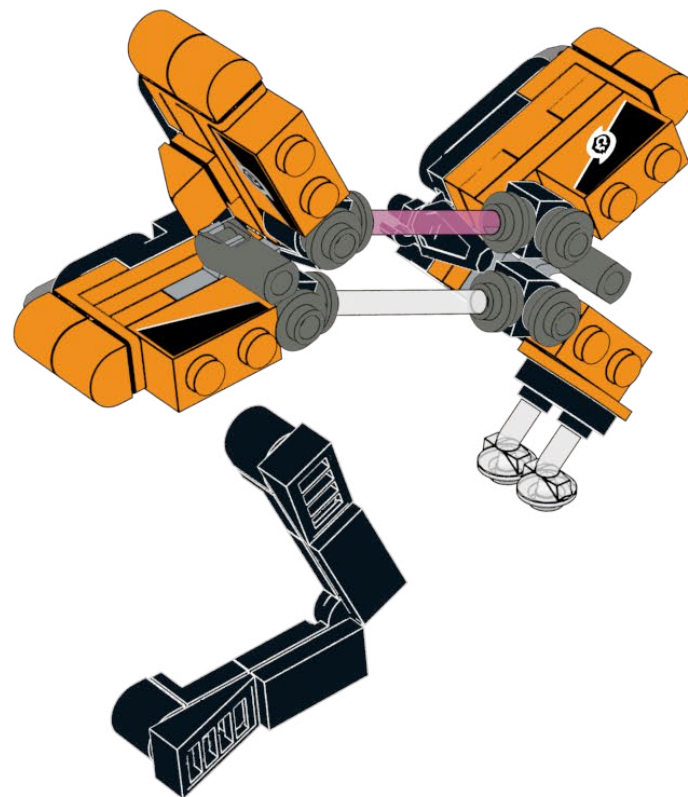

71

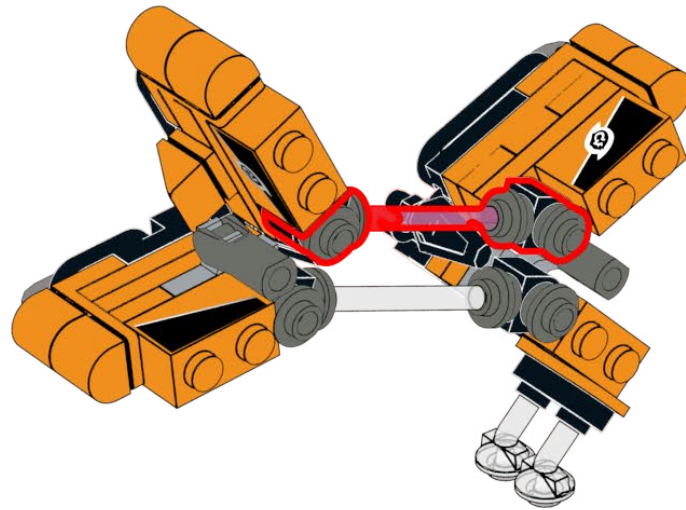

72

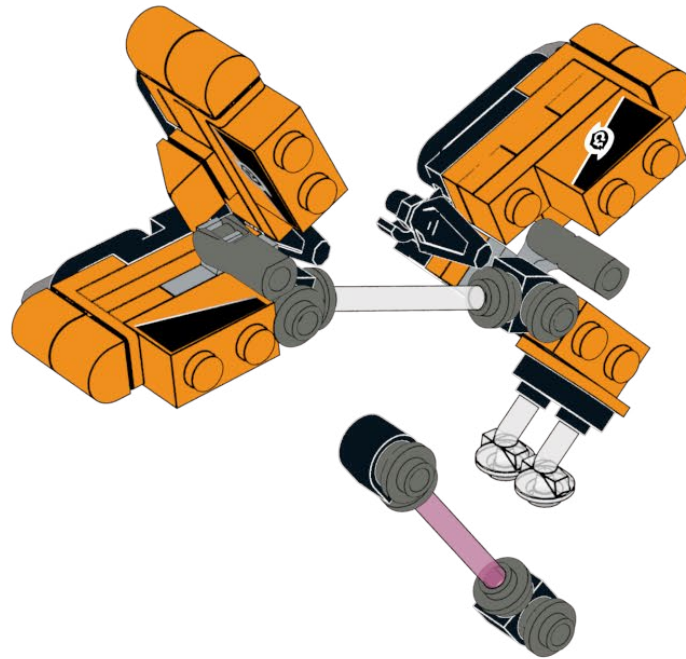

73

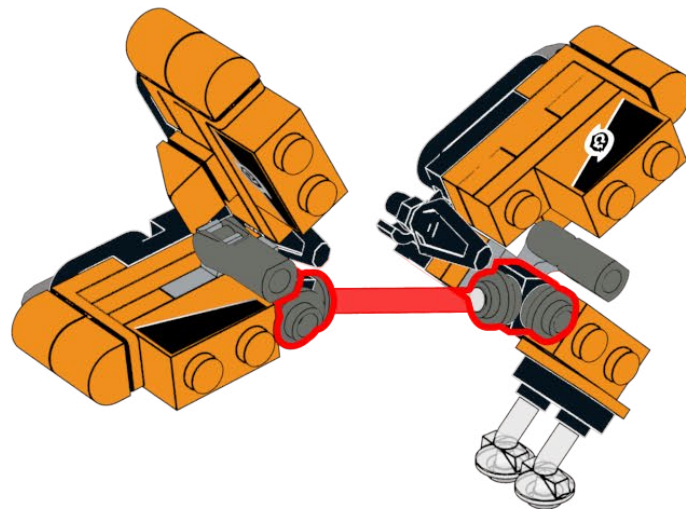

74

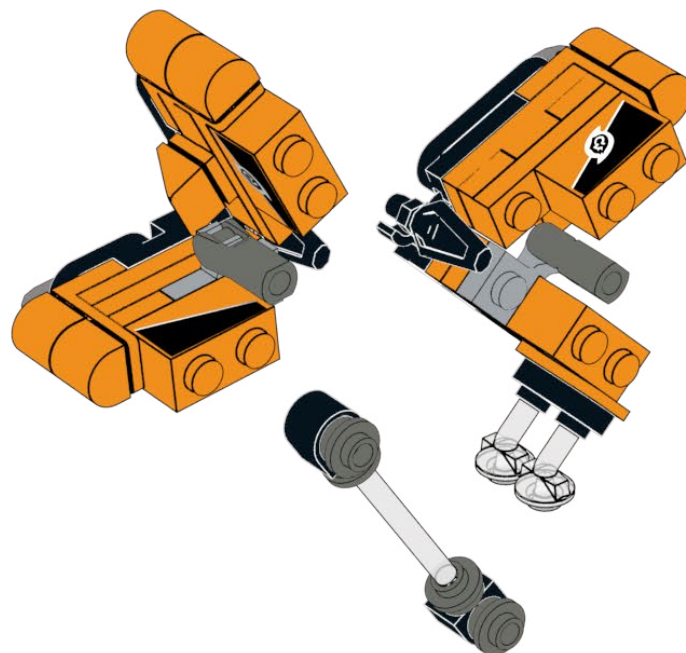

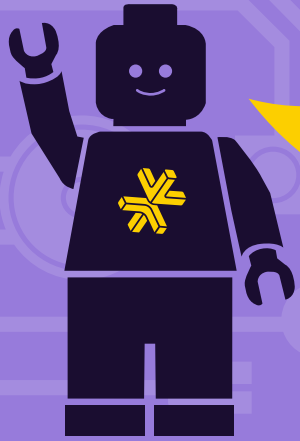

### **HOLD UP!**

You might notice some bags aren't in order, as well as left over pieces, but that's ok! We're changing the way you build LEGO!

### **HALTEN!**

Möglicherweise stellen Sie fest, dass einige Beutel nicht in Ordnung sind und auch Teile übrig bleiben, aber das ist in Ordnung! Wir verändern die Art und Weise, wie Sie LEGO bauen!

### **TENIR BON!**

Vous remarquerez peut-être que certains sacs sont en panne, ainsi que des morceaux restants, mais ce n'est pas grave ! Nous changeons la façon dont vous construisez LEGO !

### **HALT!**

Sie werden möglicherweise bemerken, dass einige tüten durcheinander sind und teile übrig bleiben, aber das ist in Ordnung! Wir ändern die art und weise, wie Sie LEGO bauen!

### **¡ESPERA!**

Es posible que notes que algunas bolsas están fuera de servicio, así como piezas sobrantes, ¡pero está bien! ¡Estamos cambiando la forma en que construyes LEGO!

### **暫停!**

你可能会注意到一些袋子顺序错乱, 以及一些剩余的部件, 但没关系! 我们正在改变你搭建乐高的方式!

#### Open LMB Bag 02

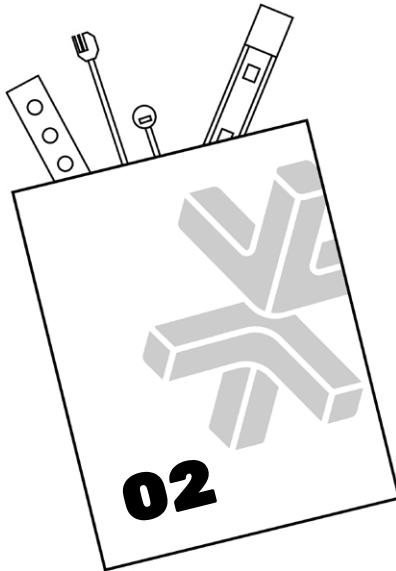

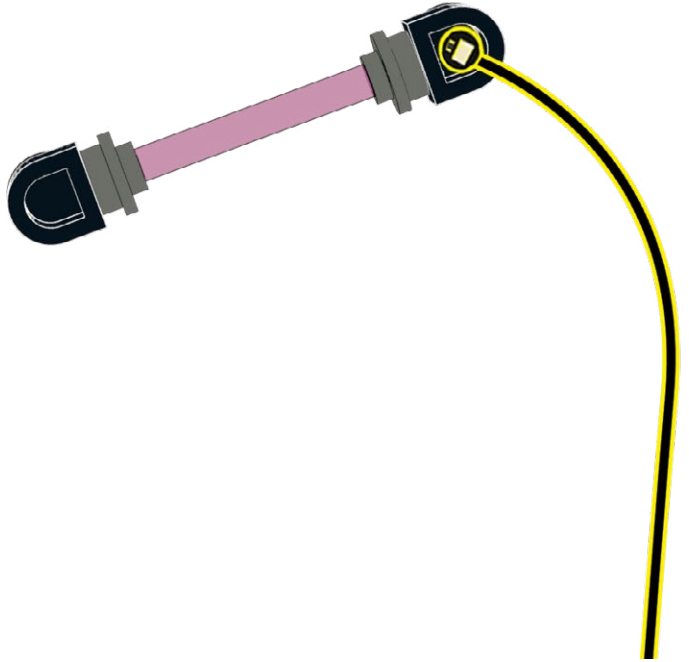
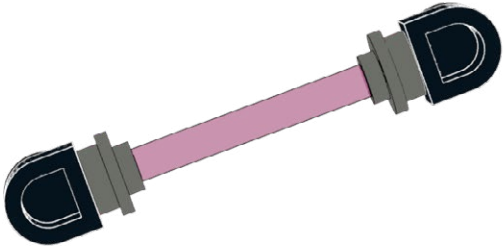
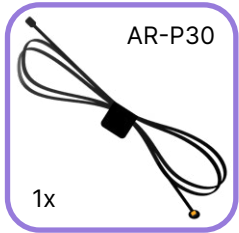
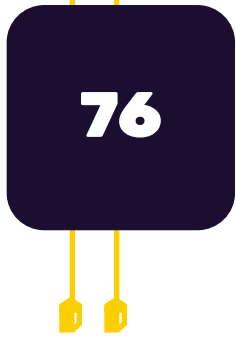

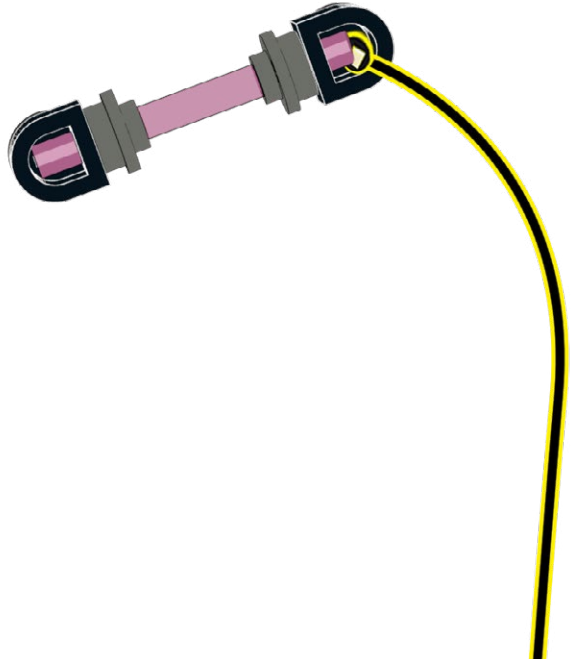
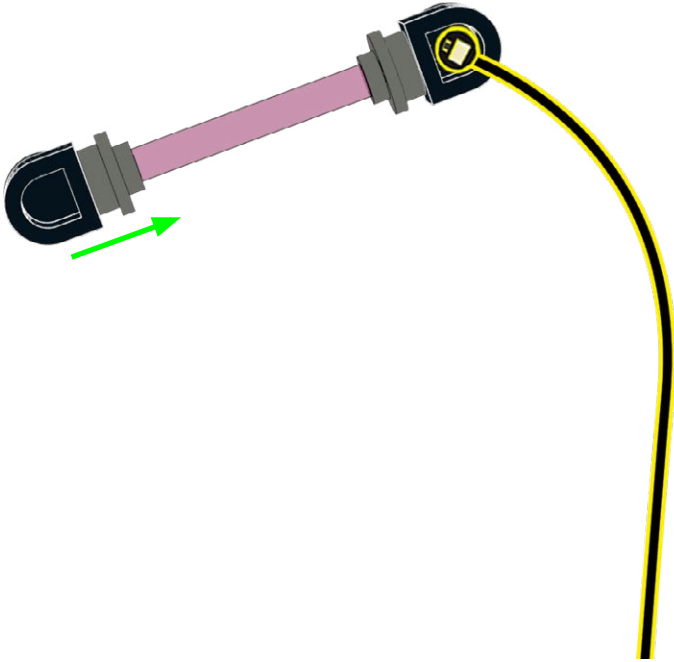



79

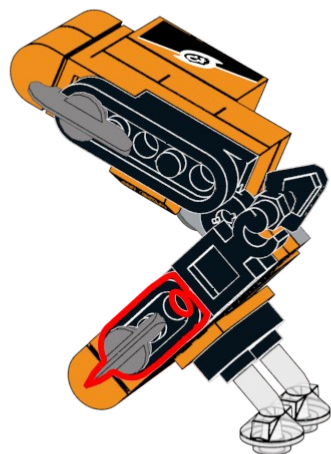

80

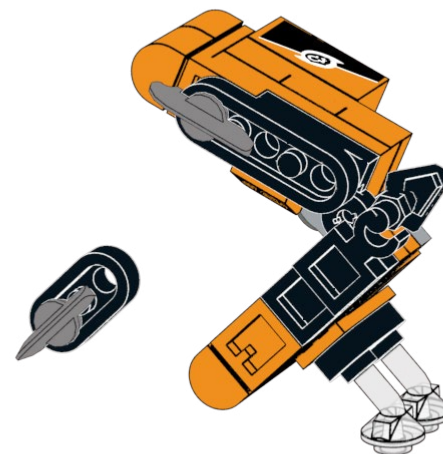

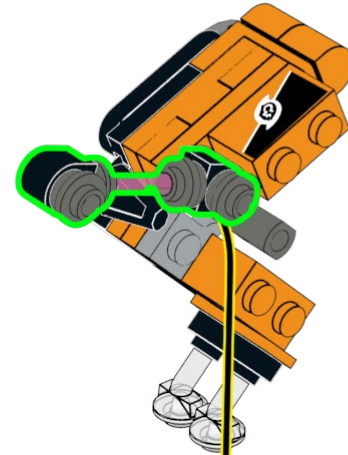
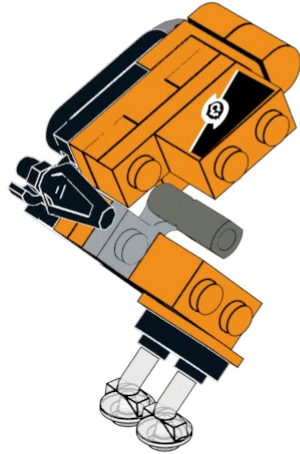
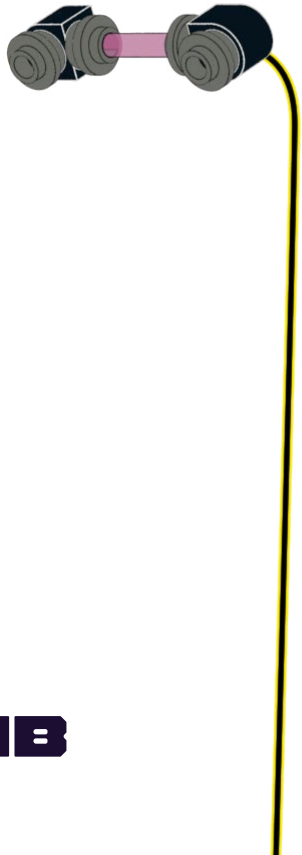

83

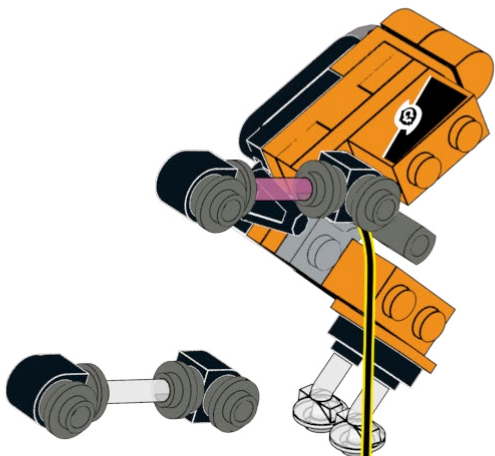

84

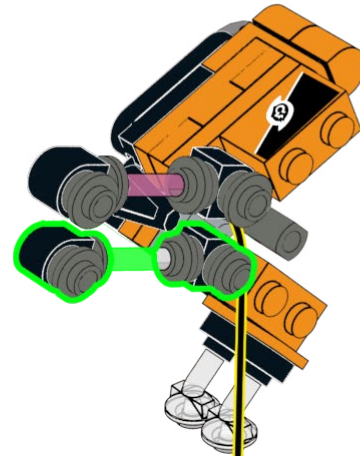

85

86

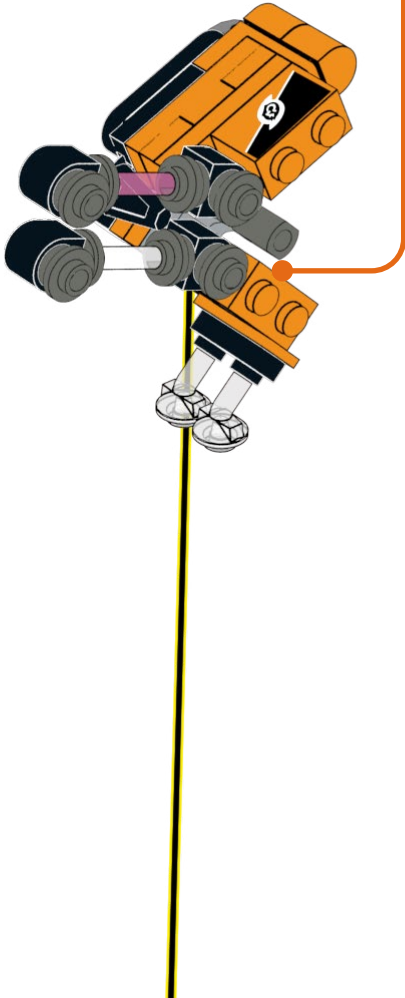
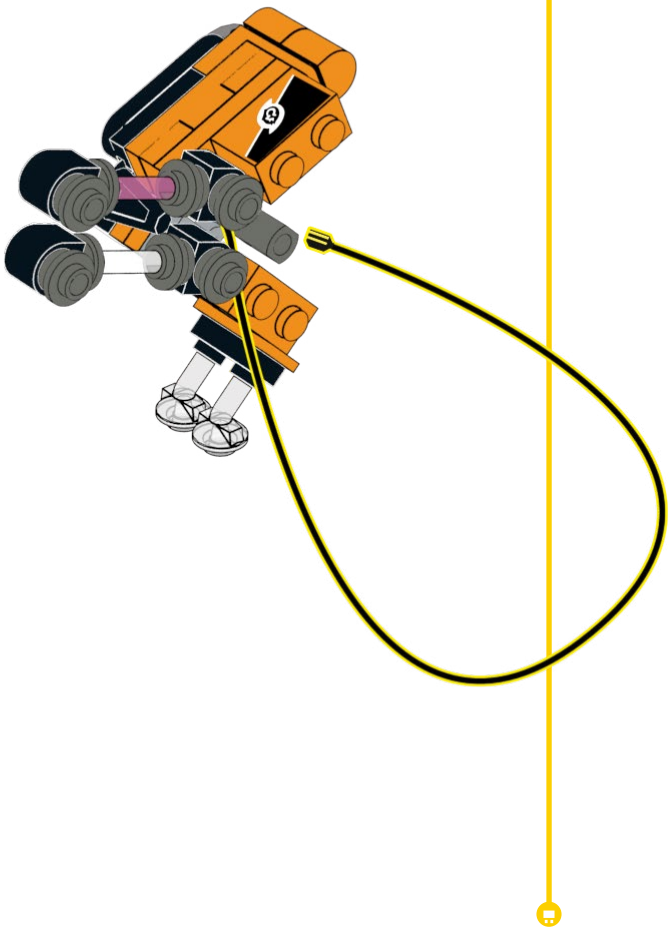
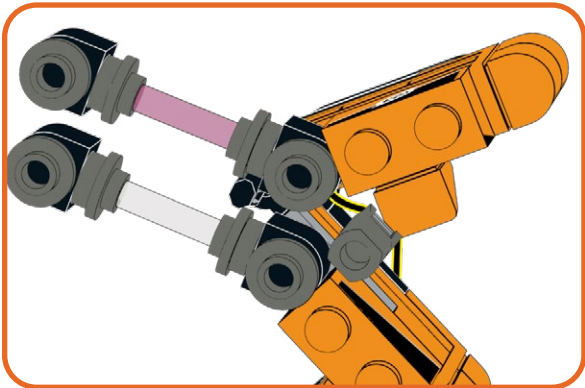

87

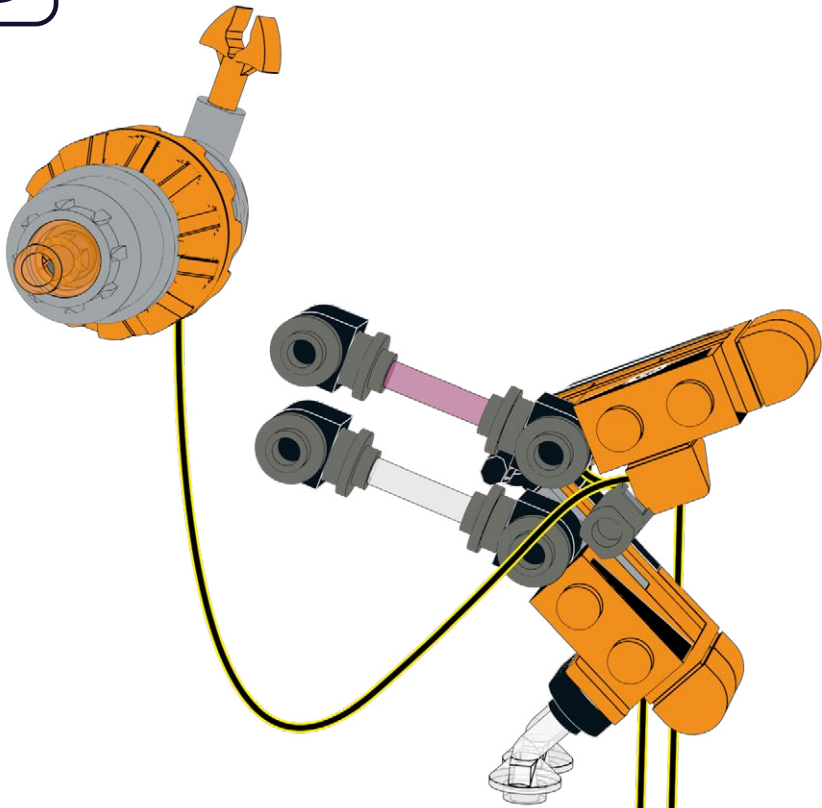

88

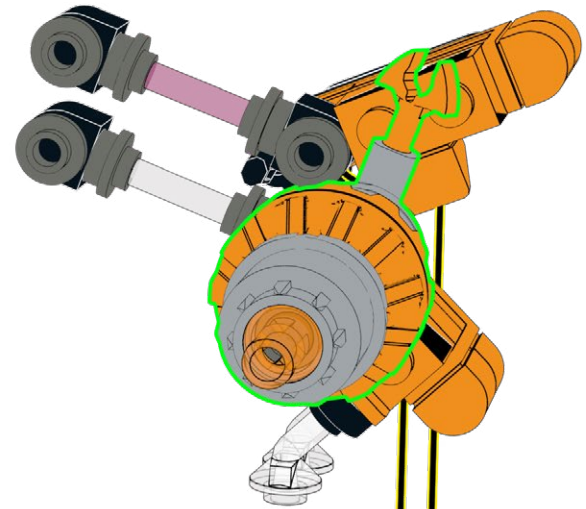

89

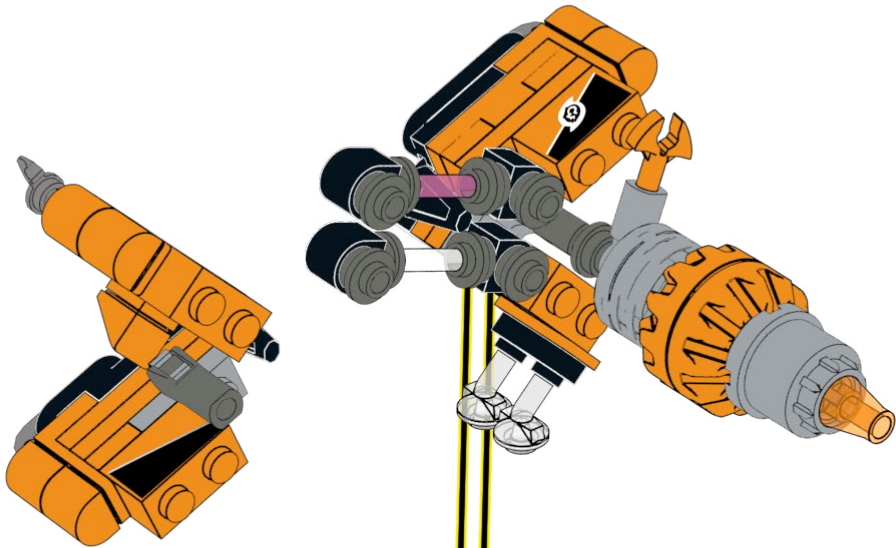

90

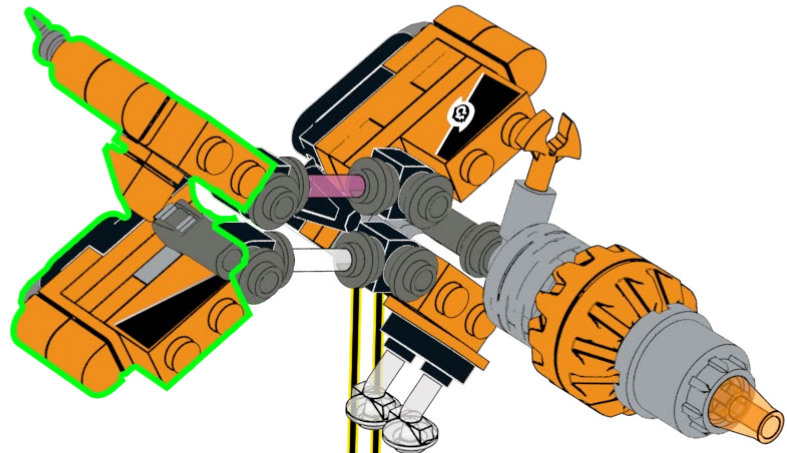

91

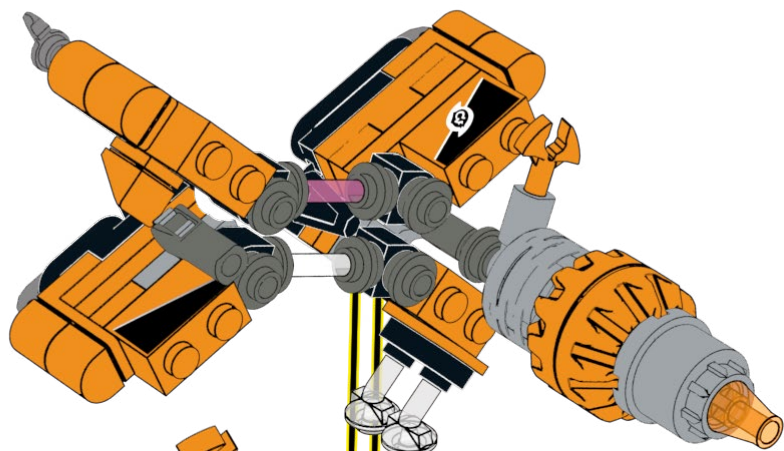

92

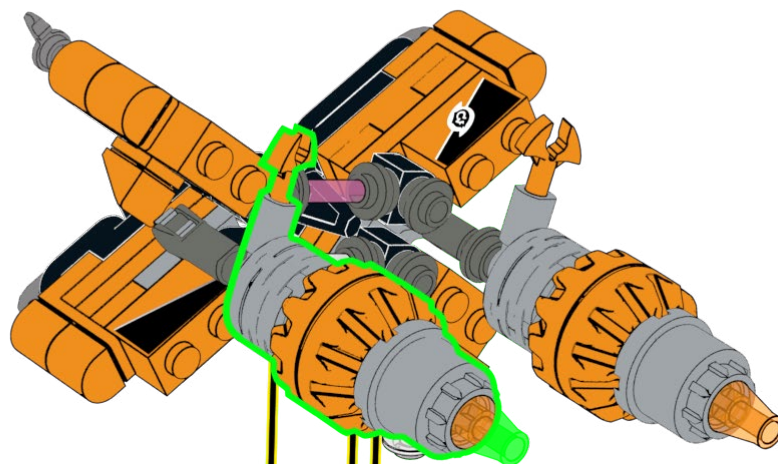

93

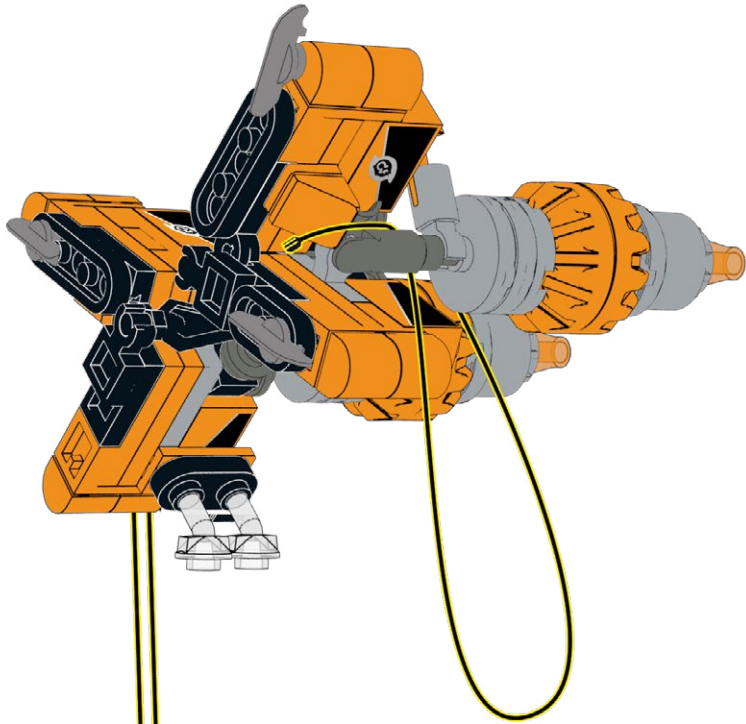

94

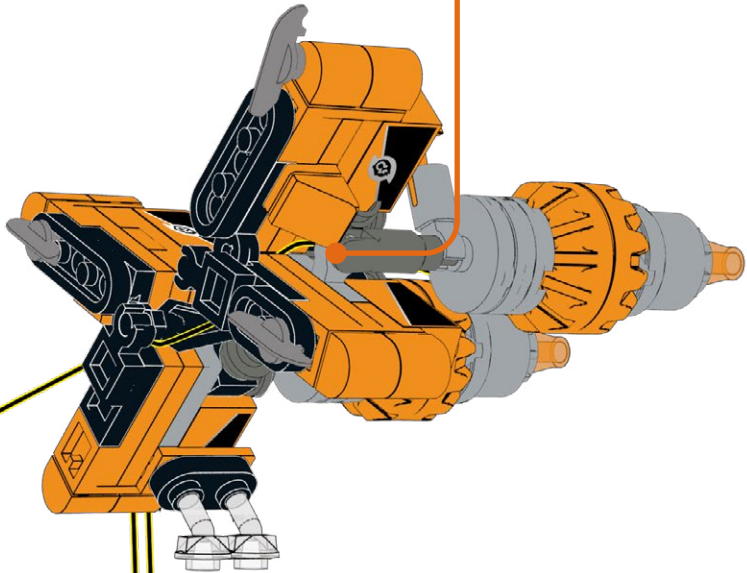
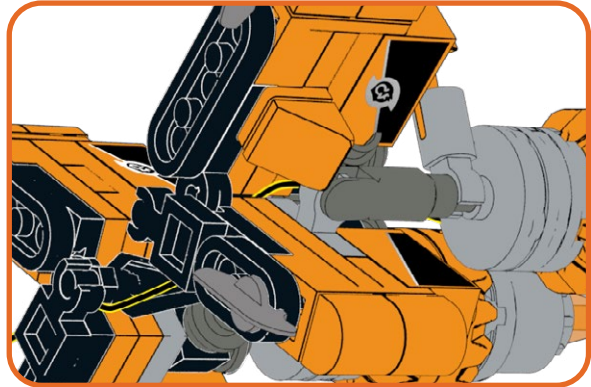



95

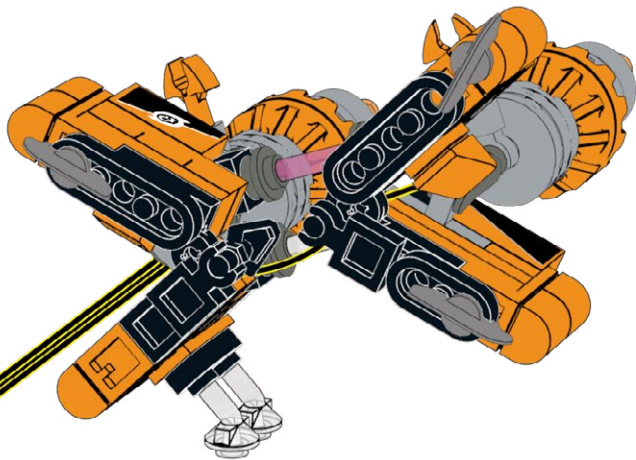

96

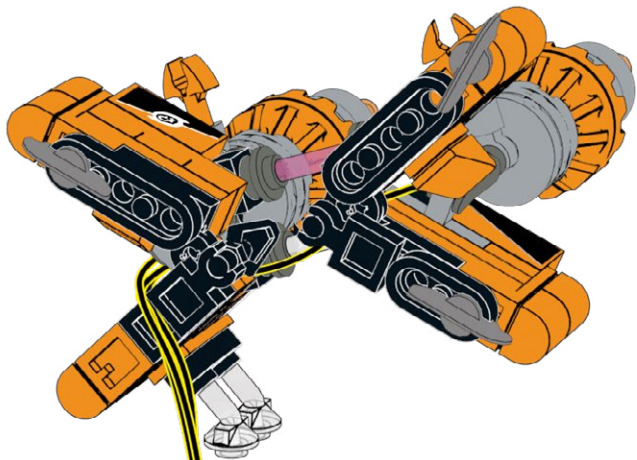

97

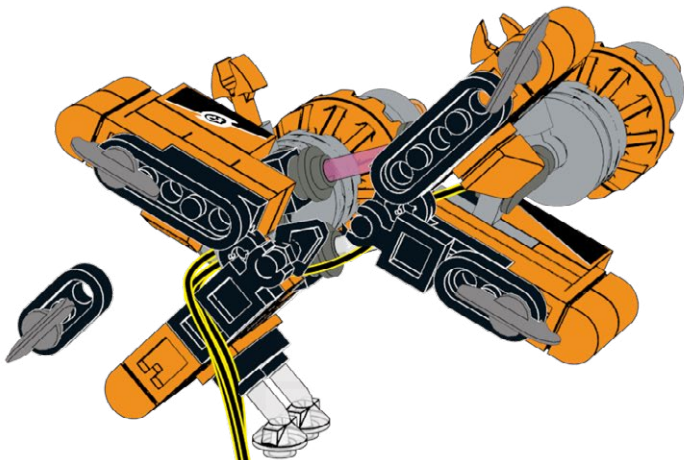

98

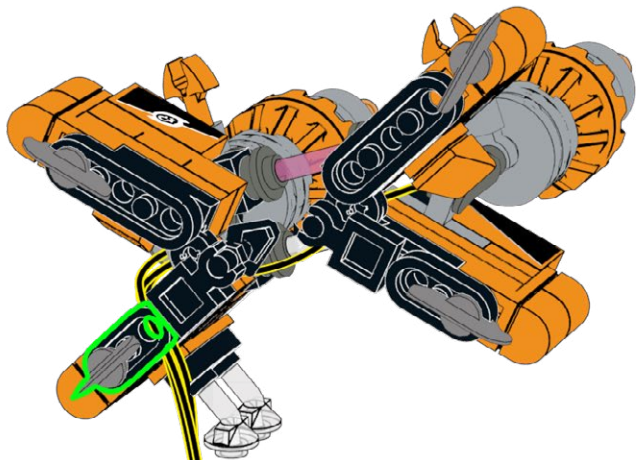

99

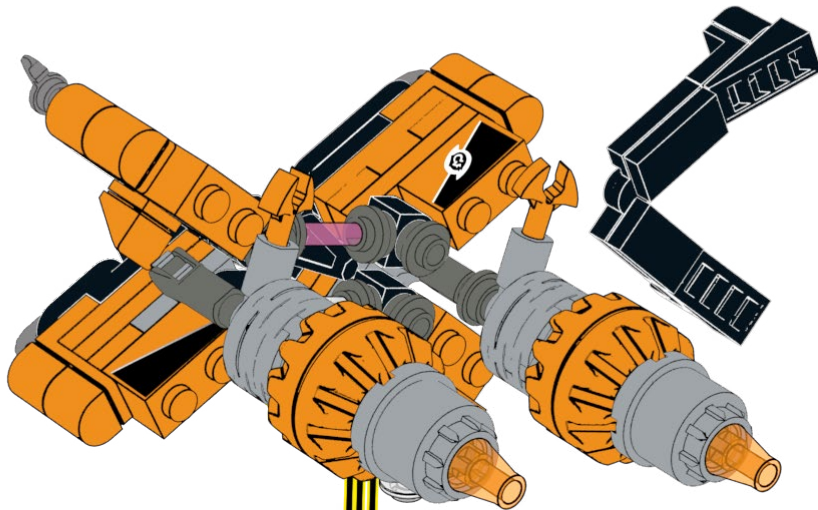

100

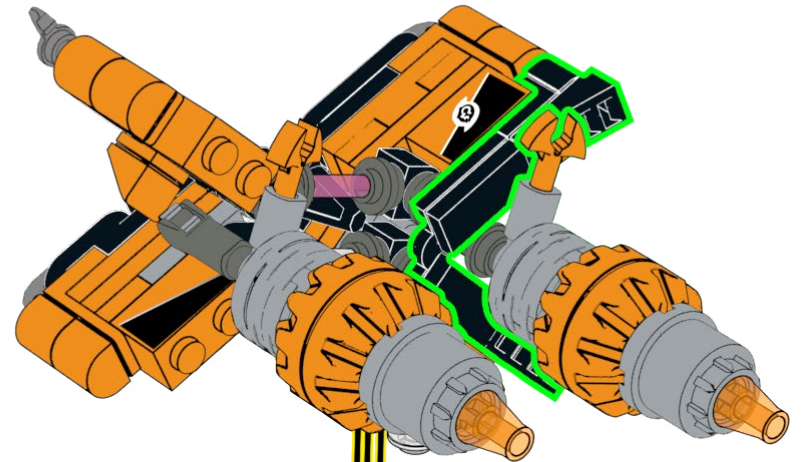

101

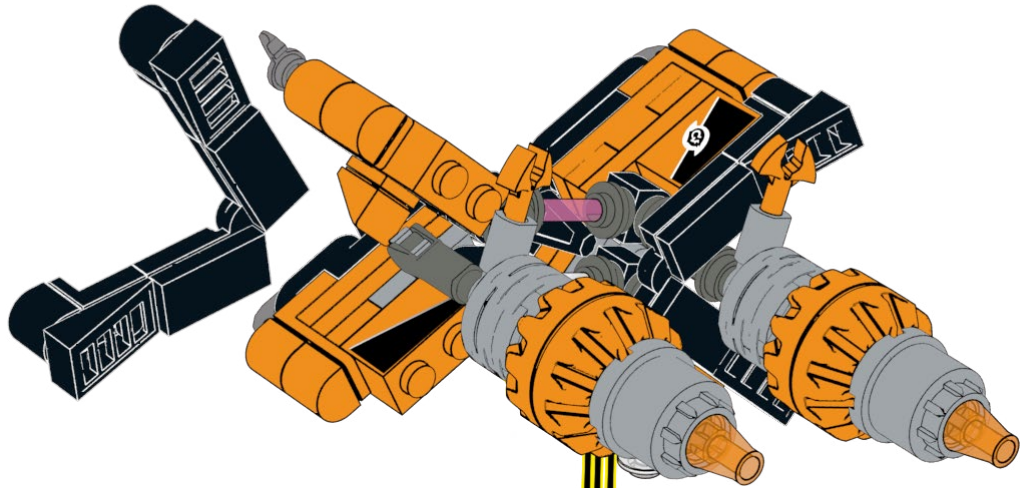

102

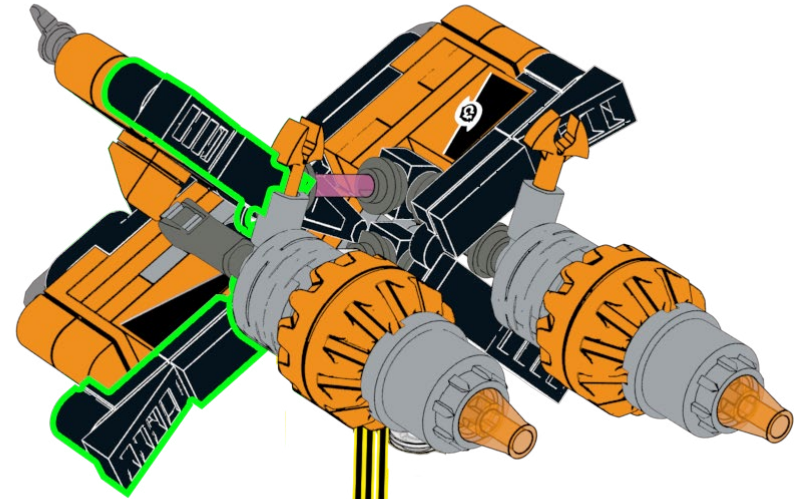

# 103

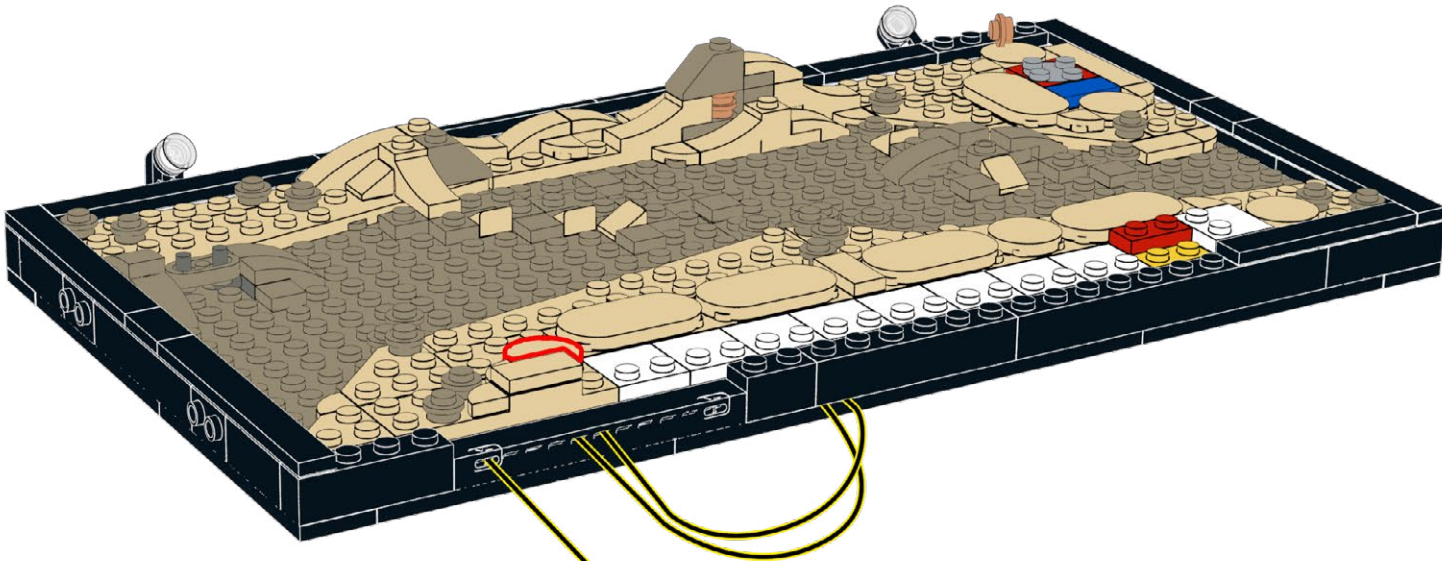

# 104

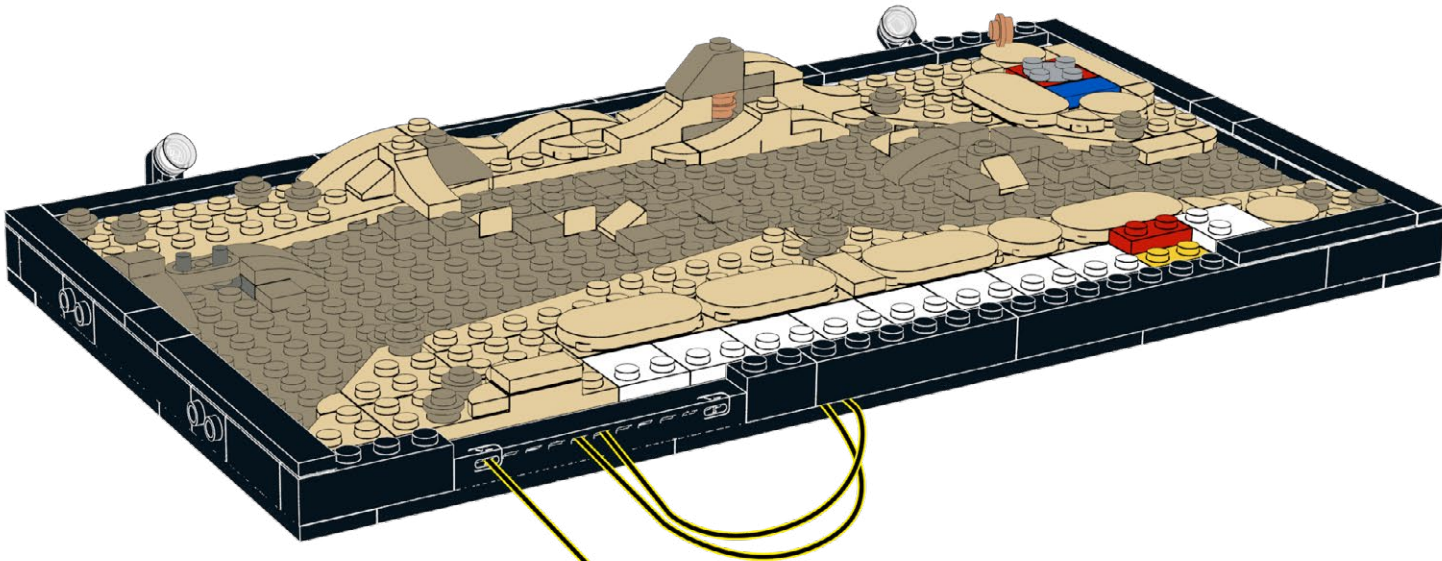

105

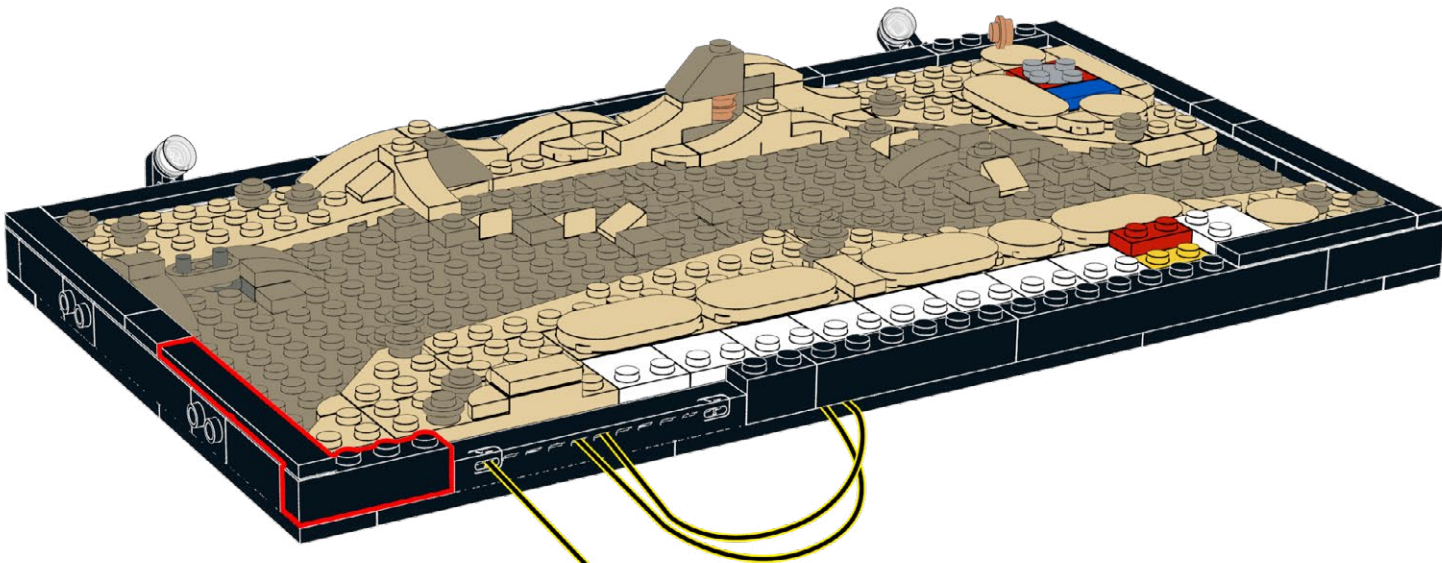

106

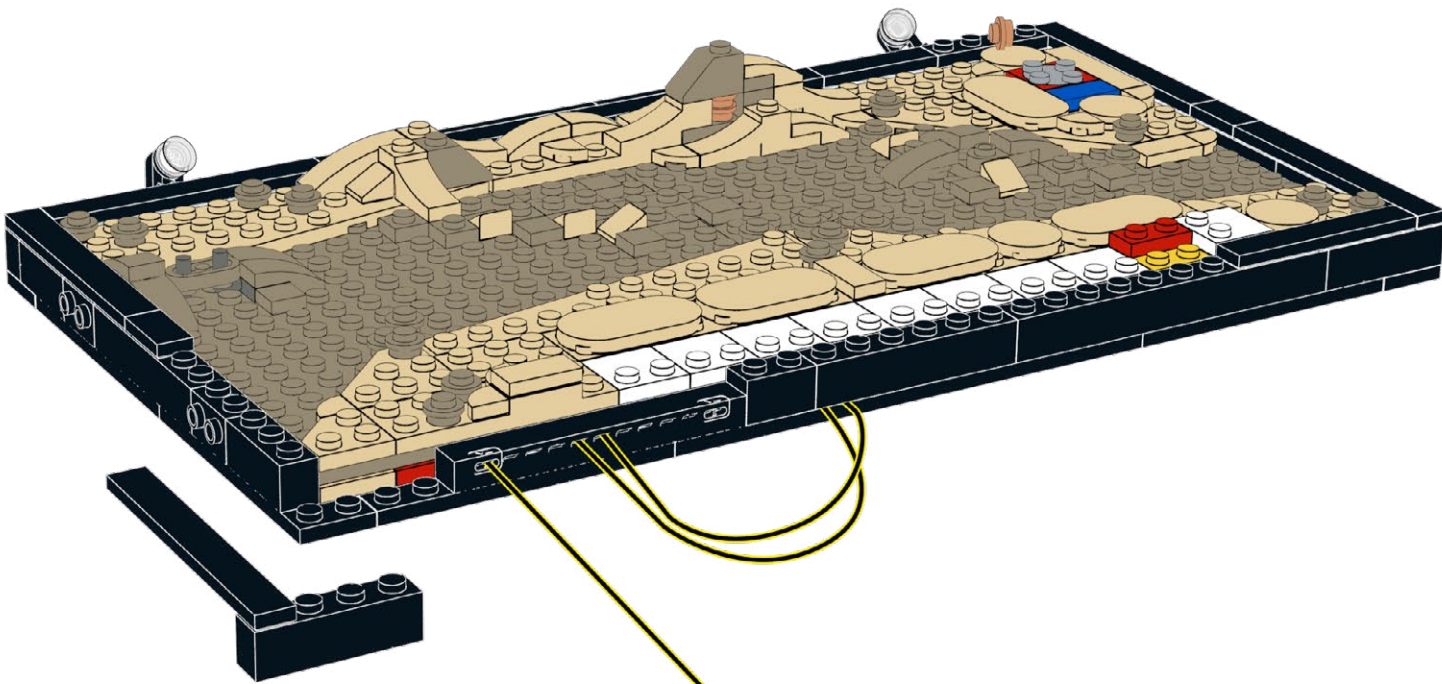



107

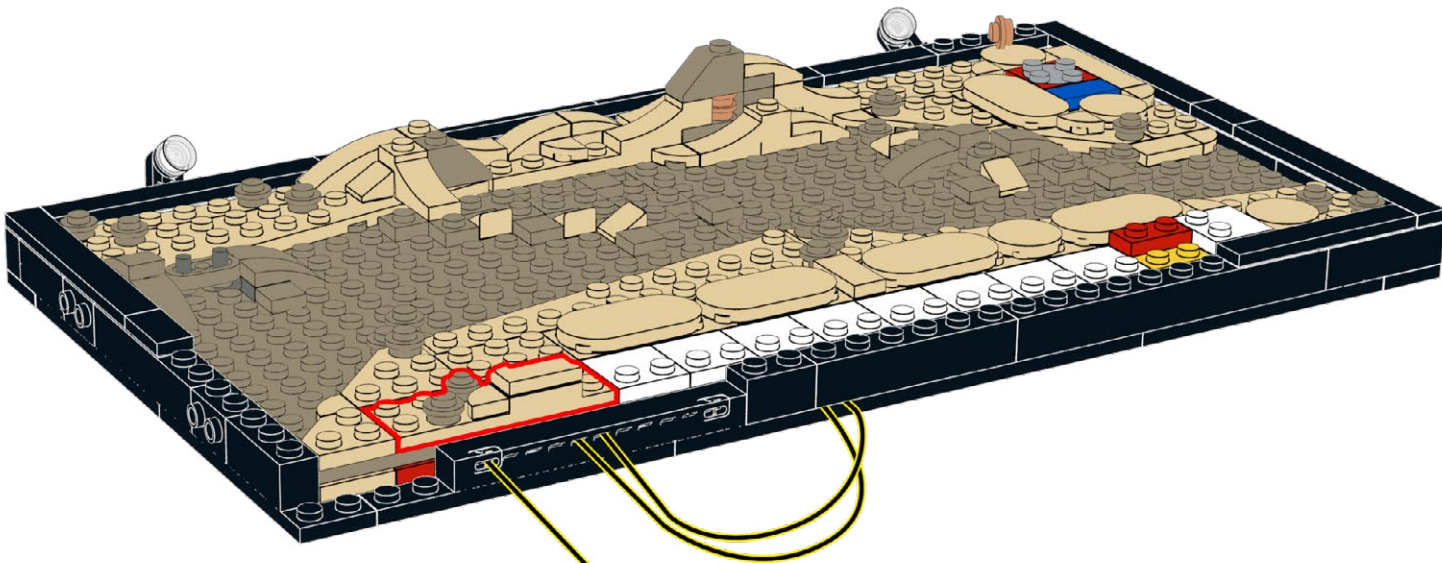

108

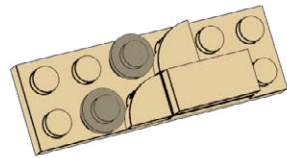
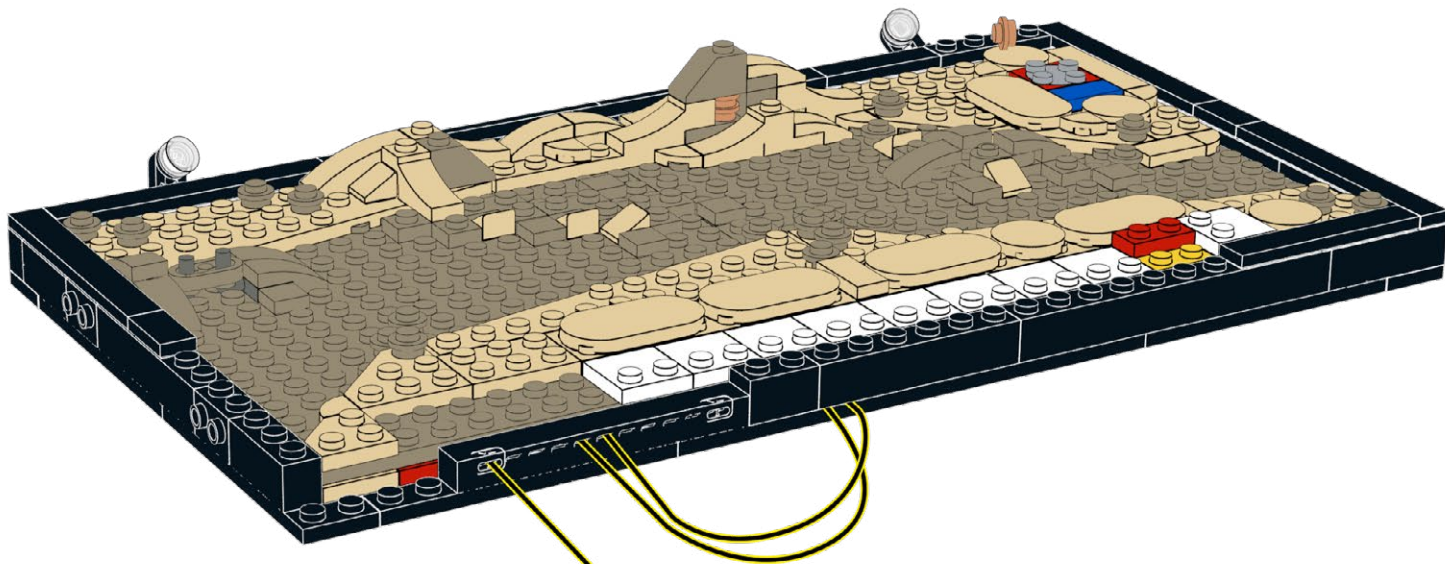

109

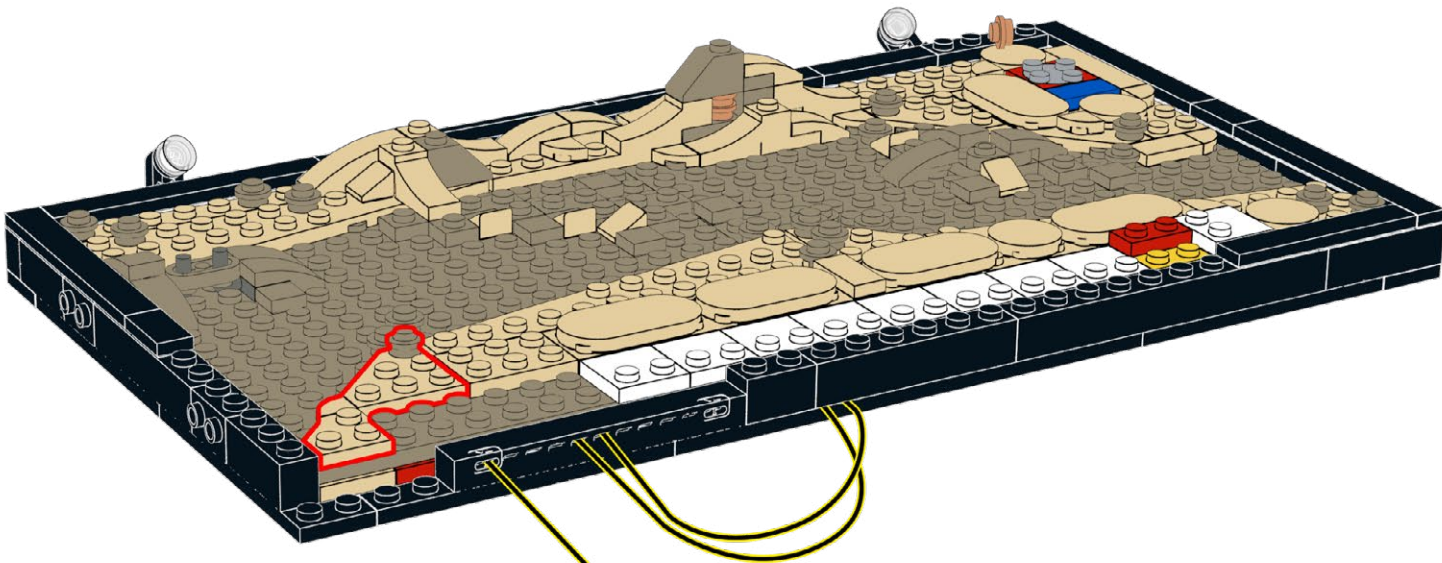

110

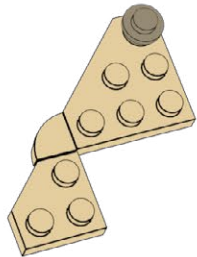
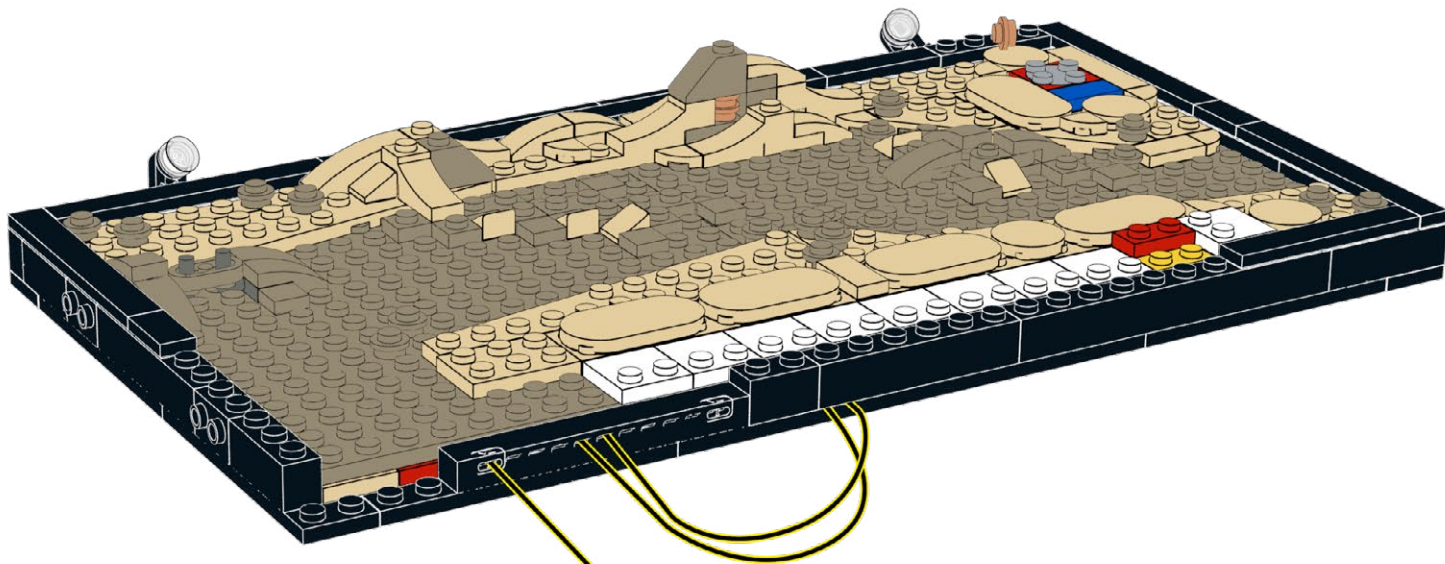

111

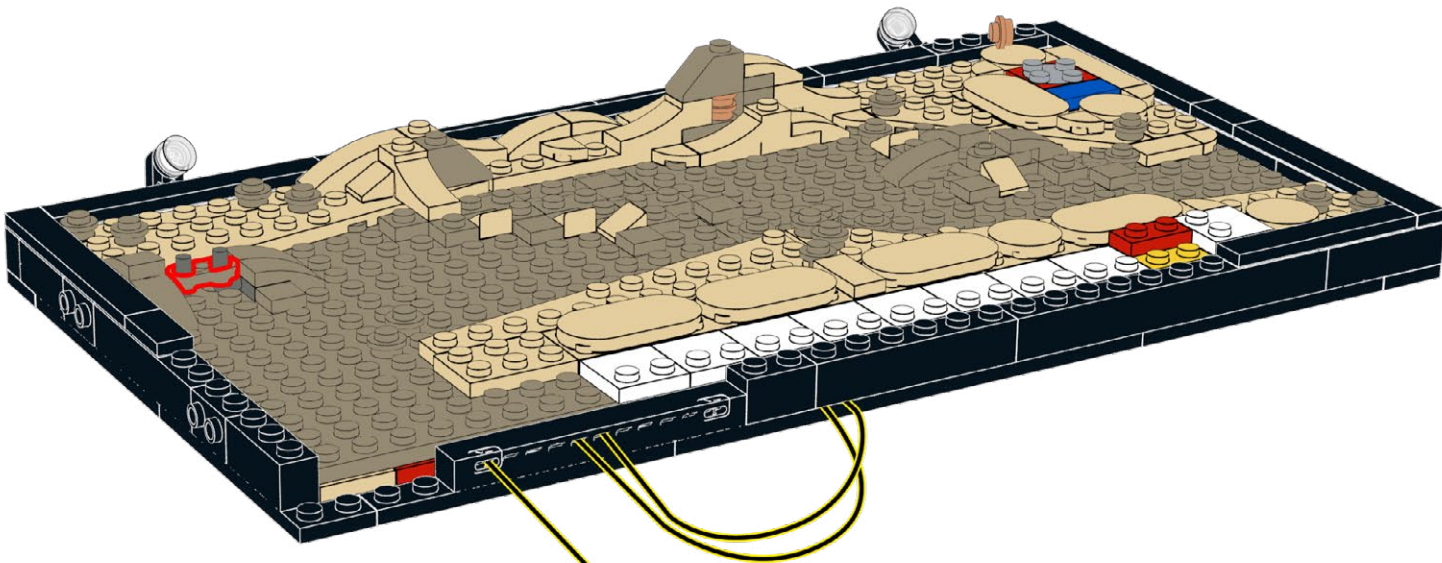

112

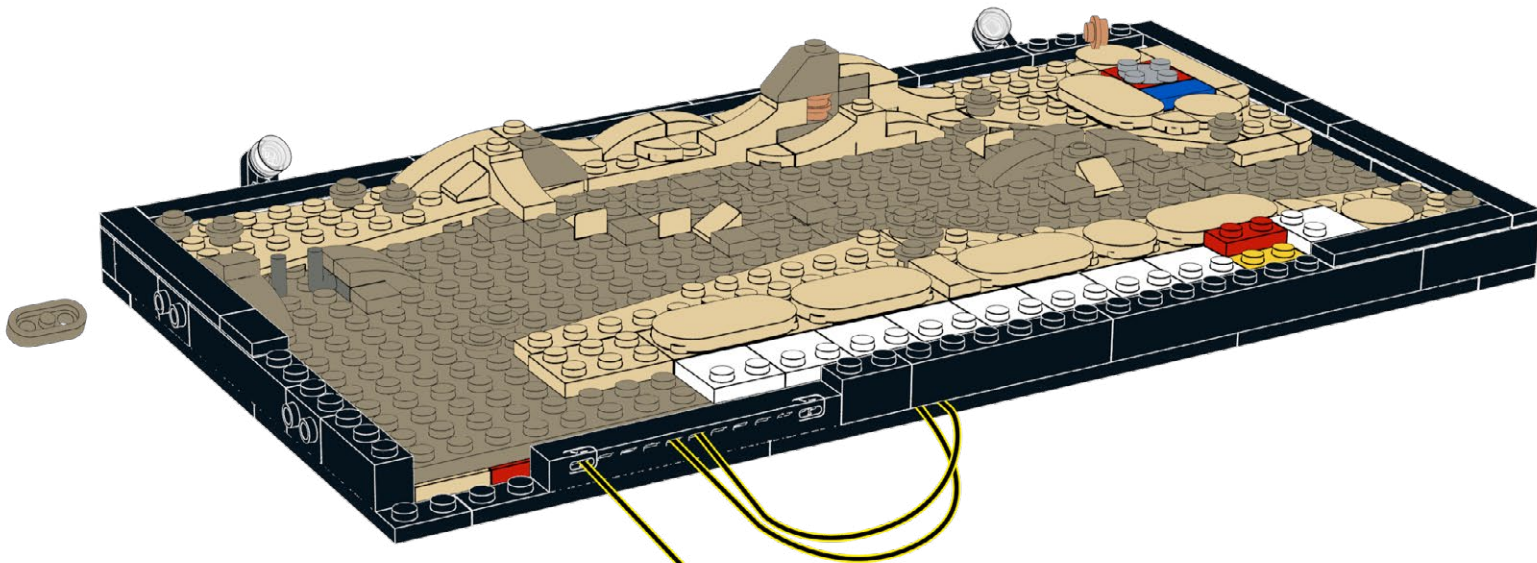

113

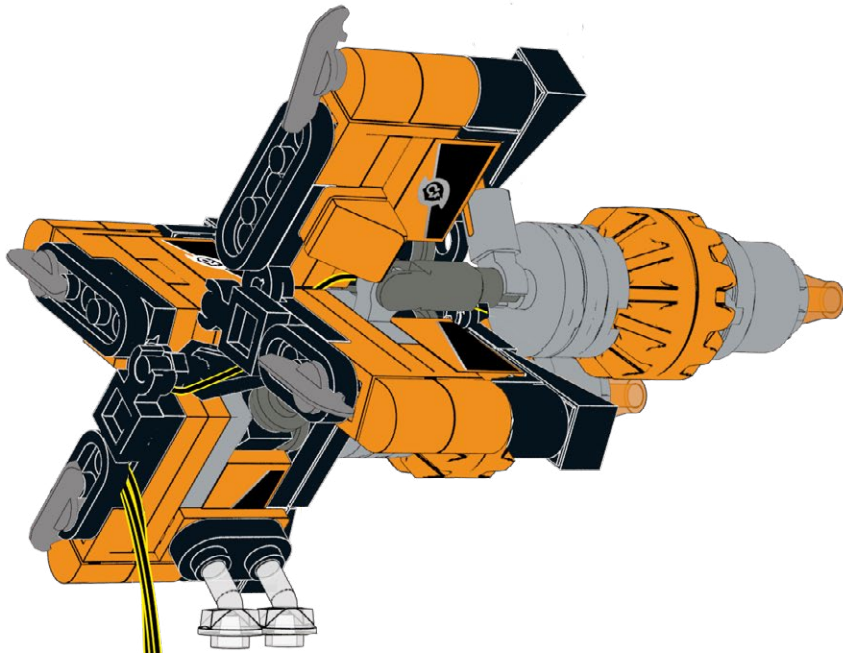

114

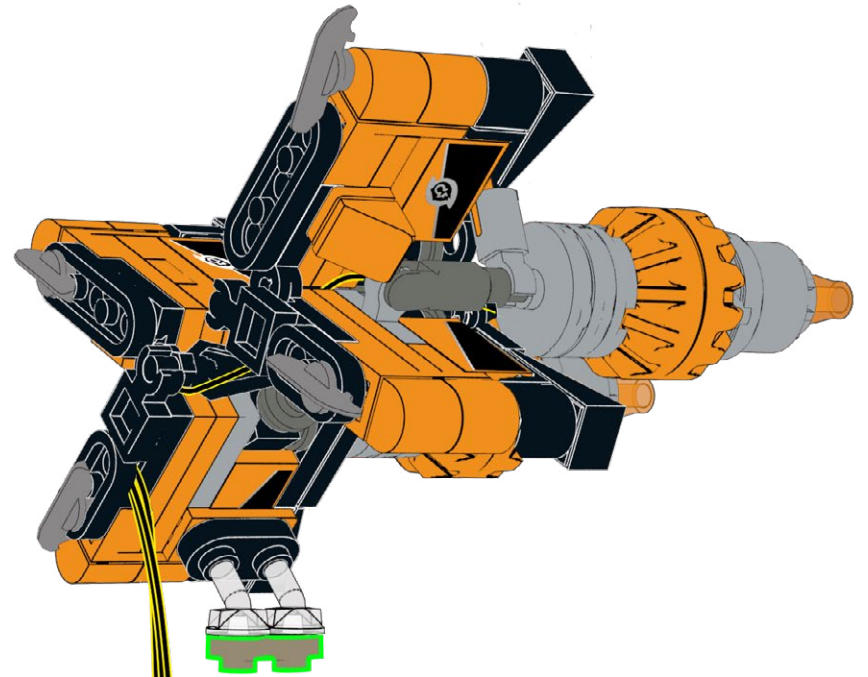

115

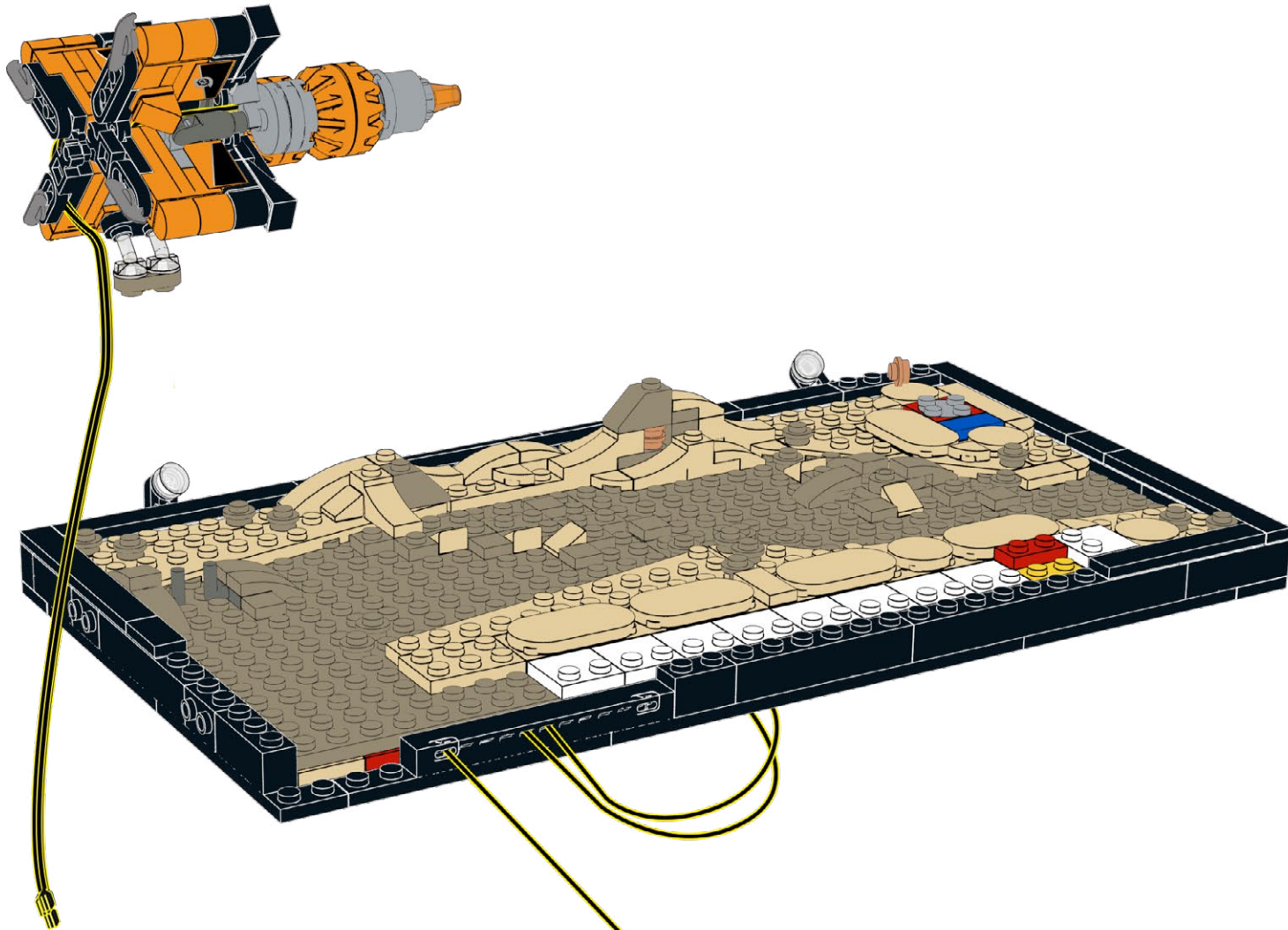



116

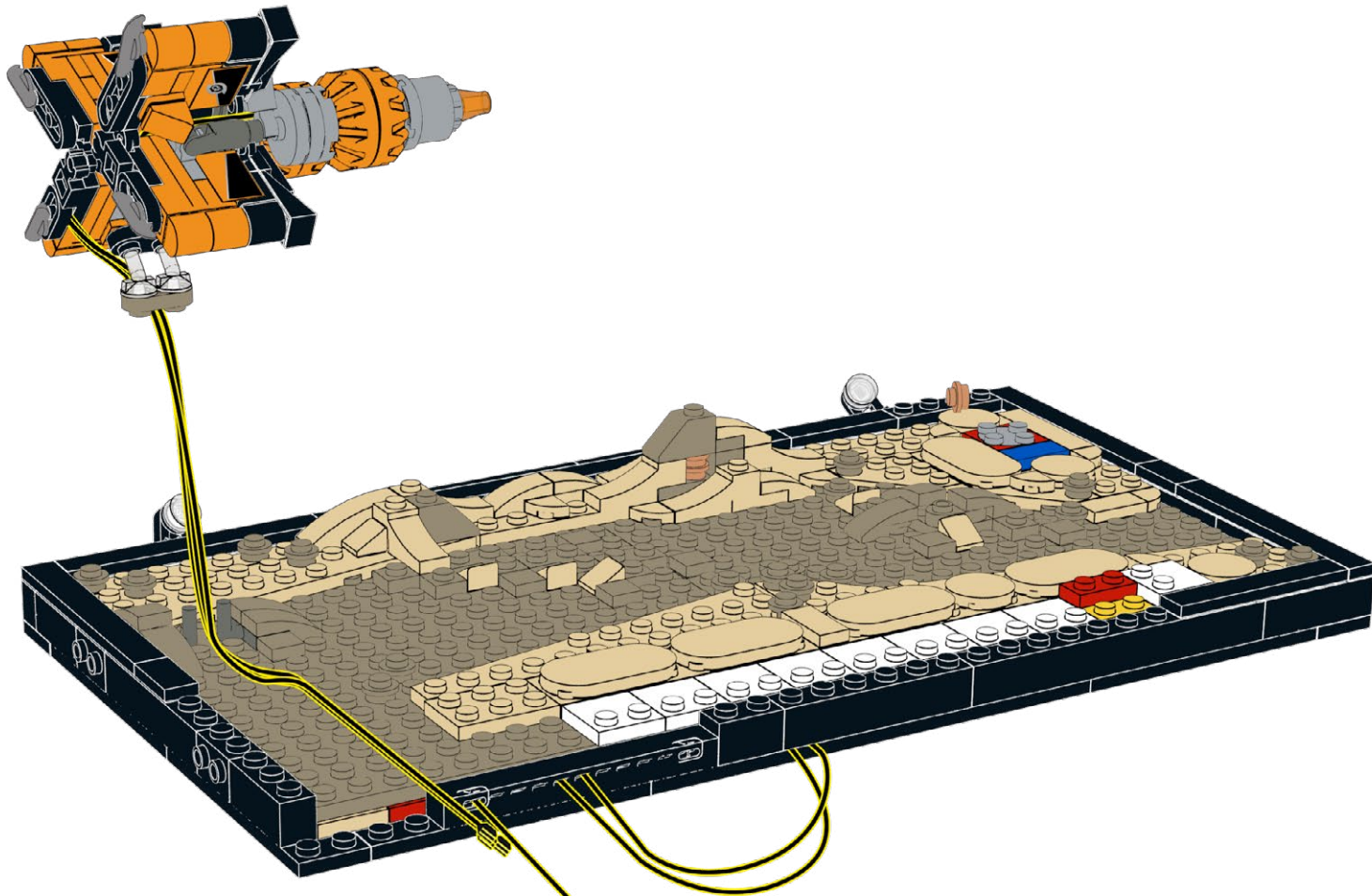

117

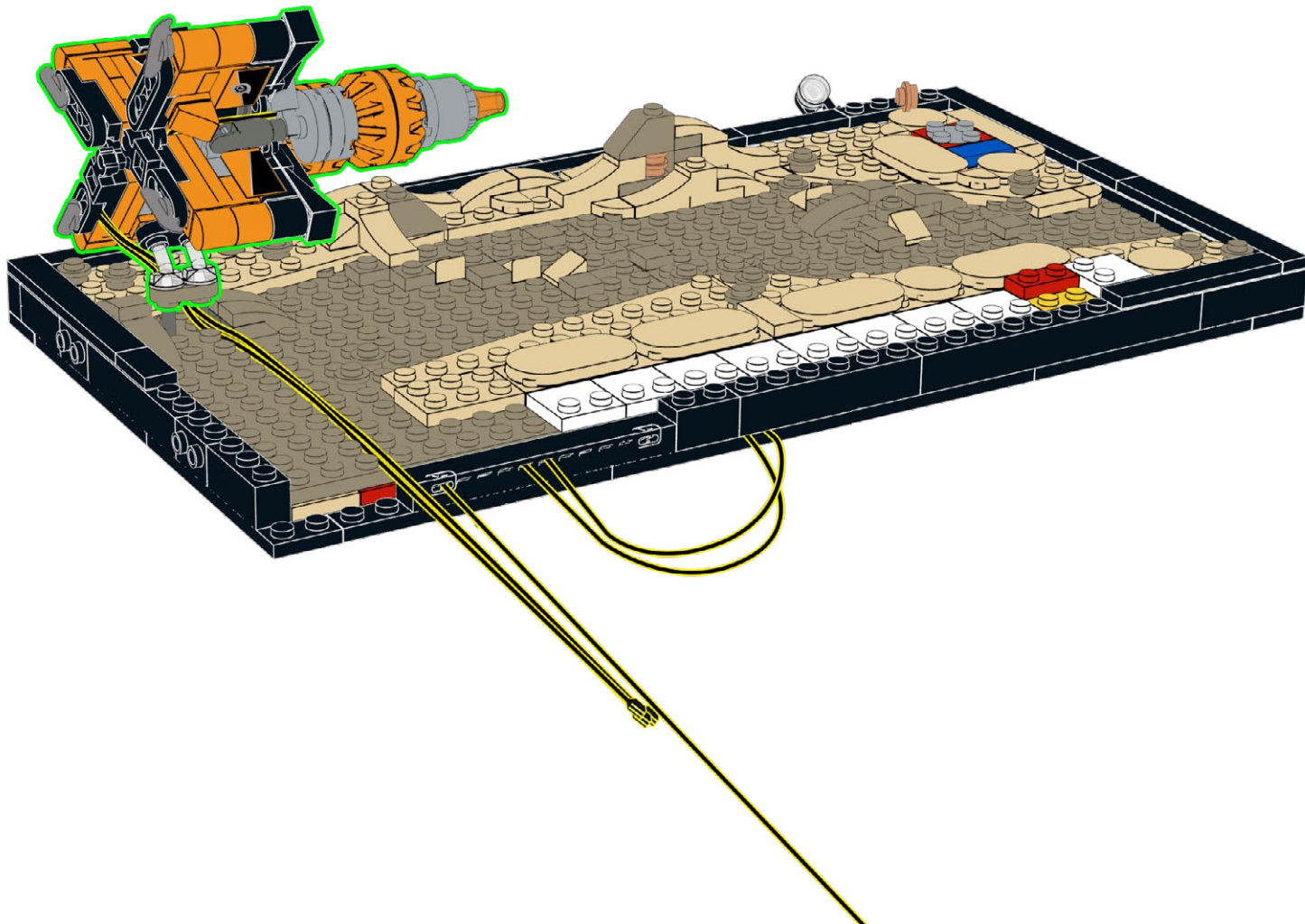

118

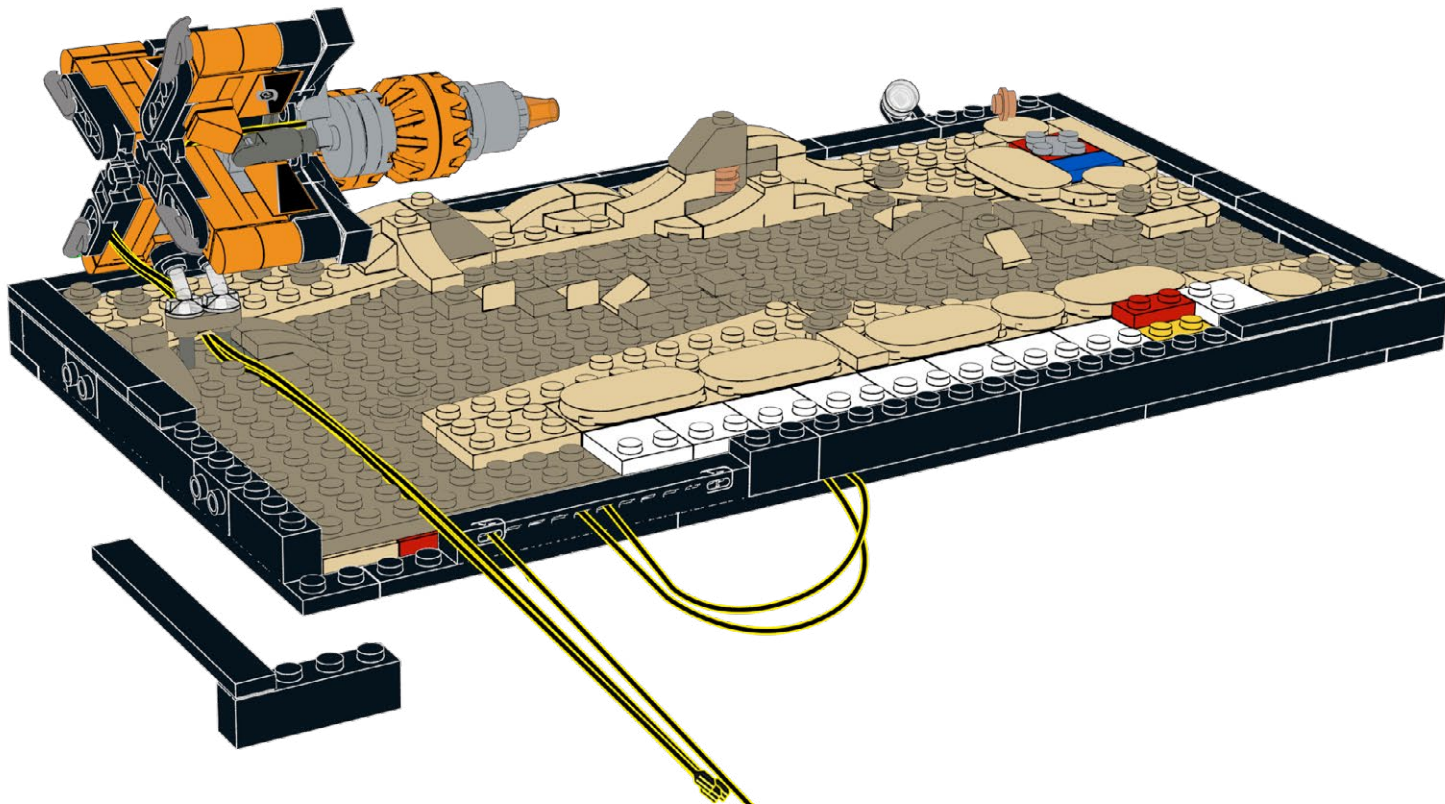

119

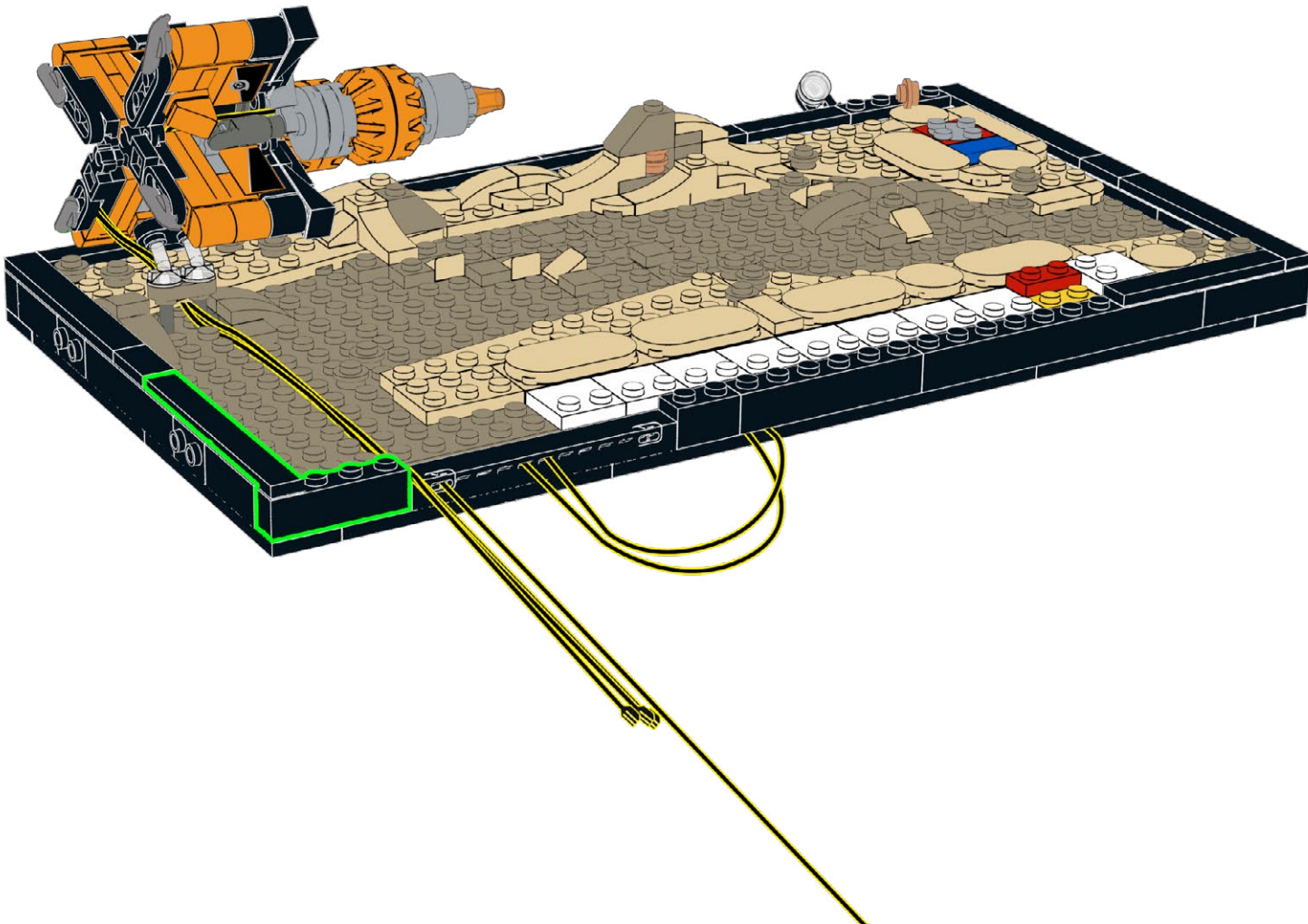

120

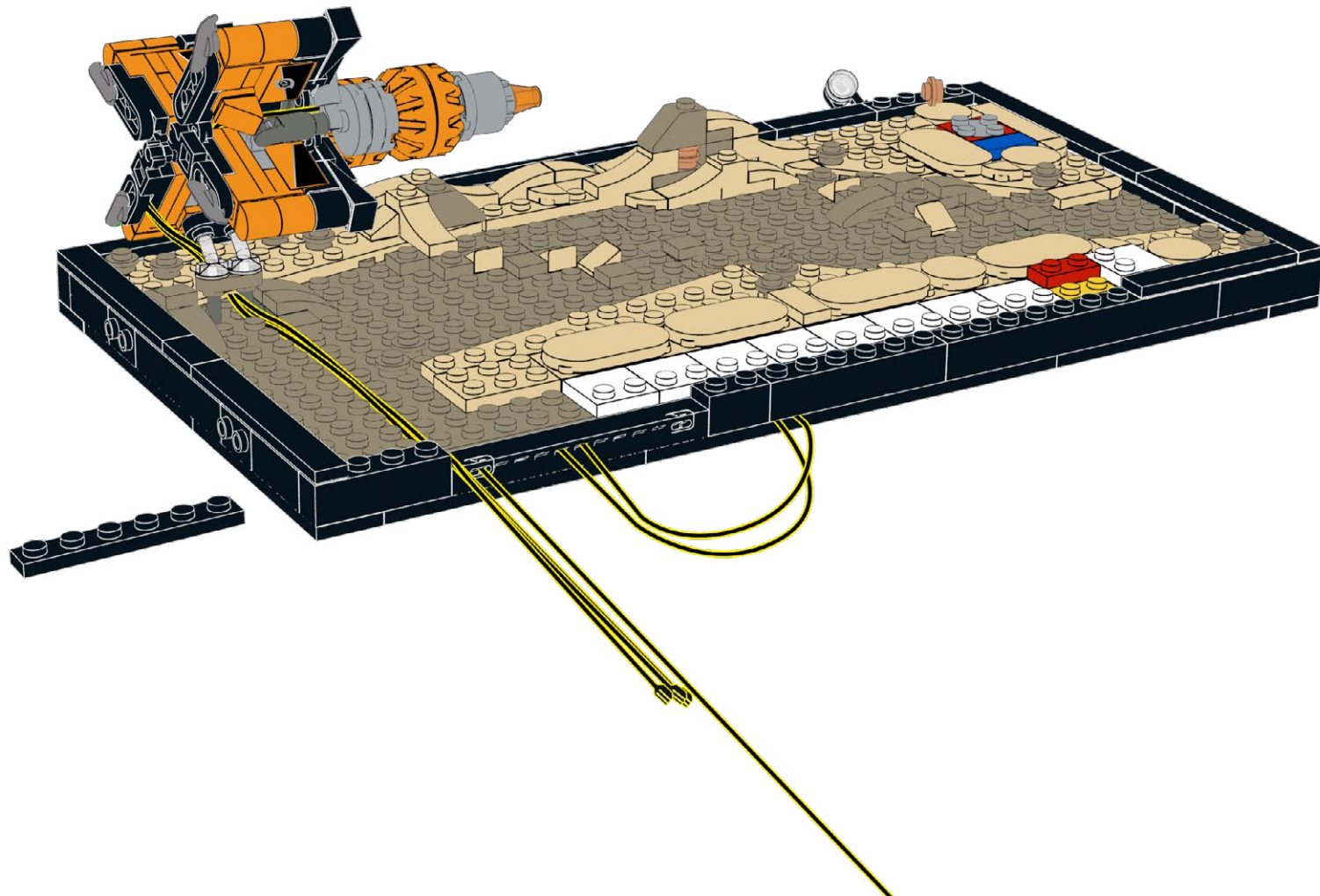

121

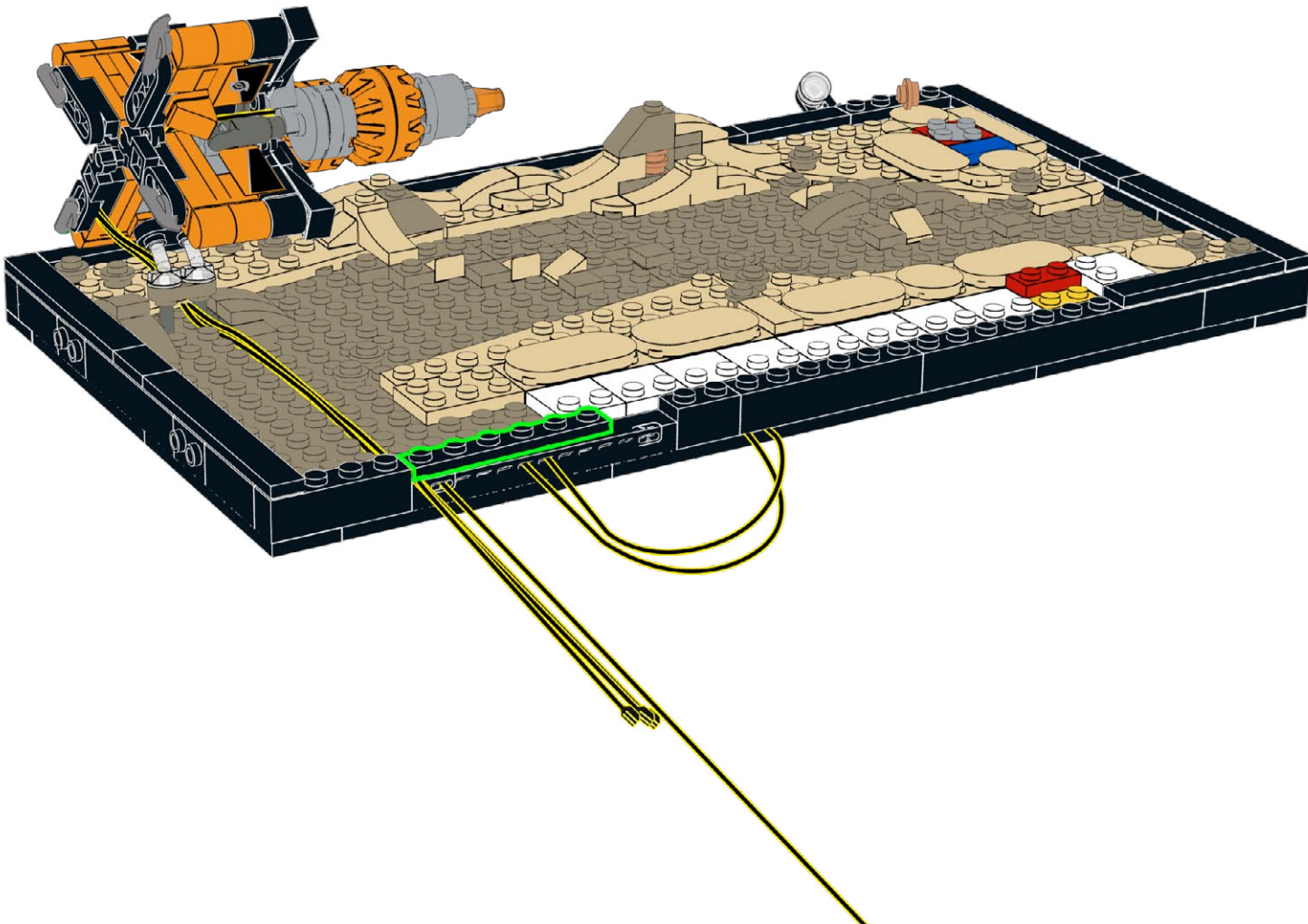

122

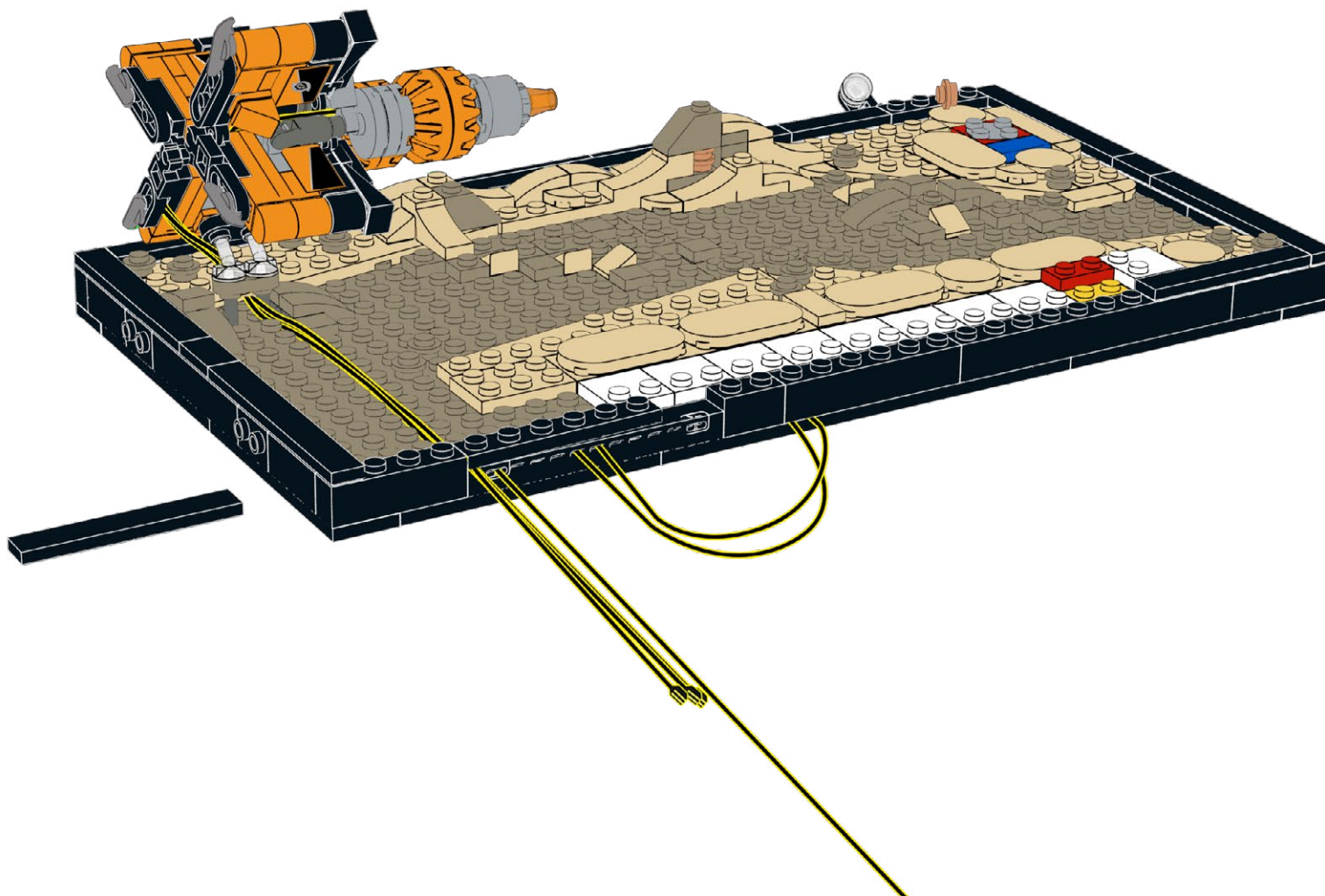

123

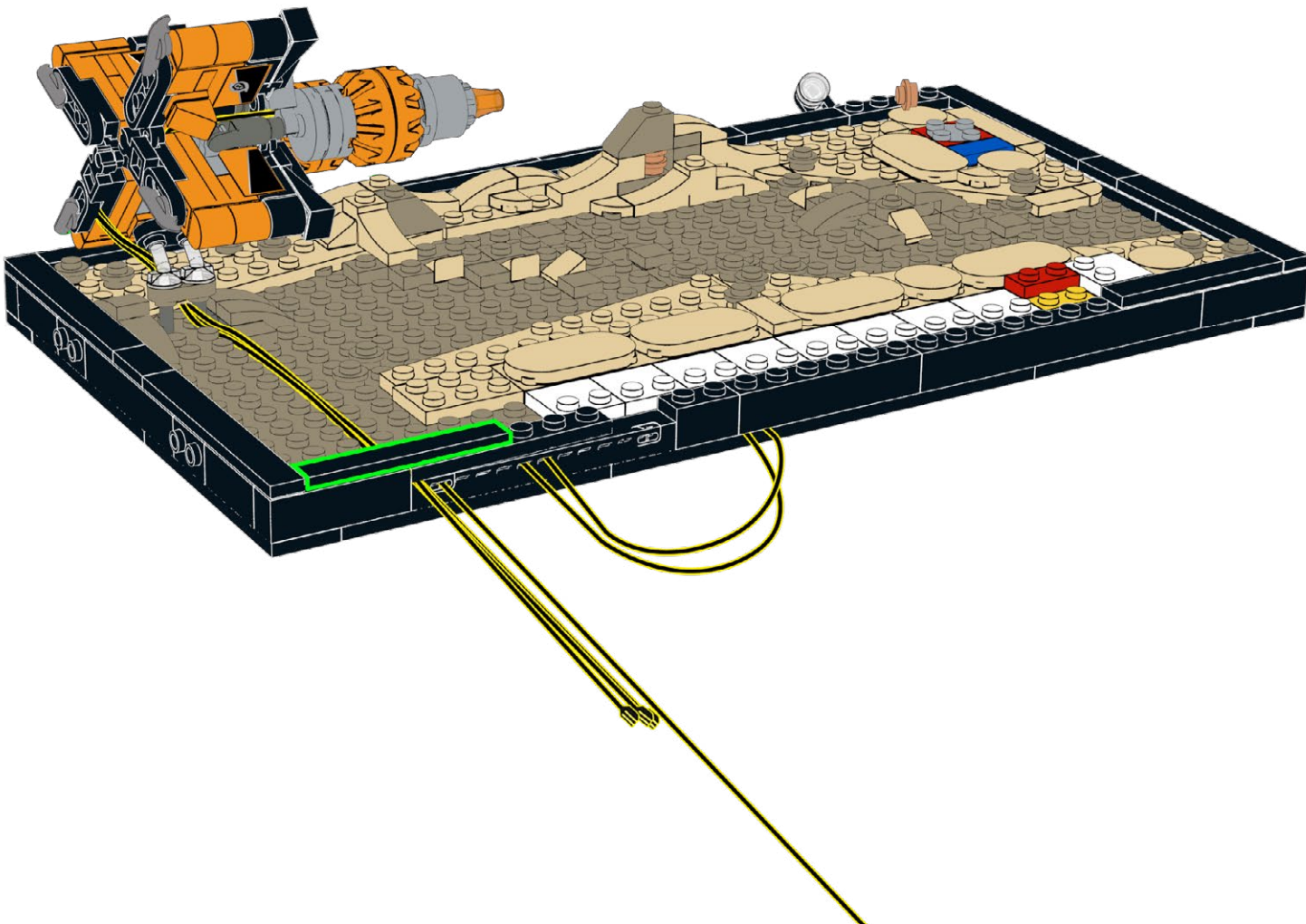



124

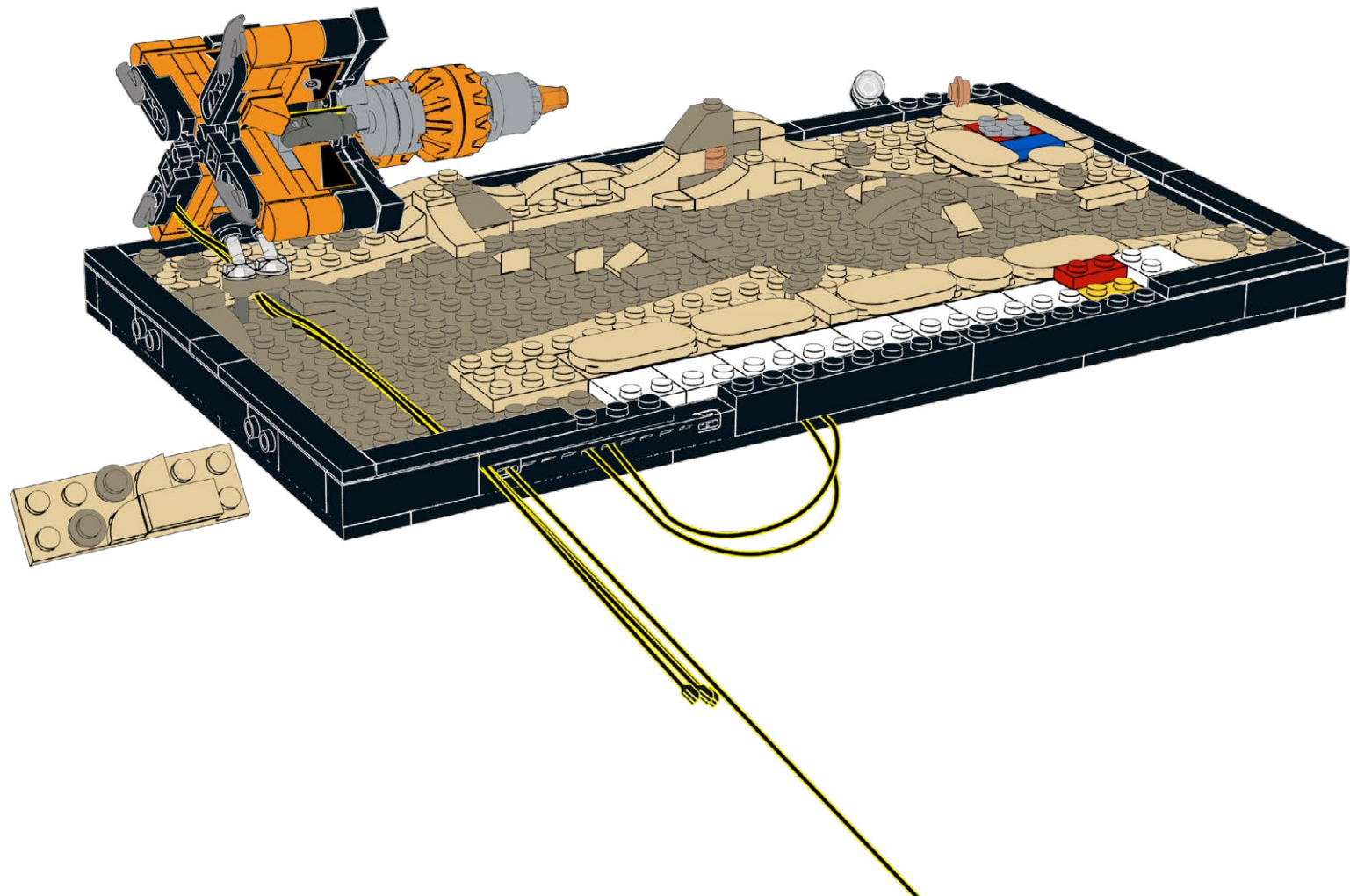
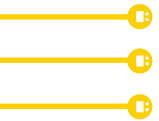

125

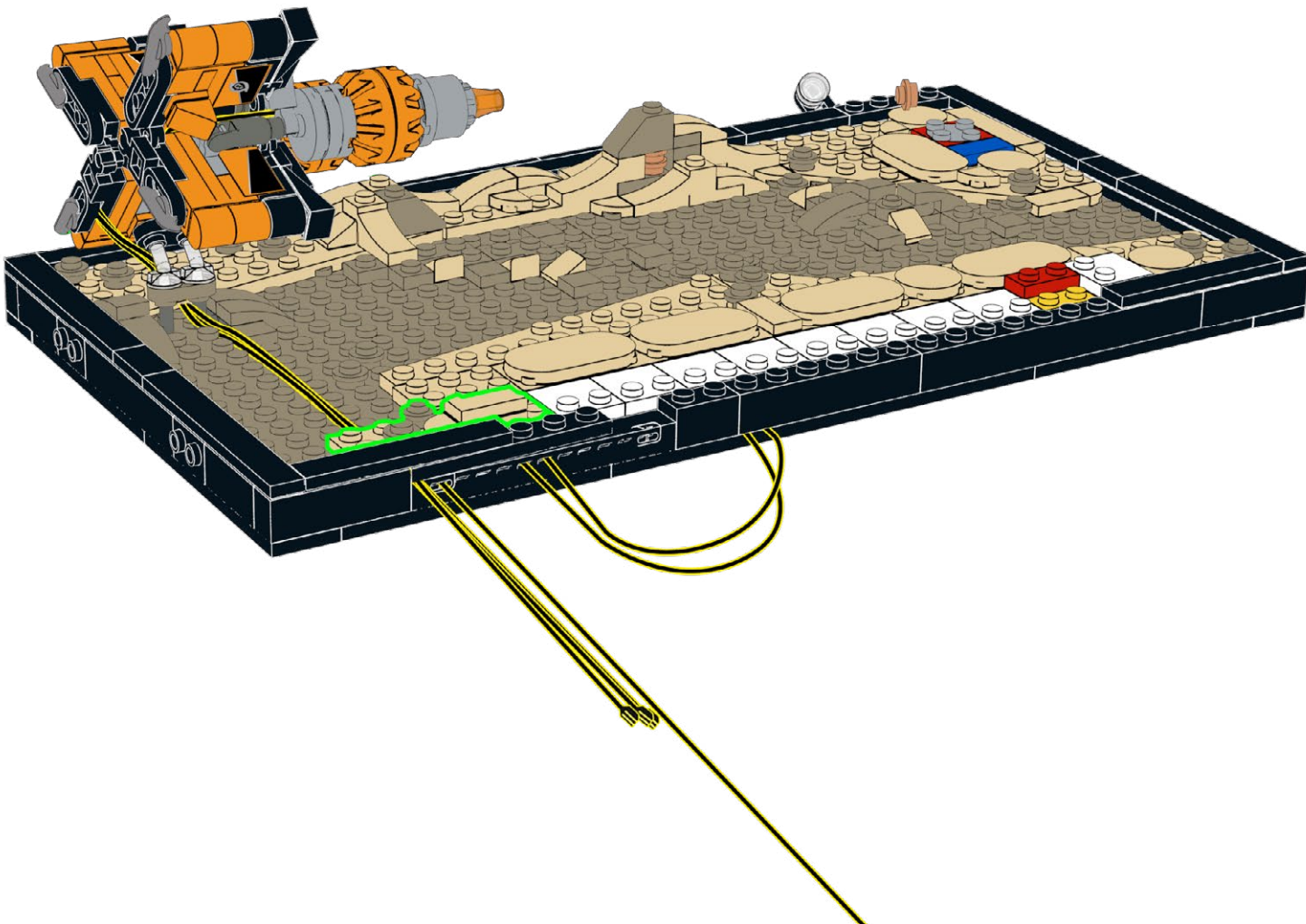

126

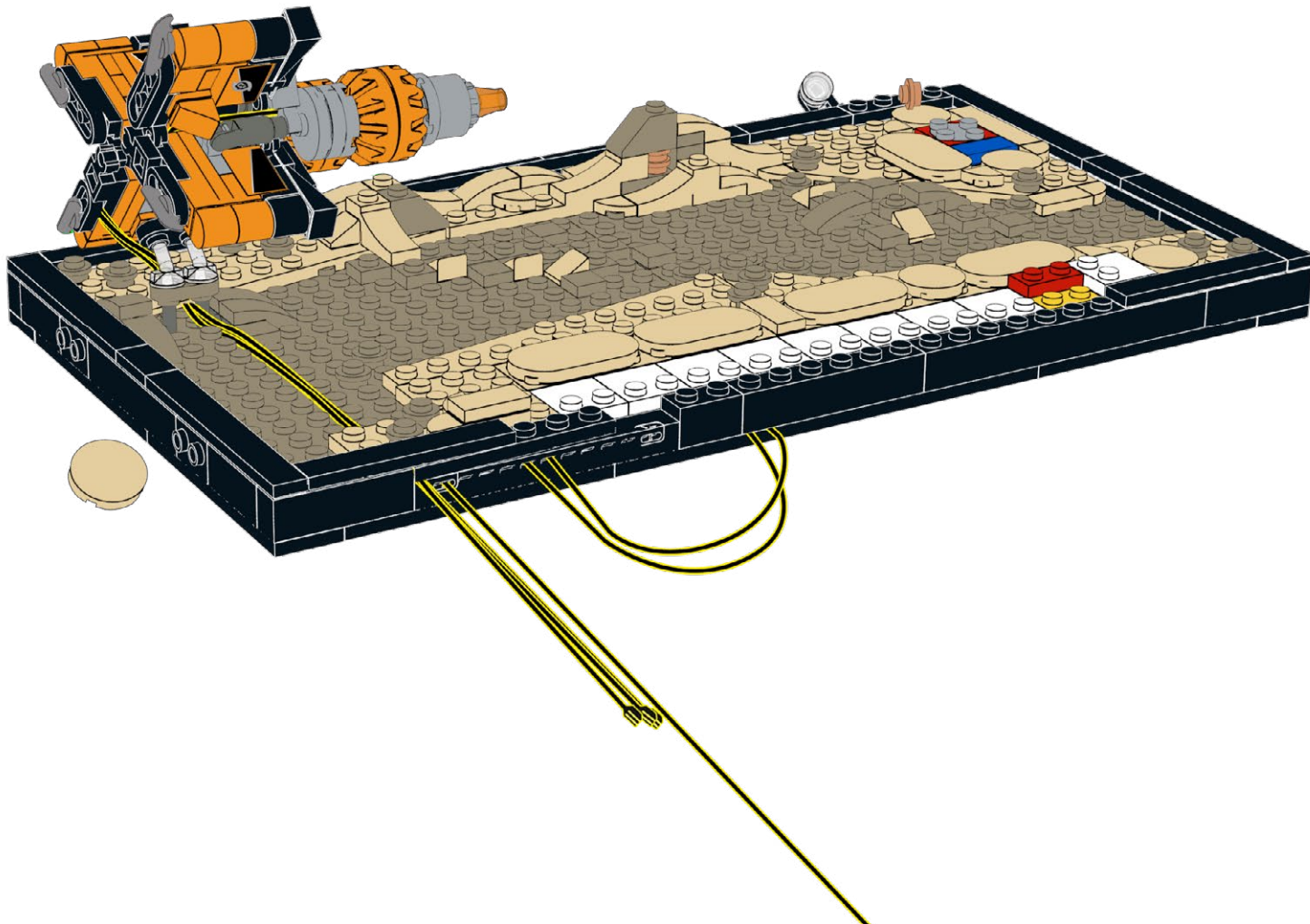

127

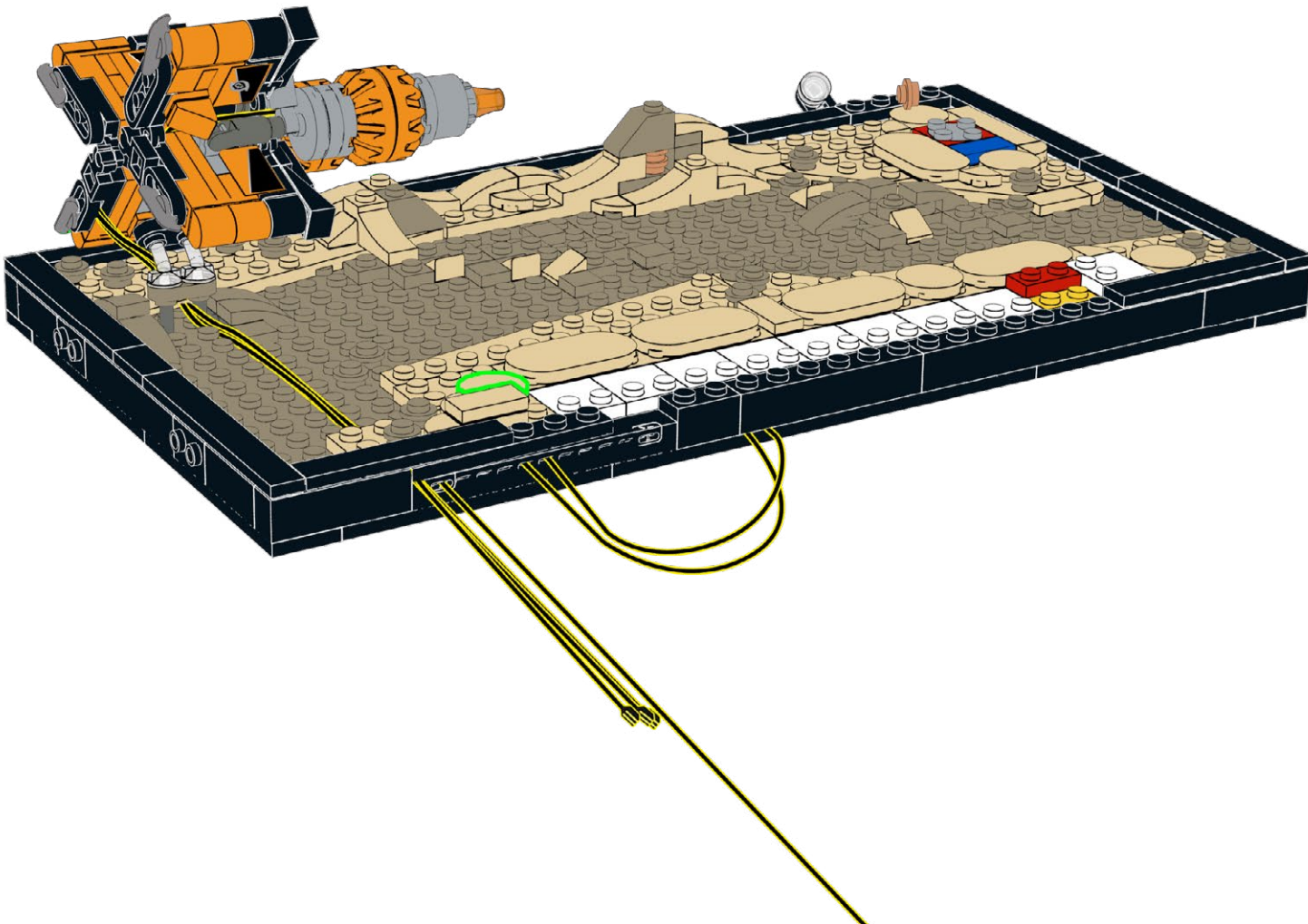

128

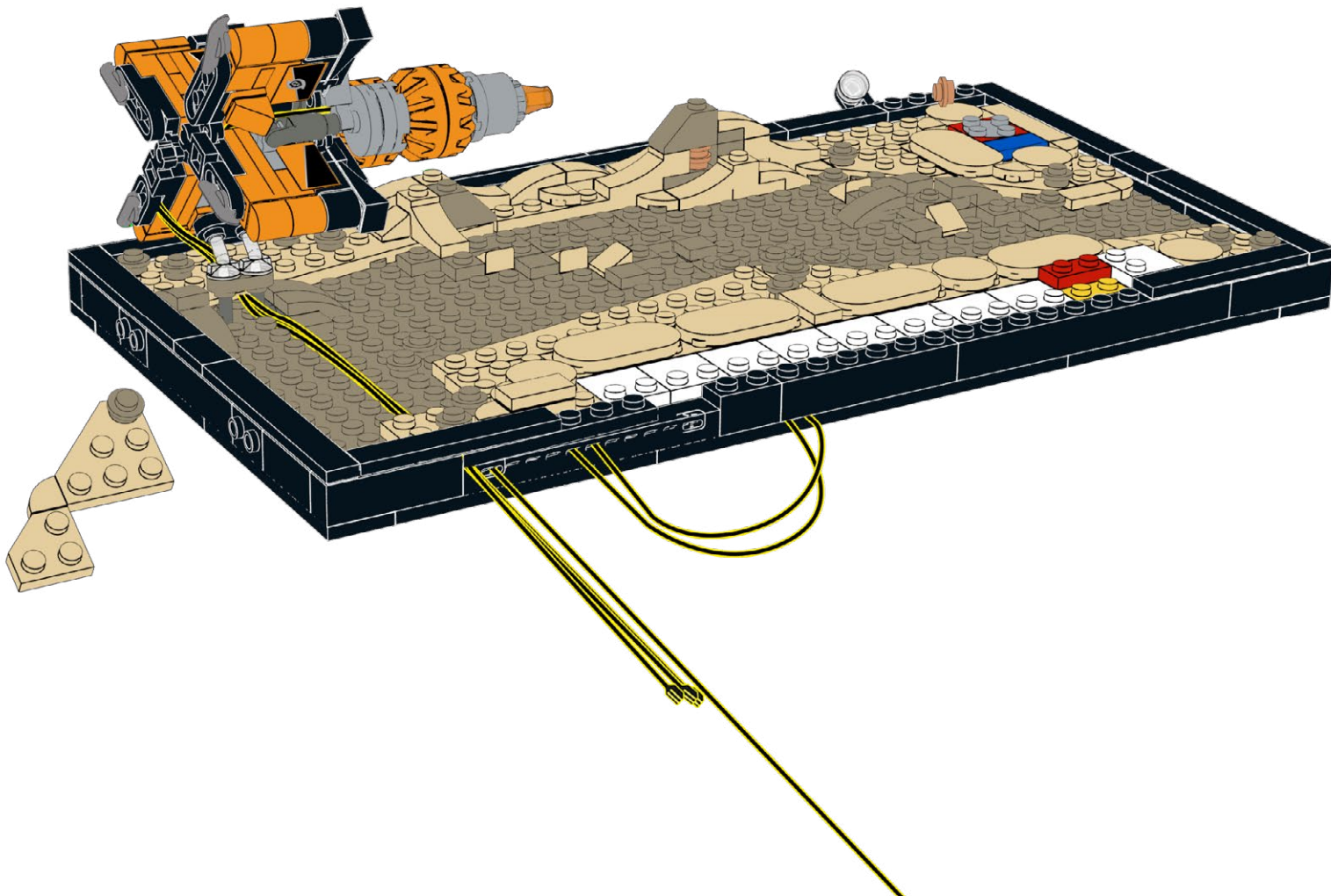

129

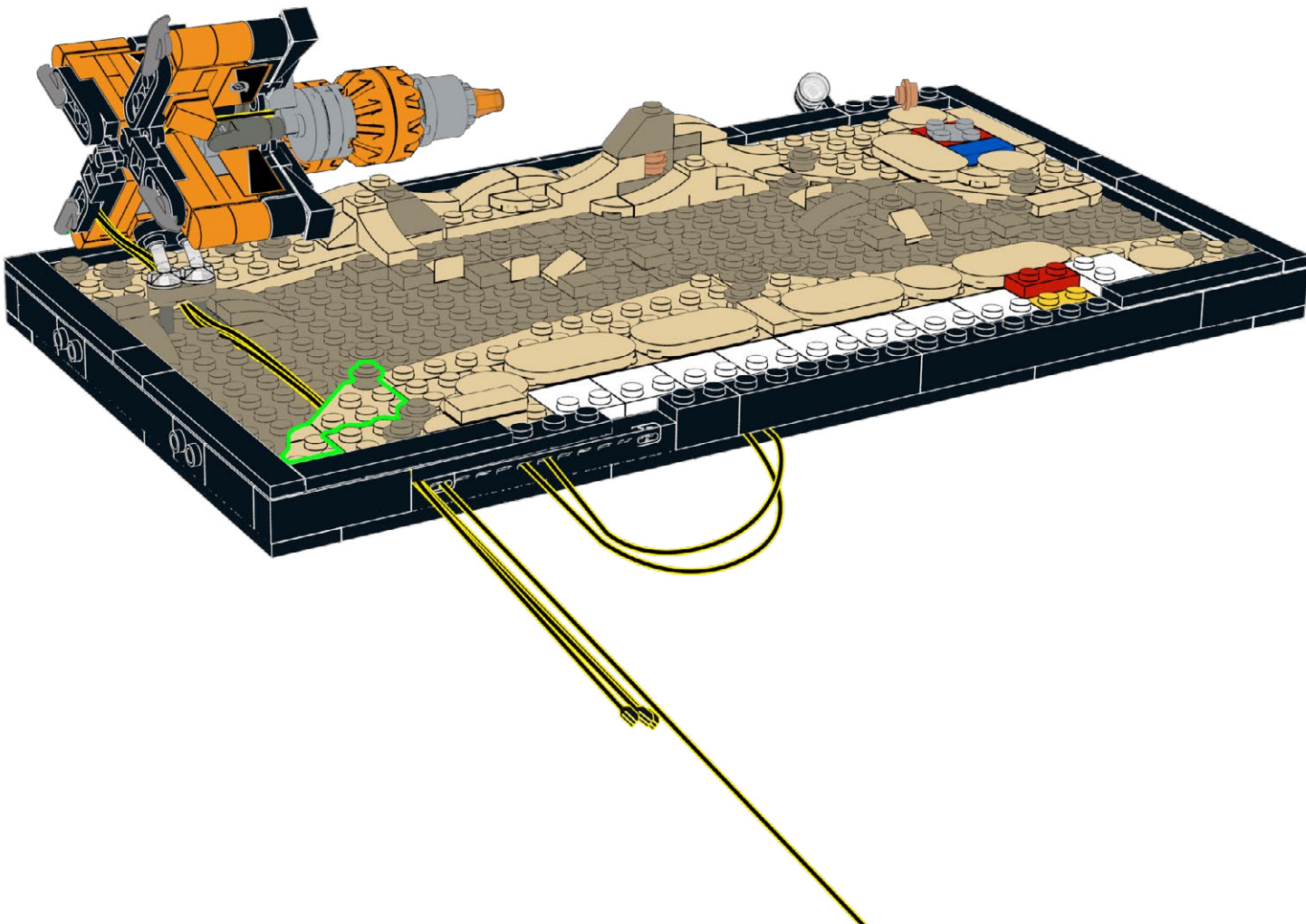

130

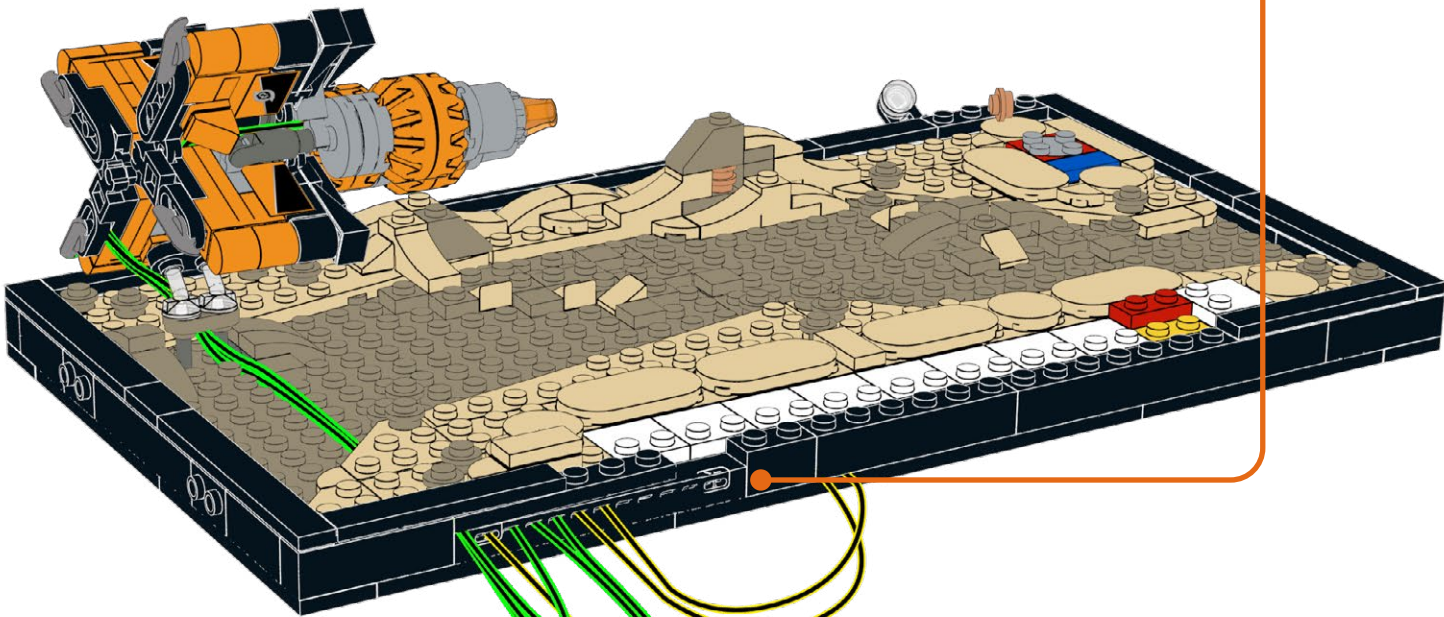

131

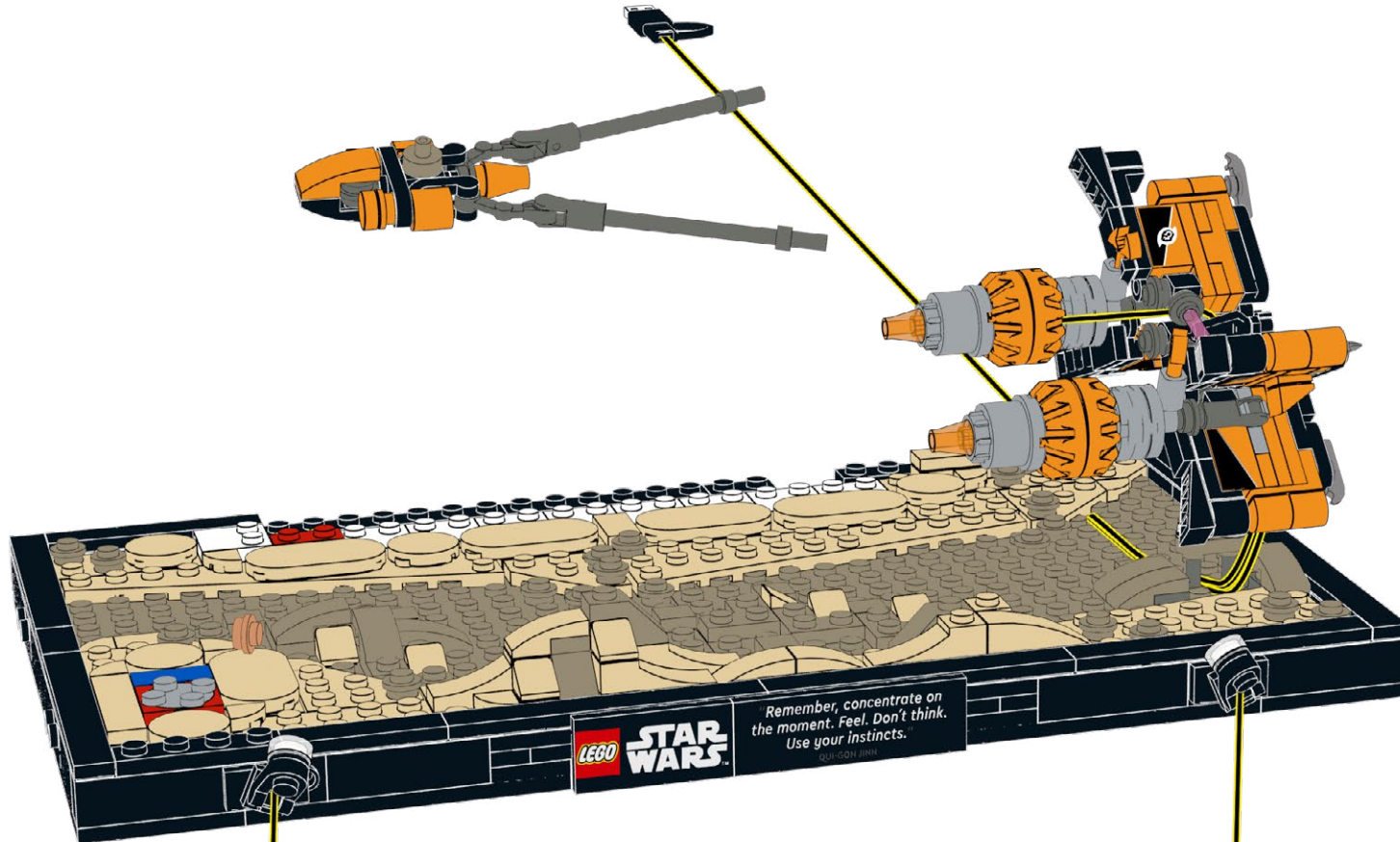



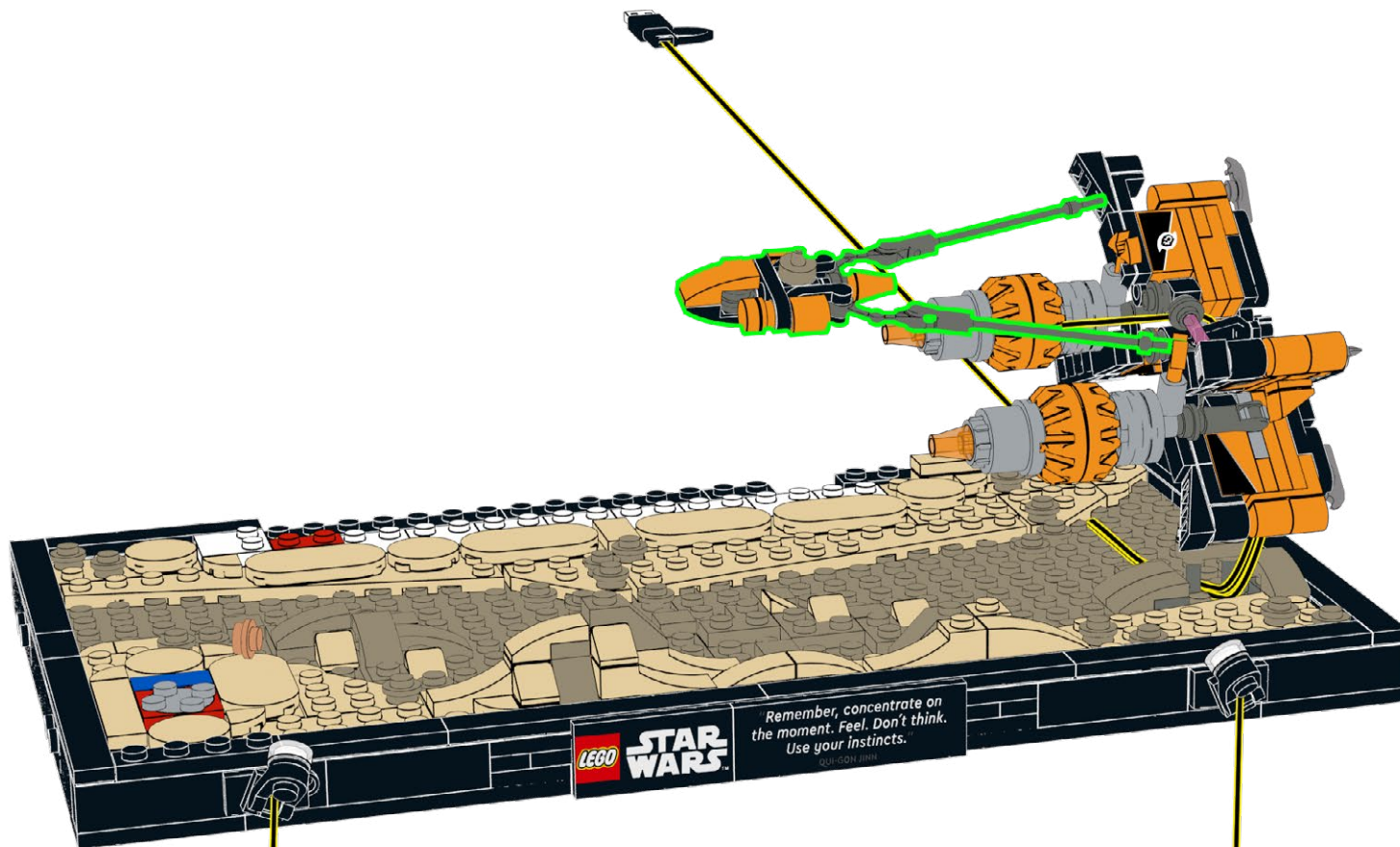

133

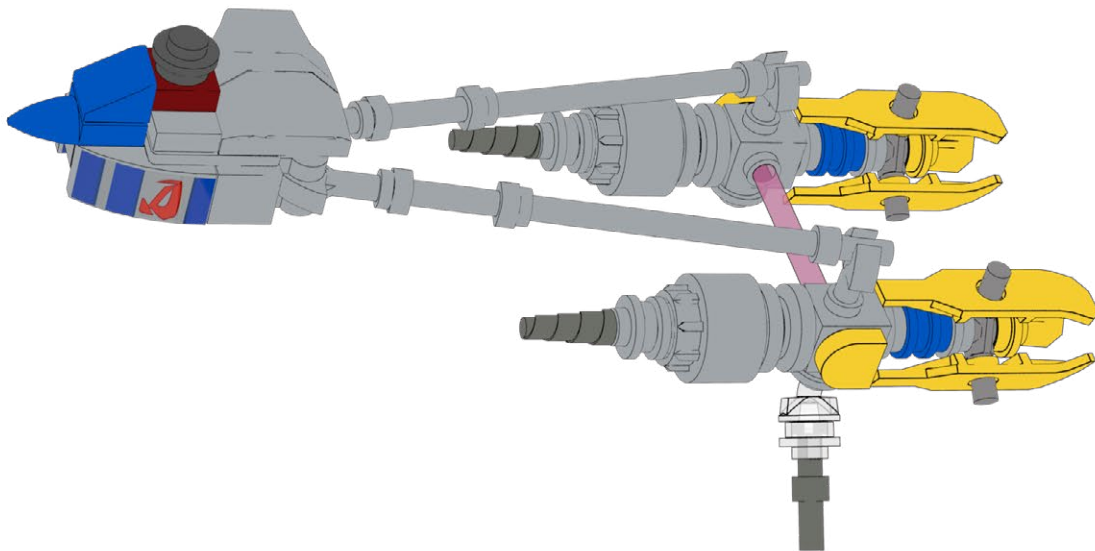

134

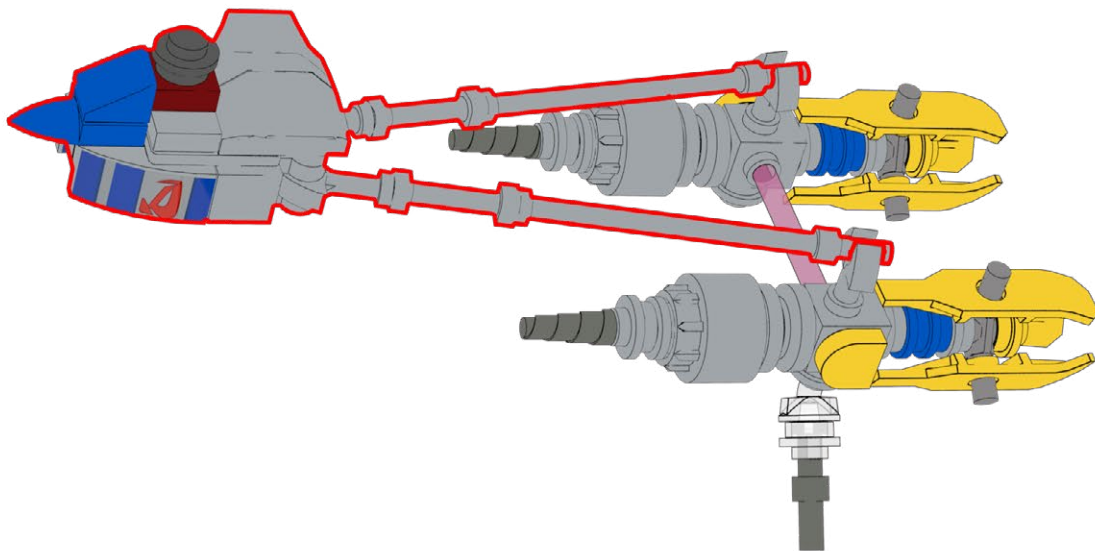

135

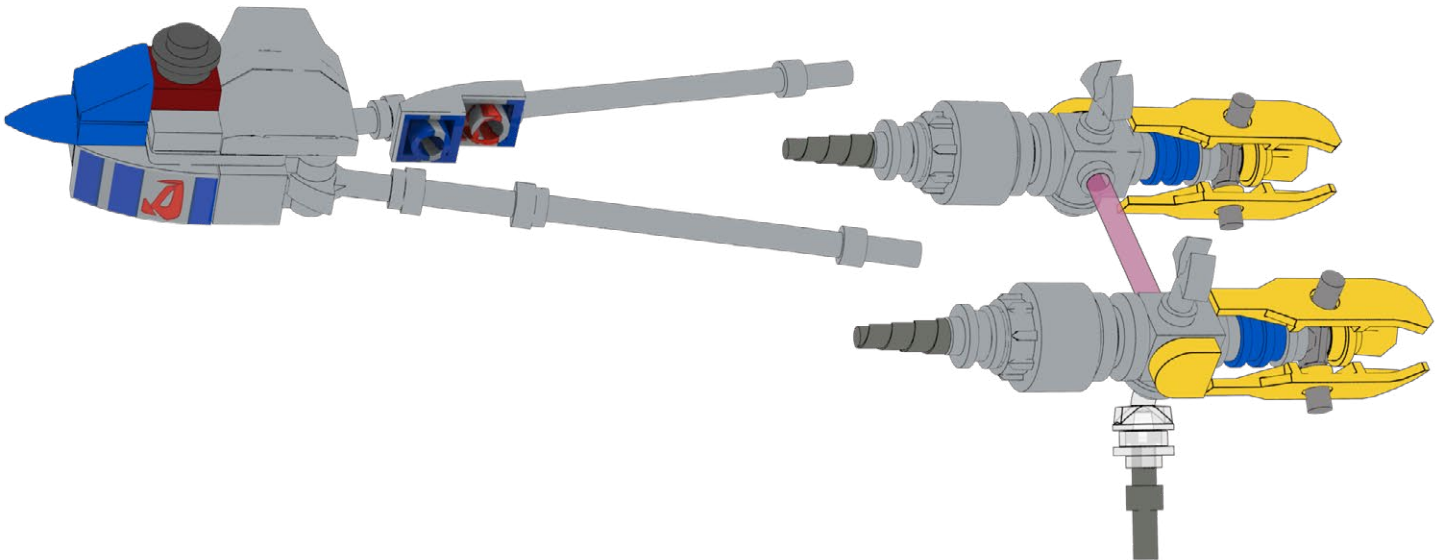

136

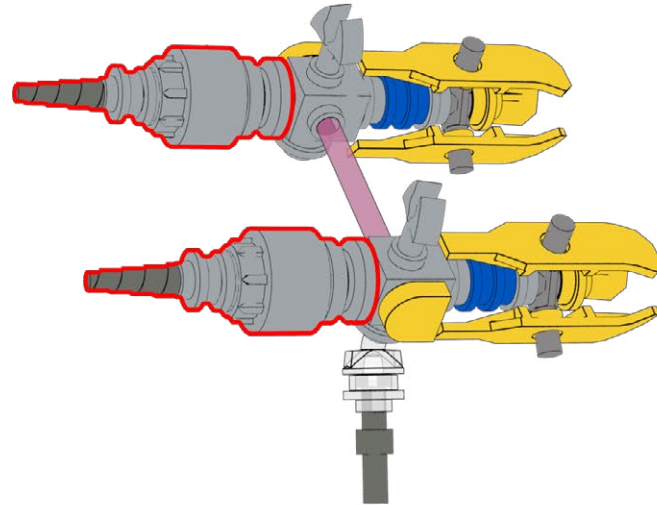

137

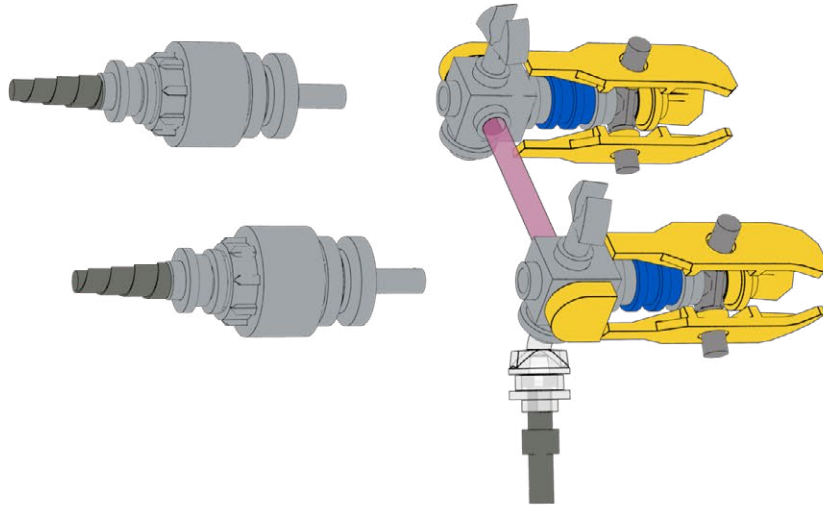



### **HOLD UP!**

You might notice some bags aren't in order, as well as left over pieces, but that's ok! We're changing the way you build LEGO!

### **HALTEN!**

Möglicherweise stellen Sie fest, dass einige Beutel nicht in Ordnung sind und auch Teile übrig bleiben, aber das ist in Ordnung! Wir verändern die Art und Weise, wie Sie LEGO bauen!

### **TENIR BON!**

Vous remarquerez peut-être que certains sacs sont en panne, ainsi que des morceaux restants, mais ce n'est pas grave ! Nous changeons la façon dont vous construisez LEGO !

### **HALT!**

Sie werden möglicherweise bemerken, dass einige tüten durcheinander sind und teile übrig bleiben, aber das ist in Ordnung! Wir ändern die art und weise, wie Sie LEGO bauen!

### **¡ESPERA!**

Es posible que notes que algunas bolsas están fuera de servicio, así como piezas sobrantes, ¡pero está bien! ¡Estamos cambiando la forma en que construyes LEGO!

### **暫停!**

你可能会注意到一些袋子顺序错乱, 以及一些剩余的部件, 但没关系! 我们正在改变你搭建乐高的方式!

#### Open LMB Bag 03

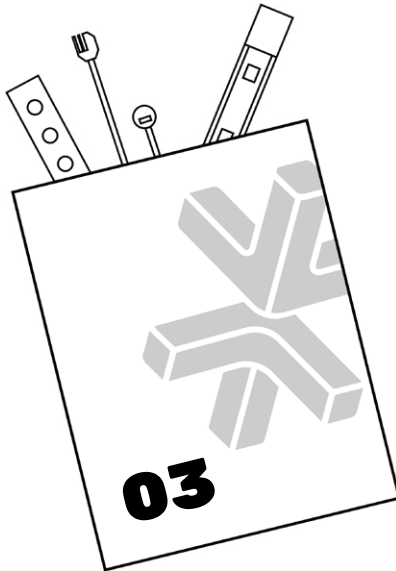

# 138

1

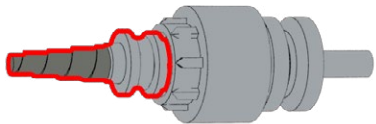

2

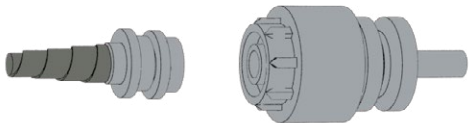

# 139

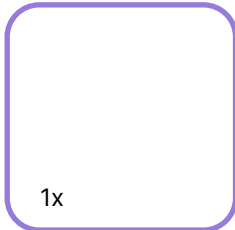
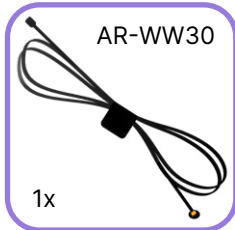

1

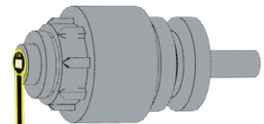

2

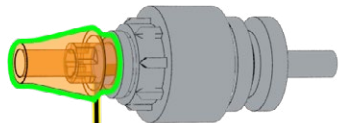





1

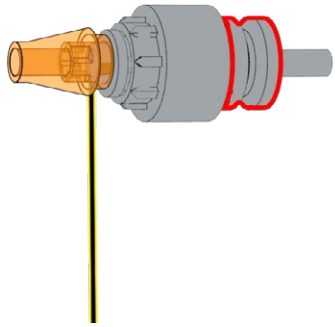

2

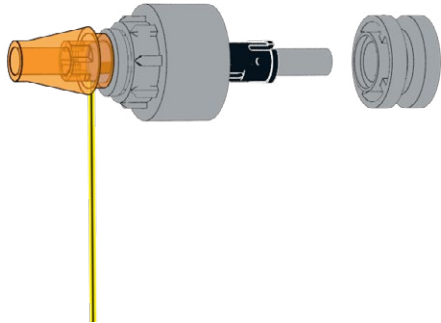

1

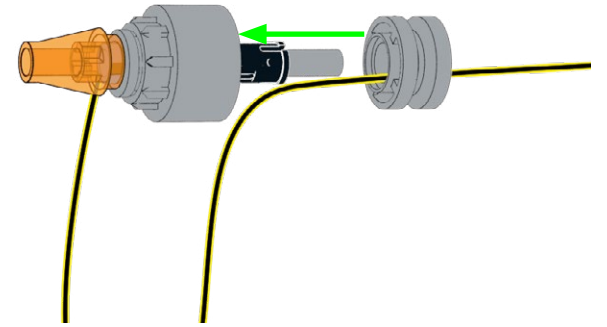

2

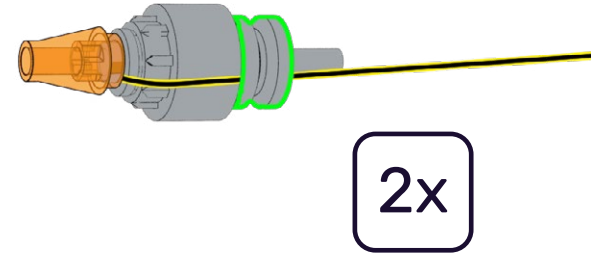

2x

142

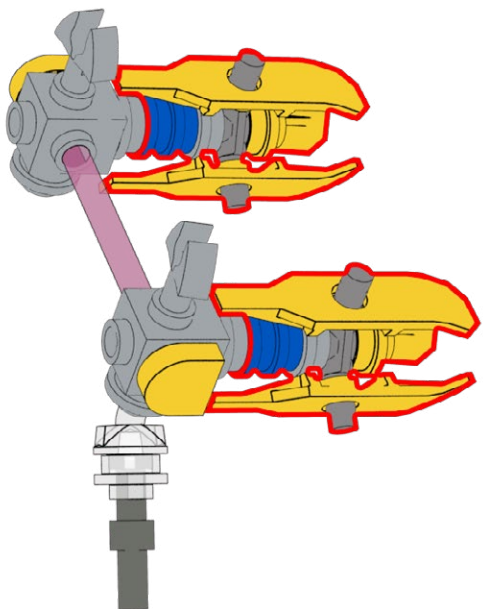

143

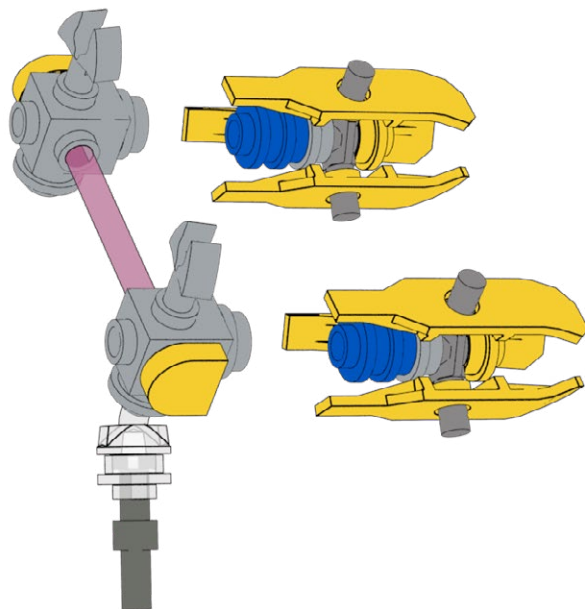

144

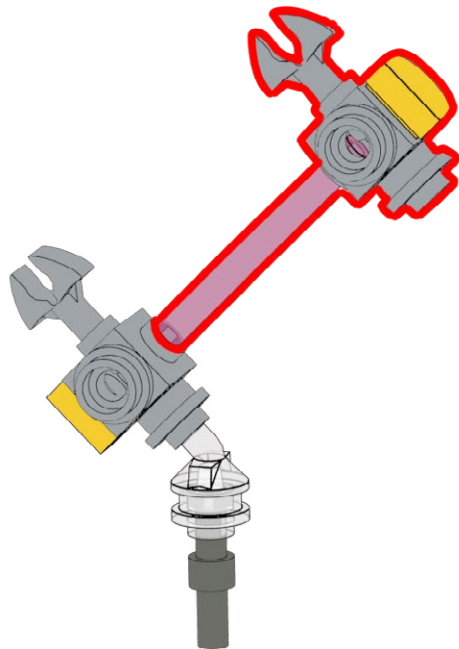

145

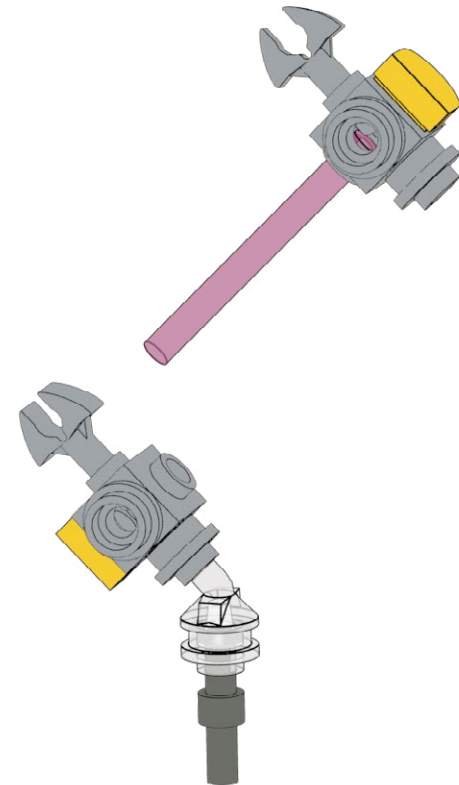

146

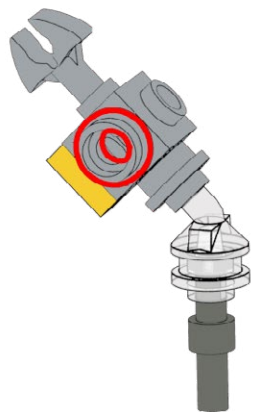

147

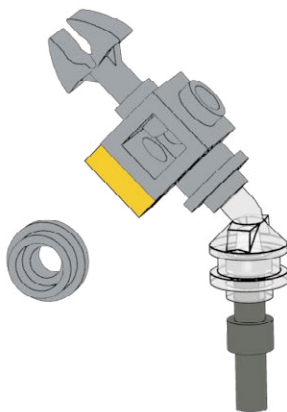

**148**

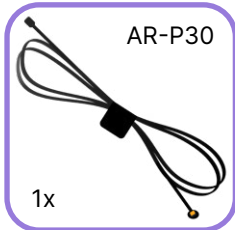

**149**

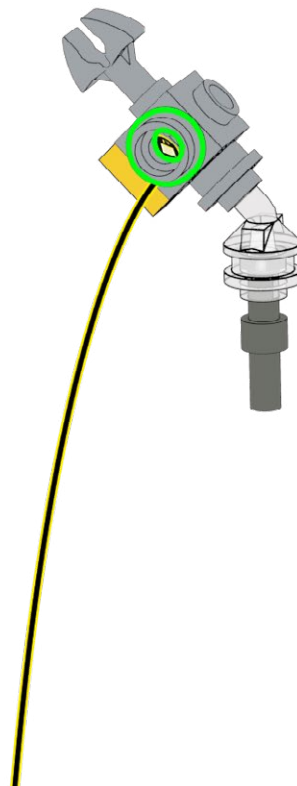
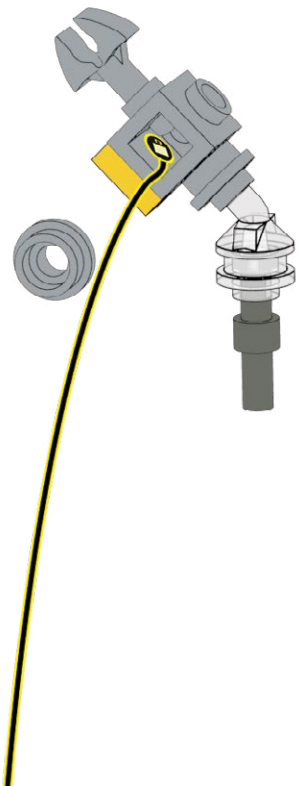

**150**

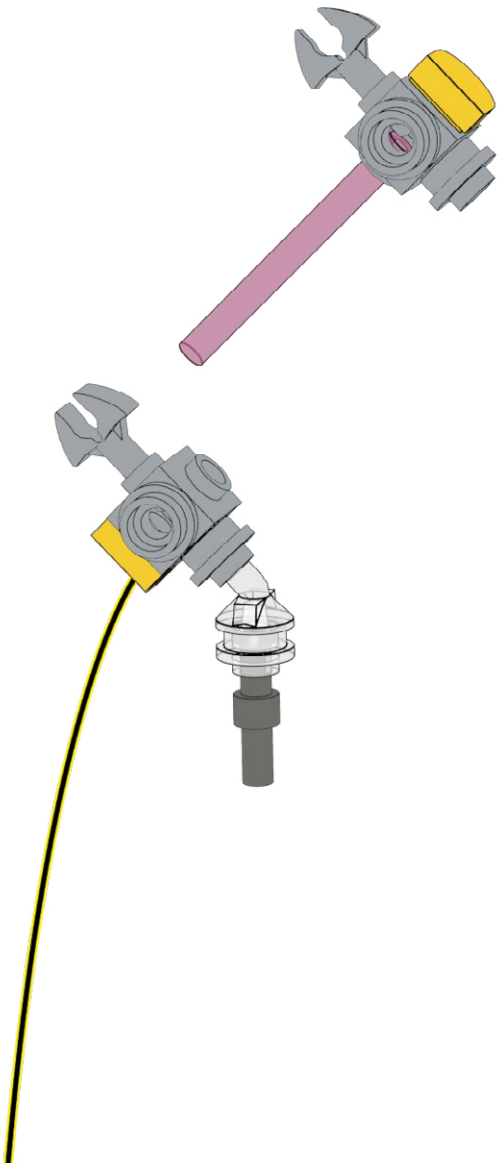

**151**

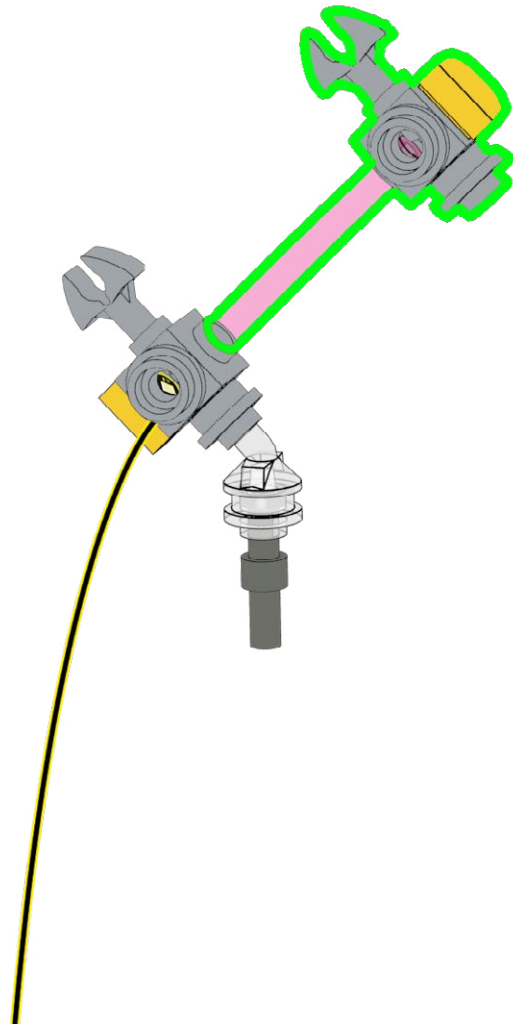

152

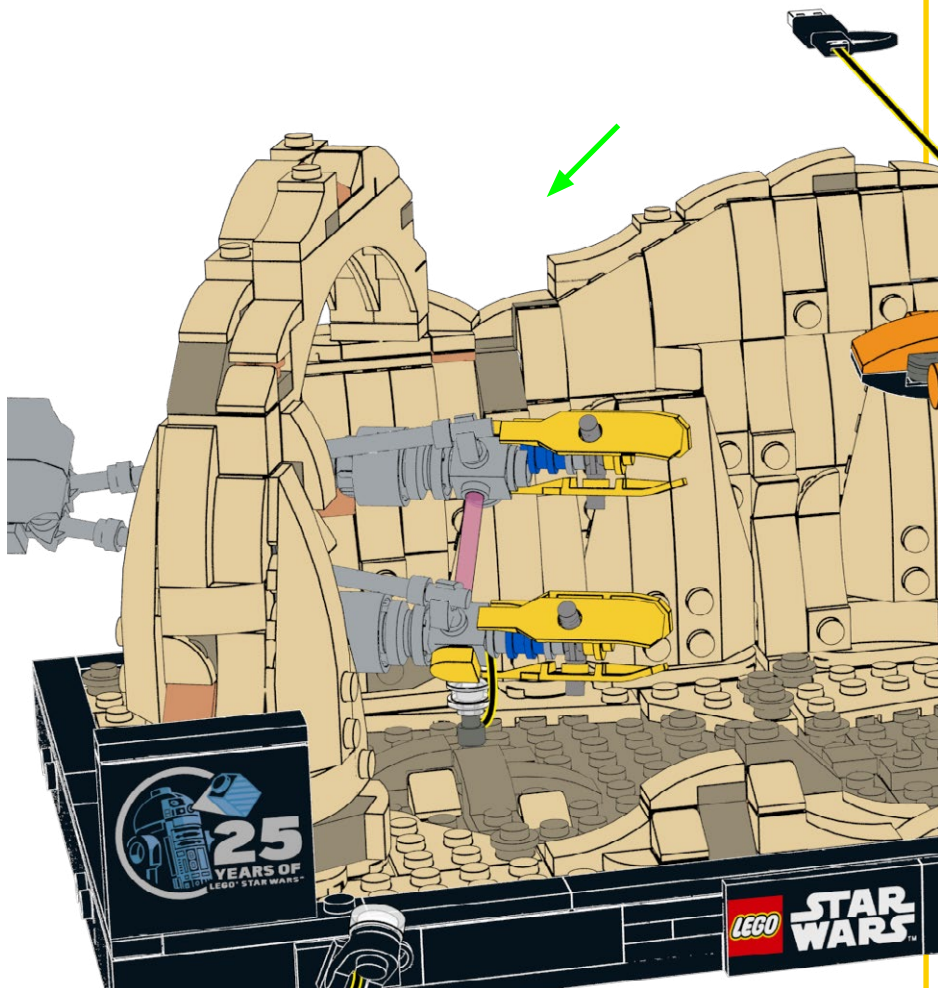

153

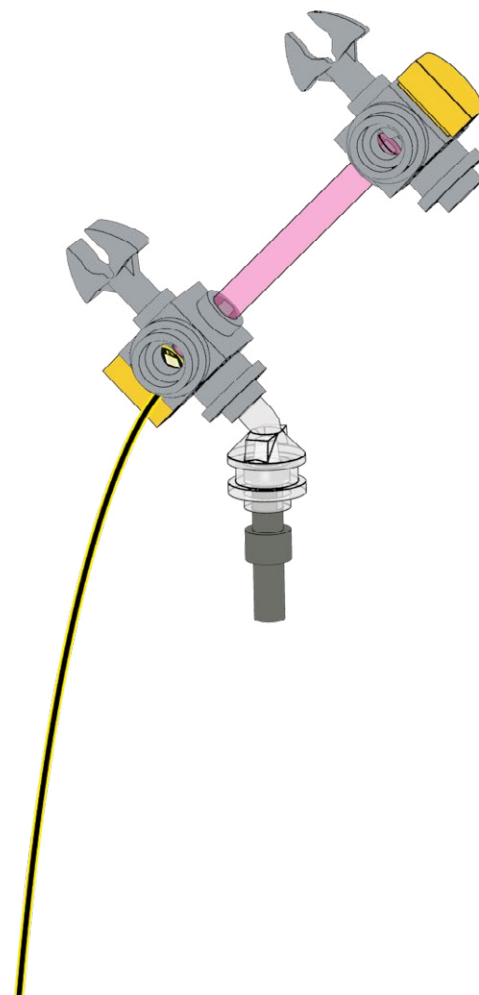

**154**

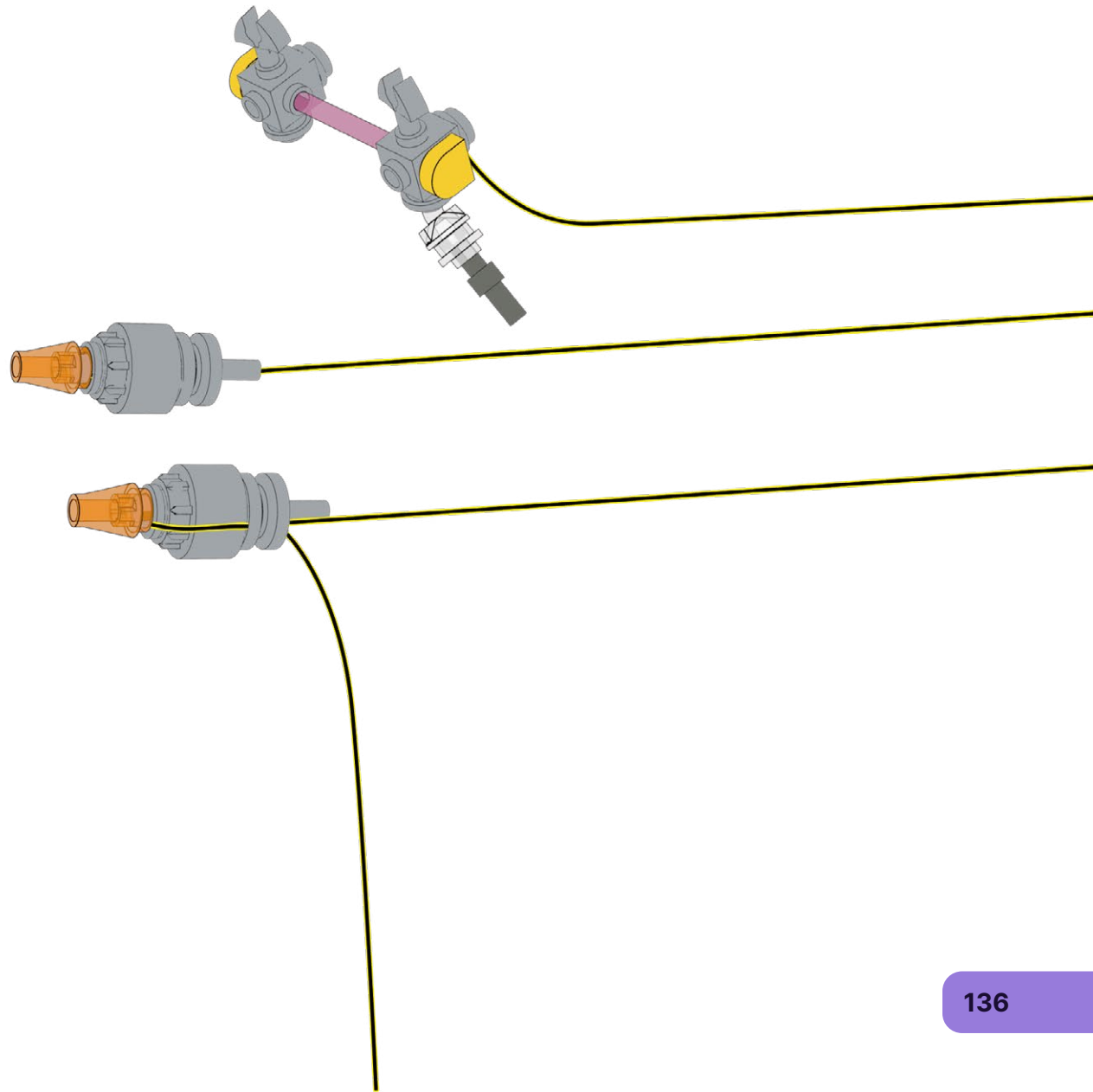



**155**

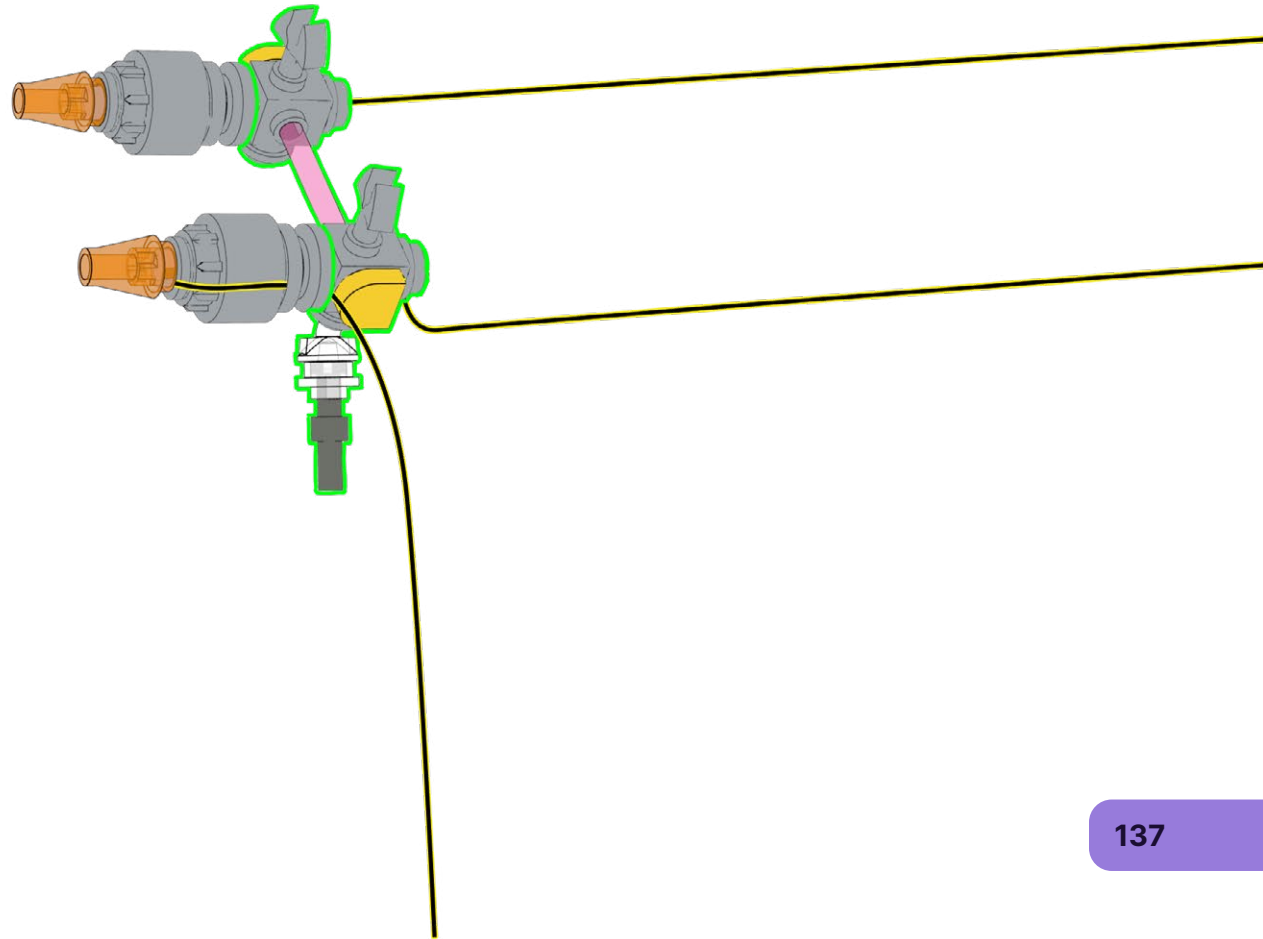

156

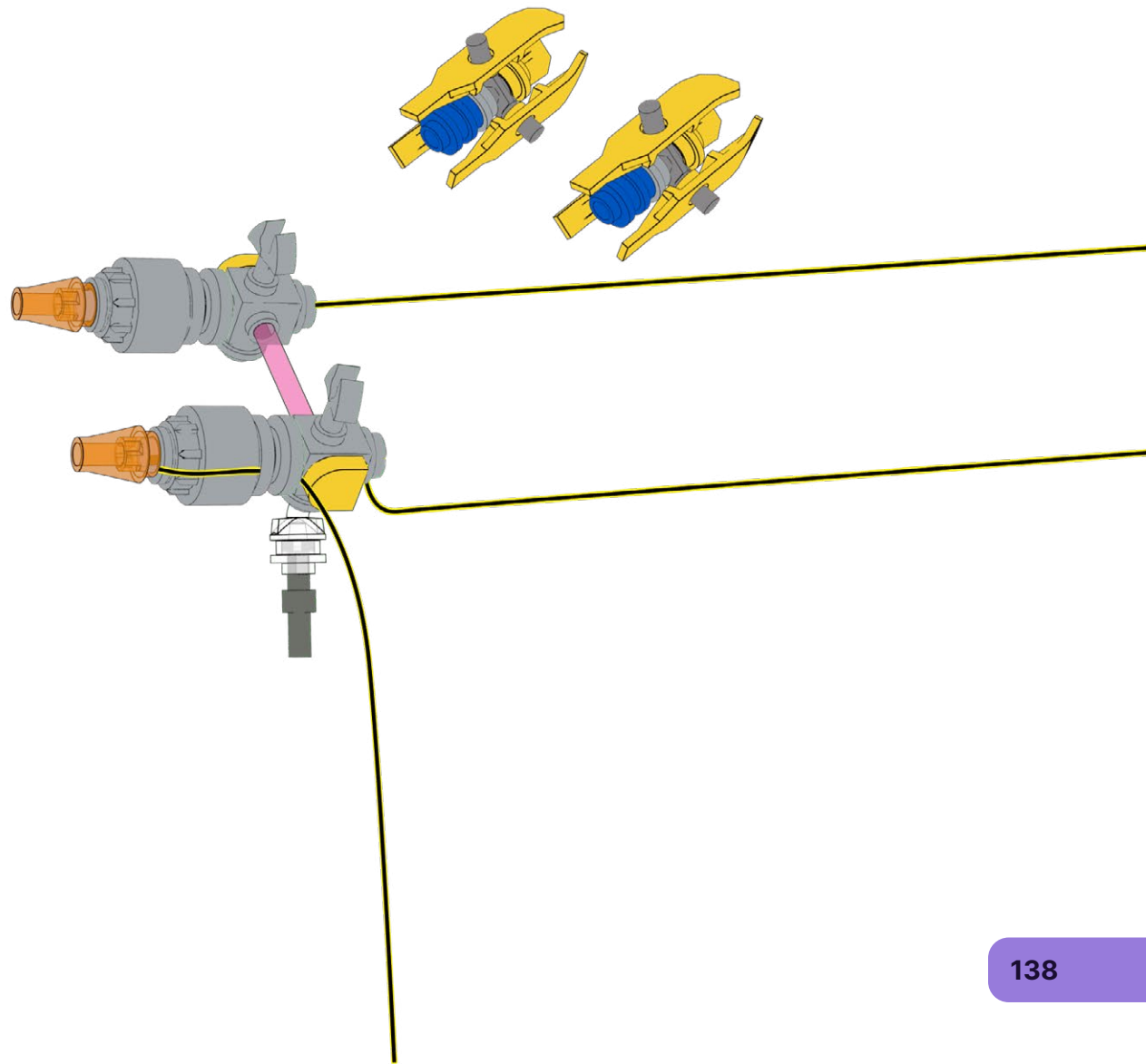

157

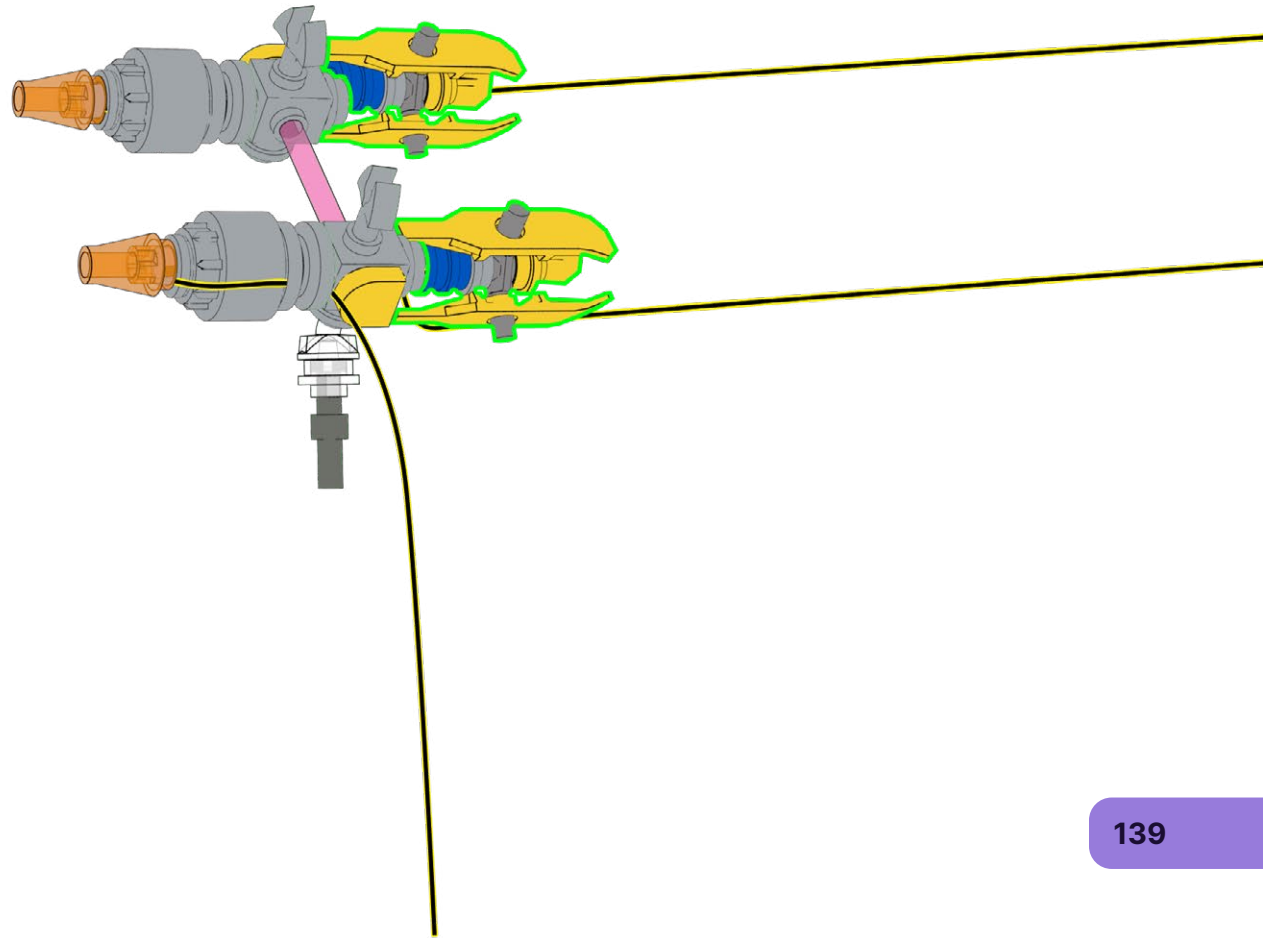

158

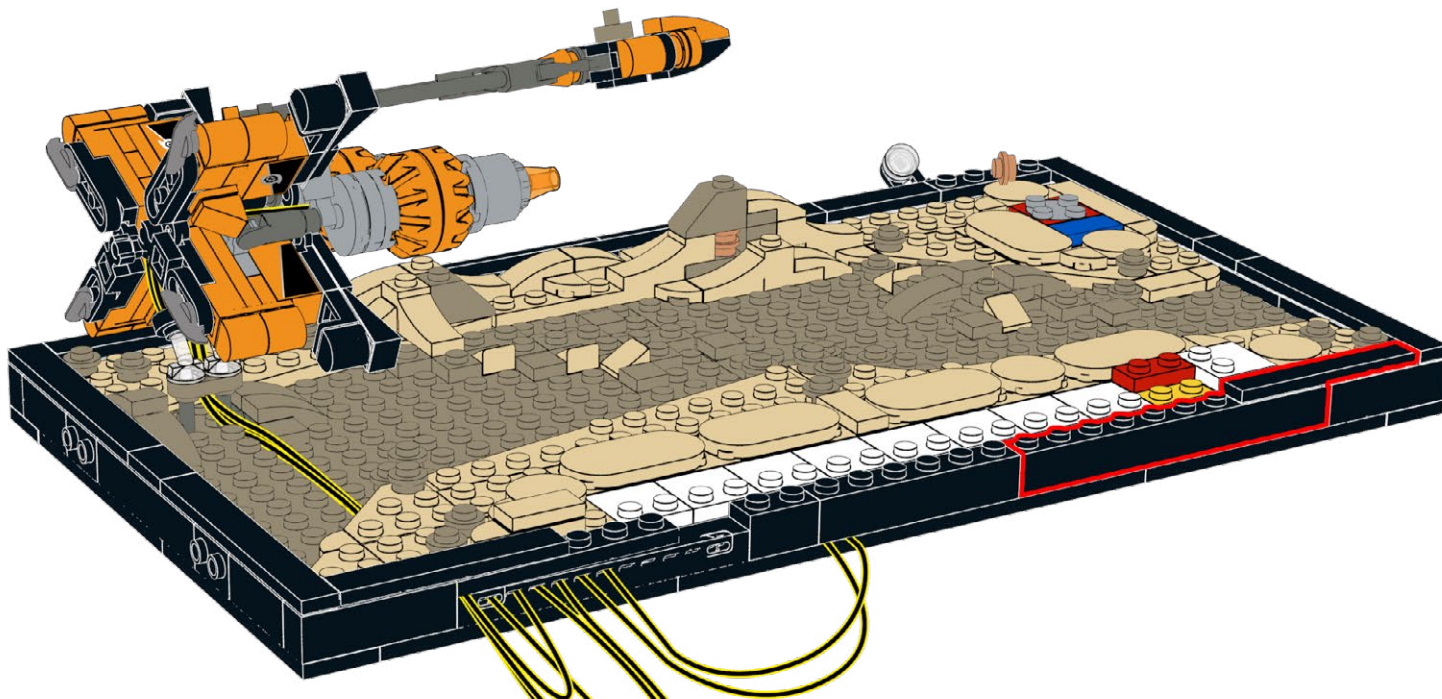

159

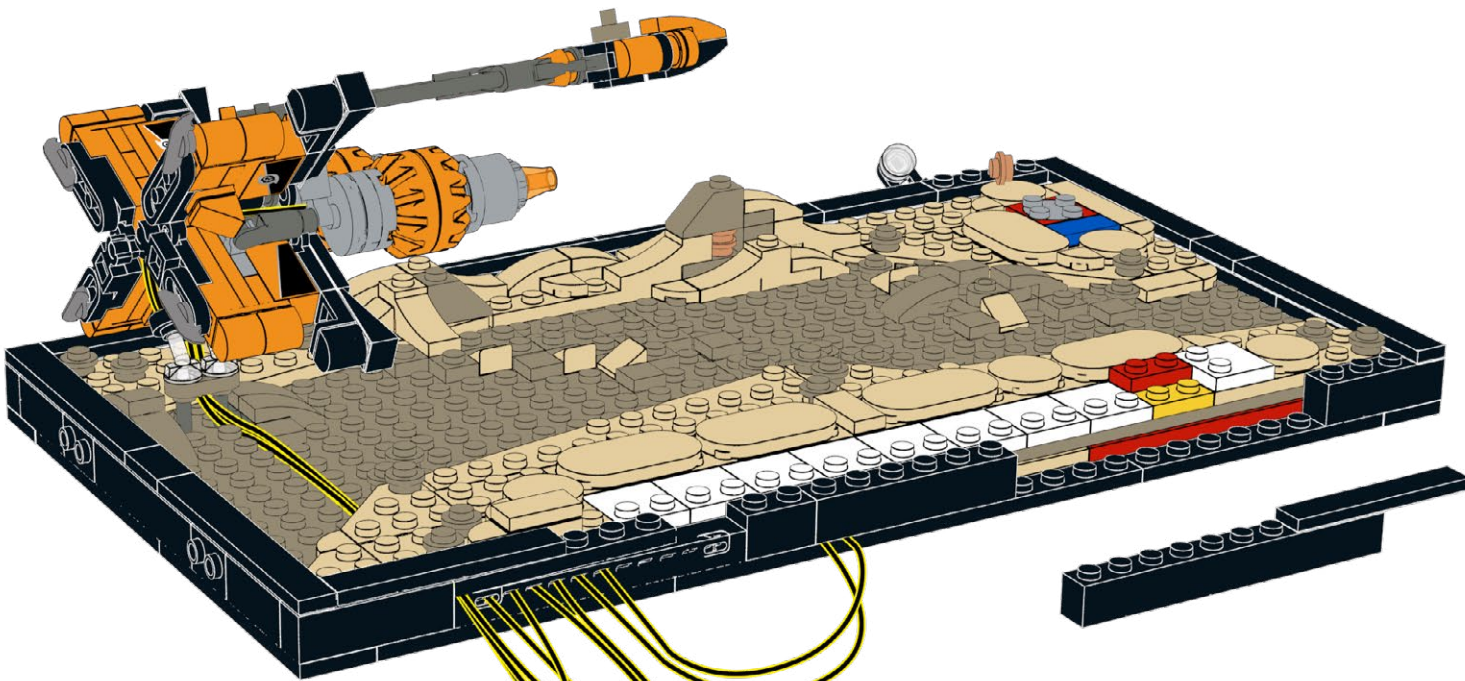

160

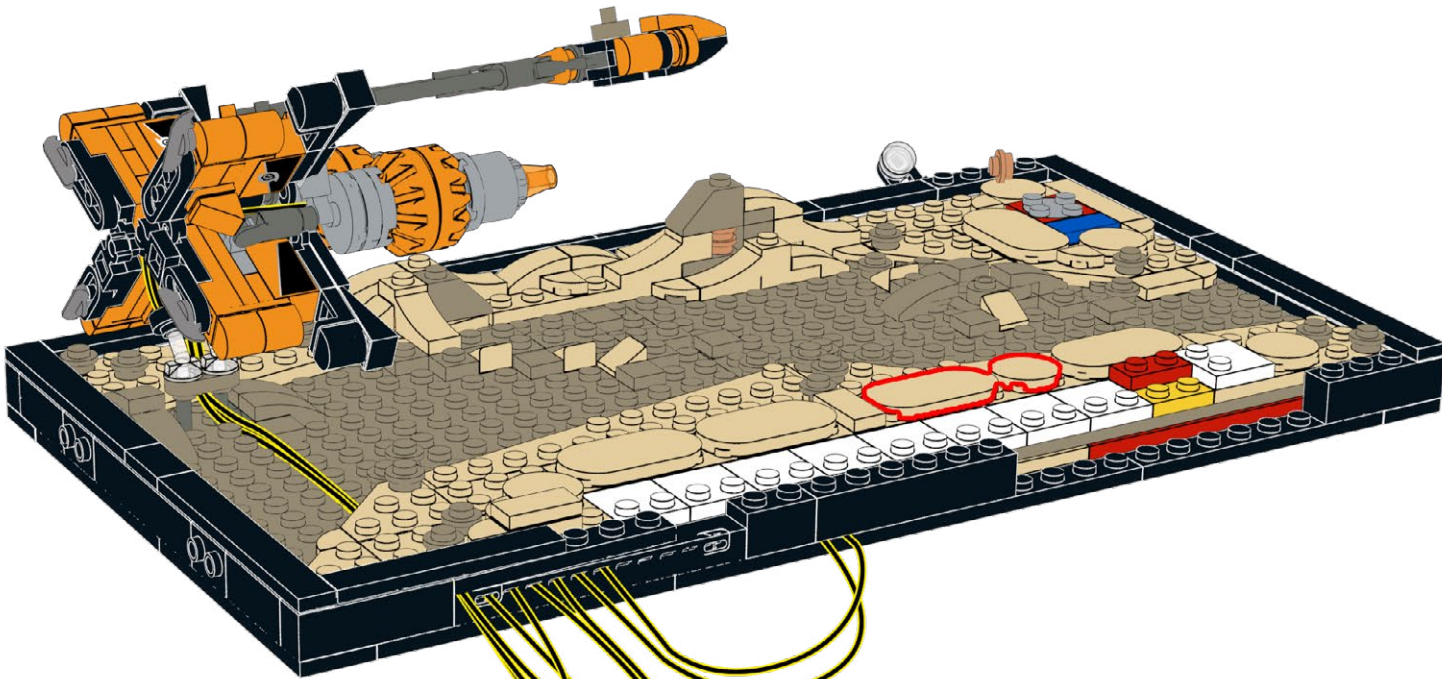

161

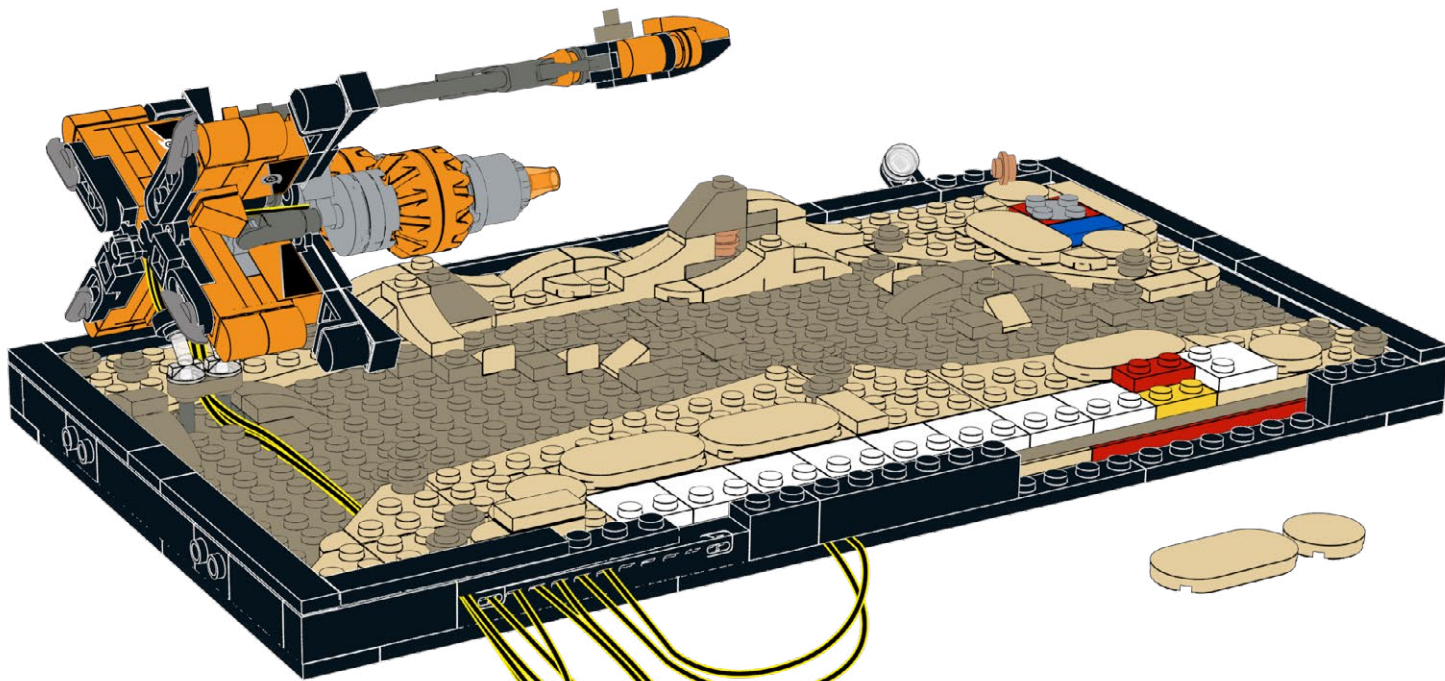

162

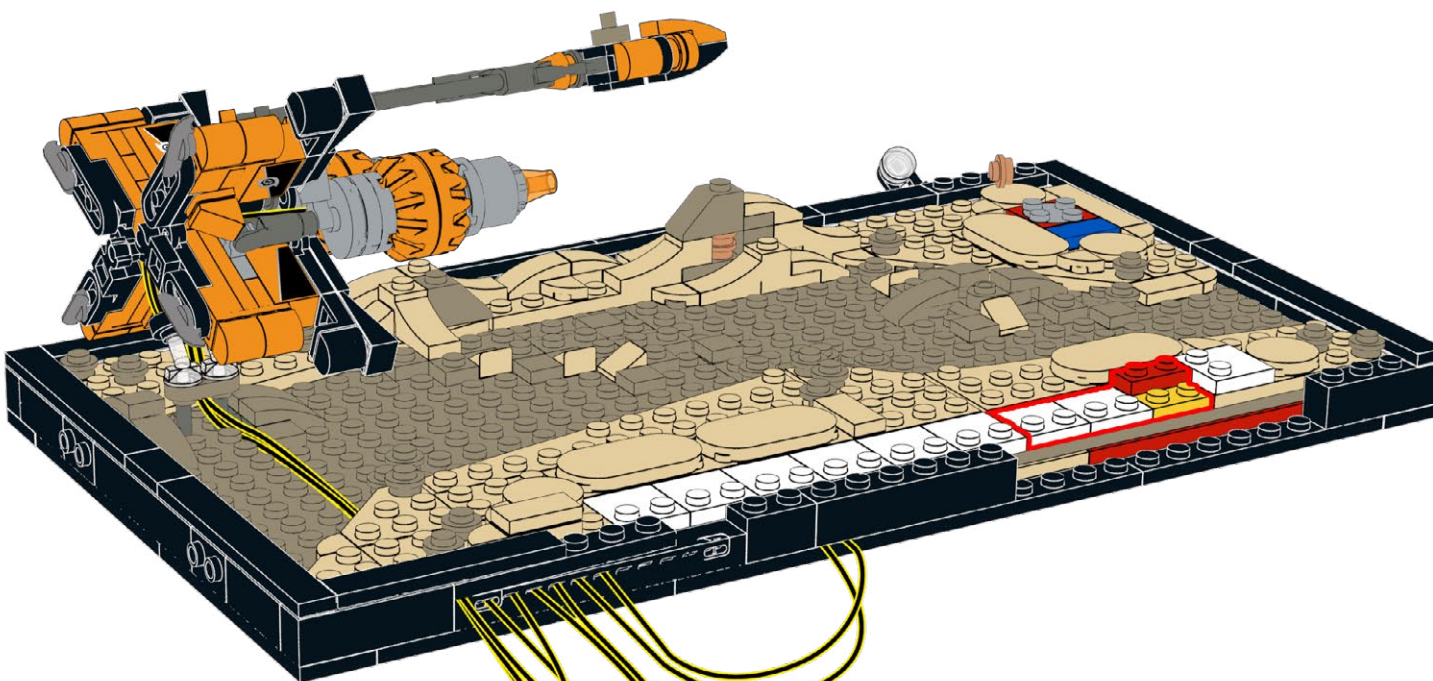



163

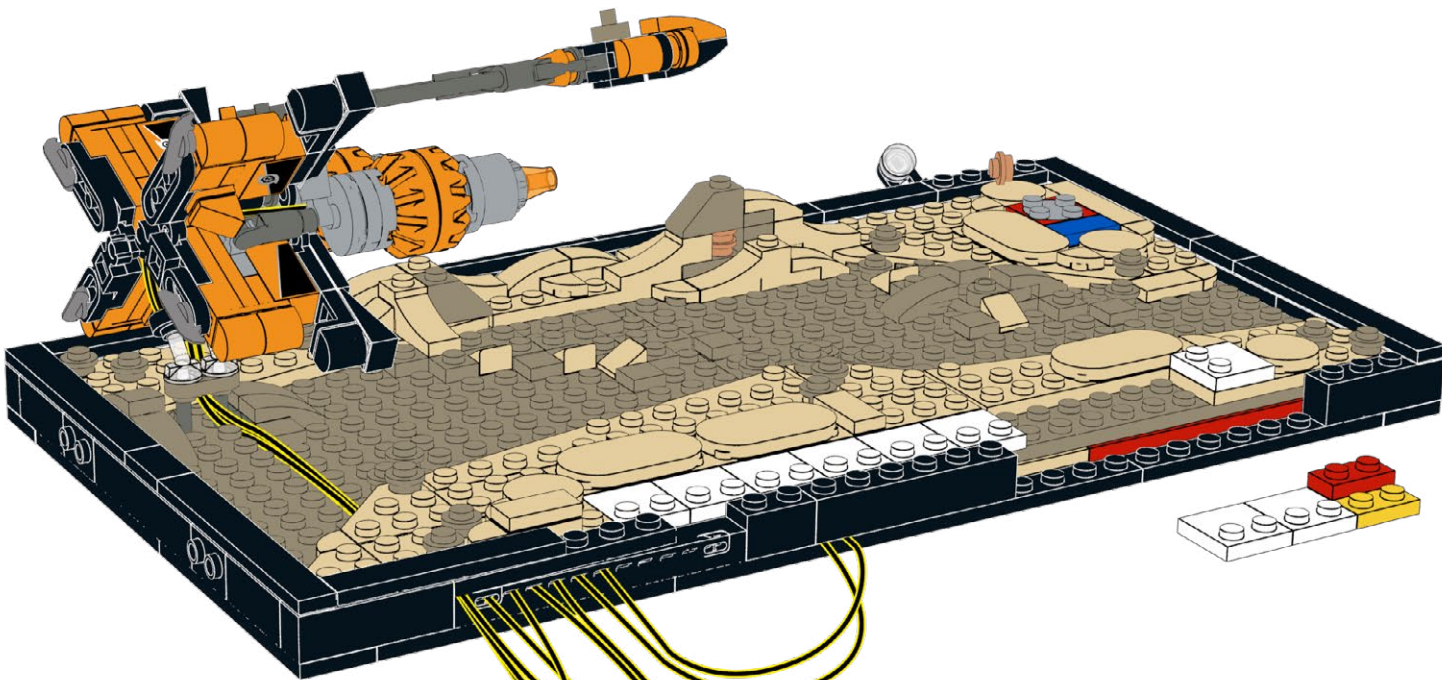

164

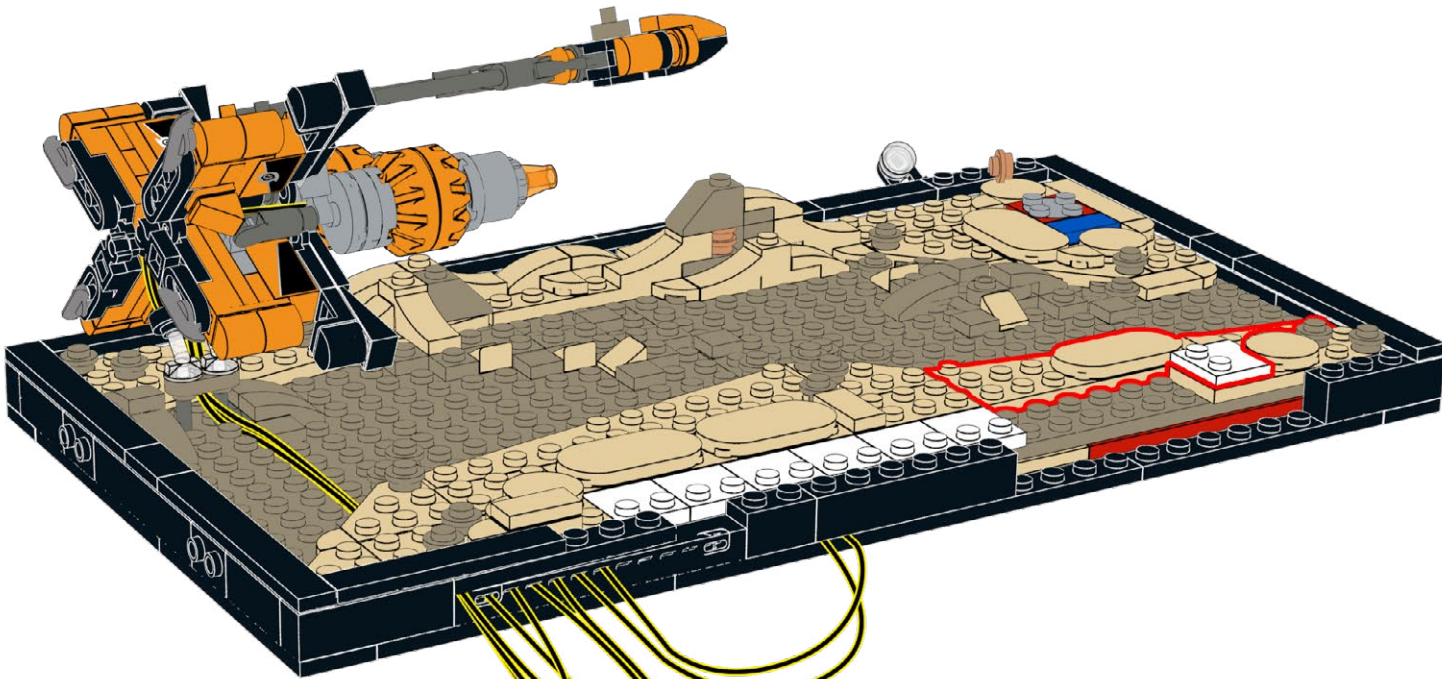

165

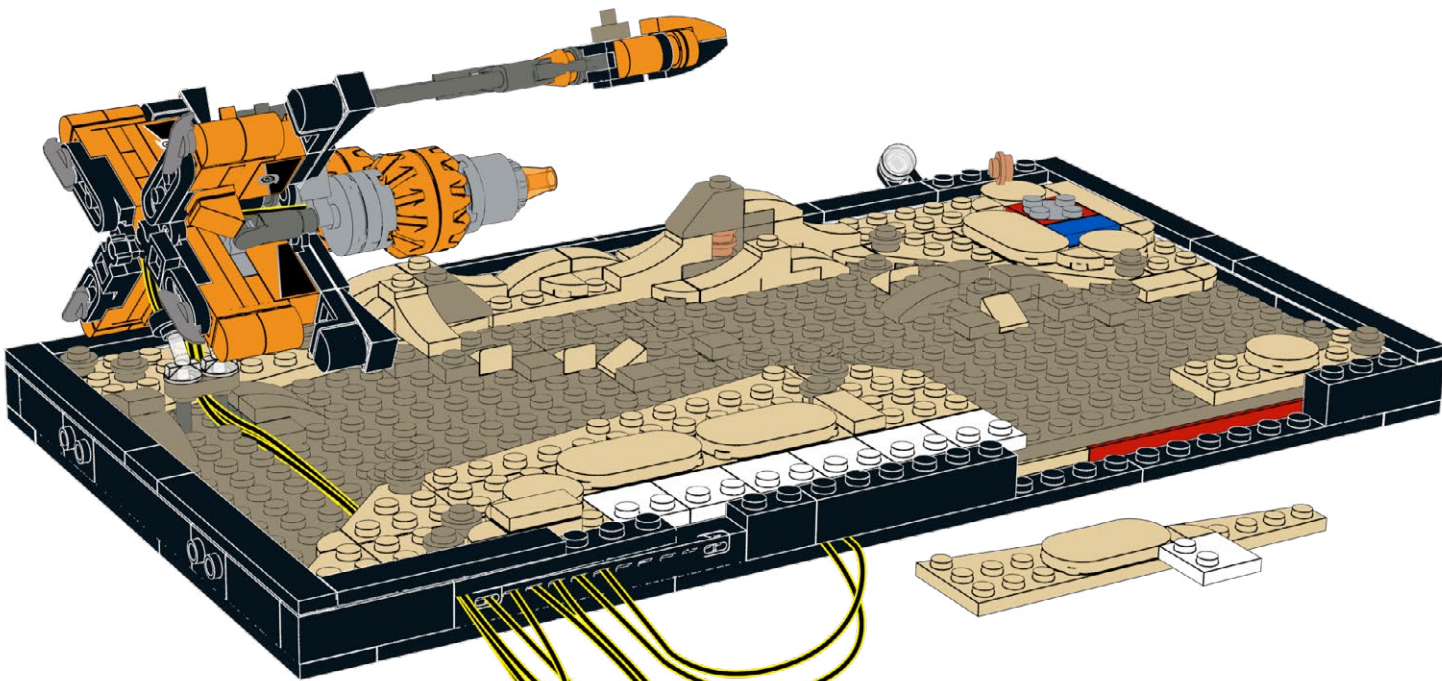

166

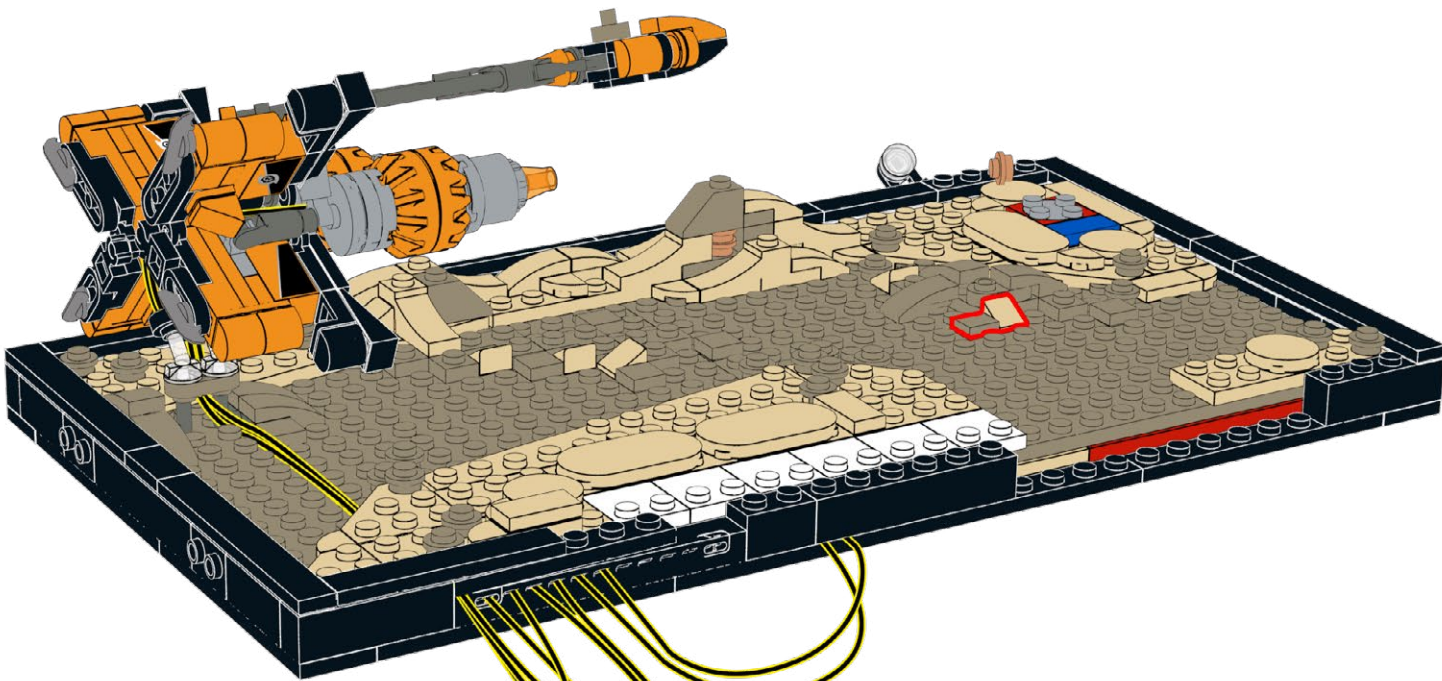

167

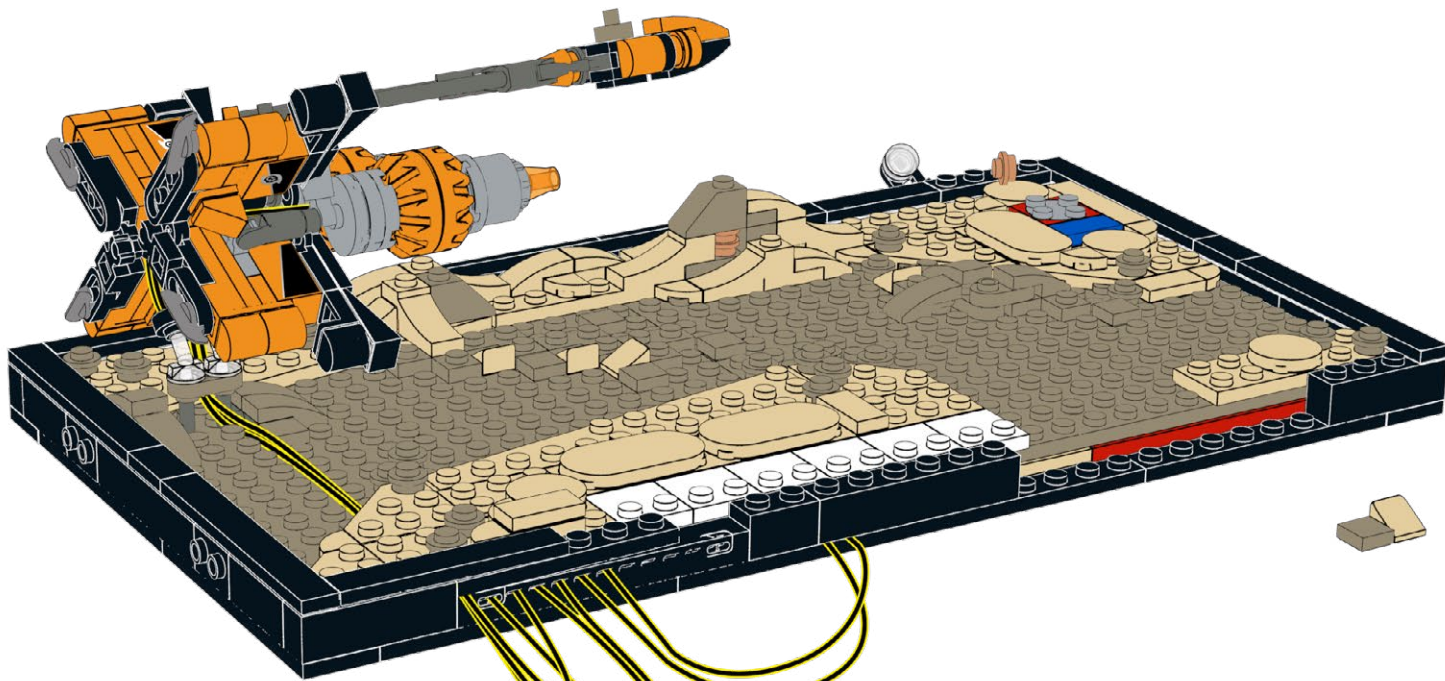

168

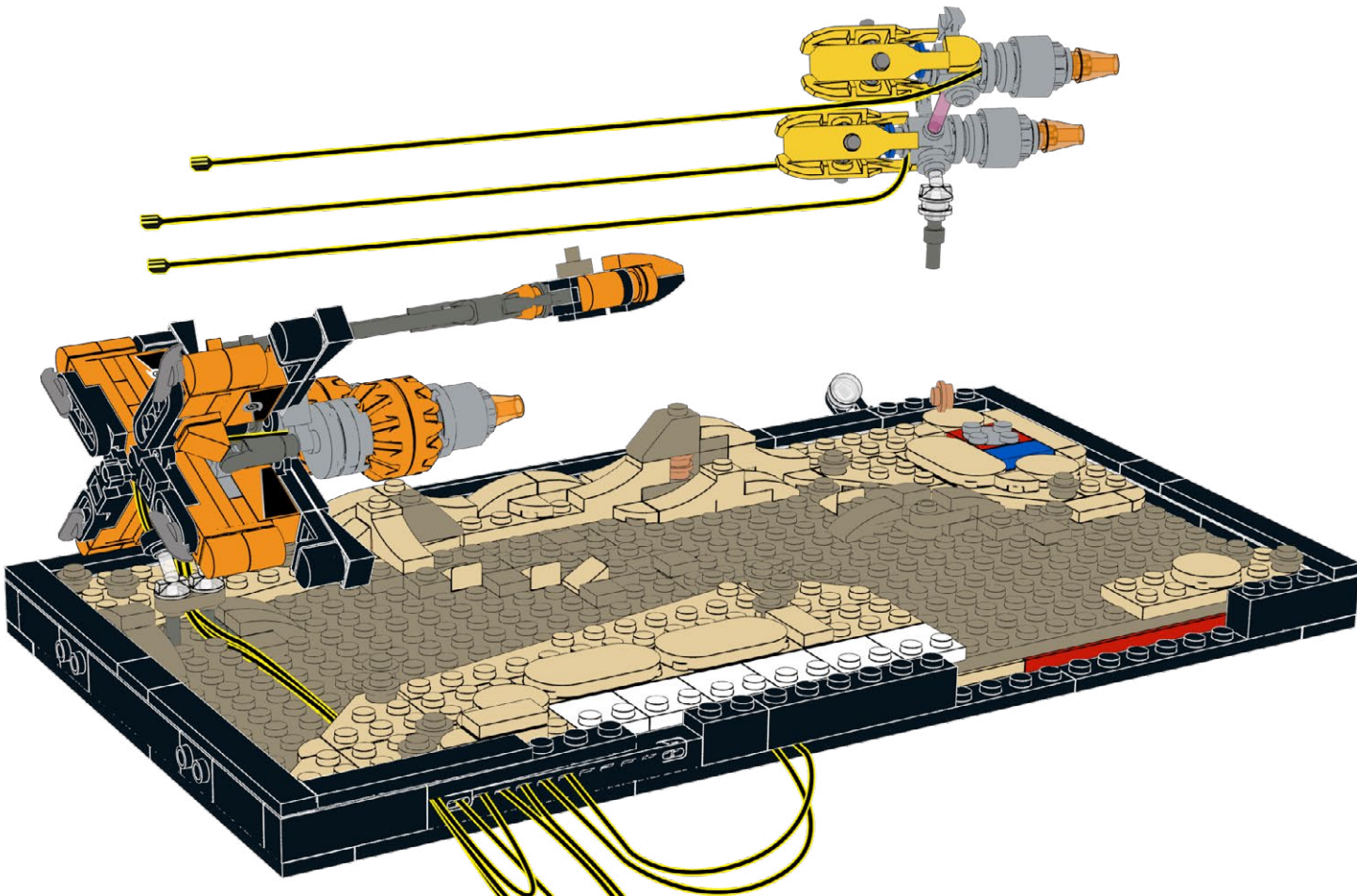

169

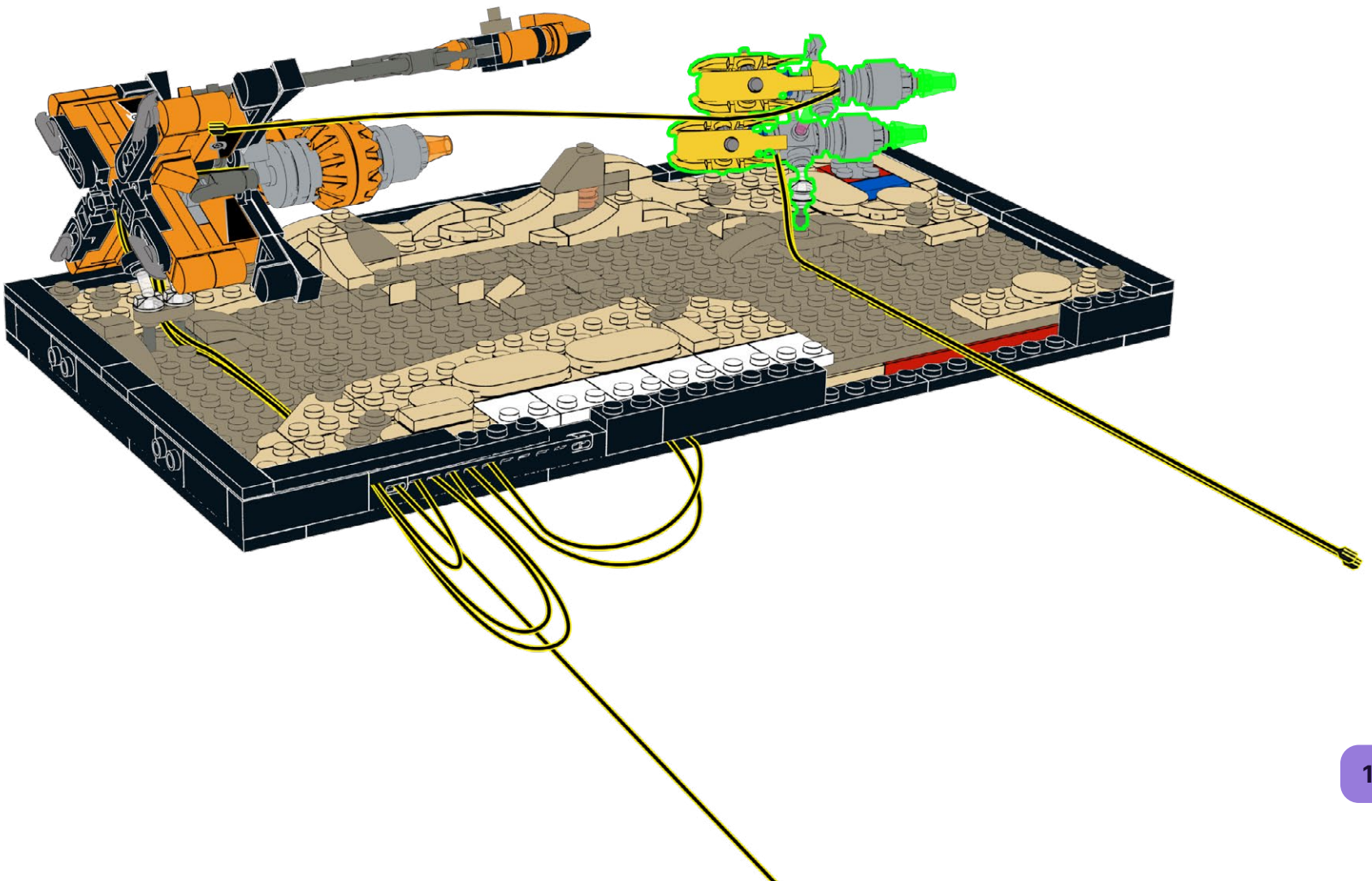

170

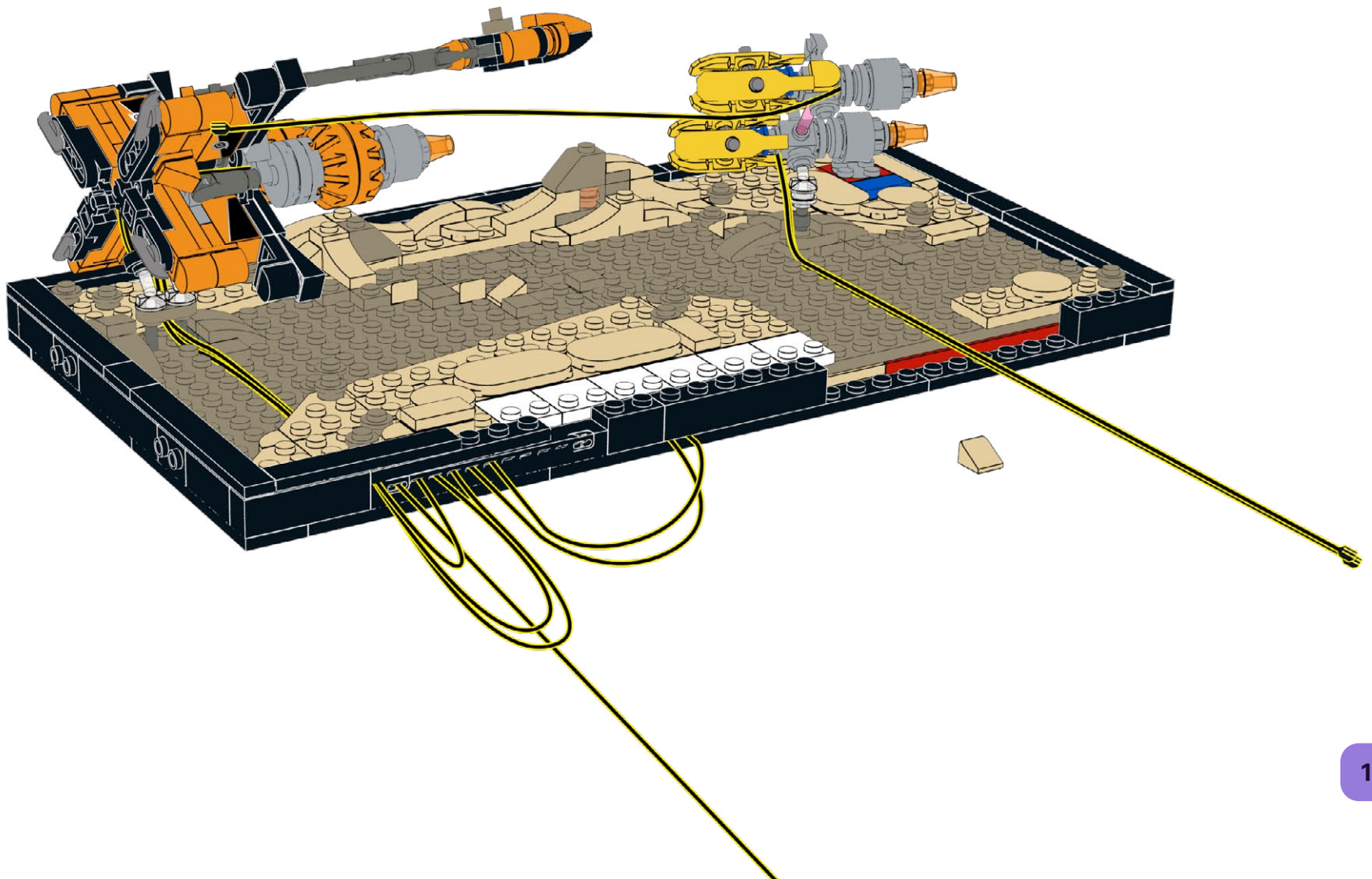



171

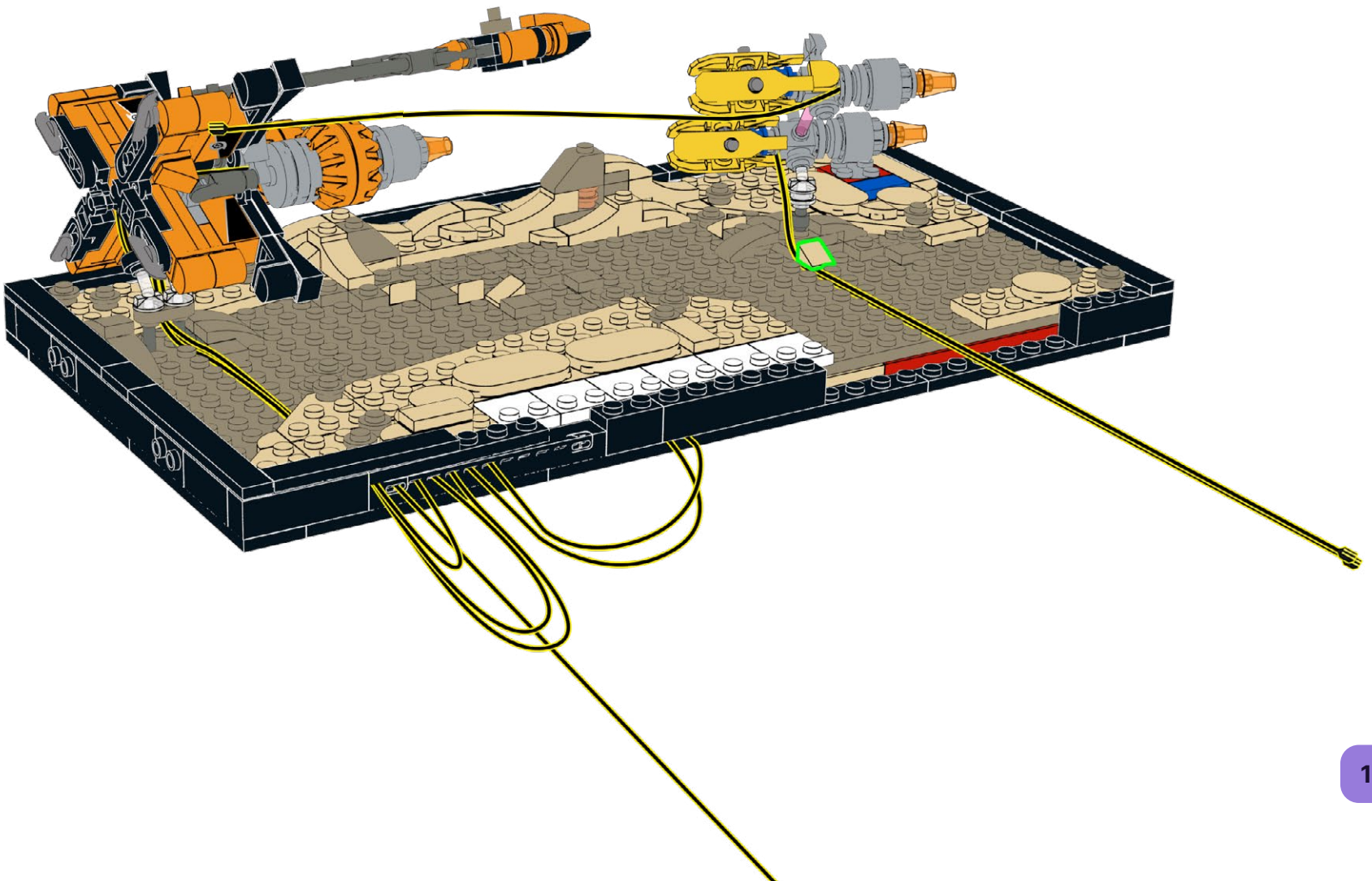

172

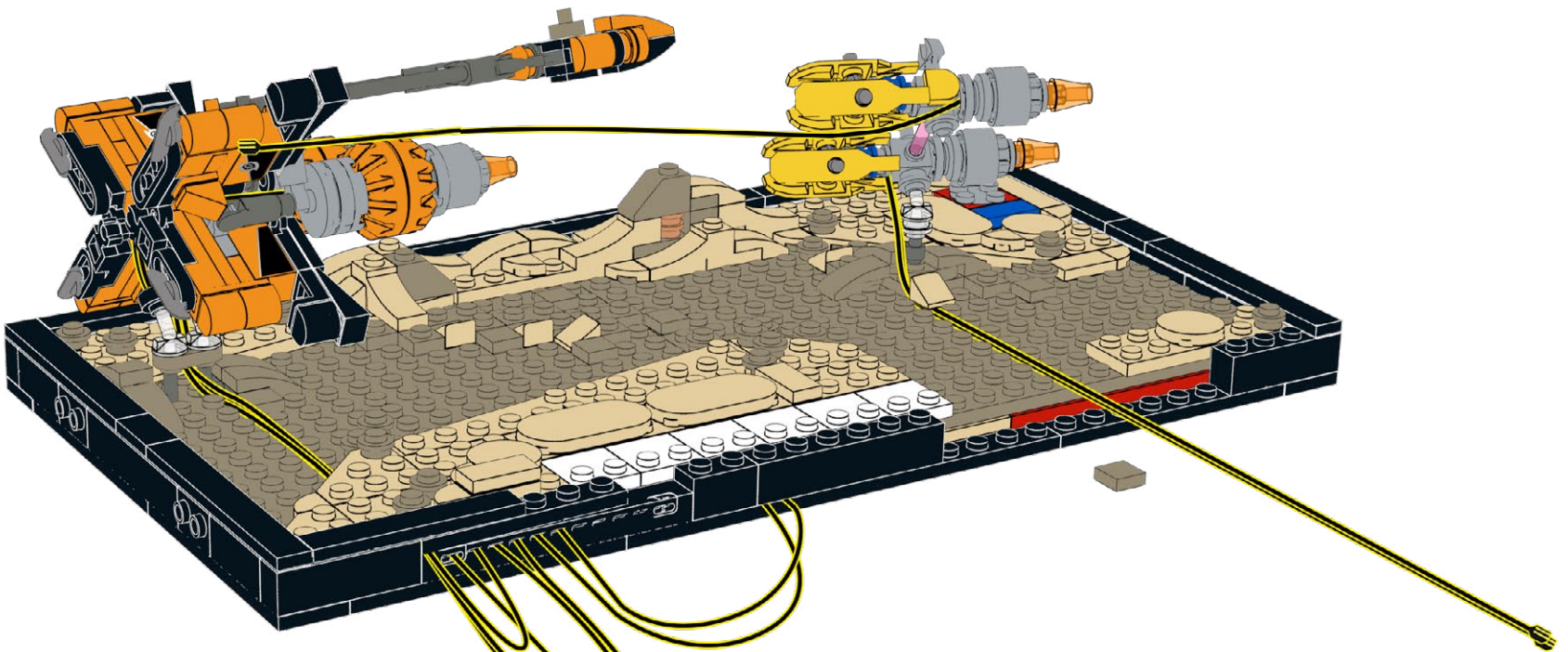

173

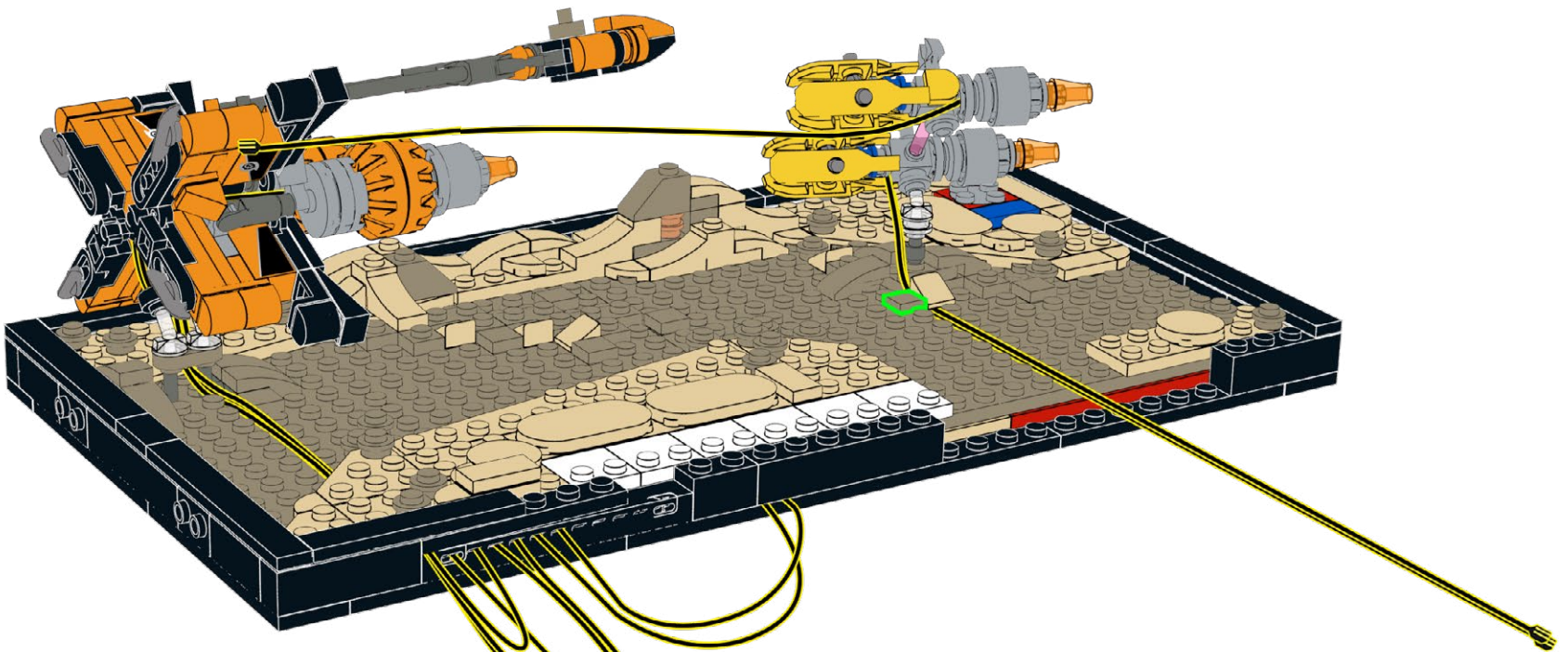

174

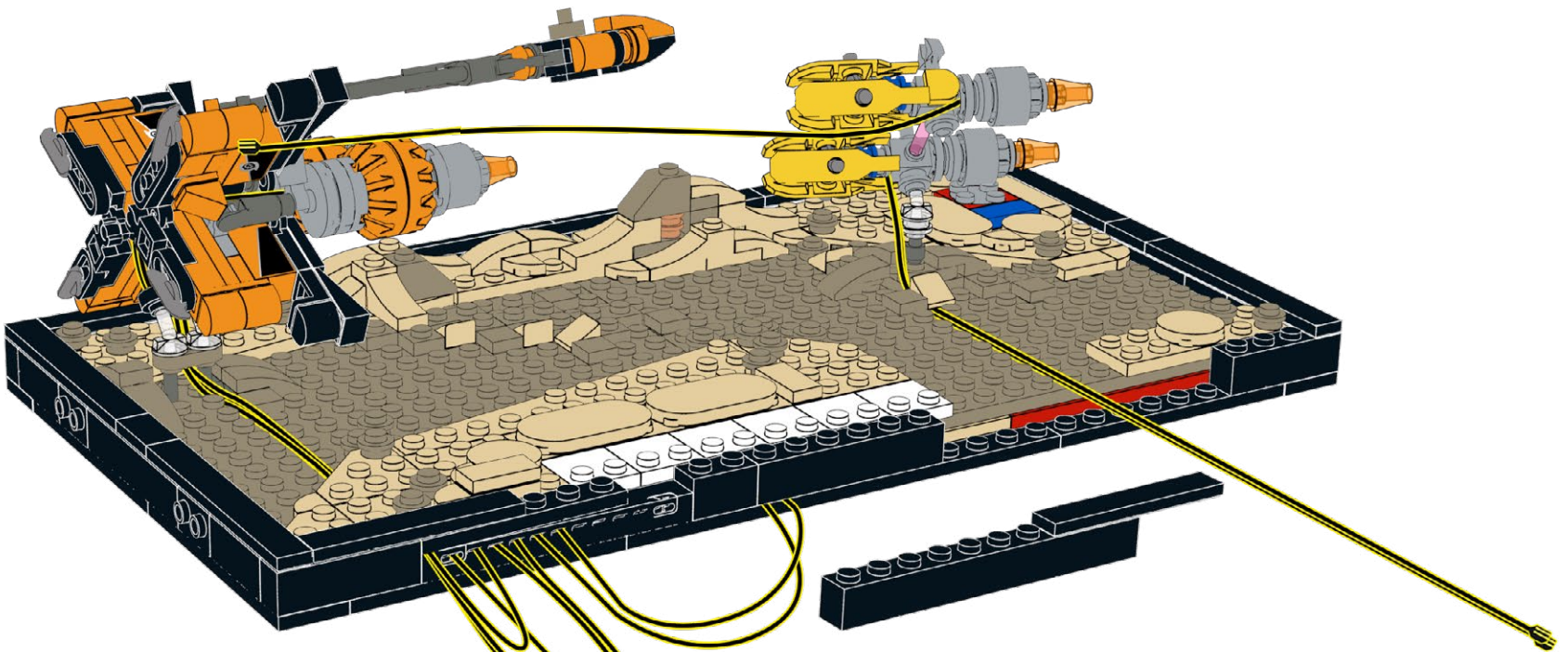

175

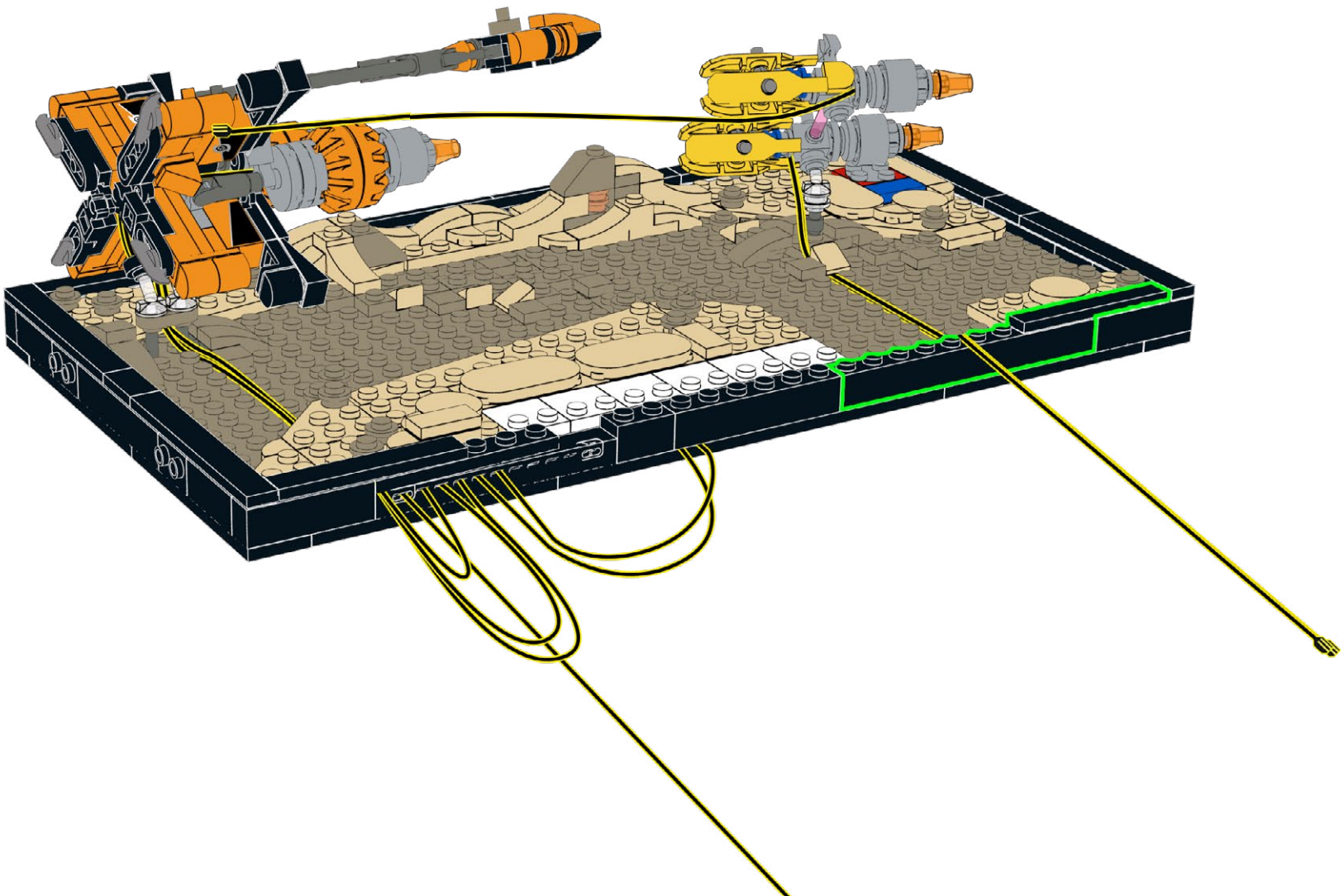

176

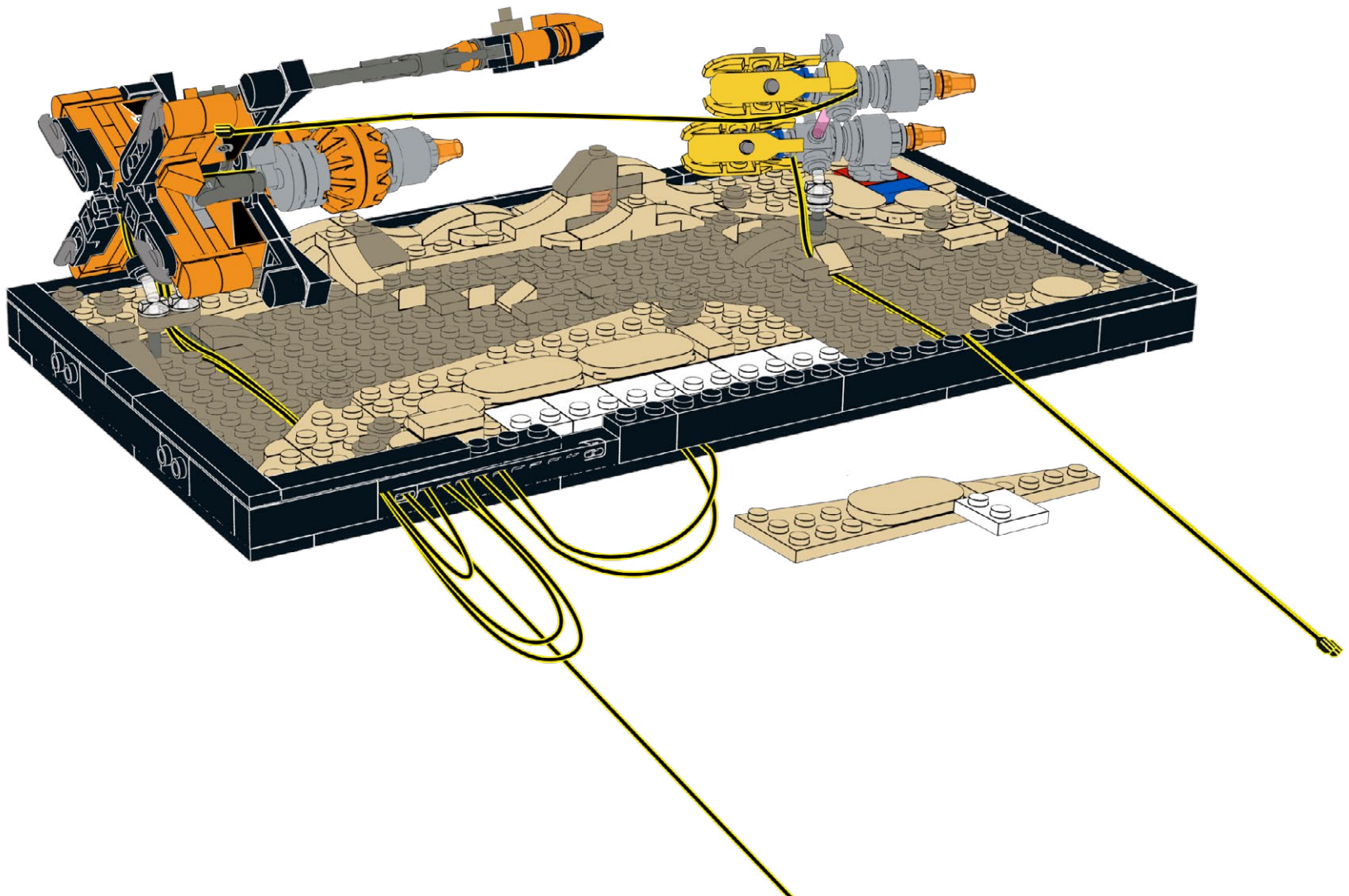

177

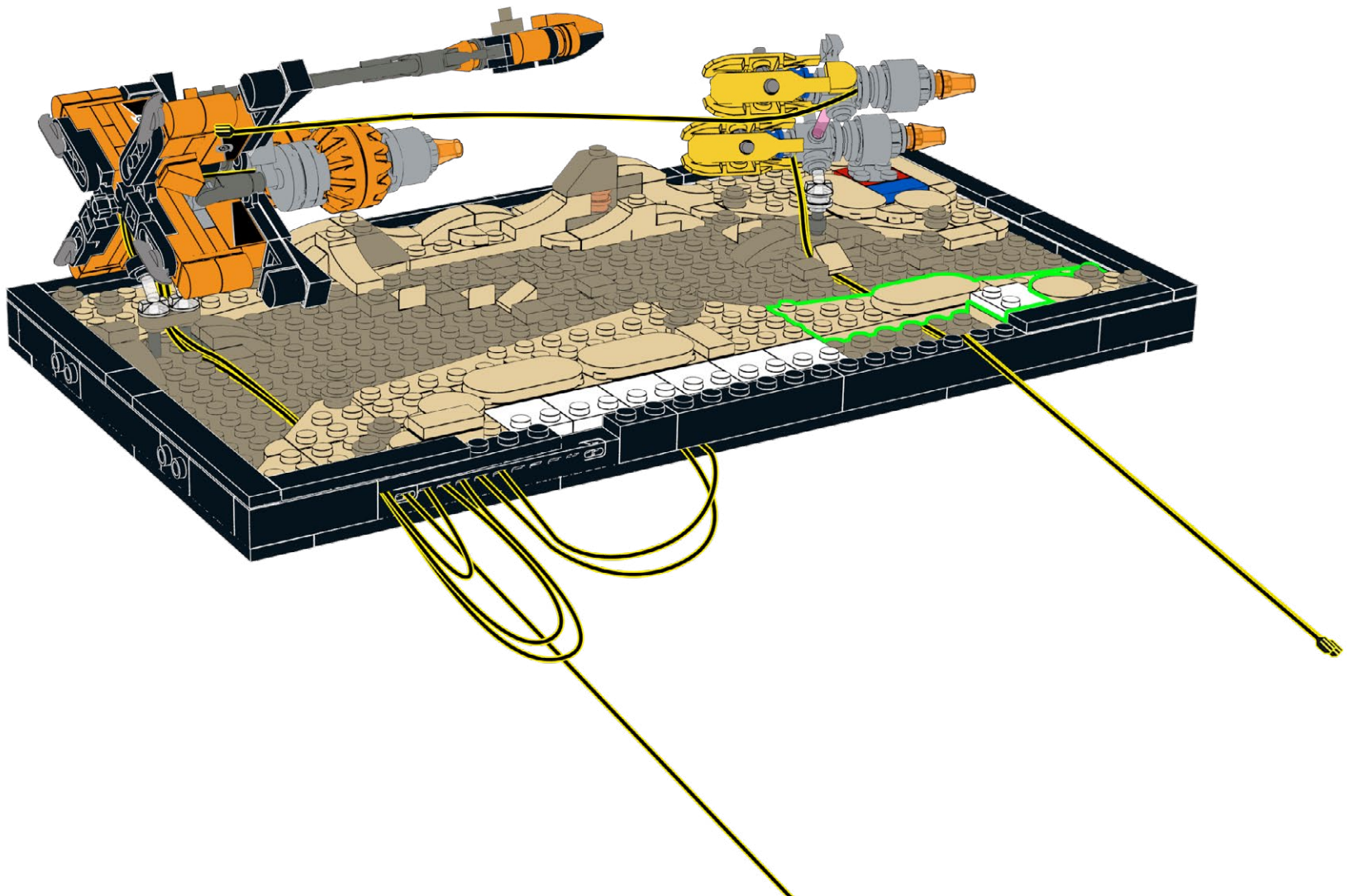

178

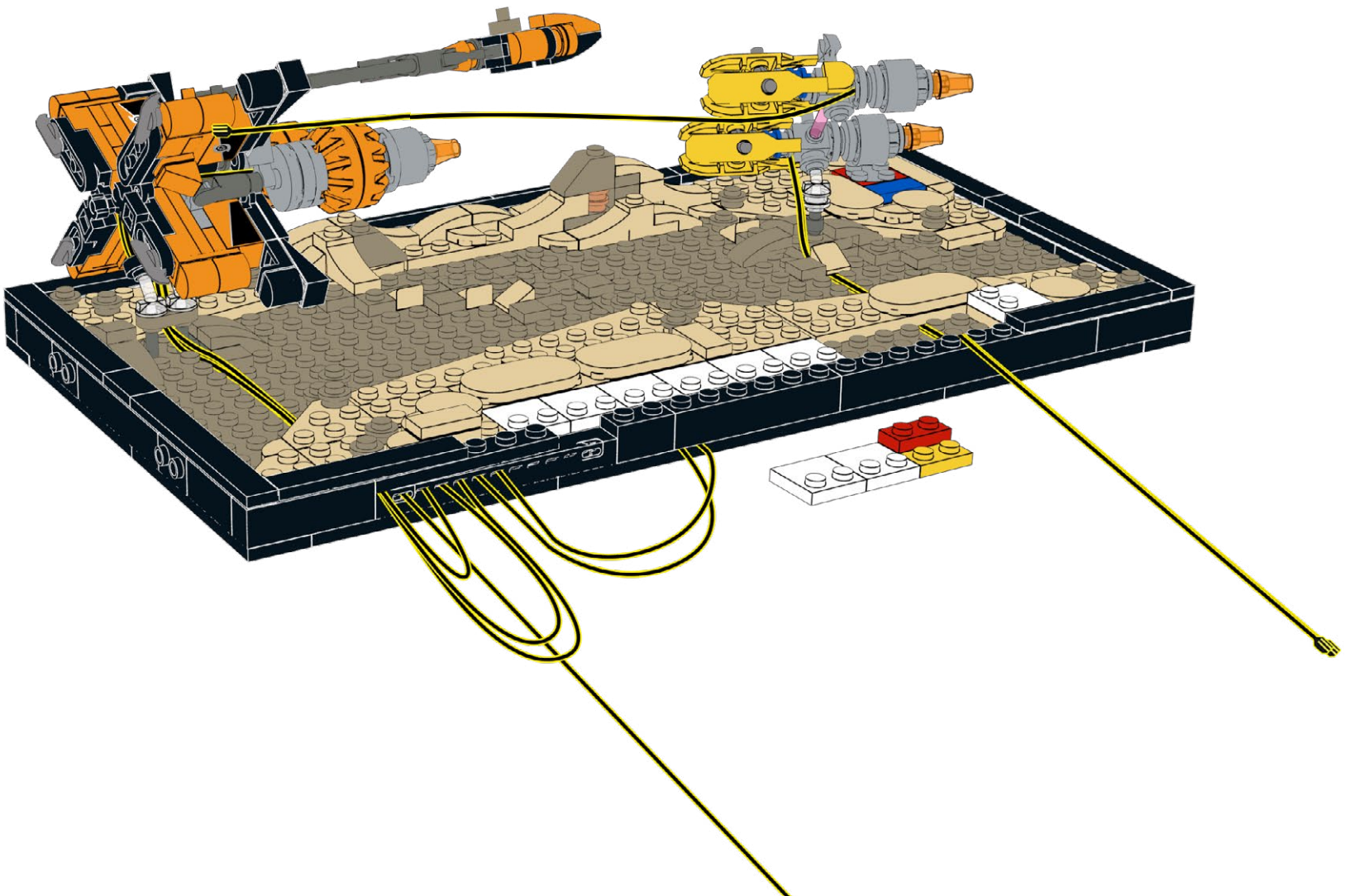



179

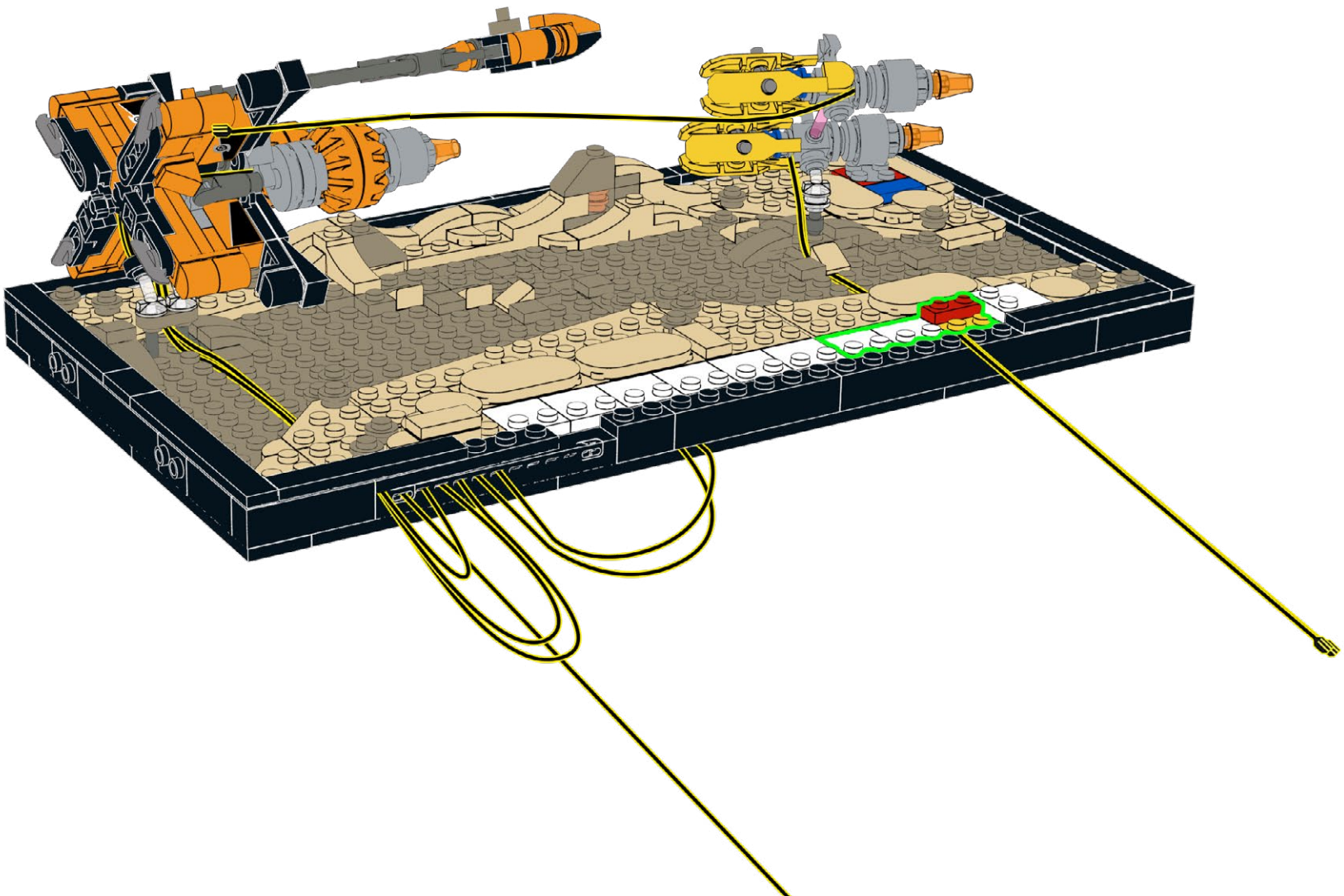

180

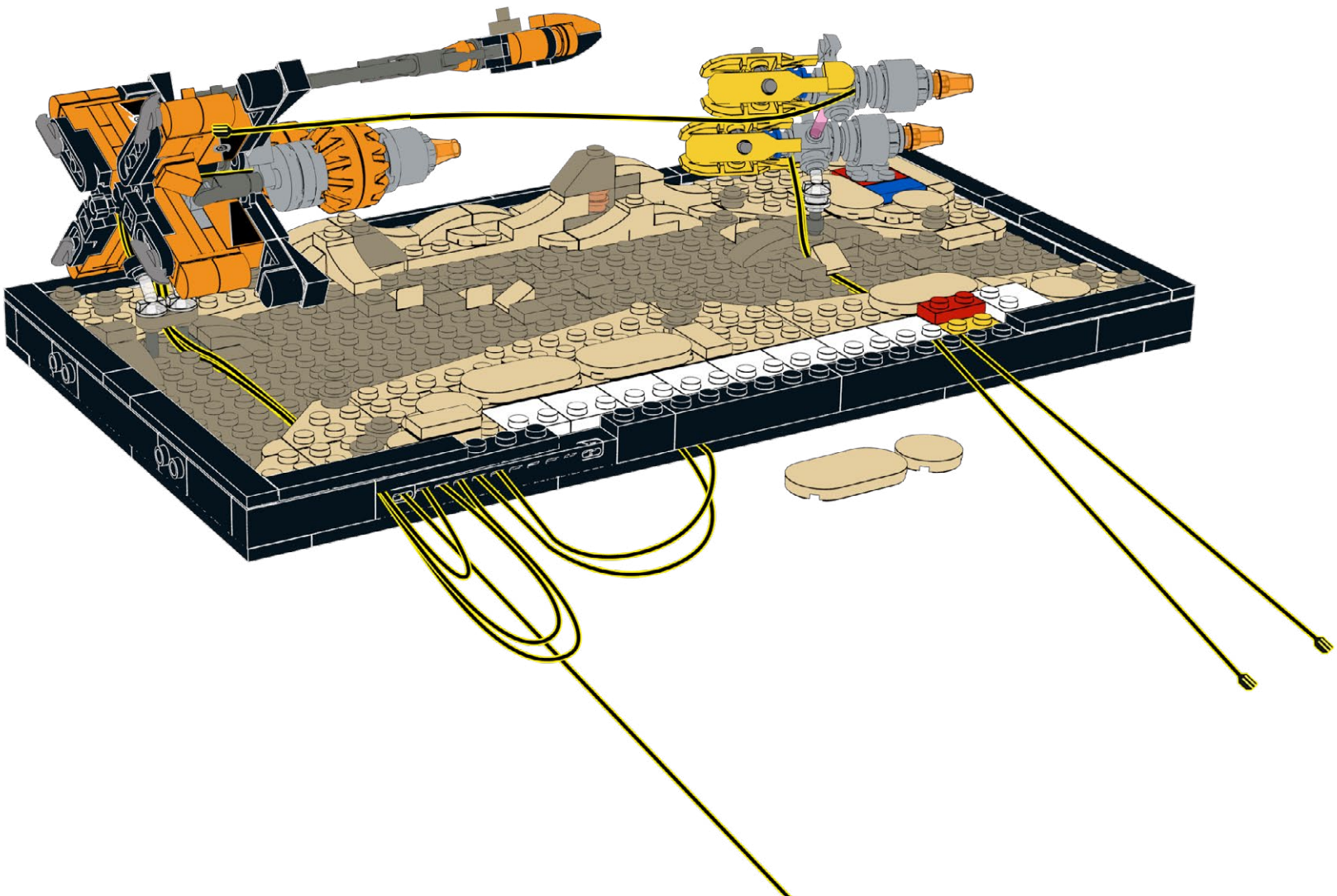

181

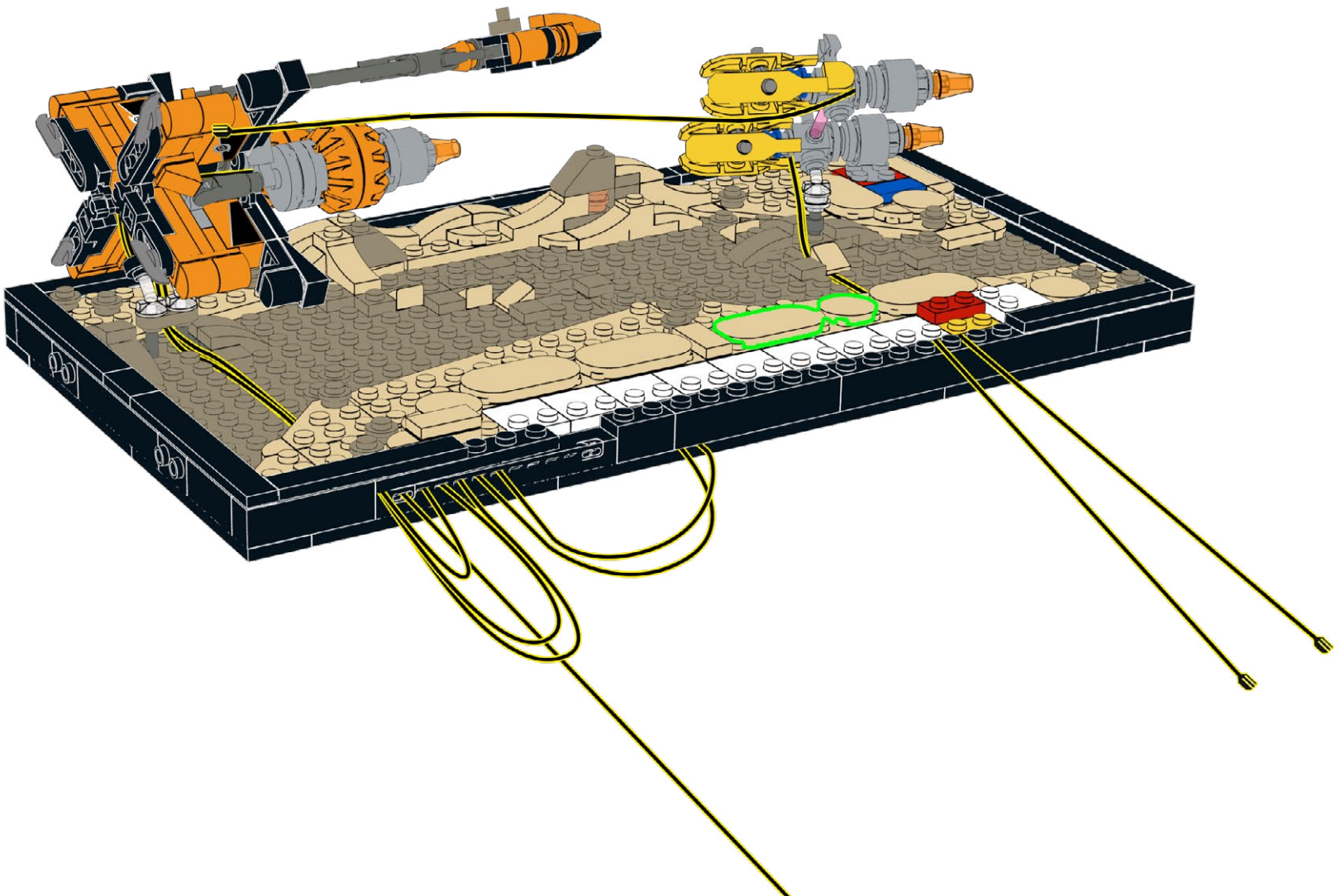

182

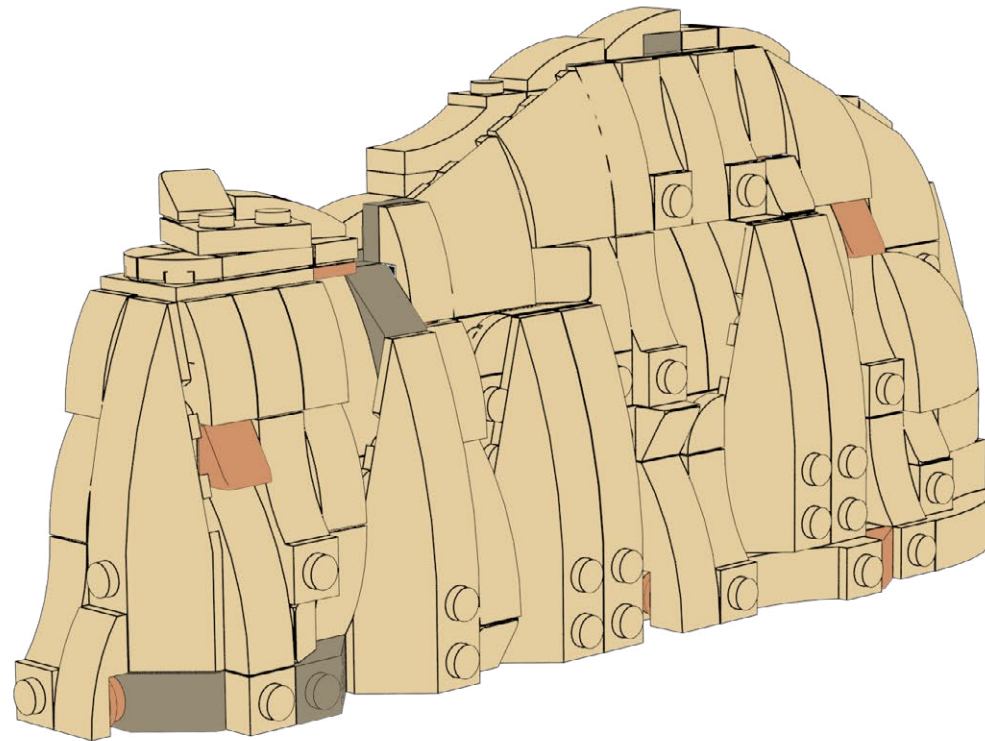

183

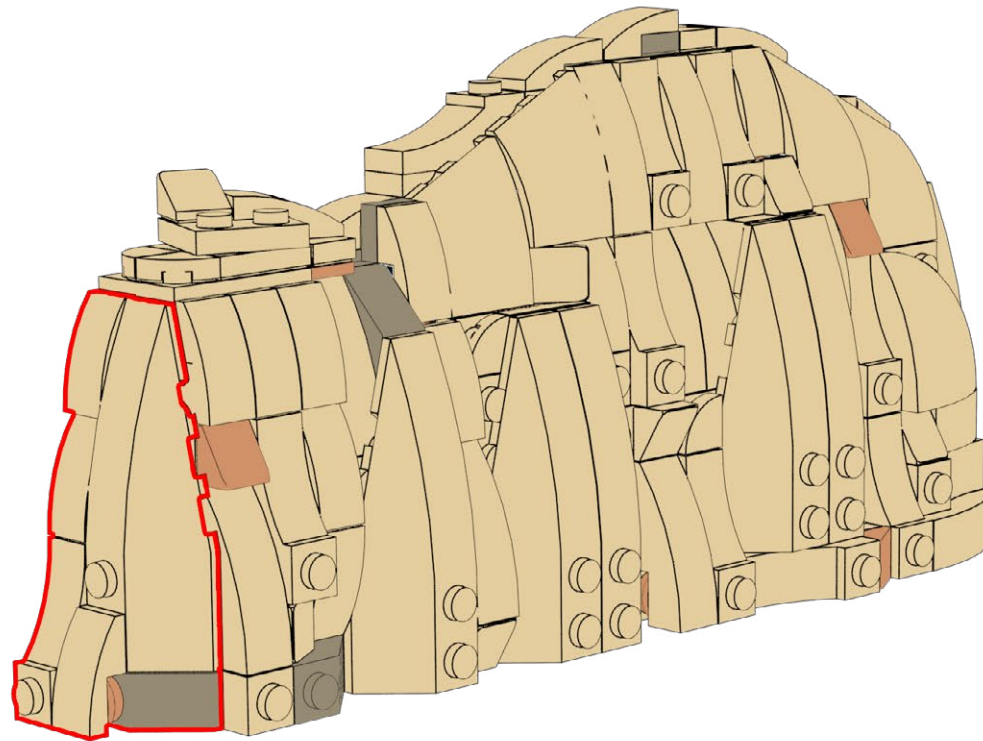

184

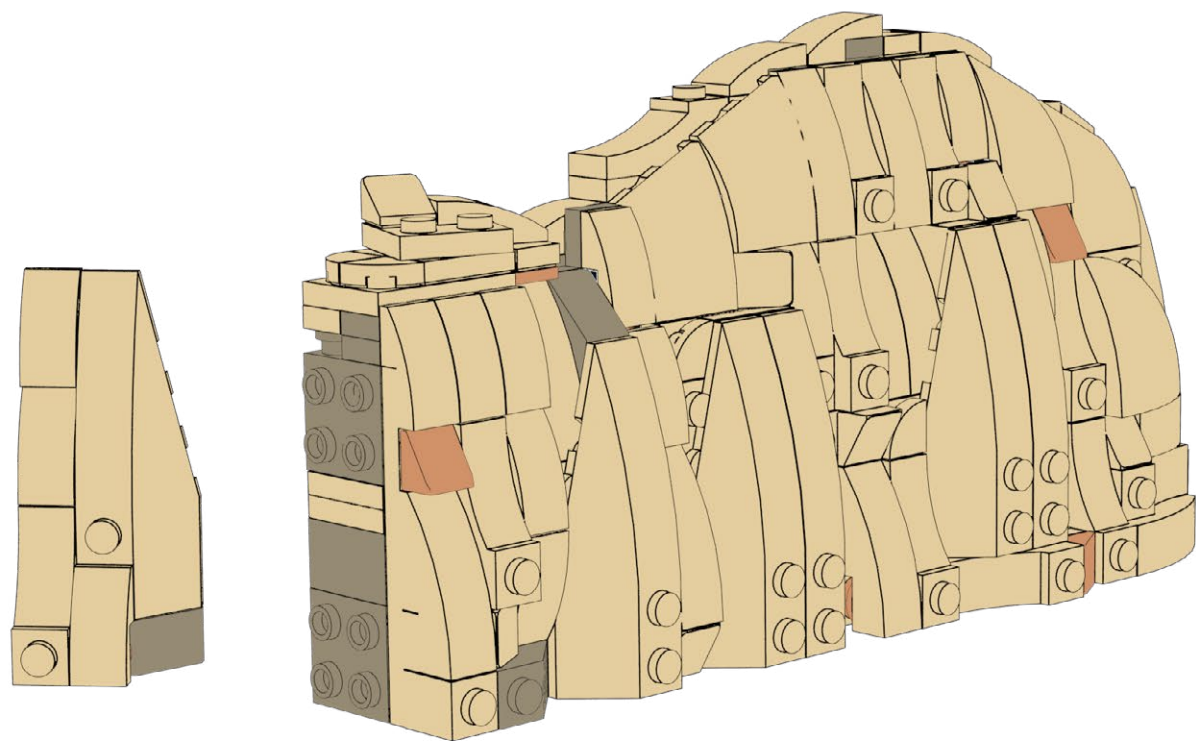

185

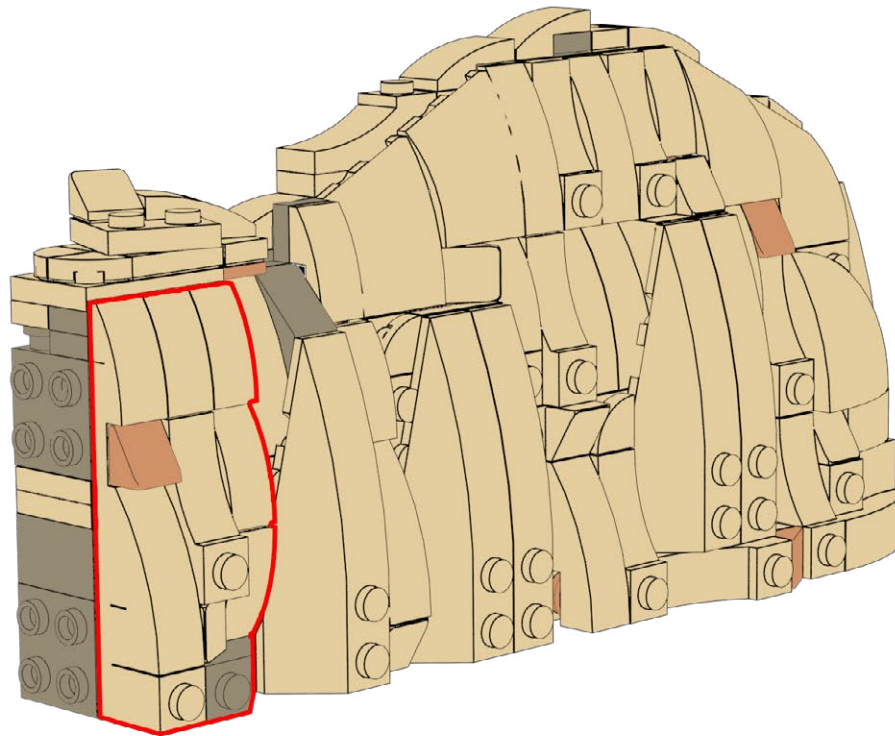

186

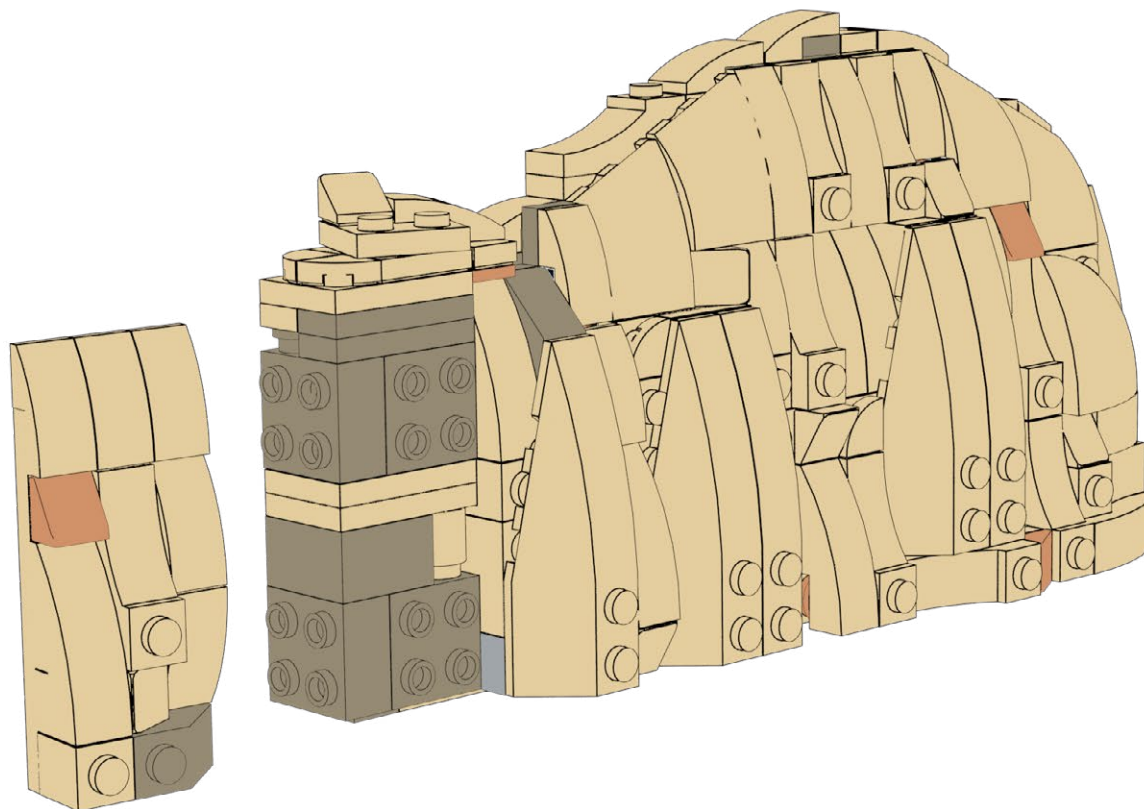



187

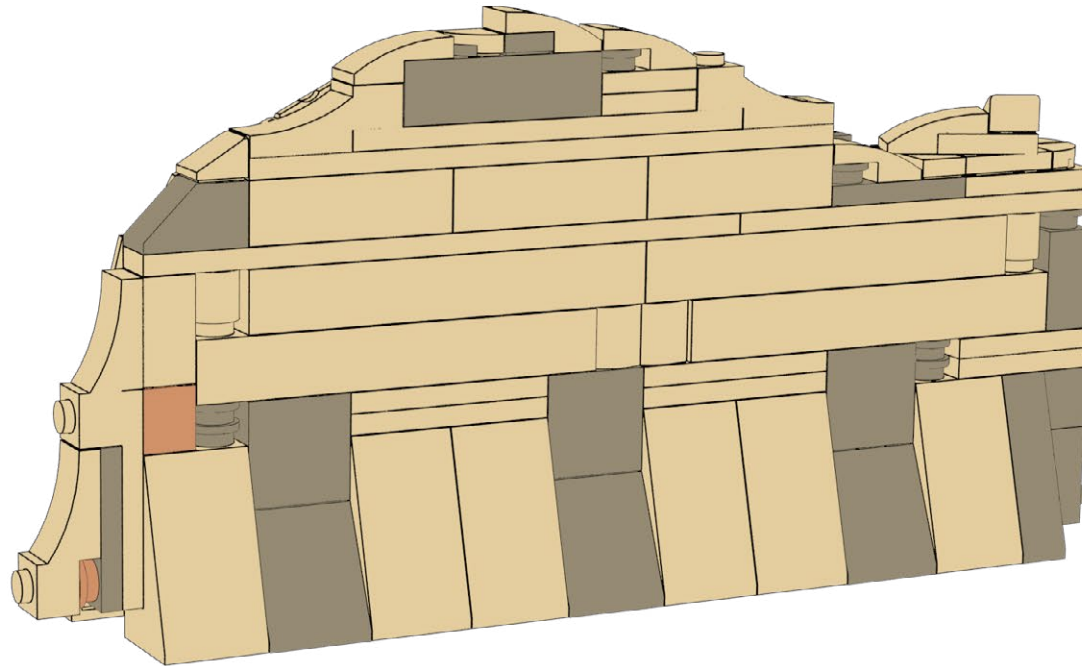

188

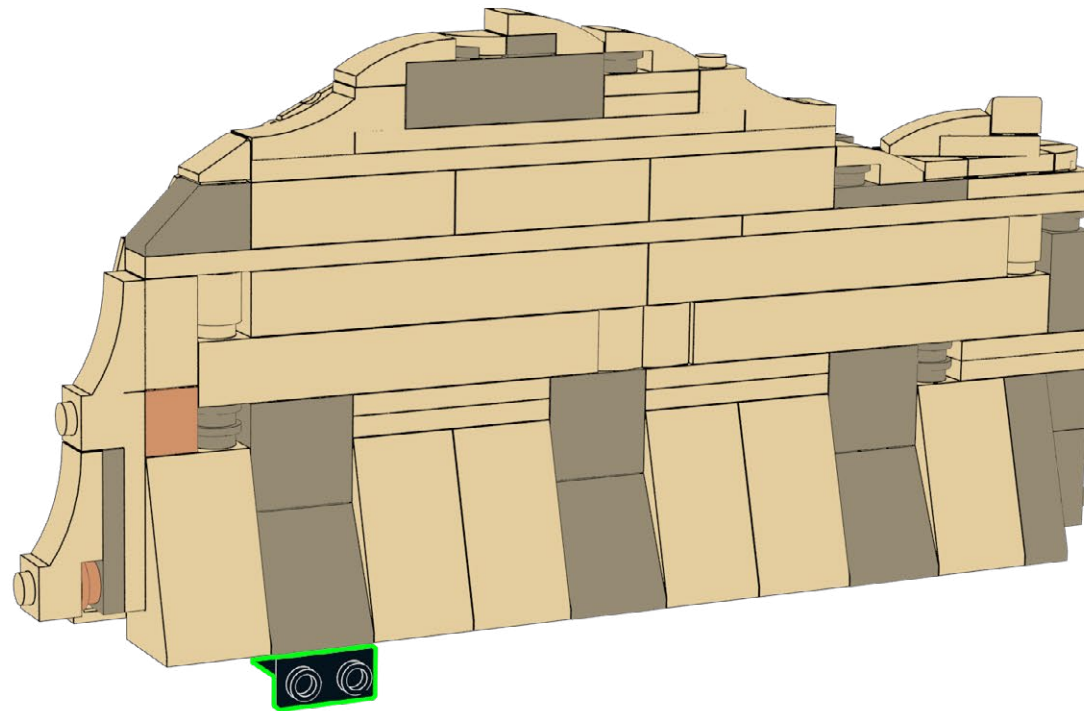
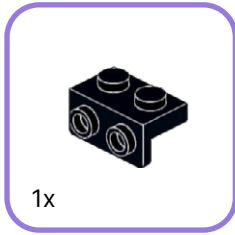

189

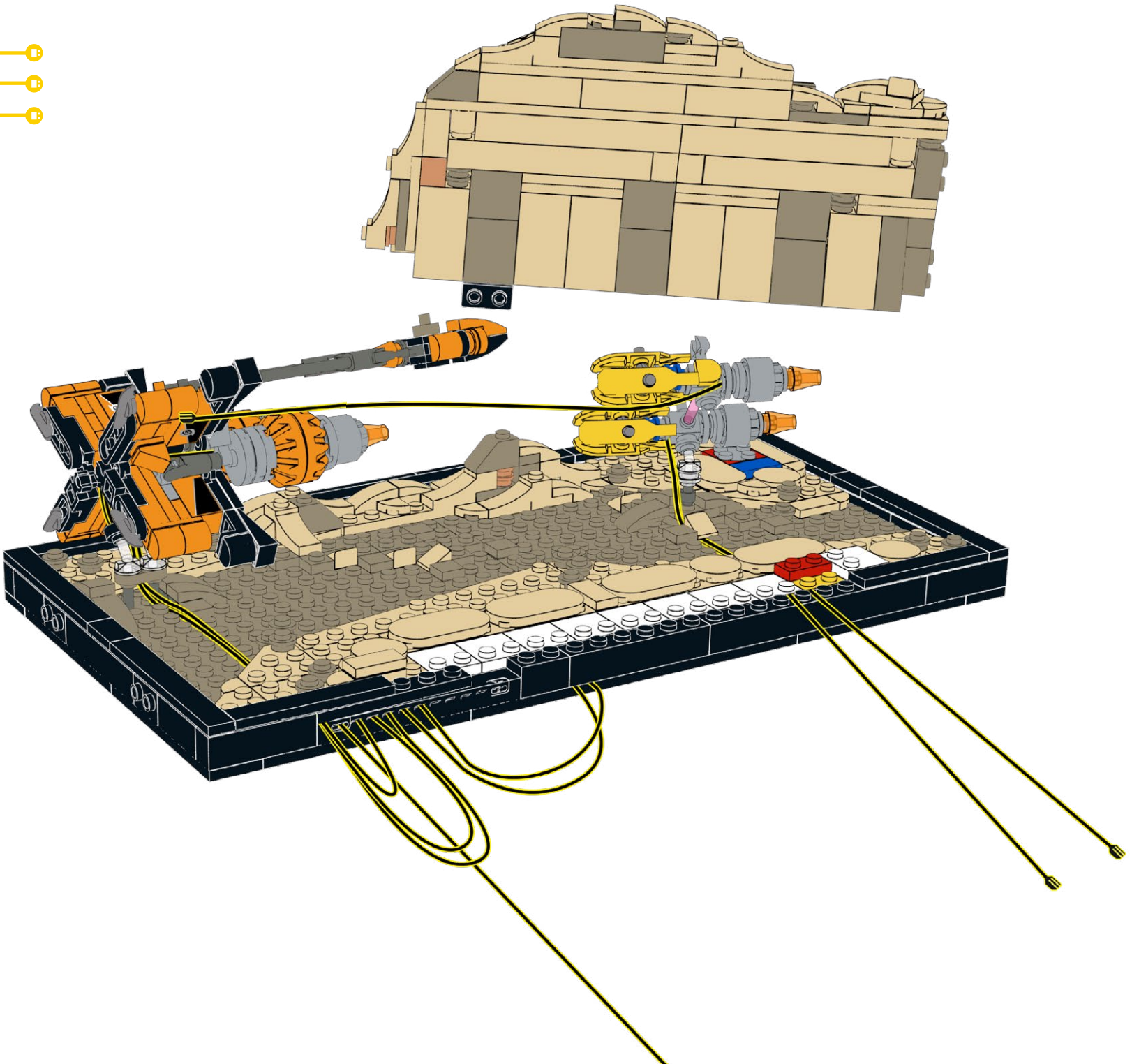

190

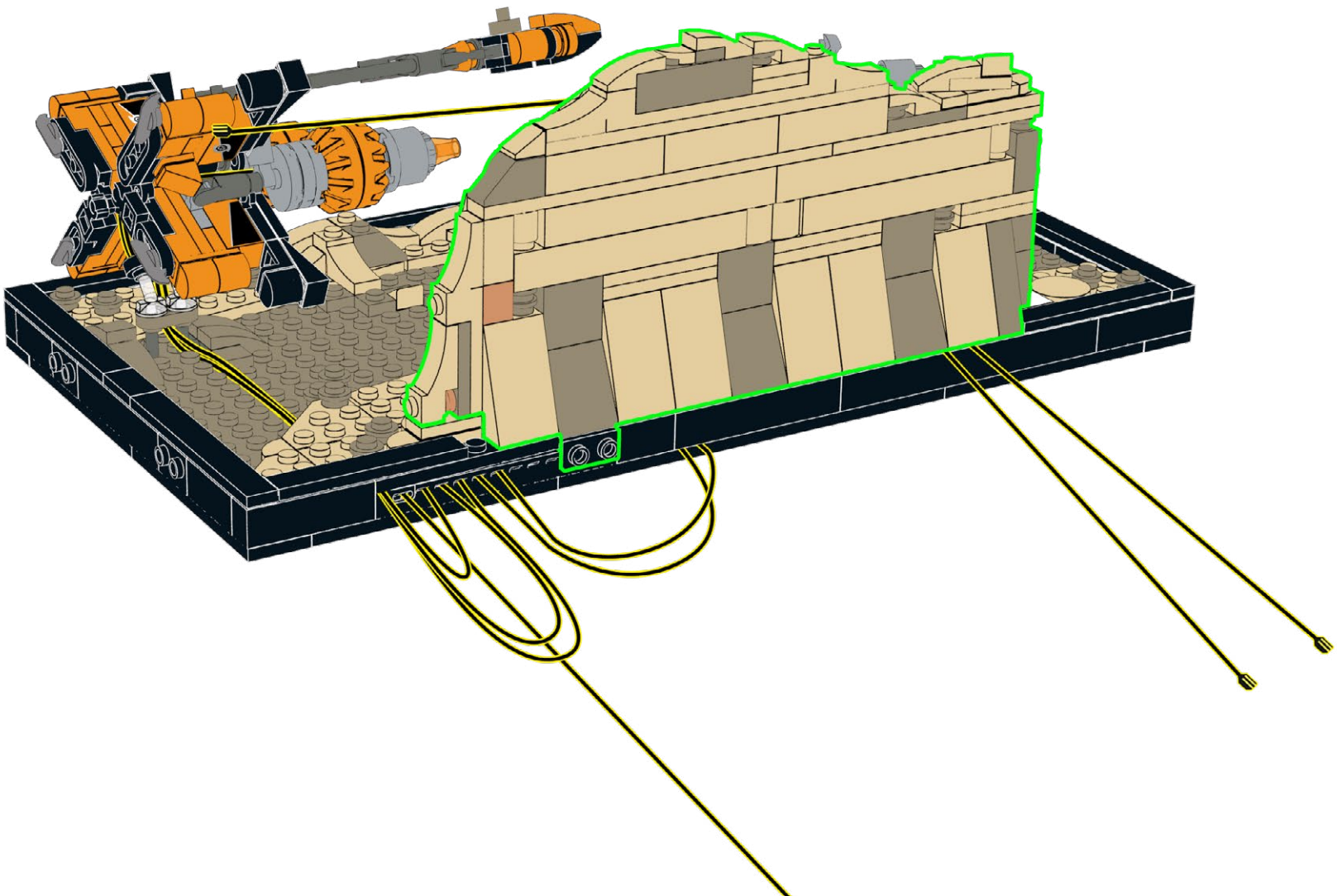

191

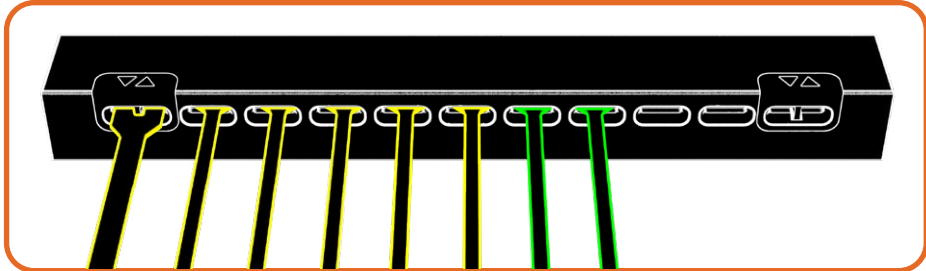
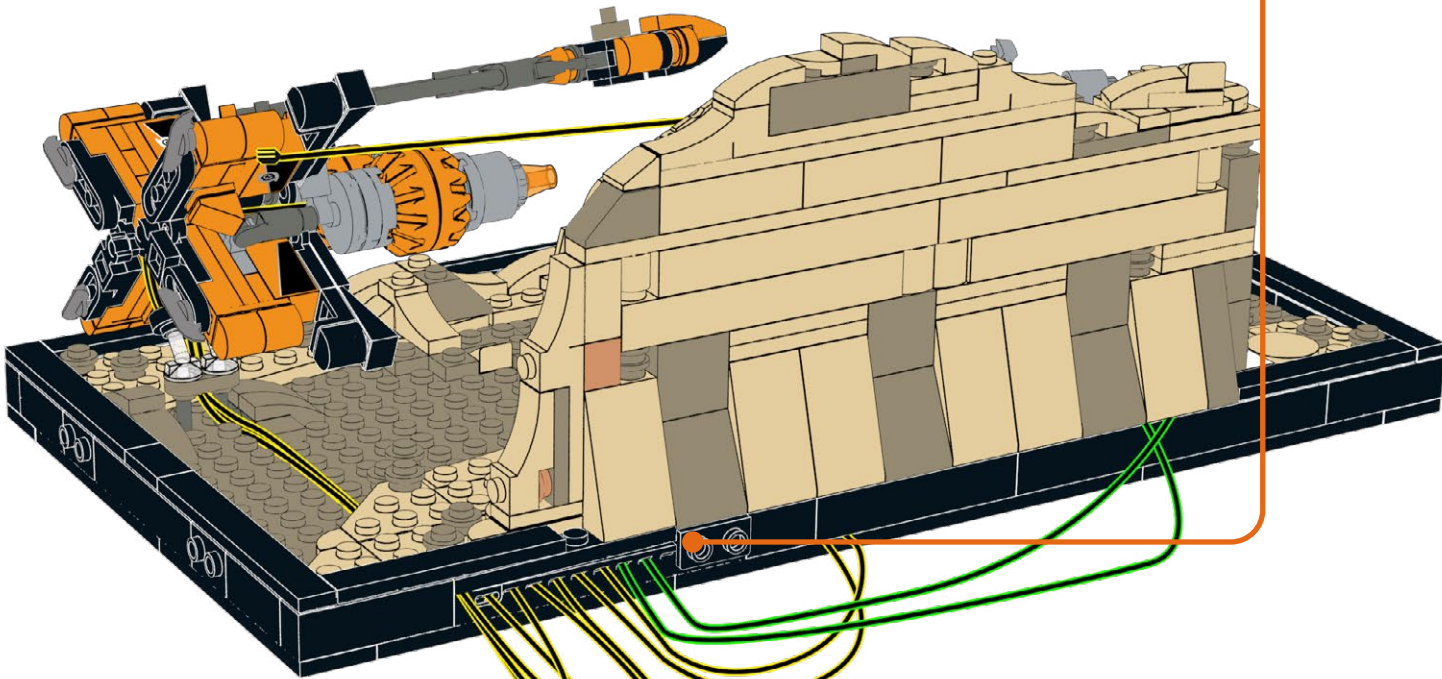

192

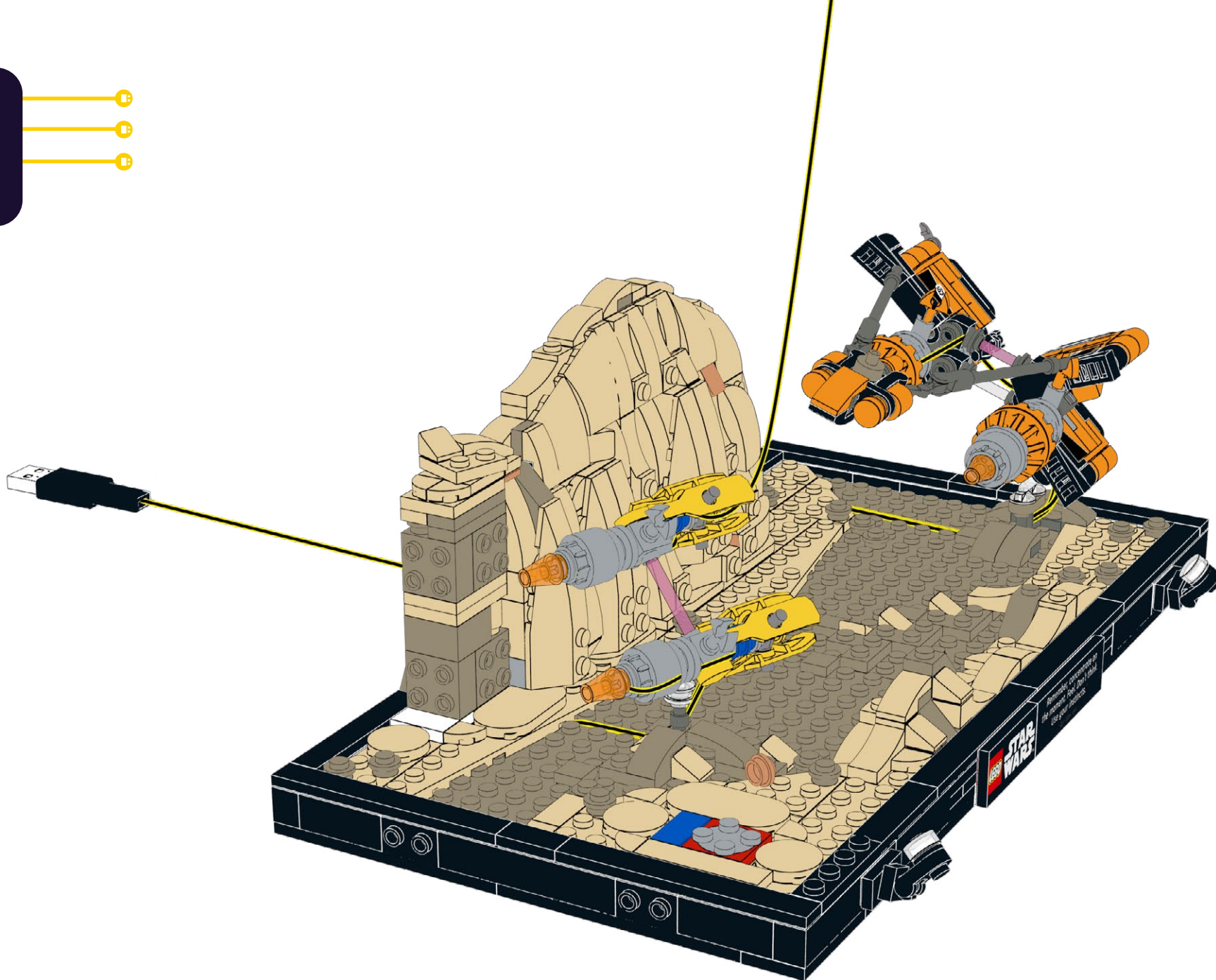

193

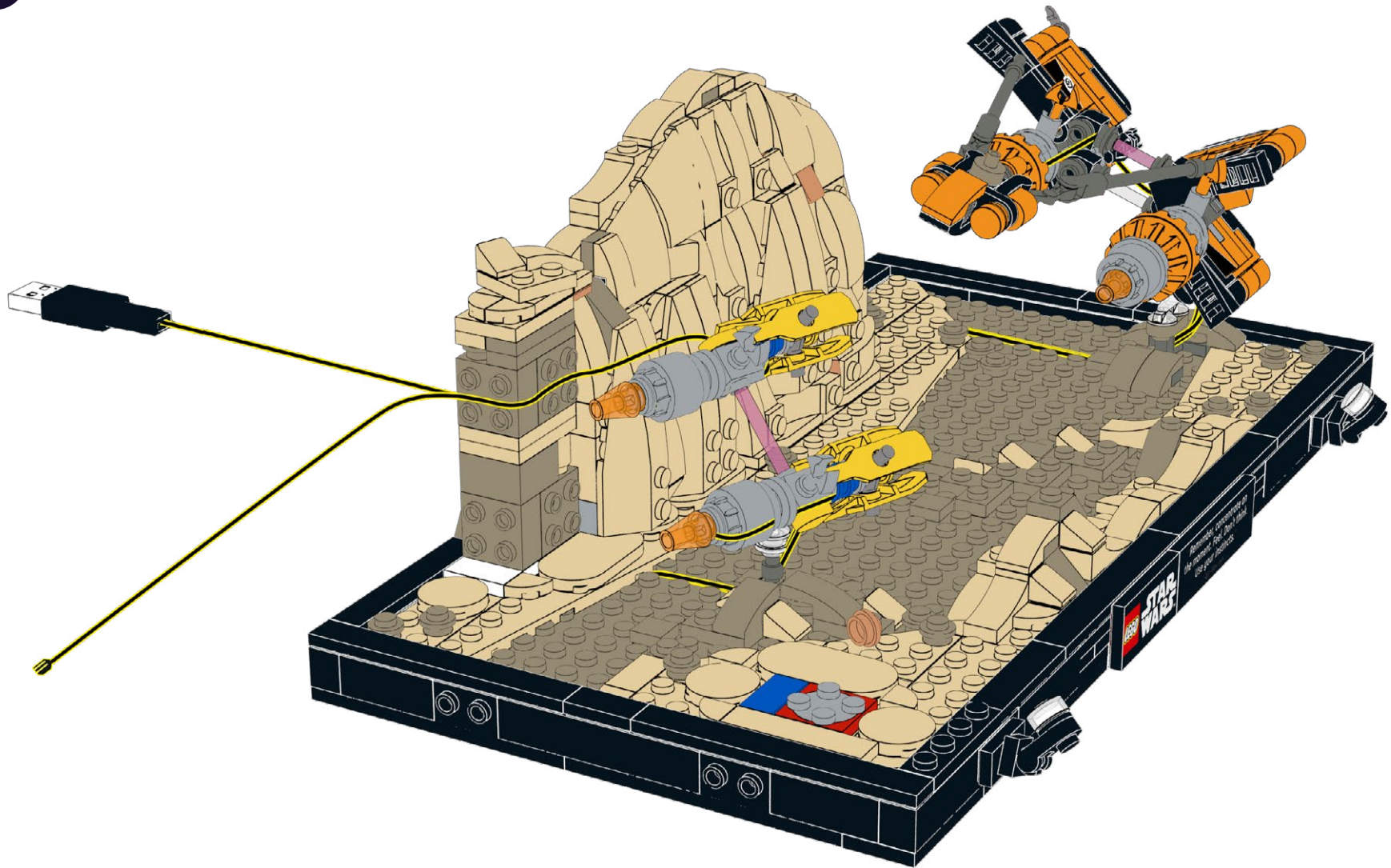

194

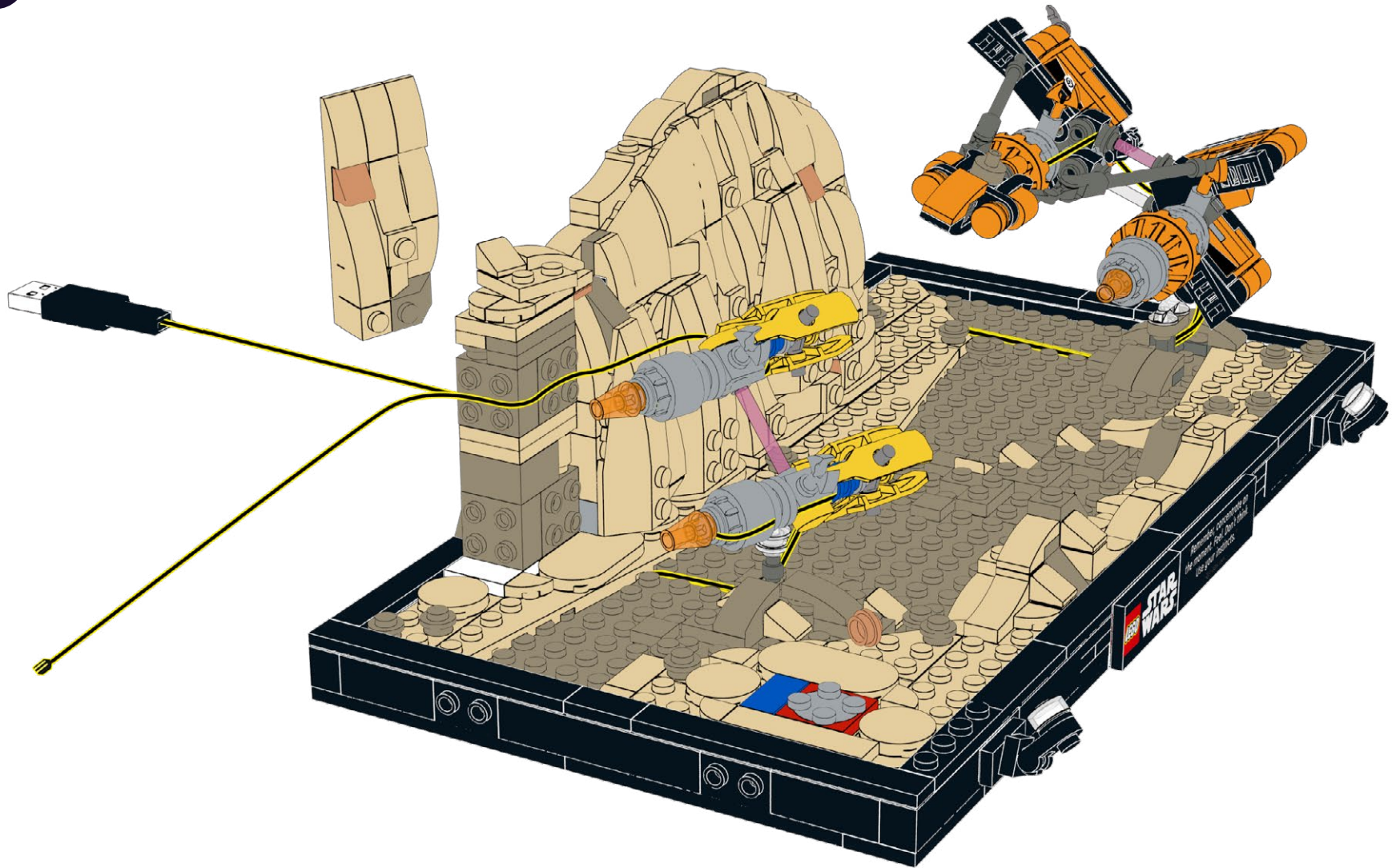



195

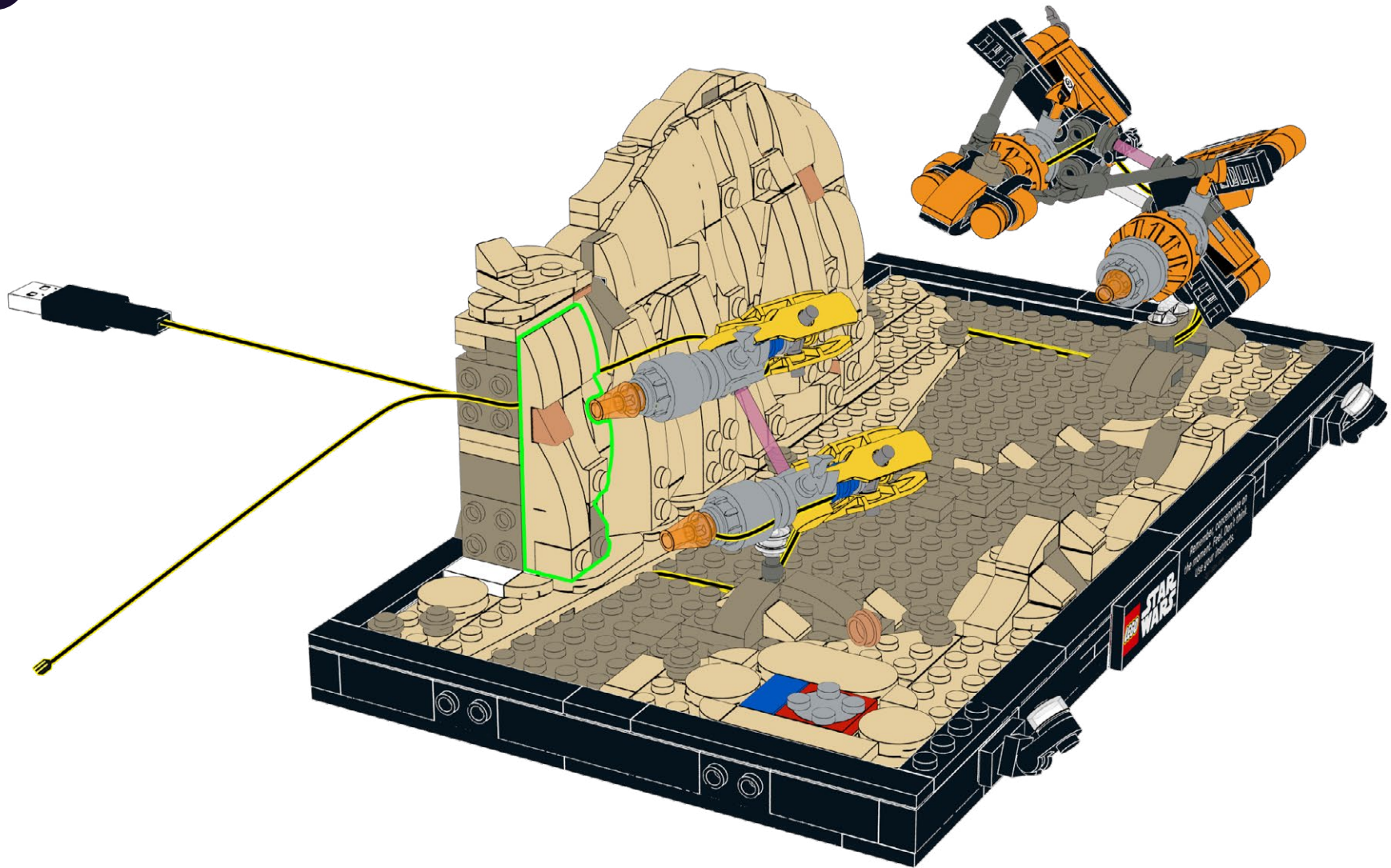

196

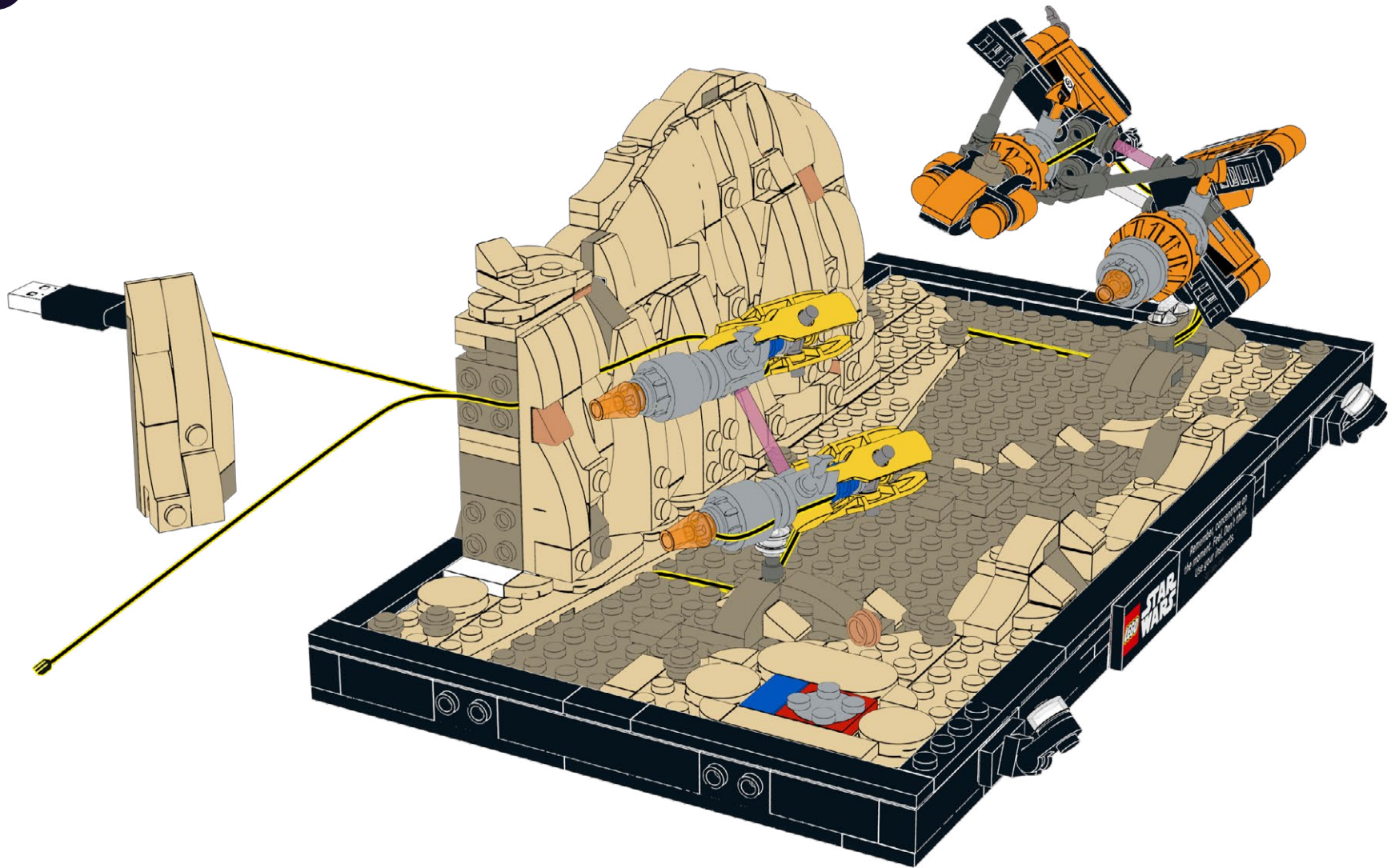

197

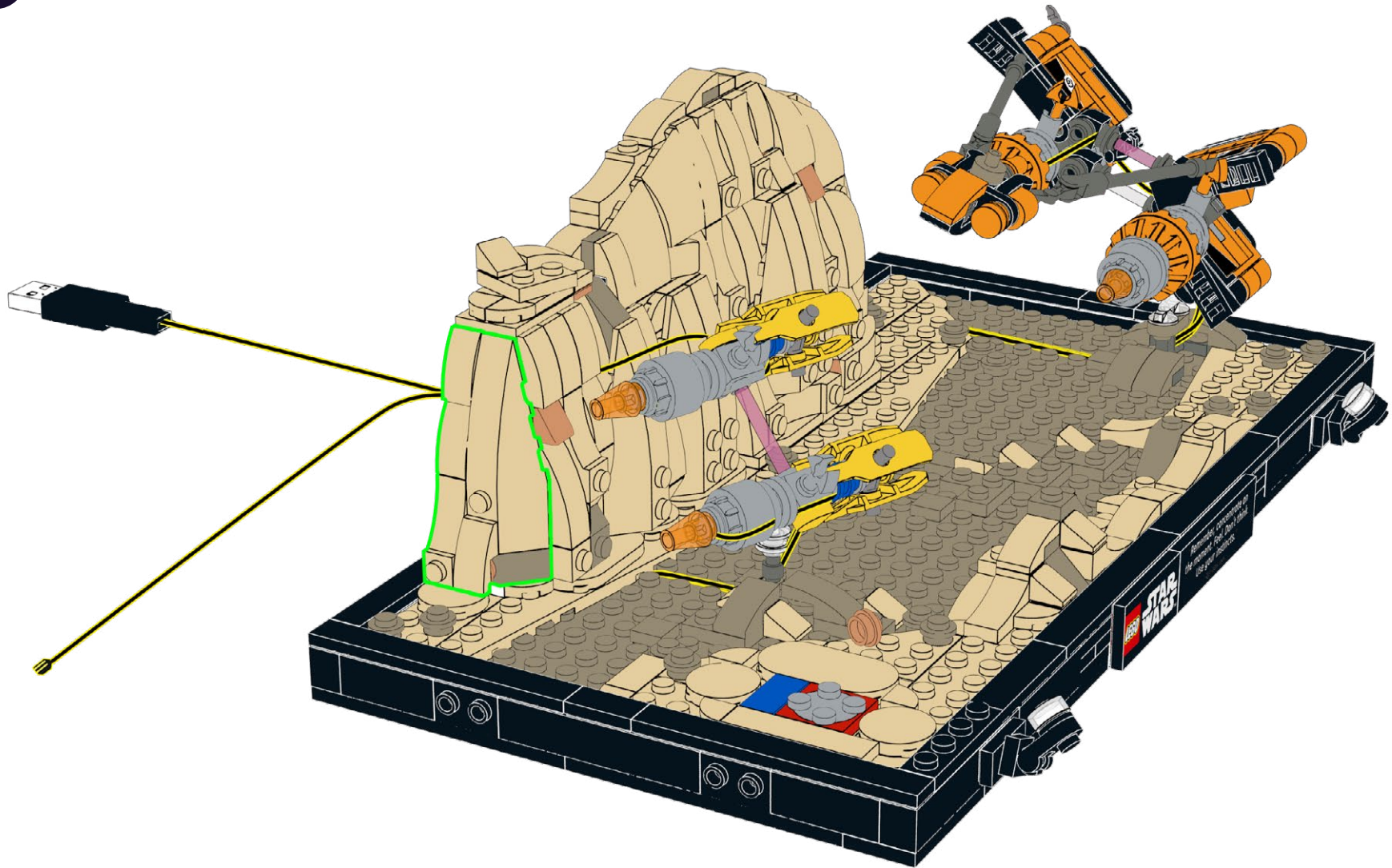

198

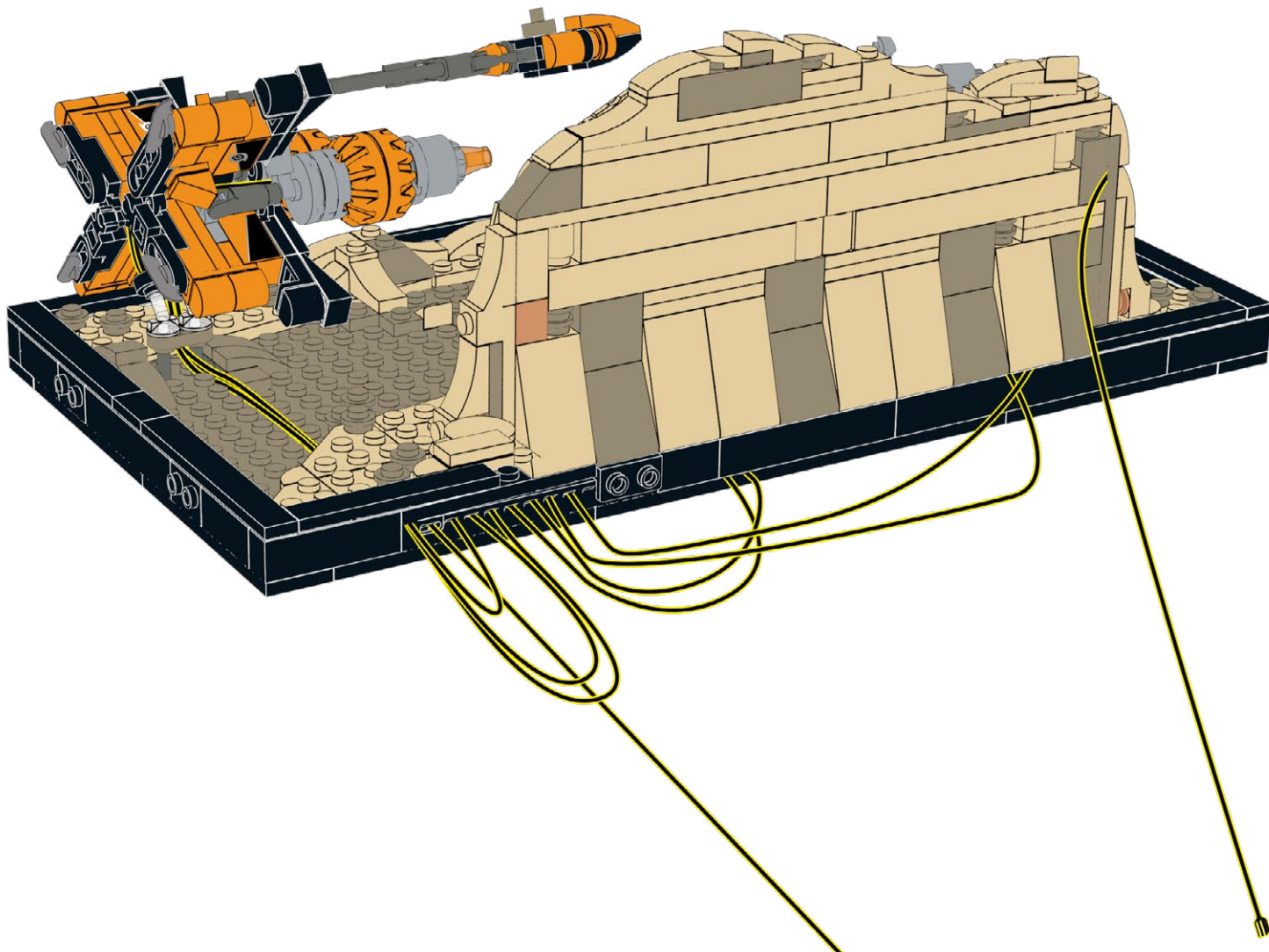

199

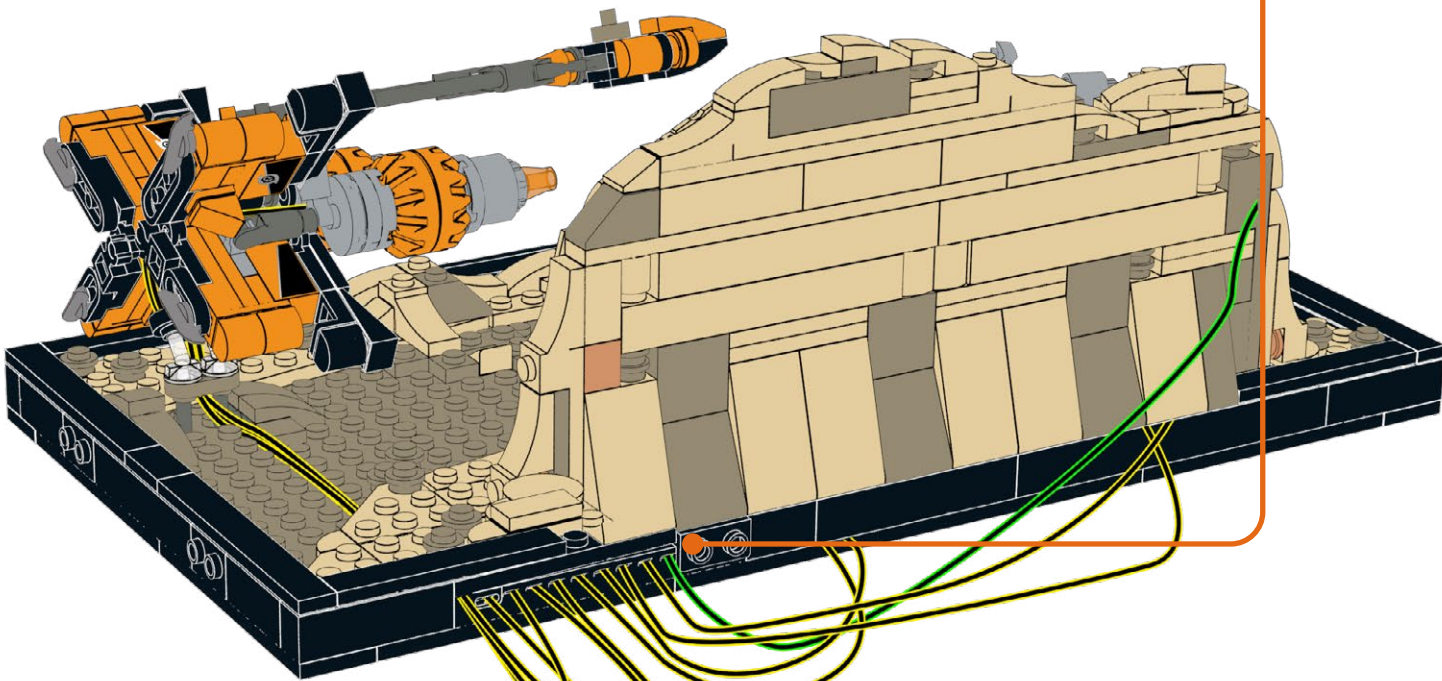

200

E-1x2

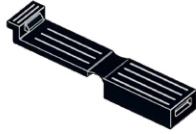

1x

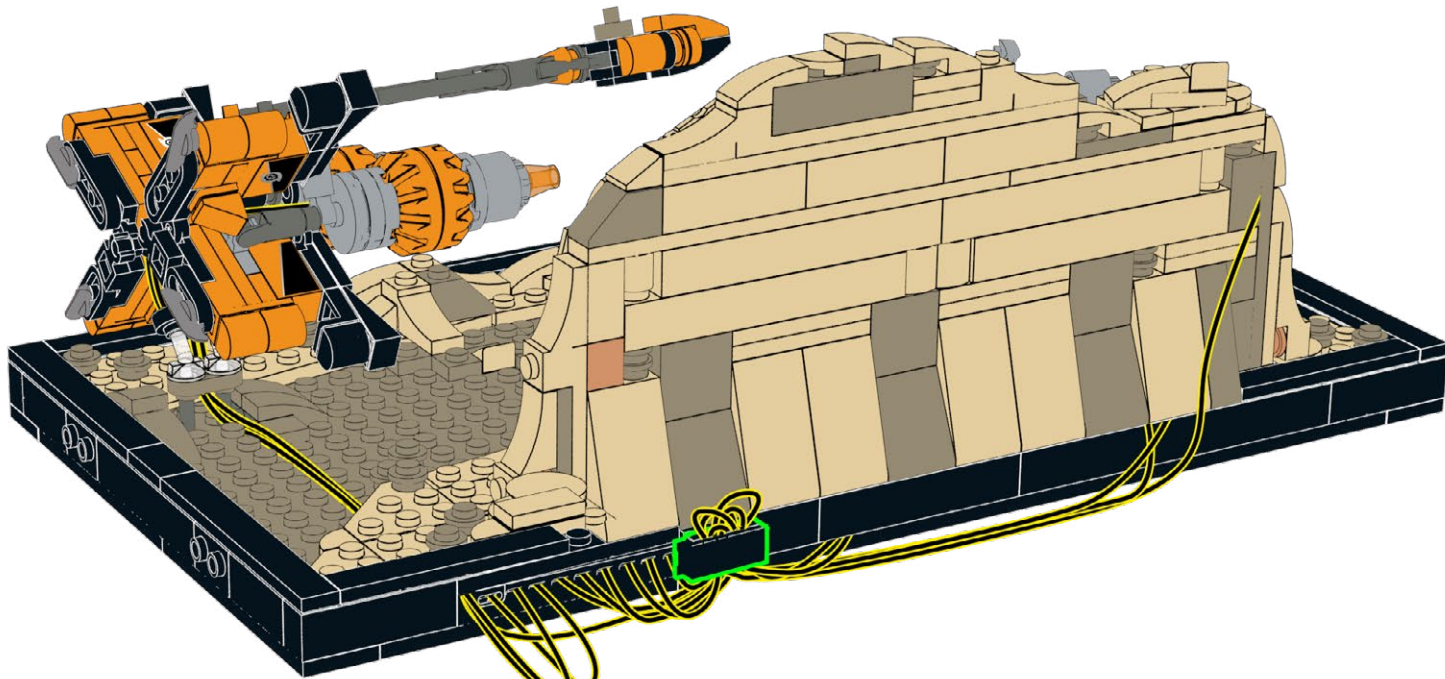

# 201

1

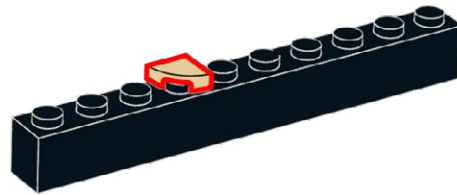

2

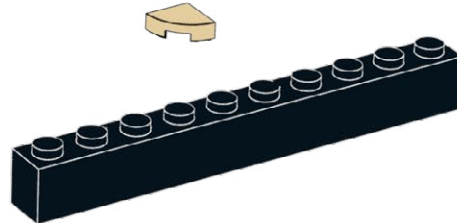

202

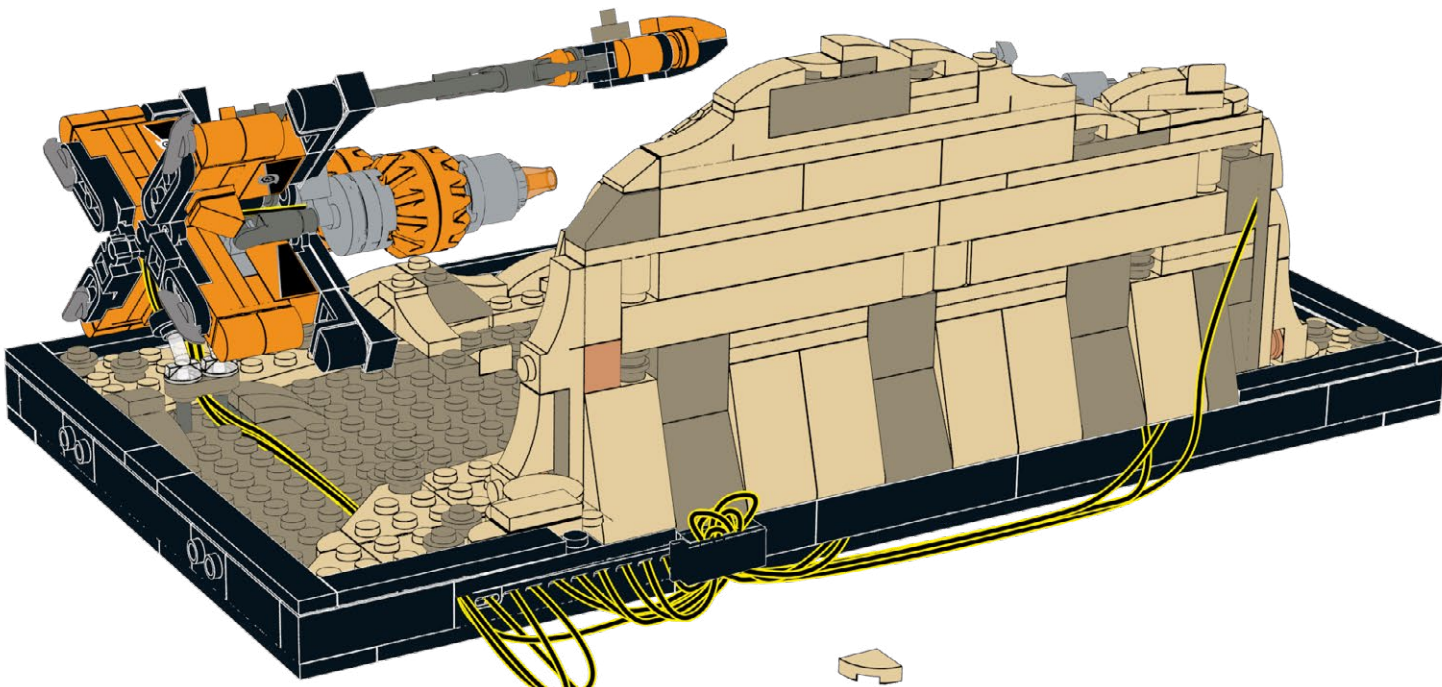



203

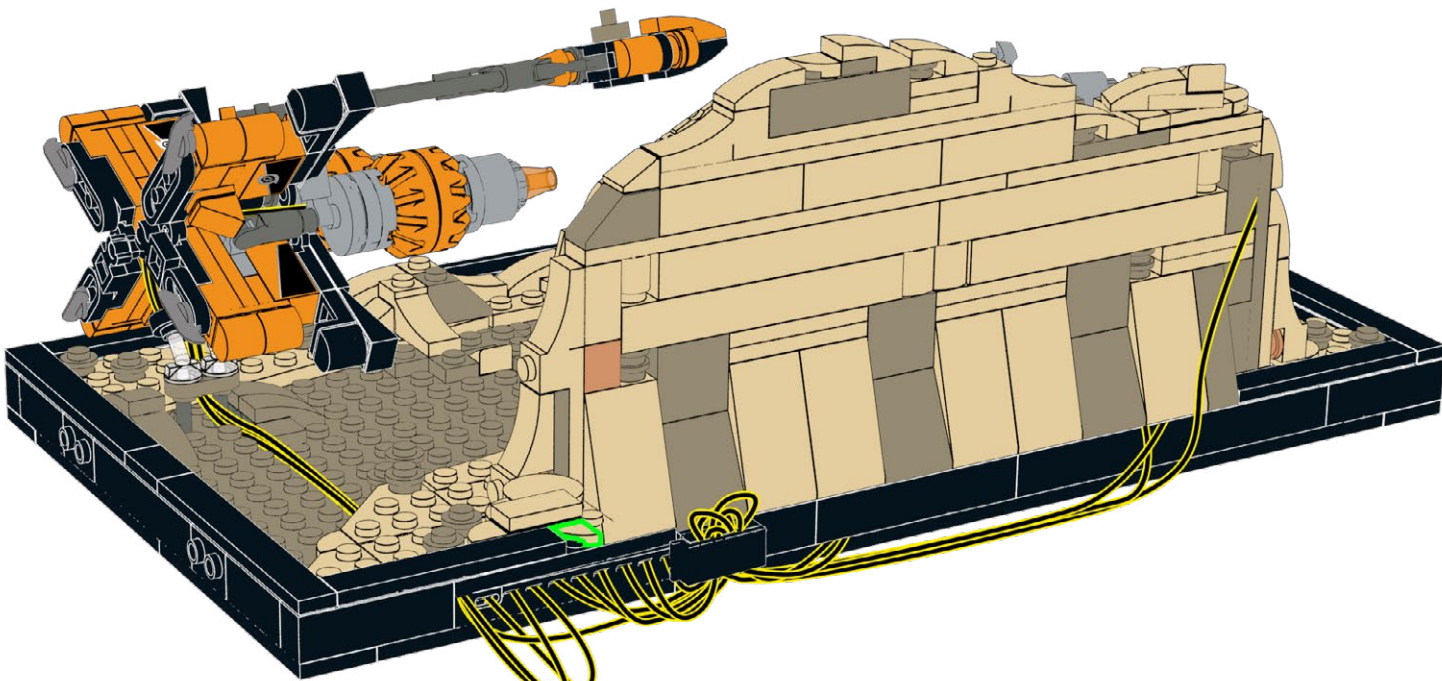

204

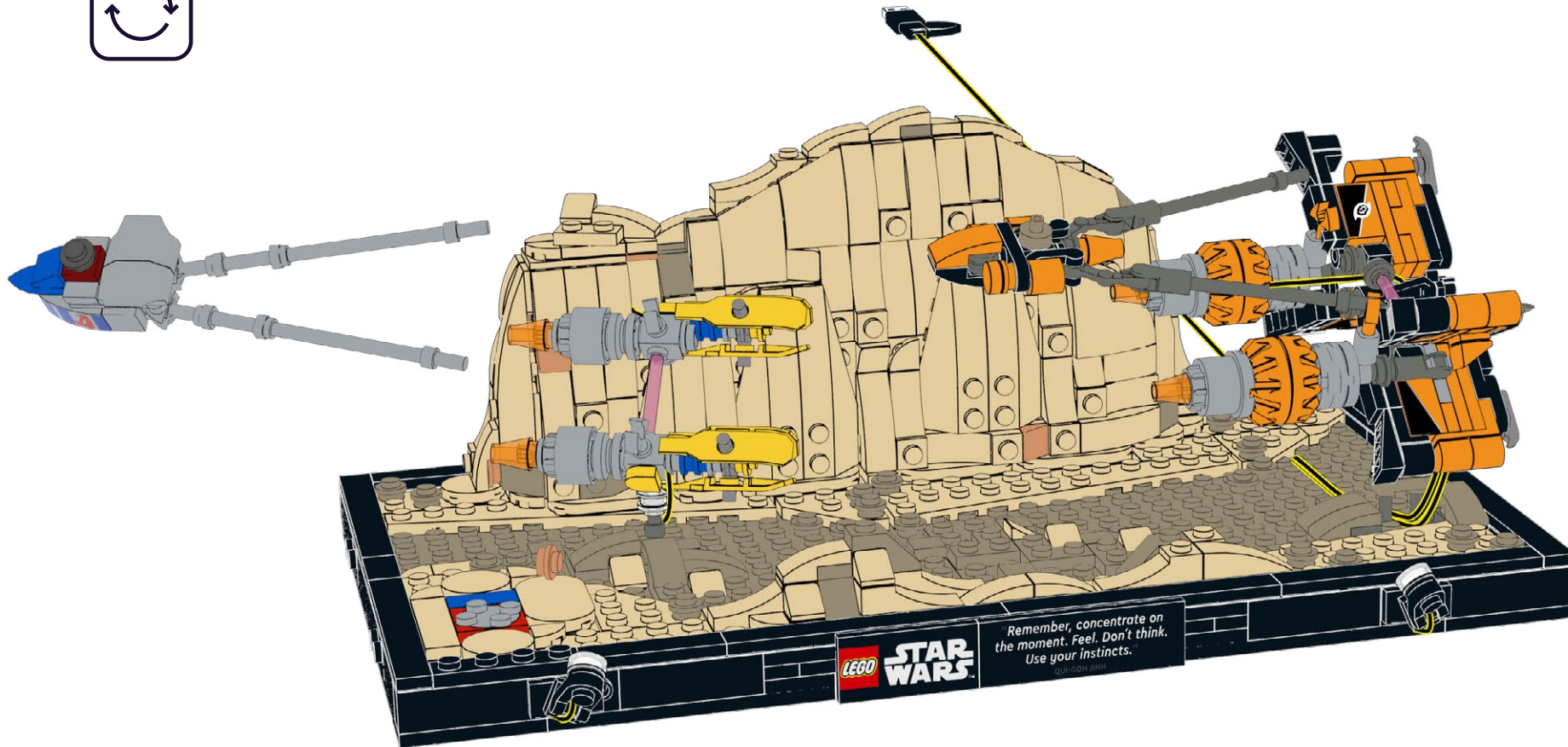

205

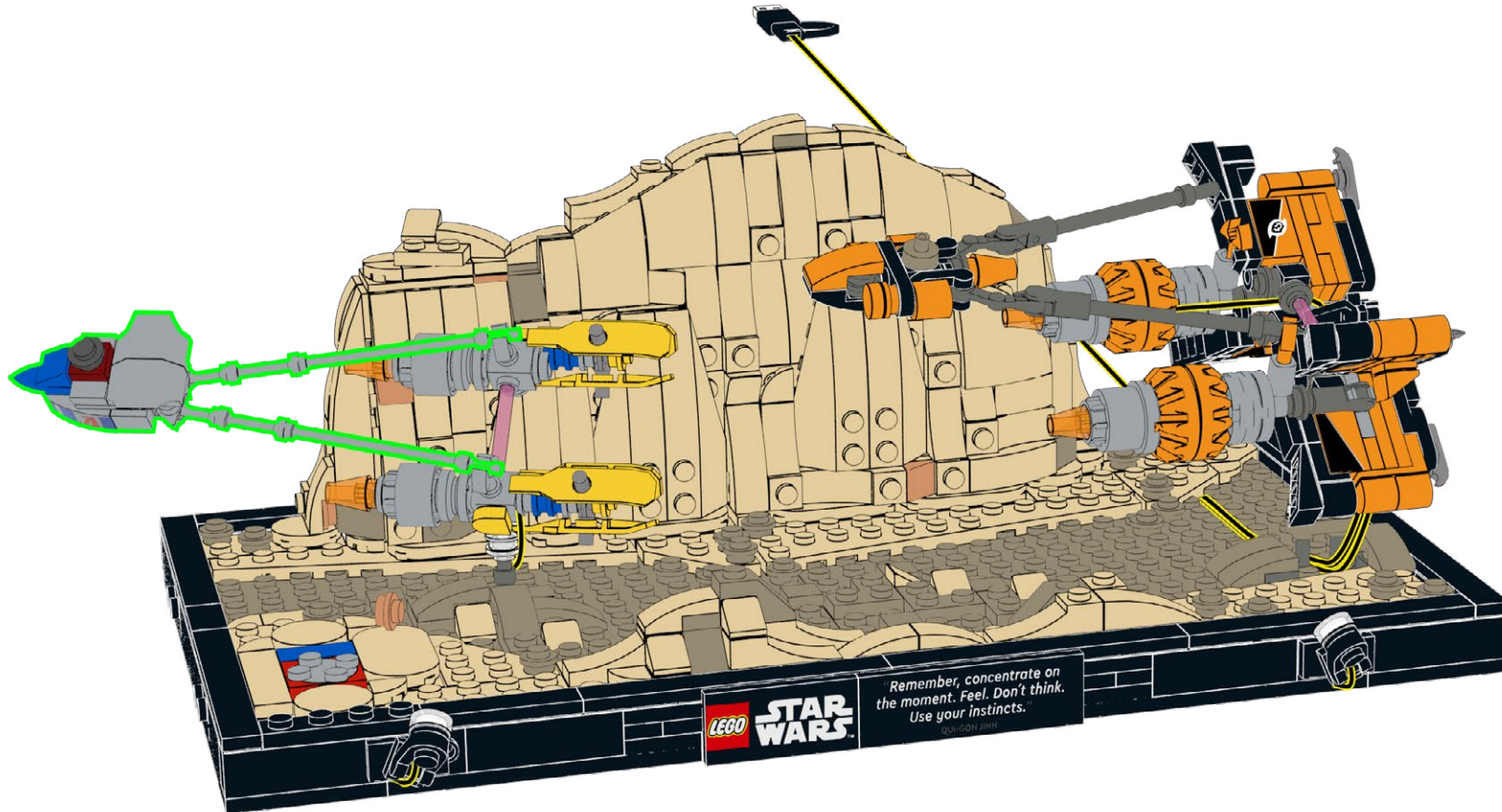

LEGO STAR WARS

Remember, concentrate on the moment. Feel. Don't think. Use your instincts.

206

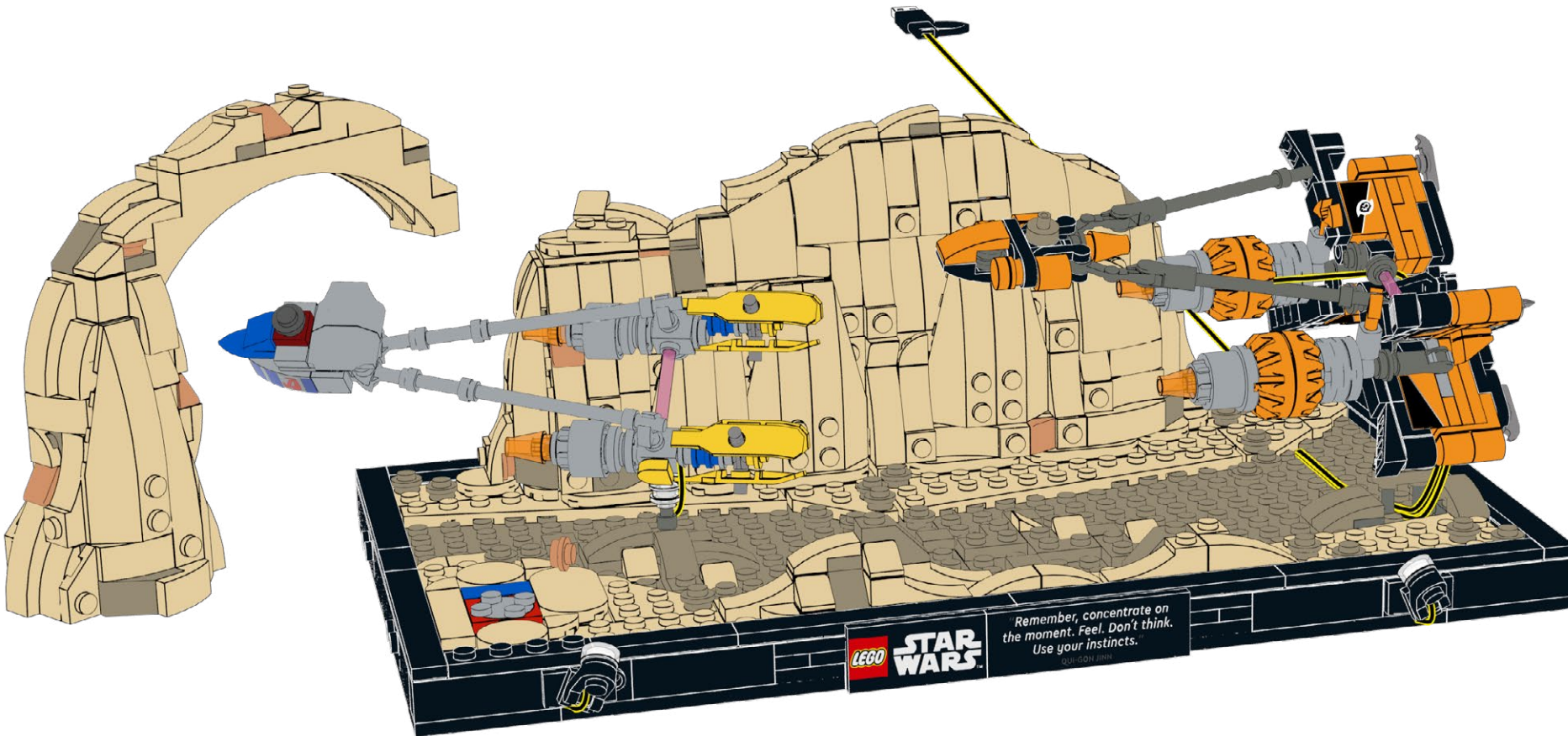

LEGO STAR WARS

Remember, concentrate on the moment. Feel. Don't think. Use your instincts.

207

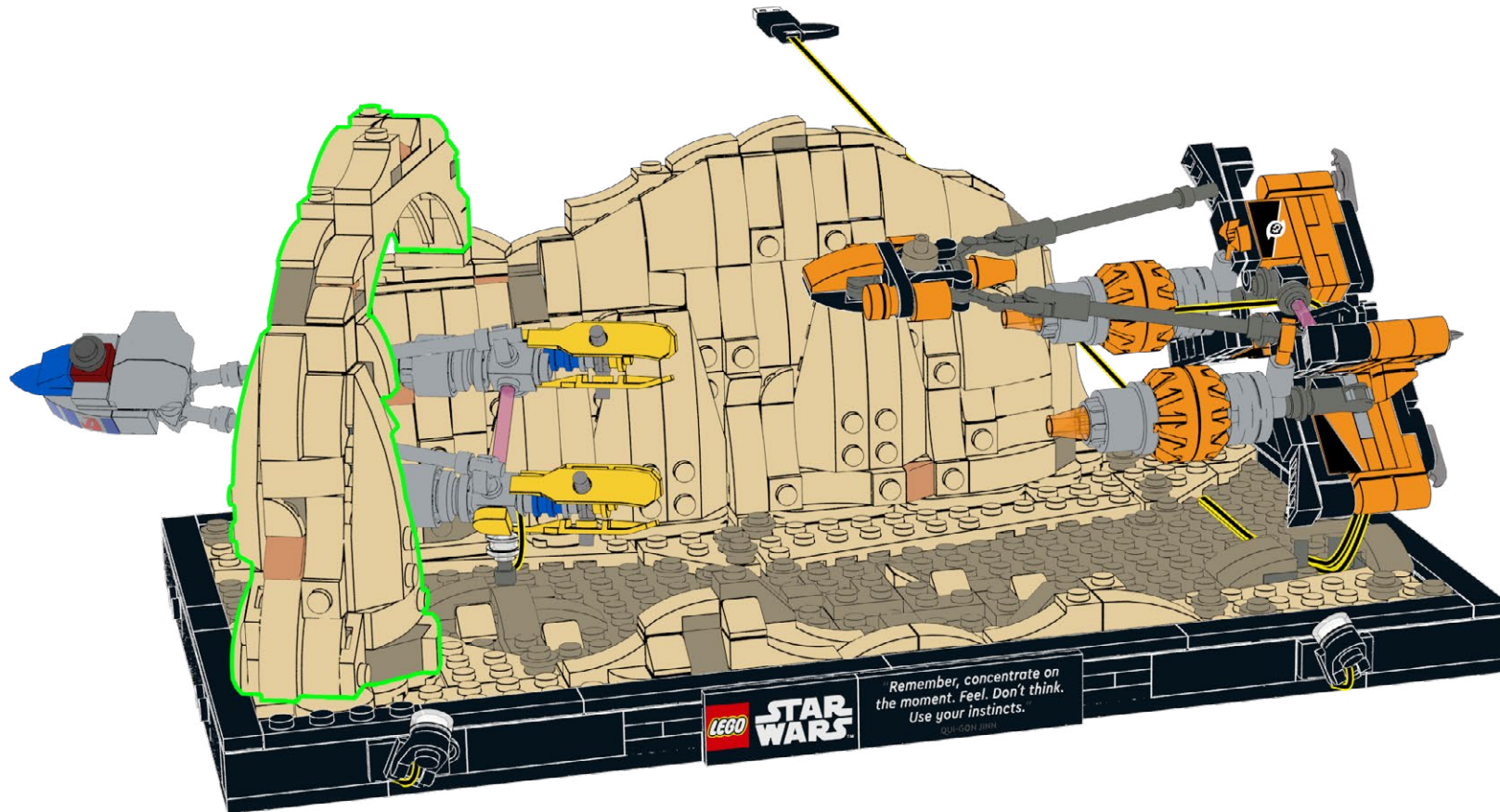

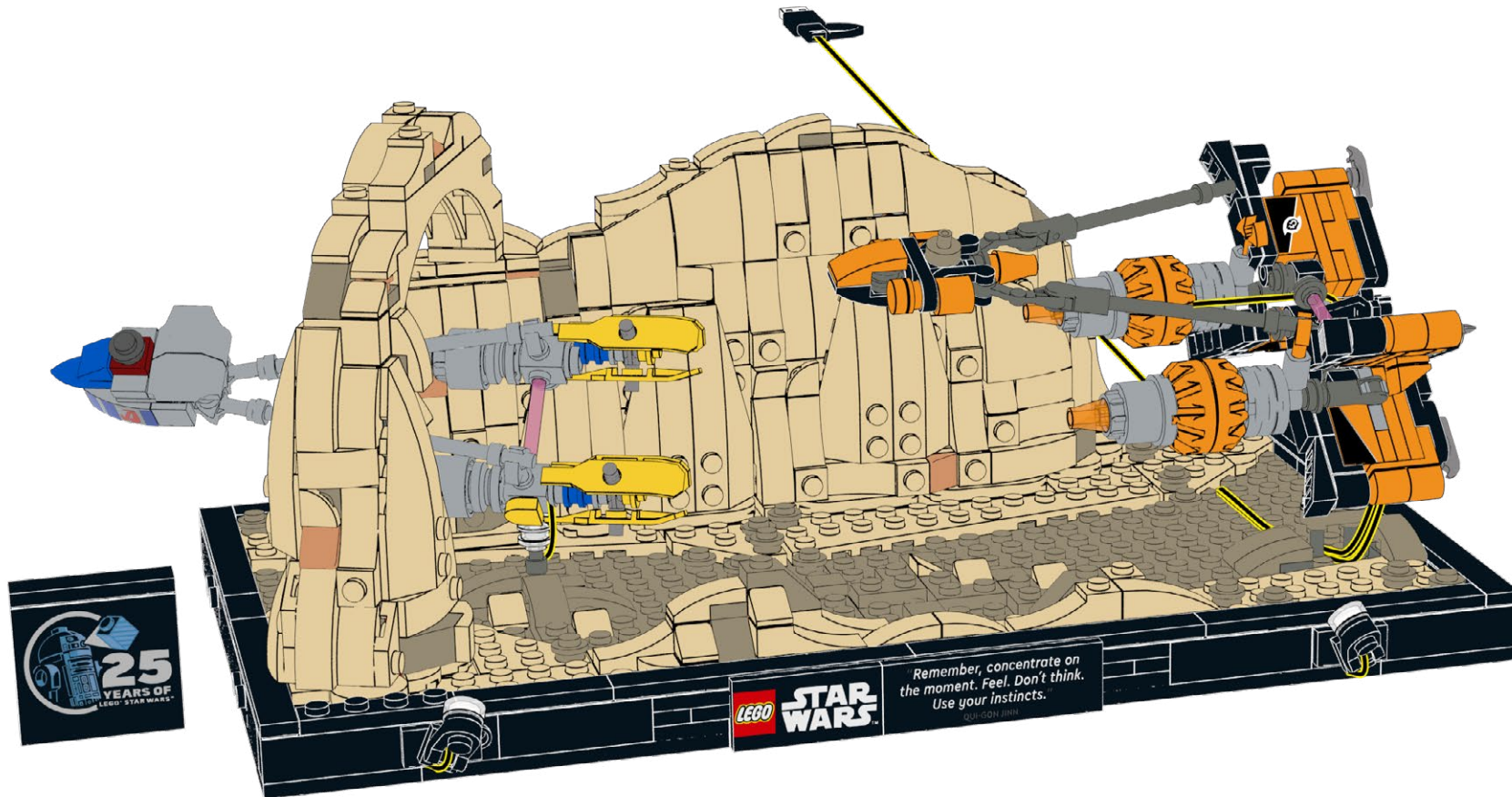

209

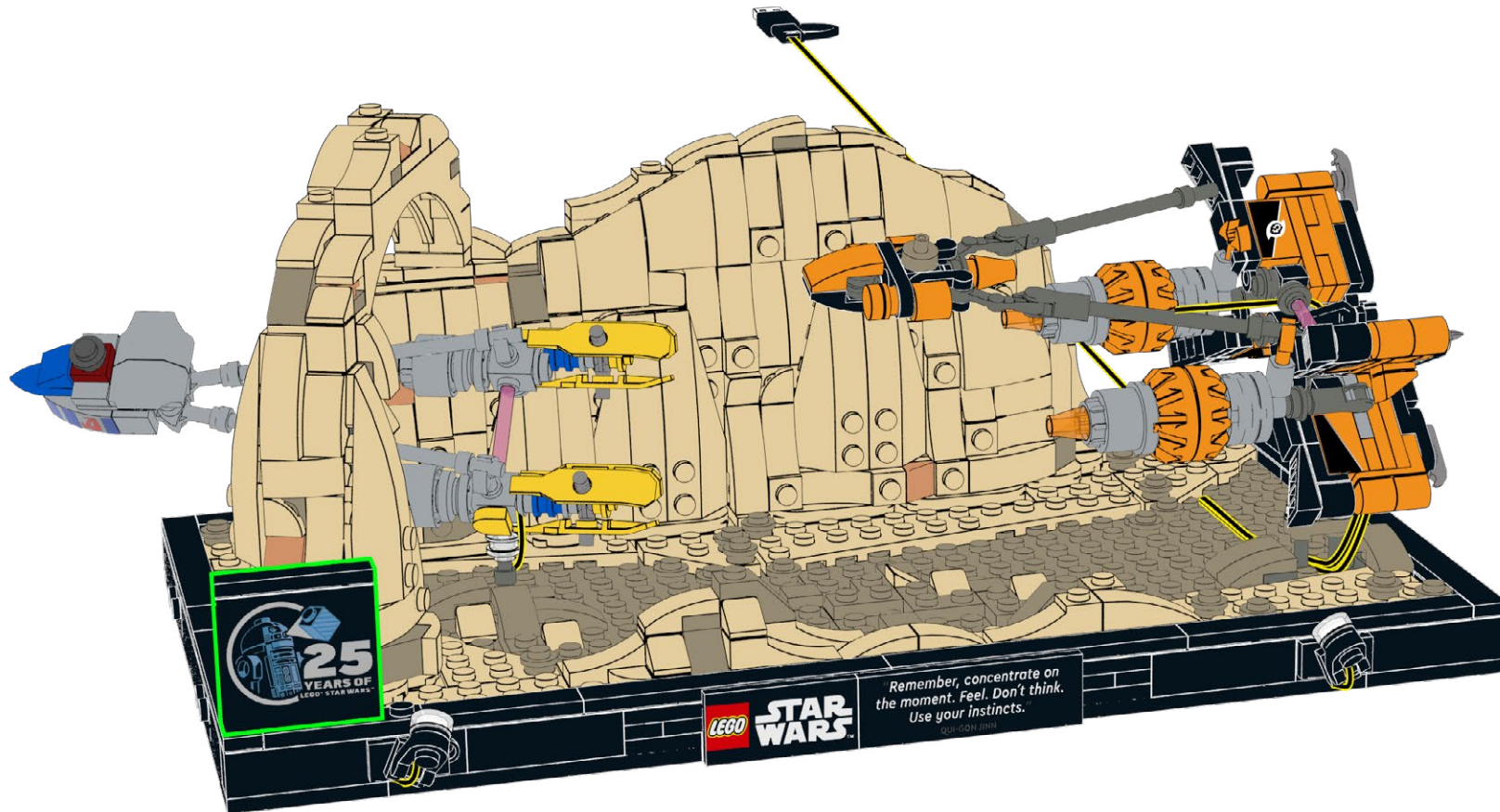

210

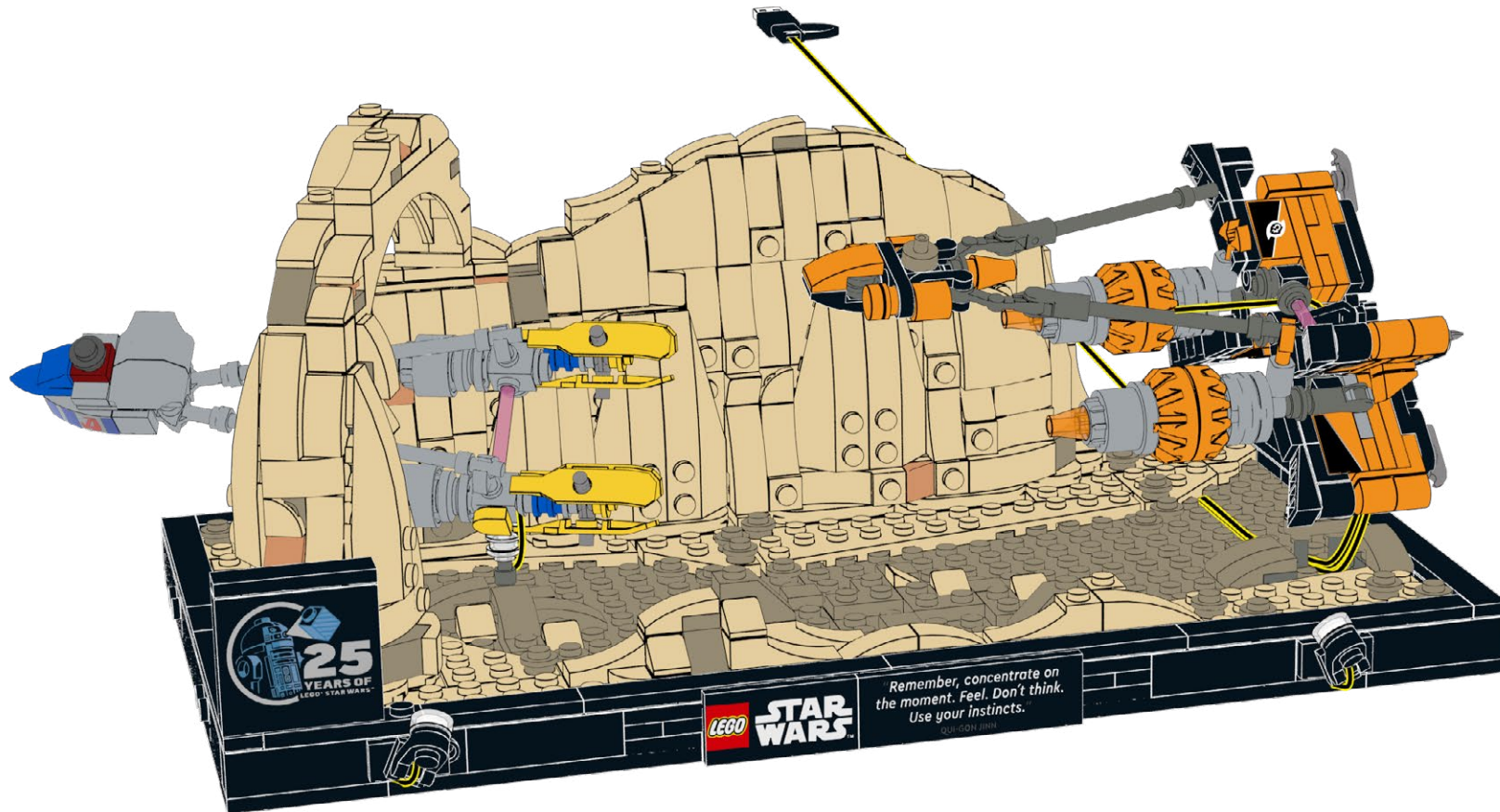



211



212



# FINAL PRODUCT



# PACKAGE CONTENTS



**4x** AR-WW30  
Astro Light Regular  
Warm White 30cm



**2x** A-CAP  
Astro Cap



**2x** AR-P30  
Astro Light Regular  
Pink 30cm

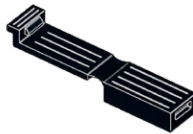

**1x** E-1x2  
Eclipse 1x2



**2x** AL-WW30  
Astro Light Large  
Warm White 30cm



**1x** Flex Belt-30  
Belt 30cm



**1x** D-9  
Dock-9

# PACKAGE CONTENTS



**2x** Tile, Modified 1 × 1 with Open O Clip  
Black



**2x** Round Plate 1×1 w Open Stud  
Black



**2x** Plate, Round 1 × 1 with Bar Handle  
Black

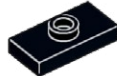

**2x** Plate, Modified 1 × 2 with 1 Stud with Groove (Jumper)  
Black



**4x** Cone 1×1 with Top Groove  
Trans-Orange



**1x** Bracket 1×2 - 1×2  
Black



**1x** Plate 1×6  
Black

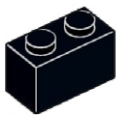

**1x** Brick 1×2  
Black

# CONTACT US

Click below for customer support, or general inquiries.

Cliquez ci-dessous pour accéder au support client ou aux renseignements généraux.

Clicca qui sotto per l'assistenza clienti o per richieste generali.

Contact Us



Contactez-nous



Contattaci



Klicken sie unten für kundensupport oder allgemeine anfragen.

Haga clic a continuación para atención al cliente o consultas generales.

点击下方获取客户支持或一般咨询。

Kontaktieren sie uns



Contáctanos



联系我们



## TROUBLESHOOTING

If you're stuck, scan the QR code for troubleshooting.

Se sei bloccato, scansiona il codice QR per la risoluzione dei problemi.

Wenn Sie nicht weiterkommen, scannen Sie den QR-Code zur Fehlerbehebung.

Si vous êtes bloqué, scannez le code QR pour le dépannage

Si está atascado, escanee el código QR para solucionar el problema.

如果遇到问题, 请扫描二维码进行故障排除

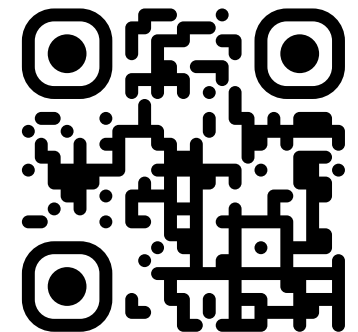



# LIGHTMYBRICKS

[lightmybricks.com](http://lightmybricks.com)



LEGO® is a trademark of the LEGO Group of companies, which does not sponsor, authorize or endorse this product. All LEGO® sets featured in images are sold separately. This is not a LEGO® product. The LEGO Group is not liable for any loss, injury or damage arising from the use or misuse of this product. ©2024 Light My Bricks Pty Ltd. All rights reserved. [www.lightmybricks.com](http://www.lightmybricks.com)

Our components are designed and packaged in Australia by Light My Bricks Pty Ltd. Components are manufactured in China. 3fl bldg C, Shuanghuan Quanxin Technology Information Industry Park Baolong Street, Longgang District, Shenzhen, China. Imported in Australia by Light My Bricks Pty Ltd, 5/26 Rushdale St, Knoxfield, VIC, 3180, Australia.

WARNING: CHOKING HAZARD - Small parts. Not for children under 3 years.

AVERTISSEMENT : RISQUE D'ÉTOUFFEMENT - Petites pièces. Ne convient pas aux enfants de moins de 3 ans.

ATTENZIONE: PERICOLO DI SOFFOCAMENTO - Piccole parti. Non adatto a bambini di età inferiore a 3 anni.

WARNUNG: ERSTICKUNGSGEFAHR - Kleine Teile. Nicht für Kinder unter 3 Jahren geeignet.

ADVERTENCIA: PELIGRO DE ASFIXIA - Piezas pequeñas. No son apto para niños menores de 3 años.

警告：窒息危险 - 小零件。不适合3岁以下儿童。