

LIGHT KIT INSTALLATION GUIDE

FERRARI DAYTONA SP3

FOR LEGO
SET
#42143

CONTENTS



03

Getting Started

- 04** Legend
- 05** Component Handling
- 06** Blueprint

07

Instructions

- 19** LMB Bag 01
- 88** LMB Bag 02
- 126** LMB Bag 03

168

Final Product

- 169** Contents & Glossary
- 171** Contact & Troubleshooting

GETTING STARTED



Bold, beautiful and bright, Light My Bricks elevates your favourite LEGO set from knick-knack to statement piece. Create a talking point at home or in the office that speaks to your passions with Light My Bricks. To learn more, click below.

[Learn More](#)



Audacieux, beau et lumineux, Light My Bricks élève votre ensemble LEGO préféré du statut de bibelot à celui de pièce maîtresse. Que ce soit à la maison ou au bureau, partagez votre passion des LEGO avec Light My Bricks. Cliquez ci-dessous pour en savoir plus.

[En savoir plus](#)



Audace, bello e luminoso, Light My Bricks eleva il tuo set LEGO preferito da soprammobile a pezzo di tendenza. Crea un punto di discussione a casa o in ufficio che parli alle tue passioni con Light My Bricks. Per saperne di più, clicca qui sotto.

[Ulteriori Informazioni](#)



Mutig, schön und hell – Light My Bricks verwandelt Ihr Lieblings-LEGO-Set von einem schnickschnack in ein statement-stück. Schaffen sie einen gesprächspunkt zu hause oder im büro, der Ihre leidenschaften widerspiegelt, mit Light My Bricks. Um mehr zu erfahren, klicken sie unten.

[Mehr erfahren](#)



Audaz, hermoso y brillante, Light My Bricks eleva tu set LEGO favorito de una chuchería a una pieza llamativa. Crea un tema de conversación en casa o en la oficina que hable de tus pasiones con Light My Bricks. Para obtener más información, haga clic a continuación.

[Más información](#)



大胆、美丽而明亮，Light My Bricks 将你喜爱的乐高套装从小摆件提升为引人注目的装饰品。在家或办公室打造一个能表达你激情的话题，了解更多，请点击下方。

[了解更多](#)



LEGEND

Rotate Set



Retournez L'ensemble
Ruota Set
Set Drehen
Rotar Conjunto
旋转套件

Add Part



Ajoutez une Pièce
Aggiungi Parte
Teil Hinzufügen
Agregar Pieza
添加零件

Click



Cliquez
Clic
Klicken
Clic
点击

Pinch/Fold



Pincez/Pliez
Pizzicare/Piegare
Kneifen/Falten
Pellizcar/Doblar
折叠

Pull Cable



Tirez le Cable
Tirare il Cavo
Kabel Ziehen
Tirar del Cable
拉动电缆

Repeat Step



Répétez
Ripetere
Wiederholen
Repetir
重复

Sticker



Autocollant
Adesivo
Aufkleber
Pegatina
贴纸

Power On Test



Test de mise sous tension
Test di Potenza
Stromtest
Prueba de Energía
电源测试

Disconnect Power

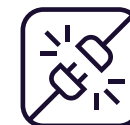

Débranchez L'alimentation
Scollegare L'alimentazione
Strom Trennen
Desconectar la Energía
断开电源

Troubleshoot



Dépanner
Risolvere
Fehlerbehebung
Solución de Problemas
故障排除

COMPONENT HANDLING

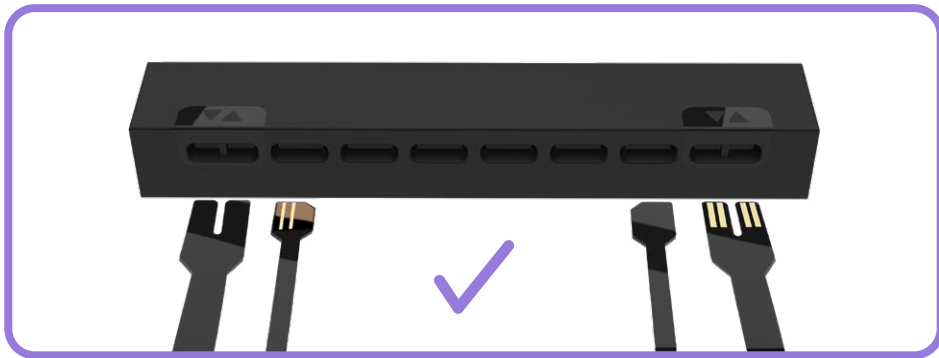
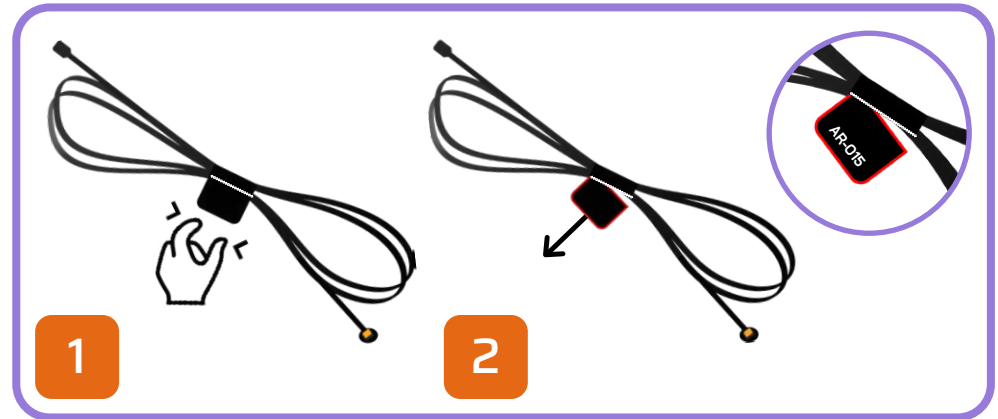
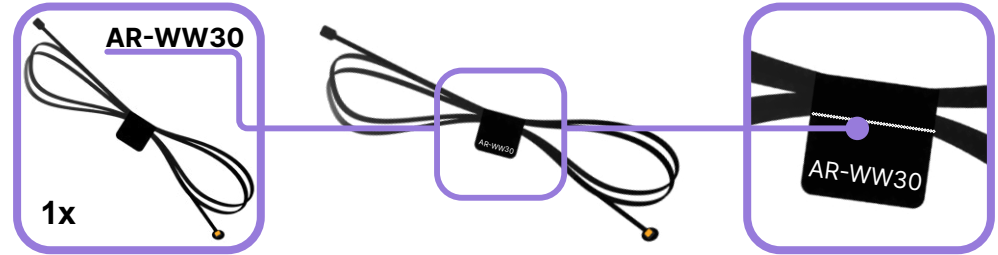
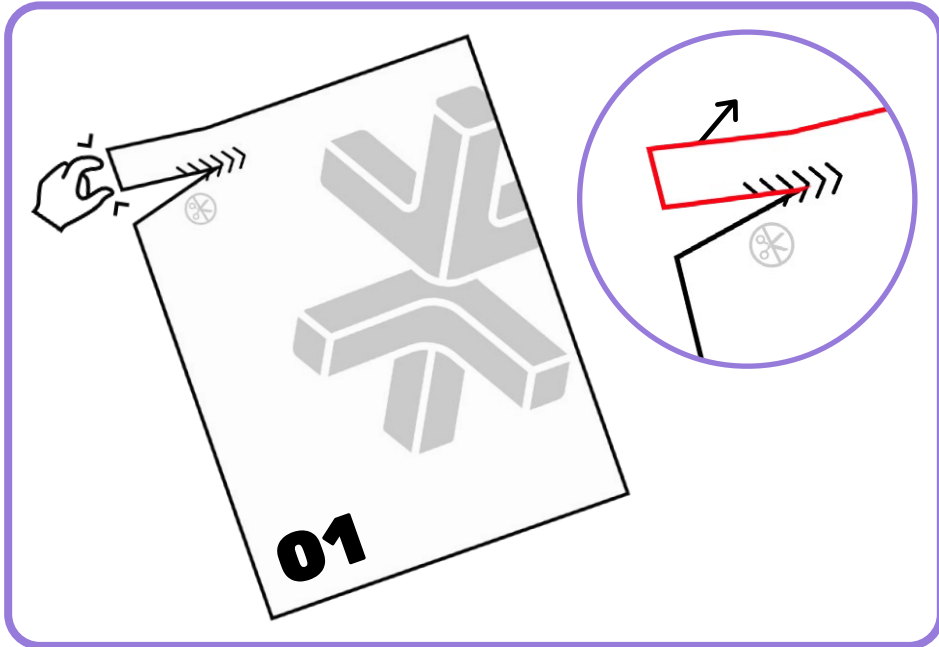

BLUEPRINT

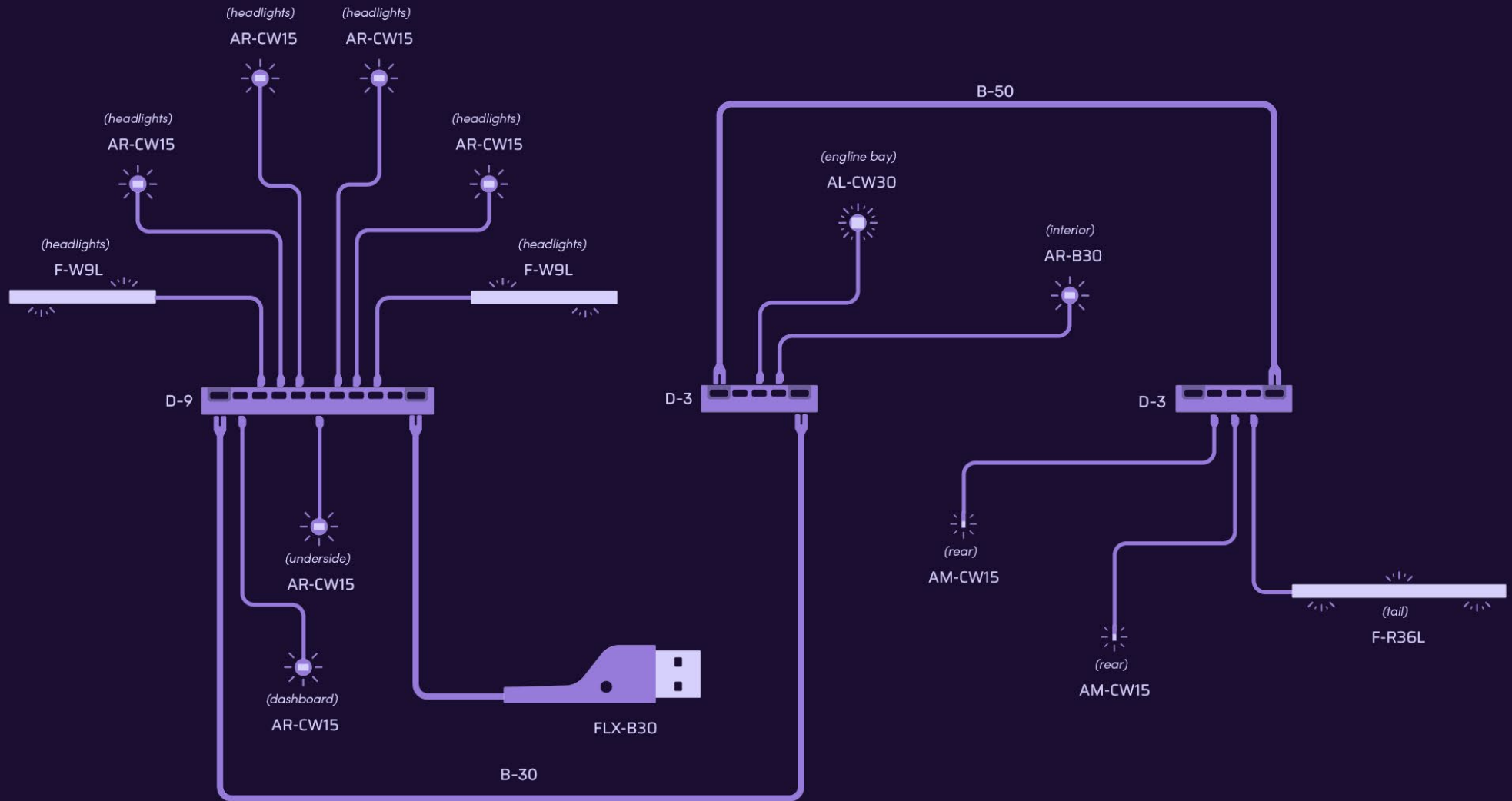

1

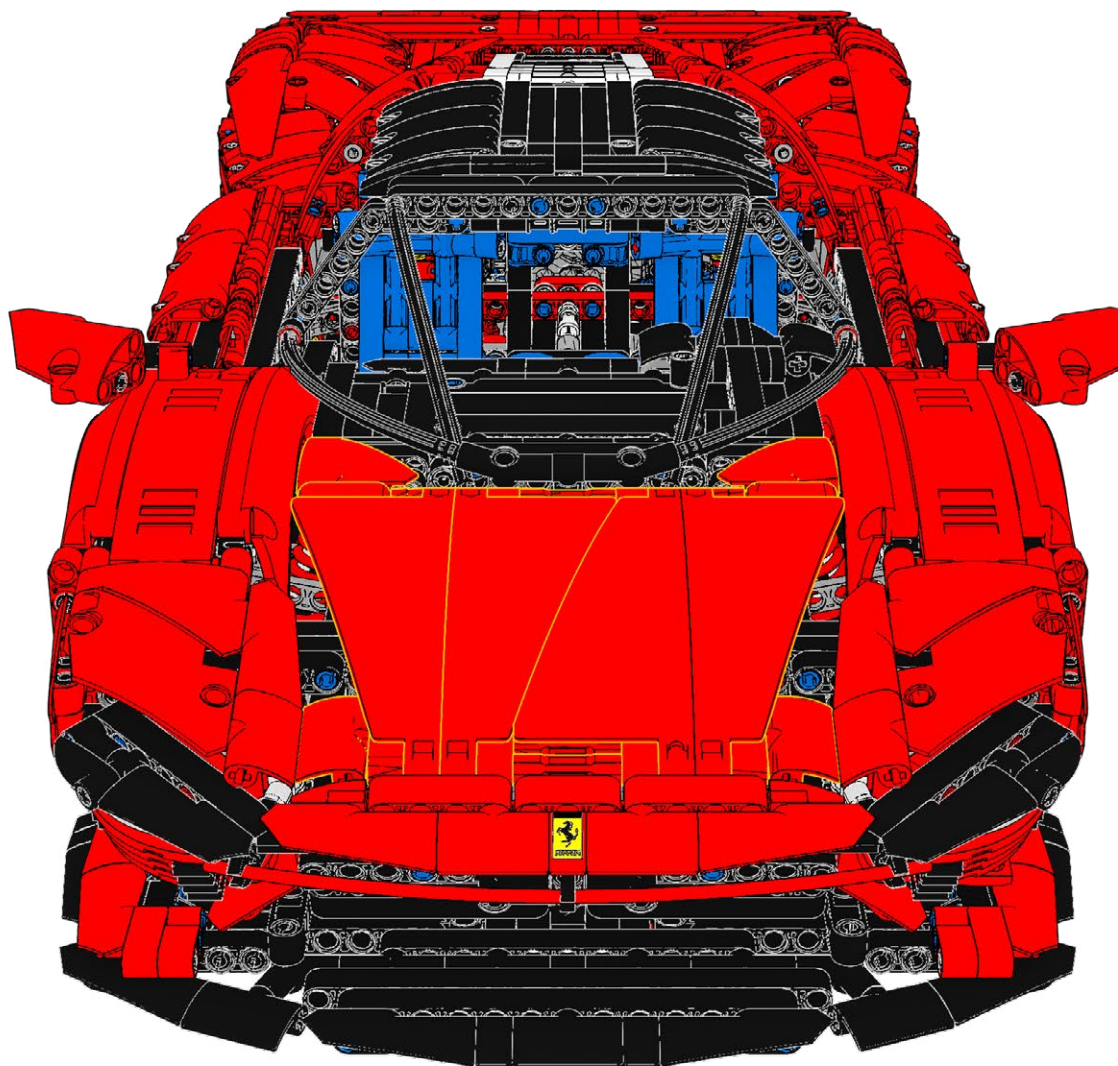

2

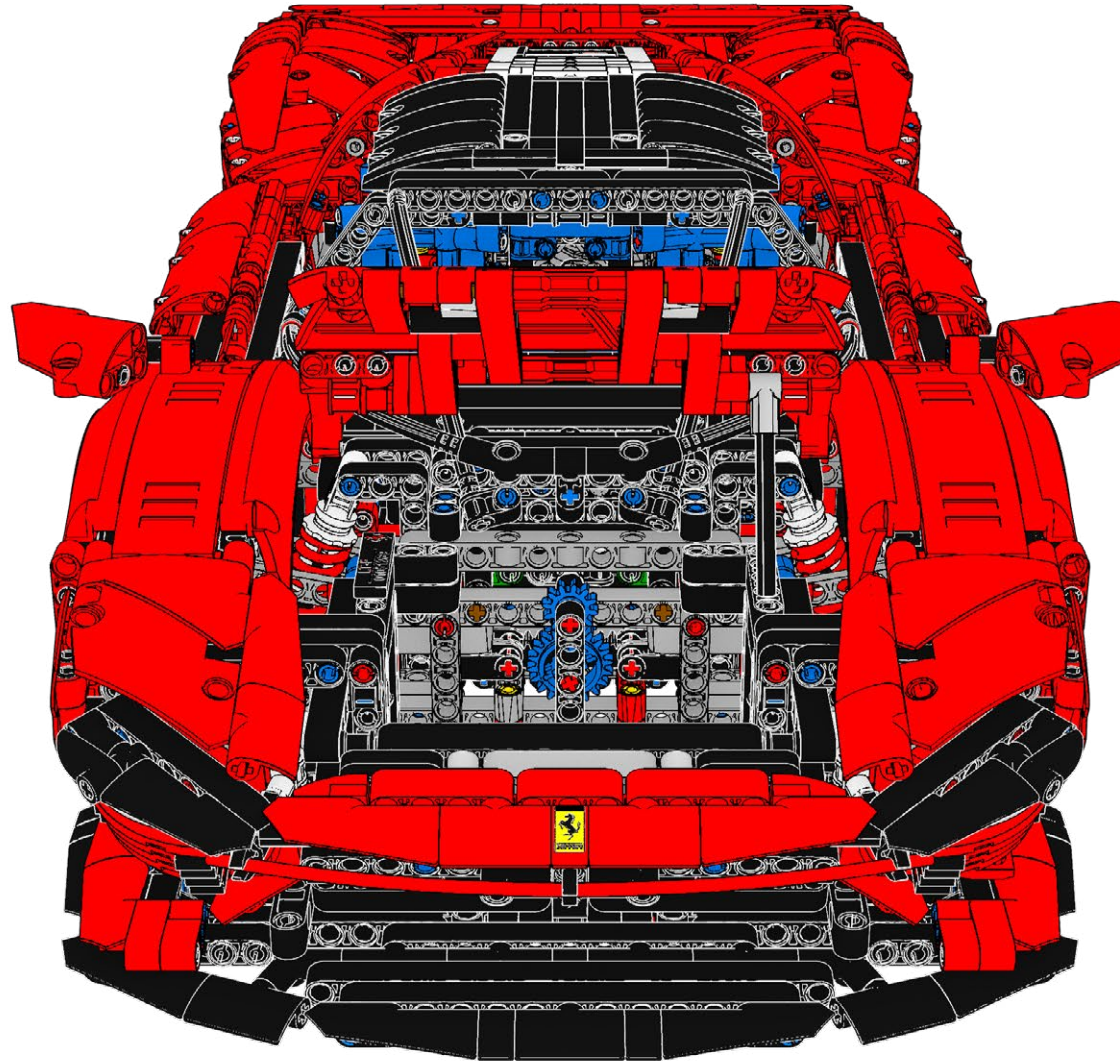

3

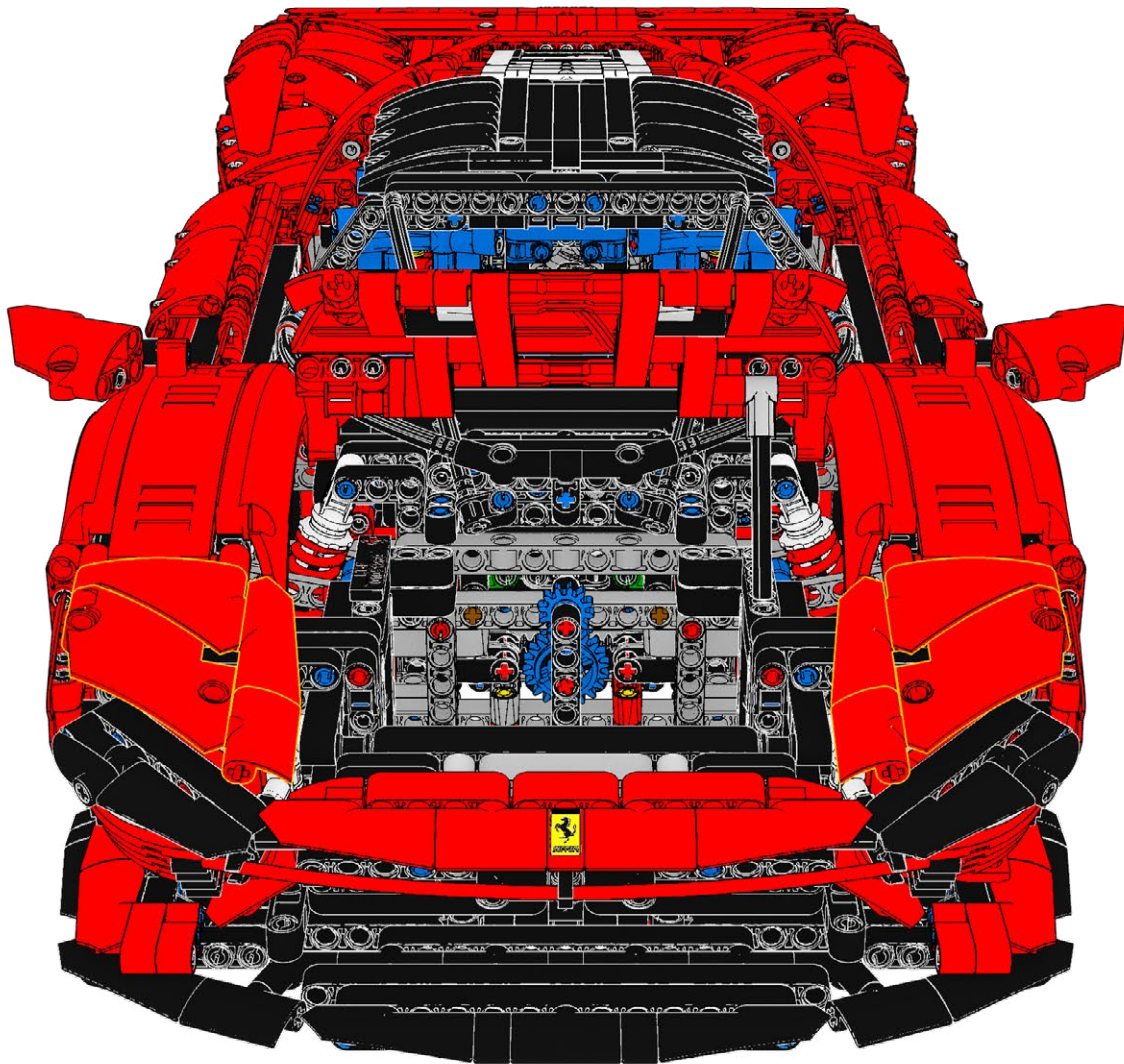

4

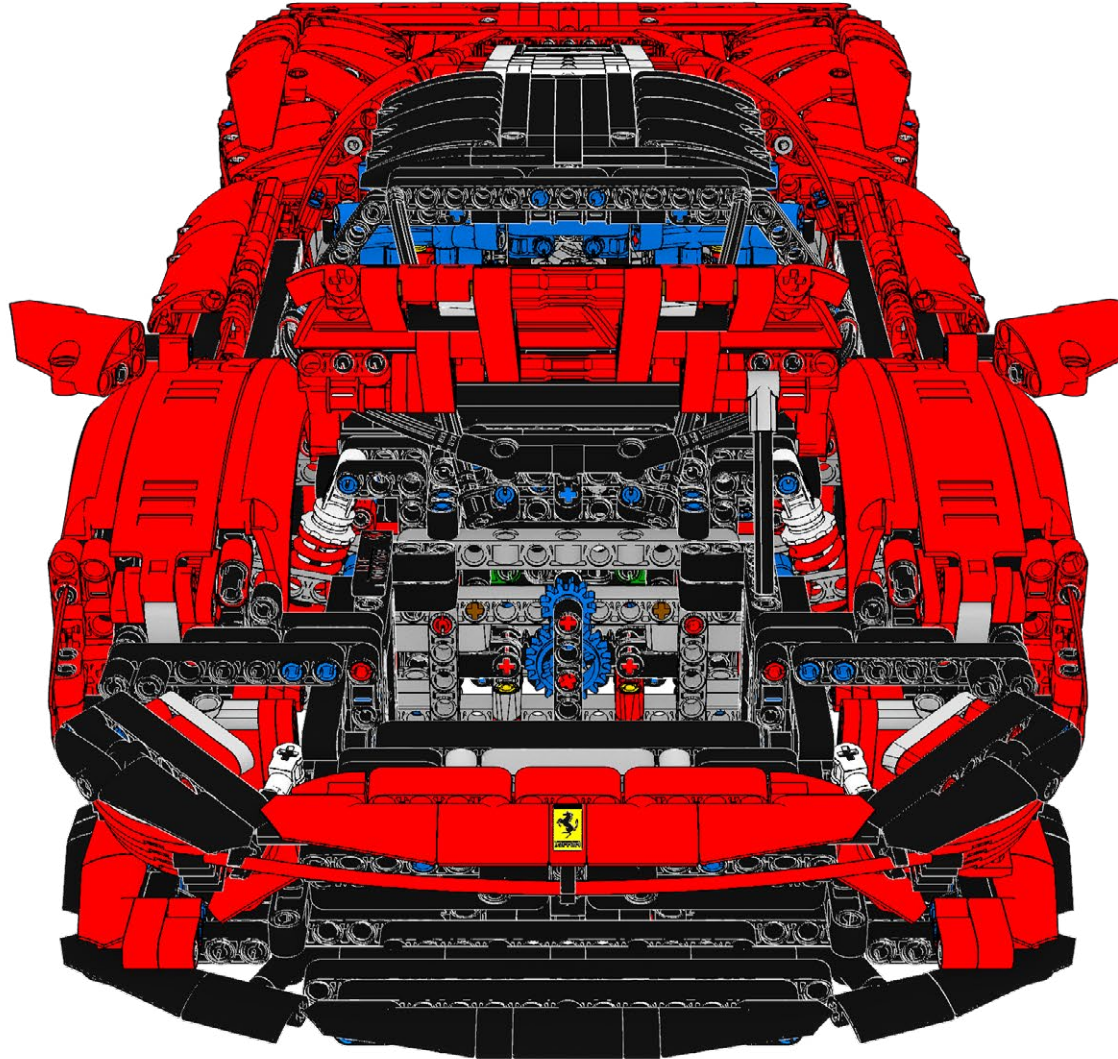

5

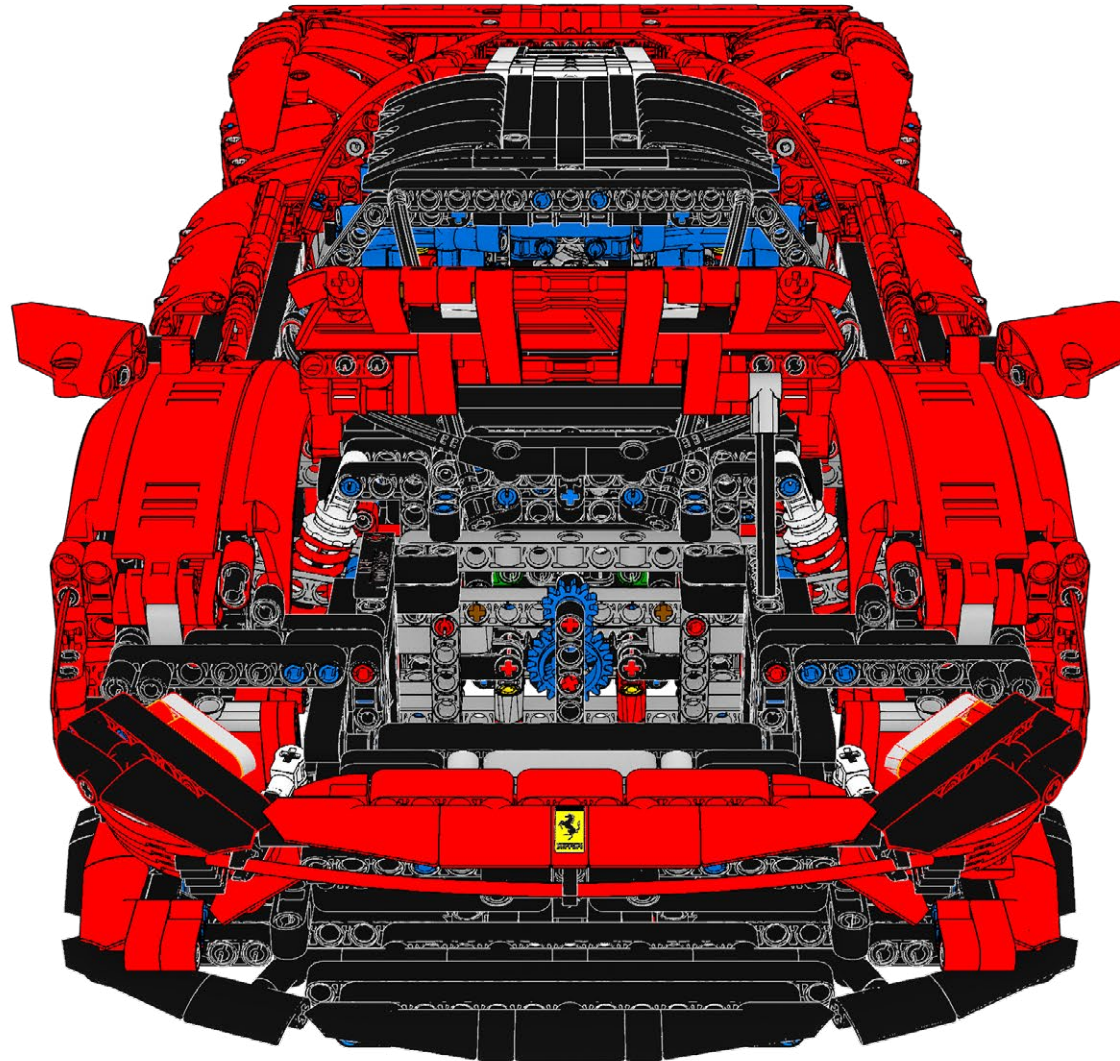

6

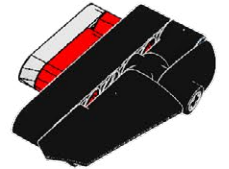
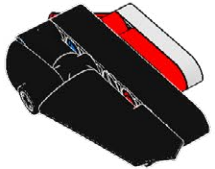
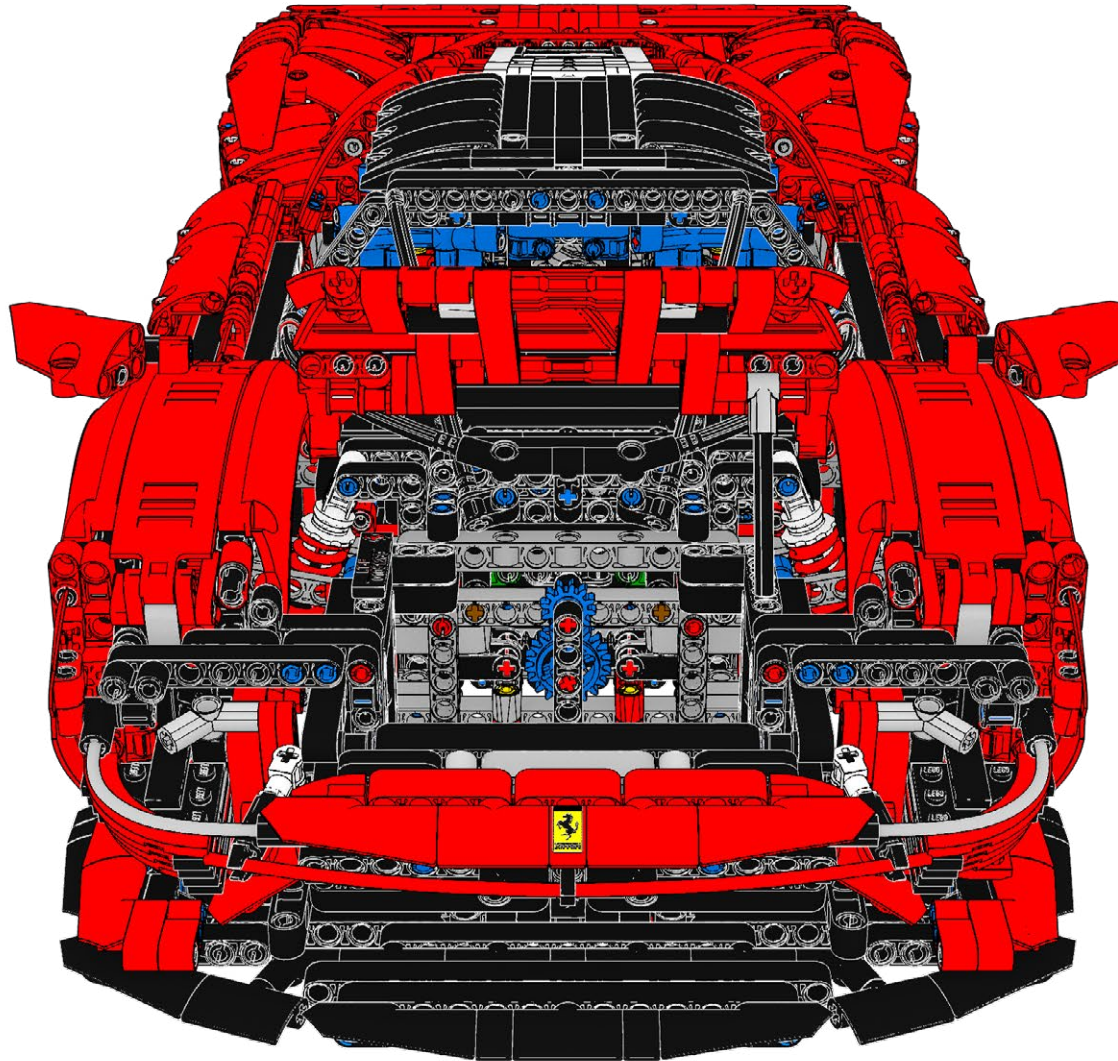

7

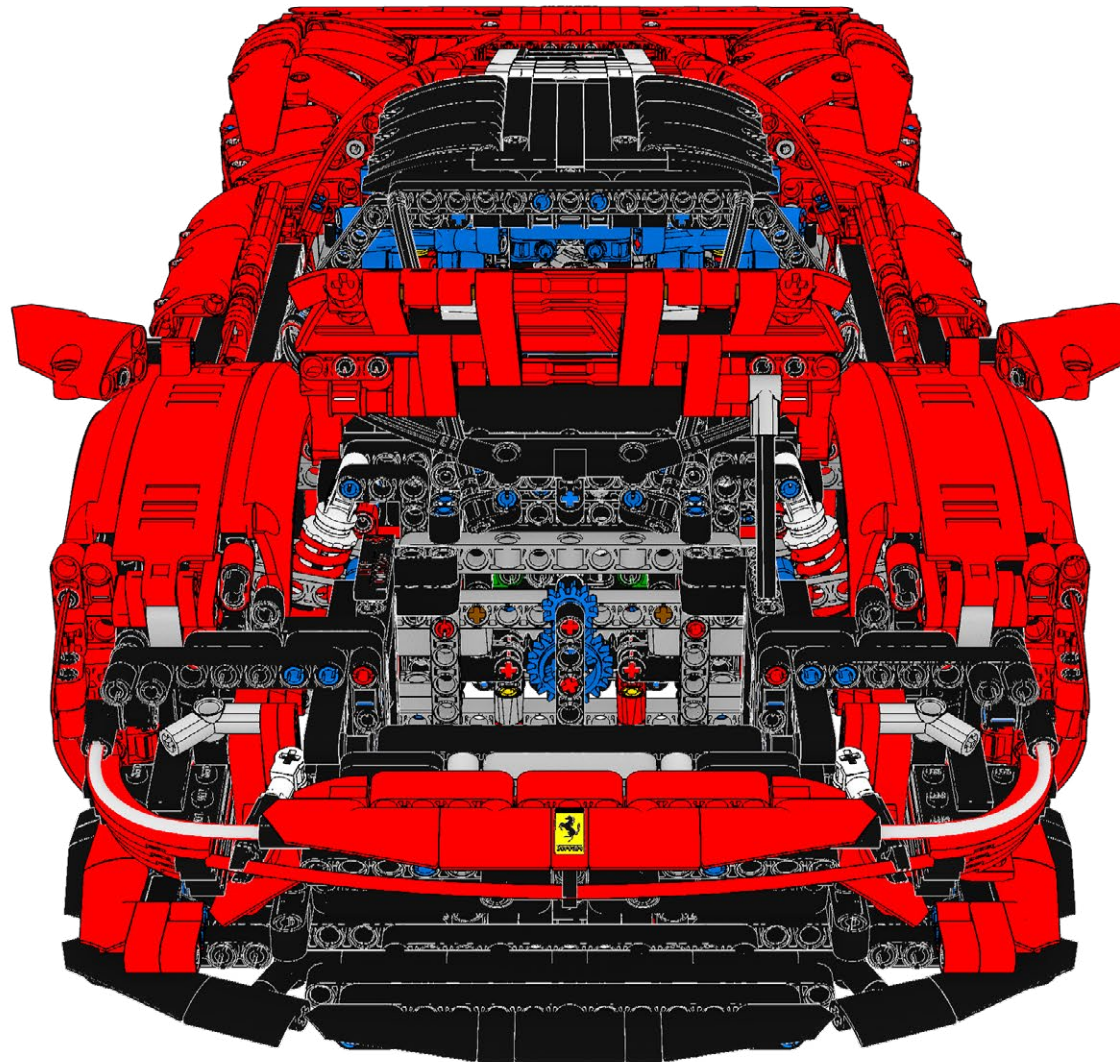

8

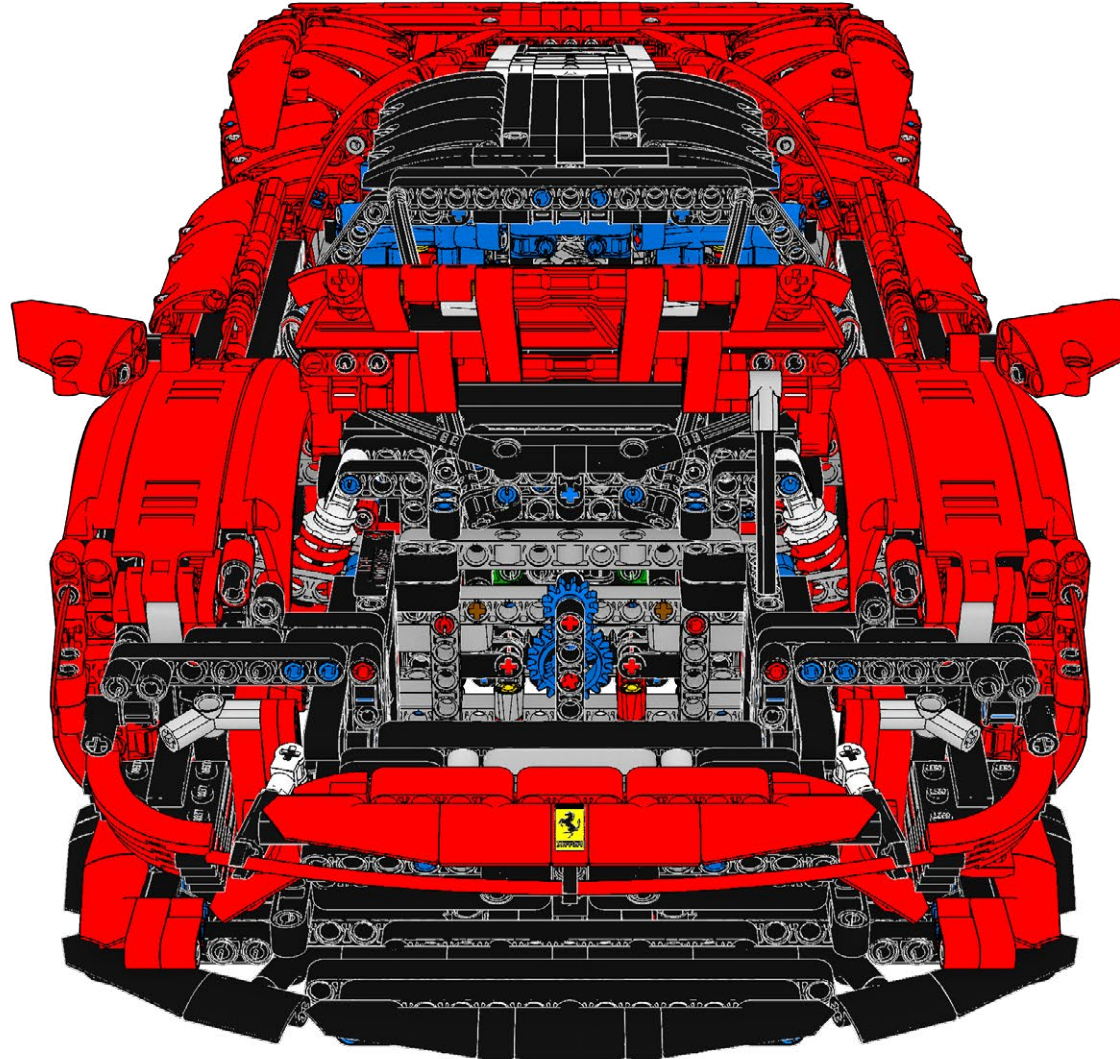

9

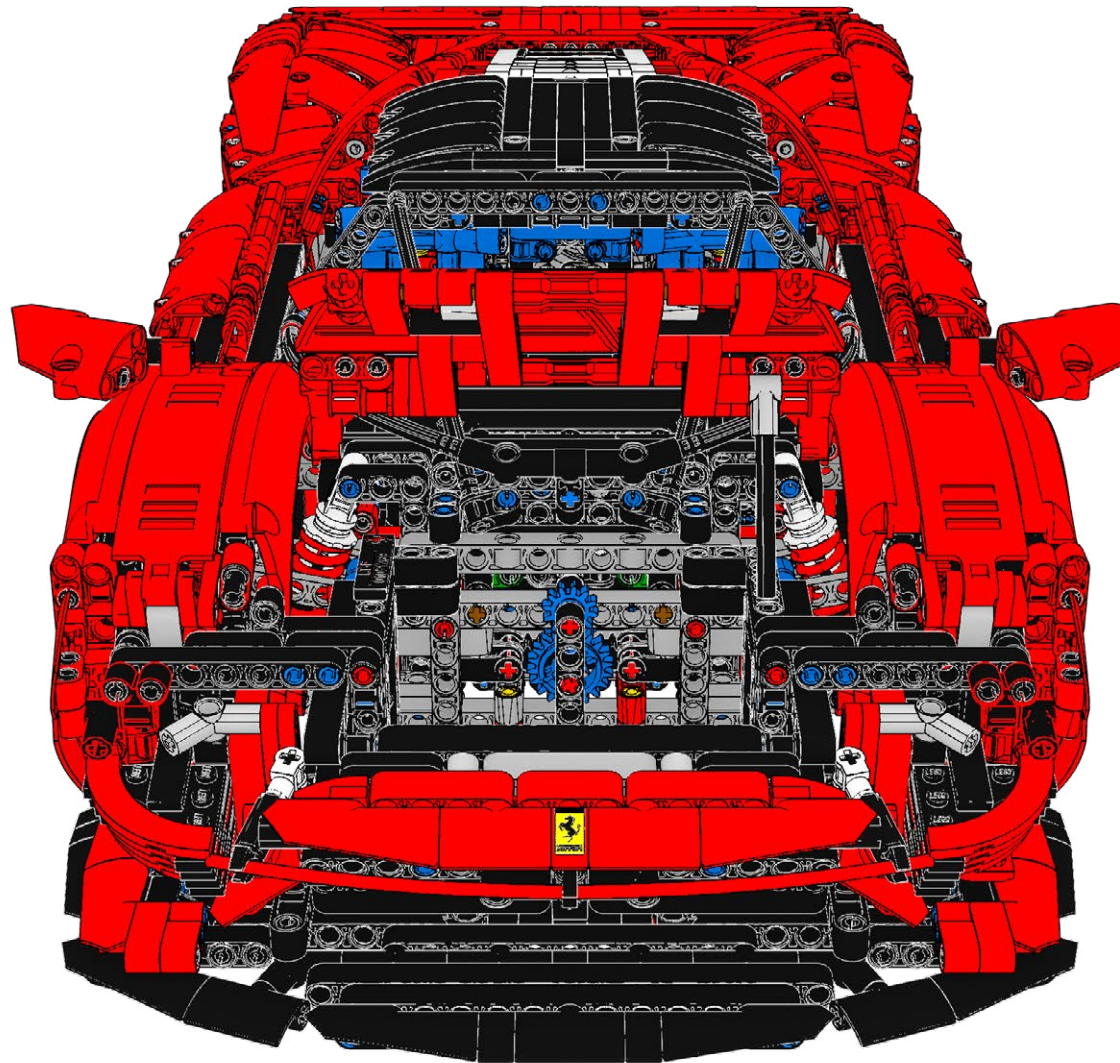

10

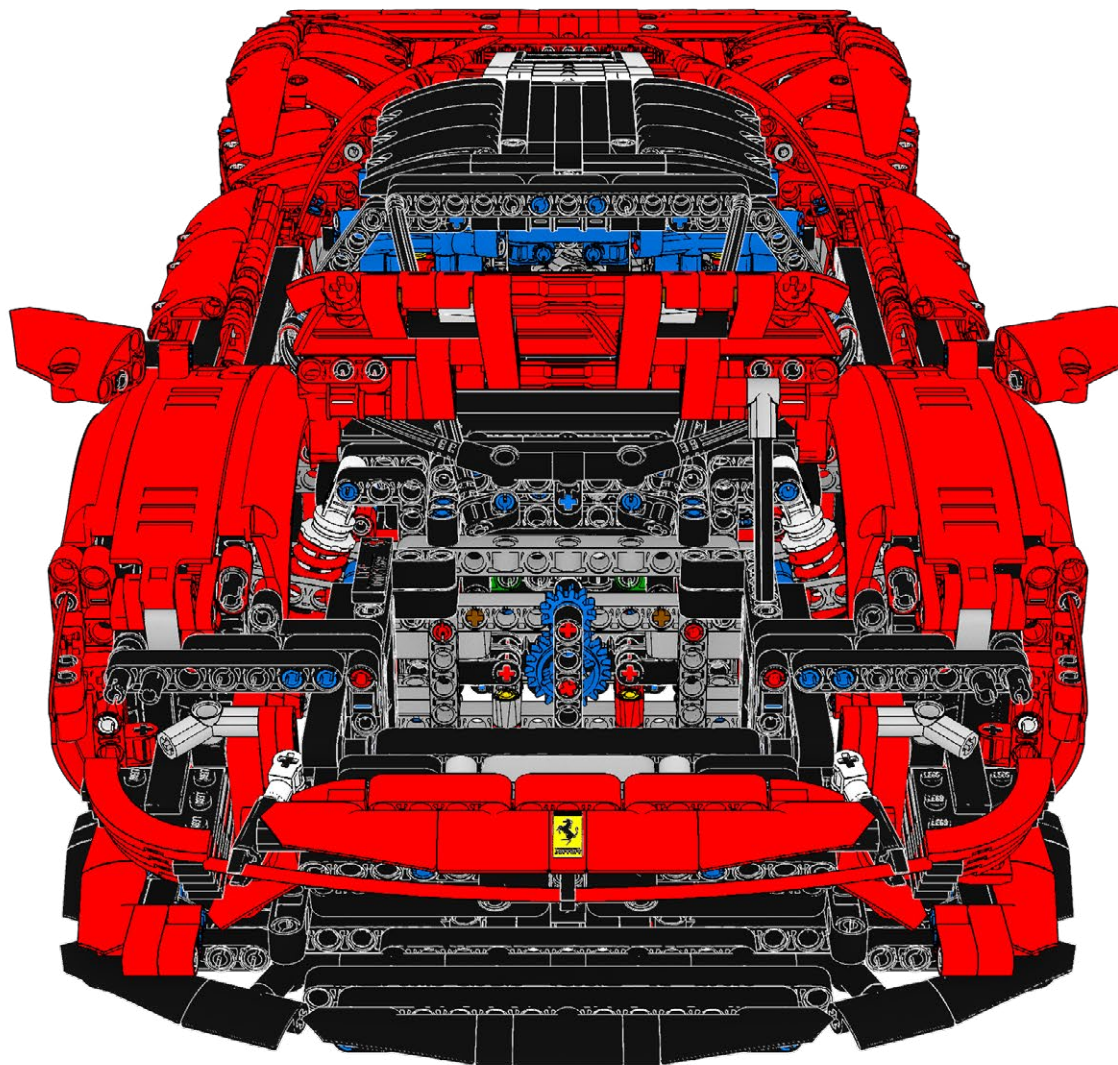

11

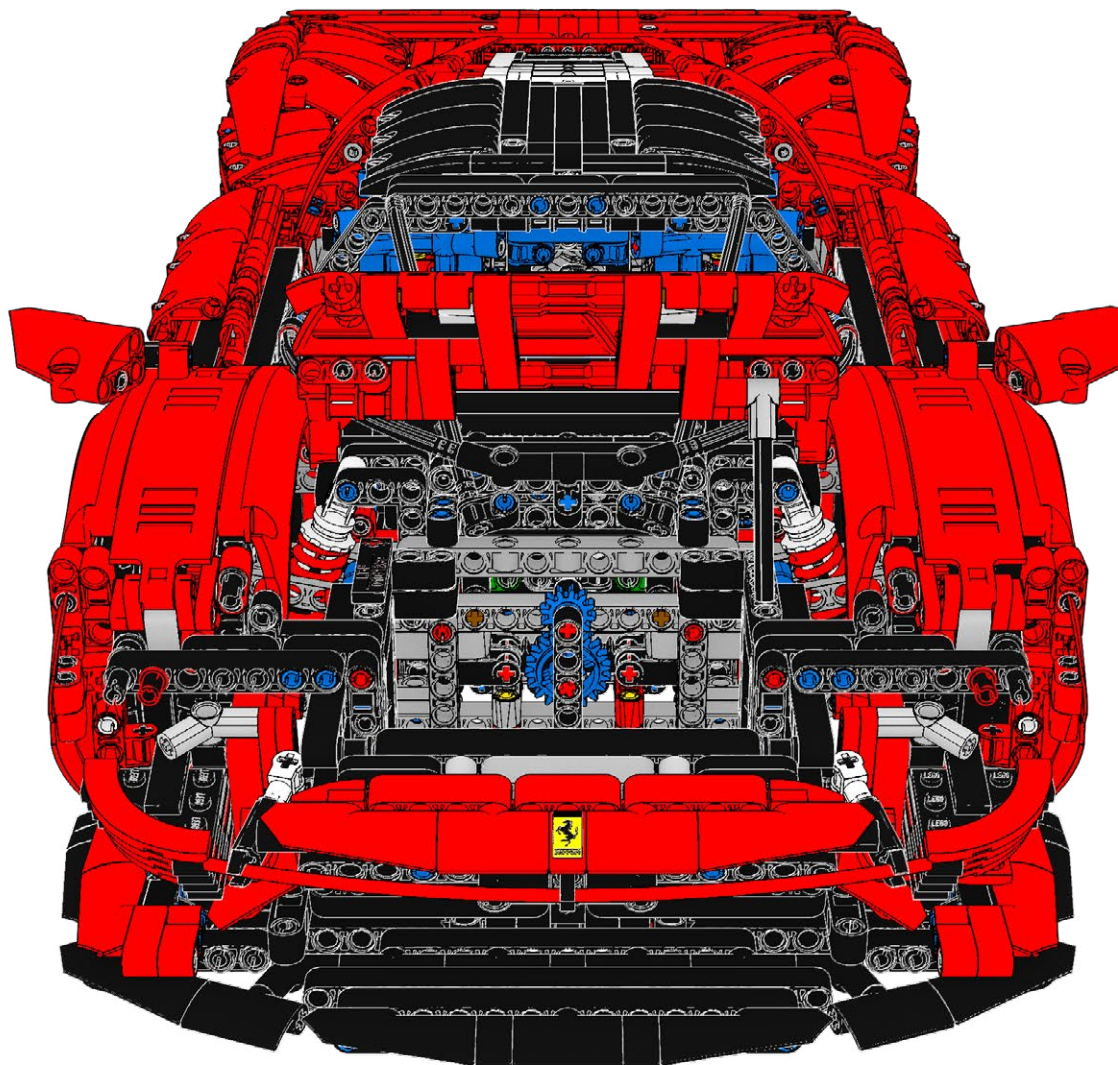

12

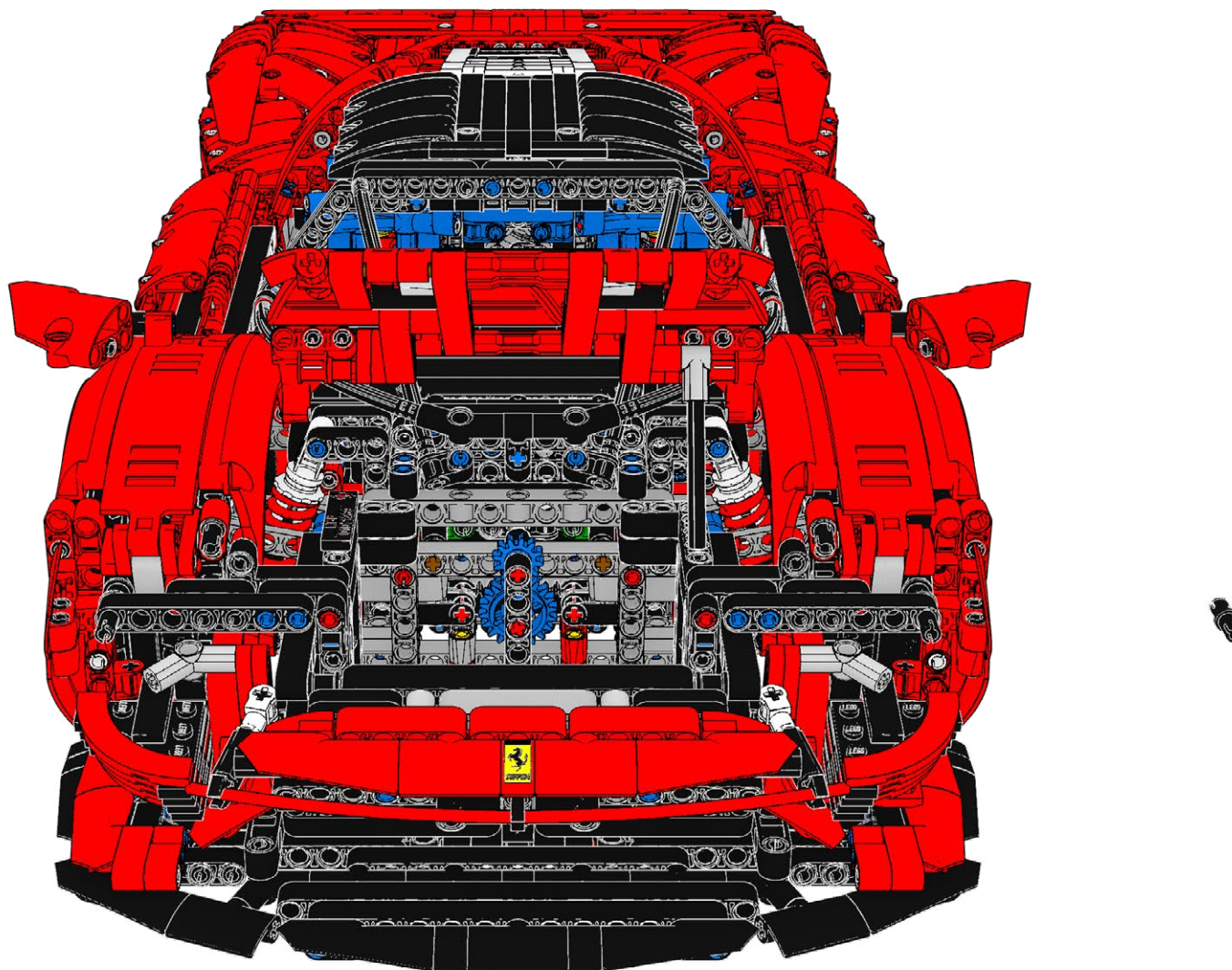



HOLD UP!

You might notice some bags are out of order, as well as left over pieces, but that's ok! We're changing the way you build LEGO!

HALTEN!

Möglicherweise stellen Sie fest, dass einige Beutel nicht in Ordnung sind und auch Teile übrig bleiben, aber das ist in Ordnung! Wir verändern die Art und Weise, wie Sie LEGO bauen!

TENIR BON!

Vous remarquerez peut-être que certains sacs sont en panne, ainsi que des morceaux restants, mais ce n'est pas grave ! Nous changeons la façon dont vous construisez LEGO !

SOSTENERE!

Potresti notare che alcune borse sono fuori uso, così come alcuni pezzi avanzati, ma va bene! Stiamo cambiando il modo in cui costruisci i LEGO!

¡SOSTENER!

Puede que notes que algunas bolsas están fuera de orden, así como piezas sobrantes, ¡pero está bien! ¡Estamos cambiando la forma de construir LEGO!

耽误!

您可能会注意到有些袋子坏了, 还有剩余的碎片, 但这没关系! 我们正在改变您搭建乐高的方式!

Open LMB Bag 01

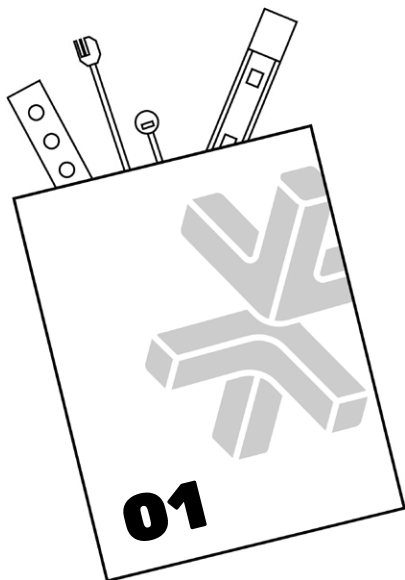

13



2x

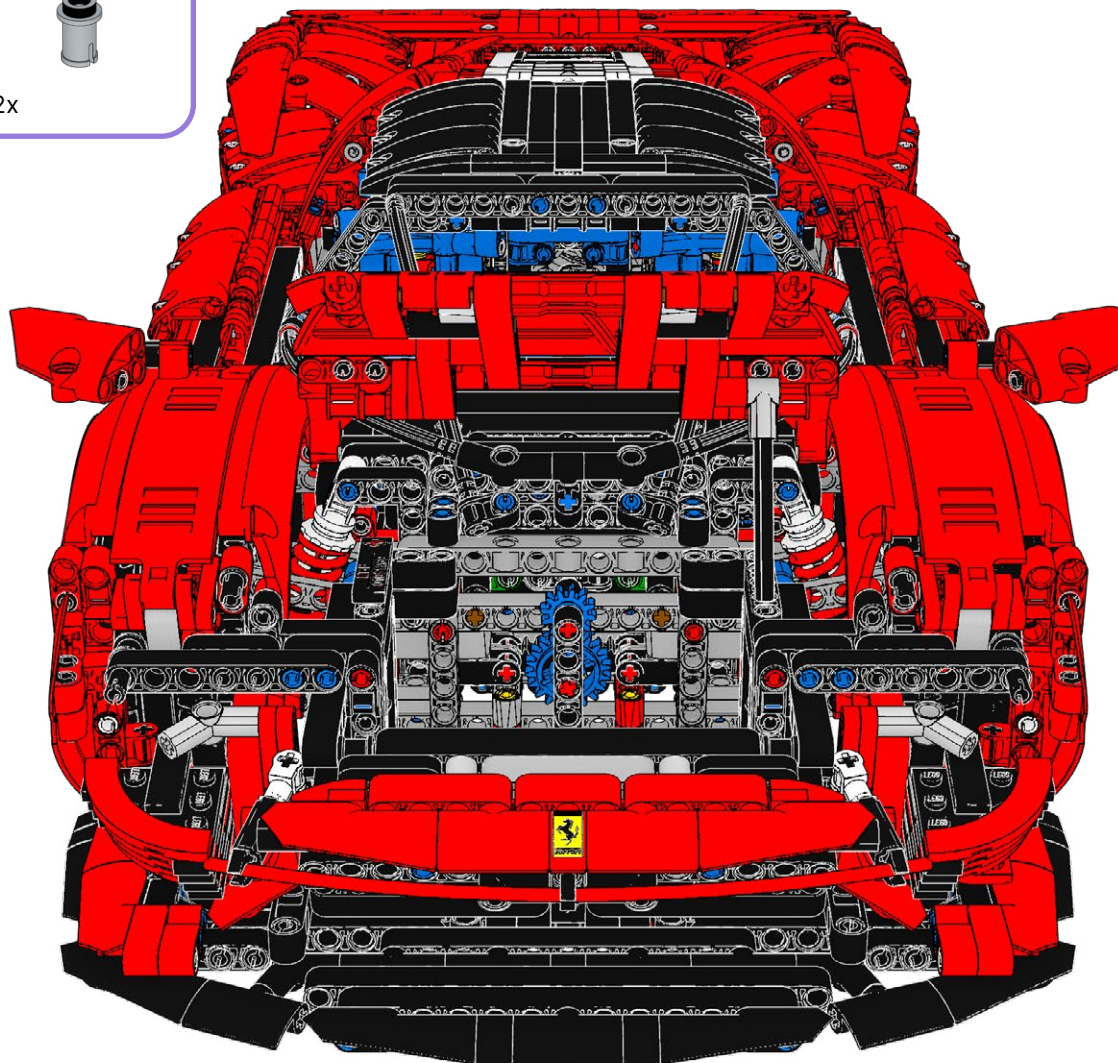

14

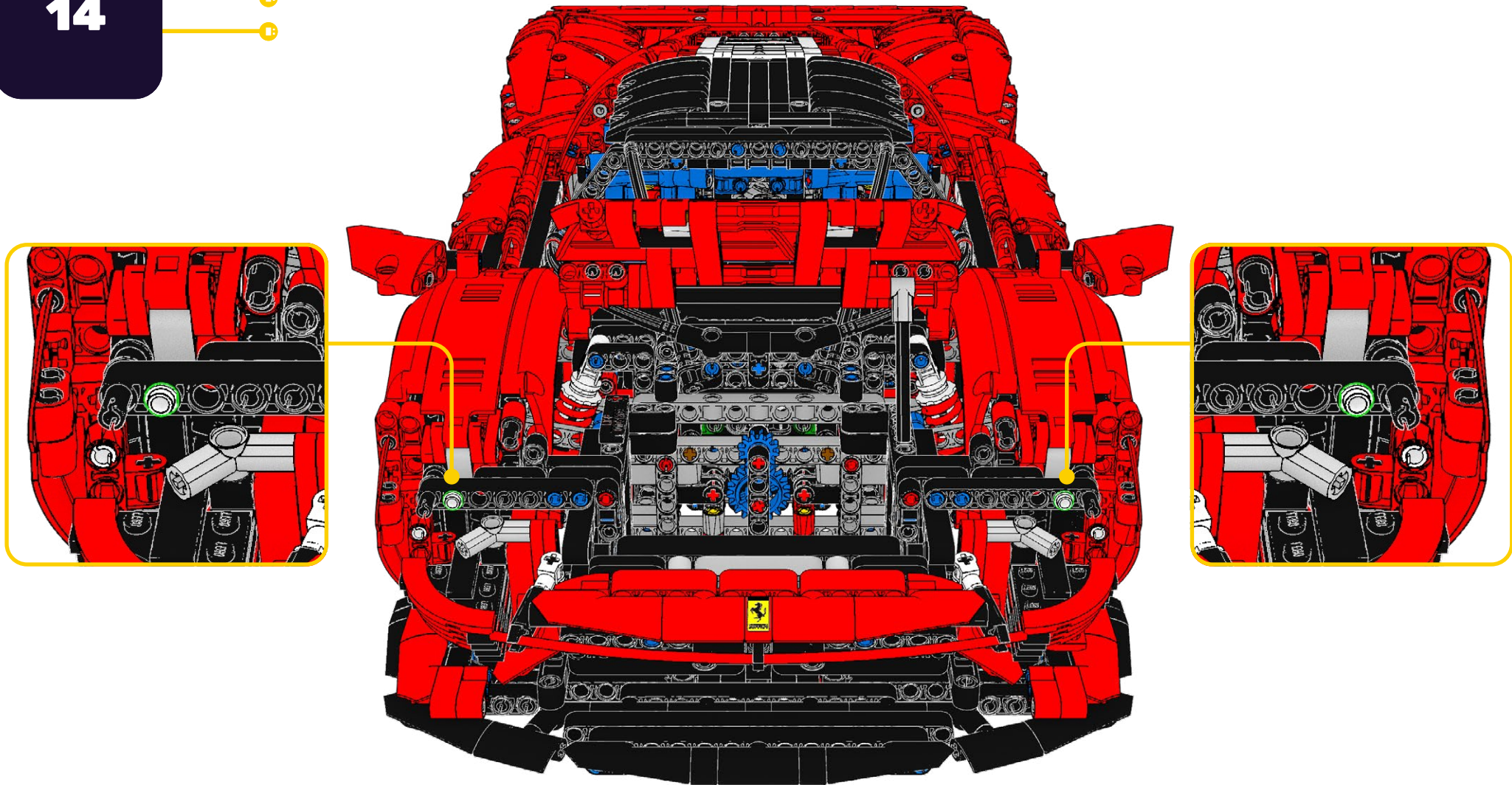

15

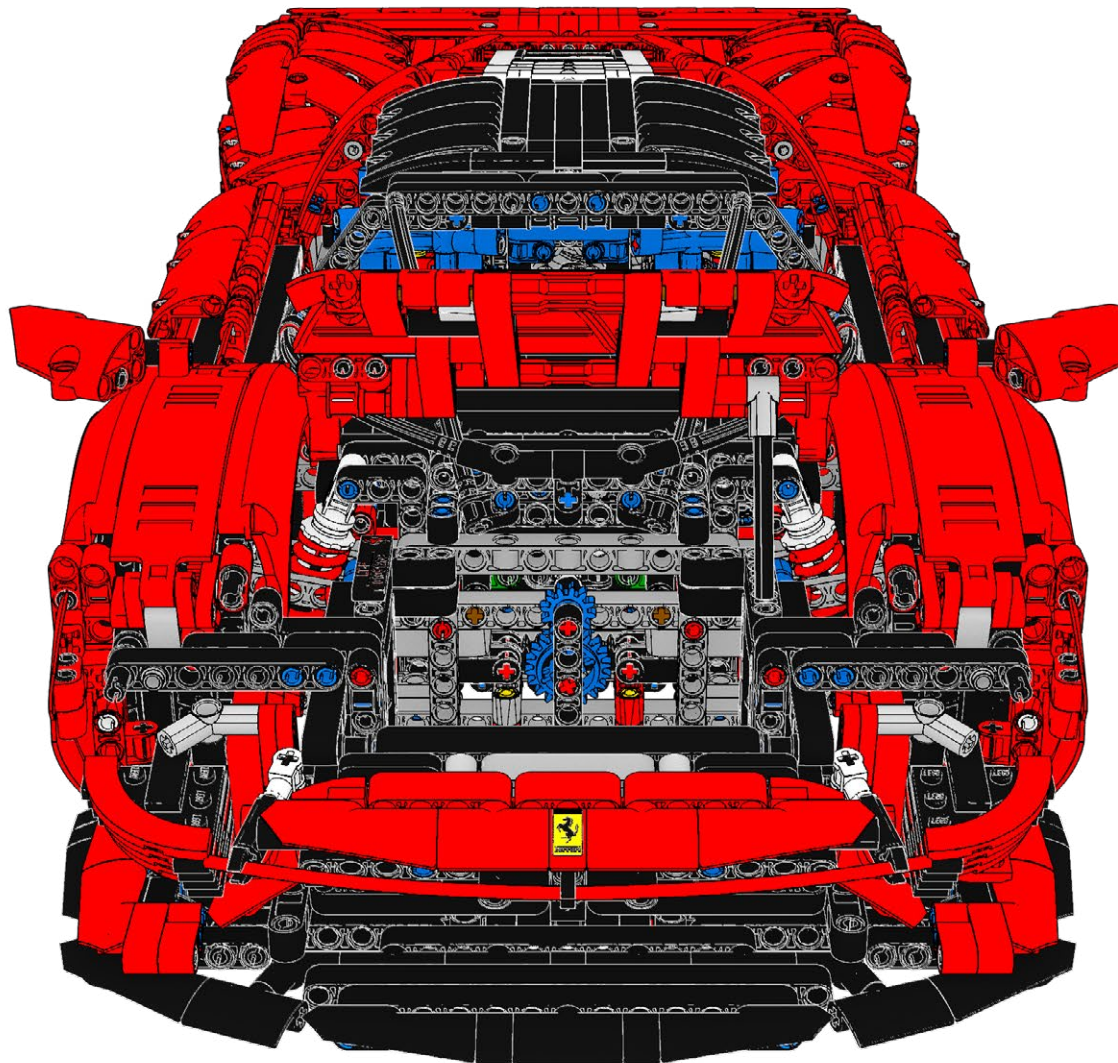

16

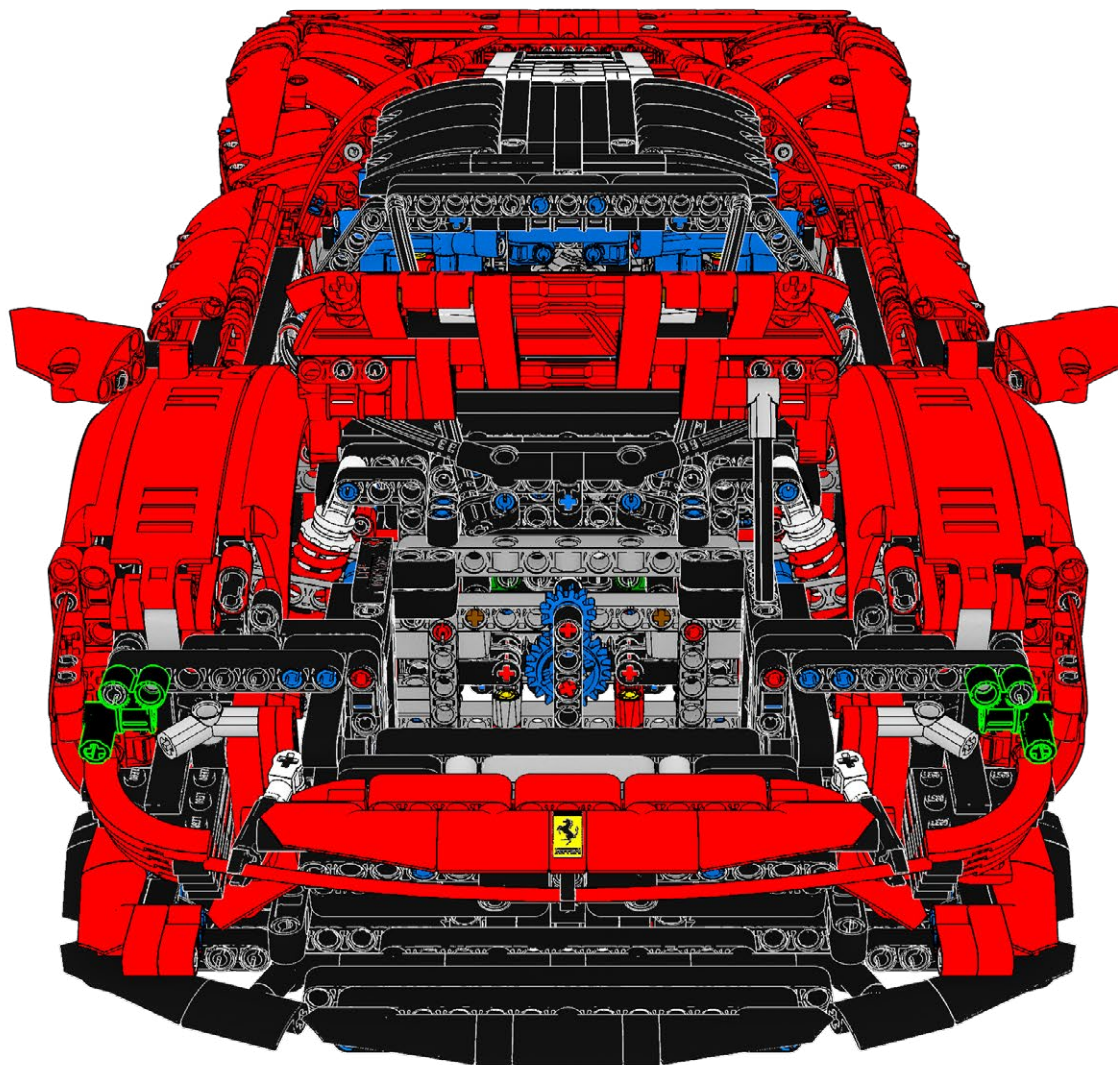

17

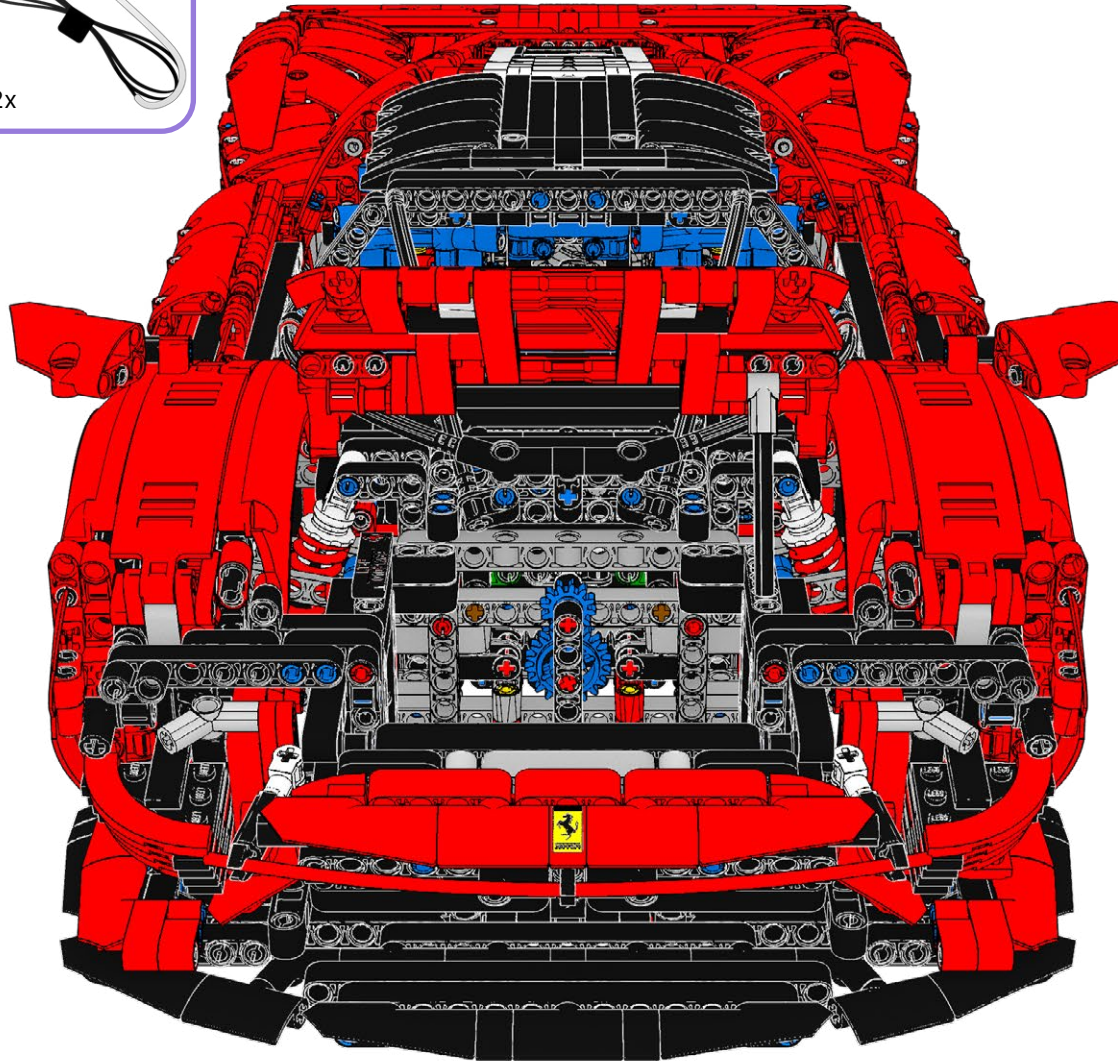
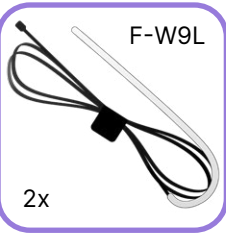

18

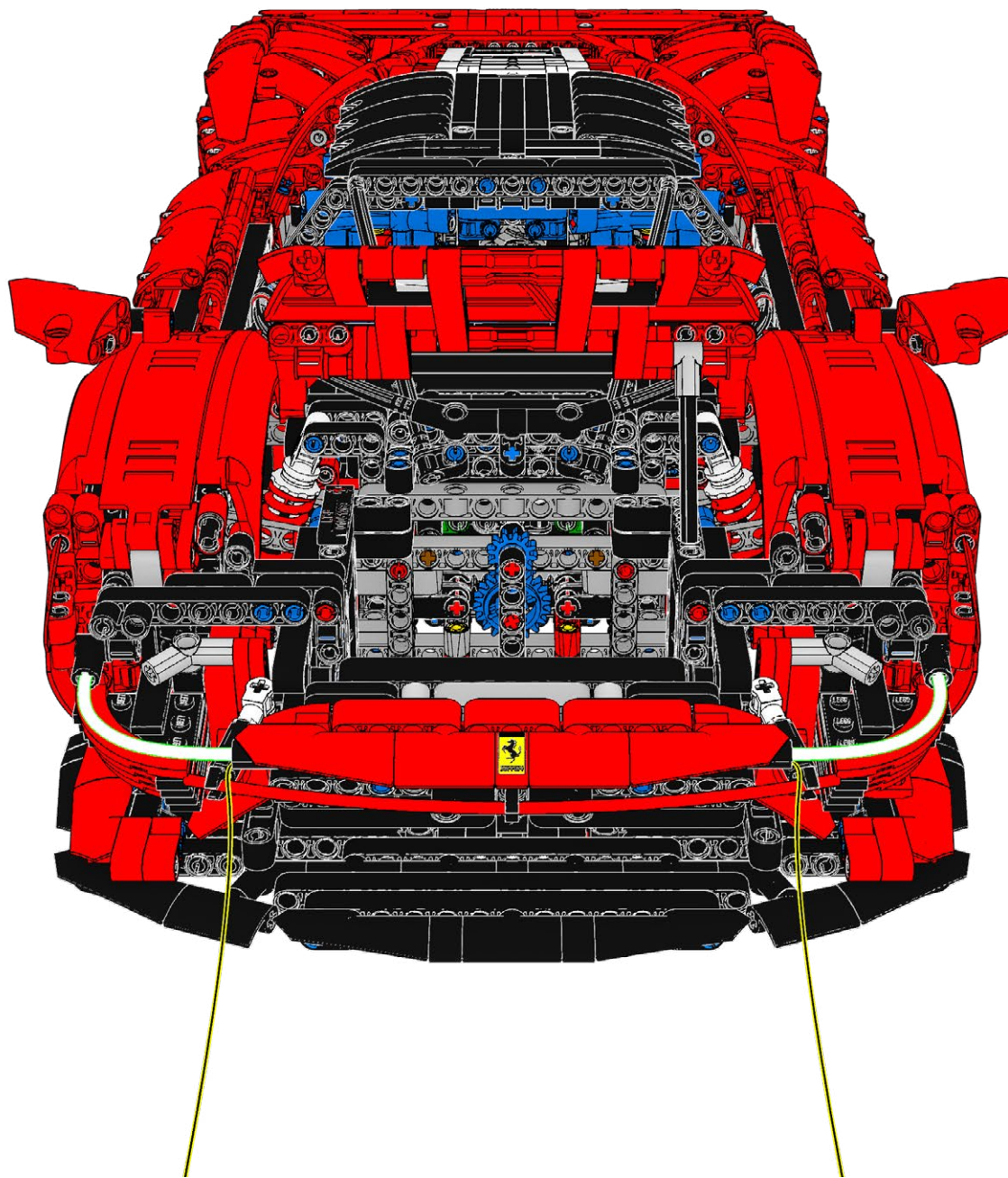

19

AR-CW15

2x

2x

20

2x

1

2

3

1

2

3



1

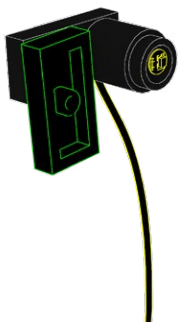

2



3

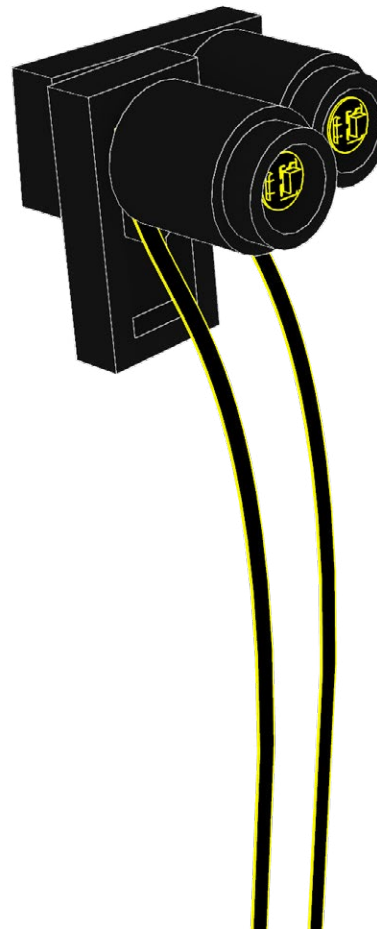
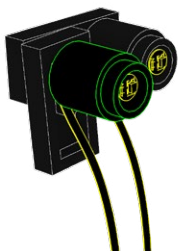

23

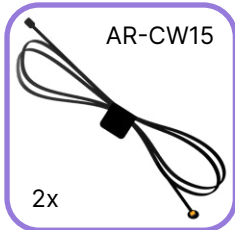

1



2

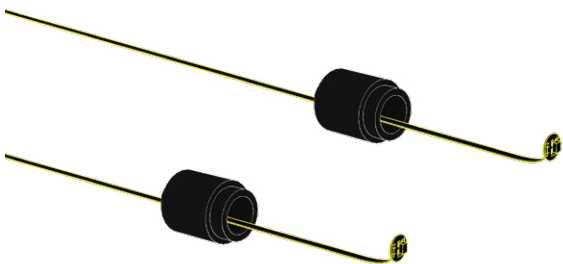

3

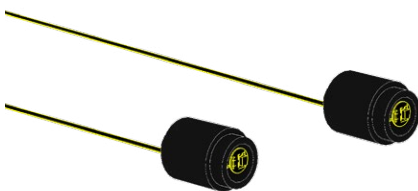

24

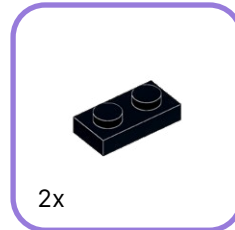

1



2



3





1

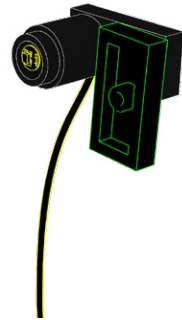

2



3

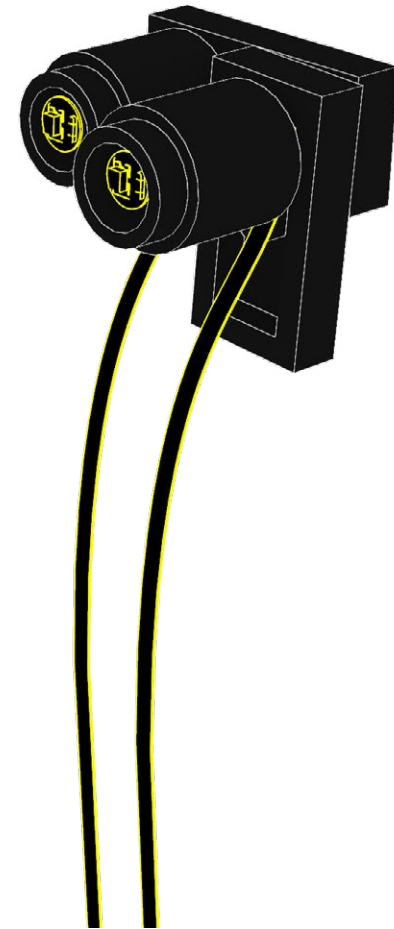
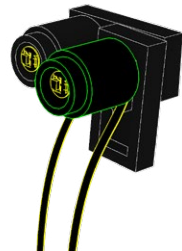

27

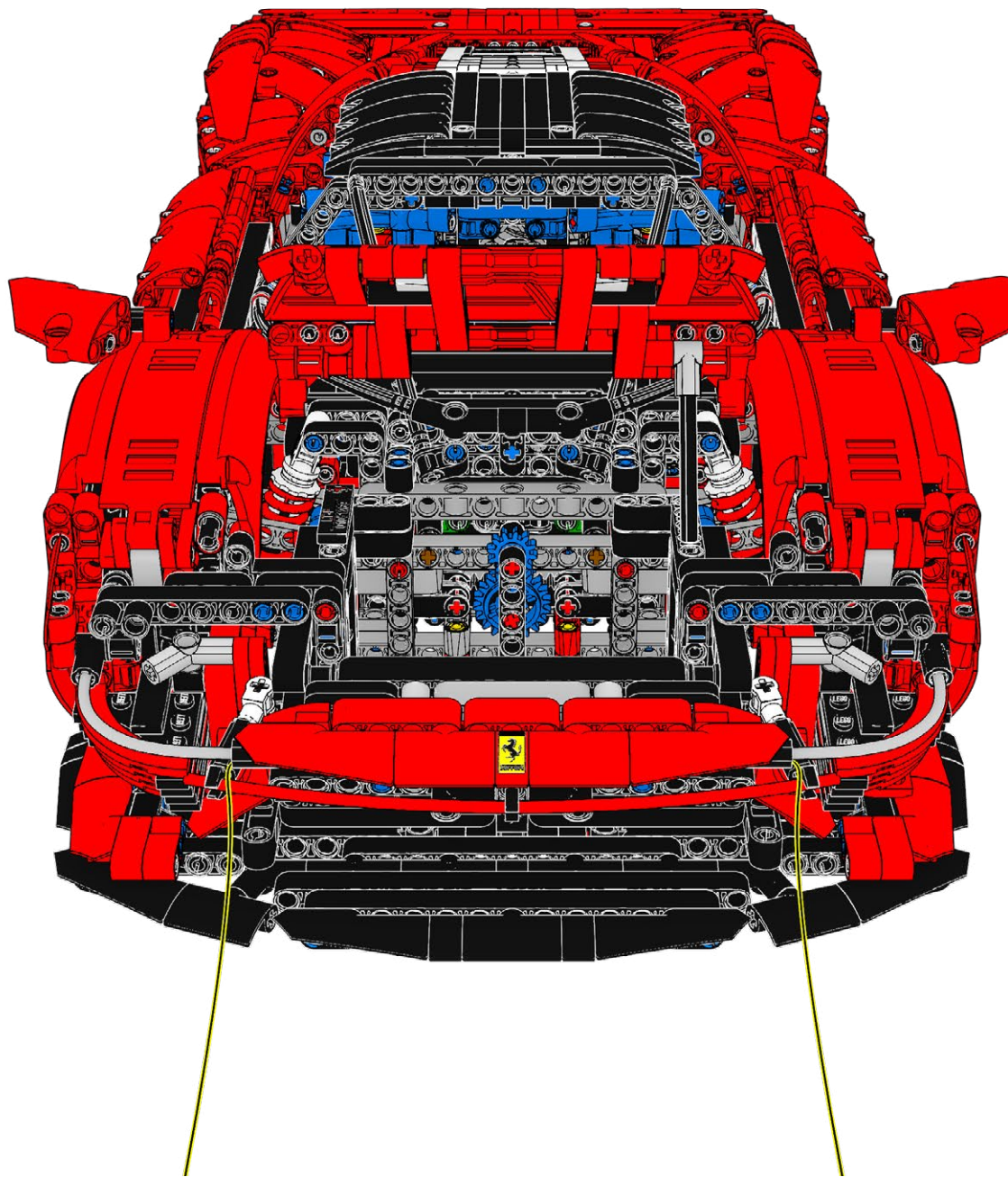

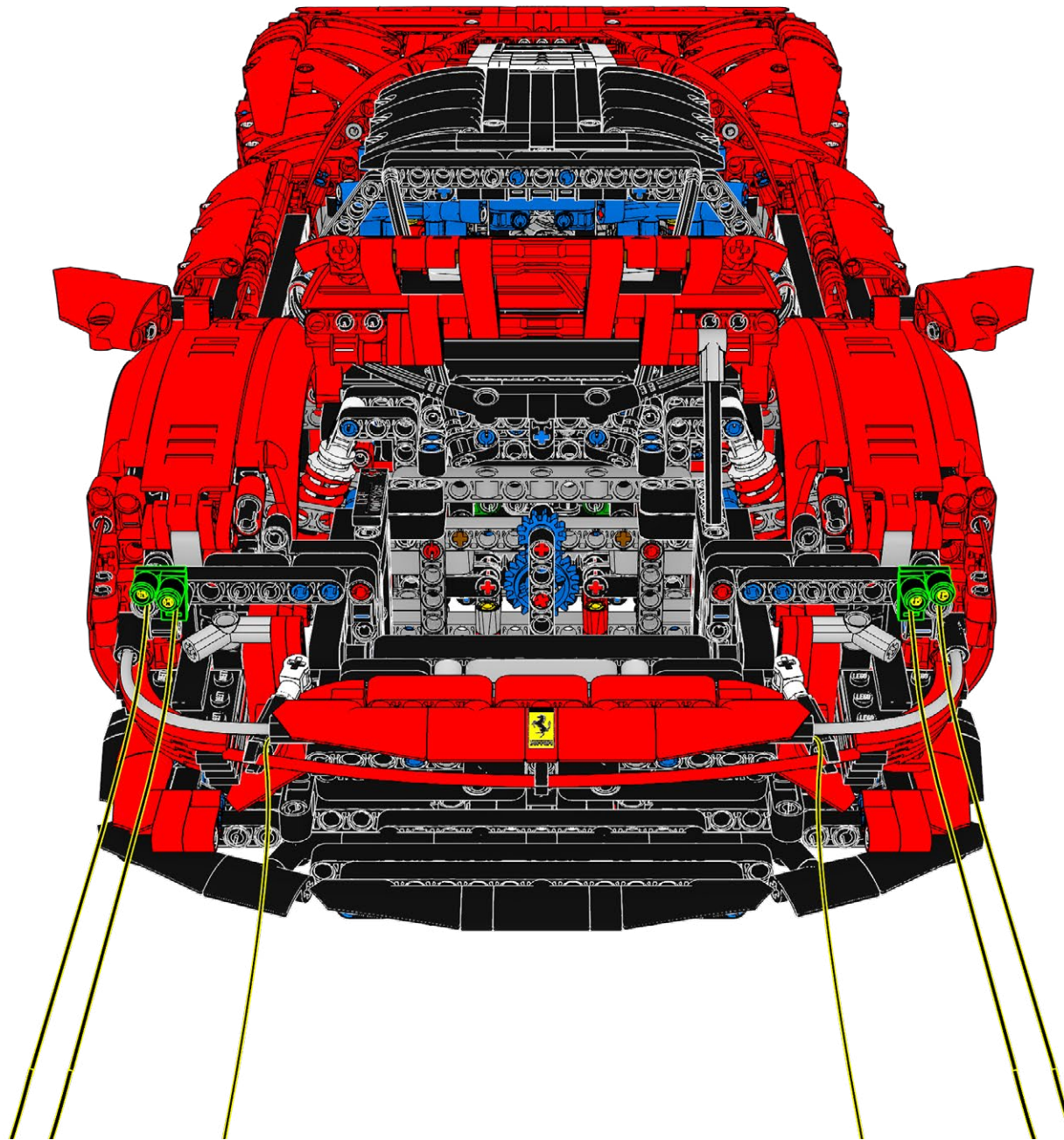

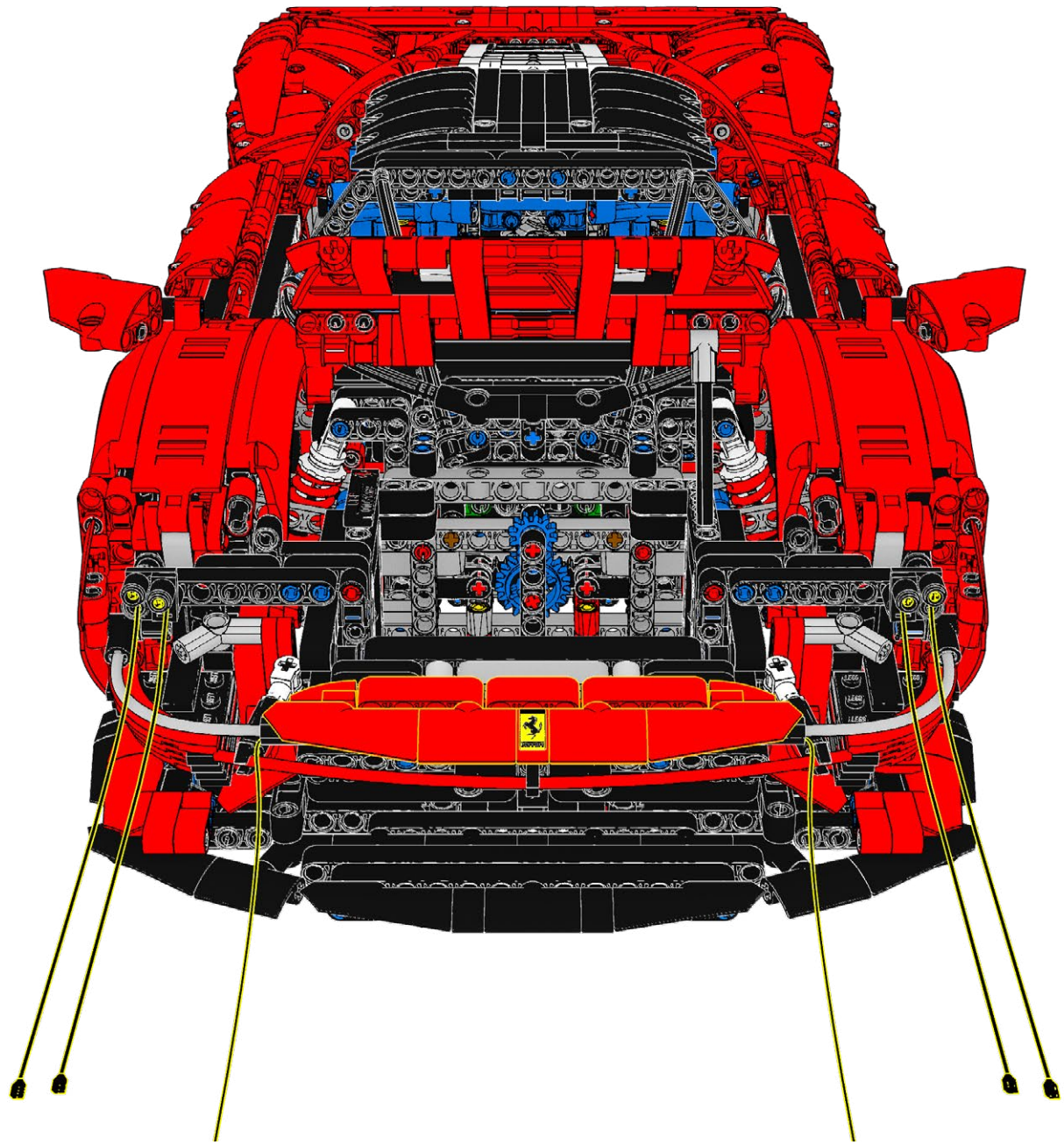

30

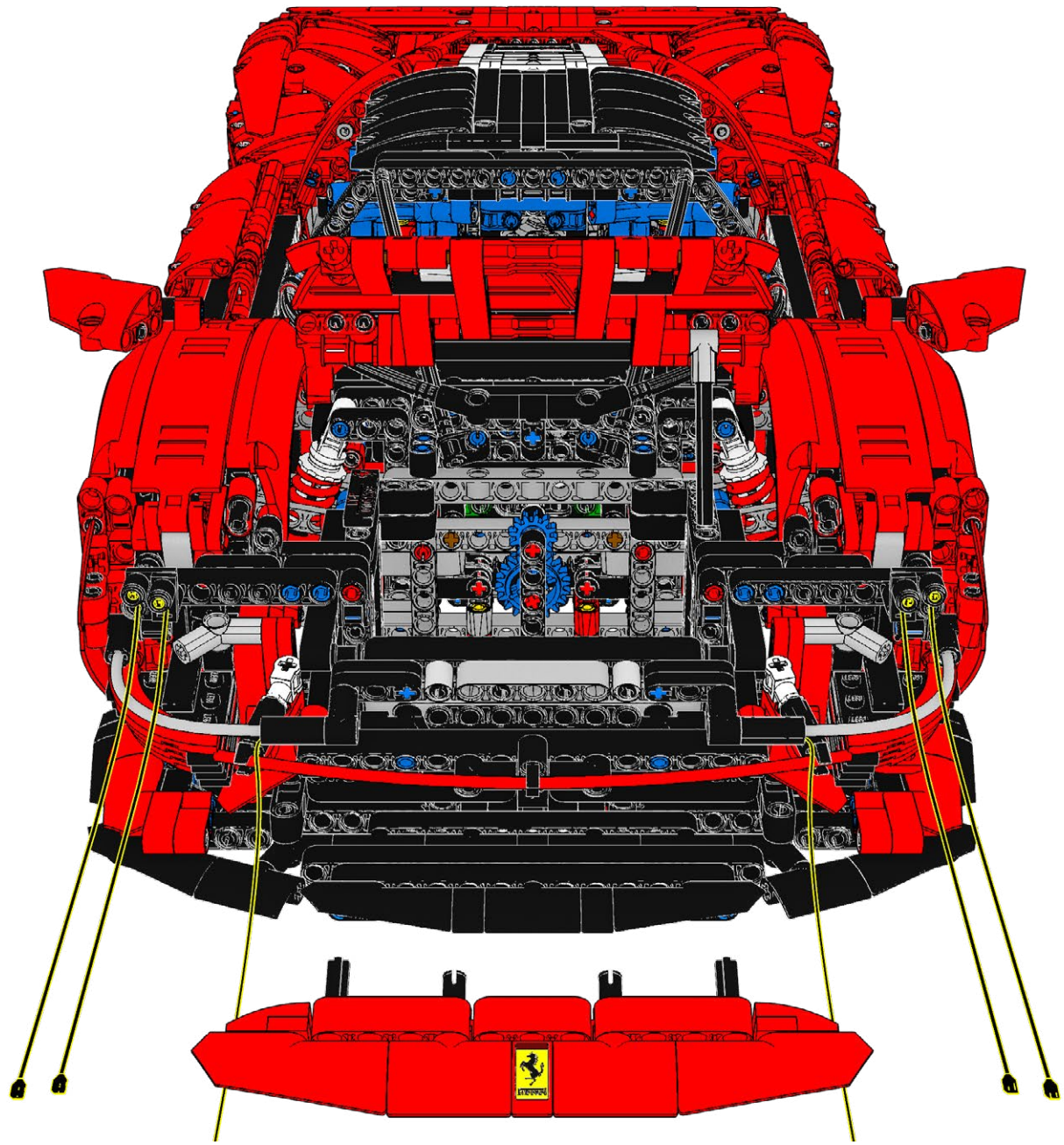

31

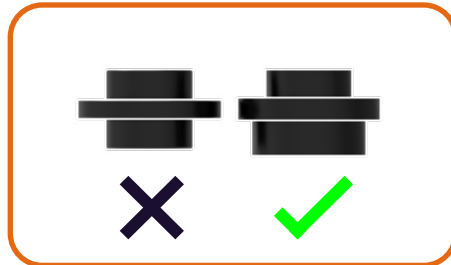
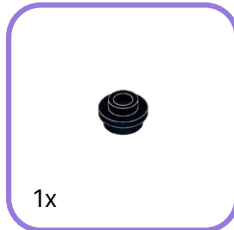
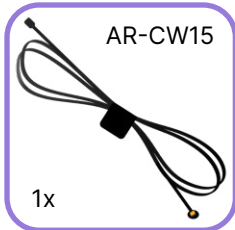

1



2

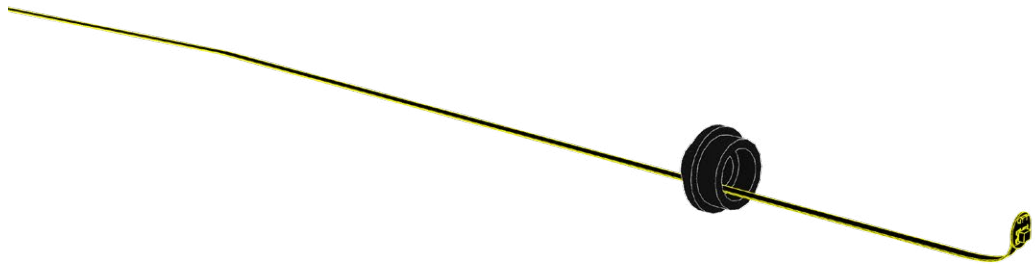

3

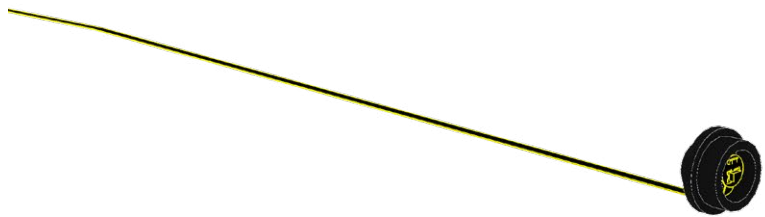

32

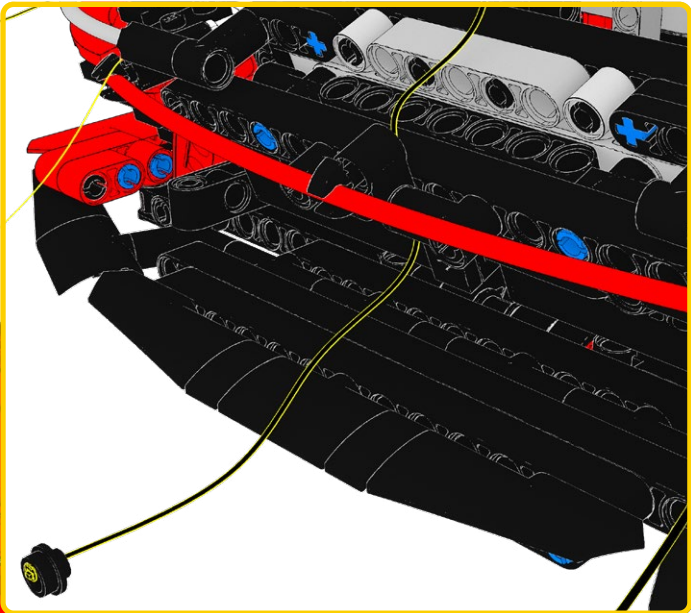
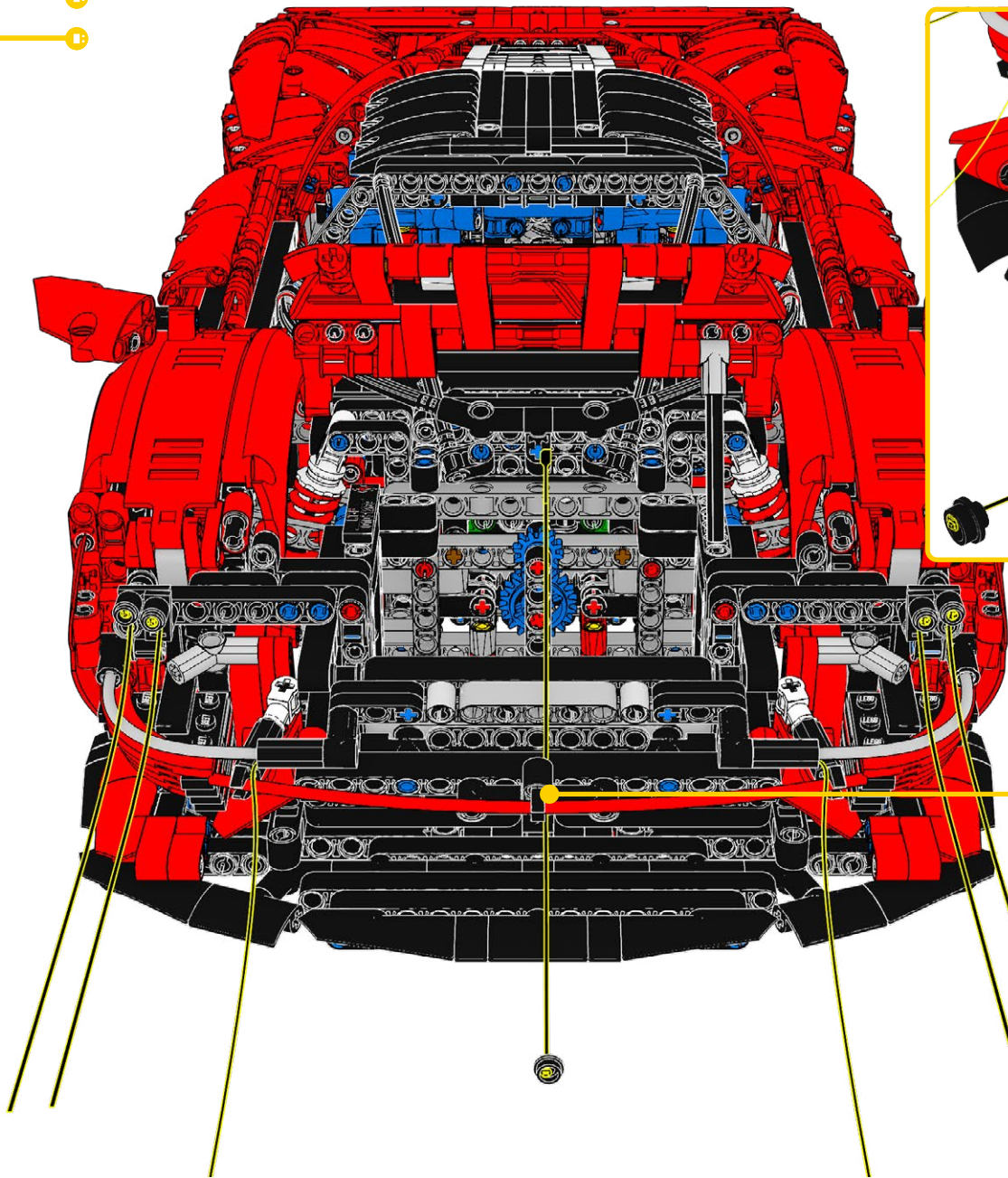

33

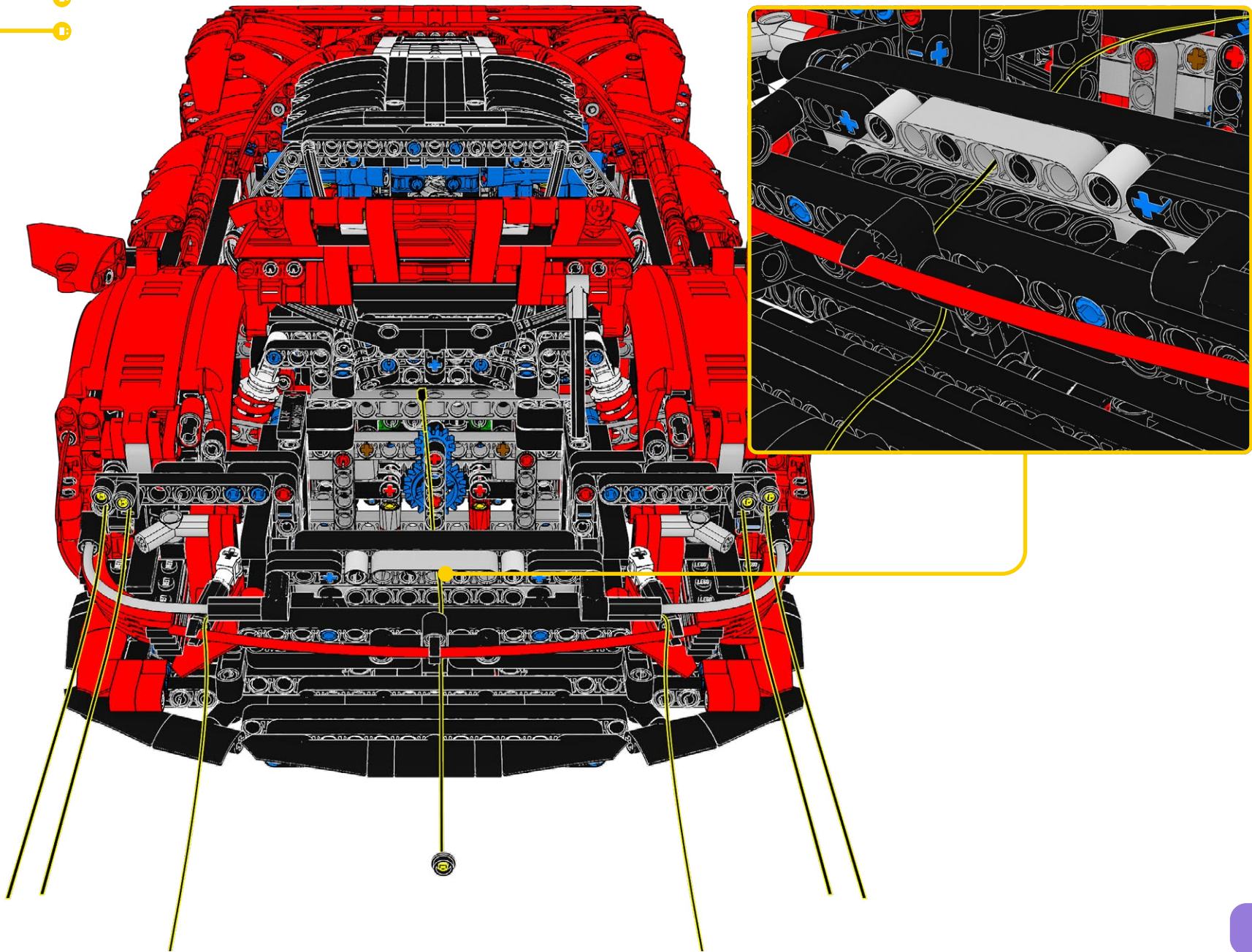

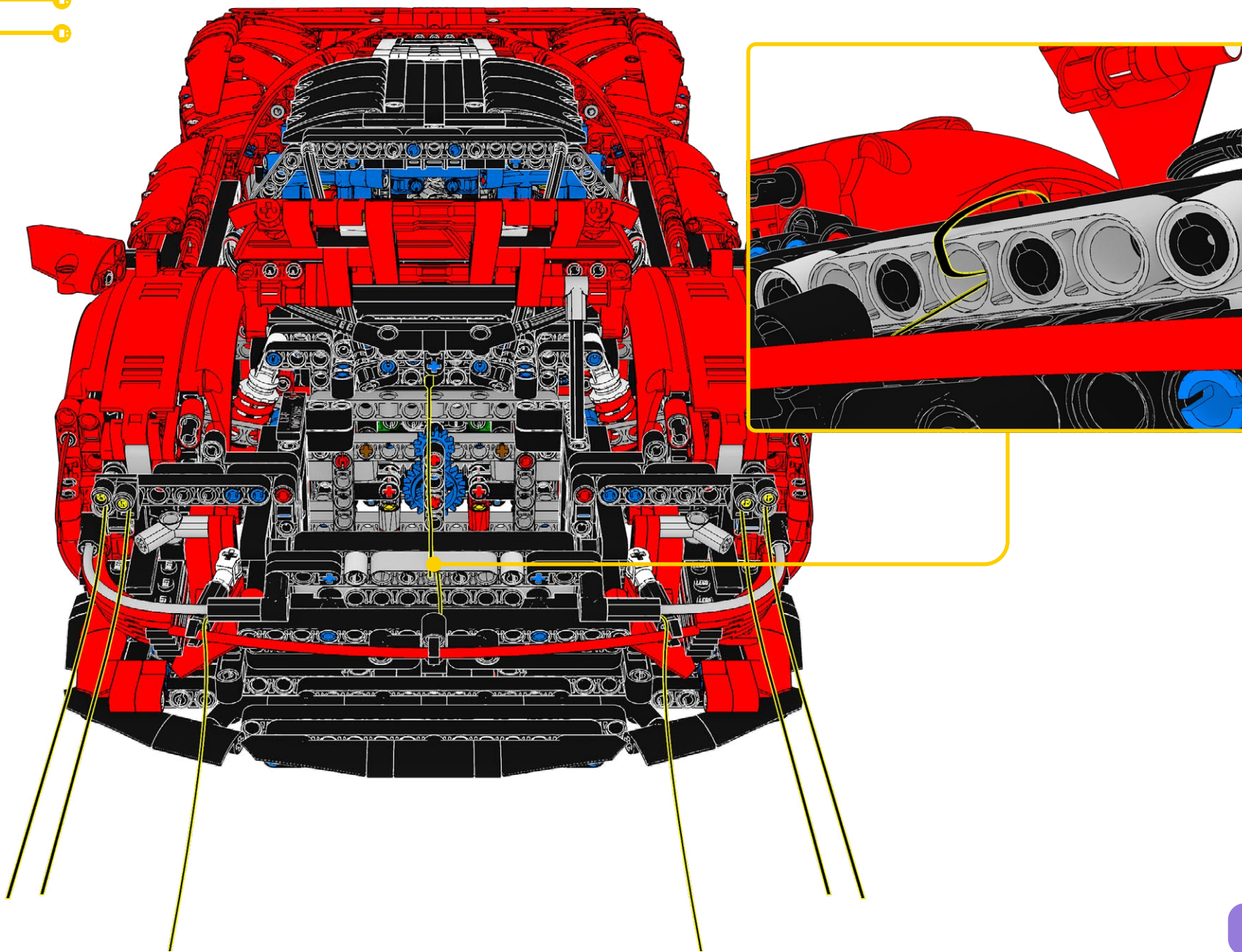

35

T-1x1
3x

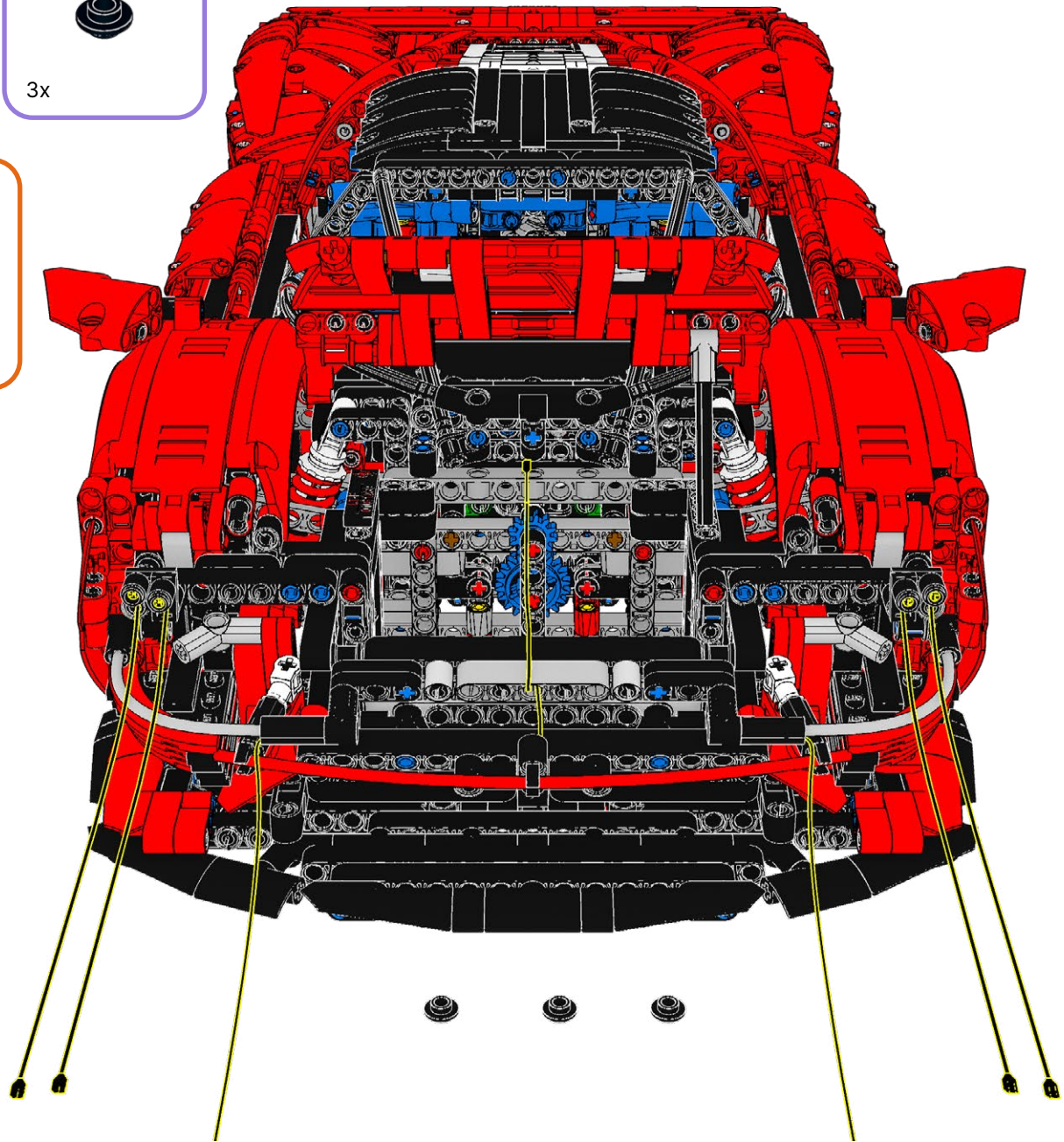
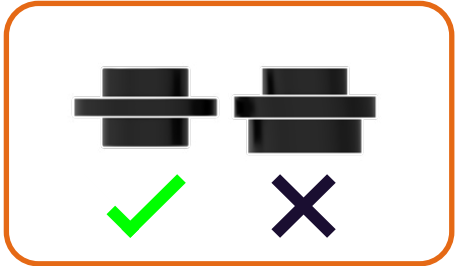

36

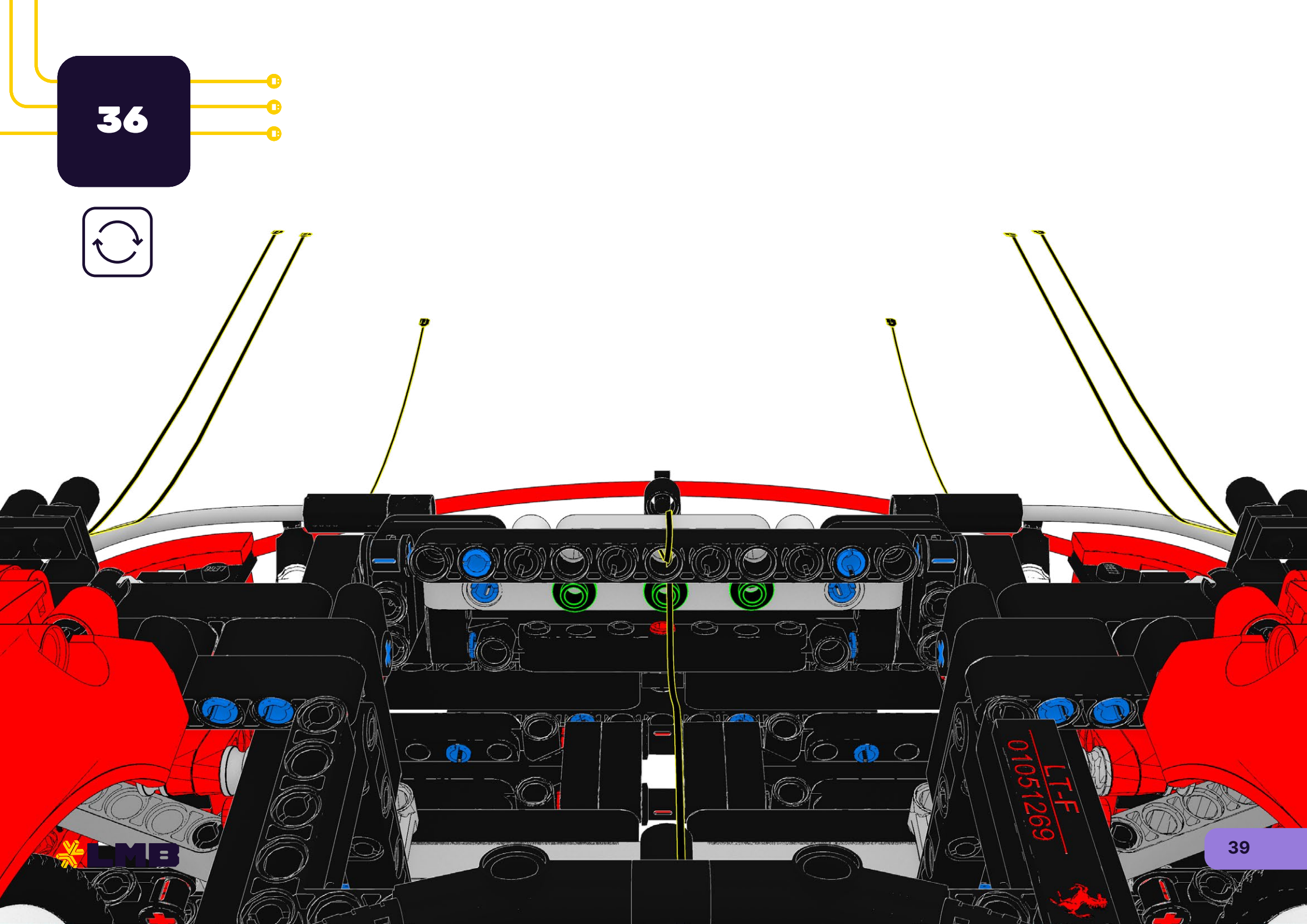

 **LMB**

LT-F
01051269



37

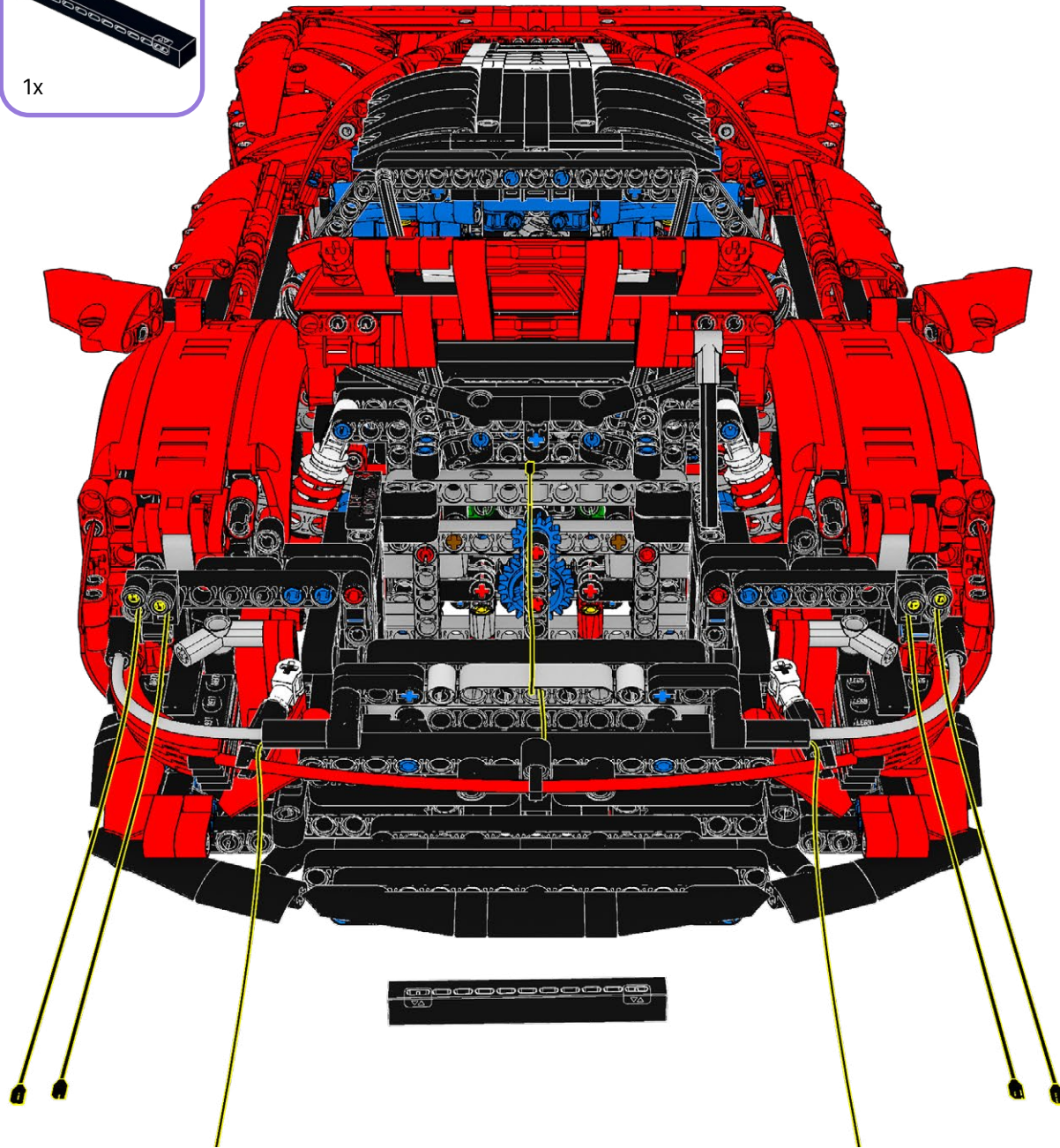
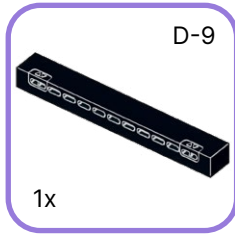

38

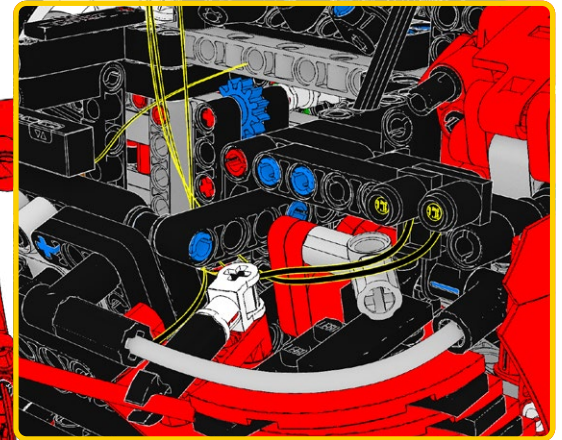
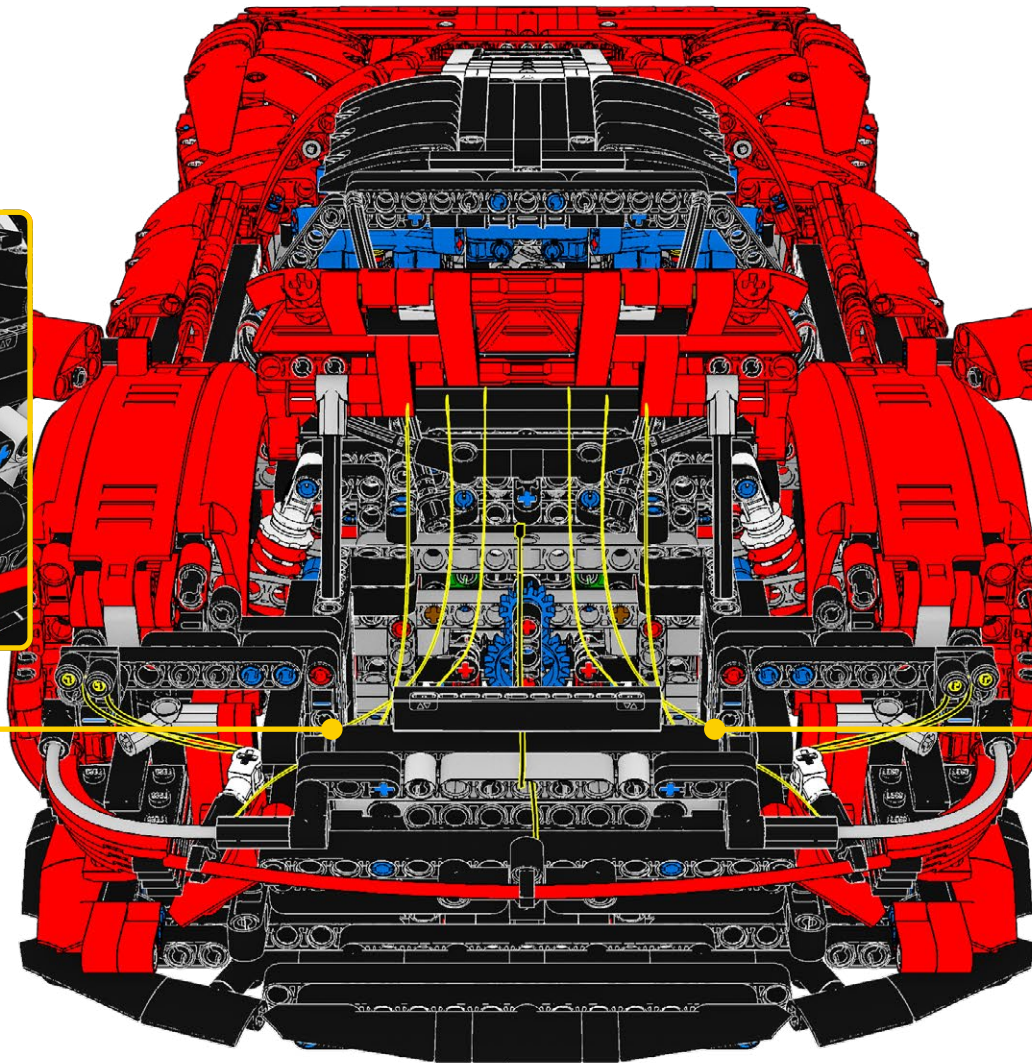
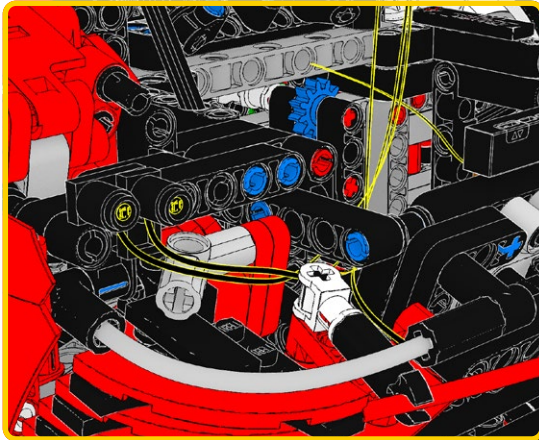

39

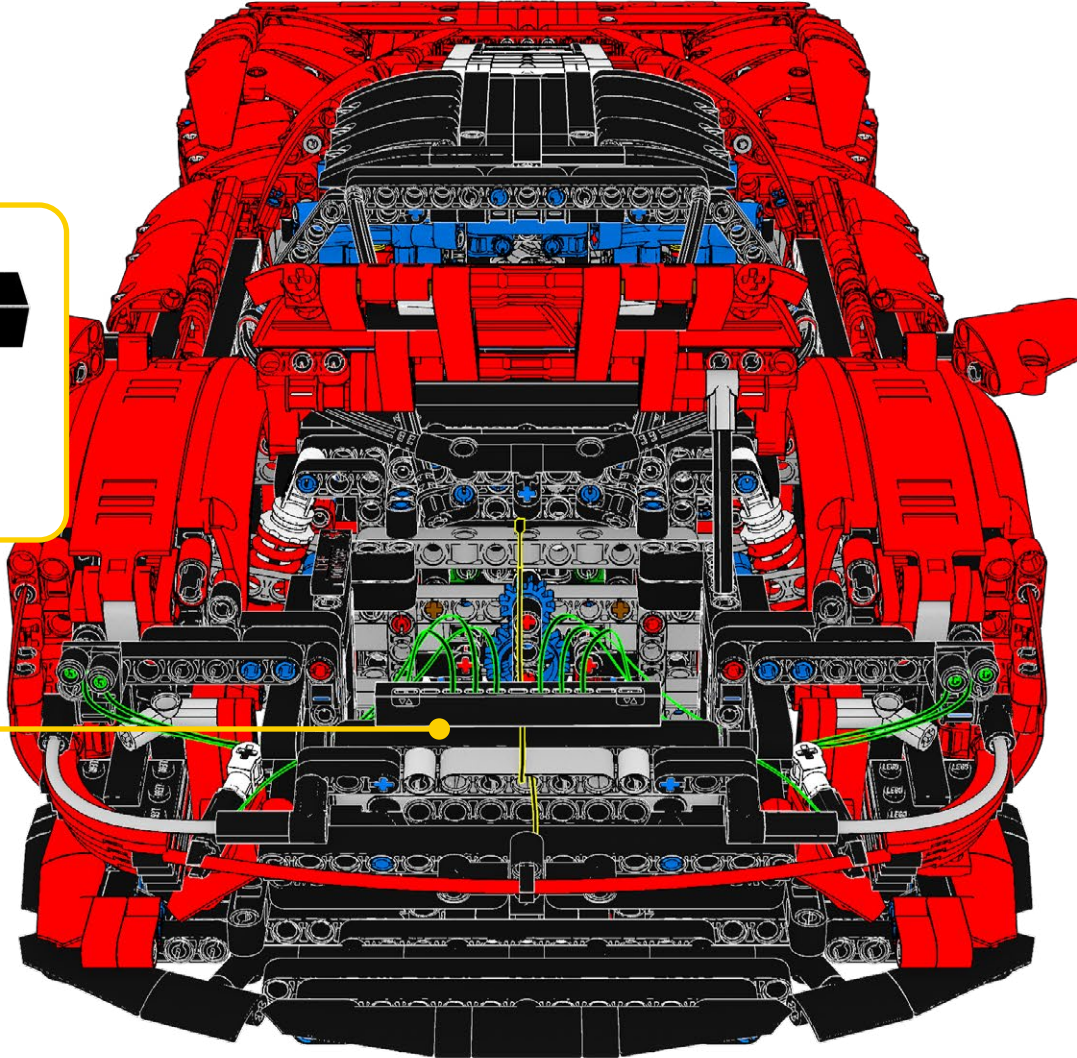
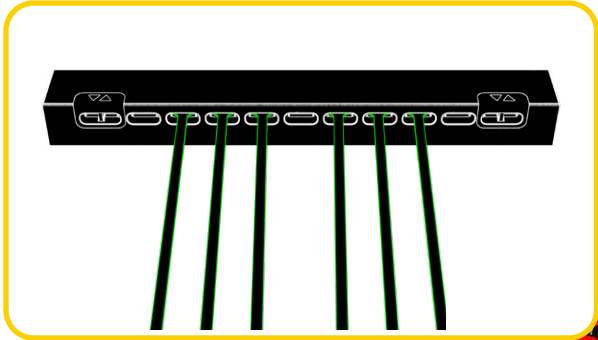

40

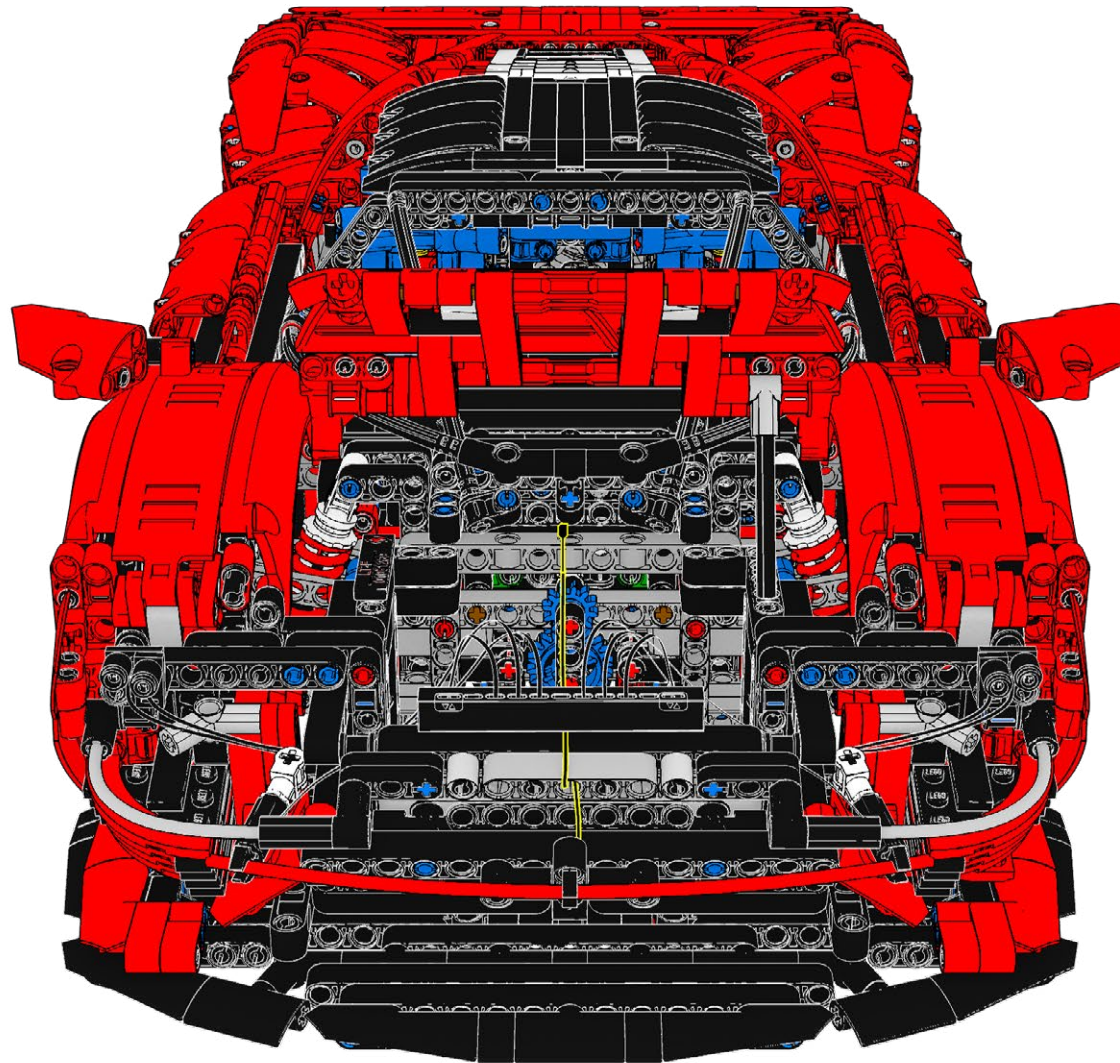

41

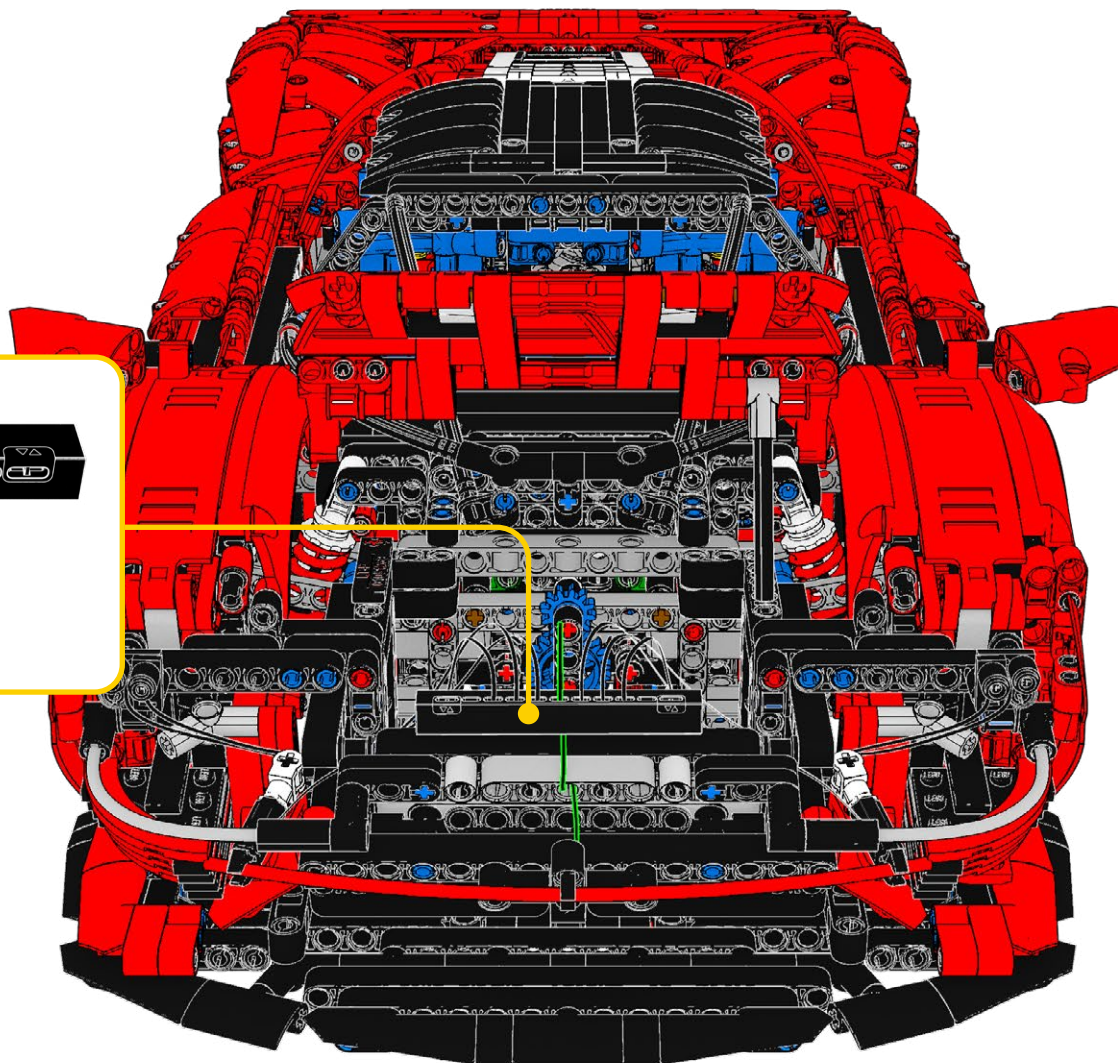
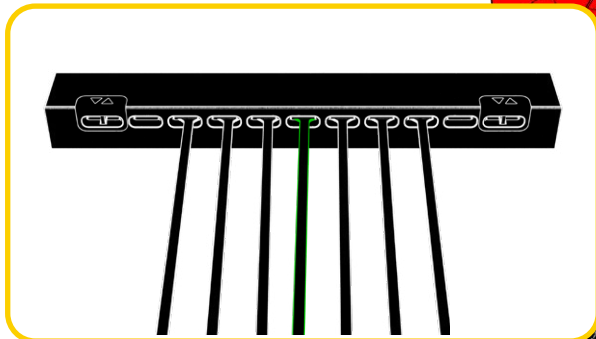

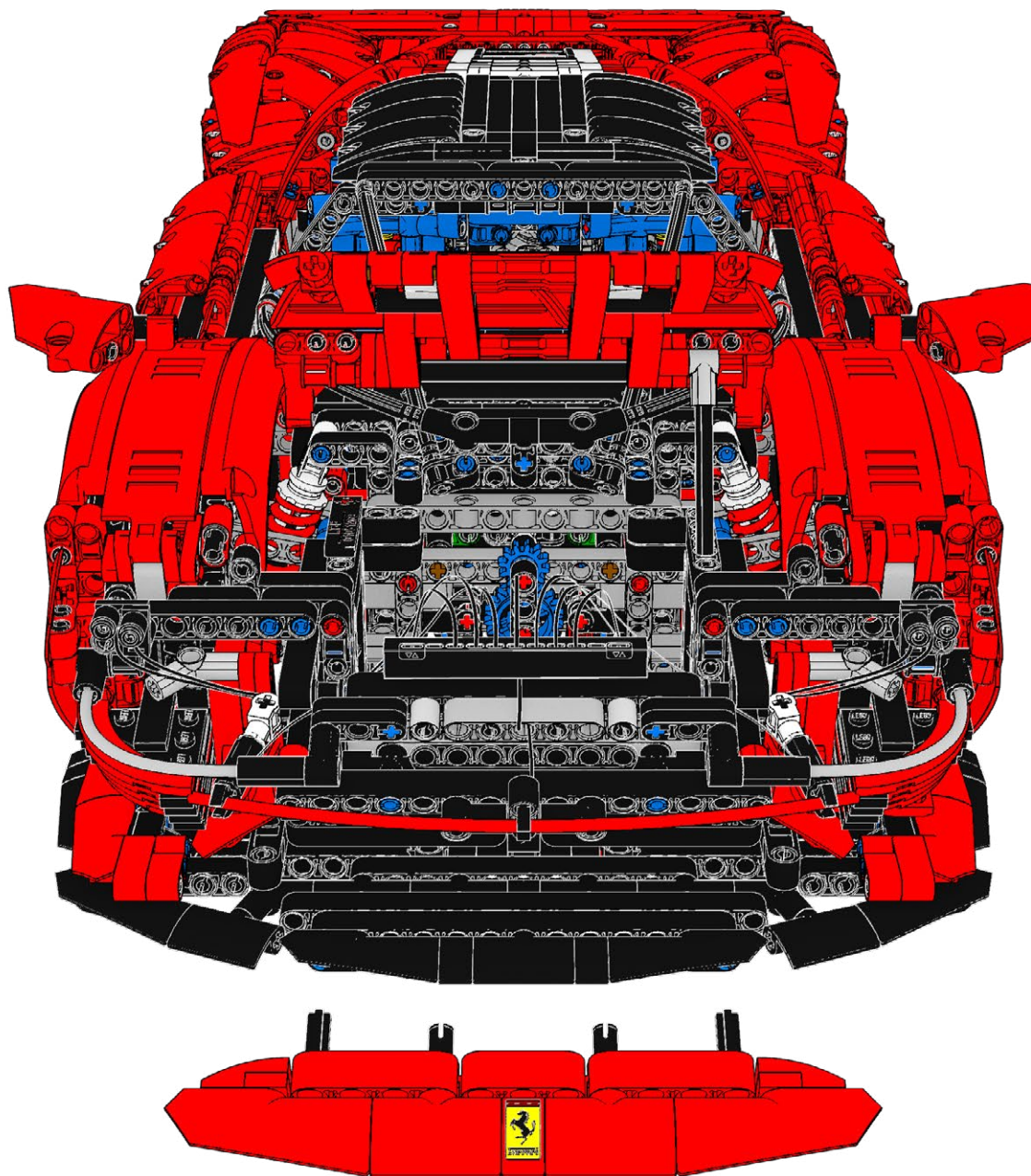

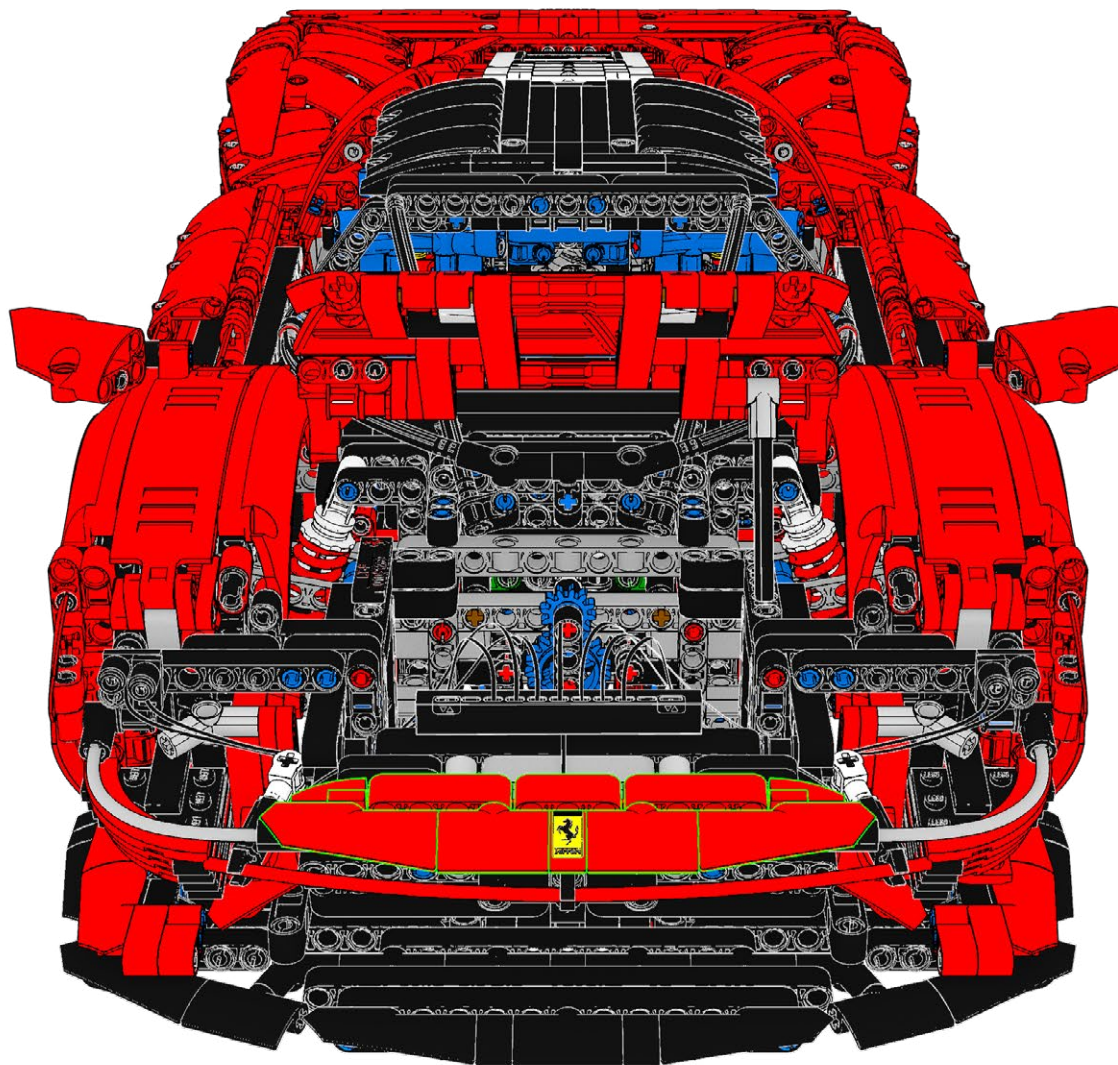

44

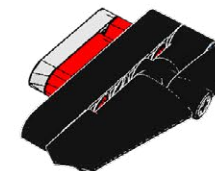
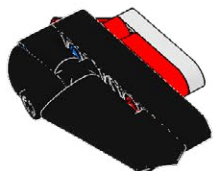
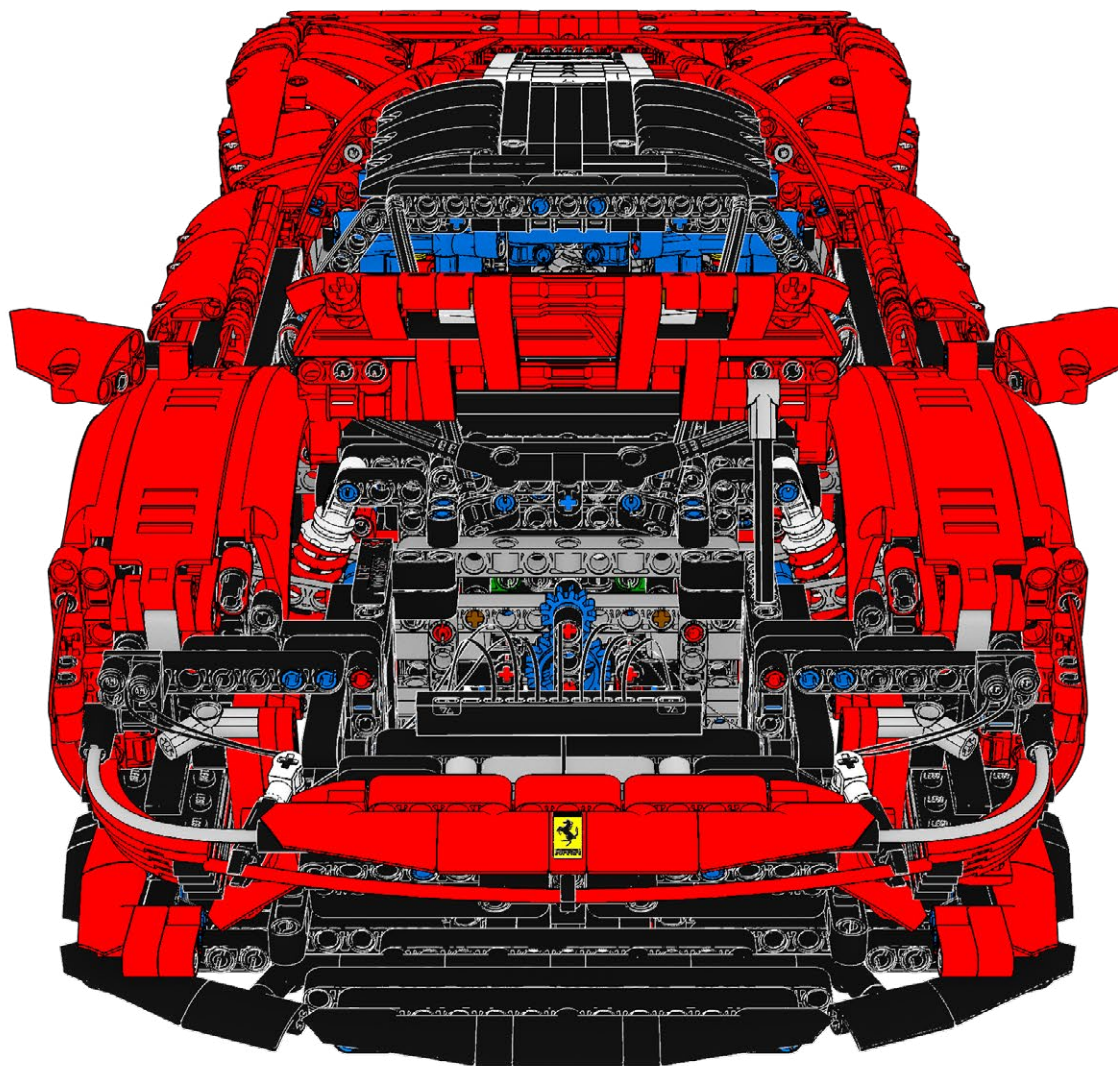

45

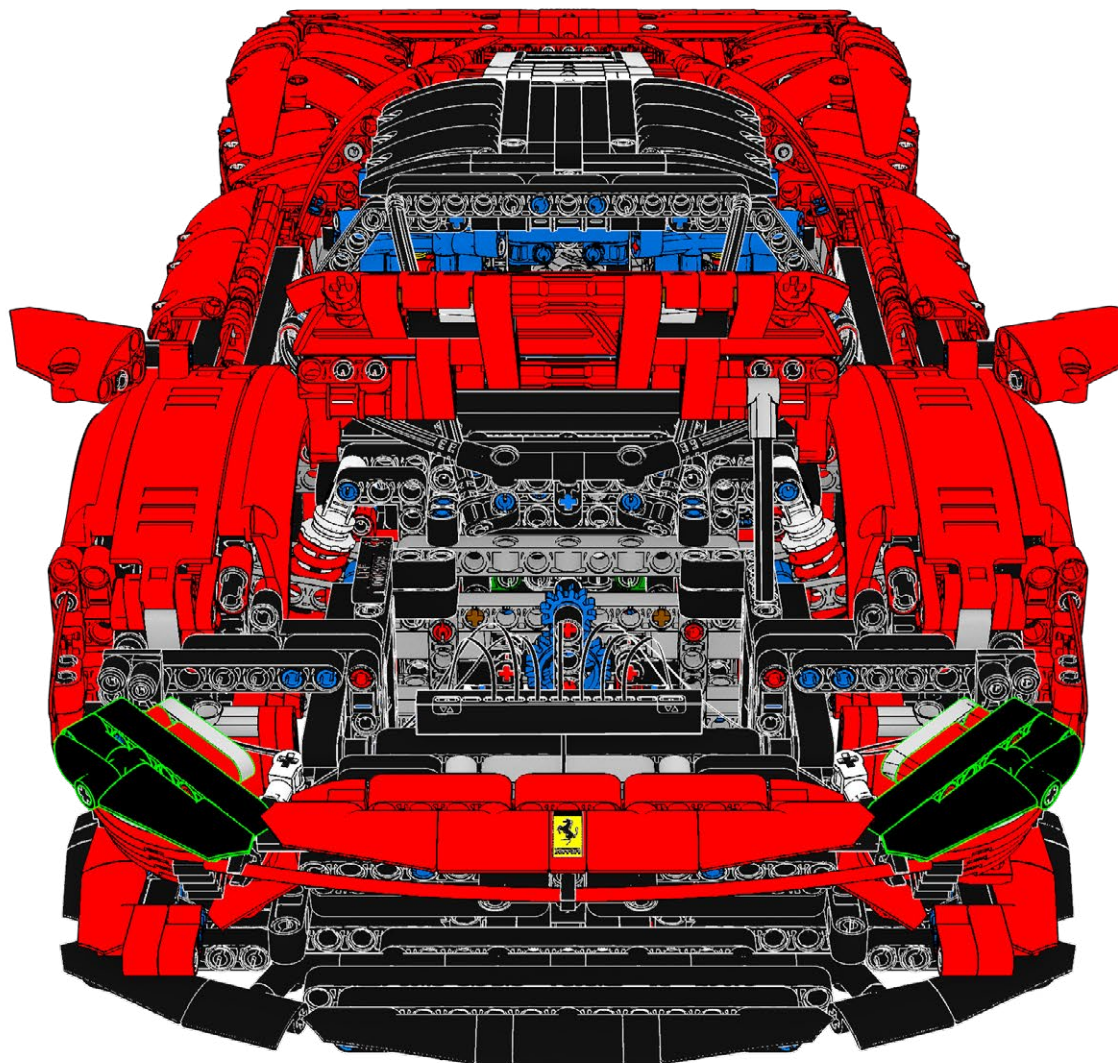

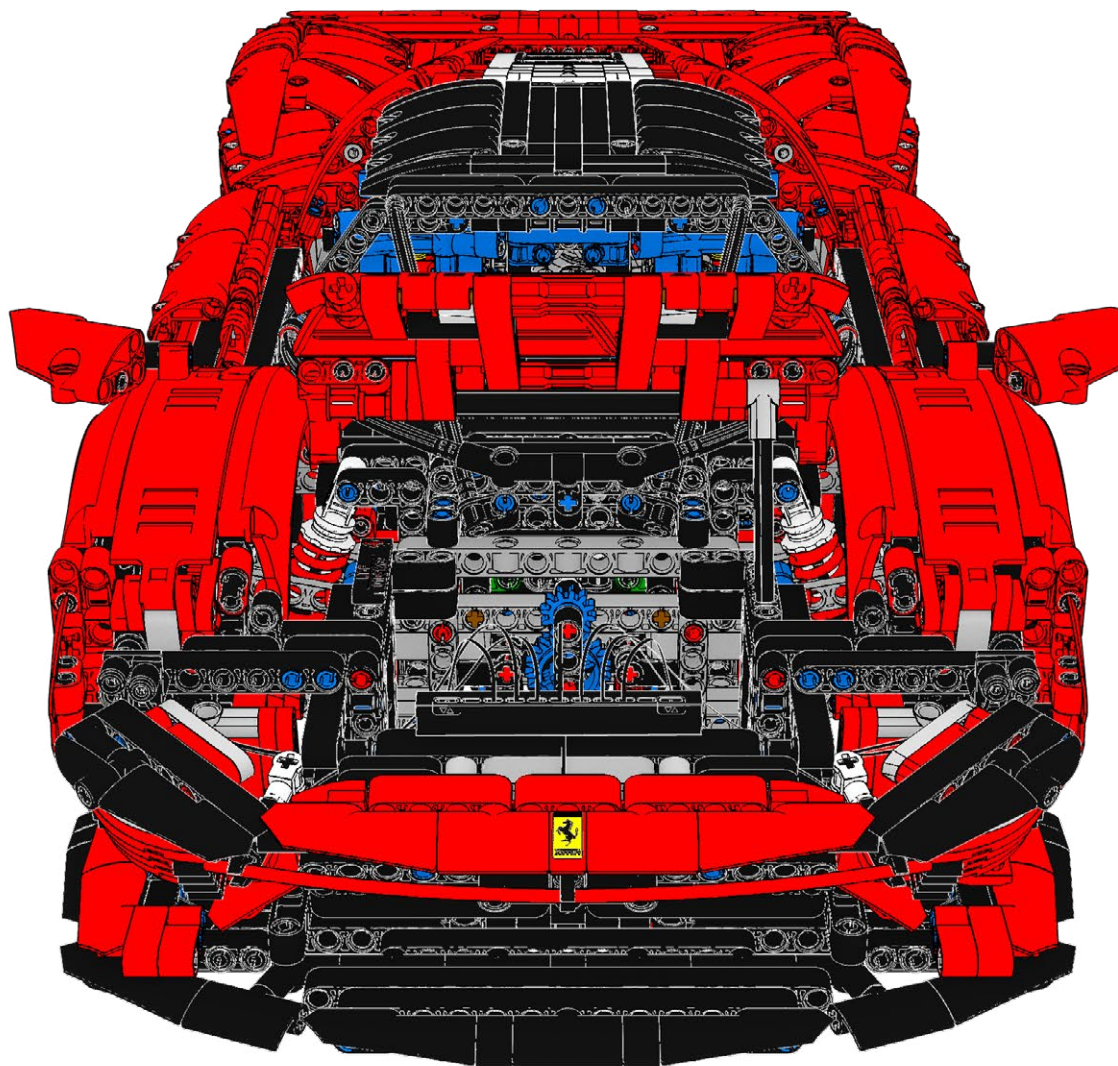

47

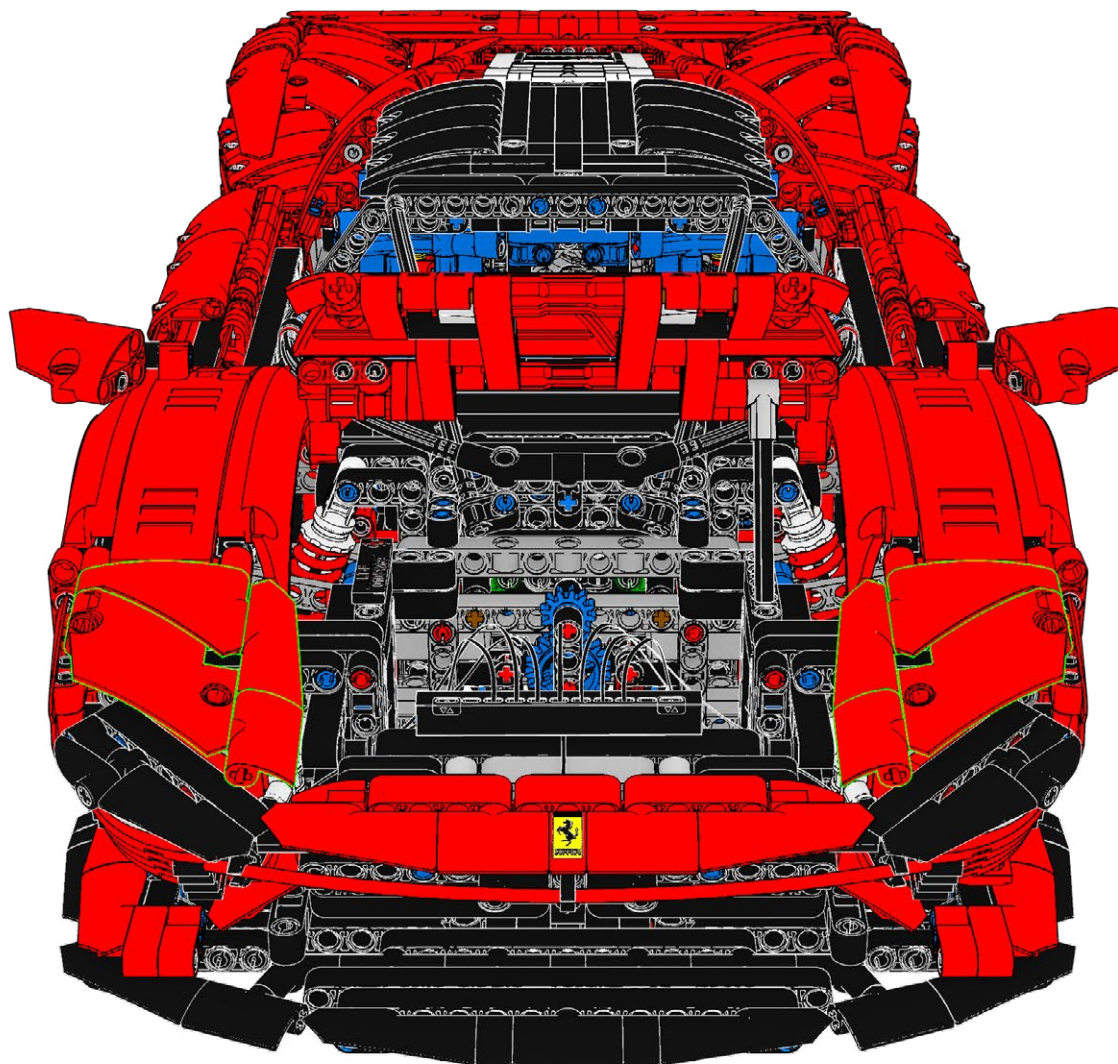

48

FLX-B30

1x

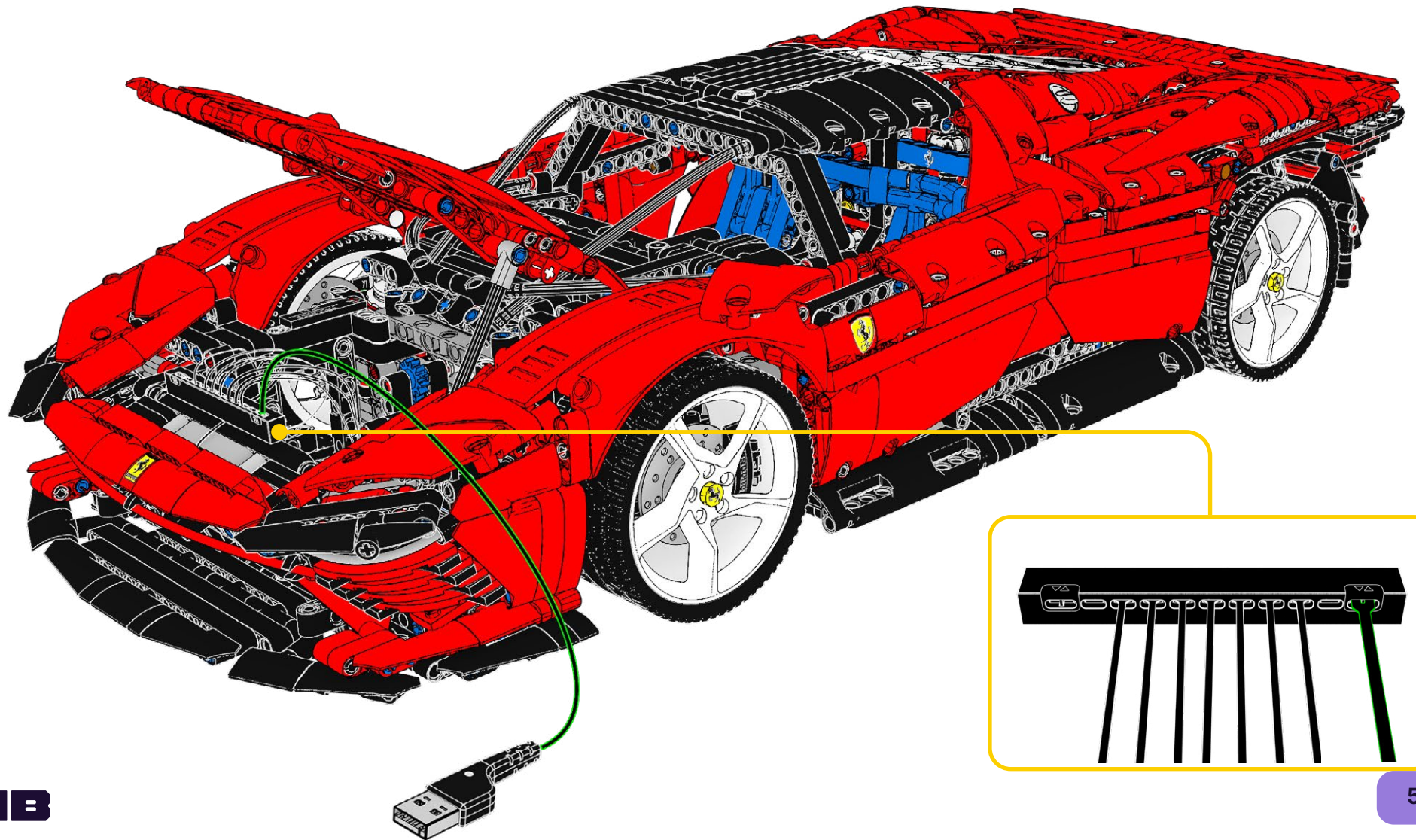

49



50

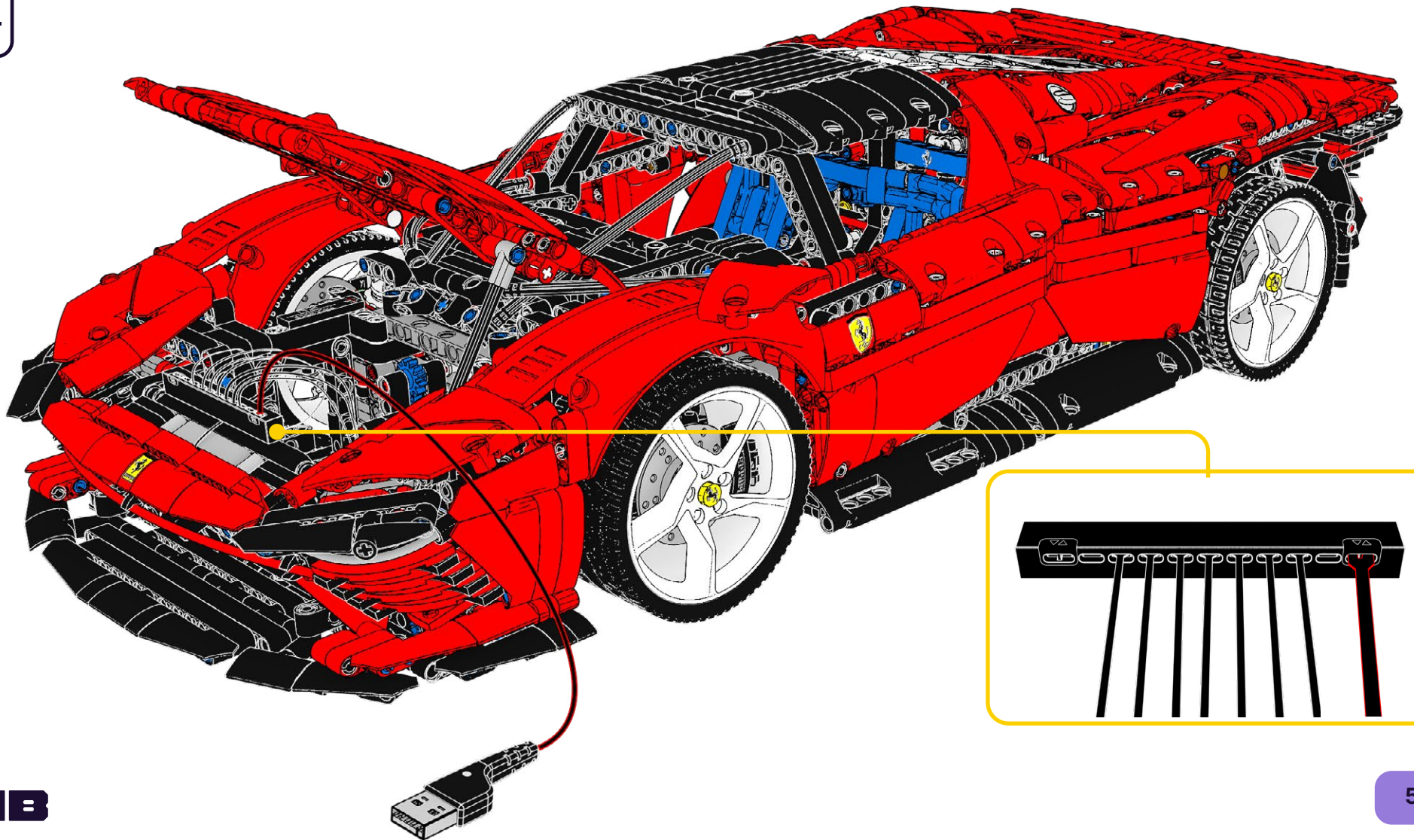

51

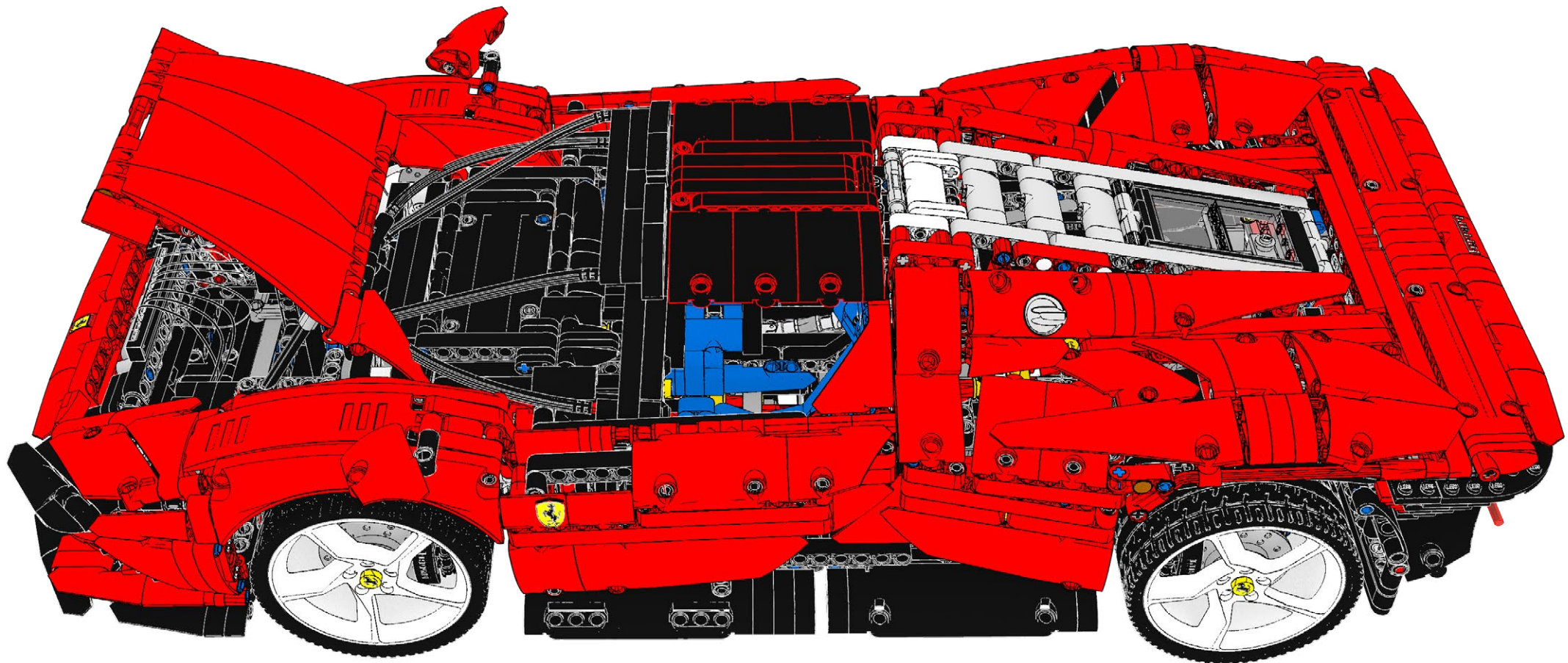

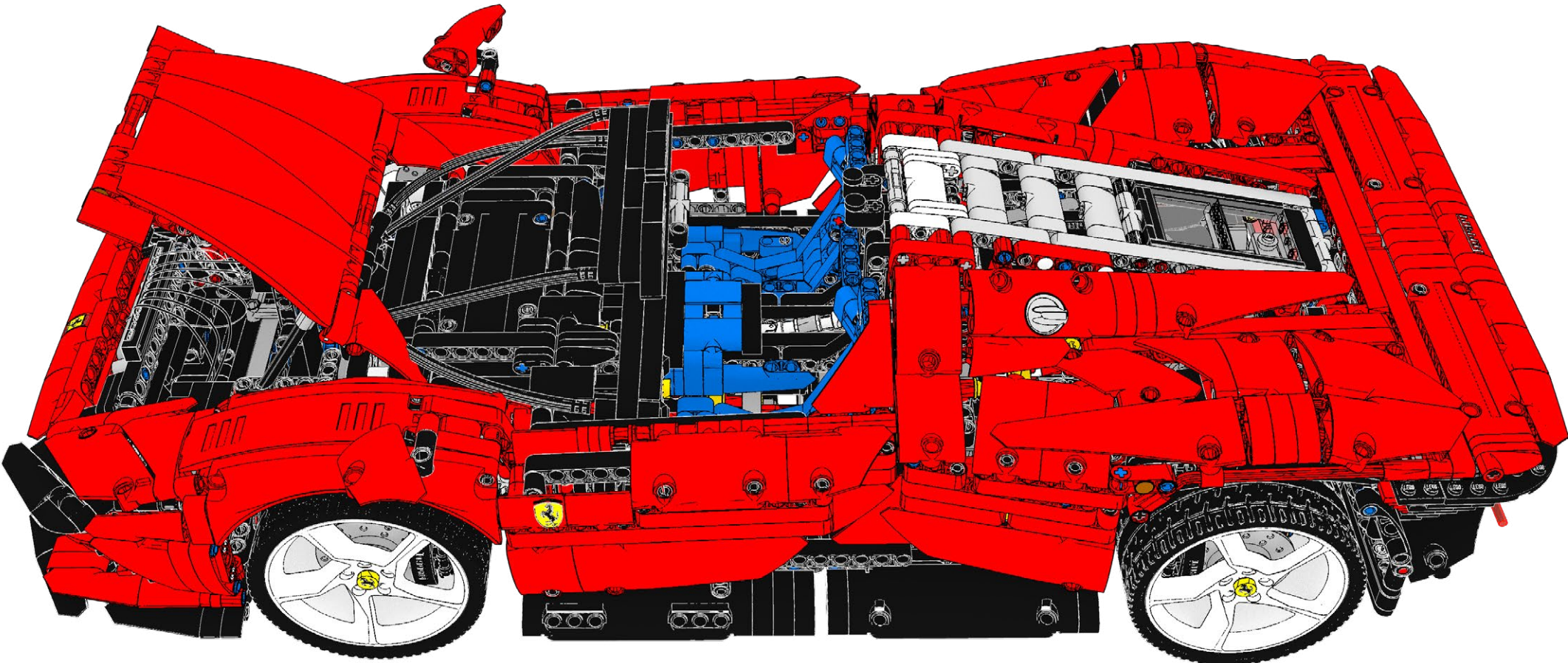
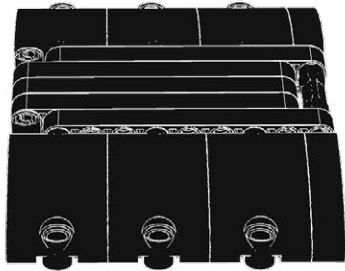

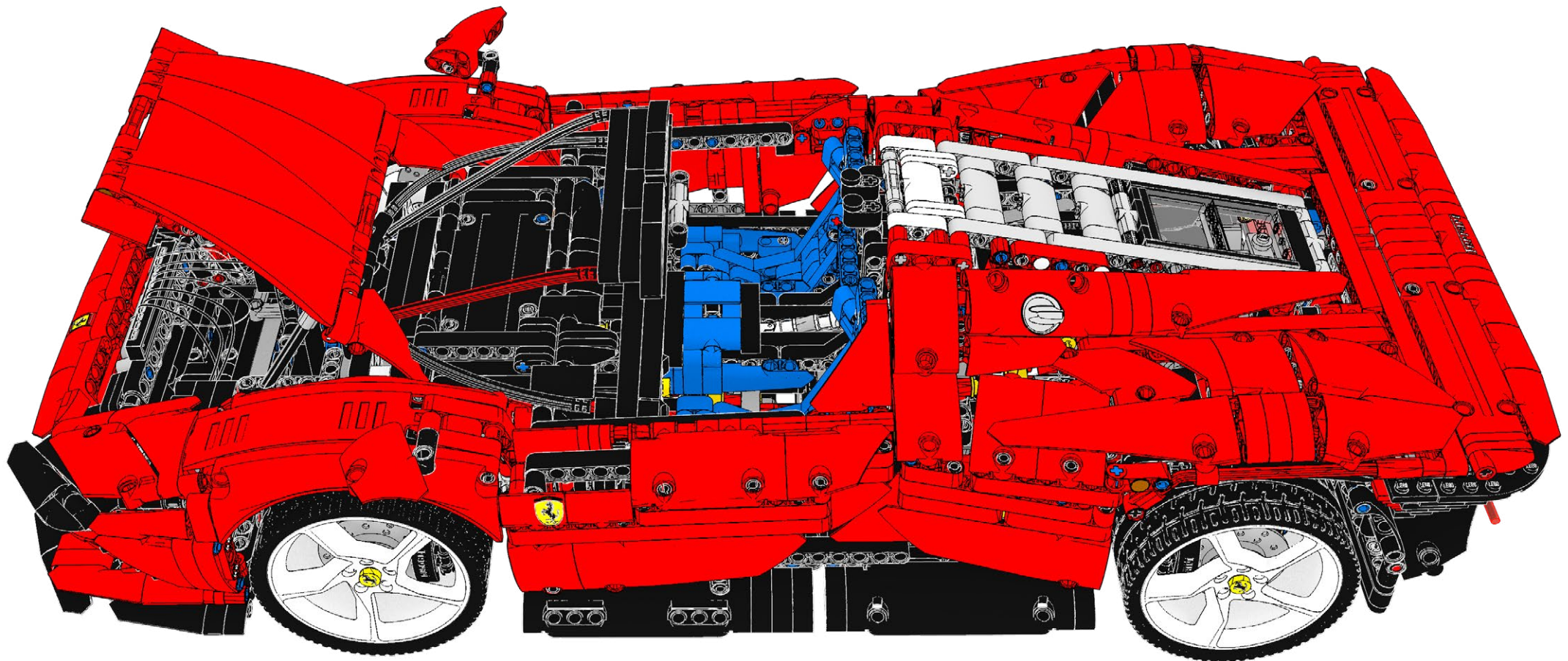

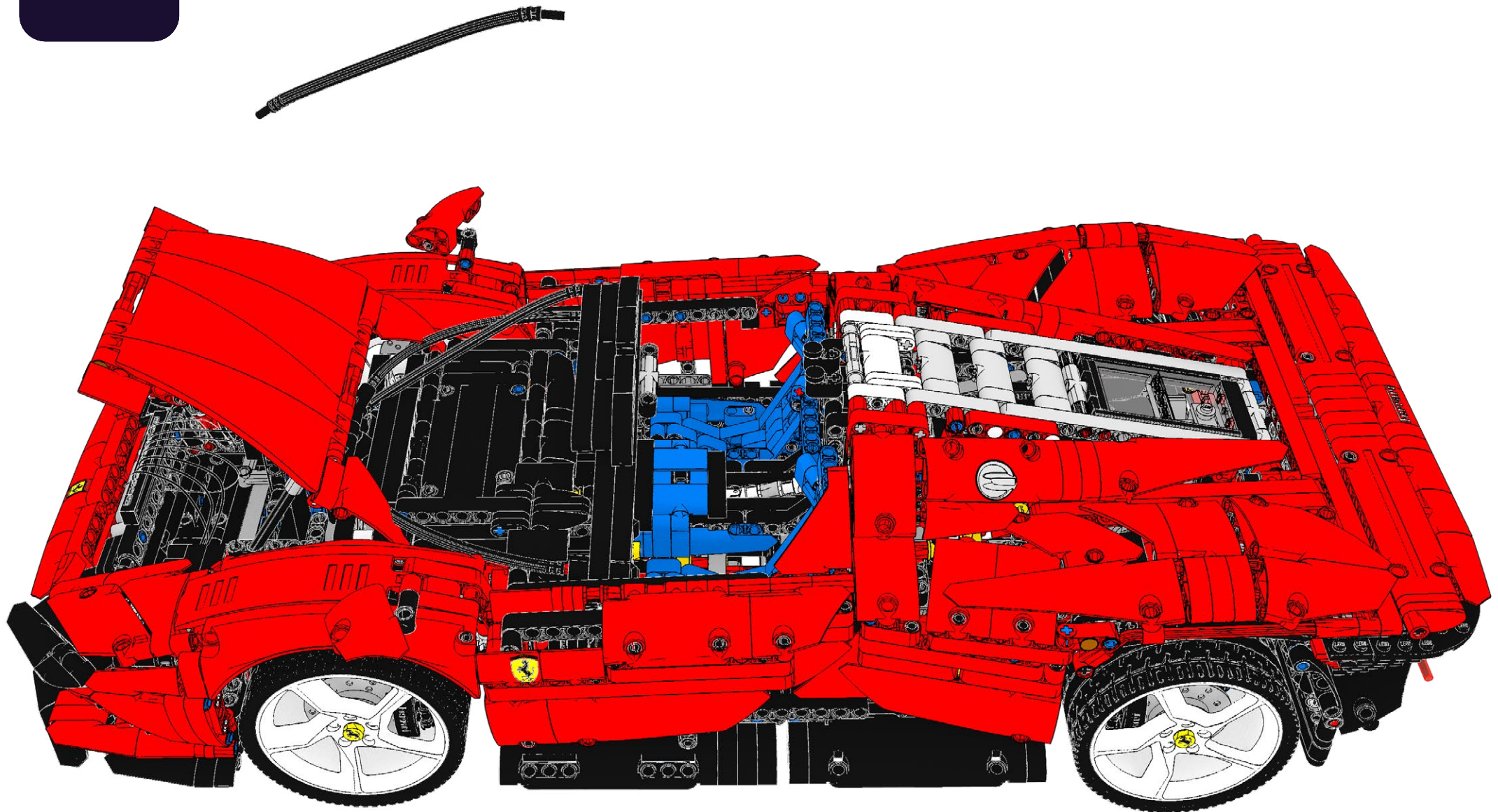

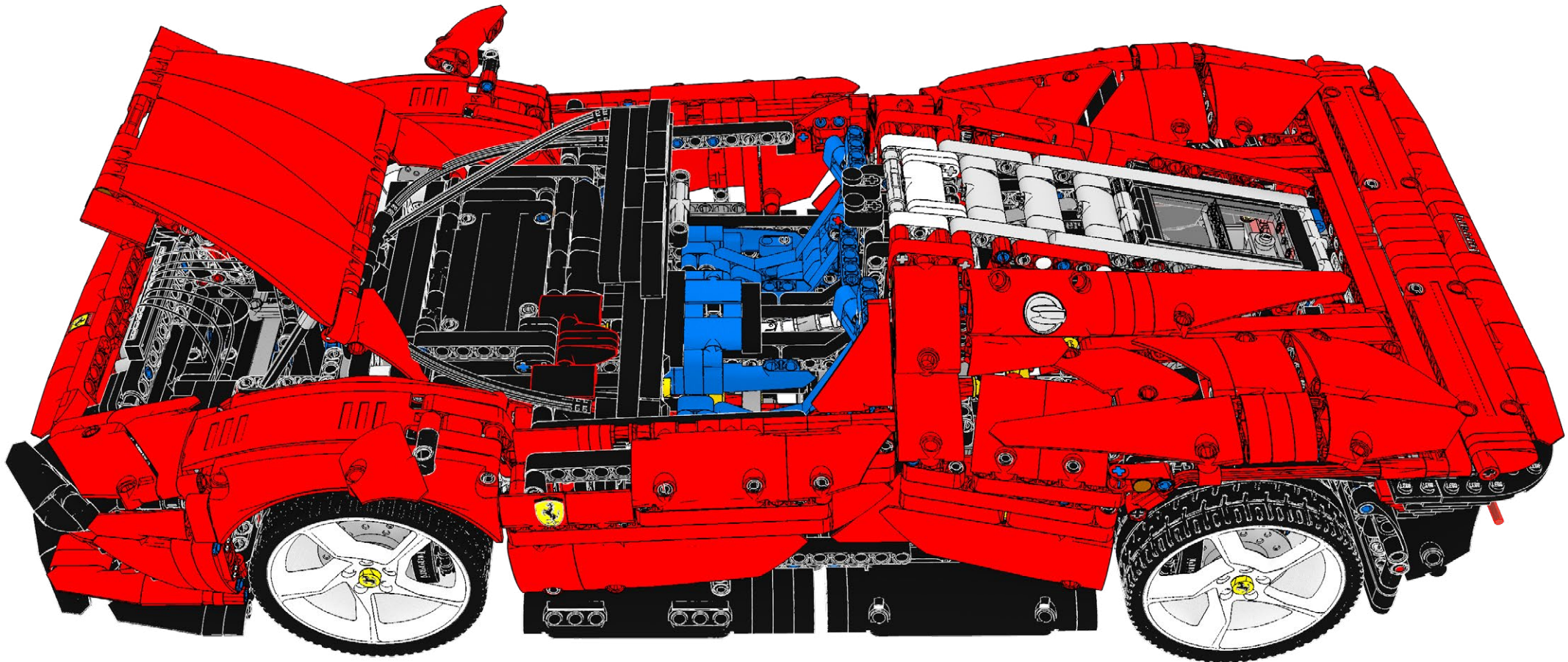

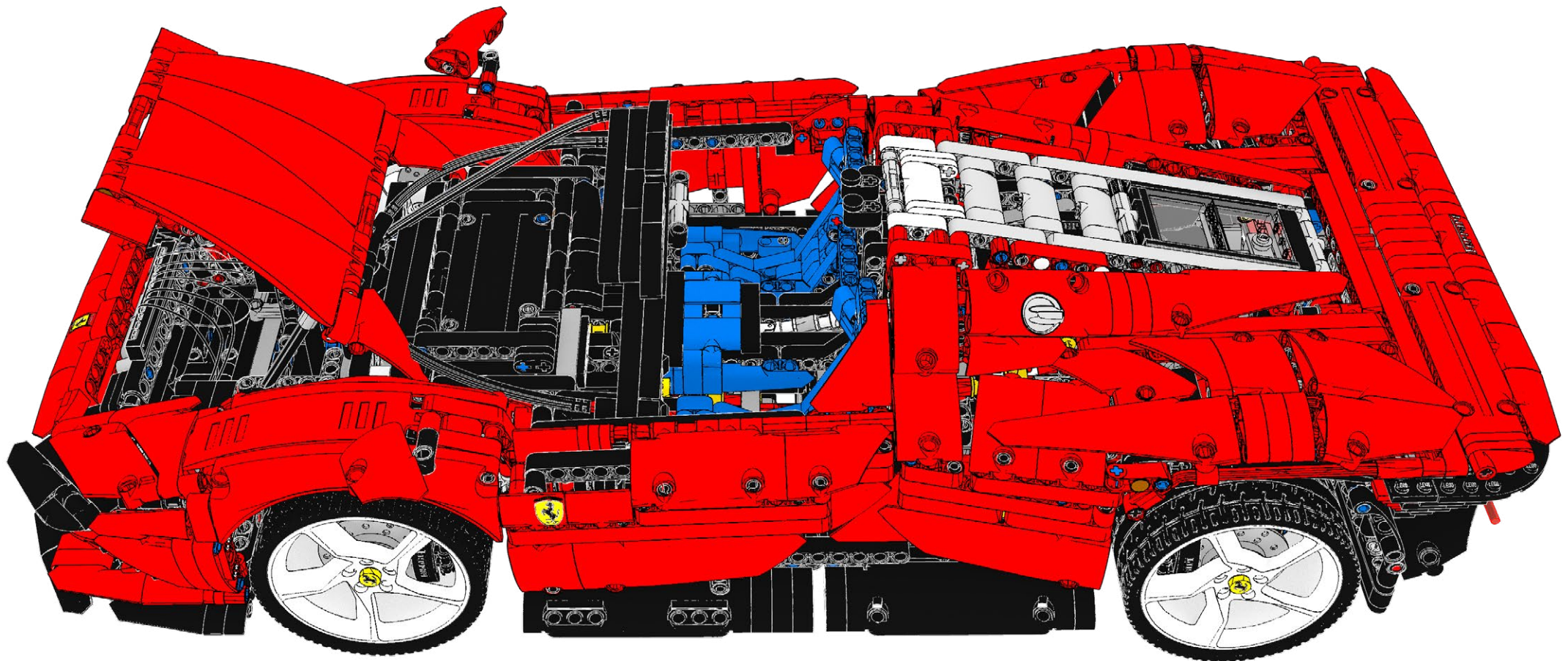

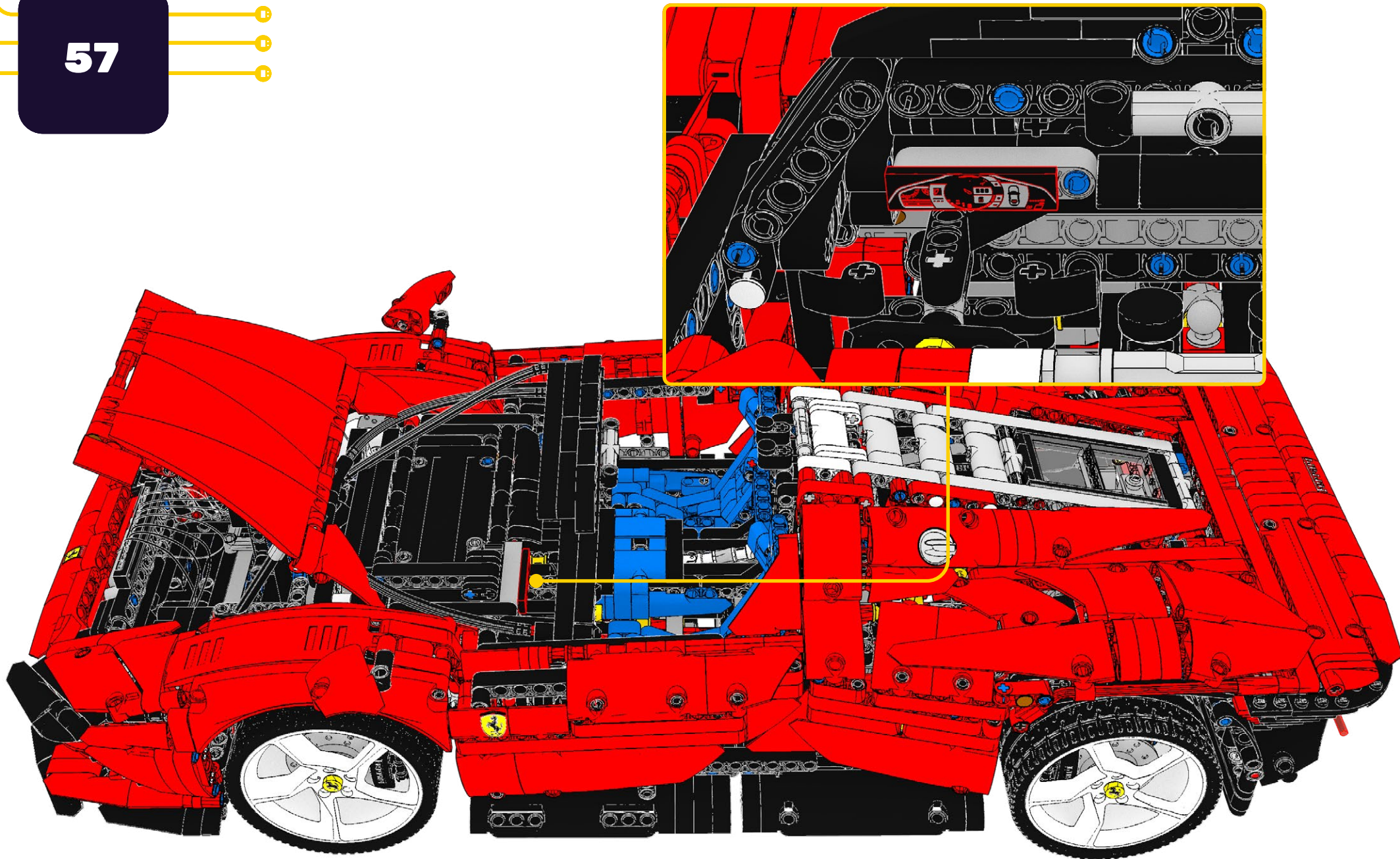

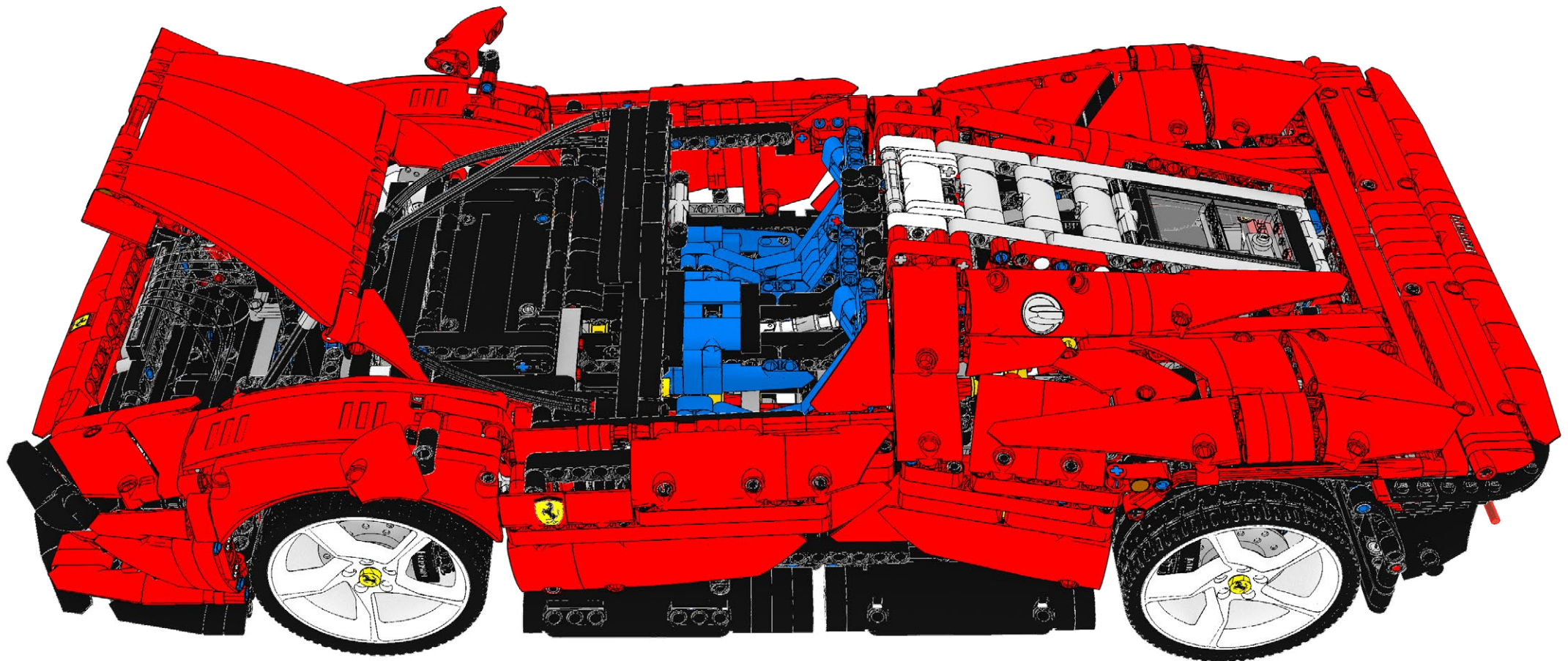

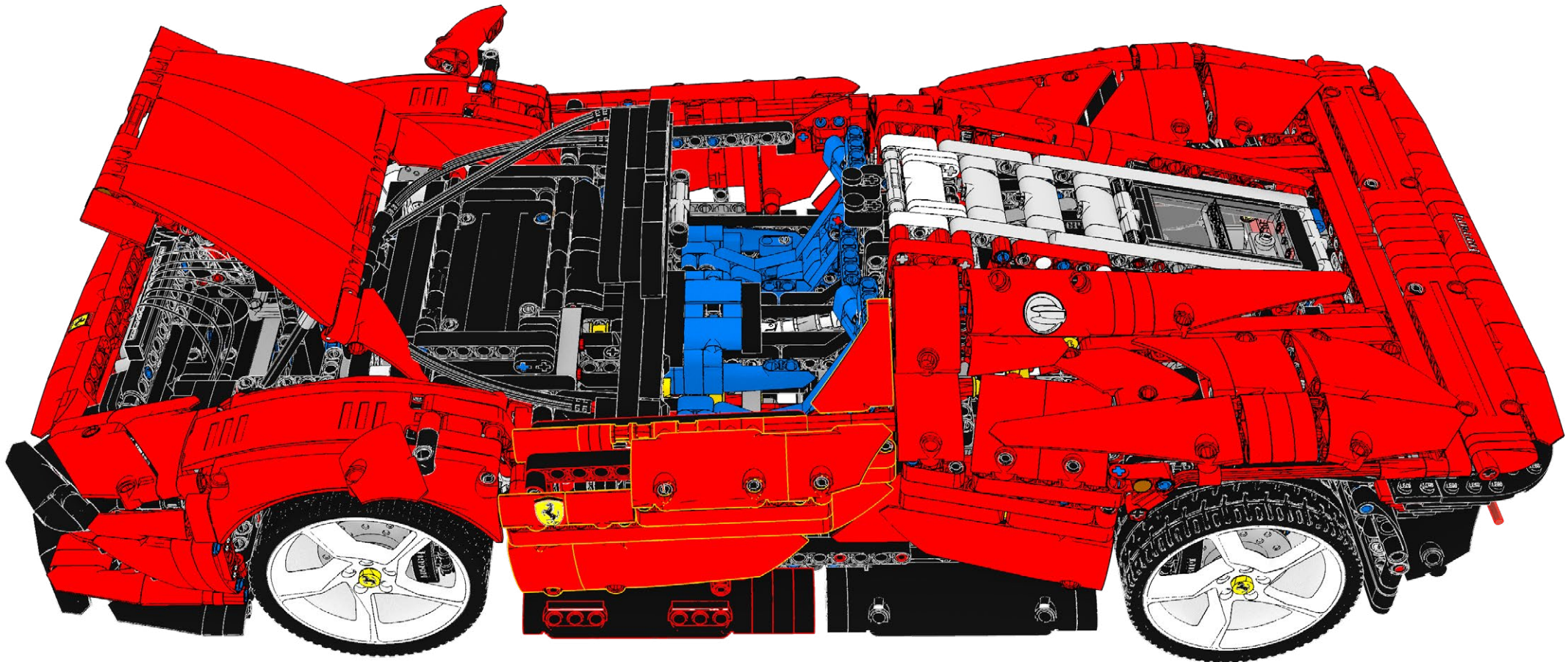

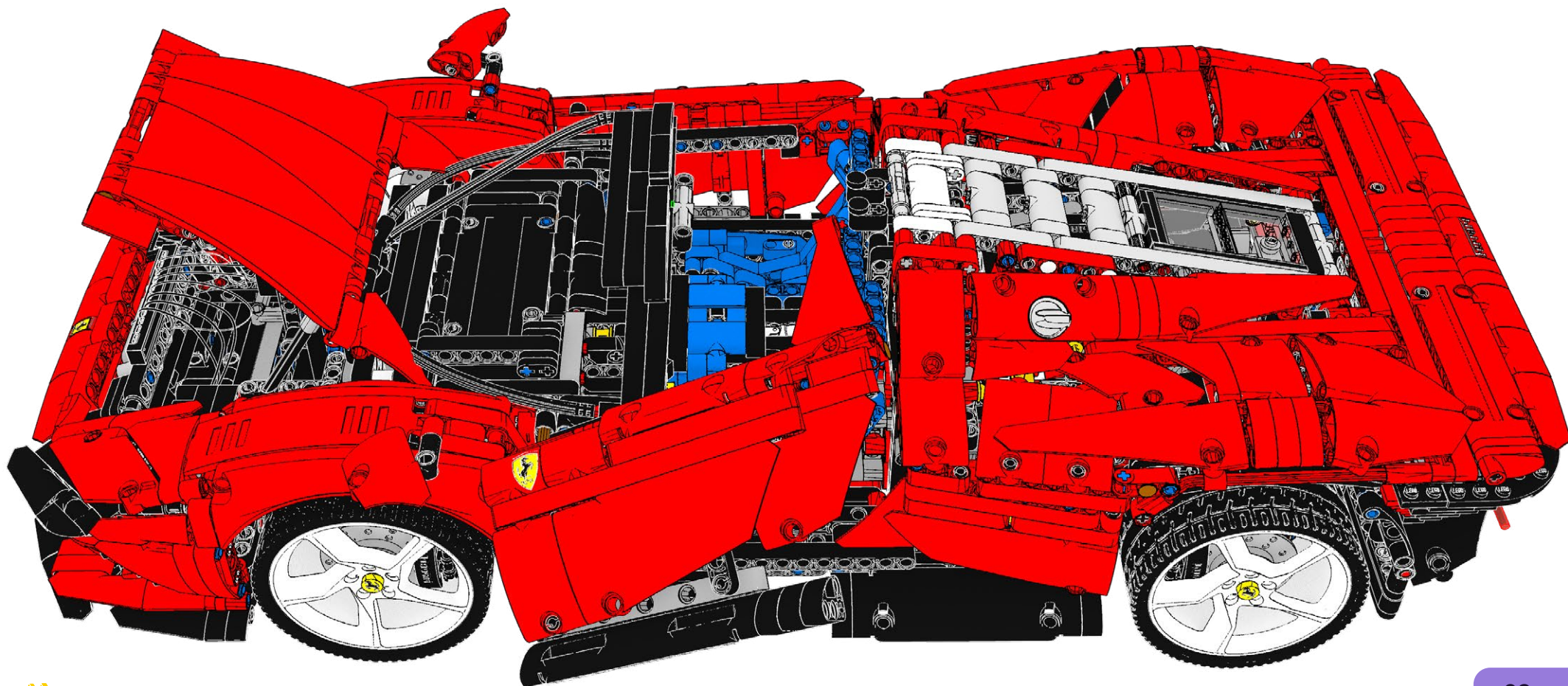

61

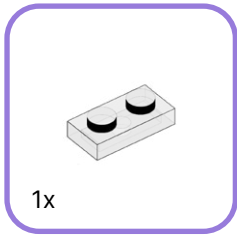

1



2



3



62

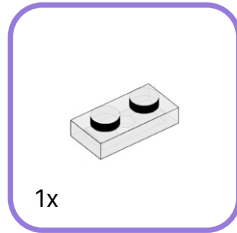

1

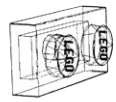

2



3

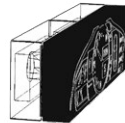

63

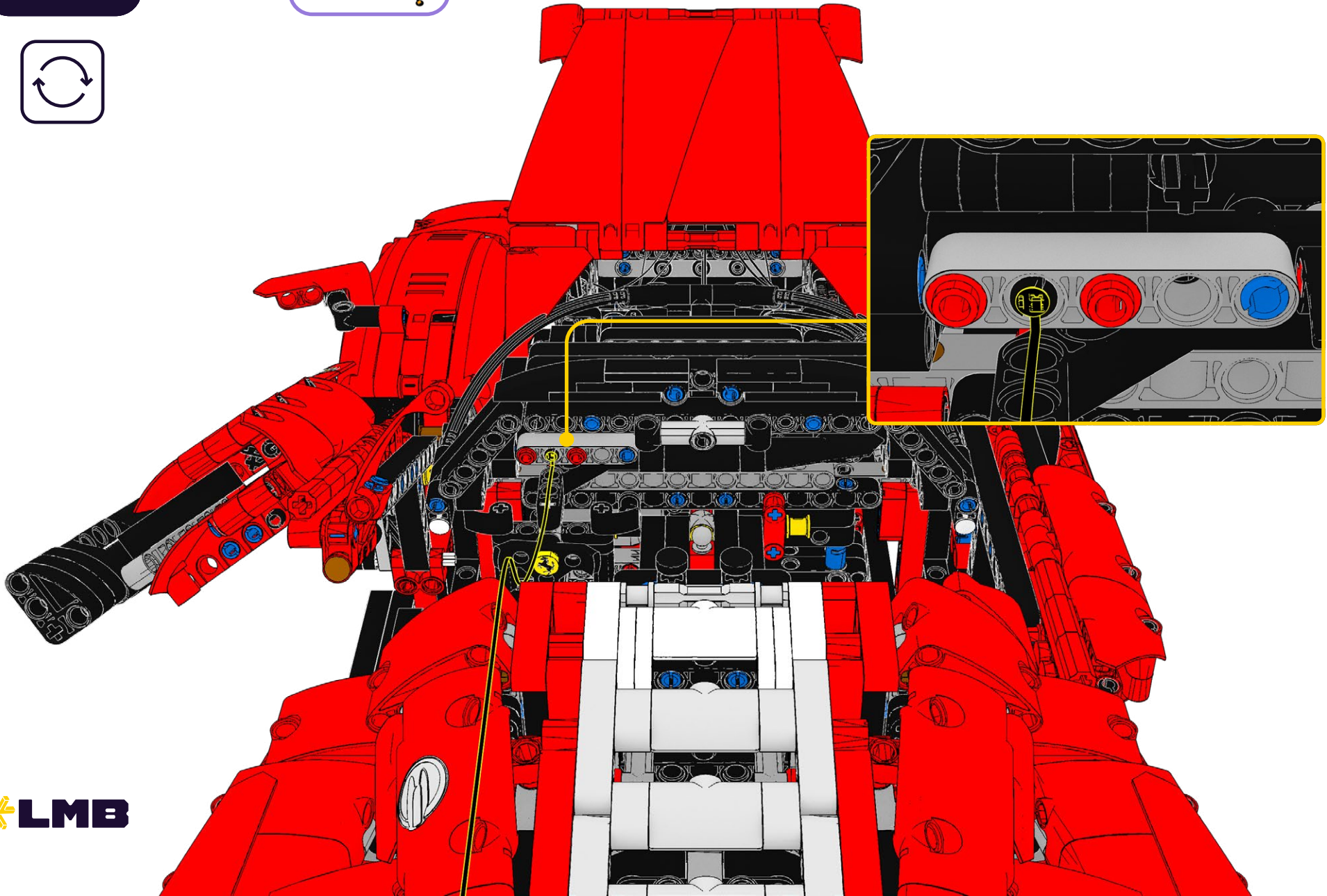
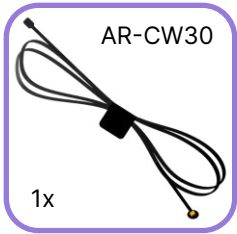

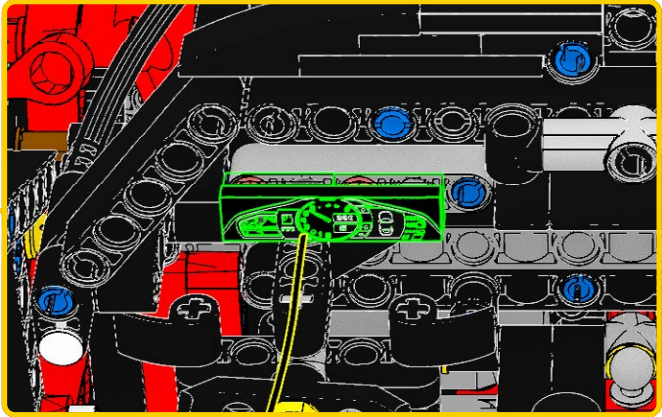
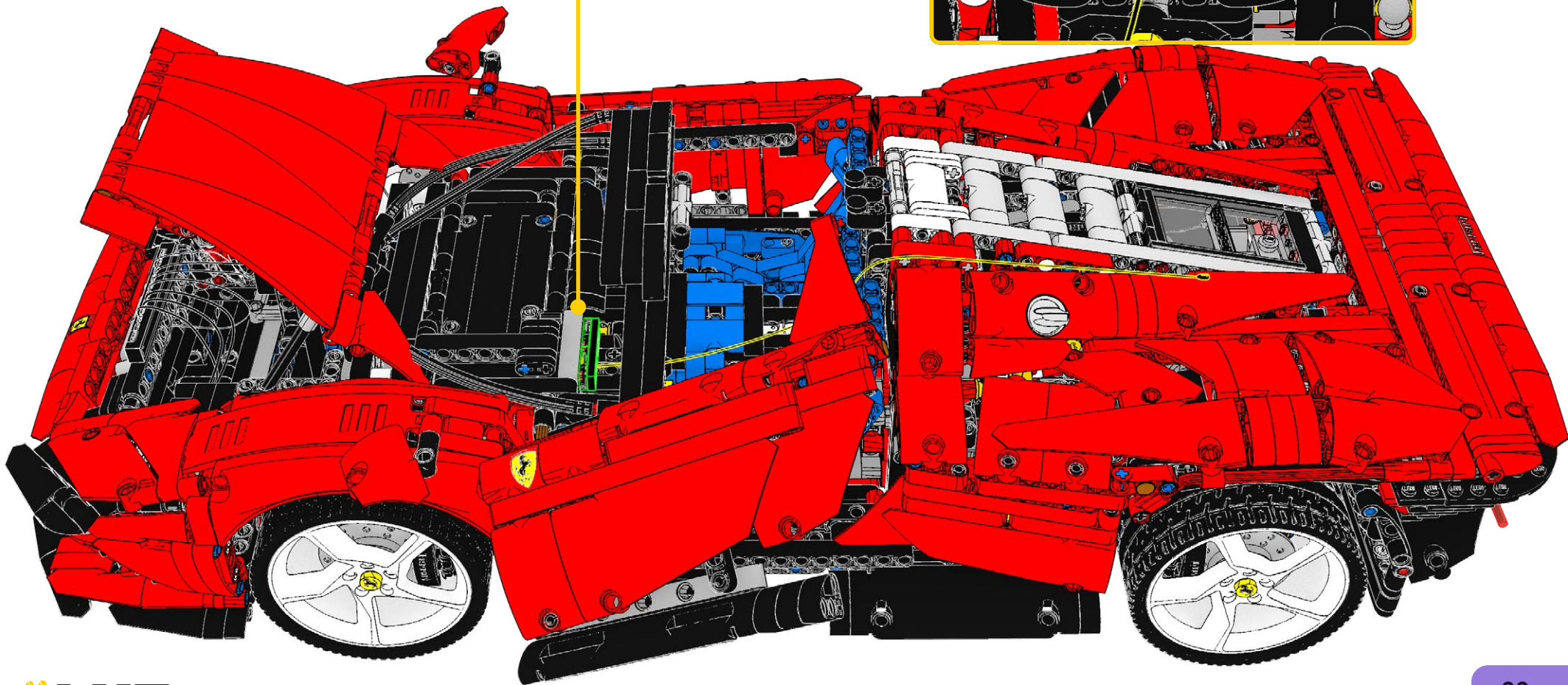

65

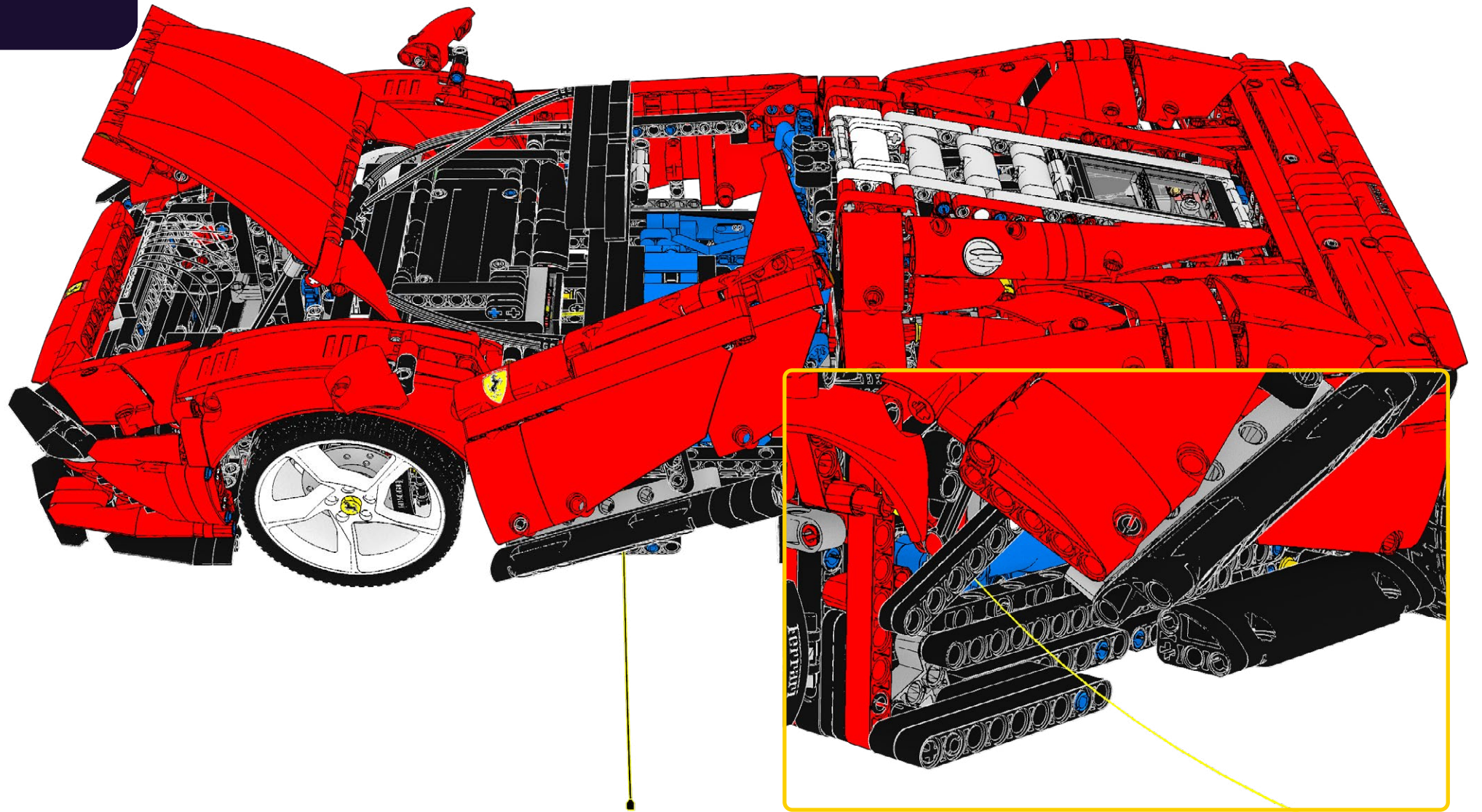

66

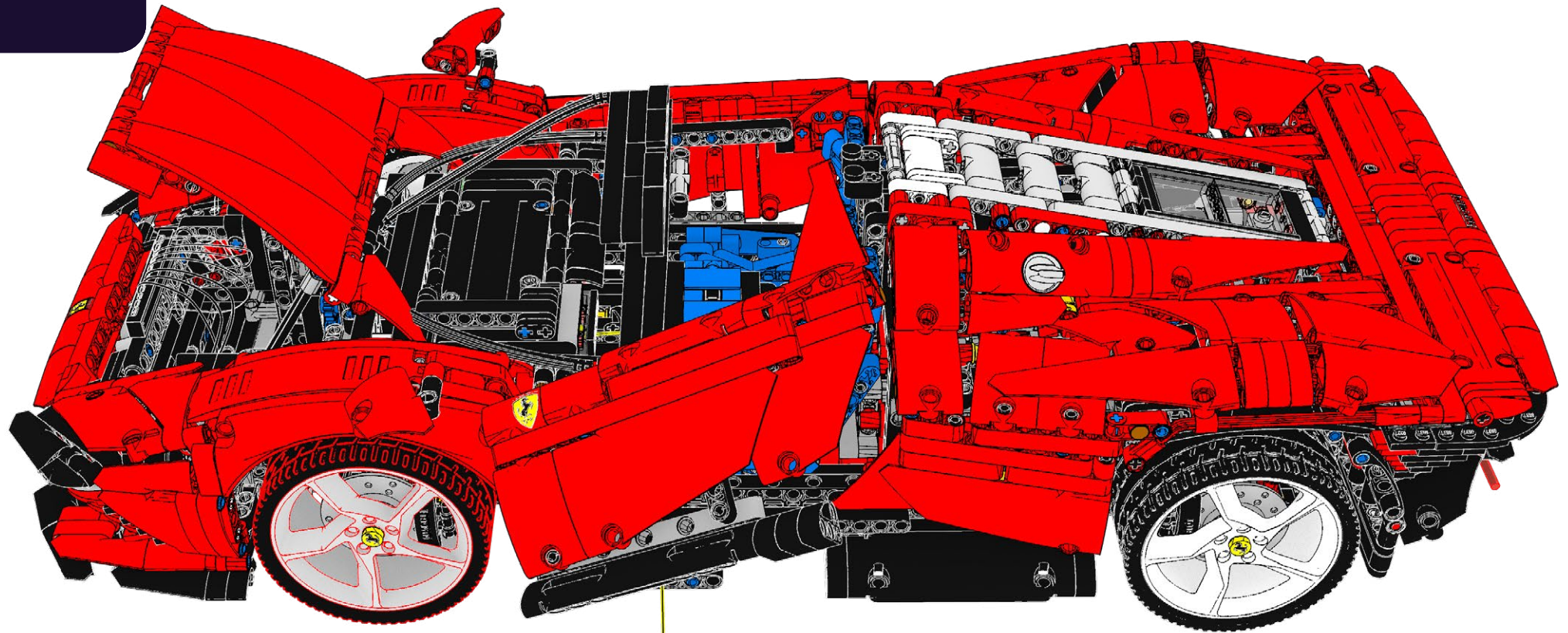

67

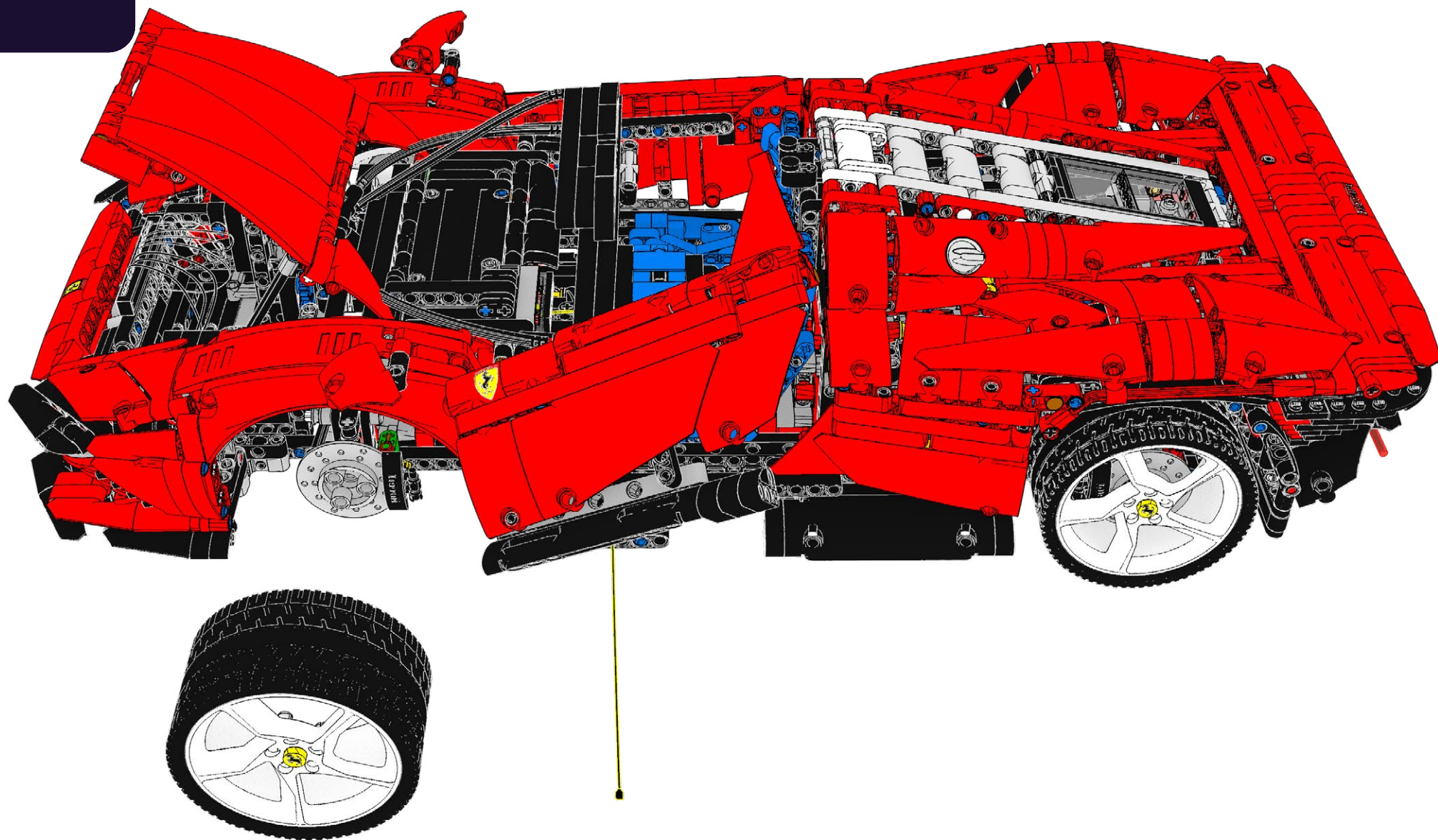

68

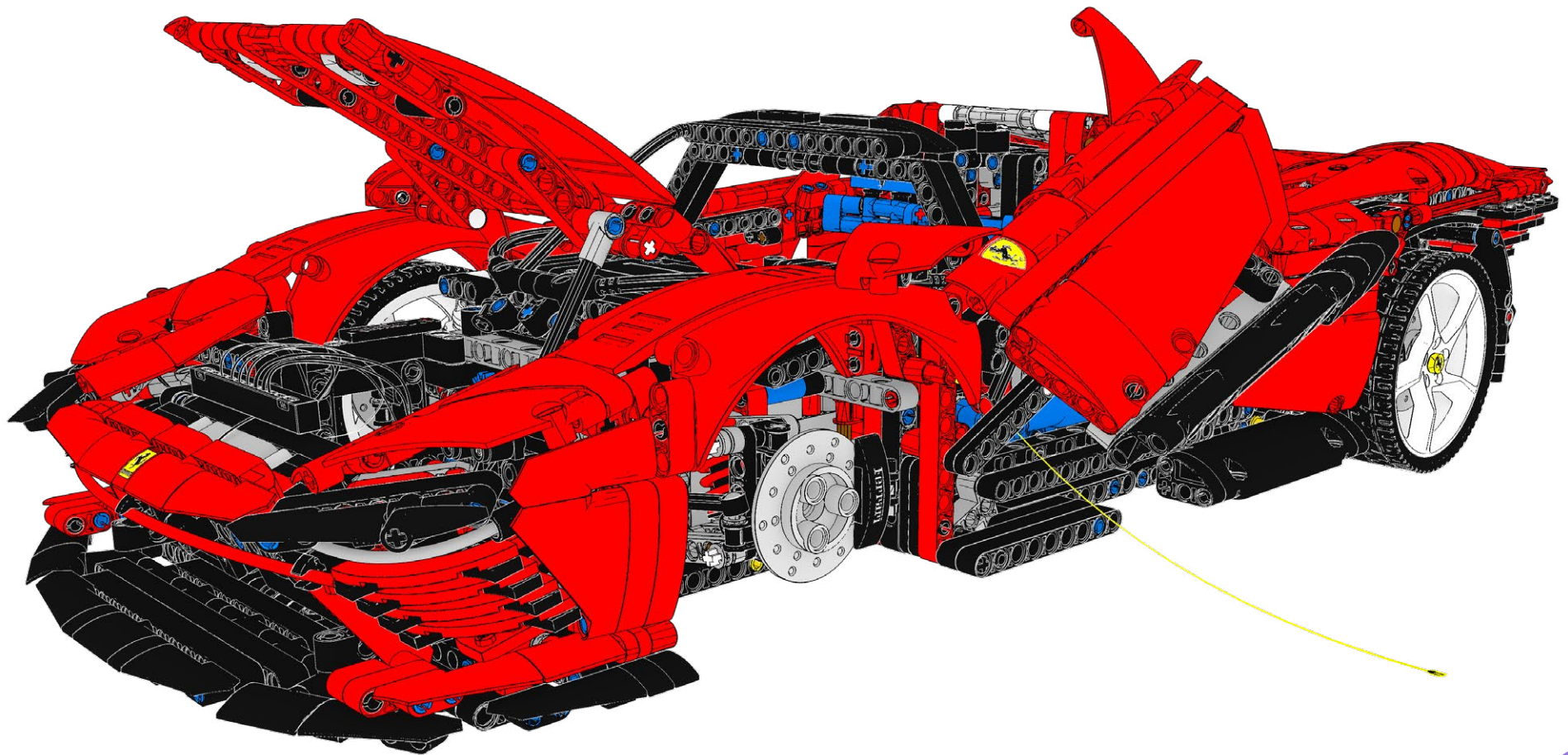

69

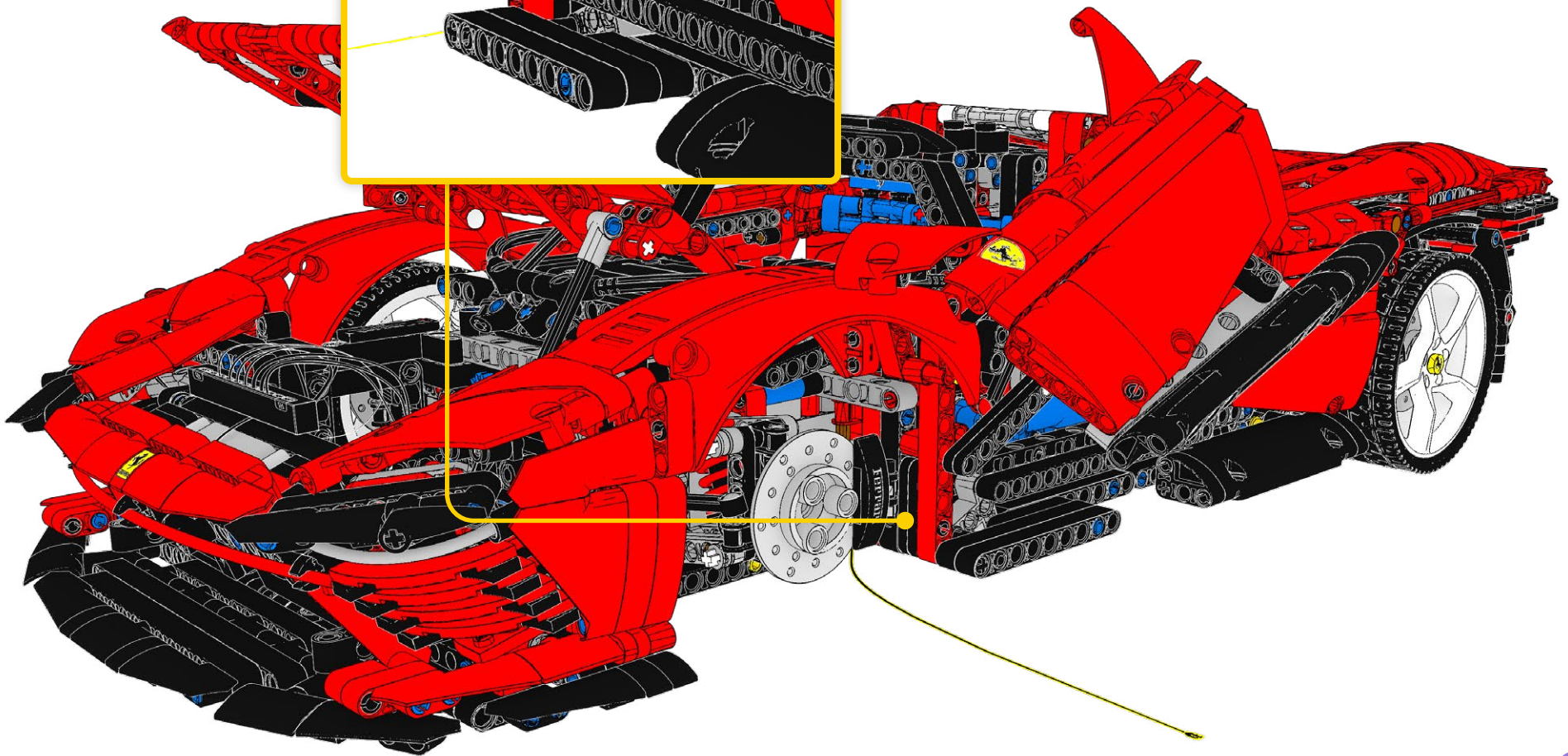
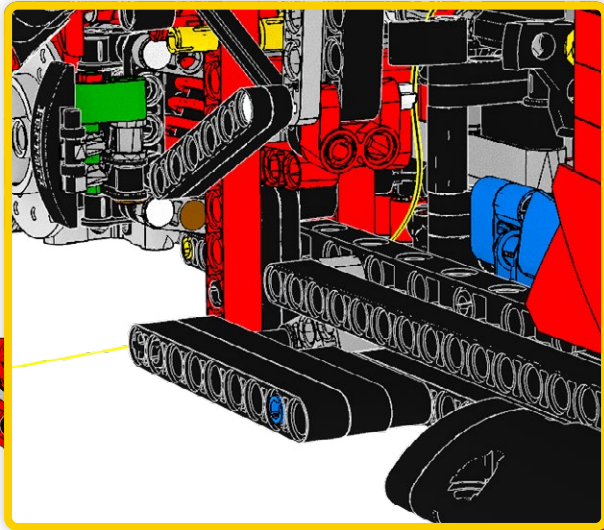

70

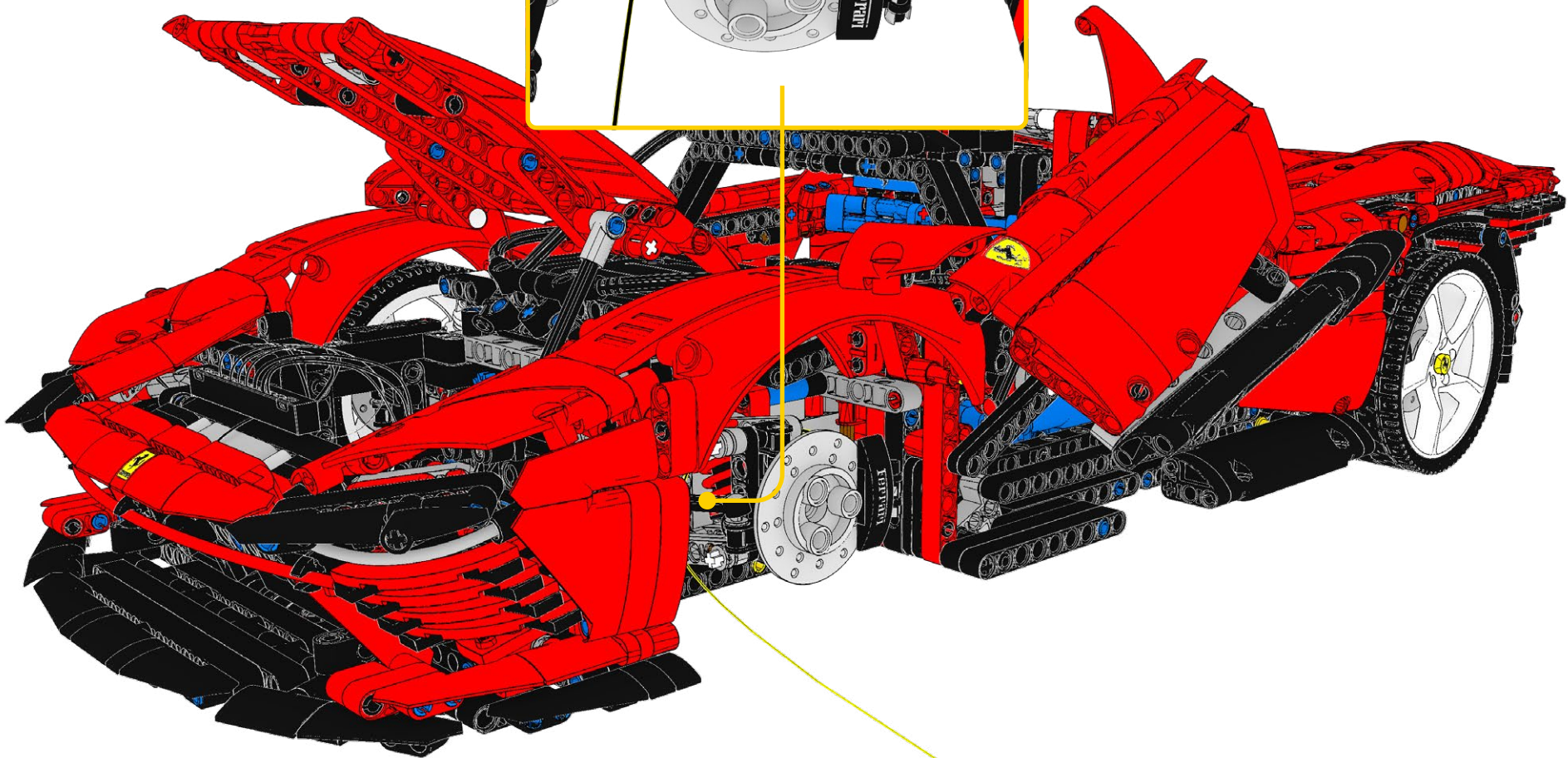
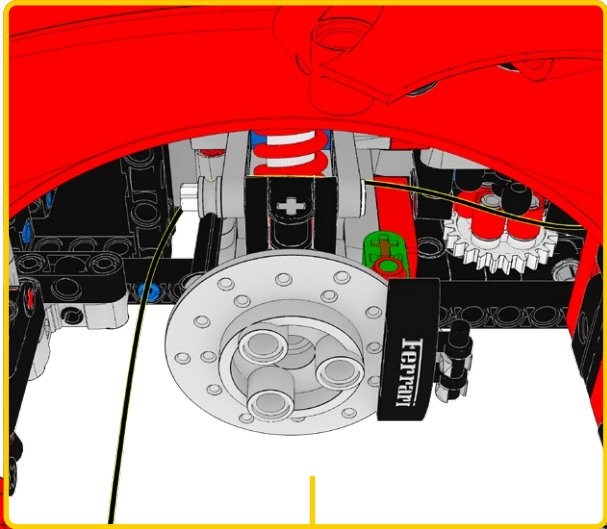

71

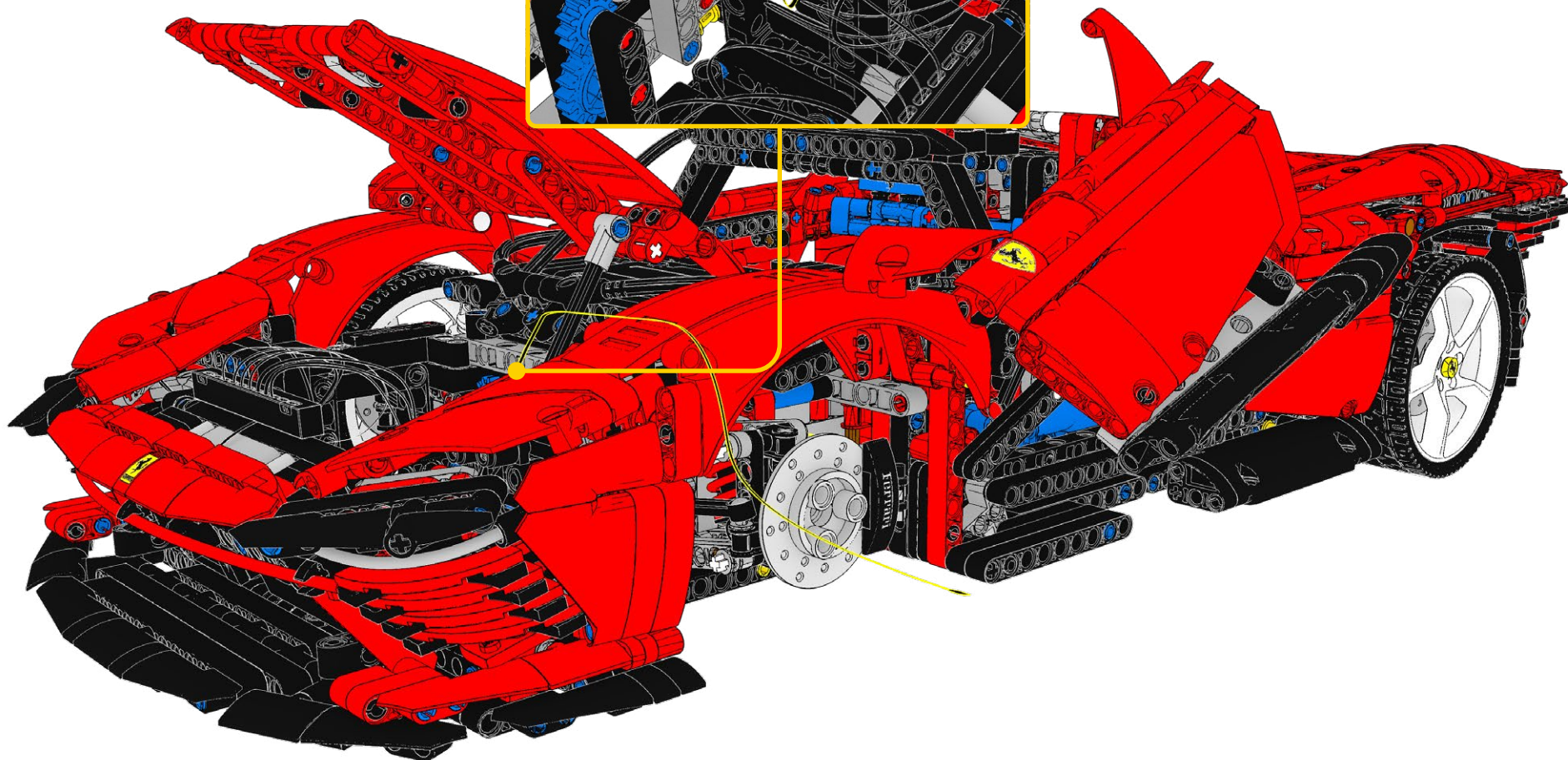
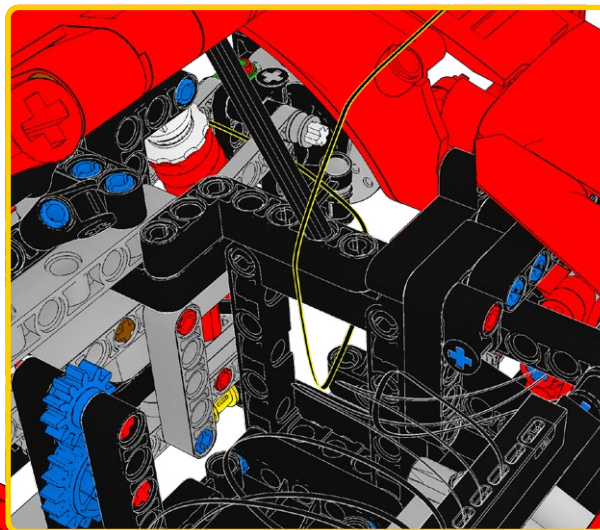

72

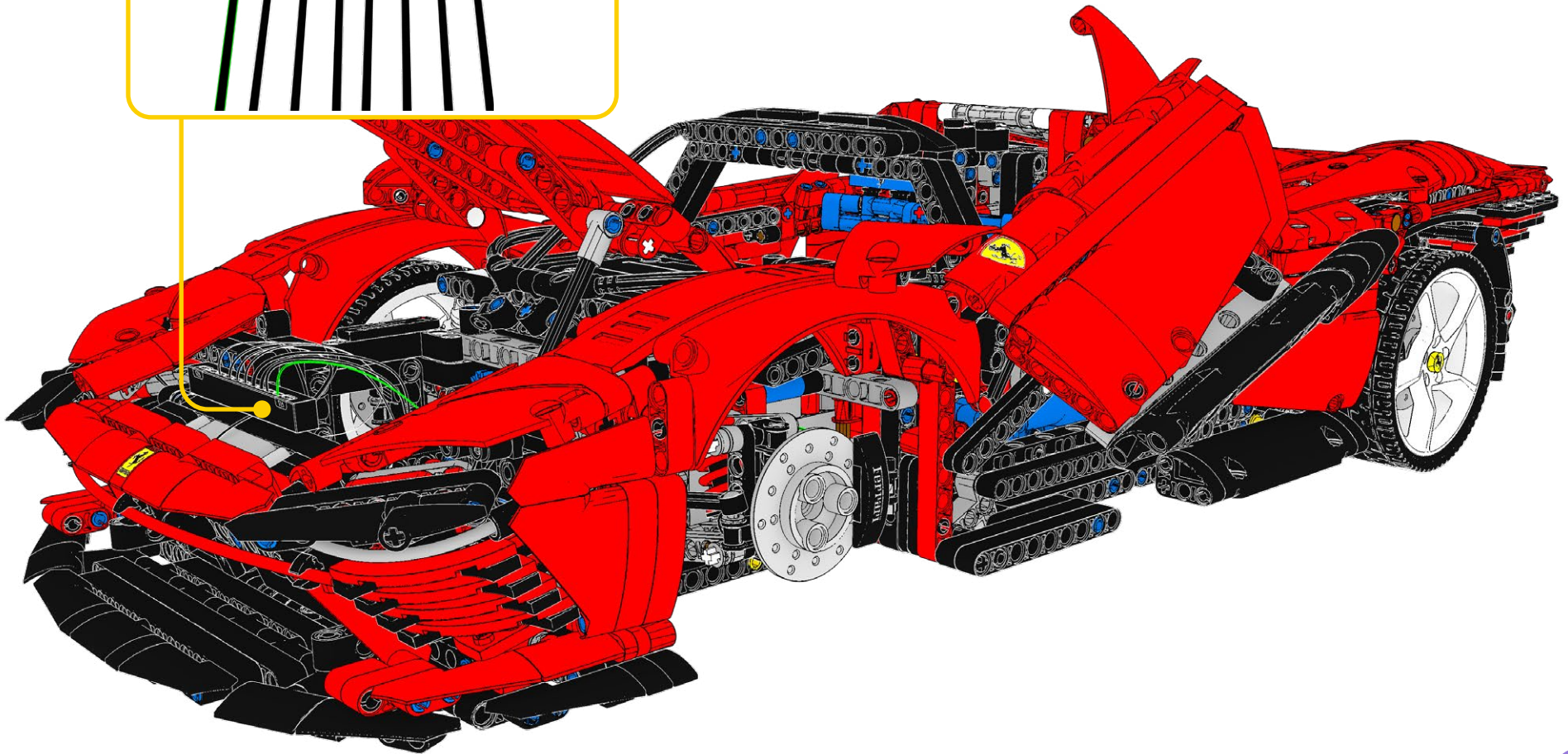
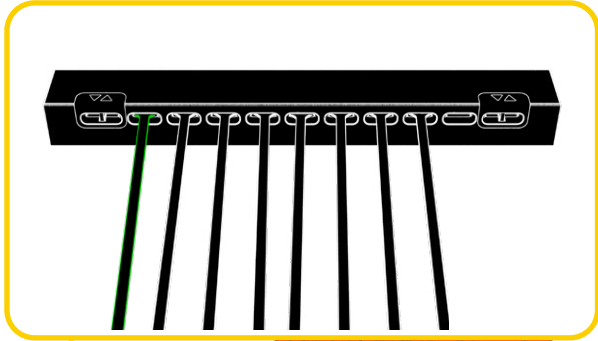

73

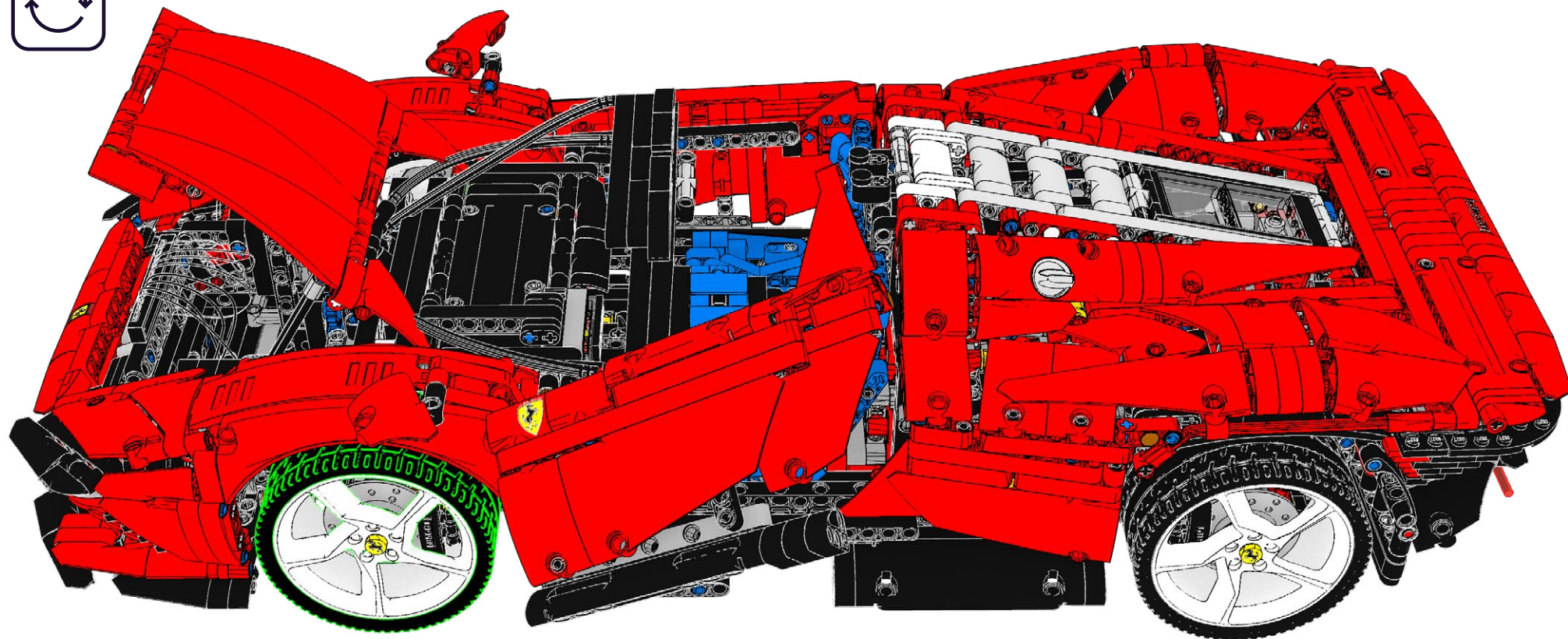

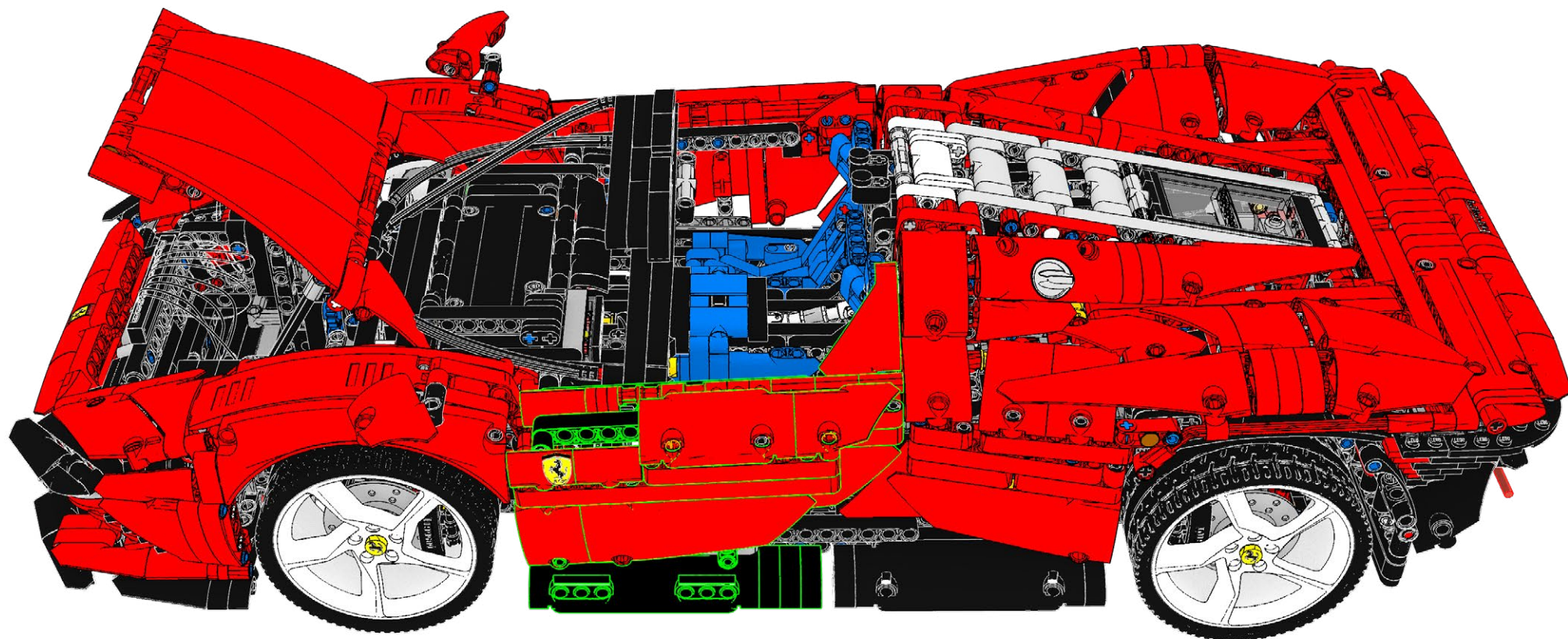

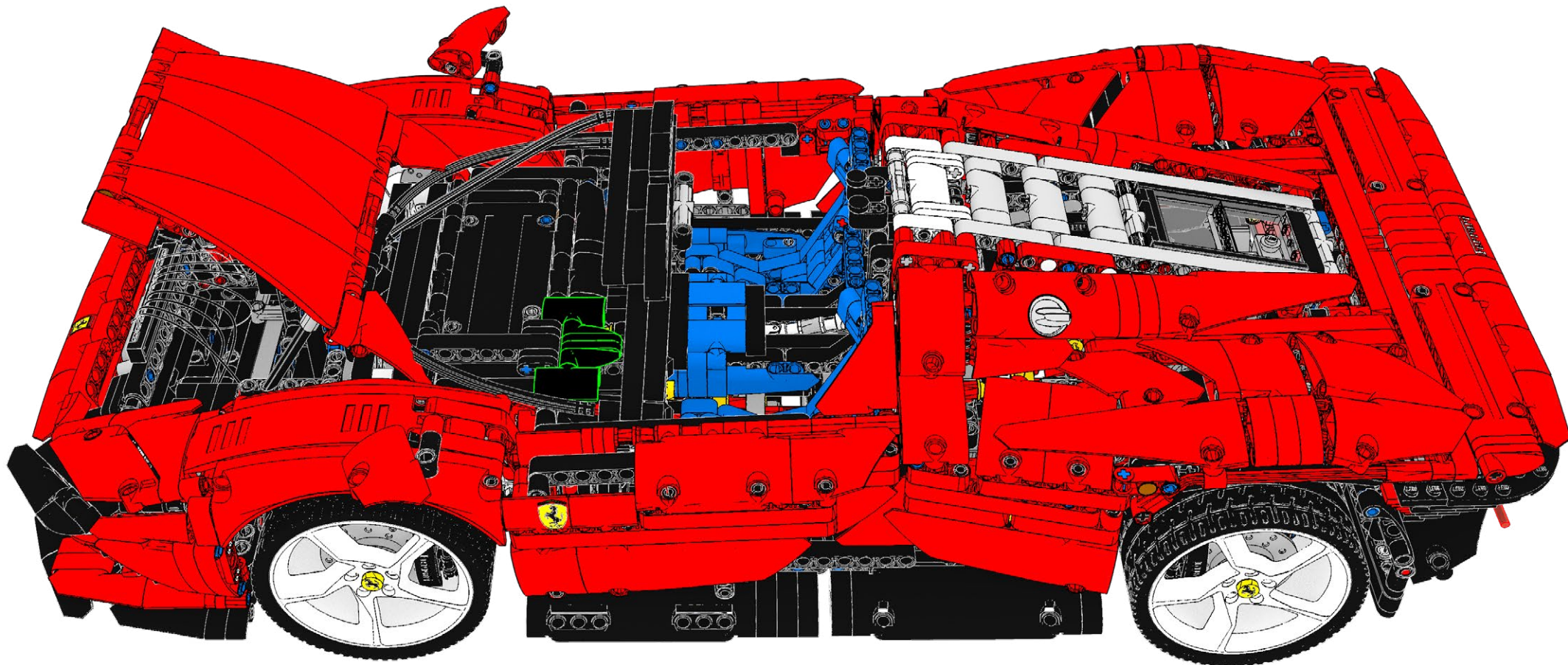

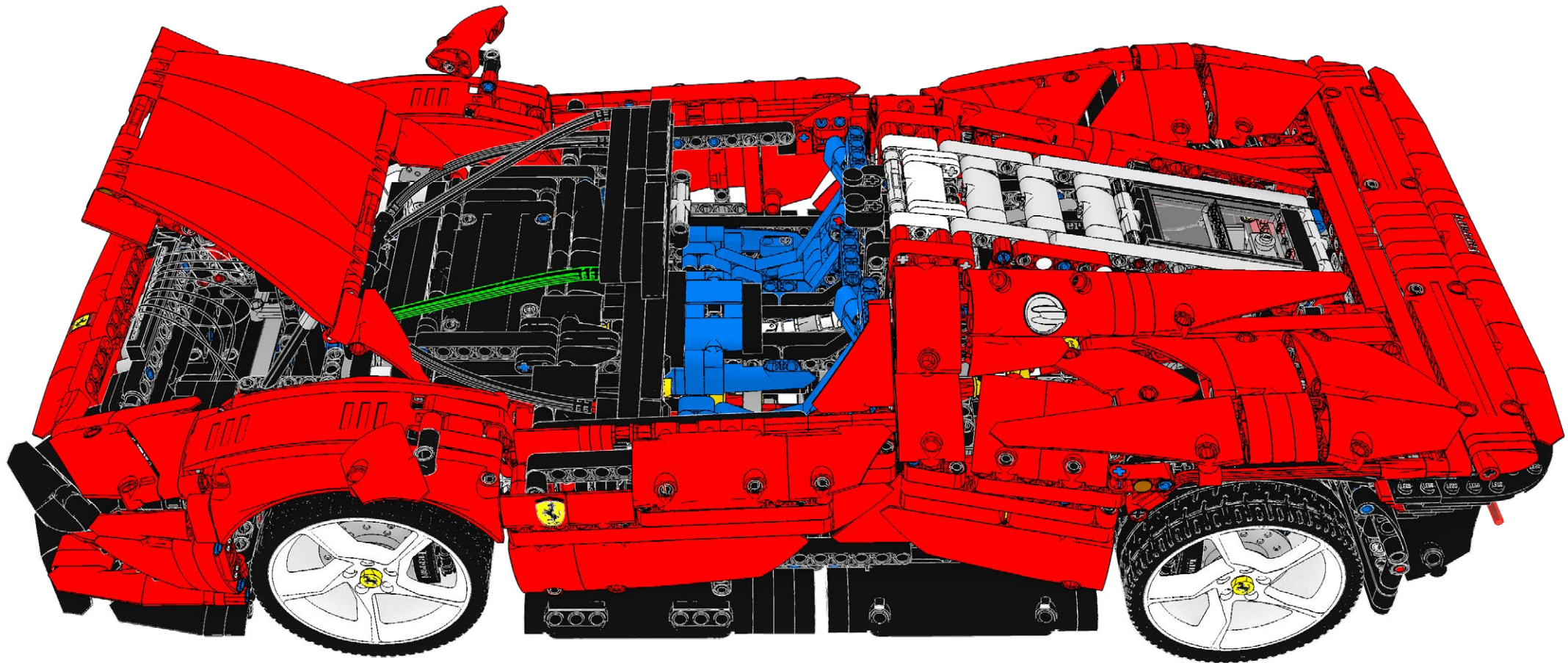

77

B-30

1x

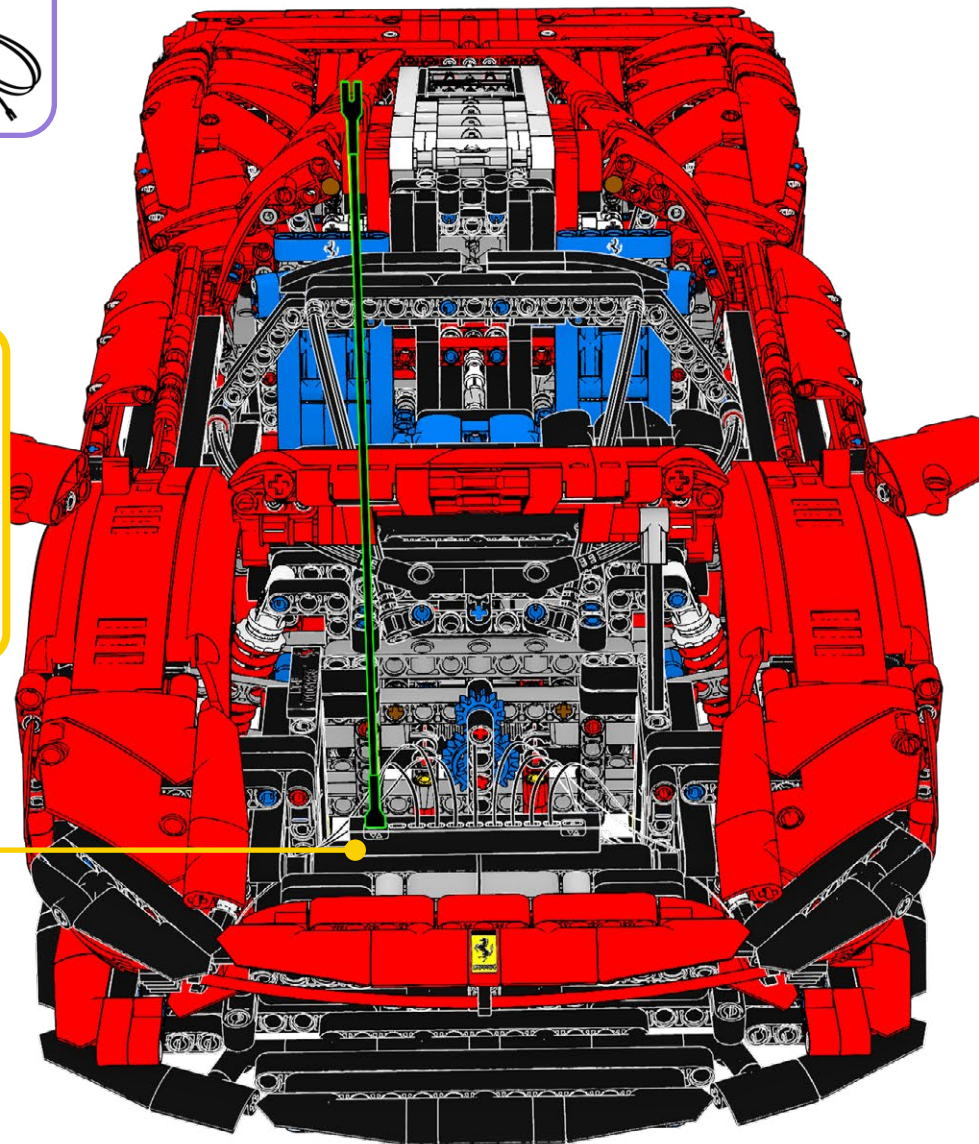
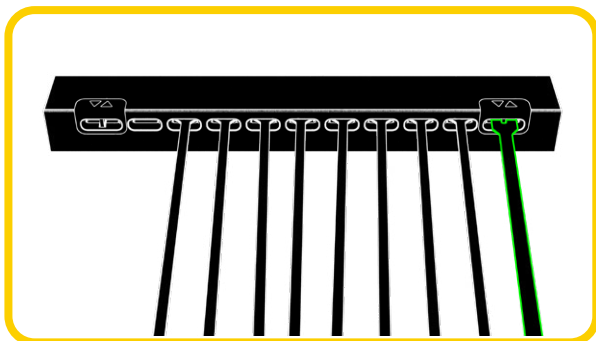

78

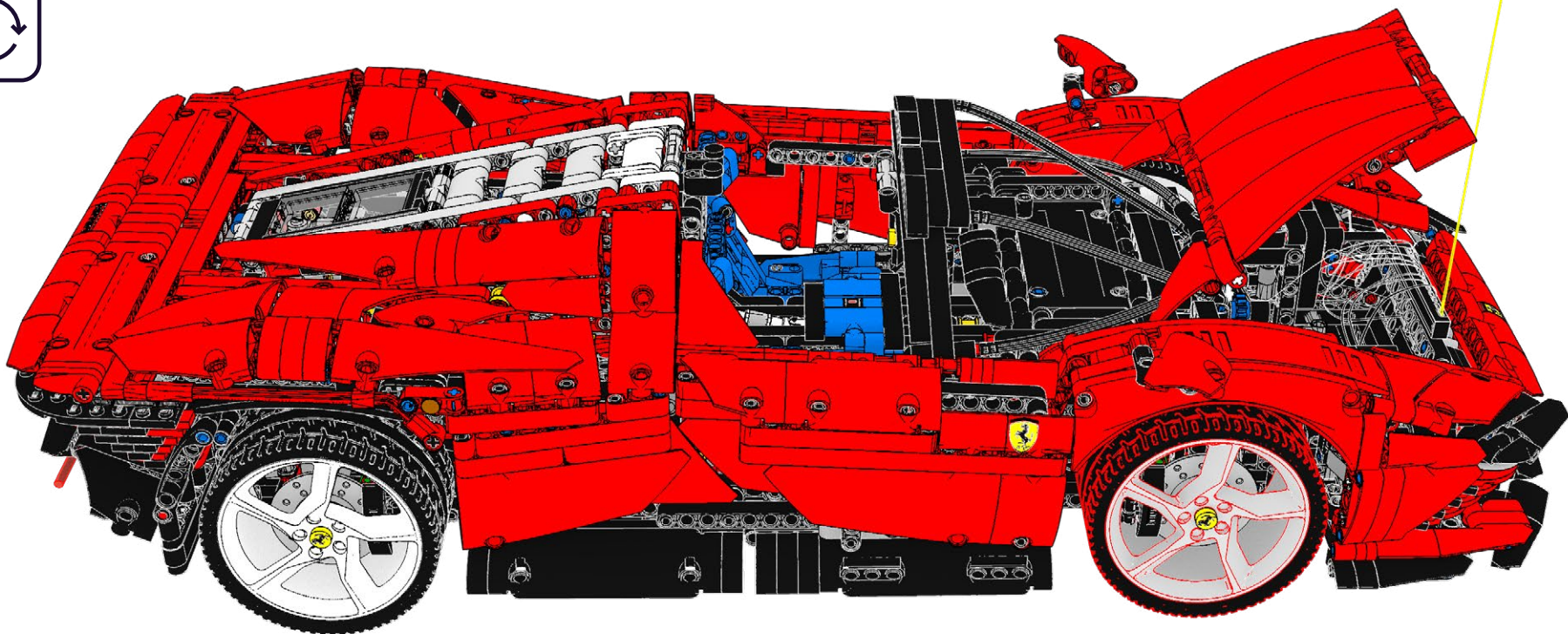

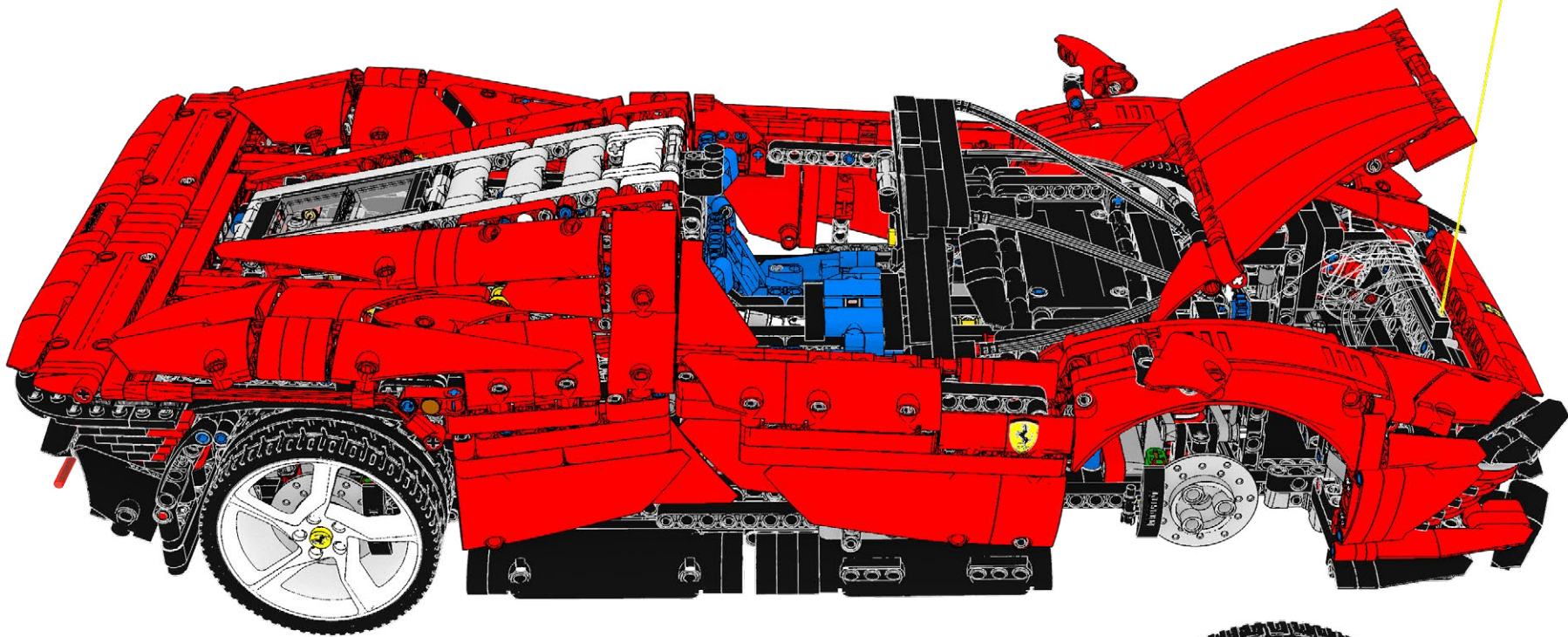

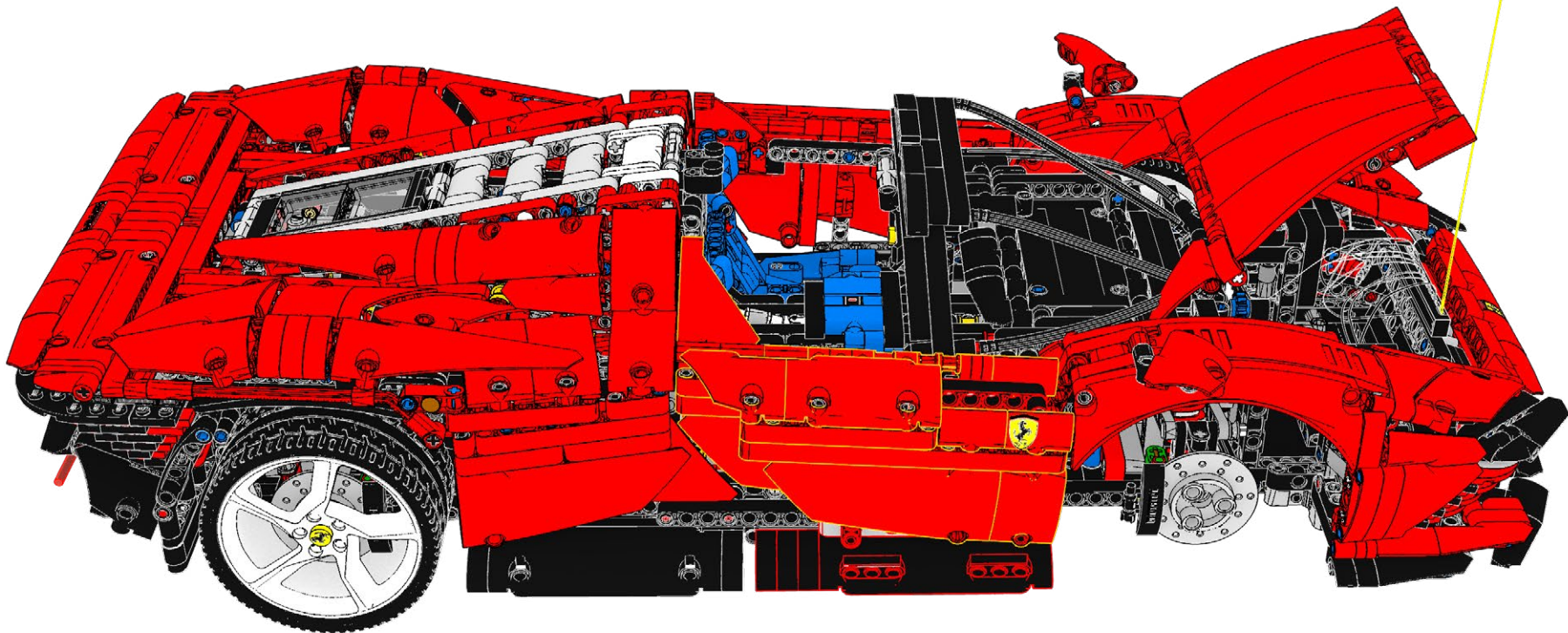

81

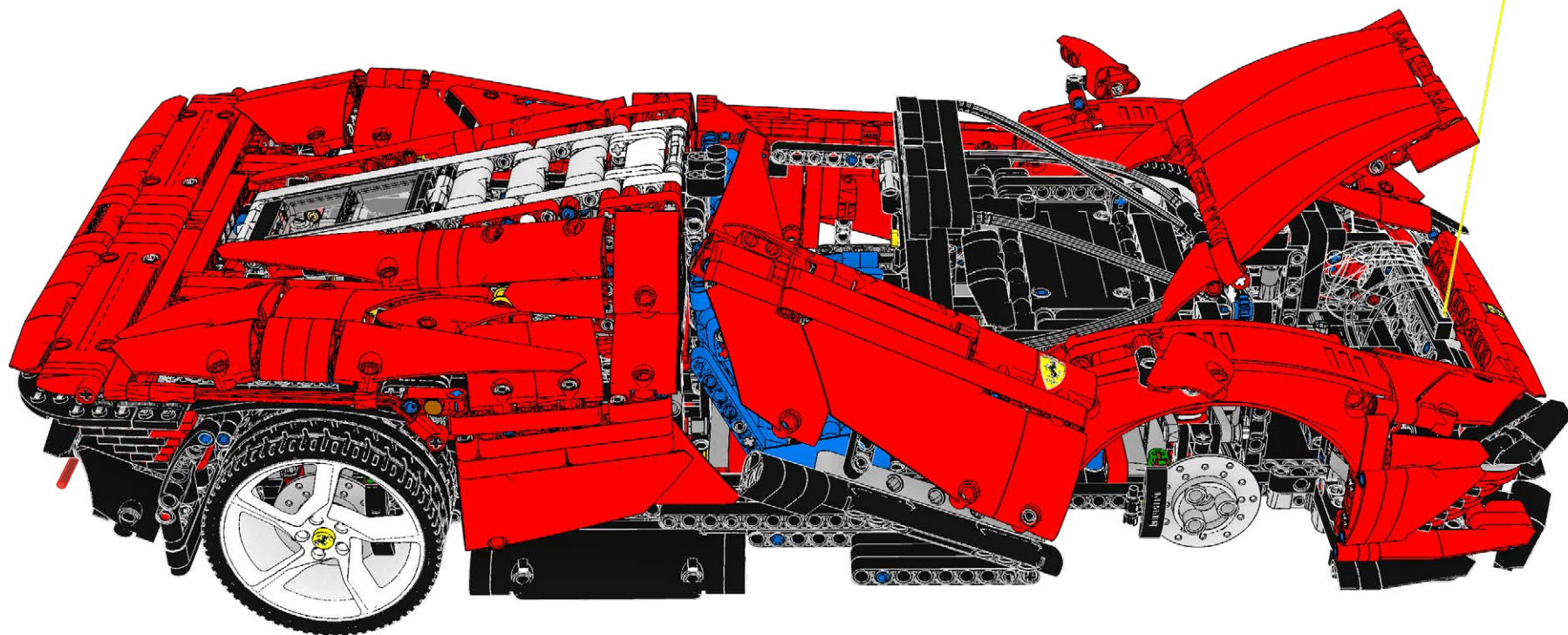

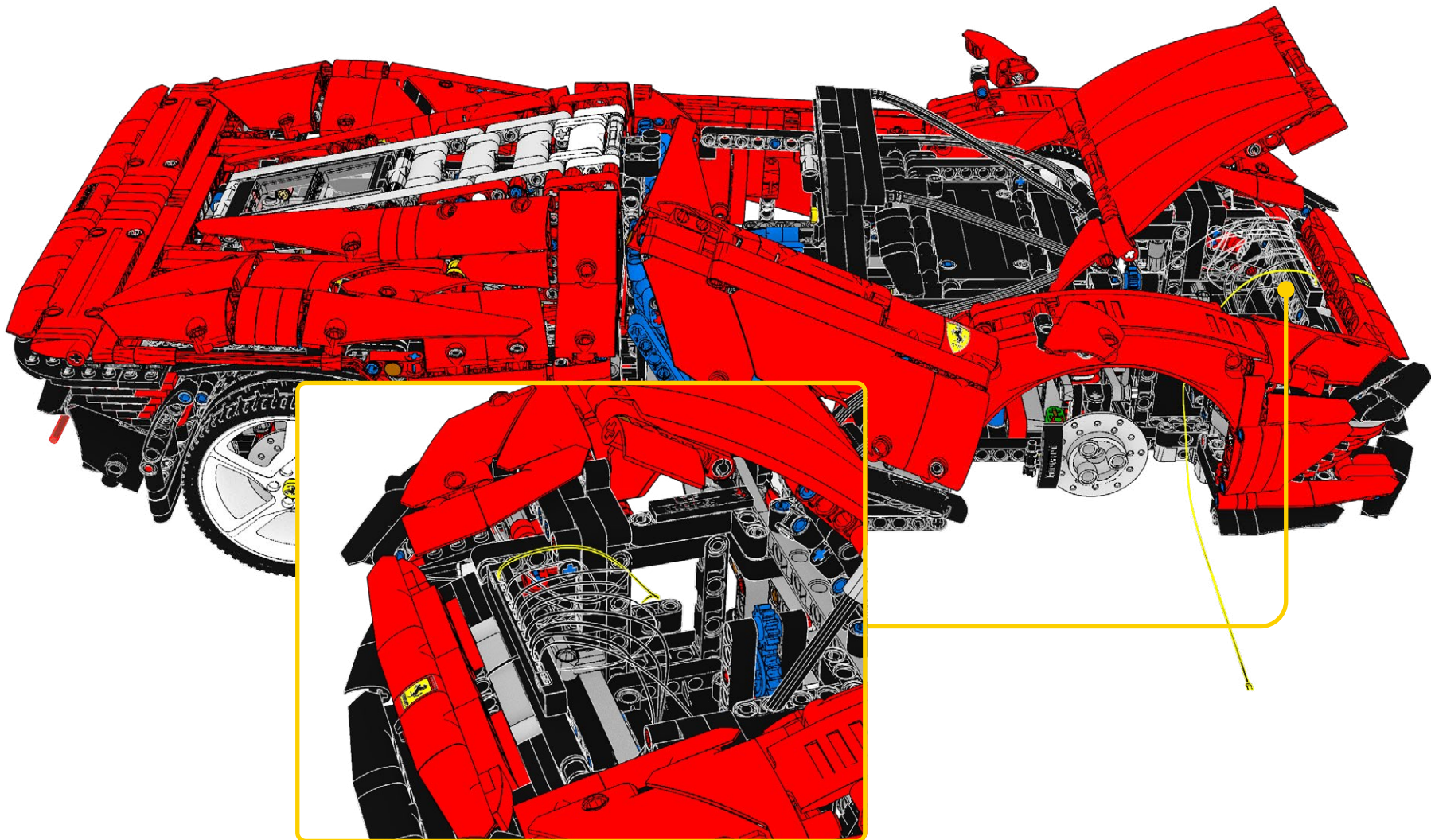

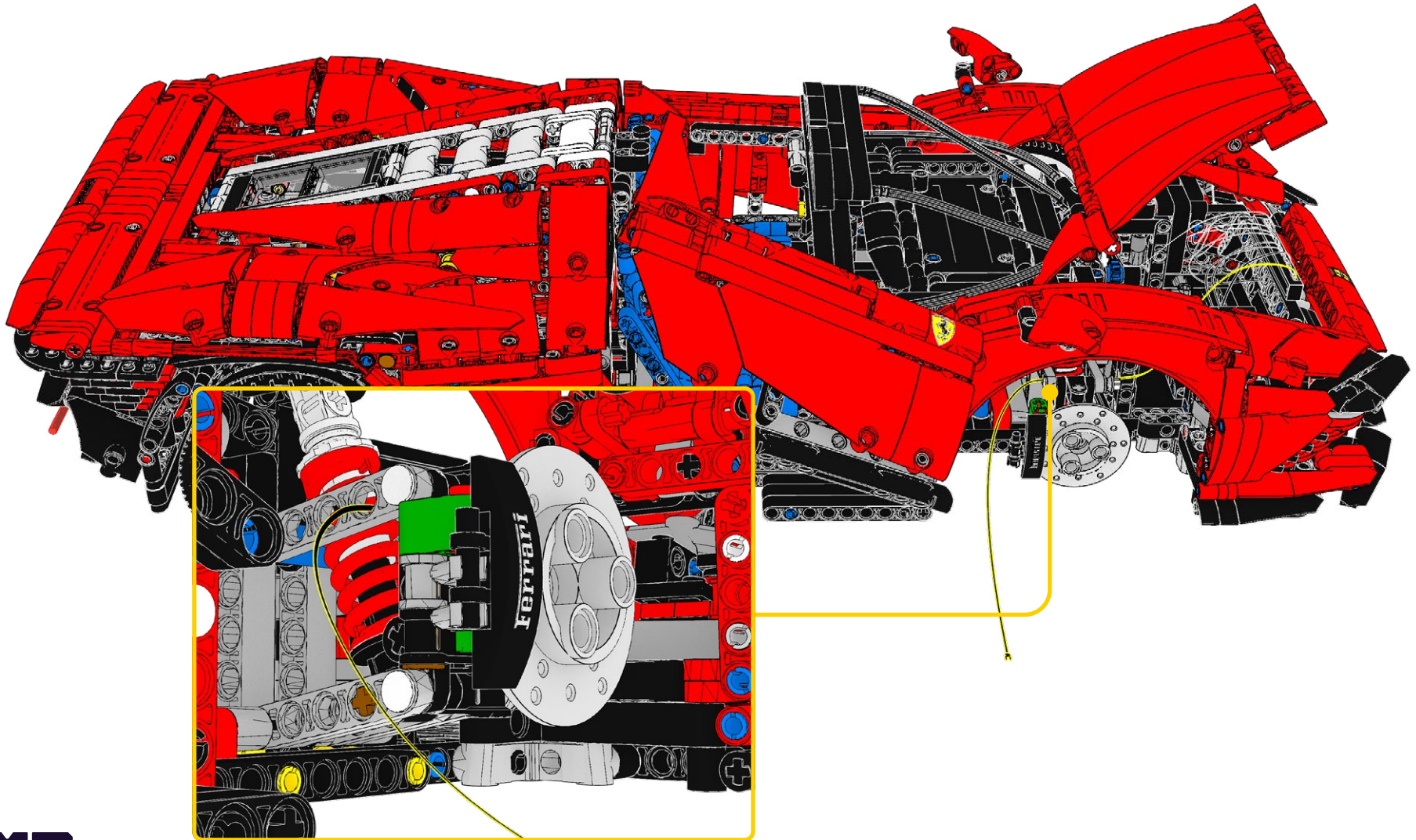

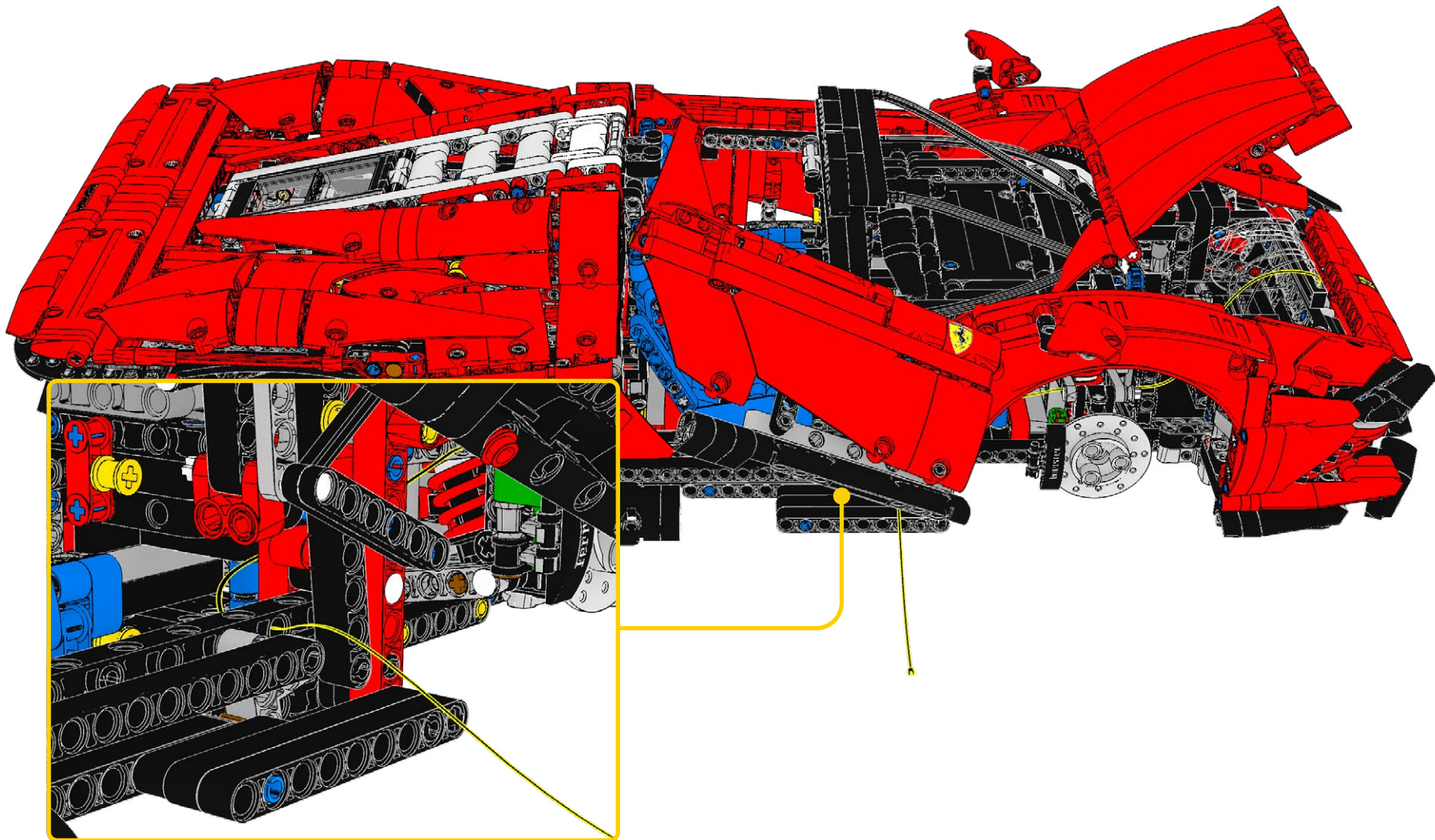

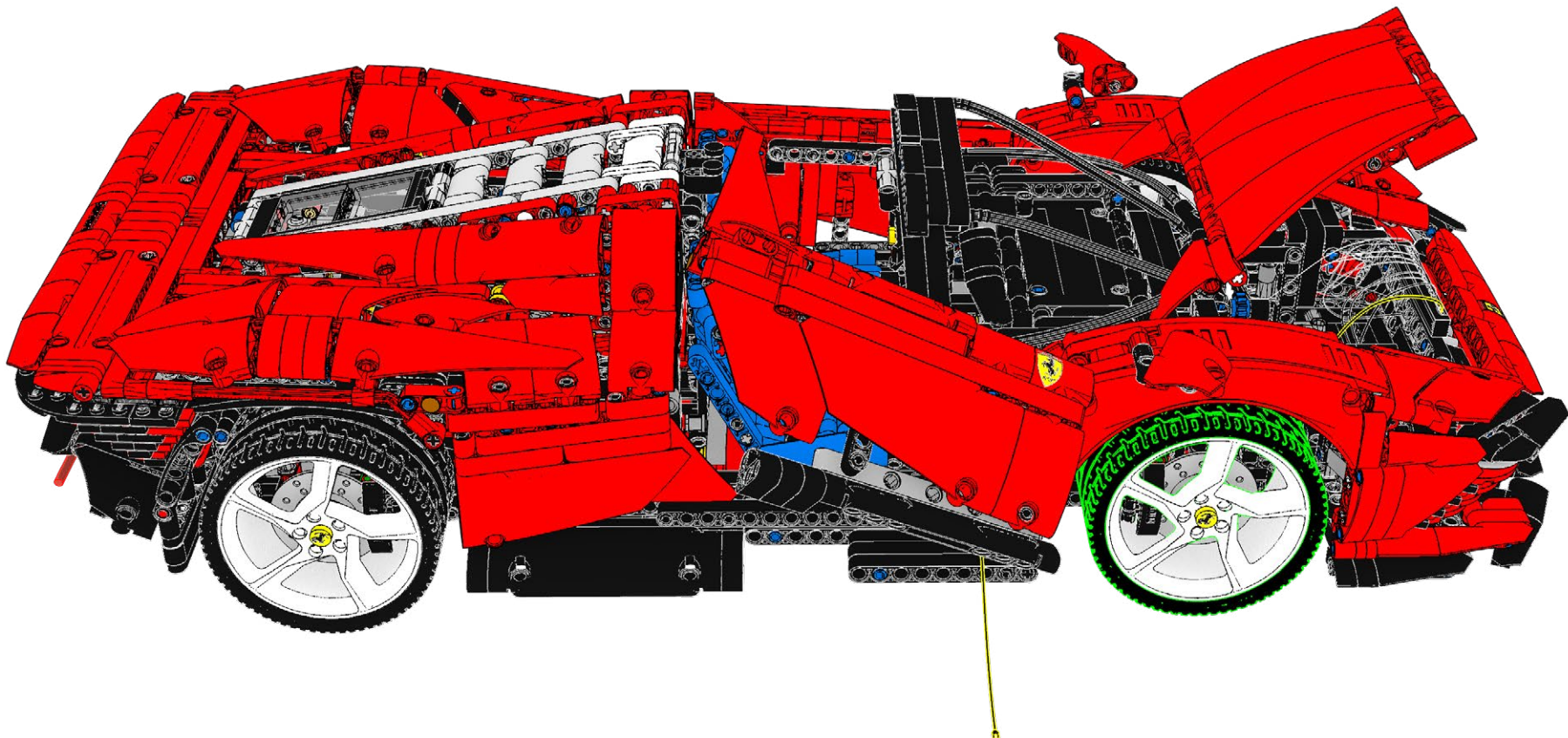

**HOLD UP!**

You might notice some bags are out of order, as well as left over pieces, but that's ok! We're changing the way you build LEGO!

HALTEN!

Möglicherweise stellen Sie fest, dass einige Beutel nicht in Ordnung sind und auch Teile übrig bleiben, aber das ist in Ordnung! Wir verändern die Art und Weise, wie Sie LEGO bauen!

TENIR BON!

Vous remarquerez peut-être que certains sacs sont en panne, ainsi que des morceaux restants, mais ce n'est pas grave ! Nous changeons la façon dont vous construisez LEGO !

SOSTENERE!

Potresti notare che alcune borse sono fuori uso, così come alcuni pezzi avanzati, ma va bene! Stiamo cambiando il modo in cui costruisci i LEGO!

¡SOSTENER!

Puede que notes que algunas bolsas están fuera de orden, así como piezas sobrantes, ¡pero está bien! ¡Estamos cambiando la forma de construir LEGO!

耽误!

您可能会注意到有些袋子坏了, 还有剩余的碎片, 但这没关系! 我们正在改变您搭建乐高的方式!

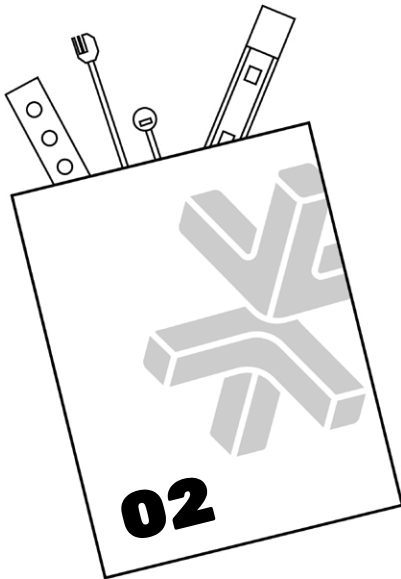
Open LMB Bag 02

86

T-1x1
2x

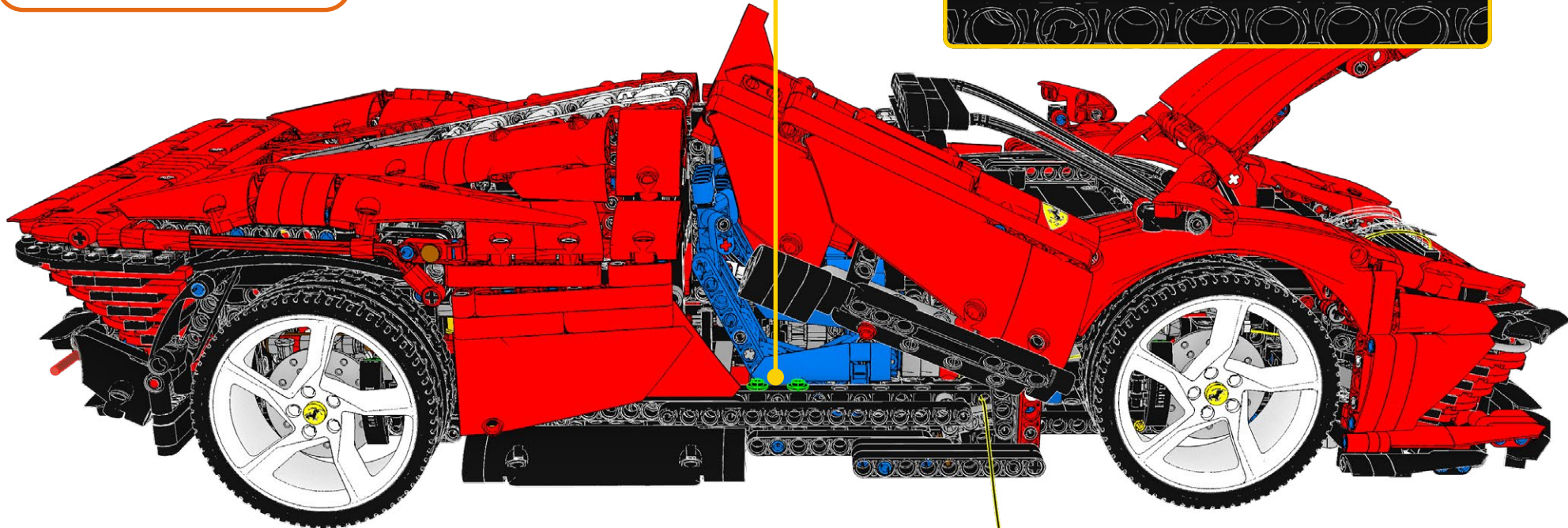
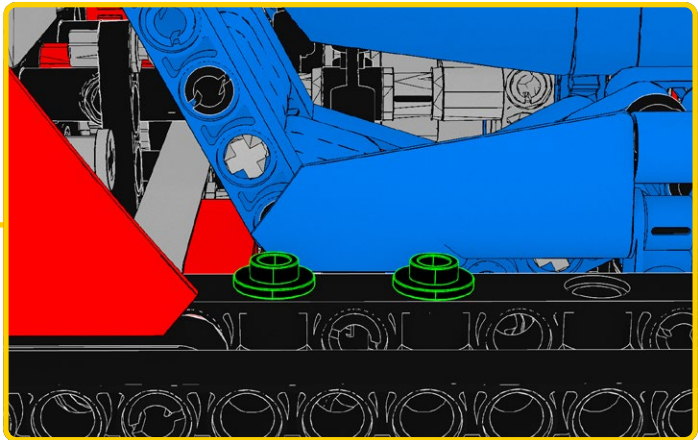
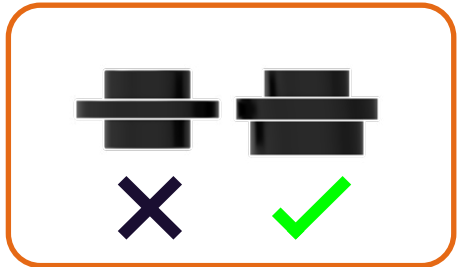

87

D-3

1x

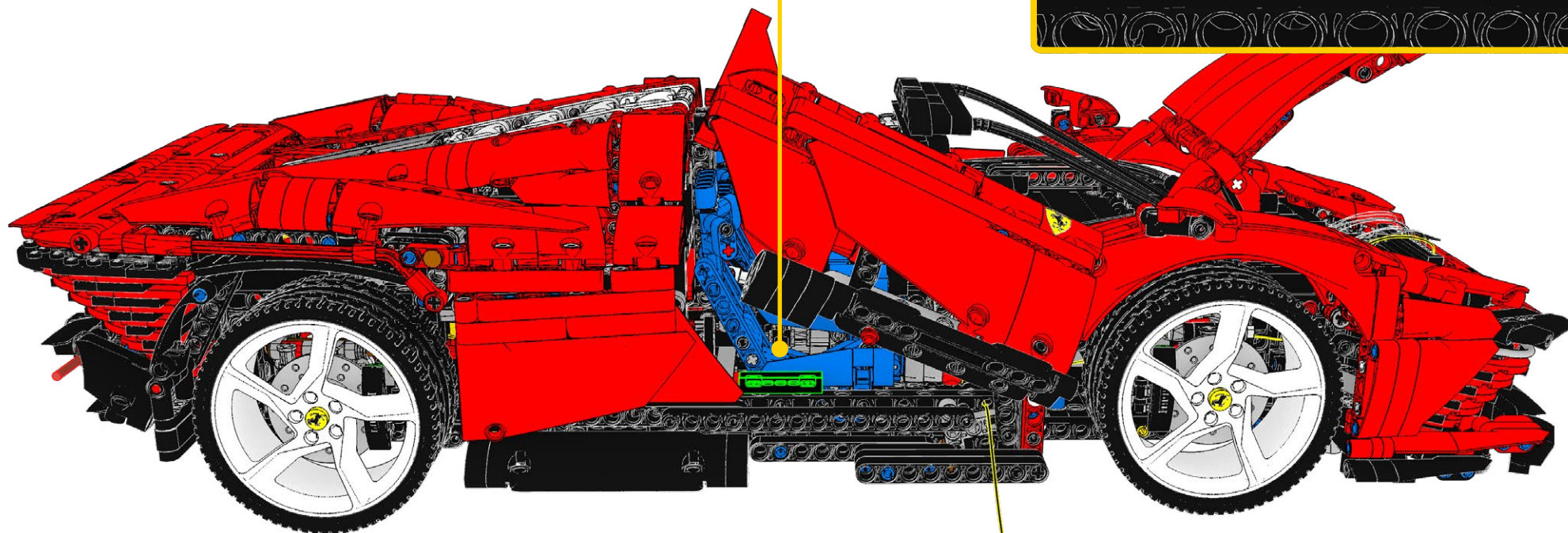
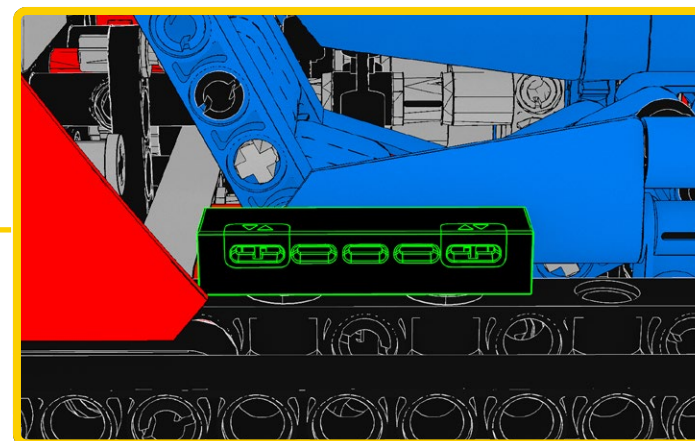

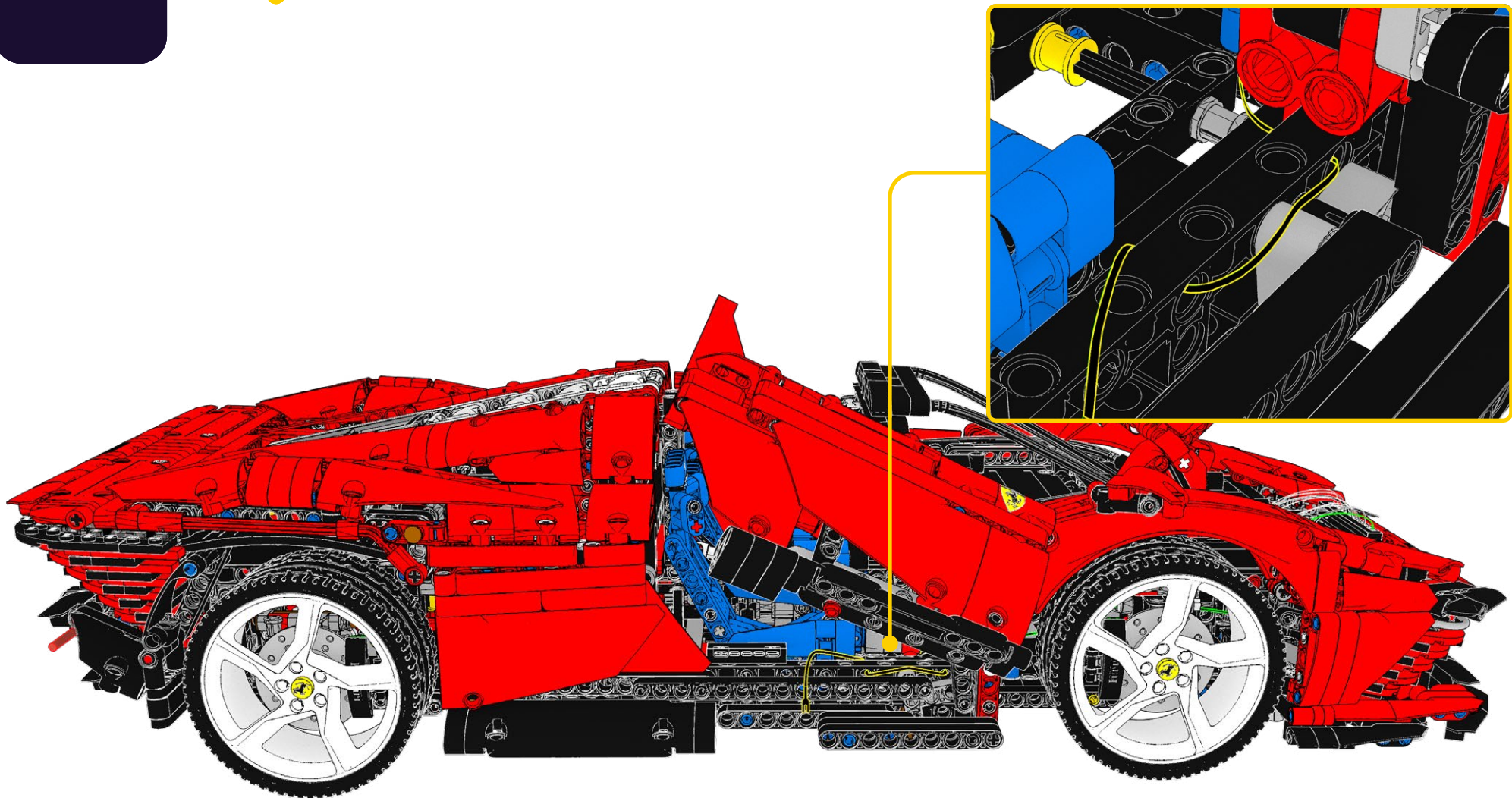

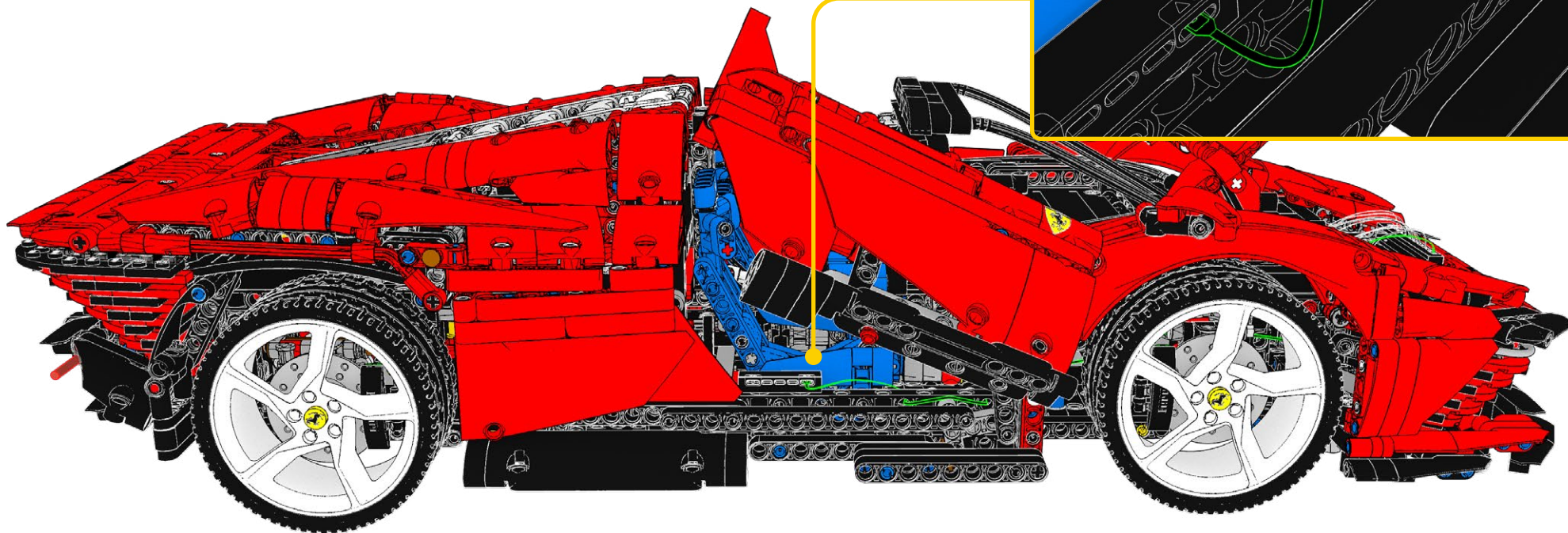
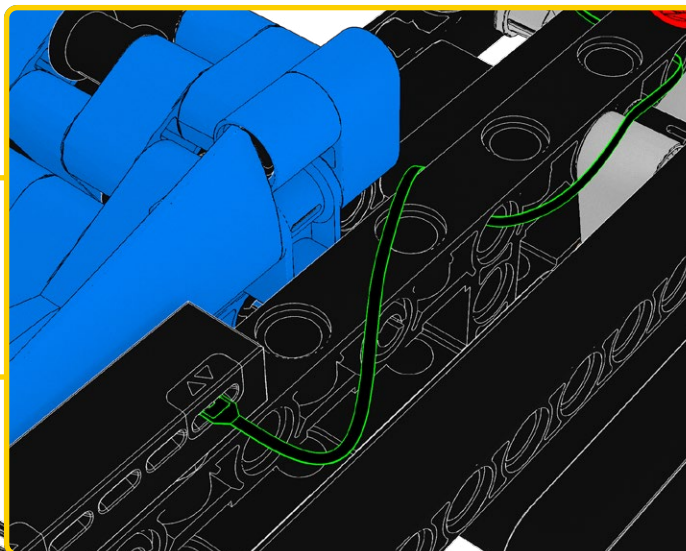
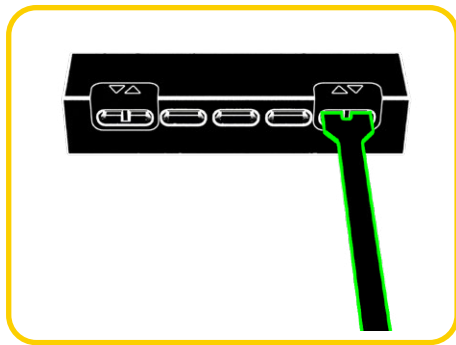

90

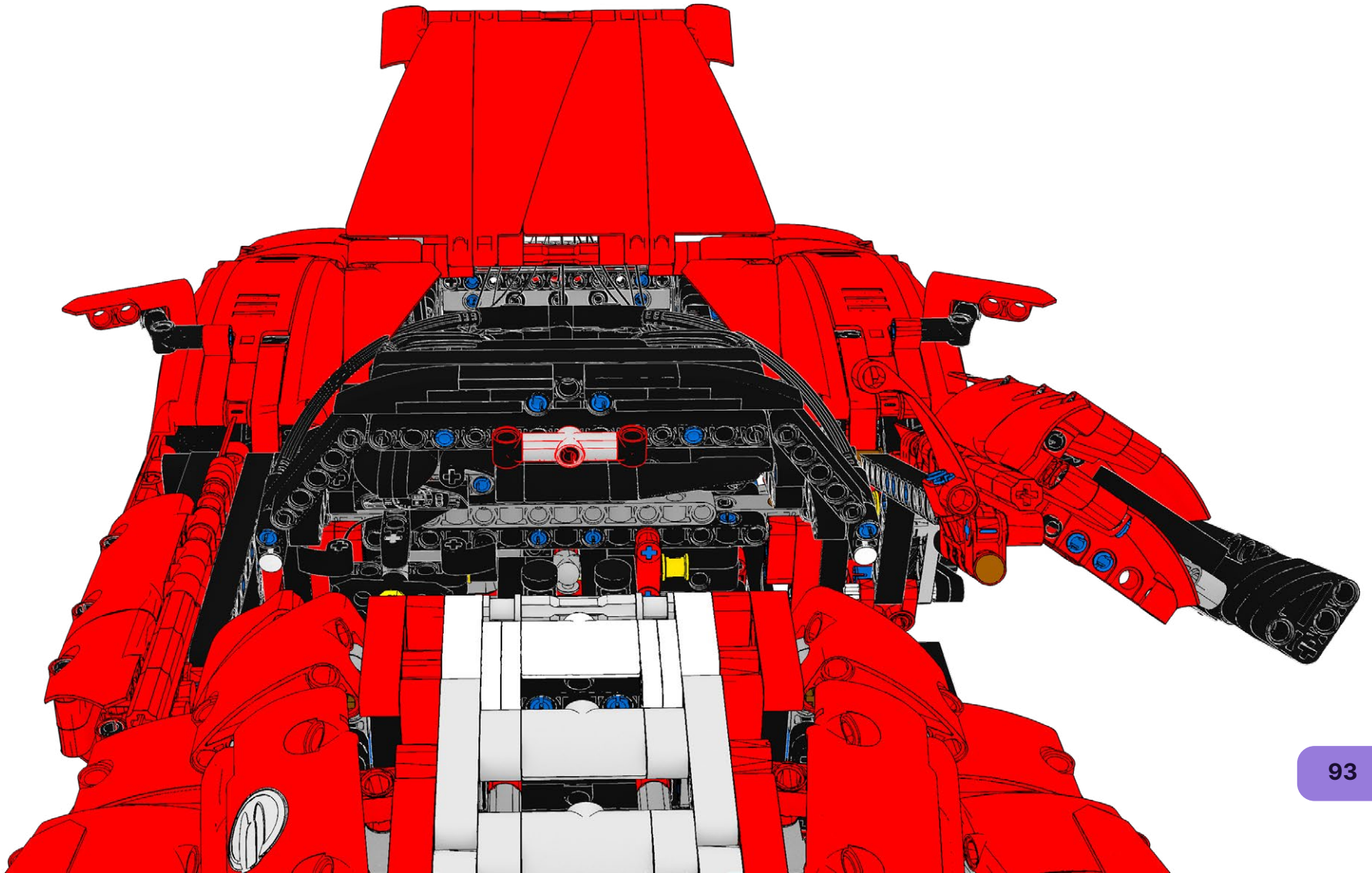

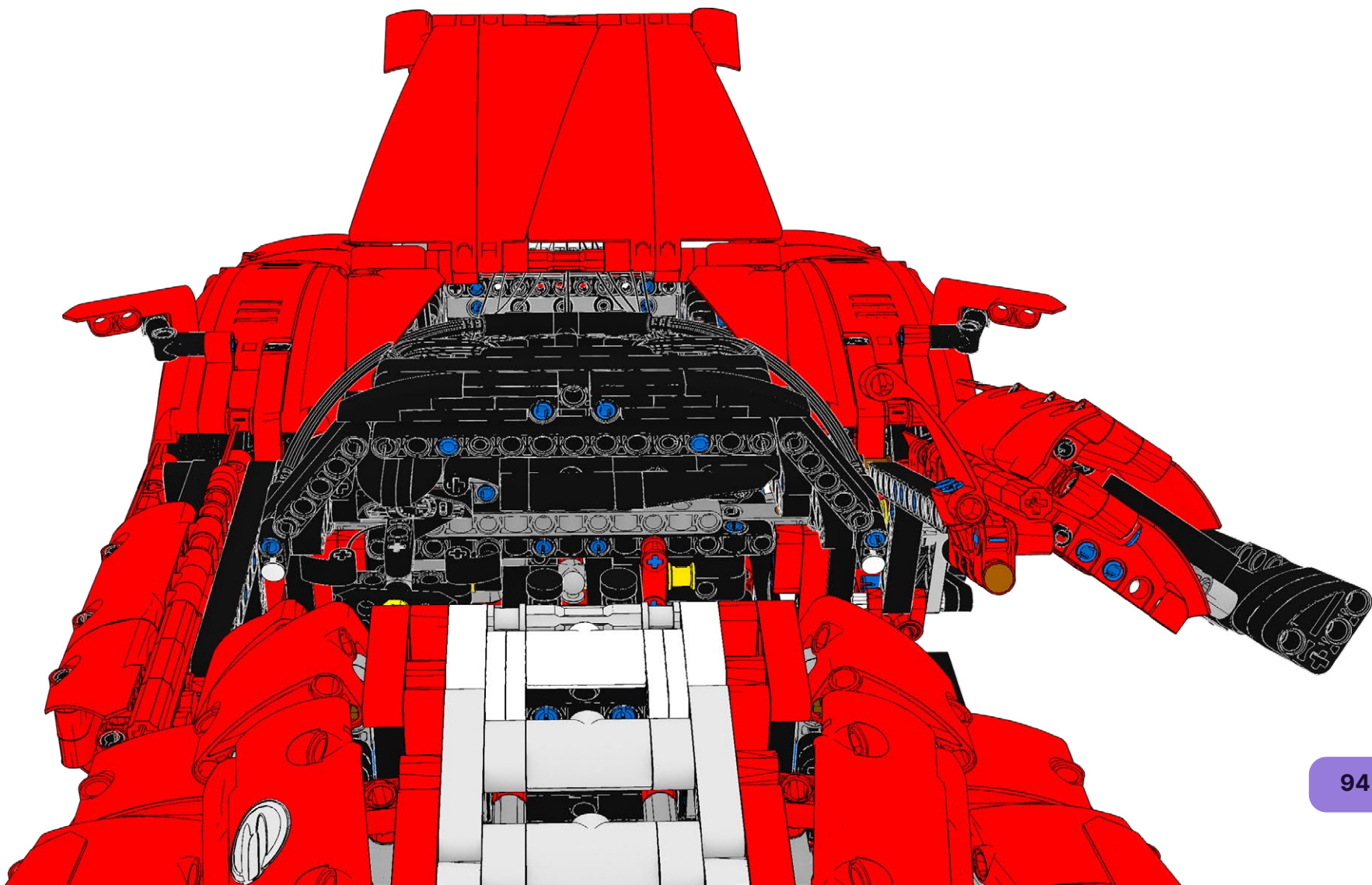

92

1

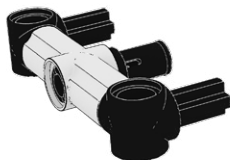

2

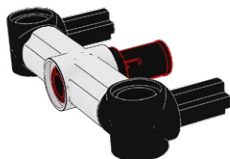

3

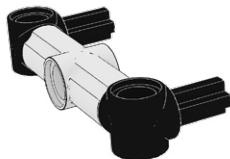

93

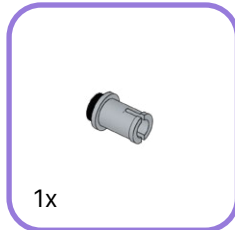

1

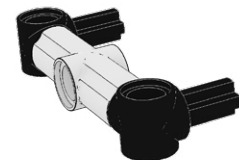

2

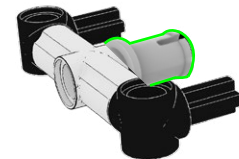

3

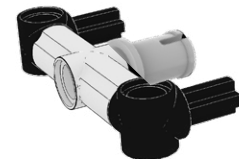

94

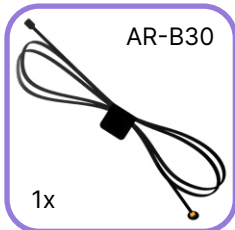

1

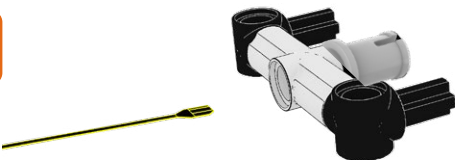

2

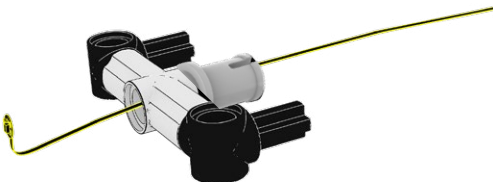

3

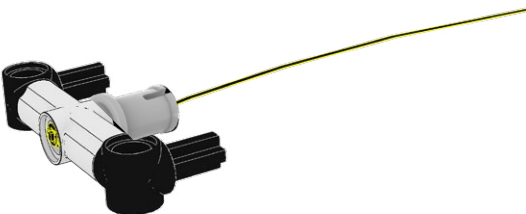

95

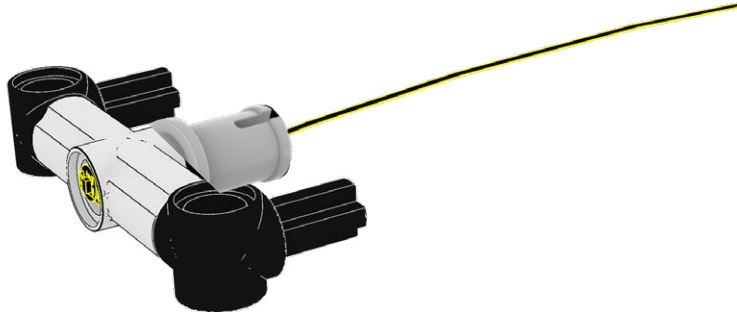

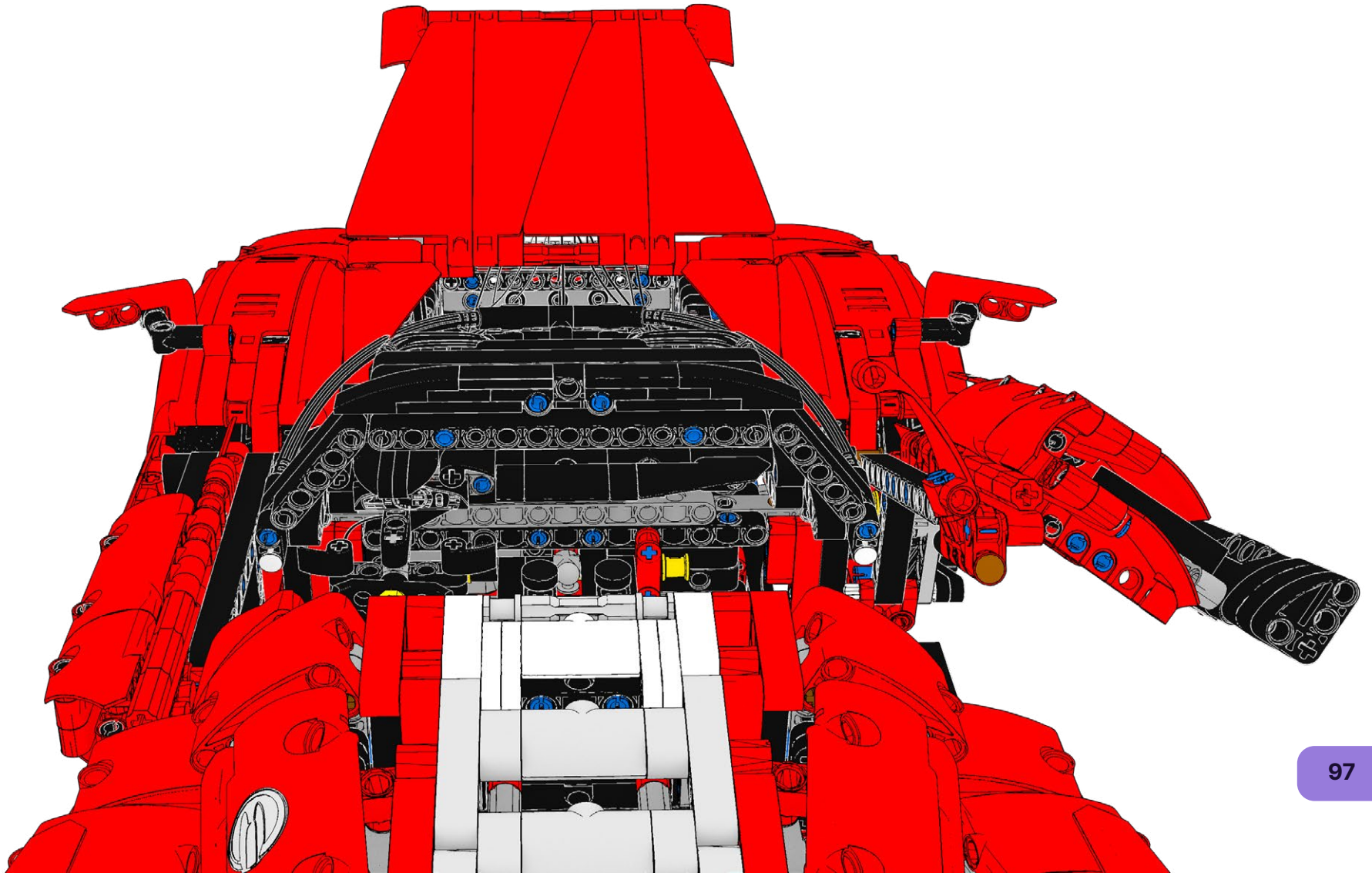
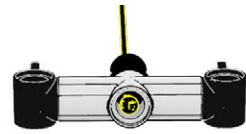

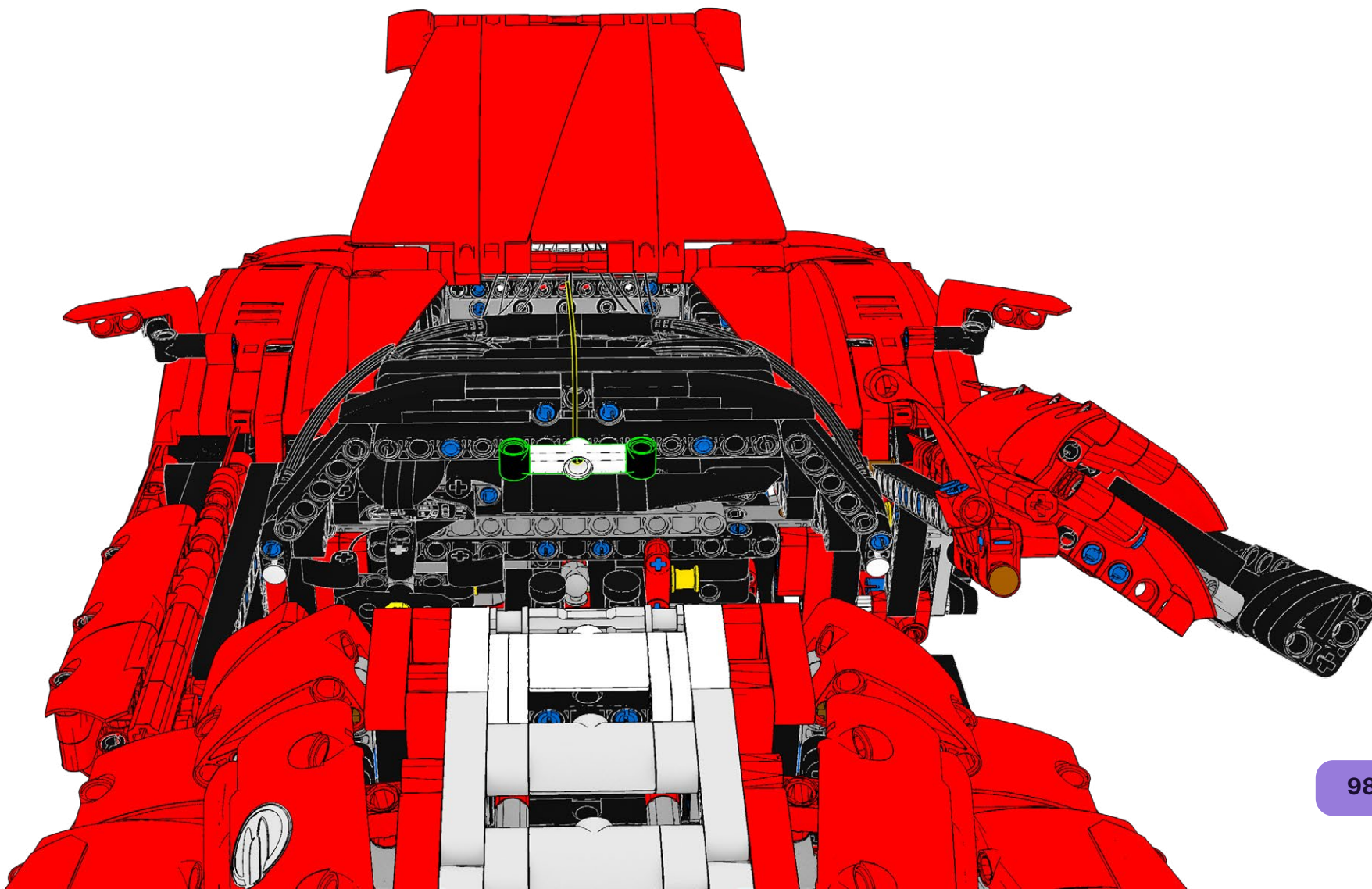

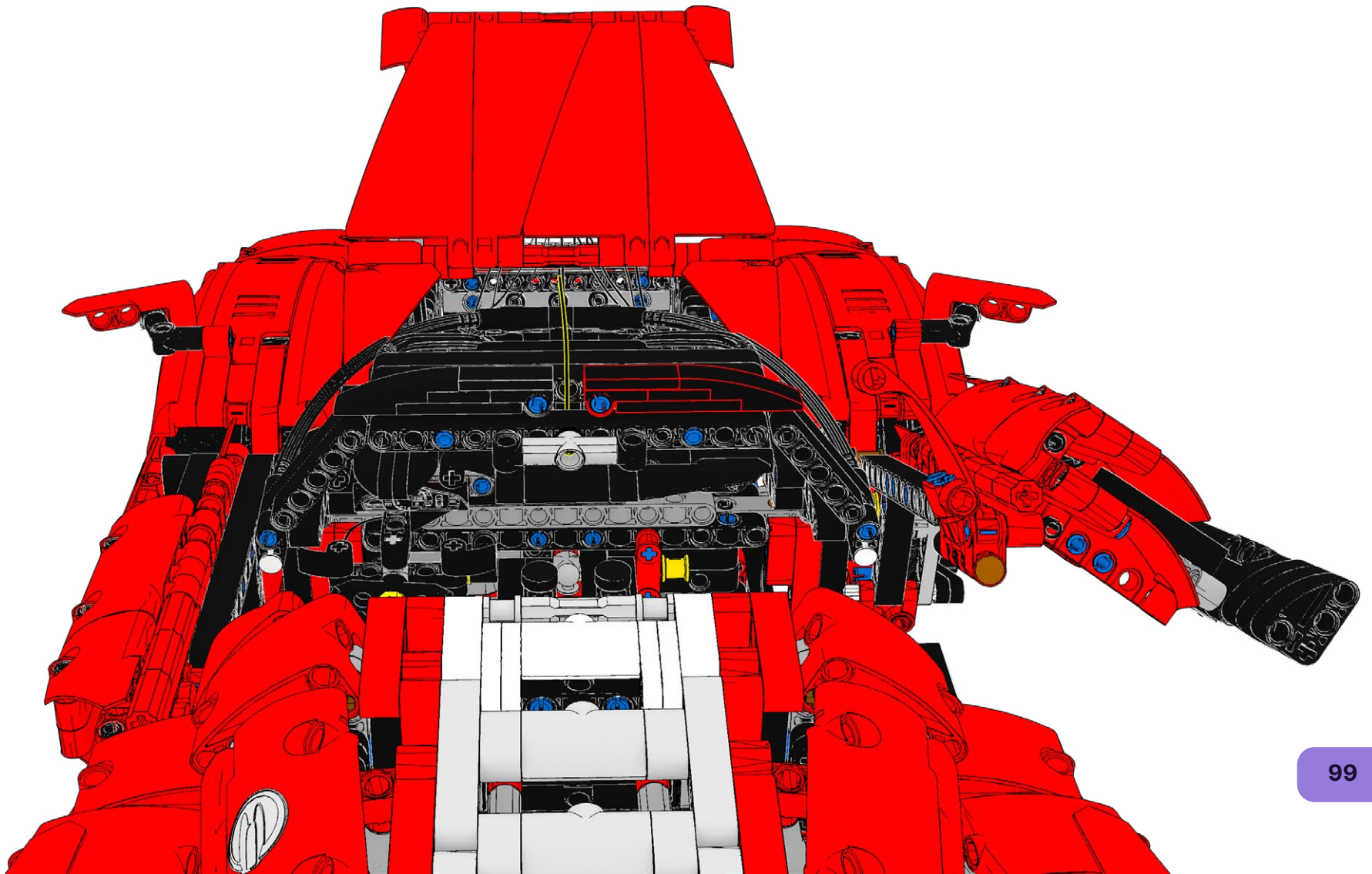

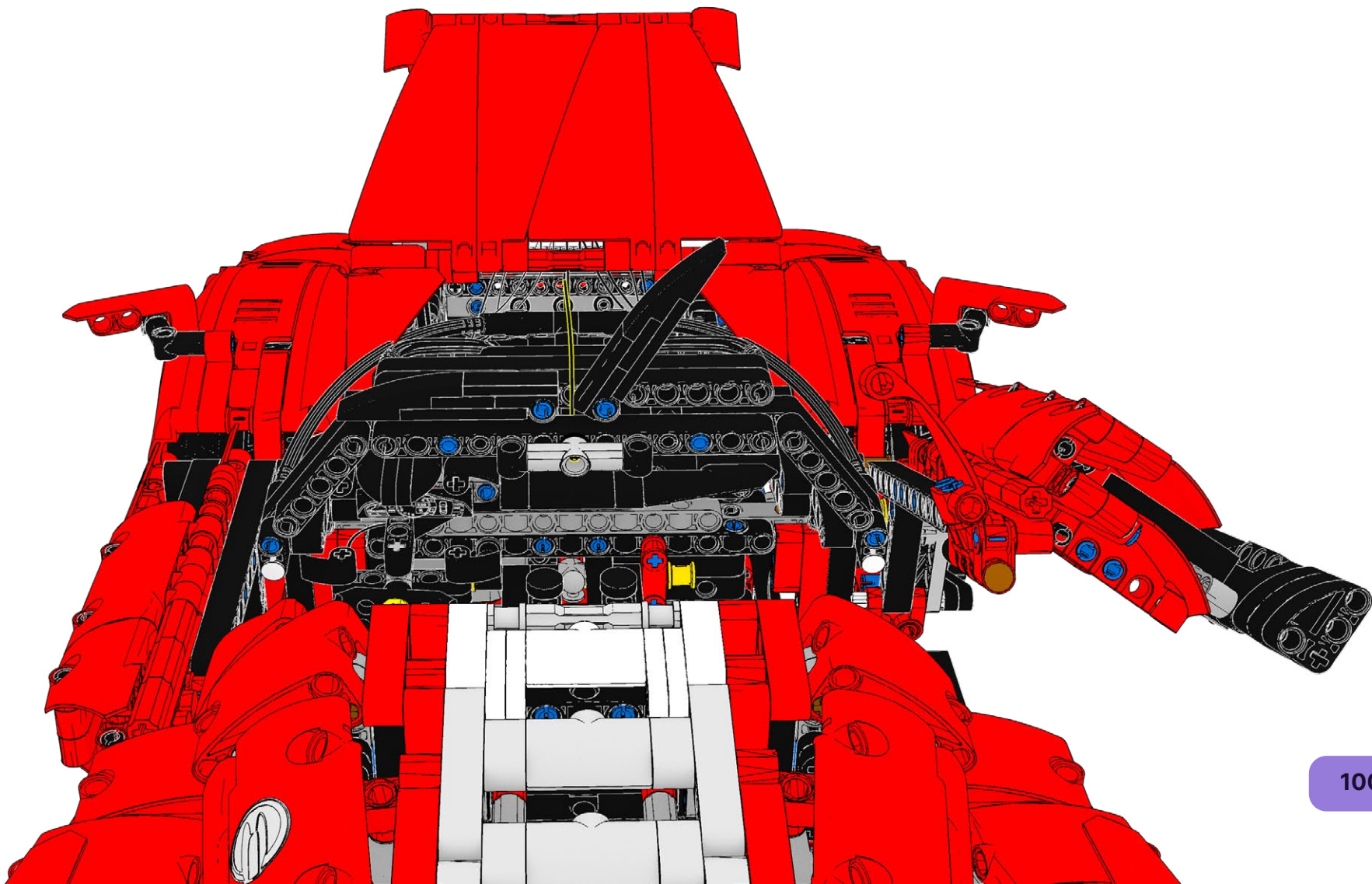

100

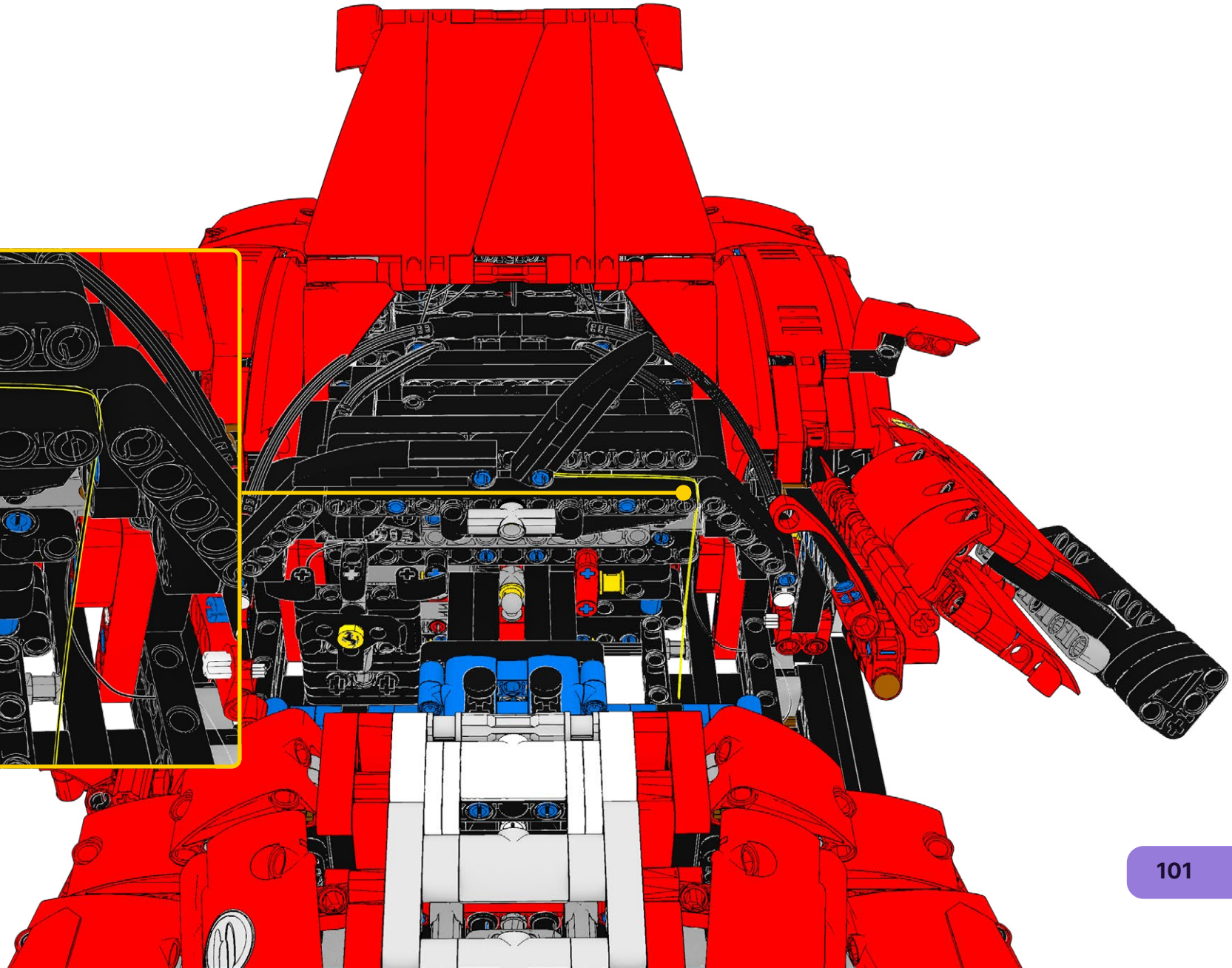
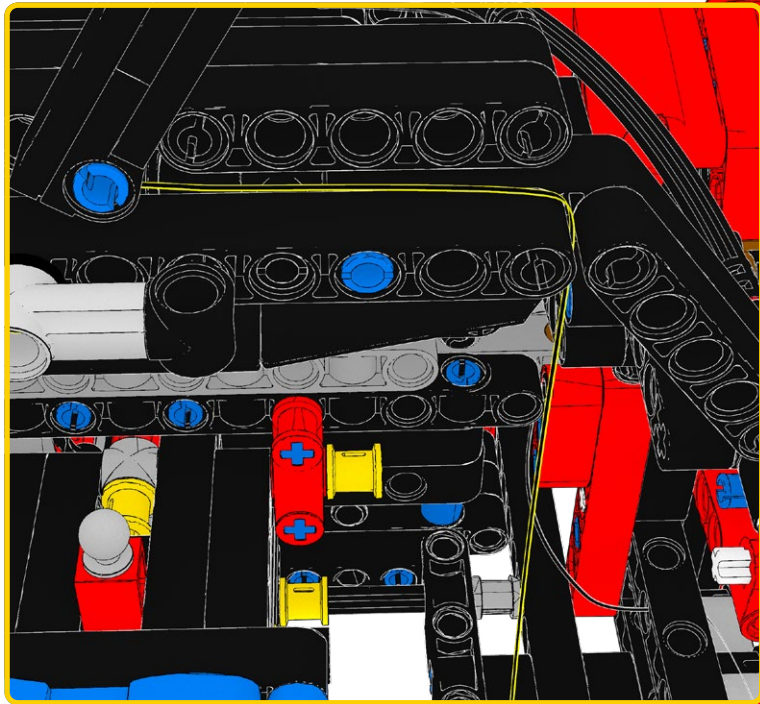

101

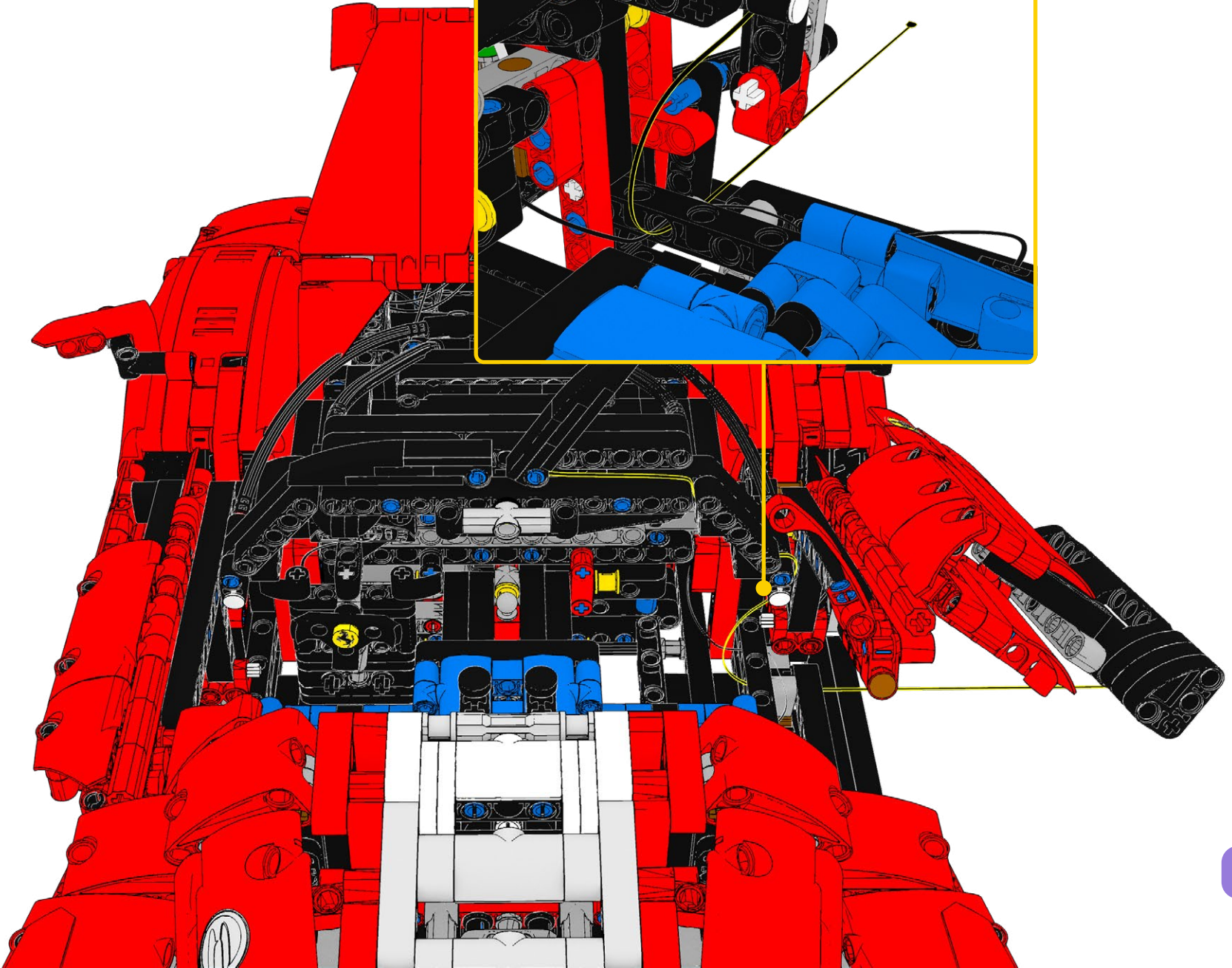
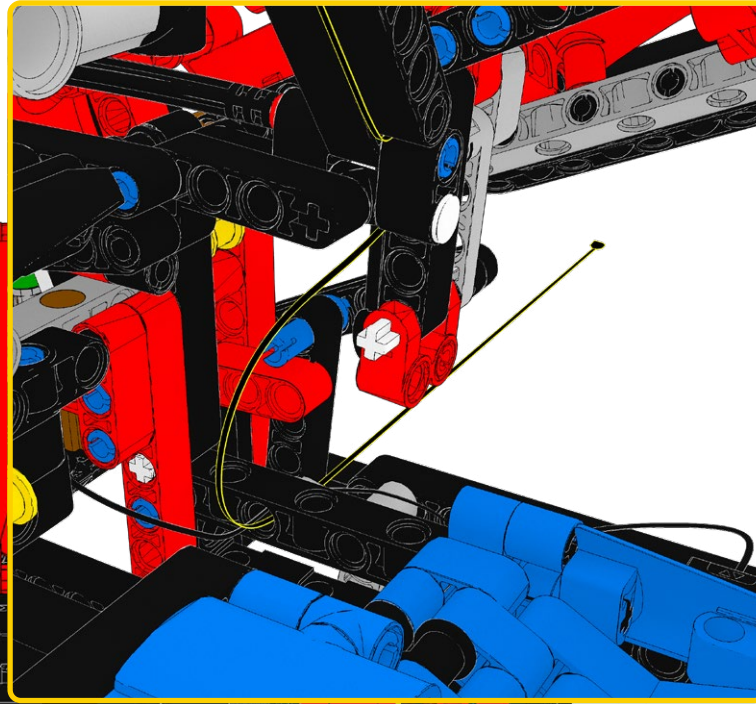

102

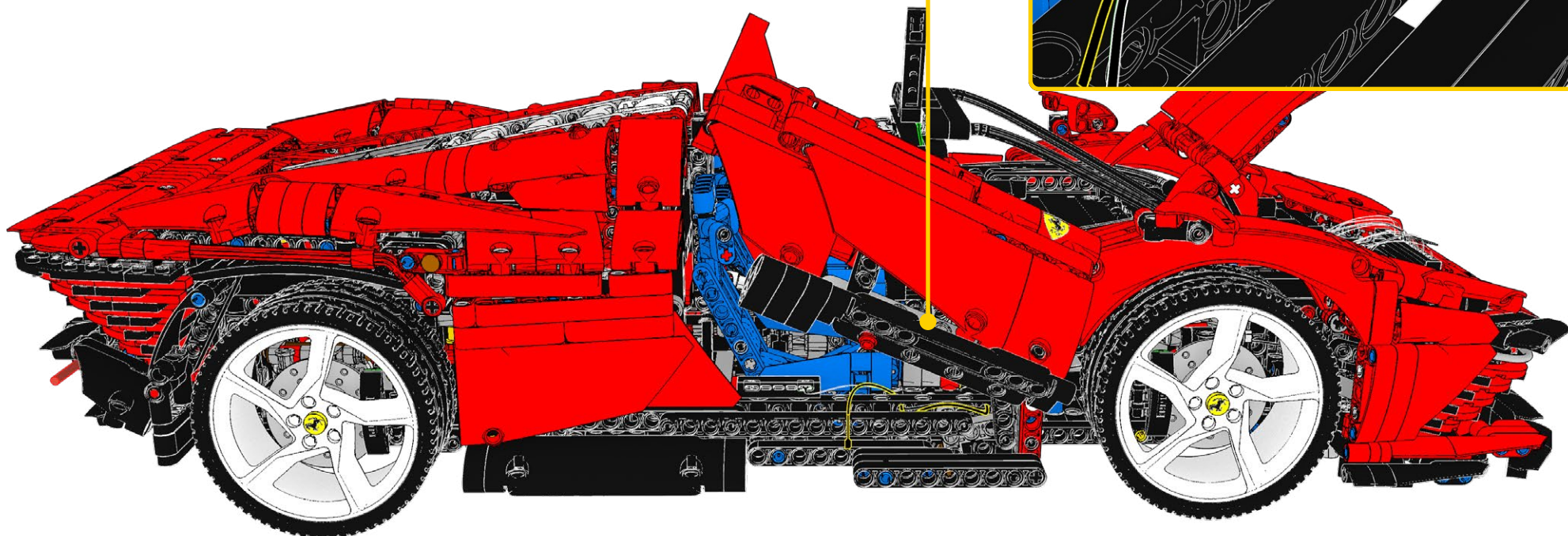

103

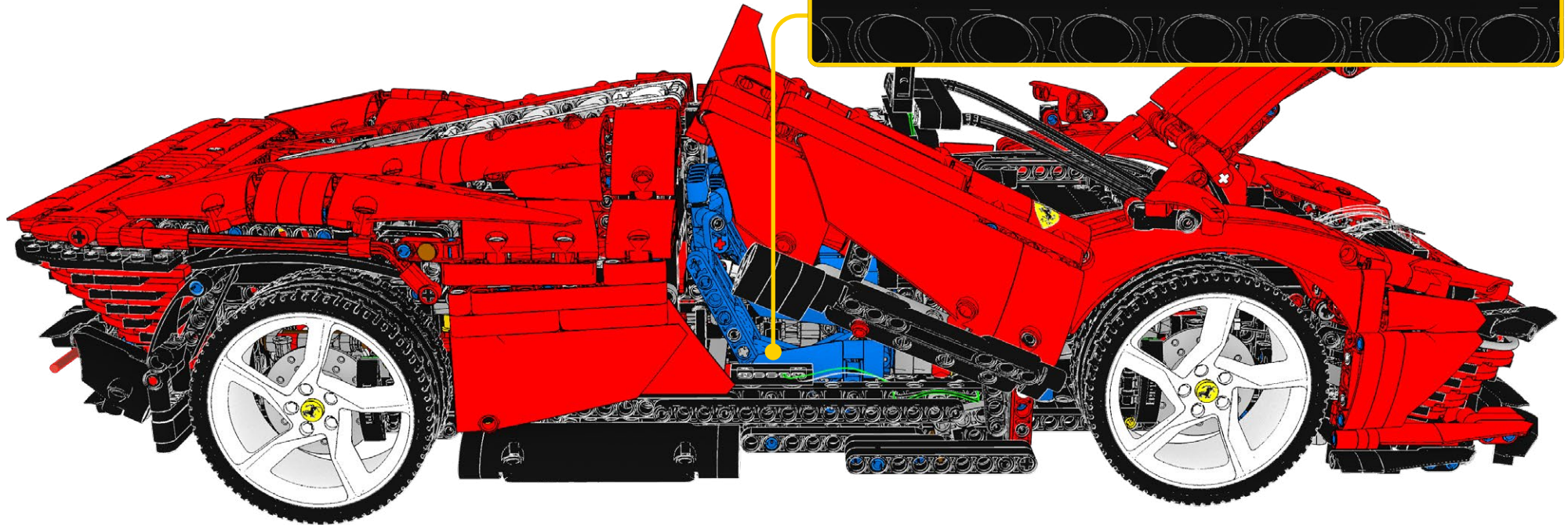
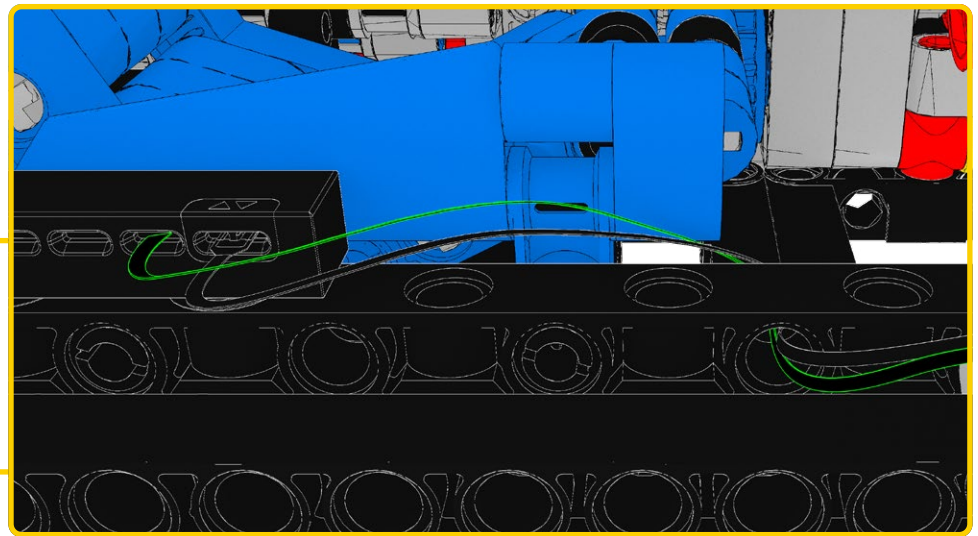
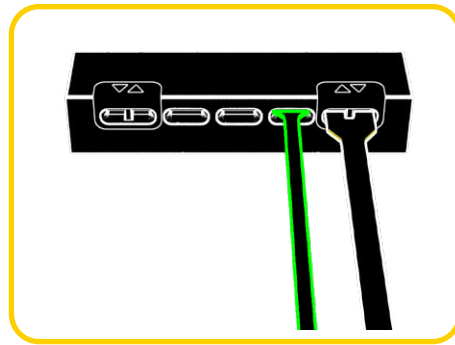

104

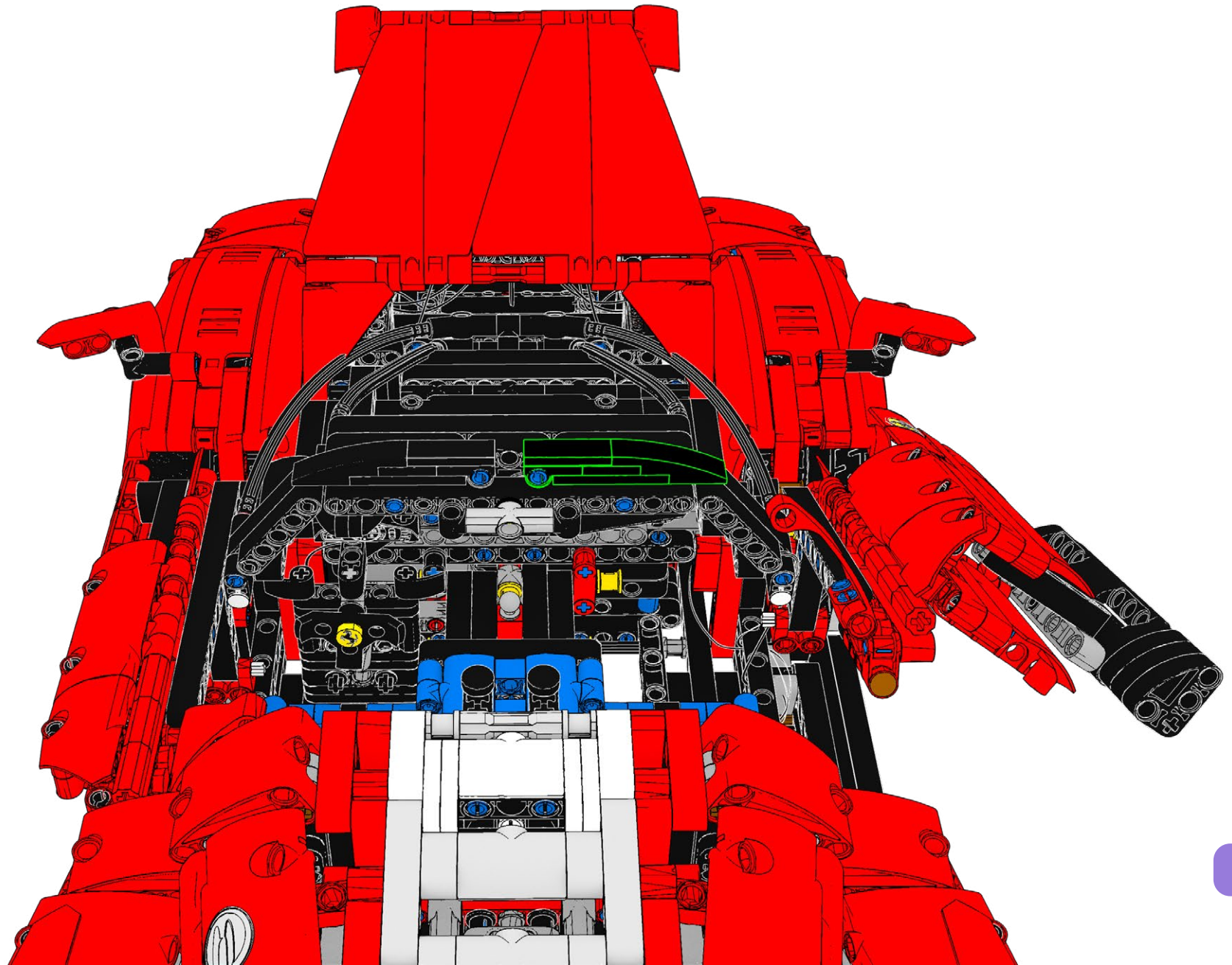

105

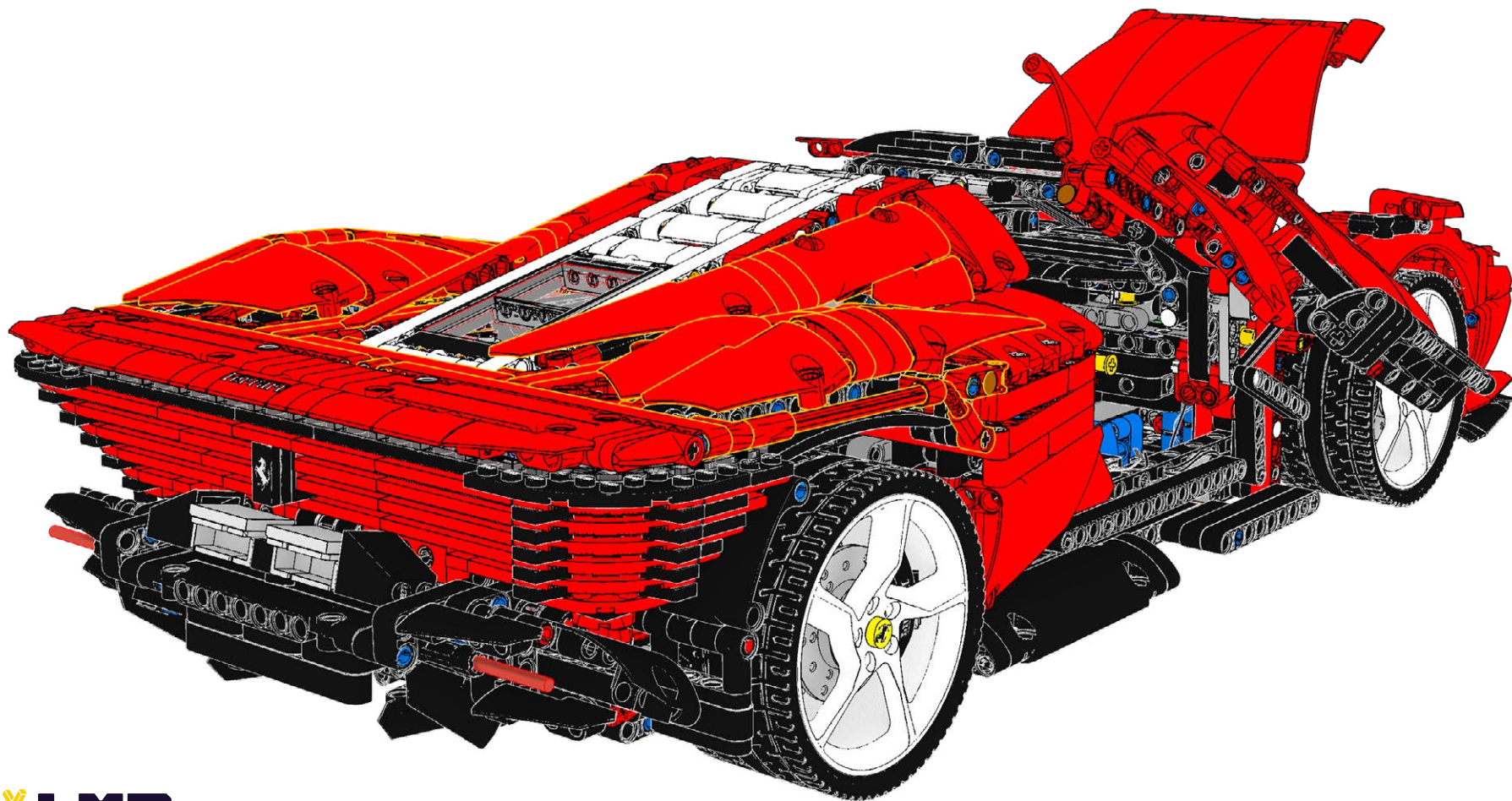

106

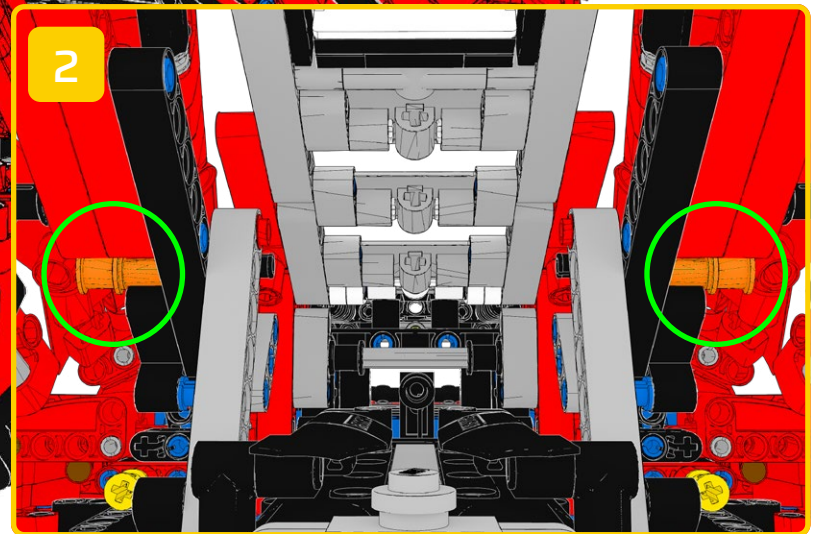
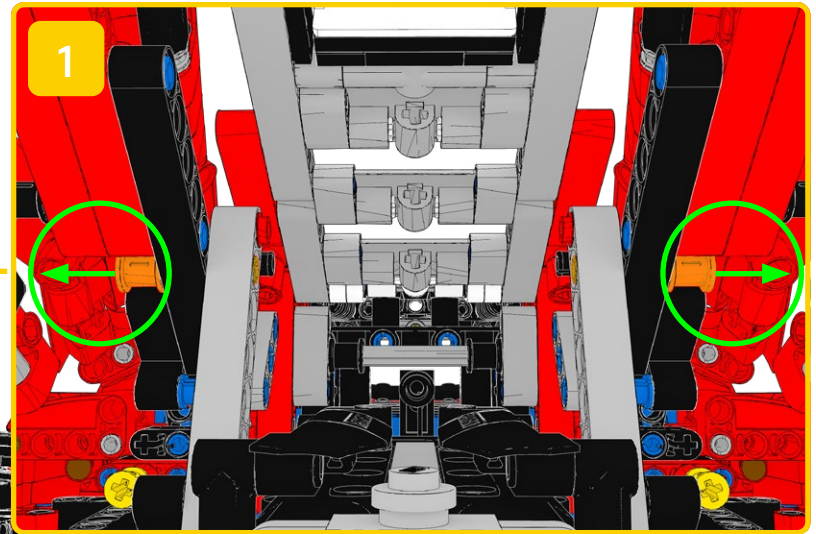
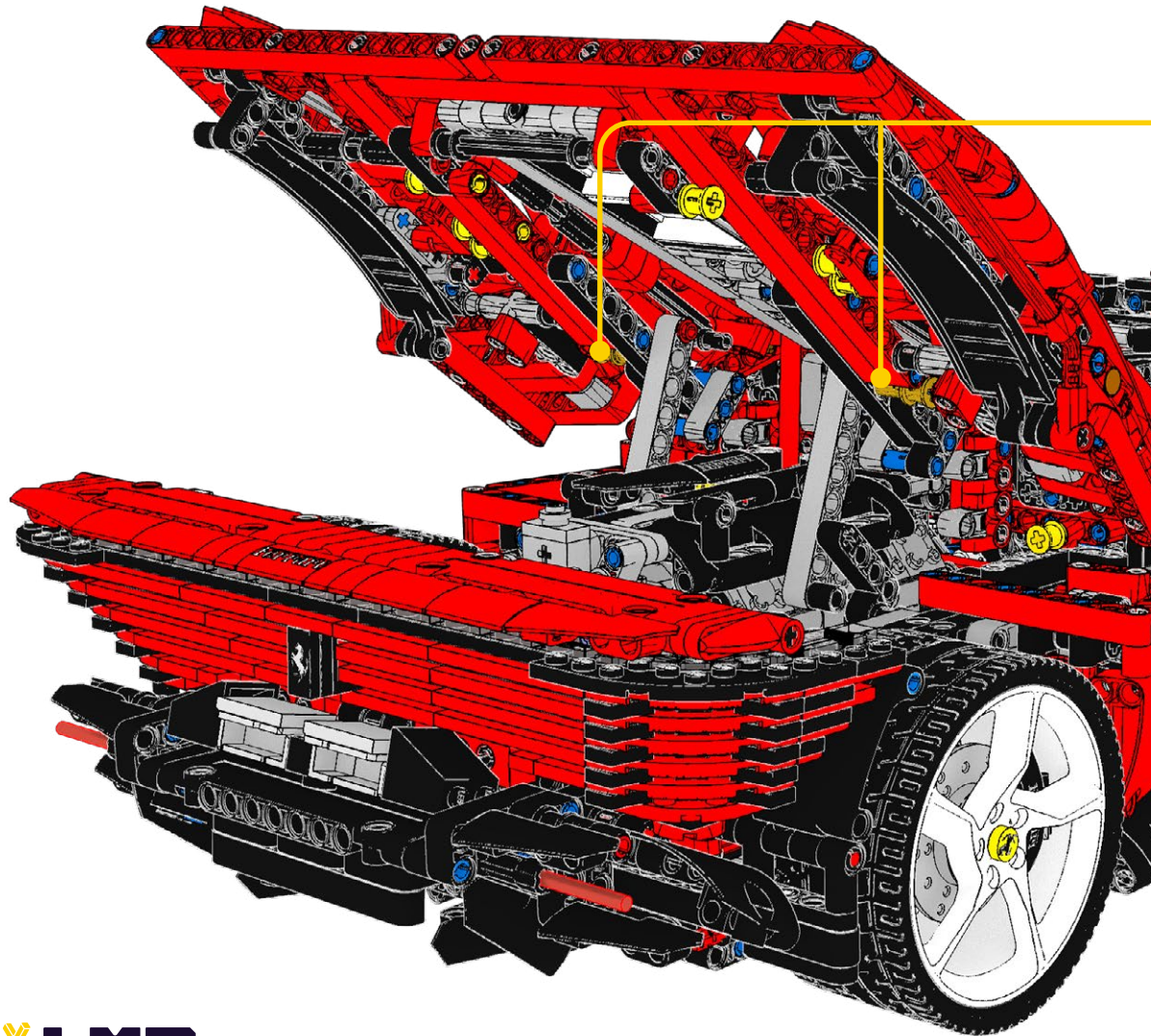

107

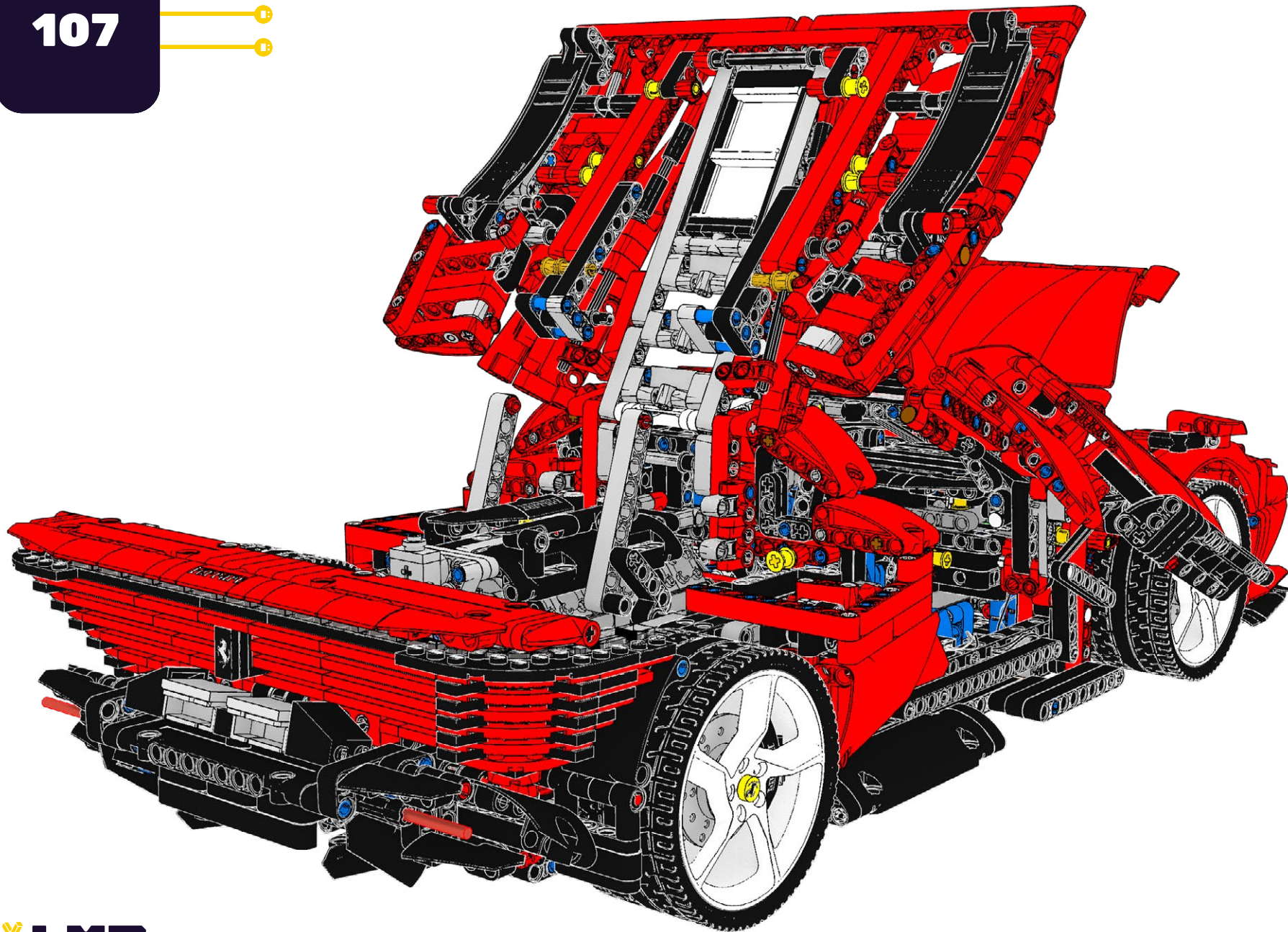

108

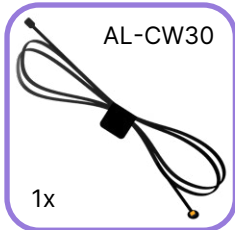

1



2

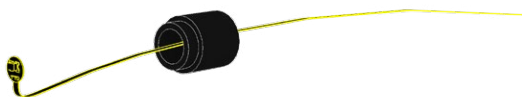

3



109

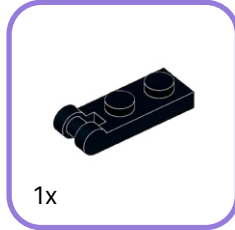

1



2



3



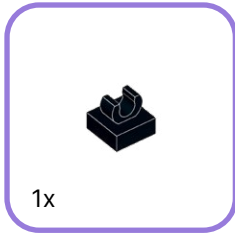

1

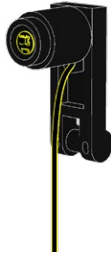

2

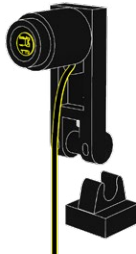

3

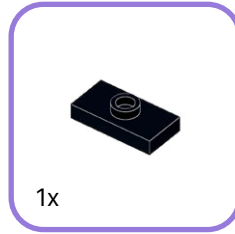
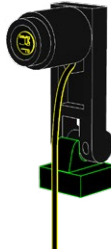

1

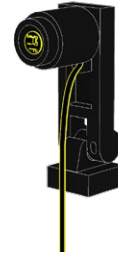

2

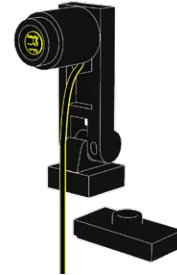

3

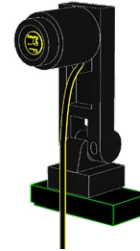

112

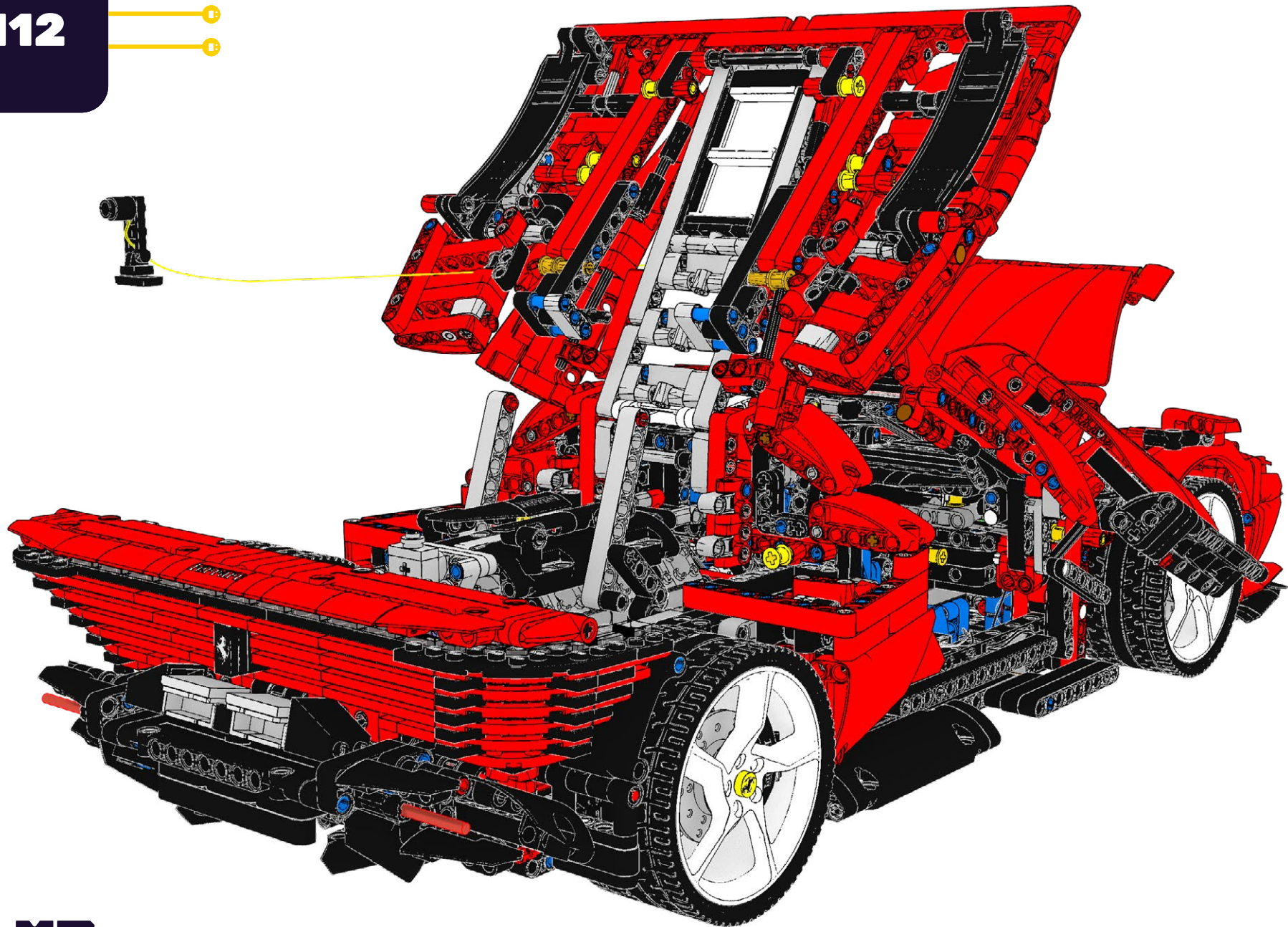

113

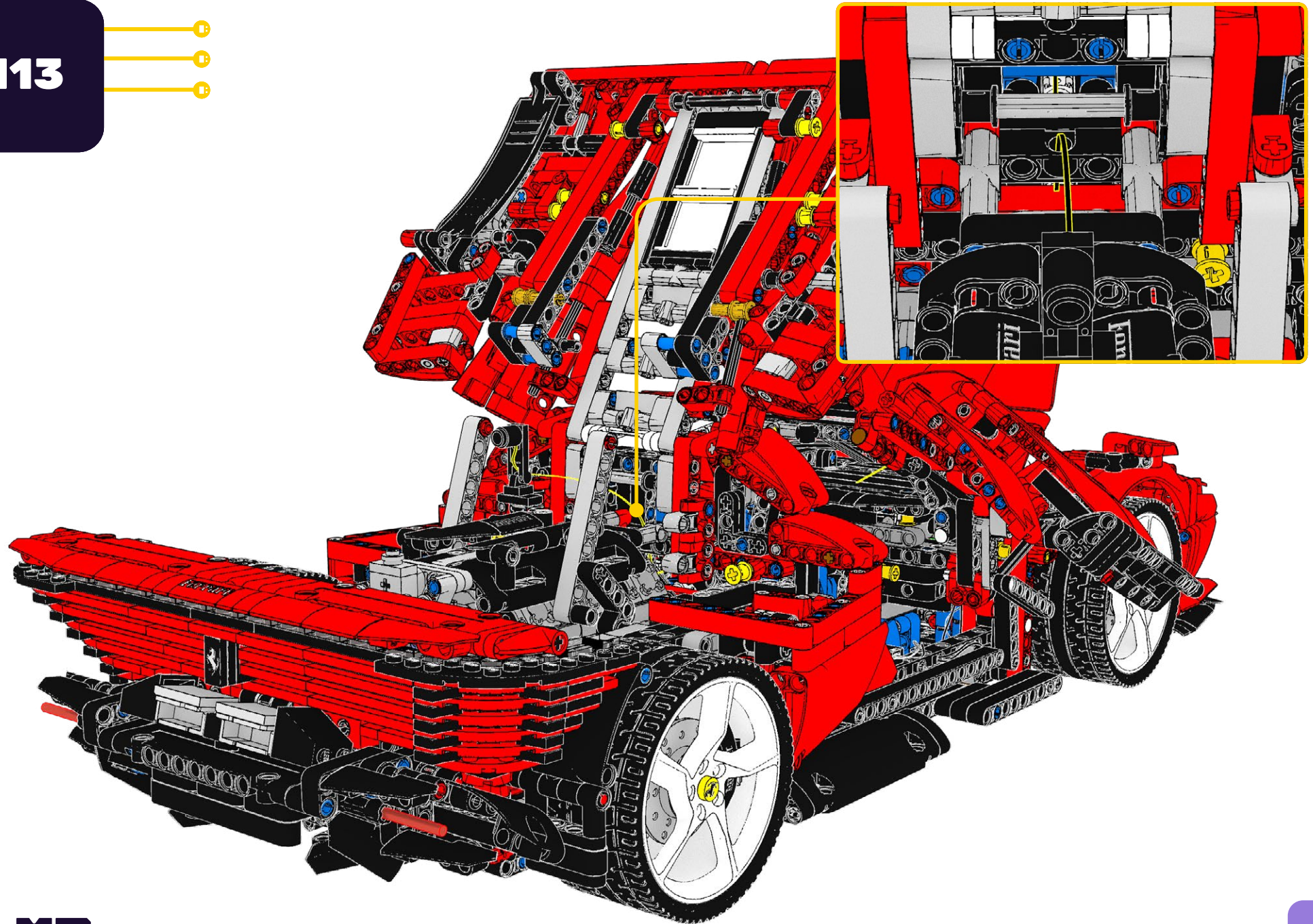

114

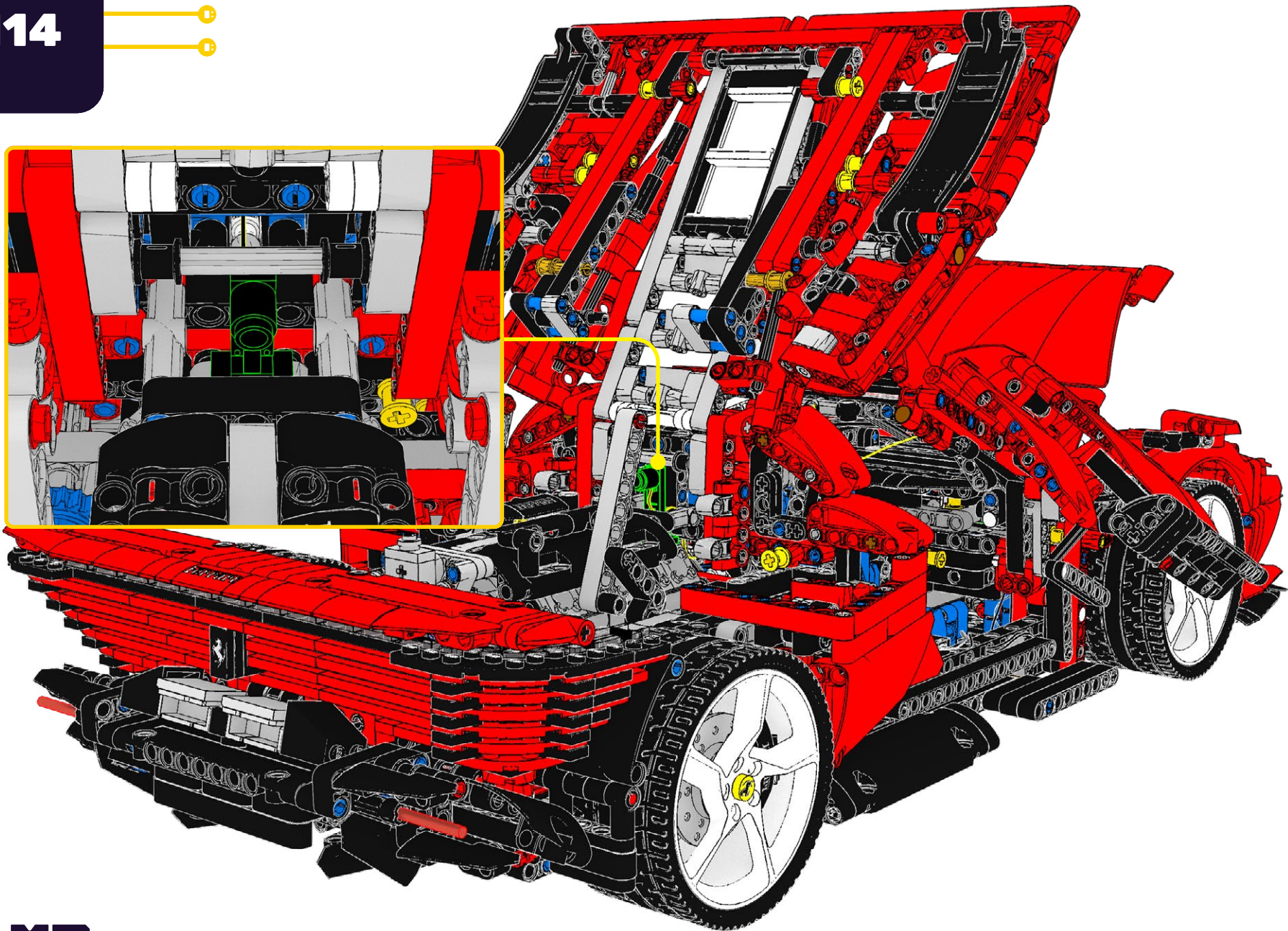

115

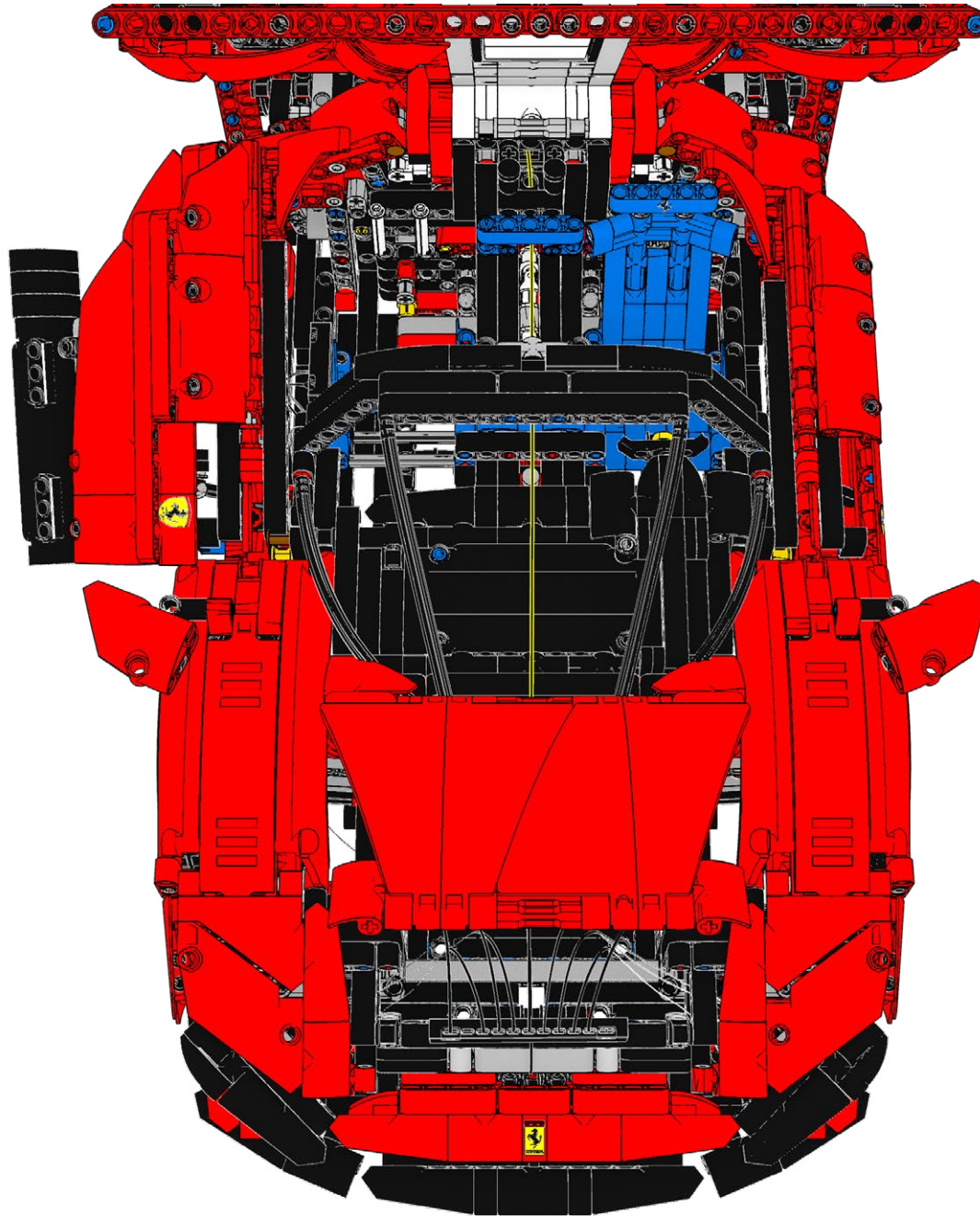
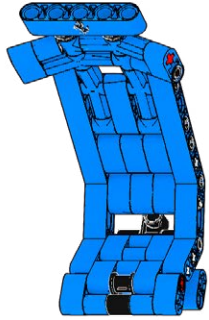

116

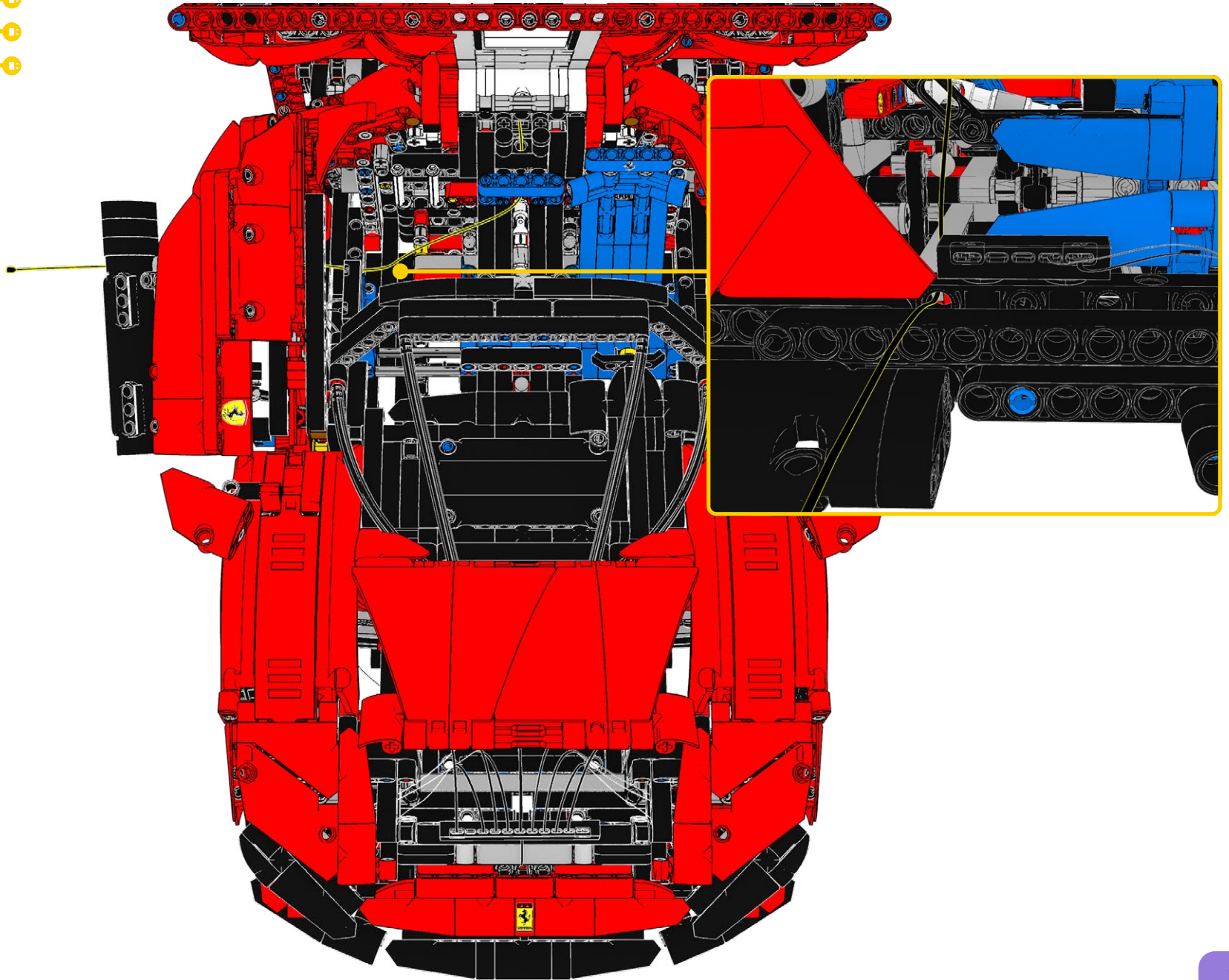

117

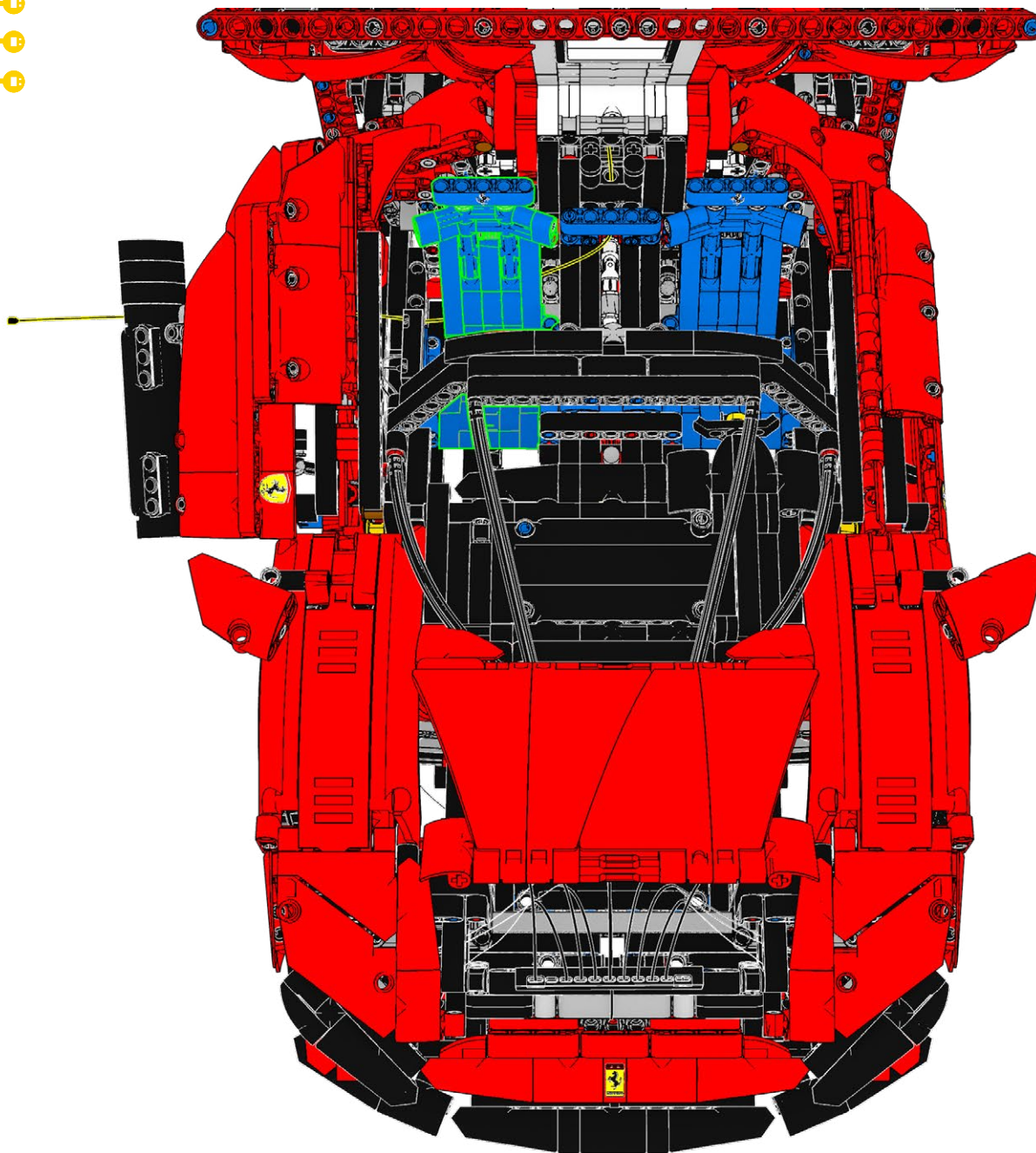

118

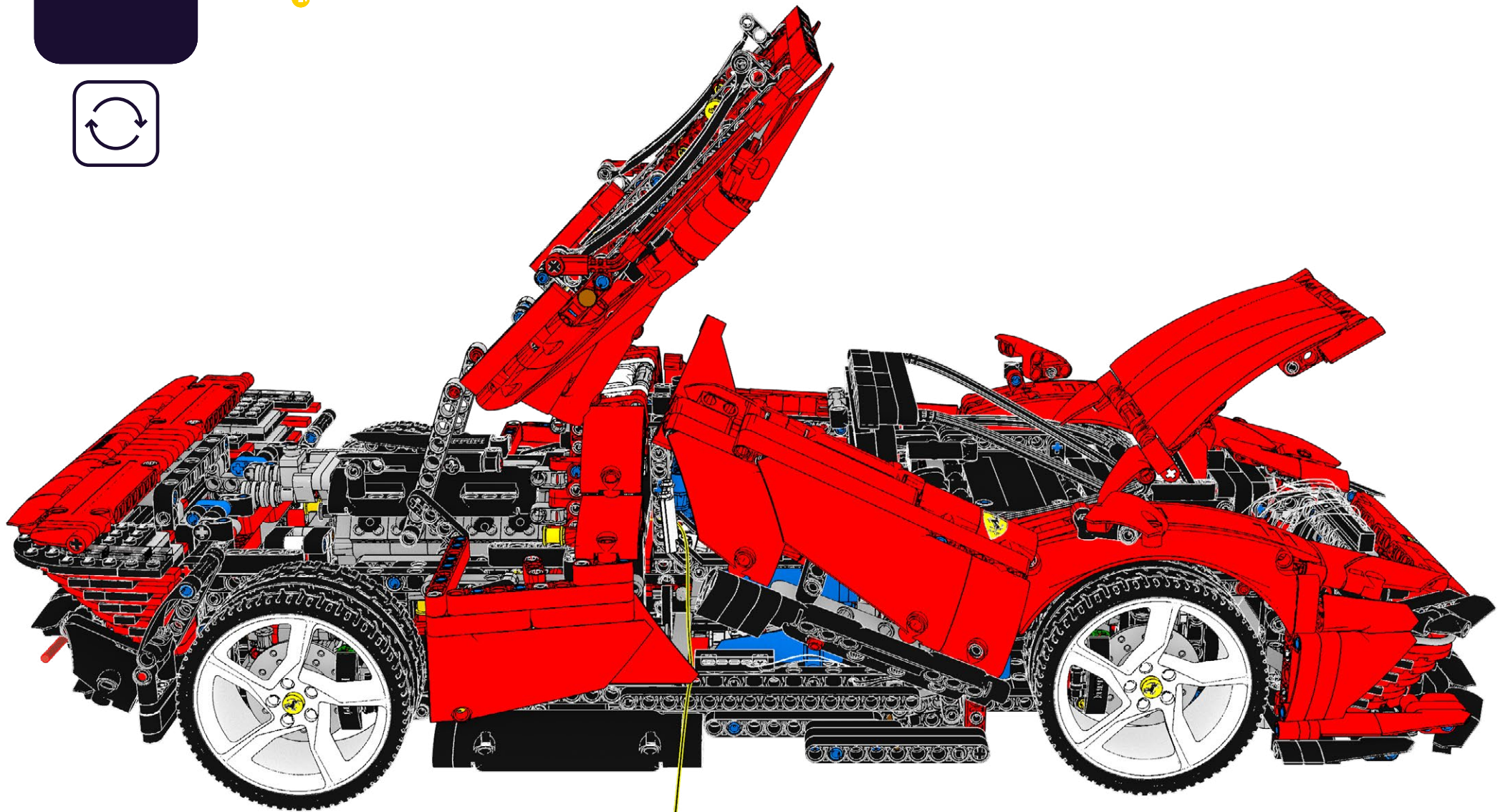

119

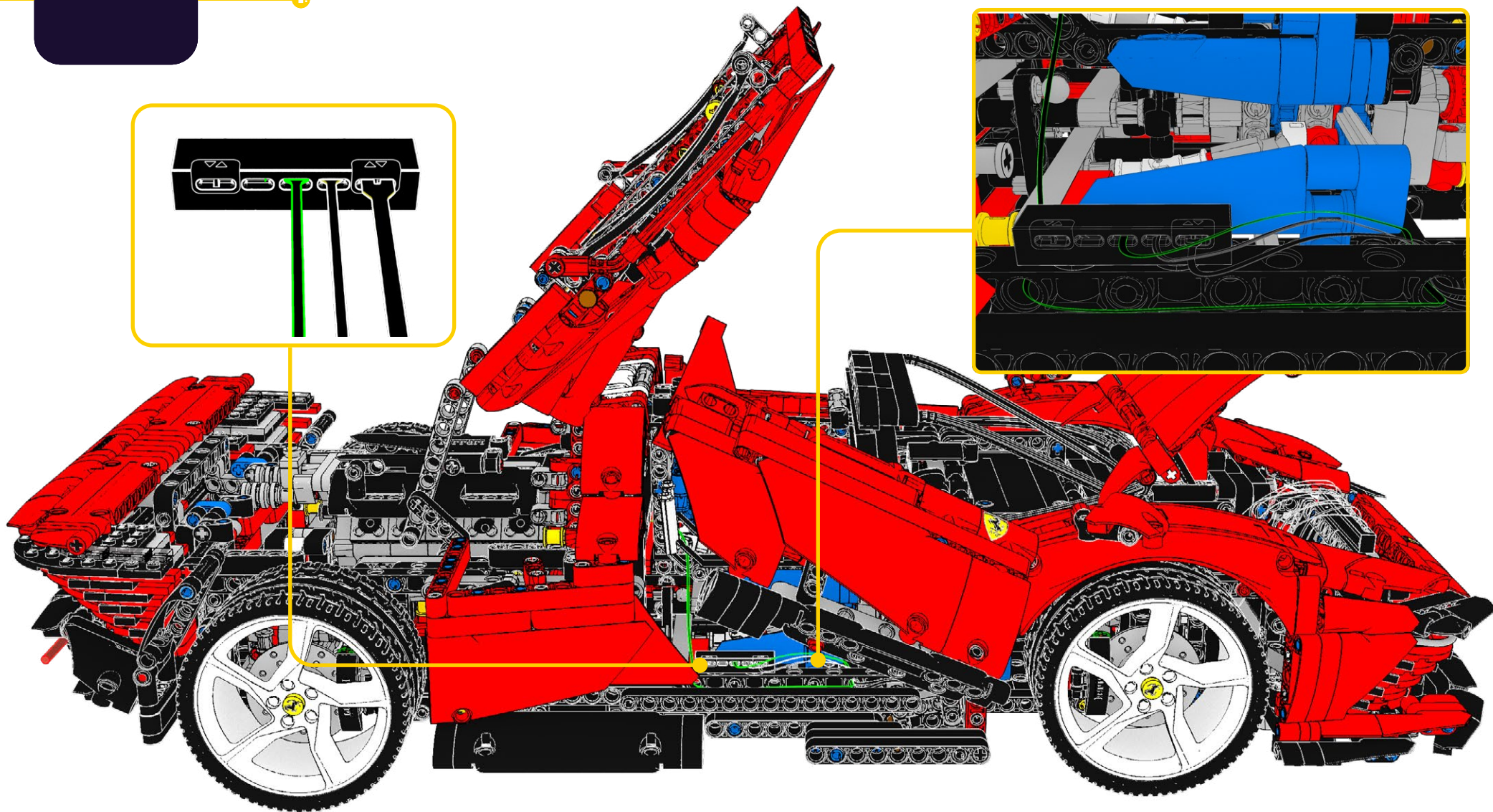

120

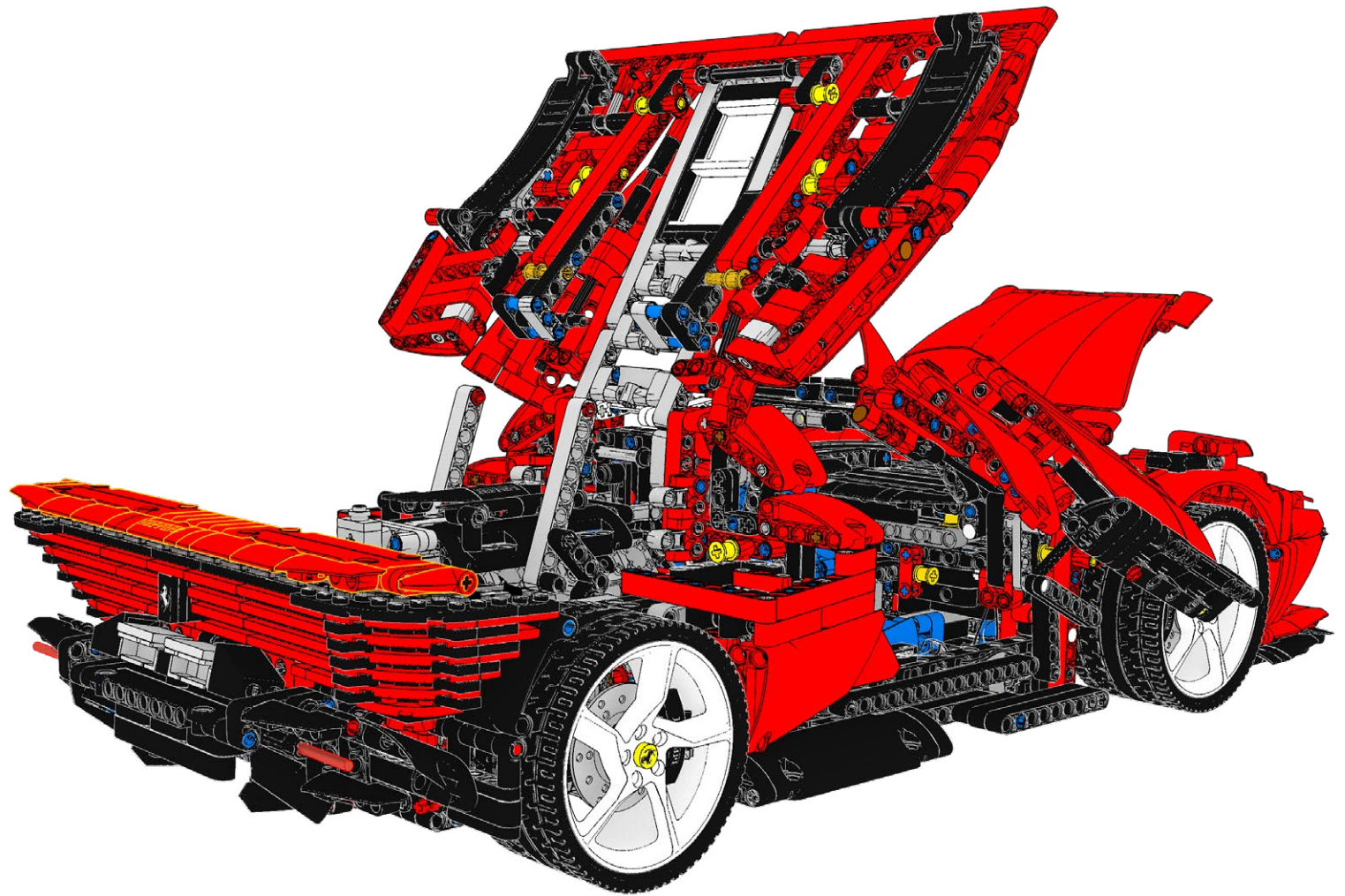

121

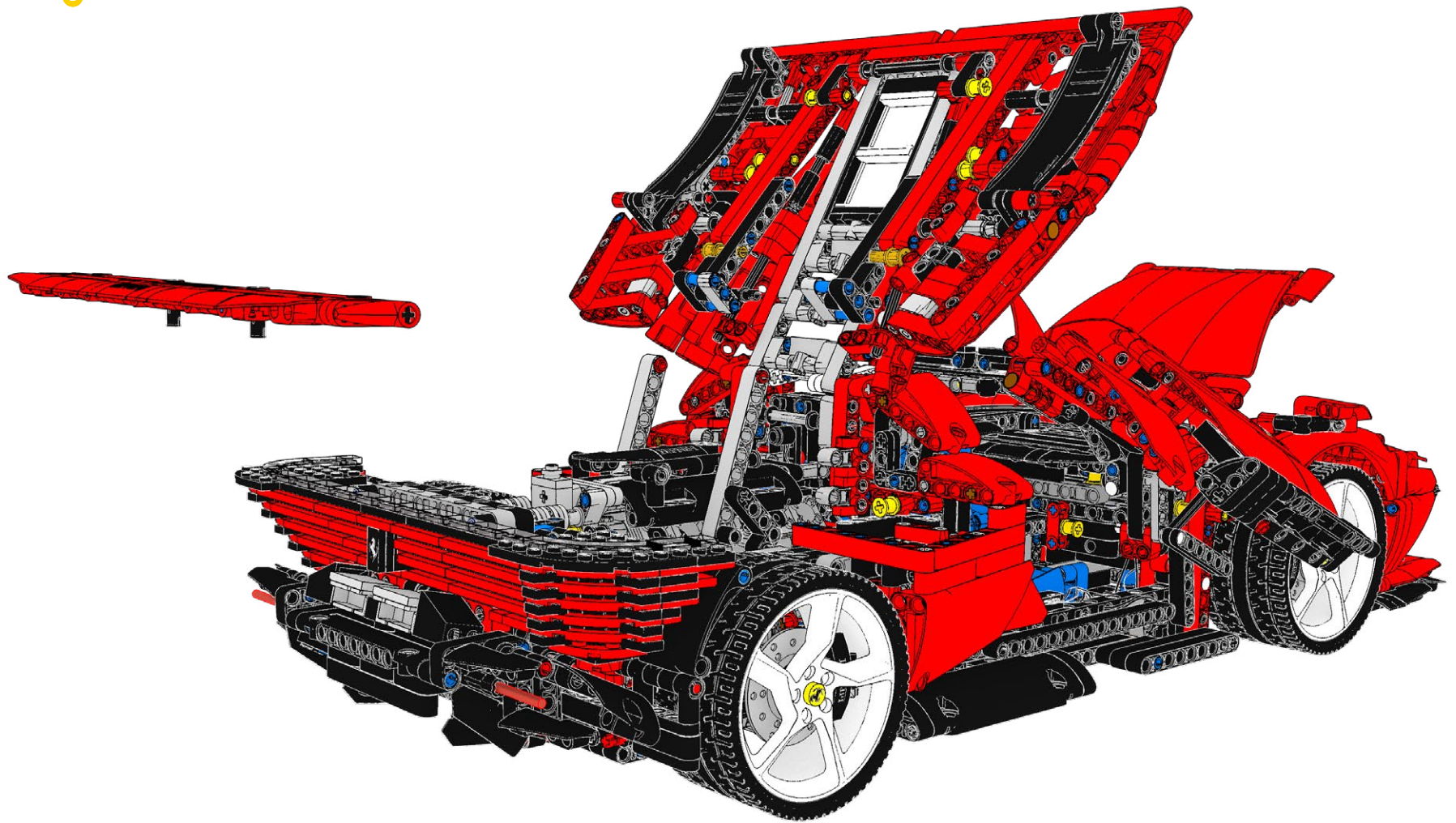

122

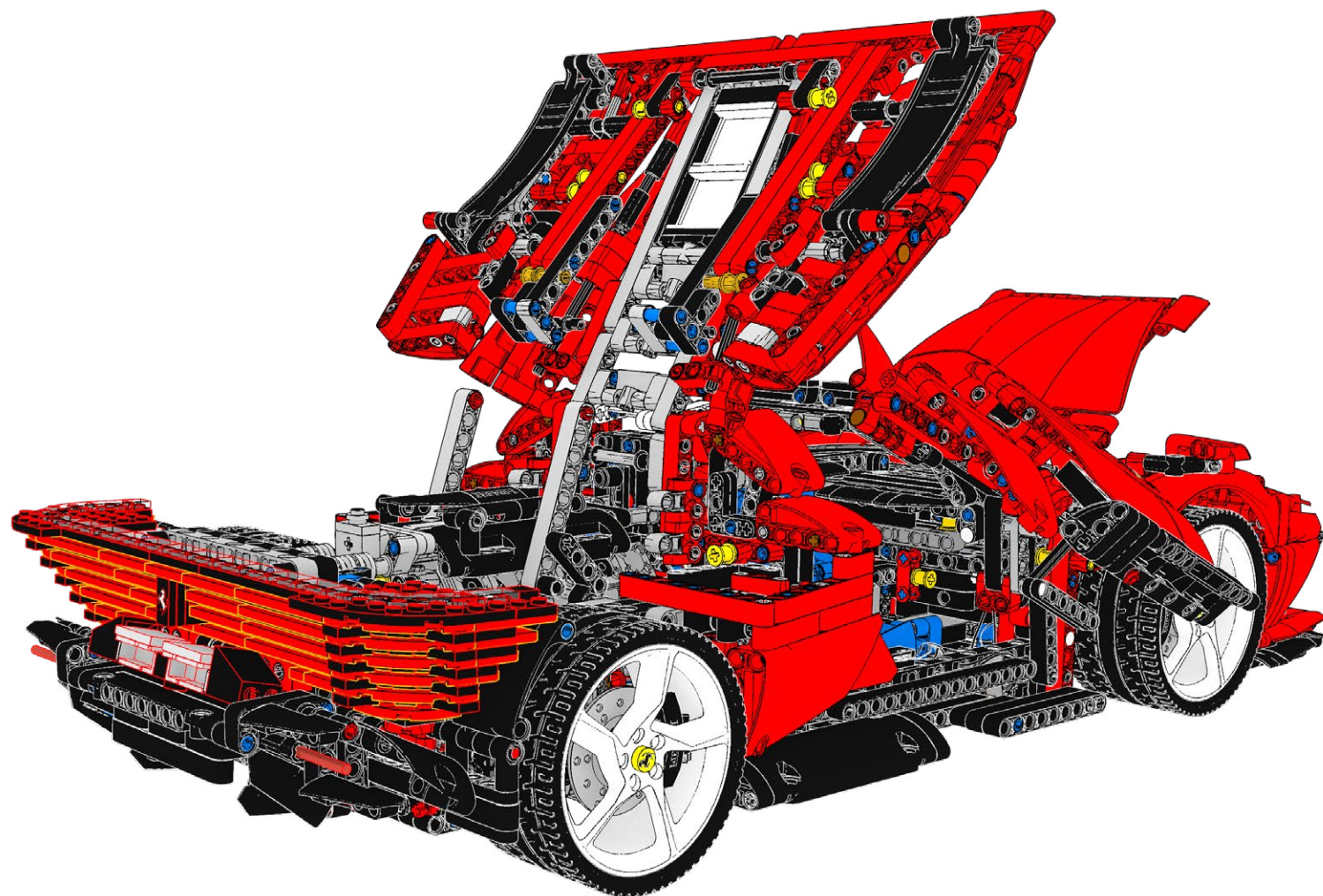

123

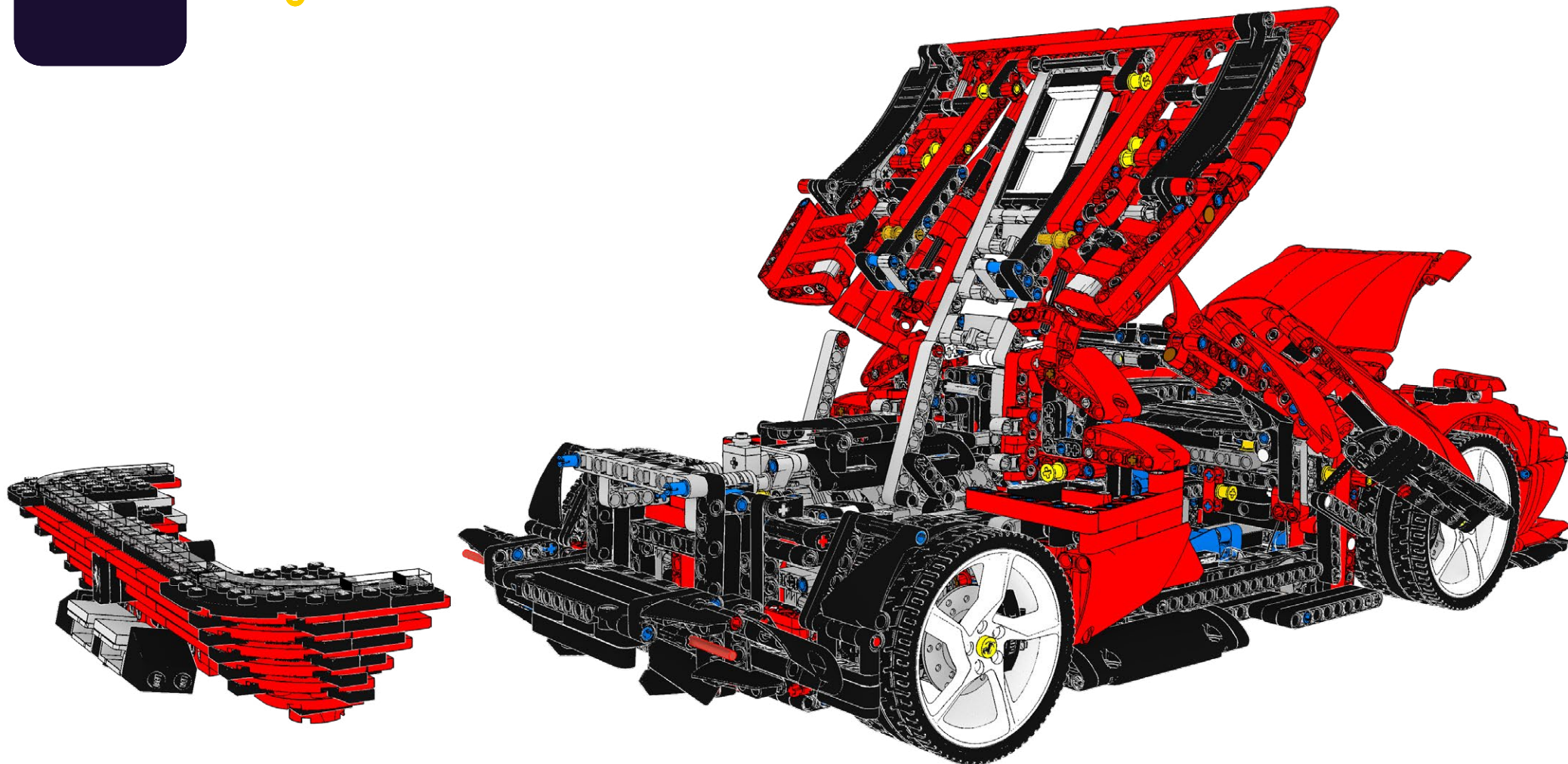

124

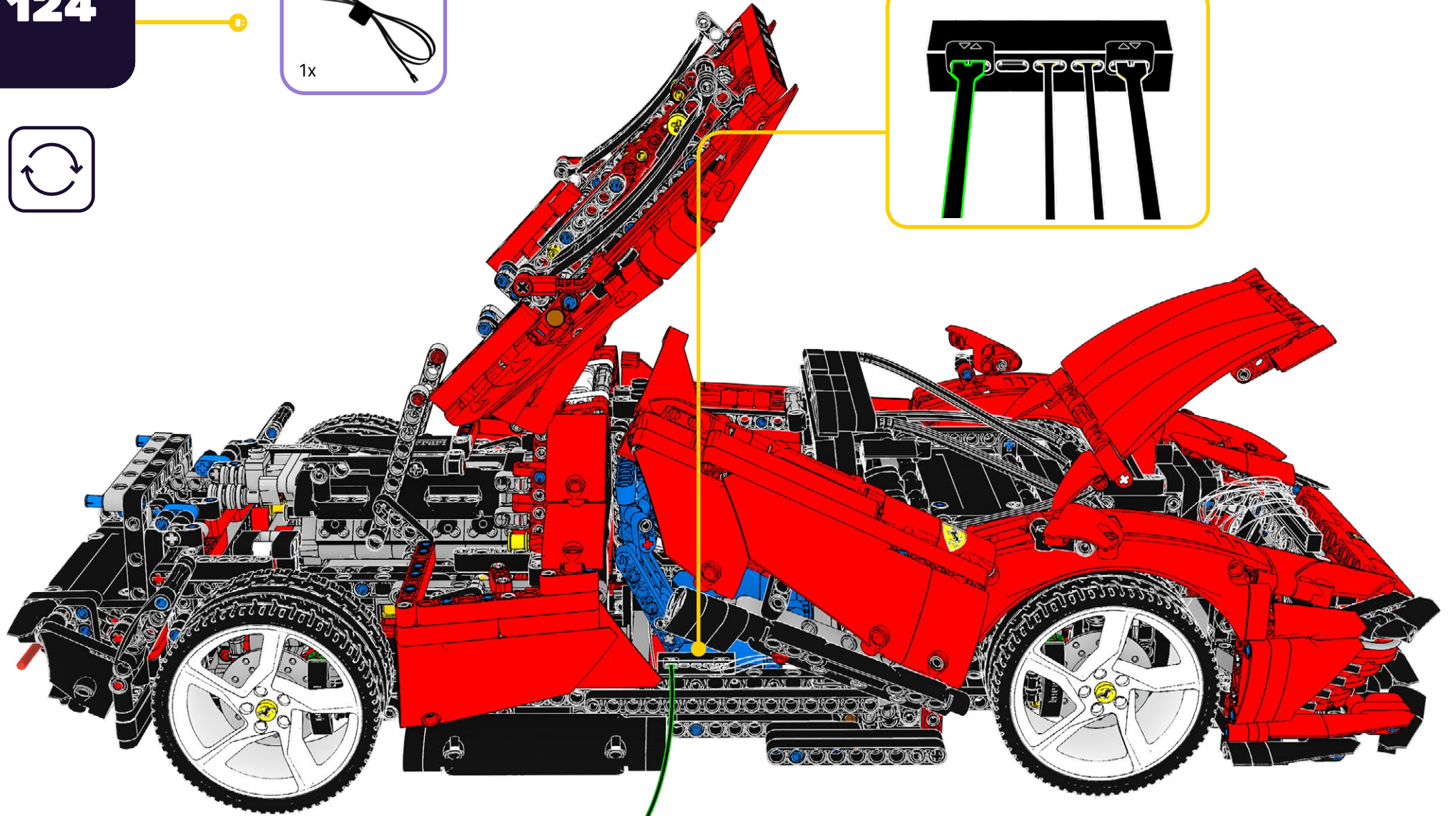
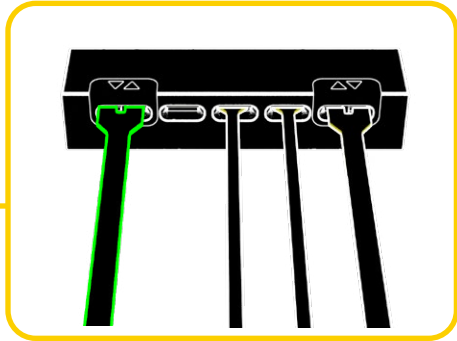
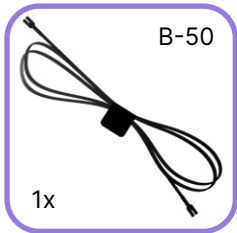

125

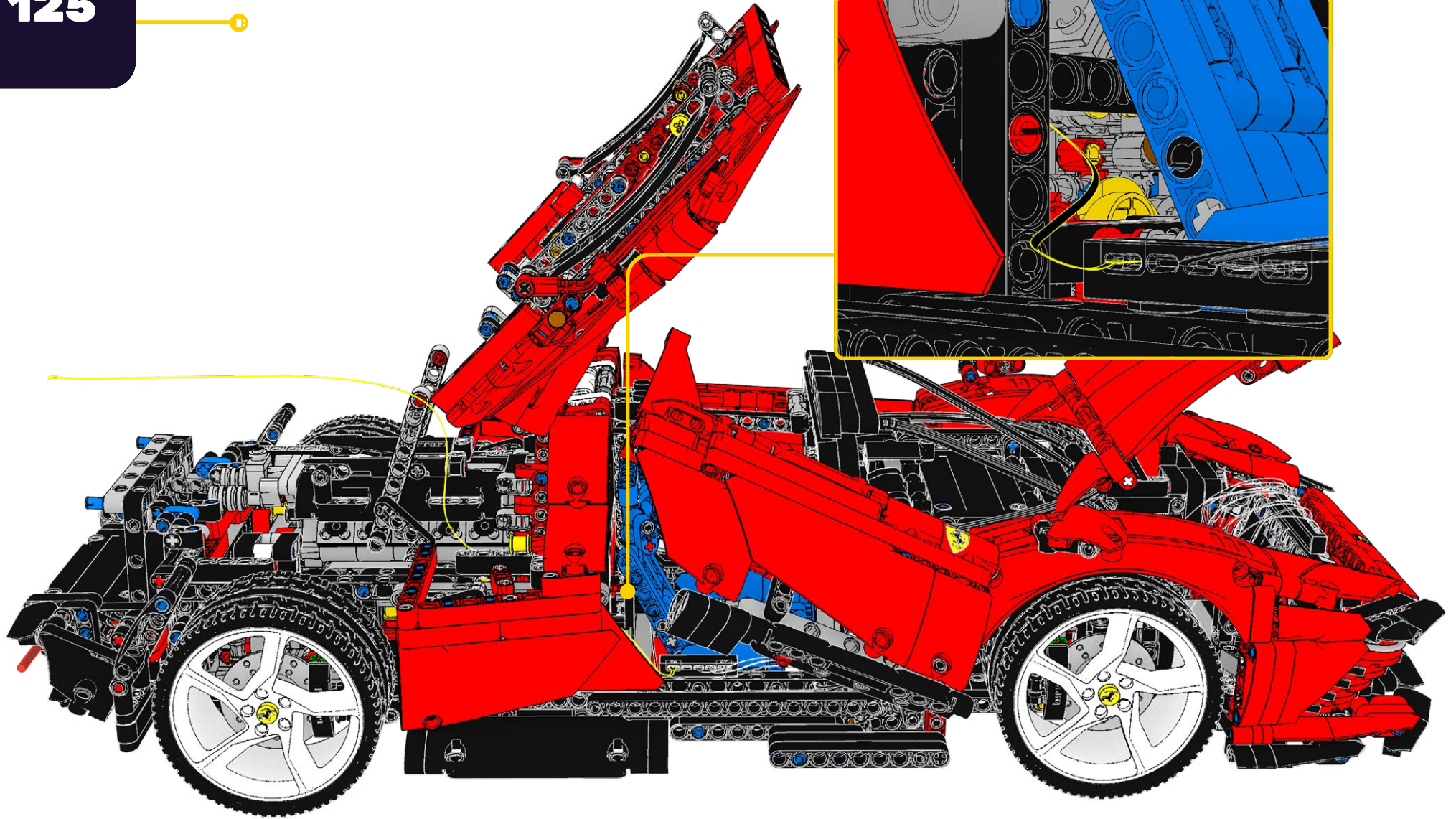

126

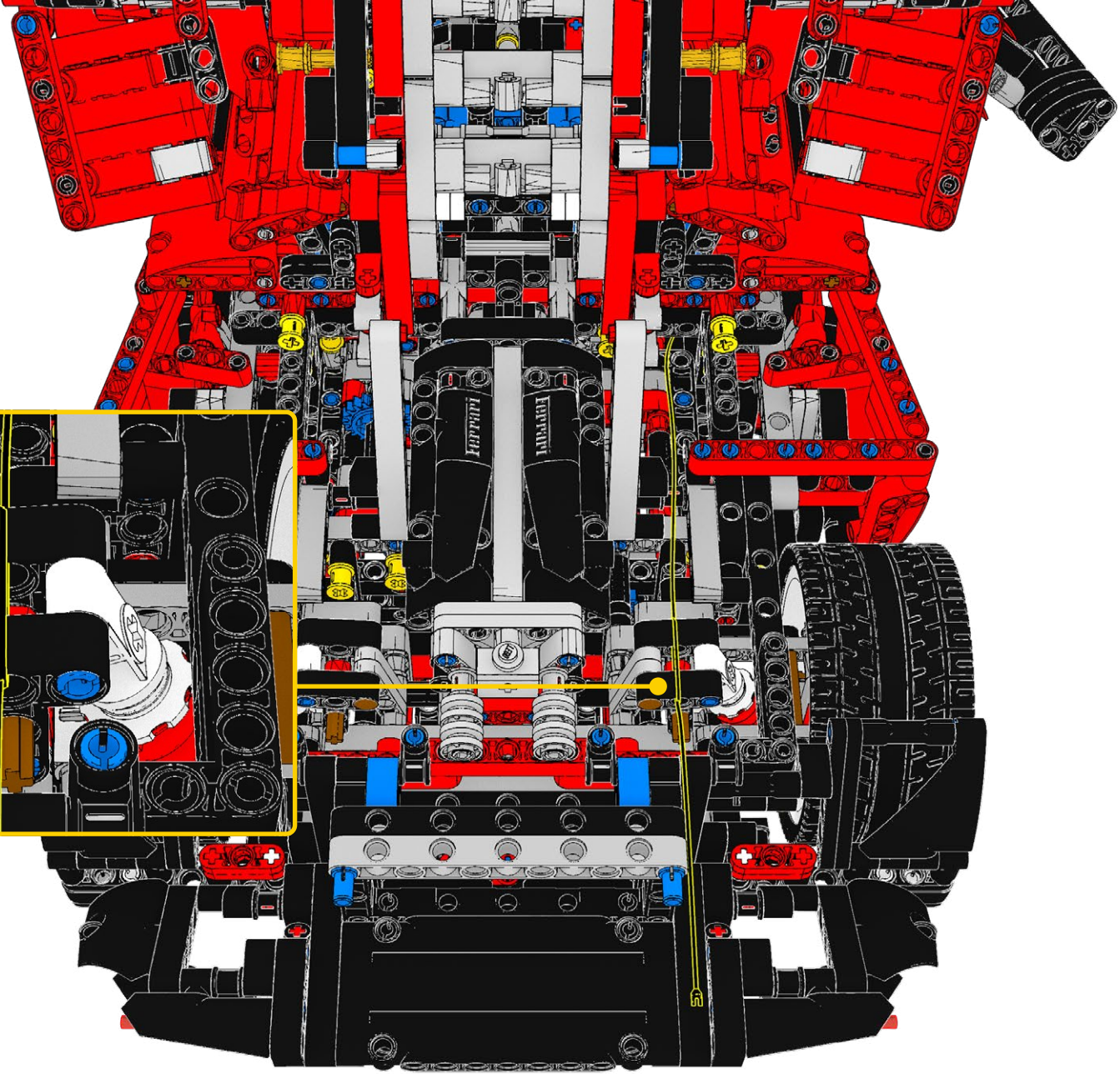
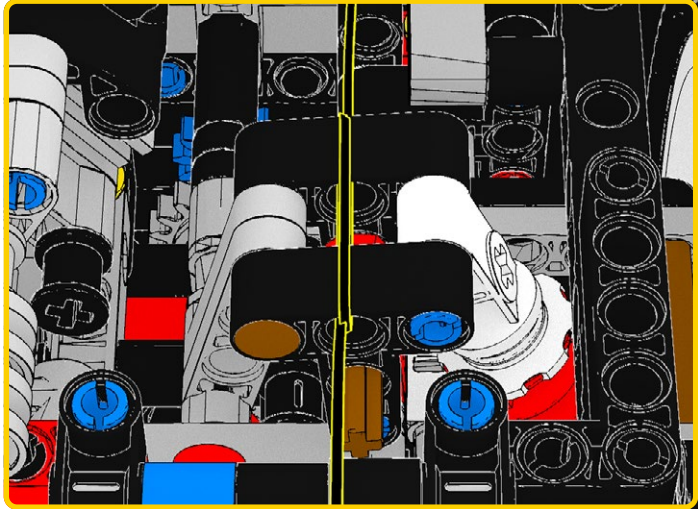

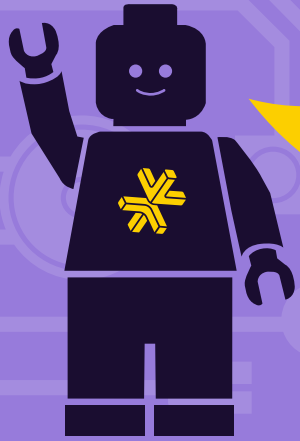
**HOLD UP!**

You might notice some bags are out of order, as well as left over pieces, but that's ok! We're changing the way you build LEGO!

HALTEN!

Möglicherweise stellen Sie fest, dass einige Beutel nicht in Ordnung sind und auch Teile übrig bleiben, aber das ist in Ordnung! Wir verändern die Art und Weise, wie Sie LEGO bauen!

TENIR BON!

Vous remarquerez peut-être que certains sacs sont en panne, ainsi que des morceaux restants, mais ce n'est pas grave ! Nous changeons la façon dont vous construisez LEGO !

SOSTENERE!

Potresti notare che alcune borse sono fuori uso, così come alcuni pezzi avanzati, ma va bene! Stiamo cambiando il modo in cui costruisci i LEGO!

¡SOSTENER!

Puede que notes que algunas bolsas están fuera de orden, así como piezas sobrantes, ¡pero está bien! ¡Estamos cambiando la forma de construir LEGO!

耽误!

您可能会注意到有些袋子坏了, 还有剩余的碎片, 但这没关系! 我们正在改变您搭建乐高的方式!

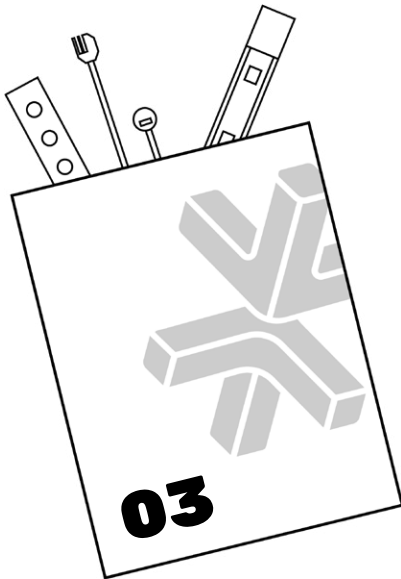
Open LMB Bag 03

127

T-1x1

2x

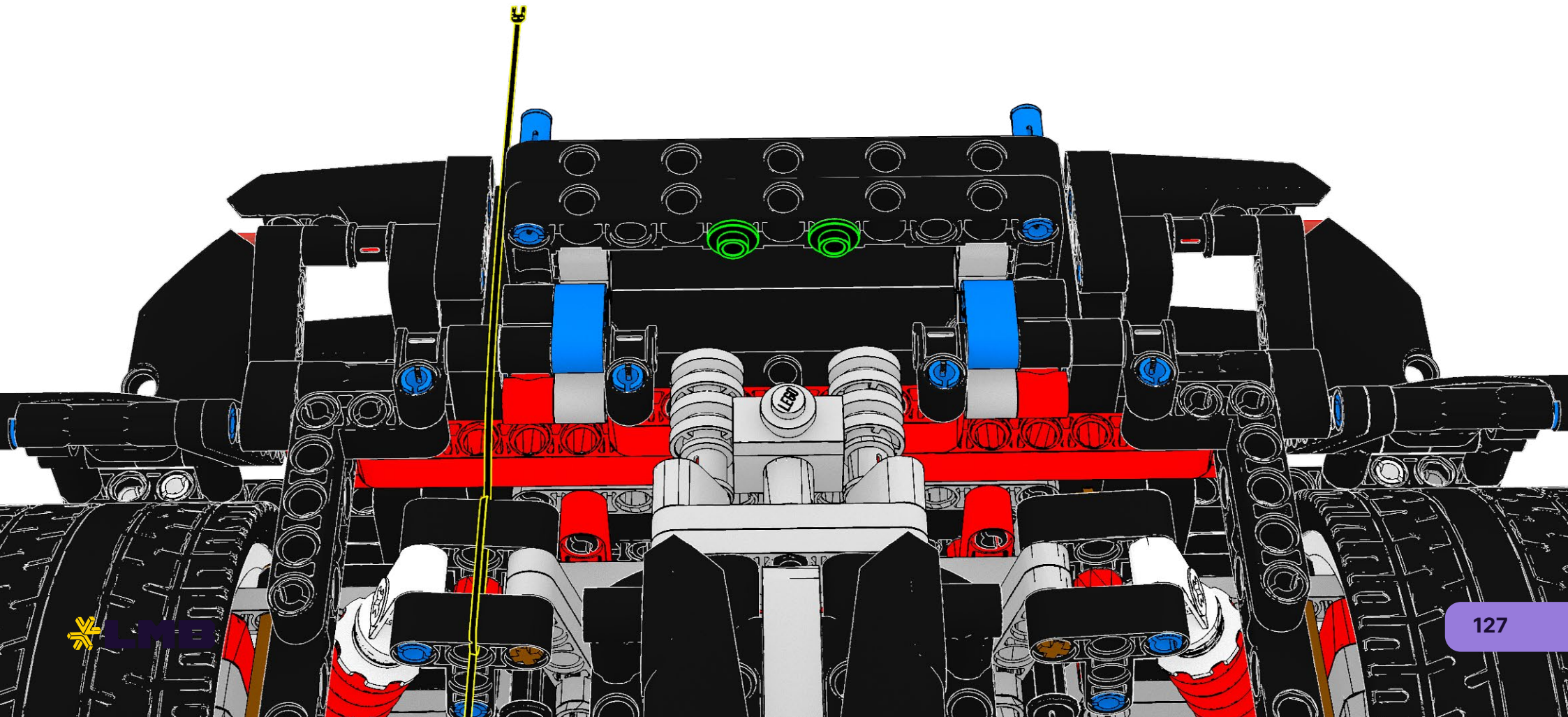
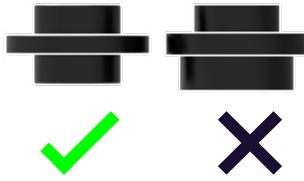

128

D-3



1x

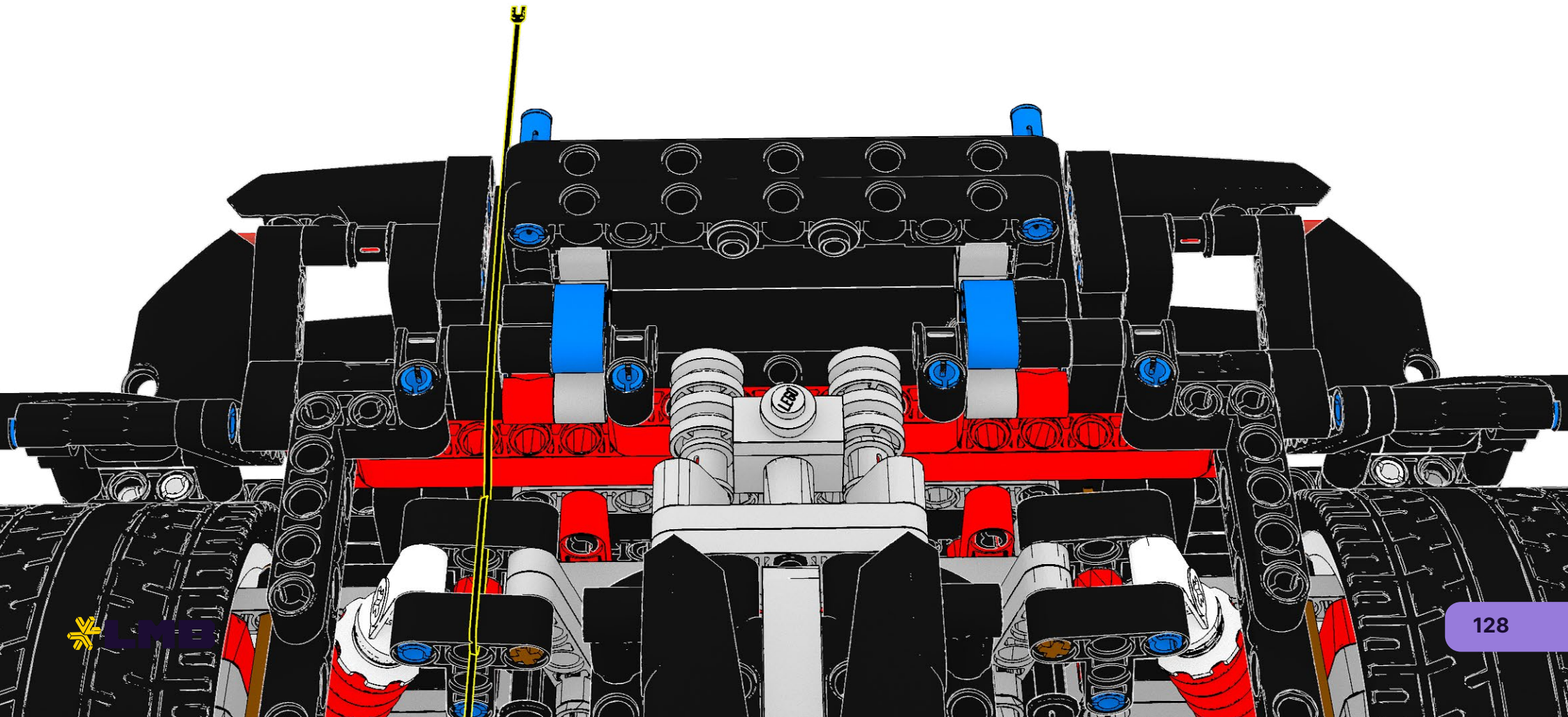

129

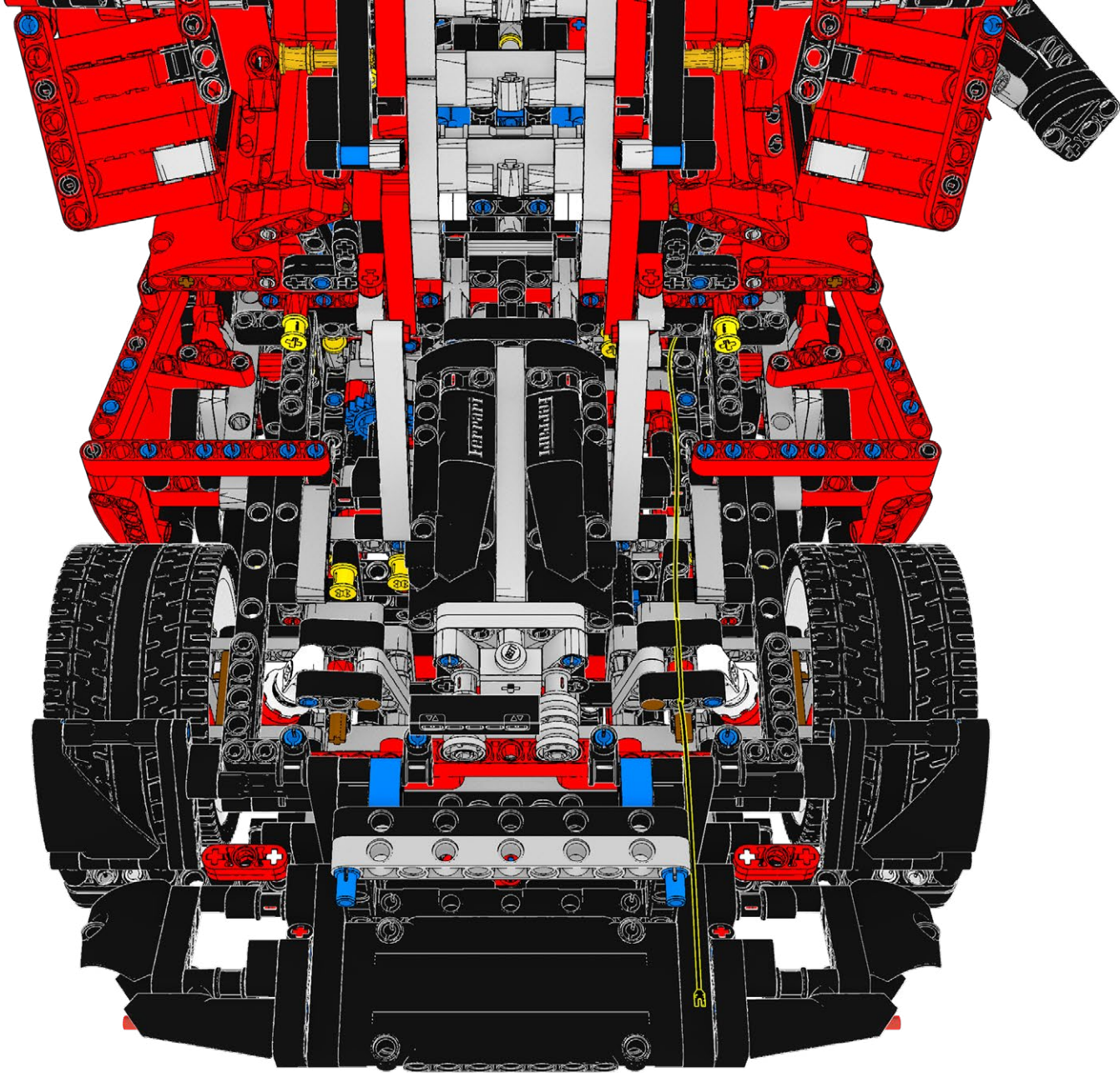

130

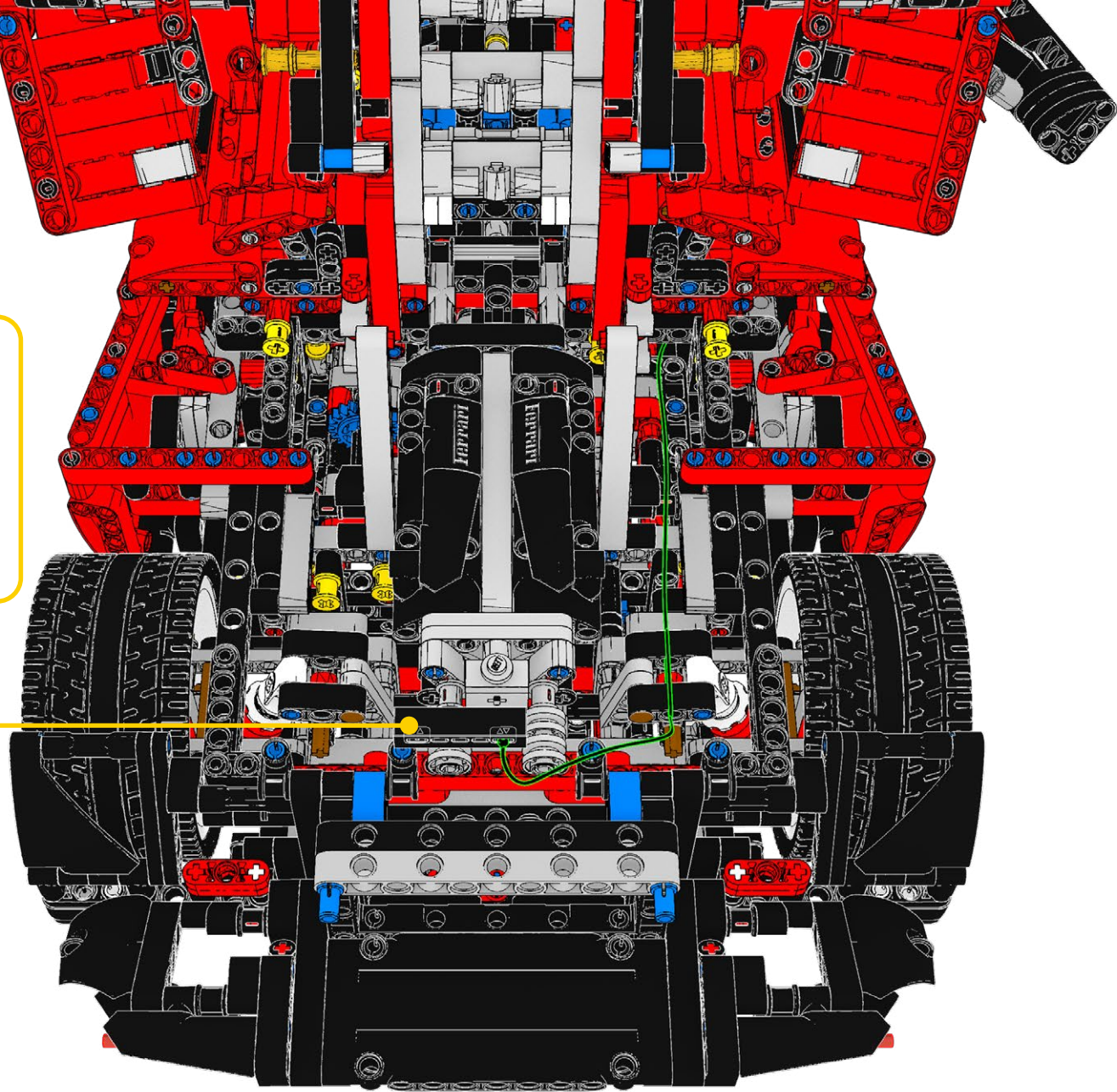
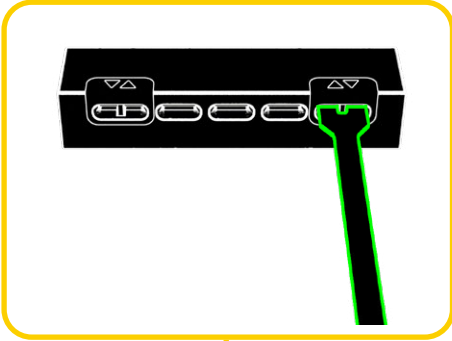

131

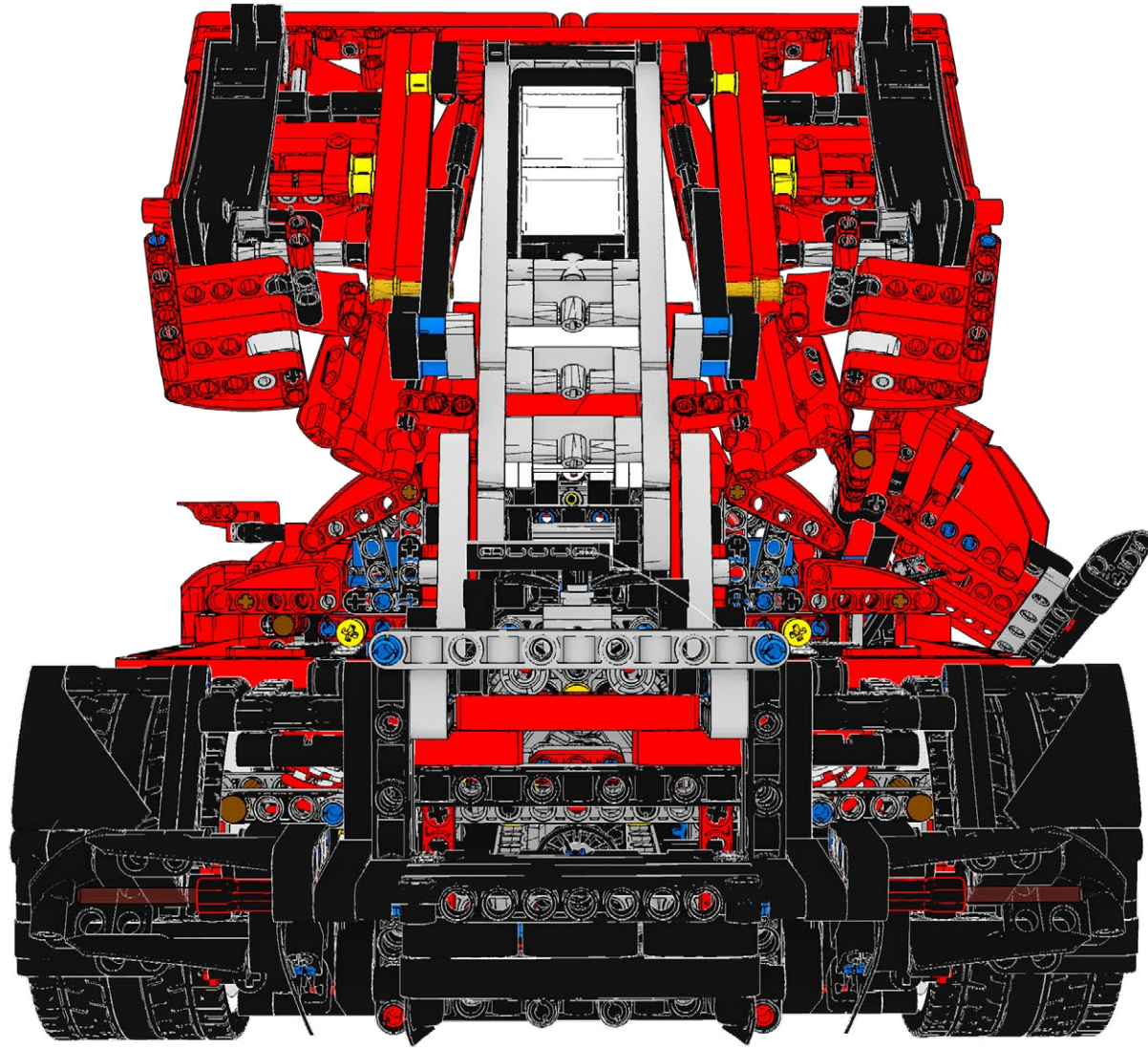

132

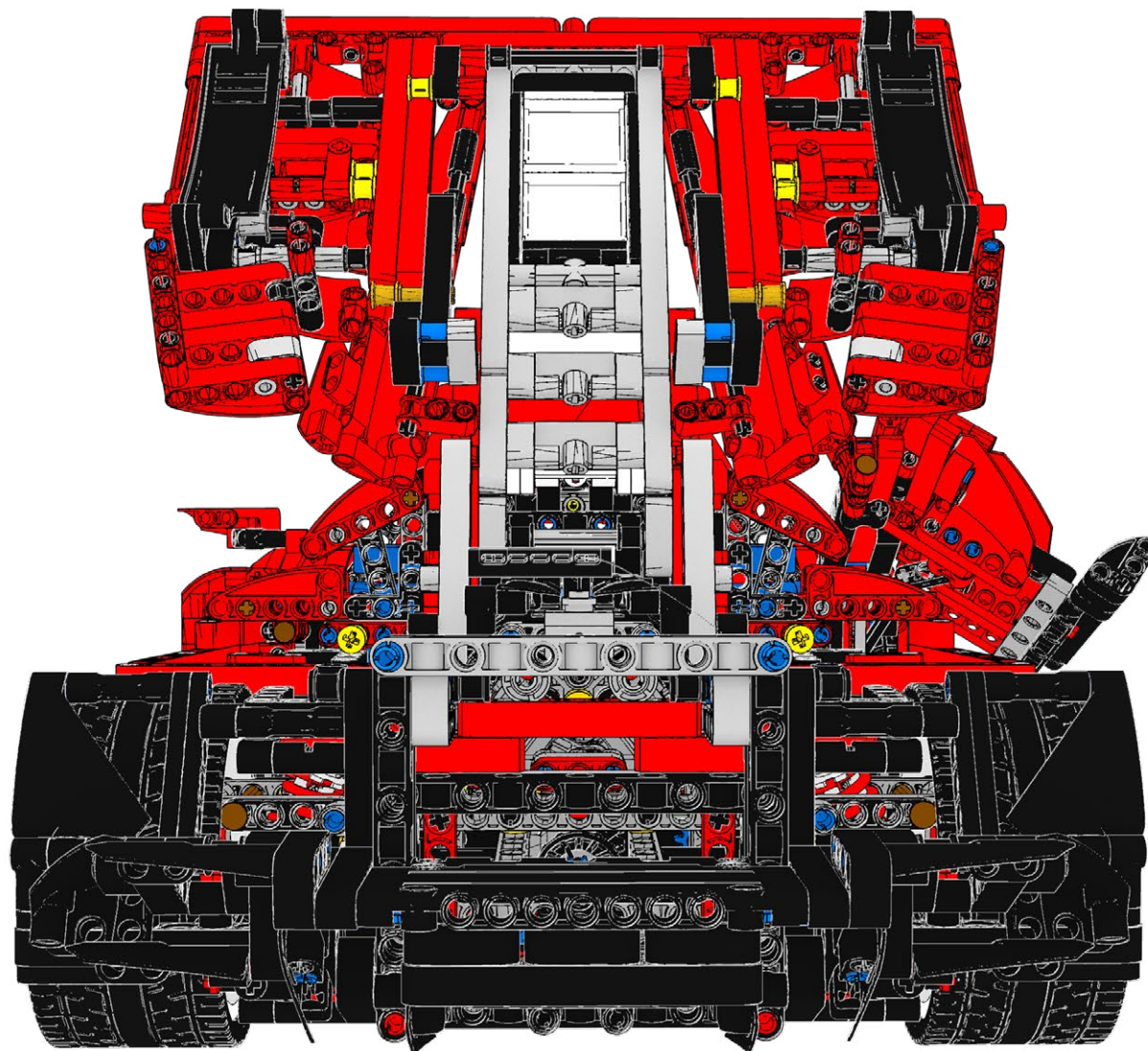

133

1



2



3



134

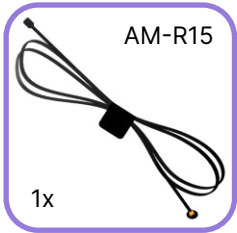

1



2



3

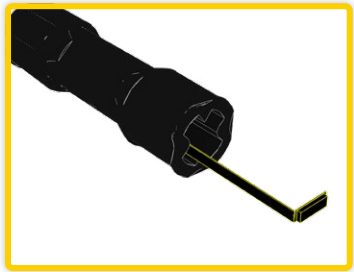



1



2



3



2x

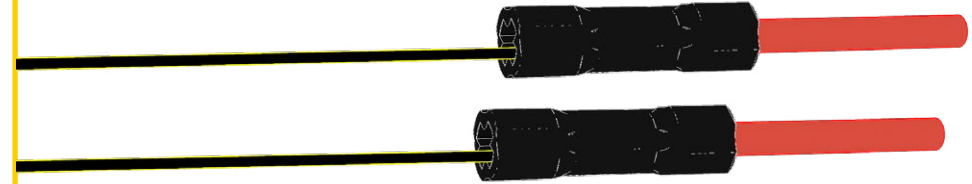

137

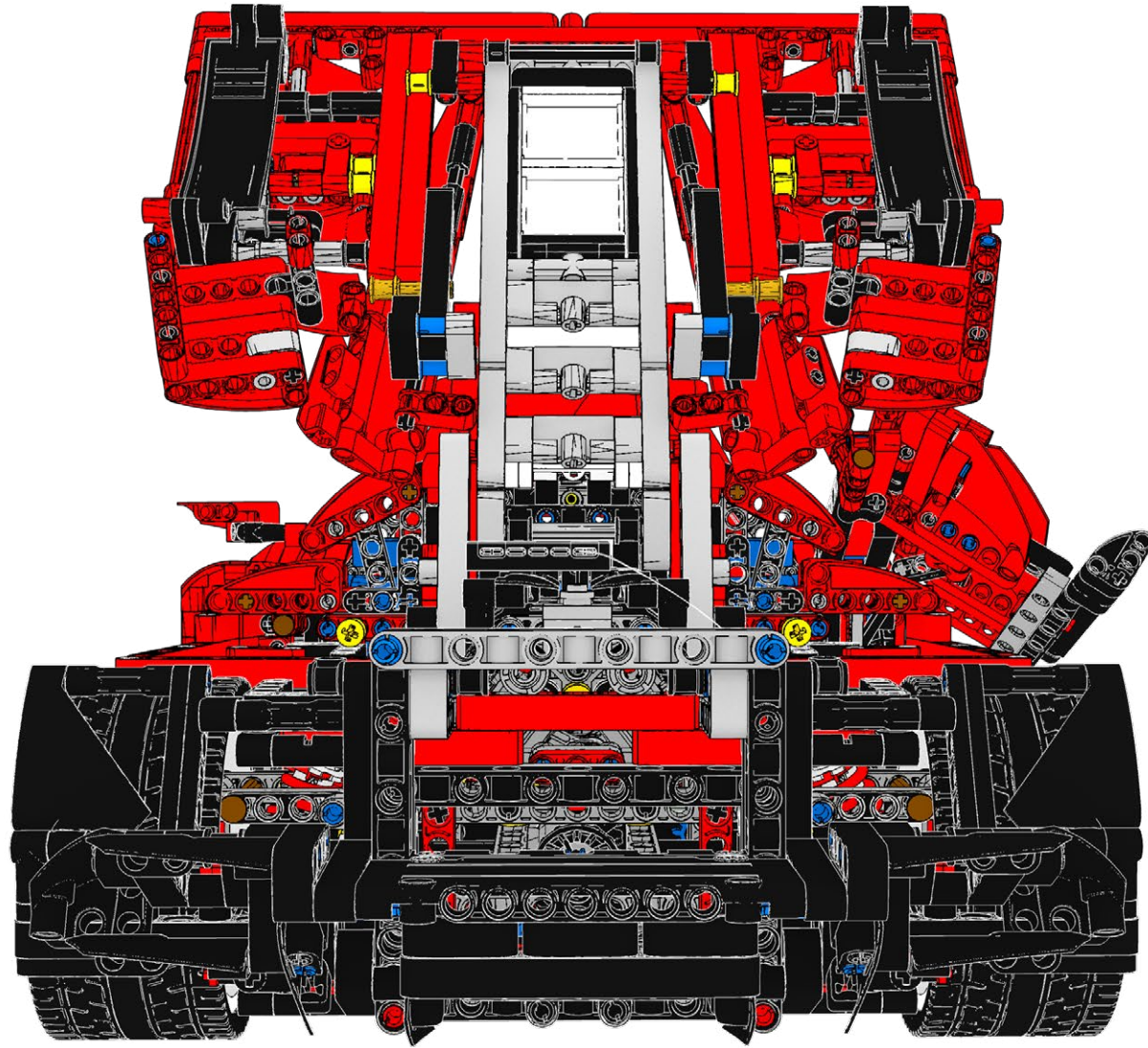

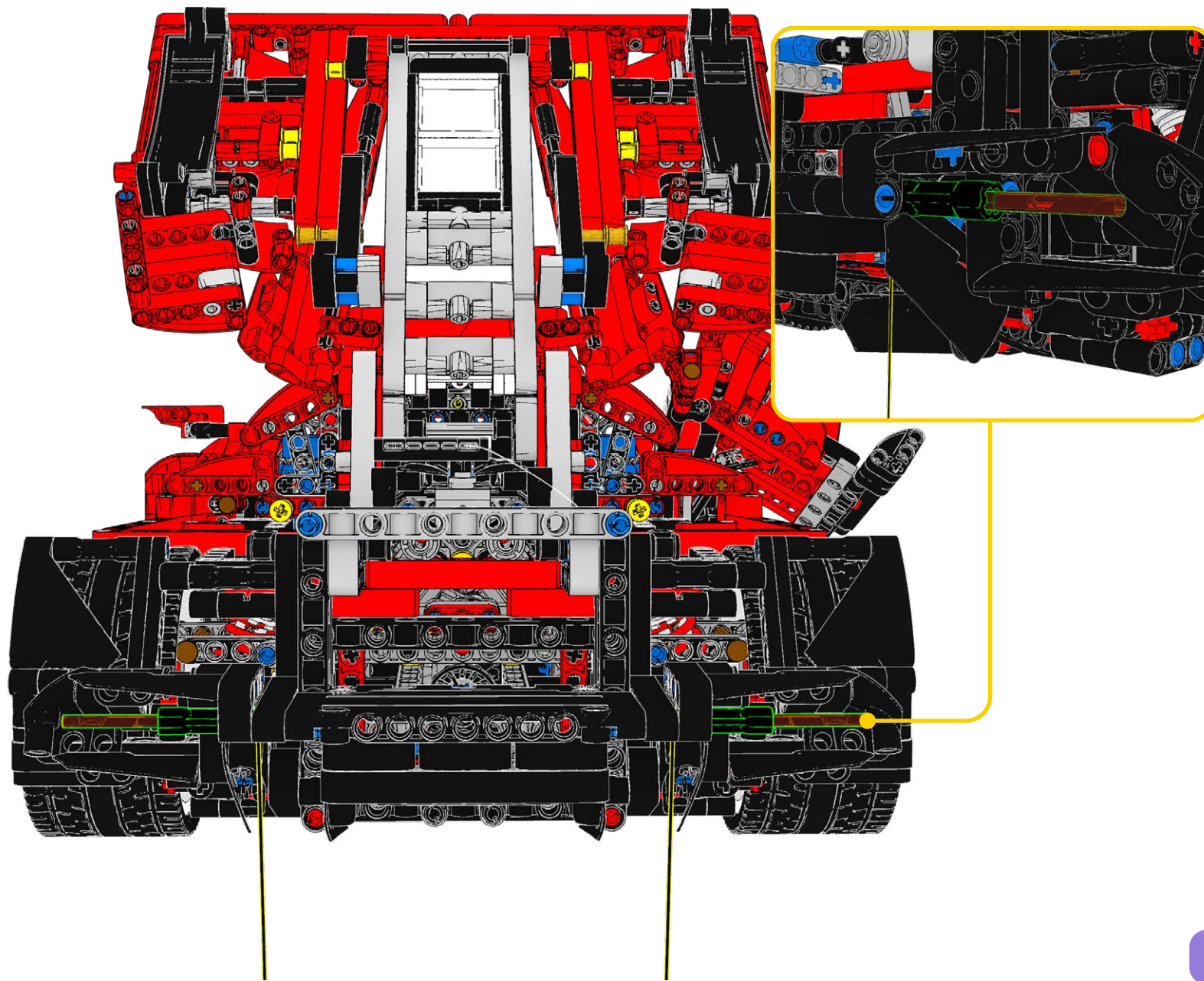

139

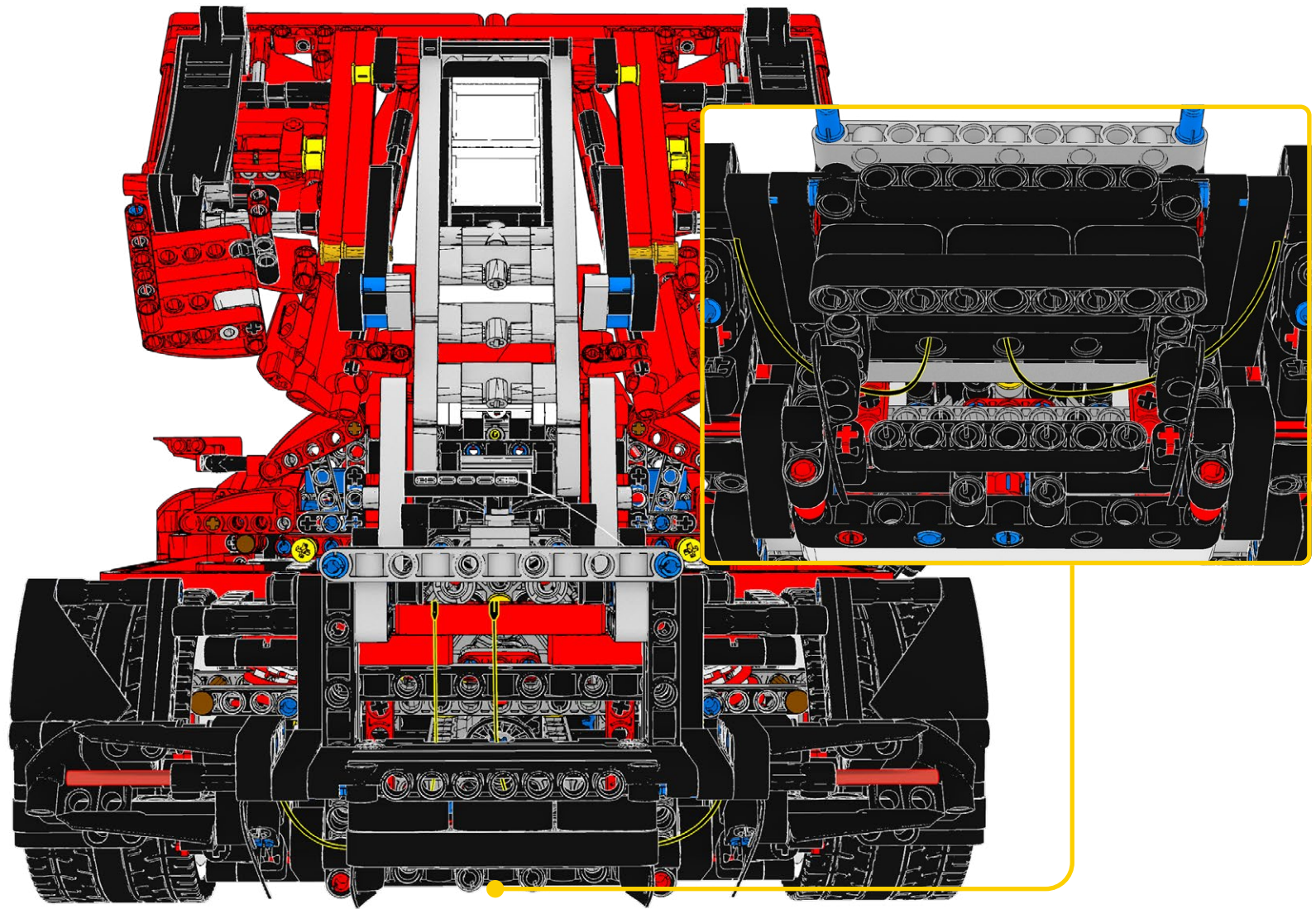

140

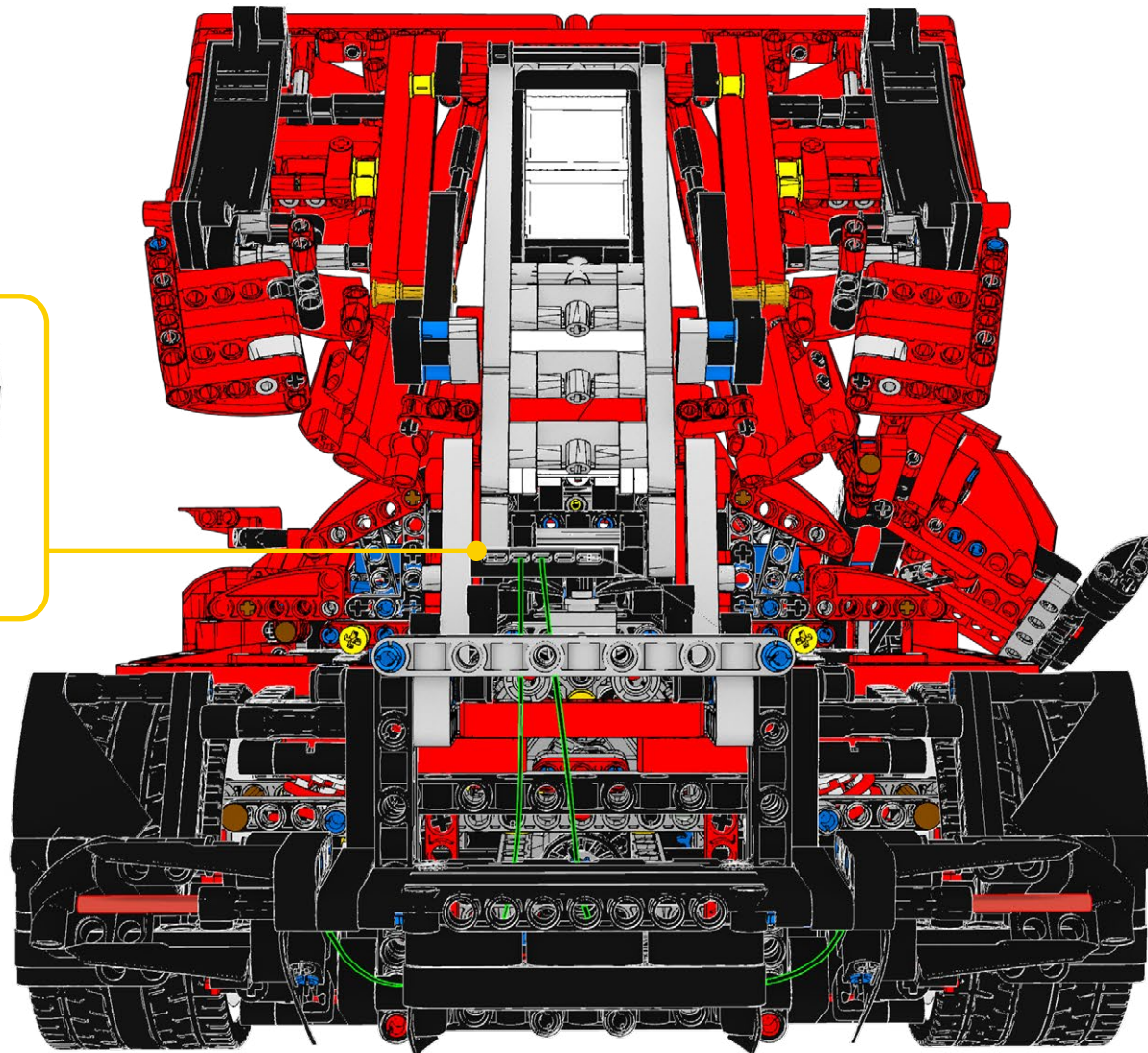
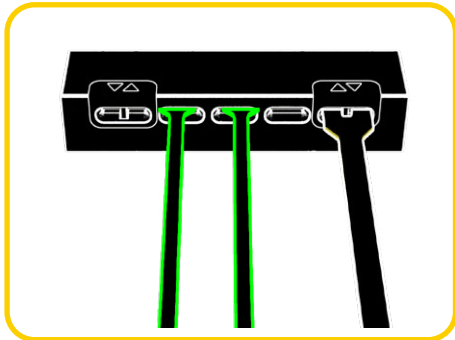

141

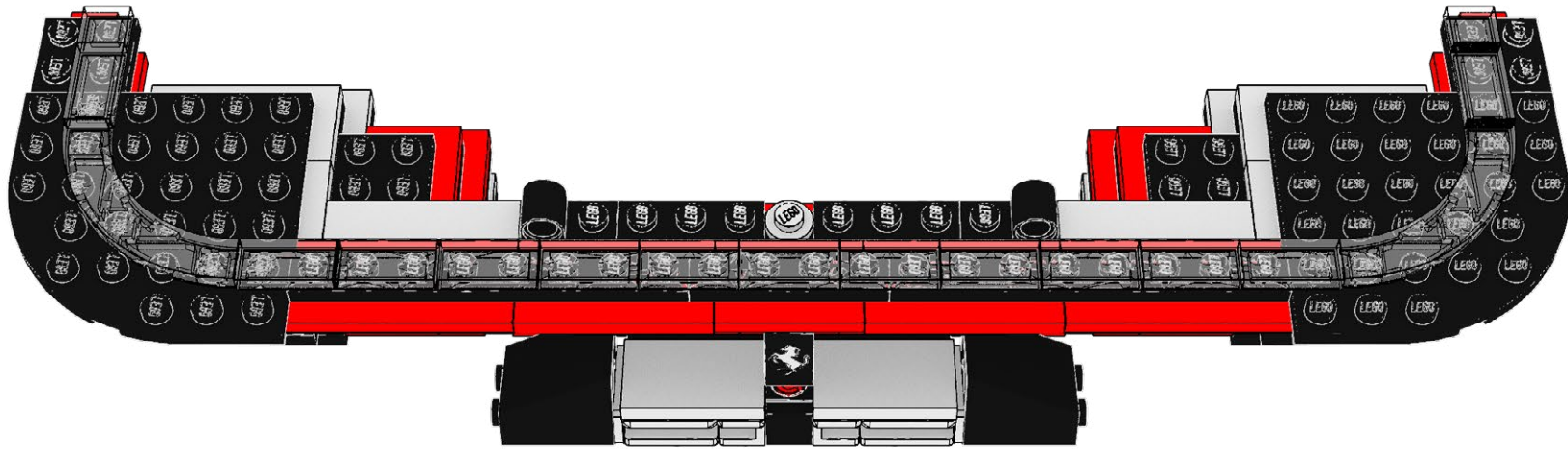

142

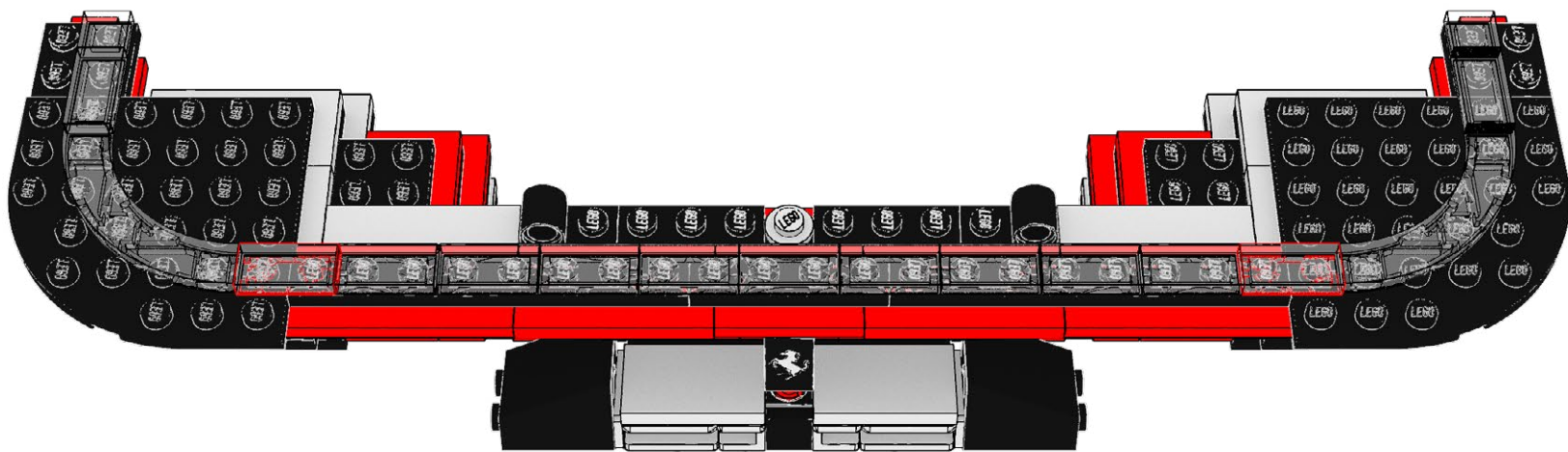

143

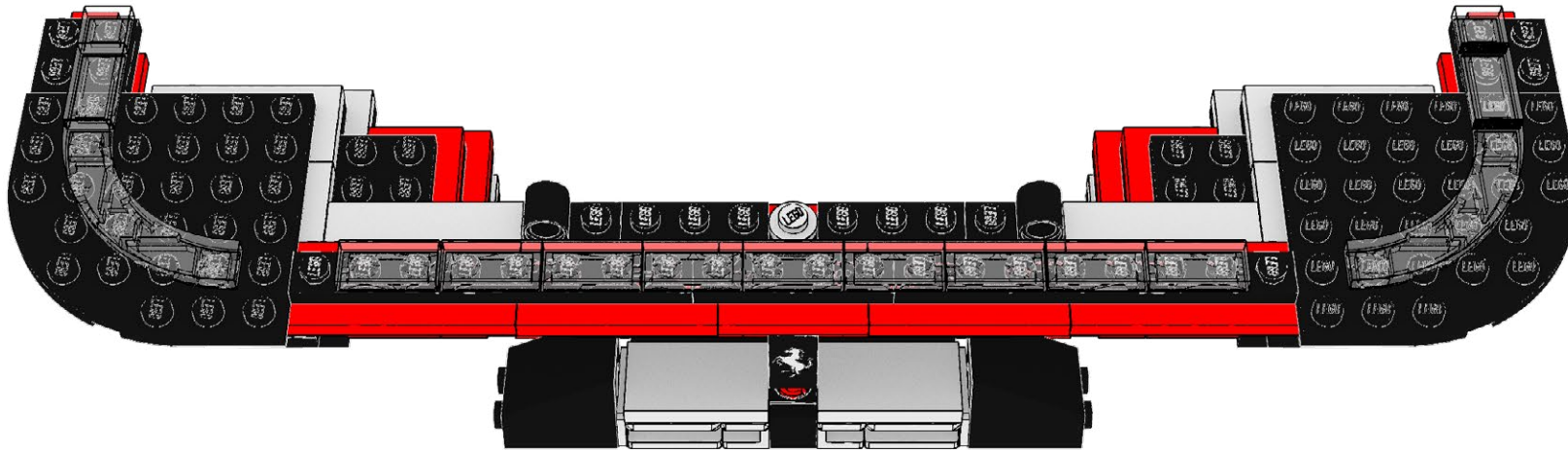
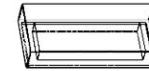

144

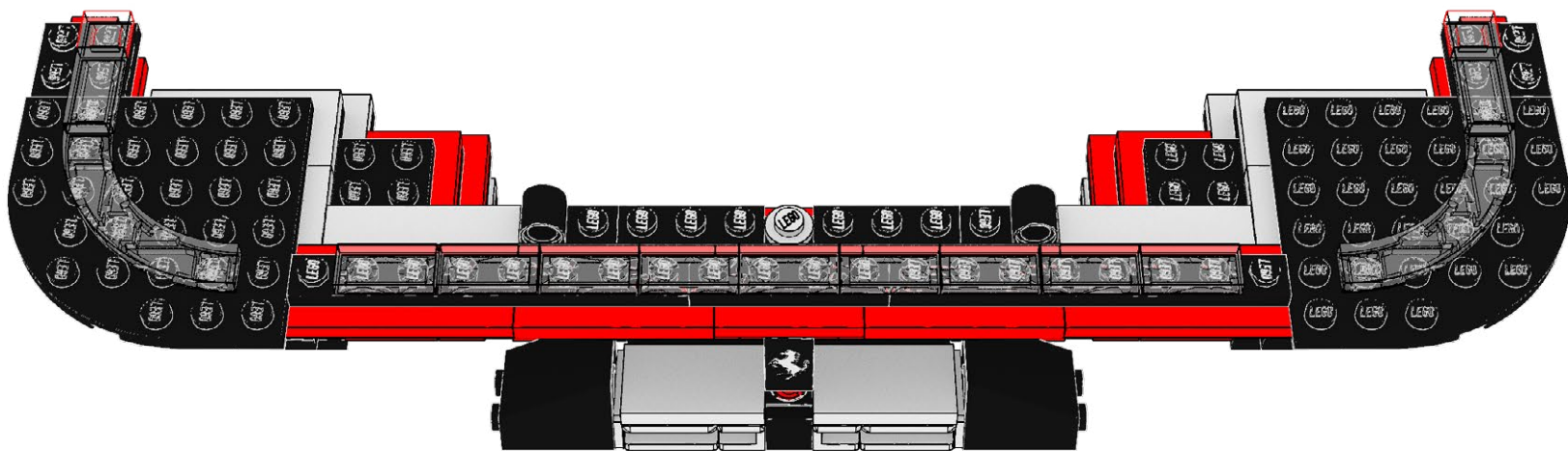

145

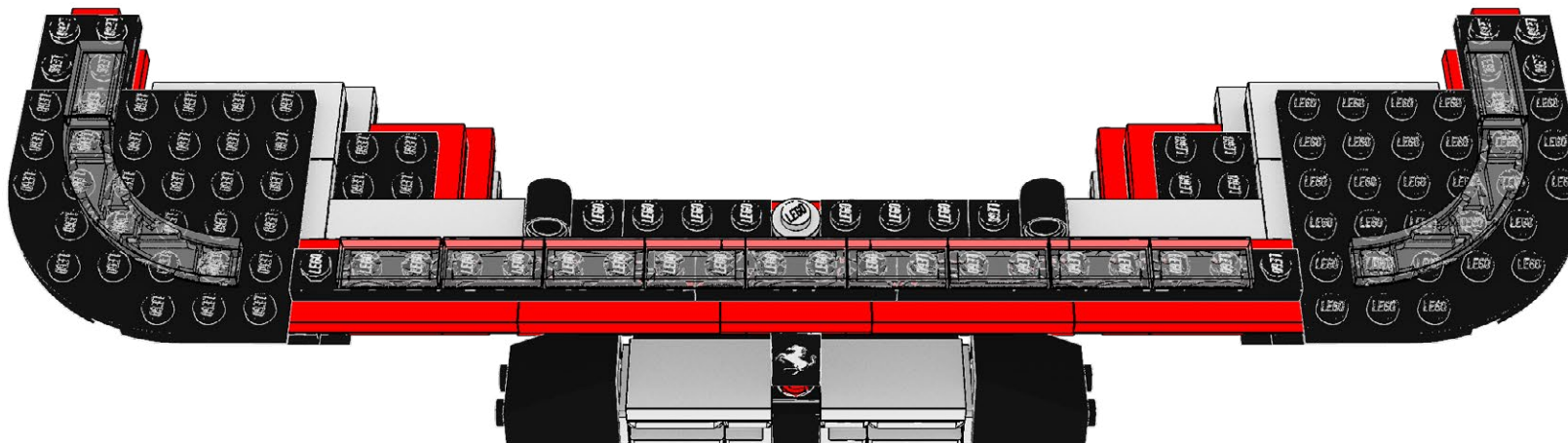

146

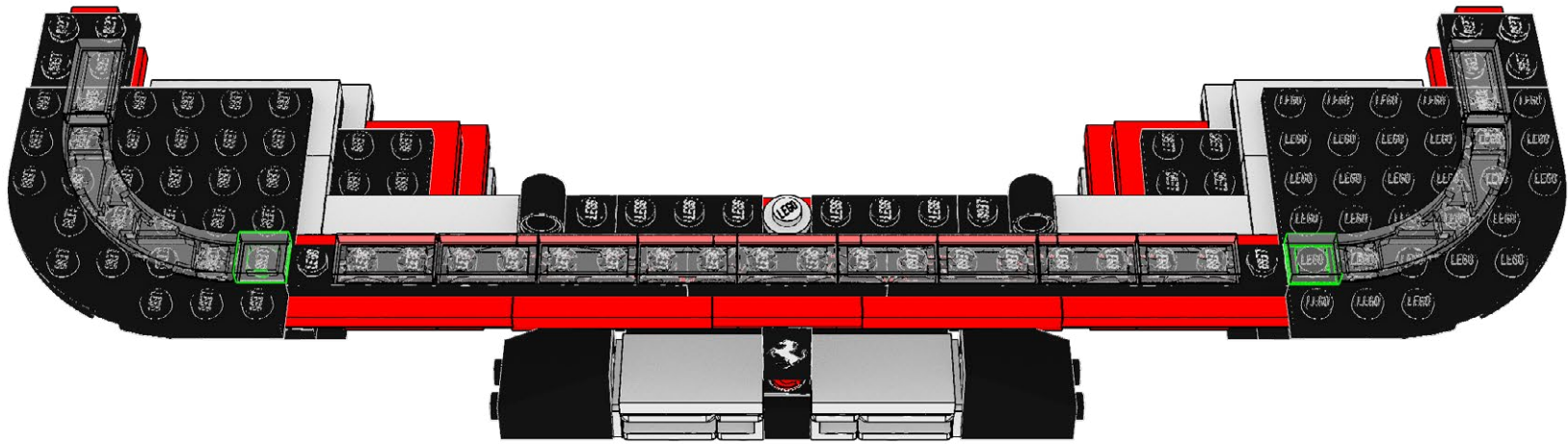

147

2x

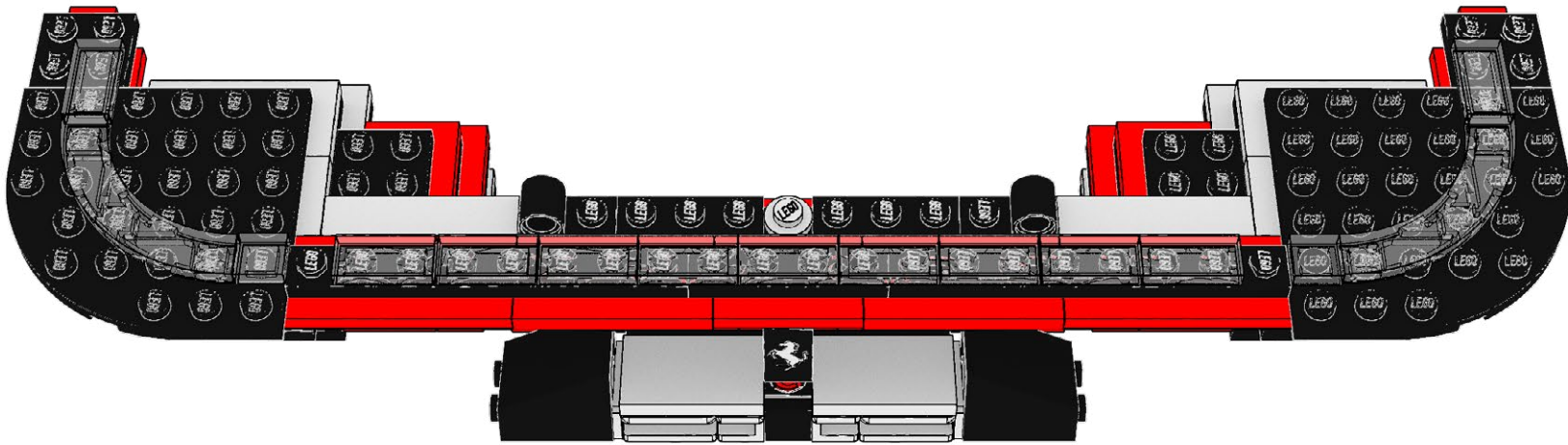

148

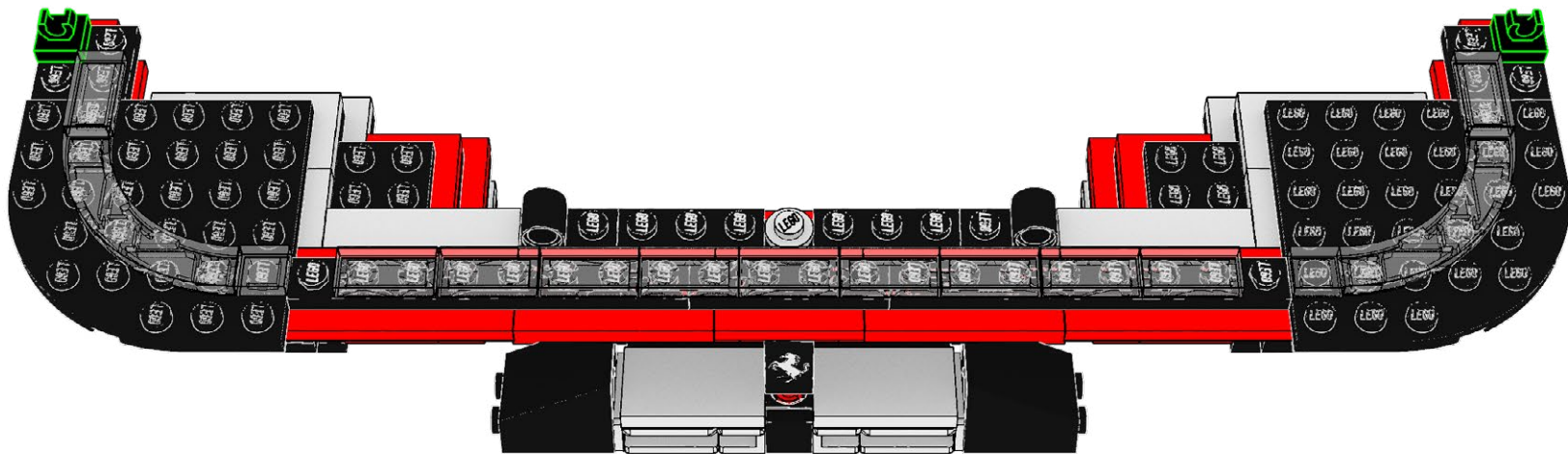

149



2x

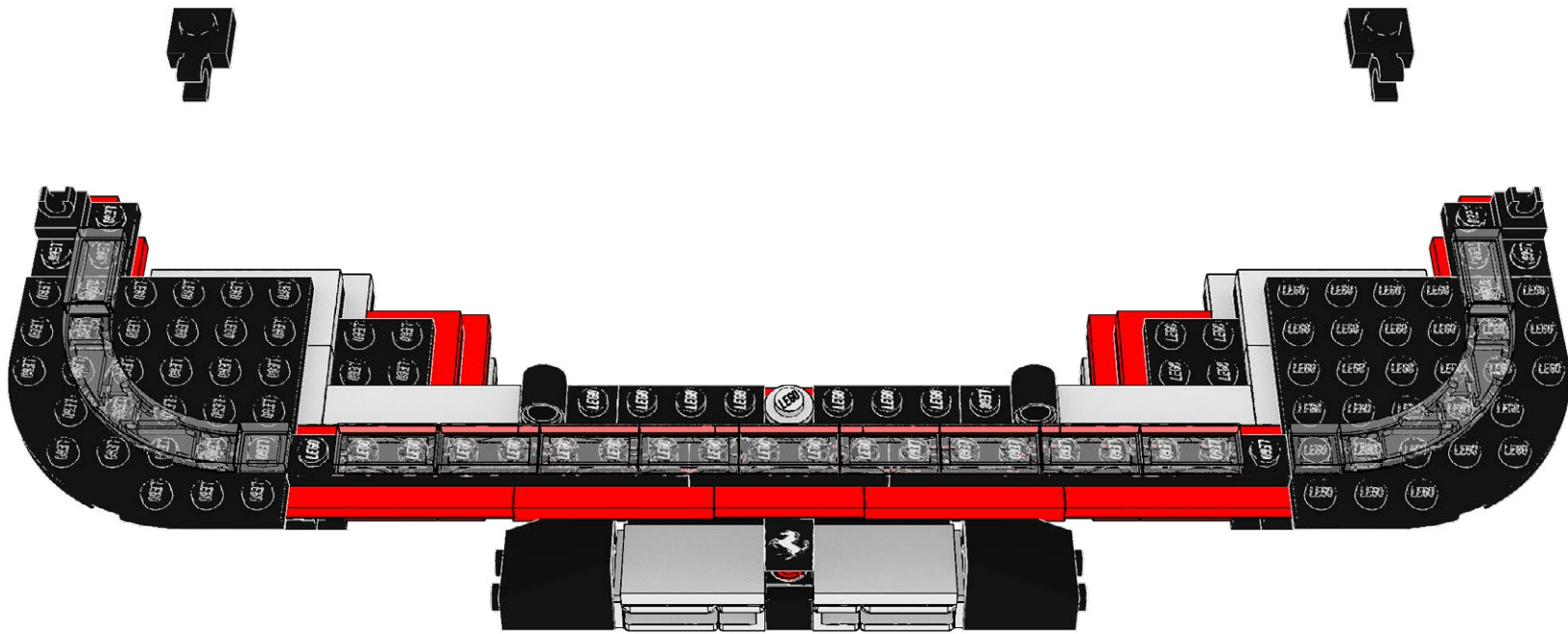

150

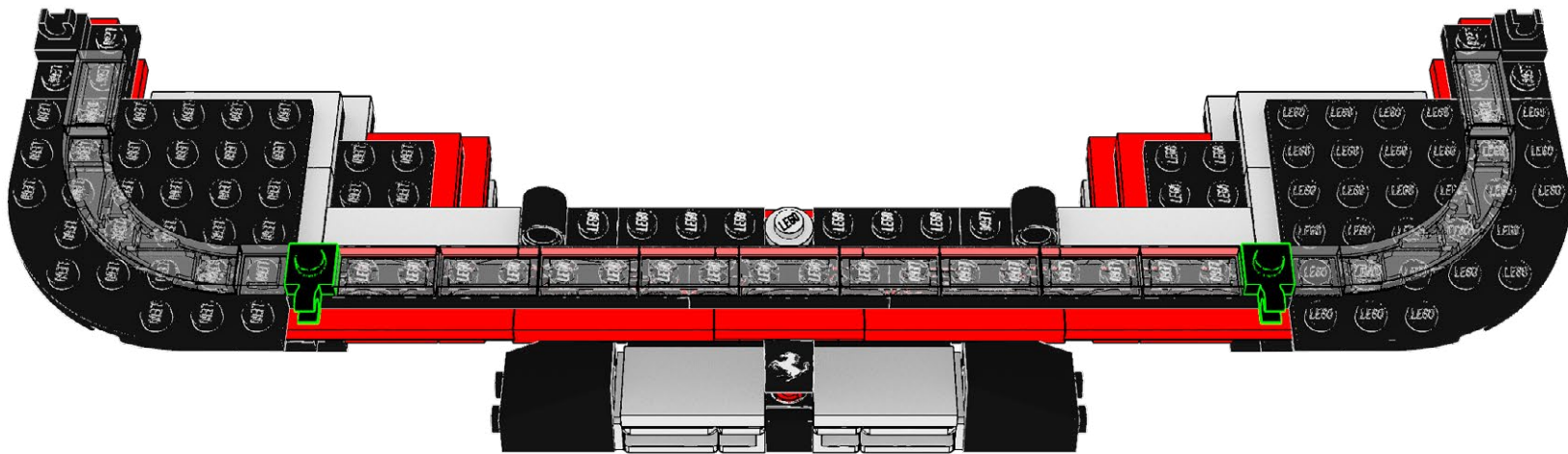

151

F-R36L

1x

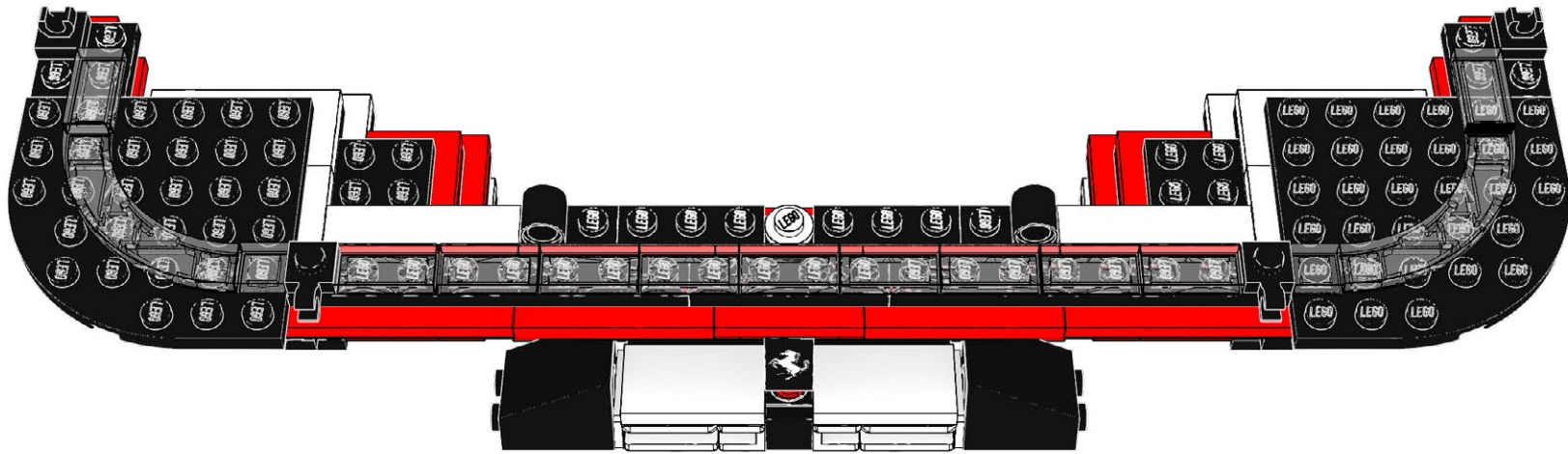

152

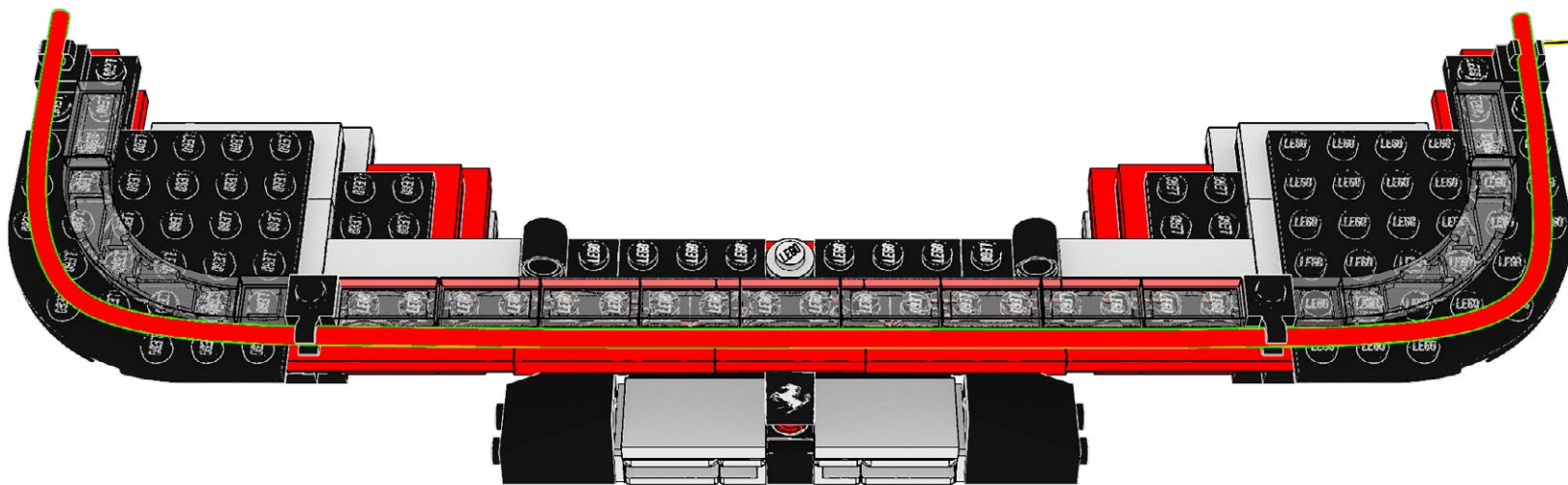

153

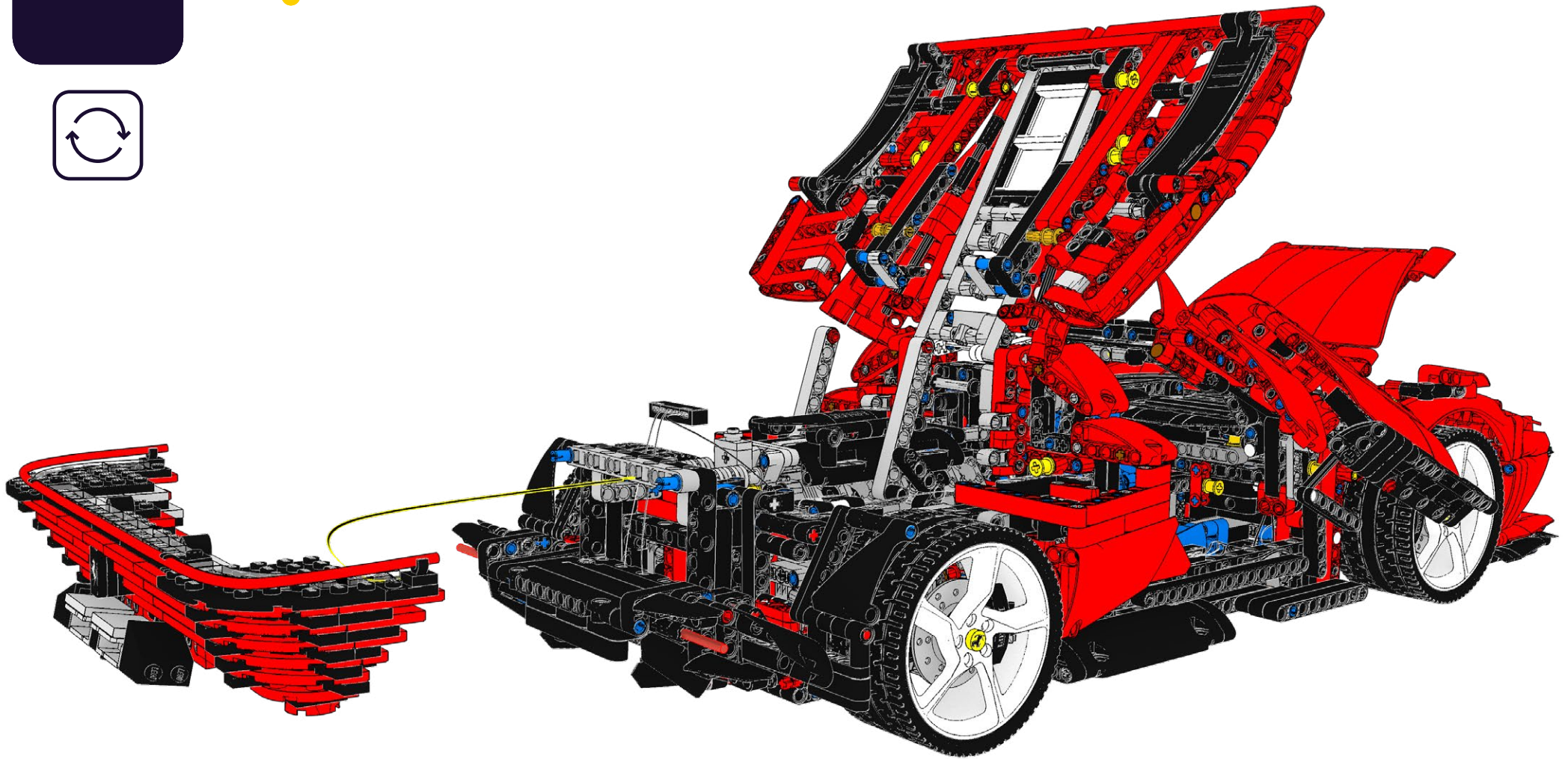

154

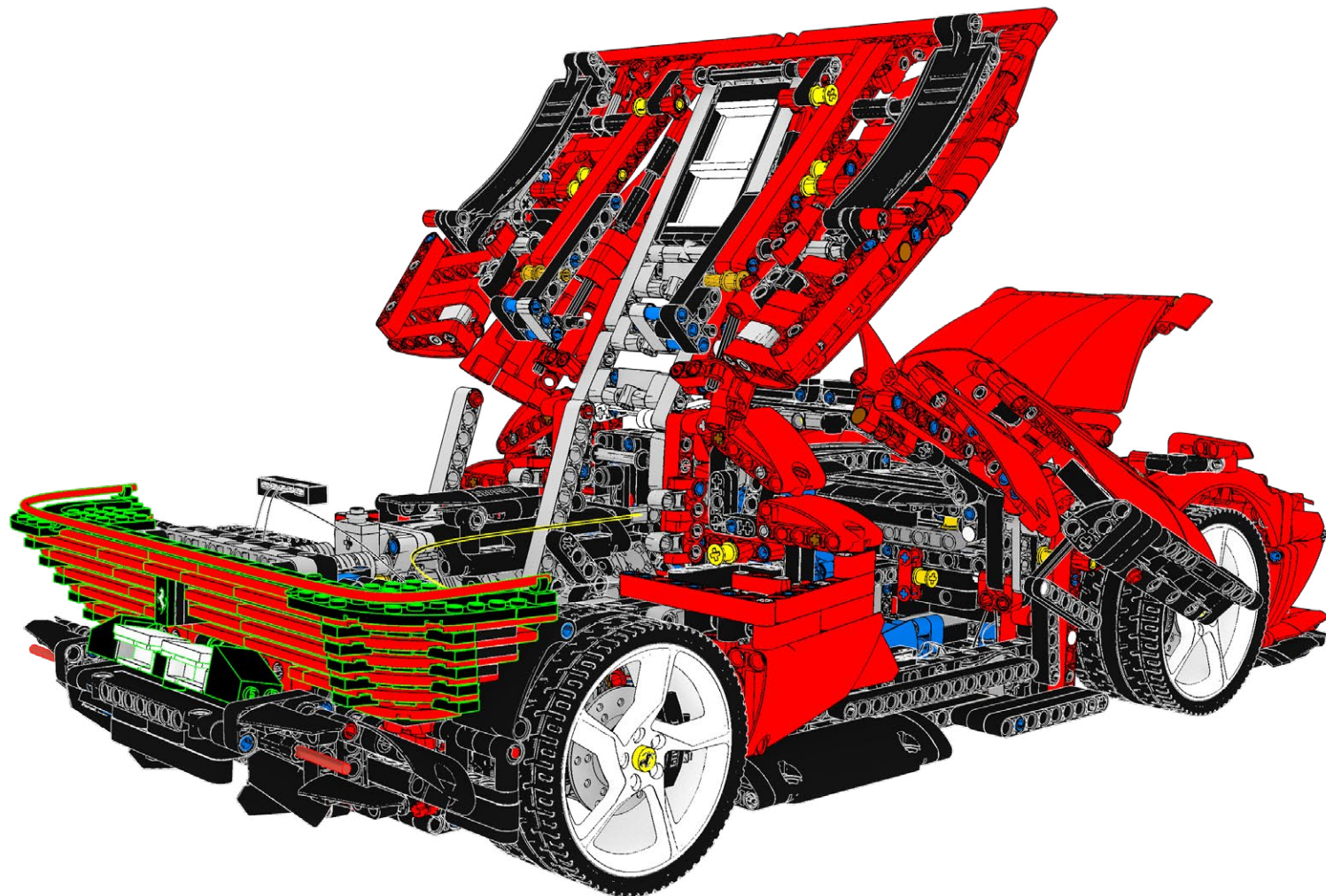

155

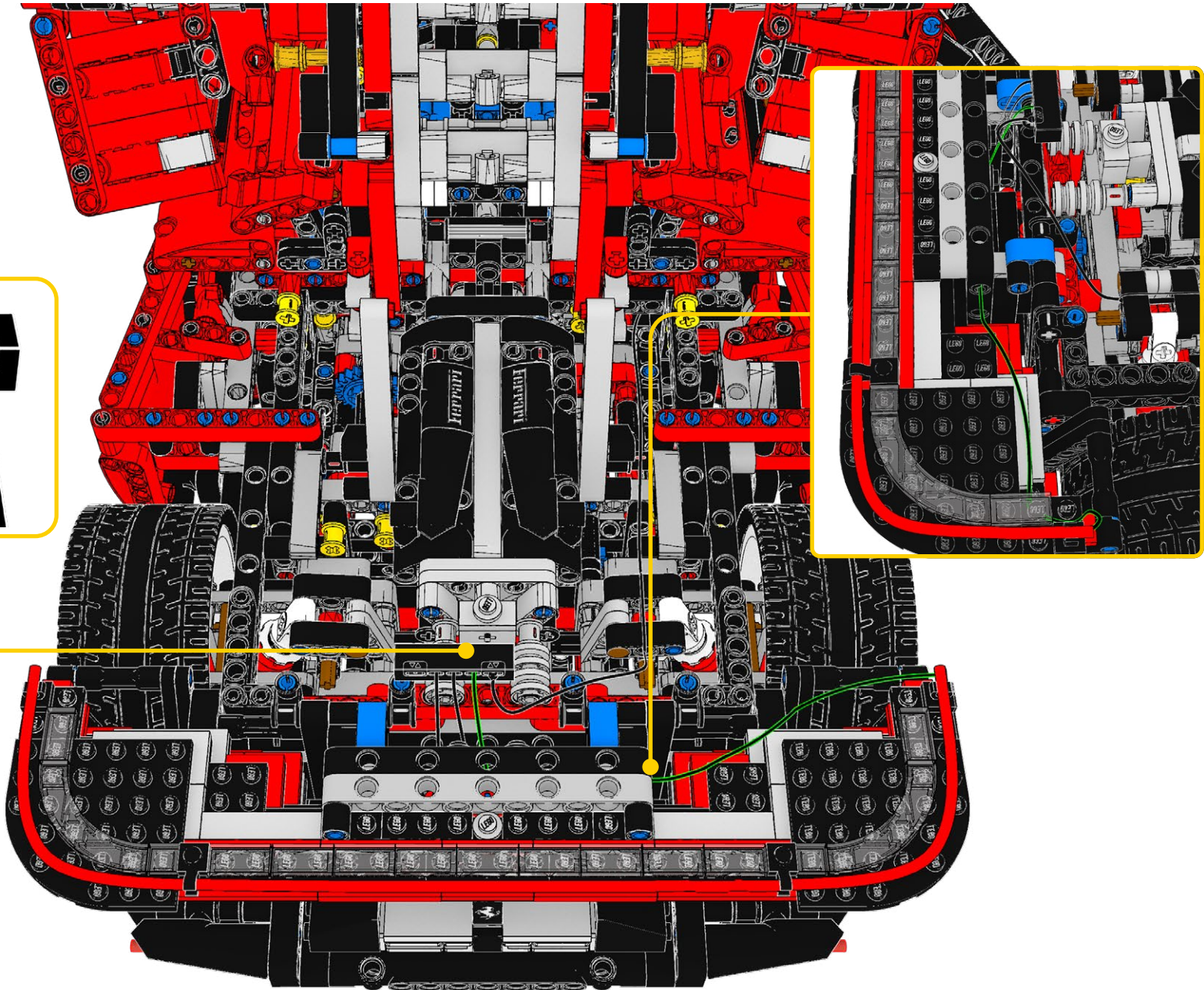

156

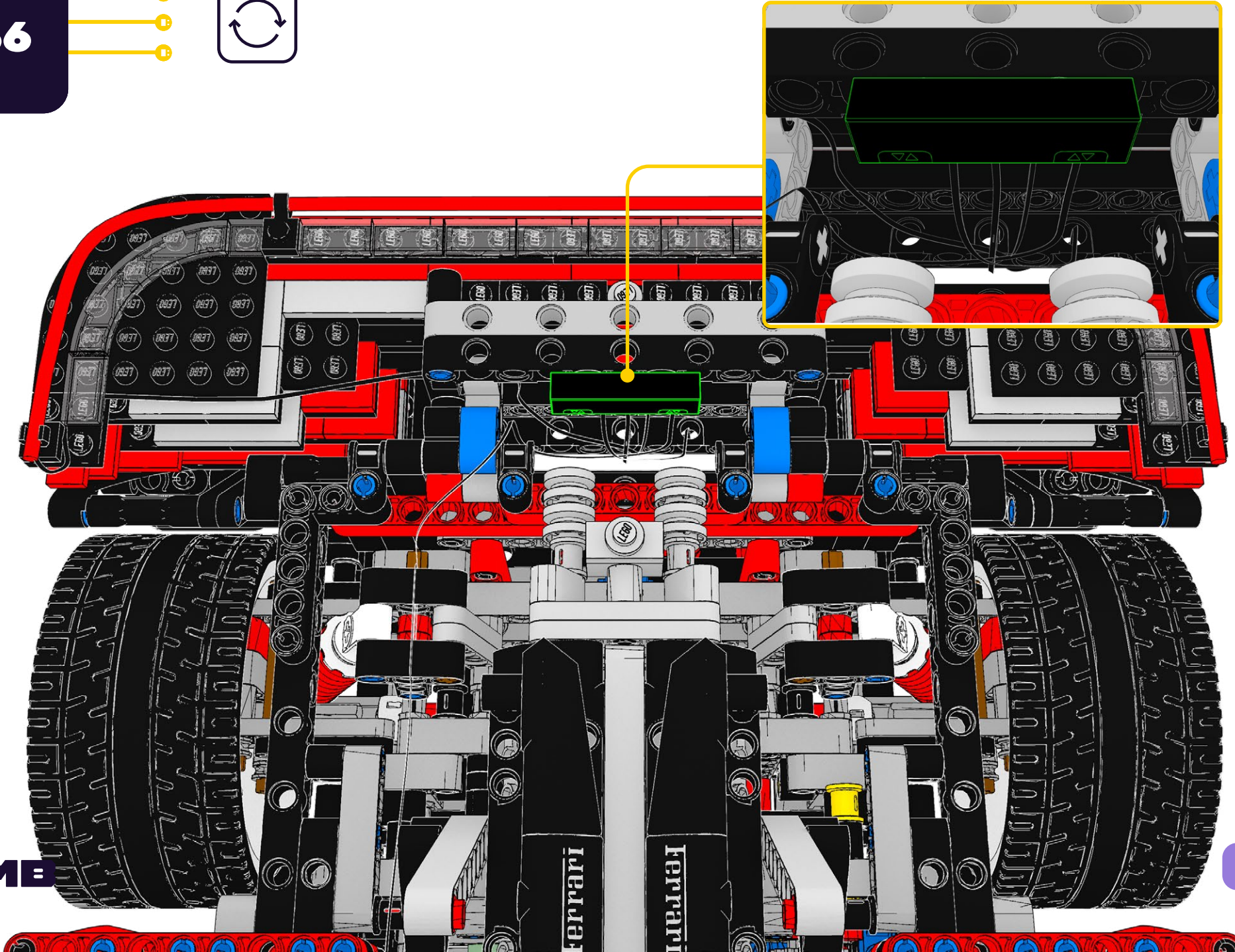

157

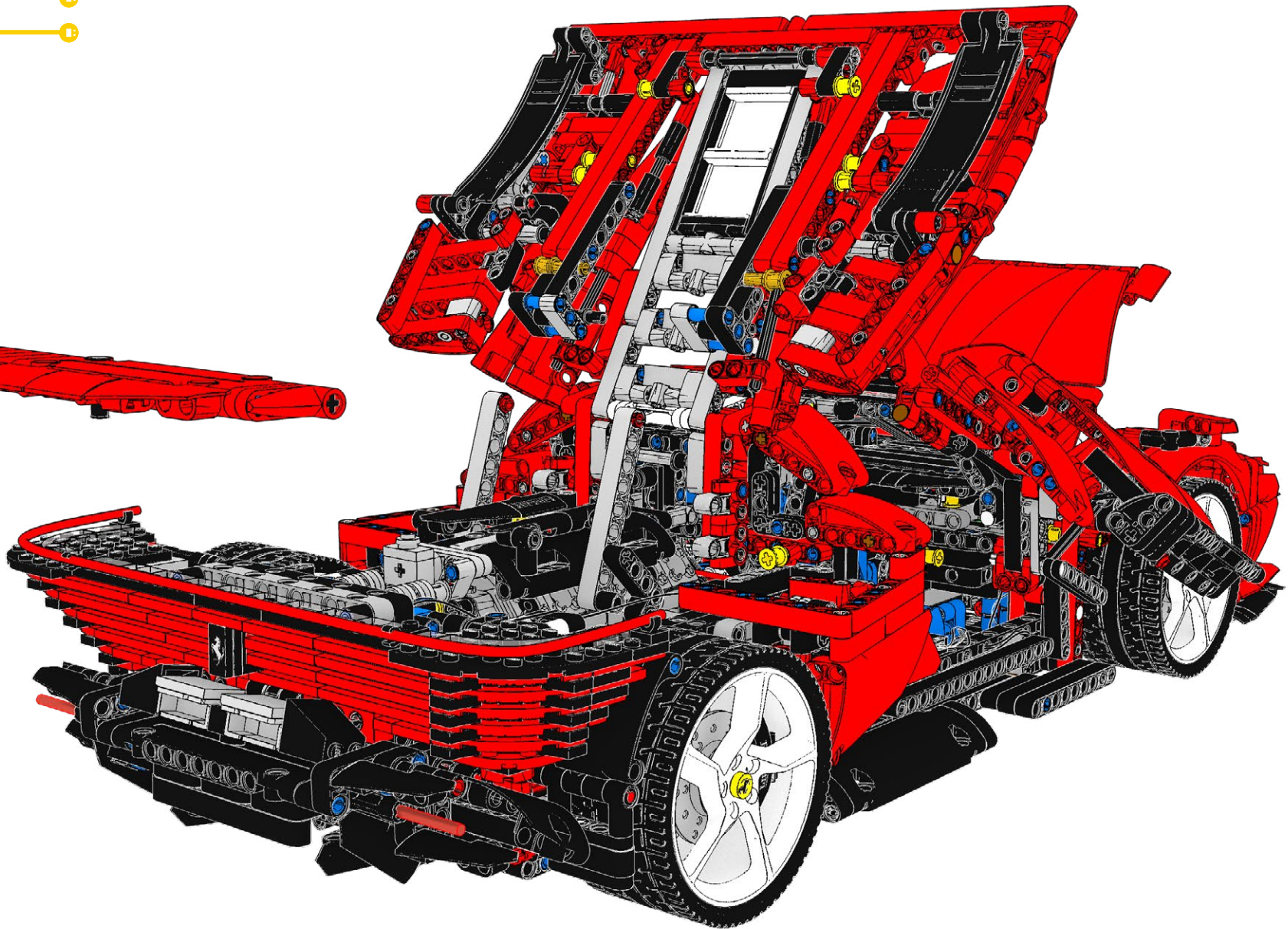

158

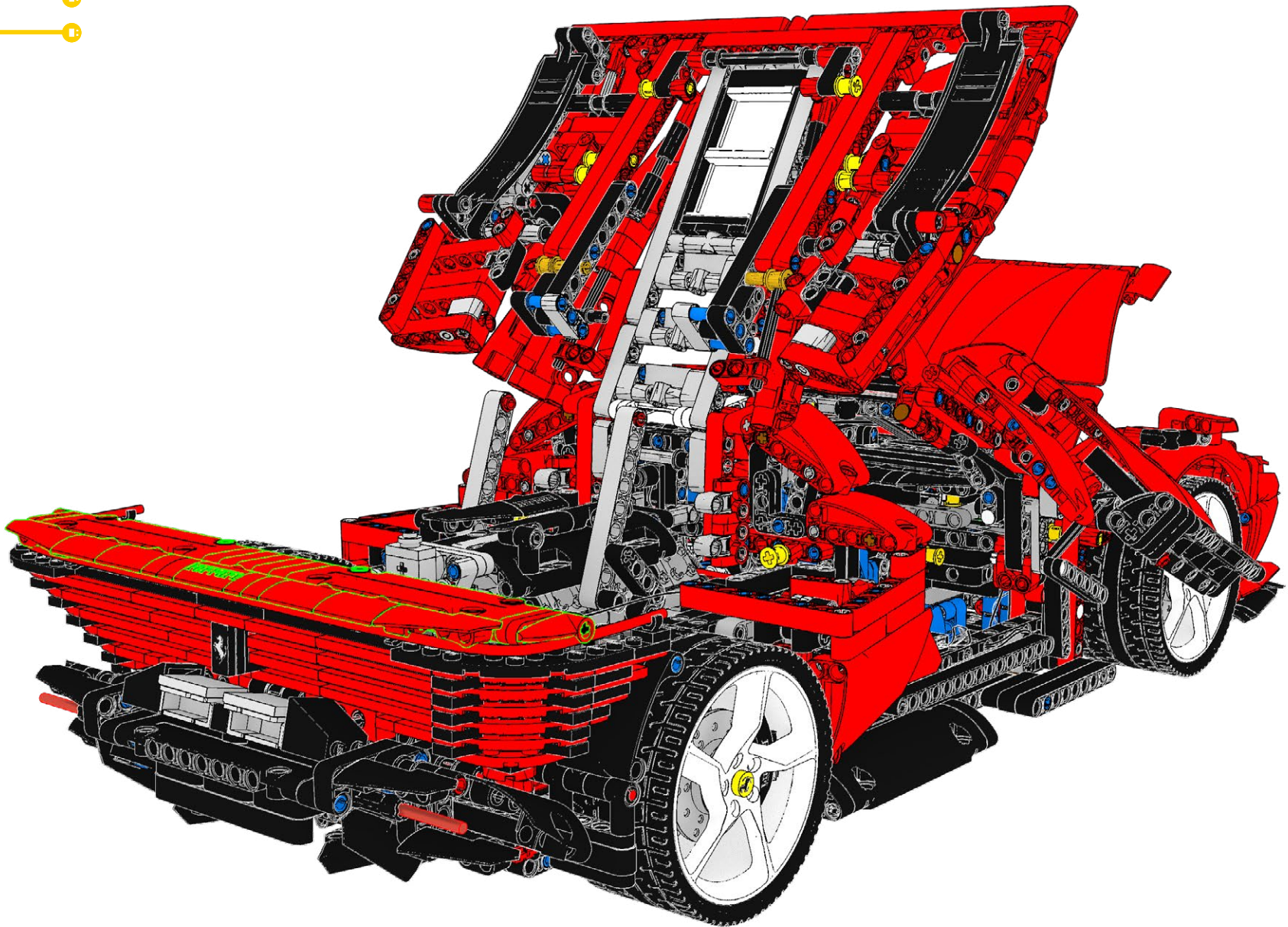

159

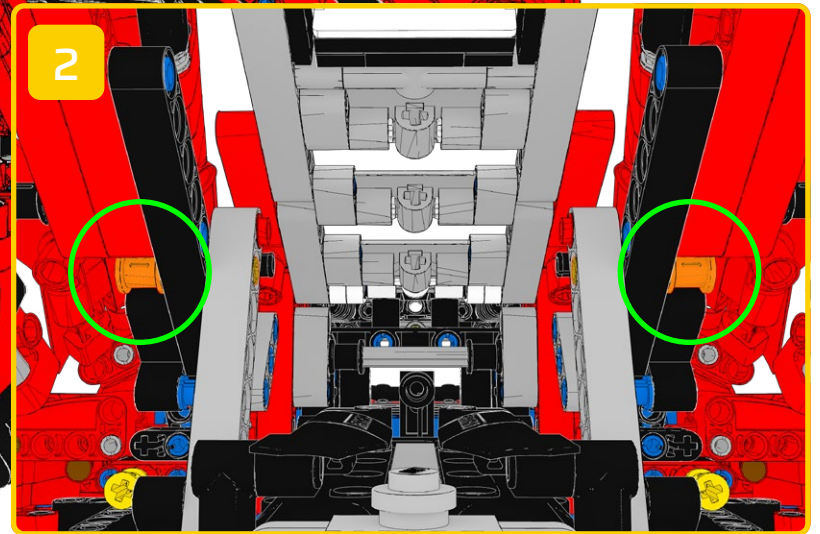
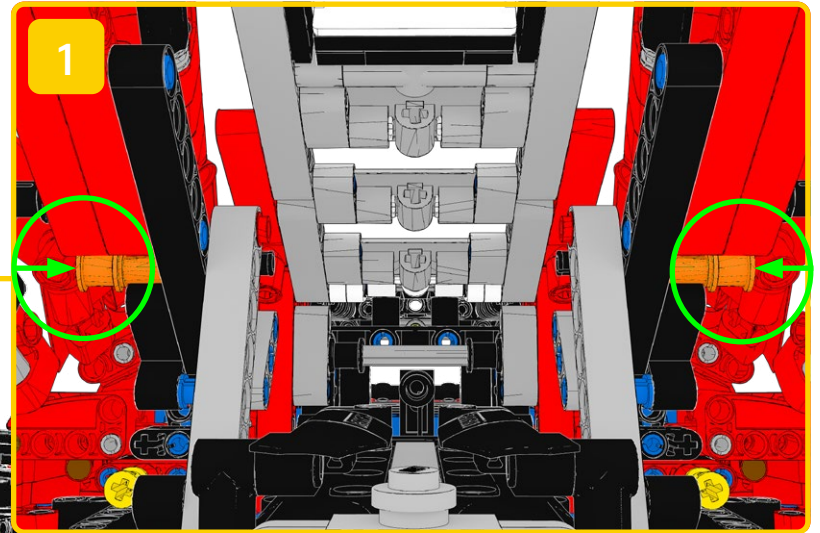
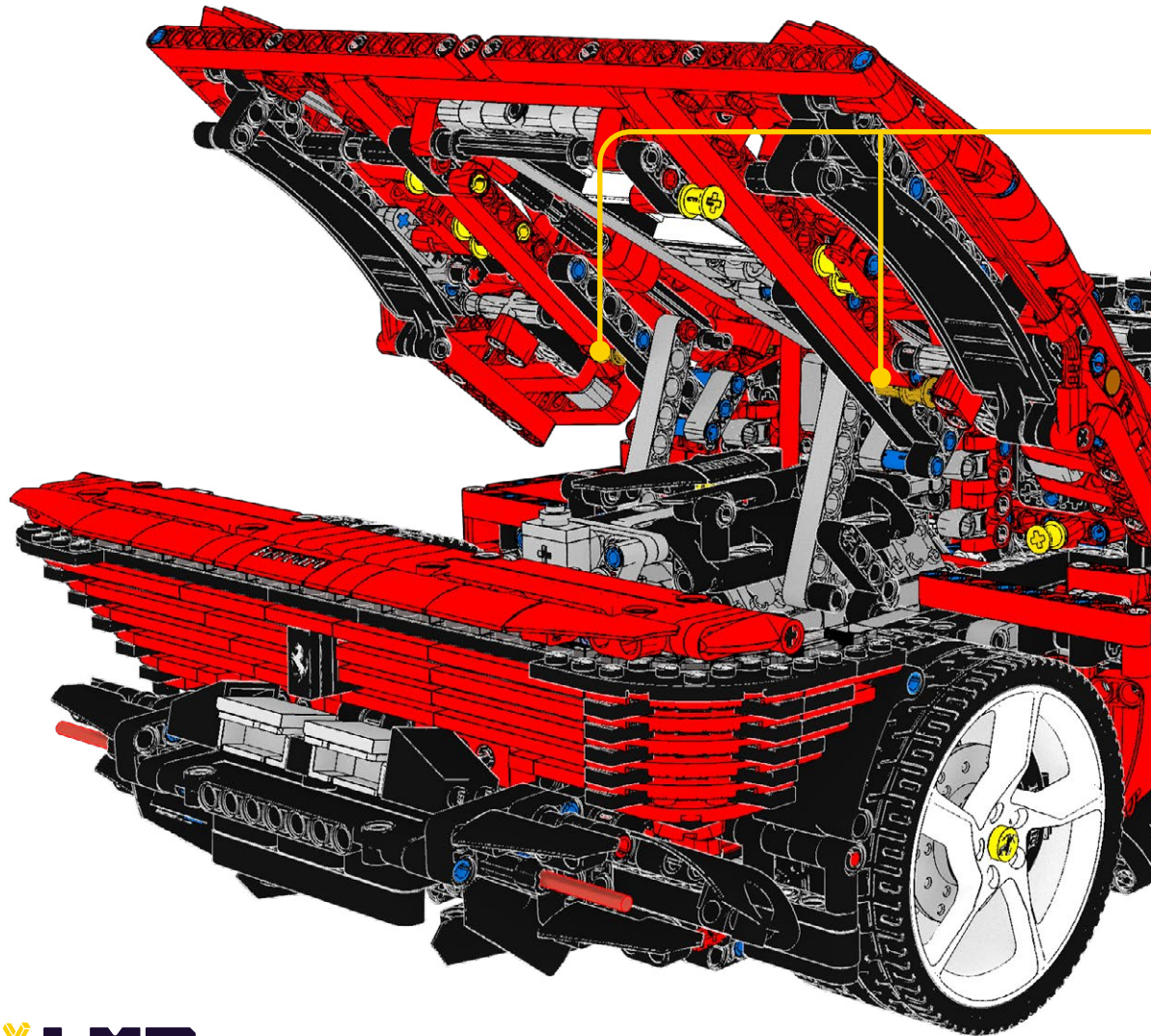

160

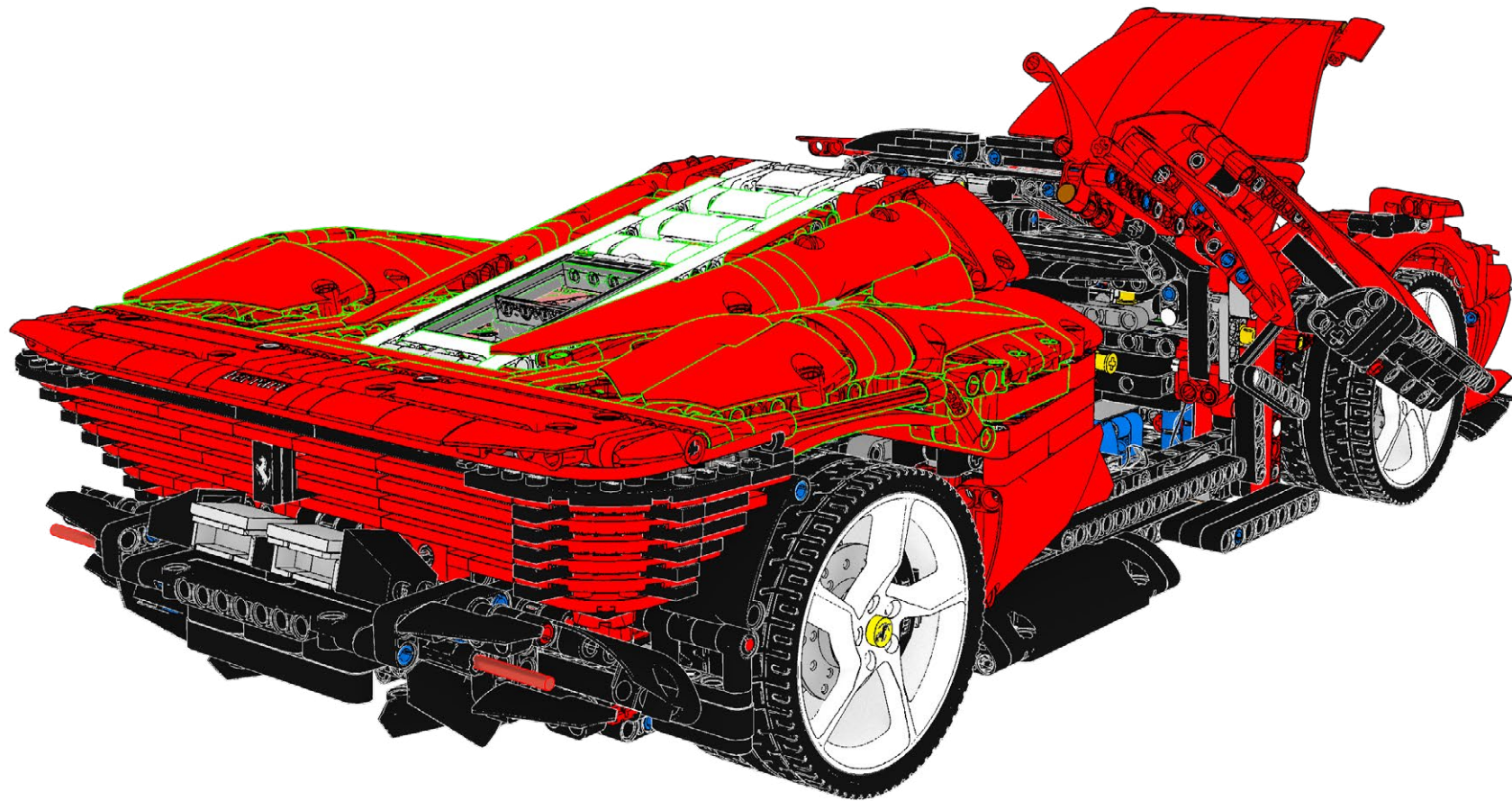

161

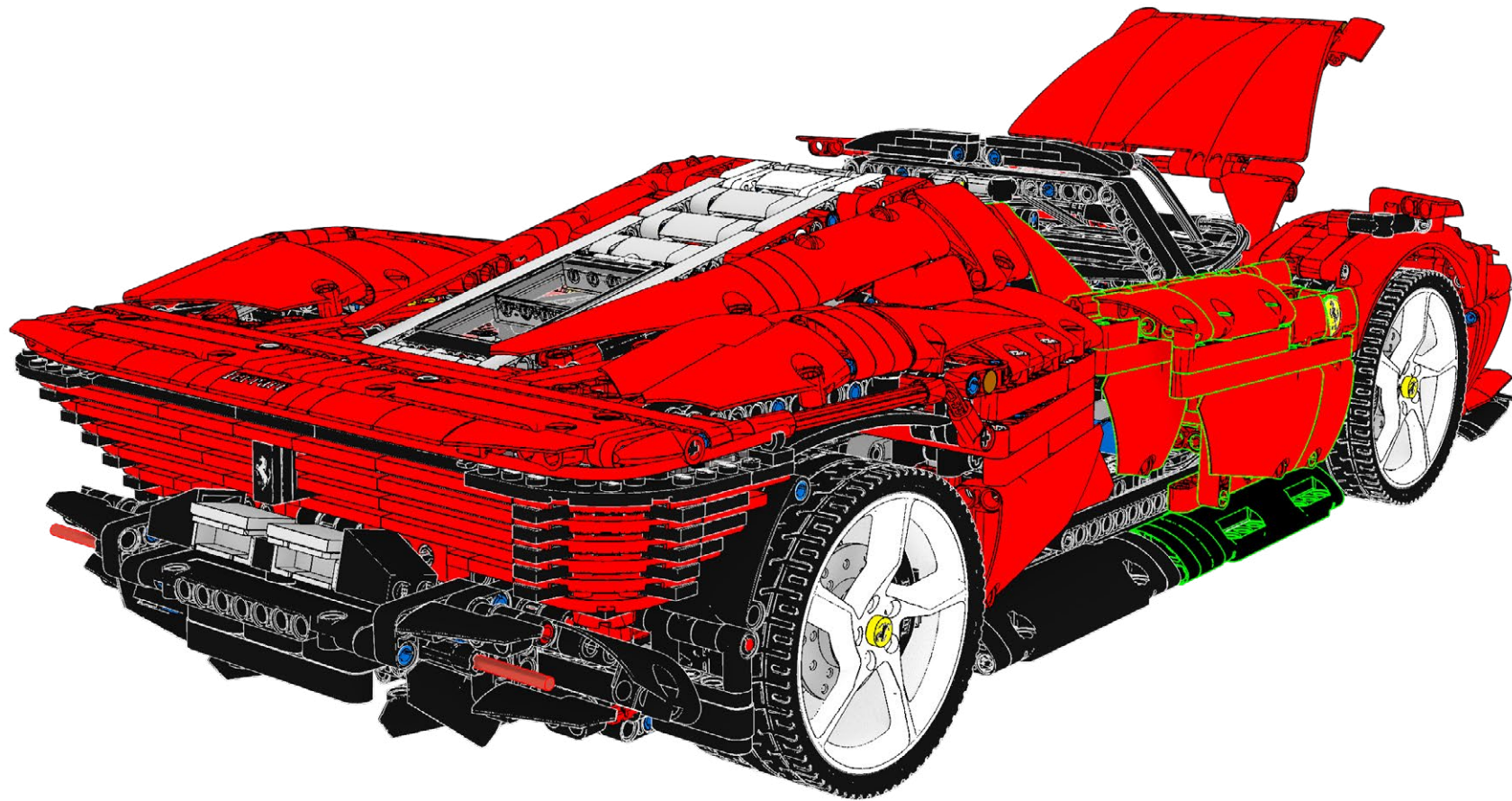

162

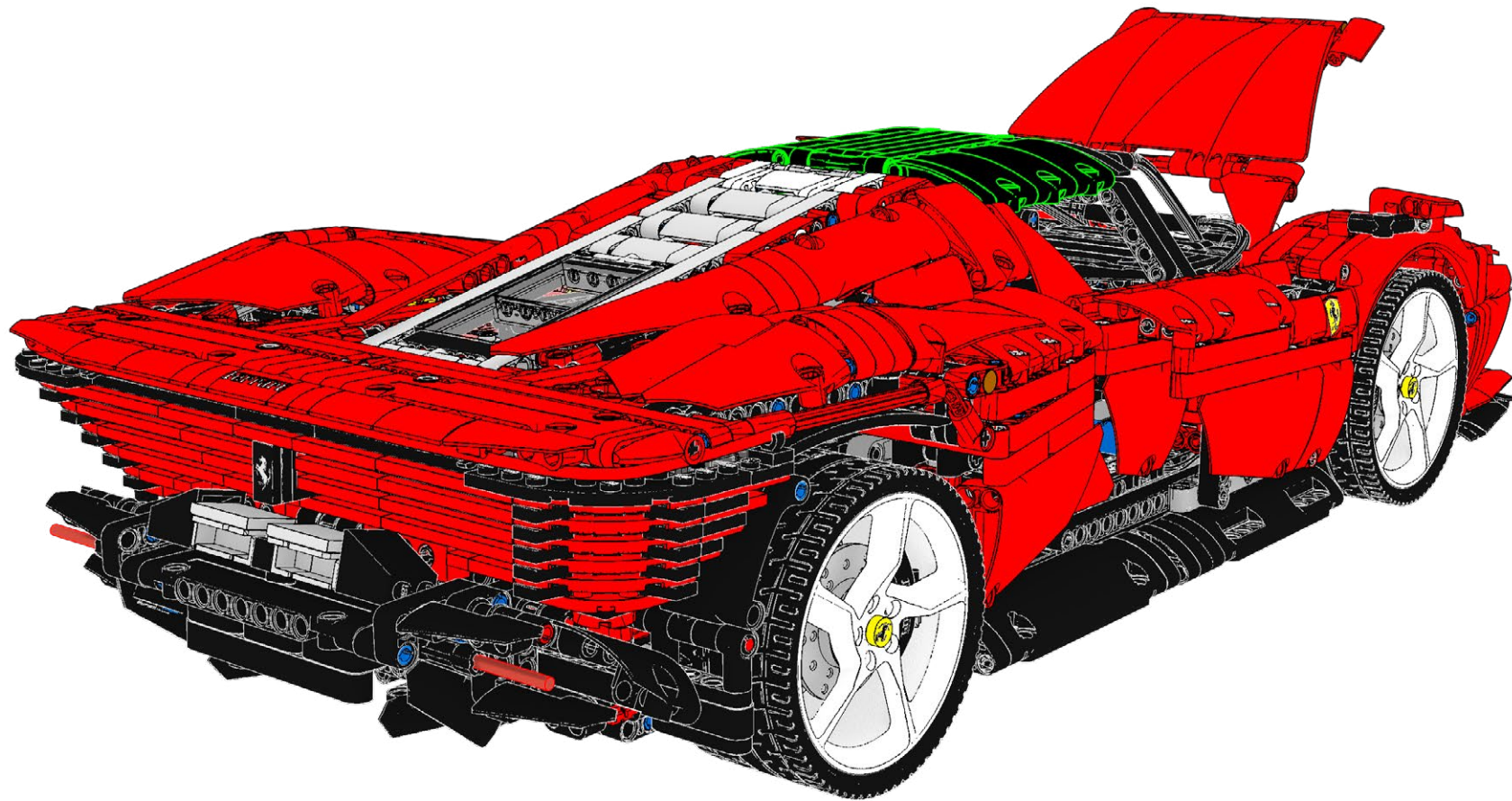

163

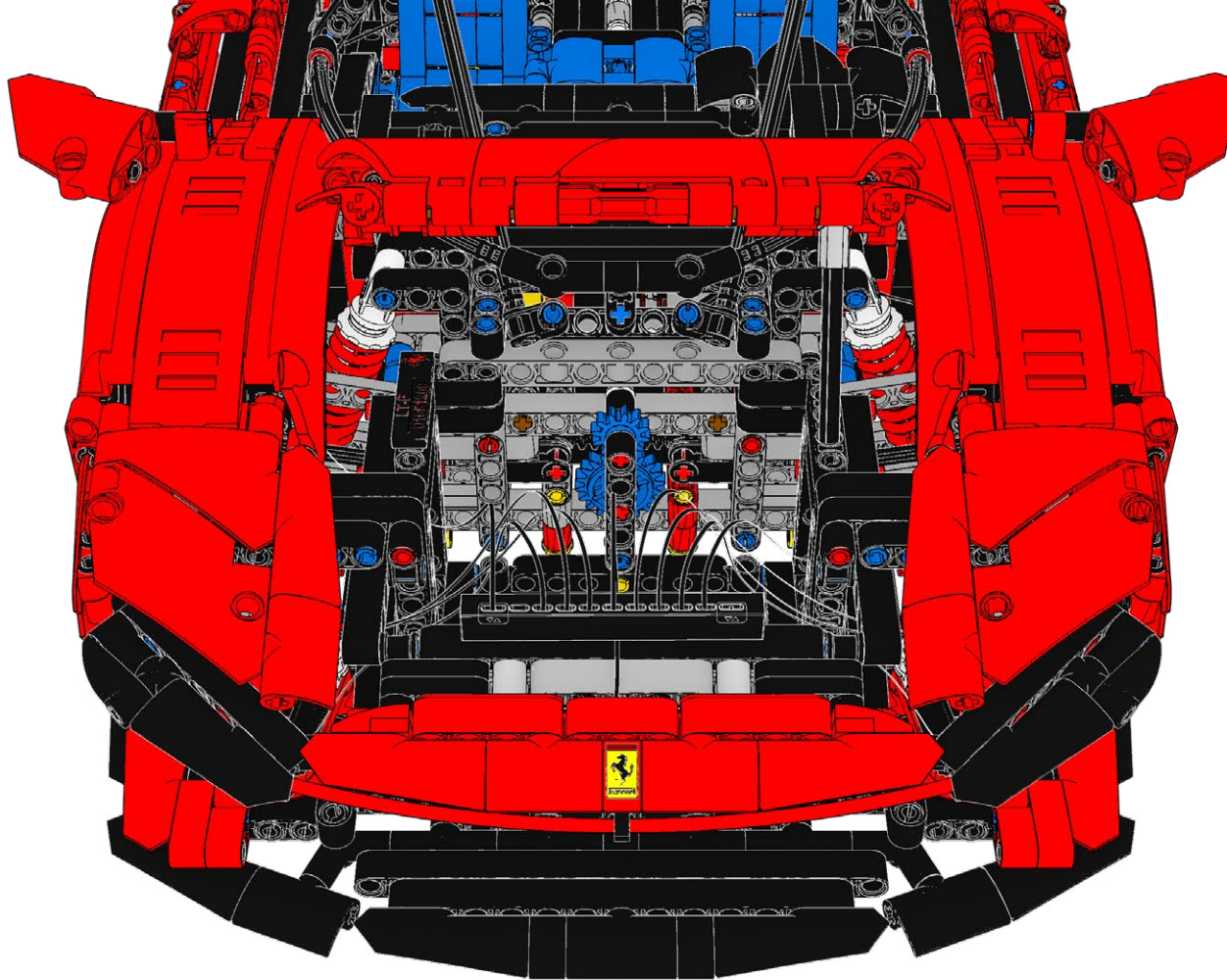

164

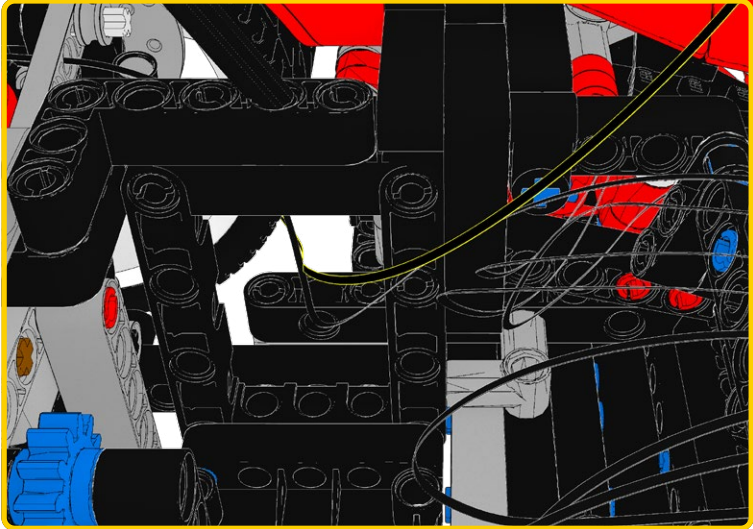
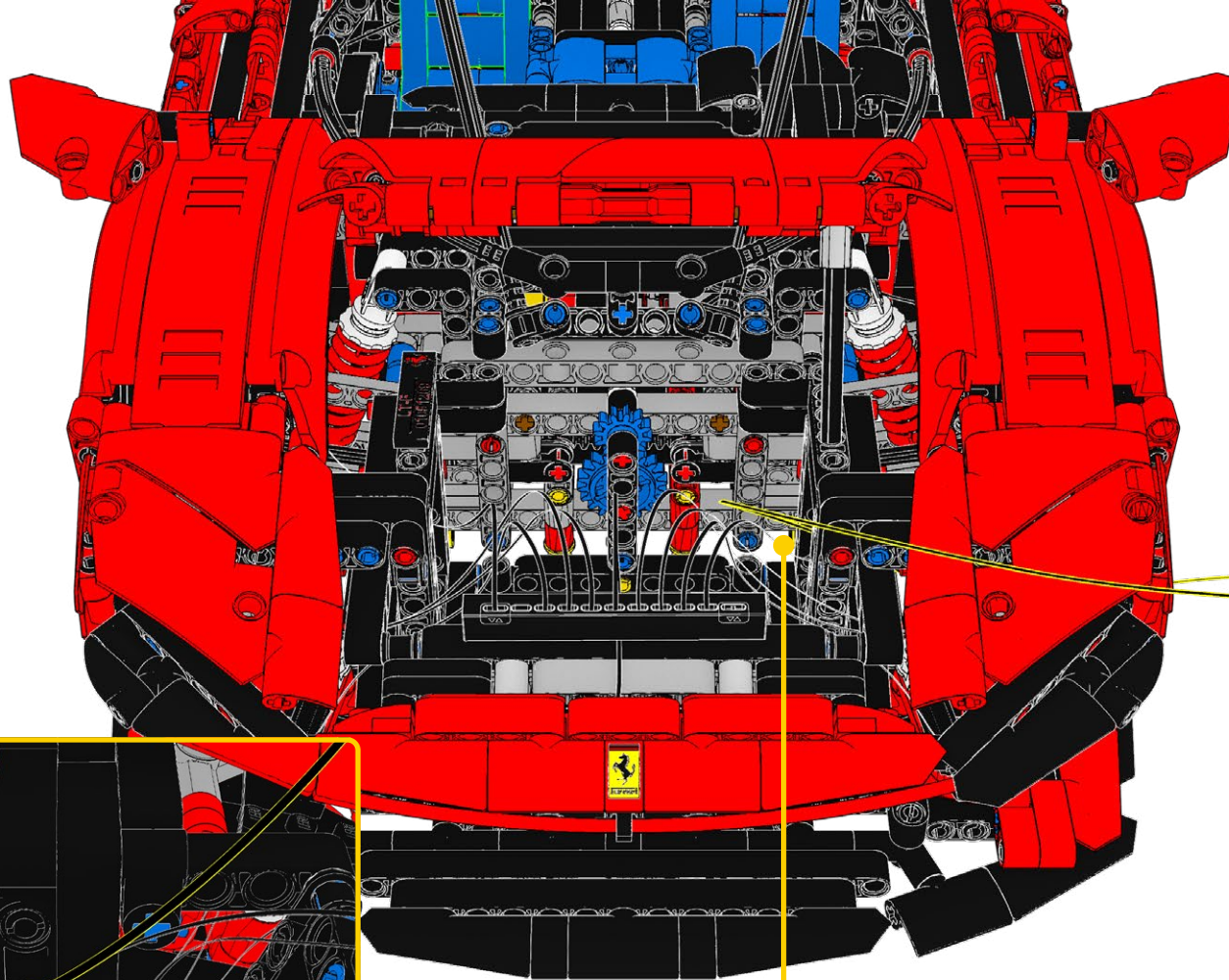

165

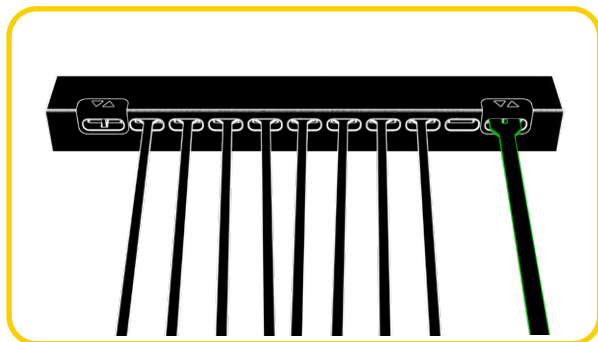
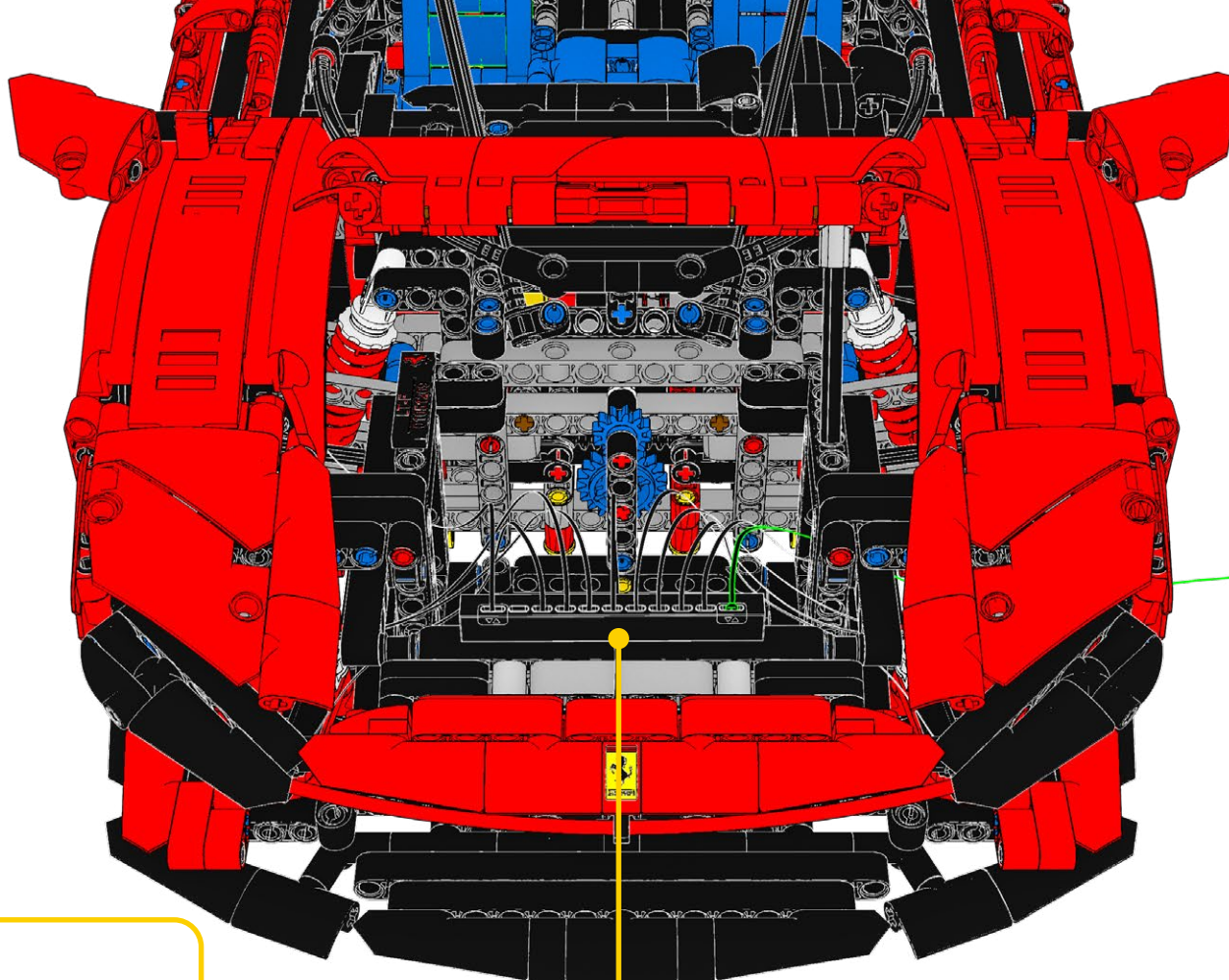

166

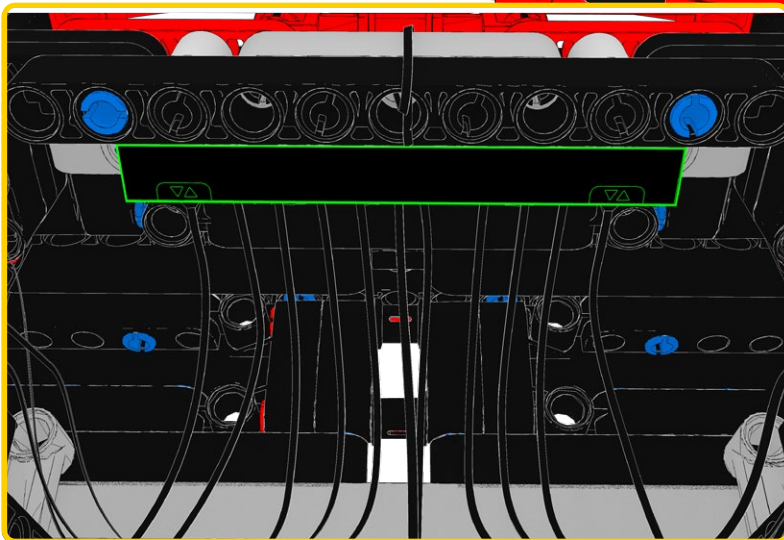
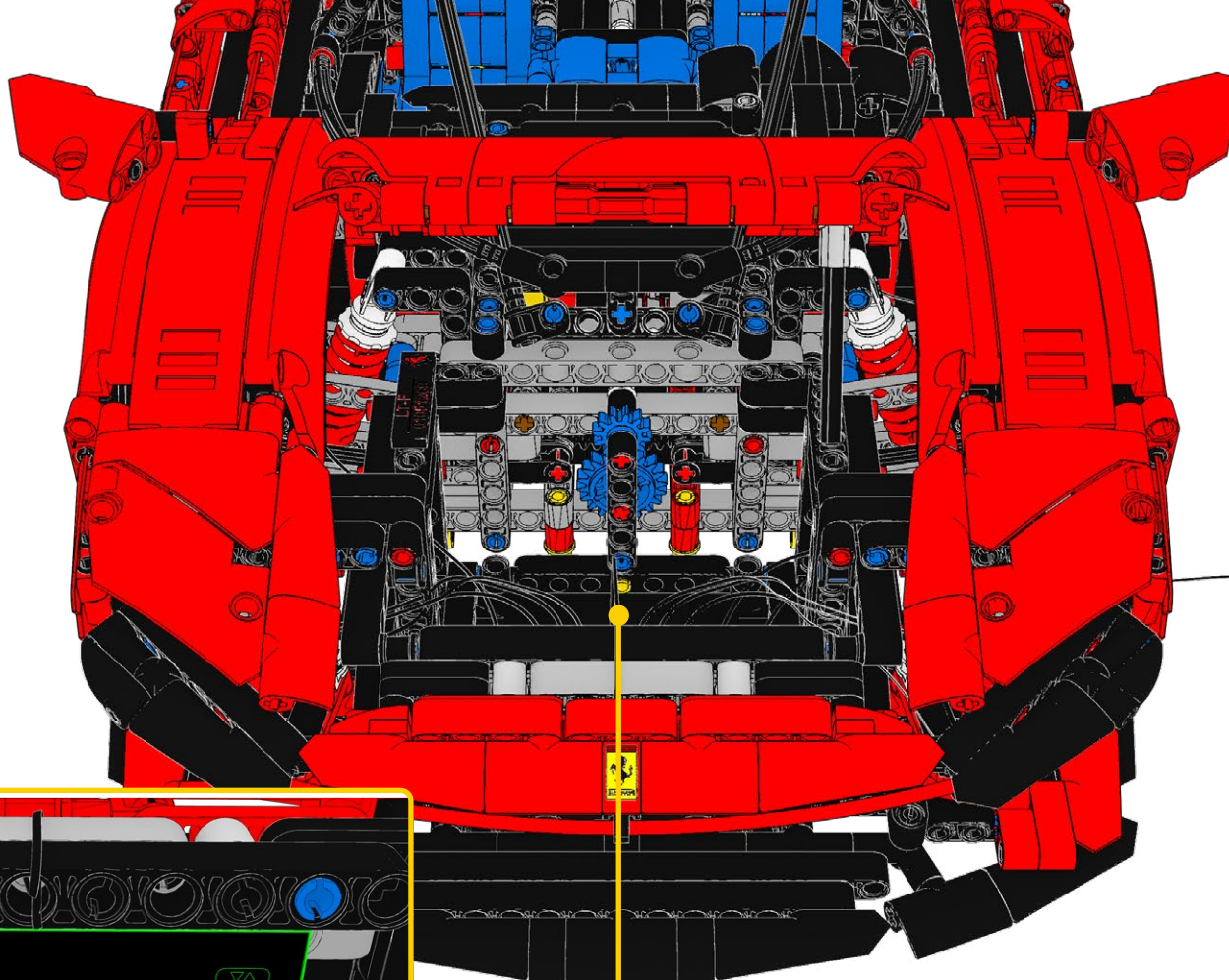

167

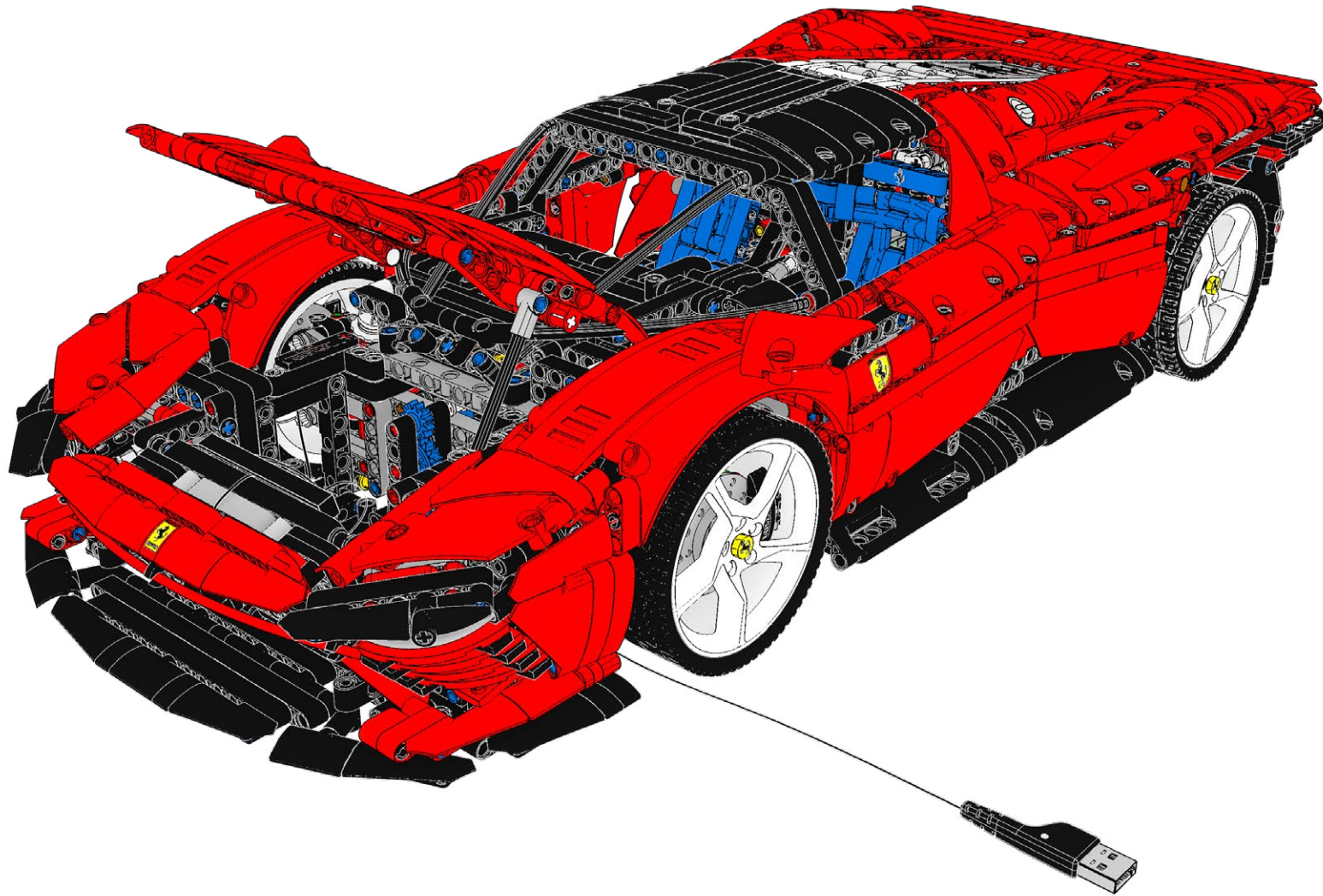

168

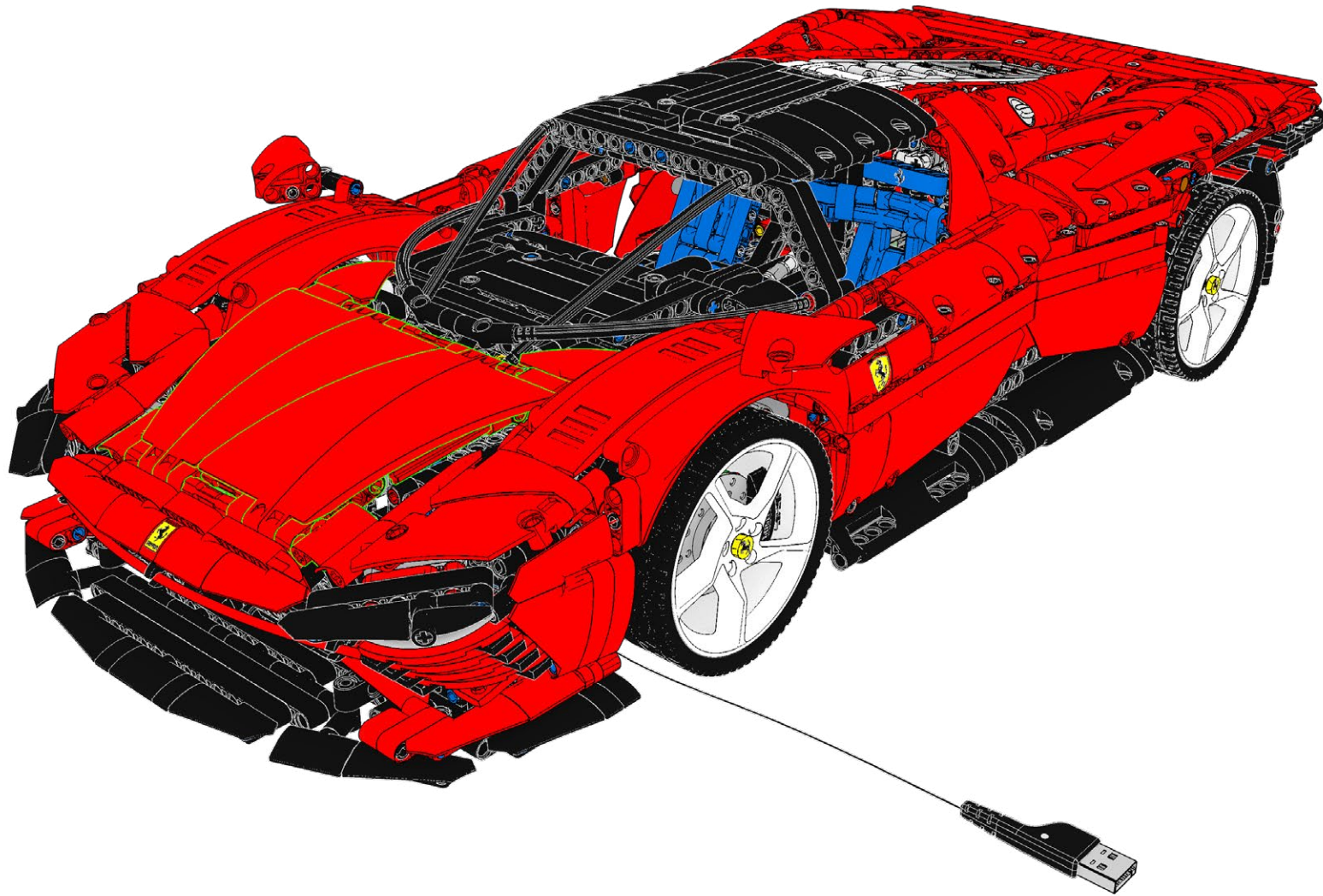

169



FINAL PRODUCT



CONTENTS & GLOSSARY



5x AR-CW15
Astro Light Regular
Cool White 15cm



1x AR-CW30
Astro Light Regular
Cool White 30cm



1x AR-B30
Astro Light Regular
Blue 30cm



1x AL-CW30
Astro Light Large
Cool White 30cm



2x AM-R30
Astro Light Micro
Red 15cm



1x F-R36L
Flare Light Red 36L



2x F-W9L
Flare Light White 9L



1x AR-B30
Astro Light Regular
Cool White 30cm



2x D-3
Dock-3



7x NMT-1X1
Tether 1x1



1x FLX-B30
Flux Belt 30cm

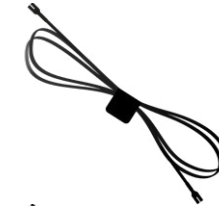

1x B-50
Belt 50cm



1x B-30
Belt 30cm

CONTENTS & GLOSSARY



1x Plate, Round 1×1 with Open Stud - Black



2x Plate, Modified 1×1 with Open O Clip (Horizontal Grip) - Black



5x Brick, Round 1×1 Open Stud - Black



3x Technic, Pin 1×2 without Frction Ridges - Light Bluish Gray



1x Plate, Modified 1×2 with Bar Handle on End - Black

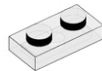

2x Plate 1×2 - Trans-Clear



3x Tile, Modified 1×2 with Bar Handle on End - Black



4x Plate 1×2 - Black

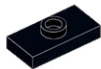

1x Plate, Modified 1×2 with 1 Stud with Groove and Bottom Stud Holder (Jumper) - Black

CONTACT US

Click below for customer support, or general inquiries.

Cliquez ci-dessous pour accéder au support client ou aux renseignements généraux.

Clicca qui sotto per l'assistenza clienti o per richieste generali.

Contact Us



Contactez-nous



Contattaci



Klicken sie unten für kundensupport oder allgemeine anfragen.

Haga clic a continuación para atención al cliente o consultas generales.

点击下方获取客户支持或一般咨询。

Kontaktieren sie uns



Contáctanos



联系我们



TROUBLESHOOTING

If you're stuck, scan the QR code for troubleshooting.

Se sei bloccato, scansiona il codice QR per la risoluzione dei problemi.

Wenn Sie nicht weiterkommen, scannen Sie den QR-Code zur Fehlerbehebung.

Si vous êtes bloqué, scannez le code QR pour le dépannage

Si está atascado, escanee el código QR para solucionar el problema.

如果遇到问题, 请扫描二维码进行故障排除

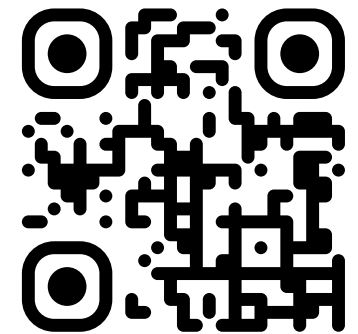



LIGHTMYBRICKS

lightmybricks.com



LEGO® is a trademark of the LEGO Group of companies, which does not sponsor, authorize or endorse this product. All LEGO® sets featured in images are sold separately. This is not a LEGO® product. The LEGO Group is not liable for any loss, injury or damage arising from the use or misuse of this product. ©2024 Light My Bricks Pty Ltd. All rights reserved. www.lightmybricks.com

Our components are designed and packaged in Australia by Light My Bricks Pty Ltd. Components are manufactured in China. 3fl bldg C, Shuanghuan Quanxin Technology Information Industry Park Baolong Street, Longgang District, Shenzhen, China. Imported in Australia by Light My Bricks Pty Ltd, 5/26 Rushdale St, Knoxfield, VIC, 3180, Australia.

WARNING: CHOKING HAZARD - Small parts. Not for children under 3 years.

AVERTISSEMENT : RISQUE D'ÉTOUFFEMENT - Petites pièces. Ne convient pas aux enfants de moins de 3 ans.

ATTENZIONE: PERICOLO DI SOFFOCAMENTO - Piccole parti. Non adatto a bambini di età inferiore a 3 anni.

WARNUNG: ERSTICKUNGSGEFAHR - Kleine Teile. Nicht für Kinder unter 3 Jahren geeignet.

ADVERTENCIA: PELIGRO DE ASFIXIA - Piezas pequeñas. No son apto para niños menores de 3 años.

警告：窒息危险 - 小零件。不适合3岁以下儿童。