

LIGHT KIT INSTALLATION GUIDE

**THE LORD OF THE RINGS:
RIVENDELL**

FOR LEGO
SET
#10316

CONTENTS



3

Getting Started

- 4** Legend
- 5** Component Handling
- 6** Blueprint

7

Instructions

- 17** LMB Bag 1
- 60** LMB Bag 2
- 128** LMB Bag 3
- 161** LMB Bag 4
- 187** LMB Bag 5
- 245** LMB Bag 6
- 290** LMB Bag 7

325

Final Product

- 326** Contents & Glossary
- 328** Contact & Troubleshooting

GETTING STARTED



Bold, beautiful and bright, Light My Bricks elevates your favourite LEGO set from knick-knack to statement piece. Create a talking point at home or in the office that speaks to your passions with Light My Bricks. To learn more, click below.

[Learn More](#)



Audacieux, beau et lumineux, Light My Bricks élève votre ensemble LEGO préféré du statut de bibelot à celui de pièce maîtresse. Que ce soit à la maison ou au bureau, partagez votre passion des LEGO avec Light My Bricks. Cliquez ci-dessous pour en savoir plus.

[En savoir plus](#)



Audace, bello e luminoso, Light My Bricks eleva il tuo set LEGO preferito da soprammobile a pezzo di tendenza. Crea un punto di discussione a casa o in ufficio che parli alle tue passioni con Light My Bricks. Per saperne di più, clicca qui sotto.

[Ulteriori Informazioni](#)



Mutig, schön und hell – Light My Bricks verwandelt Ihr Lieblings-LEGO-Set von einem schnickschnack in ein statement-stück. Schaffen sie einen gesprächspunkt zu hause oder im büro, der Ihre leidenschaften widerspiegelt, mit Light My Bricks. Um mehr zu erfahren, klicken sie unten.

[Mehr erfahren](#)



Audaz, hermoso y brillante, Light My Bricks eleva tu set LEGO favorito de una chuchería a una pieza llamativa. Crea un tema de conversación en casa o en la oficina que hable de tus pasiones con Light My Bricks. Para obtener más información, haga clic a continuación.

[Más información](#)



大胆、美丽而明亮，Light My Bricks 将你喜爱的乐高套装从小摆件提升为引人注目的装饰品。在家或办公室打造一个能表达你激情的话题，了解更多，请点击下方。

[了解更多](#)



LEGEND

Rotate Set



Retournez L'ensemble
Ruota Set
Set Drehen
Rotar Conjunto
旋转套件

Add Part



Ajoutez une Pièce
Aggiungi Parte
Teil Hinzufügen
Agregar Pieza
添加零件

Click



Cliquez
Clic
Klicken
Clic
点击

Pinch/Fold



Pincez/Pliez
Pizzicare/Piegare
Kneifen/Falten
Pellizcar/Doblar
折叠

Pull Cable



Tirez le Cable
Tirare il Cavo
Kabel Ziehen
Tirar del Cable
拉动电缆

Repeat Step



Répétez
Ripetere
Wiederholen
Repetir
重复

Sticker



Autocollant
Adesivo
Aufkleber
Pegatina
贴纸

Power On Test



Test de mise sous tension
Test di Potenza
Stromtest
Prueba de Energía
电源测试

Disconnect Power

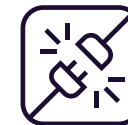

Débranchez L'alimentation
Scollegare L'alimentazione
Strom Trennen
Desconectar la Energía
断开电源

Troubleshoot



Dépanner
Risolvere
Fehlerbehebung
Solución de Problemas
故障排除

COMPONENT HANDLING

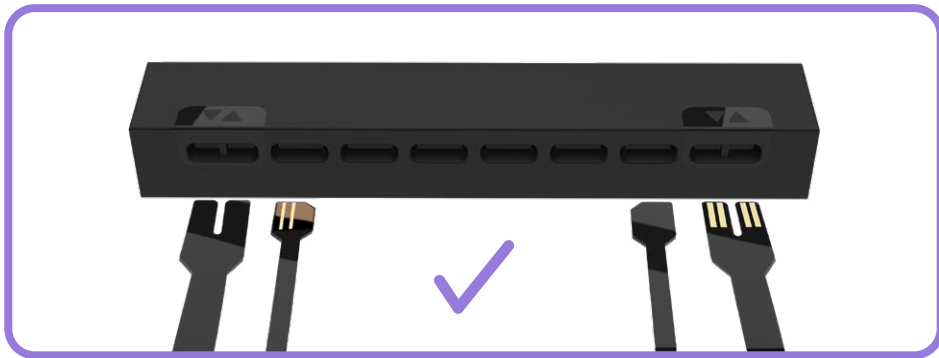
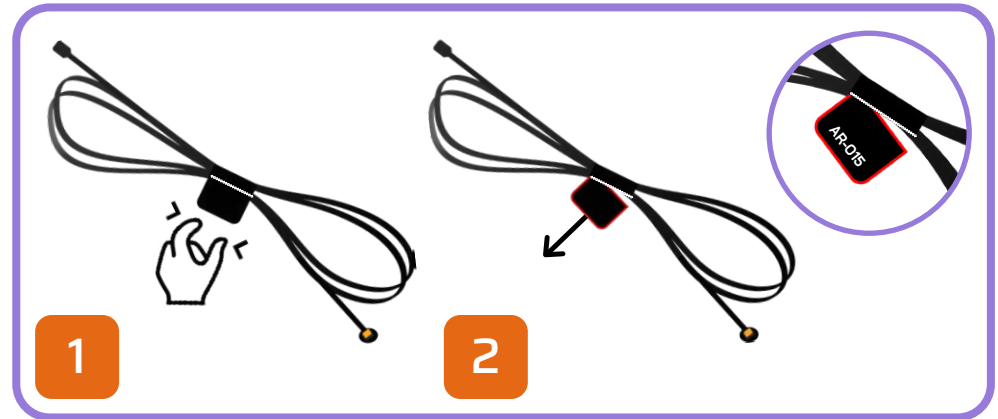
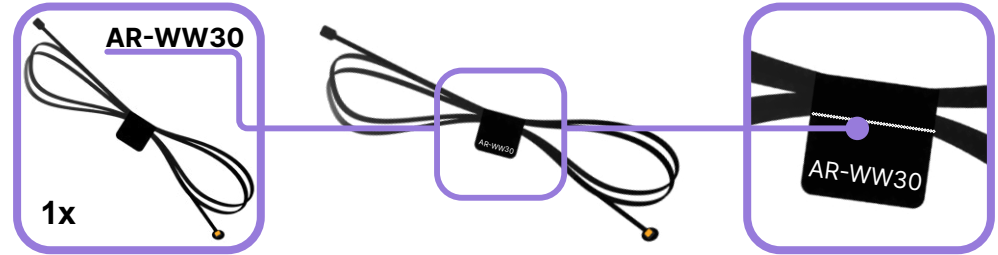
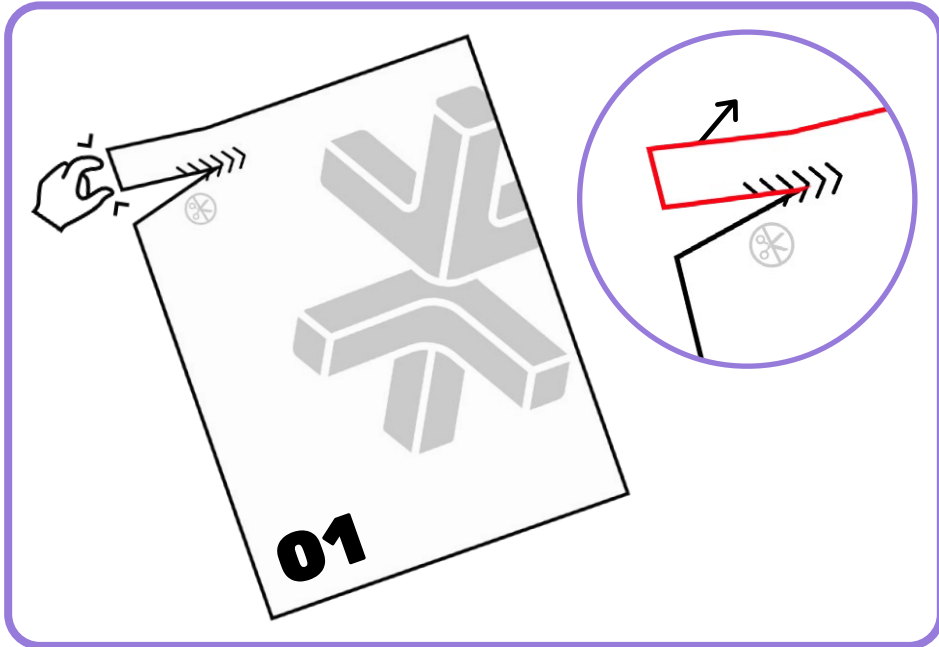

BLUEPRINT

Part 1 - Tower

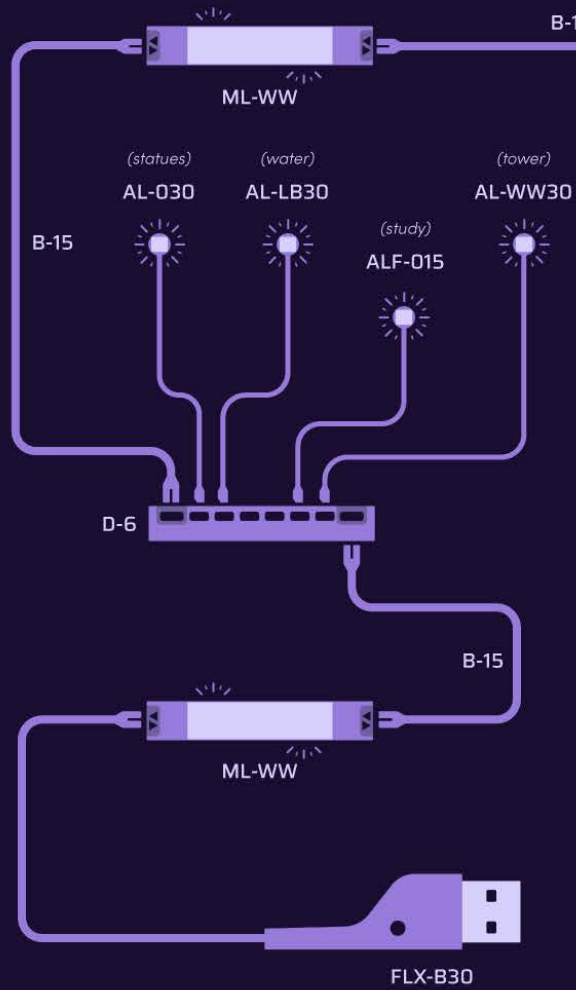

Part 2 - Hall

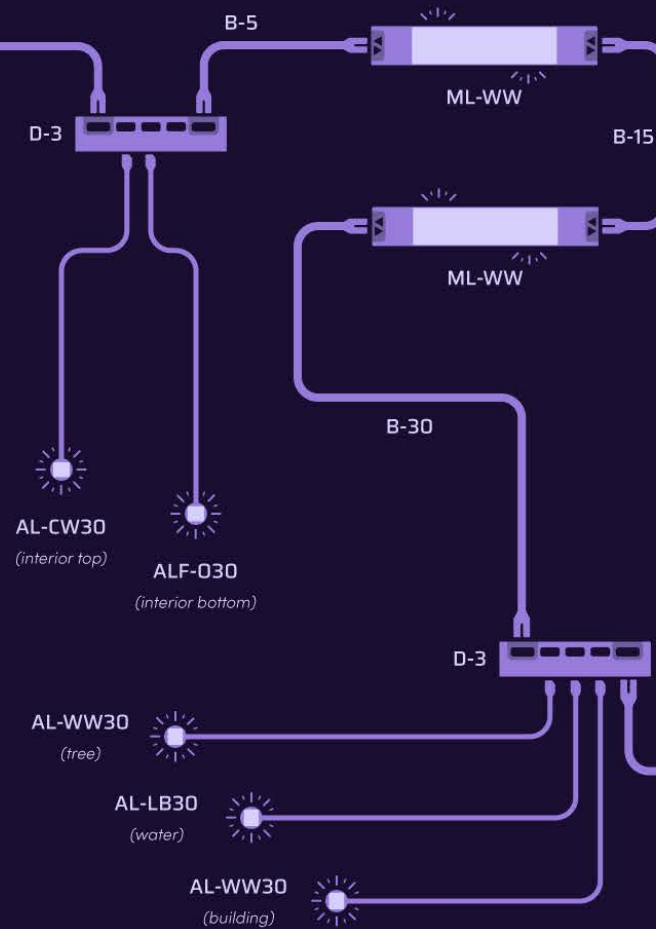

Part 3 - Gazebo

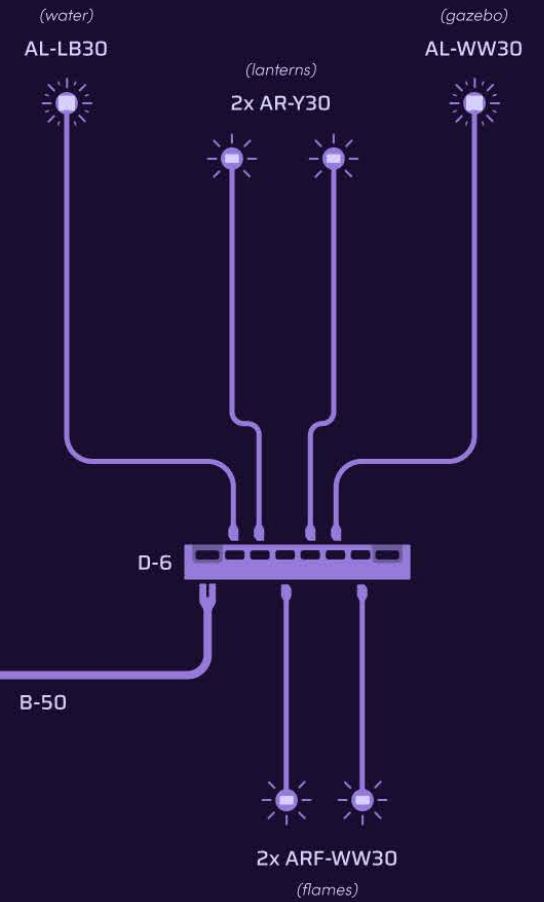

1



2

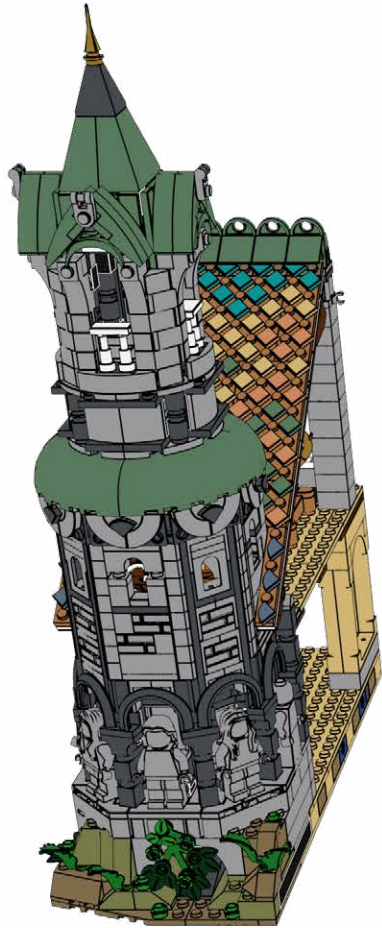

3

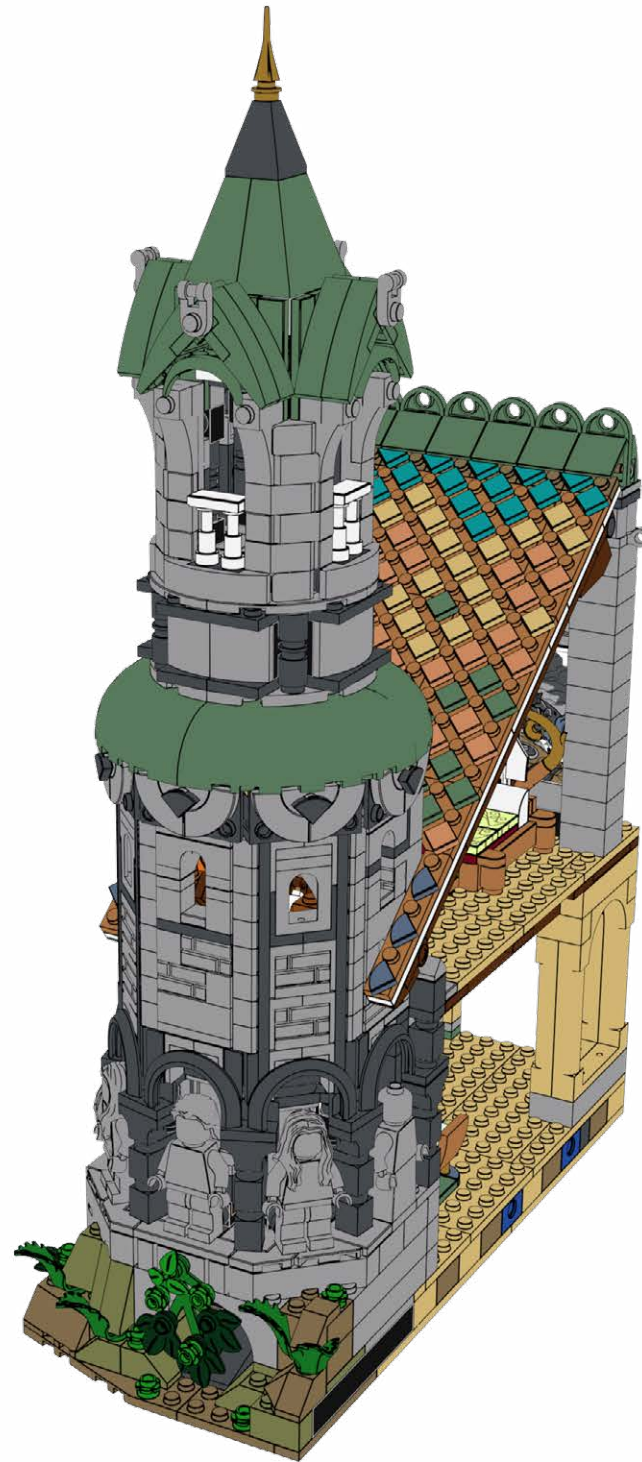

4

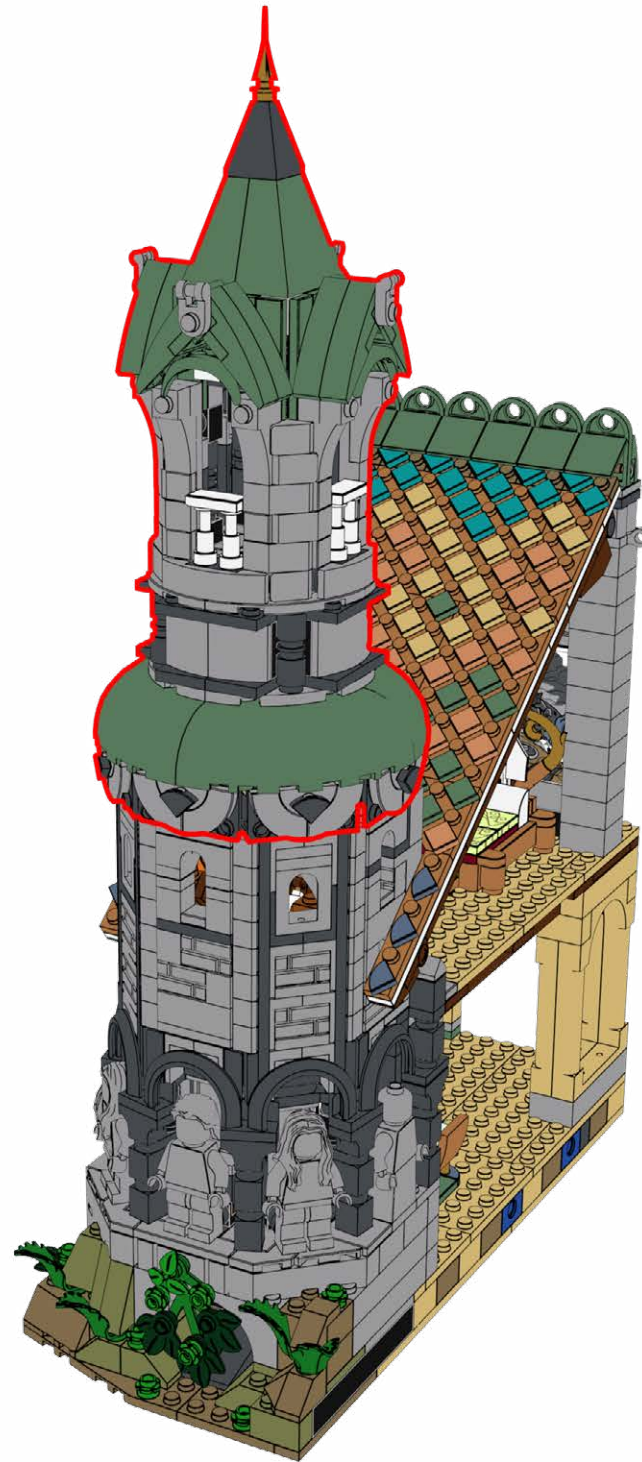

5

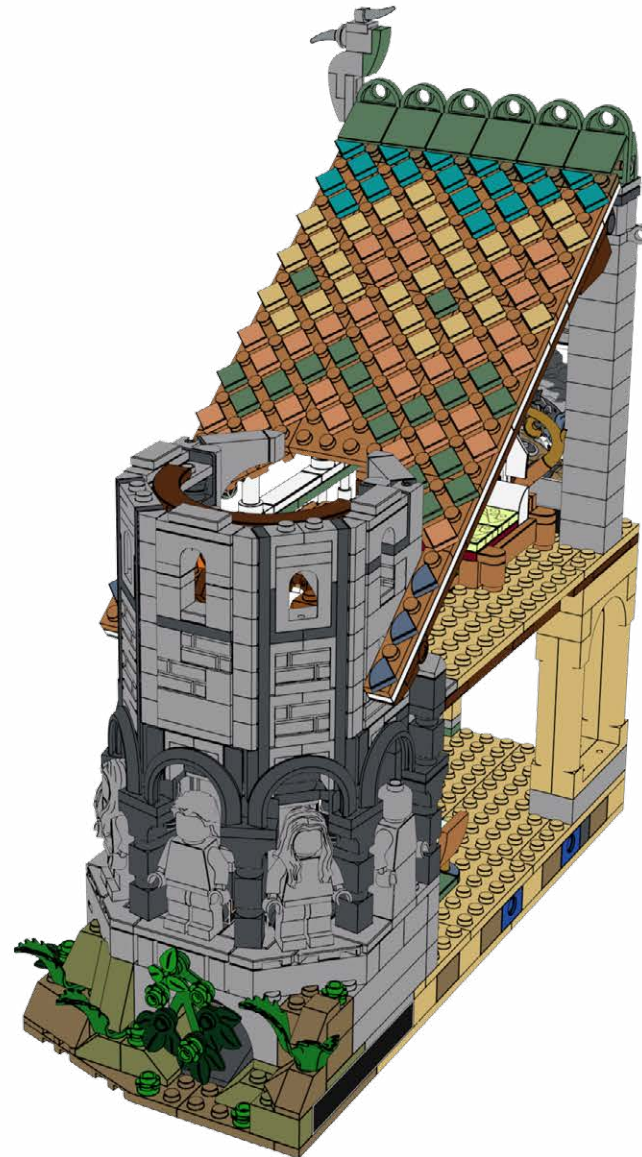
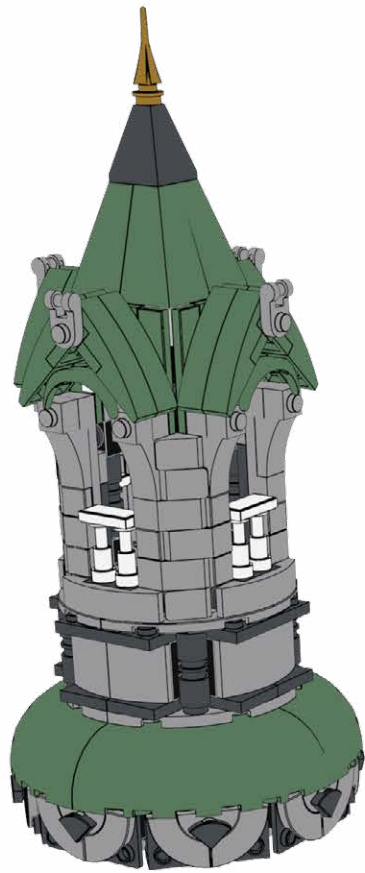

6

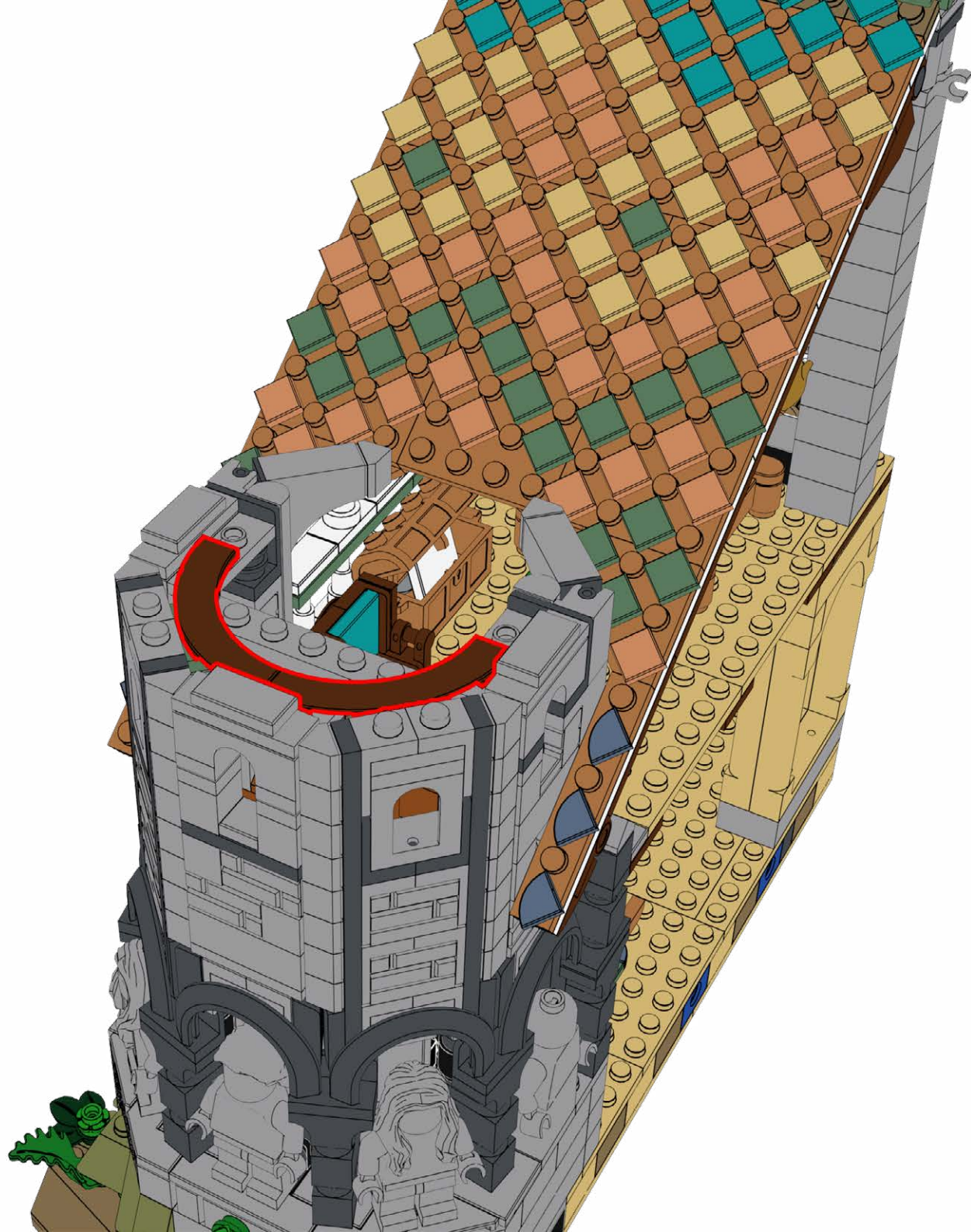

7

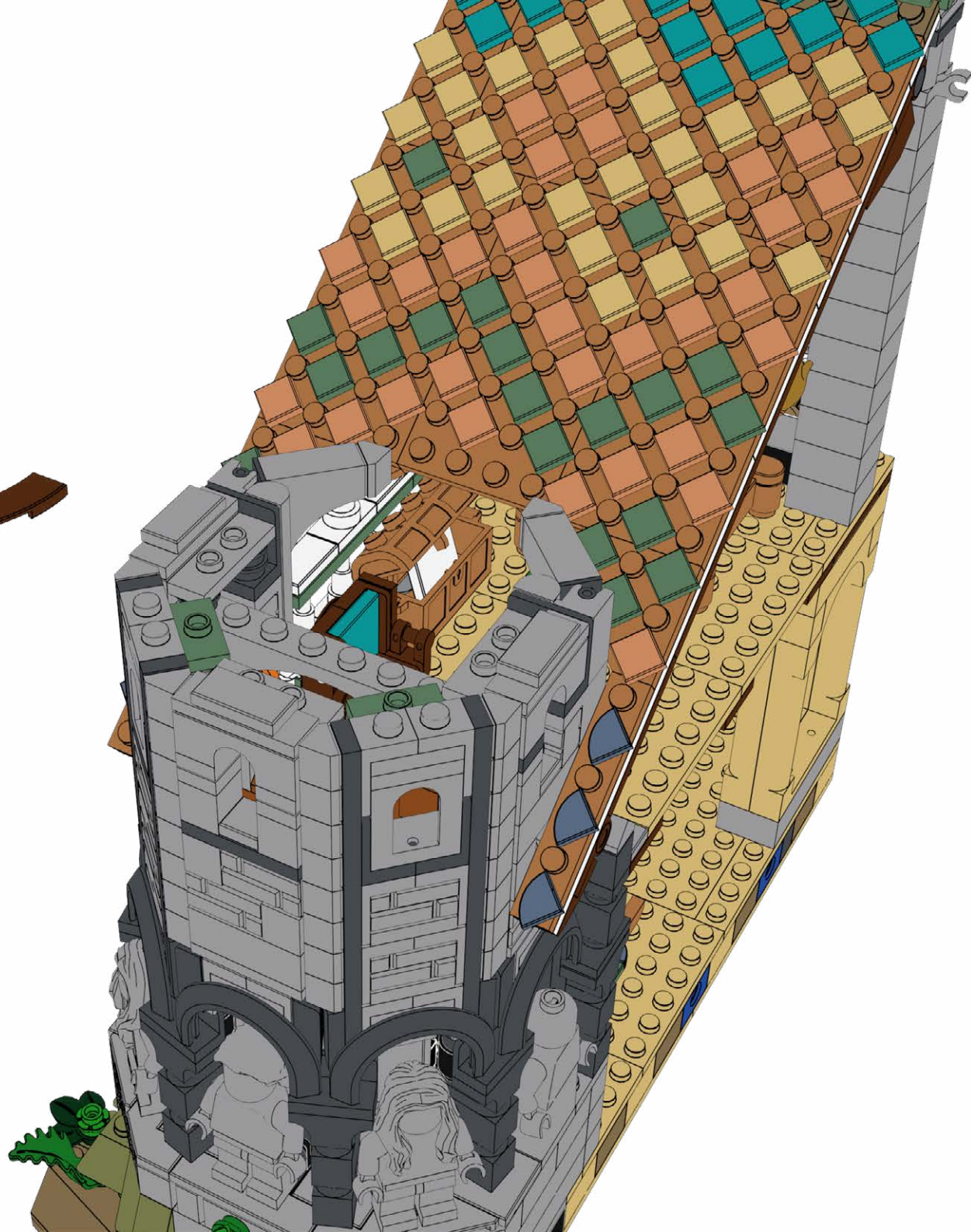
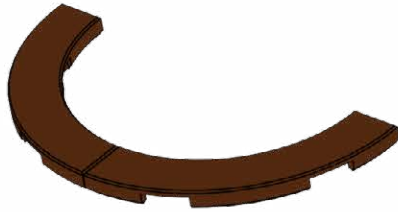

8

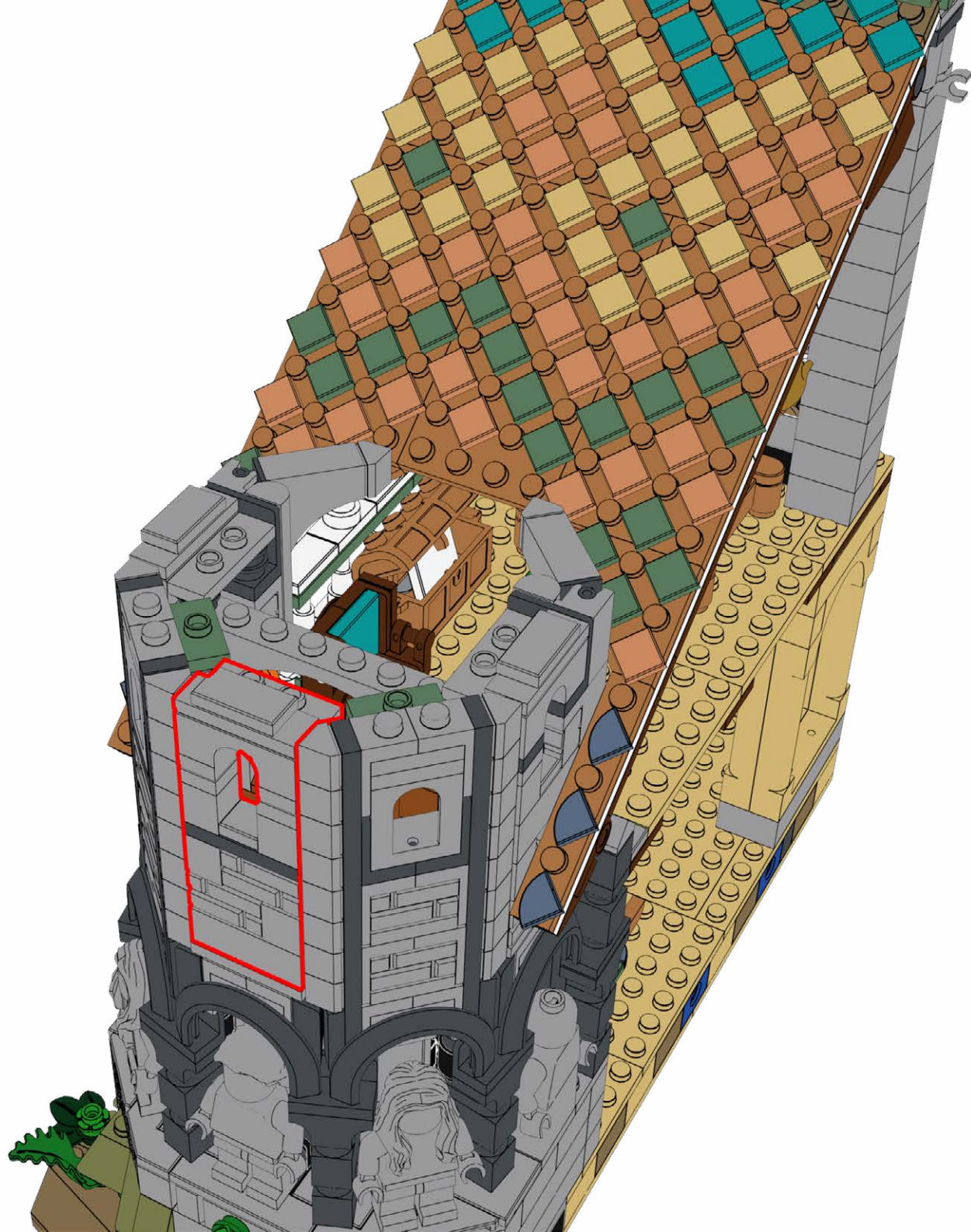

9

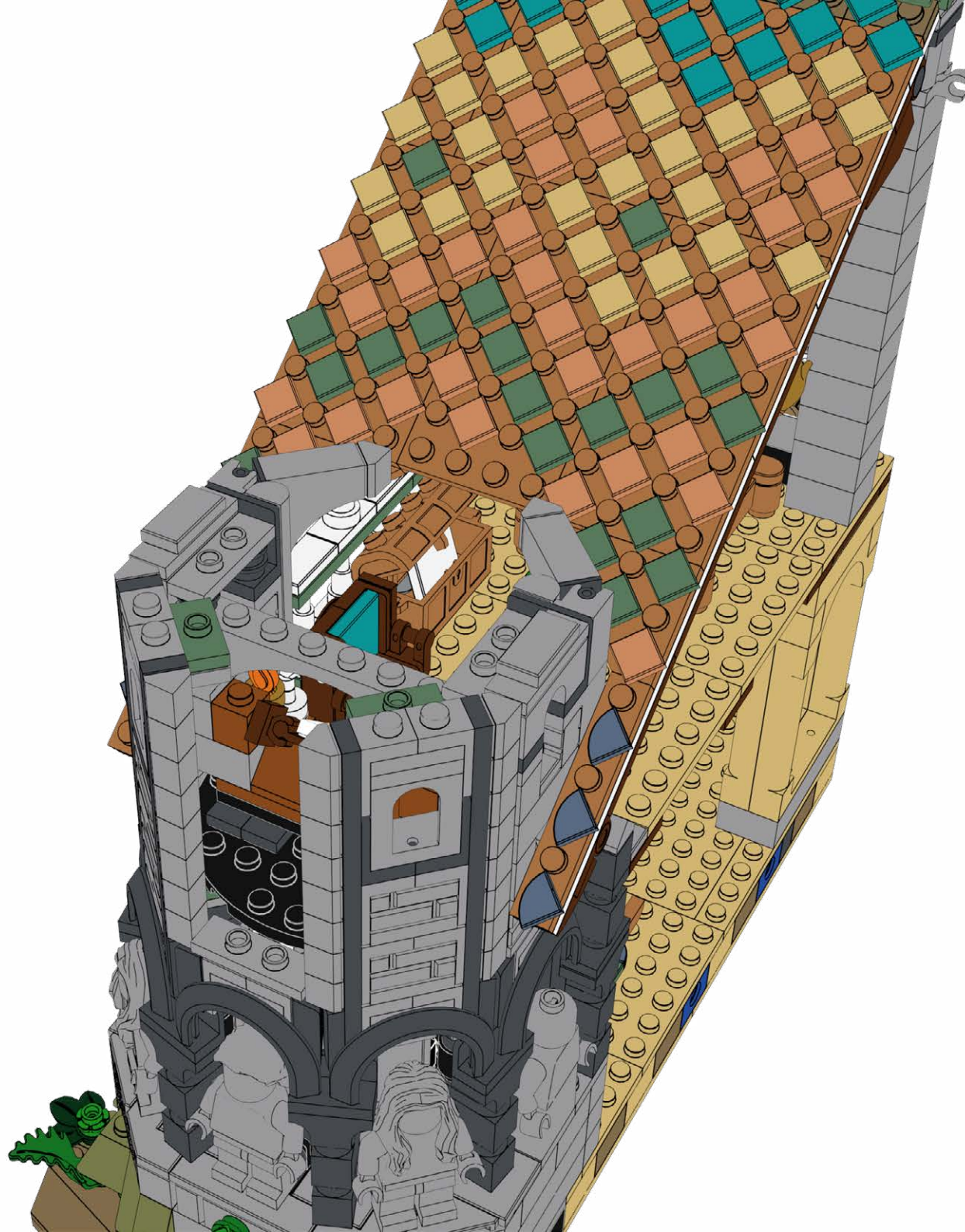
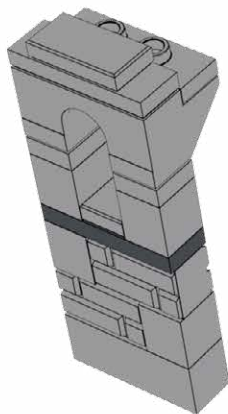

10



**HOLD UP!**

You might notice some bags are out of order, as well as left over pieces, but that's ok! We're changing the way you build LEGO!

HALTEN!

Möglicherweise stellen Sie fest, dass einige Beutel nicht in Ordnung sind und auch Teile übrig bleiben, aber das ist in Ordnung! Wir verändern die Art und Weise, wie Sie LEGO bauen!

TENIR BON!

Vous remarquerez peut-être que certains sacs sont en panne, ainsi que des morceaux restants, mais ce n'est pas grave ! Nous changeons la façon dont vous construisez LEGO !

SOSTENERE!

Potresti notare che alcune borse sono fuori uso, così come alcuni pezzi avanzati, ma va bene! Stiamo cambiando il modo in cui costruisci i LEGO!

¡SOSTENER!

Puede que notes que algunas bolsas están fuera de orden, así como piezas sobrantes, ¡pero está bien! ¡Estamos cambiando la forma de construir LEGO!

耽误!

您可能会注意到有些袋子坏了, 还有剩余的碎片, 但这没关系! 我们正在改变您搭建乐高的方式!

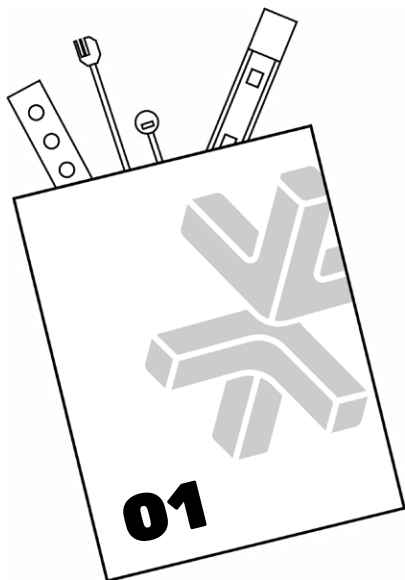
Open LMB Bag 01

11

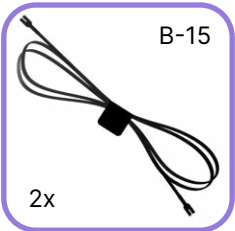

1

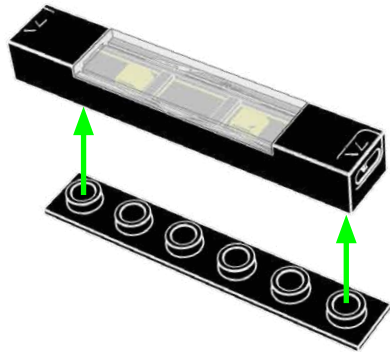

2

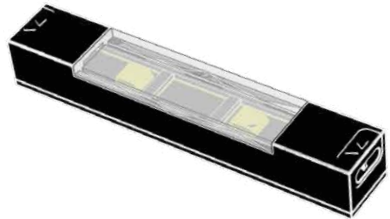

3

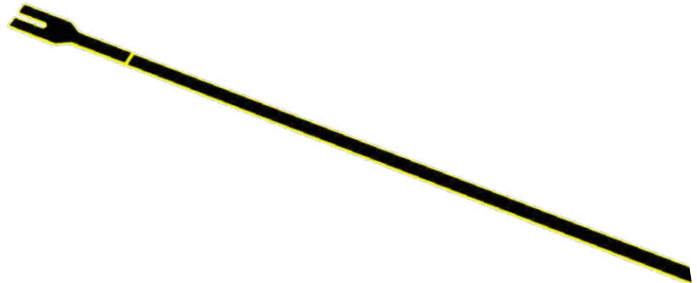
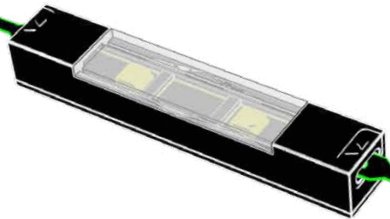

12



13

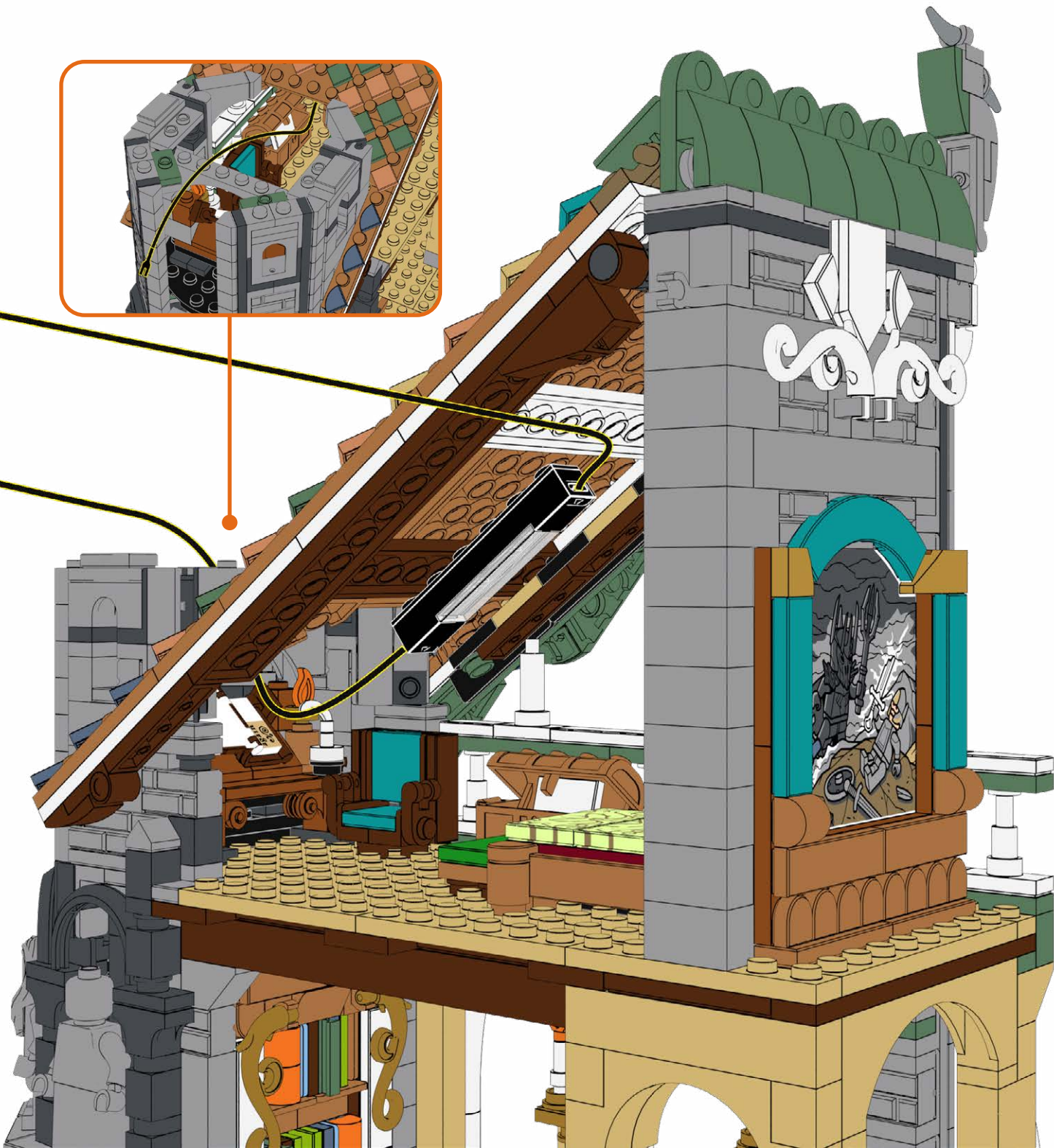
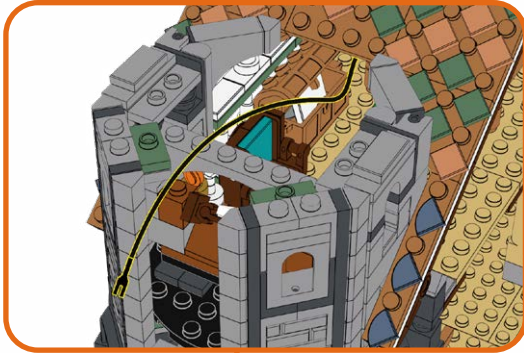

14



15

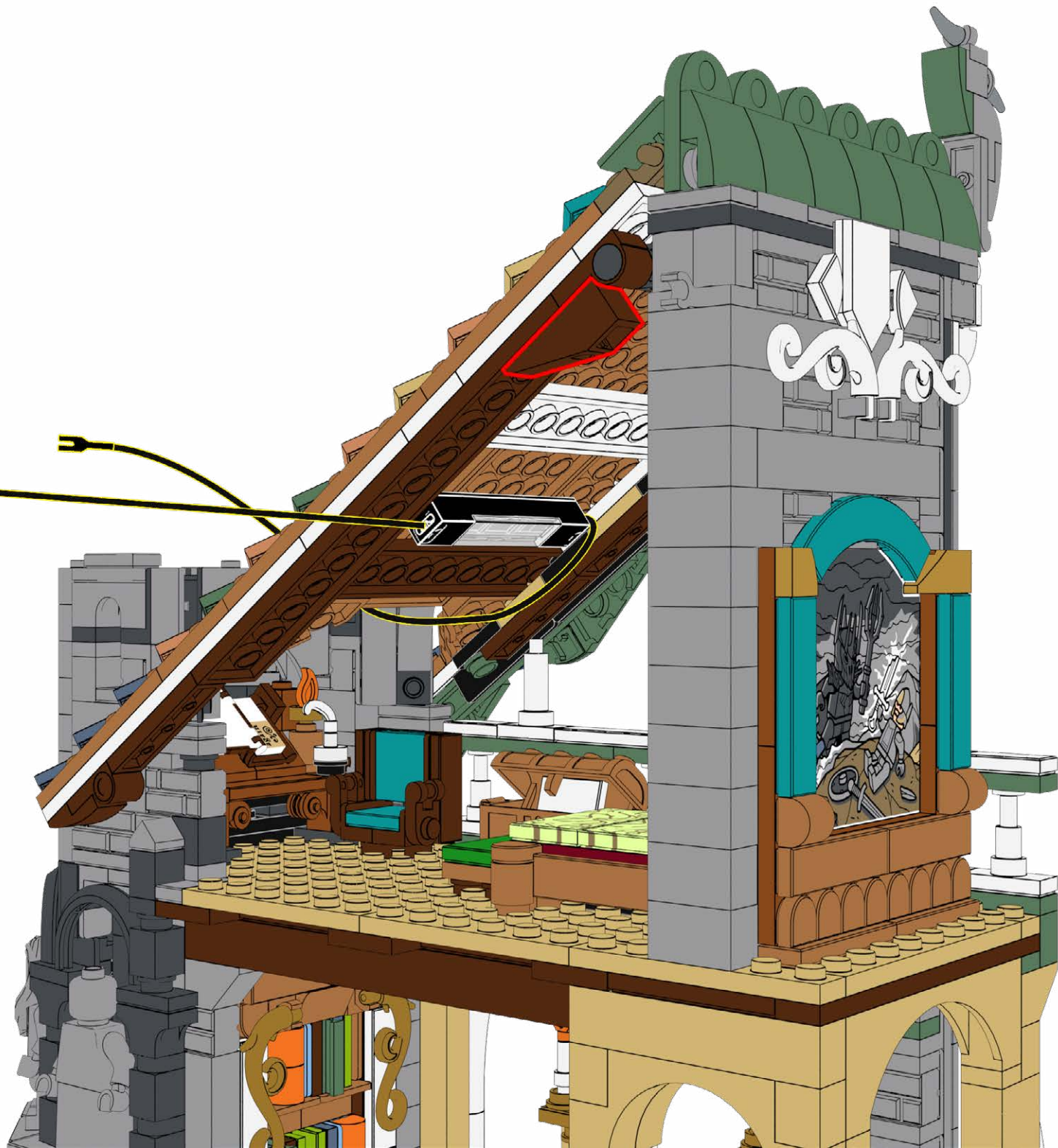

16



17



18

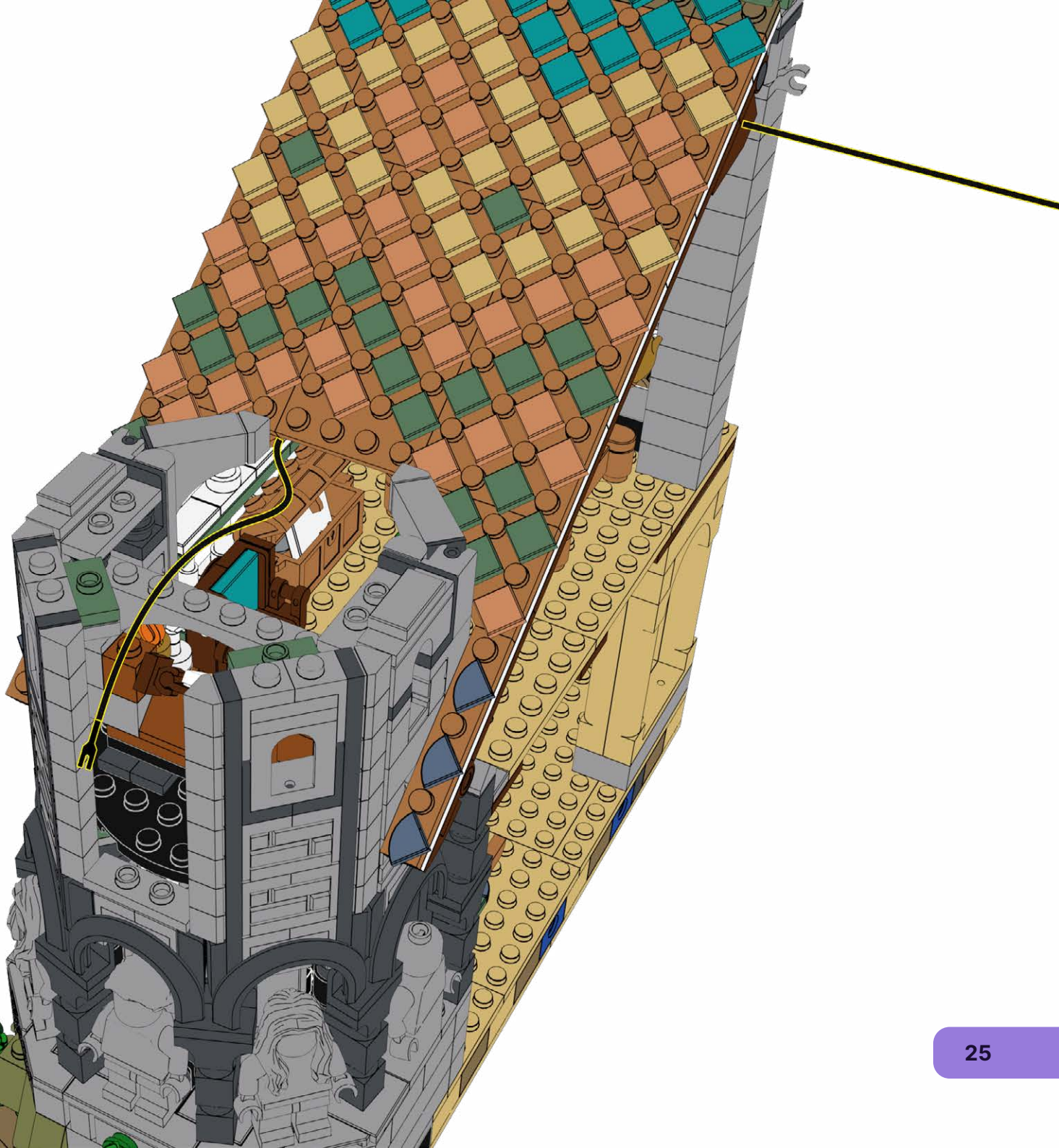
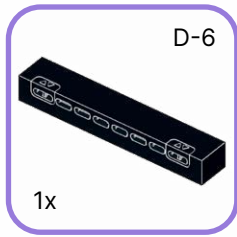

19

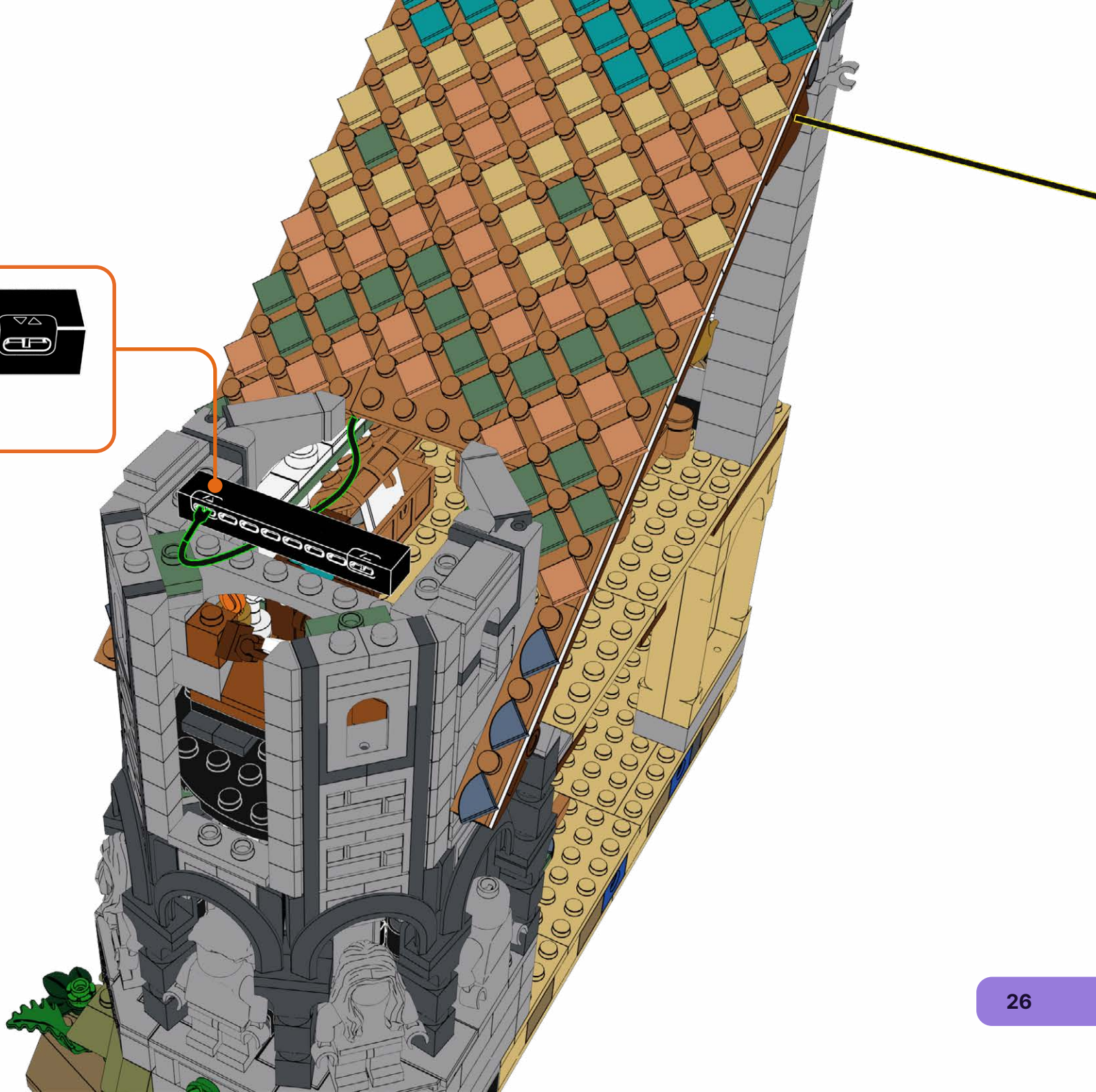

20

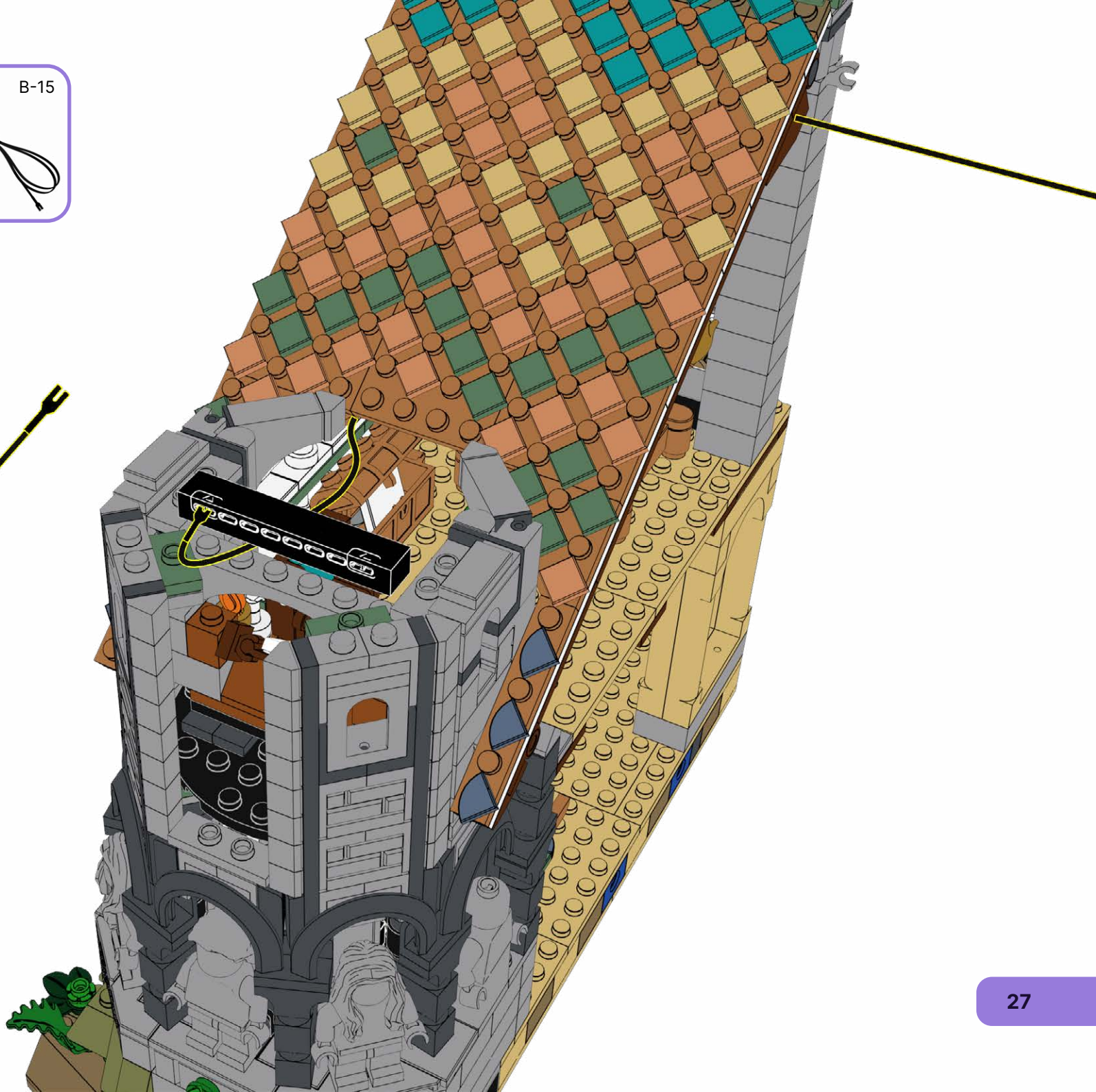
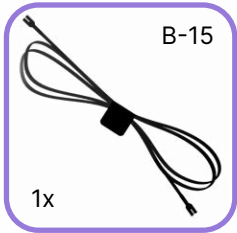

21

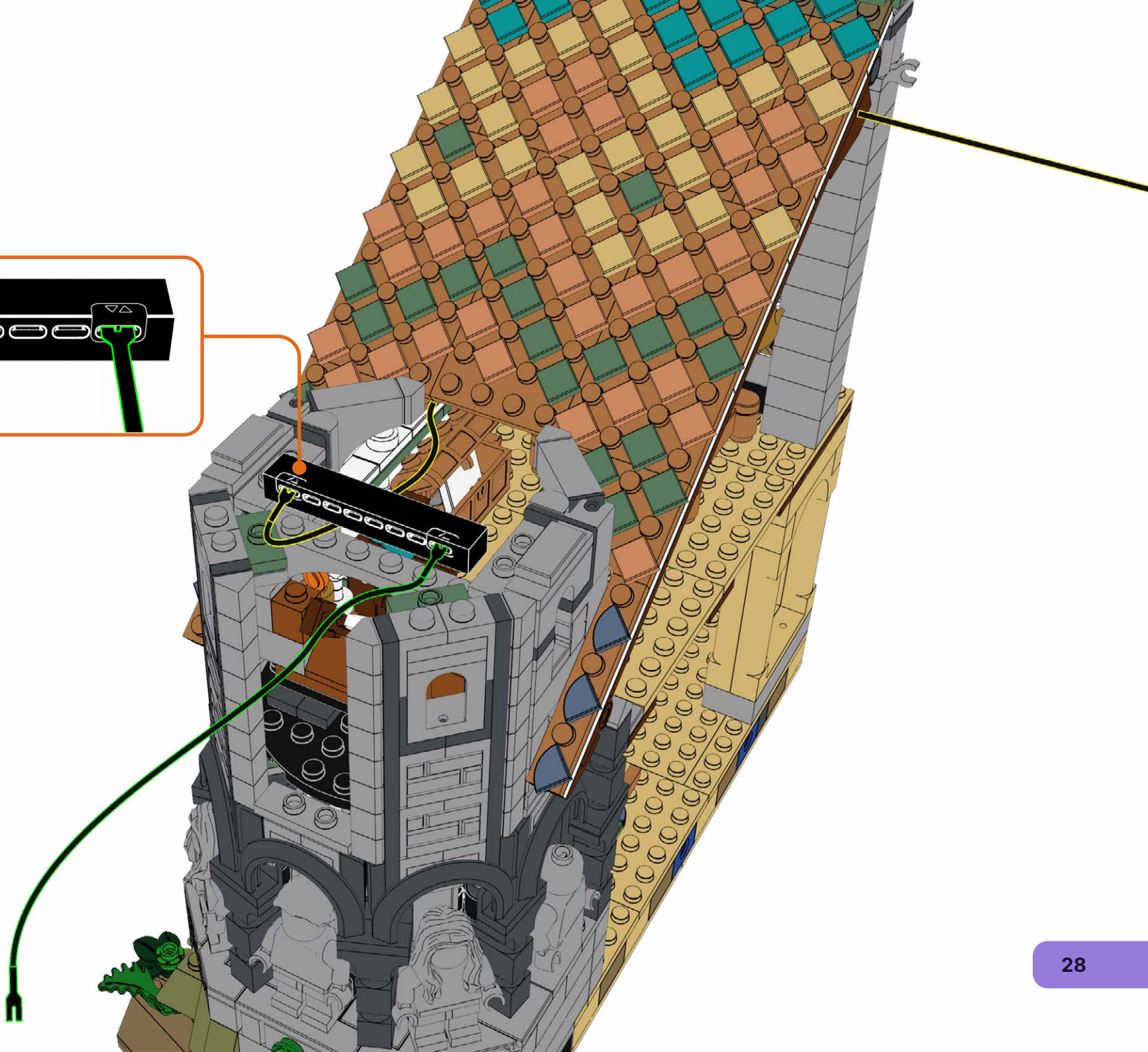

22

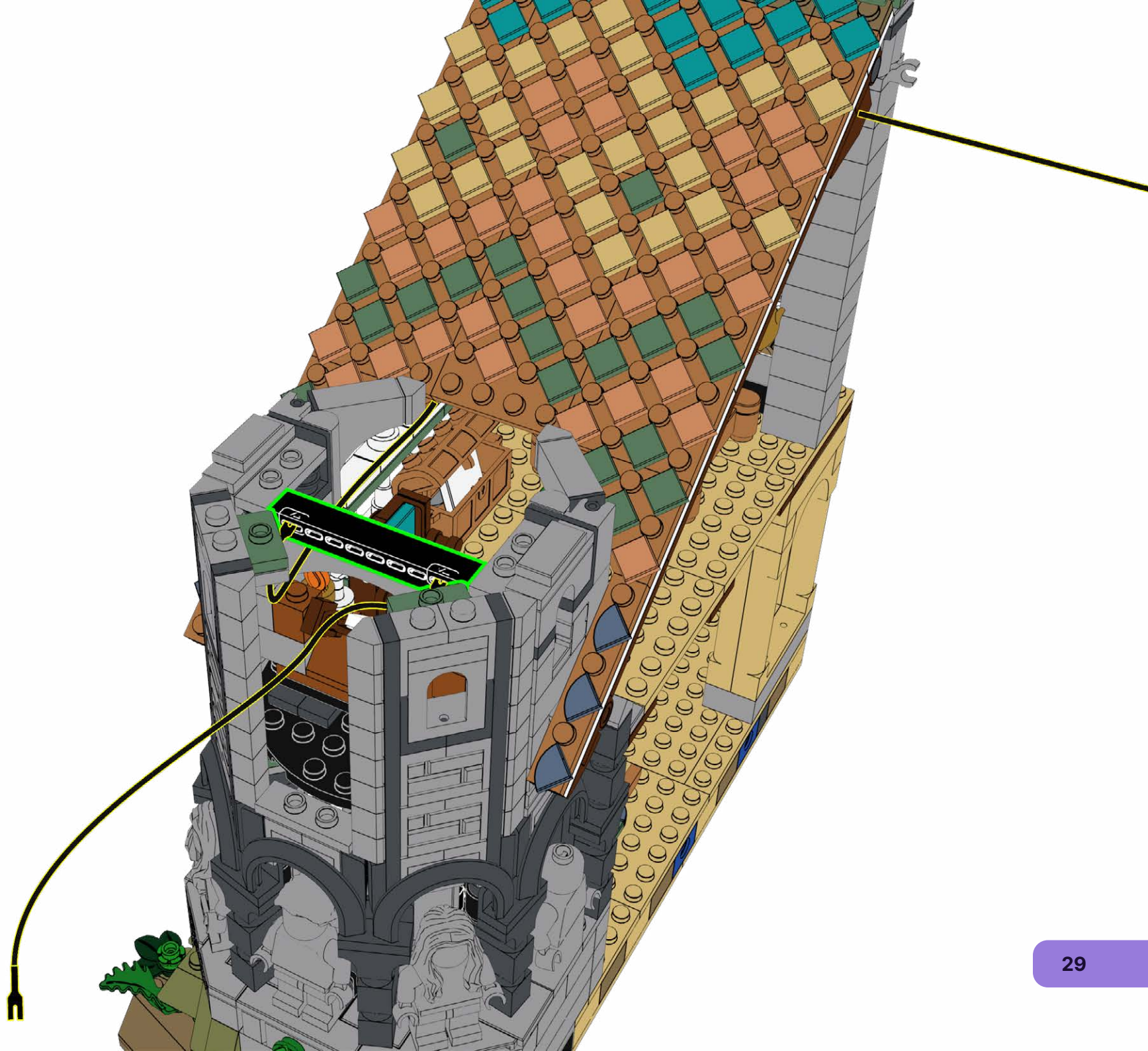

23

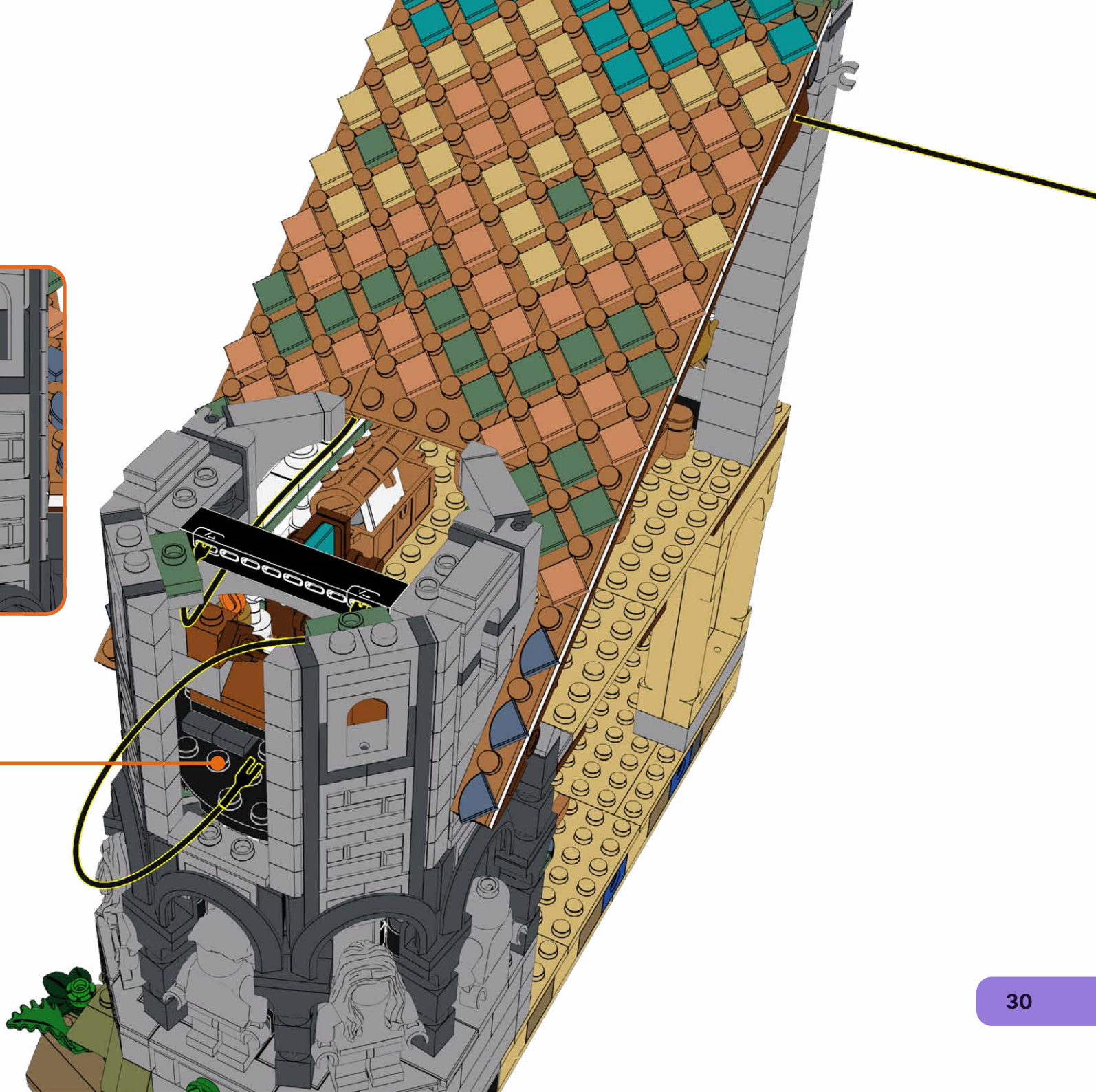

24

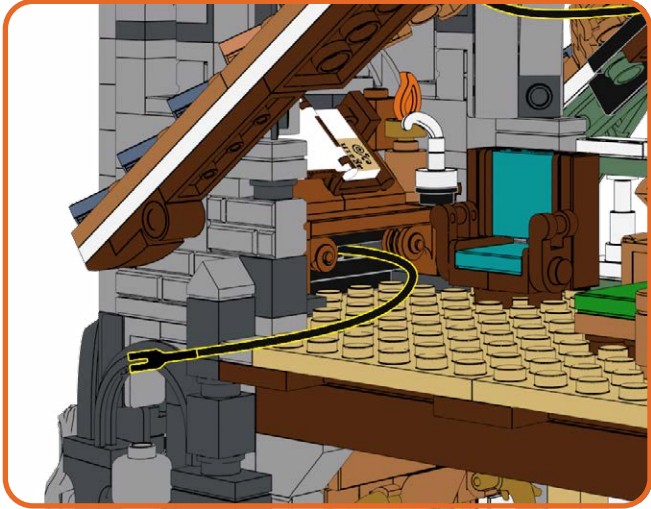

25

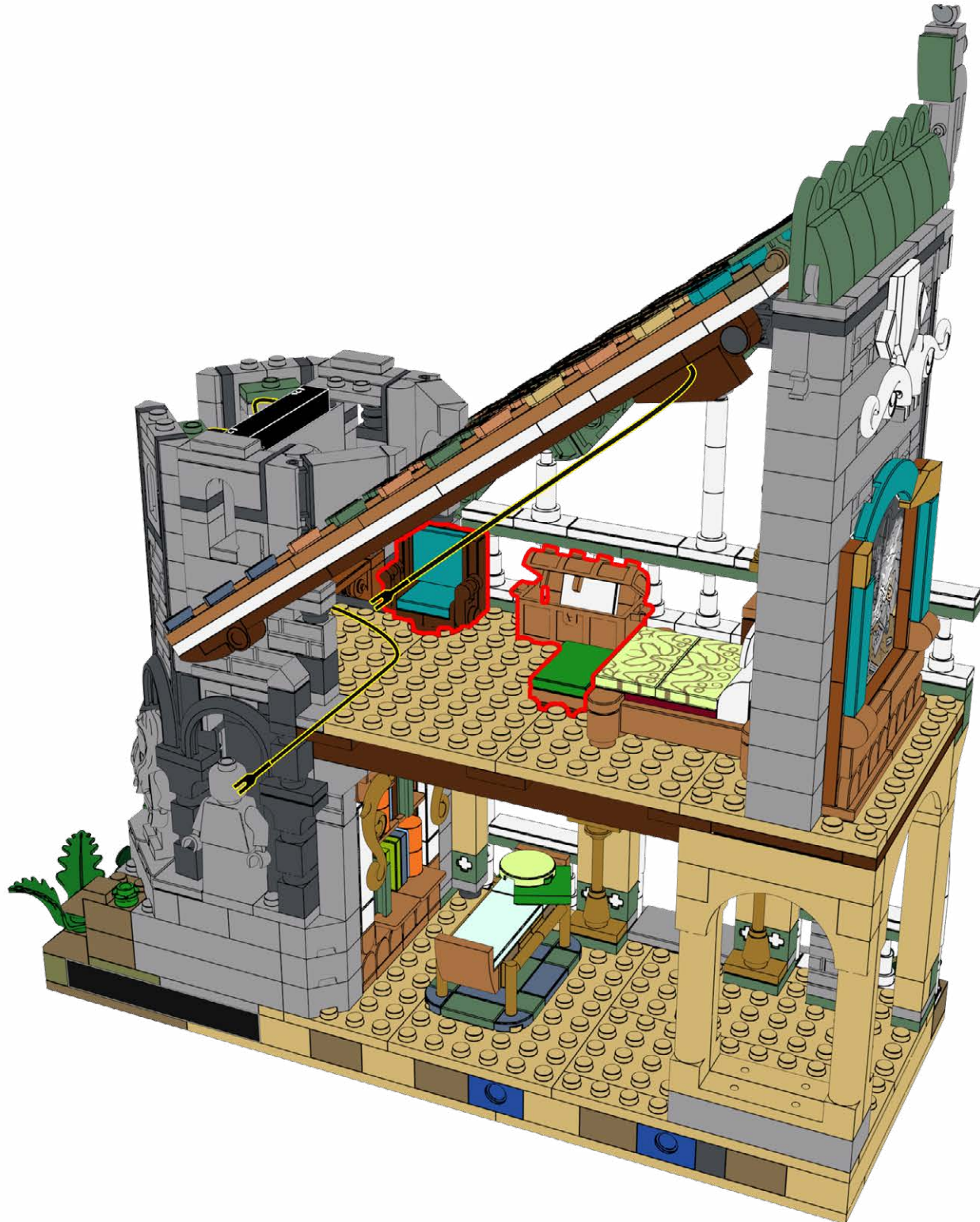

26

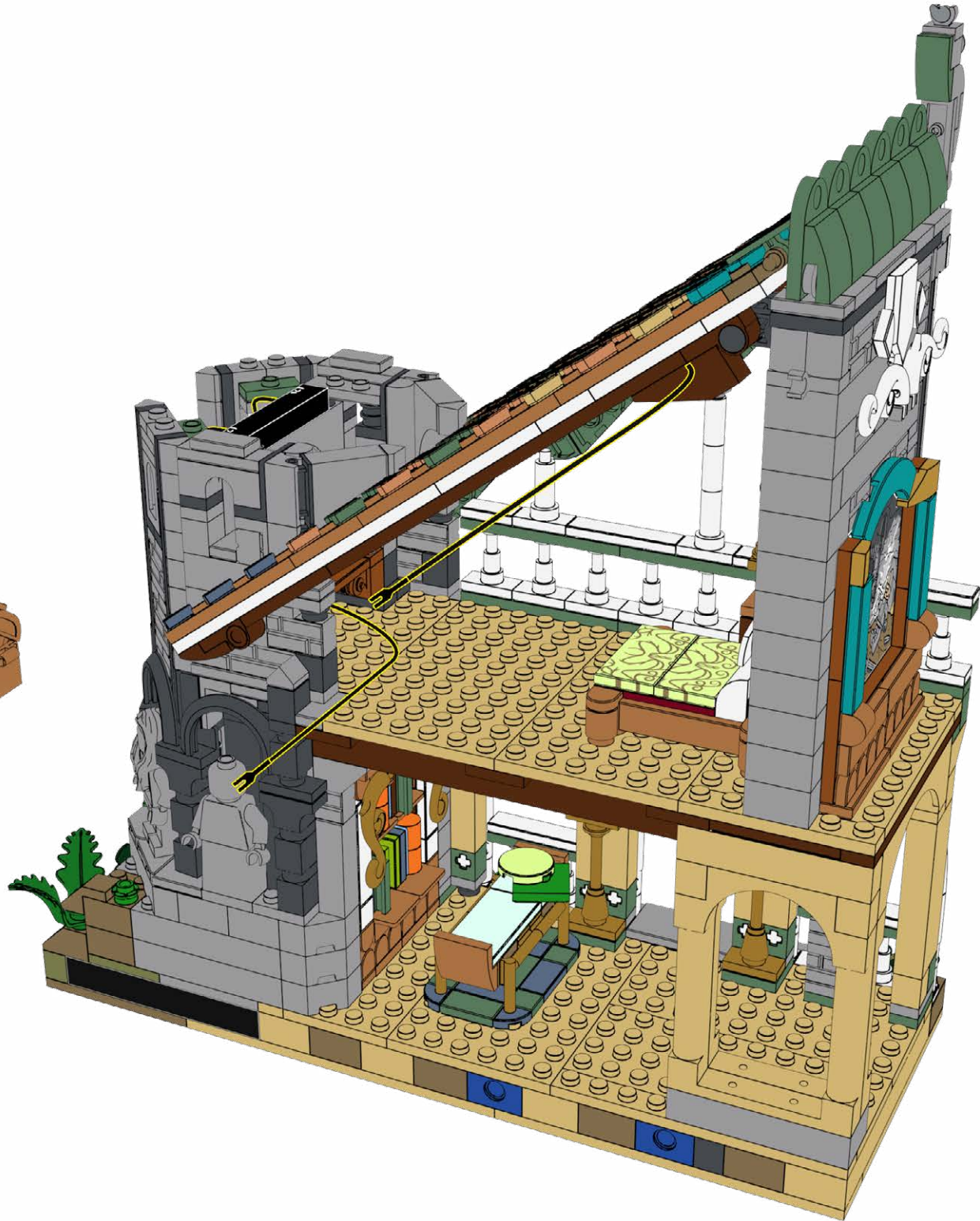

27

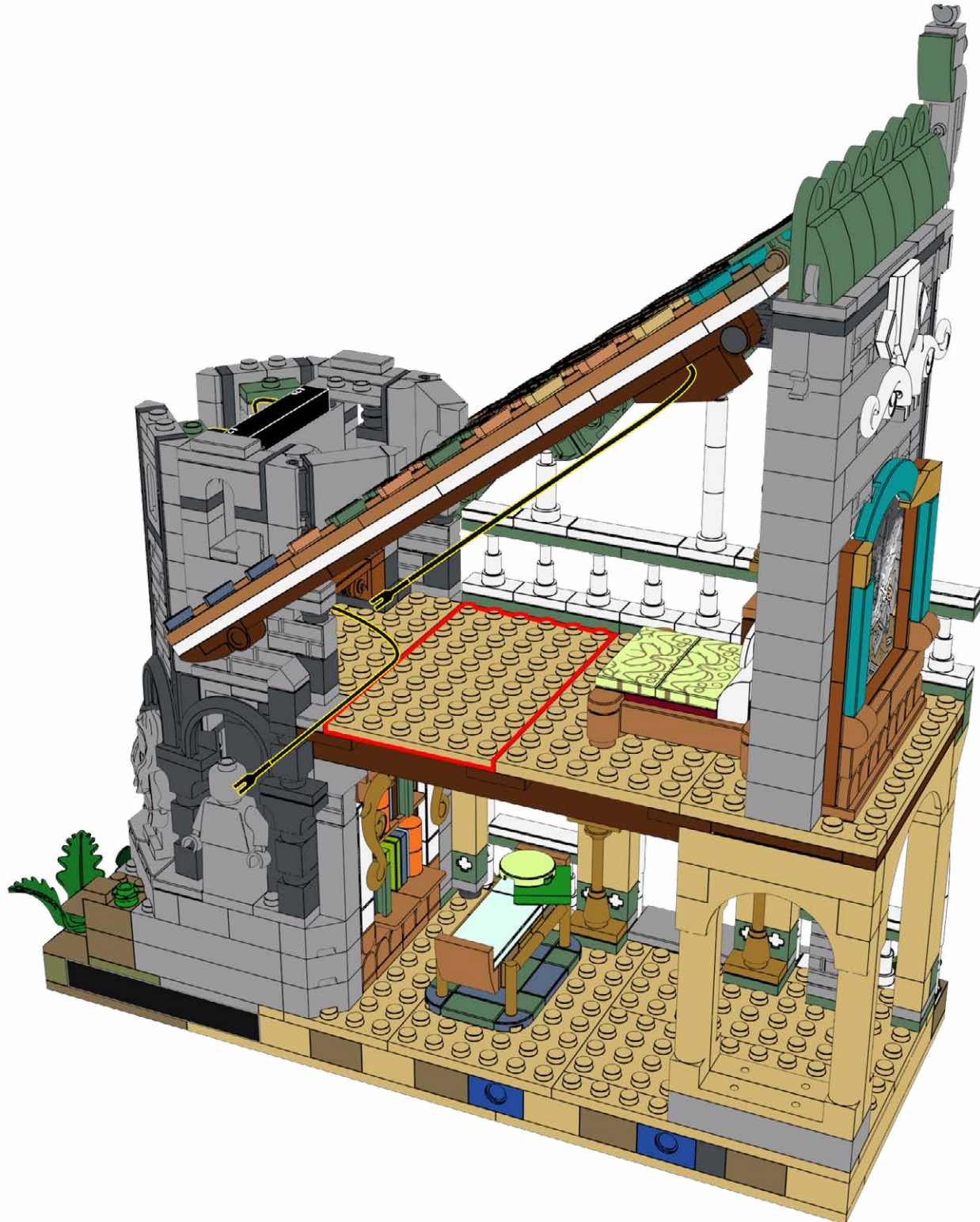

28

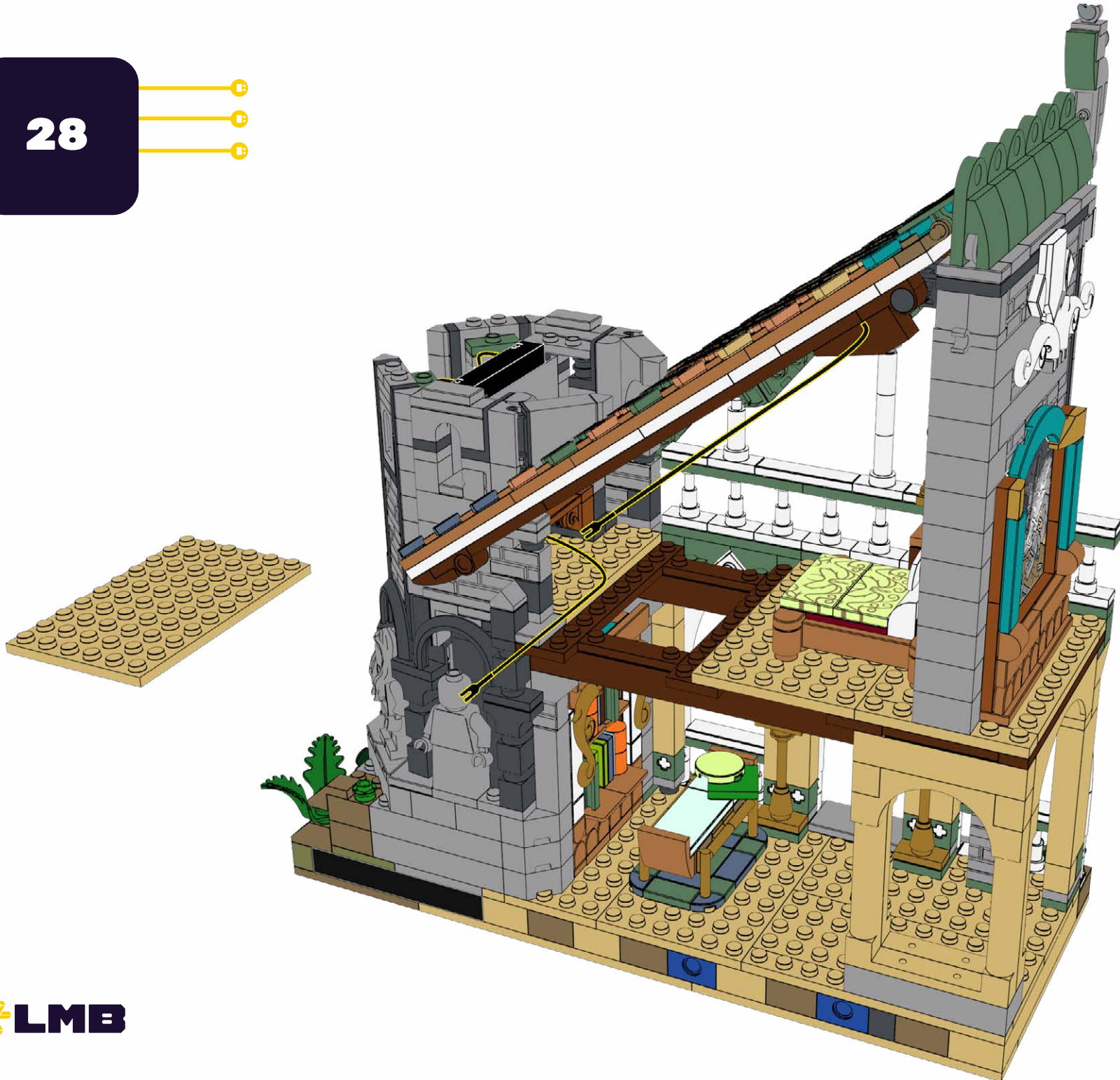

29

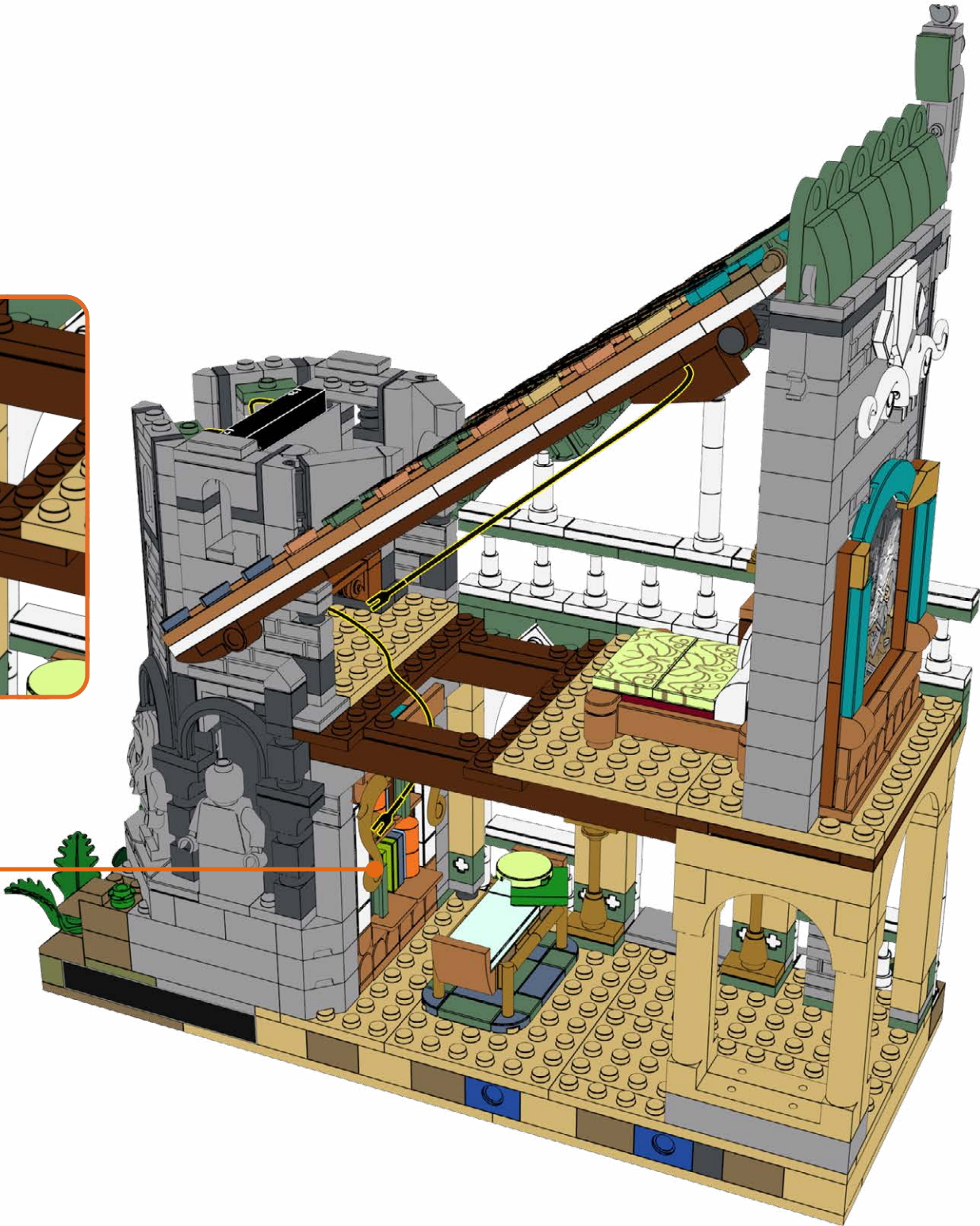
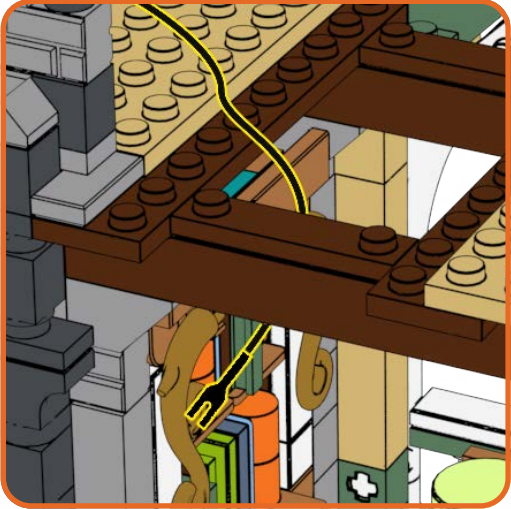

30



31



32

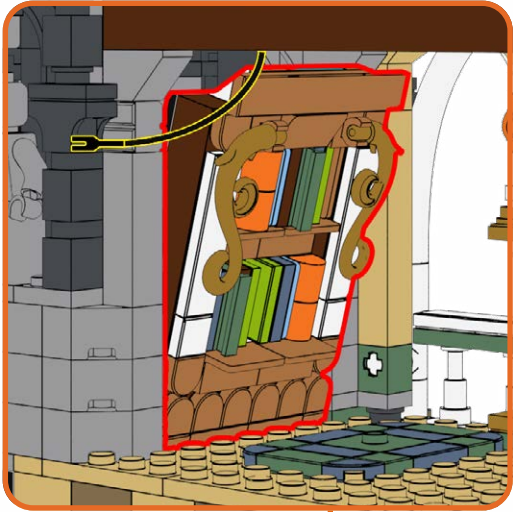

33

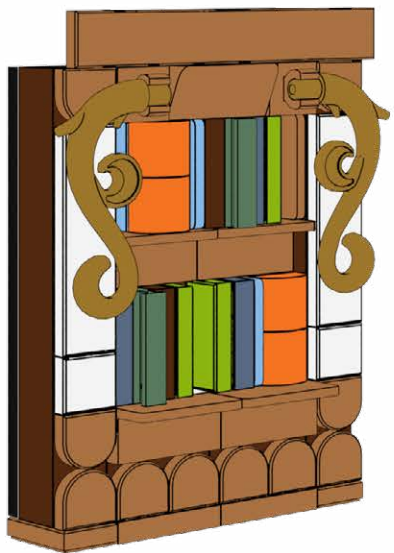

34

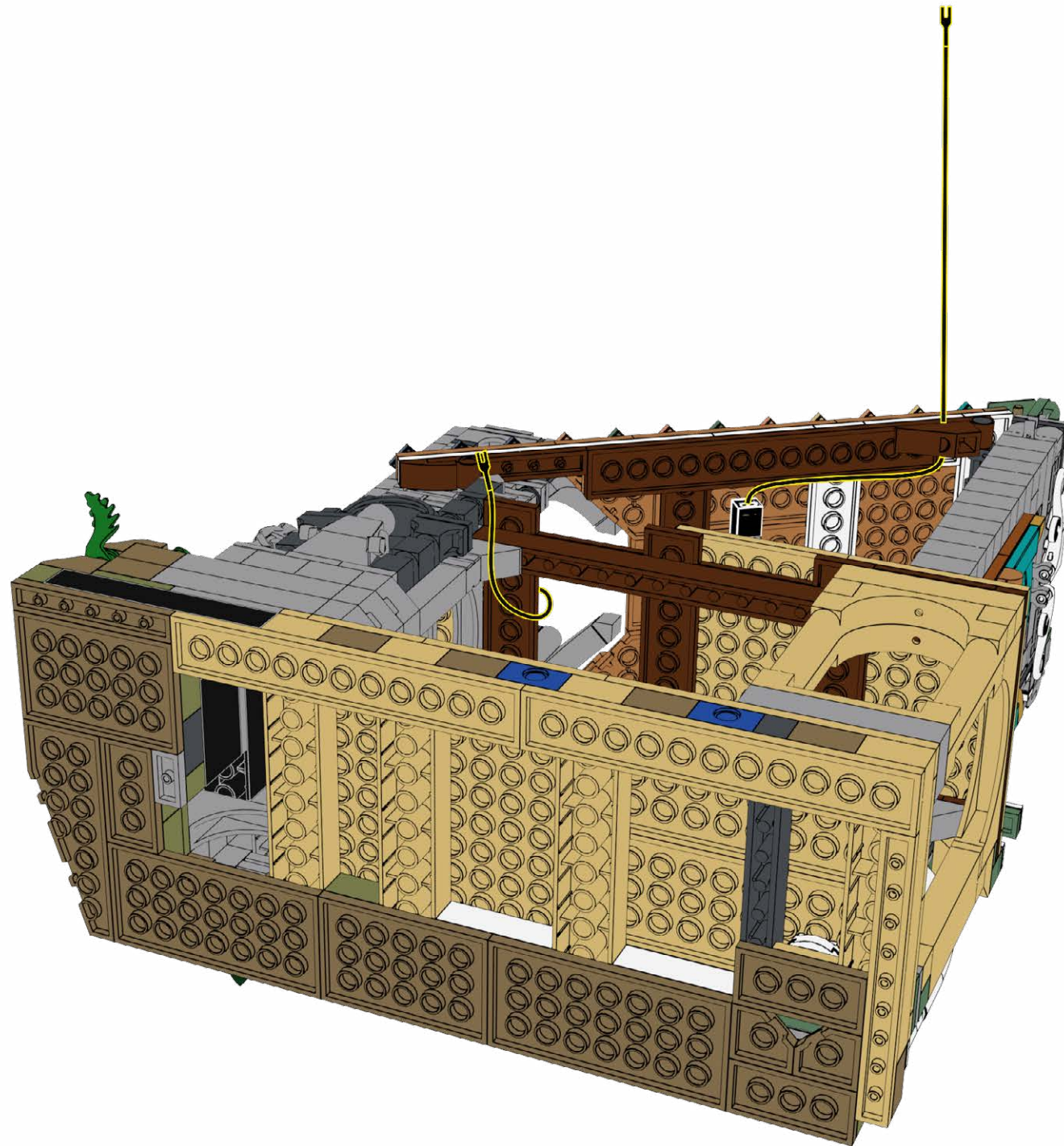

35

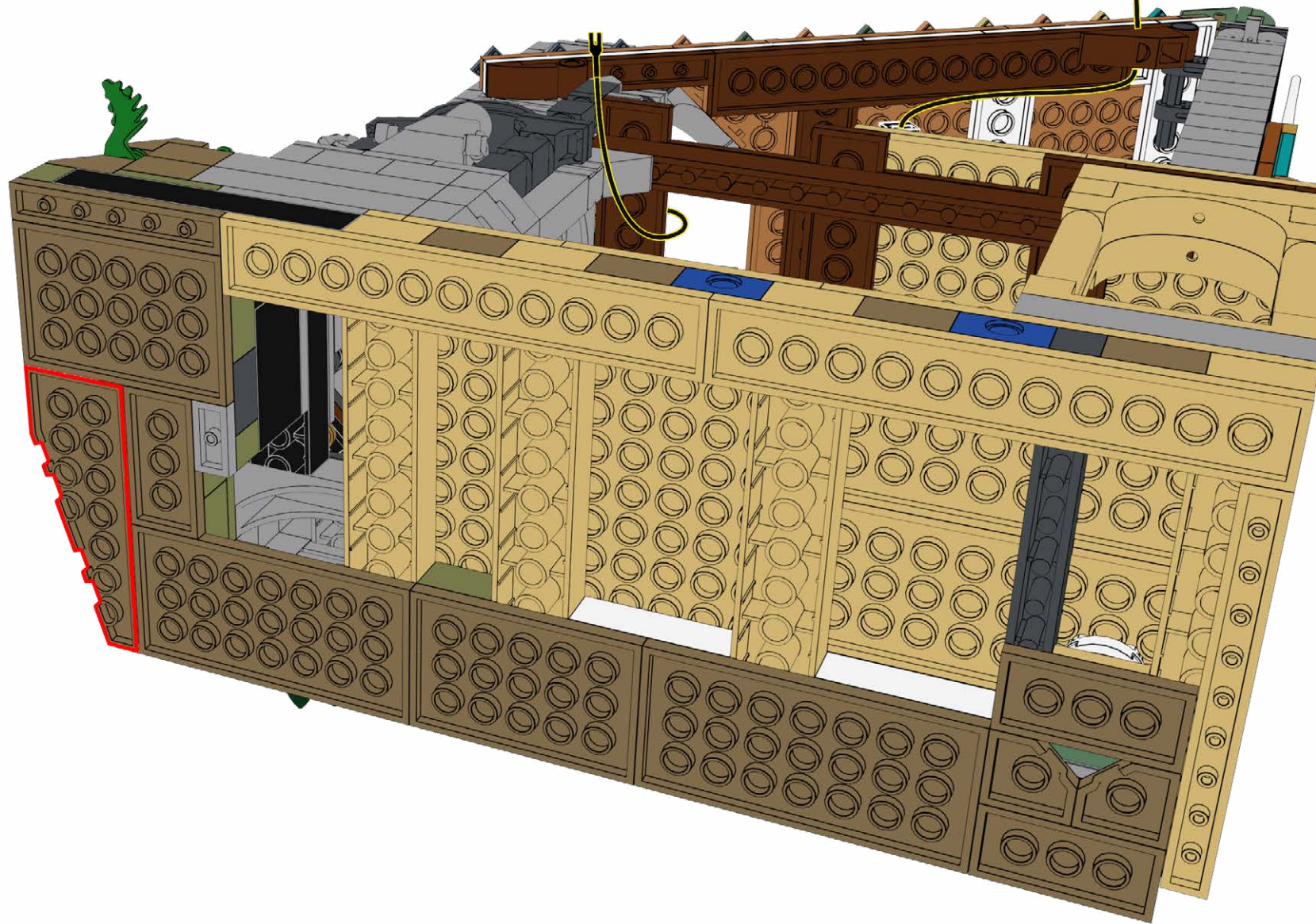

36

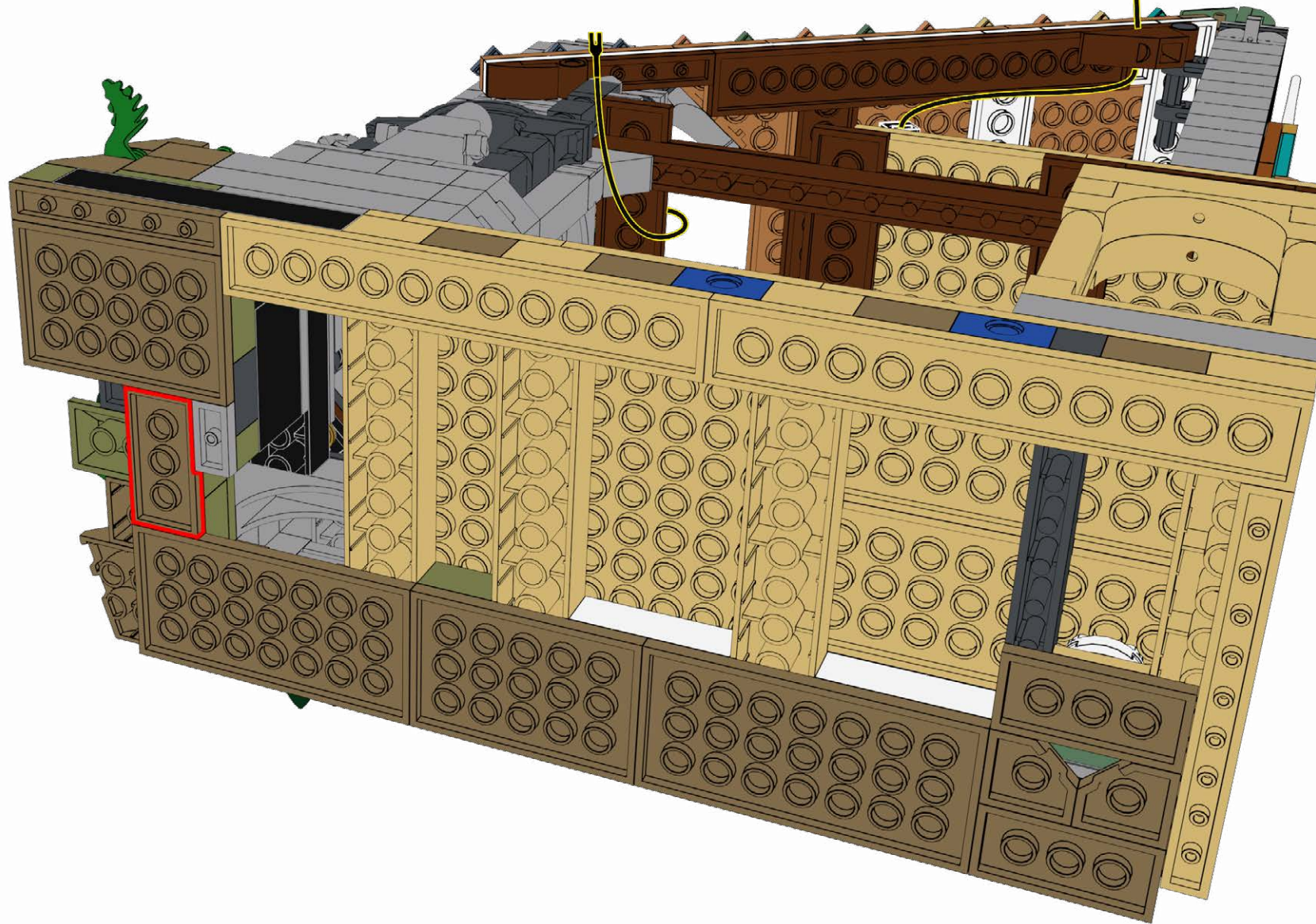
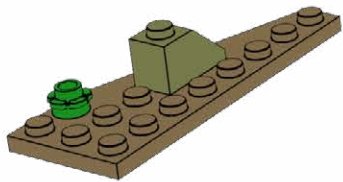

37

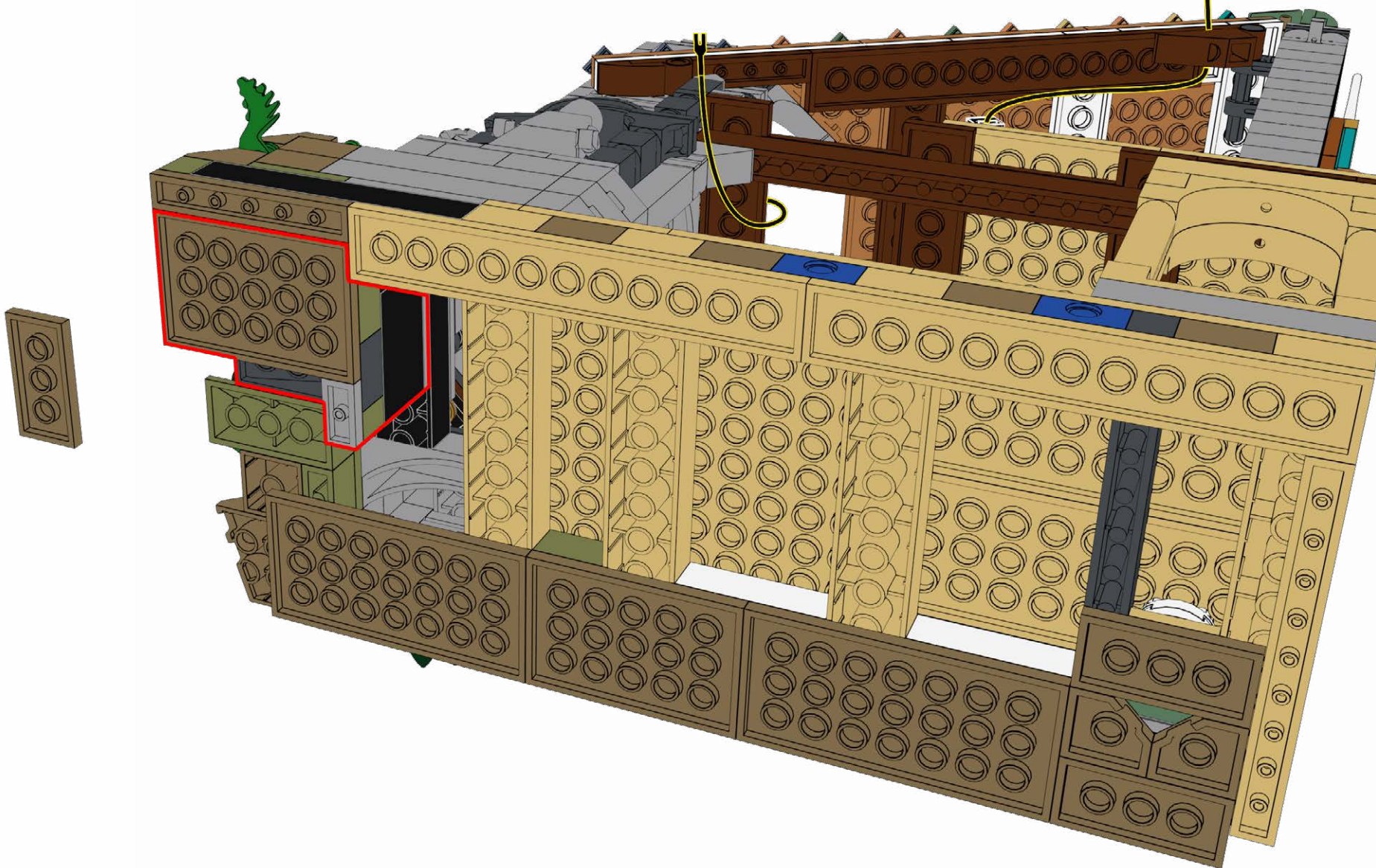

38

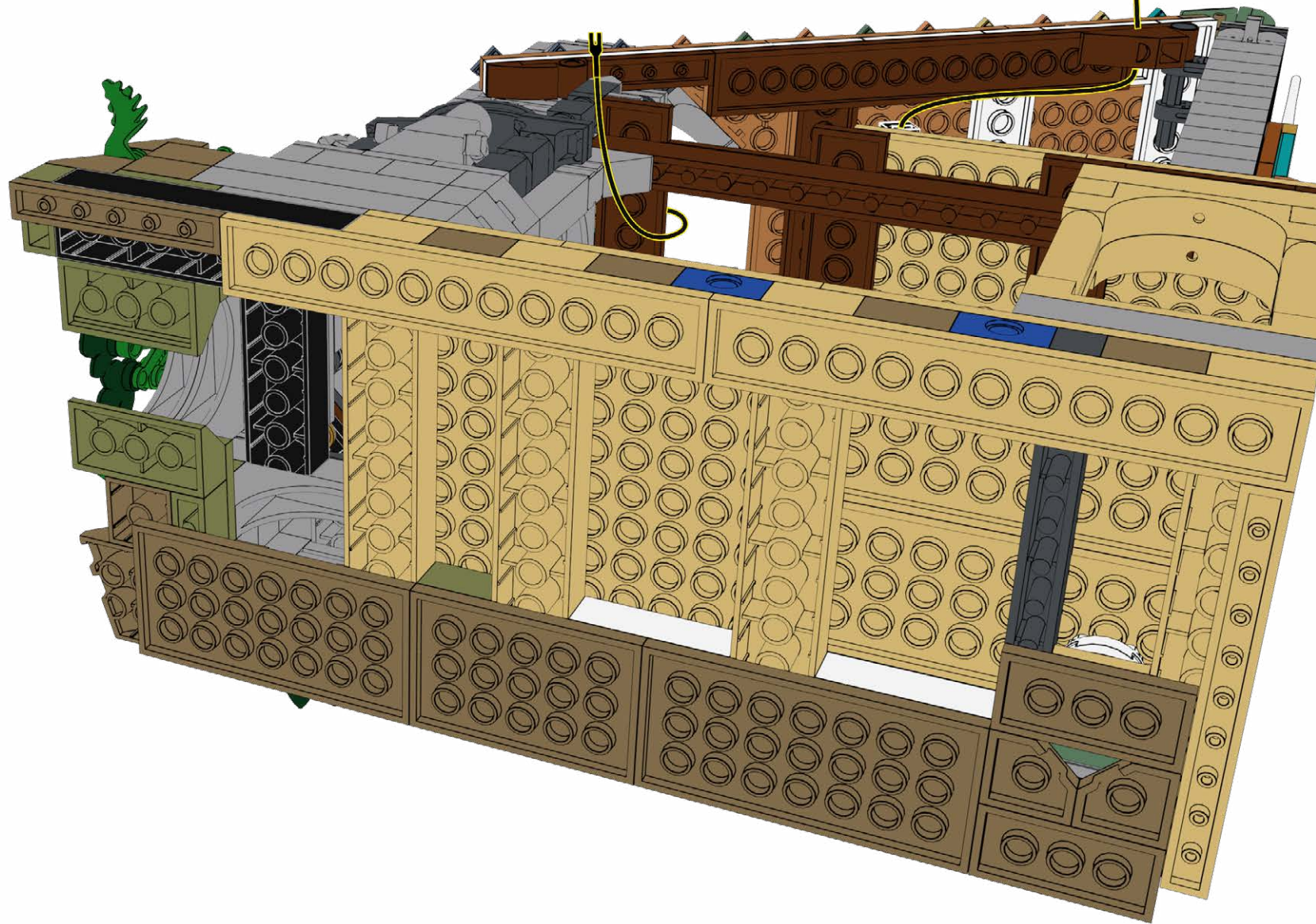
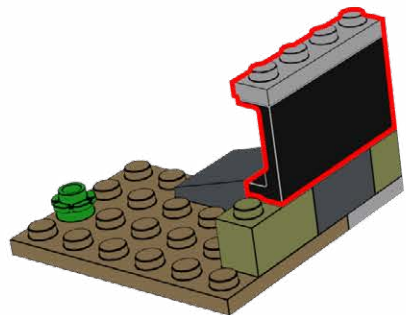

39

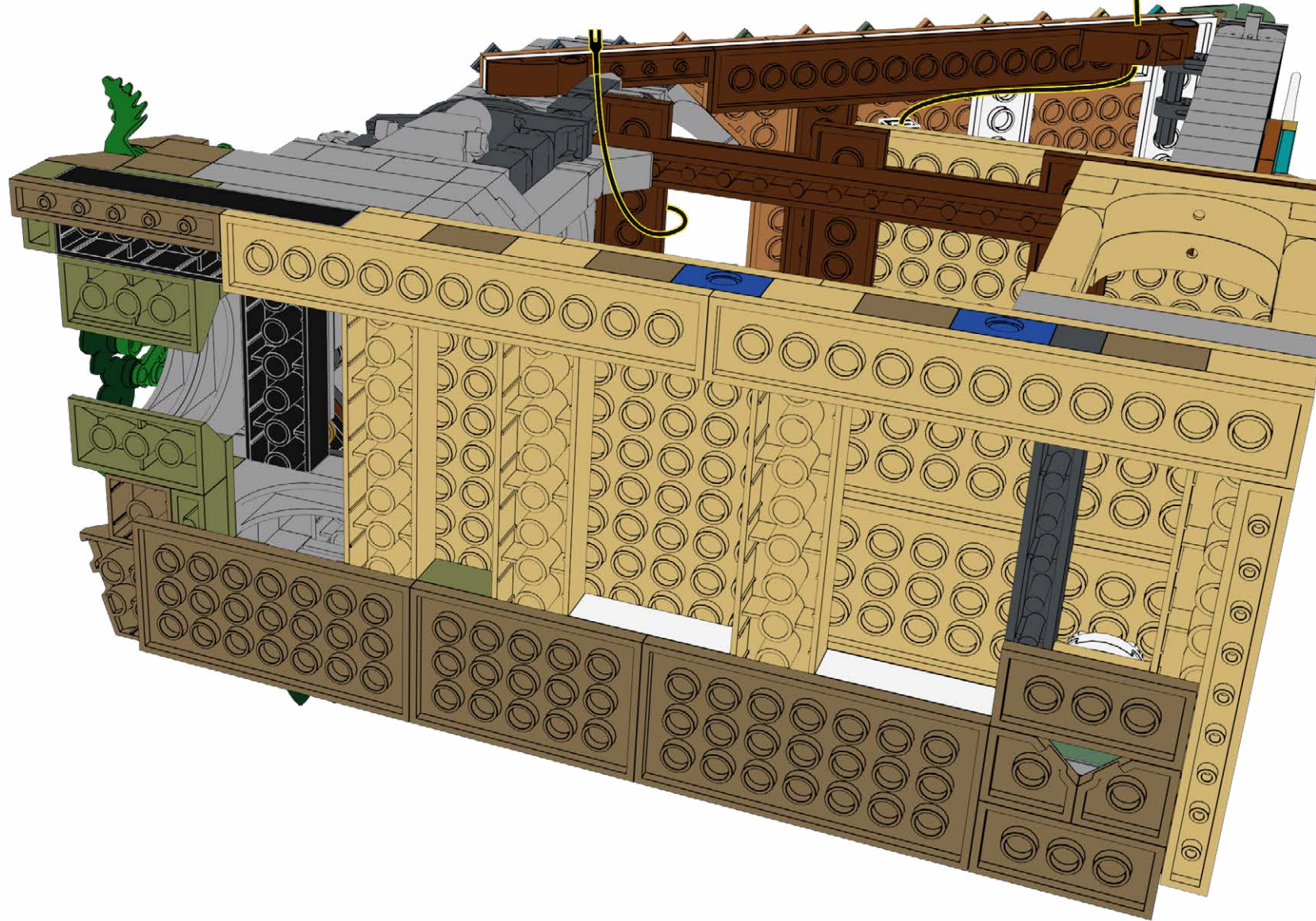
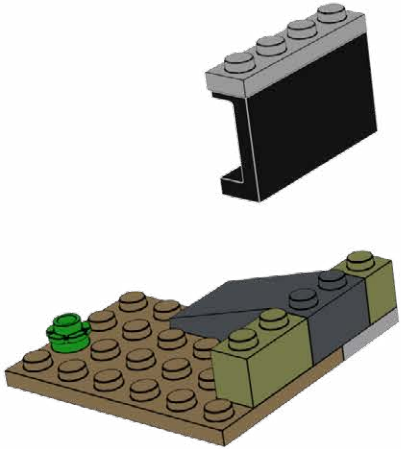

40

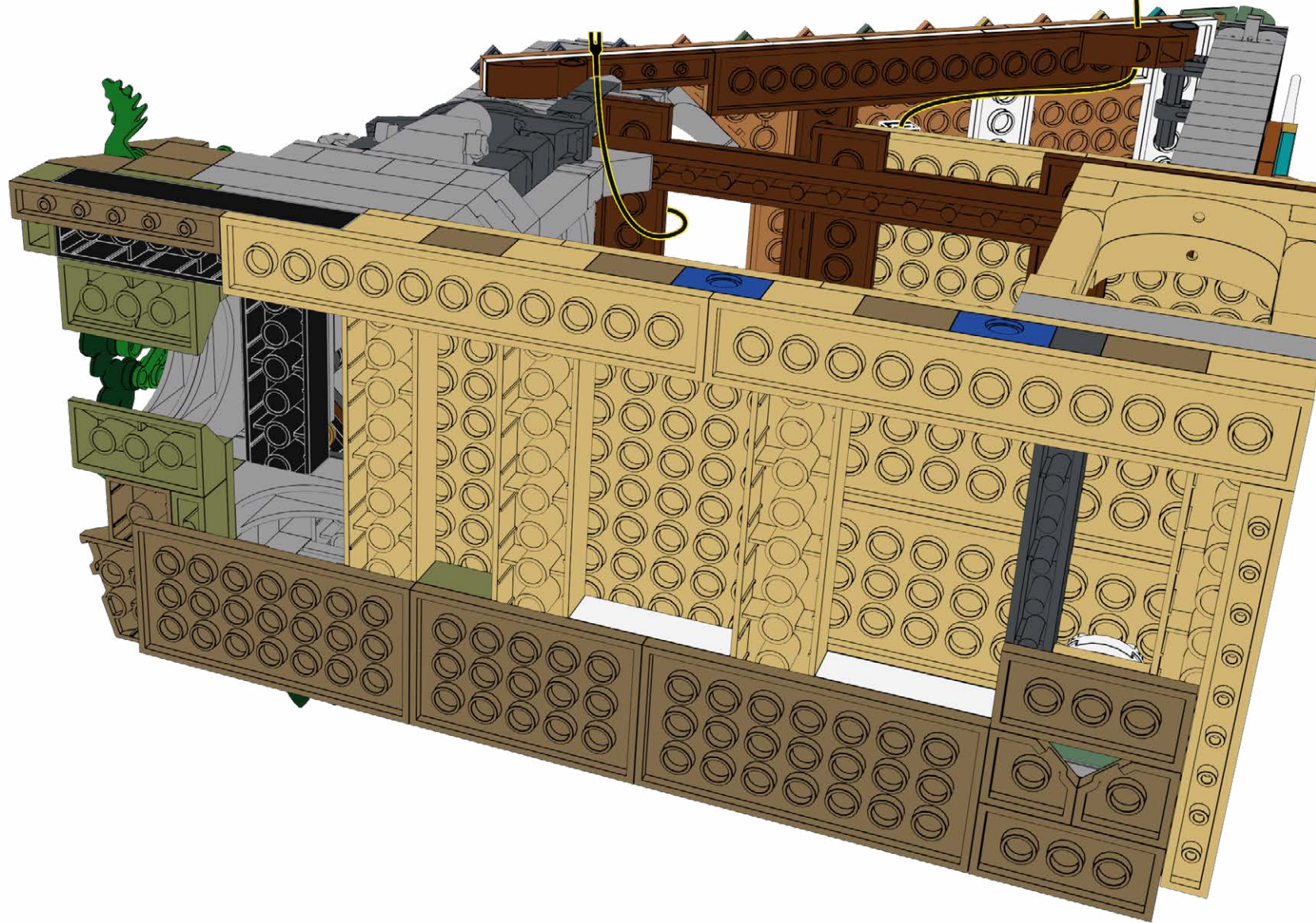
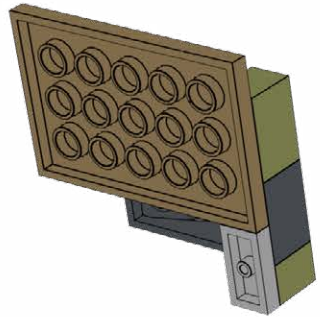

41

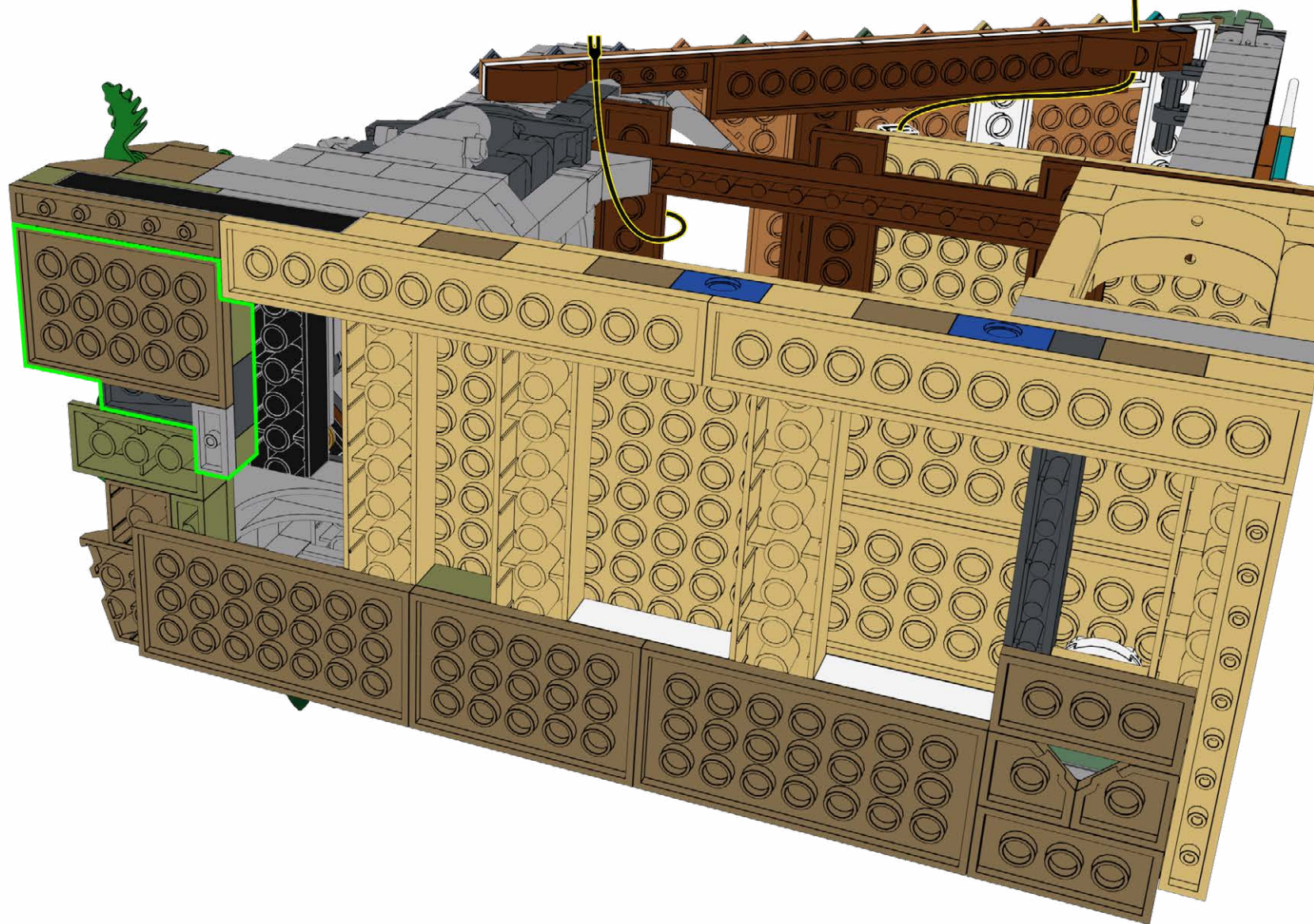

42

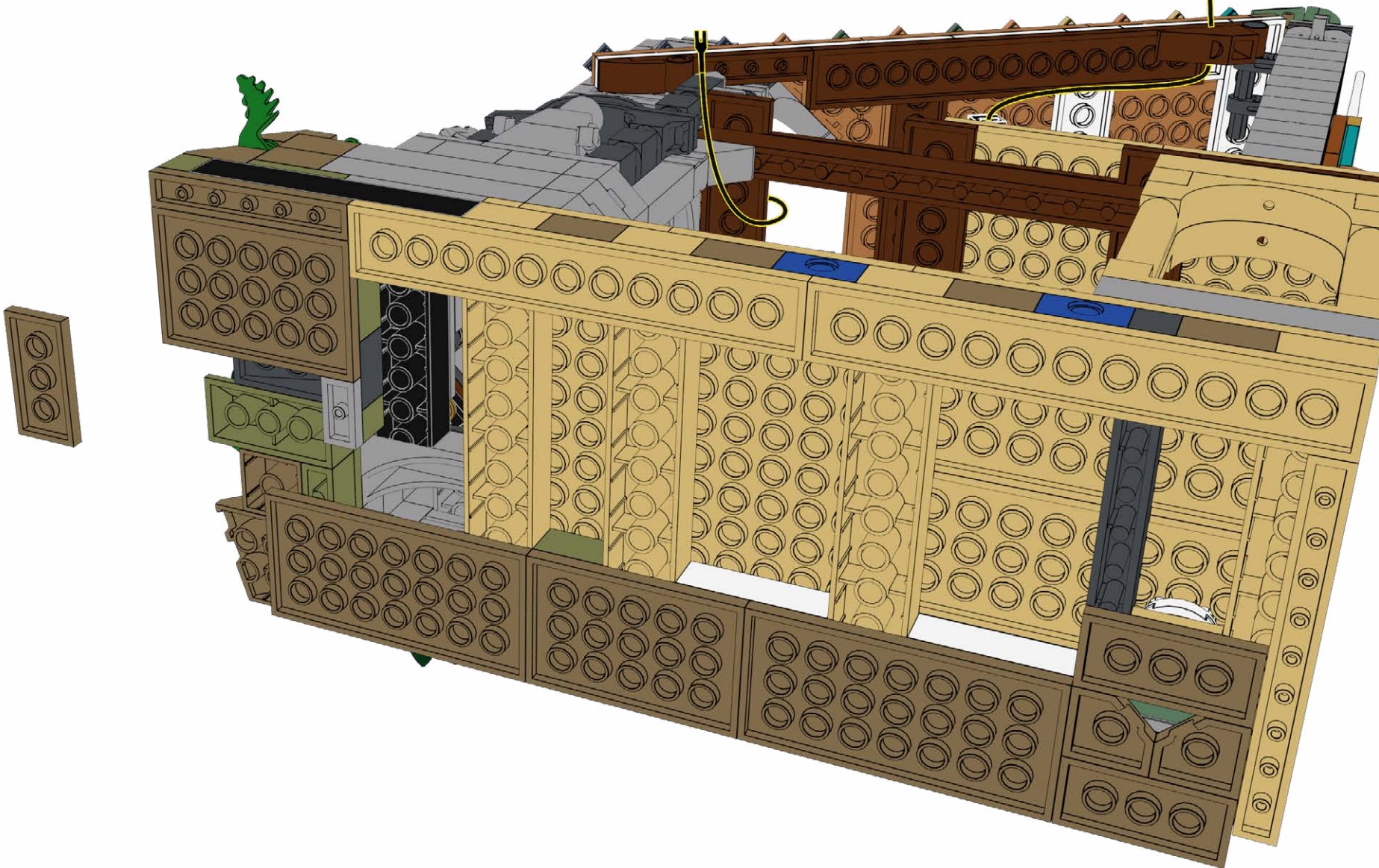

43

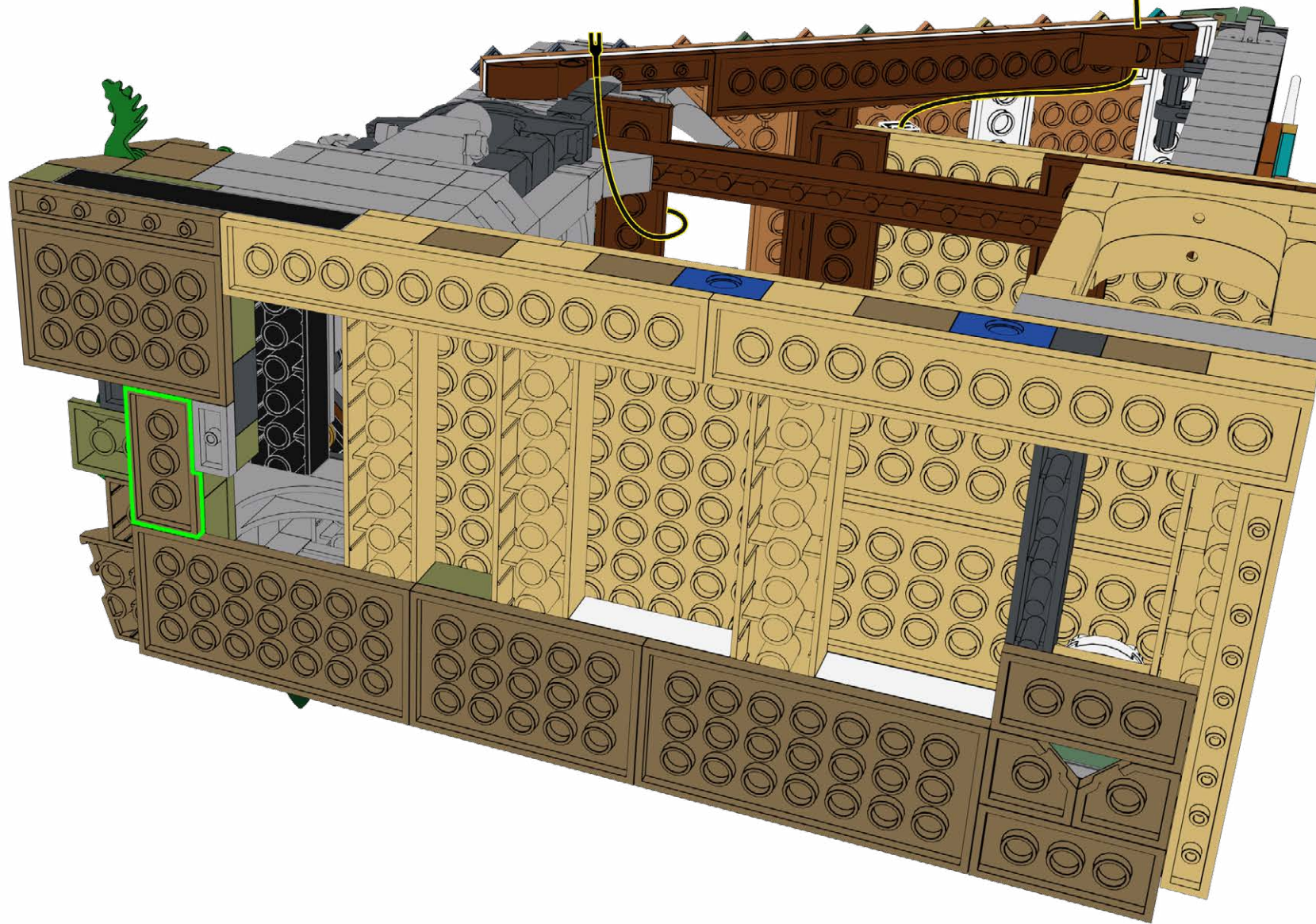

44

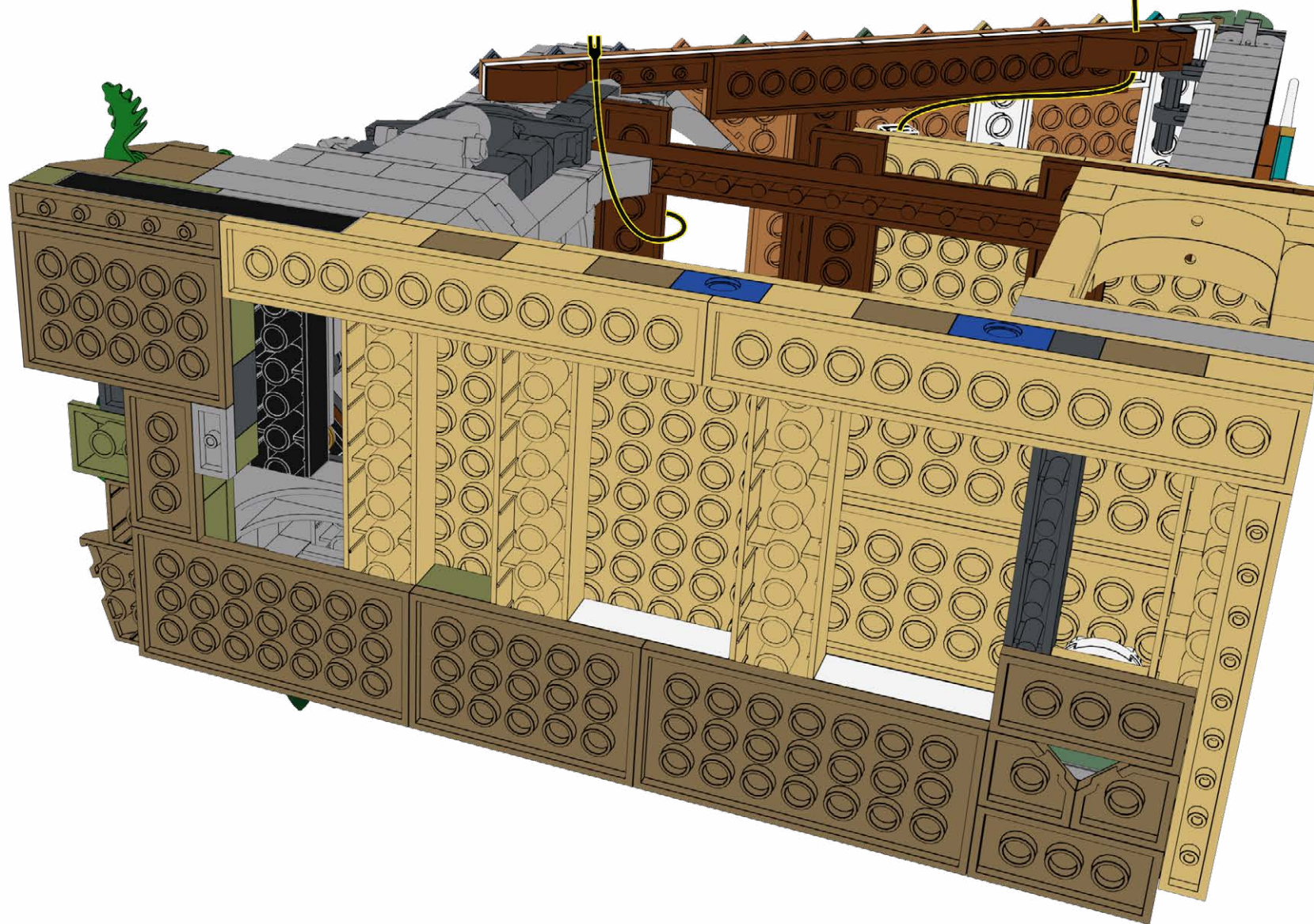
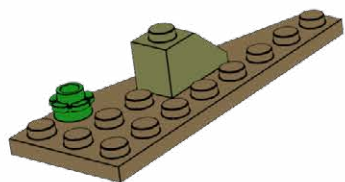

45

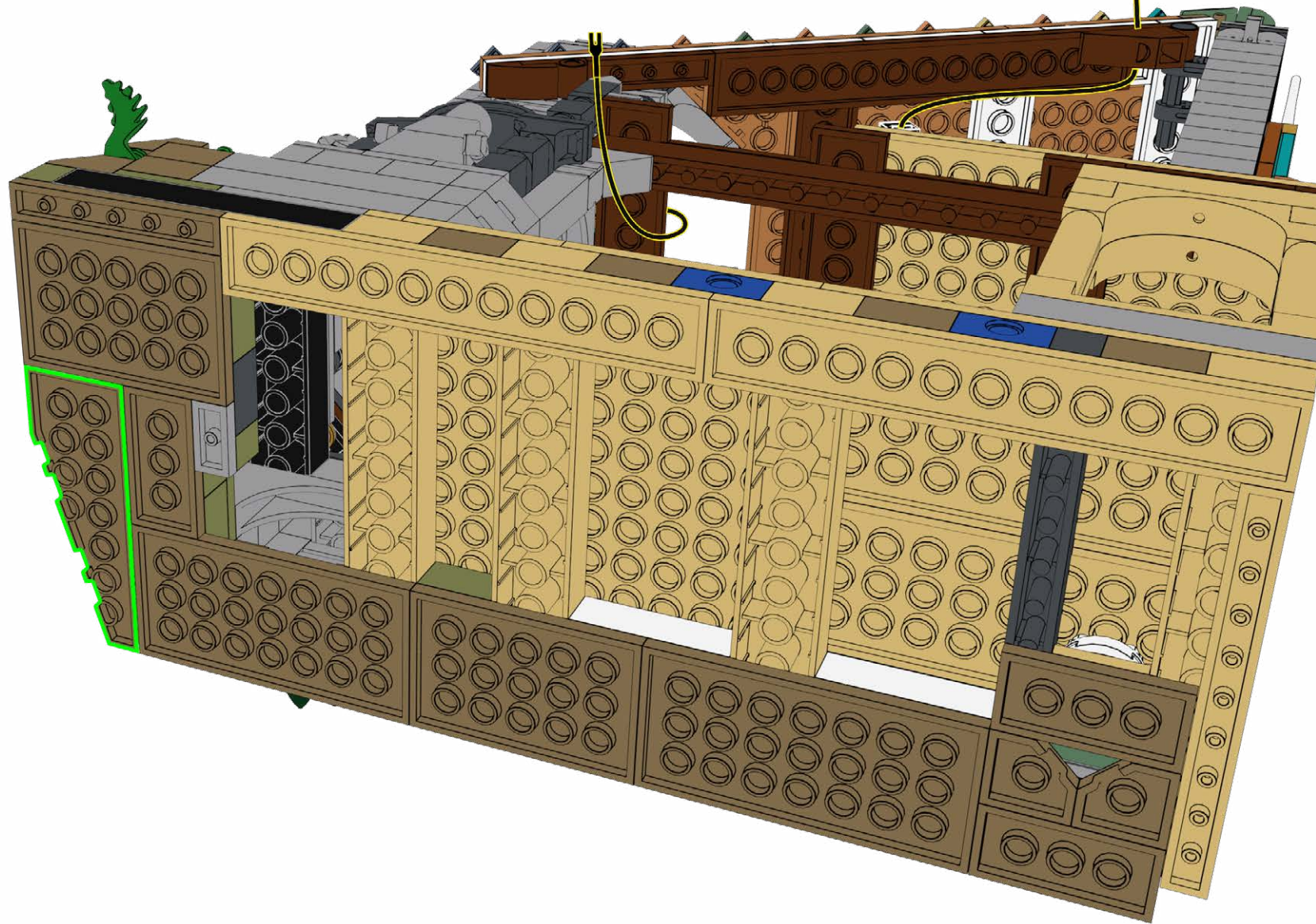

46



47

ML-WW

T-1x6



1x

1x

1

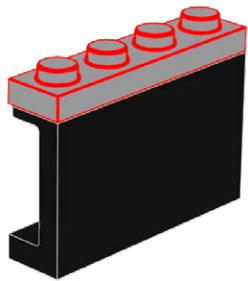

2

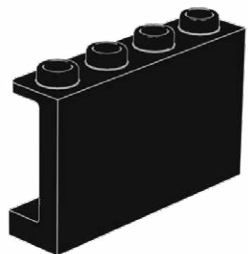
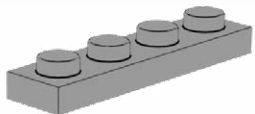

1

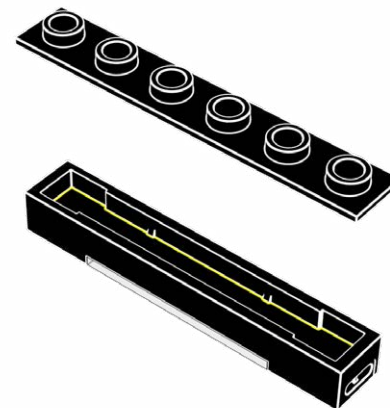

2

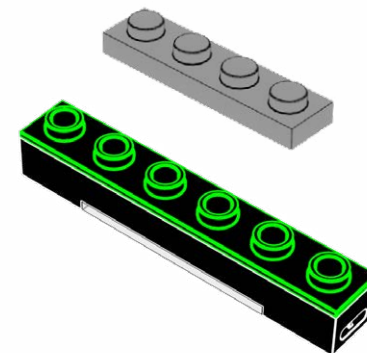

3

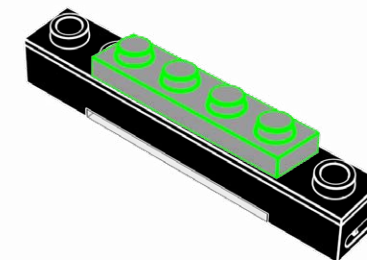

48

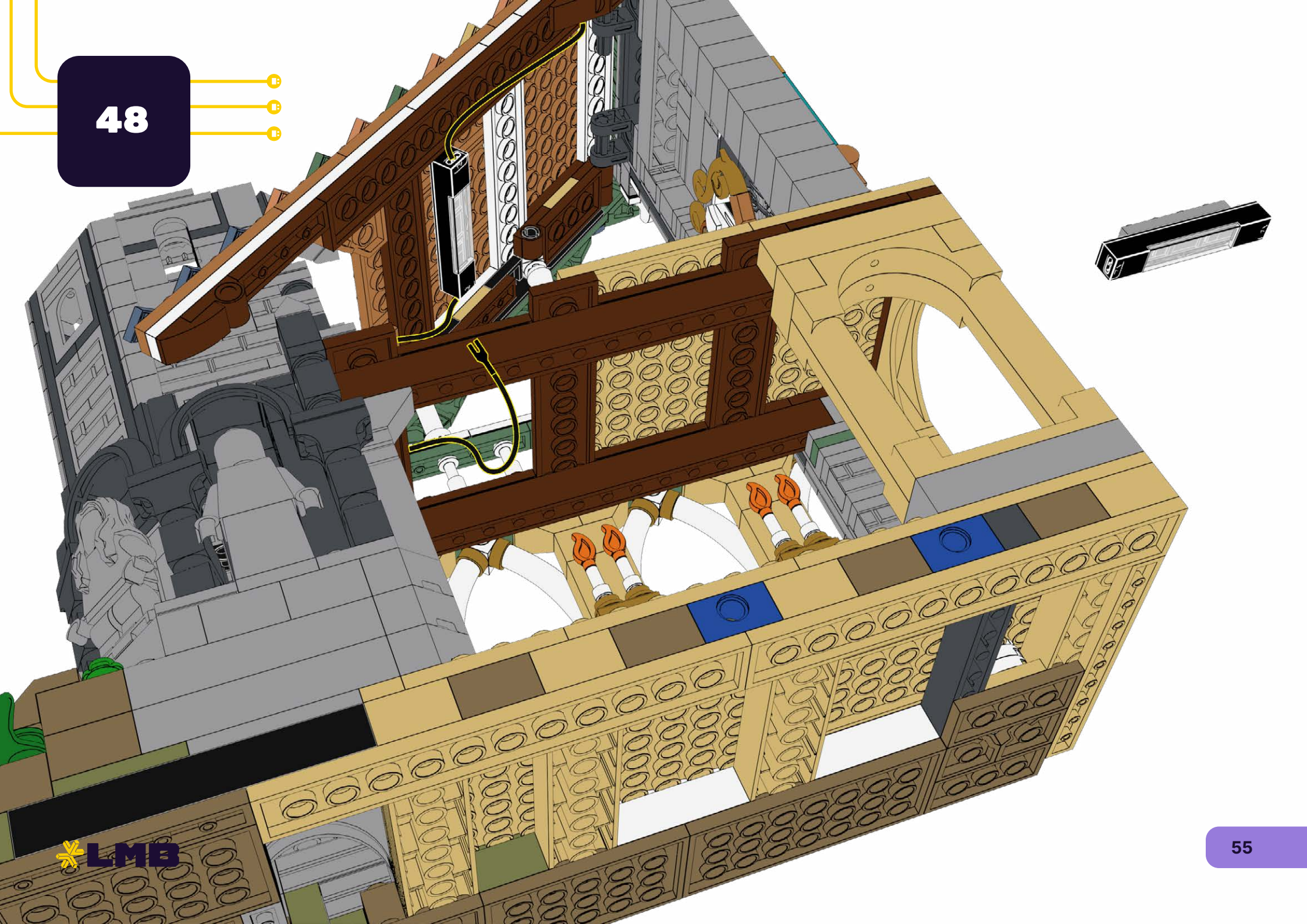

49

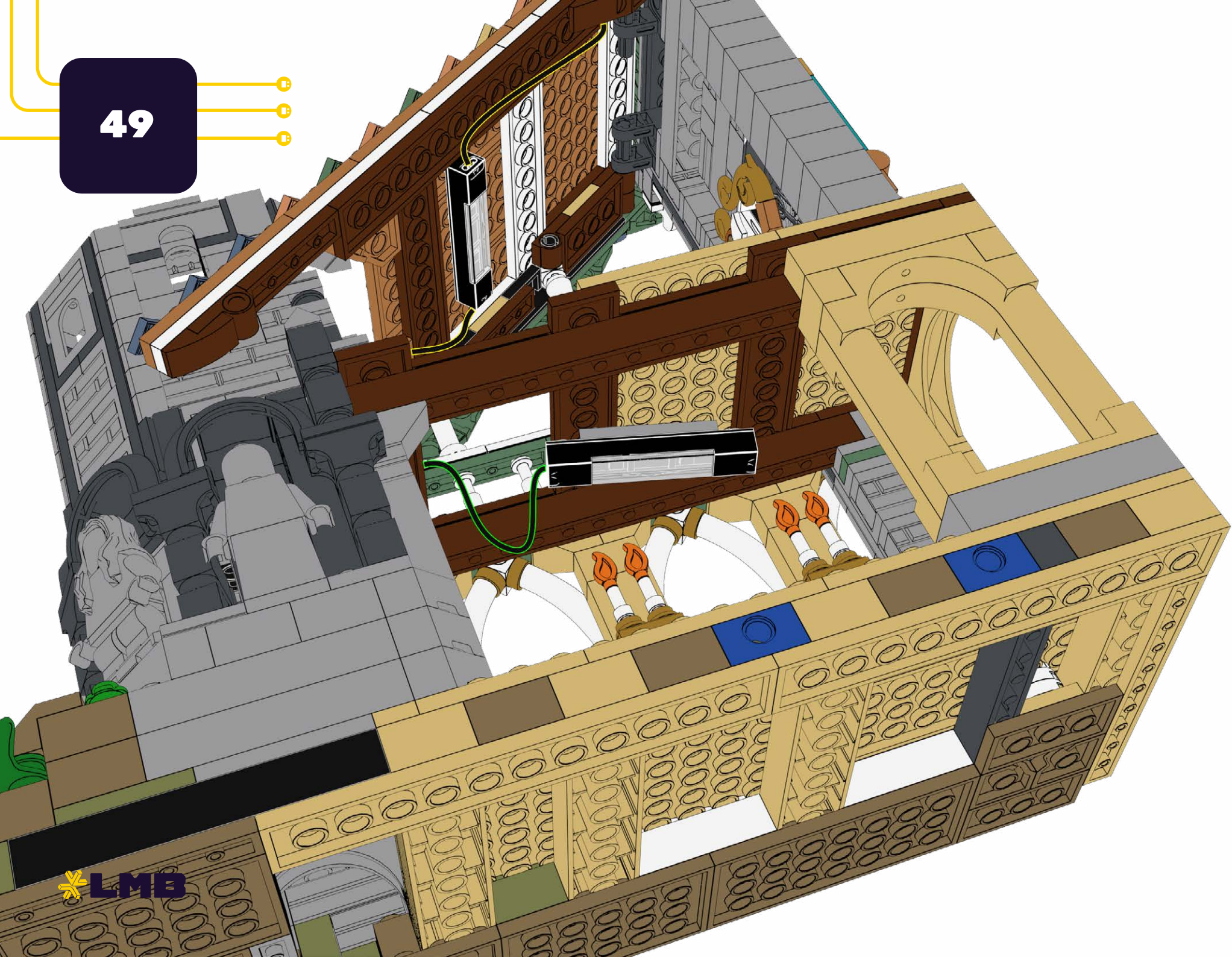

50

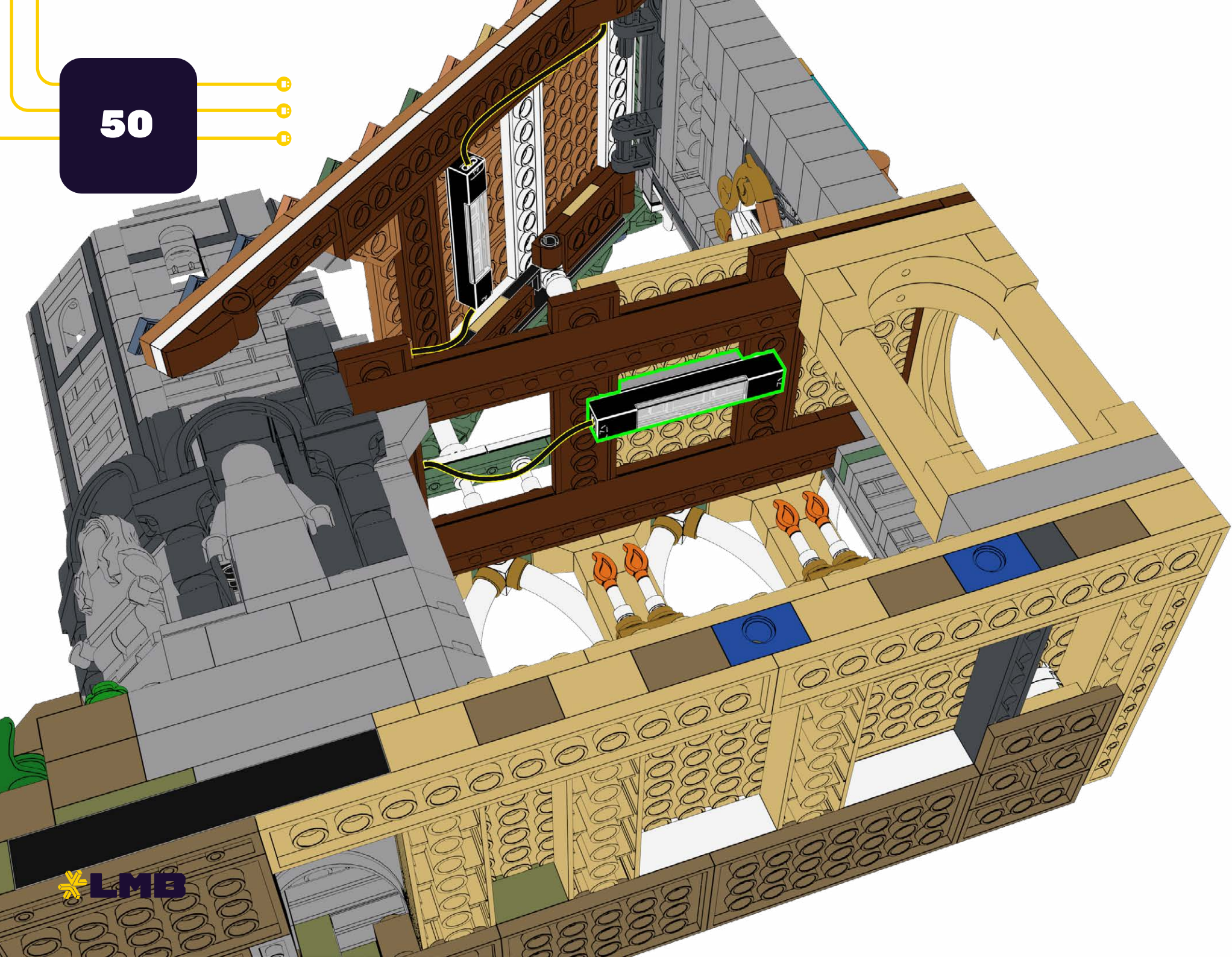

51

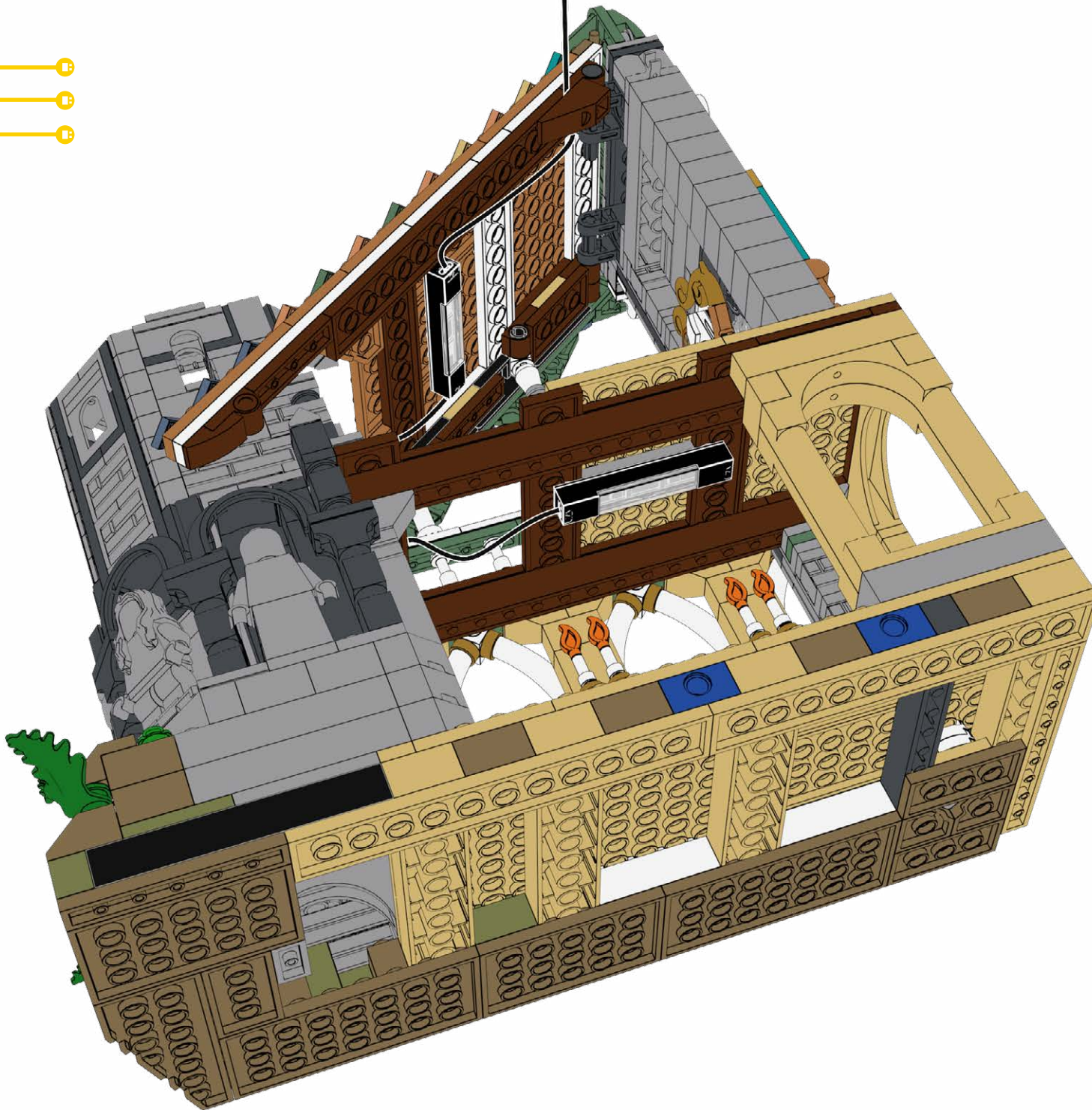

52

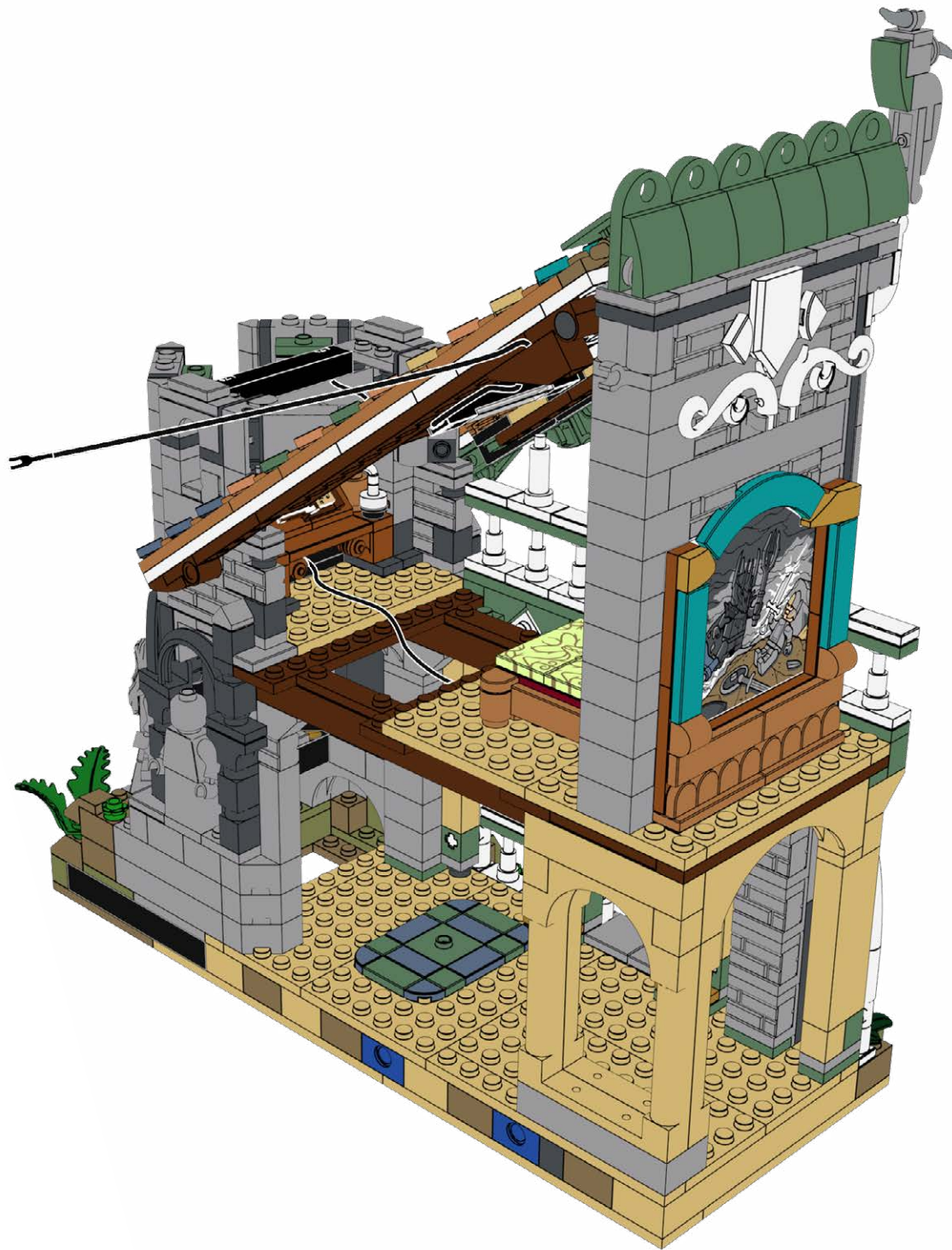

**HOLD UP!**

You might notice some bags are out of order, as well as left over pieces, but that's ok! We're changing the way you build LEGO!

HALTEN!

Möglicherweise stellen Sie fest, dass einige Beutel nicht in Ordnung sind und auch Teile übrig bleiben, aber das ist in Ordnung! Wir verändern die Art und Weise, wie Sie LEGO bauen!

TENIR BON!

Vous remarquerez peut-être que certains sacs sont en panne, ainsi que des morceaux restants, mais ce n'est pas grave ! Nous changeons la façon dont vous construisez LEGO !

SOSTENERE!

Potresti notare che alcune borse sono fuori uso, così come alcuni pezzi avanzati, ma va bene! Stiamo cambiando il modo in cui costruisci i LEGO!

¡SOSTENER!

Puede que notes que algunas bolsas están fuera de orden, así como piezas sobrantes, ¡pero está bien! ¡Estamos cambiando la forma de construir LEGO!

耽误!

您可能会注意到有些袋子坏了, 还有剩余的碎片, 但这没关系! 我们正在改变您搭建乐高的方式!

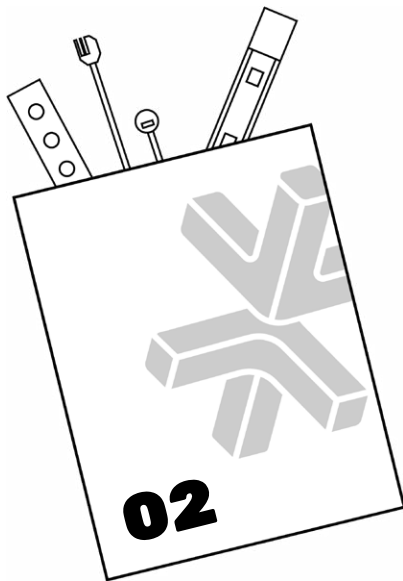
Open LMB Bag 02

53

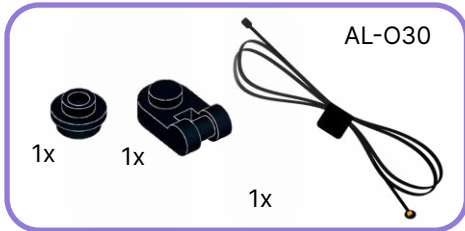

1

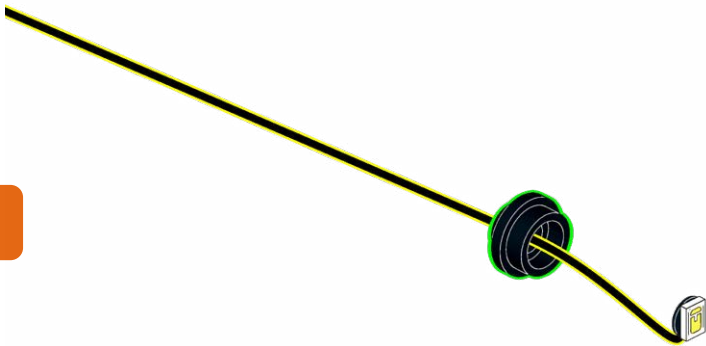

2

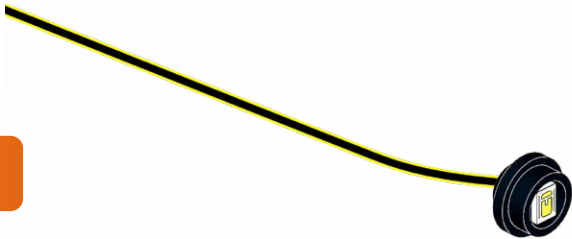

3

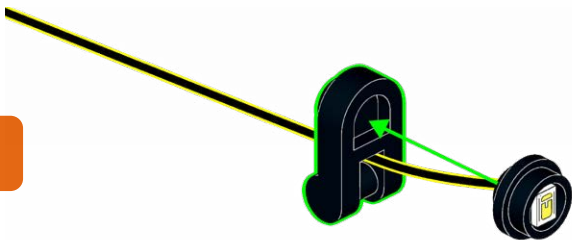

54

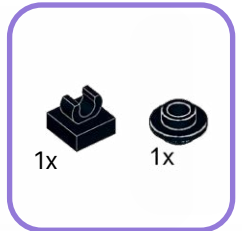

1

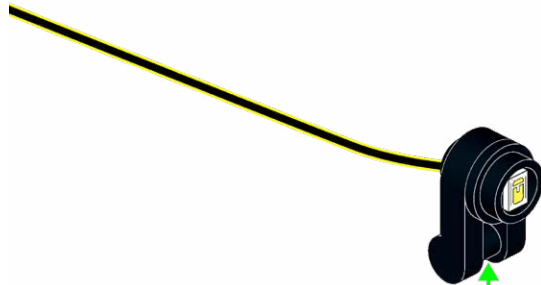

2

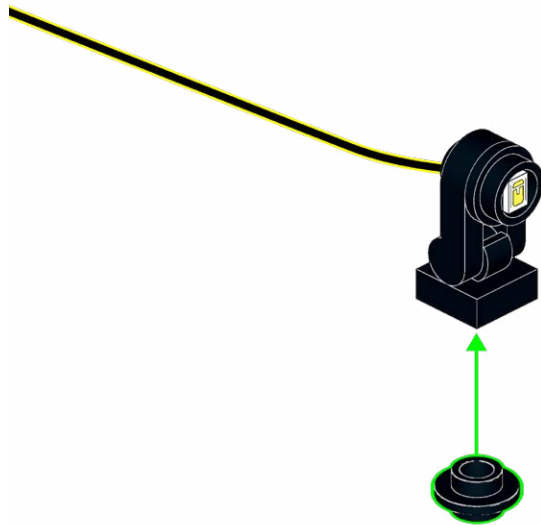

55

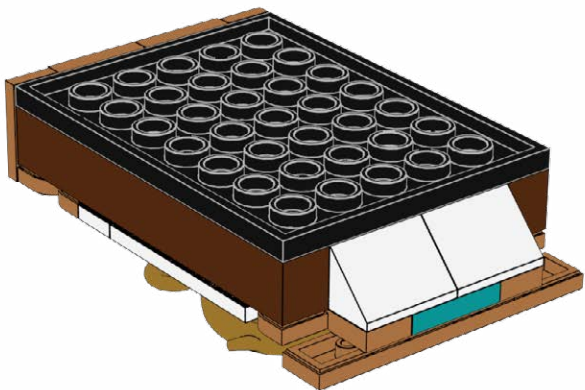

56

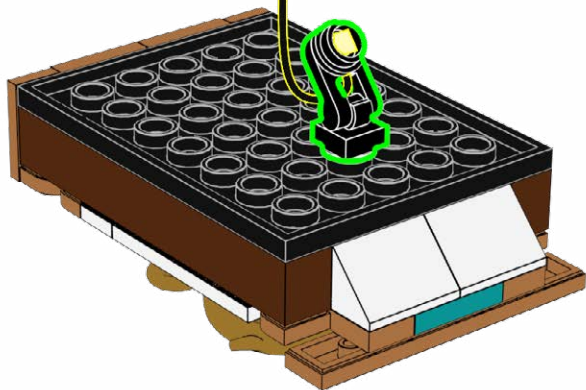
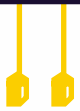

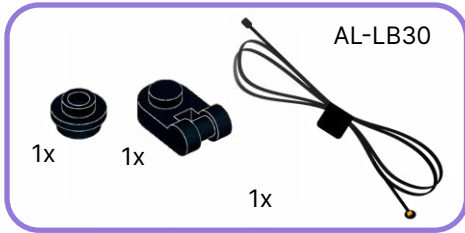

1

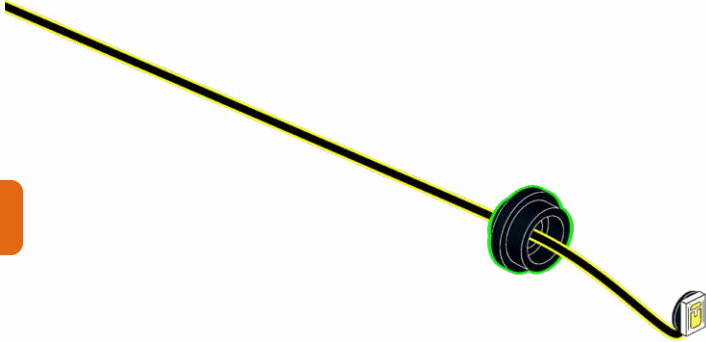

2

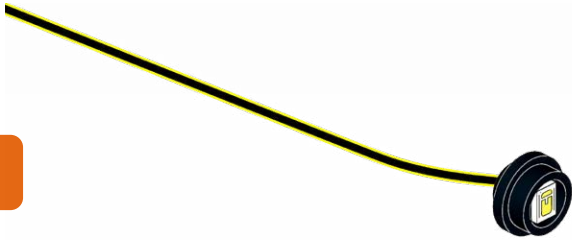

3

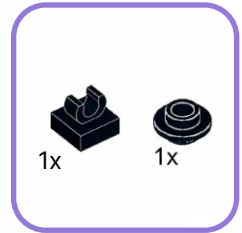
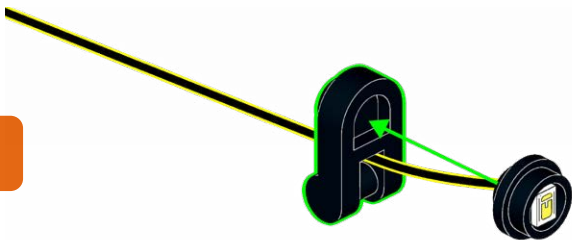

1

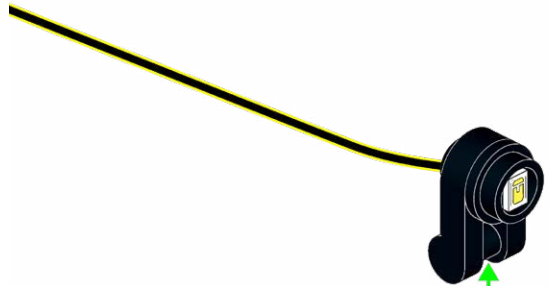

2

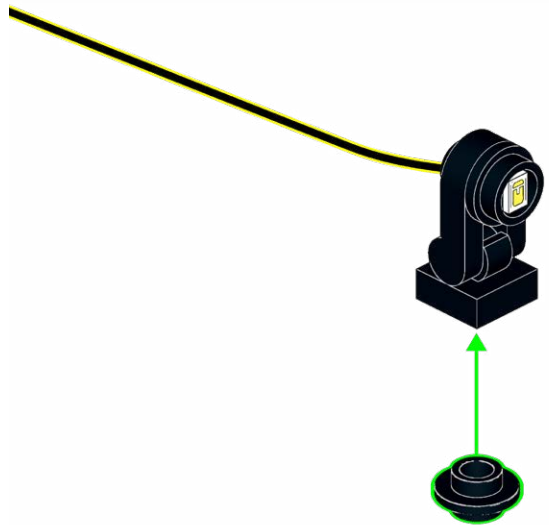

59

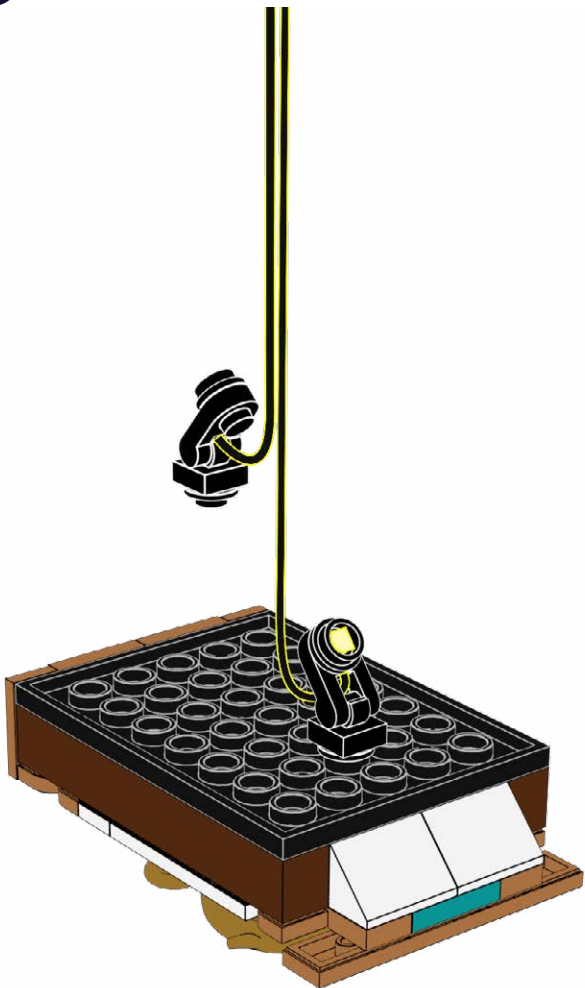

60

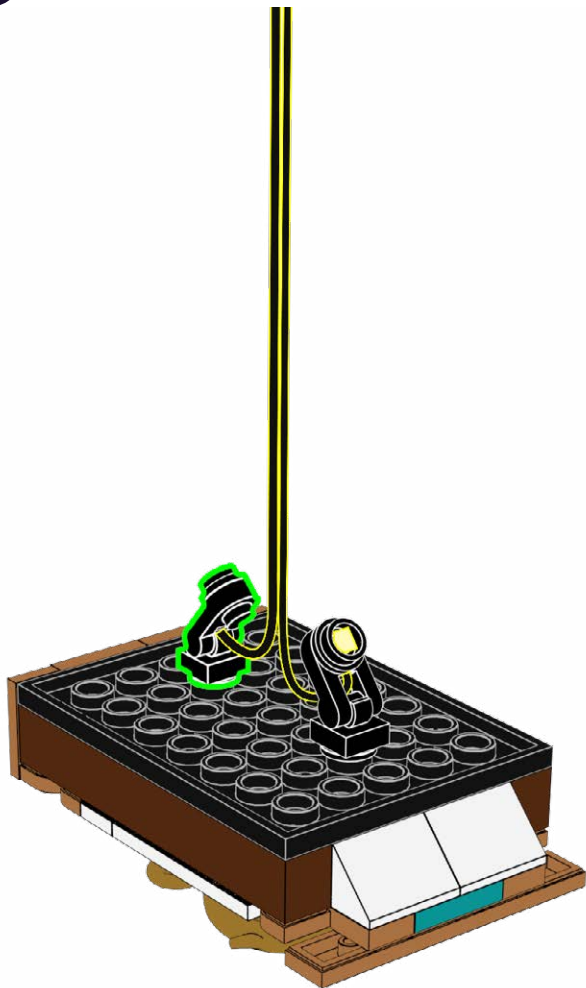

61

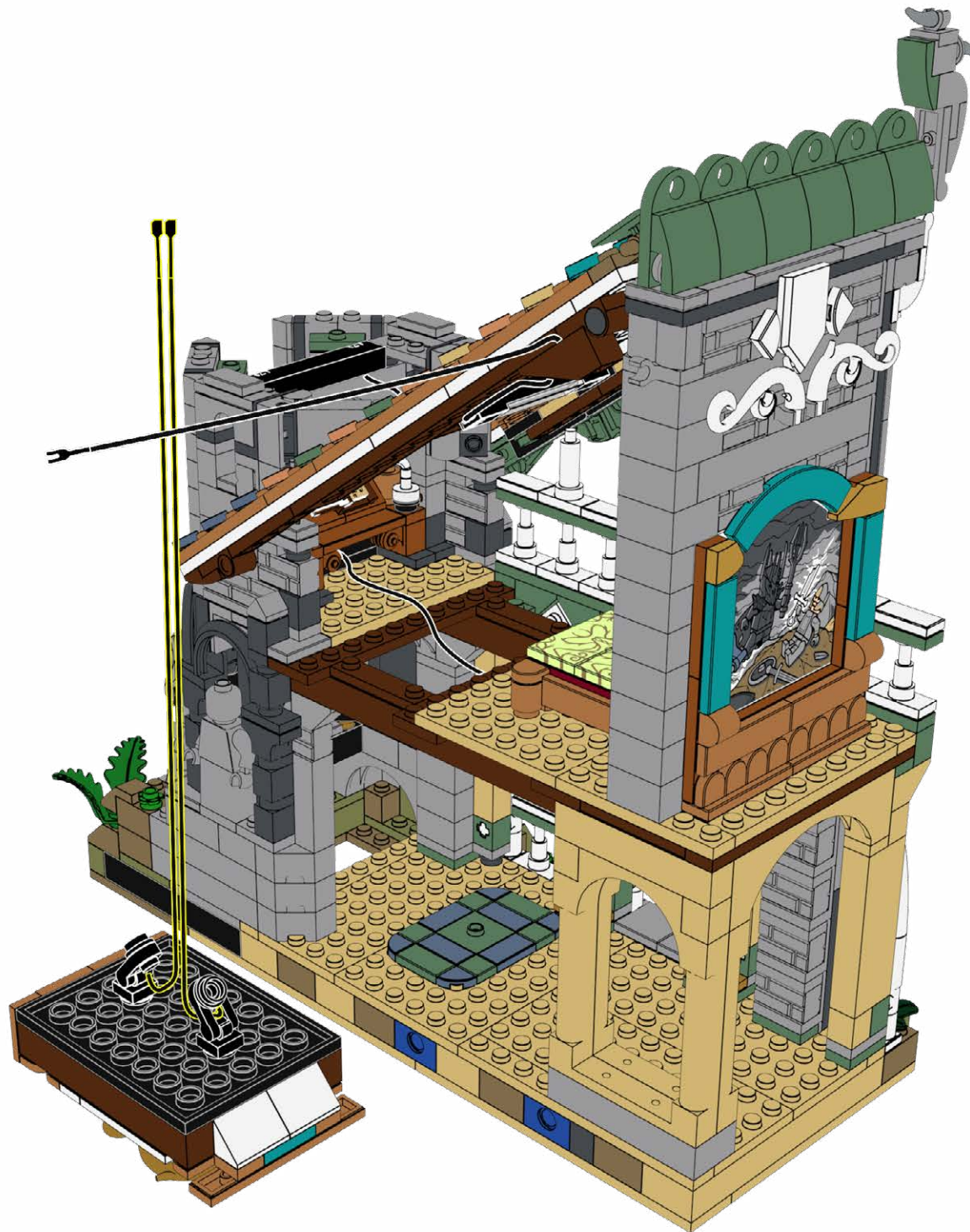

62

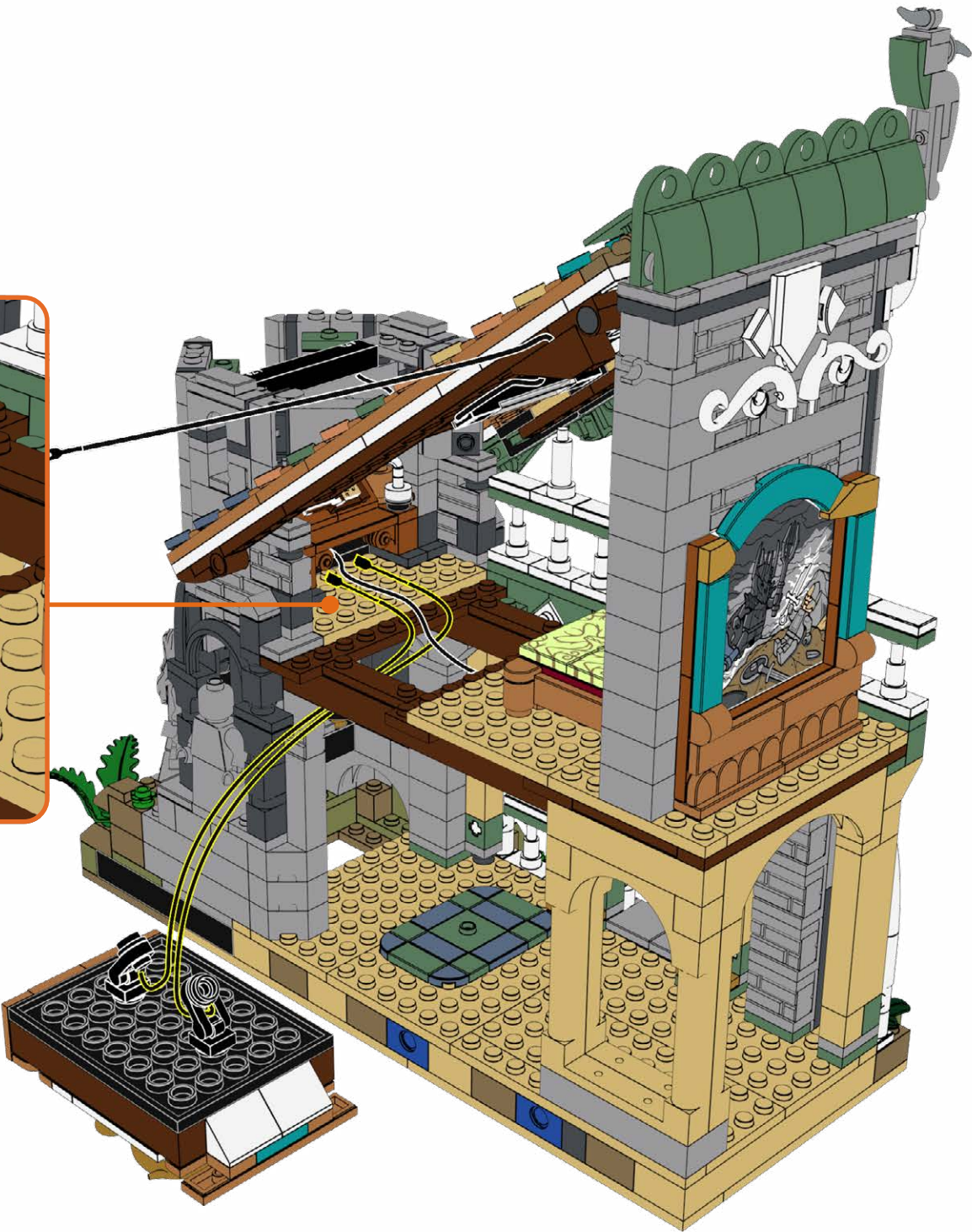
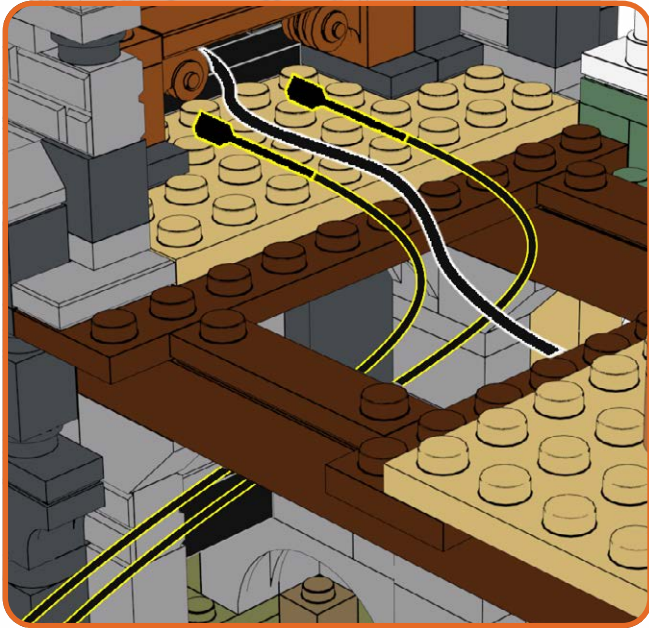

63

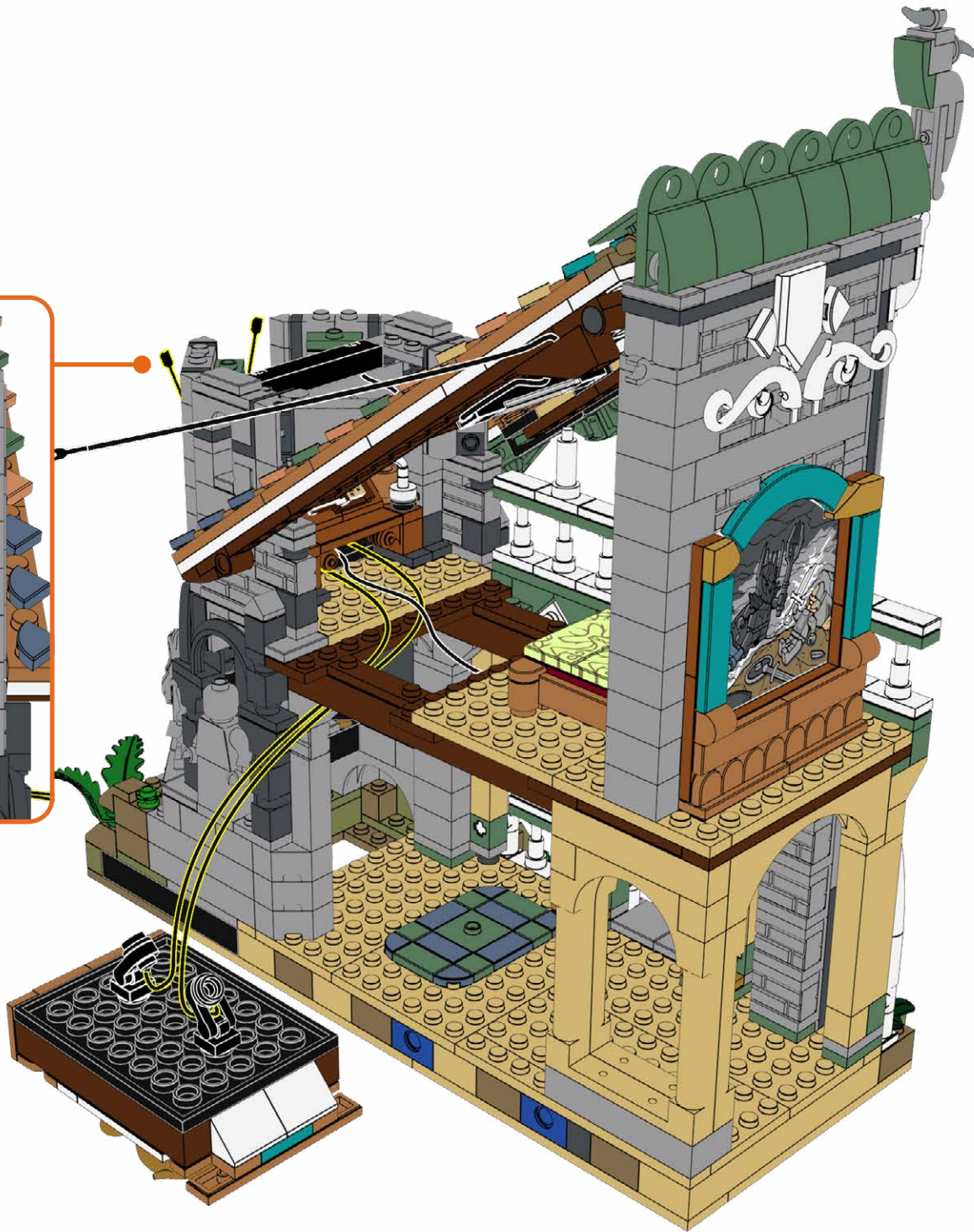

64

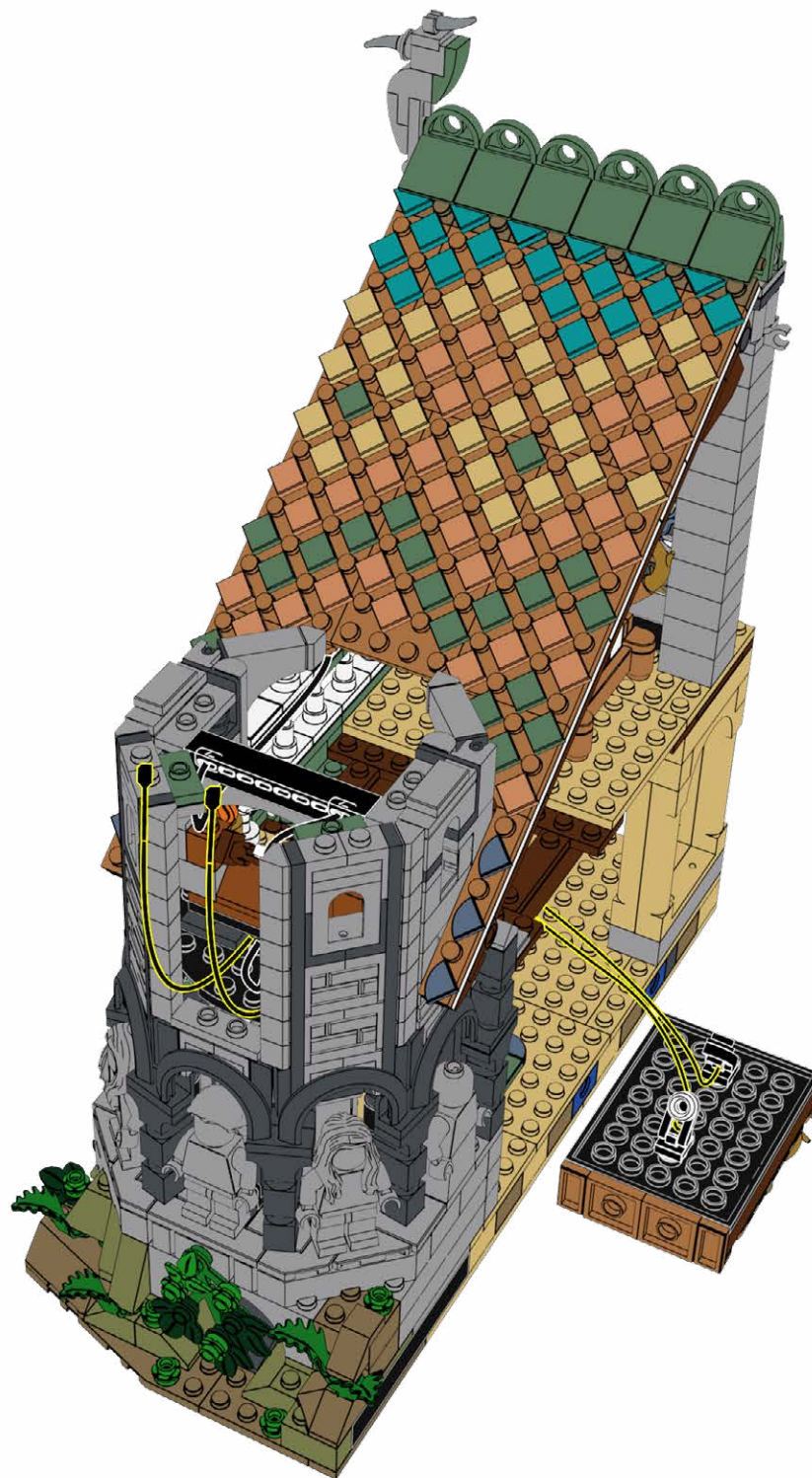

65

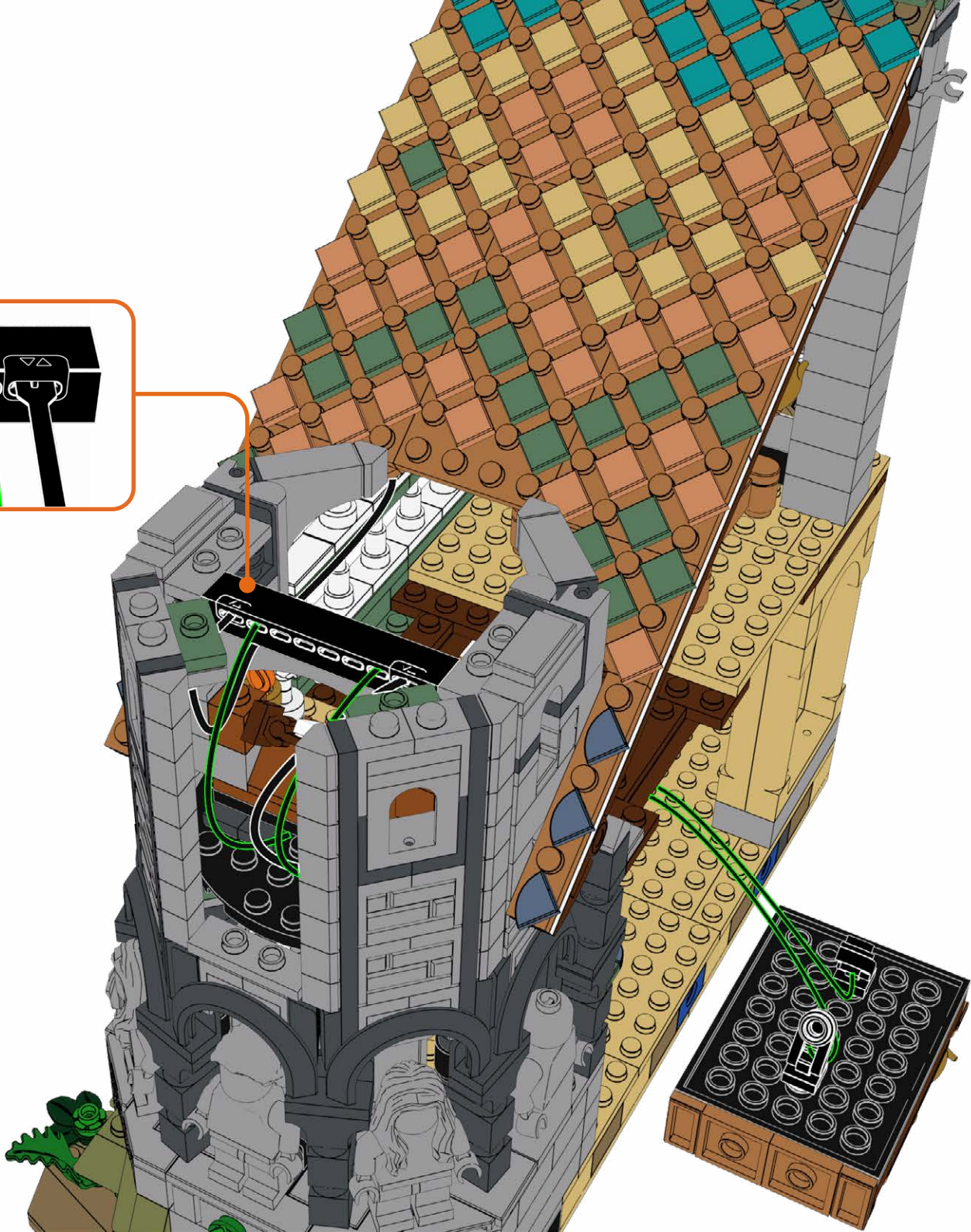
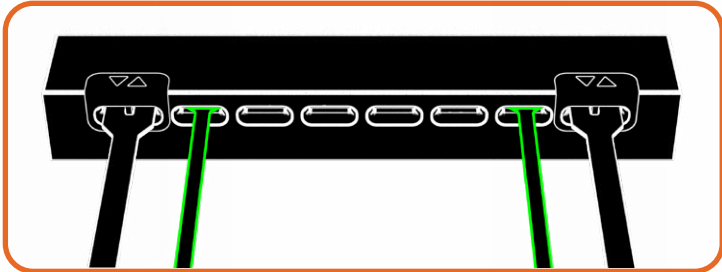

66

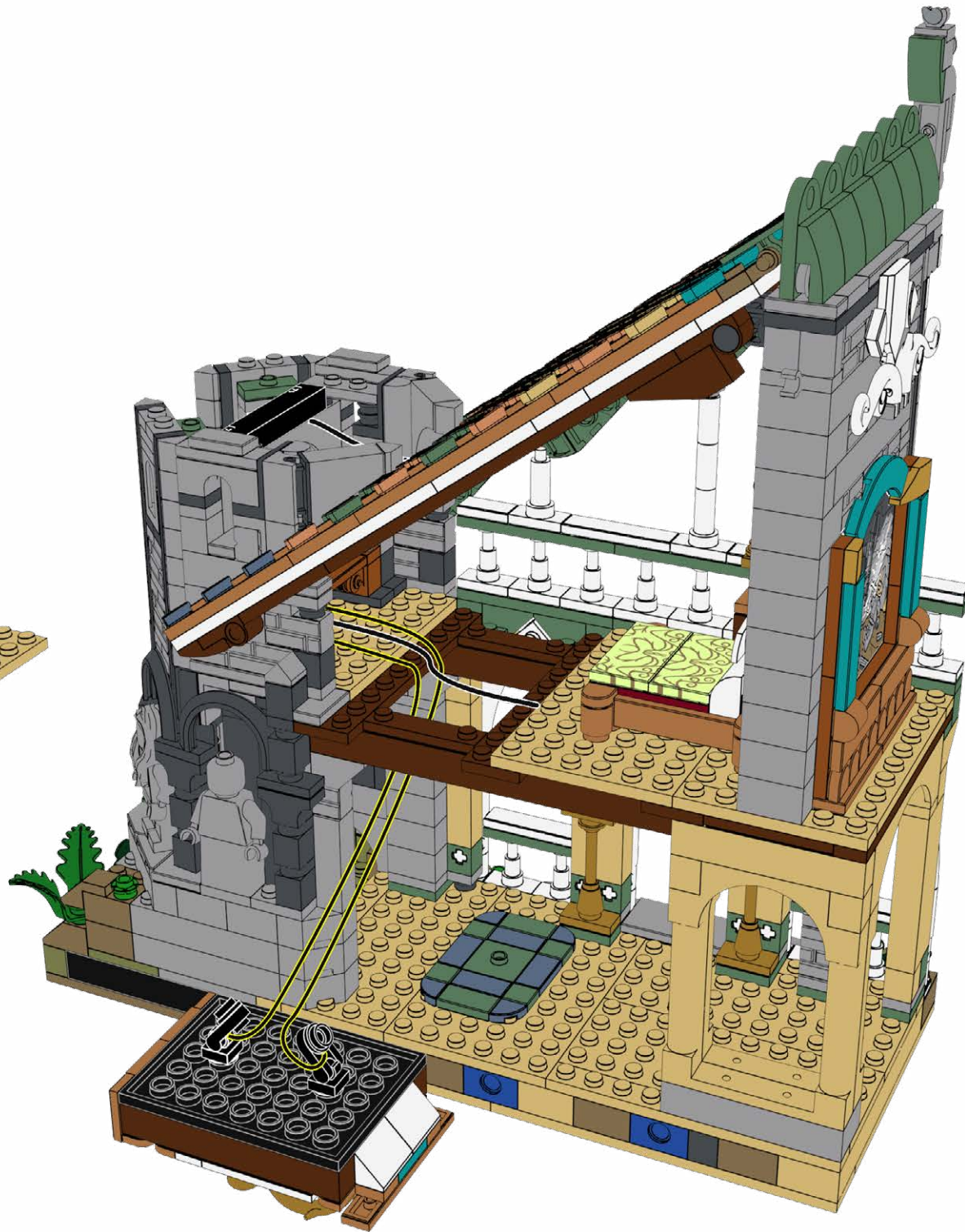

67

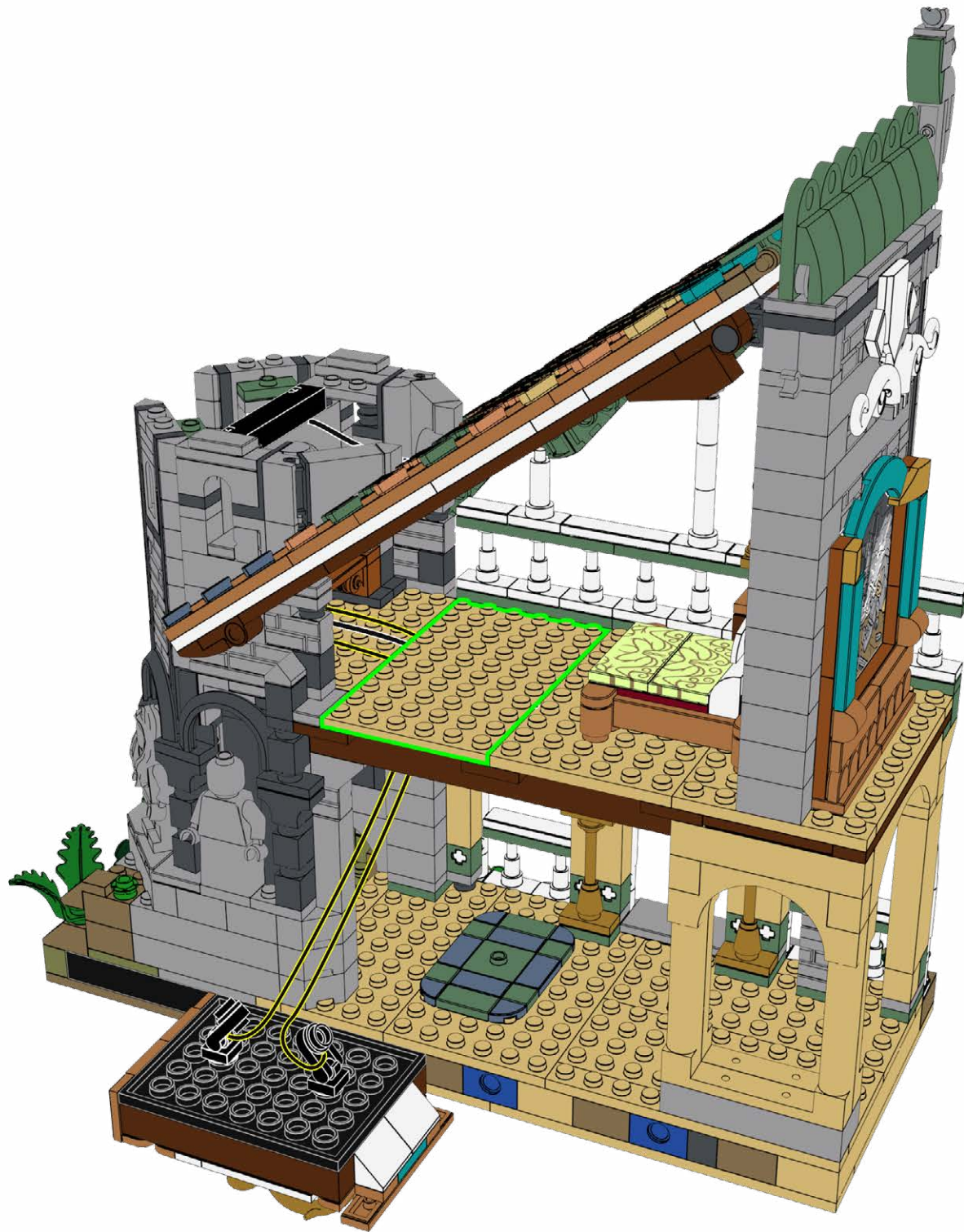

68



69



70



71



72



73

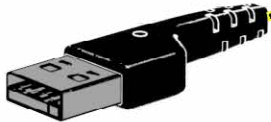

74



75



76

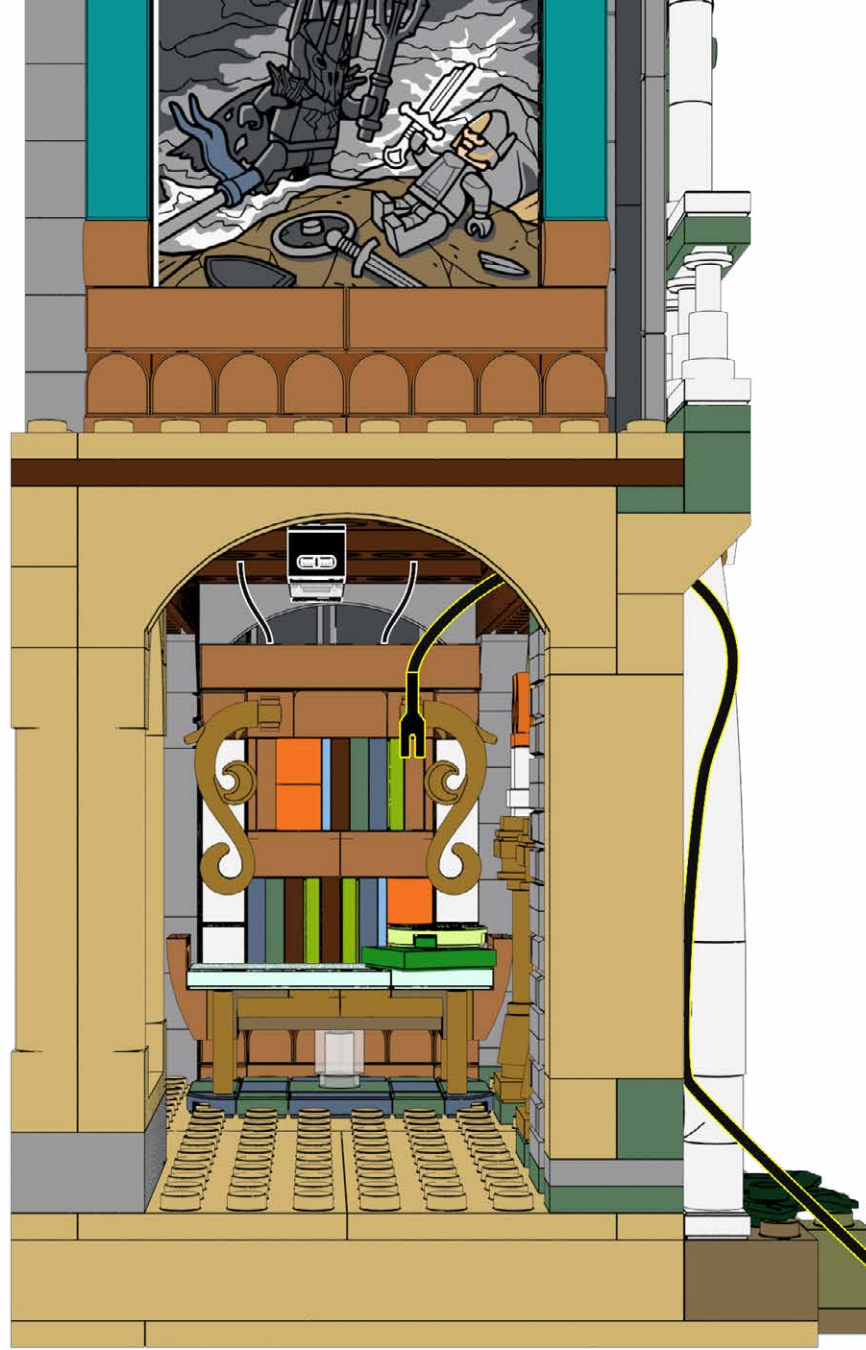

77

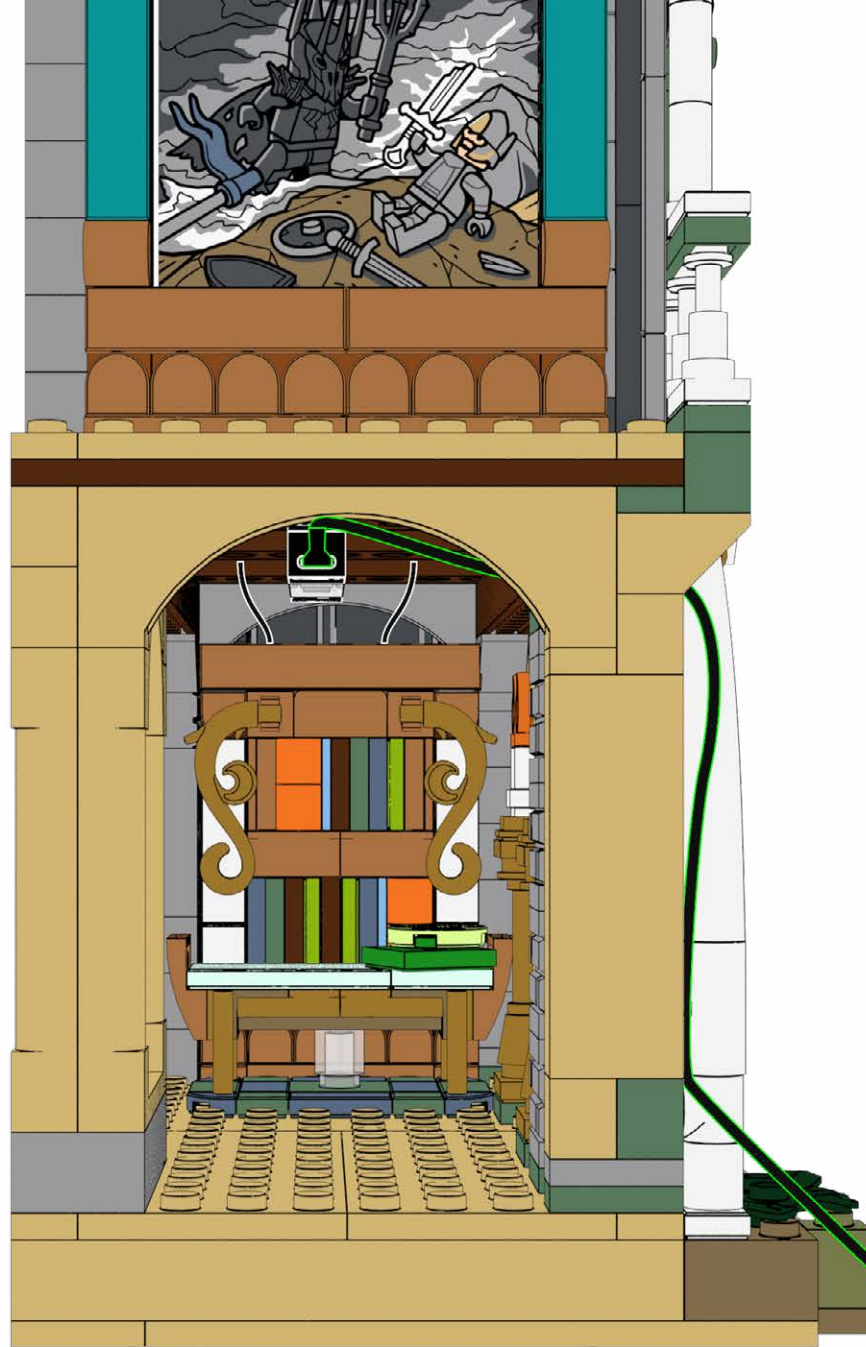

78



79

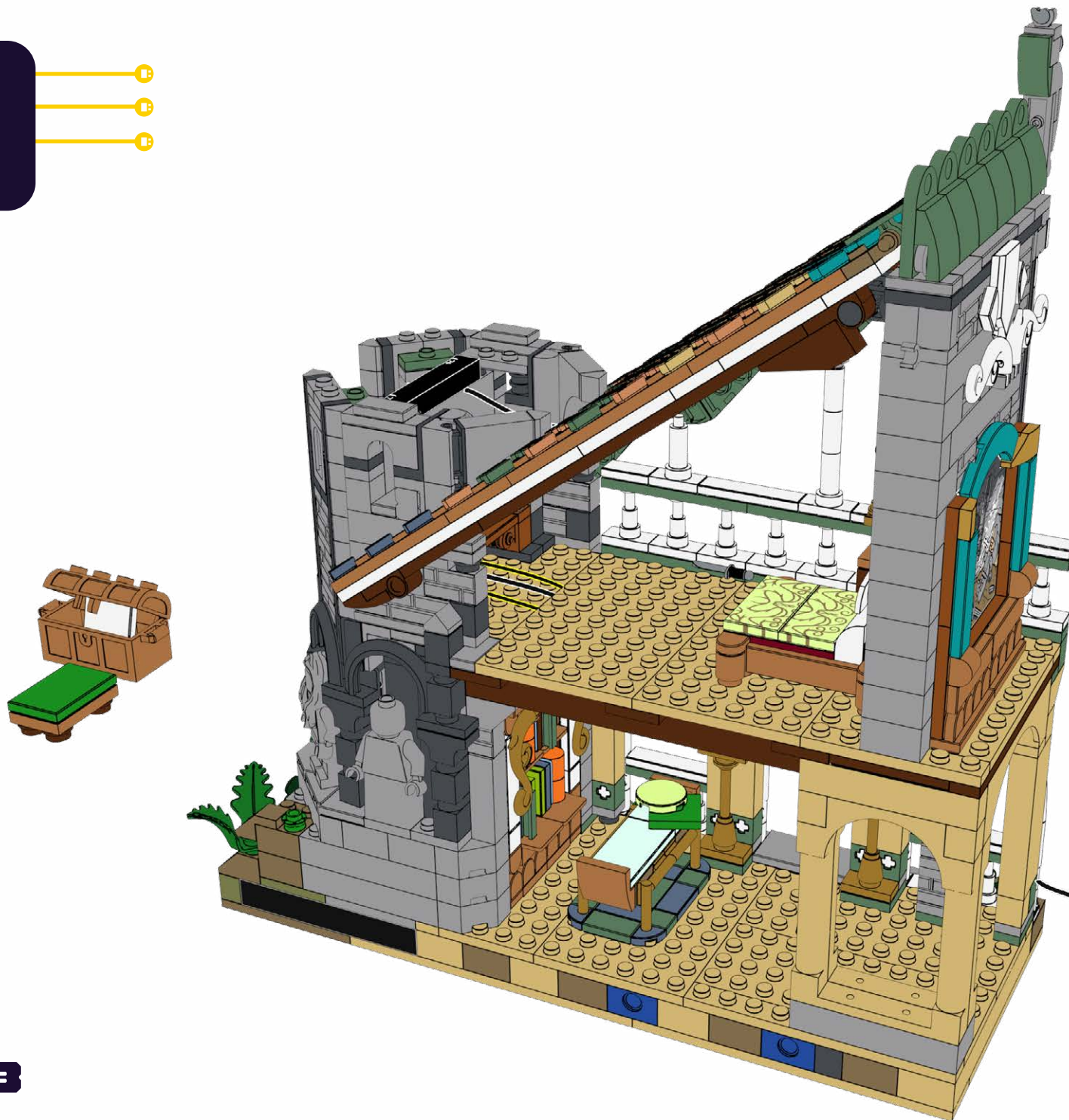

80

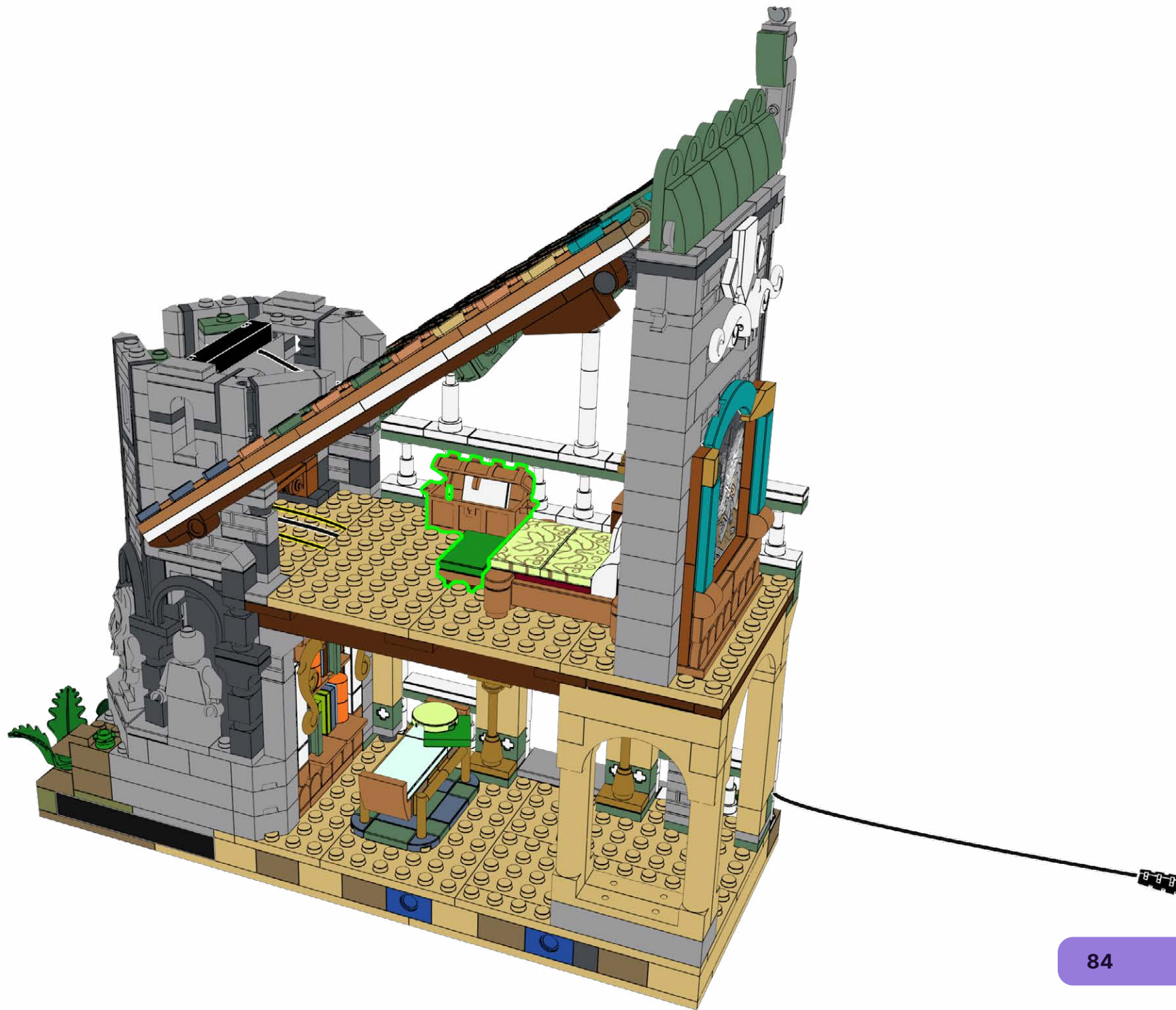

81

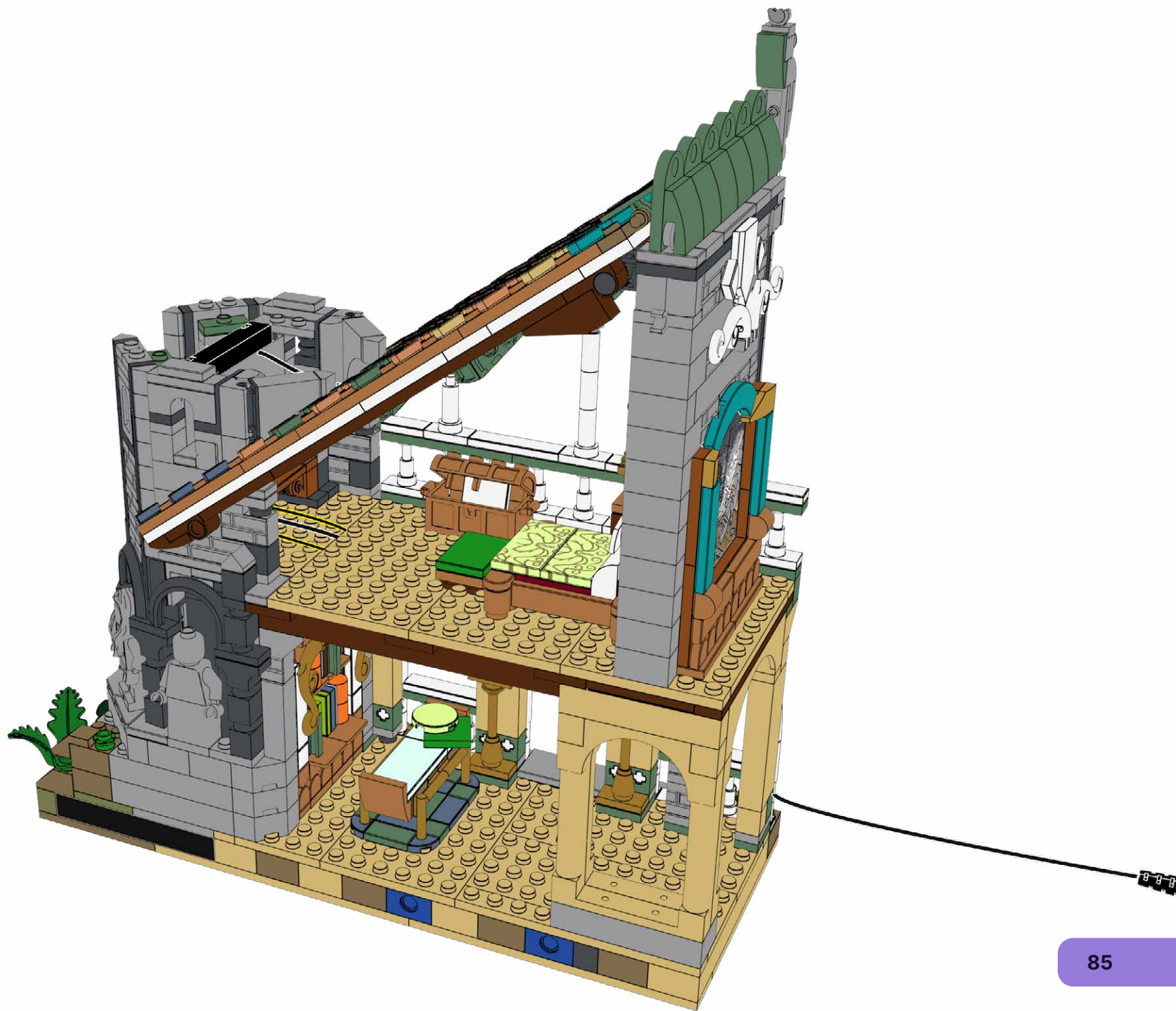

82

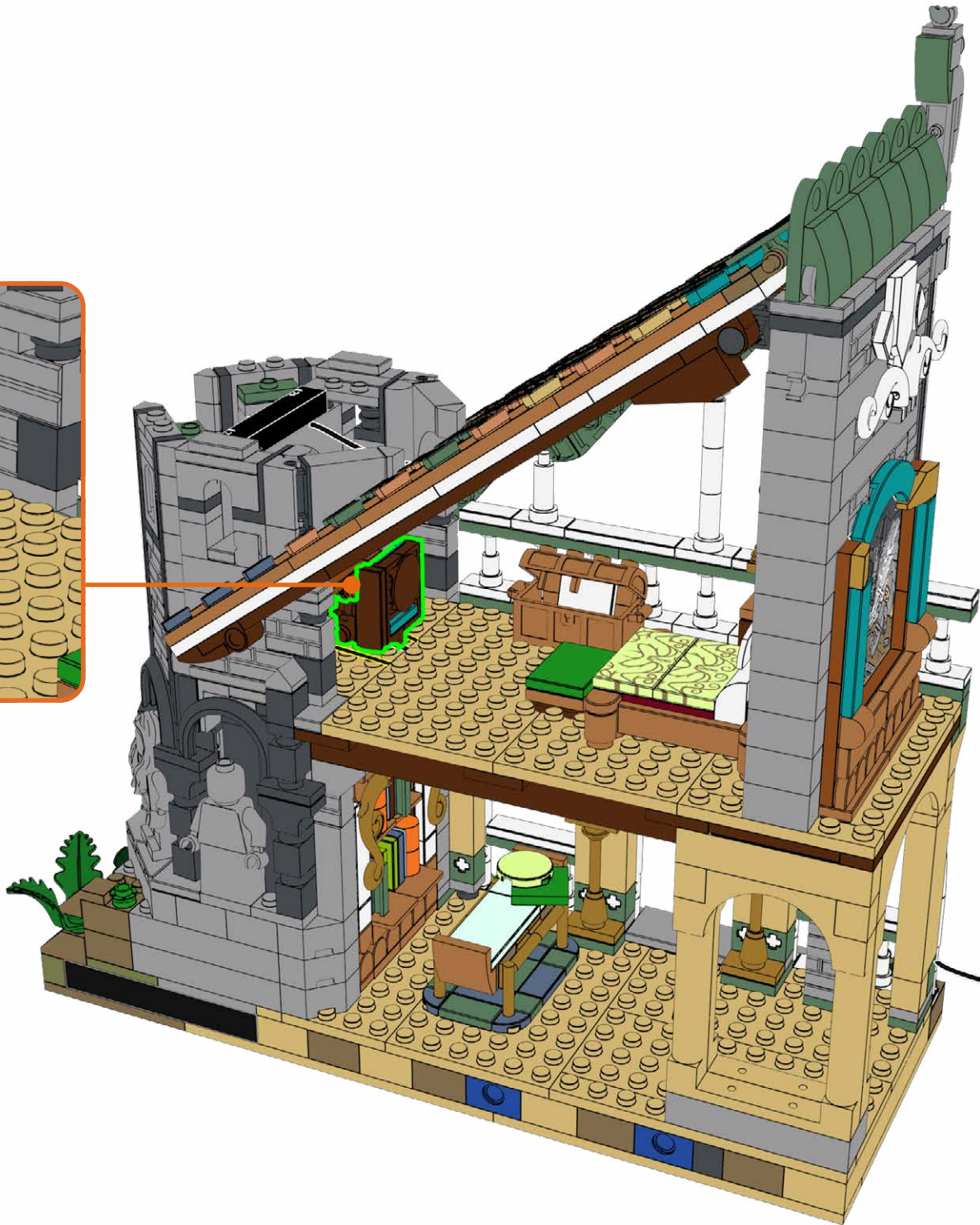
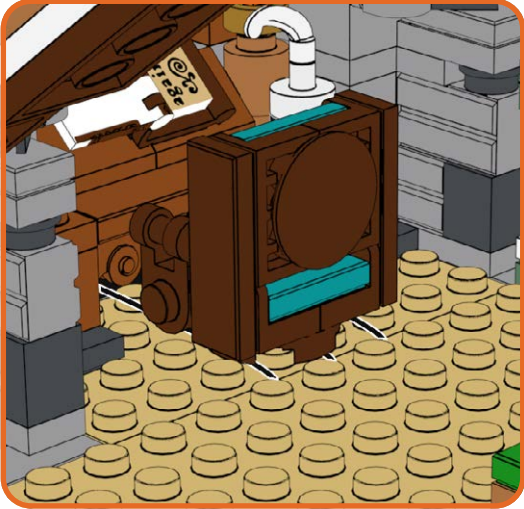

83

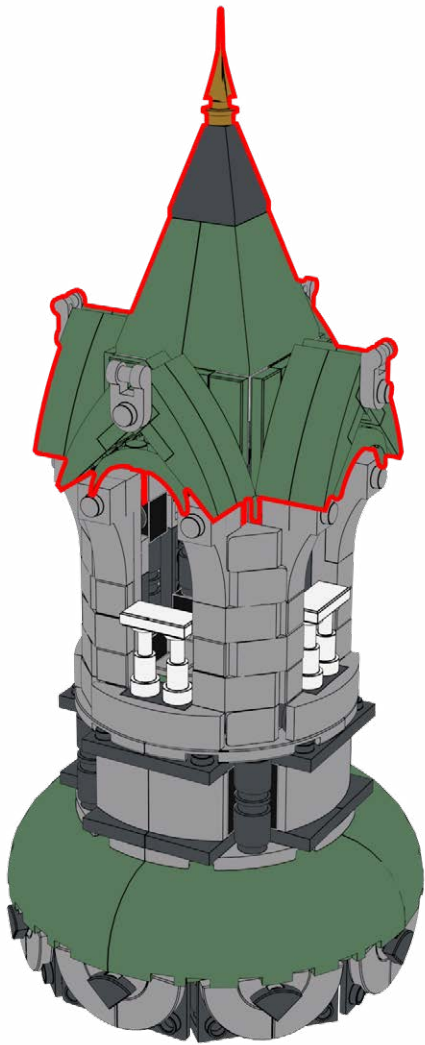

84

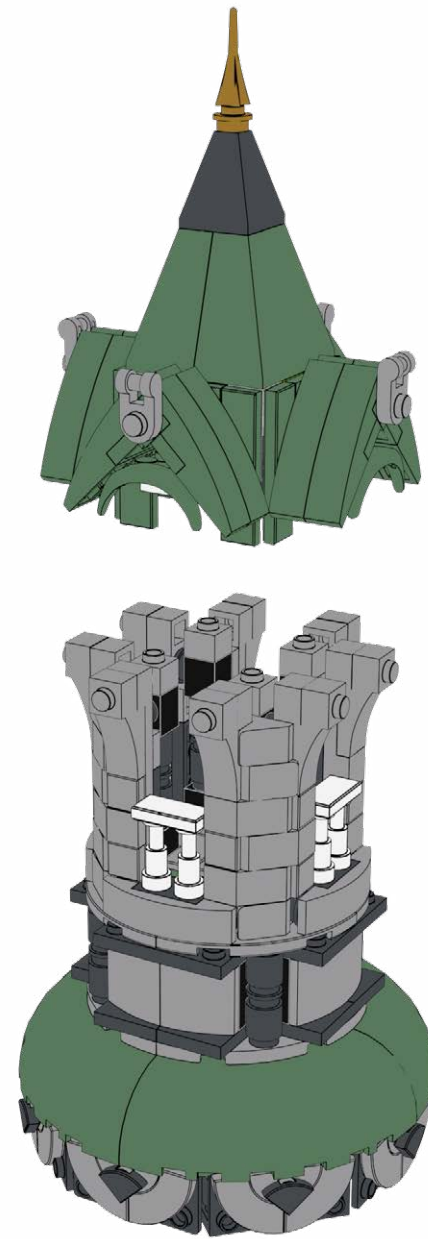

85

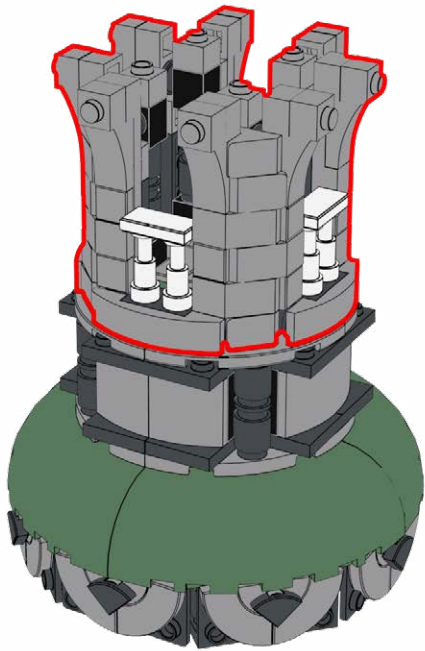

86

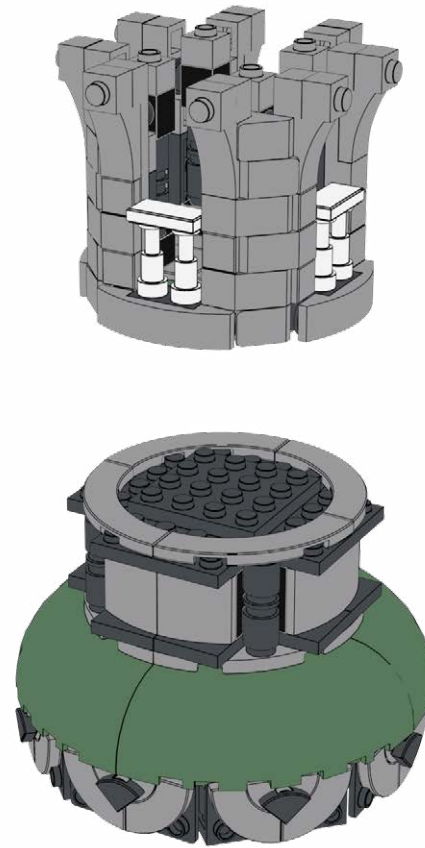

87

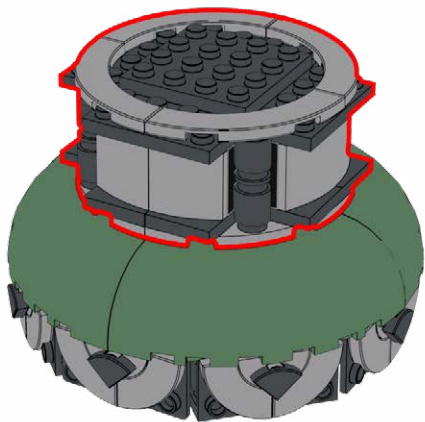

88

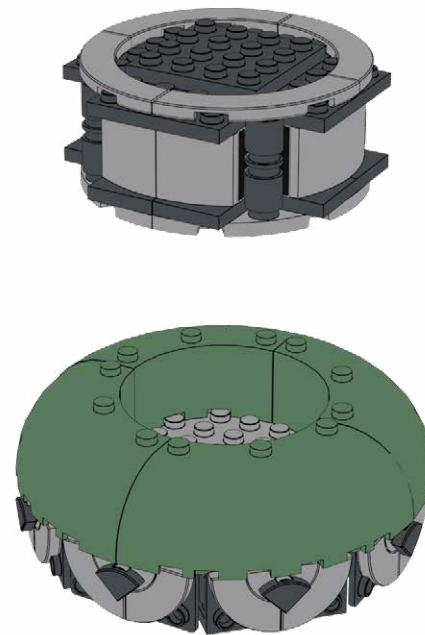

89

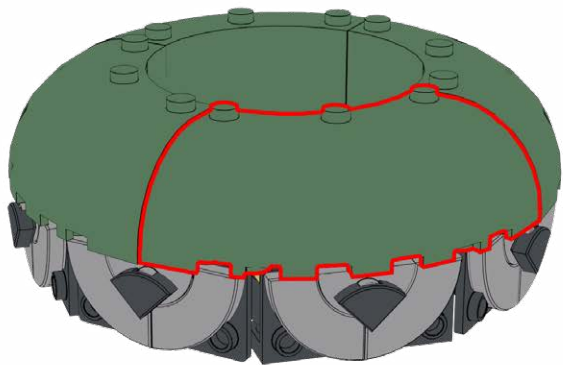

90

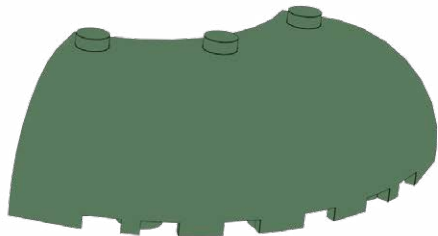
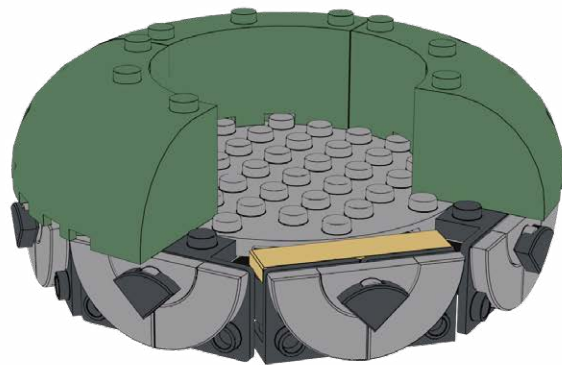

91

AL-WW30

1x

1x

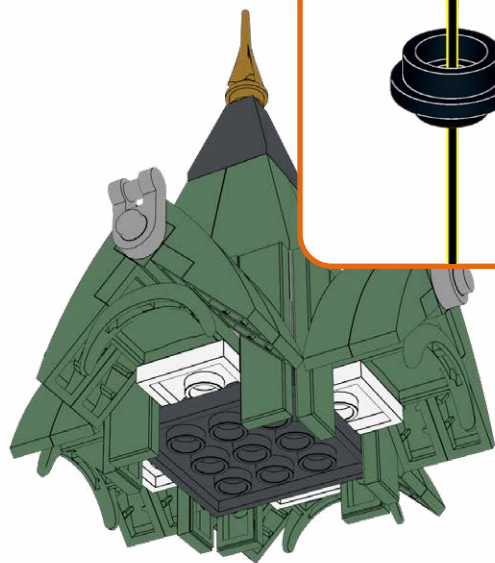
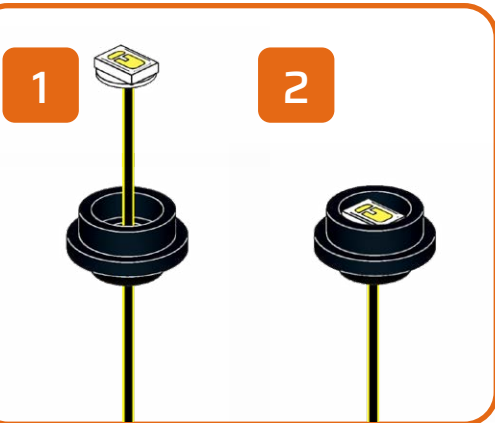

92

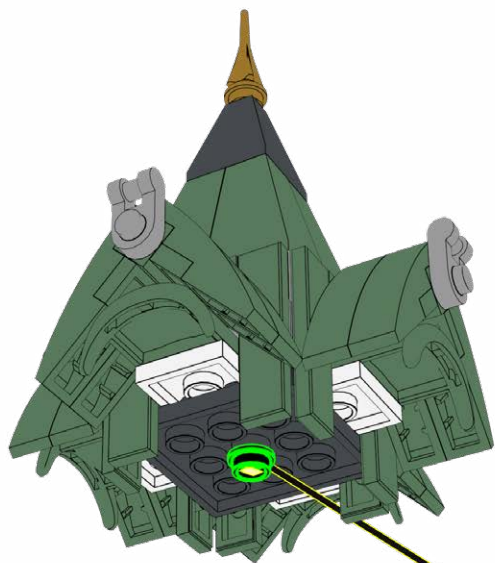

93

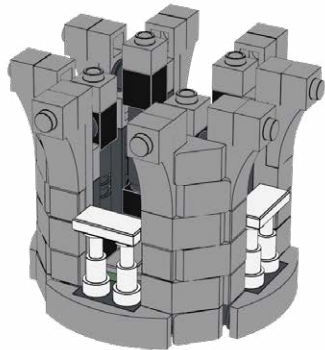
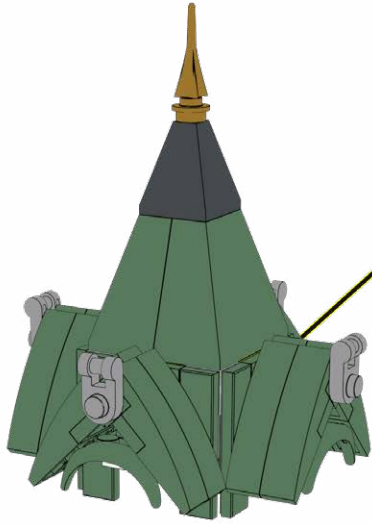

94

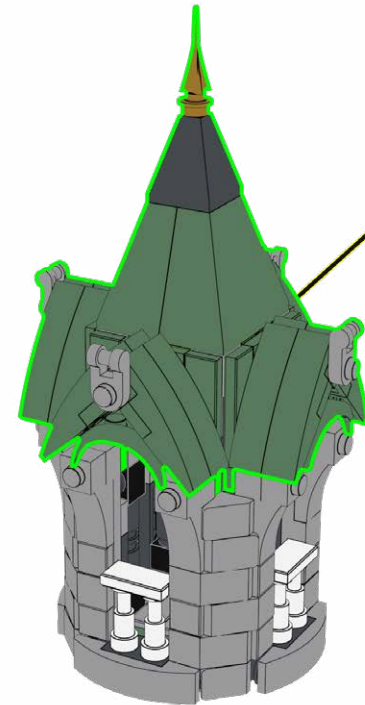

95

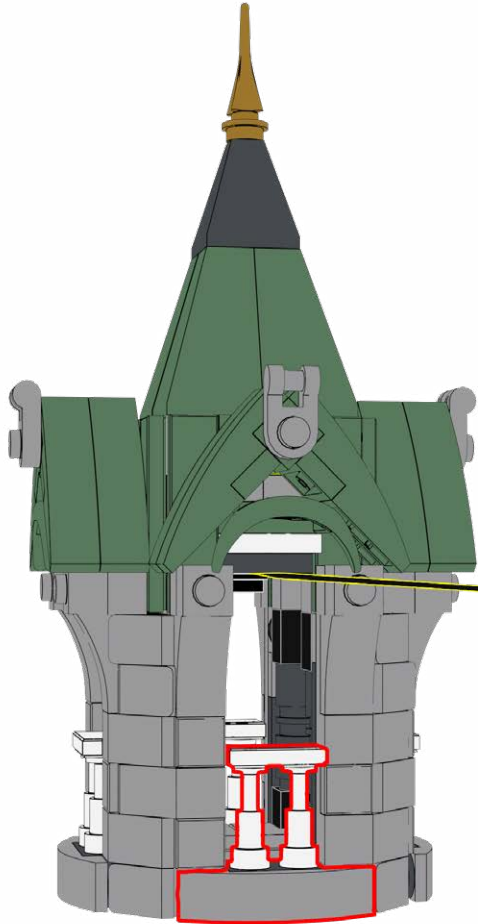

96

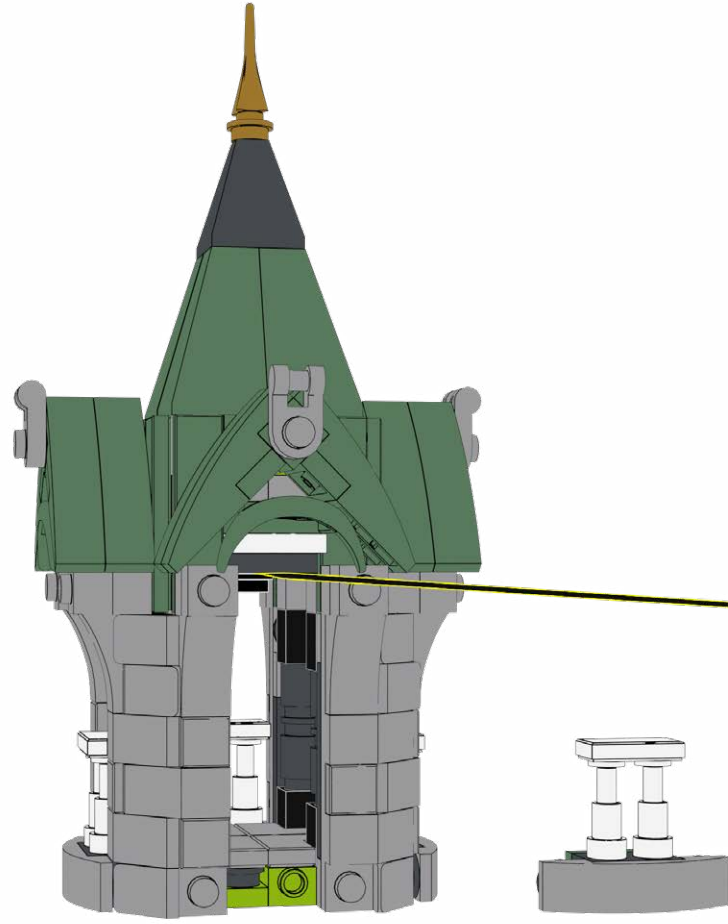

97

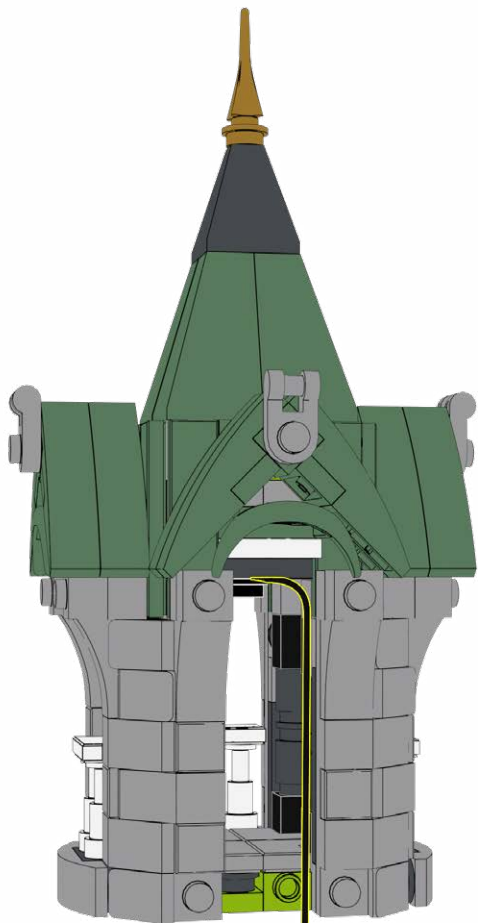

98

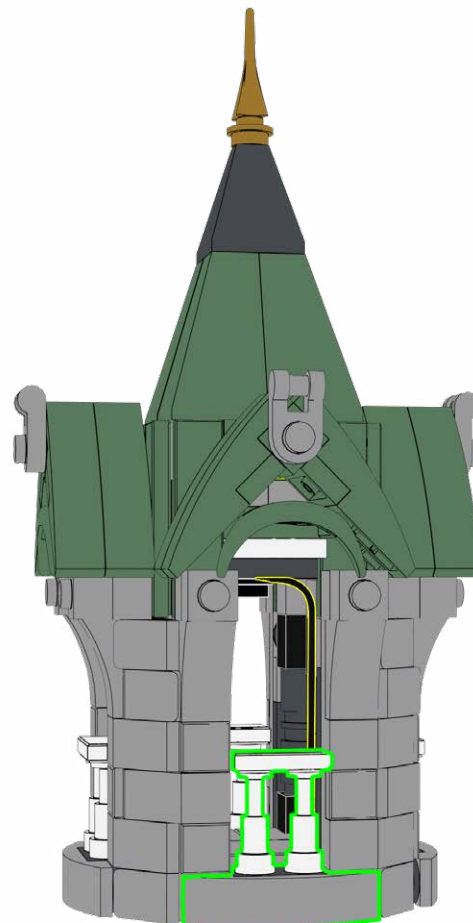
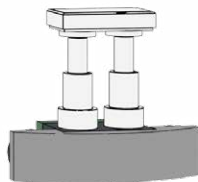

99

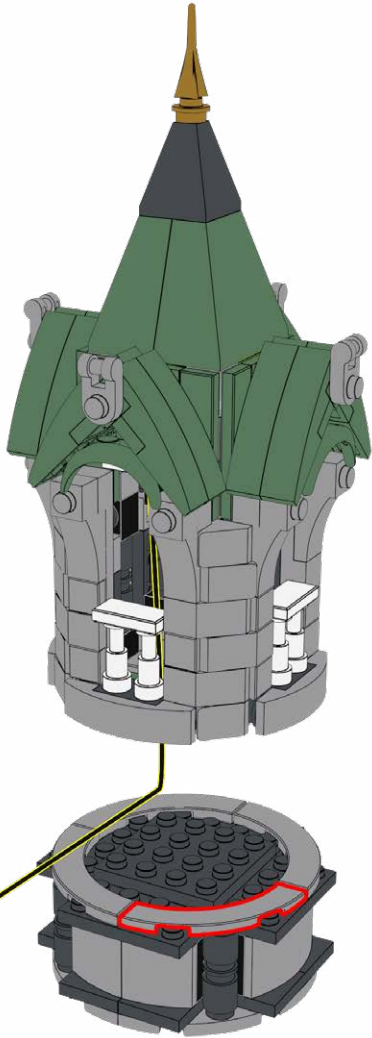

100

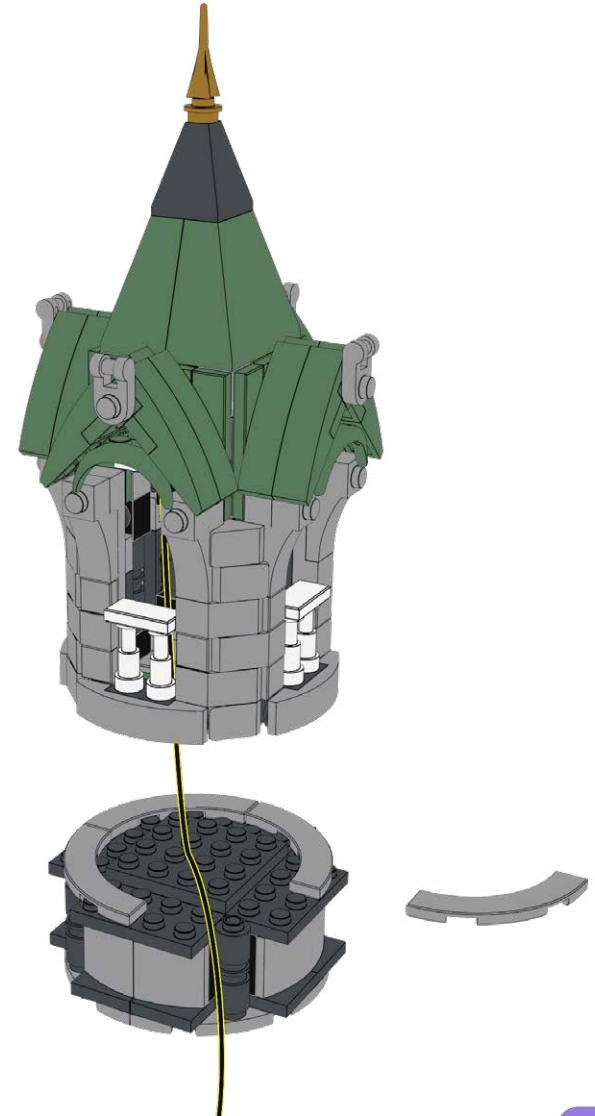

101

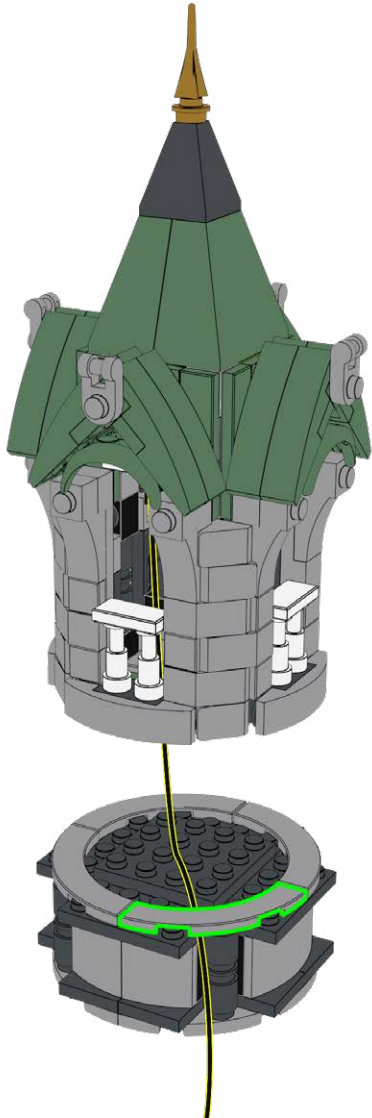

102

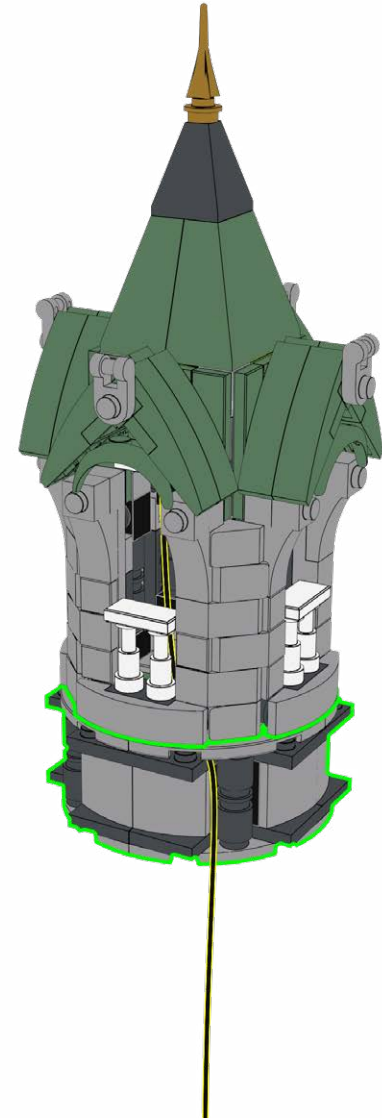

103

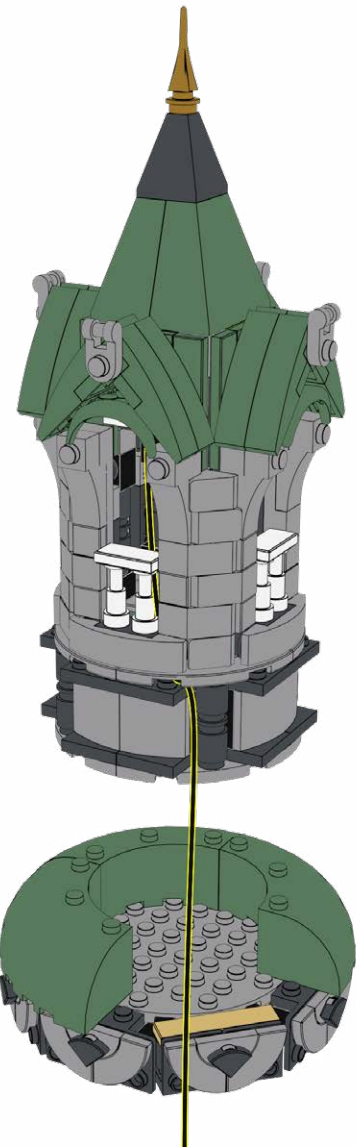

104

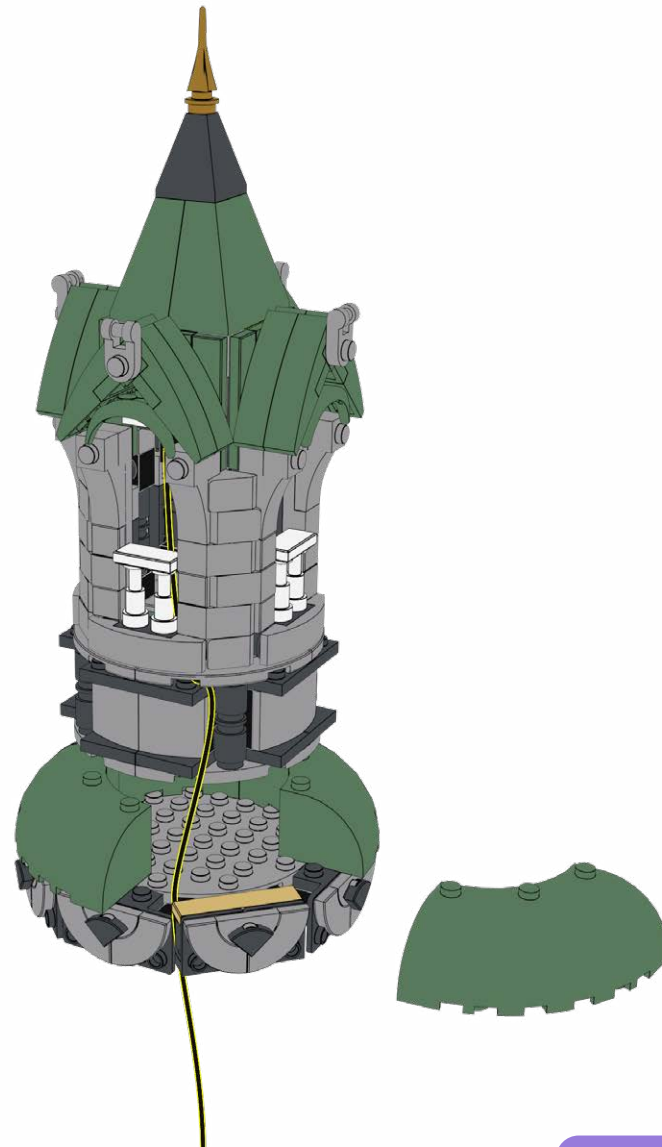

105

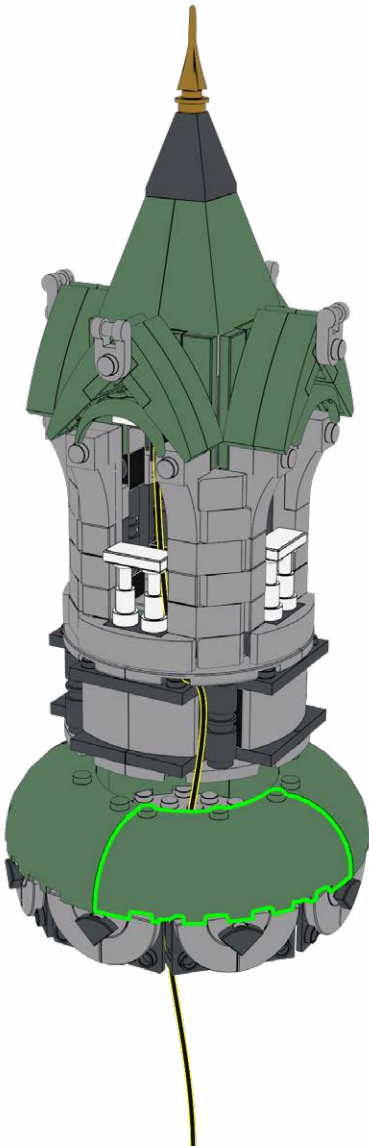

106

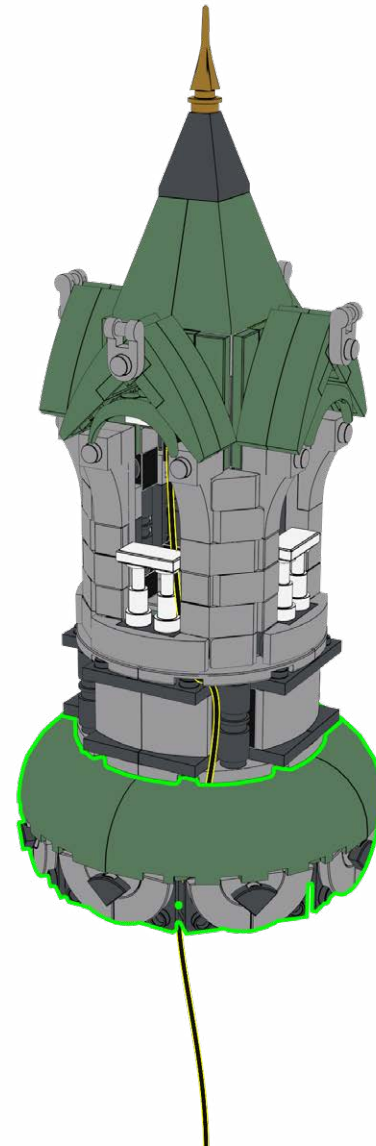

107

ALF-O15

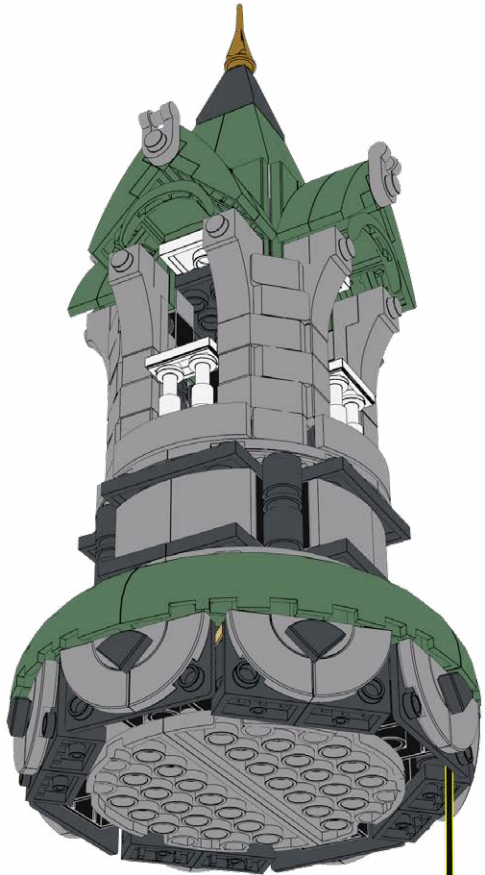

108

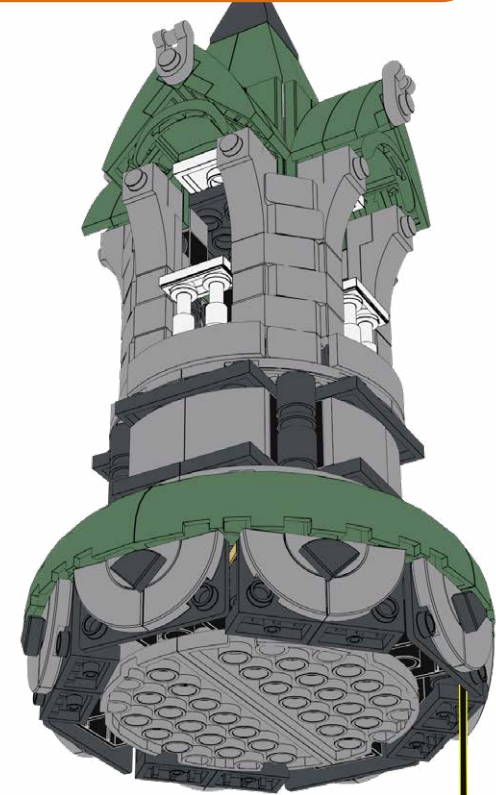
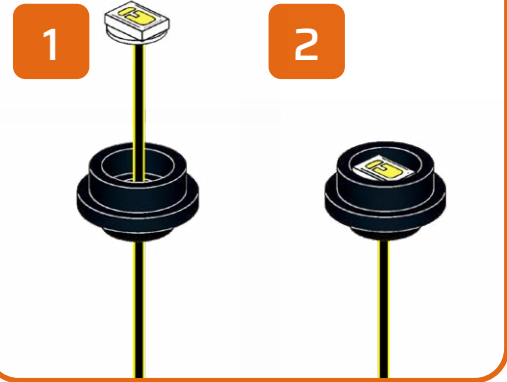

109

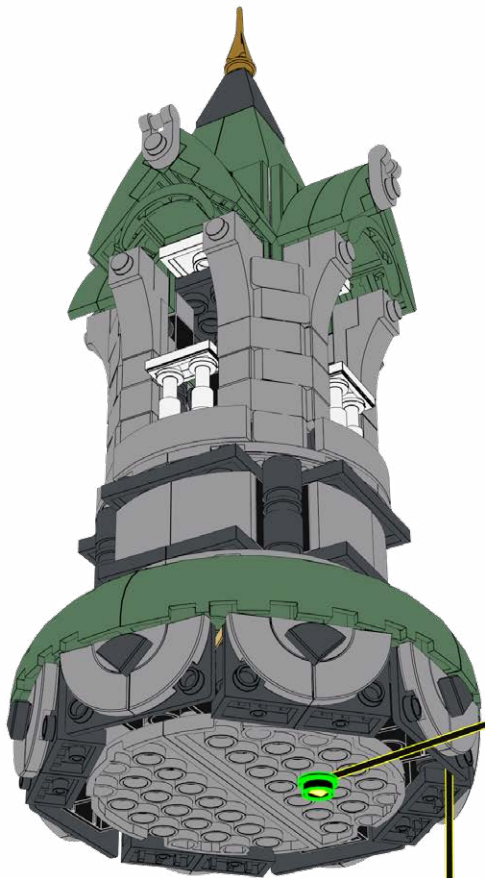

110

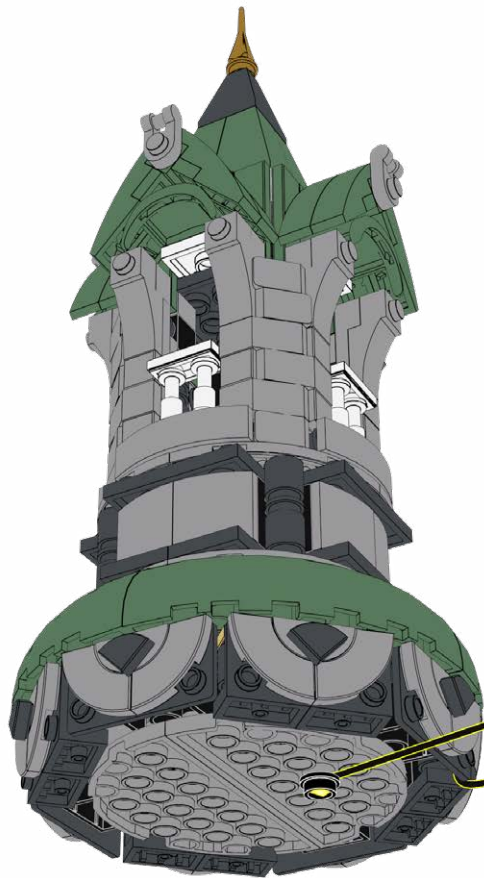

111



112

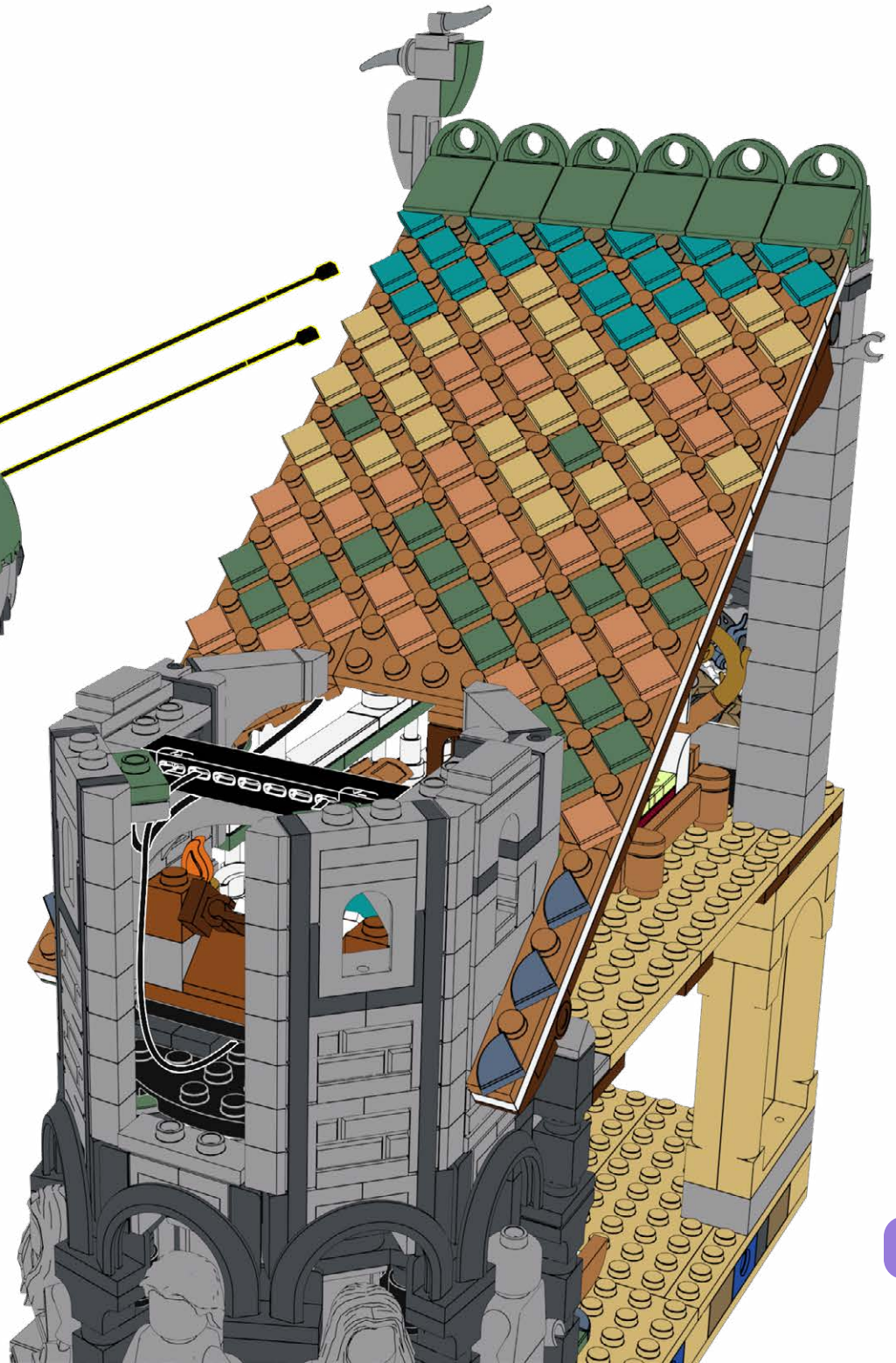
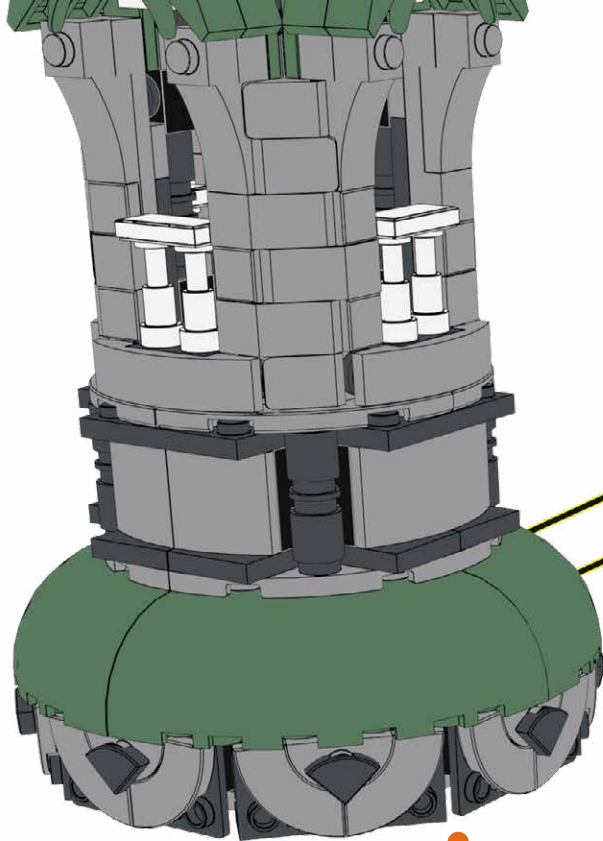
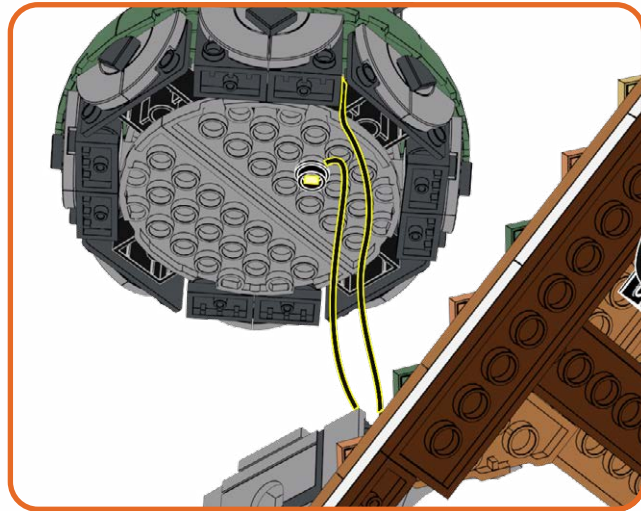

113

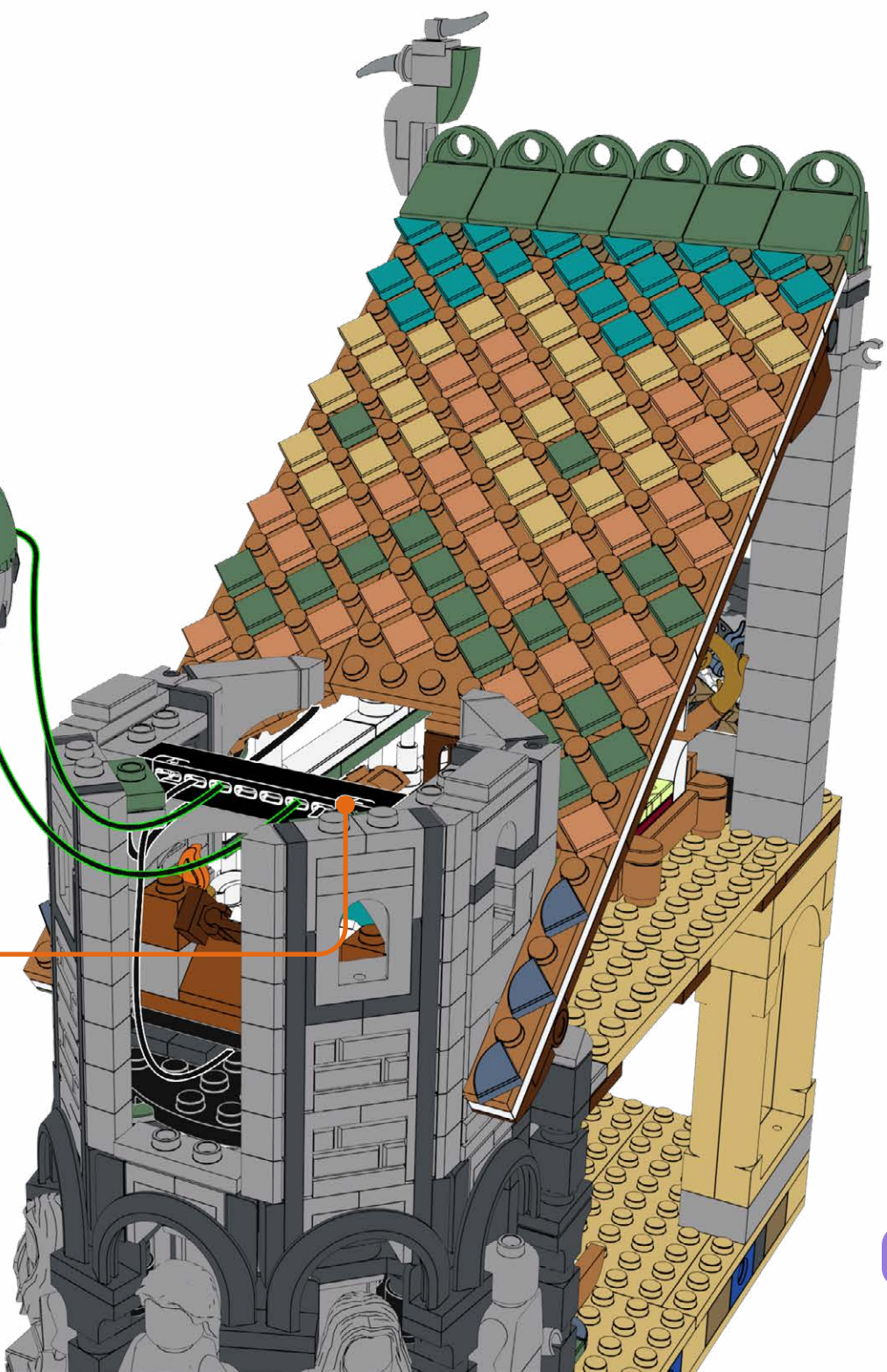
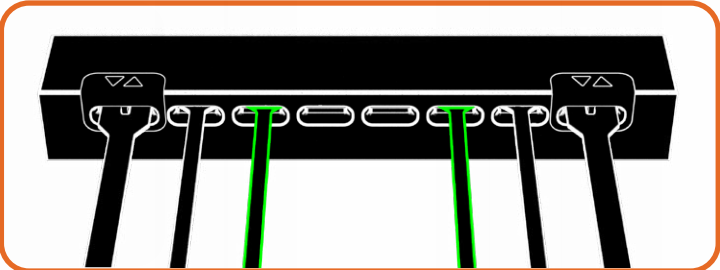
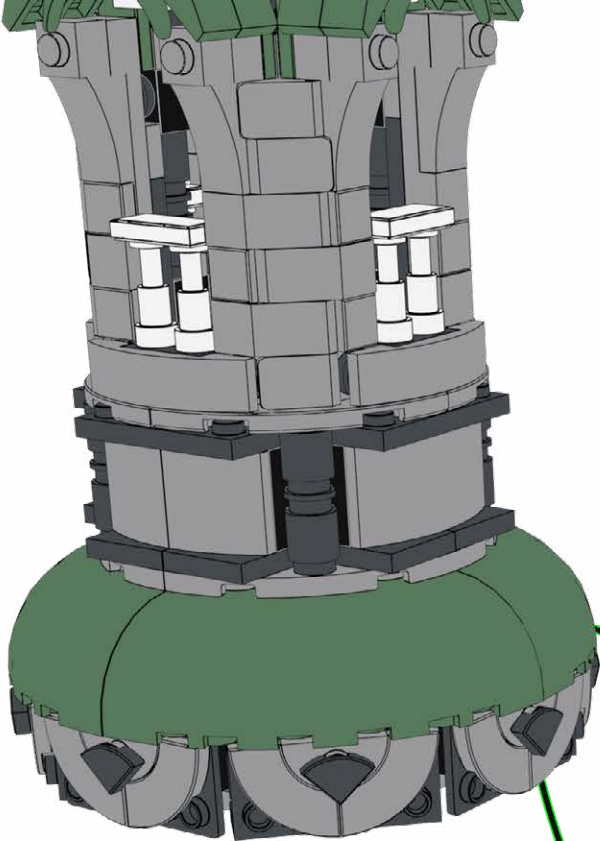

114

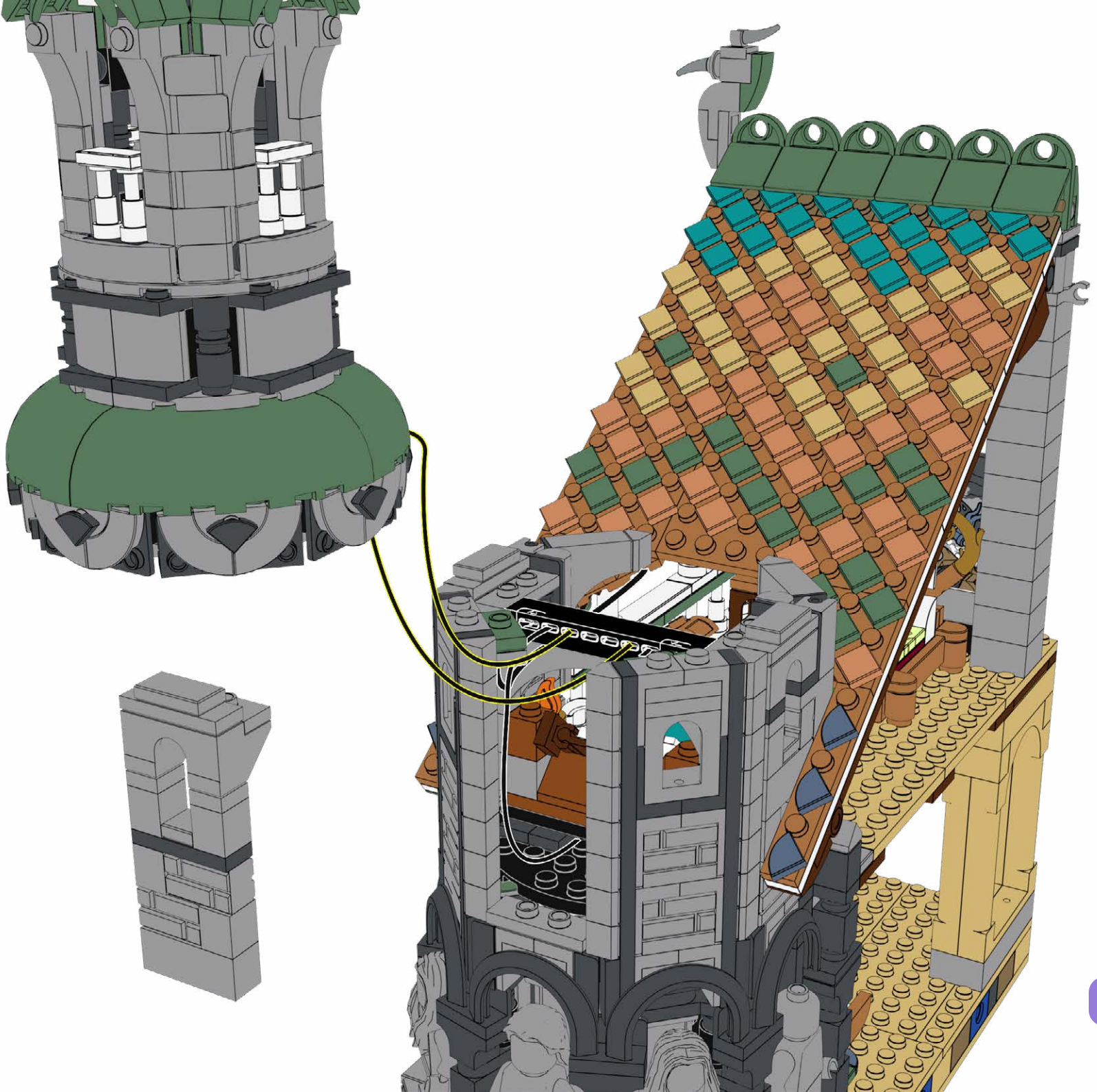

115

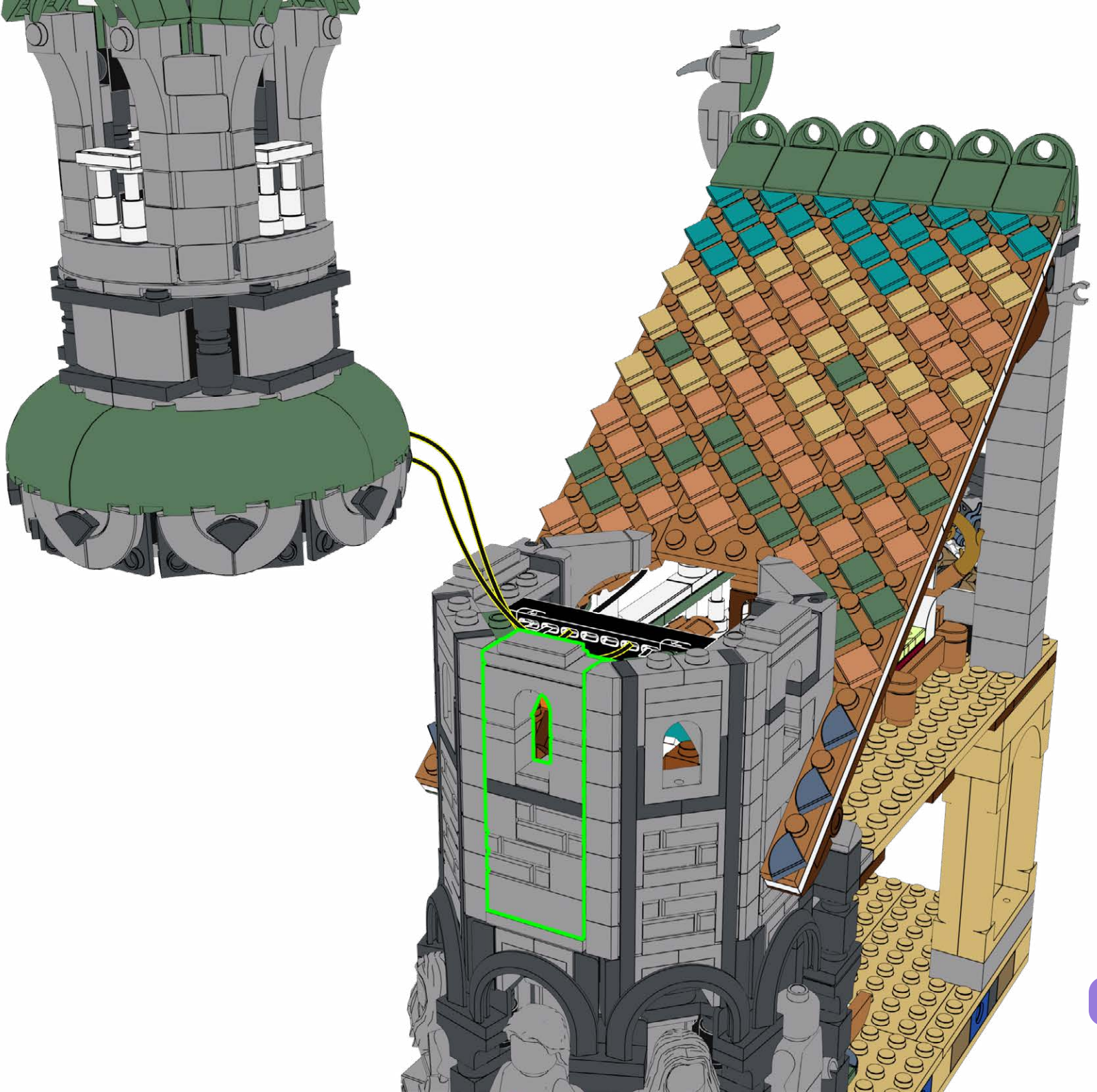

116

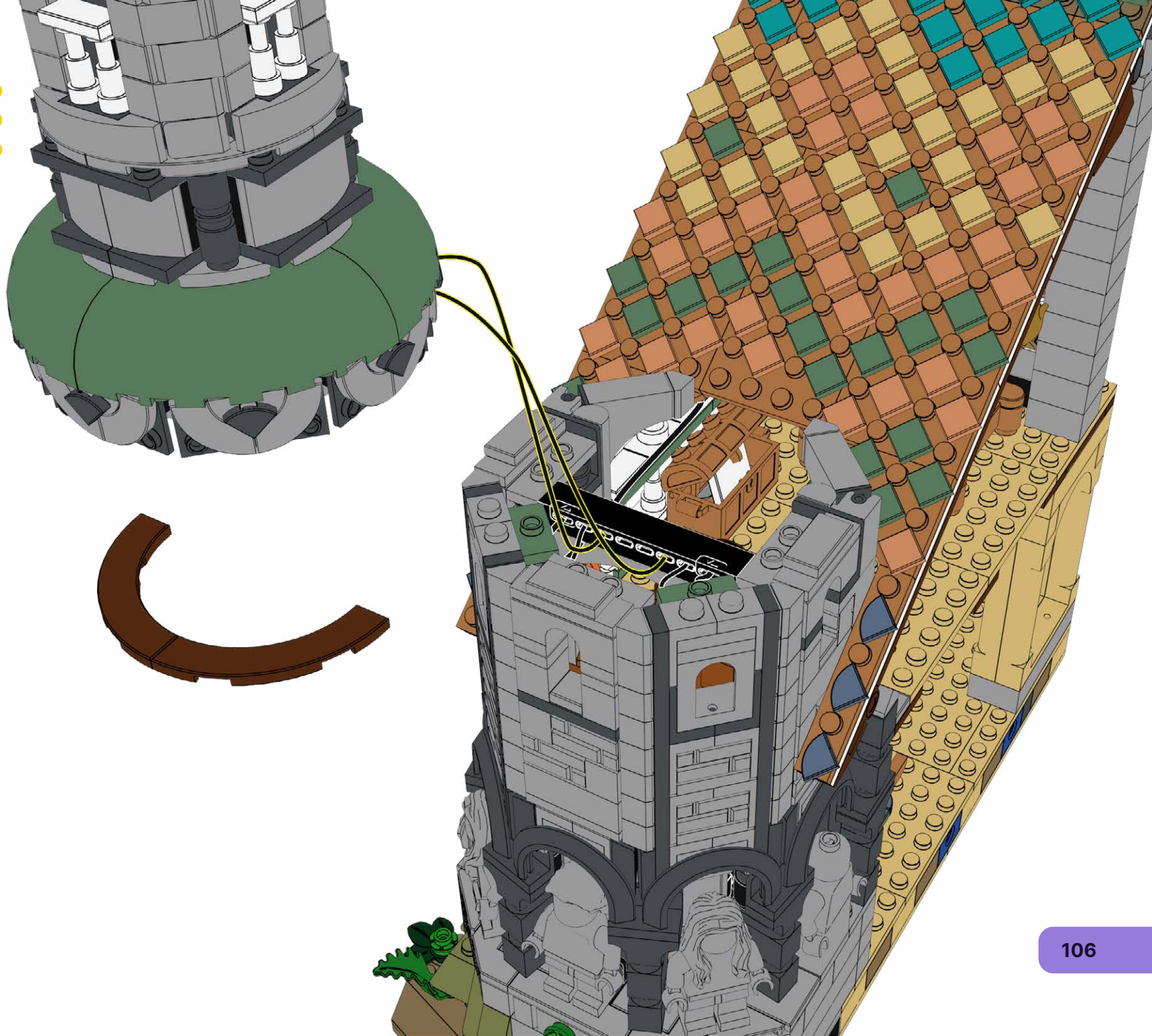

117

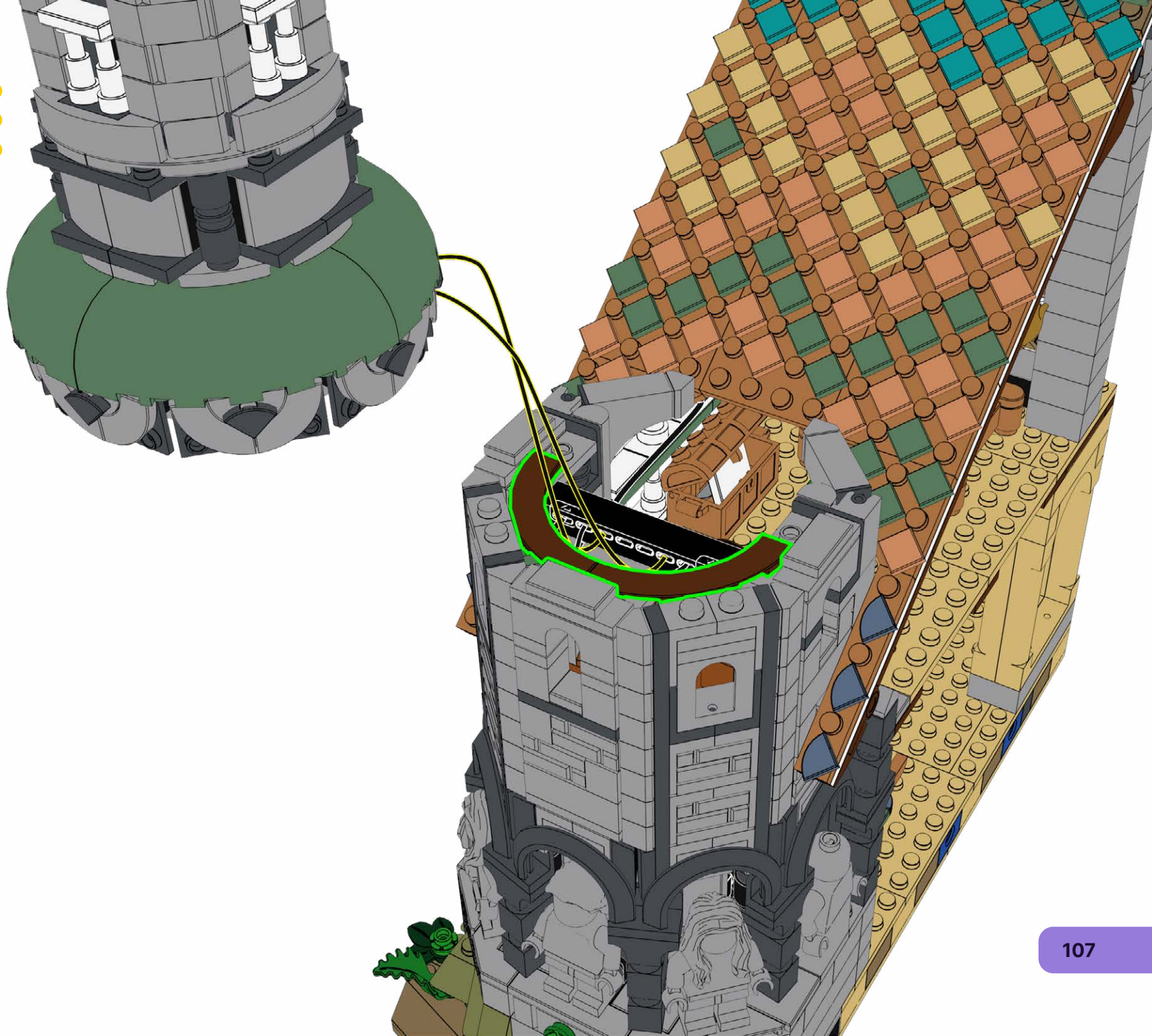

118

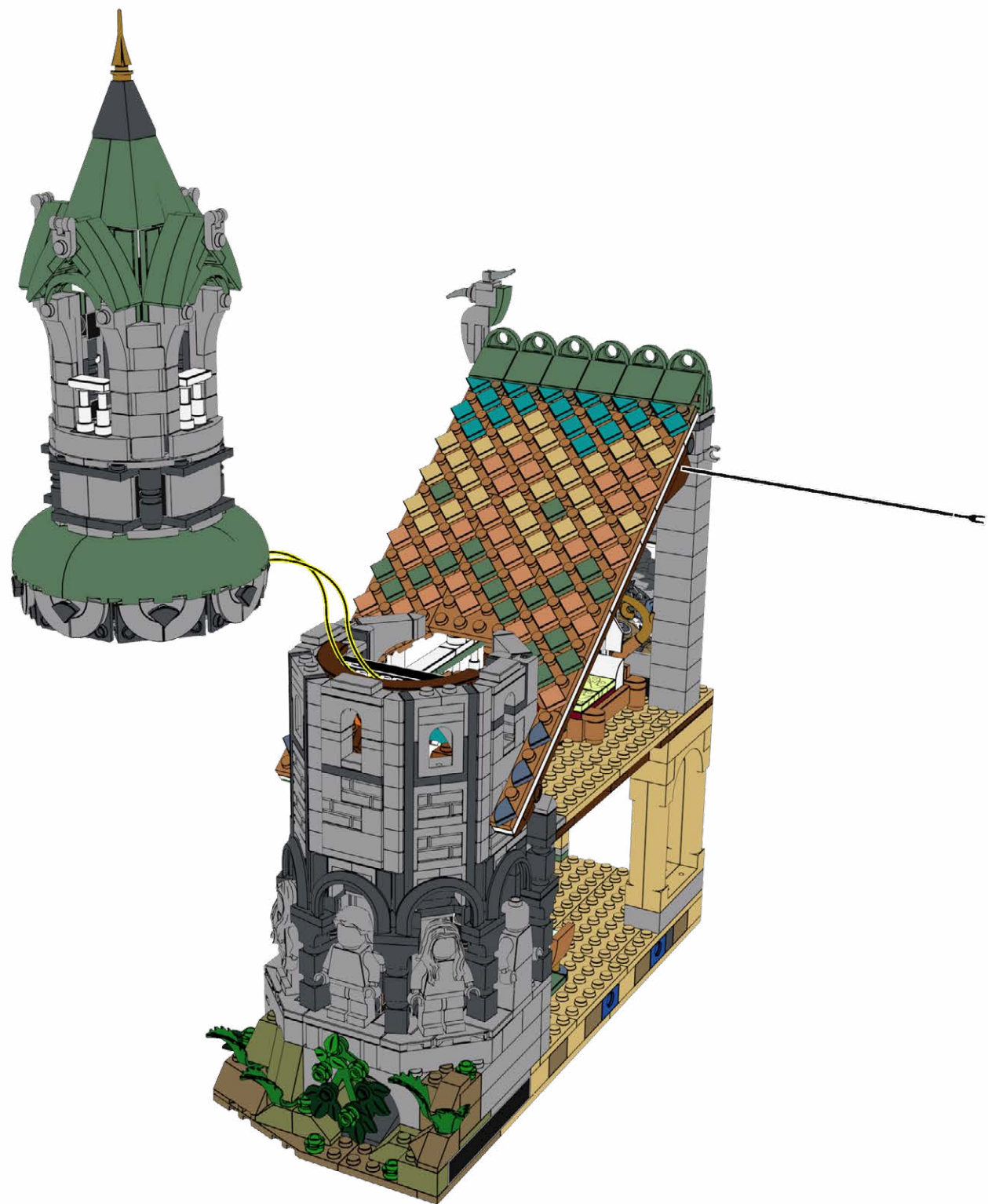

119

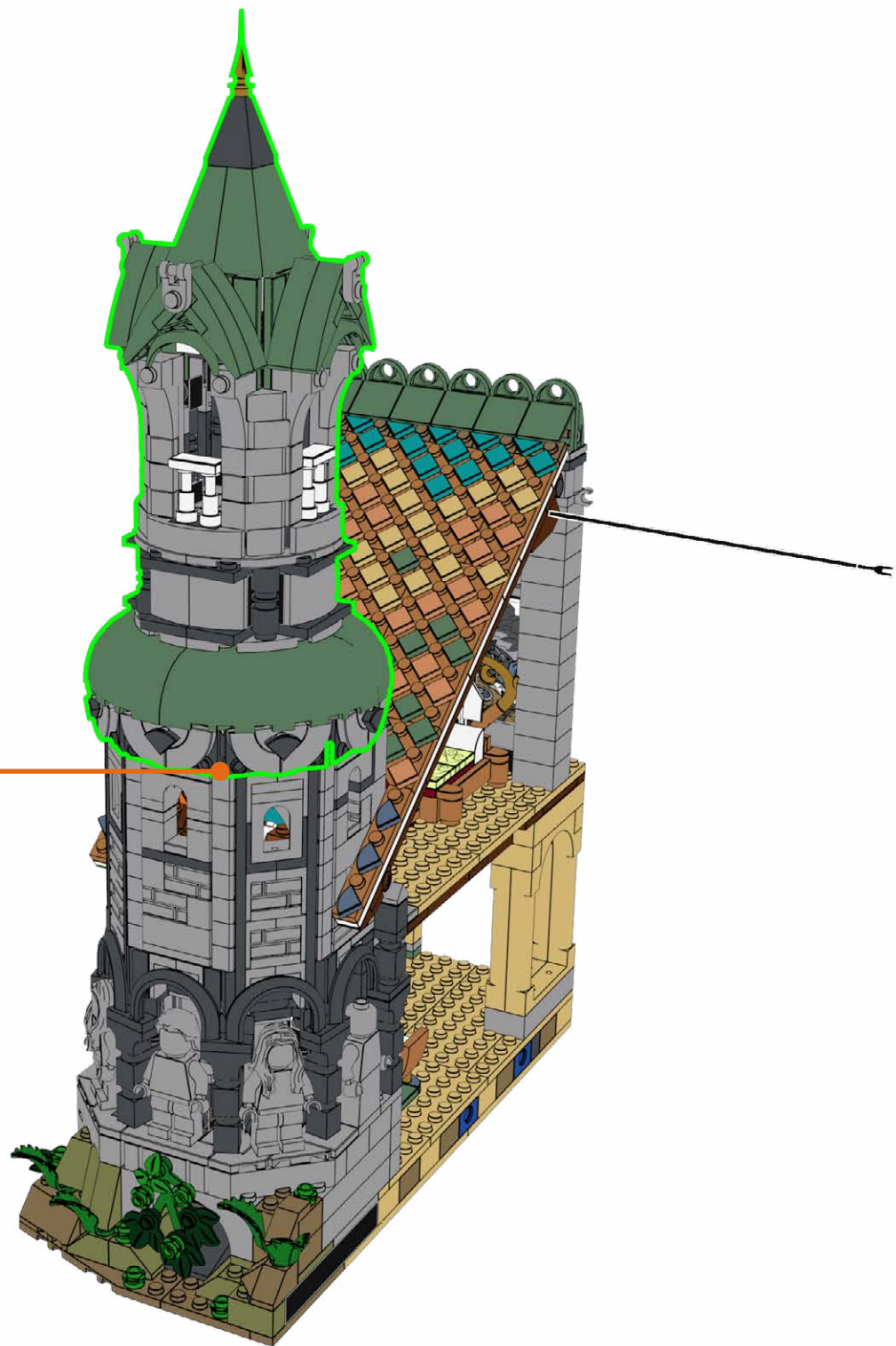
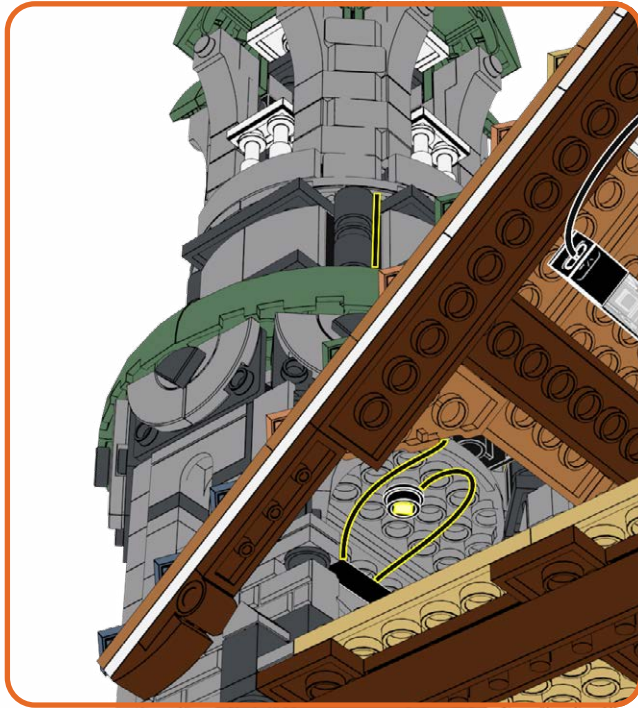

120



Light Test
Lichttest
Test de lumière
Prova della luce
prueba de luz
灯光测试

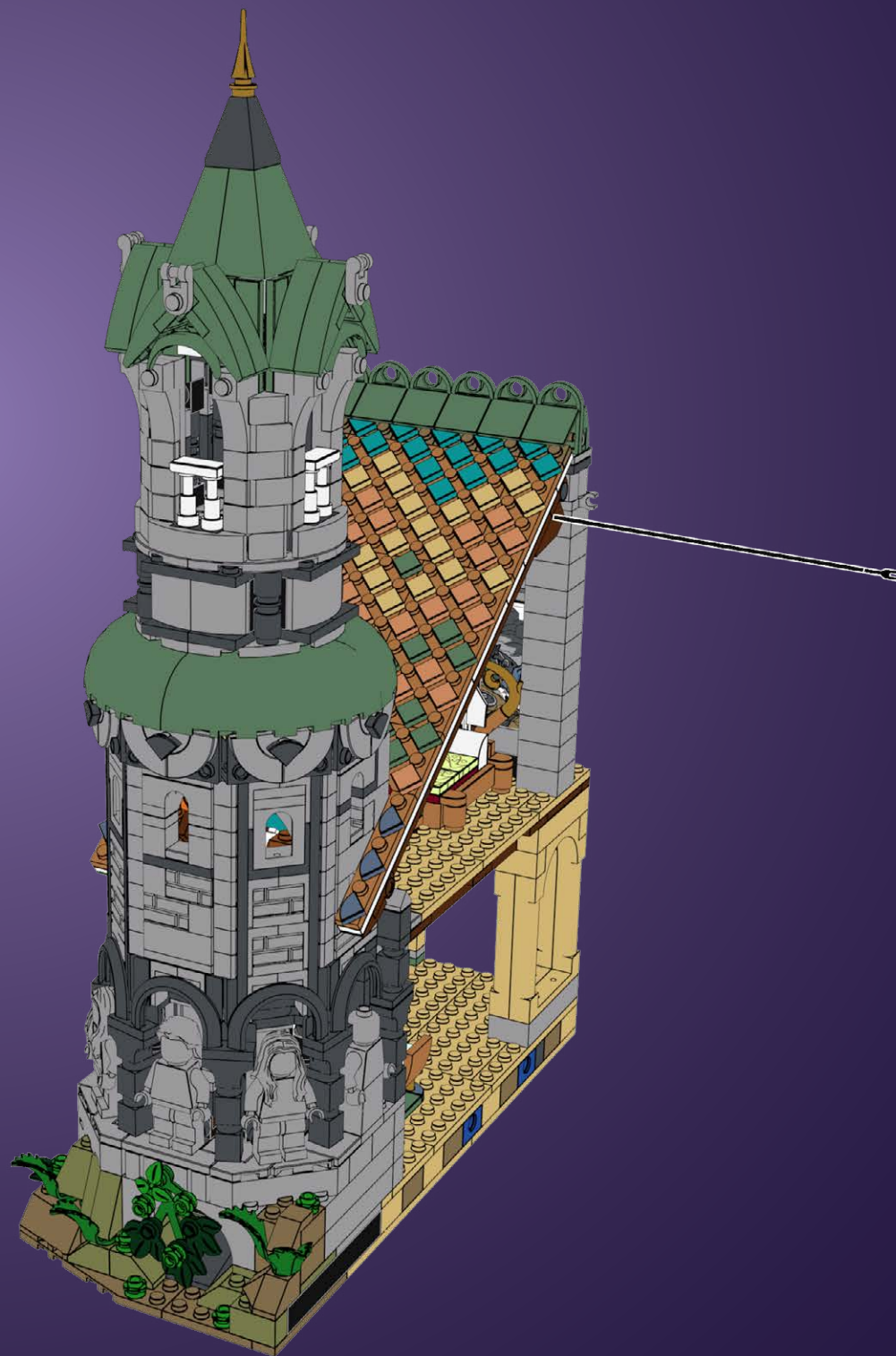

121



122



123



124



125



126



127

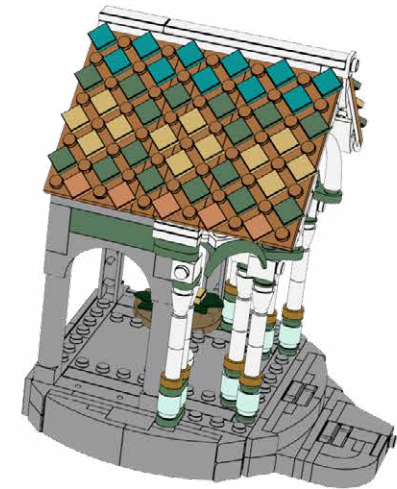

128



129



130



131



132



133



134

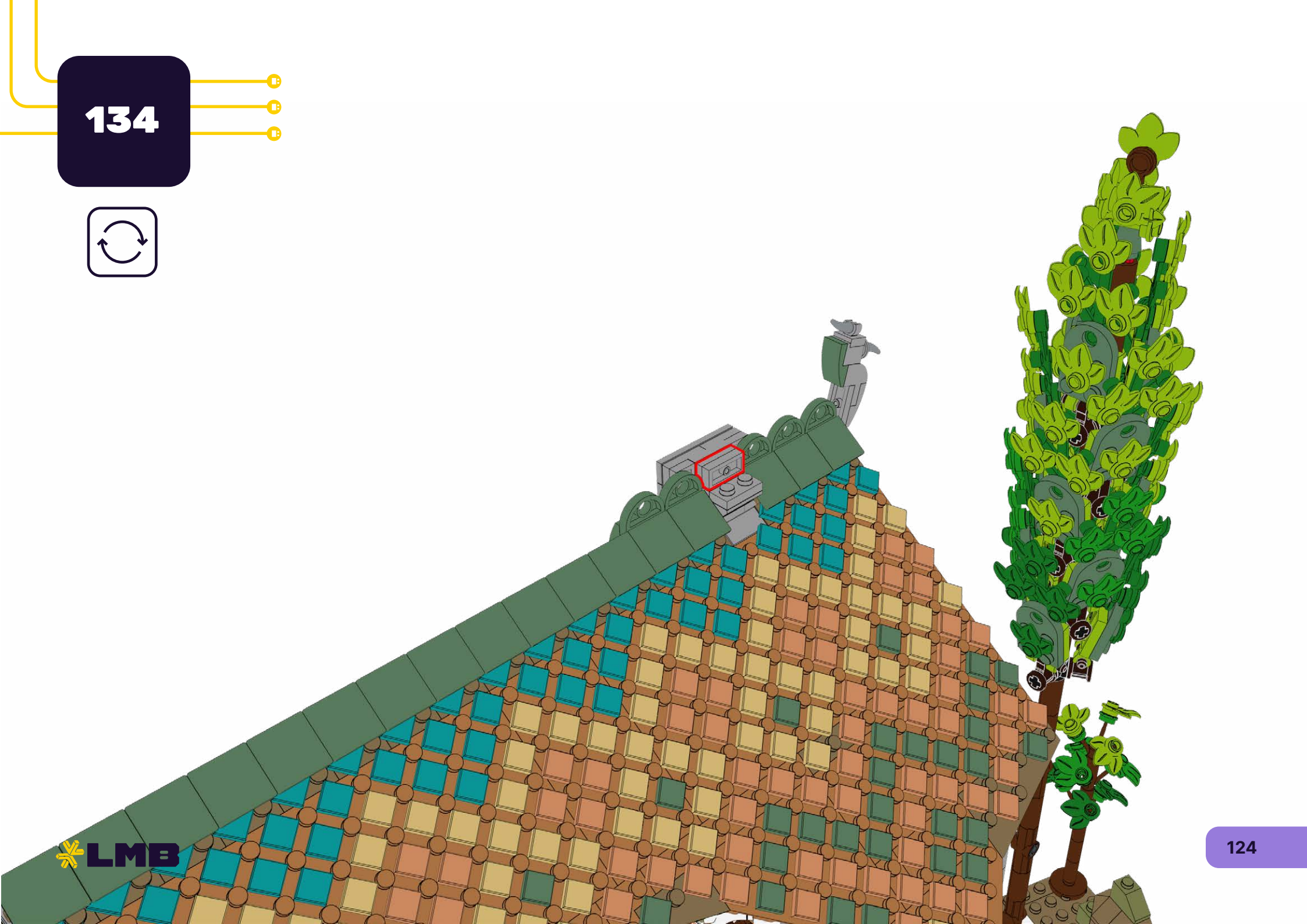

135

1

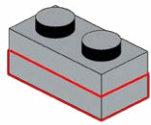

2

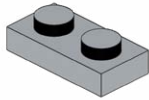
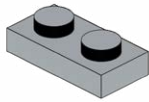

136

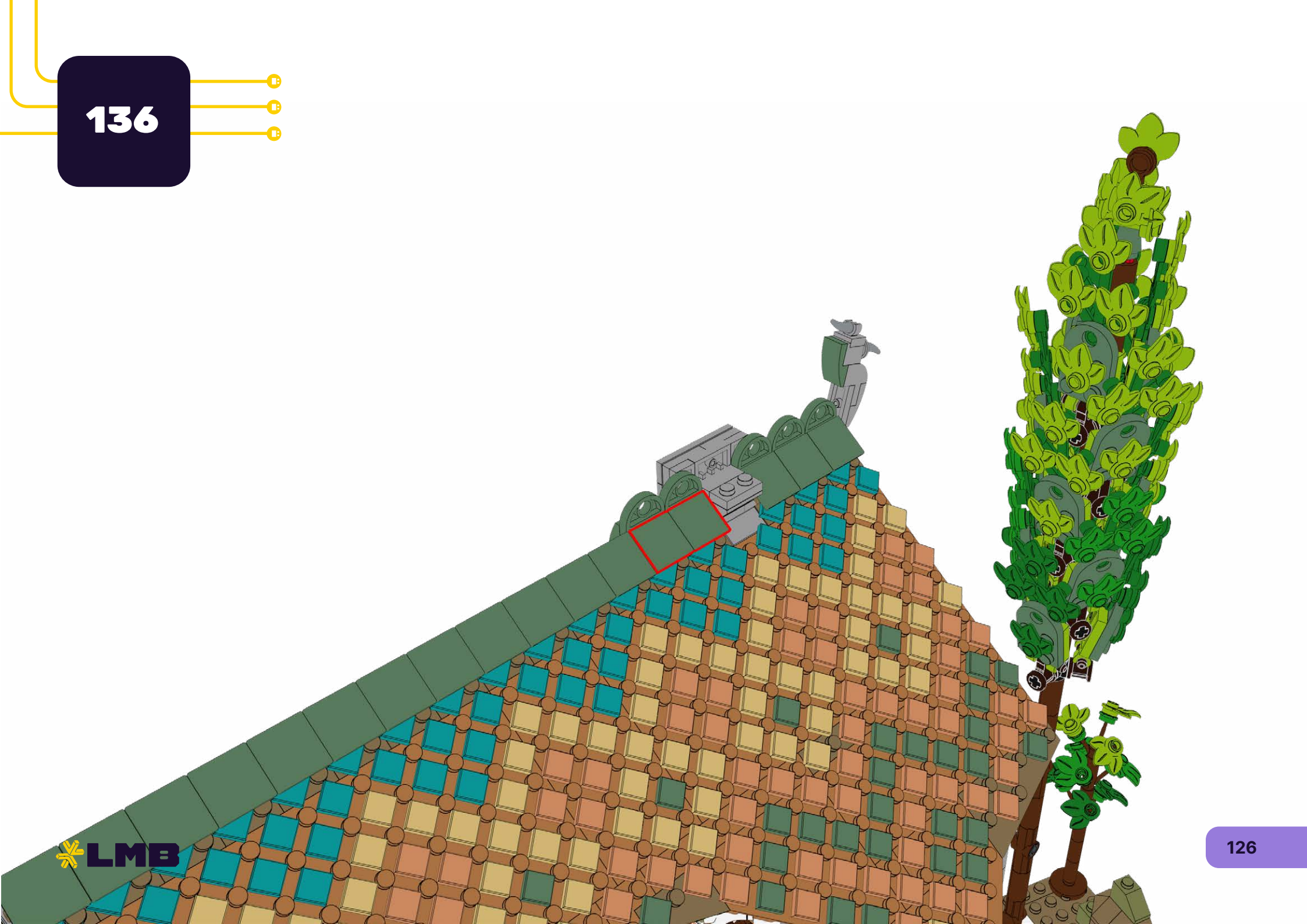

137

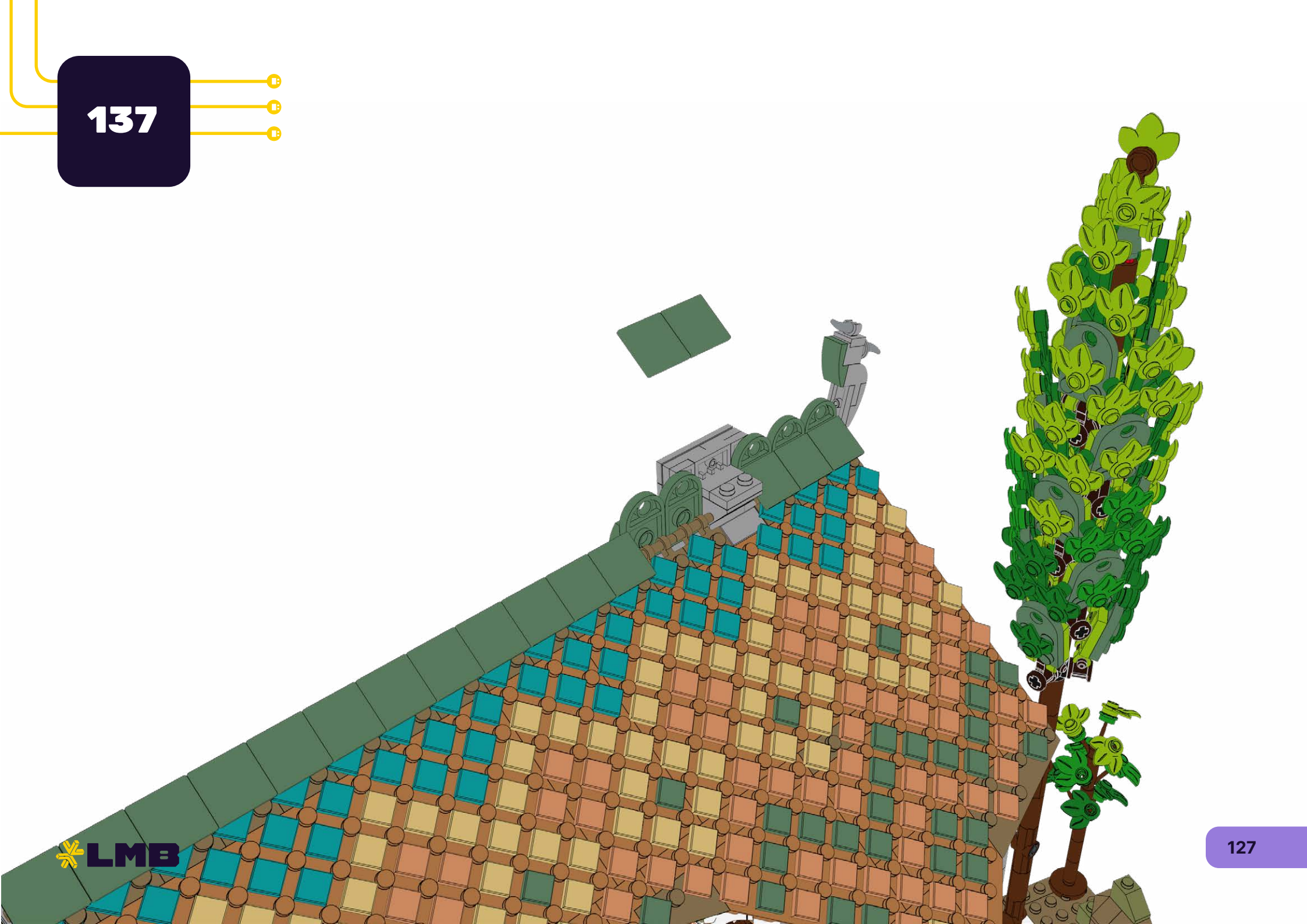

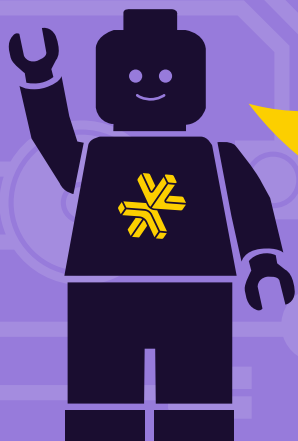
**HOLD UP!**

You might notice some bags are out of order, as well as left over pieces, but that's ok! We're changing the way you build LEGO!

HALTEN!

Möglicherweise stellen Sie fest, dass einige Beutel nicht in Ordnung sind und auch Teile übrig bleiben, aber das ist in Ordnung! Wir verändern die Art und Weise, wie Sie LEGO bauen!

TENIR BON!

Vous remarquerez peut-être que certains sacs sont en panne, ainsi que des morceaux restants, mais ce n'est pas grave ! Nous changeons la façon dont vous construisez LEGO !

SOSTENERE!

Potresti notare che alcune borse sono fuori uso, così come alcuni pezzi avanzati, ma va bene! Stiamo cambiando il modo in cui costruisci i LEGO!

¡SOSTENER!

Puede que notes que algunas bolsas están fuera de orden, así como piezas sobrantes, ¡pero está bien! ¡Estamos cambiando la forma de construir LEGO!

耽误!

您可能会注意到有些袋子坏了, 还有剩余的碎片, 但这没关系! 我们正在改变您搭建乐高的方式!

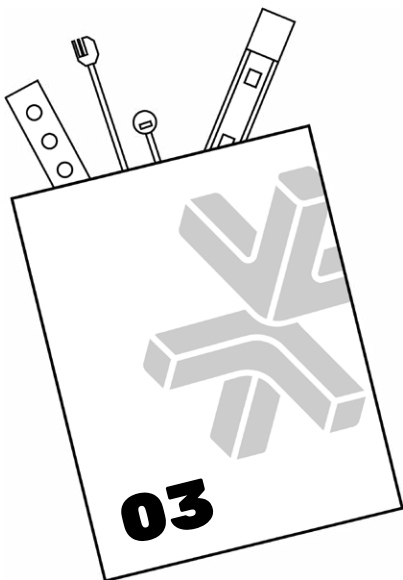
Open LMB Bag 03

138

AL-WW30

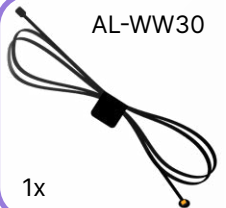

1x

1x

1



2

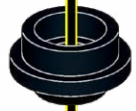

139

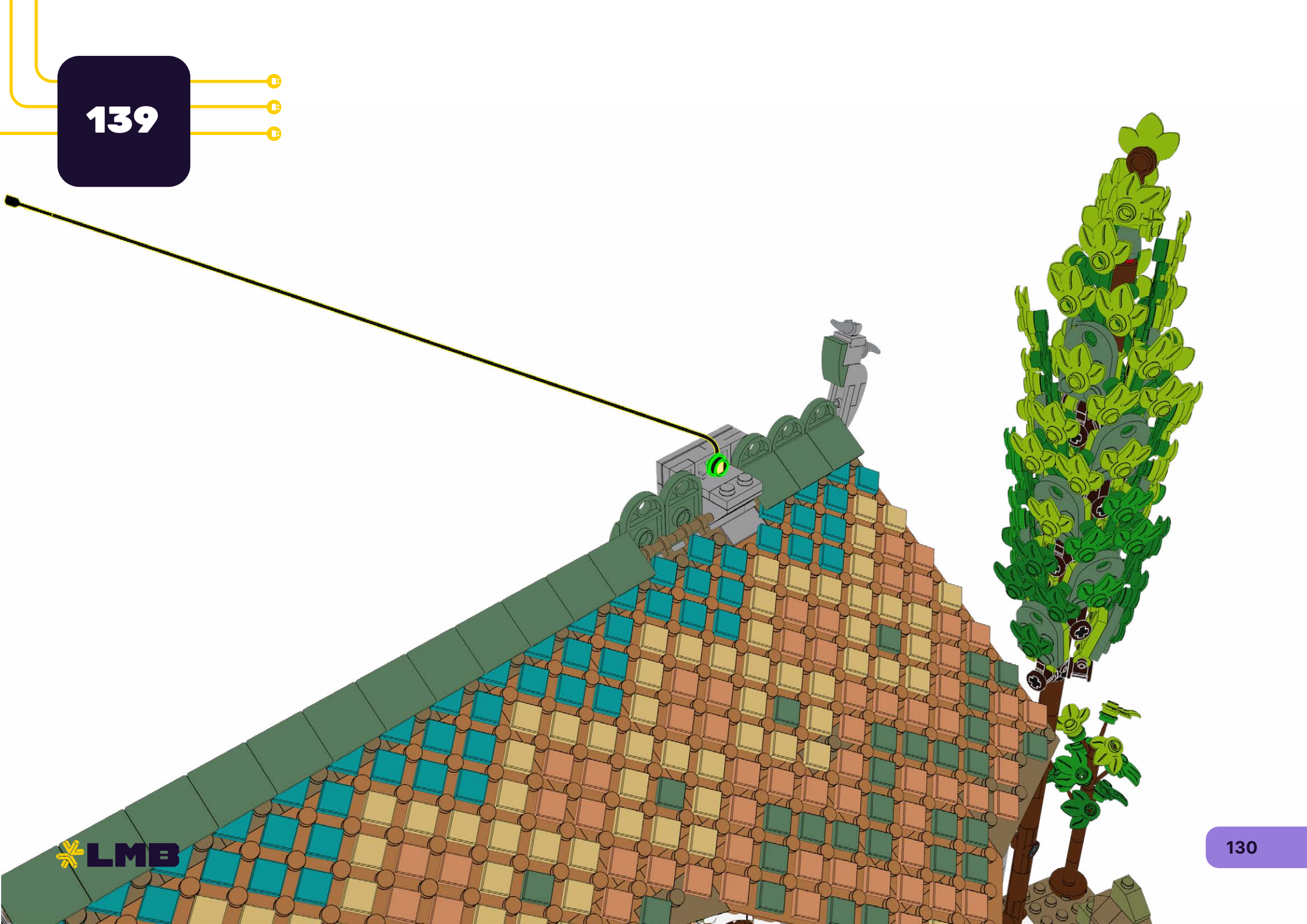

140

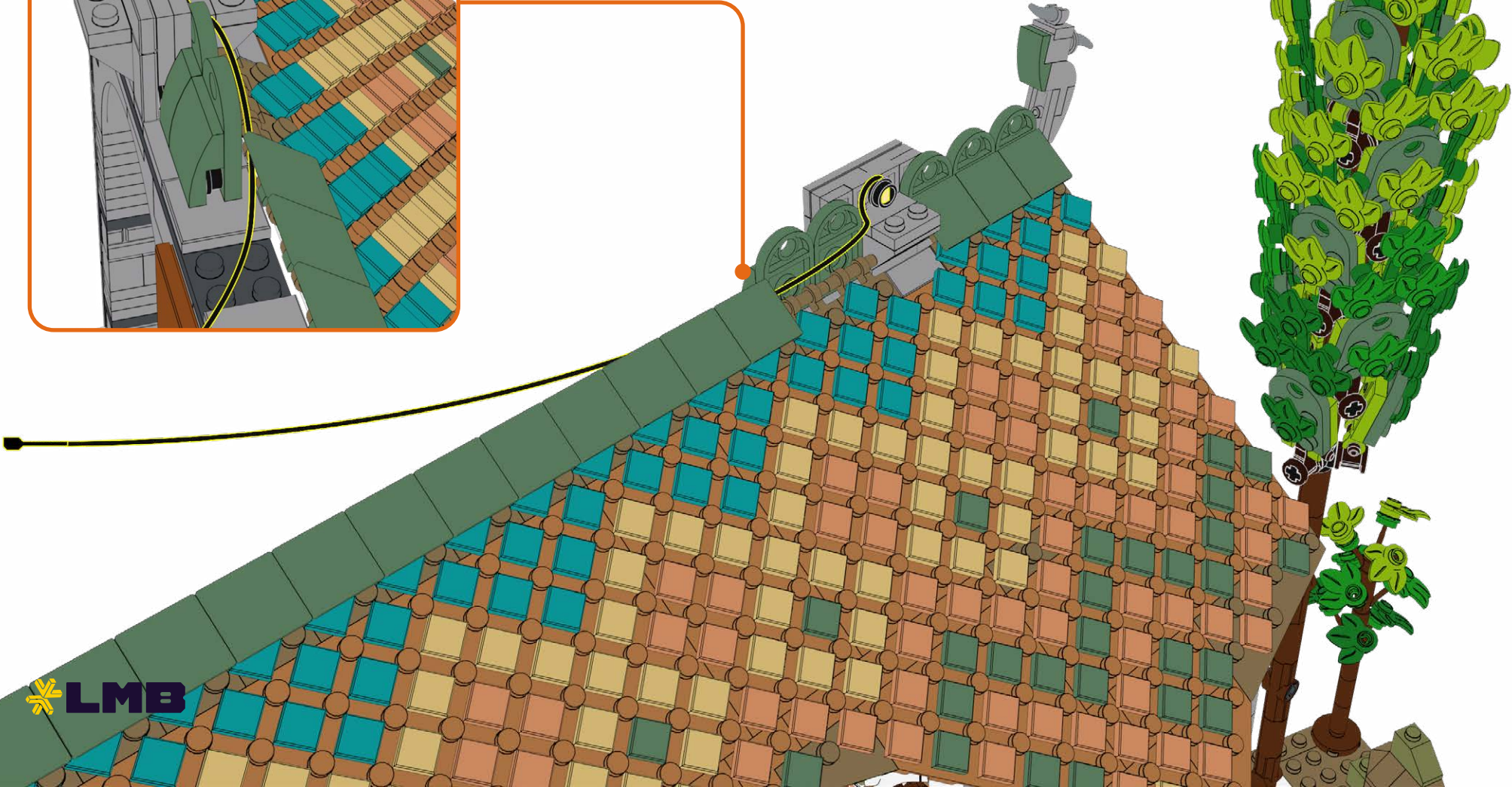
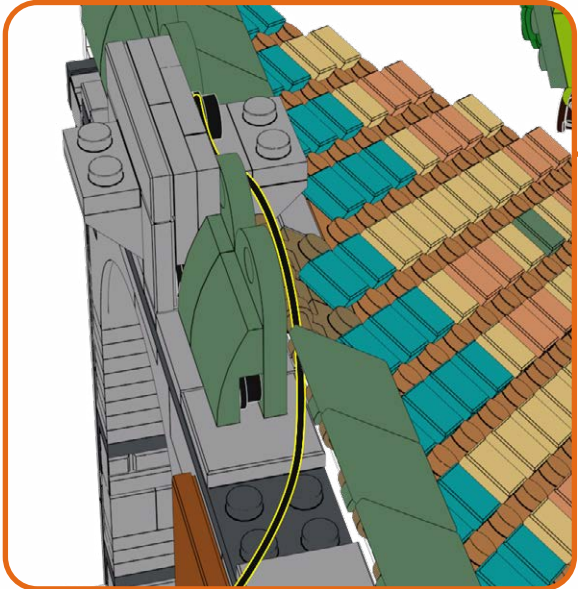

141

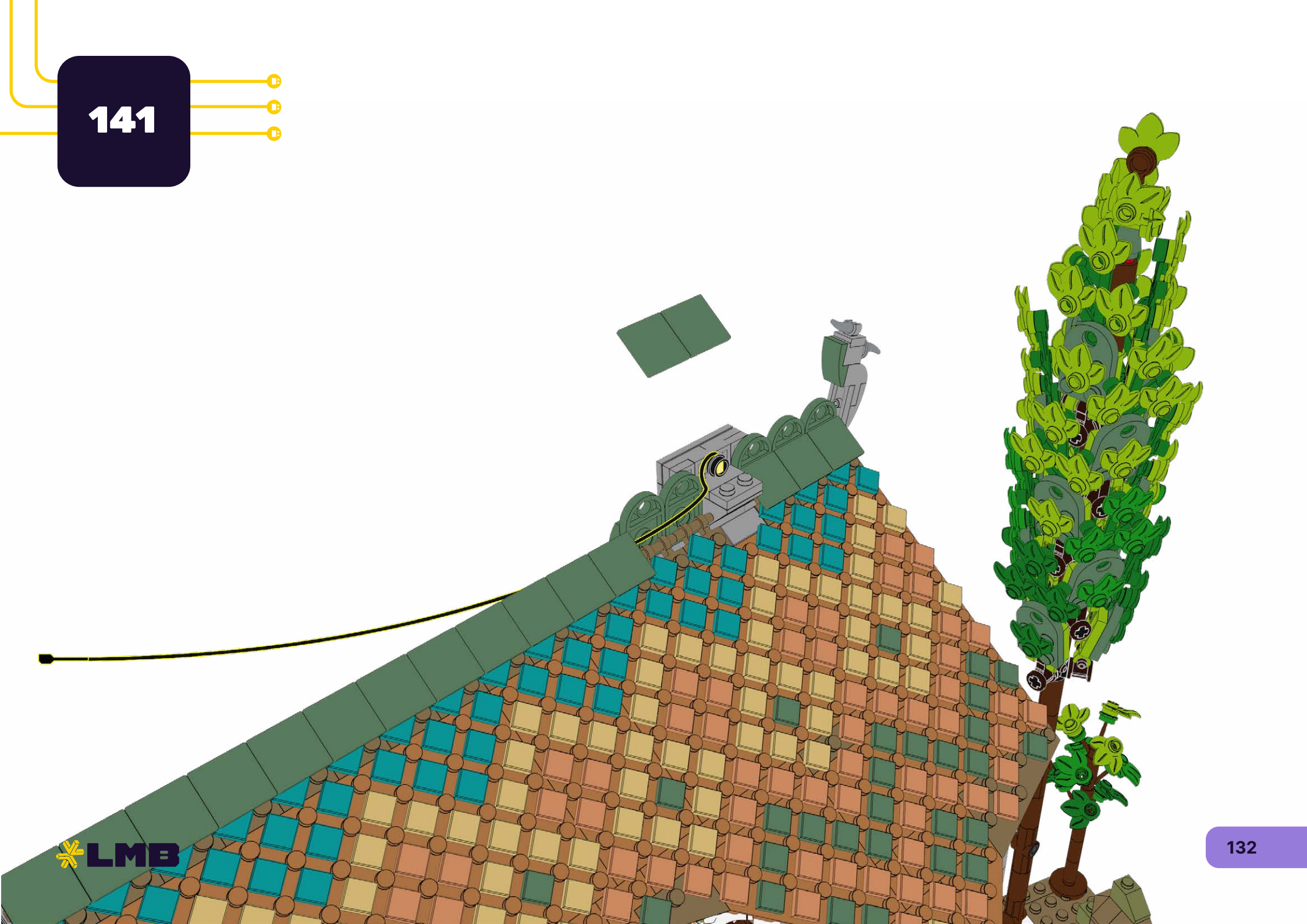

142

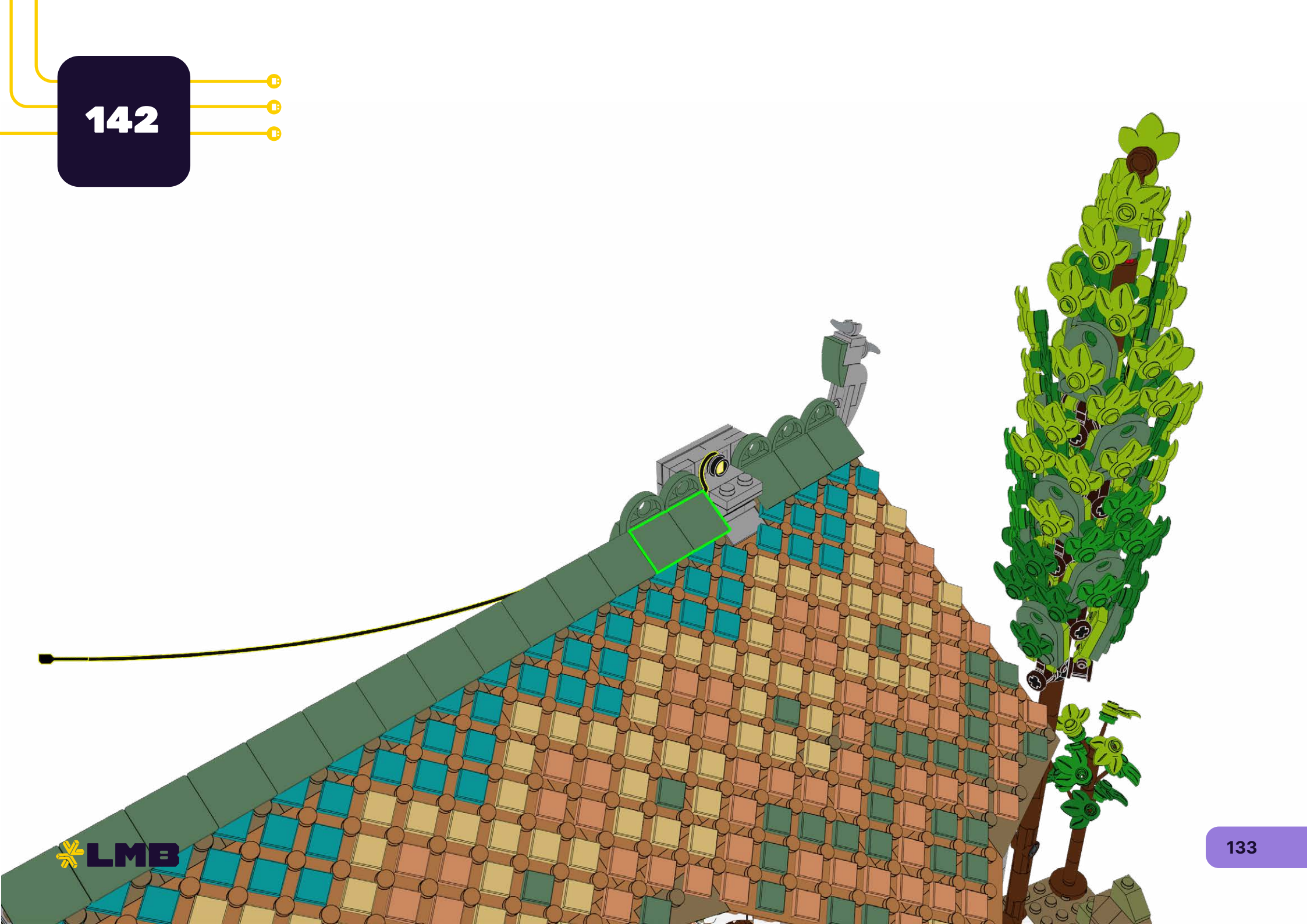

143



144

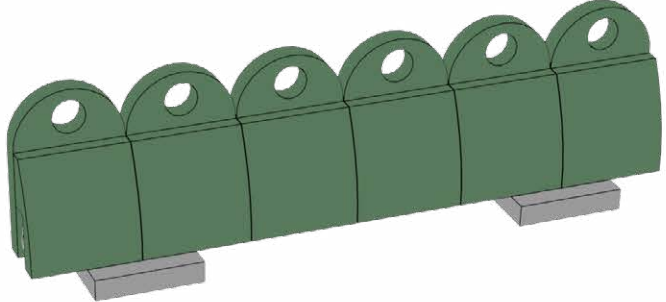

145



146

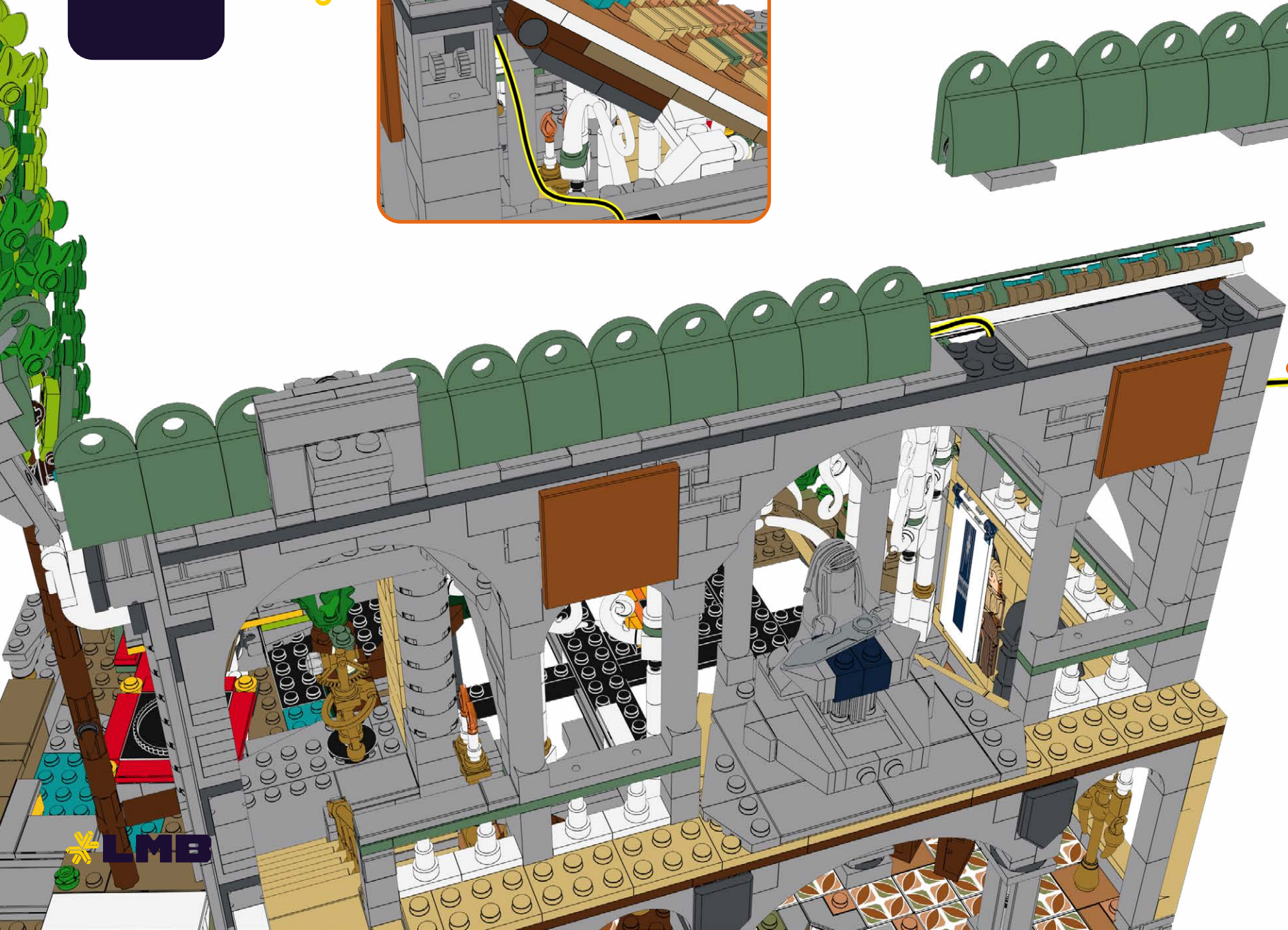
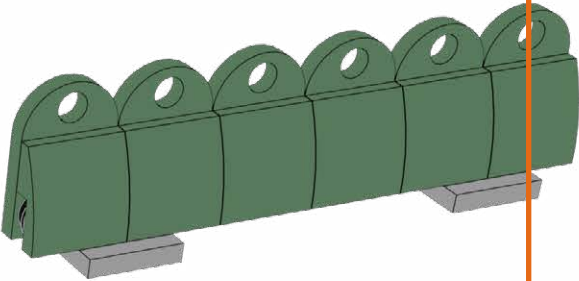
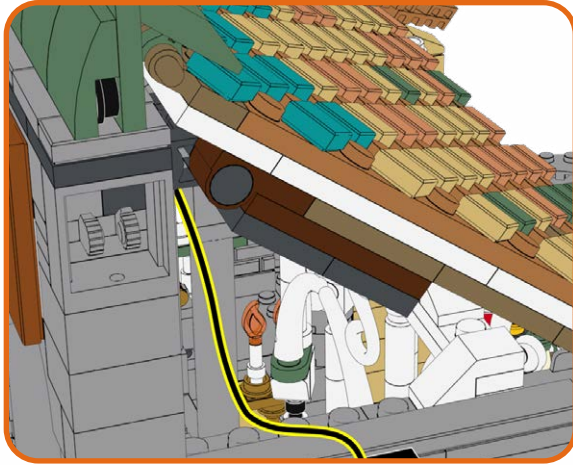

147



148



149



150



D-3



1x



151

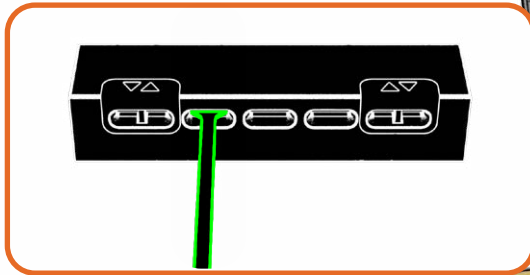

152

ALF-O30

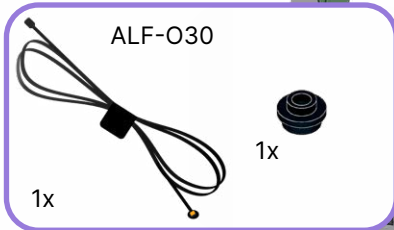

1x

1x



1

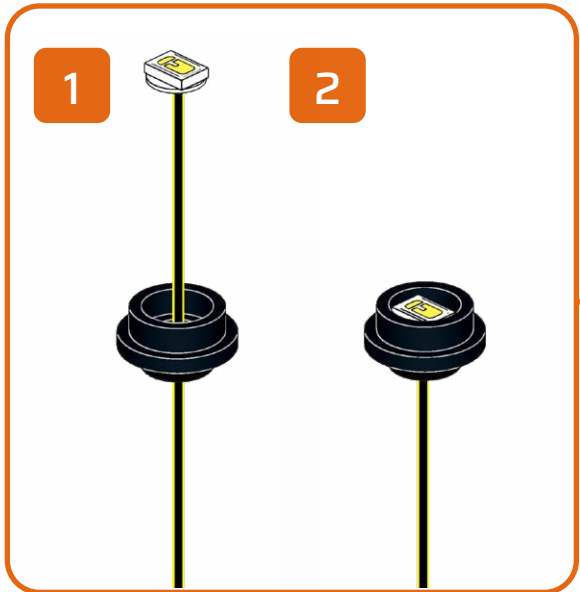

2

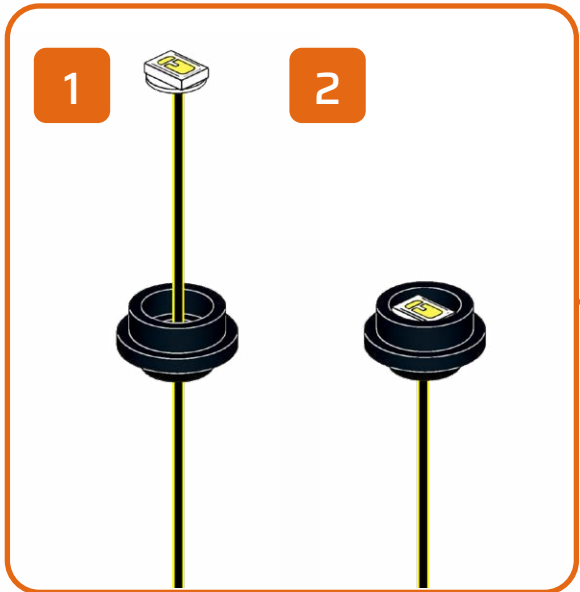

153

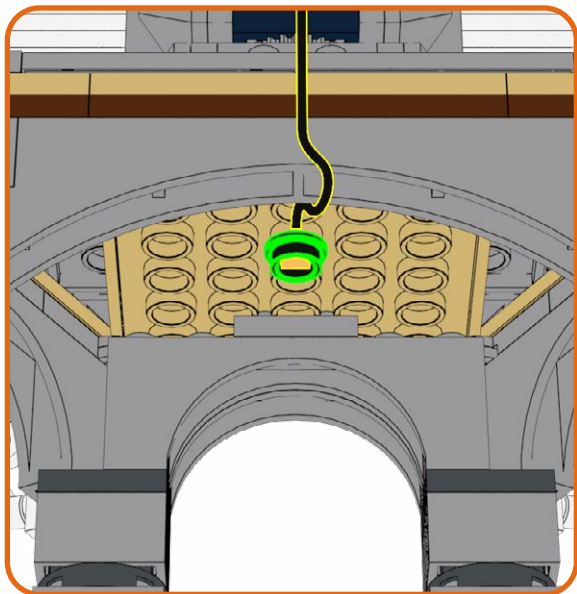

154



155



156



157



1x



158

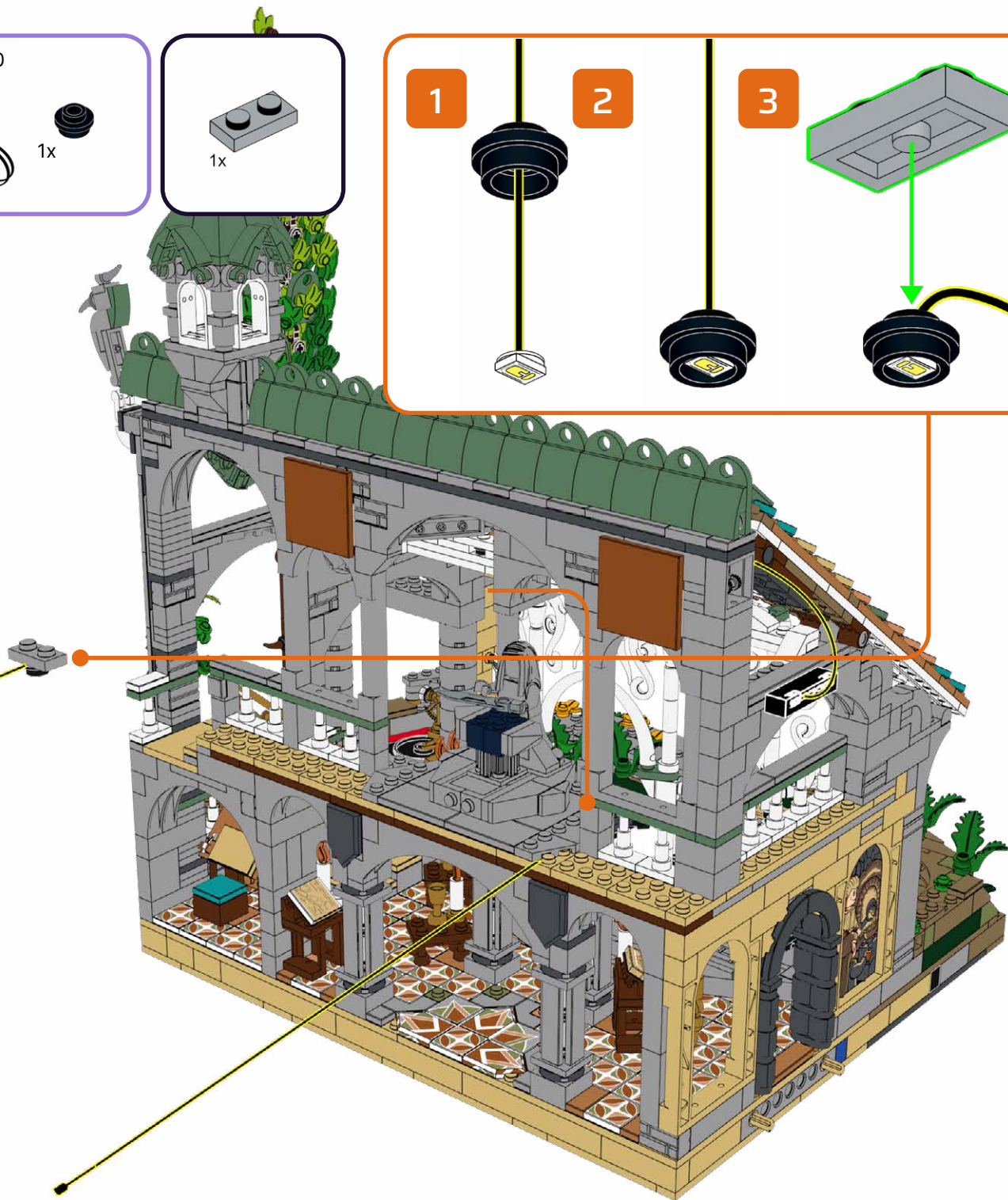
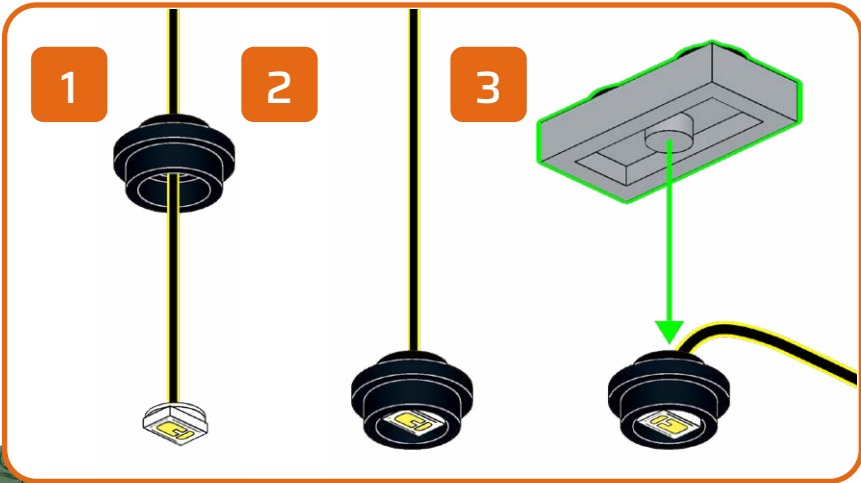
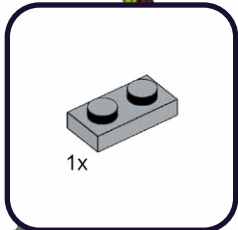
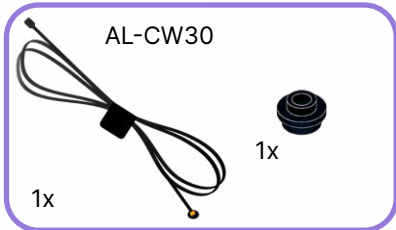

159

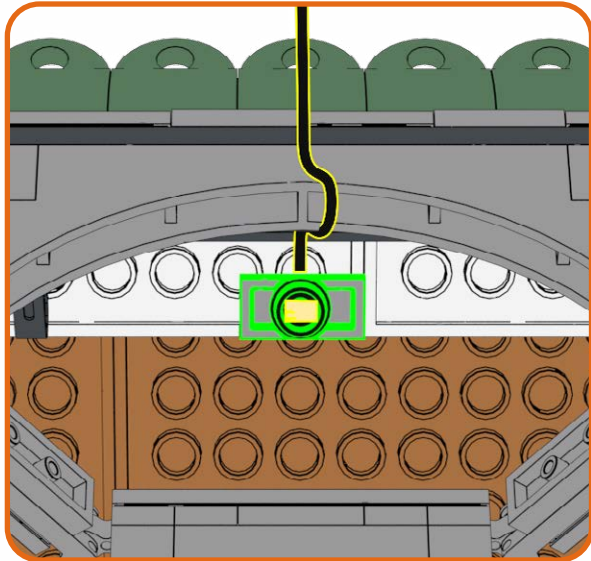

160

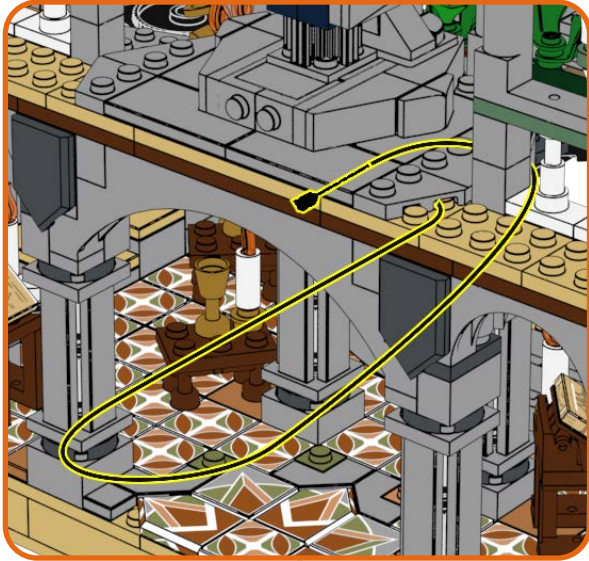

161

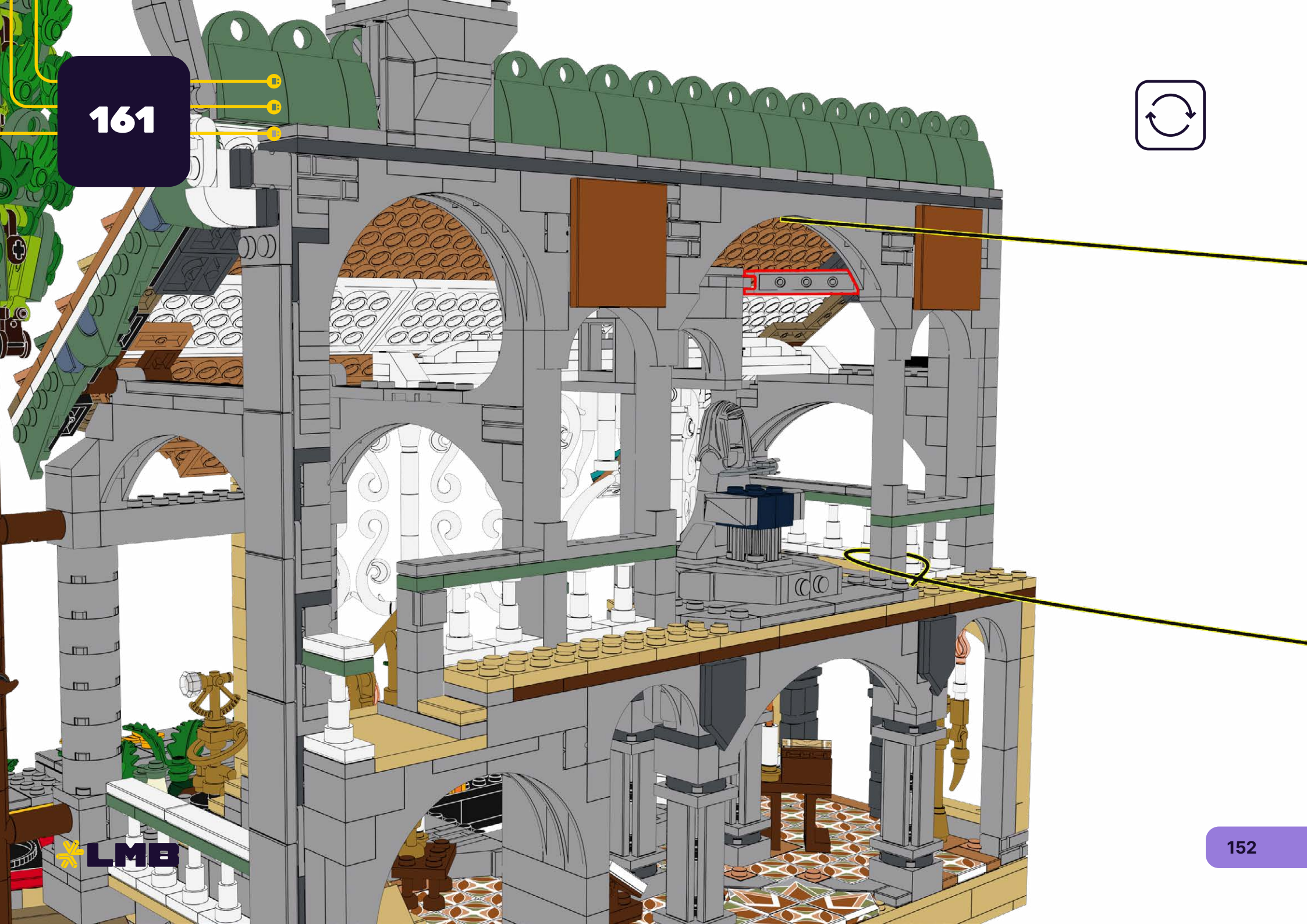

162



163

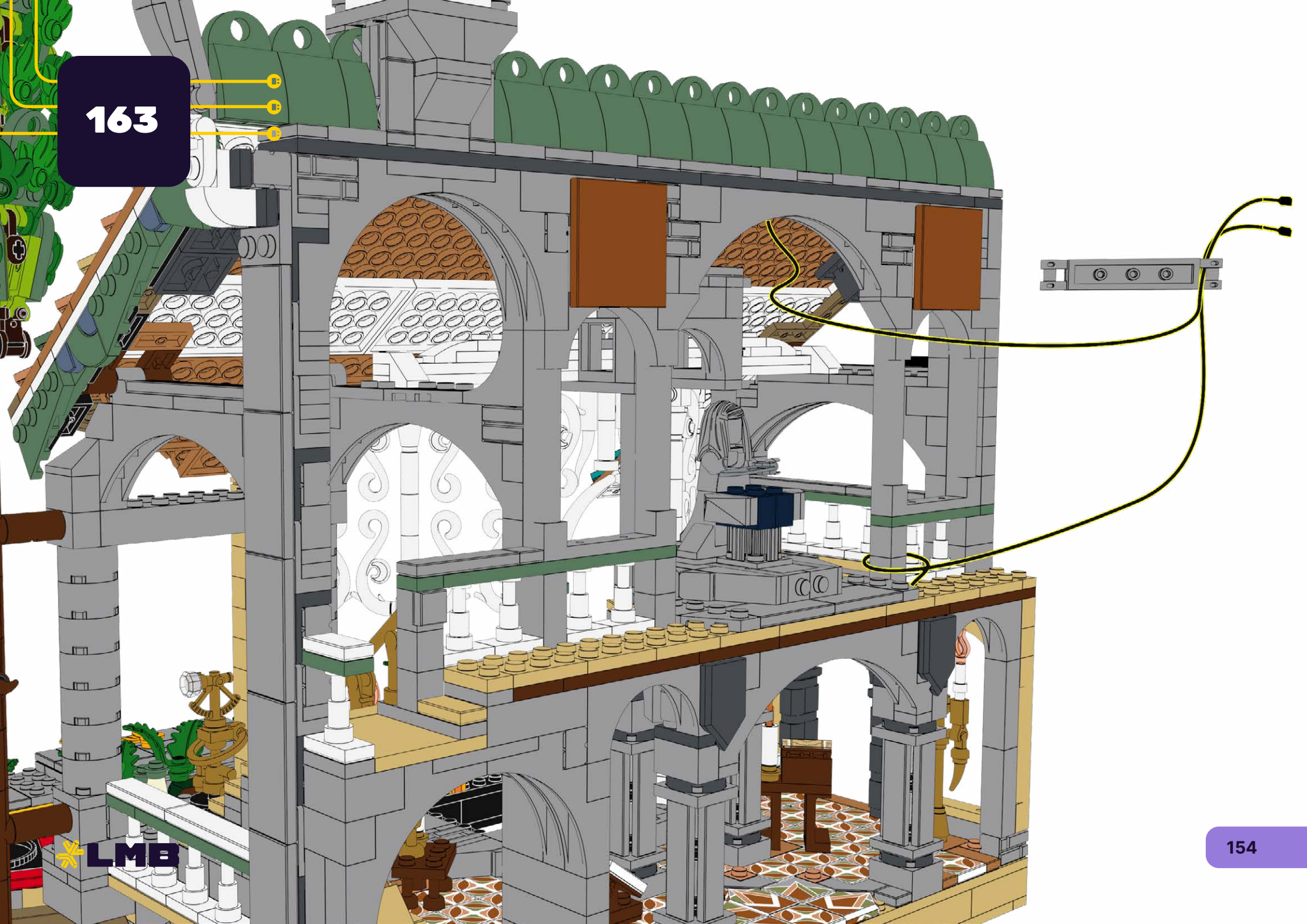

164

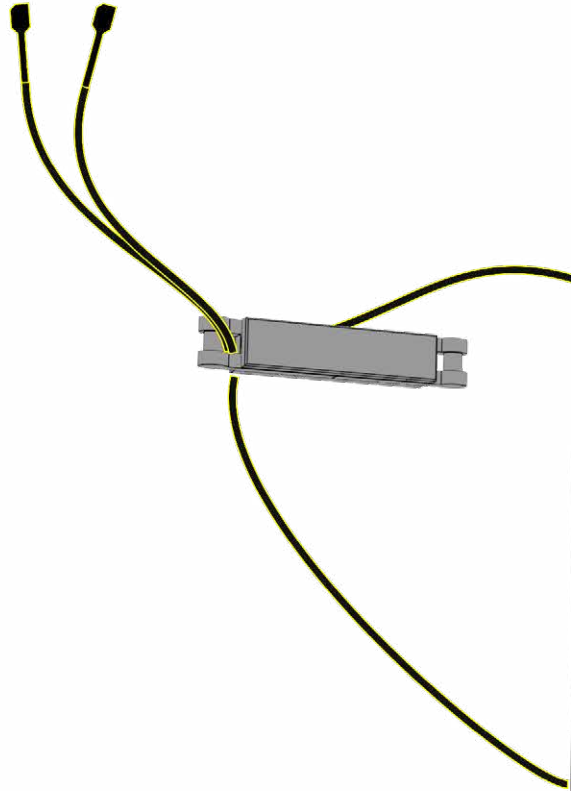

165

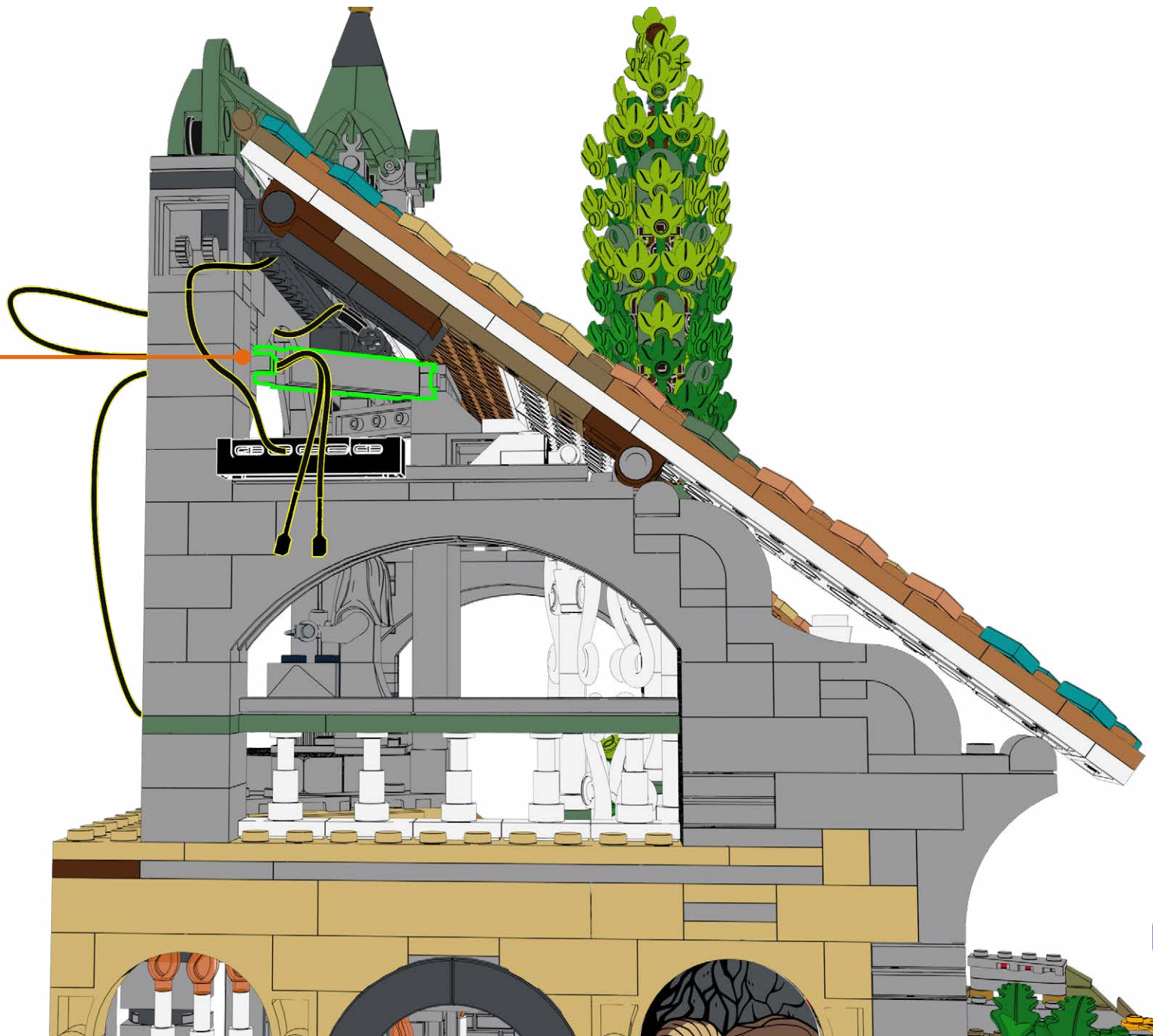
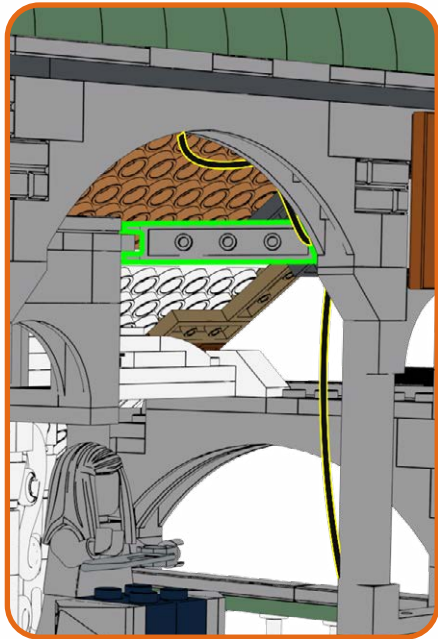

166

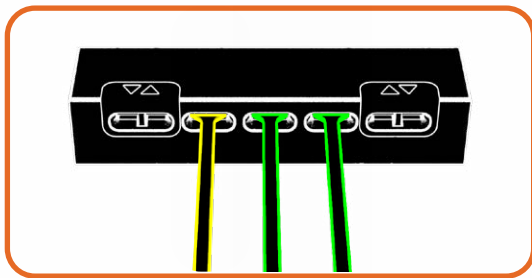

167



B-5

1x



168

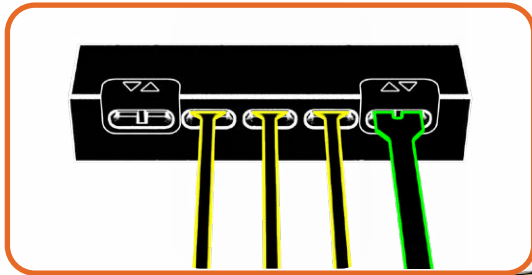

169

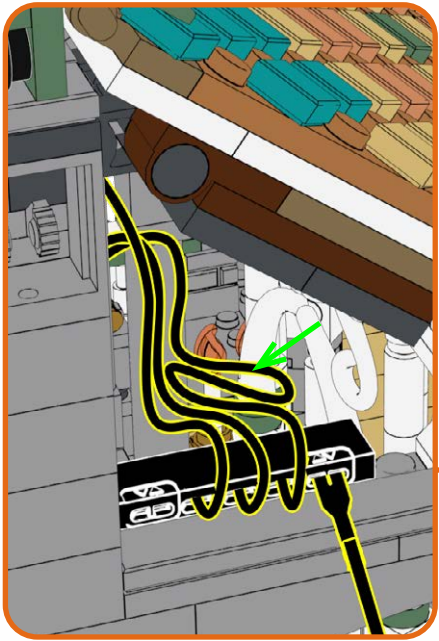

**HOLD UP!**

You might notice some bags are out of order, as well as left over pieces, but that's ok! We're changing the way you build LEGO!

HALTEN!

Möglicherweise stellen Sie fest, dass einige Beutel nicht in Ordnung sind und auch Teile übrig bleiben, aber das ist in Ordnung! Wir verändern die Art und Weise, wie Sie LEGO bauen!

TENIR BON!

Vous remarquerez peut-être que certains sacs sont en panne, ainsi que des morceaux restants, mais ce n'est pas grave ! Nous changeons la façon dont vous construisez LEGO !

SOSTENERE!

Potresti notare che alcune borse sono fuori uso, così come alcuni pezzi avanzati, ma va bene! Stiamo cambiando il modo in cui costruisci i LEGO!

¡SOSTENER!

Puede que notes que algunas bolsas están fuera de orden, así como piezas sobrantes, ¡pero está bien! ¡Estamos cambiando la forma de construir LEGO!

耽误!

您可能会注意到有些袋子坏了, 还有剩余的碎片, 但这没关系! 我们正在改变您搭建乐高的方式!

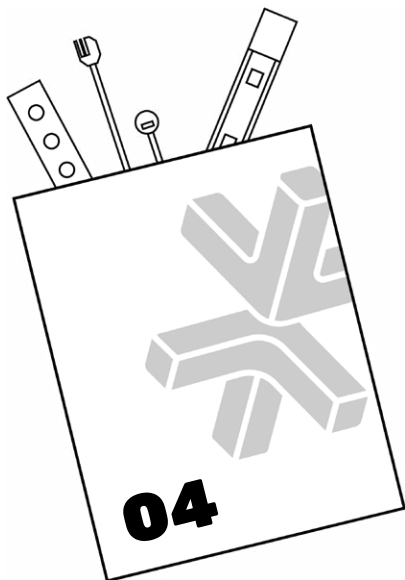
Open LMB Bag 04

170

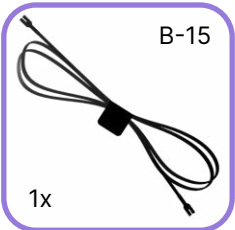

1

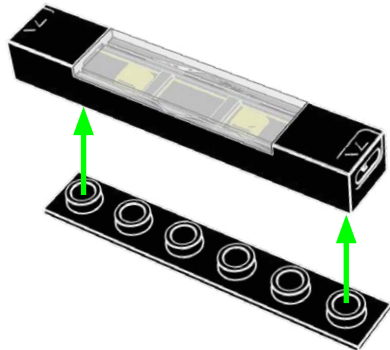

2

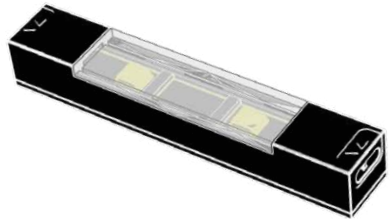

3

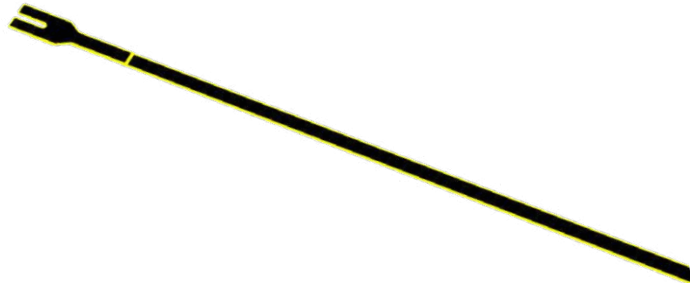
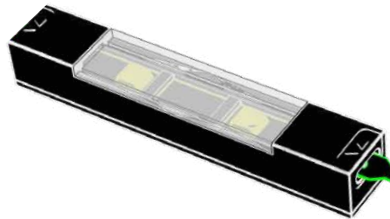

171

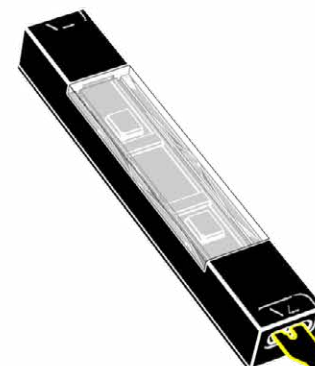

172

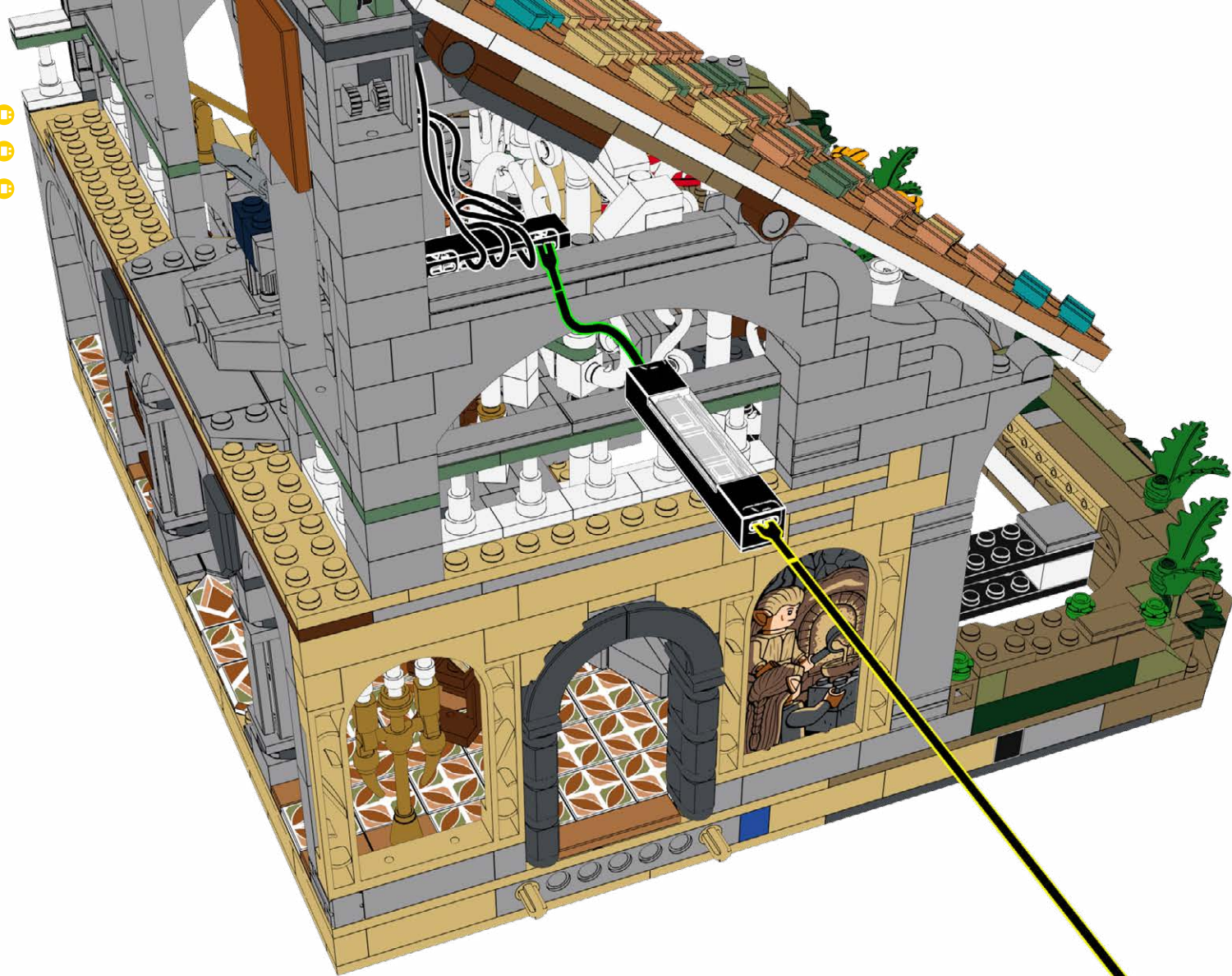

173

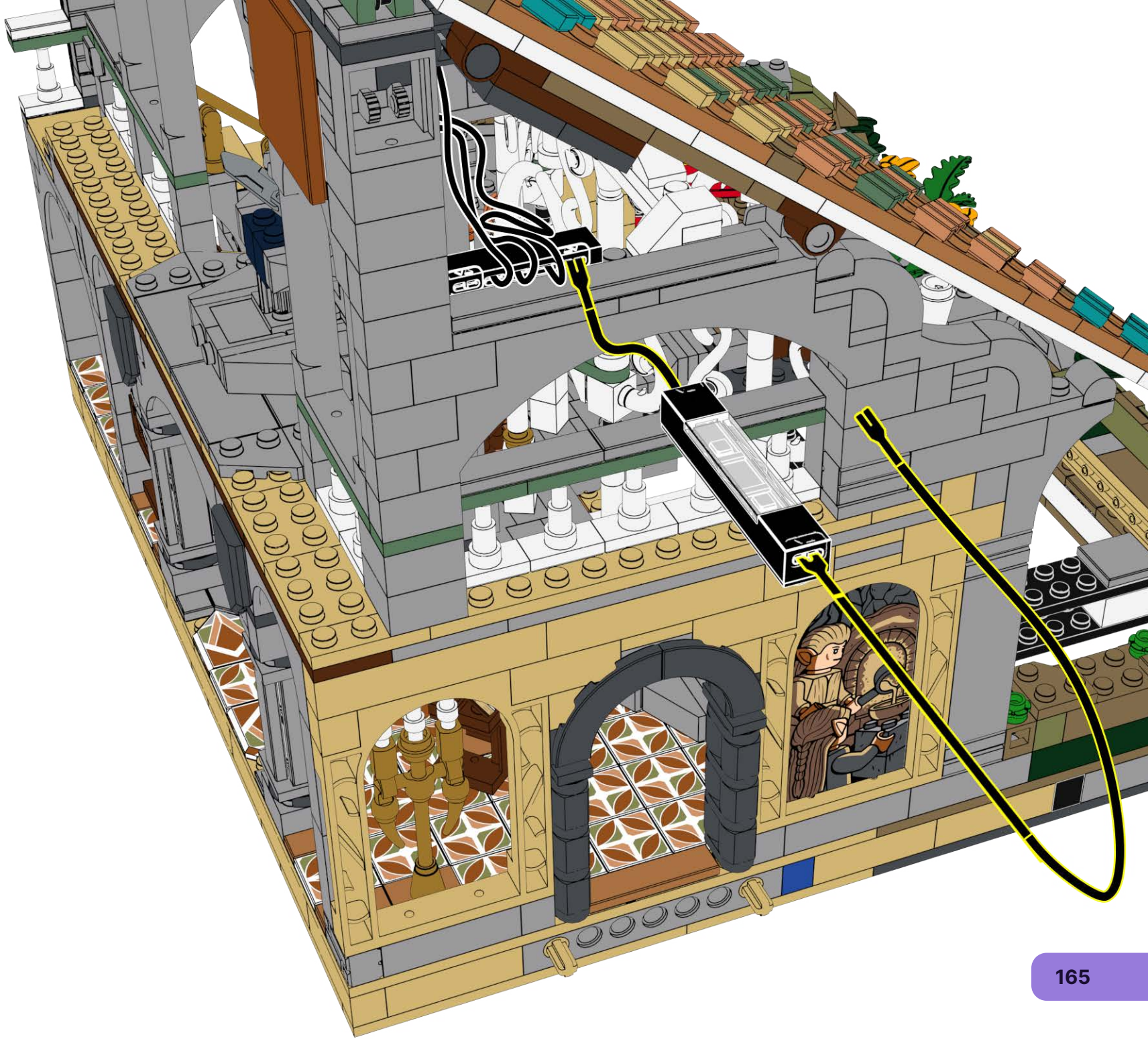

174



175

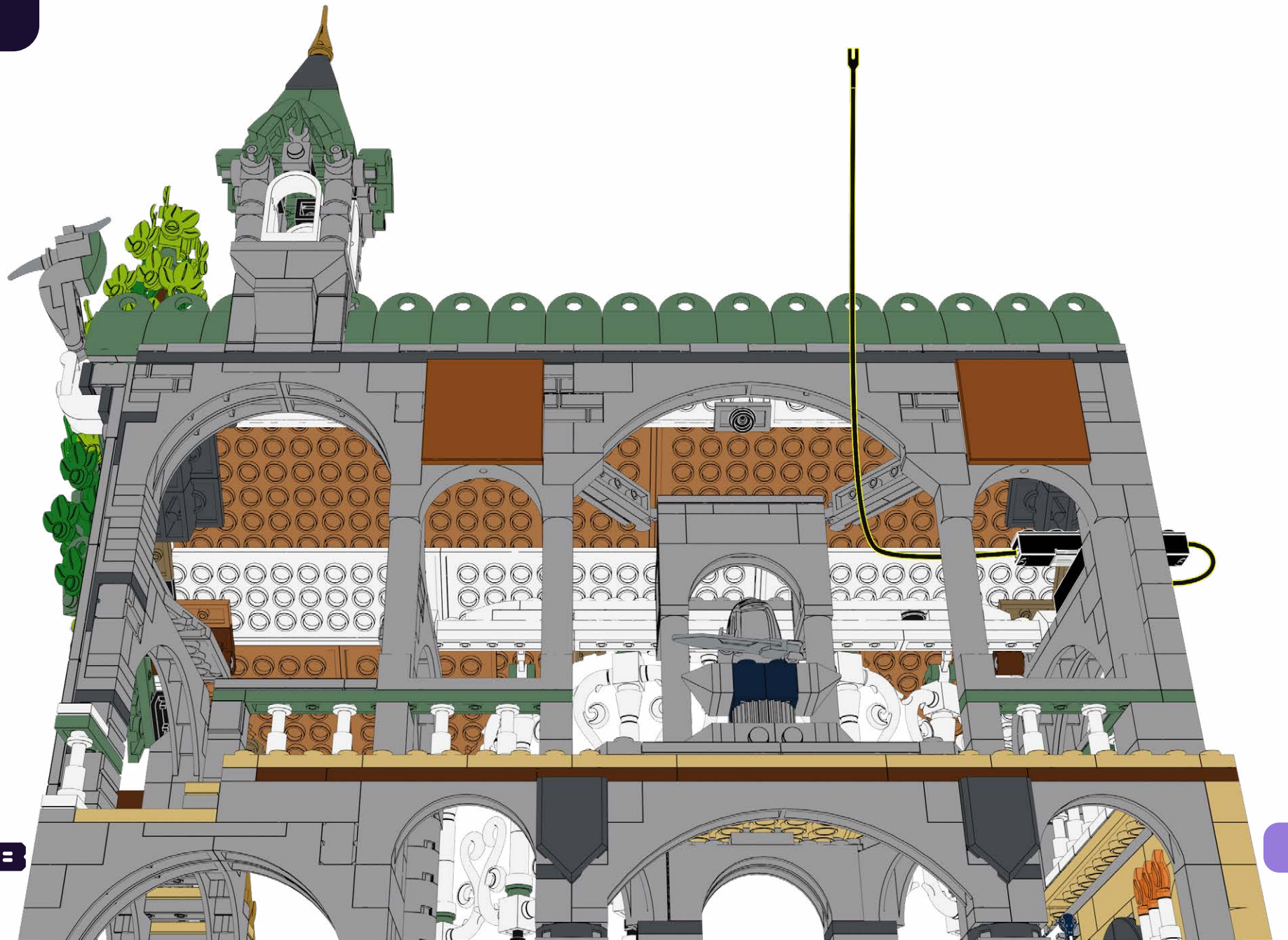

176

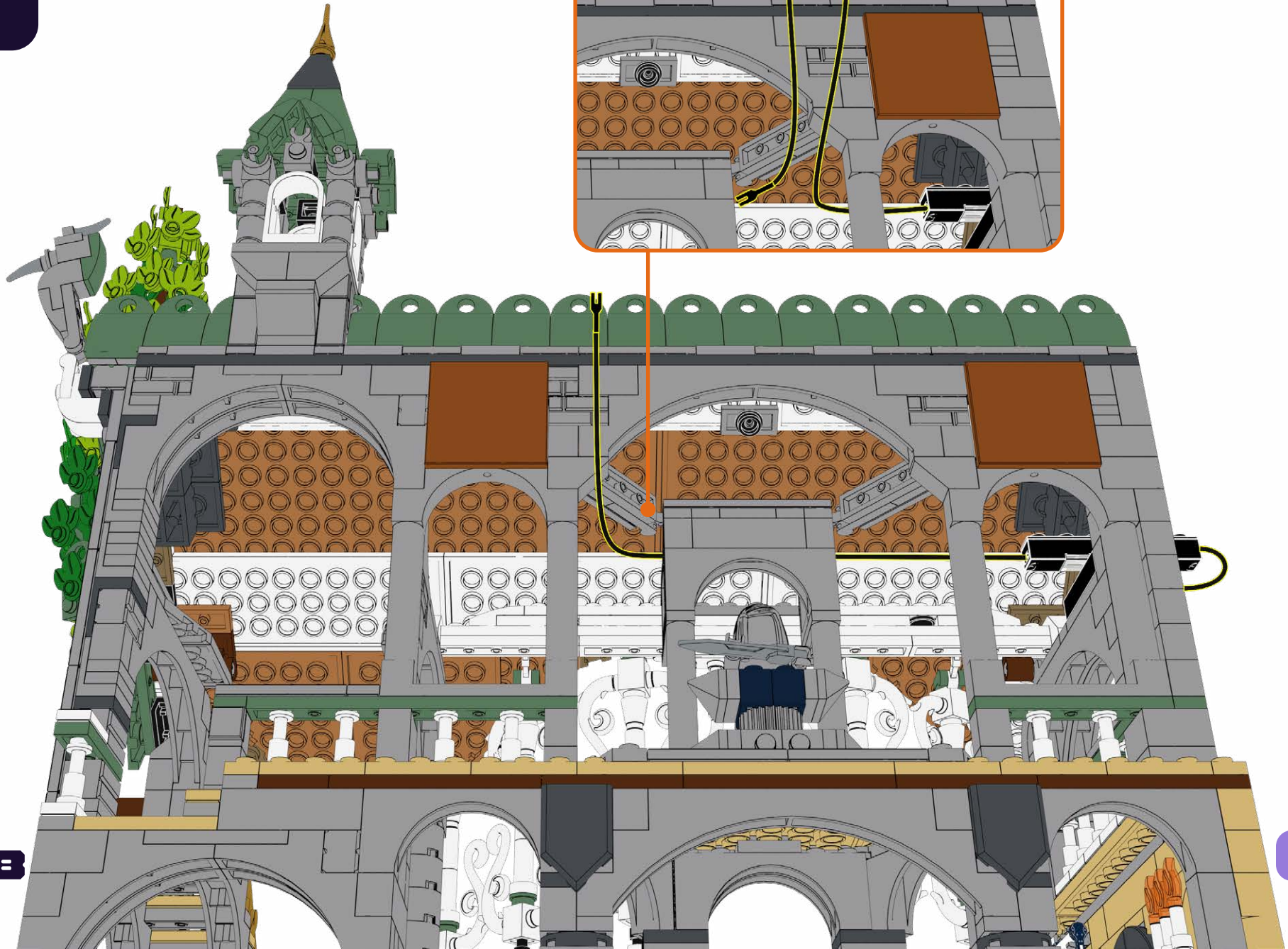

177

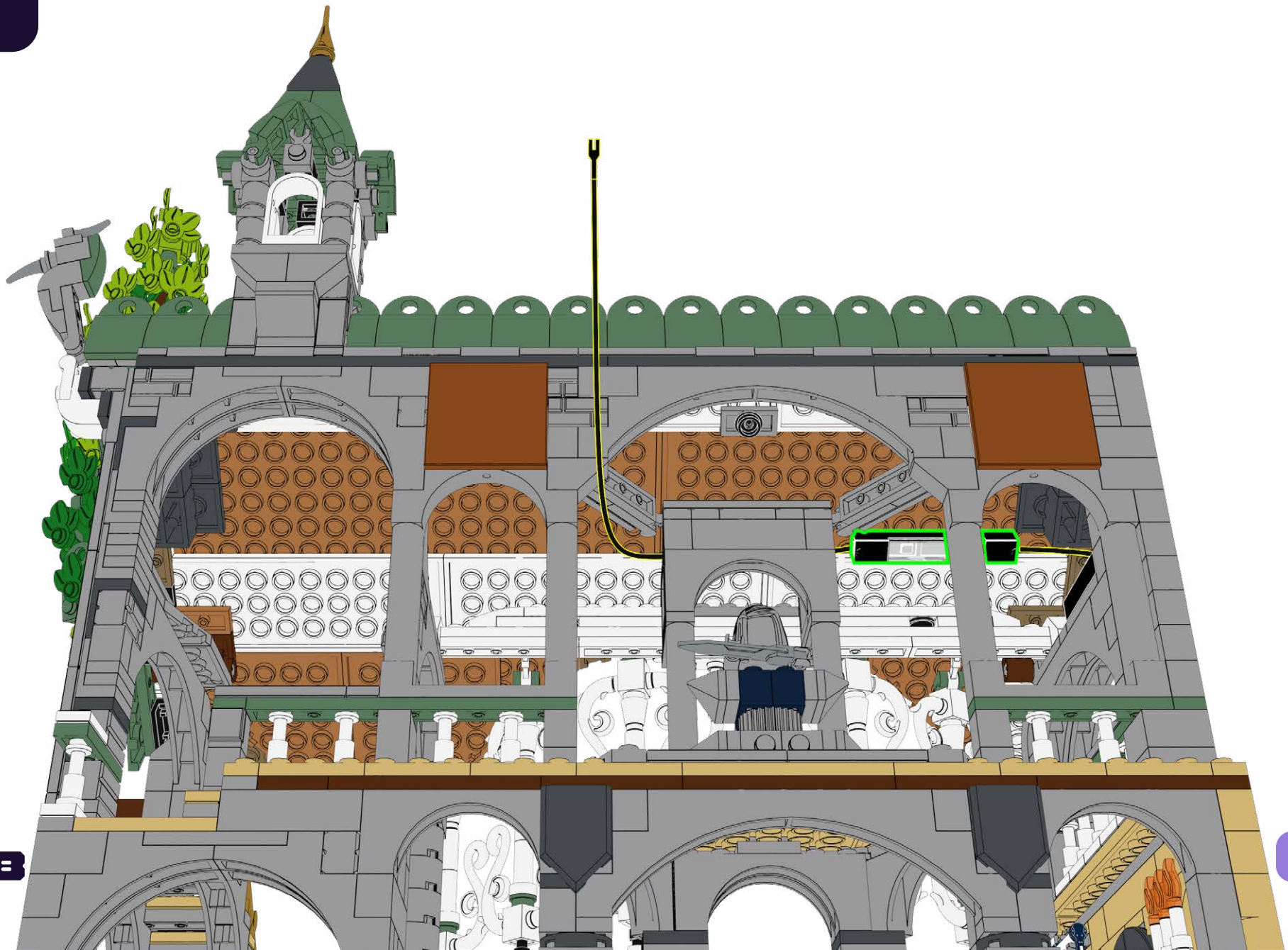

178

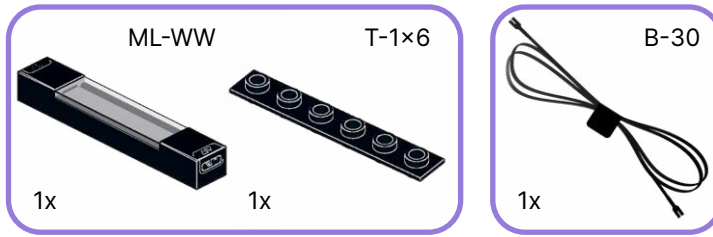

1

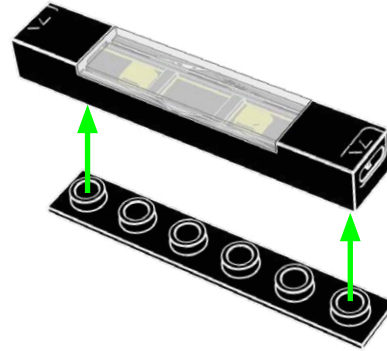

2

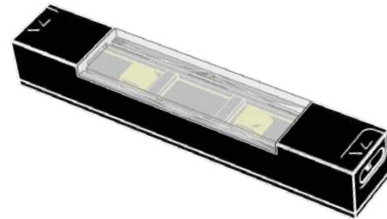

3

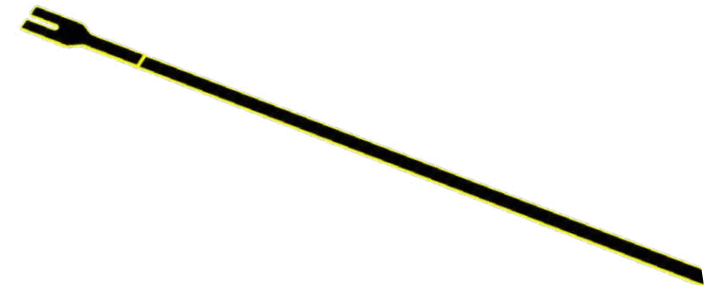
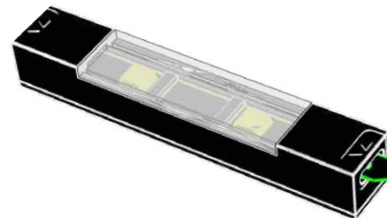

179

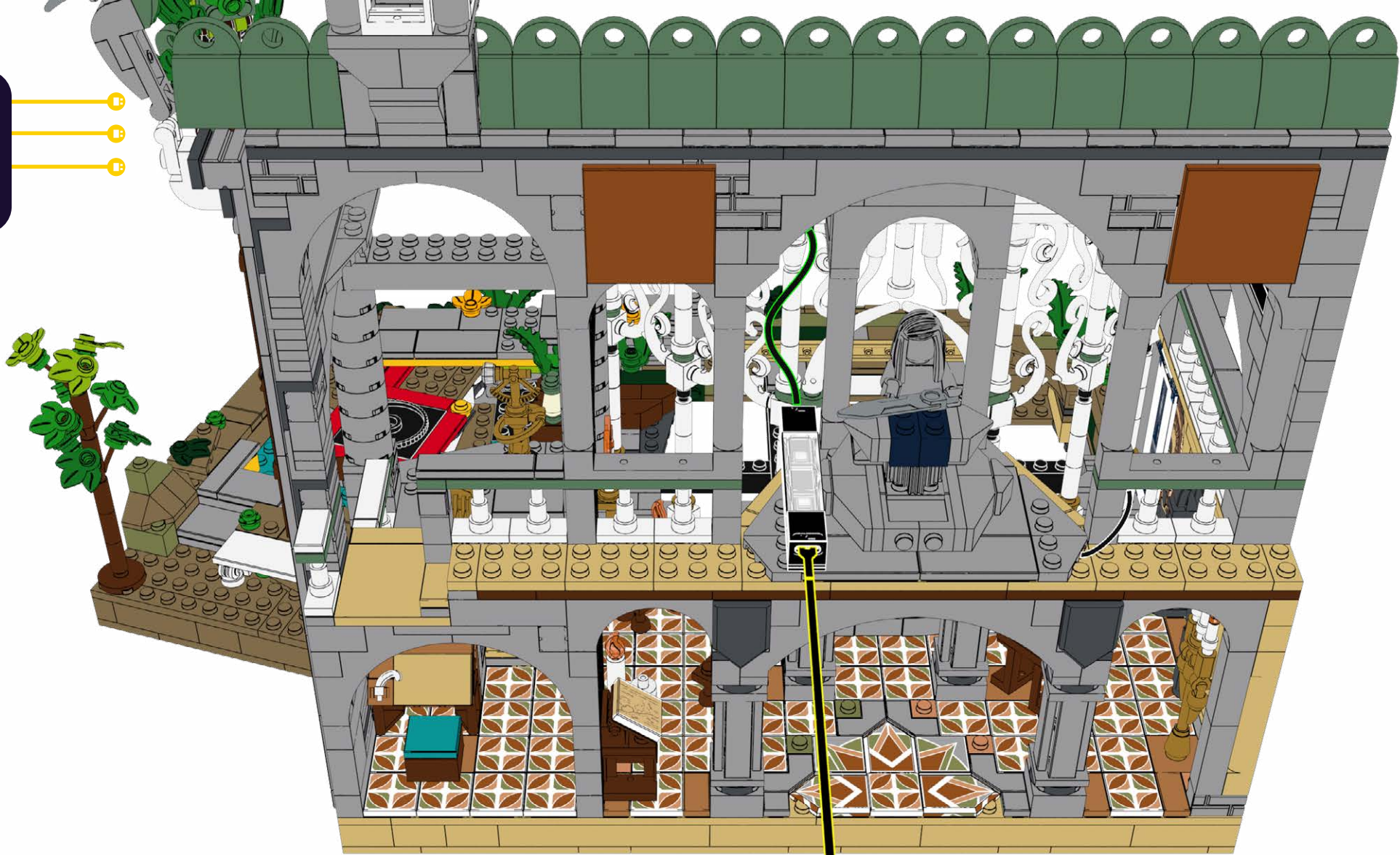

180

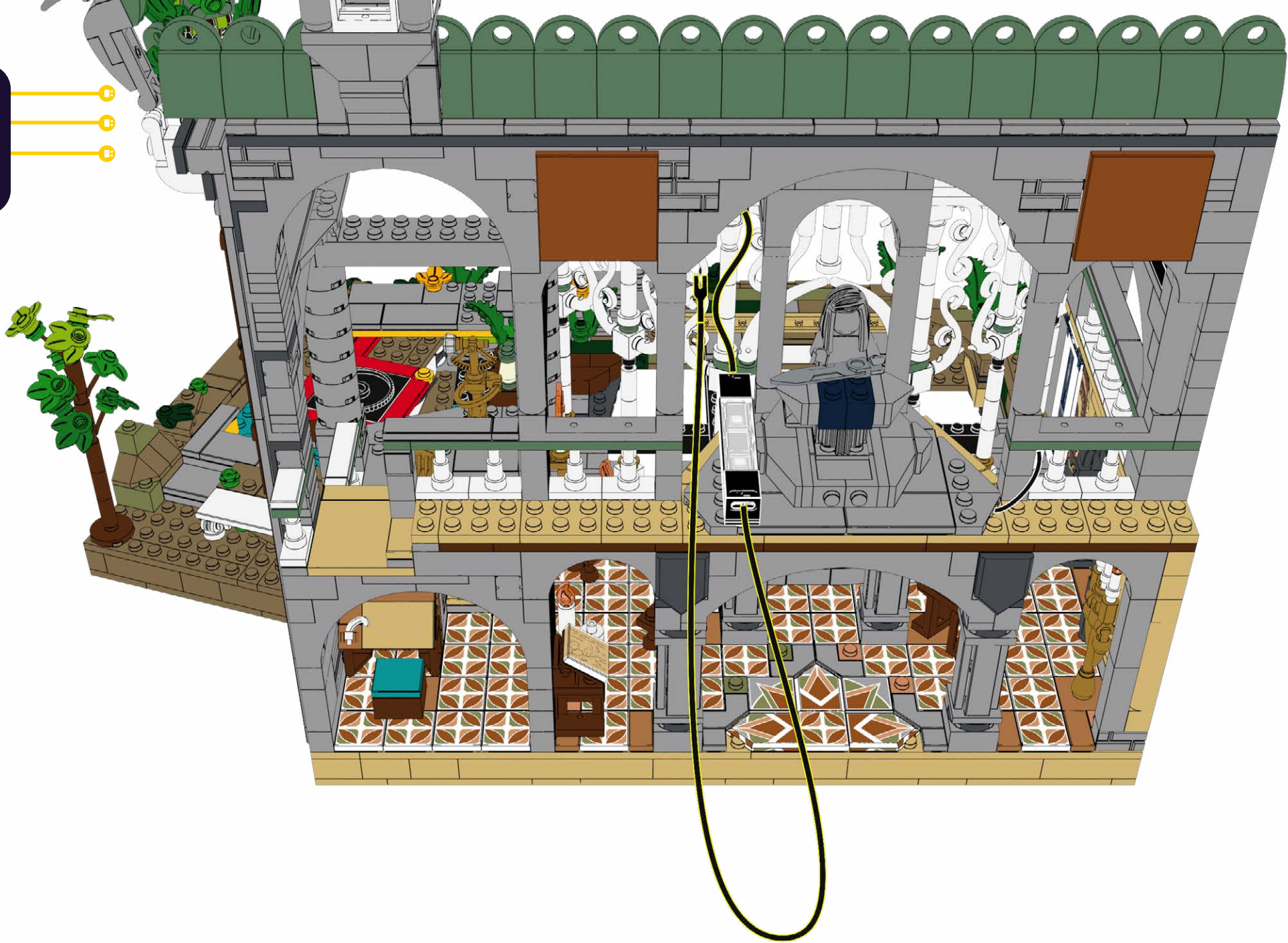

181



182



183



184



185



186



187



188



189



190



191

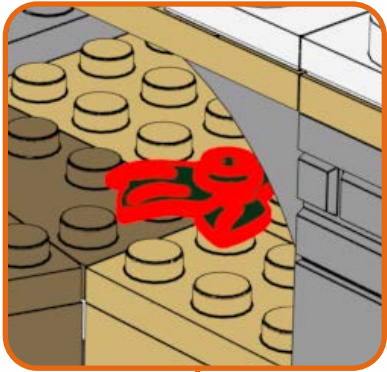

192



193

D-3



1x



194

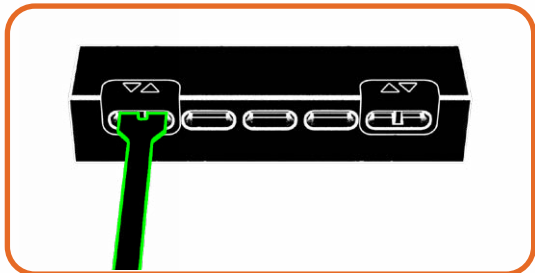

**HOLD UP!**

You might notice some bags are out of order, as well as left over pieces, but that's ok! We're changing the way you build LEGO!

HALTEN!

Möglicherweise stellen Sie fest, dass einige Beutel nicht in Ordnung sind und auch Teile übrig bleiben, aber das ist in Ordnung! Wir verändern die Art und Weise, wie Sie LEGO bauen!

TENIR BON!

Vous remarquerez peut-être que certains sacs sont en panne, ainsi que des morceaux restants, mais ce n'est pas grave ! Nous changeons la façon dont vous construisez LEGO !

SOSTENERE!

Potresti notare che alcune borse sono fuori uso, così come alcuni pezzi avanzati, ma va bene! Stiamo cambiando il modo in cui costruisci i LEGO!

¡SOSTENER!

Puede que notes que algunas bolsas están fuera de orden, así como piezas sobrantes, ¡pero está bien! ¡Estamos cambiando la forma de construir LEGO!

耽误!

您可能会注意到有些袋子坏了, 还有剩余的碎片, 但这没关系! 我们正在改变您搭建乐高的方式!

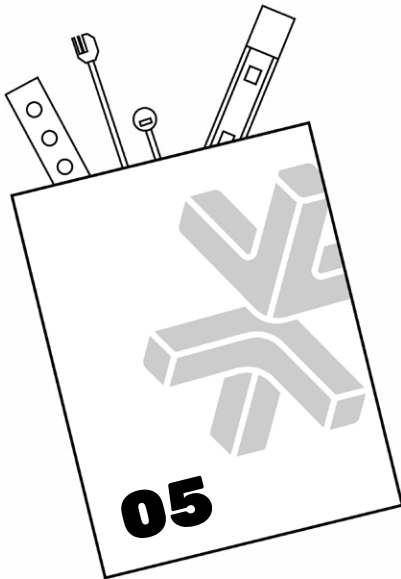
Open LMB Bag 05

195



196



197

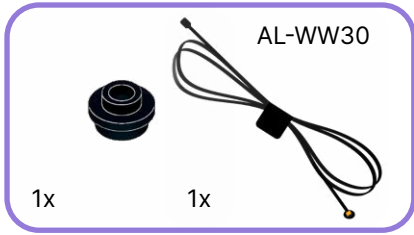

1

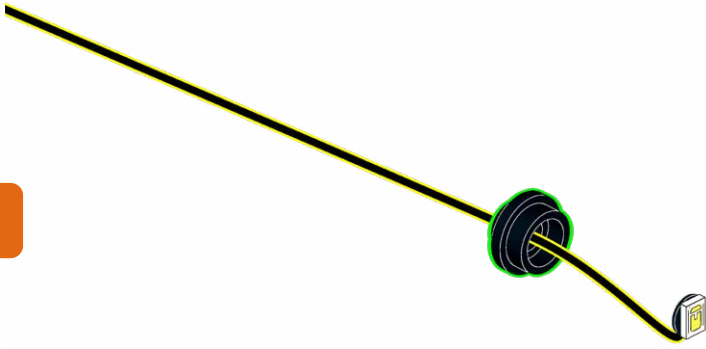

2

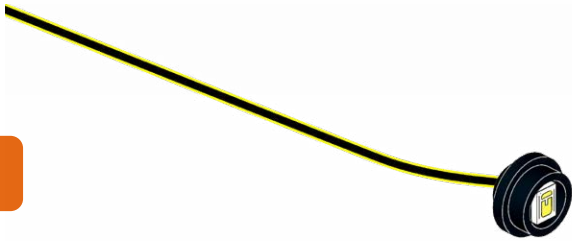

3

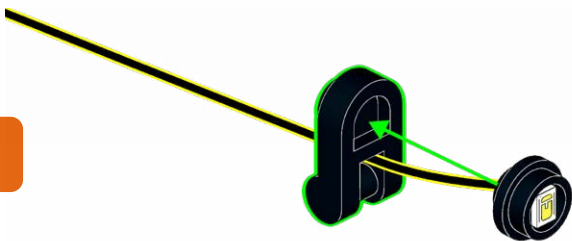

198

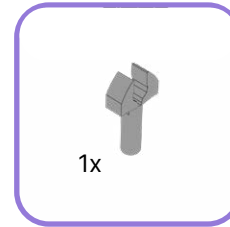

1

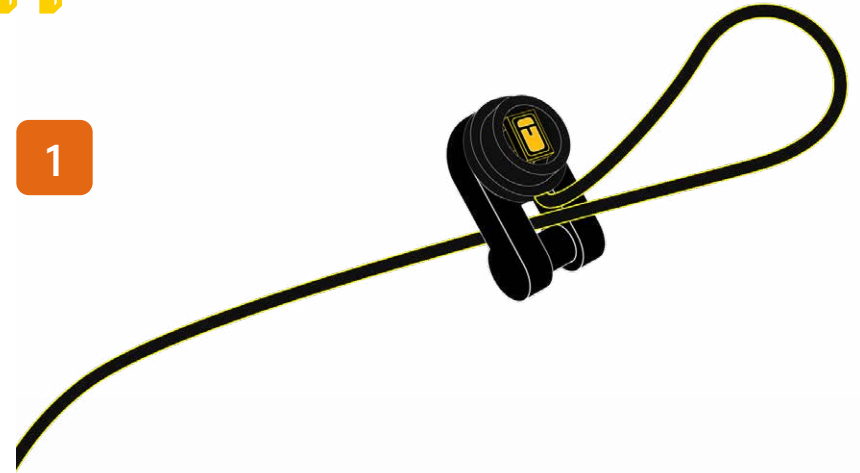

2

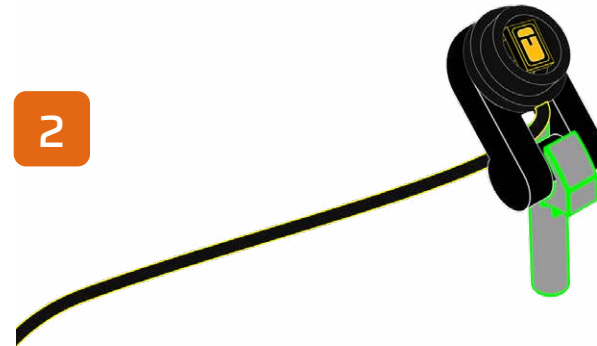

199



200



201

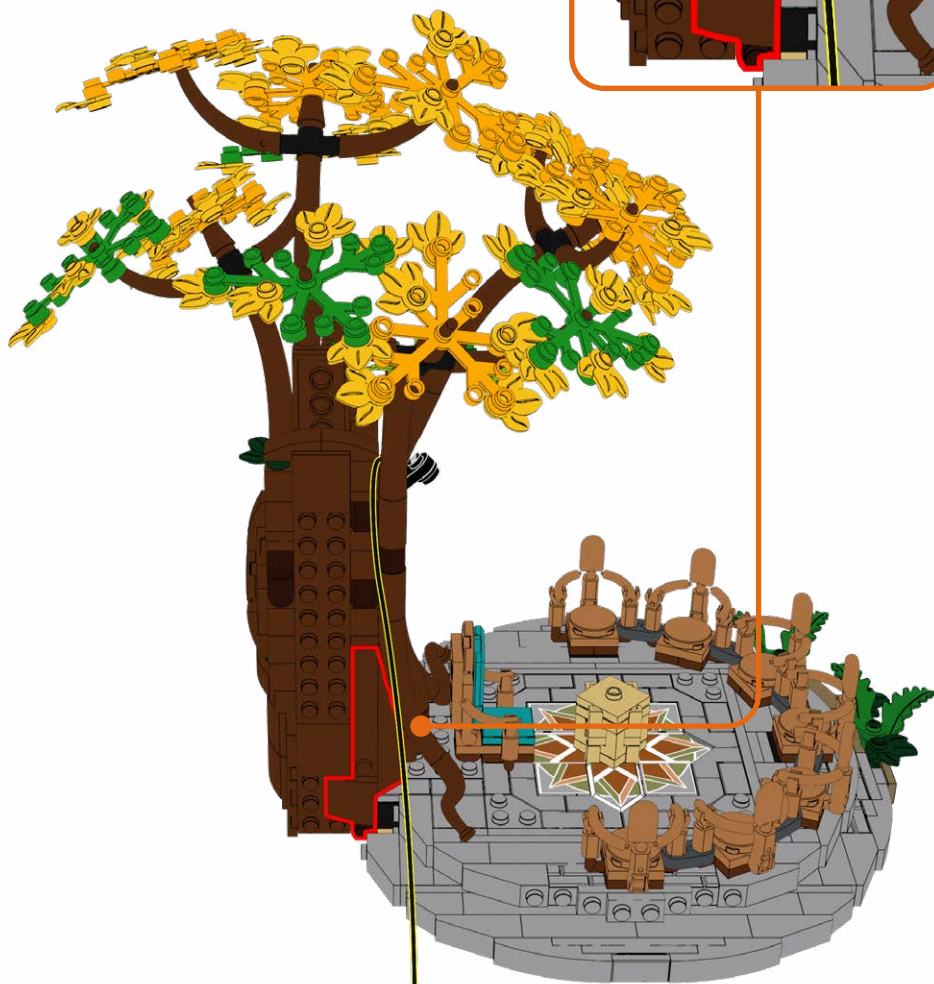
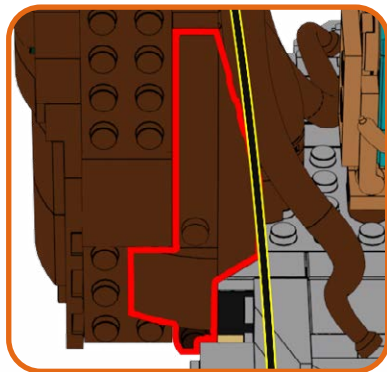

202



203

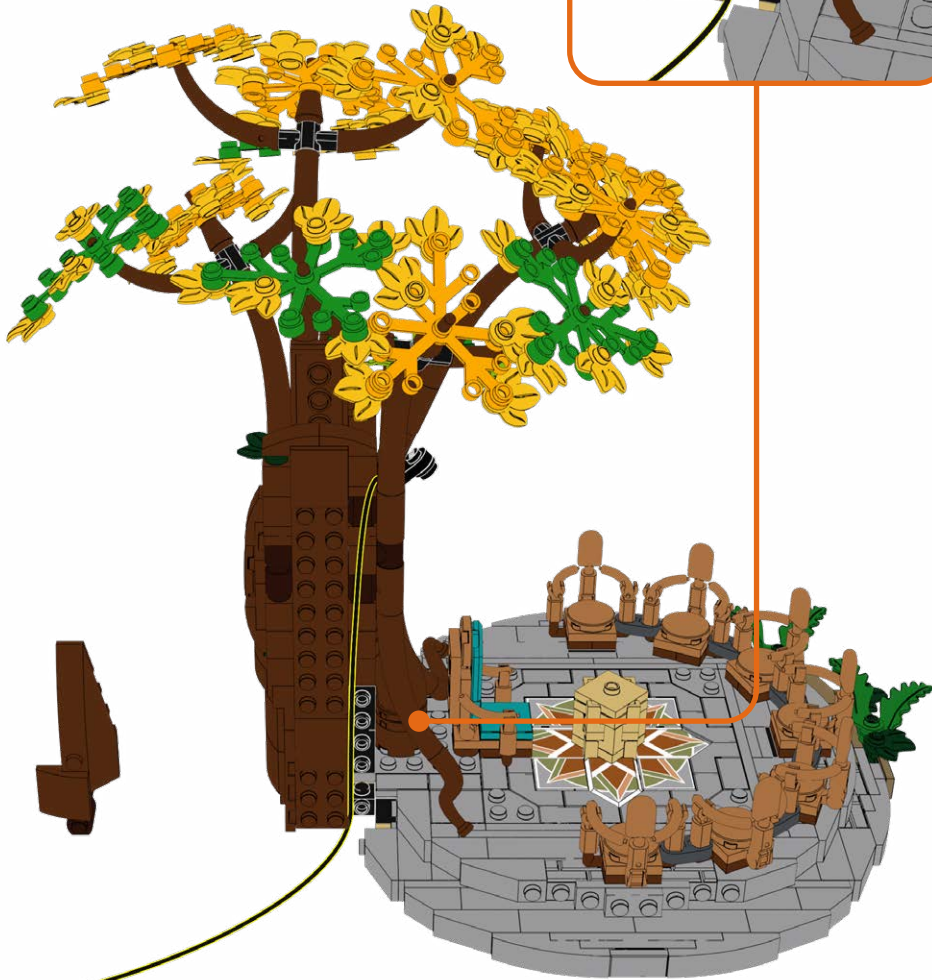
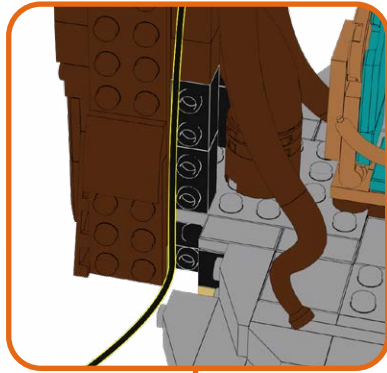

204



205



206

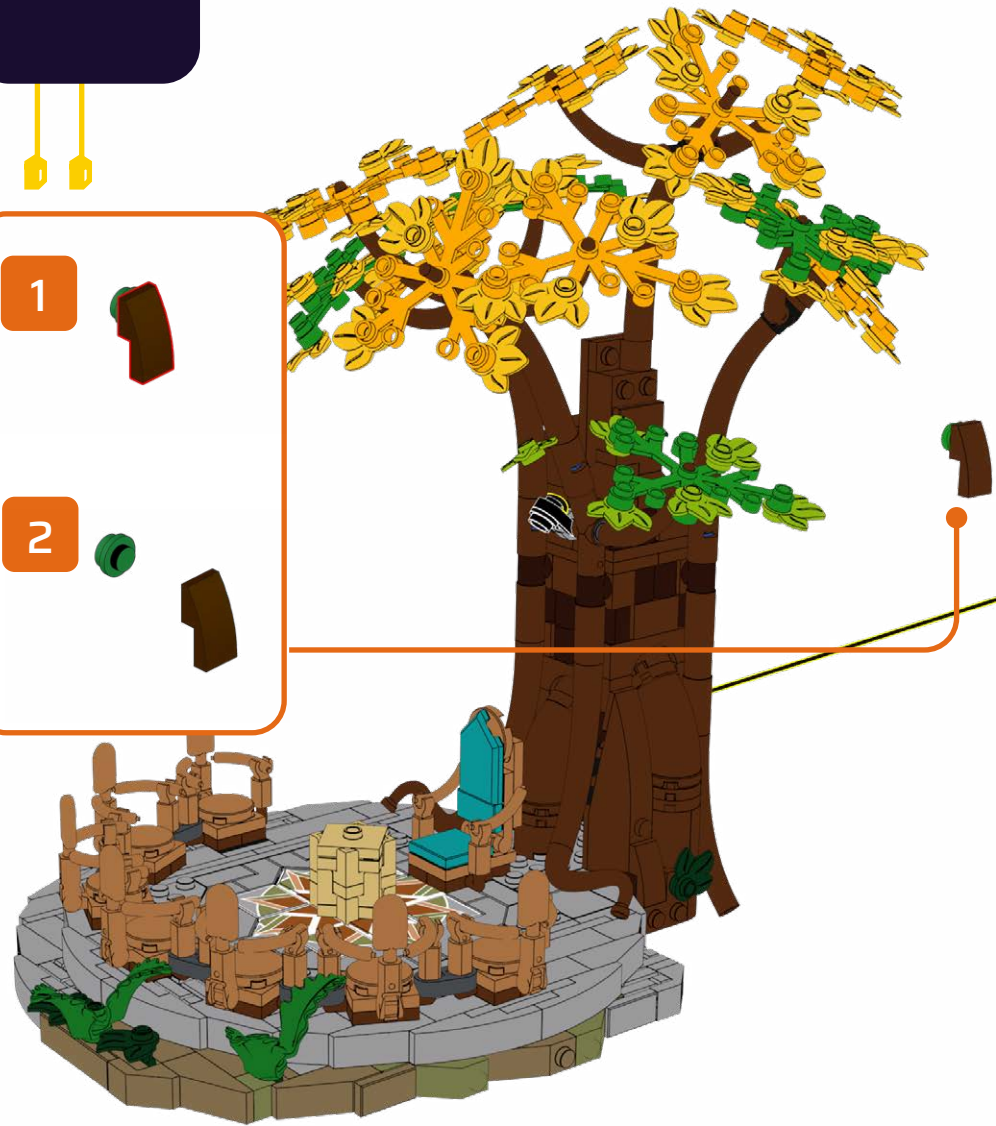
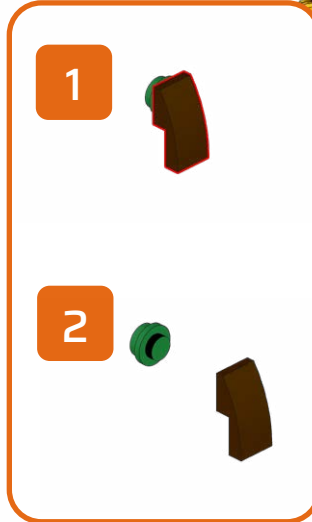

207

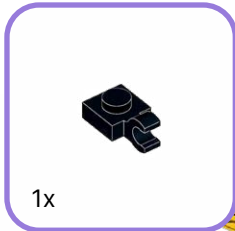

208



209



210



211

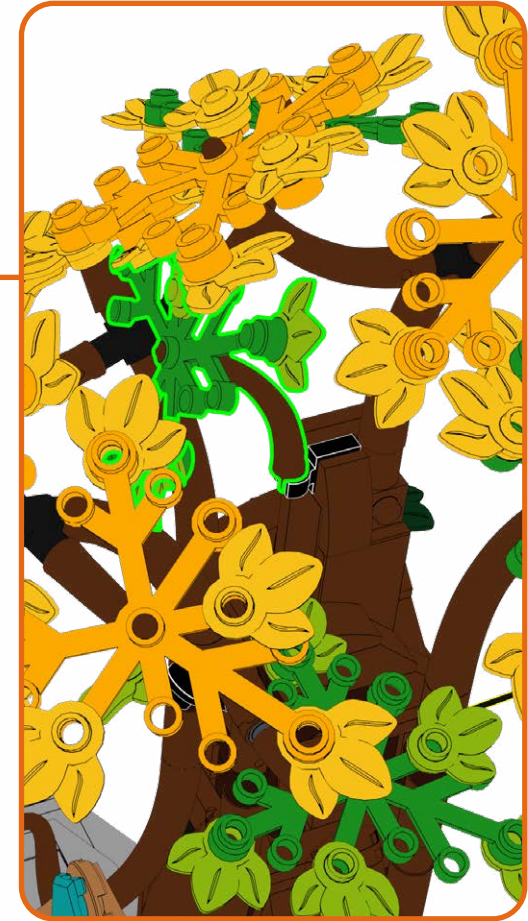

212



213



214



215



216



217



218



219



220



221



222

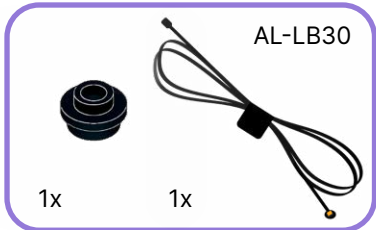

1

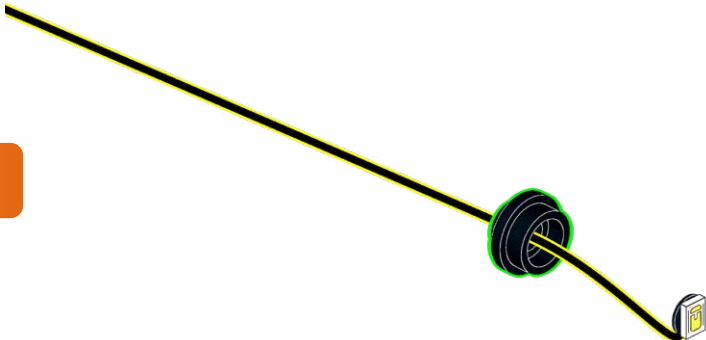

2

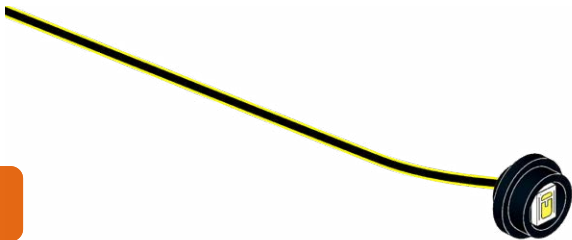

1

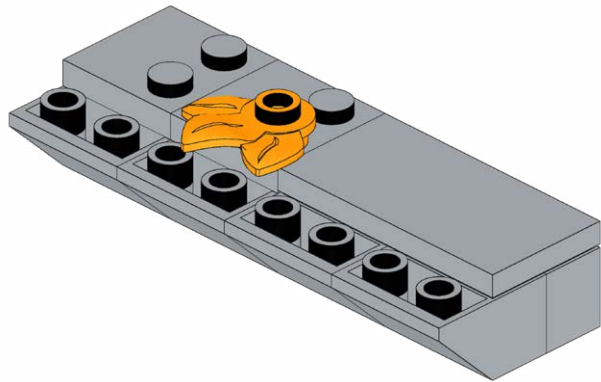

2

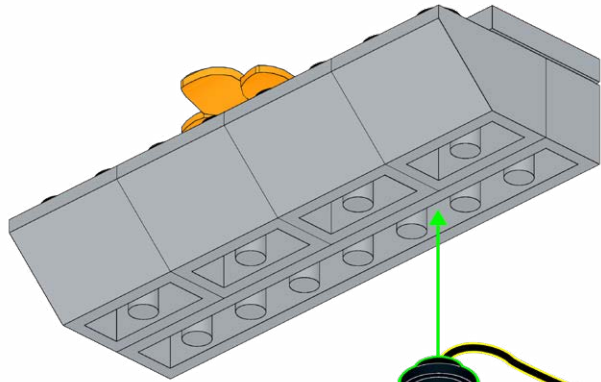

3

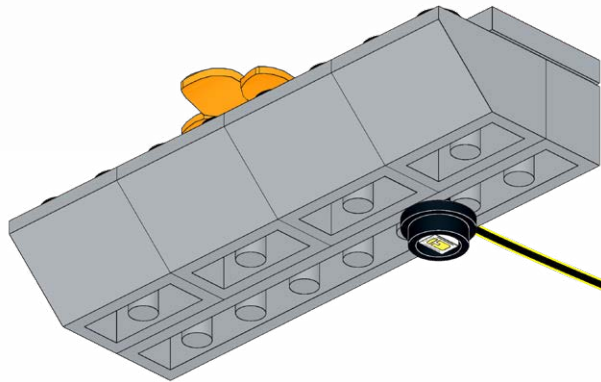

223



224



225



226



227



228



229



230



231

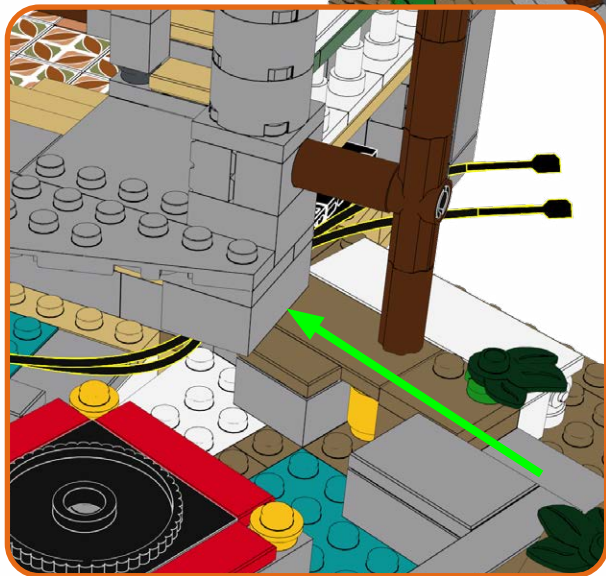

232



233



234

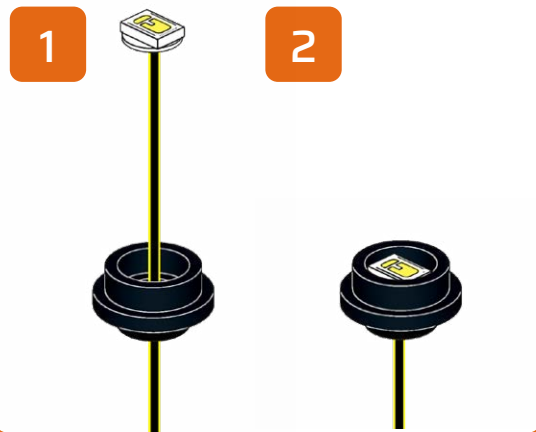
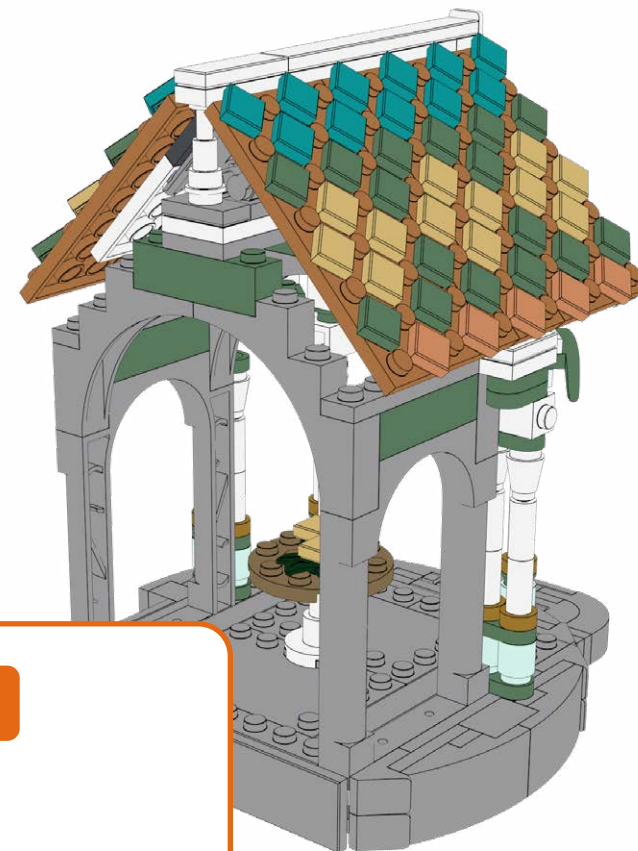
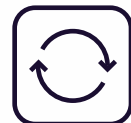
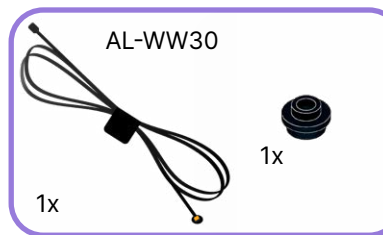

235

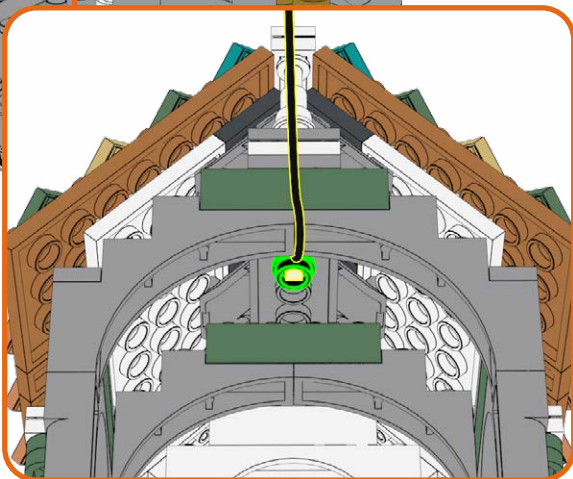
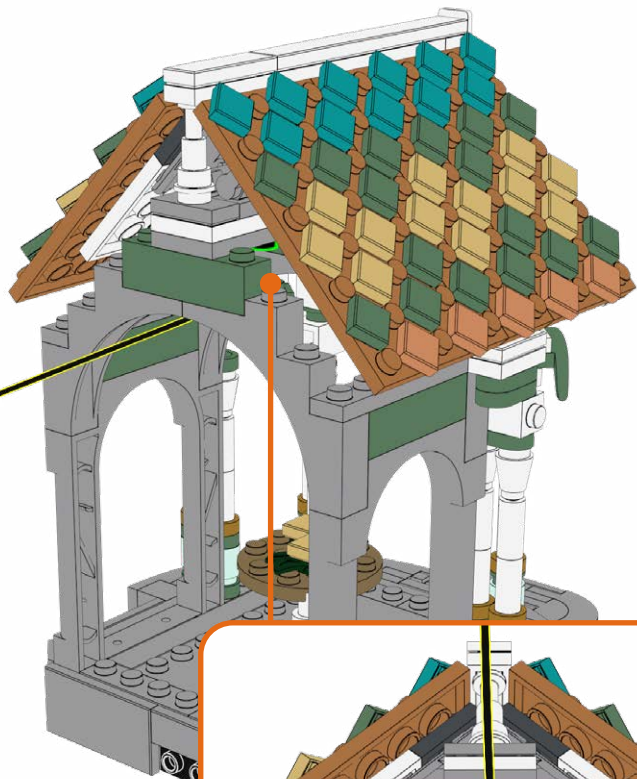

236

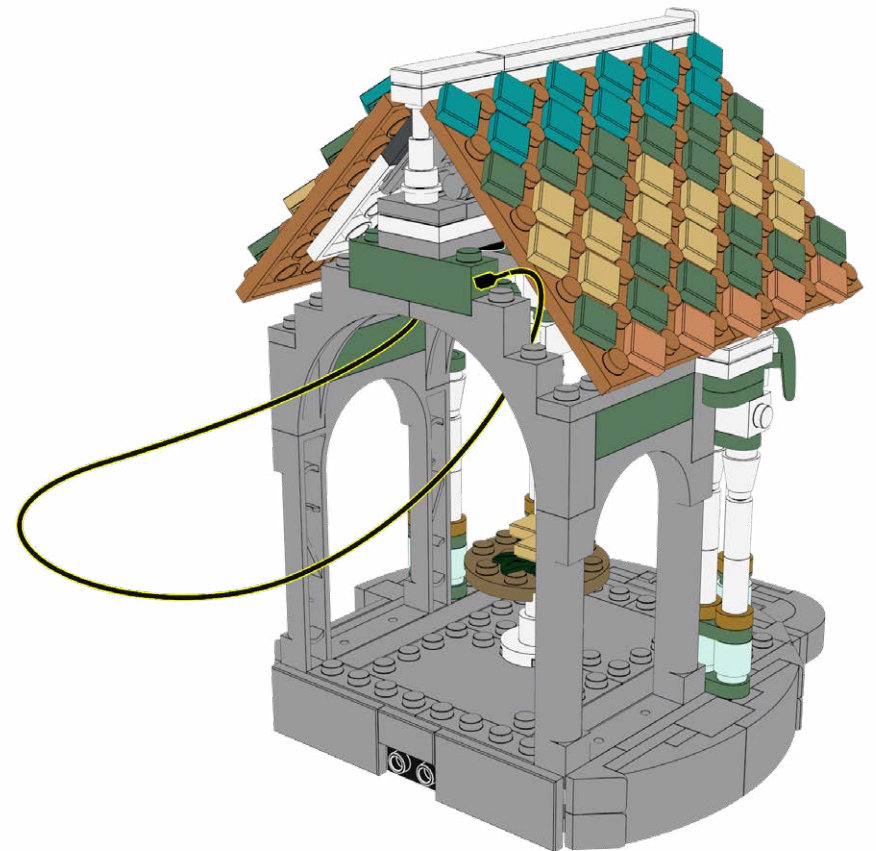

237

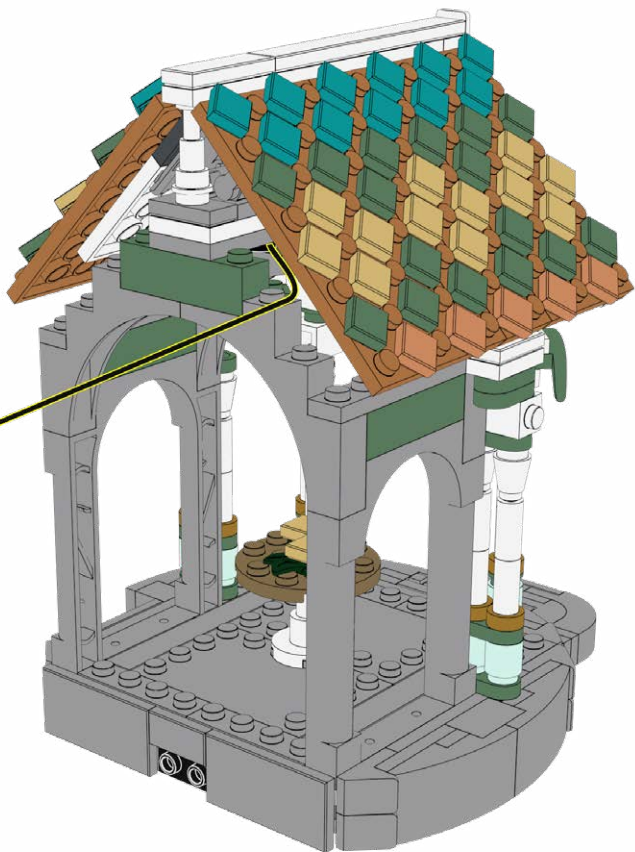

238

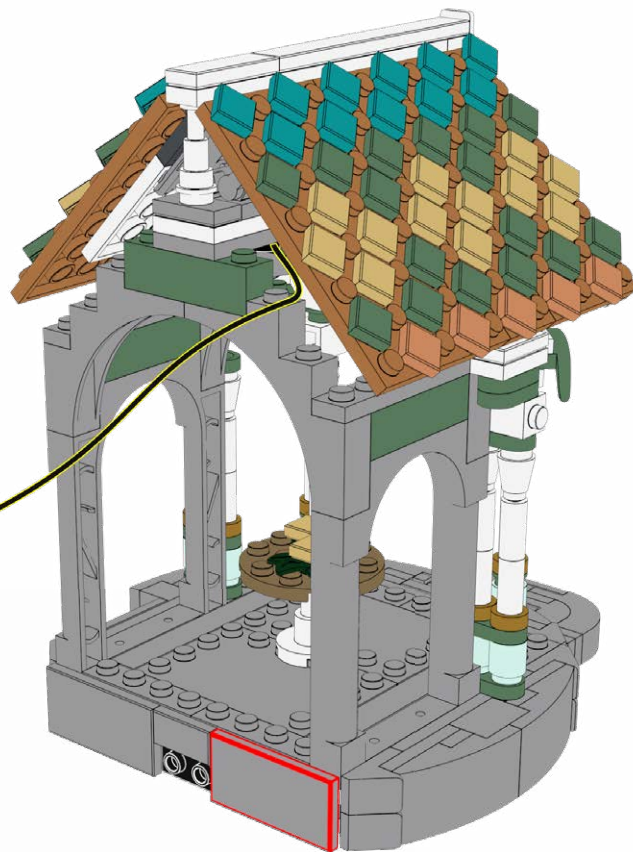

239

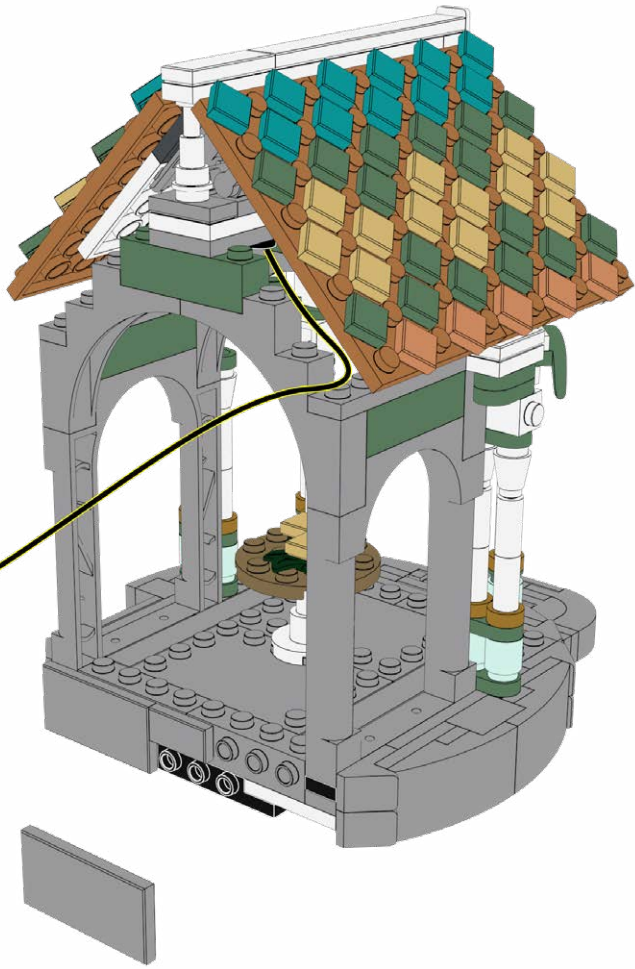

240

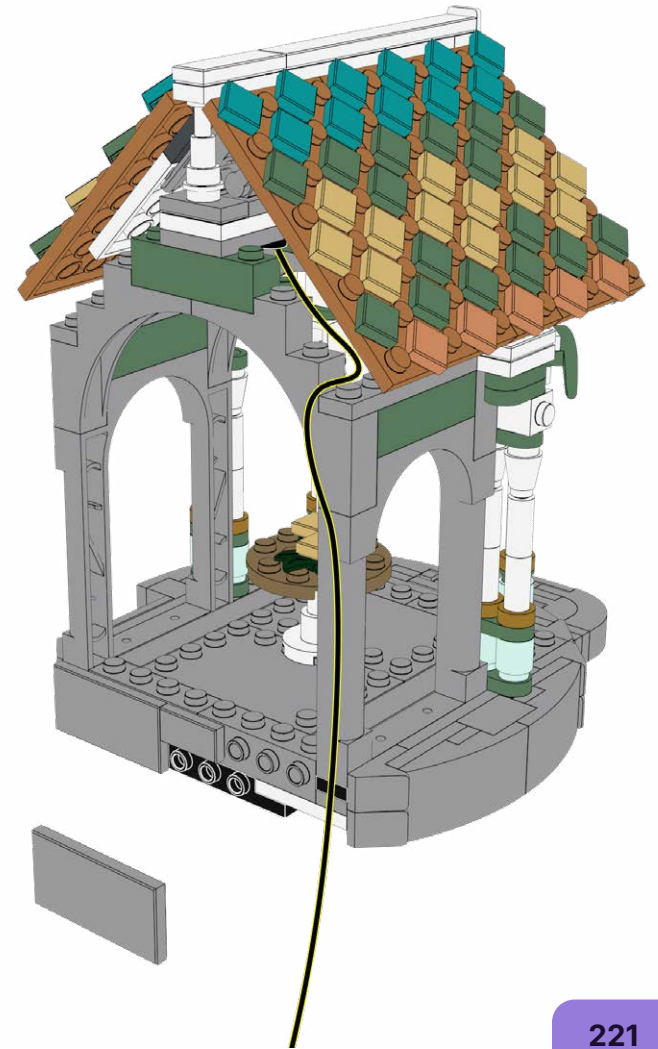

241

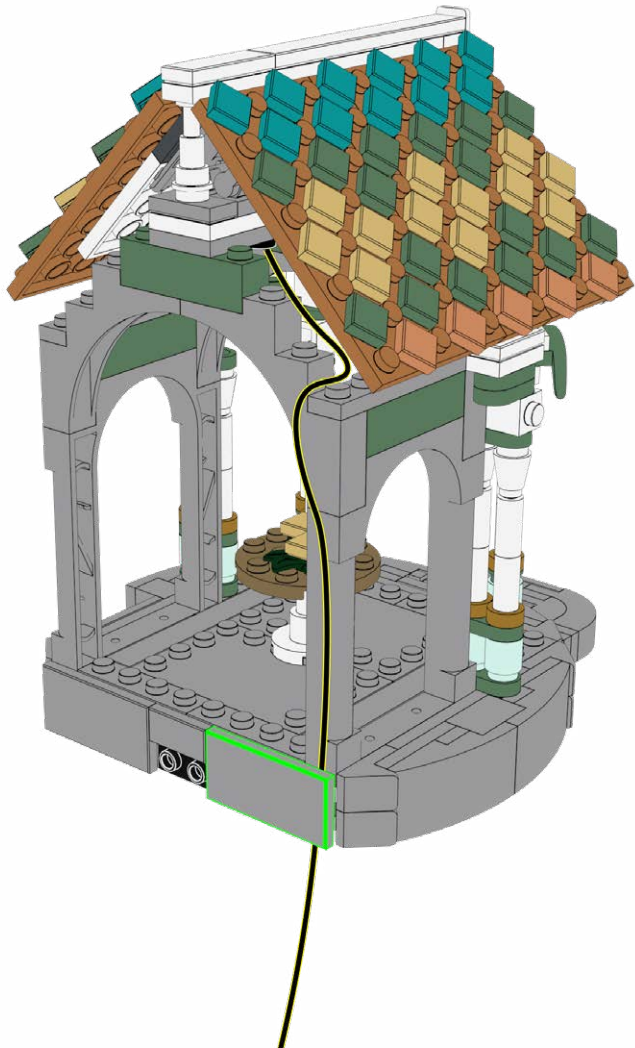

242

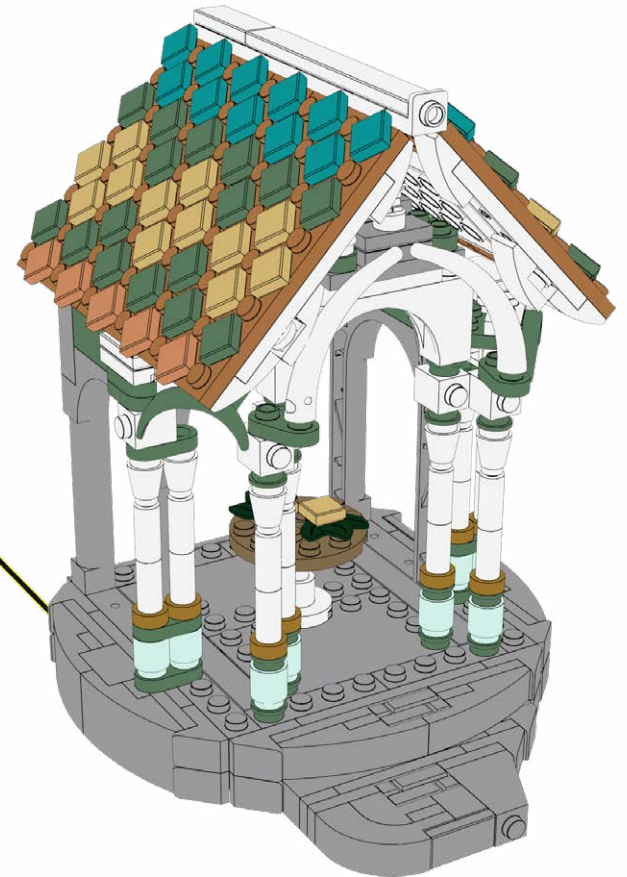

243



244



245



246

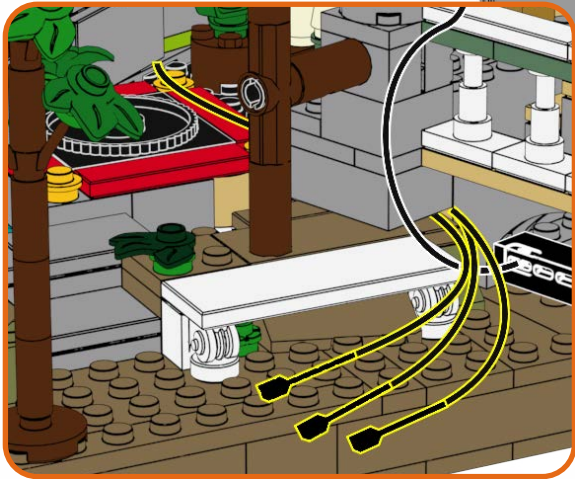

247

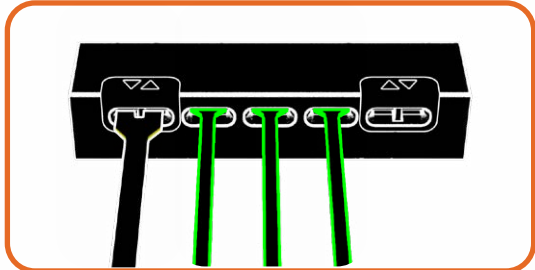

248



249

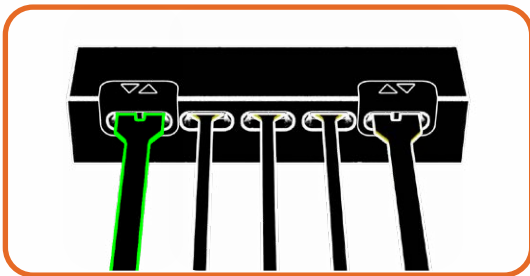
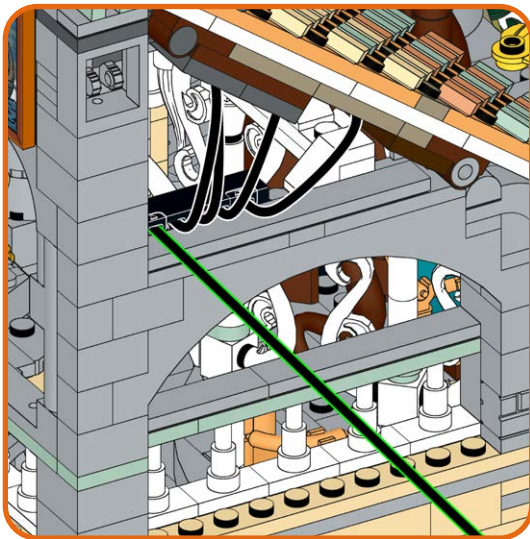

250



251



Light Test
Lichttest
Test de lumière
Prova della luce
prueba de luz
灯光测试



252



253



254



255



256



257



258



259



260



261



262

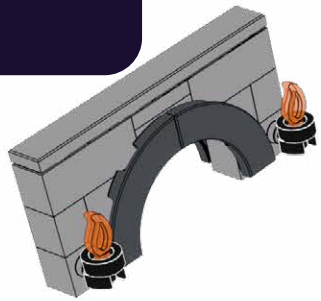

263



264



**HOLD UP!**

You might notice some bags are out of order, as well as left over pieces, but that's ok! We're changing the way you build LEGO!

HALTEN!

Möglicherweise stellen Sie fest, dass einige Beutel nicht in Ordnung sind und auch Teile übrig bleiben, aber das ist in Ordnung! Wir verändern die Art und Weise, wie Sie LEGO bauen!

TENIR BON!

Vous remarquerez peut-être que certains sacs sont en panne, ainsi que des morceaux restants, mais ce n'est pas grave ! Nous changeons la façon dont vous construisez LEGO !

SOSTENERE!

Potresti notare che alcune borse sono fuori uso, così come alcuni pezzi avanzati, ma va bene! Stiamo cambiando il modo in cui costruisci i LEGO!

¡SOSTENER!

Puede que notes que algunas bolsas están fuera de orden, así como piezas sobrantes, ¡pero está bien! ¡Estamos cambiando la forma de construir LEGO!

耽误!

您可能会注意到有些袋子坏了, 还有剩余的碎片, 但这没关系! 我们正在改变您搭建乐高的方式!

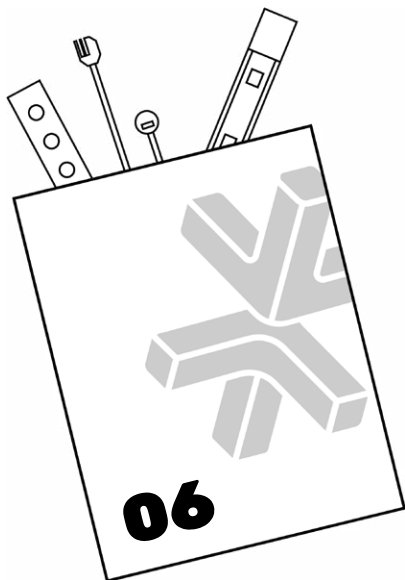
Open LMB Bag 06

265

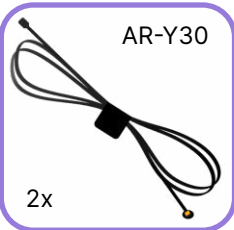
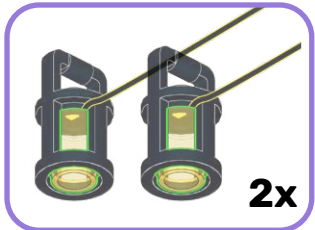

1



2

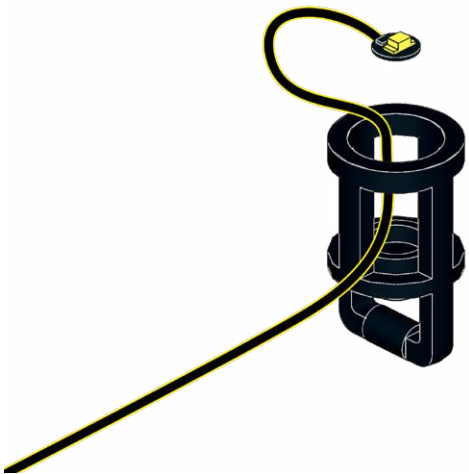

3

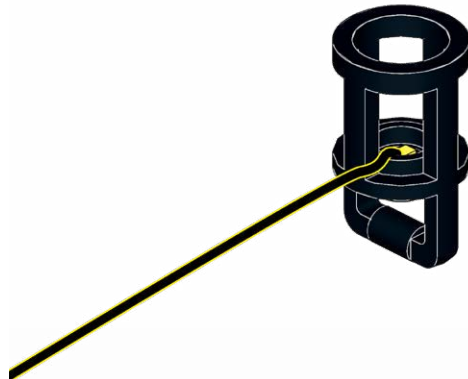

4

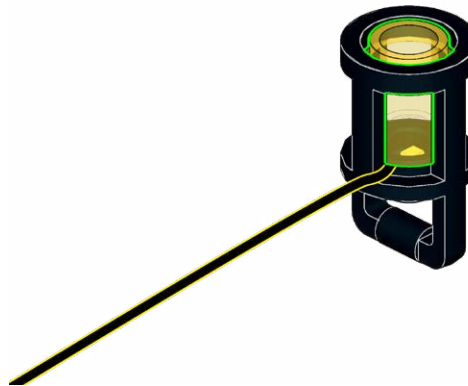

2x

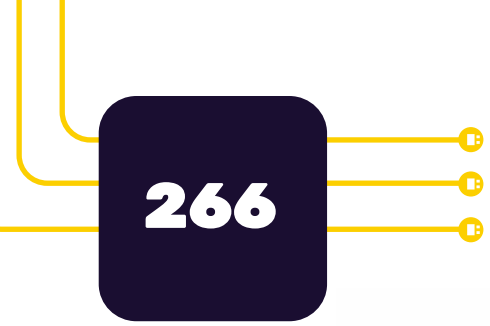

1

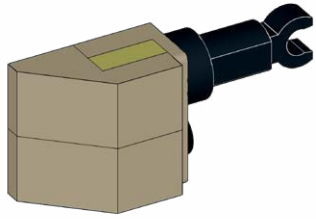

2

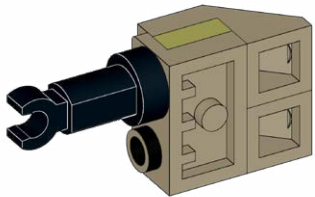

3

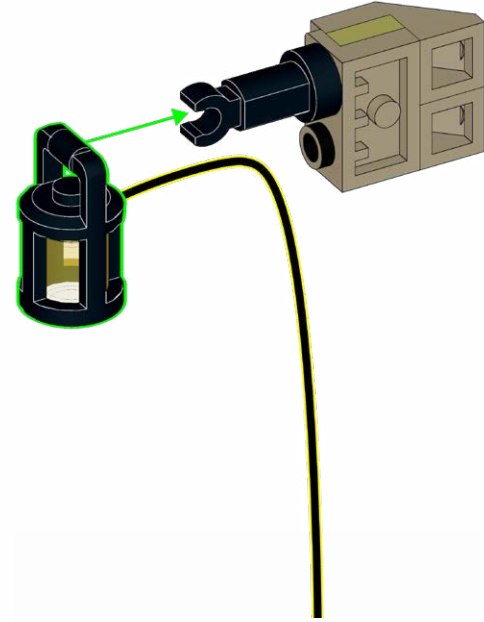

4

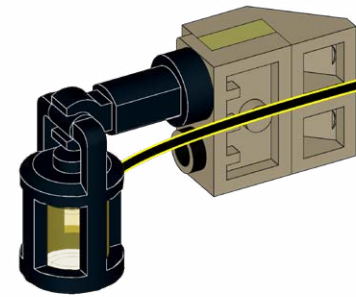

267



268



269



270



271



272

1

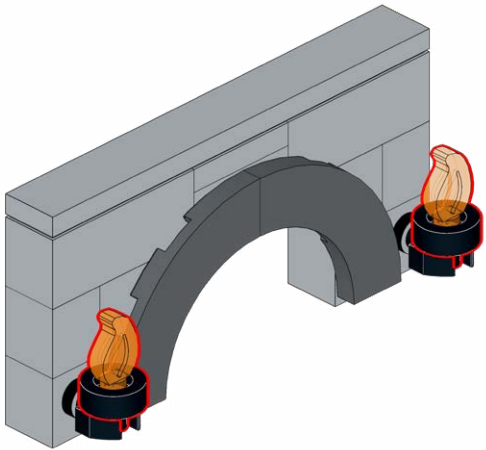

2

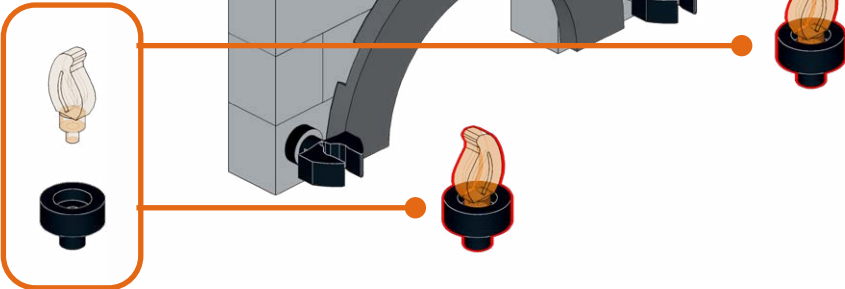

273

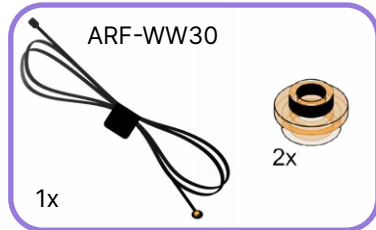

1



2



274

1



2

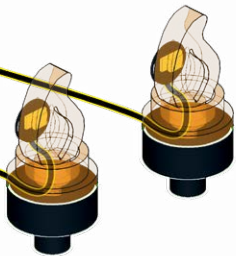

2x

275

1

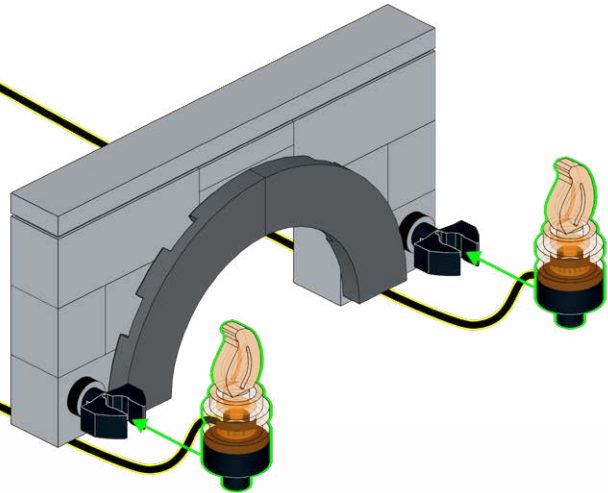

2

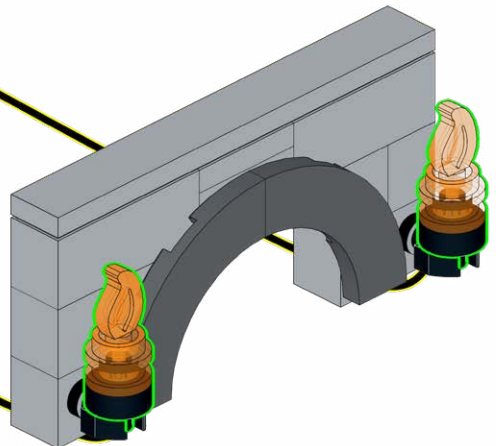

276



277



278



279



280



281



282



283



284



285

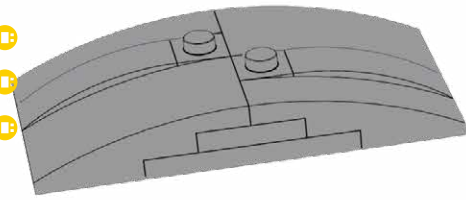

286



287



288

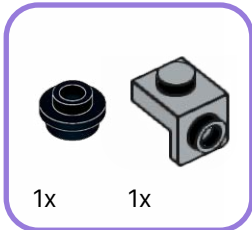
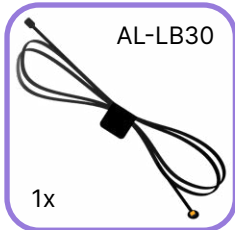

1

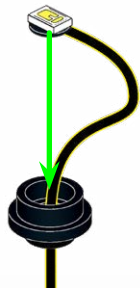

2



3

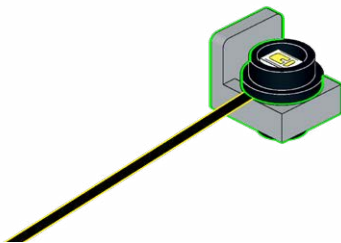

289

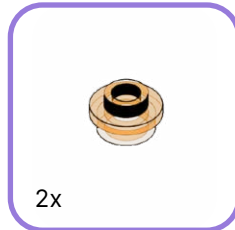

1

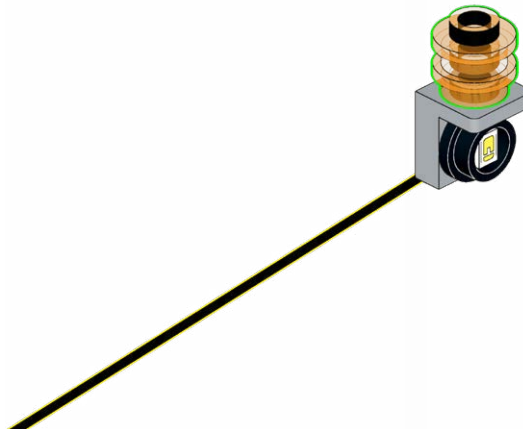
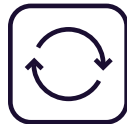

2

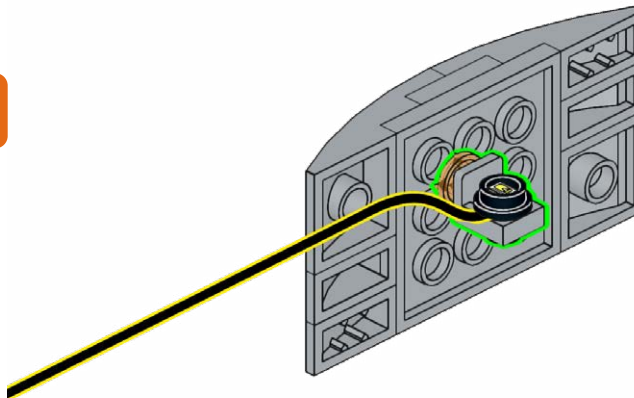

290



291



292



293



294

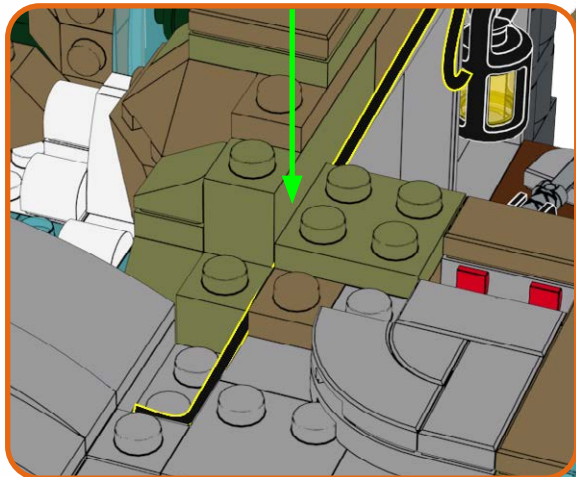

295

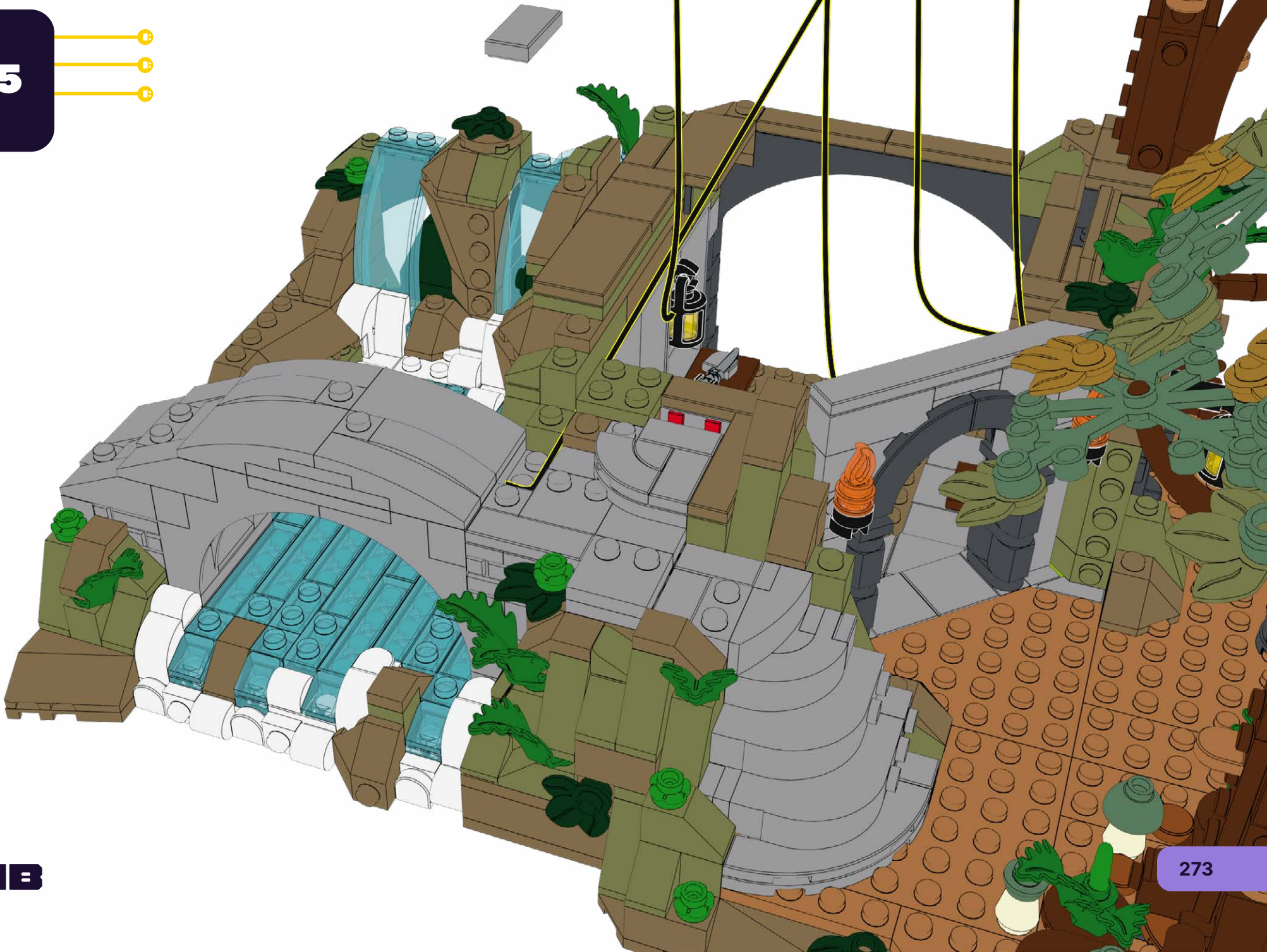

296

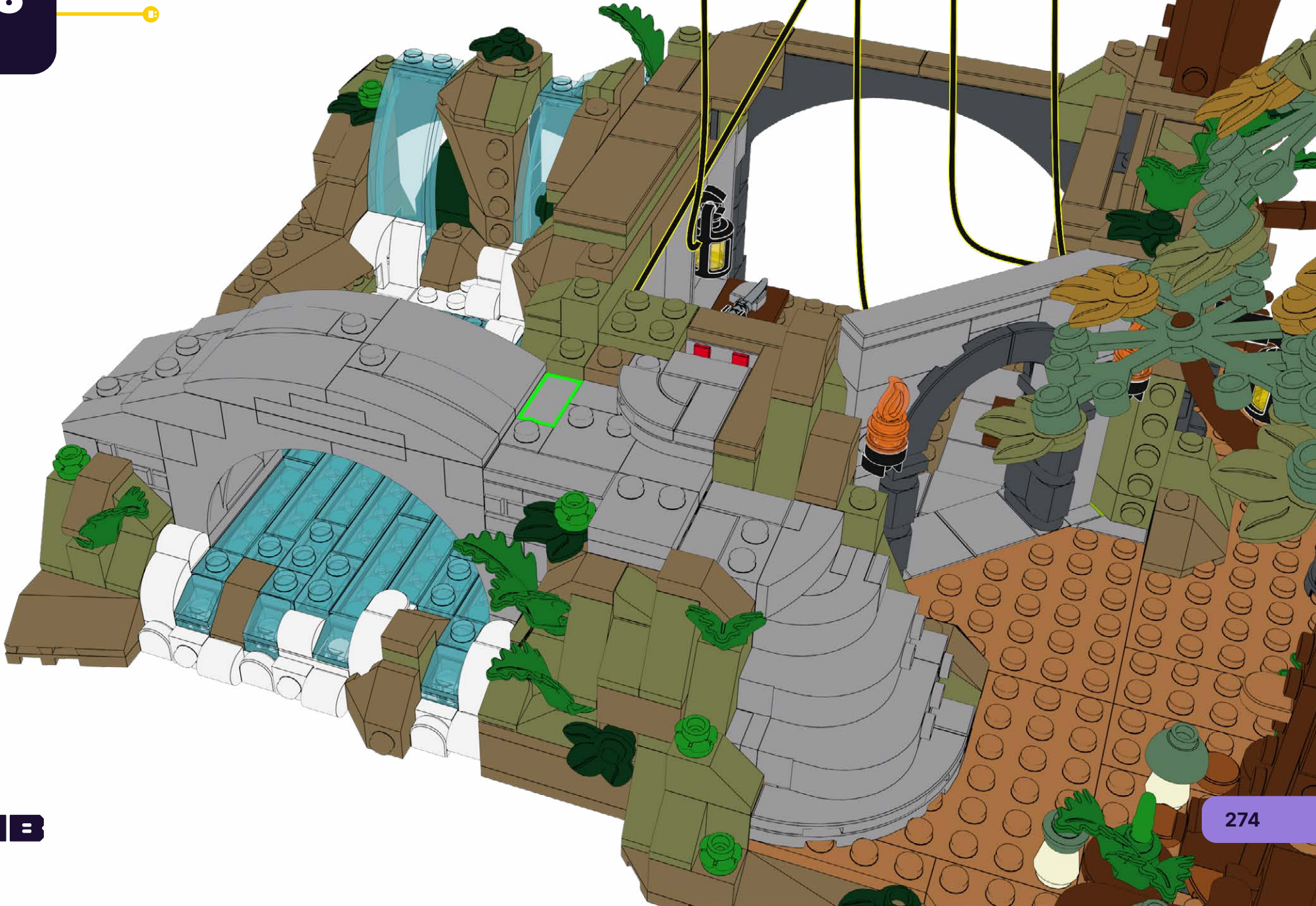

297



298



299

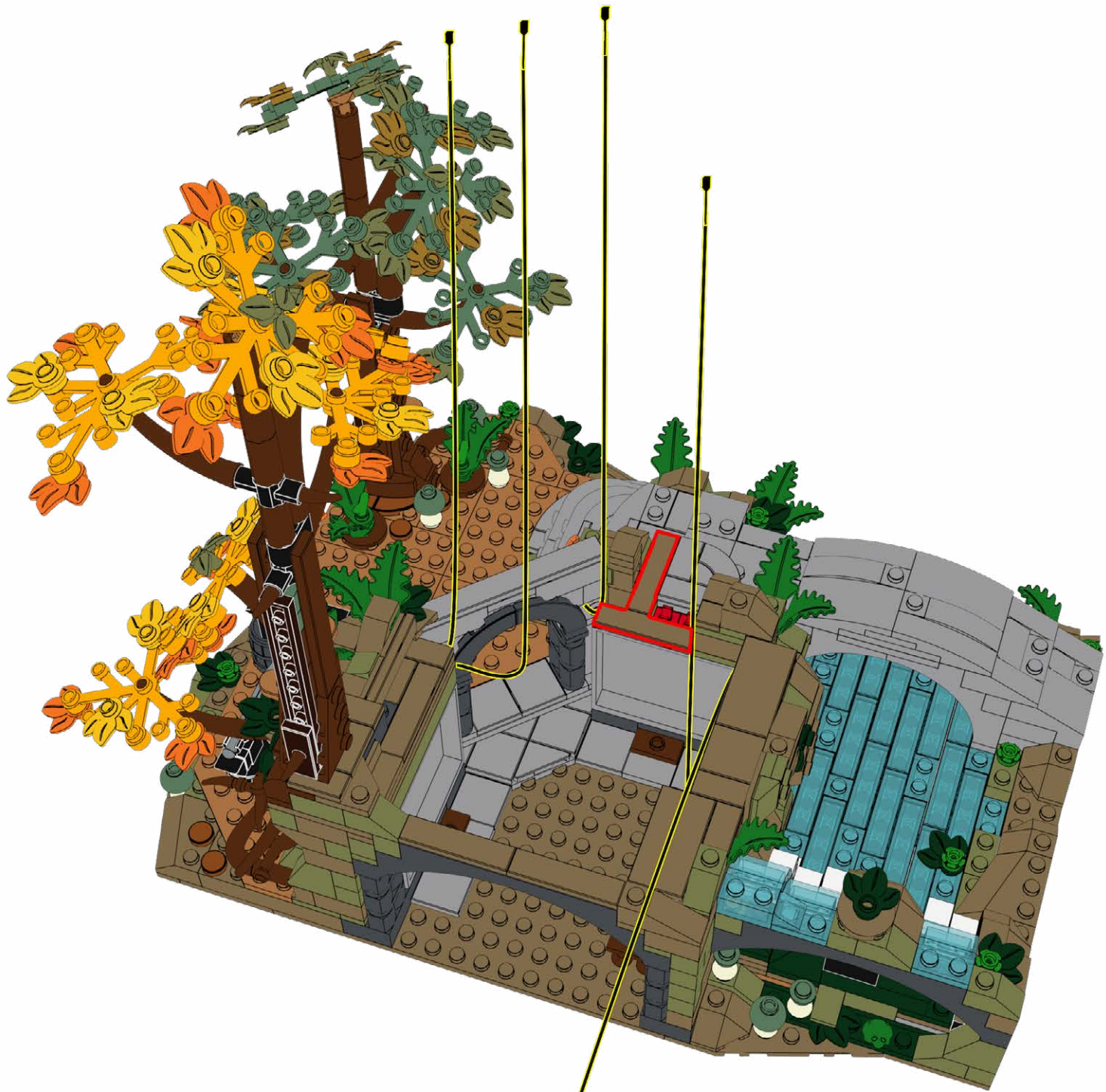

300



301



302

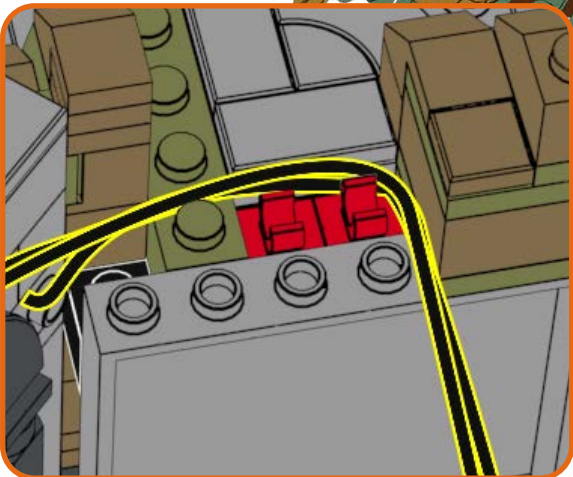

303

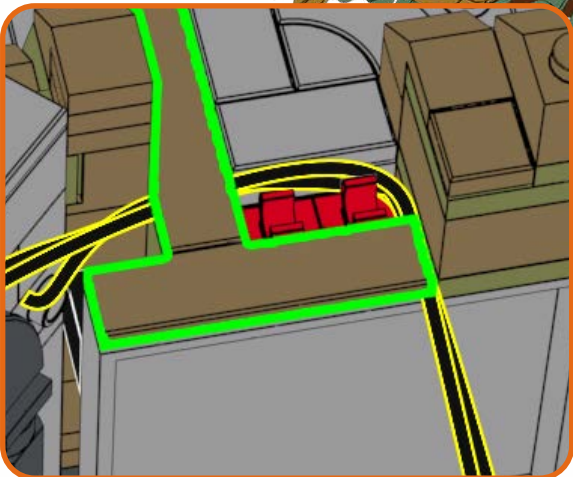

304



305



306



307



308



309



310

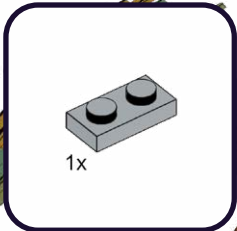

311



**HOLD UP!**

You might notice some bags are out of order, as well as left over pieces, but that's ok! We're changing the way you build LEGO!

HALTEN!

Möglicherweise stellen Sie fest, dass einige Beutel nicht in Ordnung sind und auch Teile übrig bleiben, aber das ist in Ordnung! Wir verändern die Art und Weise, wie Sie LEGO bauen!

TENIR BON!

Vous remarquerez peut-être que certains sacs sont en panne, ainsi que des morceaux restants, mais ce n'est pas grave ! Nous changeons la façon dont vous construisez LEGO !

SOSTENERE!

Potresti notare che alcune borse sono fuori uso, così come alcuni pezzi avanzati, ma va bene! Stiamo cambiando il modo in cui costruisci i LEGO!

¡SOSTENER!

Puede que notes que algunas bolsas están fuera de orden, así como piezas sobrantes, ¡pero está bien! ¡Estamos cambiando la forma de construir LEGO!

耽误!

您可能会注意到有些袋子坏了, 还有剩余的碎片, 但这没关系! 我们正在改变您搭建乐高的方式!

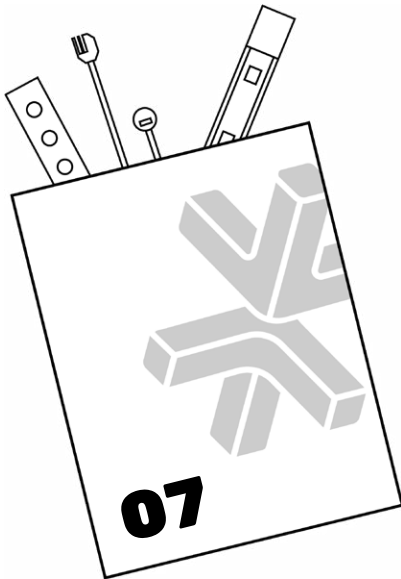
Open LMB Bag 07

312

D-6 T-1x6

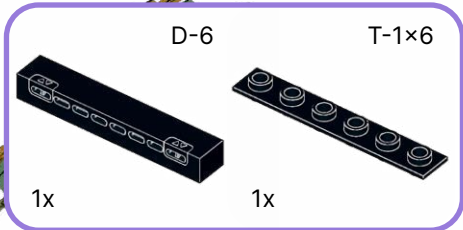

1x 1x

1 2

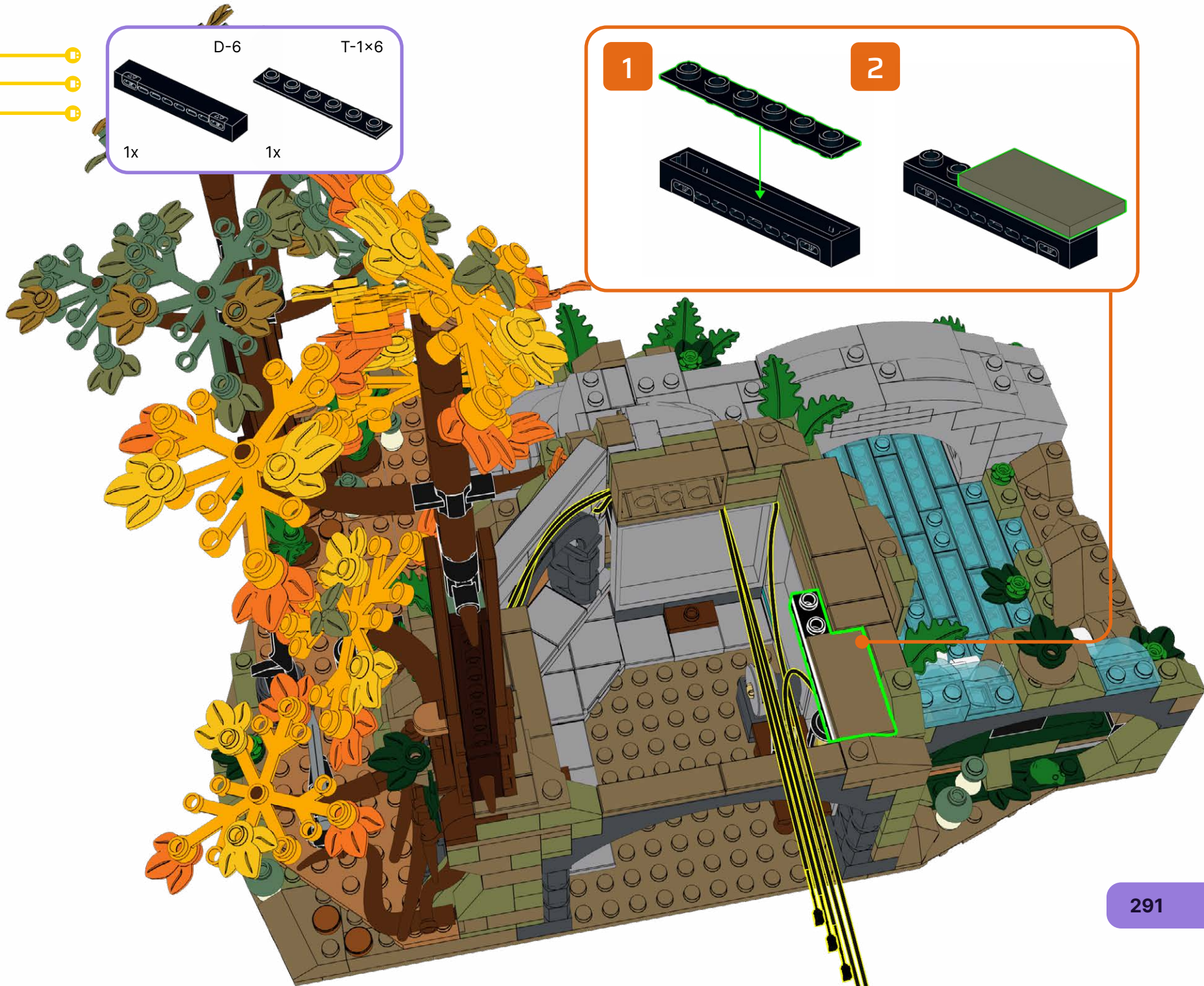
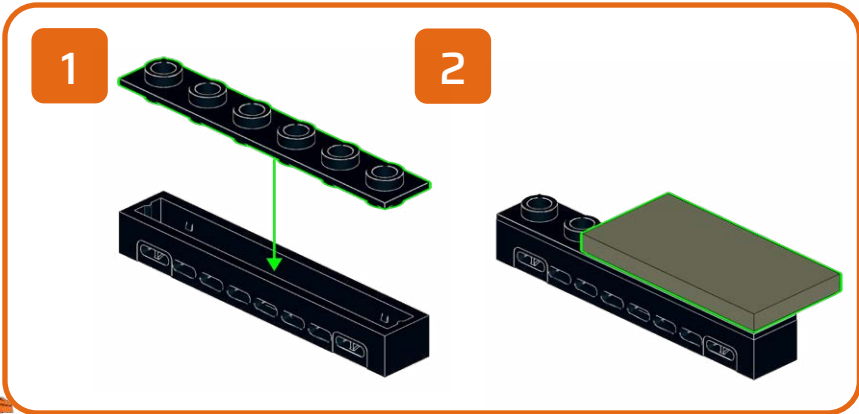

313

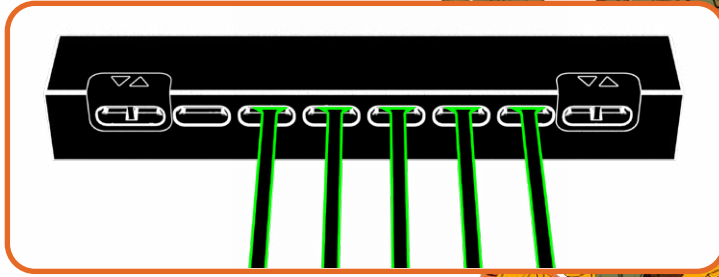

314

E-1x2 T-1x2

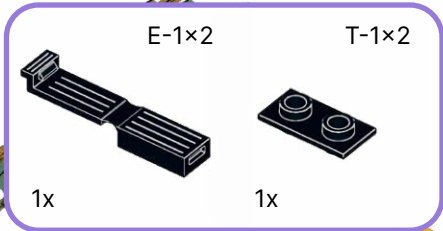

1x 1x

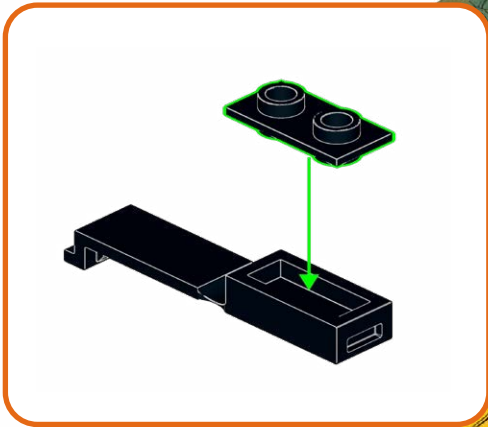

315



316



317



318

B-50

1x



319

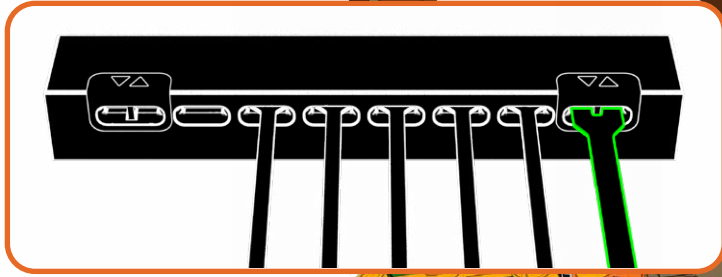

320



321



322



323



324



325



326



327



328



329



330

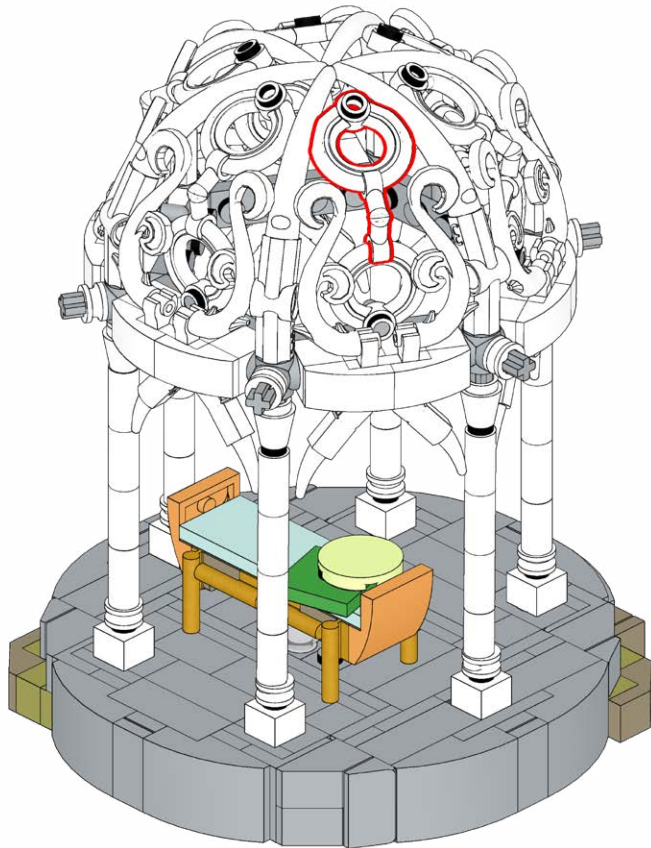

331

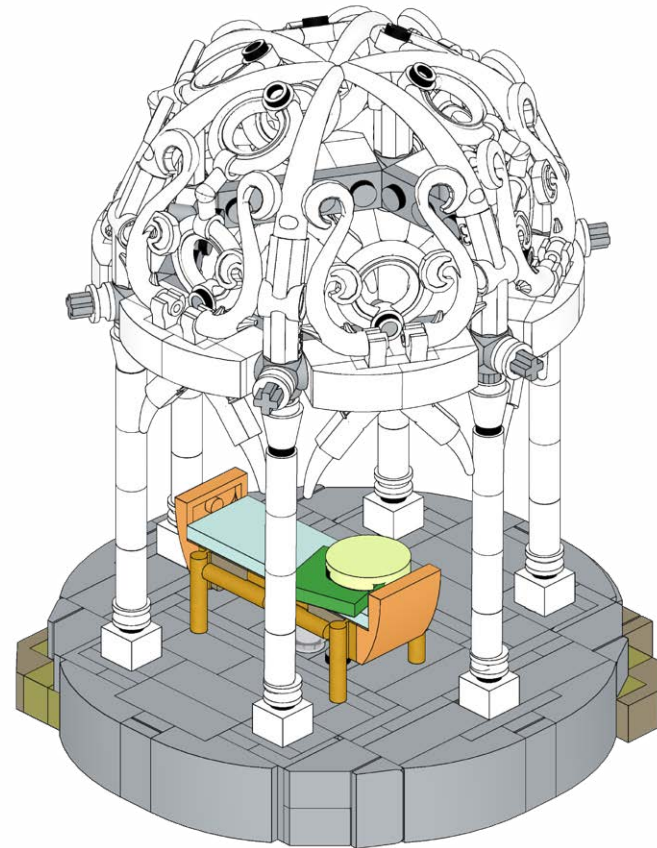

332

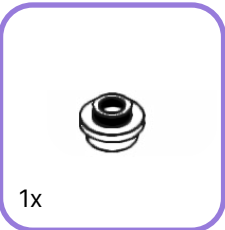
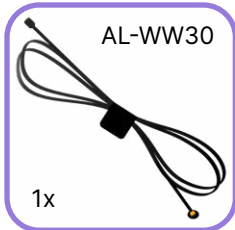

1

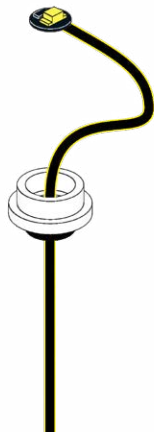

2



333

1

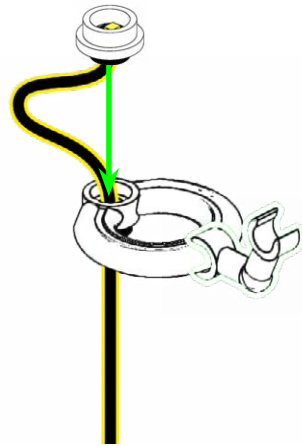

2

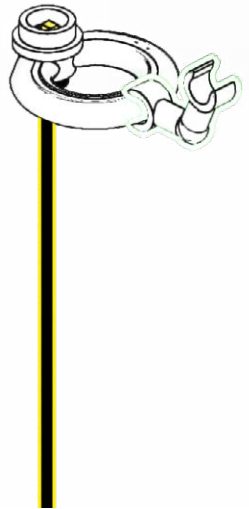

334

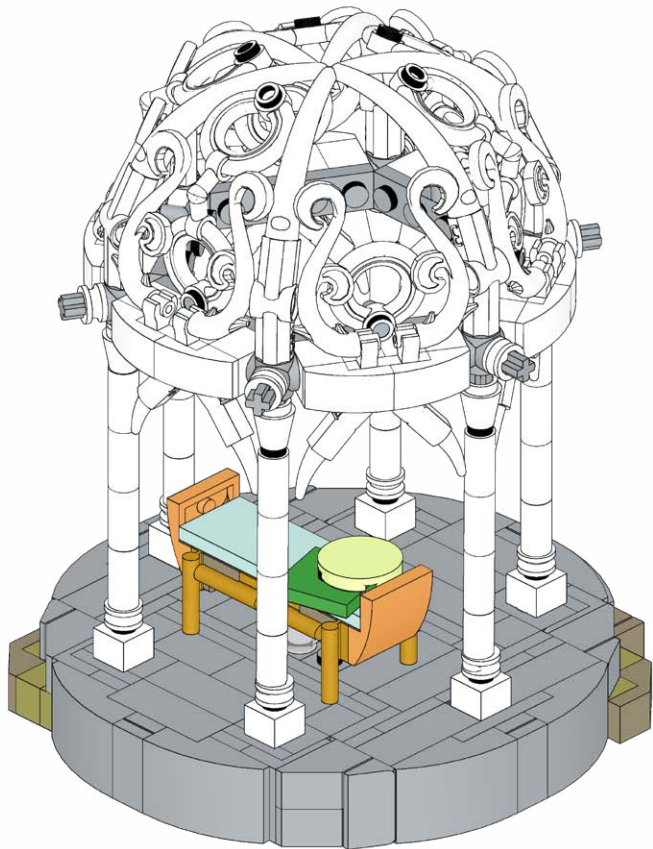

335

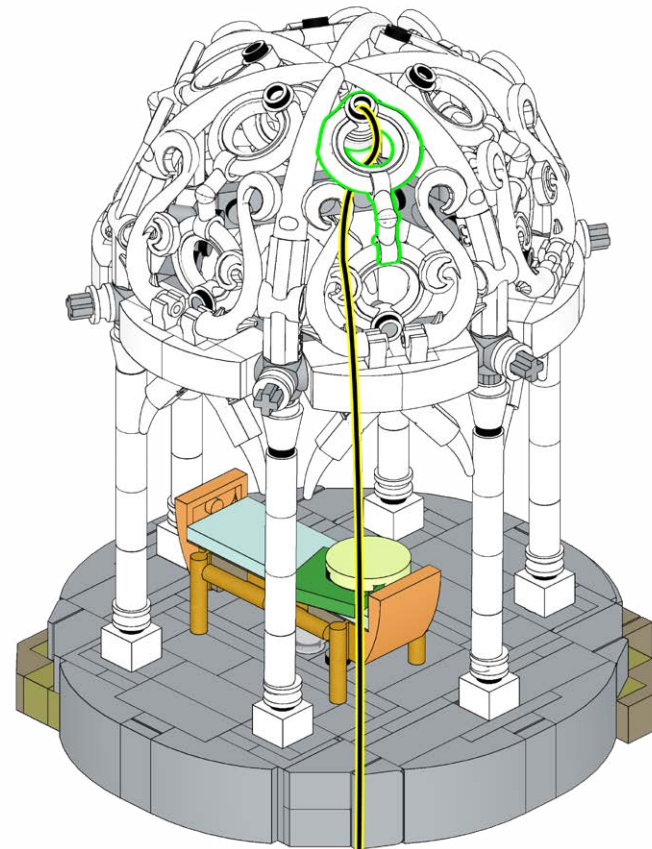

336

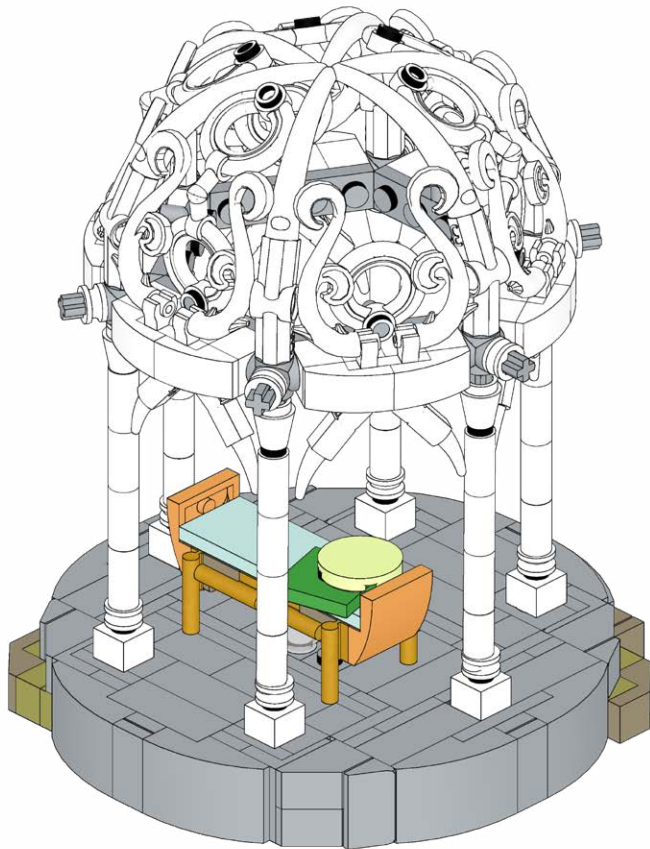

337

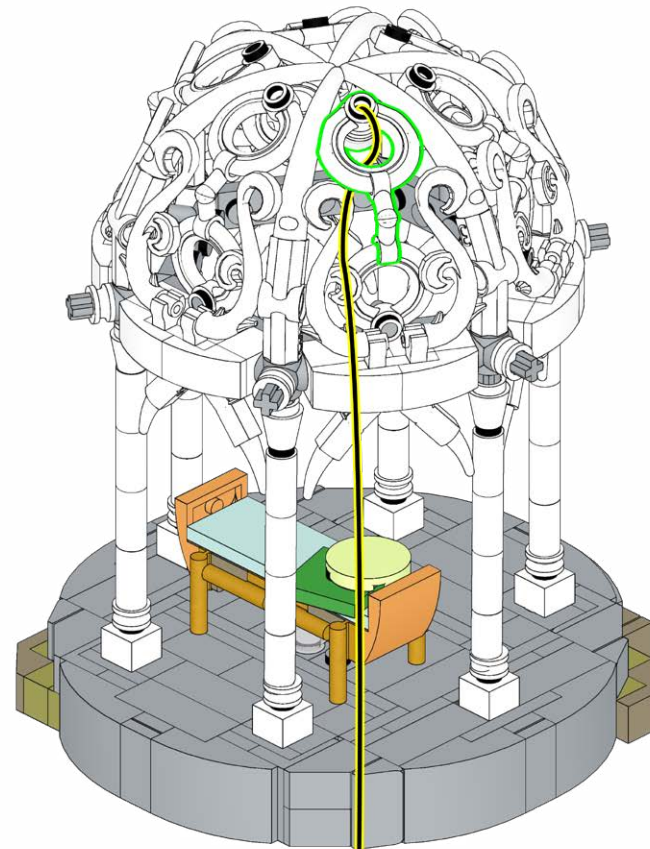

338

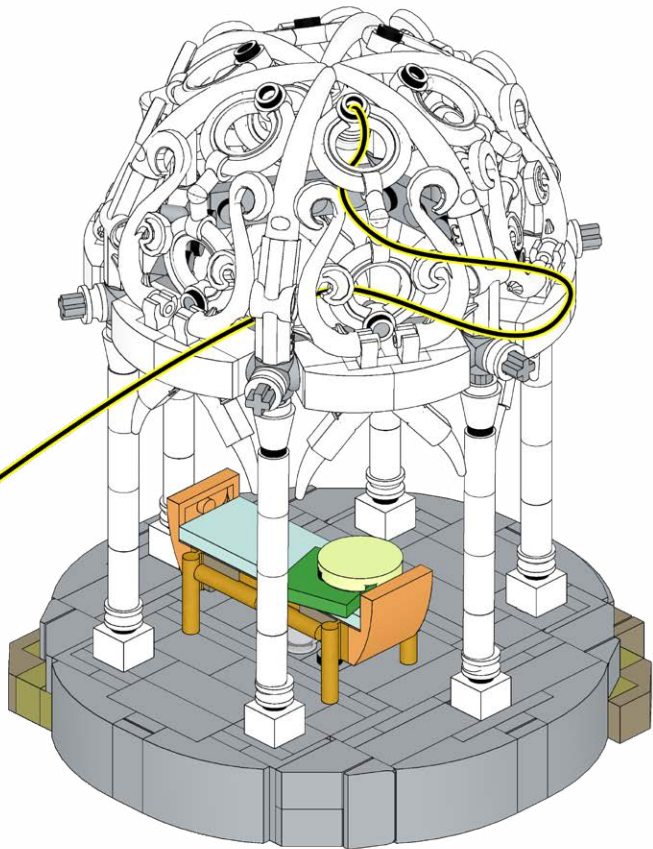

339

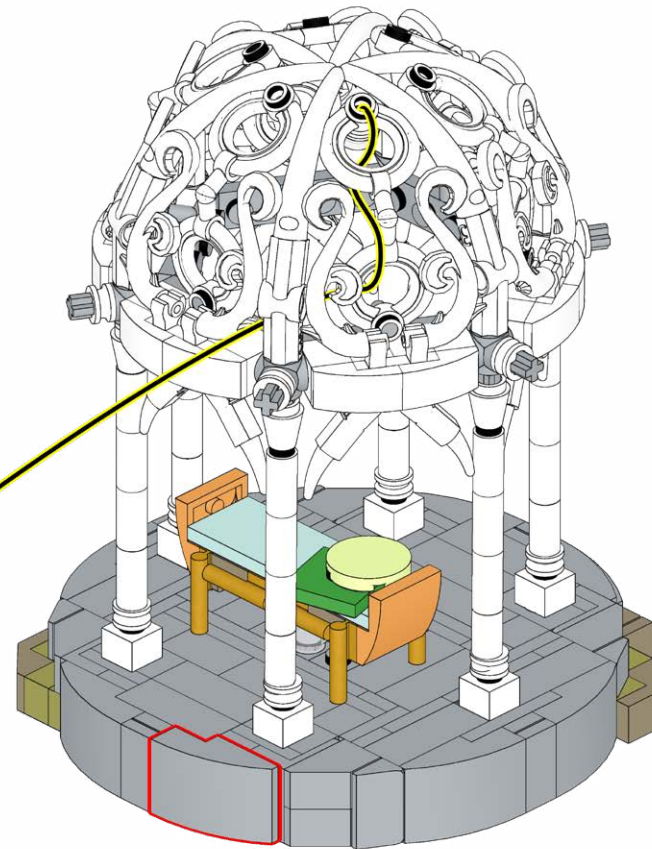

340

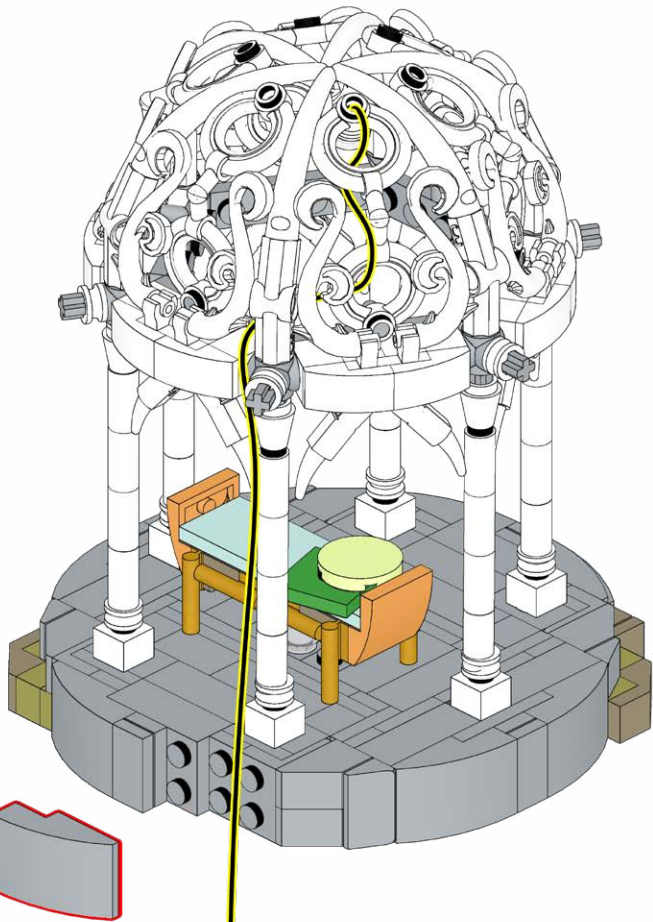

341

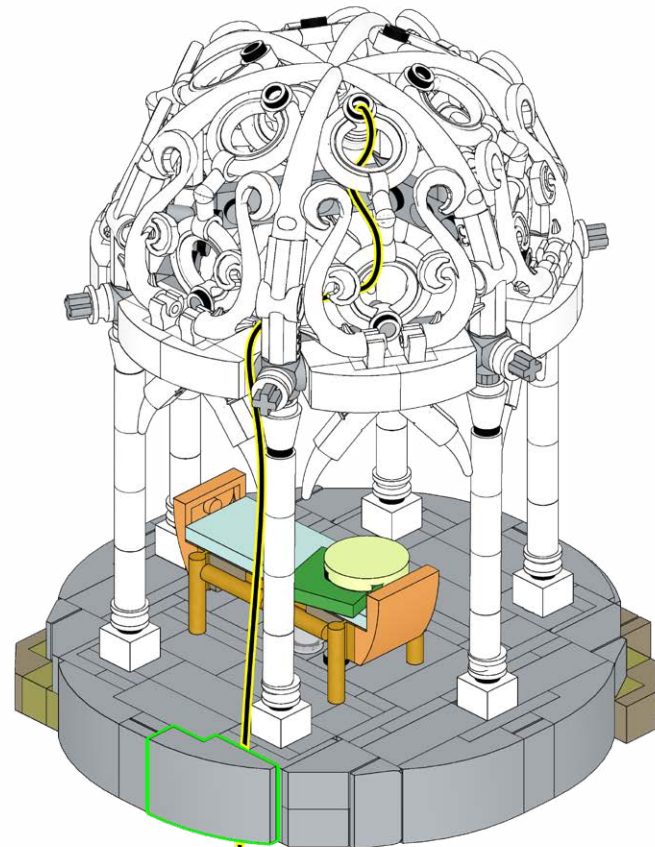

342



343

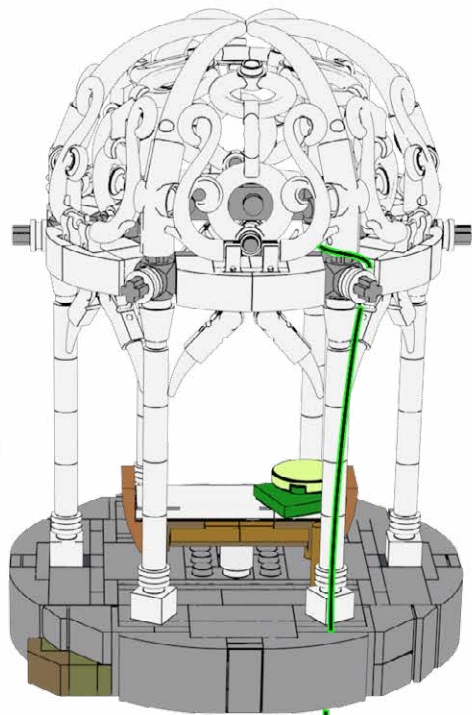
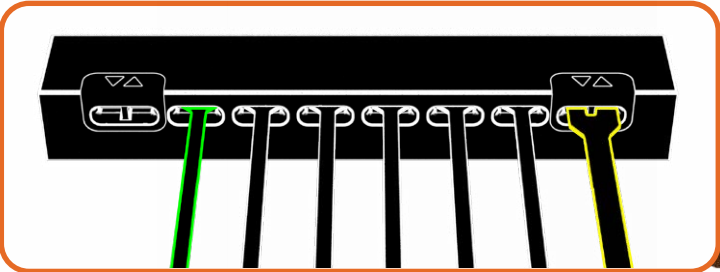

344



345



346



347

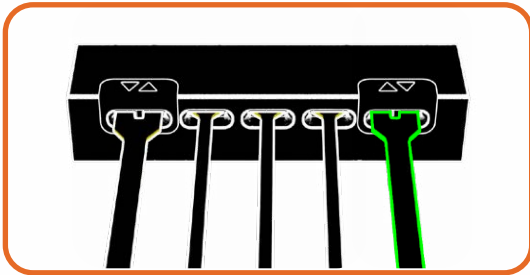

348

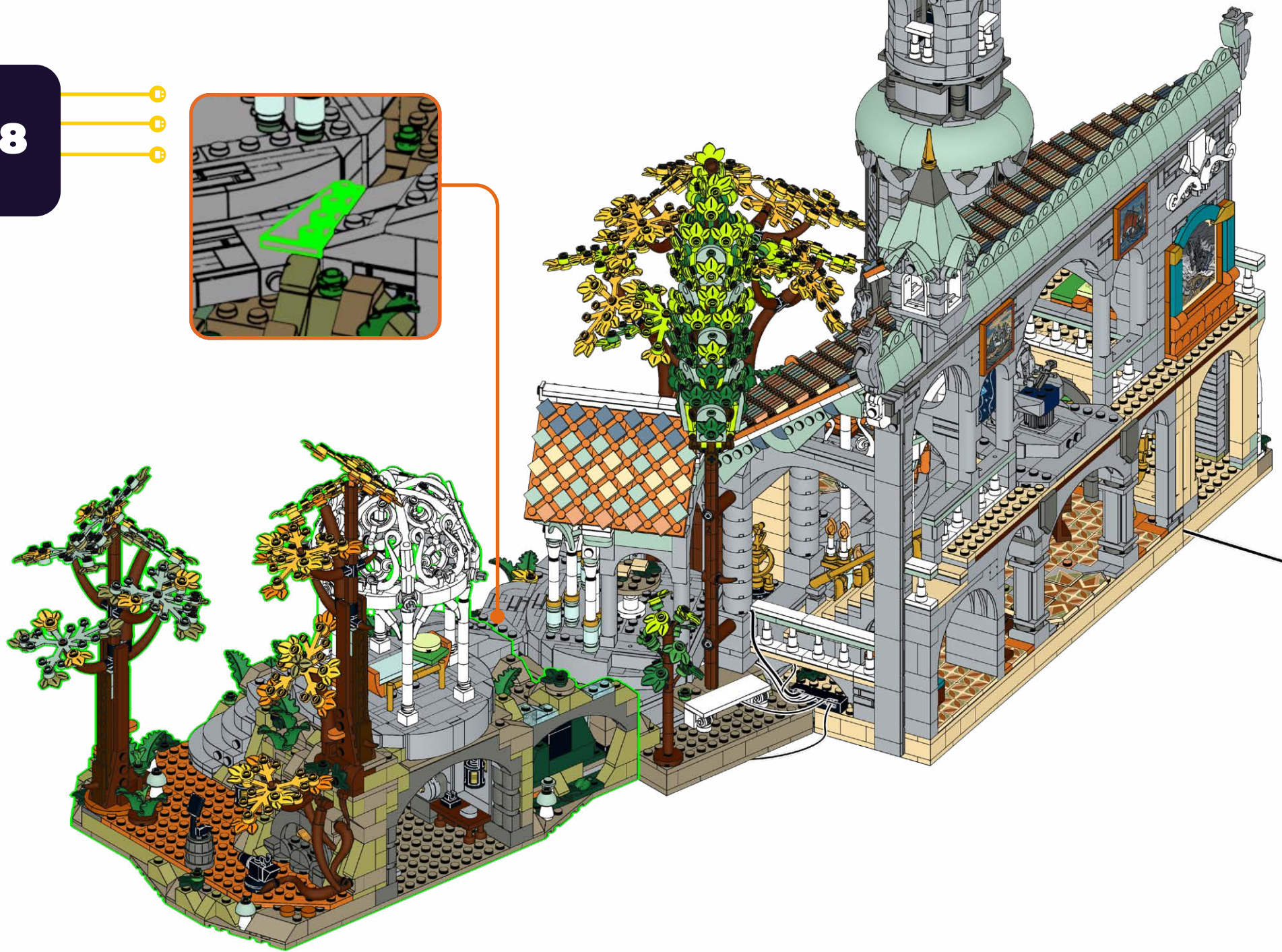
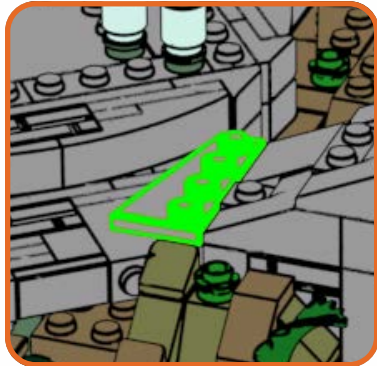

349



350



351



FINAL PRODUCT



CONTENTS & GLOSSARY



5x AL-WW30
Astro Large Warm White - 30cm



1x AL-CW30
Astro Large Cool White - 30cm



1x D-3
Dock 3



1x AL-O30
Astro Large Orange - 30cm



2x AR-Y30
Astro Regular Yellow - 30cm



5x T-1x6
Tether 1x6



1x ALF-O30
Astro Large Flicker Orange - 30cm



2x ARF-WW30
Astro Regular Flicker Warm White - 30cm



5x T-1x1
Tether 1x1



1x ALF-O15
Astro Large Flicker Orange - 15cm



4x ML-WW
Meteor Light - Warm White

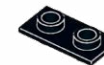

1x T-1x2
Tether 1x2



3x AL-LB30
Astro Large Light Blue - 30cm



1x D-6
Dock 6

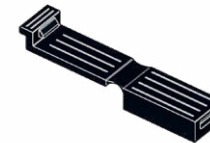

1x E-1x2
Eclipse 1x2

CONTENTS & GLOSSARY



1x **B-5**
Belt 5



11x **Plate, Round 1x1 Open Stud - Black**

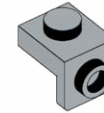

1x **Bracket 1x1 - 1x1 - Light Grey**



4x **B-15**
Belt 15



4x **Plate, Round 1x1 Open Stud - Trans Orange**

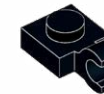

1x **Plate, Modified 1x1 with Open O Clip (Horizontal Grip) - Black**



1x **B-30**
Belt 30



1x **Plate, Round 1x1 Open Stud - White**

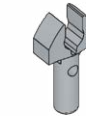

1x **Bar 1L with Clip Mechanical Claw - Cut Edges and Hole on Side - Light Grey**



1x **B-50**
Belt 50



2x **Tile, Modified 1x1 with Open O Clip - Black**



1x **FLXB-30**
Flux Belt 30cm

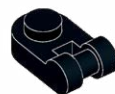

3x **Round 1x1 Mod Rounded w Handle - Black**

CONTACT US

Click below for customer support, or general inquiries.

Cliquez ci-dessous pour accéder au support client ou aux renseignements généraux.

Clicca qui sotto per l'assistenza clienti o per richieste generali.

Contact Us



Contactez-nous



Contattaci



Klicken sie unten für kundensupport oder allgemeine anfragen.

Haga clic a continuación para atención al cliente o consultas generales.

点击下方获取客户支持或一般咨询。

Kontaktieren sie uns



Contáctanos



联系我们



TROUBLESHOOTING

If you're stuck, scan the QR code for troubleshooting.

Se sei bloccato, scansiona il codice QR per la risoluzione dei problemi.

Wenn Sie nicht weiterkommen, scannen Sie den QR-Code zur Fehlerbehebung.

Si vous êtes bloqué, scannez le code QR pour le dépannage

Si está atascado, escanee el código QR para solucionar el problema.

如果遇到问题, 请扫描二维码进行故障排除

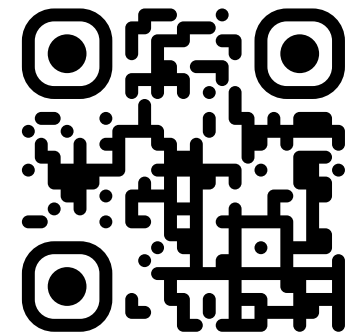



LIGHTMYBRICKS

lightmybricks.com



LEGO® is a trademark of the LEGO Group of companies, which does not sponsor, authorize or endorse this product. All LEGO® sets featured in images are sold separately. This is not a LEGO® product. The LEGO Group is not liable for any loss, injury or damage arising from the use or misuse of this product. ©2024 Light My Bricks Pty Ltd. All rights reserved. www.lightmybricks.com

Our components are designed and packaged in Australia by Light My Bricks Pty Ltd. Components are manufactured in China. 3fl bldg C, Shuanghuan Quanxin Technology Information Industry Park Baolong Street, Longgang District, Shenzhen, China. Imported in Australia by Light My Bricks Pty Ltd, 5/26 Rushdale St, Knoxfield, VIC, 3180, Australia.

WARNING: CHOKING HAZARD - Small parts. Not for children under 3 years.

AVERTISSEMENT : RISQUE D'ÉTOUFFEMENT - Petites pièces. Ne convient pas aux enfants de moins de 3 ans.

ATTENZIONE: PERICOLO DI SOFFOCAMENTO - Piccole parti. Non adatto a bambini di età inferiore a 3 anni.

WARNUNG: ERSTICKUNGSGEFAHR - Kleine Teile. Nicht für Kinder unter 3 Jahren geeignet.

ADVERTENCIA: PELIGRO DE ASFIXIA - Piezas pequeñas. No son apto para niños menores de 3 años.

警告：窒息危险 - 小零件。不适合3岁以下儿童。