



**LIGHT  
BRICKS™**



## LIGHT KIT INSTALLATION GUIDE

**LORD OF THE RINGS  
RIVENDELL (PART 3)**

FOR LEGO  
SET  
#10316



## 3

### Getting Started

- 4 Legend
- 5 Component Handling
- 6 Blueprint

## 7

### Instructions

- 7 Bag 12 & 13
- 22 Bag 14 + LMB Bag 06 & 07
- 47 Bag 15
- 71 Bag 16 & 17
- 100 Bag 18
- 148 Bag 19
- 186 Bag 20
- 201 Bag 21 & 22

## 225

### Final Product

- 226 Contents & Glossary
- 228 Contact & Troubleshooting

# GETTING STARTED



Bold, beautiful and bright, Light My Bricks elevates your favourite LEGO set from knick-knack to statement piece. Create a talking point at home or in the office that speaks to your passions with Light My Bricks. To learn more, click below.

[Learn More](#)



Audacieux, beau et lumineux, Light My Bricks élève votre ensemble LEGO préféré du statut de bibelot à celui de pièce maîtresse. Que ce soit à la maison ou au bureau, partagez votre passion des LEGO avec Light My Bricks. Cliquez ci-dessous pour en savoir plus.

[En savoir plus](#)



Audace, bello e luminoso, Light My Bricks eleva il tuo set LEGO preferito da soprammobile a pezzo di tendenza. Crea un punto di discussione a casa o in ufficio che parli alle tue passioni con Light My Bricks. Per saperne di più, clicca qui sotto.

[Ulteriori Informazioni](#)



Mutig, schön und hell – Light My Bricks verwandelt Ihr Lieblings-LEGO-Set von einem schnickschnack in ein statement-stück. Schaffen sie einen gesprächspunkt zu hause oder im büro, der Ihre leidenschaften widerspiegelt, mit Light My Bricks. Um mehr zu erfahren, klicken sie unten.

[Mehr erfahren](#)



Audaz, hermoso y brillante, Light My Bricks eleva tu set LEGO favorito de una chuchería a una pieza llamativa. Crea un tema de conversación en casa o en la oficina que hable de tus pasiones con Light My Bricks. Para obtener más información, haga clic a continuación.

[Más información](#)



大胆、美丽而明亮，Light My Bricks 将你喜爱的乐高套装从小摆件提升为引人注目的装饰品。在家或办公室打造一个能表达你激情的话题，了解更多，请点击下方。

[了解更多](#)



# LEGEND

## Rotate Set



Retournez L'ensemble  
Ruota Set  
Set Drehen  
Rotar Conjunto  
旋转套件

## Add Part



Ajoutez une Pièce  
Aggiungi Parte  
Teil Hinzufügen  
Agregar Pieza  
添加零件

## Click



Cliquez  
Clic  
Klicken  
Clic  
点击

## Pinch/Fold



Pincez/Pliez  
Pizzicare/Piegare  
Kneifen/Falten  
Pellizcar/Doblar  
折叠

## Pull Cable



Tirez le Cable  
Tirare il Cavo  
Kabel Ziehen  
Tirar del Cable  
拉动电缆

## Repeat Step



Répétez  
Ripetere  
Wiederholen  
Repetir  
重复

## Sticker



Autocollant  
Adesivo  
Aufkleber  
Pegatina  
贴纸

## Power On Test



Test de mise sous tension  
Test di Potenza  
Stromtest  
Prueba de Energía  
电源测试

## Disconnect Power



Débranchez L'alimentation  
Scollegare L'alimentazione  
Strom Trennen  
Desconectar la Energía  
断开电源

## Troubleshoot



Dépanner  
Risolvere  
Fehlerbehebung  
Solución de Problemas  
故障排除

# COMPONENT HANDLING

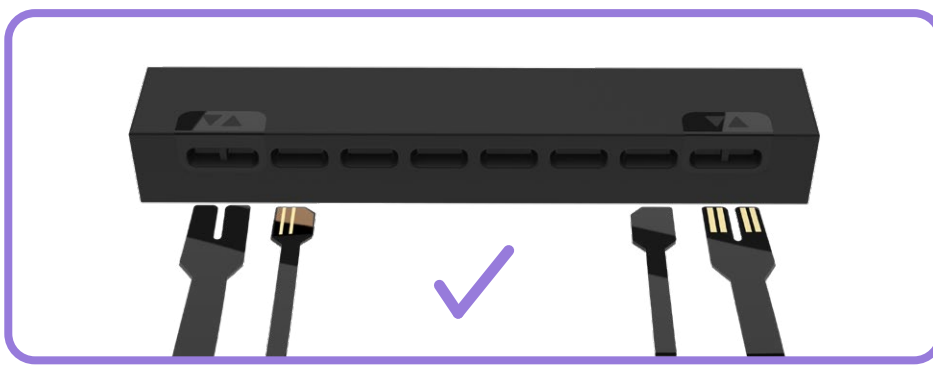
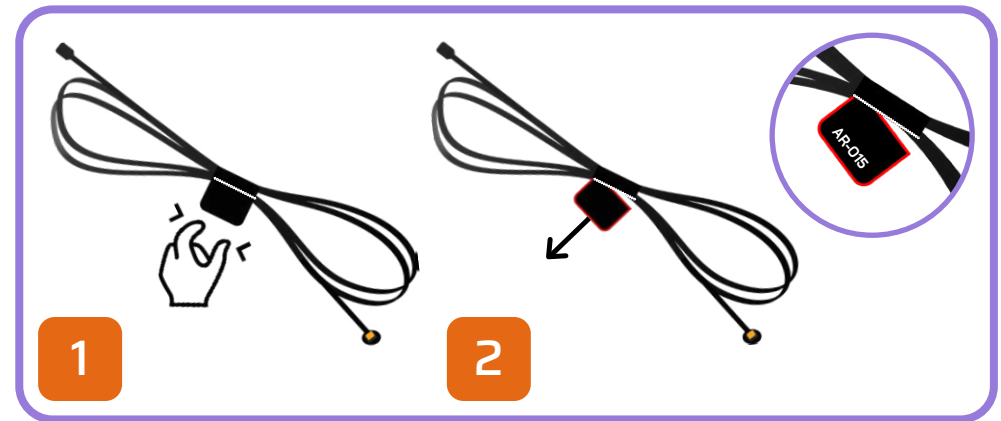
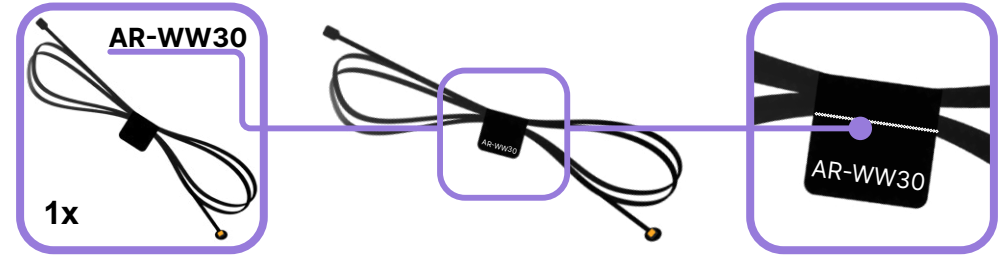
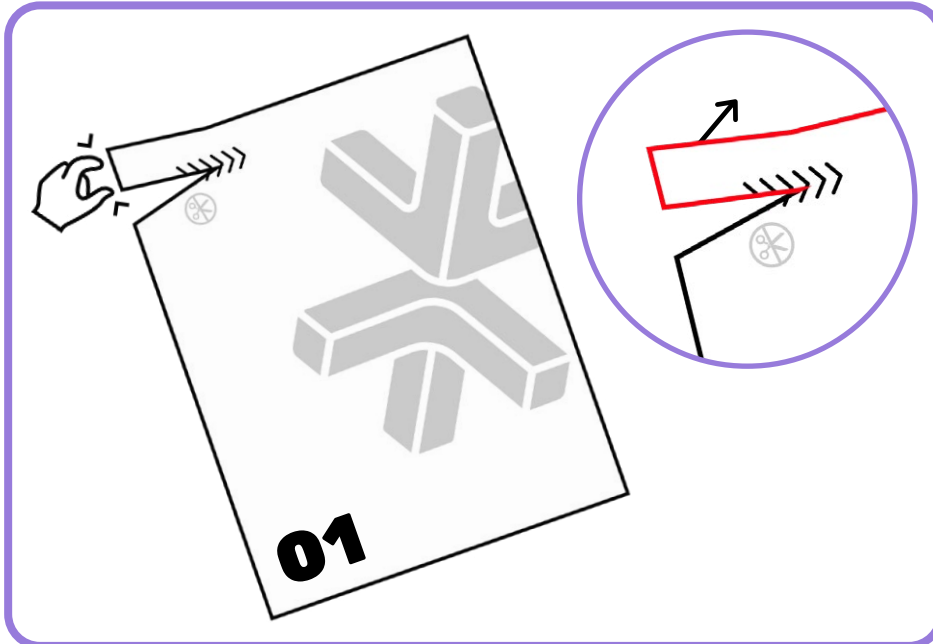

# BLUEPRINT

Part 1 - Tower

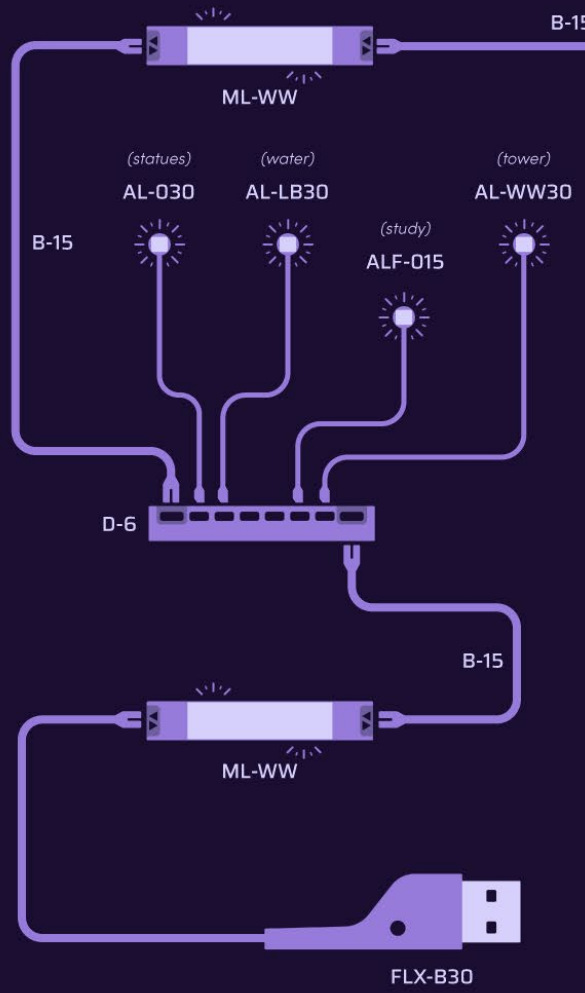

Part 2 - Hall

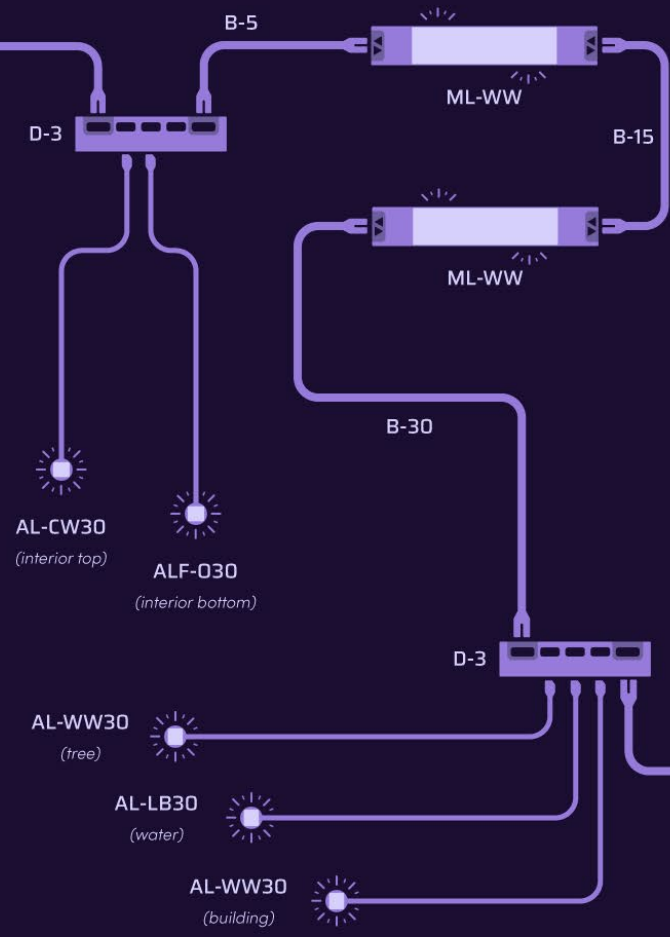

Part 3 - Gazebo

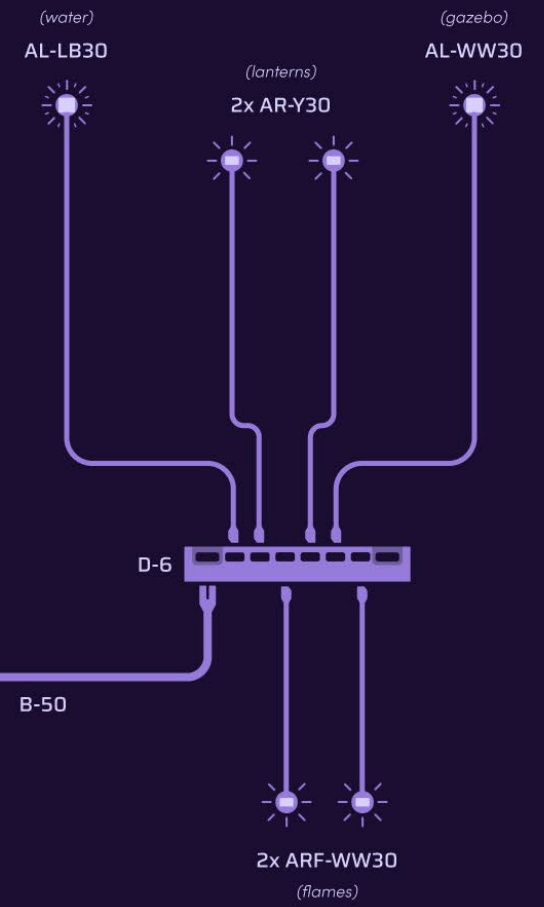

**HOLD UP!**

You might notice some bags are out of order, as well as left over pieces, but that's ok! We're changing the way you build LEGO!

**HALTEN!**

Möglicherweise stellen Sie fest, dass einige Beutel nicht in Ordnung sind und auch Teile übrig bleiben, aber das ist in Ordnung! Wir verändern die Art und Weise, wie Sie LEGO bauen!

**TENIR BON!**

Vous remarquerez peut-être que certains sacs sont en panne, ainsi que des morceaux restants, mais ce n'est pas grave ! Nous changeons la façon dont vous construisez LEGO !

**SOSTENERE!**

Potresti notare che alcune borse sono fuori uso, così come alcuni pezzi avanzati, ma va bene! Stiamo cambiando il modo in cui costruisci i LEGO!

**¡SOSTENER!**

Puede que notes que algunas bolsas están fuera de orden, así como piezas sobrantes, ¡pero está bien! ¡Estamos cambiando la forma de construir LEGO!

**耽误!**

您可能会注意到有些袋子坏了, 还有剩余的碎片, 但这没关系! 我们正在改变您搭建乐高的方式!

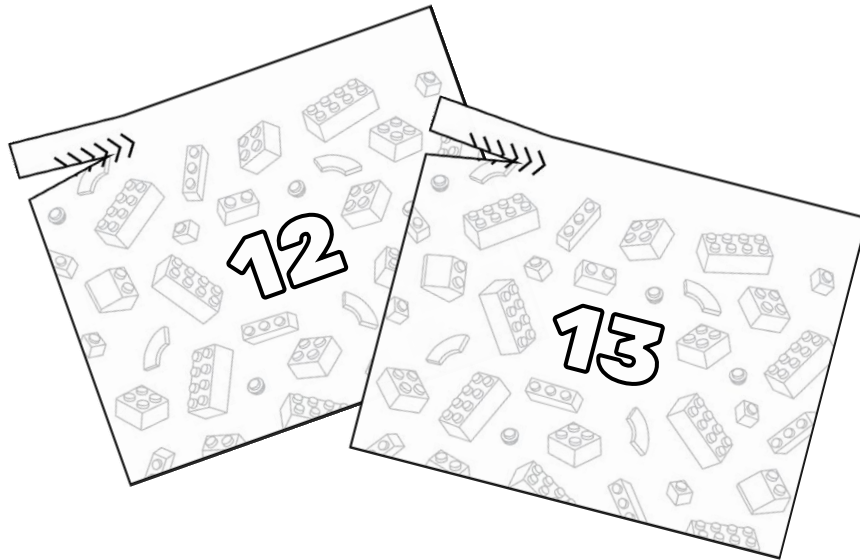
**Open LEGO® Bags 12 & 13**

1

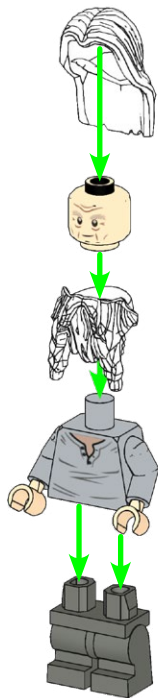
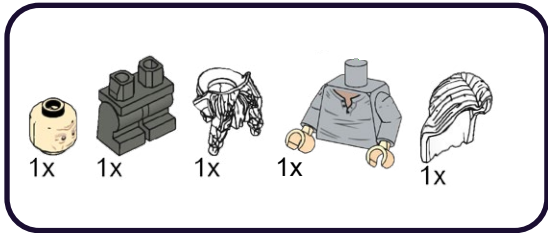

2





# 3

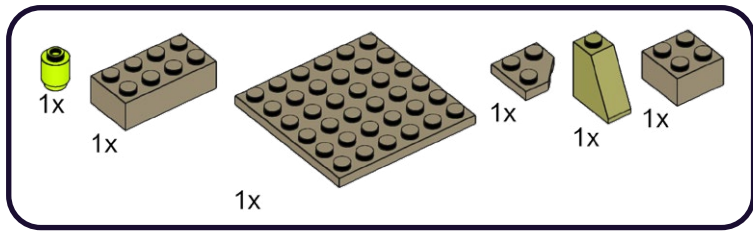

1

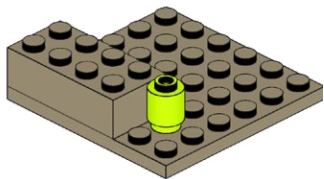

2

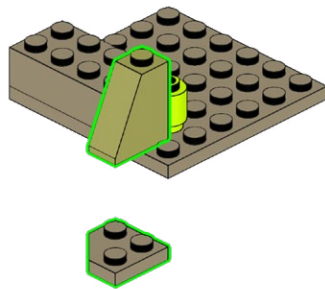

3

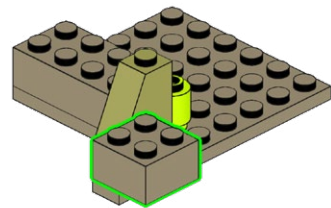

# 4

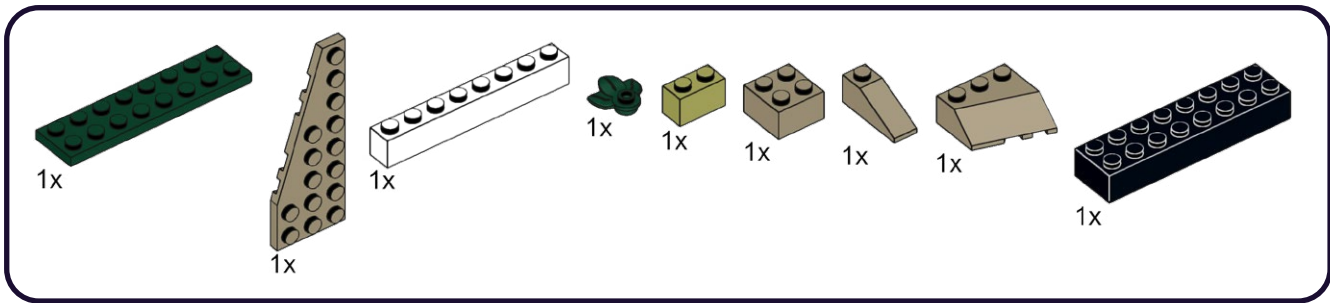

1

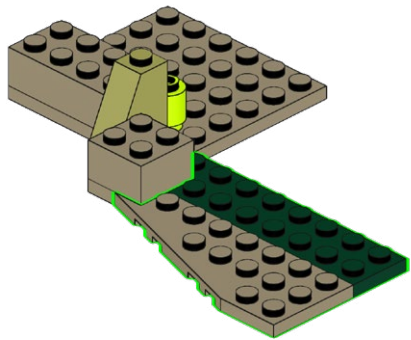

2

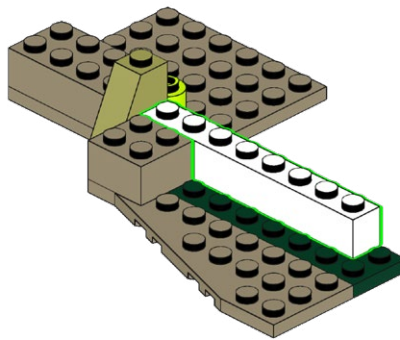

3

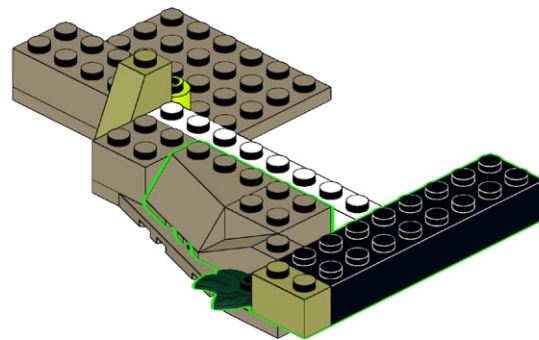

# 5

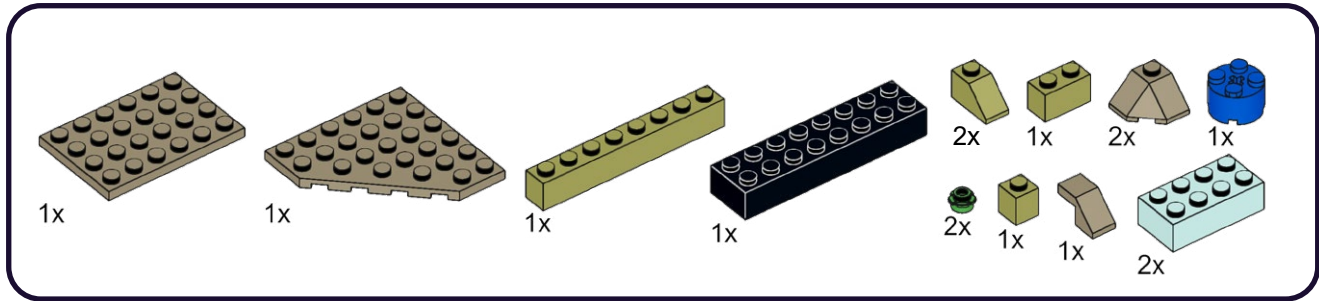

1

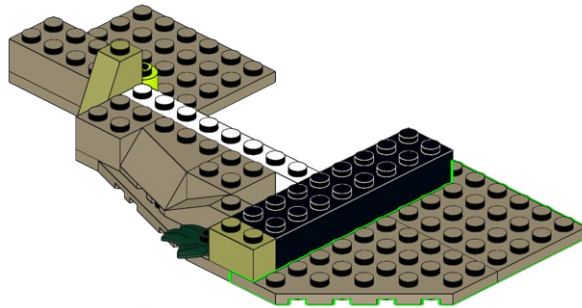

2

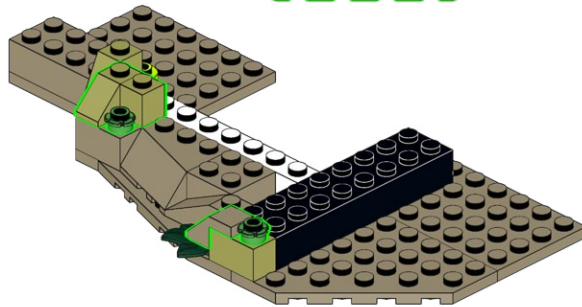

3

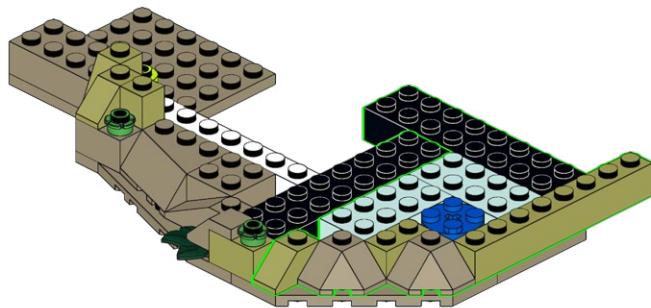

# 6

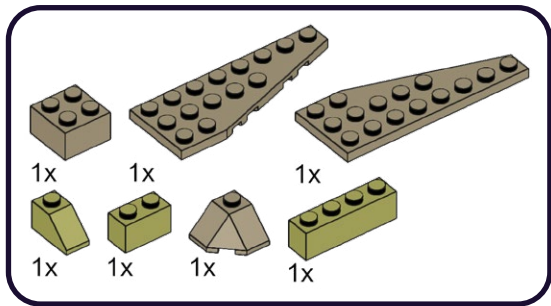

1

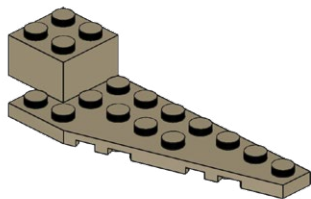

2

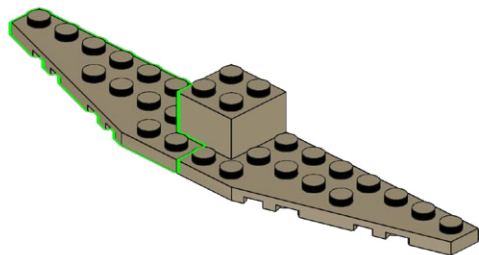

3

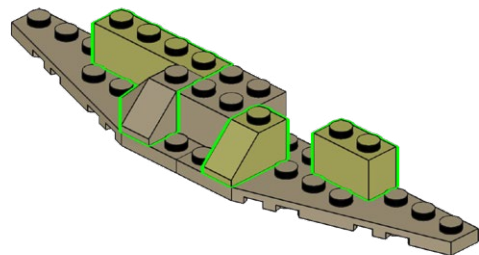

# 7

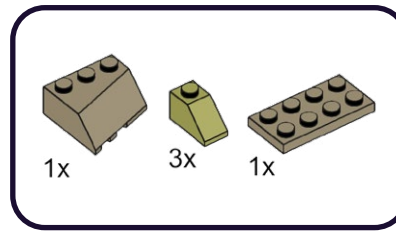

1

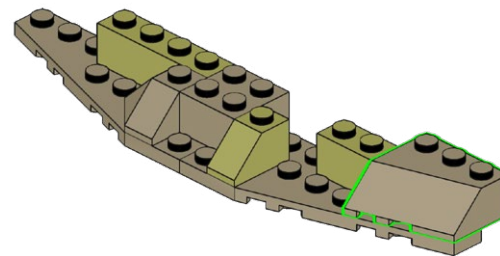

2

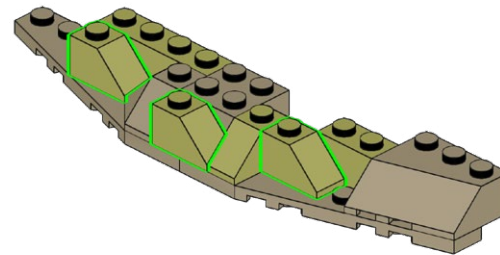

3

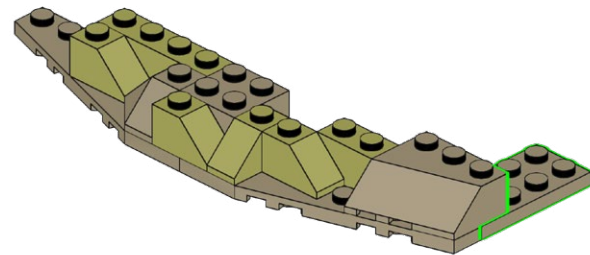

# 8

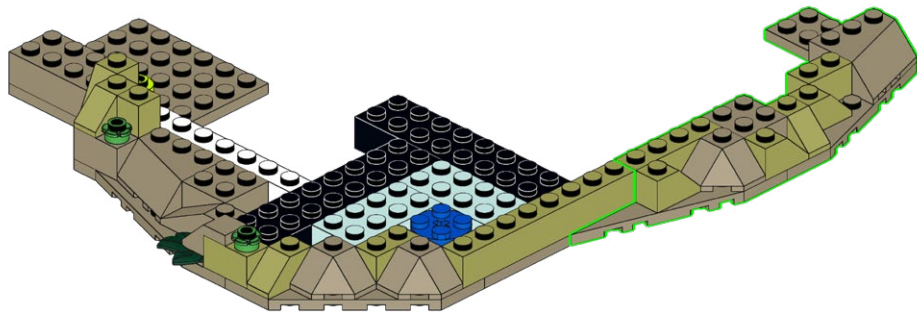

# 9

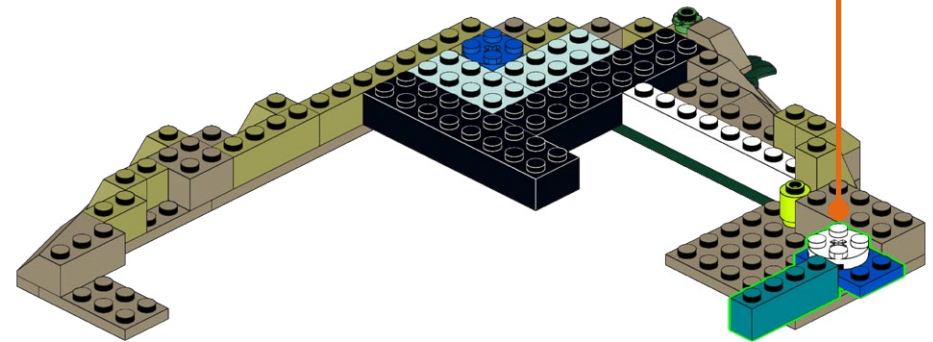
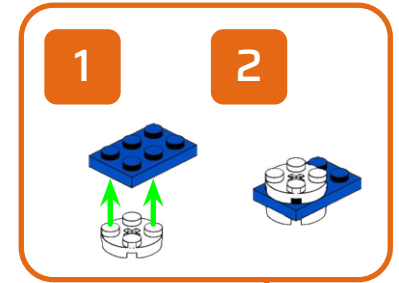
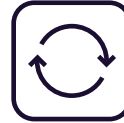
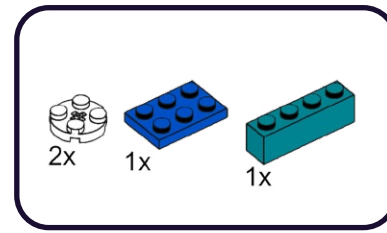

10

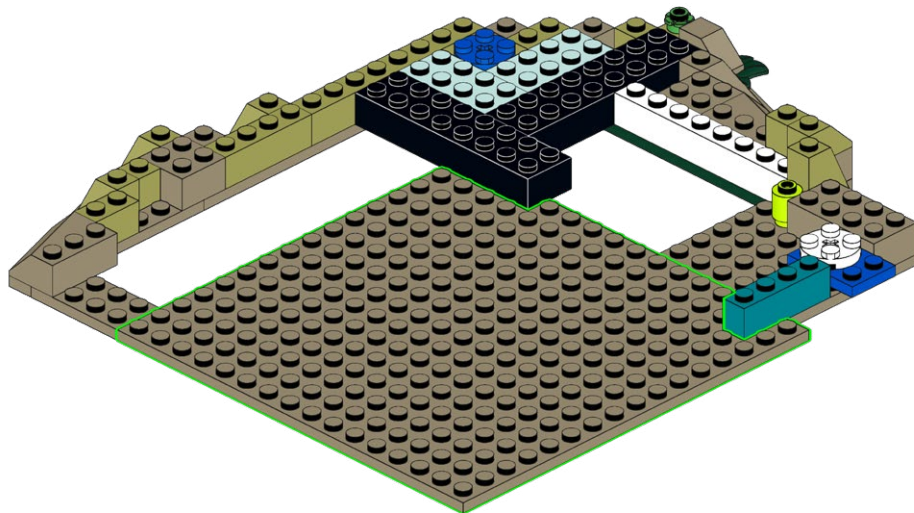
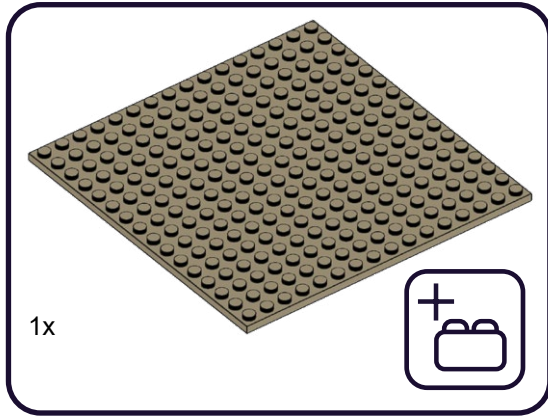

11

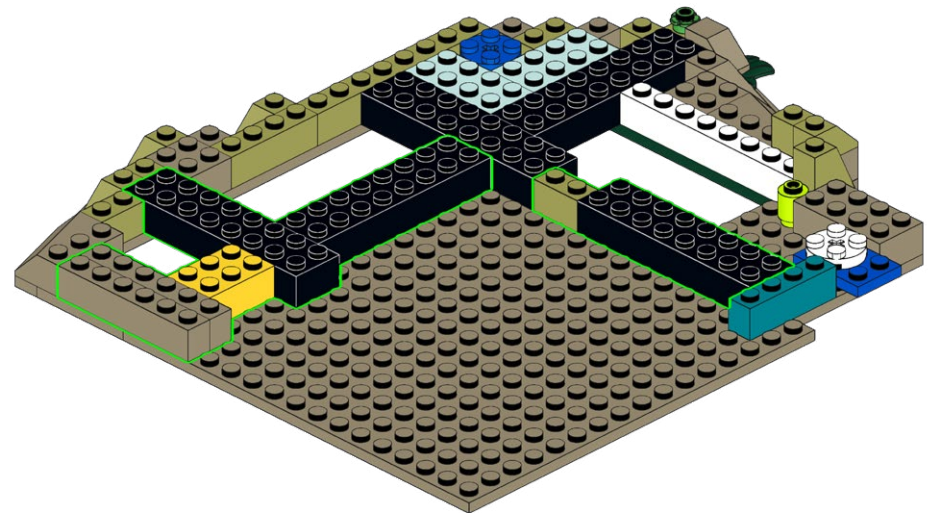
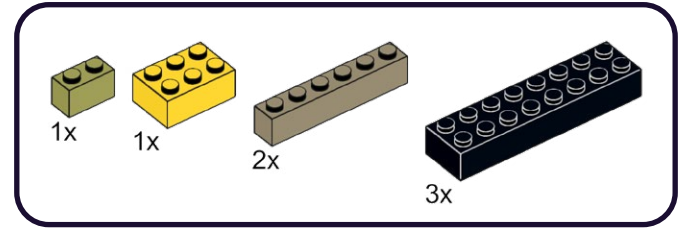

12

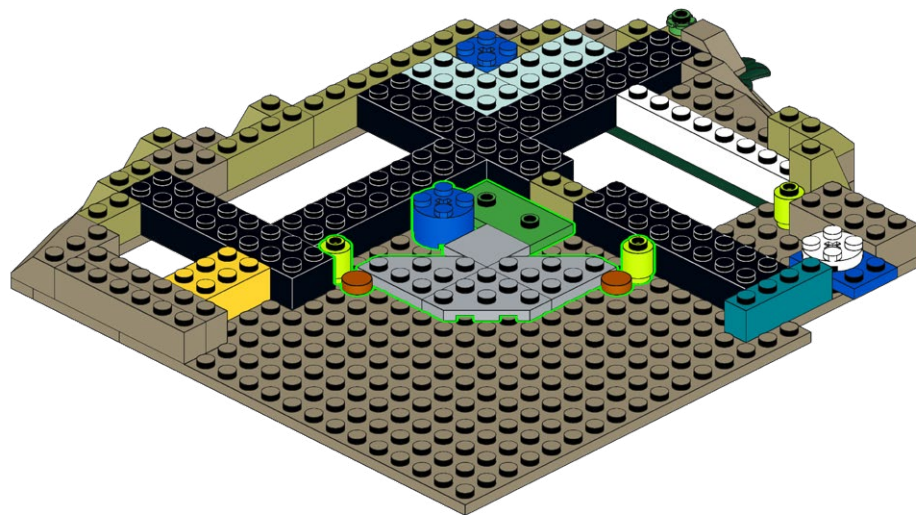
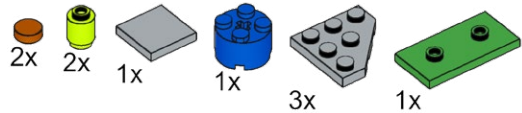

13

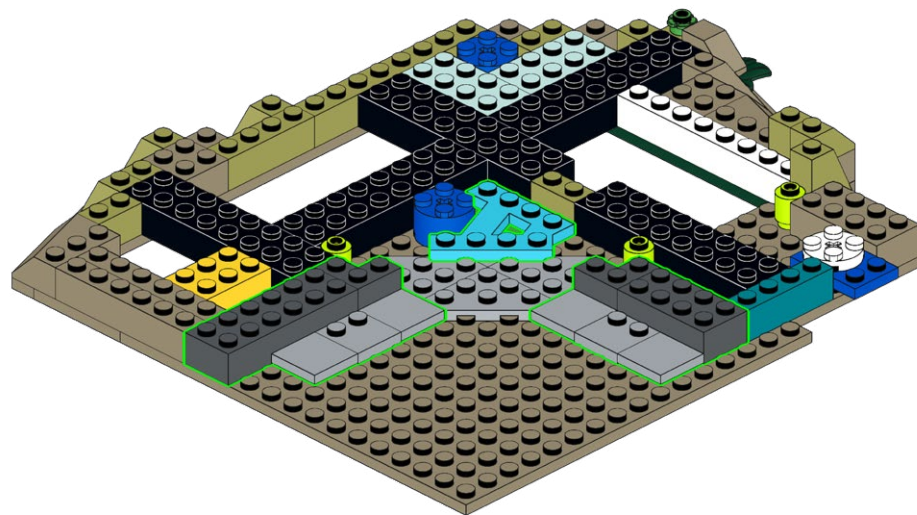
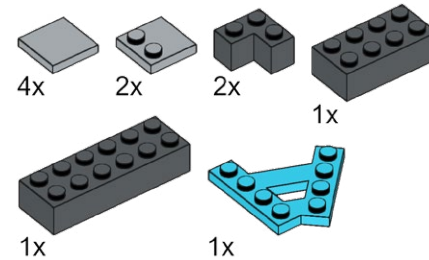

14

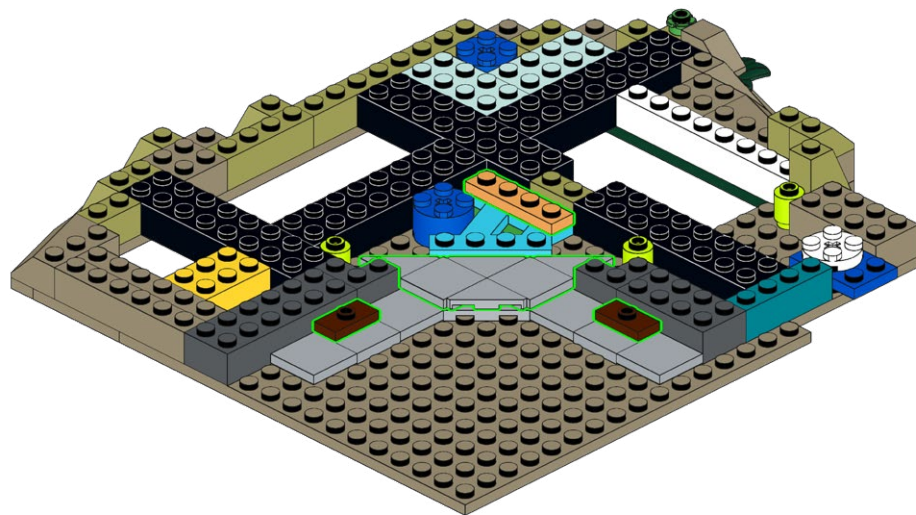
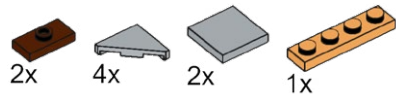

15

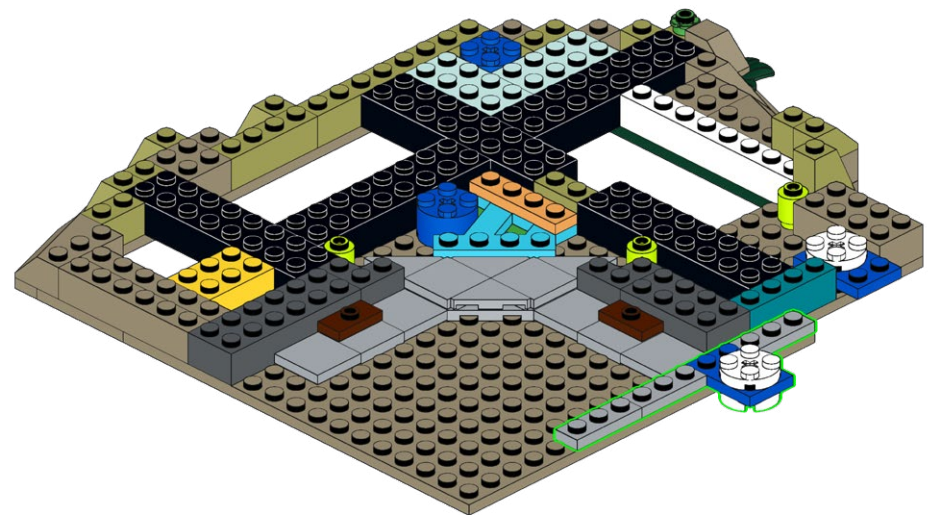
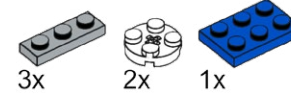



16

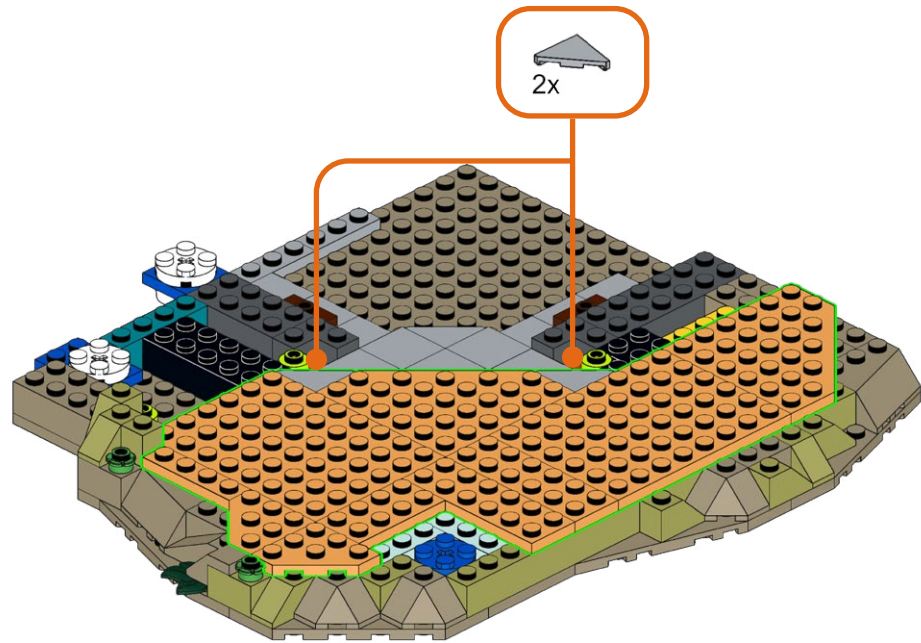
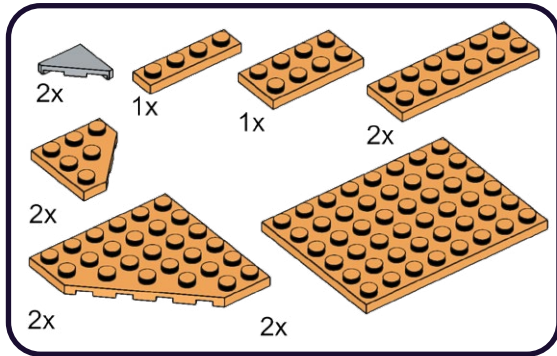

17

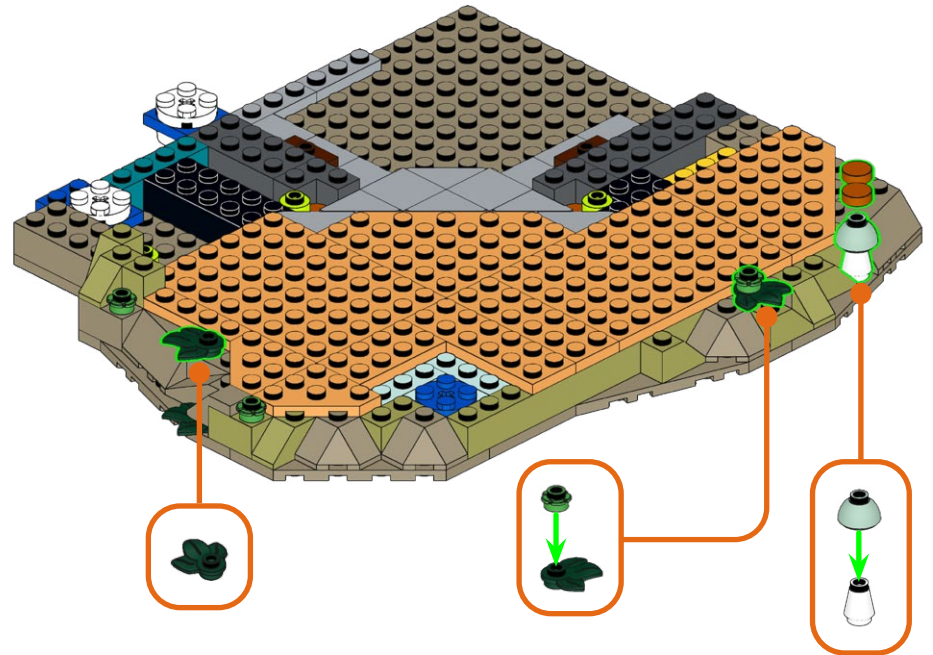
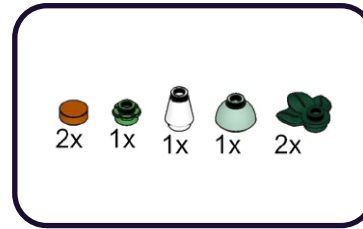

18

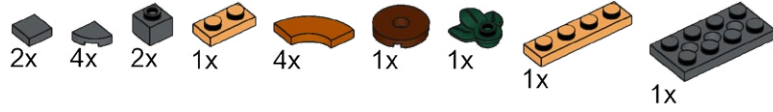

2x

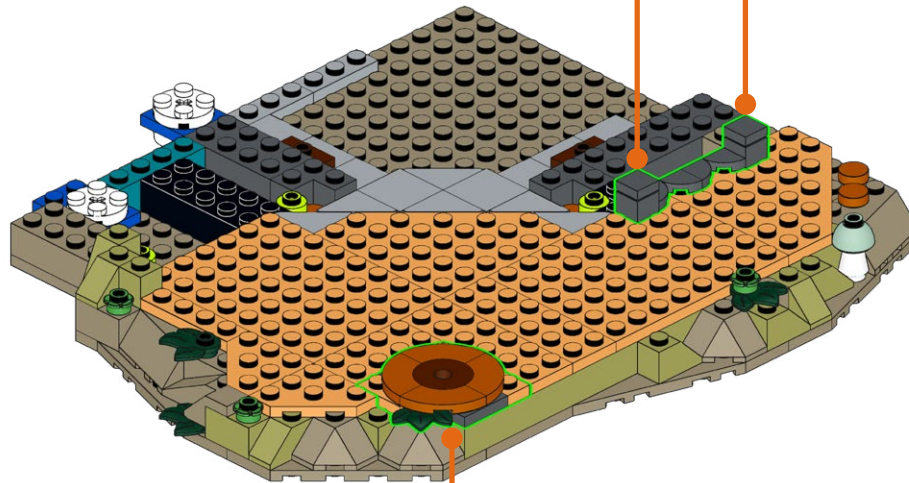

1

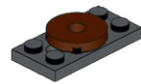

2

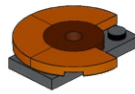

3

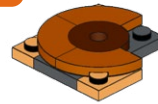

4



19

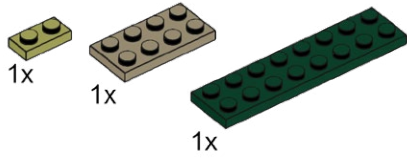

1

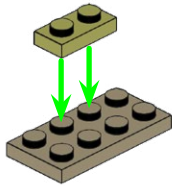

2

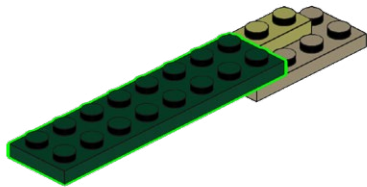

20

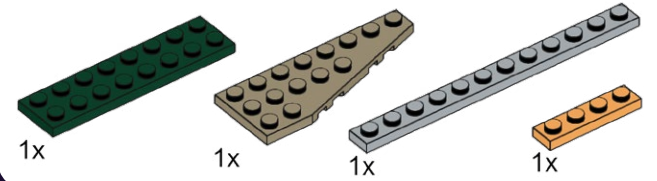

1

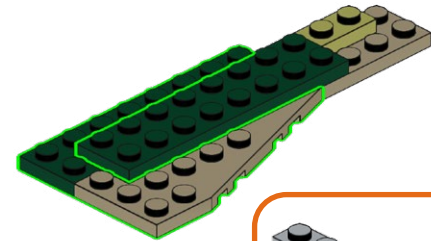

2

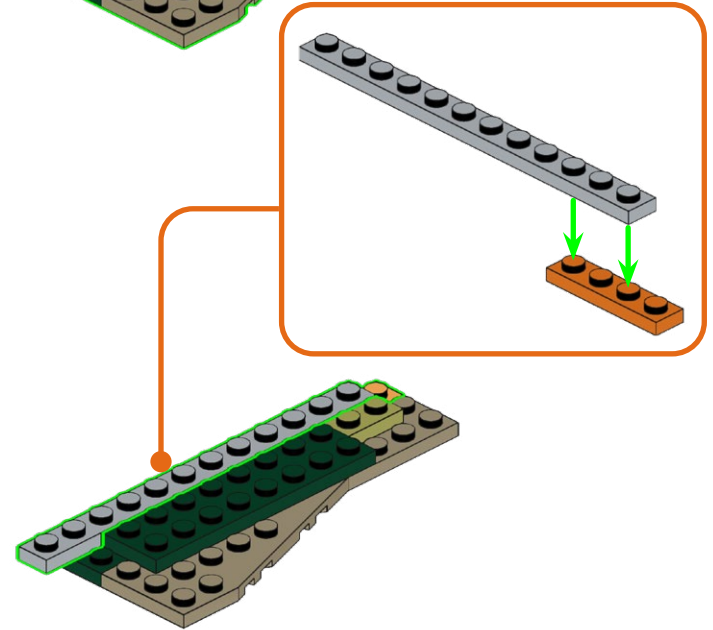

21

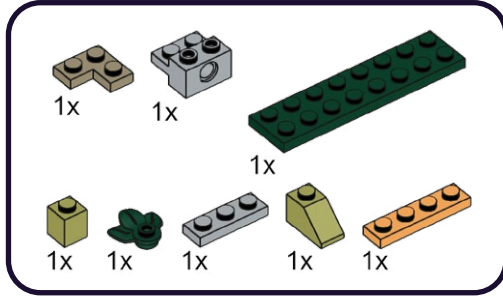

1

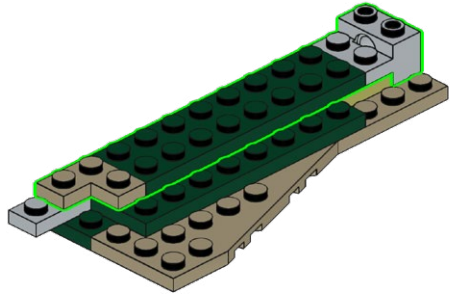

2

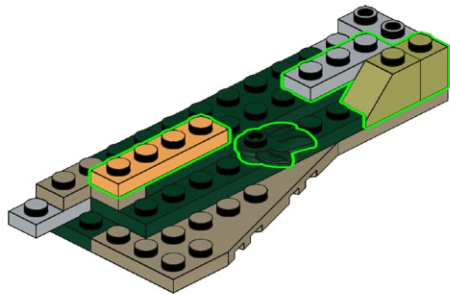

22

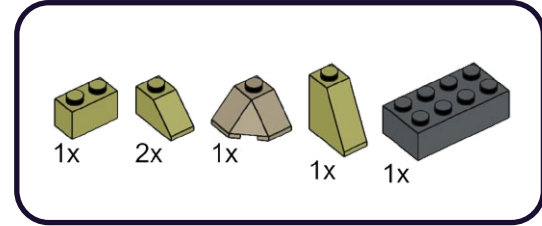

1

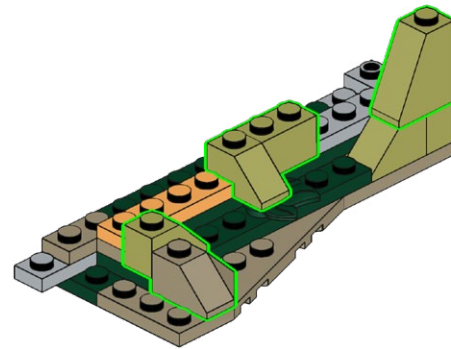

2

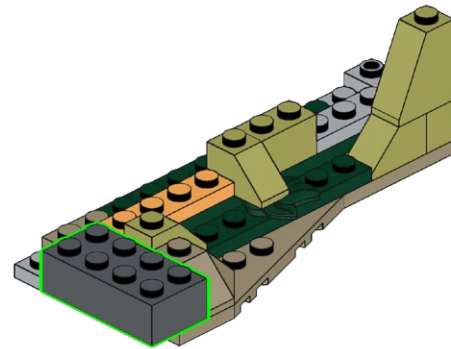

23

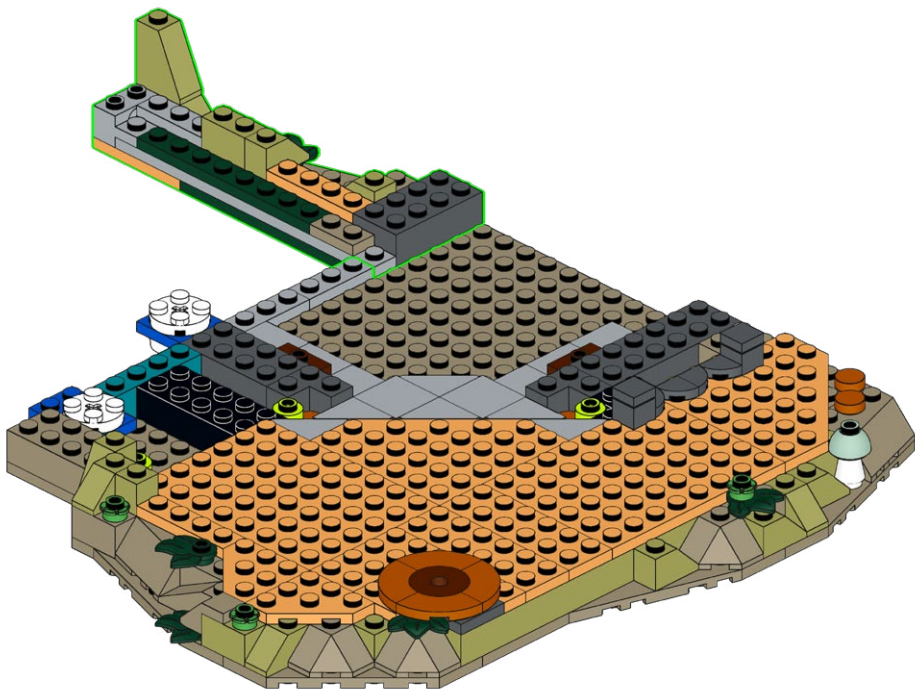

24

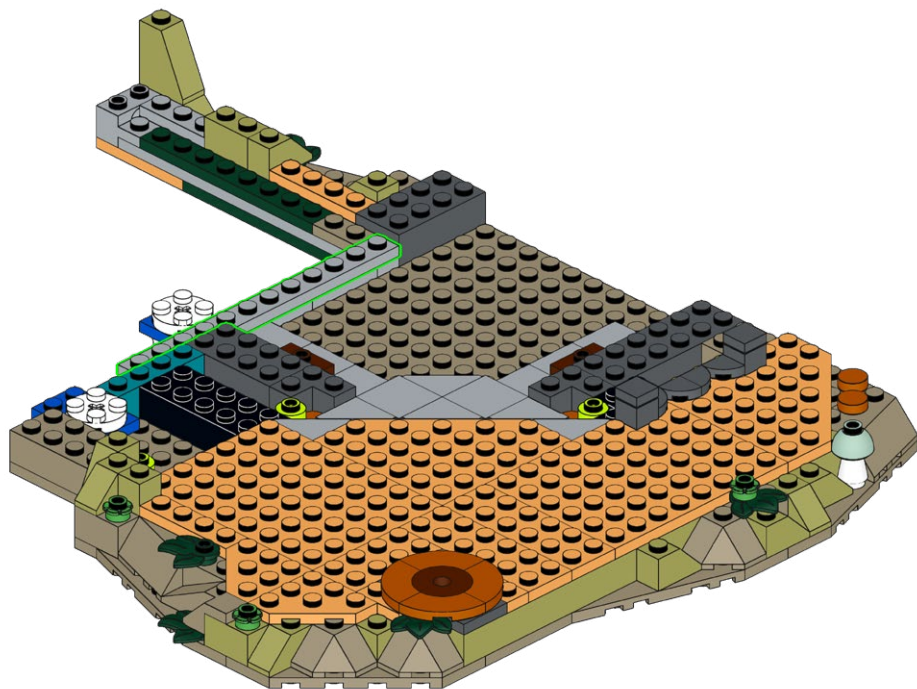
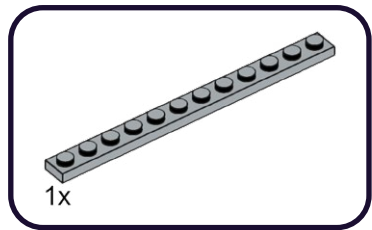

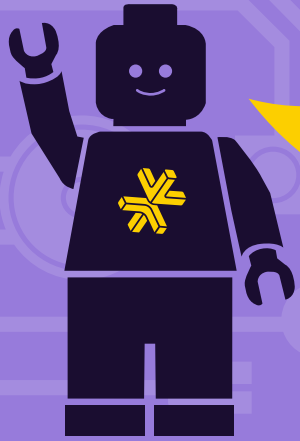
**HOLD UP!**

You might notice some bags are out of order, as well as left over pieces, but that's ok! We're changing the way you build LEGO!

**HALTEN!**

Möglicherweise stellen Sie fest, dass einige Beutel nicht in Ordnung sind und auch Teile übrig bleiben, aber das ist in Ordnung! Wir verändern die Art und Weise, wie Sie LEGO bauen!

**TENIR BON!**

Vous remarquerez peut-être que certains sacs sont en panne, ainsi que des morceaux restants, mais ce n'est pas grave ! Nous changeons la façon dont vous construisez LEGO !

**SOSTENERE!**

Potresti notare che alcune borse sono fuori uso, così come alcuni pezzi avanzati, ma va bene! Stiamo cambiando il modo in cui costruisci i LEGO!

**¡SOSTENER!**

Puede que notes que algunas bolsas están fuera de orden, así como piezas sobrantes, ¡pero está bien! ¡Estamos cambiando la forma de construir LEGO!

**耽误!**

您可能会注意到有些袋子坏了, 还有剩余的碎片, 但这没关系! 我们正在改变您搭建乐高的方式!

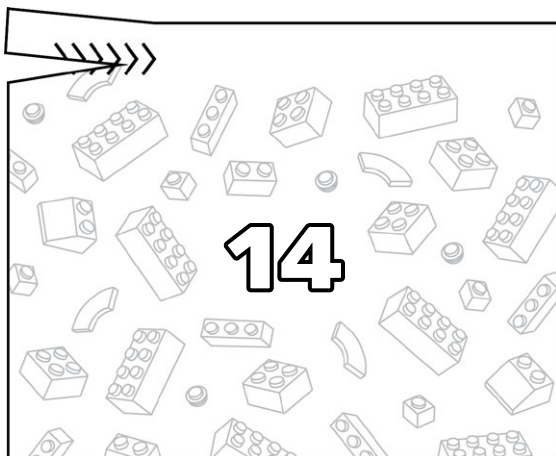
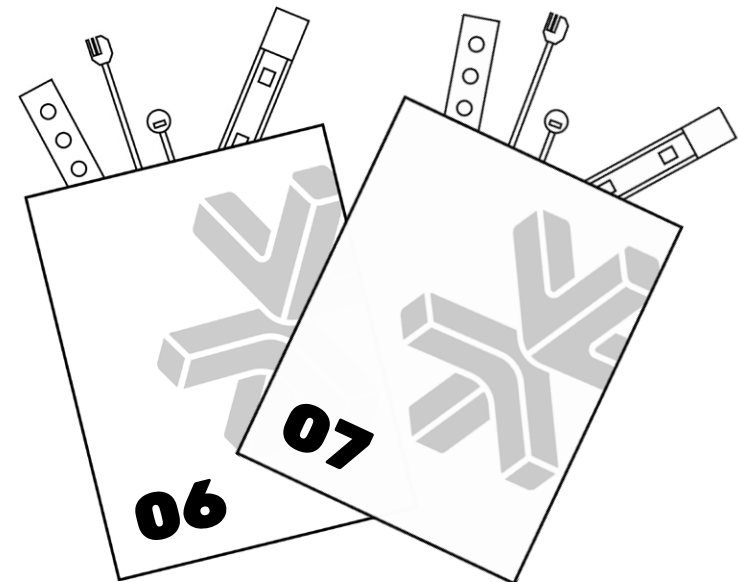
**Open LEGO® Bag 14****Open LMB Bag 06 & 07**

25

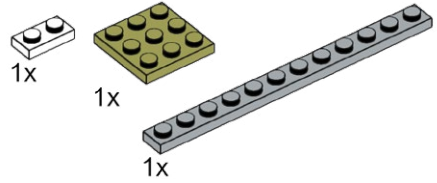

1

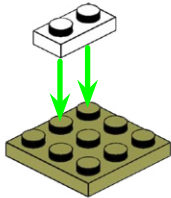

2

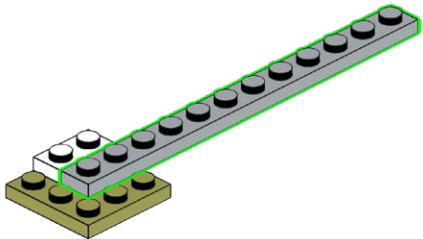

26

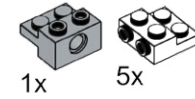

1

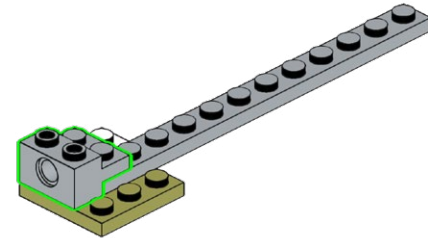

2

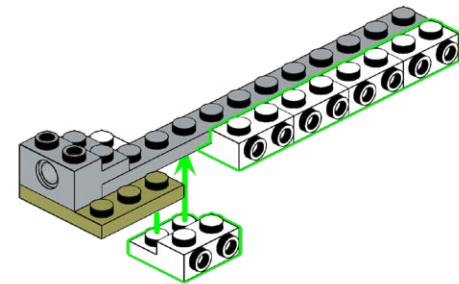

# 27

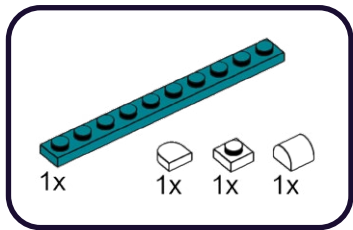

1

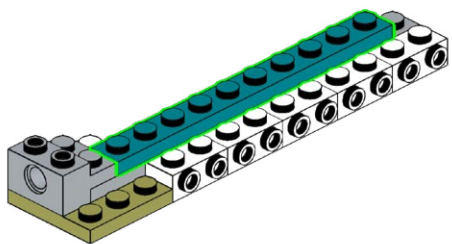

2

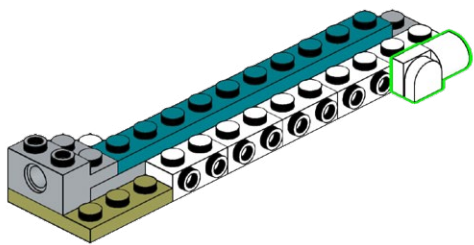

# 28

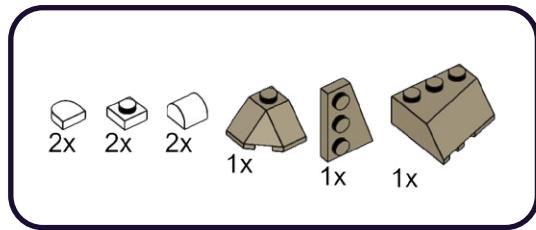

1

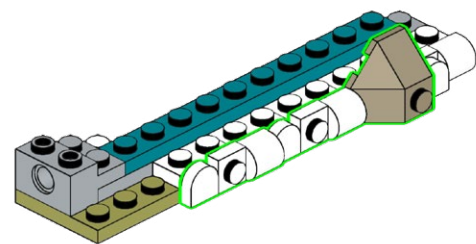

2

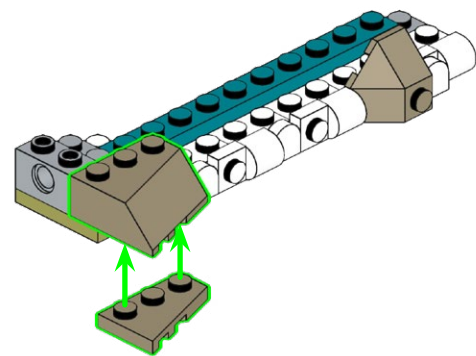



29

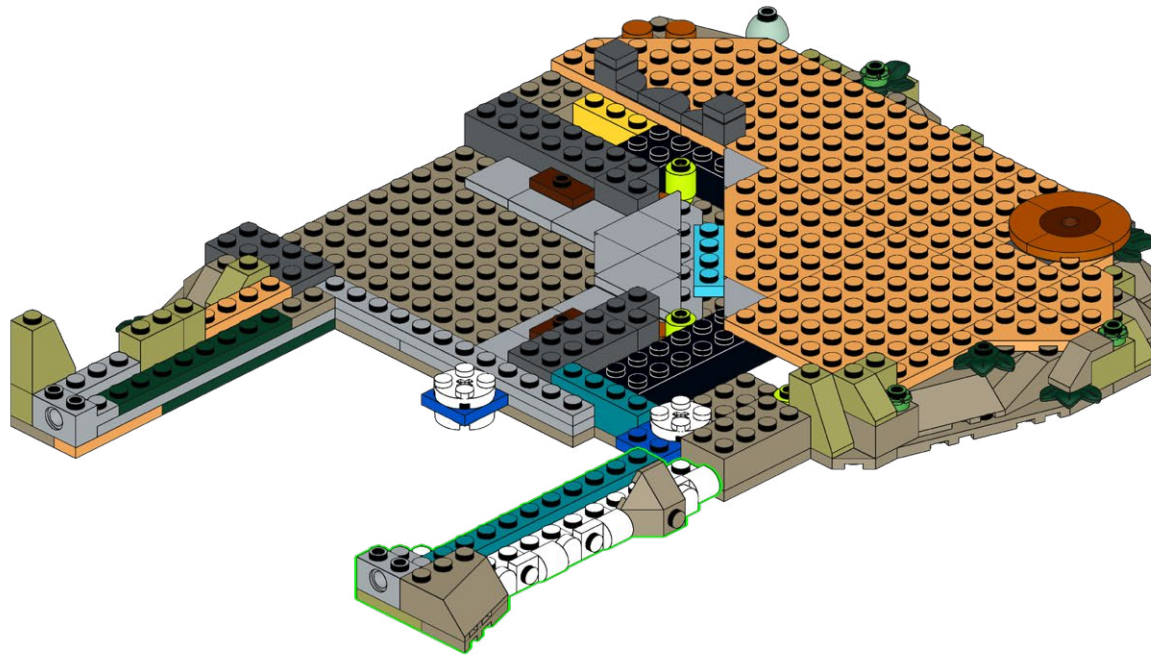

30

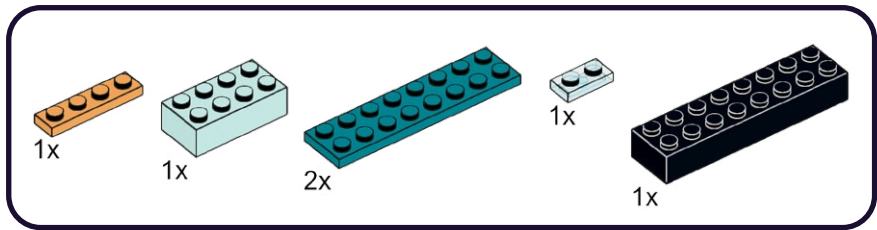

1

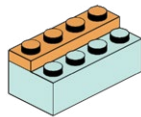

2

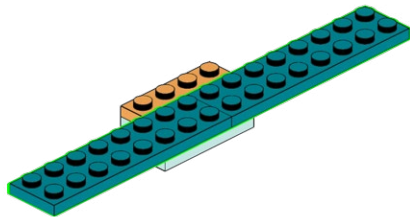

3

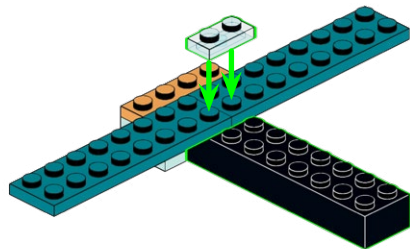

31

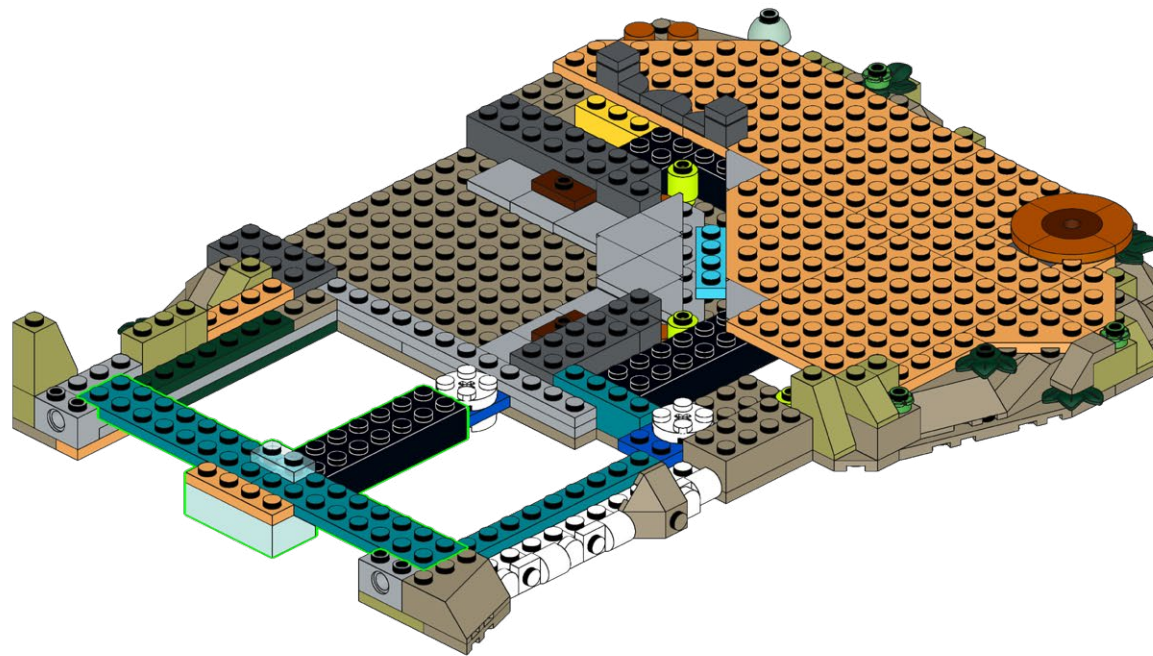

# 32

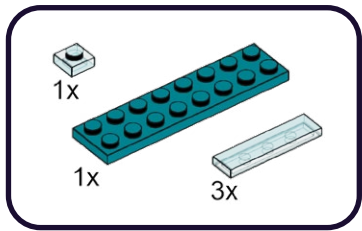

1

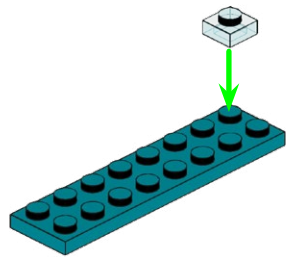

2

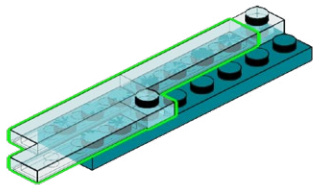

# 33

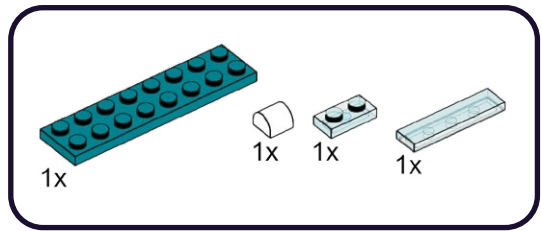

1

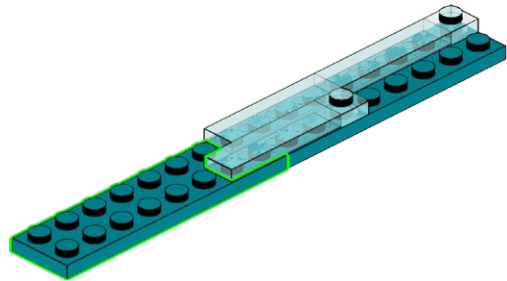

2

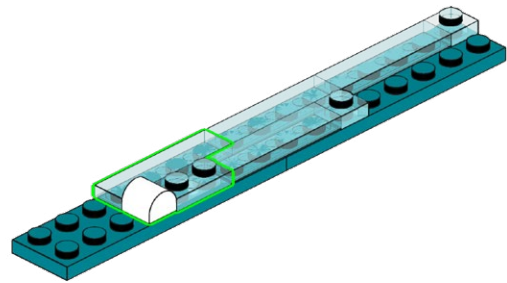

34

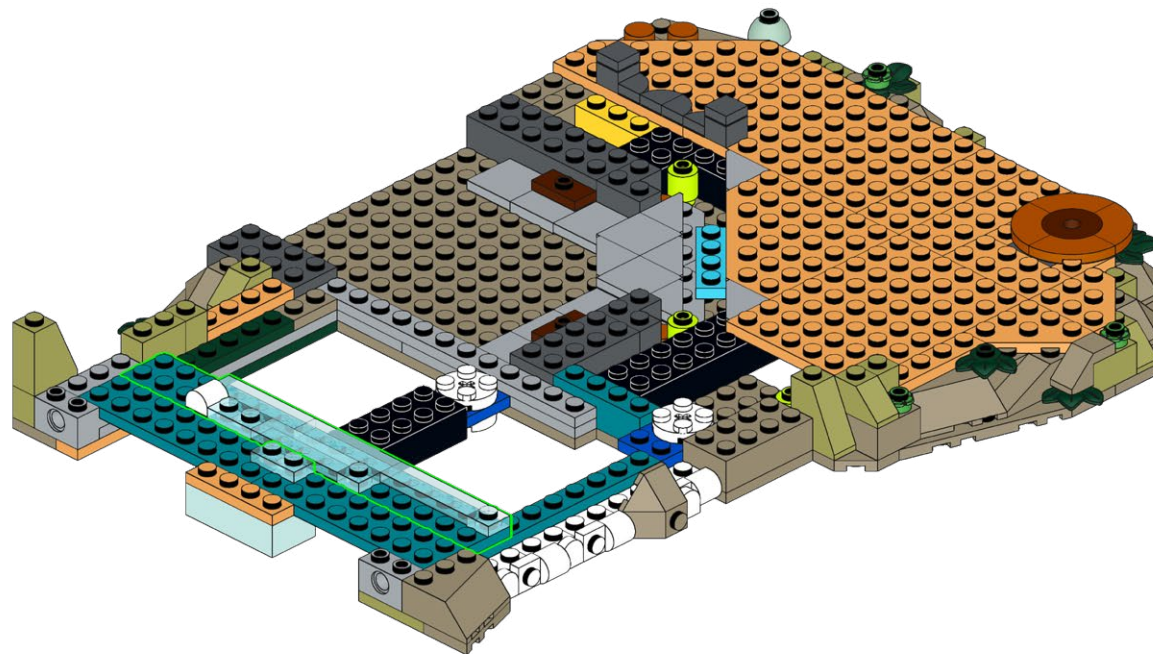

35

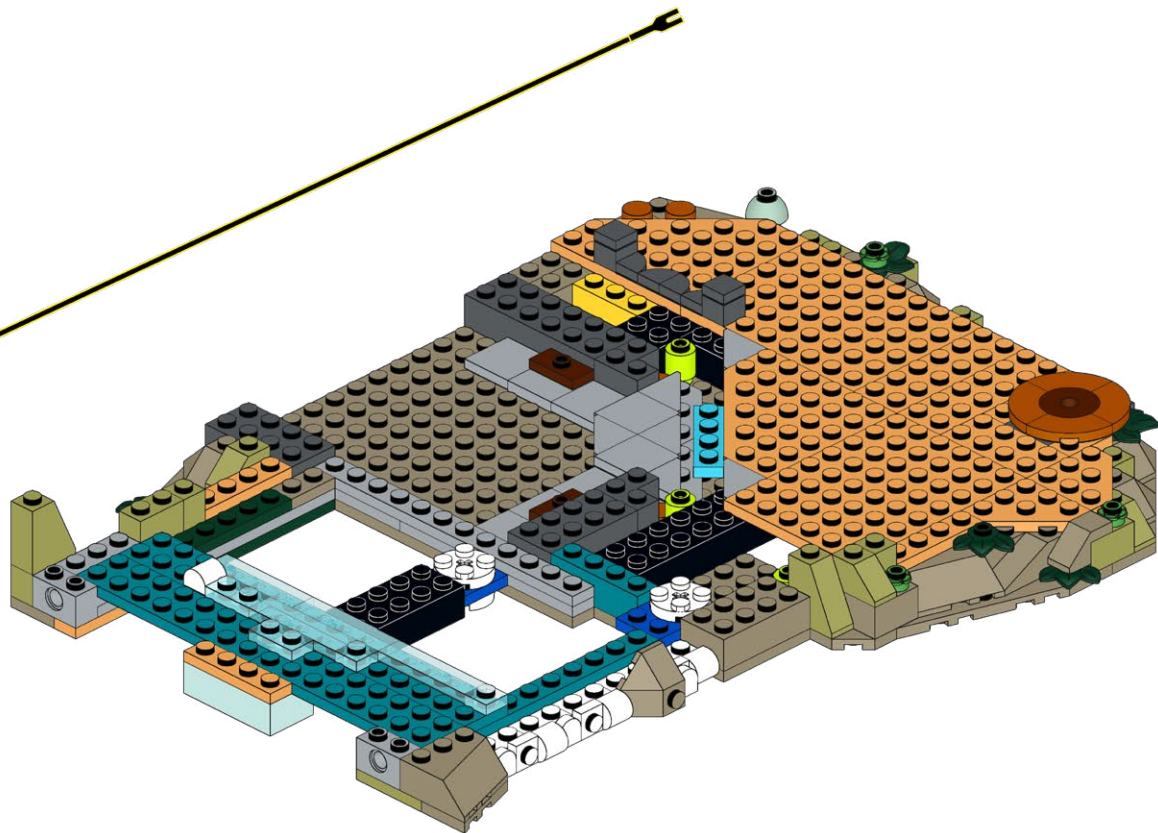
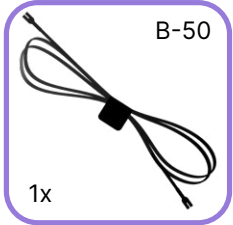

36

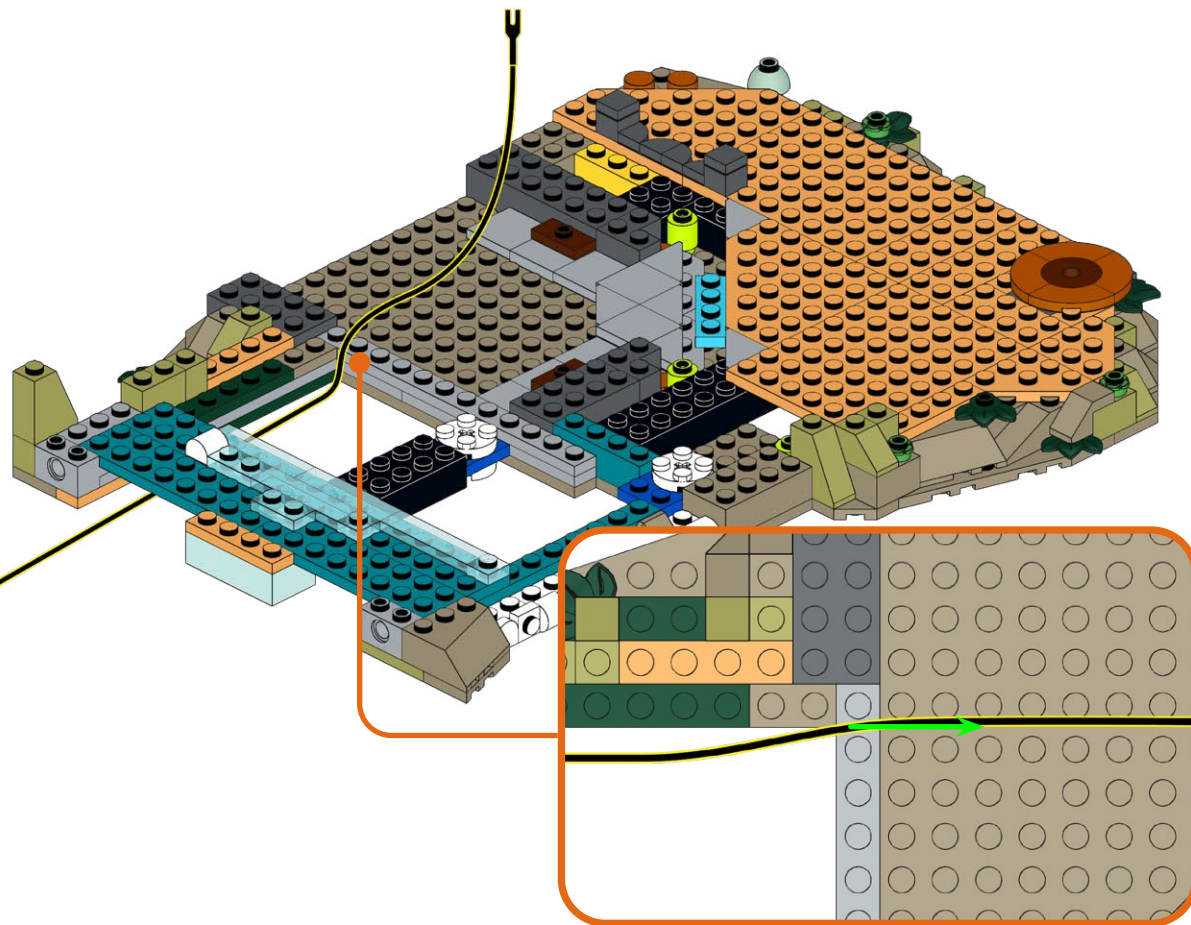

# 37

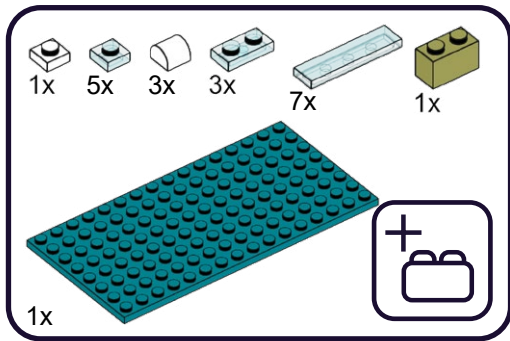

1

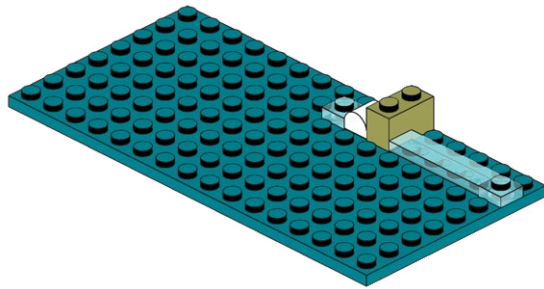

2

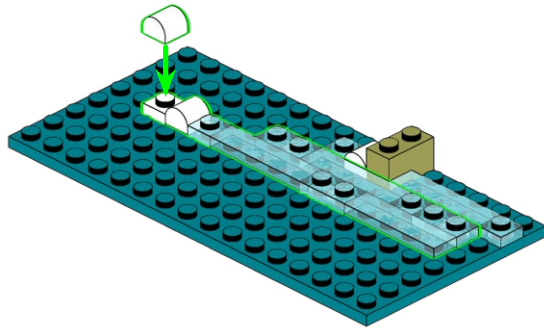

3

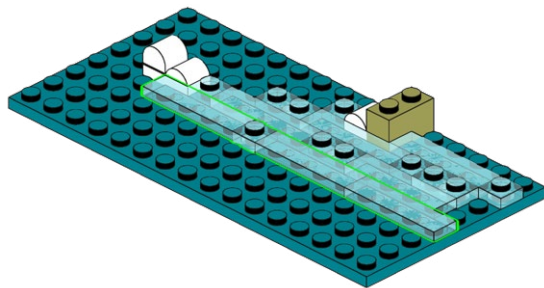

# 38

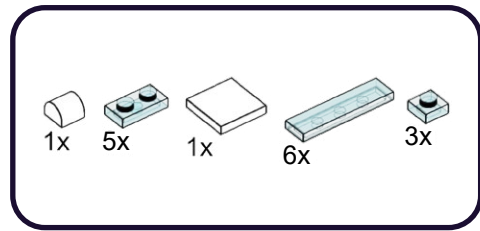

1

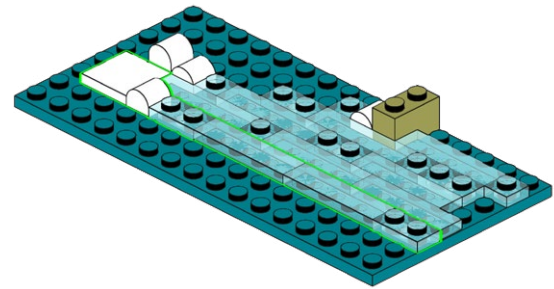

2

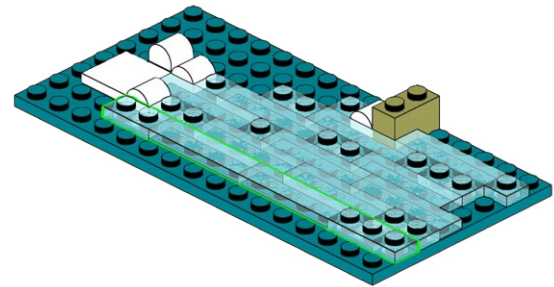

3

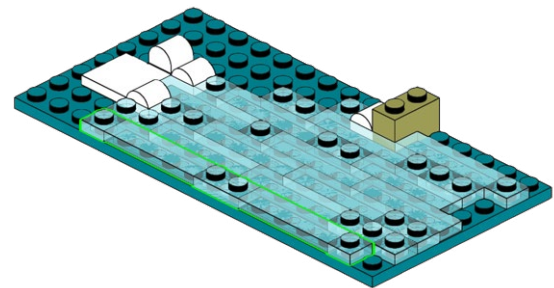



39

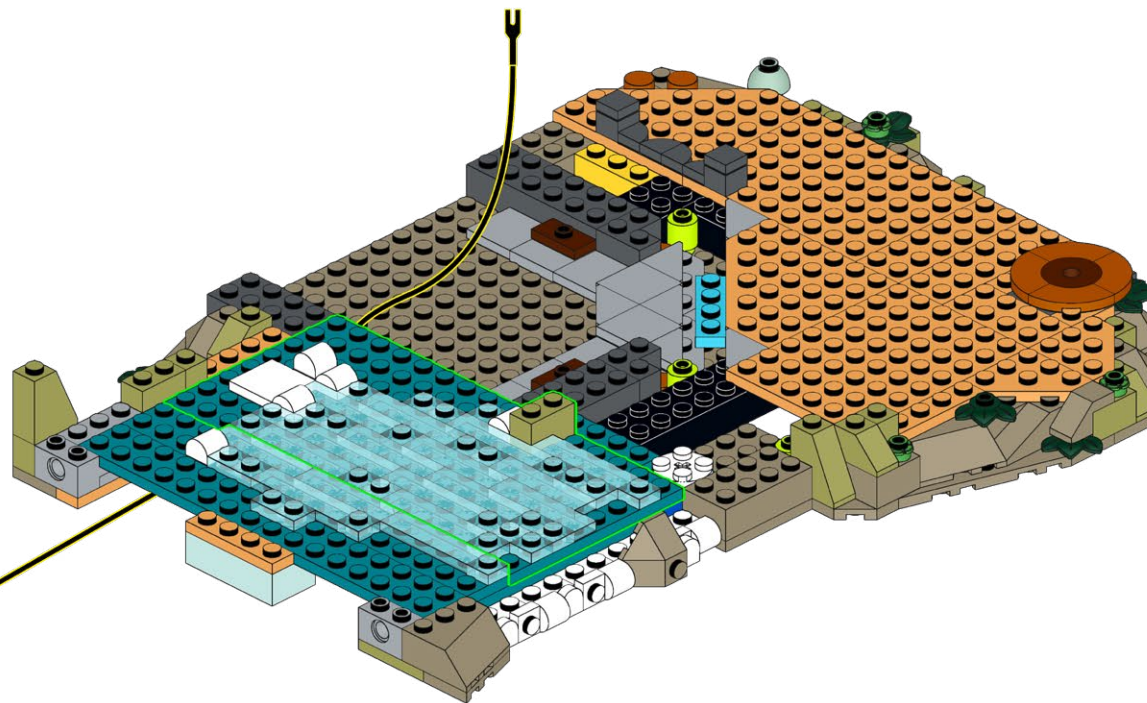

40

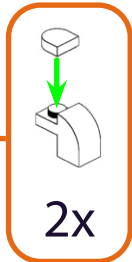
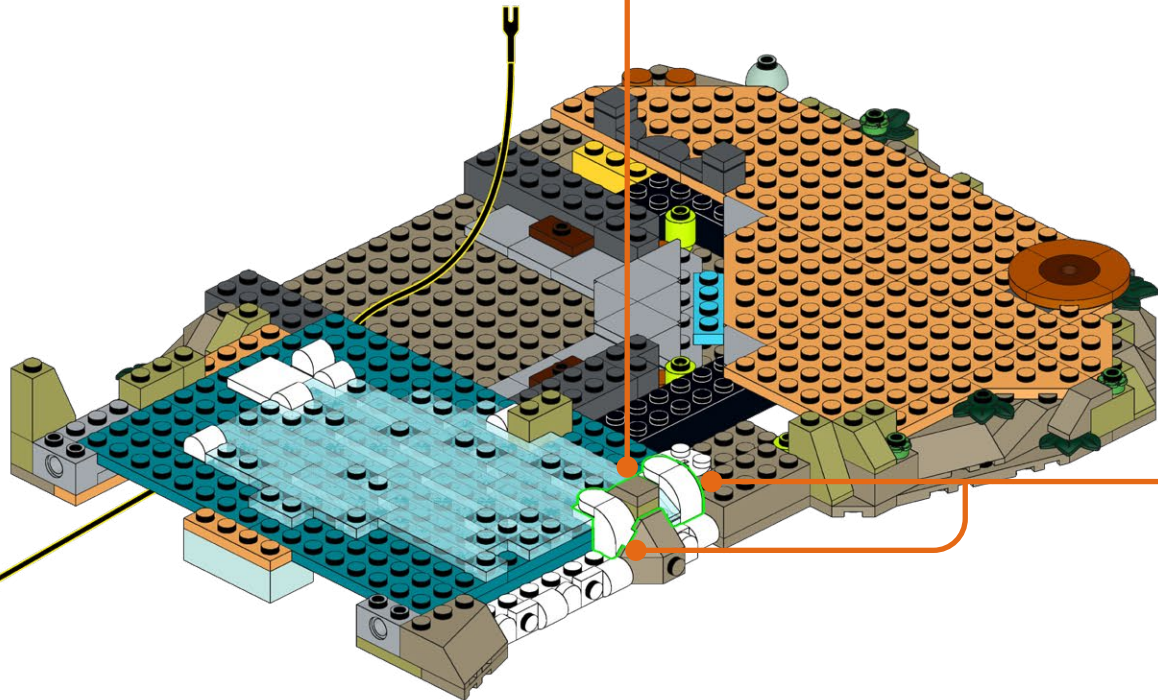
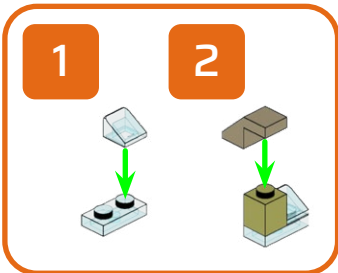

41

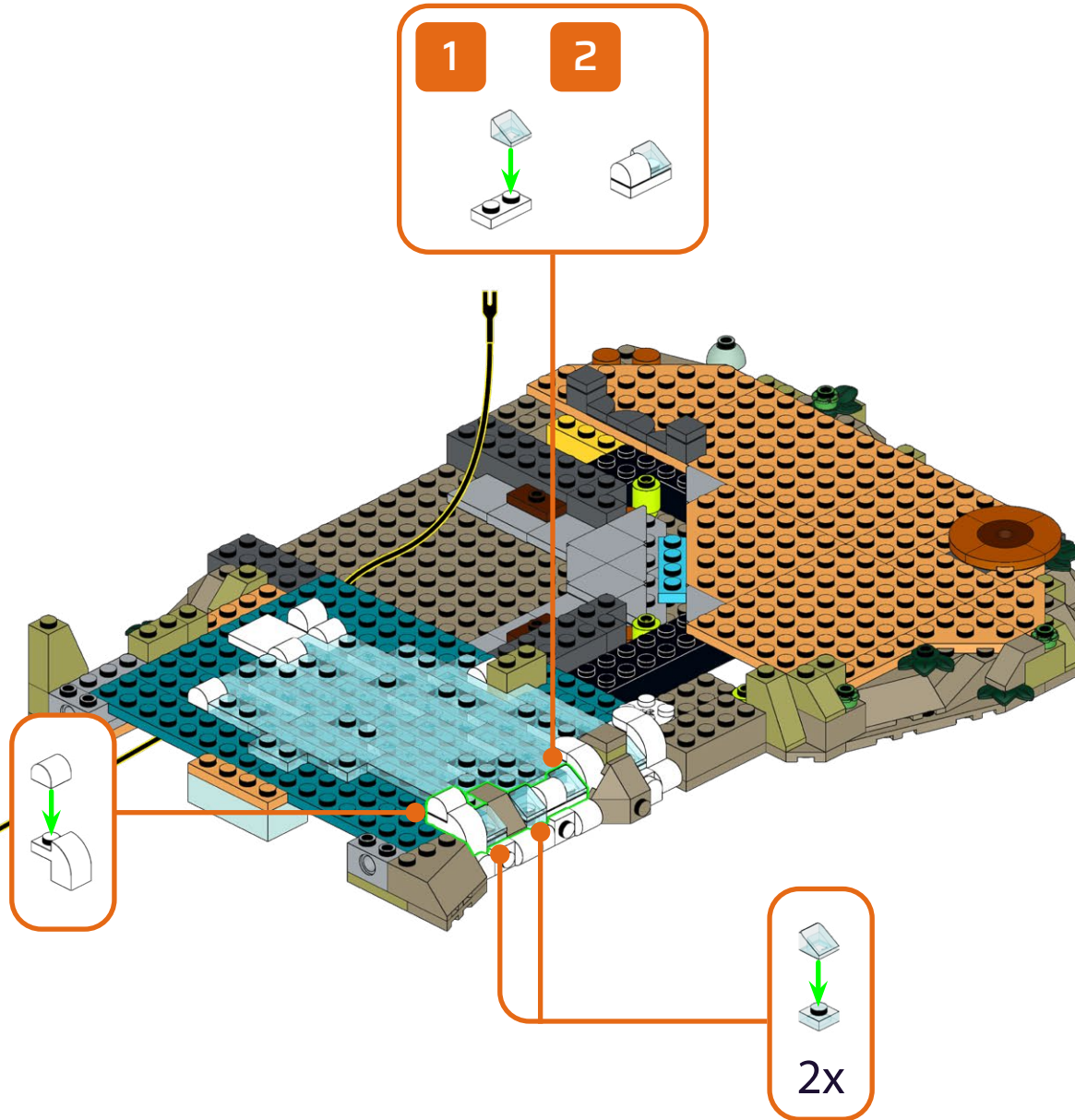

42



1x



3x

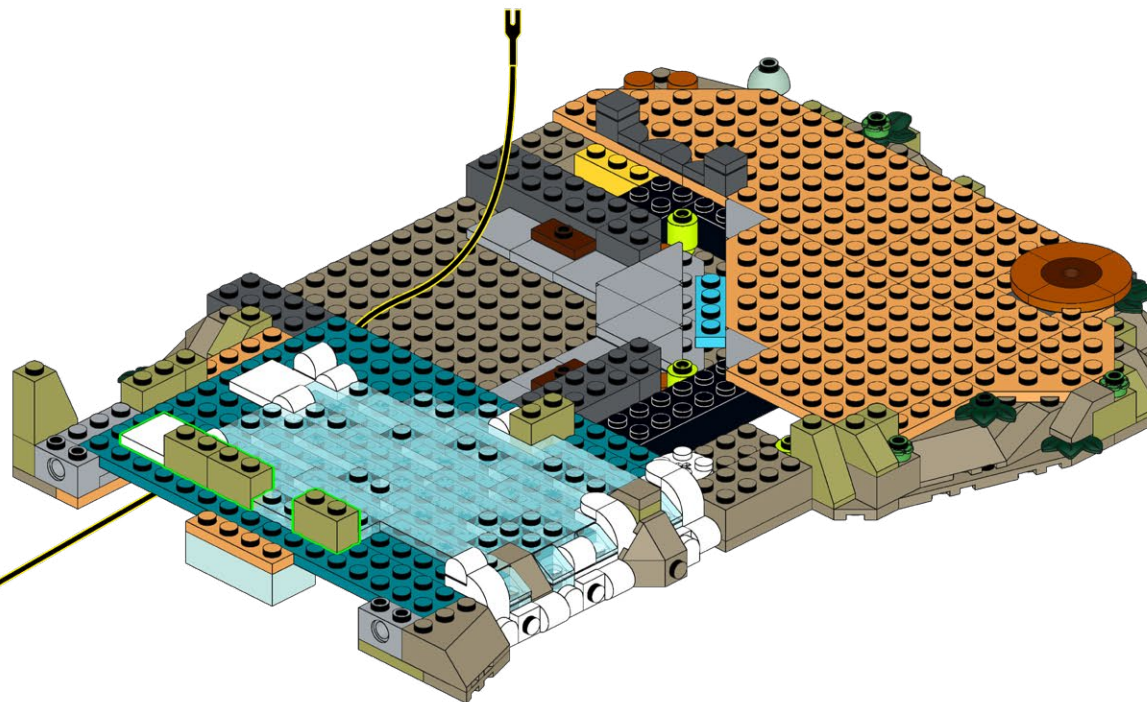

43

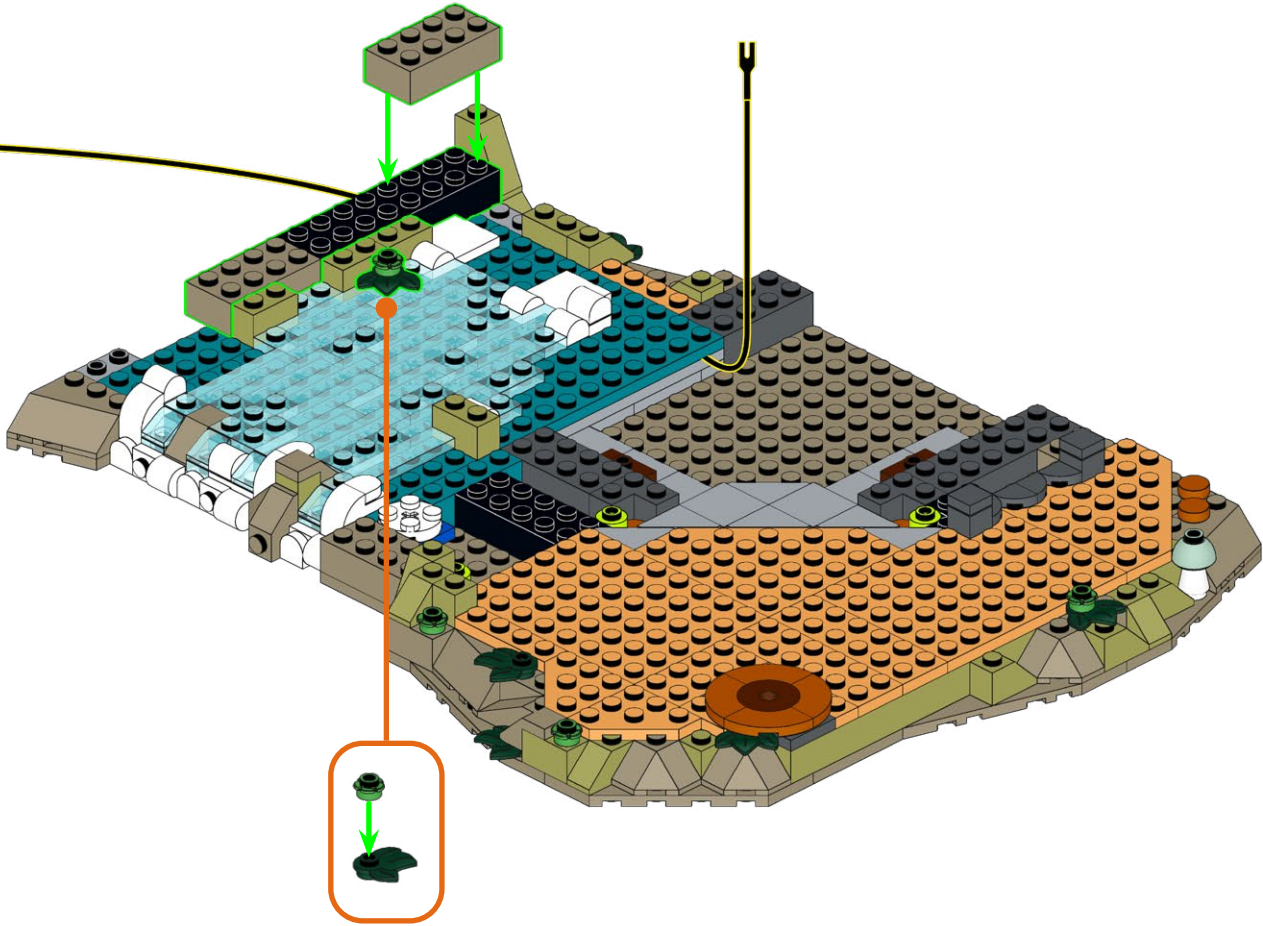
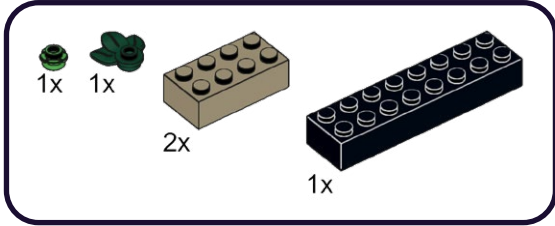

44

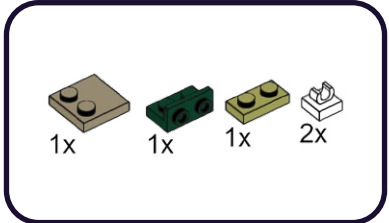

1

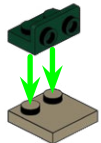

2

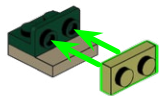

3

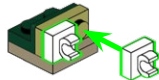

45

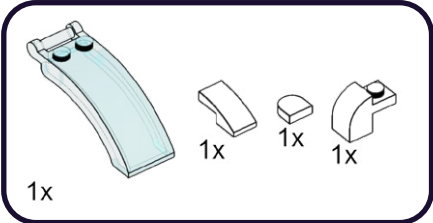

1

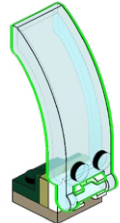

2



3

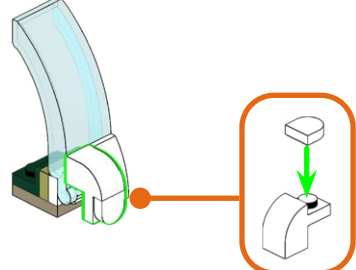

46

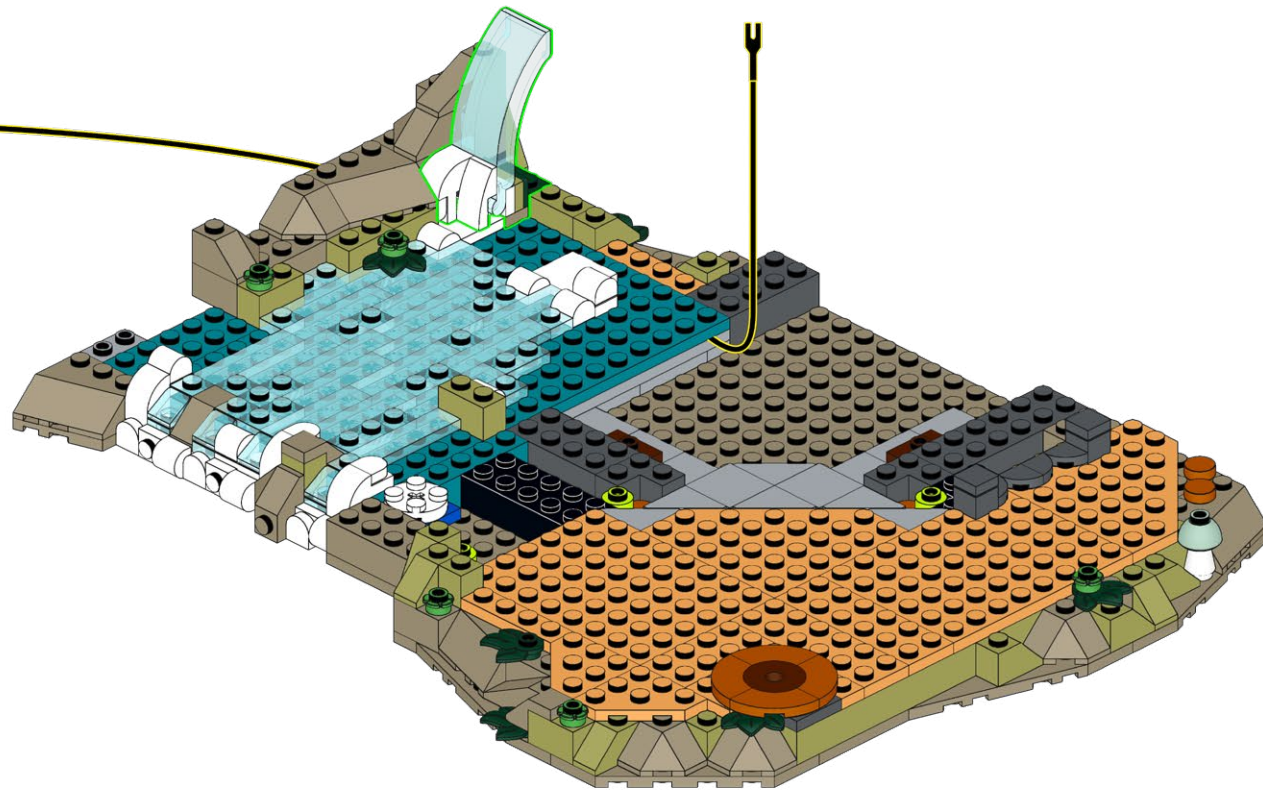
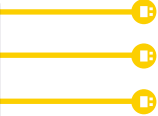

47

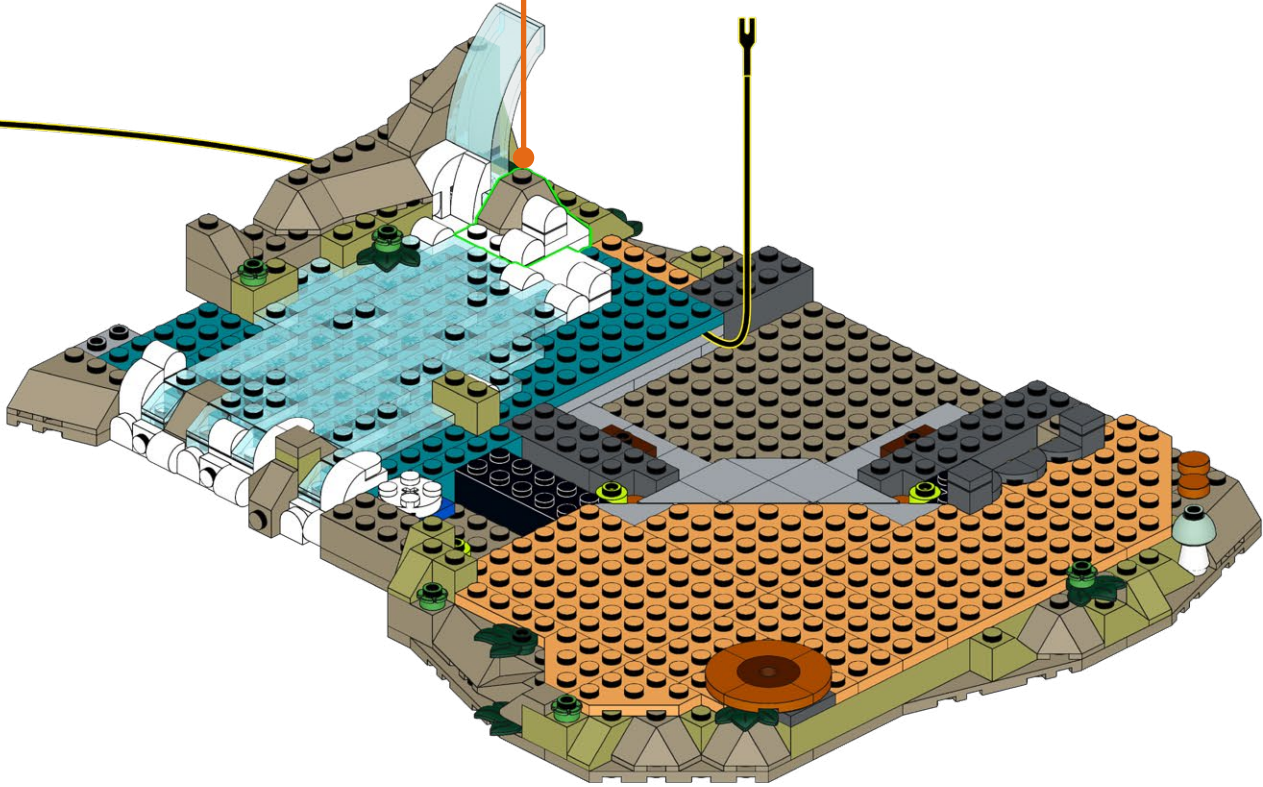
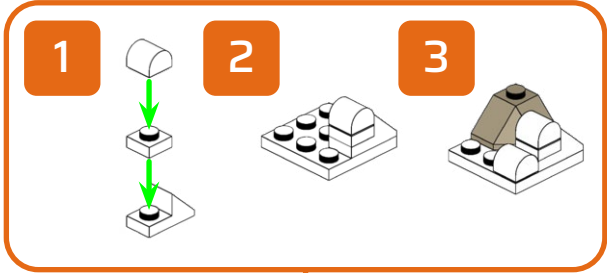



48

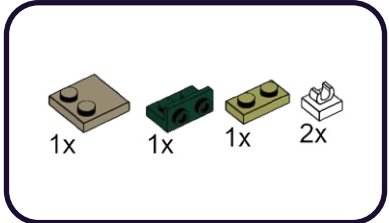

1

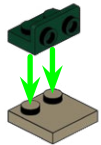

2

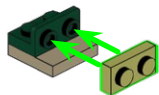

3

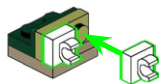

49

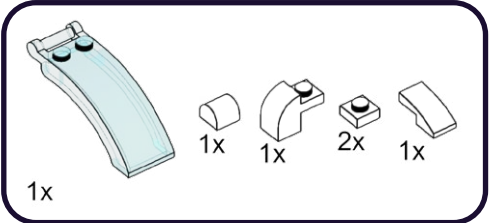

1



2

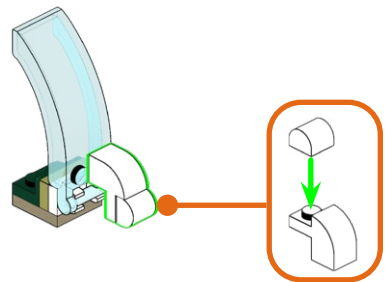

3

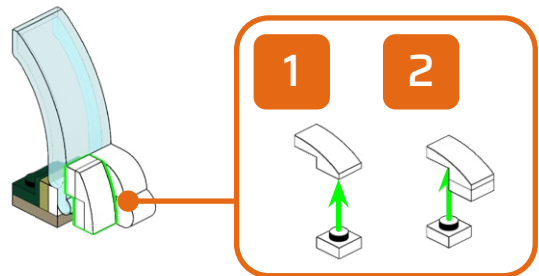

50

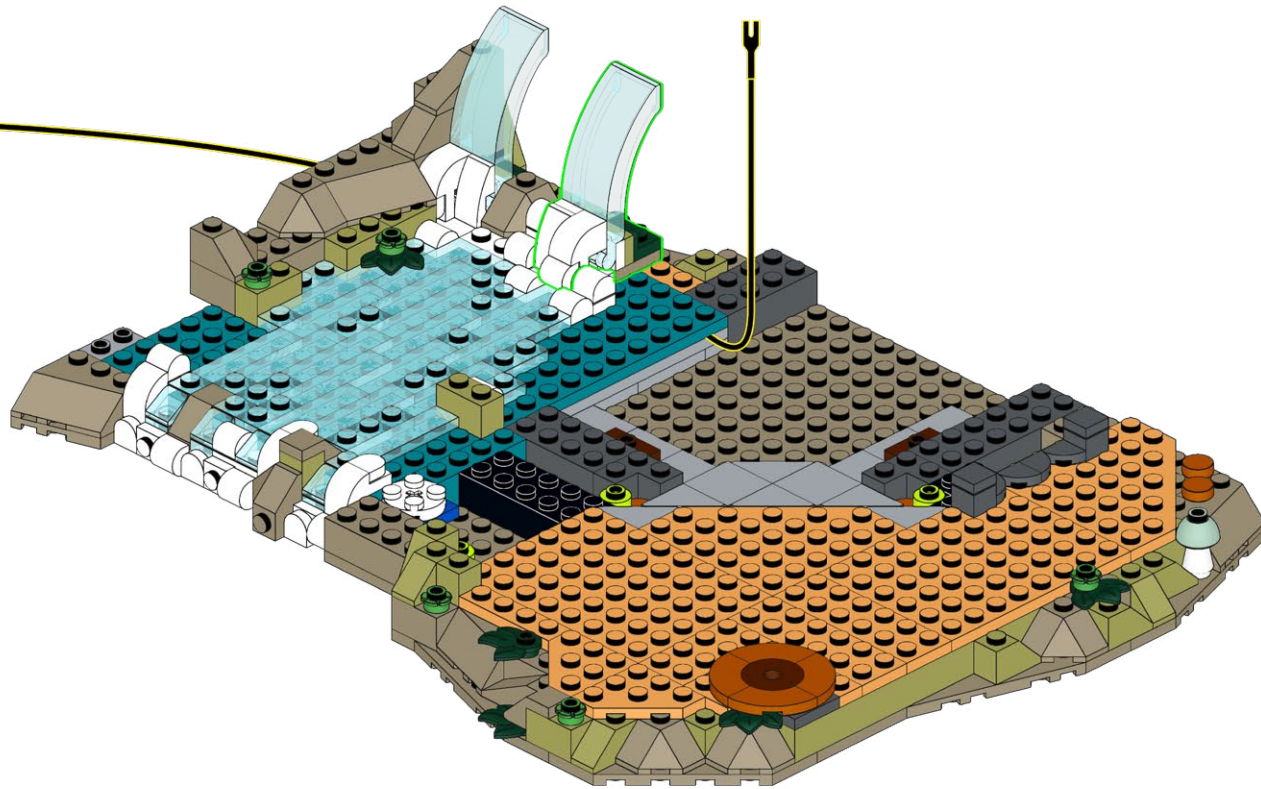
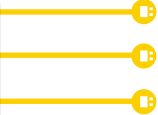

51

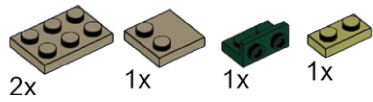

1

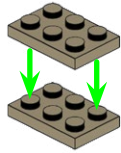

2

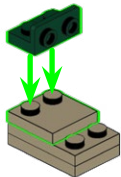

3

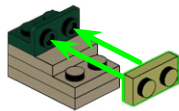

52

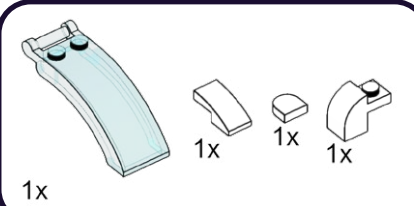

1

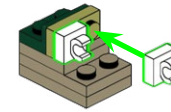

2

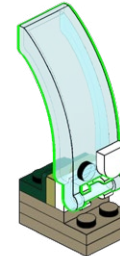

3

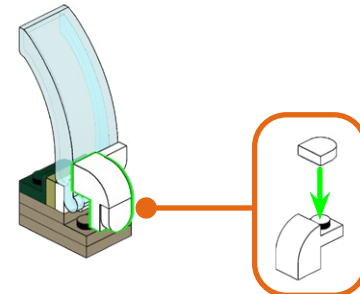

53

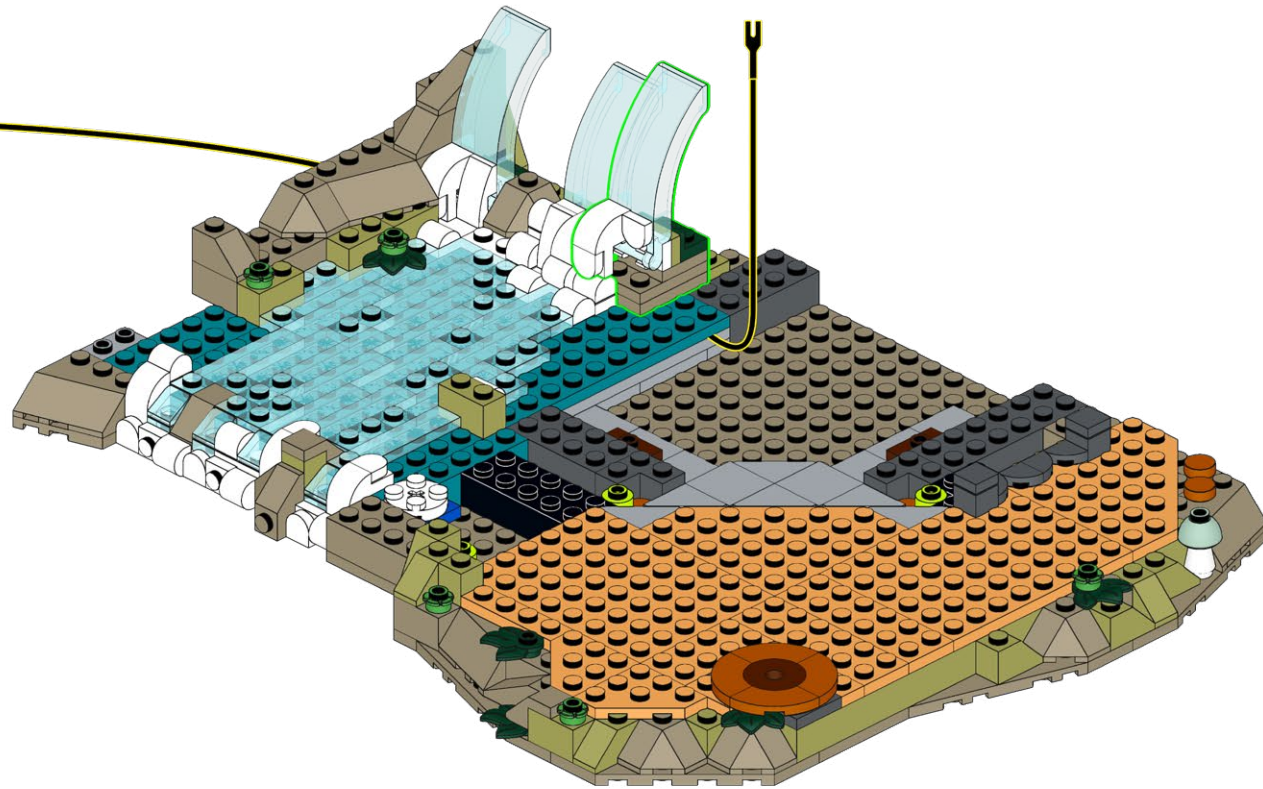
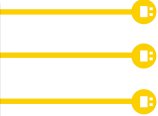

54

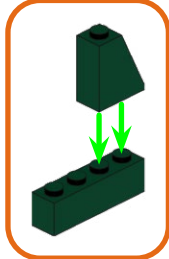
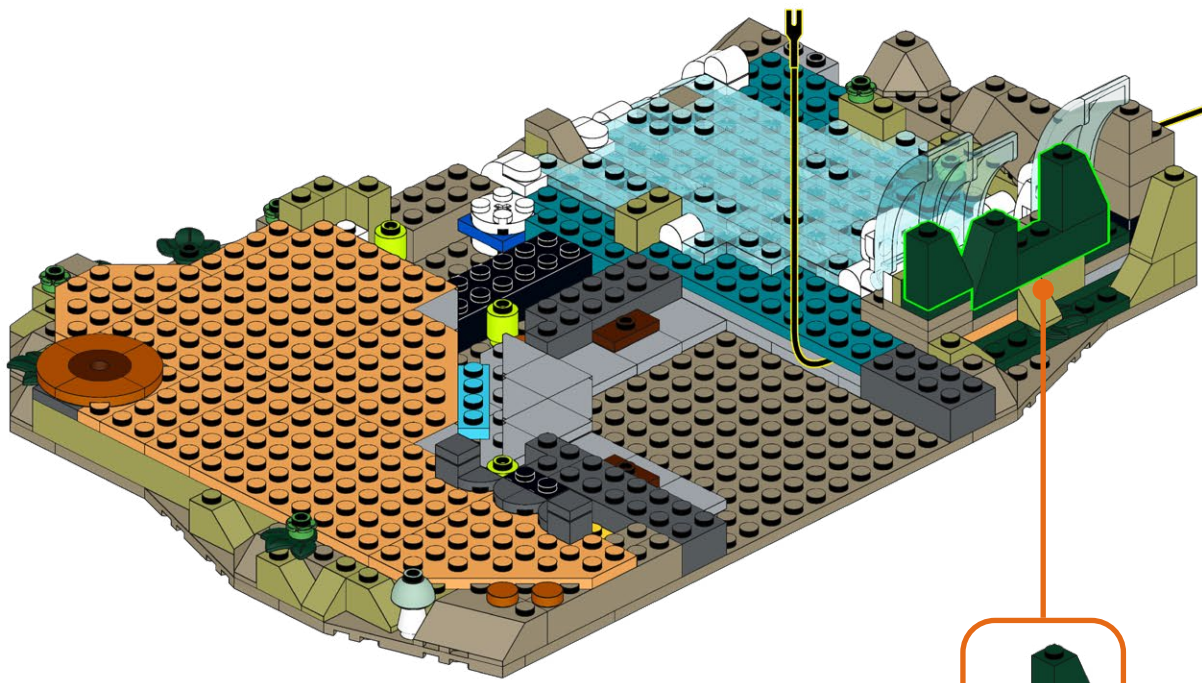
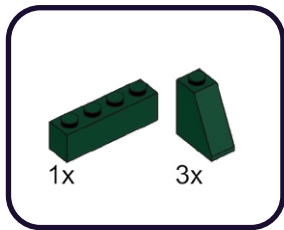

55

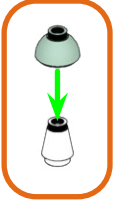
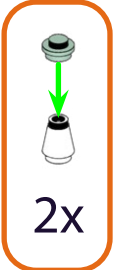
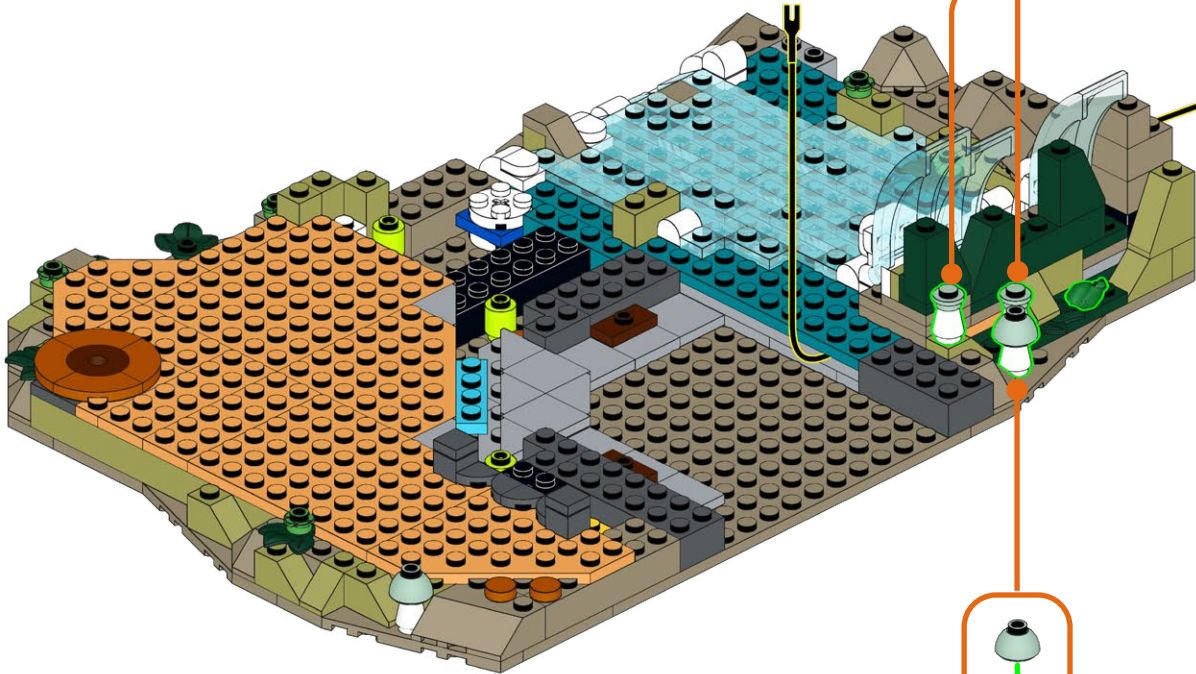
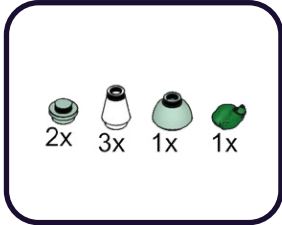

**HOLD UP!**

You might notice some bags are out of order, as well as left over pieces, but that's ok! We're changing the way you build LEGO!

**HALTEN!**

Möglicherweise stellen Sie fest, dass einige Beutel nicht in Ordnung sind und auch Teile übrig bleiben, aber das ist in Ordnung! Wir verändern die Art und Weise, wie Sie LEGO bauen!

**TENIR BON!**

Vous remarquerez peut-être que certains sacs sont en panne, ainsi que des morceaux restants, mais ce n'est pas grave ! Nous changeons la façon dont vous construisez LEGO !

**SOSTENERE!**

Potresti notare che alcune borse sono fuori uso, così come alcuni pezzi avanzati, ma va bene! Stiamo cambiando il modo in cui costruisci i LEGO!

**¡SOSTENER!**



Puede que notes que algunas bolsas están fuera de orden, así como piezas sobrantes, ¡pero está bien! ¡Estamos cambiando la forma de construir LEGO!

**耽误!**

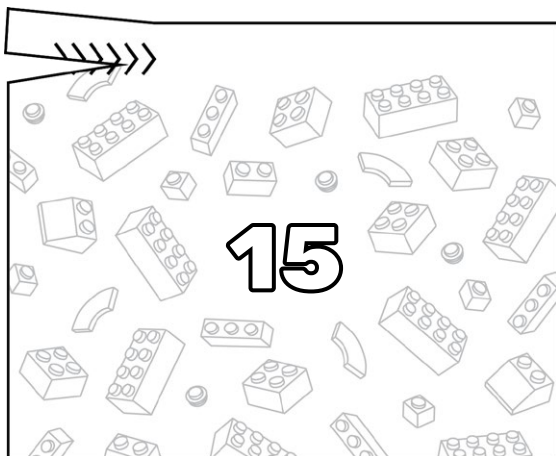
您可能会注意到有些袋子坏了, 还有剩余的碎片, 但这没关系! 我们正在改变您搭建乐高的方式!

**Open LEGO® Bag 15**

# 56

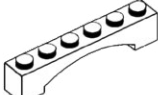
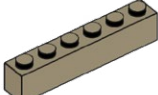
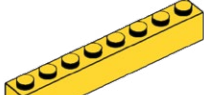
- 1x 
- 2x 
- 1x 
- 1x 
- 2x 
- 1x 

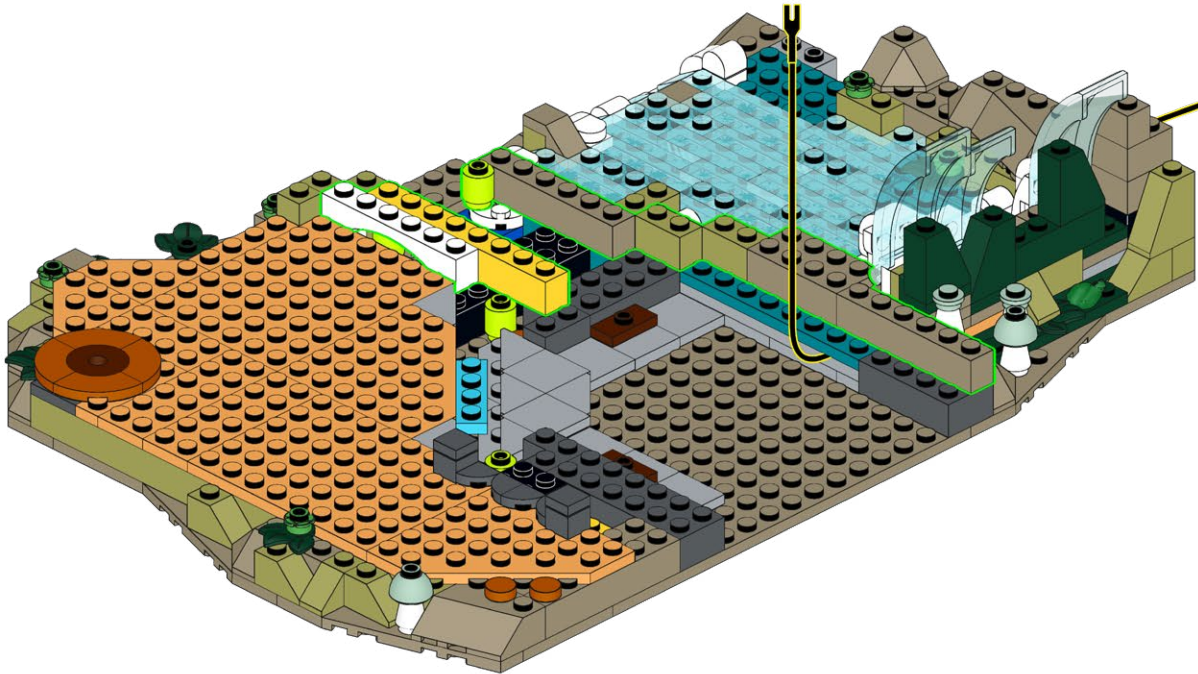



57

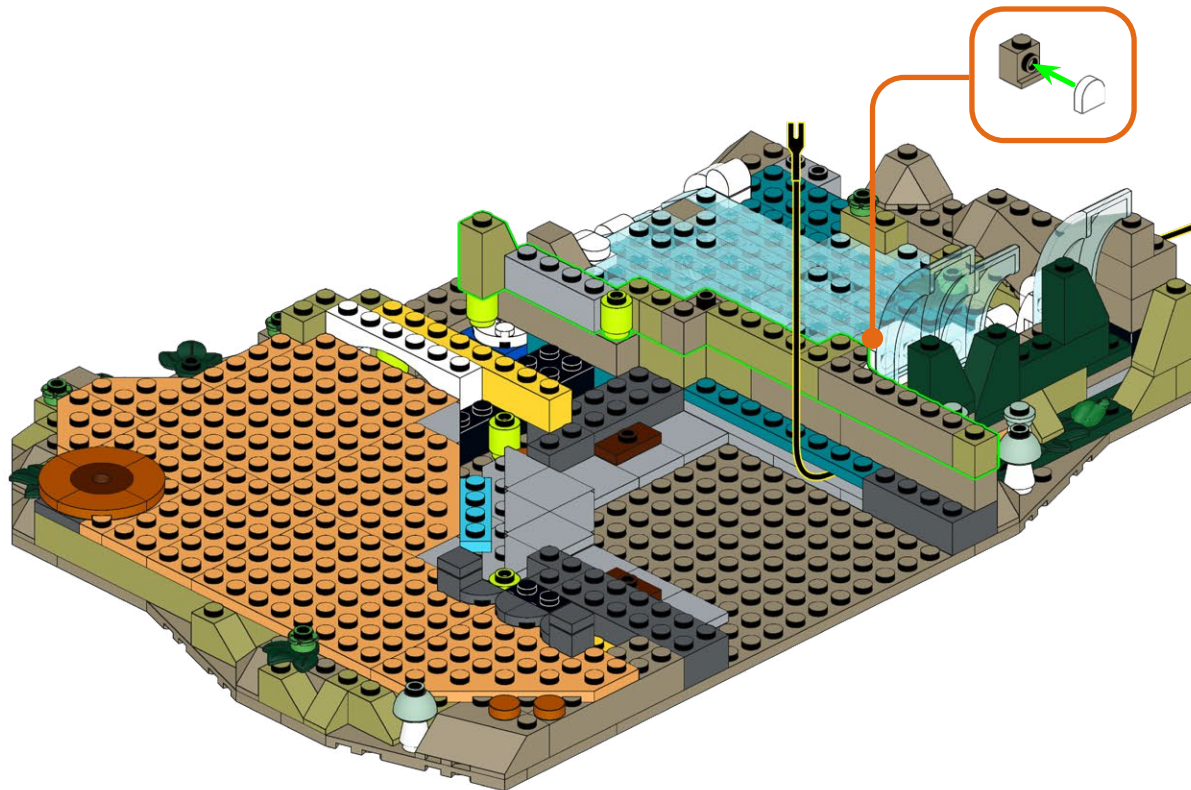
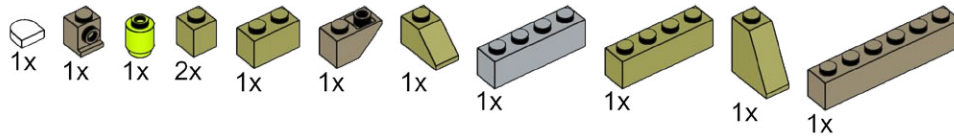

58

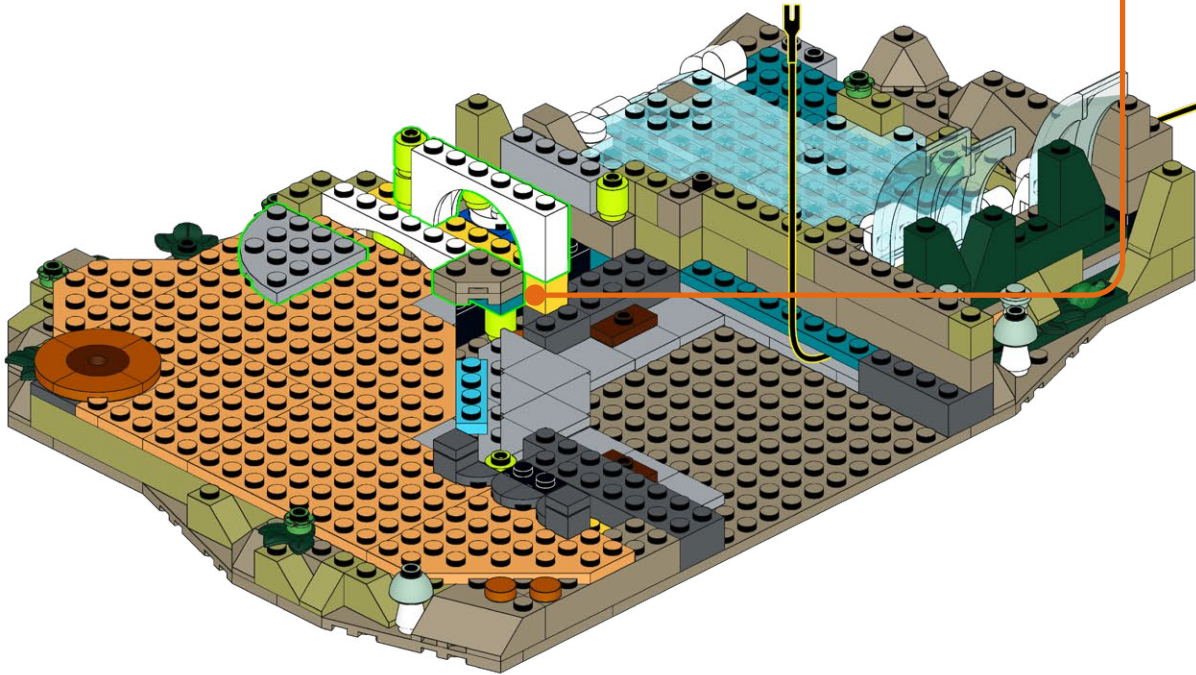
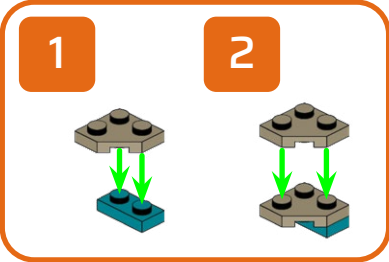
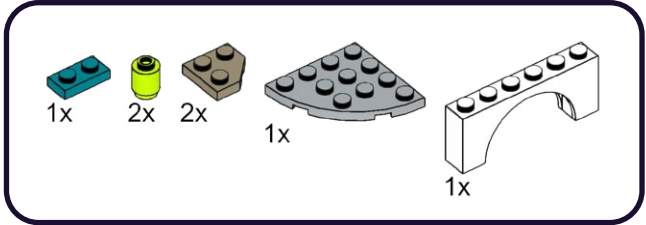

59

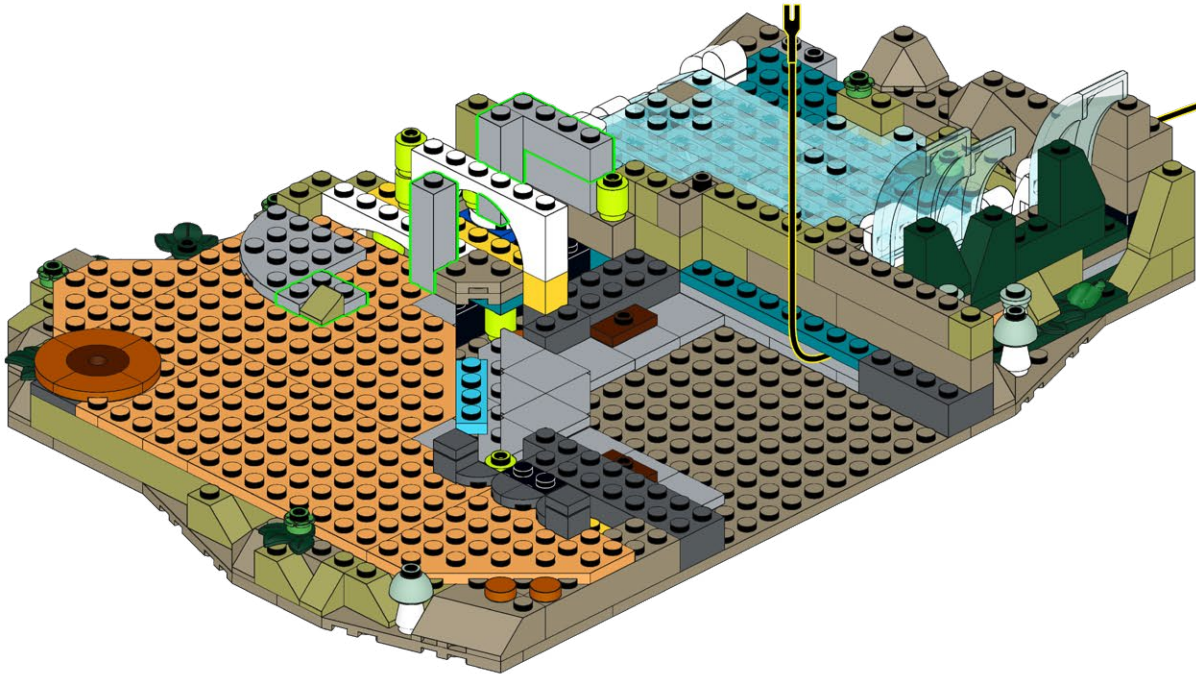
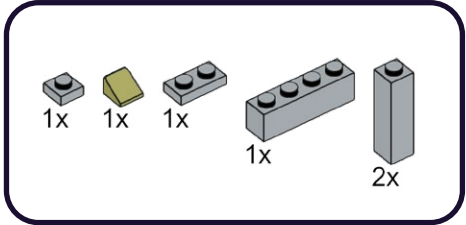

60

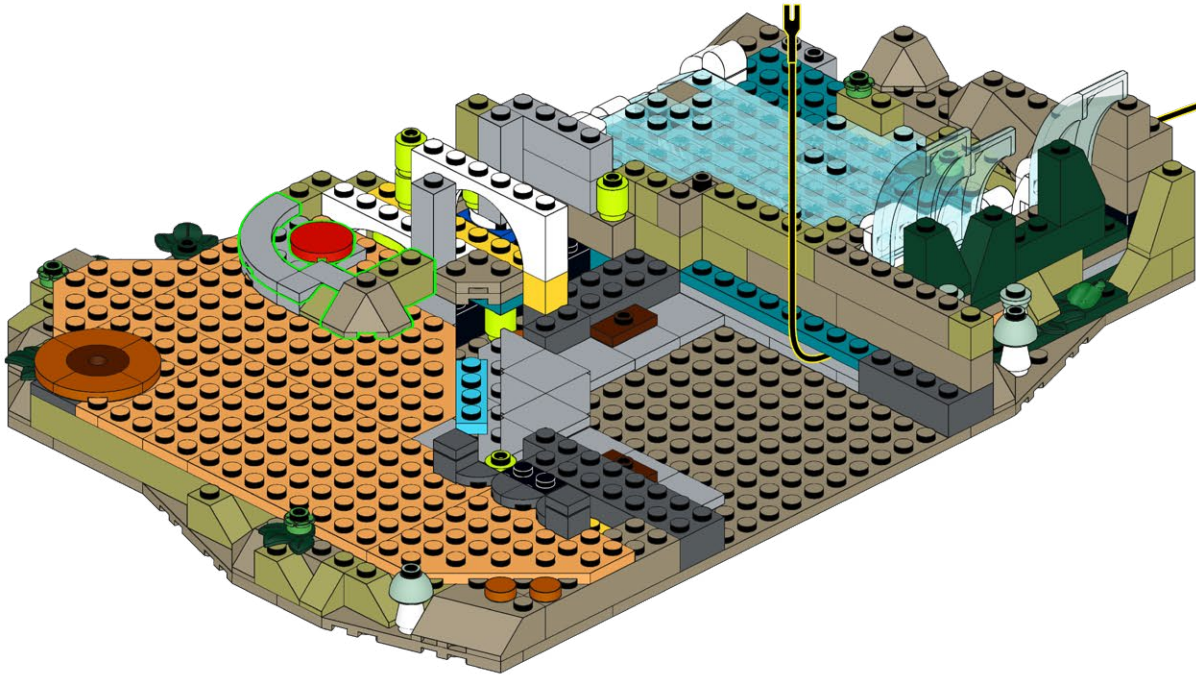
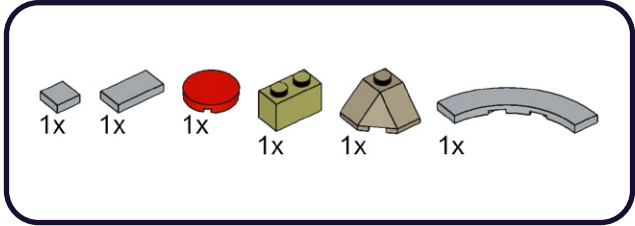

61

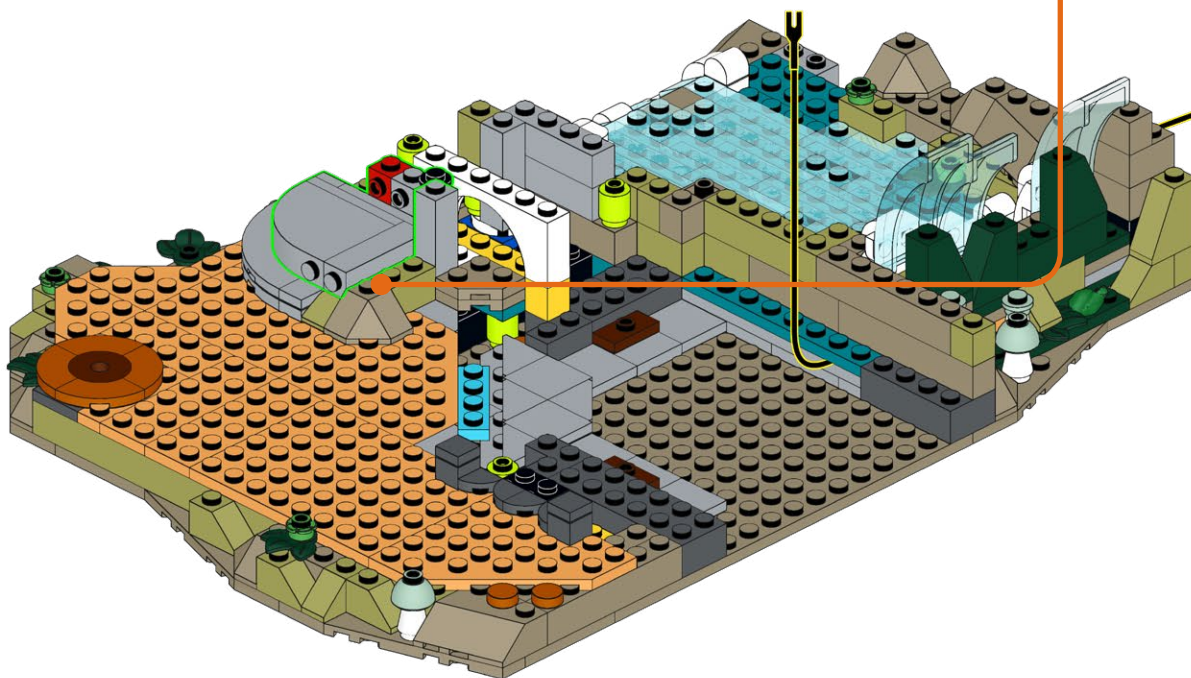
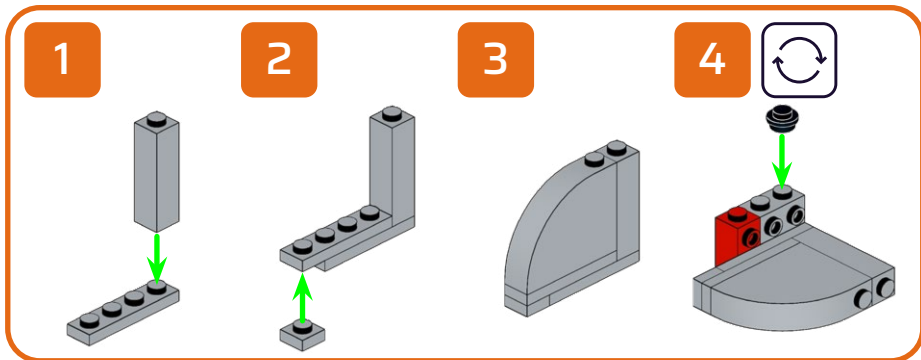
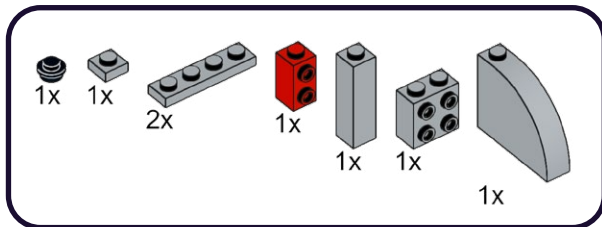

62

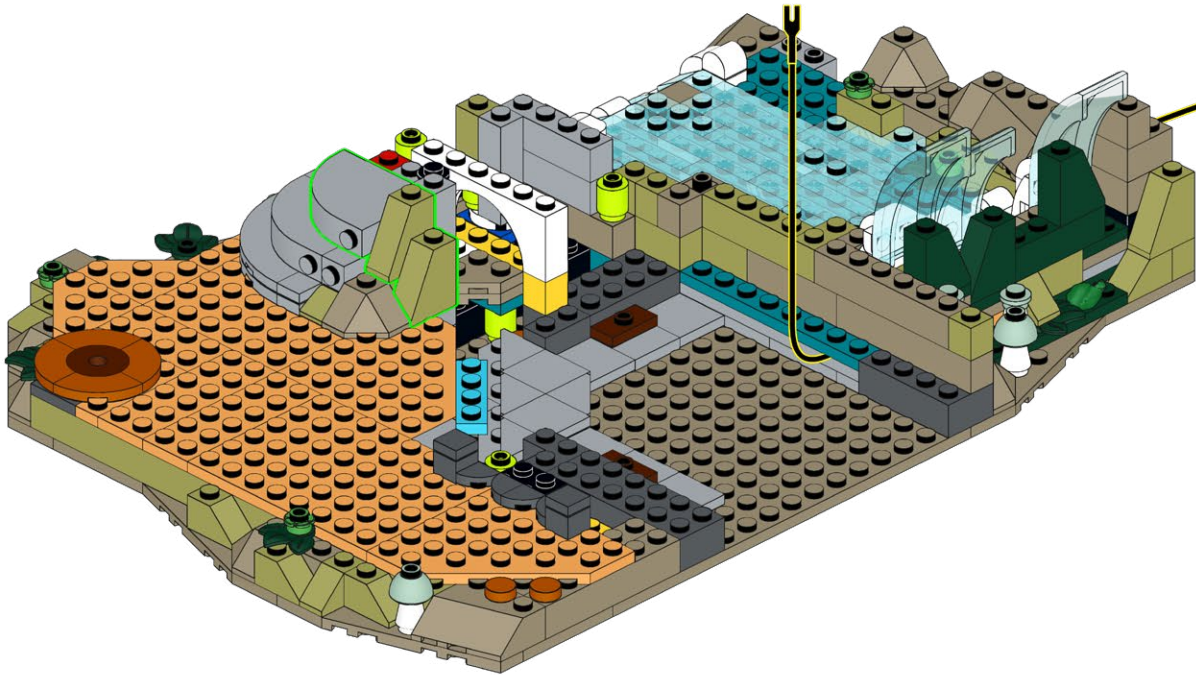
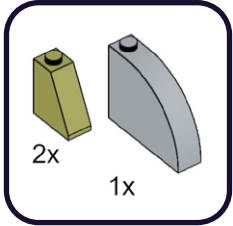

# 63

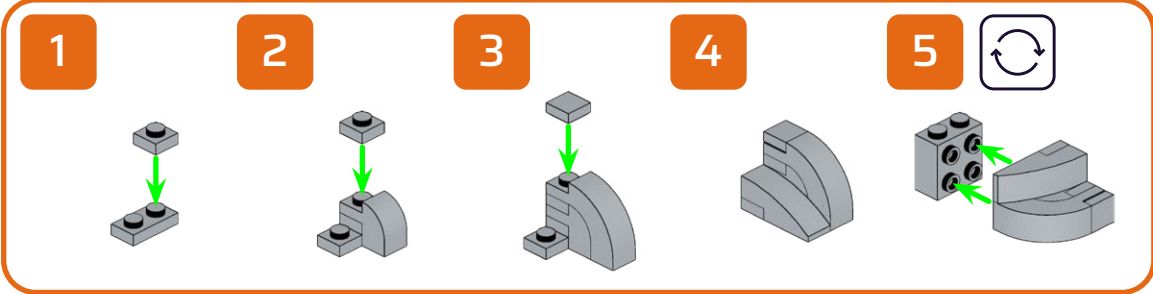
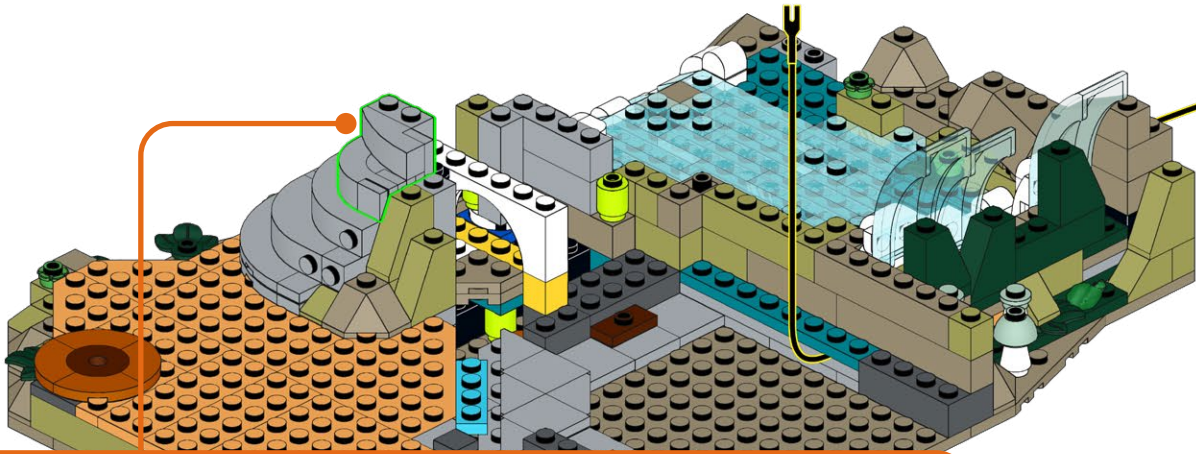
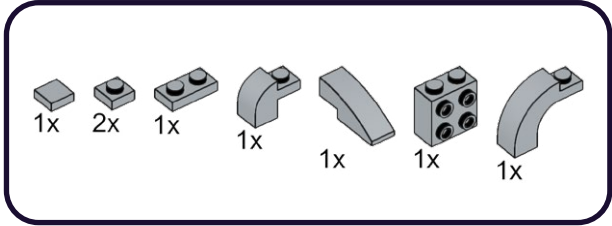

64

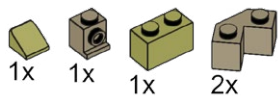

1

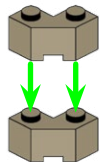

2

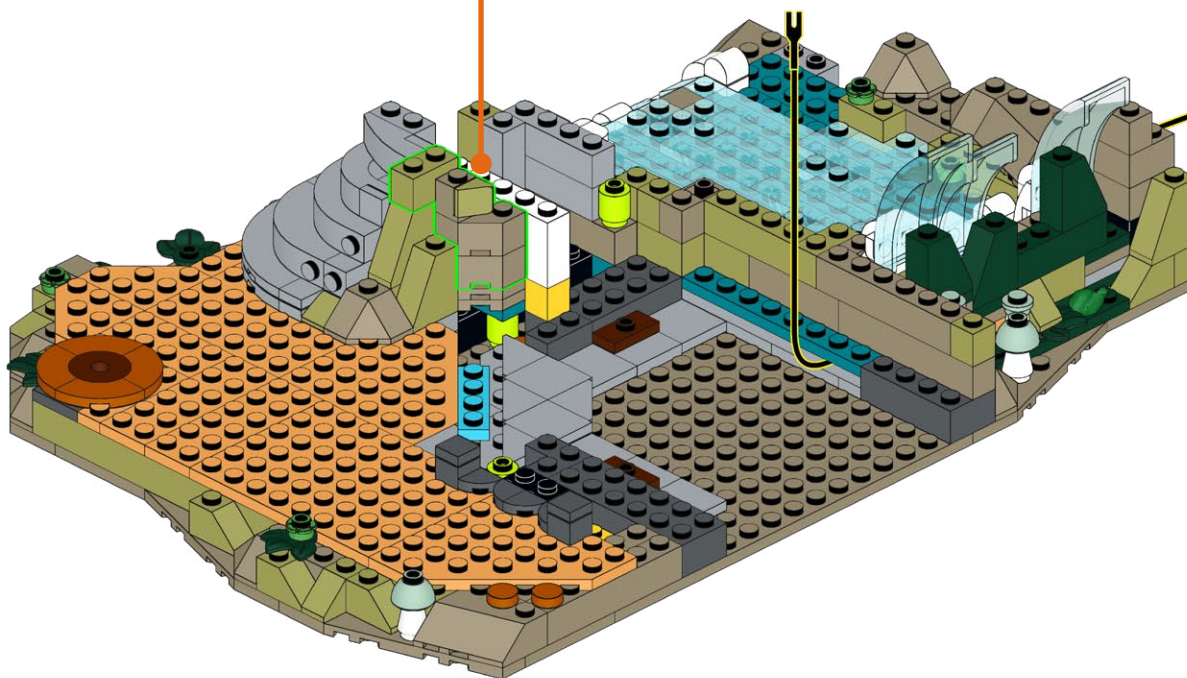
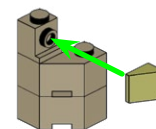



65

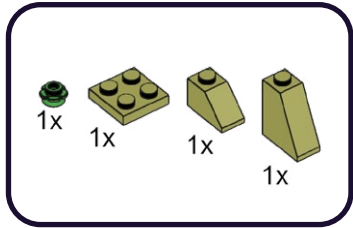

1x 1x 1x 1x

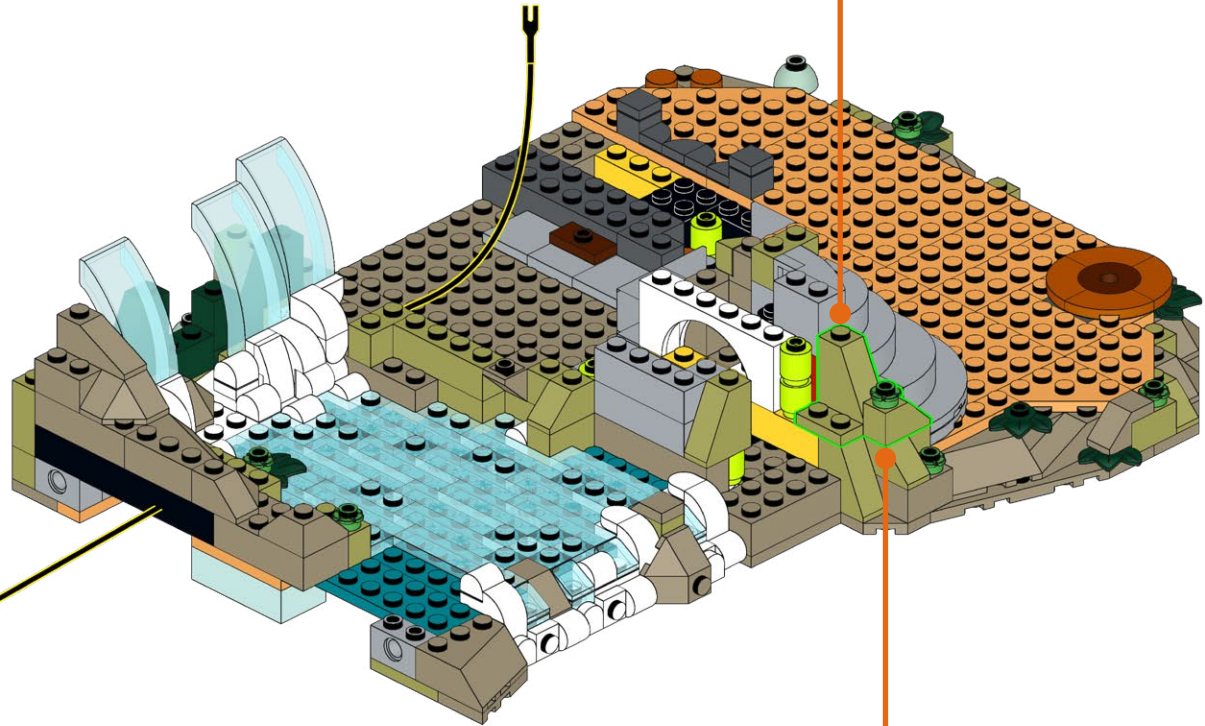
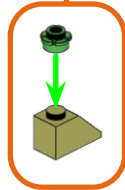
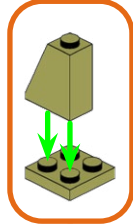

# 66

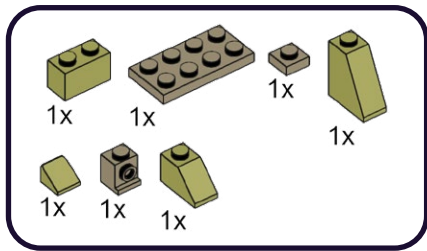

1

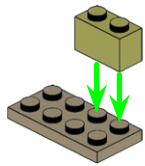

2

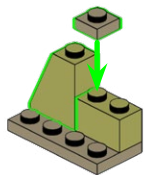

3

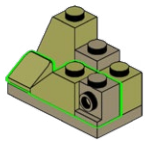

# 67

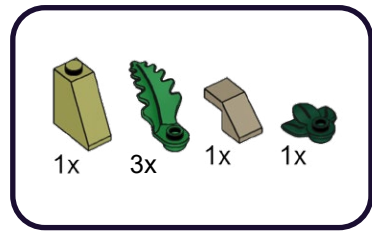

1

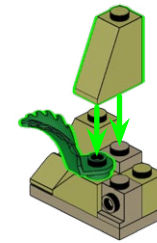

2

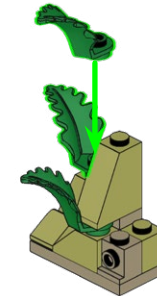

3

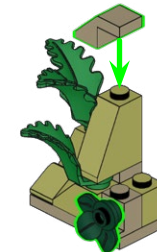

68

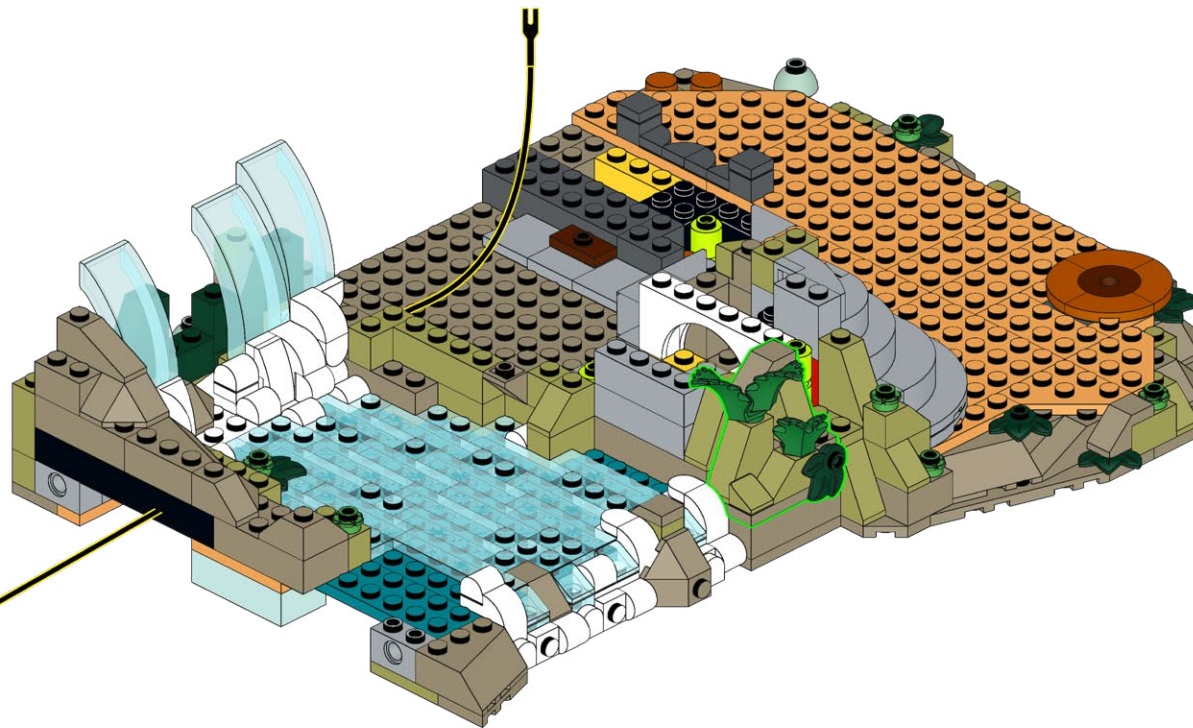

69

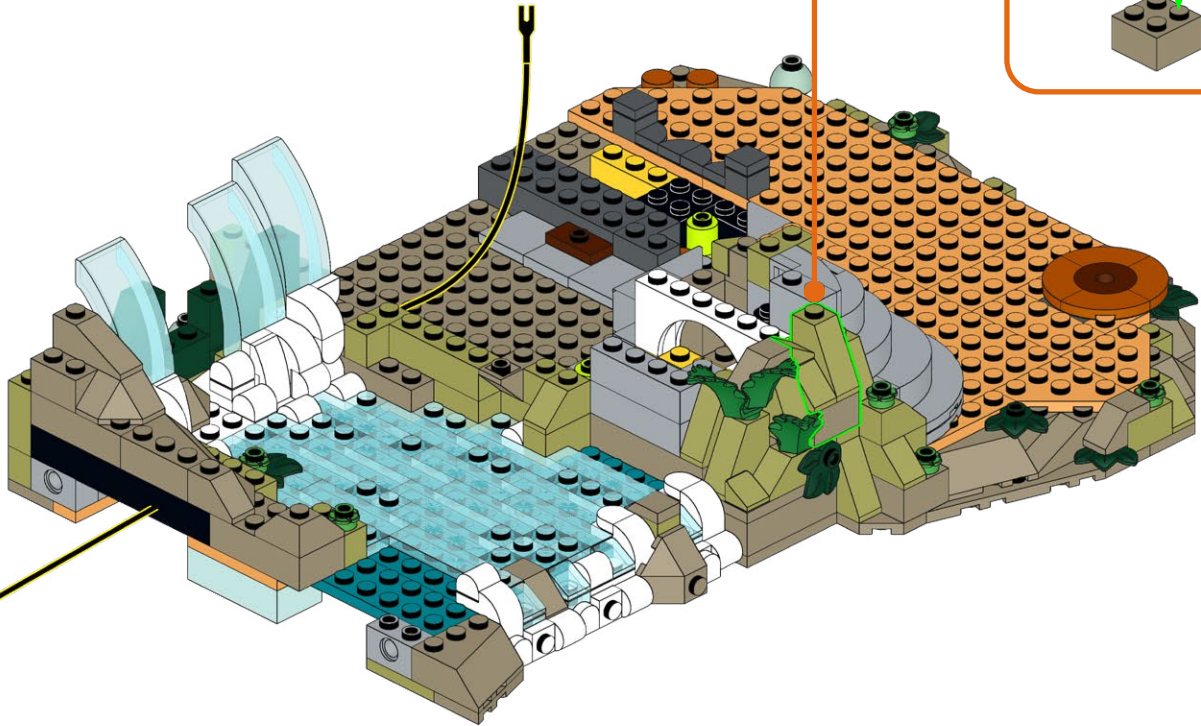
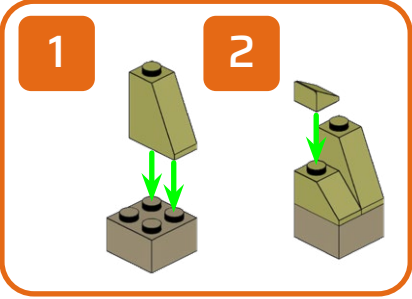
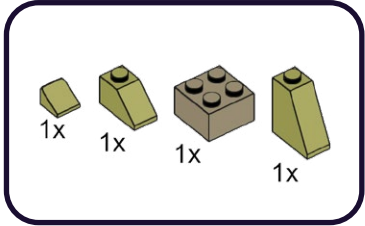

70

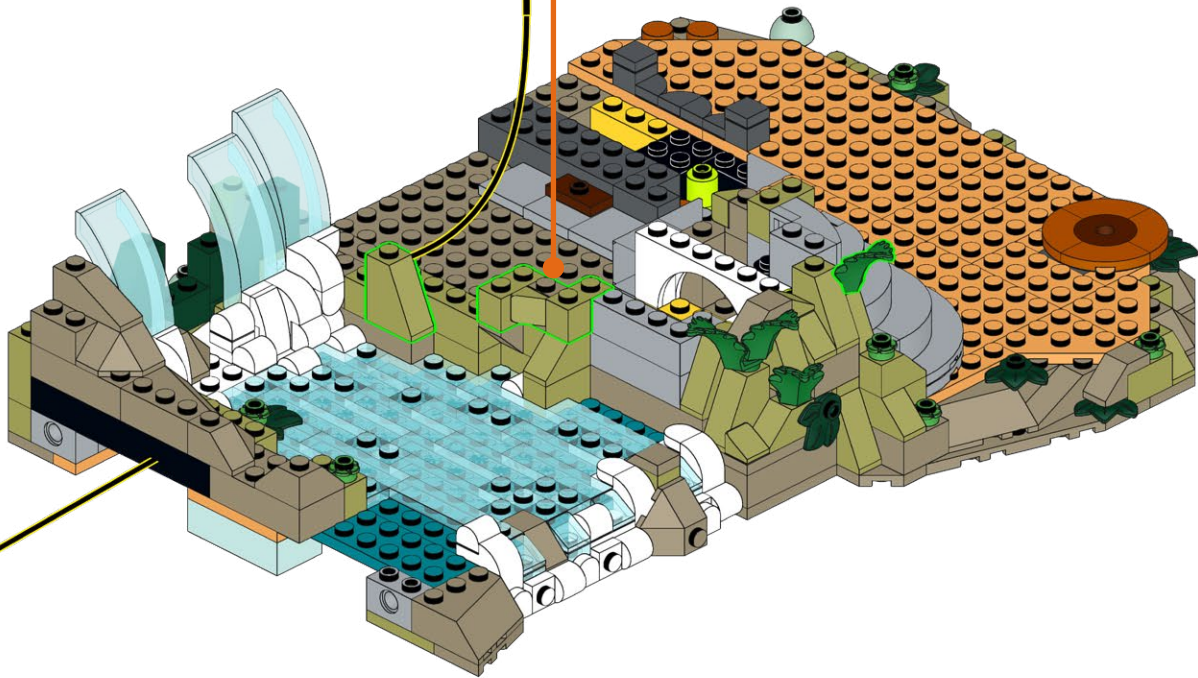
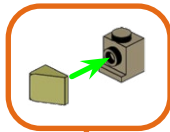
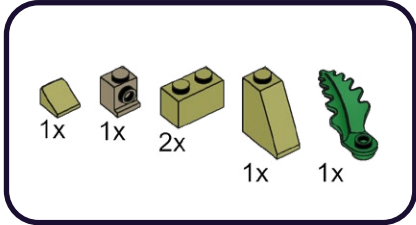

71

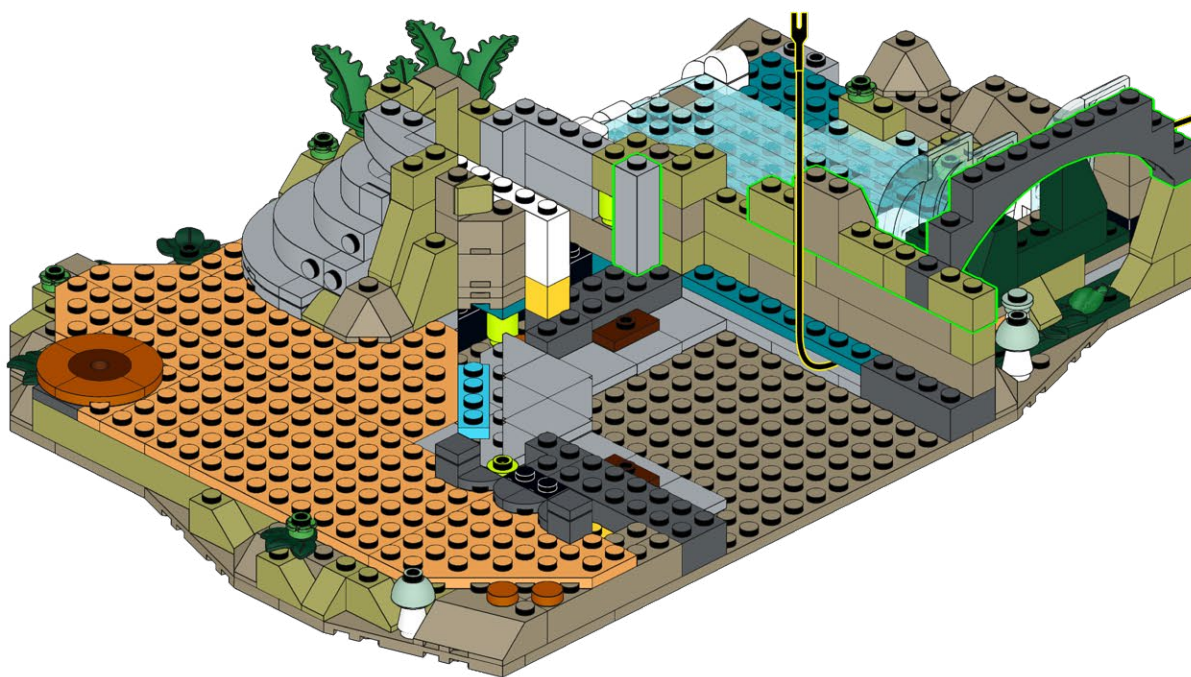
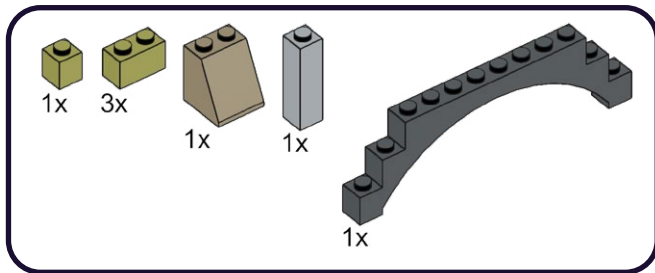

72

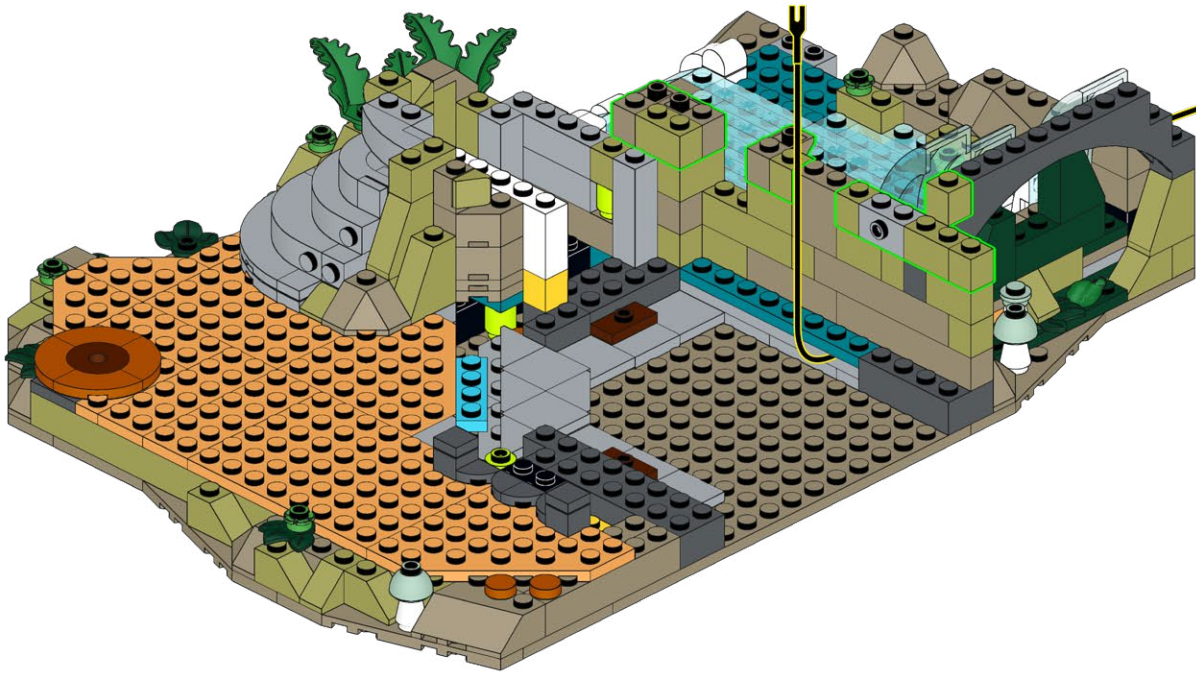
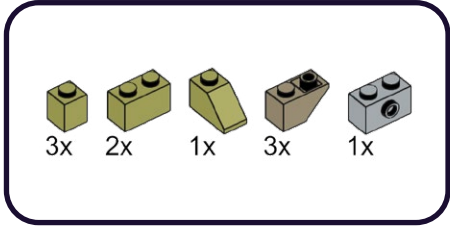

73

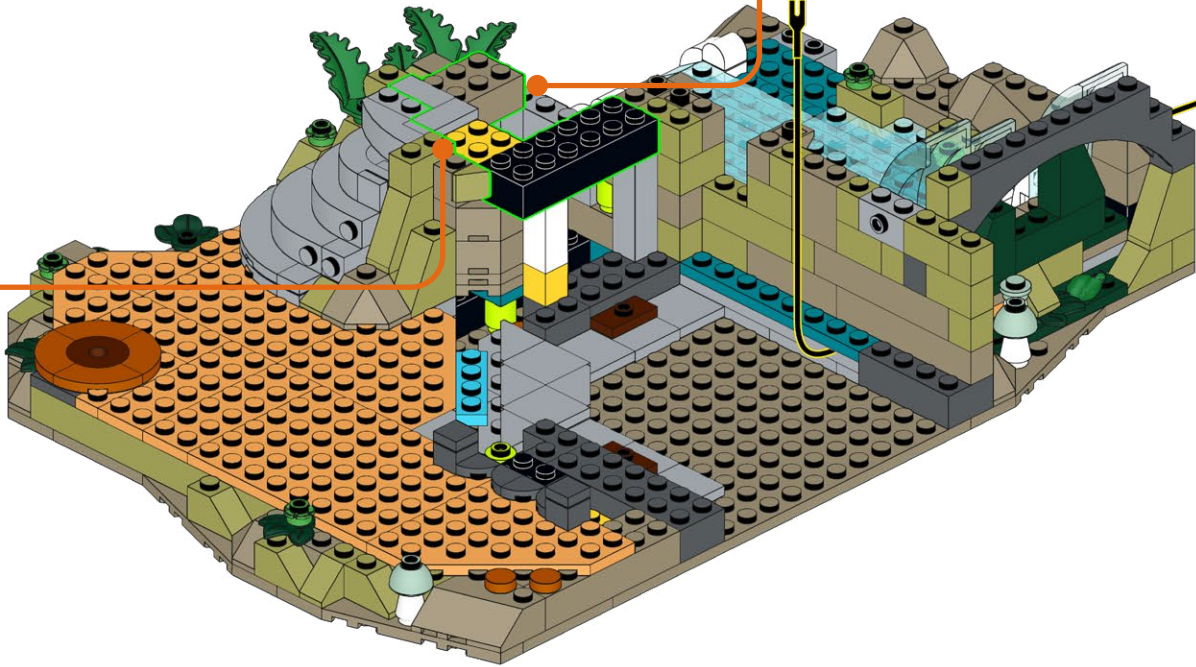
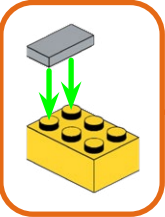
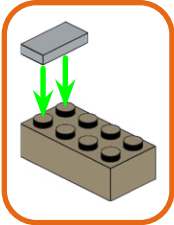
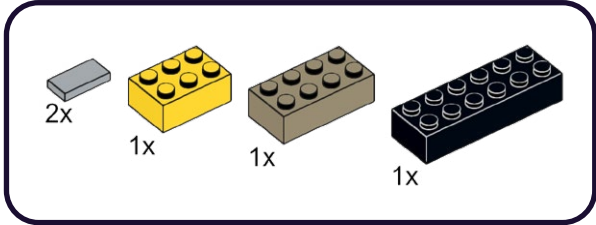



74

- 1x
- 2x
- 1x
- 2x
- 3x
- 1x
- 1x



75

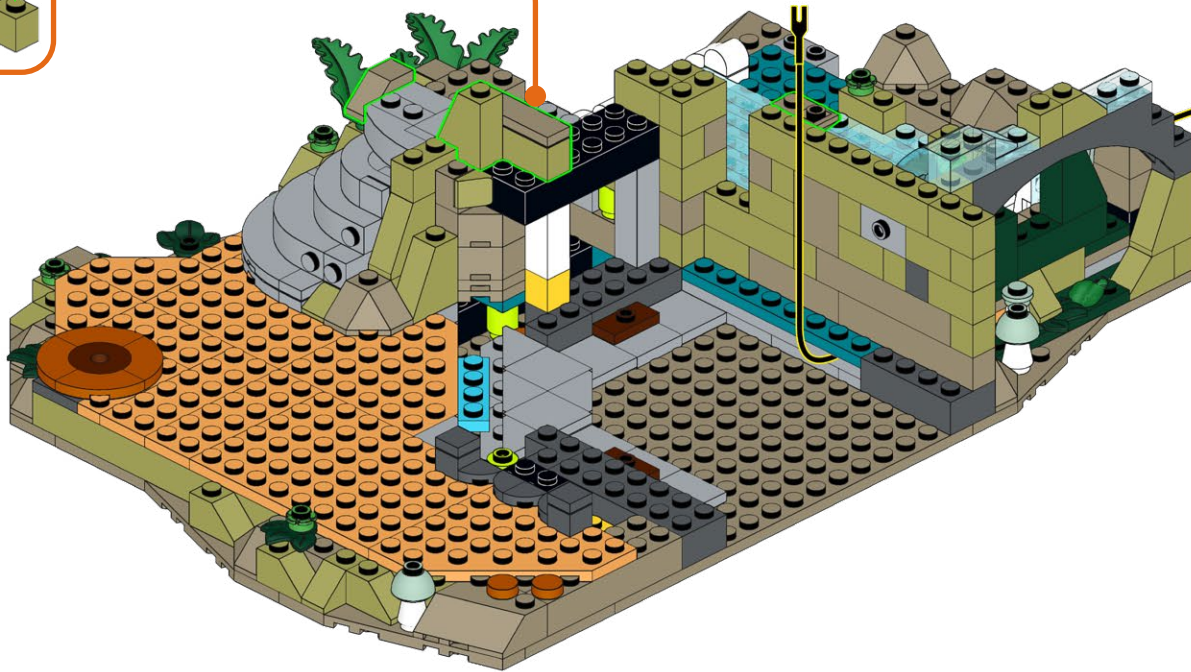
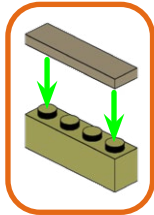
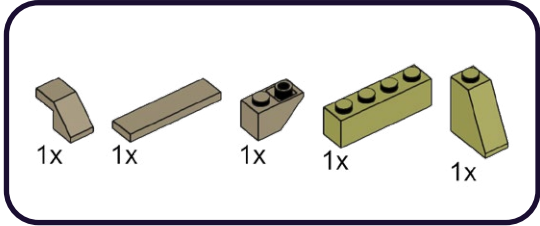

76

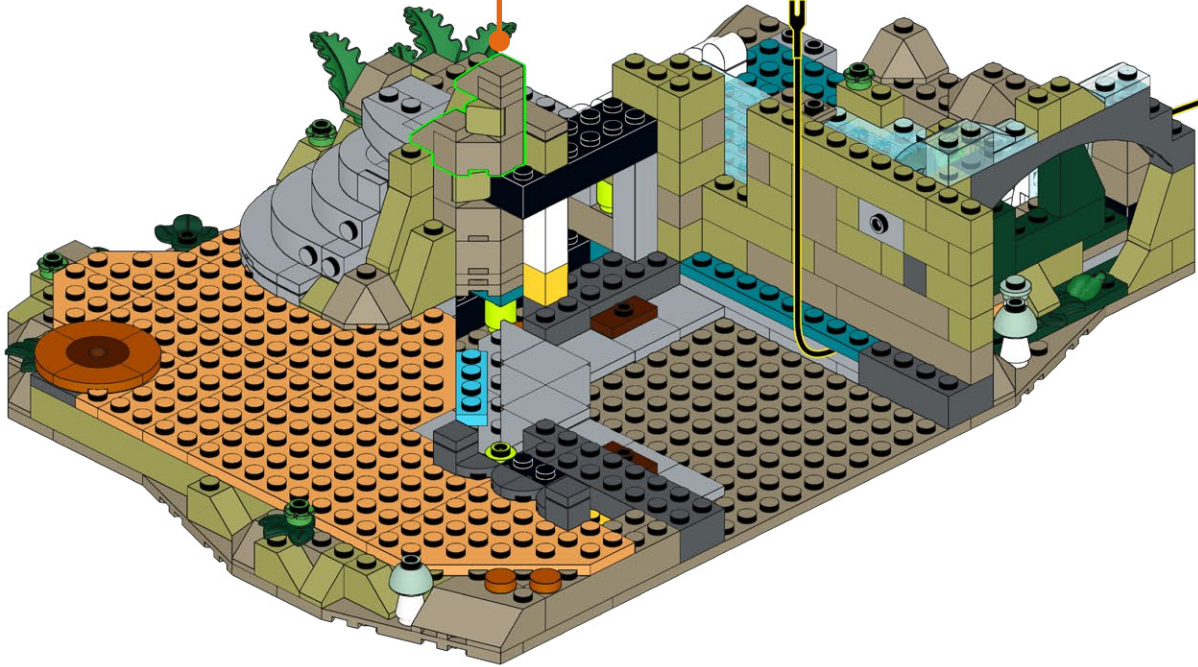
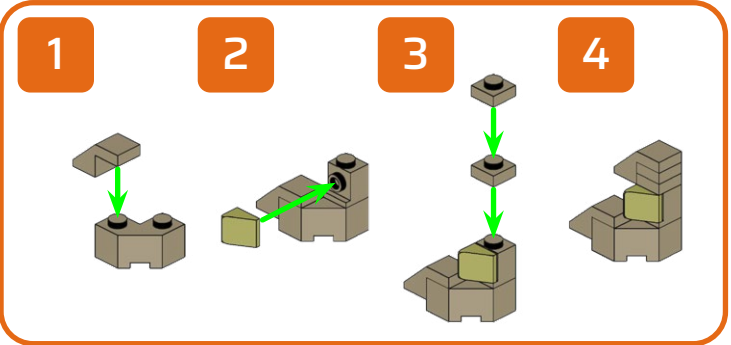
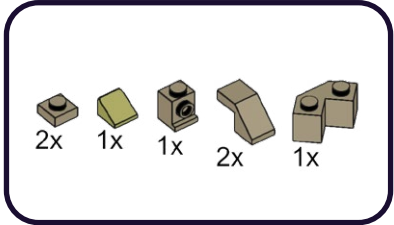



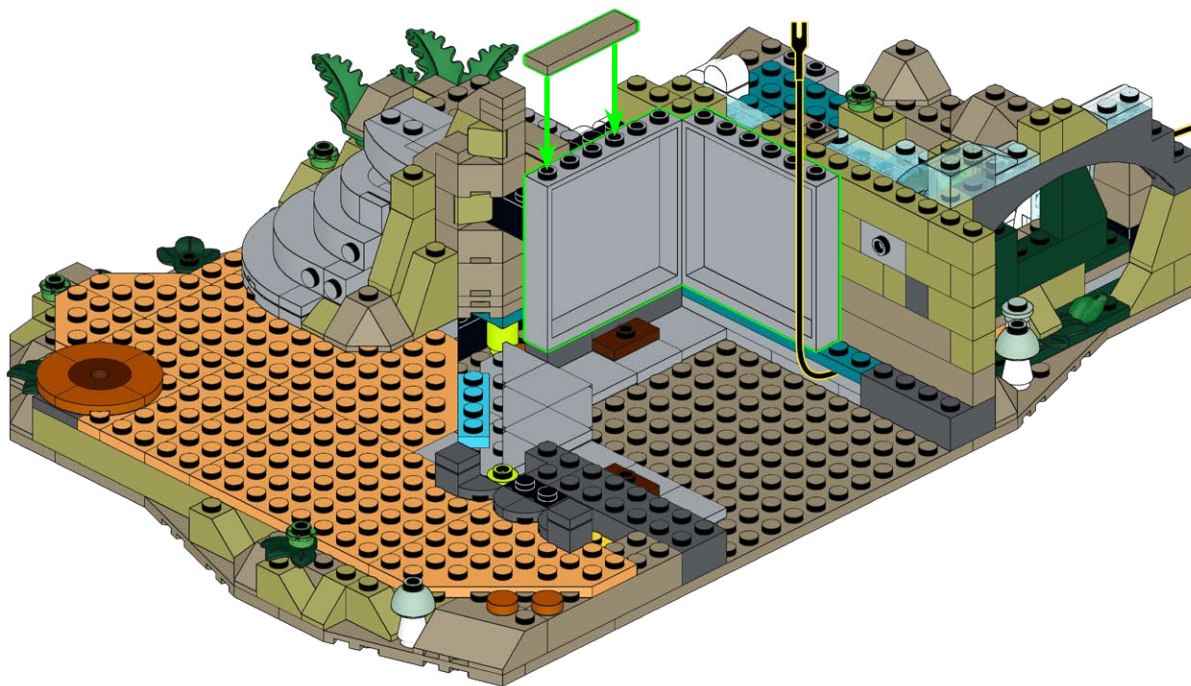
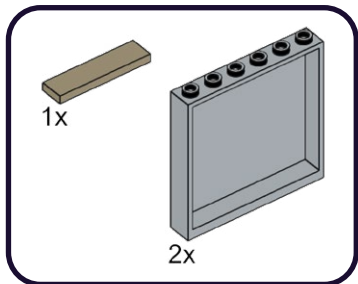

77

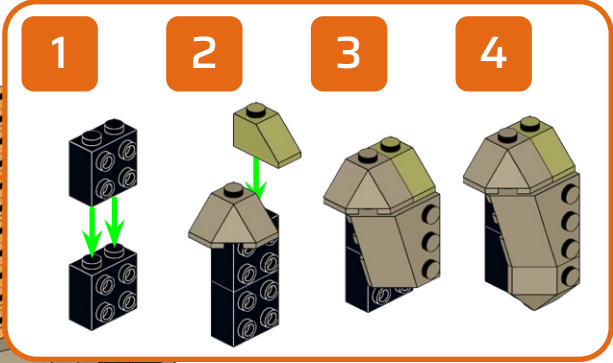
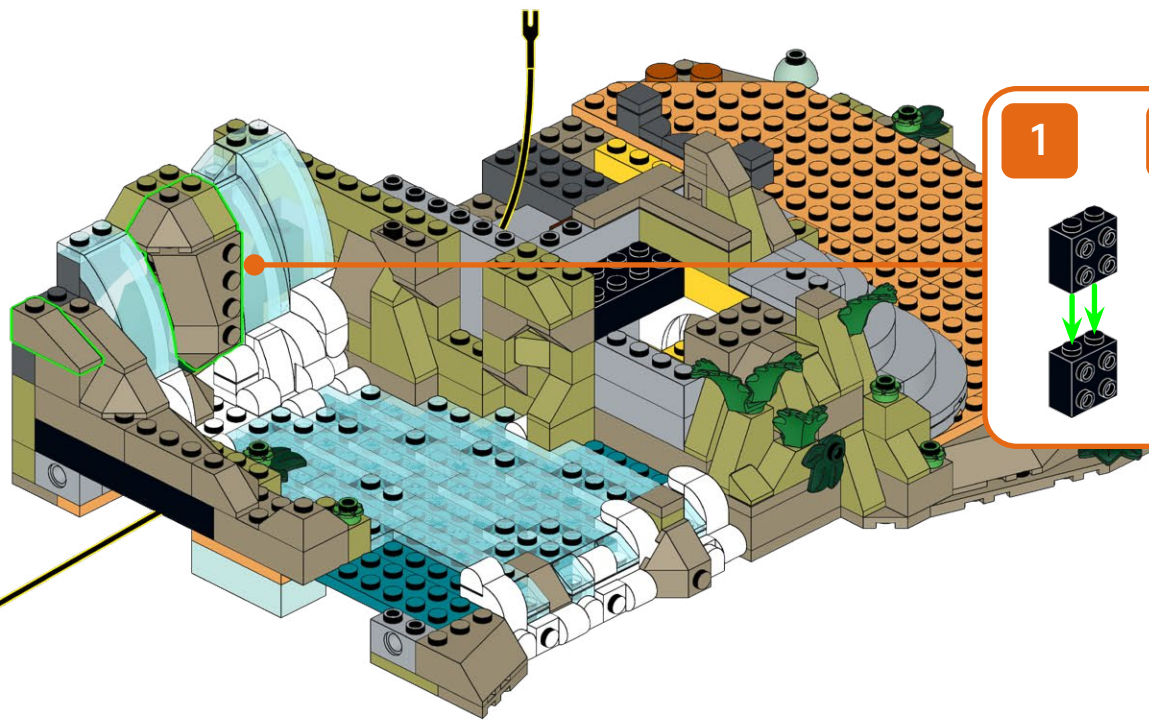
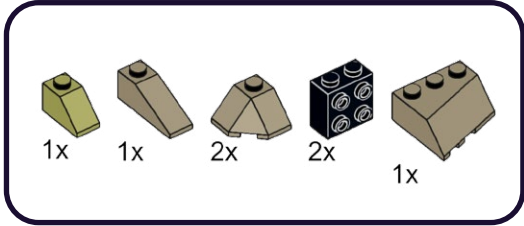

78



79

- 1x 
- 1x 
- 1x 
- 2x 

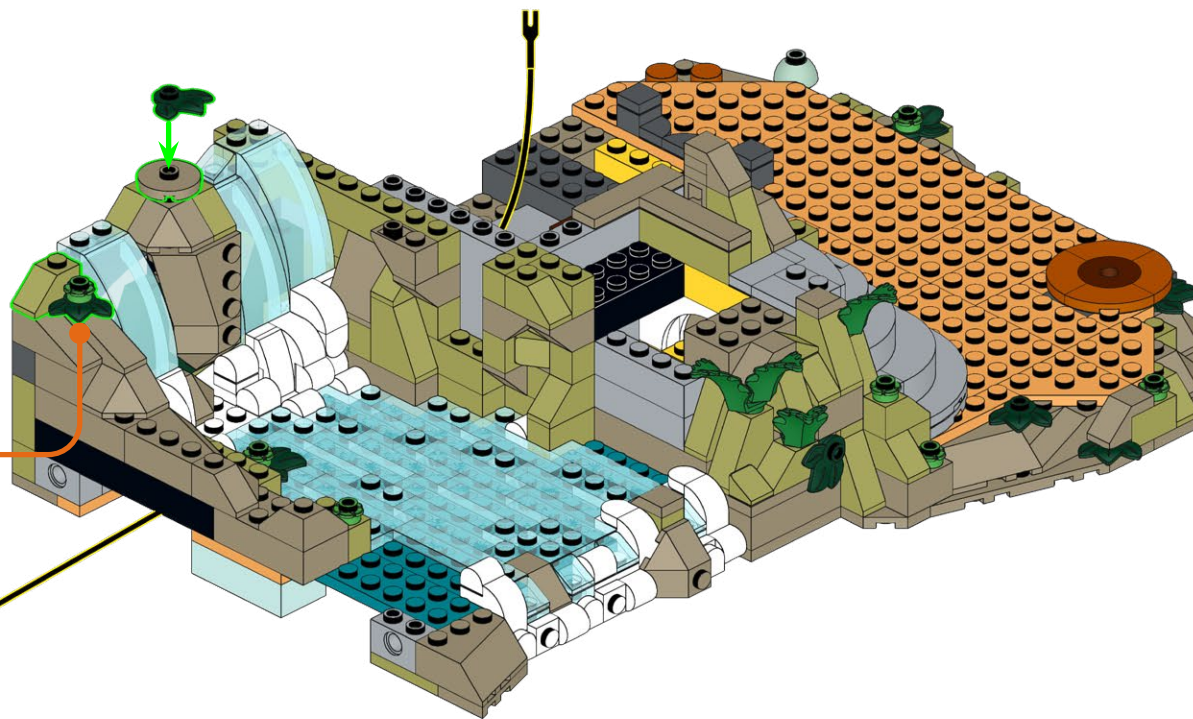
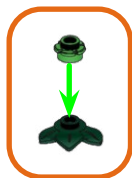

**HOLD UP!**

You might notice some bags are out of order, as well as left over pieces, but that's ok! We're changing the way you build LEGO!

**HALTEN!**

Möglicherweise stellen Sie fest, dass einige Beutel nicht in Ordnung sind und auch Teile übrig bleiben, aber das ist in Ordnung! Wir verändern die Art und Weise, wie Sie LEGO bauen!

**TENIR BON!**

Vous remarquerez peut-être que certains sacs sont en panne, ainsi que des morceaux restants, mais ce n'est pas grave ! Nous changeons la façon dont vous construisez LEGO !

**SOSTENERE!**

Potresti notare che alcune borse sono fuori uso, così come alcuni pezzi avanzati, ma va bene! Stiamo cambiando il modo in cui costruisci i LEGO!

**¡SOSTENER!**

Puede que notes que algunas bolsas están fuera de orden, así como piezas sobrantes, ¡pero está bien! ¡Estamos cambiando la forma de construir LEGO!

**耽误!**

您可能会注意到有些袋子坏了, 还有剩余的碎片, 但这没关系! 我们正在改变您搭建乐高的方式!

Open LEGO® Bag 16 & 17

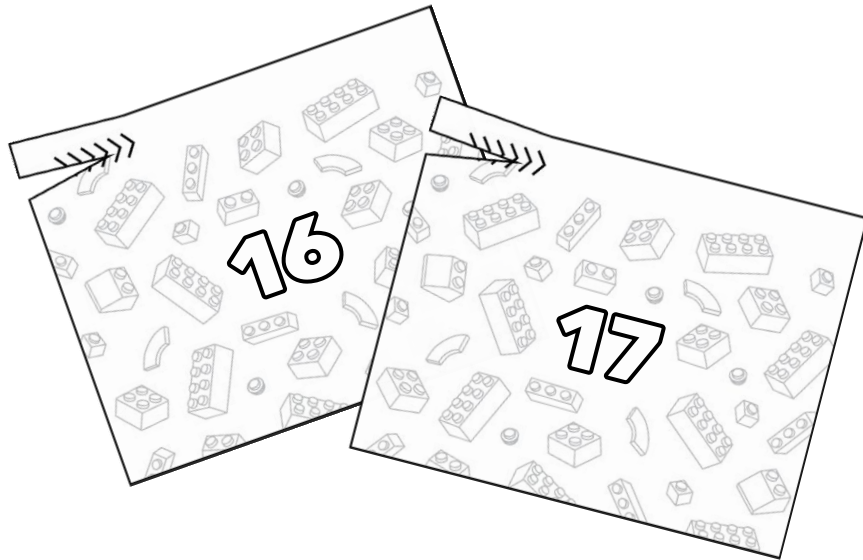

# 80

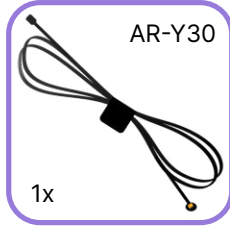
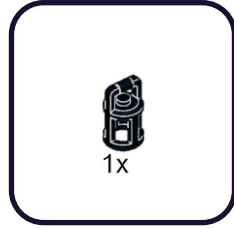

1

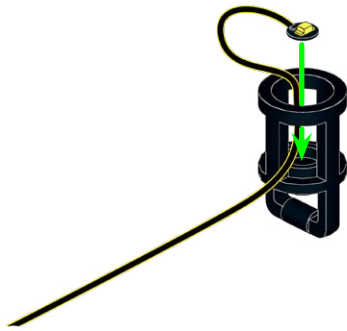

2

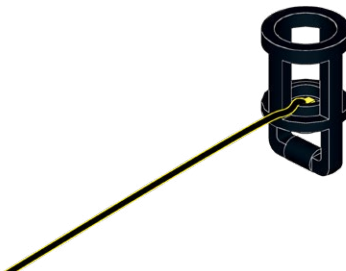

# 81

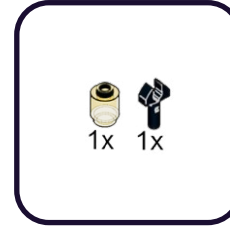

1

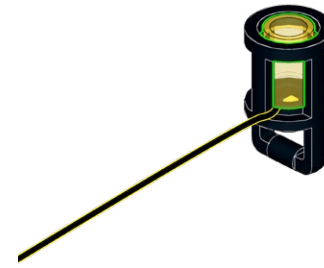

2

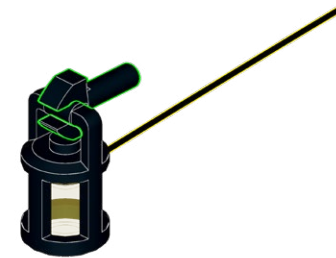



82

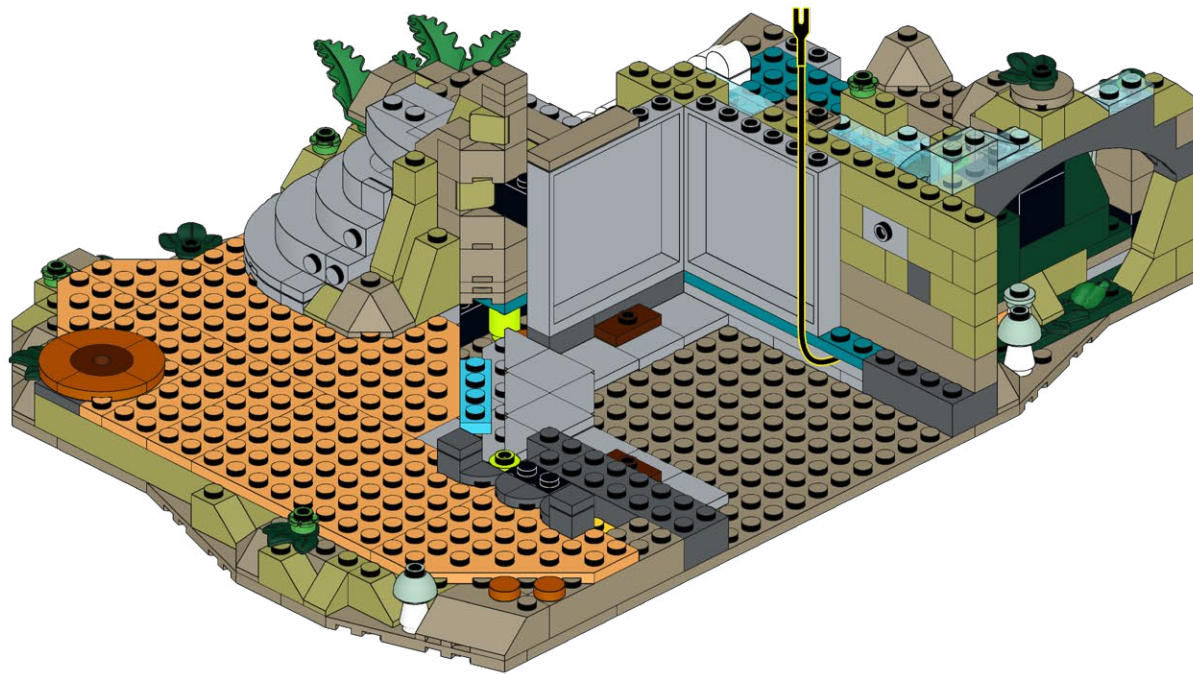

83

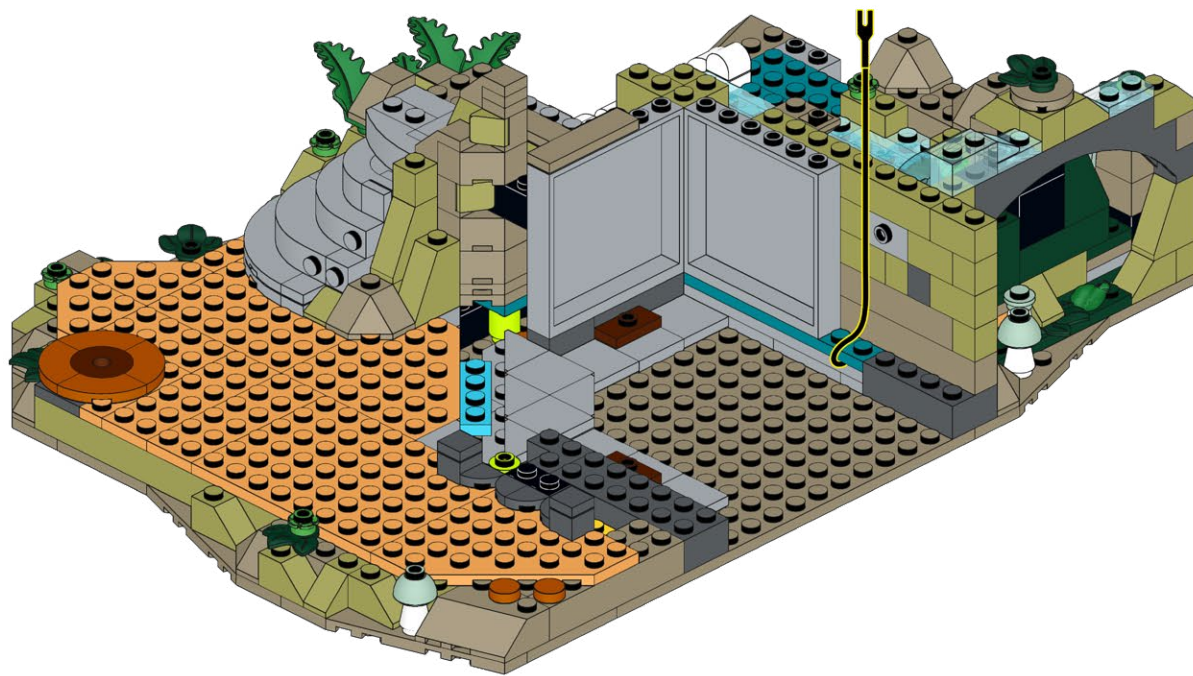

84

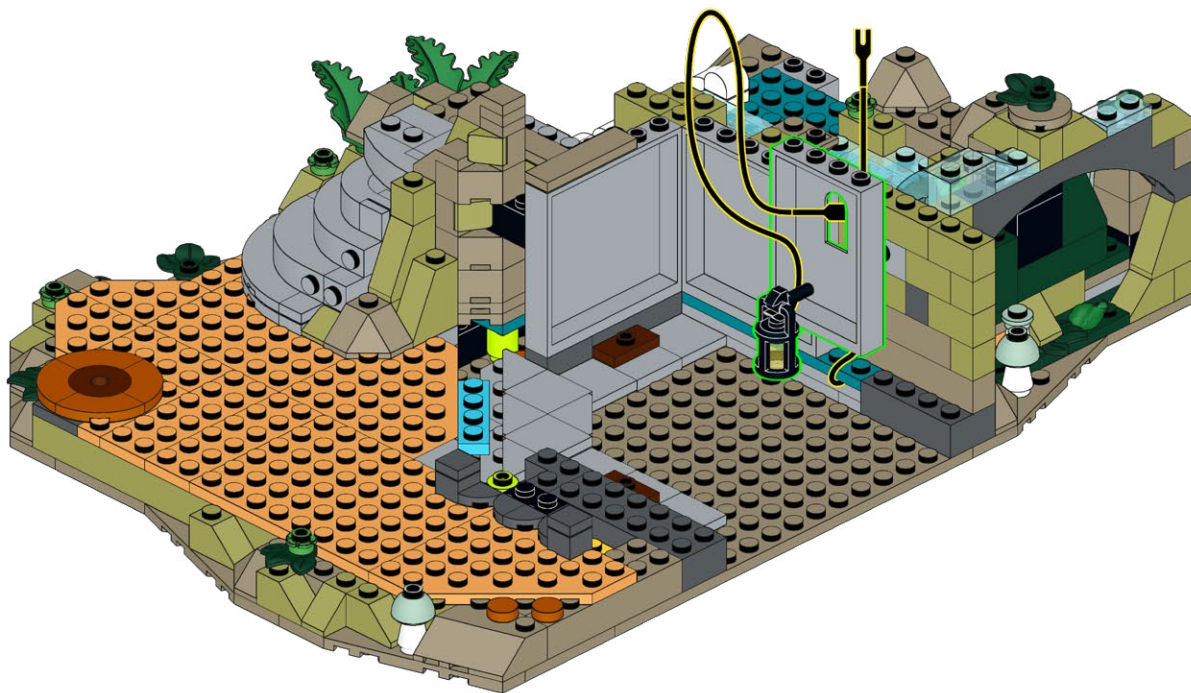
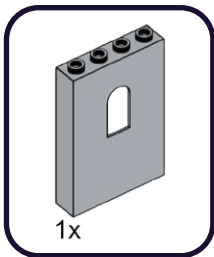

85

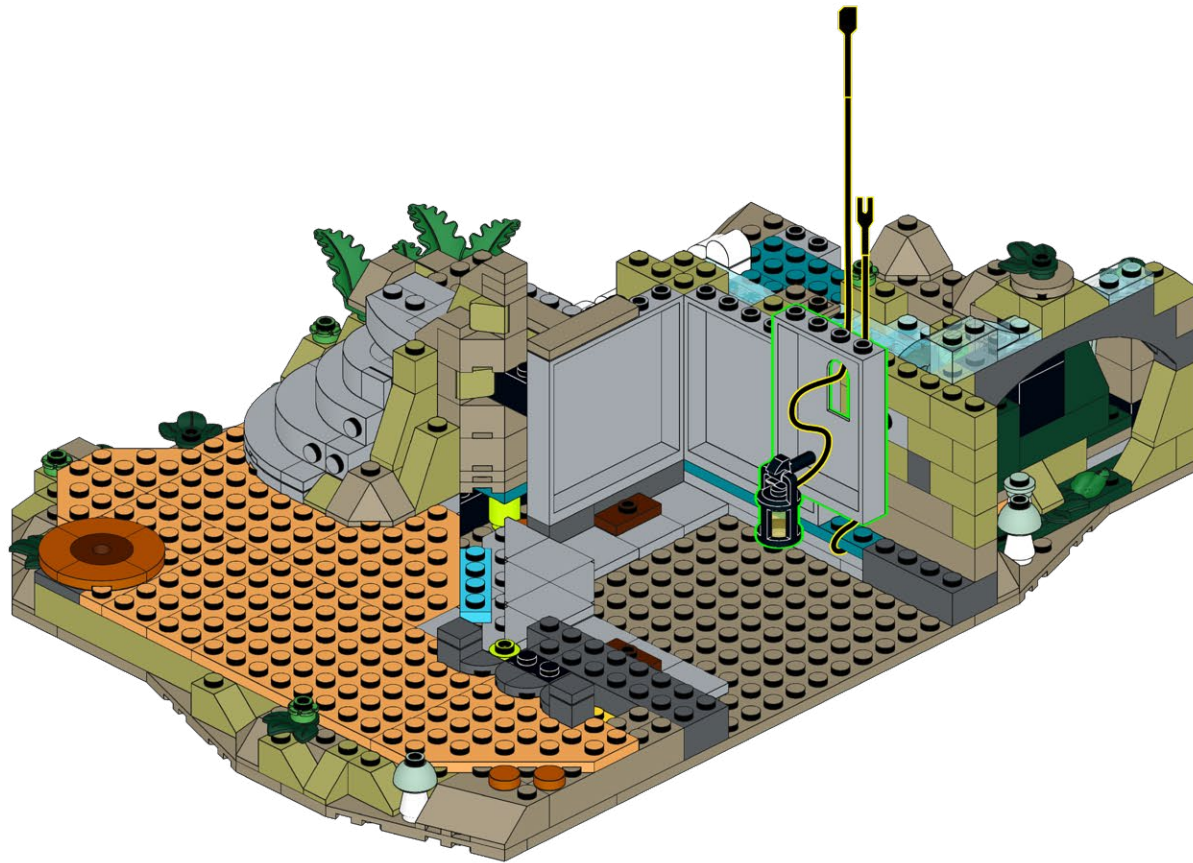

86

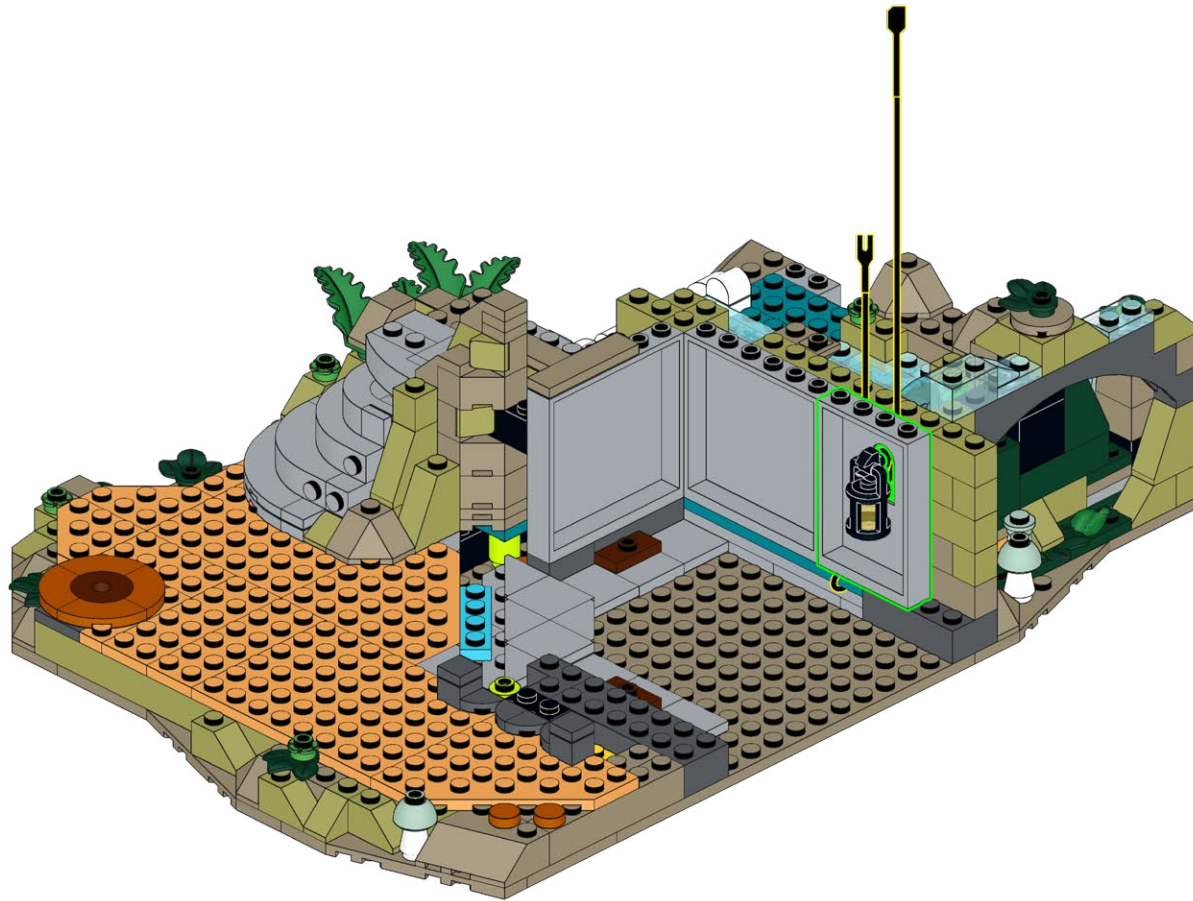

87

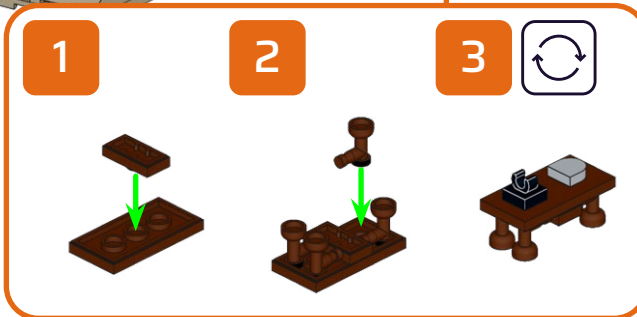
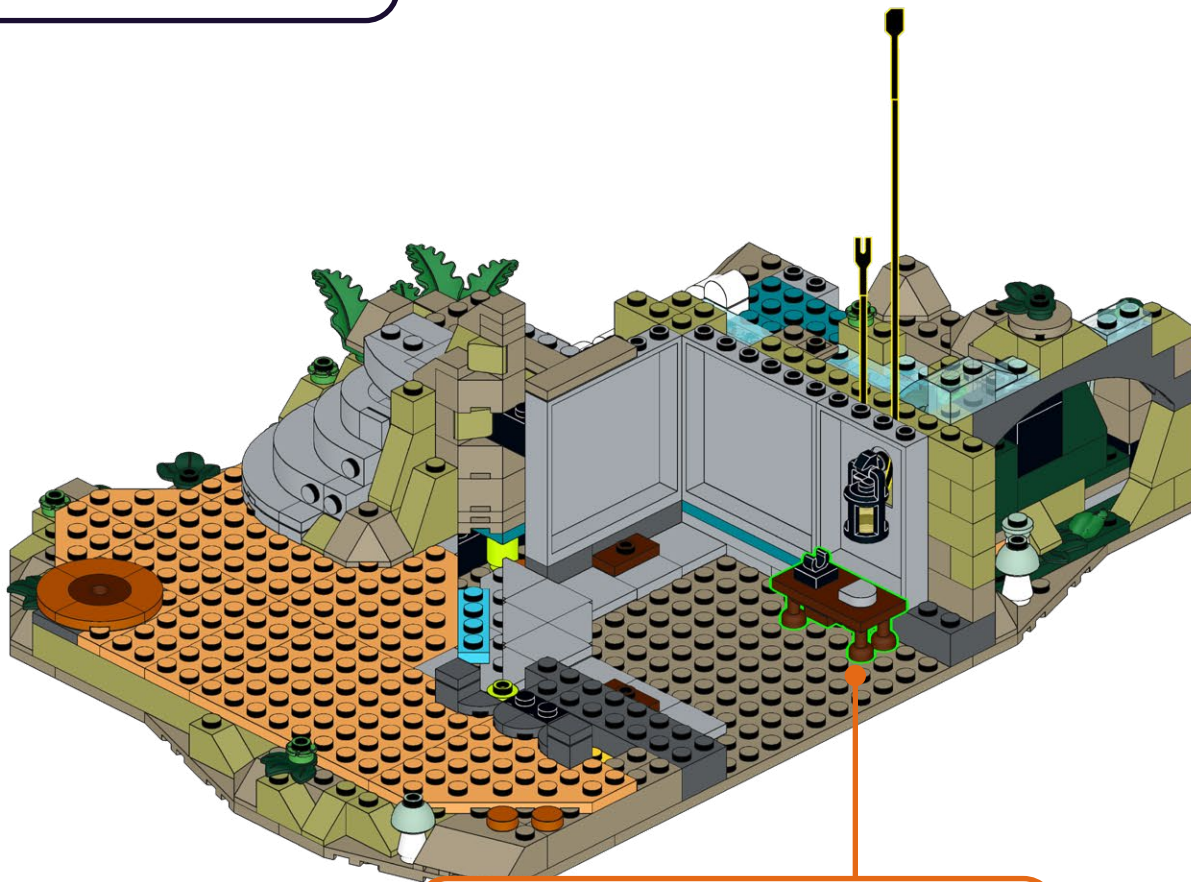
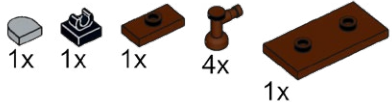

88

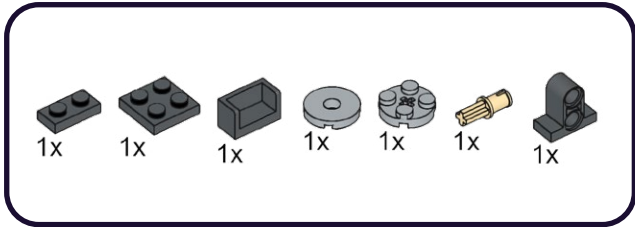

1

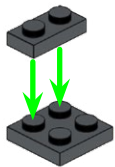

2

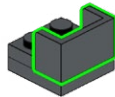

3

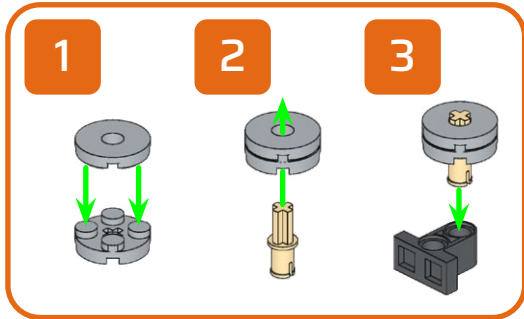
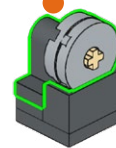

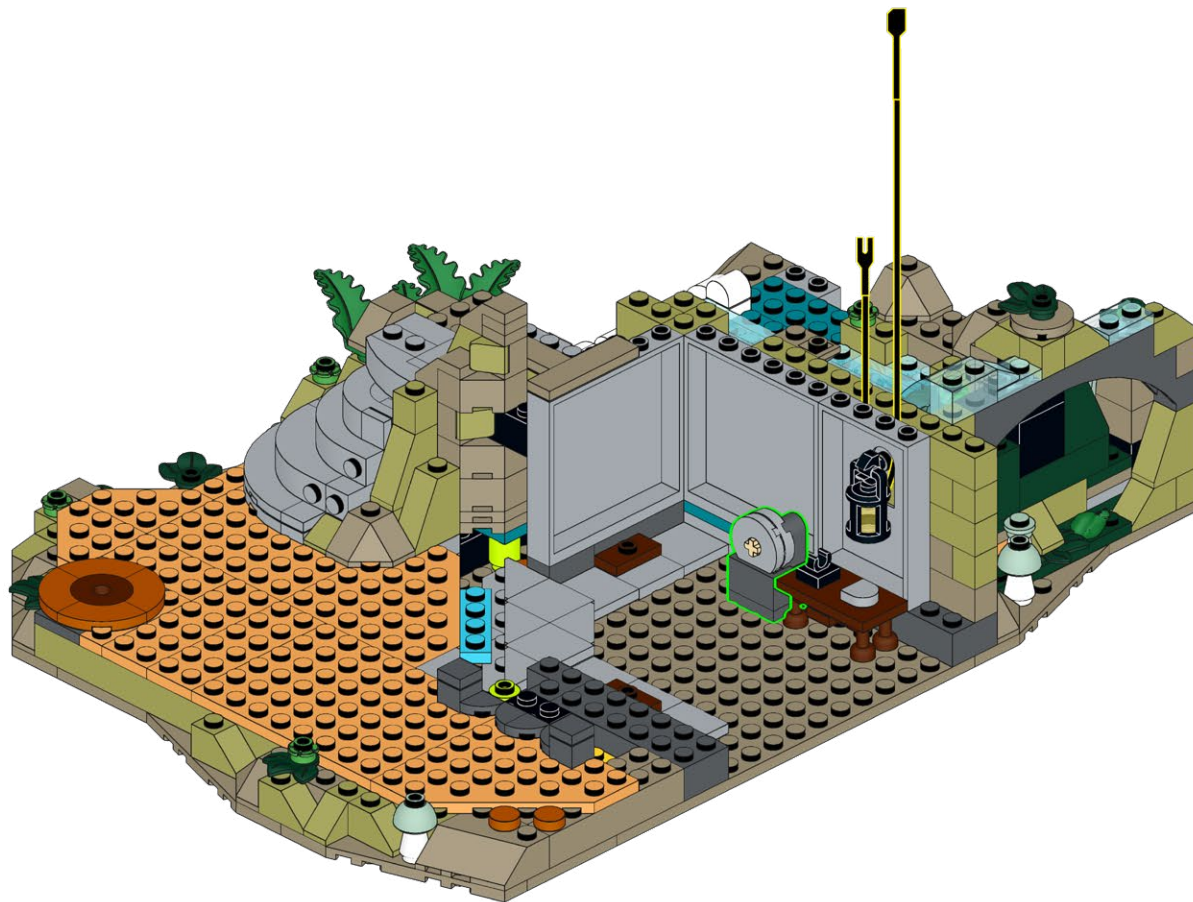



90

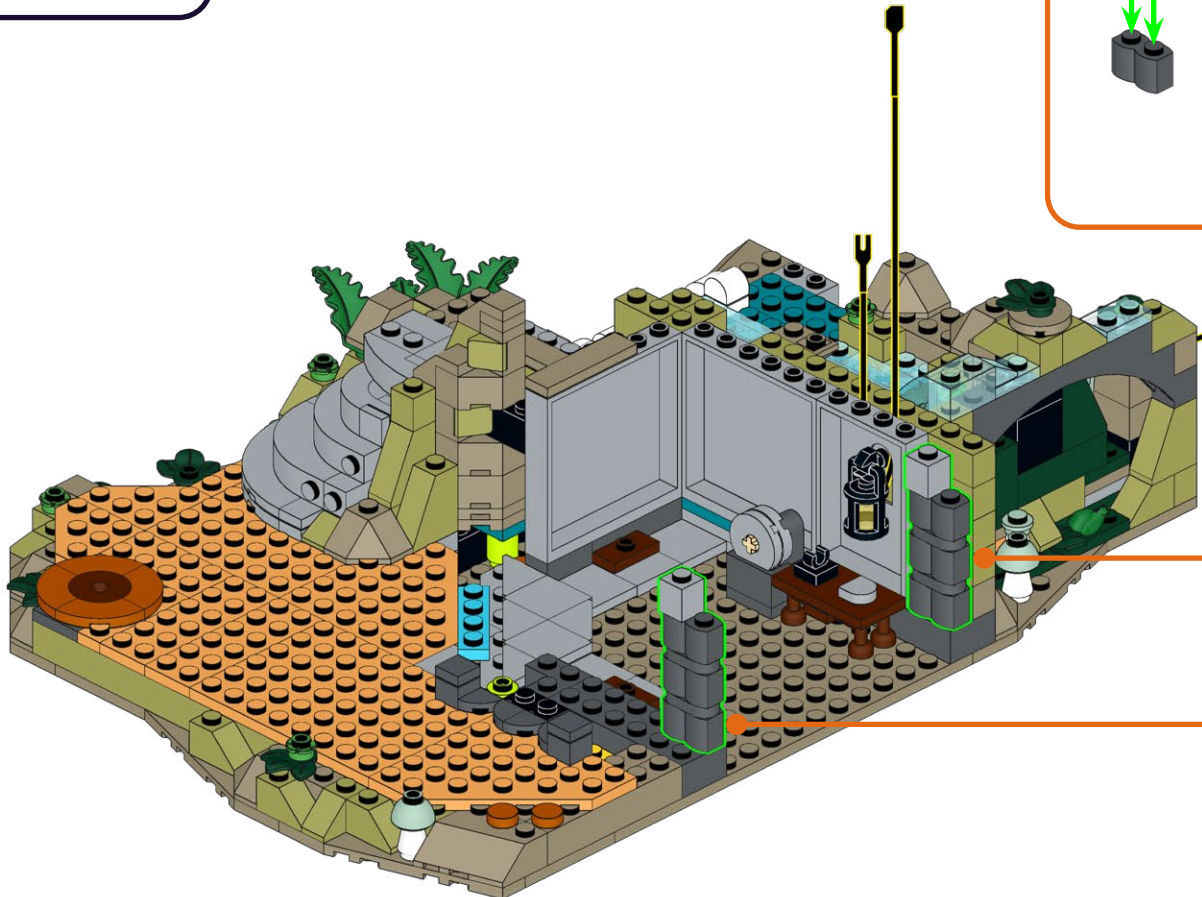
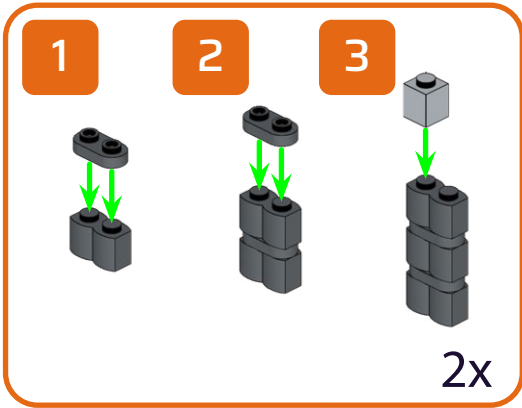
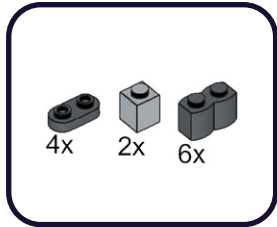

91

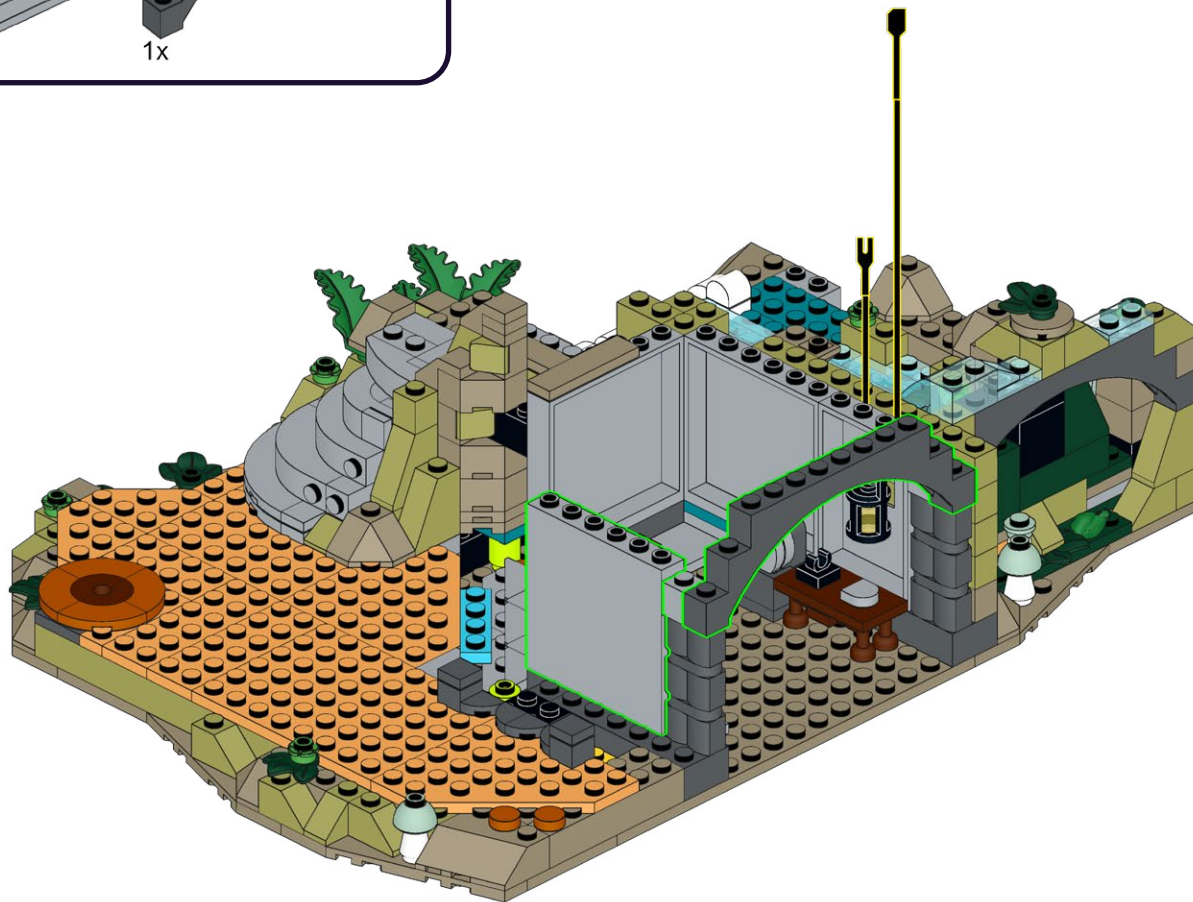
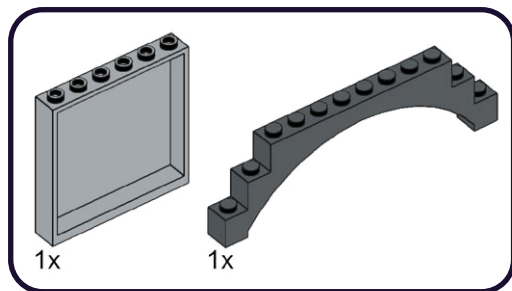

92

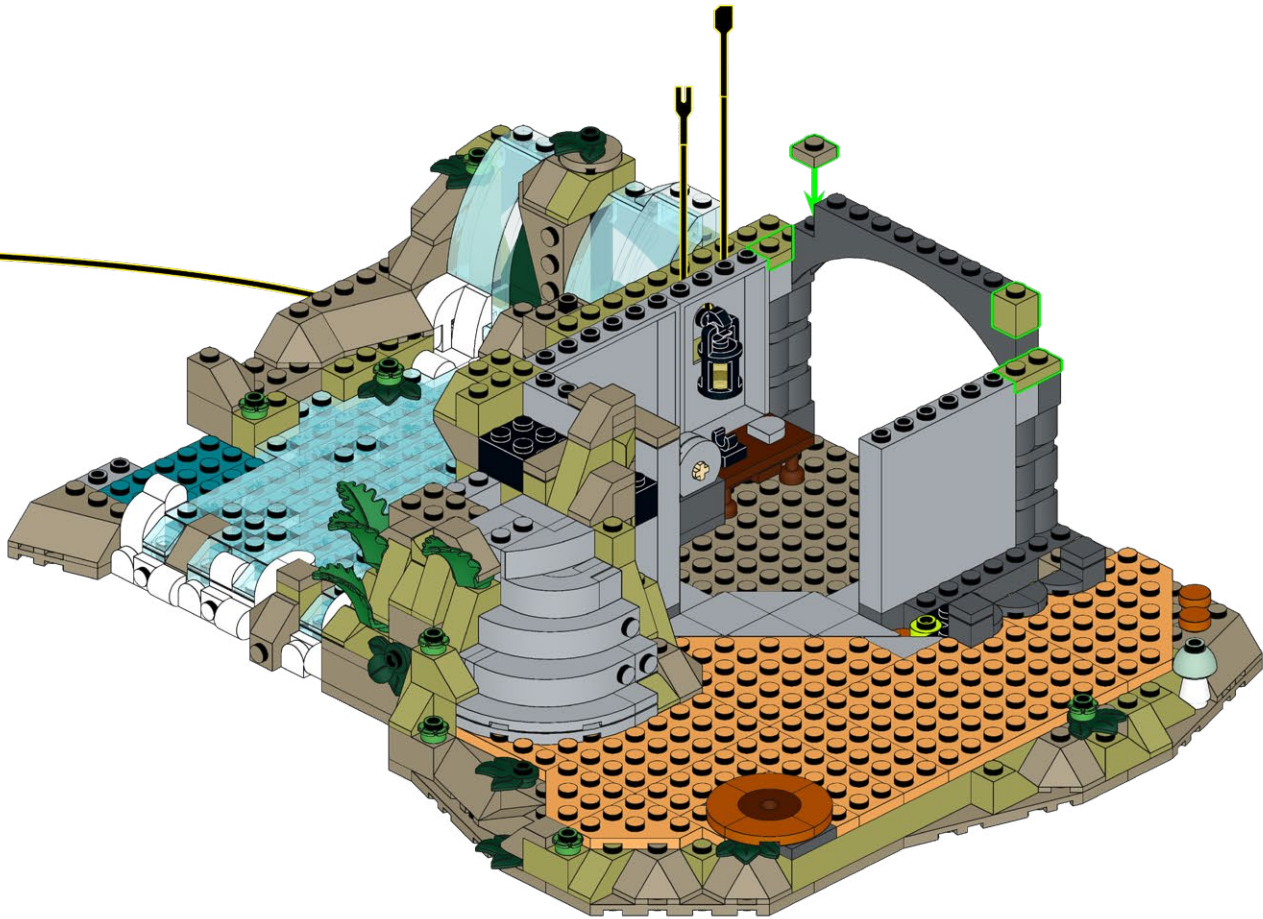
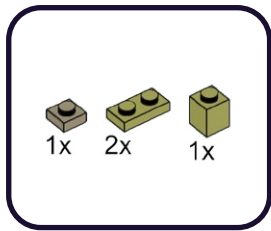

93

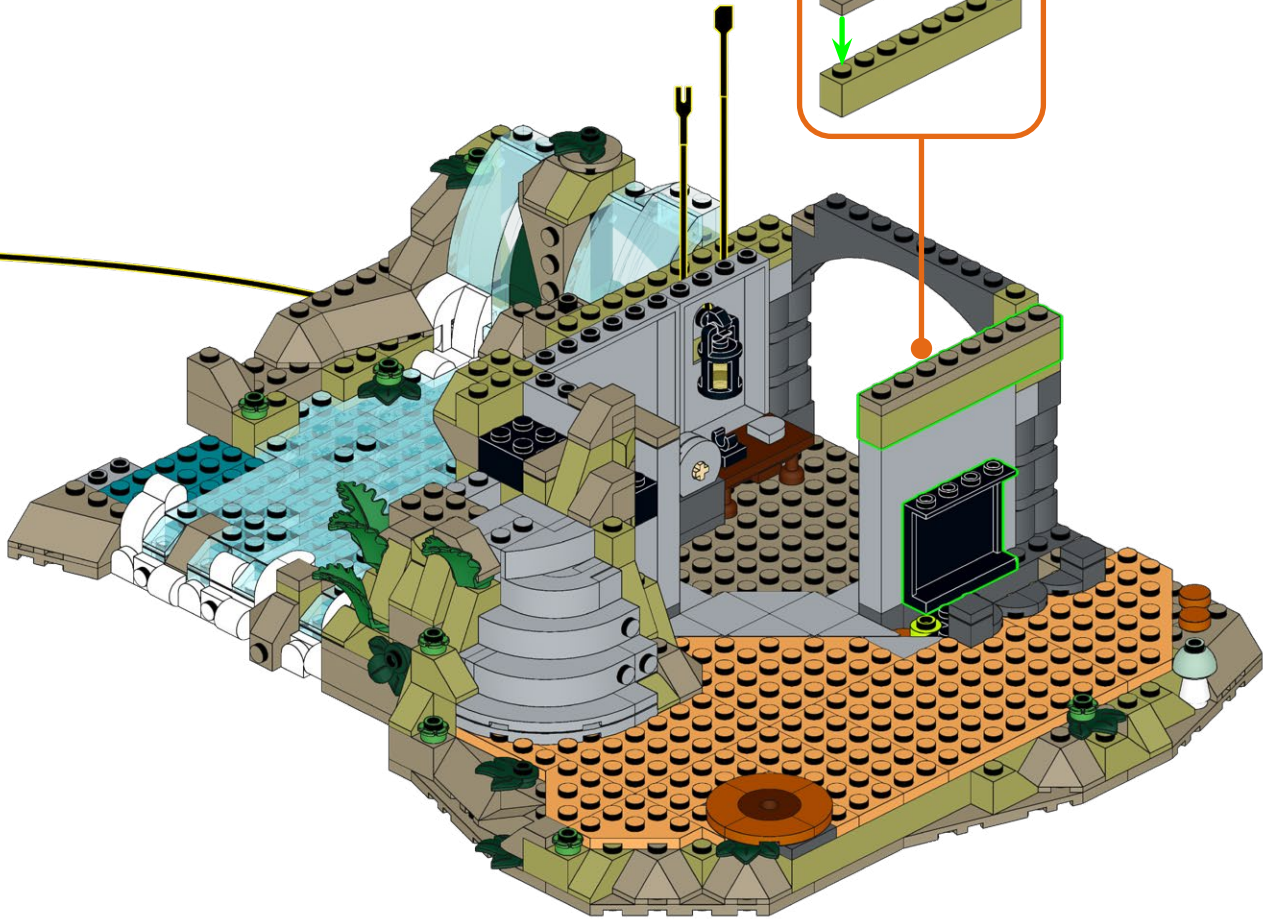
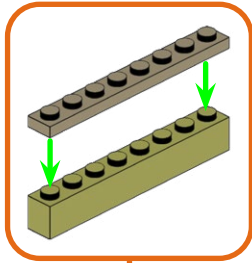
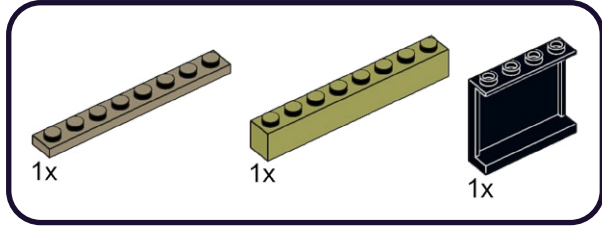

94

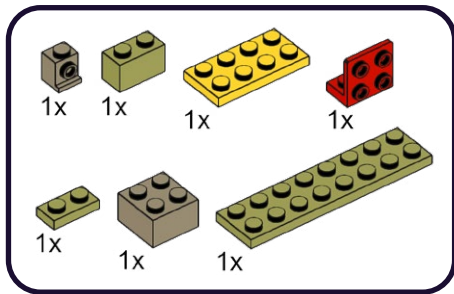

1

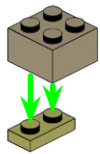

2

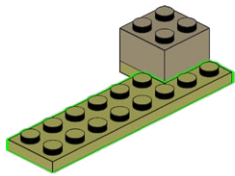

3

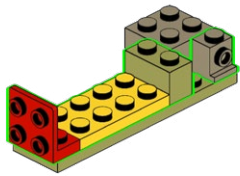

95

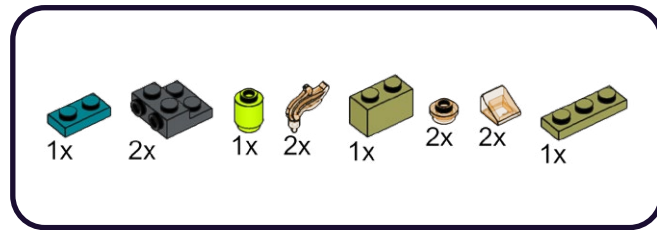

1

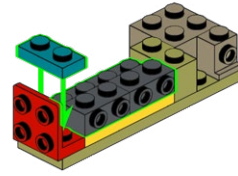

2

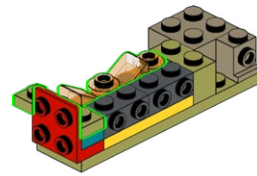

3

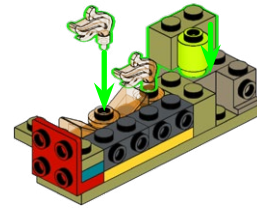

# 96

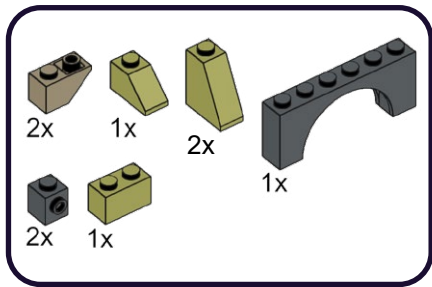

1

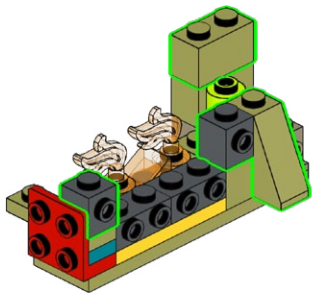

2

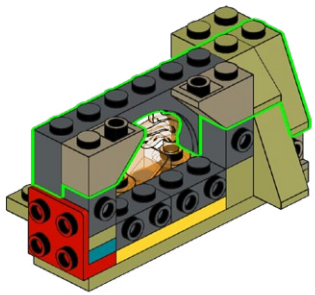

# 97

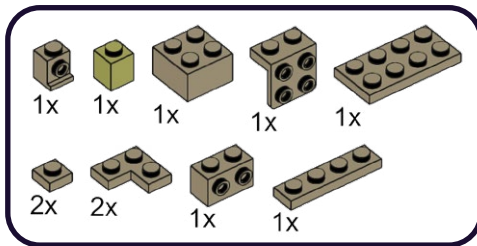

1

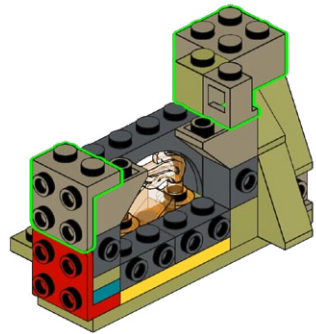

2

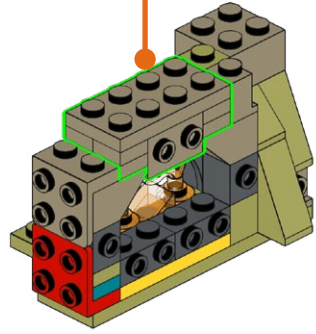

- 1
- 2
- 3
- 4

98

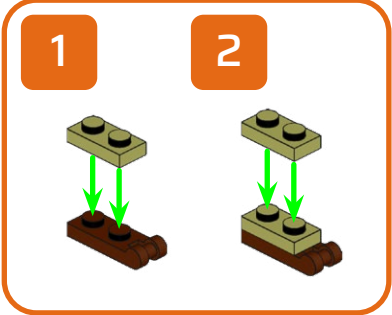
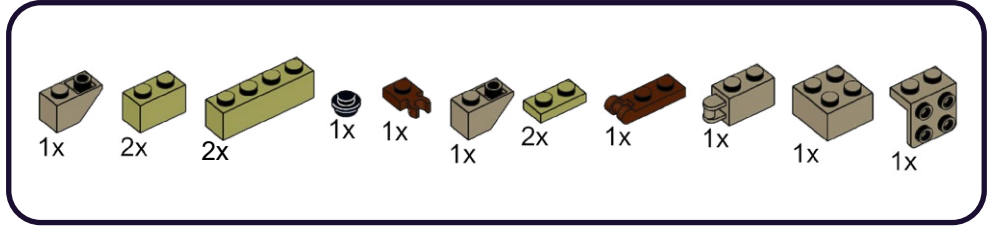

1

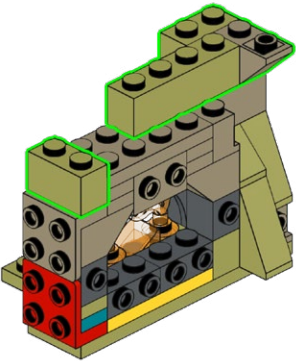

2

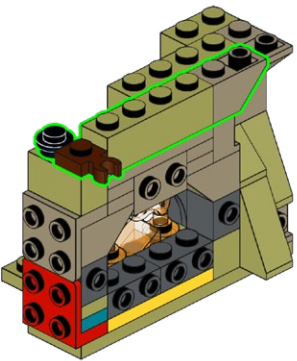

3

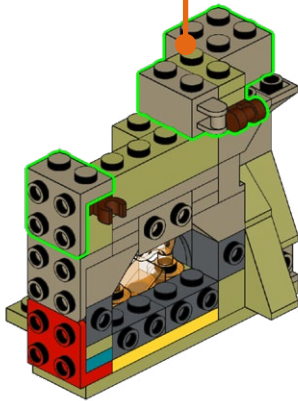

99

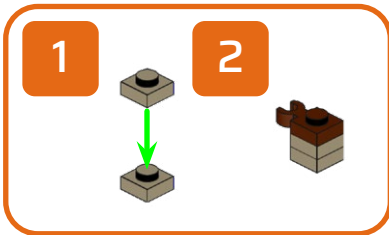
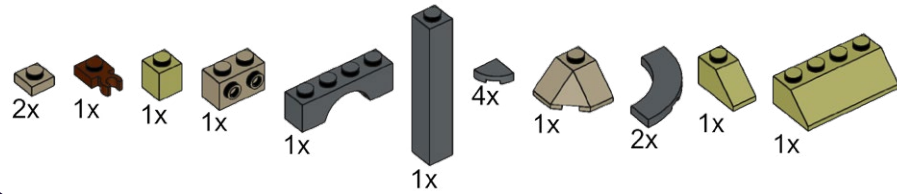

1

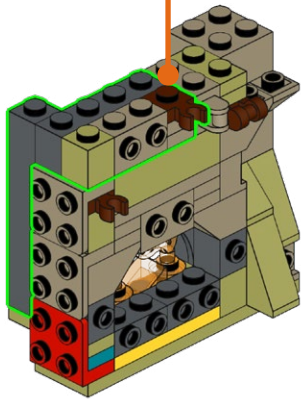

2

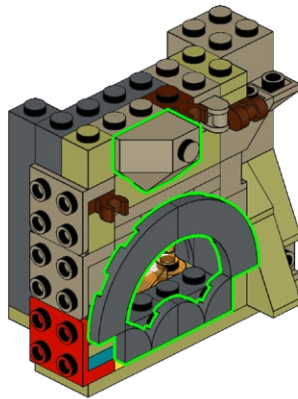

3

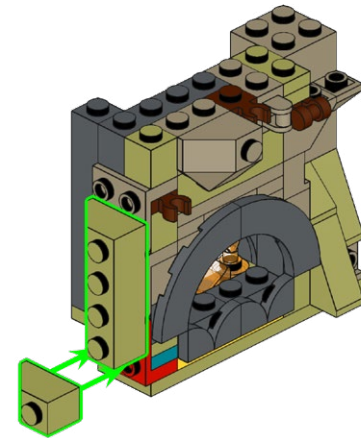



100

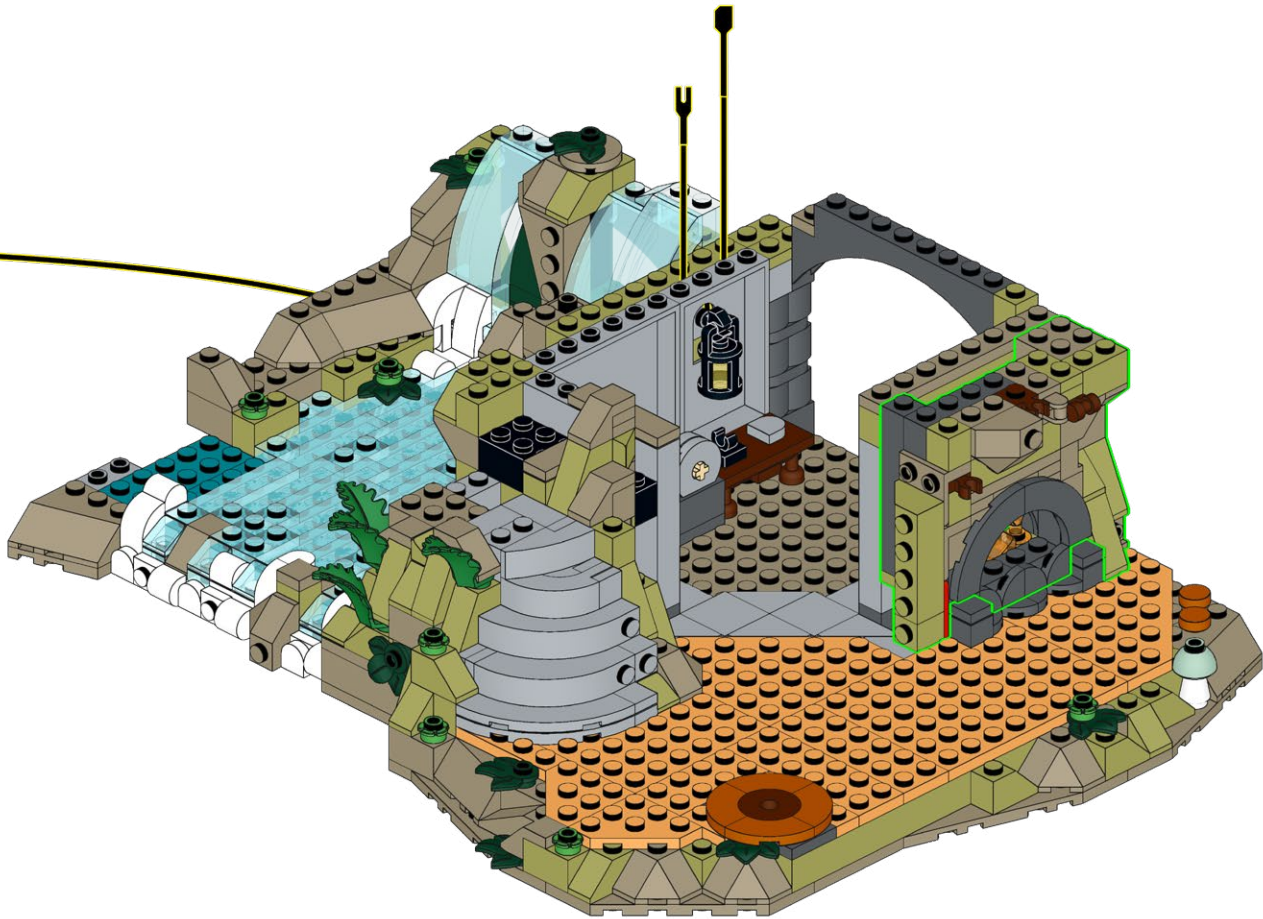

101

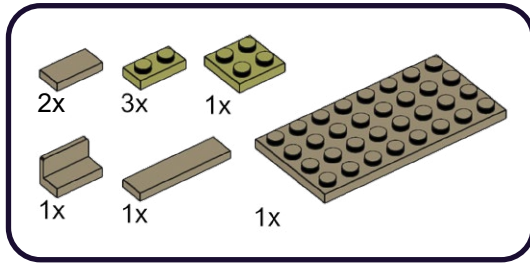

1

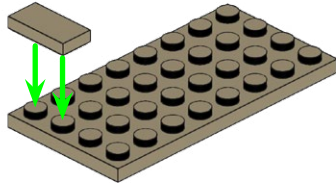

2

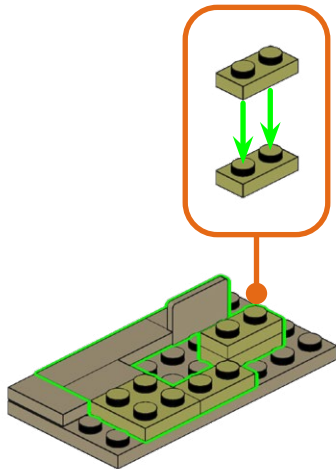

102

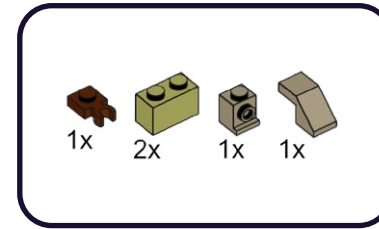

1

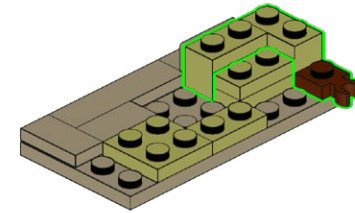

2

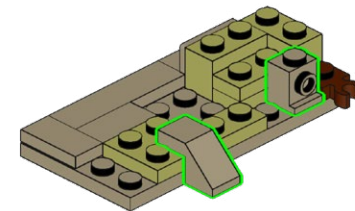

# 103

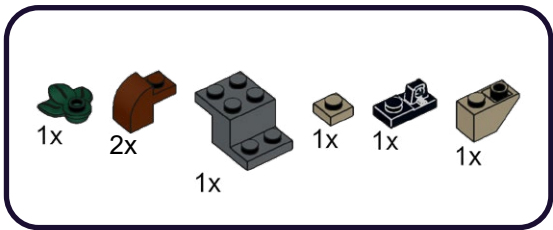

1

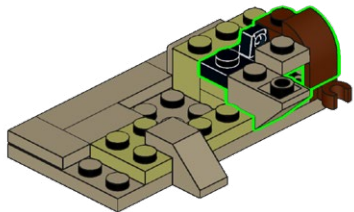

2

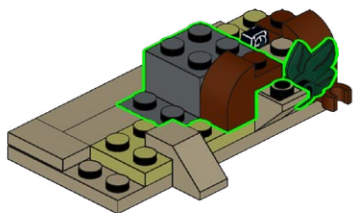

# 104

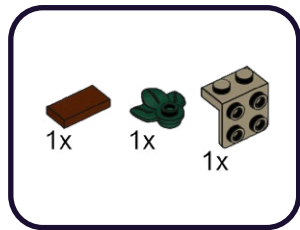

1

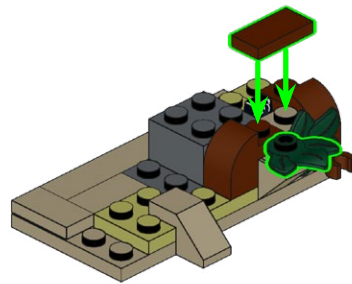

2

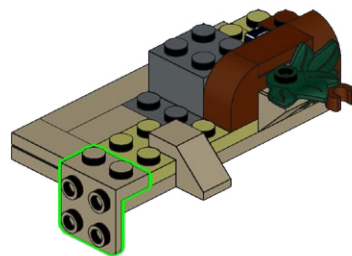

105

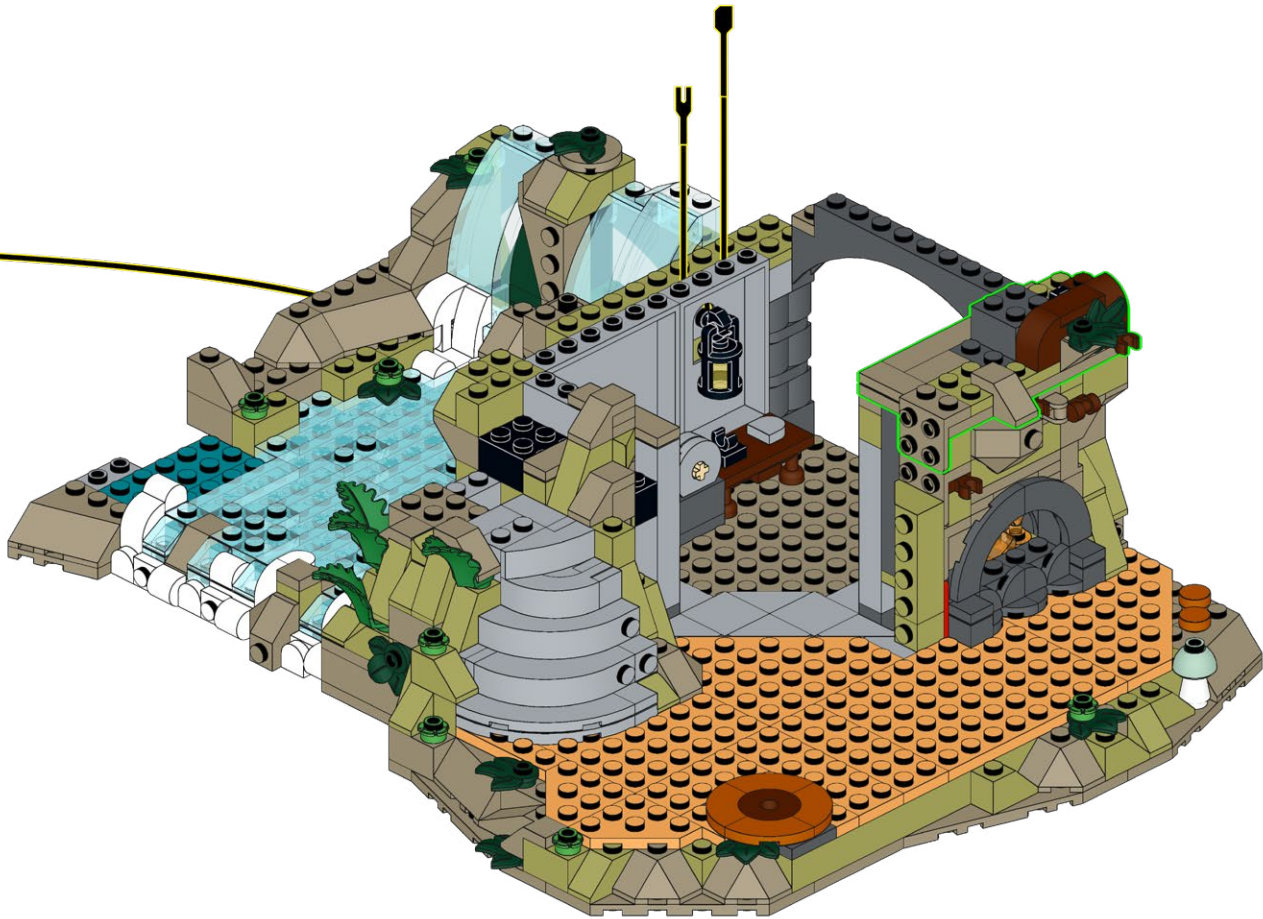

# 106

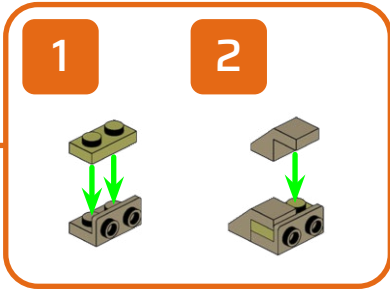
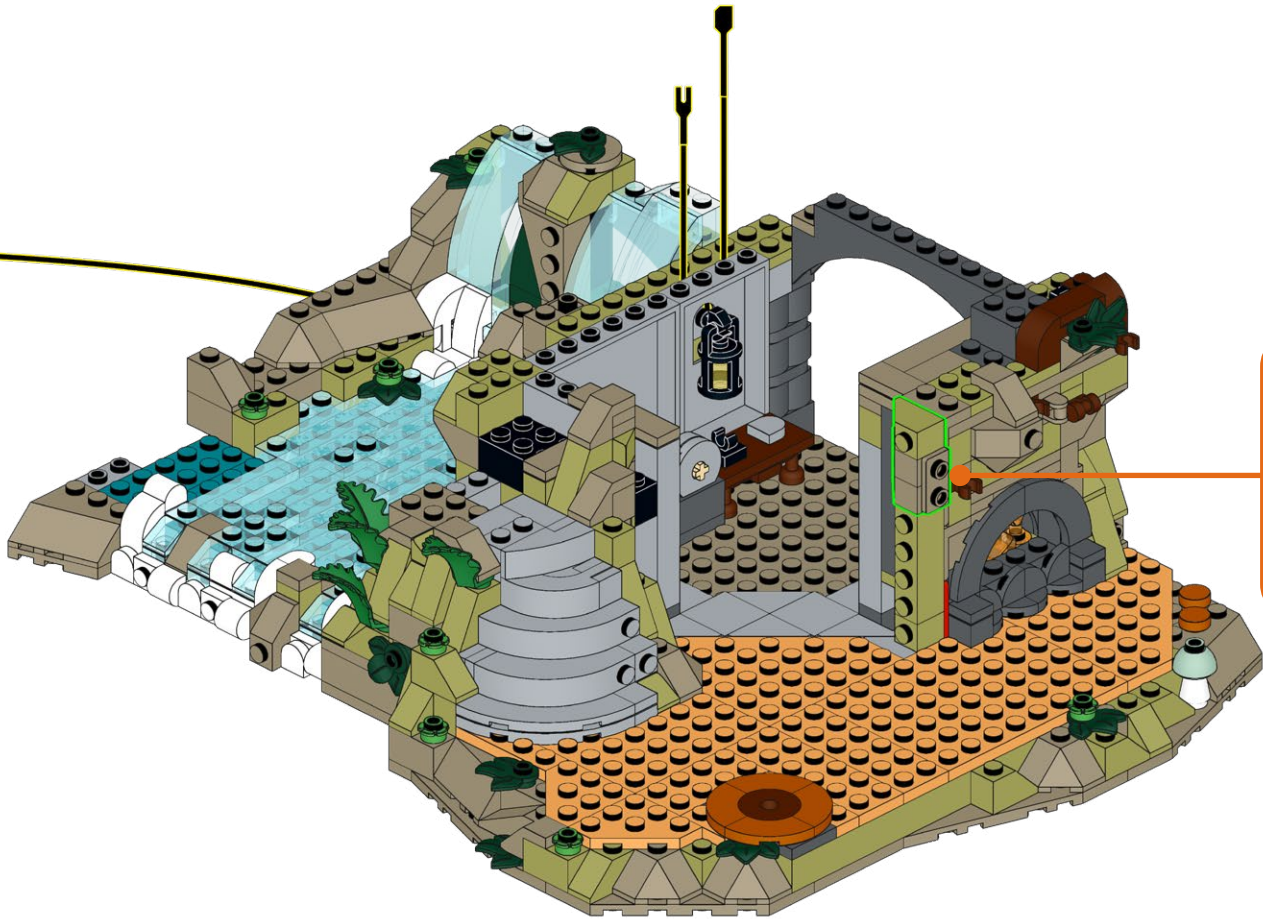
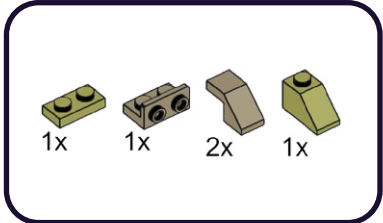

107

1x 1x

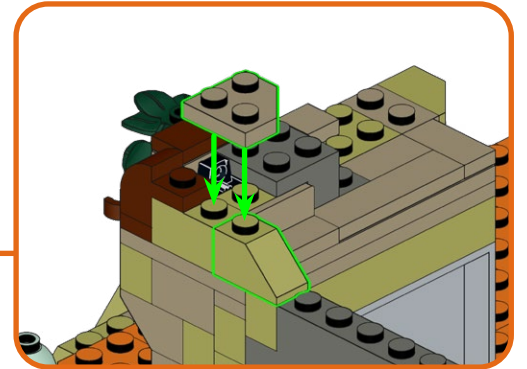
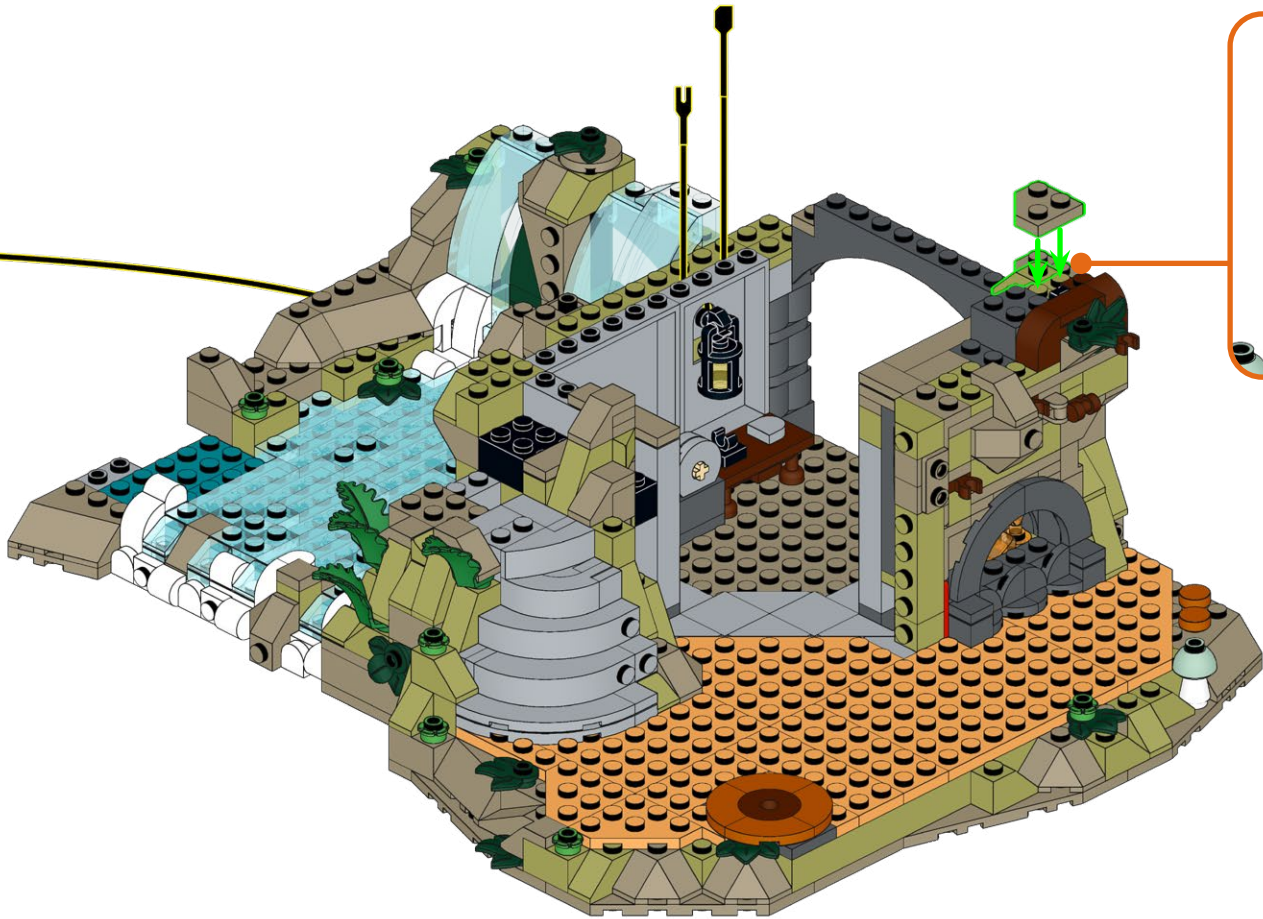

108

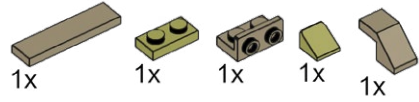

1

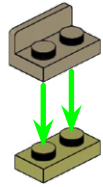

2

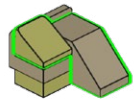

3

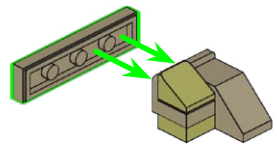

109

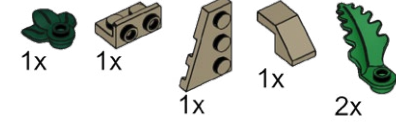

1

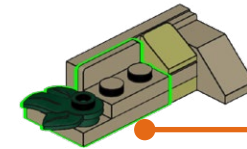

2

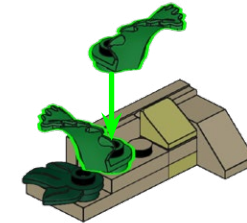

3

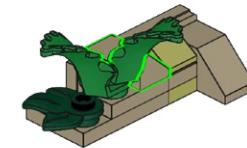

1

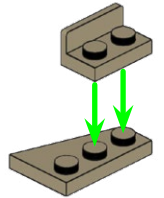

2

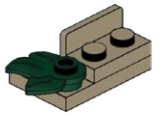

110

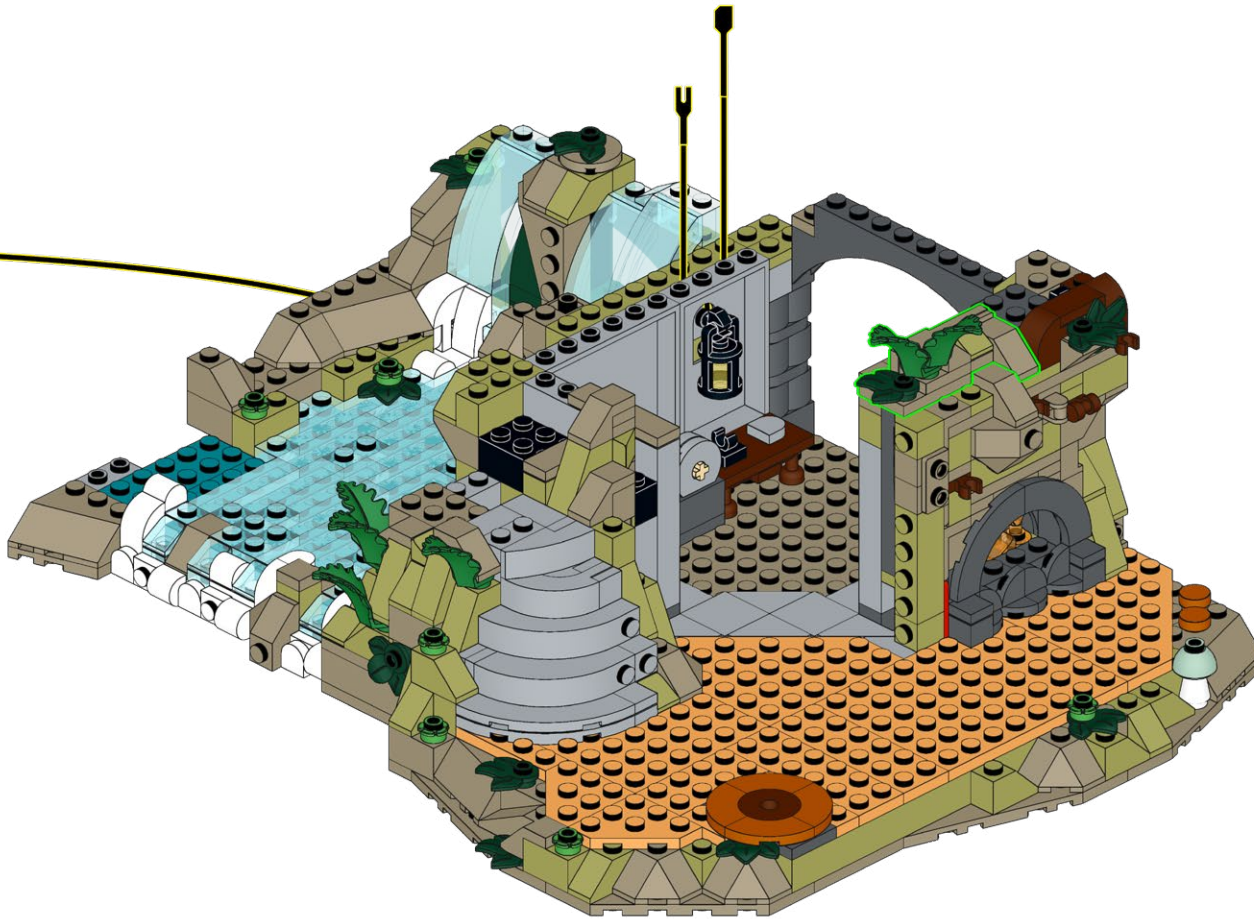



111

3x

1x

2x

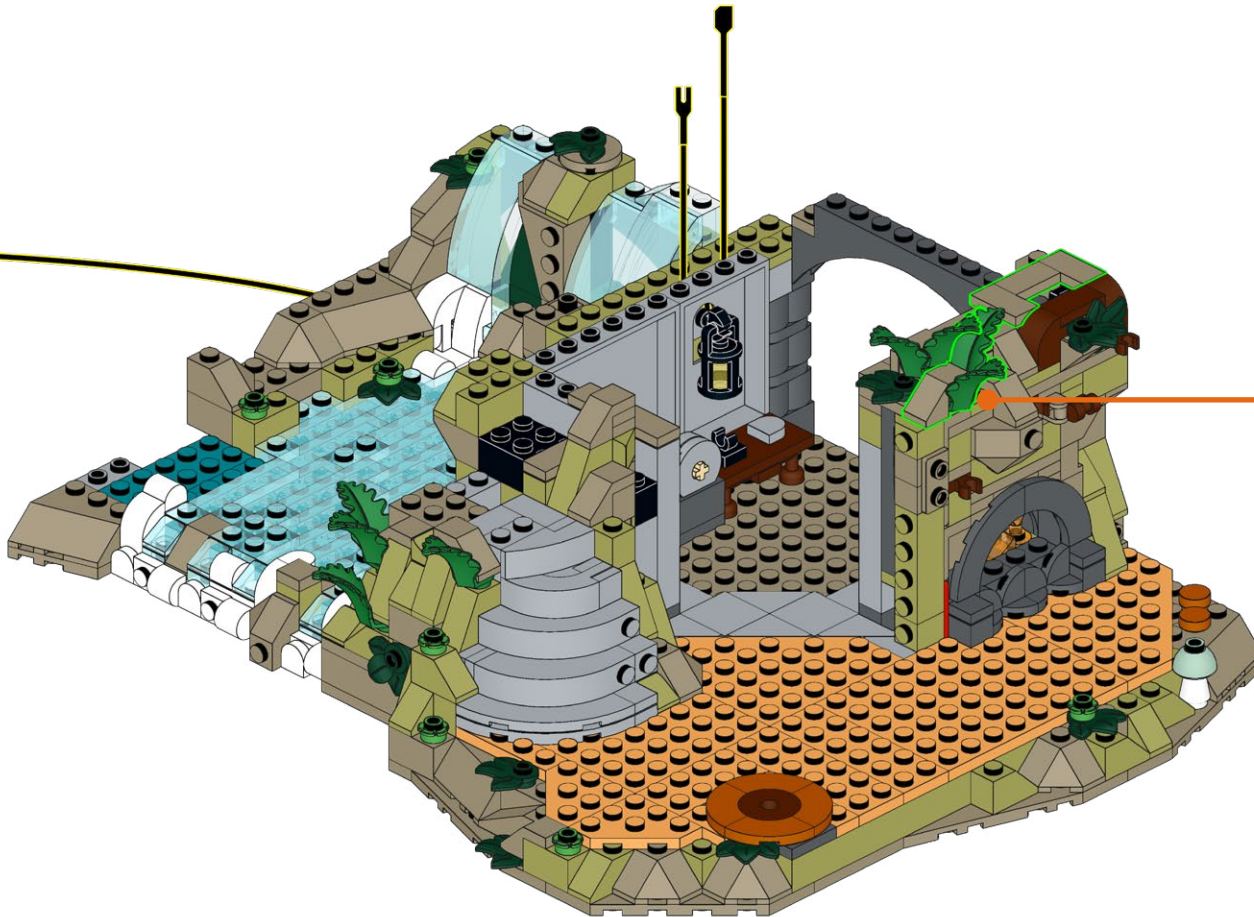

1



2



112

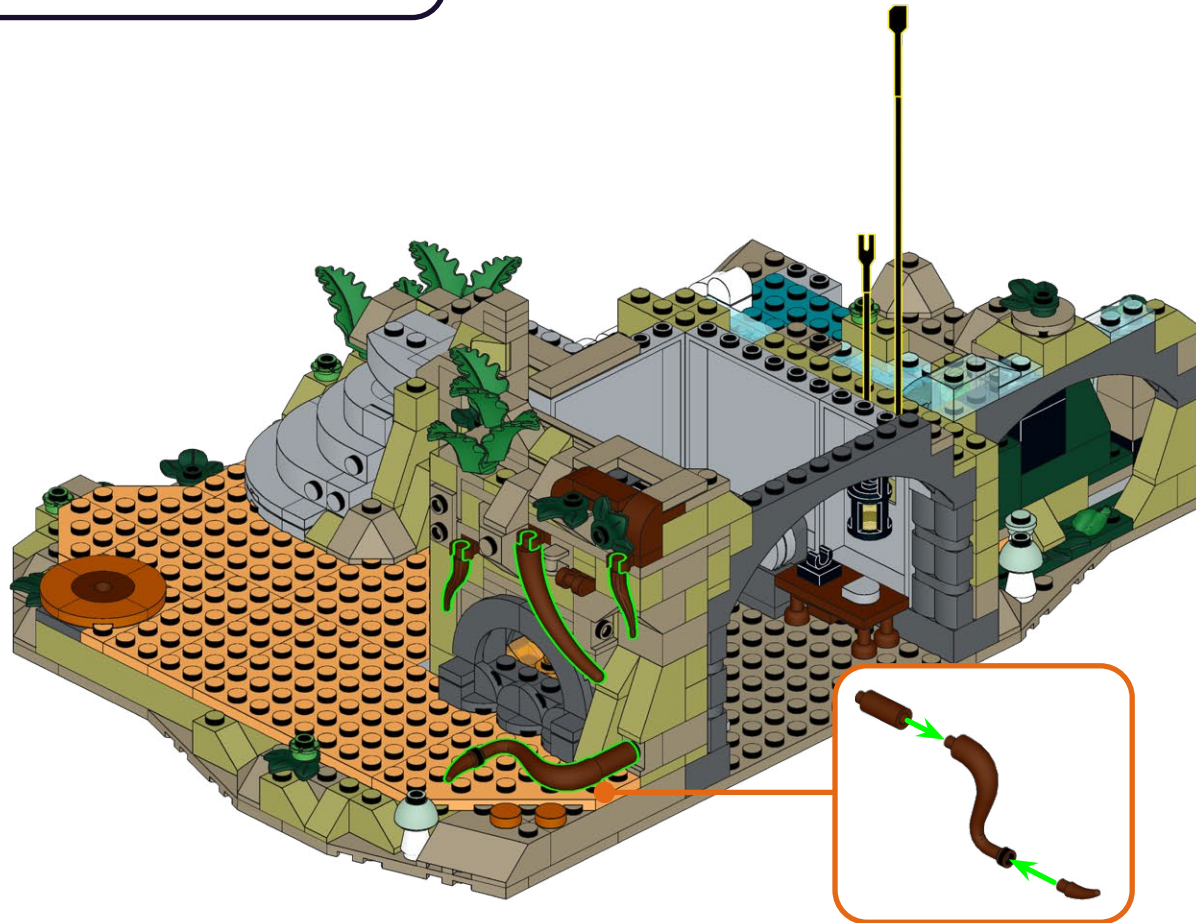
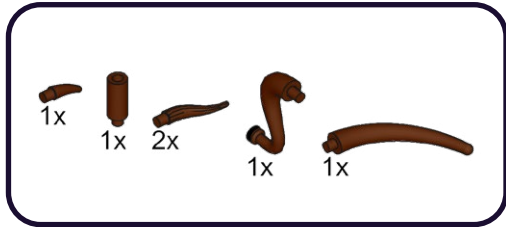

113

1x

1x

1x

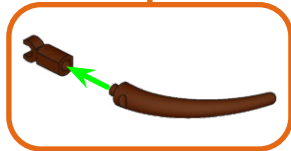

**HOLD UP!**

You might notice some bags are out of order, as well as left over pieces, but that's ok! We're changing the way you build LEGO!

**HALTEN!**

Möglicherweise stellen Sie fest, dass einige Beutel nicht in Ordnung sind und auch Teile übrig bleiben, aber das ist in Ordnung! Wir verändern die Art und Weise, wie Sie LEGO bauen!

**TENIR BON!**

Vous remarquerez peut-être que certains sacs sont en panne, ainsi que des morceaux restants, mais ce n'est pas grave ! Nous changeons la façon dont vous construisez LEGO !

**SOSTENERE!**

Potresti notare che alcune borse sono fuori uso, così come alcuni pezzi avanzati, ma va bene! Stiamo cambiando il modo in cui costruisci i LEGO!

**¡SOSTENER!**

Puede que notes que algunas bolsas están fuera de orden, así como piezas sobrantes, ¡pero está bien! ¡Estamos cambiando la forma de construir LEGO!

**耽误!**

您可能会注意到有些袋子坏了, 还有剩余的碎片, 但这没关系! 我们正在改变您搭建乐高的方式!

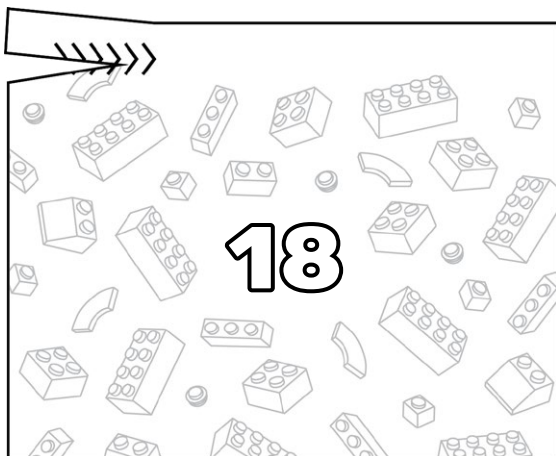
**Open LEGO® Bag 1**

114

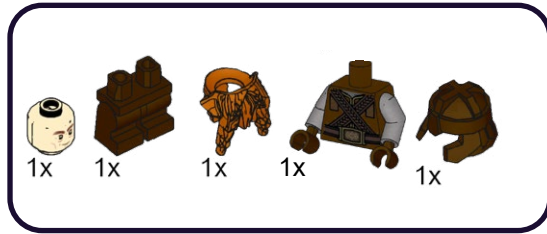

115



116



117

- 1x [1x 1/2 tan brick]
- 2x [2x 1x tan brick]
- 1x [1x 1x tan brick with hole]
- 1x [1x 2x tan brick]
- 1x [1x 1x tan brick with hole]
- 1x [1x 2x tan brick]
- 1x [1x 3x tan brick]
- 1x [1x green bush]
- 2x [2x 1x tan brick]



- 1 [2x 1x tan brick]
- 2 [2x 1x tan brick]
- 3 [2x 1x tan brick]
- 4 [2x 1x tan brick with hole]

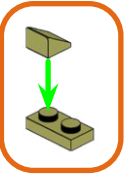
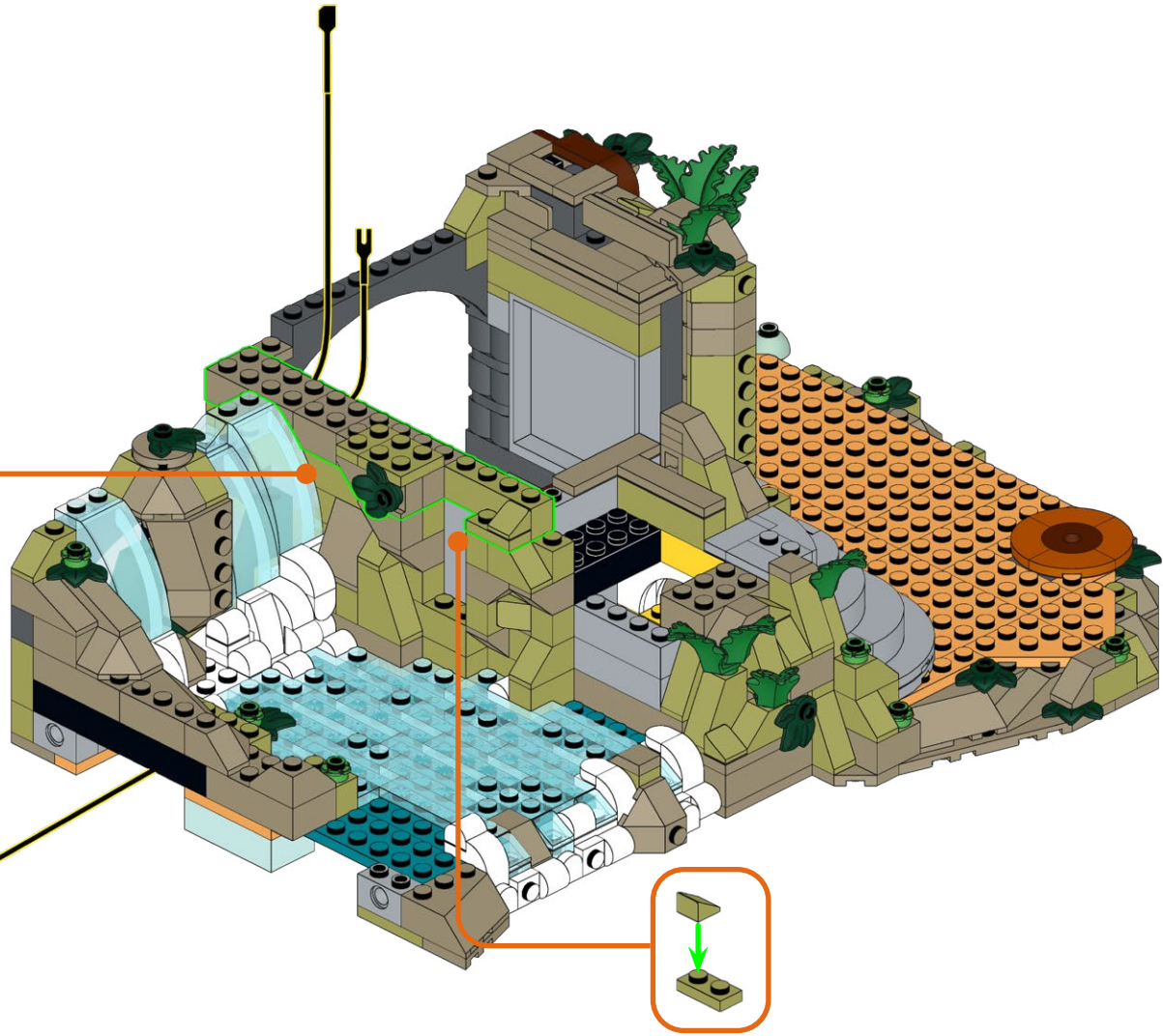

118

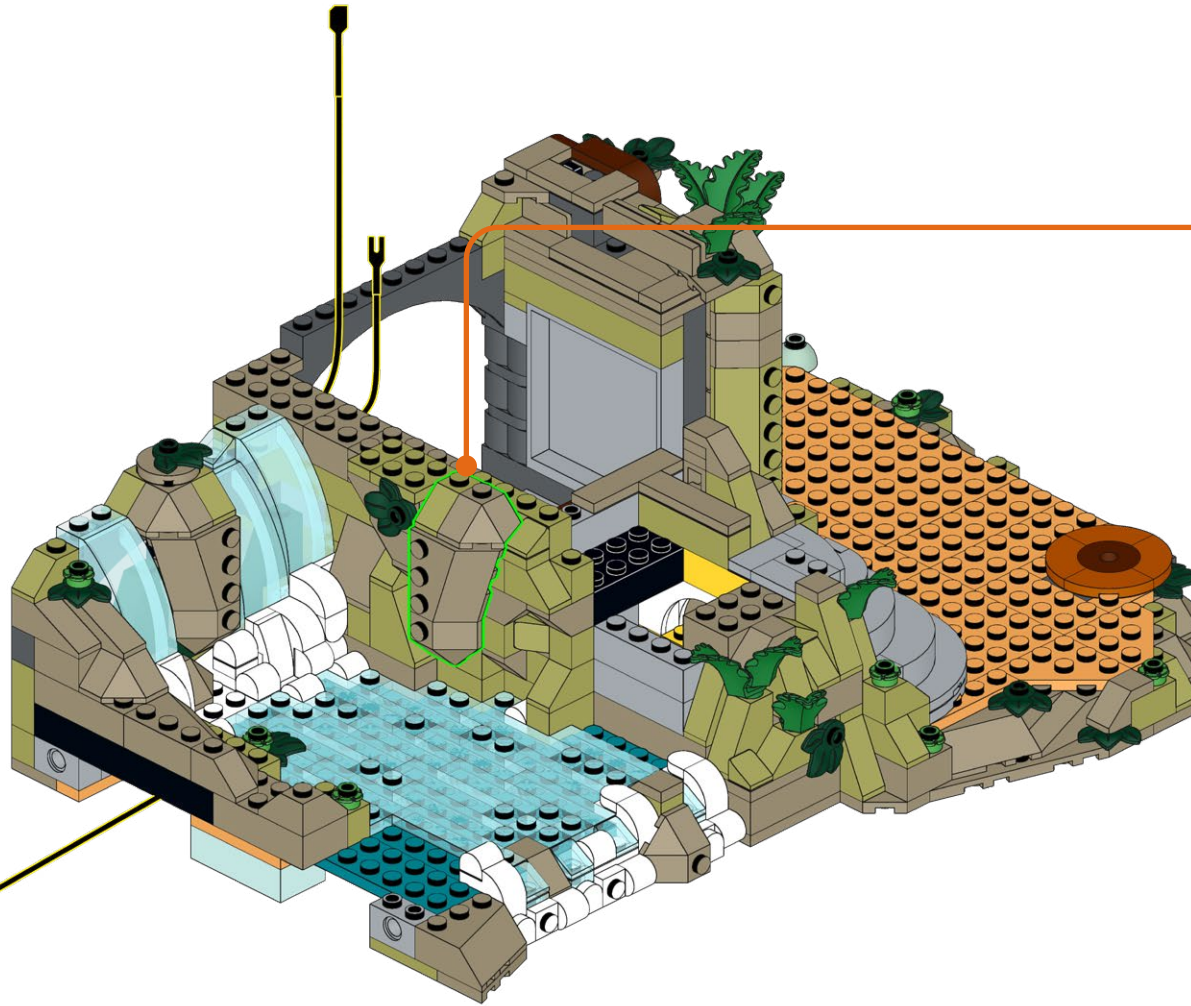
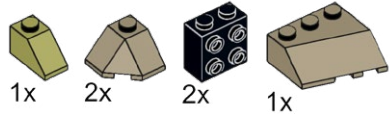

1

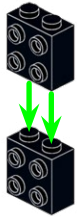

2

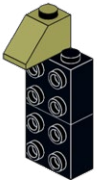

3



4

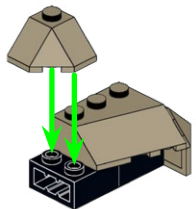



119

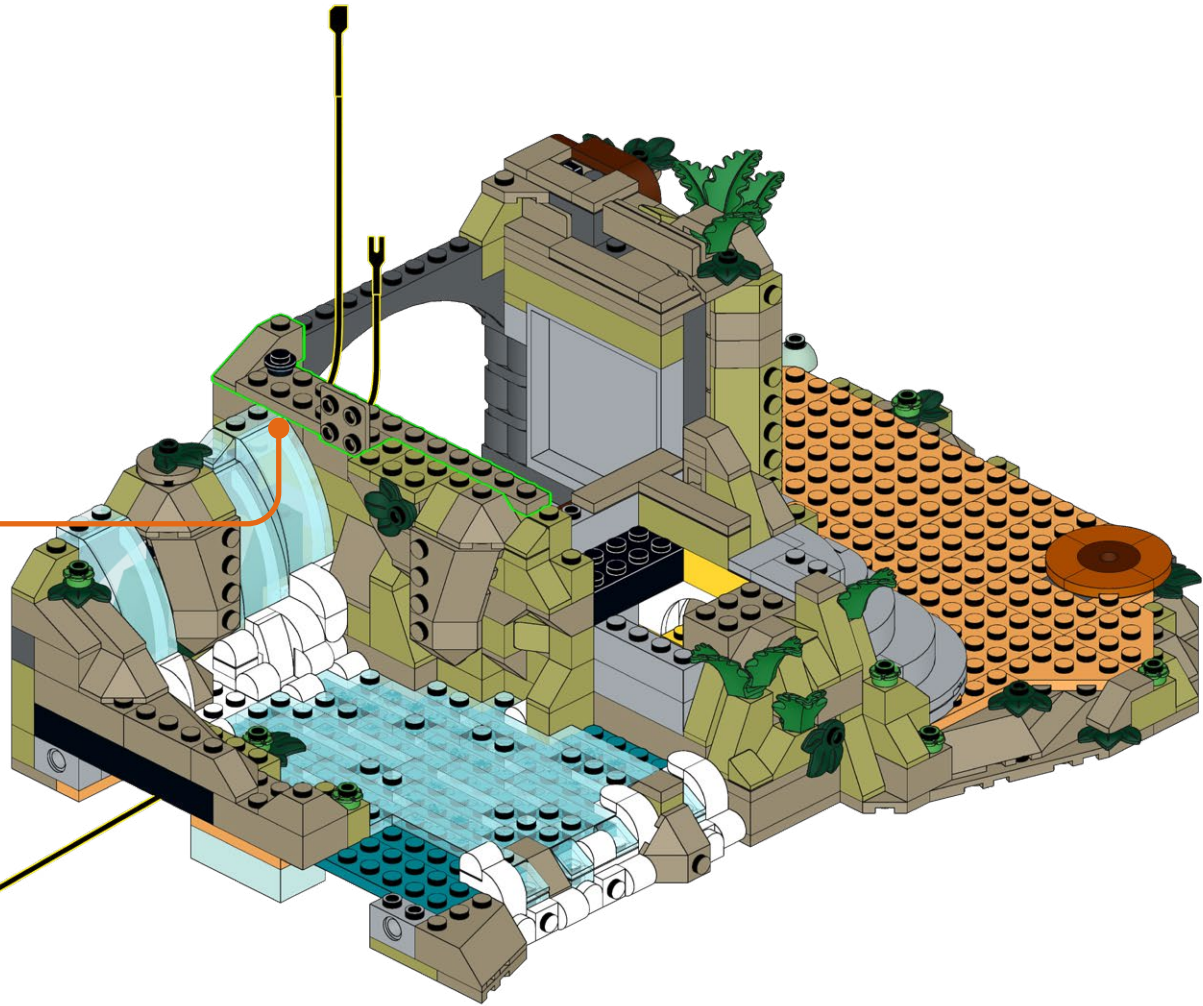
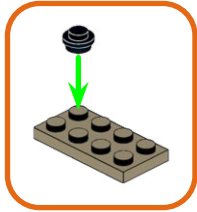
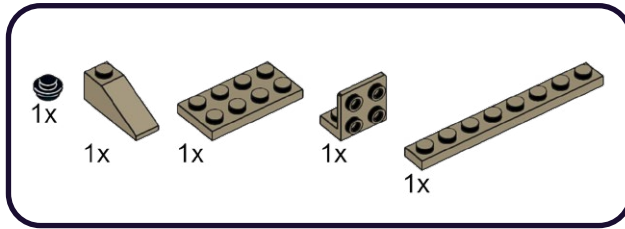

# 120

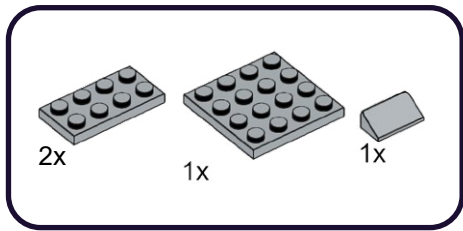

1

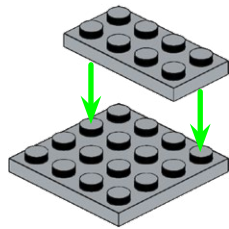

2

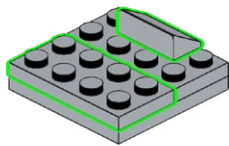

# 121

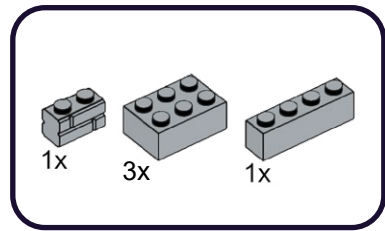

1

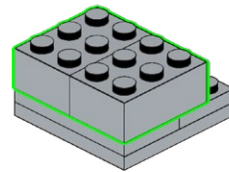

2

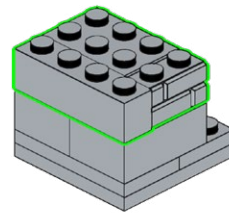

122

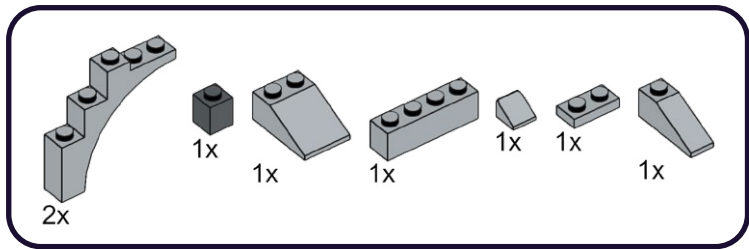

1

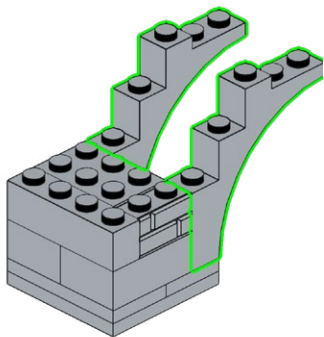

2

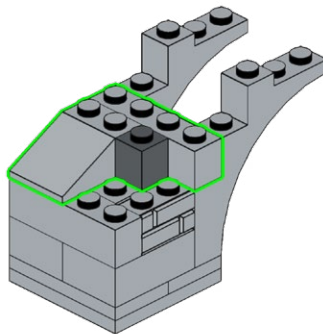

3

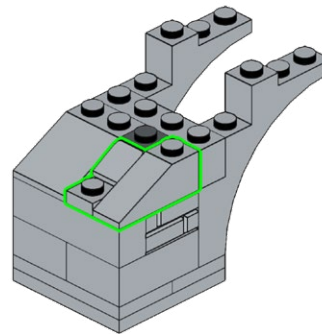

123

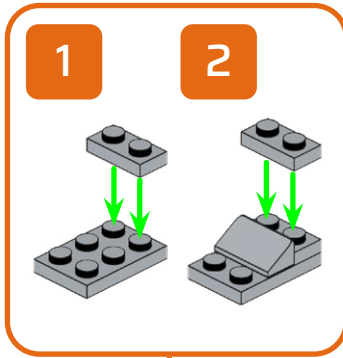
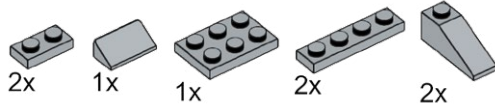

1

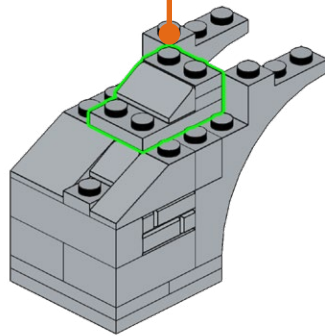

2

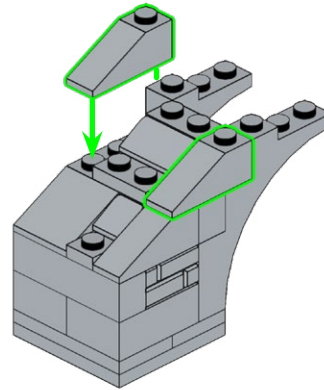

3

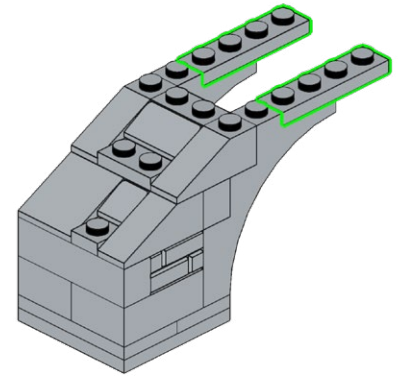

# 124

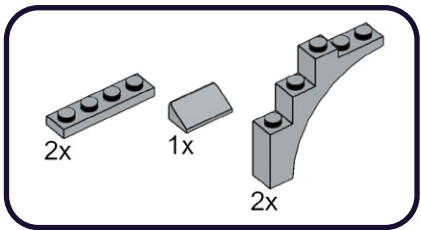

1

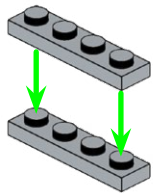

2

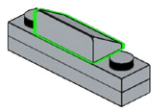

3

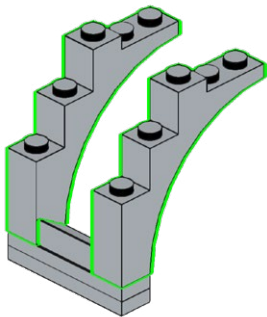

# 125

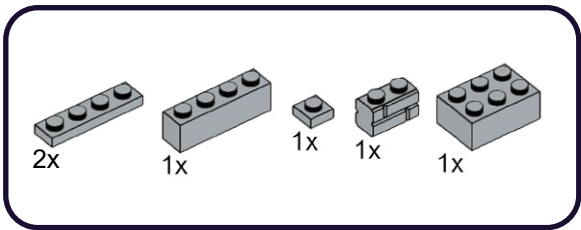

1

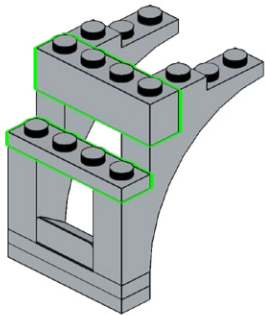

2

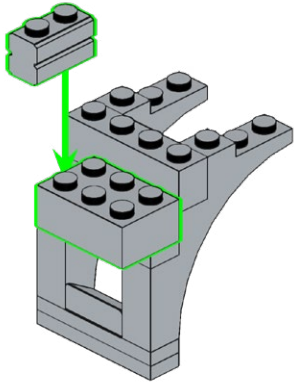

3

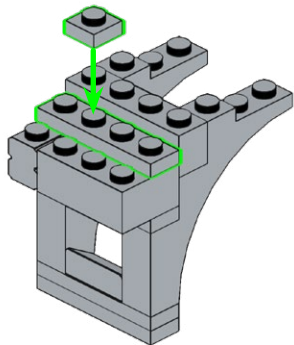

126

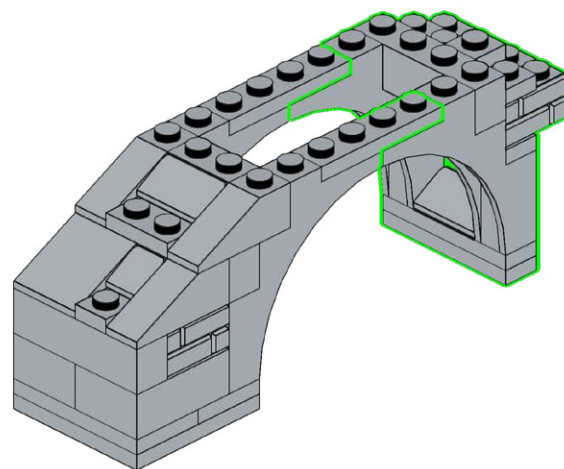

127

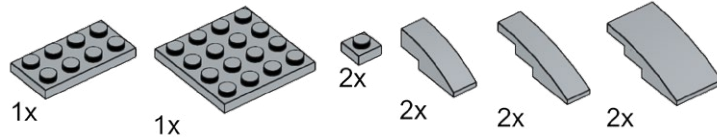

1

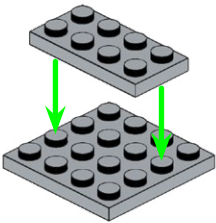

2

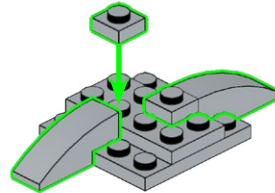

3

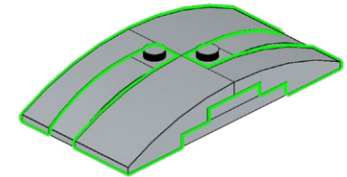

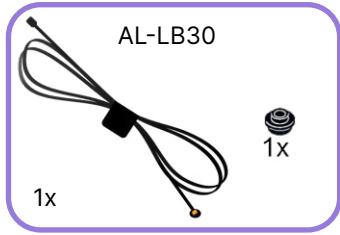

1

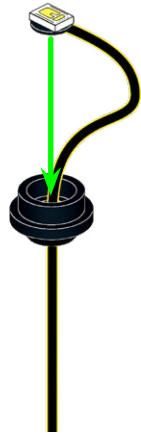

2

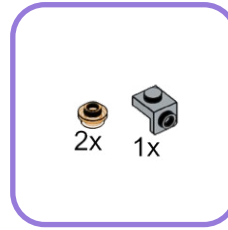

1

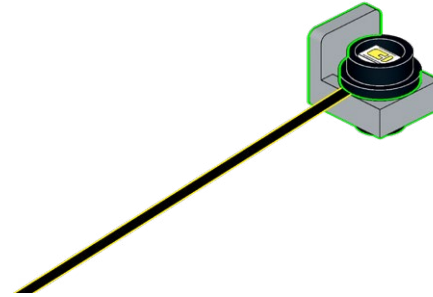

2

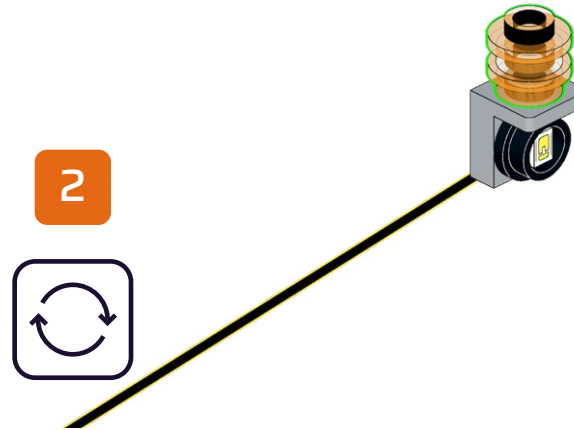



# 130

1

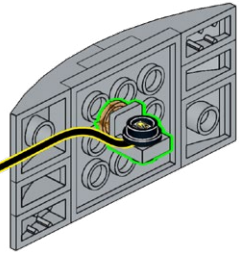

2

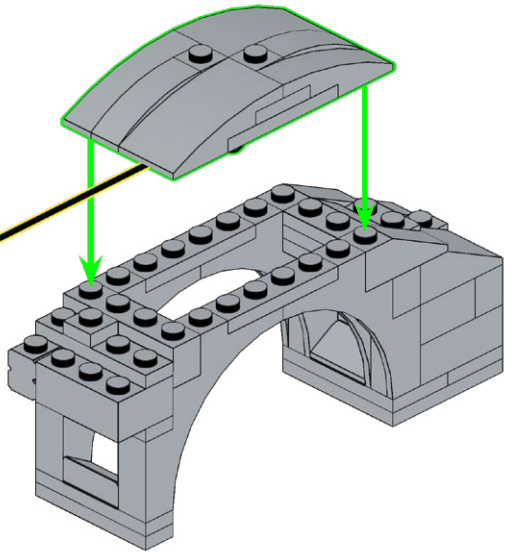

# 131

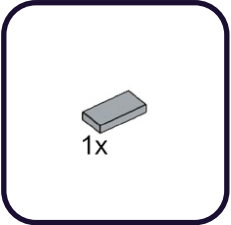

1

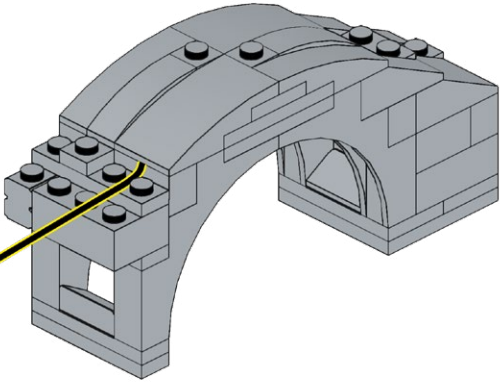

2

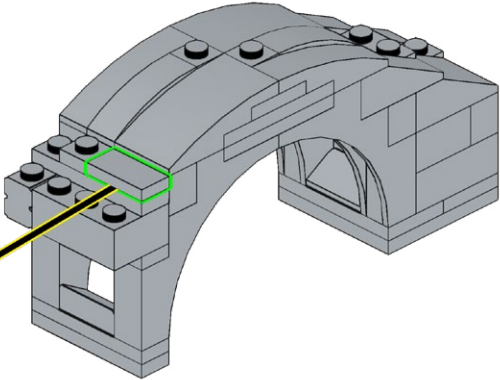

132

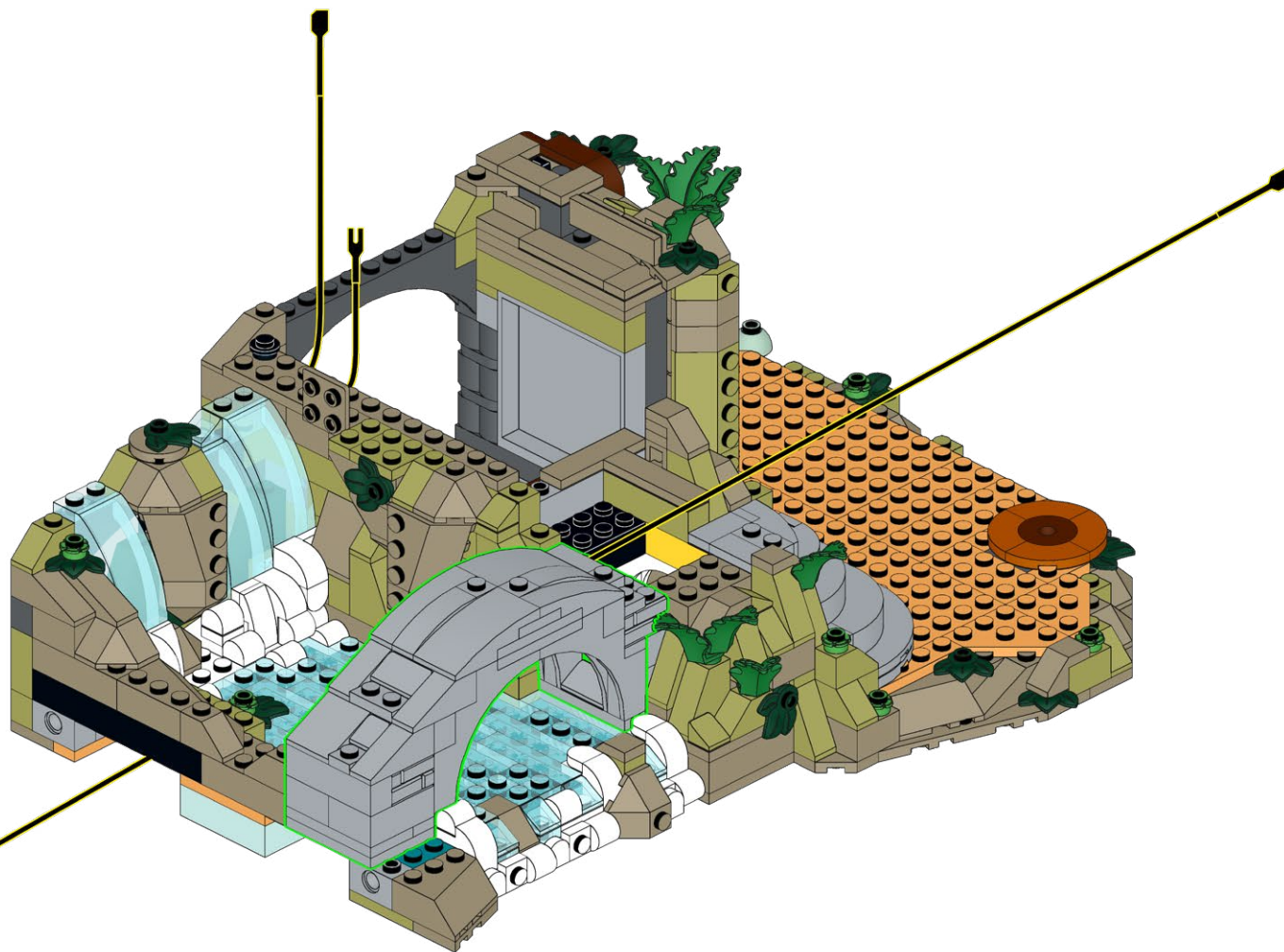

133

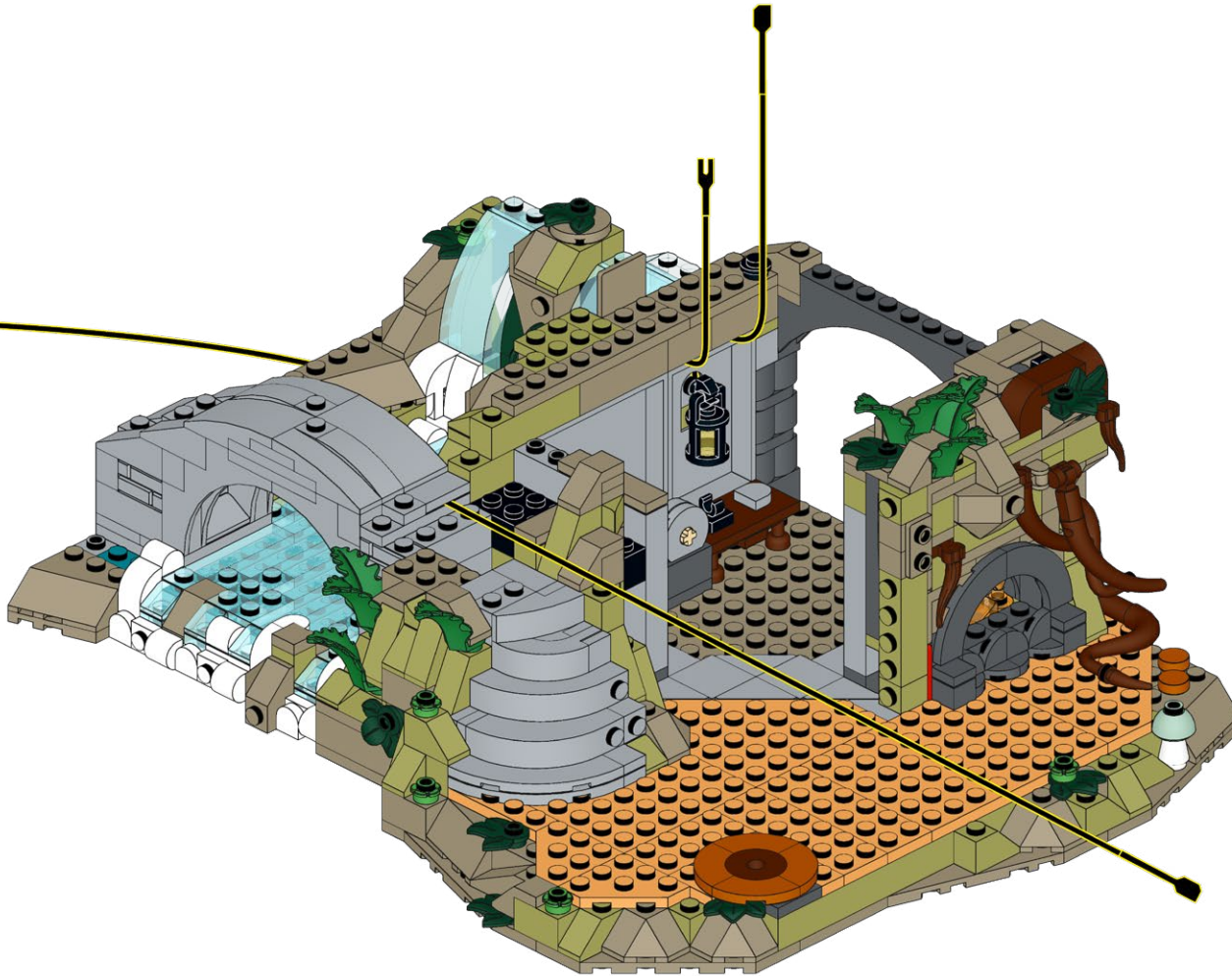

134



135

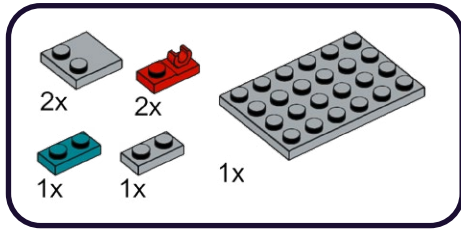

1

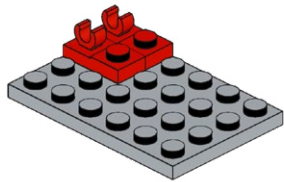

2

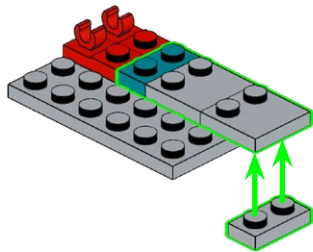

136

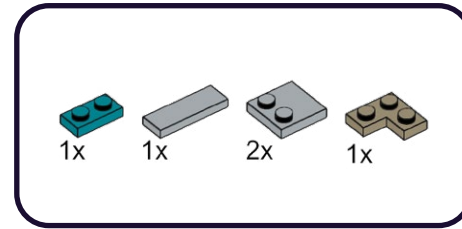

1

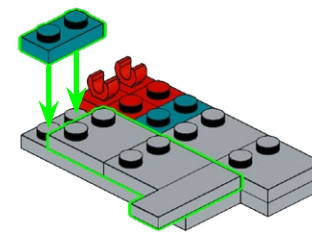

2

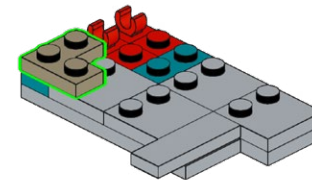

137

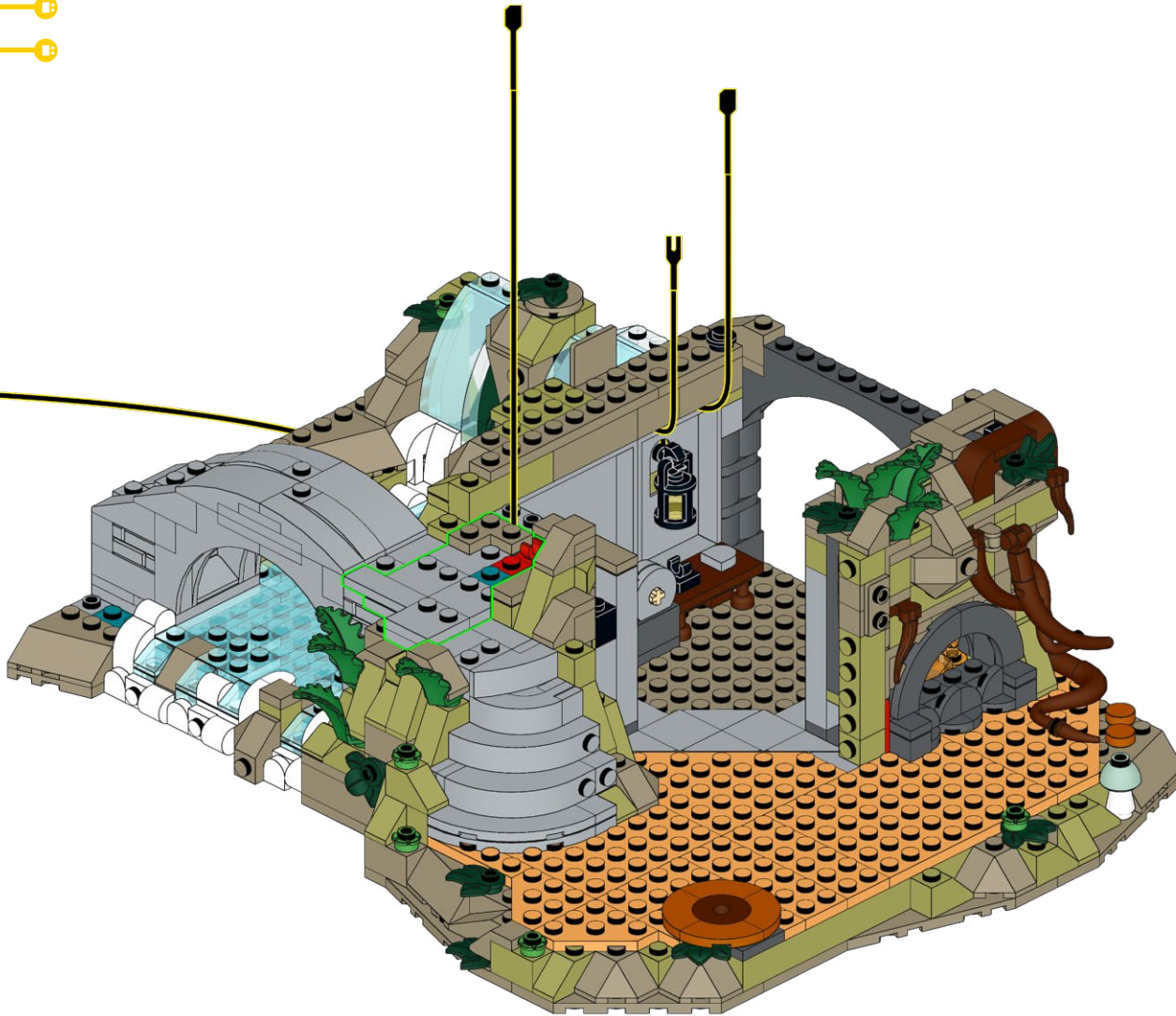

**138**



- 1x
- 1x
- 2x
- 1x
- 1x
- 1x

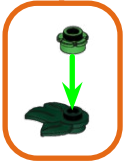
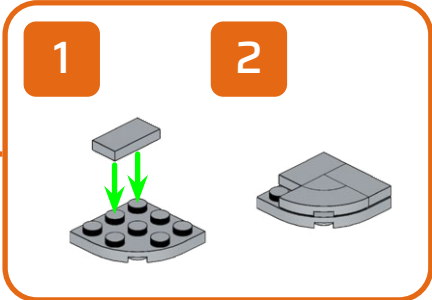
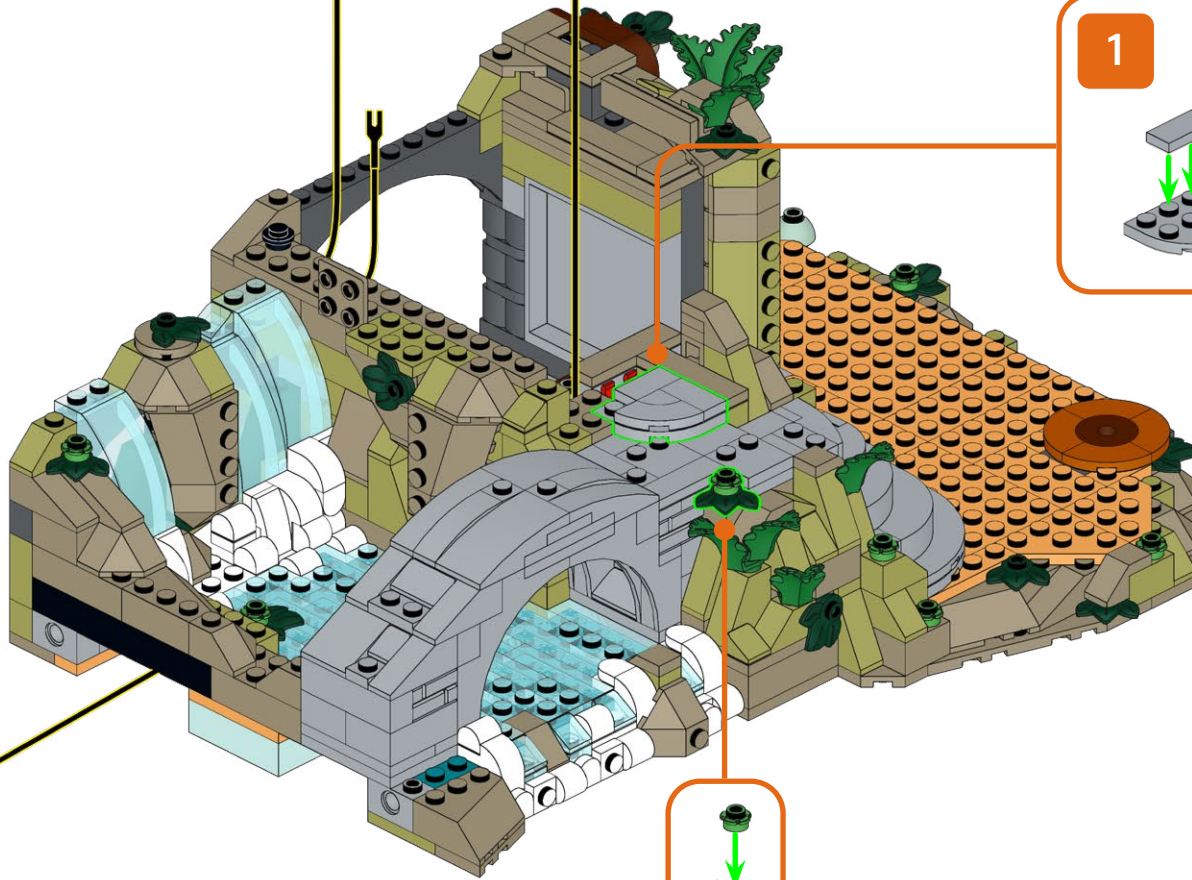

# 139

- 1x
- 1x
- 1x
- 2x
- 1x
- 1x

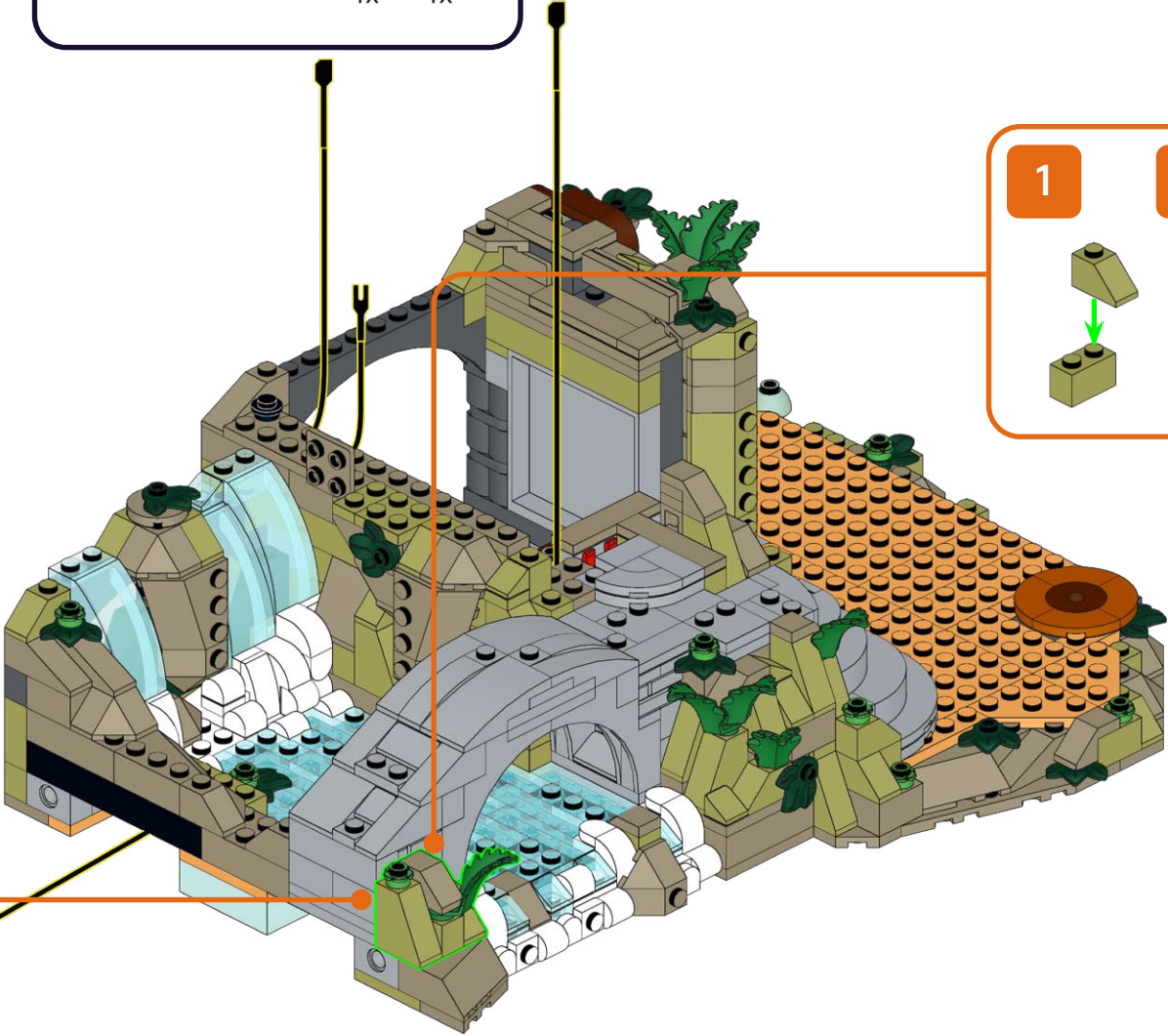
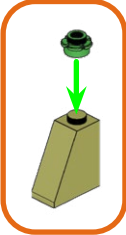
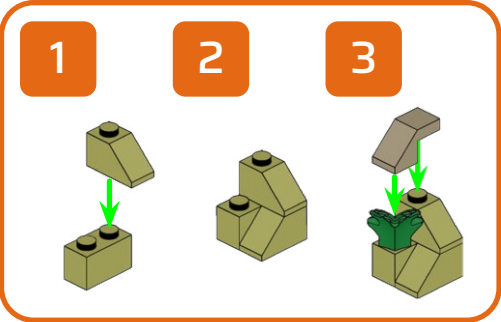



140

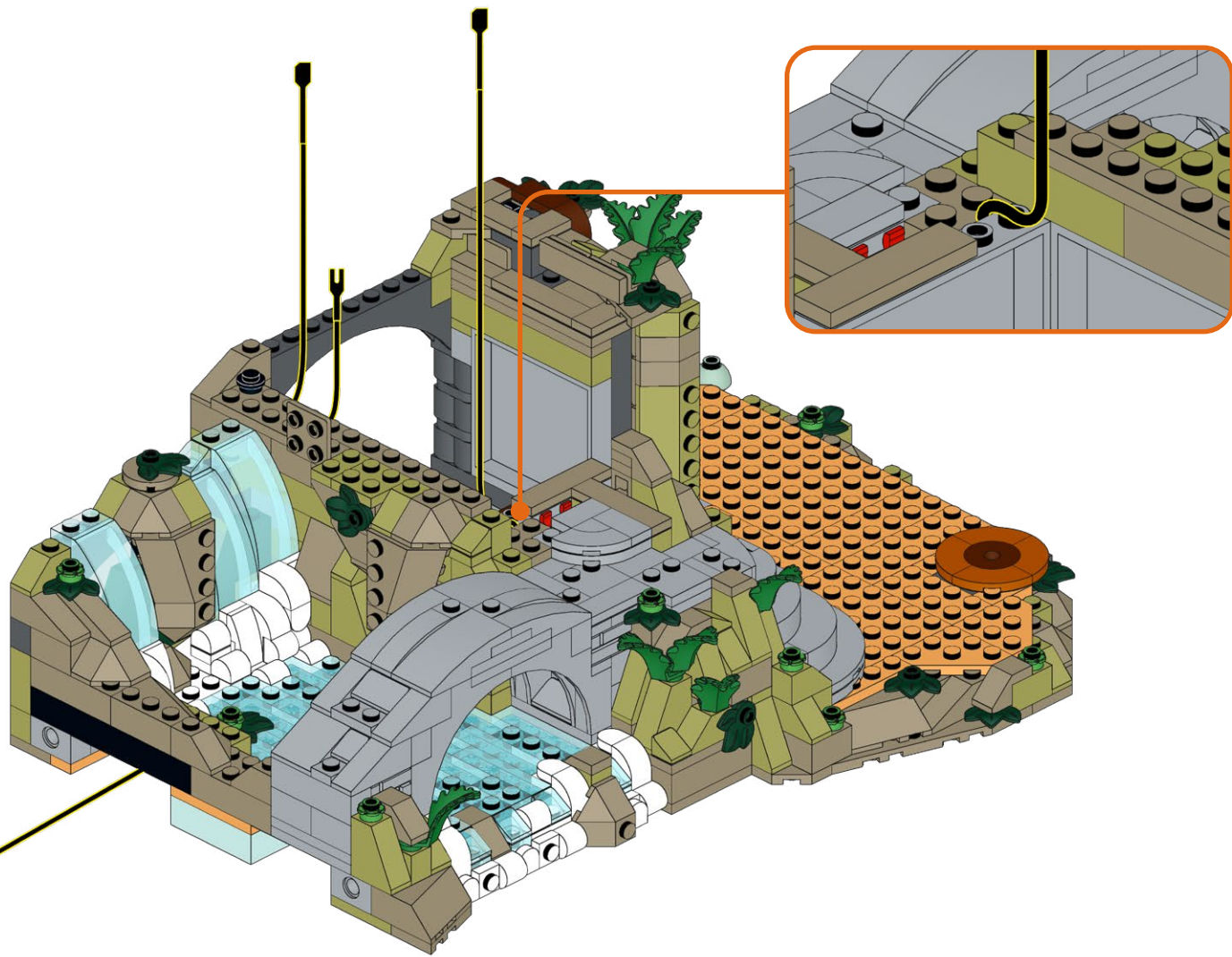

141

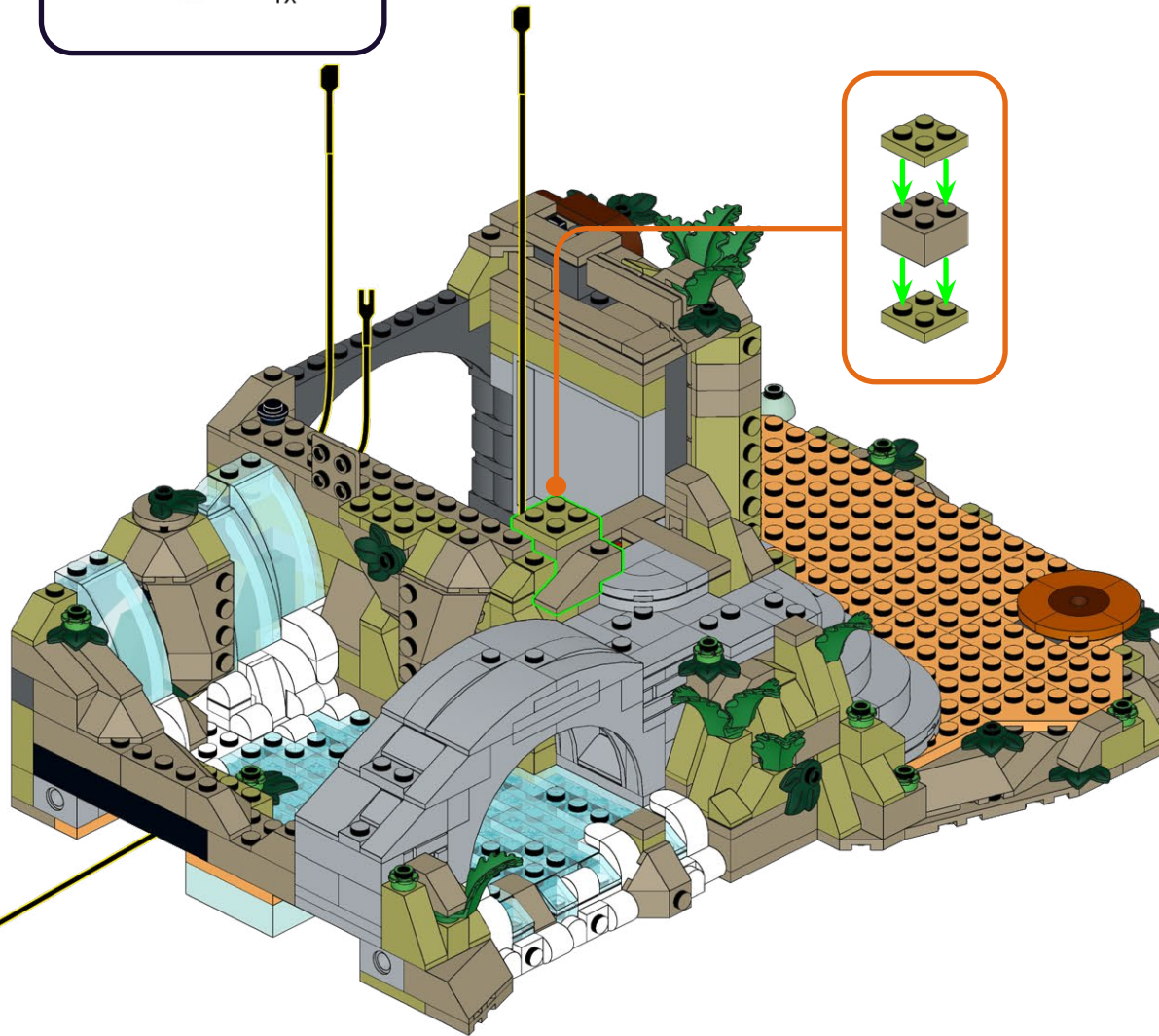
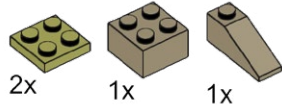

# 142

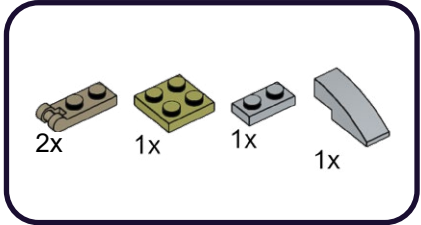

1

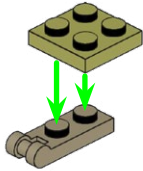

2

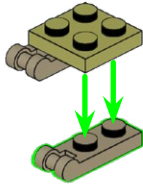

3

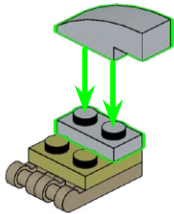

# 143

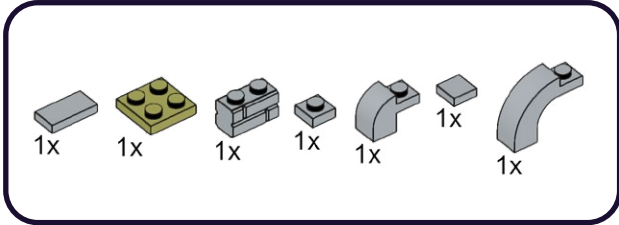

1

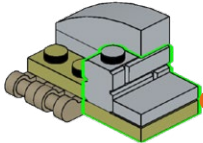

2

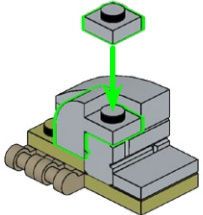

3

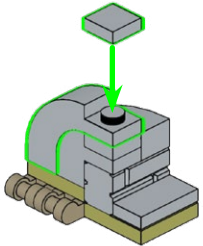

1

2

144

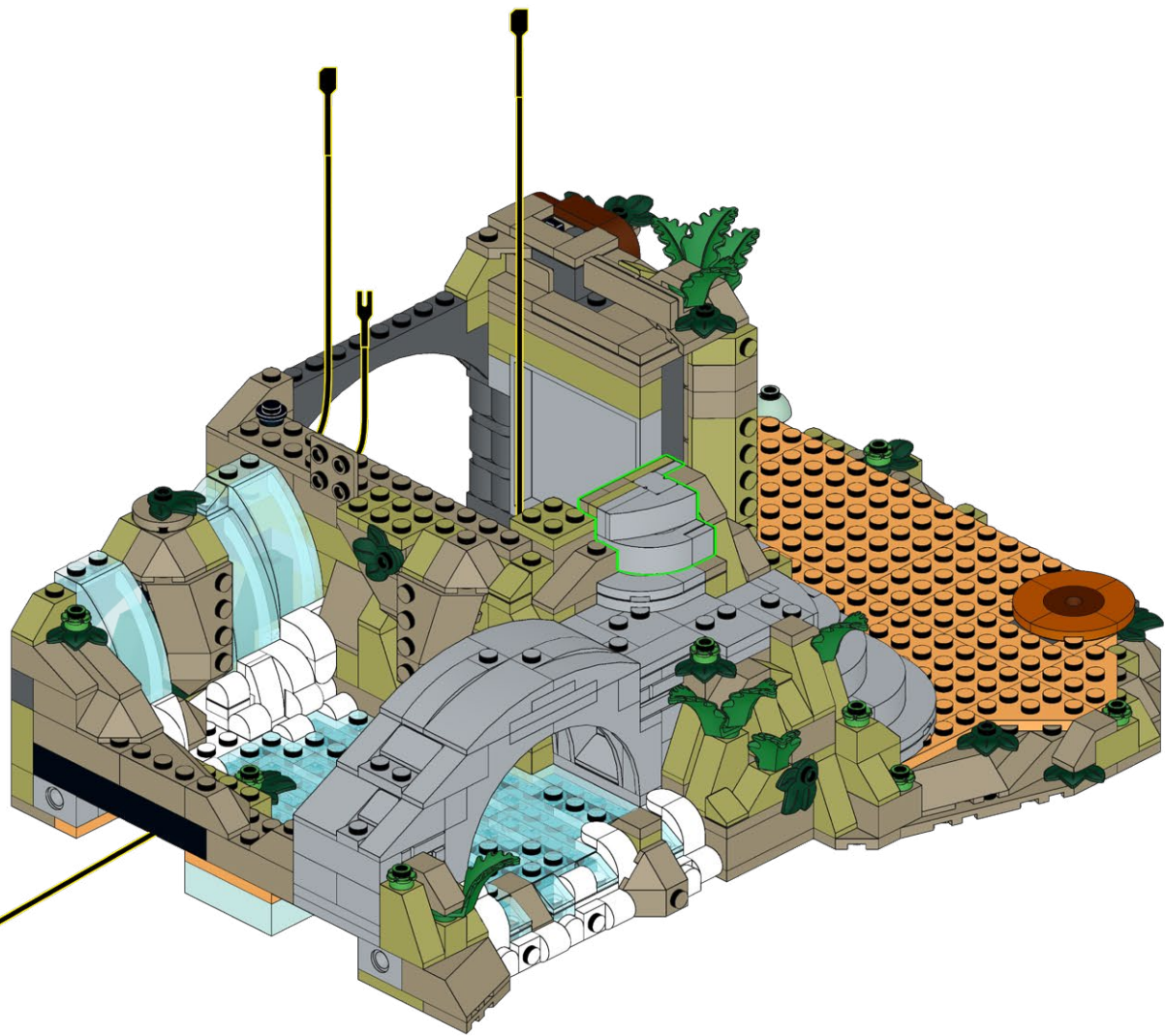

145

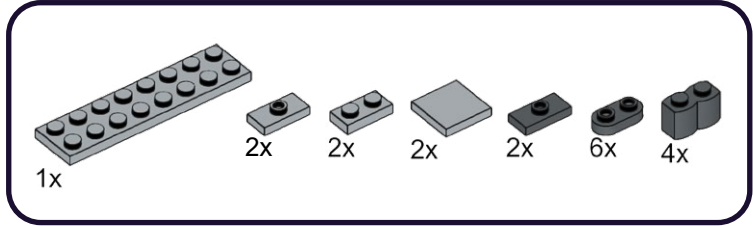

1

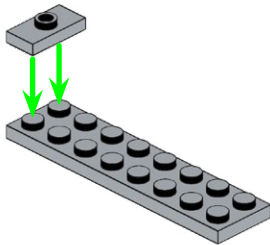

2

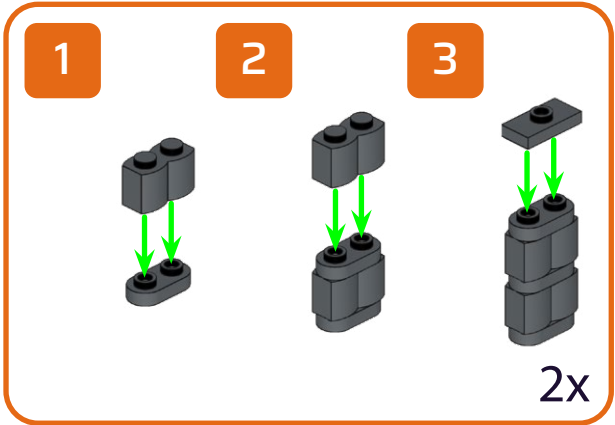
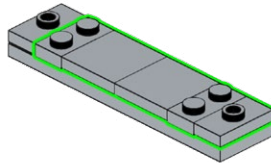

3

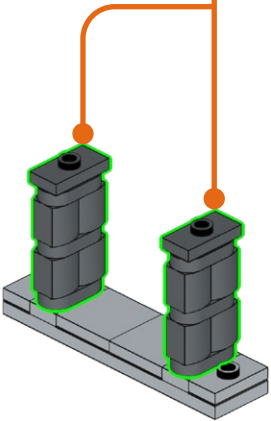

146

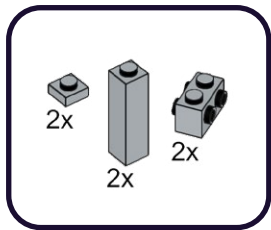

1

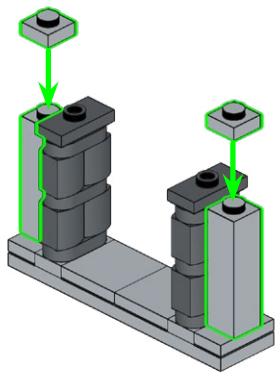

2

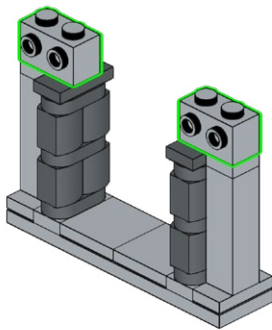

147

1x 2x

ARF-WW30

1x

148

1x 1x

1

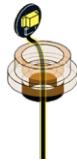

2



1



2

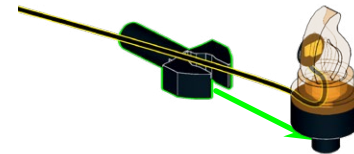

2x

149

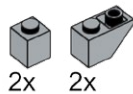

1

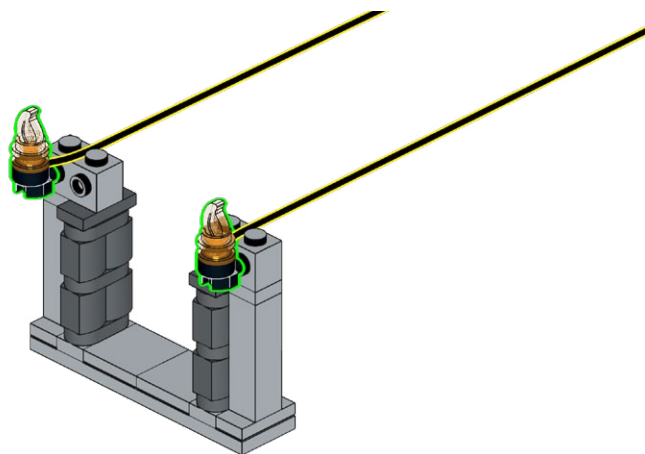

2

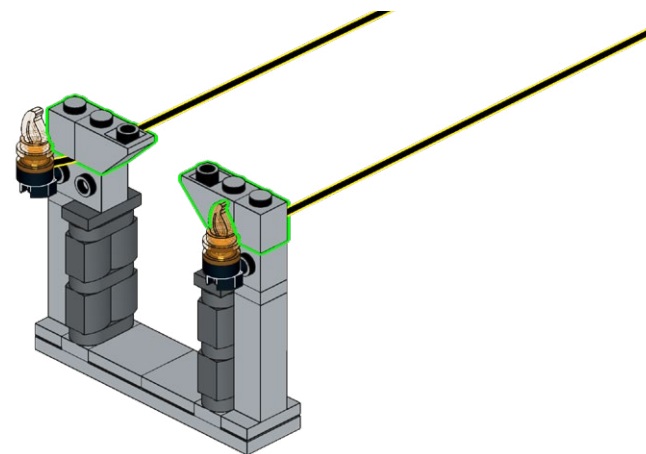



150

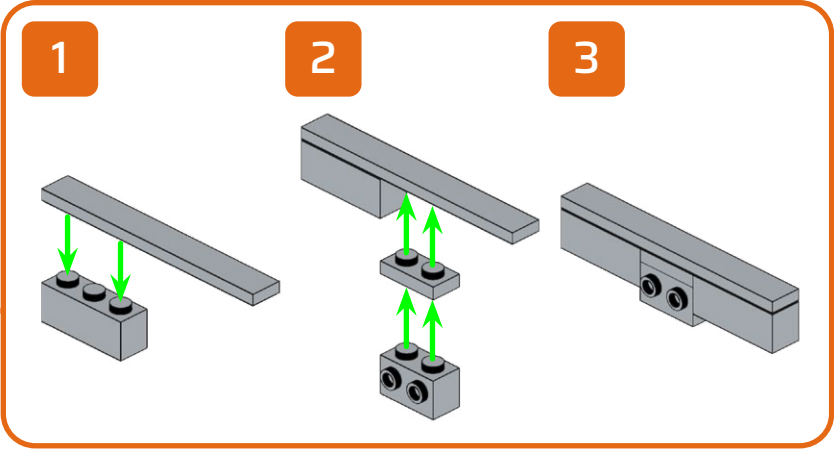
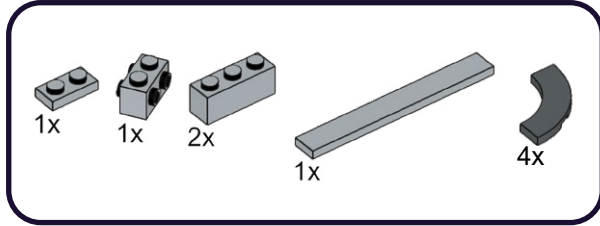

1

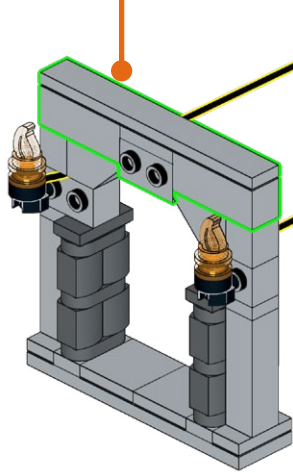

2

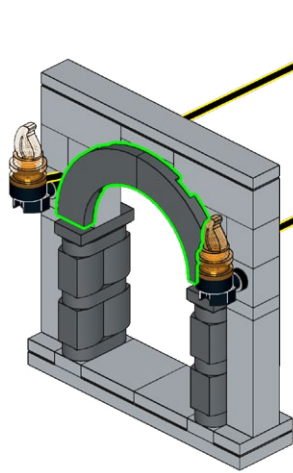

3

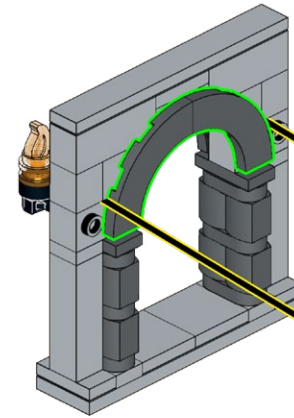

151

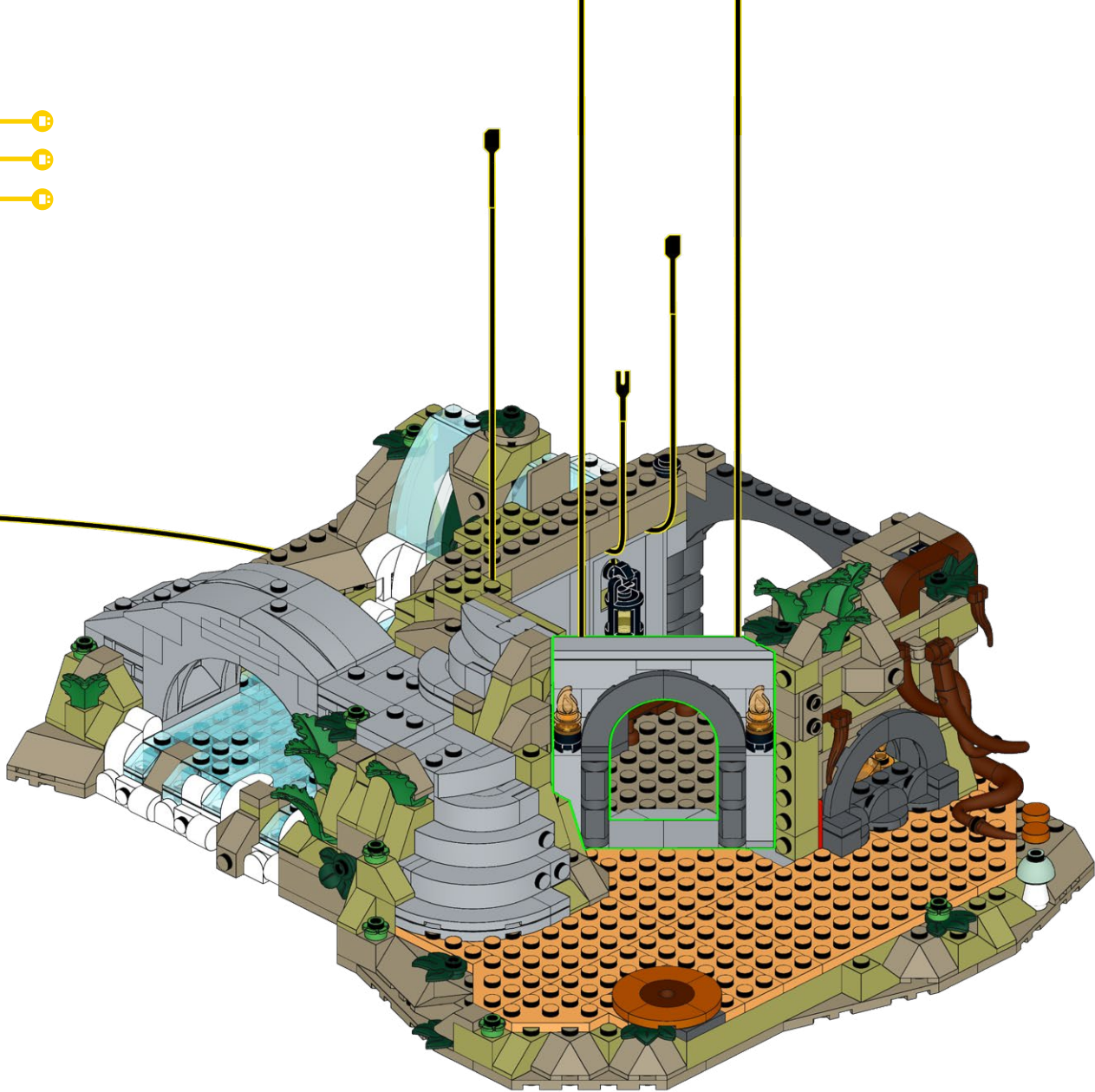

152

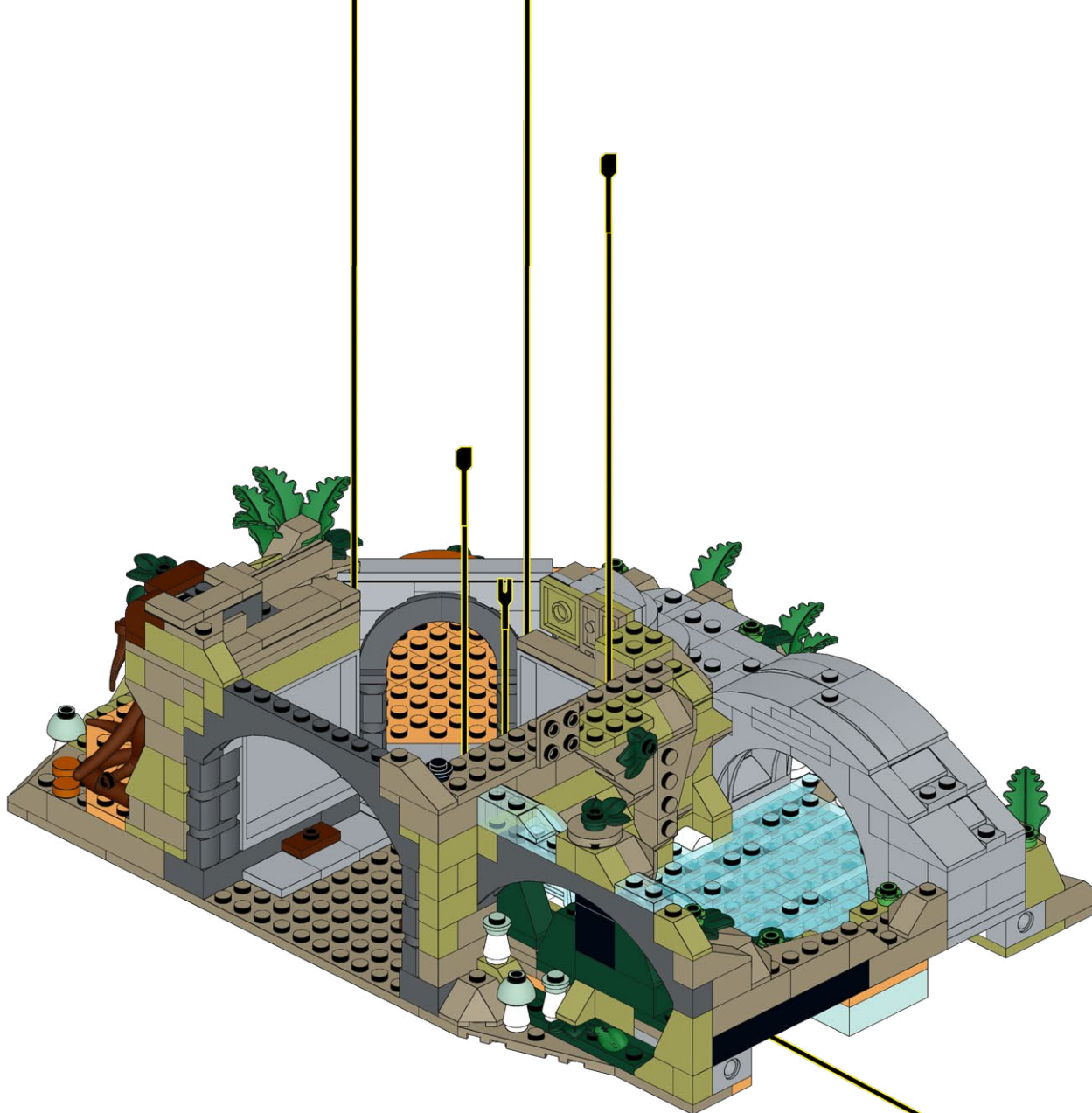

153

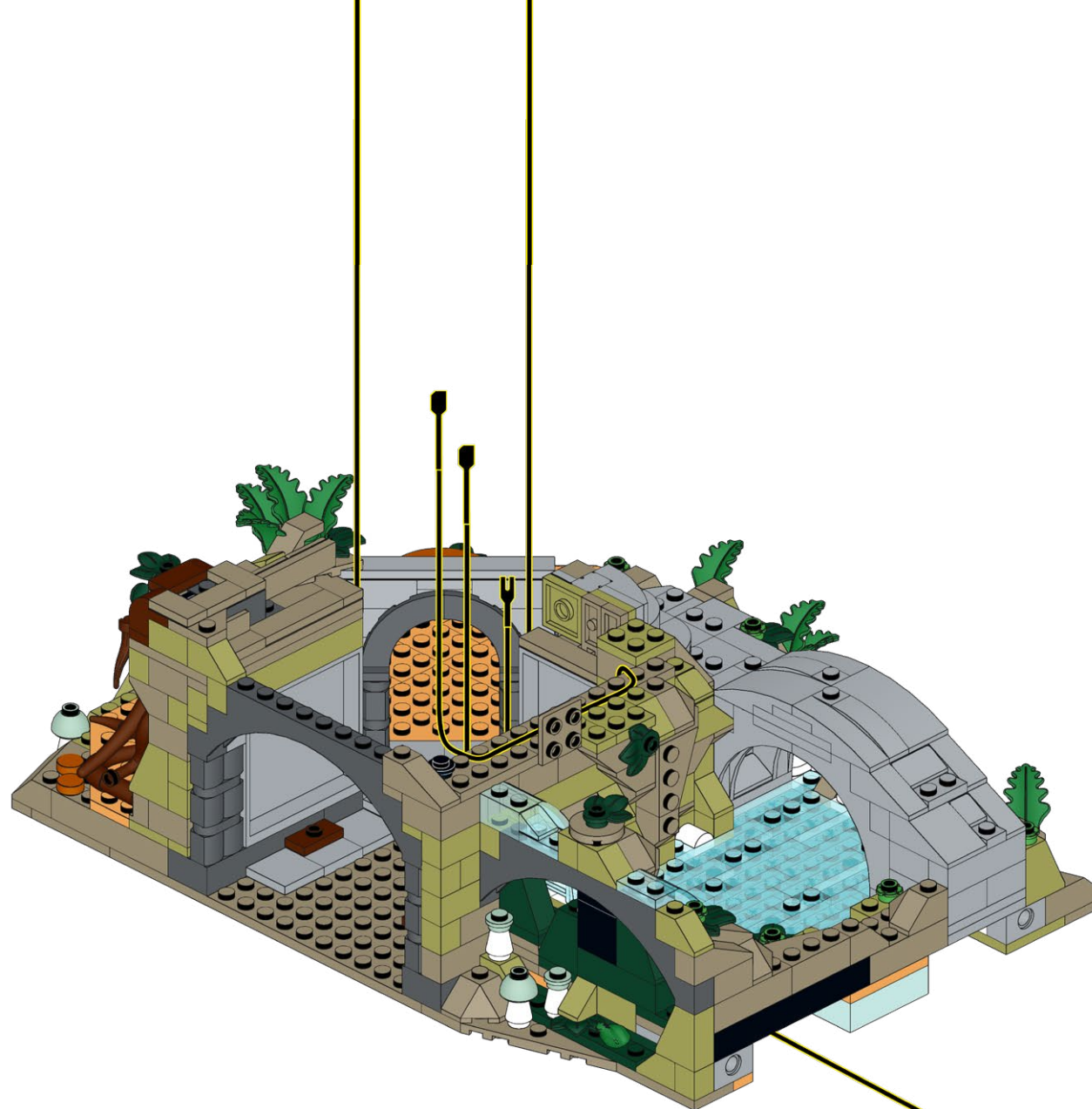

154

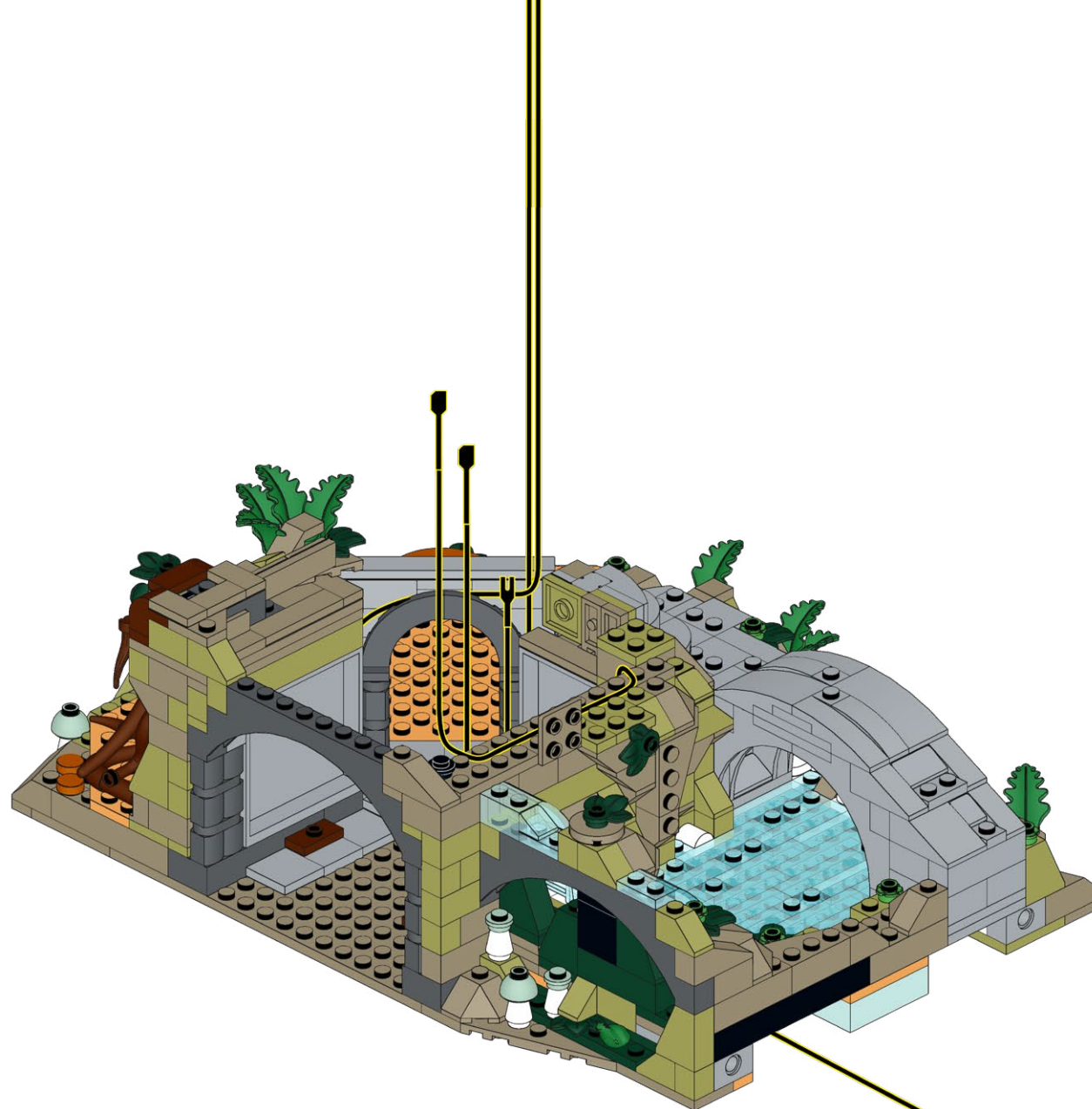

155



156



157

1x





158



159

1x

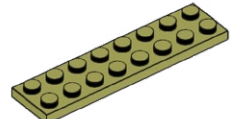

1x



160

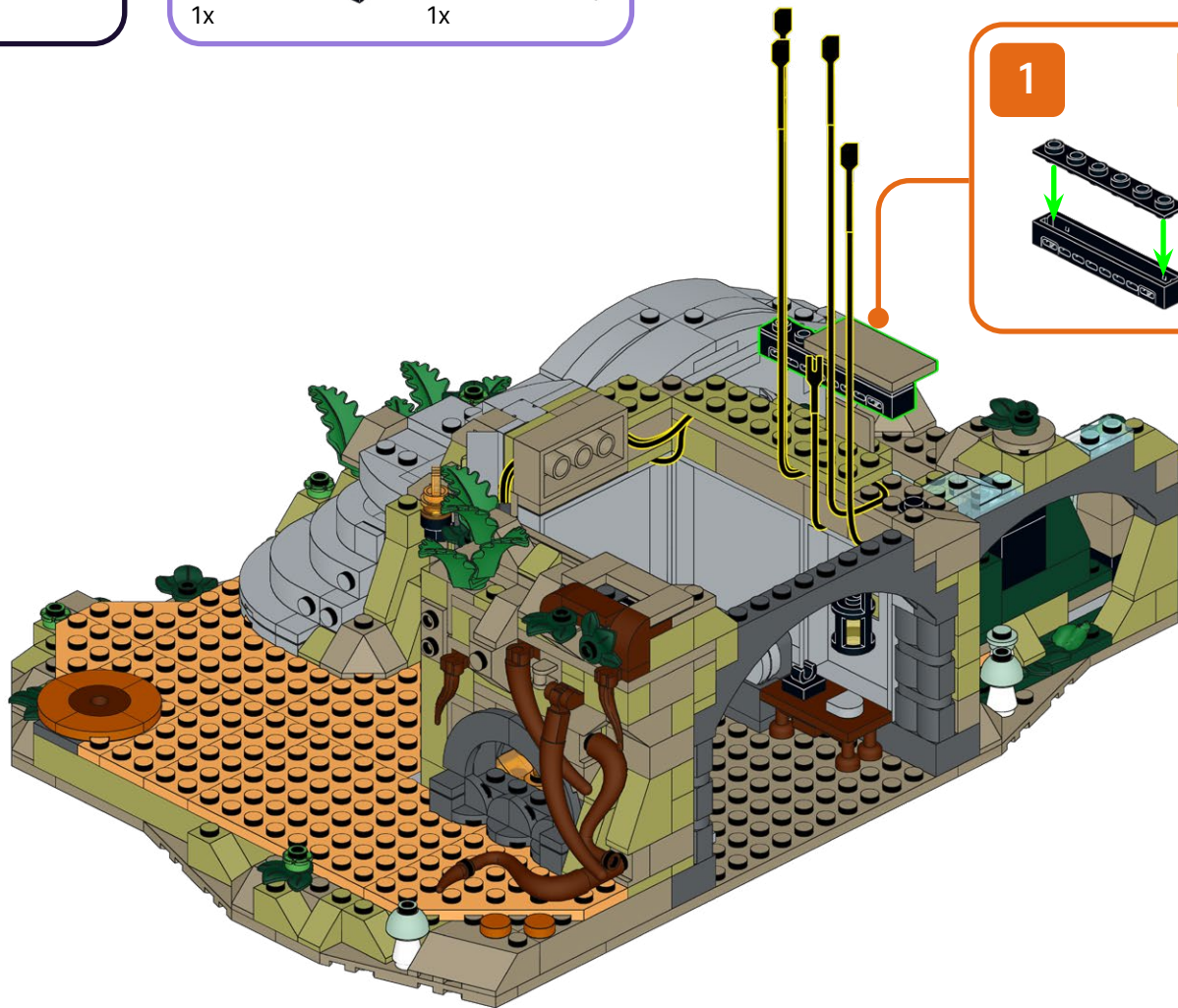
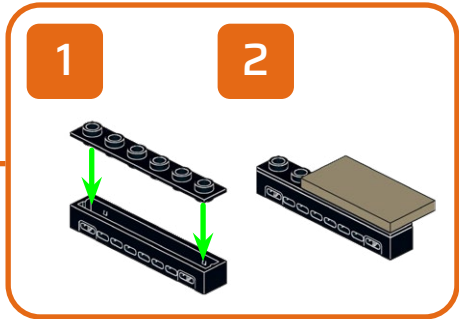
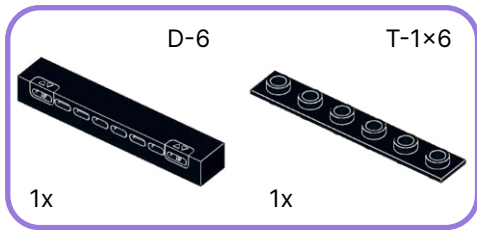
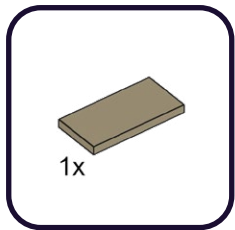

161

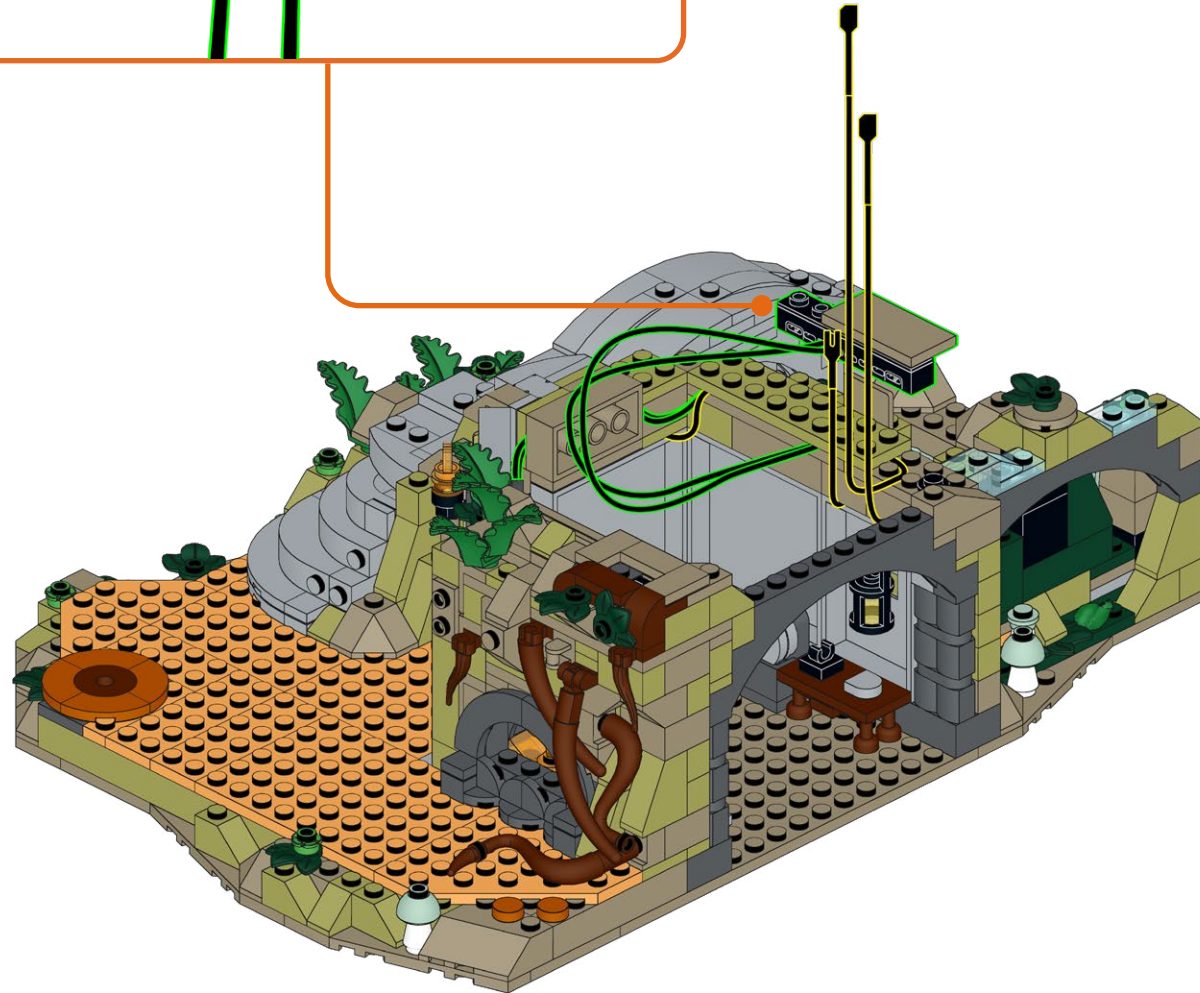
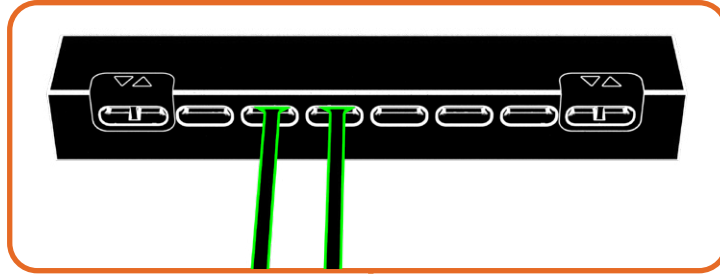

162

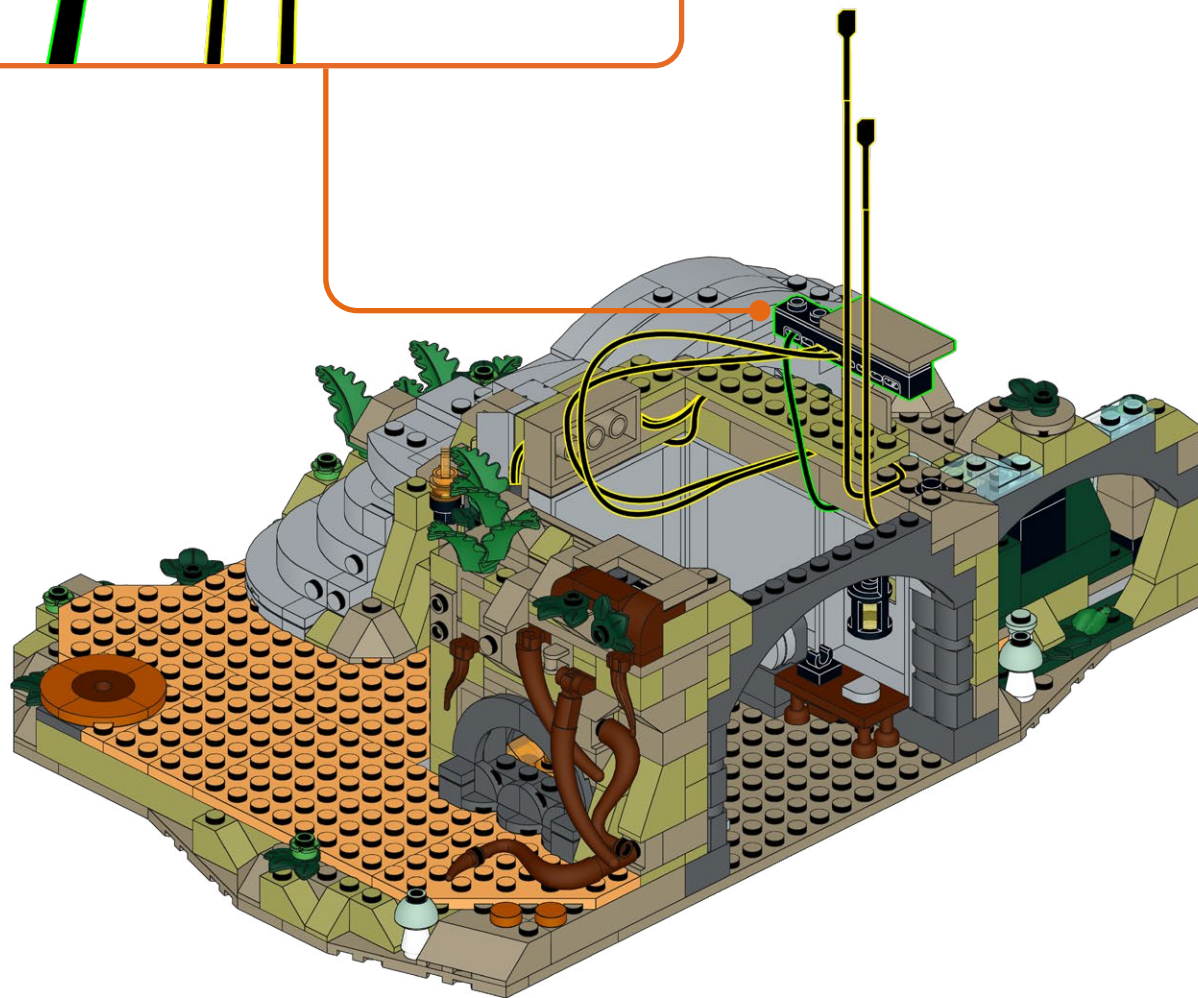
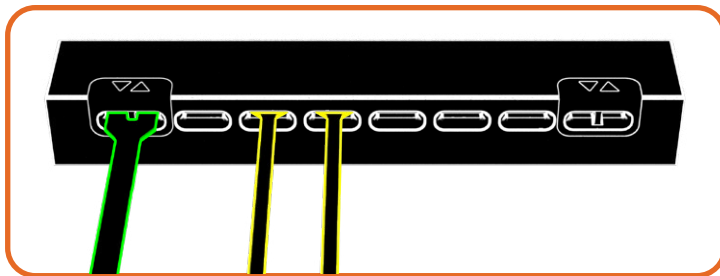

163

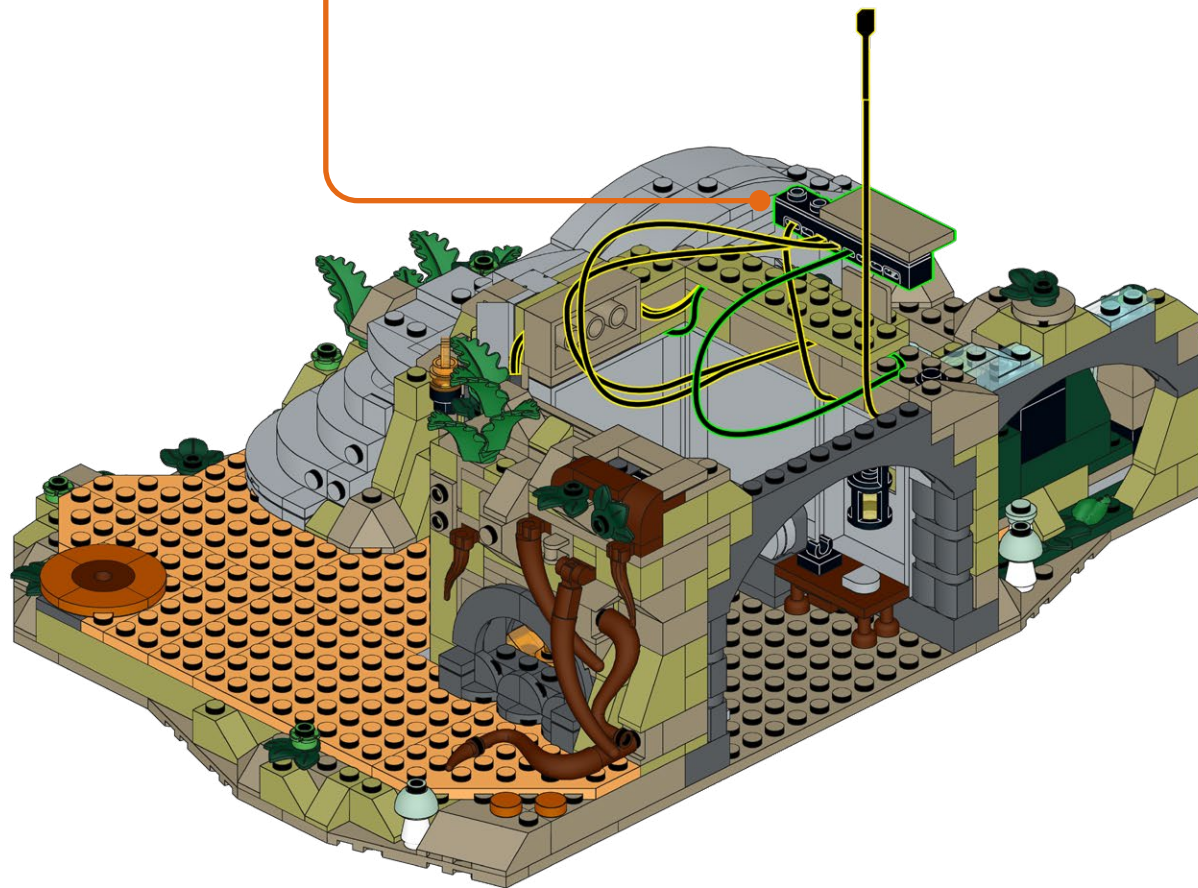
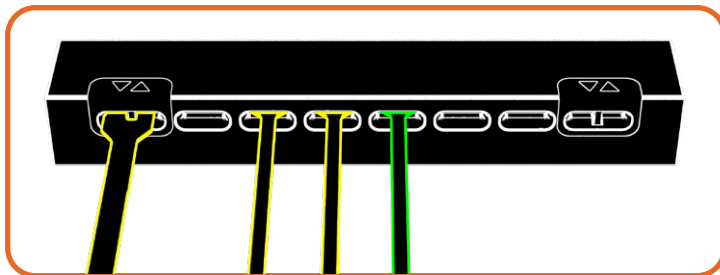

164

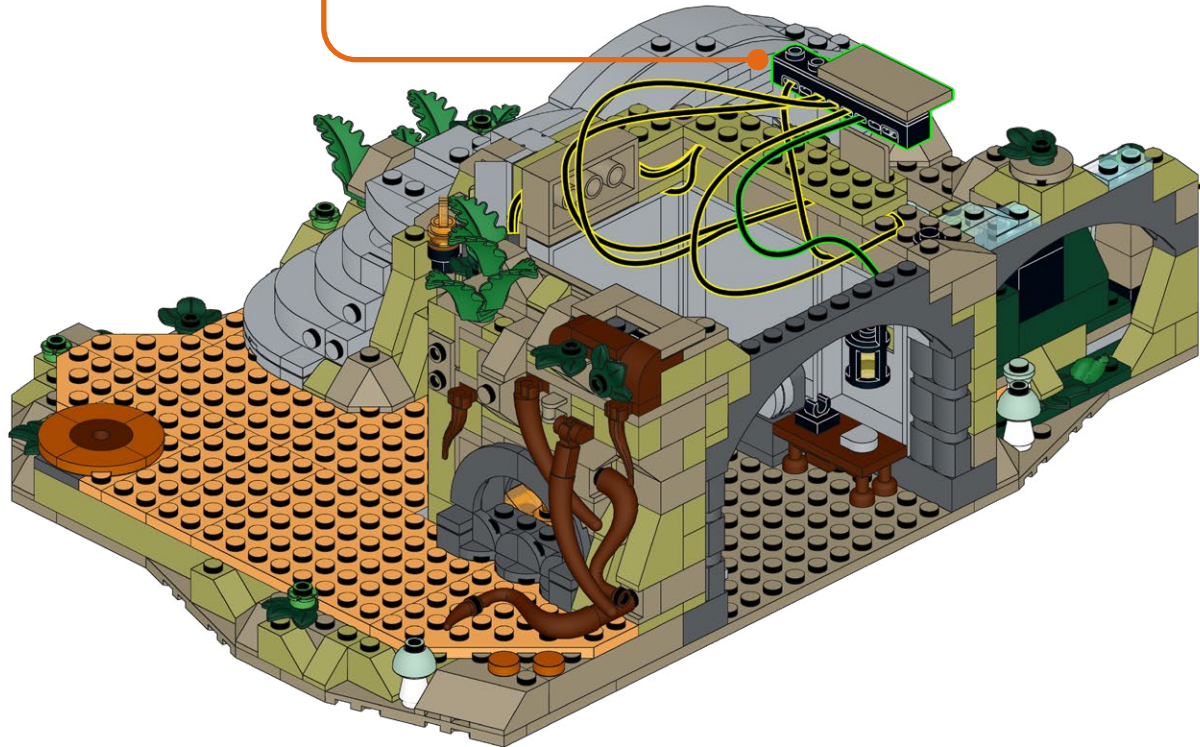
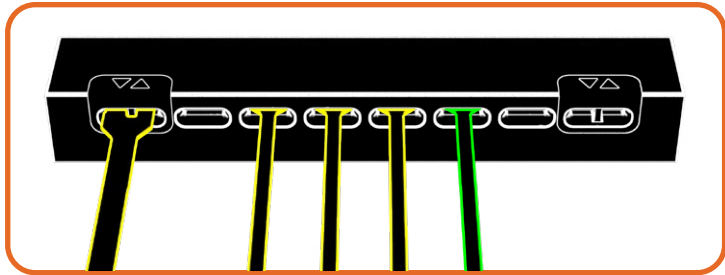

165





166

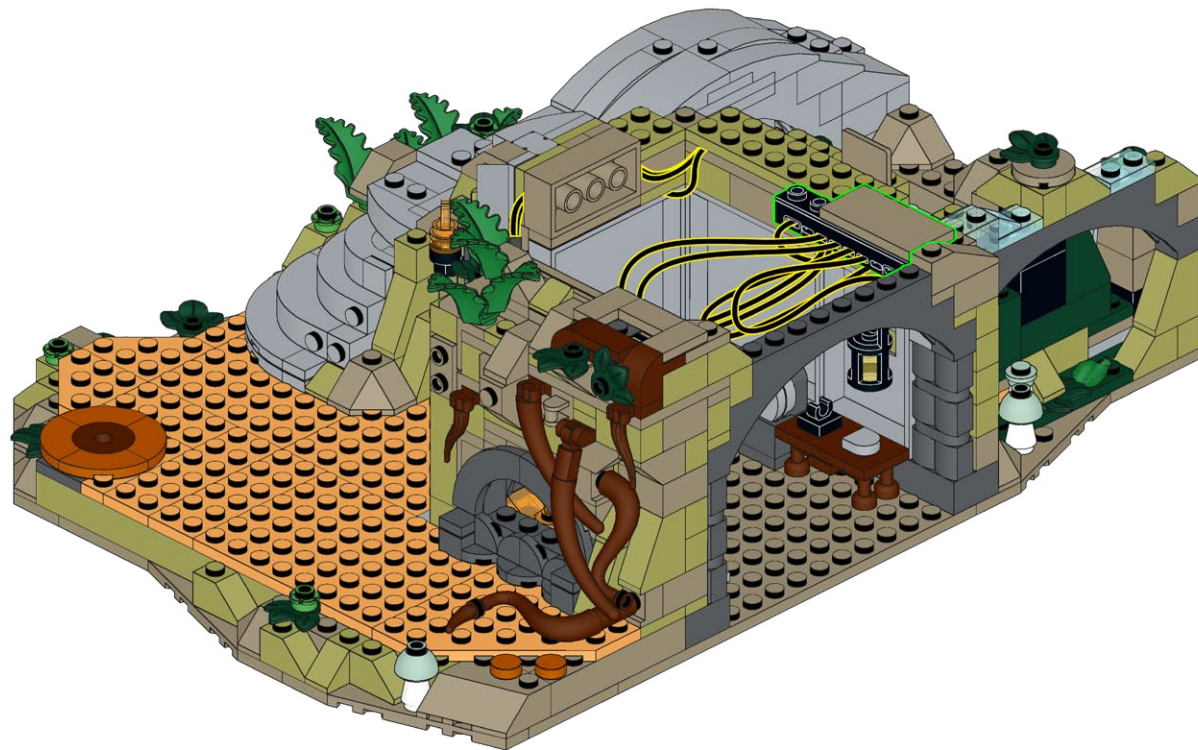

167

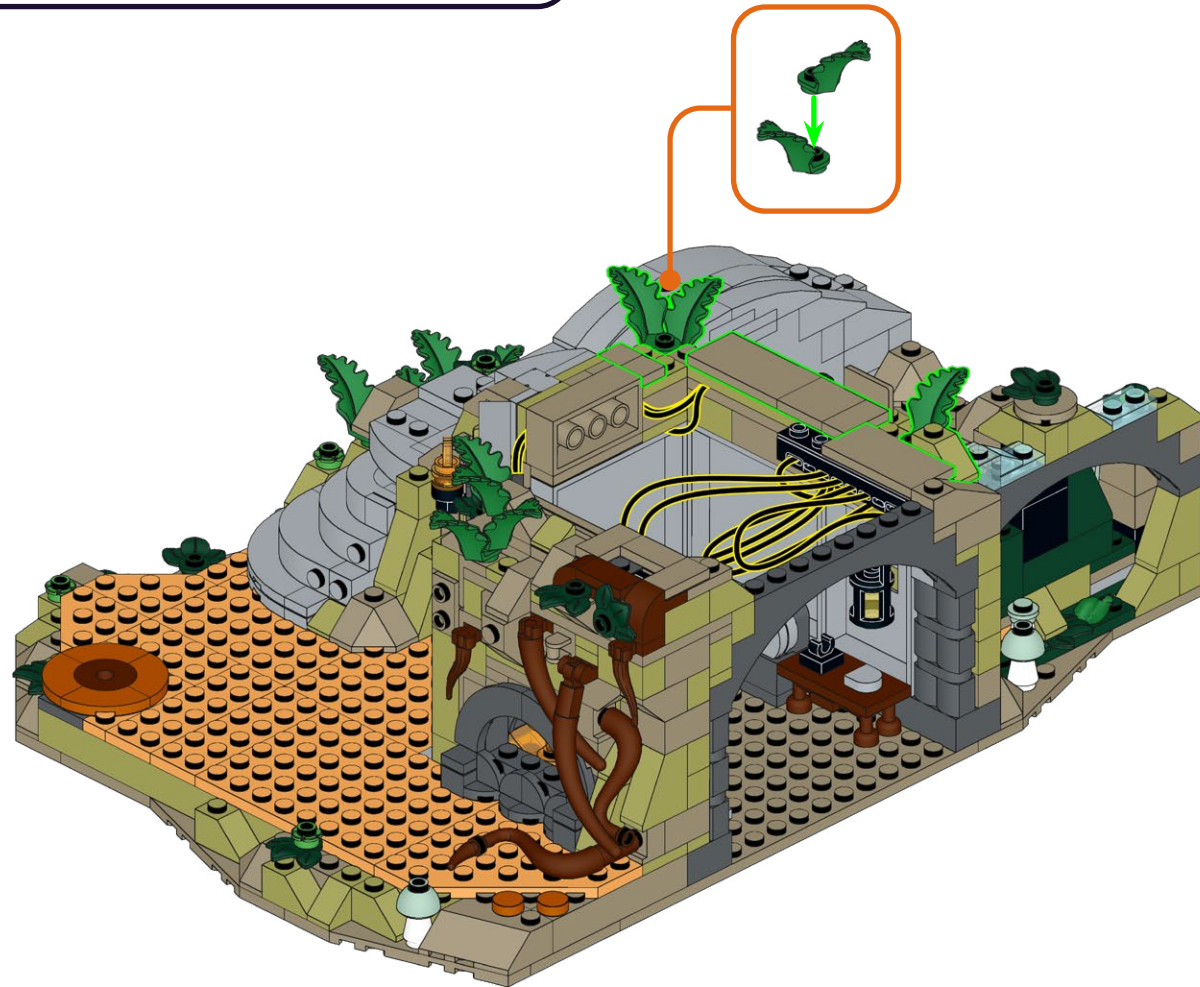
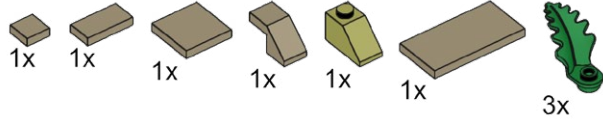

168

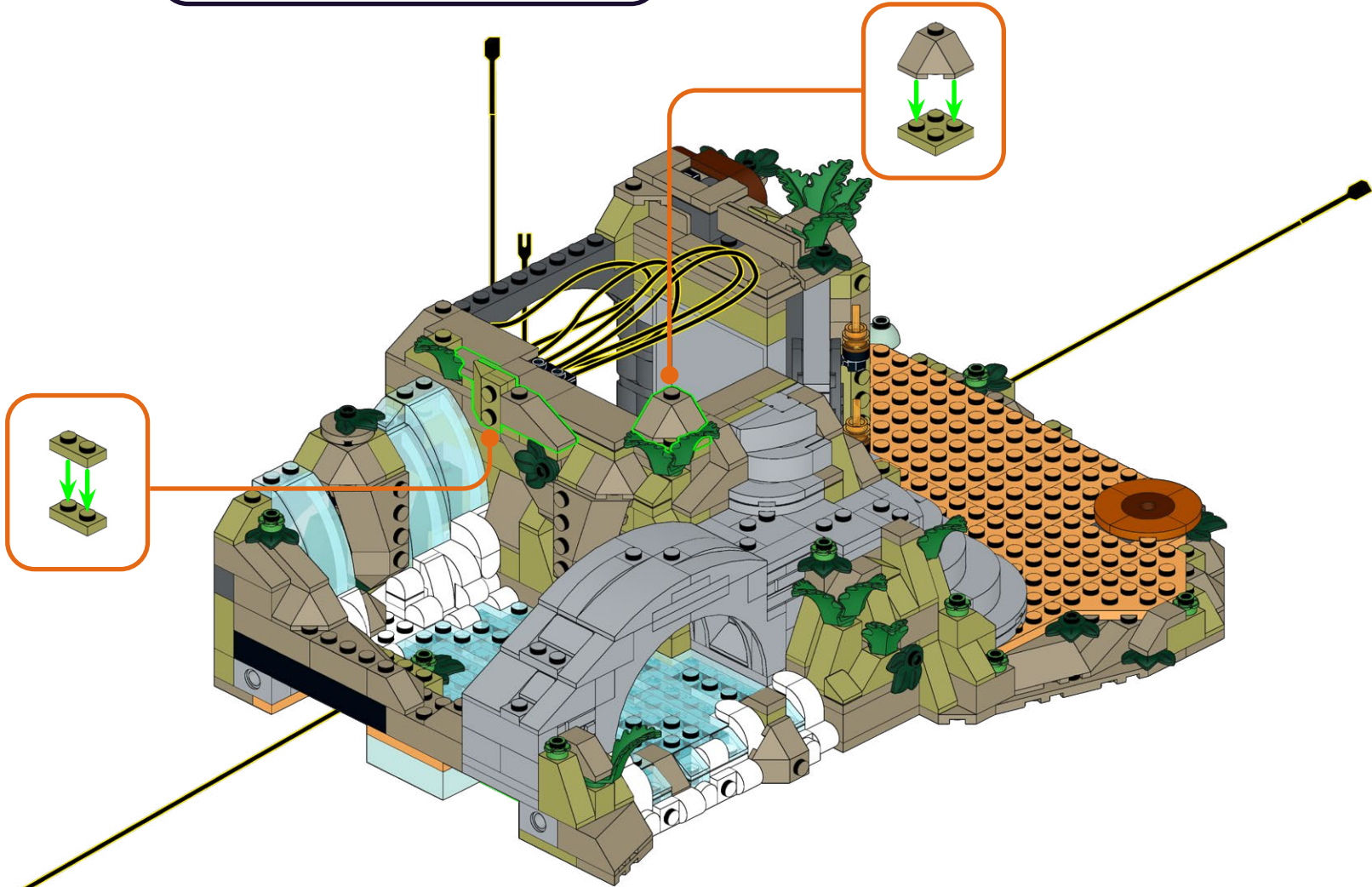
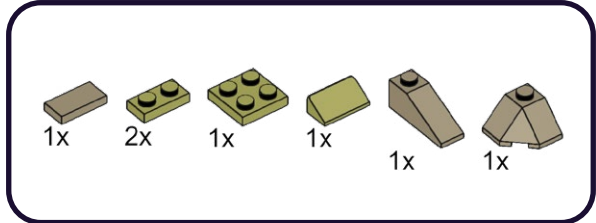

**HOLD UP!**

You might notice some bags are out of order, as well as left over pieces, but that's ok! We're changing the way you build LEGO!

**HALTEN!**

Möglicherweise stellen Sie fest, dass einige Beutel nicht in Ordnung sind und auch Teile übrig bleiben, aber das ist in Ordnung! Wir verändern die Art und Weise, wie Sie LEGO bauen!

**TENIR BON!**

Vous remarquerez peut-être que certains sacs sont en panne, ainsi que des morceaux restants, mais ce n'est pas grave ! Nous changeons la façon dont vous construisez LEGO !

**SOSTENERE!**

Potresti notare che alcune borse sono fuori uso, così come alcuni pezzi avanzati, ma va bene! Stiamo cambiando il modo in cui costruisci i LEGO!

**¡SOSTENER!**

Puede que notes que algunas bolsas están fuera de orden, así como piezas sobrantes, ¡pero está bien! ¡Estamos cambiando la forma de construir LEGO!

**耽误!**

您可能会注意到有些袋子坏了, 还有剩余的碎片, 但这没关系! 我们正在改变您搭建乐高的方式!

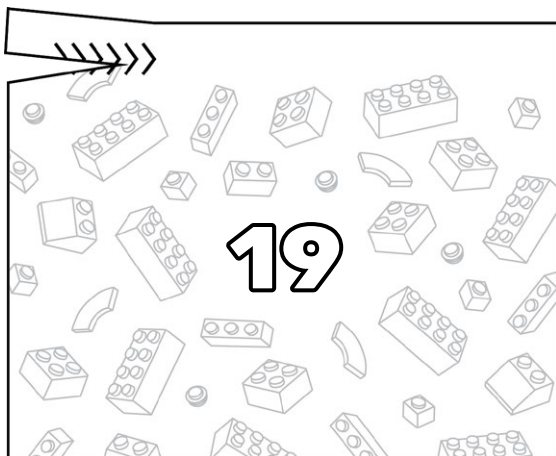
**Open LEGO® Bag 19**

169

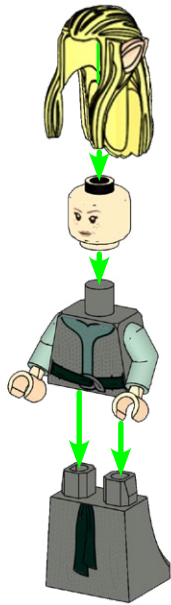
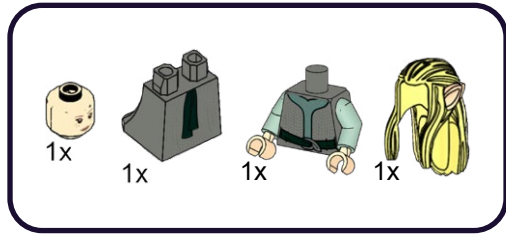

170



171

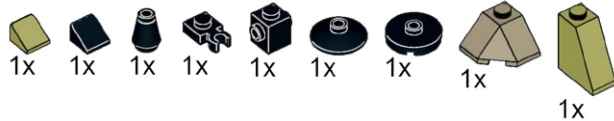

1 2 3 4

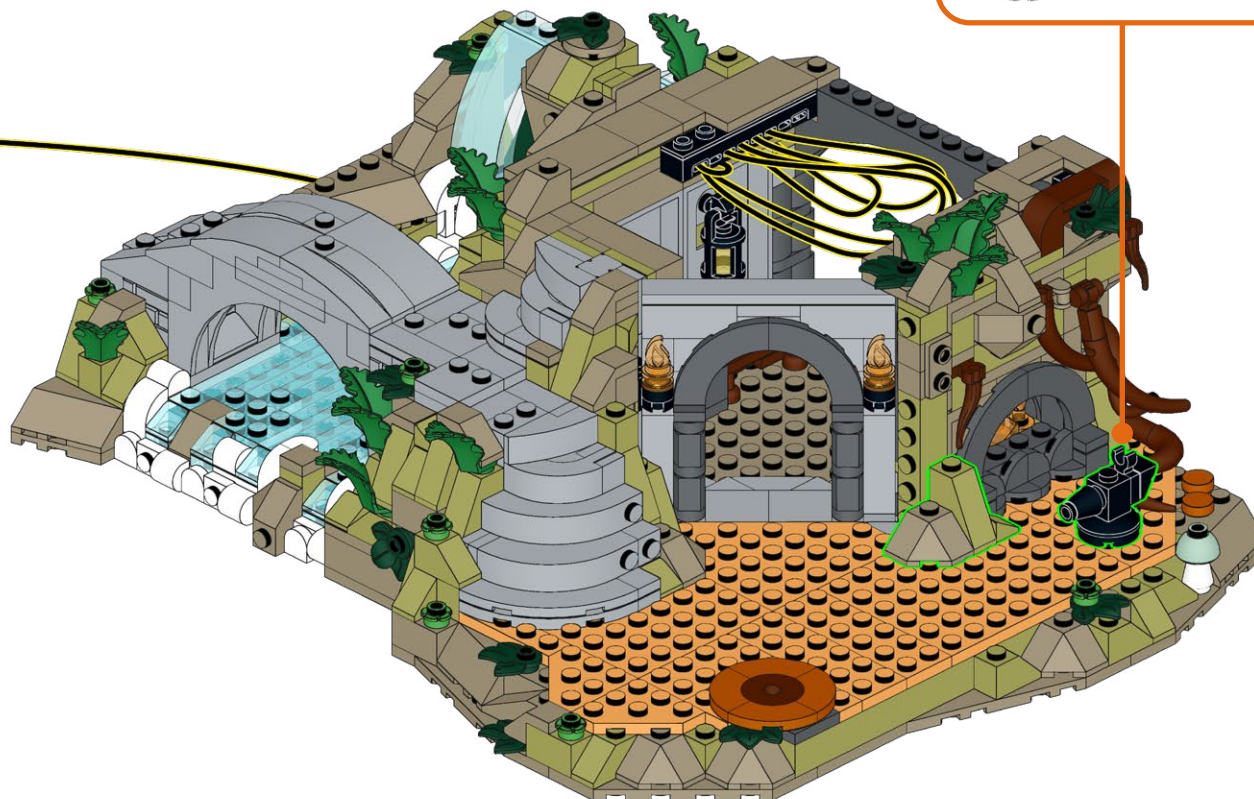
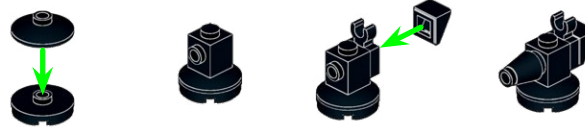

172

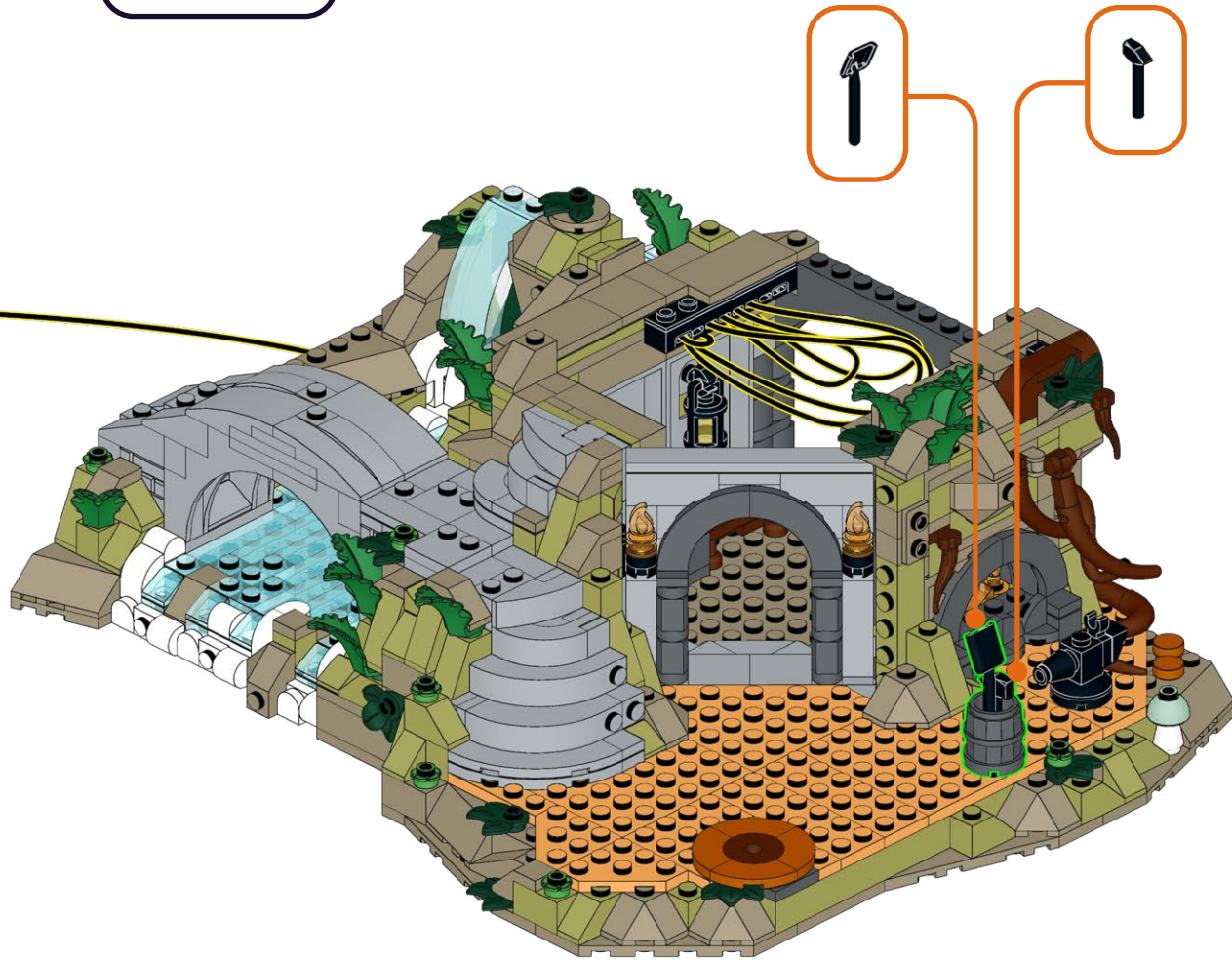

173



1x

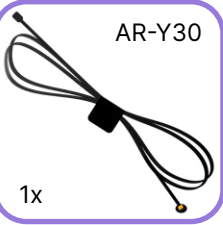

1x

1

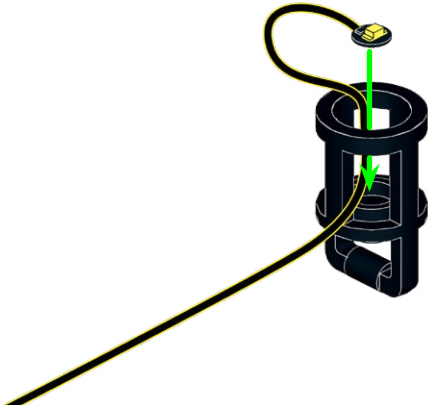

2

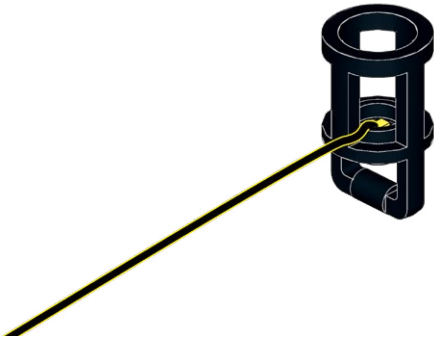

174



1x



1x



1x

1

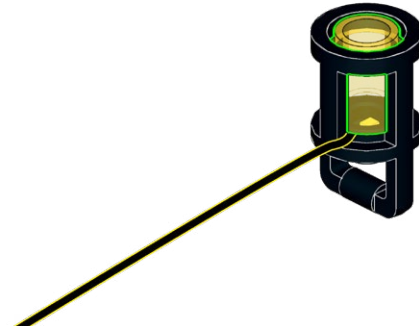

2

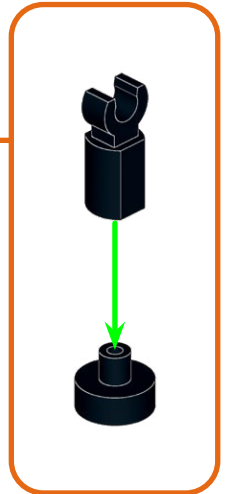
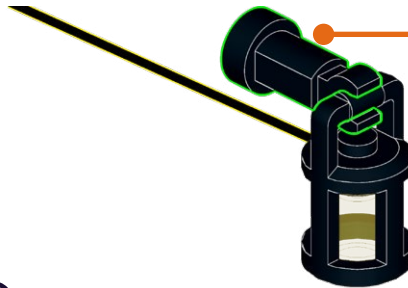
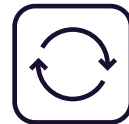



175

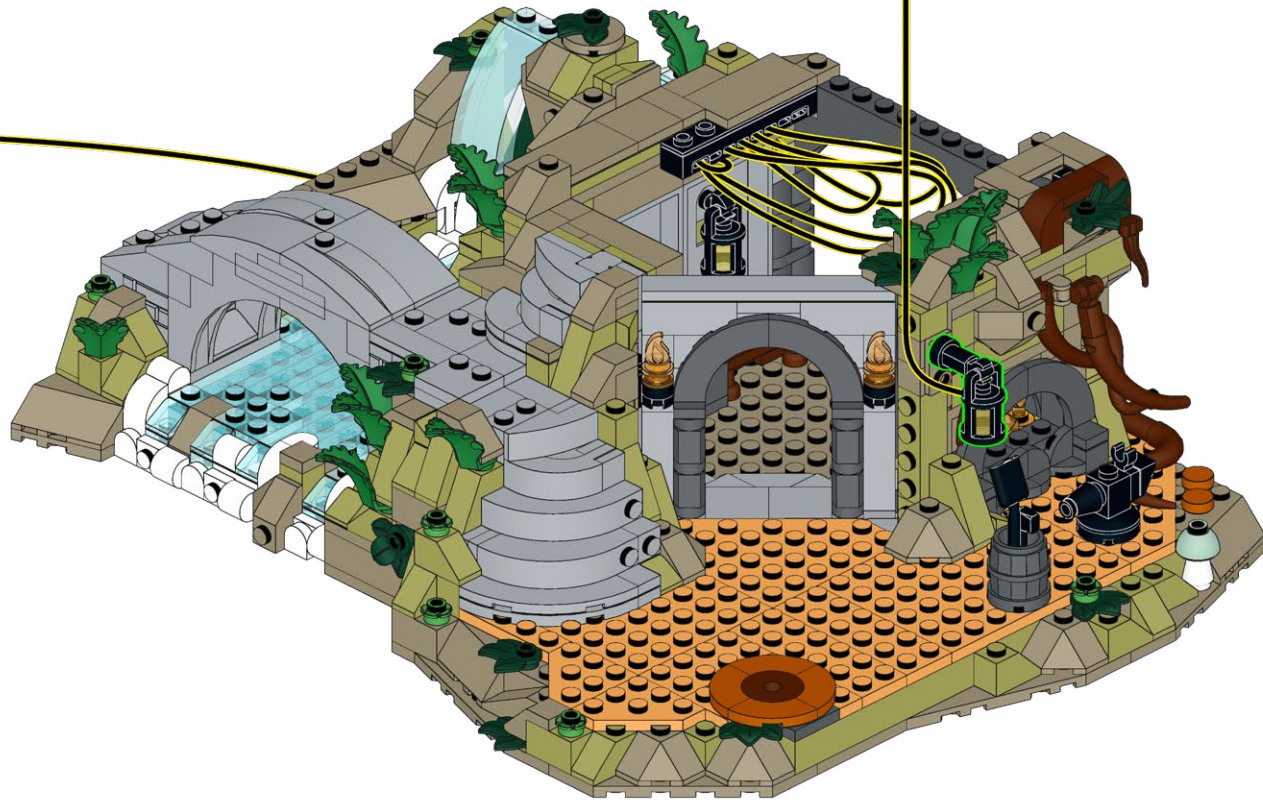

176

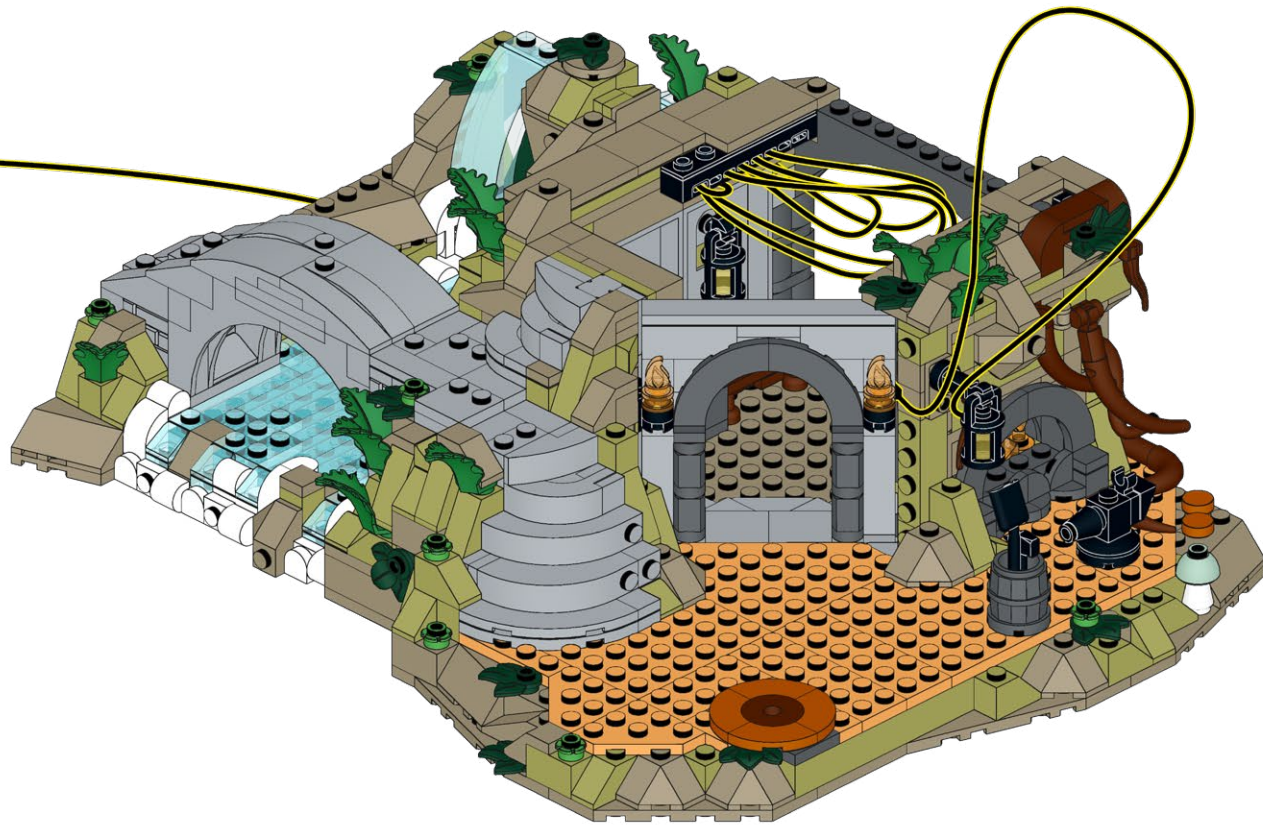

177

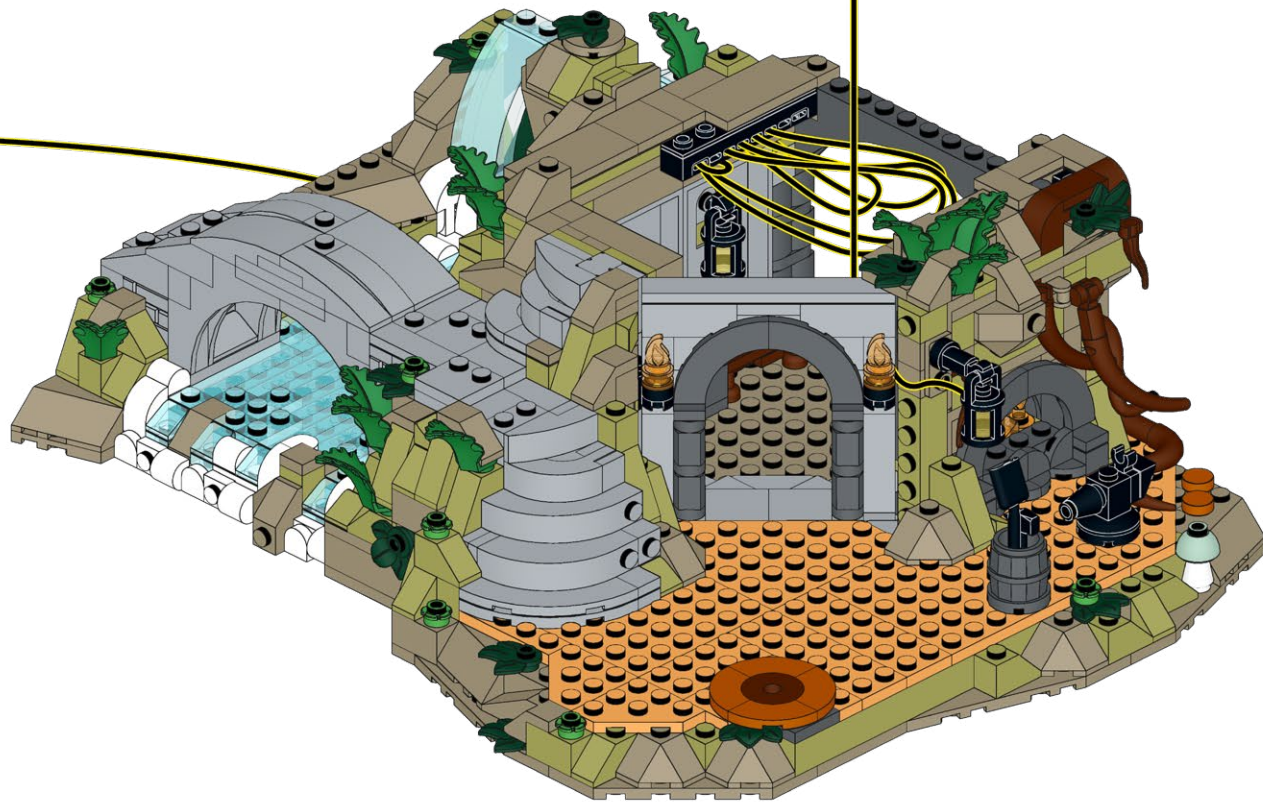

178



179



180

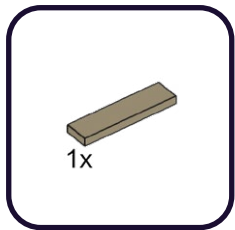

181

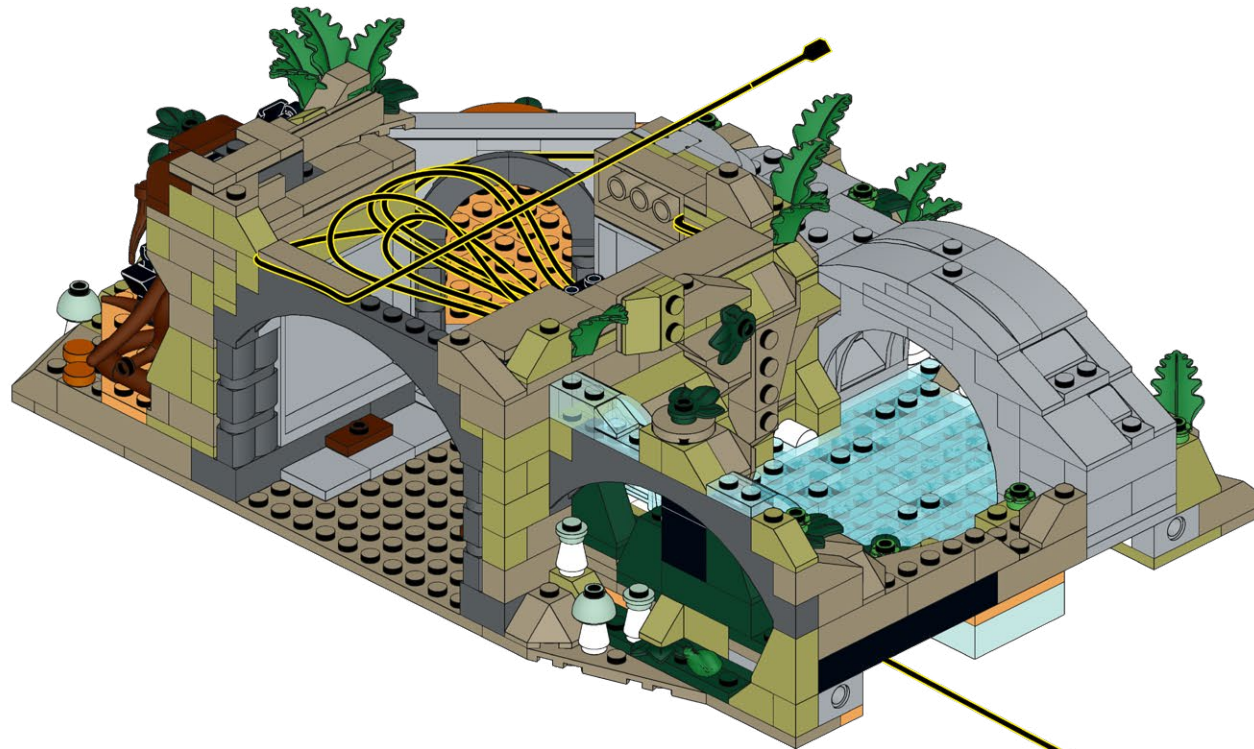

182

1x

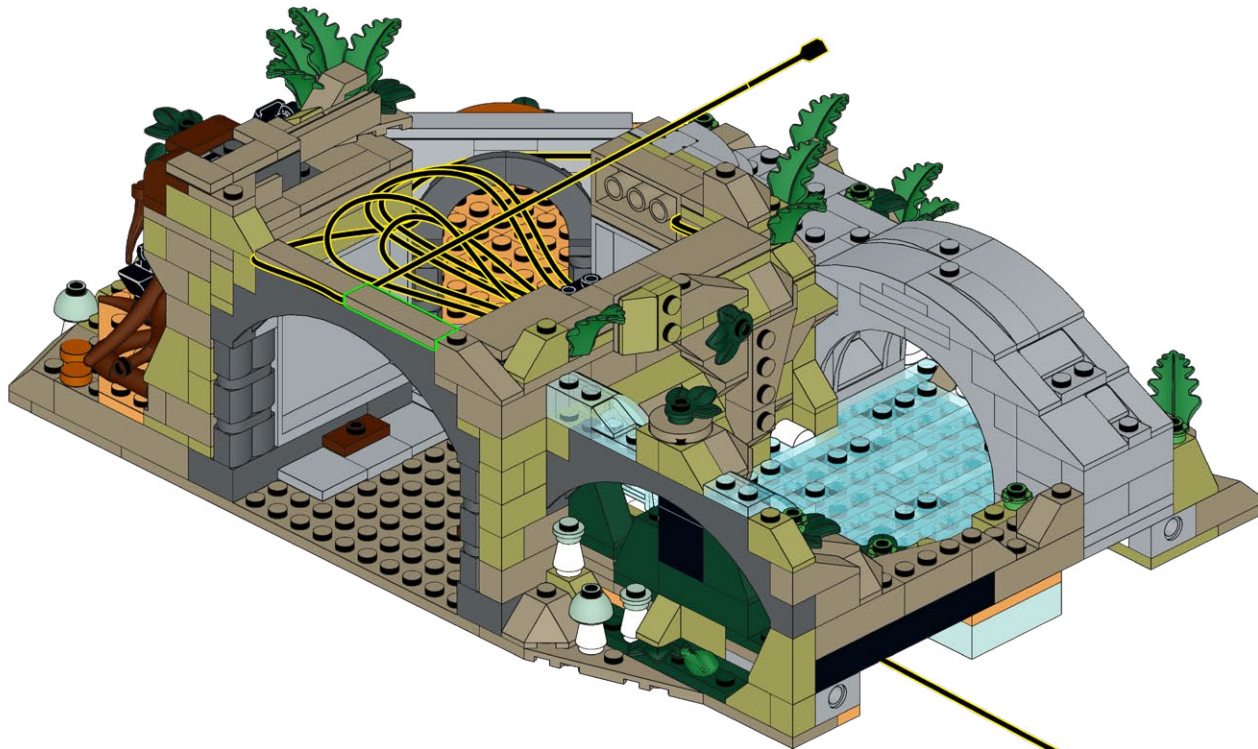



183



184

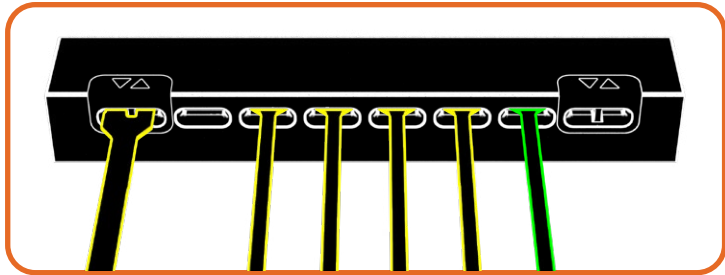

185

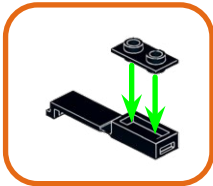
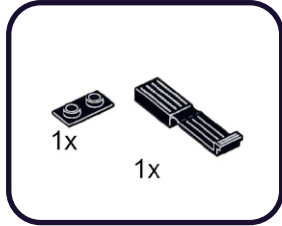

186



187



188

- 2x
- 1x
- 3x
- 2x
- 2x

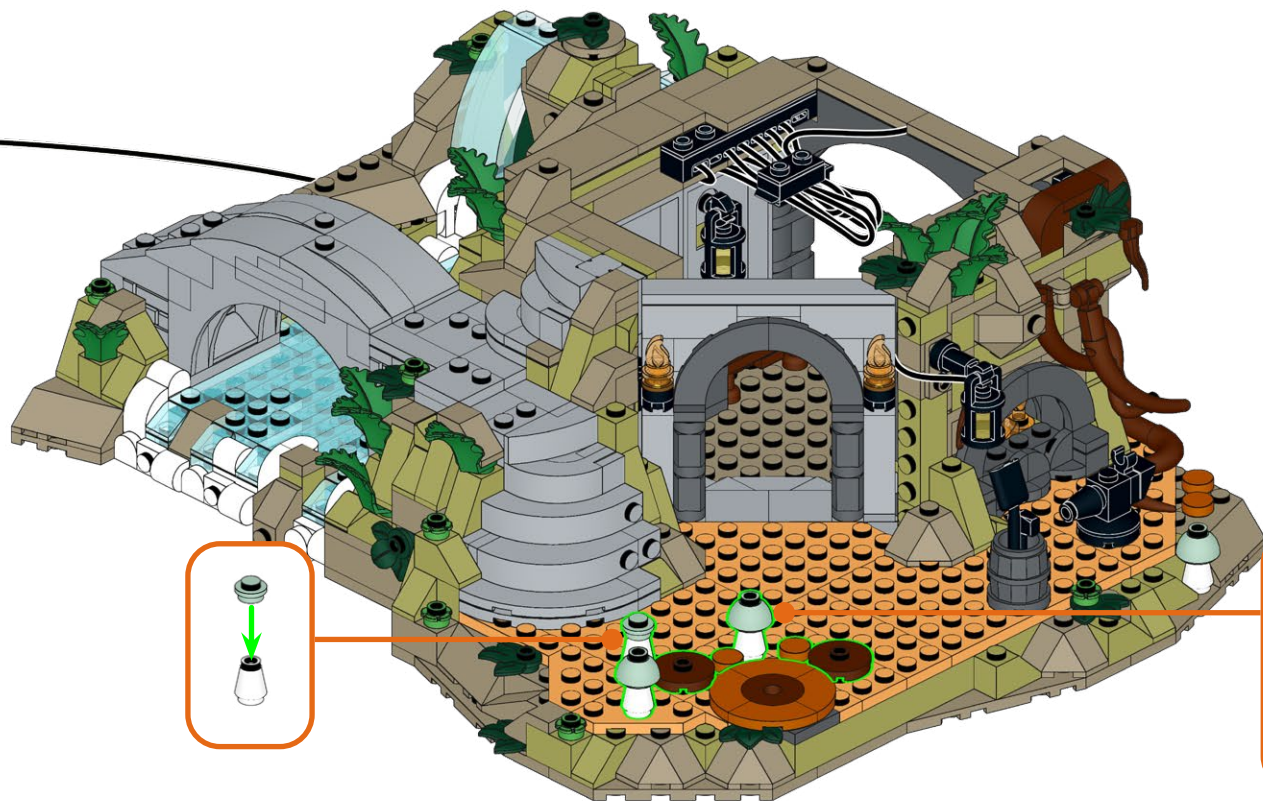

2x

189

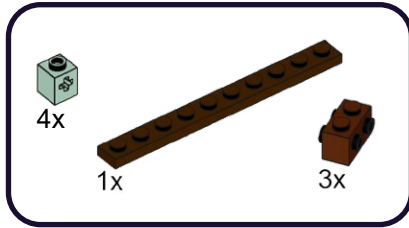

1

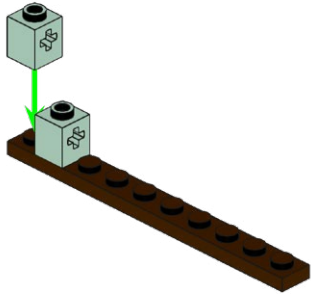

2

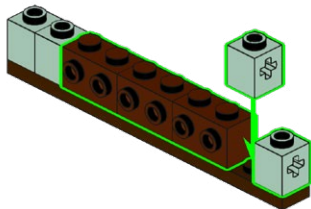

190

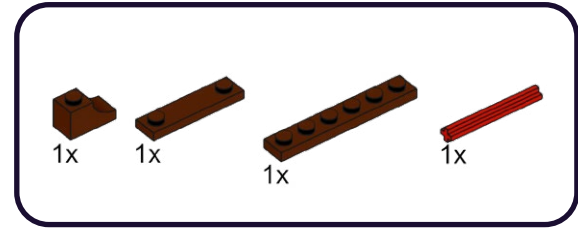

1

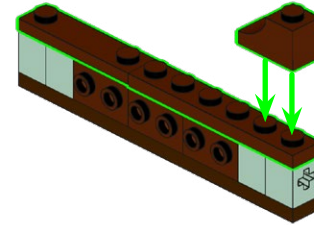

2

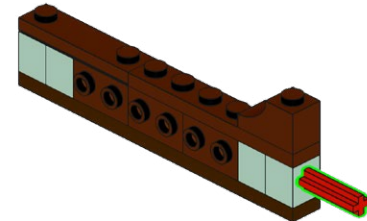

191

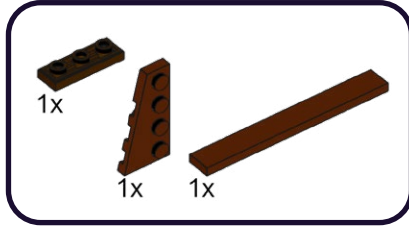

1

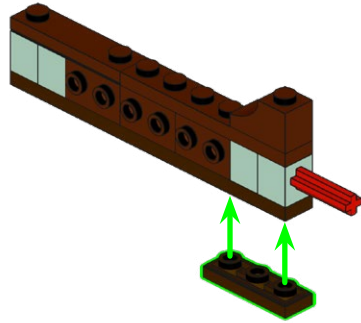

2

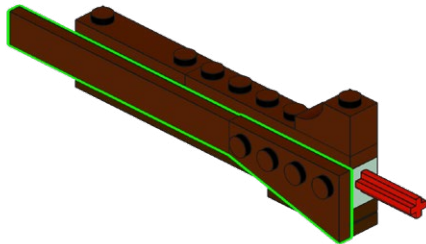

192

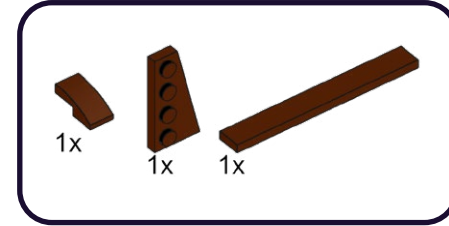

1

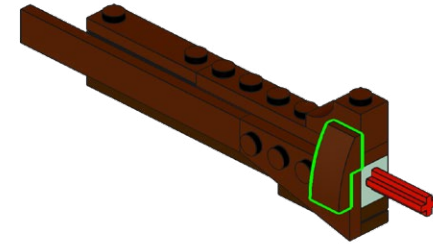

2

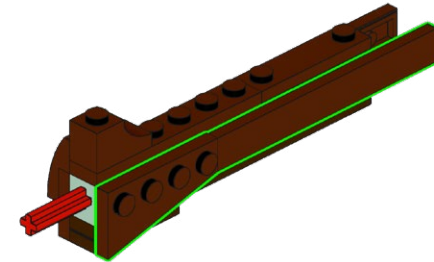



193

1x 1x

1

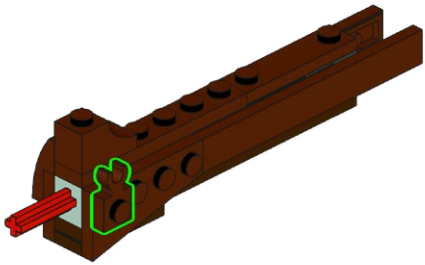

2

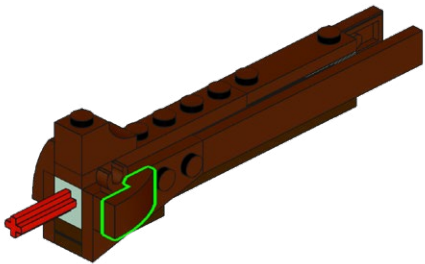

194

2x 1x 1x

1

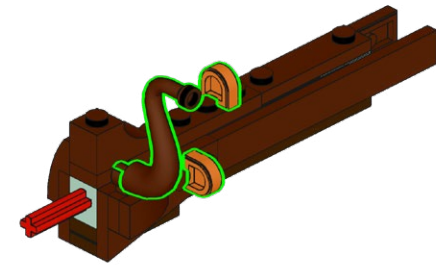

2

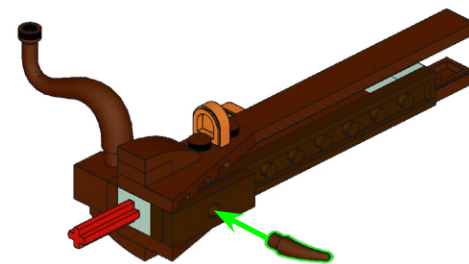
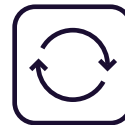

195

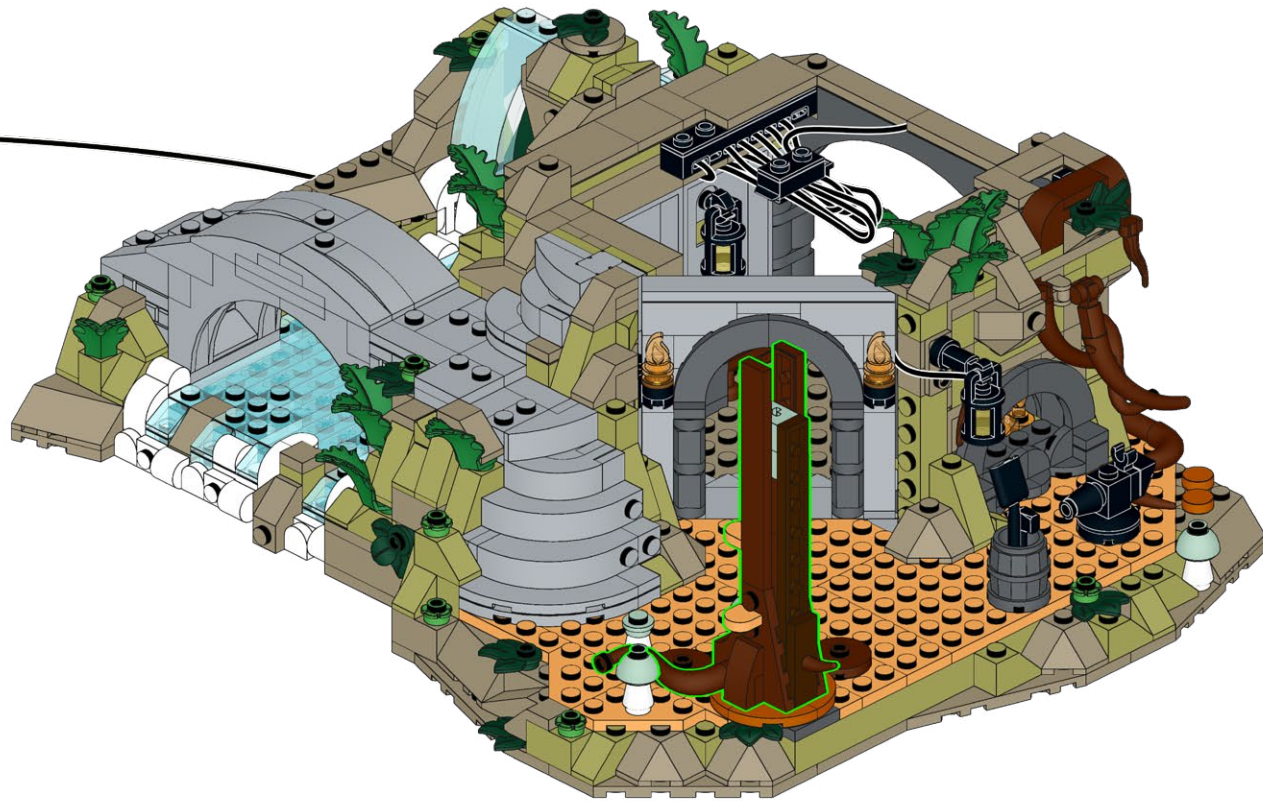

196

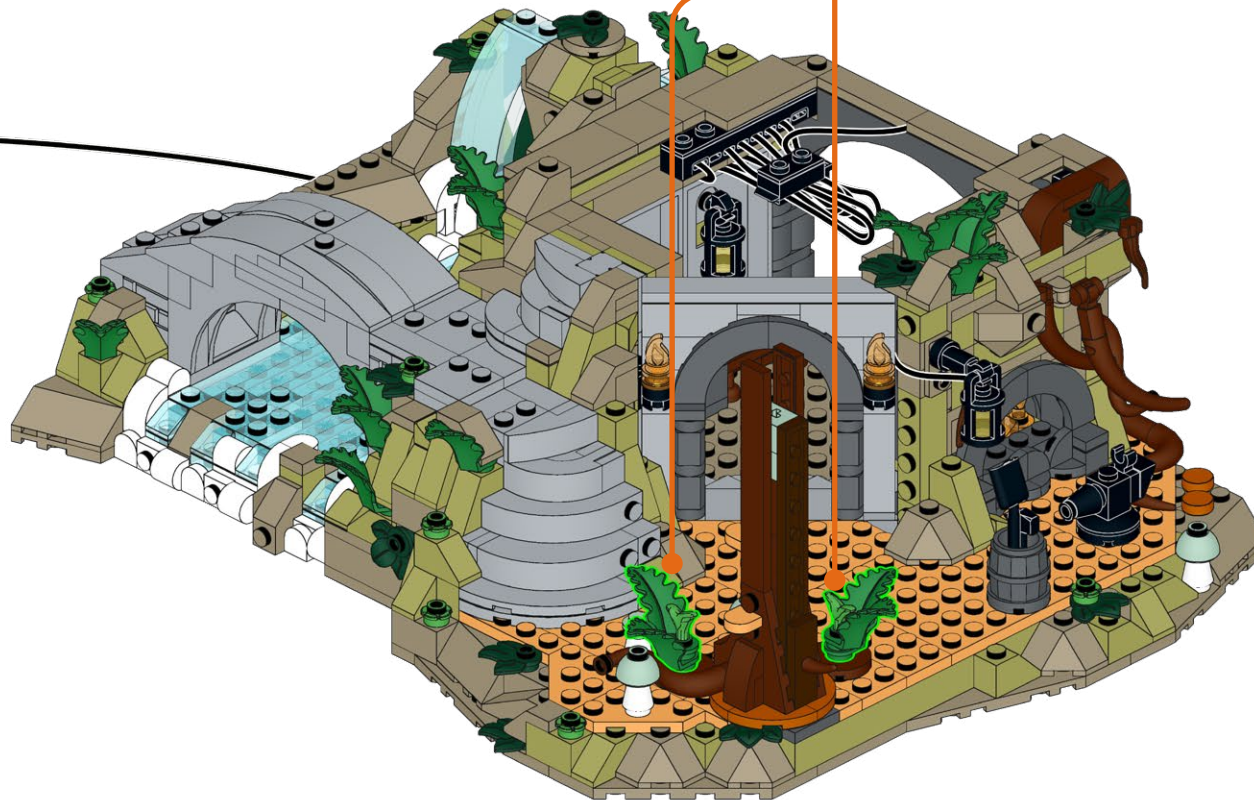
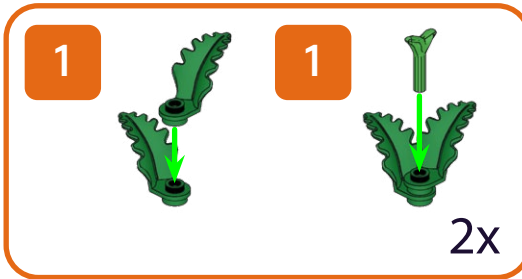

197



1

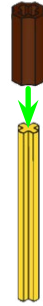

2



198



1



2

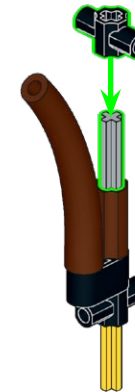

199

4x

1x

1x

200

1x

2x

1x

1

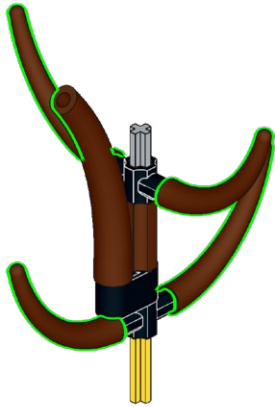

2

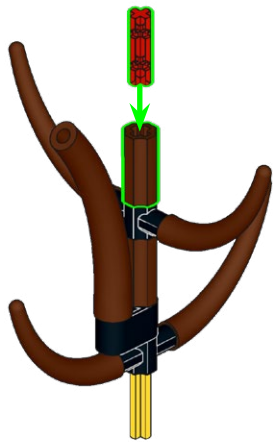

1

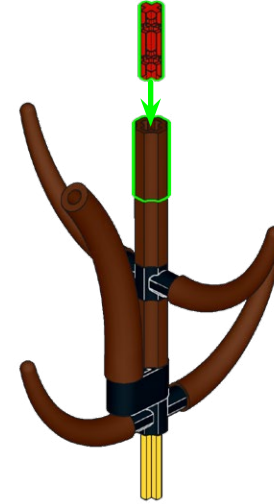

2

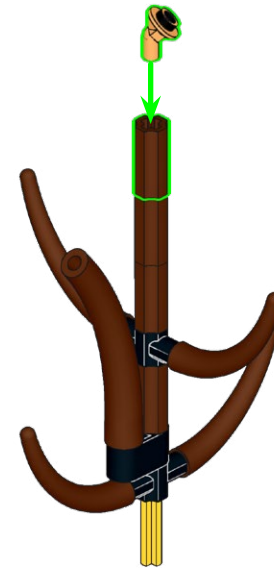

201

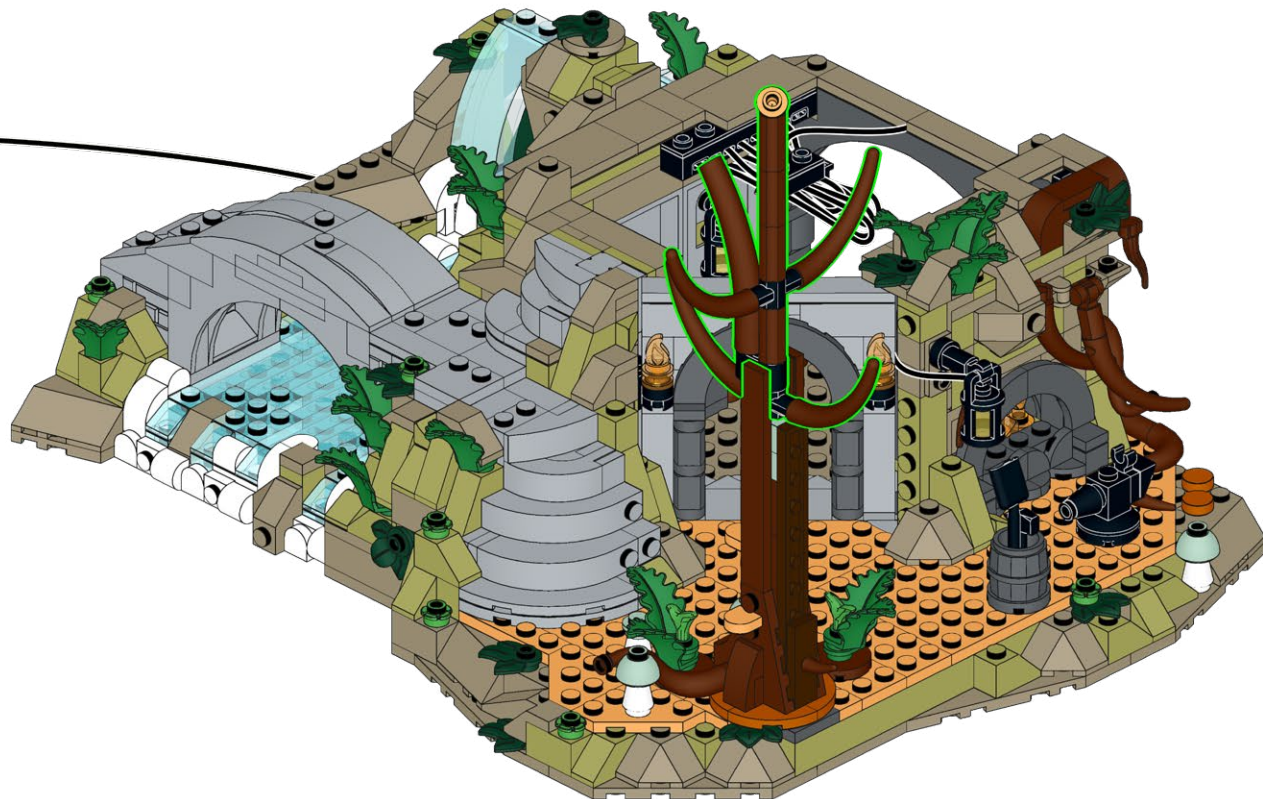

# 202

12x 8x 4x

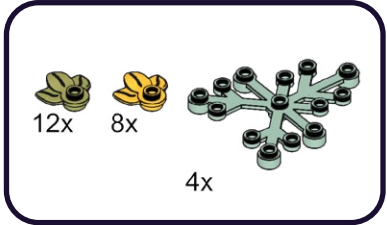

1 2 3 4x

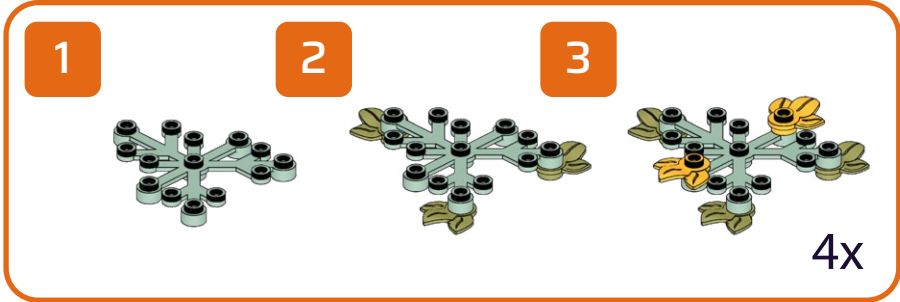

# 203

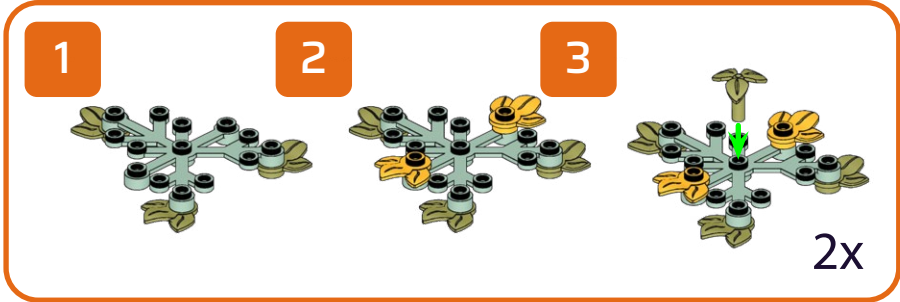
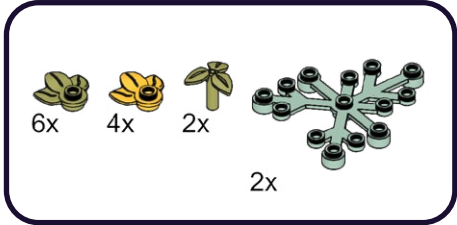



# 204

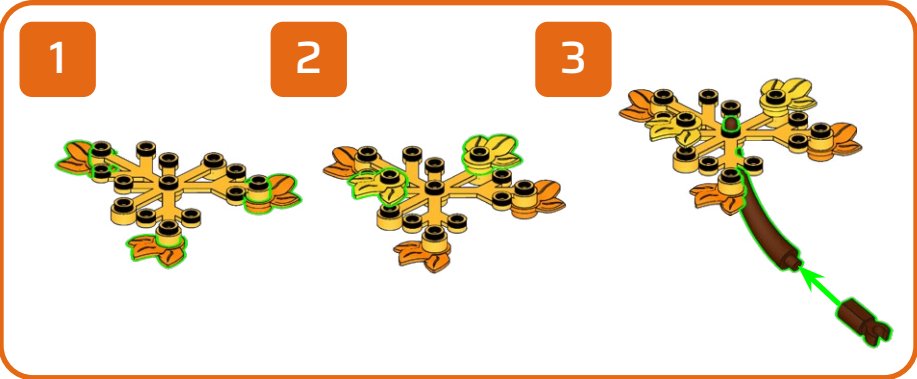

205

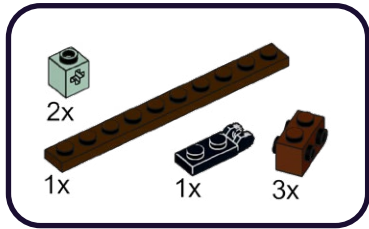

1

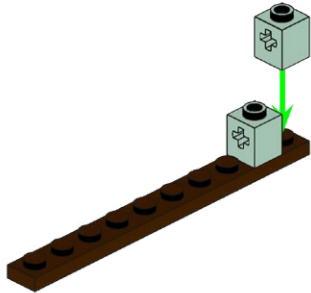

2

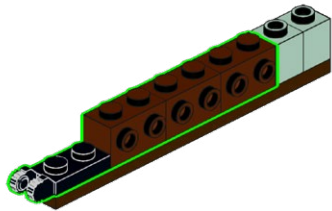

206

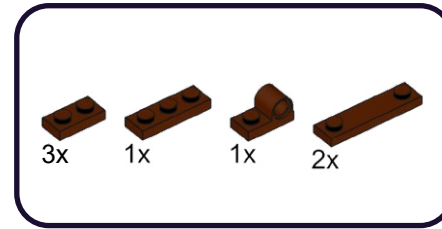

1

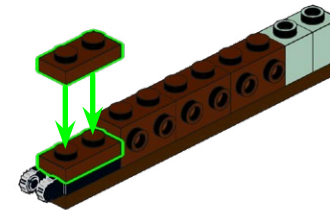

2

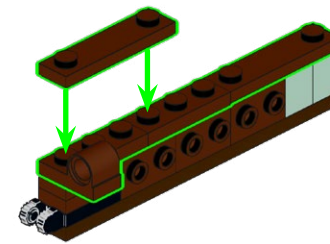

# 207

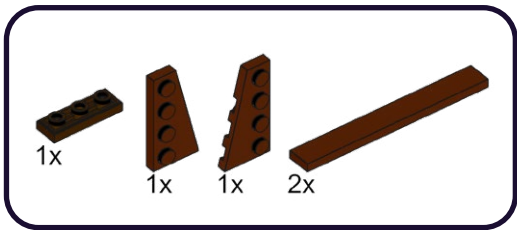

1

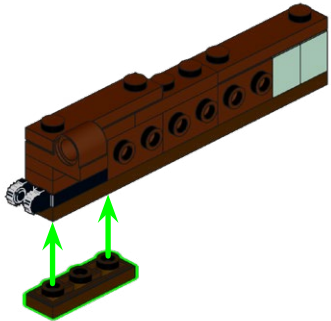

2

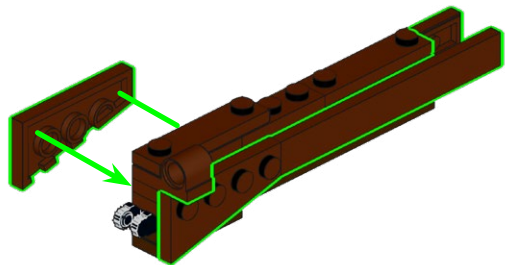

# 208

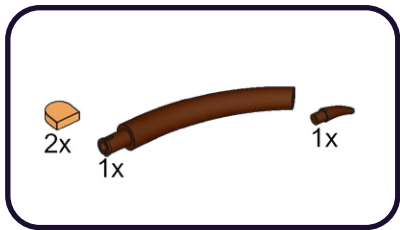

1

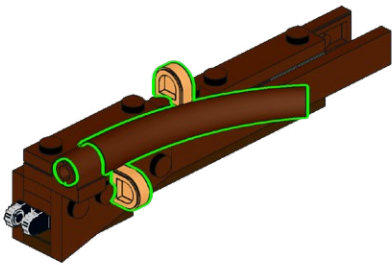

2

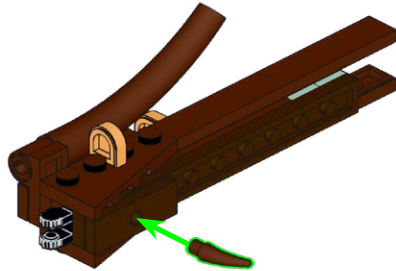

209



# 210

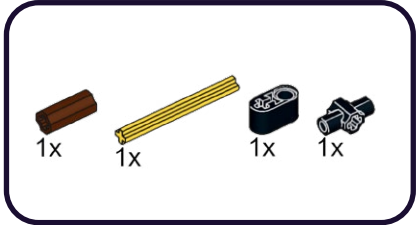

1

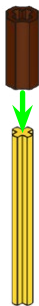

2

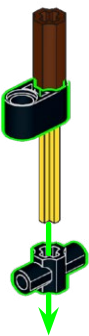

# 211

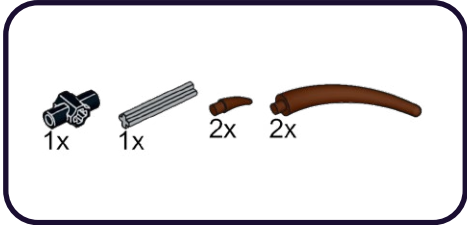

1

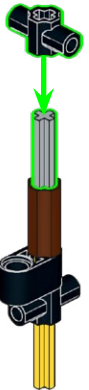

2

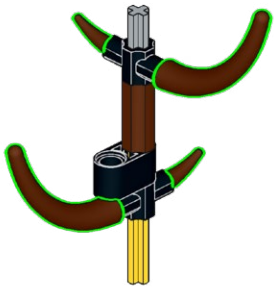

212

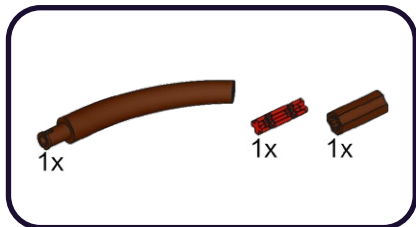

1

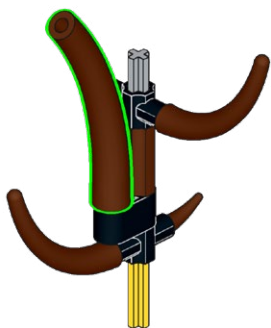

2

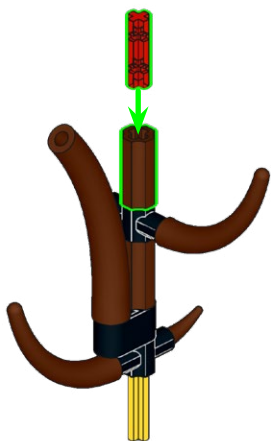

213

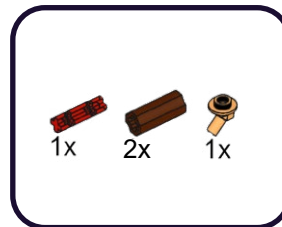

1

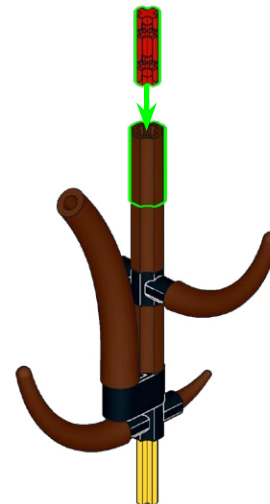

2

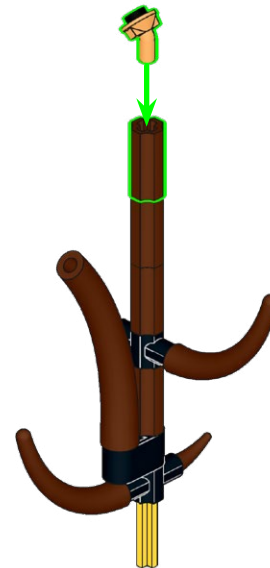

214



215

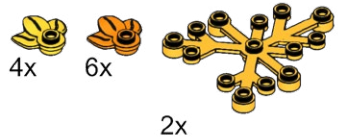

1

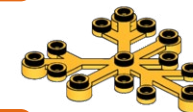

2

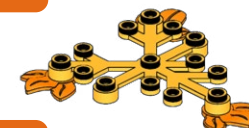

3



2x



216



1x

3x

2x

1x

1

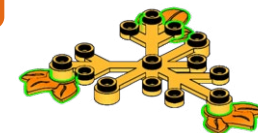

2

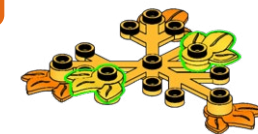

3

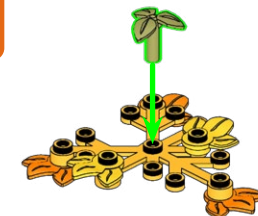

3x

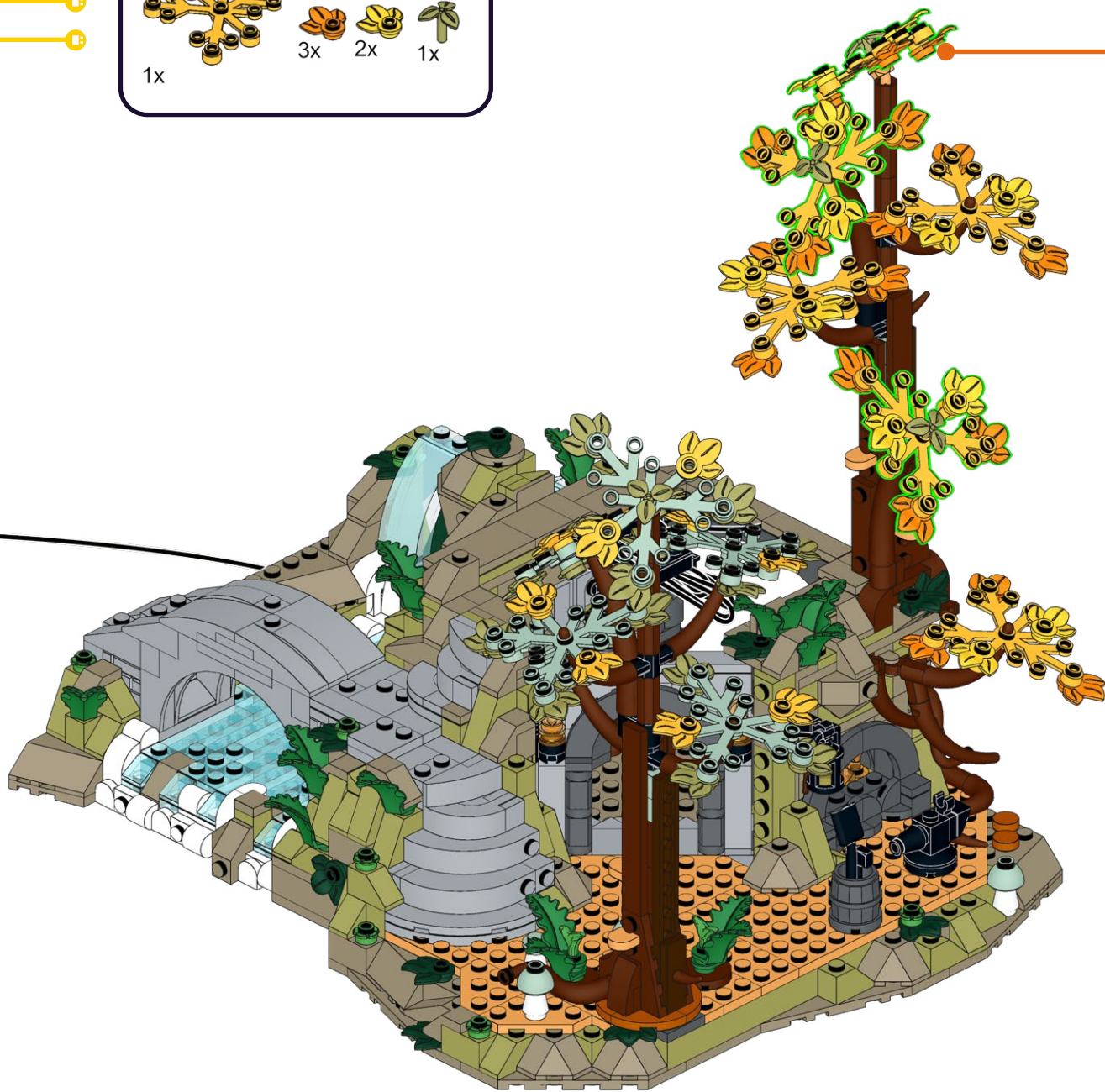

**HOLD UP!**

You might notice some bags are out of order, as well as left over pieces, but that's ok! We're changing the way you build LEGO!

**HALTEN!**

Möglicherweise stellen Sie fest, dass einige Beutel nicht in Ordnung sind und auch Teile übrig bleiben, aber das ist in Ordnung! Wir verändern die Art und Weise, wie Sie LEGO bauen!

**TENIR BON!**

Vous remarquerez peut-être que certains sacs sont en panne, ainsi que des morceaux restants, mais ce n'est pas grave ! Nous changeons la façon dont vous construisez LEGO !

**SOSTENERE!**

Potresti notare che alcune borse sono fuori uso, così come alcuni pezzi avanzati, ma va bene! Stiamo cambiando il modo in cui costruisci i LEGO!

**¡SOSTENER!**

Puede que notes que algunas bolsas están fuera de orden, así como piezas sobrantes, ¡pero está bien! ¡Estamos cambiando la forma de construir LEGO!

**耽误!**

您可能会注意到有些袋子坏了, 还有剩余的碎片, 但这没关系! 我们正在改变您搭建乐高的方式!

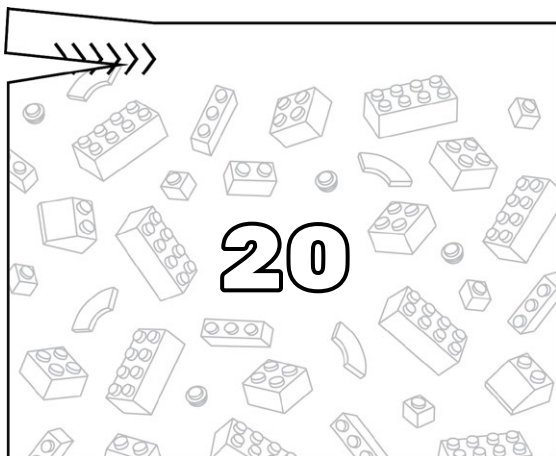
**Open LEGO® Bag 20**

217

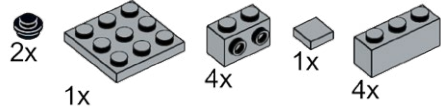

1

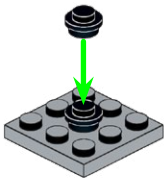

2

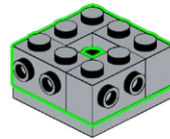

3

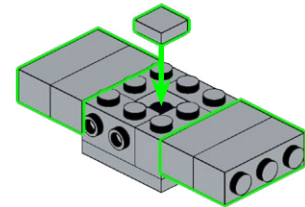

218

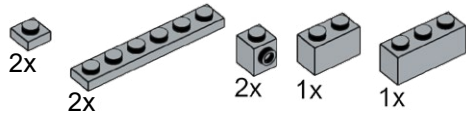

1

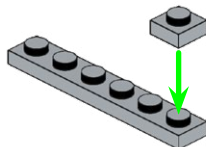

2

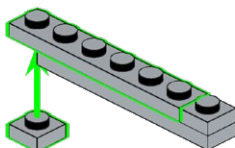

3

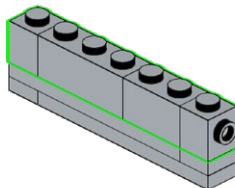

219

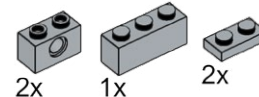

1

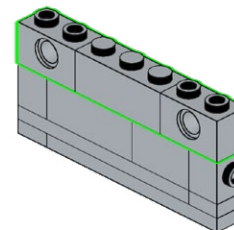

2

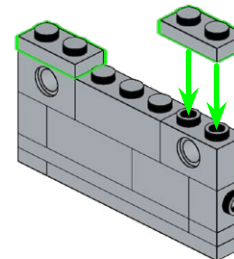

2x

3

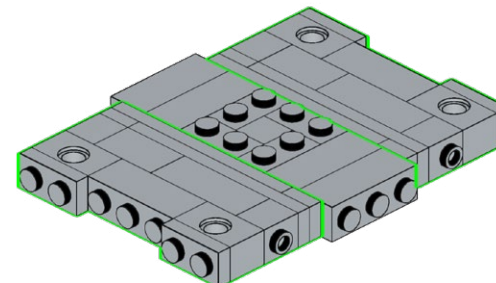

220

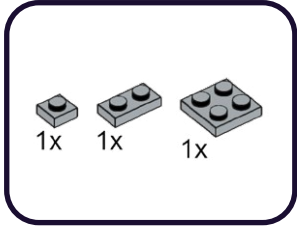
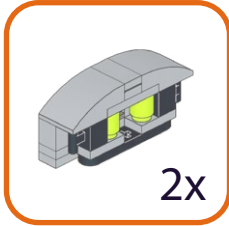

1

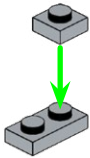

2



221

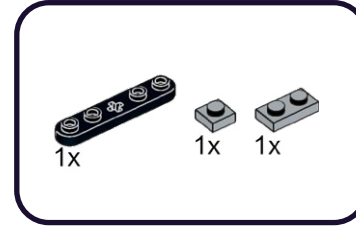

1

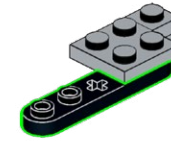

2

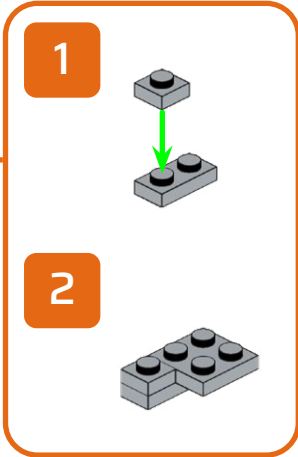
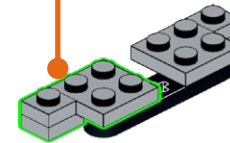

# 222

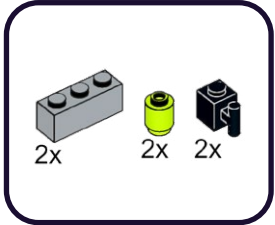

1

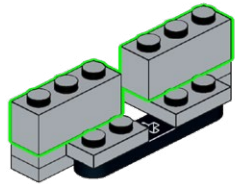

2

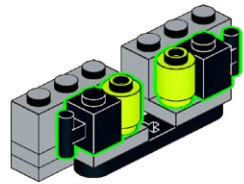

# 223

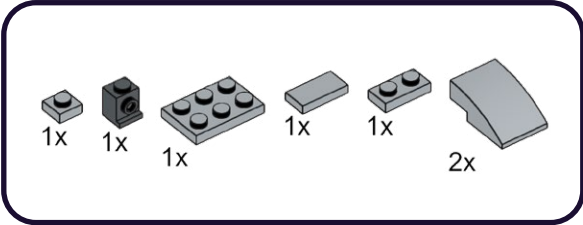

1

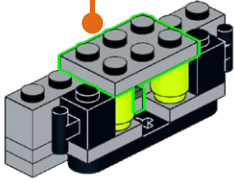

1

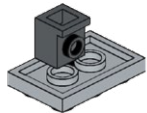

2

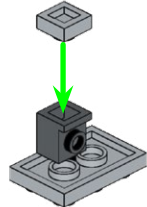

2

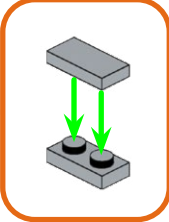
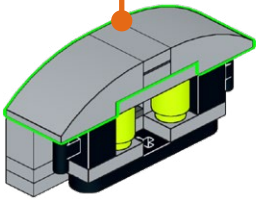

2x

224

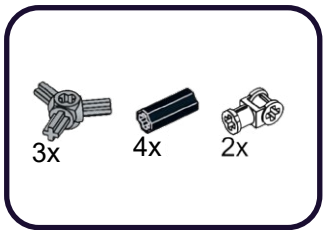

1

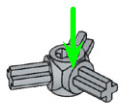

2



3

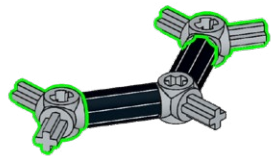

4

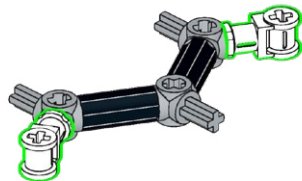

5

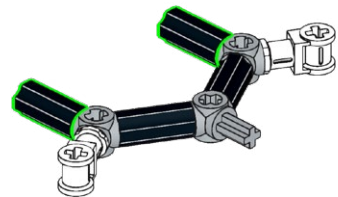

**225**

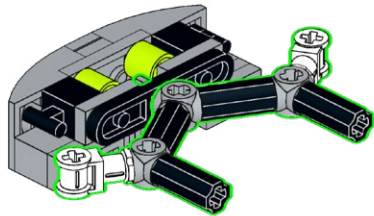

**226**

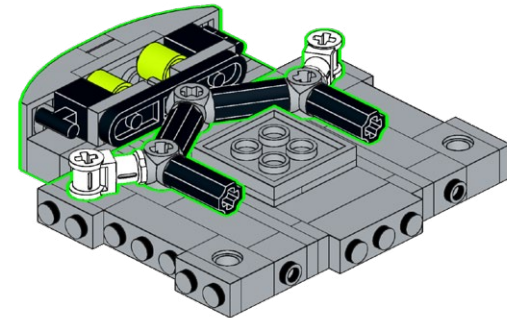



# 227

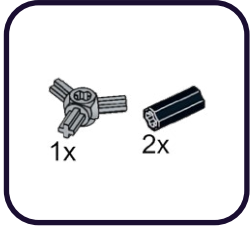

1



2



# 228

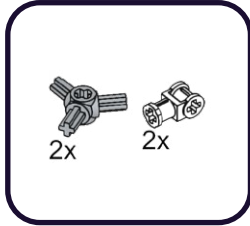

1

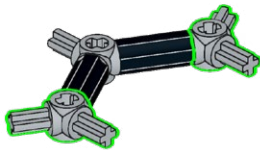

2

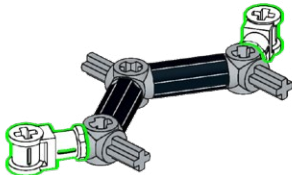

229

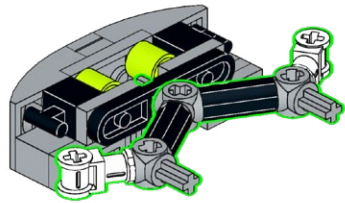

230

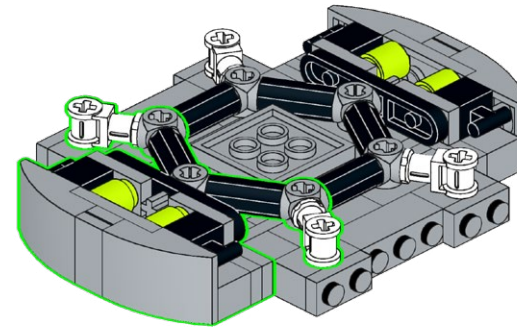
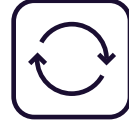

231

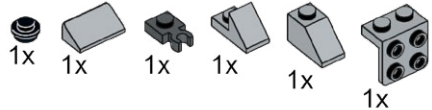

1

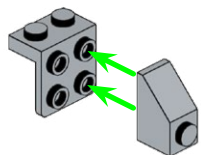

2

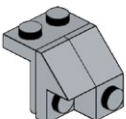

3

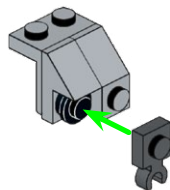

4

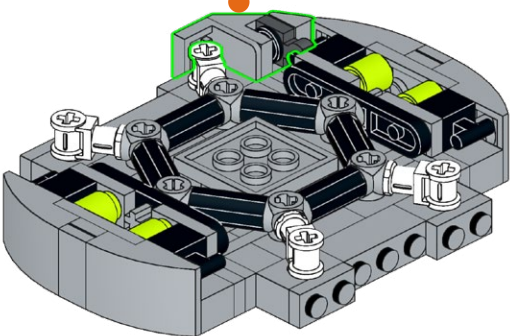
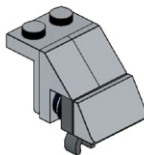

232

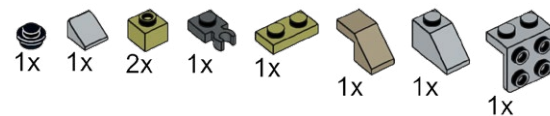

1

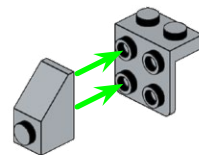

2

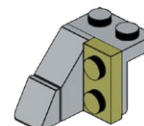

3

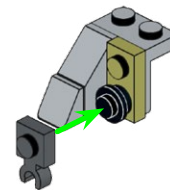

4

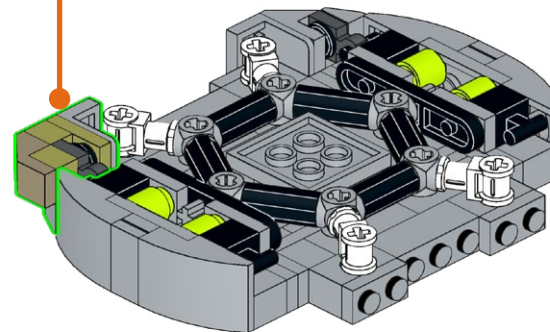
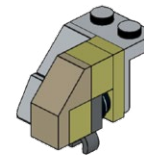

233

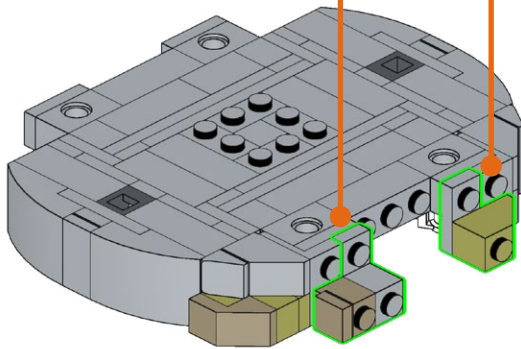
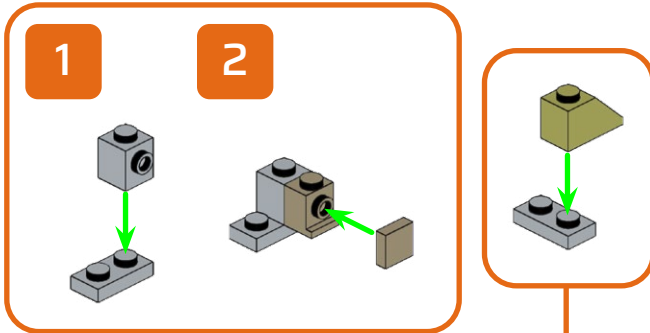
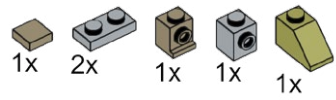

234

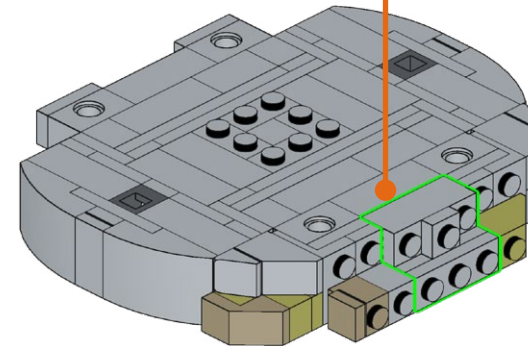
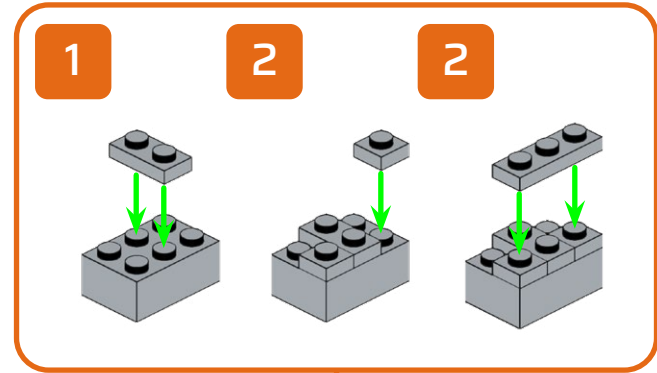
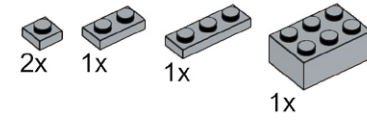

**235**

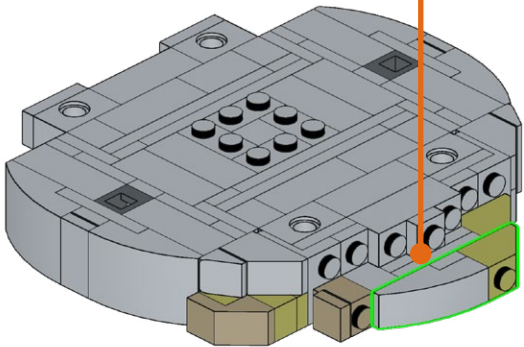
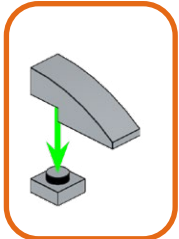
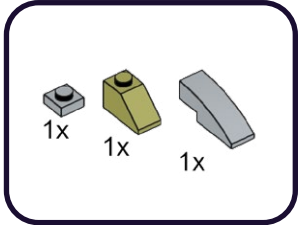

**236**

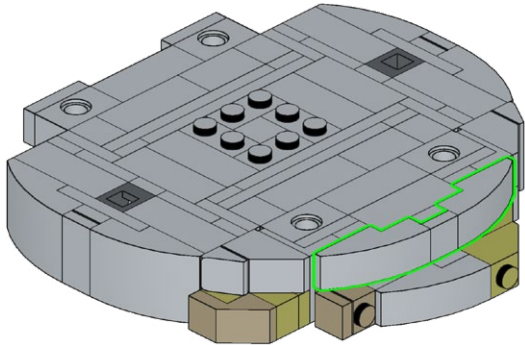
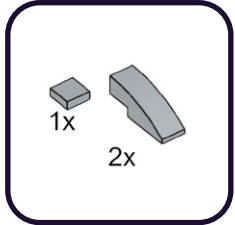

# 237

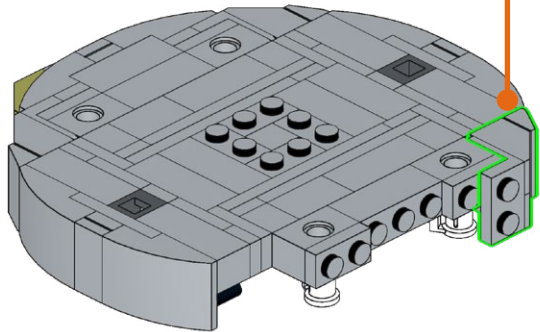
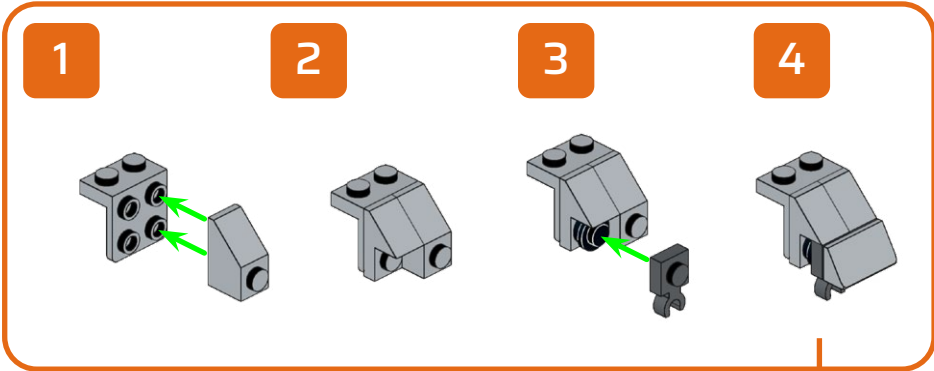
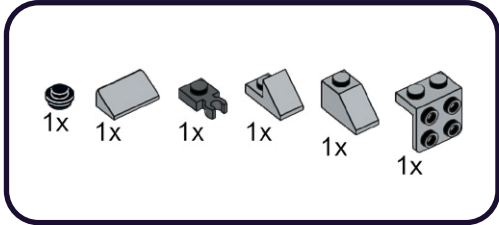

# 238

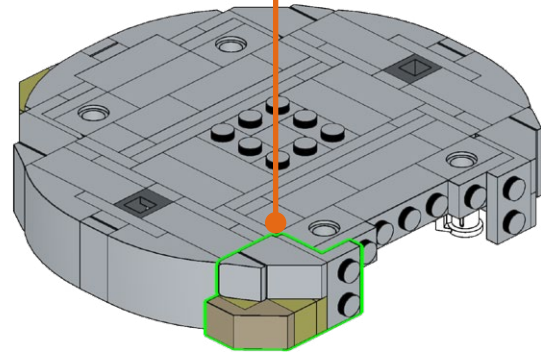
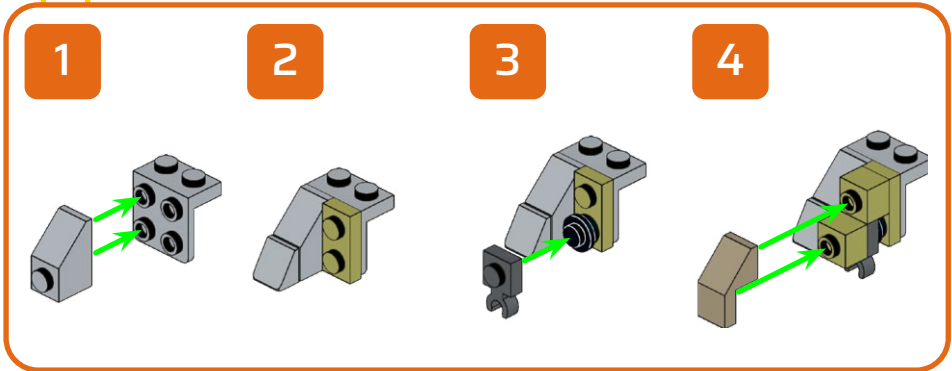
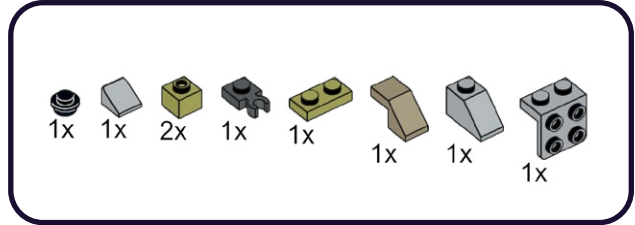

239

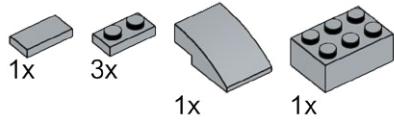

1

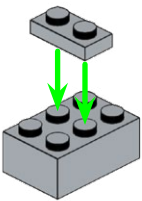

2

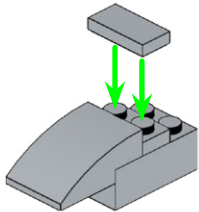

3

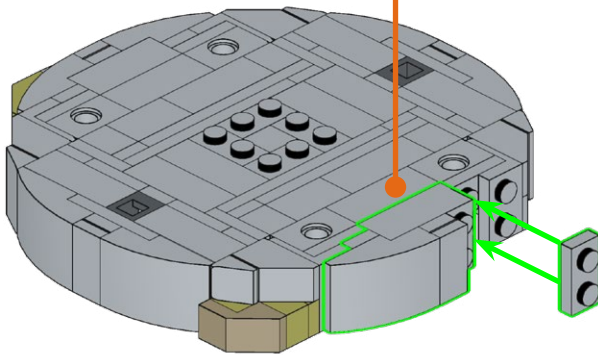
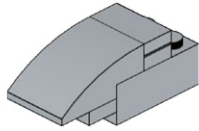

240

6x

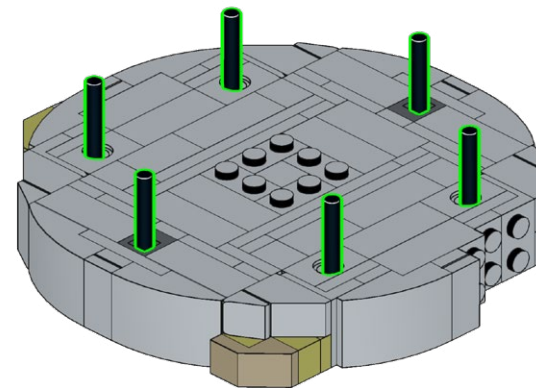

**241**

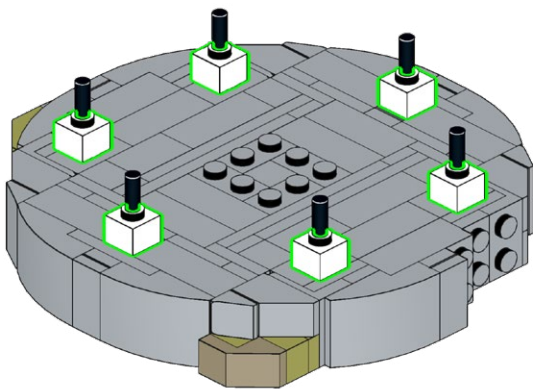
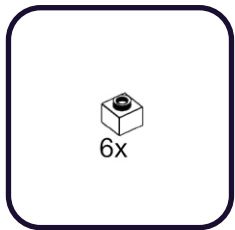

**242**

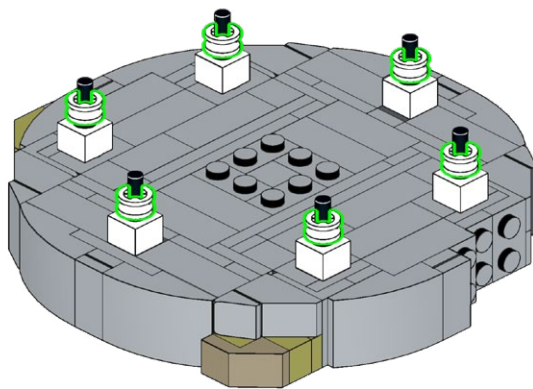



**HOLD UP!**

You might notice some bags are out of order, as well as left over pieces, but that's ok! We're changing the way you build LEGO!

**HALTEN!**

Möglicherweise stellen Sie fest, dass einige Beutel nicht in Ordnung sind und auch Teile übrig bleiben, aber das ist in Ordnung! Wir verändern die Art und Weise, wie Sie LEGO bauen!

**TENIR BON!**

Vous remarquerez peut-être que certains sacs sont en panne, ainsi que des morceaux restants, mais ce n'est pas grave ! Nous changeons la façon dont vous construisez LEGO !

**SOSTENERE!**

Potresti notare che alcune borse sono fuori uso, così come alcuni pezzi avanzati, ma va bene! Stiamo cambiando il modo in cui costruisci i LEGO!

**¡SOSTENER!**

Puede que notes que algunas bolsas están fuera de orden, así como piezas sobrantes, ¡pero está bien! ¡Estamos cambiando la forma de construir LEGO!

**耽误!**

您可能会注意到有些袋子坏了, 还有剩余的碎片, 但这没关系! 我们正在改变您搭建乐高的方式!

Open LEGO® Bag 21 & 22

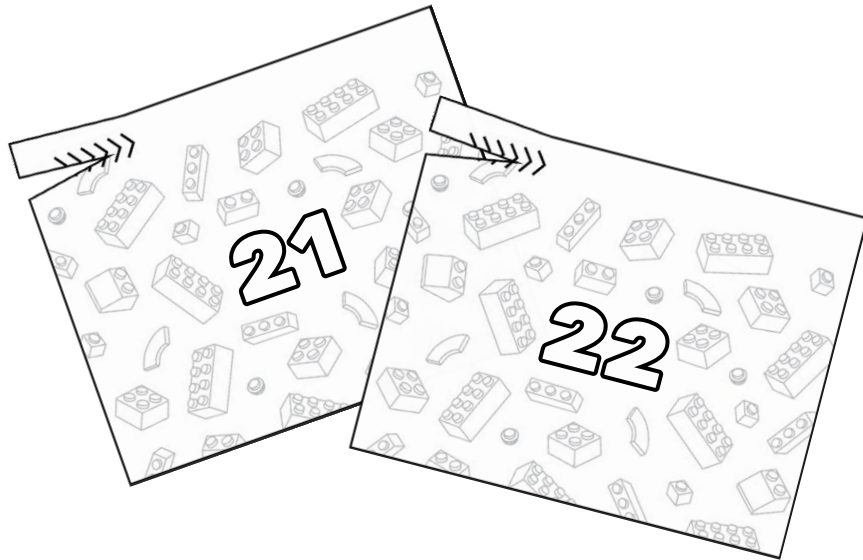

243

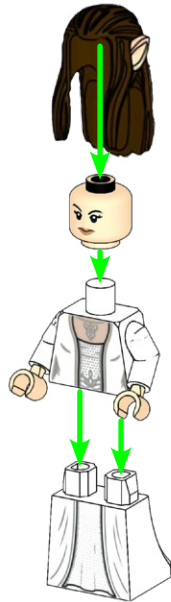
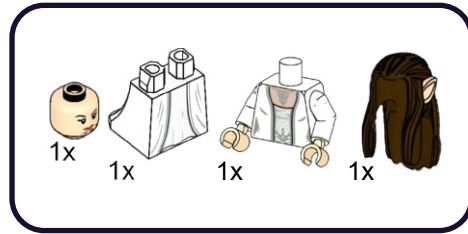

244

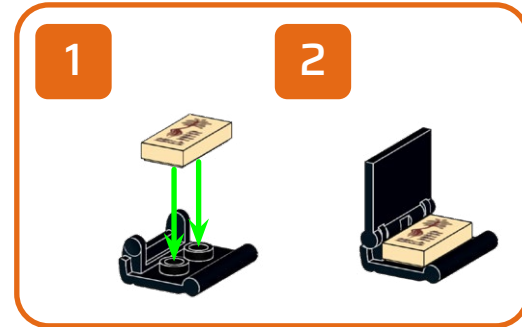
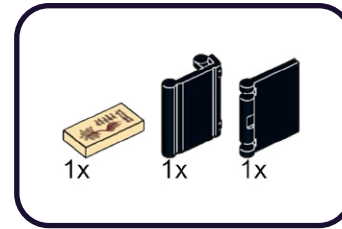

245

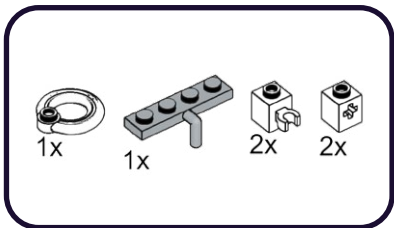

1

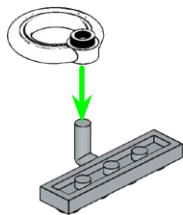

2

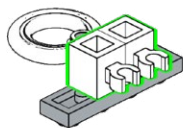

3

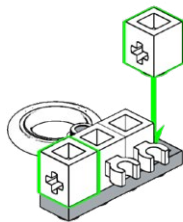

246

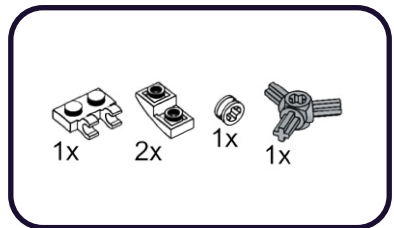

1

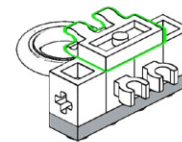

2

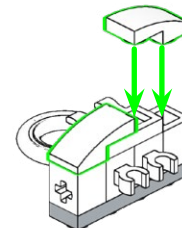

3

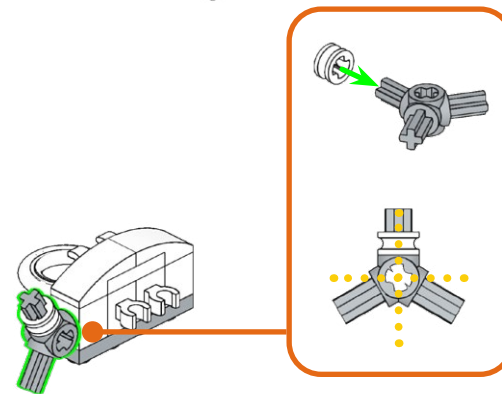

6x

**247**

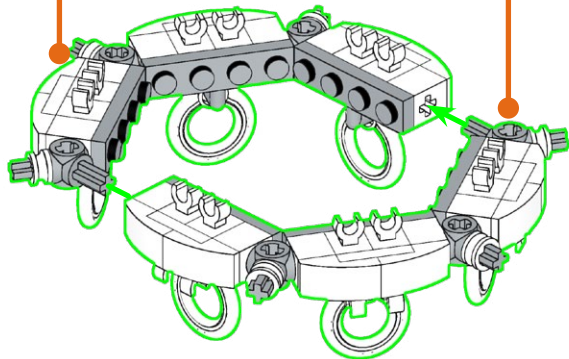
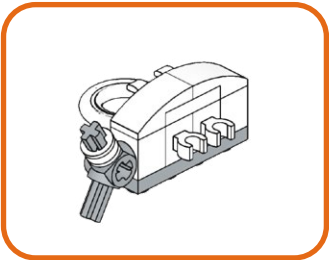

**248**

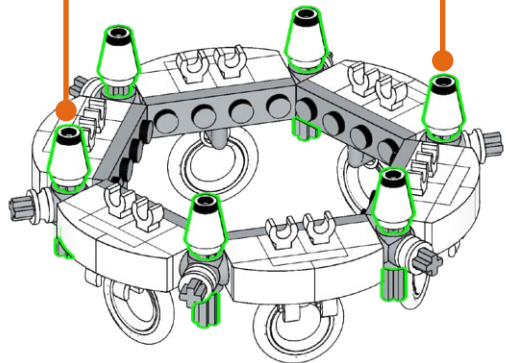
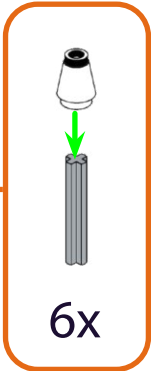

249



6x

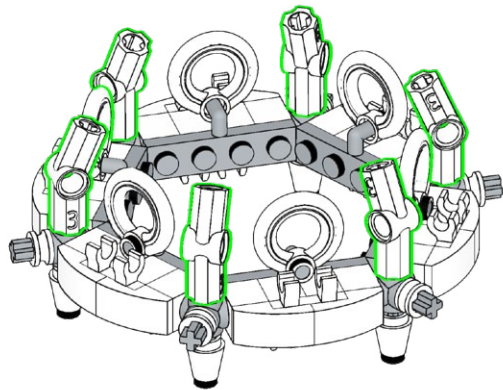

250



5x

5x

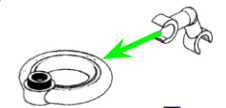

5x

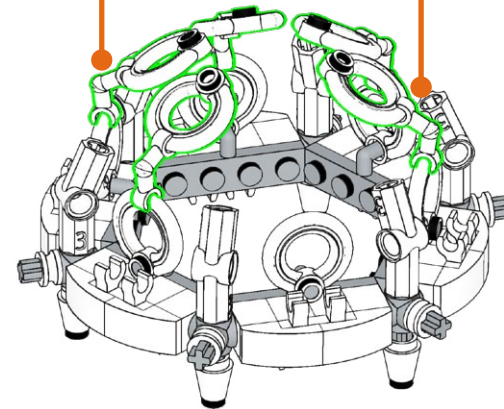

**251**

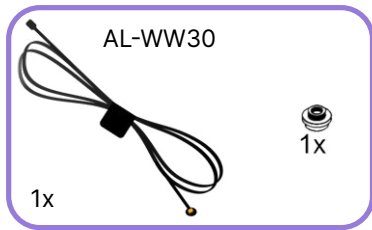

**1**

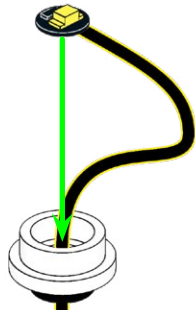

**2**

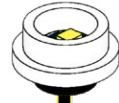

252

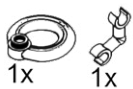

1

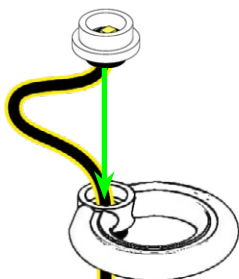

2



3

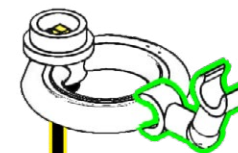

253

1

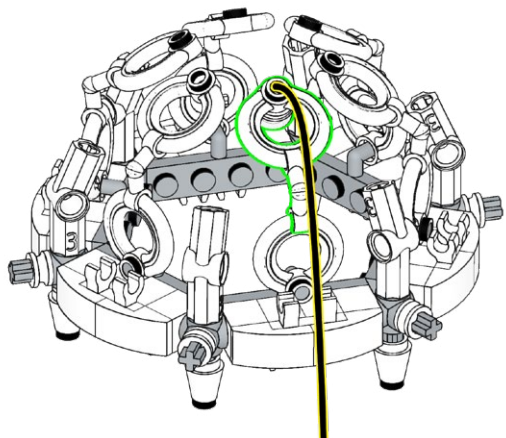

2

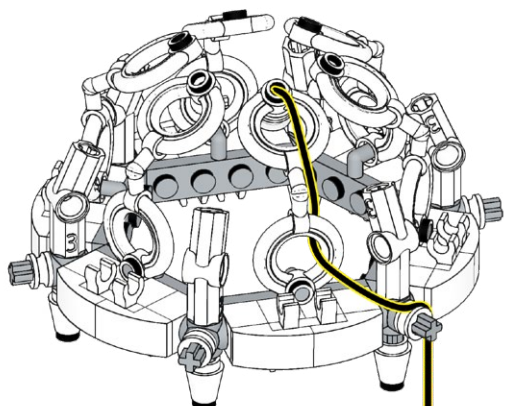

254

6x

12x

1

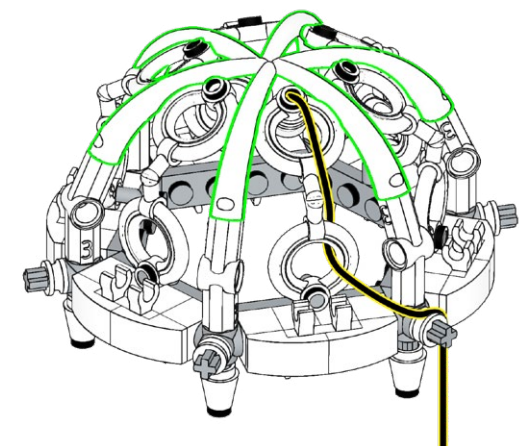

2

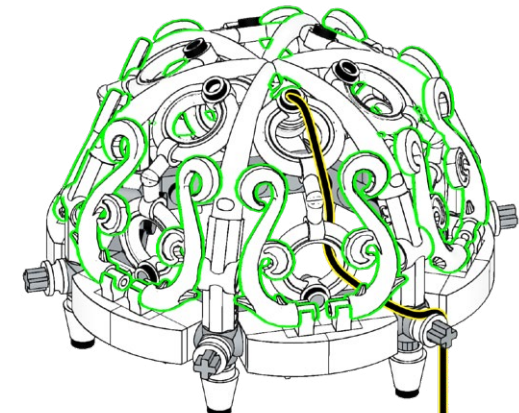



**255**

24x

**256**

12x 12x

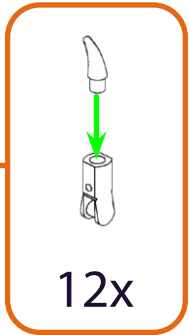
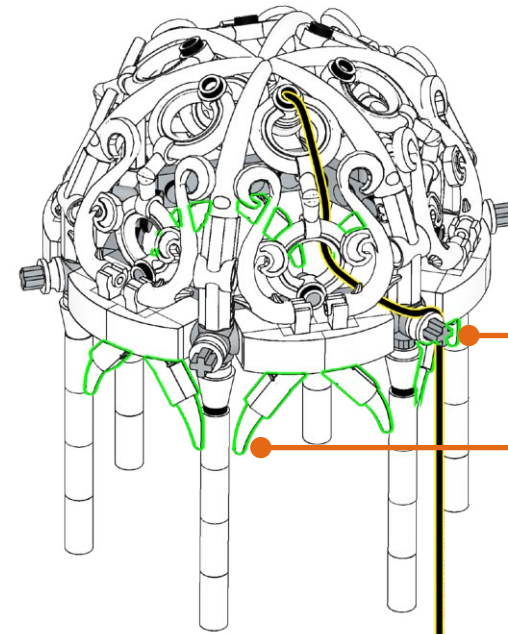
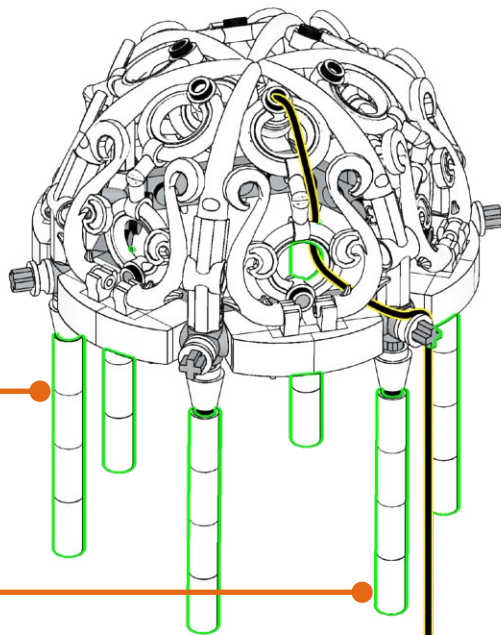
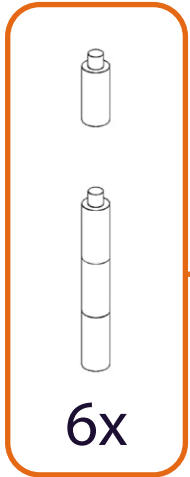

257

1x

1

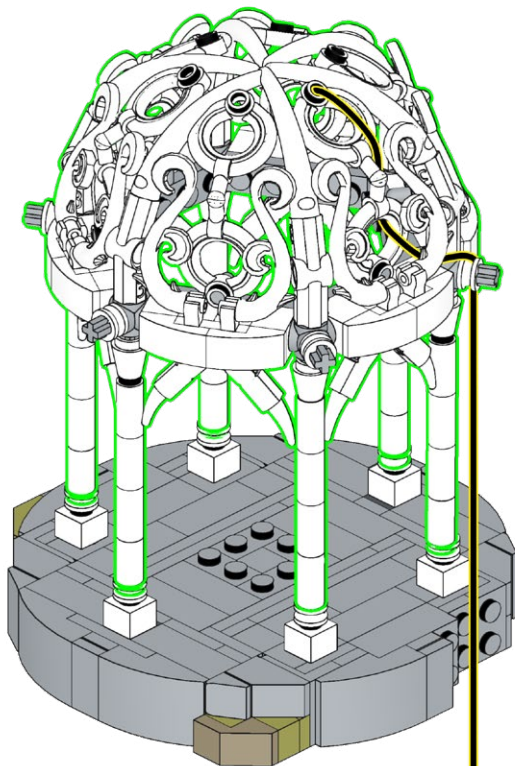

2

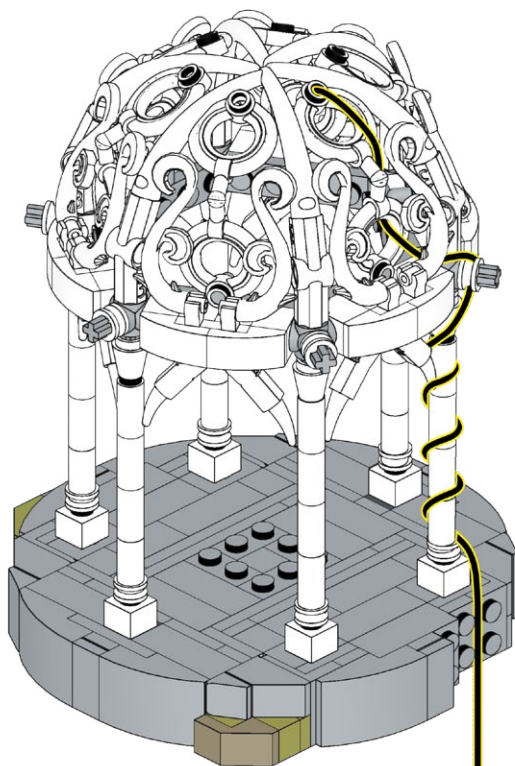

3

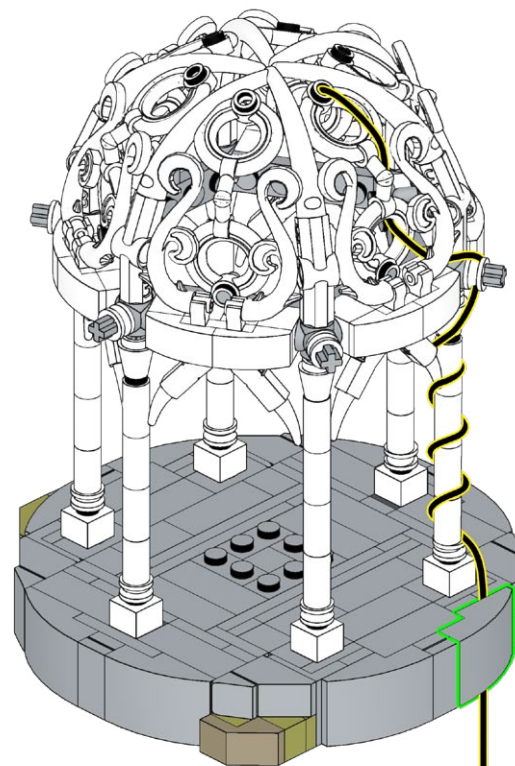

258



1x

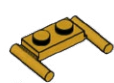

2x

1

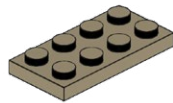

2

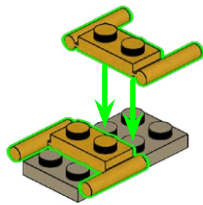

259



2x



2x

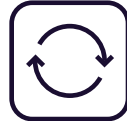

1

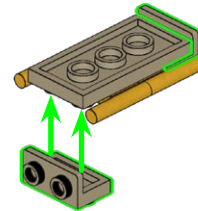

2

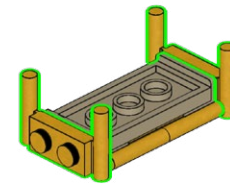

# 260

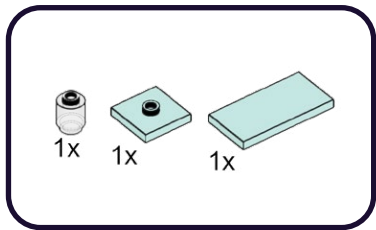

1

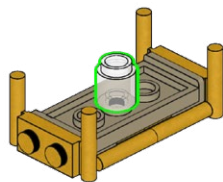

2

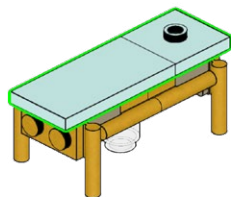

# 261

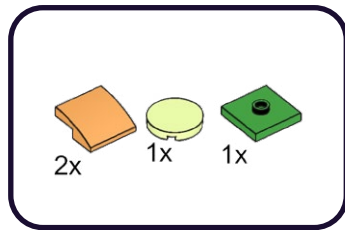

1

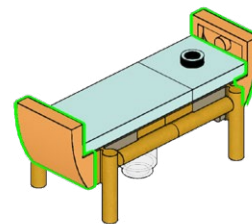

2

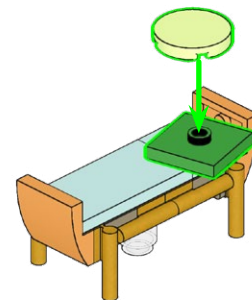

262

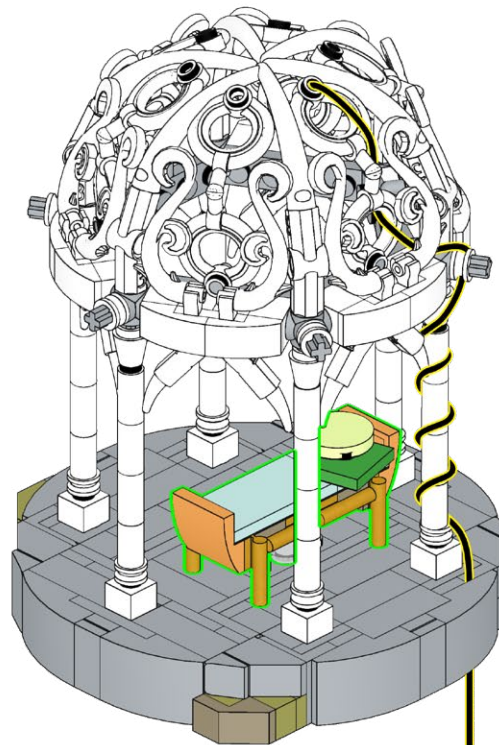

263



264



265





266



267



268



269

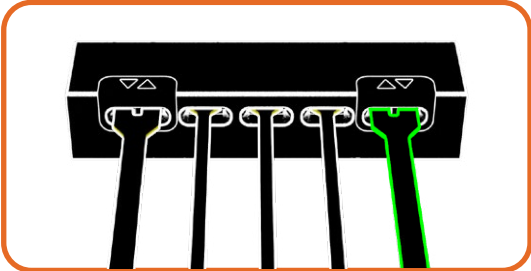

270



271

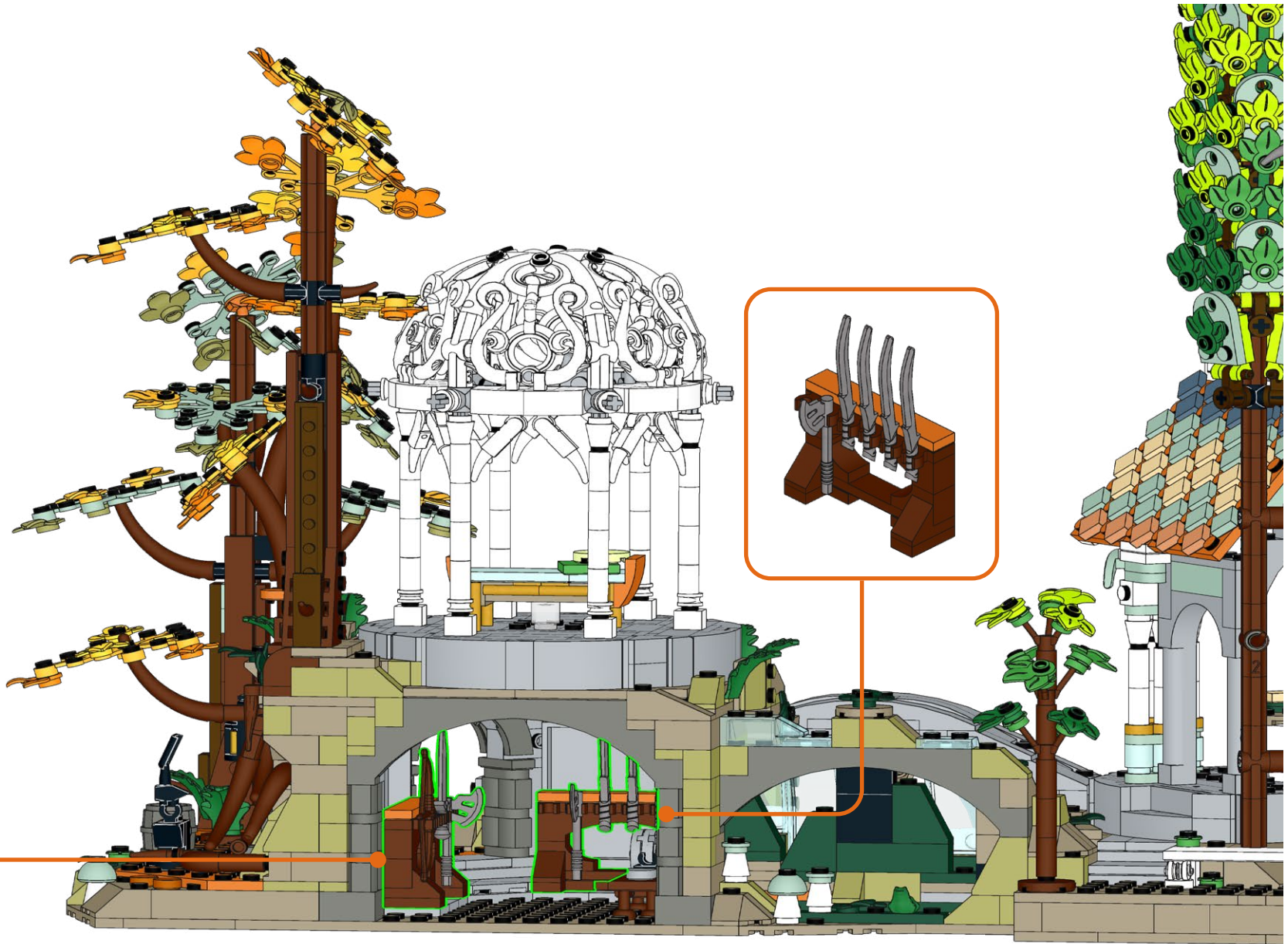
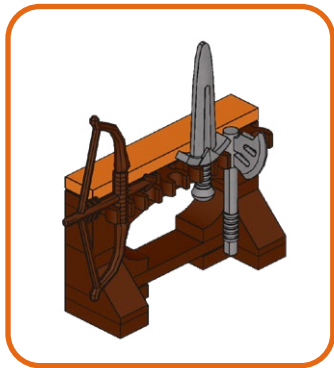

272

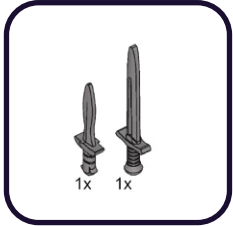

273



Light Test  
Lichttest  
Test de lumière  
Prova della luce  
prueba de luz  
灯光测试





# FINAL PRODUCT



# CONTENTS & GLOSSARY



**5x AL-WW30**  
Astro Large Warm White - 30cm



**1x AL-CW30**  
Astro Large Cool White - 30cm



**1x D-3**  
Dock 3



**1x AL-O30**  
Astro Large Orange - 30cm



**2x AR-Y30**  
Astro Regular Yellow - 30cm



**5x T-1x6**  
Tether 1x6



**1x ALF-O30**  
Astro Large Flicker Orange - 30cm



**2x ARF-WW30**  
Astro Regular Flicker Warm White - 30cm



**5x T-1x1**  
Tether 1x1



**1x ALF-O15**  
Astro Large Flicker Orange - 15cm



**4x ML-WW**  
Meteor Light - Warm White

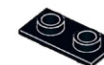

**1x T-1x2**  
Tether 1x2



**3x AL-LB30**  
Astro Large Light Blue - 30cm



**1x D-6**  
Dock 6

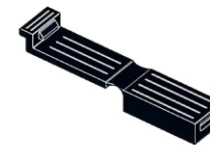

**1x E-1x2**  
Eclipse 1x2

# CONTENTS & GLOSSARY



1x **B-5**  
Belt 5



11x **Plate, Round 1x1 Open Stud - Black**

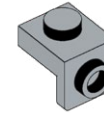

1x **Bracket 1x1 - 1x1 - Light Grey**



4x **B-15**  
Belt 15



4x **Plate, Round 1x1 Open Stud - Trans Orange**

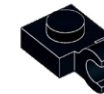

1x **Plate, Modified 1x1 with Open O Clip (Horizontal Grip) - Black**



1x **B-30**  
Belt 30



1x **Plate, Round 1x1 Open Stud - White**

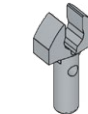

1x **Bar 1L with Clip Mechanical Claw - Cut Edges and Hole on Side - Light Grey**



1x **B-50**  
Belt 50



2x **Tile, Modified 1x1 with Open O Clip - Black**



1x **FLXB-30**  
Flux Belt 30cm



3x **Round 1x1 Mod Rounded w Handle - Black**

# CONTACT US

Click below for customer support, or general inquiries.

Cliquez ci-dessous pour accéder au support client ou aux renseignements généraux.

Clicca qui sotto per l'assistenza clienti o per richieste generali.

Contact Us



Contactez-nous



Contattaci



Klicken sie unten für kundensupport oder allgemeine anfragen.

Haga clic a continuación para atención al cliente o consultas generales.

点击下方获取客户支持或一般咨询。

Kontaktieren sie uns



Contáctanos



联系我们



## TROUBLESHOOTING

If you're stuck, scan the QR code for troubleshooting.

Se sei bloccato, scansiona il codice QR per la risoluzione dei problemi.

Wenn Sie nicht weiterkommen, scannen Sie den QR-Code zur Fehlerbehebung.

Si vous êtes bloqué, scannez le code QR pour le dépannage

Si está atascado, escanee el código QR para solucionar el problema.

如果遇到问题, 请扫描二维码进行故障排除

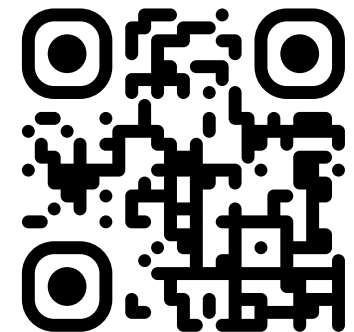



# LIGHTMYBRICKS

[lightmybricks.com](http://lightmybricks.com)



LEGO® is a trademark of the LEGO Group of companies, which does not sponsor, authorize or endorse this product. All LEGO® sets featured in images are sold separately. This is not a LEGO® product. The LEGO Group is not liable for any loss, injury or damage arising from the use or misuse of this product. ©2024 Light My Bricks Pty Ltd. All rights reserved. [www.lightmybricks.com](http://www.lightmybricks.com)

Our components are designed and packaged in Australia by Light My Bricks Pty Ltd. Components are manufactured in China. 3fl bldg C, Shuanghuan Quanxin Technology Information Industry Park Baolong Street, Longgang District, Shenzhen, China. Imported in Australia by Light My Bricks Pty Ltd, 5/26 Rushdale St, Knoxfield, VIC, 3180, Australia.

WARNING: CHOKING HAZARD - Small parts. Not for children under 3 years.

AVERTISSEMENT : RISQUE D'ÉTOUFFEMENT - Petites pièces. Ne convient pas aux enfants de moins de 3 ans.

ATTENZIONE: PERICOLO DI SOFFOCAMENTO - Piccole parti. Non adatto a bambini di età inferiore a 3 anni.

WARNUNG: ERSTICKUNGSGEFAHR - Kleine Teile. Nicht für Kinder unter 3 Jahren geeignet.

ADVERTENCIA: PELIGRO DE ASFIXIA - Piezas pequeñas. No son apto para niños menores de 3 años.

警告：窒息危险 - 小零件。不适合3岁以下儿童。