

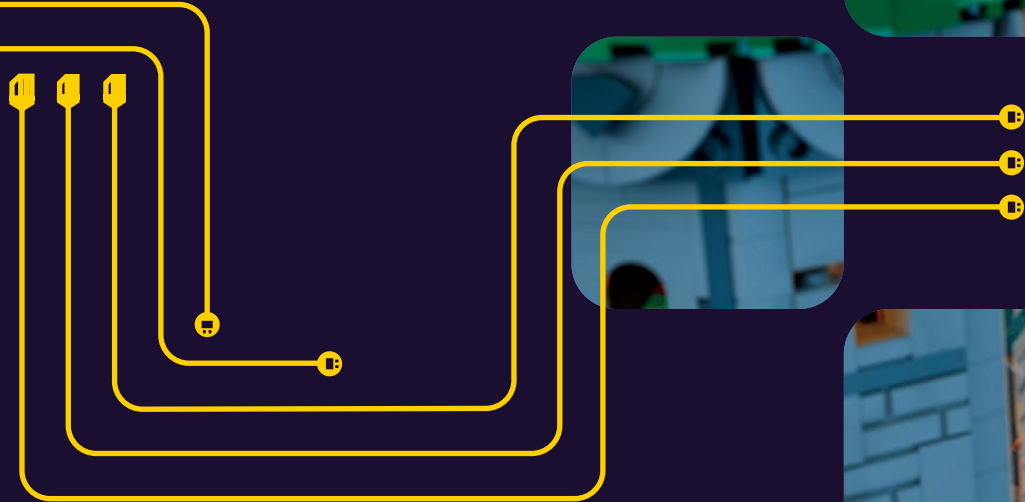

**LIGHT  
BRICKS™**



## LIGHT KIT INSTALLATION GUIDE

**LORD OF THE RINGS  
RIVENDELL (PART 2)**

FOR LEGO  
SET  
#10316



## 3

### Getting Started

- 4 Legend
- 5 Component Handling
- 6 Blueprint

## 7

### Instructions

- 7 Bag 23
- 19 Bag 24 & 25 + LMB Bag 05
- 42 Bag 26 + LMB Bag 03
- 70 Bag 27
- 92 Bag 28 & 29
- 115 Bag 30
- 142 Bag 31 & 32
- 162 Bag 33 + LMB Bag 04
- 186 Bag 34
- 211 Bag 35
- 228 Bag 36
- 251 Bag 37, 38 & 39
- 281 Bag 44 & 45
- 297 Bag 46
- 305 Bag 47
- 343 Bag 48 & 49
- 356 Bag 40
- 372 Bag 41
- 397 Bag 42 & 43

## 428

### Power On Test

- 429 Contact & Troubleshooting



# GETTING STARTED



Bold, beautiful and bright, Light My Bricks elevates your favourite LEGO set from knick-knack to statement piece. Create a talking point at home or in the office that speaks to your passions with Light My Bricks. To learn more, click below.

[Learn More](#)



Audacieux, beau et lumineux, Light My Bricks élève votre ensemble LEGO préféré du statut de bibelot à celui de pièce maîtresse. Que ce soit à la maison ou au bureau, partagez votre passion des LEGO avec Light My Bricks. Cliquez ci-dessous pour en savoir plus.

[En savoir plus](#)



Audace, bello e luminoso, Light My Bricks eleva il tuo set LEGO preferito da soprammobile a pezzo di tendenza. Crea un punto di discussione a casa o in ufficio che parli alle tue passioni con Light My Bricks. Per saperne di più, clicca qui sotto.

[Ulteriori Informazioni](#)



Mutig, schön und hell – Light My Bricks verwandelt Ihr Lieblings-LEGO-Set von einem schnickschnack in ein statement-stück. Schaffen sie einen gesprächspunkt zu hause oder im büro, der Ihre leidenschaften widerspiegelt, mit Light My Bricks. Um mehr zu erfahren, klicken sie unten.

[Mehr erfahren](#)



Audaz, hermoso y brillante, Light My Bricks eleva tu set LEGO favorito de una chuchería a una pieza llamativa. Crea un tema de conversación en casa o en la oficina que hable de tus pasiones con Light My Bricks. Para obtener más información, haga clic a continuación.

[Más información](#)



大胆、美丽而明亮，Light My Bricks 将你喜爱的乐高套装从小摆件提升为引人注目的装饰品。在家或办公室打造一个能表达你激情的话题，了解更多，请点击下方。

[了解更多](#)



# LEGEND

## Rotate Set



Retournez L'ensemble  
Ruota Set  
Set Drehen  
Rotar Conjunto  
旋转套件

## Add Part



Ajoutez une Pièce  
Aggiungi Parte  
Teil Hinzufügen  
Agregar Pieza  
添加零件

## Click



Cliquez  
Clic  
Klicken  
Clic  
点击

## Pinch/Fold



Pincez/Pliez  
Pizzicare/Piegare  
Kneifen/Falten  
Pellizcar/Doblar  
折叠

## Pull Cable



Tirez le Cable  
Tirare il Cavo  
Kabel Ziehen  
Tirar del Cable  
拉动电缆

## Repeat Step



Répétez  
Ripetere  
Wiederholen  
Repetir  
重复

## Sticker



Autocollant  
Adesivo  
Aufkleber  
Pegatina  
贴纸

## Power On Test



Test de mise sous tension  
Test di Potenza  
Stromtest  
Prueba de Energía  
电源测试

## Disconnect Power



Débranchez L'alimentation  
Scollegare L'alimentazione  
Strom Trennen  
Desconectar la Energía  
断开电源

## Troubleshoot



Dépanner  
Risolvere  
Fehlerbehebung  
Solución de Problemas  
故障排除

# COMPONENT HANDLING

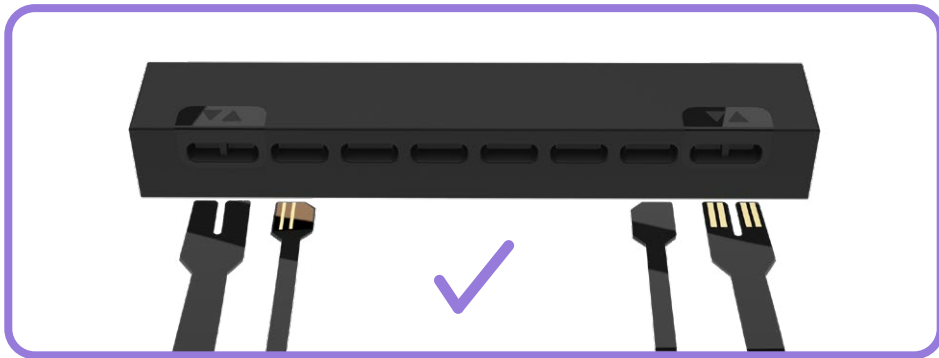
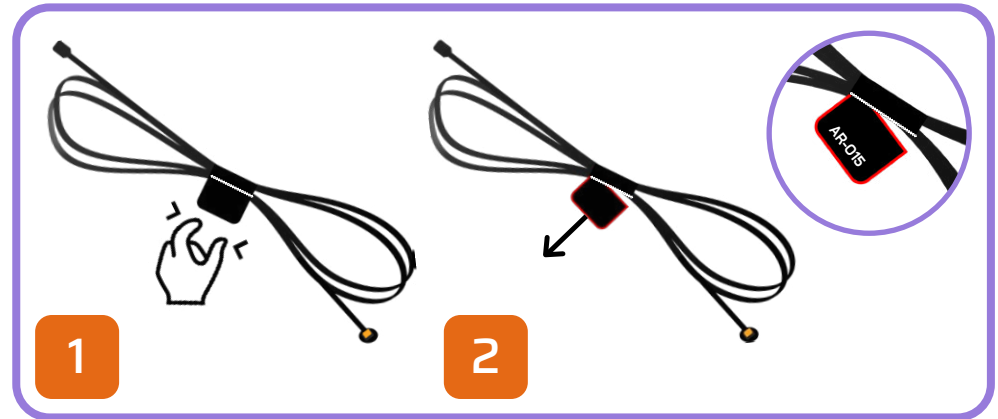
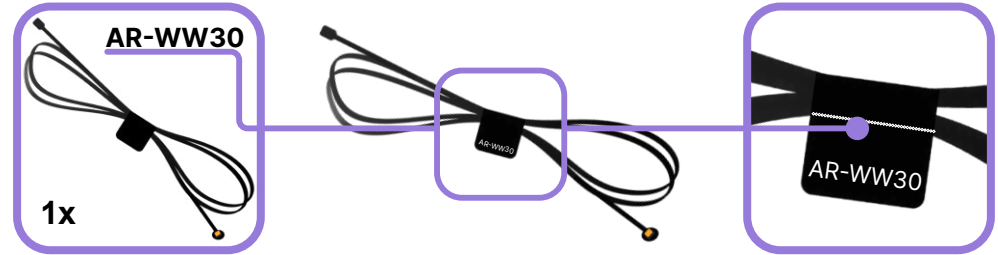
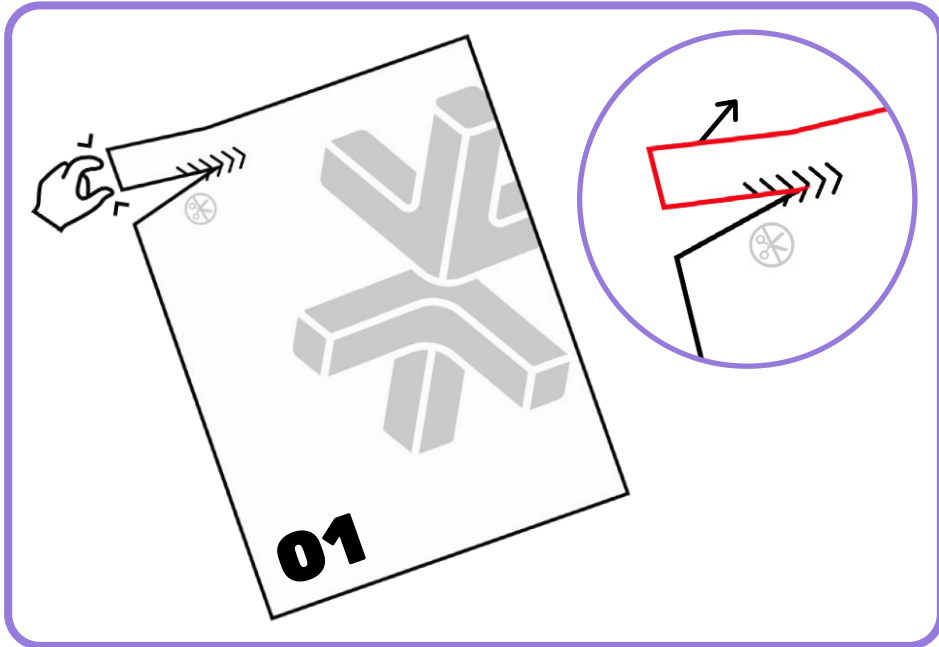



# BLUEPRINT

Part 1 - Tower

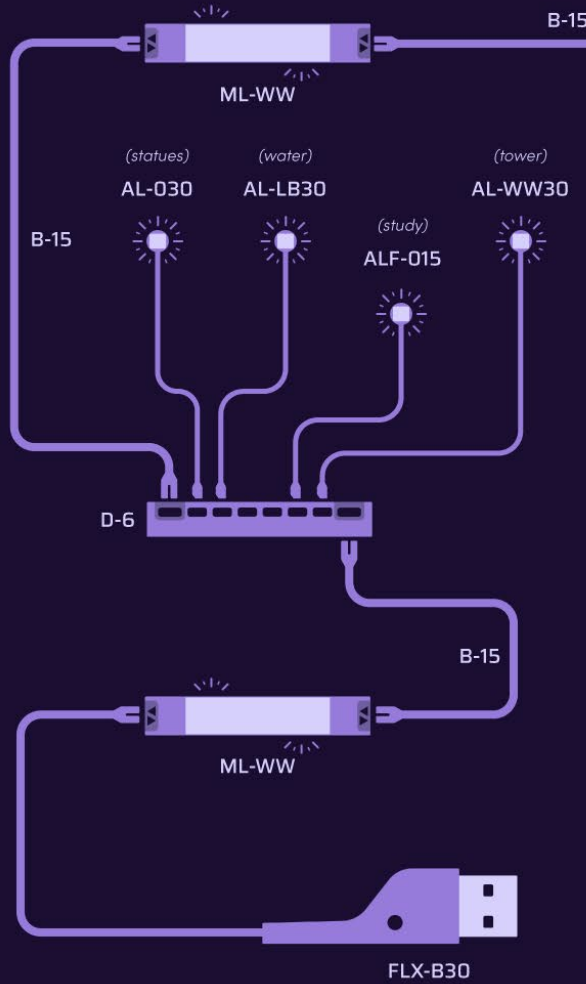

Part 2 - Hall

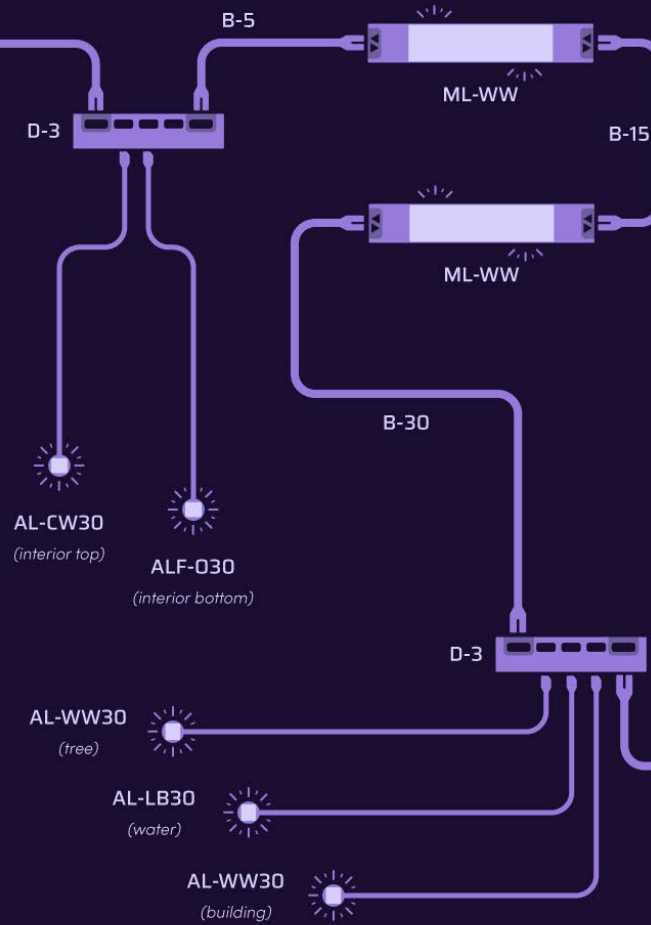

Part 3 - Gazebo

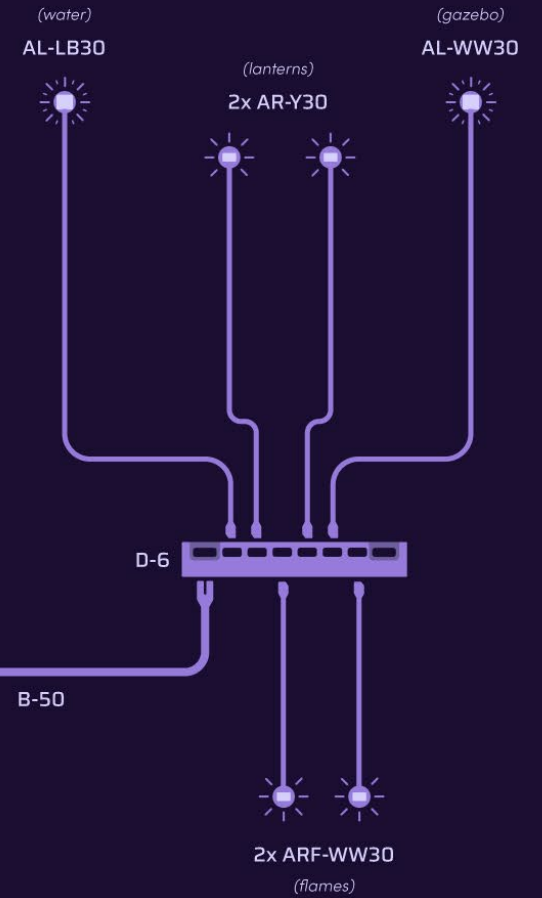



### **HOLD UP!**

You might notice some bags aren't in order, as well as left over pieces, but that's ok! We're changing the way you build LEGO!

### **ATTENDEZ!**

Vous remarquerez peut-être que certains sacs, ainsi que certaines pièces, ne sont pas dans le bon ordre. Mais pas de panique! Nous changeons simplement la façon avec laquelle vous construisez vos LEGO!

### **ASPETTA!**

Potresti notare che alcuni sacchetti non sono in ordine, così come i pezzi avanzati, ma va bene così! Stiamo cambiando il modo in cui costruisci i LEGO!

### **HALT!**

Sie werden möglicherweise bemerken, dass einige tüten durcheinander sind und teile übrig bleiben, aber das ist in Ordnung! Wir ändern die art und weise, wie Sie LEGO bauen!

### **¡ESPERA!**

Es posible que notes que algunas bolsas están fuera de servicio, así como piezas sobrantes, ¡pero está bien! ¡Estamos cambiando la forma en que construyes LEGO!

### **暫停!**

你可能会注意到一些袋子顺序错乱, 以及一些剩余的部件, 但没关系! 我们正在改变你搭建乐高的方式!

### Open LEGO® Bag 23

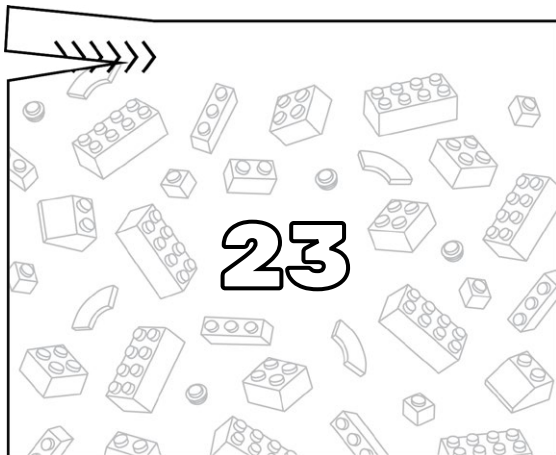

# 1

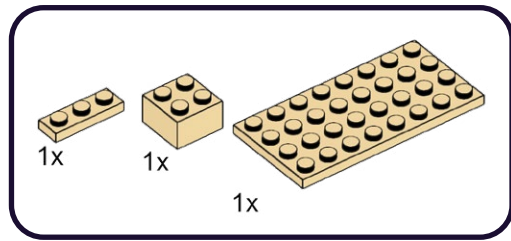

## 1

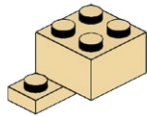

## 2

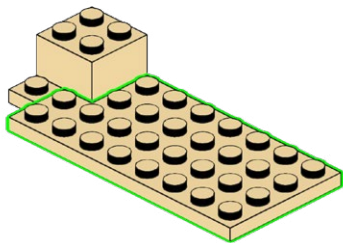

# 2

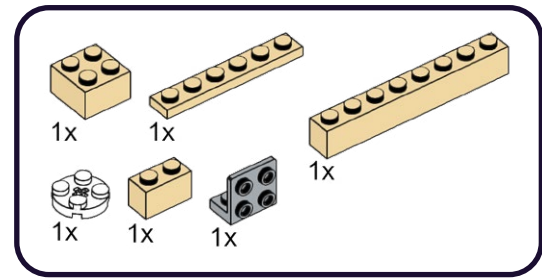

## 1

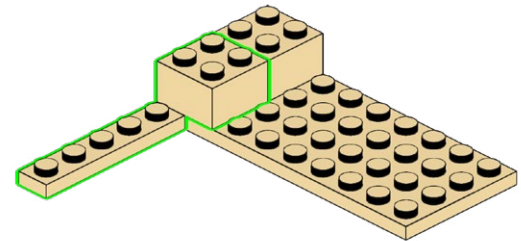

## 2

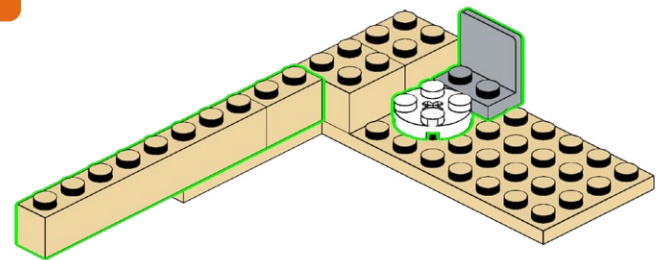



3

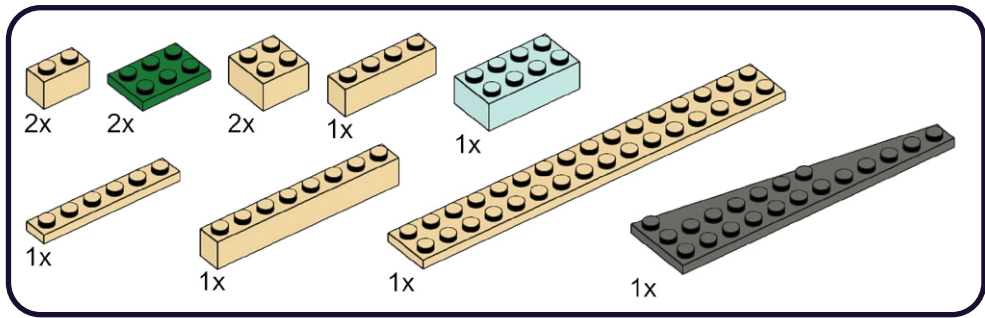

1

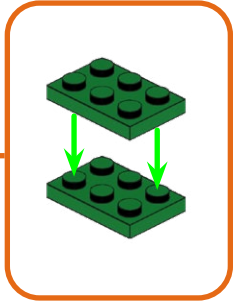
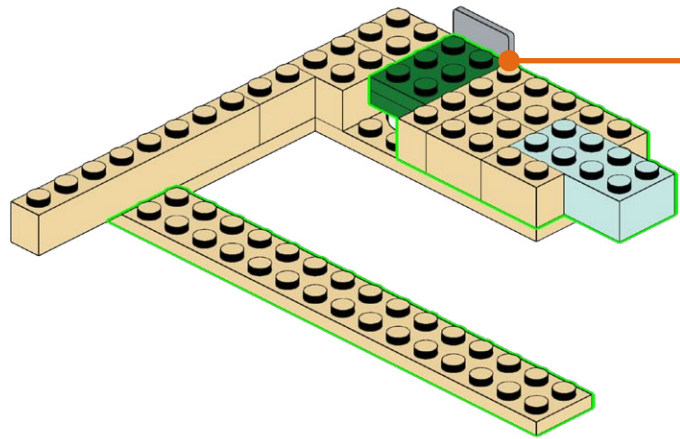

2

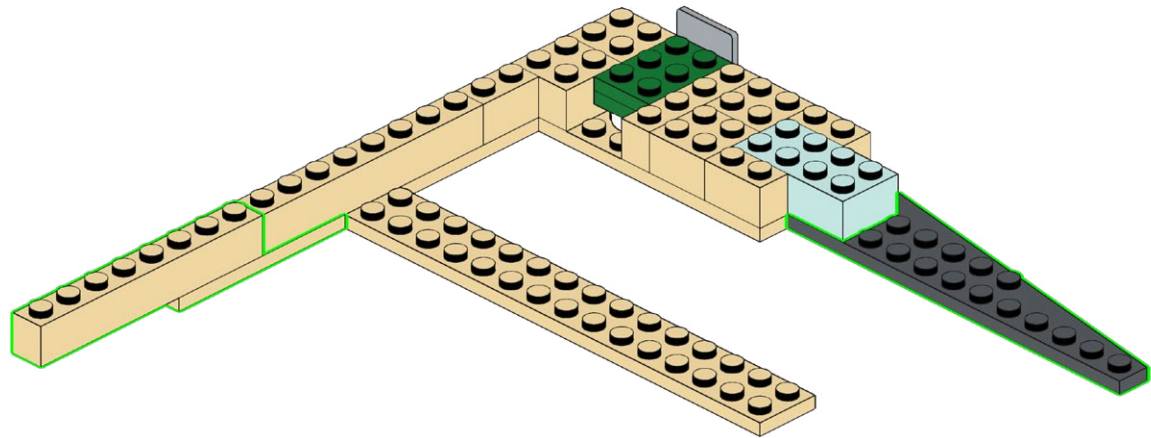

4

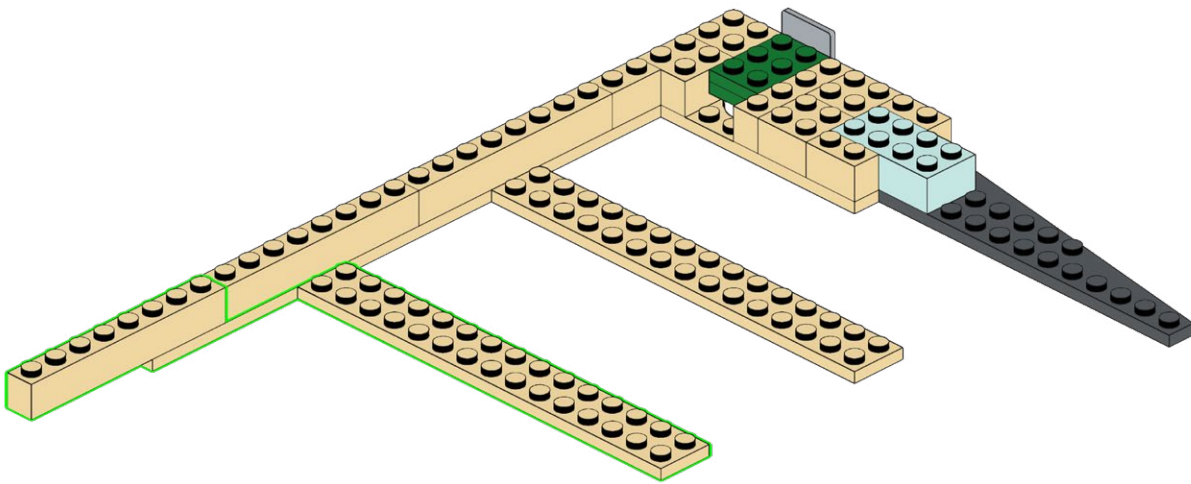
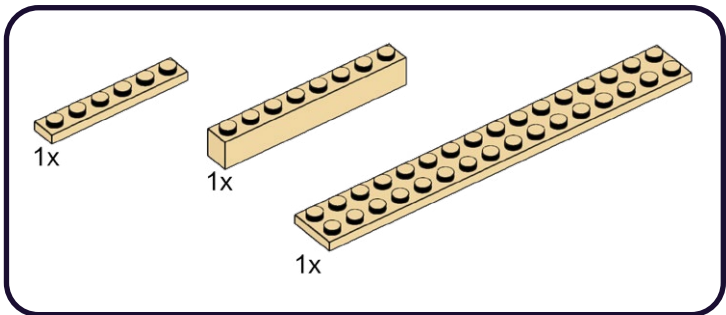

5

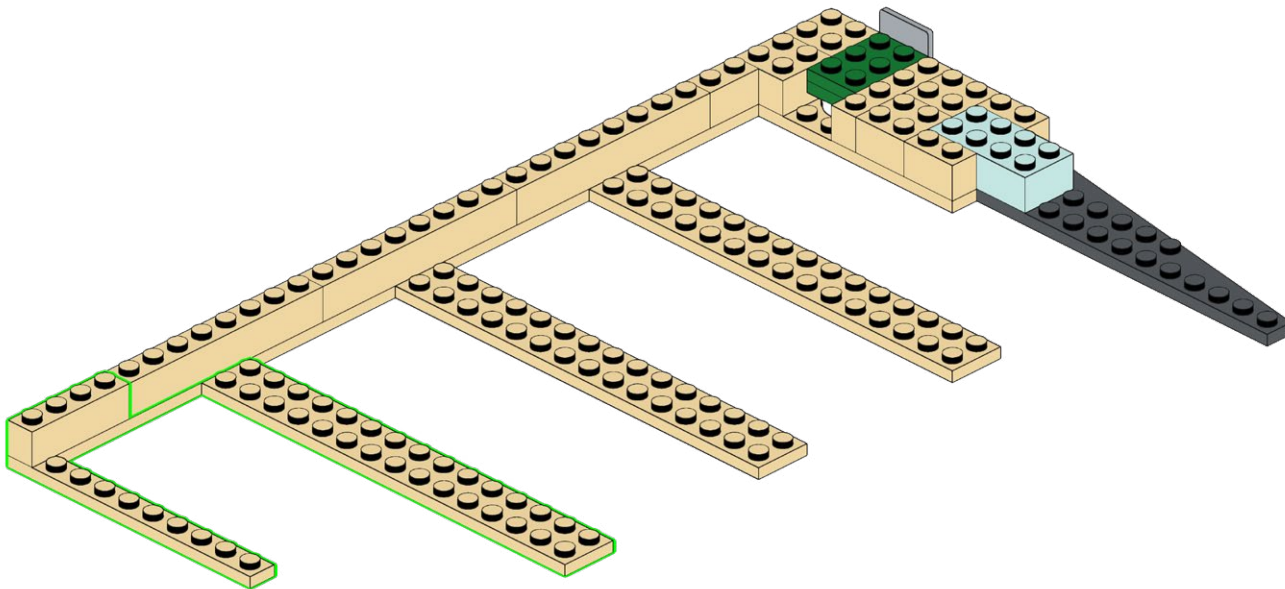
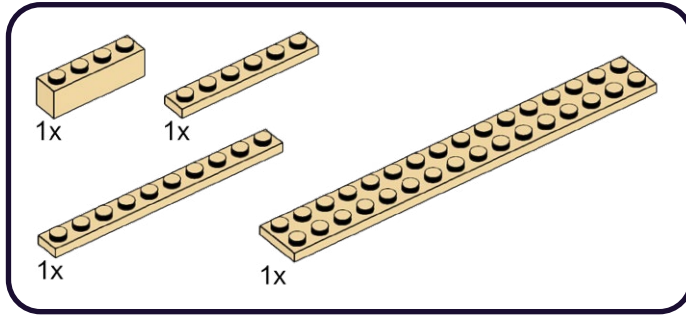



6

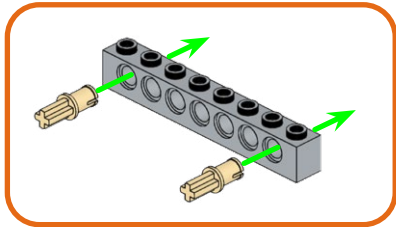
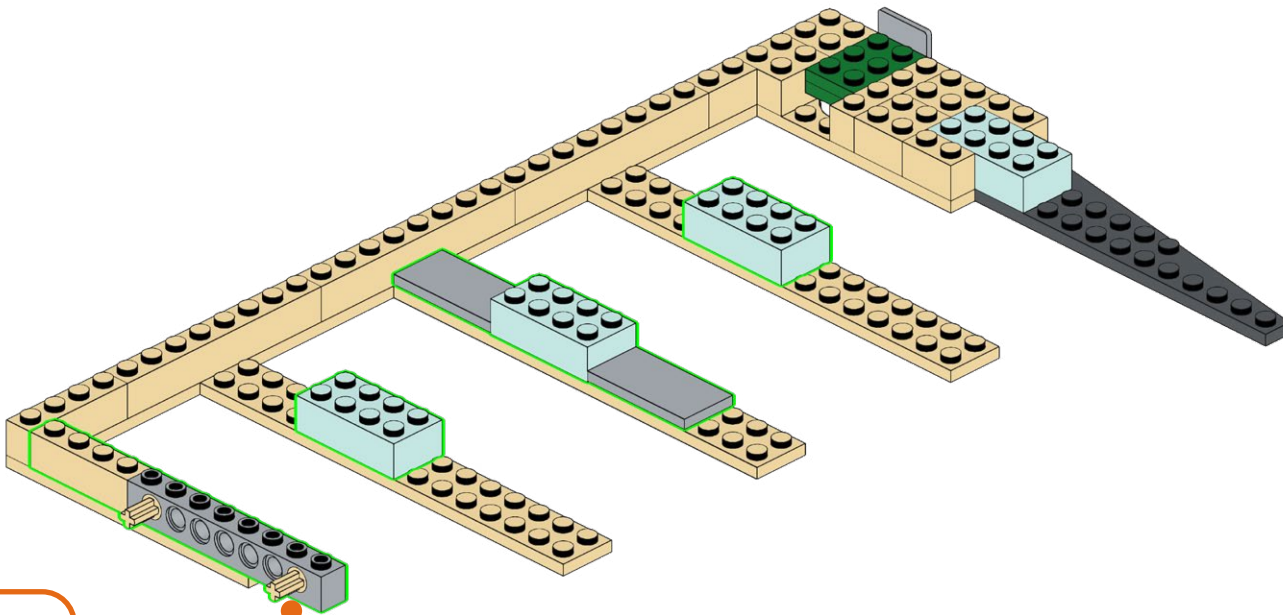
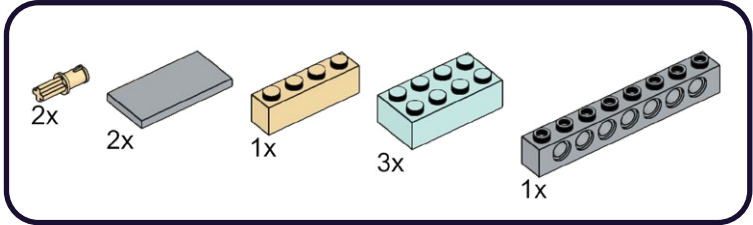

7

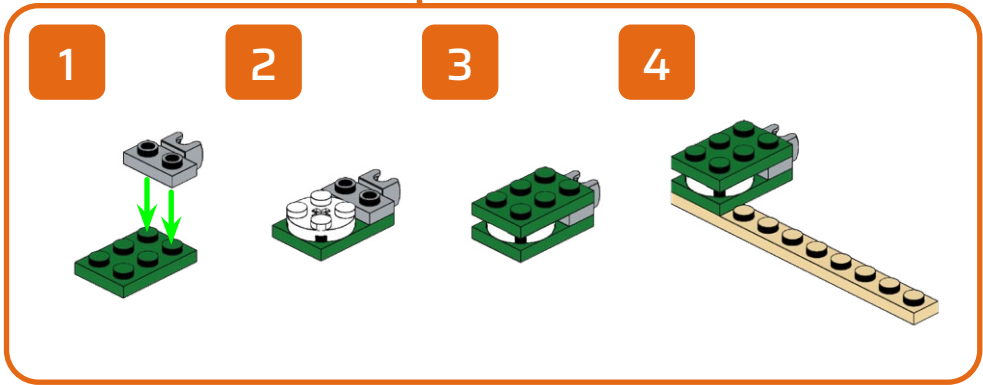
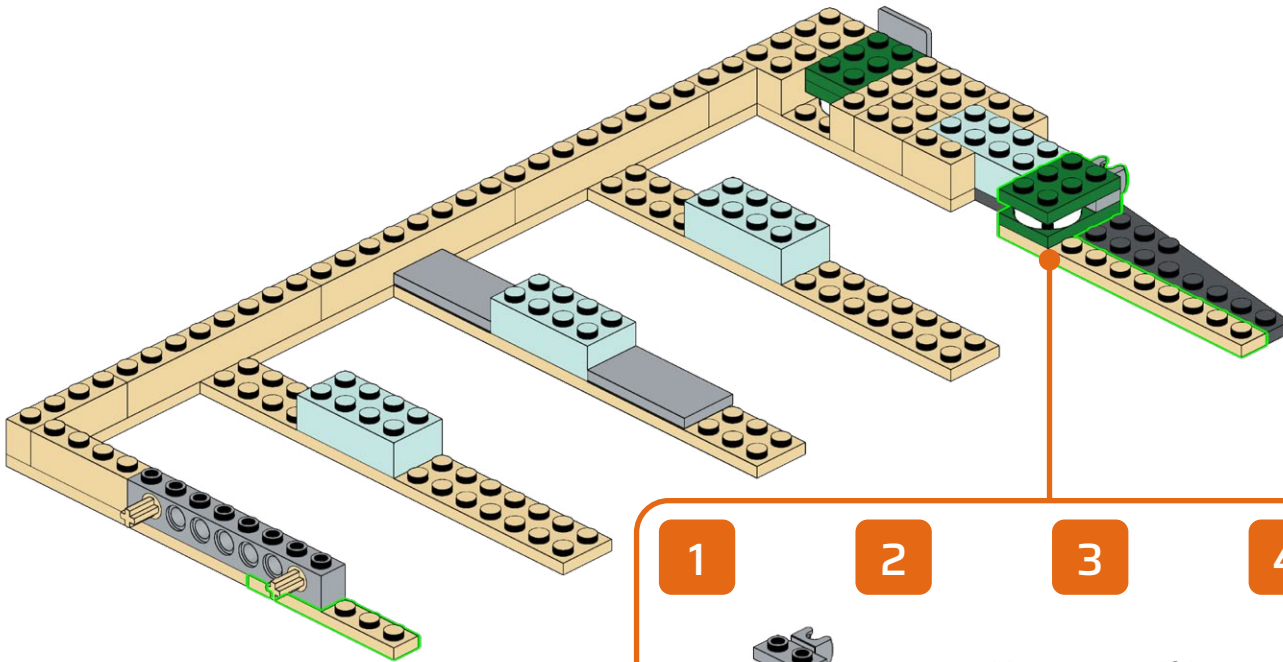
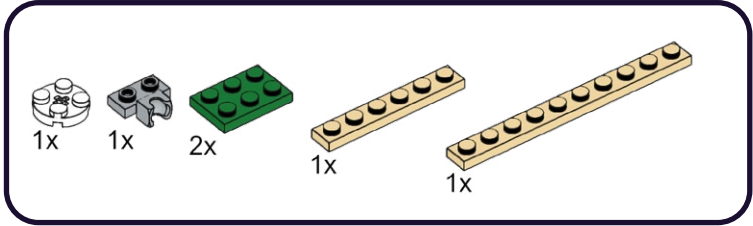

8

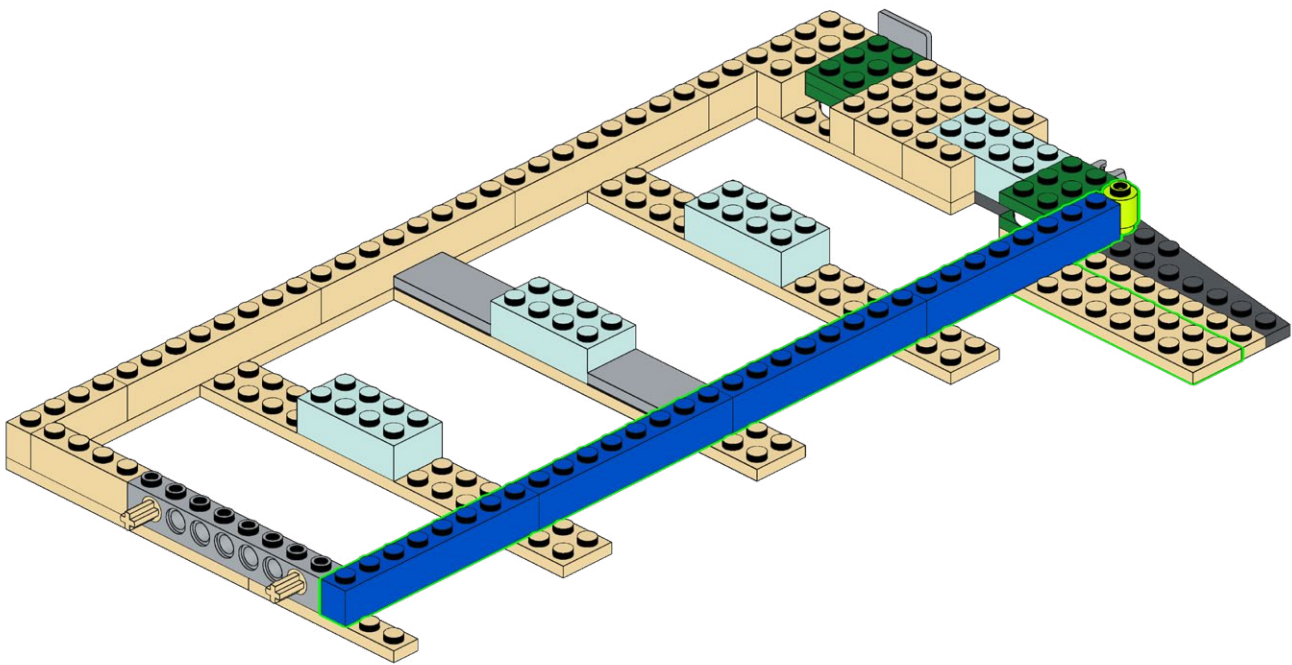
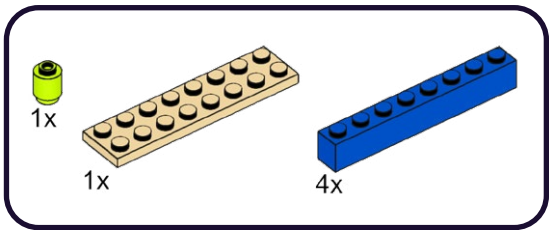

9

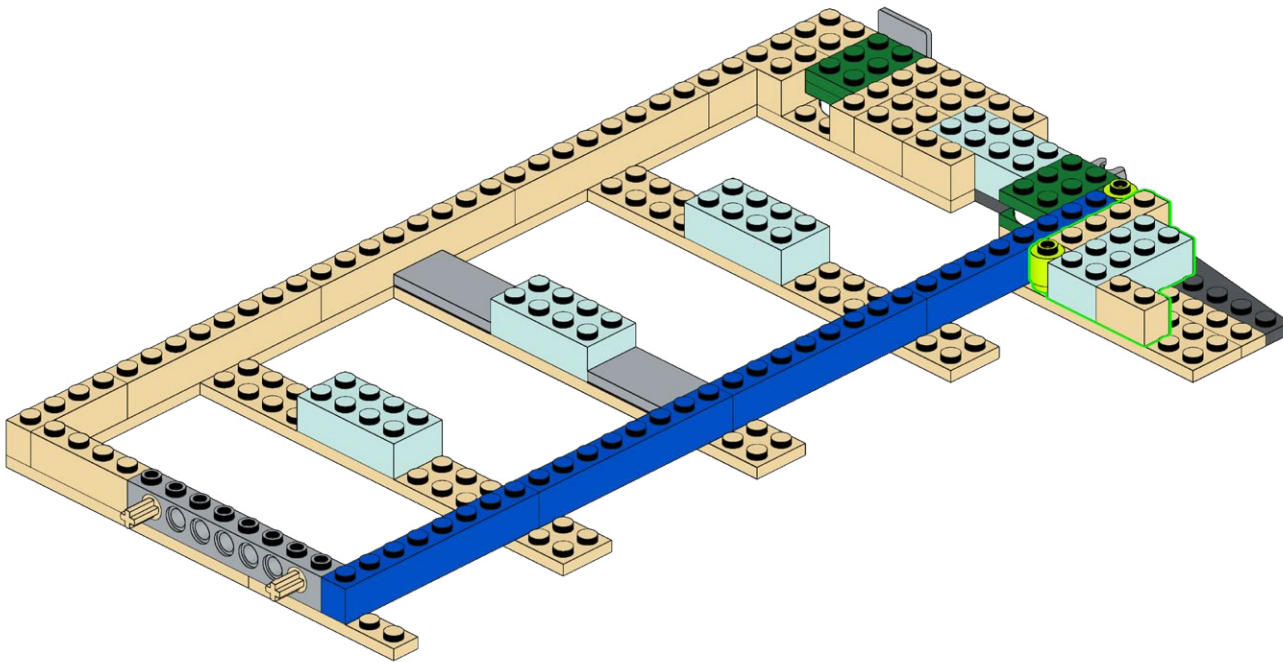
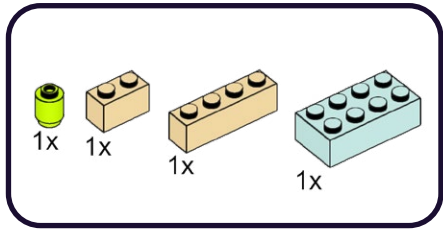

10

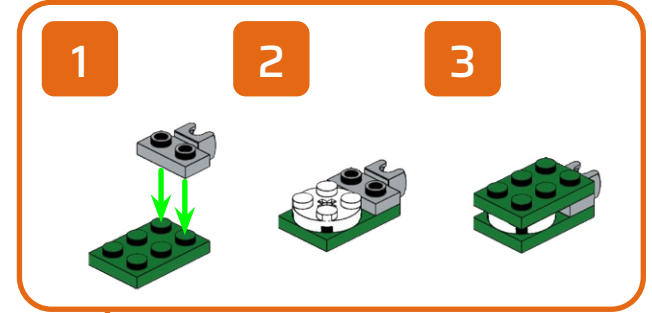
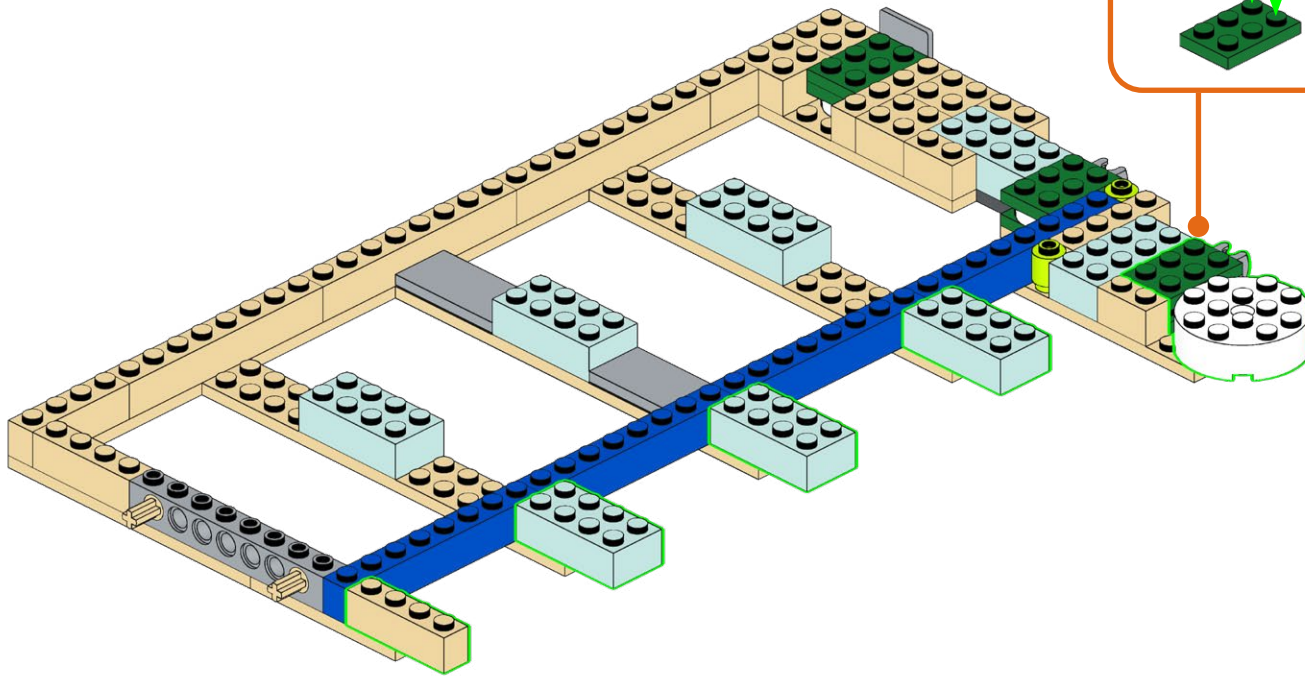
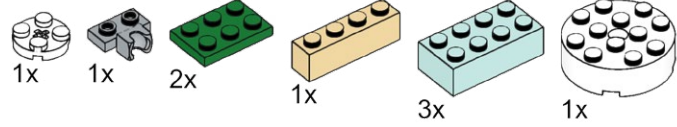

11

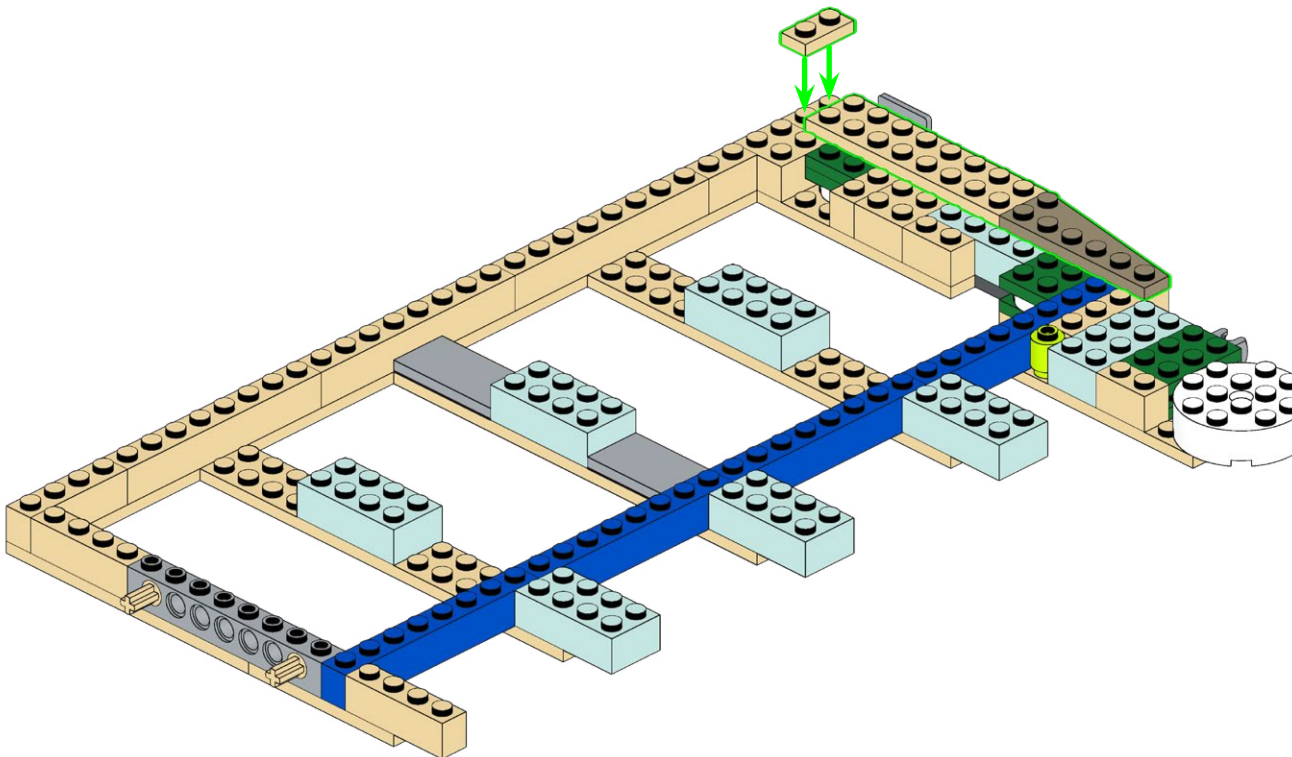
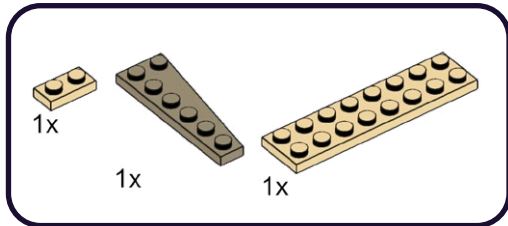



12

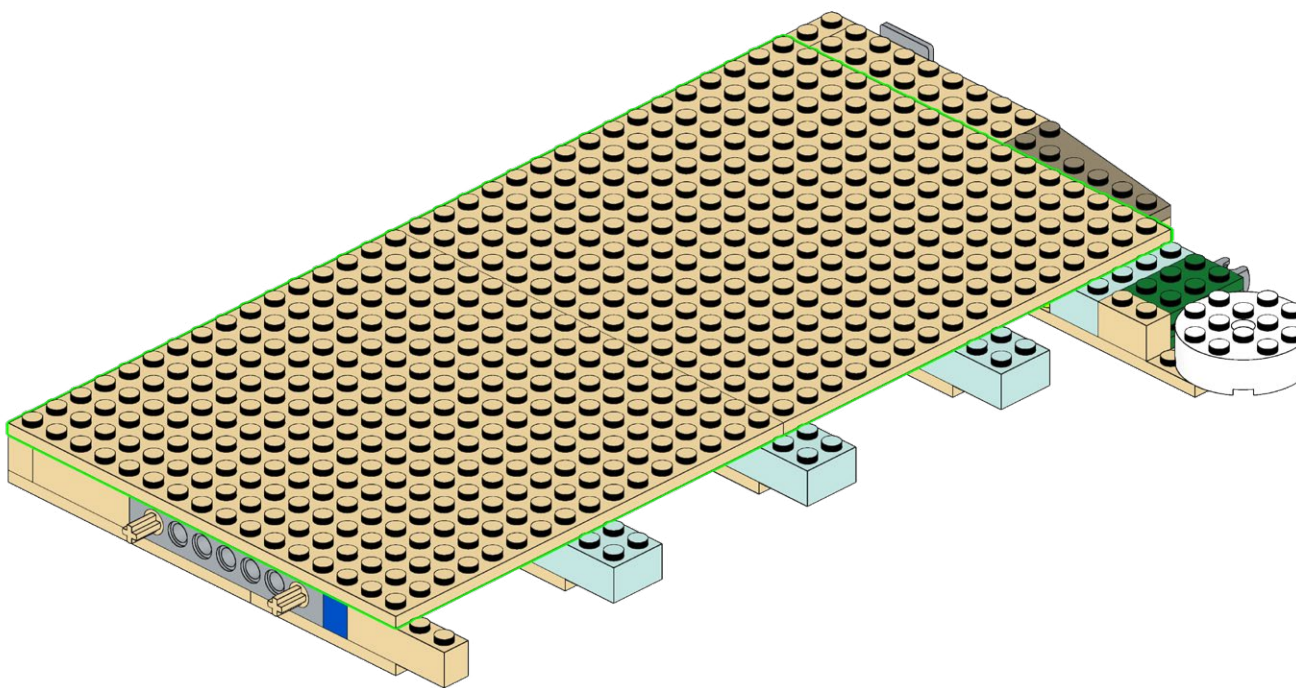
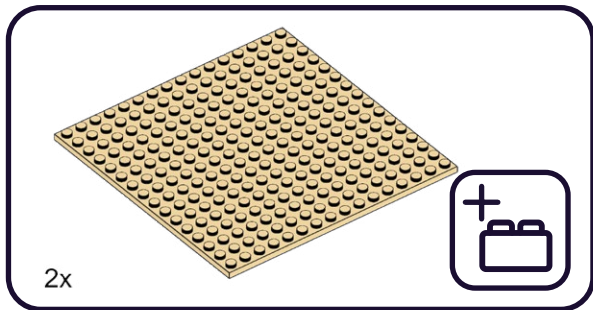



### **HOLD UP!**

You might notice some bags aren't in order, as well as left over pieces, but that's ok! We're changing the way you build LEGO!

### **ATTENDEZ!**

Vous remarquerez peut-être que certains sacs, ainsi que certaines pièces, ne sont pas dans le bon ordre. Mais pas de panique! Nous changeons simplement la façon avec laquelle vous construisez vos LEGO!

### **ASPETTA!**

Potresti notare che alcuni sacchetti non sono in ordine, così come i pezzi avanzati, ma va bene così! Stiamo cambiando il modo in cui costruisci i LEGO!

### **HALT!**

Sie werden möglicherweise bemerken, dass einige tüten durcheinander sind und teile übrig bleiben, aber das ist in Ordnung! Wir ändern die art und weise, wie Sie LEGO bauen!

### **¡ESPERA!**

Es posible que notes que algunas bolsas están fuera de servicio, así como piezas sobrantes, ¡pero está bien! ¡Estamos cambiando la forma en que construyes LEGO!

### **暫停!**

你可能会注意到一些袋子顺序错乱, 以及一些剩余的部件, 但没关系! 我们正在改变你搭建乐高的方式!

#### Open LEGO® Bags 24 & 25

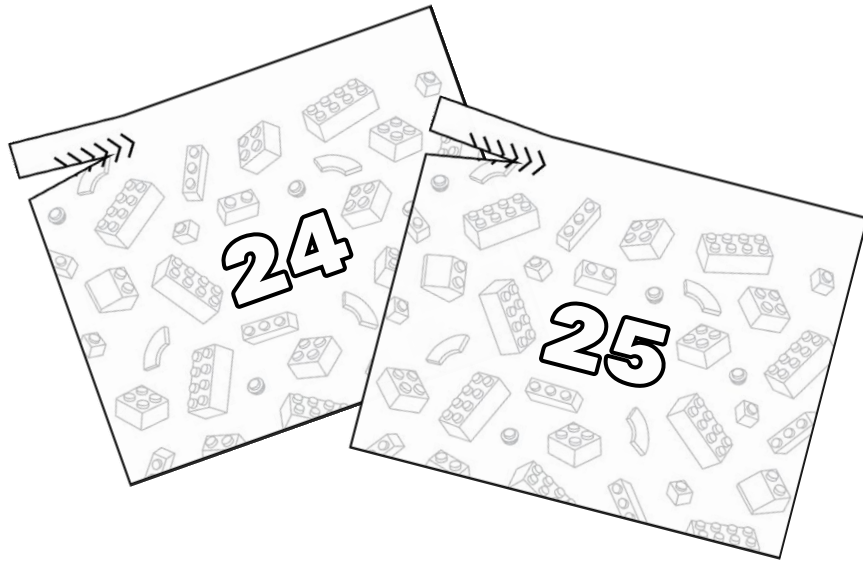

#### Open LMB Bag 05

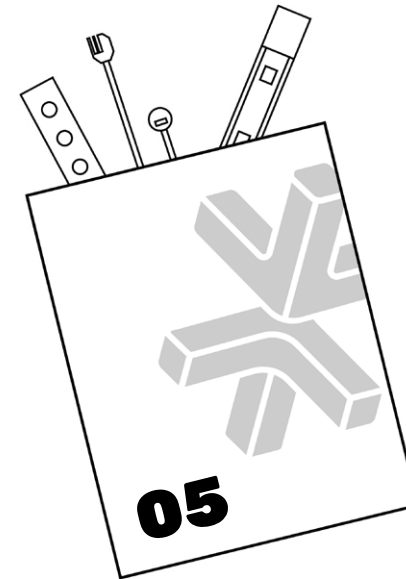

13

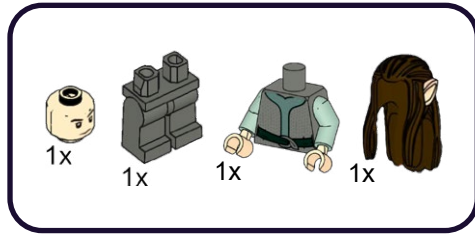

14



15

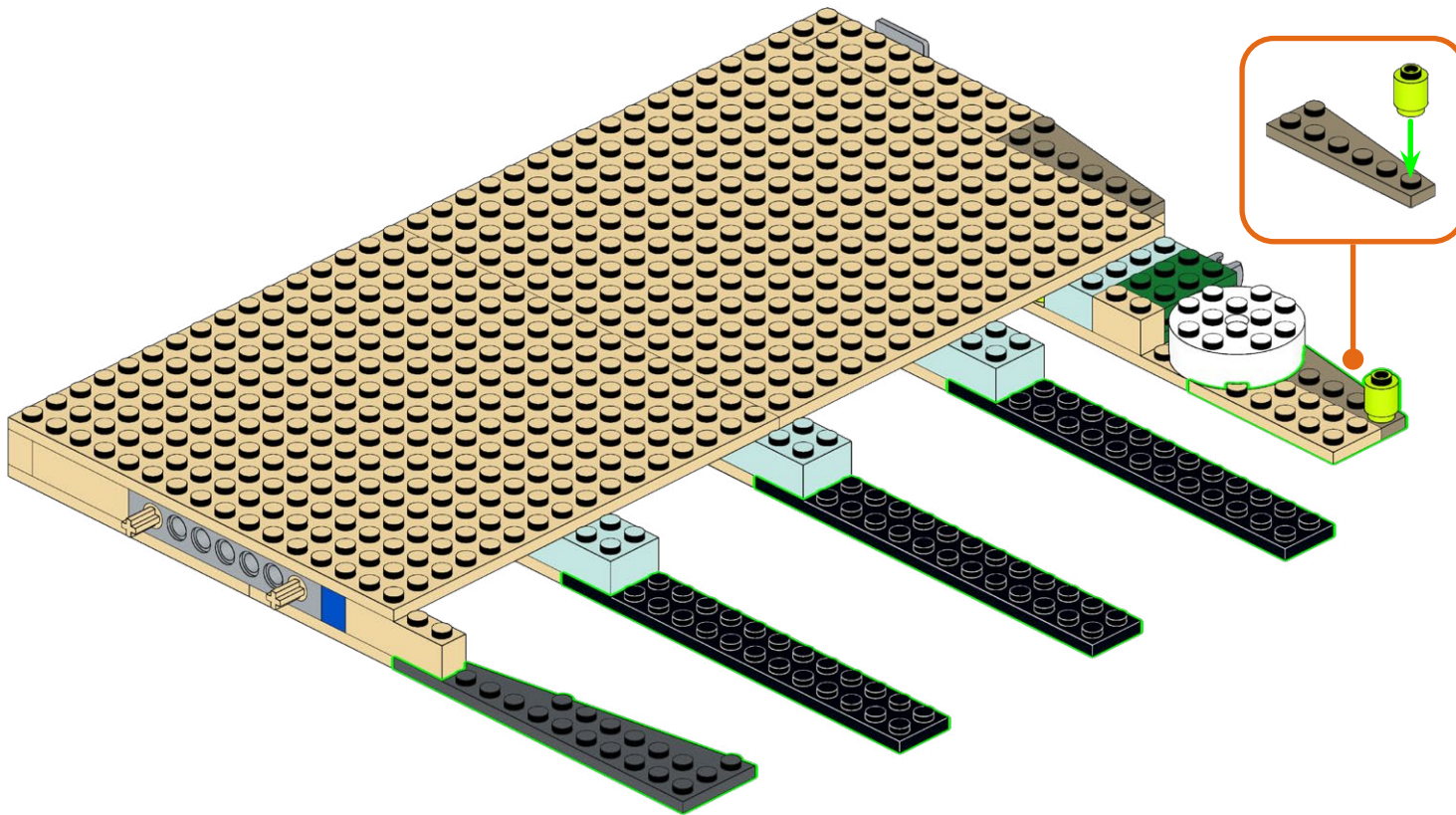
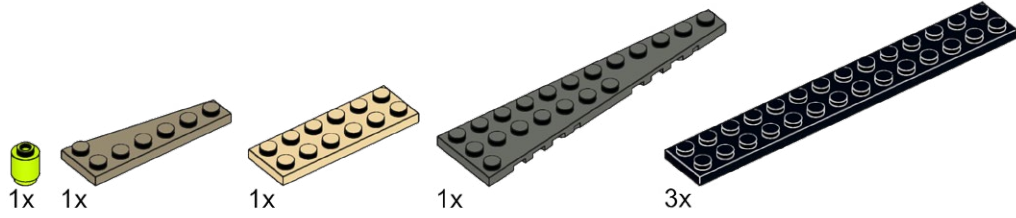



16

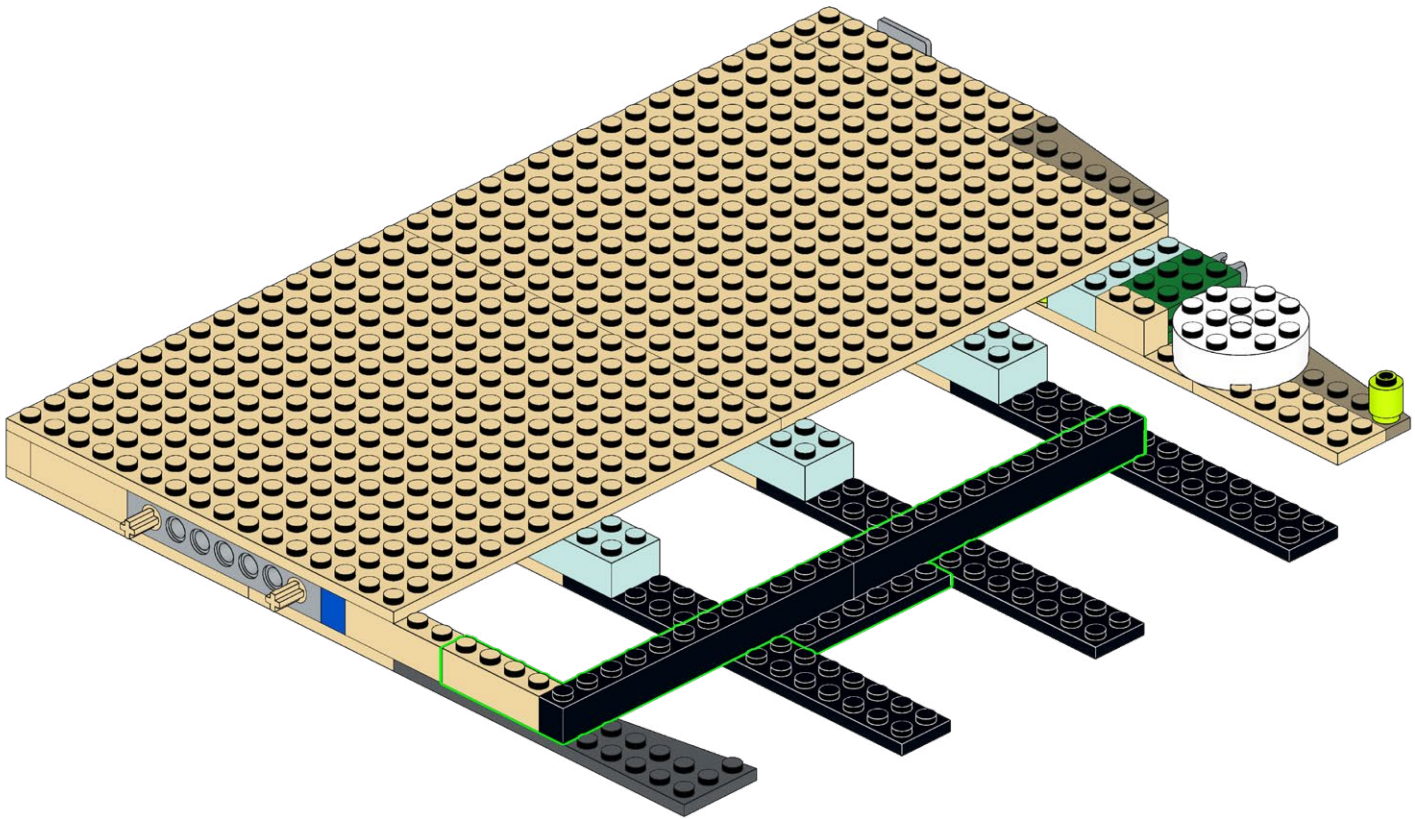
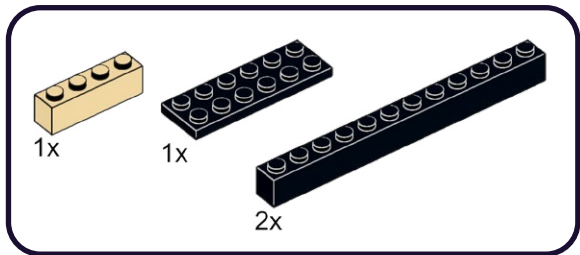

17

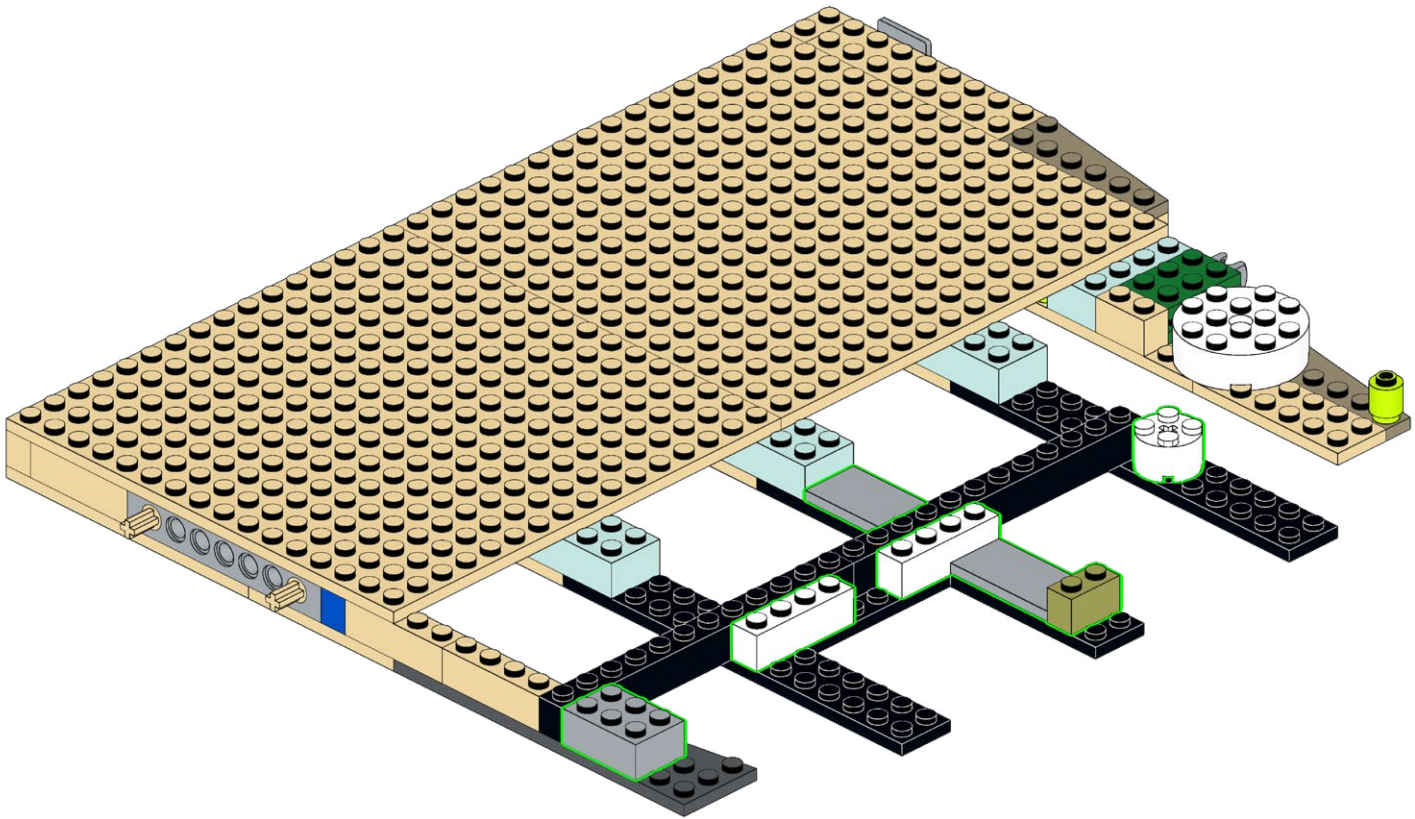
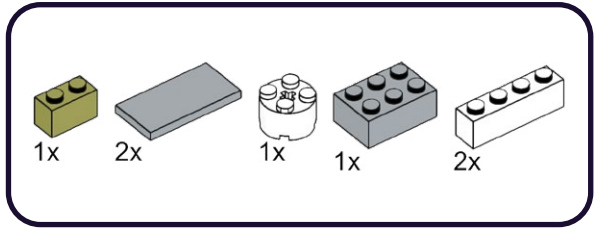



18

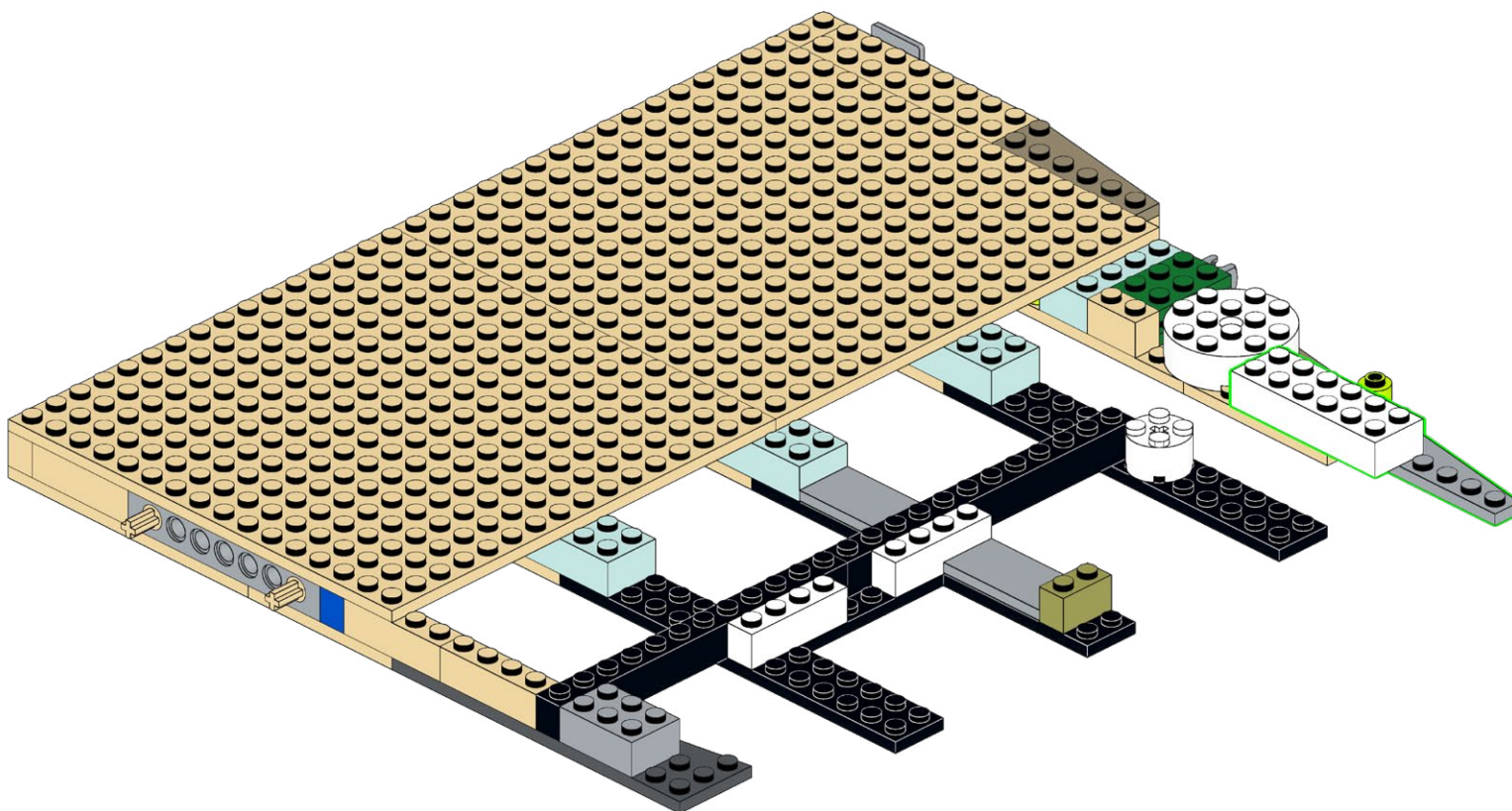
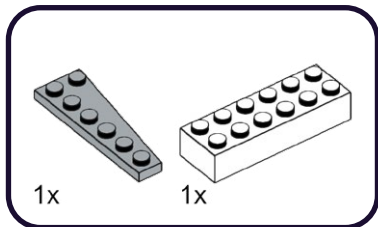

19

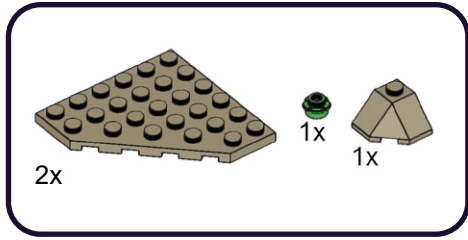

1

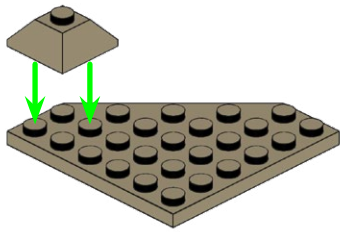

2

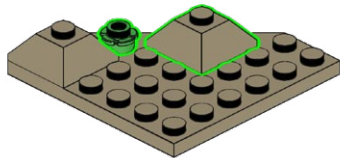

20

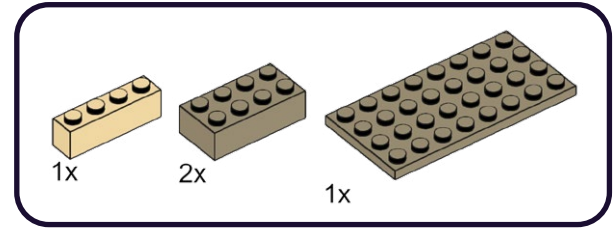

1

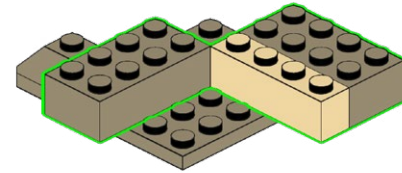

2

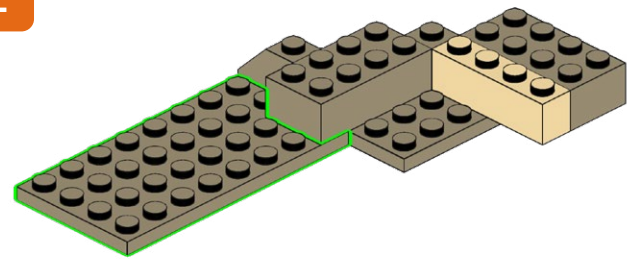

21

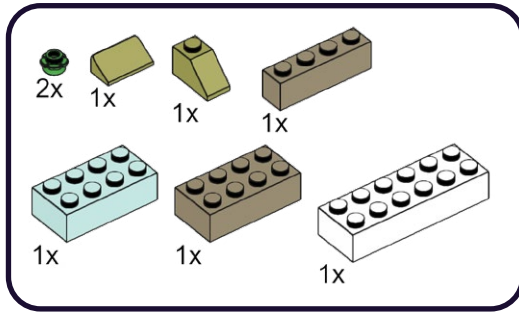

1

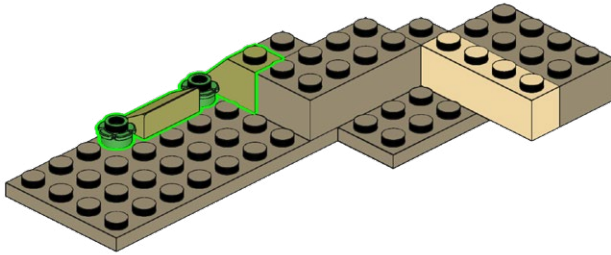

2

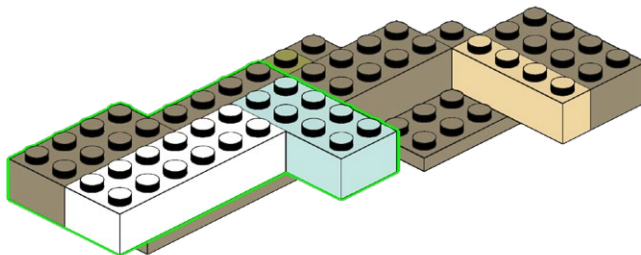

22

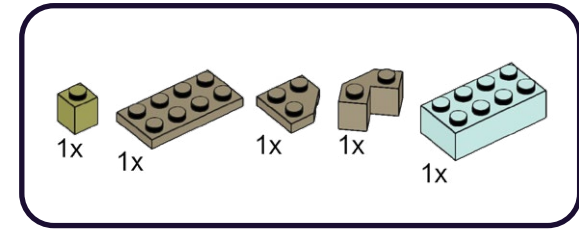

1

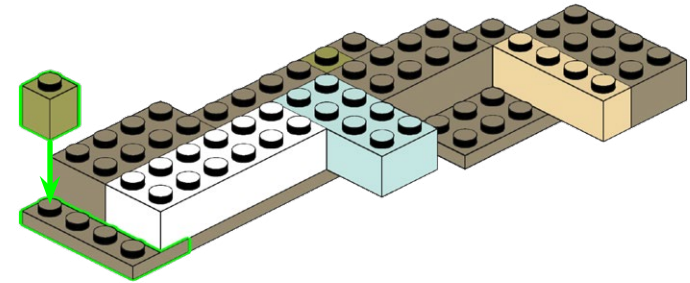

2

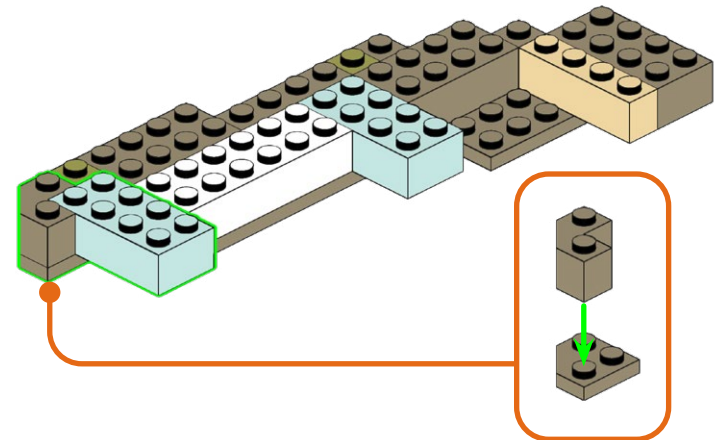

# 23

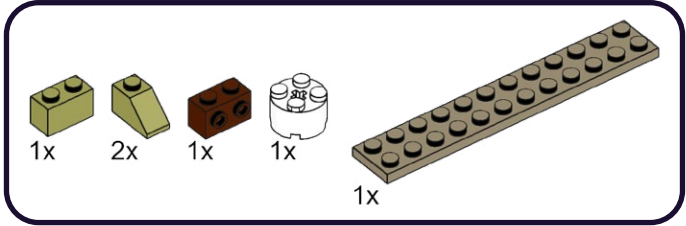

1

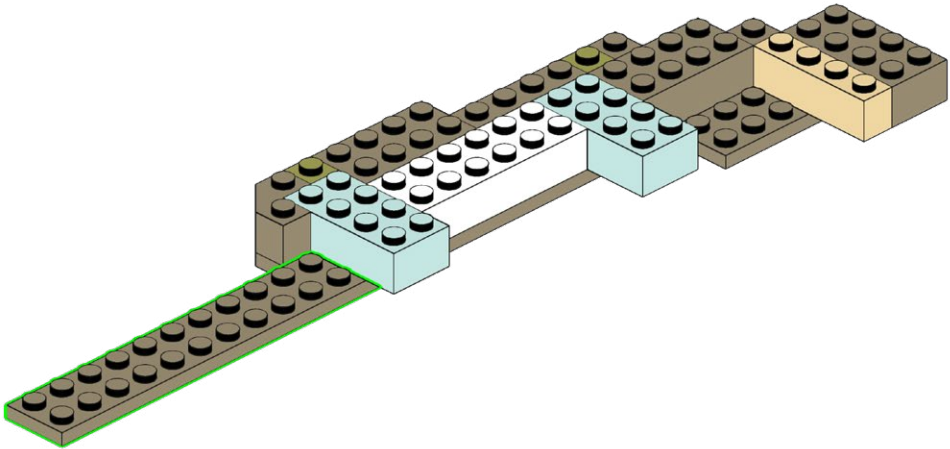

2

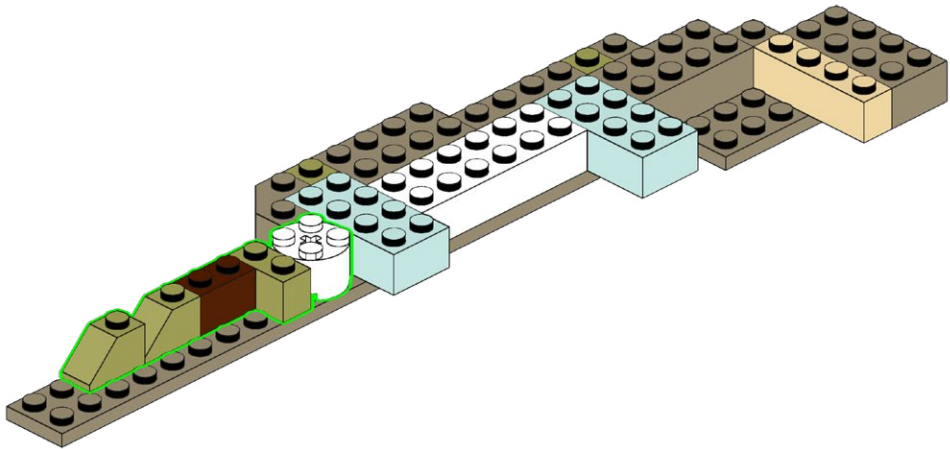

24

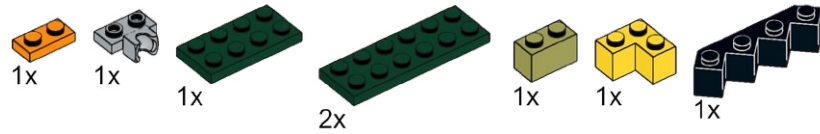

1

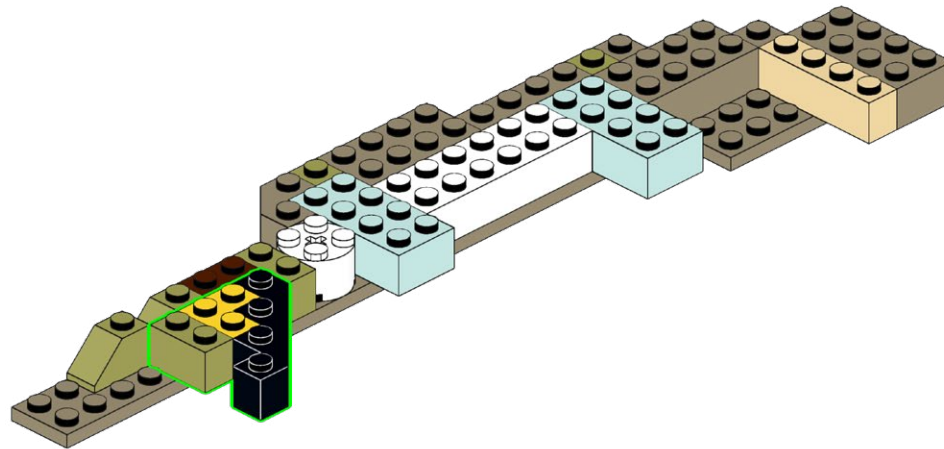

2

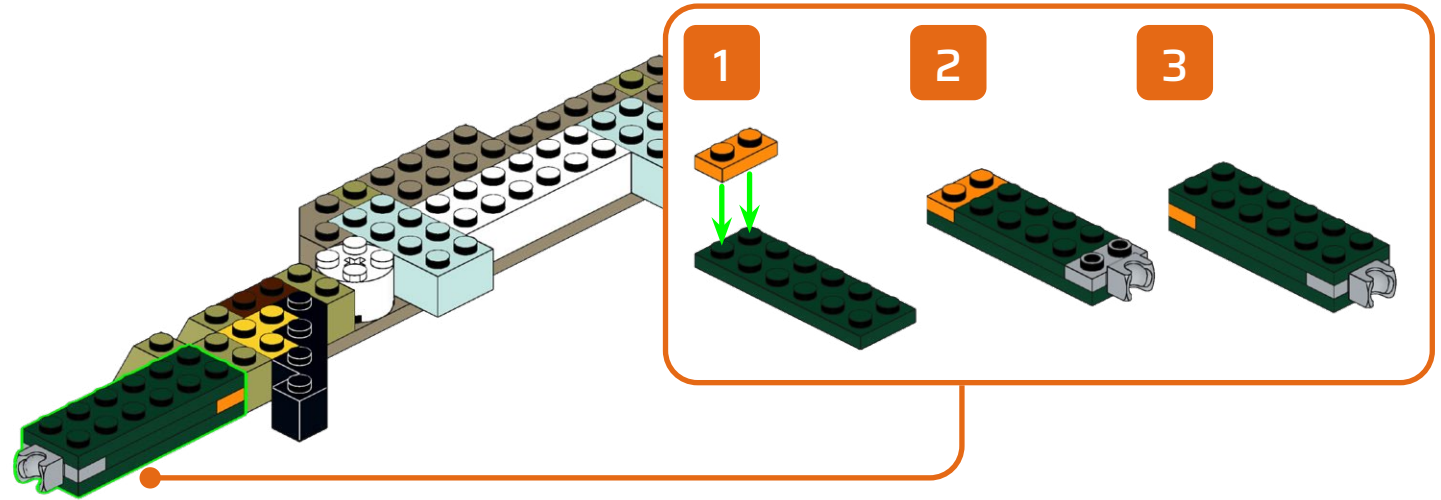



# 25

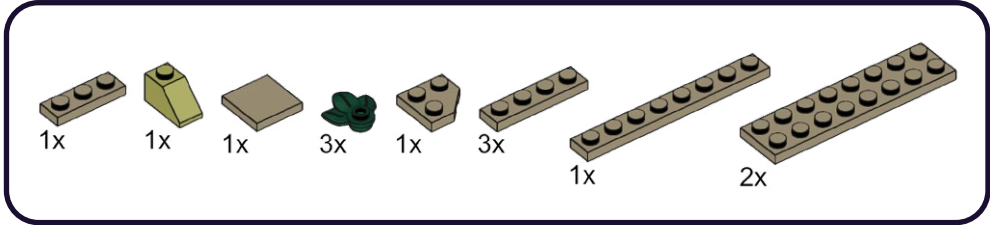

1

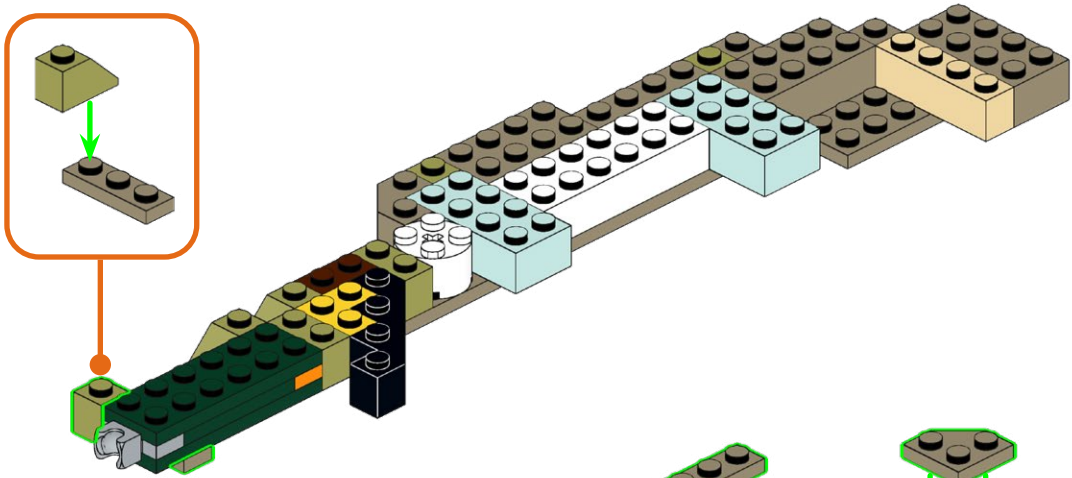

2

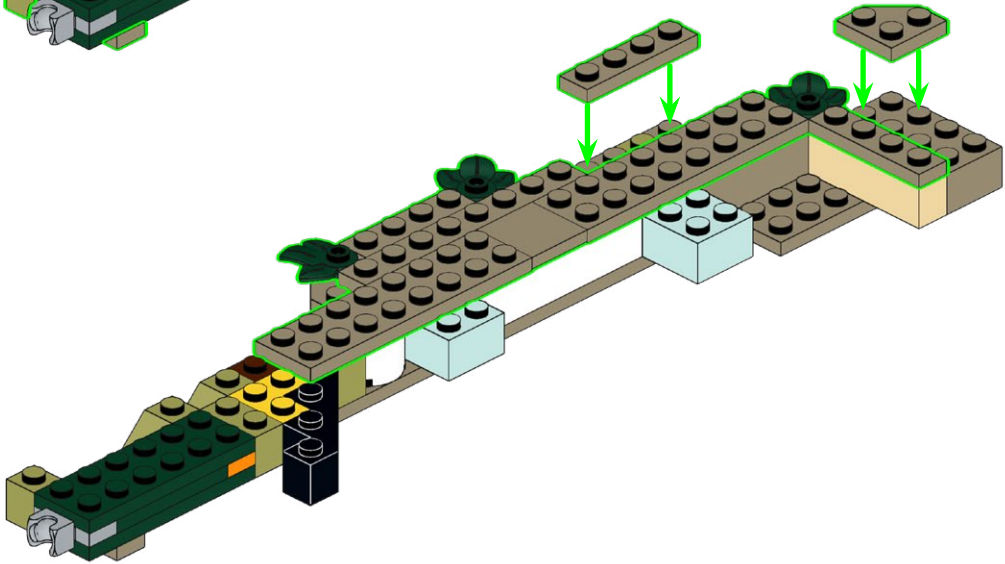



26

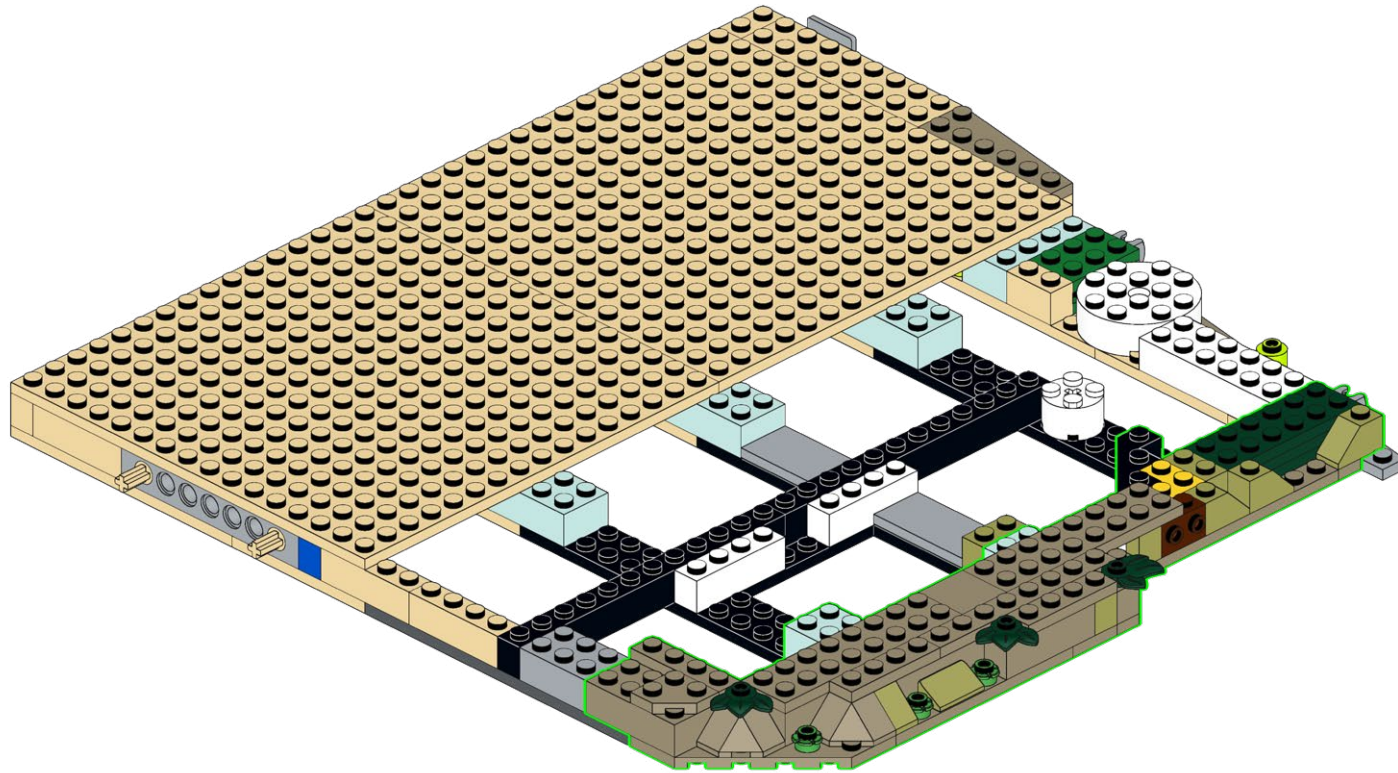

27

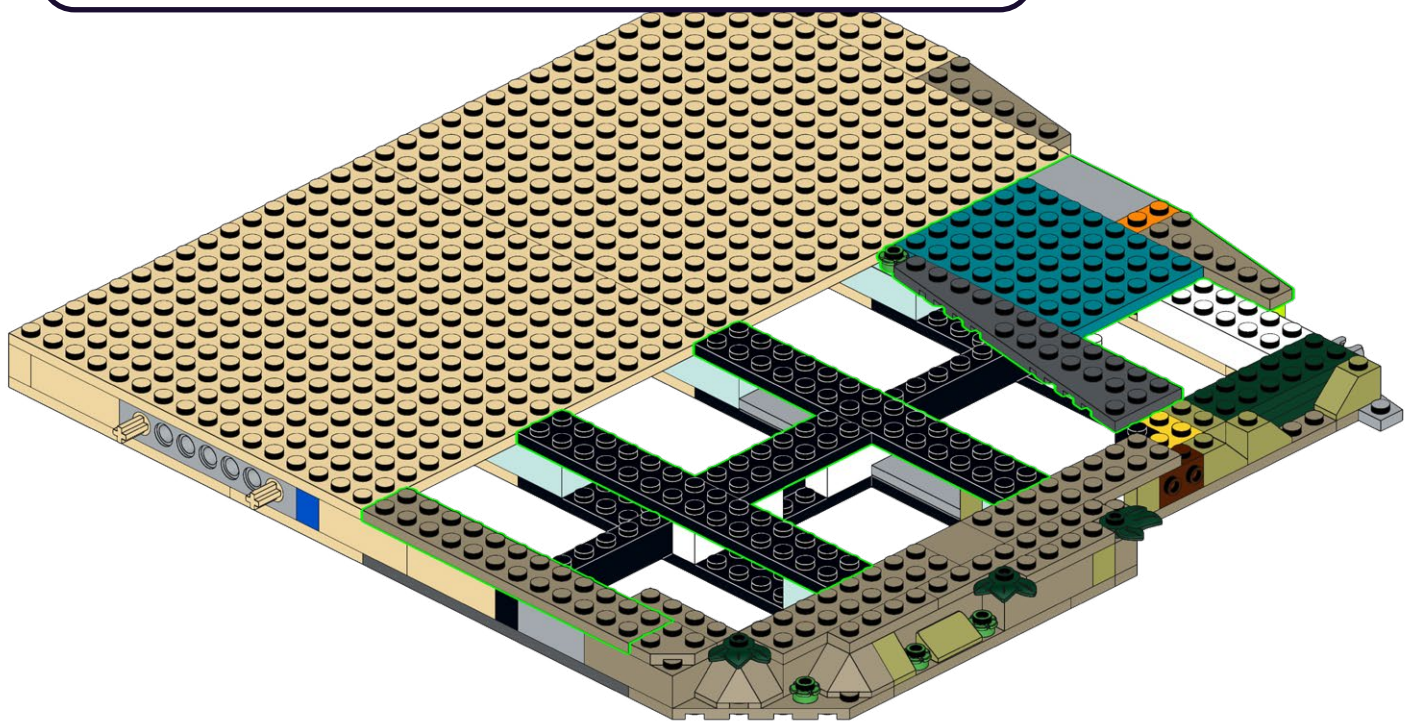
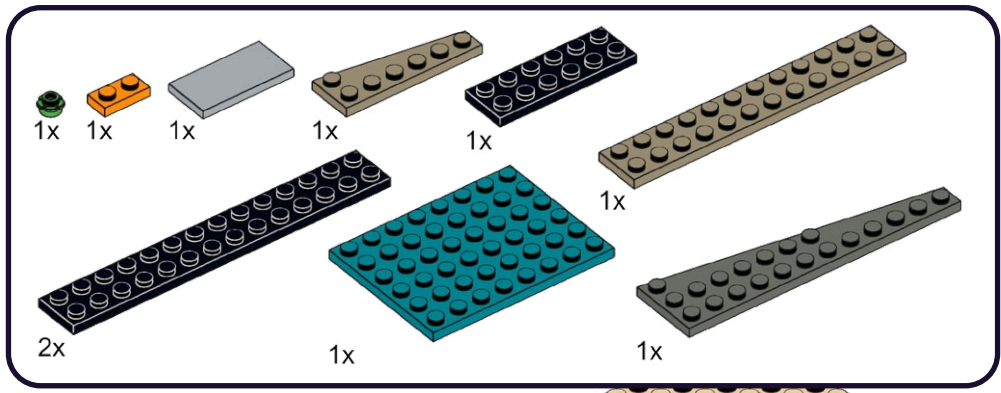



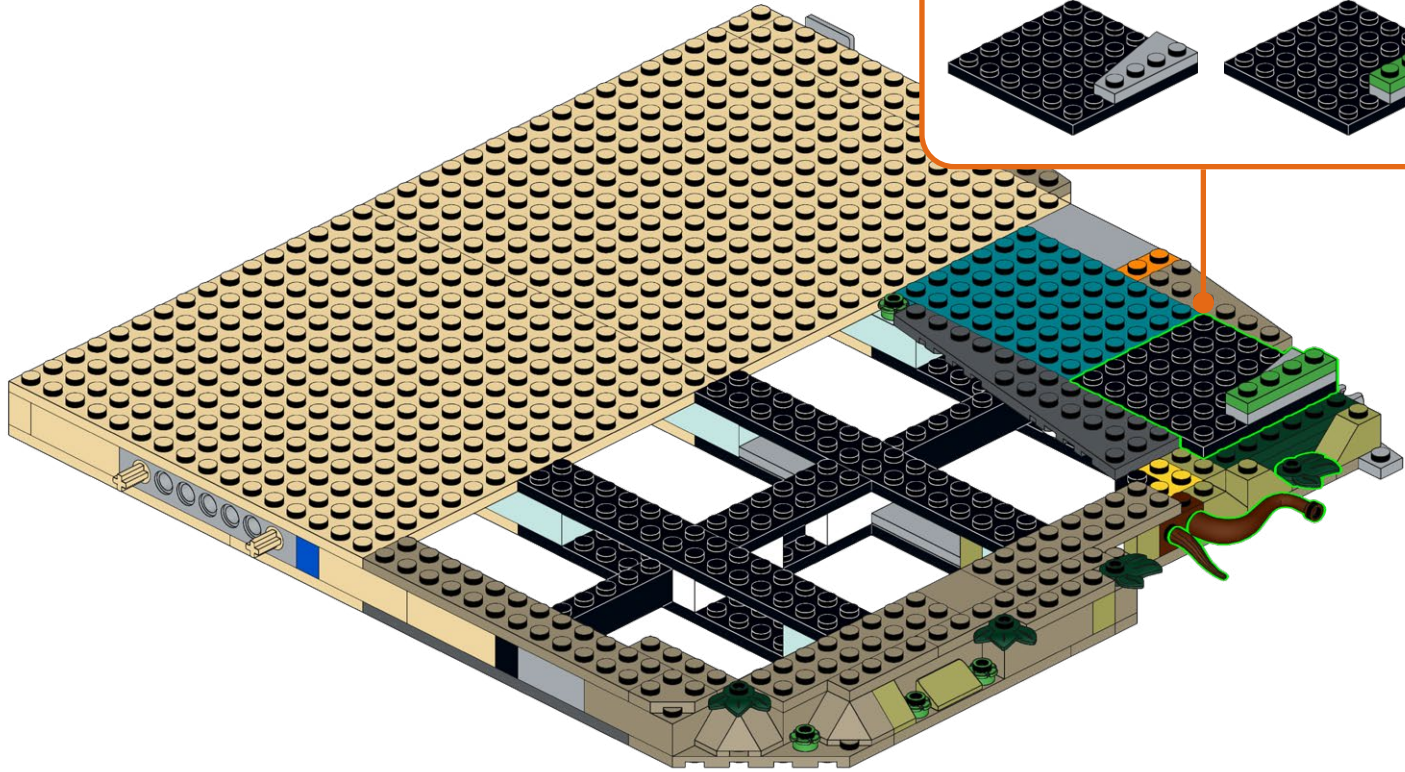
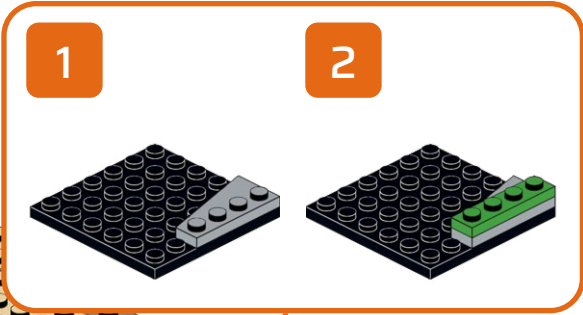
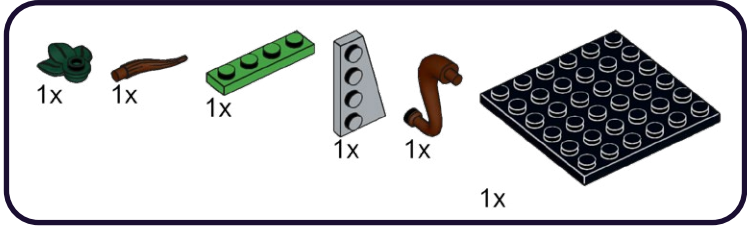

28





# 29

- 2x 
- 1x 
- 1x 
- 2x 
- 1x 

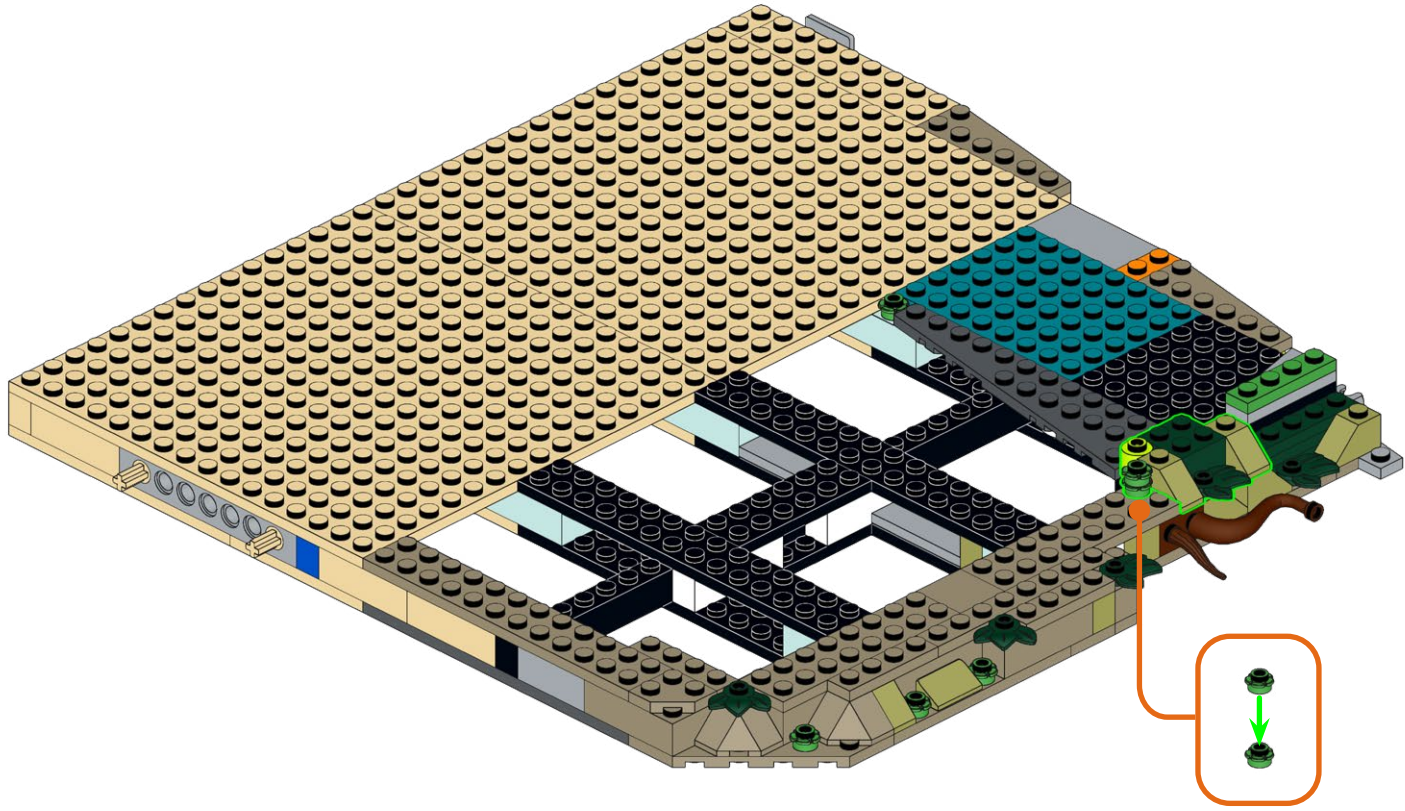

30

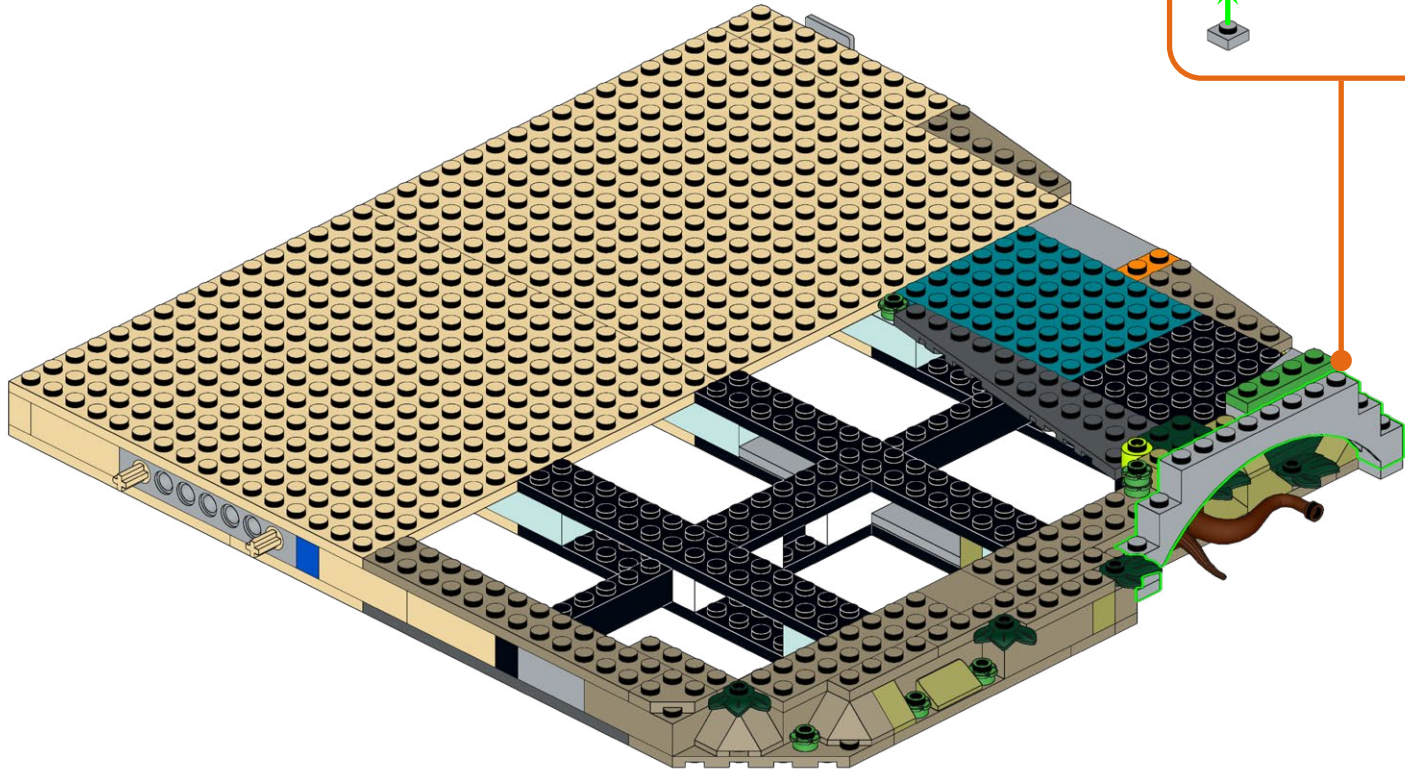
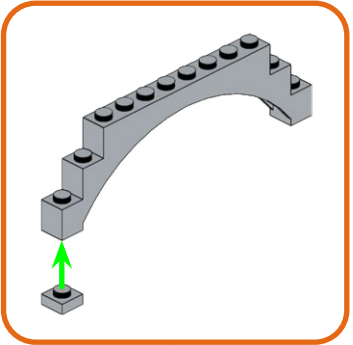
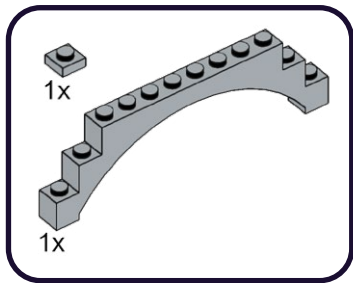

31

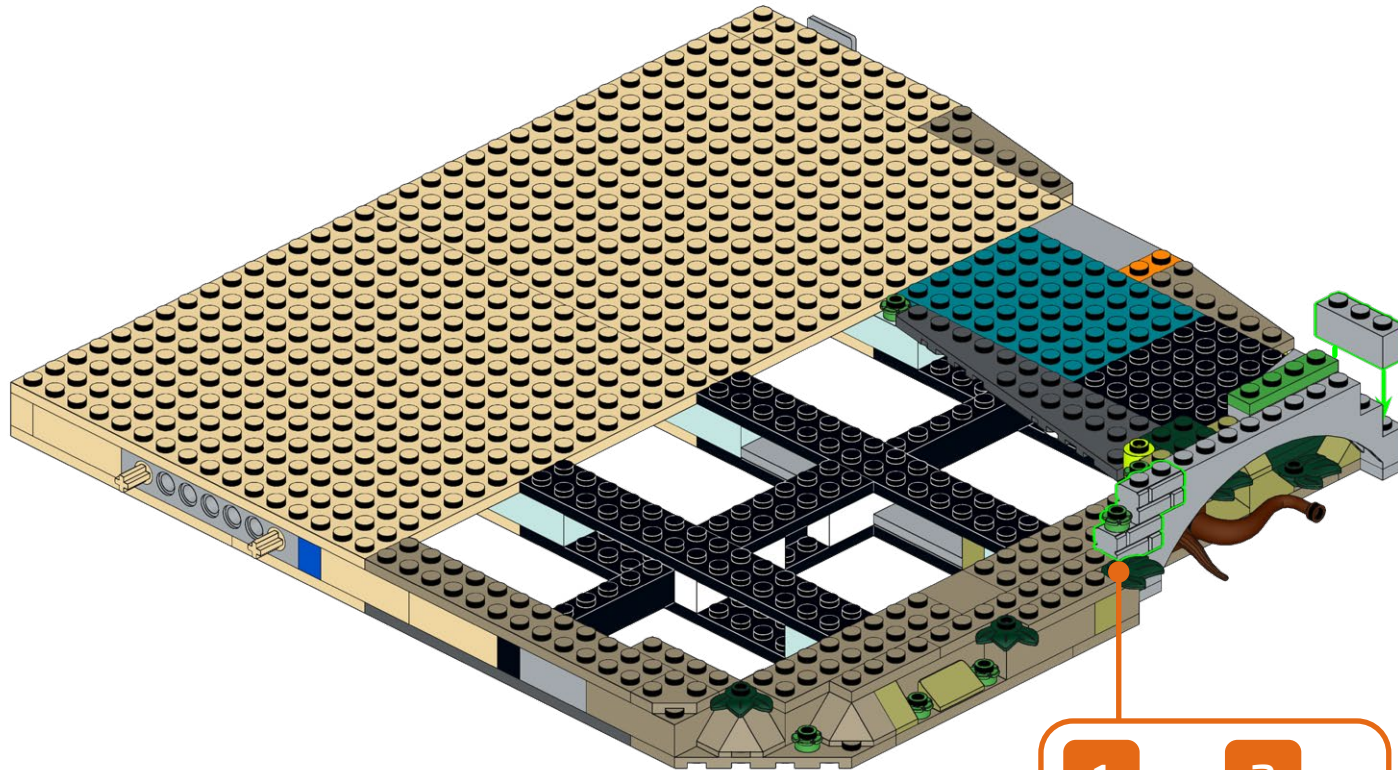
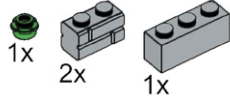

1

2

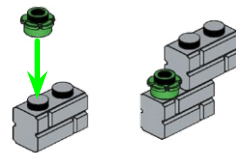



32

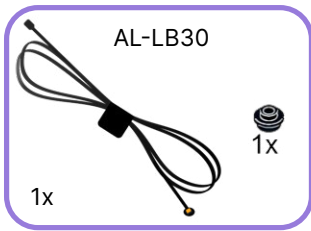
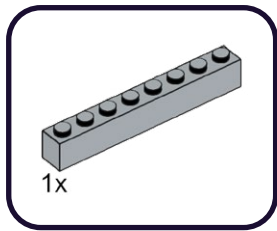

1

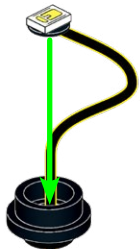

2



3

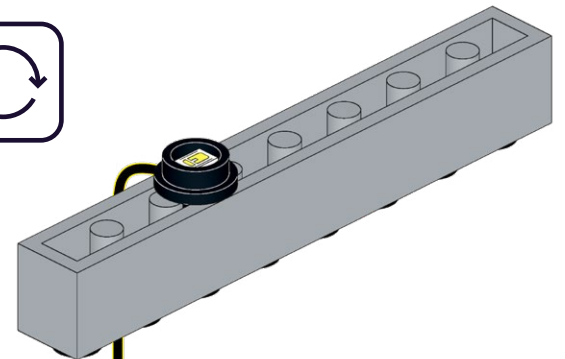
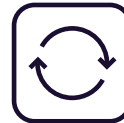

33

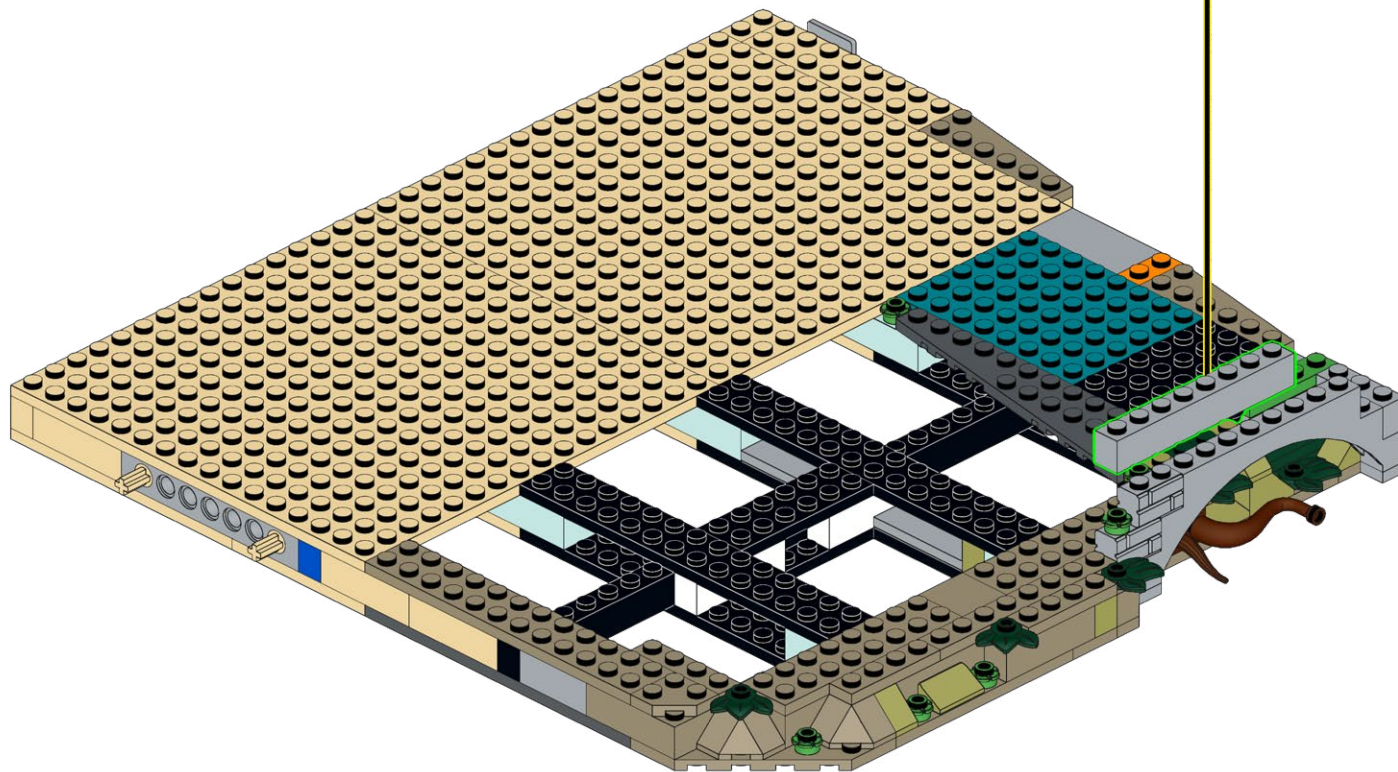

34

2x

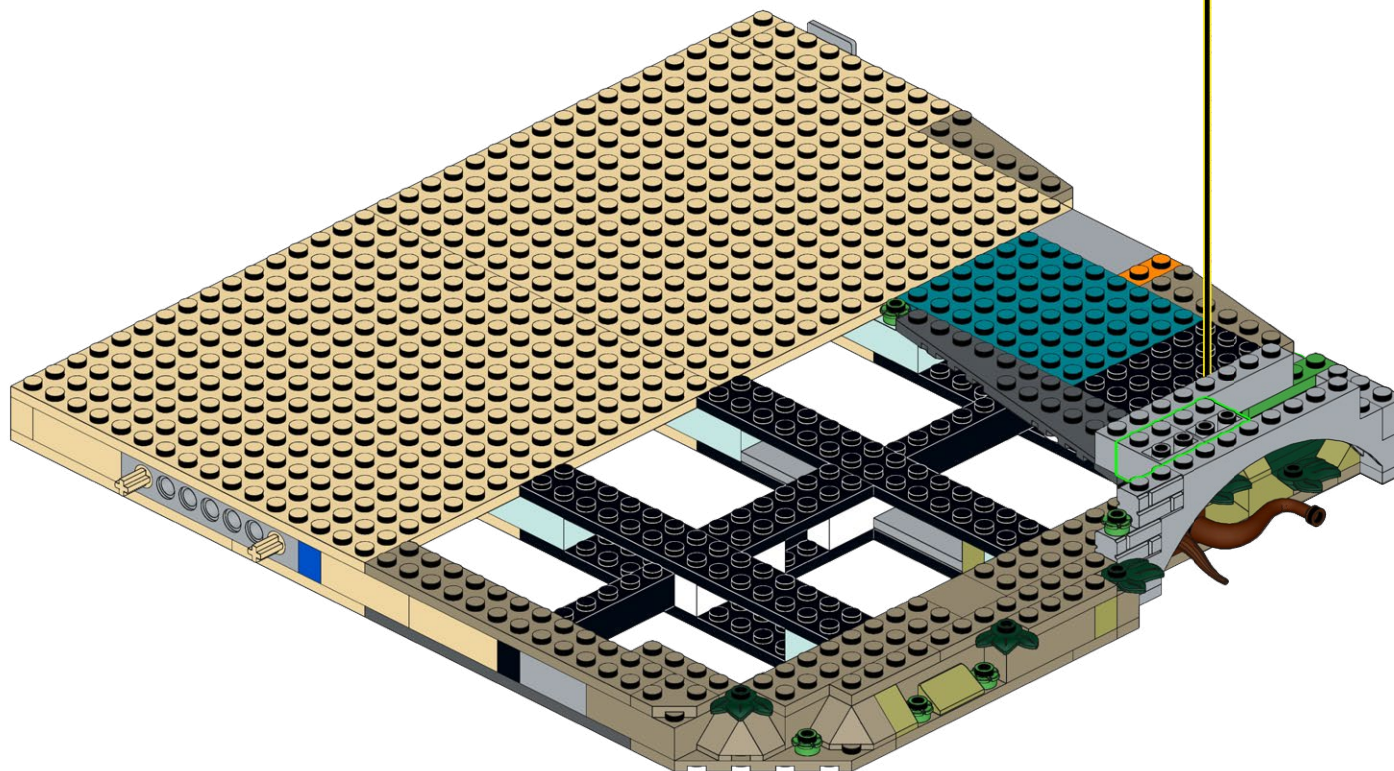

35

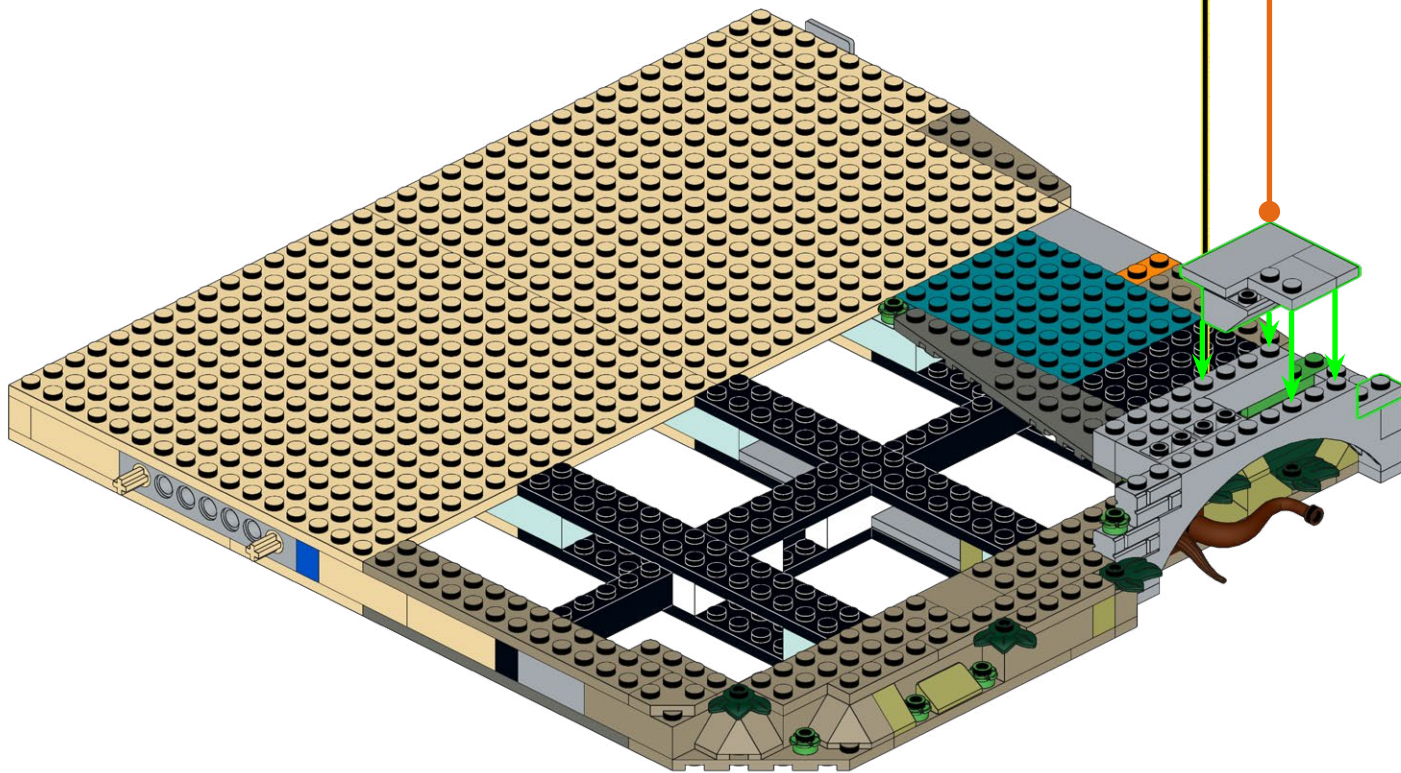
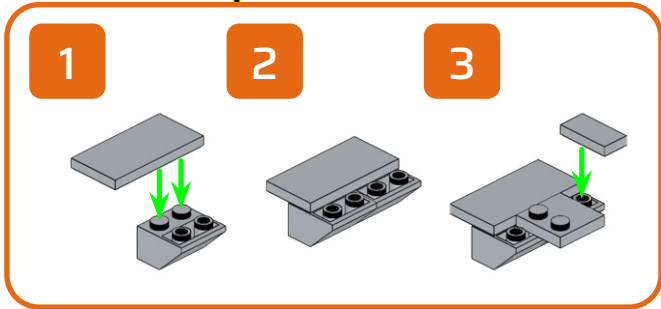
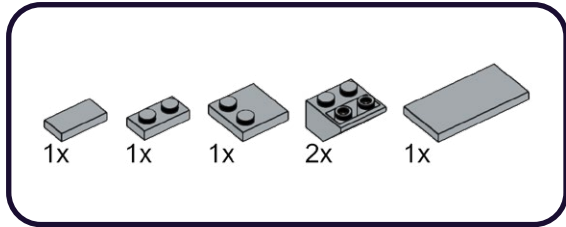



36

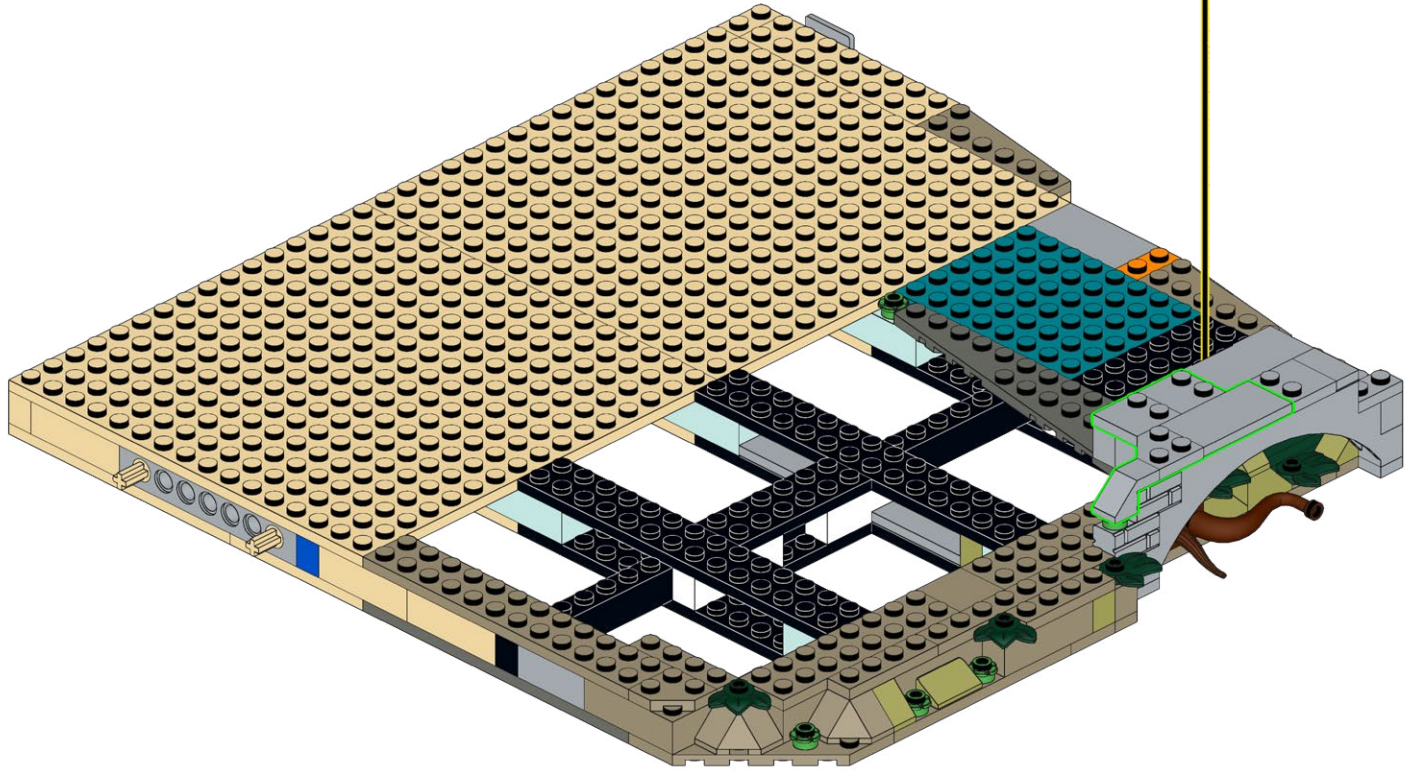
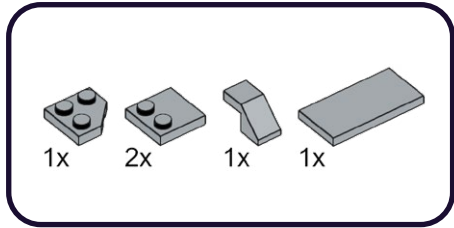

37

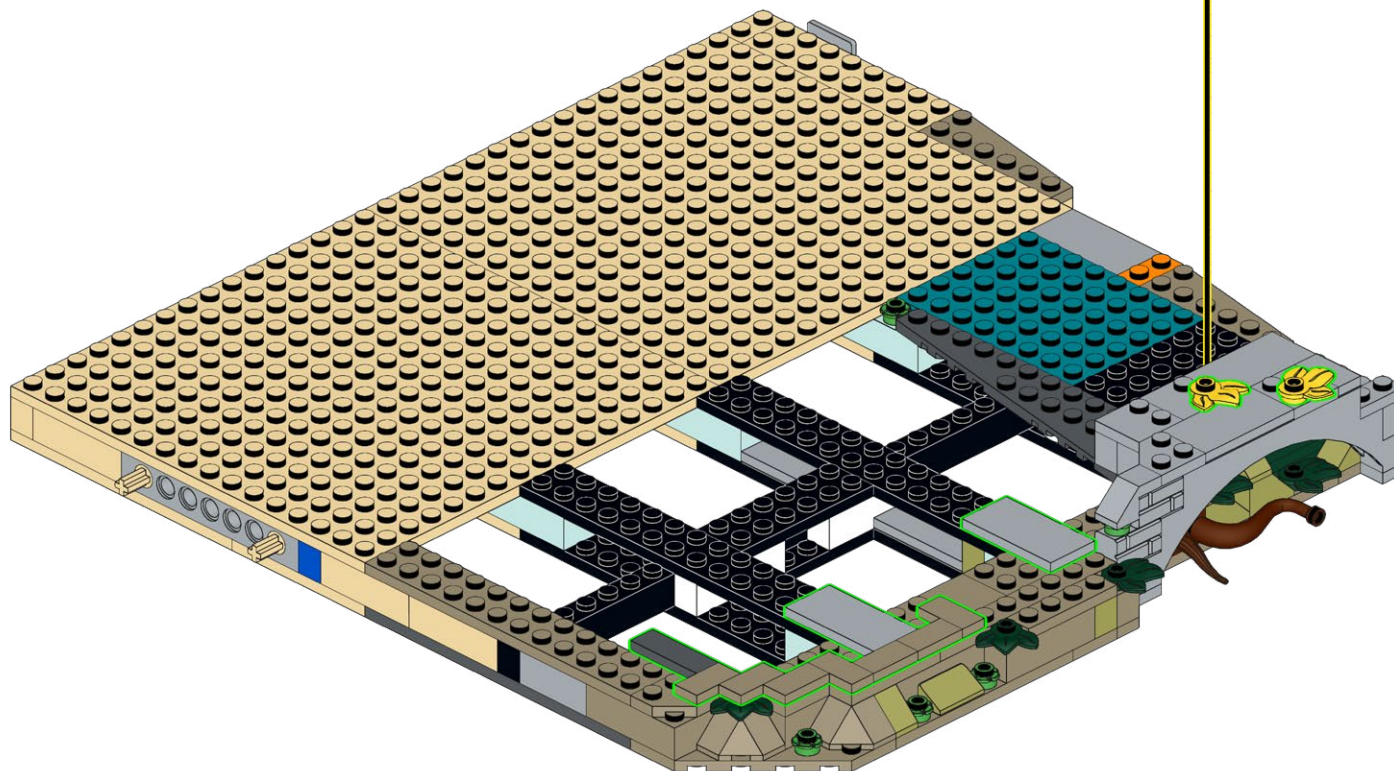





### **HOLD UP!**

You might notice some bags aren't in order, as well as left over pieces, but that's ok! We're changing the way you build LEGO!

### **ATTENDEZ!**

Vous remarquerez peut-être que certains sacs, ainsi que certaines pièces, ne sont pas dans le bon ordre. Mais pas de panique! Nous changeons simplement la façon avec laquelle vous construisez vos LEGO!

### **ASPETTA!**

Potresti notare che alcuni sacchetti non sono in ordine, così come i pezzi avanzati, ma va bene così! Stiamo cambiando il modo in cui costruisci i LEGO!

### **HALT!**

Sie werden möglicherweise bemerken, dass einige tüten durcheinander sind und teile übrig bleiben, aber das ist in Ordnung! Wir ändern die art und weise, wie Sie LEGO bauen!

### **¡ESPERA!**

Es posible que notes que algunas bolsas están fuera de servicio, así como piezas sobrantes, ¡pero está bien! ¡Estamos cambiando la forma en que construyes LEGO!

### **暫停!**

你可能会注意到一些袋子顺序错乱, 以及一些剩余的部件, 但没关系! 我们正在改变你搭建乐高的方式!

#### Open LEGO® Bag 26

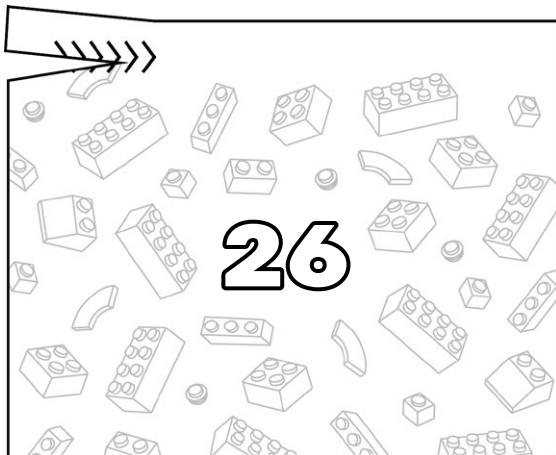

#### Open LMB Bag 03

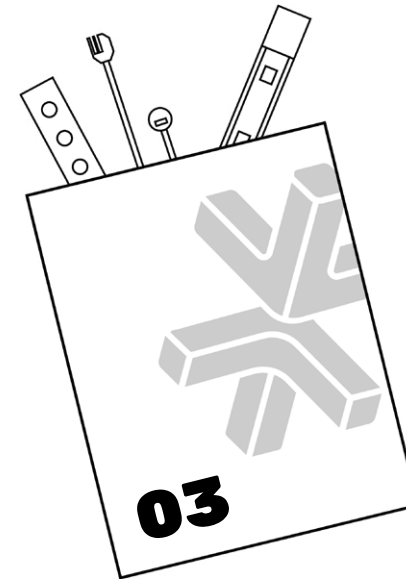

38

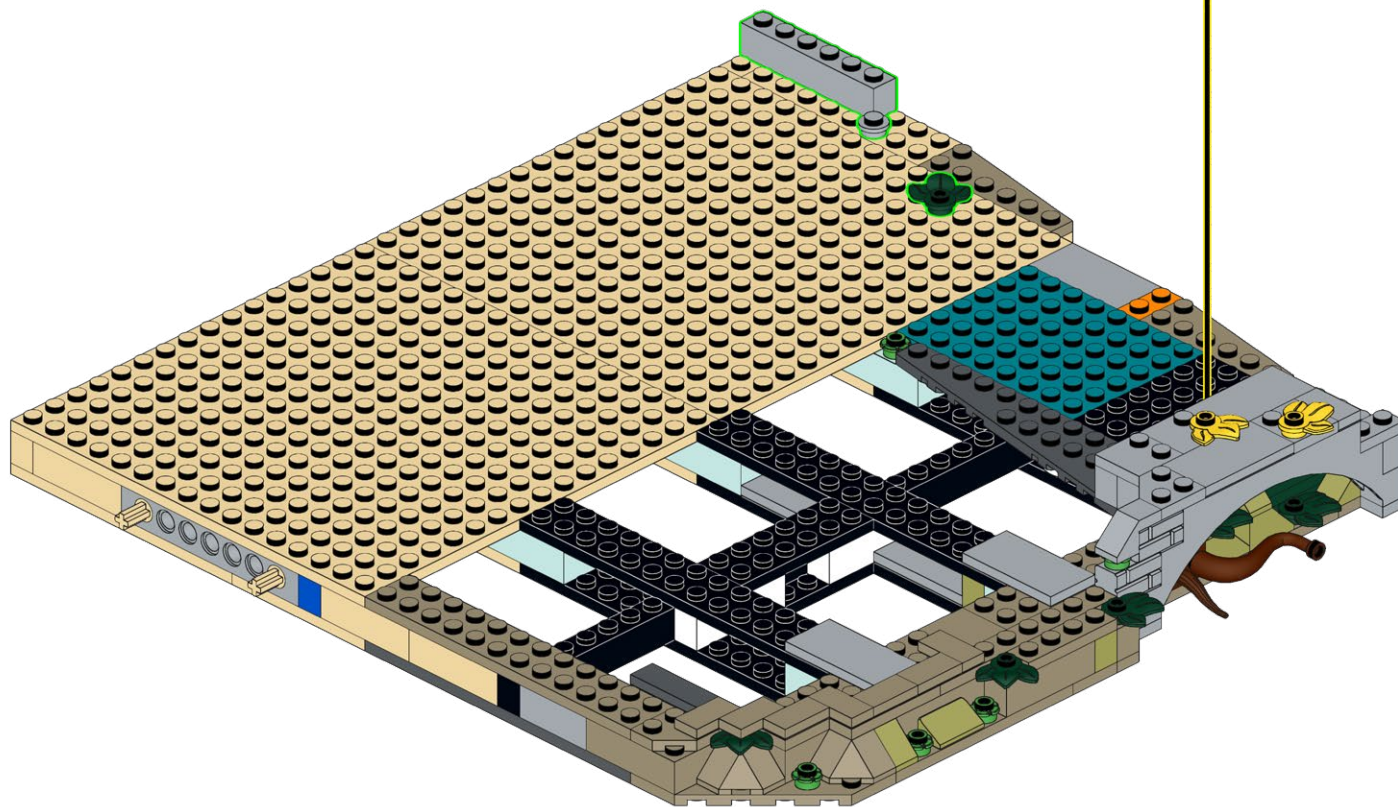
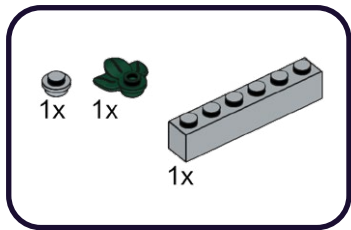

39

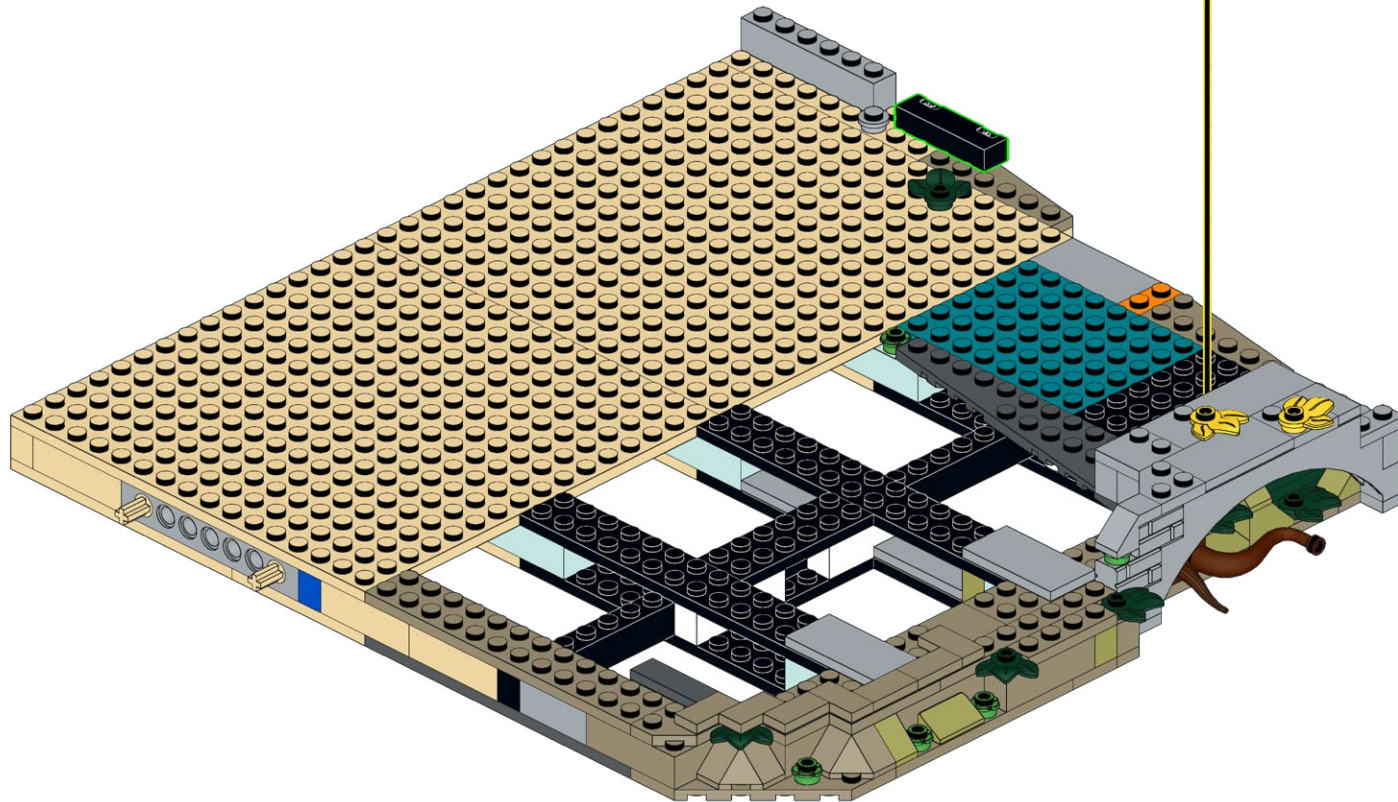
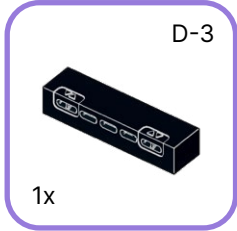



40

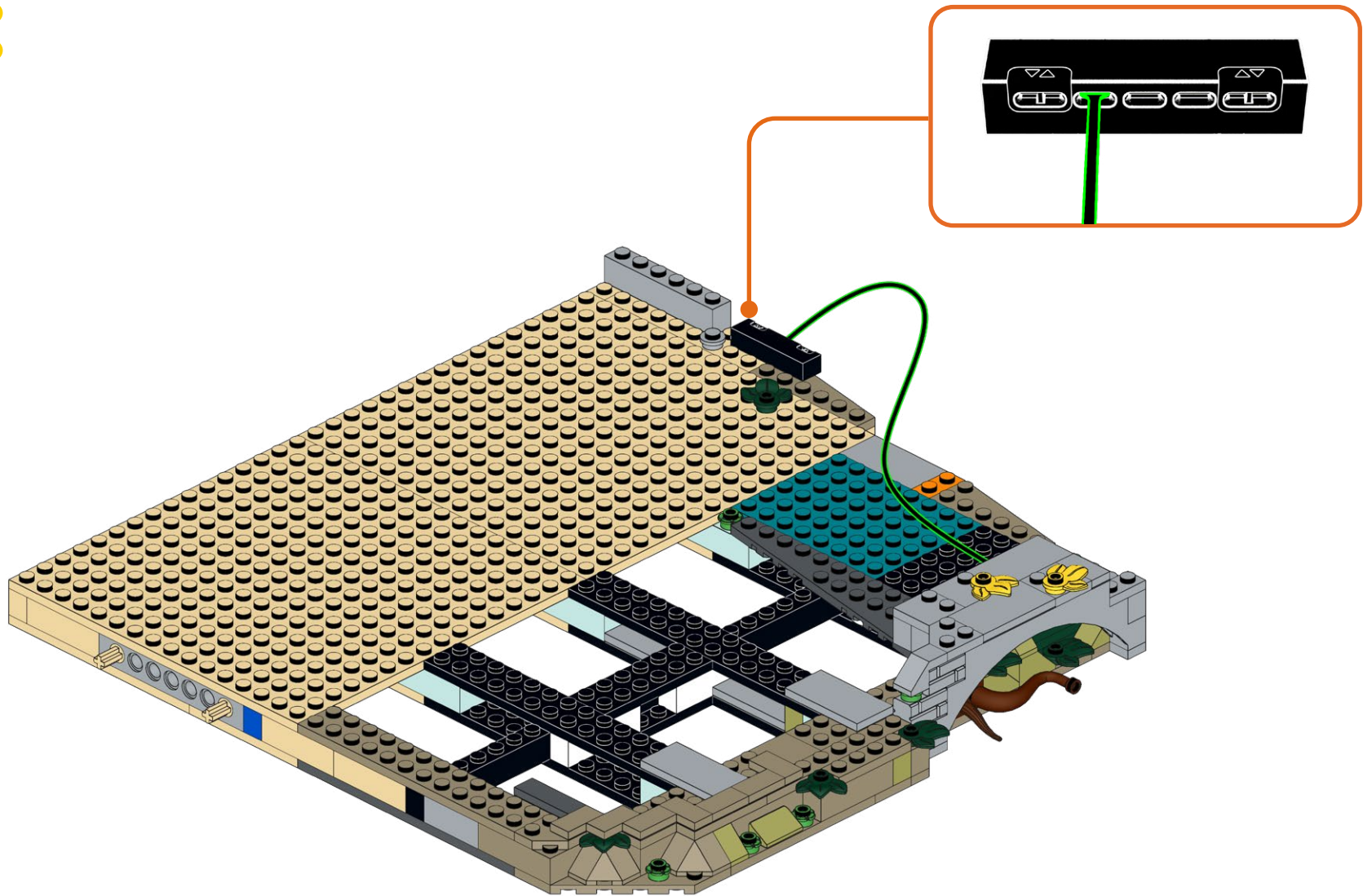



41

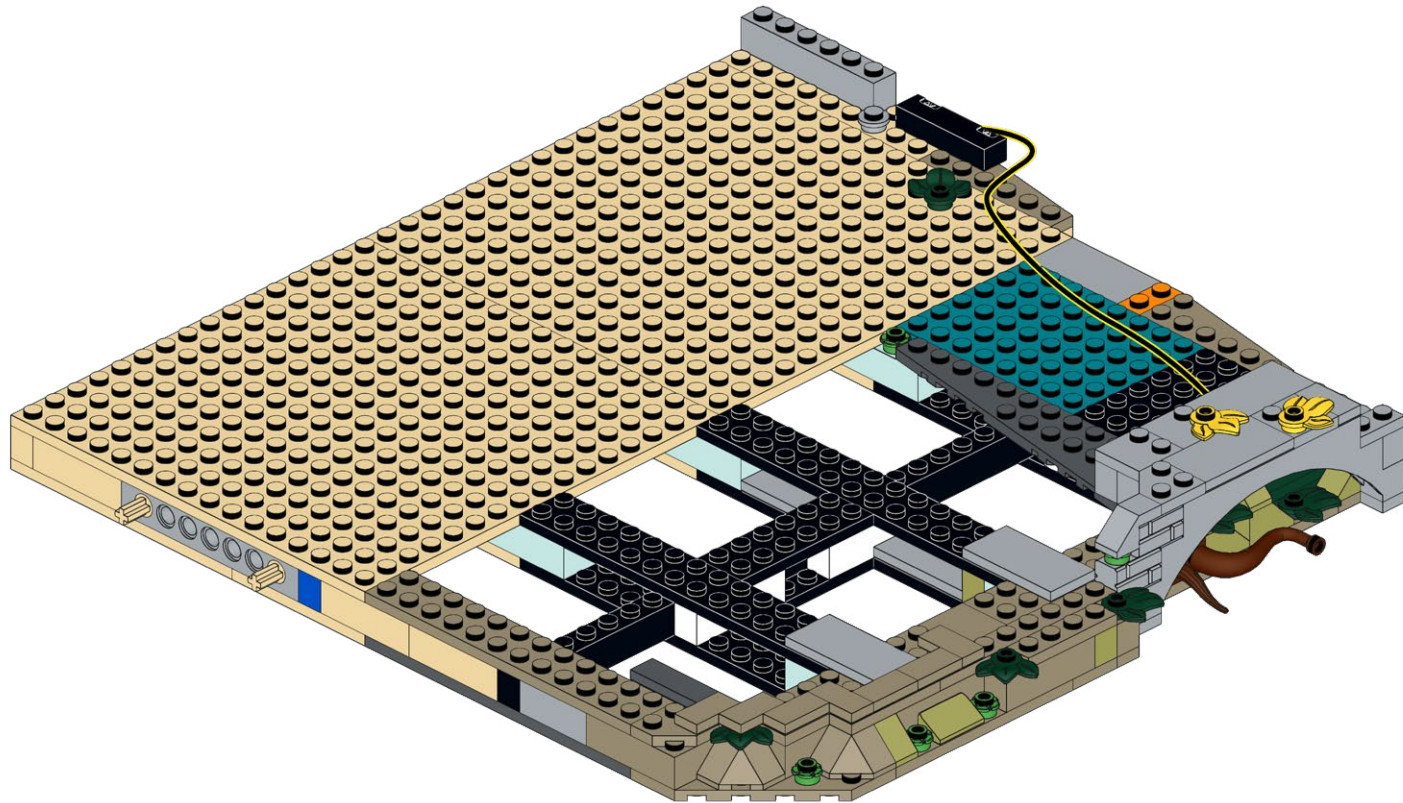

42

1x

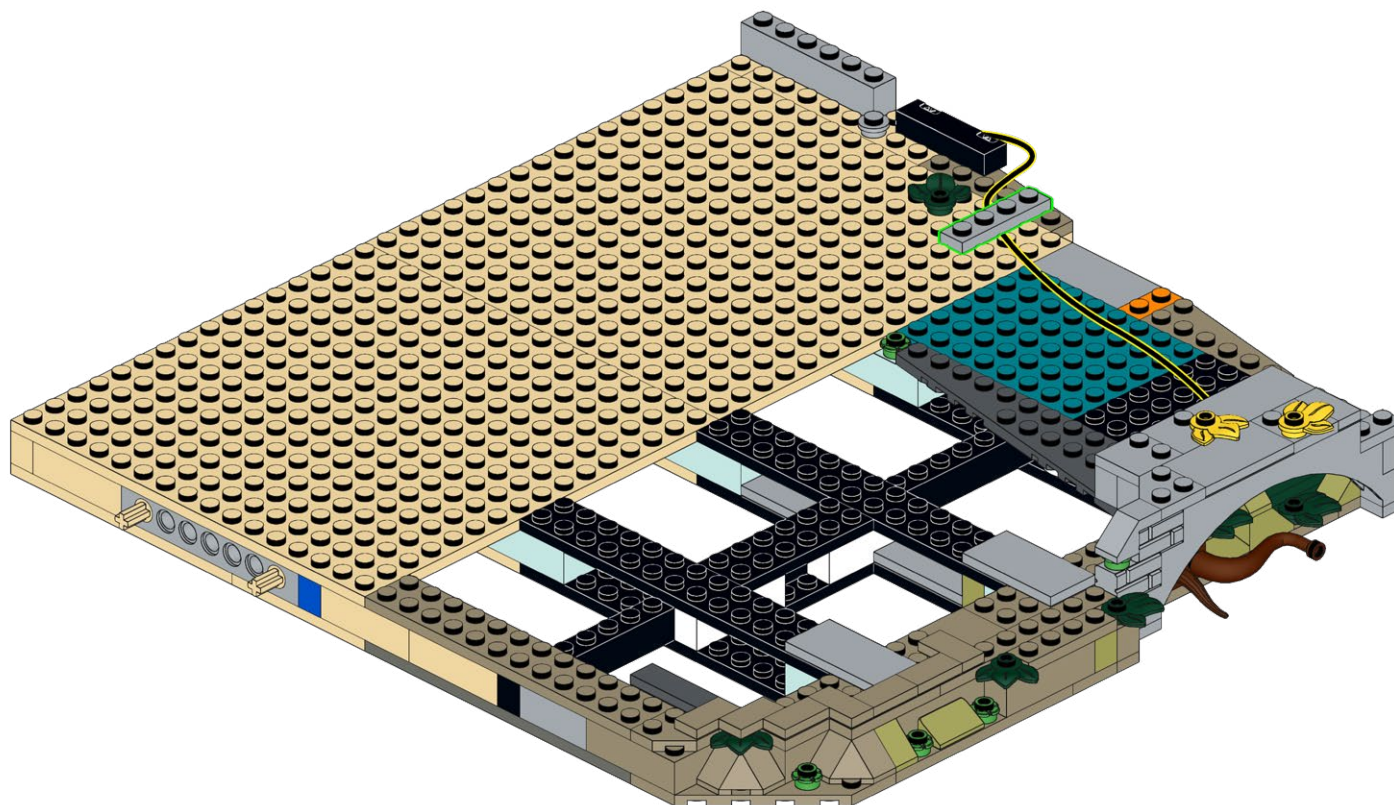

43

1x

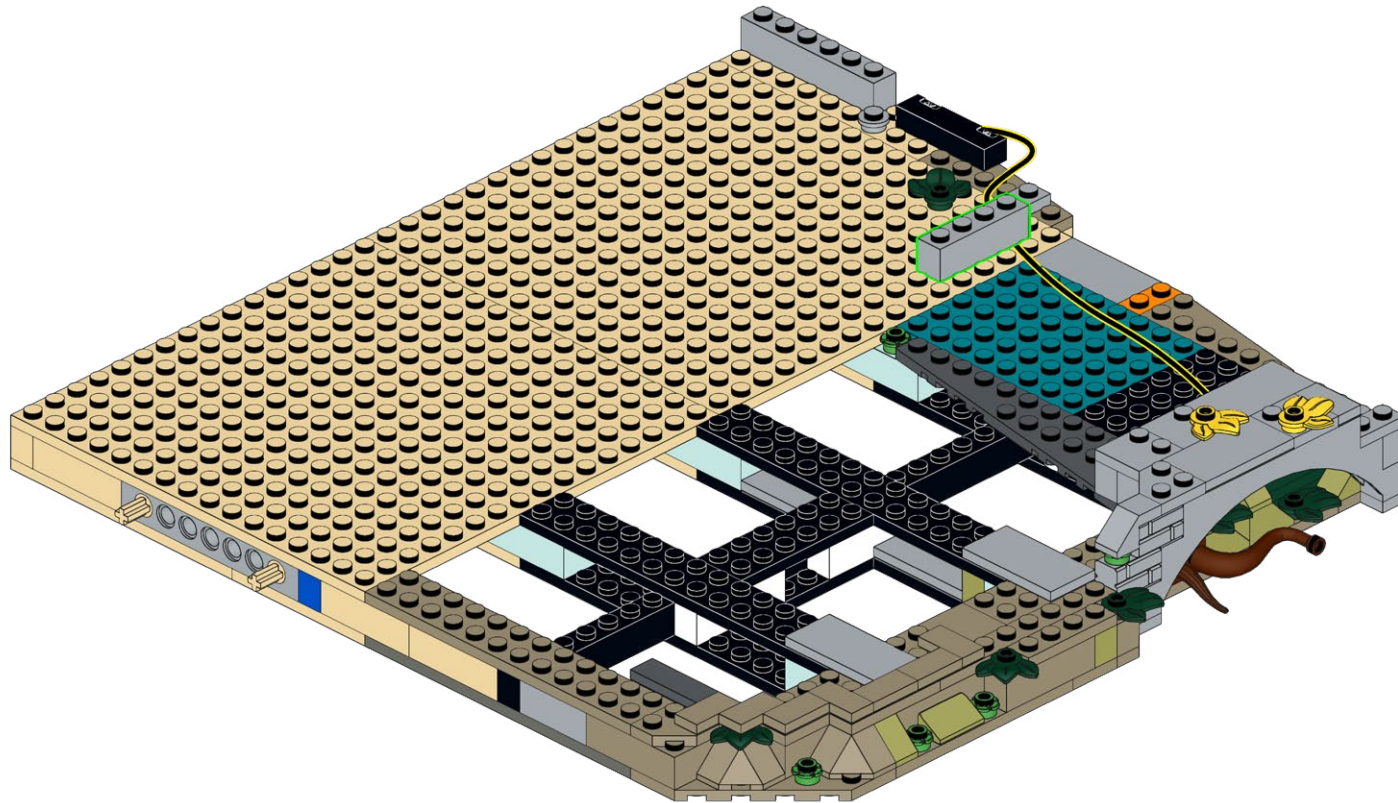



44

1x

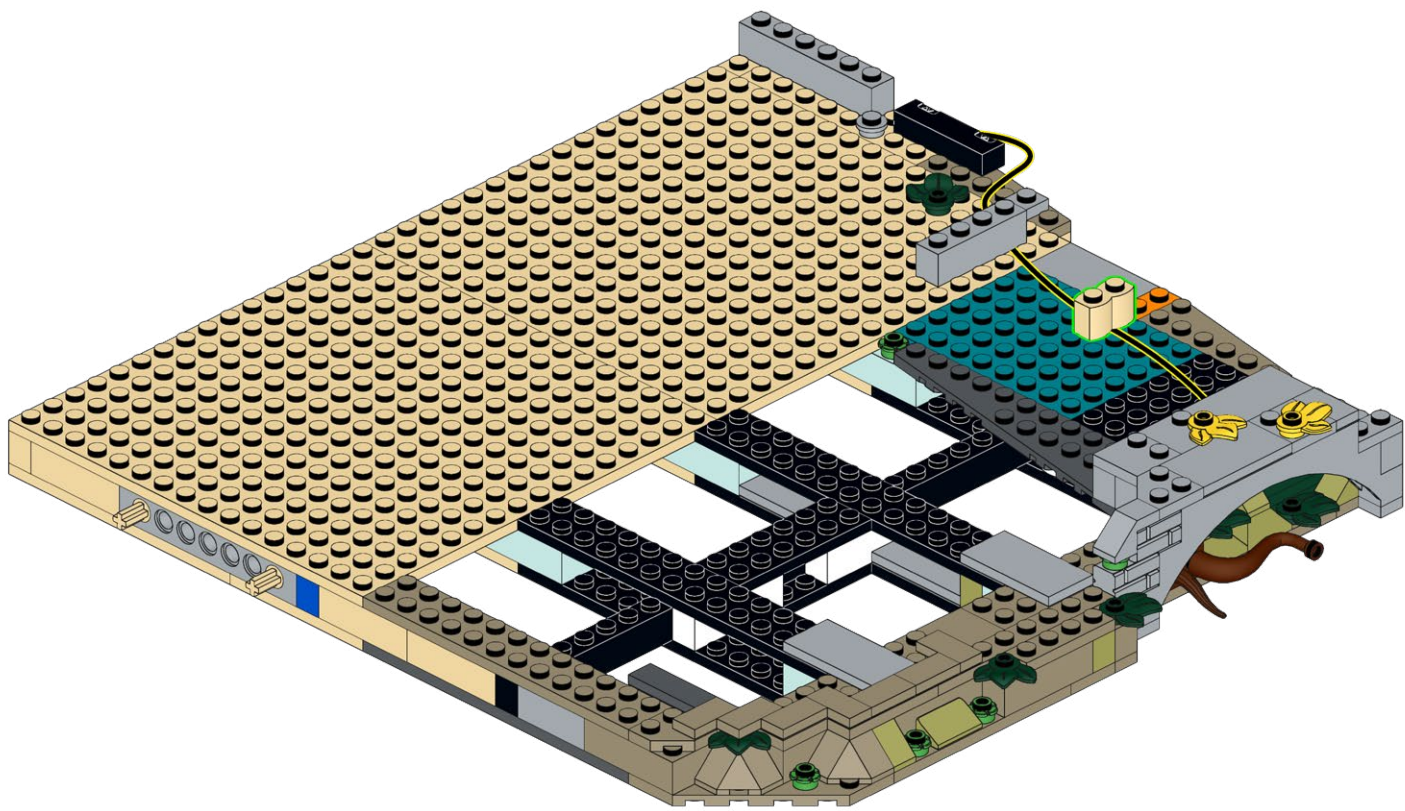



45

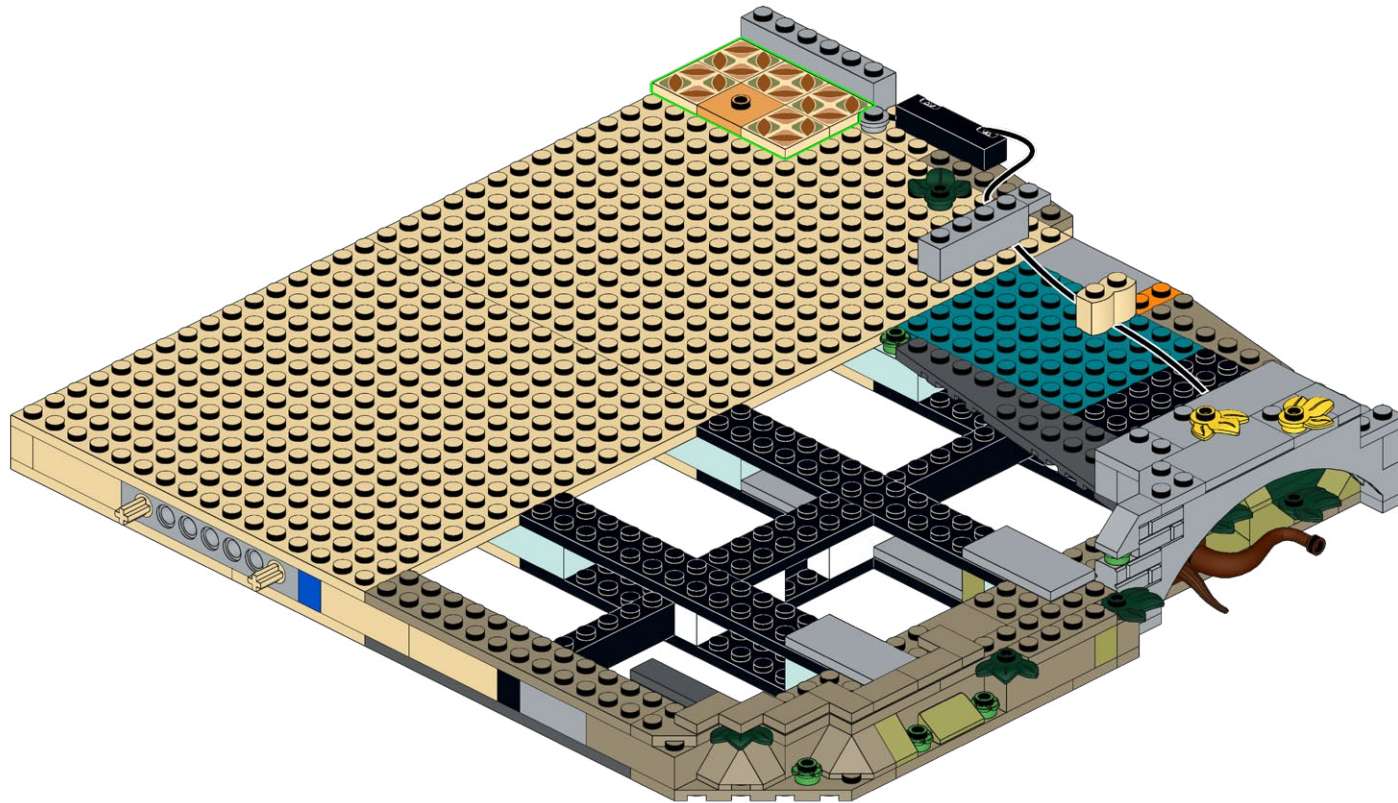
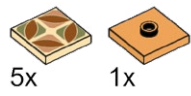

46

8x

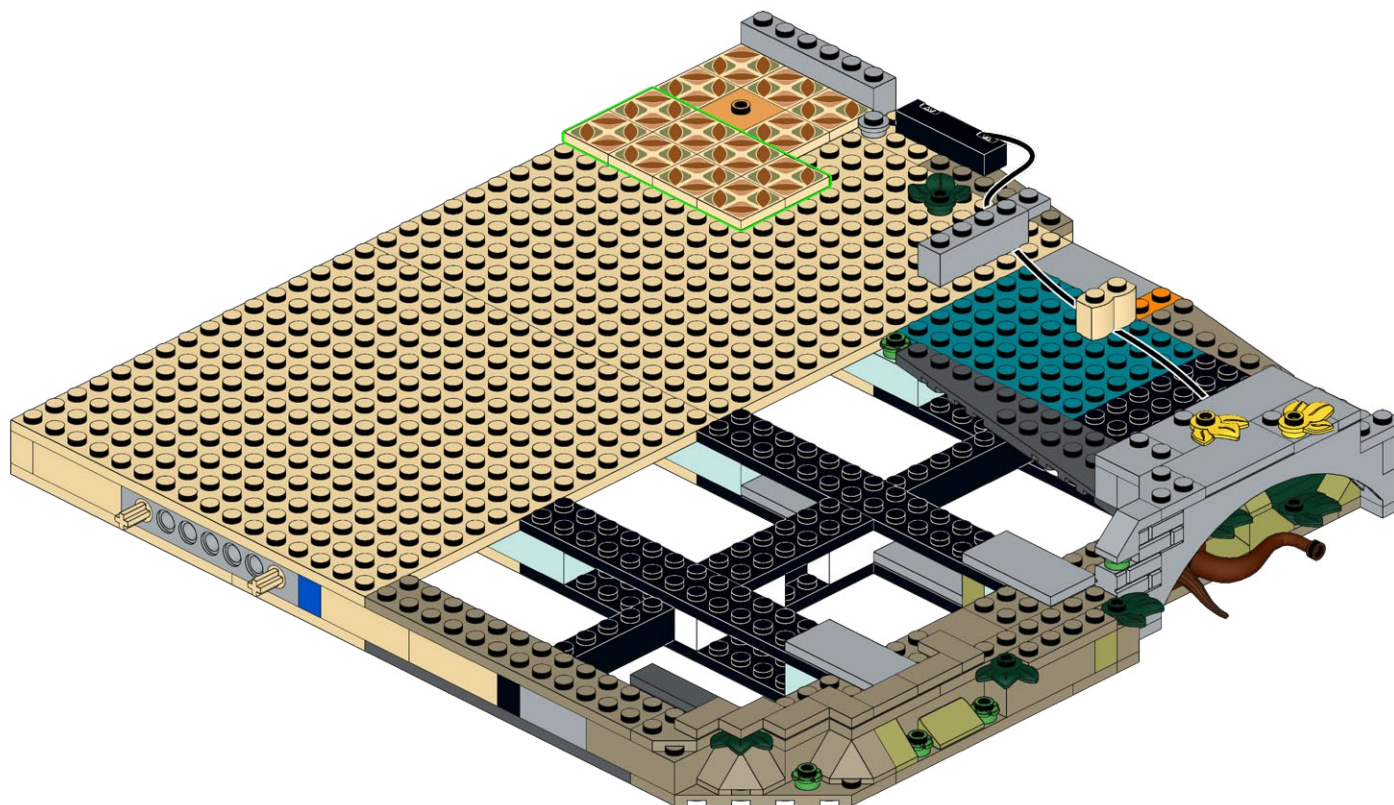

47

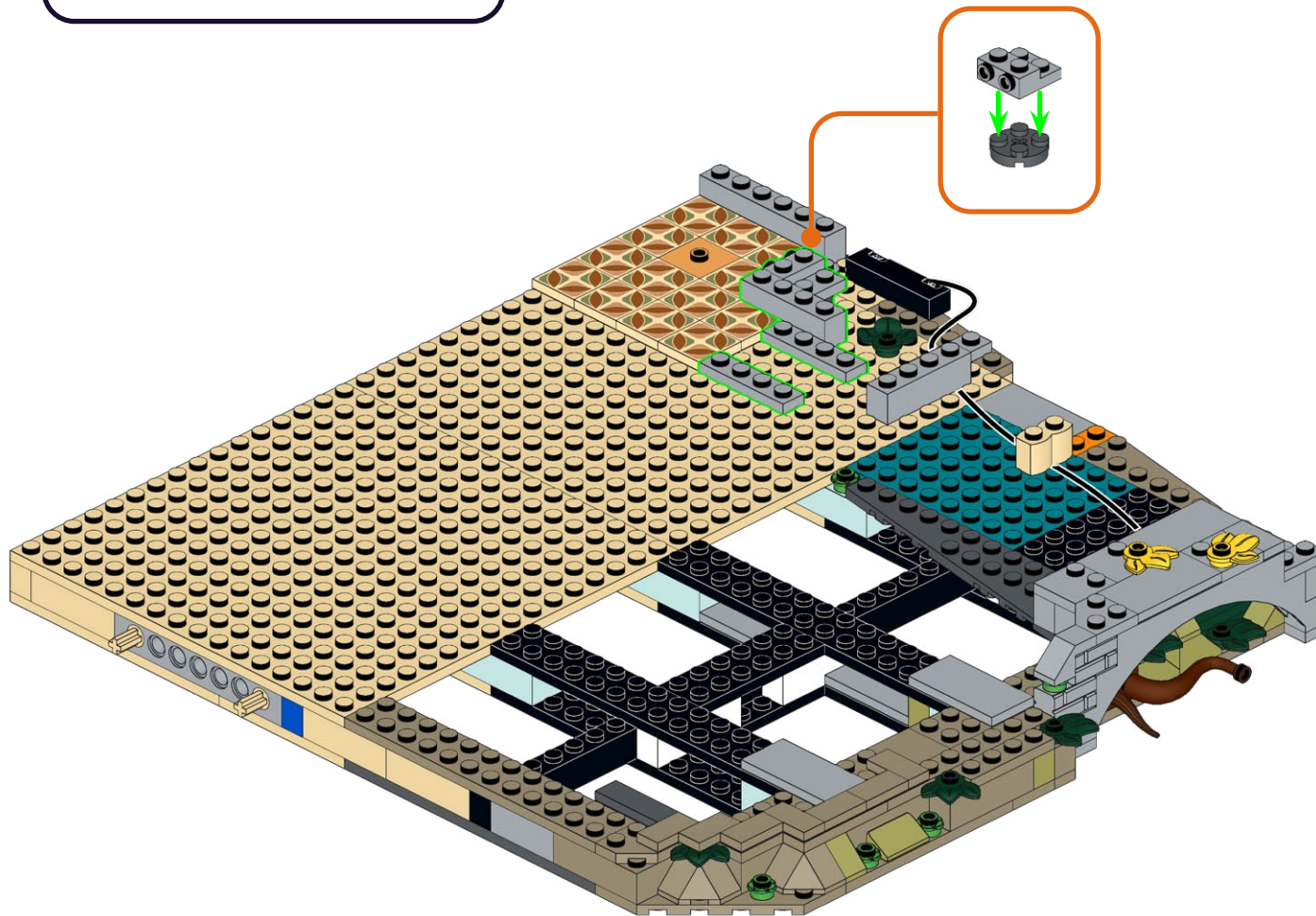
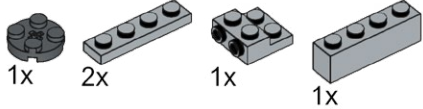



48

- 4x
- 2x
- 10x
- 1x
- 1x
- 1x

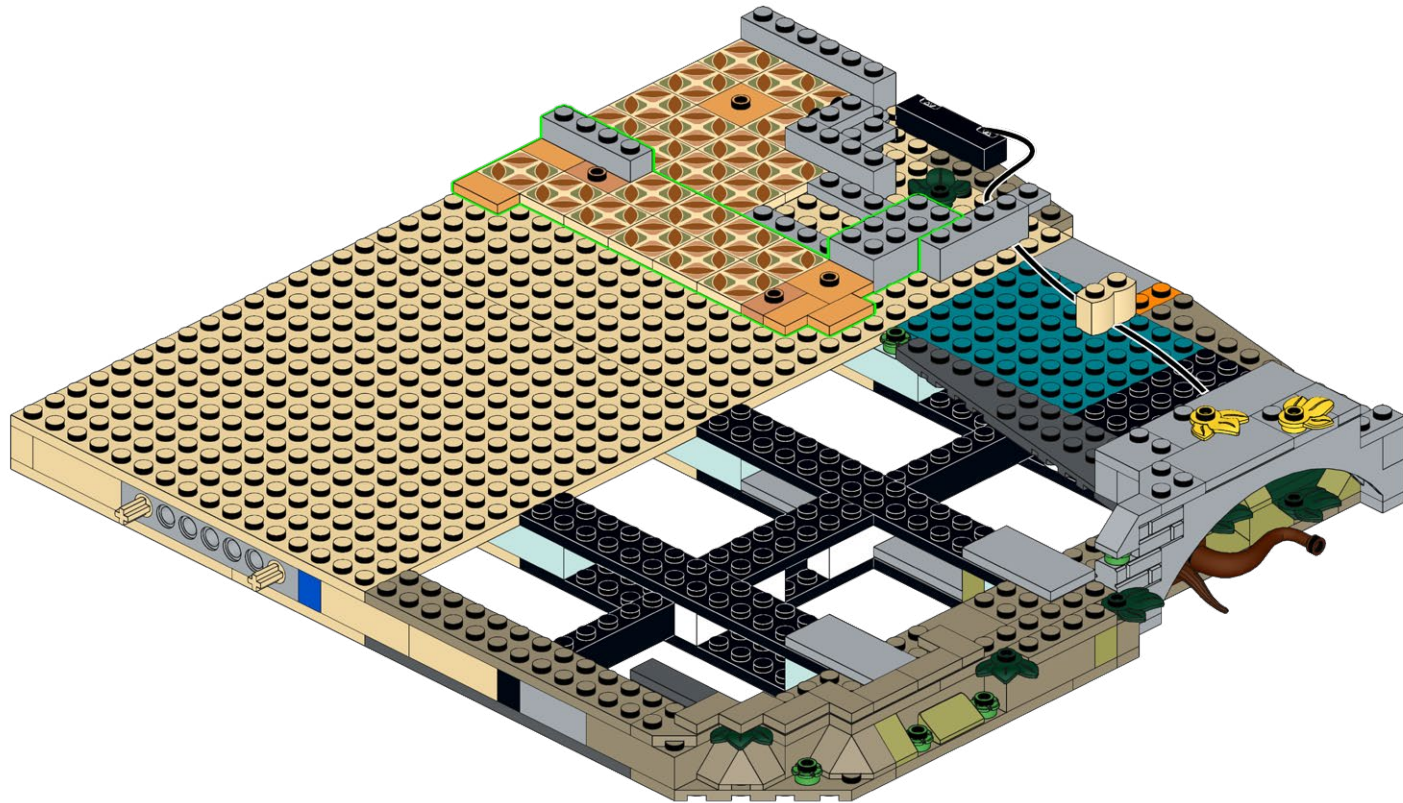







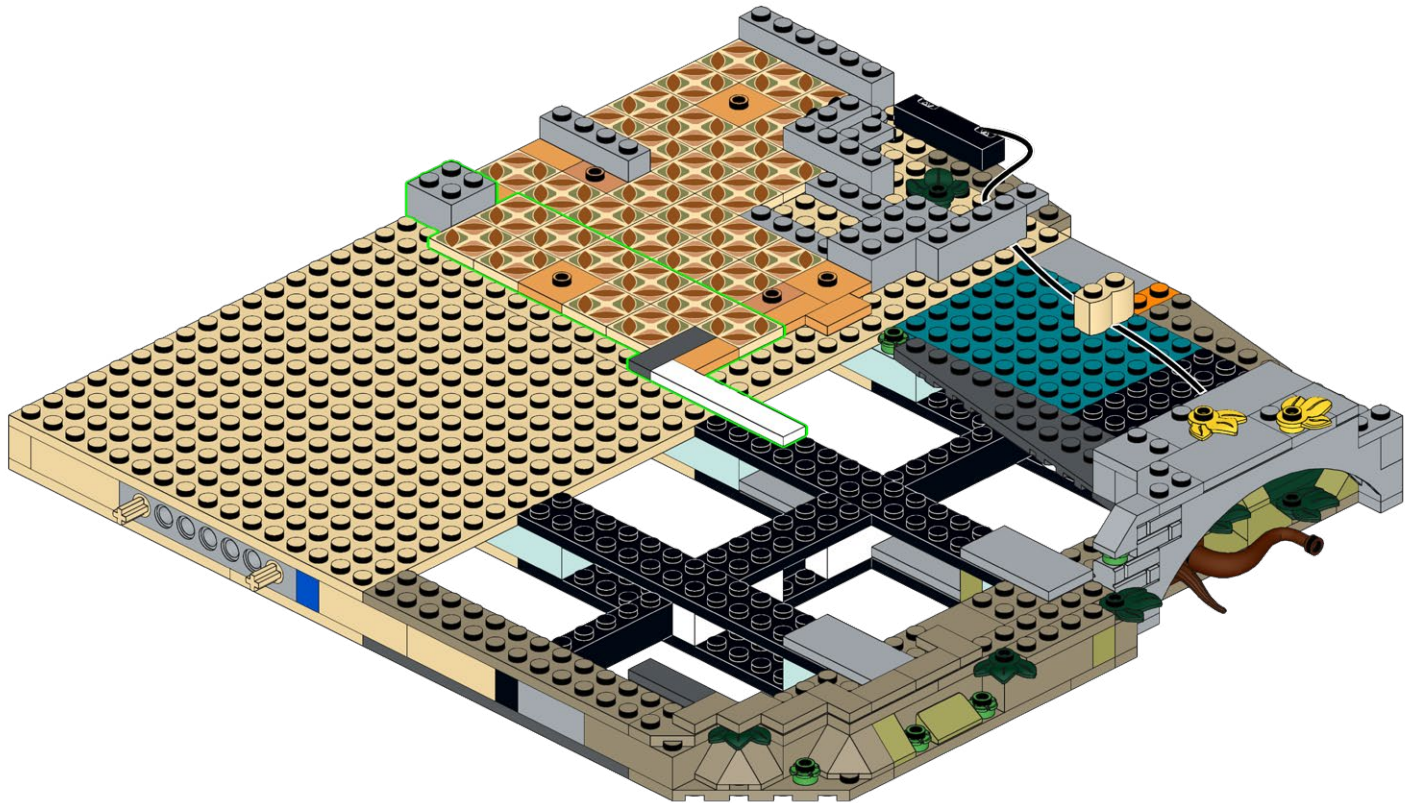

# 49

- 1x [Orange 1x2 Technic Brick]
- 10x [Orange 1x2 Technic Brick with 2x2 Hole]
- 1x [Grey 1x2 Technic Brick]
- 1x [Orange 1x2 Technic Brick with Pin Hole]
- 1x [Grey 1x2 Technic Brick with 4 Pins]
- 1x [White 1x2 Technic Beam]



50

- 2x 
- 2x 
- 2x 
- 4x 
- 3x 
- 2x 
- 3x 

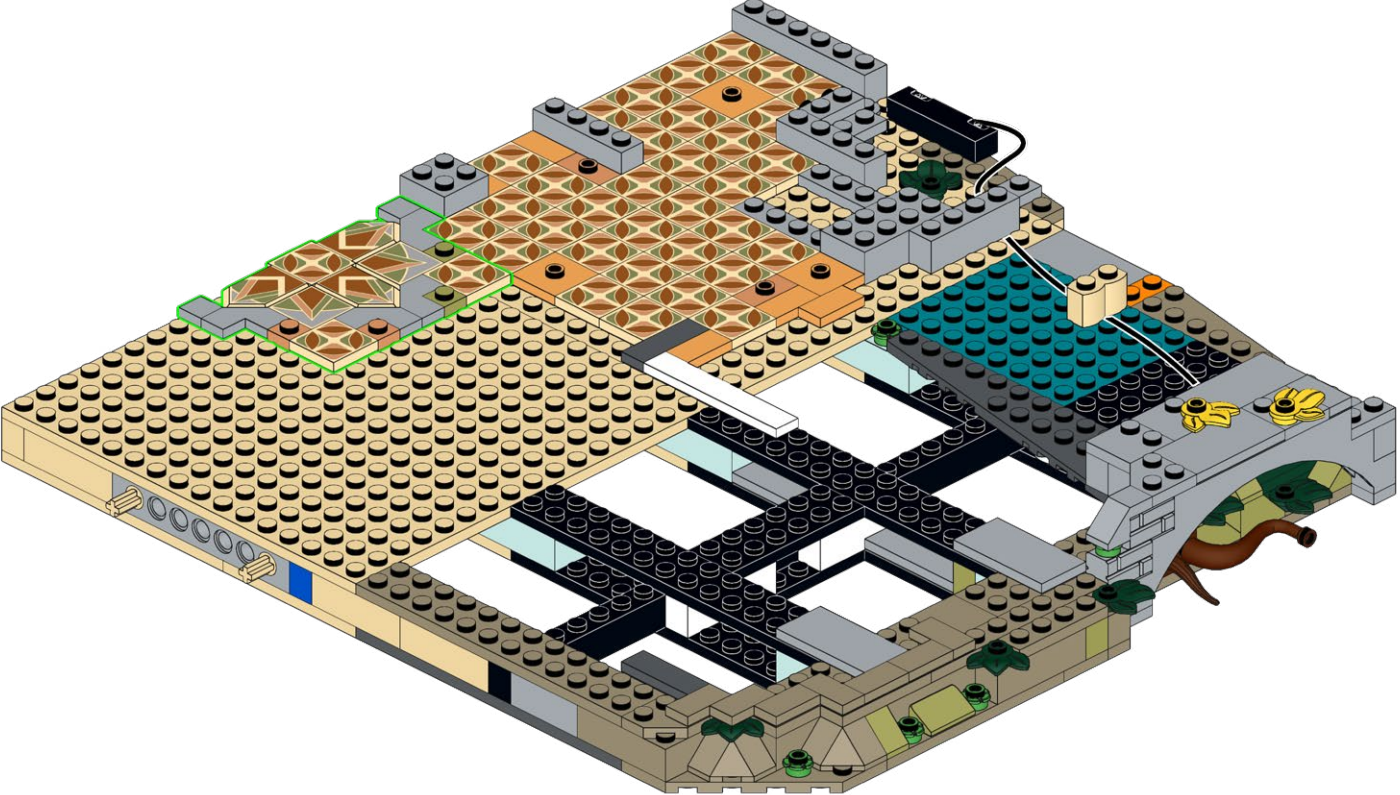



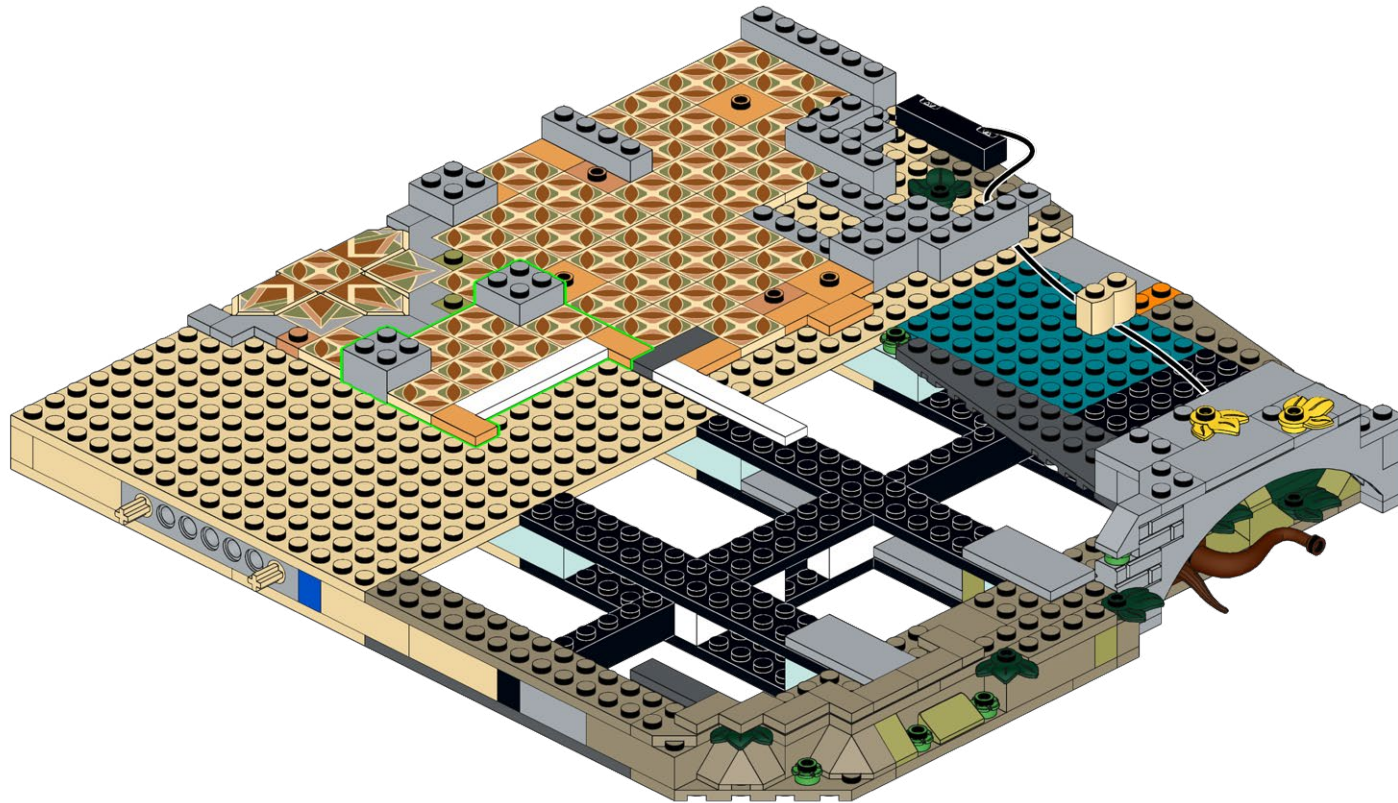
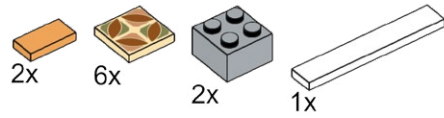



51









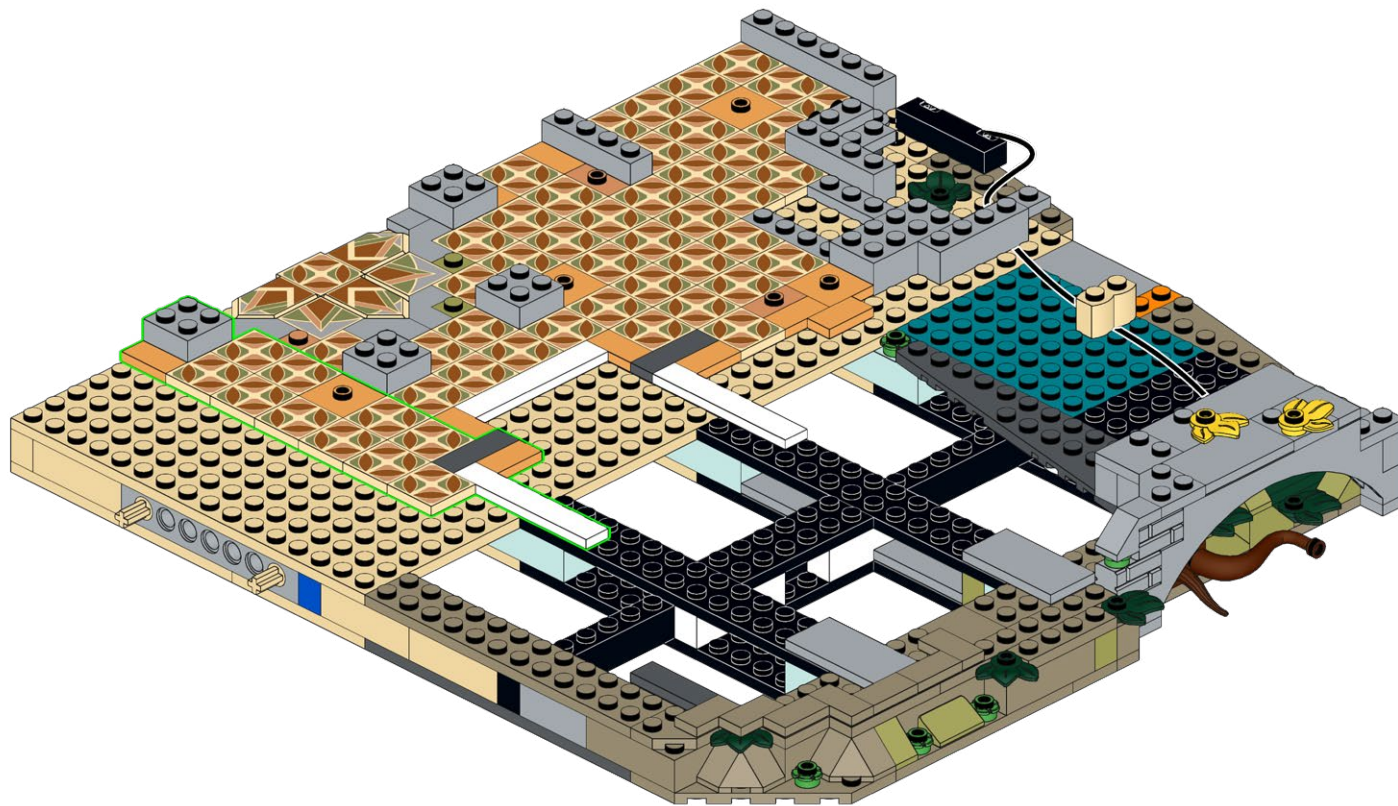

# 52

- 2x 
- 10x 
- 1x 
- 1x 
- 1x 
- 1x 





# 53

- 1x 
- 1x 
- 12x 
- 1x 
- 1x 
- 2x 

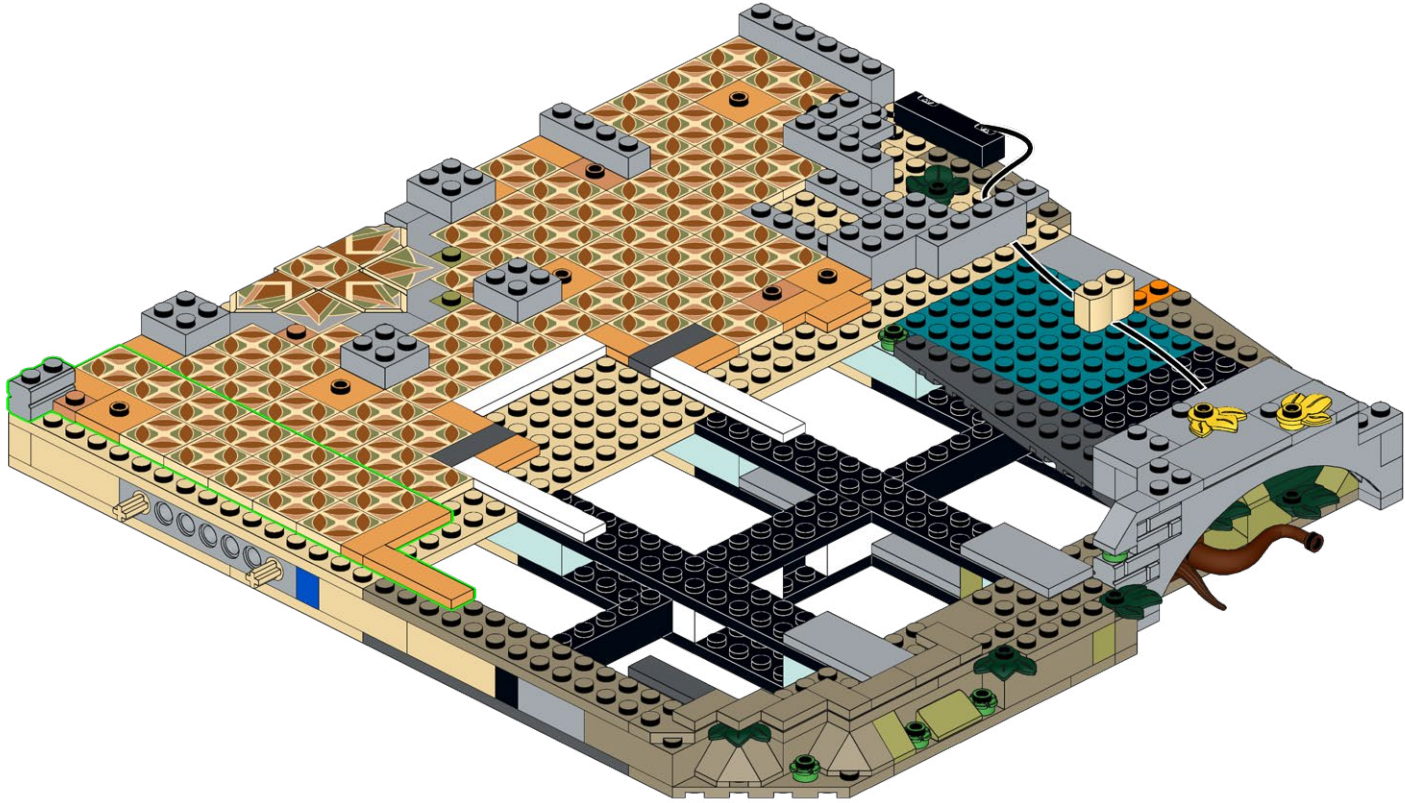

54

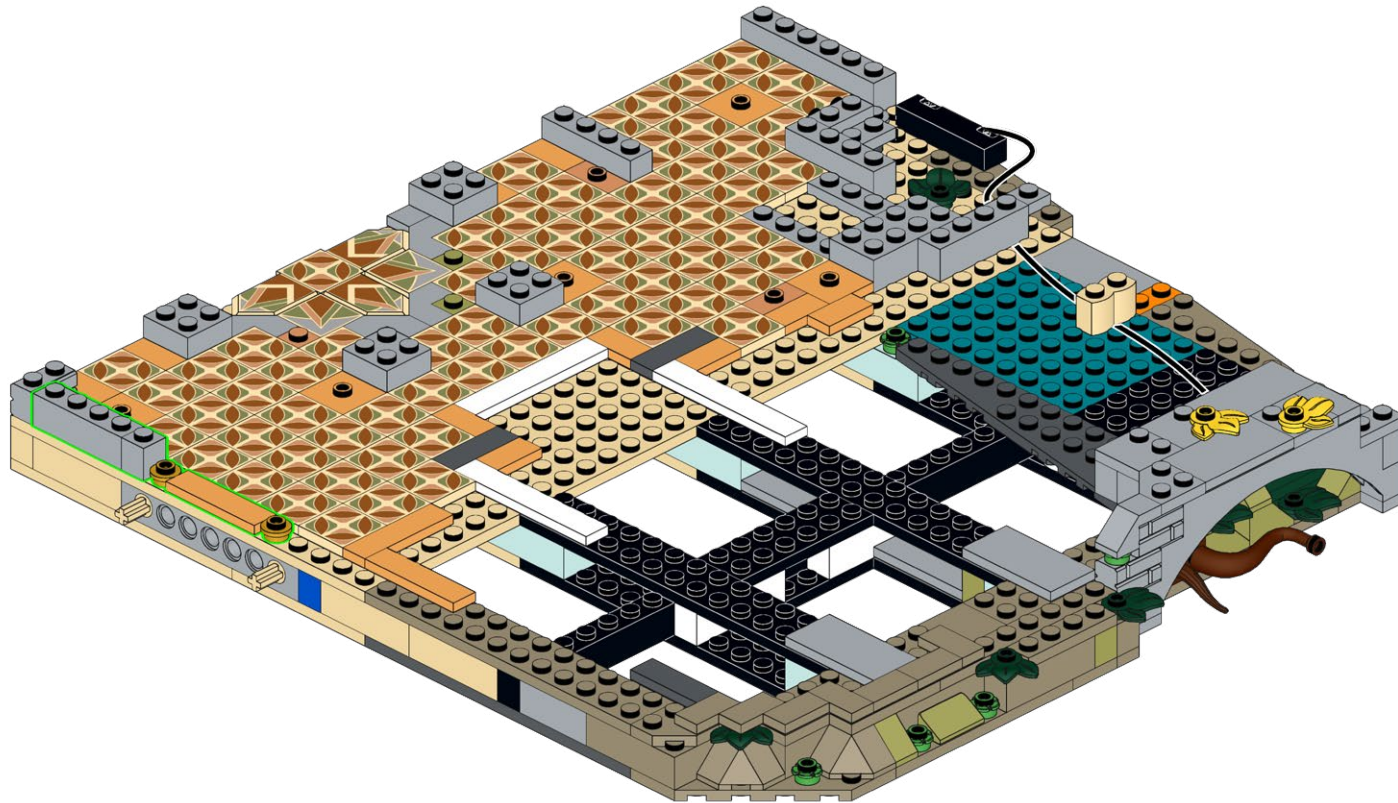
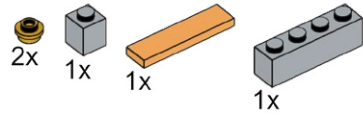

55

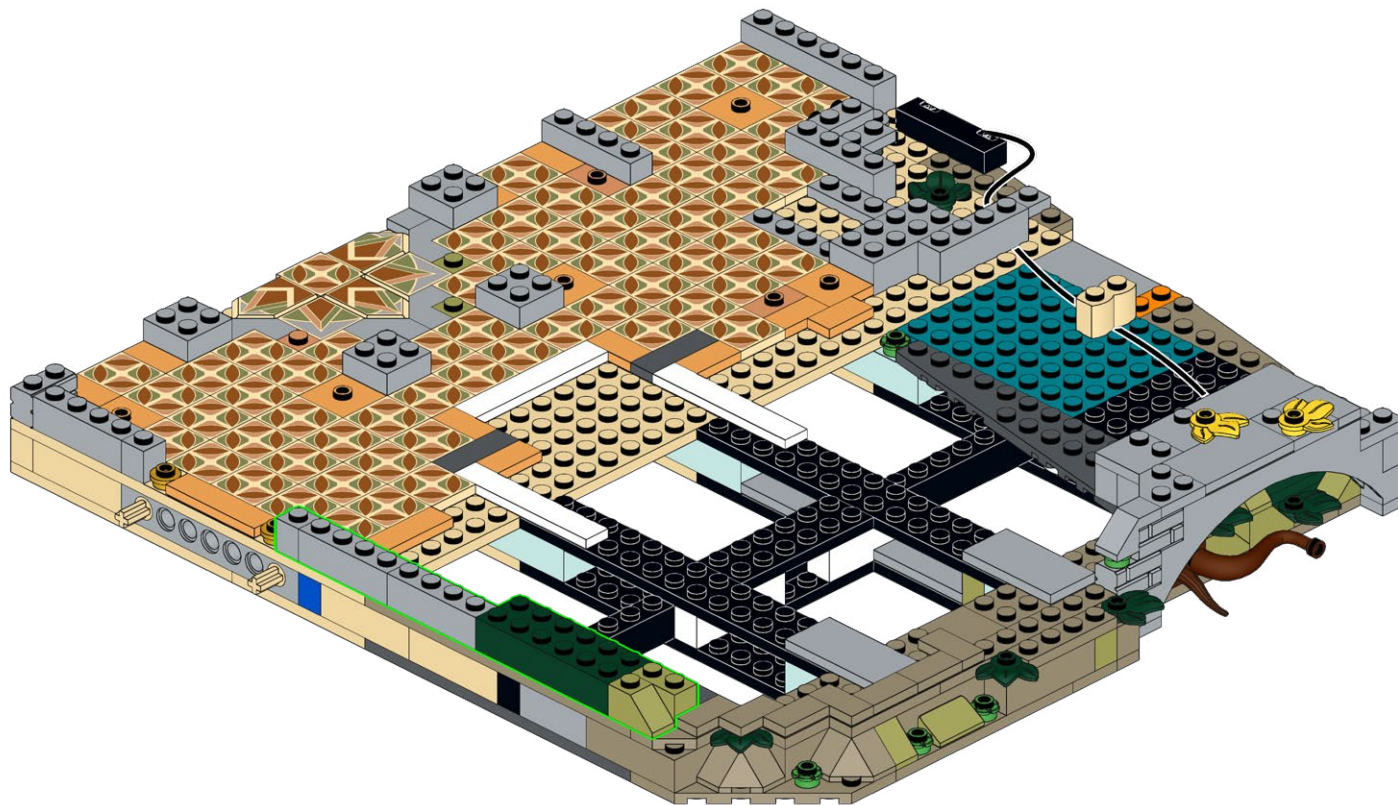
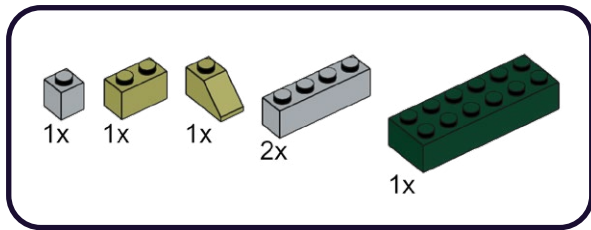



56

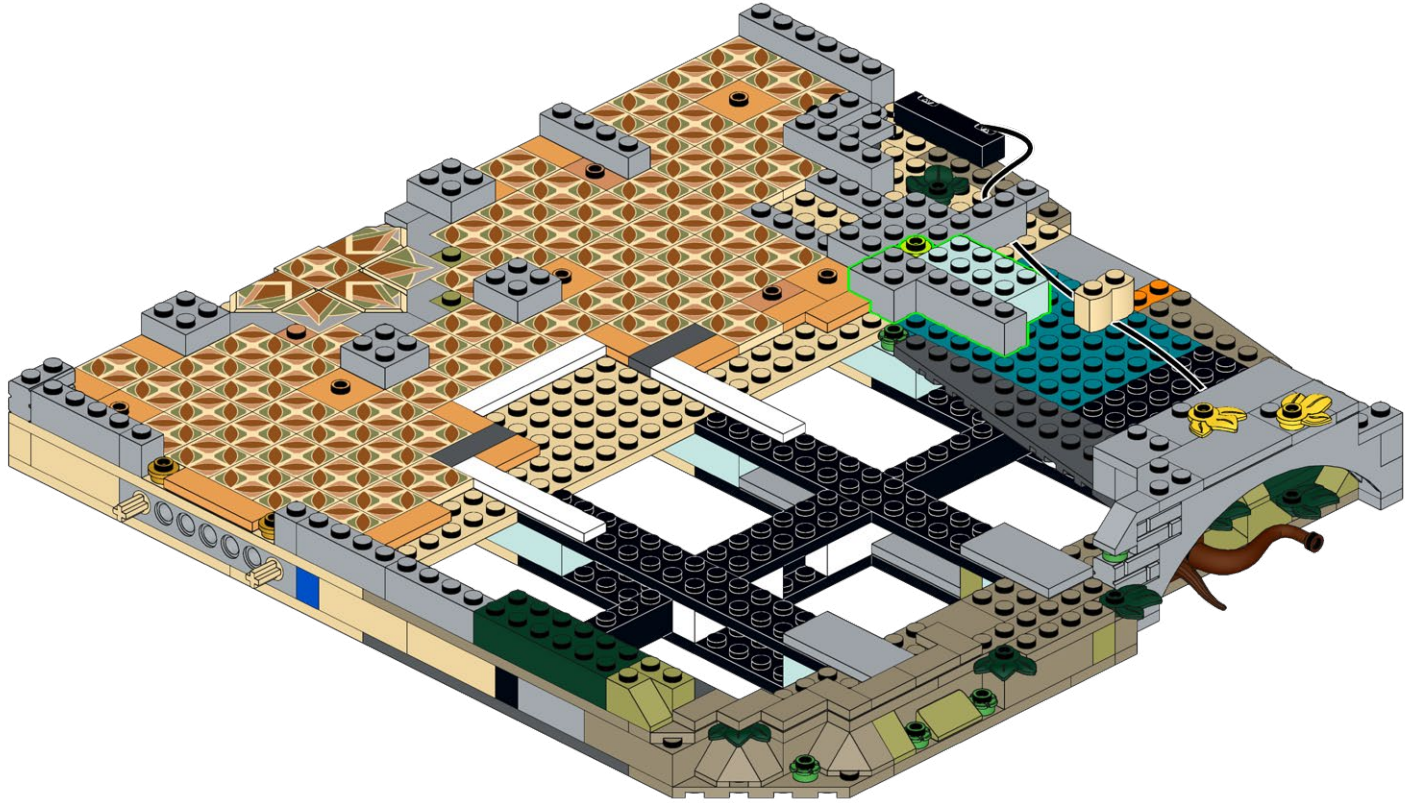
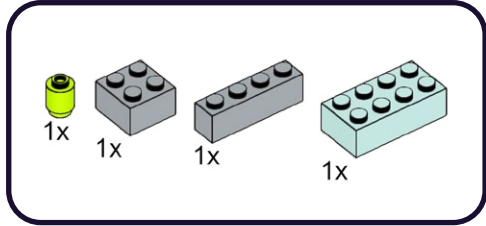



57

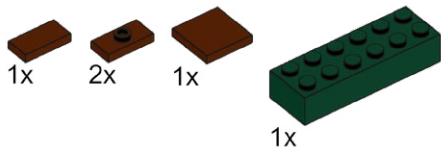

1

2

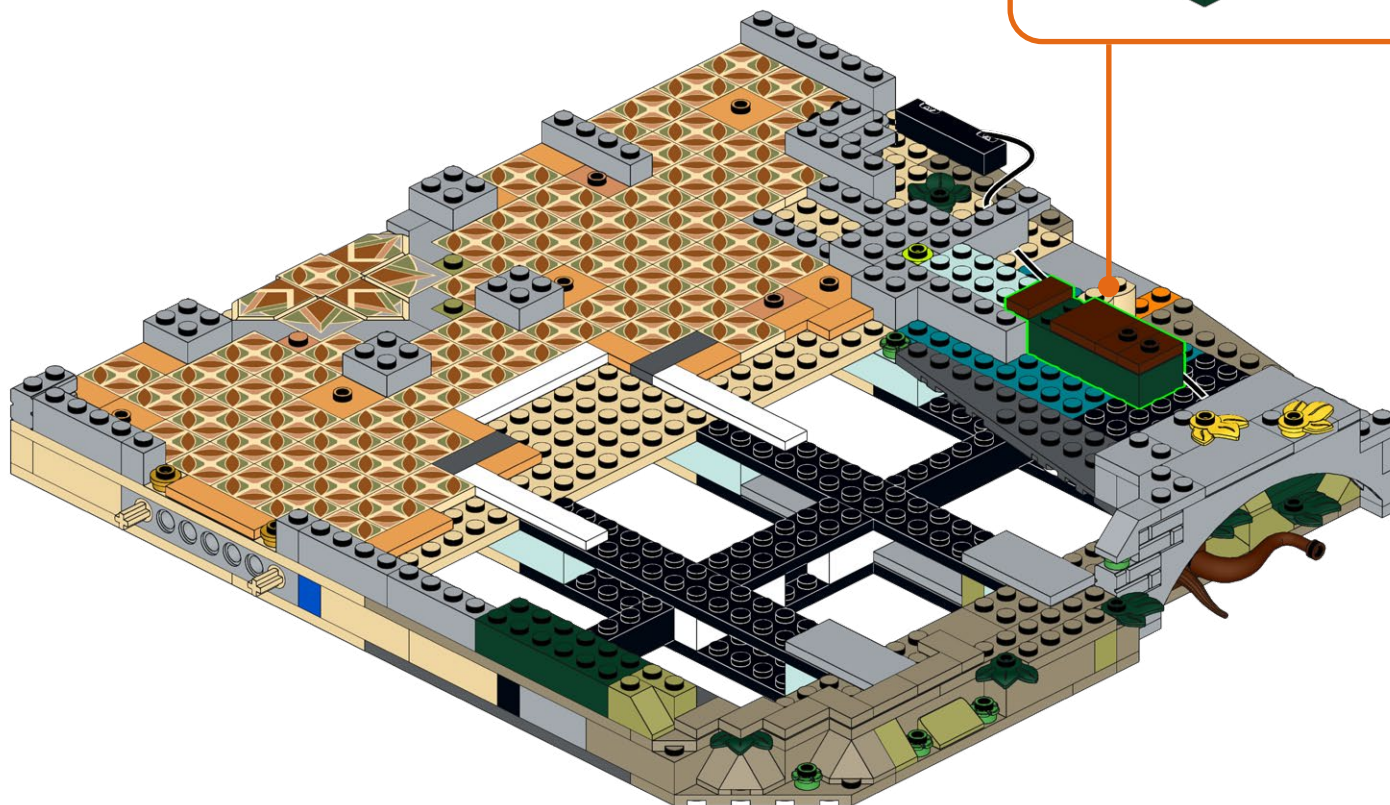
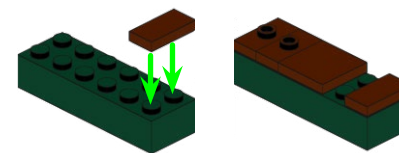

58

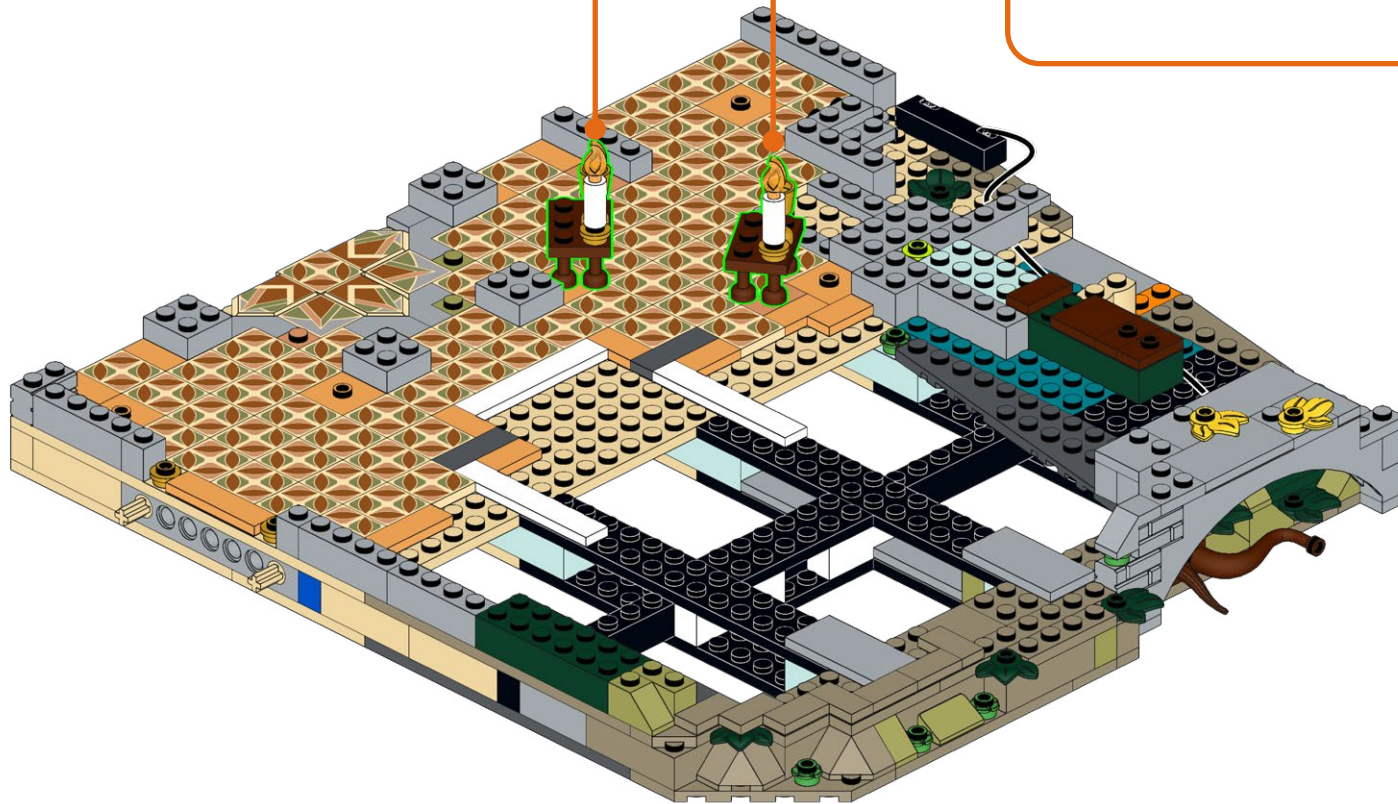
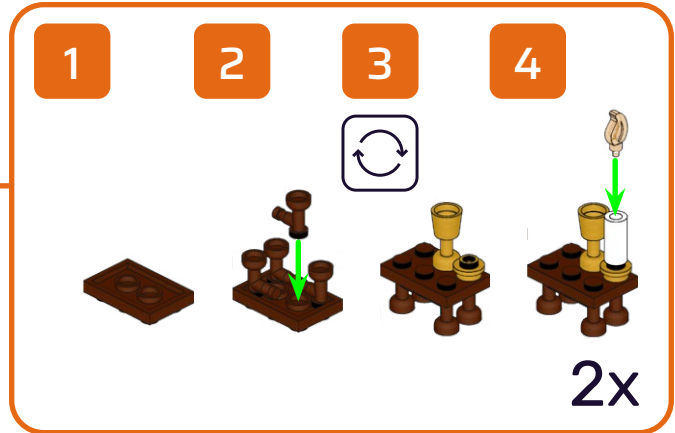
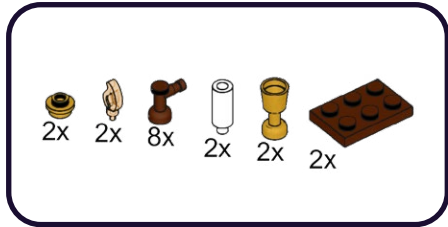

# 59

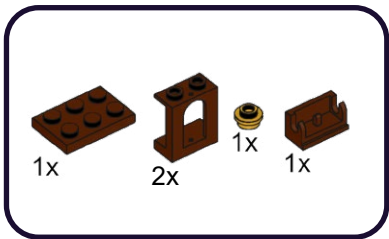

1

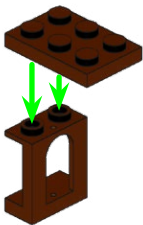

2

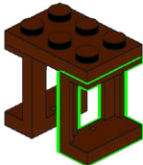

3

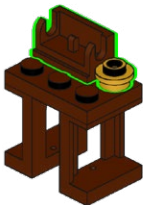

# 60

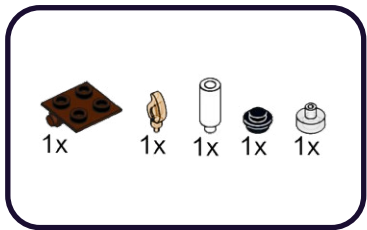

1

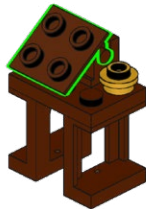

2

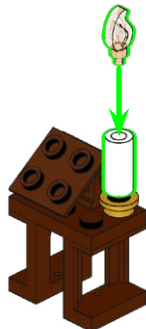

3



2x



61

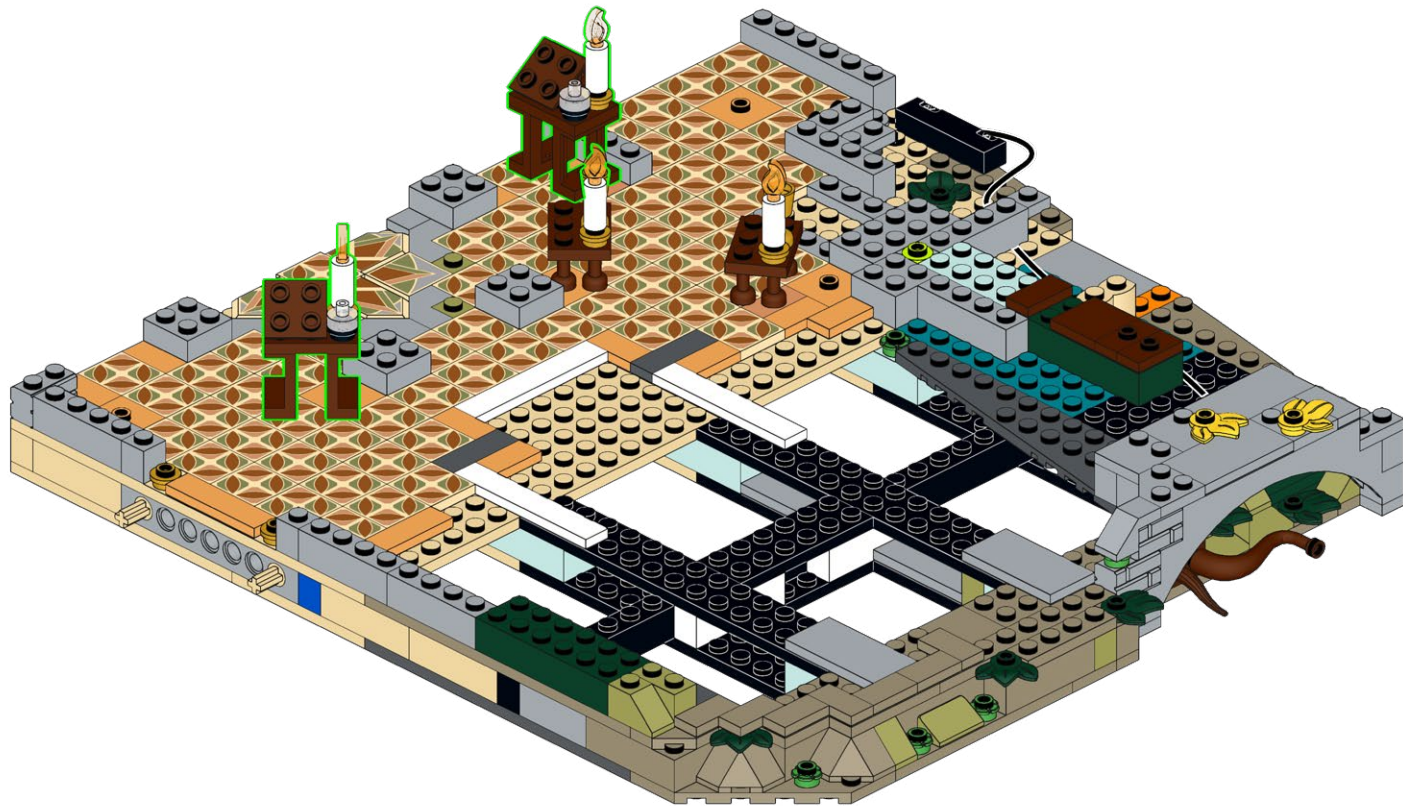



# 62

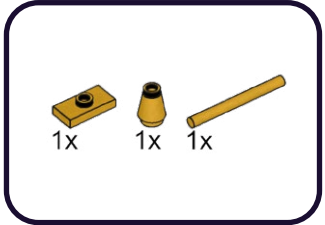

1

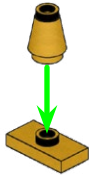

3



# 63

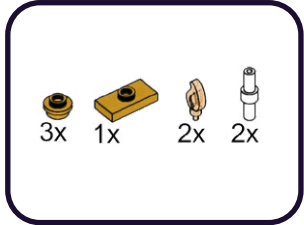

1

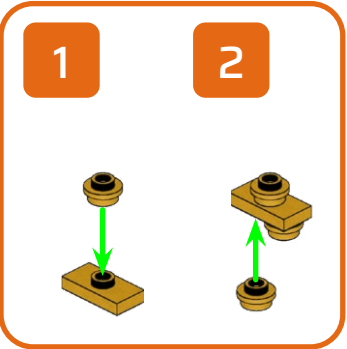

3



64

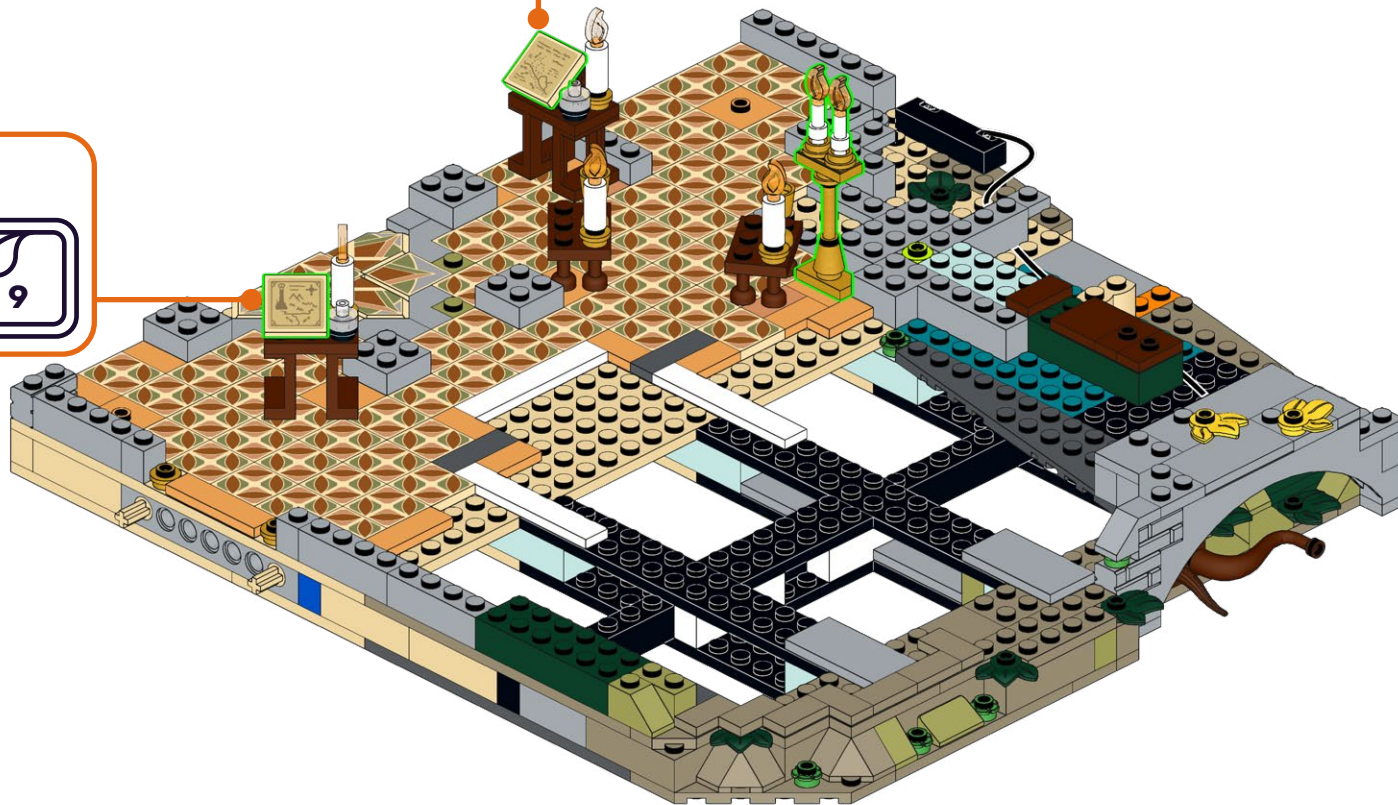
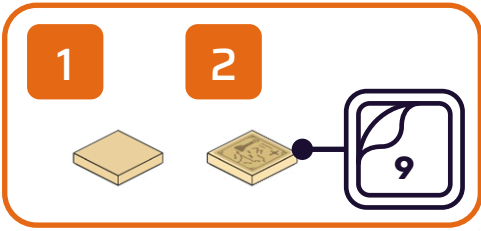
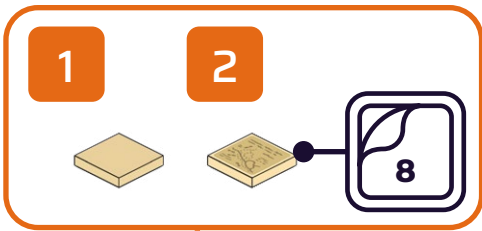
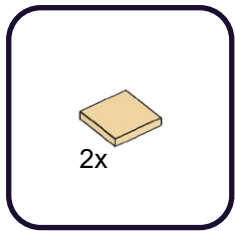

# 65

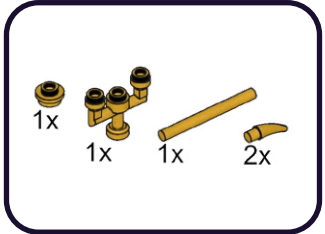

1



2

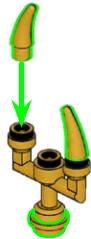

3



# 66

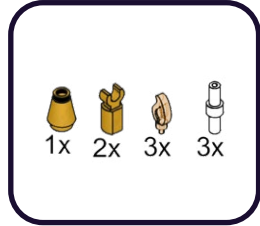

1

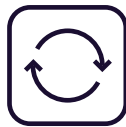

2



3

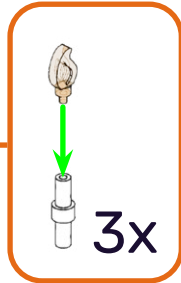

67

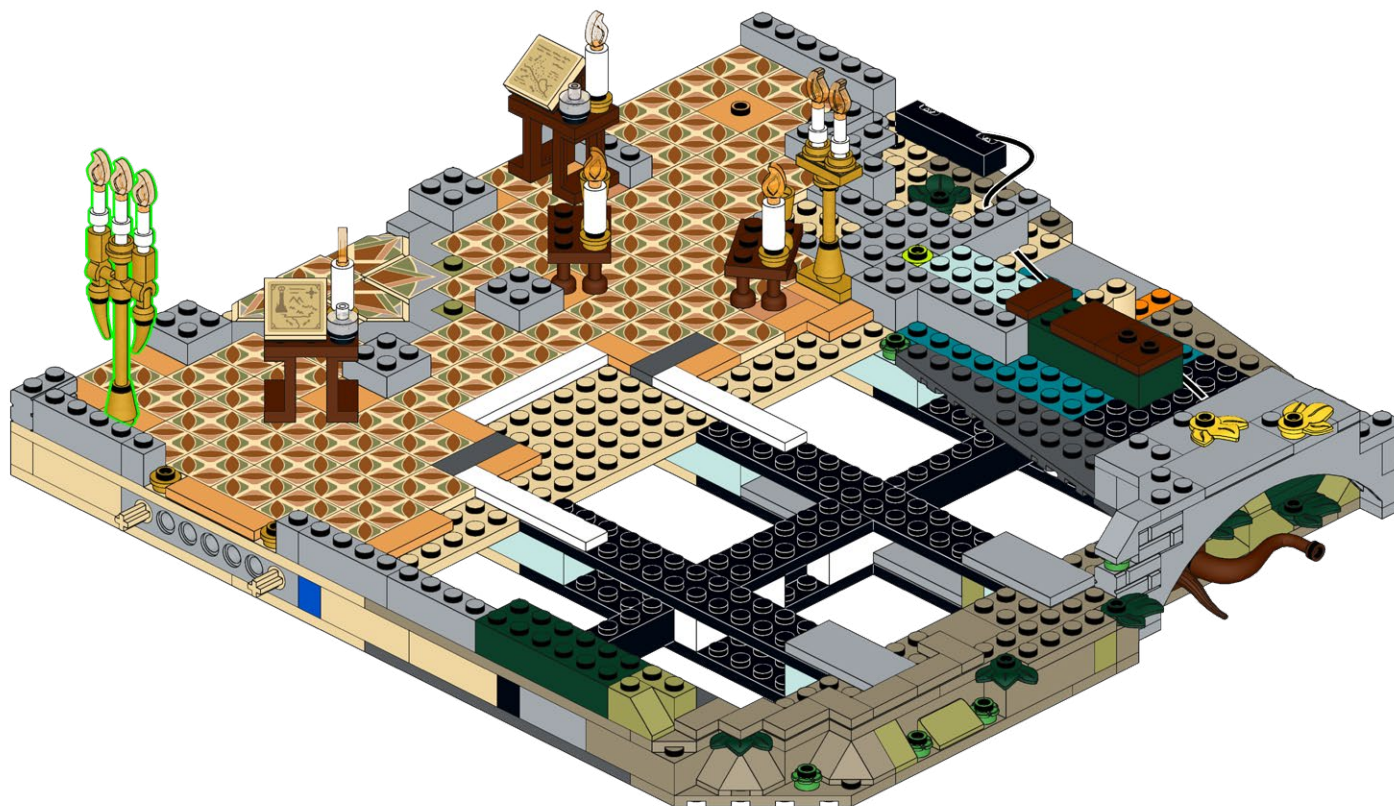



**HOLD UP!**

You might notice some bags aren't in order, as well as left over pieces, but that's ok! We're changing the way you build LEGO!

**ATTENDEZ!**

Vous remarquerez peut-être que certains sacs, ainsi que certaines pièces, ne sont pas dans le bon ordre. Mais pas de panique! Nous changeons simplement la façon avec laquelle vous construisez vos LEGO!

**ASPETTA!**

Potresti notare che alcuni sacchetti non sono in ordine, così come i pezzi avanzati, ma va bene così! Stiamo cambiando il modo in cui costruisci i LEGO!

**HALT!**

Sie werden möglicherweise bemerken, dass einige tüten durcheinander sind und teile übrig bleiben, aber das ist in Ordnung! Wir ändern die art und weise, wie Sie LEGO bauen!

**¡ESPERA!**

Es posible que notes que algunas bolsas están fuera de servicio, así como piezas sobrantes, ¡pero está bien! ¡Estamos cambiando la forma en que construyes LEGO!

**暫停!**

你可能会注意到一些袋子顺序错乱, 以及一些剩余的部件, 但没关系! 我们正在改变你搭建乐高的方式!

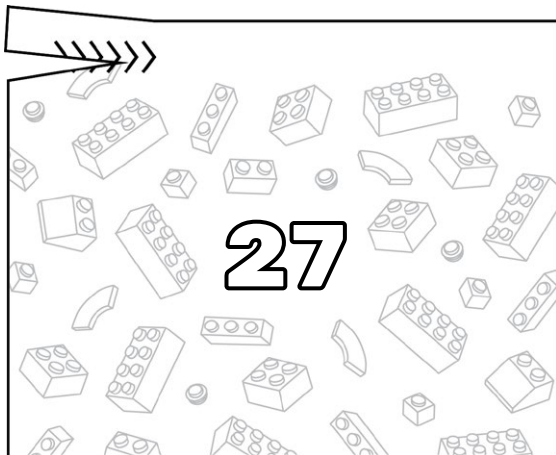
**Open LEGO® Bag 27**

# 68

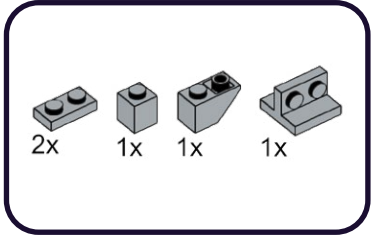

1

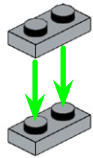

2

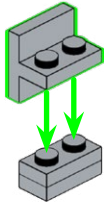

3

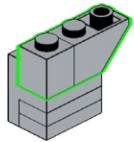

# 69

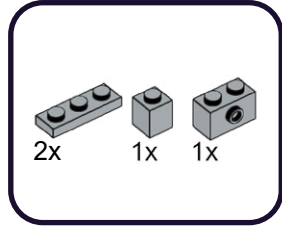

1

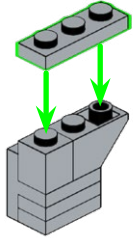

2

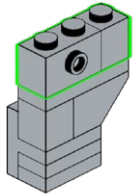

3

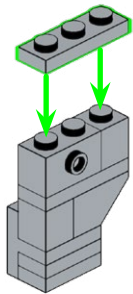

# 70

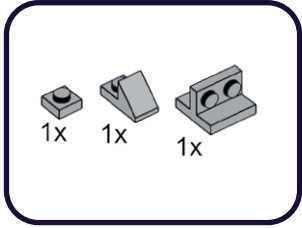

1

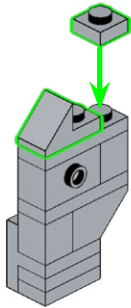

3

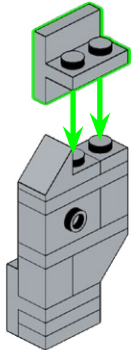

# 71

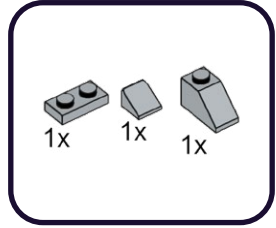

2

1

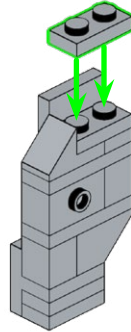

3

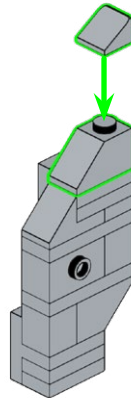

72

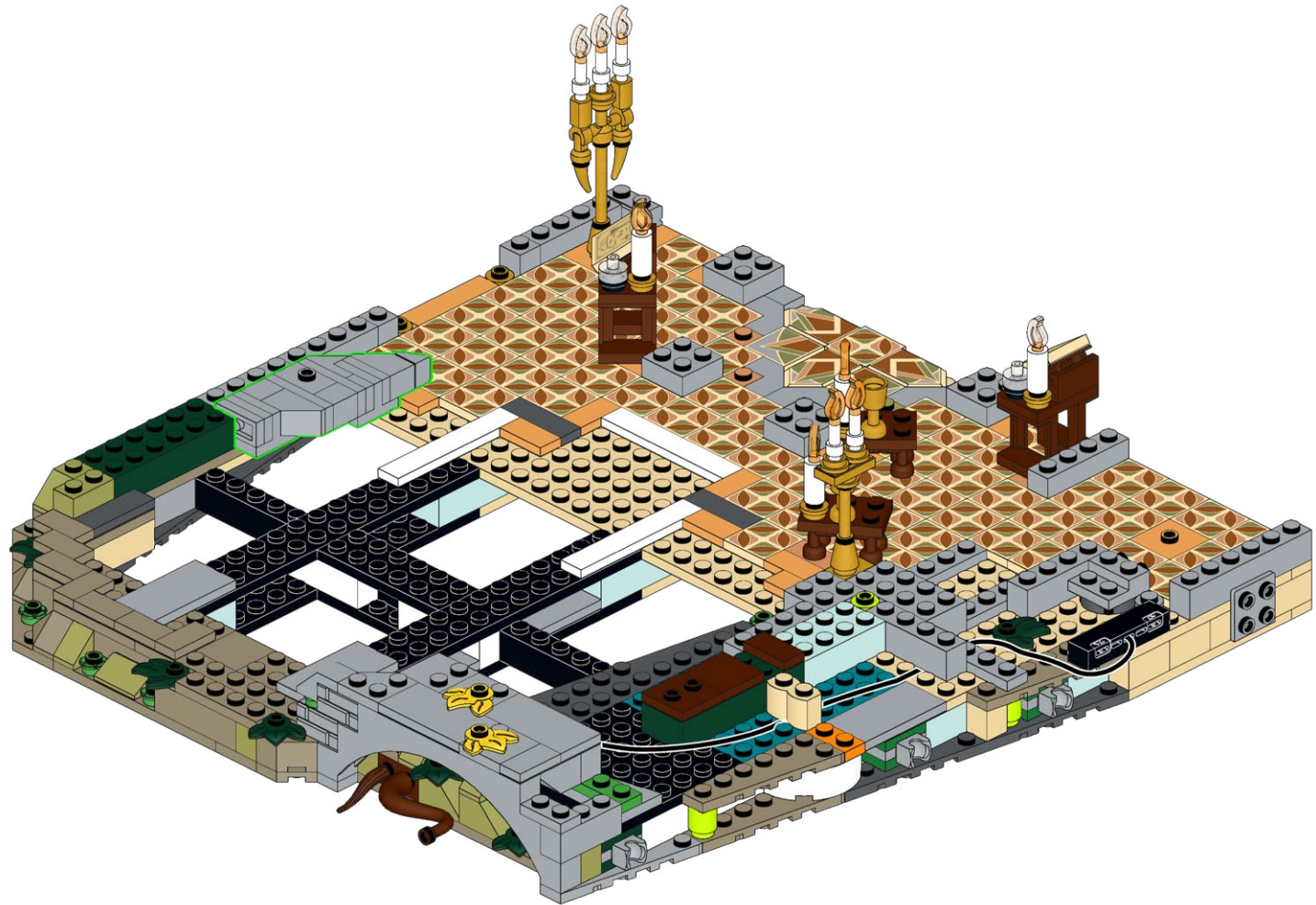



# 73

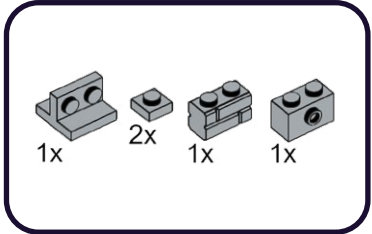

1

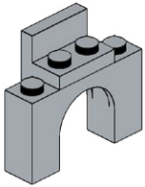

2

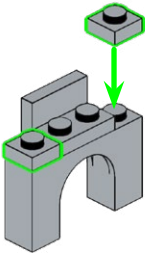

3

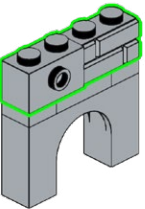

# 74

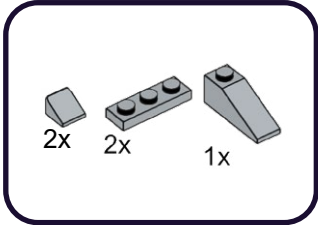

1

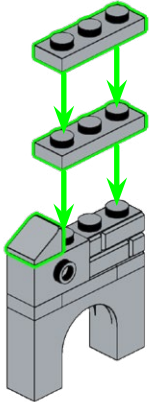

2

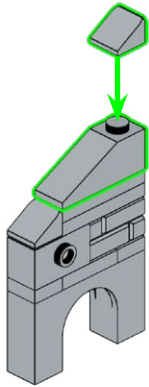

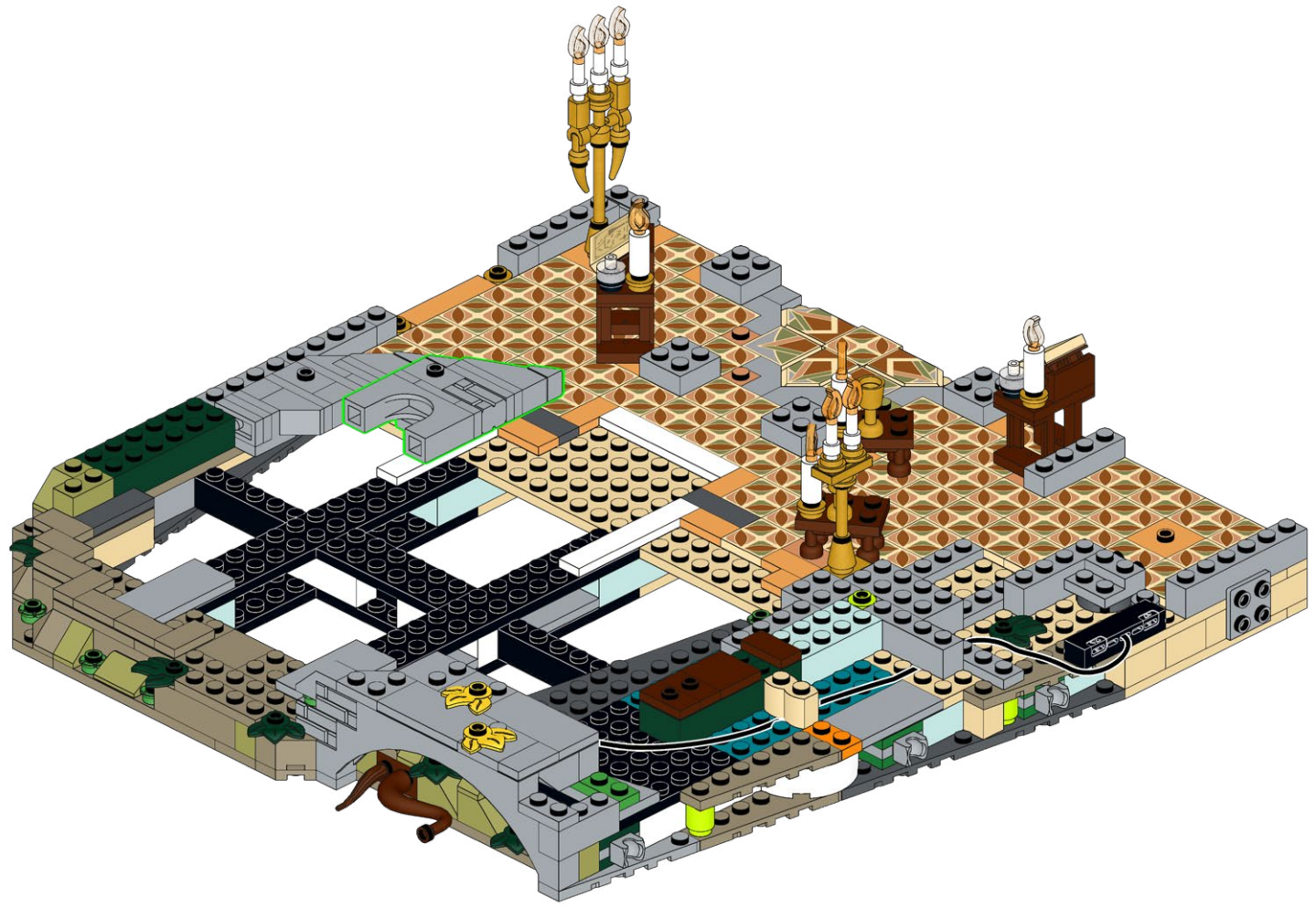

# 76

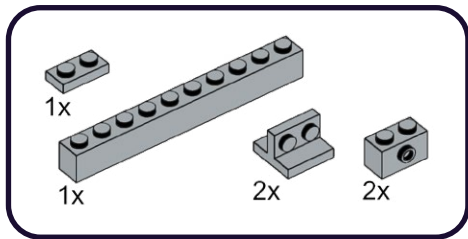

1

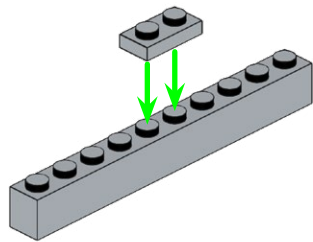

2

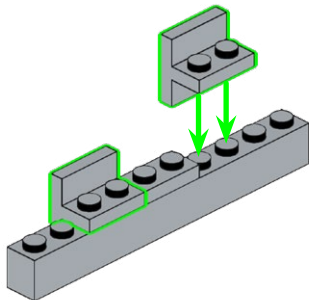

3

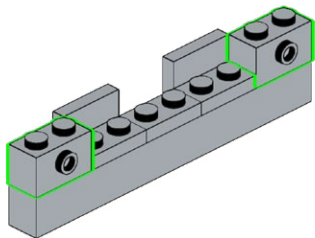

# 77

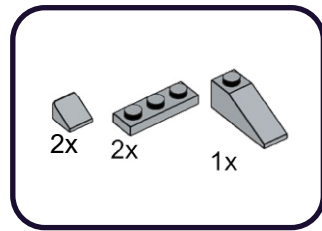

1

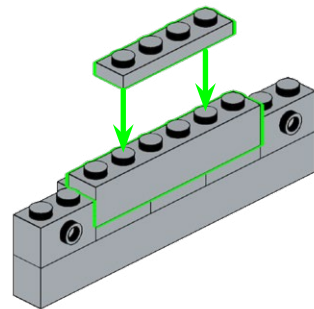

2

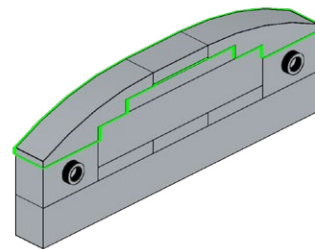

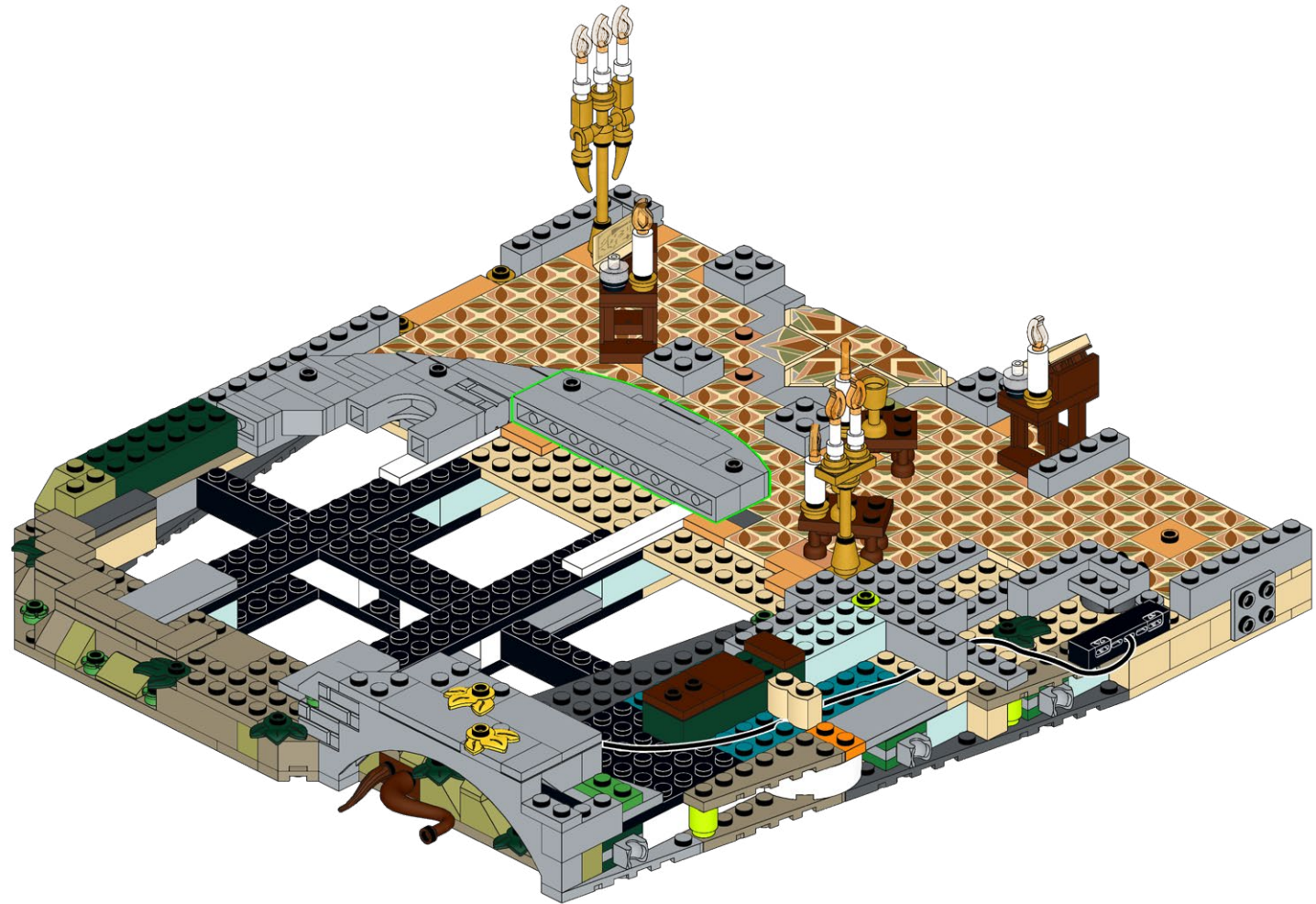



# 79

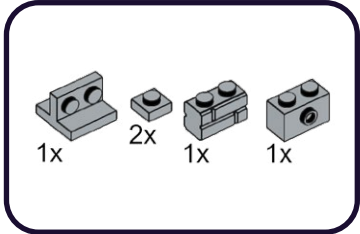

1

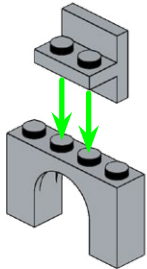

2

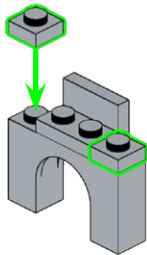

3

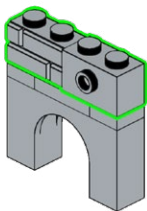

# 80

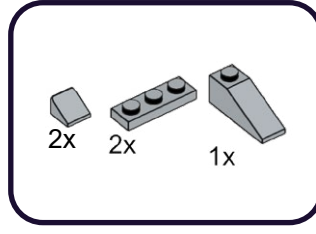

1

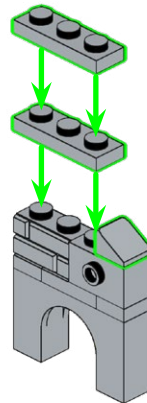

2

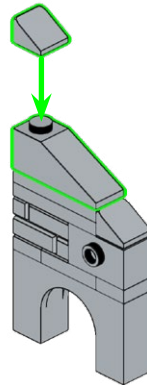

81

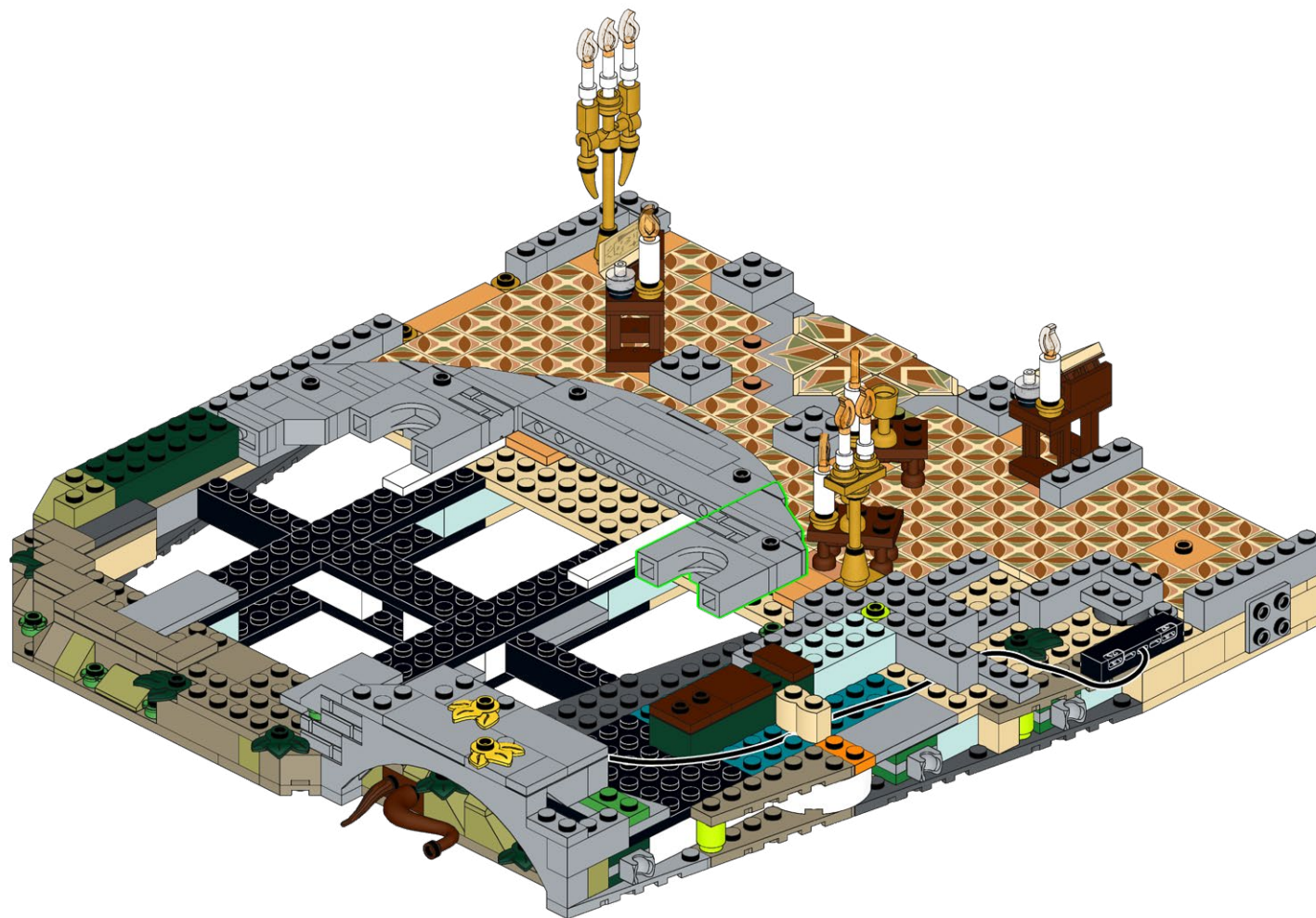

# 82

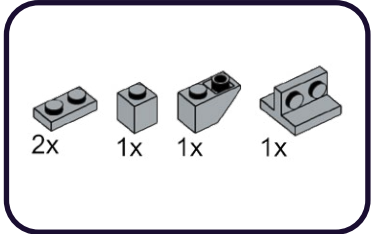

1

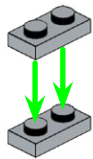

2

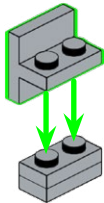

3

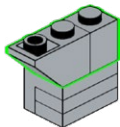

# 83

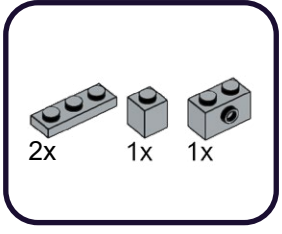

1

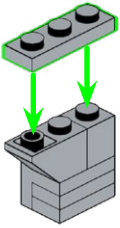

2

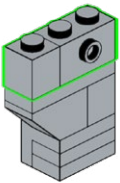

3

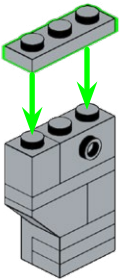

# 84

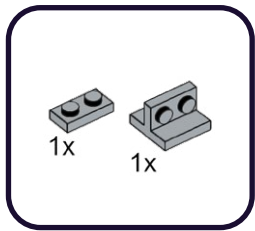

1

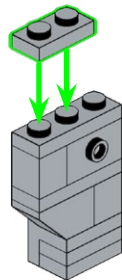

3

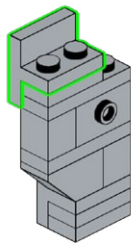

# 85

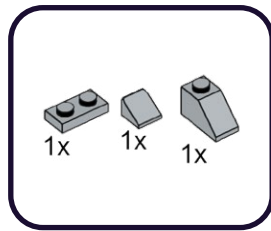

1

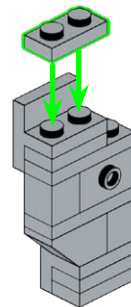

3

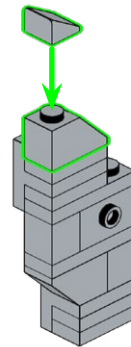



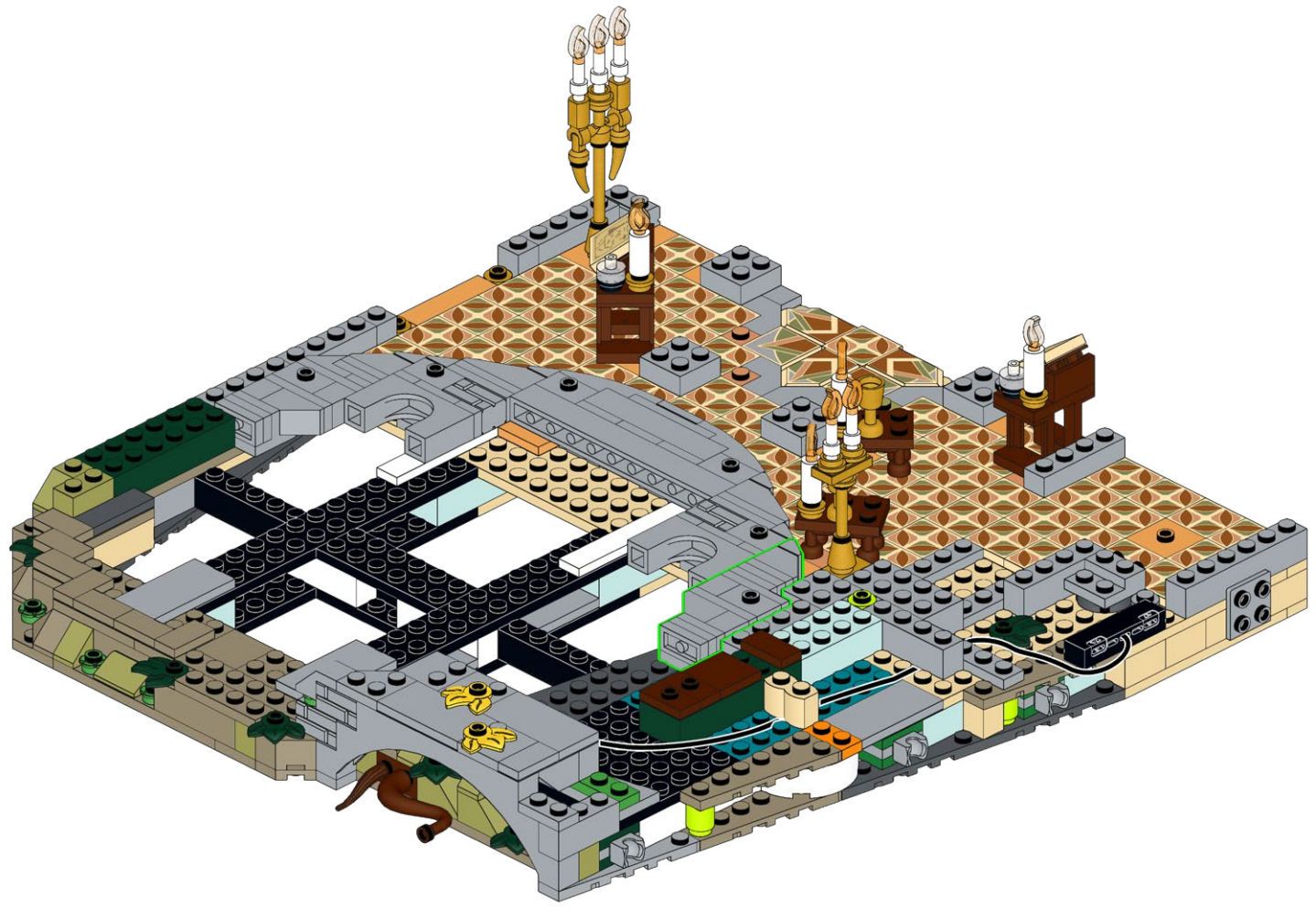

# 87

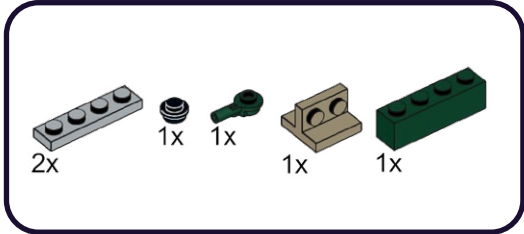

1

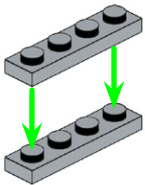

2

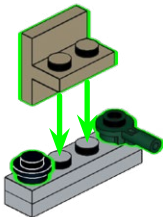

3

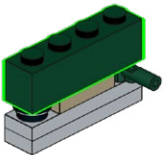

# 88

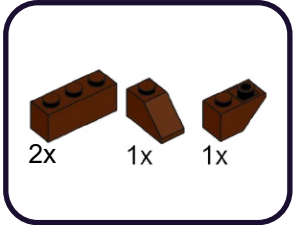

1

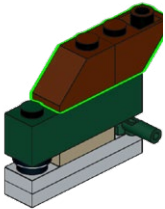

2

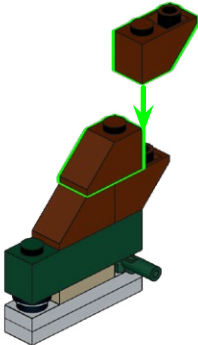

3

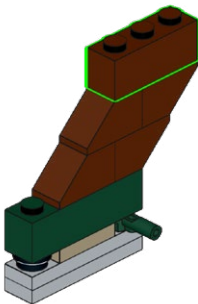

89

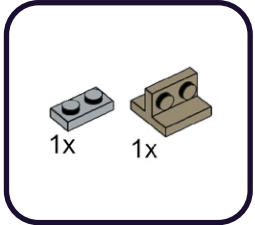

1

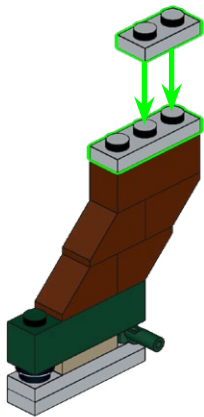

3

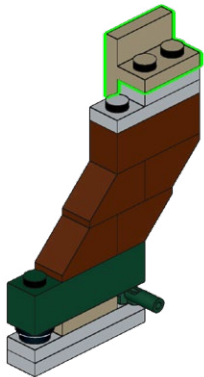

90

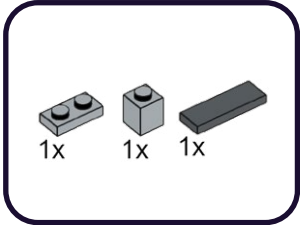

1

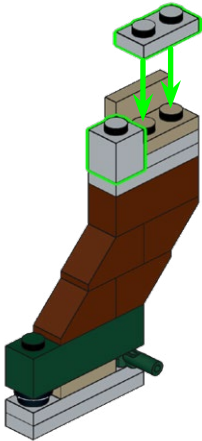

3

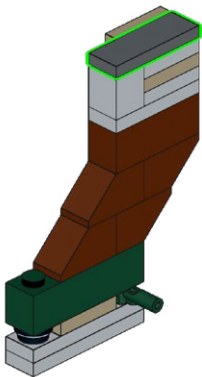



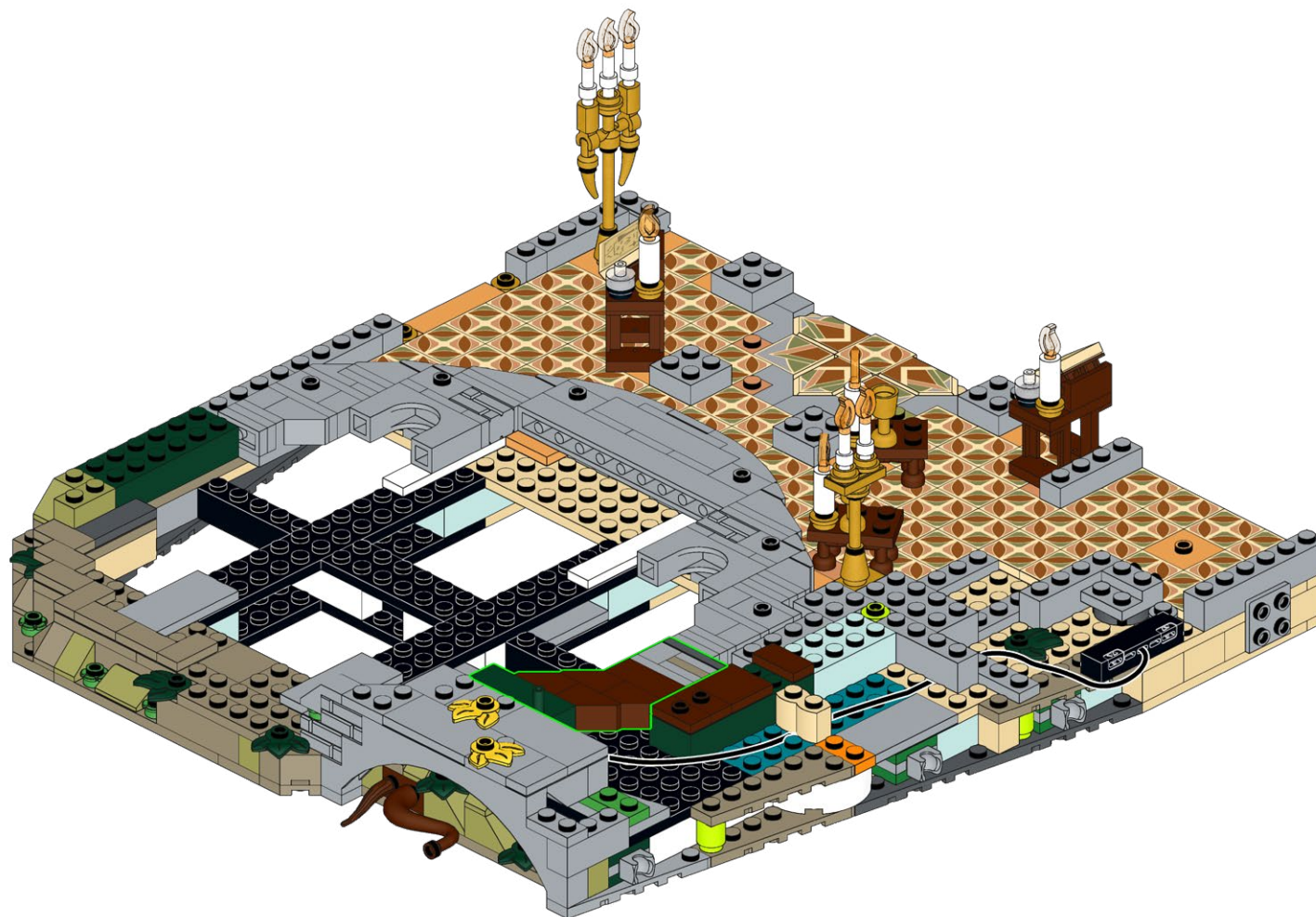

91





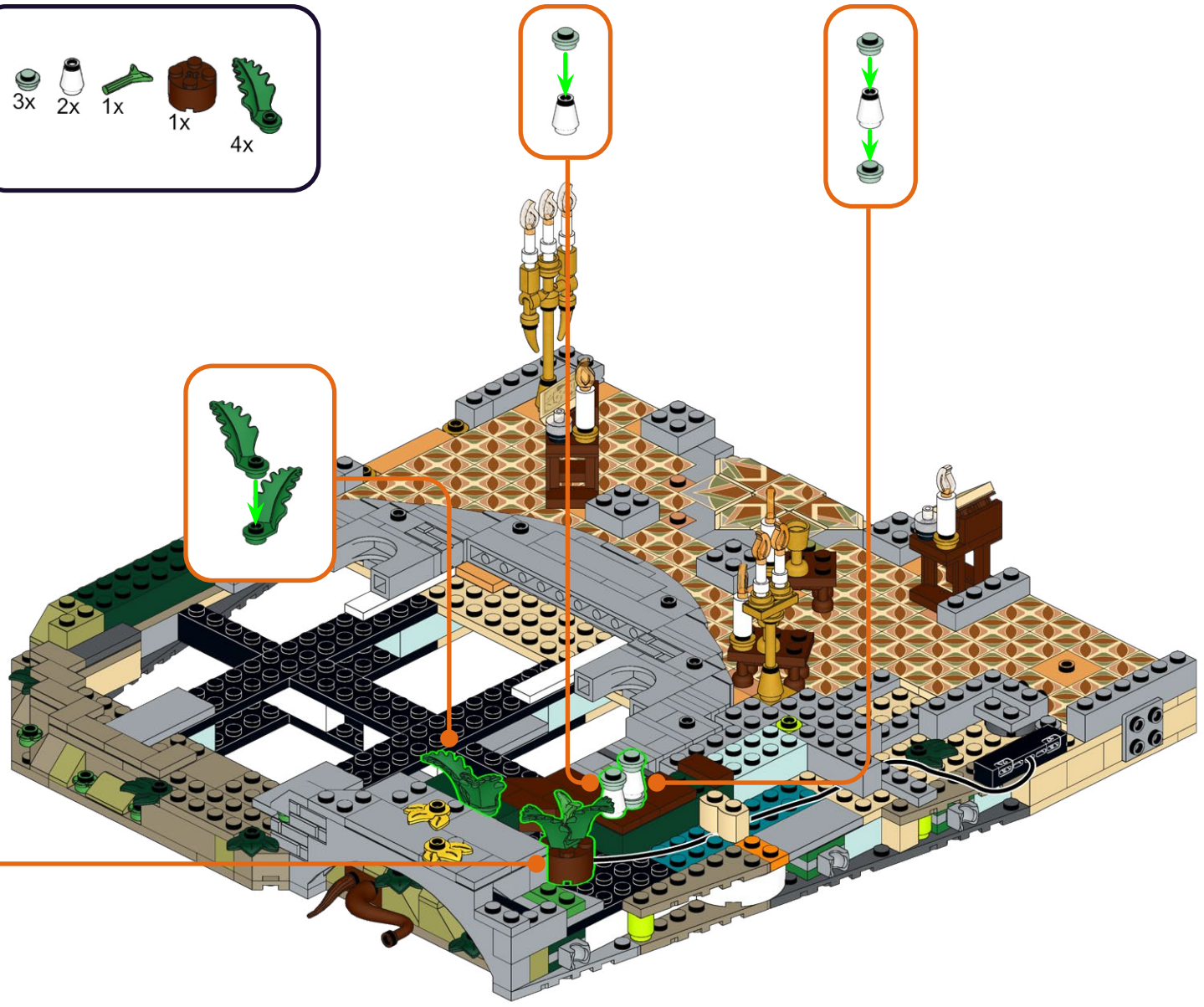

# 92

- 3x 
- 2x 
- 1x 
- 1x 
- 4x 



- 1 
- 2 

# 93

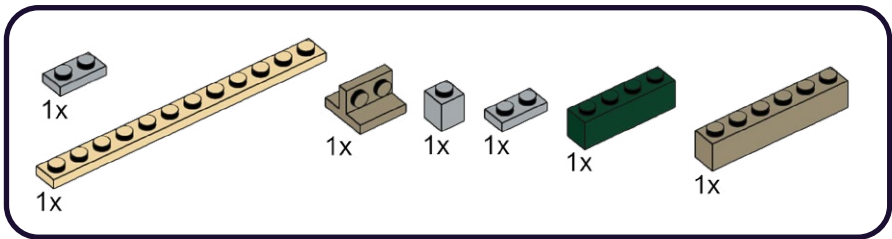

1

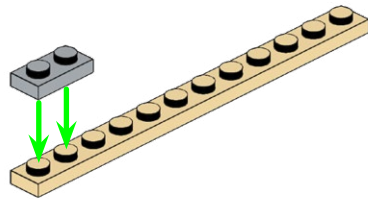

2

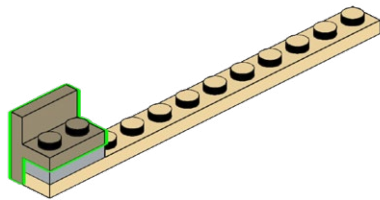

3

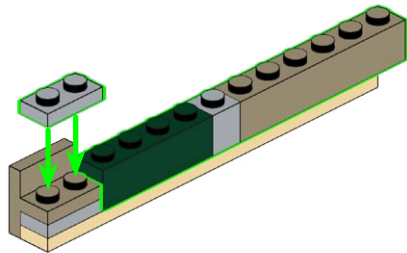

94

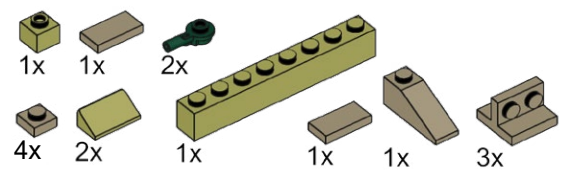

1

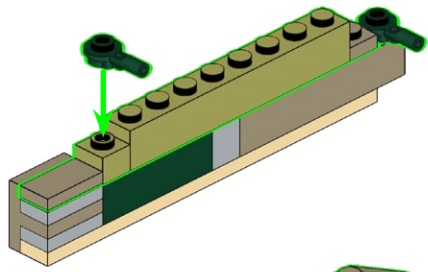

2

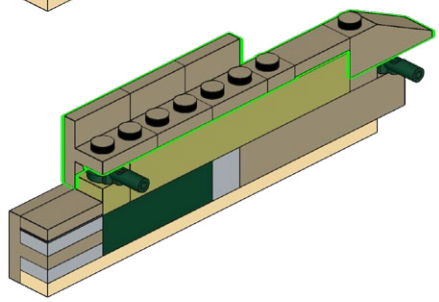

3

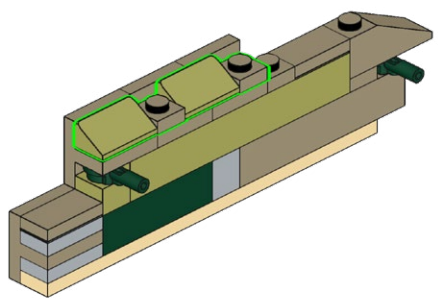

95

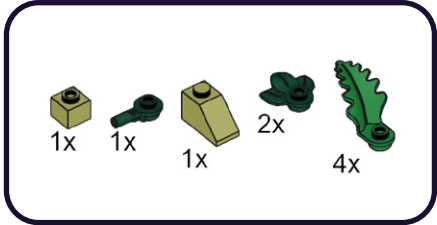

1

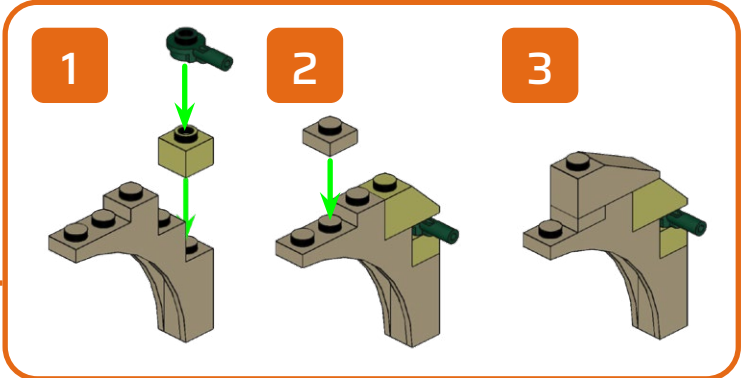
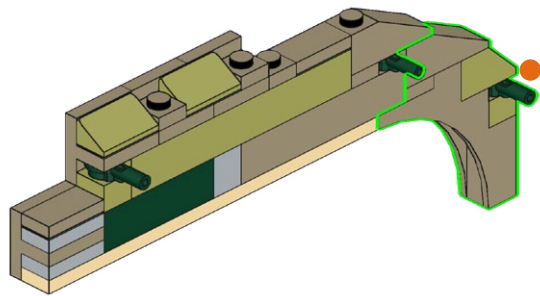

2

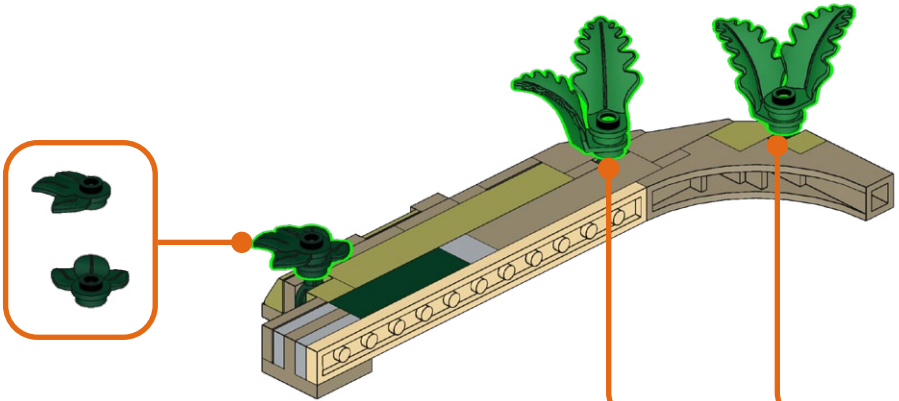



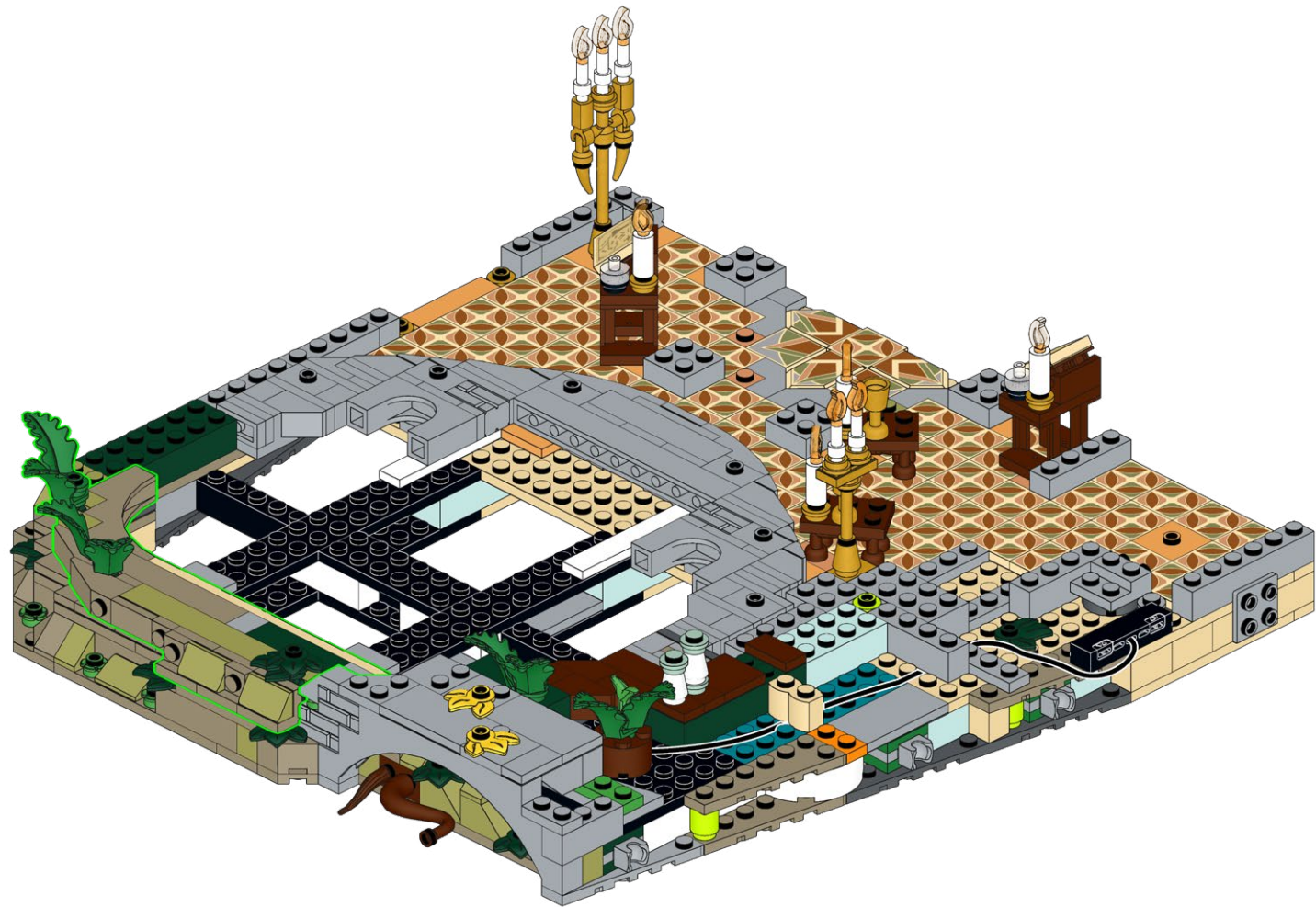

97

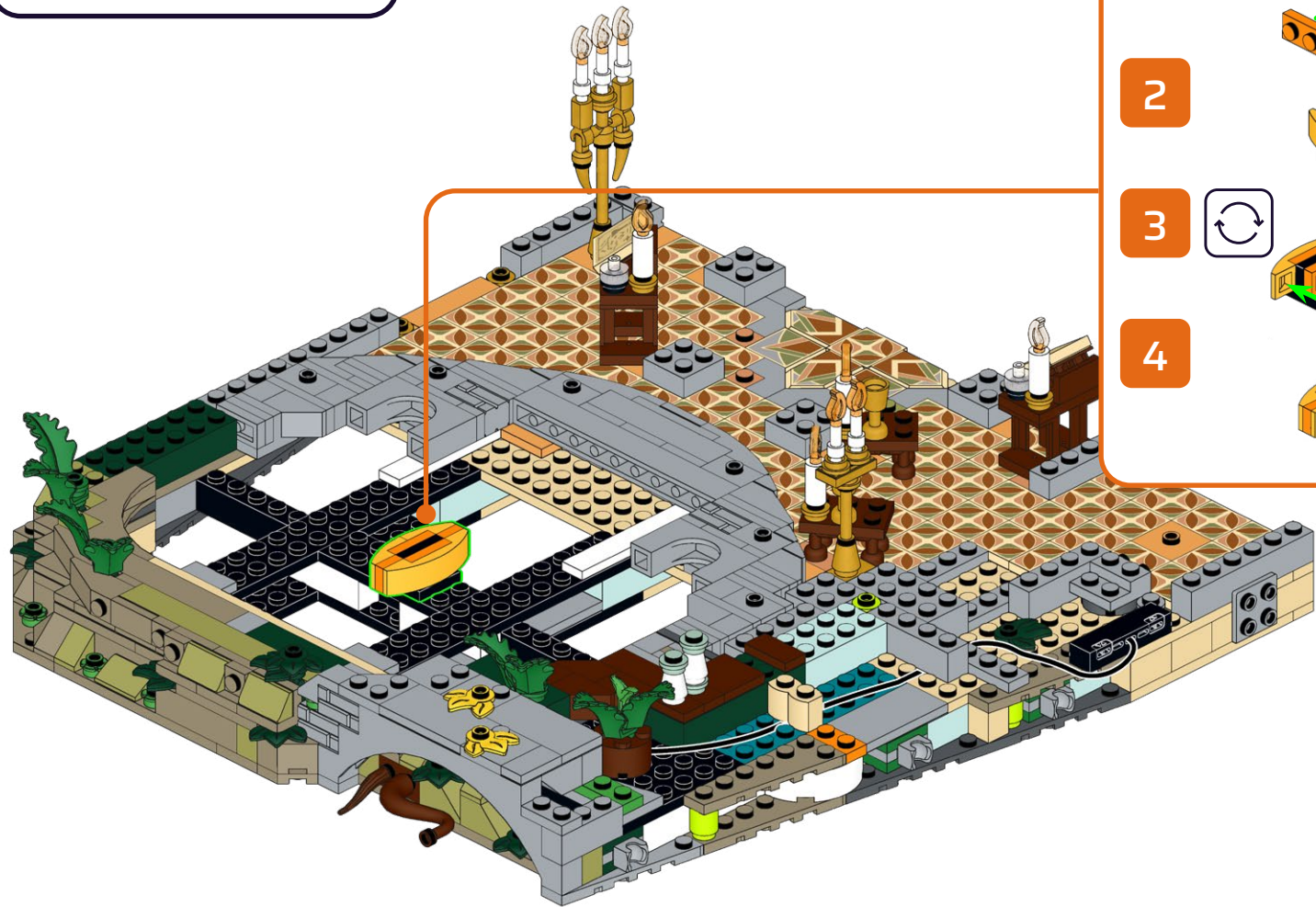
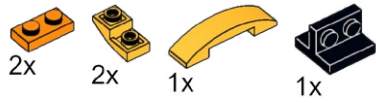

1

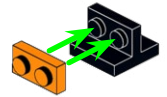

2



3

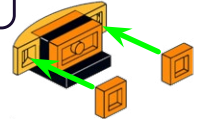

4





### **HOLD UP!**

You might notice some bags aren't in order, as well as left over pieces, but that's ok! We're changing the way you build LEGO!

### **ATTENDEZ!**

Vous remarquerez peut-être que certains sacs, ainsi que certaines pièces, ne sont pas dans le bon ordre. Mais pas de panique! Nous changeons simplement la façon avec laquelle vous construisez vos LEGO!

### **ASPETTA!**

Potresti notare che alcuni sacchetti non sono in ordine, così come i pezzi avanzati, ma va bene così! Stiamo cambiando il modo in cui costruisci i LEGO!

### **HALT!**

Sie werden möglicherweise bemerken, dass einige tüten durcheinander sind und teile übrig bleiben, aber das ist in Ordnung! Wir ändern die art und weise, wie Sie LEGO bauen!

### **¡ESPERA!**

Es posible que notes que algunas bolsas están fuera de servicio, así como piezas sobrantes, ¡pero está bien! ¡Estamos cambiando la forma en que construyes LEGO!

### **暫停!**

你可能会注意到一些袋子顺序错乱, 以及一些剩余的部件, 但没关系! 我们正在改变你搭建乐高的方式!

### Open LEGO® Bags 28 & 29



98

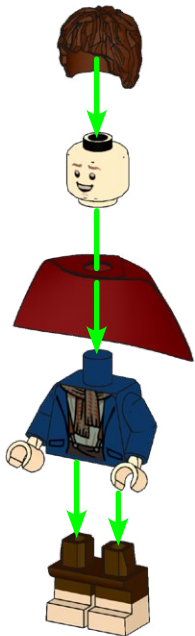
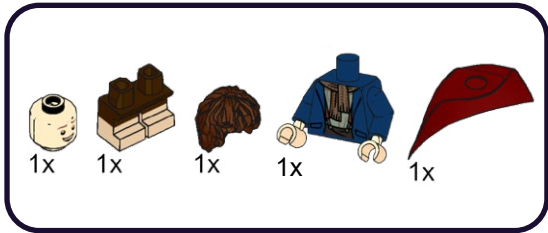

99

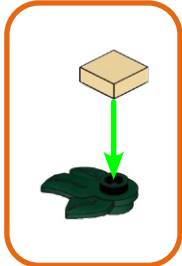
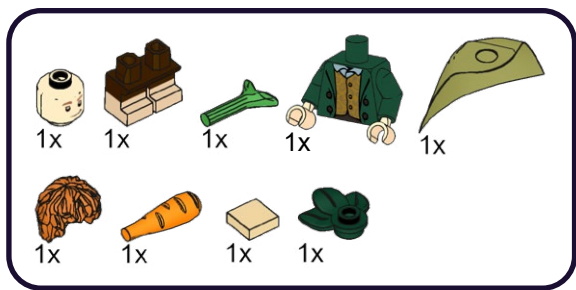



100

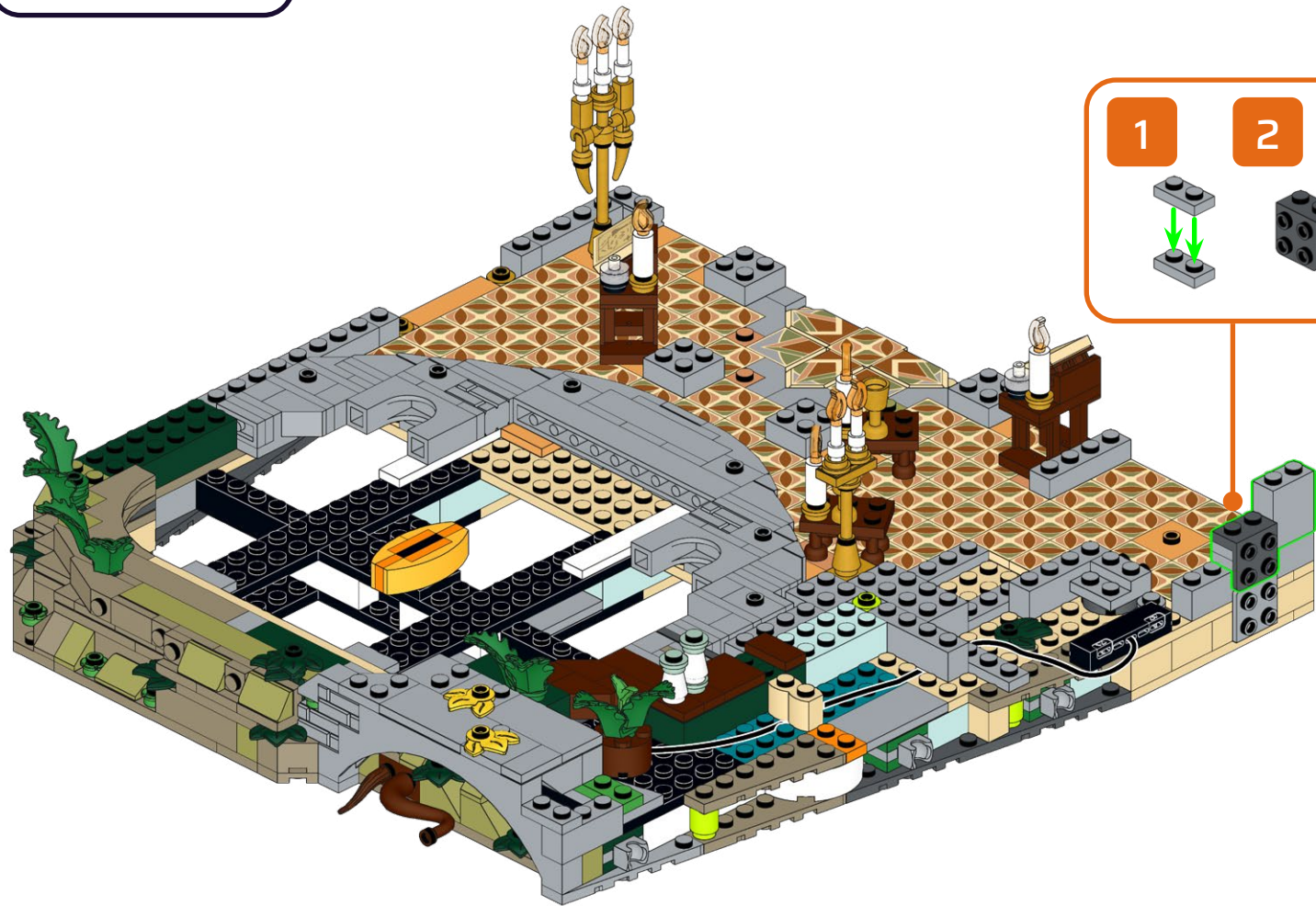
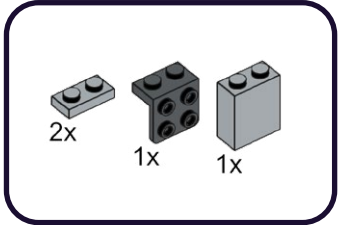

101

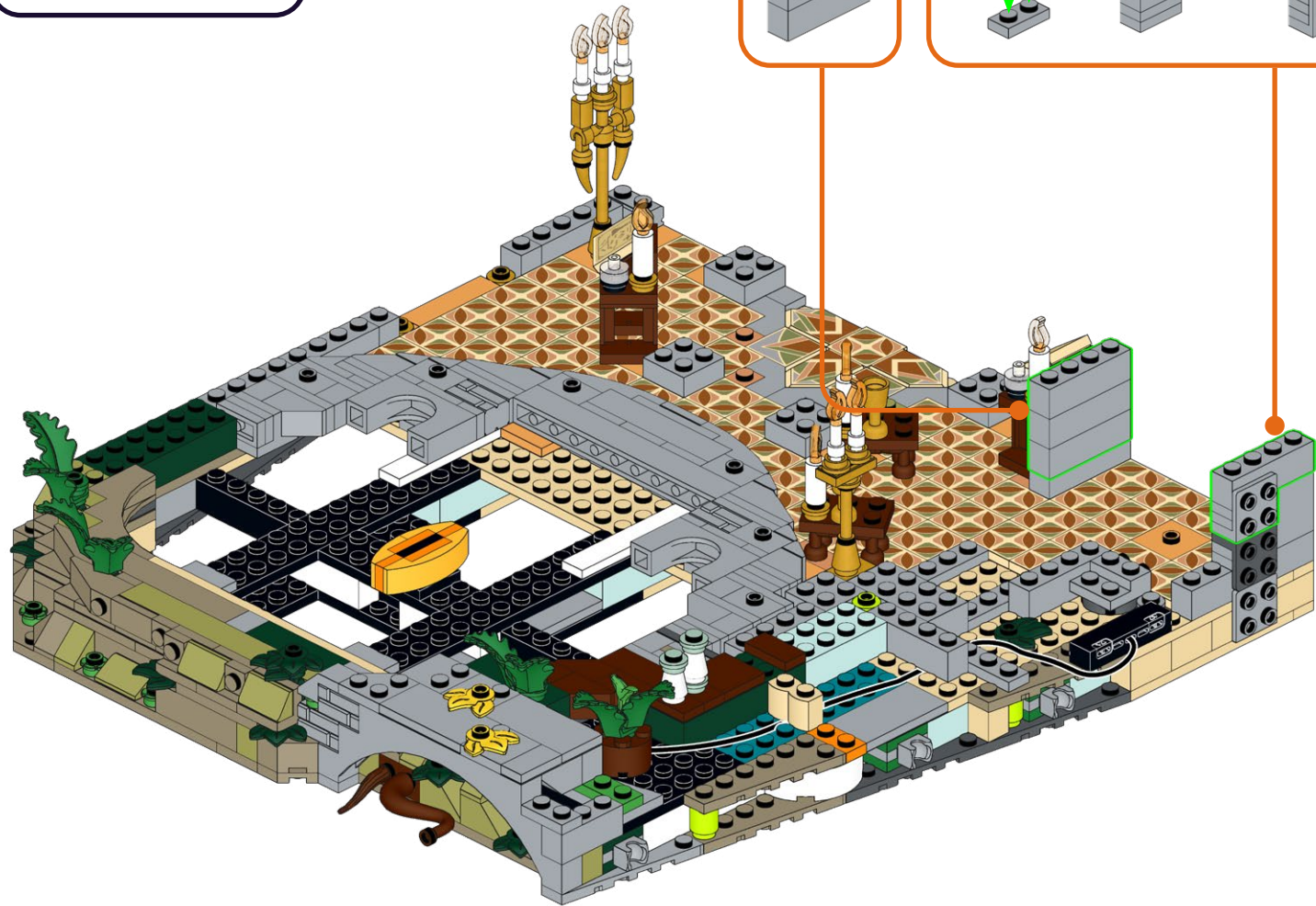
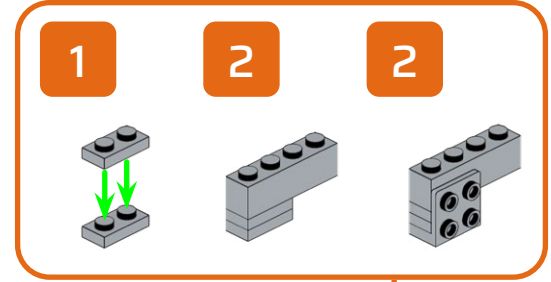
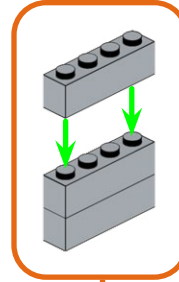
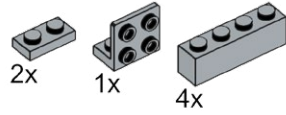



# 102

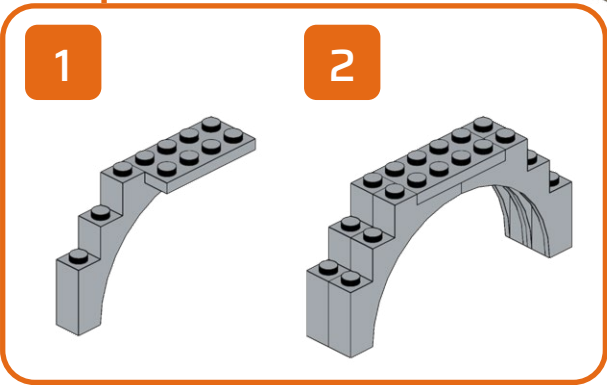
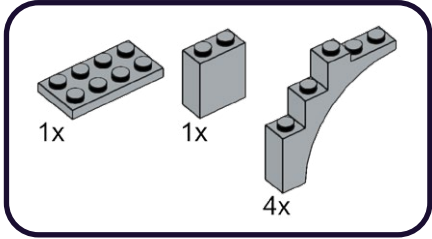

# 103

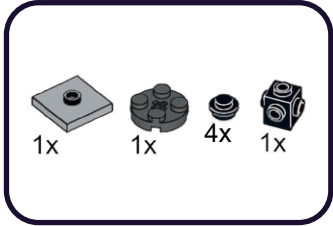

1

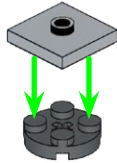

2

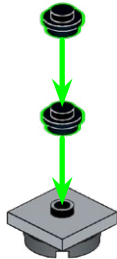

3

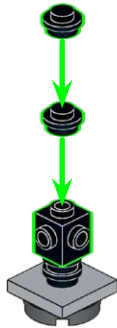

# 104

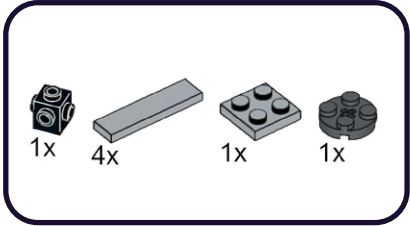

1

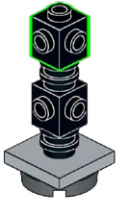

2

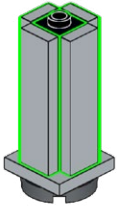

3

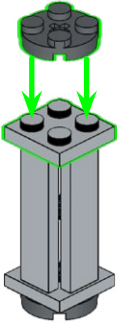

4x



105

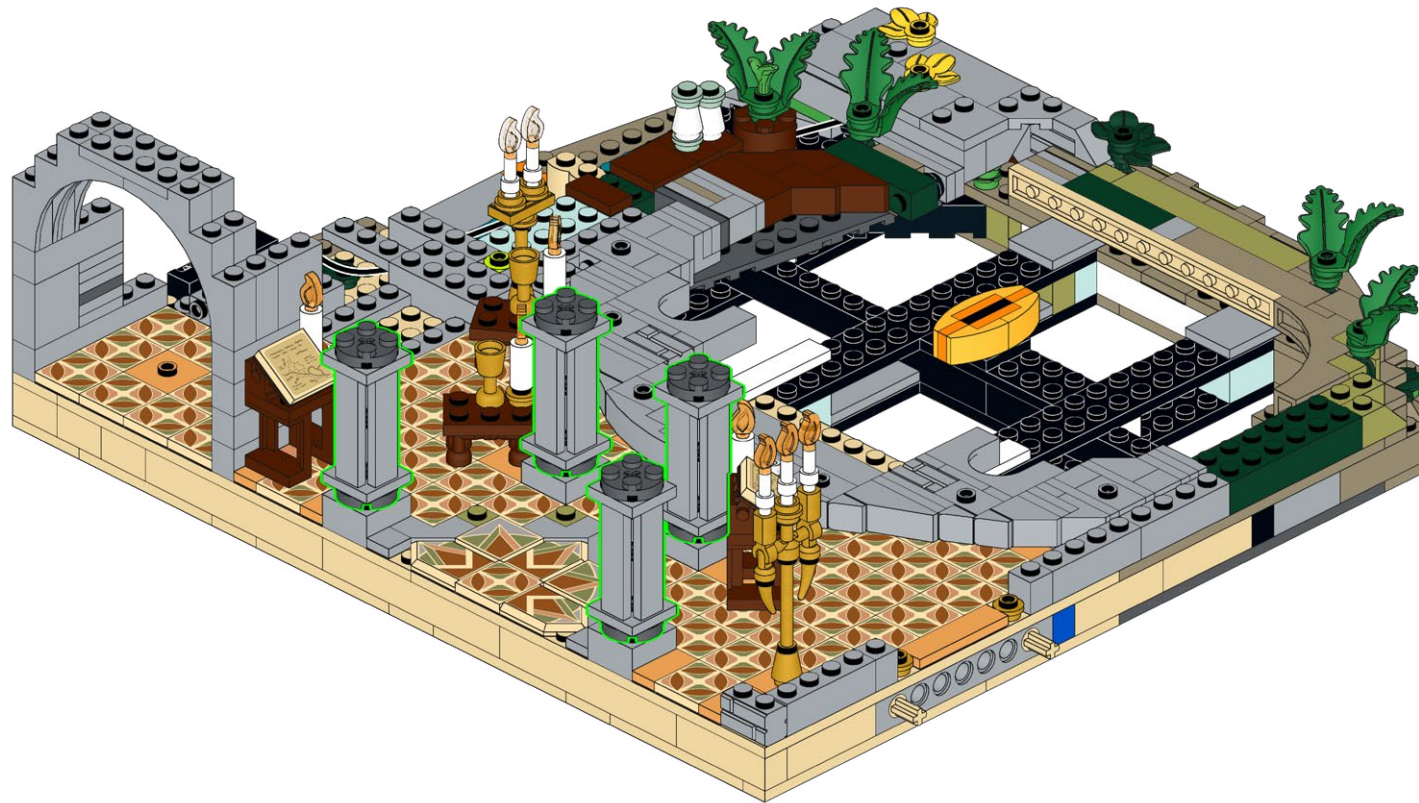

# 106

- 2x [L-shaped grey brick]
- 2x [2-hole grey brick]
- 1x [grey brick with 2 holes]
- 2x [grey brick with 2 holes]
- 2x [grey brick with 4 holes]
- 1x [grey brick with 4 holes]

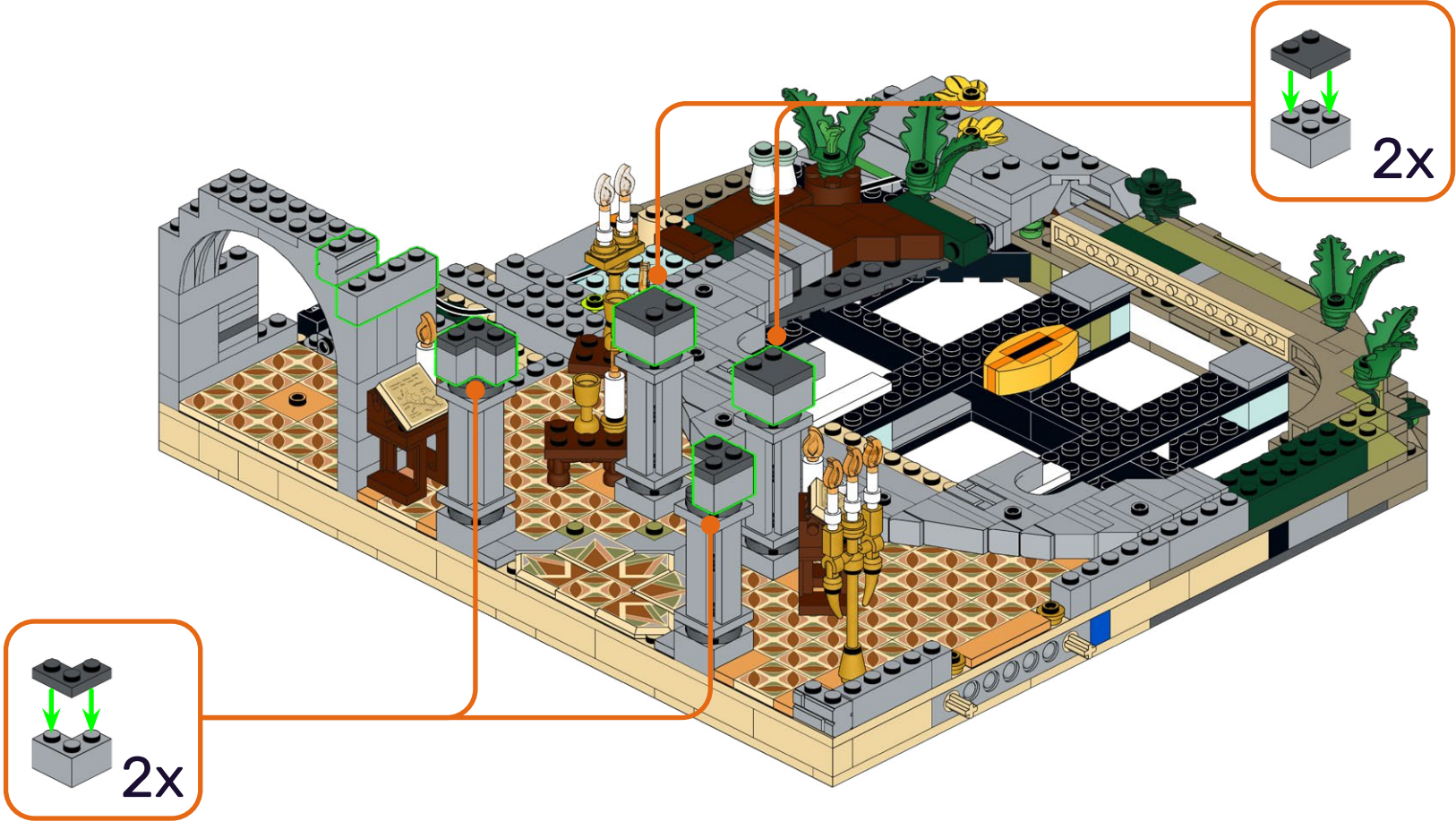

107

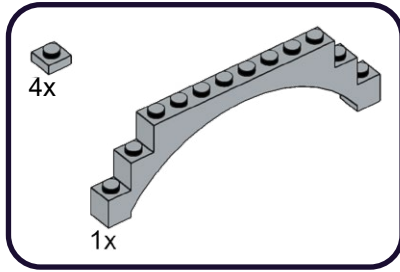

1

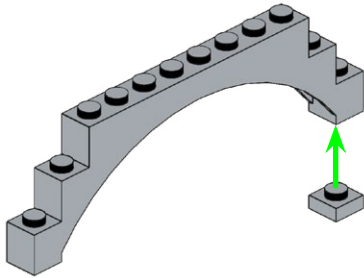

3

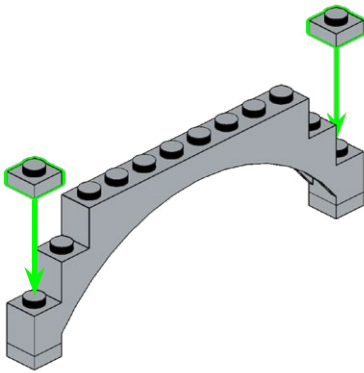

108

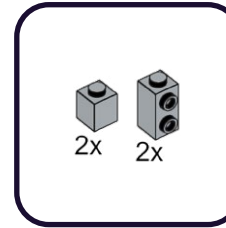

1

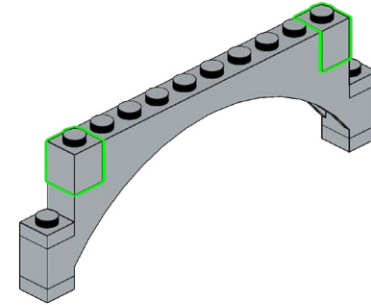

3

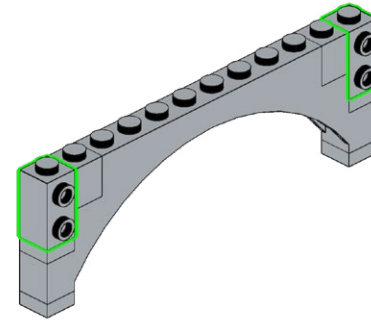



109

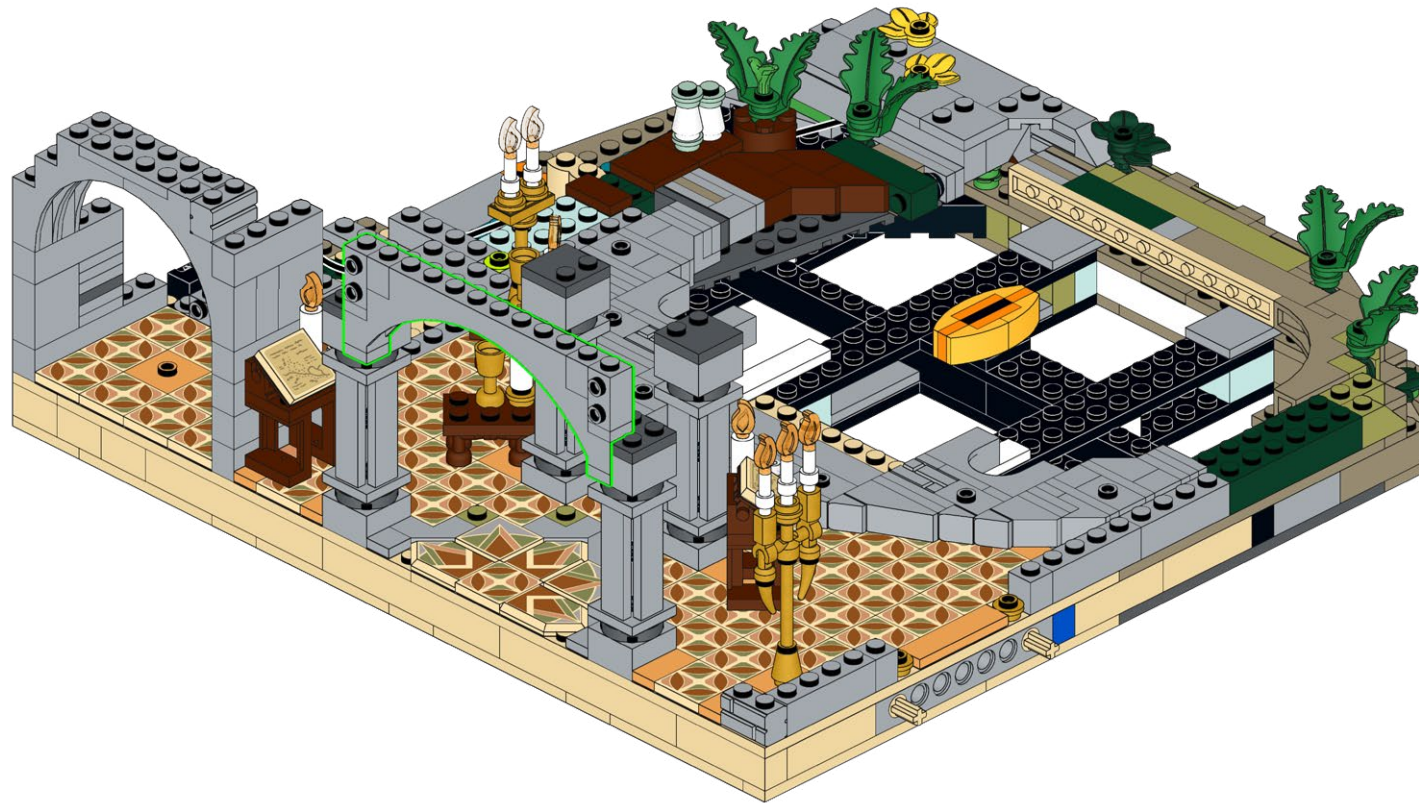



110

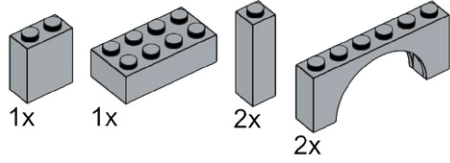

1

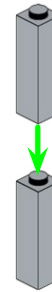

2

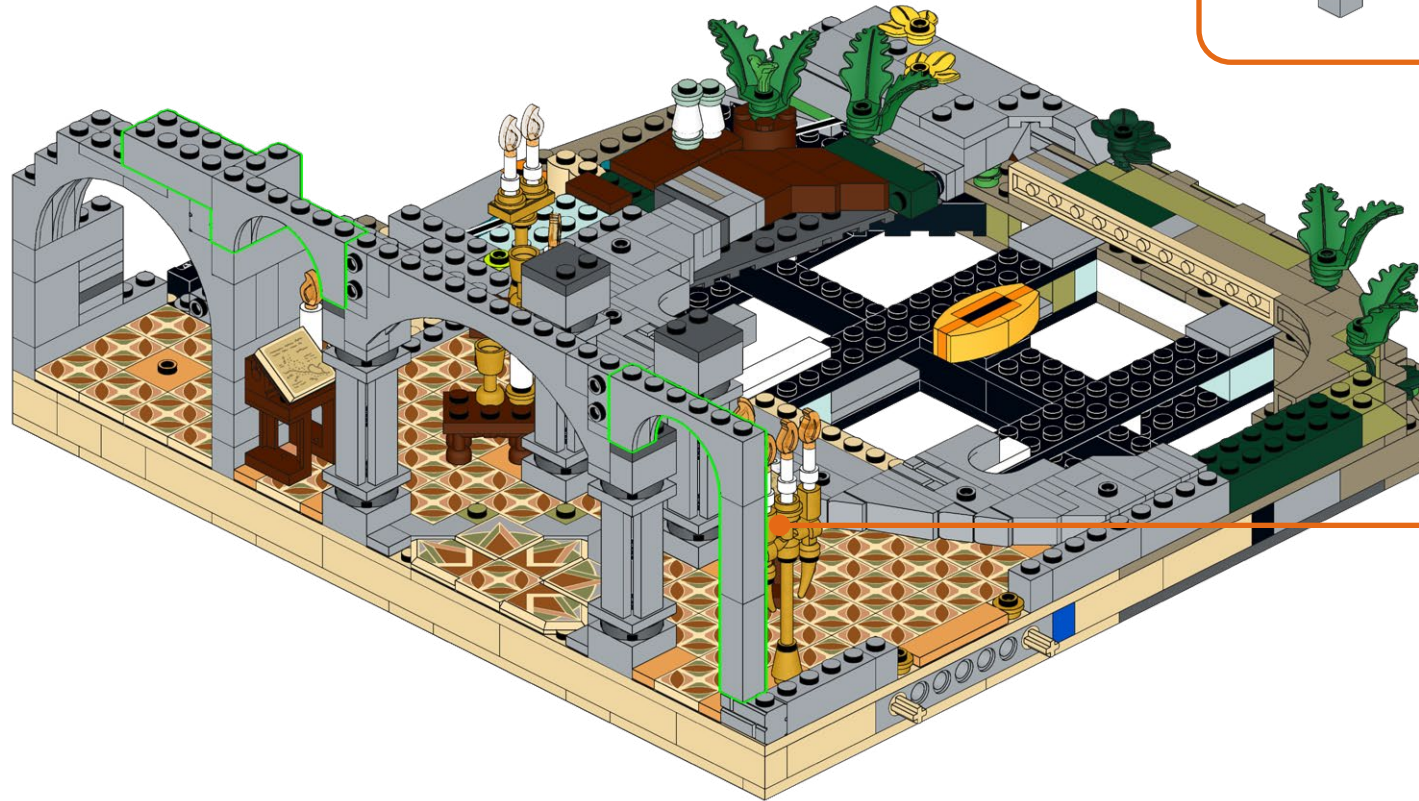
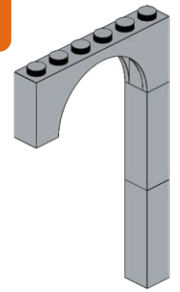

111

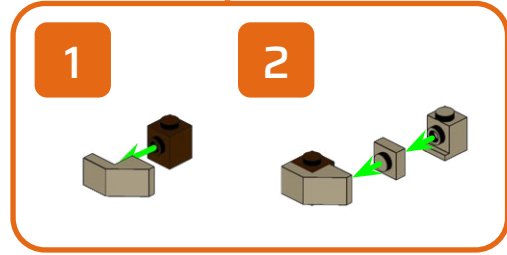
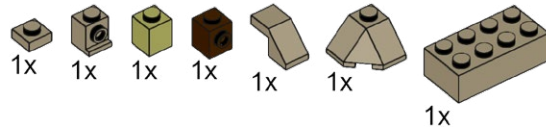

112

3x 1x 1x

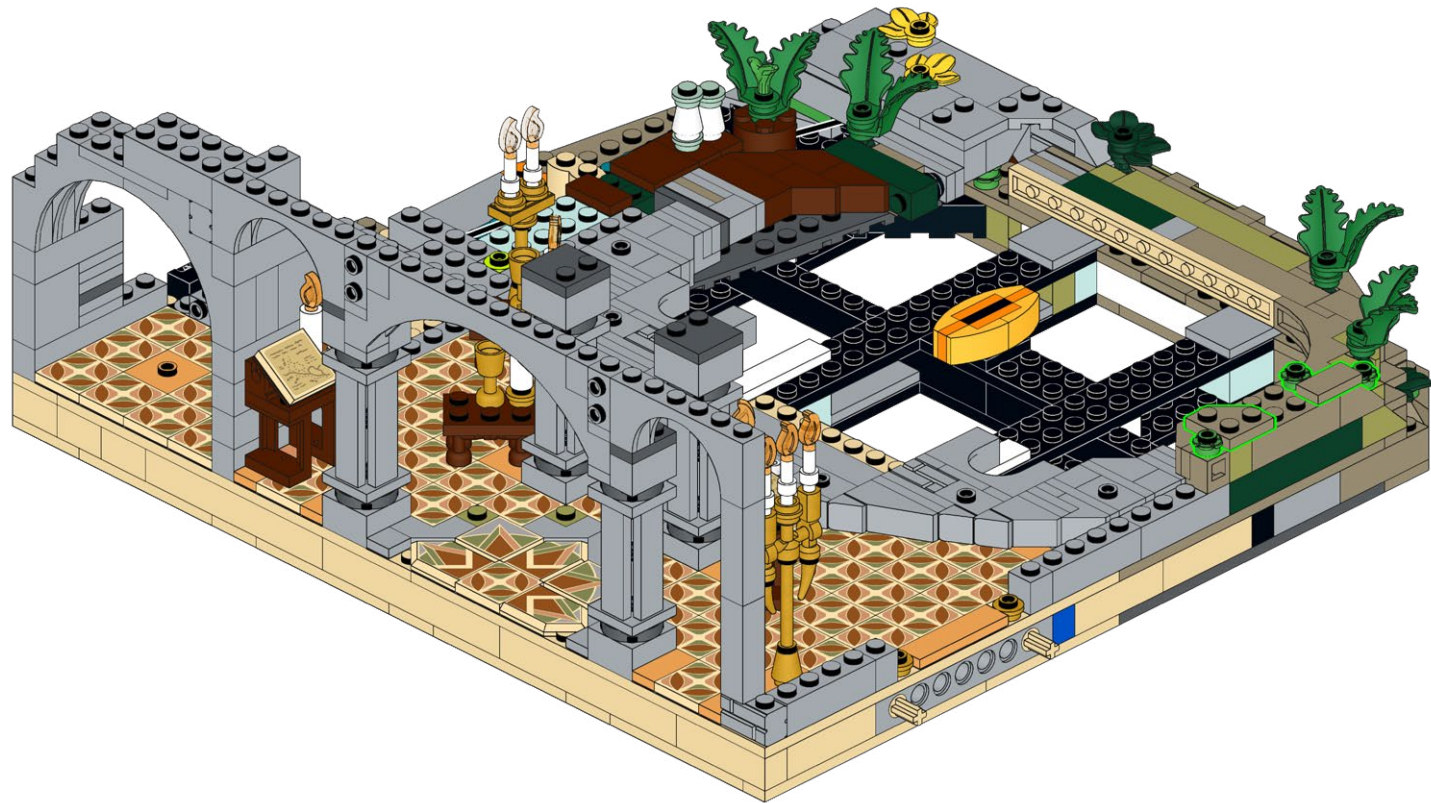



113

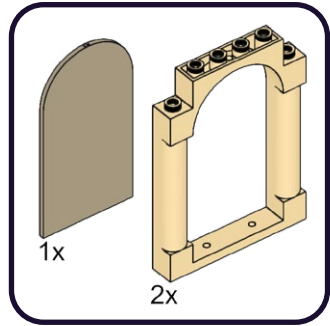



114

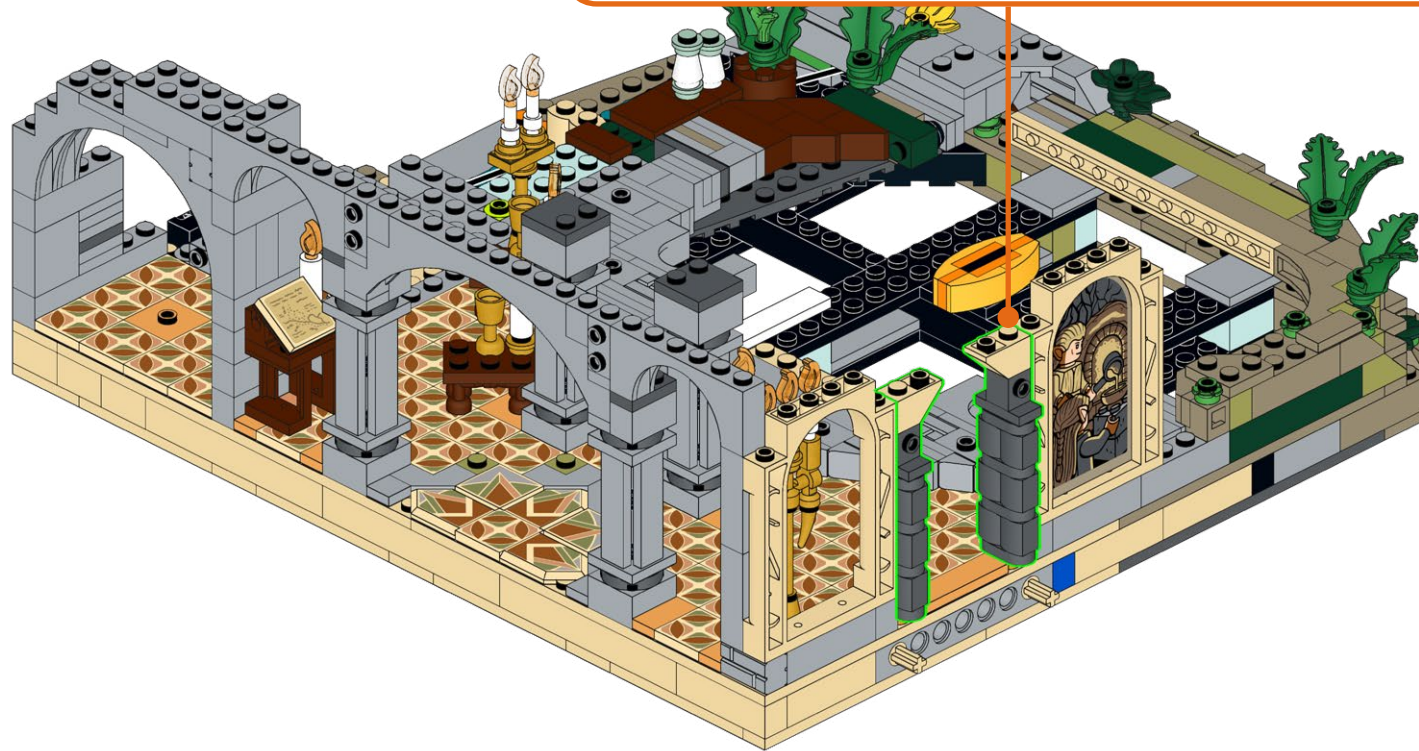
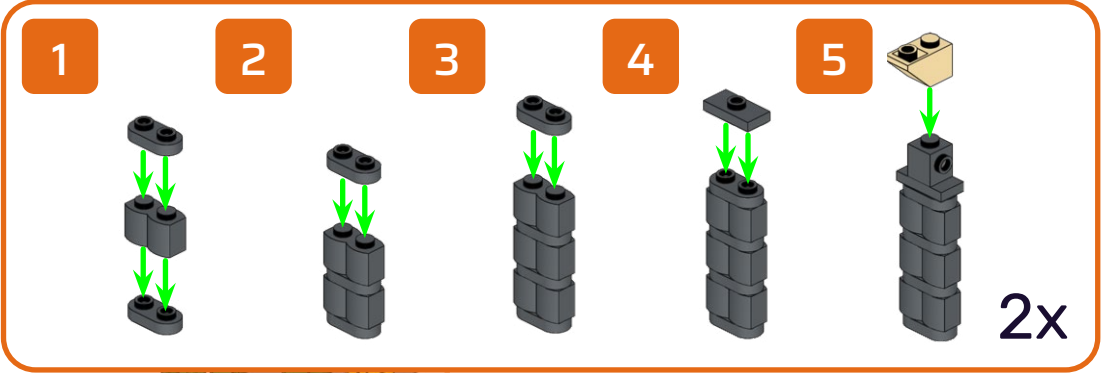
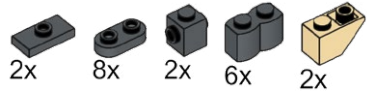

115

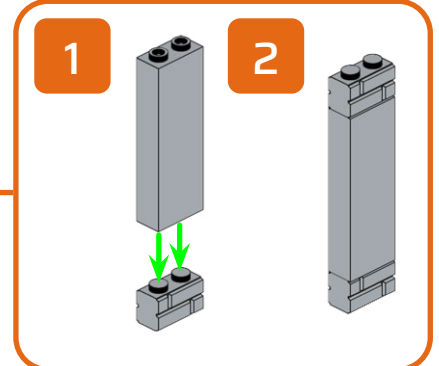
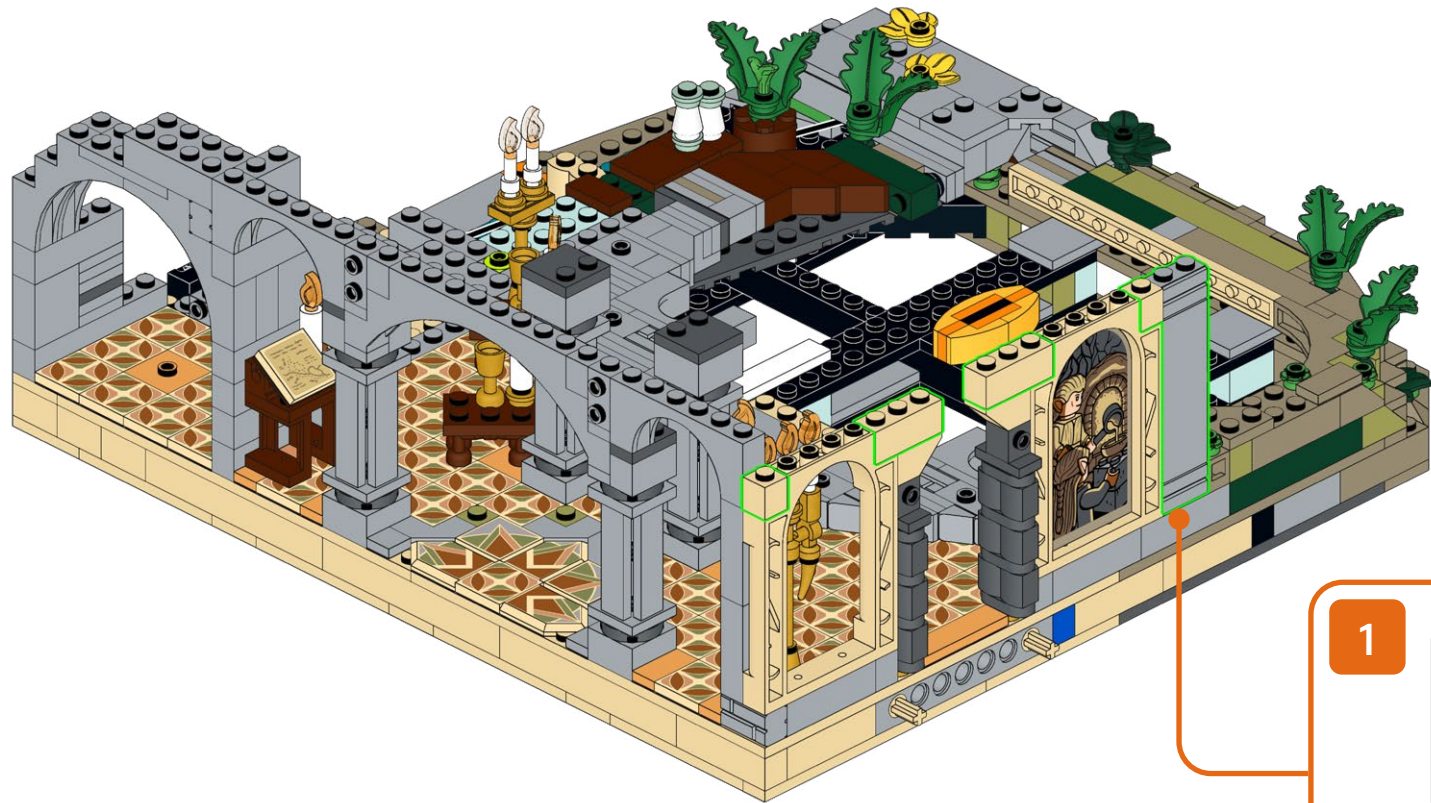
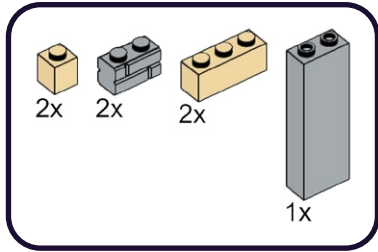

116

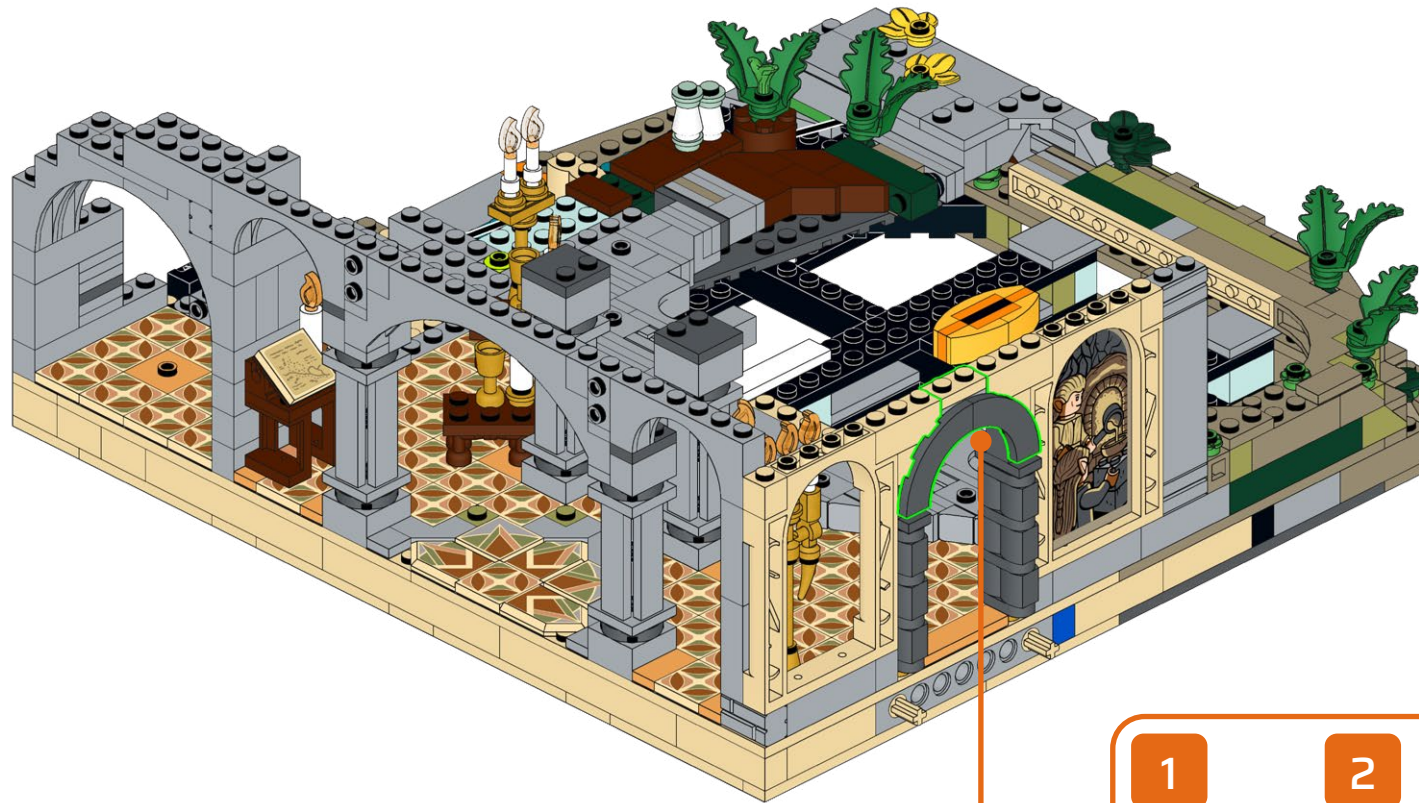
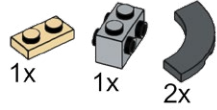

1

2

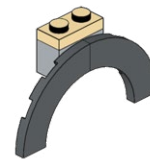
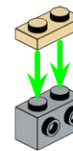



117

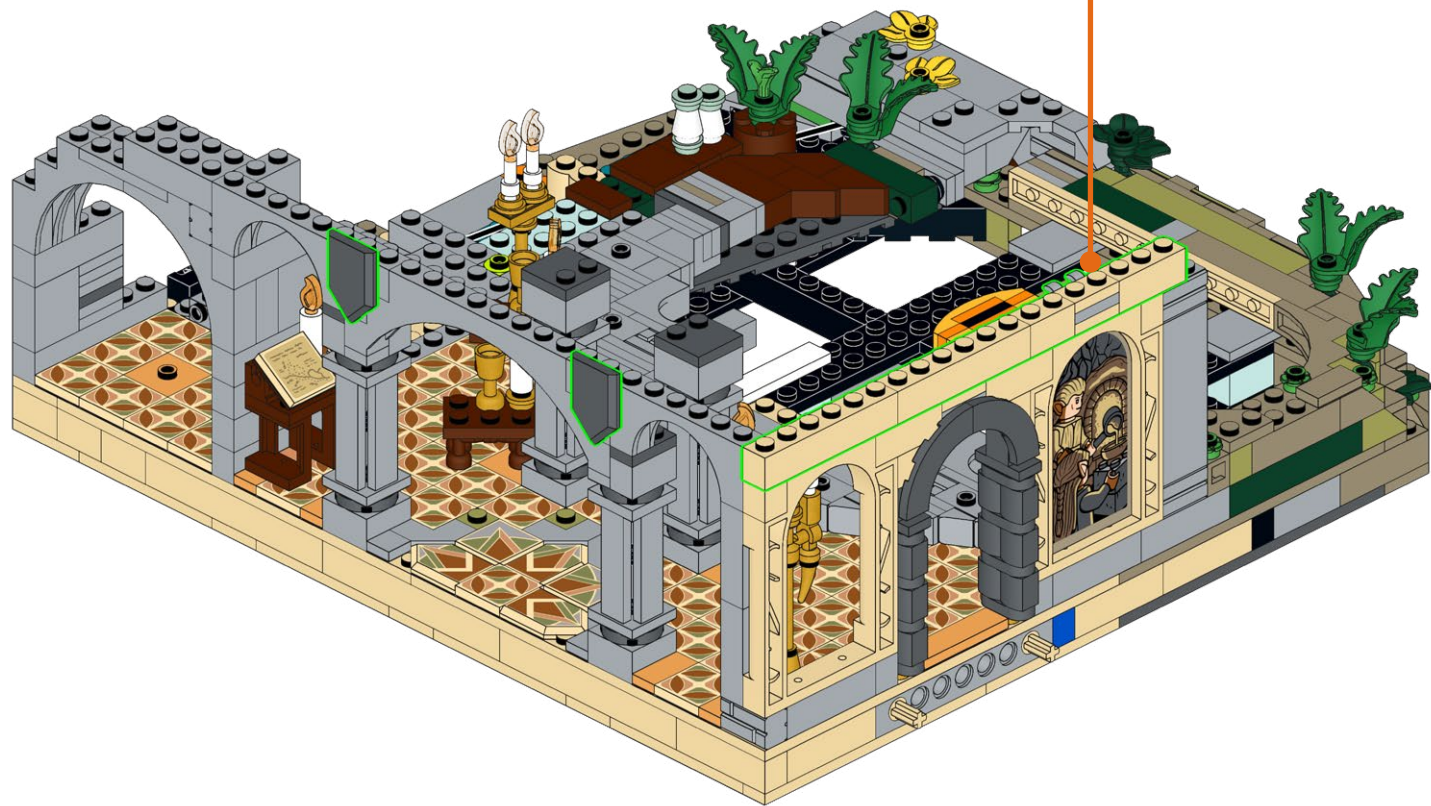
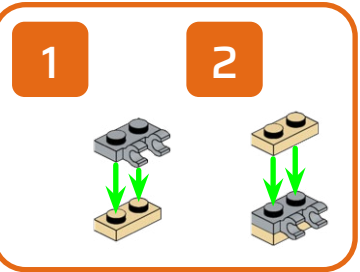
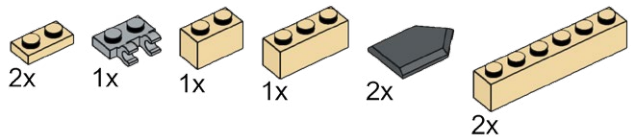



118

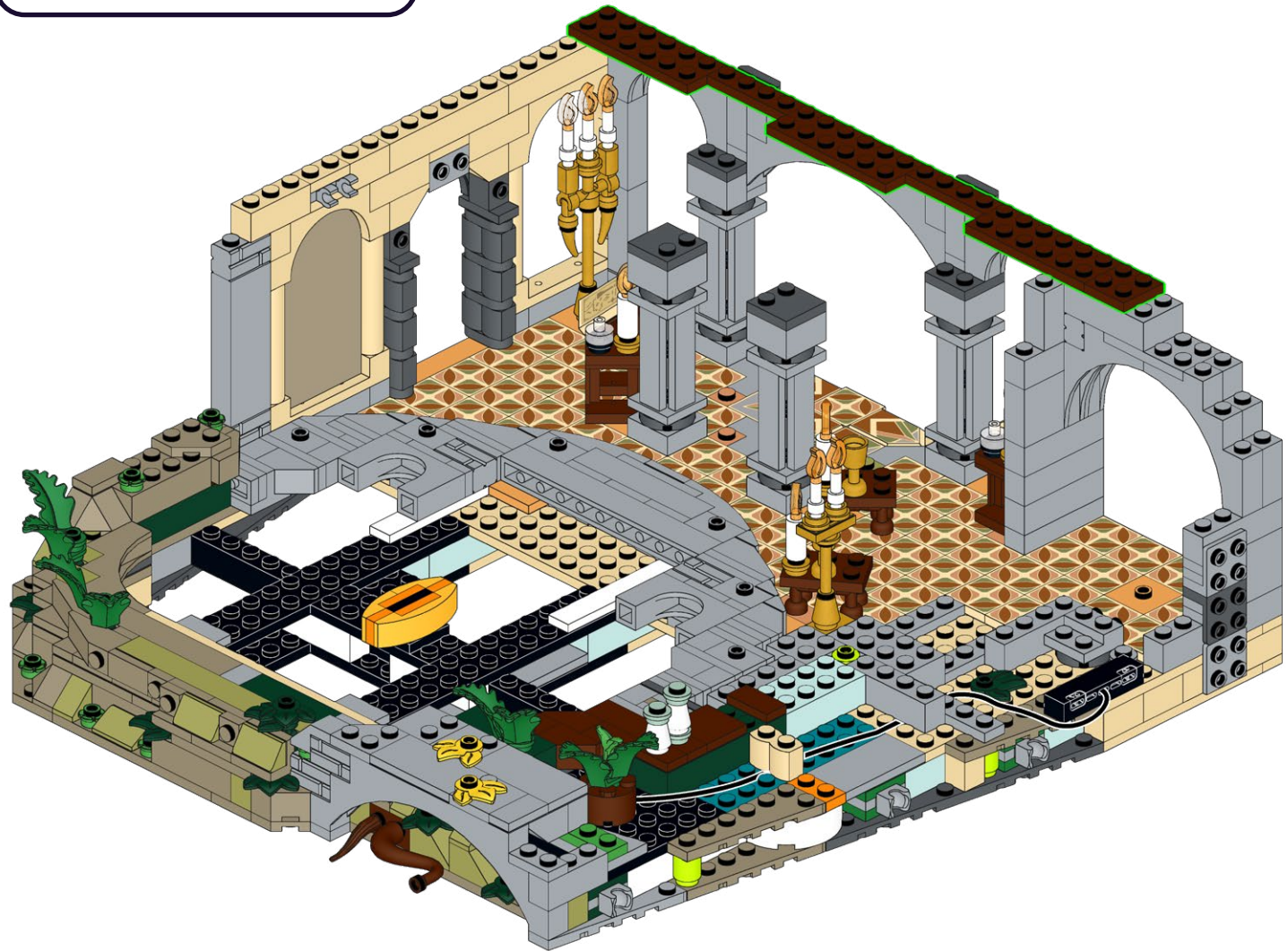
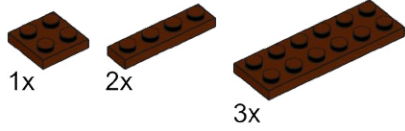

119

2x

1x

1

2

1





120

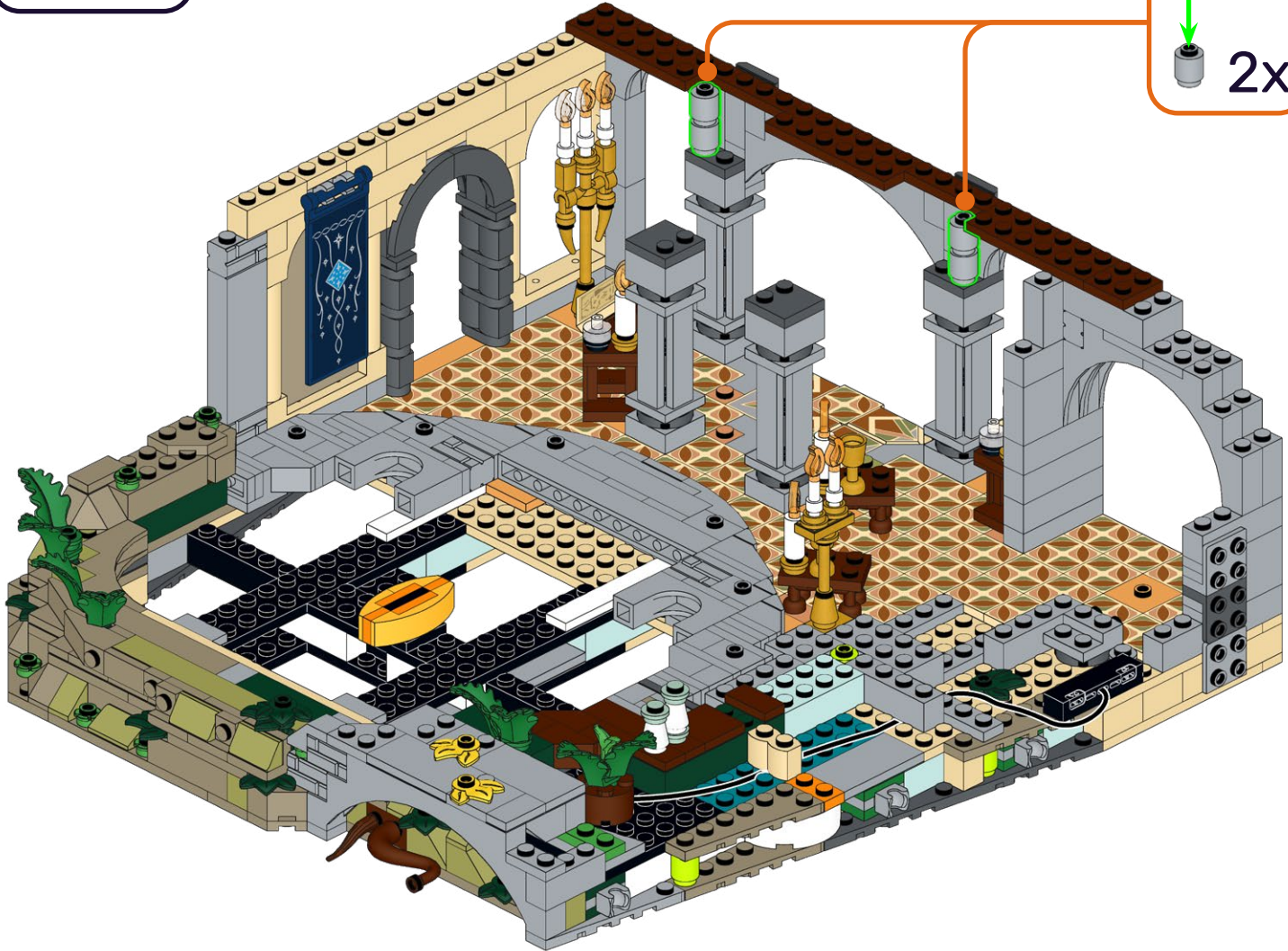
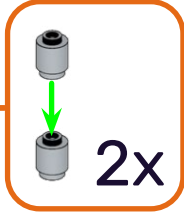
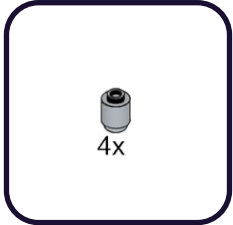

121

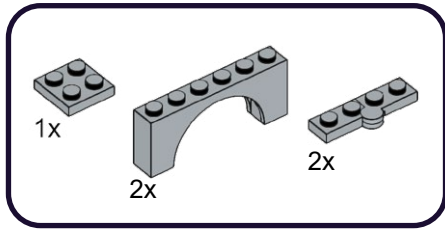

1

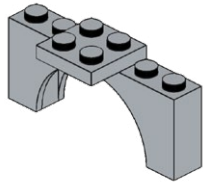

2

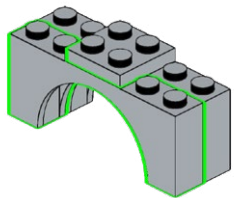

3

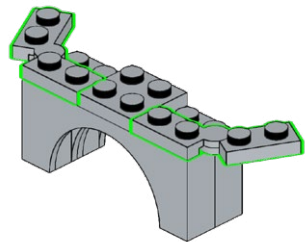

122

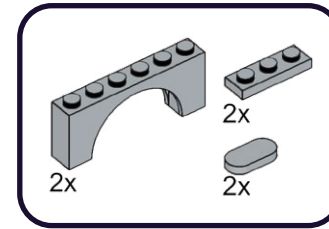

1

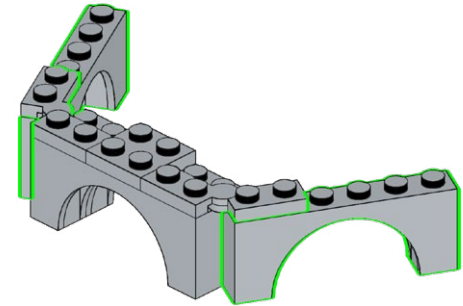

2

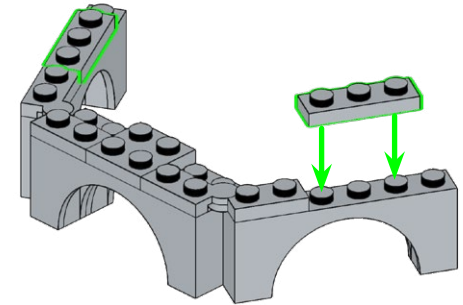

3

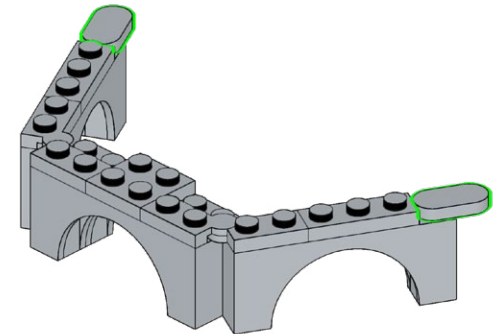



123

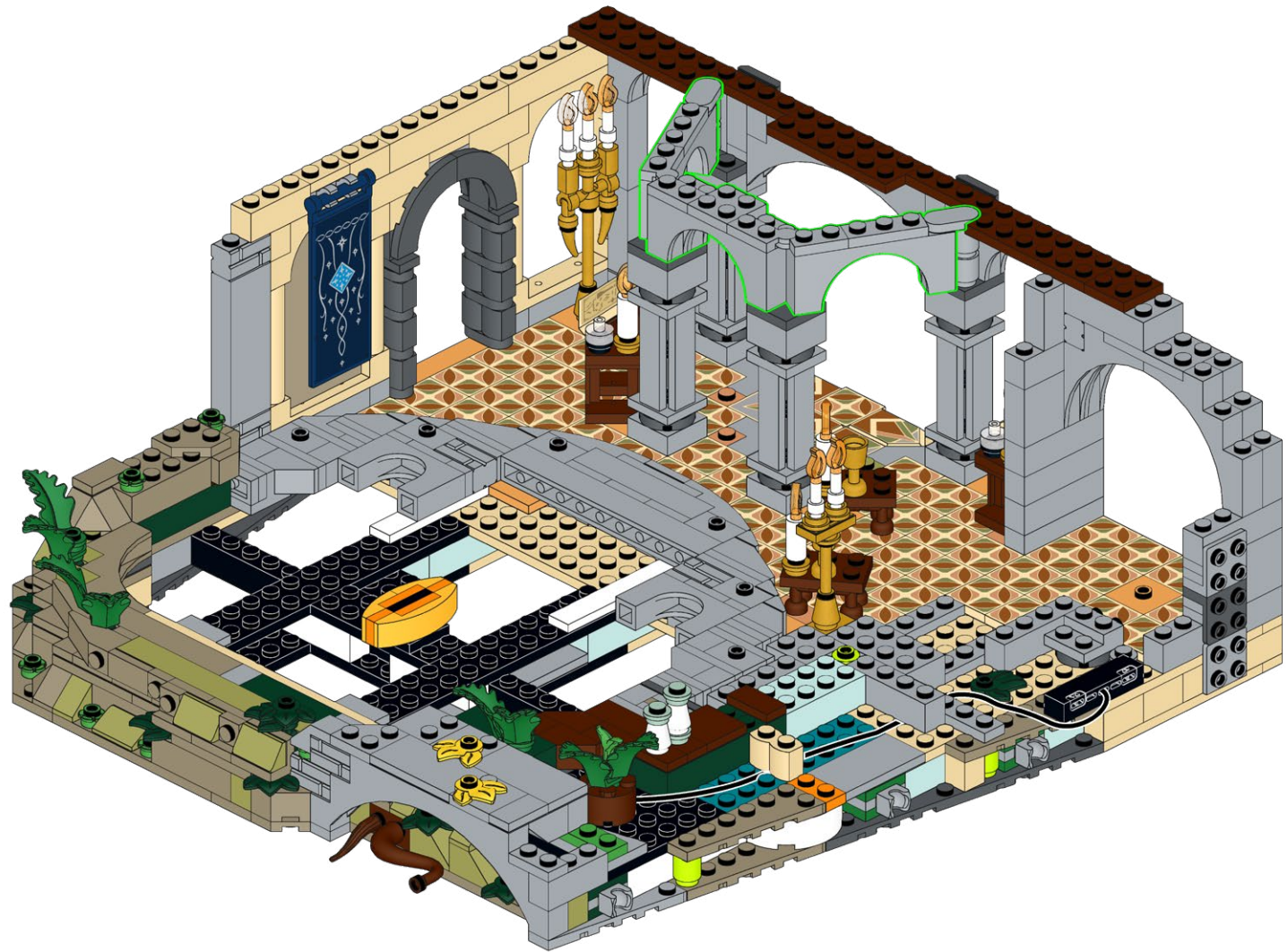

**HOLD UP!**

You might notice some bags aren't in order, as well as left over pieces, but that's ok! We're changing the way you build LEGO!

**ATTENDEZ!**

Vous remarquerez peut-être que certains sacs, ainsi que certaines pièces, ne sont pas dans le bon ordre. Mais pas de panique! Nous changeons simplement la façon avec laquelle vous construisez vos LEGO!

**ASPETTA!**

Potresti notare che alcuni sacchetti non sono in ordine, così come i pezzi avanzati, ma va bene così! Stiamo cambiando il modo in cui costruisci i LEGO!

**HALT!**

Sie werden möglicherweise bemerken, dass einige tüten durcheinander sind und teile übrig bleiben, aber das ist in Ordnung! Wir ändern die art und weise, wie Sie LEGO bauen!

**¡ESPERA!**

Es posible que notes que algunas bolsas están fuera de servicio, así como piezas sobrantes, ¡pero está bien! ¡Estamos cambiando la forma en que construyes LEGO!

**暫停!**

你可能会注意到一些袋子顺序错乱, 以及一些剩余的部件, 但没关系! 我们正在改变你搭建乐高的方式!

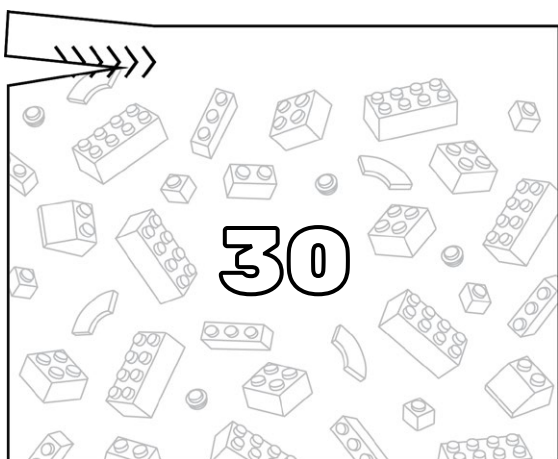
**Open LEGO® Bag 30**

124

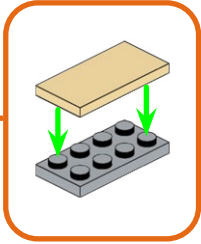
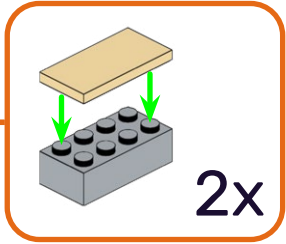
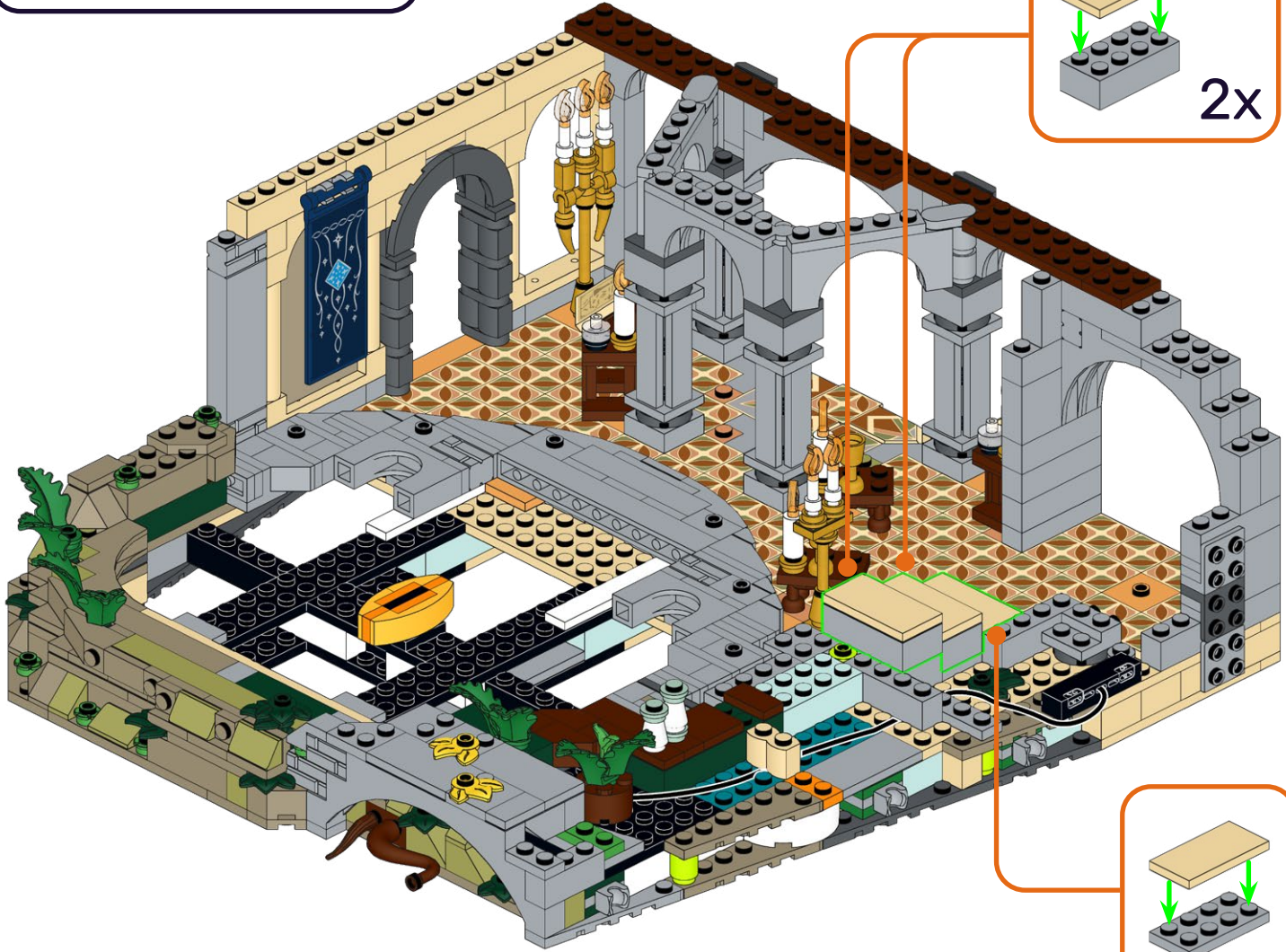
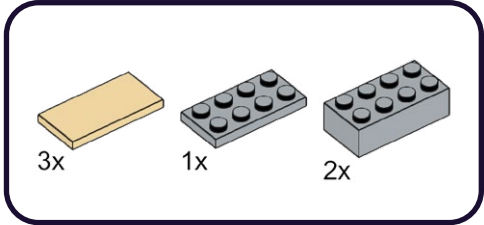



# 125

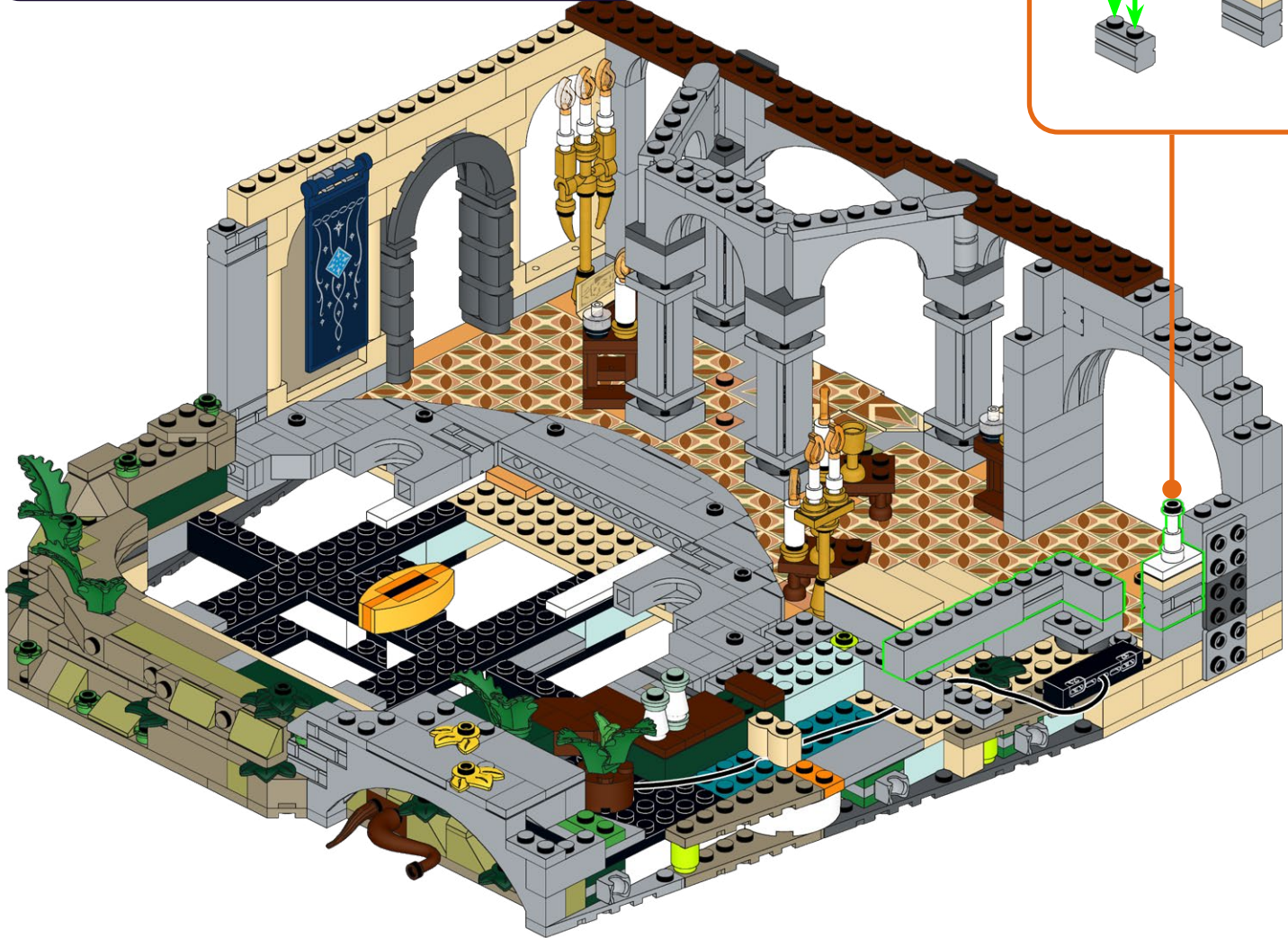
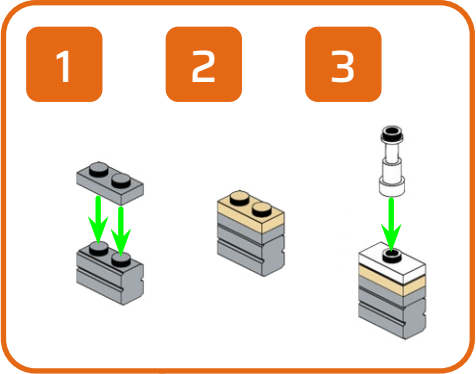
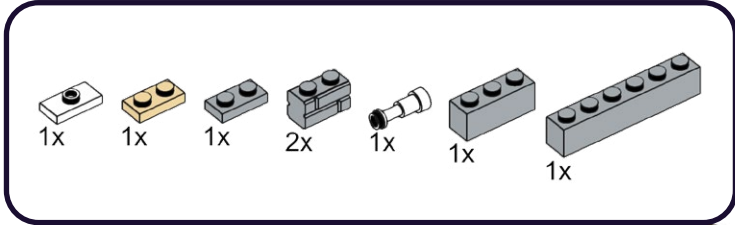



# 126

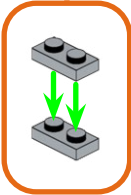
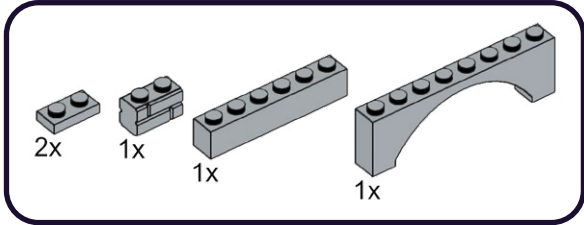

127

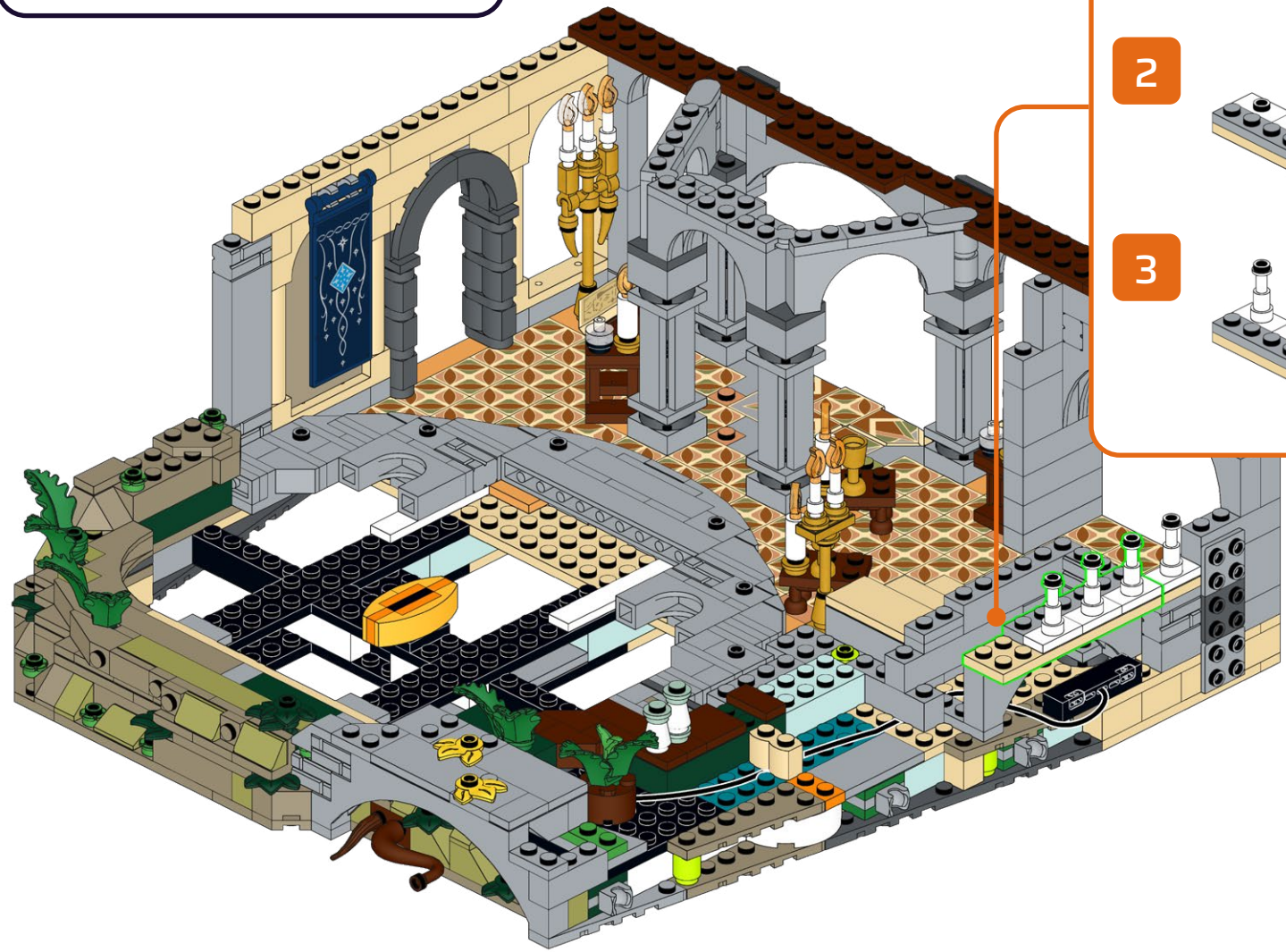
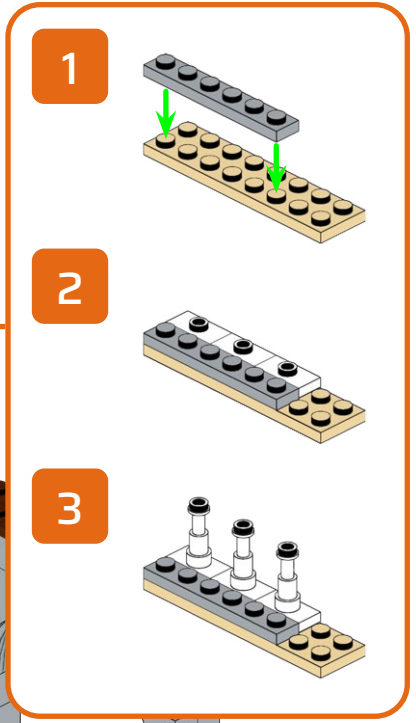
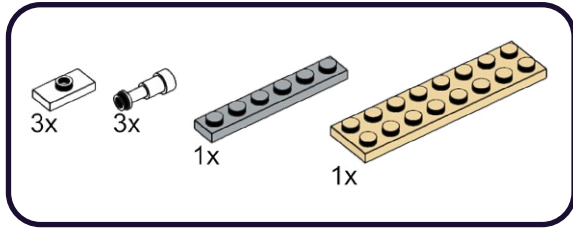



128

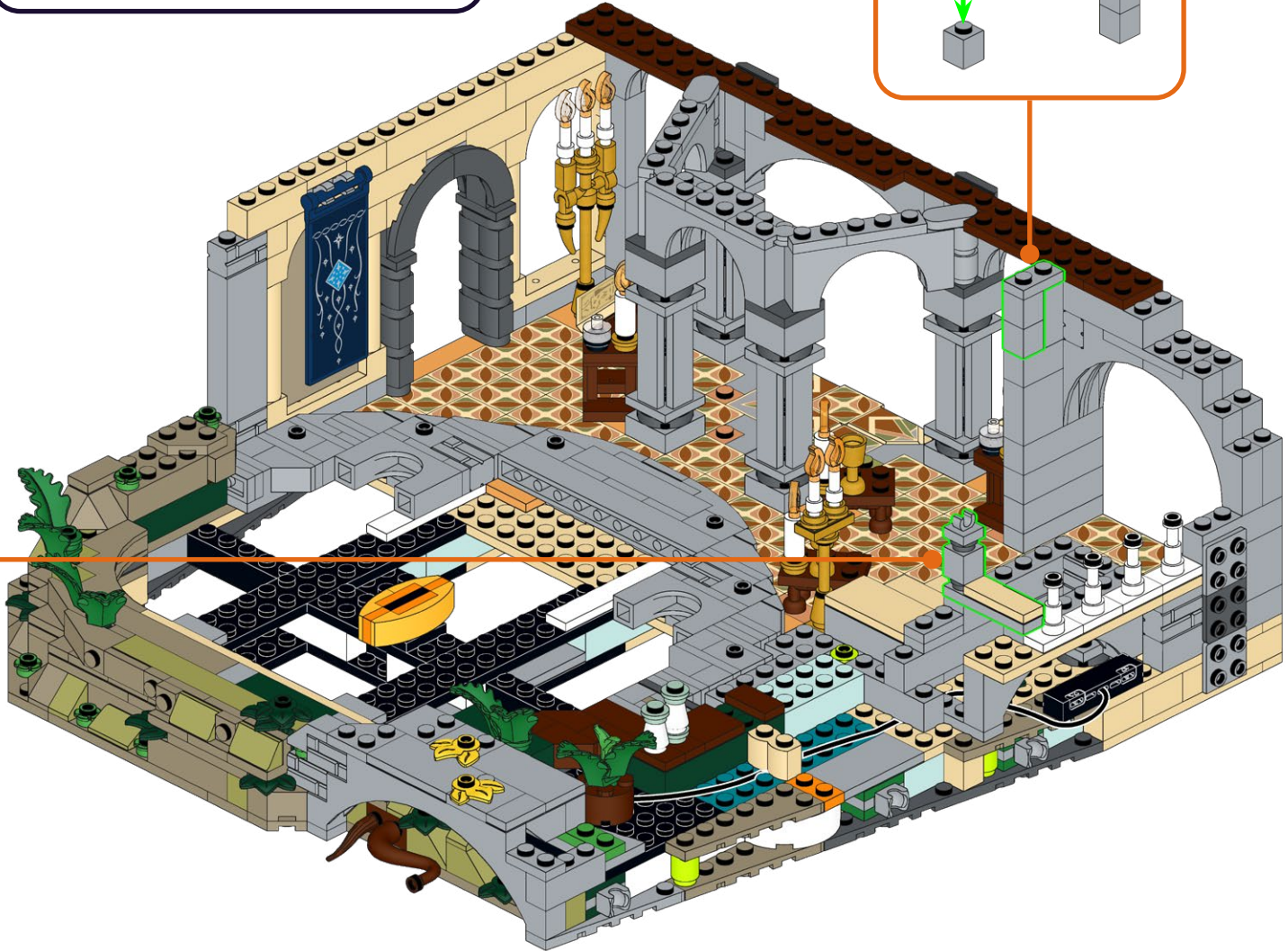
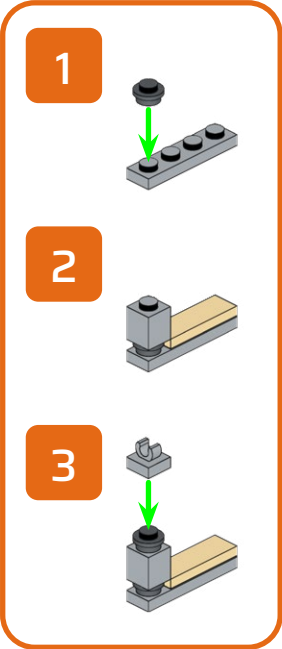
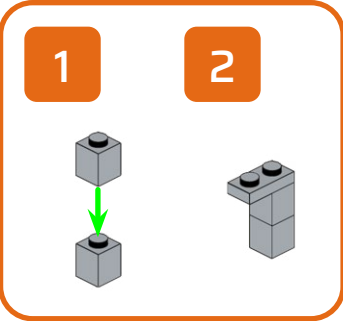
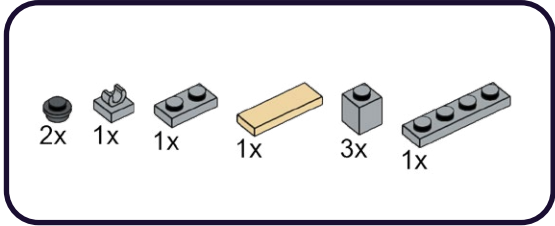

# 129

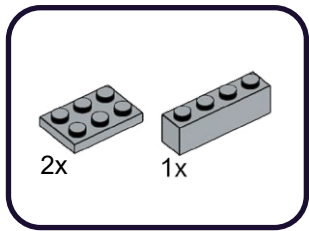

1

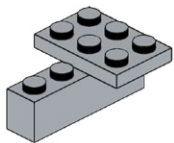

3

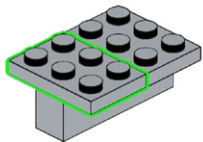

# 130

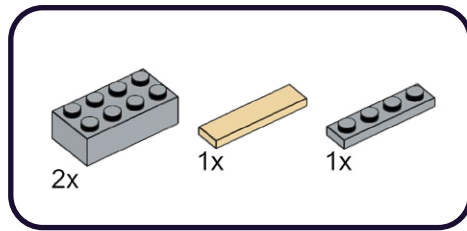

1

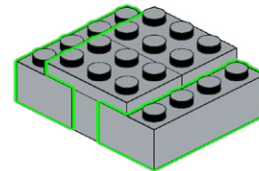

3

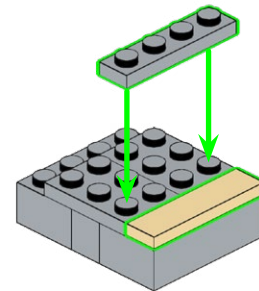





133



# 134

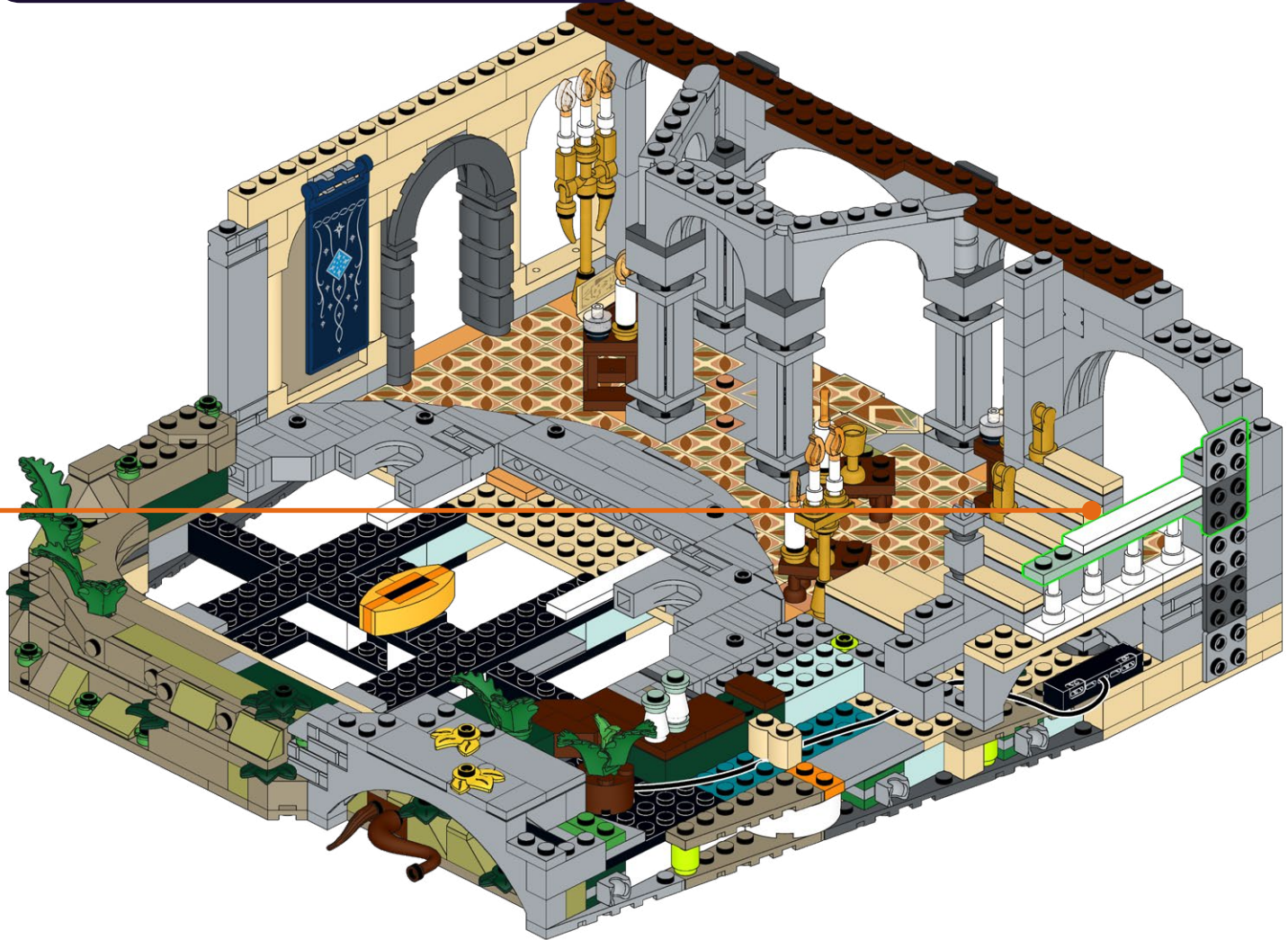
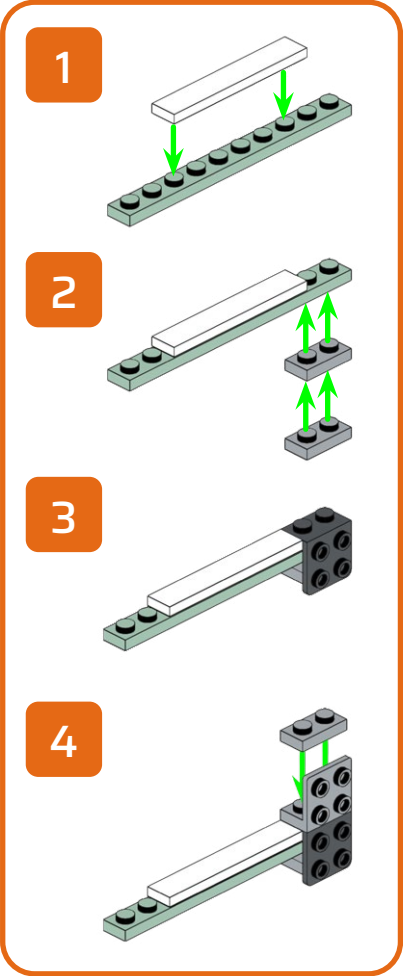
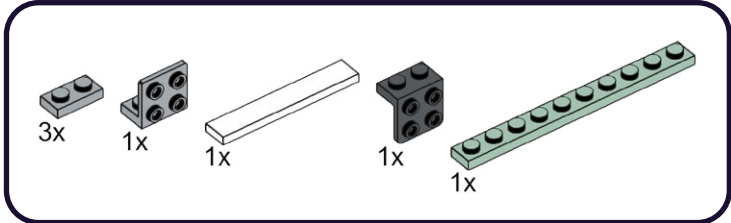

# 135

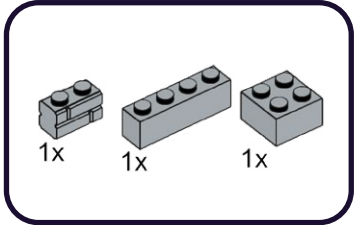

1

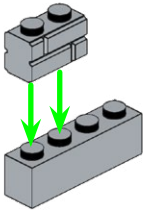

3

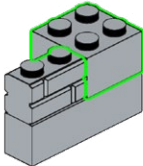

# 136

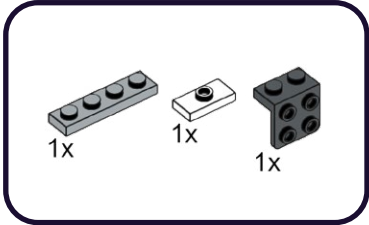

1

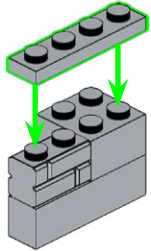

3

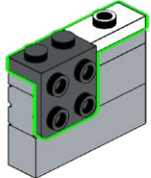



137

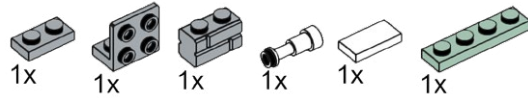

1

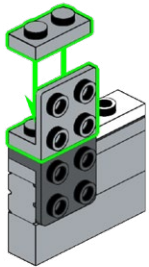

2

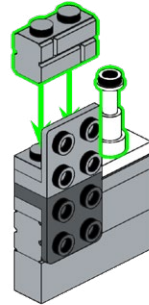

3

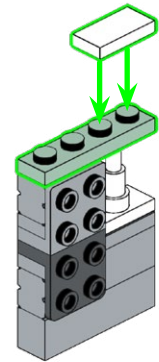

138

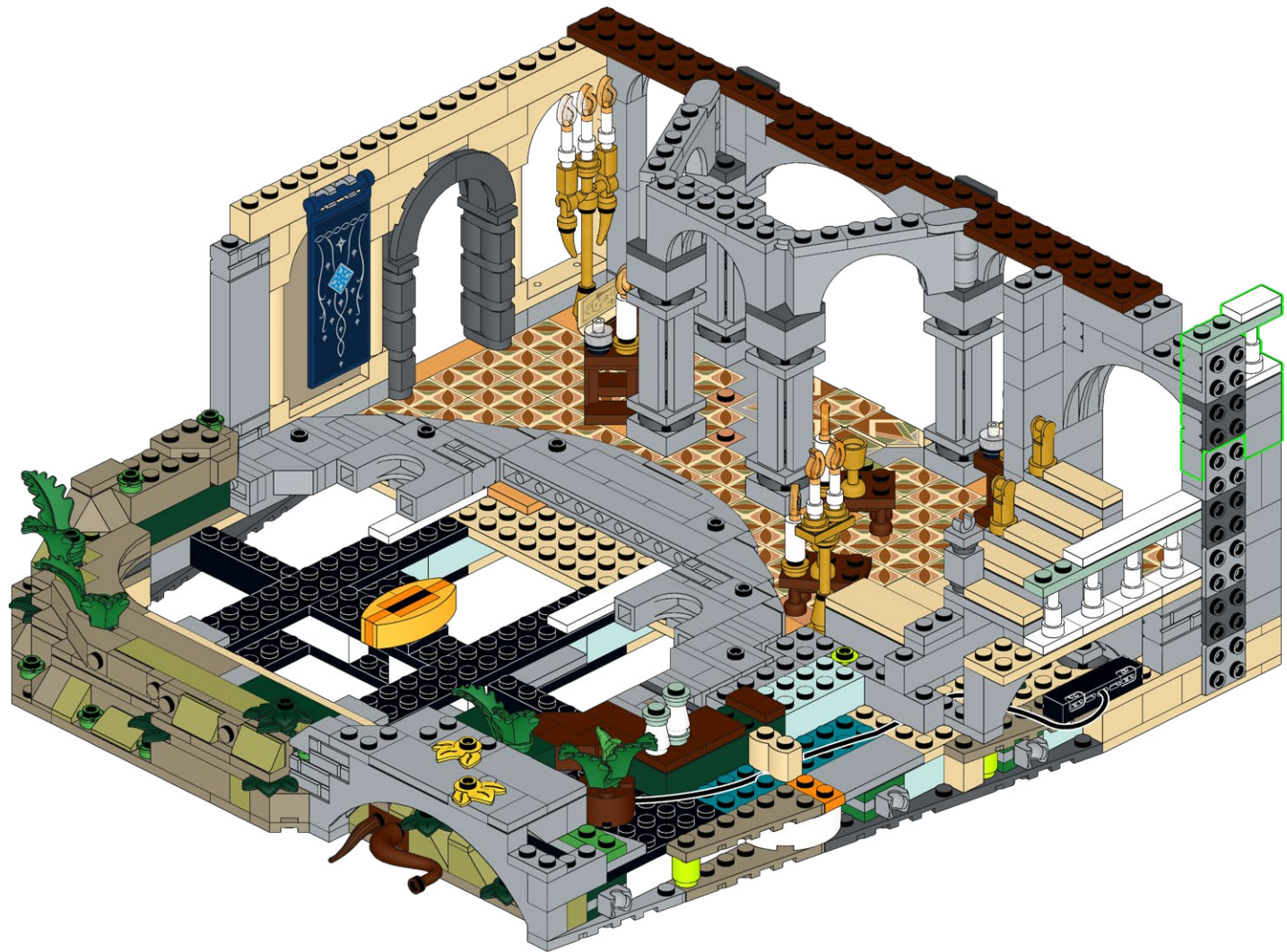

139

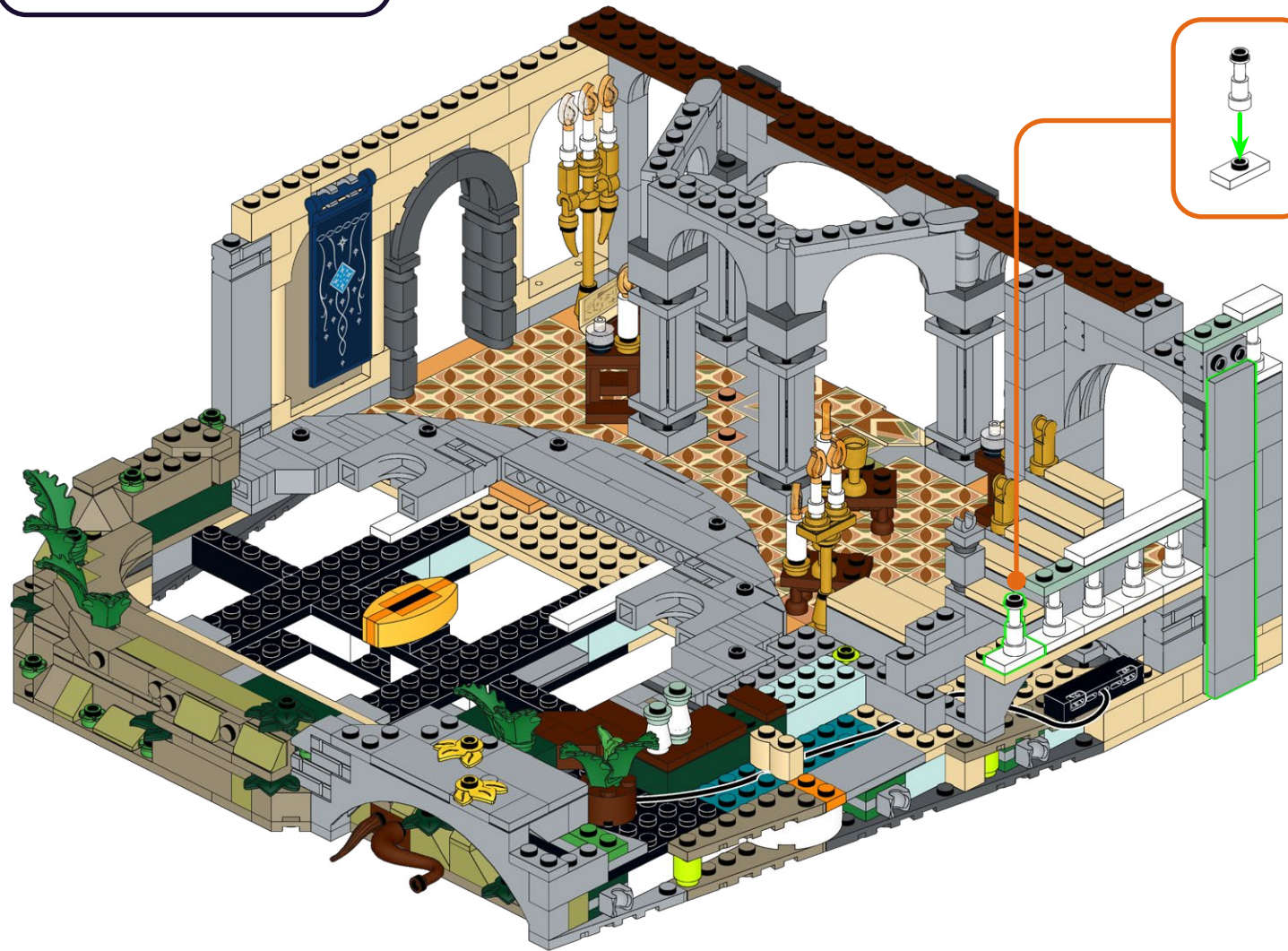
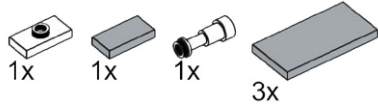



# 140

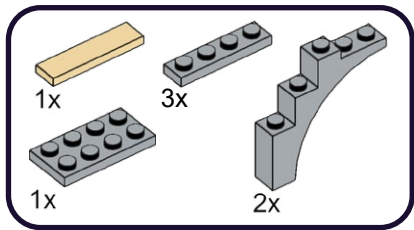

1

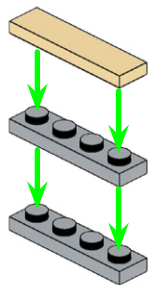

2

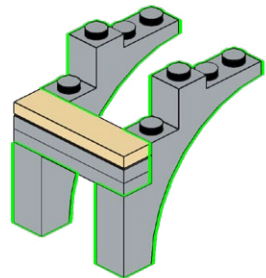

3

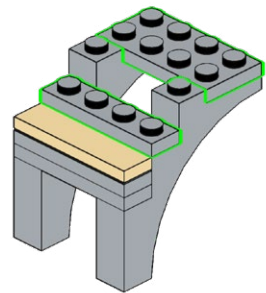

# 141

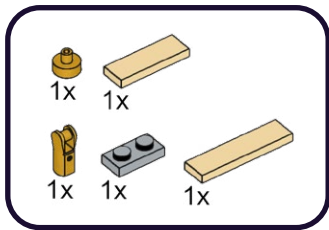

1

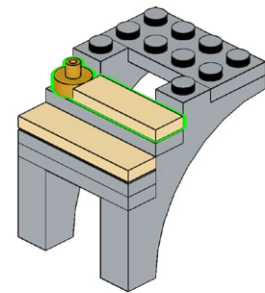

2

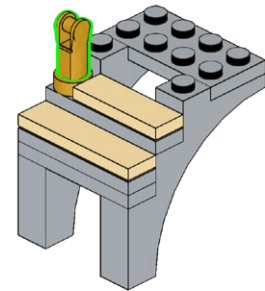

3

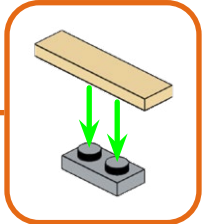
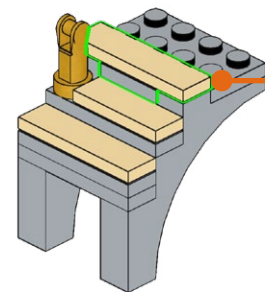





# 143

- 1x [grey 1x1 brick]
- 1x [yellow 1x1 round brick]
- 1x [tan 1x3 plate]
- 2x [grey 1x1 brick]
- 1x [grey 1x1 brick]
- 1x [yellow 1x1 round brick]
- 1x [grey 1x3 brick]
- 1x [tan 1x3 plate]

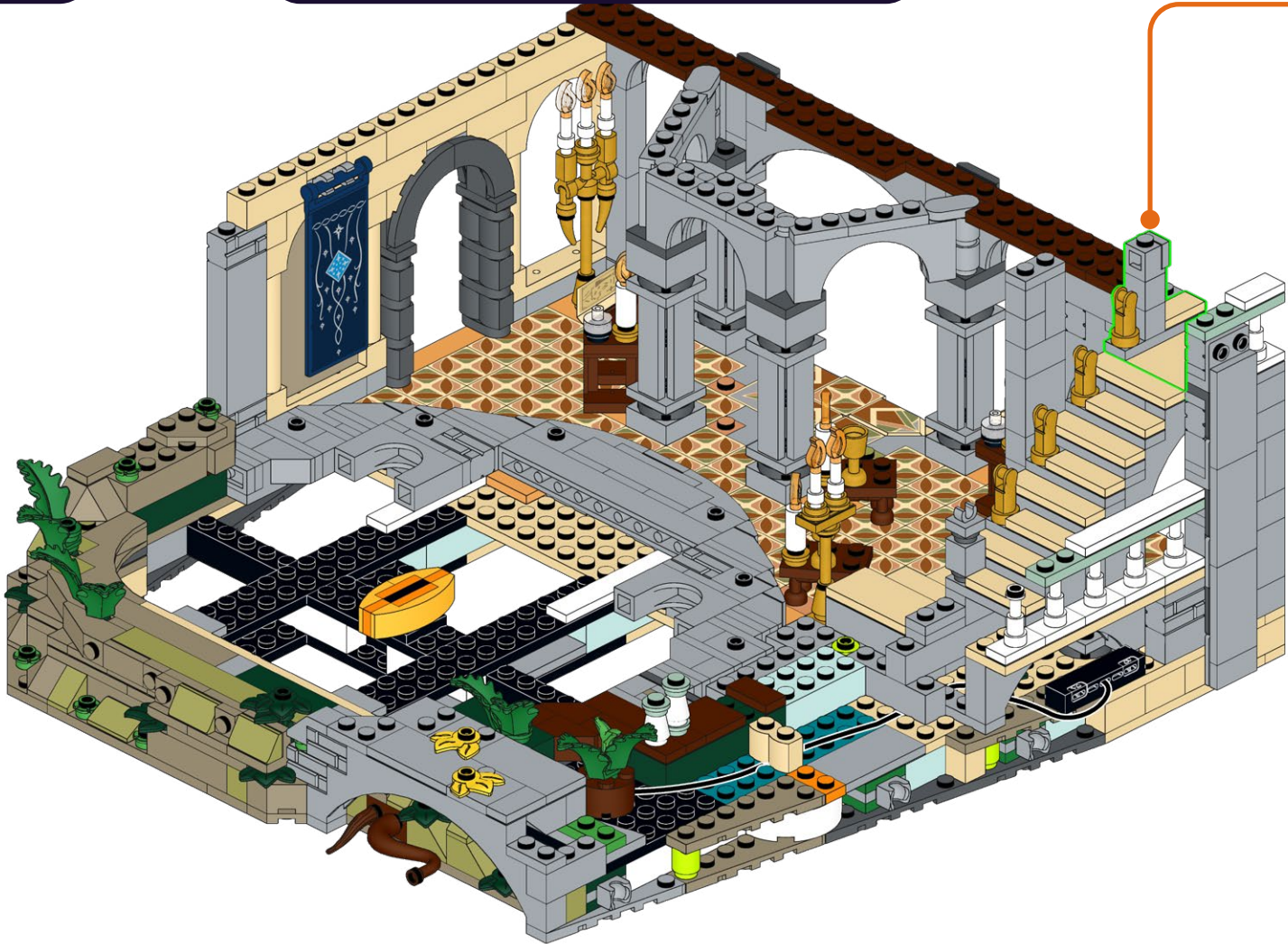

1. A grey 1x3 brick is placed on top of the tan 1x3 plate. Green arrows indicate the placement of the brick's ends on the plate's holes.
2. A grey 1x1 brick is placed on top of the grey 1x3 brick. A green arrow indicates the placement of the brick's top edge on the grey brick's top edge.
3. A yellow 1x1 round brick is placed on top of the grey 1x1 brick. A green arrow indicates the placement of the round brick's top edge on the grey brick's top edge.
4. A grey 1x1 brick is placed on top of the yellow 1x1 round brick. A green arrow indicates the placement of the grey brick's top edge on the yellow brick's top edge.



144

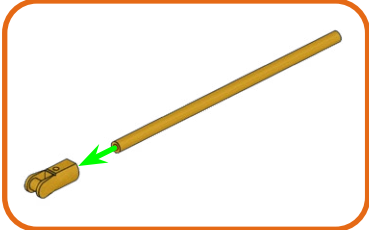
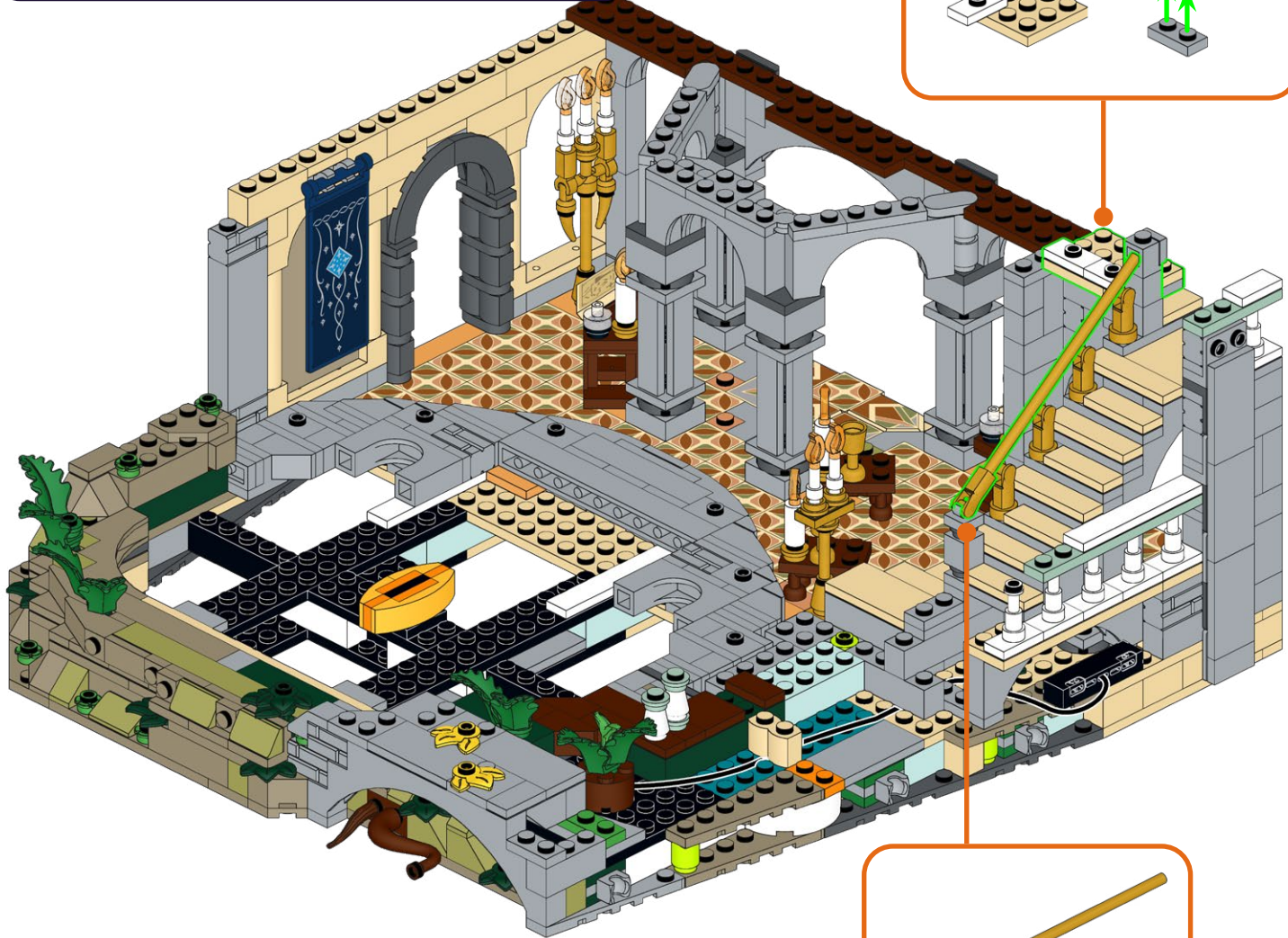
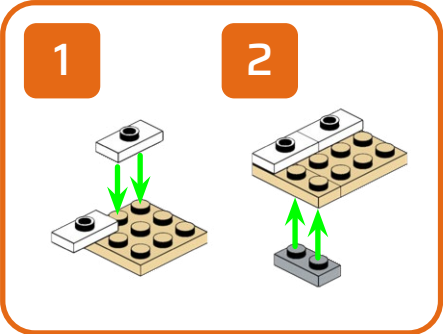
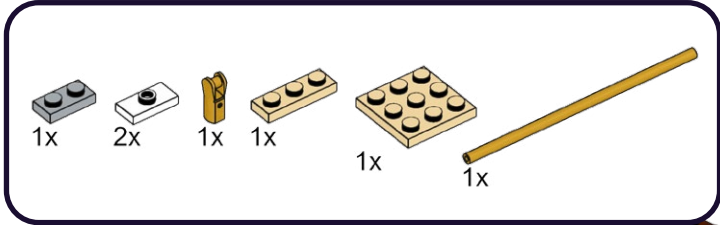

**145**

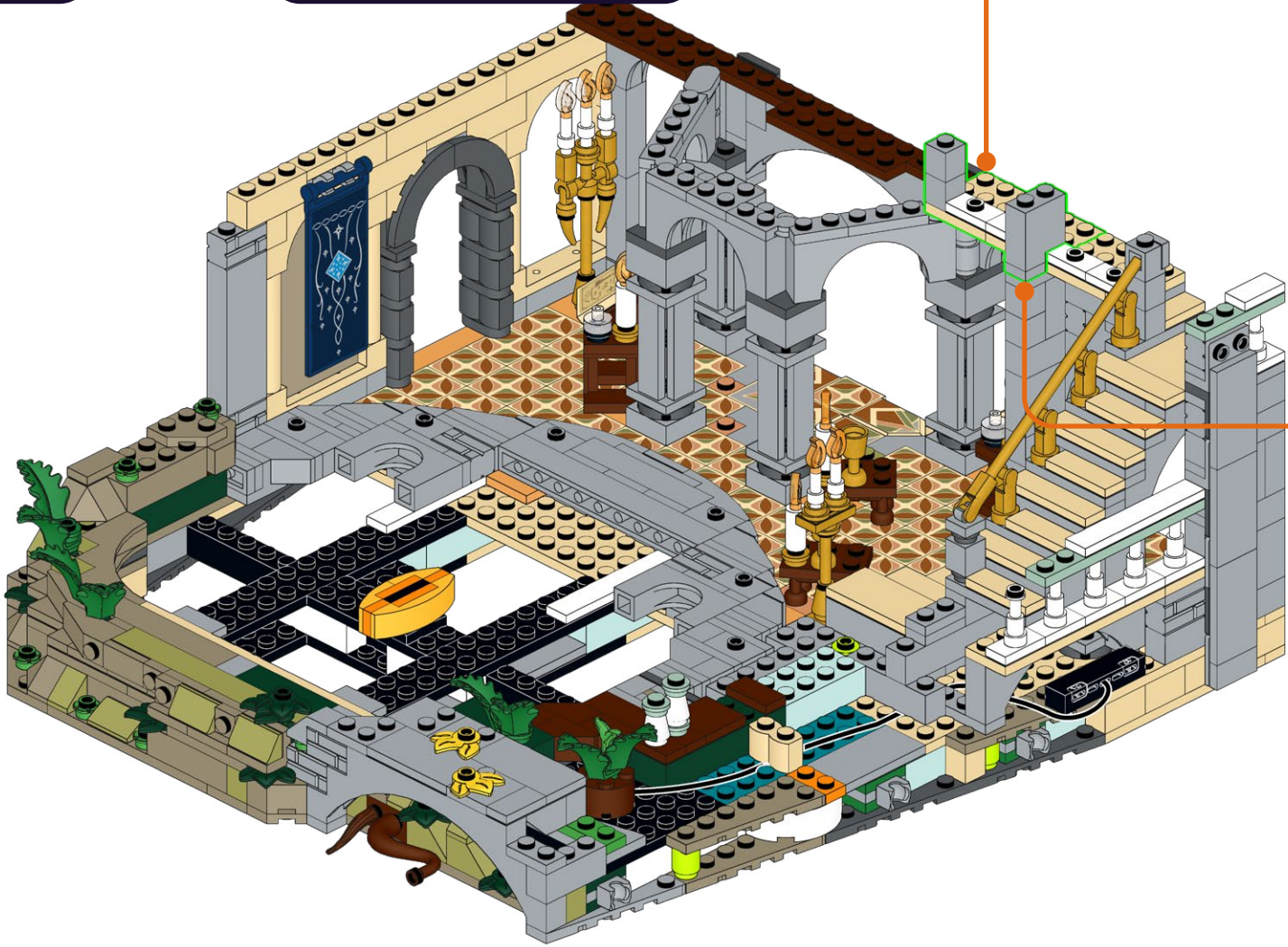
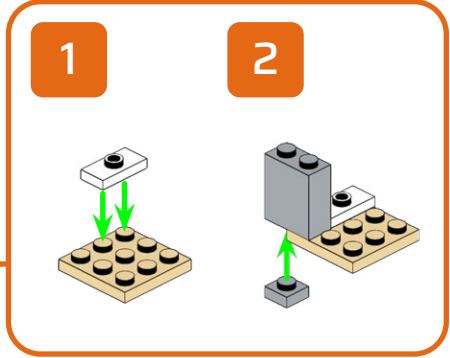
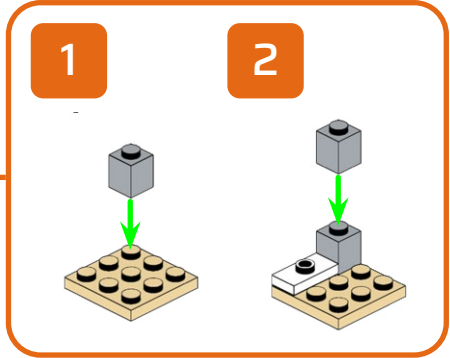
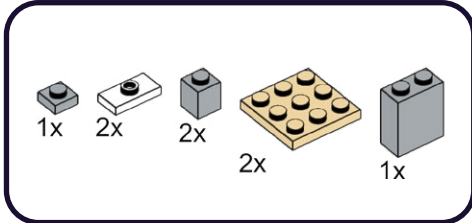



146

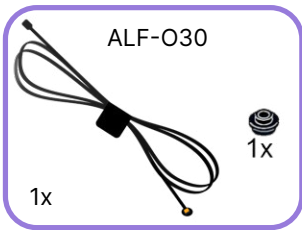
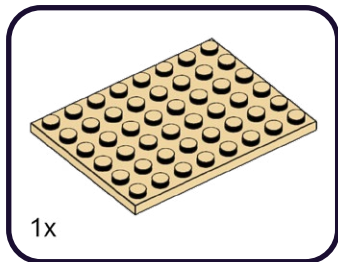

1



2



3

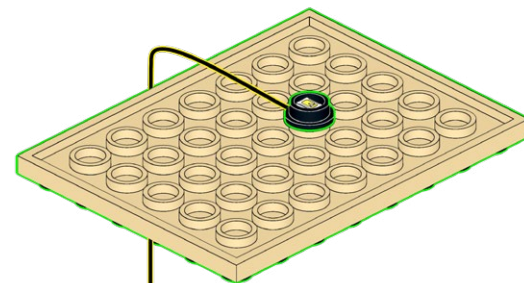



148

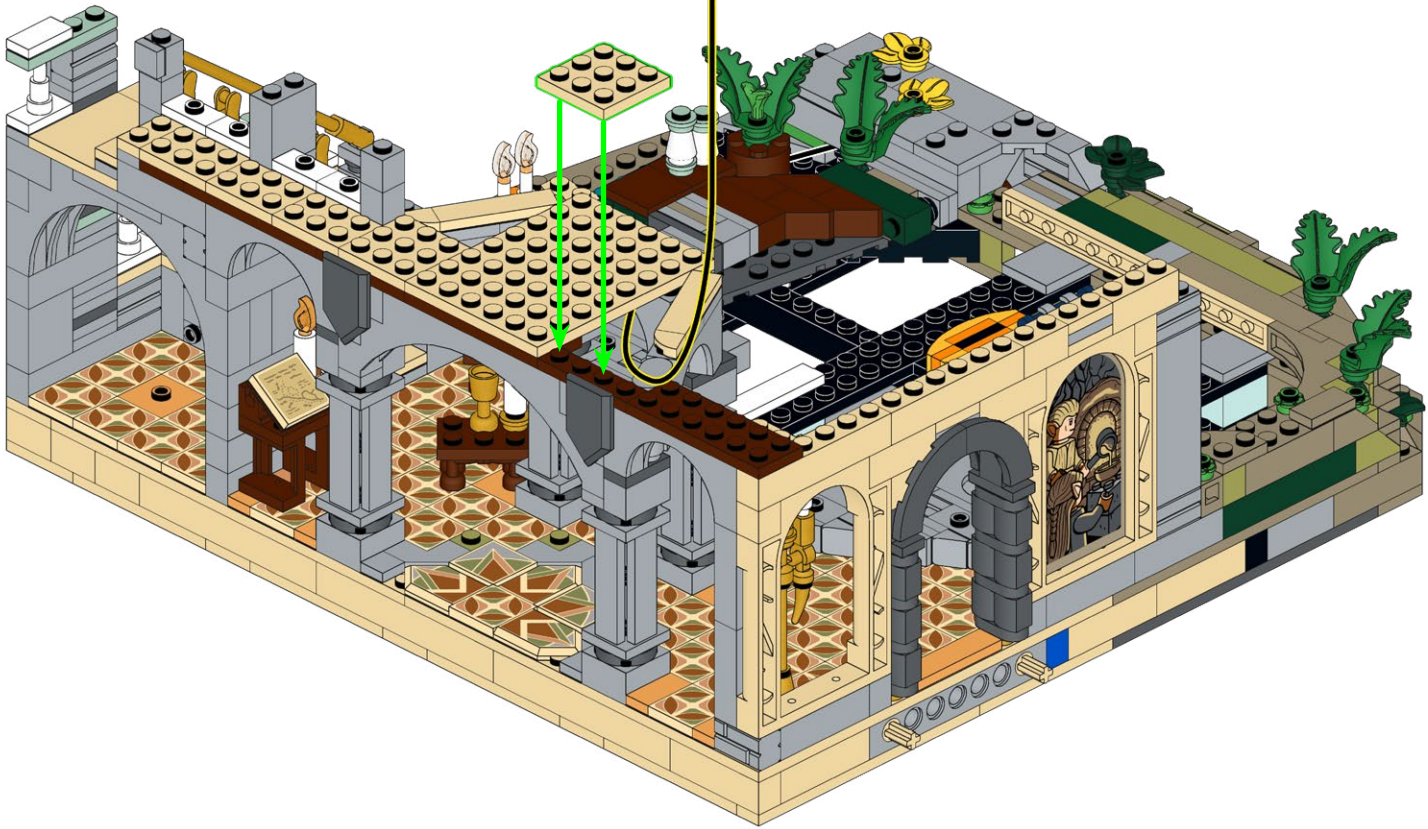
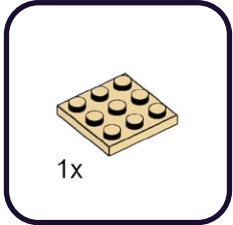



149

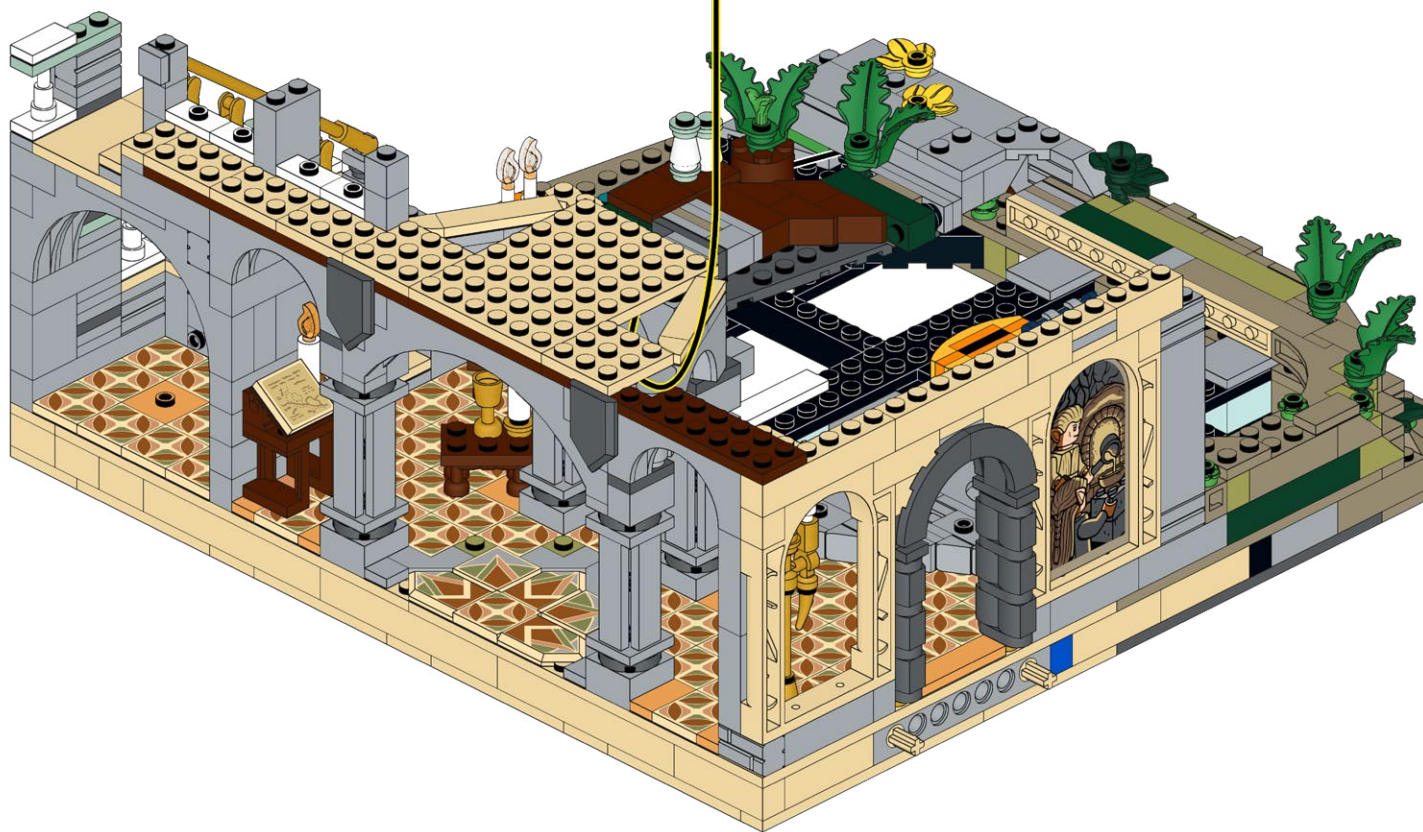

**150**

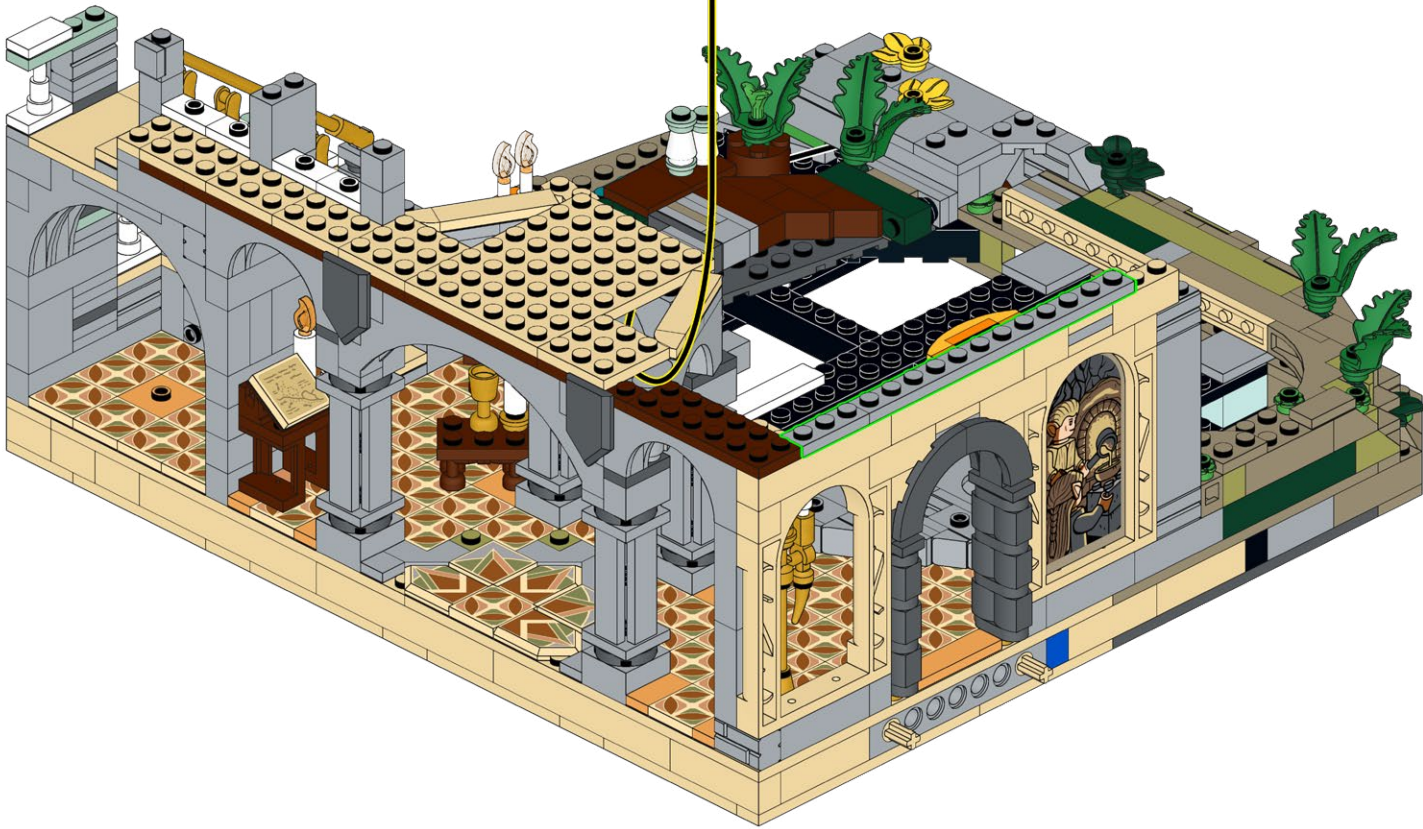
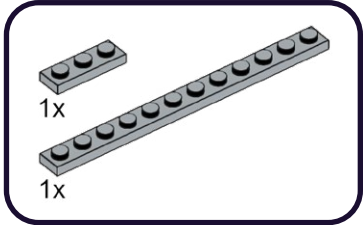



151

2x 2x 1x 2x

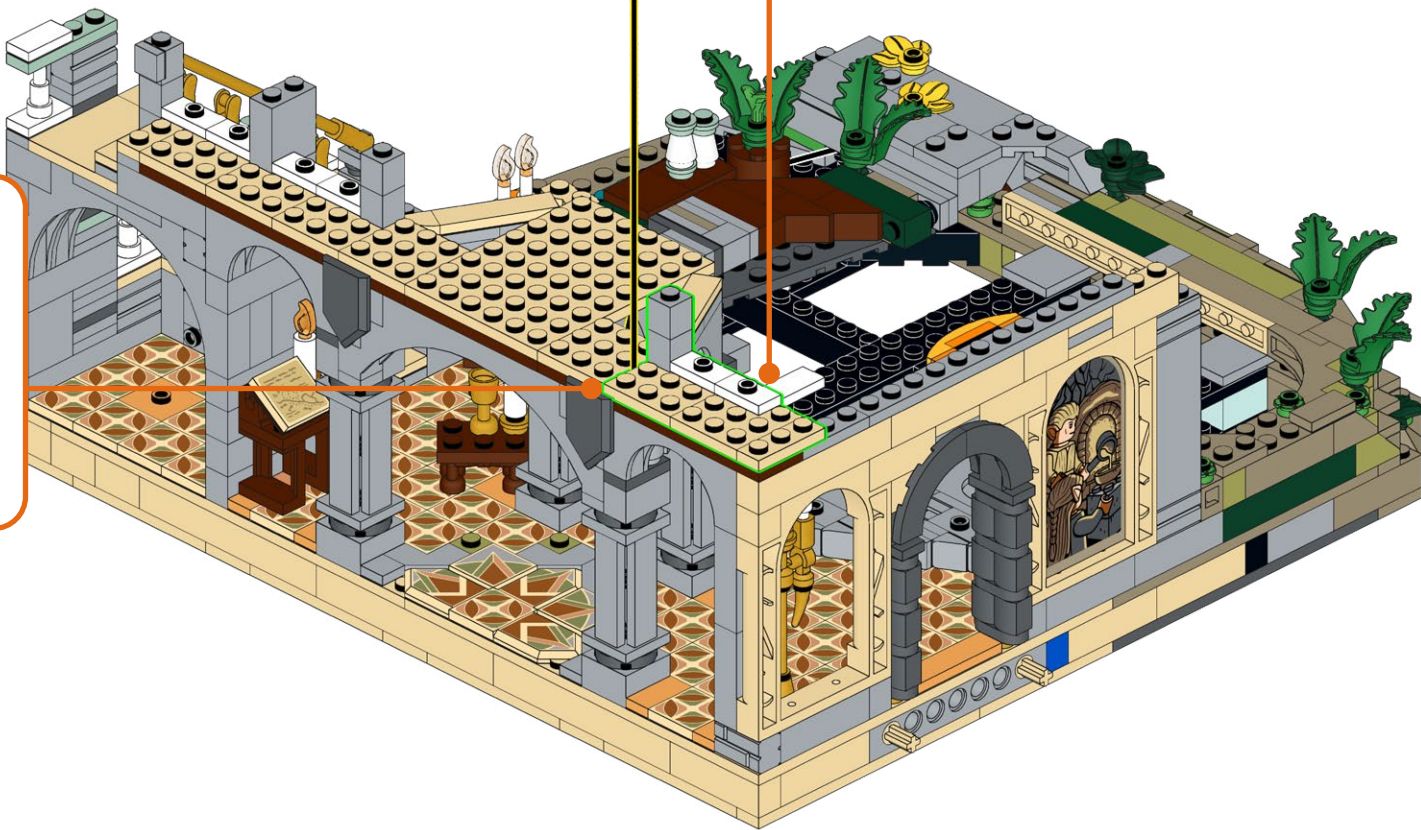
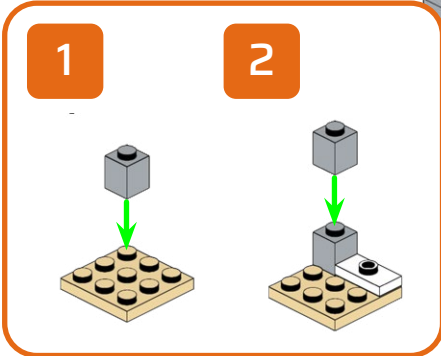
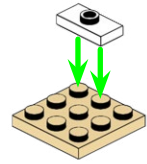



# 152

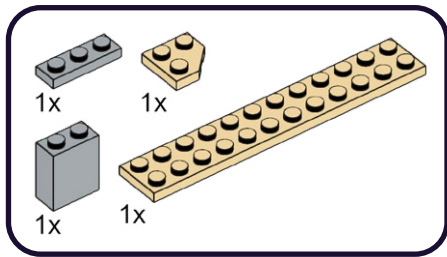

1

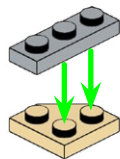

2

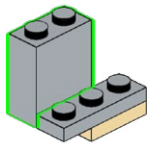

3

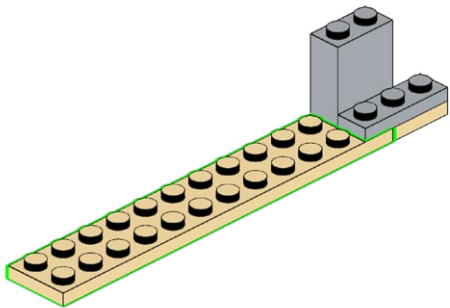

# 153

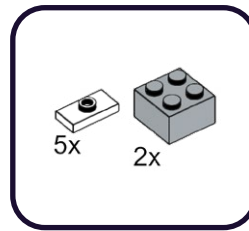

1

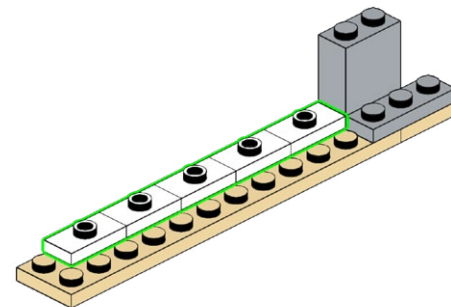

2

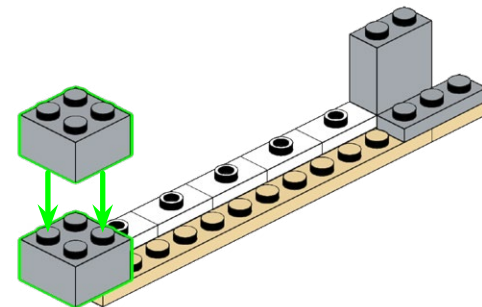

154

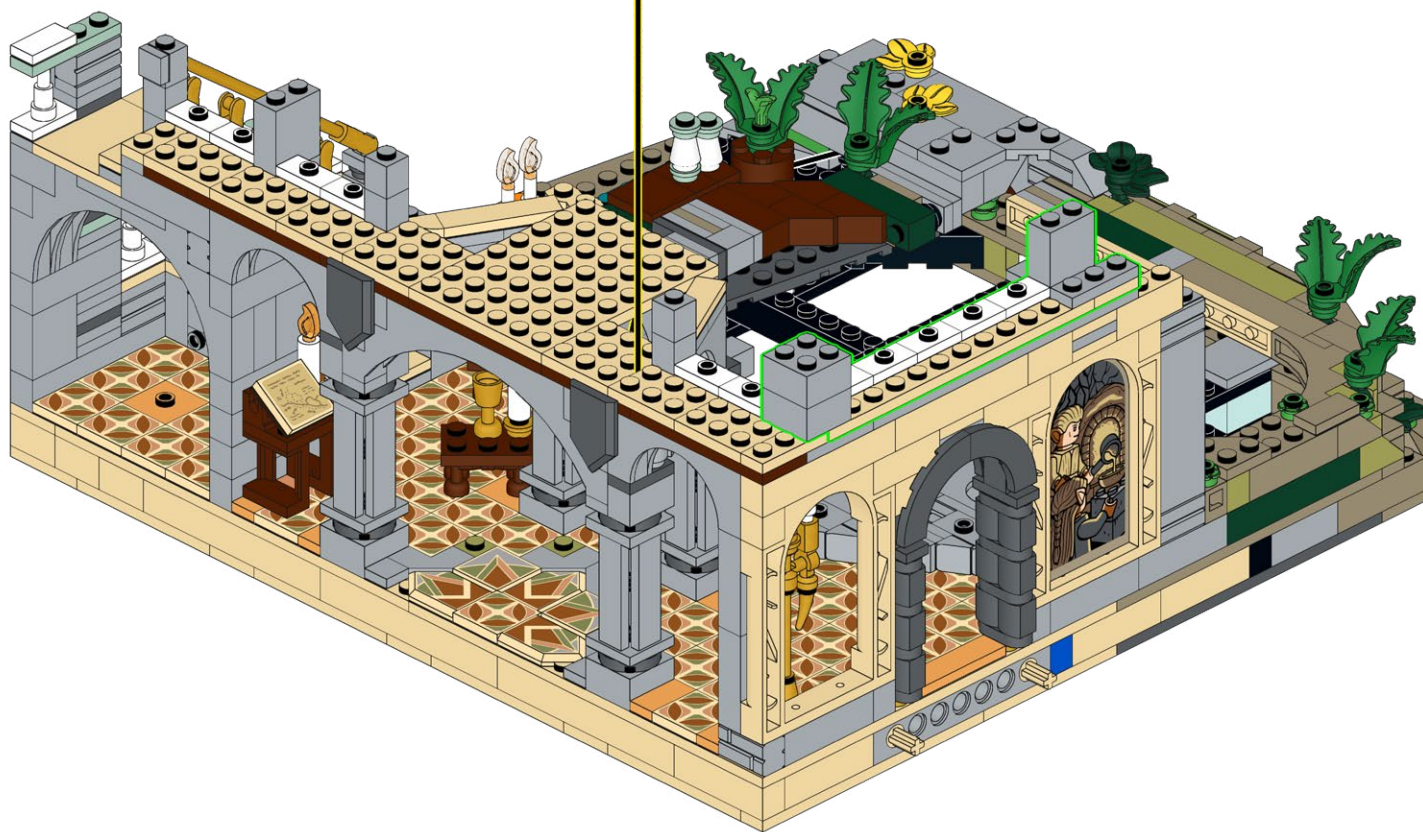

**HOLD UP!**

You might notice some bags aren't in order, as well as left over pieces, but that's ok! We're changing the way you build LEGO!

**ATTENDEZ!**

Vous remarquerez peut-être que certains sacs, ainsi que certaines pièces, ne sont pas dans le bon ordre. Mais pas de panique! Nous changeons simplement la façon avec laquelle vous construisez vos LEGO!

**ASPETTA!**

Potresti notare che alcuni sacchetti non sono in ordine, così come i pezzi avanzati, ma va bene così! Stiamo cambiando il modo in cui costruisci i LEGO!

**HALT!**

Sie werden möglicherweise bemerken, dass einige tüten durcheinander sind und teile übrig bleiben, aber das ist in Ordnung! Wir ändern die art und weise, wie Sie LEGO bauen!

**¡ESPERA!**

Es posible que notes que algunas bolsas están fuera de servicio, así como piezas sobrantes, ¡pero está bien! ¡Estamos cambiando la forma en que construyes LEGO!

**暫停!**

你可能会注意到一些袋子顺序错乱, 以及一些剩余的部件, 但没关系! 我们正在改变你搭建乐高的方式!

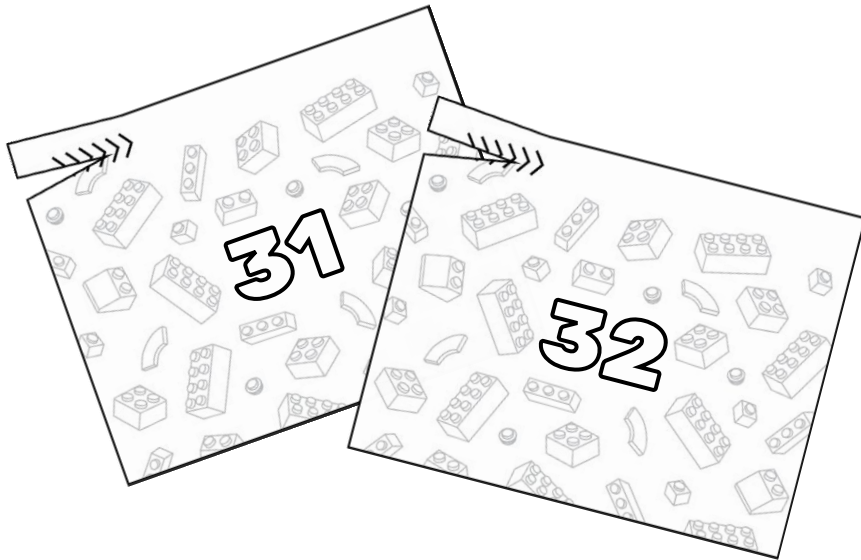
**Open LEGO® Bags 31 & 32**



155

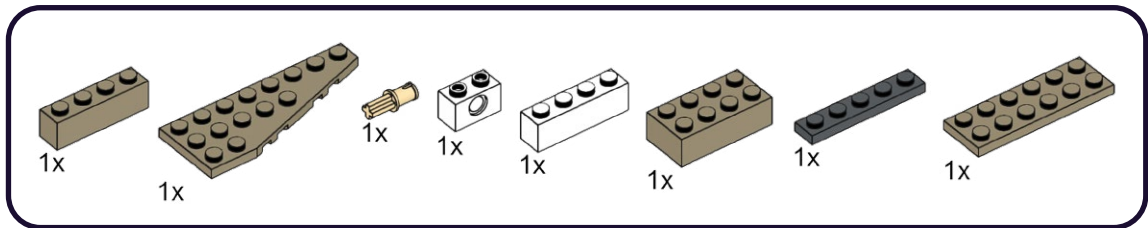

1

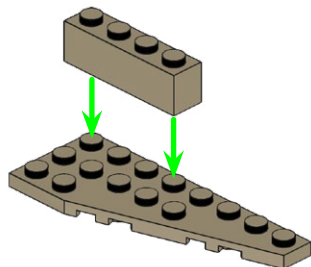

2

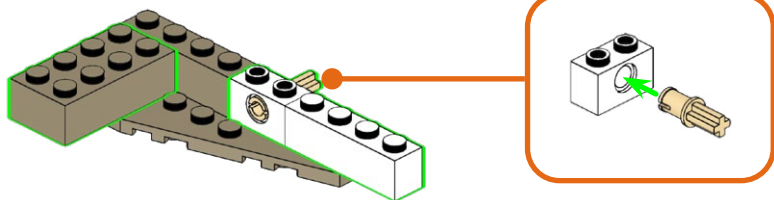

3

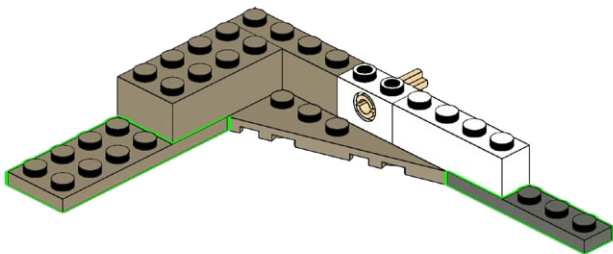

156

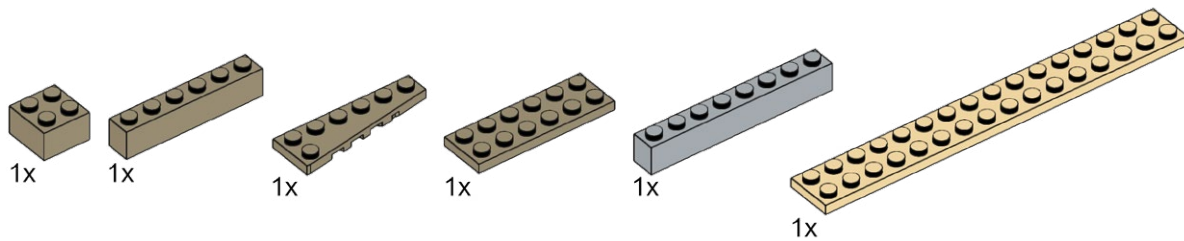

1

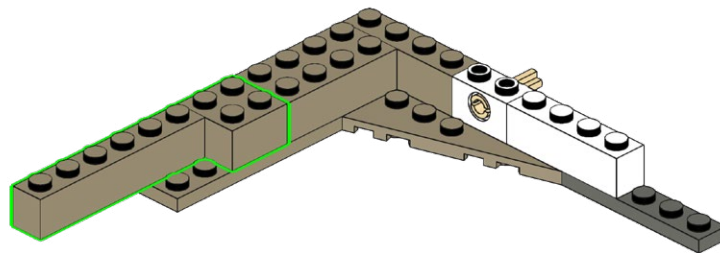

2

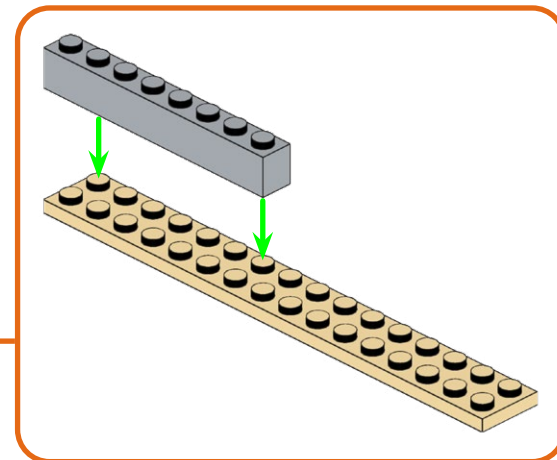
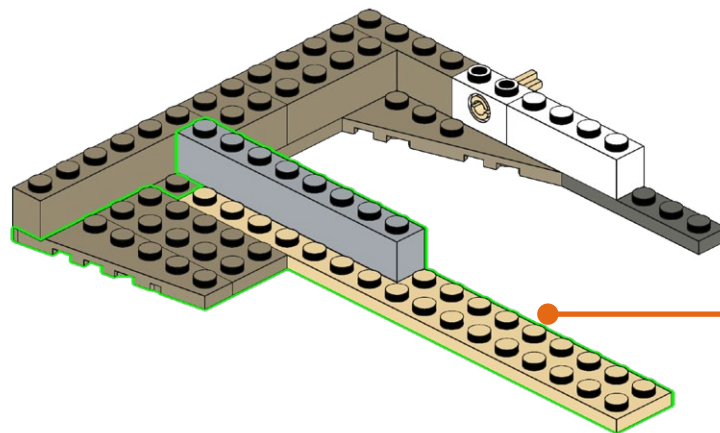

157

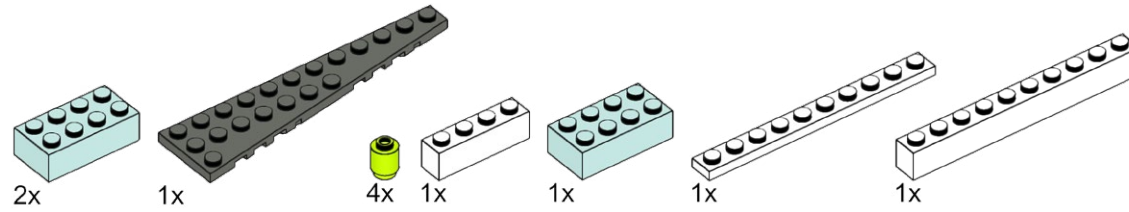

1

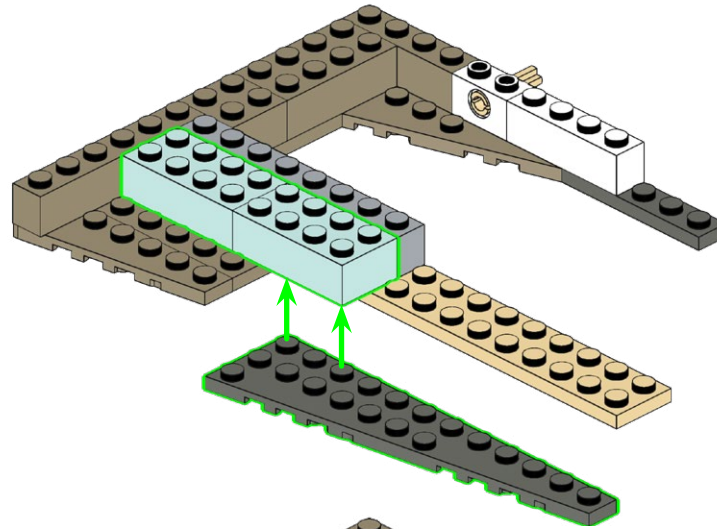

2

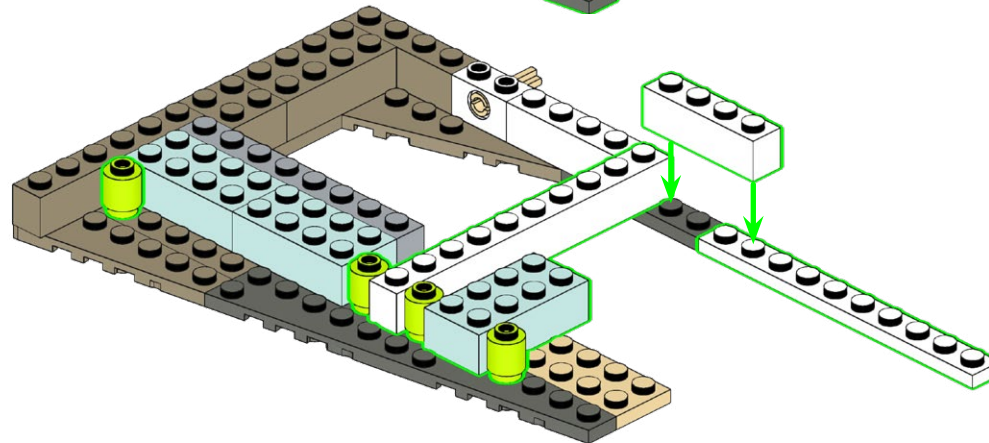



158

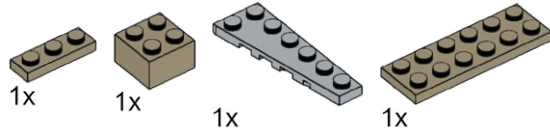

1

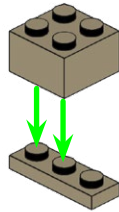

3

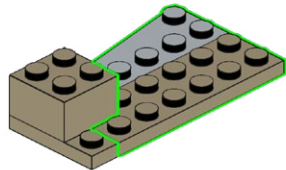

159

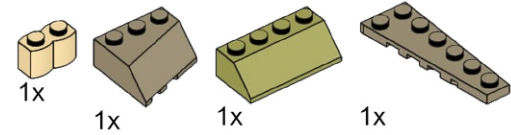

1

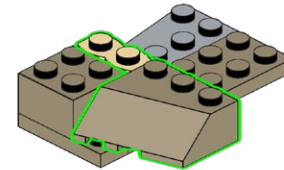

3

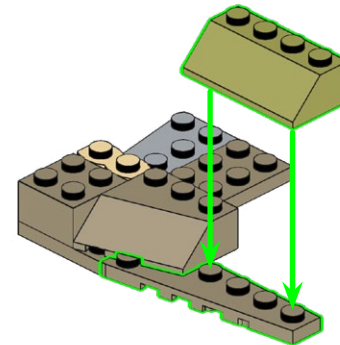

160

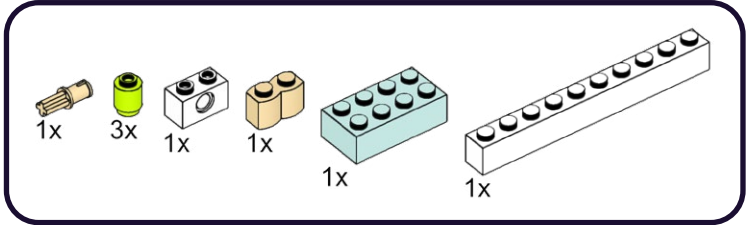

1

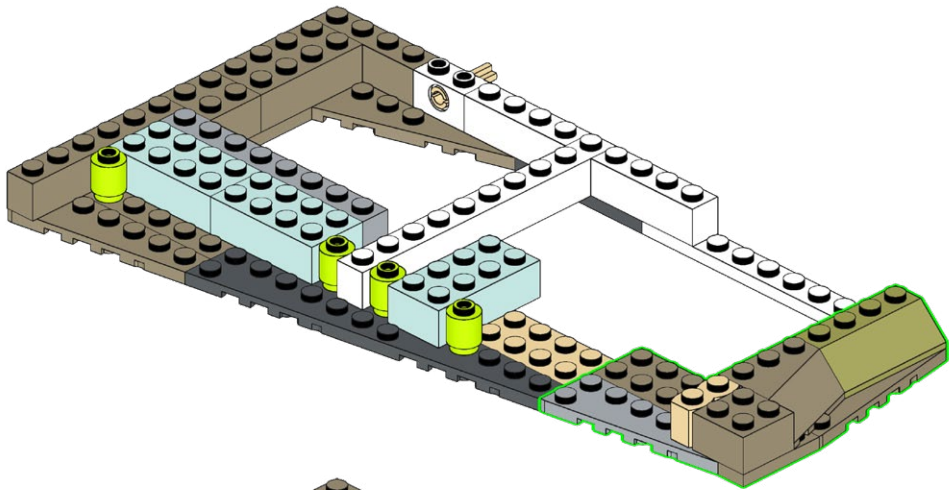

2

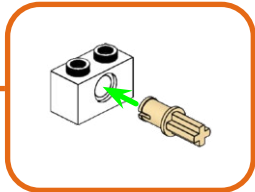
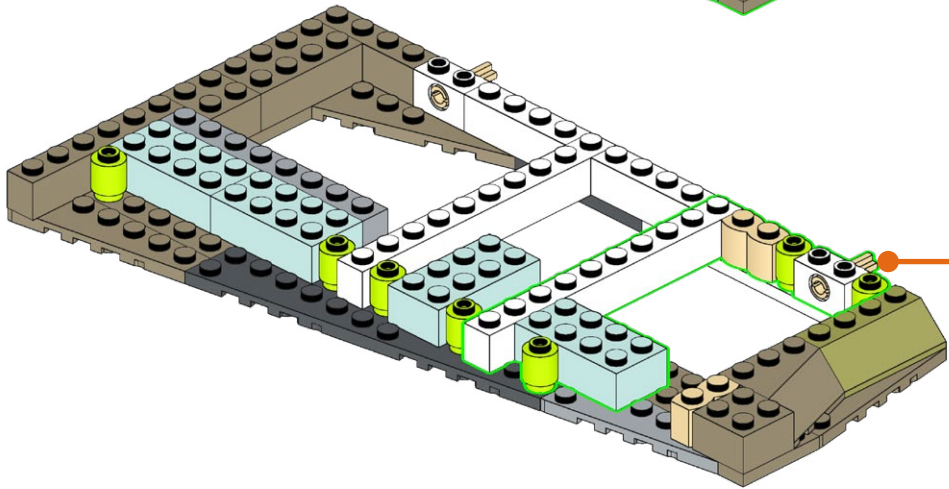

161

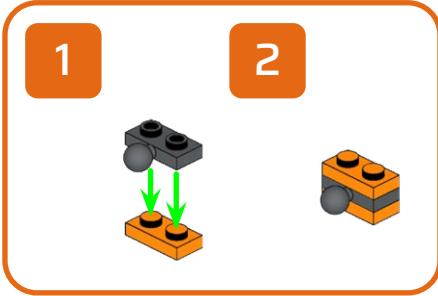
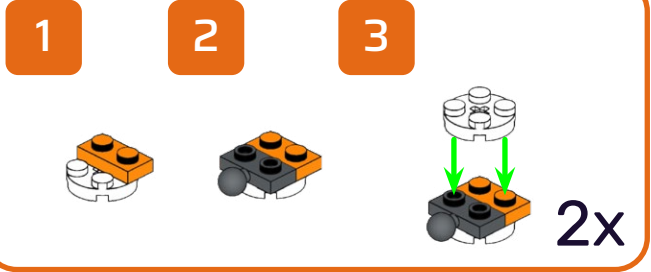
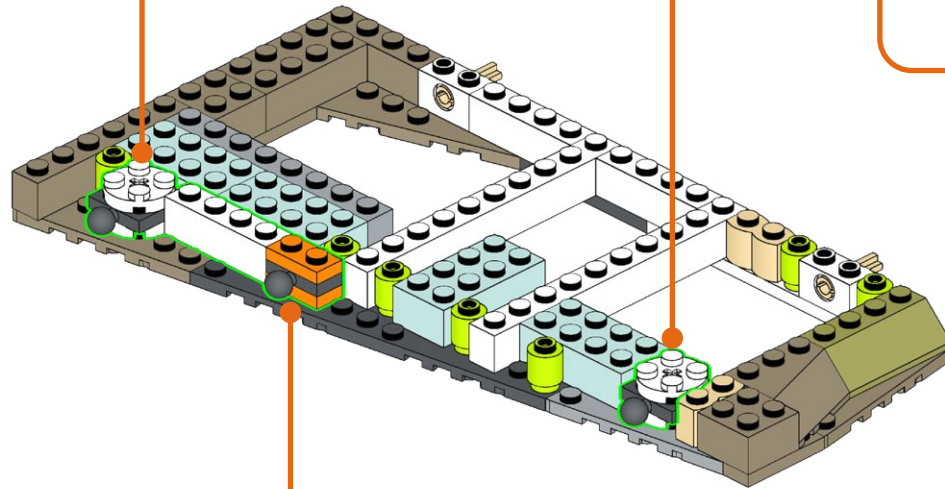
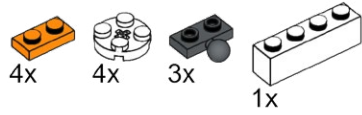



162

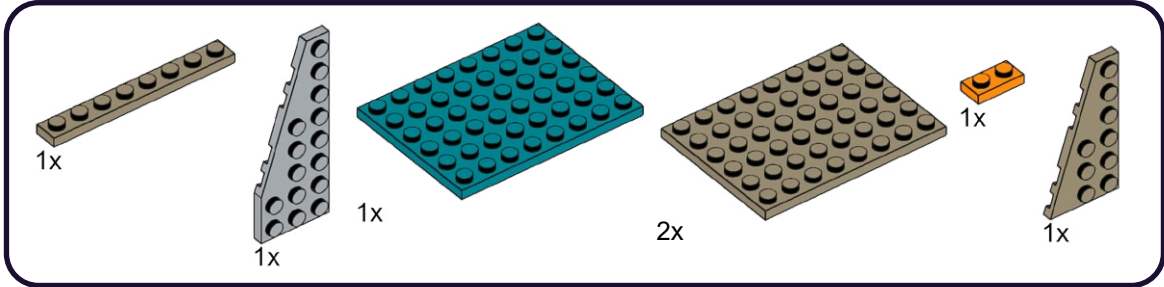

1

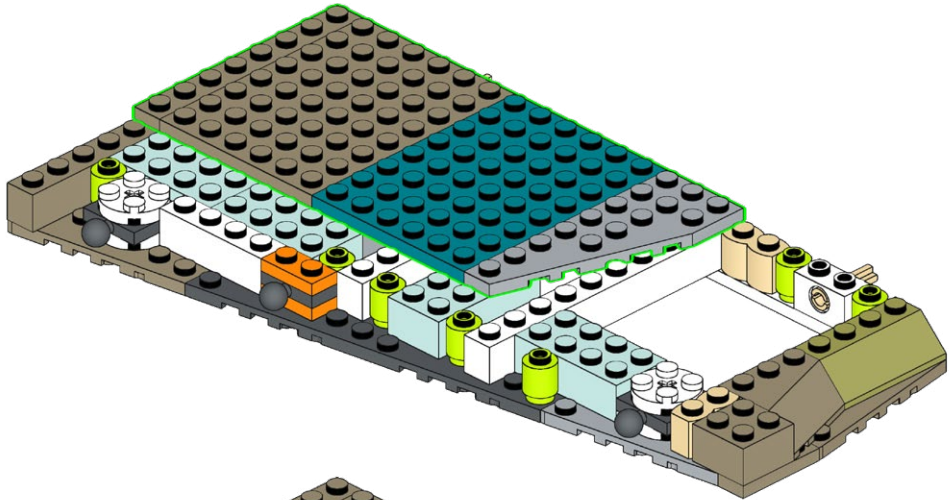

2

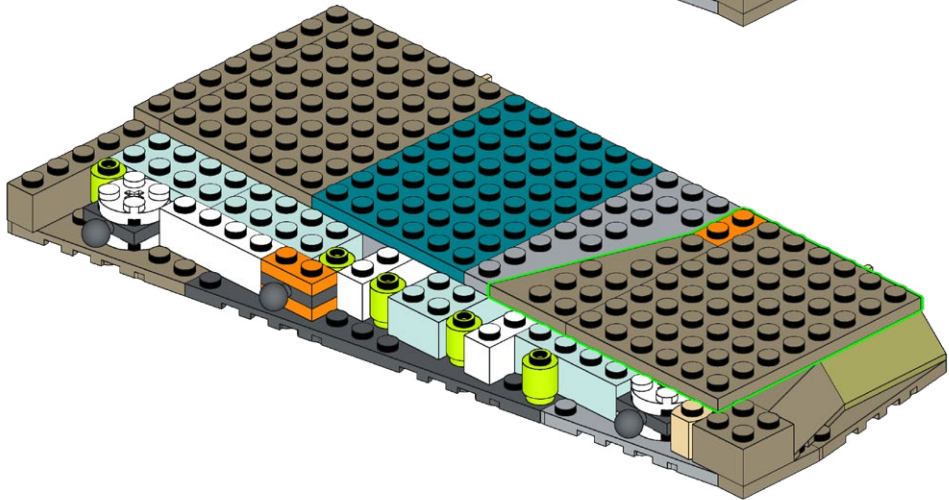

# 163

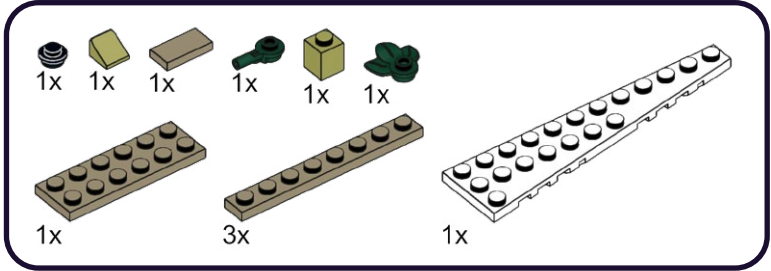

1

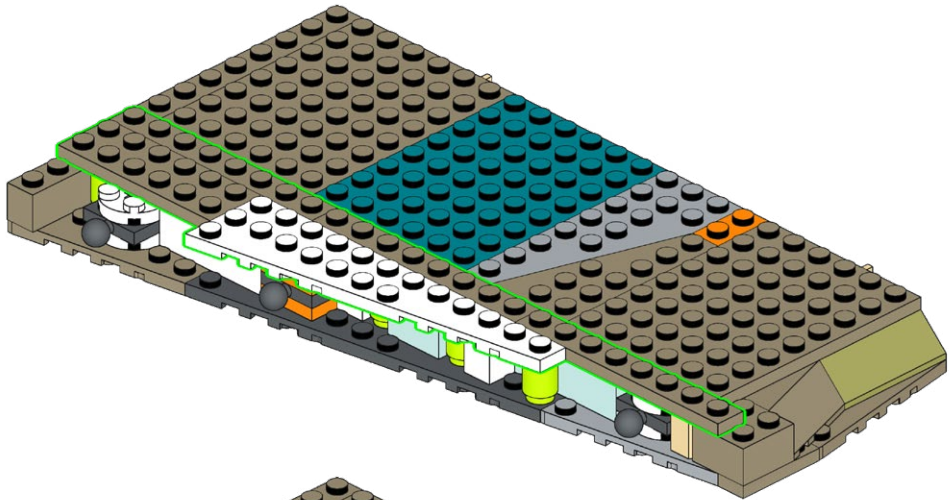

2

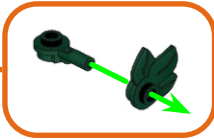
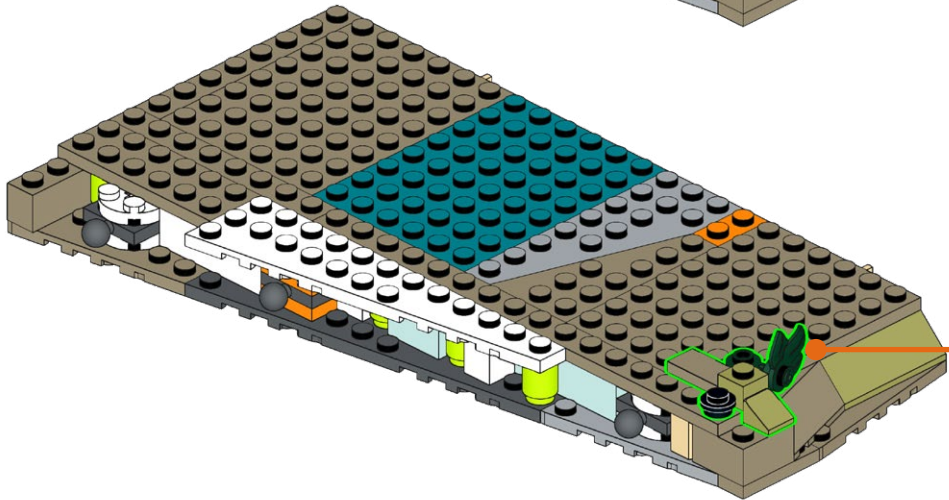

164

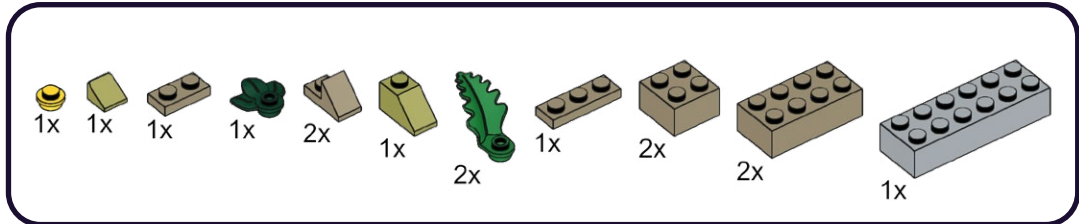

1

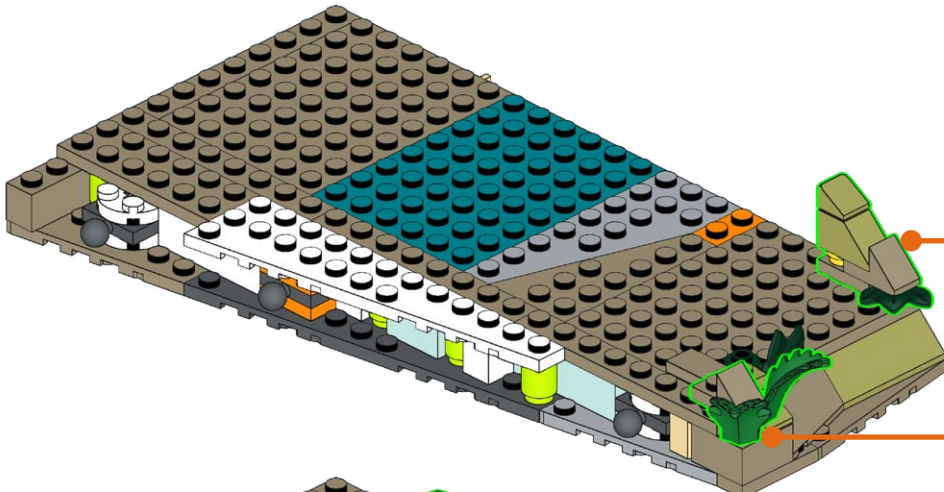

2

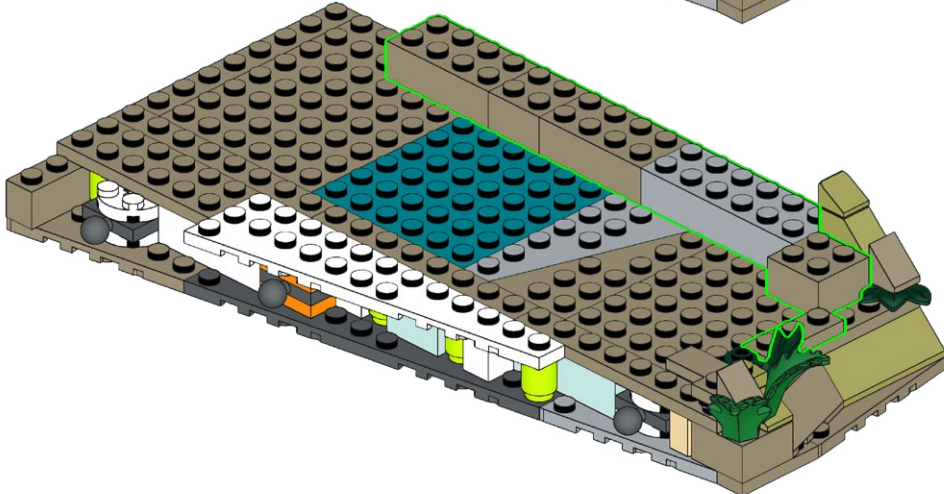

1



2



1

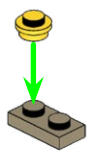

2



3



4

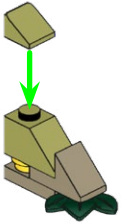

165

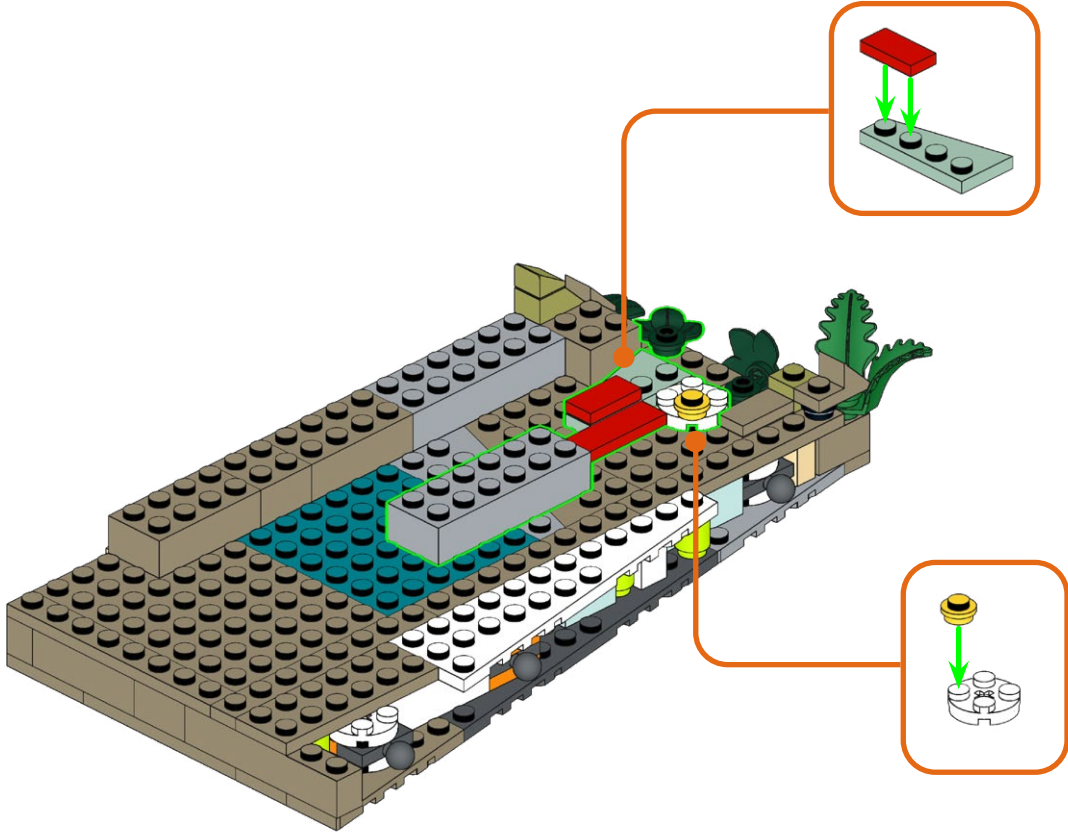
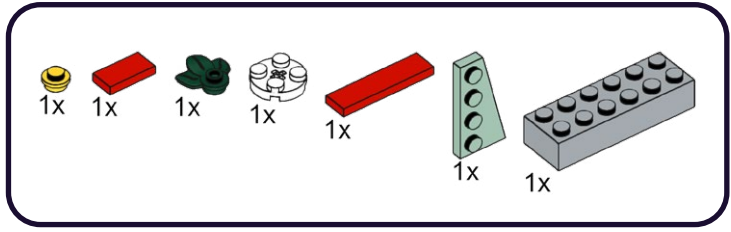



166

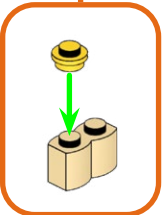
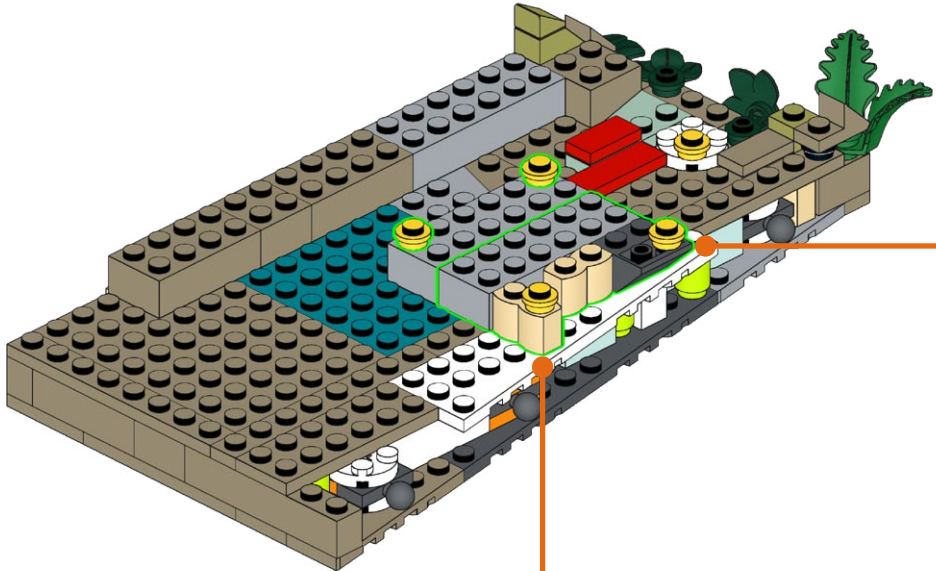
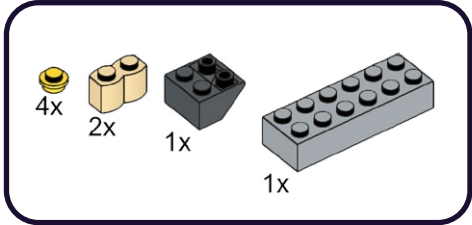

167

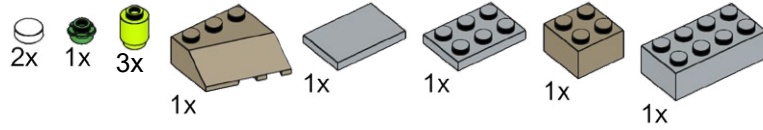

1

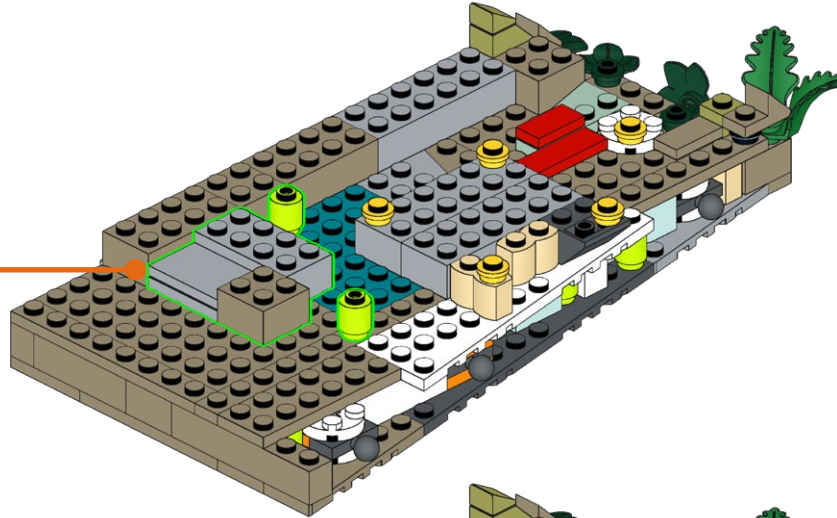
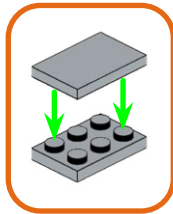

2





169

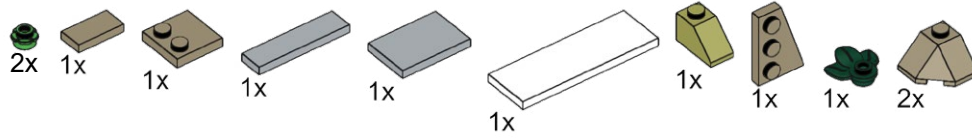

1

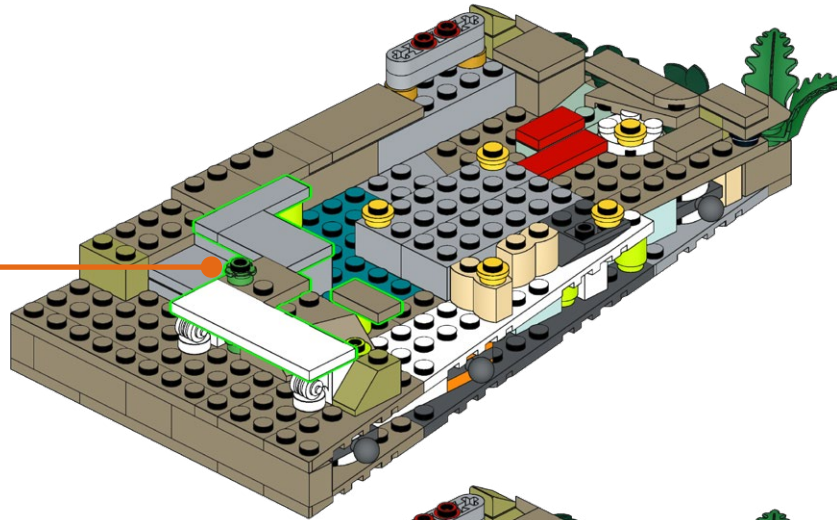
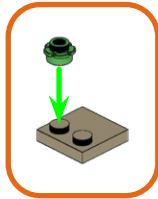

2

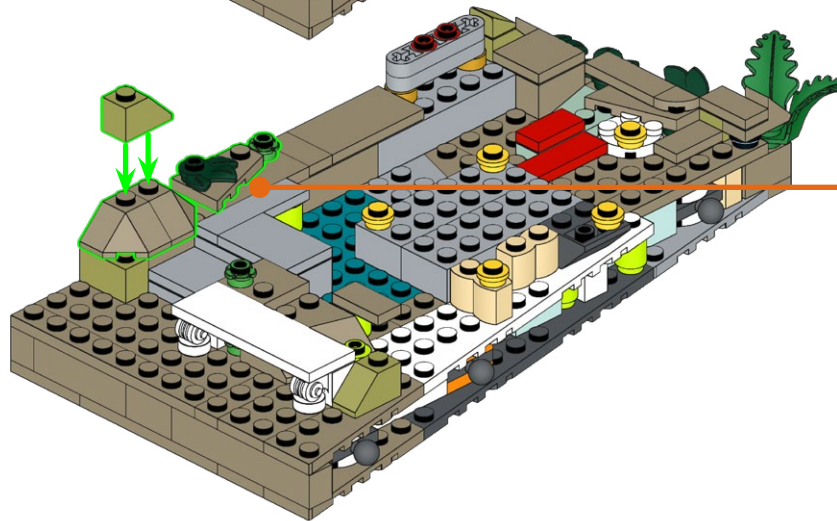
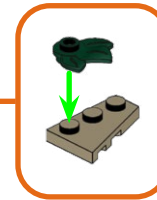



170

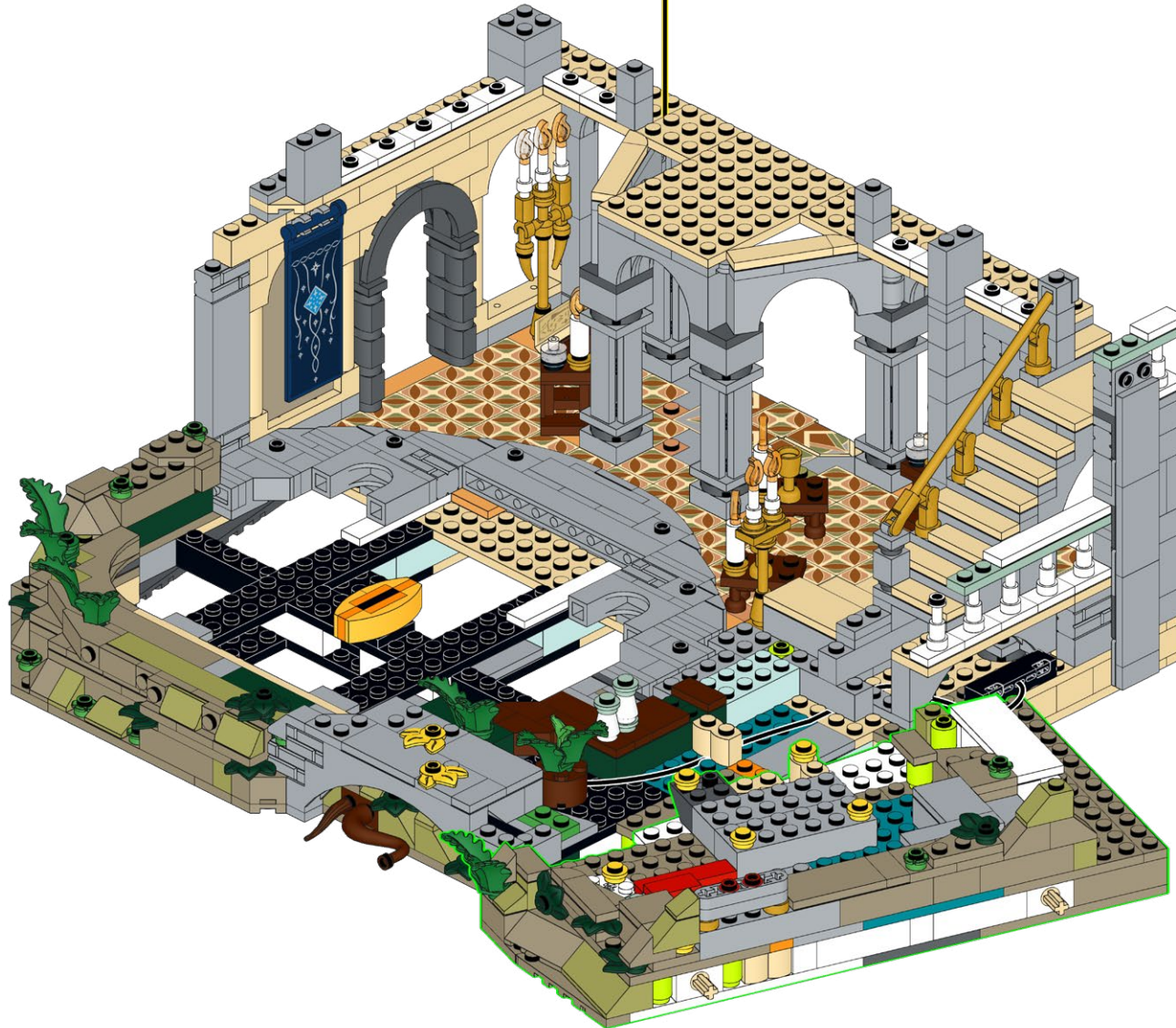

171

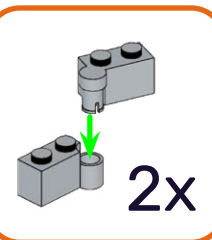
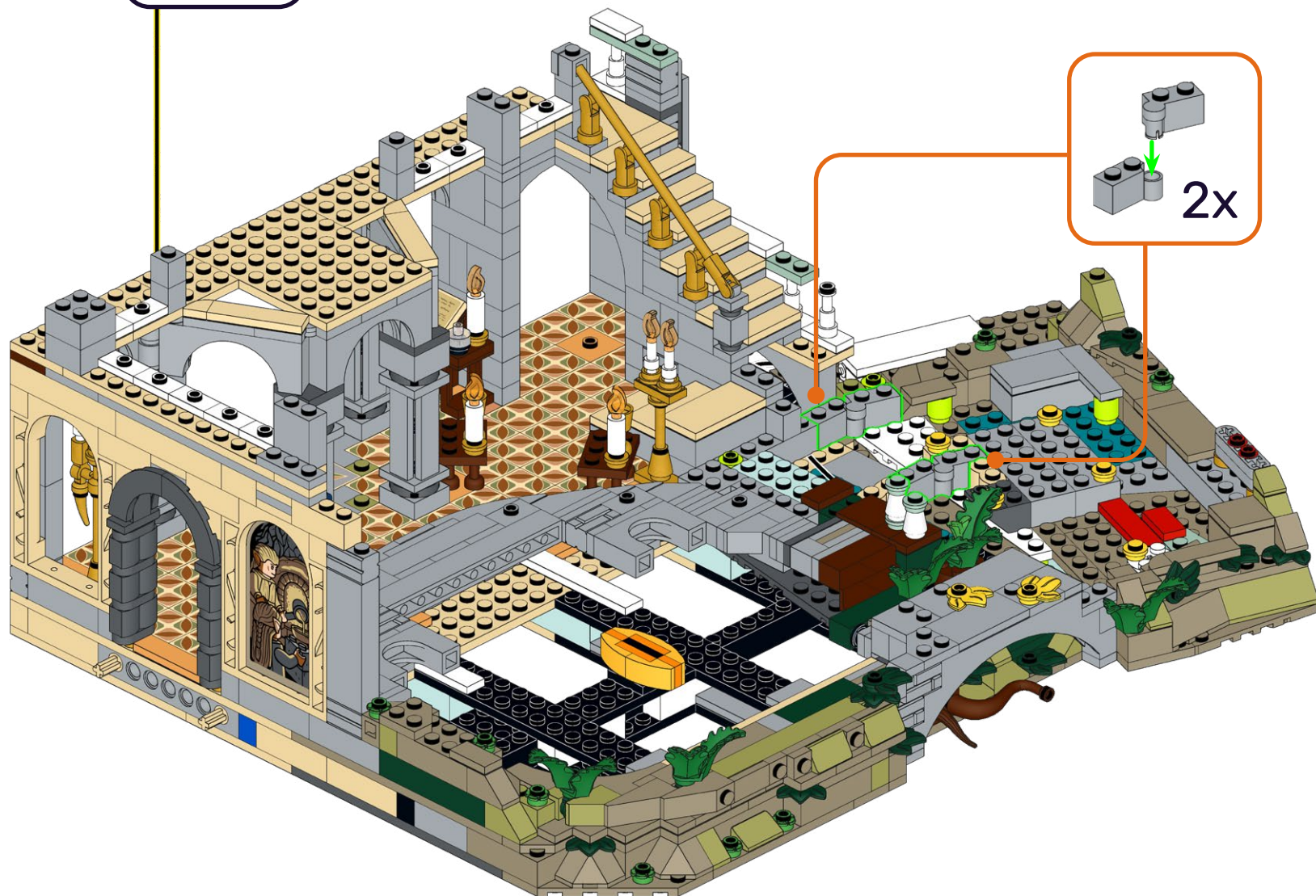
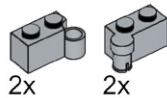



**172**

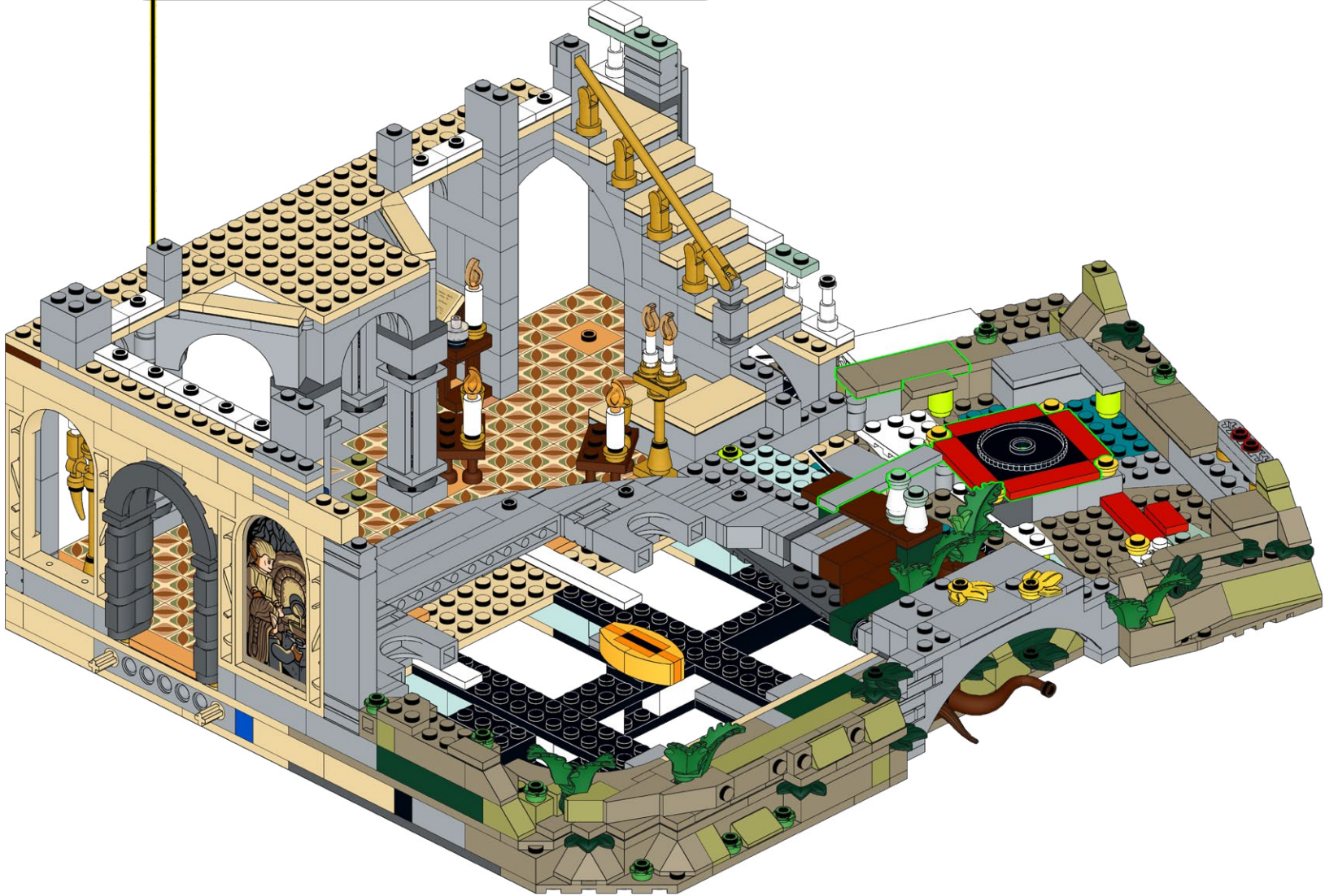
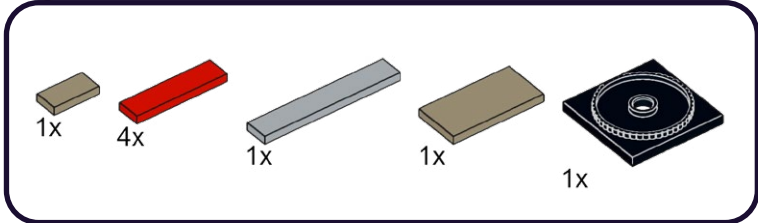

173

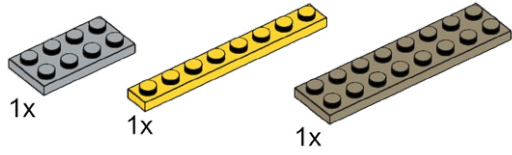

1

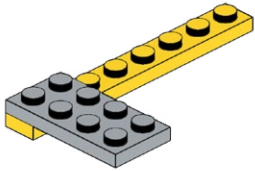

3

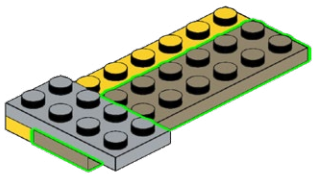

174

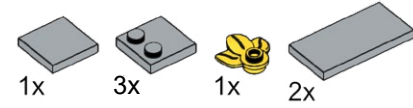

1

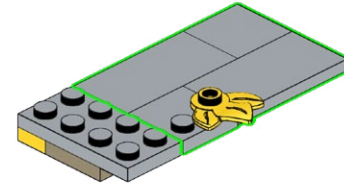

3

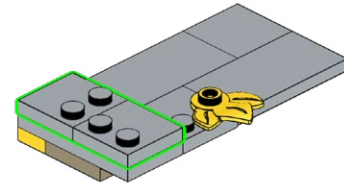



175

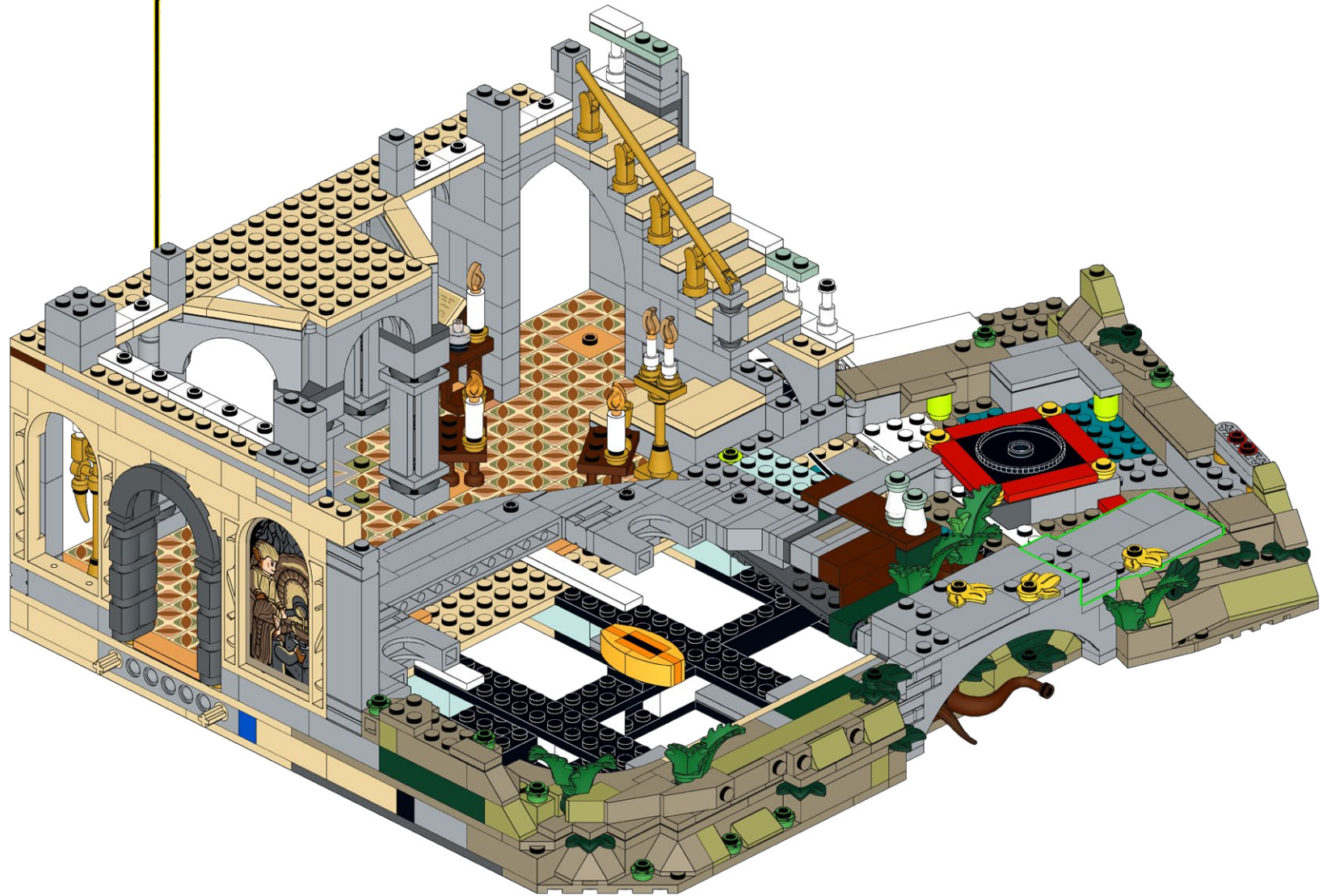



### **HOLD UP!**

You might notice some bags aren't in order, as well as left over pieces, but that's ok! We're changing the way you build LEGO!

### **ATTENDEZ!**

Vous remarquerez peut-être que certains sacs, ainsi que certaines pièces, ne sont pas dans le bon ordre. Mais pas de panique! Nous changeons simplement la façon avec laquelle vous construisez vos LEGO!

### **ASPETTA!**

Potresti notare che alcuni sacchetti non sono in ordine, così come i pezzi avanzati, ma va bene così! Stiamo cambiando il modo in cui costruisci i LEGO!

### **HALT!**

Sie werden möglicherweise bemerken, dass einige tüten durcheinander sind und teile übrig bleiben, aber das ist in Ordnung! Wir ändern die art und weise, wie Sie LEGO bauen!

### **¡ESPERA!**

Es posible que notes que algunas bolsas están fuera de servicio, así como piezas sobrantes, ¡pero está bien! ¡Estamos cambiando la forma en que construyes LEGO!

### **暫停!**

你可能会注意到一些袋子顺序错乱, 以及一些剩余的部件, 但没关系! 我们正在改变你搭建乐高的方式!

#### Open LEGO® Bag 33

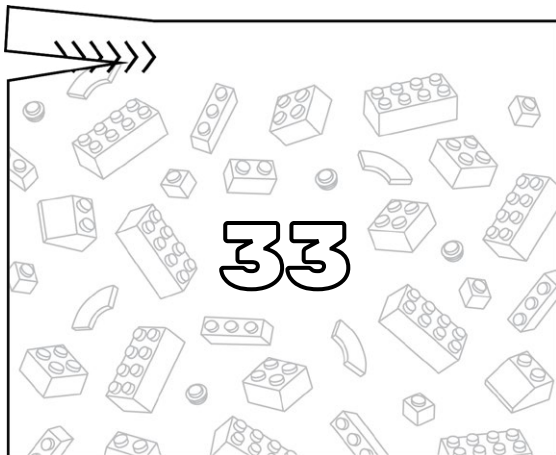

#### Open LMB Bag 04

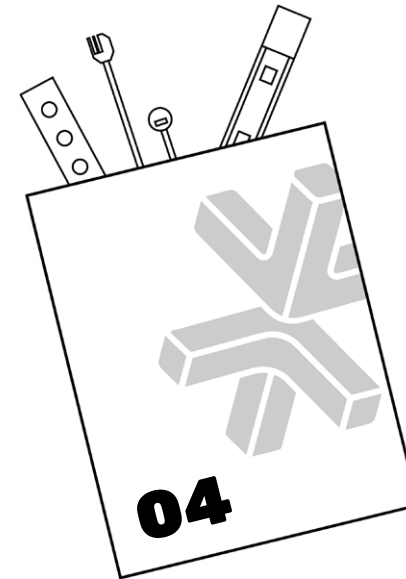

176

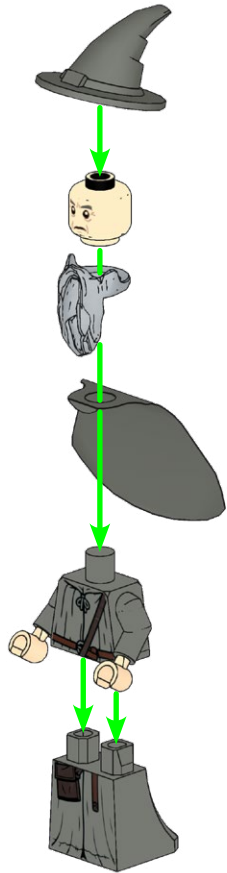
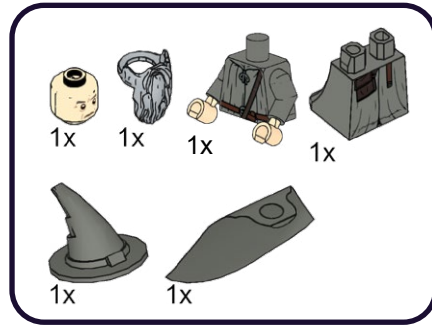

177





178

- 2x
- 2x
- 1x
- 1x
- 1x
- 4x
- 2x



179





**180**

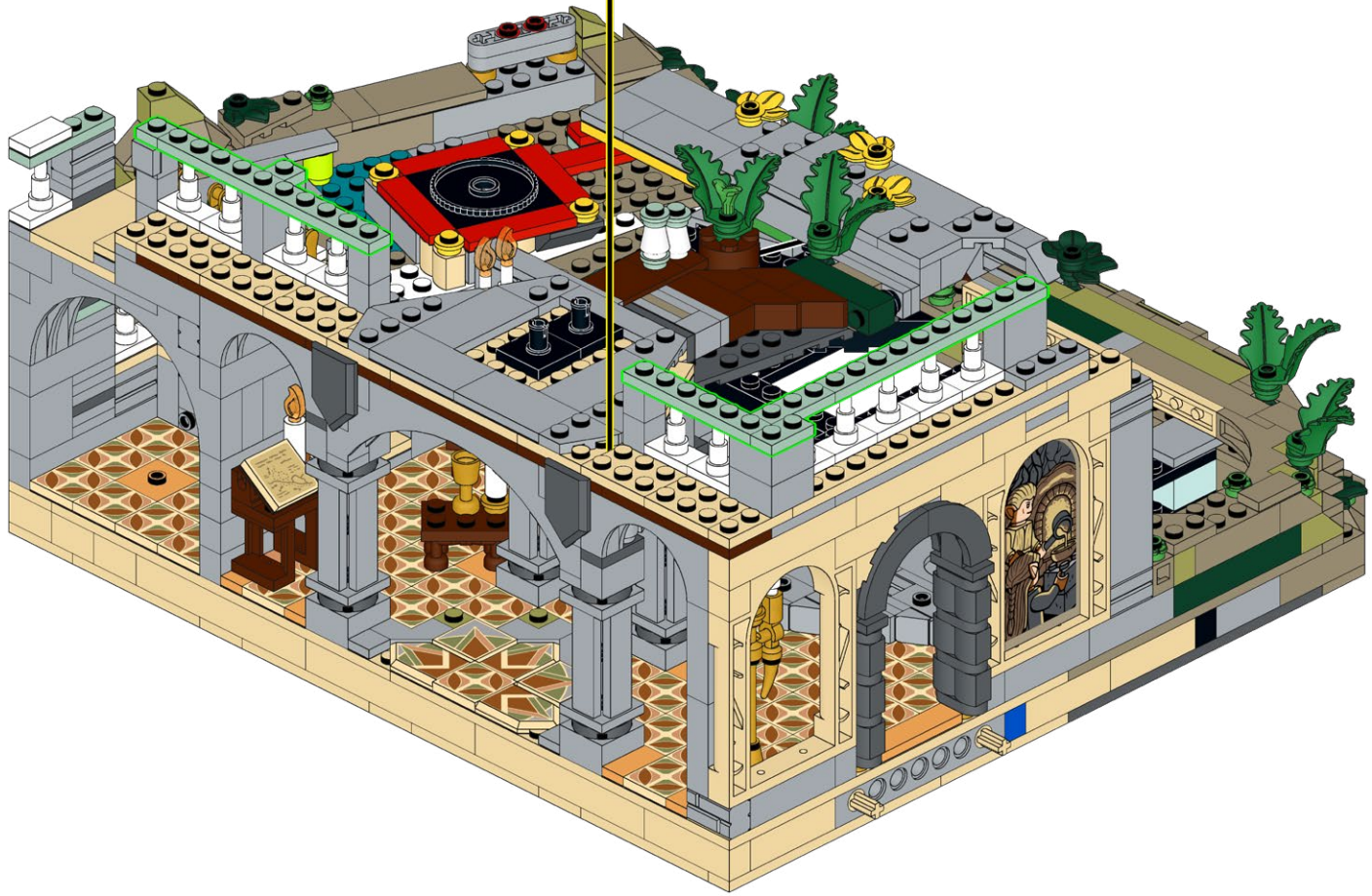
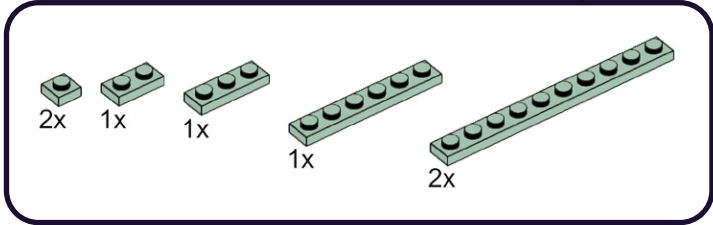

181



1

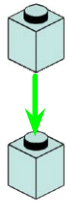

2

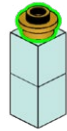

3

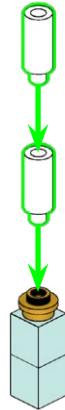

4



5

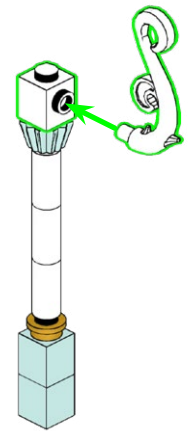





2x

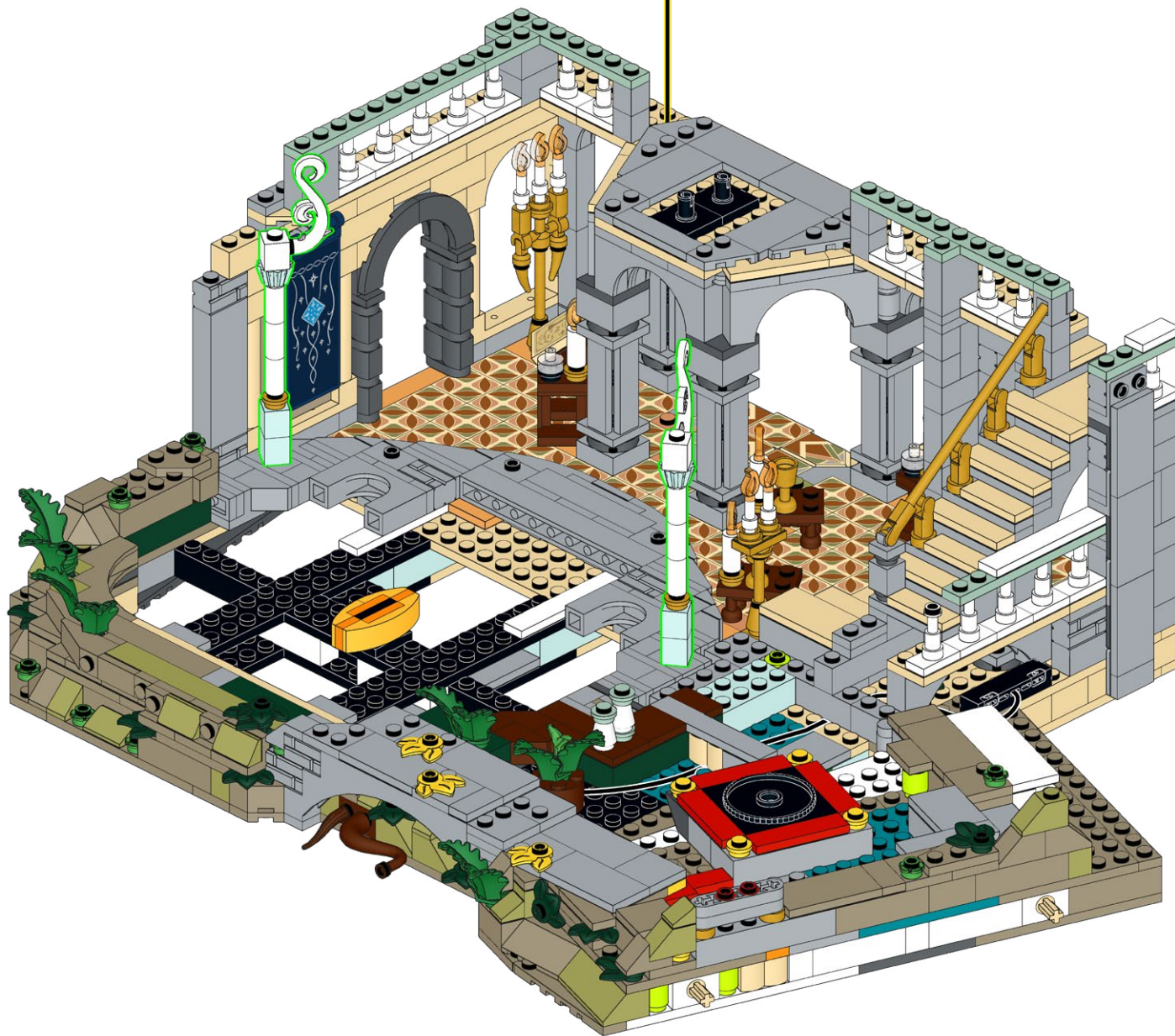

182

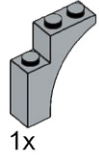

# 183

- 1x 
- 1x 
- 1x 
- 1x 
- 1x 

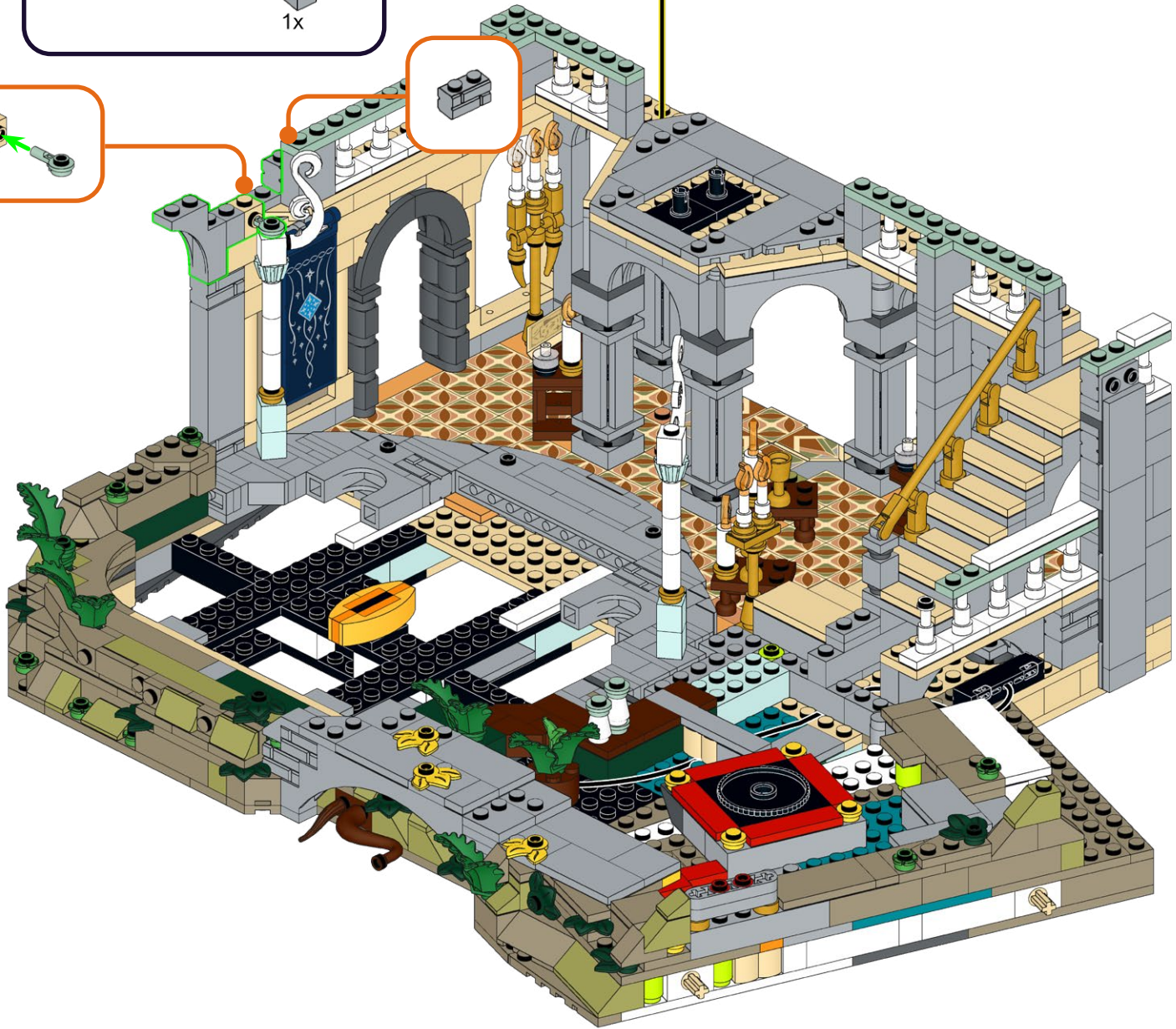
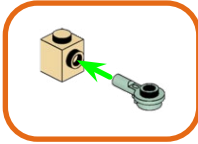



184

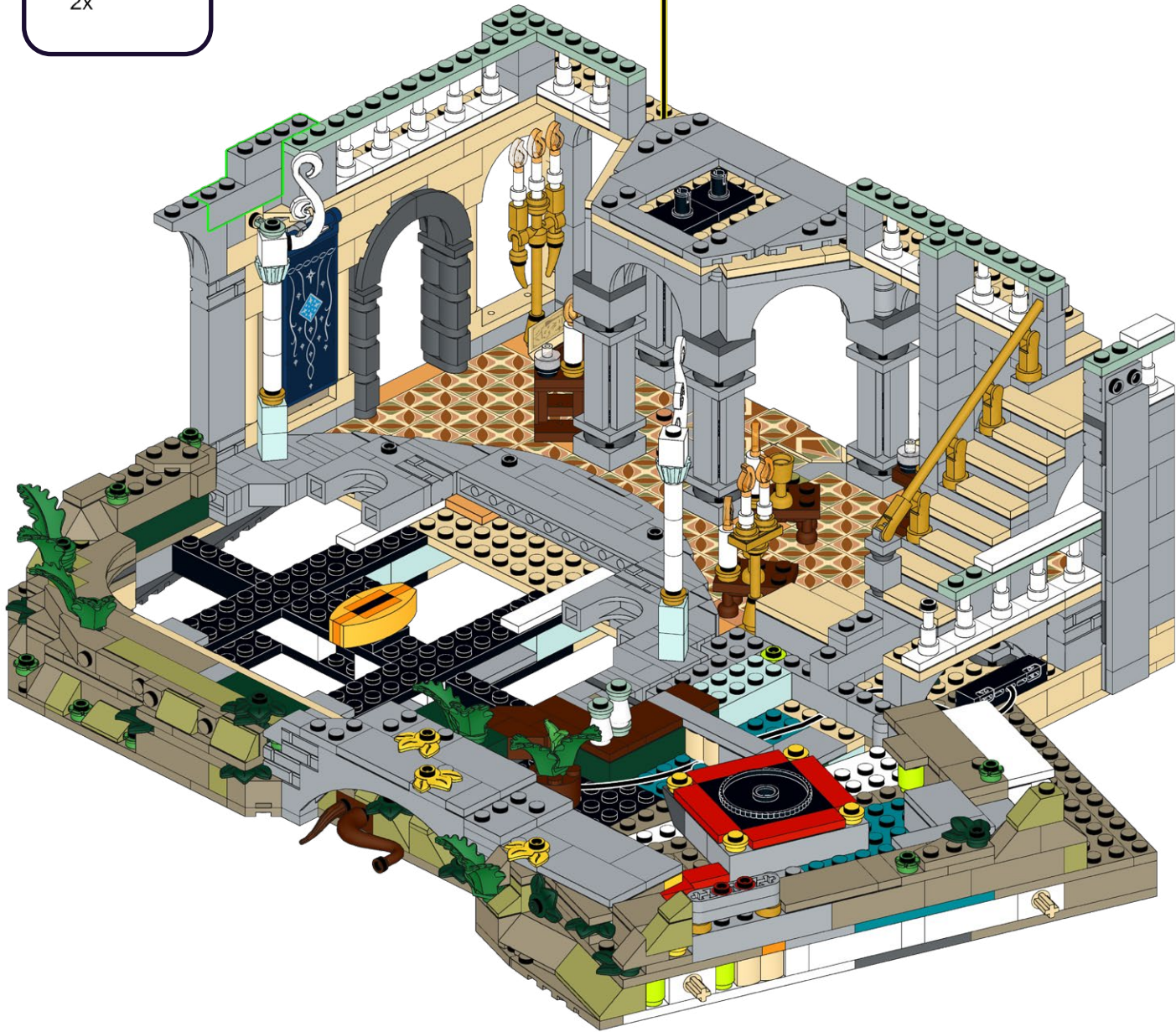
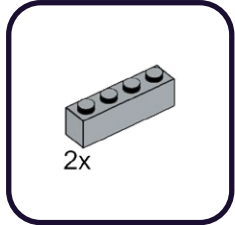



185

- 1x [white bush]
- 1x [grey bush]
- 1x [white bush]
- 1x [grey 1x4 Technic brick]
- 2x [white Technic pin]

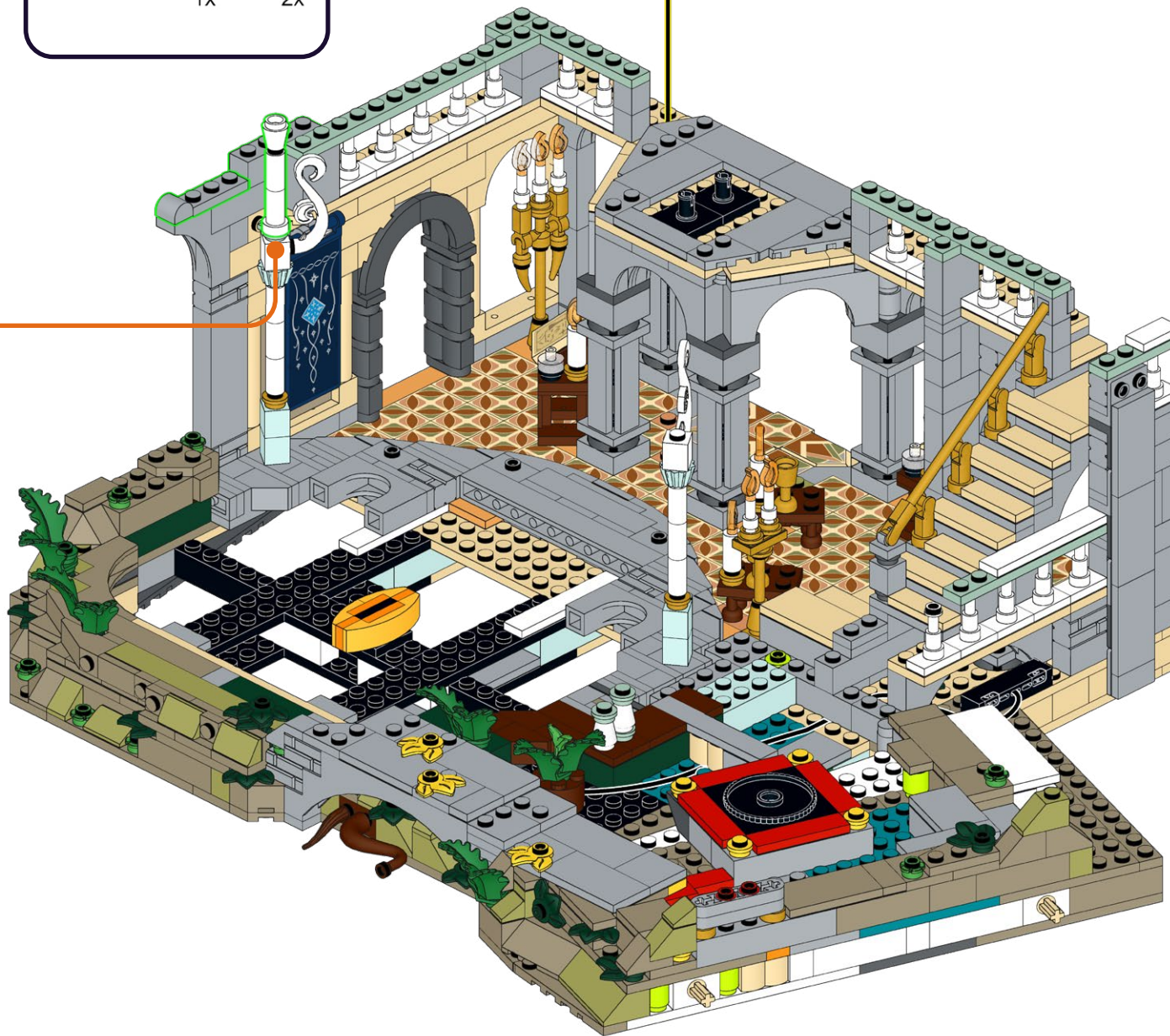
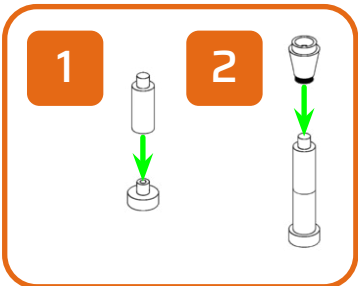

186

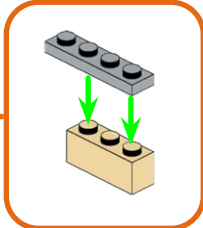
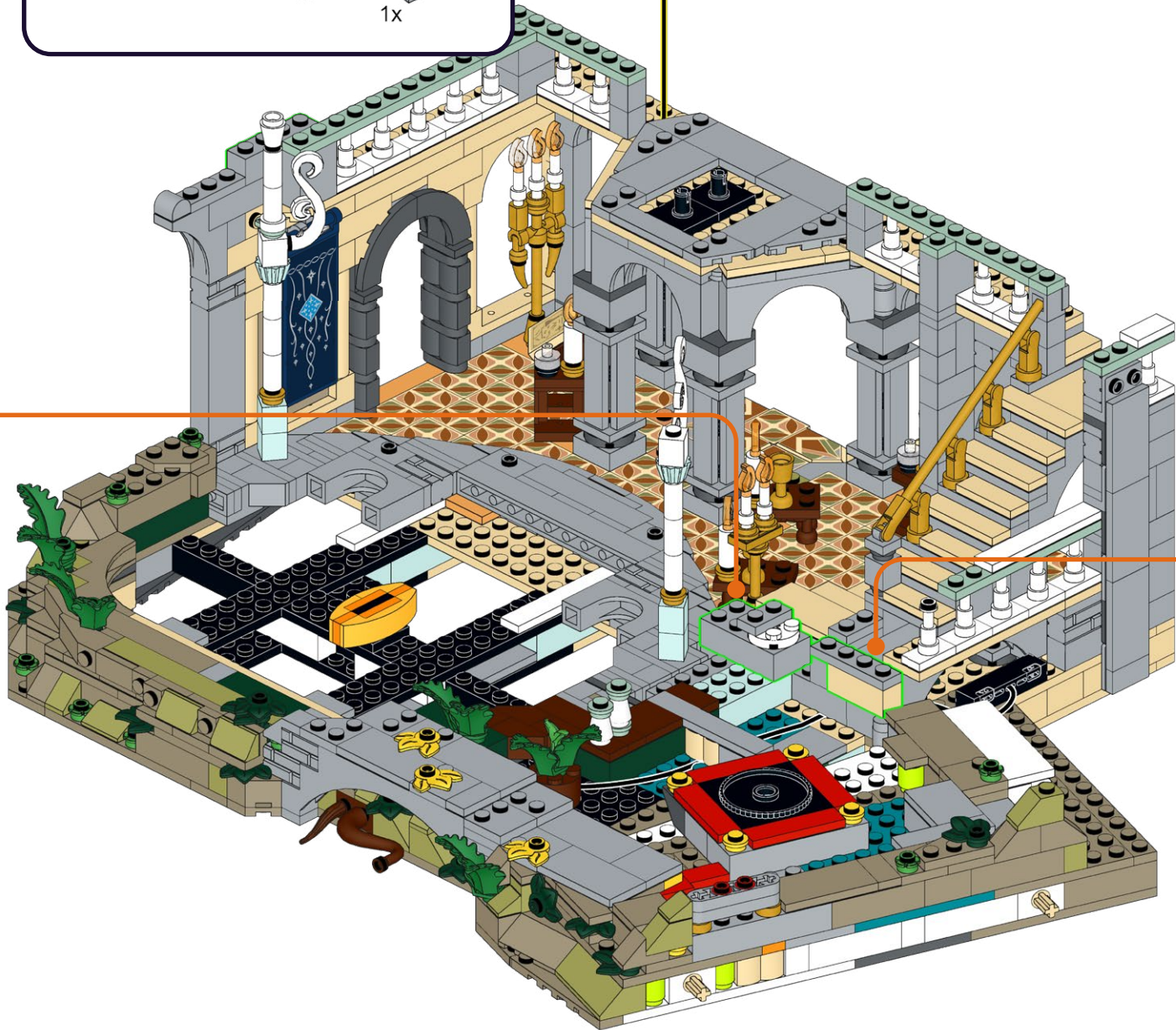
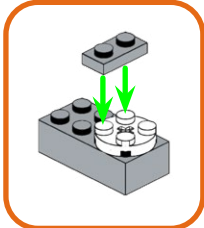
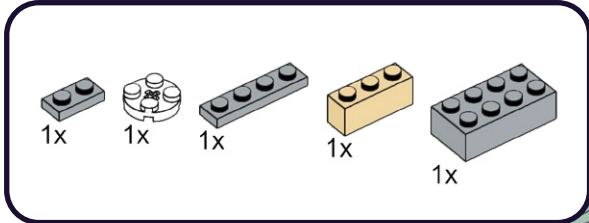



187

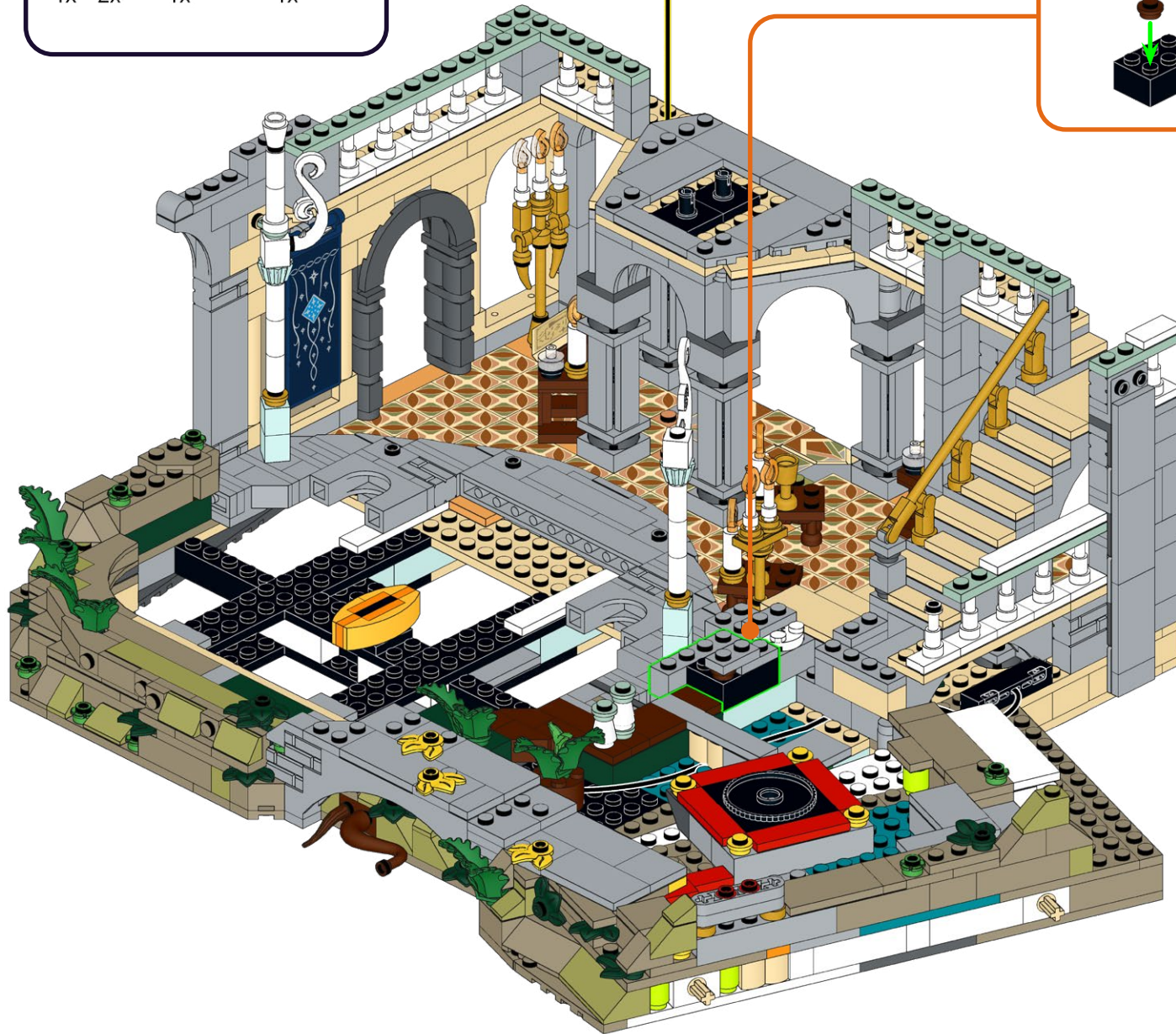
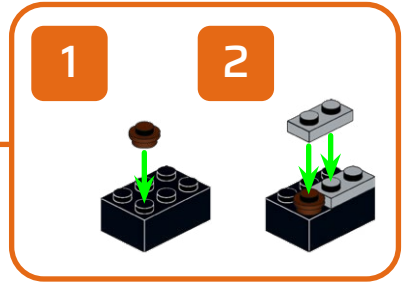
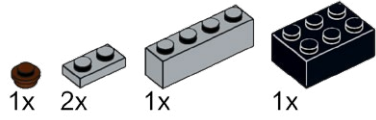



**188**

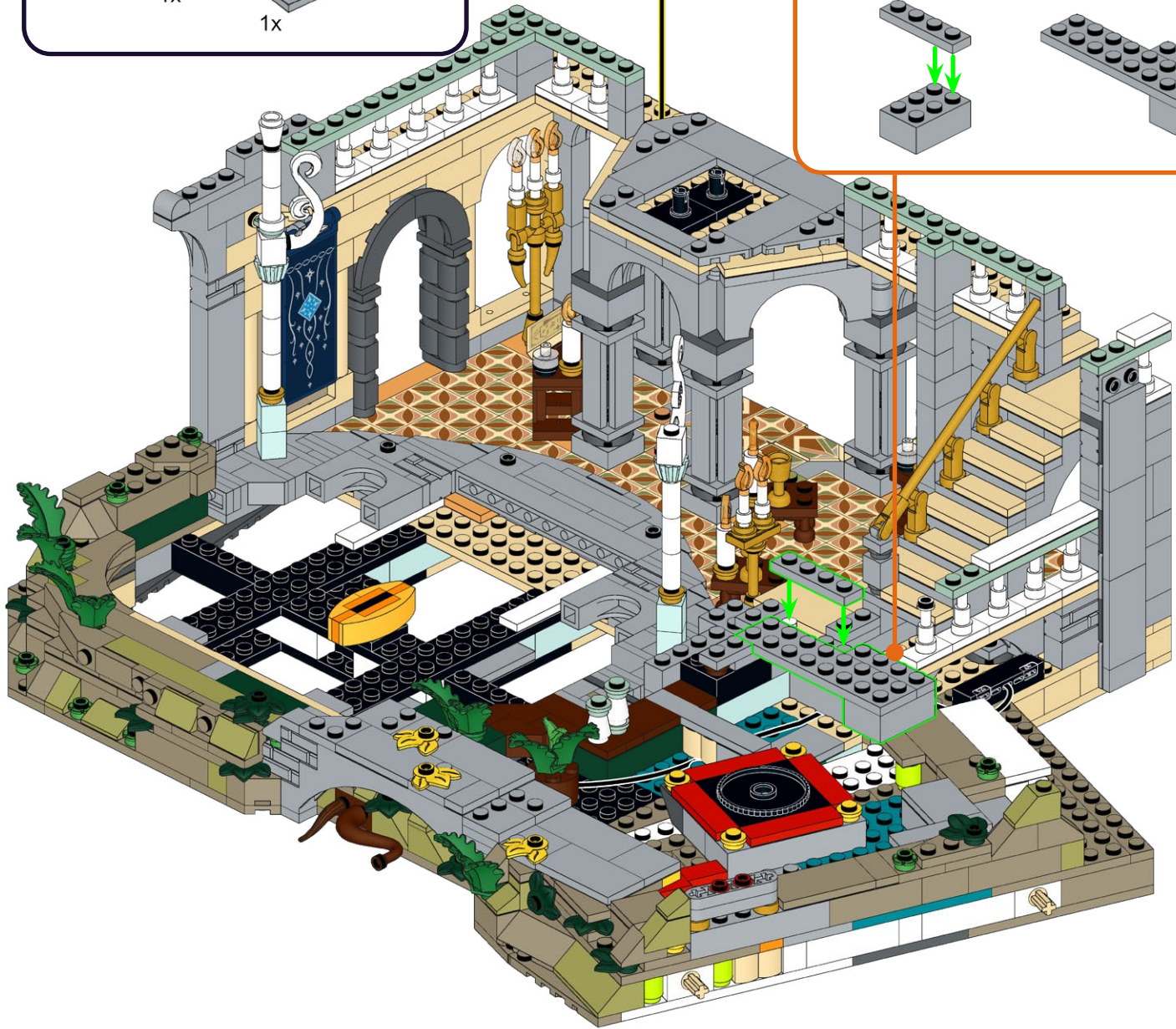
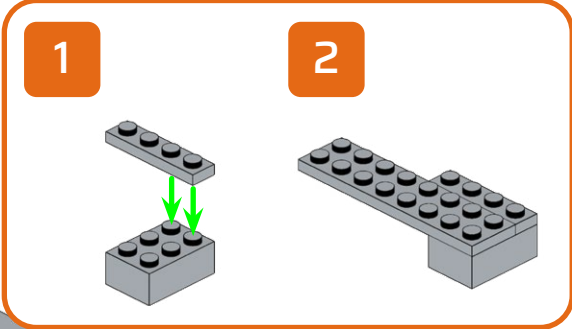
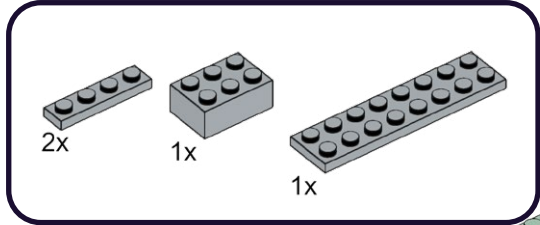

189

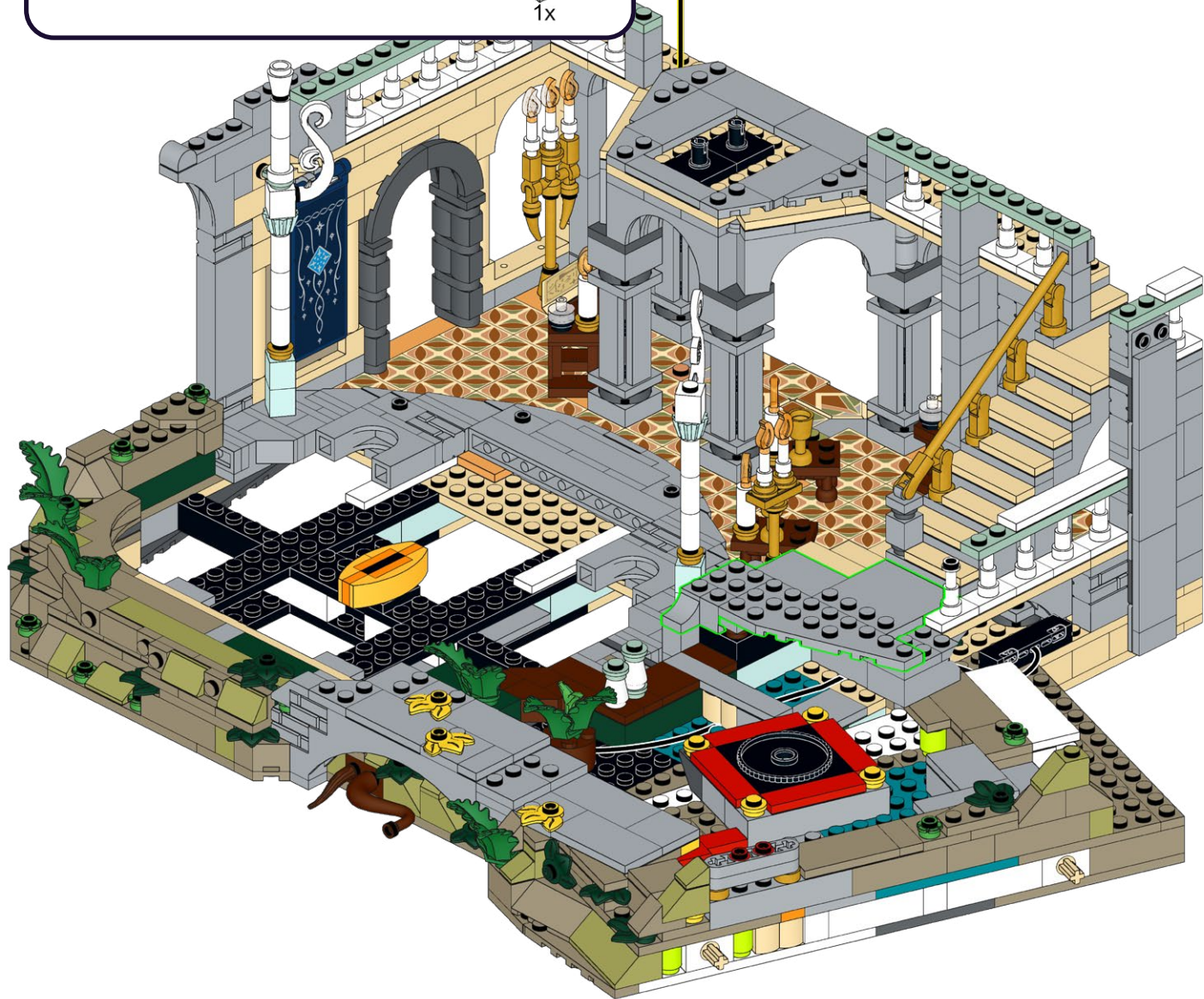
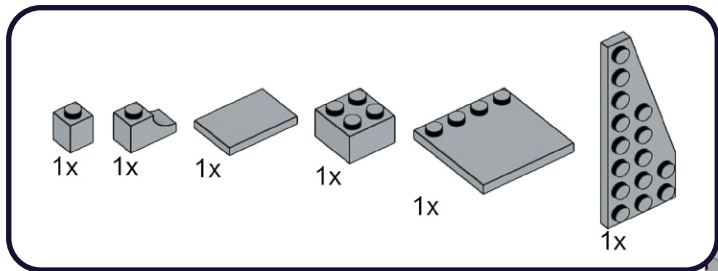



**190**

- 2x
- 1x
- 1x
- 1x
- 1x
- 4x

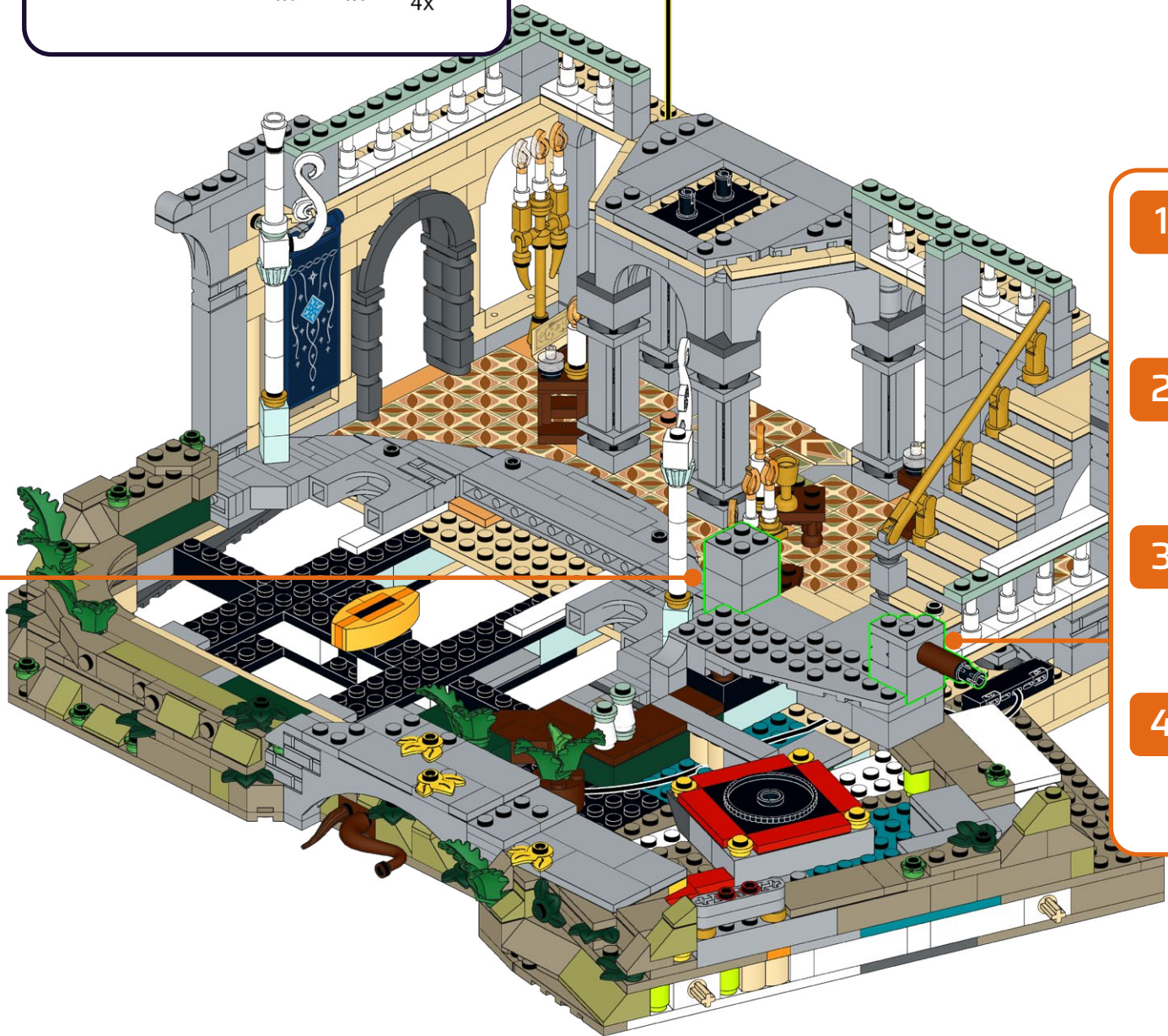
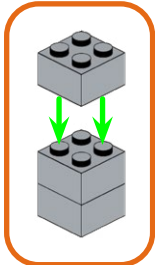

- 
- 
- 
-



191

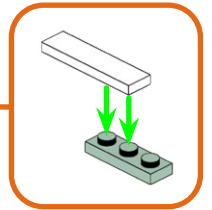
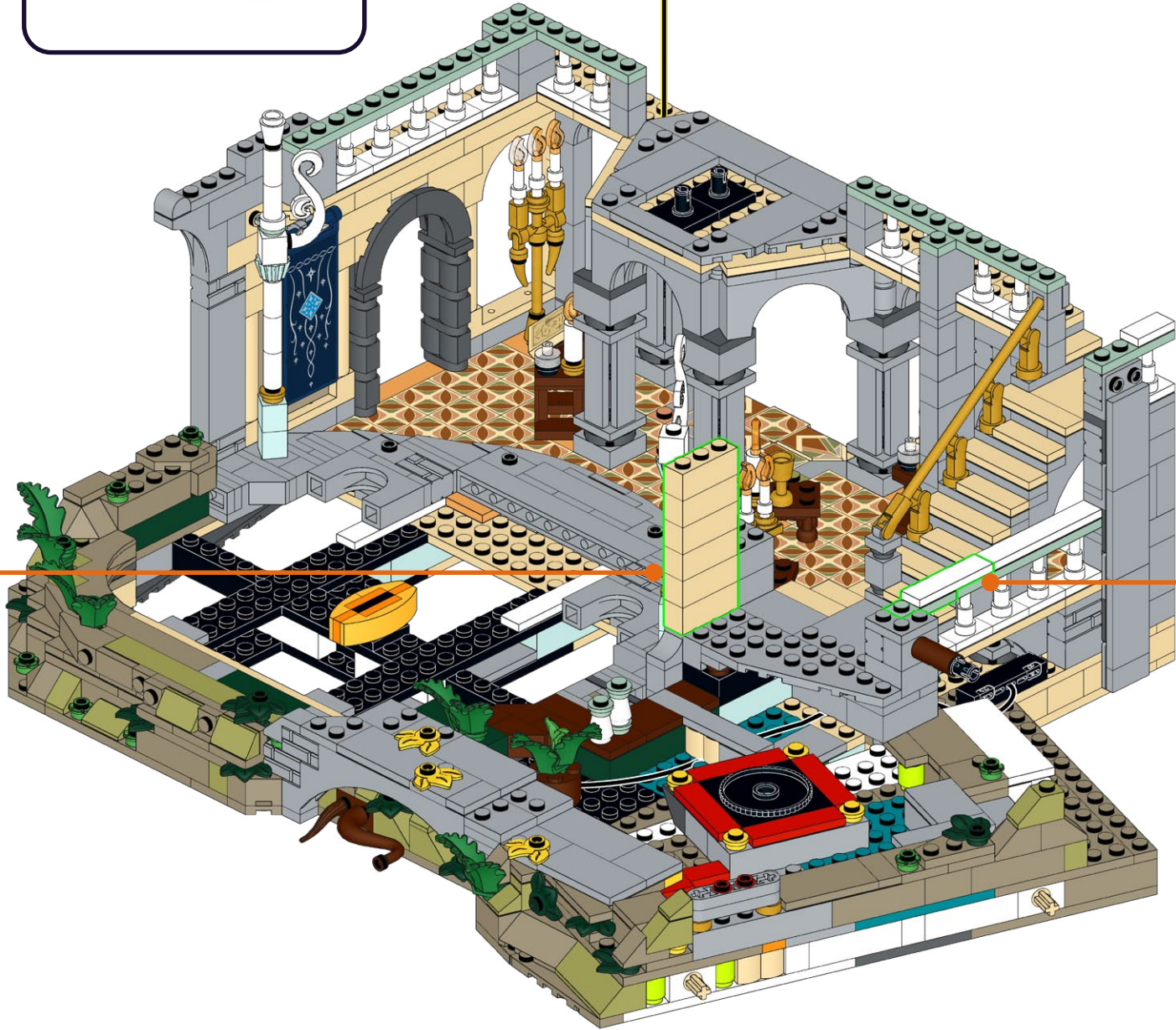
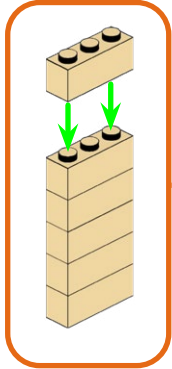
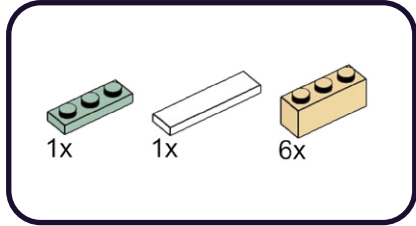

192

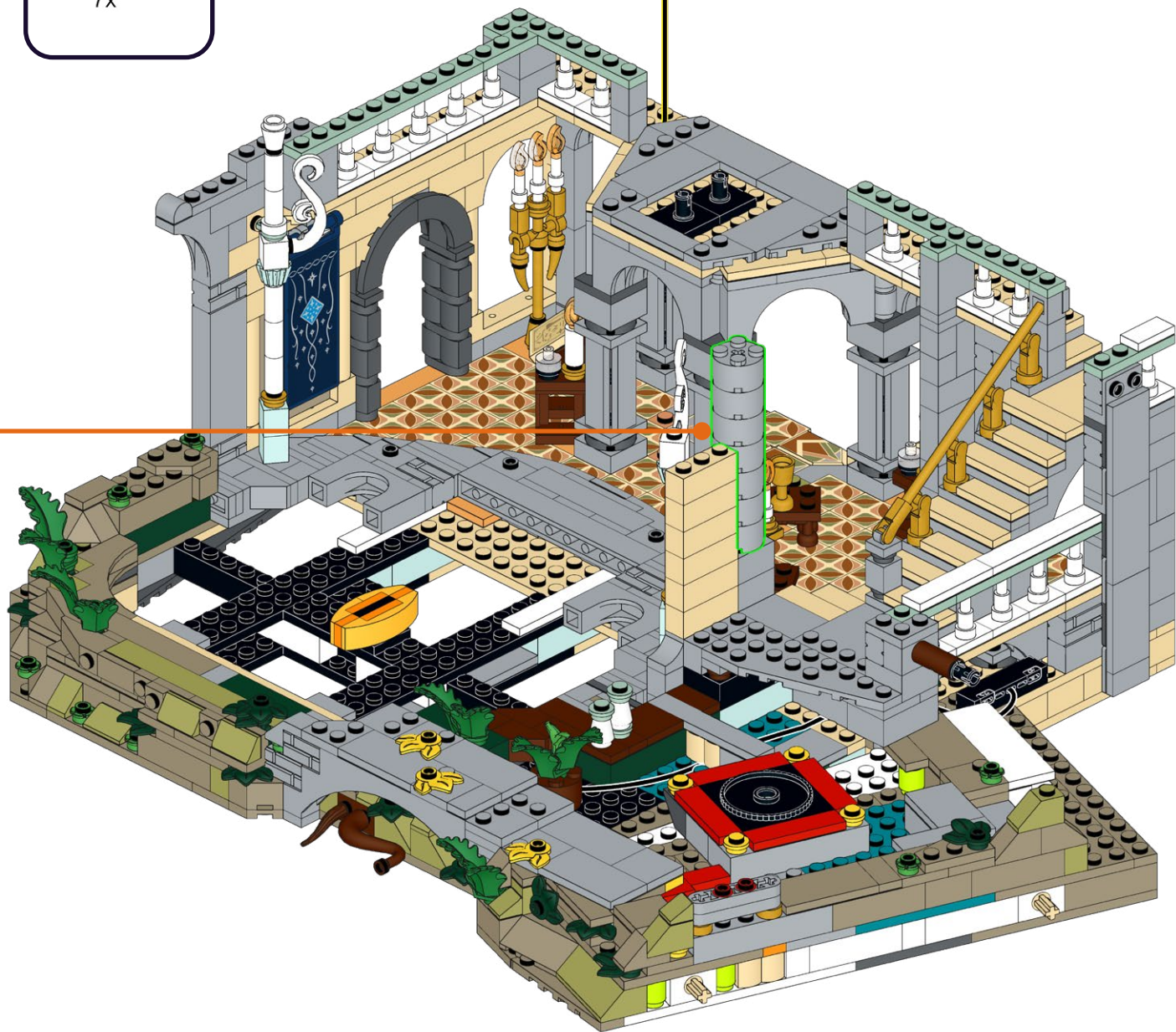
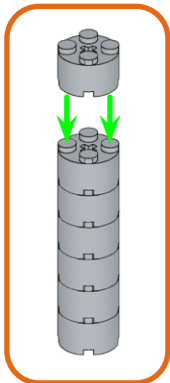
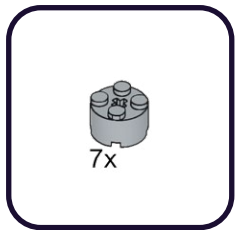



**193**

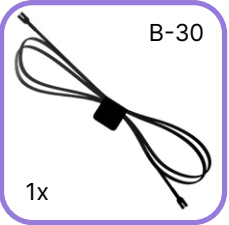
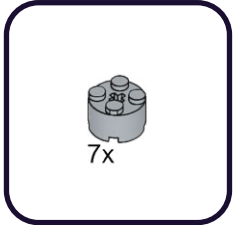

**194**

**1**



**3**



7 cm  
3"



195

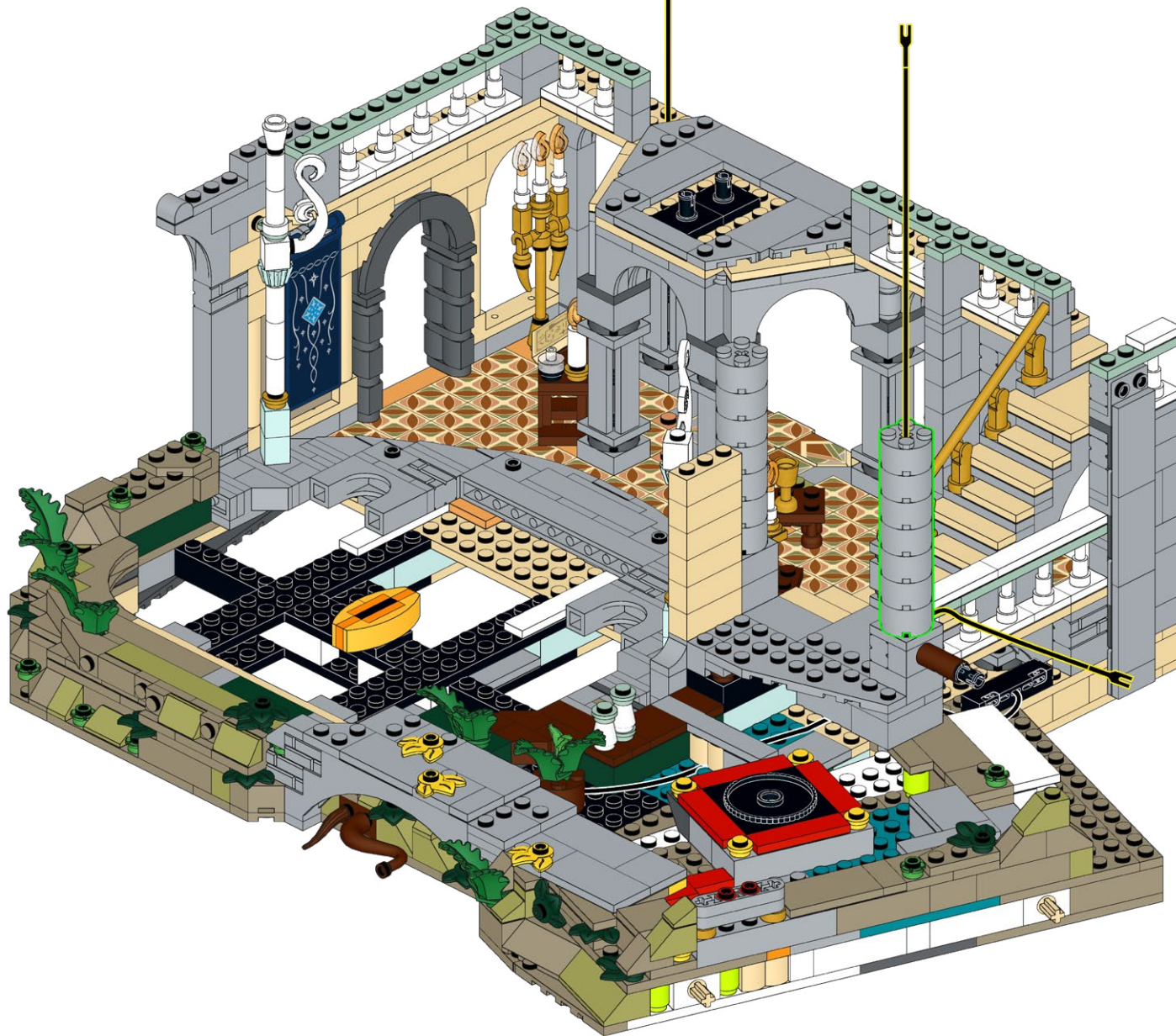

196

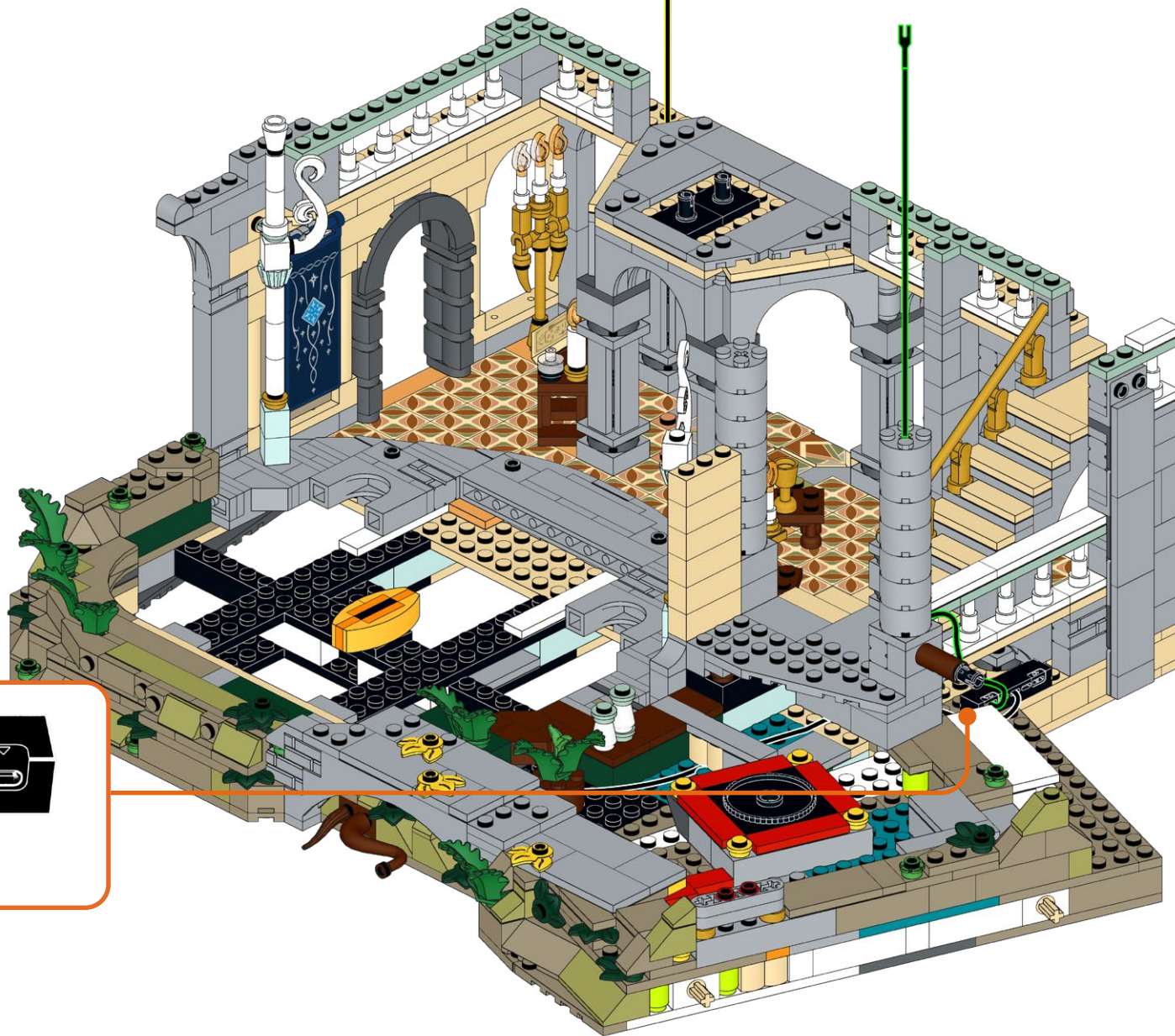



197

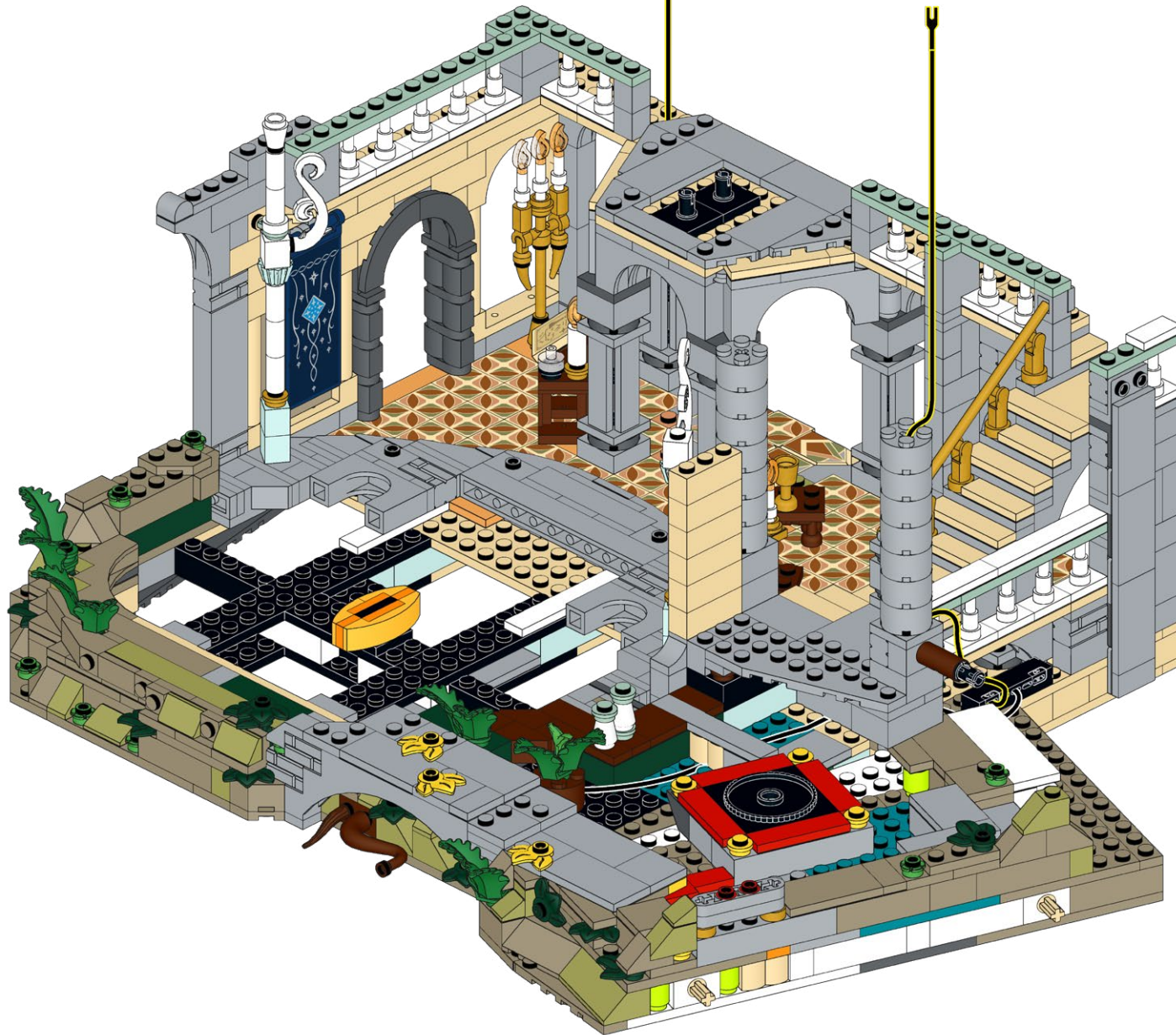



# 198

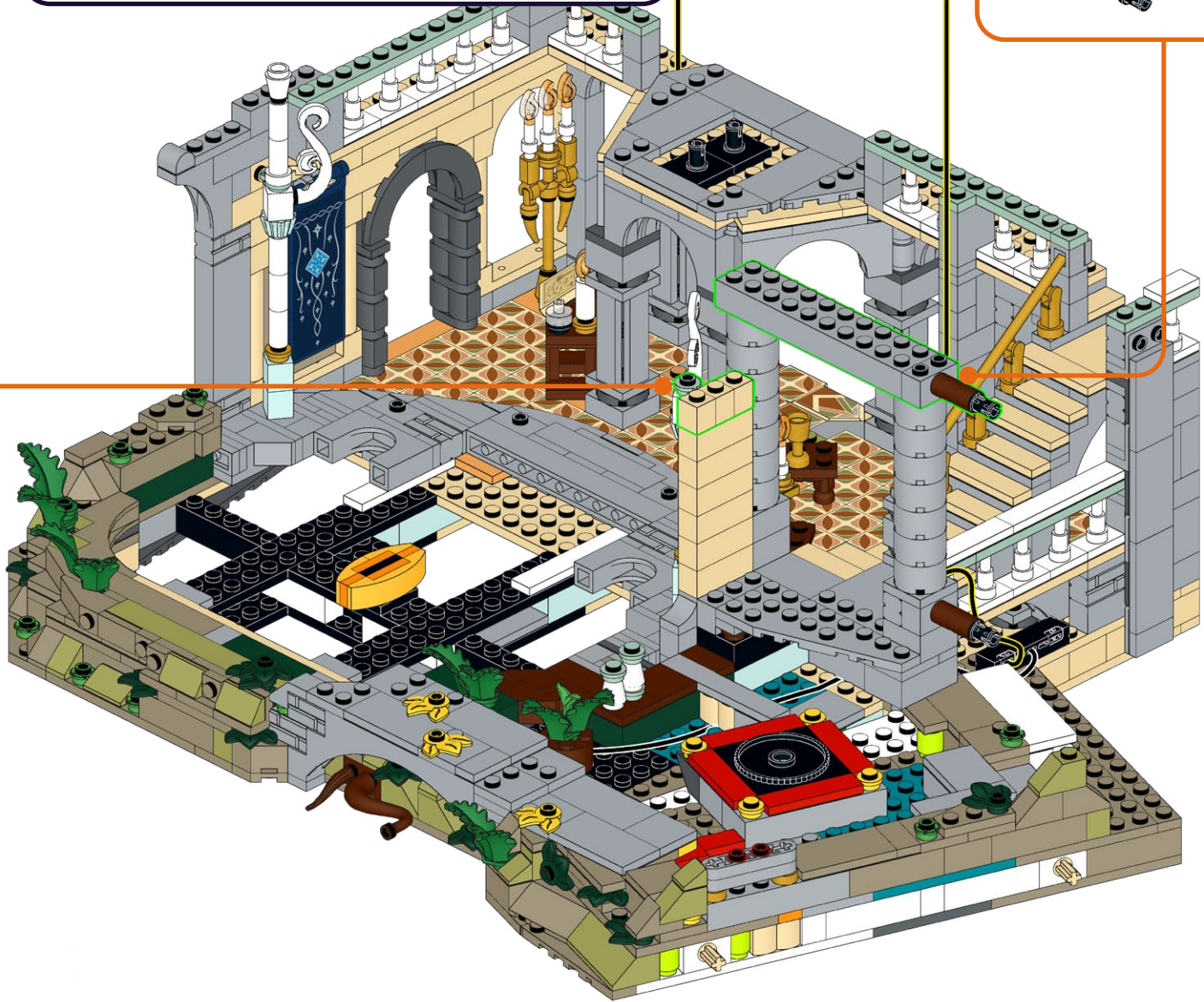
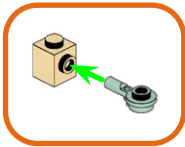
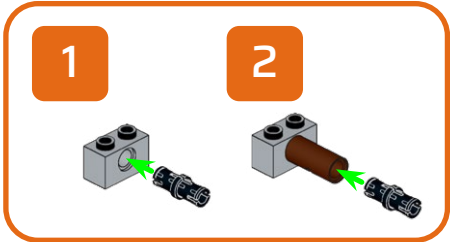
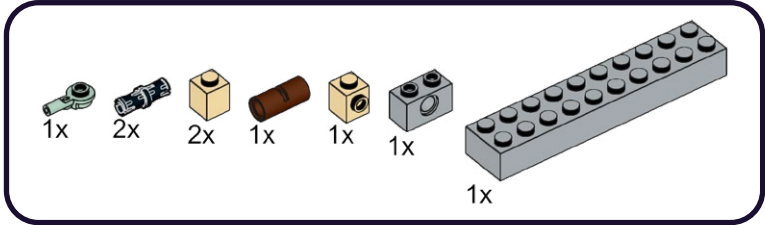



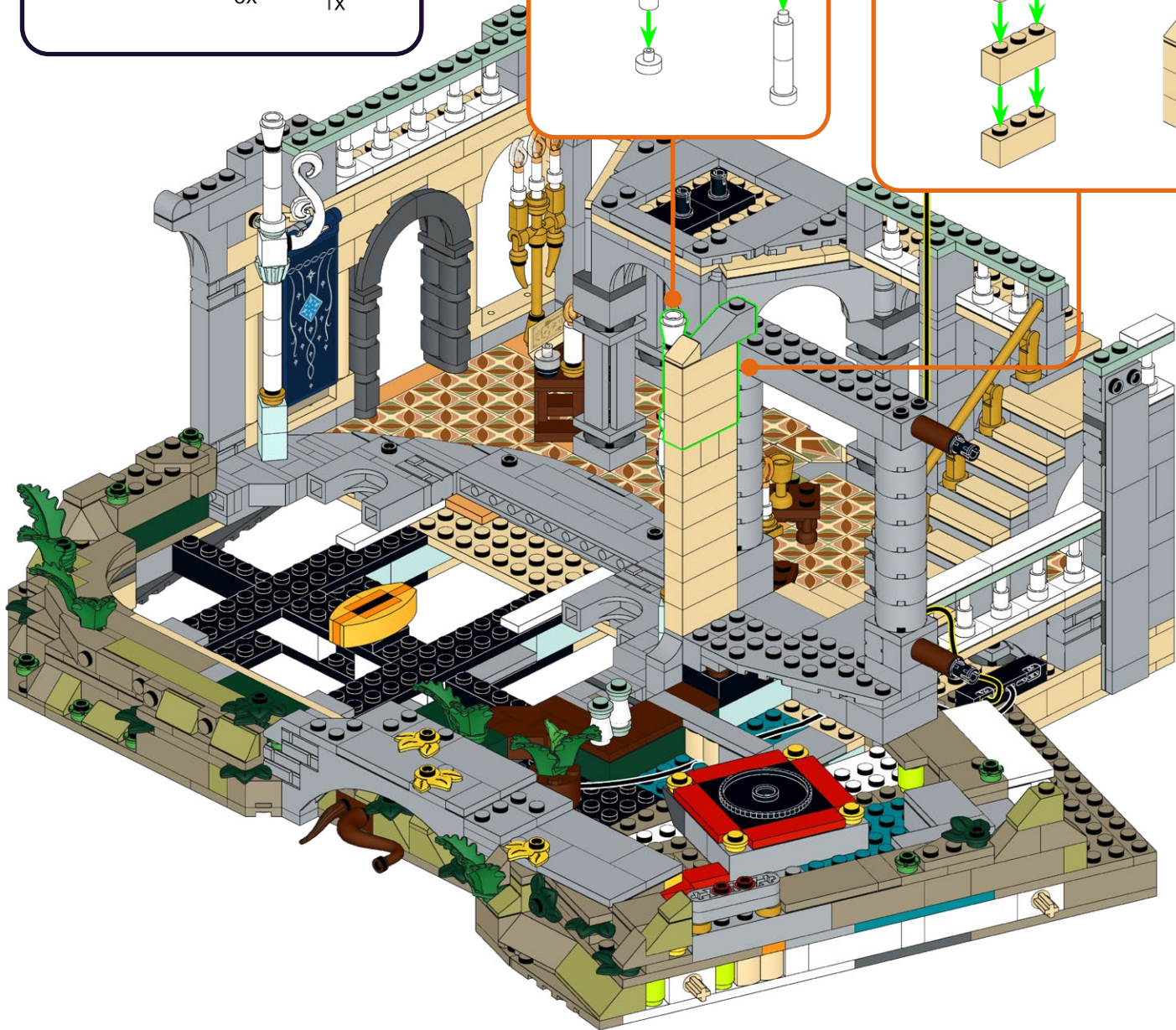
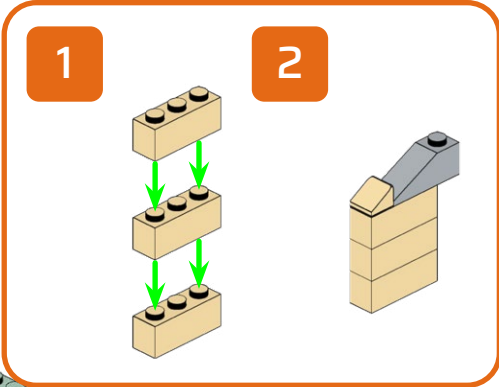
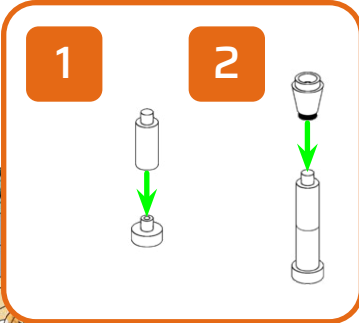
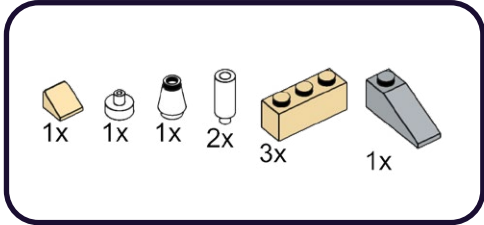









# 199



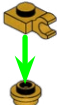

# 200

- 1x 
- 1x 
- 1x 
- 1x 
- 1x 
- 1x 
- 1x 
- 1x 

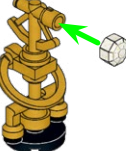
- 
- 
- 
- 
- 

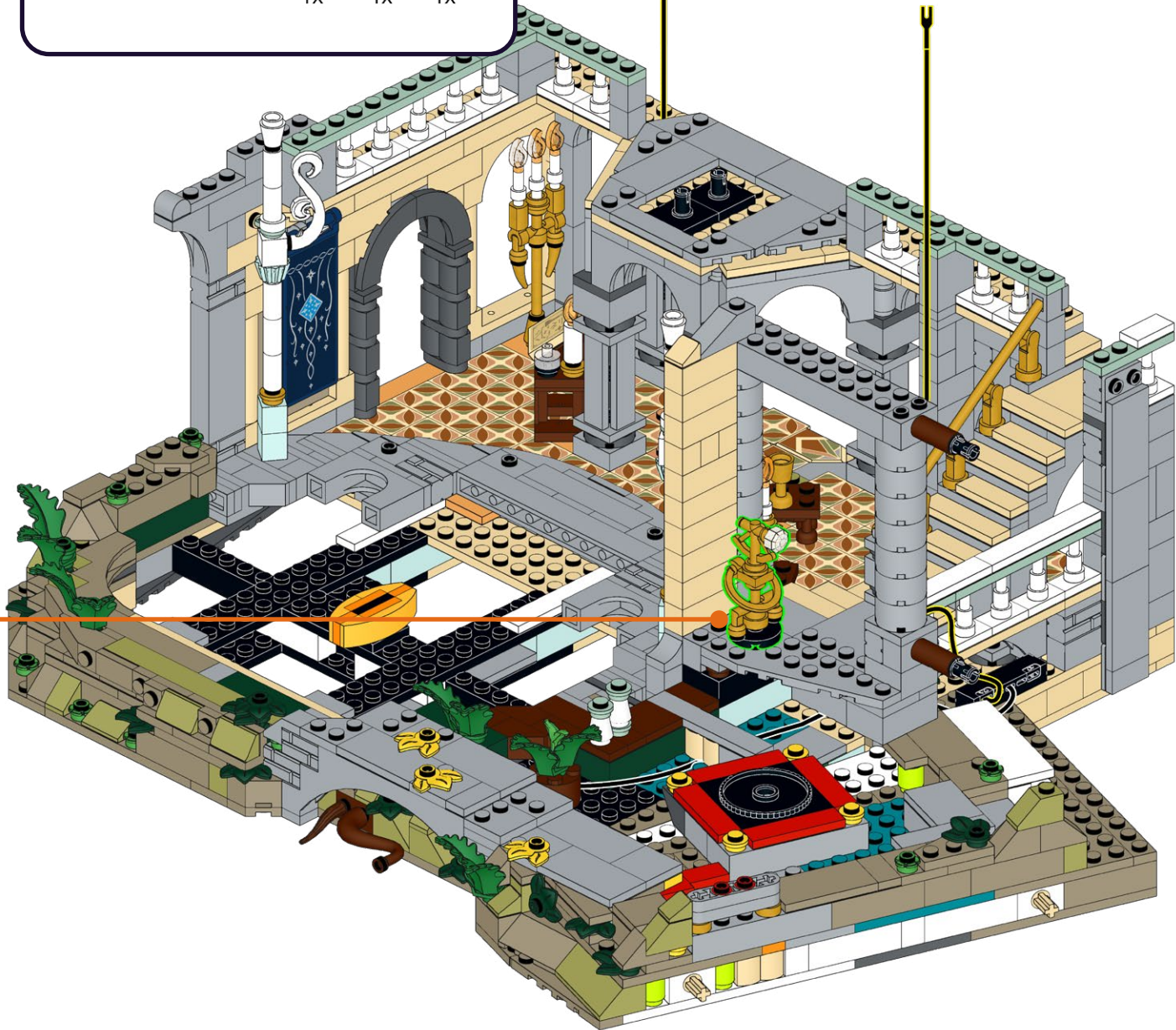



**HOLD UP!**

You might notice some bags aren't in order, as well as left over pieces, but that's ok! We're changing the way you build LEGO!

**ATTENDEZ!**

Vous remarquerez peut-être que certains sacs, ainsi que certaines pièces, ne sont pas dans le bon ordre. Mais pas de panique! Nous changeons simplement la façon avec laquelle vous construisez vos LEGO!

**ASPETTA!**

Potresti notare che alcuni sacchetti non sono in ordine, così come i pezzi avanzati, ma va bene così! Stiamo cambiando il modo in cui costruisci i LEGO!

**HALT!**

Sie werden möglicherweise bemerken, dass einige tüten durcheinander sind und teile übrig bleiben, aber das ist in Ordnung! Wir ändern die art und weise, wie Sie LEGO bauen!

**¡ESPERA!**

Es posible que notes que algunas bolsas están fuera de servicio, así como piezas sobrantes, ¡pero está bien! ¡Estamos cambiando la forma en que construyes LEGO!

**暫停!**

你可能会注意到一些袋子顺序错乱, 以及一些剩余的部件, 但没关系! 我们正在改变你搭建乐高的方式!

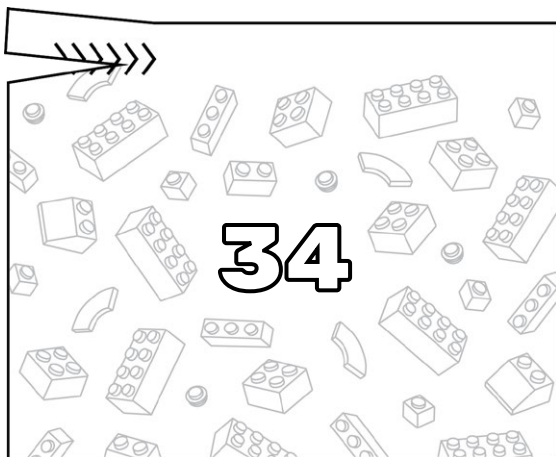
**Open LEGO® Bag 34**

# 201

- 1x [1x 1x grey 1-hole Technic brick]
- 3x [3x 1x grey 1-hole Technic brick]
- 1x [1x 1x grey 2-hole Technic brick]
- 1x [1x 1x grey 1-hole Technic Technic long brick]
- 1x [1x 2x grey 2-hole Technic brick]
- 1x [1x 2x grey 4-hole Technic brick]

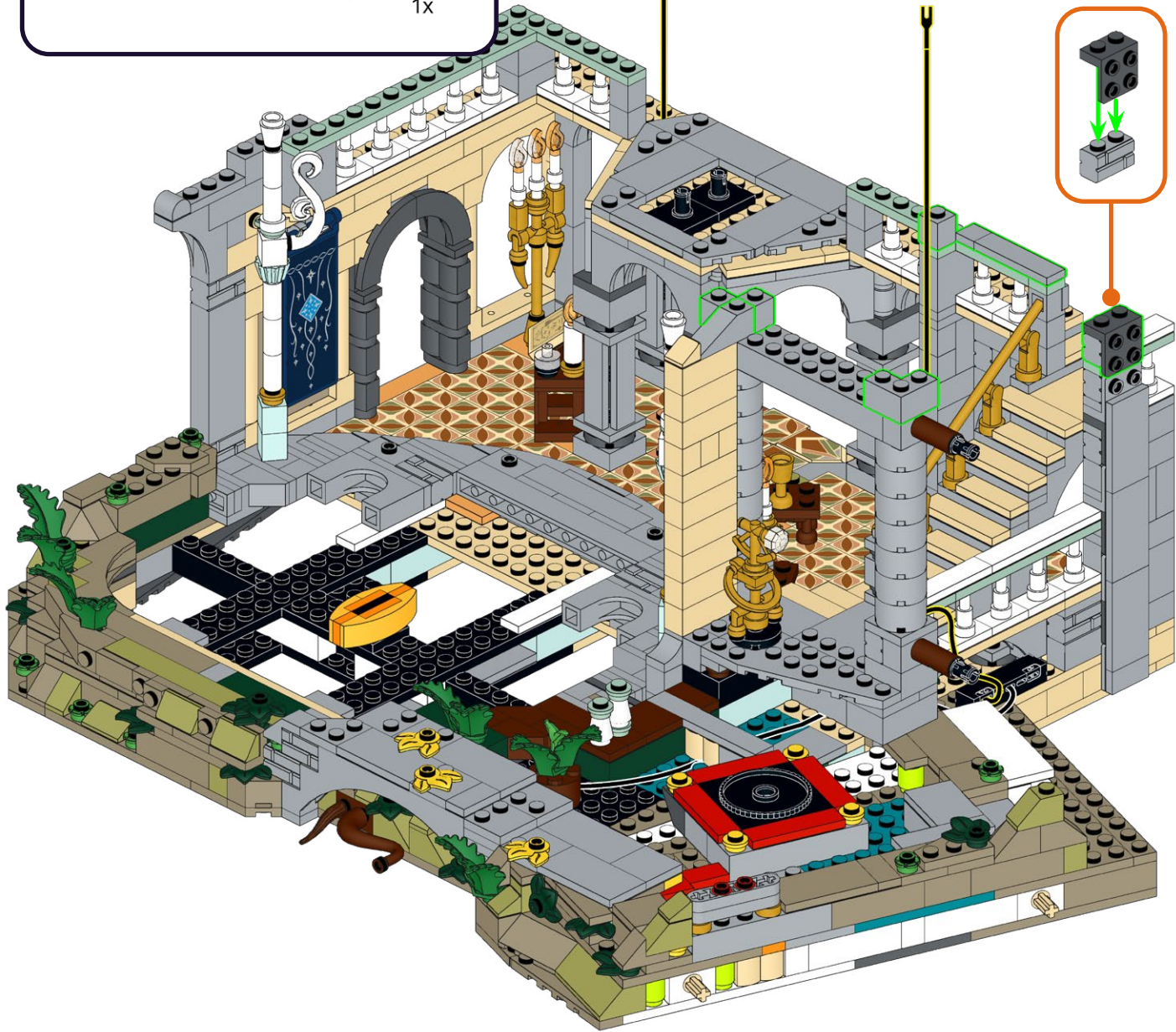

# 202

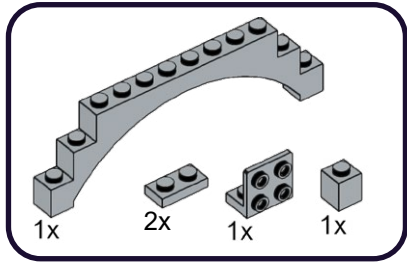

1

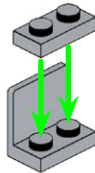

2

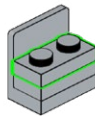

3

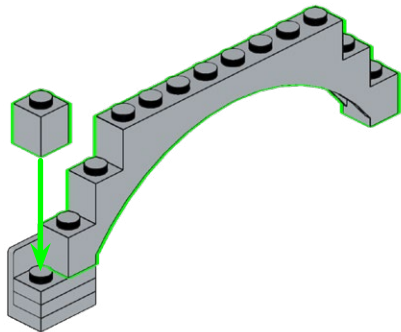

# 203

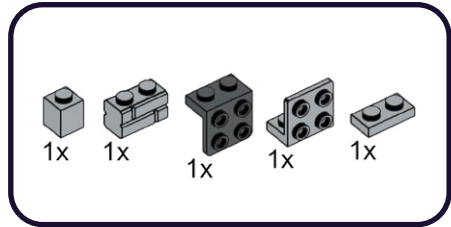

1

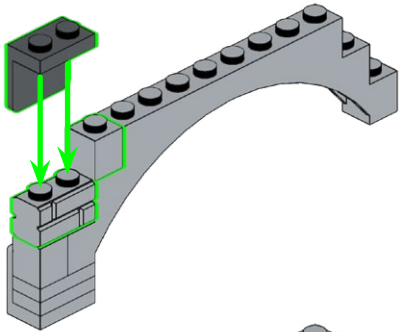

2

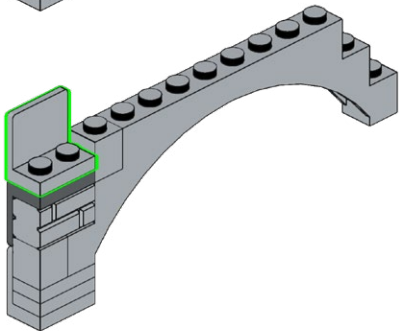

3

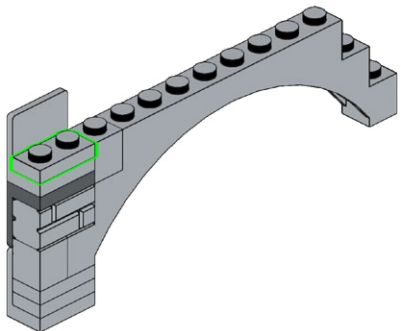



204

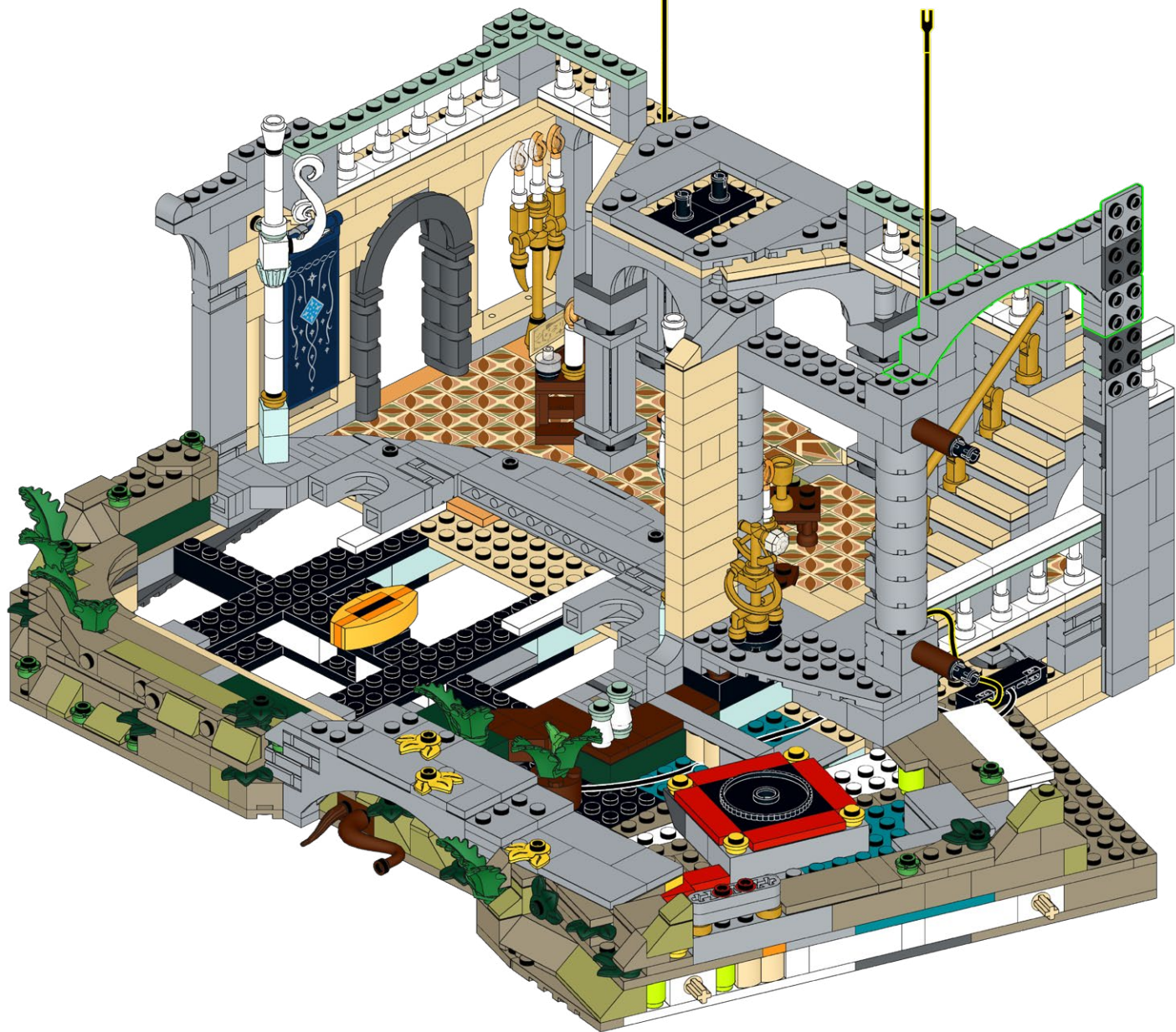

205

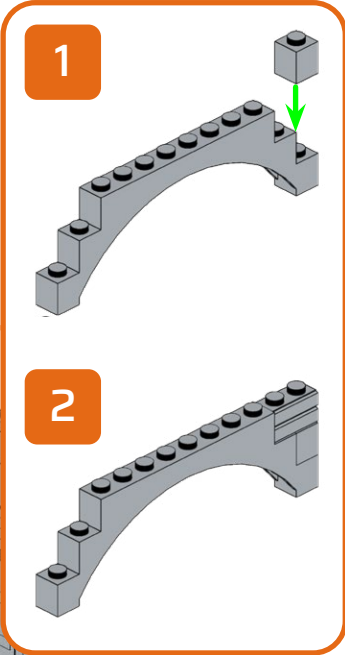
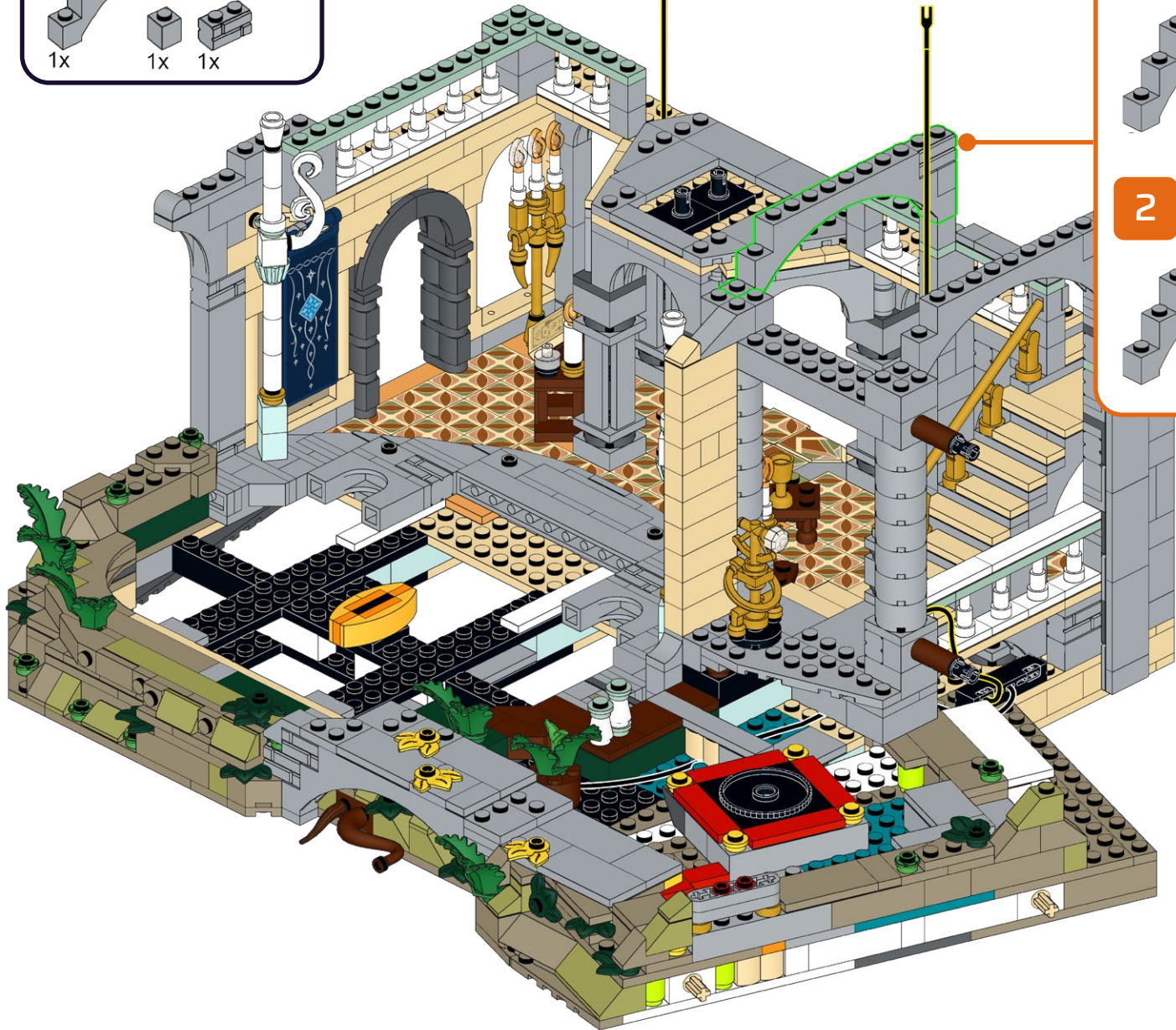
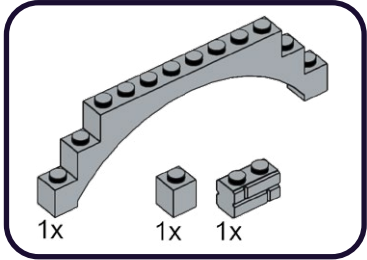



# 206

- 1x [1x 1-hole grey Technic brick]
- 2x [2x 1-hole grey Technic brick]
- 1x [1x 1-hole grey Technic Technonote]
- 1x [1x 1-hole grey Technic Technonote with hole]
- 1x [1x 2-hole grey Technic Technonote]
- 1x [1x 2-hole grey Technic Technonote with hole]
- 1x [1x 1-hole grey Technic Technonote]
- 1x [1x 1-hole grey Technic Technonote with hole]

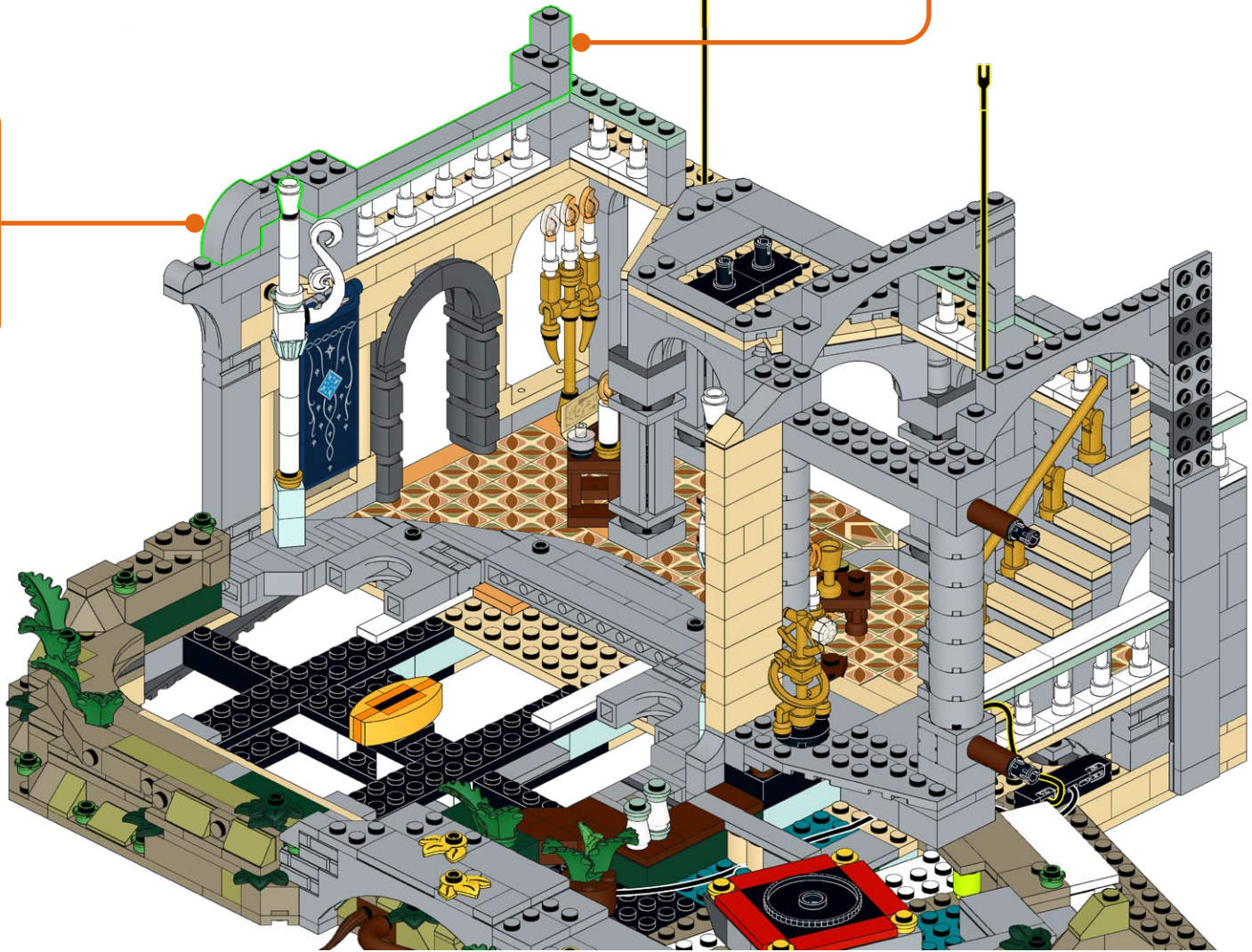
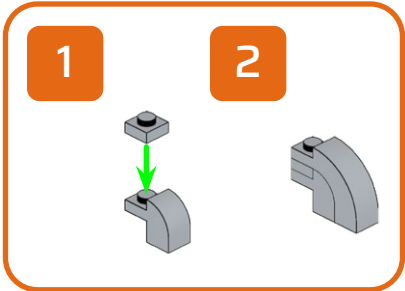
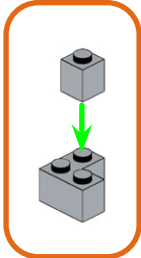



# 207

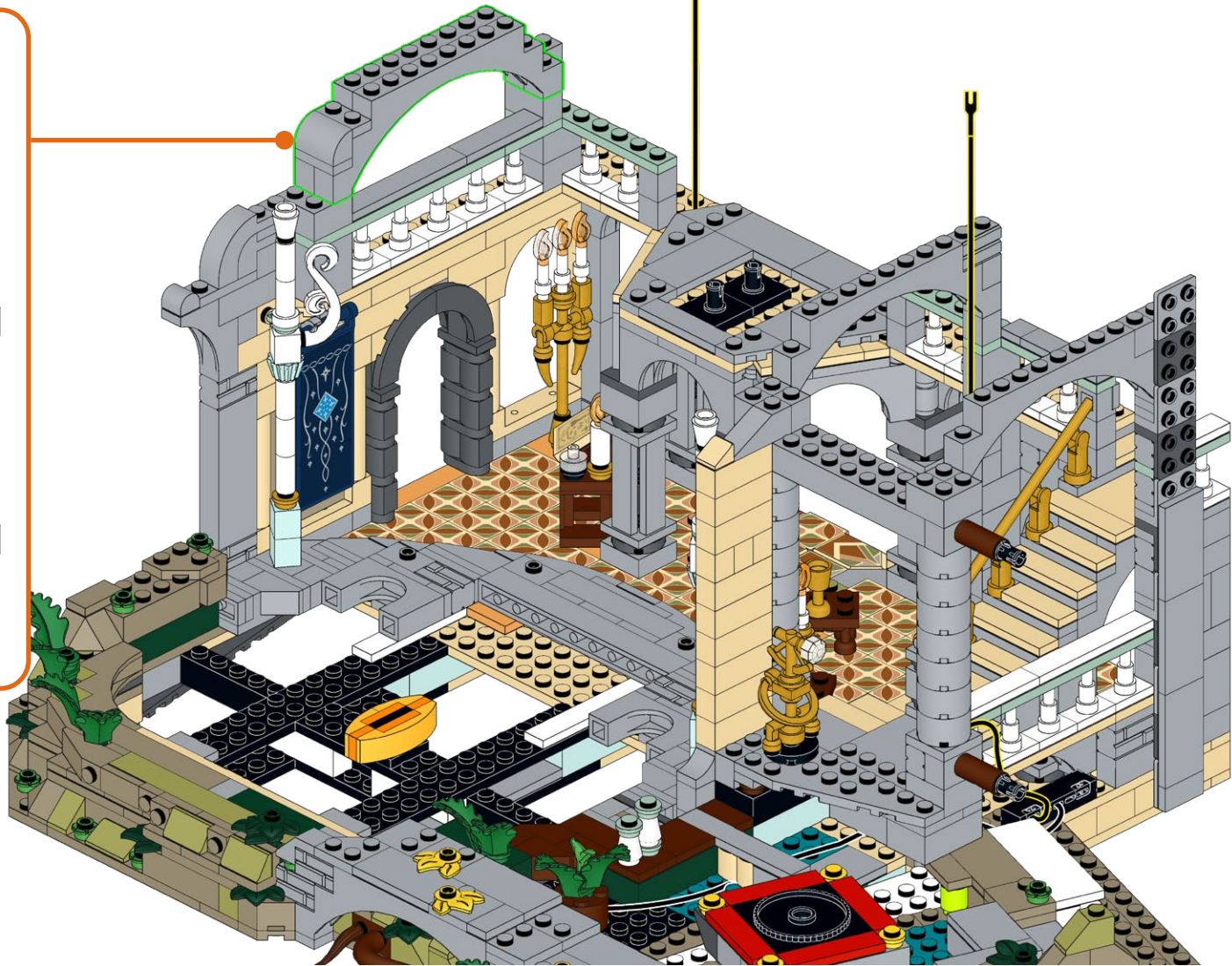
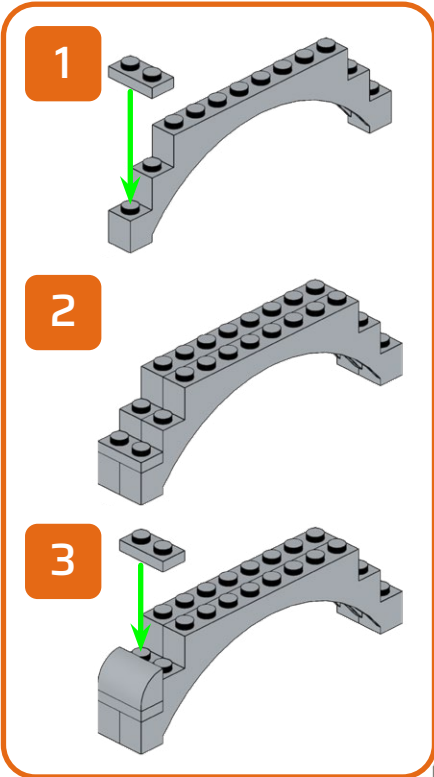
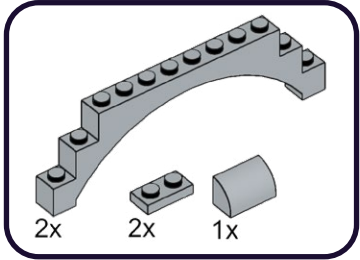

208

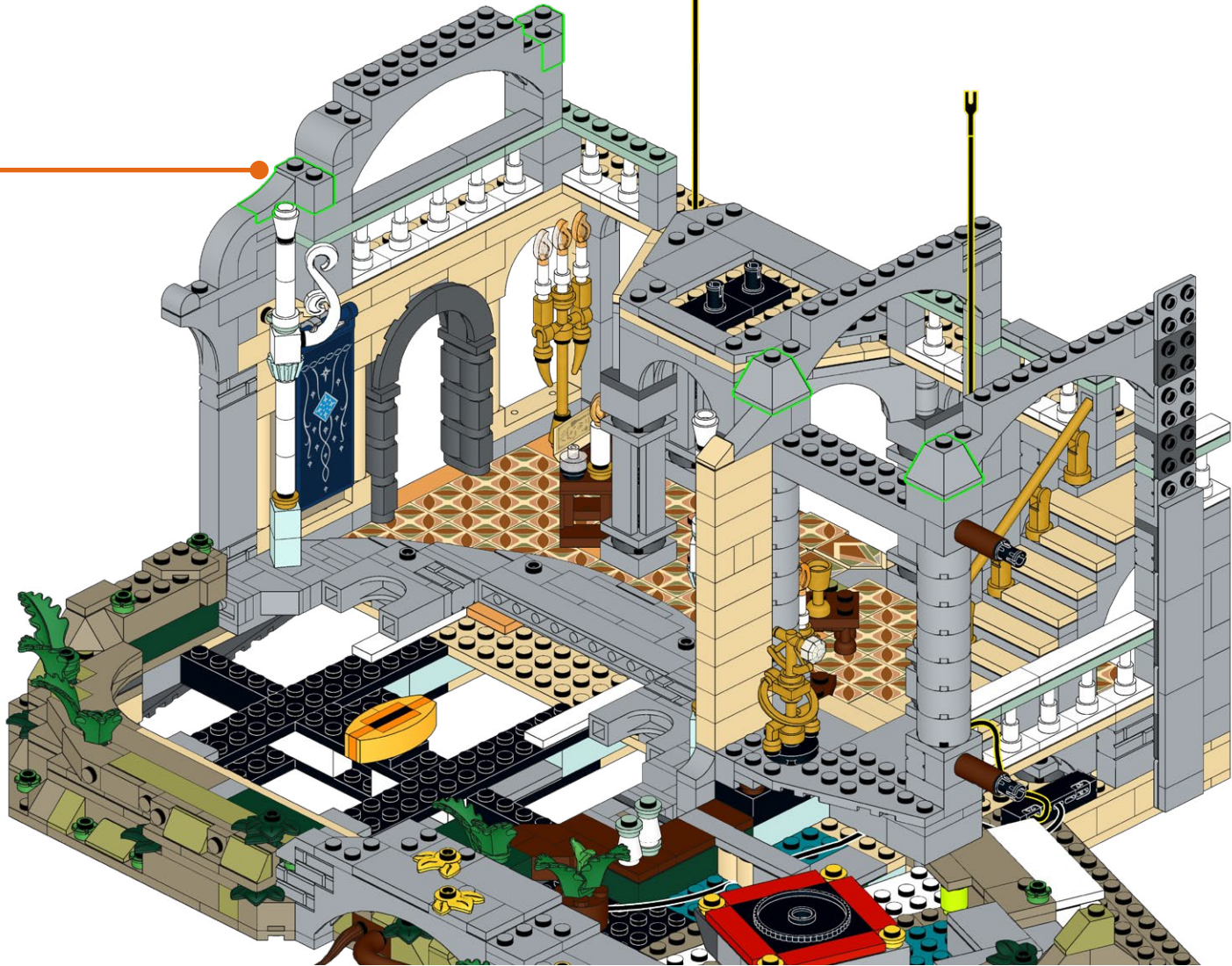
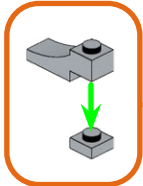
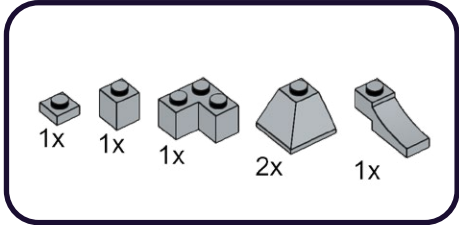



209

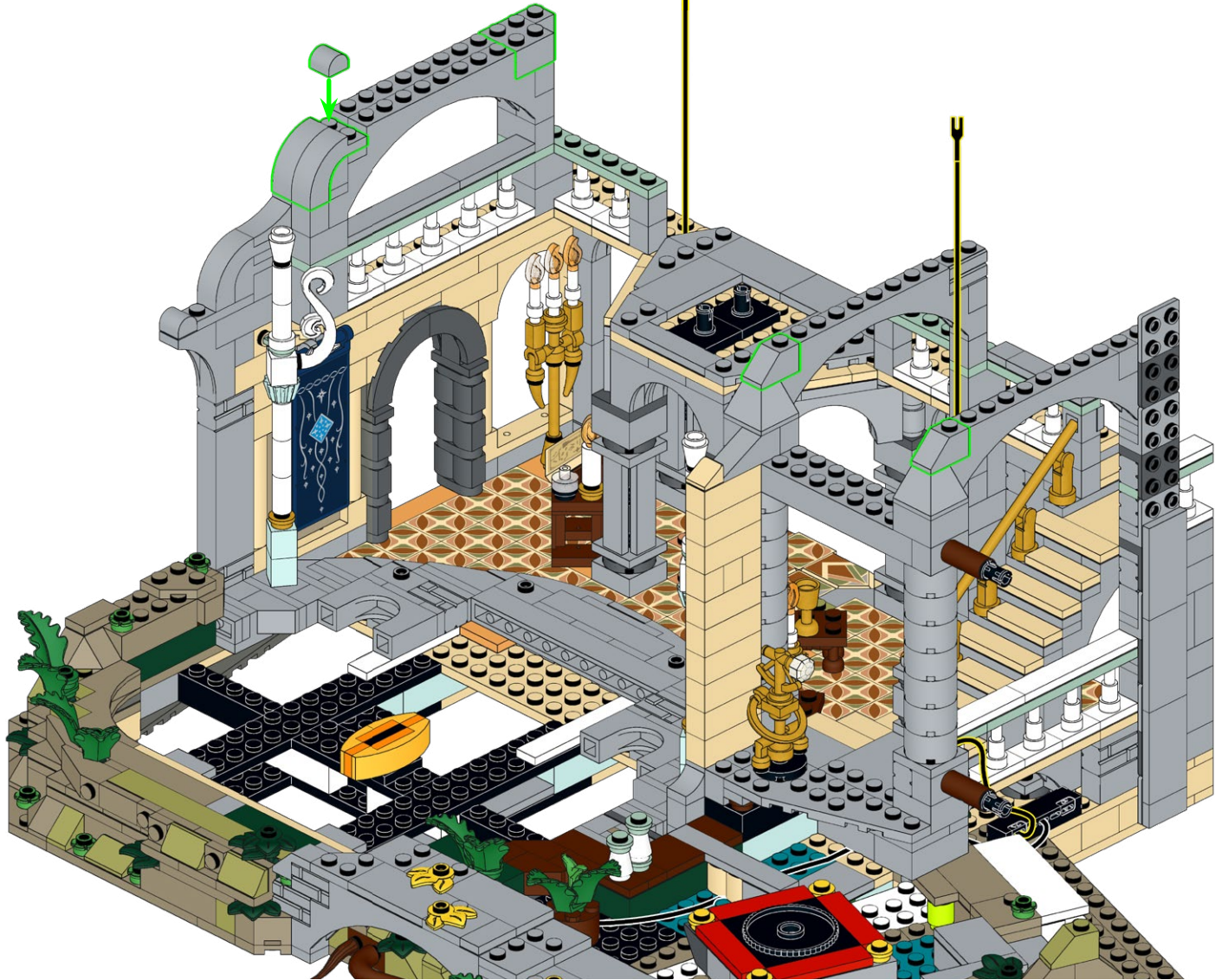
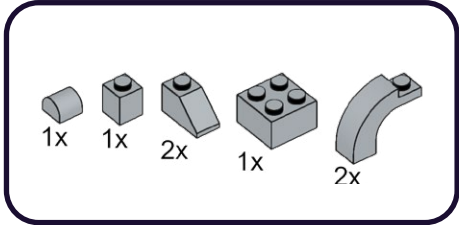



# 210

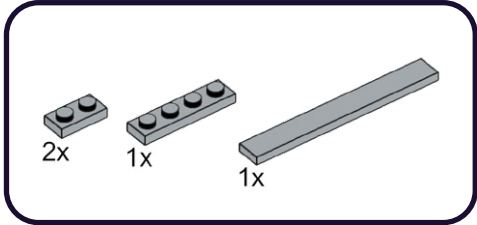

1

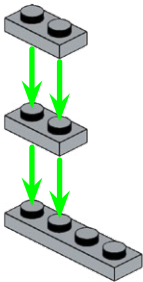

3

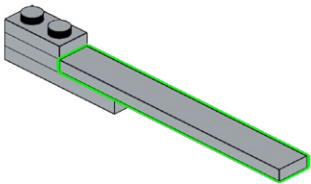

# 211

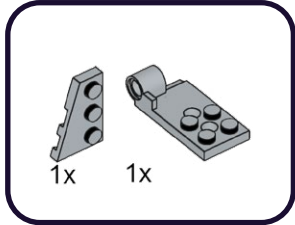

1

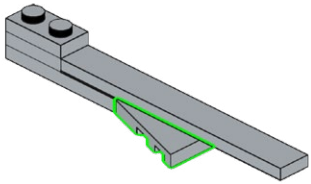

3

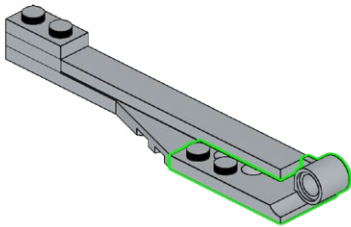

212

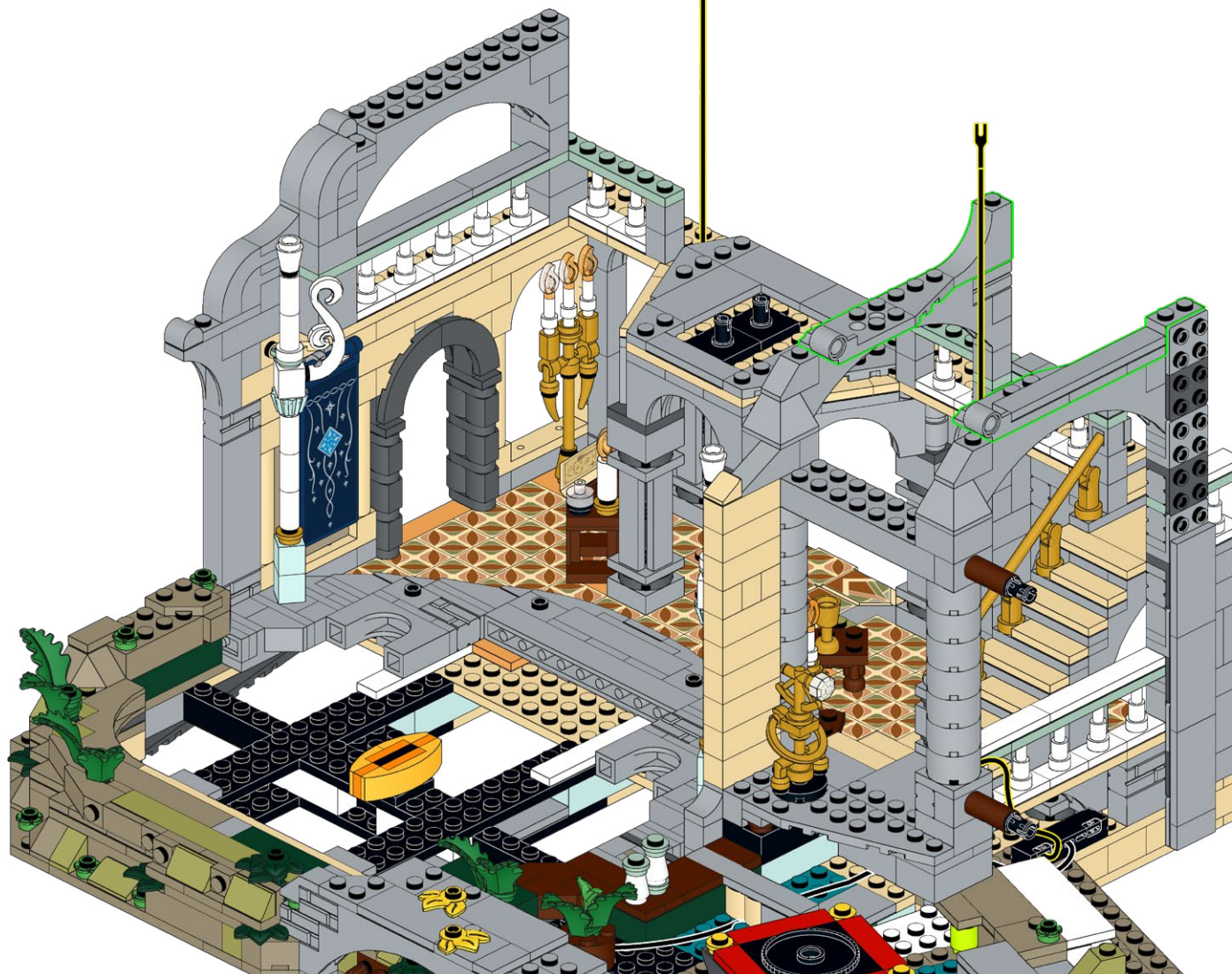
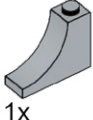
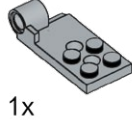

213

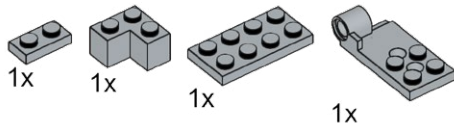



# 214

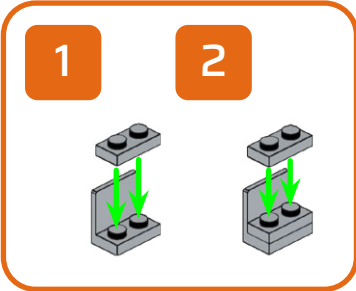
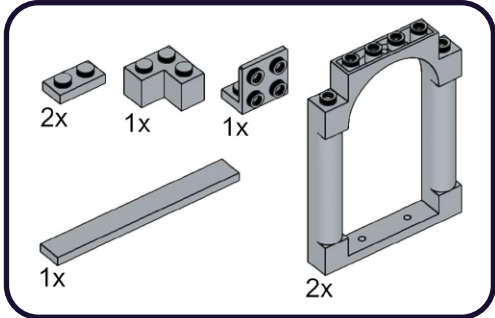

215

D-3



1x





# 216

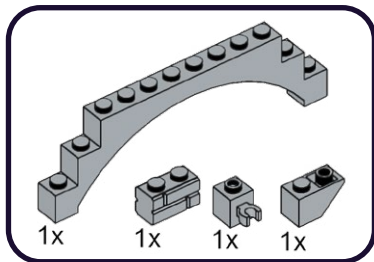

1

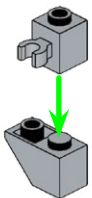

3

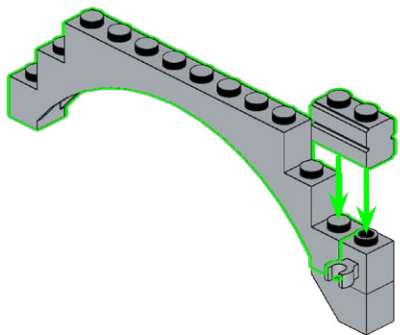

# 217

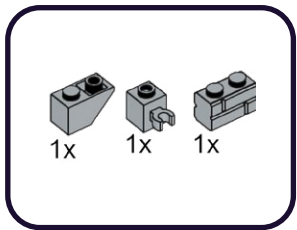

1

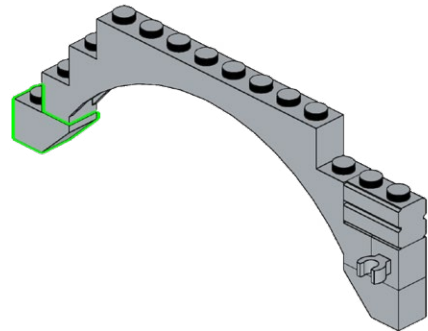

3

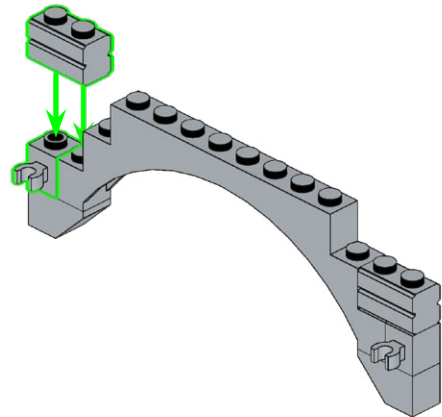



218

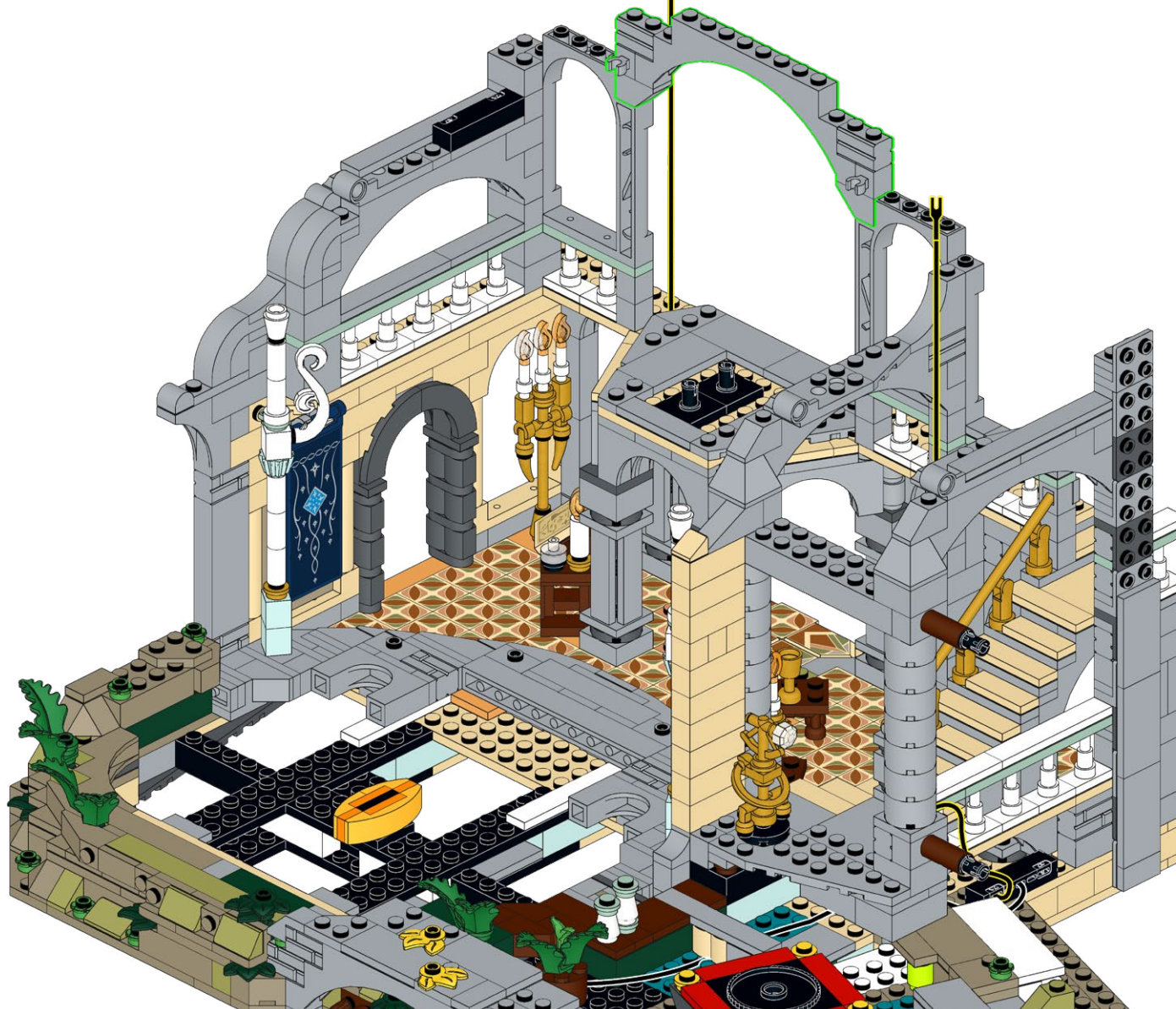

# 219

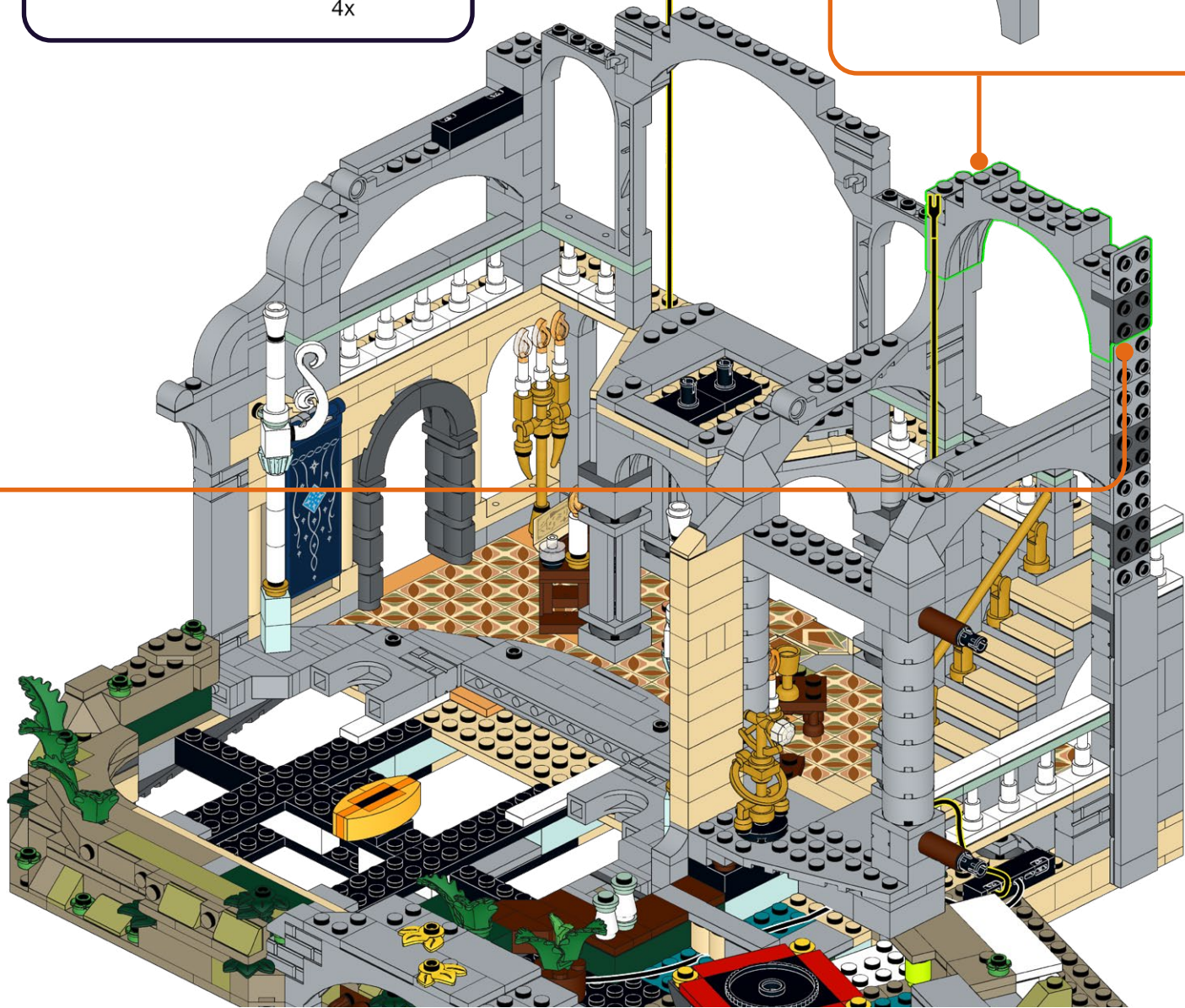
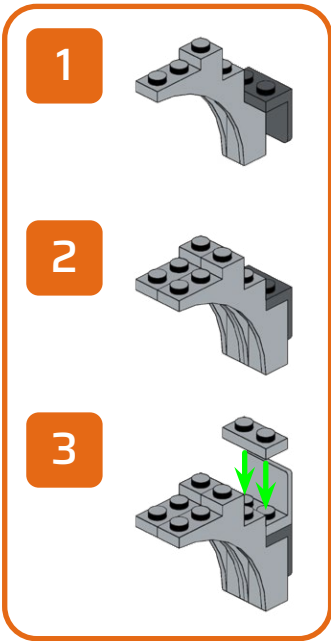
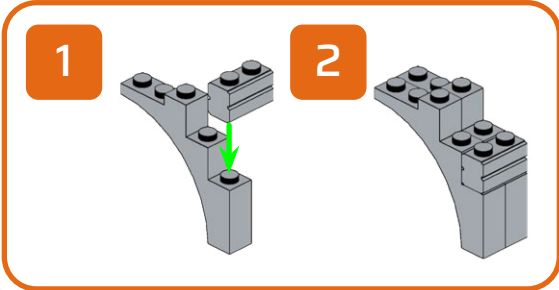
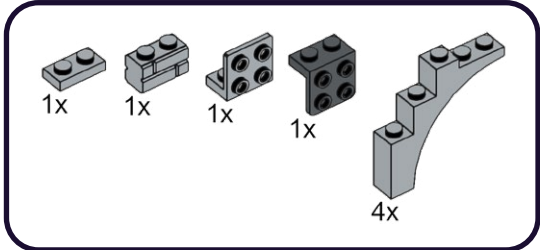



220





221

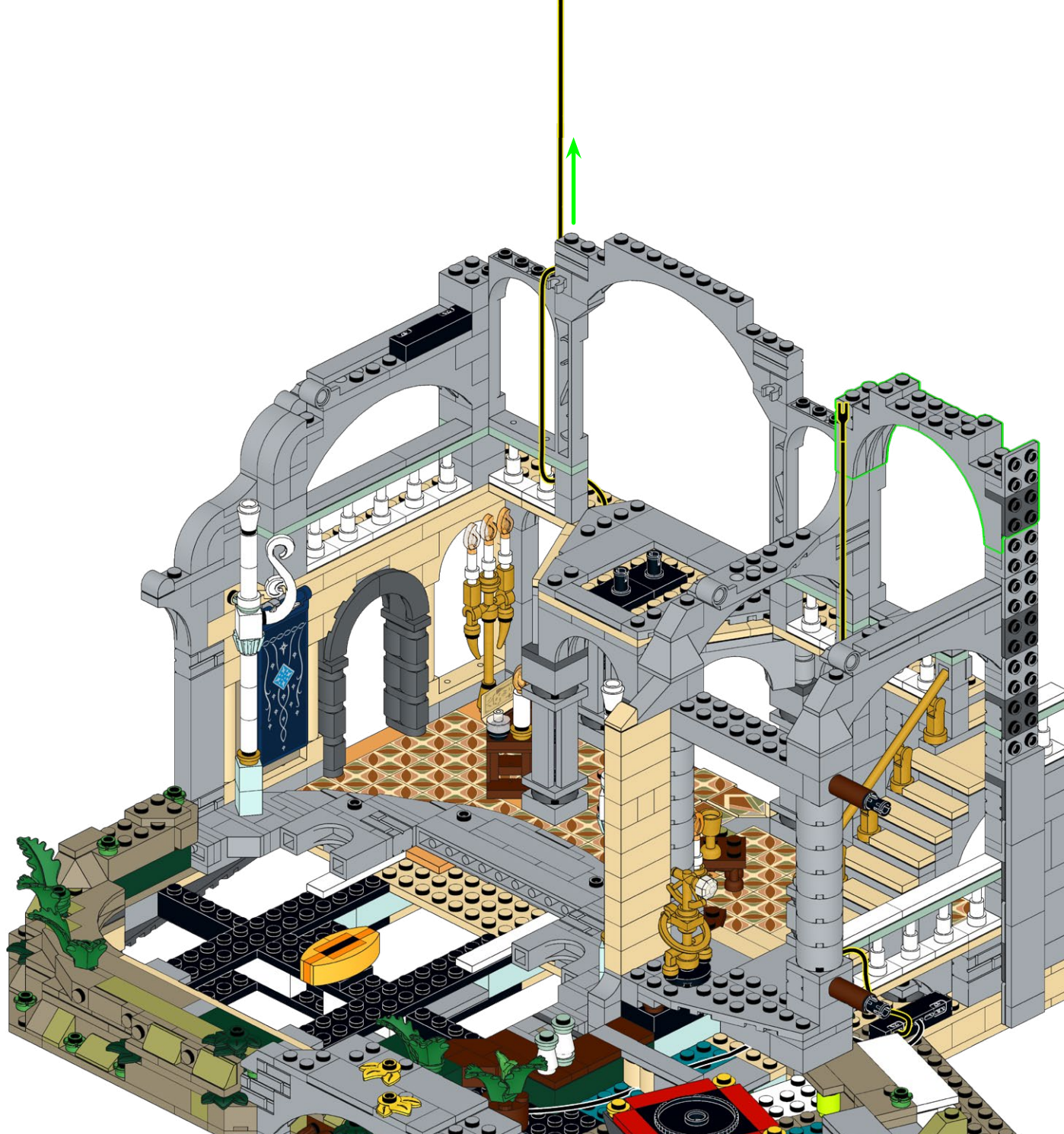

# 222

- 2x [1x1 grey brick]
- 1x [1x2 grey brick]
- 2x [1x3 grey brick]
- 2x [1x4 grey brick]
- 4x [1x2 grey brick with hole]
- 1x [1x2 grey brick with hole]

- 1 [1x2 grey brick]
- 2 [1x4 grey brick]

- 1 [1x2 grey brick]
- 2 [1x2 grey brick]
- 3 [1x2 grey brick]
- 4 [1x2 grey brick]

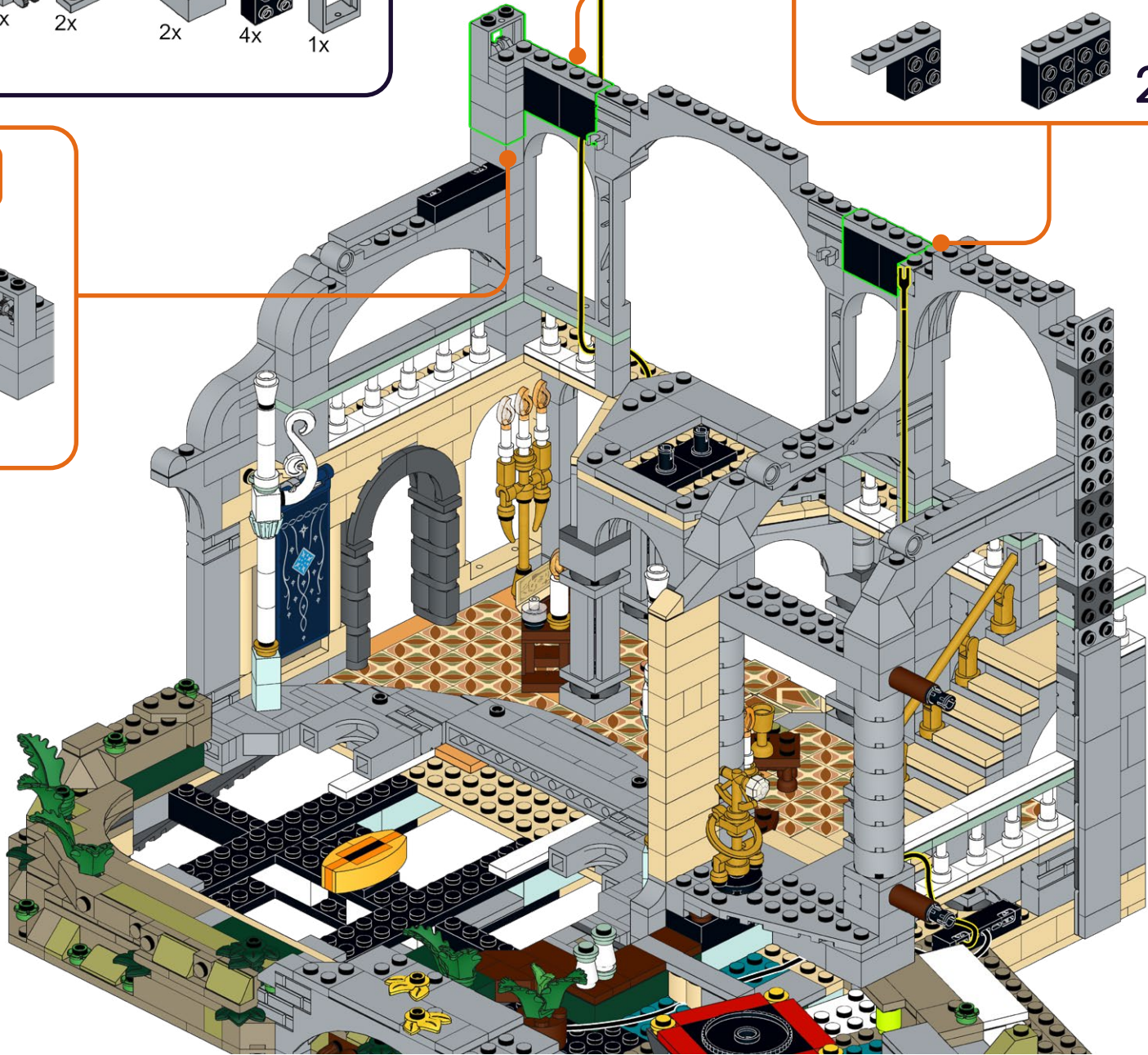



223

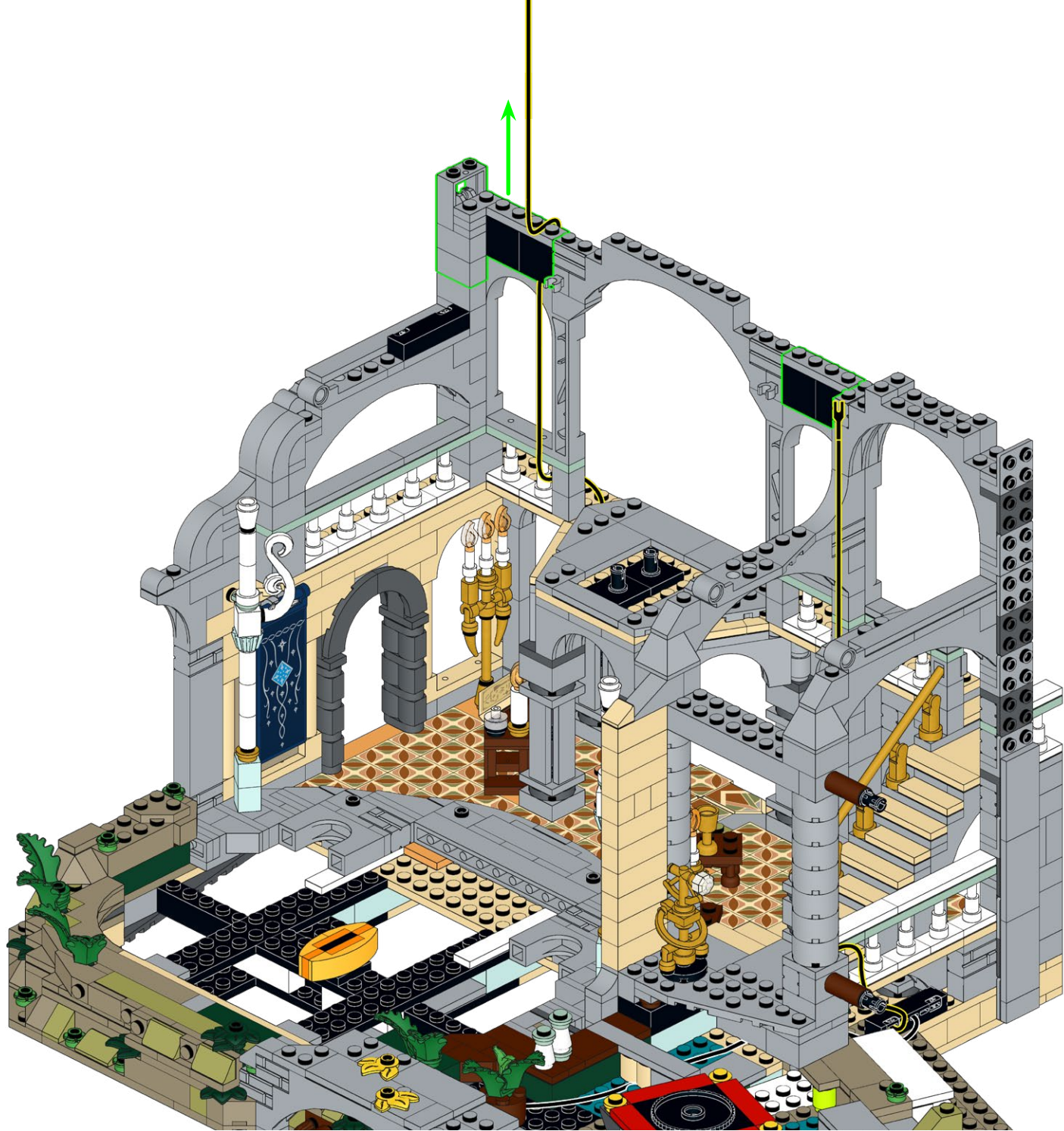



224

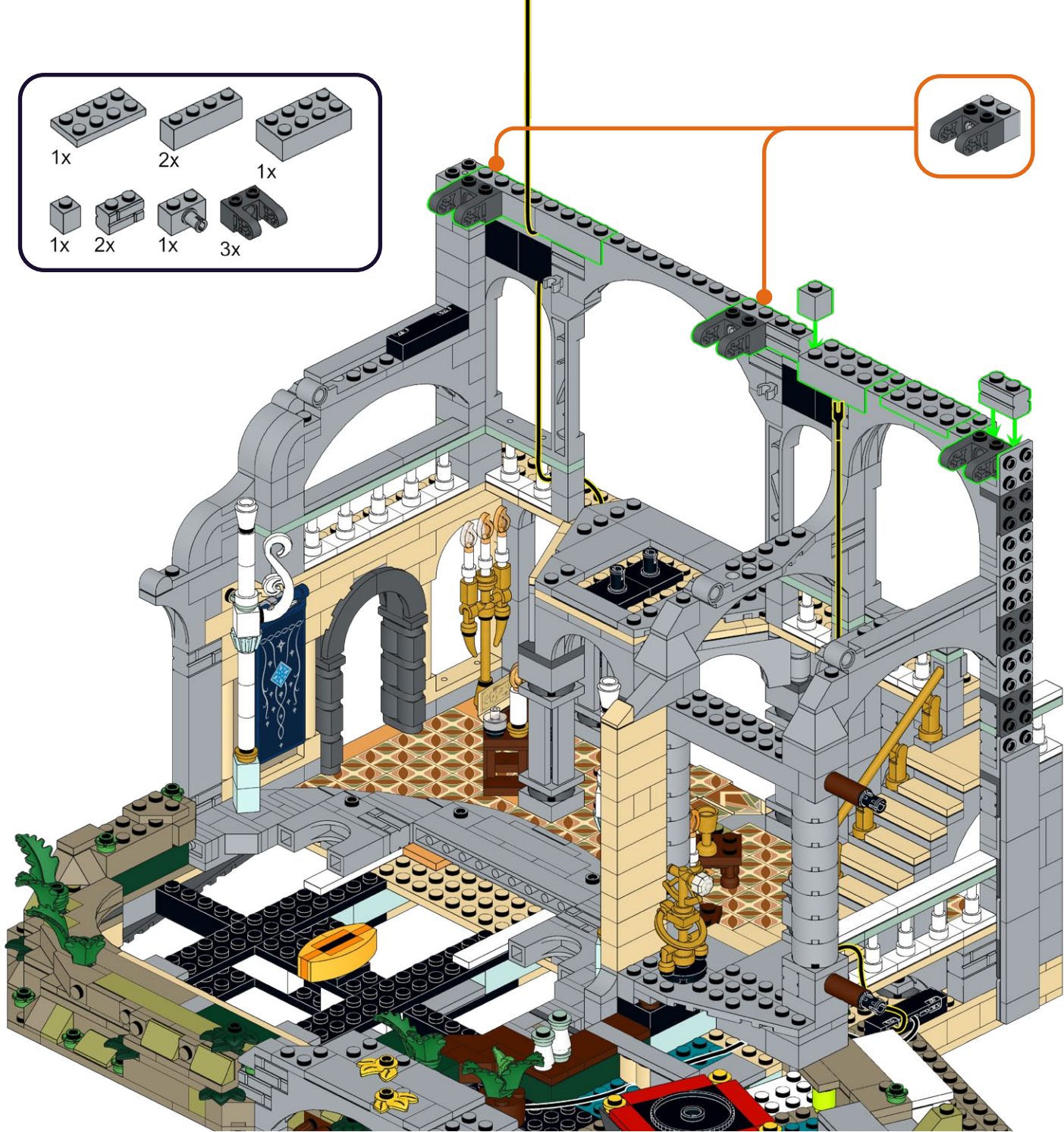
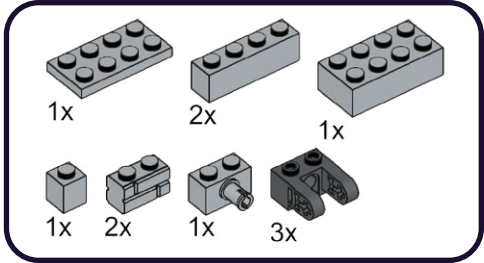

225

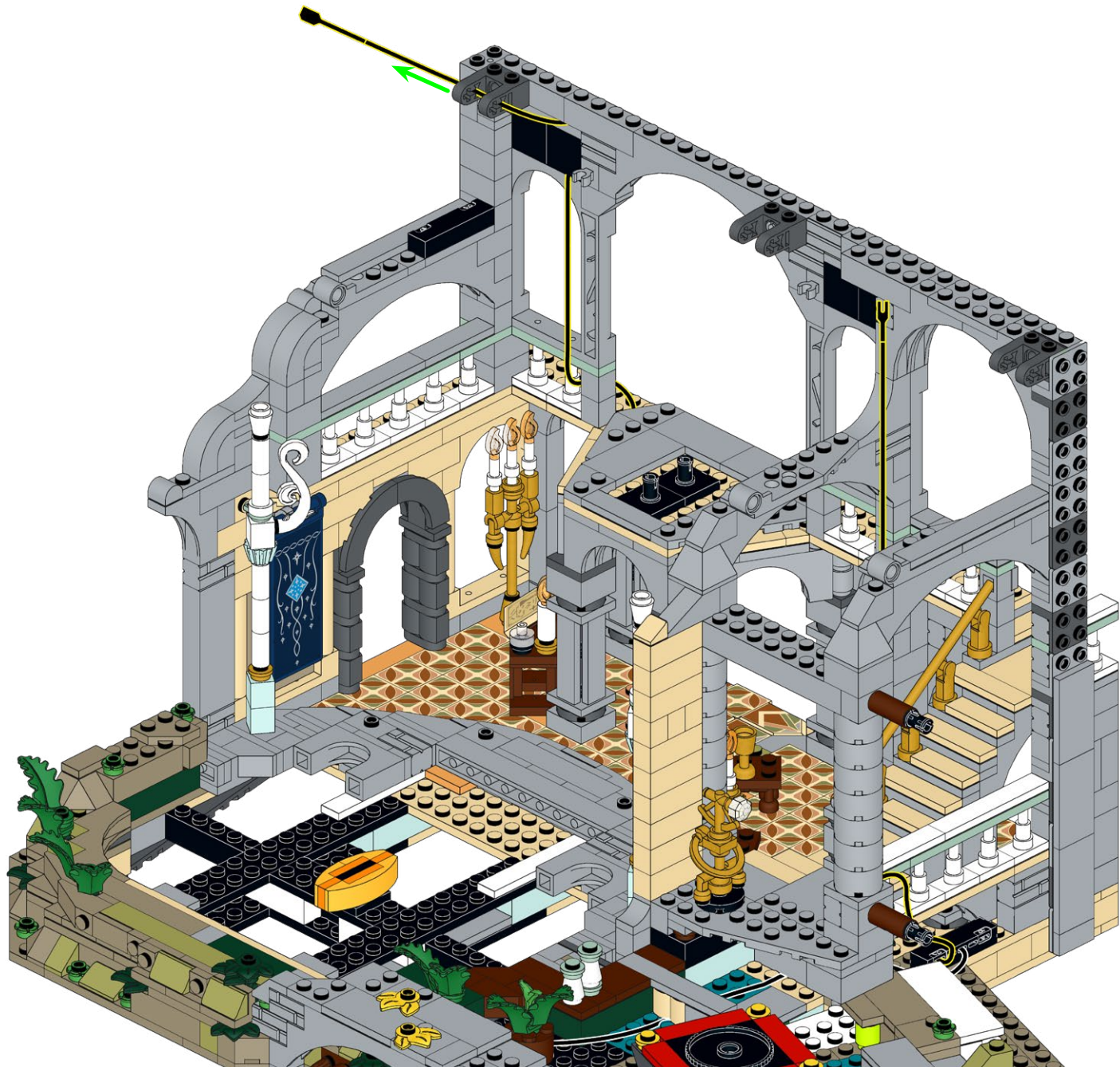



226

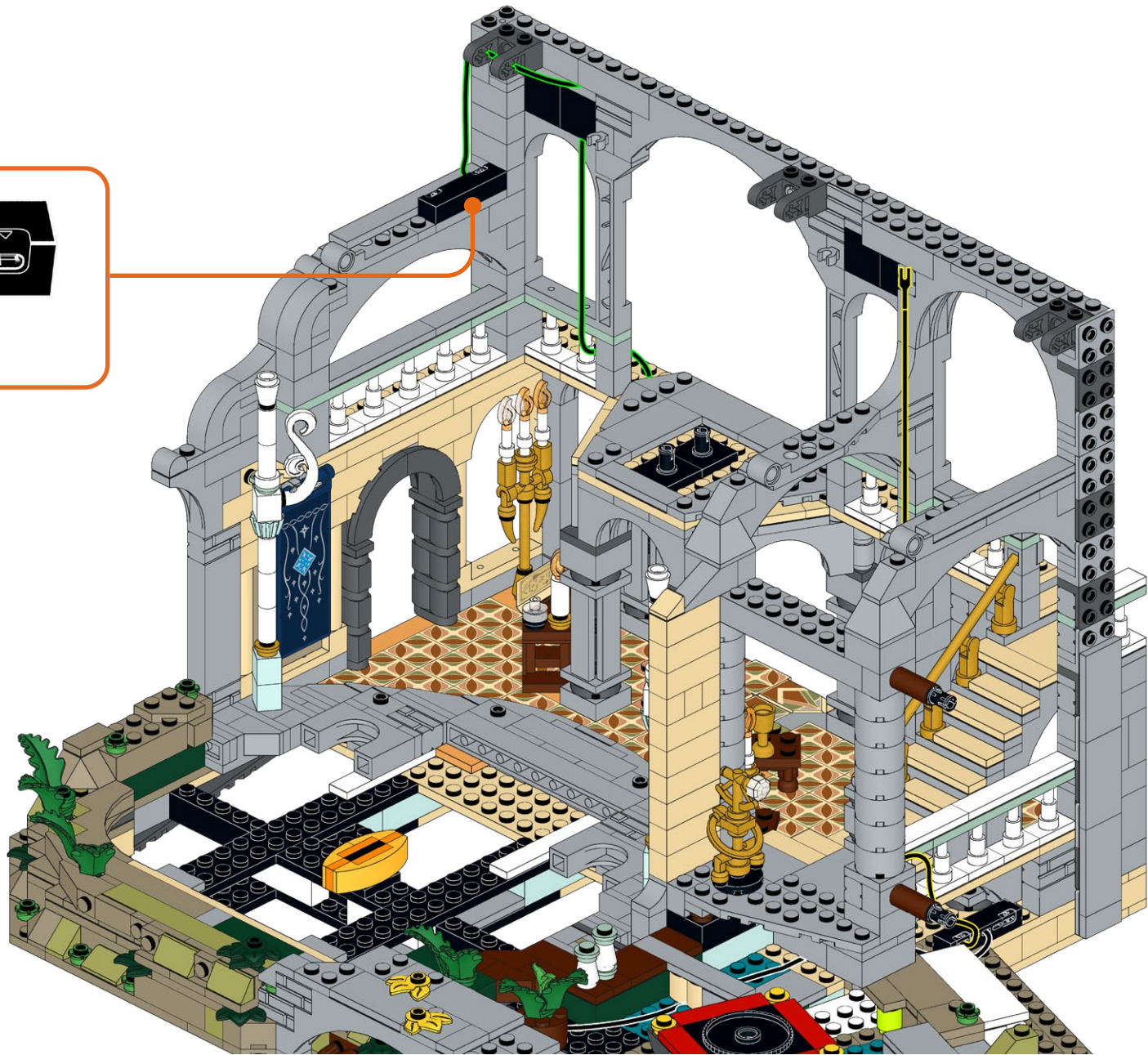
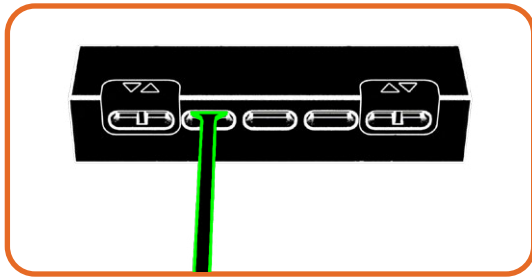



# 227

- 1x
- 2x
- 1x
- 1x
- 1x
- 3x

- 
- 
- 
- 

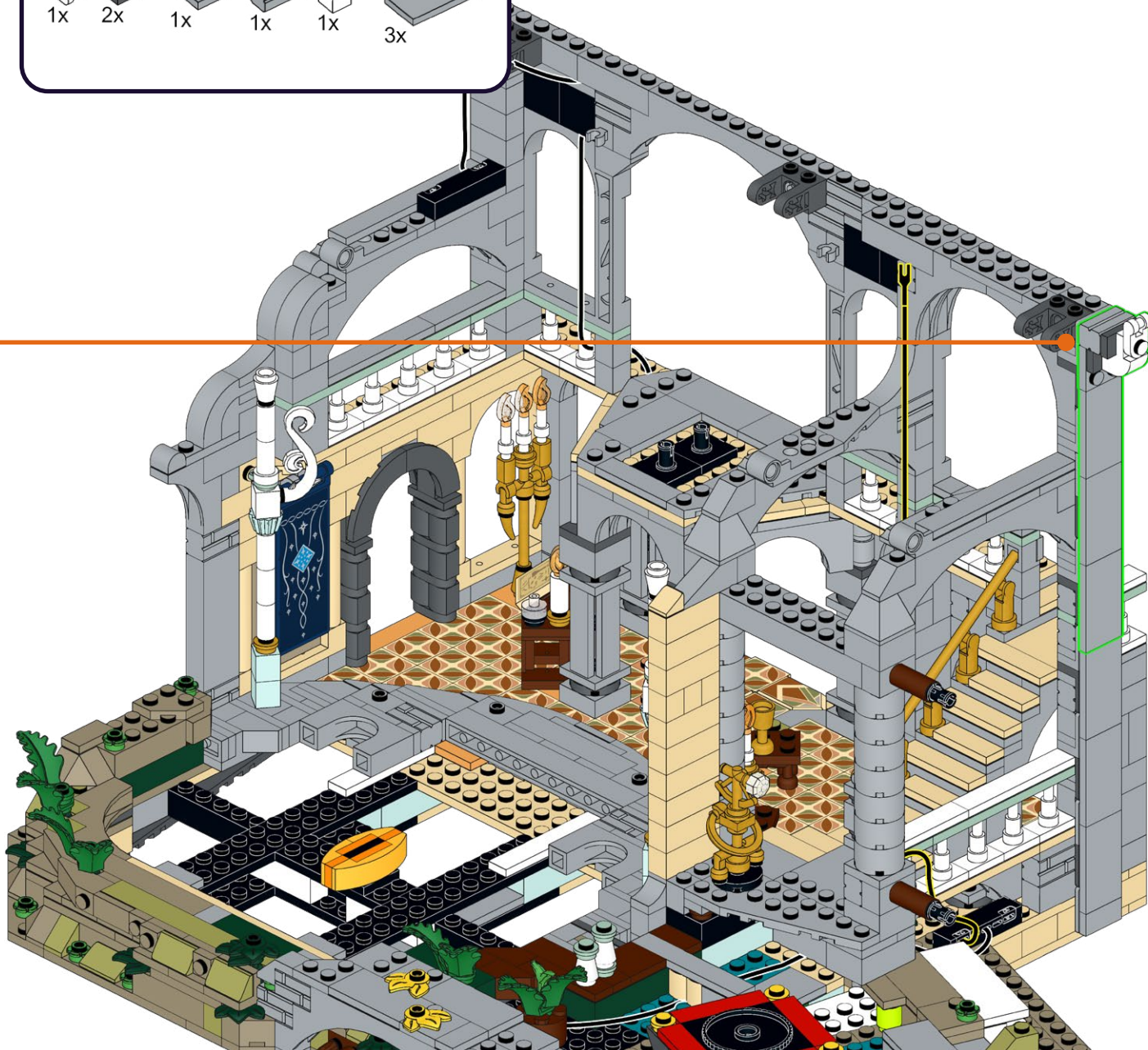



### **HOLD UP!**

You might notice some bags aren't in order, as well as left over pieces, but that's ok! We're changing the way you build LEGO!

### **ATTENDEZ!**

Vous remarquerez peut-être que certains sacs, ainsi que certaines pièces, ne sont pas dans le bon ordre. Mais pas de panique! Nous changeons simplement la façon avec laquelle vous construisez vos LEGO!

### **ASPETTA!**

Potresti notare che alcuni sacchetti non sono in ordine, così come i pezzi avanzati, ma va bene così! Stiamo cambiando il modo in cui costruisci i LEGO!

### **HALT!**

Sie werden möglicherweise bemerken, dass einige tüten durcheinander sind und teile übrig bleiben, aber das ist in Ordnung! Wir ändern die art und weise, wie Sie LEGO bauen!

### **¡ESPERA!**

Es posible que notes que algunas bolsas están fuera de servicio, así como piezas sobrantes, ¡pero está bien! ¡Estamos cambiando la forma en que construyes LEGO!

### **暫停!**

你可能会注意到一些袋子顺序错乱, 以及一些剩余的部件, 但没关系! 我们正在改变你搭建乐高的方式!

### Open LEGO® Bag 35

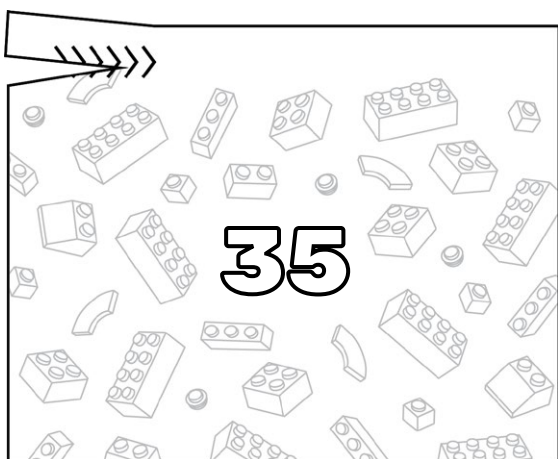



228

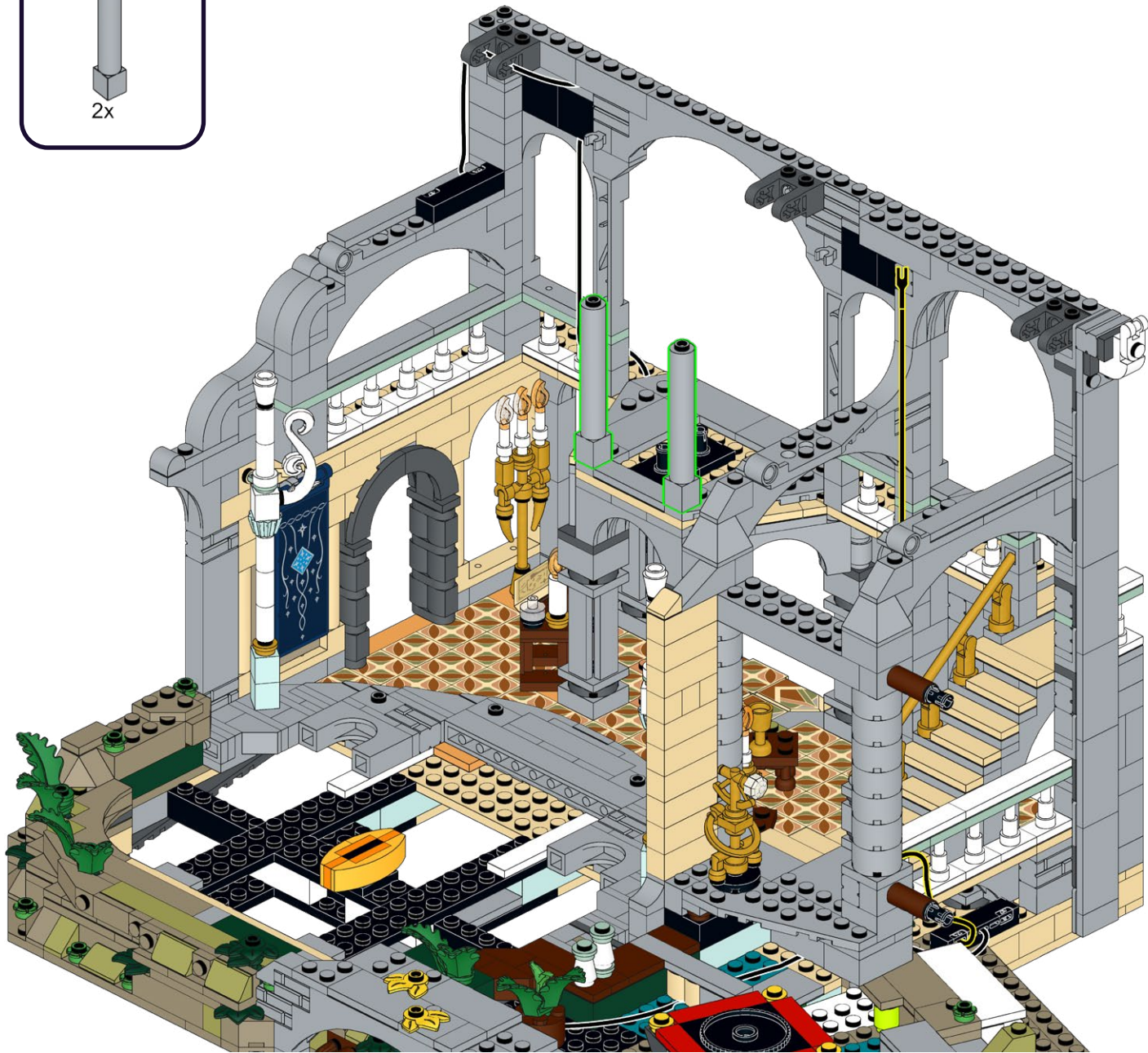
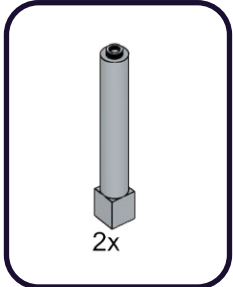



229

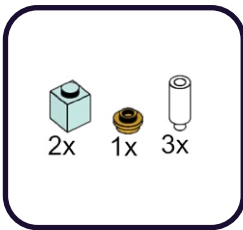
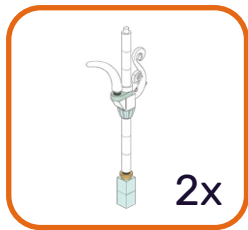

1

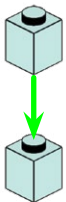

2

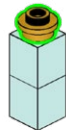

3

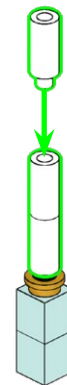



231

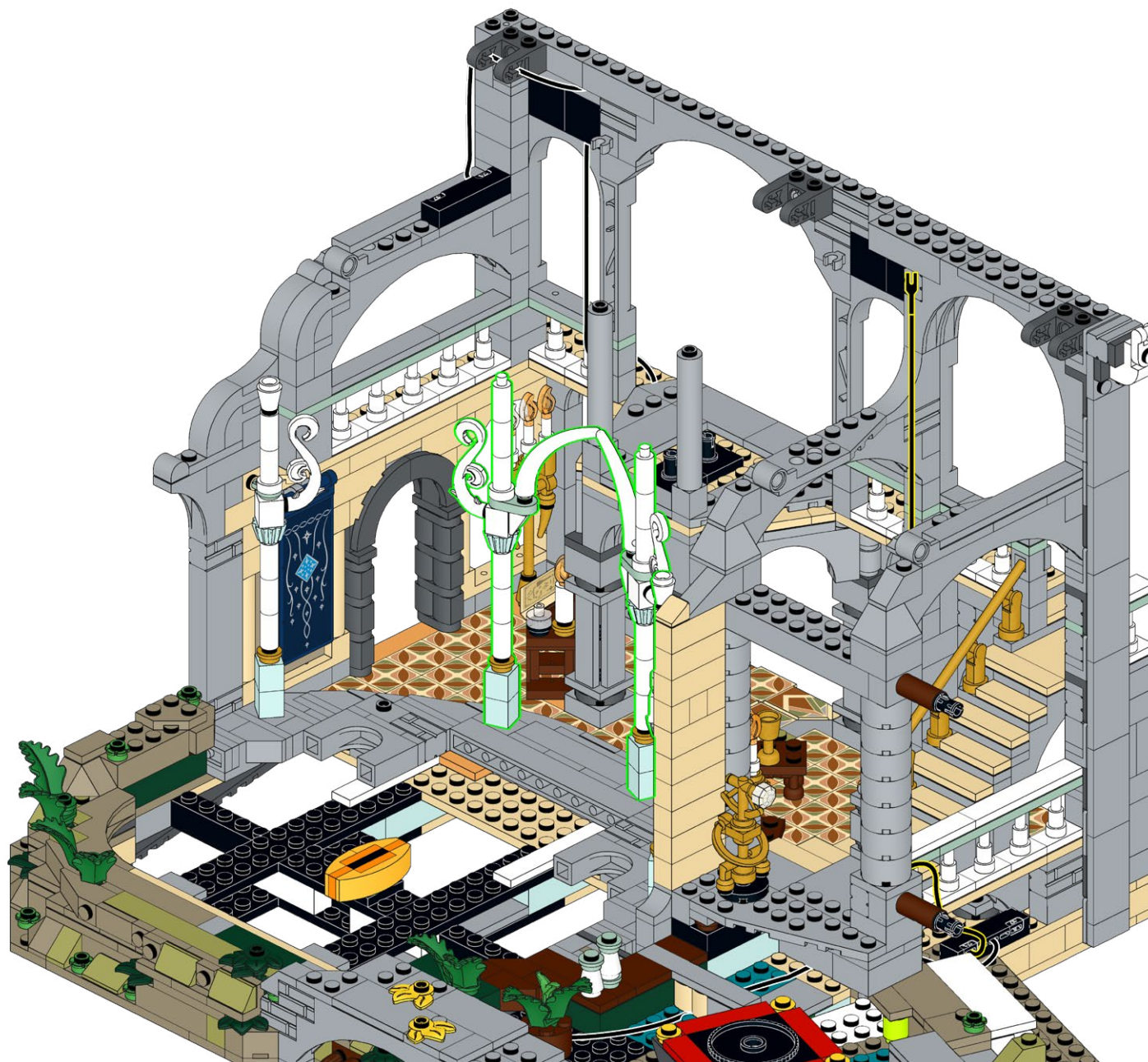



232

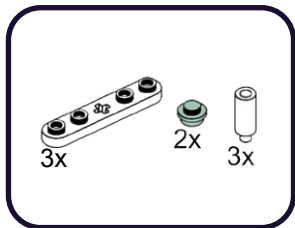

1



2

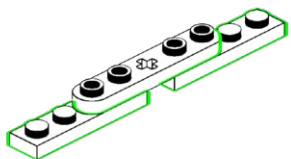

3

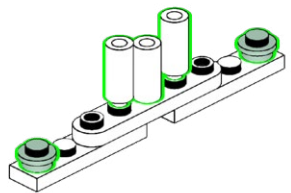

233

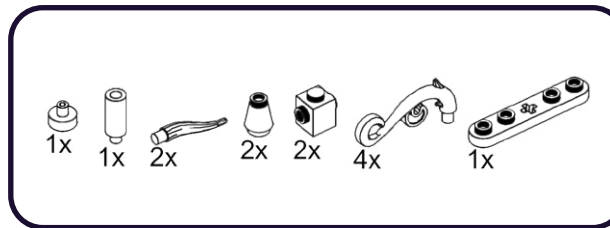

1

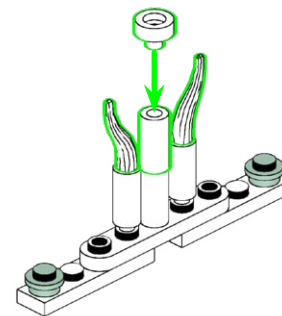

2

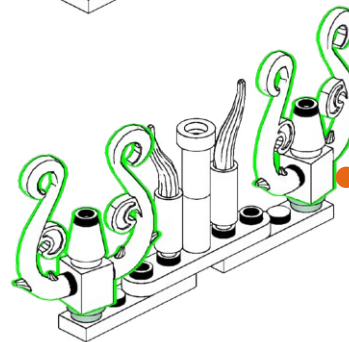

3

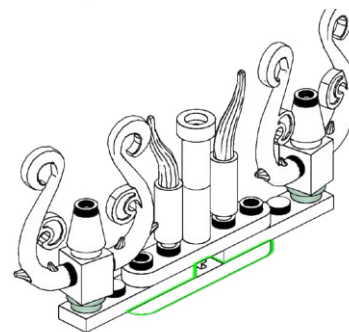

1



2



2x

234



**235**

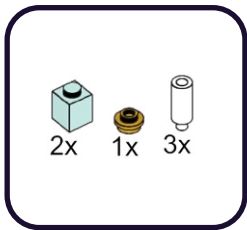
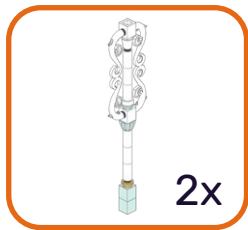

**1**

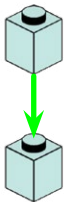

**2**

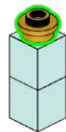

**3**





236

- 1x
- 1x
- 1x
- 1x
- 1x

1

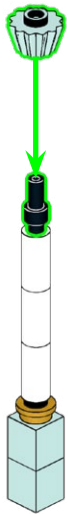

2

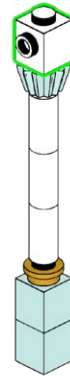

3

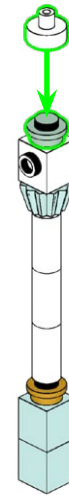

237

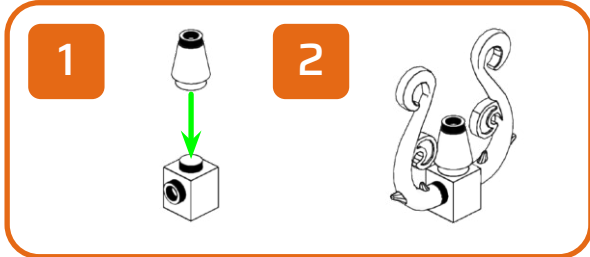
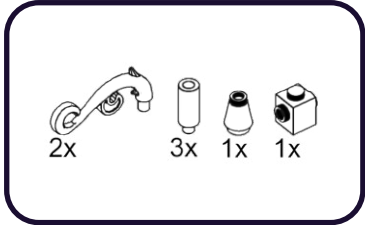

1

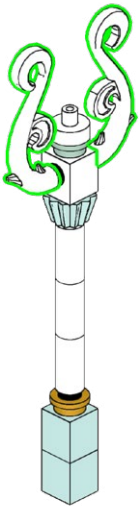

2

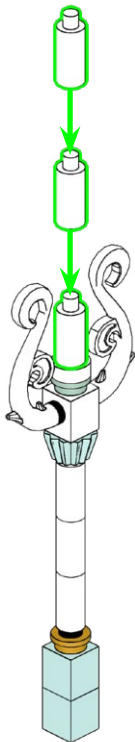

3

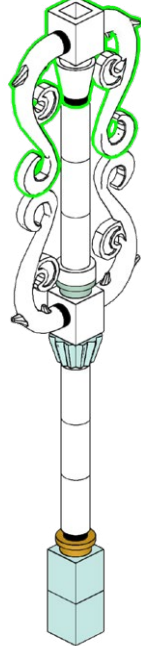

2x

238





239

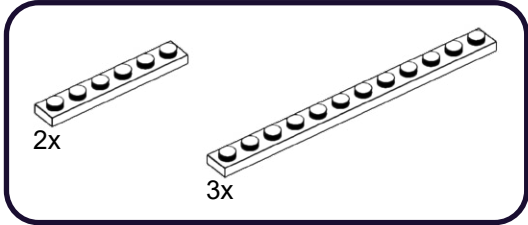

1

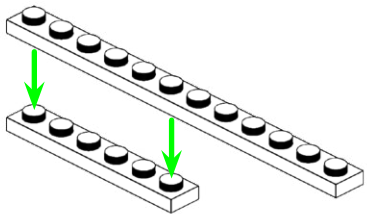

2

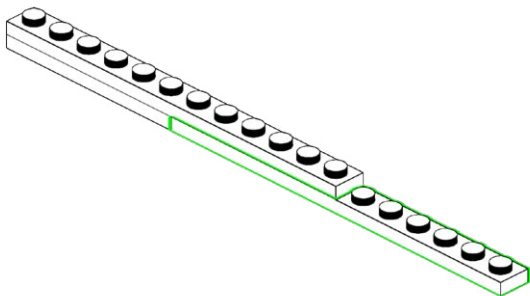

3

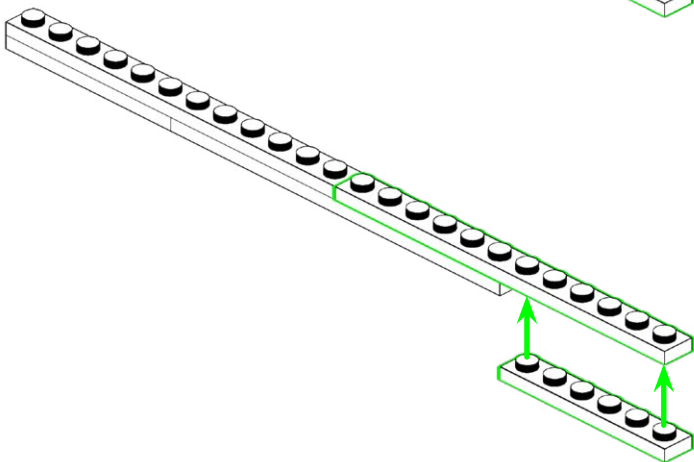

240

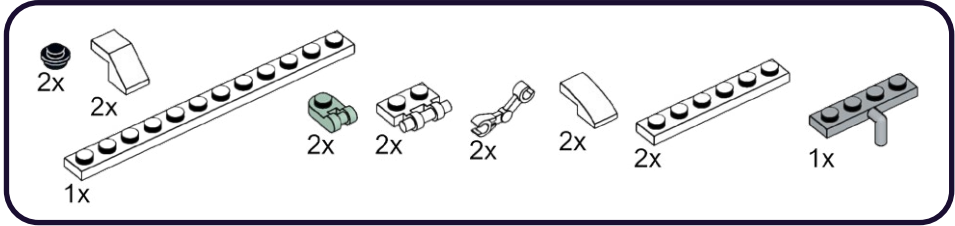

2x

1

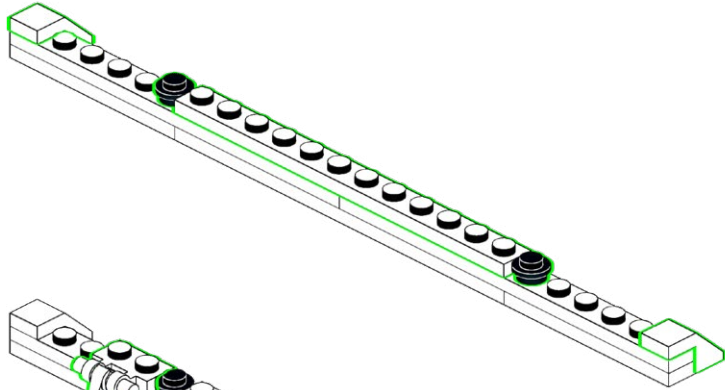

2

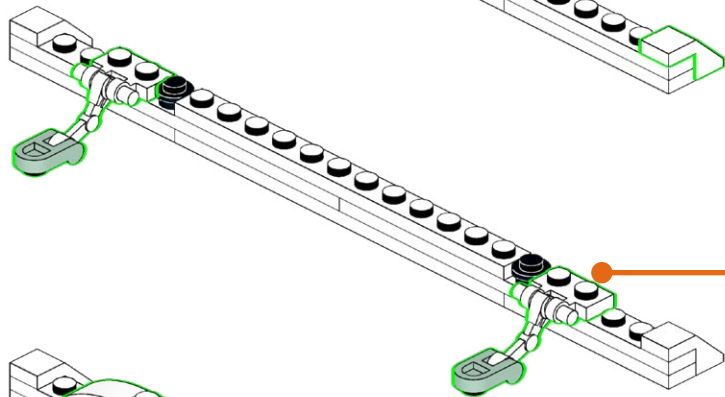

3

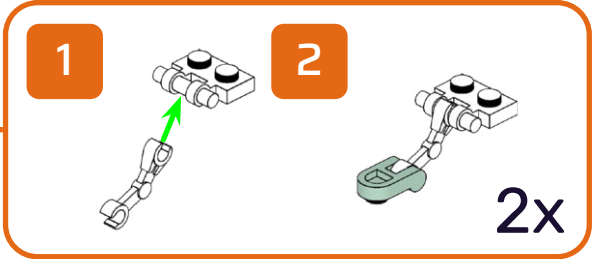
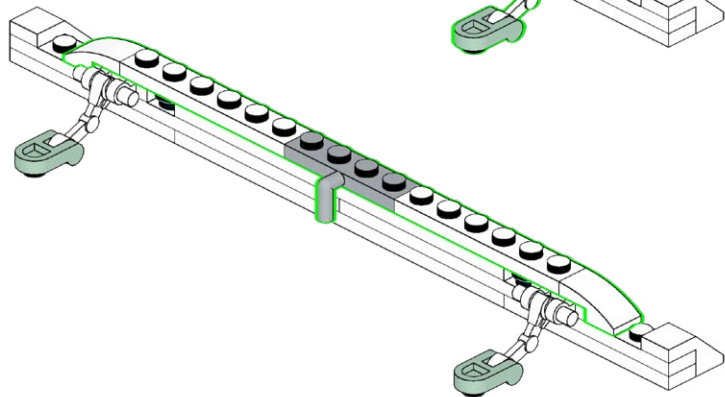

241

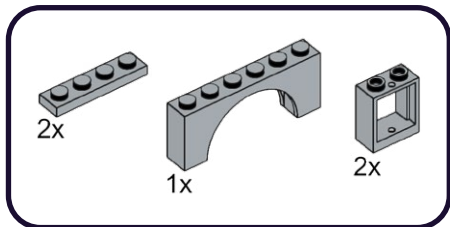

1

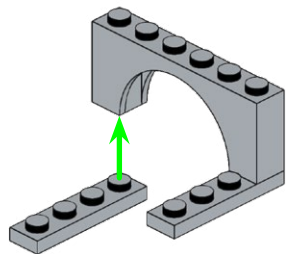

3

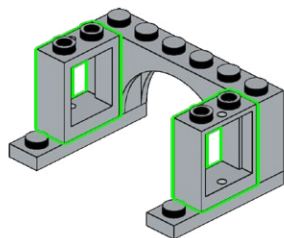

242

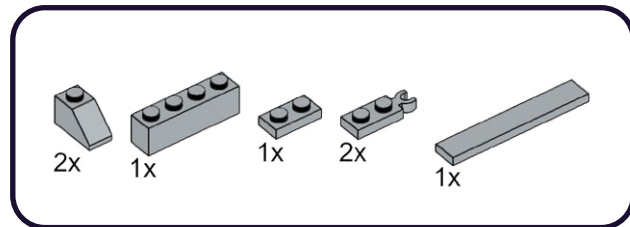

1

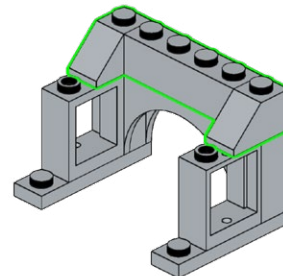

3

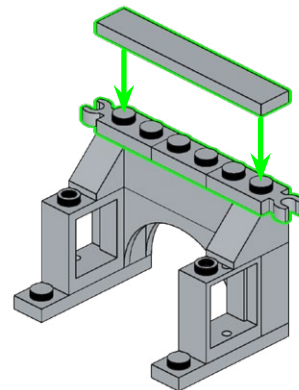



243



1

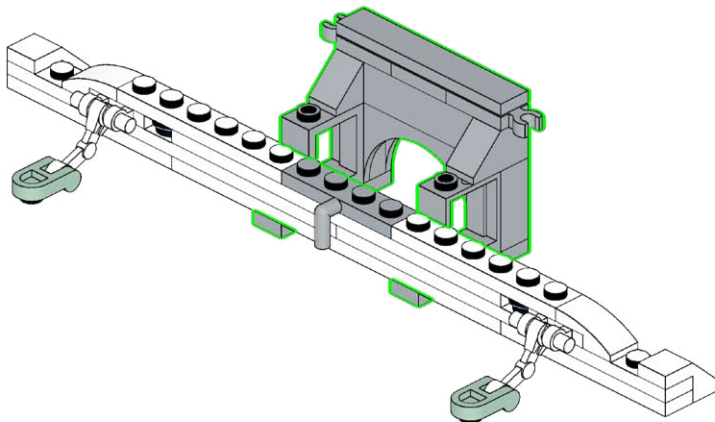

3

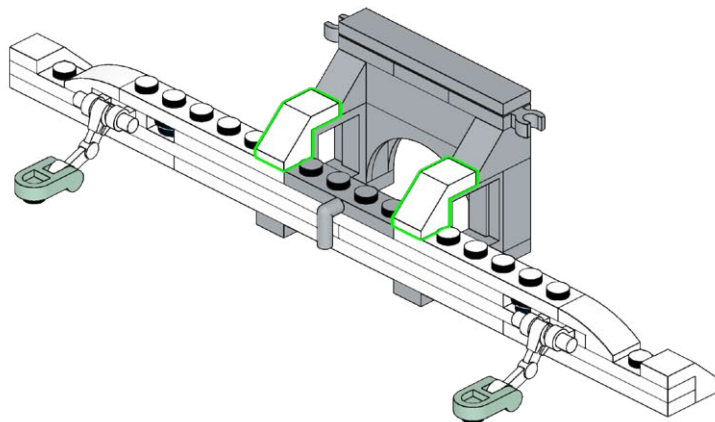

244

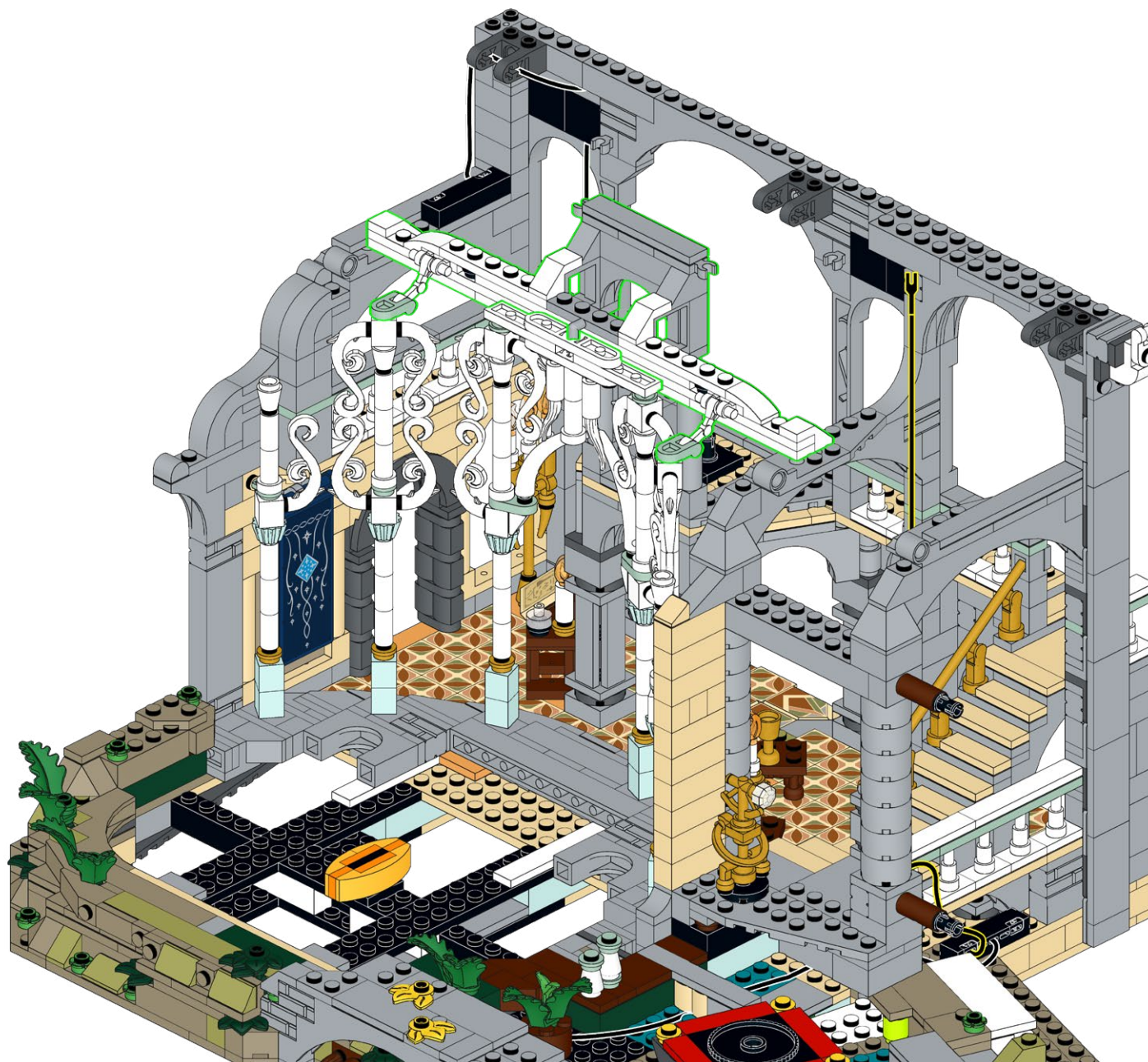



245

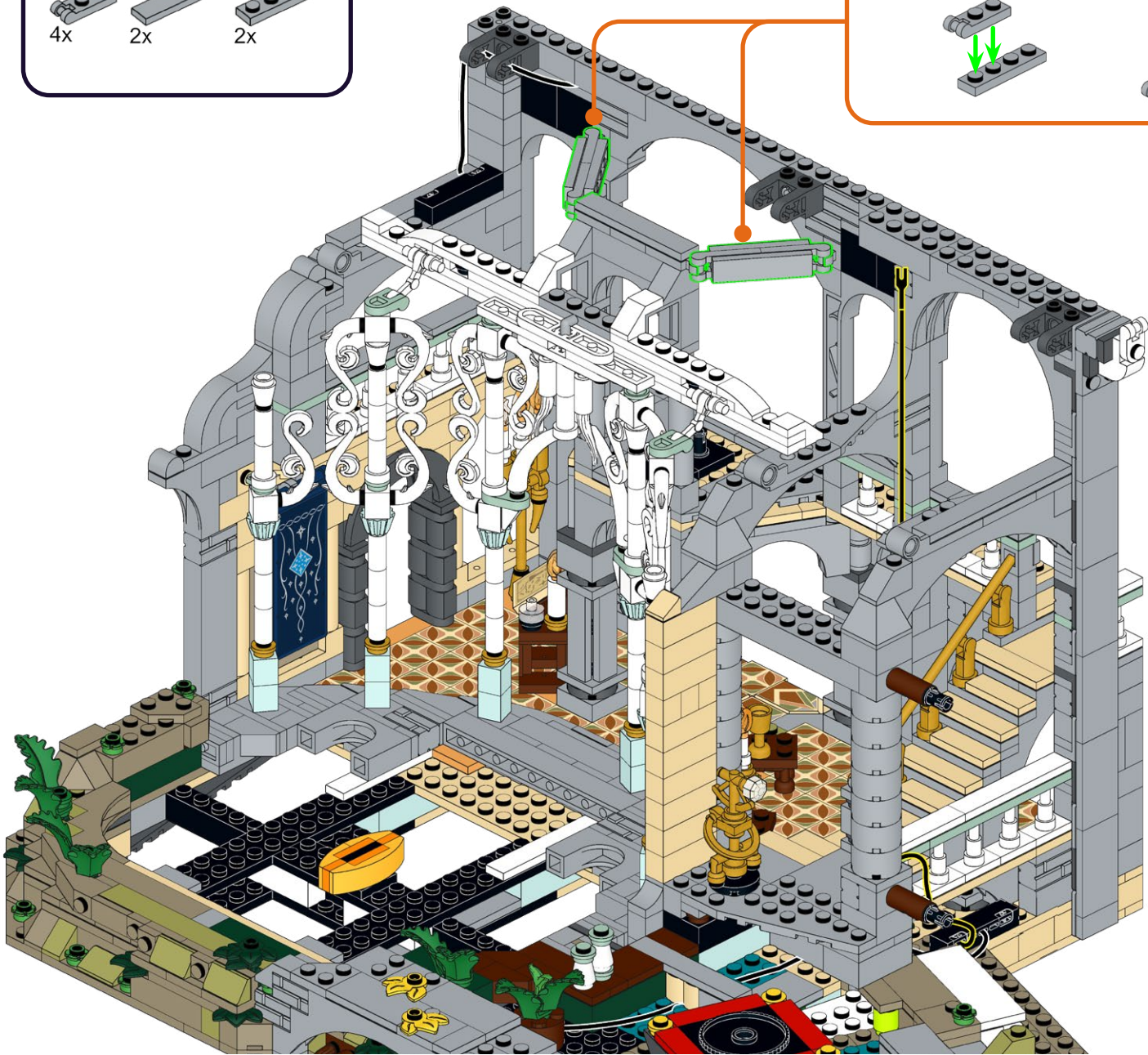
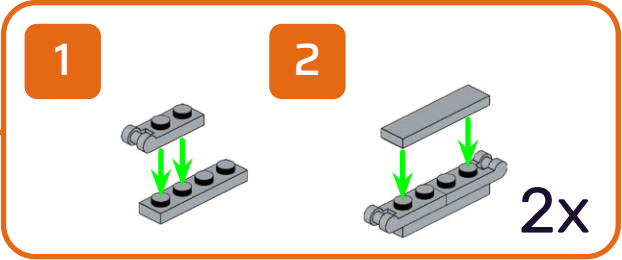
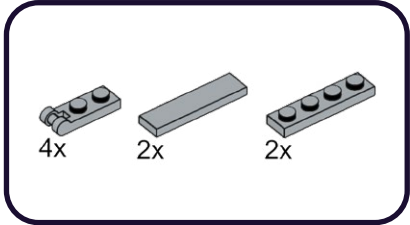



**HOLD UP!**

You might notice some bags aren't in order, as well as left over pieces, but that's ok! We're changing the way you build LEGO!

**ATTENDEZ!**

Vous remarquerez peut-être que certains sacs, ainsi que certaines pièces, ne sont pas dans le bon ordre. Mais pas de panique! Nous changeons simplement la façon avec laquelle vous construisez vos LEGO!

**ASPETTA!**

Potresti notare che alcuni sacchetti non sono in ordine, così come i pezzi avanzati, ma va bene così! Stiamo cambiando il modo in cui costruisci i LEGO!

**HALT!**

Sie werden möglicherweise bemerken, dass einige tüten durcheinander sind und teile übrig bleiben, aber das ist in Ordnung! Wir ändern die art und weise, wie Sie LEGO bauen!

**¡ESPERA!**

Es posible que notes que algunas bolsas están fuera de servicio, así como piezas sobrantes, ¡pero está bien! ¡Estamos cambiando la forma en que construyes LEGO!

**暫停!**

你可能会注意到一些袋子顺序错乱, 以及一些剩余的部件, 但没关系! 我们正在改变你搭建乐高的方式!

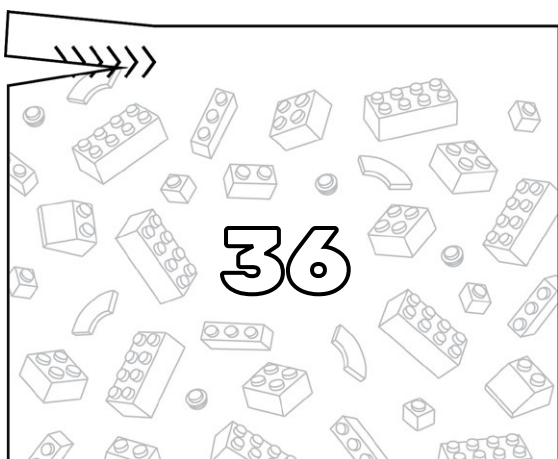
**Open LEGO® Bag 36**

246

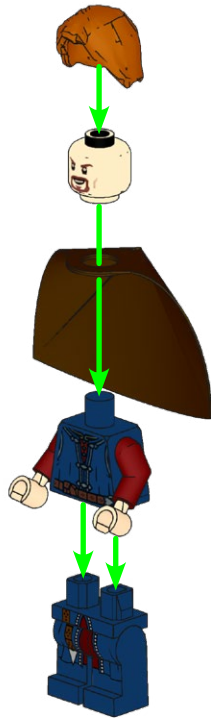
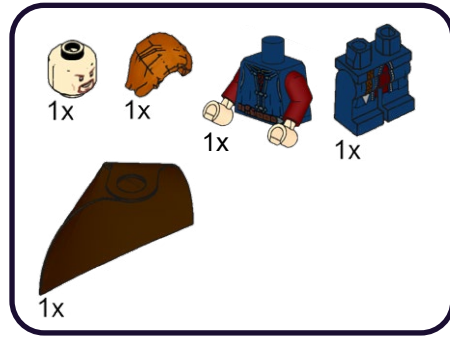

247

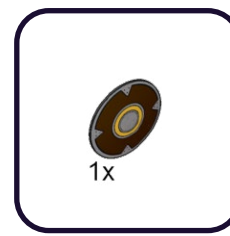

248

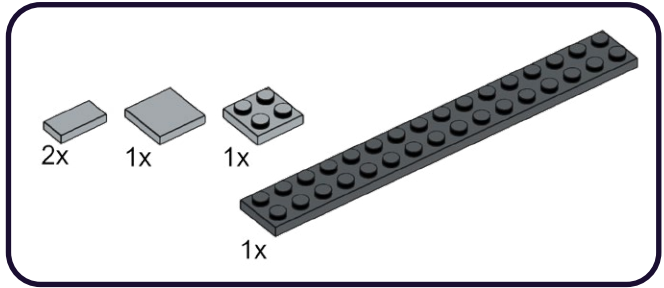

1

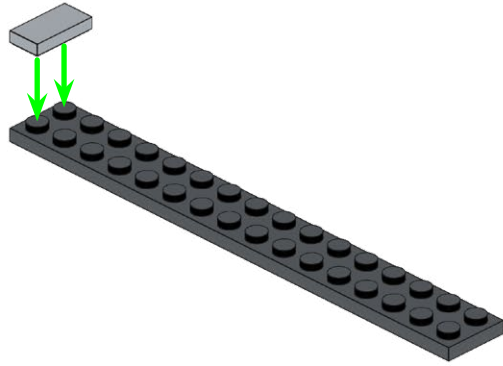

2

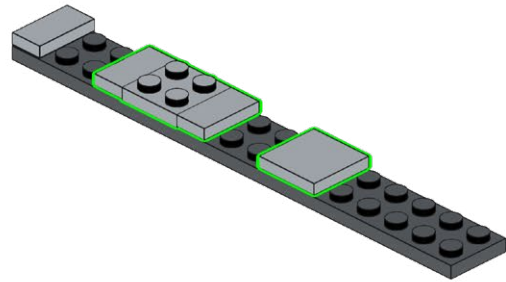



249

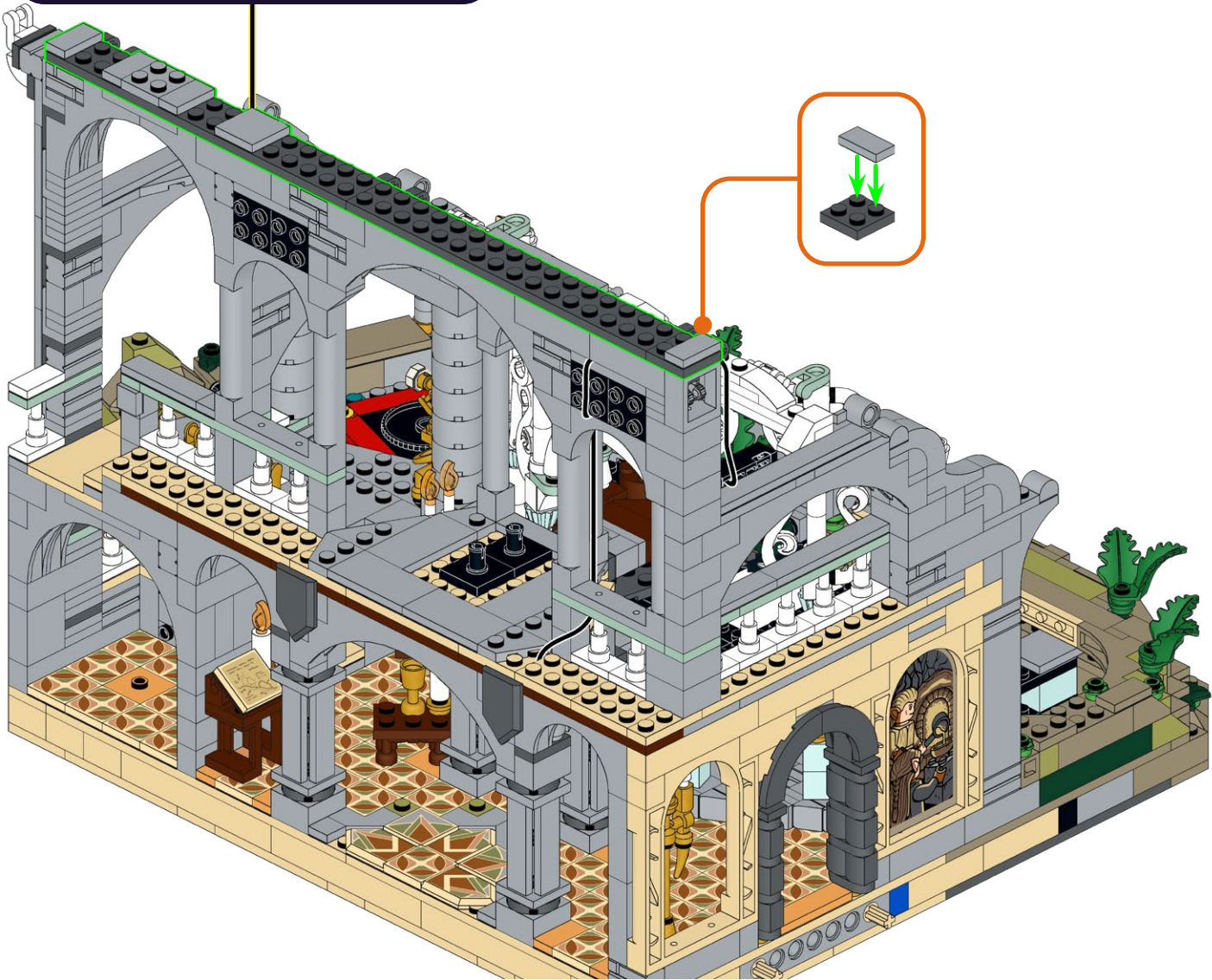
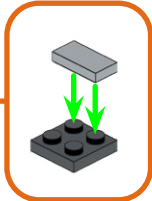
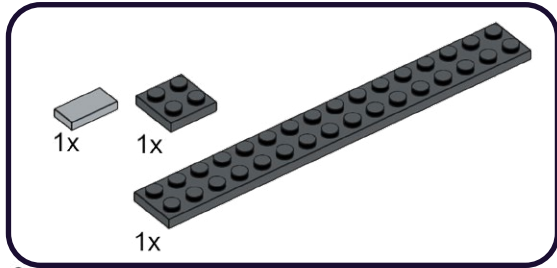

250

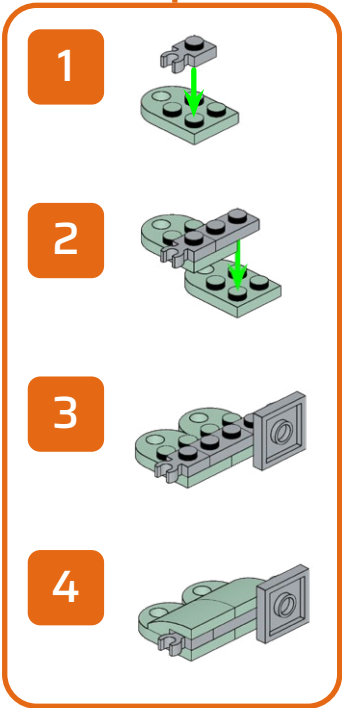
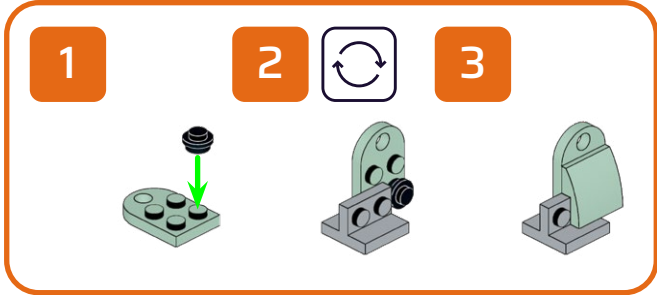
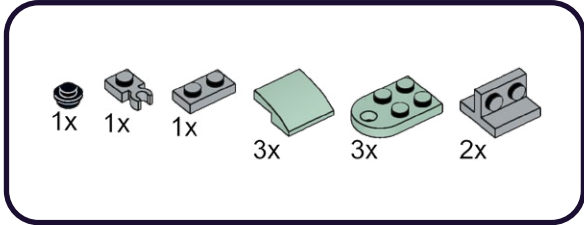

251

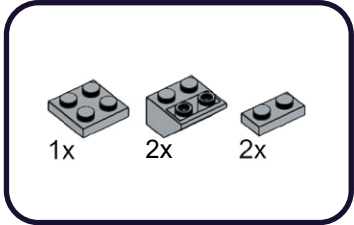

1

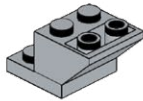

2

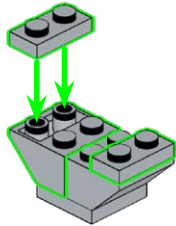



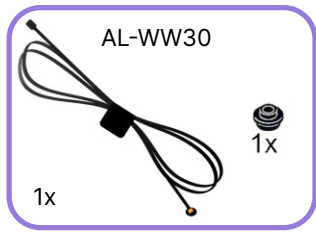

1

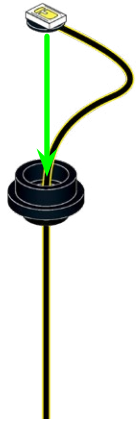

3

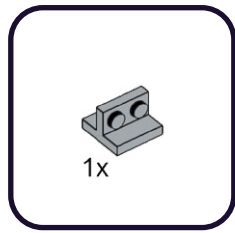

1



3

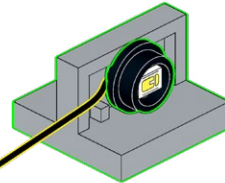
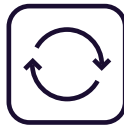

254

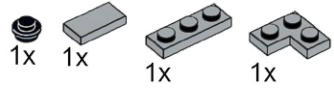

1

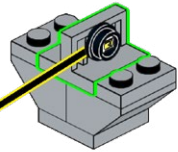

2

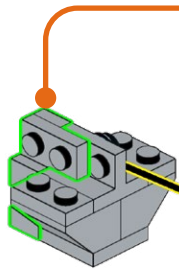

1

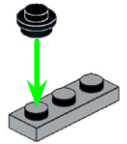

2

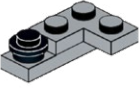

3

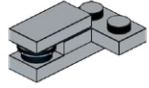

255

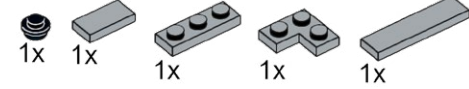

1

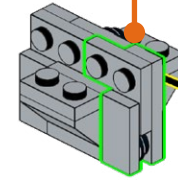

2

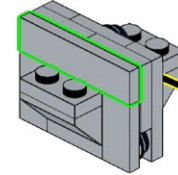

1

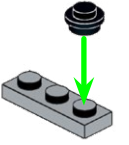

2

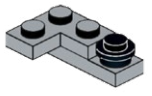

3

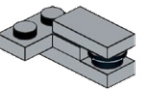

256

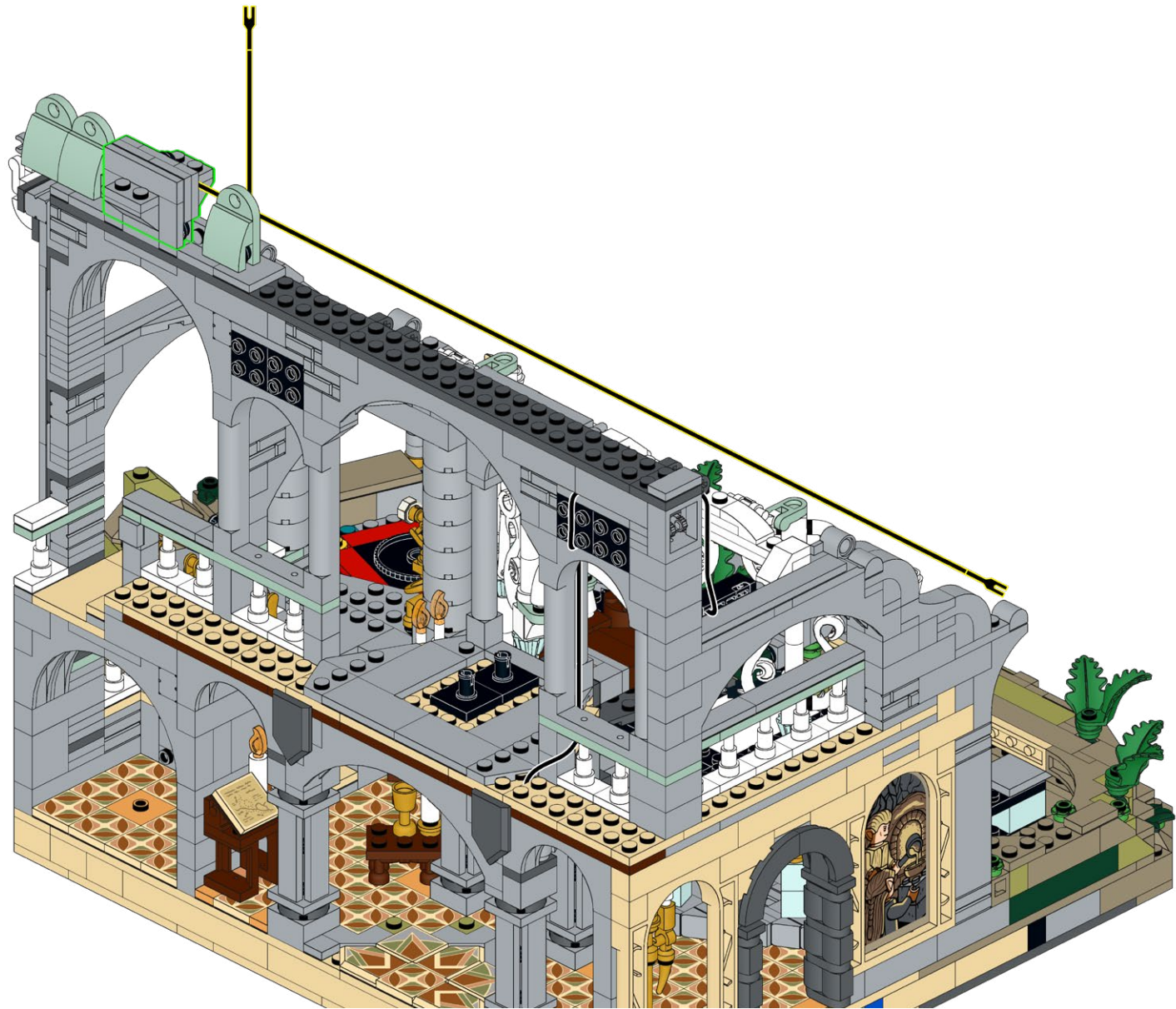



257

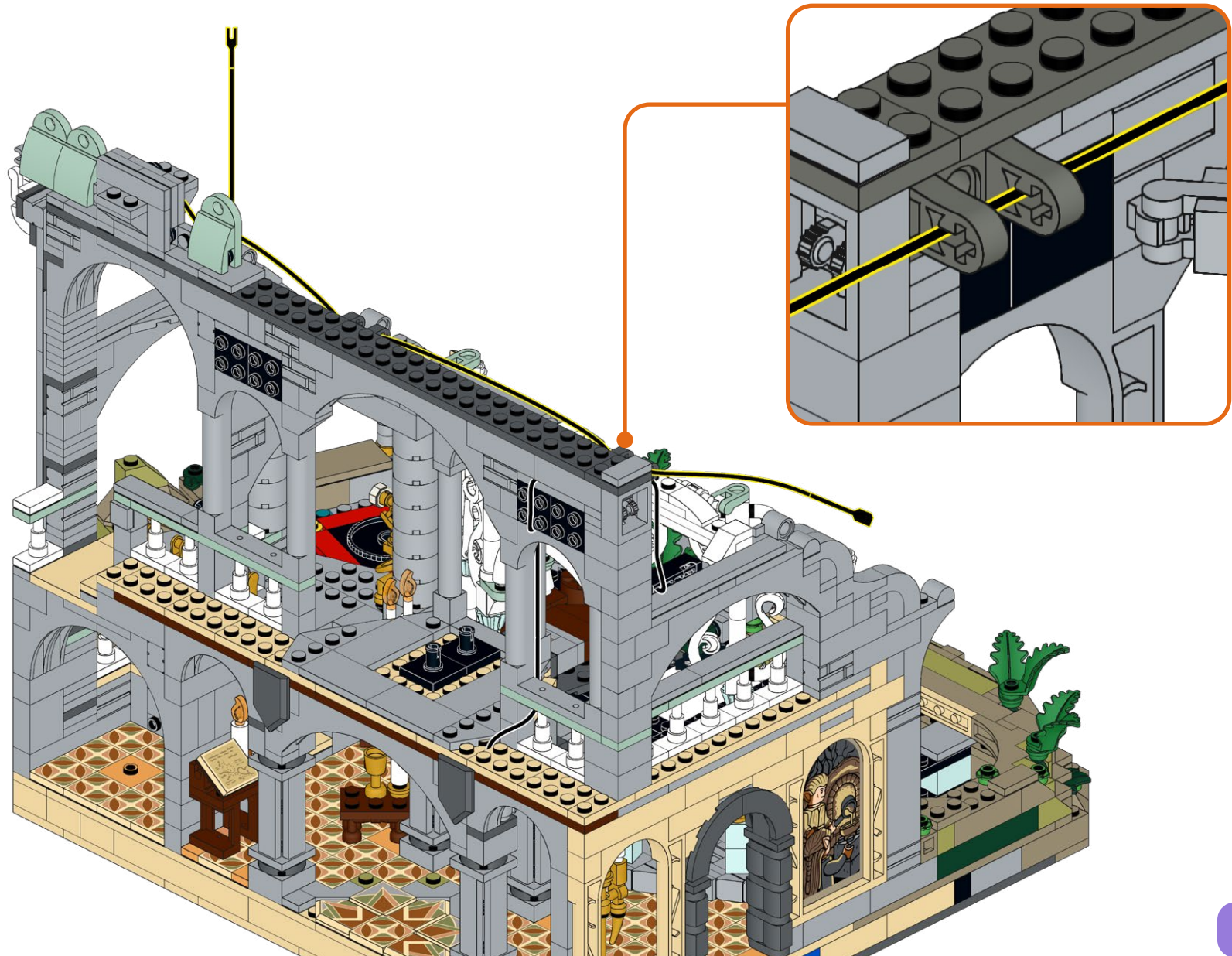

258

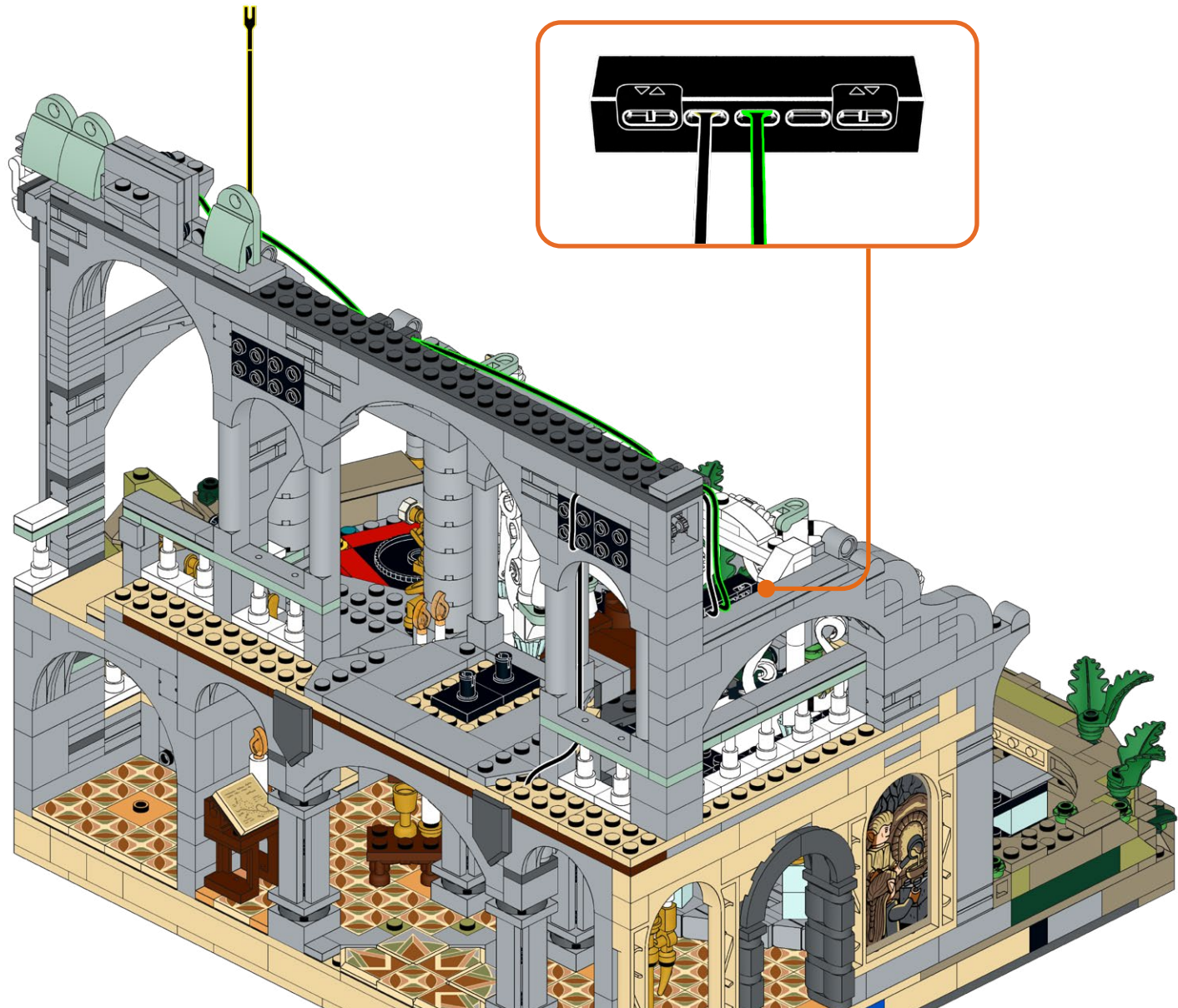



**259**

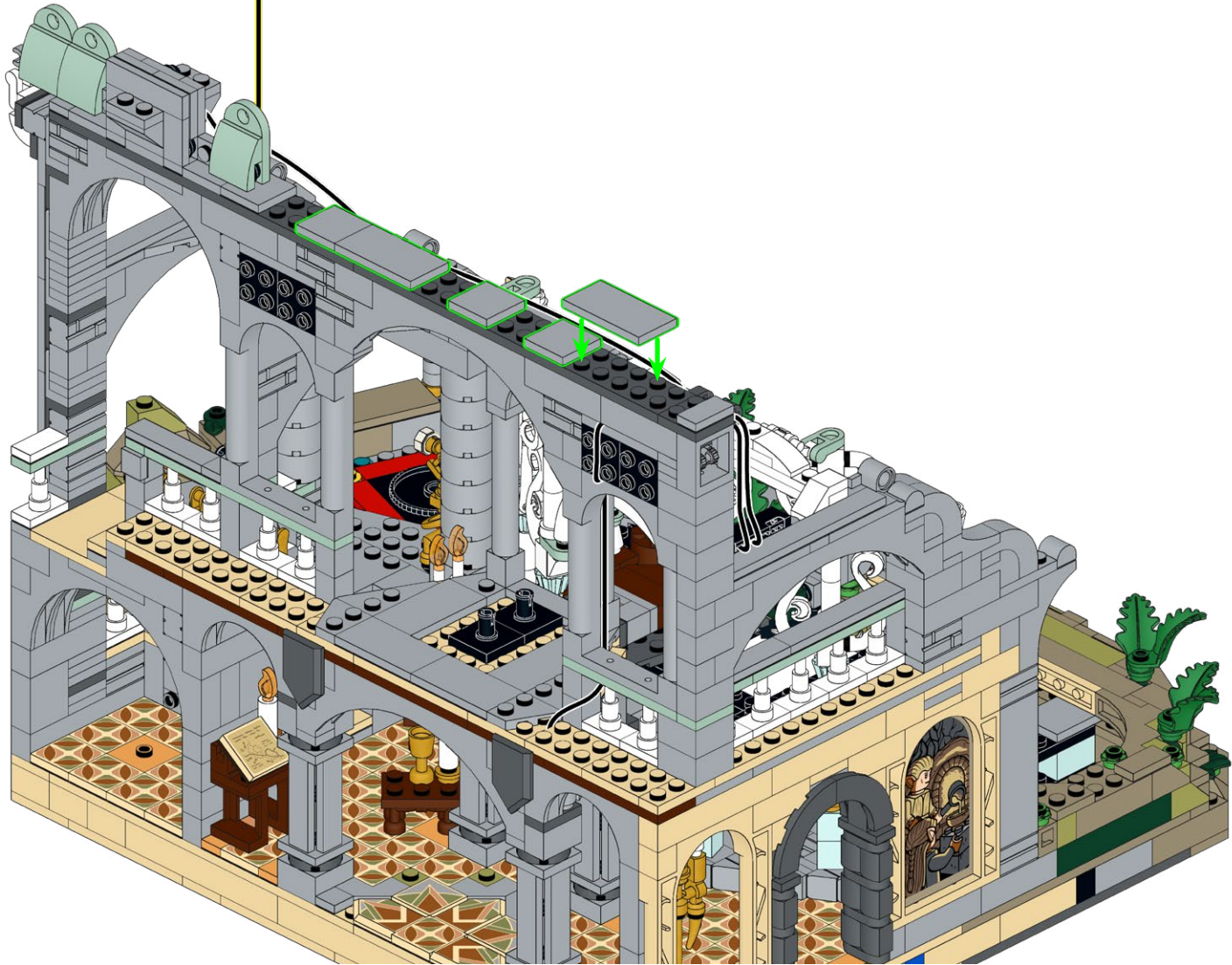
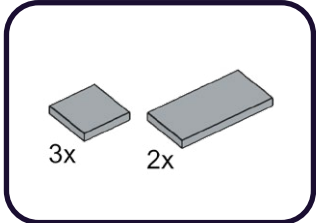



260

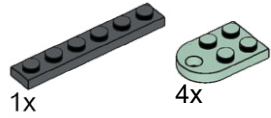

1



2

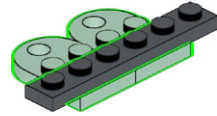

3

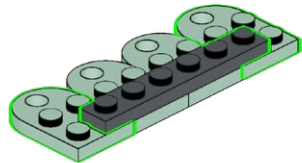

261

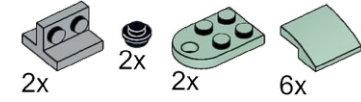

1

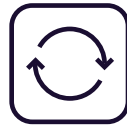
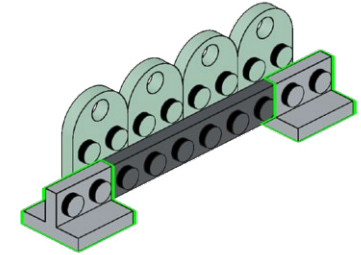

2

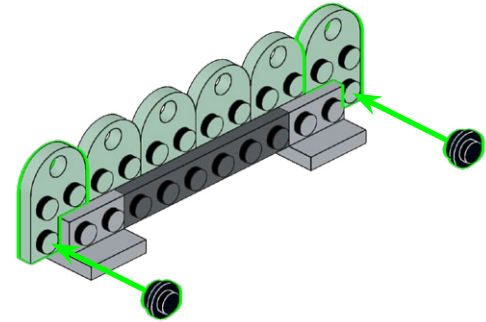

3

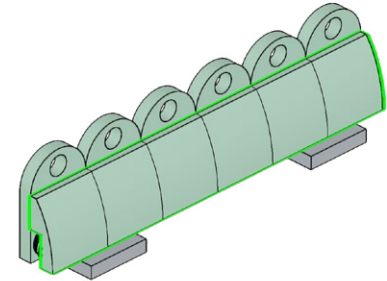

2x

262



263



2x





264

2x

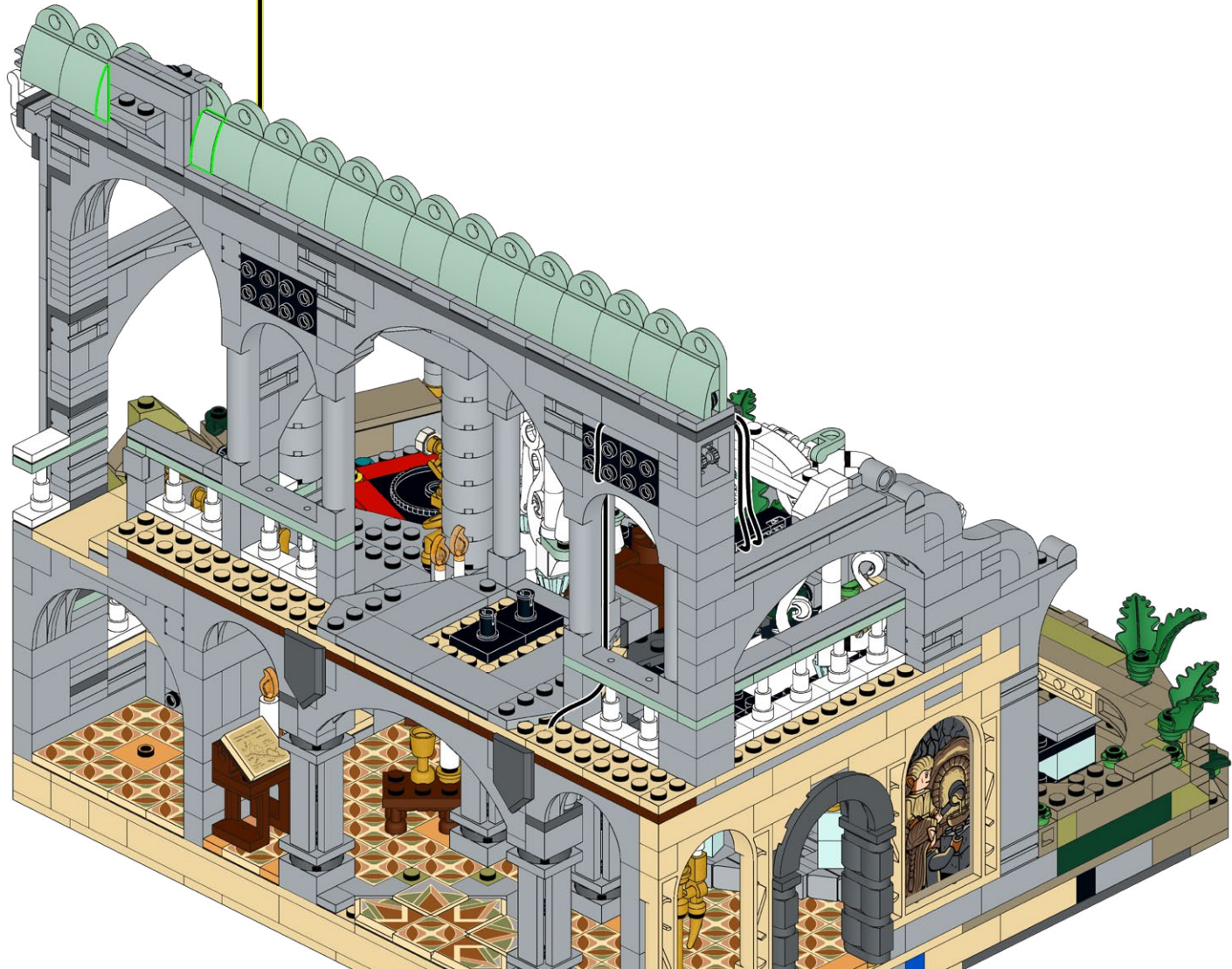

265



4x



266

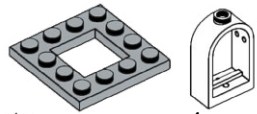

1x

4x

1

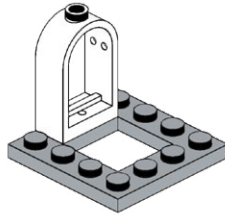

2

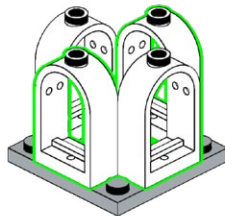

267



4x

4x

8x

4x

1

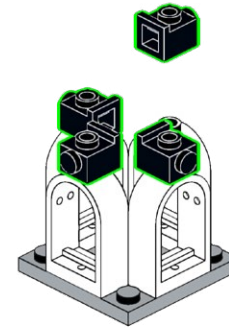

2

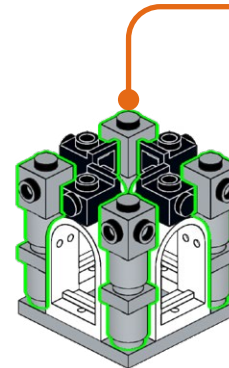

1

2

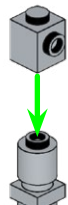

4x



268

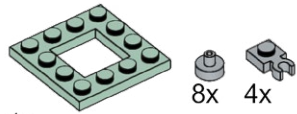

1x

8x

4x

1

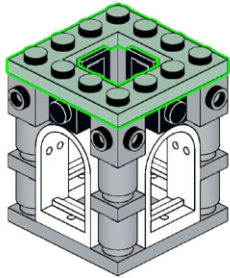

2

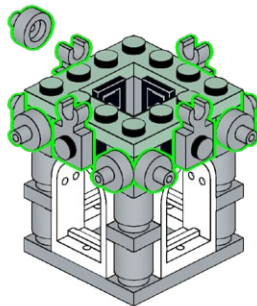

269

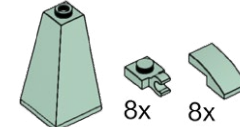

4x

8x

8x

1

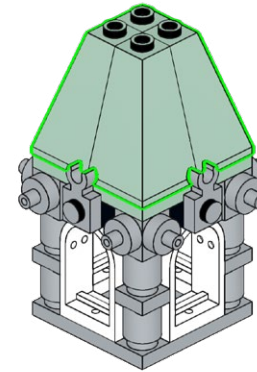

2

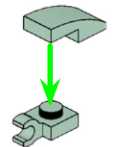
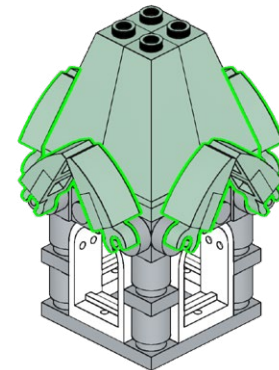

8x

**270**

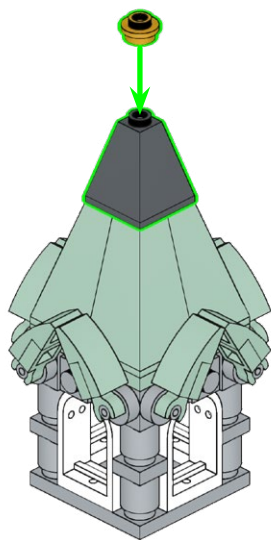

**271**

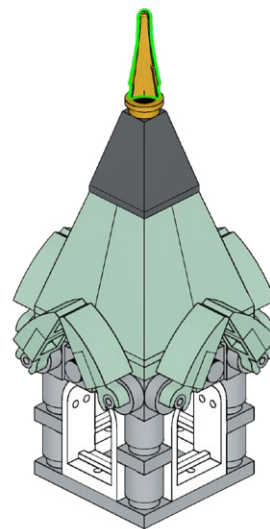
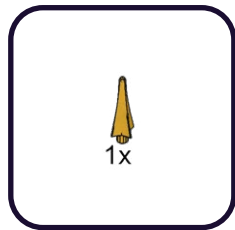

272





273

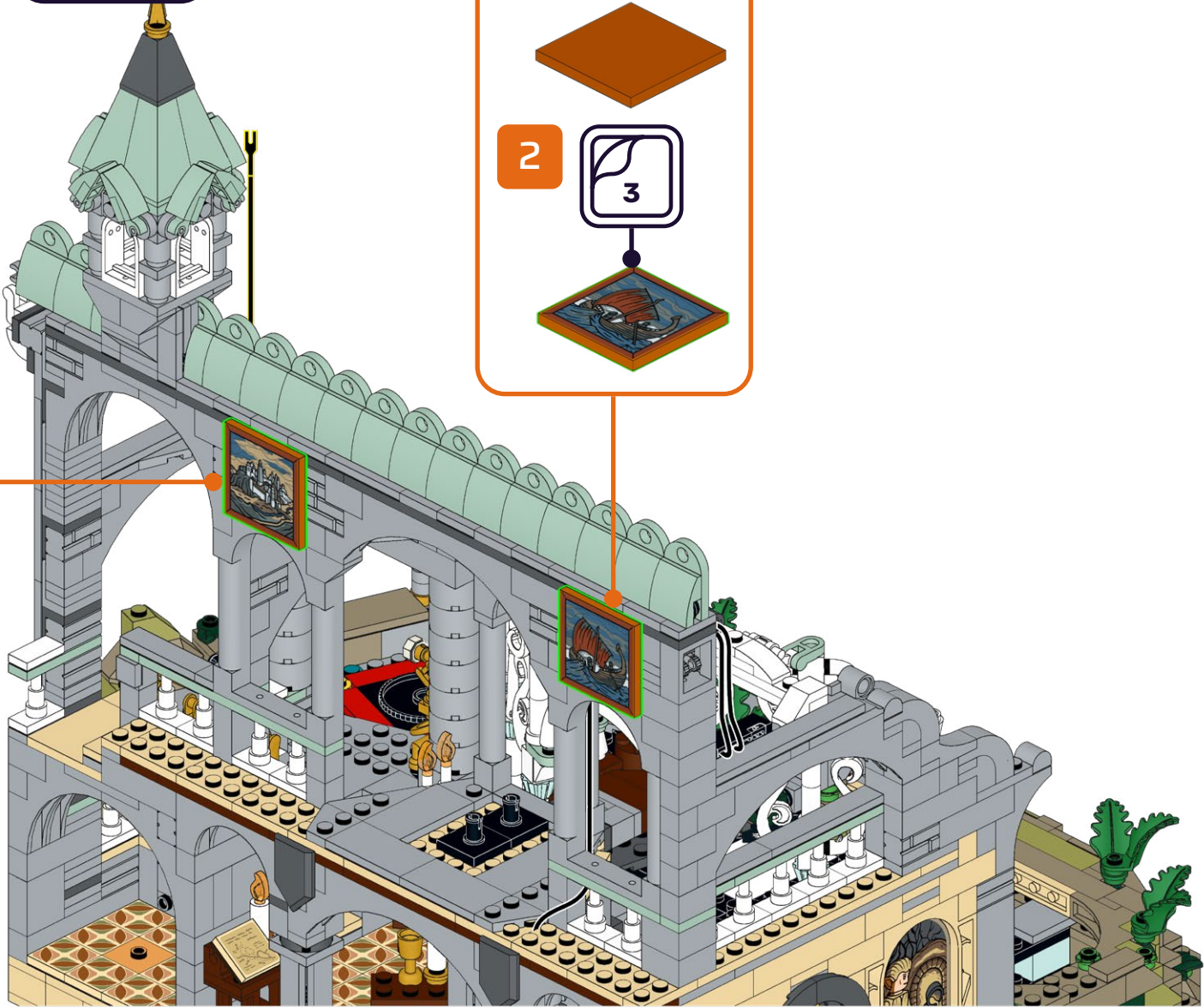
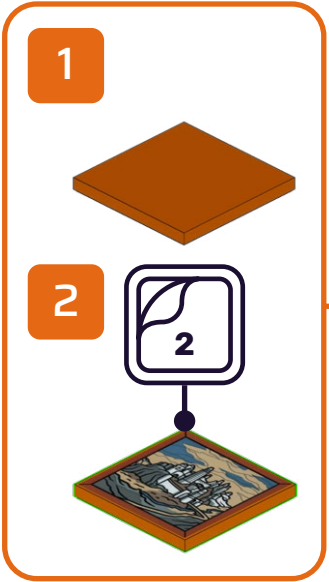
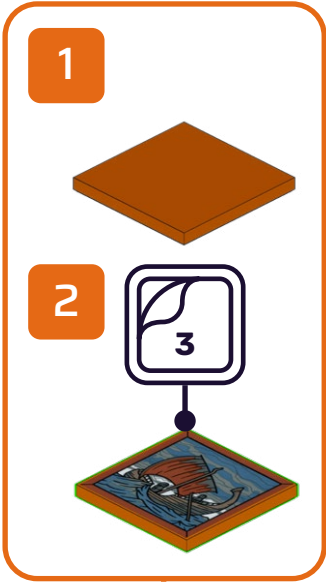
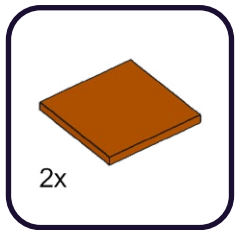

274

- 1x [Small grey round piece]
- 1x [Small grey square piece]
- 2x [Small grey curved piece]
- 1x [Small grey rectangular piece]
- 1x [Small grey square piece]
- 1x [Small grey rectangular piece]
- 1x [Small grey rectangular piece]
- 1x [Small grey curved piece]

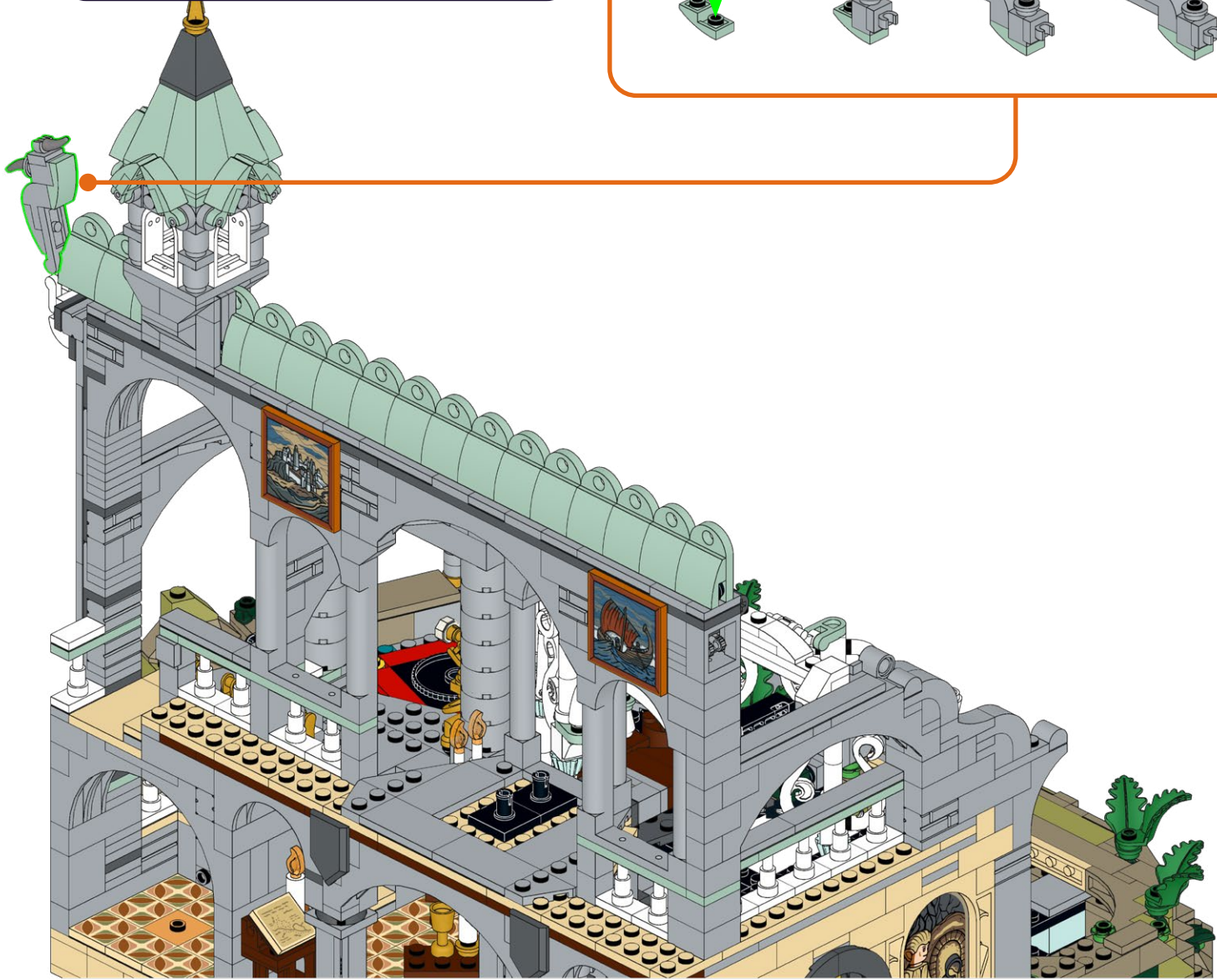
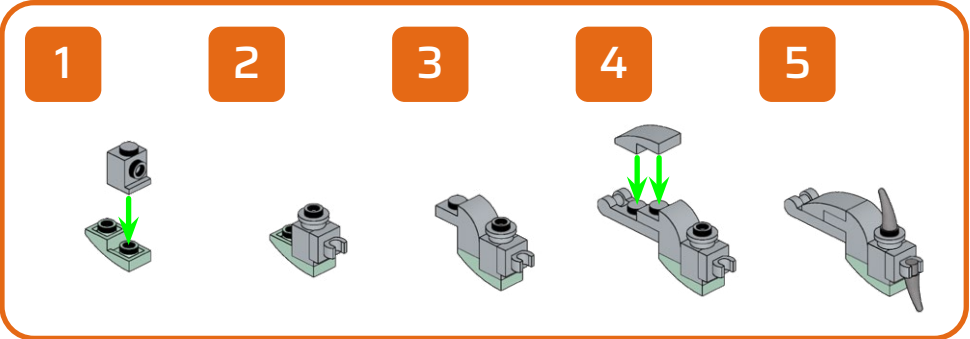



### **HOLD UP!**

You might notice some bags aren't in order, as well as left over pieces, but that's ok! We're changing the way you build LEGO!

### **ATTENDEZ!**

Vous remarquerez peut-être que certains sacs, ainsi que certaines pièces, ne sont pas dans le bon ordre. Mais pas de panique! Nous changeons simplement la façon avec laquelle vous construisez vos LEGO!

### **ASPETTA!**

Potresti notare che alcuni sacchetti non sono in ordine, così come i pezzi avanzati, ma va bene così! Stiamo cambiando il modo in cui costruisci i LEGO!

### **HALT!**

Sie werden möglicherweise bemerken, dass einige tüten durcheinander sind und teile übrig bleiben, aber das ist in Ordnung! Wir ändern die art und weise, wie Sie LEGO bauen!

### **¡ESPERA!**

Es posible que notes que algunas bolsas están fuera de servicio, así como piezas sobrantes, ¡pero está bien! ¡Estamos cambiando la forma en que construyes LEGO!

### **暫停!**

你可能会注意到一些袋子顺序错乱, 以及一些剩余的部件, 但没关系! 我们正在改变你搭建乐高的方式!

### Open LEGO® Bags 37, 38 & 39

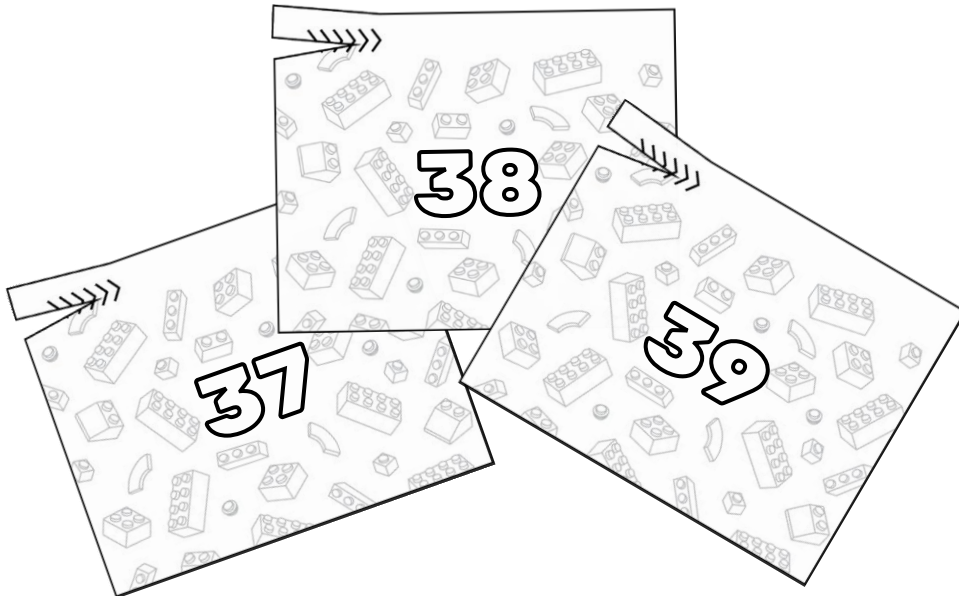



275

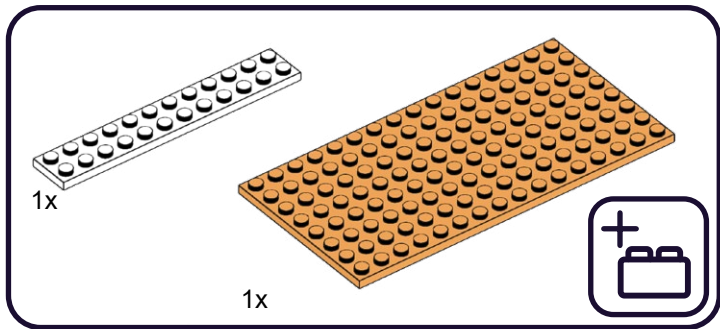

1

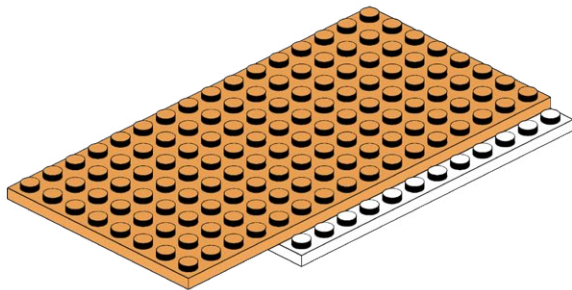

2

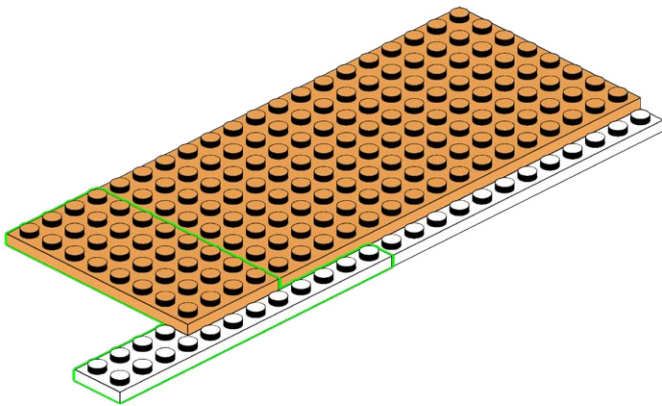



277

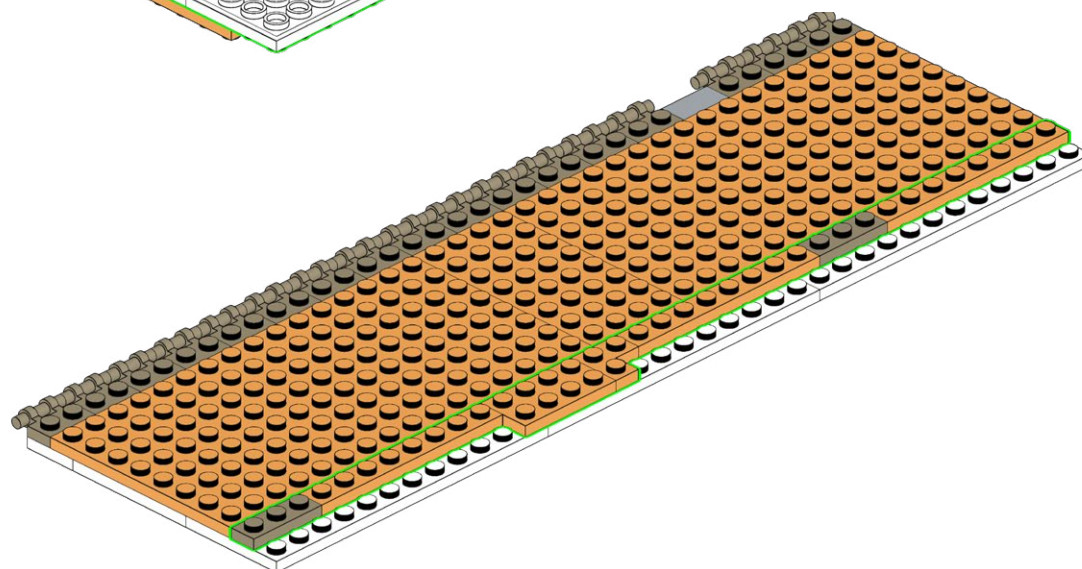
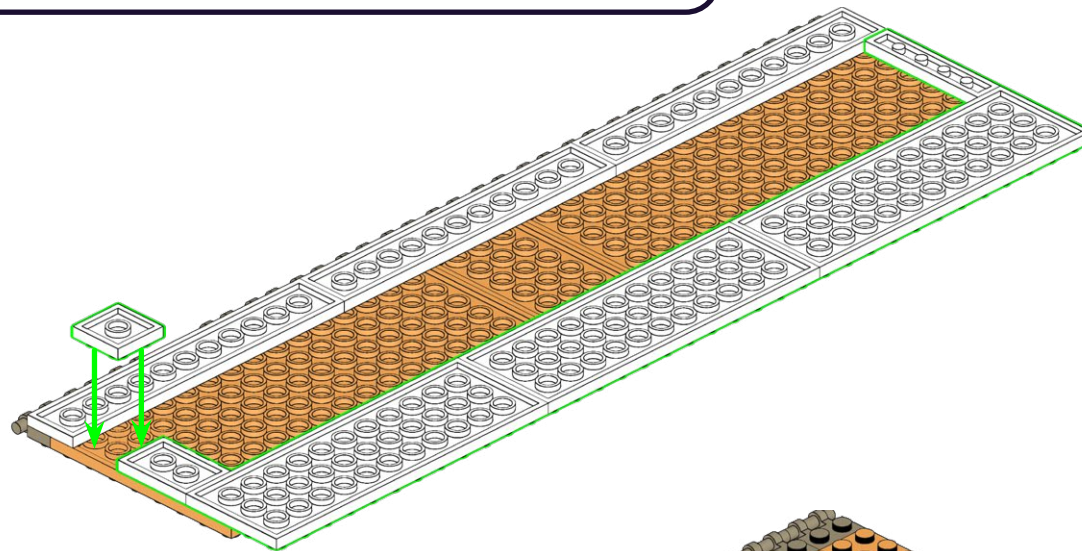
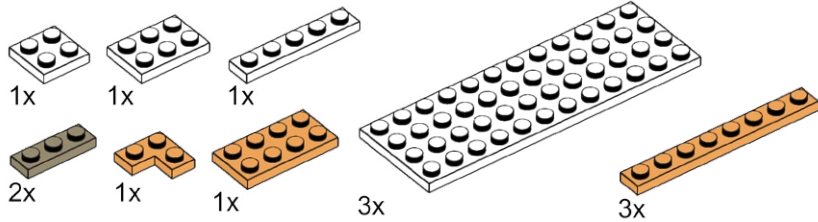



278

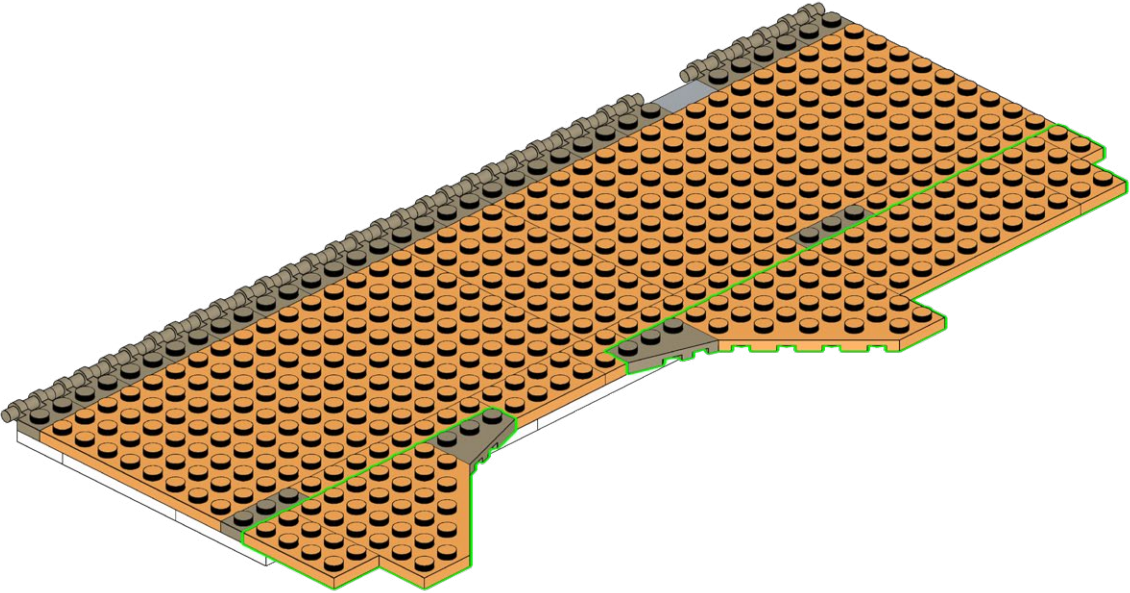
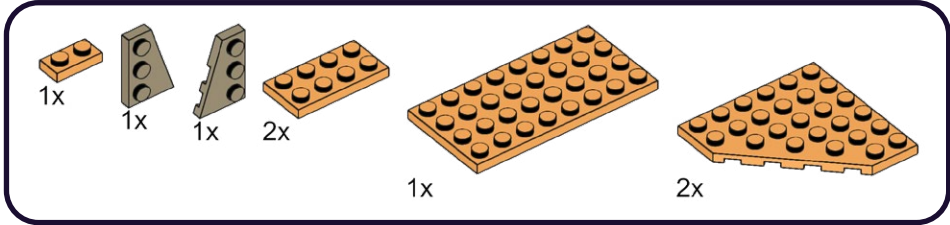

279

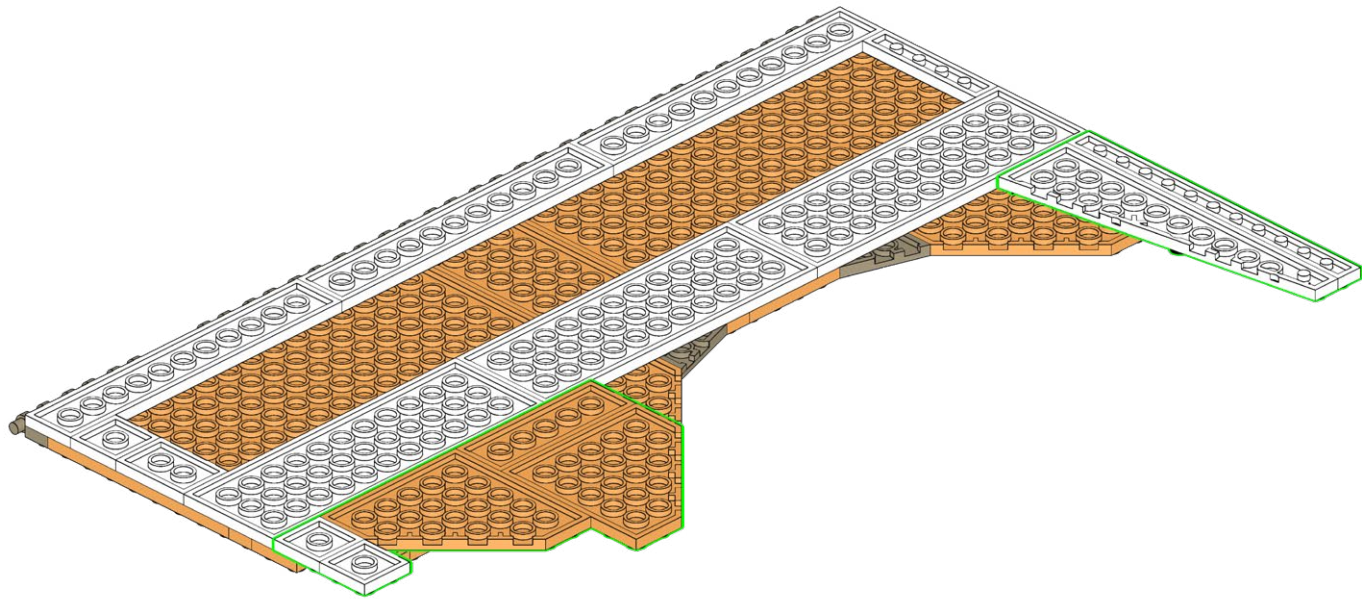
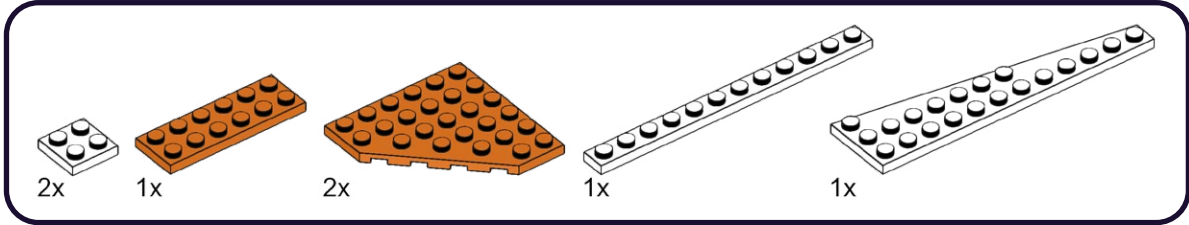

280

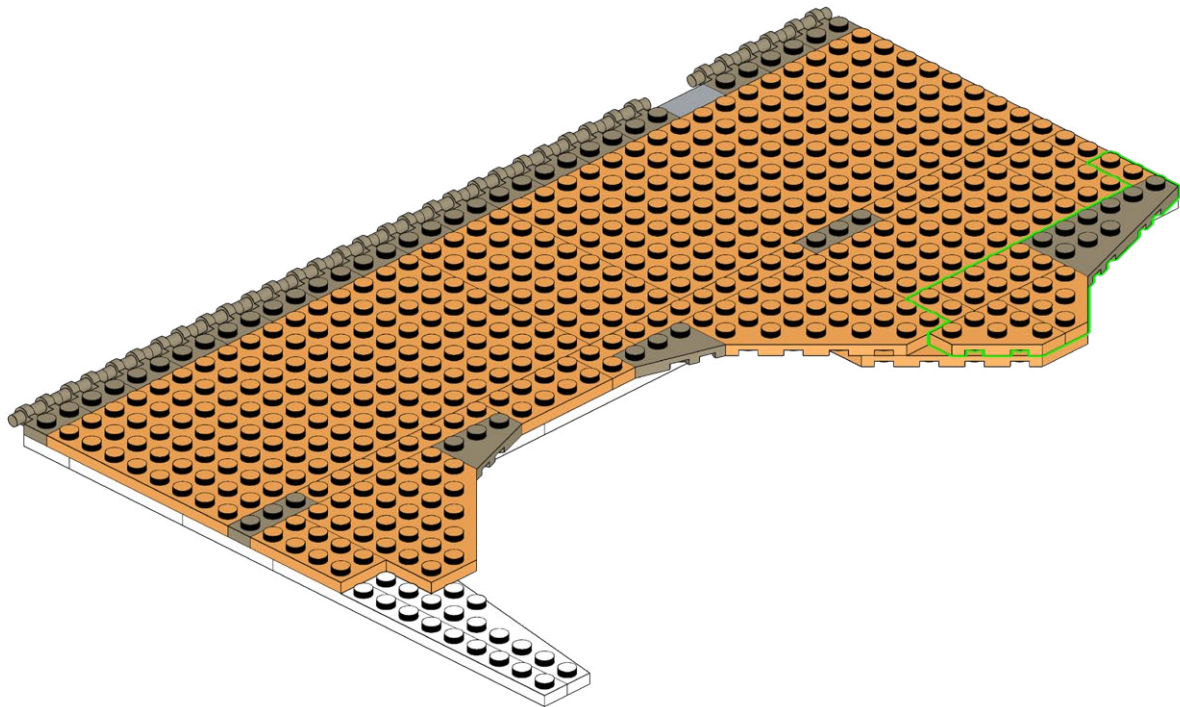
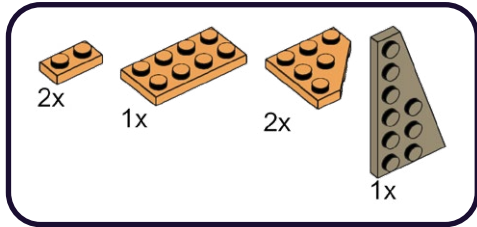



281

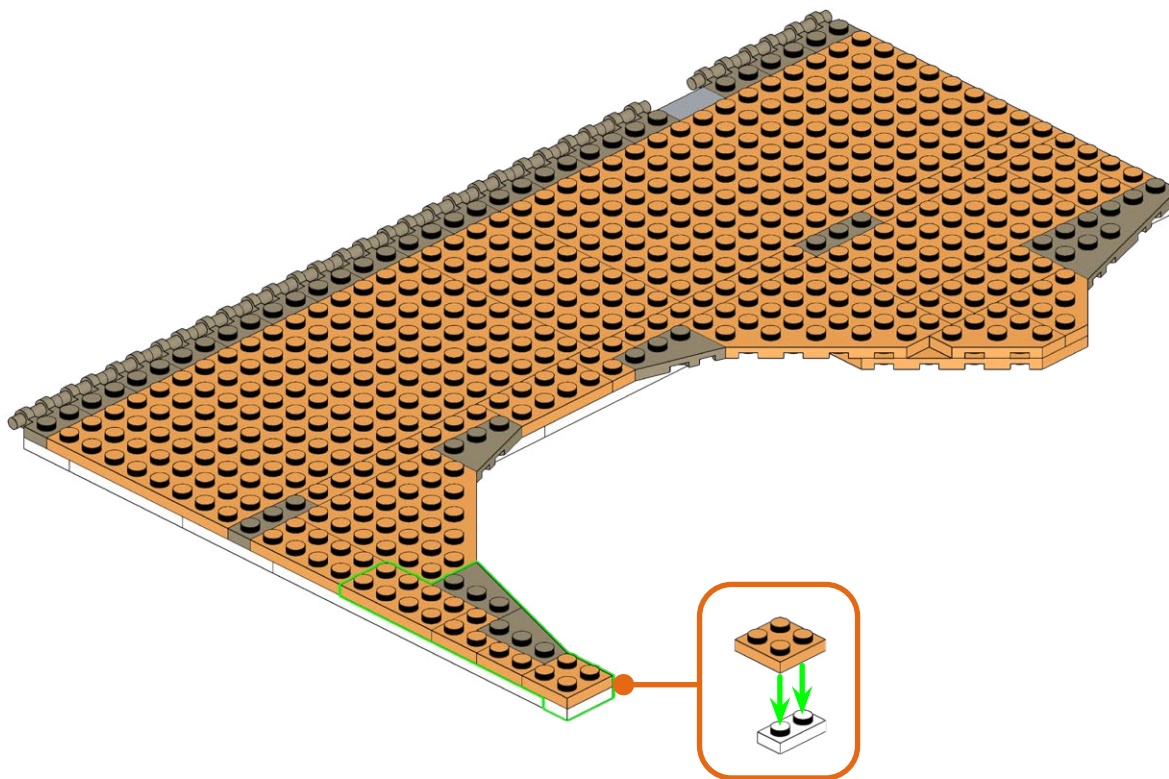
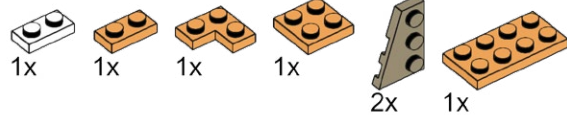

282

53x

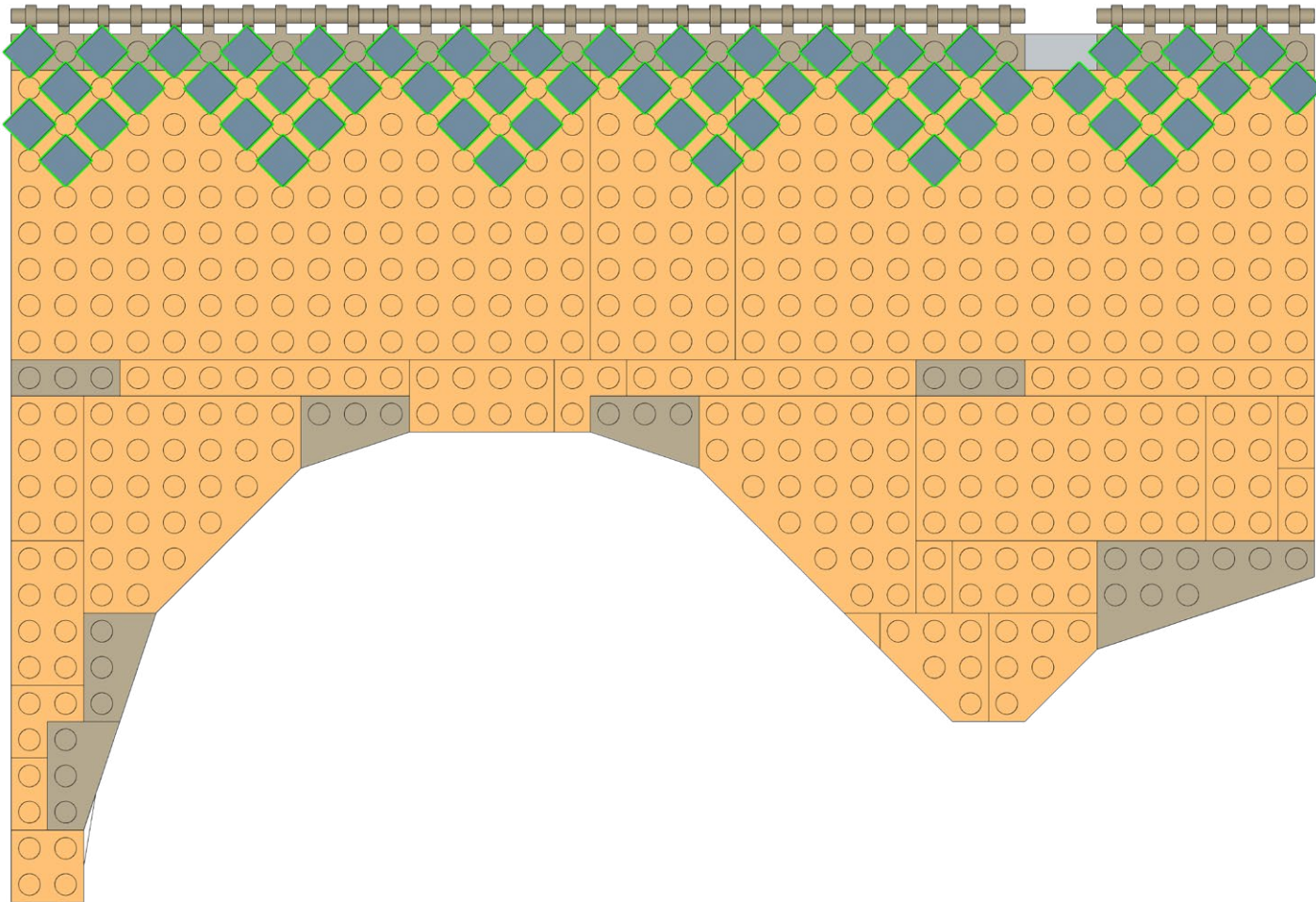

283

36x 24x

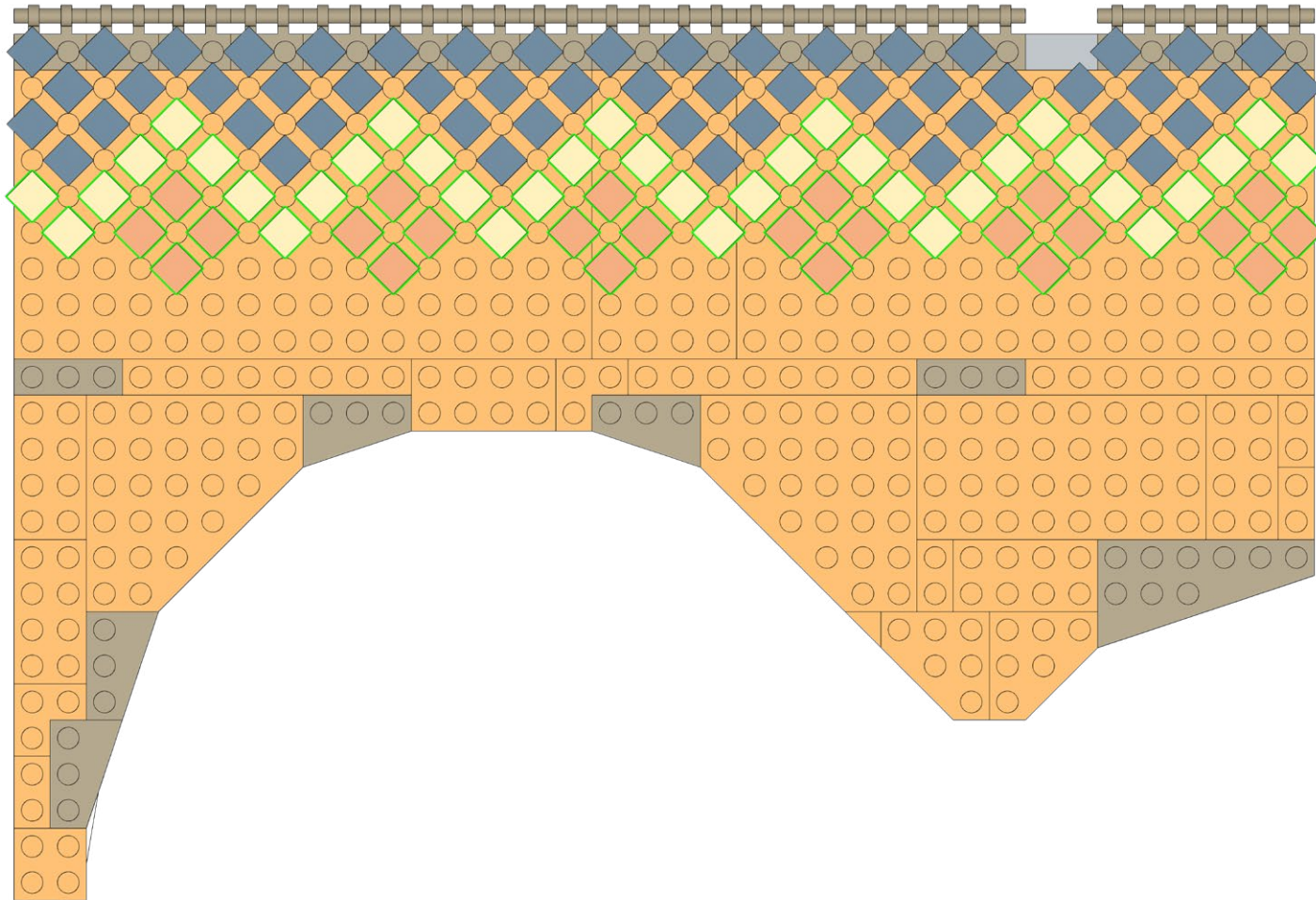



284

42x 35x

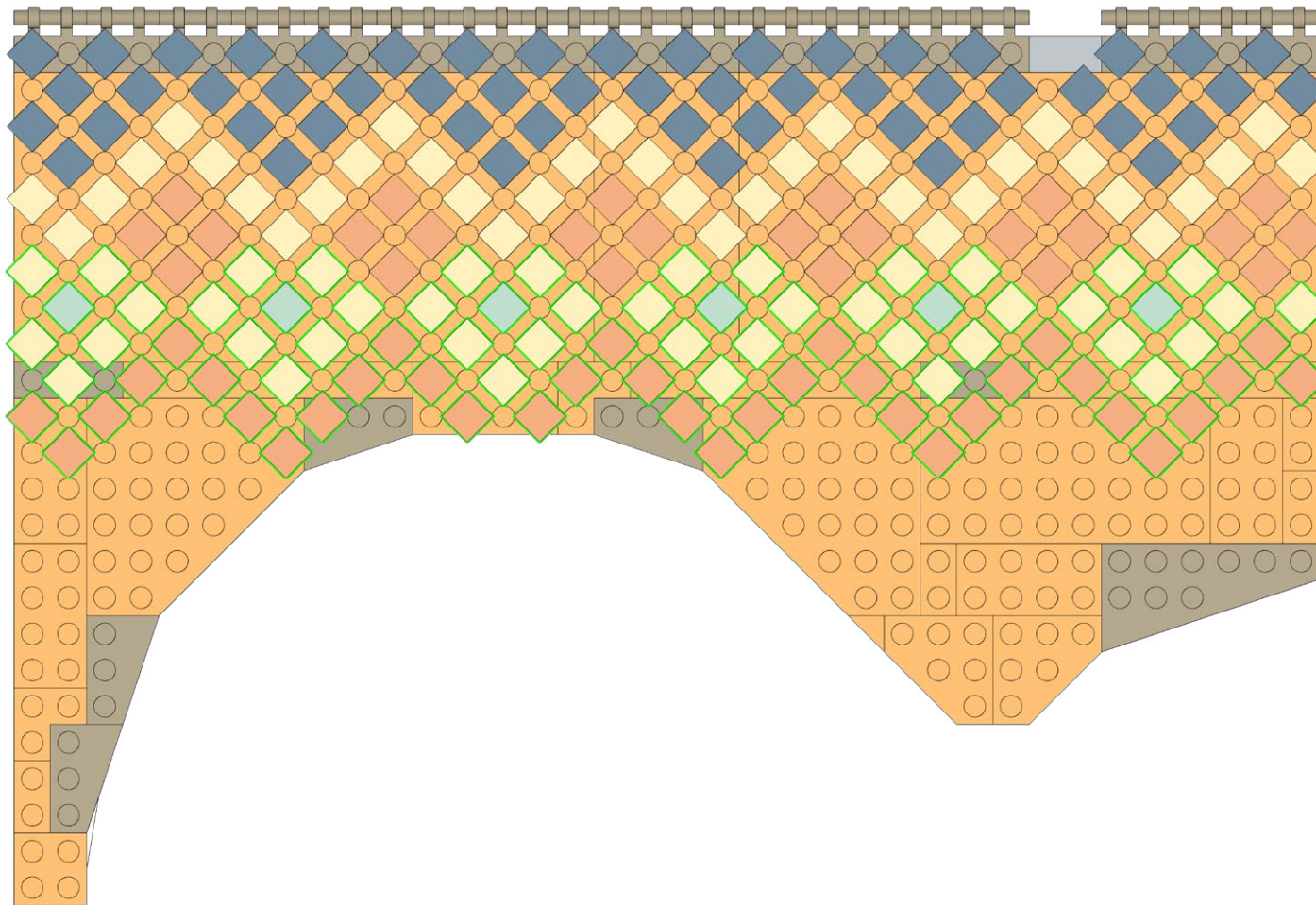

285

4x 34x 2x 30x

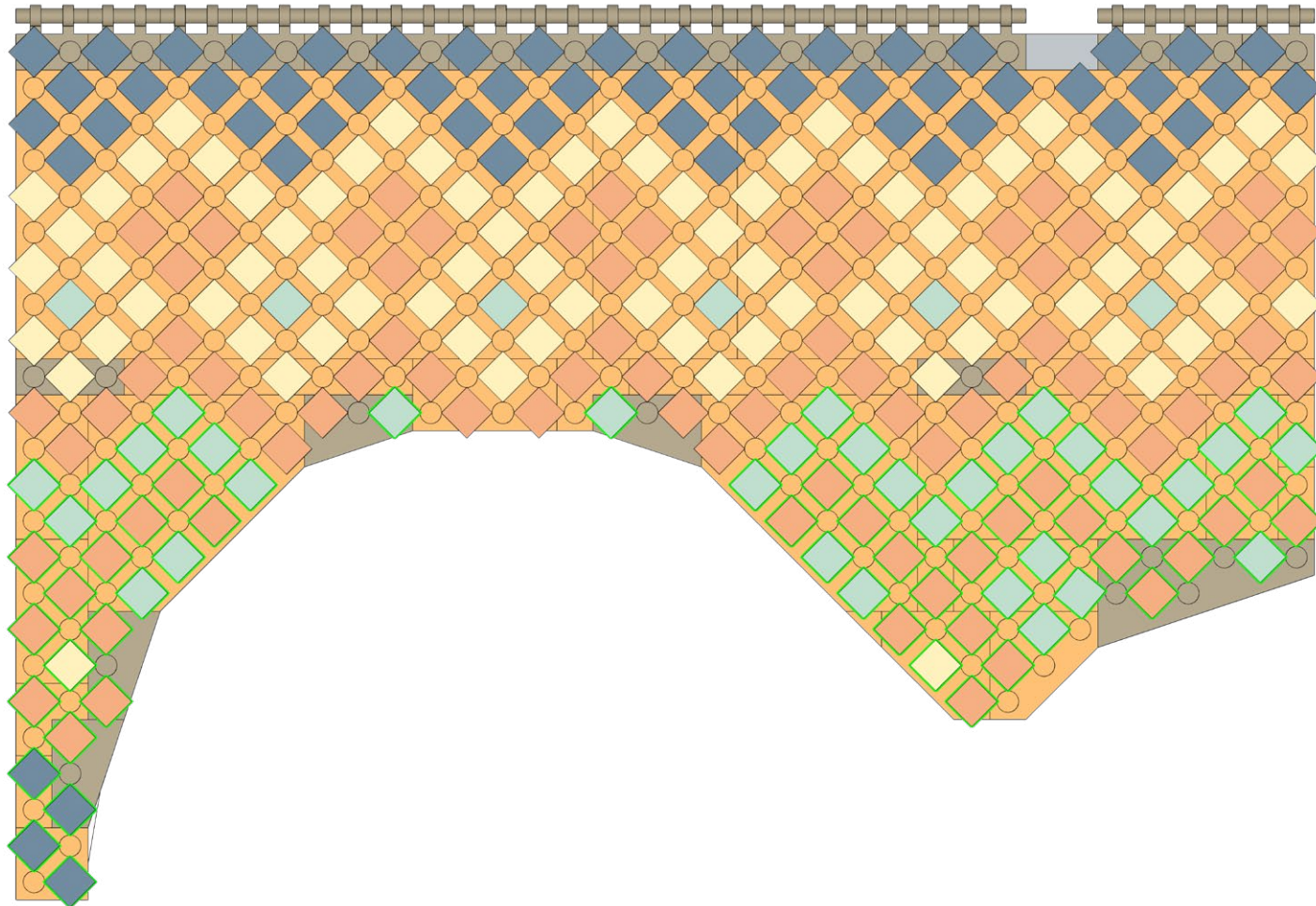

286

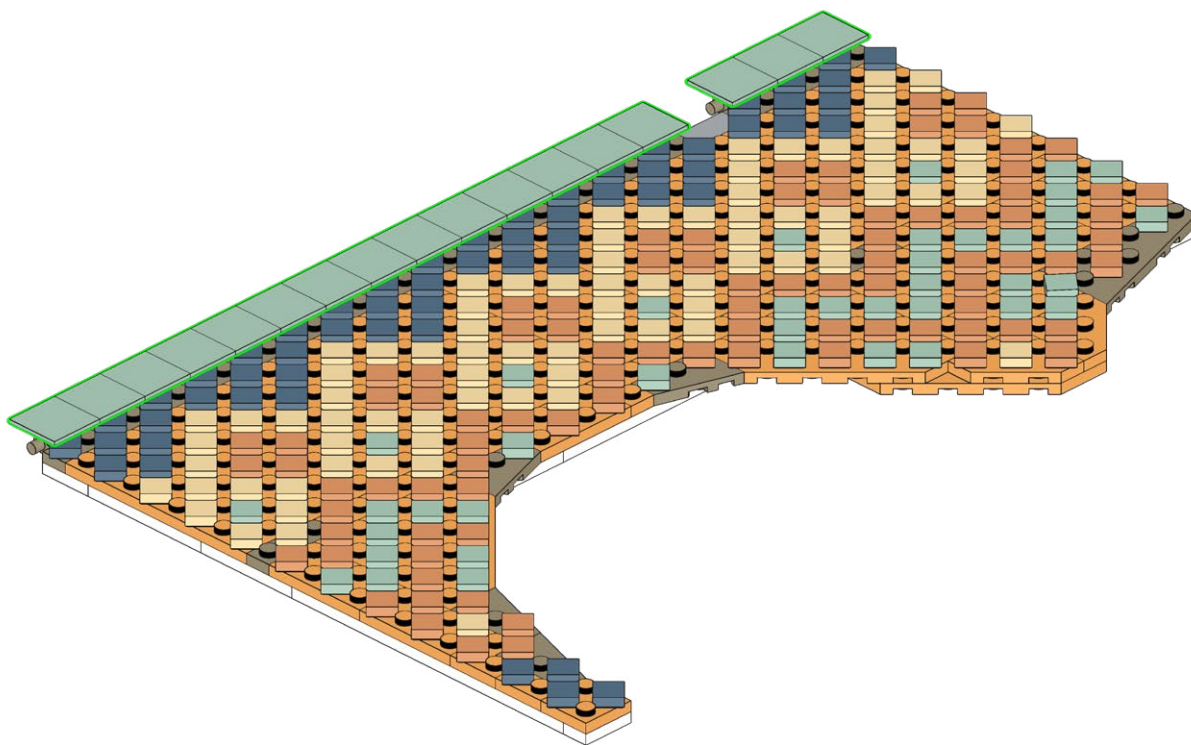
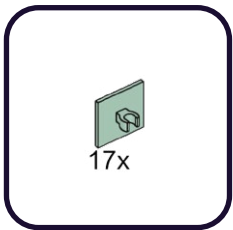



287

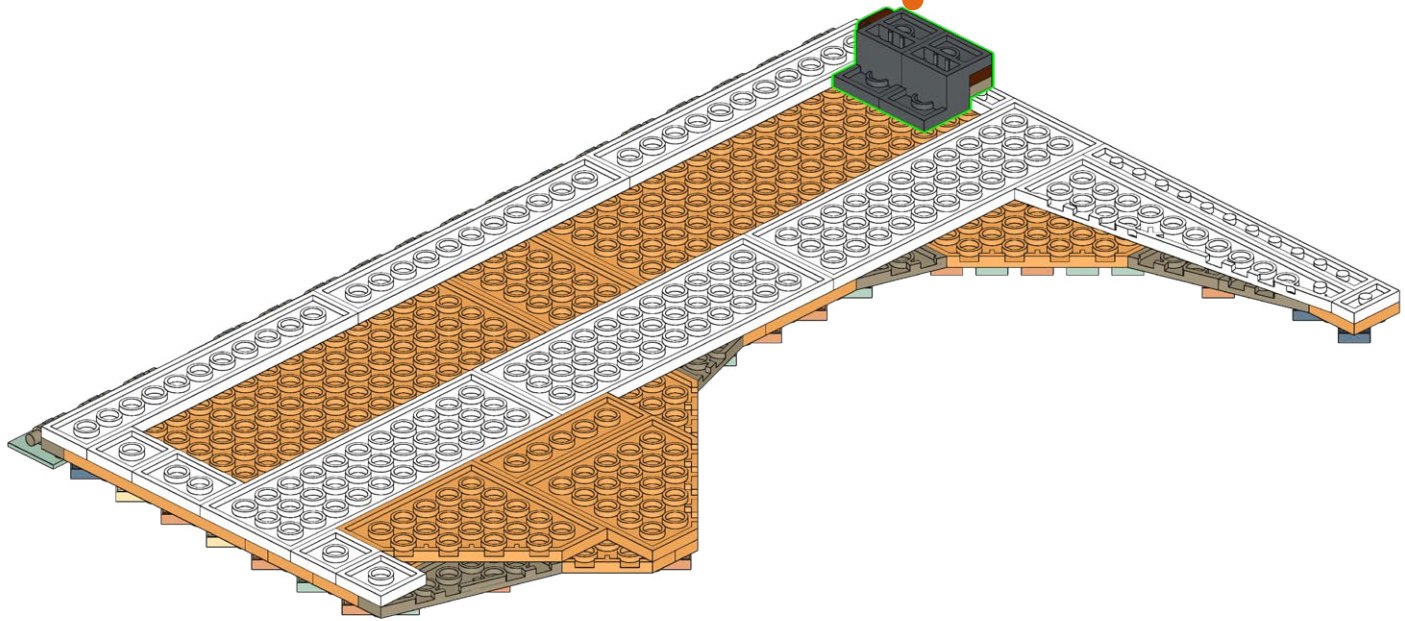
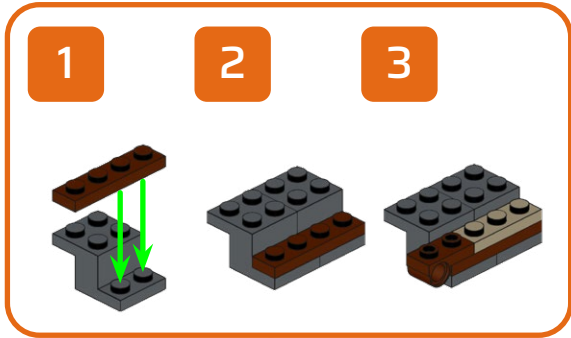
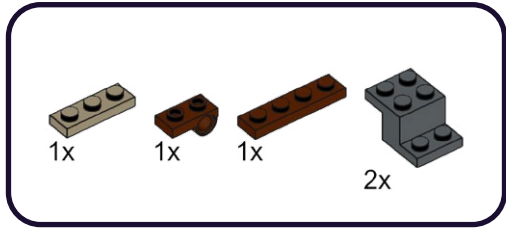

288

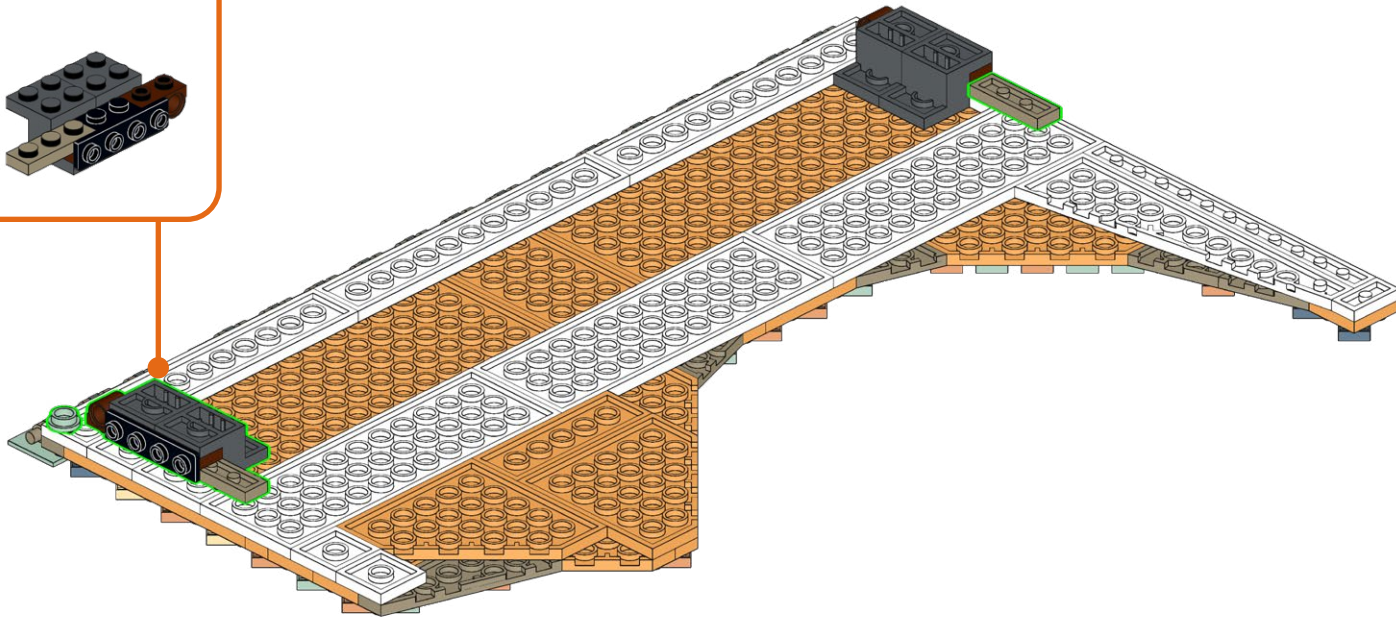
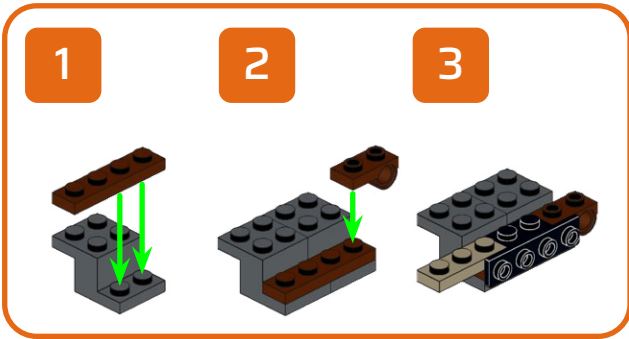
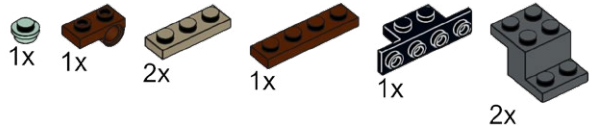

289

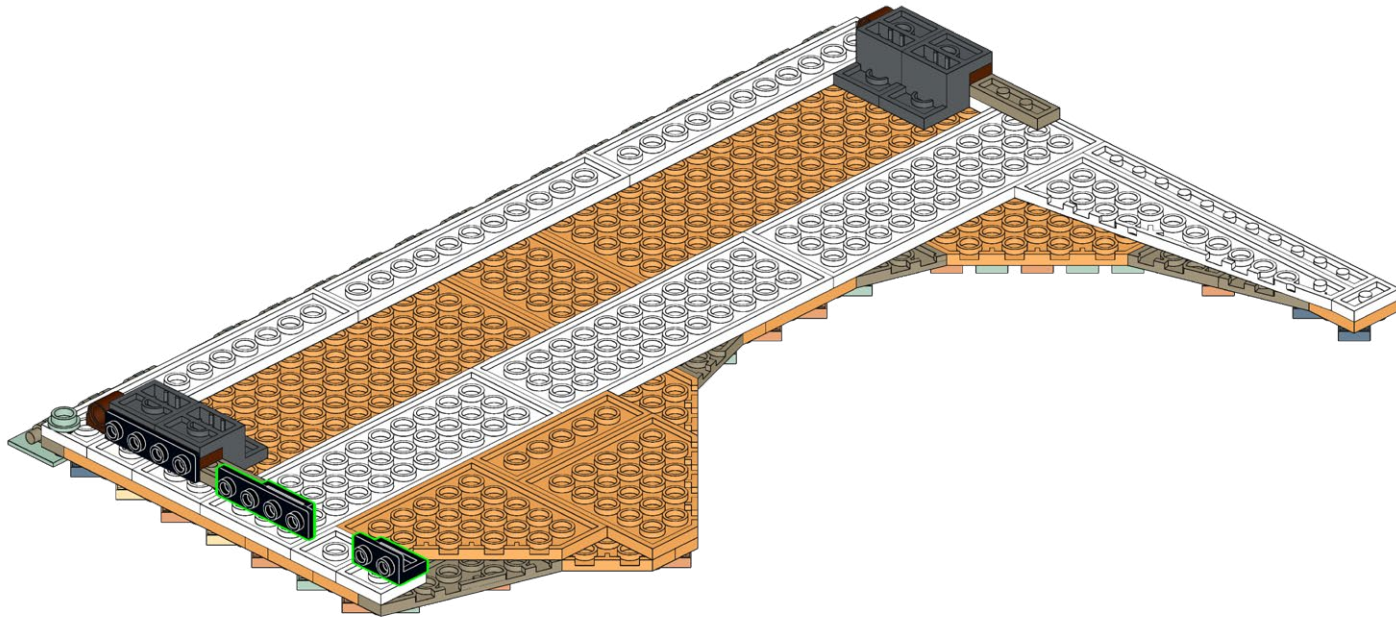
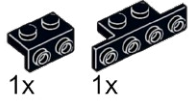



290

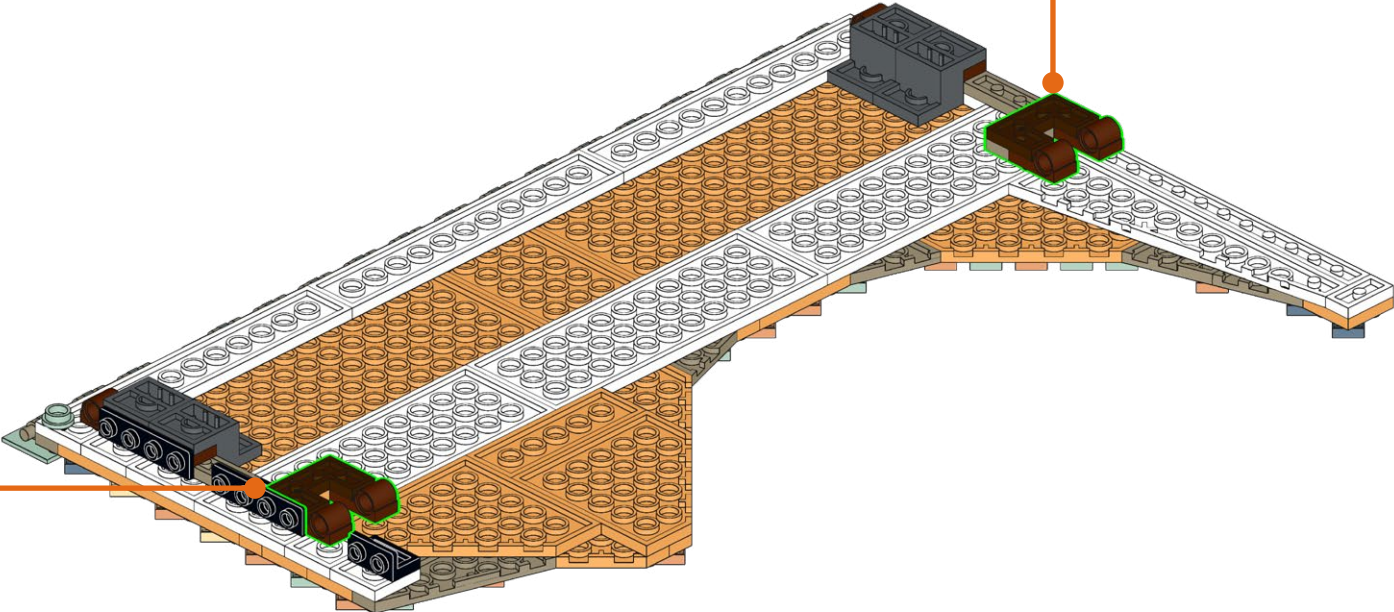
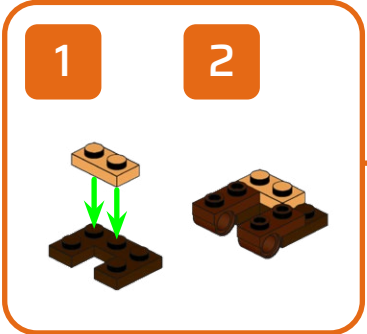
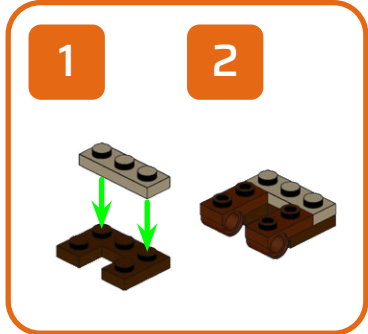
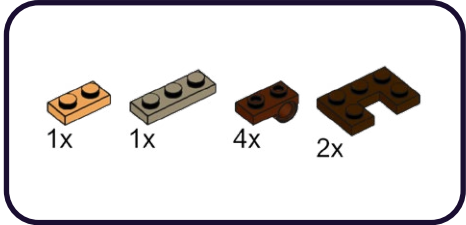

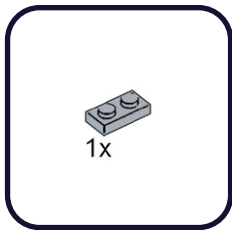
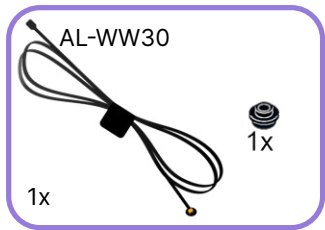

1

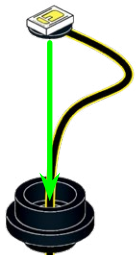

2



3

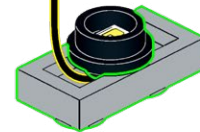

292

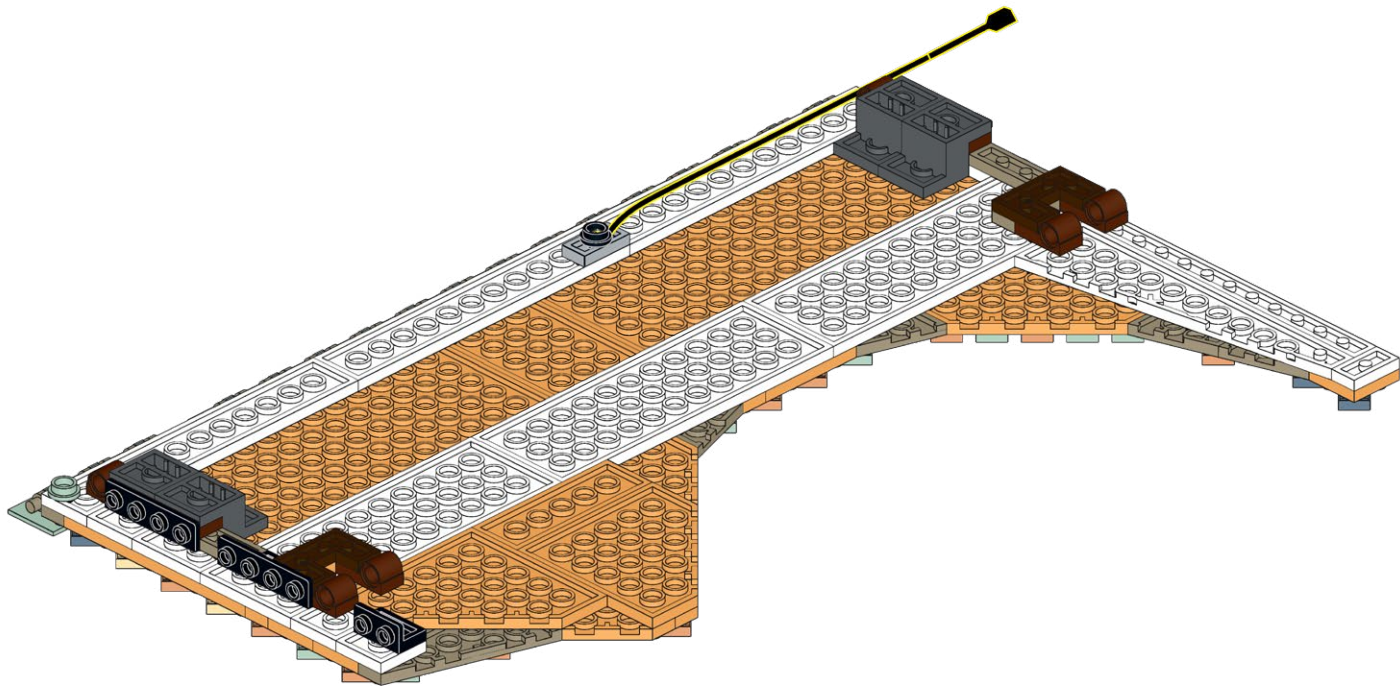



# 293

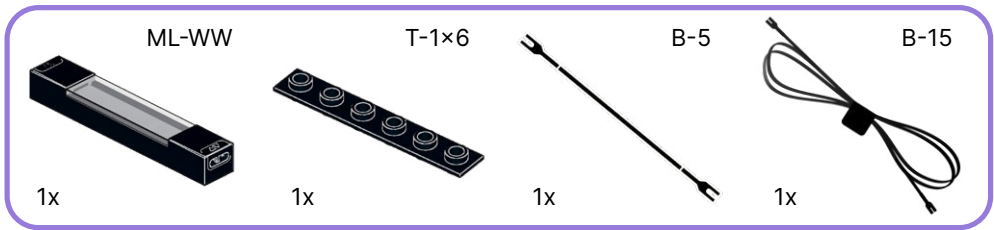

1

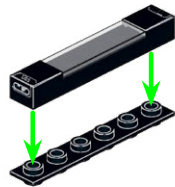

2

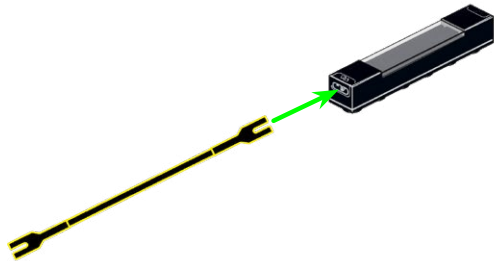

3

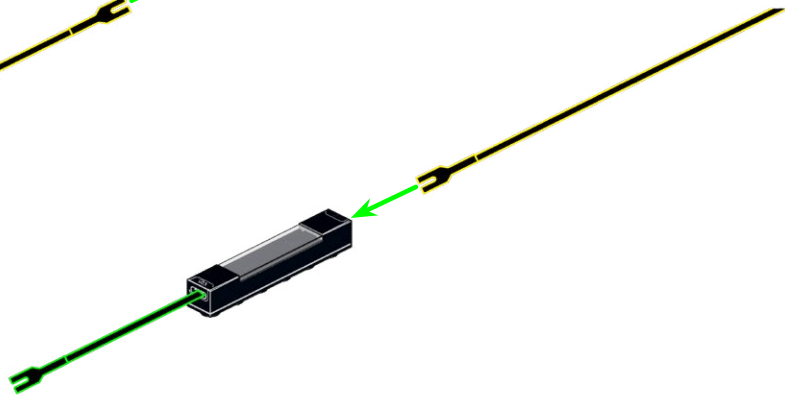

294

ML-WW

T-1x6

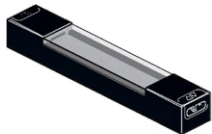

1x



1x

1

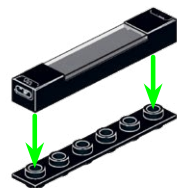

2

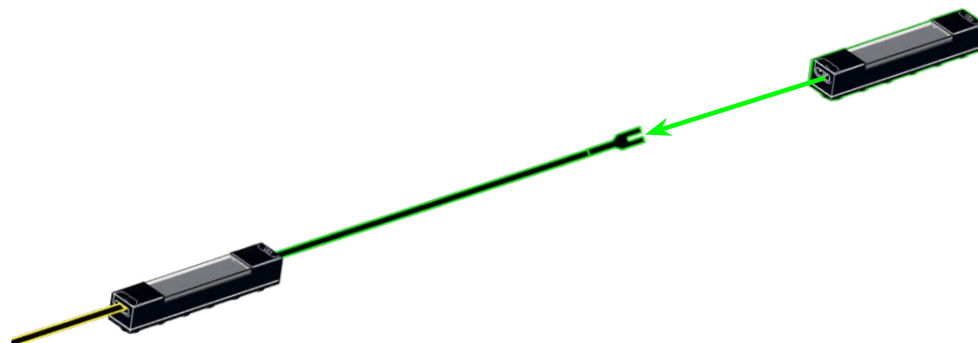

3

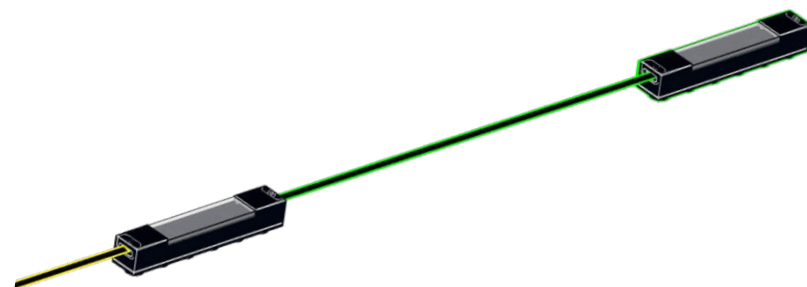

295

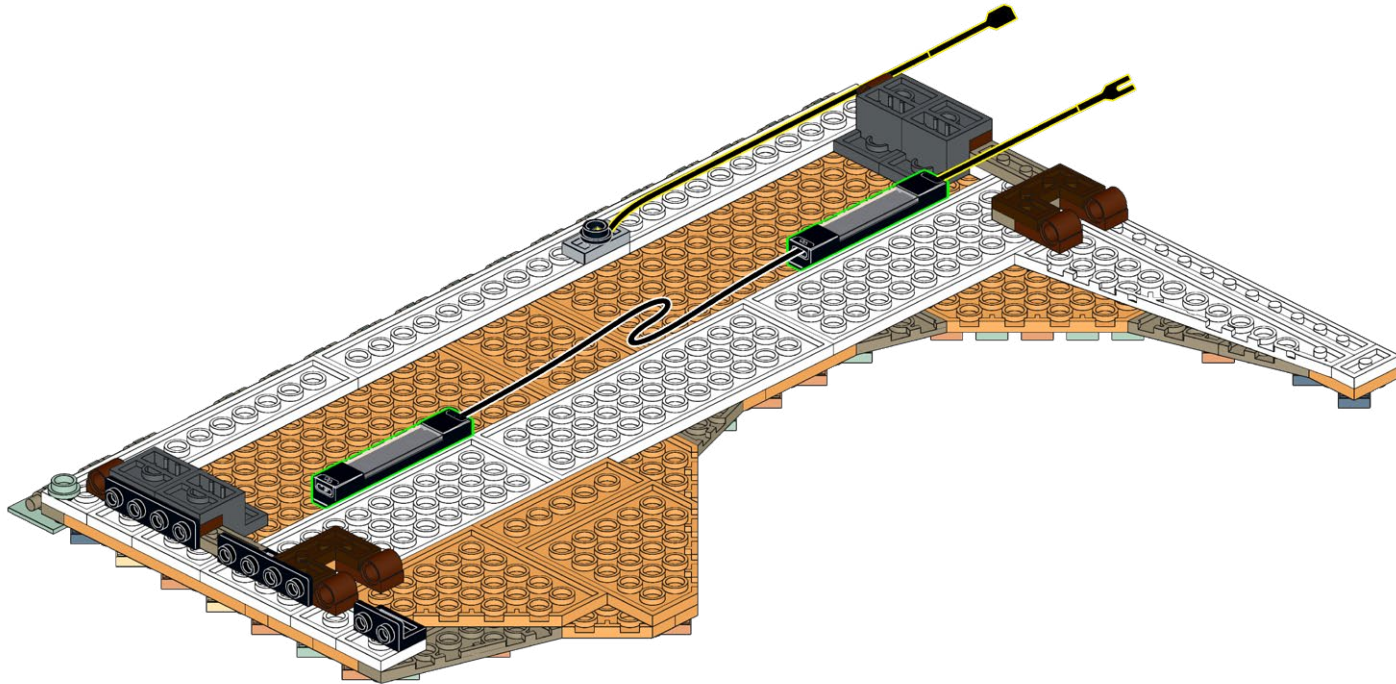



296



297





298

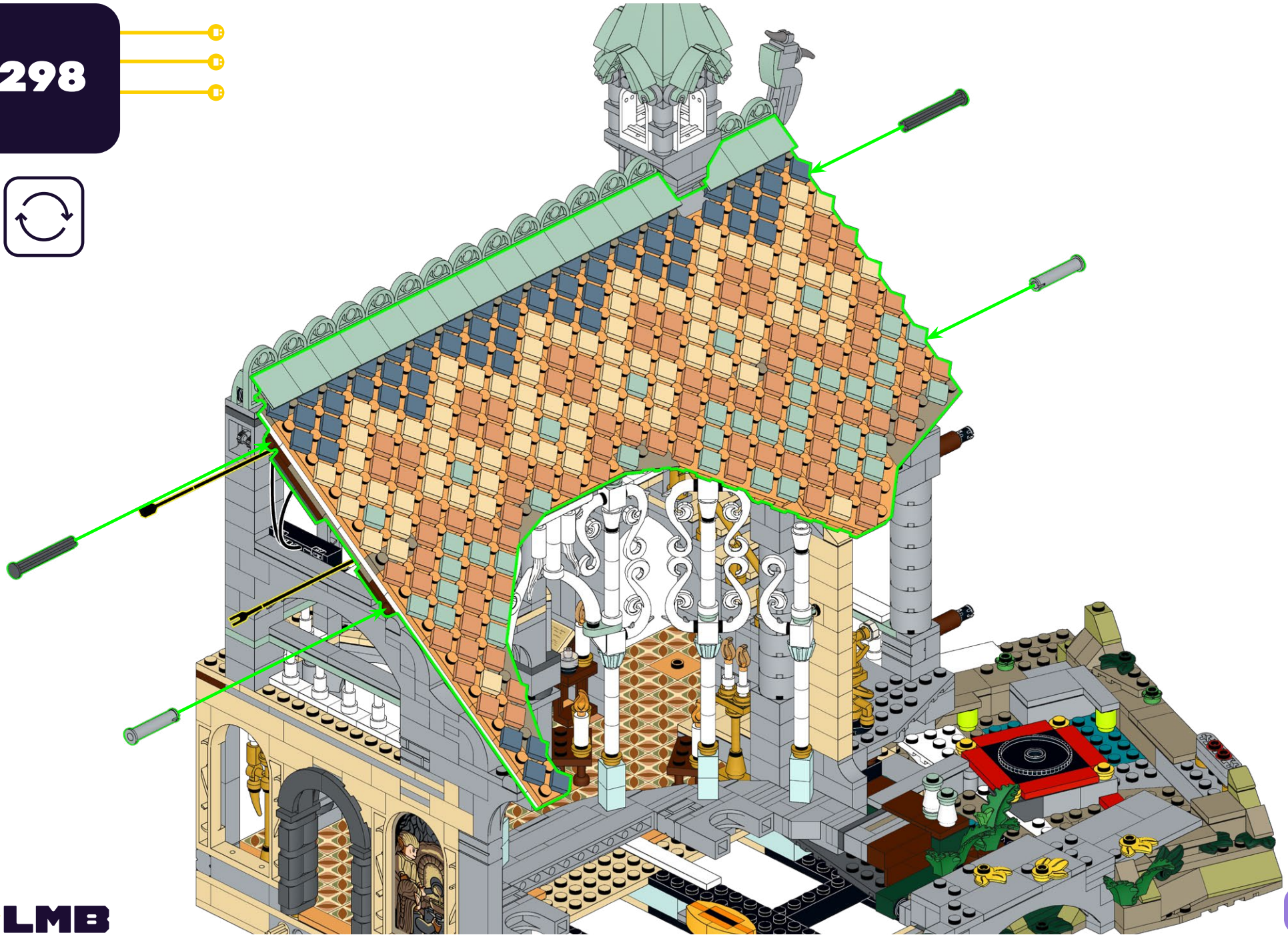



299

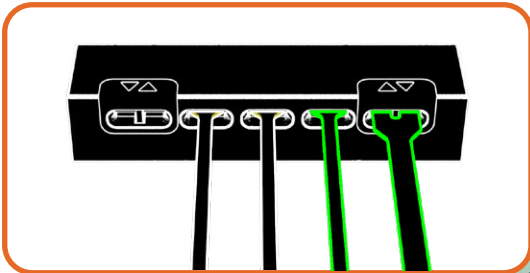

300

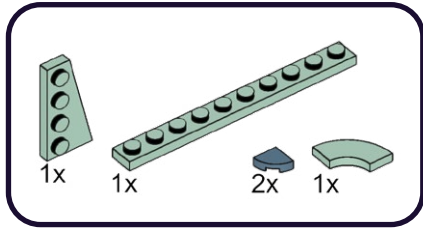

1

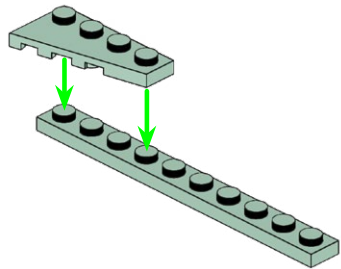

2

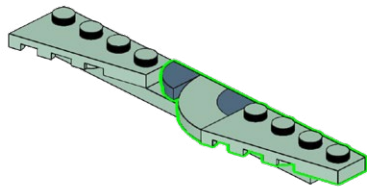

301

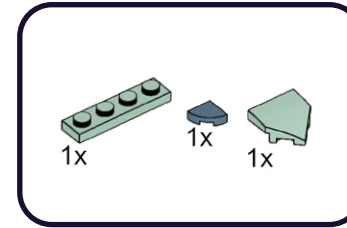

1

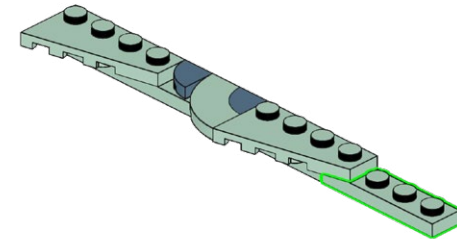

2

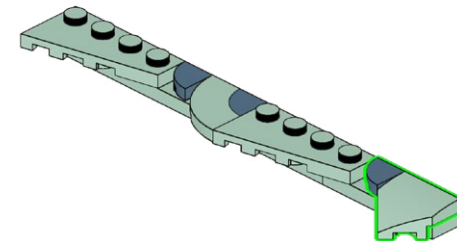



302





303

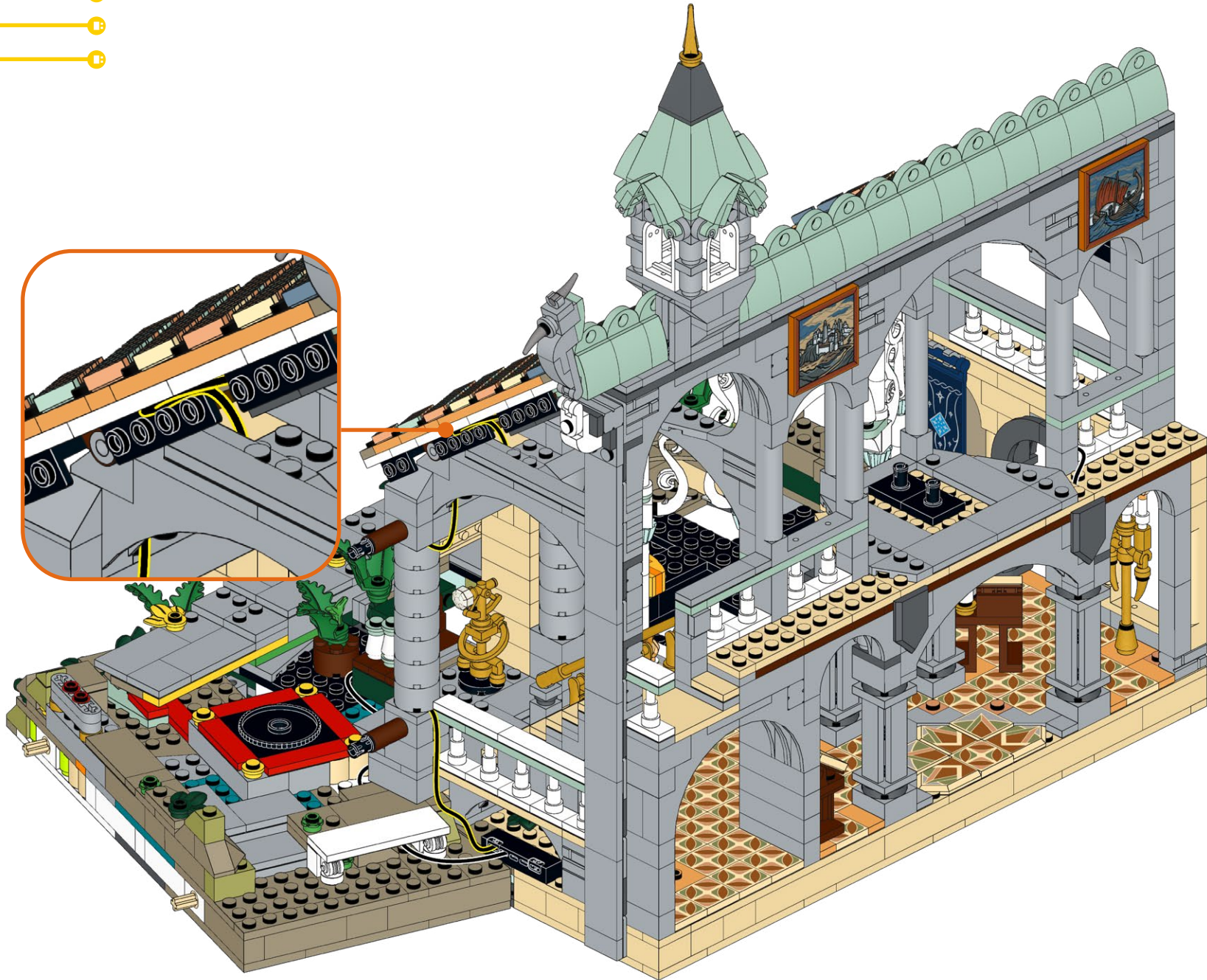



304

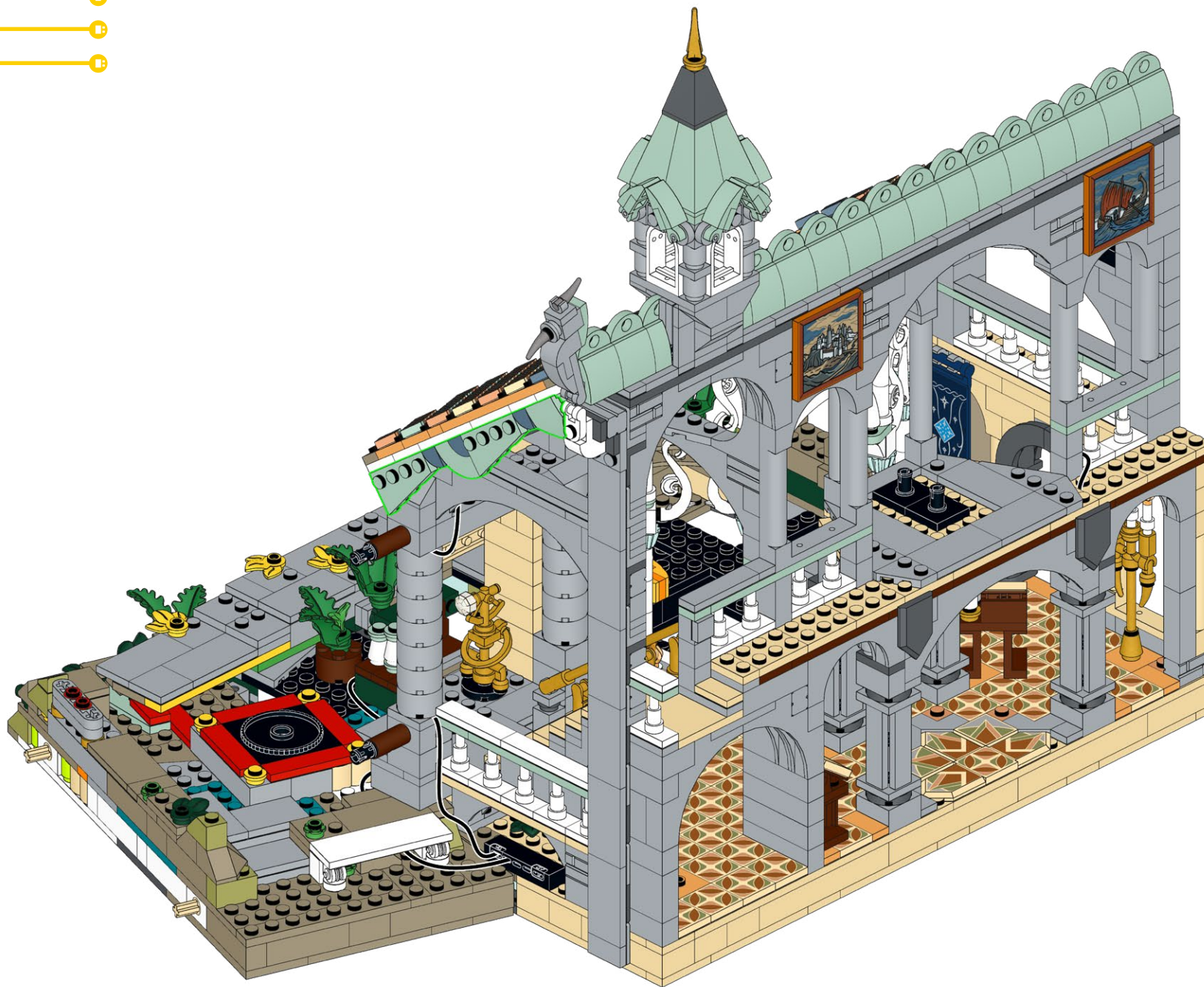

**HOLD UP!**

You might notice some bags aren't in order, as well as left over pieces, but that's ok! We're changing the way you build LEGO!

**ATTENDEZ!**

Vous remarquerez peut-être que certains sacs, ainsi que certaines pièces, ne sont pas dans le bon ordre. Mais pas de panique! Nous changeons simplement la façon avec laquelle vous construisez vos LEGO!

**ASPETTA!**

Potresti notare che alcuni sacchetti non sono in ordine, così come i pezzi avanzati, ma va bene così! Stiamo cambiando il modo in cui costruisci i LEGO!

**HALT!**

Sie werden möglicherweise bemerken, dass einige tüten durcheinander sind und teile übrig bleiben, aber das ist in Ordnung! Wir ändern die art und weise, wie Sie LEGO bauen!

**¡ESPERA!**

Es posible que notes que algunas bolsas están fuera de servicio, así como piezas sobrantes, ¡pero está bien! ¡Estamos cambiando la forma en que construyes LEGO!

**暫停!**

你可能会注意到一些袋子顺序错乱, 以及一些剩余的部件, 但没关系! 我们正在改变你搭建乐高的方式!

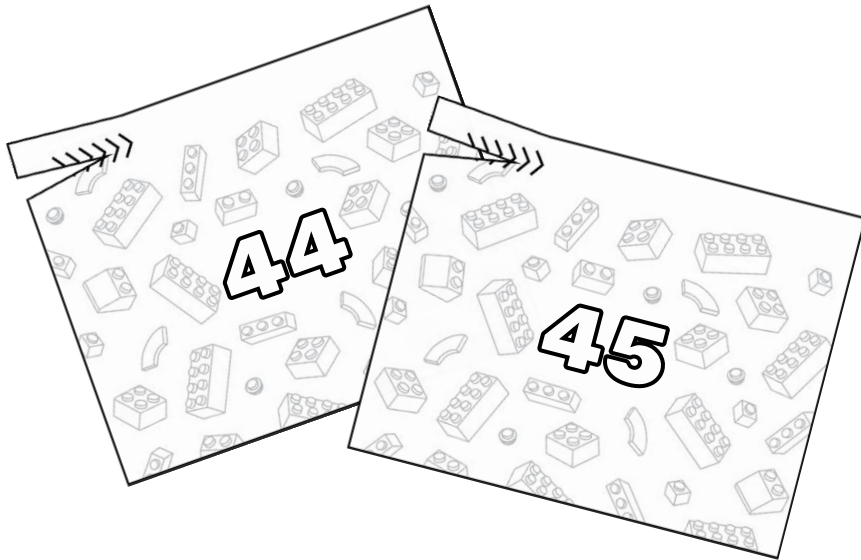
**Open LEGO® Bags 44 & 45**



**305**

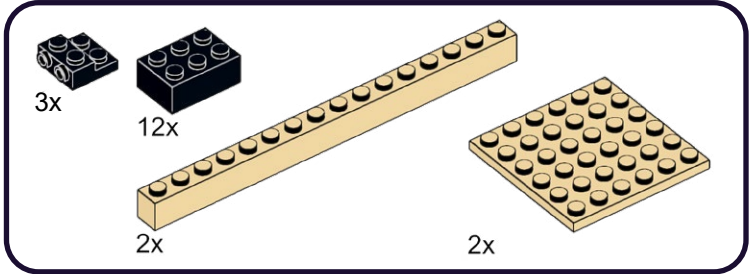

1

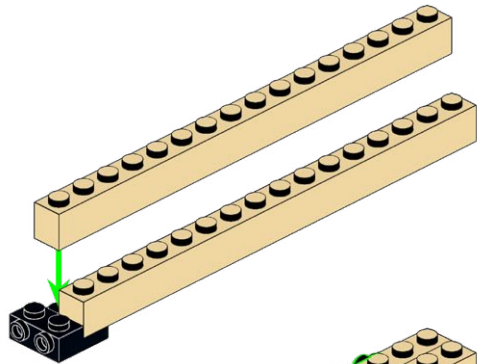

2

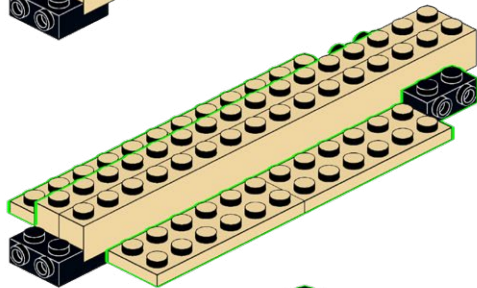

3

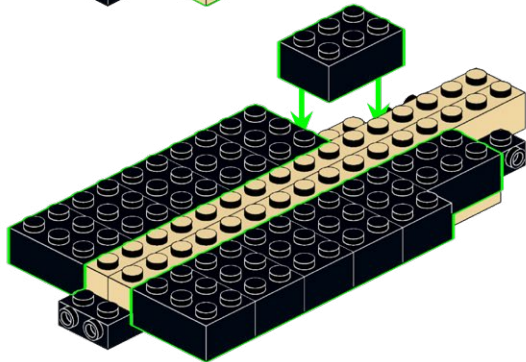

306

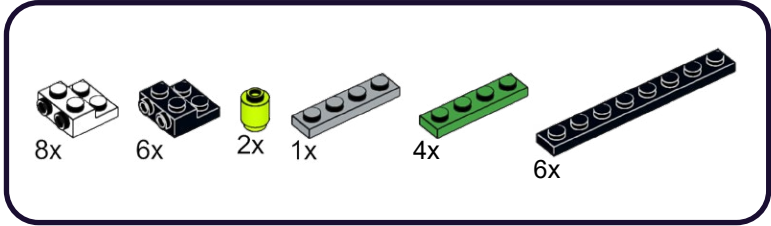

1

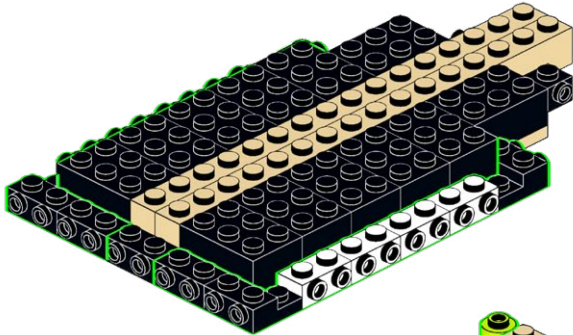

2

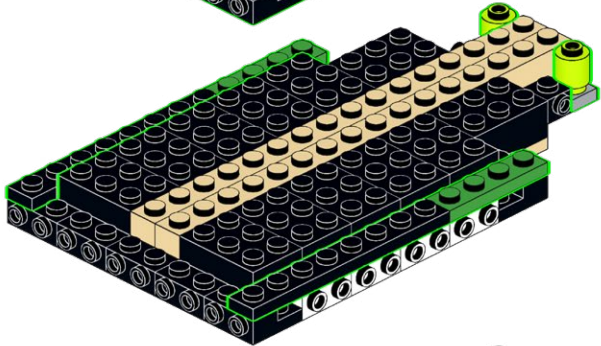

3



# 307

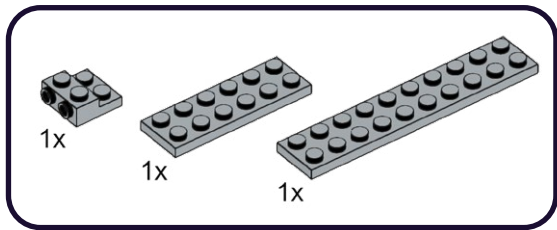

1

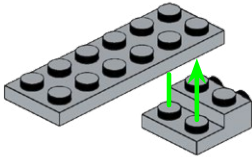

2

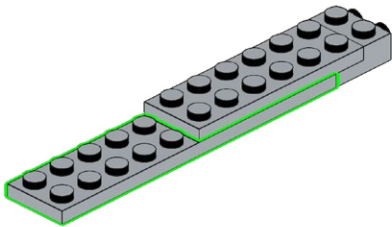

# 308

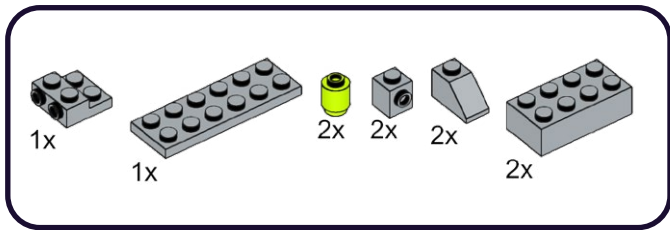

1

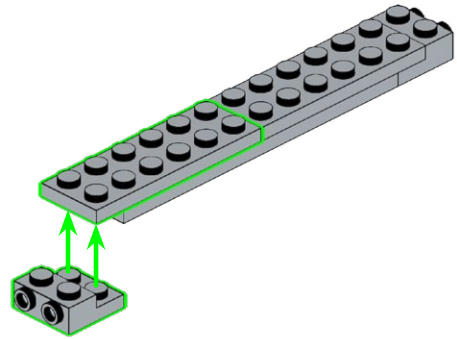

2

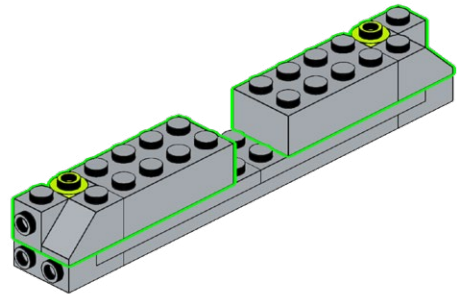



309

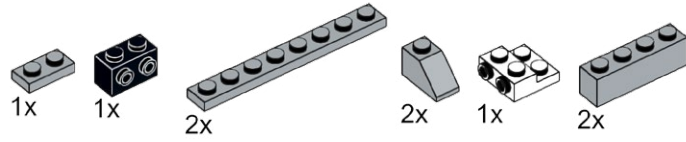

1

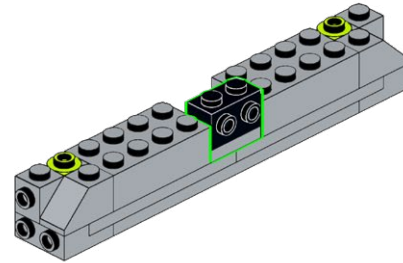

2

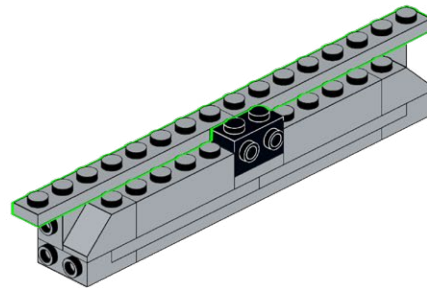

3

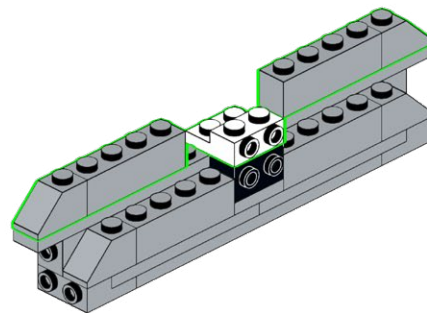

310

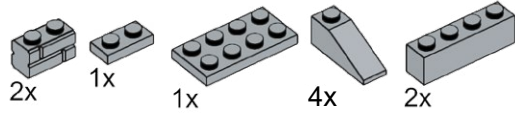

1

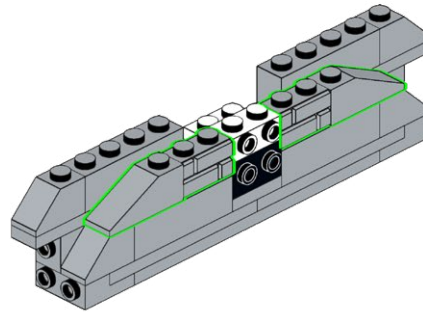

2

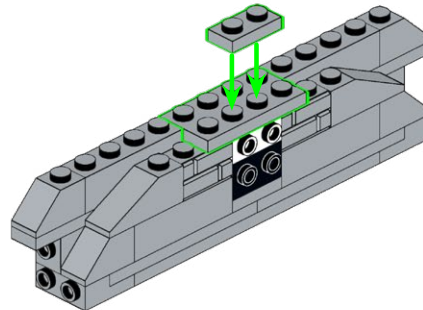

3

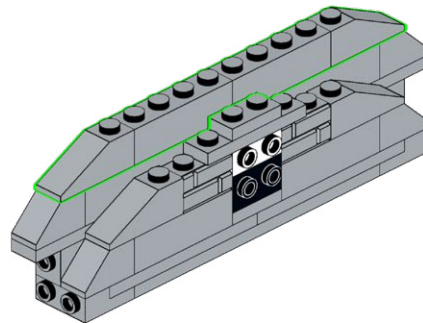

311



1

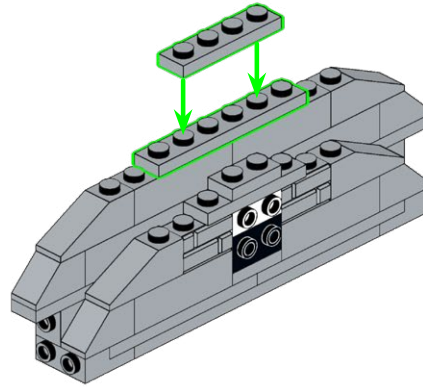

2

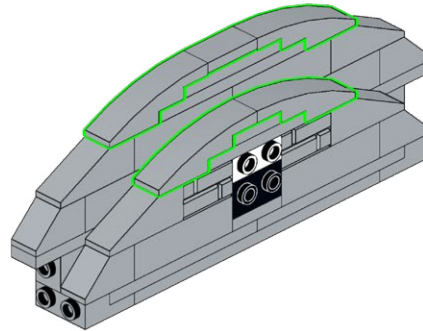



312

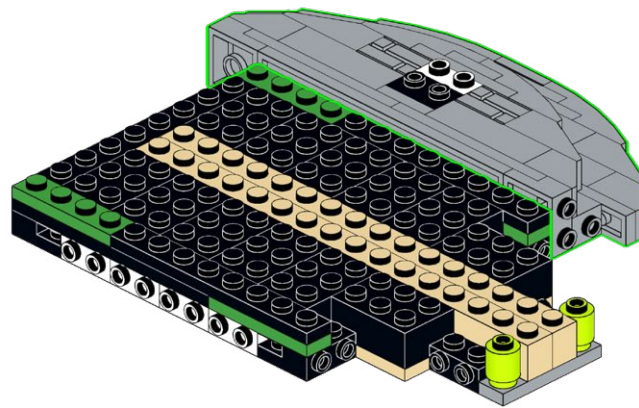

313

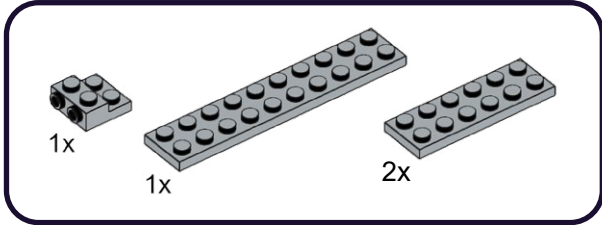

1

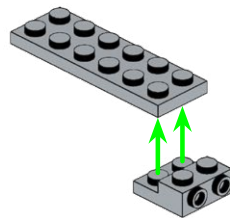

2

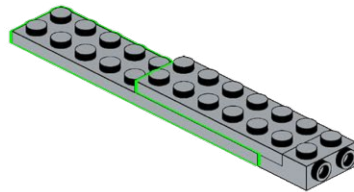

3

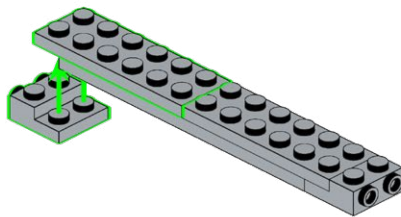

314

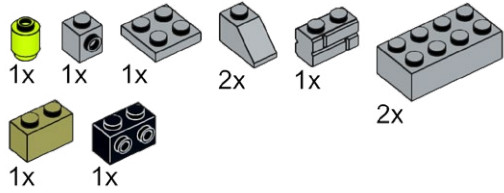

1

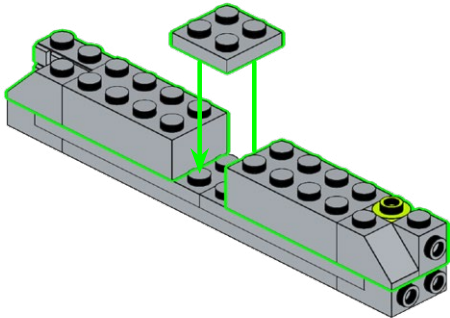

2

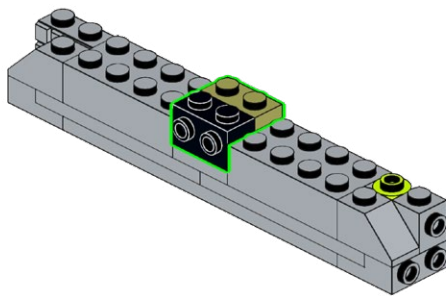

315

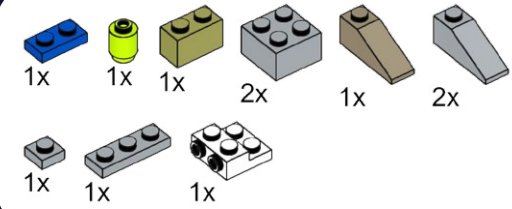

1

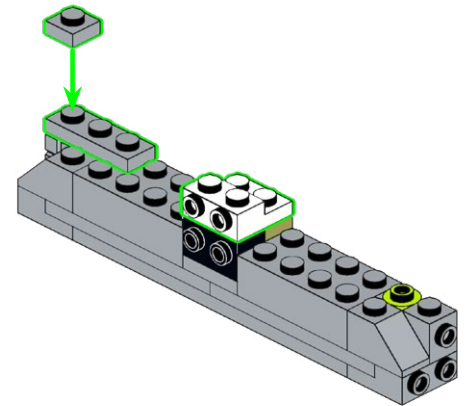

2

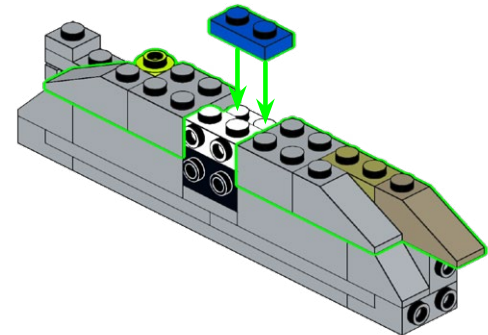



316

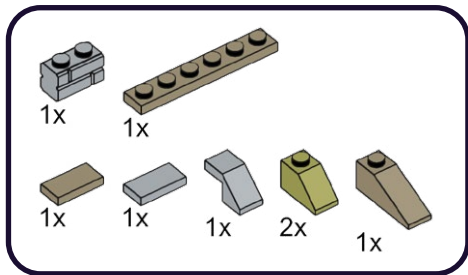

1

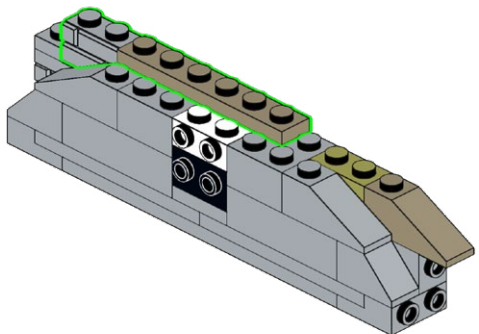

2

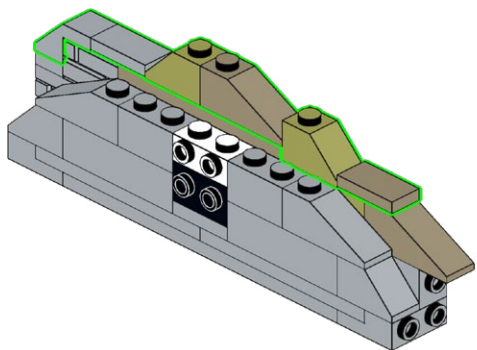

317

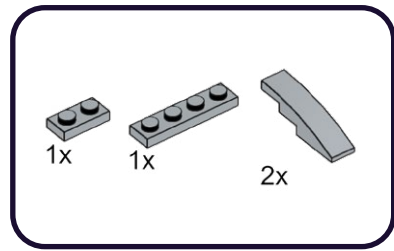

1

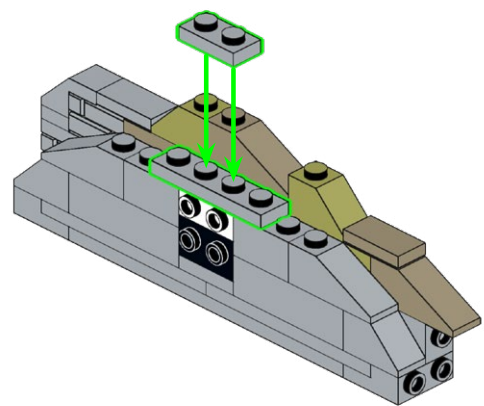

2

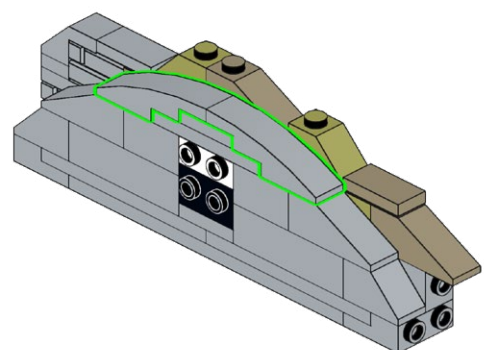

318

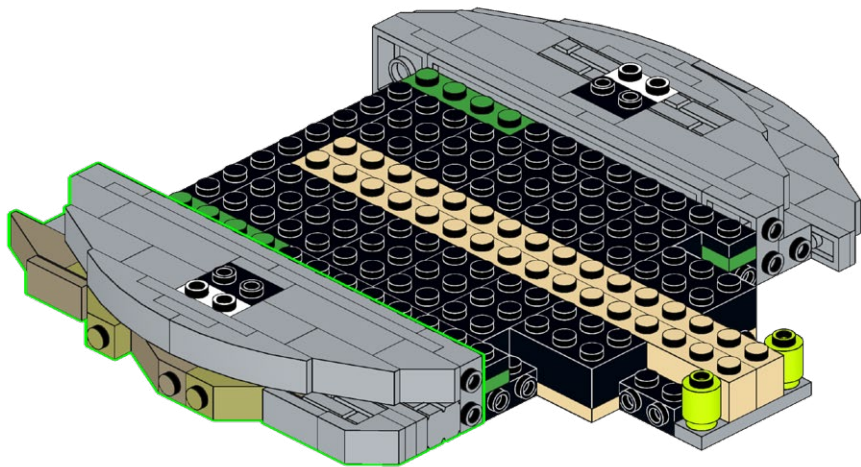

319

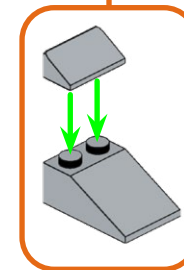
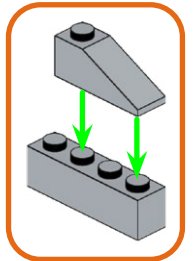
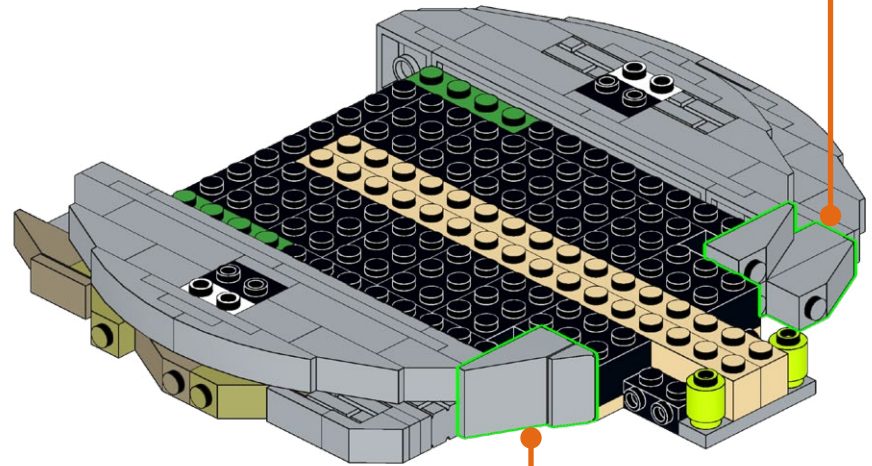
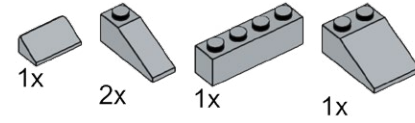

320

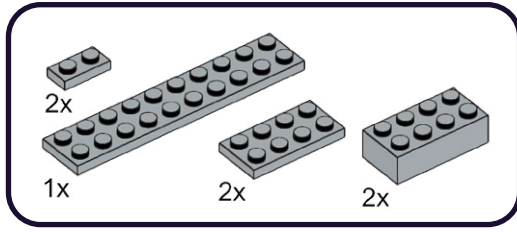

1

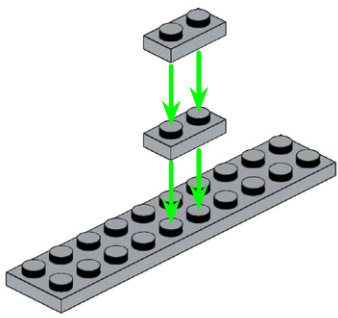

2

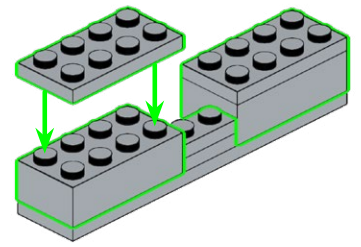

321

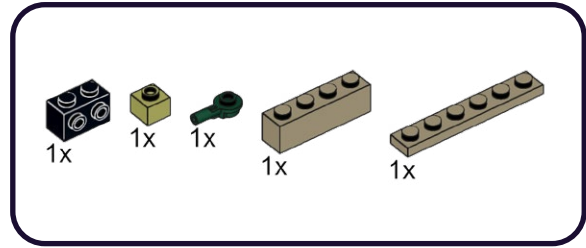

1

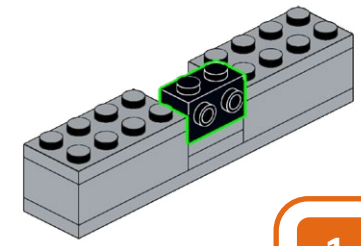

2

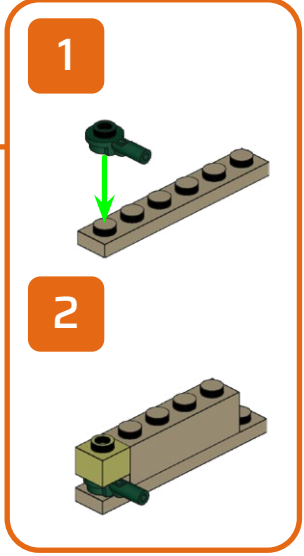
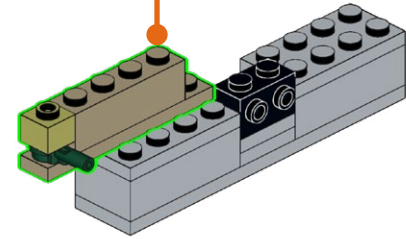



# 322

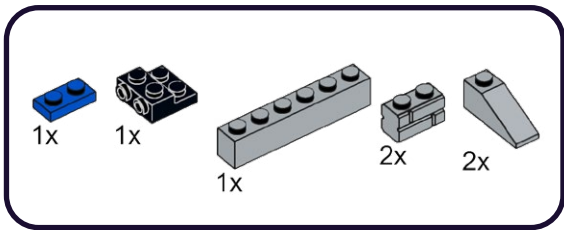

1

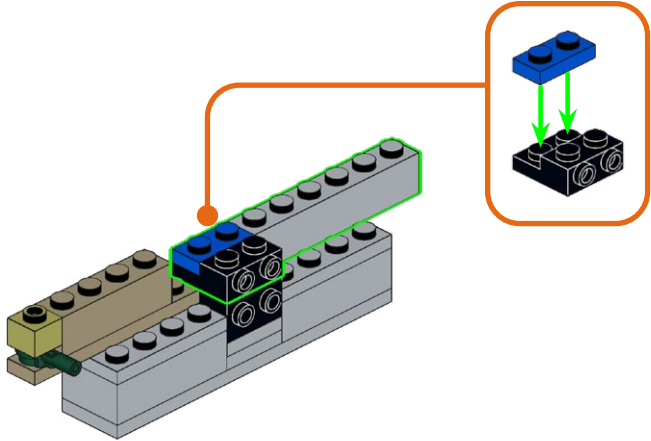

2

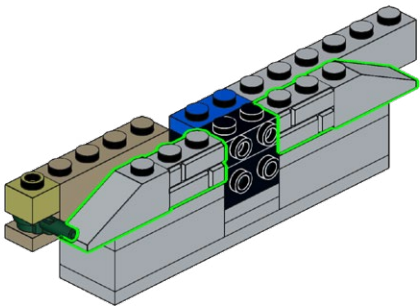

# 323

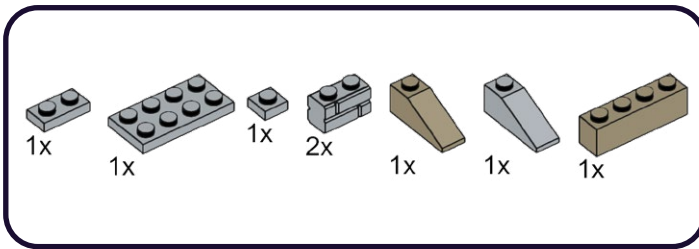

1

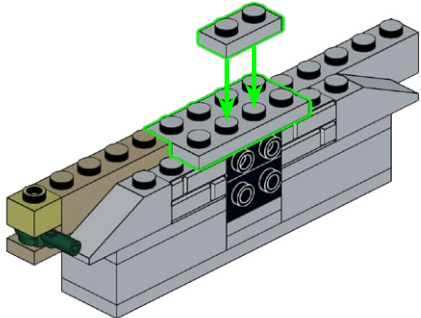

2

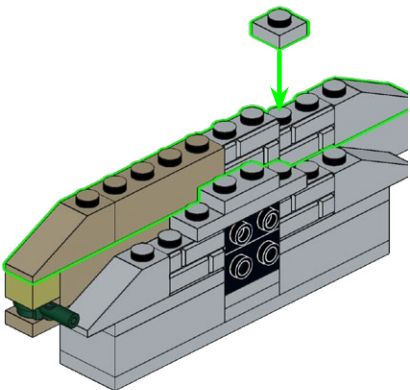

324

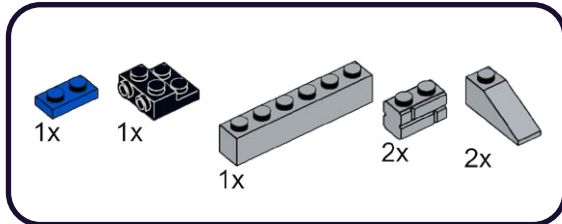

1

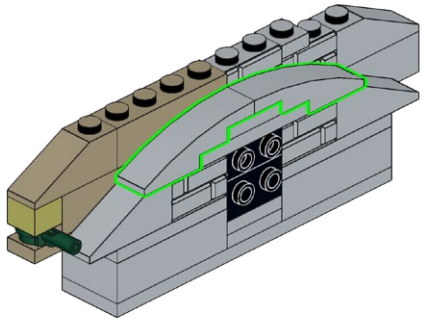

2

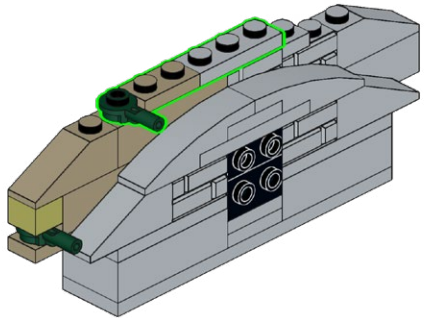

325

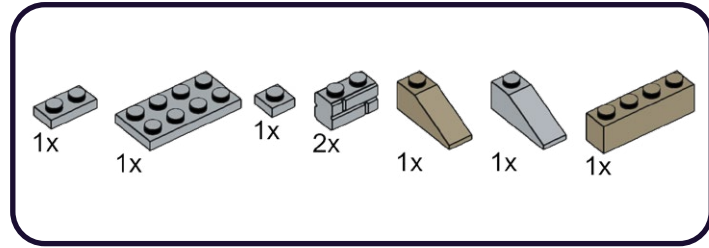

1

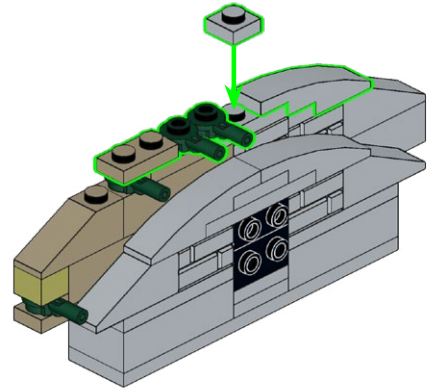

2

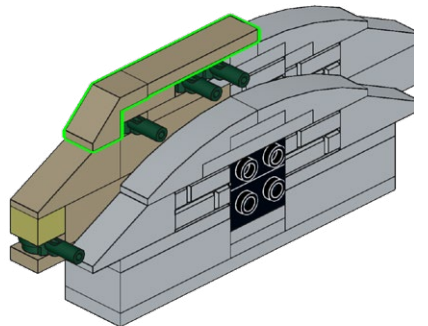

326

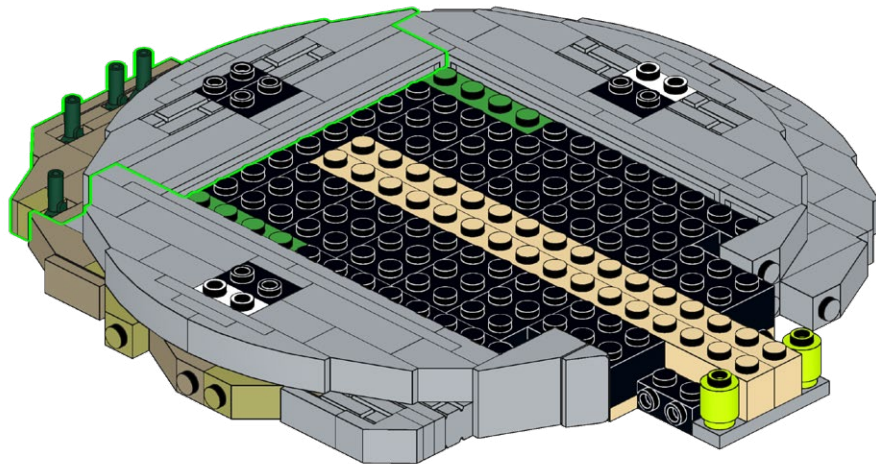

327

2x

4x



2x

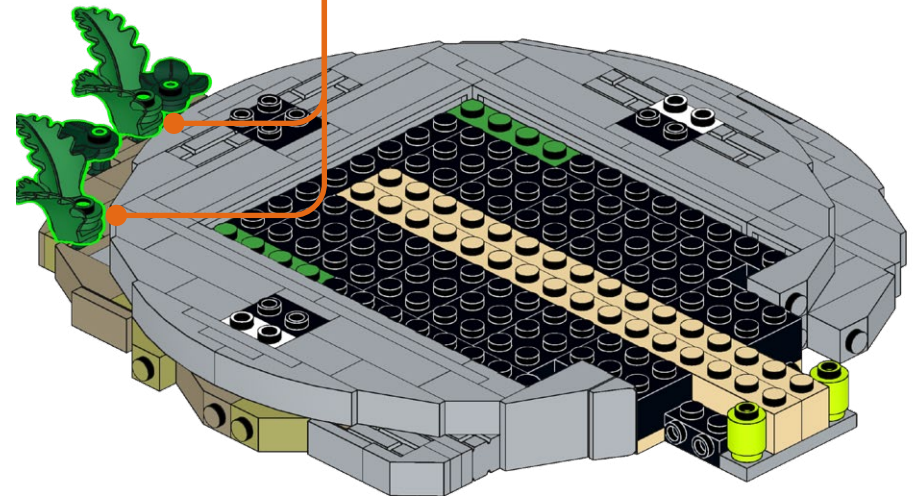



**HOLD UP!**

You might notice some bags aren't in order, as well as left over pieces, but that's ok! We're changing the way you build LEGO!

**ATTENDEZ!**

Vous remarquerez peut-être que certains sacs, ainsi que certaines pièces, ne sont pas dans le bon ordre. Mais pas de panique! Nous changeons simplement la façon avec laquelle vous construisez vos LEGO!

**ASPETTA!**

Potresti notare che alcuni sacchetti non sono in ordine, così come i pezzi avanzati, ma va bene così! Stiamo cambiando il modo in cui costruisci i LEGO!

**HALT!**

Sie werden möglicherweise bemerken, dass einige tüten durcheinander sind und teile übrig bleiben, aber das ist in Ordnung! Wir ändern die art und weise, wie Sie LEGO bauen!

**¡ESPERA!**

Es posible que notes que algunas bolsas están fuera de servicio, así como piezas sobrantes, ¡pero está bien! ¡Estamos cambiando la forma en que construyes LEGO!

**暫停!**

你可能会注意到一些袋子顺序错乱, 以及一些剩余的部件, 但没关系! 我们正在改变你搭建乐高的方式!

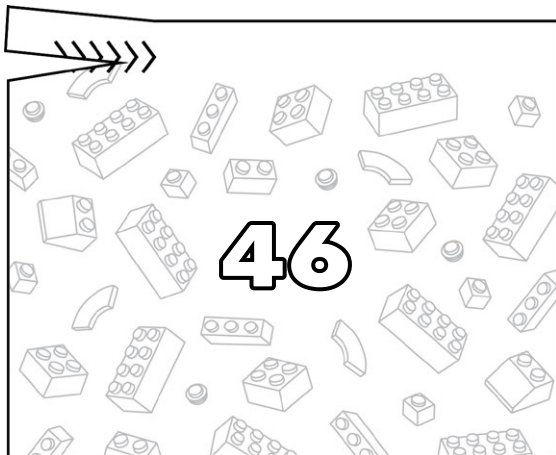
**Open LEGO® Bag 46**

328

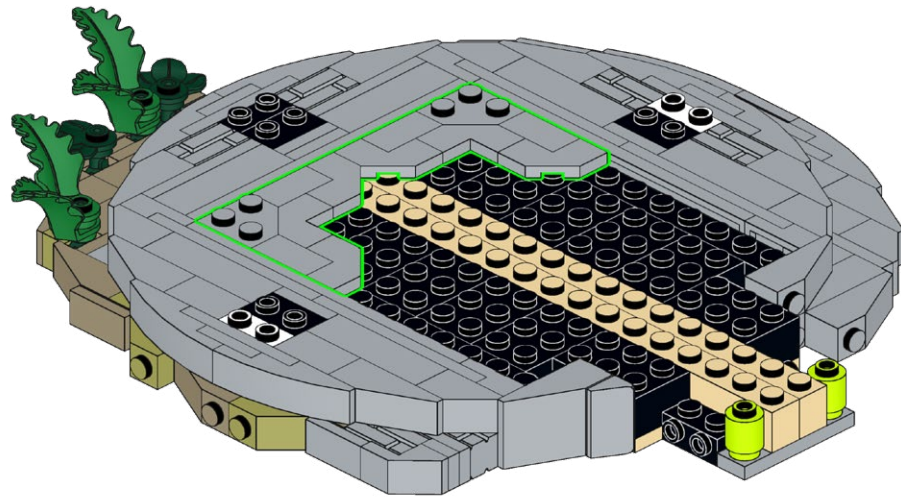
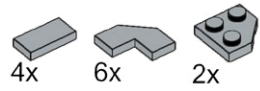

329

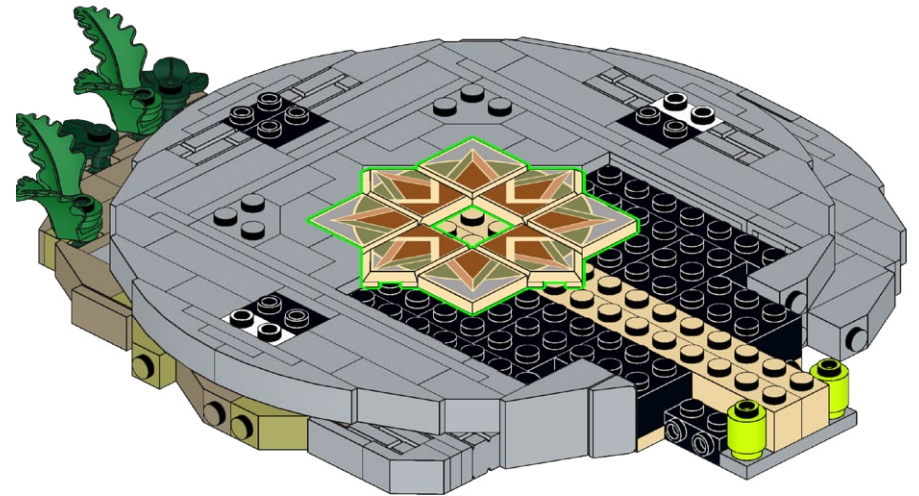
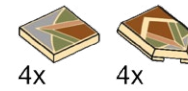

**330**

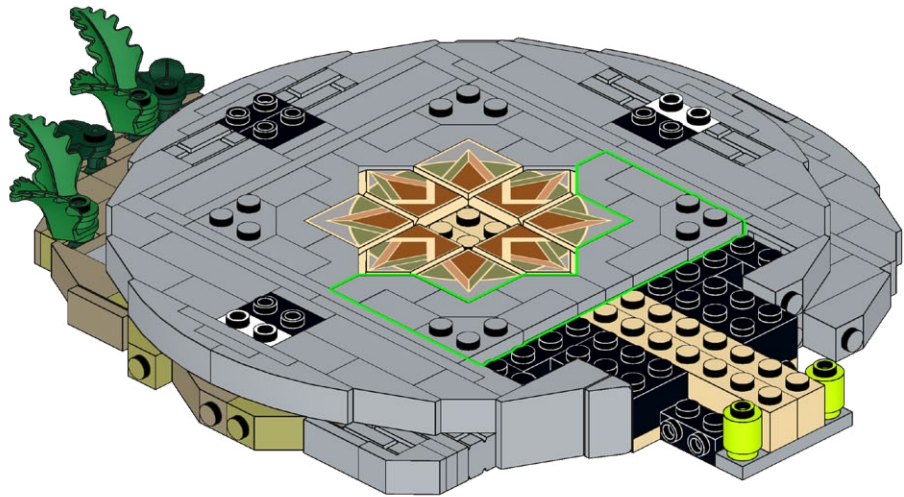
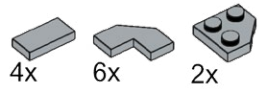

**331**

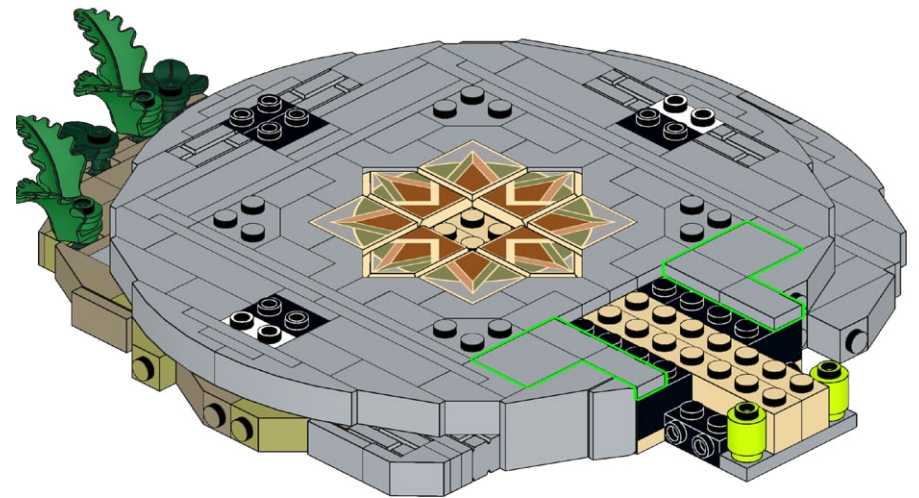
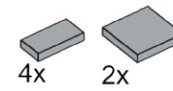



**332**

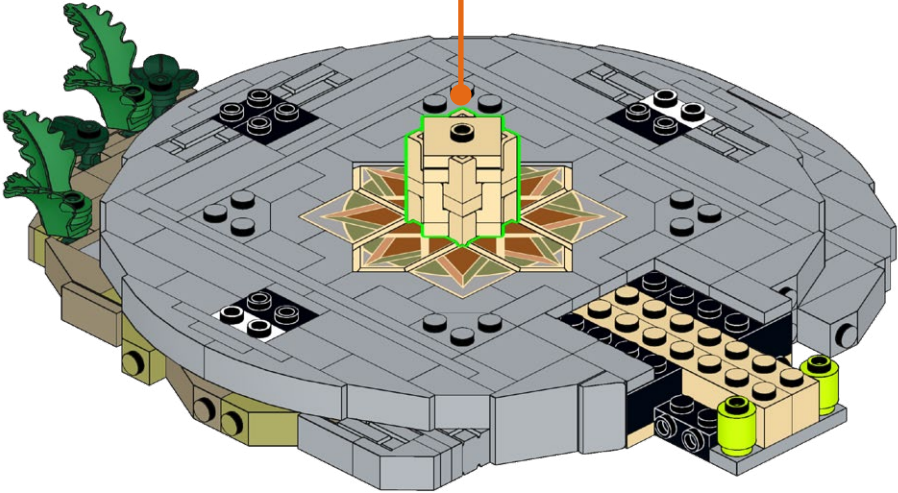
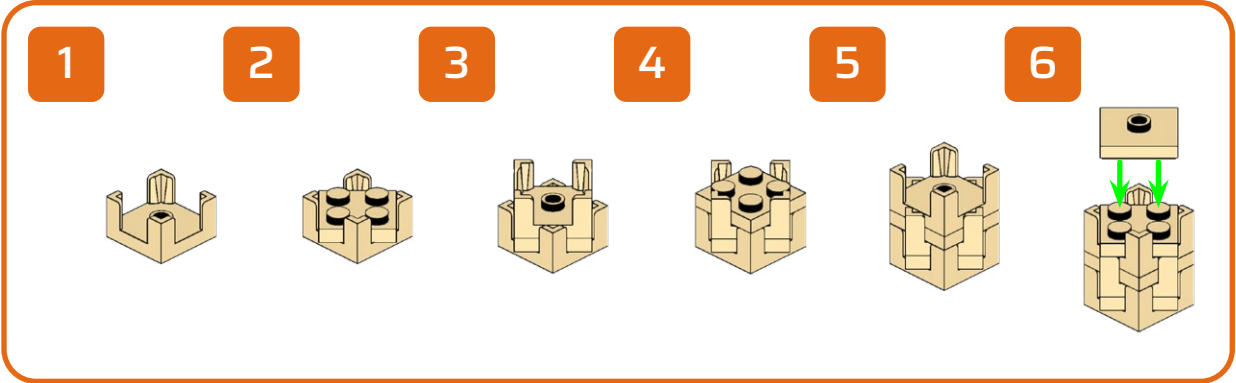
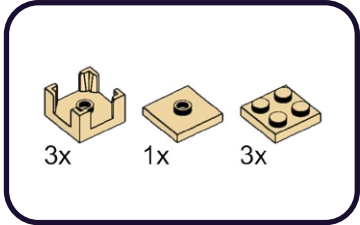

**333**

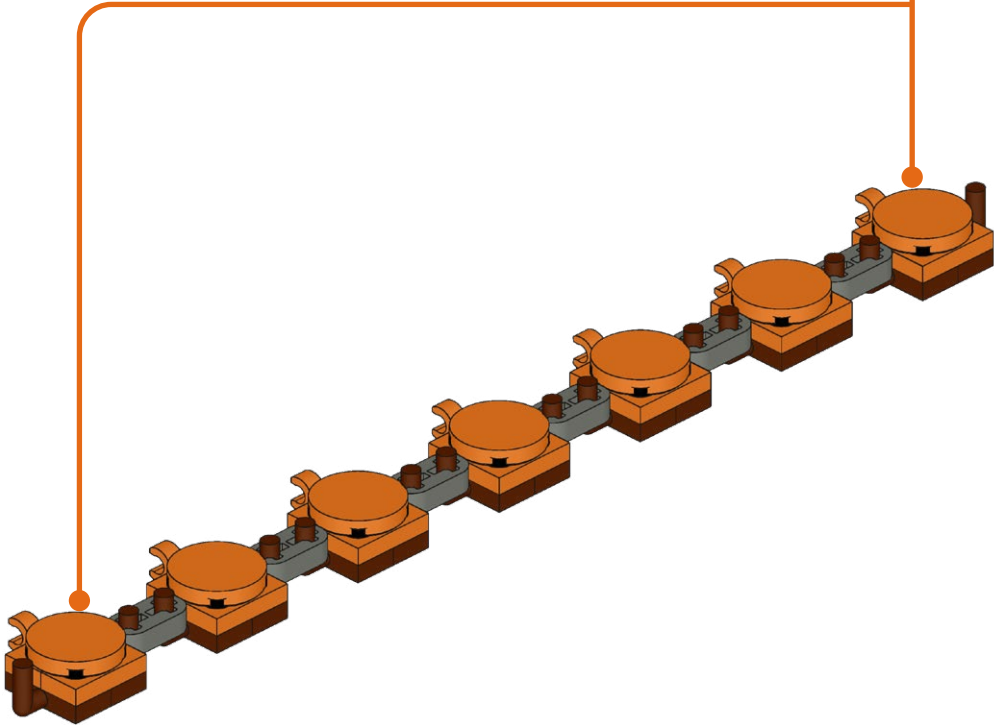
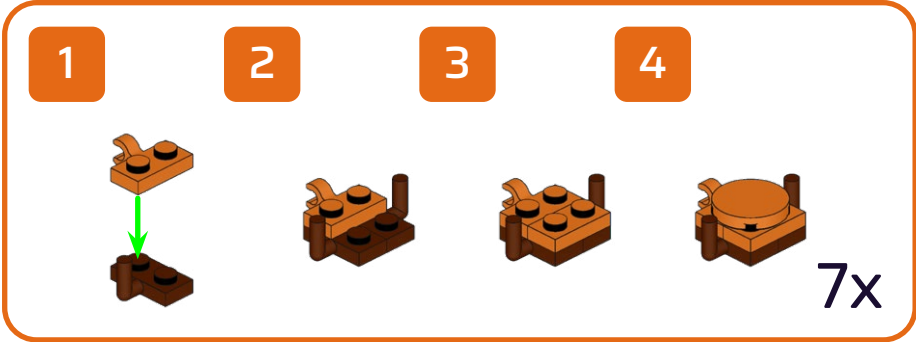
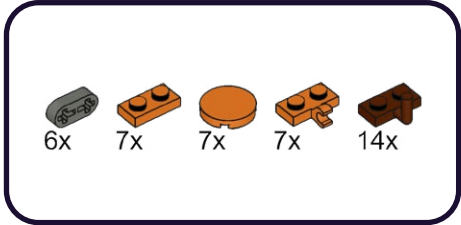

**334**

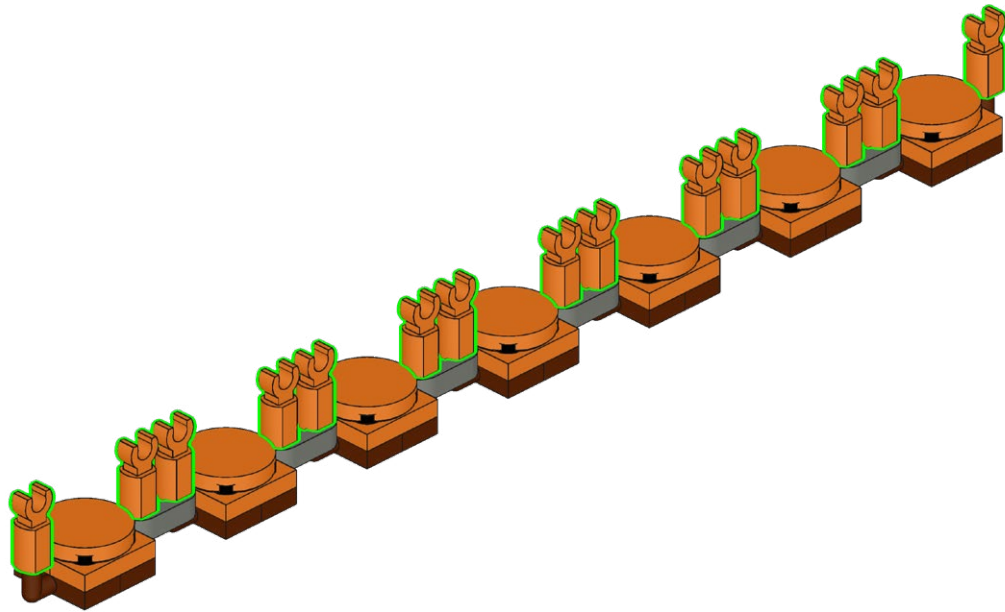
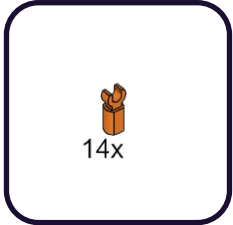



335

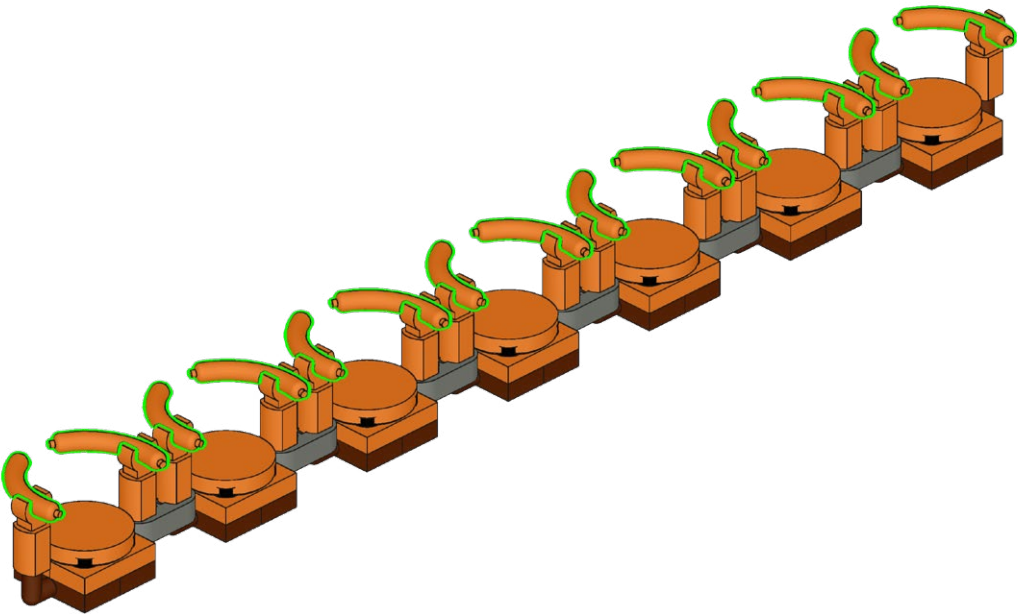
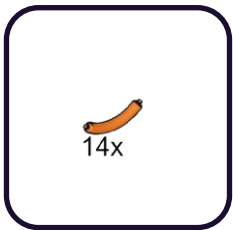

336

7x 7x

7x

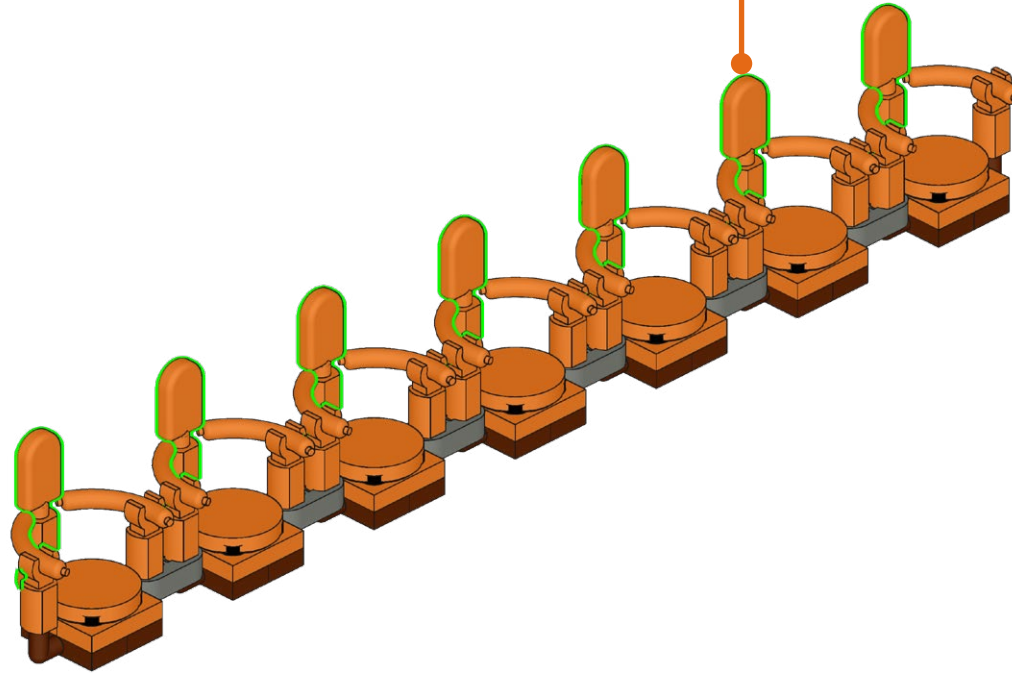

**HOLD UP!**

You might notice some bags aren't in order, as well as left over pieces, but that's ok! We're changing the way you build LEGO!

**ATTENDEZ!**

Vous remarquerez peut-être que certains sacs, ainsi que certaines pièces, ne sont pas dans le bon ordre. Mais pas de panique! Nous changeons simplement la façon avec laquelle vous construisez vos LEGO!

**ASPETTA!**

Potresti notare che alcuni sacchetti non sono in ordine, così come i pezzi avanzati, ma va bene così! Stiamo cambiando il modo in cui costruisci i LEGO!

**HALT!**

Sie werden möglicherweise bemerken, dass einige tüten durcheinander sind und teile übrig bleiben, aber das ist in Ordnung! Wir ändern die art und weise, wie Sie LEGO bauen!

**¡ESPERA!**

Es posible que notes que algunas bolsas están fuera de servicio, así como piezas sobrantes, ¡pero está bien! ¡Estamos cambiando la forma en que construyes LEGO!

**暫停!**

你可能会注意到一些袋子顺序错乱, 以及一些剩余的部件, 但没关系! 我们正在改变你搭建乐高的方式!

**Open LEGO® Bag 47**



337

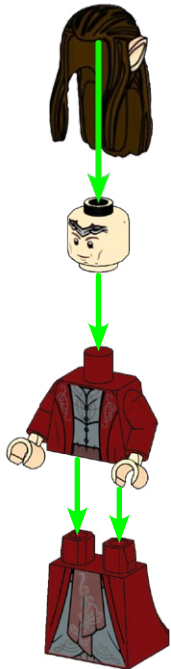
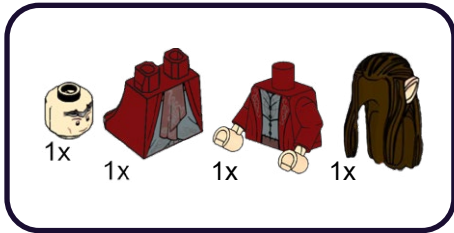

338



339

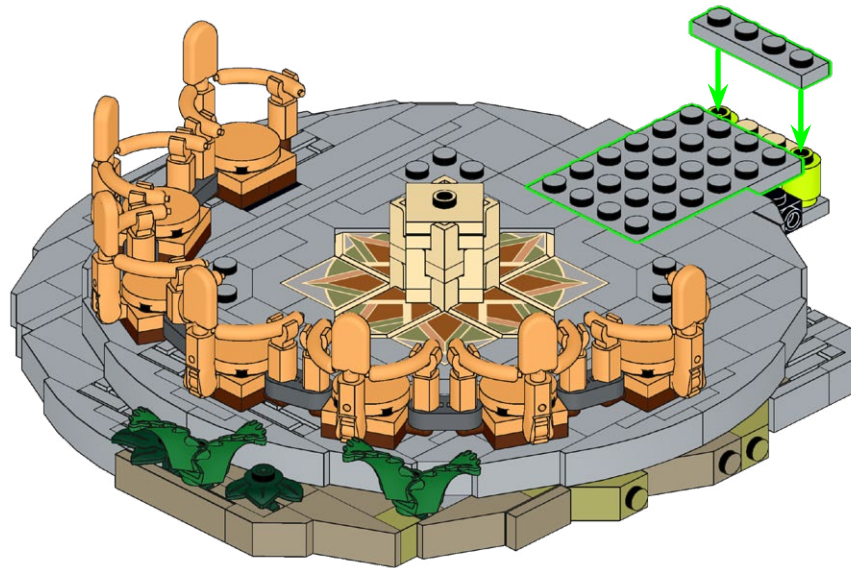
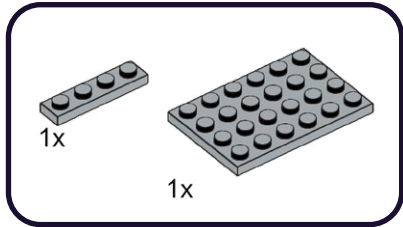

340



4x

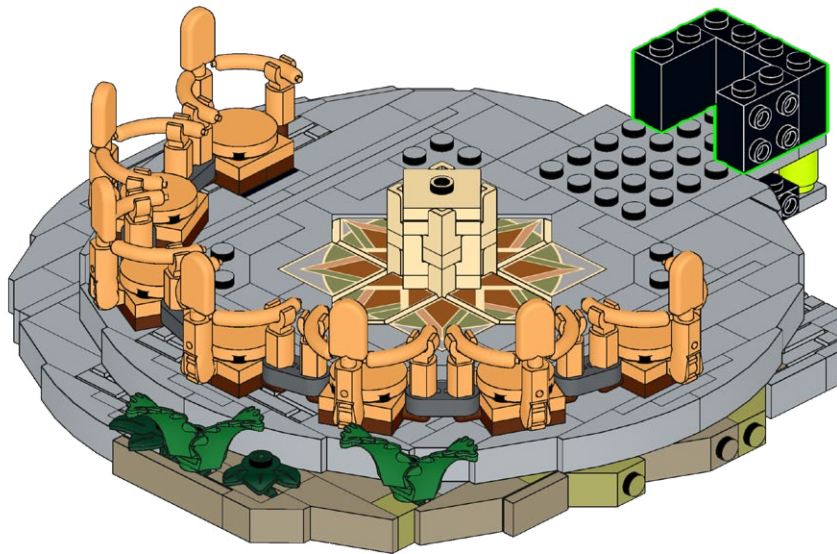

341



2x



2x



1x

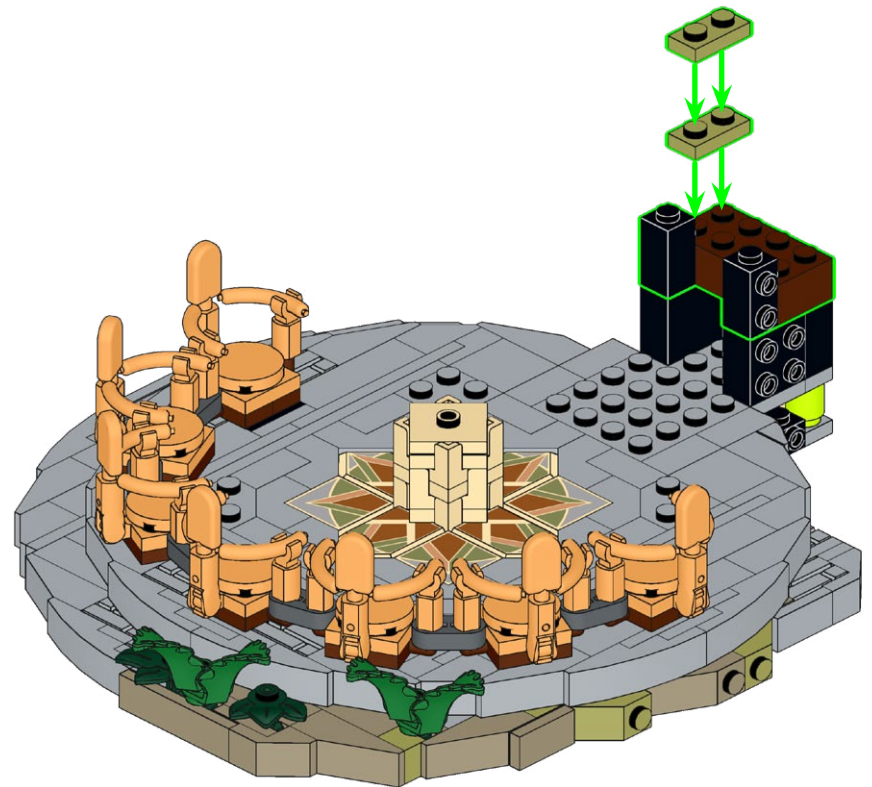



342

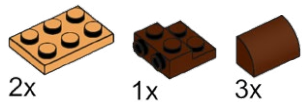

1

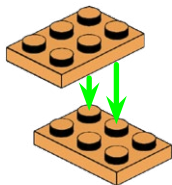

2

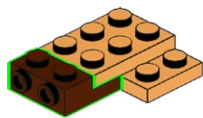

3

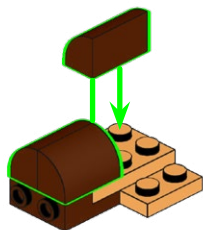

343

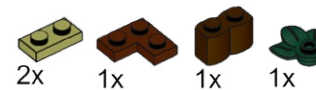

1

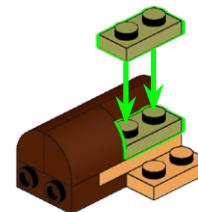

2

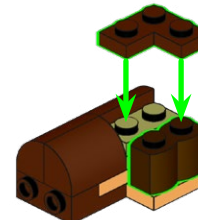

3

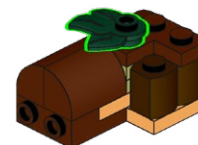

344

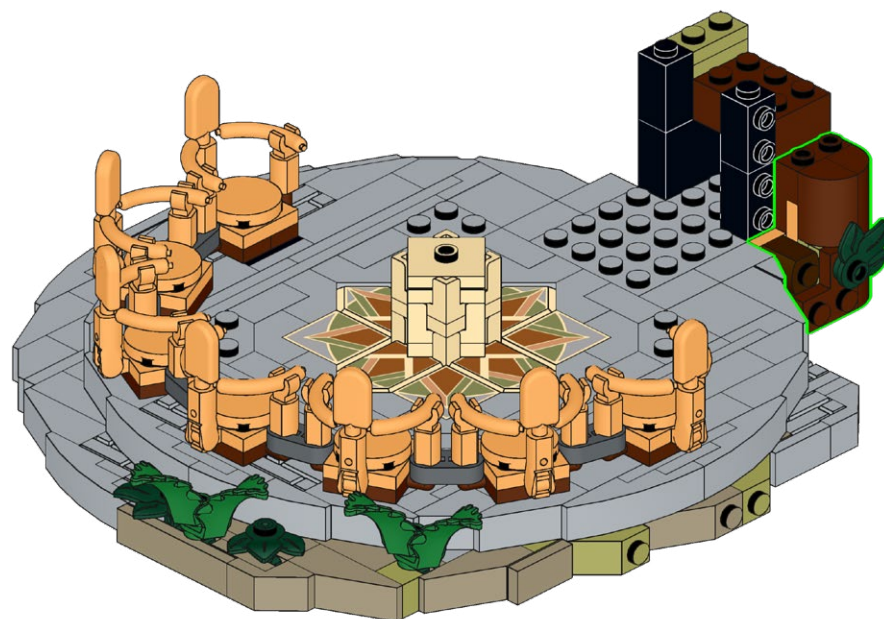

345

2x 2x 1x

1

2

3

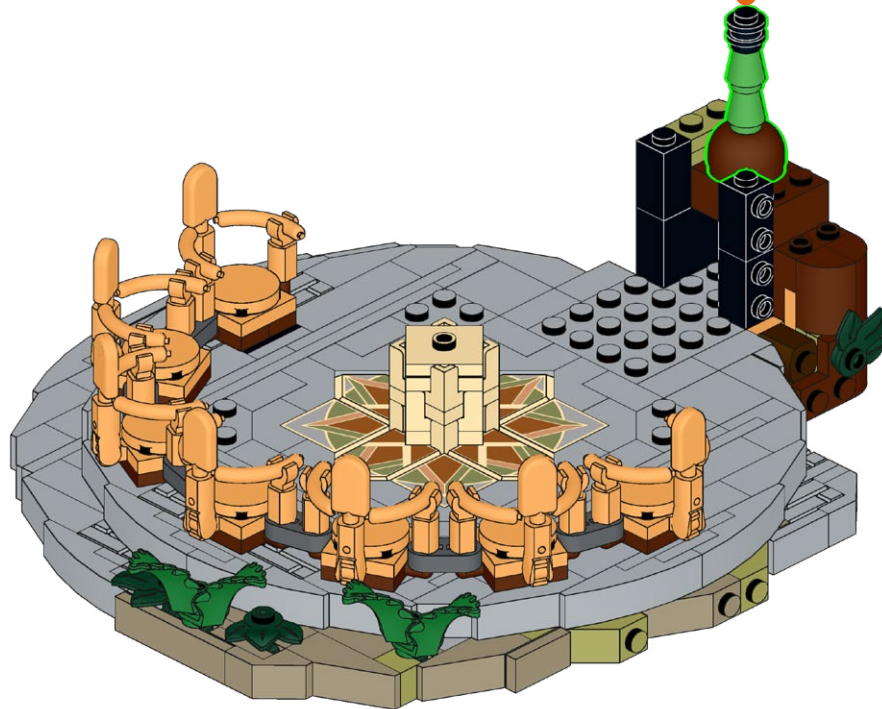



346

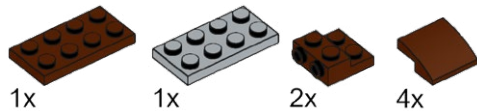

1

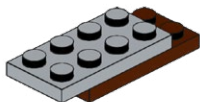

2

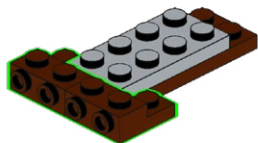

3

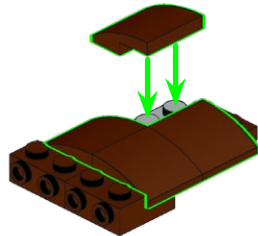

347

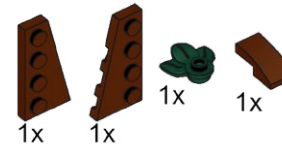

1

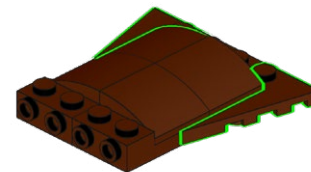

2

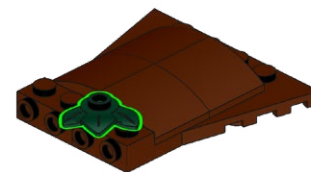

3

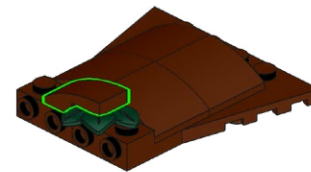

348

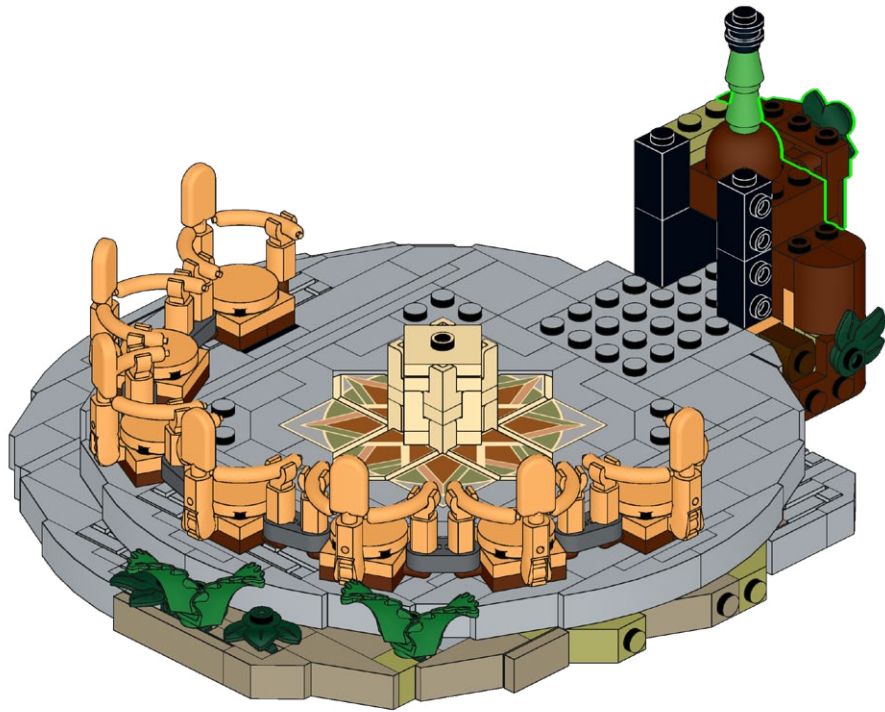

349

2x

2x

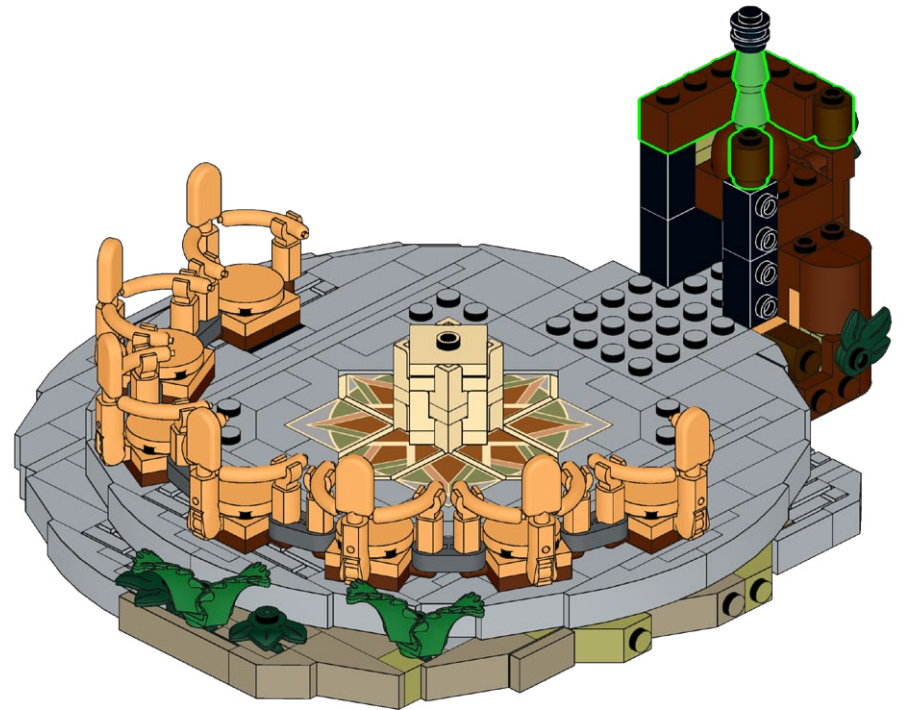

# 350

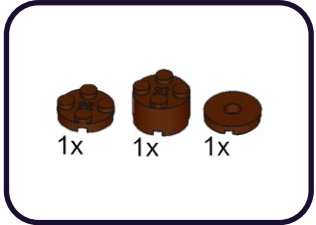

1

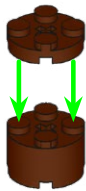

2

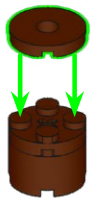

# 351

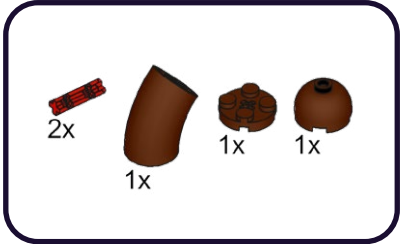

1



2

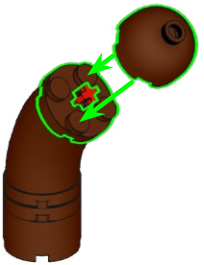



352

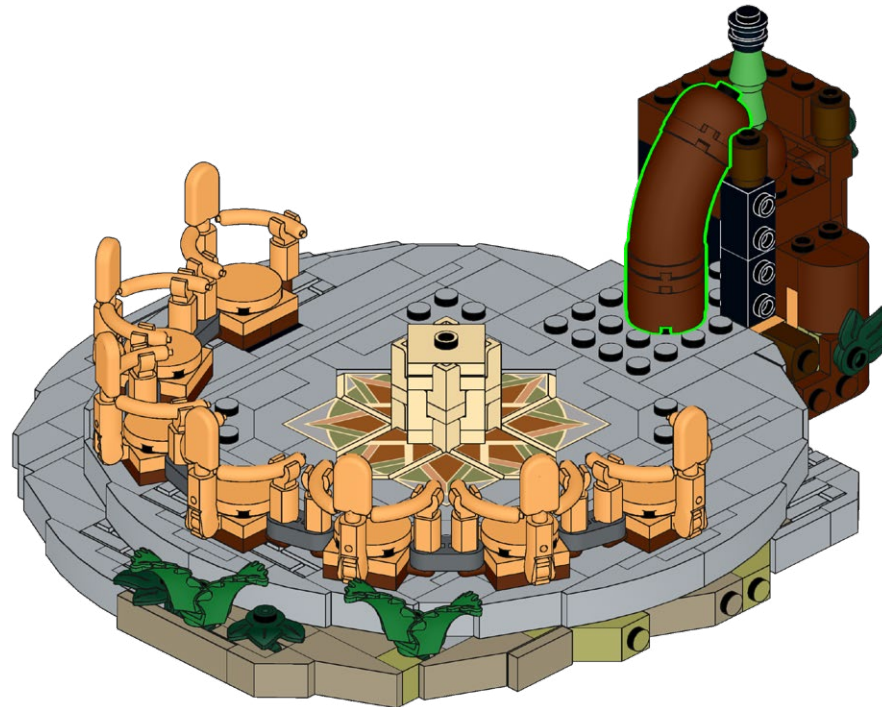

353

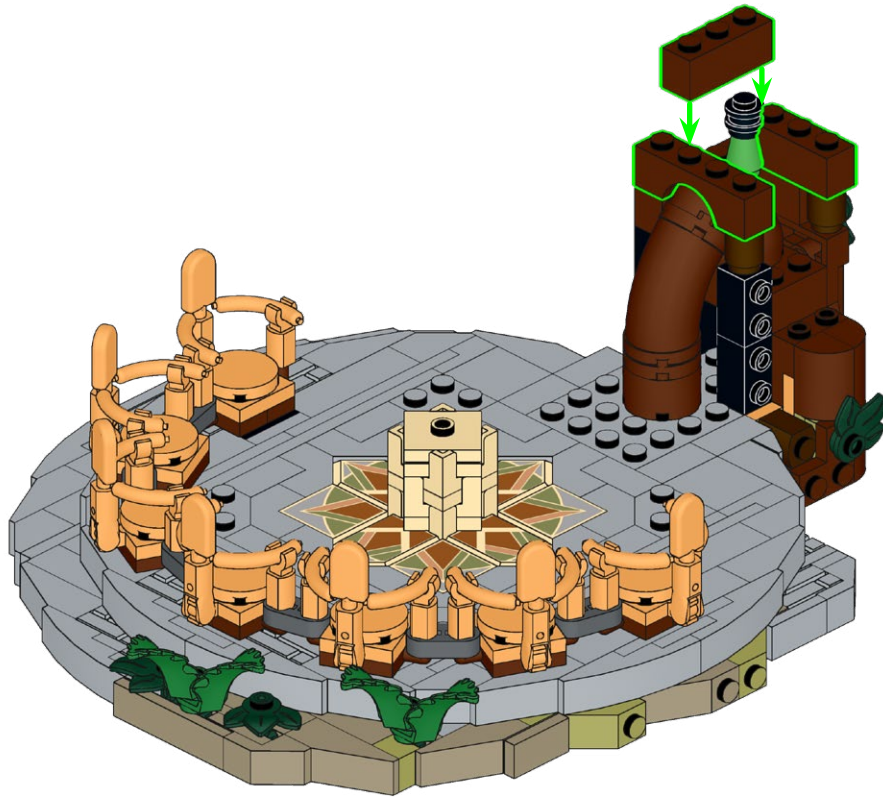
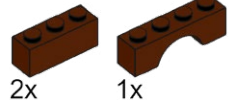

354

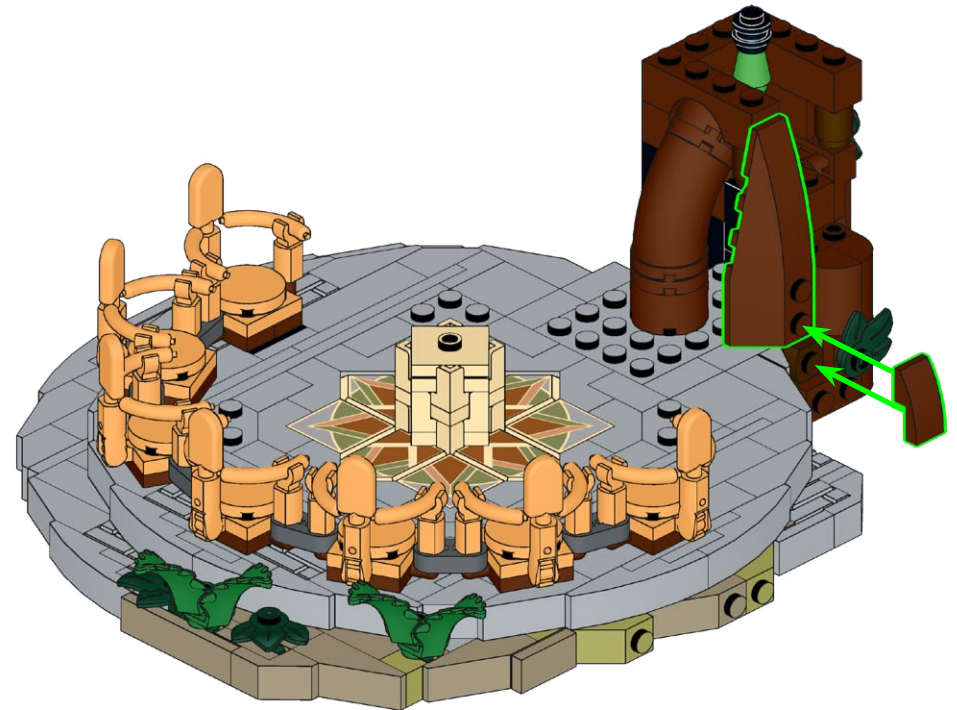
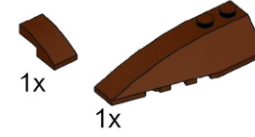

# 355

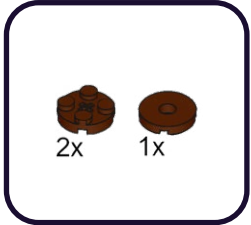

1

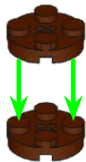

2

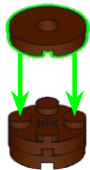

# 356

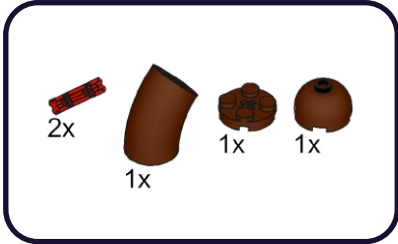

1

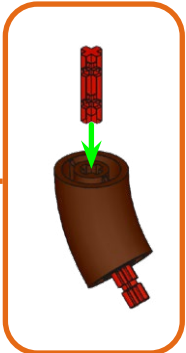

2

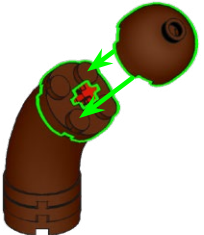



**357**

**357**



**358**

**358**

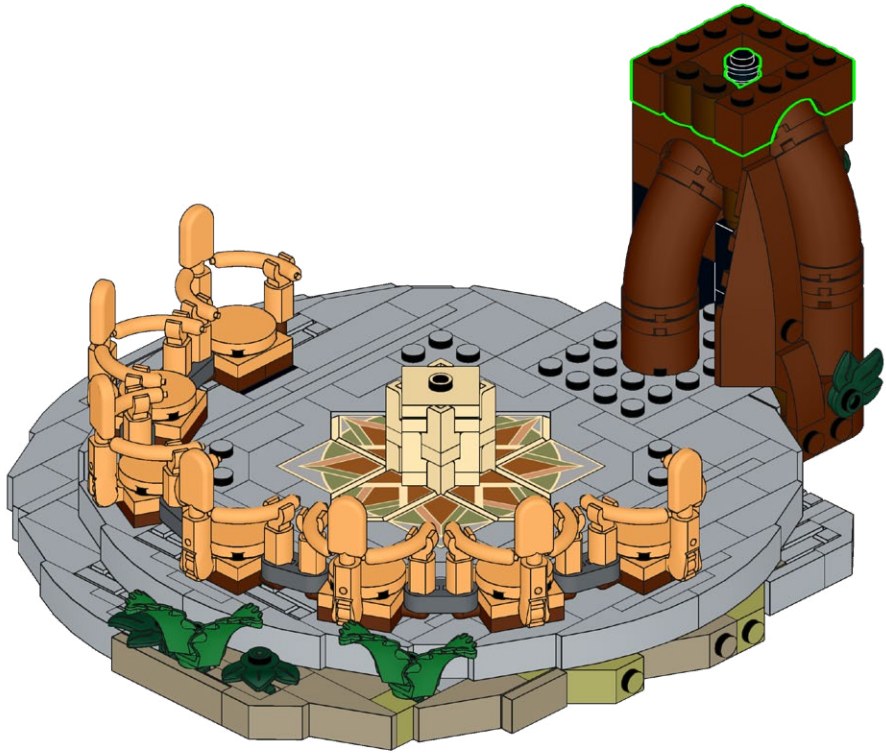
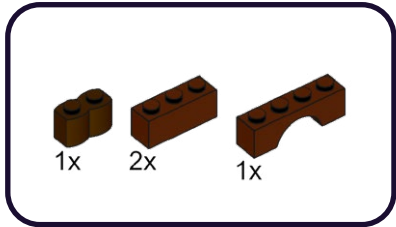

359

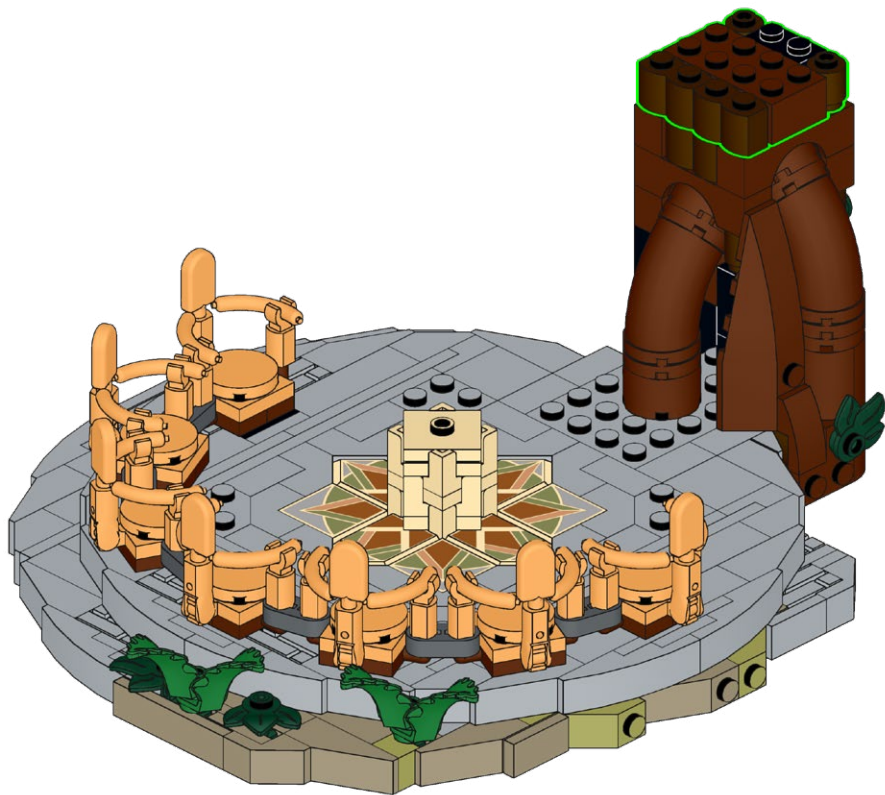
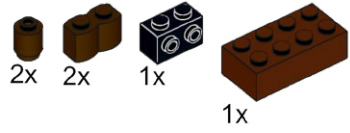

360

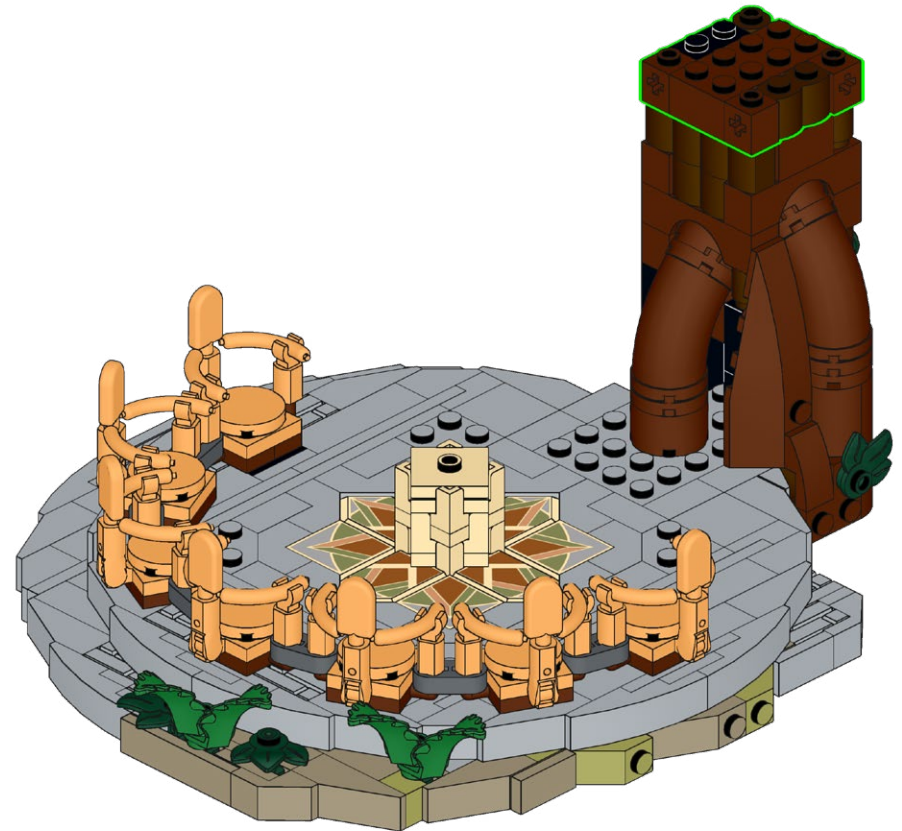
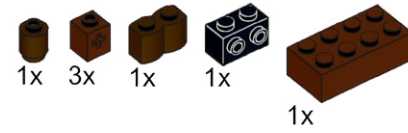

361



2x

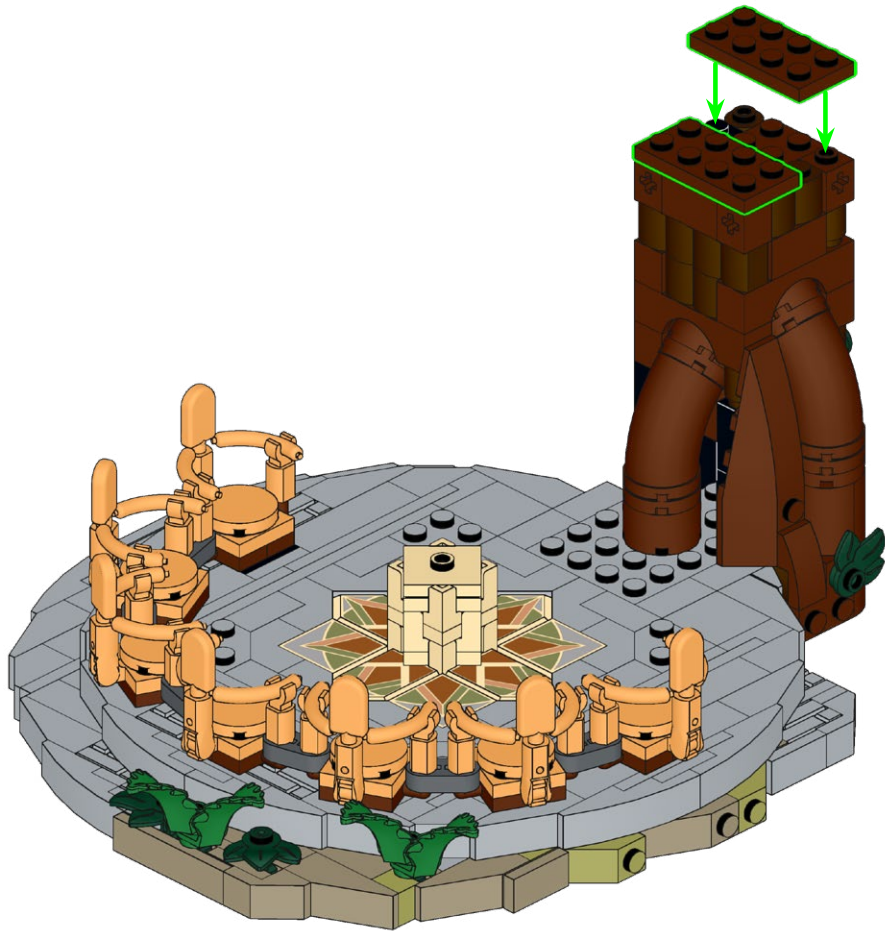

362



2x

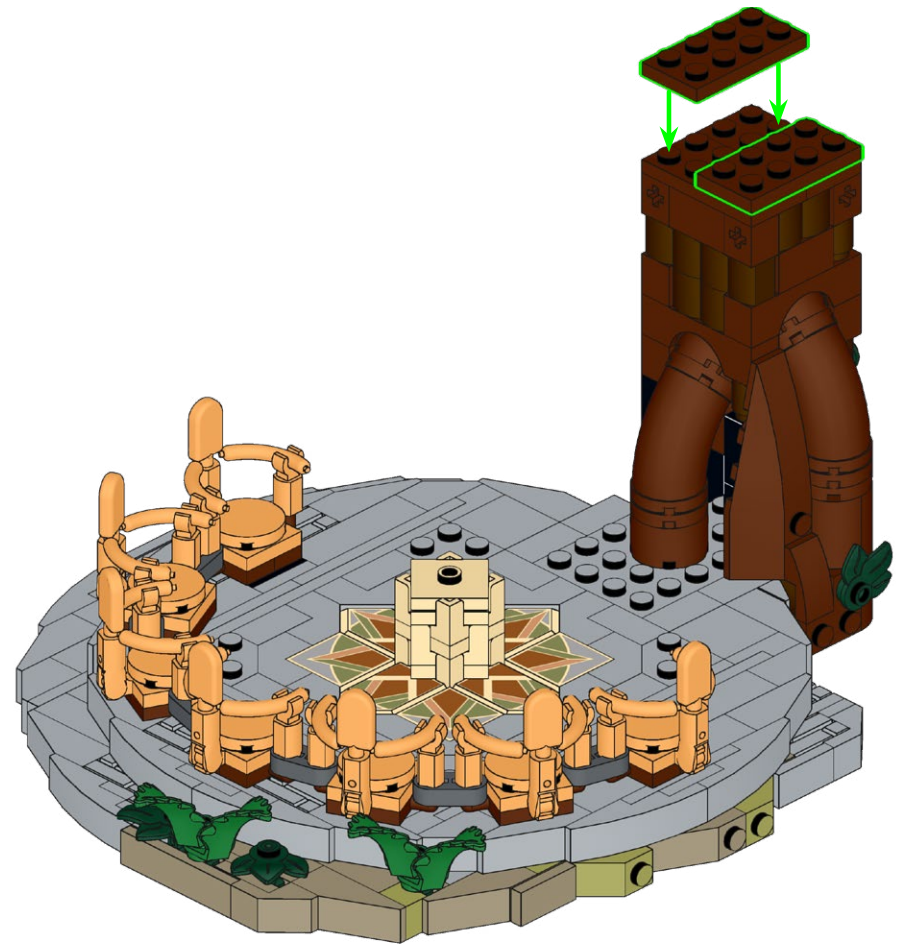



363

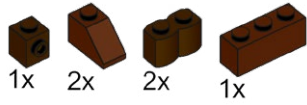

364

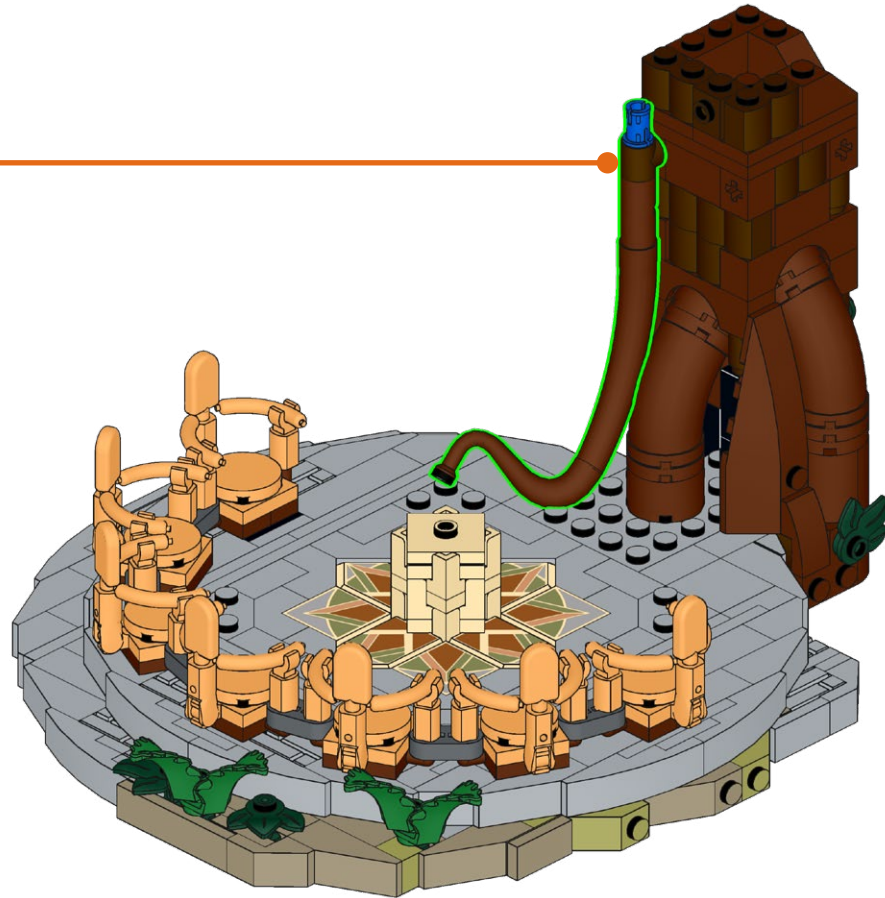
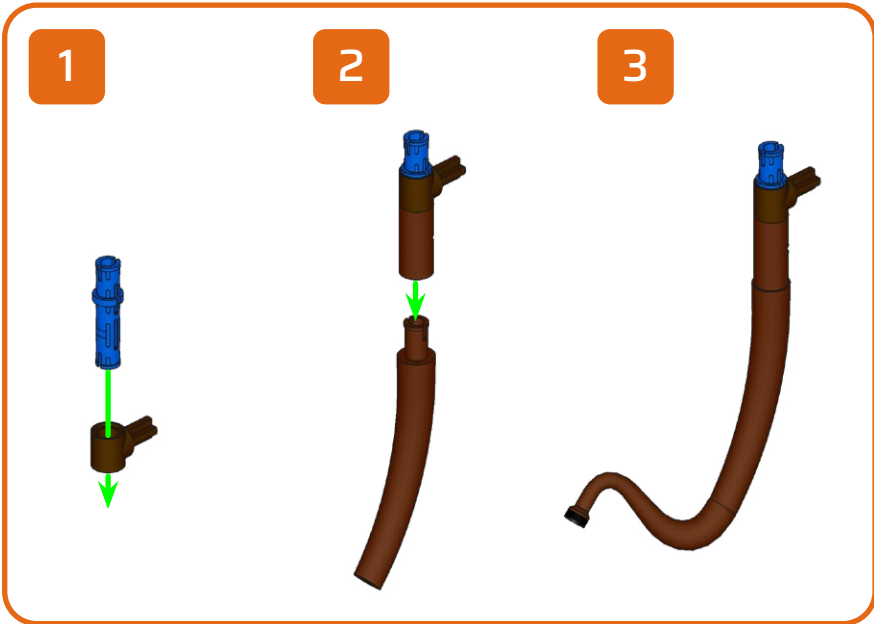
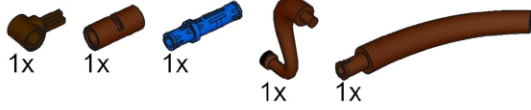

365

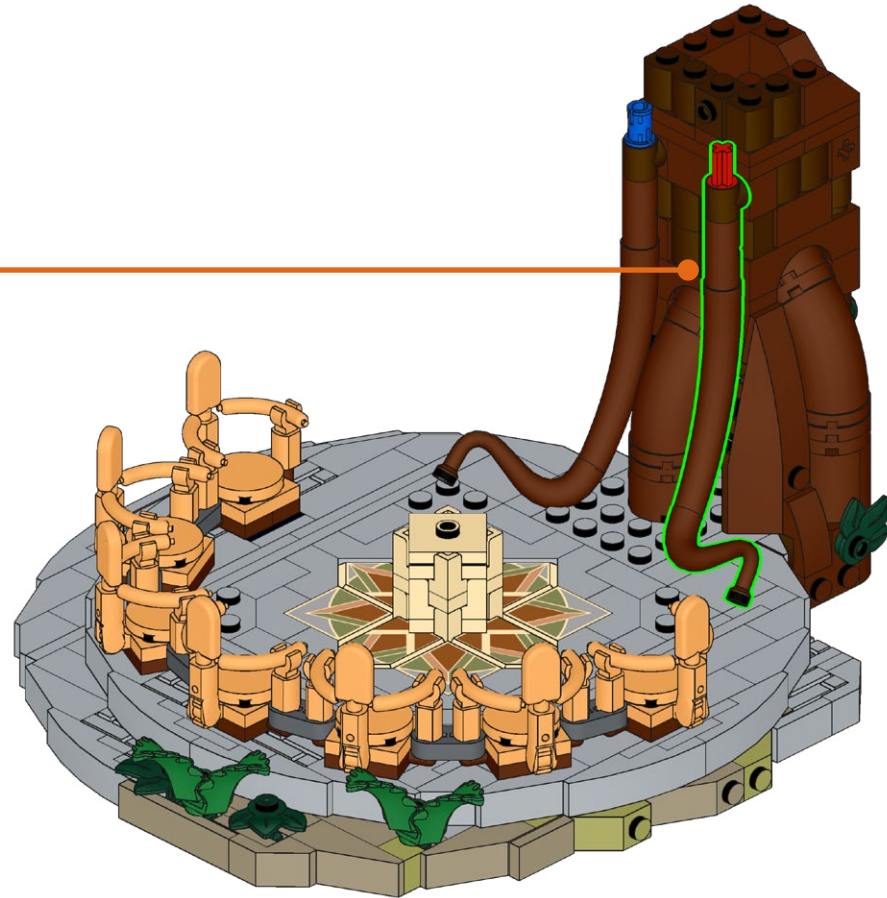
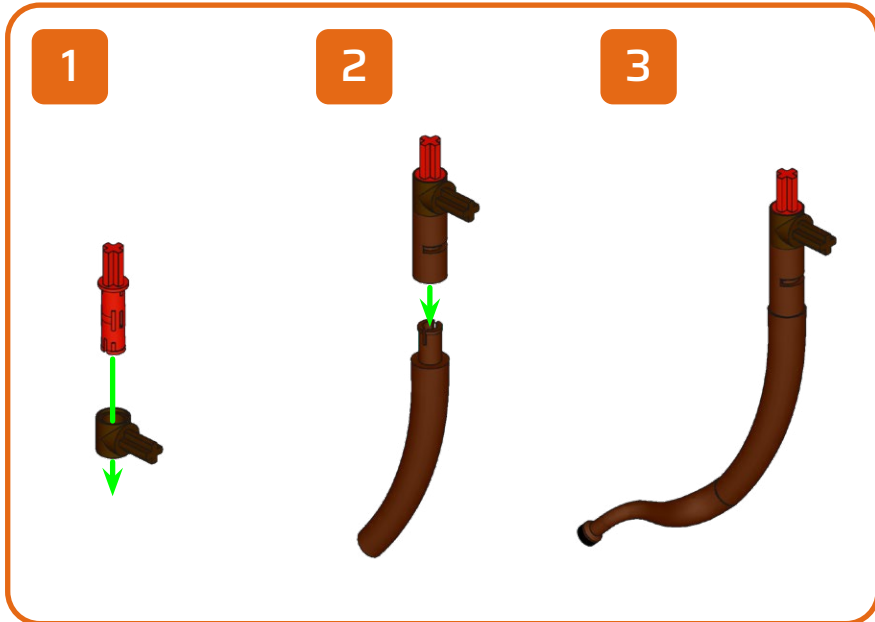
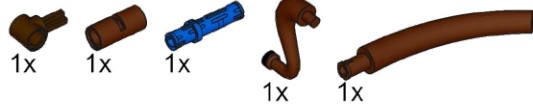



366

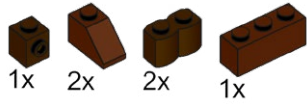

1

2

3

4

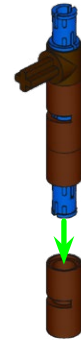
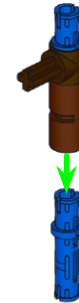
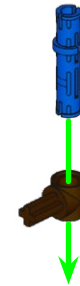

# 367

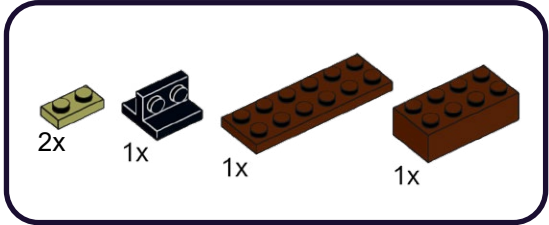

1

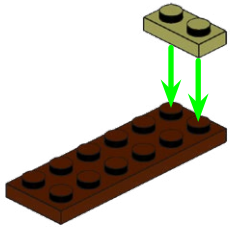

2

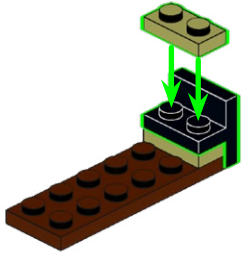

3

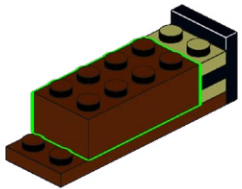

# 368

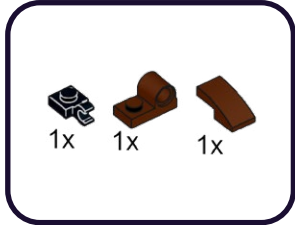

1

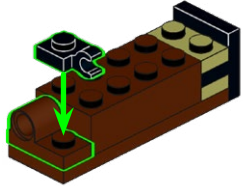

2

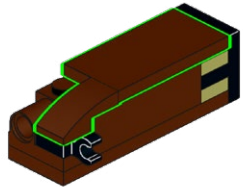

369





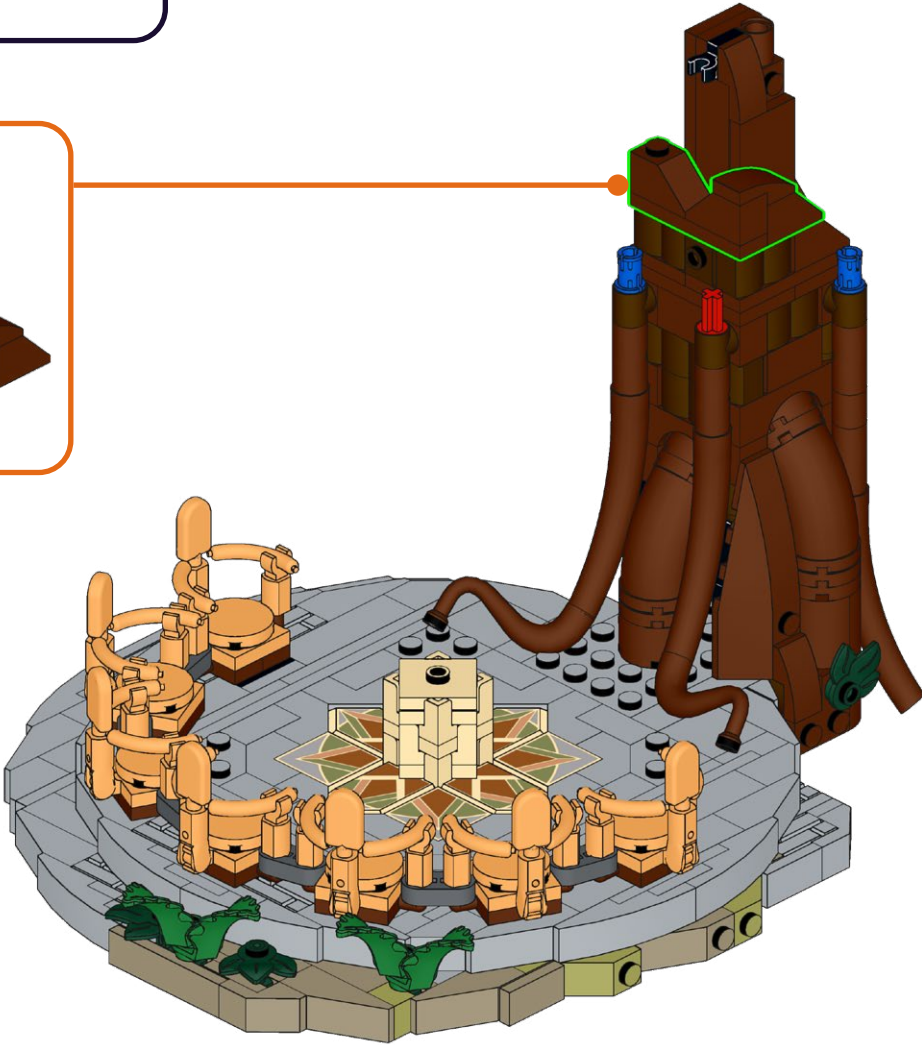
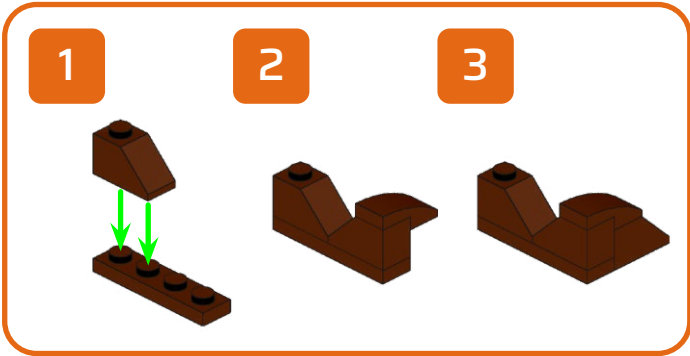
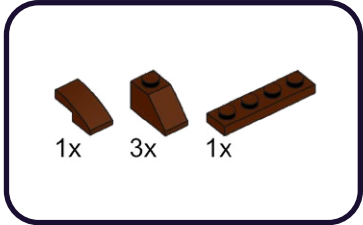

**370**



371

- 1x 
- 1x 
- 1x 

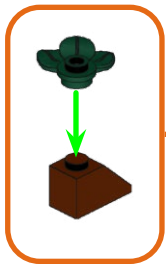

372

2x





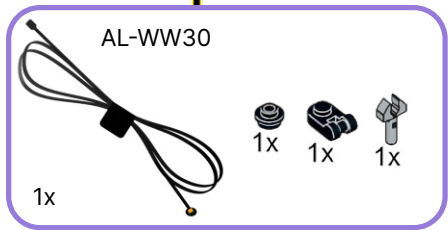

1

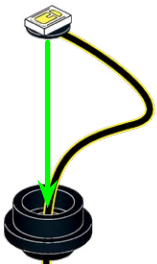

2



3



4

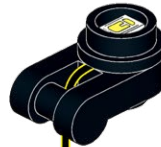

5

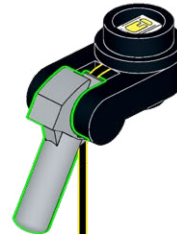

374



**375**

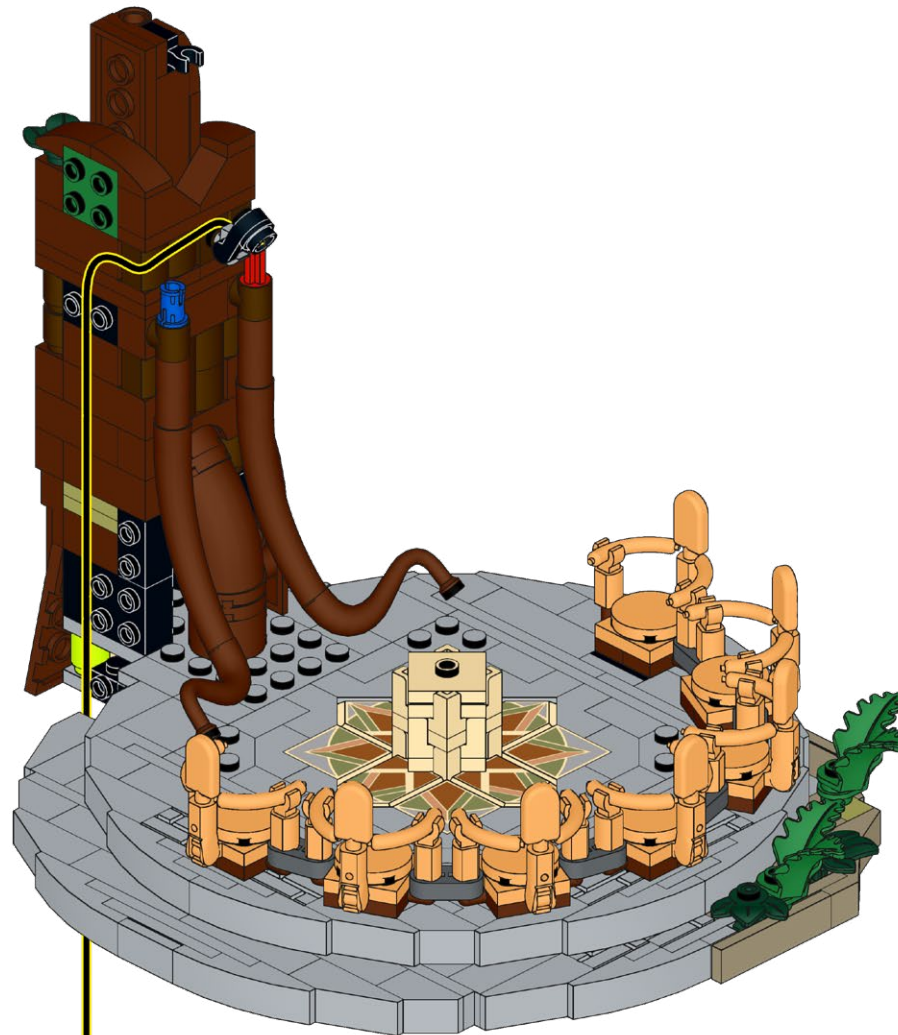



**376**

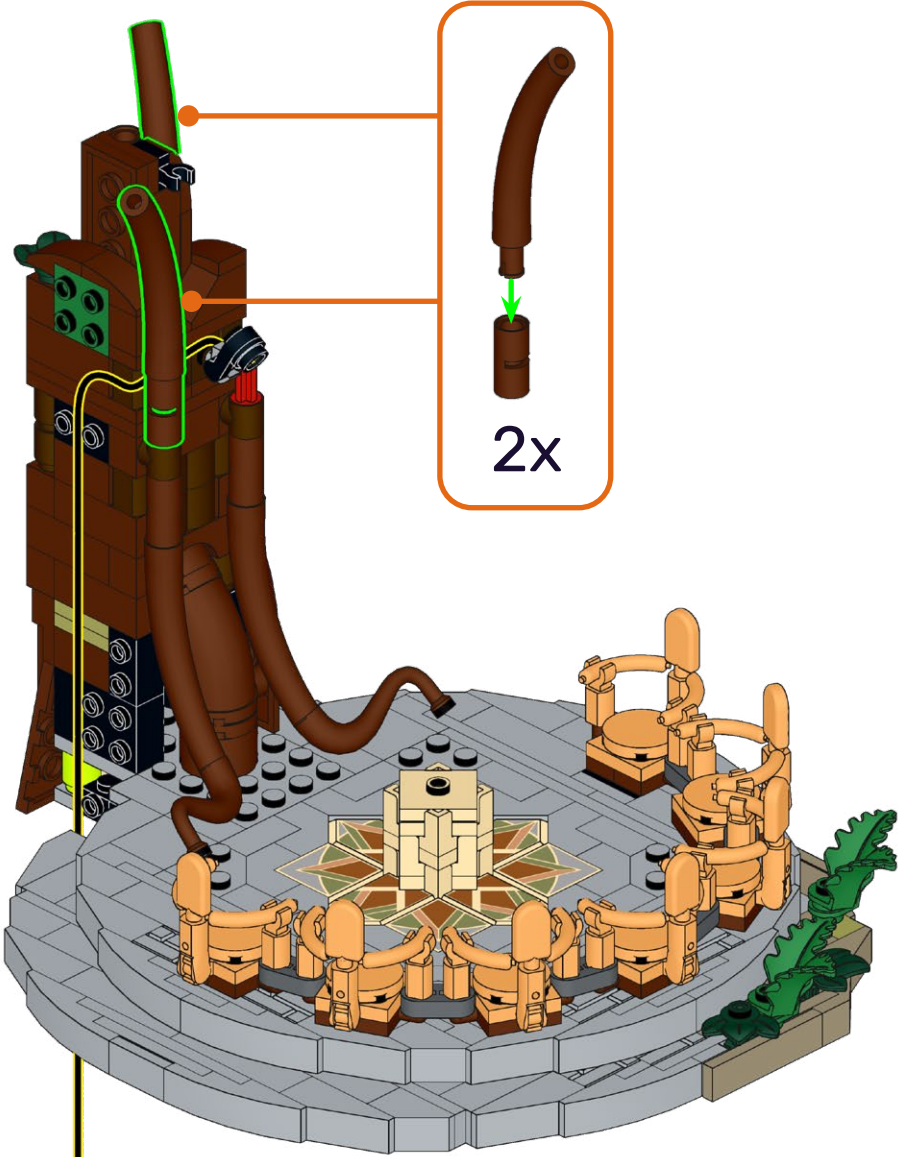
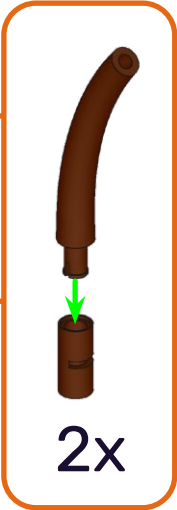
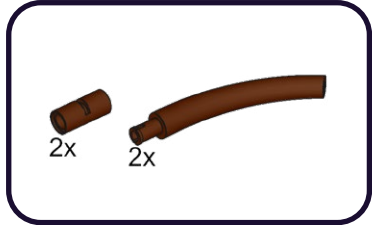

# 377

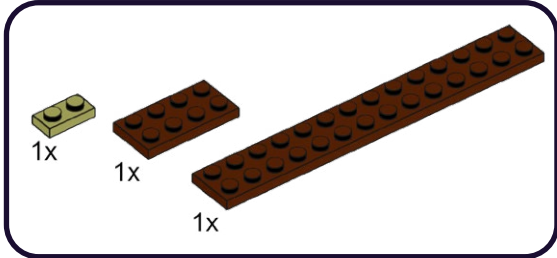

1

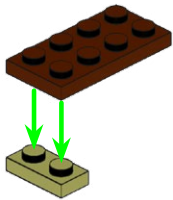

2

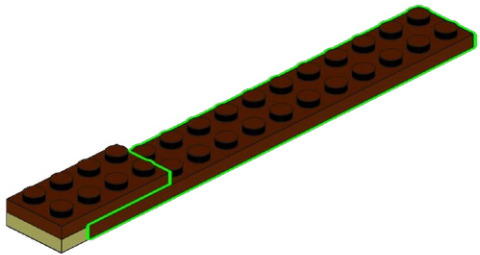

# 378

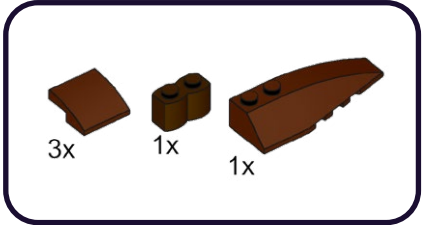

1

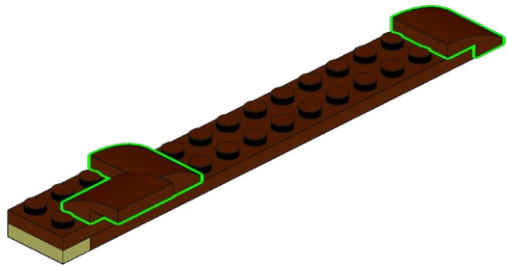

2

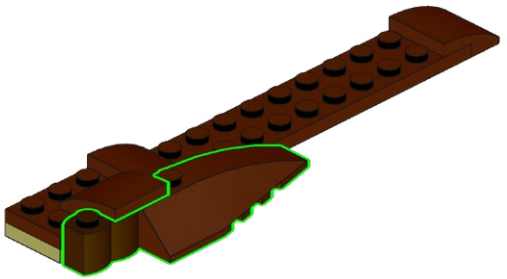

379

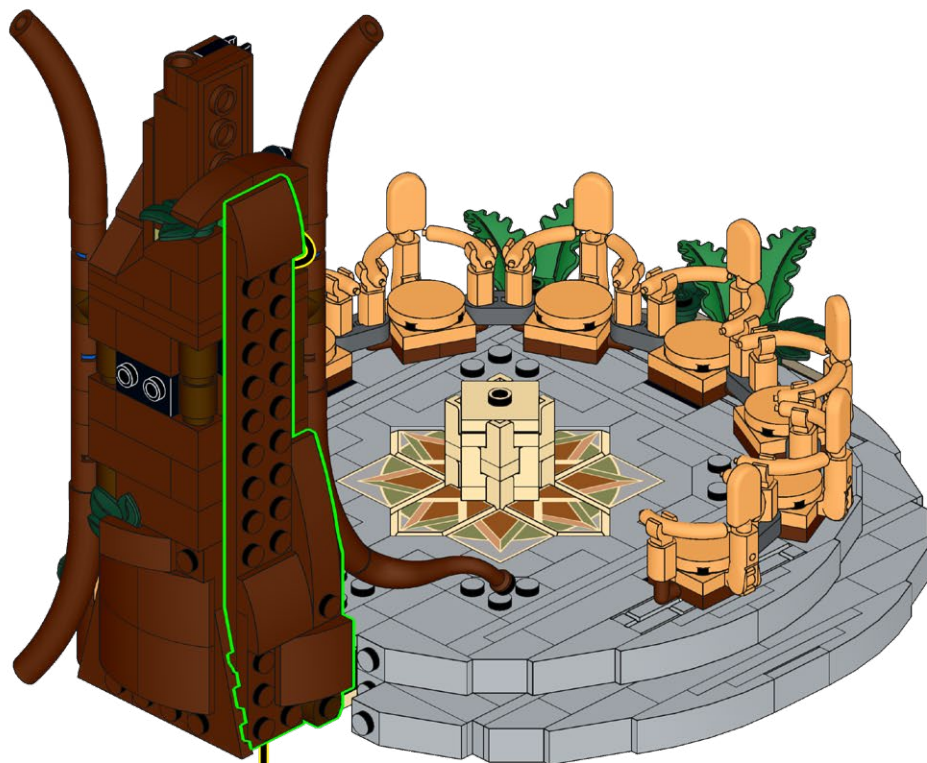



380

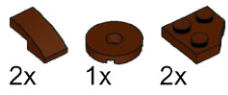

1

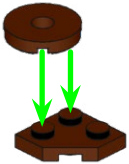

2

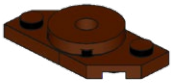

3

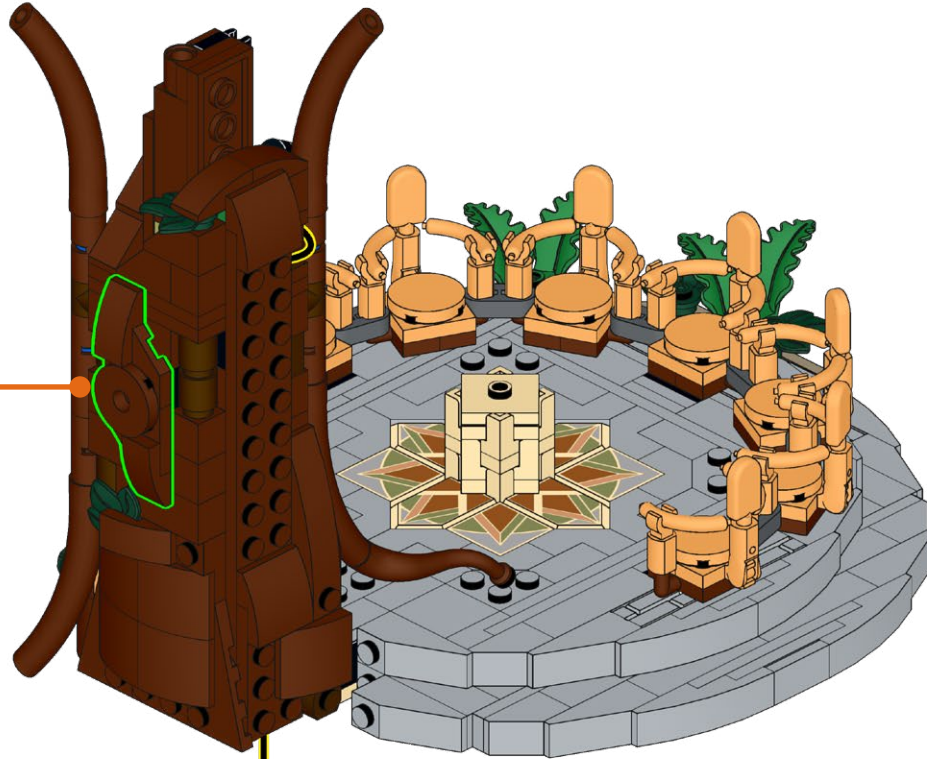
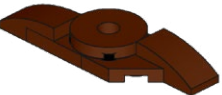

381

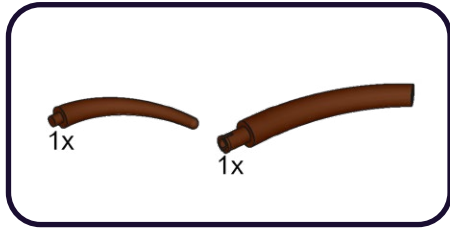

382

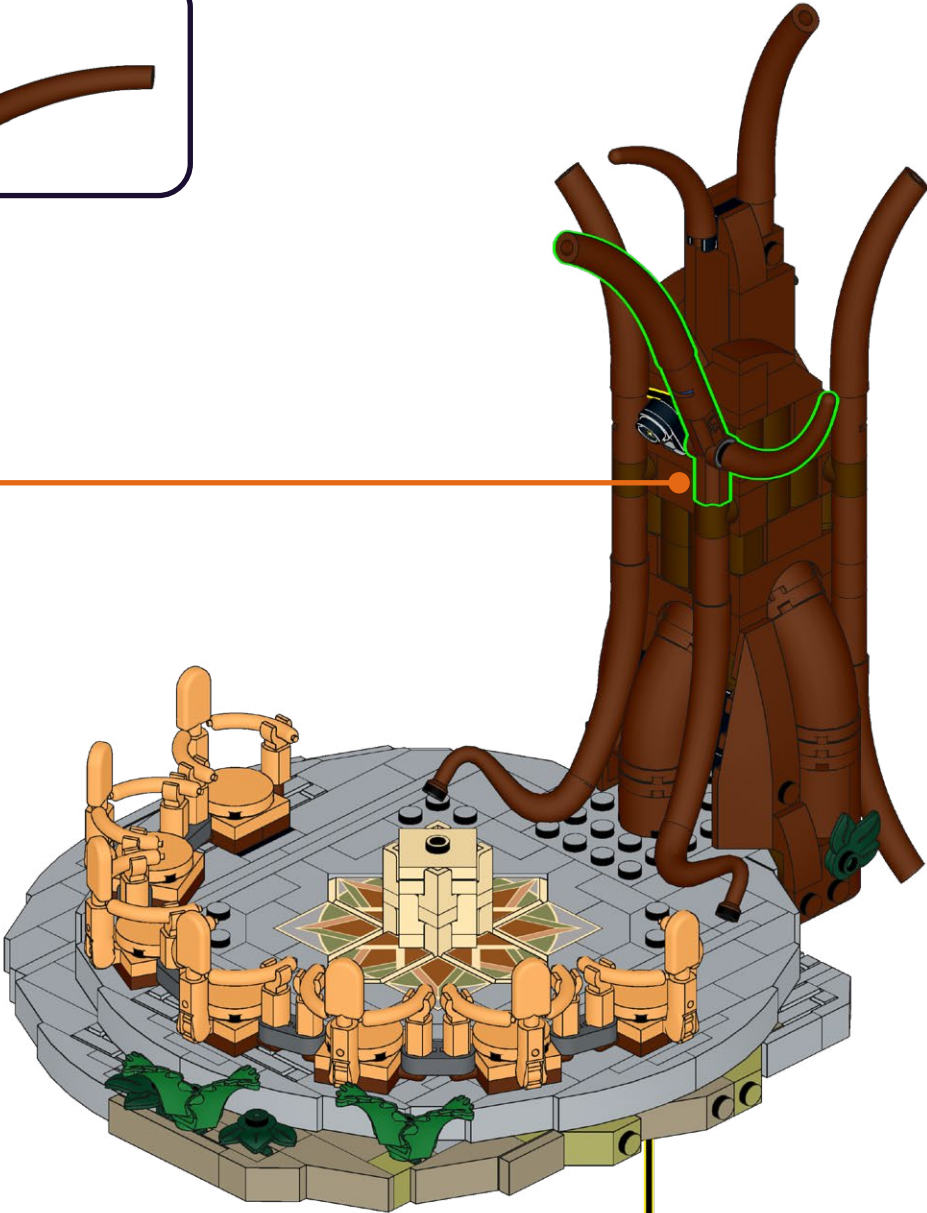
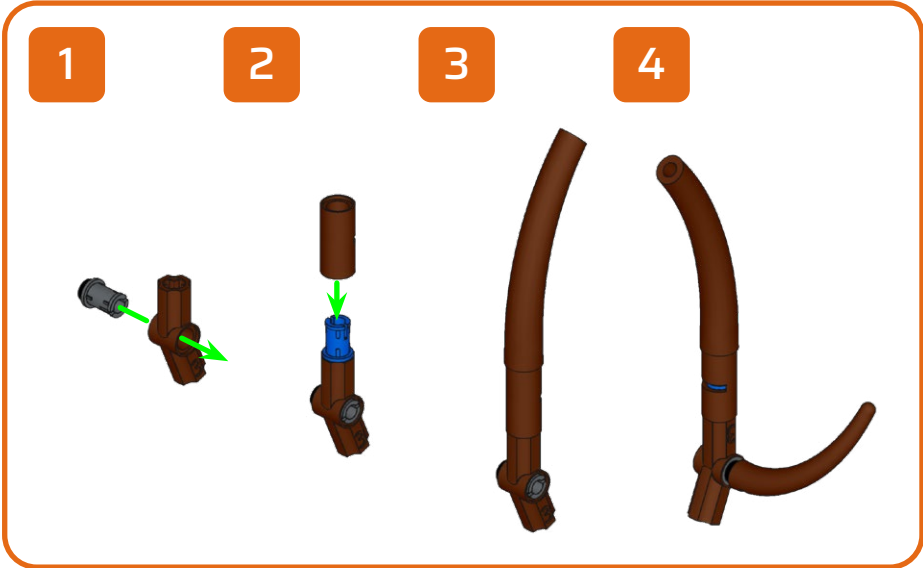
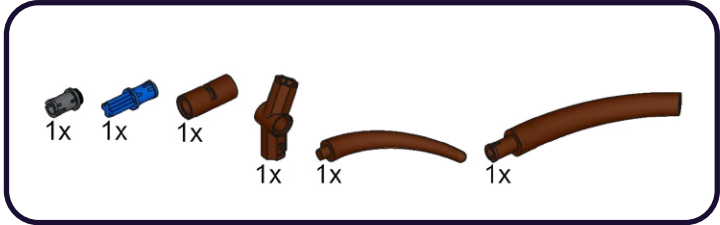



383

10x

2x

1



2

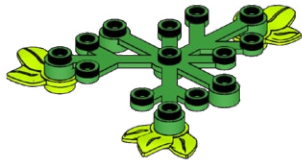

3

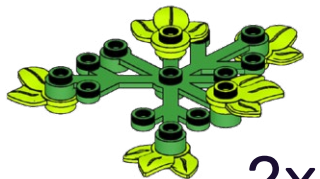

2x



**384**

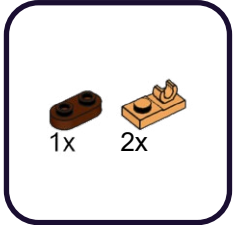

1

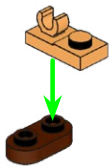

2

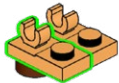

**385**

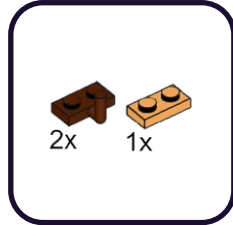

1



2

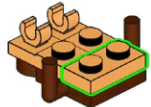

386

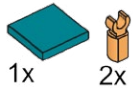

1

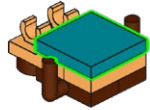

2

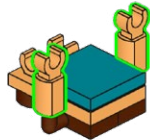

387

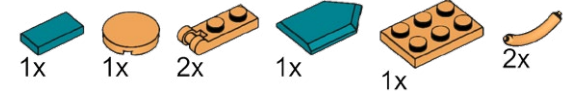

1

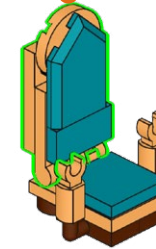

2

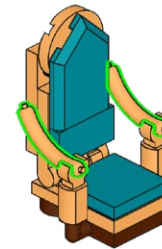

1

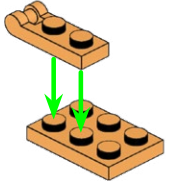

2

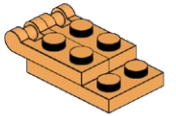

3

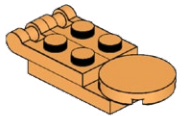

4

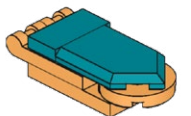



388



**HOLD UP!**

You might notice some bags aren't in order, as well as left over pieces, but that's ok! We're changing the way you build LEGO!

**ATTENDEZ!**

Vous remarquerez peut-être que certains sacs, ainsi que certaines pièces, ne sont pas dans le bon ordre. Mais pas de panique! Nous changeons simplement la façon avec laquelle vous construisez vos LEGO!

**ASPETTA!**

Potresti notare che alcuni sacchetti non sono in ordine, così come i pezzi avanzati, ma va bene così! Stiamo cambiando il modo in cui costruisci i LEGO!

**HALT!**

Sie werden möglicherweise bemerken, dass einige tüten durcheinander sind und teile übrig bleiben, aber das ist in Ordnung! Wir ändern die art und weise, wie Sie LEGO bauen!

**¡ESPERA!**

Es posible que notes que algunas bolsas están fuera de servicio, así como piezas sobrantes, ¡pero está bien! ¡Estamos cambiando la forma en que construyes LEGO!

**暫停!**

你可能会注意到一些袋子顺序错乱, 以及一些剩余的部件, 但没关系! 我们正在改变你搭建乐高的方式!

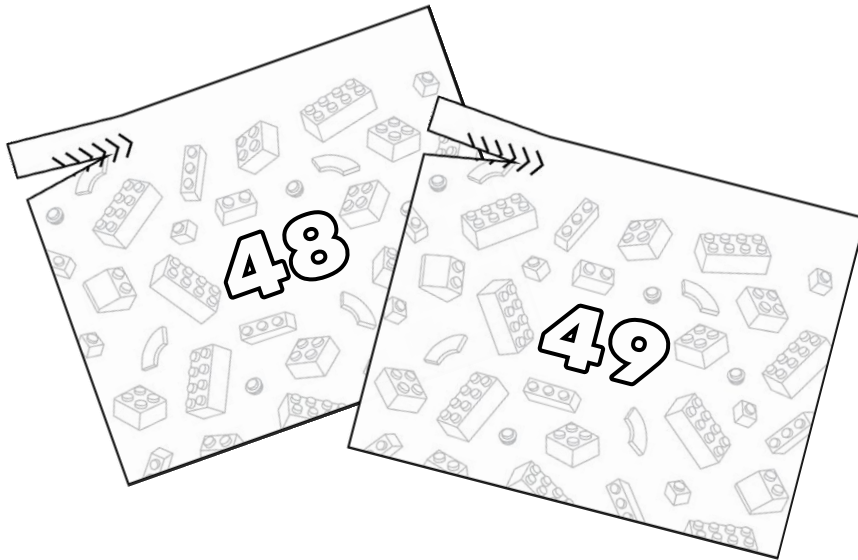
**Open LEGO® Bags 48 & 49**

389

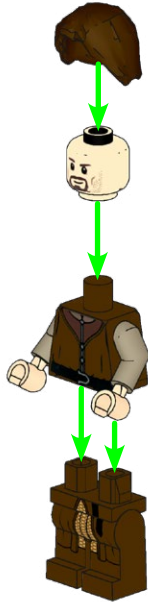
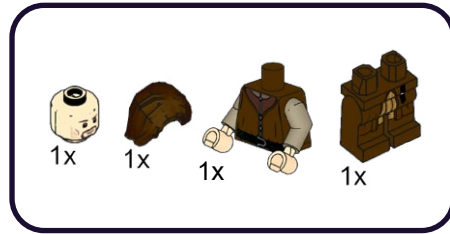

390

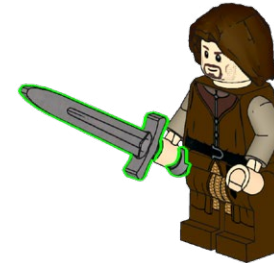
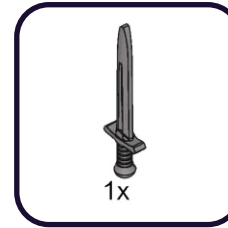



391

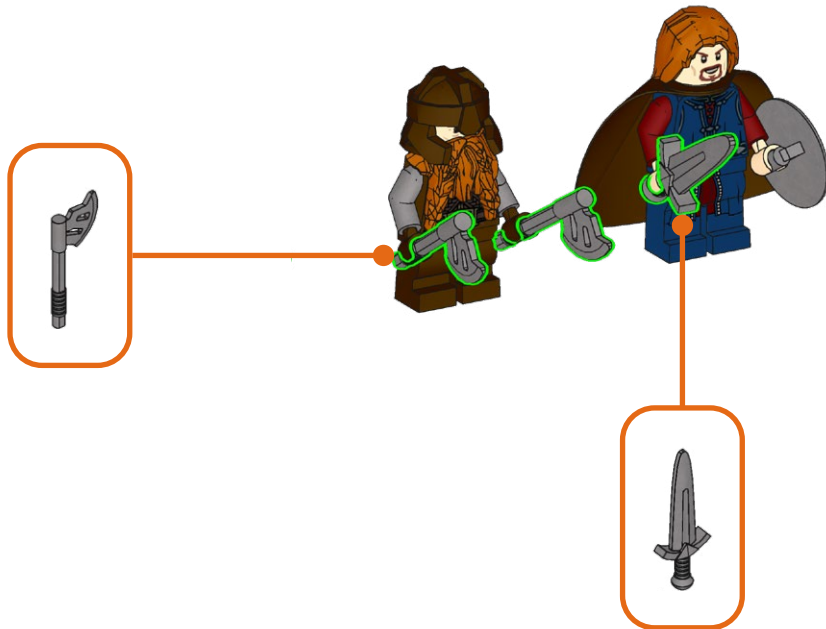
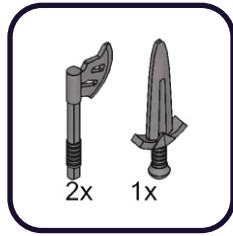

392

4x 4x 4x 8x

1



2



3



4

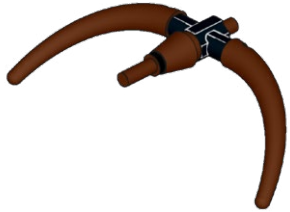

4x

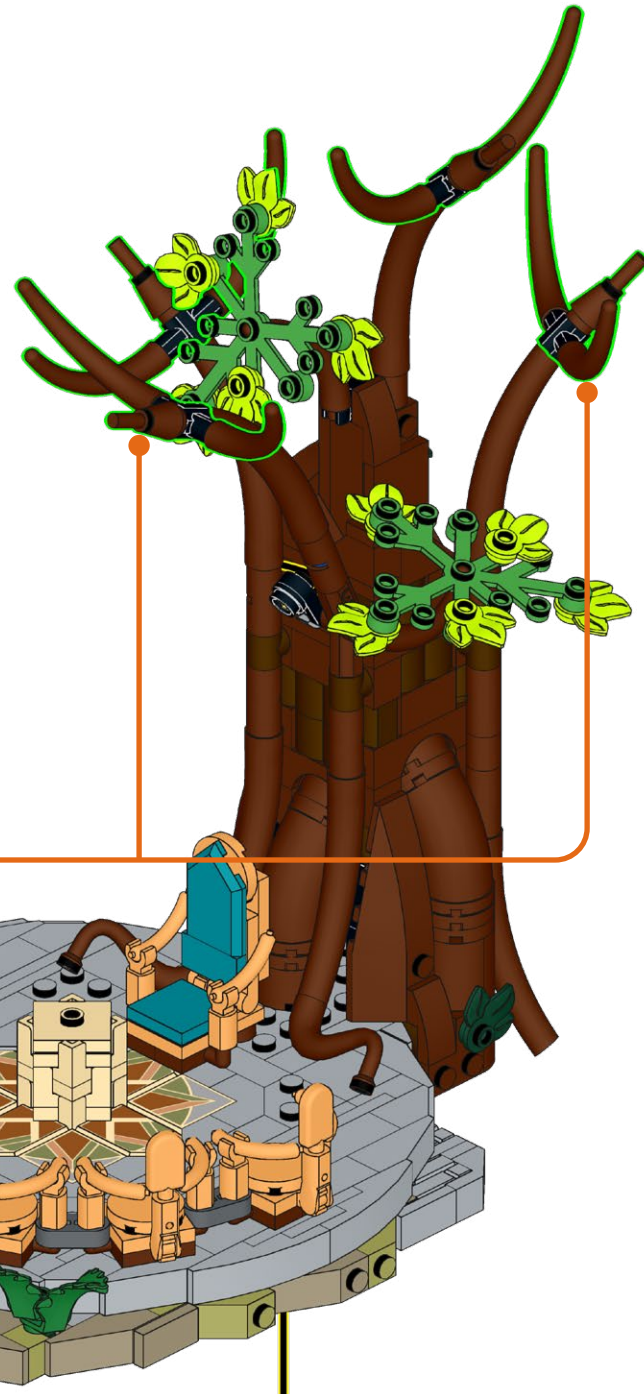

**393**

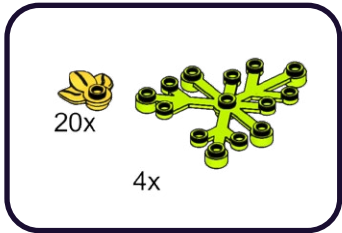

1

2

3

4x

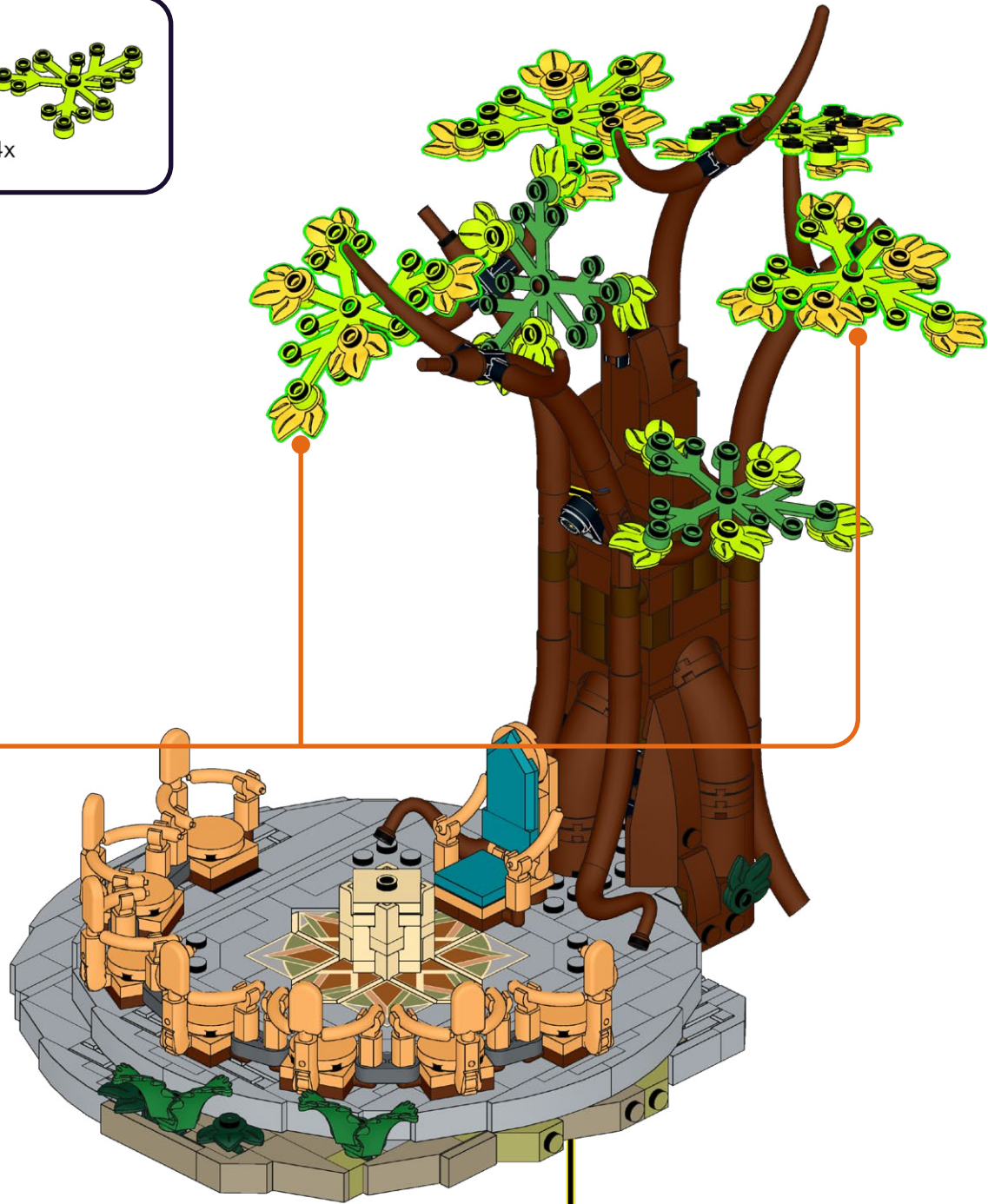



394

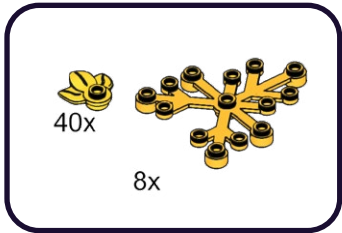

1

2

3

8x

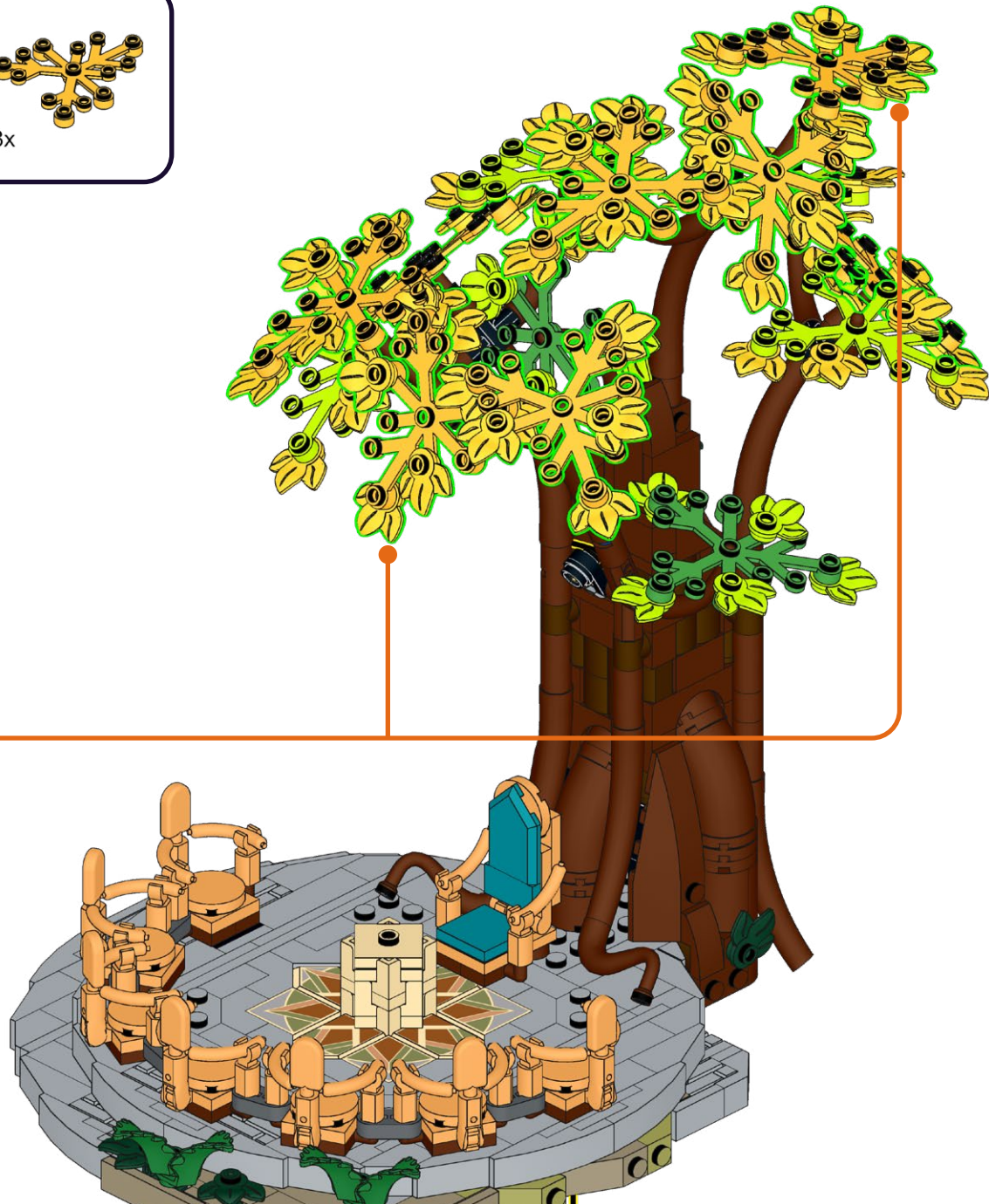

395



396





397





398





399





400





401





### **HOLD UP!**

You might notice some bags aren't in order, as well as left over pieces, but that's ok! We're changing the way you build LEGO!

### **ATTENDEZ!**

Vous remarquerez peut-être que certains sacs, ainsi que certaines pièces, ne sont pas dans le bon ordre. Mais pas de panique! Nous changeons simplement la façon avec laquelle vous construisez vos LEGO!

### **ASPETTA!**

Potresti notare che alcuni sacchetti non sono in ordine, così come i pezzi avanzati, ma va bene così! Stiamo cambiando il modo in cui costruisci i LEGO!

### **HALT!**

Sie werden möglicherweise bemerken, dass einige tüten durcheinander sind und teile übrig bleiben, aber das ist in Ordnung! Wir ändern die art und weise, wie Sie LEGO bauen!

### **¡ESPERA!**

Es posible que notes que algunas bolsas están fuera de servicio, así como piezas sobrantes, ¡pero está bien! ¡Estamos cambiando la forma en que construyes LEGO!

### **暫停!**

你可能会注意到一些袋子顺序错乱, 以及一些剩余的部件, 但没关系! 我们正在改变你搭建乐高的方式!

## Open LEGO® Bag 40

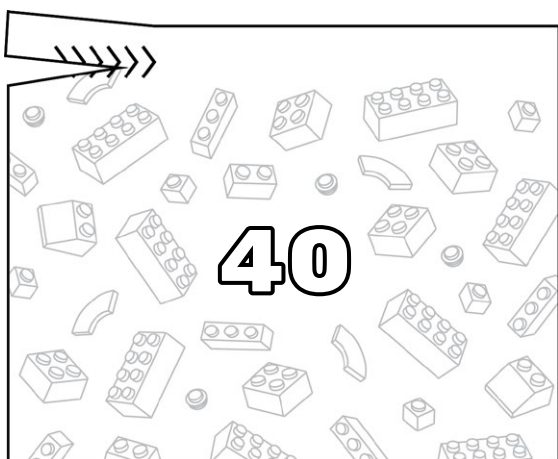



402

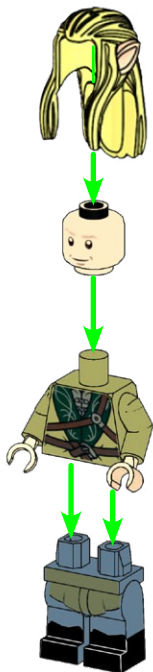
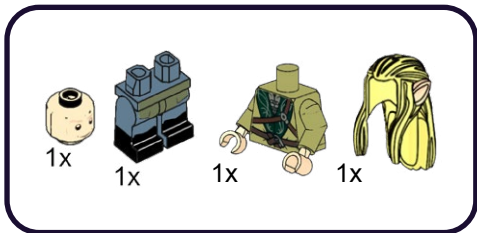

403

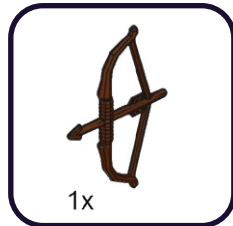

404

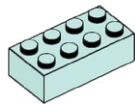

2x



1x

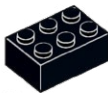

2x



4x

1

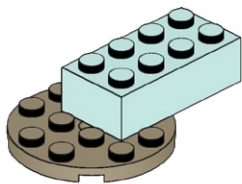

2

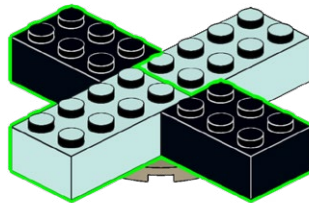

3

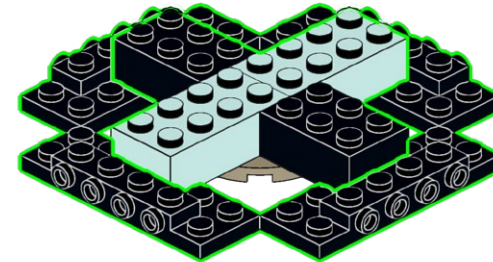

405

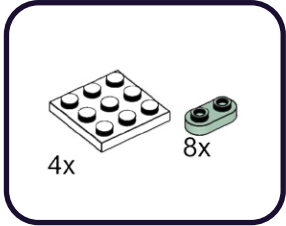

1

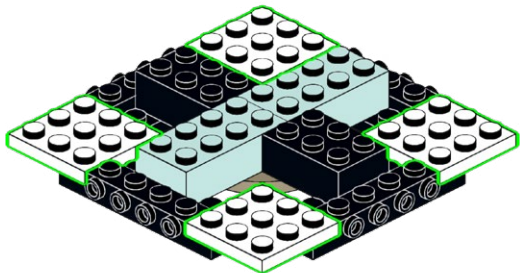

2

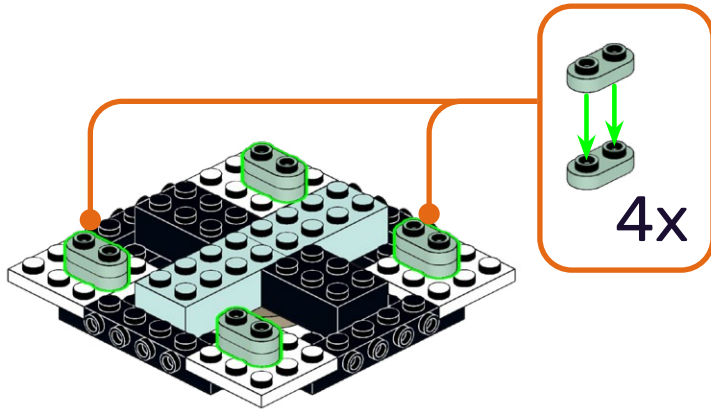

406

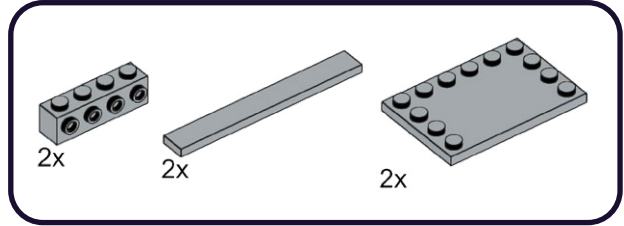

1

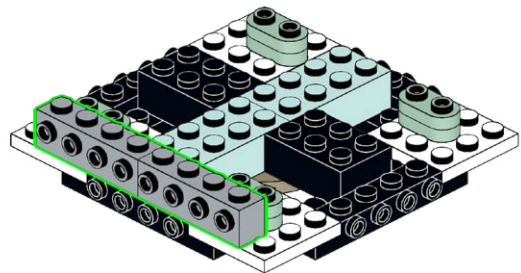

2

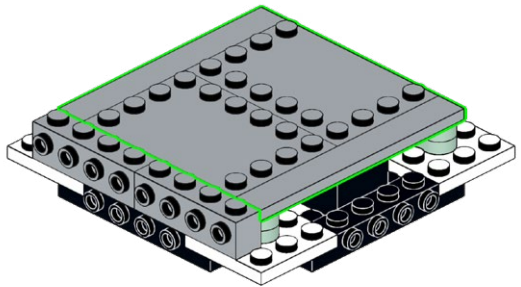



# 407

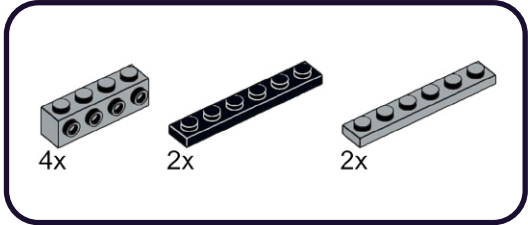

# 408

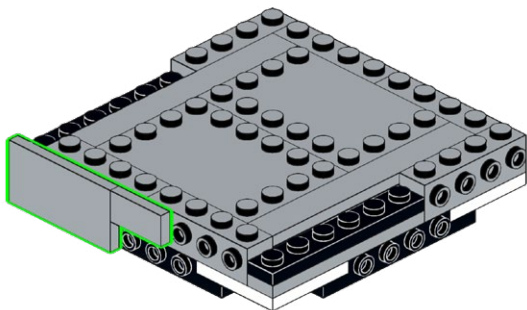
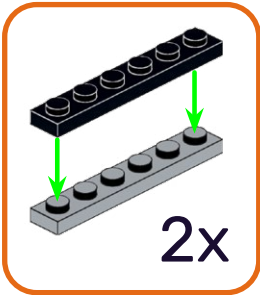
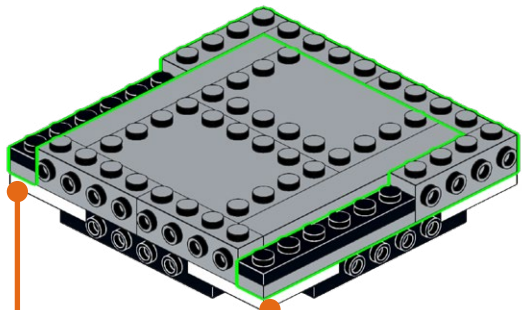
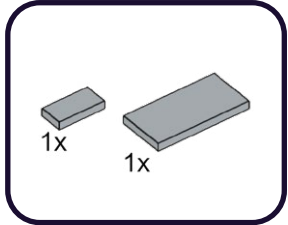

409

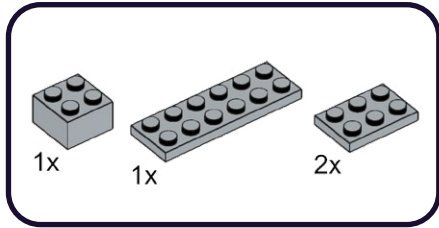

1

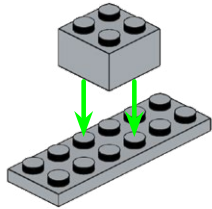

2

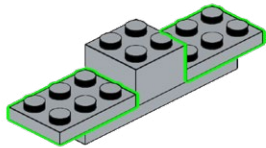

410

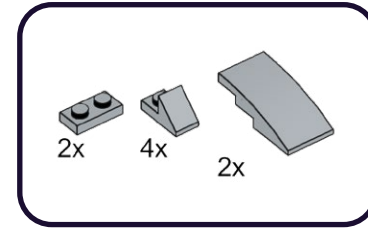

1

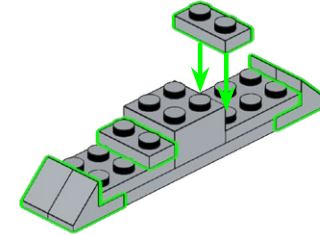

2

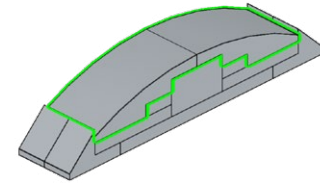

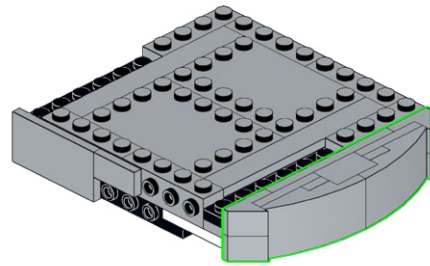



412

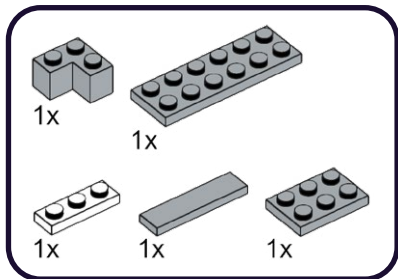

1

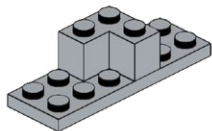

2

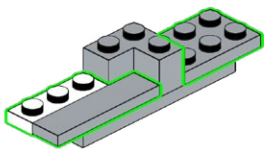

413

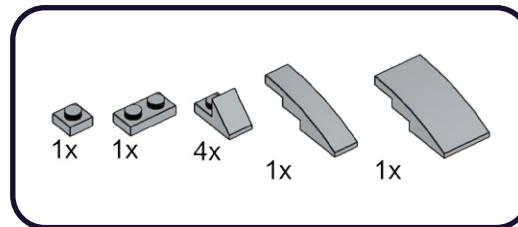

1

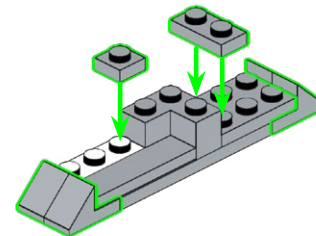

2

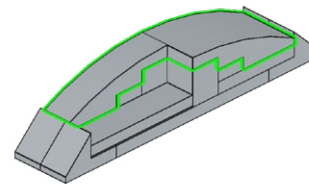

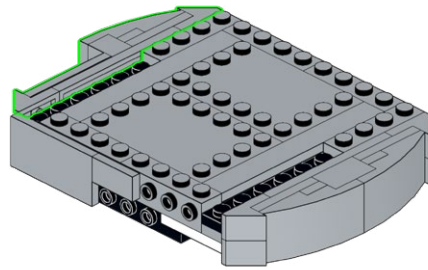

415

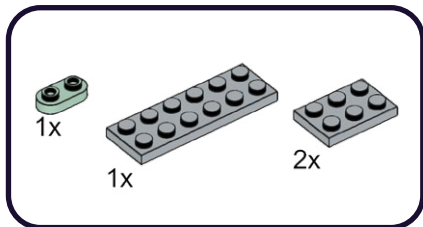

1

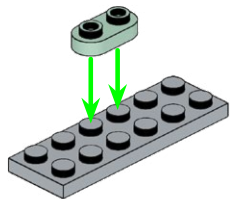

2

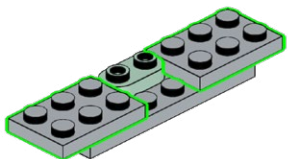

416

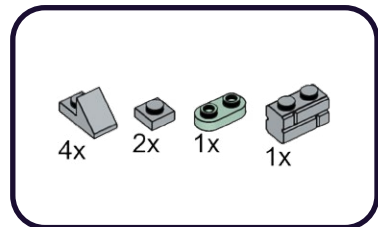

1

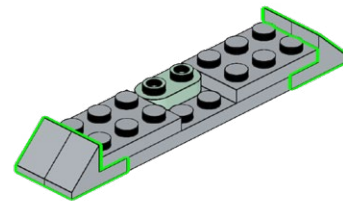

2

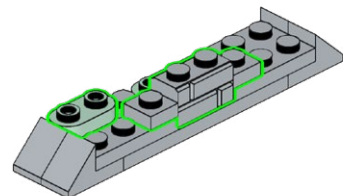



417

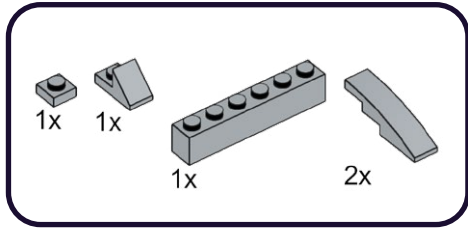

1

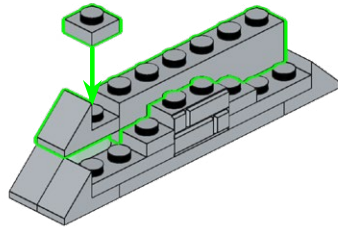

2

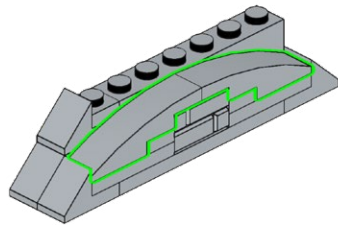

418

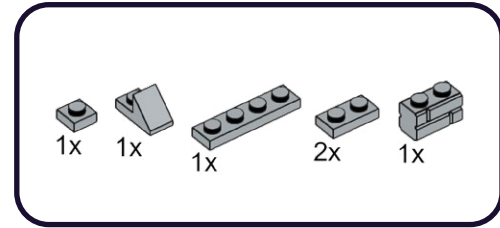

1

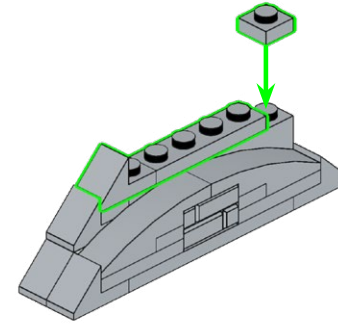

2

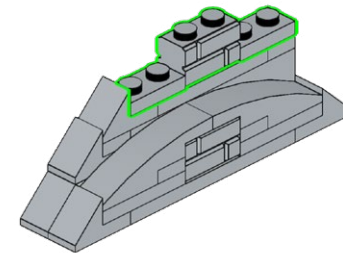

419

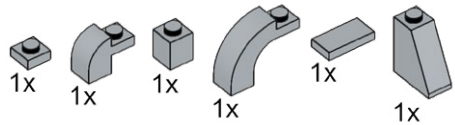

1

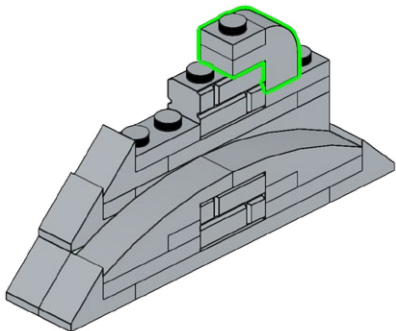

2

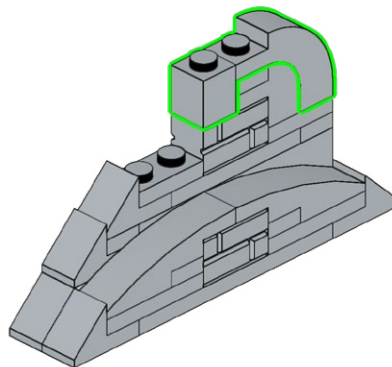

3

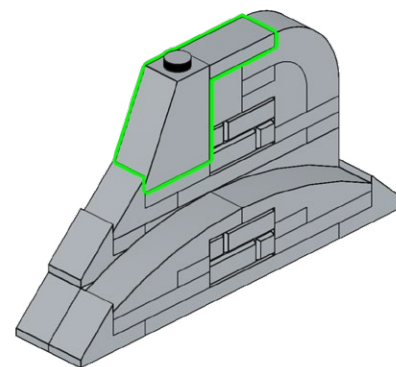

420

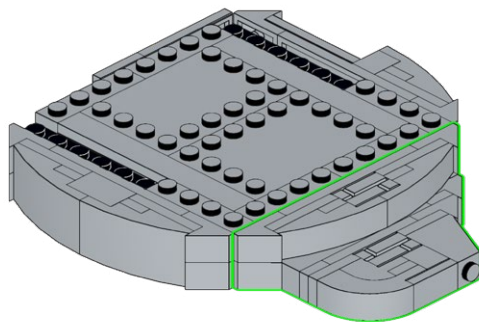



421

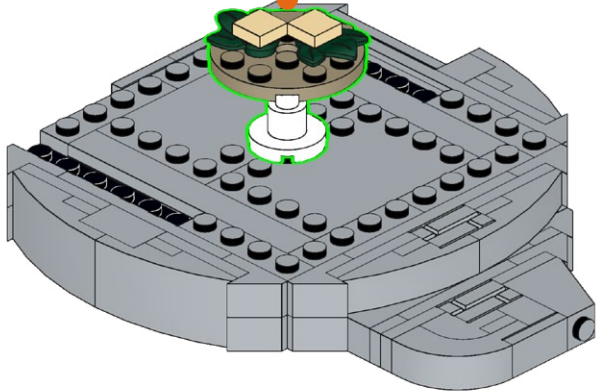
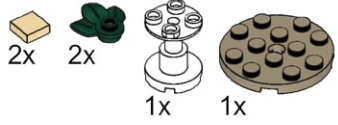

422

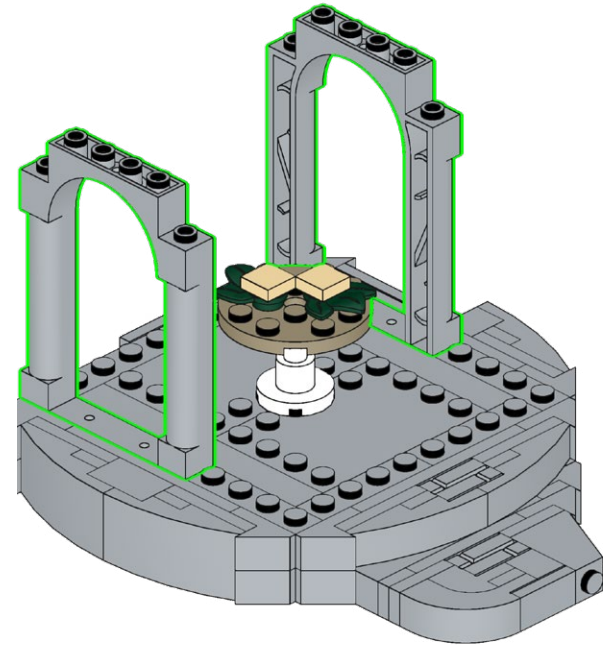
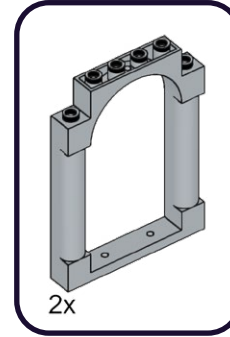

423

4x 4x 4x

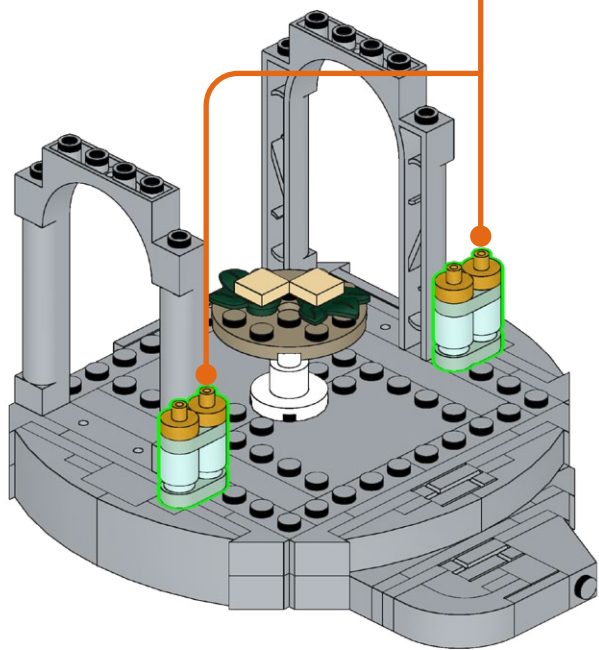
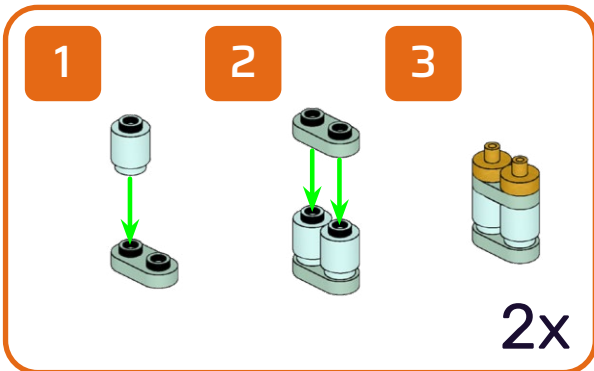

424

8x 4x 4x

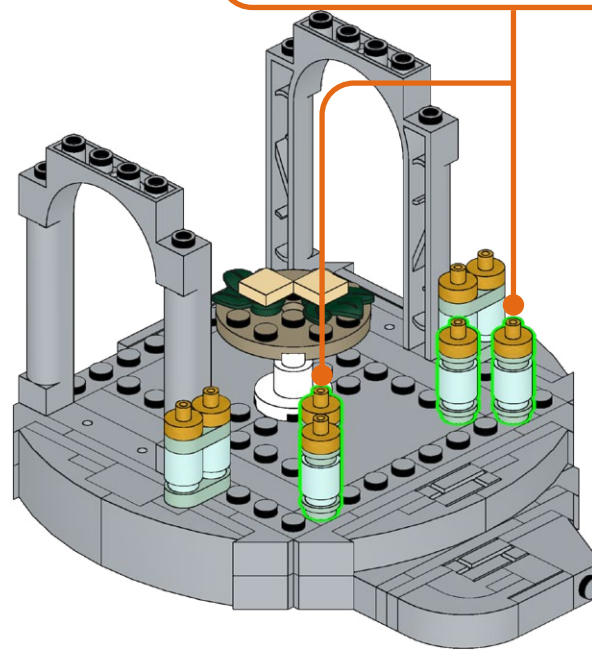
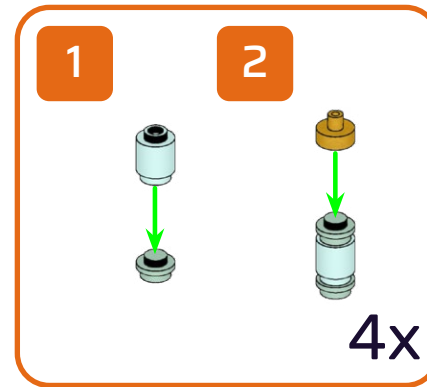

425

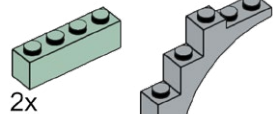

2x

4x

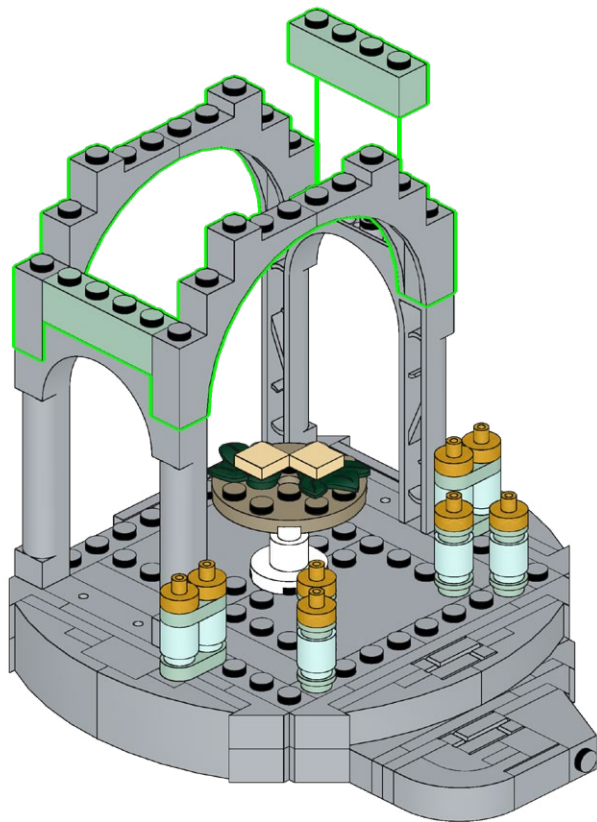

426



2x

2x

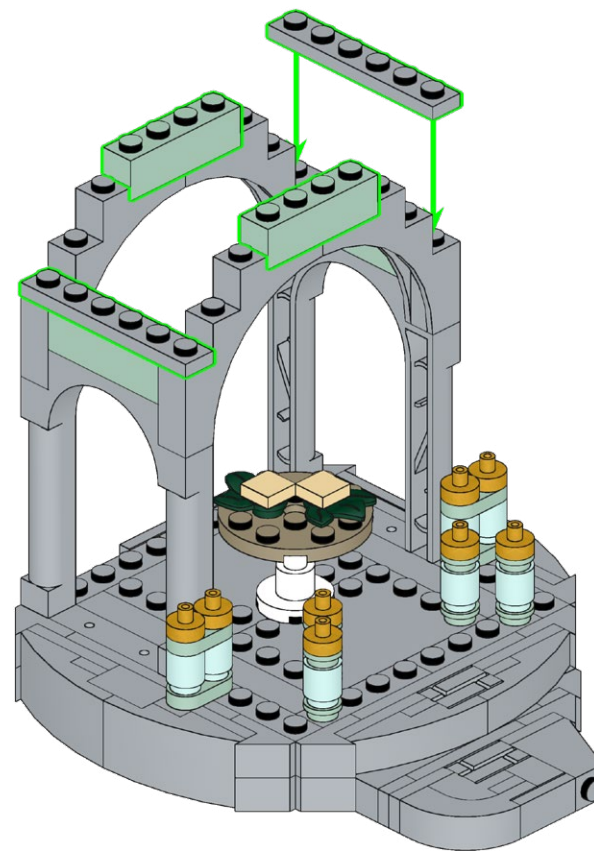



**HOLD UP!**

You might notice some bags aren't in order, as well as left over pieces, but that's ok! We're changing the way you build LEGO!

**ATTENDEZ!**

Vous remarquerez peut-être que certains sacs, ainsi que certaines pièces, ne sont pas dans le bon ordre. Mais pas de panique! Nous changeons simplement la façon avec laquelle vous construisez vos LEGO!

**ASPETTA!**

Potresti notare che alcuni sacchetti non sono in ordine, così come i pezzi avanzati, ma va bene così! Stiamo cambiando il modo in cui costruisci i LEGO!

**HALT!**

Sie werden möglicherweise bemerken, dass einige tüten durcheinander sind und teile übrig bleiben, aber das ist in Ordnung! Wir ändern die art und weise, wie Sie LEGO bauen!

**¡ESPERA!**

Es posible que notes que algunas bolsas están fuera de servicio, así como piezas sobrantes, ¡pero está bien! ¡Estamos cambiando la forma en que construyes LEGO!

**暫停!**

你可能会注意到一些袋子顺序错乱, 以及一些剩余的部件, 但没关系! 我们正在改变你搭建乐高的方式!

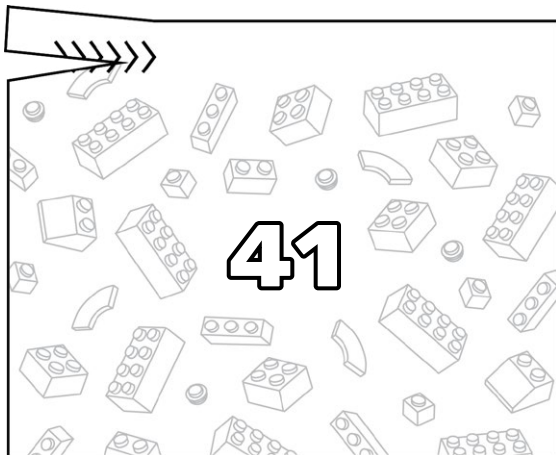
**Open LEGO® Bag 41**

427

2x 4x 8x

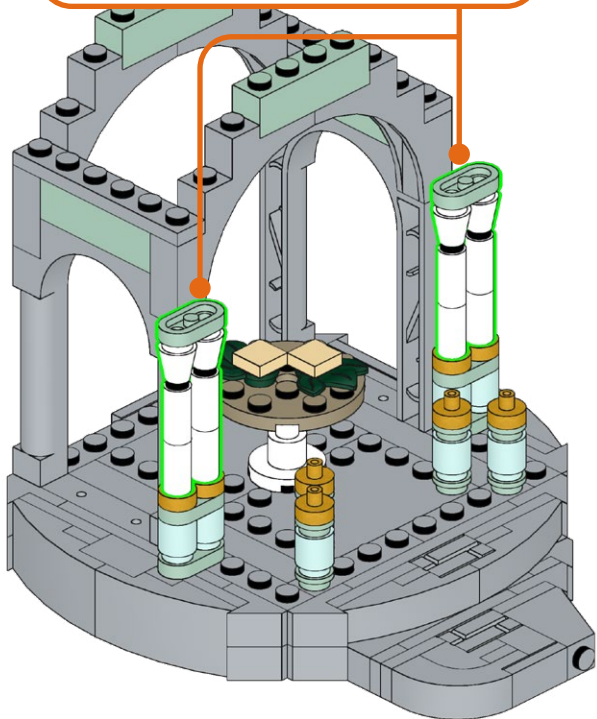
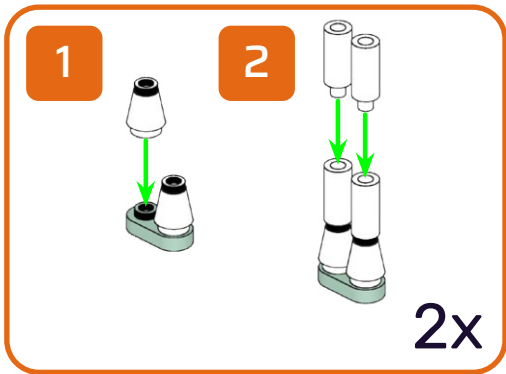

428

4x 4x 6x 8x

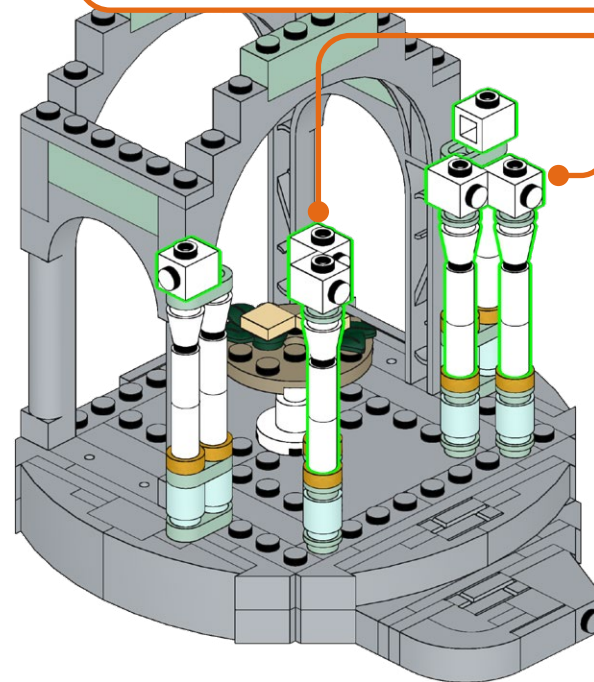
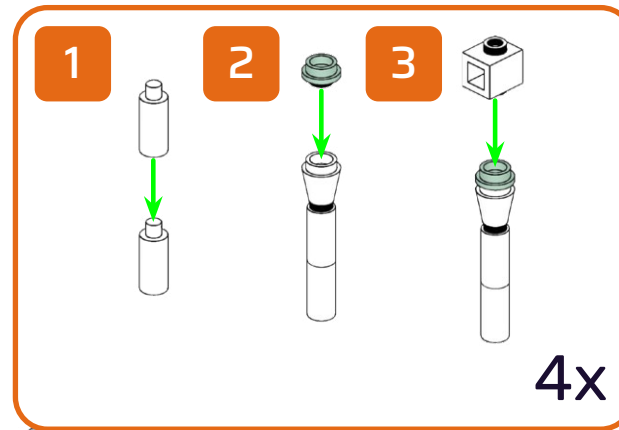

429

2x 2x

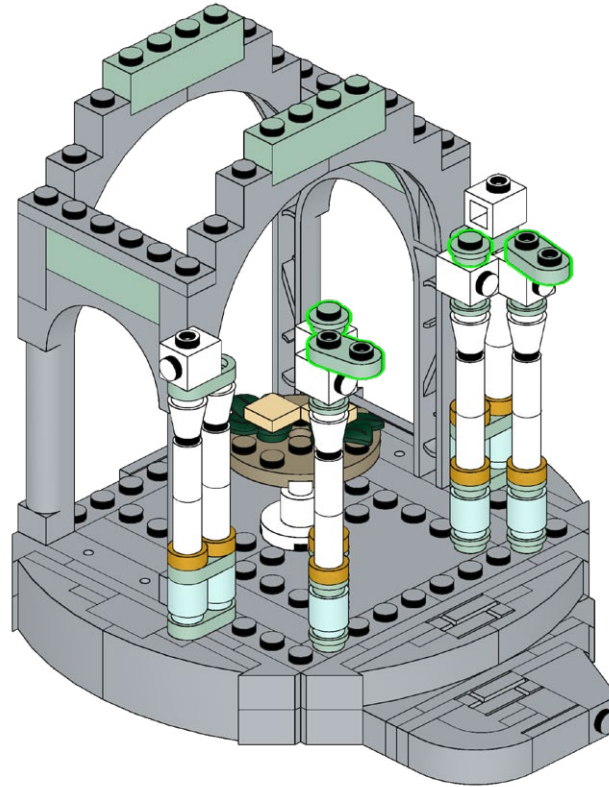



# 430

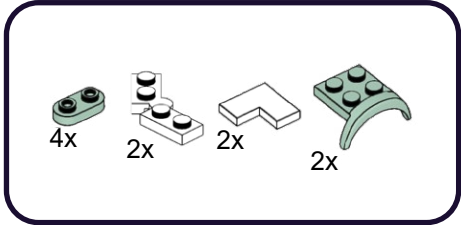

- 1
- 2
- 3
- 4

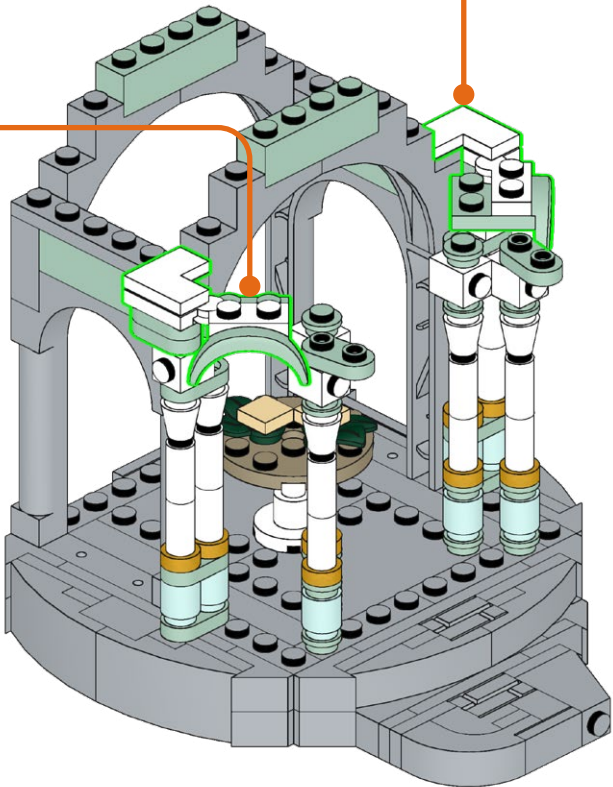

- 1
- 2
- 3
- 4

431

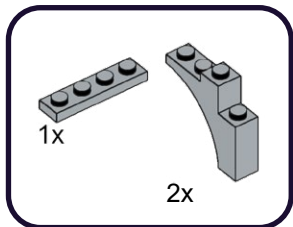

1

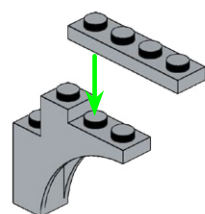

2

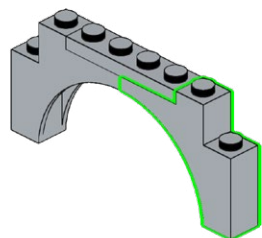

432

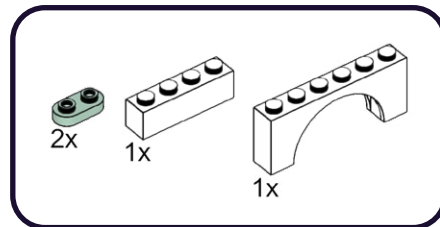

1

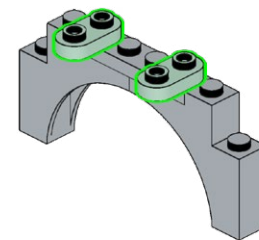

2

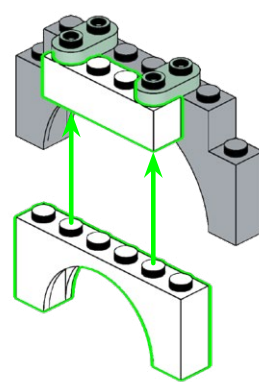

433

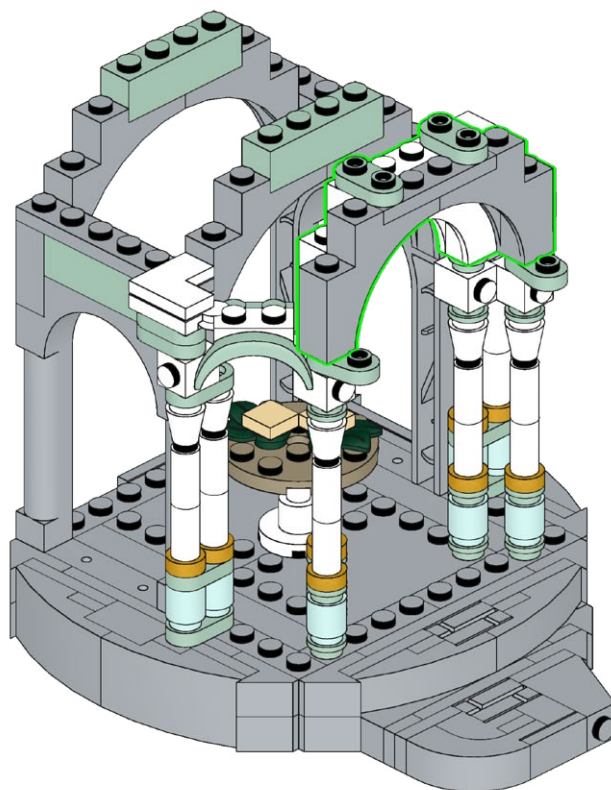



434

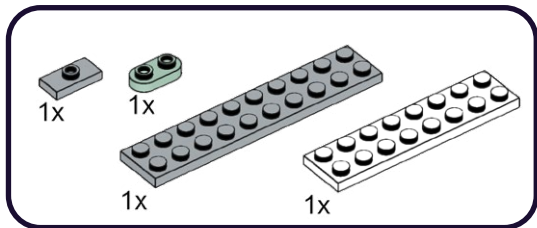

1

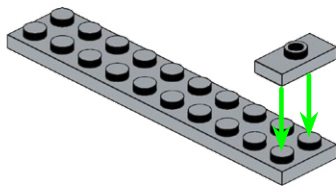

2

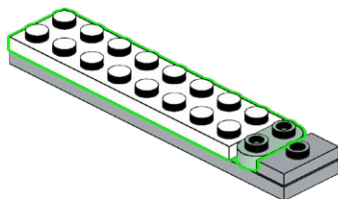

435

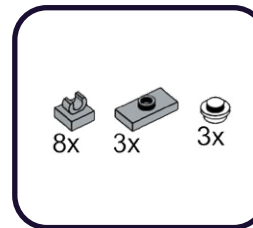

1

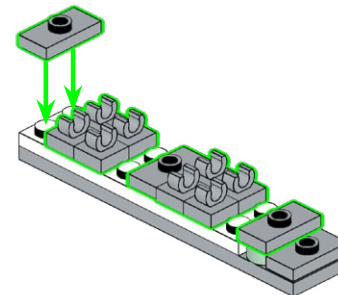

2

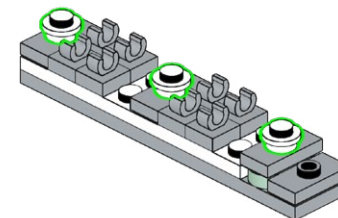

436

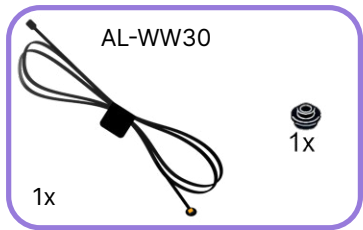

1

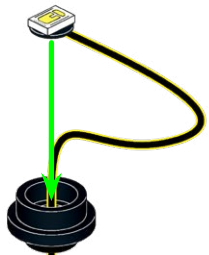

2



**437**

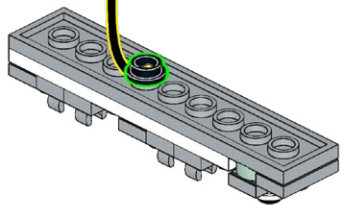

**438**

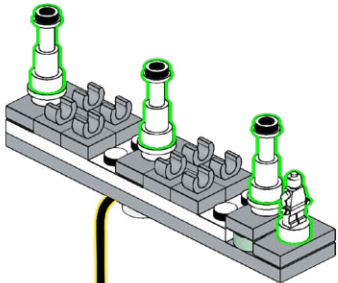
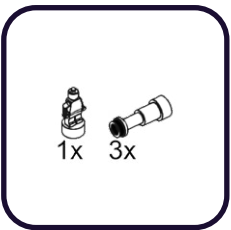



439

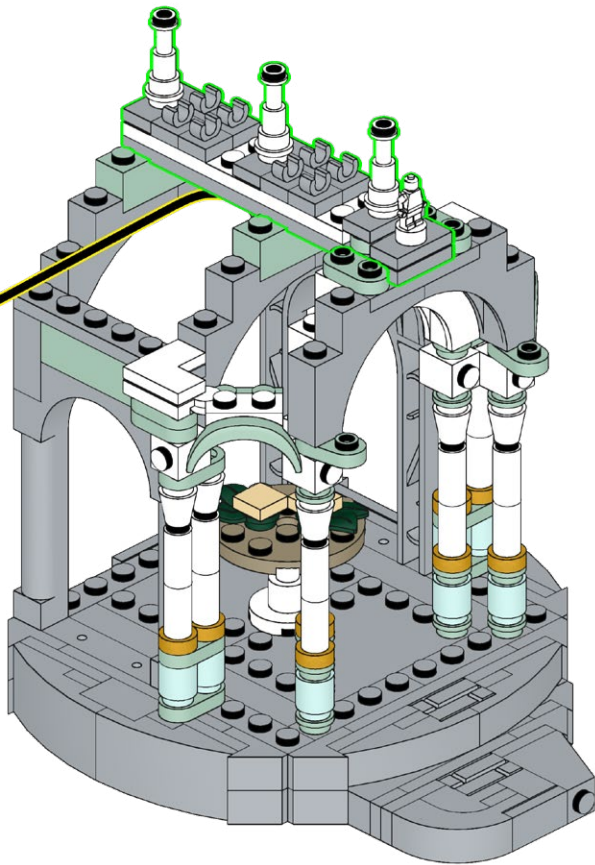

440

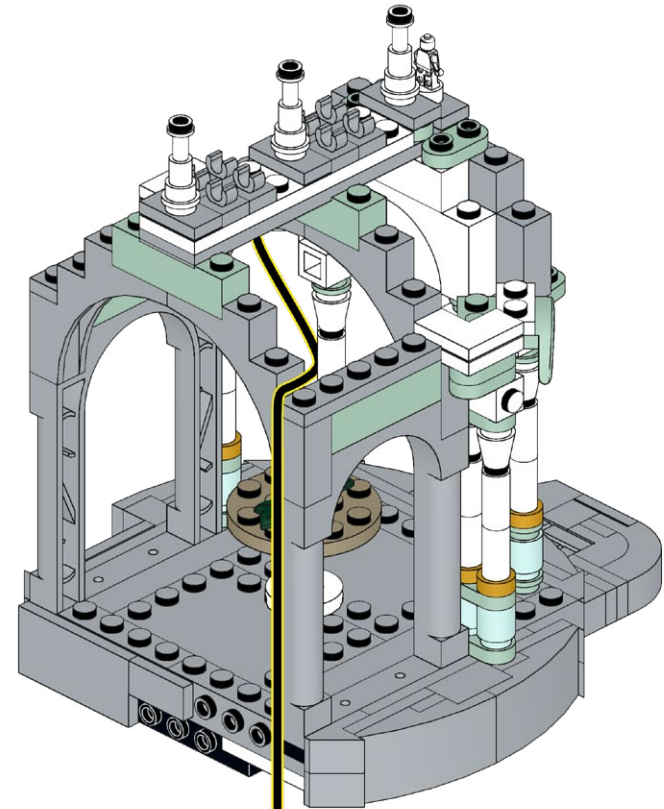

441

1x

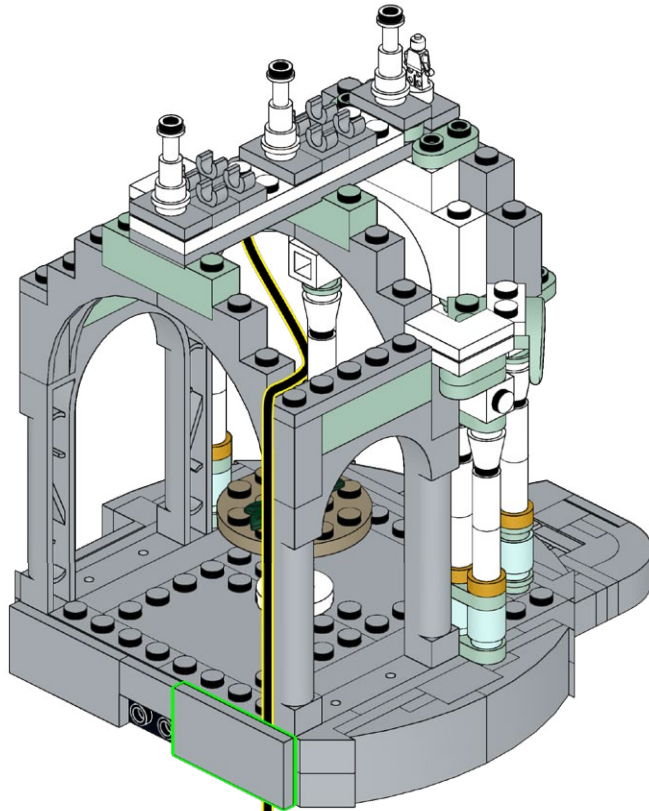
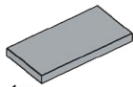

442

2x

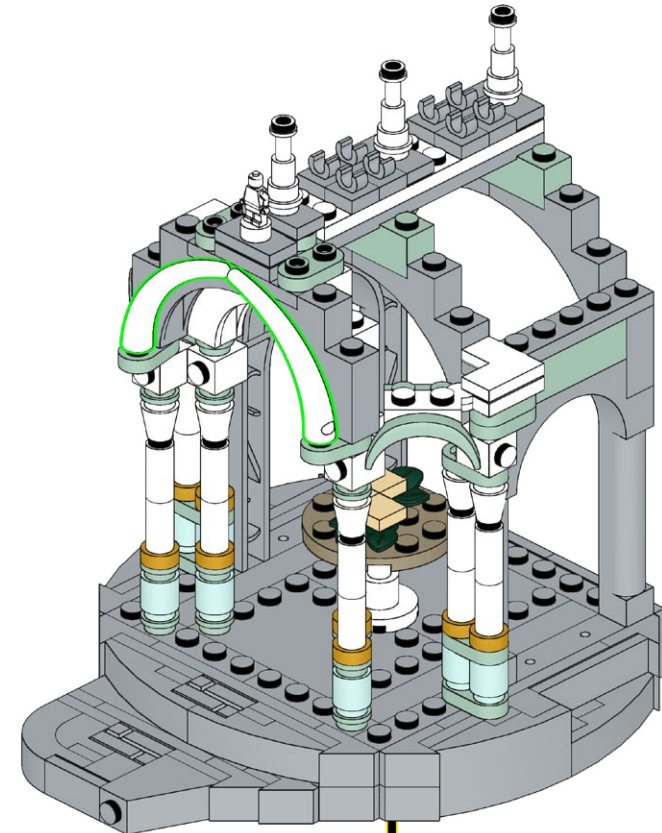

443



2x

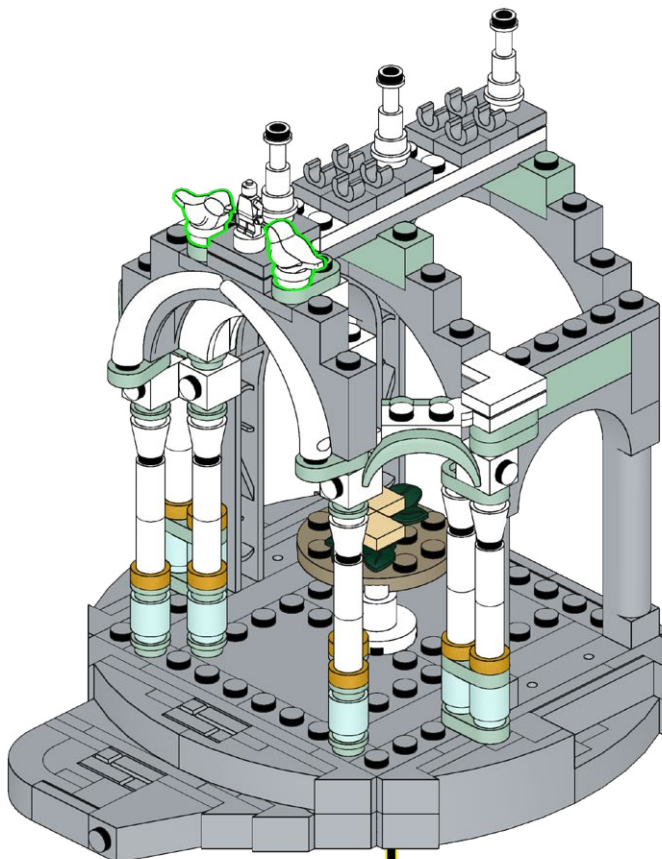



444

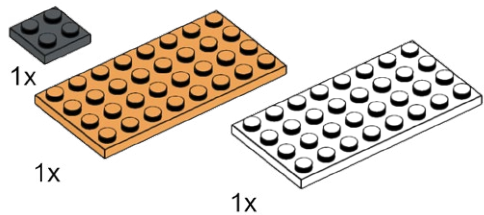

1

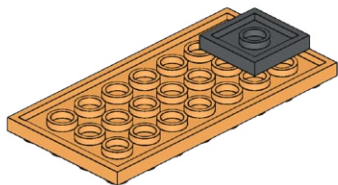

2

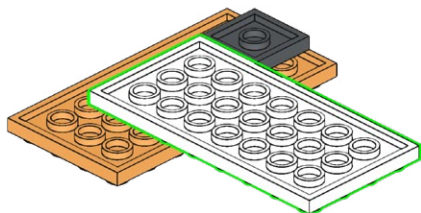

445

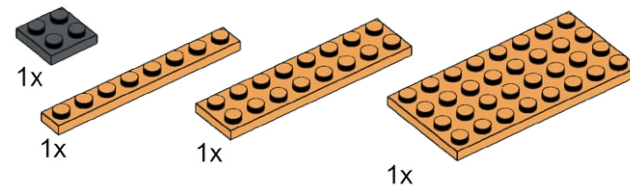

1

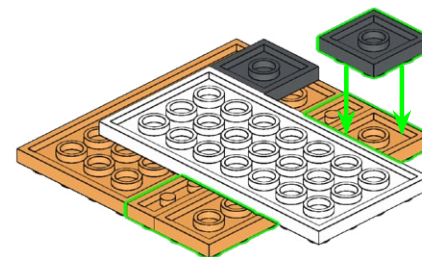

2

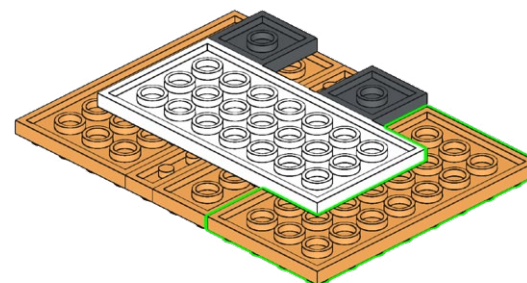

446

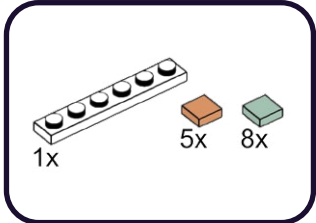

1

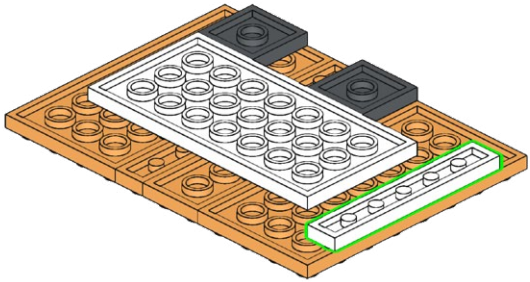

2

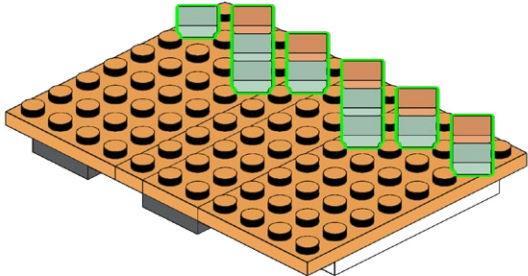

447

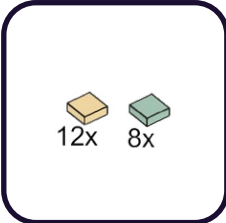

1

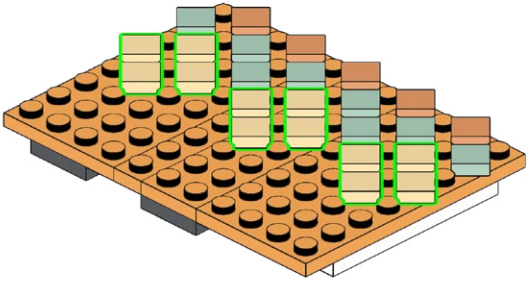

2

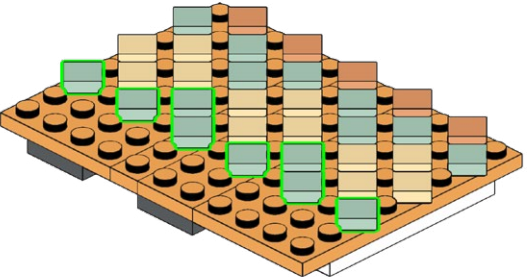

448

11x

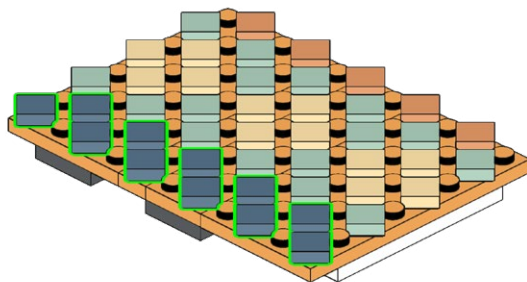

449

1x  
3x  
2x

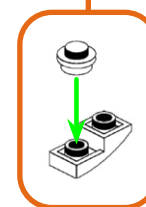
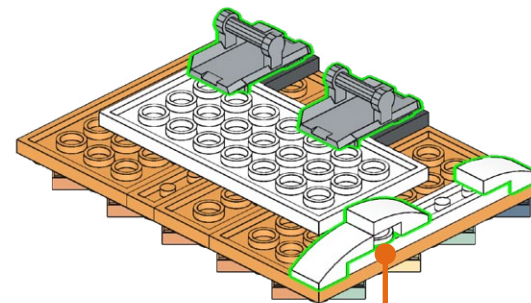



450

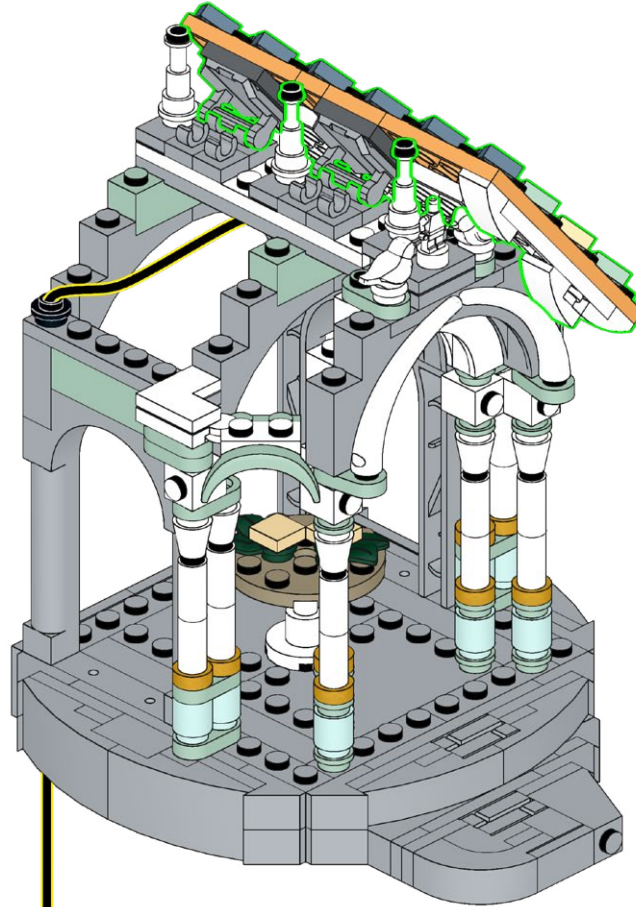

451

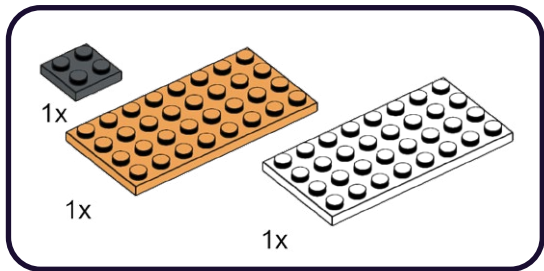

1

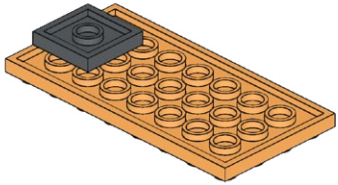

2

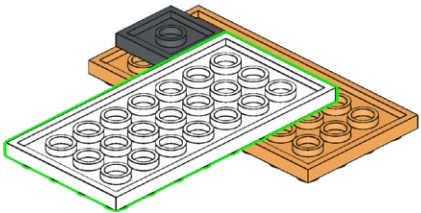

452

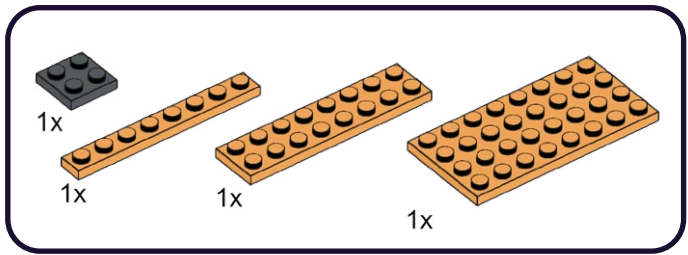

1

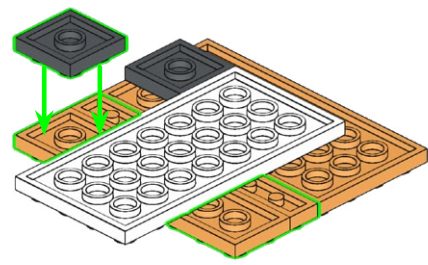

2

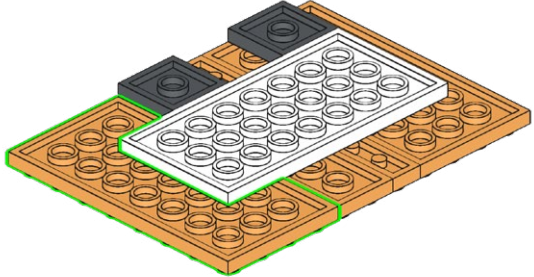

453

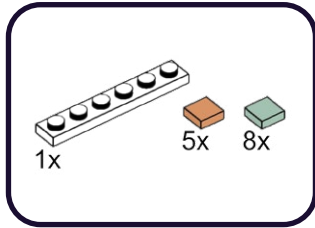

1

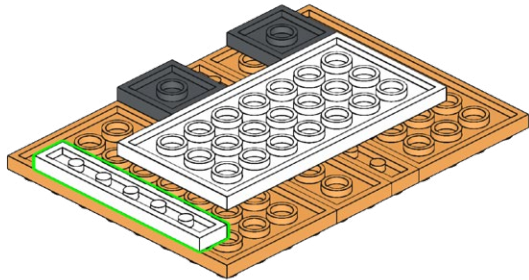

2

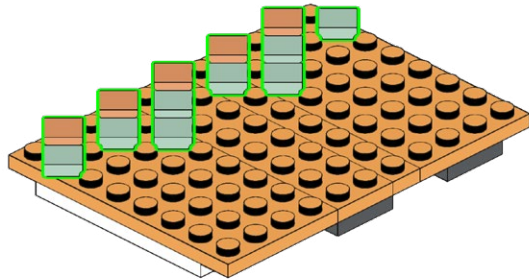

454

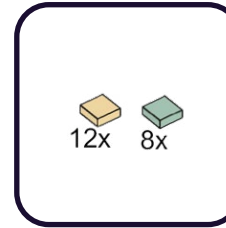

1

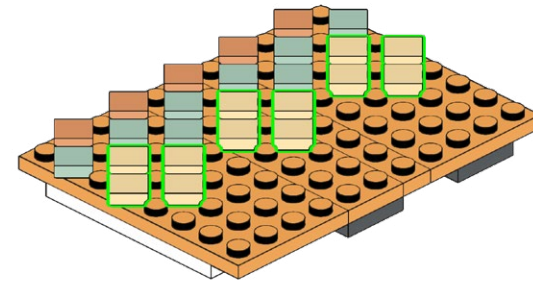

2

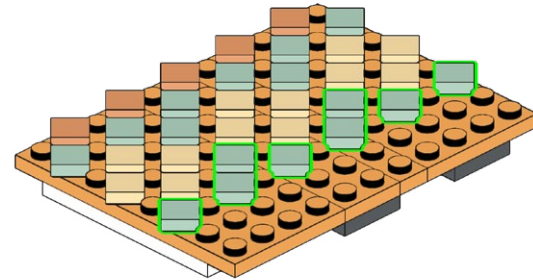



455

11x

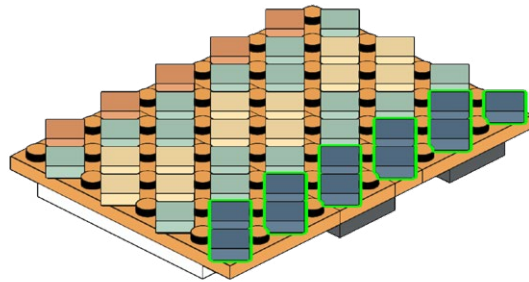

456

1x  
3x  
2x

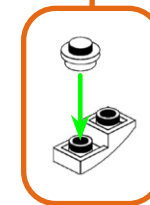
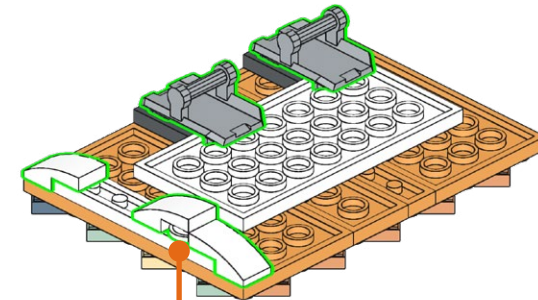

**457**

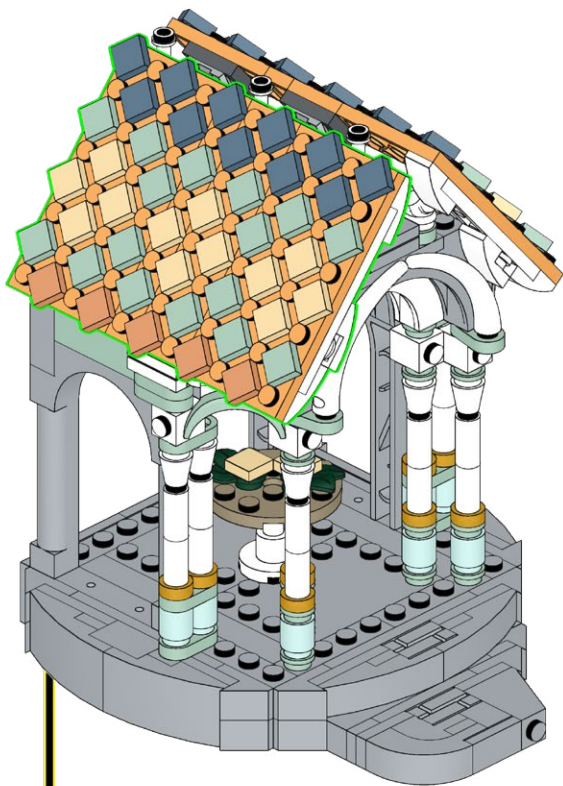

**458**

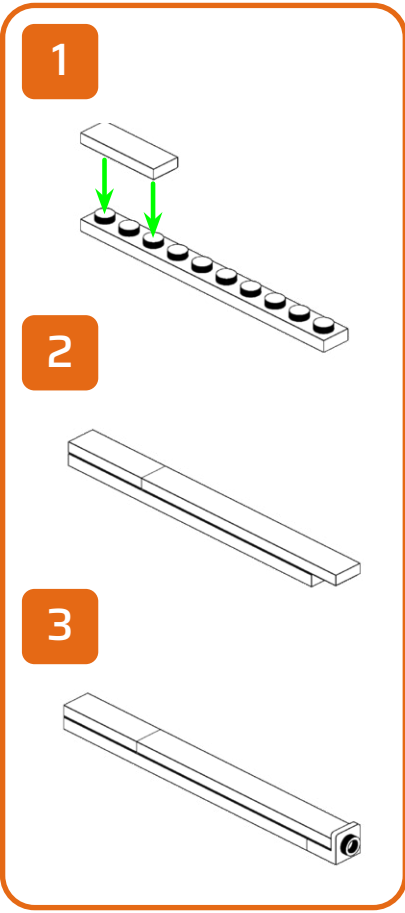
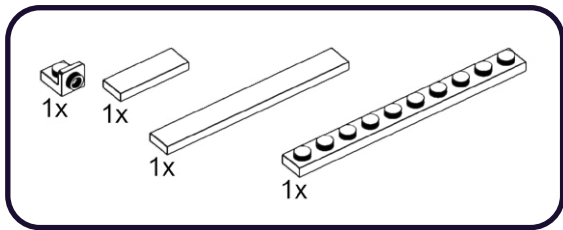



459





460





461





462





463

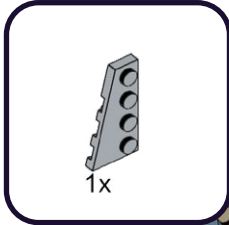

**HOLD UP!**

You might notice some bags aren't in order, as well as left over pieces, but that's ok! We're changing the way you build LEGO!

**ATTENDEZ!**

Vous remarquerez peut-être que certains sacs, ainsi que certaines pièces, ne sont pas dans le bon ordre. Mais pas de panique! Nous changeons simplement la façon avec laquelle vous construisez vos LEGO!

**ASPETTA!**

Potresti notare che alcuni sacchetti non sono in ordine, così come i pezzi avanzati, ma va bene così! Stiamo cambiando il modo in cui costruisci i LEGO!

**HALT!**

Sie werden möglicherweise bemerken, dass einige tüten durcheinander sind und teile übrig bleiben, aber das ist in Ordnung! Wir ändern die art und weise, wie Sie LEGO bauen!

**¡ESPERA!**

Es posible que notes que algunas bolsas están fuera de servicio, así como piezas sobrantes, ¡pero está bien! ¡Estamos cambiando la forma en que construyes LEGO!

**暫停!**

你可能会注意到一些袋子顺序错乱, 以及一些剩余的部件, 但没关系! 我们正在改变你搭建乐高的方式!

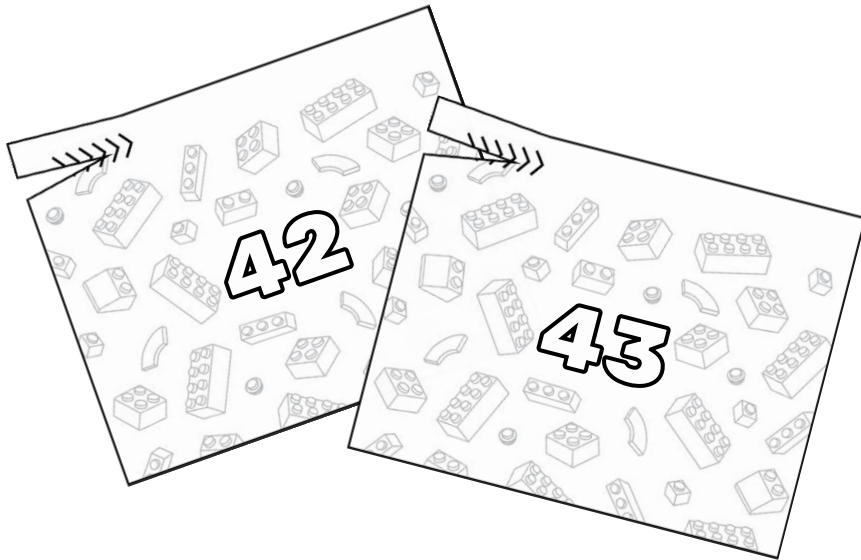
**Open LEGO® Bags 42 & 43**

464

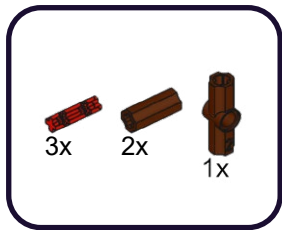

1



2



3

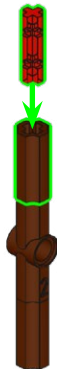



465

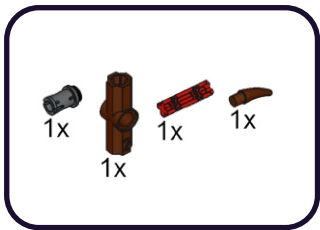

1

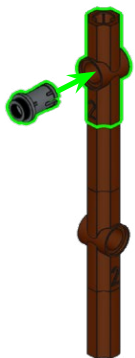

2

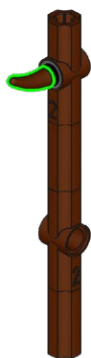

3

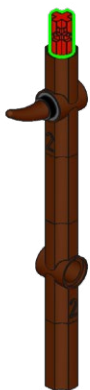

466

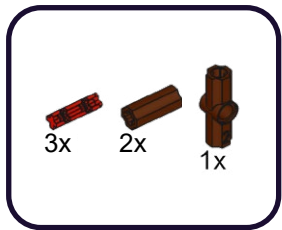

1



2



3

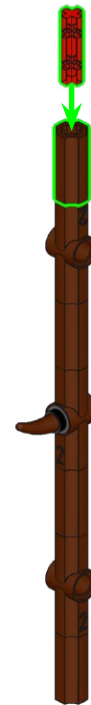

467





468

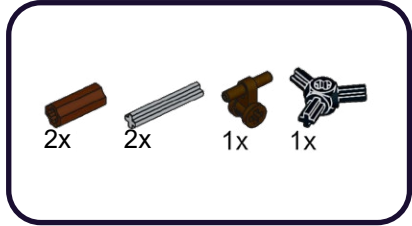

1

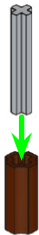

2



3

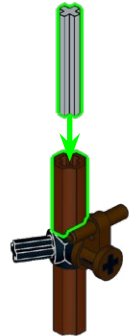

469

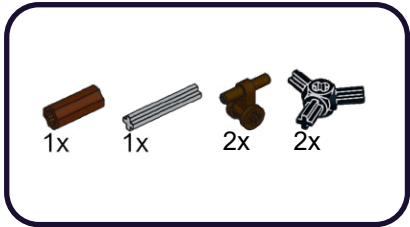

1



2

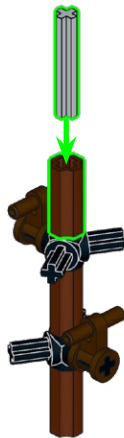

3



470

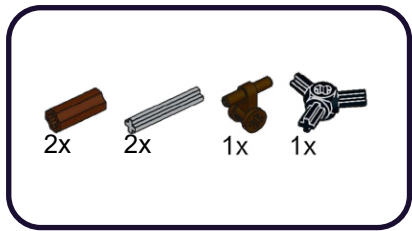

1



2



3





471

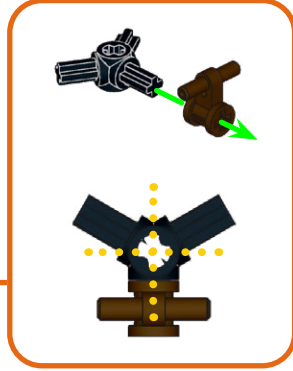

1

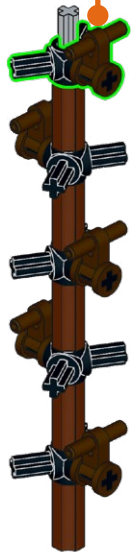

2



3



472

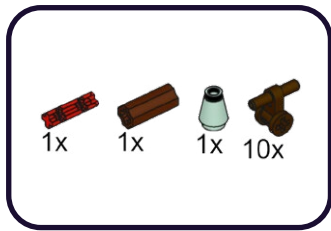

1



2



3



473



1

2

3

4   
9x





474

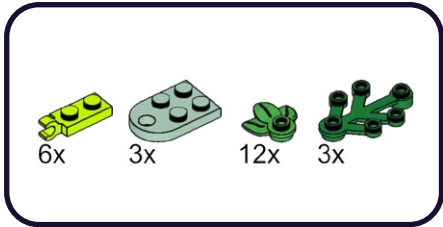

1

2

3

4

3x

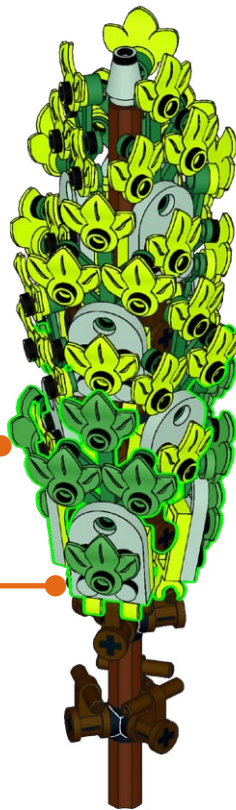

475

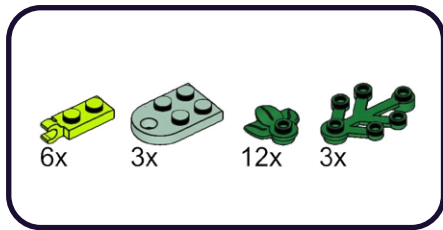

1

2

3

4

3x



476

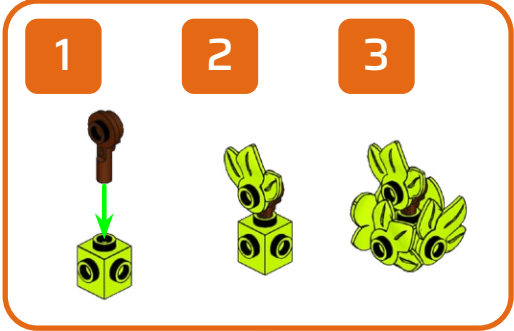



477



478

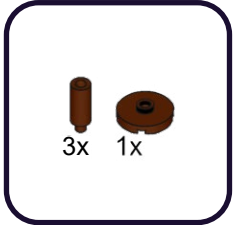

1



2

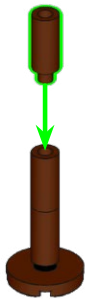

479

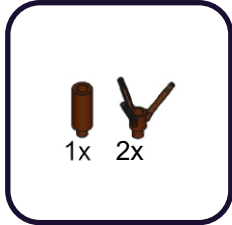

1

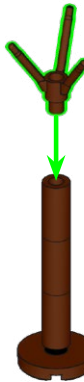

2

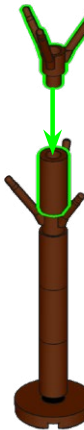

480



1



2



481



1



2



3x

3x



482



483

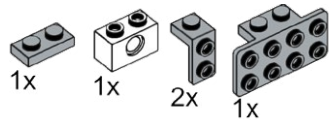

1

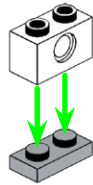

2

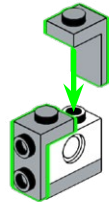

3

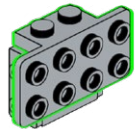

484

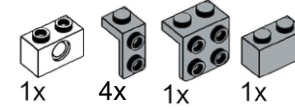

1

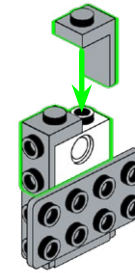

2

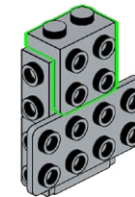

3

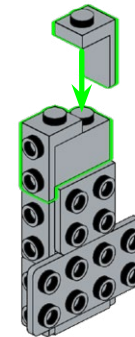

485

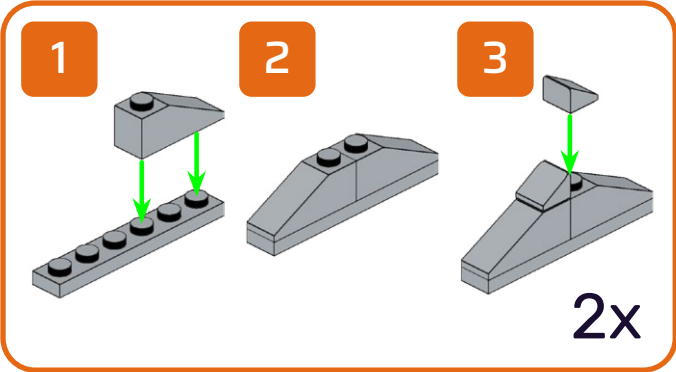
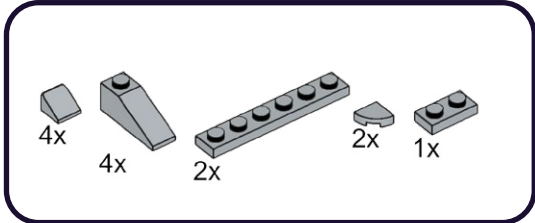

1



2

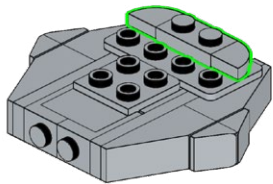
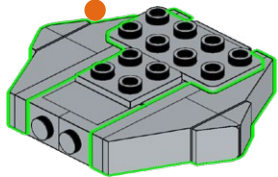

486

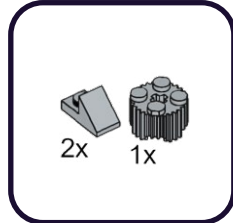

1

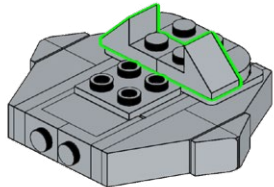

2

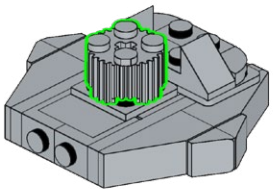



# 487

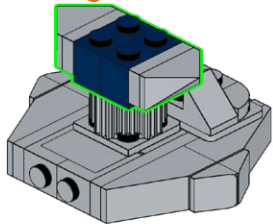
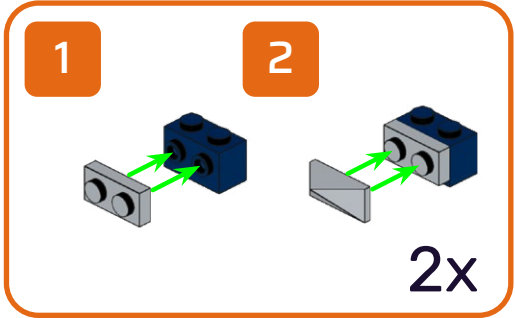
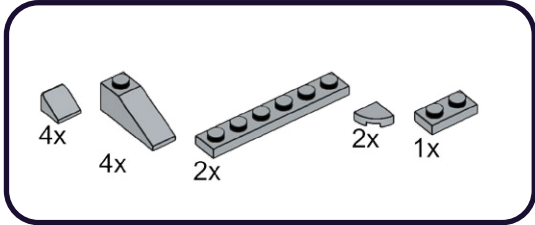

# 488

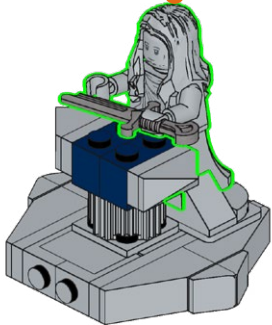
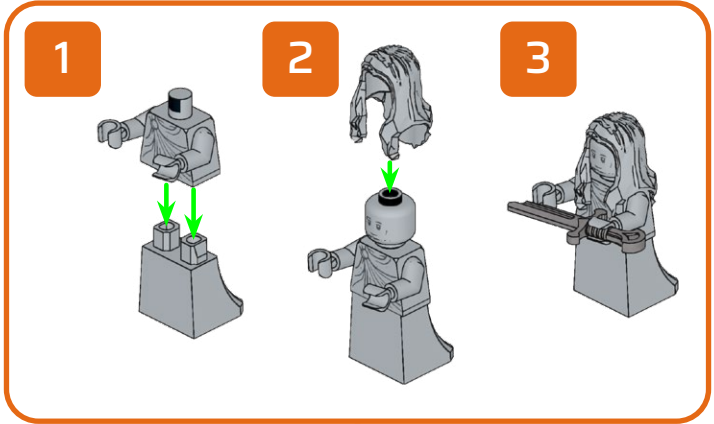
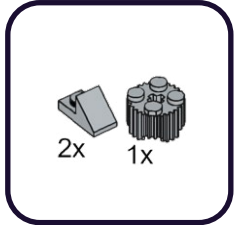

489



490

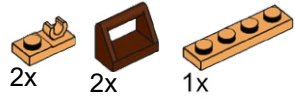

1

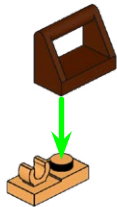

2

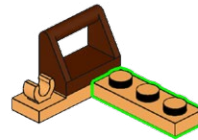

3

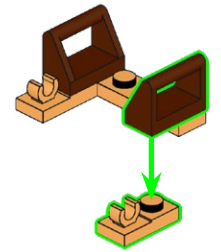



491

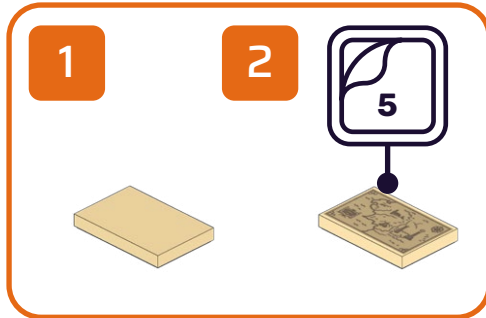
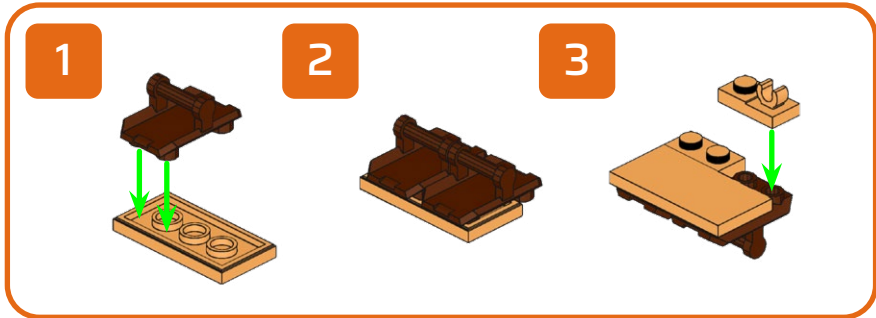
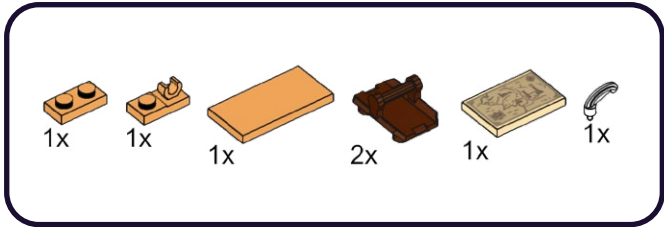

1

2

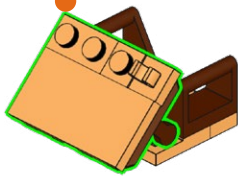

3



492

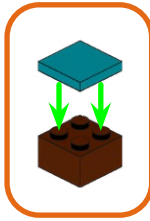
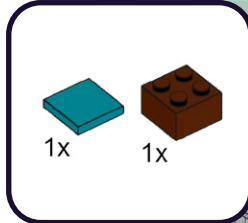



493

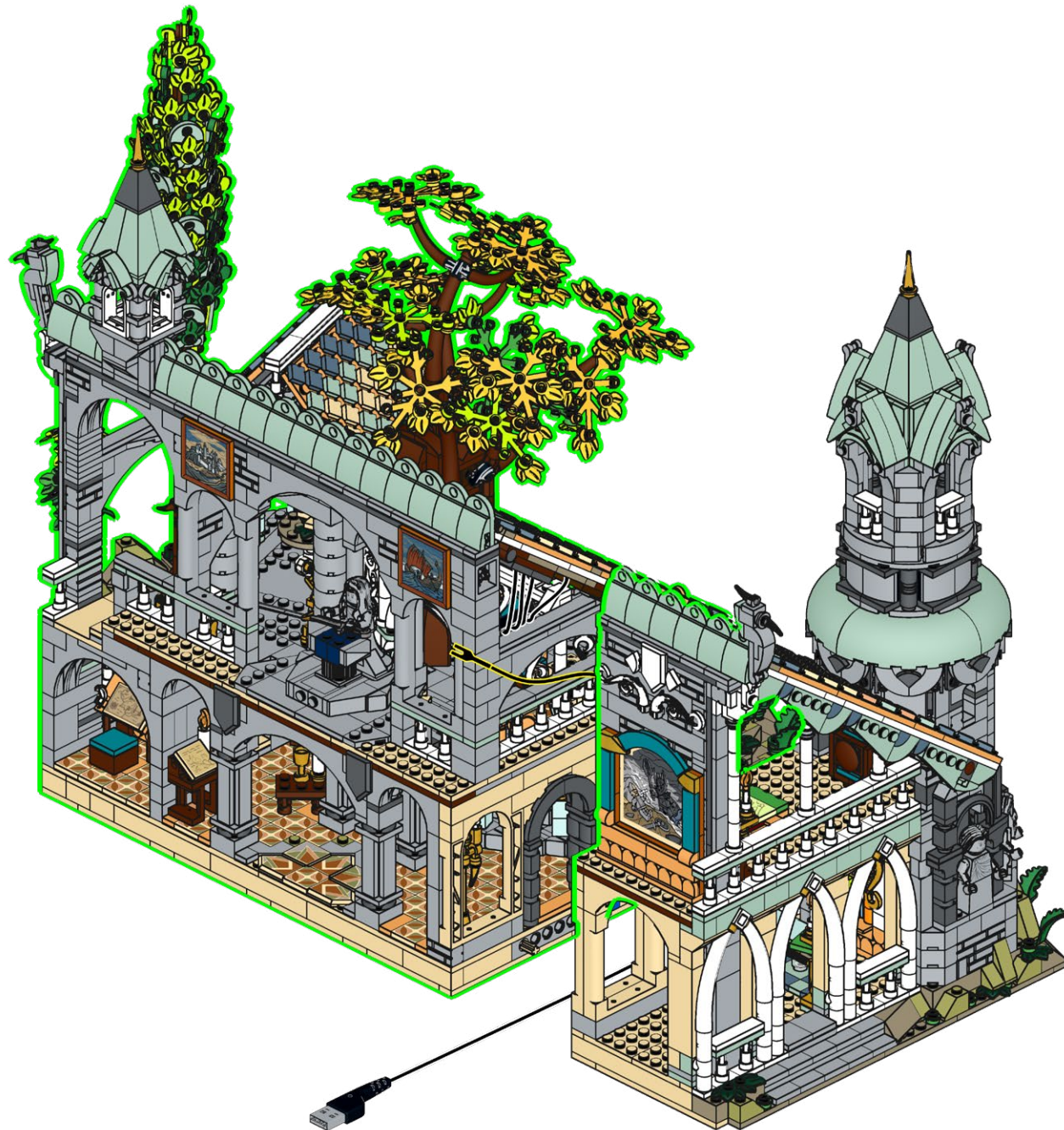



494

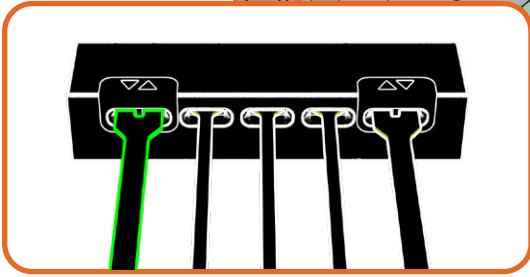
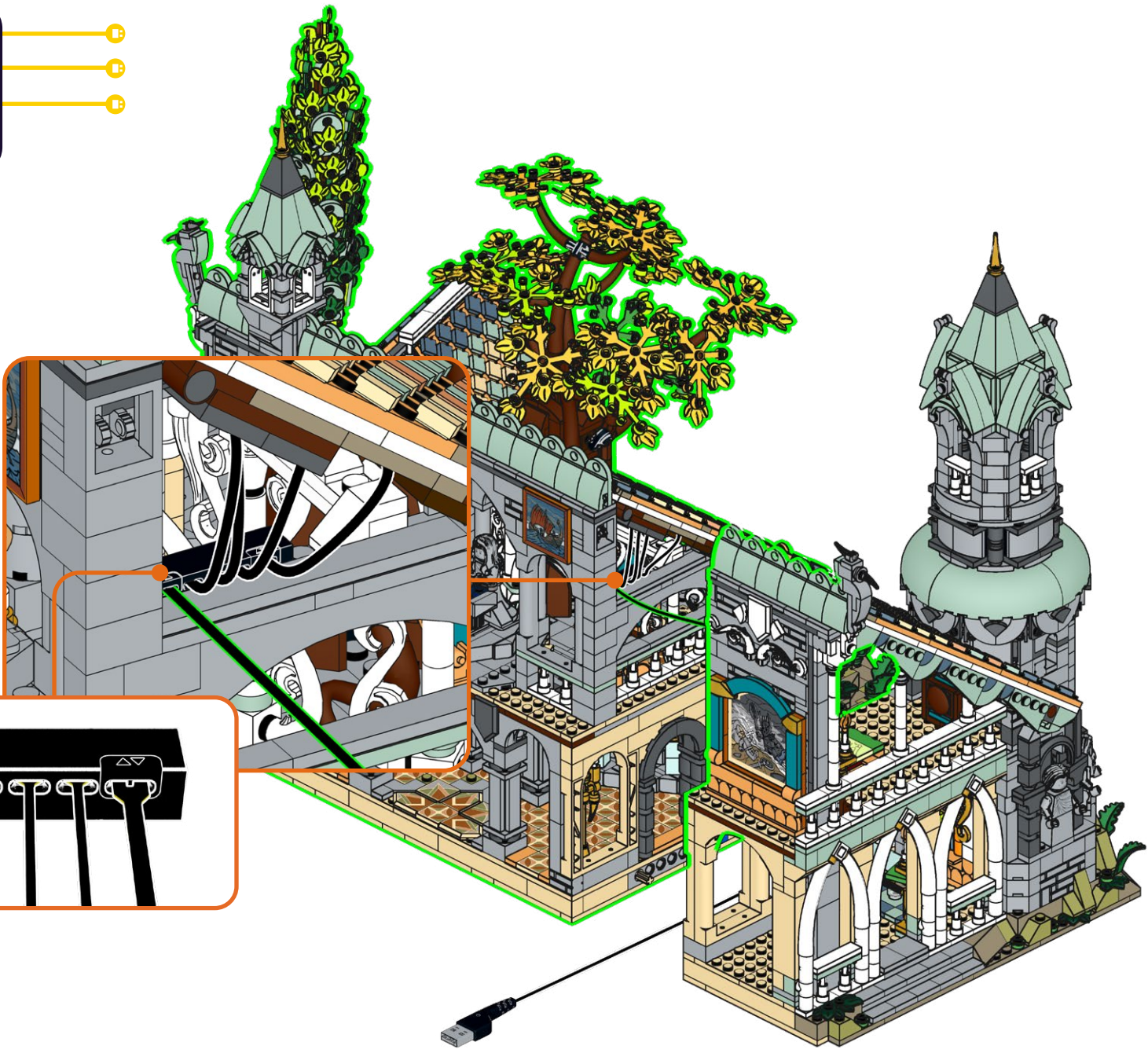
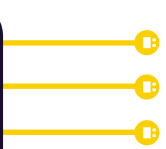

495





# 496

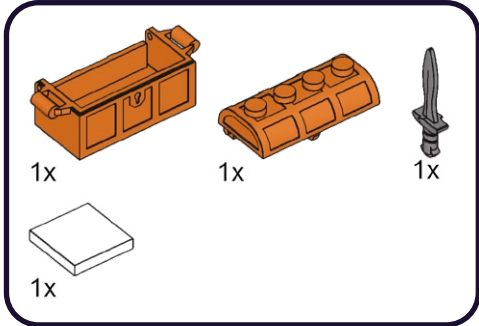

1

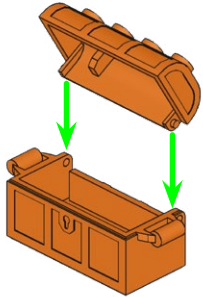

2

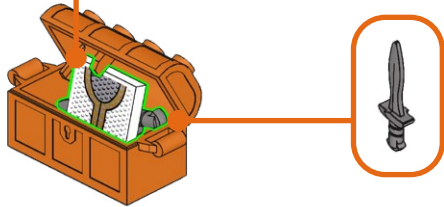
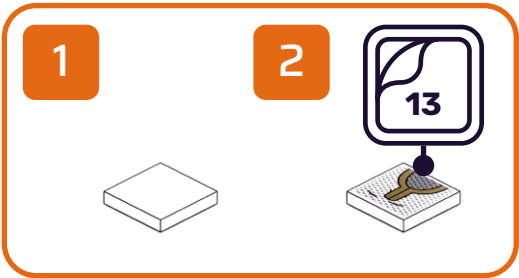

# 497





# 498

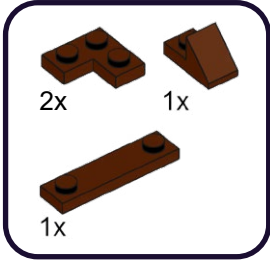

1



2

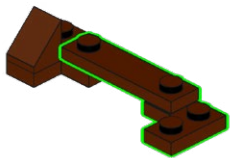

# 499

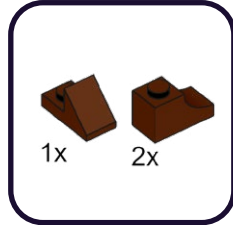

1

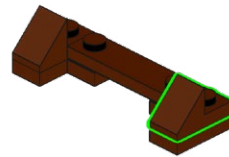

2

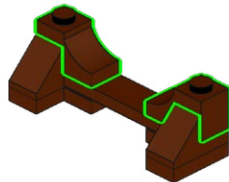

# 500

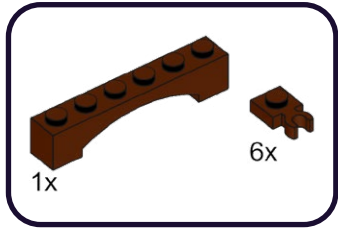

1

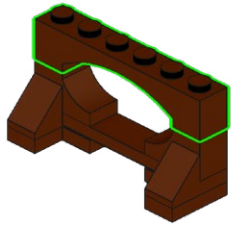

2

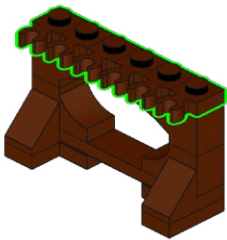

# 501

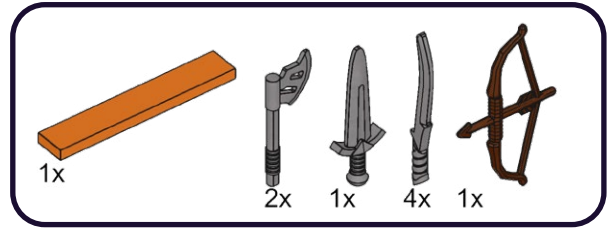

1

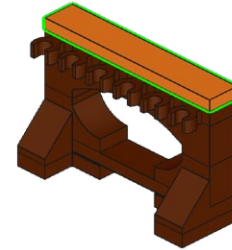

2x

2

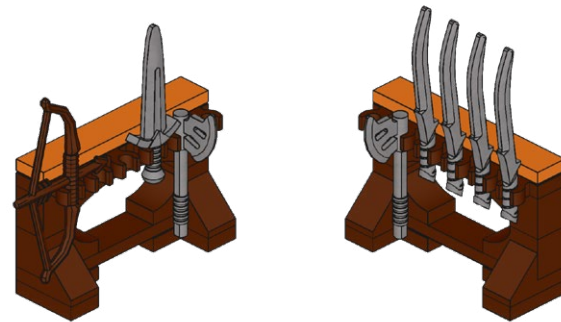

502



Power on Test  
Test de mise sous tension  
Test di Potenza  
Stromtest  
Prueba de Energía  
电源测试





# CONTACT US

Click below for customer support, or general inquiries.

Cliquez ci-dessous pour accéder au support client ou aux renseignements généraux.

Clicca qui sotto per l'assistenza clienti o per richieste generali.

Contact Us



Contactez-nous



Contattaci



Klicken sie unten für kundensupport oder allgemeine anfragen.

Haga clic a continuación para atención al cliente o consultas generales.

点击下方获取客户支持或一般咨询。

Kontaktieren sie uns



Contáctanos



联系我们



## TROUBLESHOOTING

If you're stuck, scan the QR code for troubleshooting.

Se sei bloccato, scansiona il codice QR per la risoluzione dei problemi.

Wenn Sie nicht weiterkommen, scannen Sie den QR-Code zur Fehlerbehebung.

Si vous êtes bloqué, scannez le code QR pour le dépannage

Si está atascado, escanee el código QR para solucionar el problema.

如果遇到问题, 请扫描二维码进行故障排除

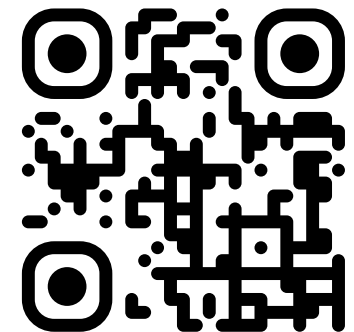



# LIGHTMYBRICKS

[lightmybricks.com](http://lightmybricks.com)



LEGO® is a trademark of the LEGO Group of companies, which does not sponsor, authorize or endorse this product. All LEGO® sets featured in images are sold separately. This is not a LEGO® product. The LEGO Group is not liable for any loss, injury or damage arising from the use or misuse of this product. ©2024 Light My Bricks Pty Ltd. All rights reserved. [www.lightmybricks.com](http://www.lightmybricks.com)

Our components are designed and packaged in Australia by Light My Bricks Pty Ltd. Components are manufactured in China. 3fl bldg C, Shuanghuan Quanxin Technology Information Industry Park Baolong Street, Longgang District, Shenzhen, China. Imported in Australia by Light My Bricks Pty Ltd, 5/26 Rushdale St, Knoxfield, VIC, 3180, Australia.

WARNING: CHOKING HAZARD - Small parts. Not for children under 3 years.

AVERTISSEMENT : RISQUE D'ÉTOUFFEMENT - Petites pièces. Ne convient pas aux enfants de moins de 3 ans.

ATTENZIONE: PERICOLO DI SOFFOCAMENTO - Piccole parti. Non adatto a bambini di età inferiore a 3 anni.

WARNUNG: ERSTICKUNGSGEFAHR - Kleine Teile. Nicht für Kinder unter 3 Jahren geeignet.

ADVERTENCIA: PELIGRO DE ASFIXIA - Piezas pequeñas. No son apto para niños menores de 3 años.

警告：窒息危险 - 小零件。不适合3岁以下儿童。