



**LIGHT  
BRICKS™**



## **LIGHT KIT INSTALLATION GUIDE**

**LORD OF THE RINGS  
RIVENDELL (PART 1)**

FOR LEGO  
SET  
#10316



## 3

### Getting Started

- 4 Legend
- 5 Component Handling
- 6 Blueprint

## 7

### Instructions

- 7 Bag 1 & 2
- 29 Bag 3 & 4 + LMB Bag 02
- 61 Bag 5 + LMB Bag 01
- 93 Bag 6
- 112 Bag 7
- 130 Bag 8
- 147 Bag 9
- 170 Bag 10
- 183 Bag 11

## 214

### Power On Test

- 215 Contact & Troubleshooting

# GETTING STARTED



Bold, beautiful and bright, Light My Bricks elevates your favourite LEGO set from knick-knack to statement piece. Create a talking point at home or in the office that speaks to your passions with Light My Bricks. To learn more, click below.

**Learn More**



Audacieux, beau et lumineux, Light My Bricks élève votre ensemble LEGO préféré du statut de bibelot à celui de pièce maîtresse. Que ce soit à la maison ou au bureau, partagez votre passion des LEGO avec Light My Bricks. Cliquez ci-dessous pour en savoir plus.

**En savoir plus**



Audace, bello e luminoso, Light My Bricks eleva il tuo set LEGO preferito da soprammobile a pezzo di tendenza. Crea un punto di discussione a casa o in ufficio che parli alle tue passioni con Light My Bricks. Per saperne di più, clicca qui sotto.

**Ulteriori Informazioni**



Mutig, schön und hell – Light My Bricks verwandelt Ihr Lieblings-LEGO-Set von einem schnickschnack in ein statement-stück. Schaffen sie einen gesprächspunkt zu hause oder im büro, der Ihre leidenschaften widerspiegelt, mit Light My Bricks. Um mehr zu erfahren, klicken sie unten.

**Mehr erfahren**



Audaz, hermoso y brillante, Light My Bricks eleva tu set LEGO favorito de una chuchería a una pieza llamativa. Crea un tema de conversación en casa o en la oficina que hable de tus pasiones con Light My Bricks. Para obtener más información, haga clic a continuación.

**Más información**



大胆、美丽而明亮，Light My Bricks 将你喜爱的乐高套装从小摆件提升为引人注目的装饰品。在家或办公室打造一个能表达你激情的话题，了解更多，请点击下方。

**了解更多**



# LEGEND

## Rotate Set



Retournez L'ensemble  
Ruota Set  
Set Drehen  
Rotar Conjunto  
旋转套件

## Add Part



Ajoutez une Pièce  
Aggiungi Parte  
Teil Hinzufügen  
Agregar Pieza  
添加零件

## Click



Cliquez  
Clic  
Klicken  
Clic  
点击

## Pinch/Fold



Pincez/Pliez  
Pizzicare/Piegare  
Kneifen/Falten  
Pellizcar/Doblar  
折叠

## Pull Cable



Tirez le Cable  
Tirare il Cavo  
Kabel Ziehen  
Tirar del Cable  
拉动电缆

## Repeat Step



Répétez  
Ripetere  
Wiederholen  
Repetir  
重复

## Sticker



Autocollant  
Adesivo  
Aufkleber  
Pegatina  
贴纸

## Power On Test



Test de mise sous tension  
Test di Potenza  
Stromtest  
Prueba de Energía  
电源测试

## Disconnect Power



Débranchez L'alimentation  
Scollegare L'alimentazione  
Strom Trennen  
Desconectar la Energía  
断开电源

## Troubleshoot



Dépanner  
Risolvere  
Fehlerbehebung  
Solución de Problemas  
故障排除

# COMPONENT HANDLING

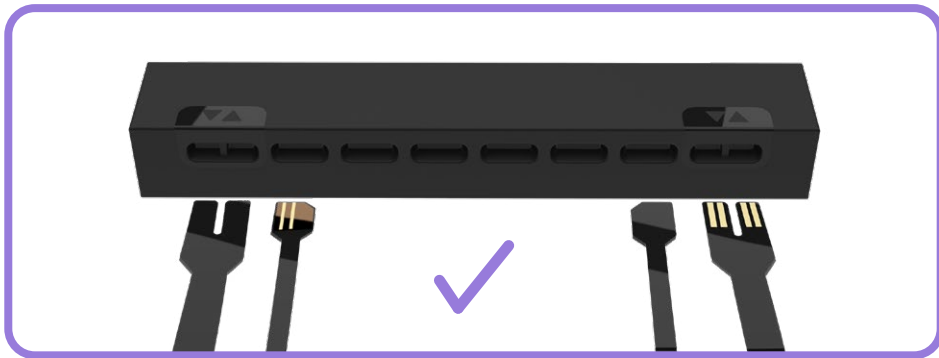
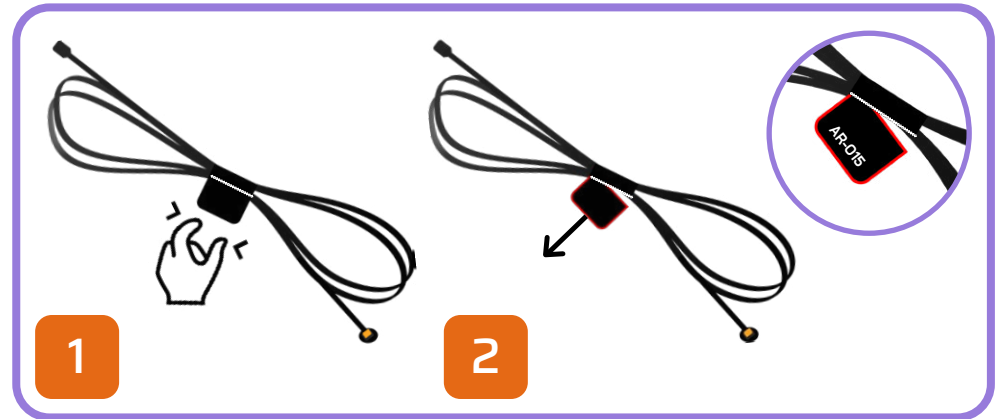
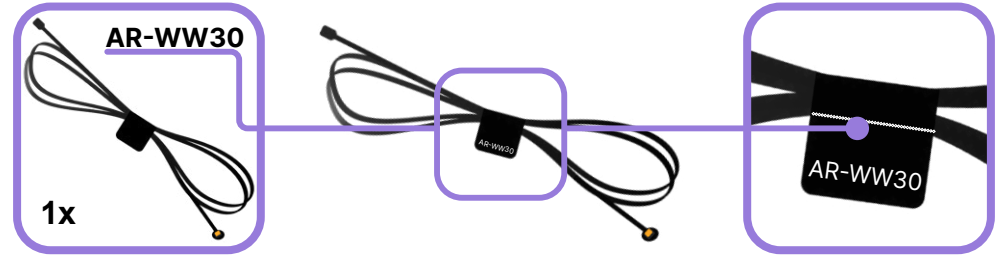
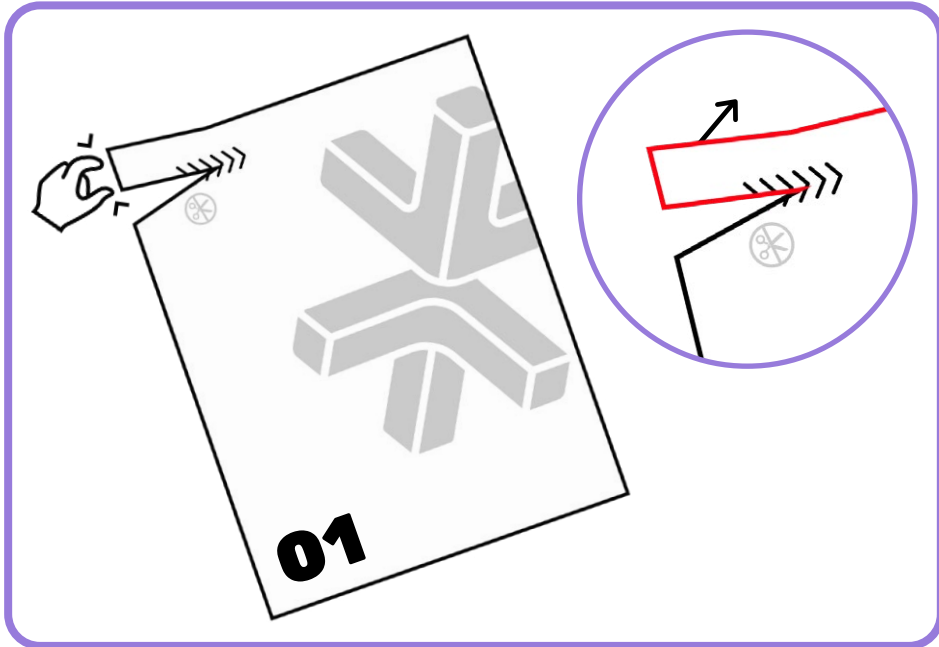

# BLUEPRINT

Part 1 - Tower

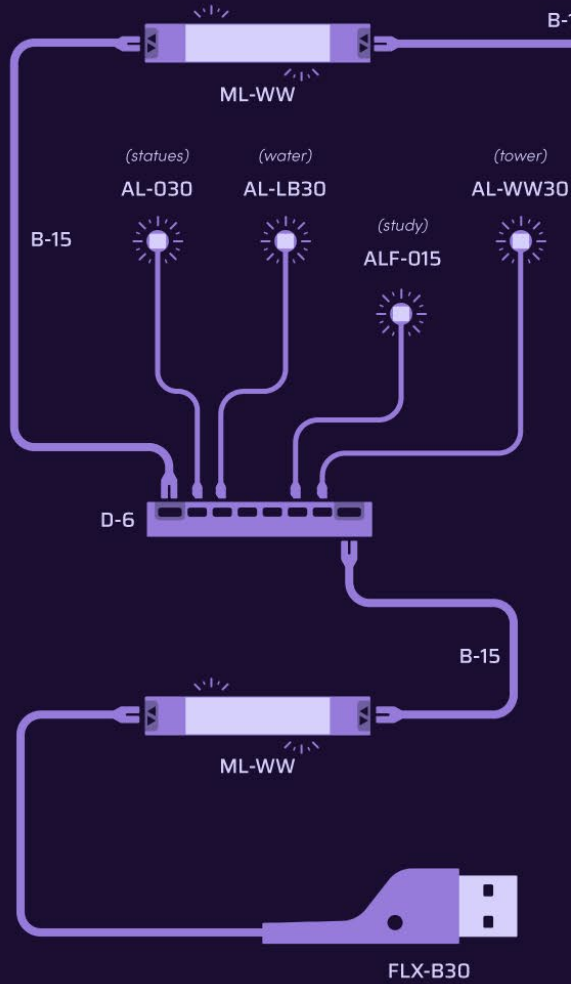

Part 2 - Hall

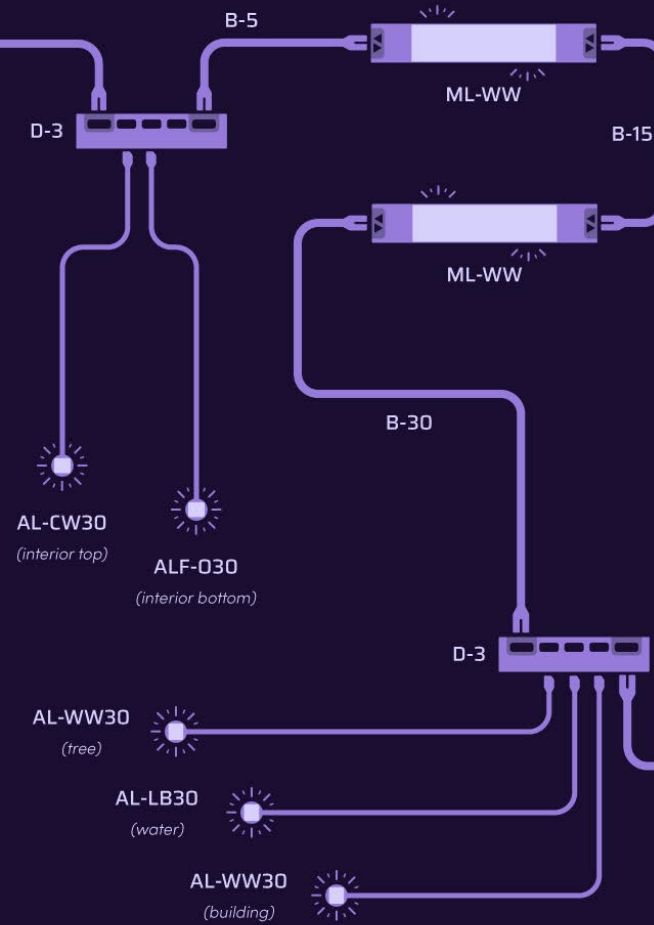

Part 3 - Gazebo

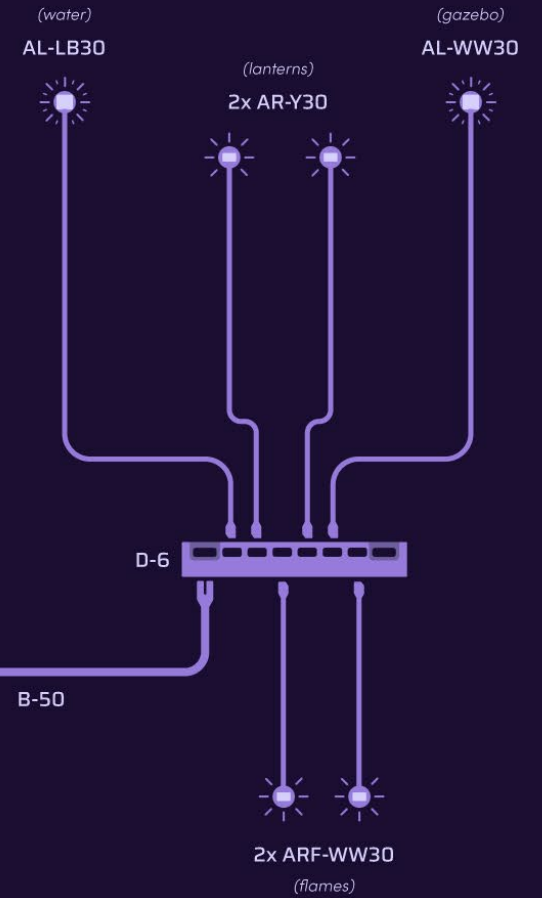

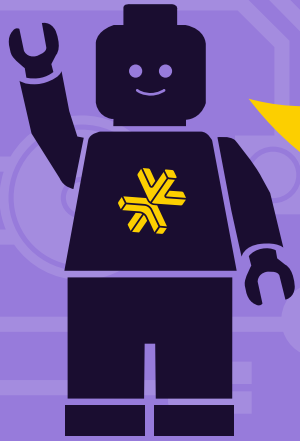
**HOLD UP!**

You might notice some bags aren't in order, as well as left over pieces, but that's ok! We're changing the way you build LEGO!

**ATTENDEZ!**

Vous remarquerez peut-être que certains sacs, ainsi que certaines pièces, ne sont pas dans le bon ordre. Mais pas de panique! Nous changeons simplement la façon avec laquelle vous construisez vos LEGO!

**ASPETTA!**

Potresti notare che alcuni sacchetti non sono in ordine, così come i pezzi avanzati, ma va bene così! Stiamo cambiando il modo in cui costruisci i LEGO!

**HALT!**

Sie werden möglicherweise bemerken, dass einige tüten durcheinander sind und teile übrig bleiben, aber das ist in Ordnung! Wir ändern die art und weise, wie Sie LEGO bauen!

**¡ESPERA!**

Es posible que notes que algunas bolsas están fuera de servicio, así como piezas sobrantes, ¡pero está bien! ¡Estamos cambiando la forma en que construyes LEGO!

**暫停!**

你可能会注意到一些袋子顺序错乱, 以及一些剩余的部件, 但没关系! 我们正在改变你搭建乐高的方式!

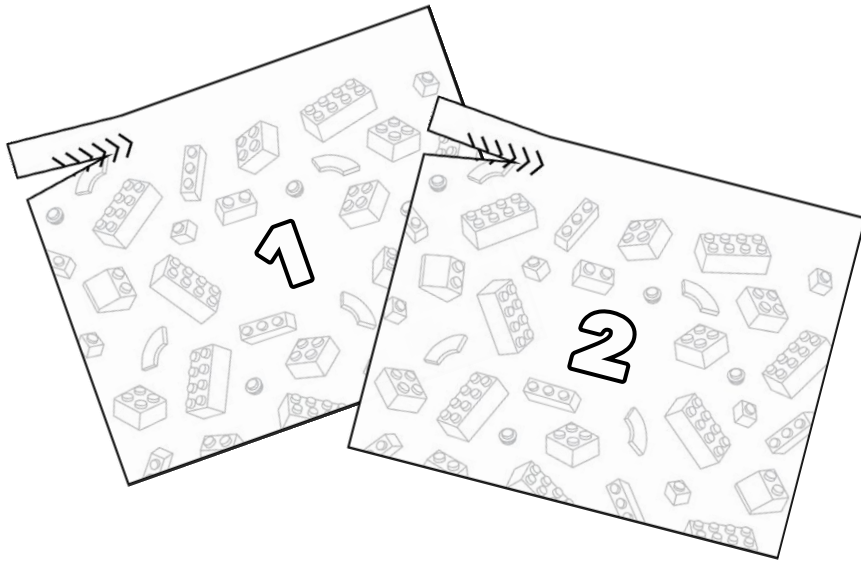
**Open LEGO® Bag 1 & 2**

1

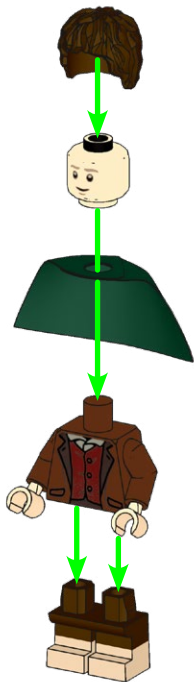
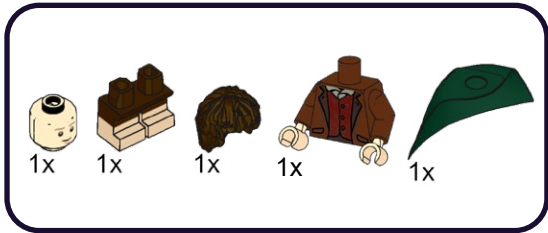

2

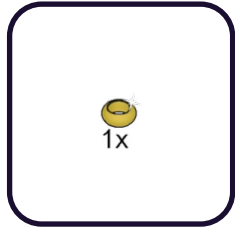



3

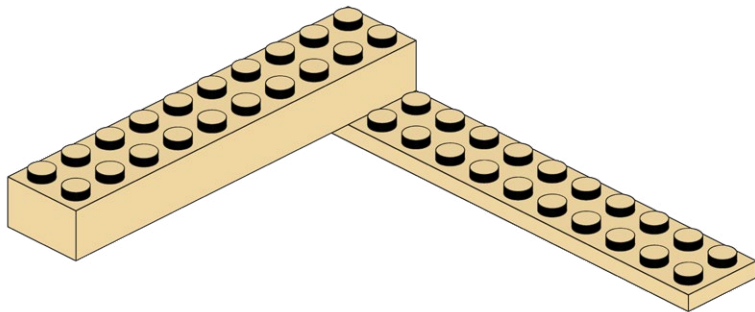
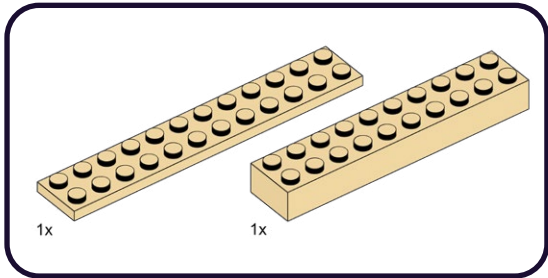

4

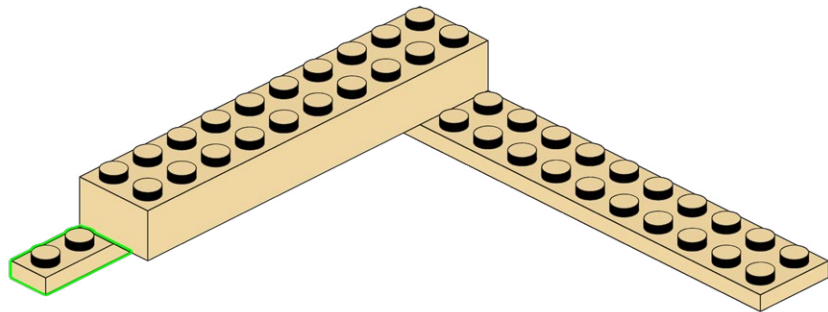
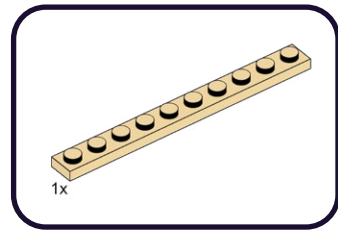

5

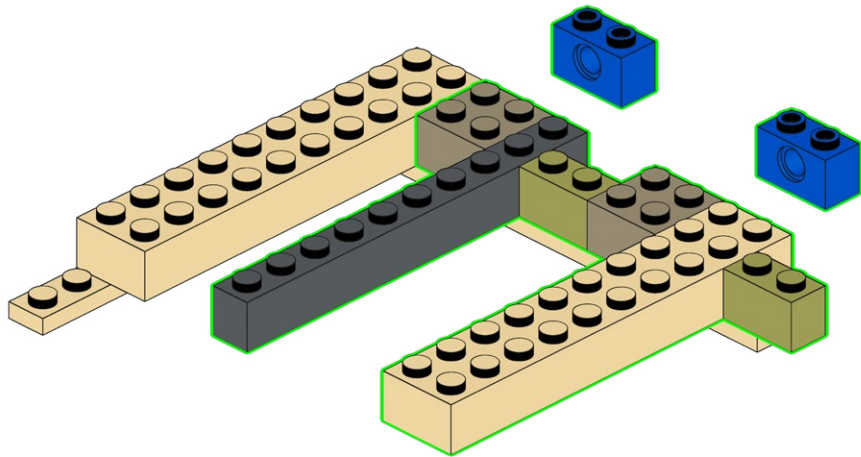
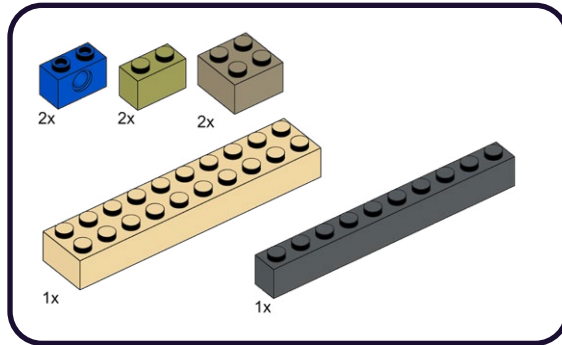

6

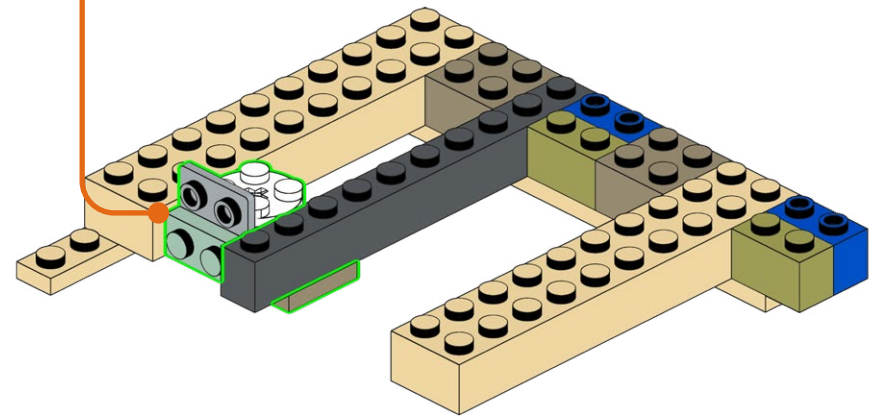
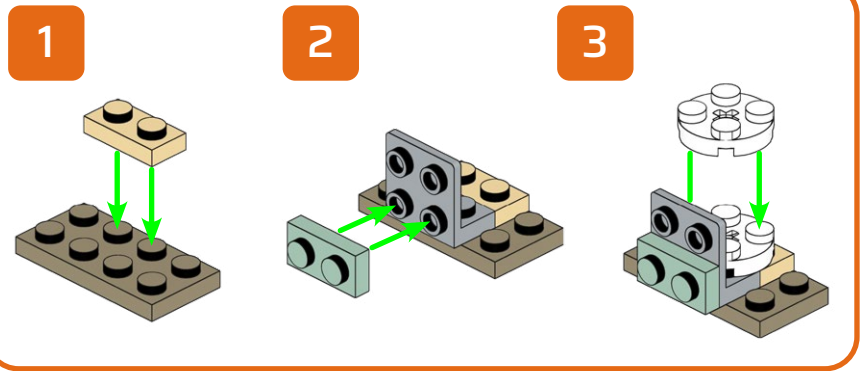
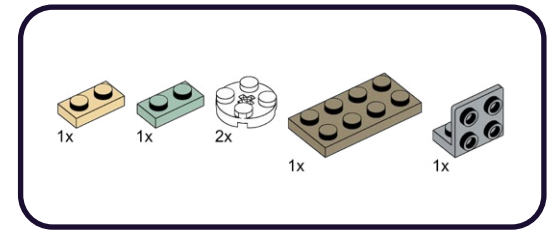

7

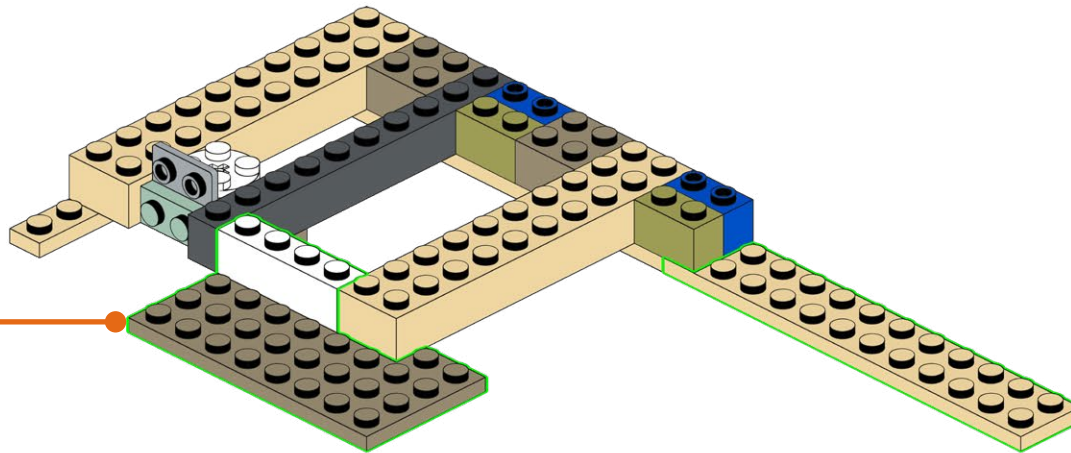
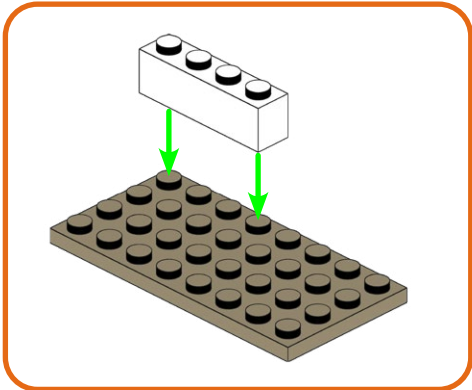
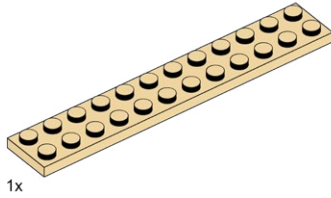
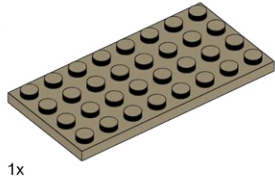
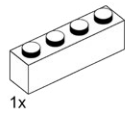

8

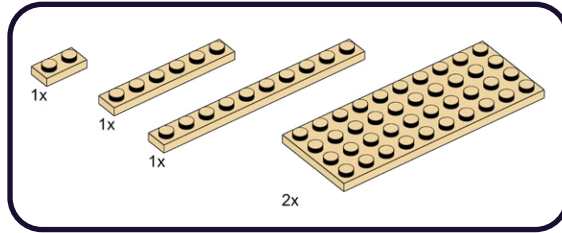

9

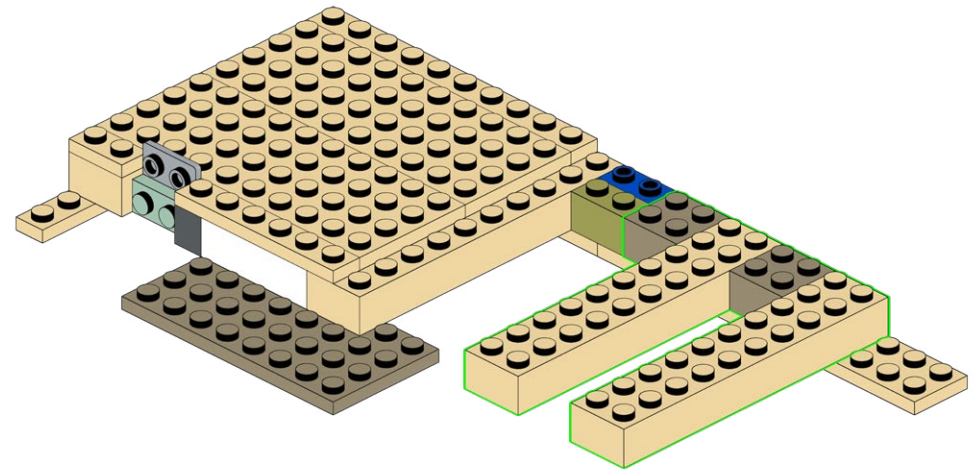
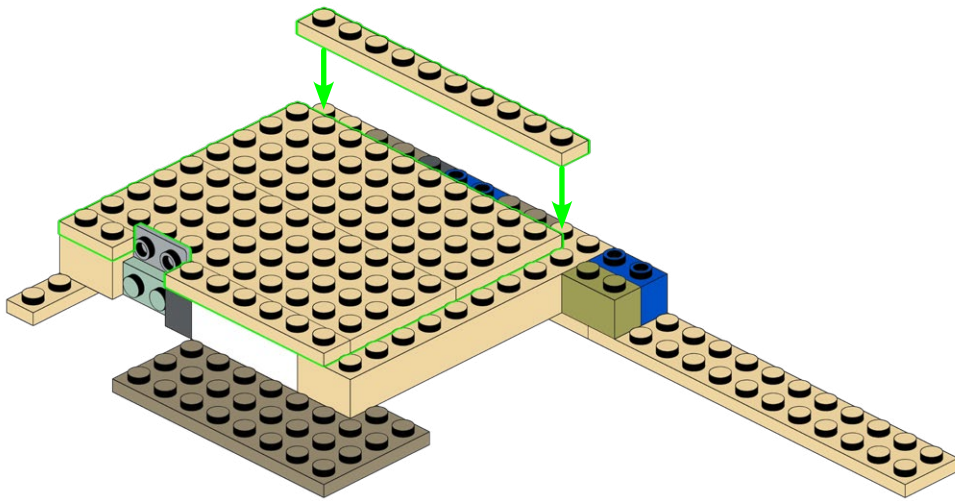
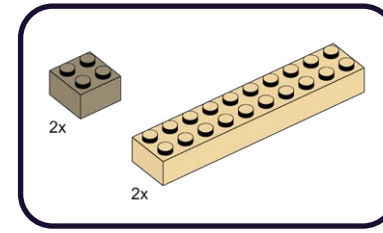



11

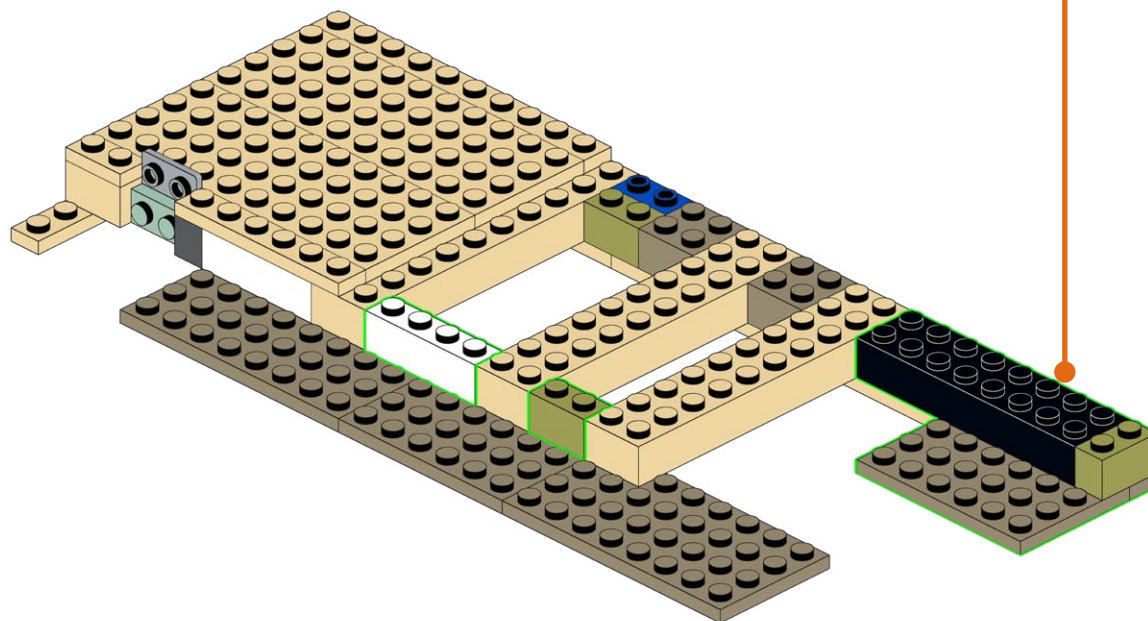
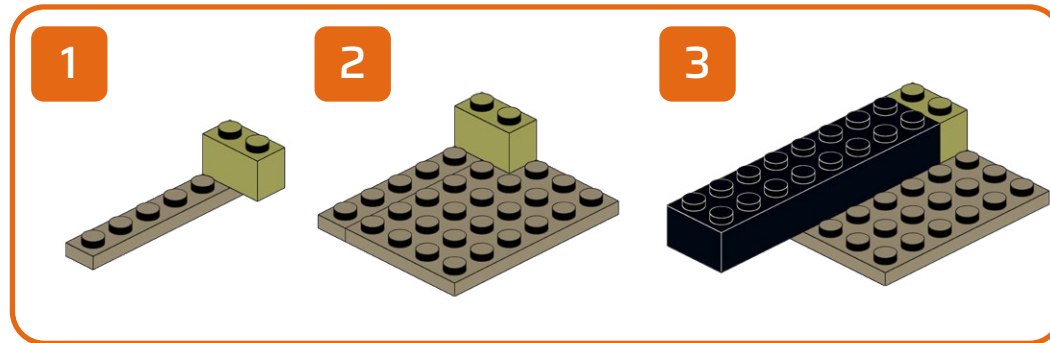
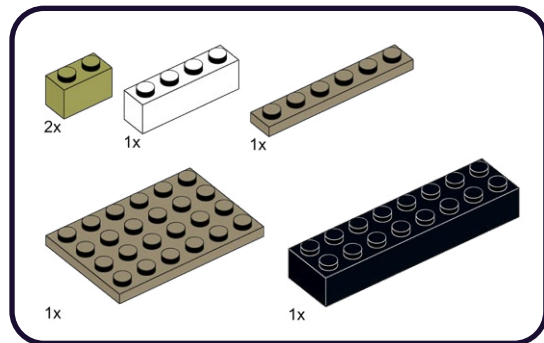

12

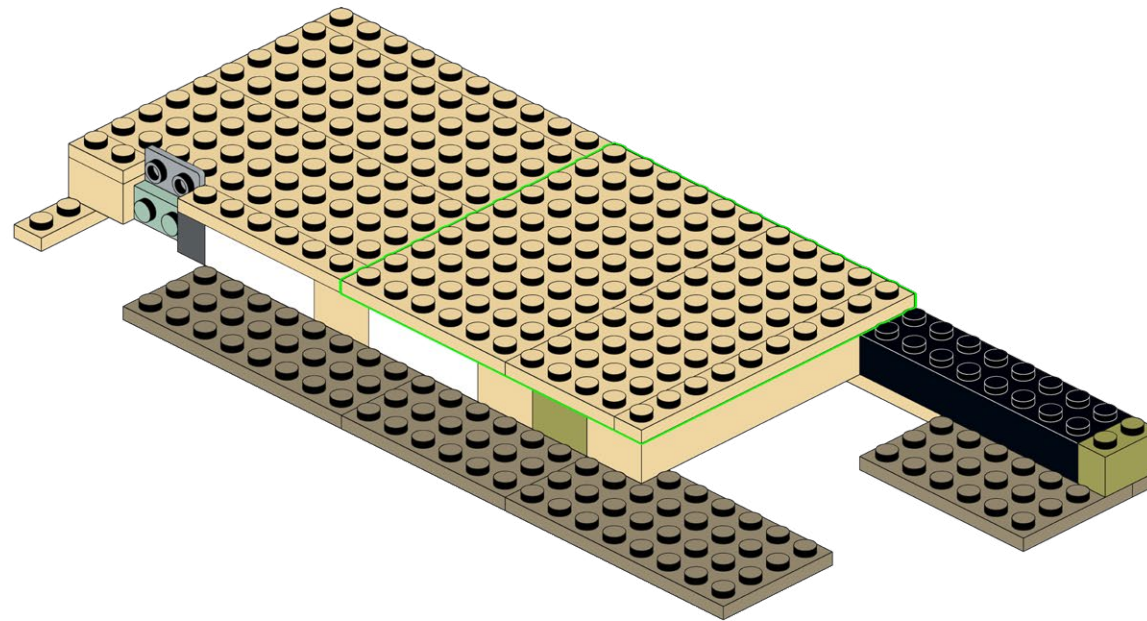
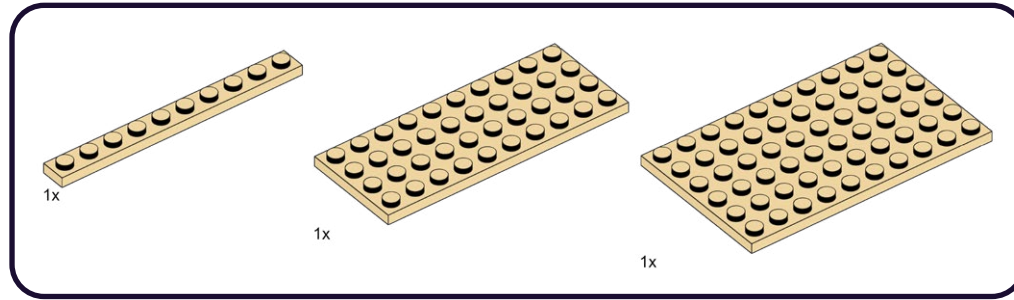

13

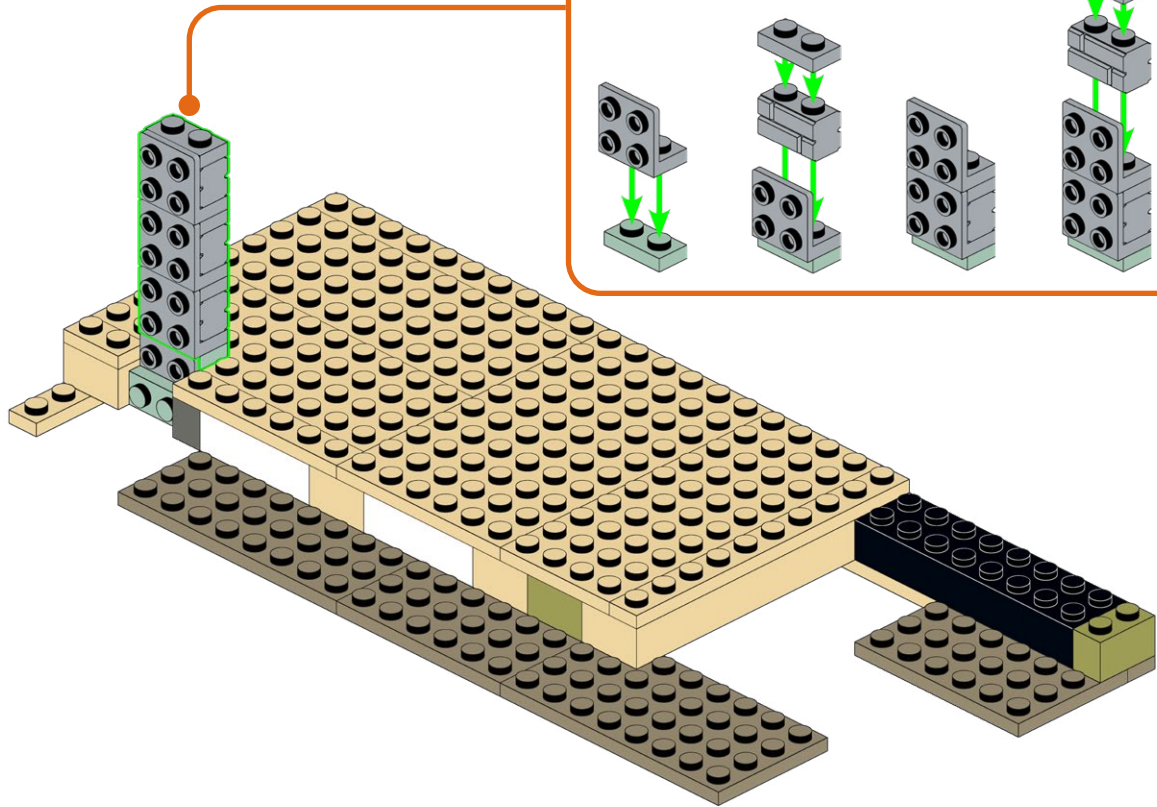
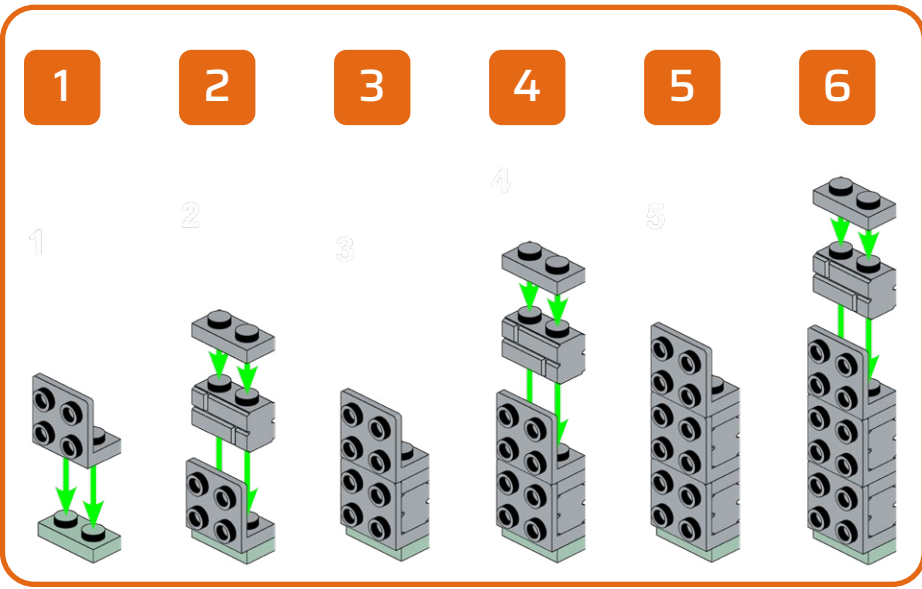
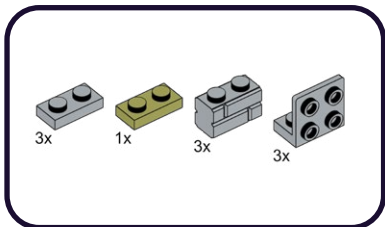



14

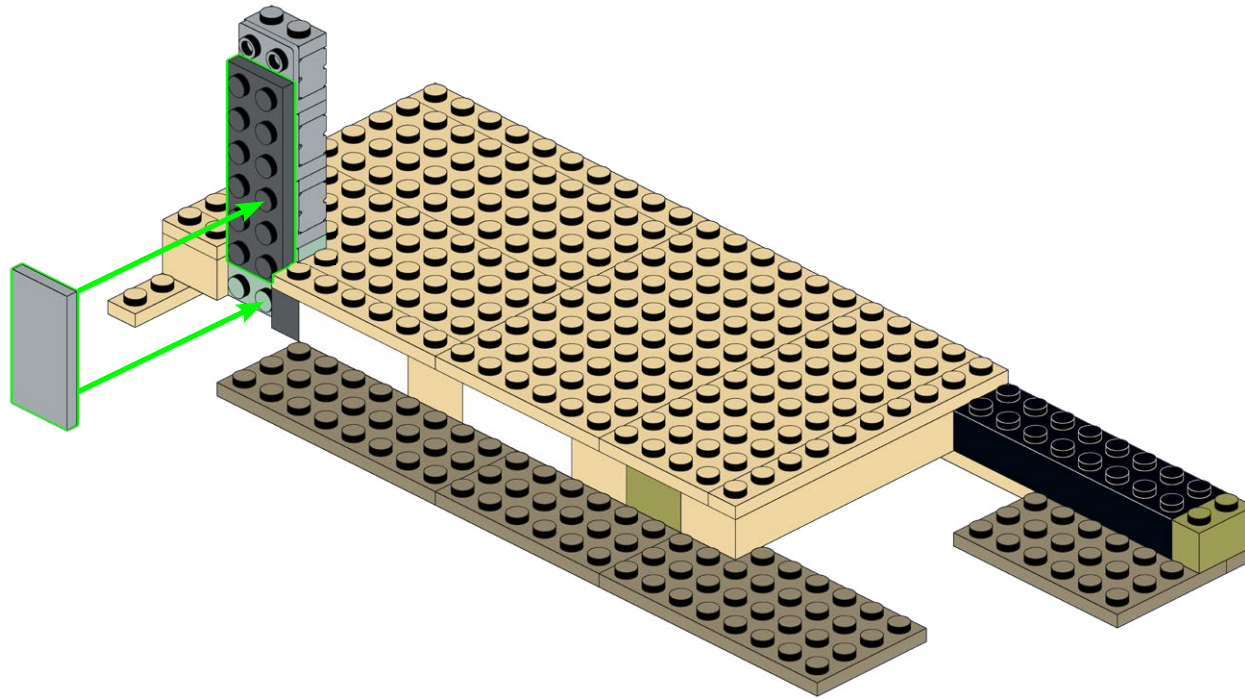
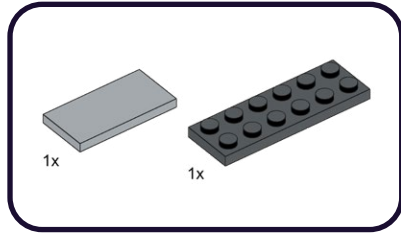

15

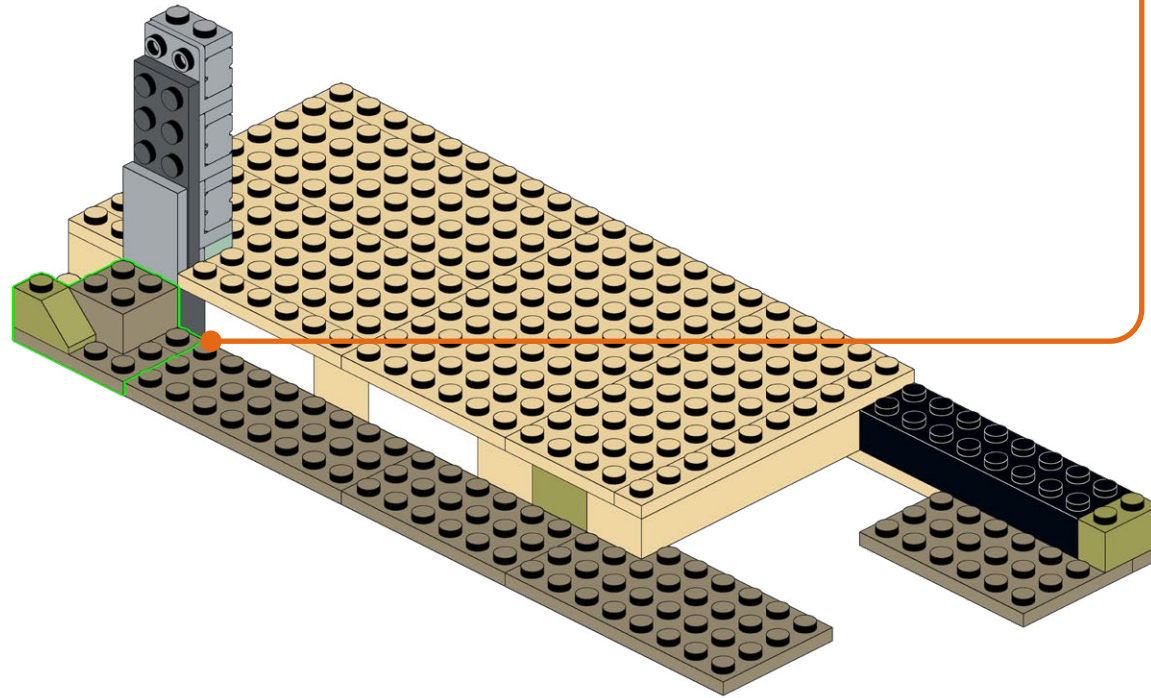
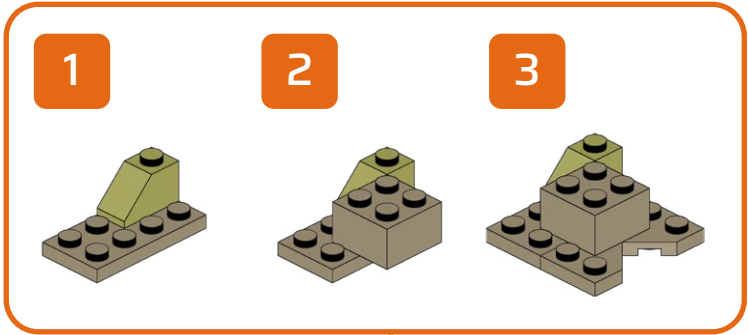
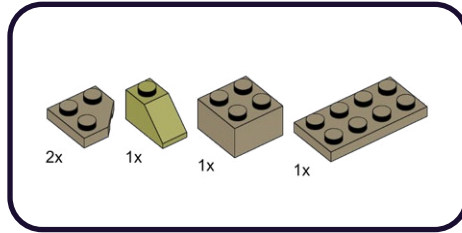

16

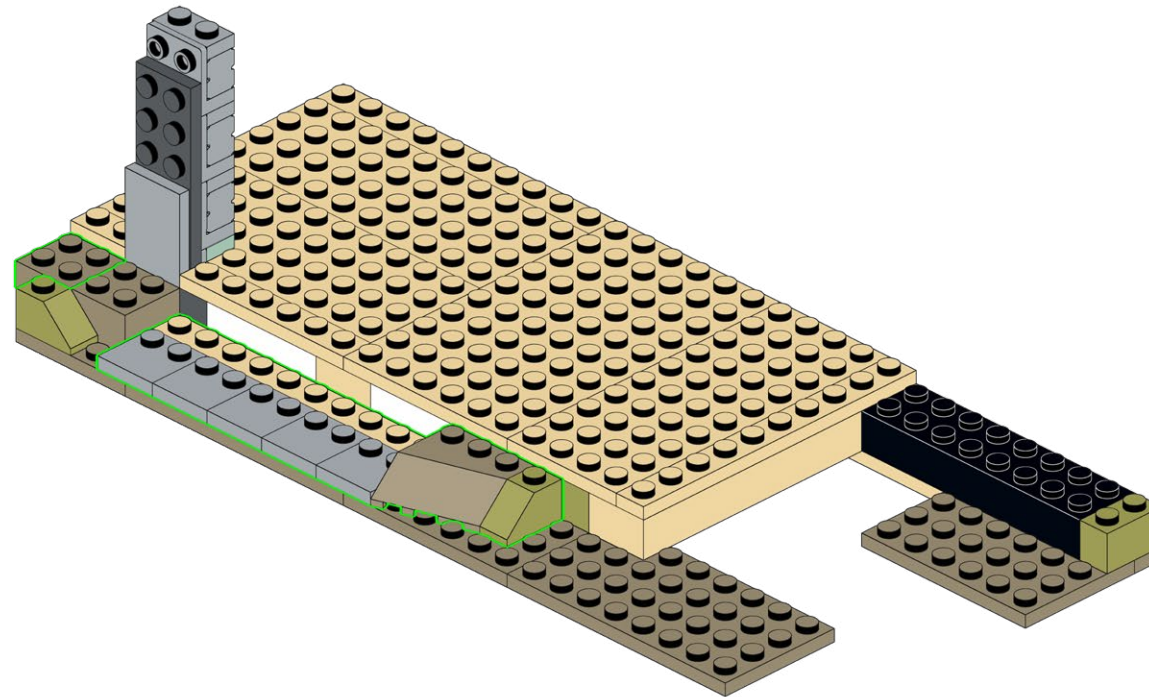
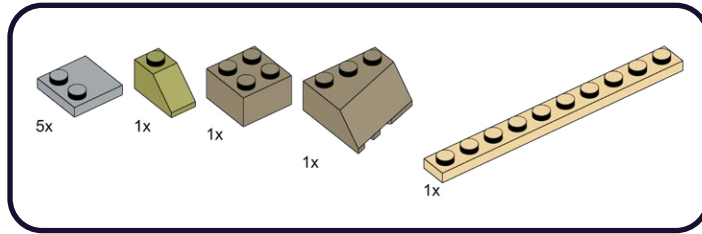

17

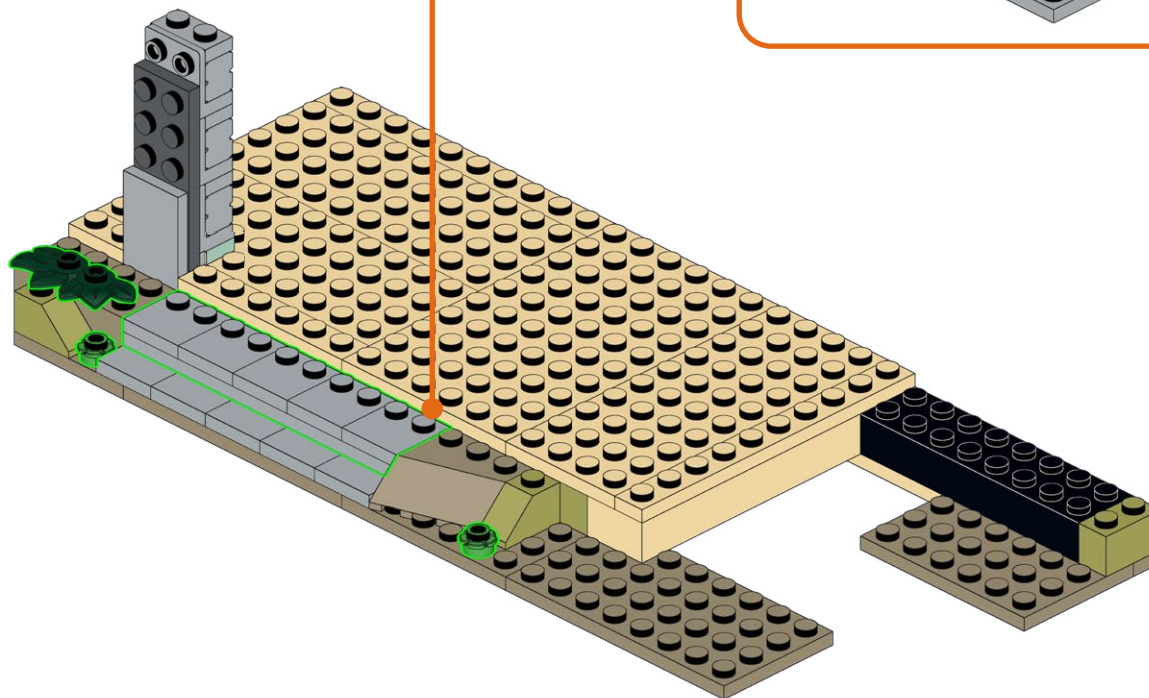
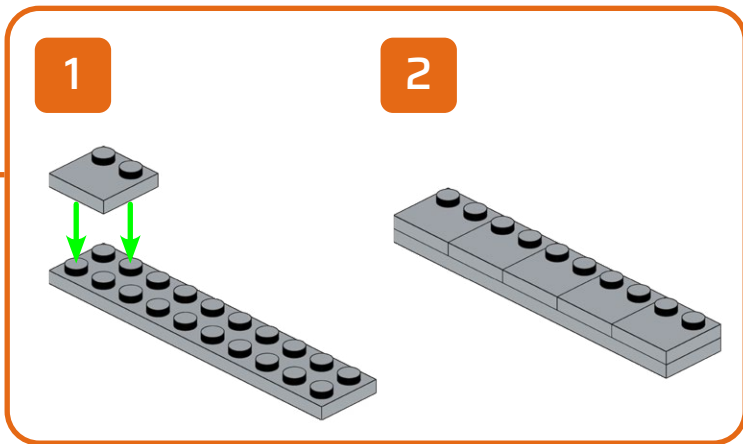
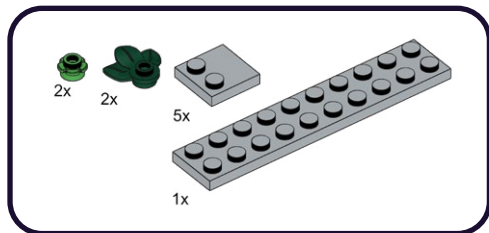

18

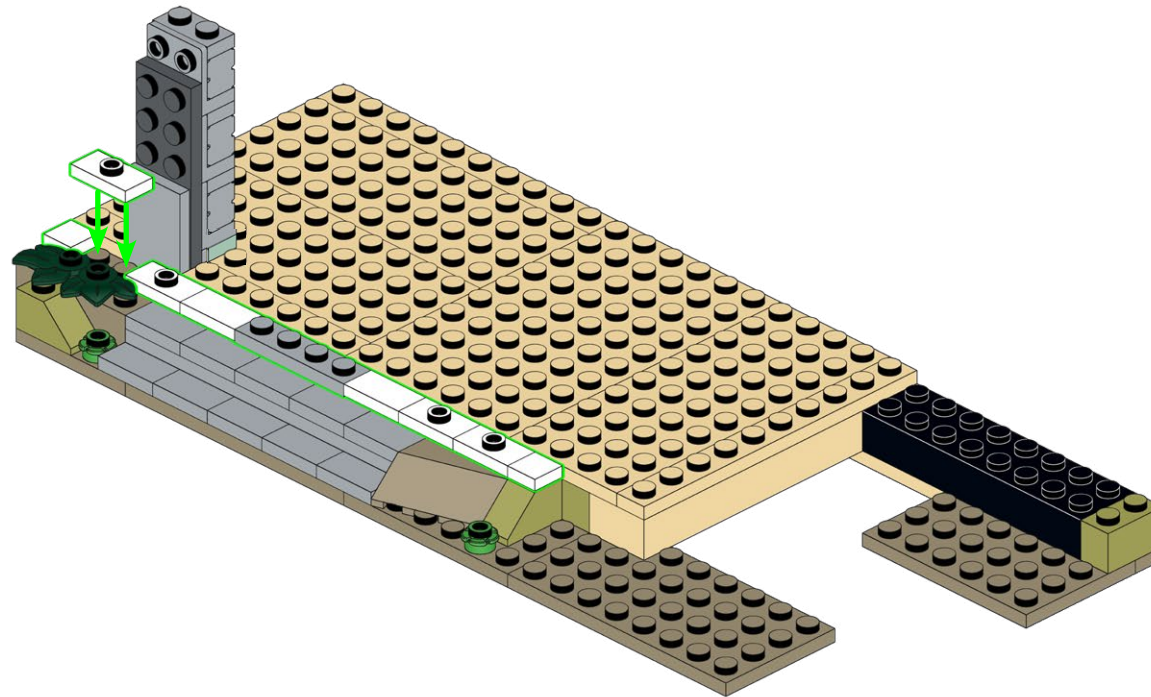
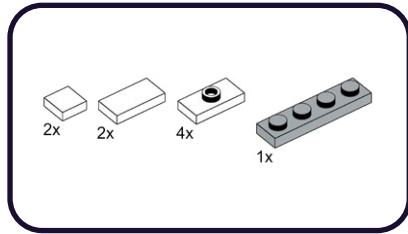

19

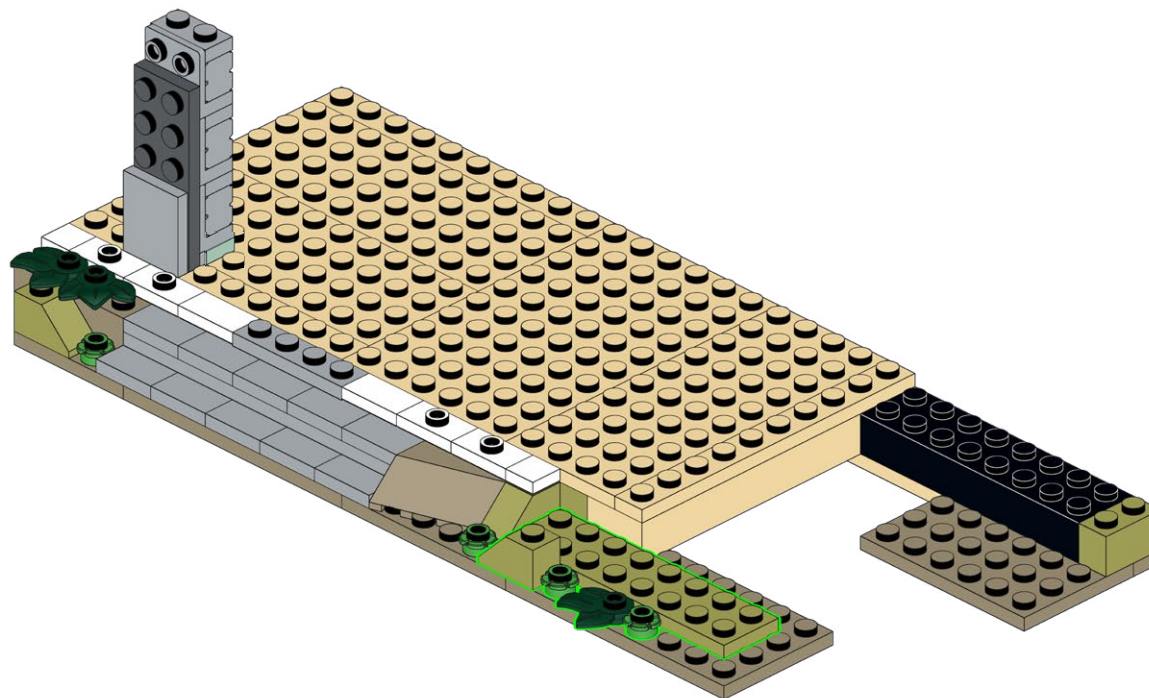
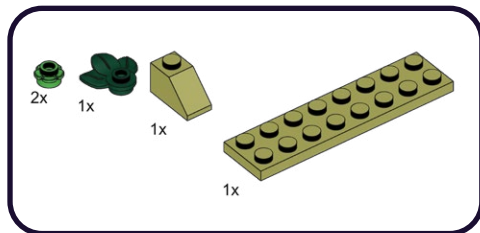



21

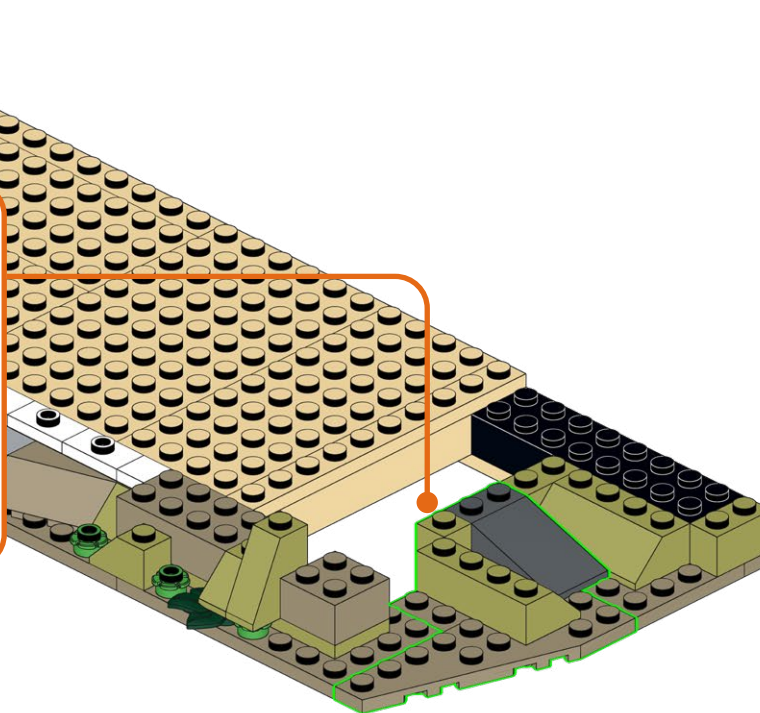
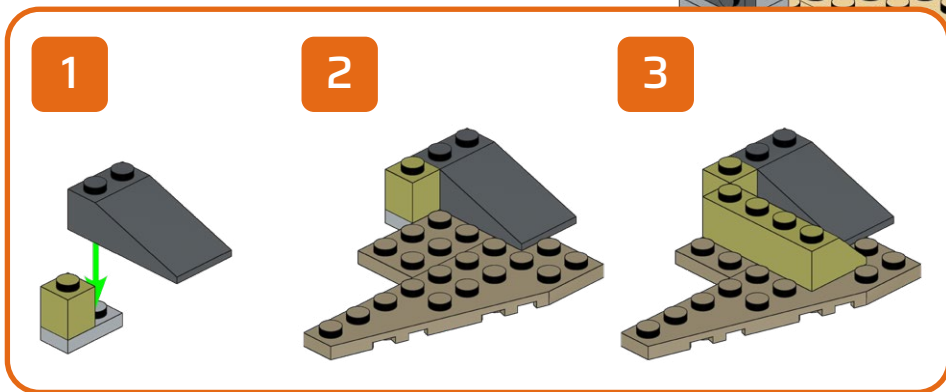
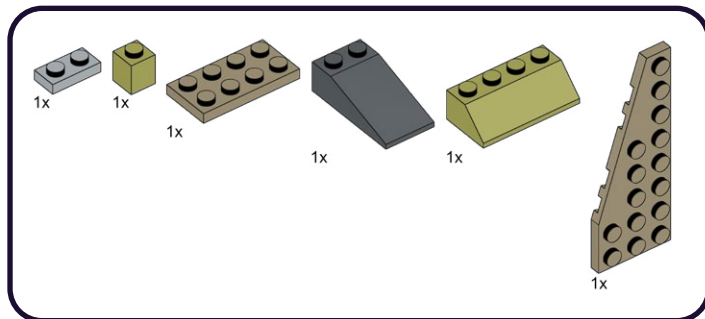



22

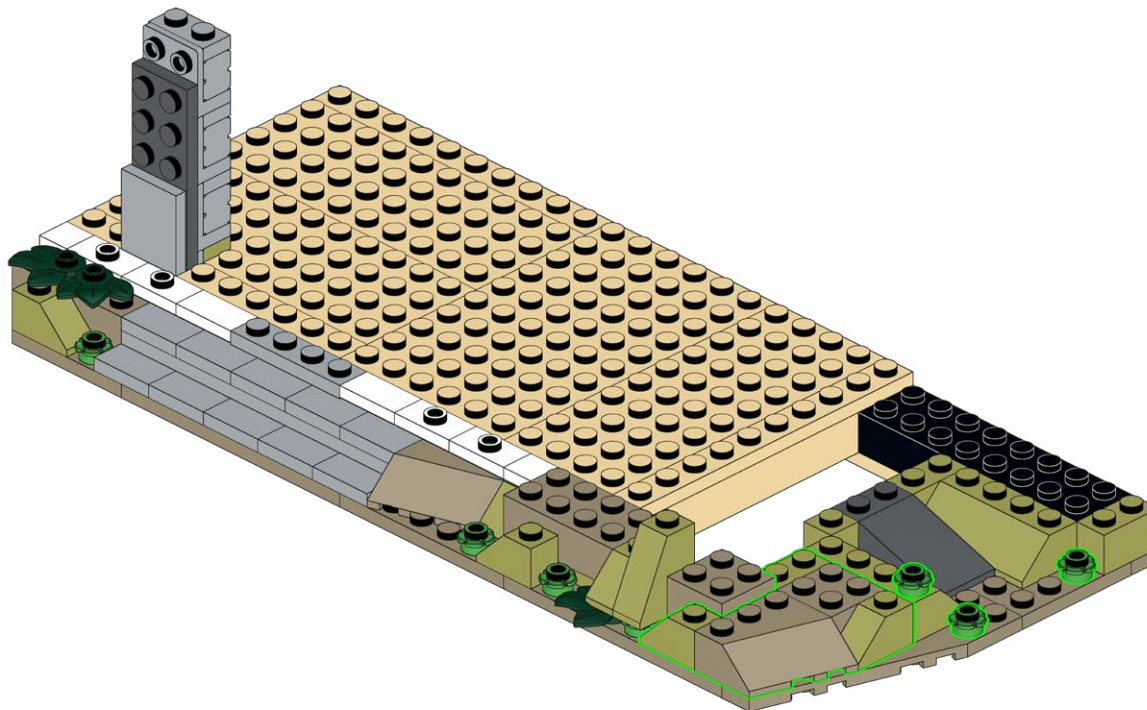
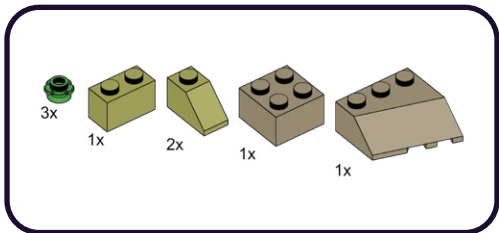

23

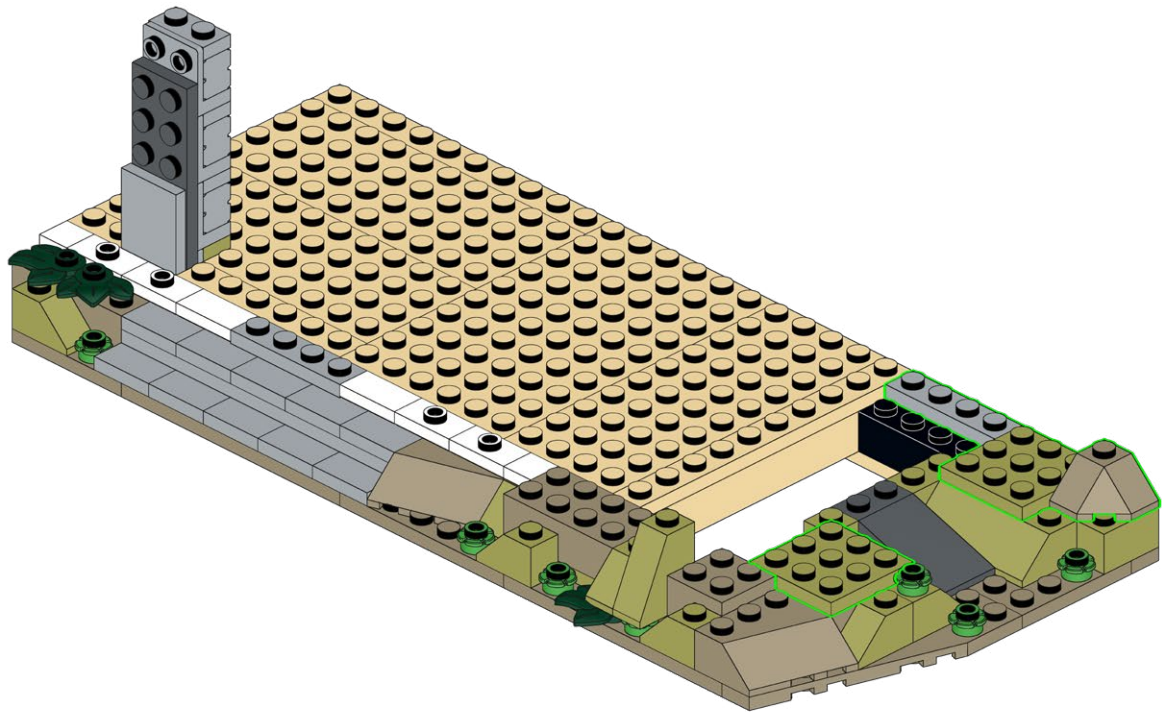
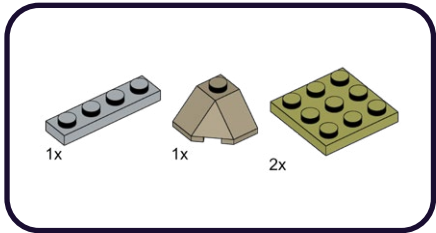

24

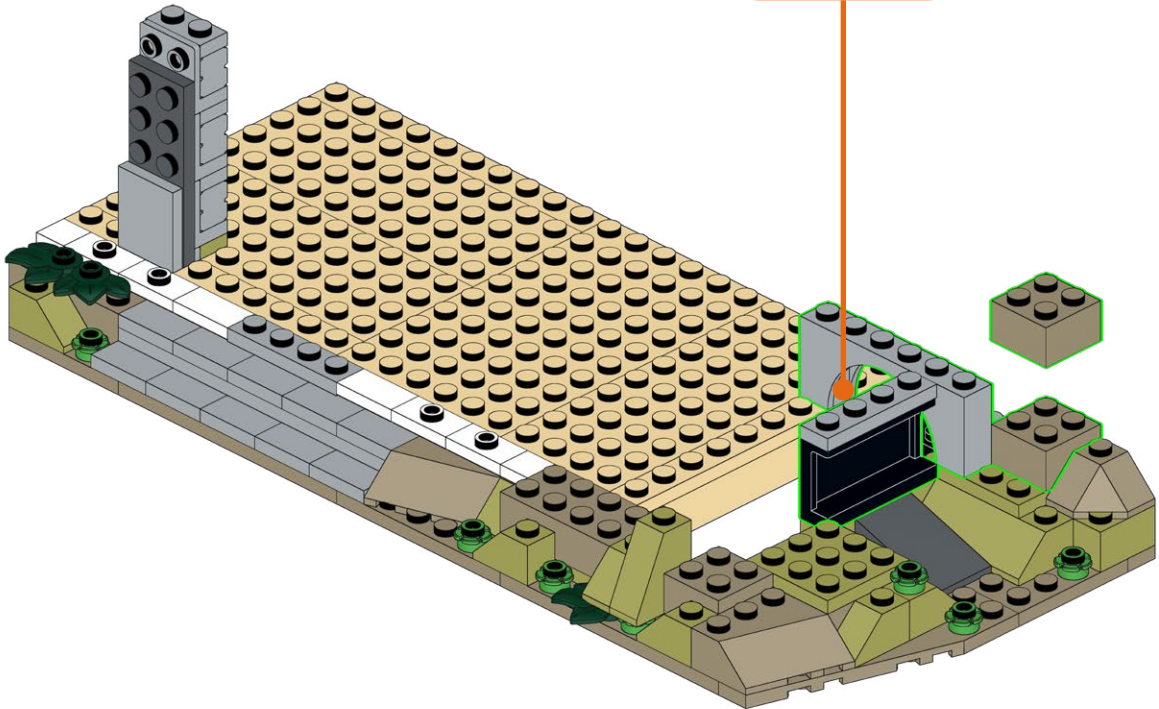
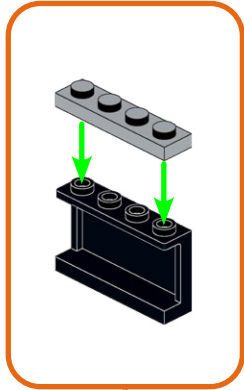
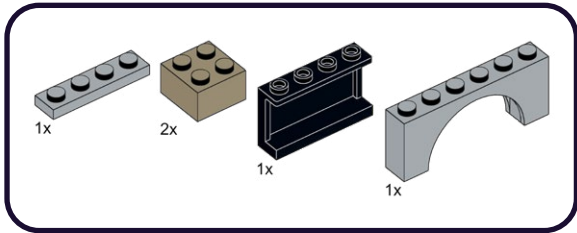

25

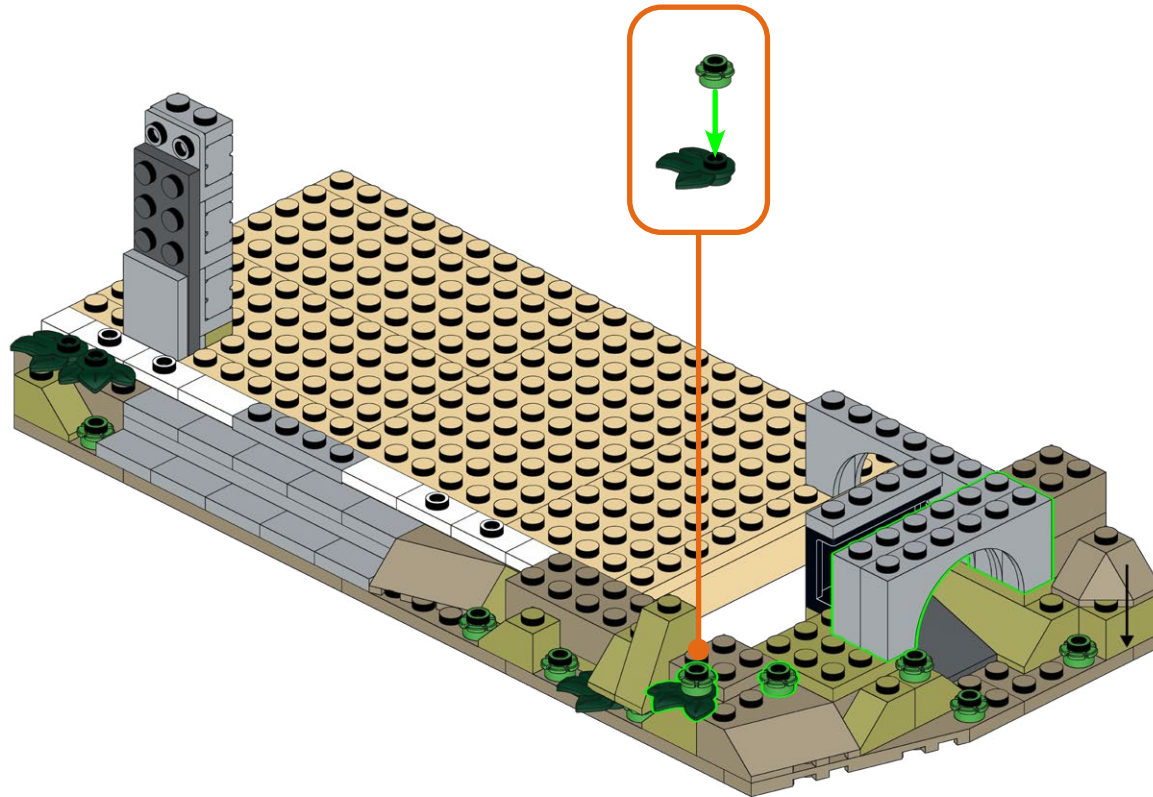
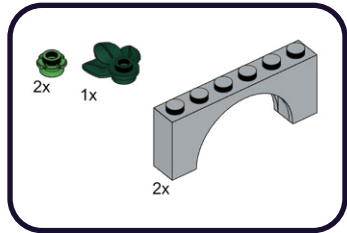

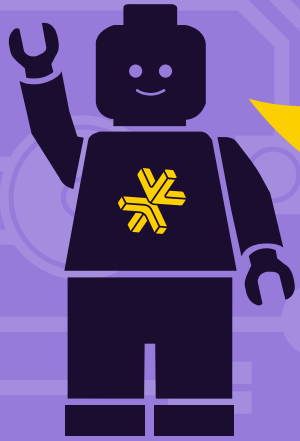

### **HOLD UP!**

You might notice some bags aren't in order, as well as left over pieces, but that's ok! We're changing the way you build LEGO!

### **ATTENDEZ!**

Vous remarquerez peut-être que certains sacs, ainsi que certaines pièces, ne sont pas dans le bon ordre. Mais pas de panique! Nous changeons simplement la façon avec laquelle vous construisez vos LEGO!

### **ASPETTA!**

Potresti notare che alcuni sacchetti non sono in ordine, così come i pezzi avanzati, ma va bene così! Stiamo cambiando il modo in cui costruisci i LEGO!

### **HALT!**

Sie werden möglicherweise bemerken, dass einige tüten durcheinander sind und teile übrig bleiben, aber das ist in Ordnung! Wir ändern die art und weise, wie Sie LEGO bauen!

### **¡ESPERA!**

Es posible que notes que algunas bolsas están fuera de servicio, así como piezas sobrantes, ¡pero está bien! ¡Estamos cambiando la forma en que construyes LEGO!

### **暫停!**

你可能会注意到一些袋子顺序错乱, 以及一些剩余的部件, 但没关系! 我们正在改变你搭建乐高的方式!

### Open LEGO® Bag 3 & 4

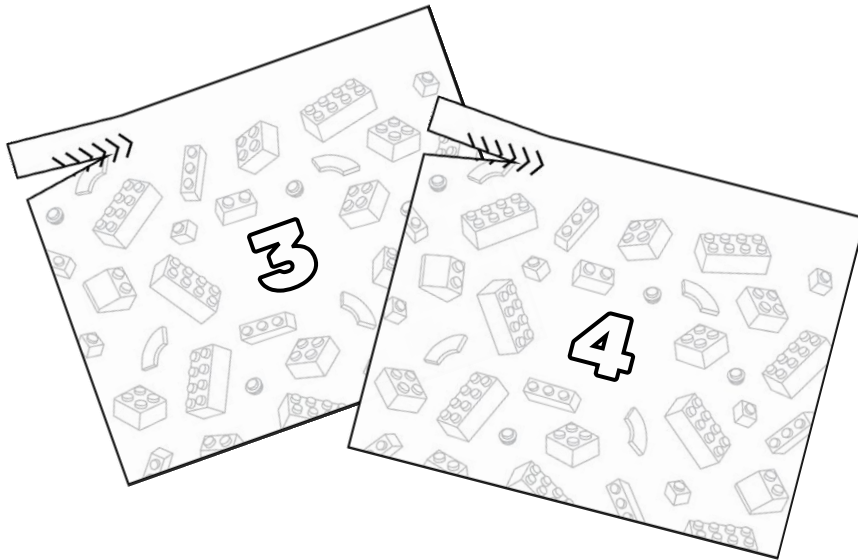

### Open LMB Bag 02

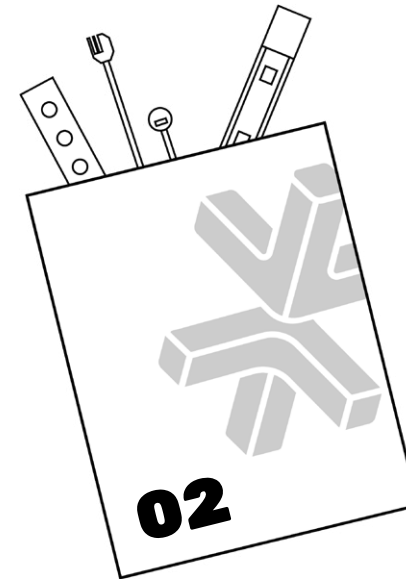

26

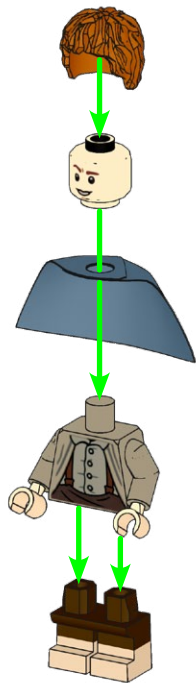
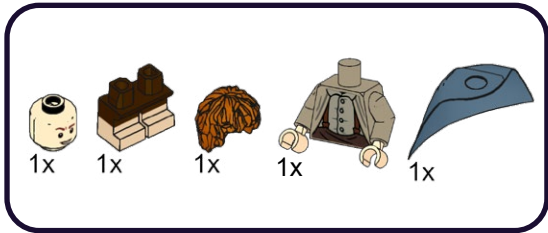

27



28

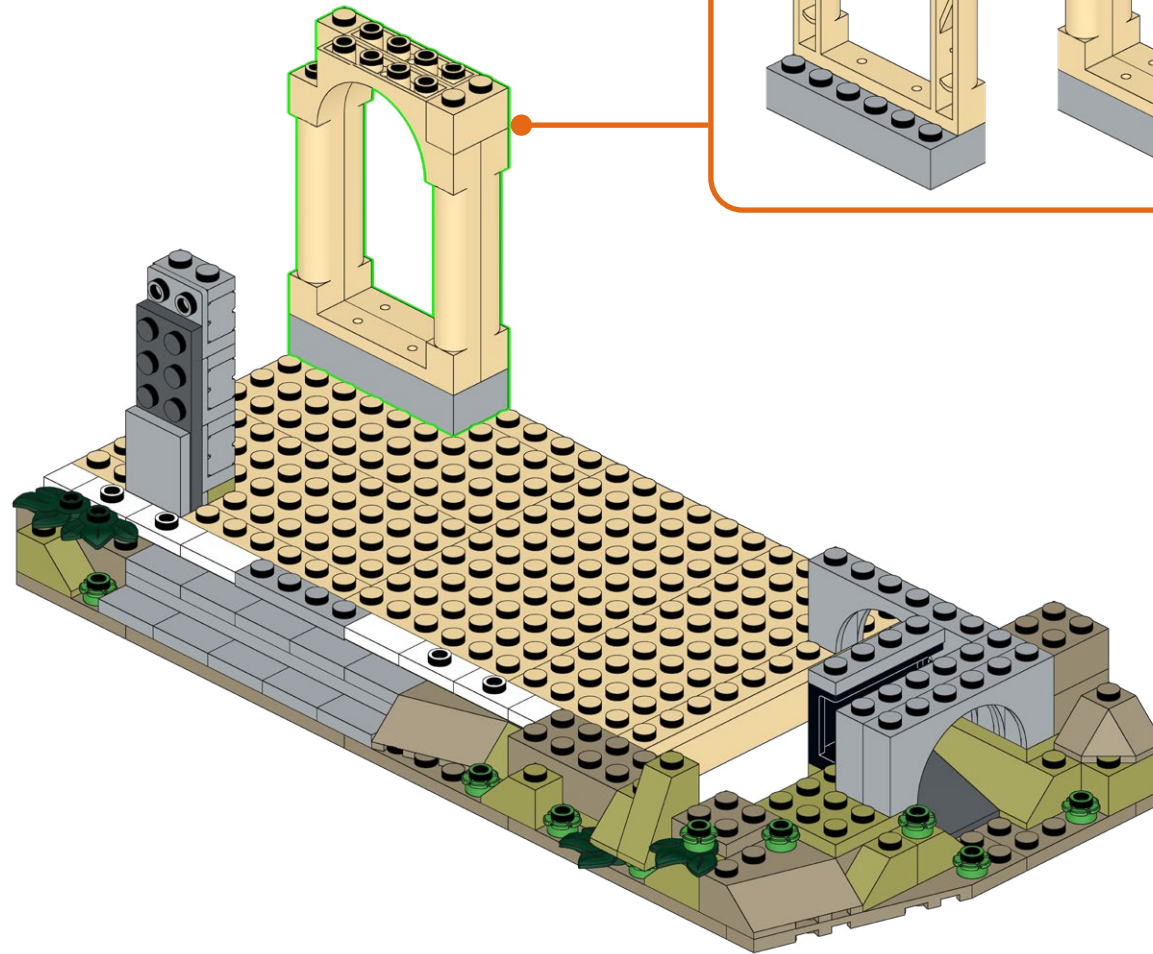
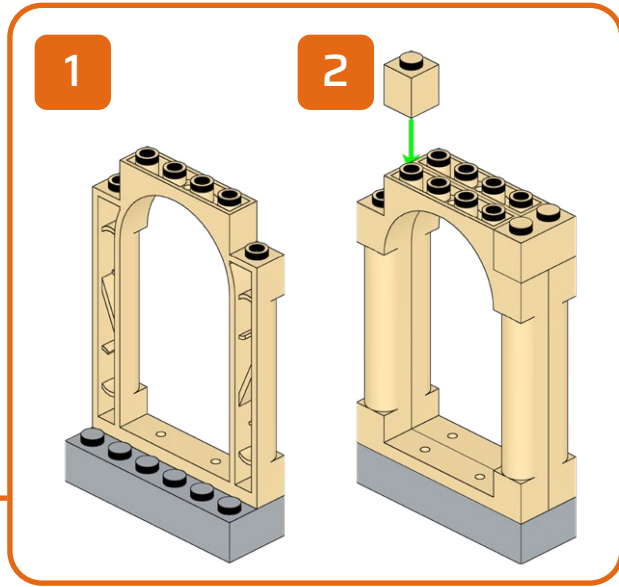
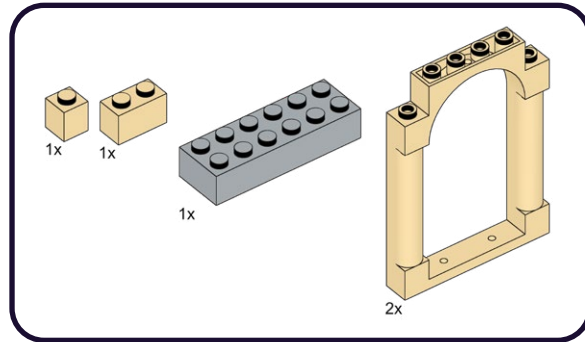

29

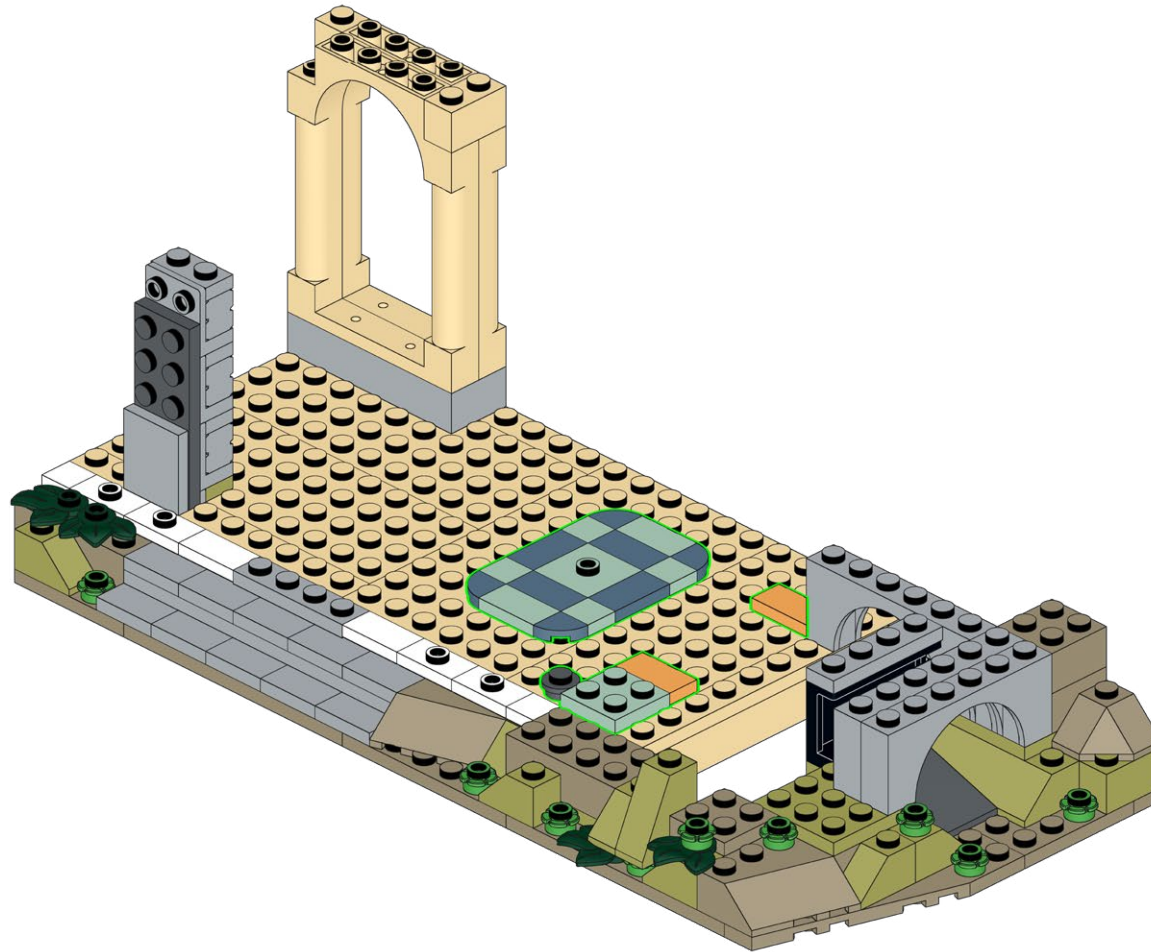
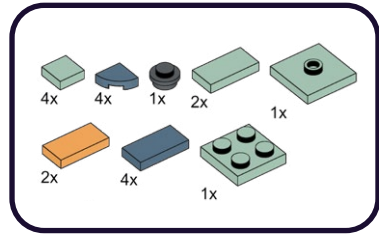



30

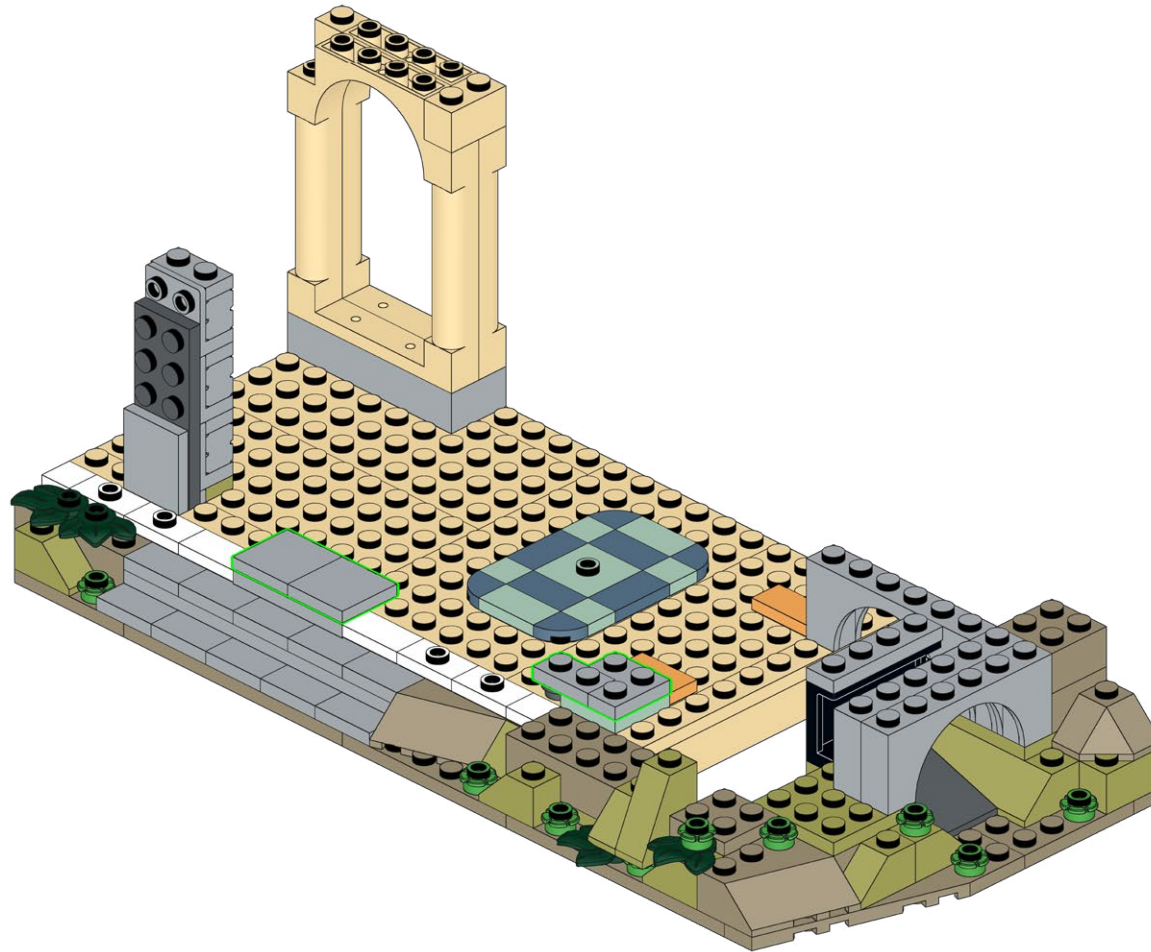
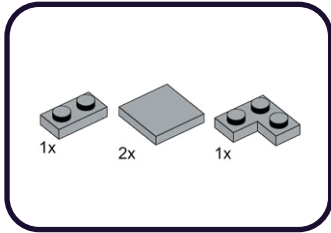

31

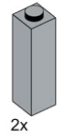

2x

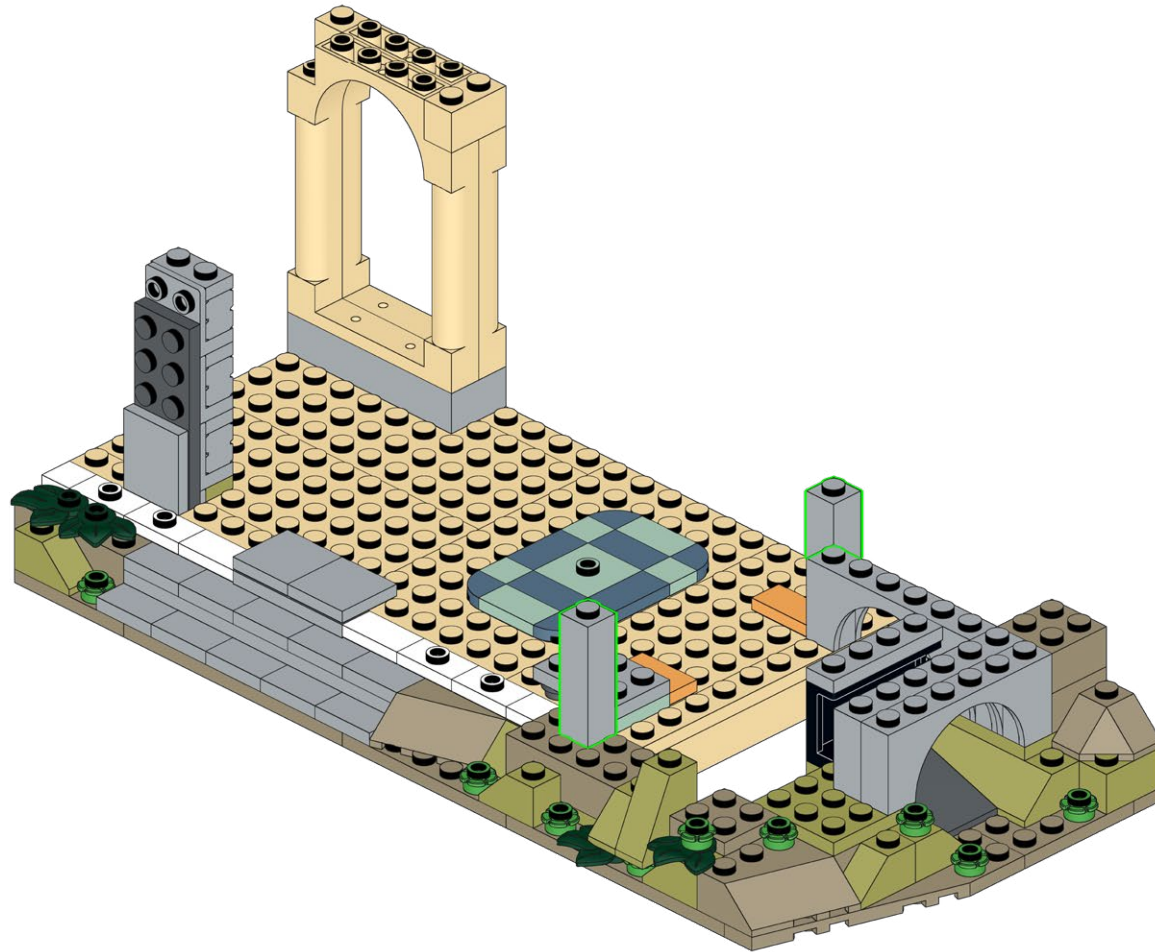

# 32

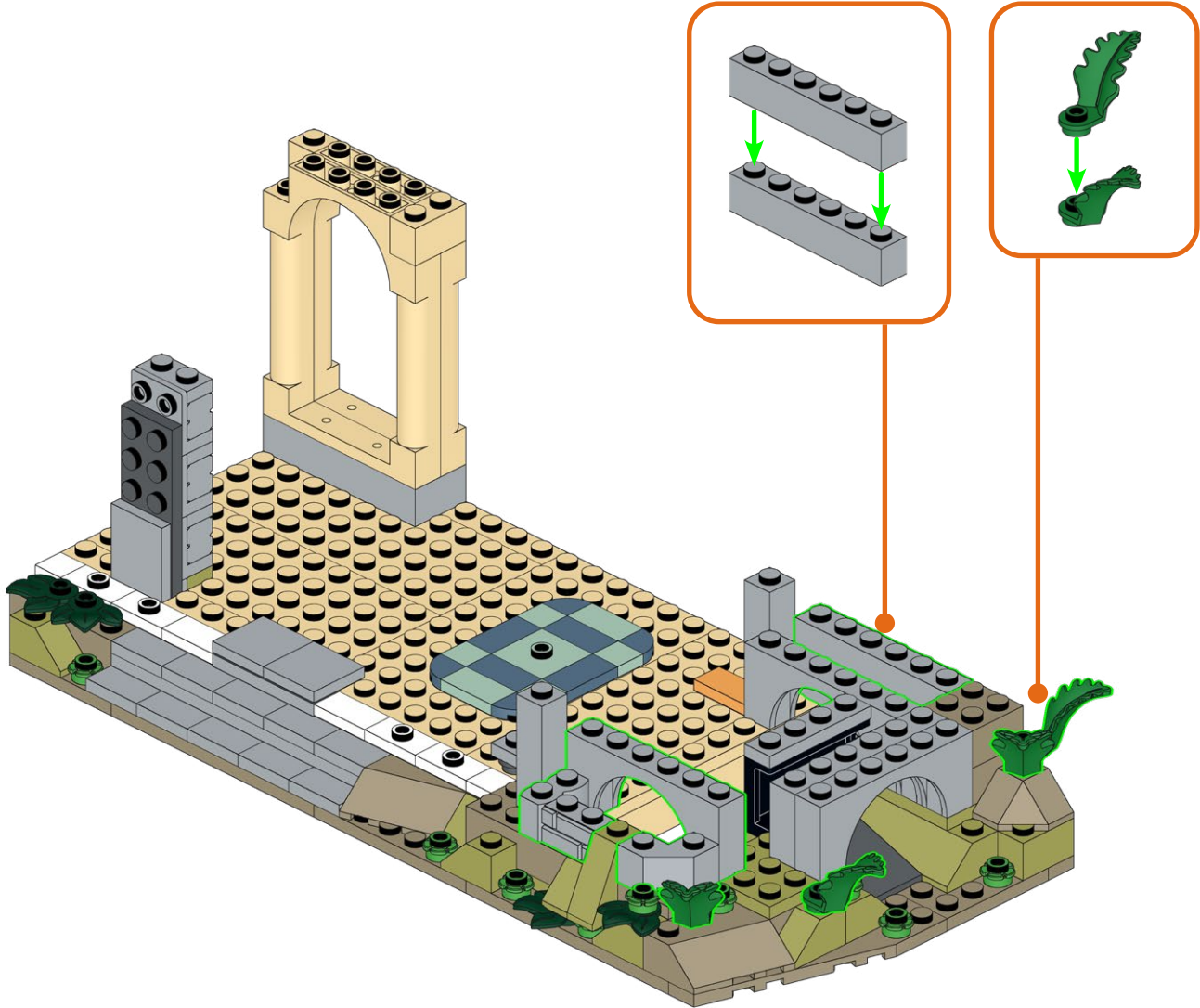
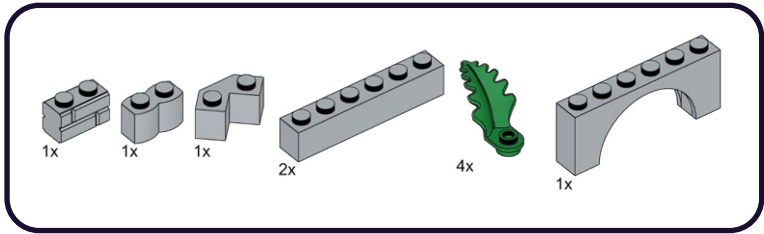

33

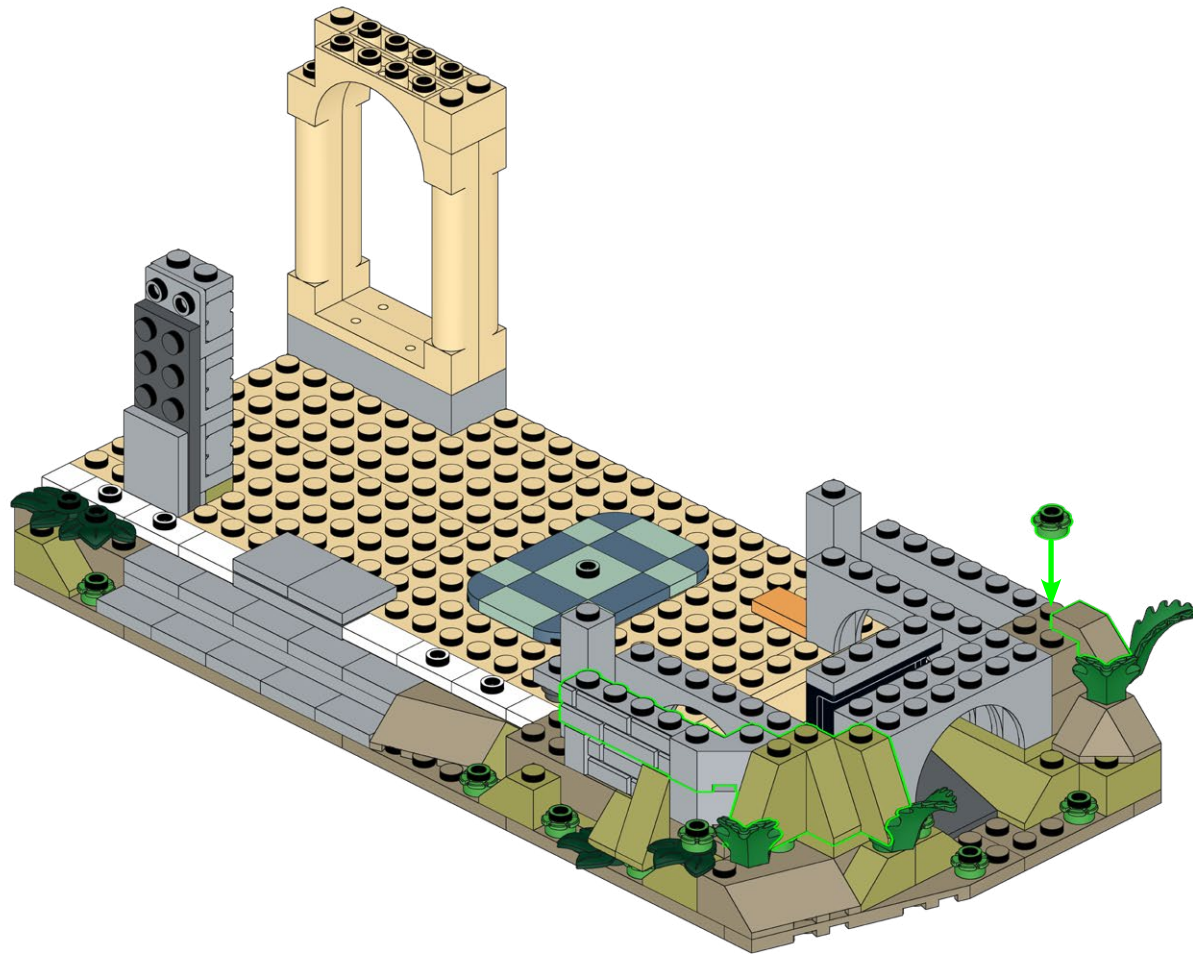
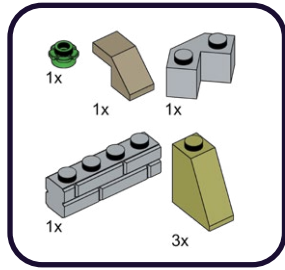

34

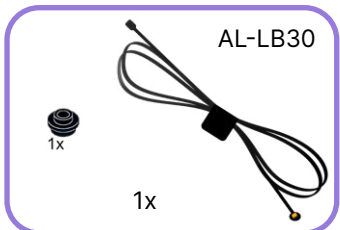

1



2



35

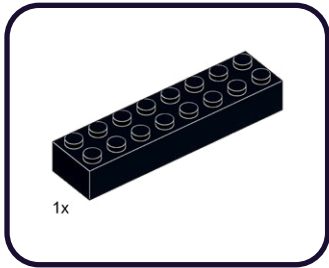

1

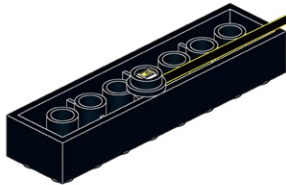

2

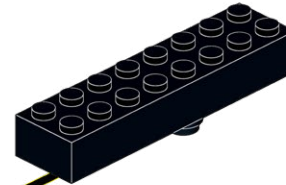
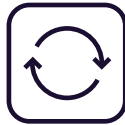

36

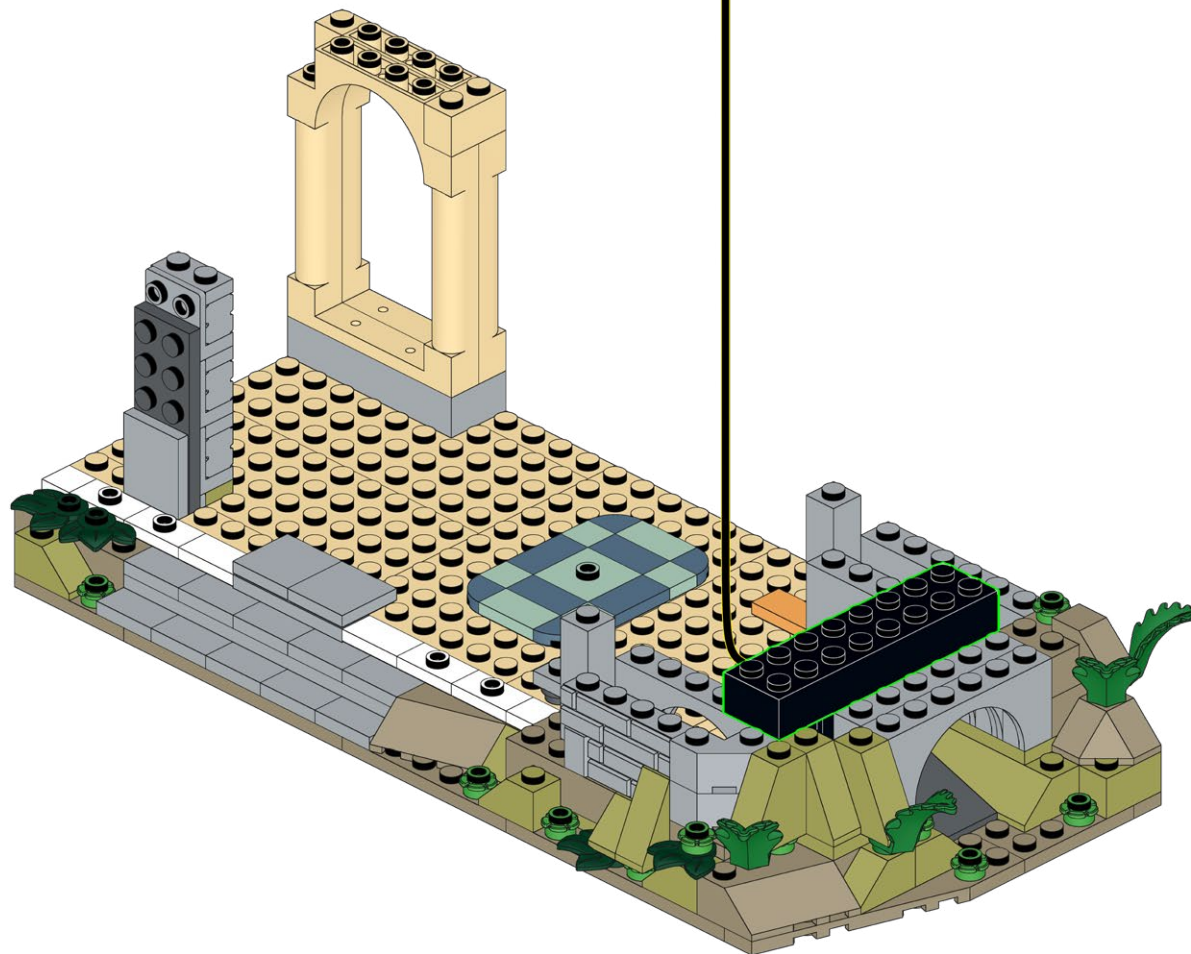

37

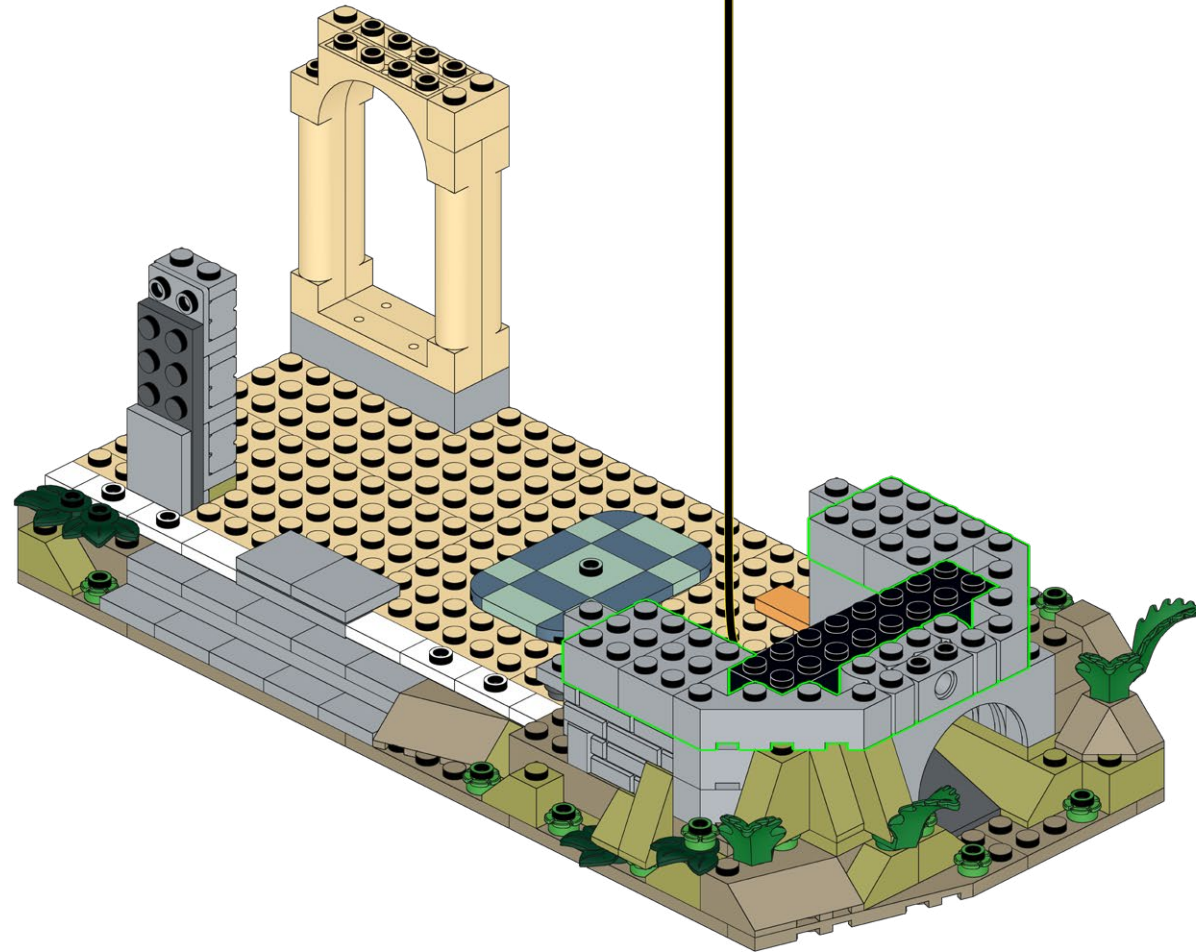
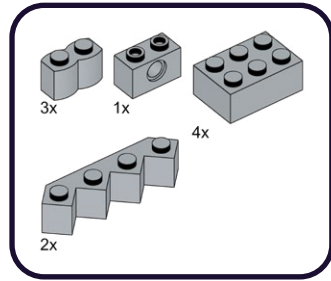



38

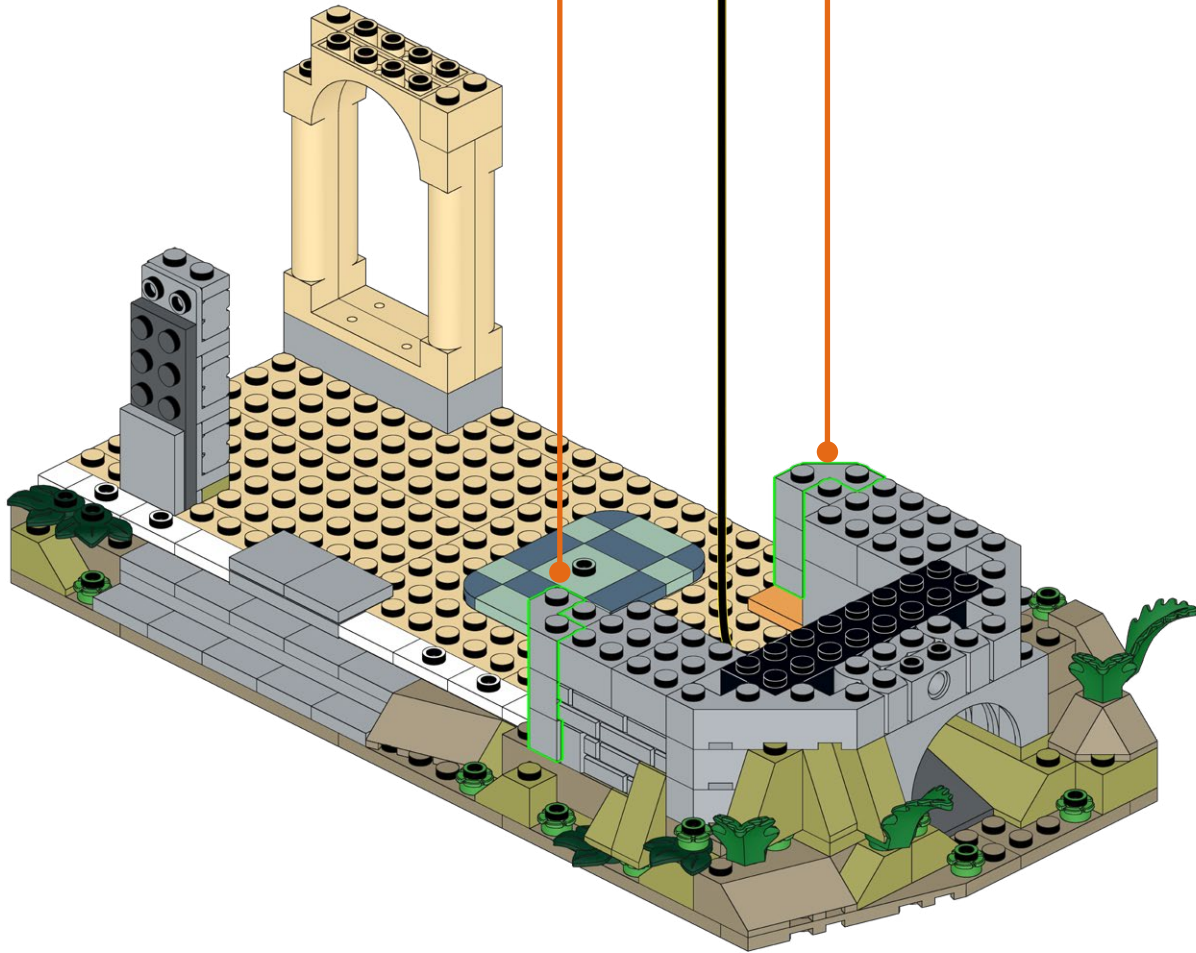
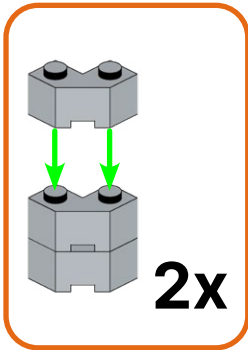
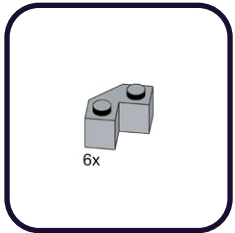

39

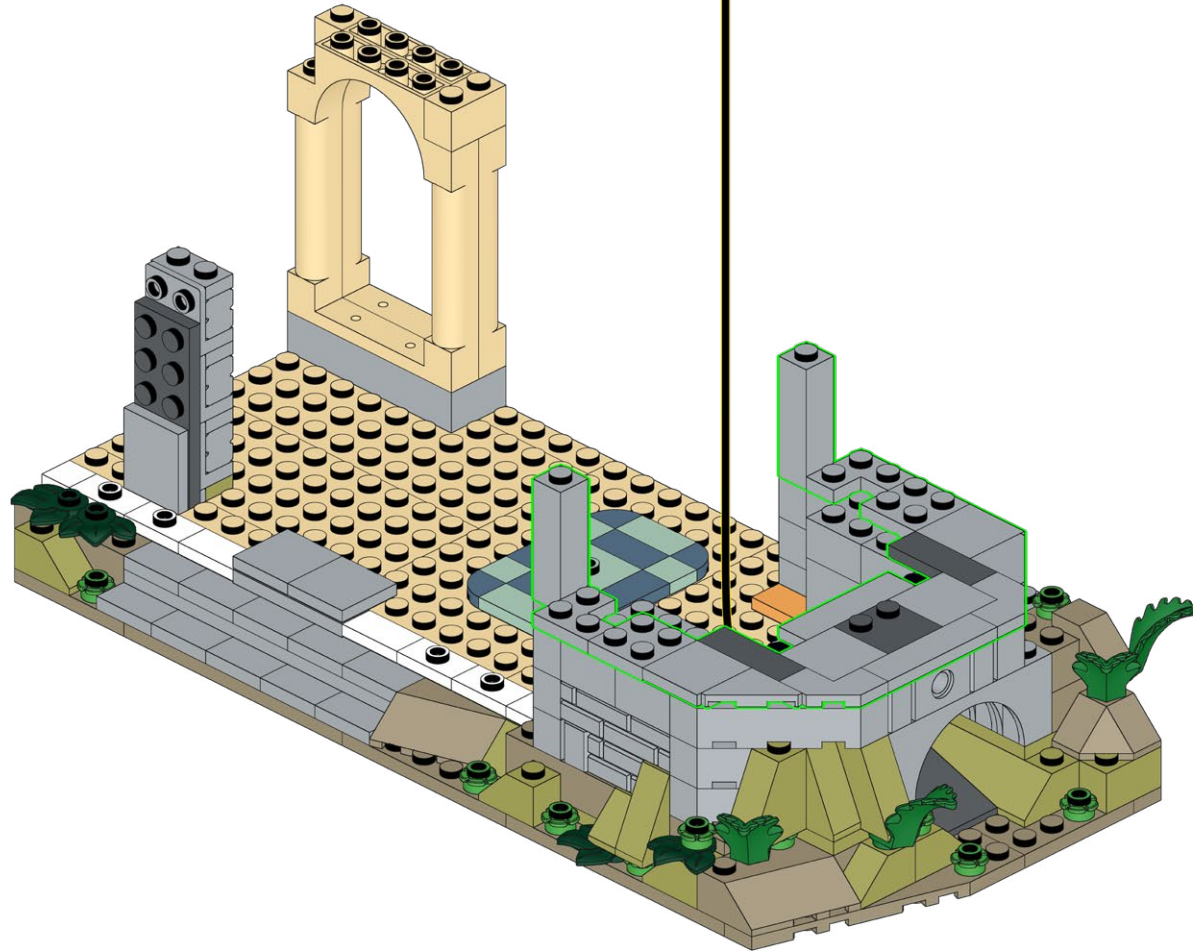
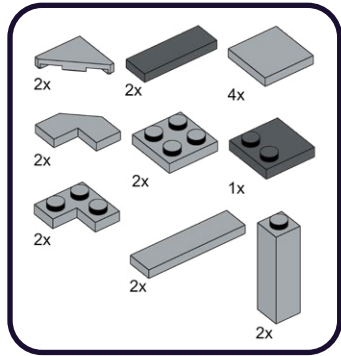

40

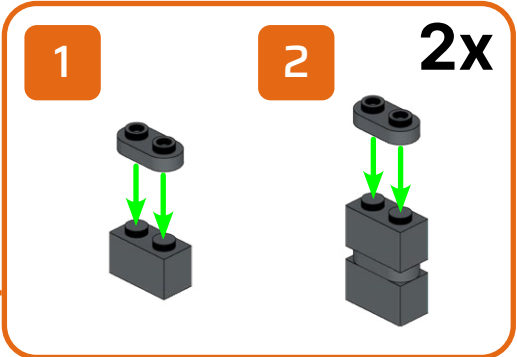
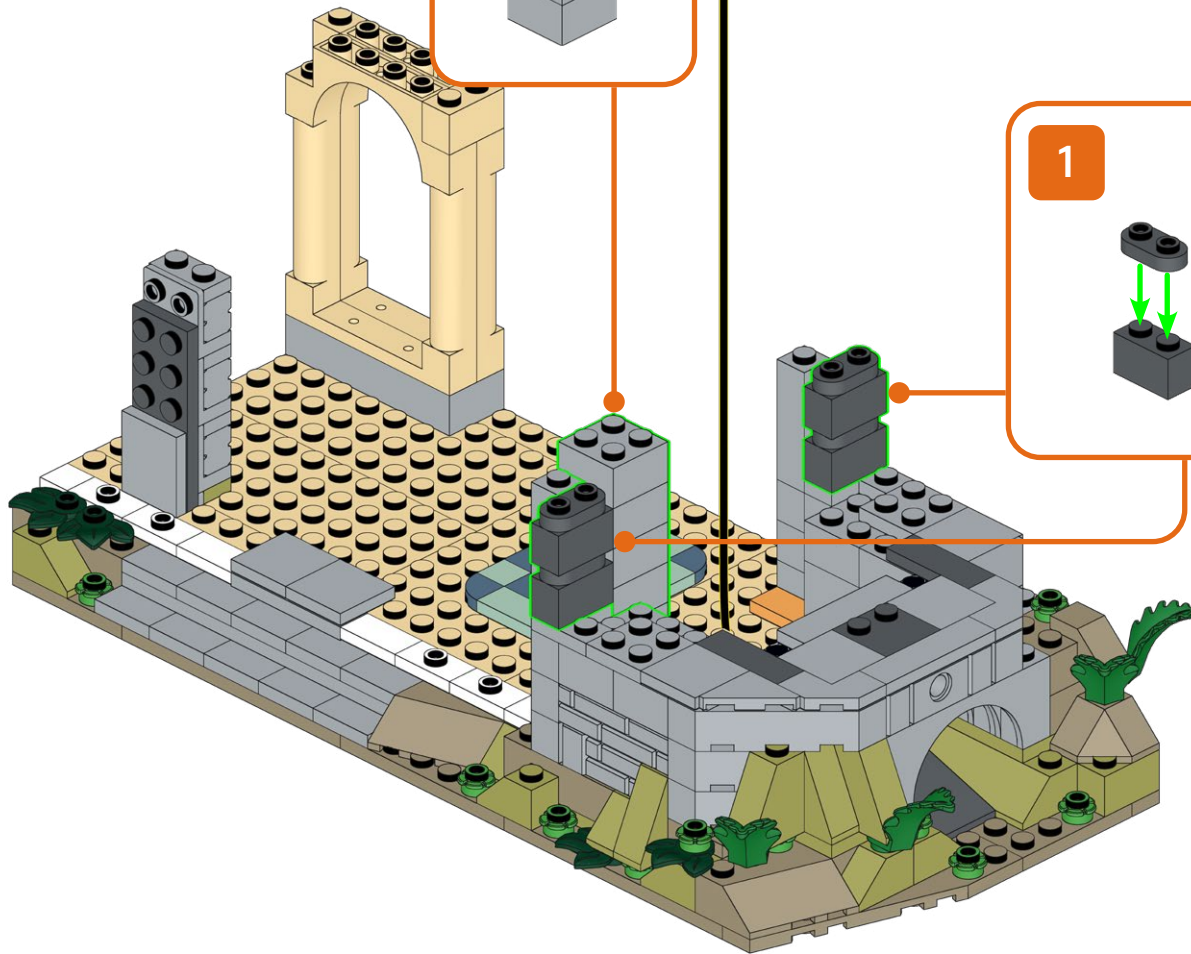
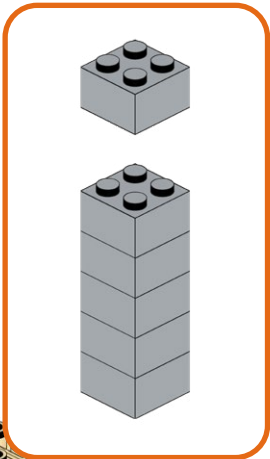
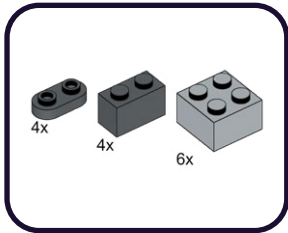

41

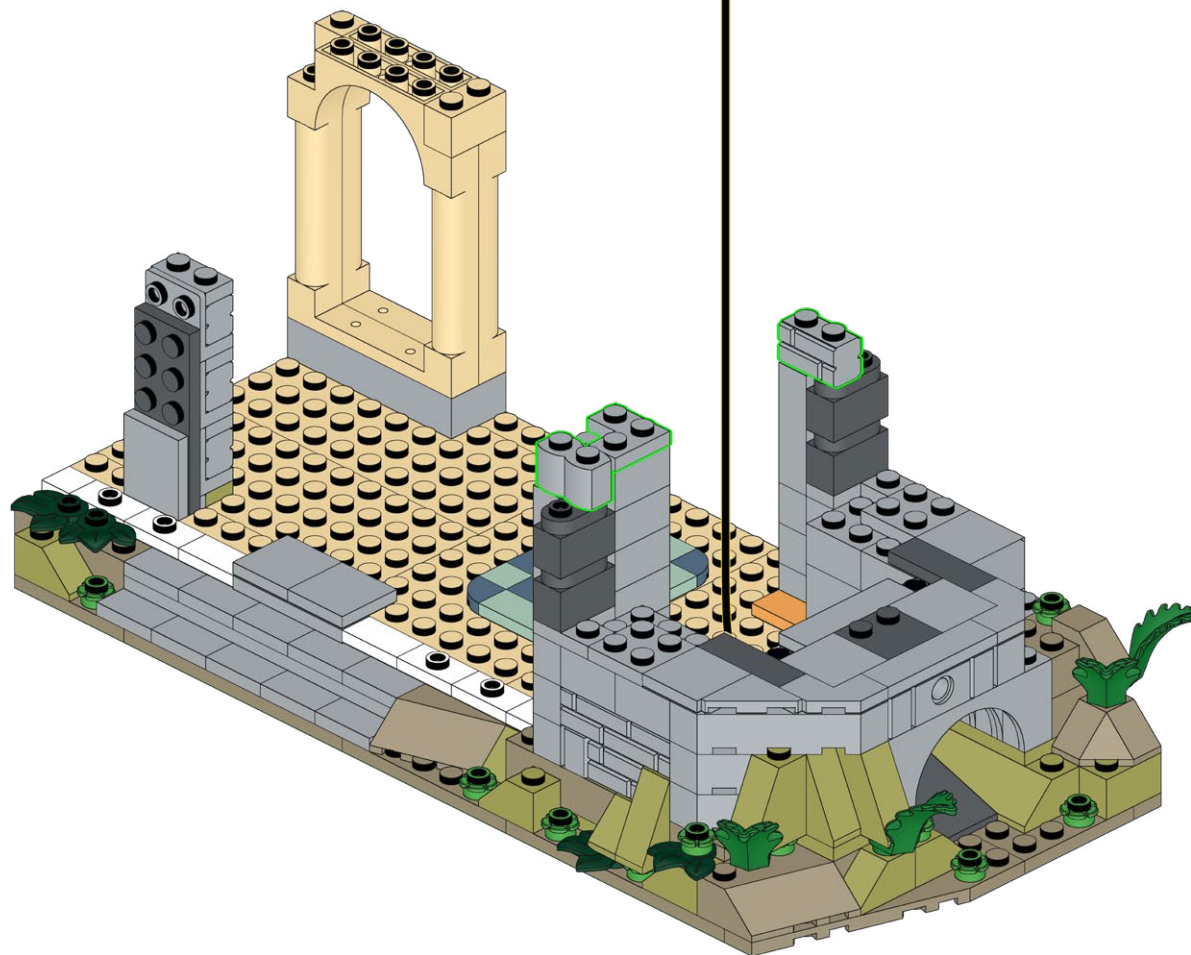
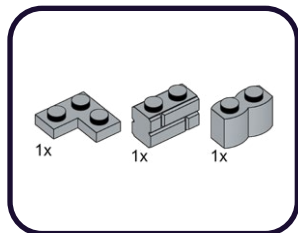

# 42

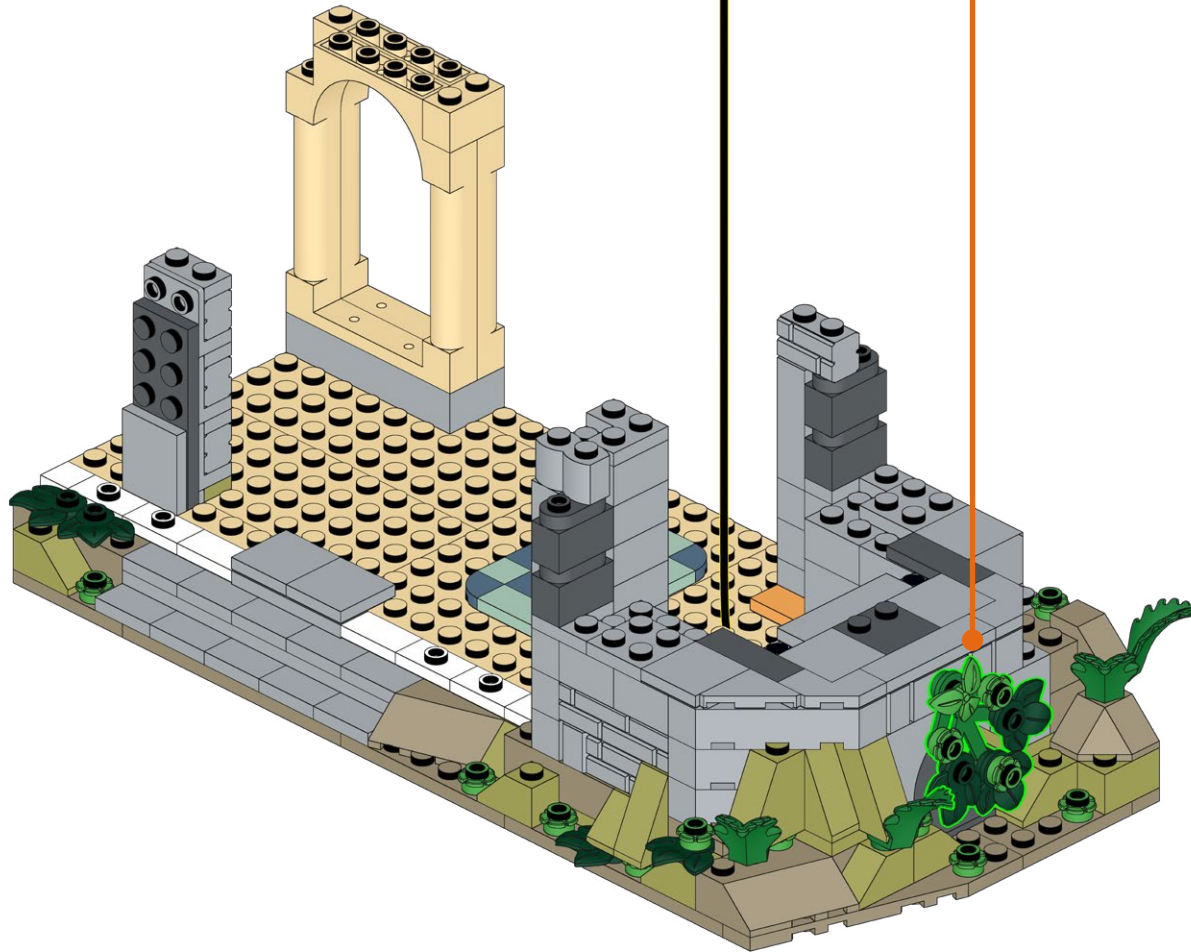
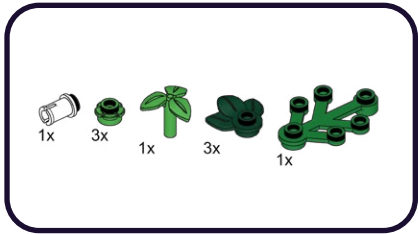

- 1
- 2
- 3
- 4
- 5

# 43

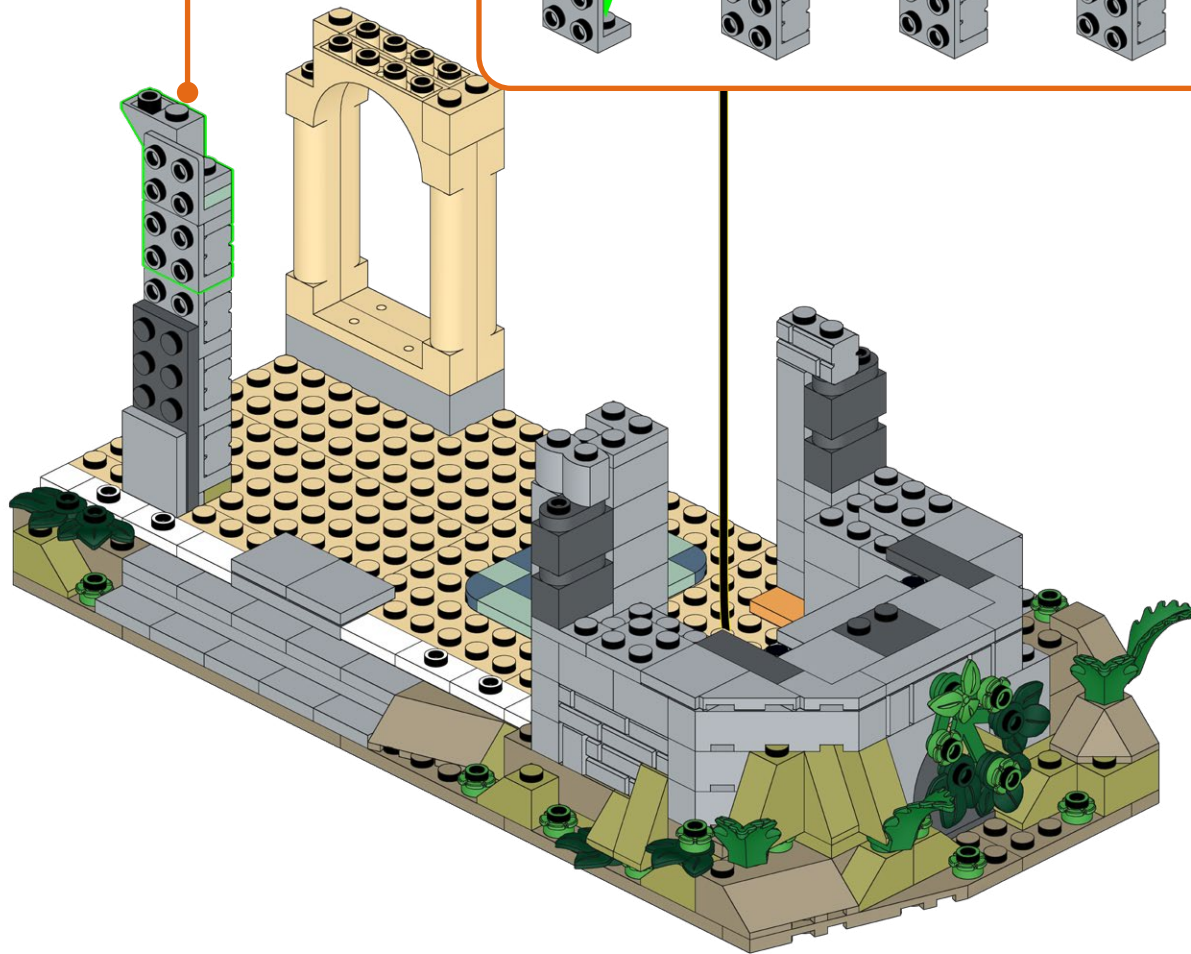
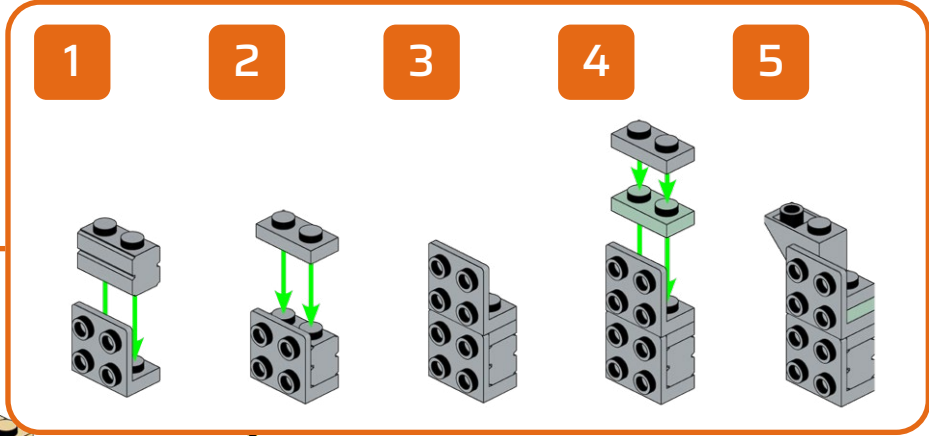
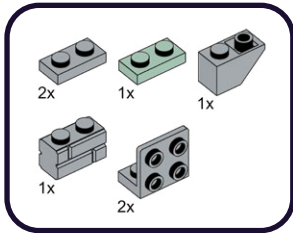

44

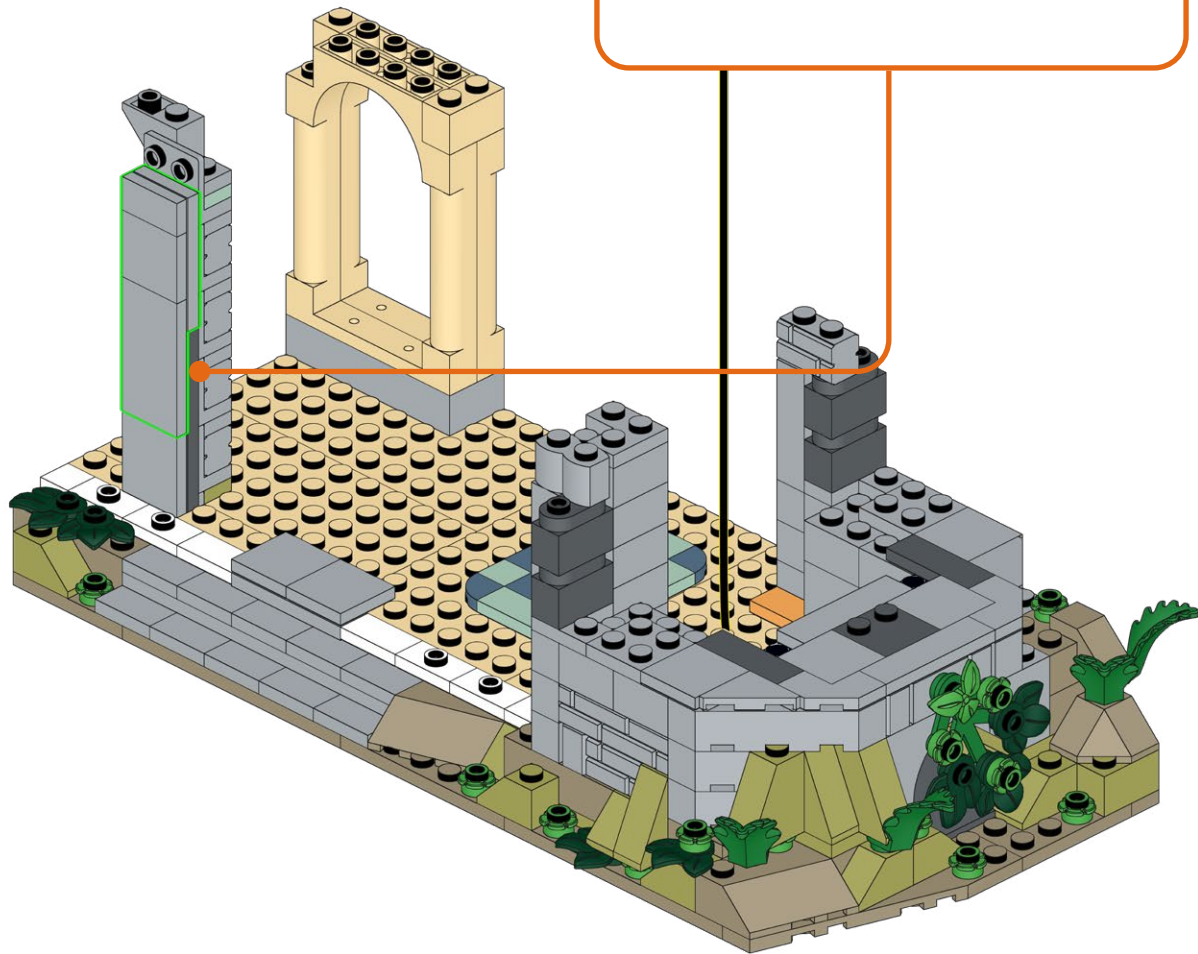
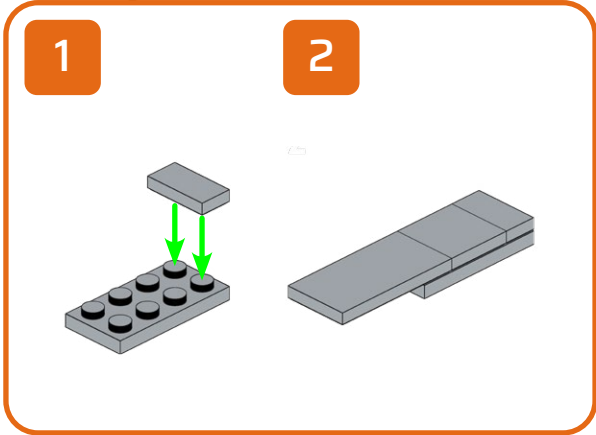
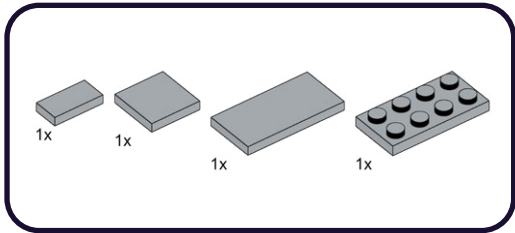





46

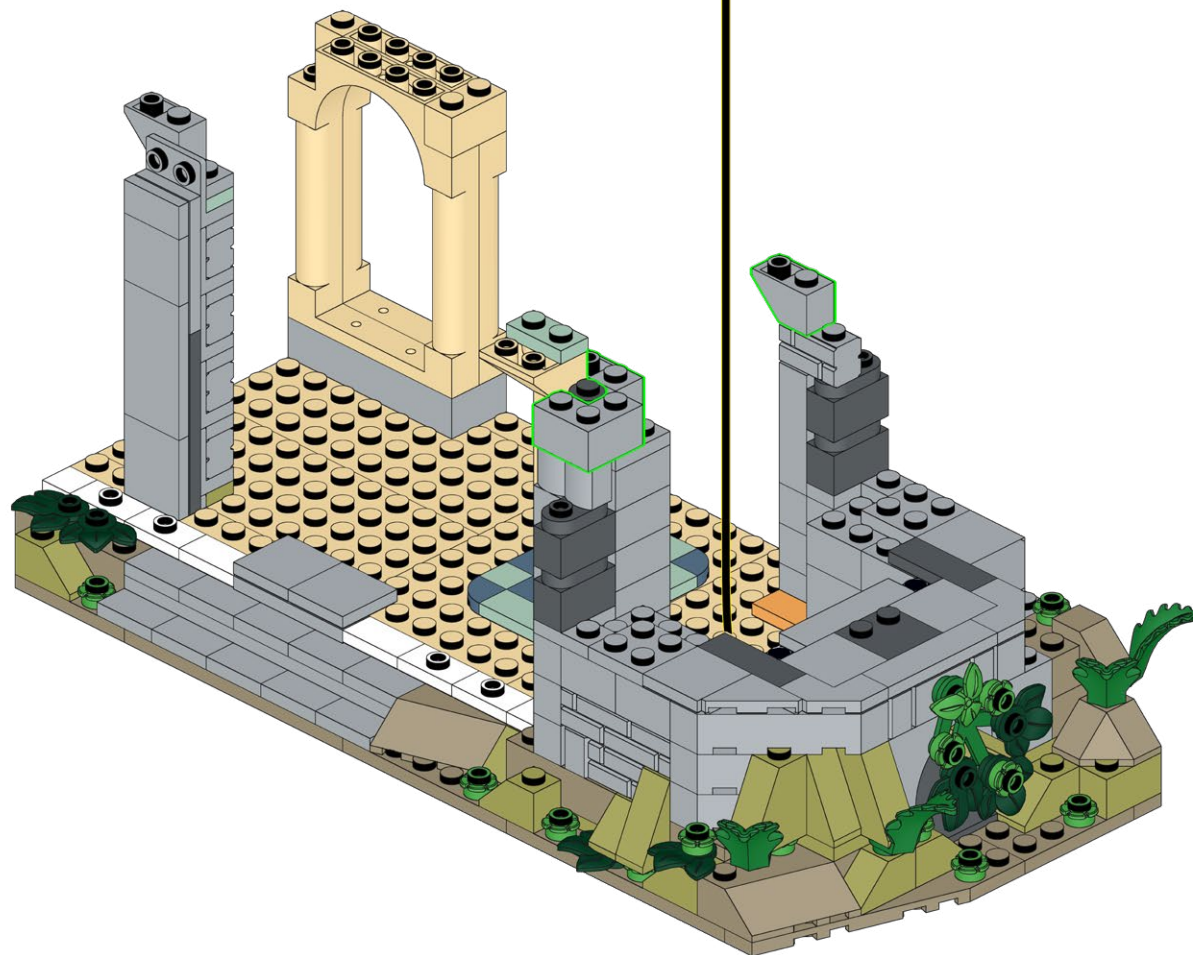
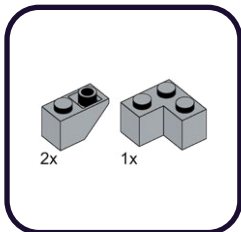

47

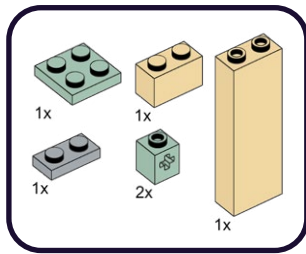
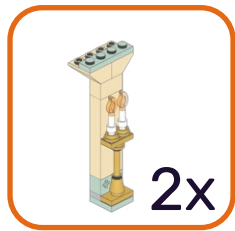

1

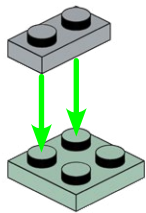

2

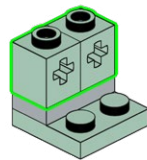

3

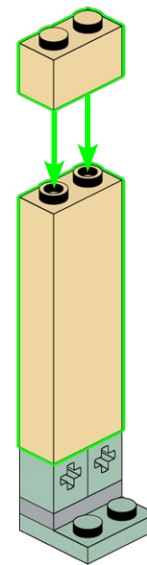

48

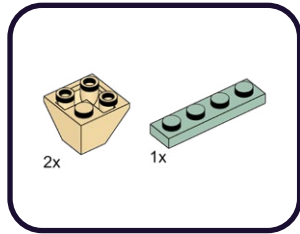

1

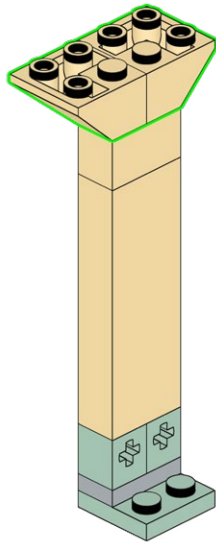

2

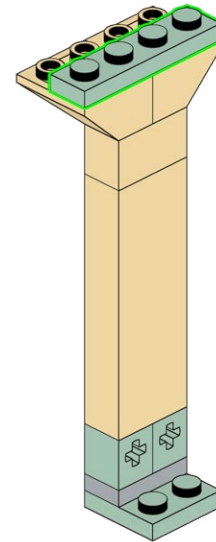

49

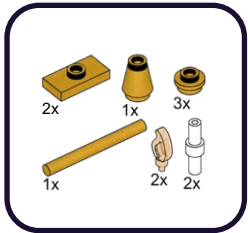

1

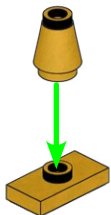

2

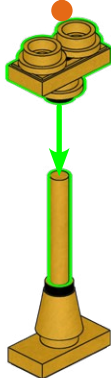

3

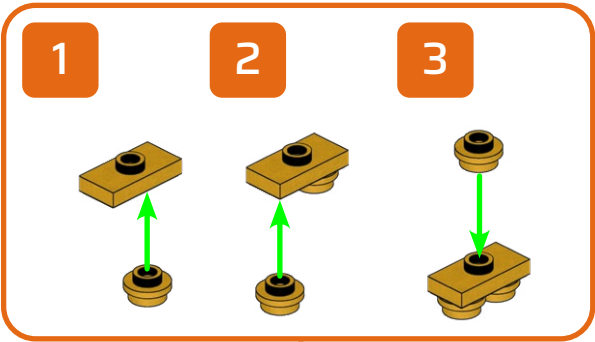

50

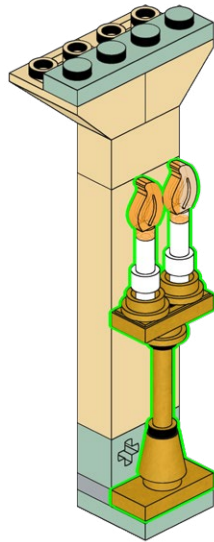

2x

51

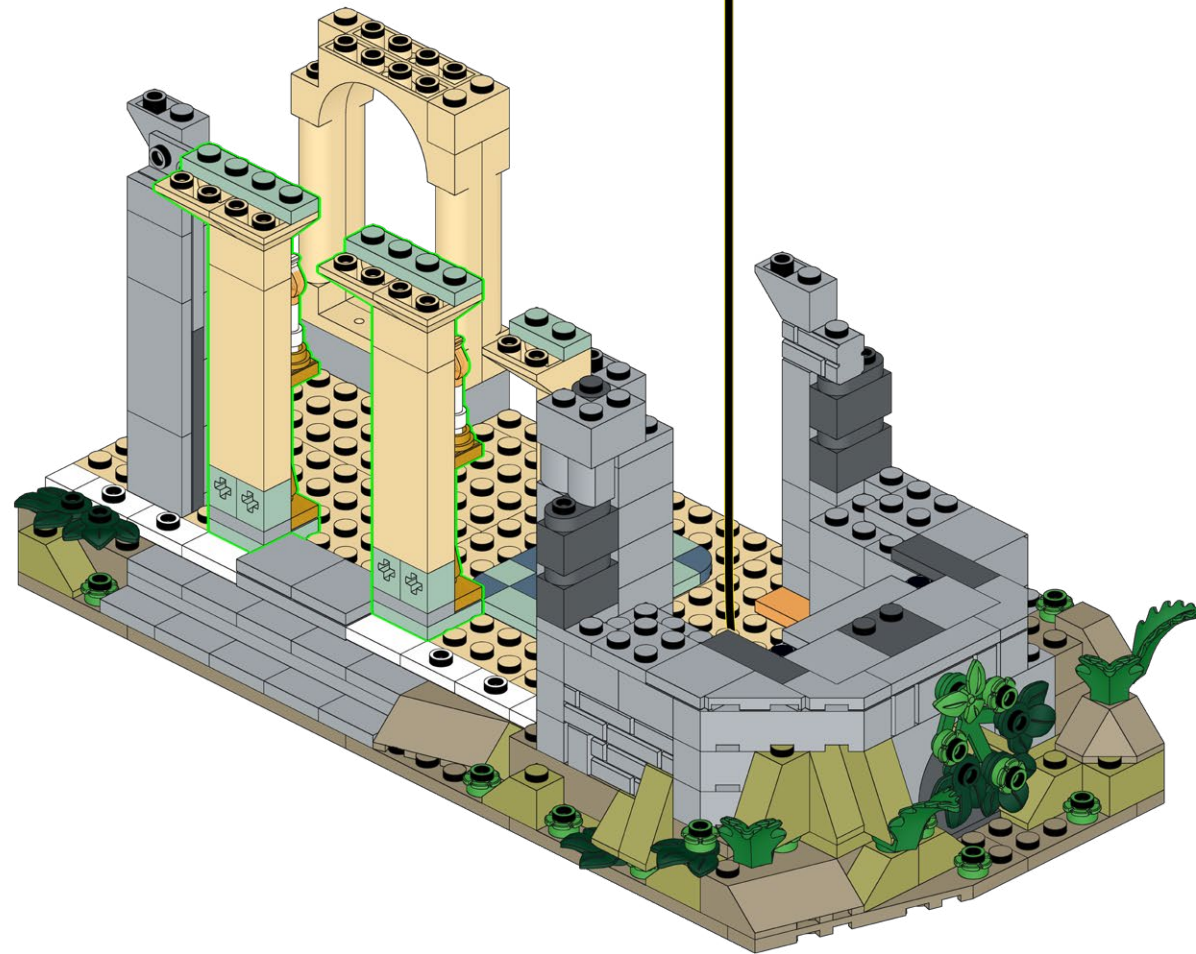



53

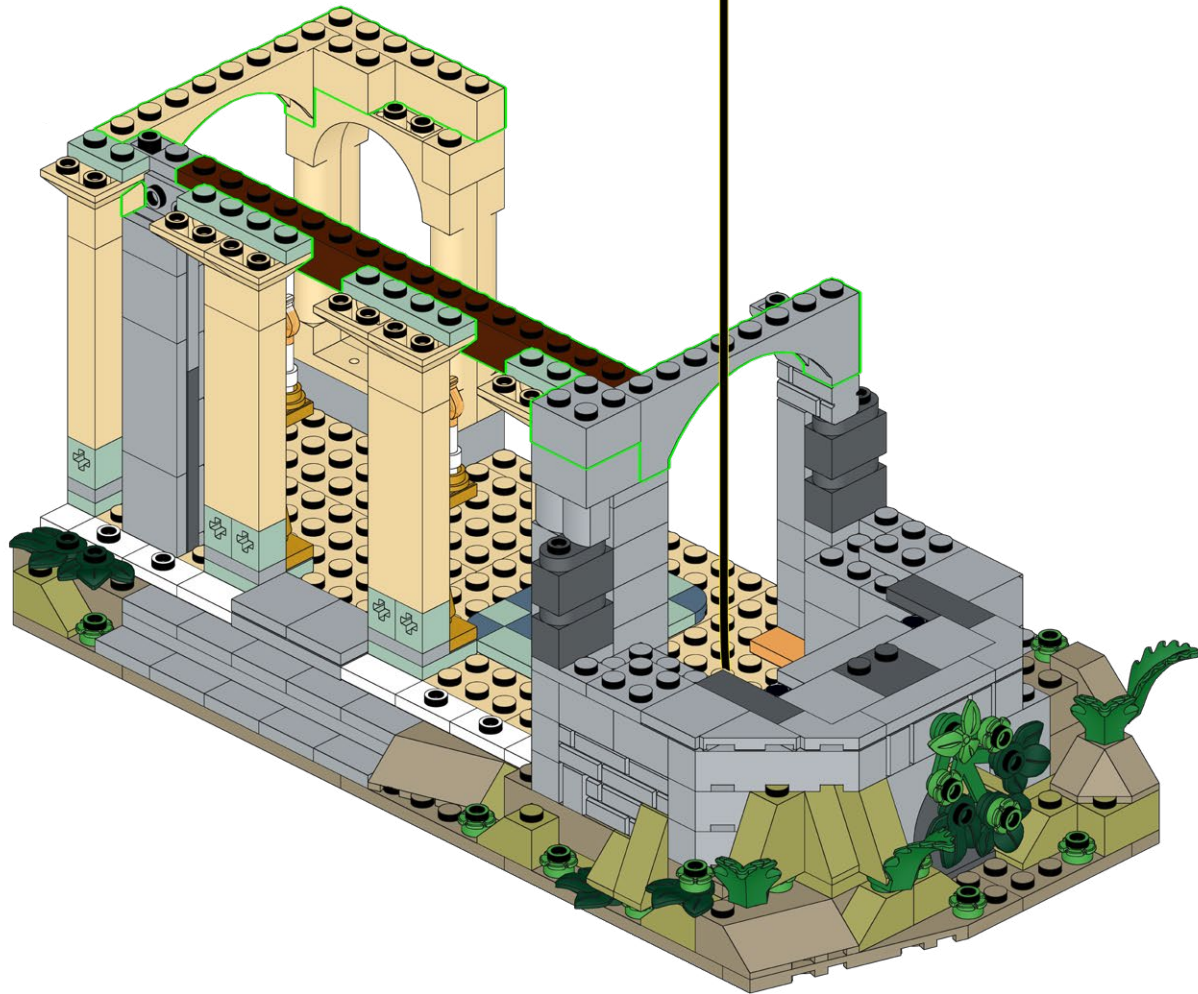
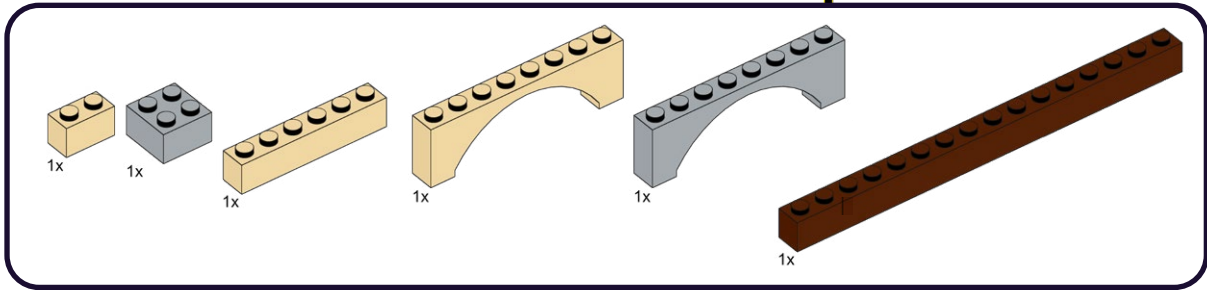



54

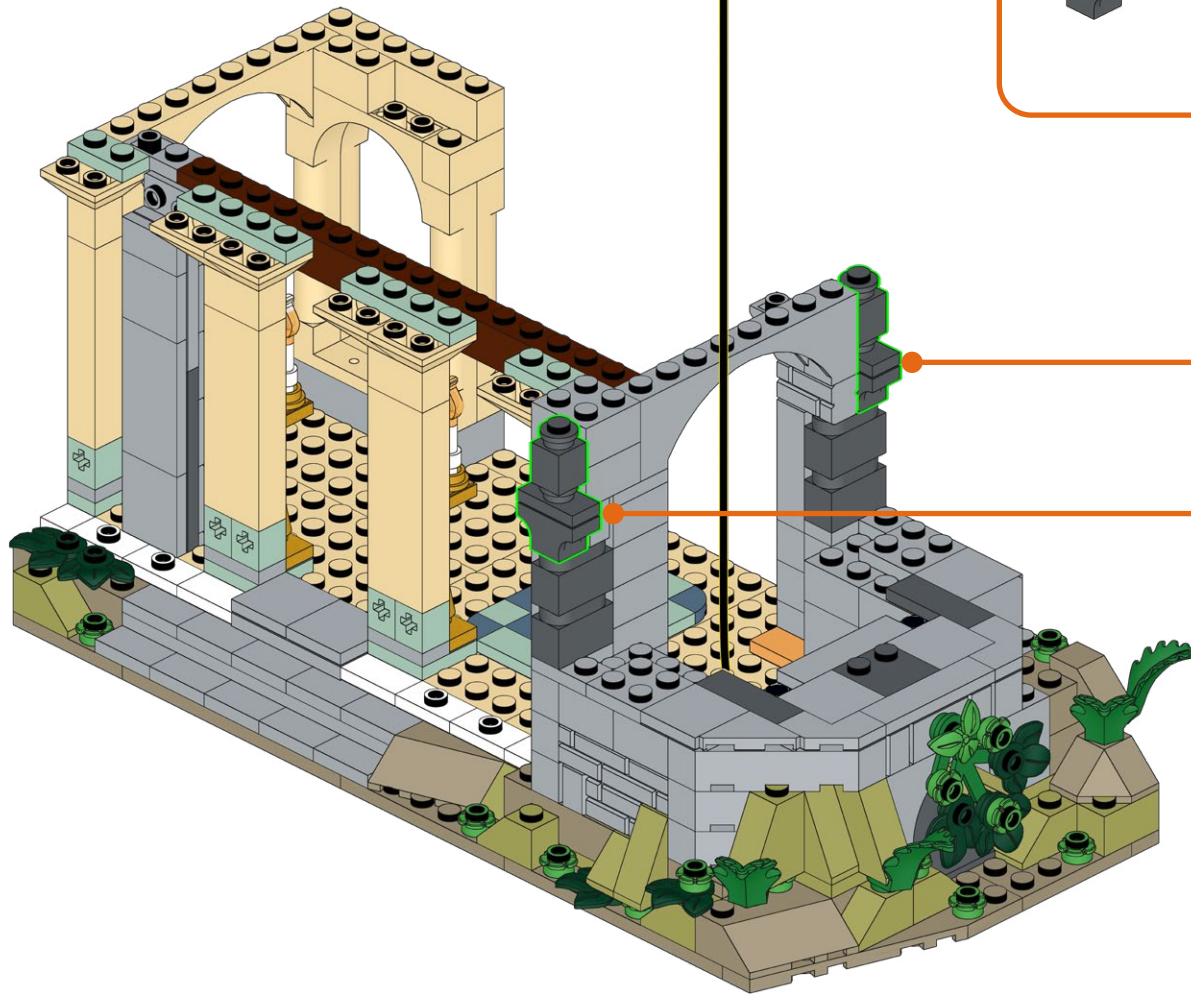
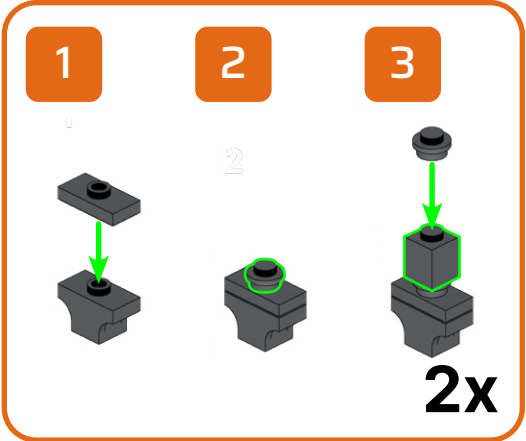
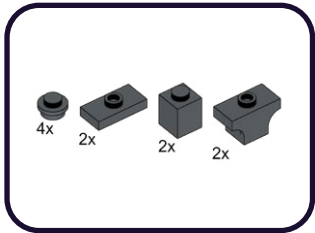

55

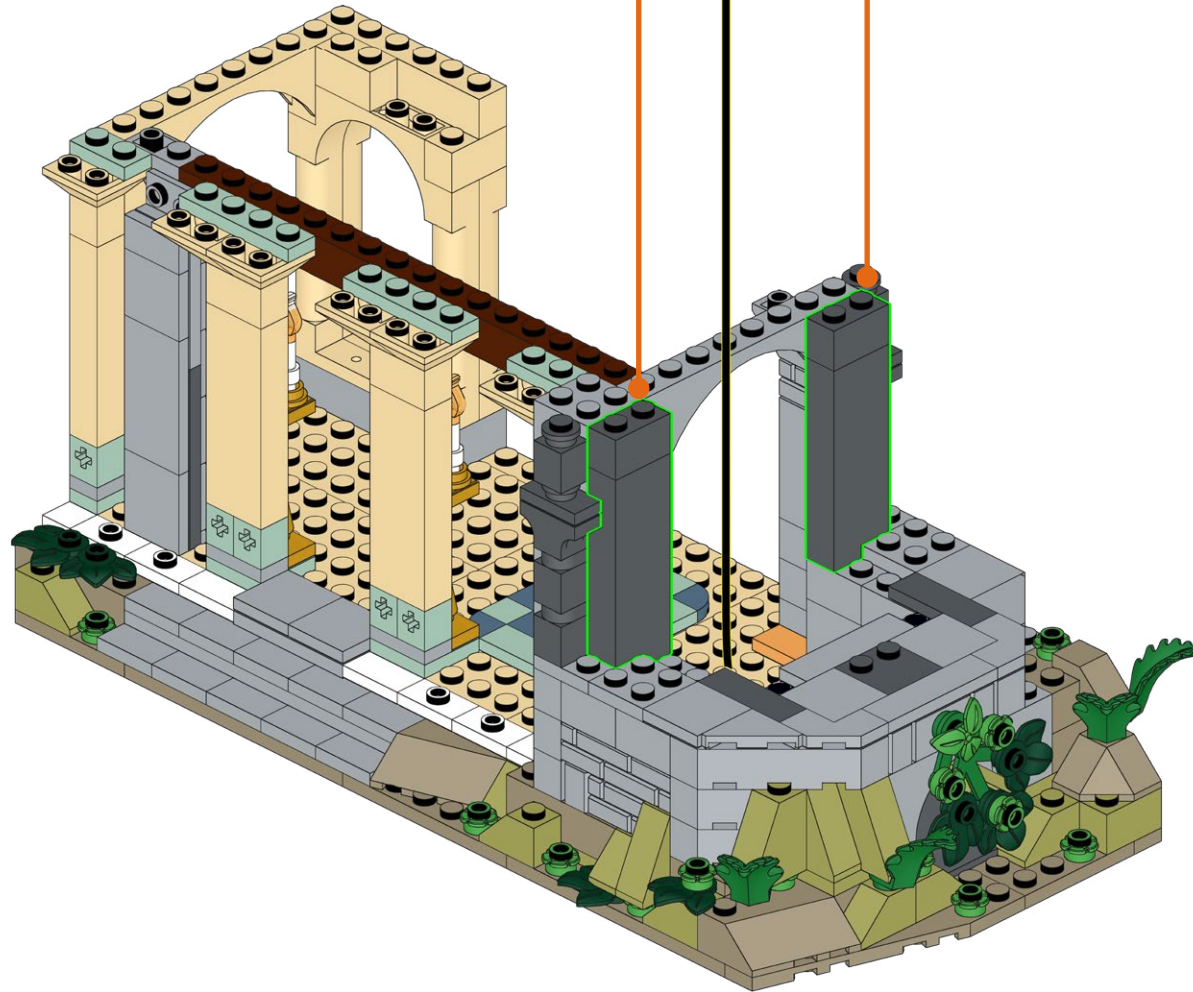
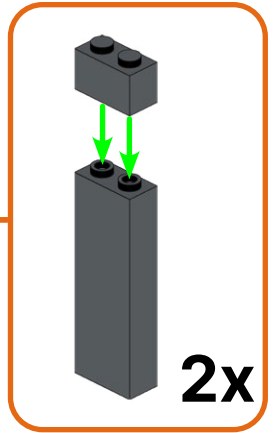
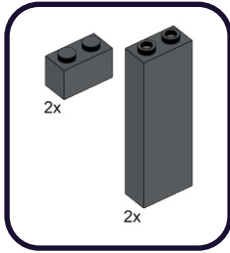

56

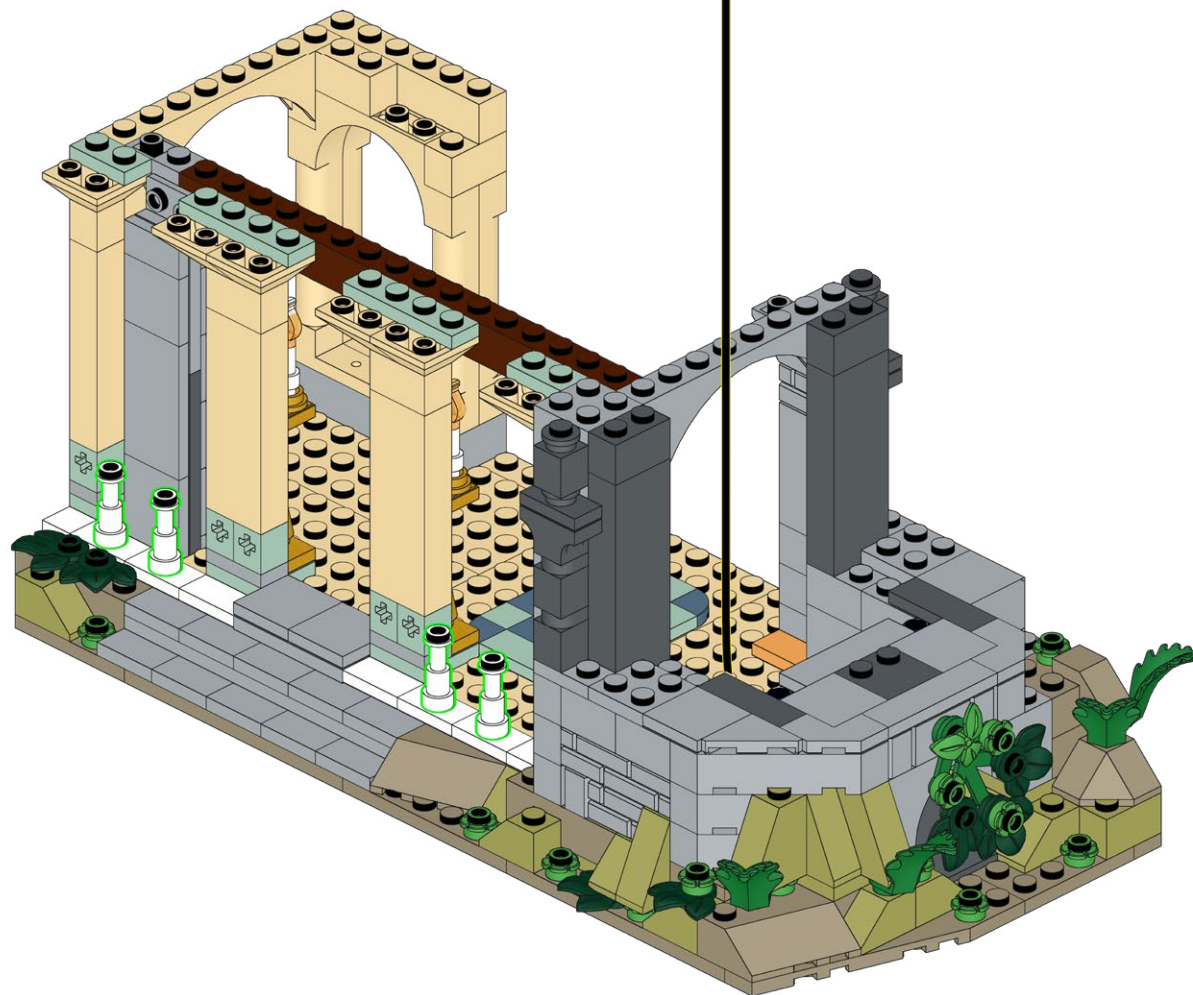

57

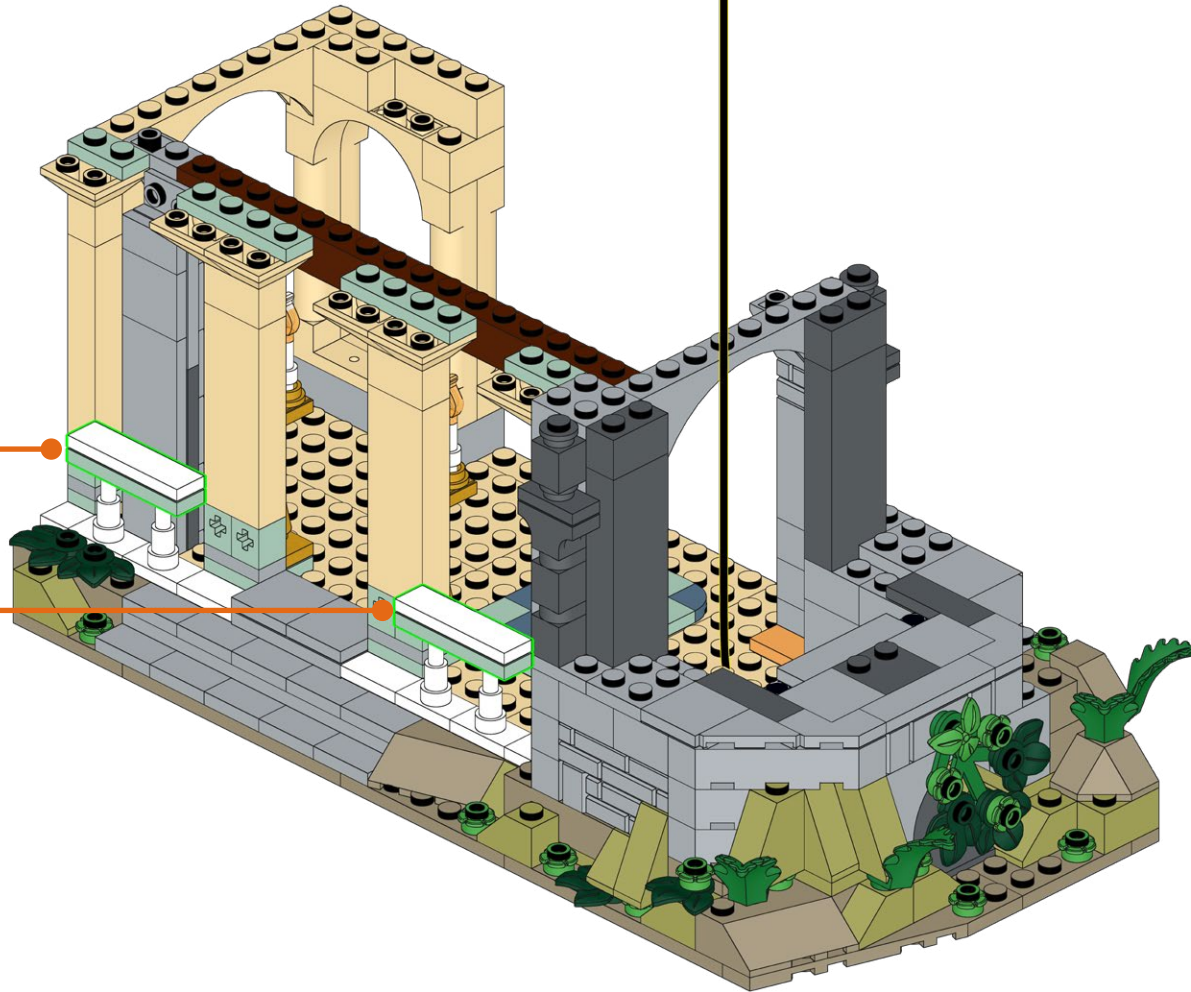
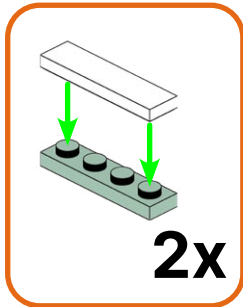
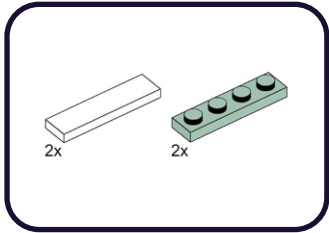

**HOLD UP!**

You might notice some bags aren't in order, as well as left over pieces, but that's ok! We're changing the way you build LEGO!

**ATTENDEZ!**

Vous remarquerez peut-être que certains sacs, ainsi que certaines pièces, ne sont pas dans le bon ordre. Mais pas de panique! Nous changeons simplement la façon avec laquelle vous construisez vos LEGO!

**ASPETTA!**

Potresti notare che alcuni sacchetti non sono in ordine, così come i pezzi avanzati, ma va bene così! Stiamo cambiando il modo in cui costruisci i LEGO!

**HALT!**

Sie werden möglicherweise bemerken, dass einige tüten durcheinander sind und teile übrig bleiben, aber das ist in Ordnung! Wir ändern die art und weise, wie Sie LEGO bauen!

**¡ESPERA!**

Es posible que notes que algunas bolsas están fuera de servicio, así como piezas sobrantes, ¡pero está bien! ¡Estamos cambiando la forma en que construyes LEGO!

**暫停!**

你可能会注意到一些袋子顺序错乱, 以及一些剩余的部件, 但没关系! 我们正在改变你搭建乐高的方式!

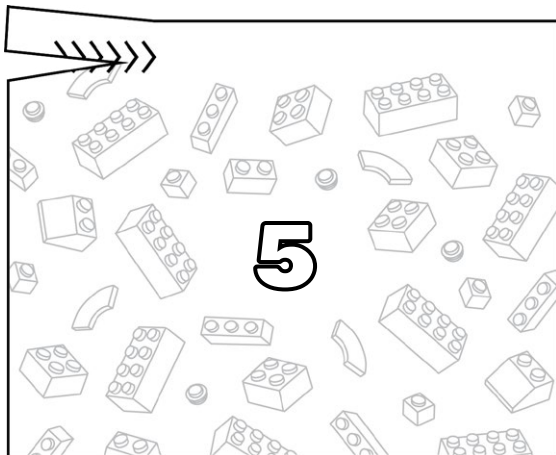
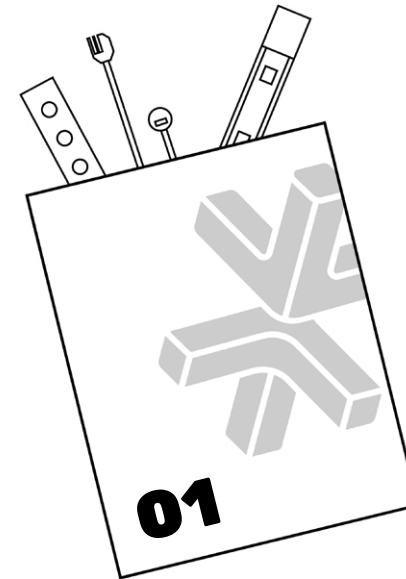
**Open LEGO® Bag 5****Open LMB Bag 01**

# 58

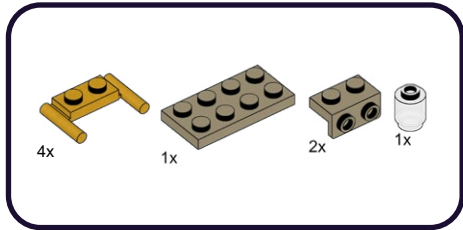

1

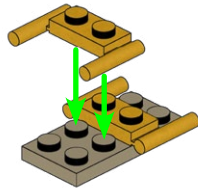

2

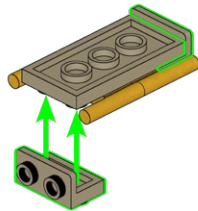

3

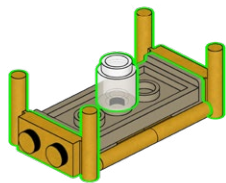

# 59

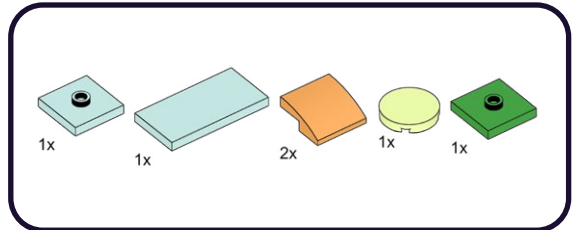

1

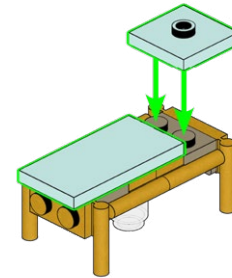
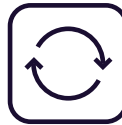

2

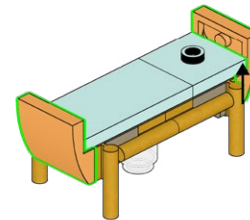

3

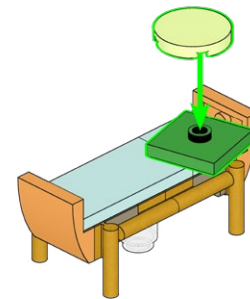

60

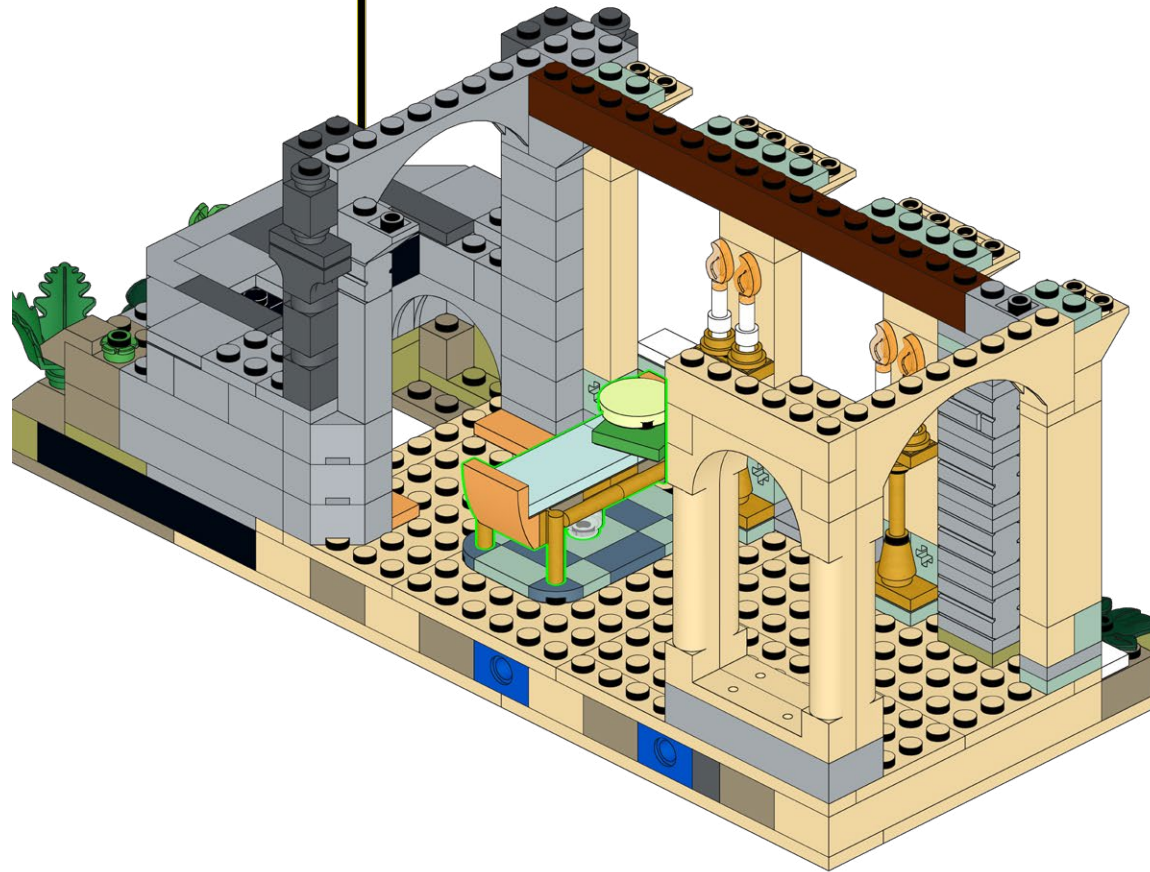

61

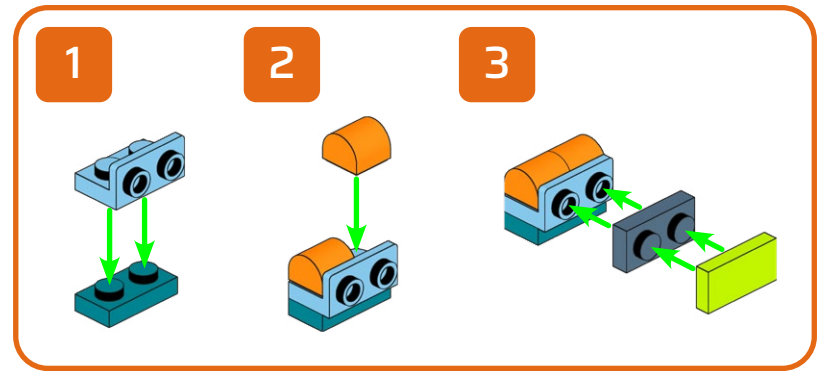
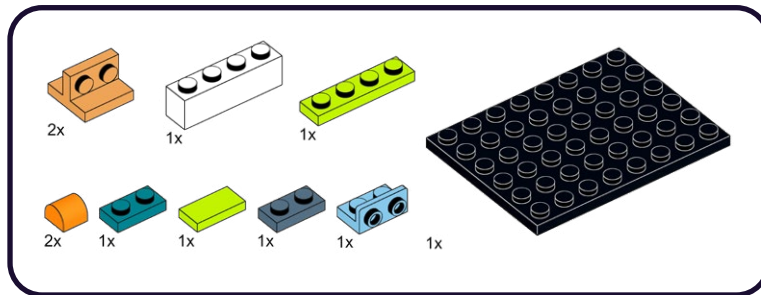

1

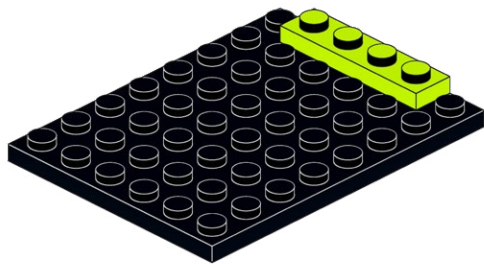

2

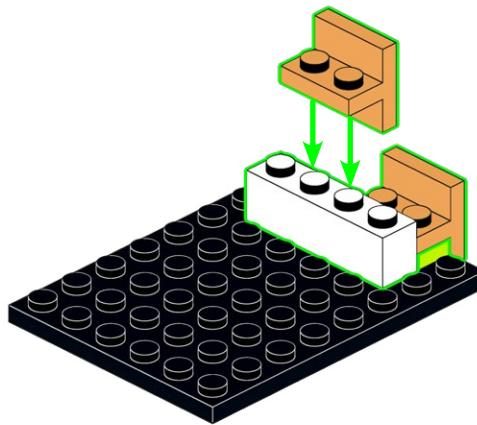

3

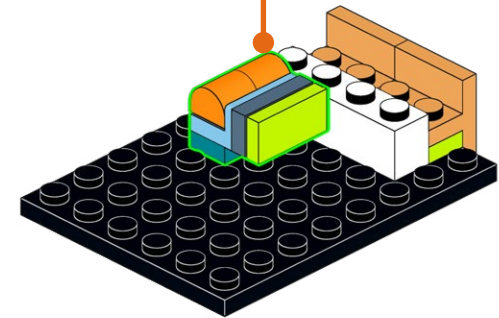



62

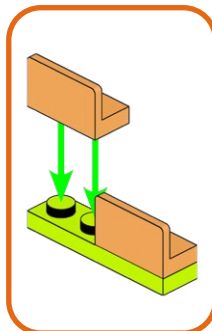
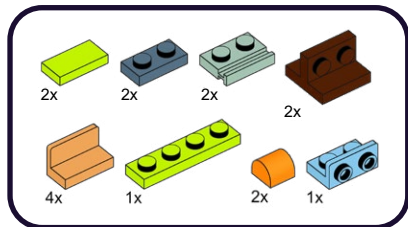

1

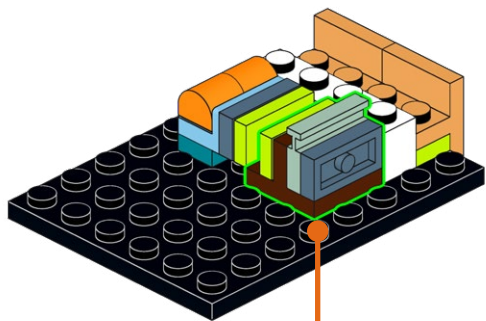

2

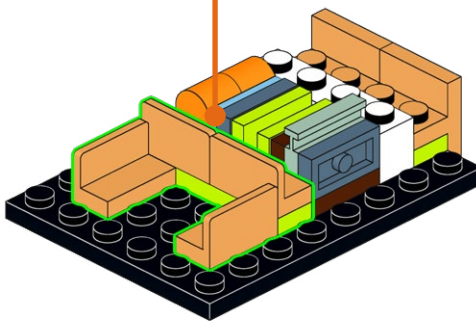

3

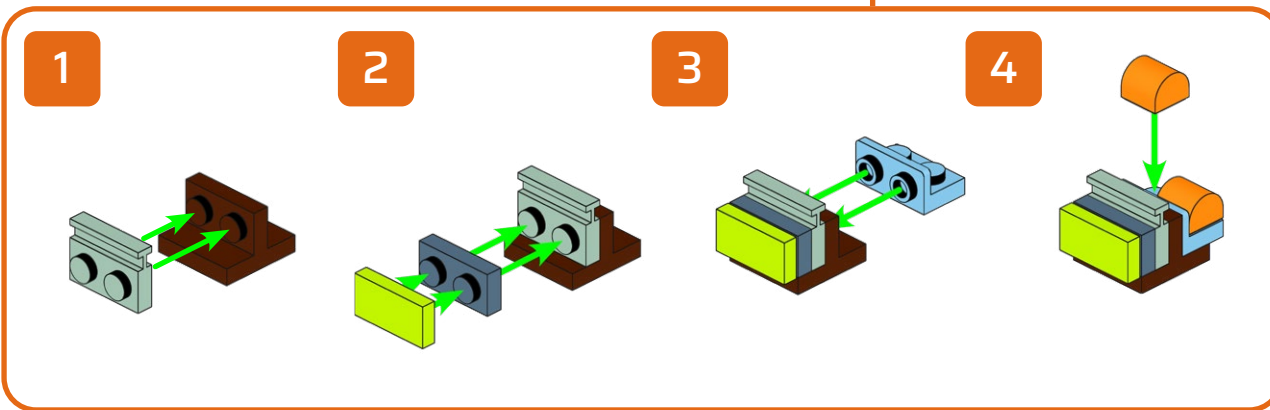
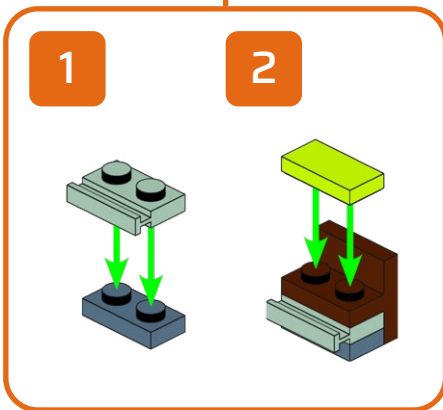
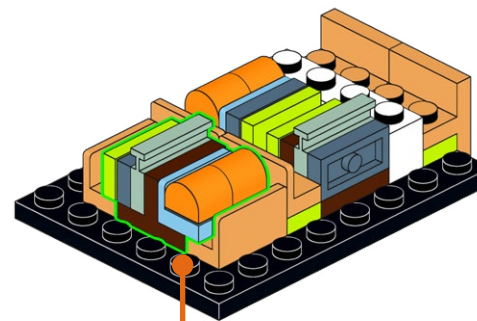

63

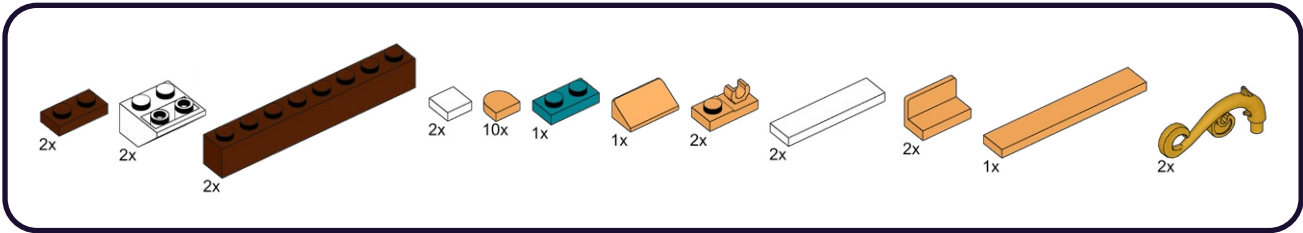

1

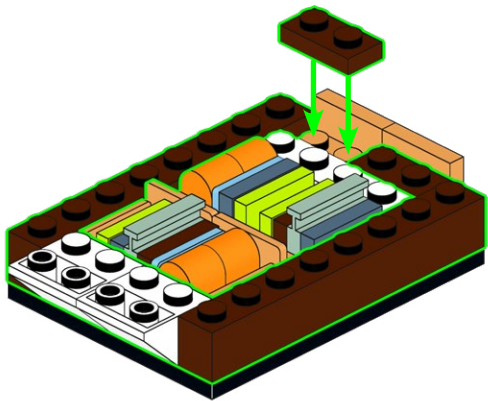

2

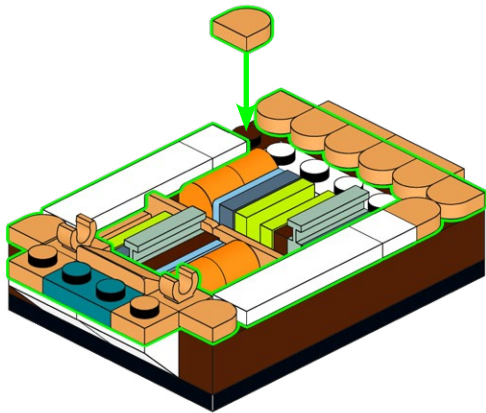

3

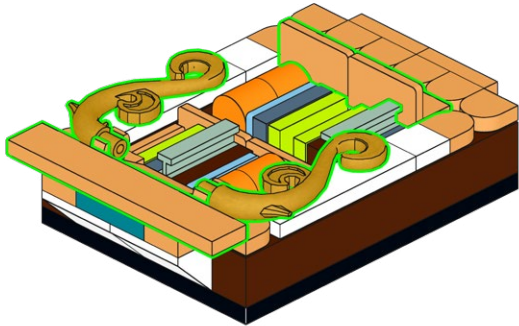

64

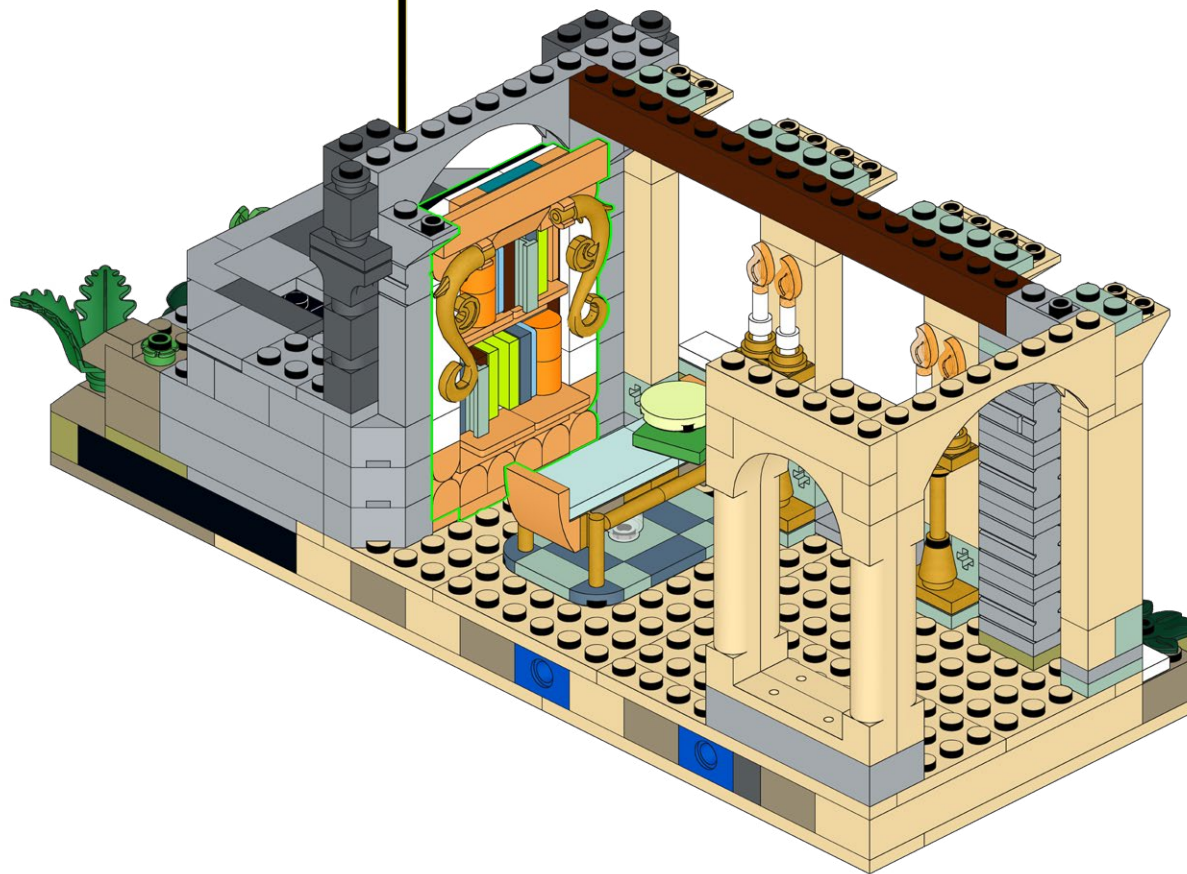

65

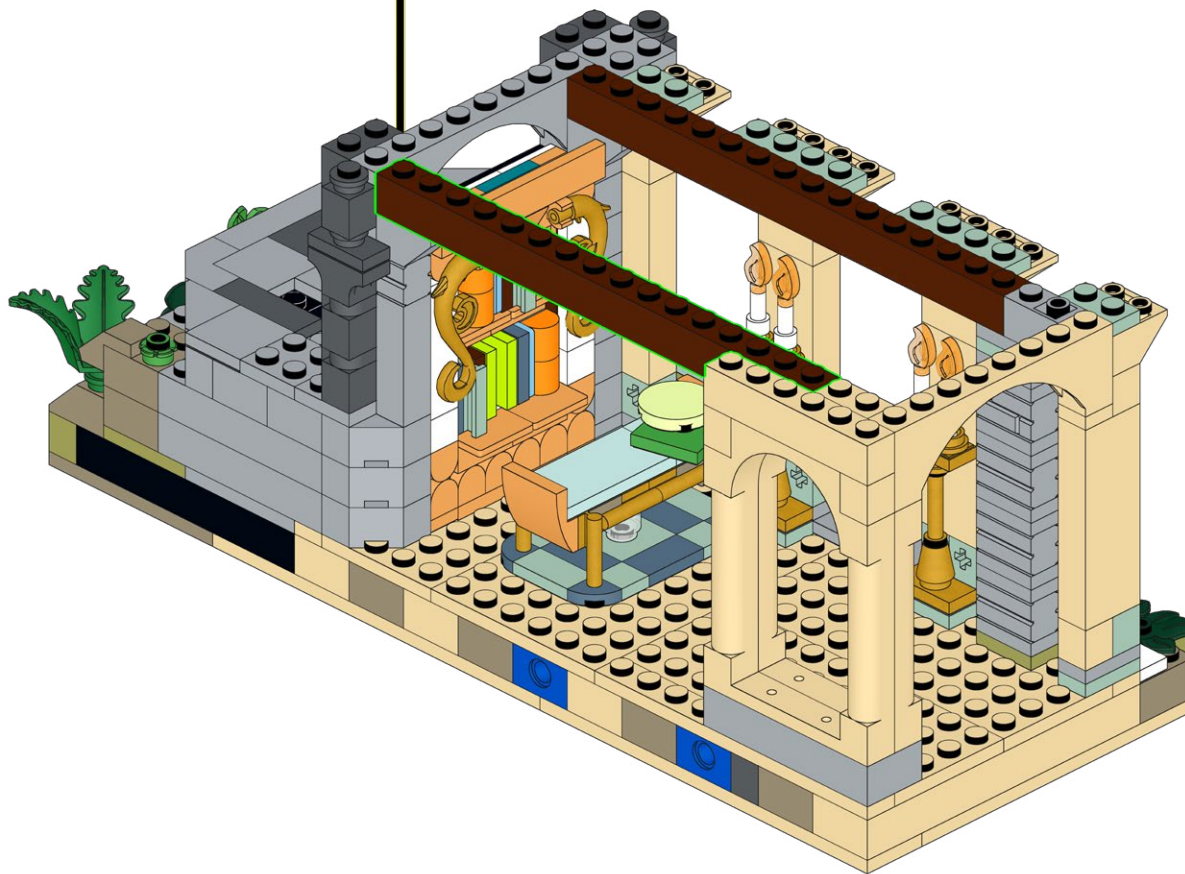
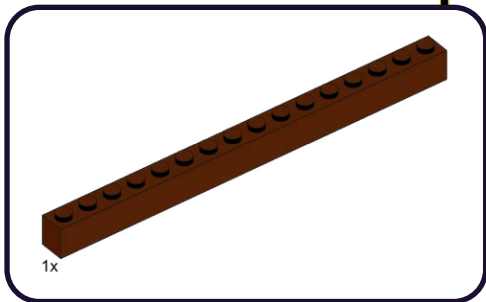

66

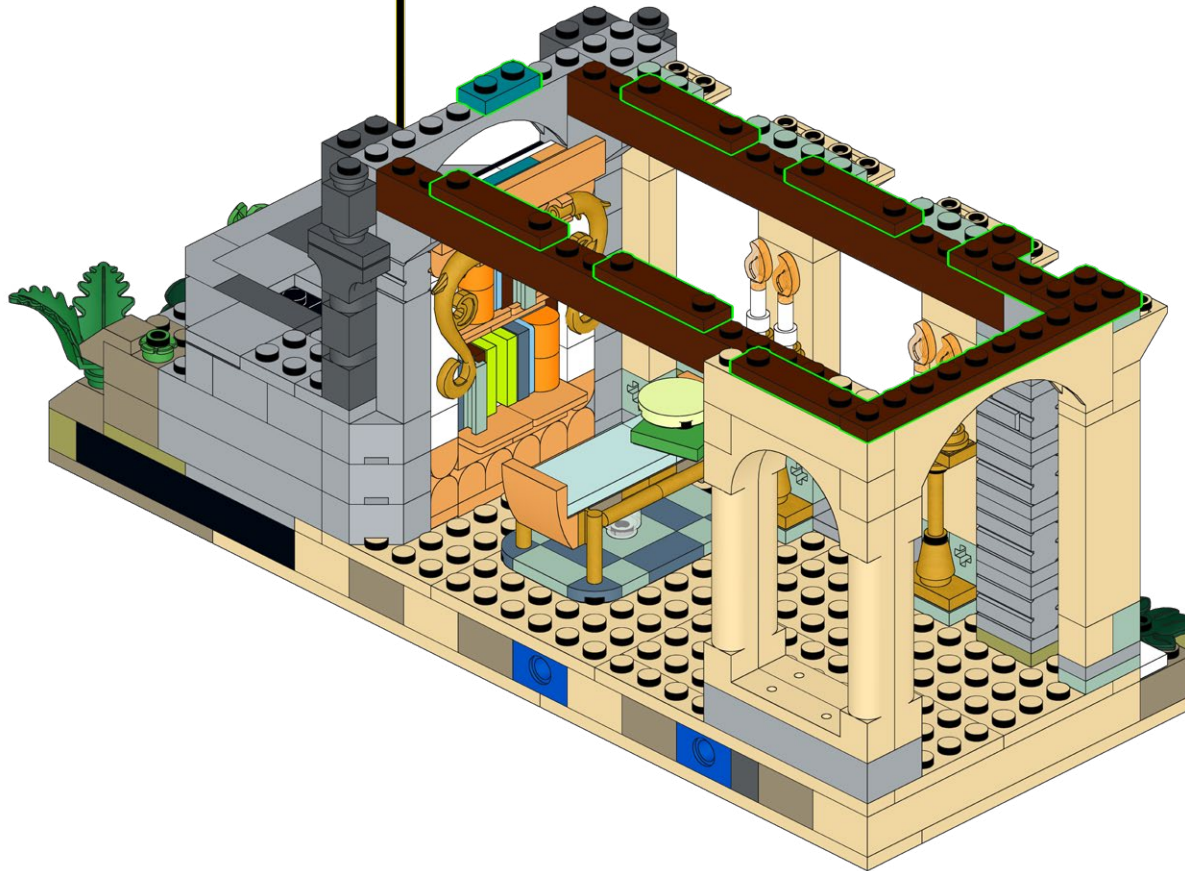
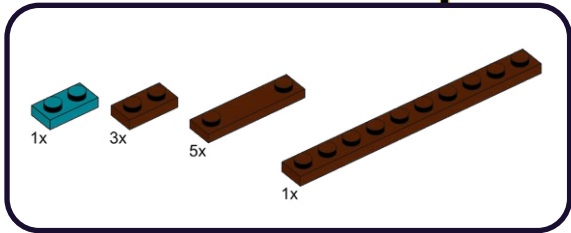

67

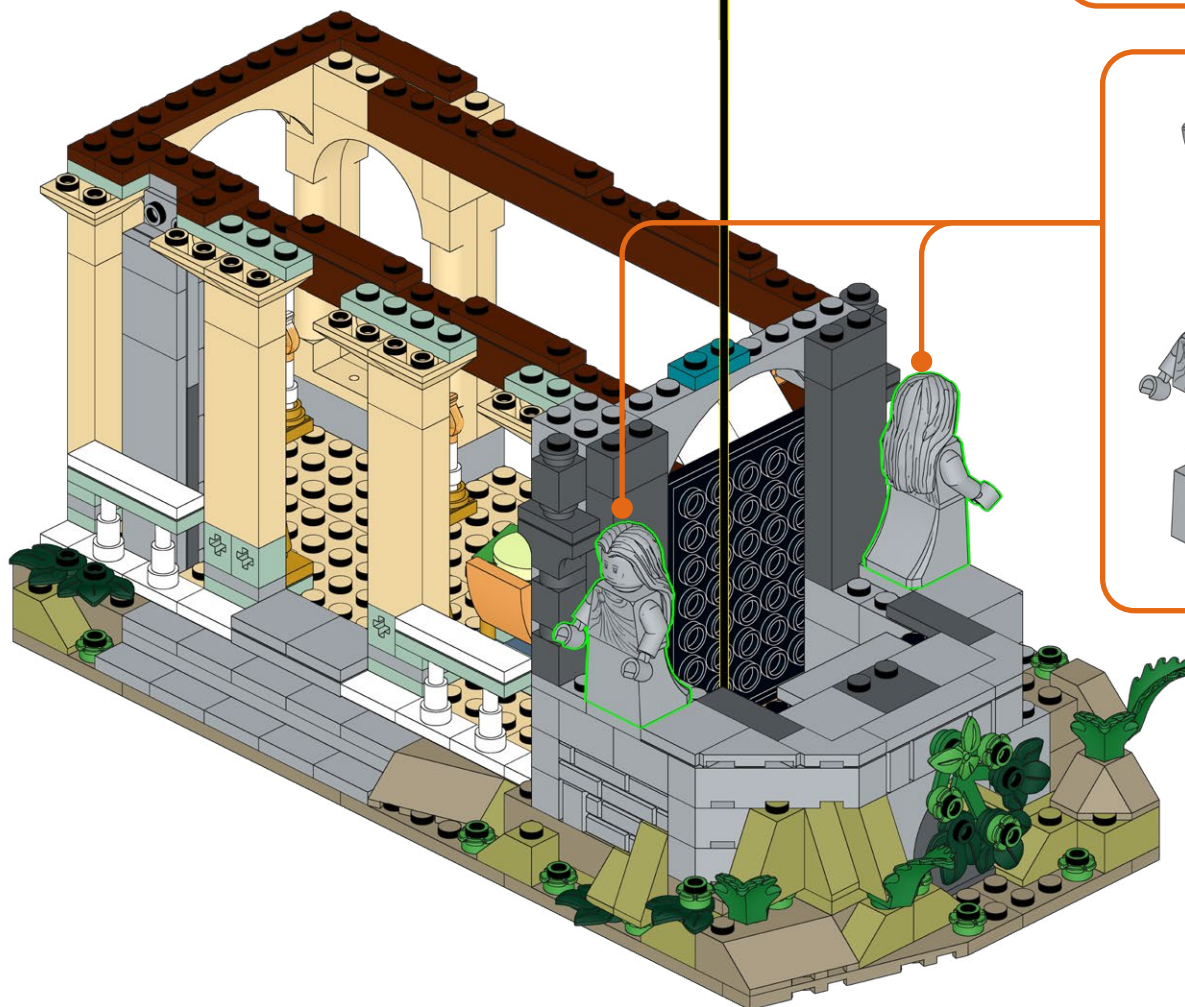
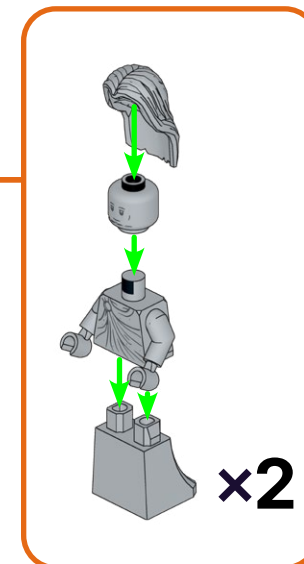
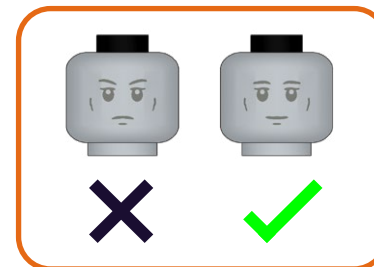
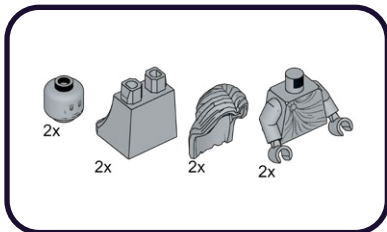

# 68

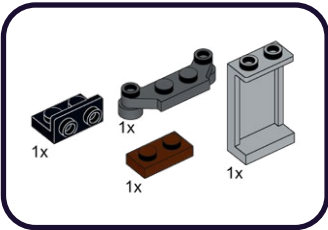
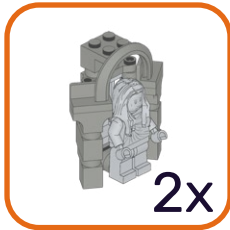

1

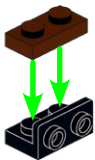

2

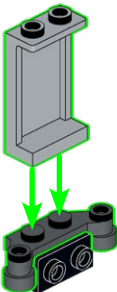

# 69

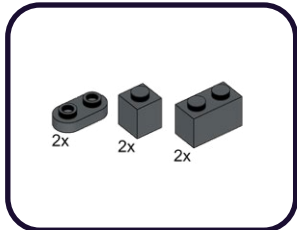

1

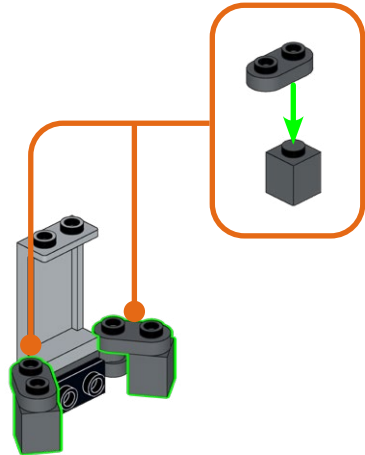

2

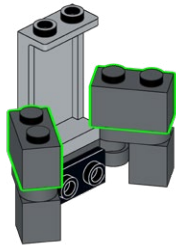

# 70



1

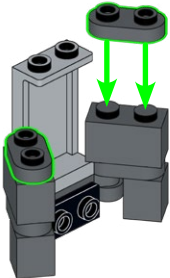

2

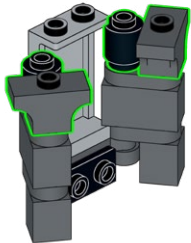

# 71

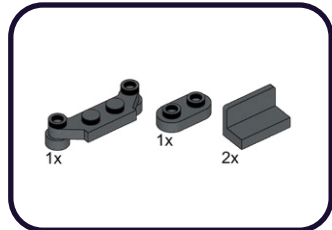

1

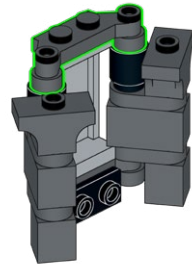

2

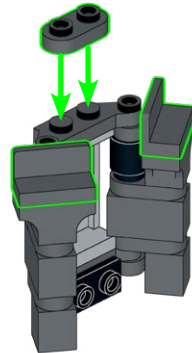



72

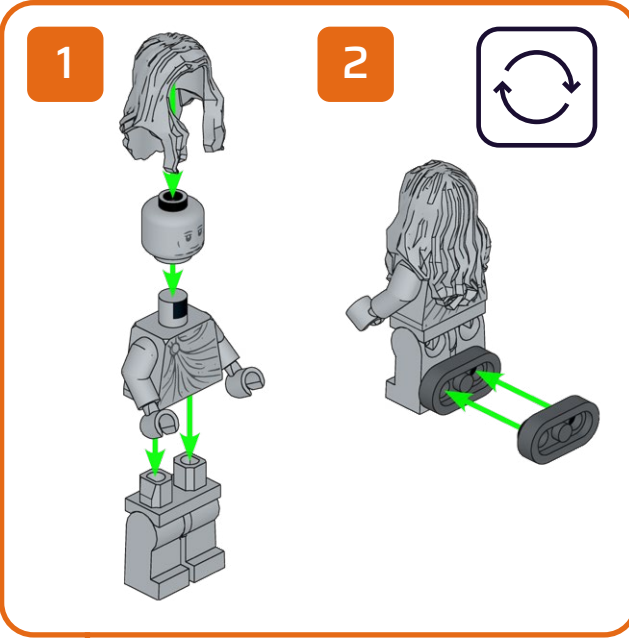
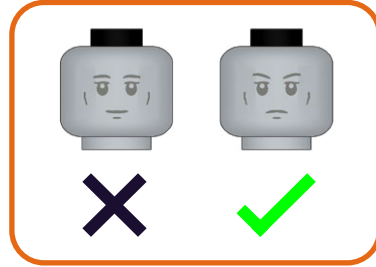
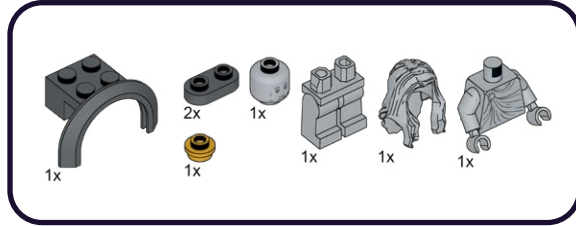

1

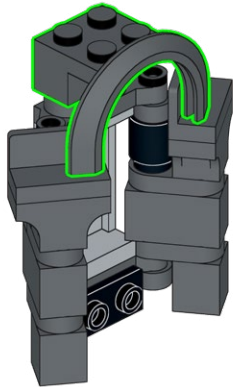

2

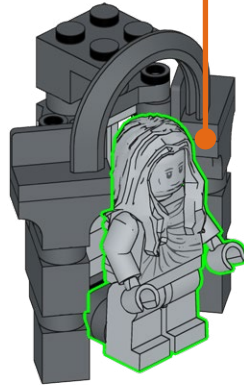

3

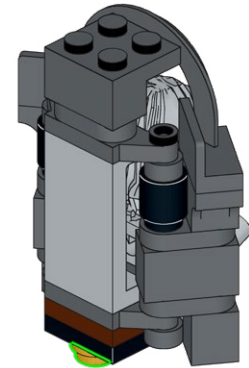

×2

73

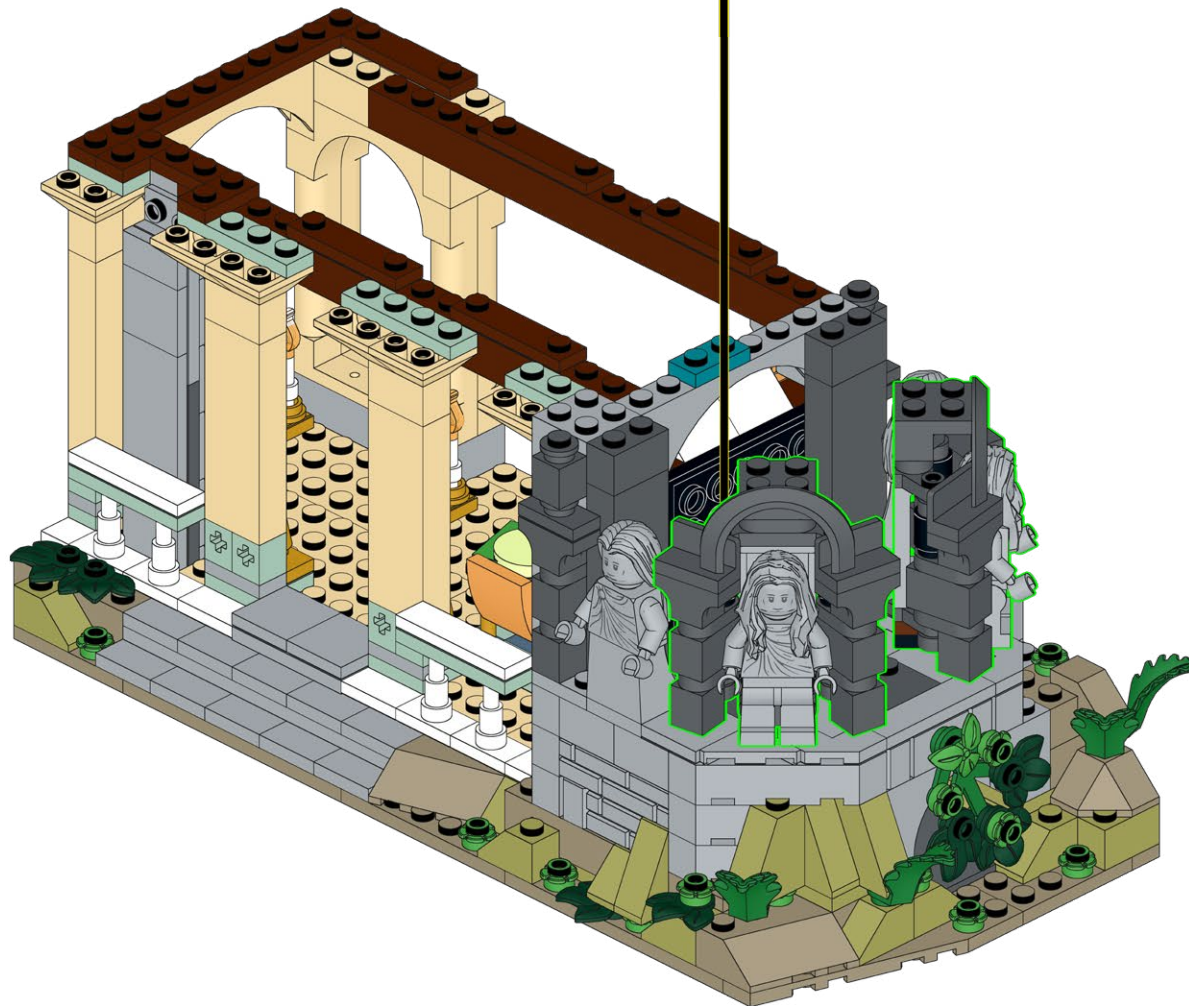

74

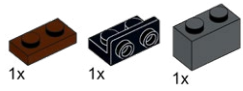

1

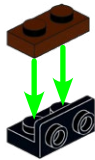

2



75

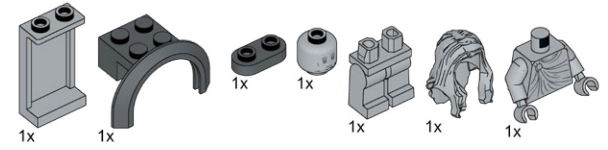

1

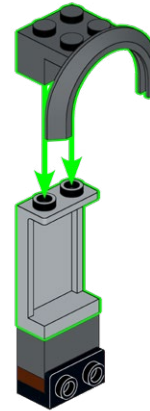

2

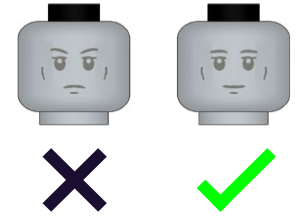
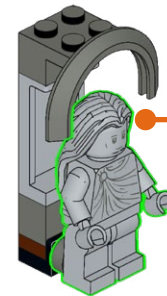

1

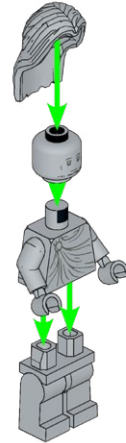

2





77

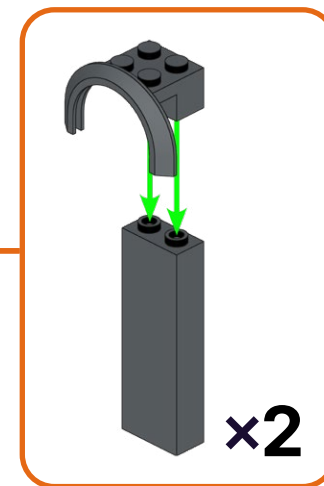
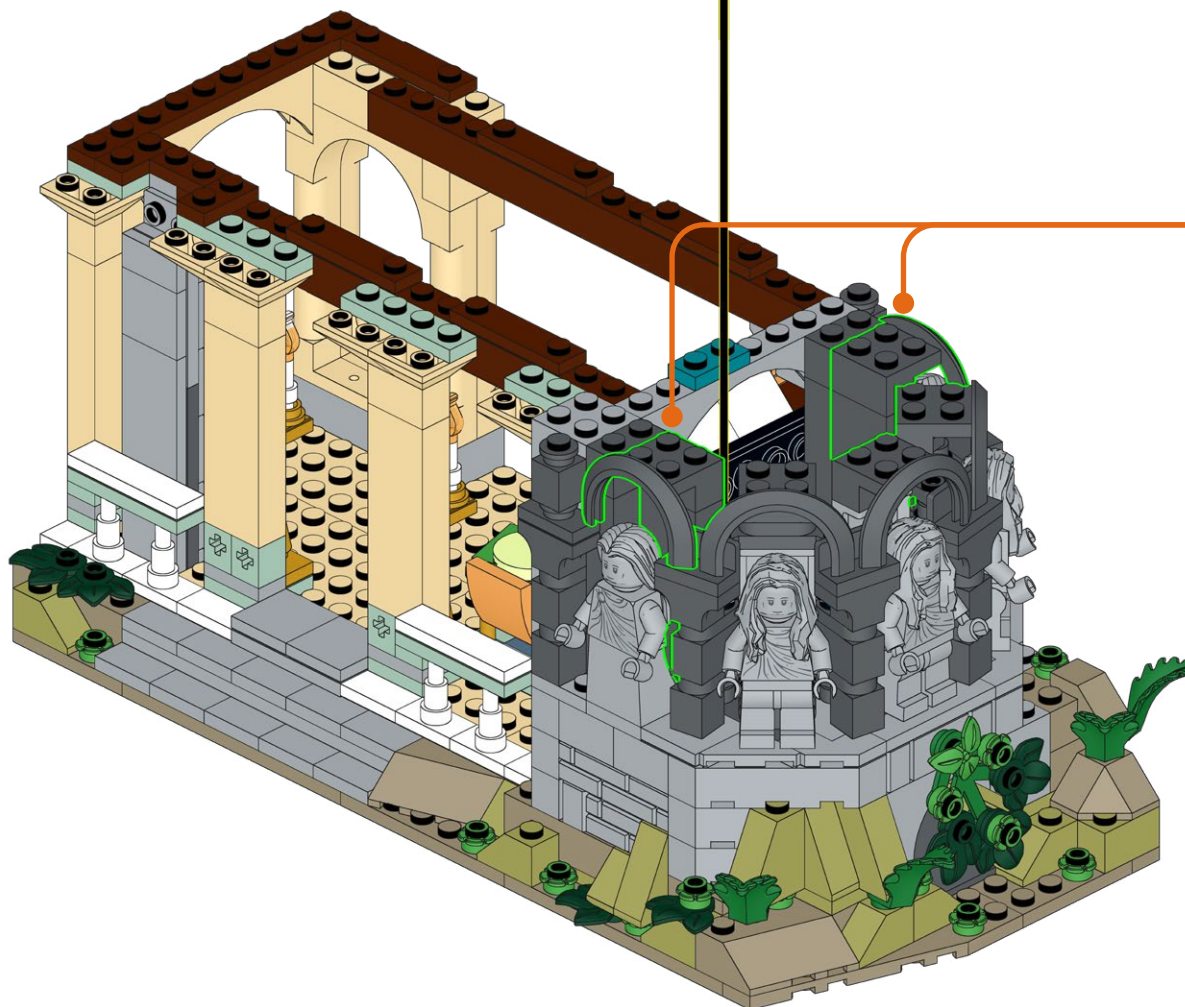
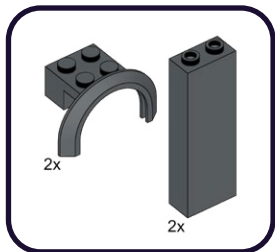

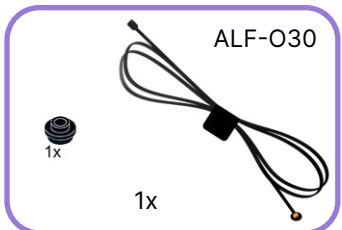

1



2



79

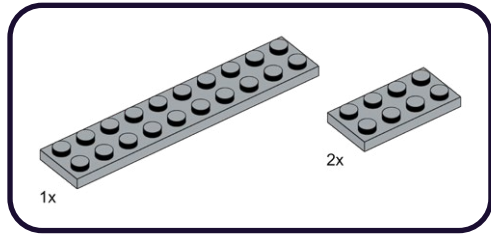

1

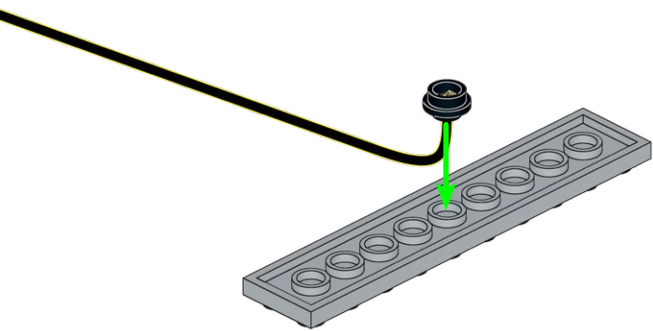

2

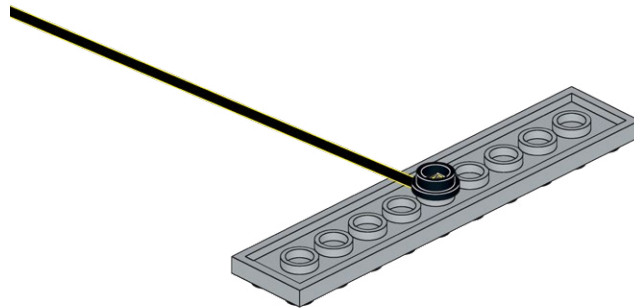

3

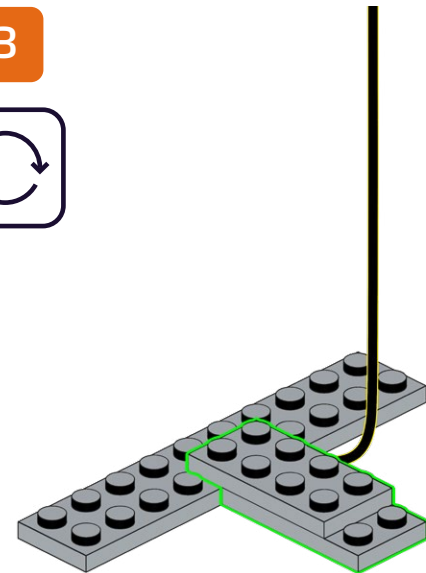

80

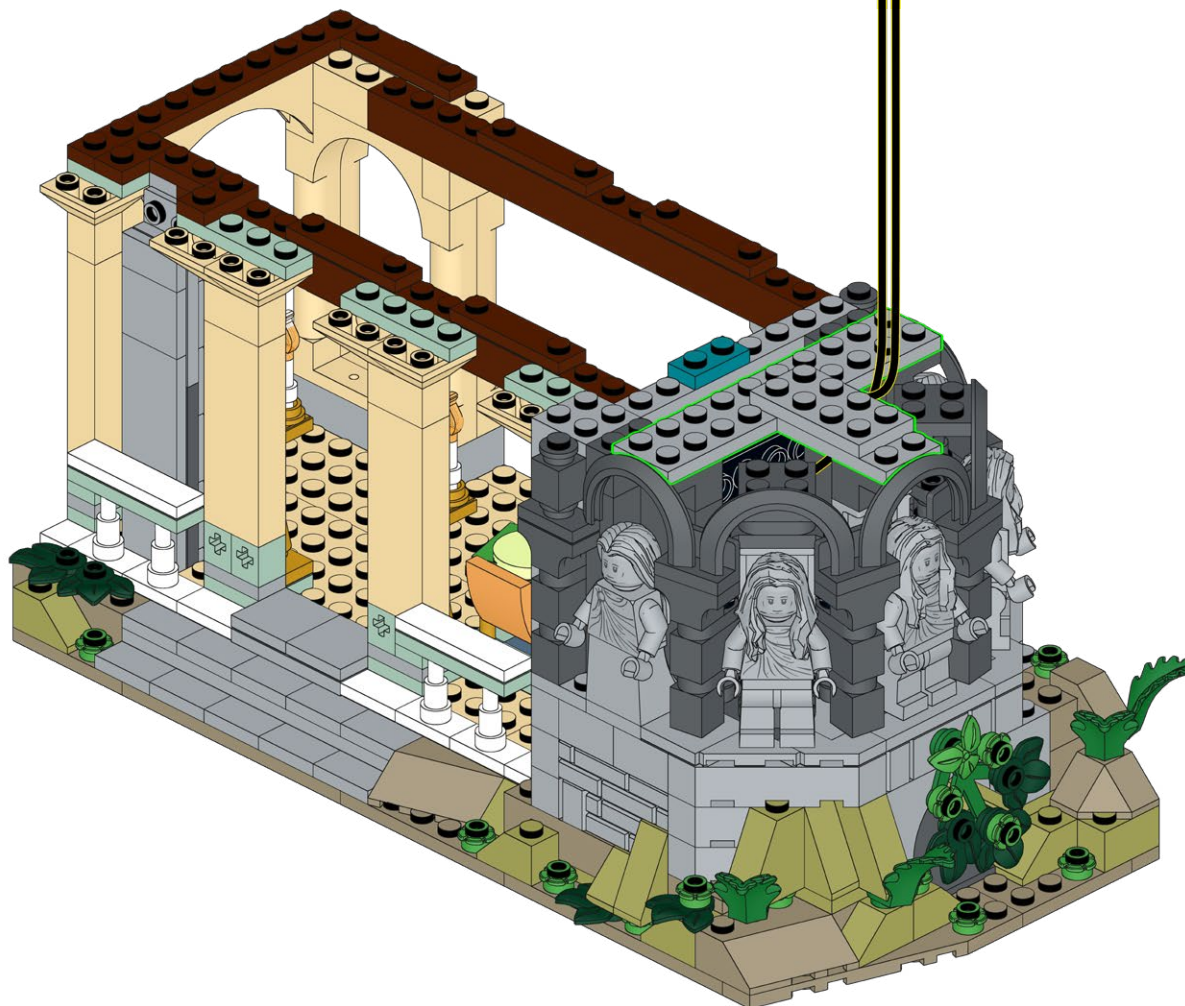



81

1x 2x

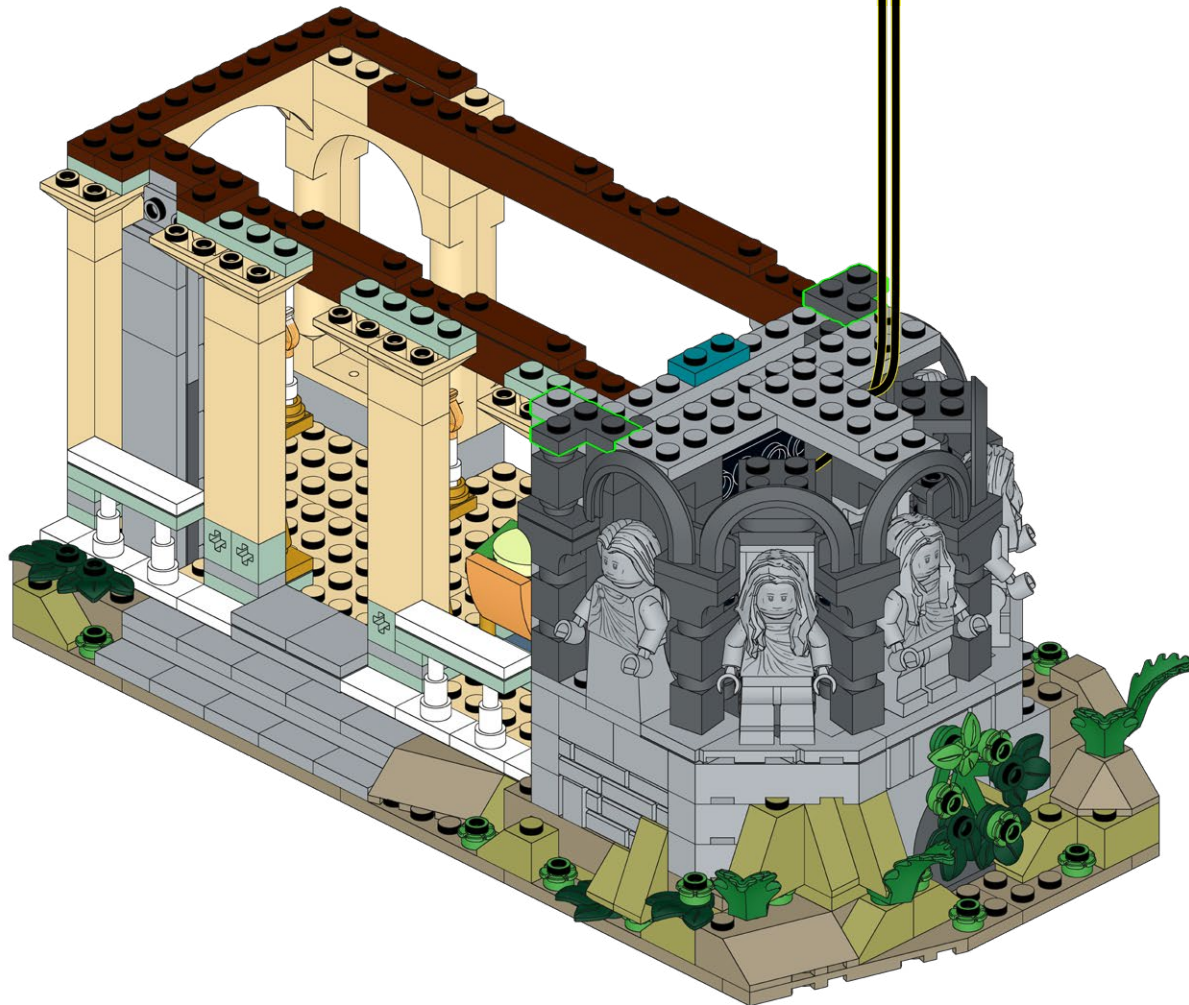

82

4x

4x

2x

2x

83

1x

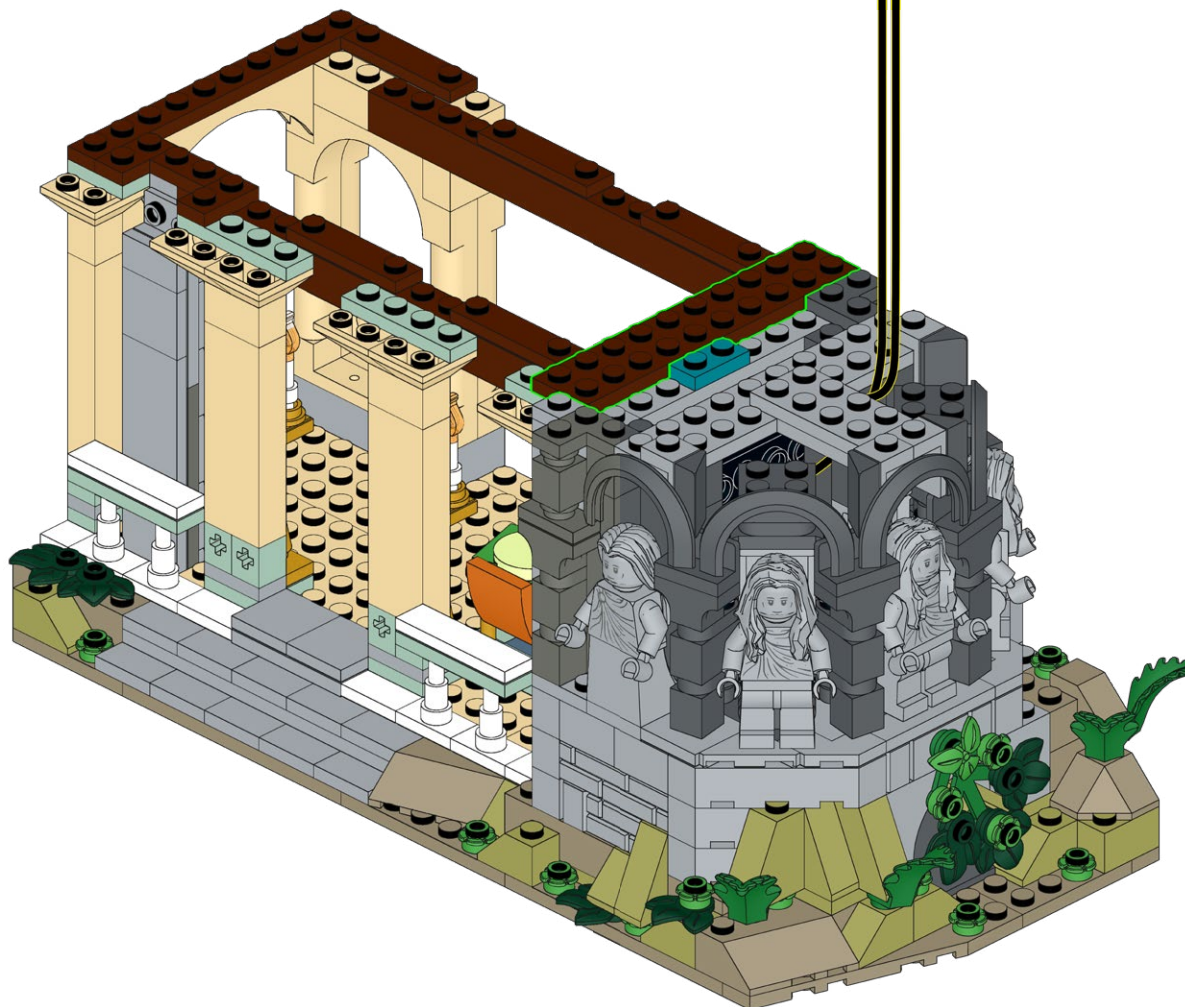
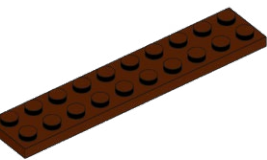

84

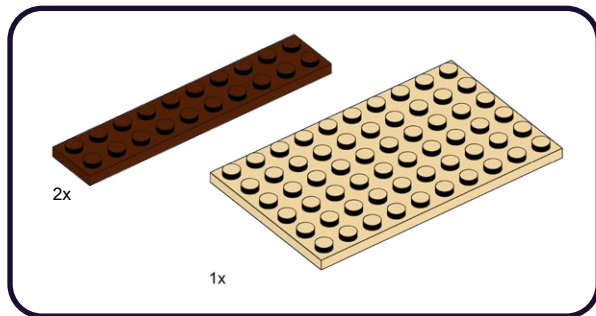

1

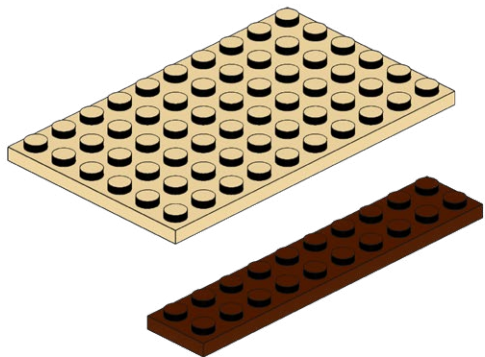

2

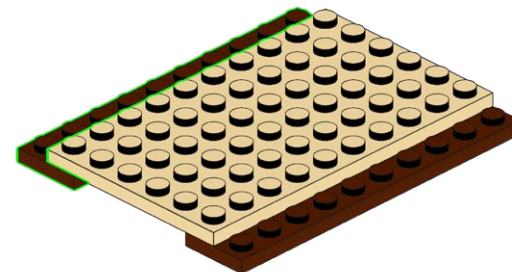
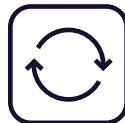

85

T-1x6	ML-WW	B-30
		
1x	1x	1x

1

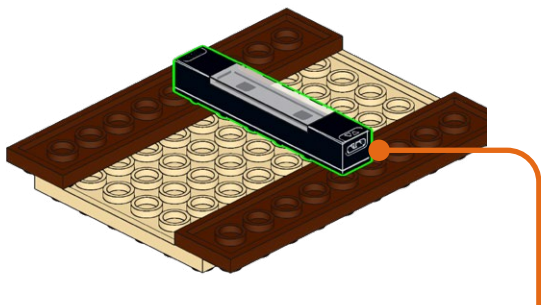

2

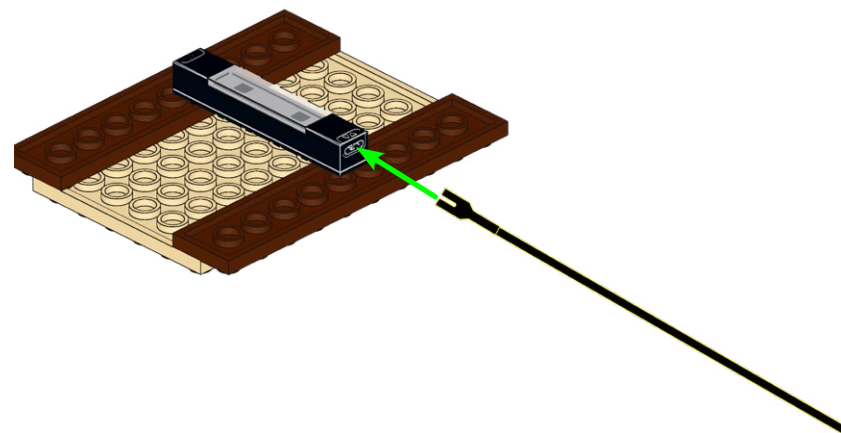

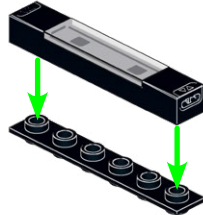
1	2
	

86



1

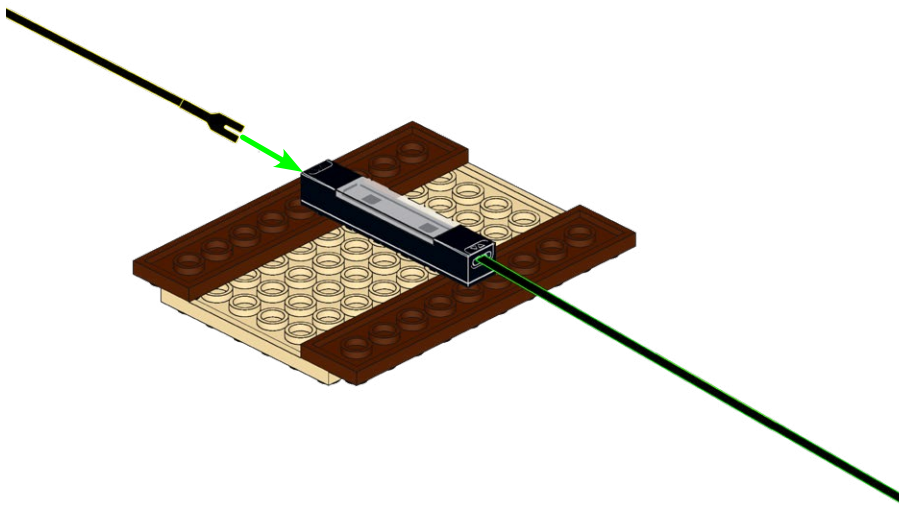

2

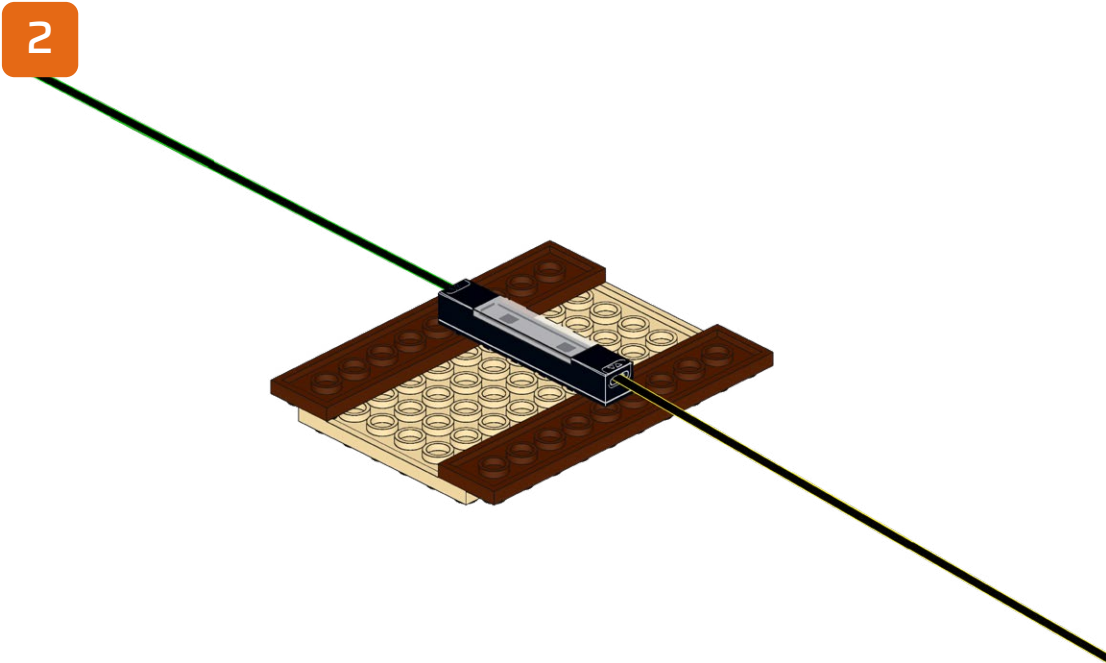

87

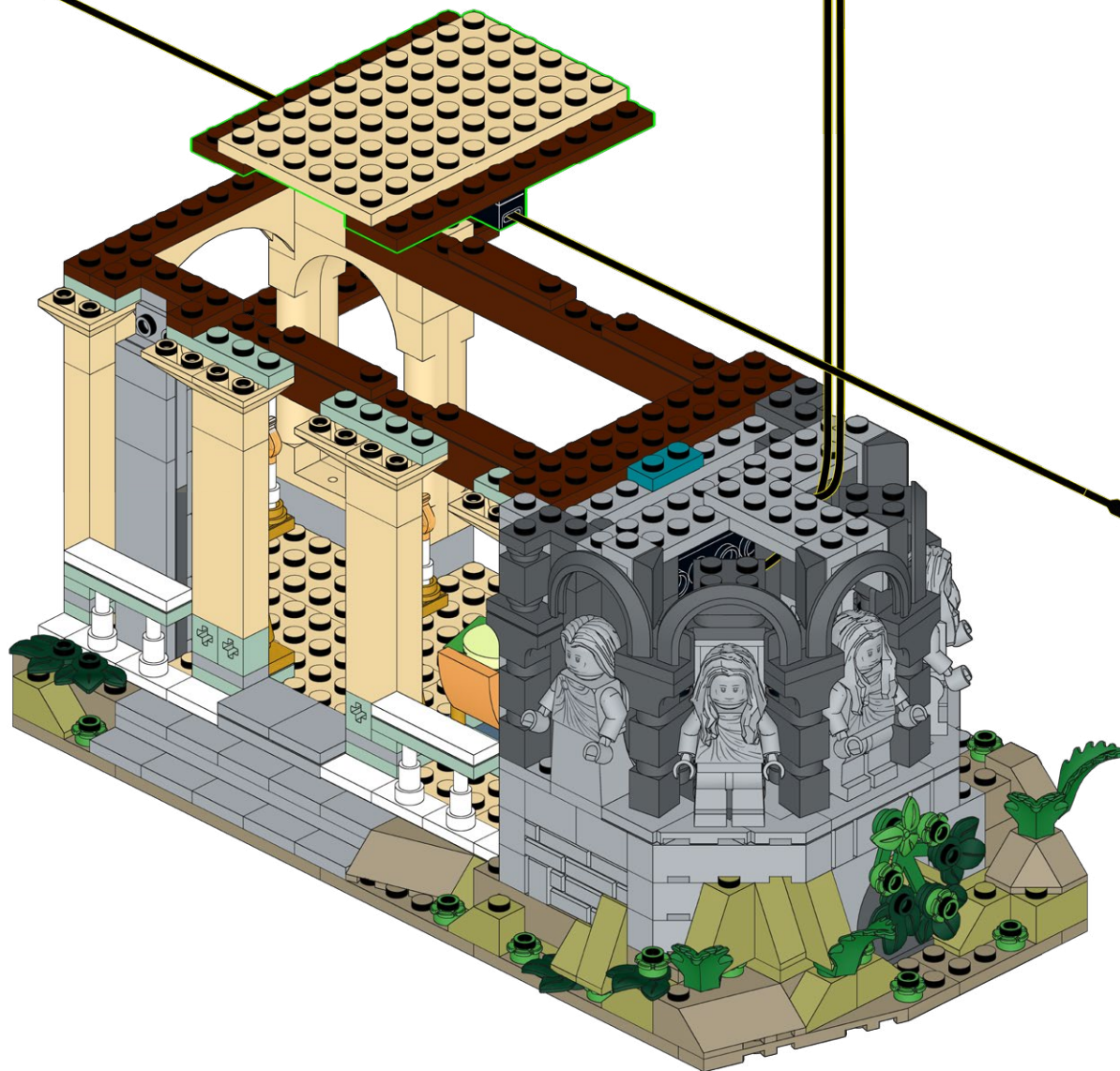

88

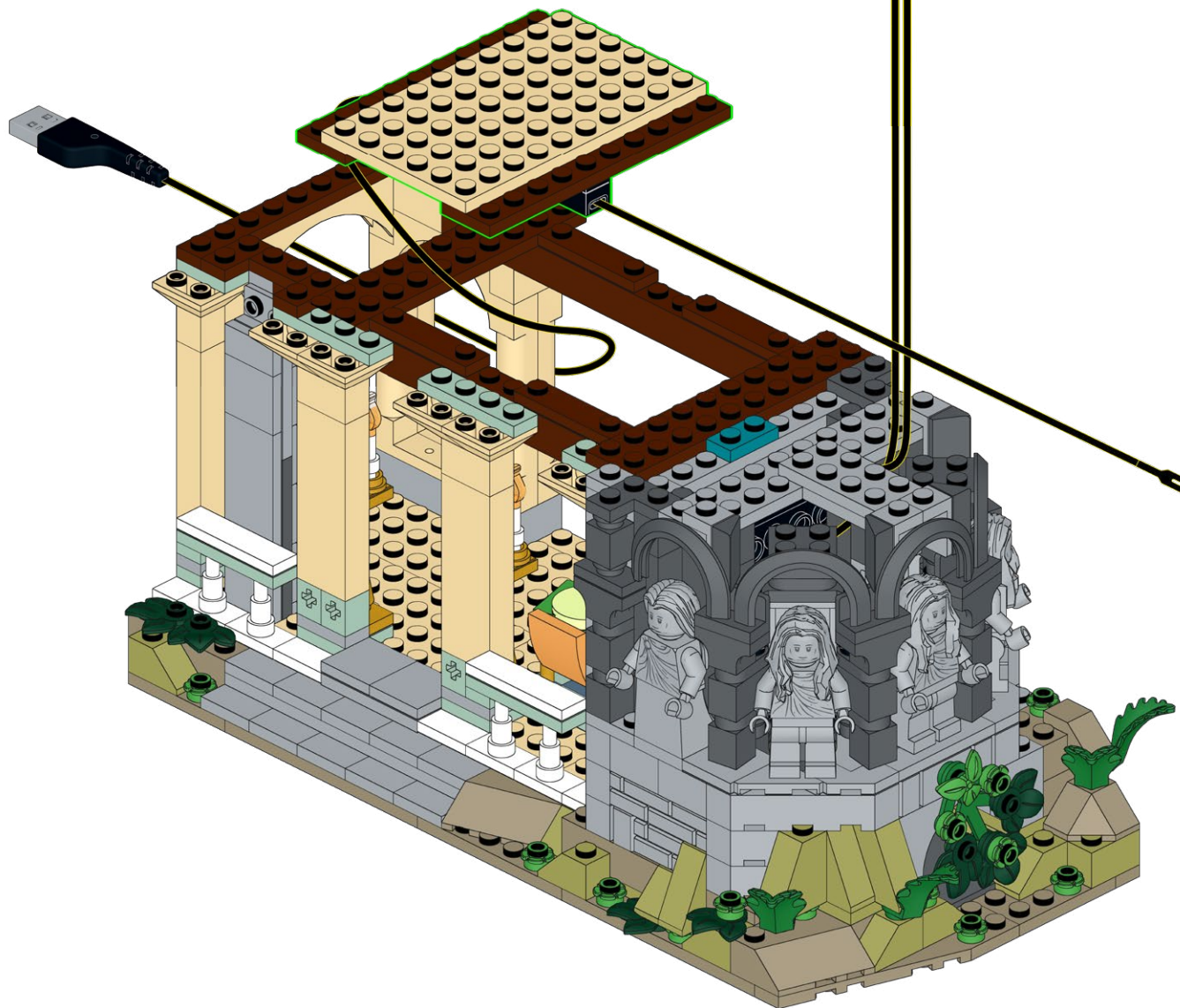



89

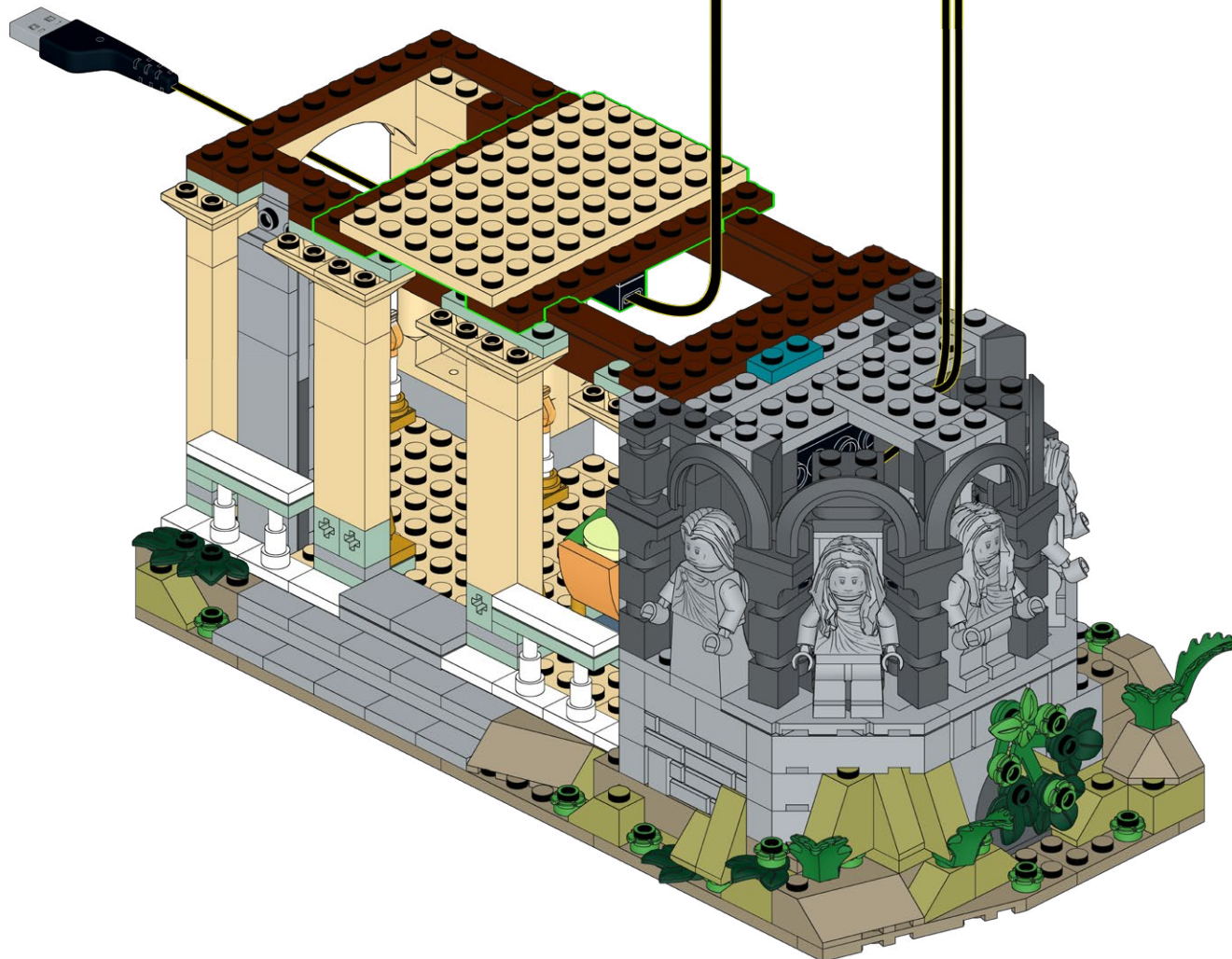

90

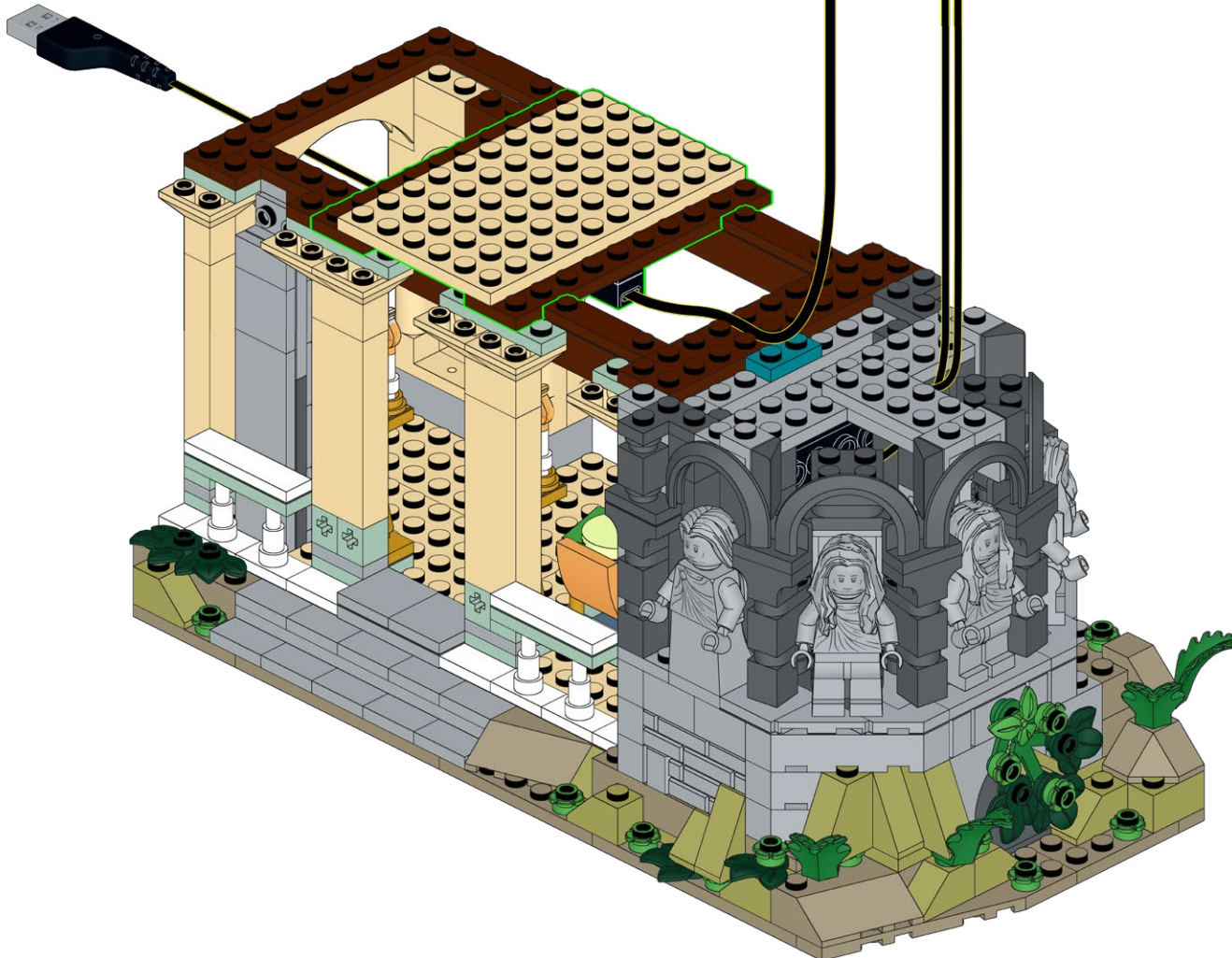

91

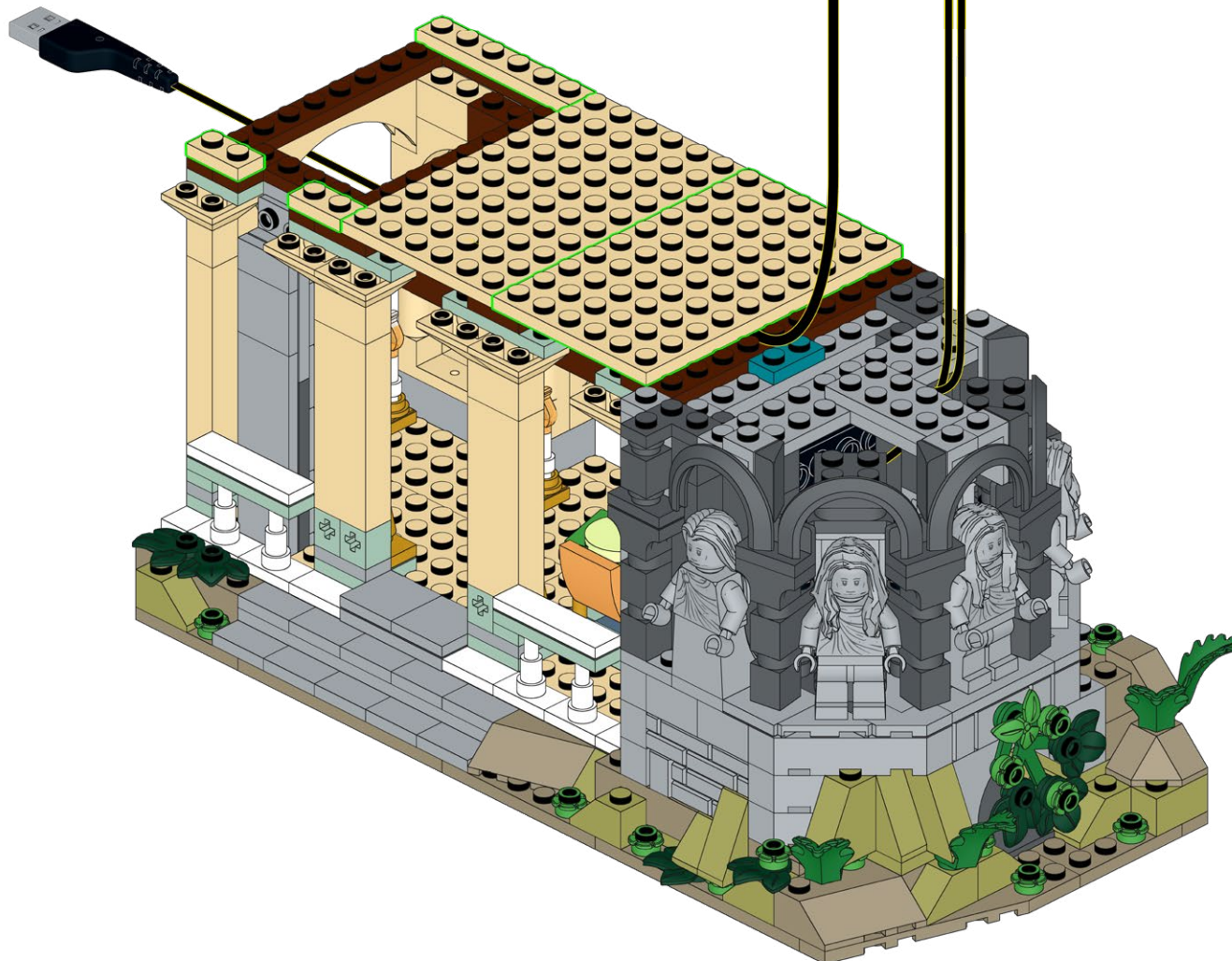
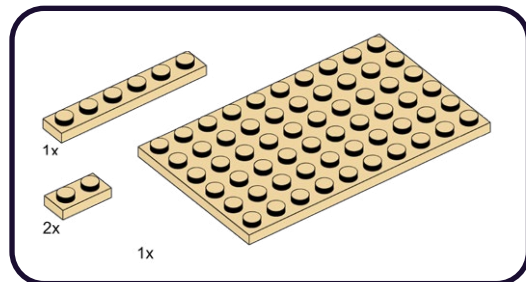

92

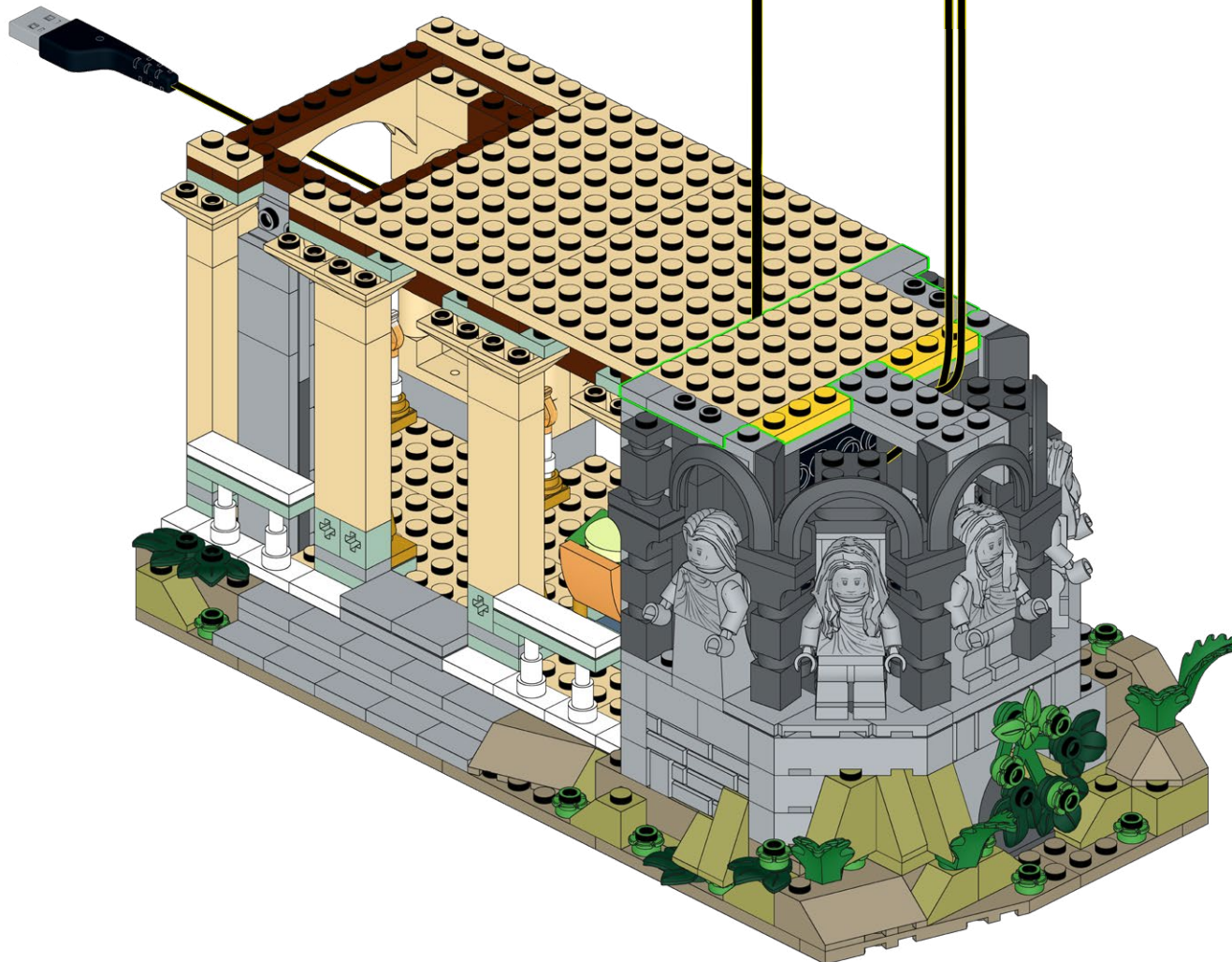
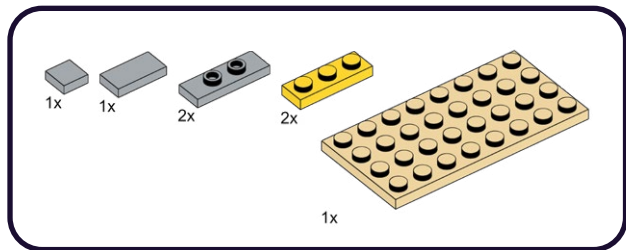

**HOLD UP!**

You might notice some bags aren't in order, as well as left over pieces, but that's ok! We're changing the way you build LEGO!

**ATTENDEZ!**

Vous remarquerez peut-être que certains sacs, ainsi que certaines pièces, ne sont pas dans le bon ordre. Mais pas de panique! Nous changeons simplement la façon avec laquelle vous construisez vos LEGO!

**ASPETTA!**

Potresti notare che alcuni sacchetti non sono in ordine, così come i pezzi avanzati, ma va bene così! Stiamo cambiando il modo in cui costruisci i LEGO!

**HALT!**

Sie werden möglicherweise bemerken, dass einige tüten durcheinander sind und teile übrig bleiben, aber das ist in Ordnung! Wir ändern die art und weise, wie Sie LEGO bauen!

**¡ESPERA!**

Es posible que notes que algunas bolsas están fuera de servicio, así como piezas sobrantes, ¡pero está bien! ¡Estamos cambiando la forma en que construyes LEGO!

**暫停!**

你可能会注意到一些袋子顺序错乱, 以及一些剩余的部件, 但没关系! 我们正在改变你搭建乐高的方式!

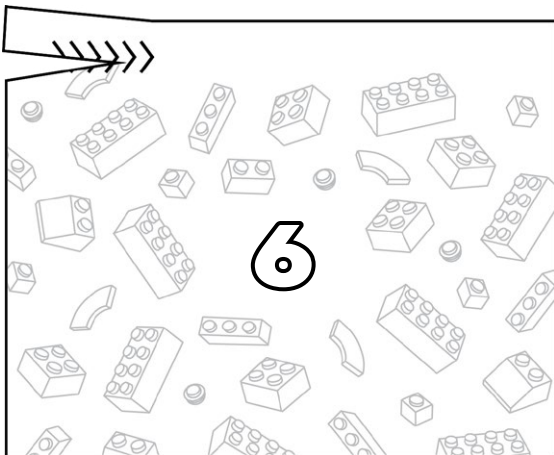
**Open LEGO® Bag 6**

93

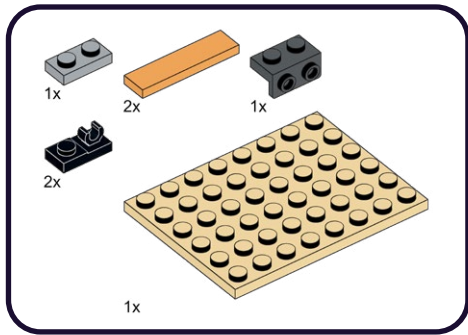

1

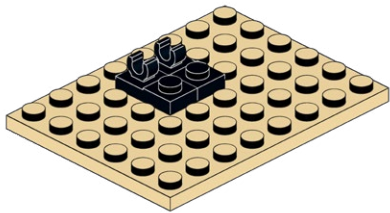

2

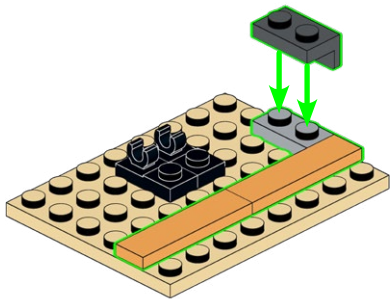

94

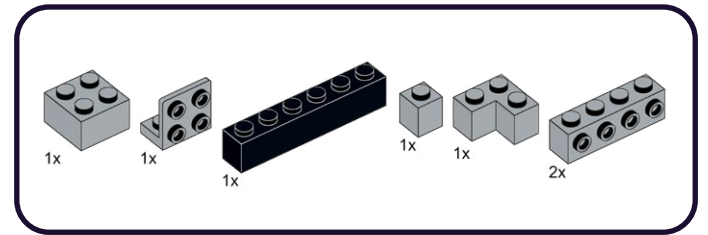

1

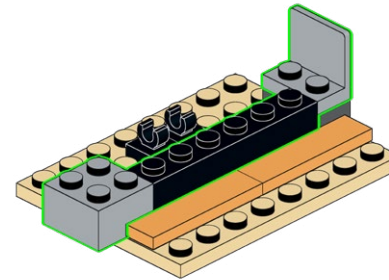

2

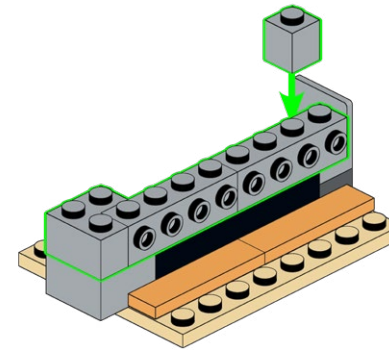

95

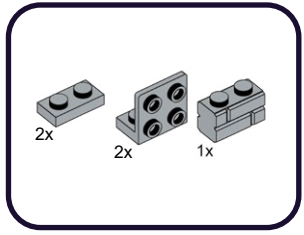

1

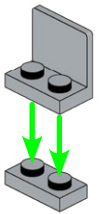

2

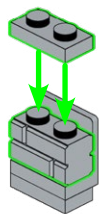

3

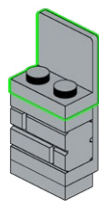

96

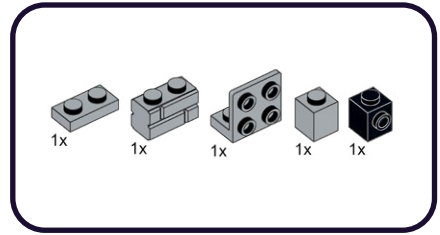

1

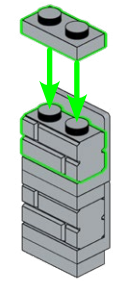

2

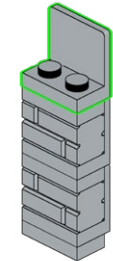

3

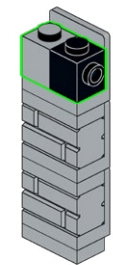

97

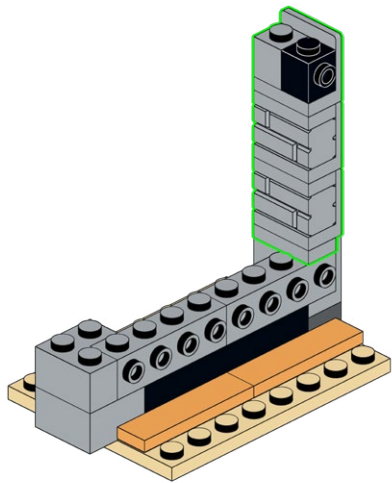

98

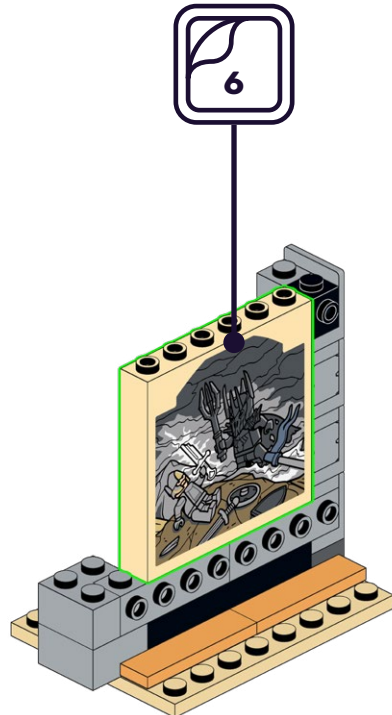
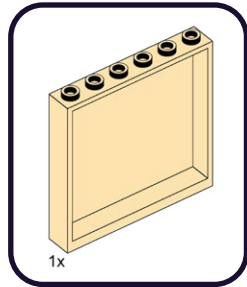



99

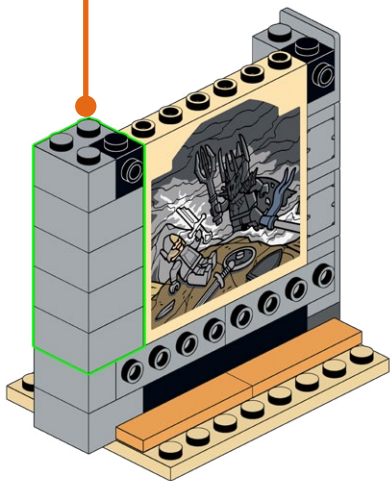
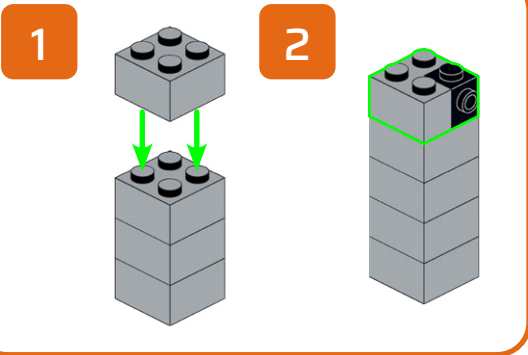
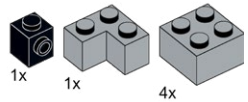

100

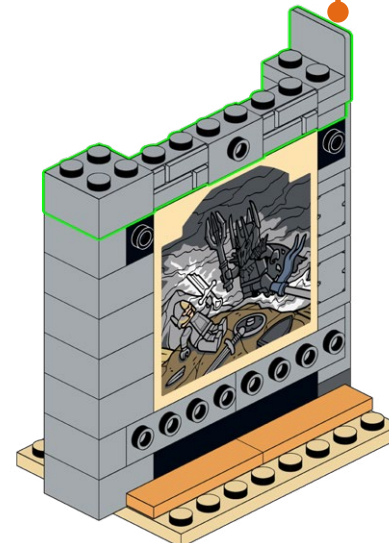
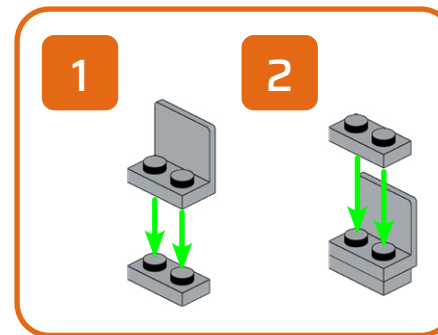
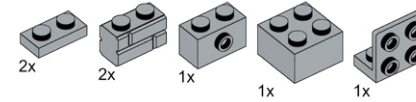

101

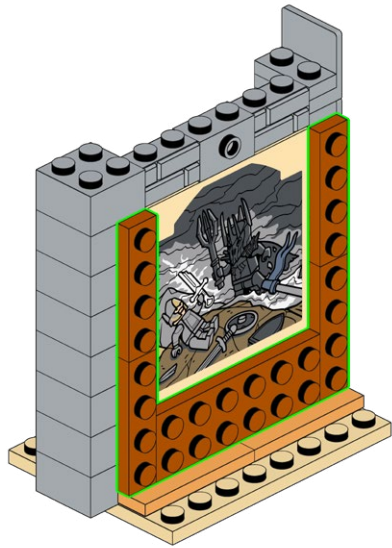
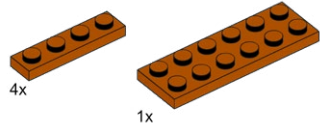

102

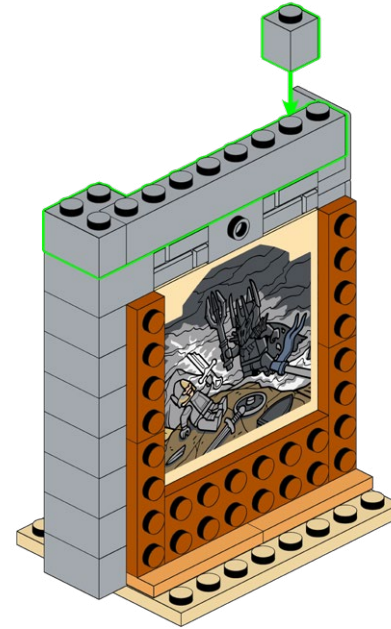
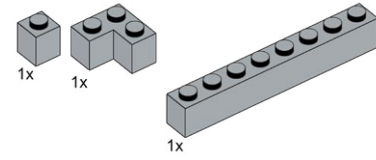

103

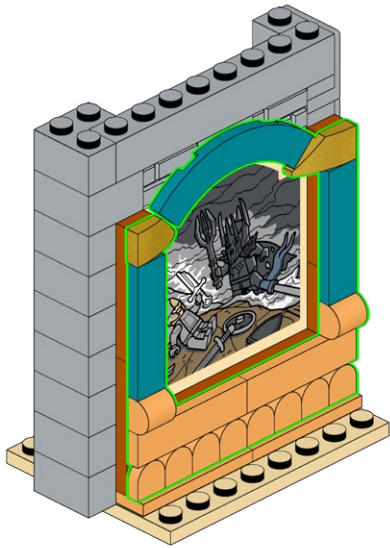
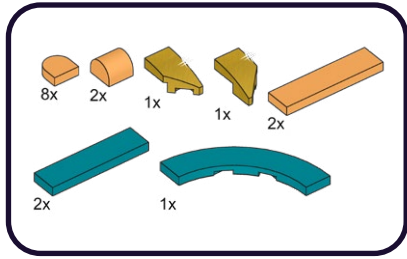

104

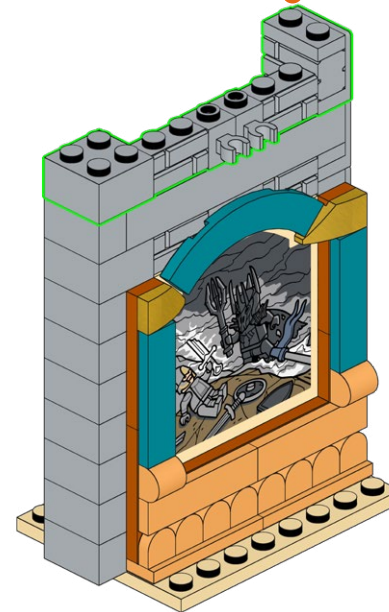
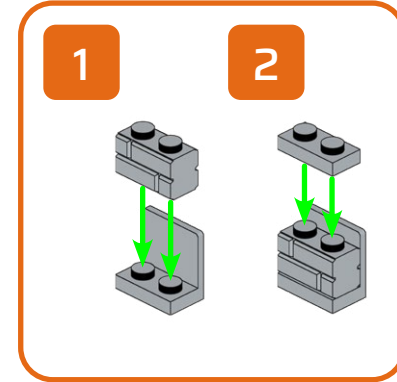
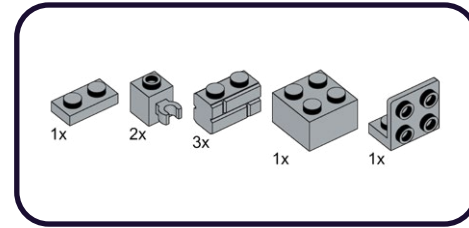

105

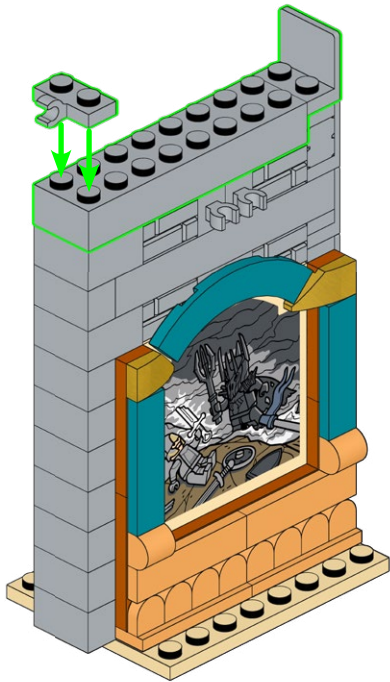
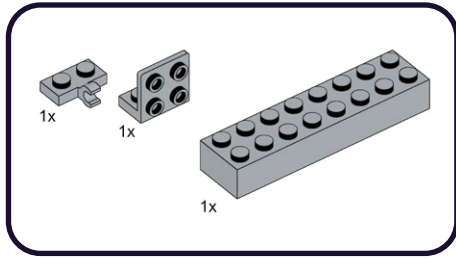

106

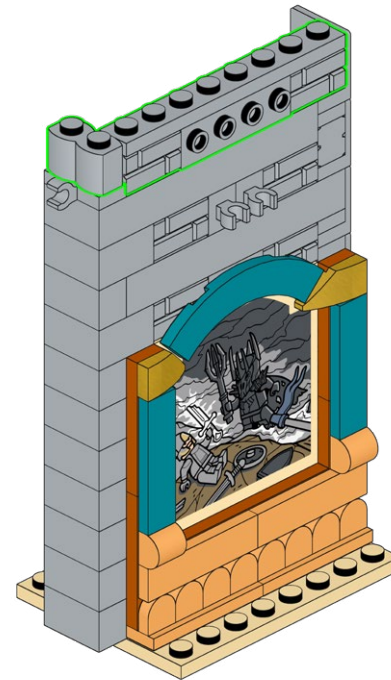
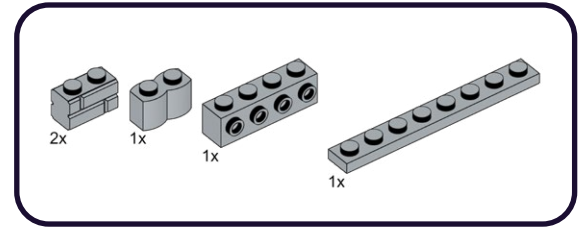

107

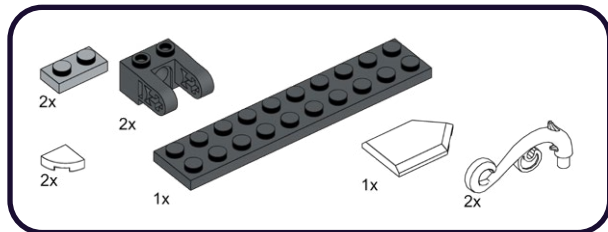

1

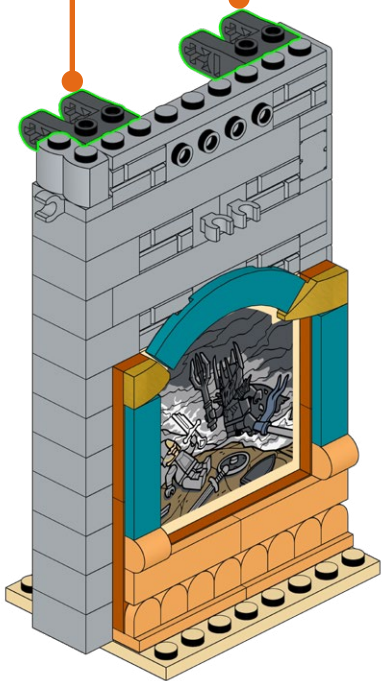
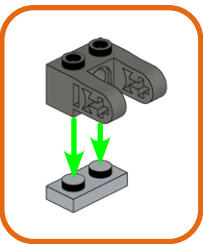

2

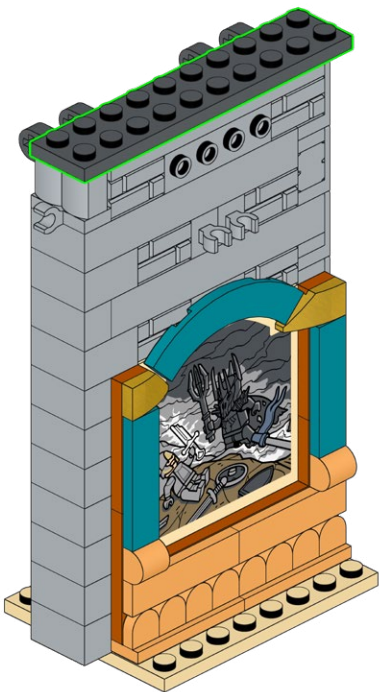

3

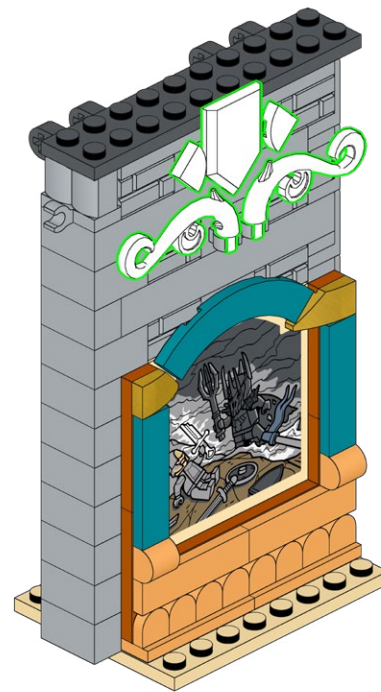

108

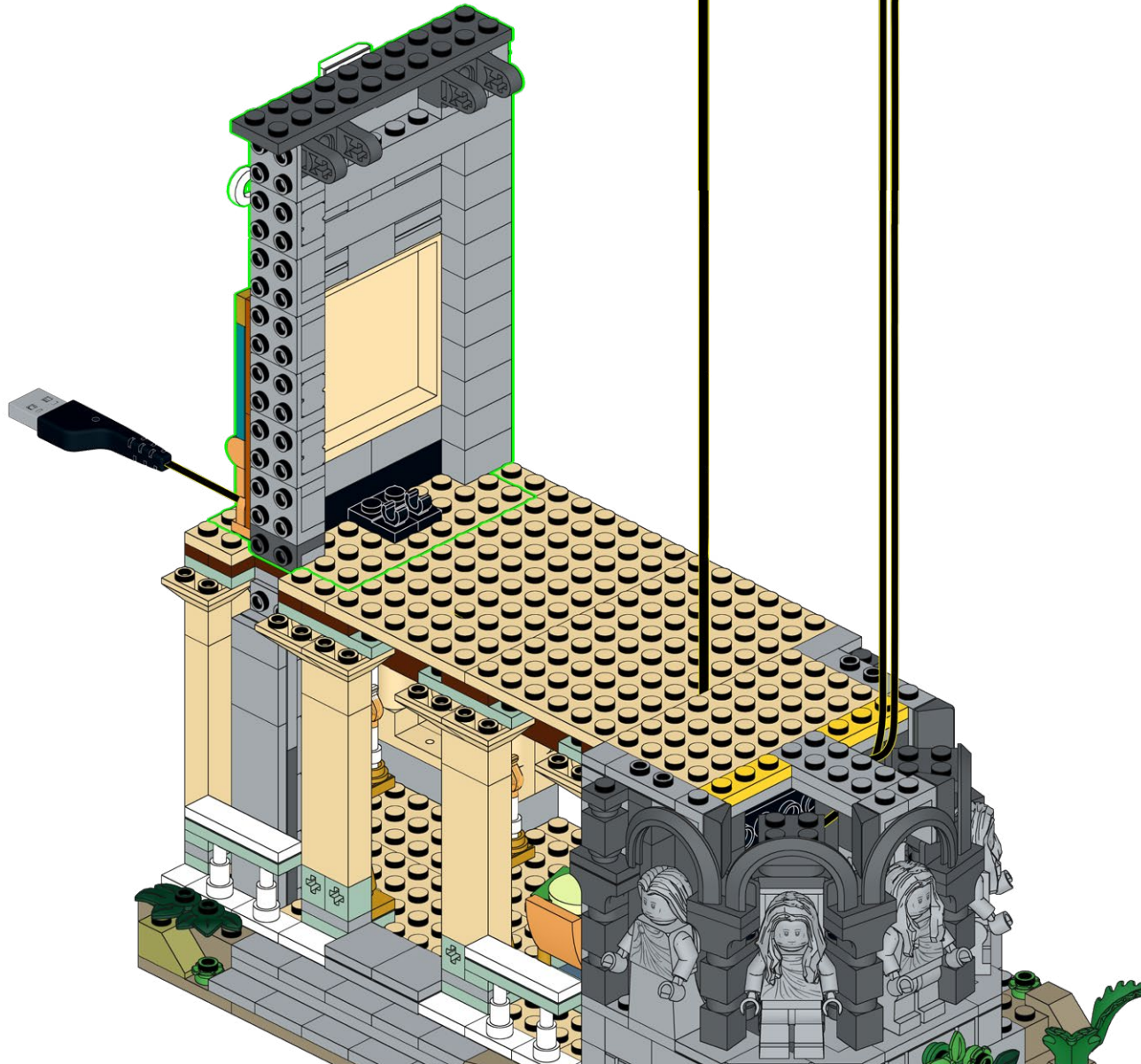

109

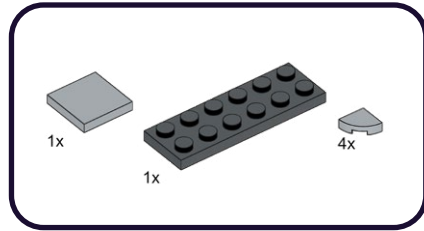

1

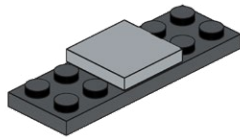

2

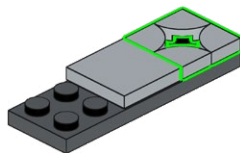

110

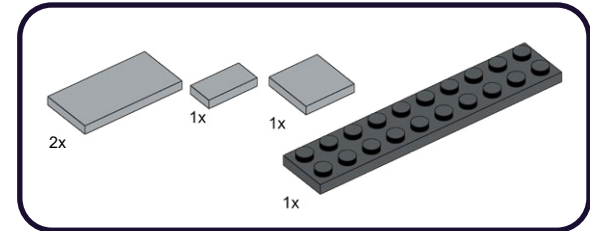

1

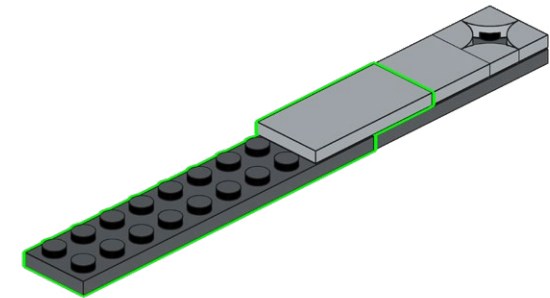

2

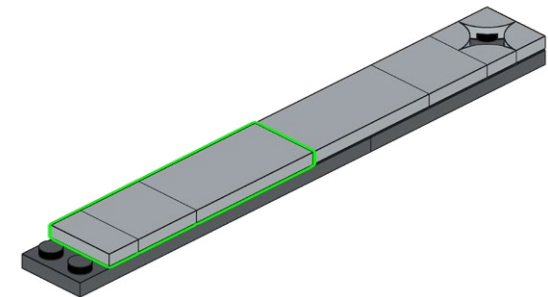

111

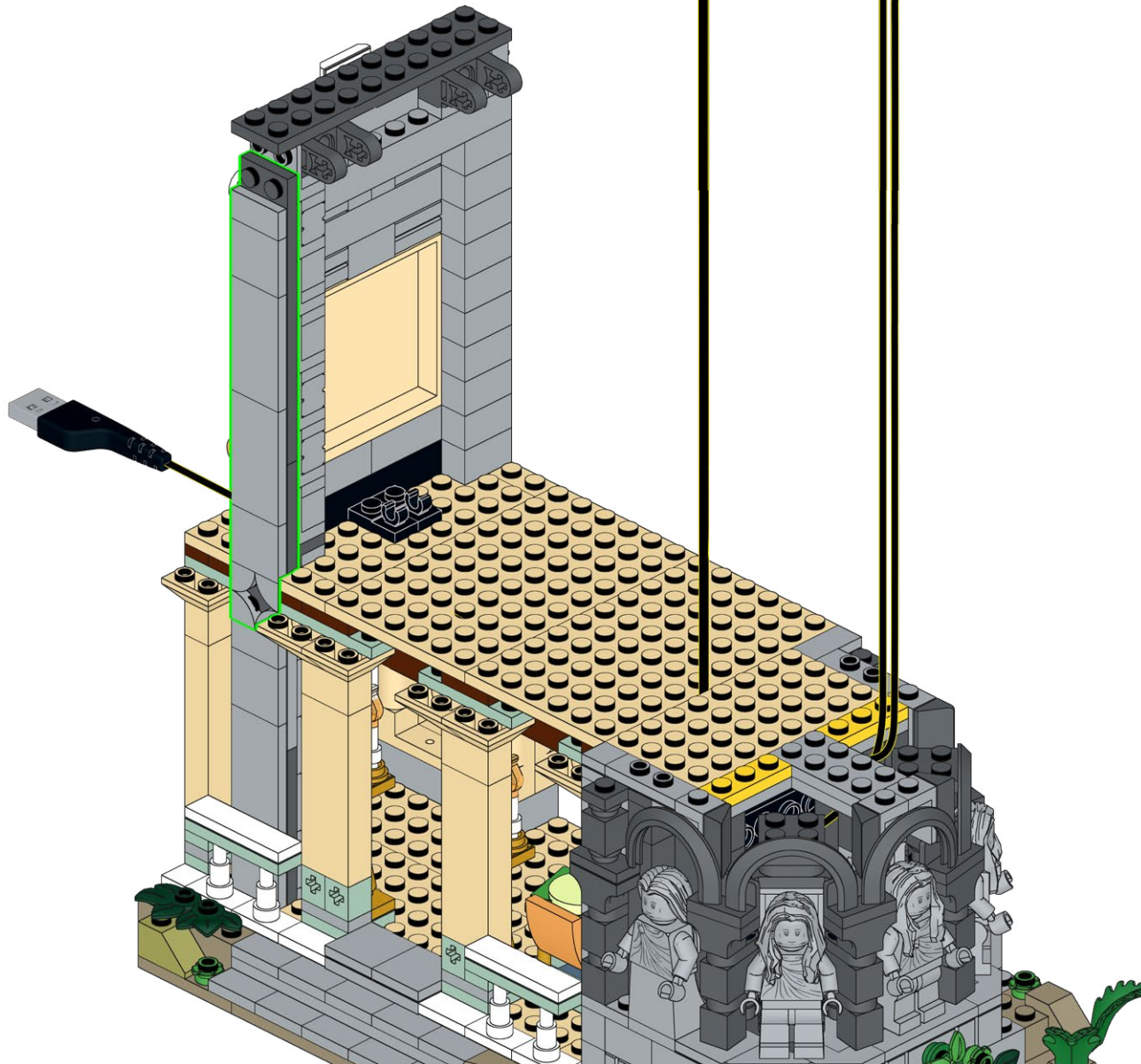



112

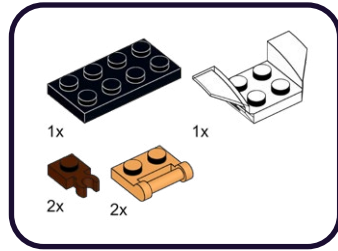

1

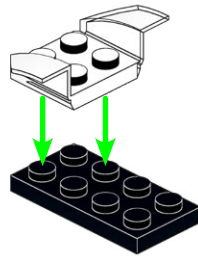

2

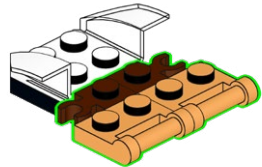

113

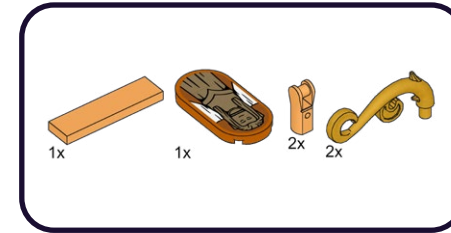

1

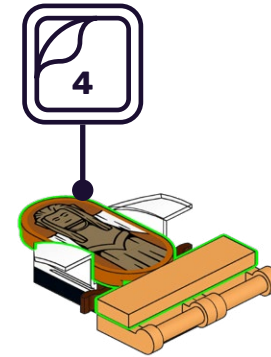

2

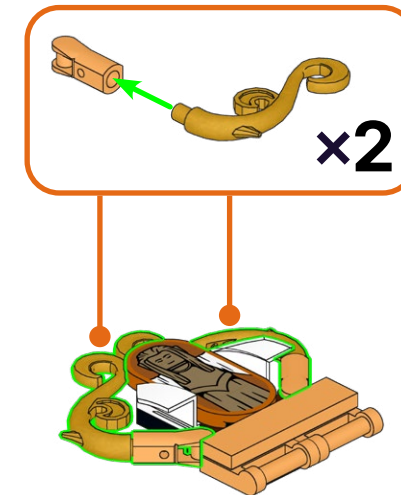

114





117

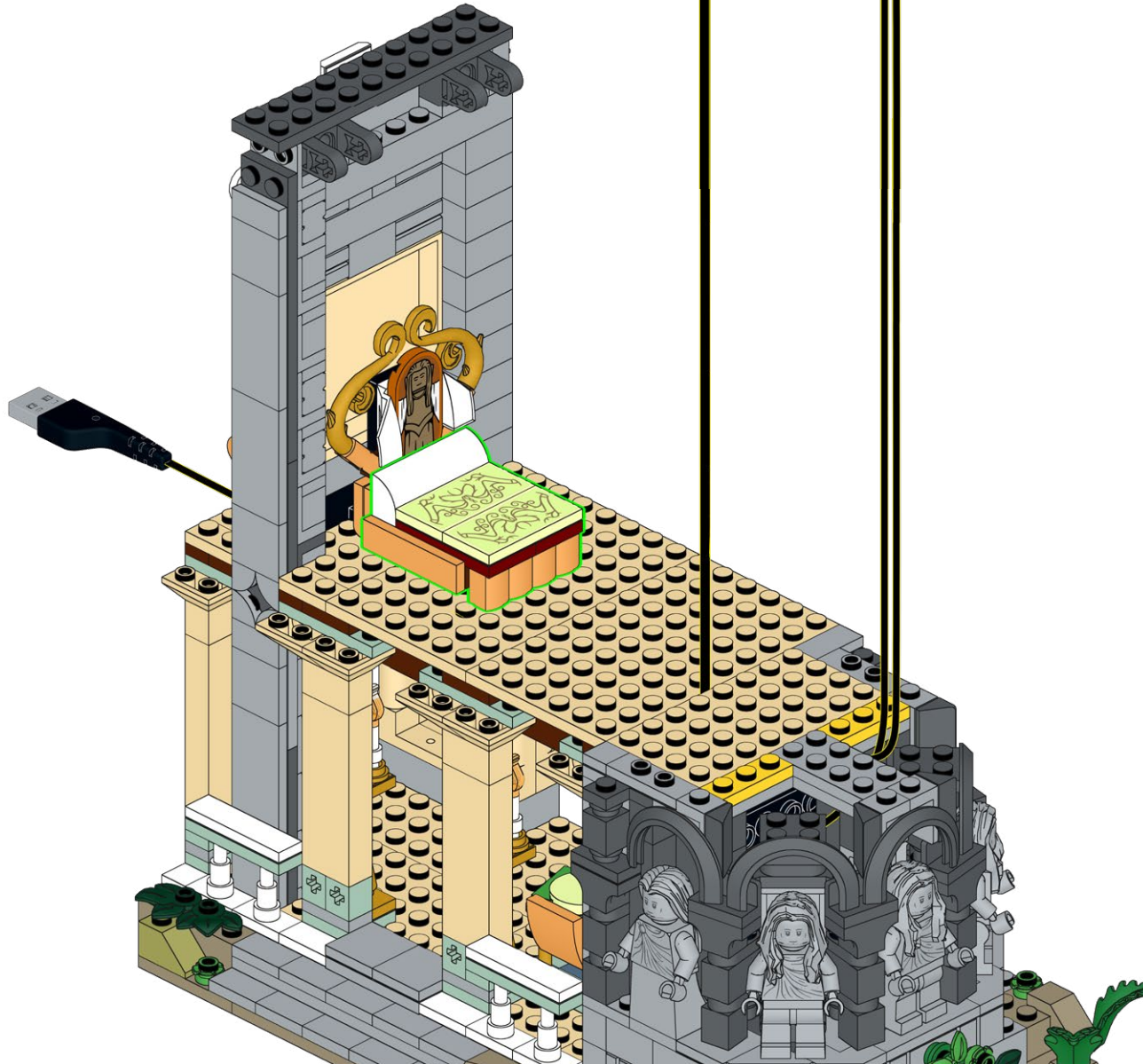

118

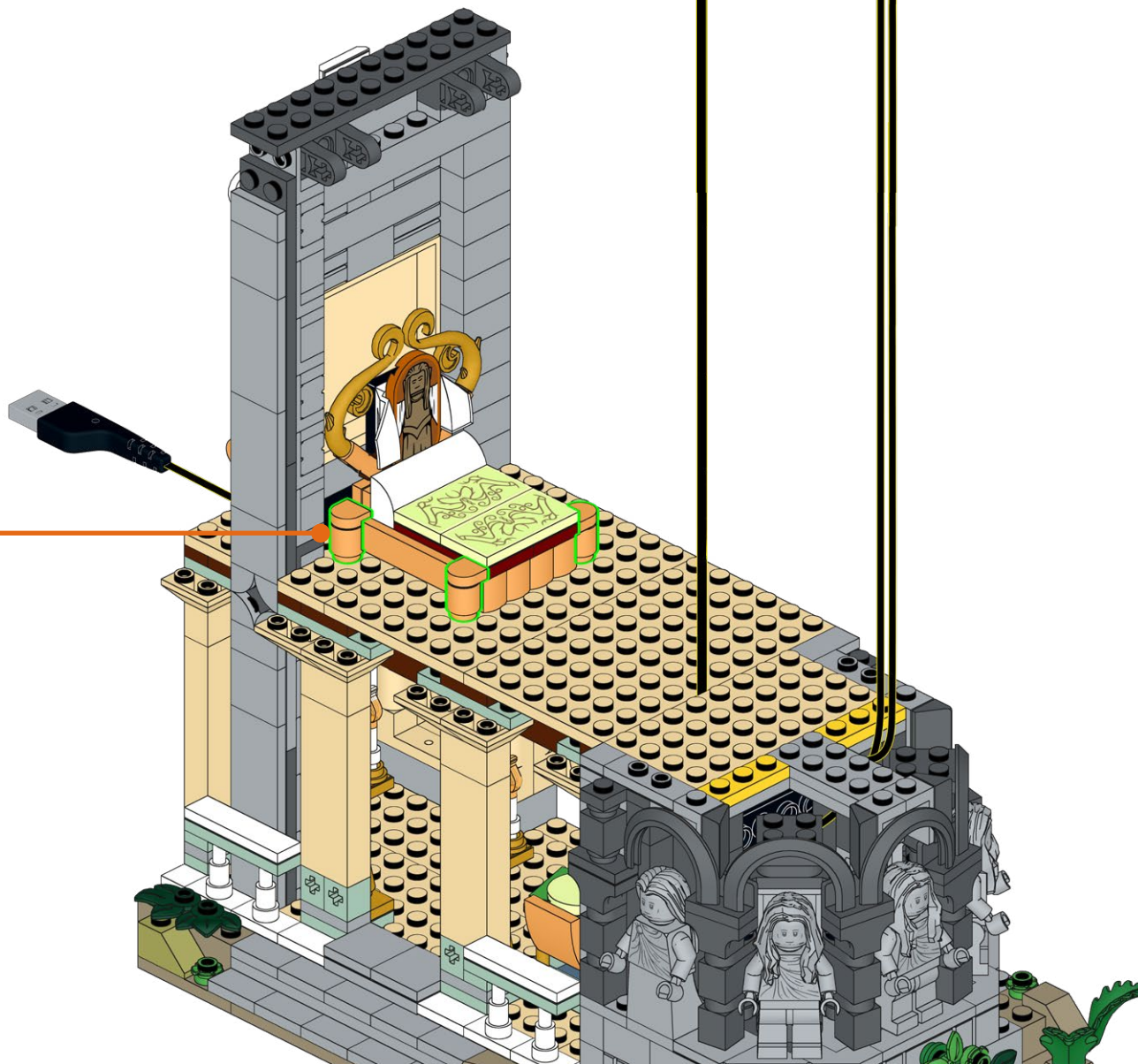
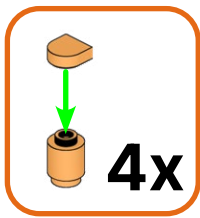

119

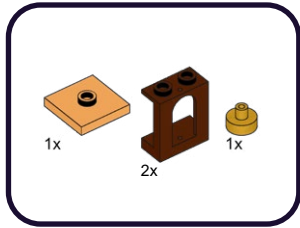

1

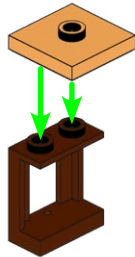

2

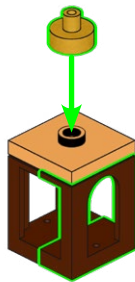

120

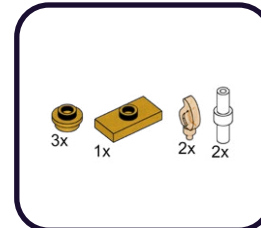

1

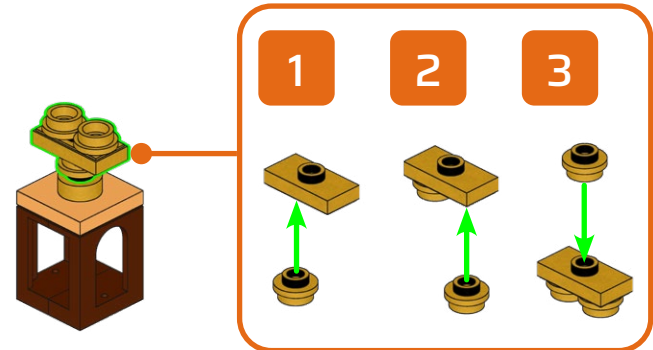

2

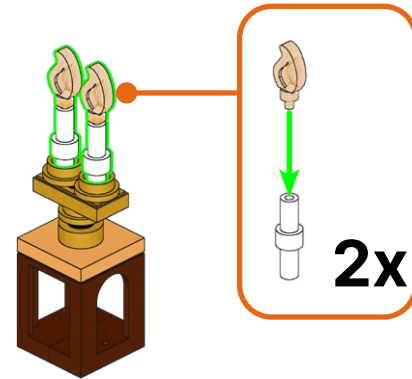

121

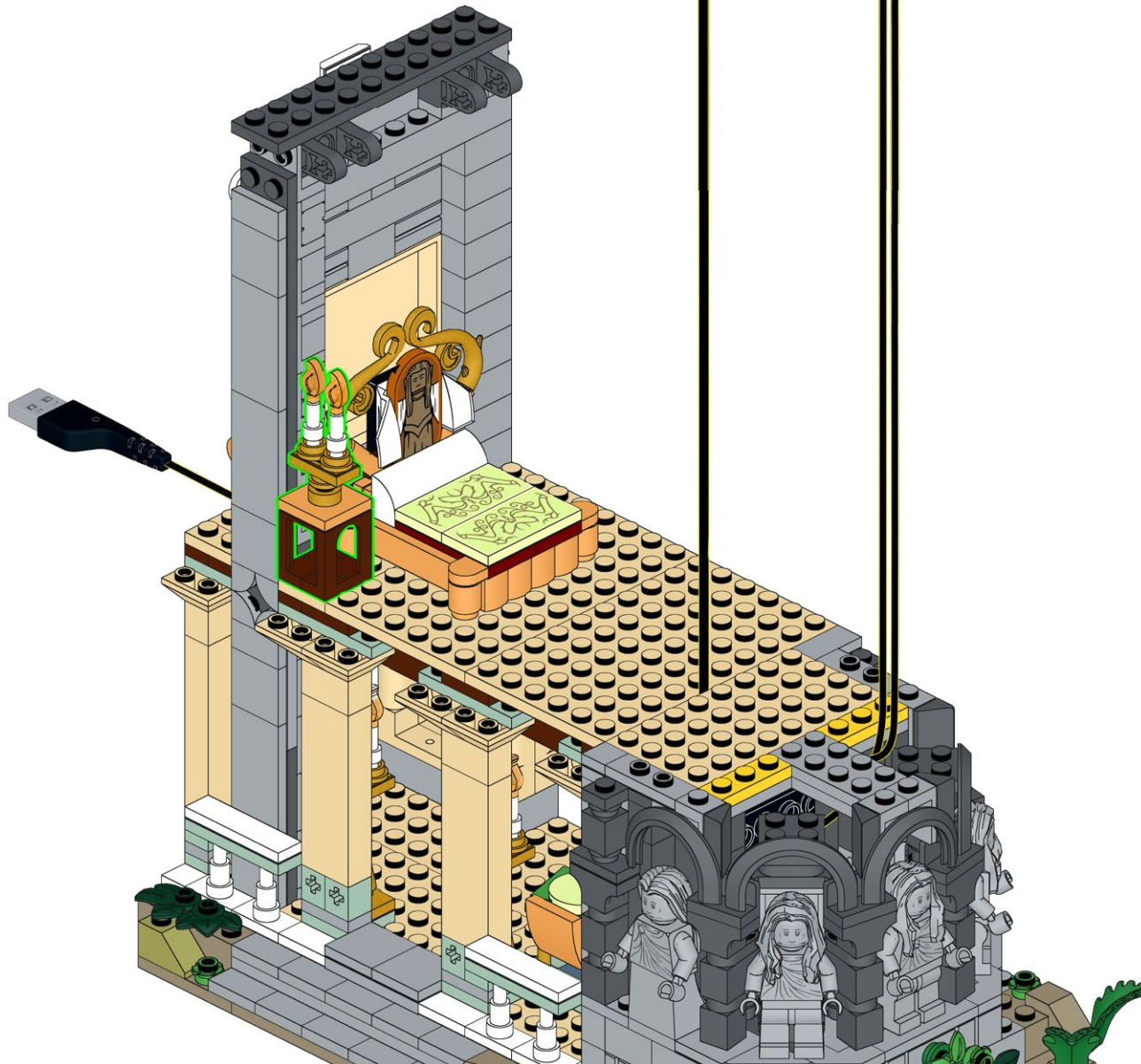

**HOLD UP!**

You might notice some bags aren't in order, as well as left over pieces, but that's ok! We're changing the way you build LEGO!

**ATTENDEZ!**

Vous remarquerez peut-être que certains sacs, ainsi que certaines pièces, ne sont pas dans le bon ordre. Mais pas de panique! Nous changeons simplement la façon avec laquelle vous construisez vos LEGO!

**ASPETTA!**

Potresti notare che alcuni sacchetti non sono in ordine, così come i pezzi avanzati, ma va bene così! Stiamo cambiando il modo in cui costruisci i LEGO!

**HALT!**

Sie werden möglicherweise bemerken, dass einige tüten durcheinander sind und teile übrig bleiben, aber das ist in Ordnung! Wir ändern die art und weise, wie Sie LEGO bauen!

**¡ESPERA!**

Es posible que notes que algunas bolsas están fuera de servicio, así como piezas sobrantes, ¡pero está bien! ¡Estamos cambiando la forma en que construyes LEGO!

**暫停!**

你可能会注意到一些袋子顺序错乱, 以及一些剩余的部件, 但没关系! 我们正在改变你搭建乐高的方式!

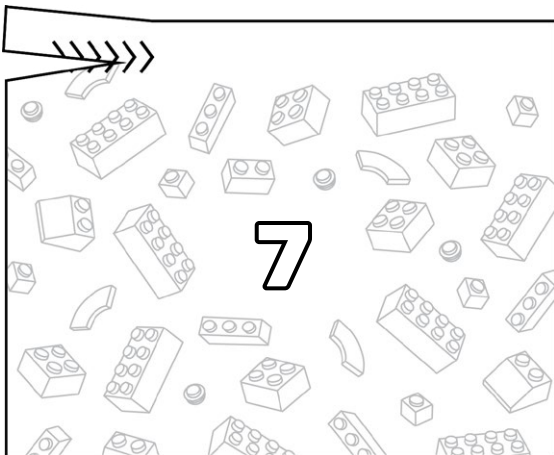
**Open LEGO® Bag 7**



122

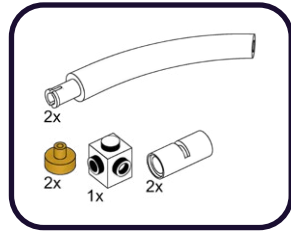

1



2

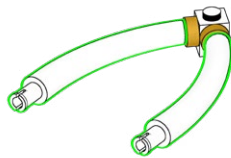

3

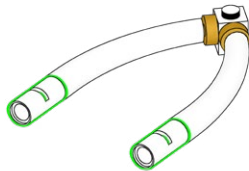

123

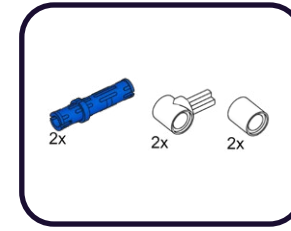

1

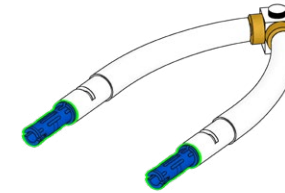

2

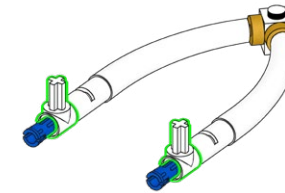

3

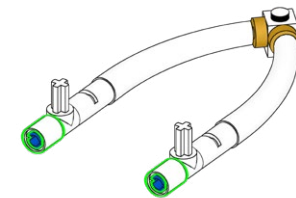

3x

124



125

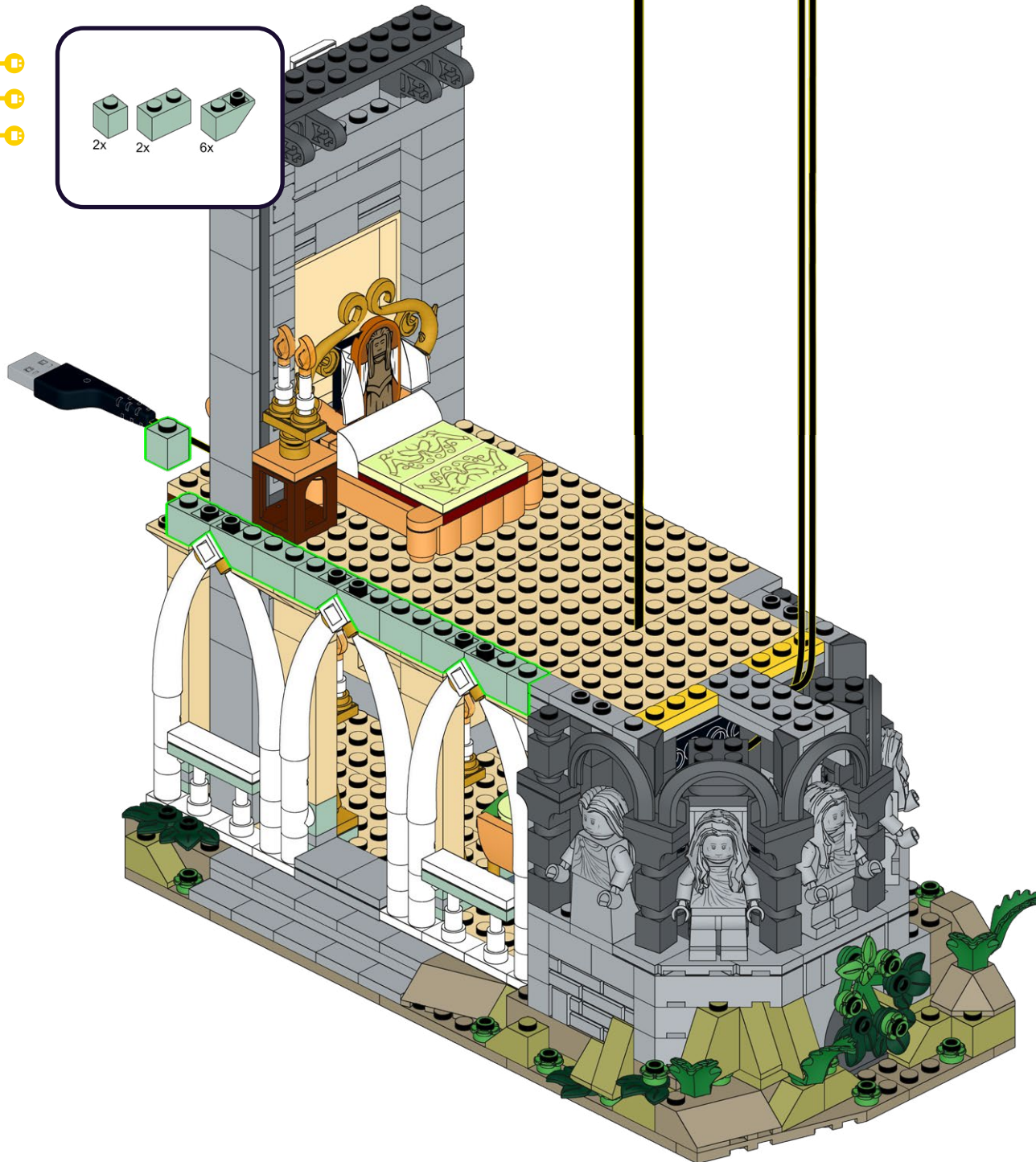
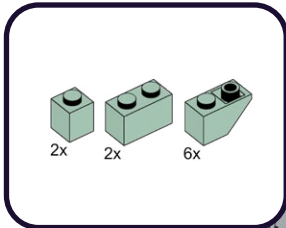

126

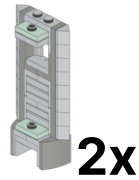

2x

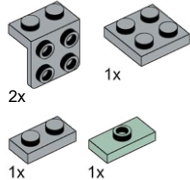

2x

1x

1x

1x

127

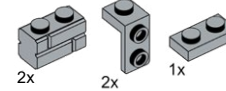

2x

2x

1x

1

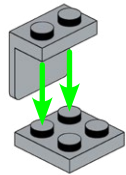

2

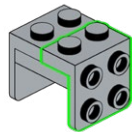

3

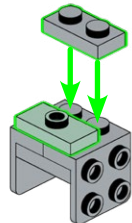

1

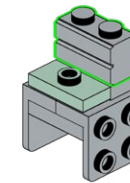

2

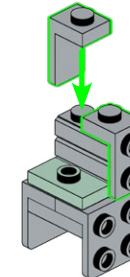

3

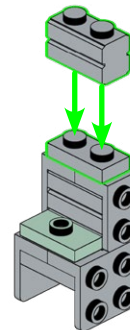

128

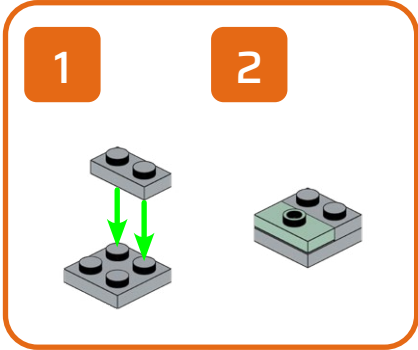
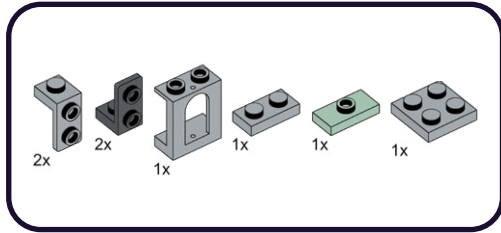

1

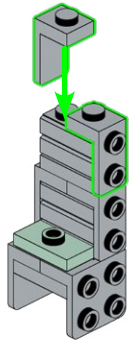

2

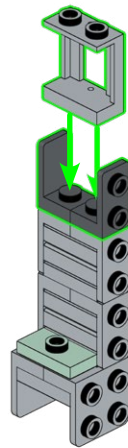

3

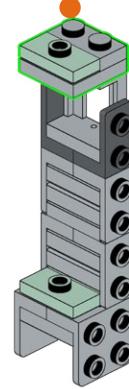

129

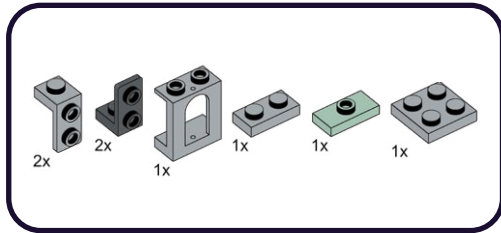

1

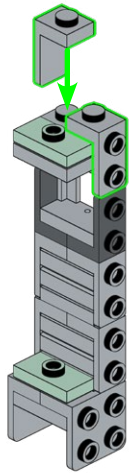

2

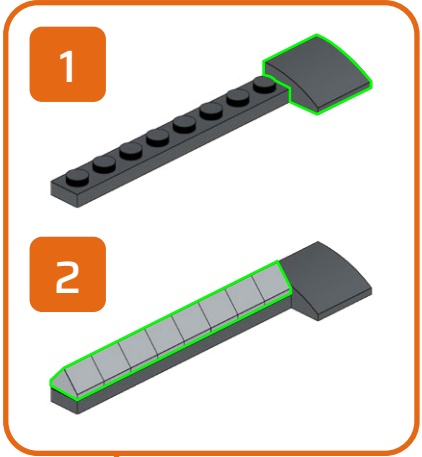
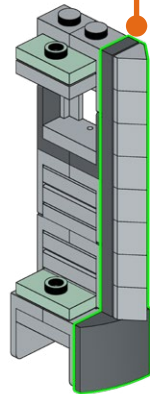

3

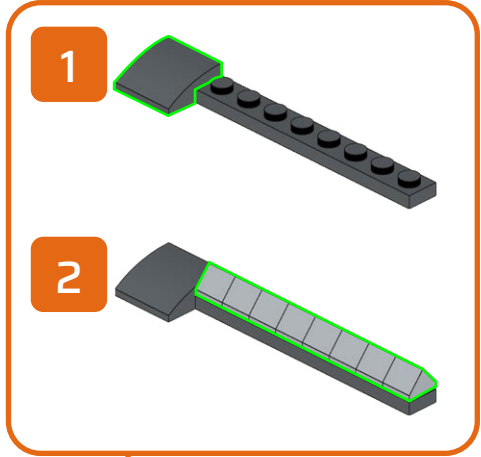

2x

130

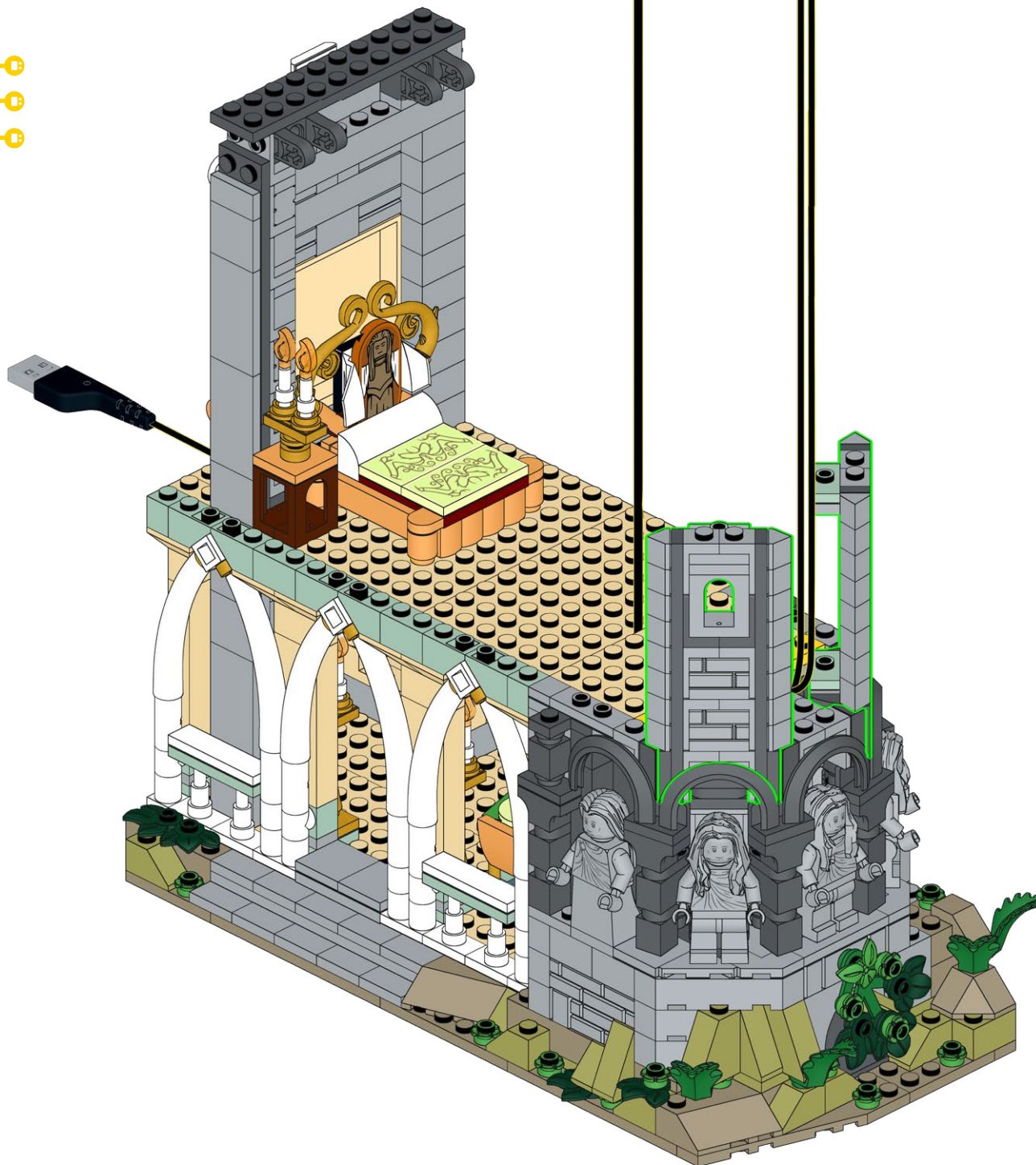

# 131

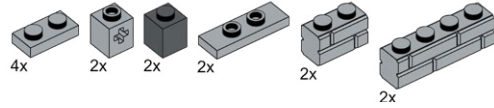

- 1
- 2
- 3
- 4

- 1
- 2
- 3
- 4

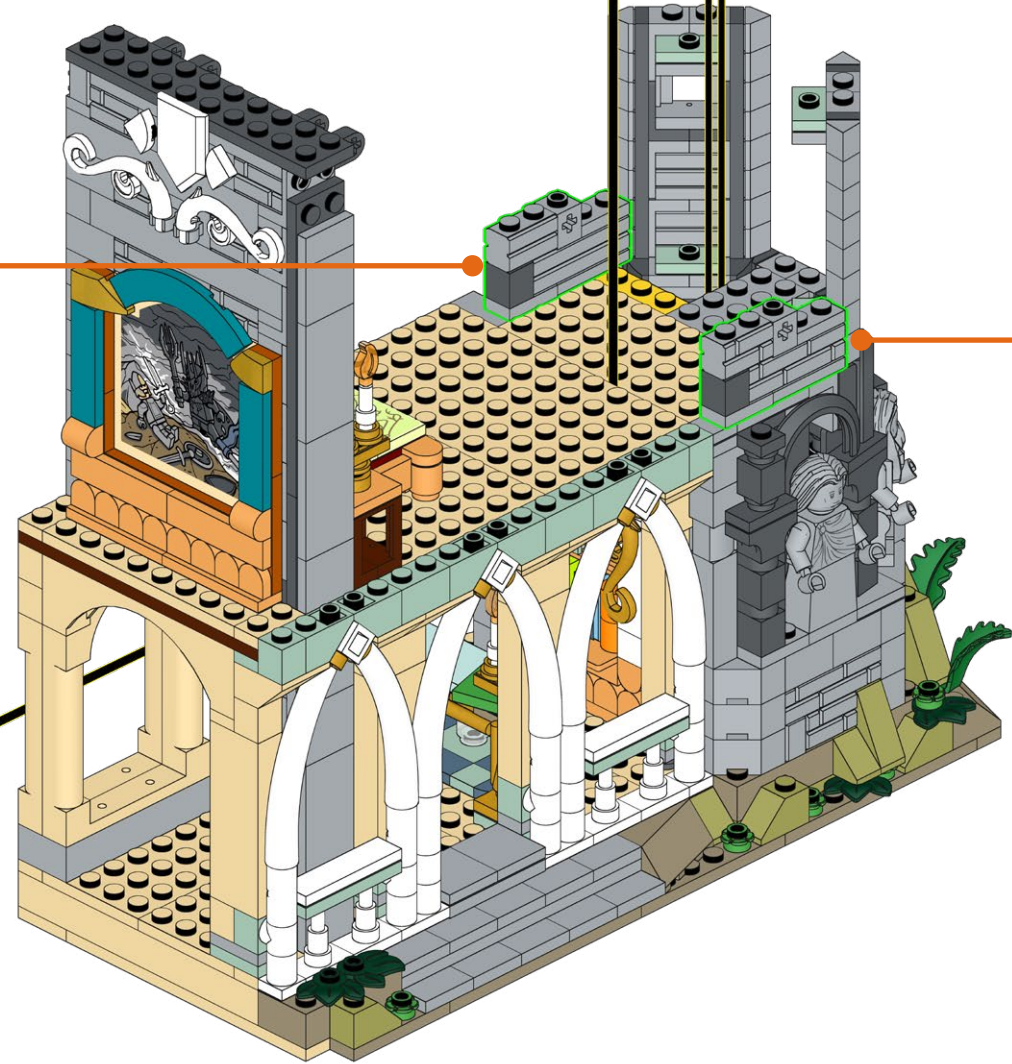



132

2x 2x 2x

1

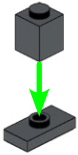

2



2x

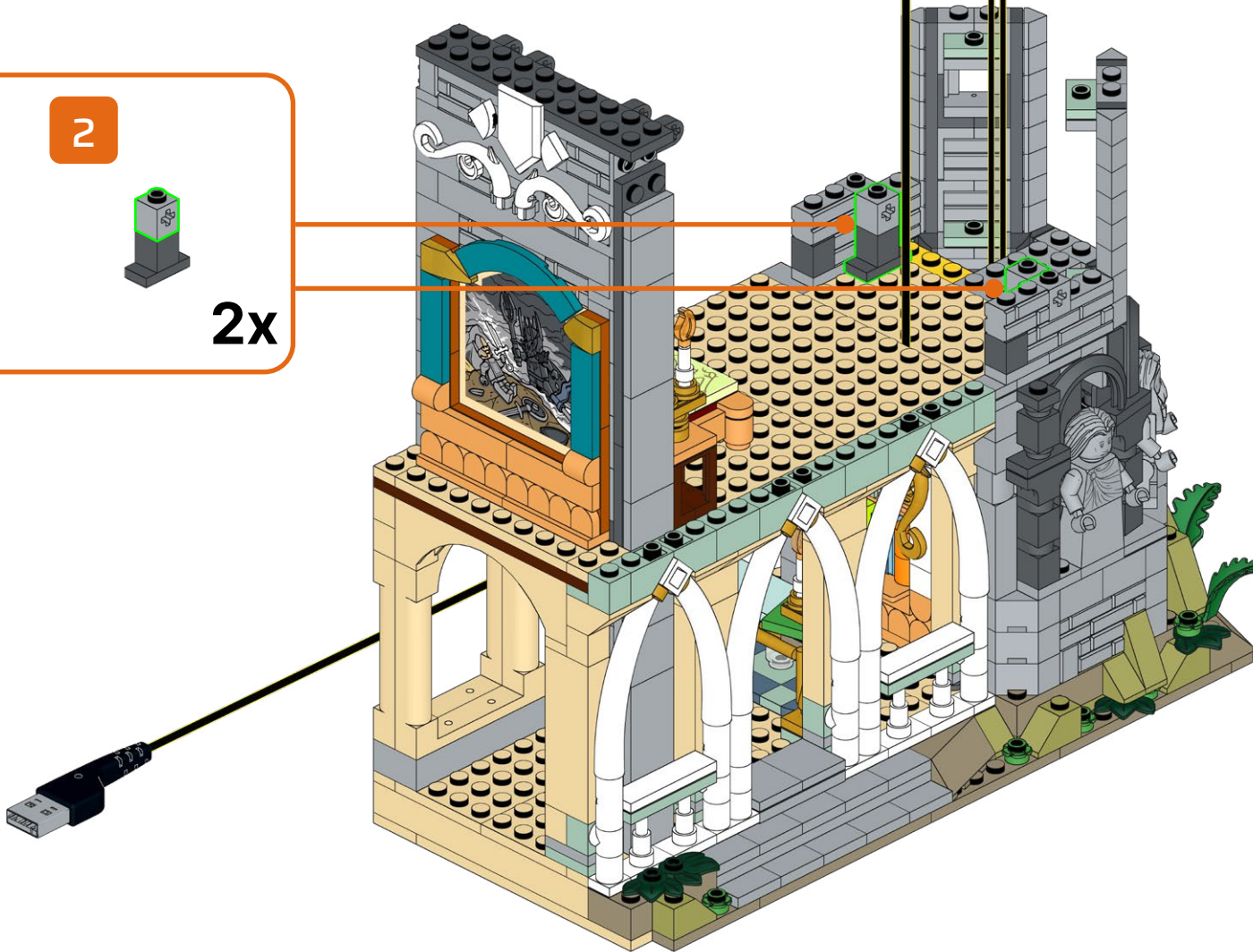

133

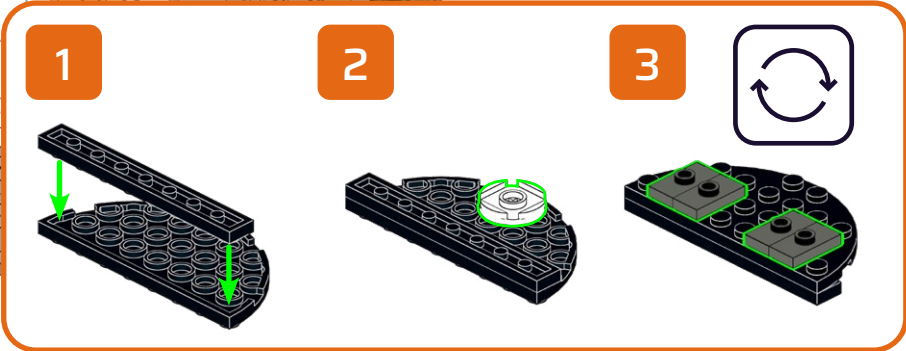
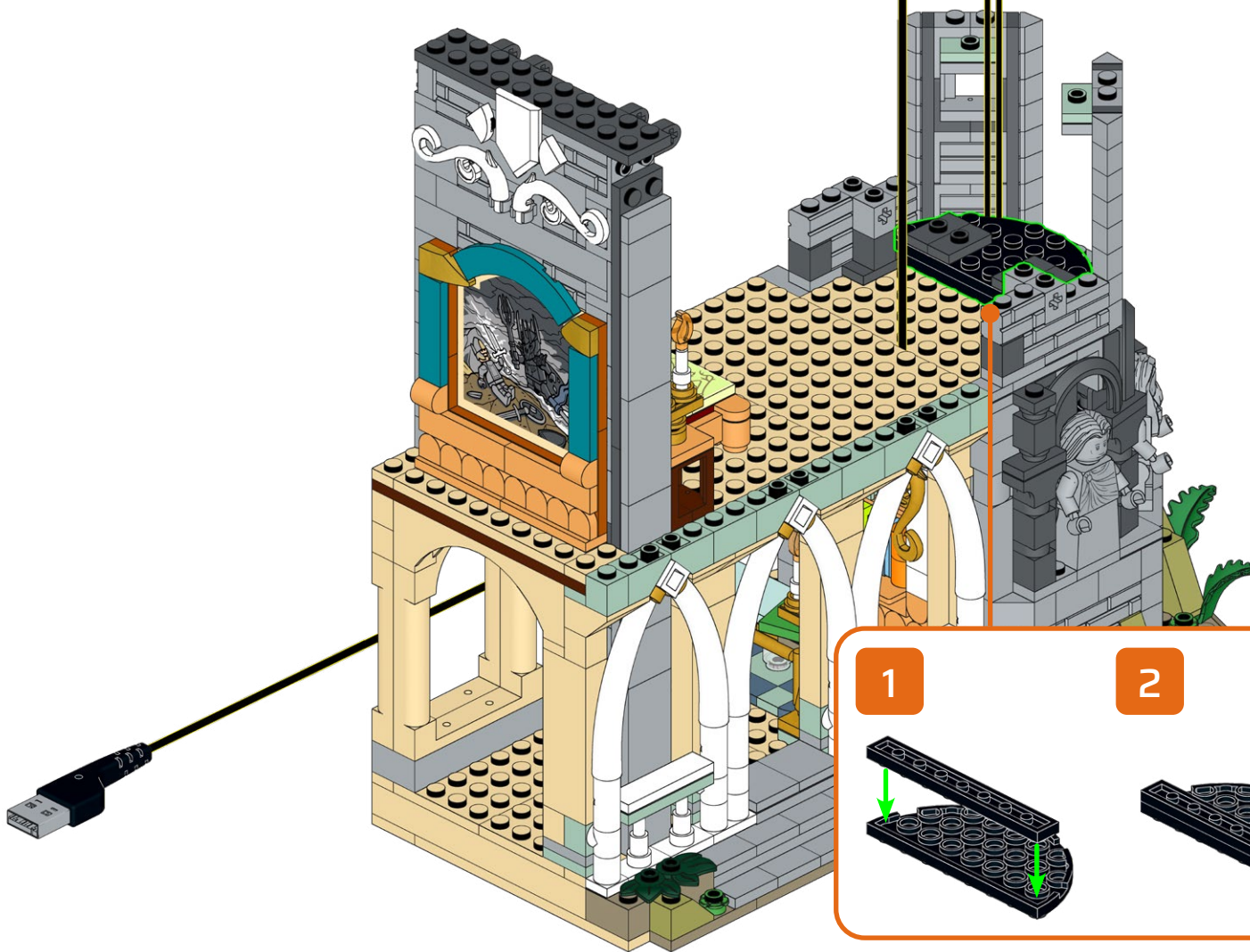
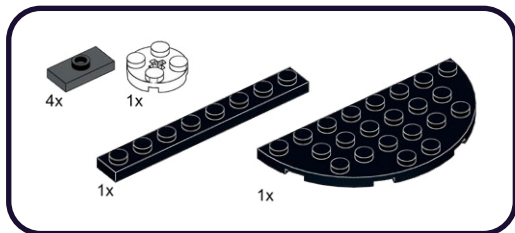

134

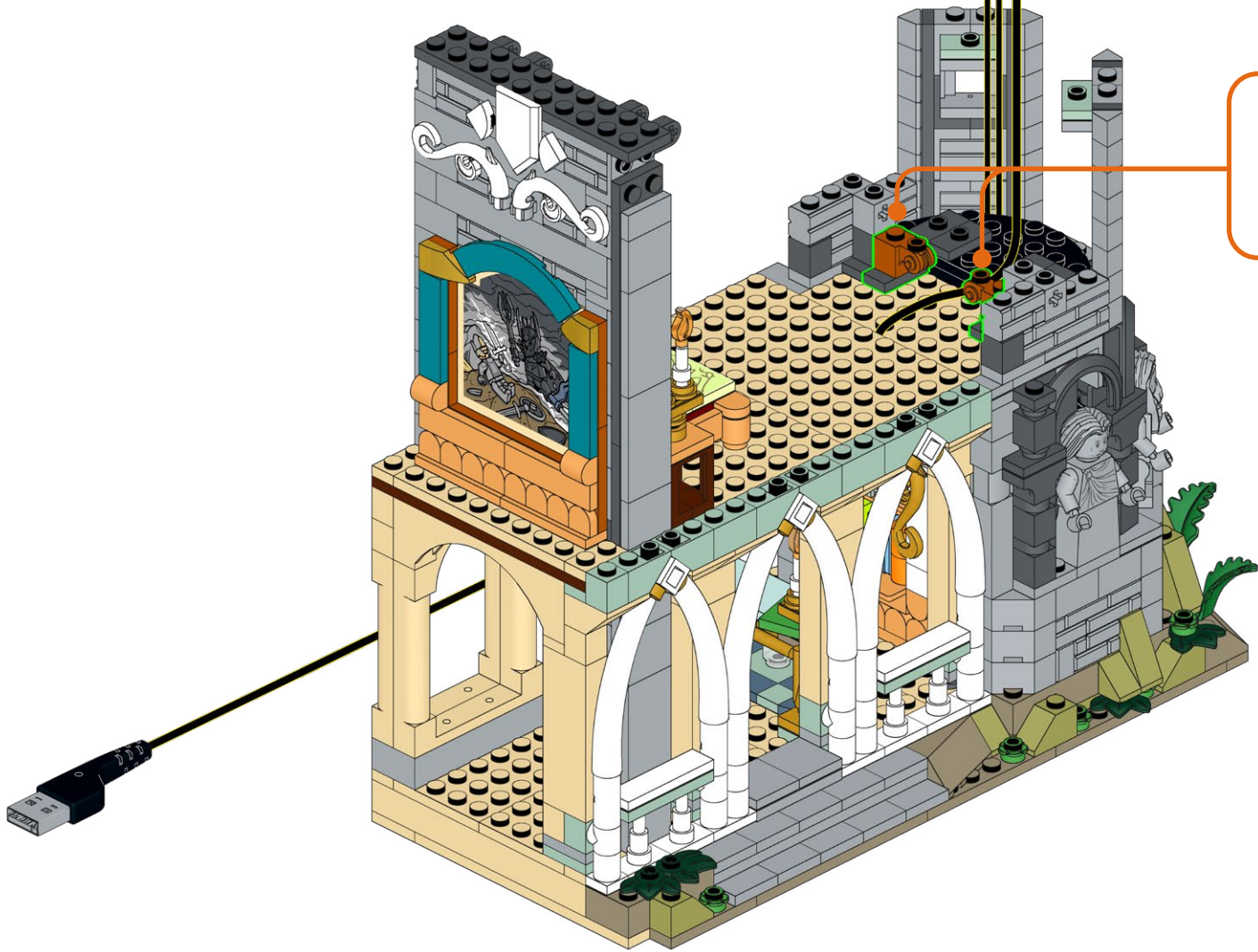
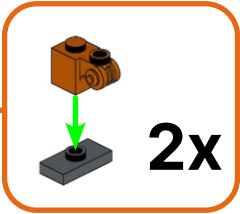
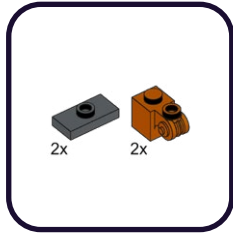

135

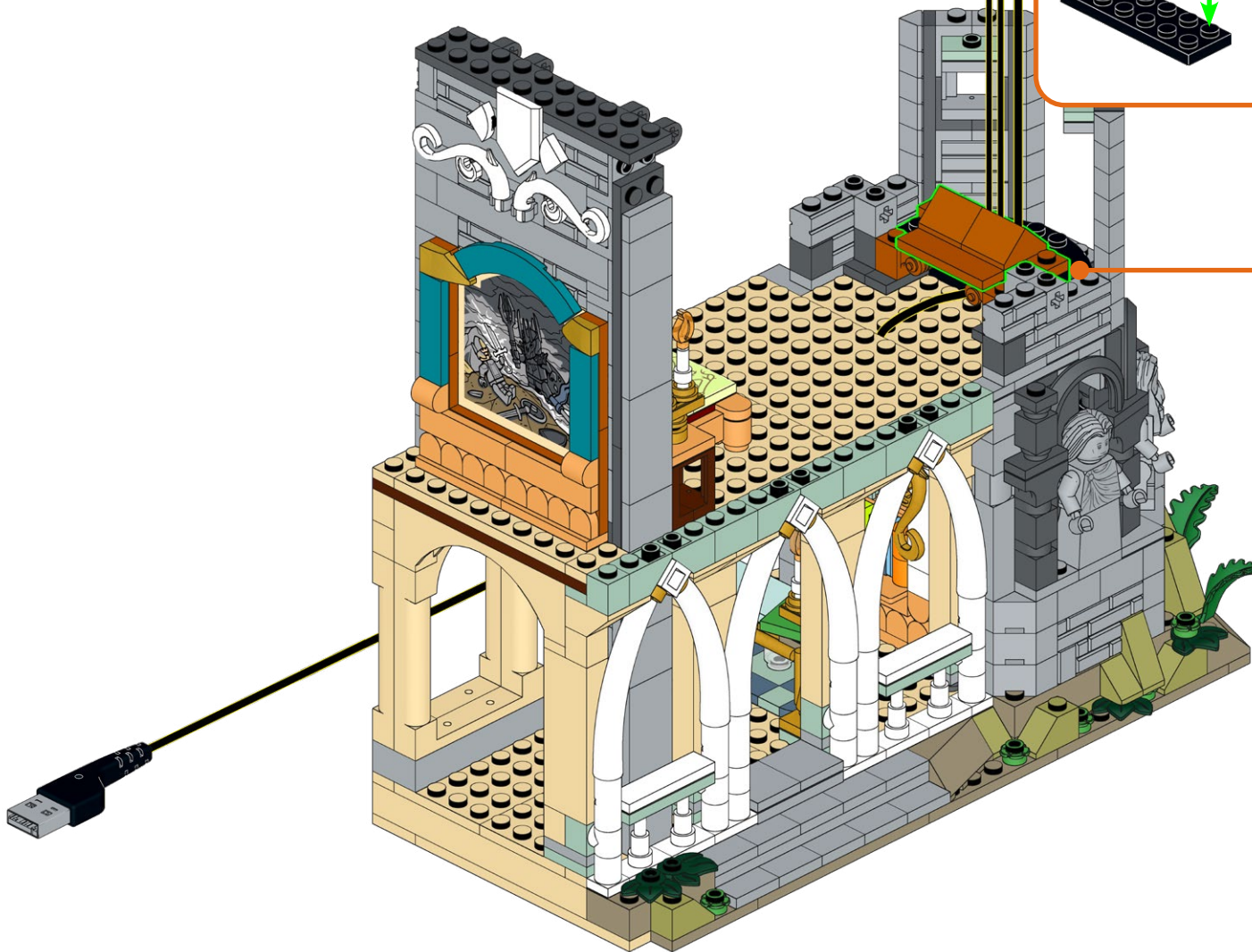
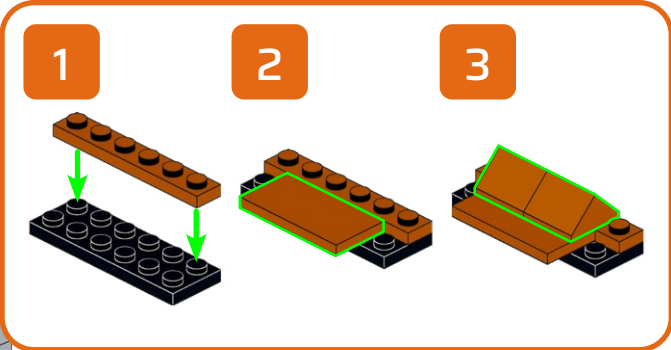
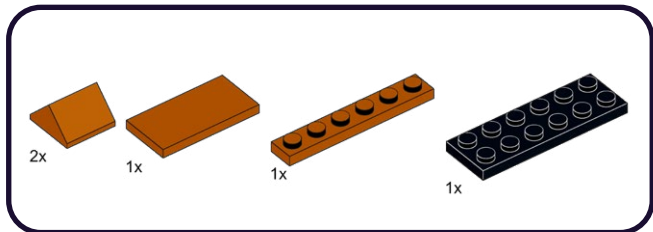

136

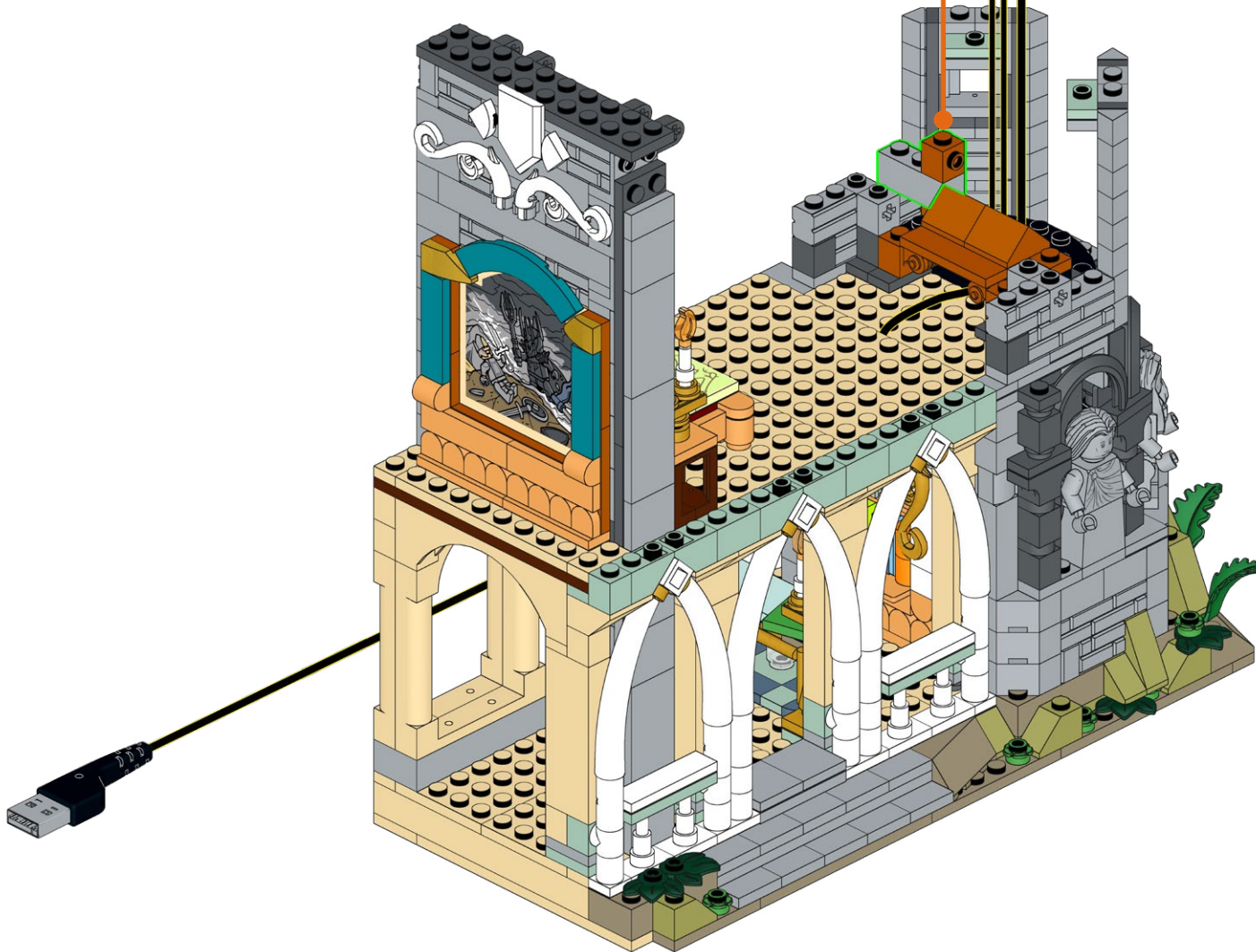
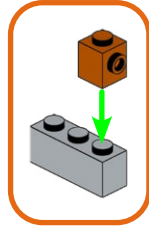
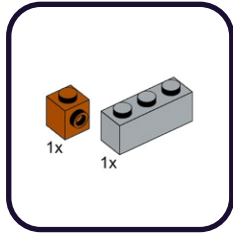

137

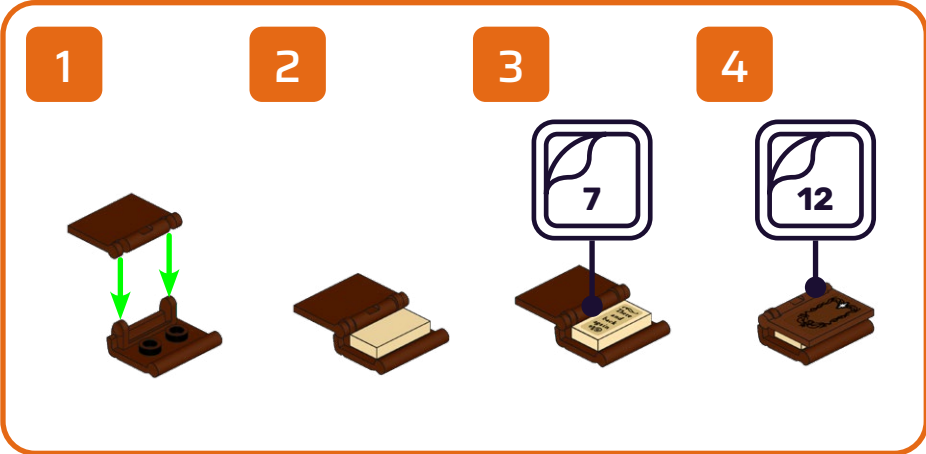
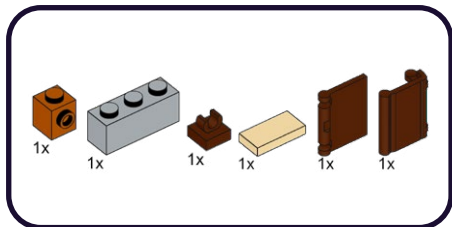

1

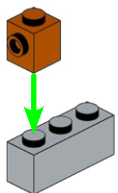

2

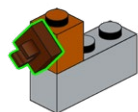

3

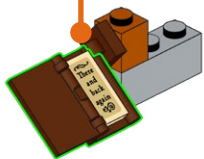

138

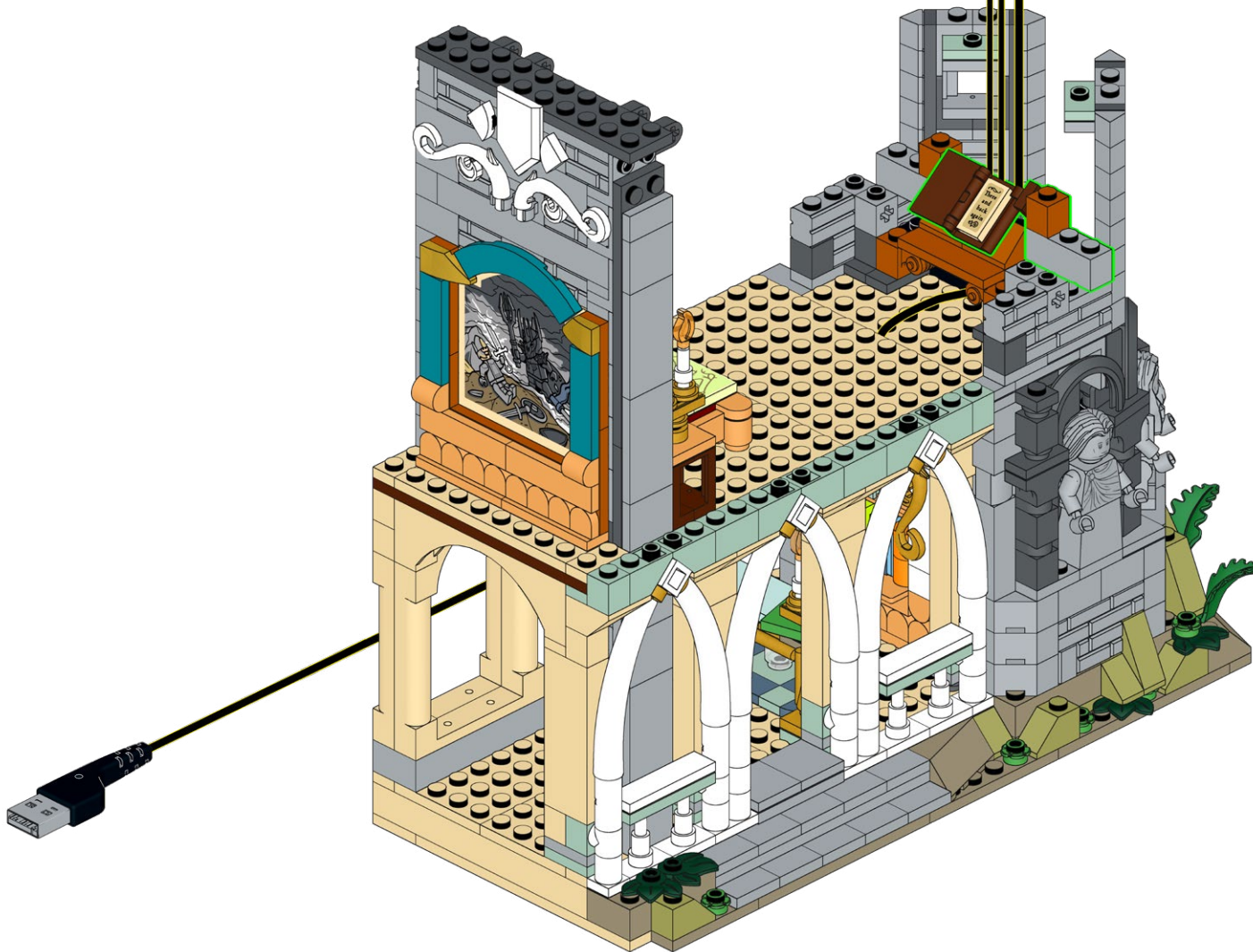

139

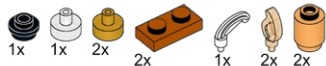

1

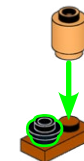

2



2

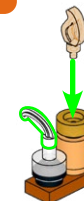

1

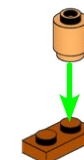

2

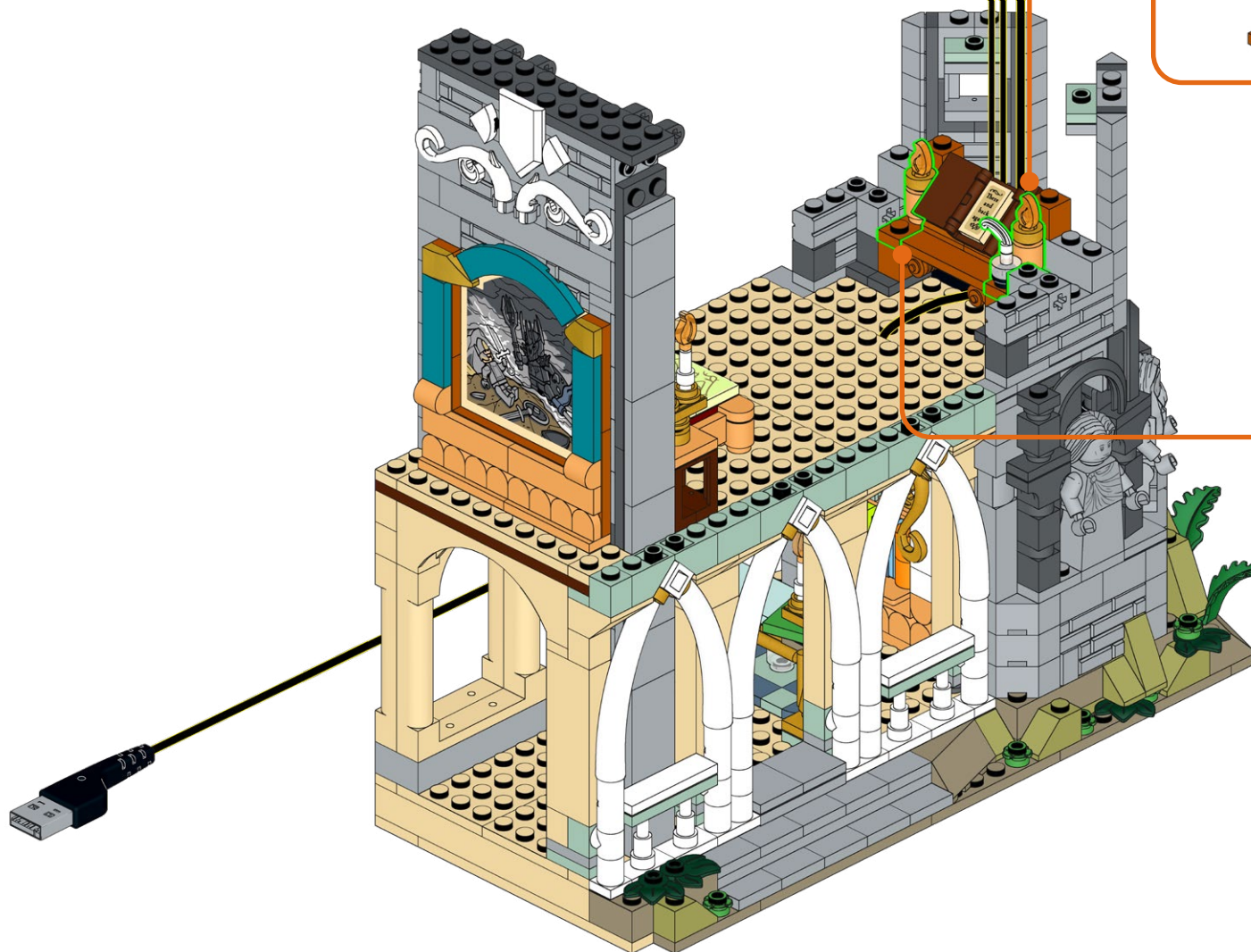
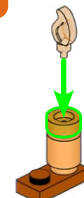



140

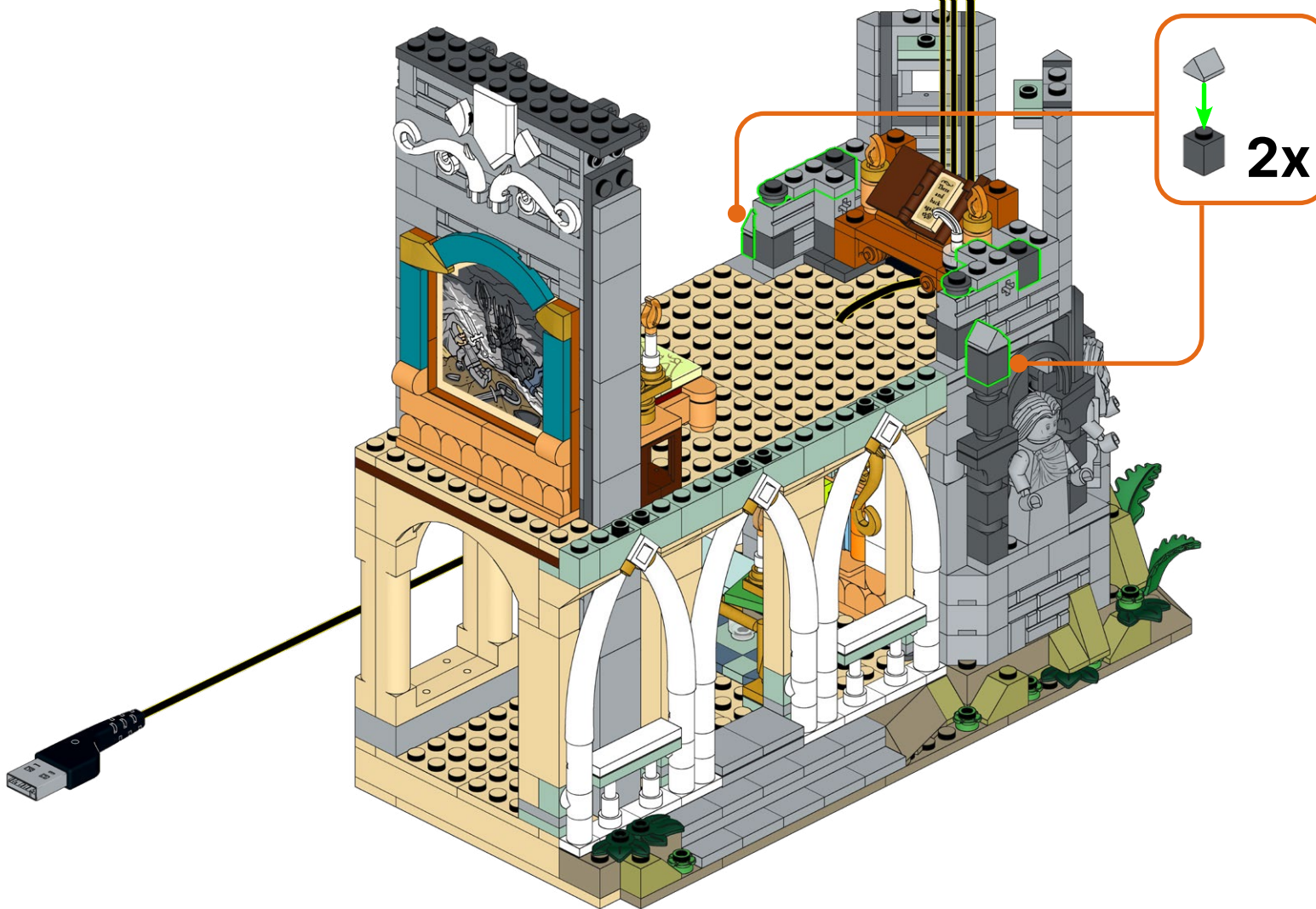
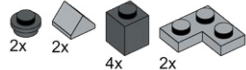



### **HOLD UP!**

You might notice some bags aren't in order, as well as left over pieces, but that's ok! We're changing the way you build LEGO!

### **ATTENDEZ!**

Vous remarquerez peut-être que certains sacs, ainsi que certaines pièces, ne sont pas dans le bon ordre. Mais pas de panique! Nous changeons simplement la façon avec laquelle vous construisez vos LEGO!

### **ASPETTA!**

Potresti notare che alcuni sacchetti non sono in ordine, così come i pezzi avanzati, ma va bene così! Stiamo cambiando il modo in cui costruisci i LEGO!

### **HALT!**

Sie werden möglicherweise bemerken, dass einige tüten durcheinander sind und teile übrig bleiben, aber das ist in Ordnung! Wir ändern die art und weise, wie Sie LEGO bauen!

### **¡ESPERA!**

Es posible que notes que algunas bolsas están fuera de servicio, así como piezas sobrantes, ¡pero está bien! ¡Estamos cambiando la forma en que construyes LEGO!

### **暫停!**

你可能会注意到一些袋子顺序错乱, 以及一些剩余的部件, 但没关系! 我们正在改变你搭建乐高的方式!

### Open LEGO® Bag 8

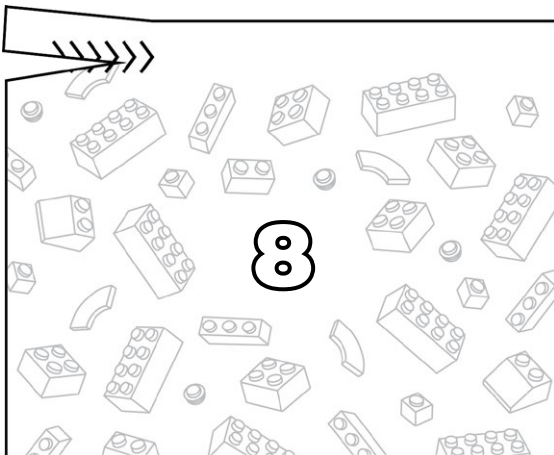

141

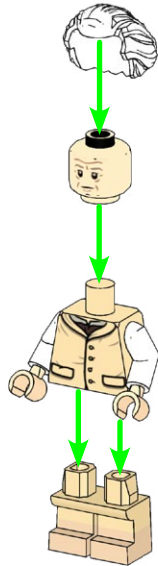
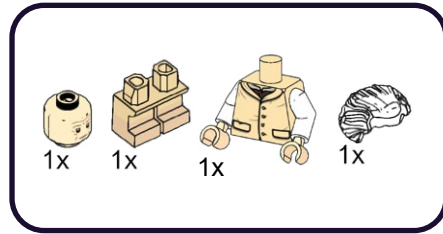

142

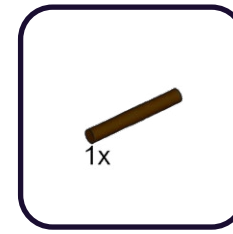

143

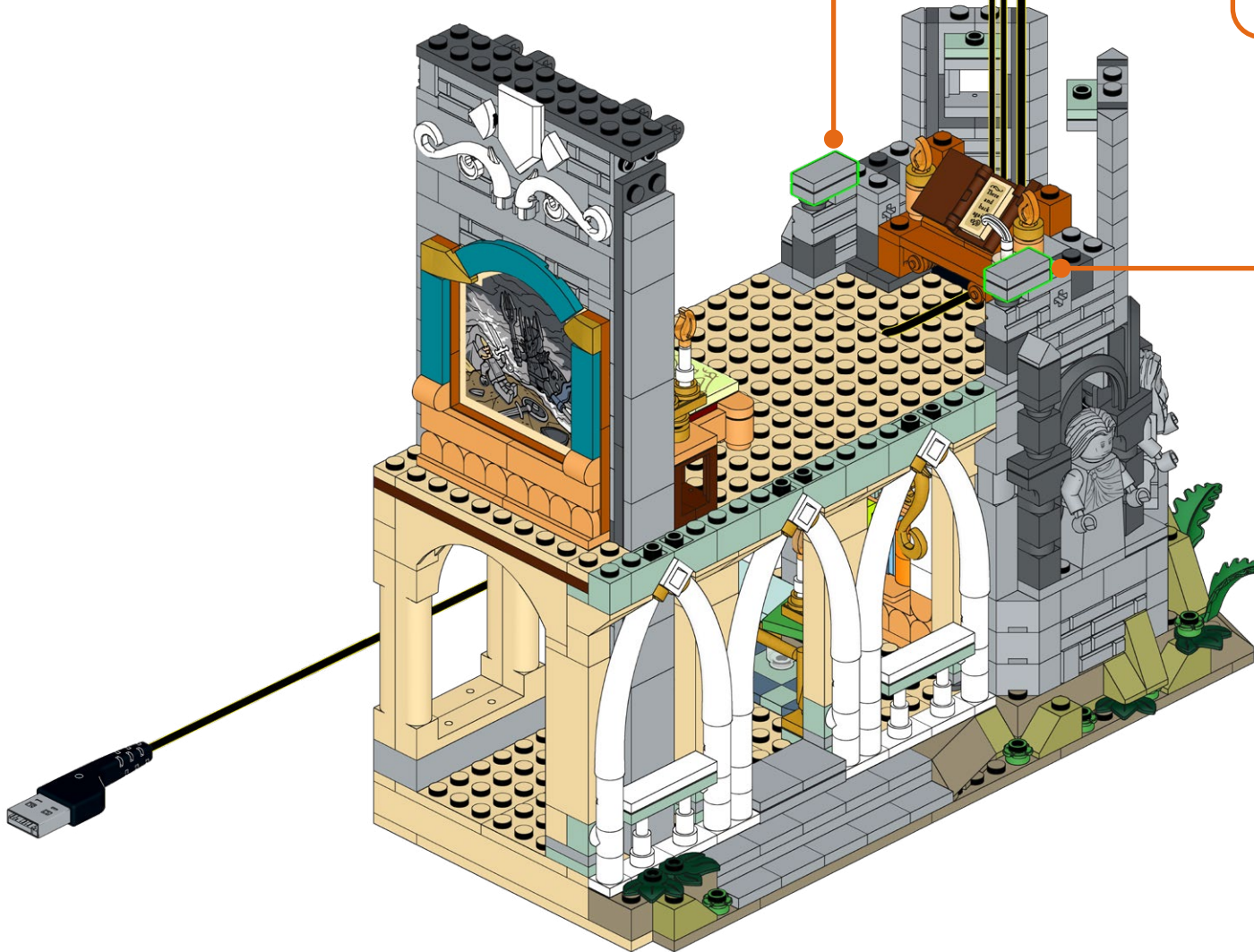
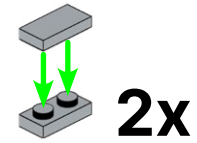
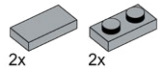

144

1x 2x 1x

1

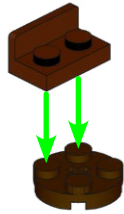

2

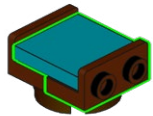

145

1x 1x 2x  
2x 2x

1

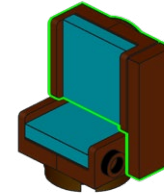

2

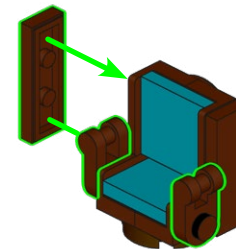

1

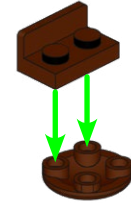

2

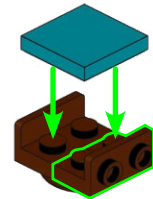

3

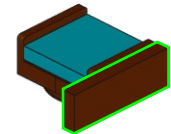

146

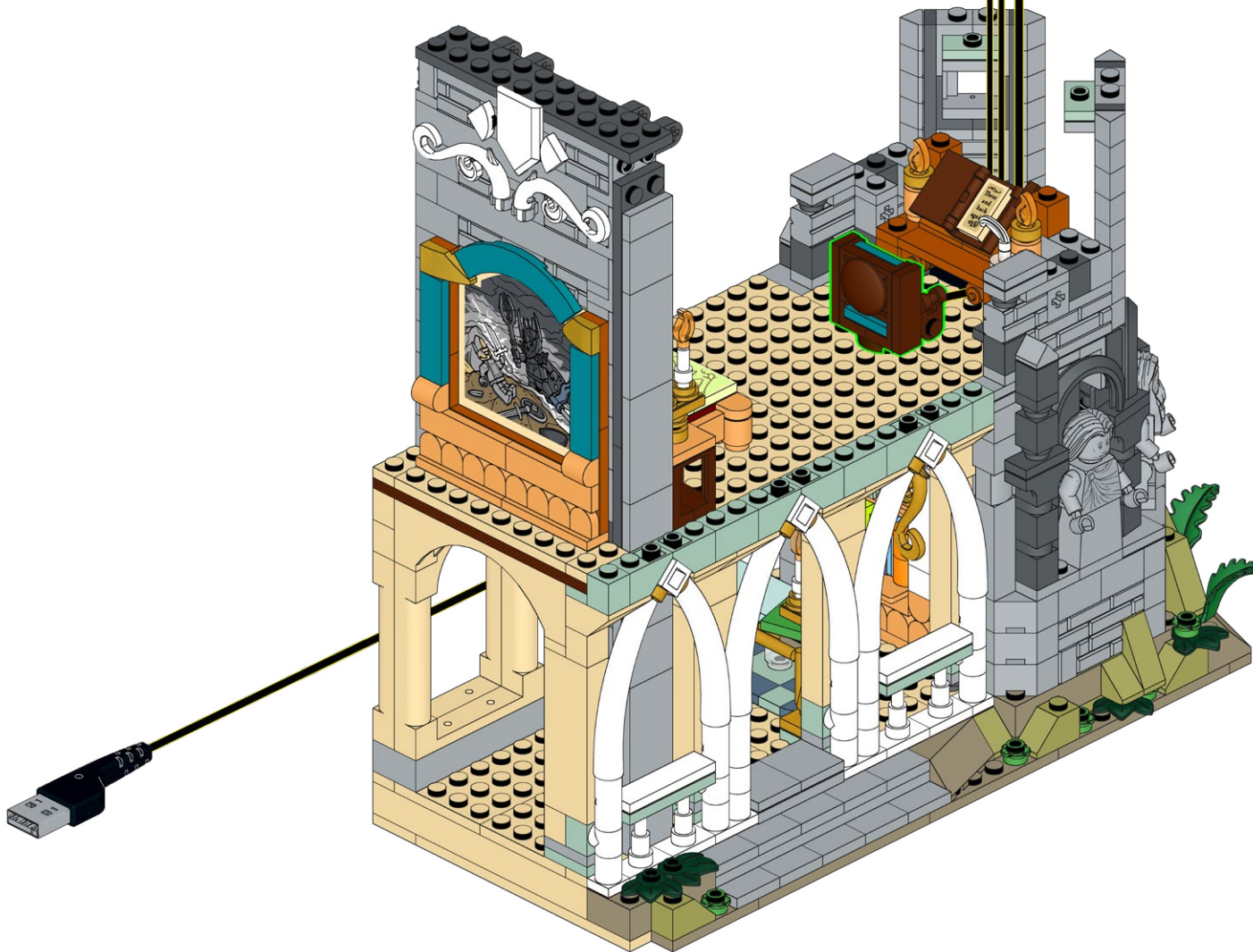

147

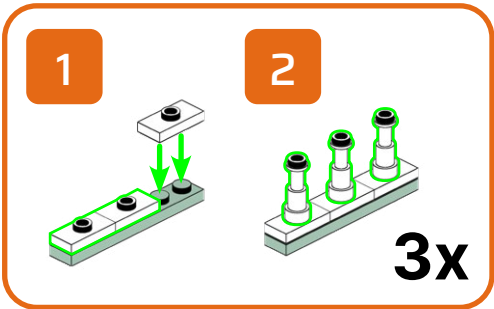
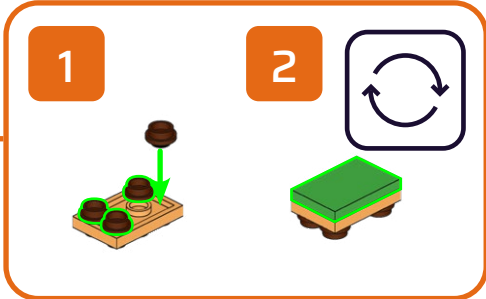
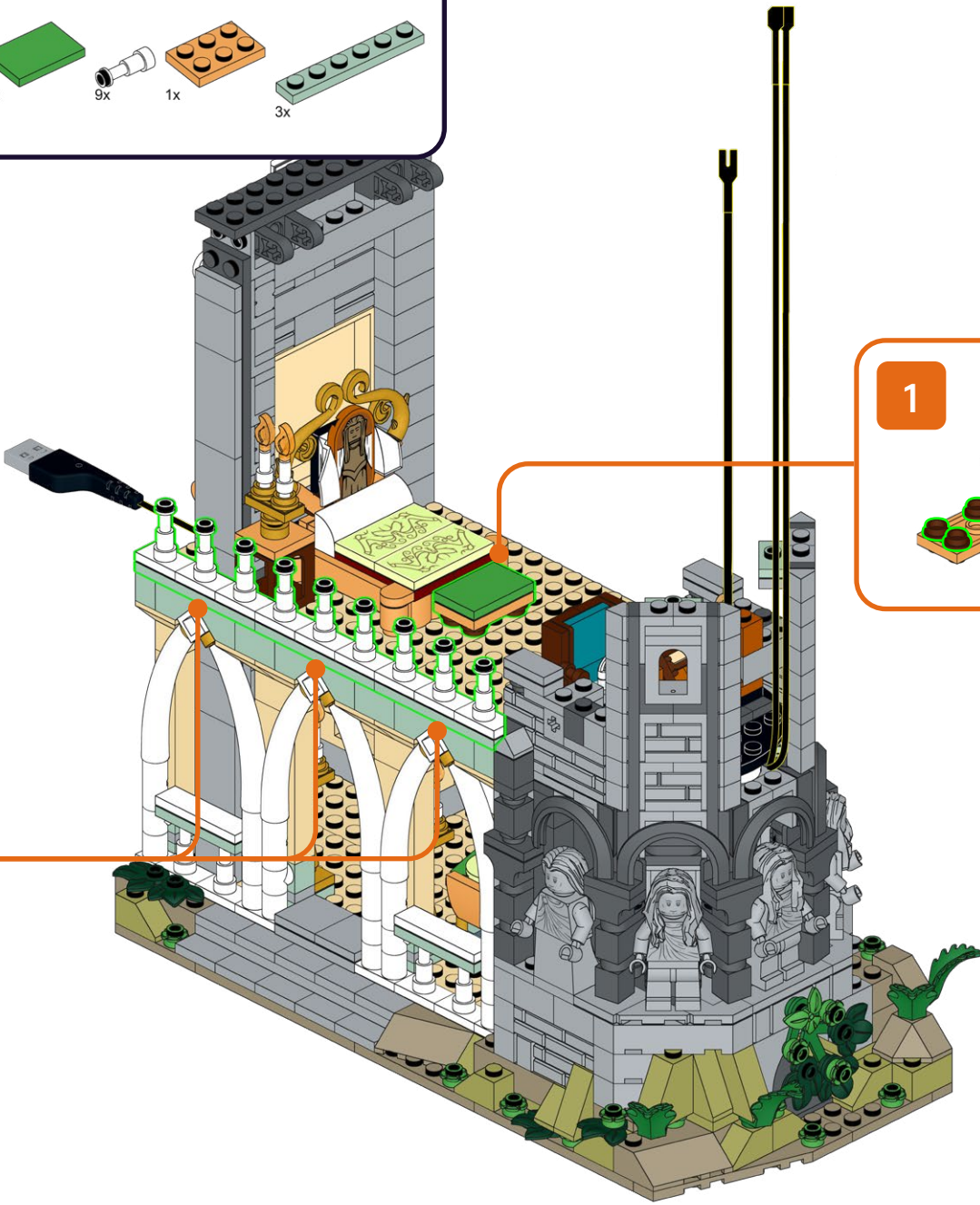
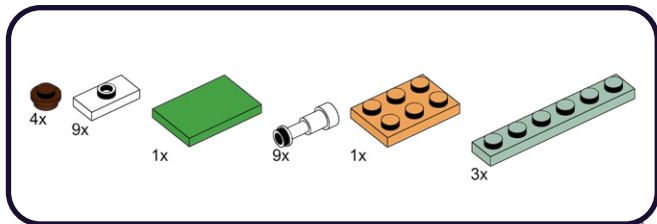

148

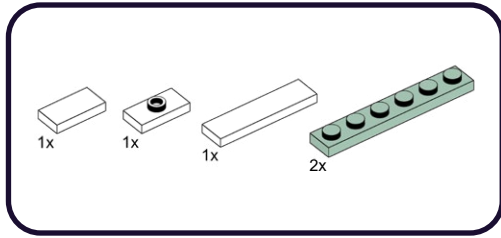

1

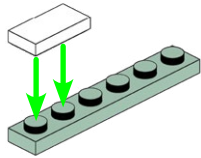

2

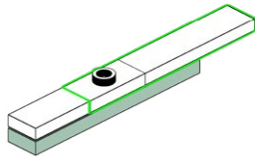

3

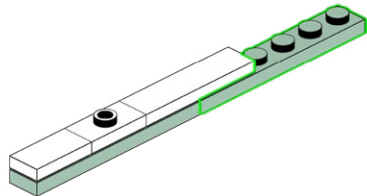

149

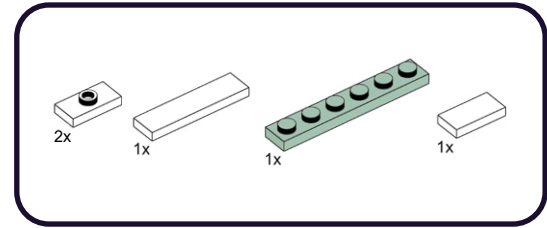

1

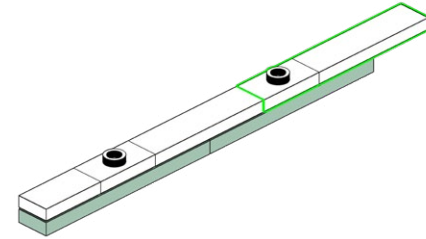

2

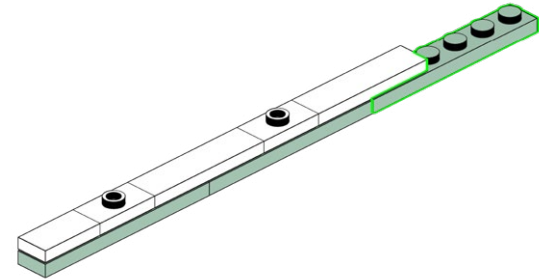

3

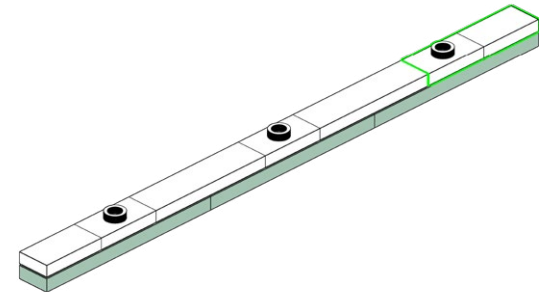



150

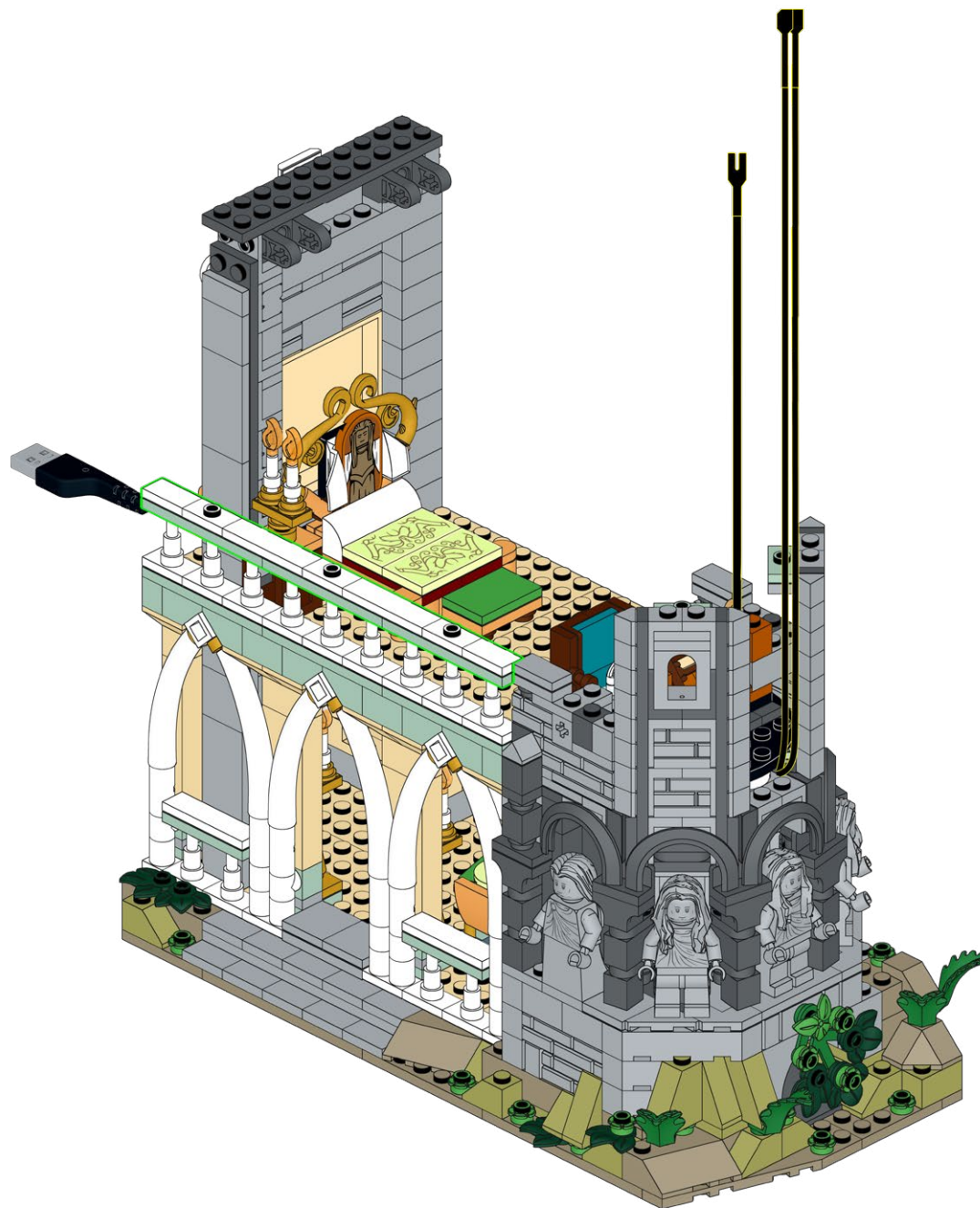

151

1x  
2x  
4x

1

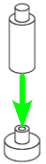

2



3

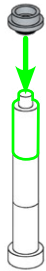

152

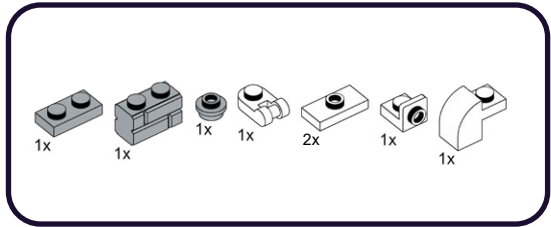

1

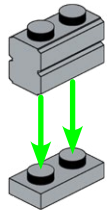

3

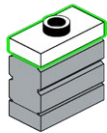

3

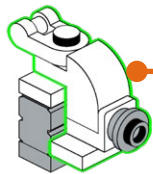

1

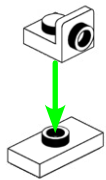

2

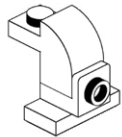

3

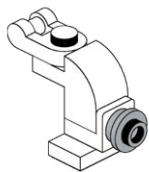

153

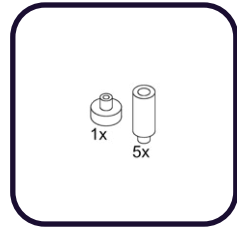

1

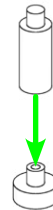

2

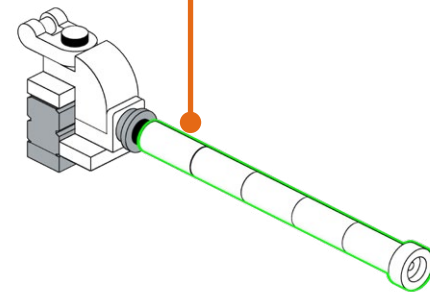

154



155

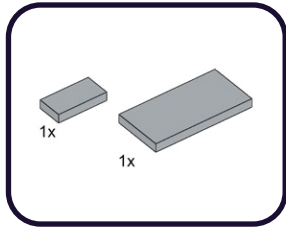

156

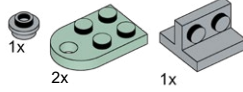

1

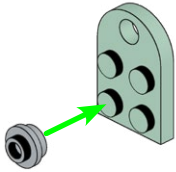

2

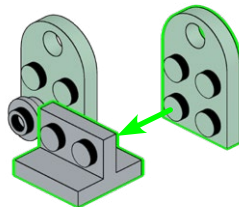

157

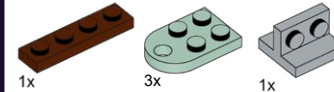

1

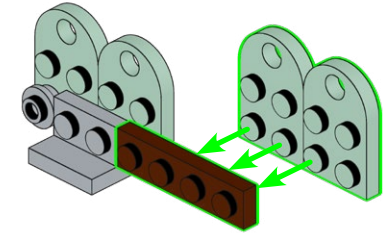

2

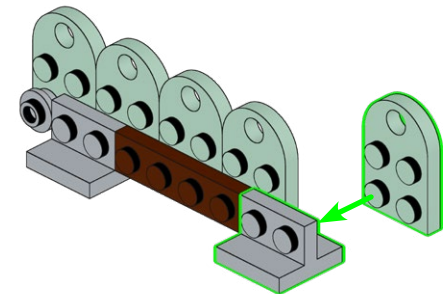

158

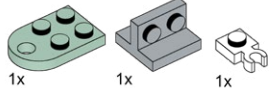

1

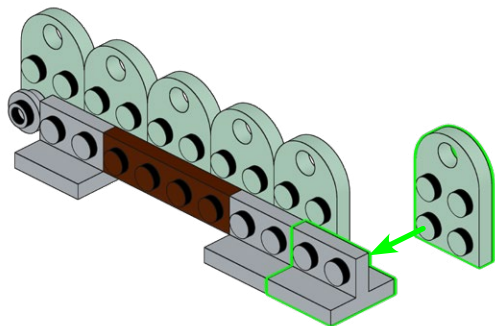

2

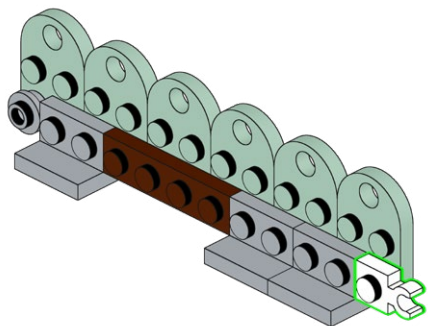

159

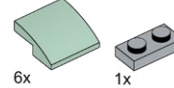

1

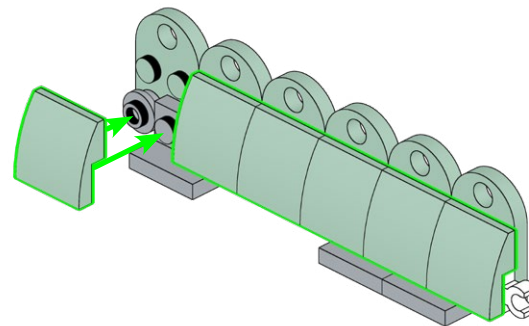

2

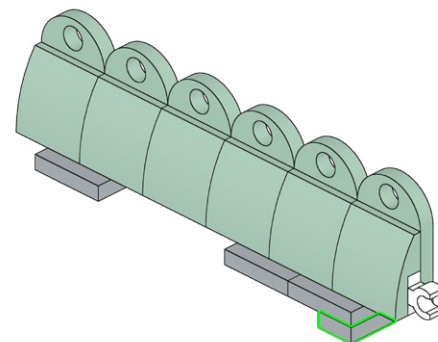

160





161

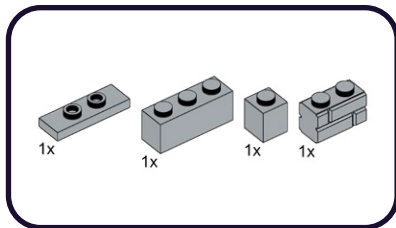

1

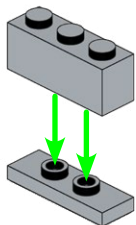

2

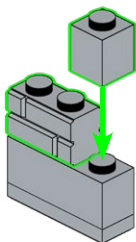

162

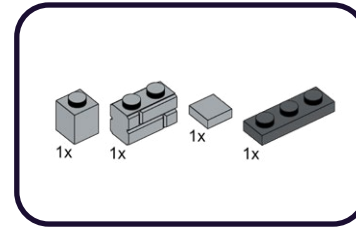

1

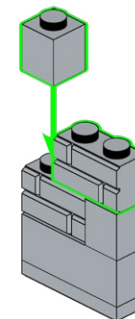

2

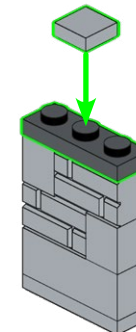

163

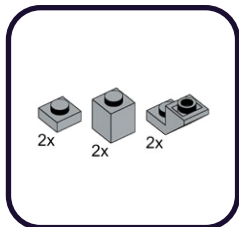

1

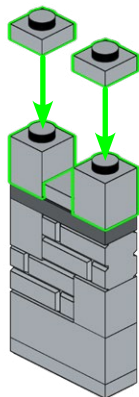

2

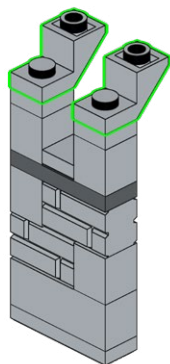

164

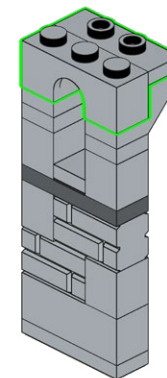
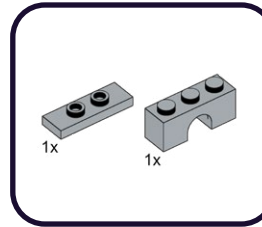

To be used later  
 Zur späteren Verwendung  
 A utiliser plus tard  
 Da utilizzare successivamente  
 Para ser usado más tarde  
 稍后使用

**HOLD UP!**

You might notice some bags aren't in order, as well as left over pieces, but that's ok! We're changing the way you build LEGO!

**ATTENDEZ!**

Vous remarquerez peut-être que certains sacs, ainsi que certaines pièces, ne sont pas dans le bon ordre. Mais pas de panique! Nous changeons simplement la façon avec laquelle vous construisez vos LEGO!

**ASPETTA!**

Potresti notare che alcuni sacchetti non sono in ordine, così come i pezzi avanzati, ma va bene così! Stiamo cambiando il modo in cui costruisci i LEGO!

**HALT!**

Sie werden möglicherweise bemerken, dass einige tüten durcheinander sind und teile übrig bleiben, aber das ist in Ordnung! Wir ändern die art und weise, wie Sie LEGO bauen!

**¡ESPERA!**

Es posible que notes que algunas bolsas están fuera de servicio, así como piezas sobrantes, ¡pero está bien! ¡Estamos cambiando la forma en que construyes LEGO!

**暫停!**

你可能会注意到一些袋子顺序错乱, 以及一些剩余的部件, 但没关系! 我们正在改变你搭建乐高的方式!

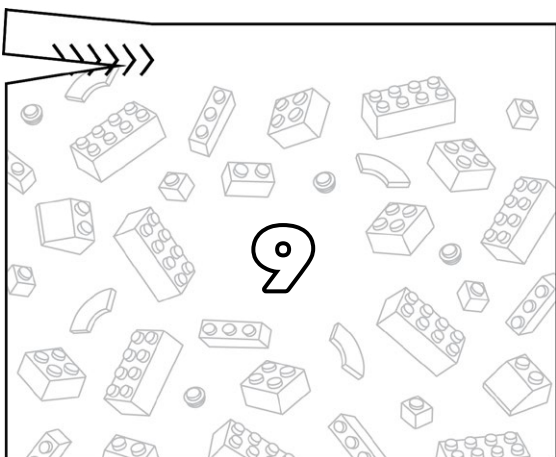
**Open LEGO® Bag 9**

165

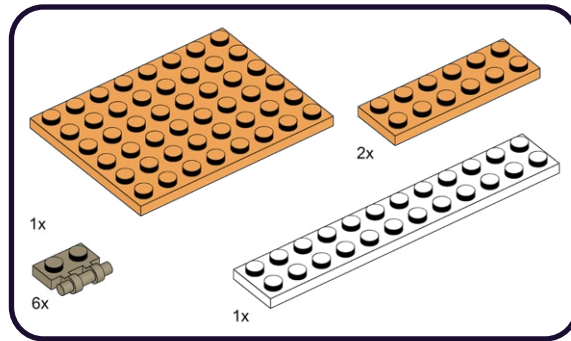

1

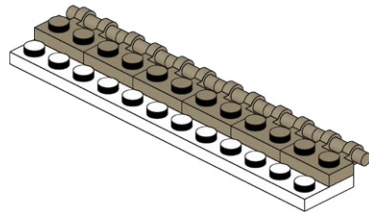

2

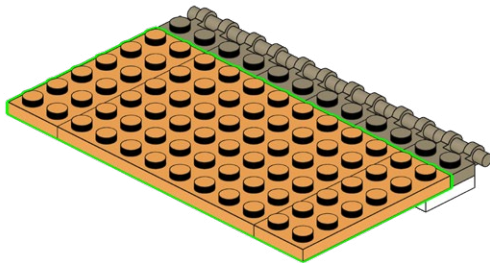

166

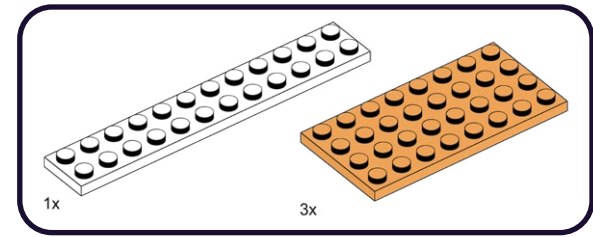

1

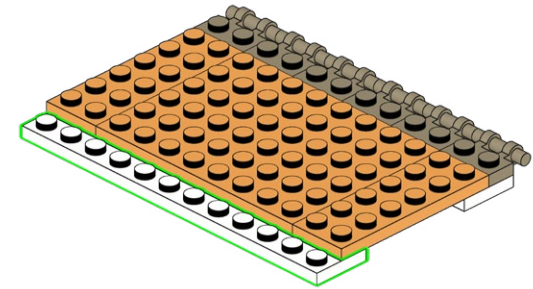

2

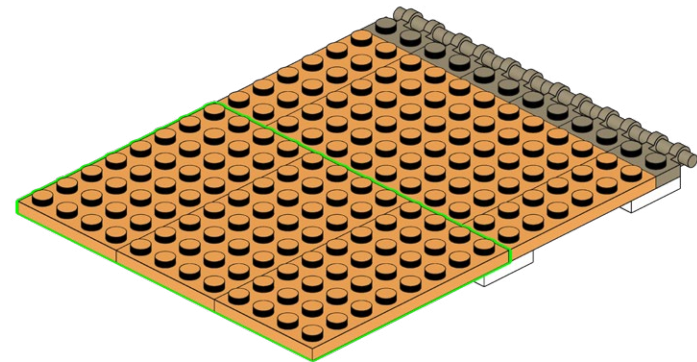

167

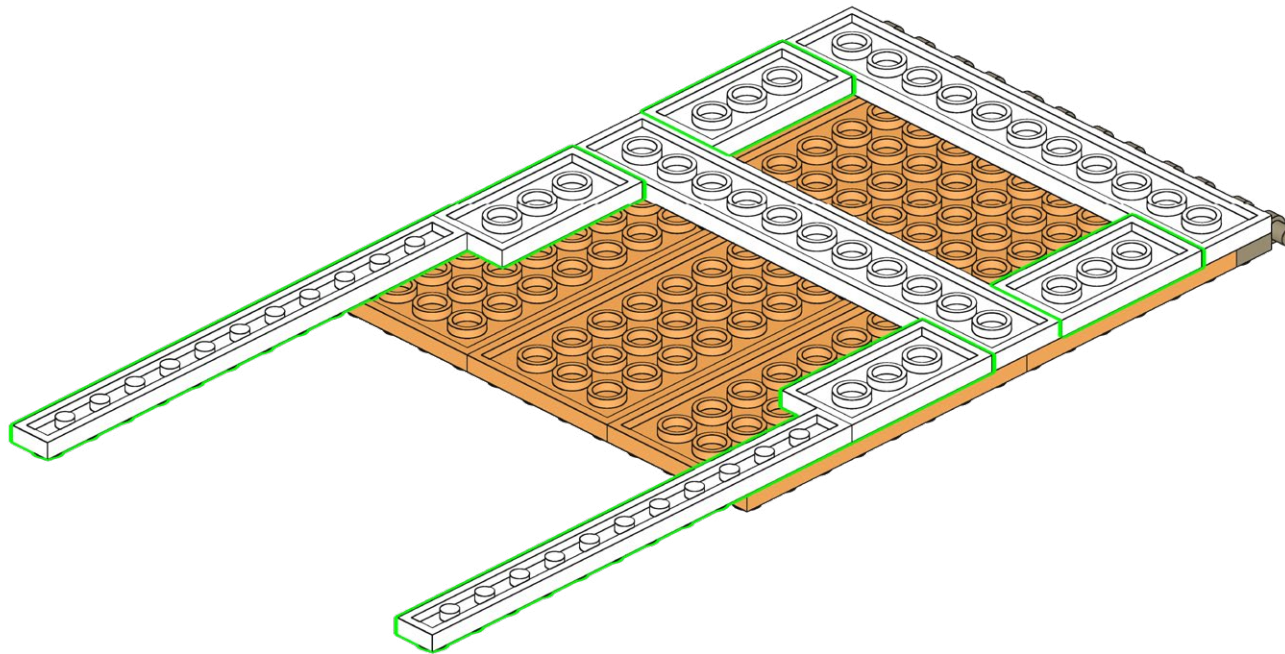
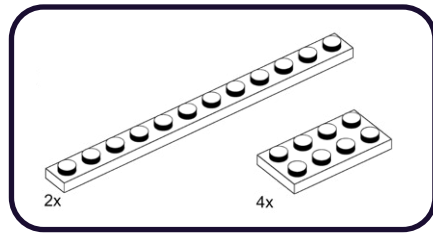

168

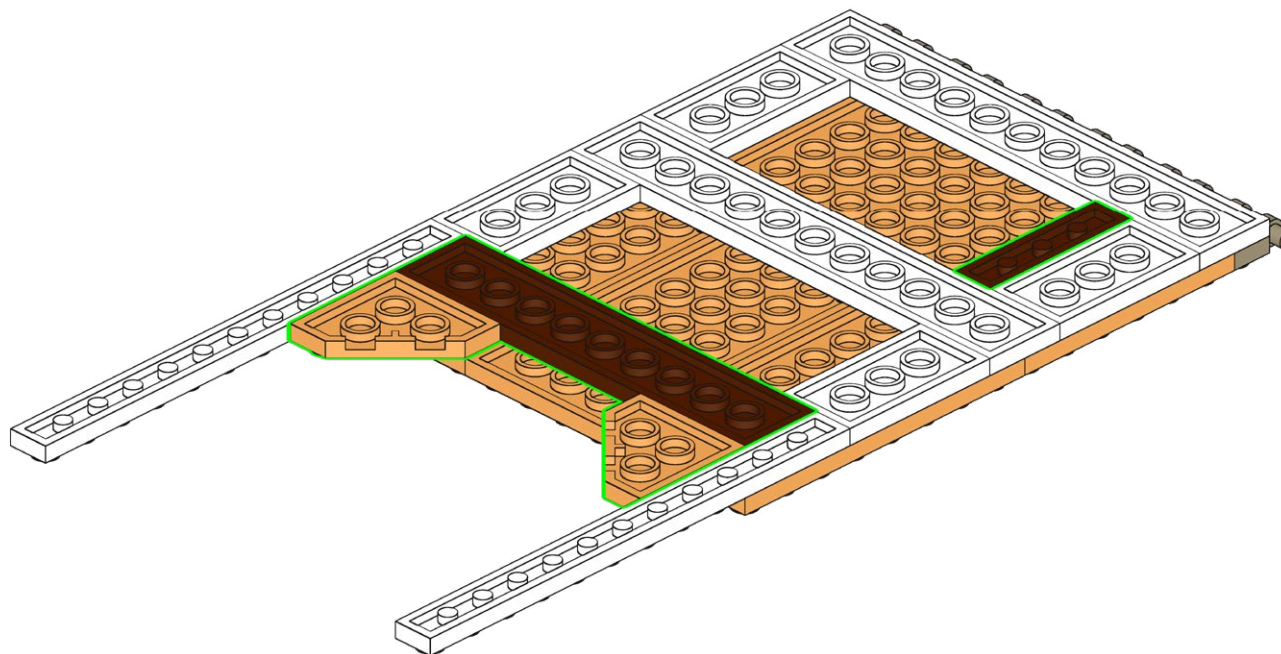
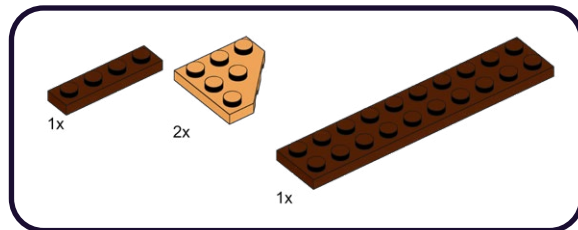

169

2x

2x

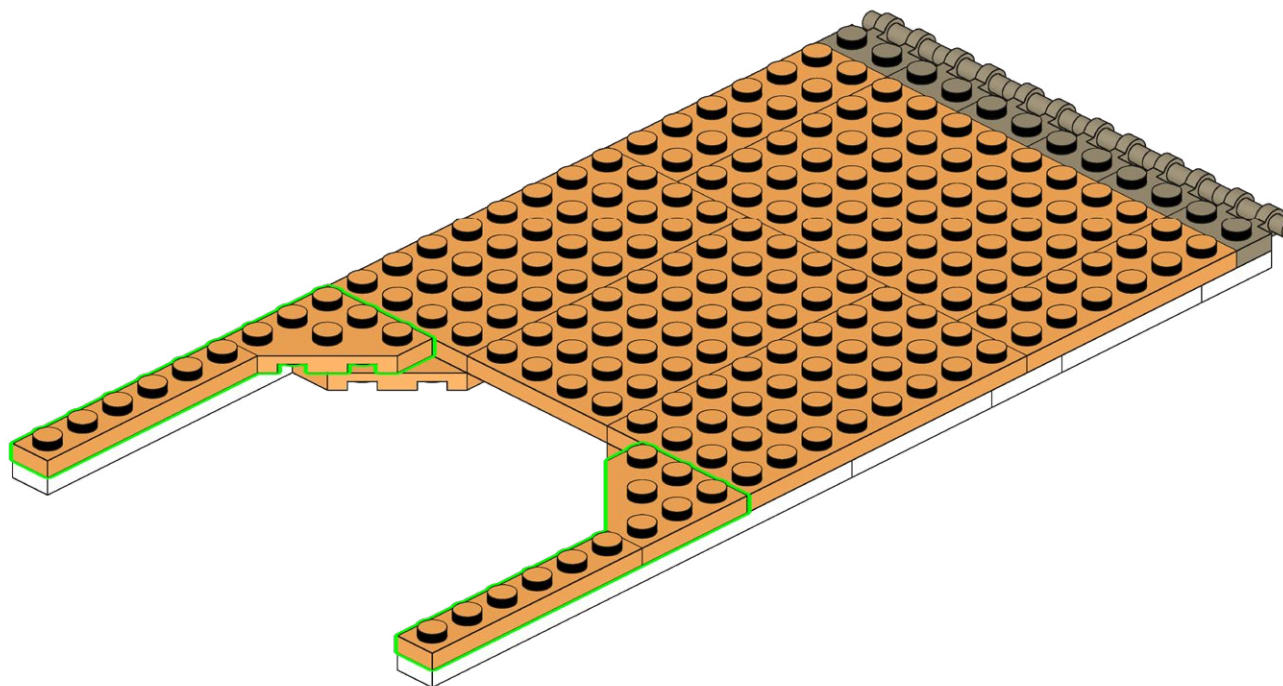

**170**

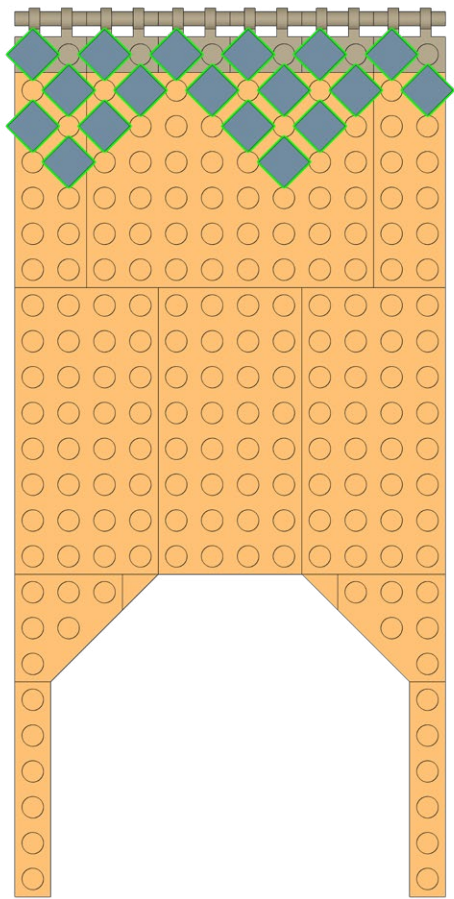
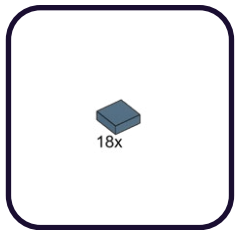

**171**

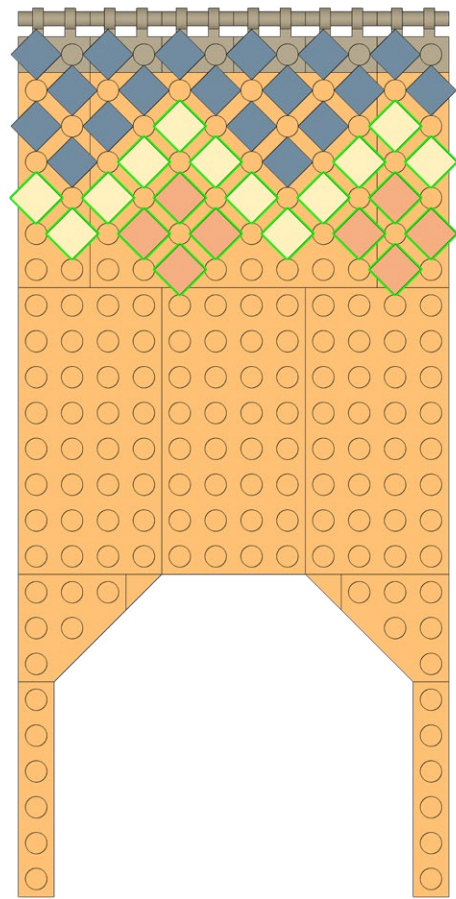
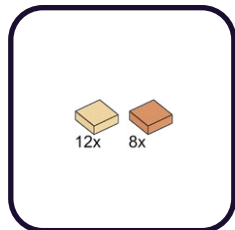



172

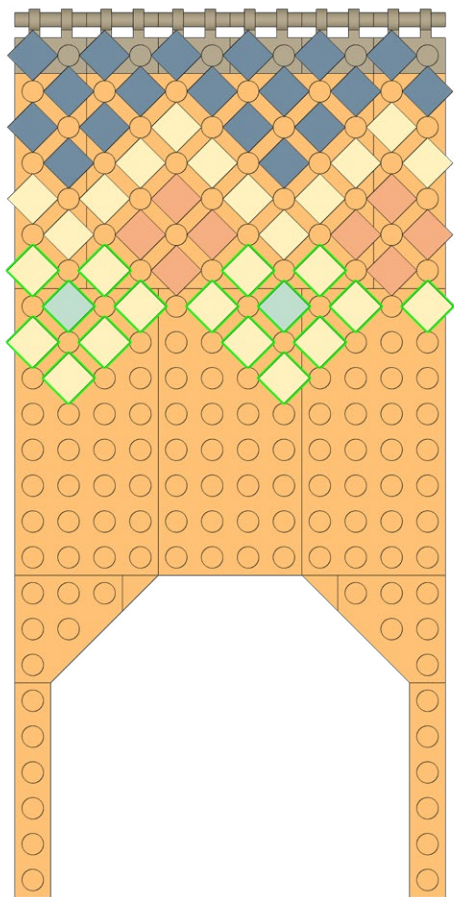
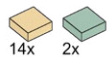

173

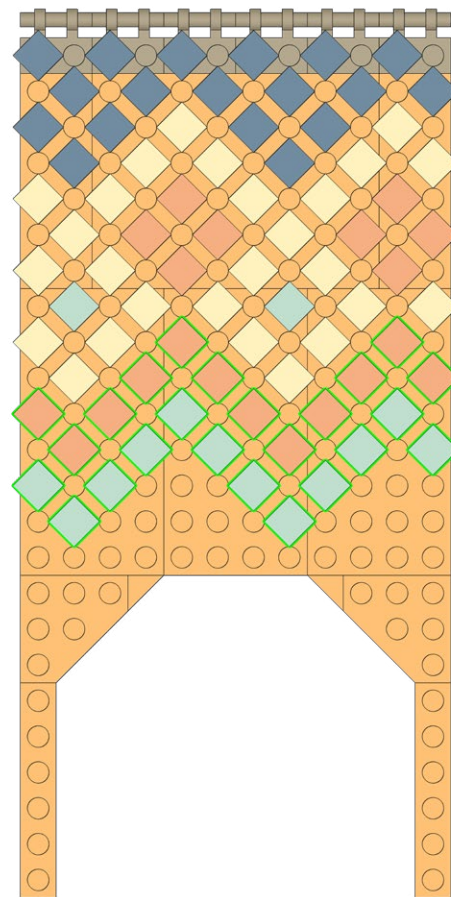
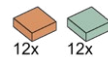

174

6x 10x 5x

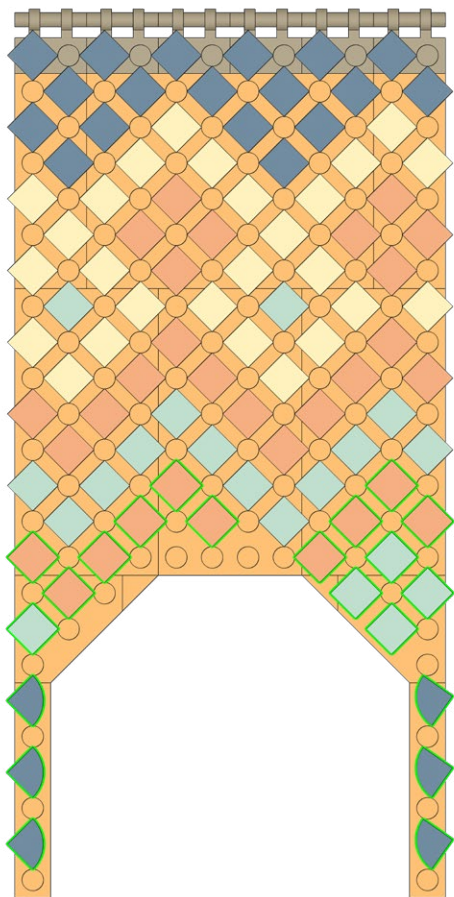

175

6x

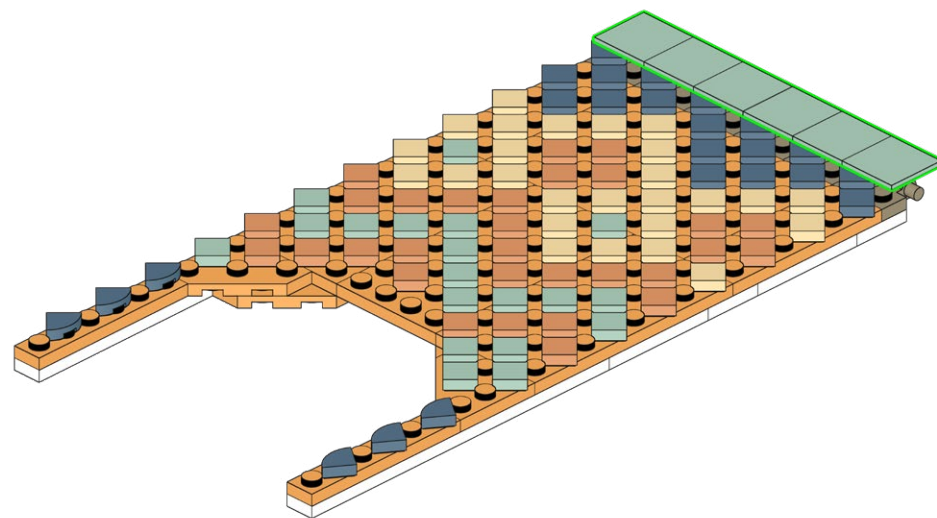

176

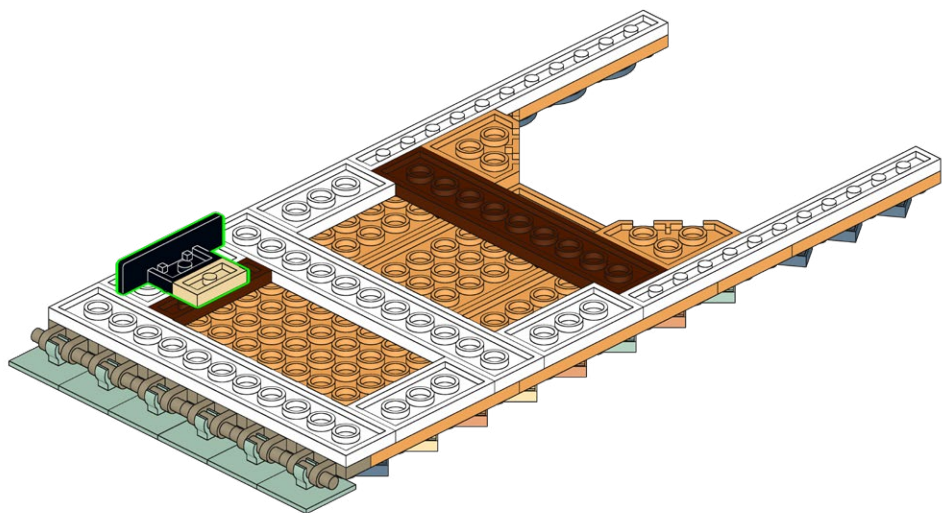
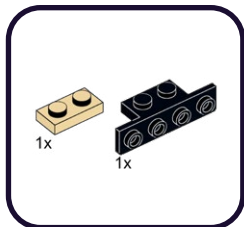

177

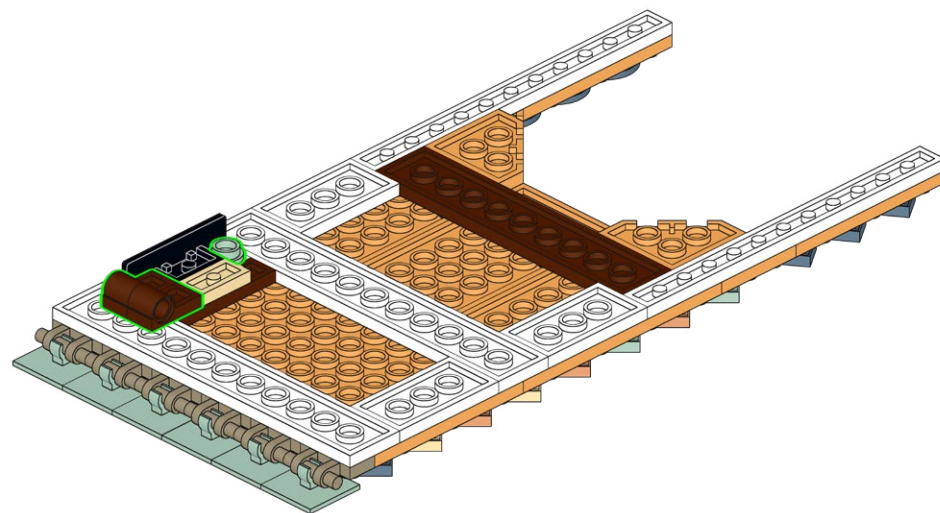
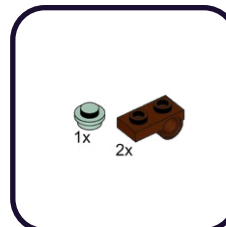

178

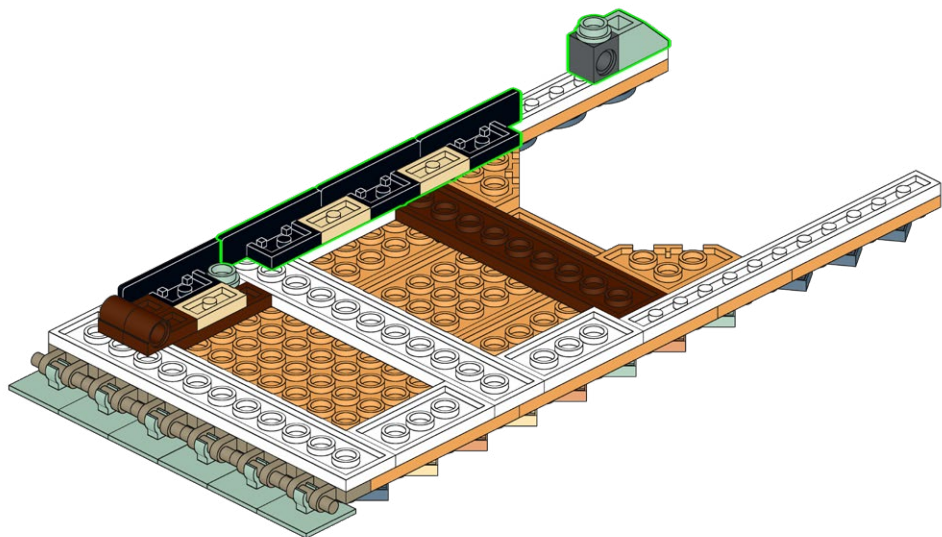
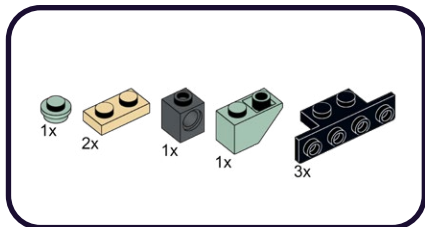

179

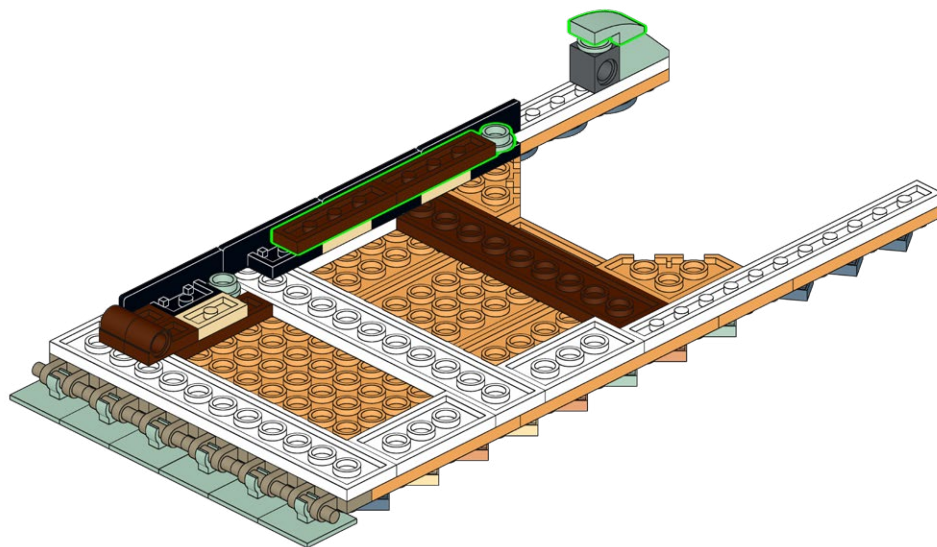
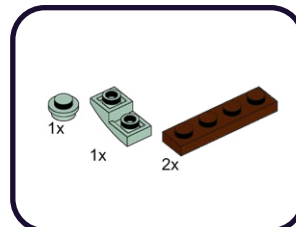

180

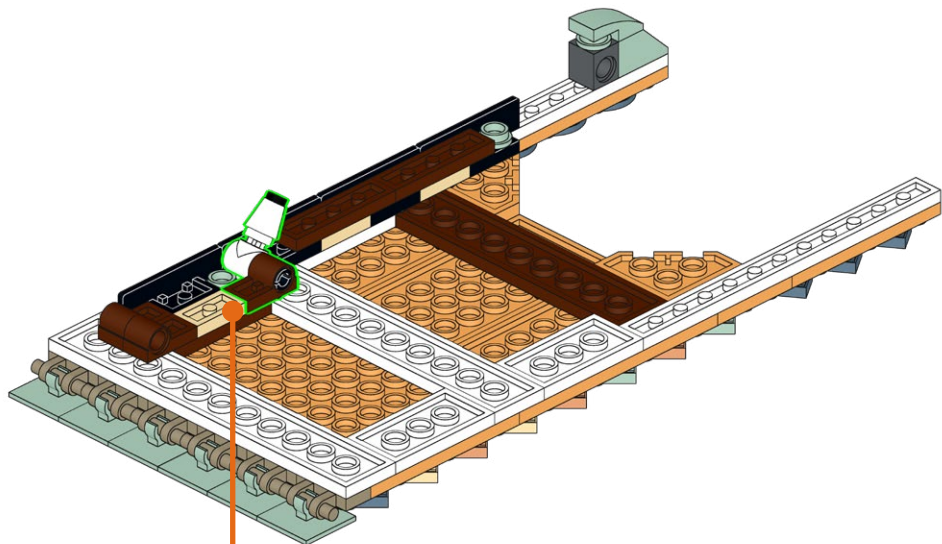
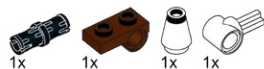

1

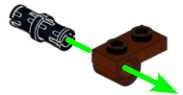

2

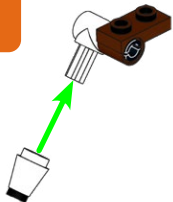

181

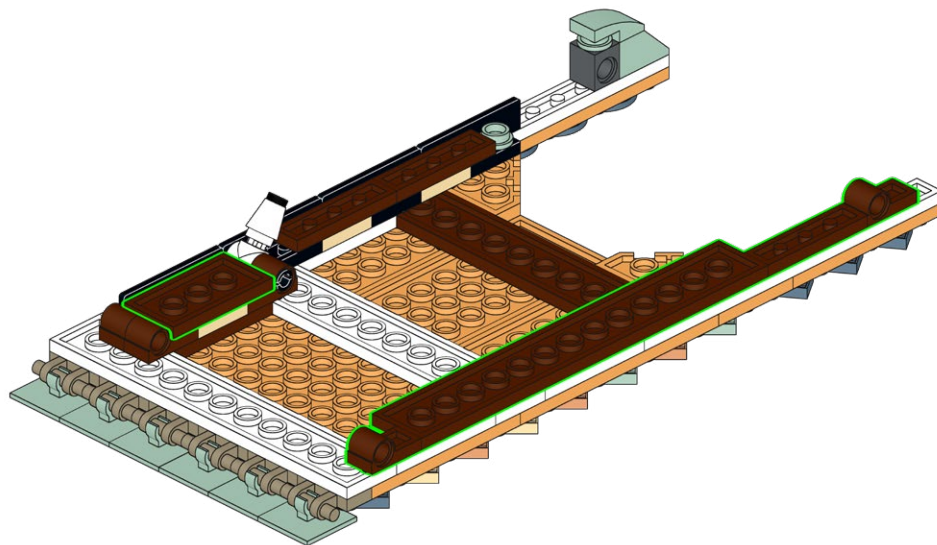
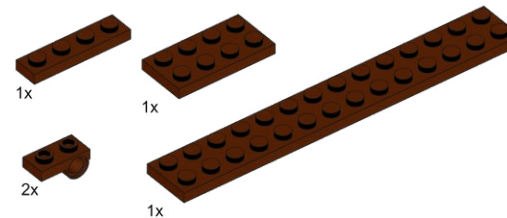

182

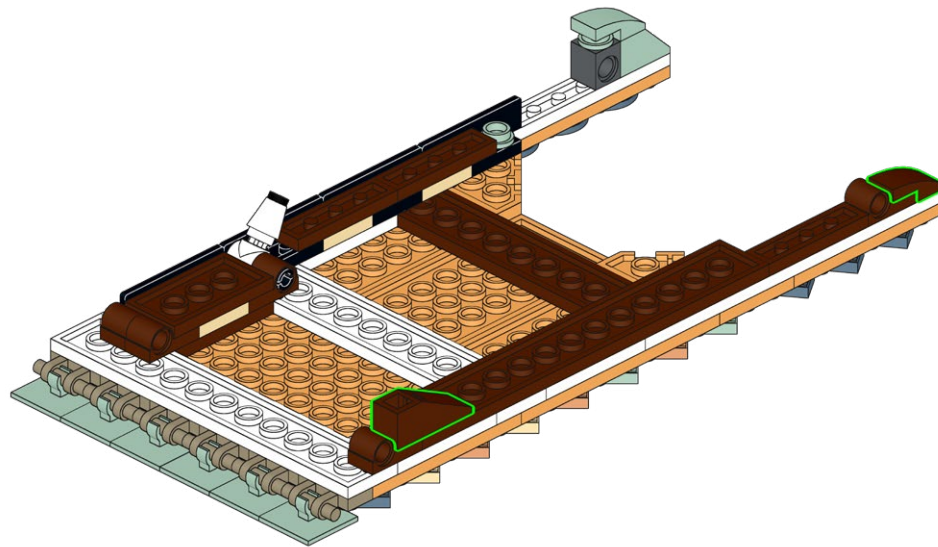
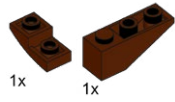

# 183

T-1x6 1x

ML-WW 1x

B-15 1x

1

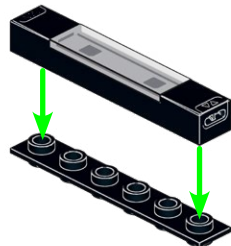

2

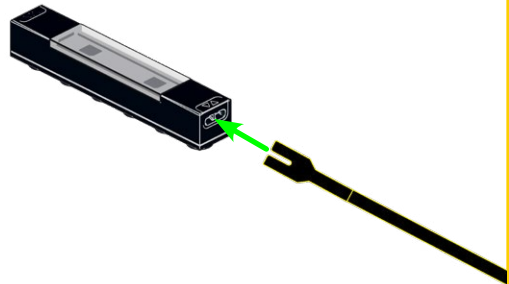

# 184

B-15 1x

1

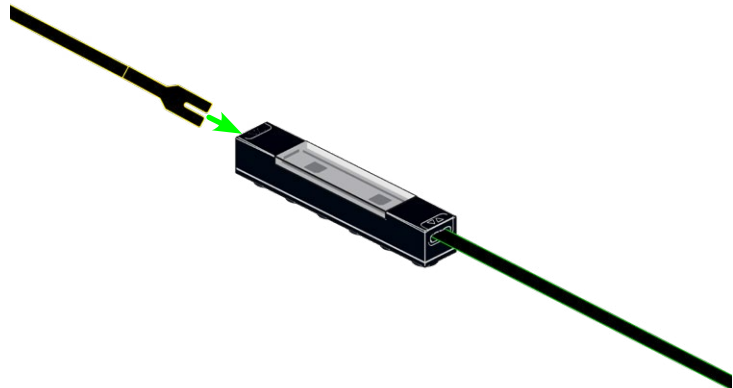

2

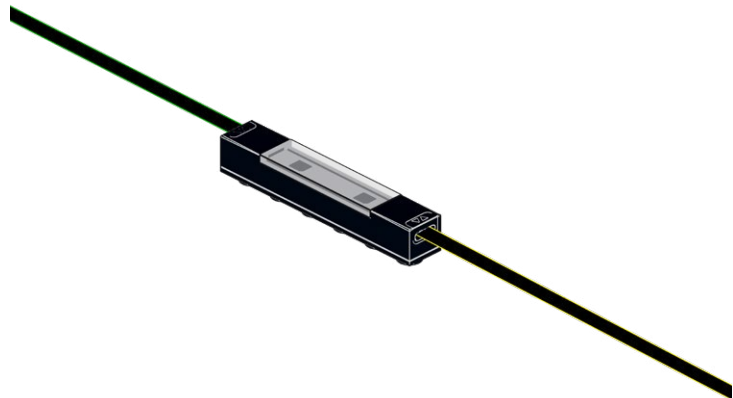

185

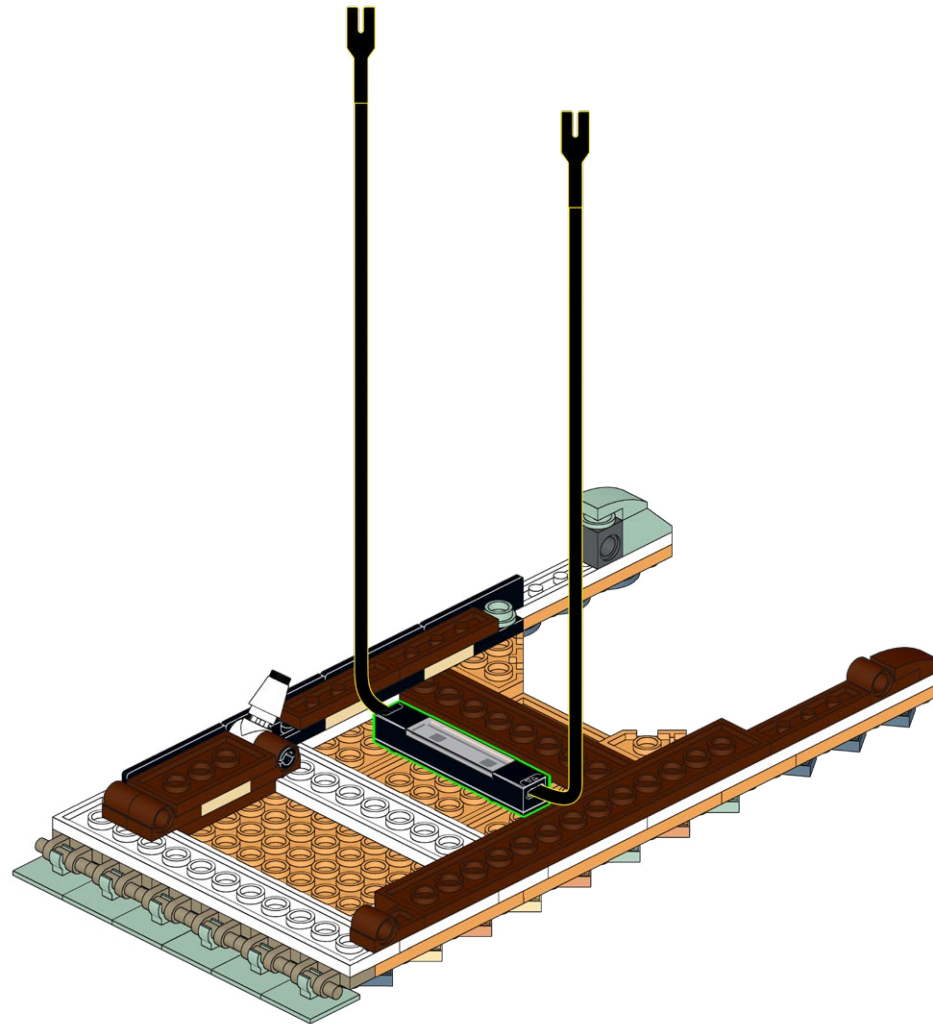



186

1x

1x

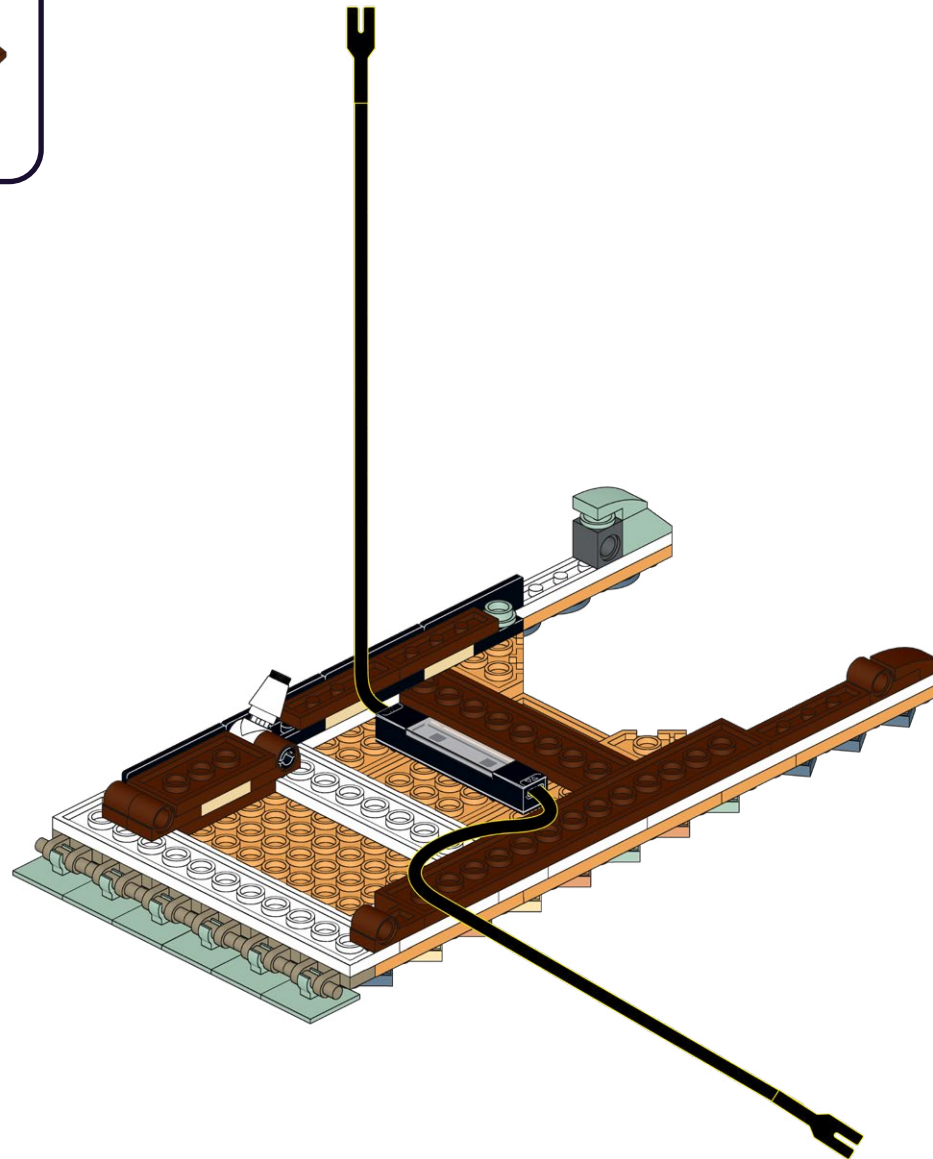

187

1x

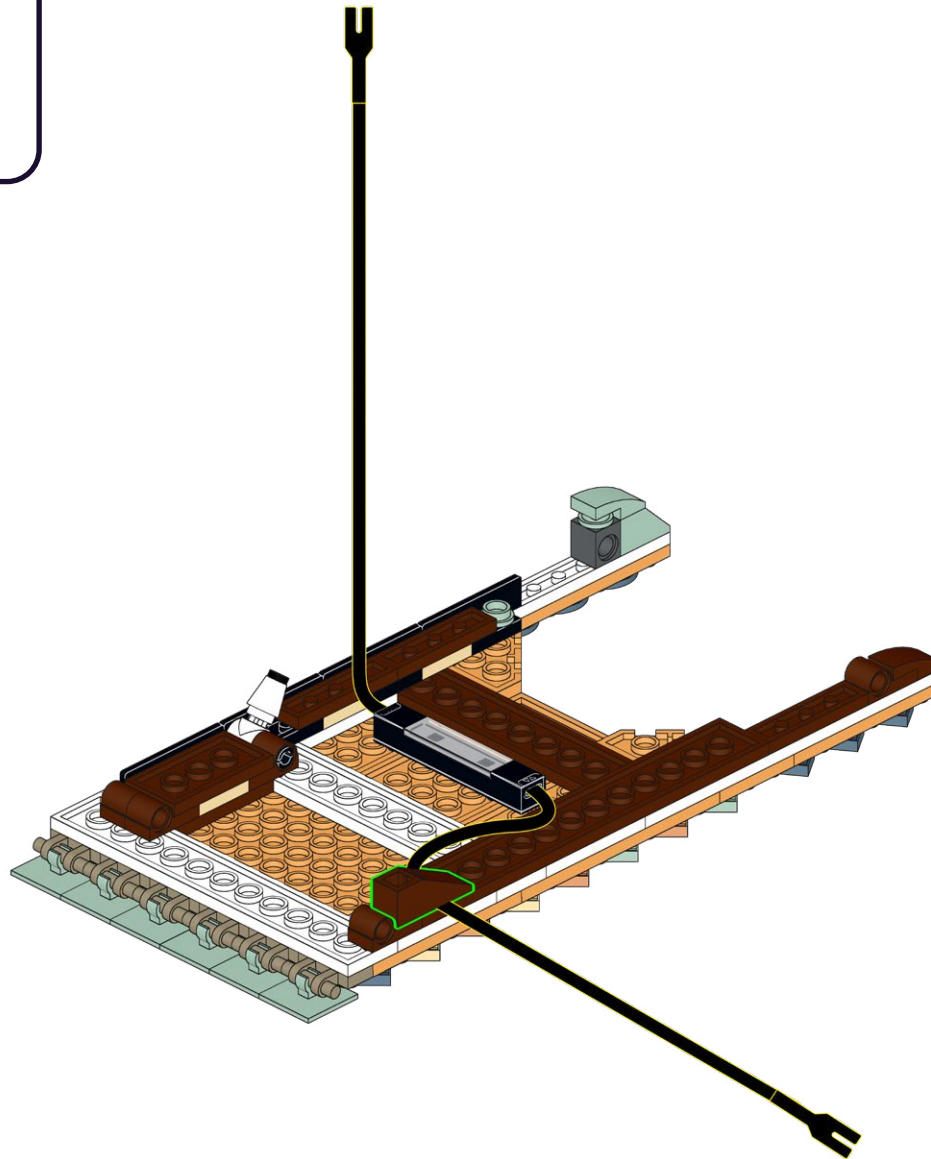

188

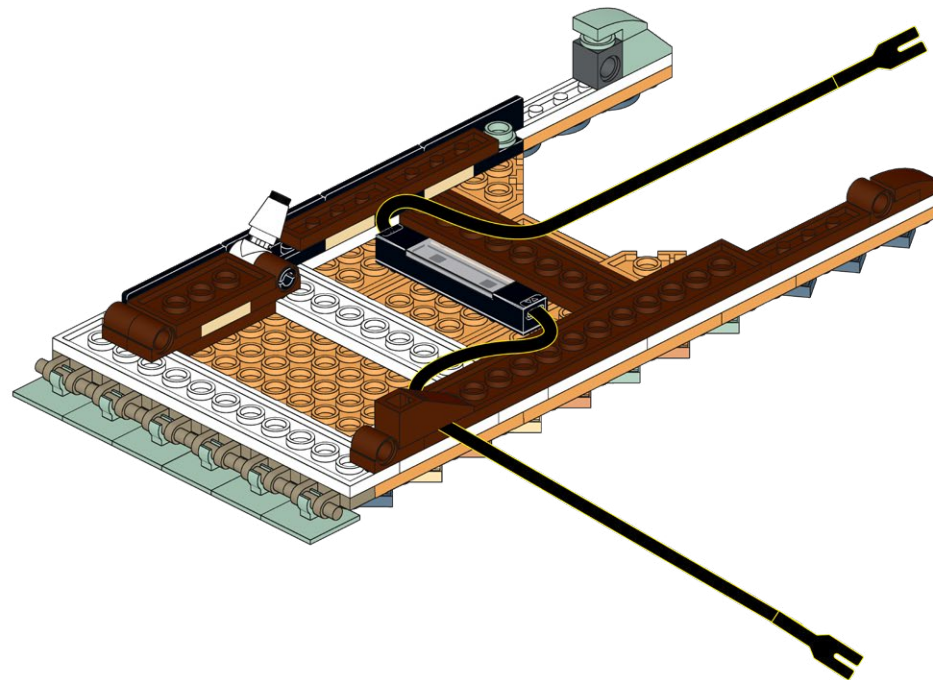

189

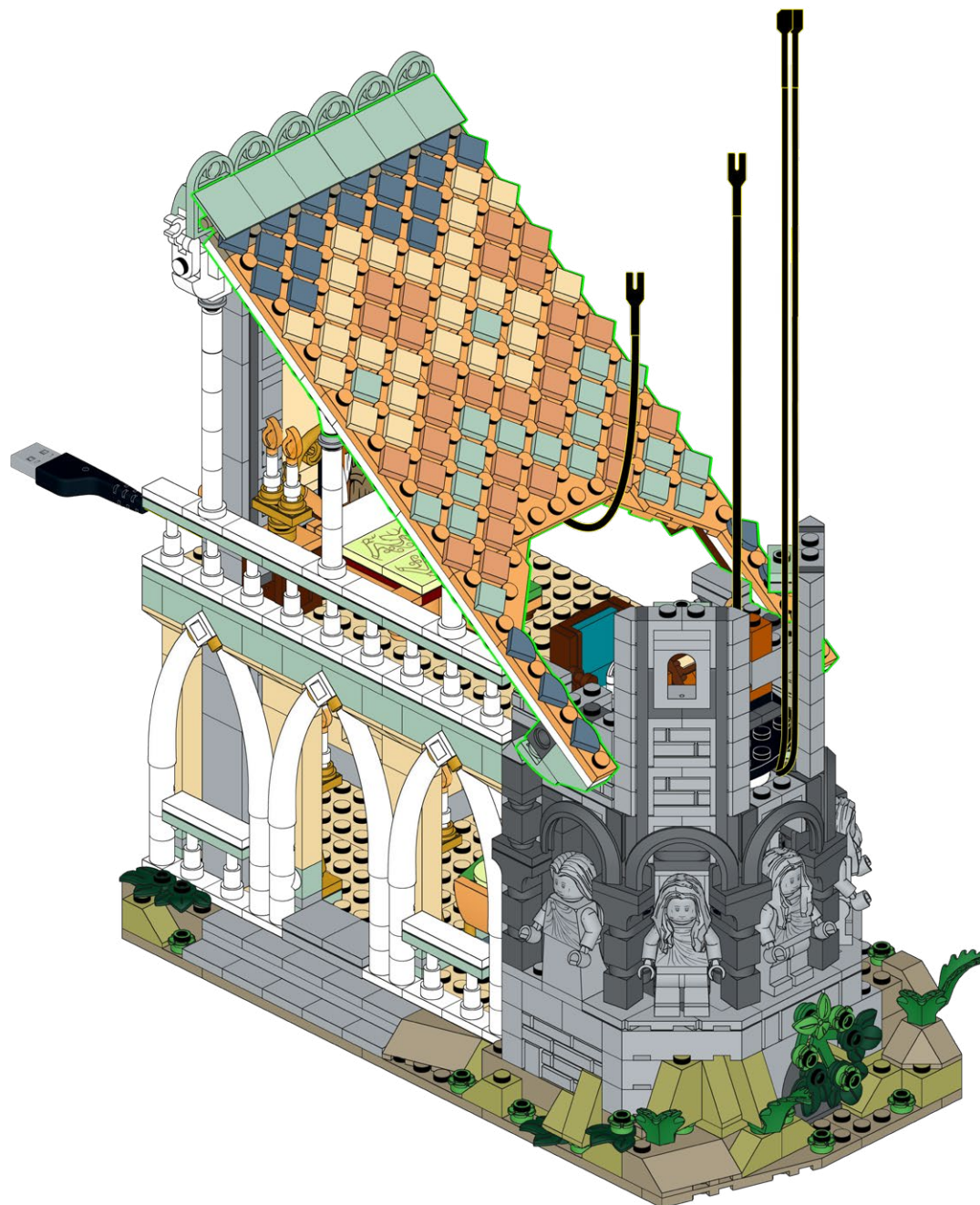

190

3x

1x

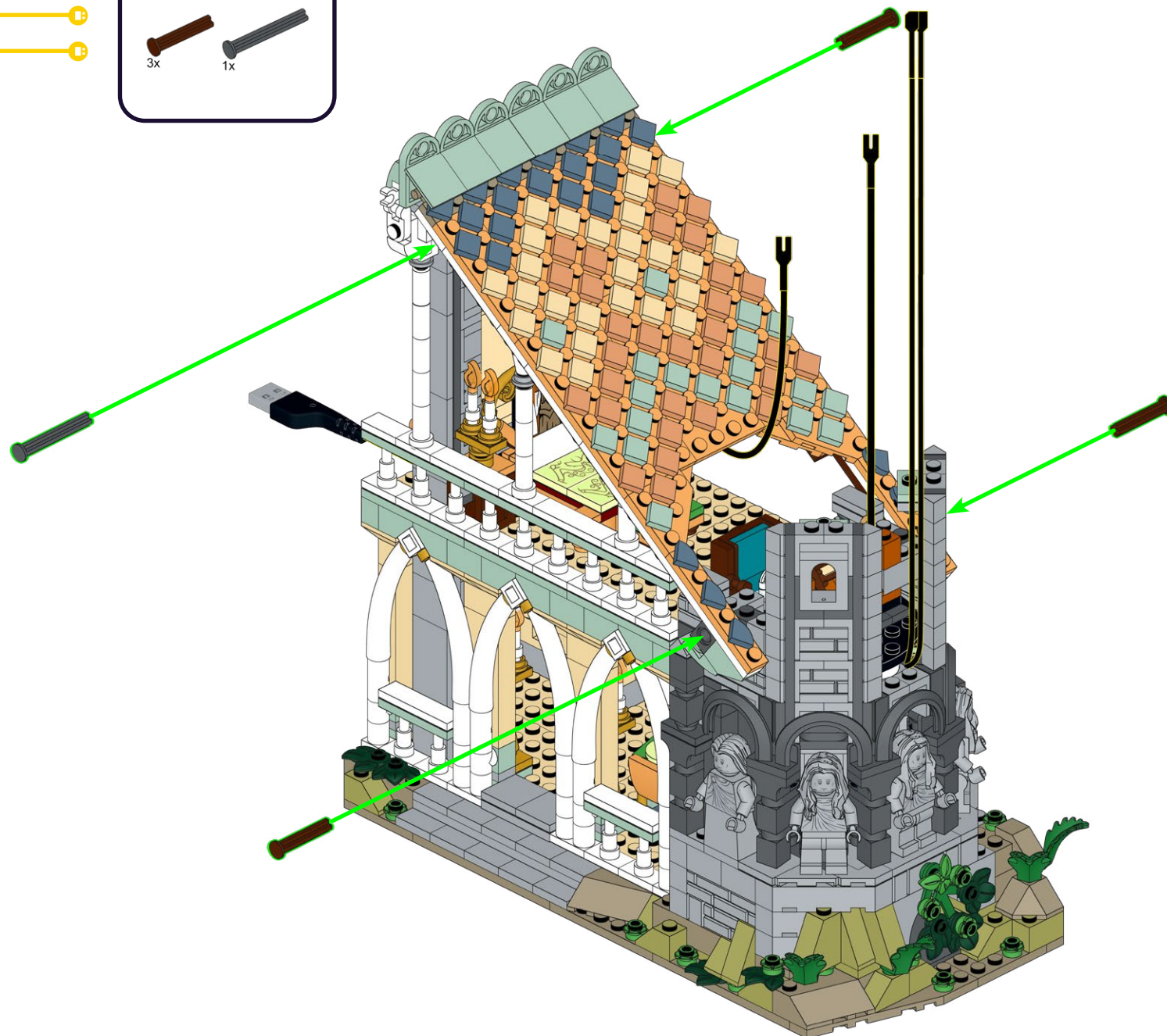

191

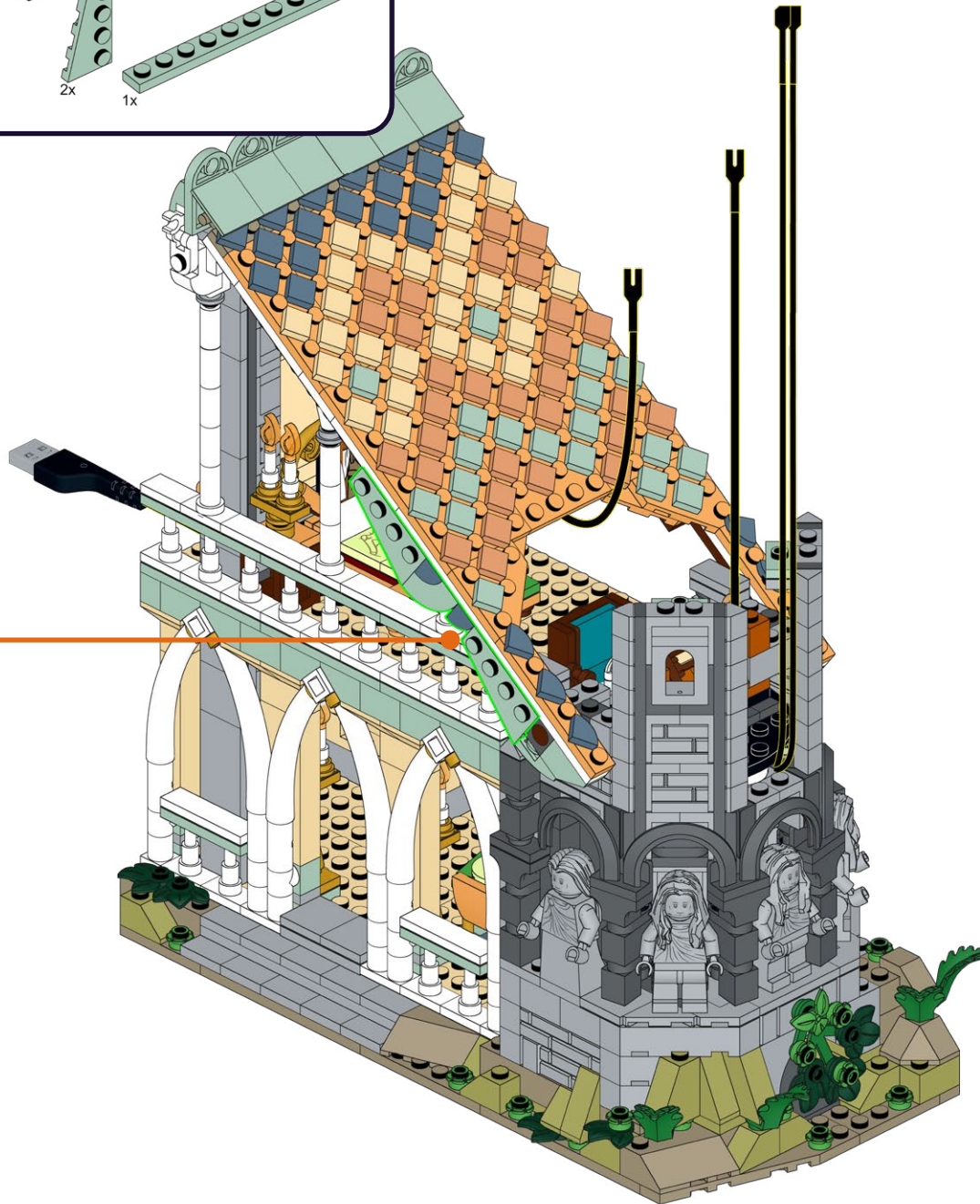
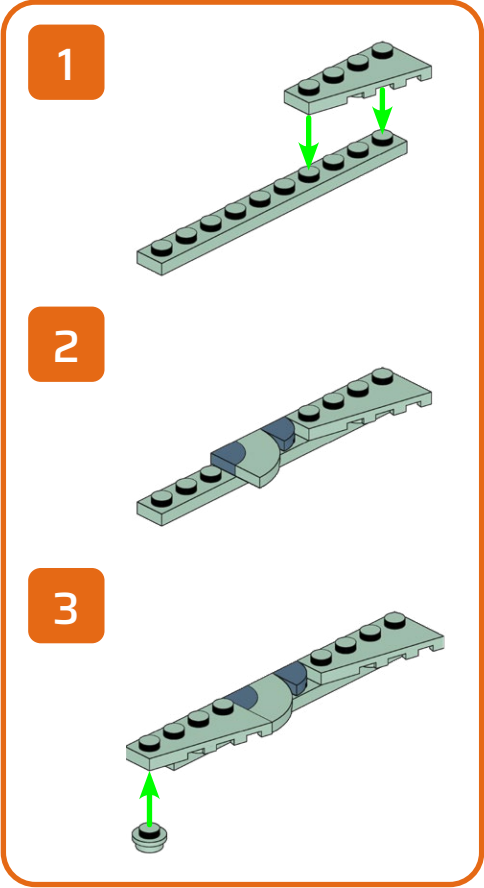
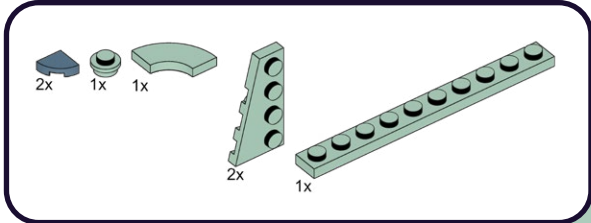

192

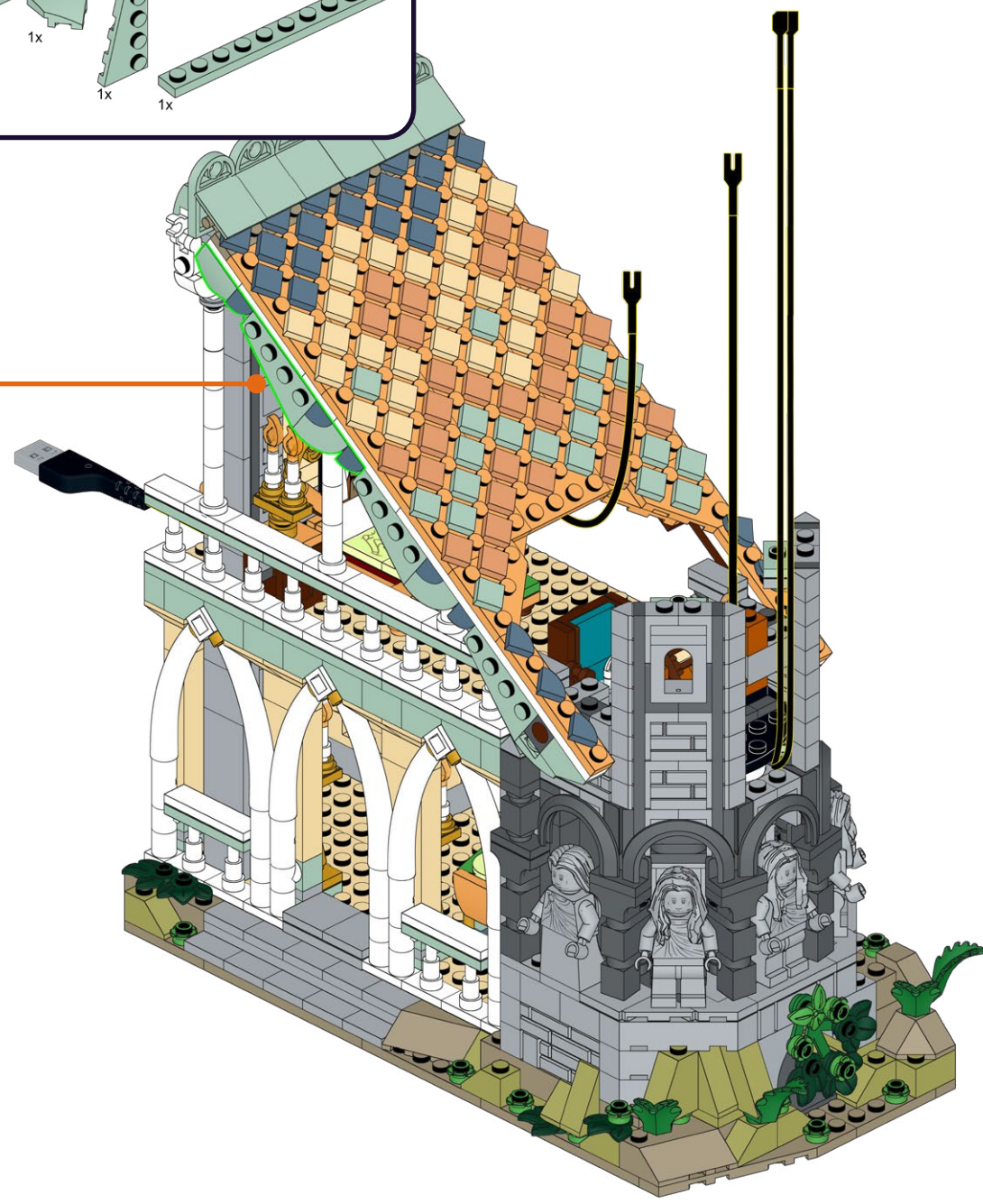
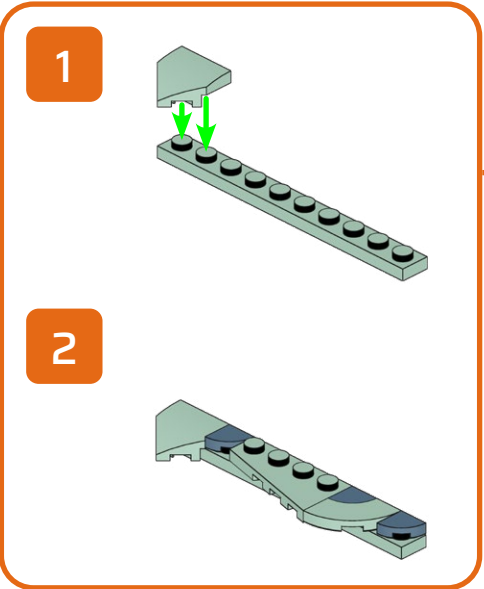
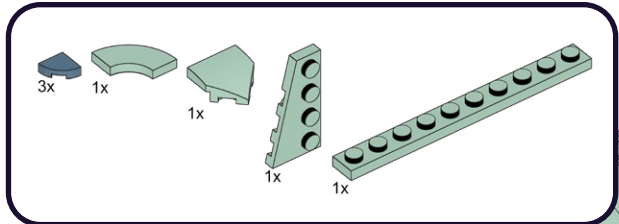

193

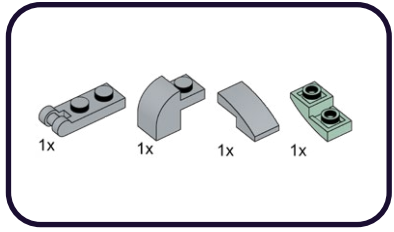

1

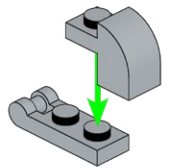

2

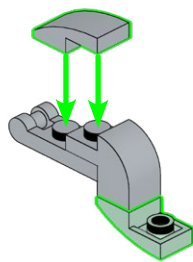

194

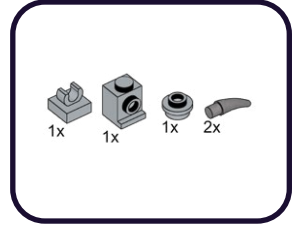

1

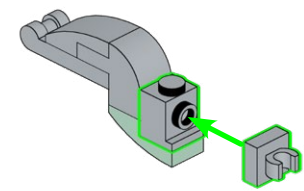

2

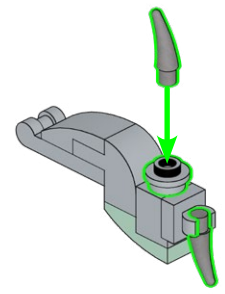



195

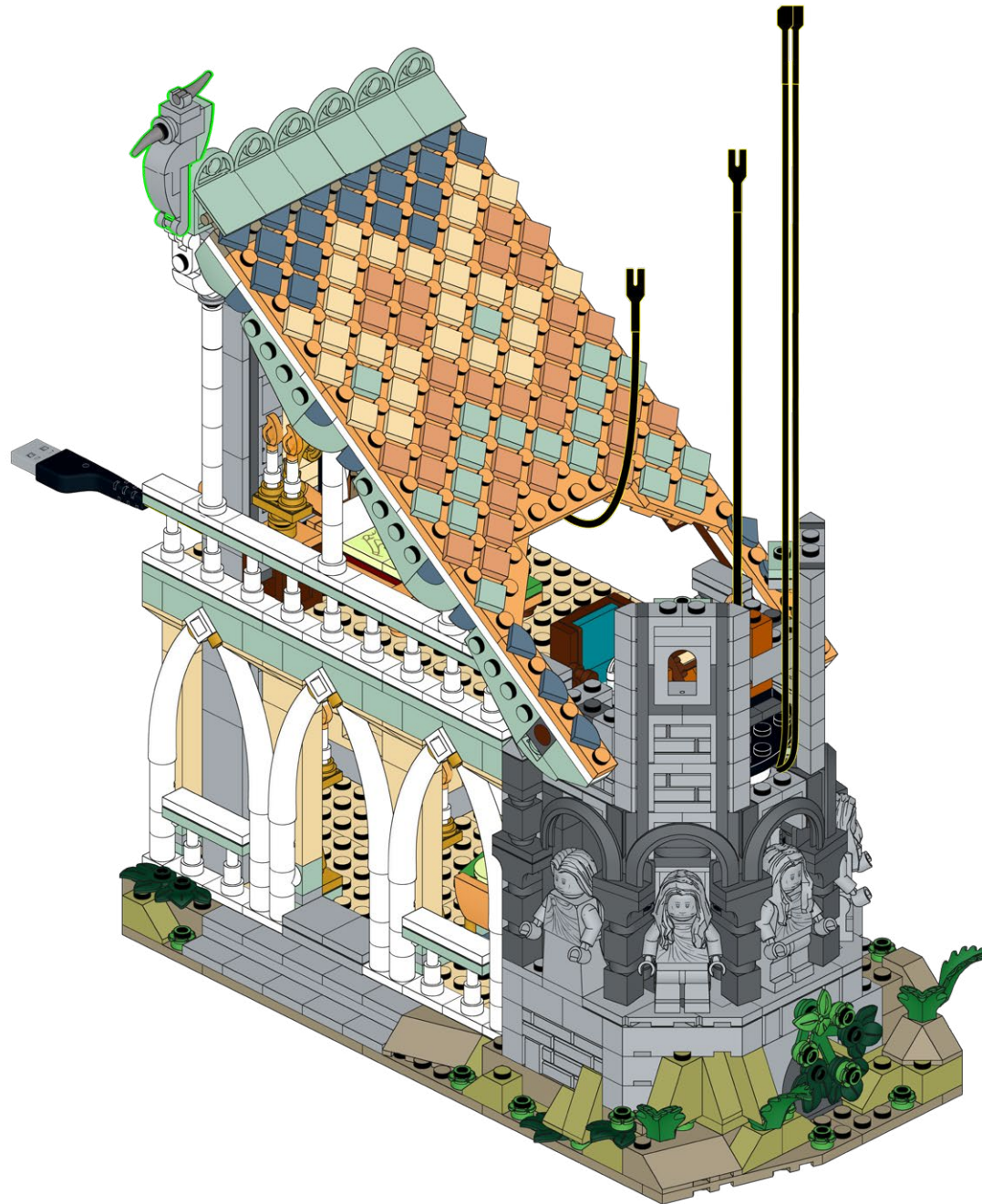

**HOLD UP!**

You might notice some bags aren't in order, as well as left over pieces, but that's ok! We're changing the way you build LEGO!

**ATTENDEZ!**

Vous remarquerez peut-être que certains sacs, ainsi que certaines pièces, ne sont pas dans le bon ordre. Mais pas de panique! Nous changeons simplement la façon avec laquelle vous construisez vos LEGO!

**ASPETTA!**

Potresti notare che alcuni sacchetti non sono in ordine, così come i pezzi avanzati, ma va bene così! Stiamo cambiando il modo in cui costruisci i LEGO!

**HALT!**

Sie werden möglicherweise bemerken, dass einige tüten durcheinander sind und teile übrig bleiben, aber das ist in Ordnung! Wir ändern die art und weise, wie Sie LEGO bauen!

**¡ESPERA!**

Es posible que notes que algunas bolsas están fuera de servicio, así como piezas sobrantes, ¡pero está bien! ¡Estamos cambiando la forma en que construyes LEGO!

**暫停!**

你可能会注意到一些袋子顺序错乱, 以及一些剩余的部件, 但没关系! 我们正在改变你搭建乐高的方式!

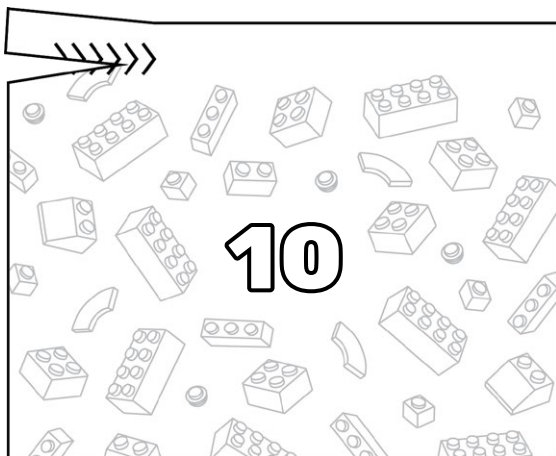
**Open LEGO® Bag 10**

196

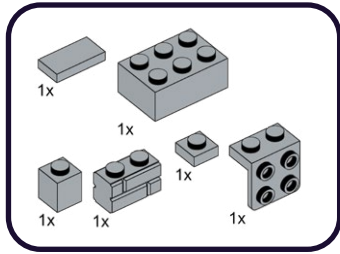

1

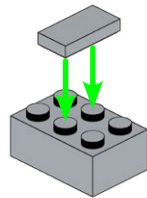

2

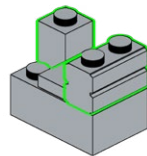

3

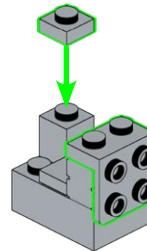

197

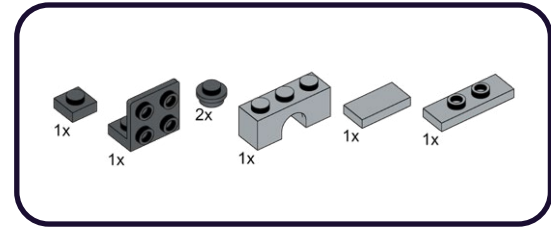

1

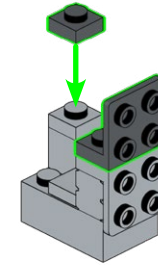

2

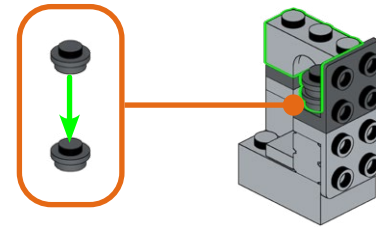

3

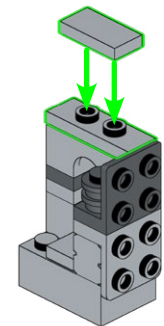

198

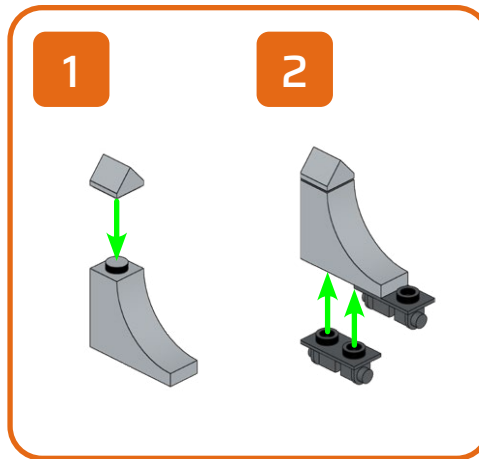
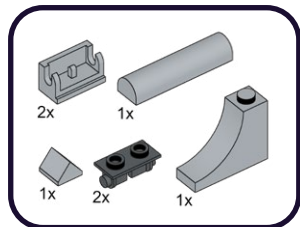

1

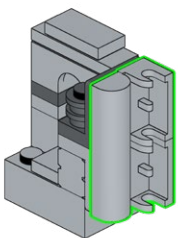

2

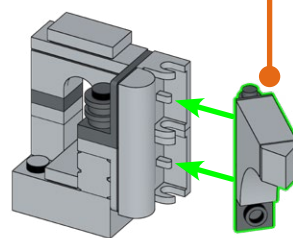

3

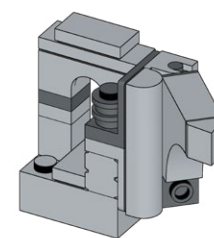

199

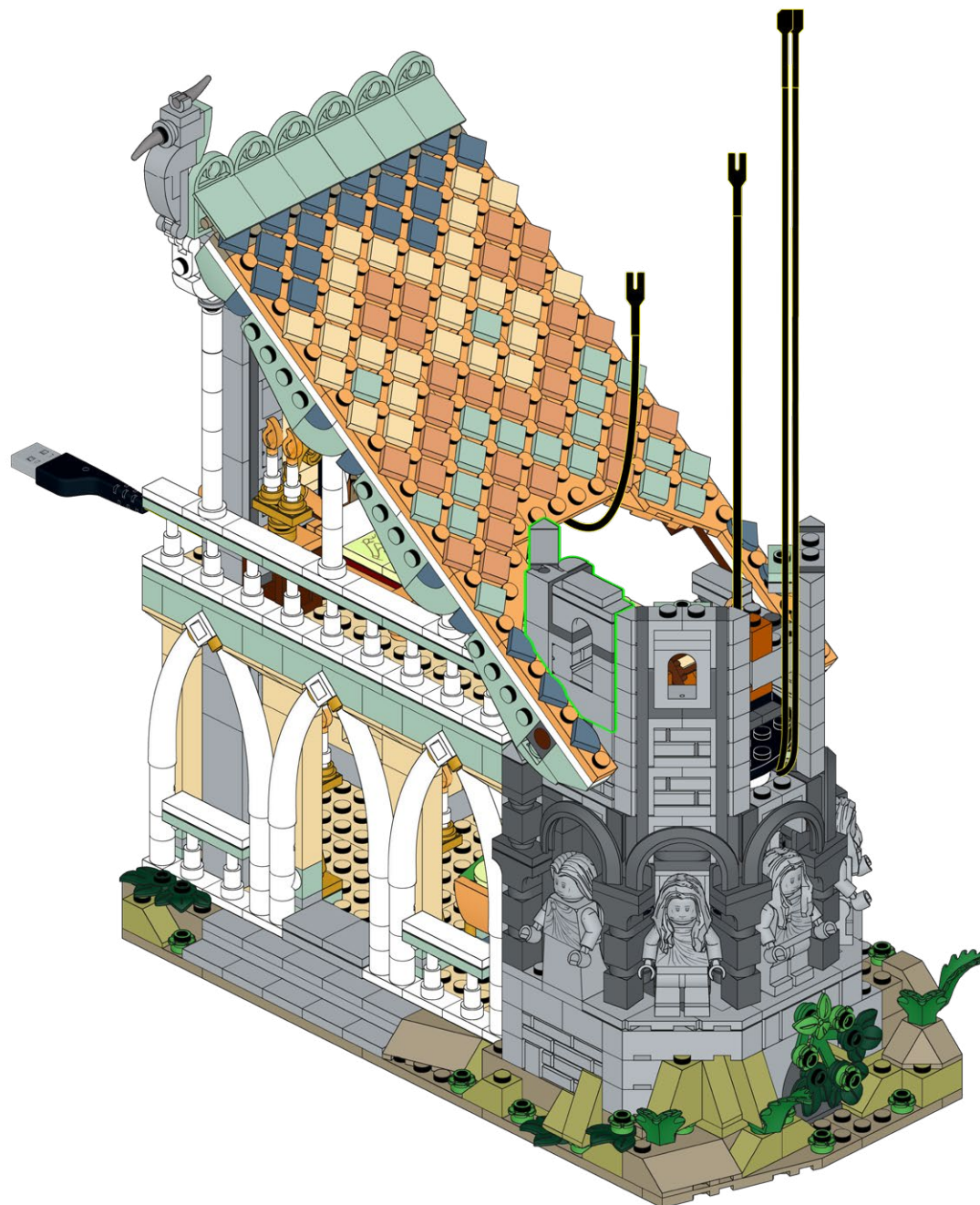

# 200

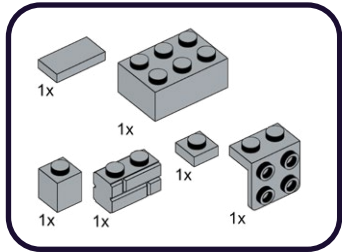

1

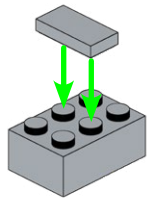

2

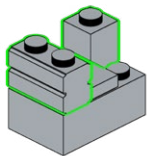

3

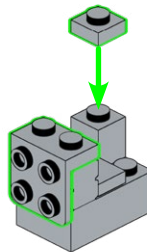

# 201

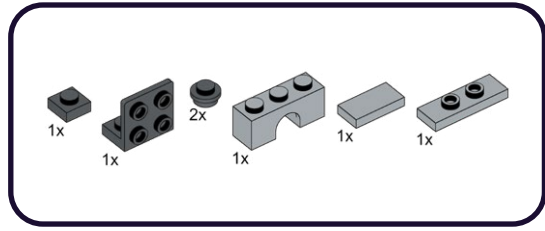

1

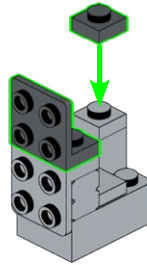

2

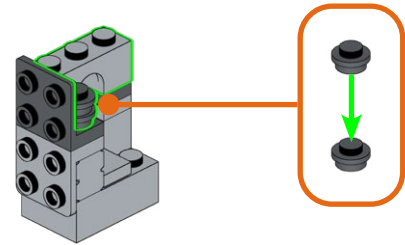

3

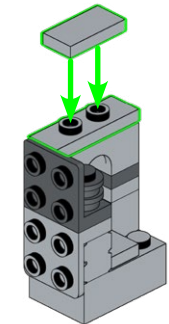

202

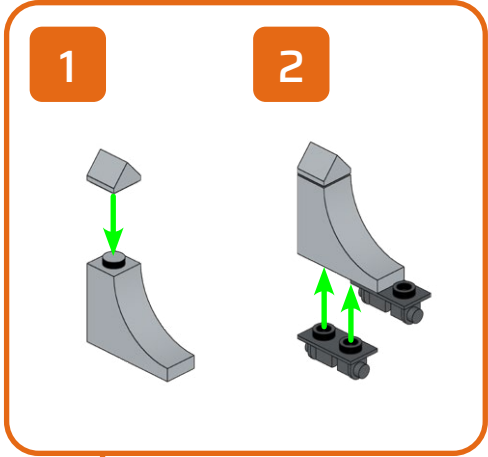
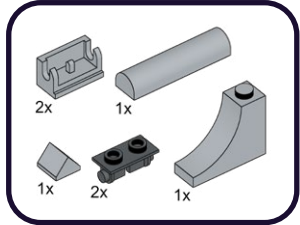

1

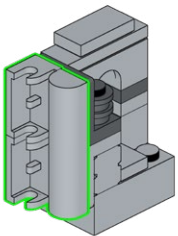

2

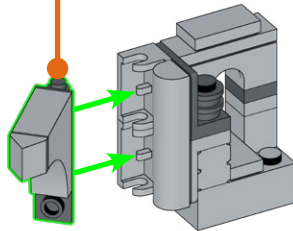

3

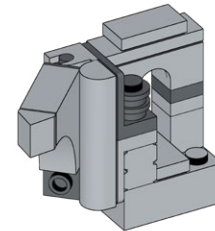

203

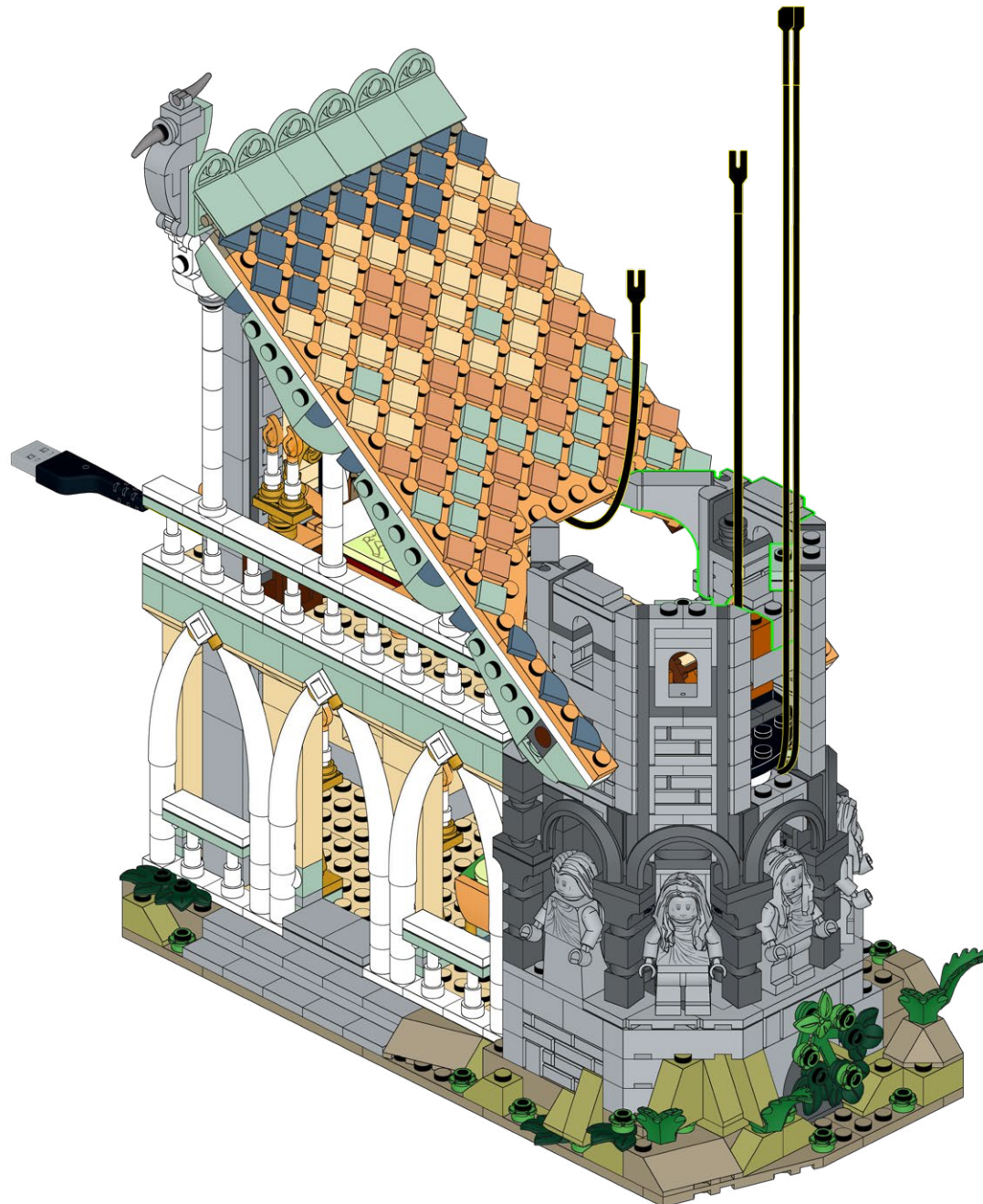



204

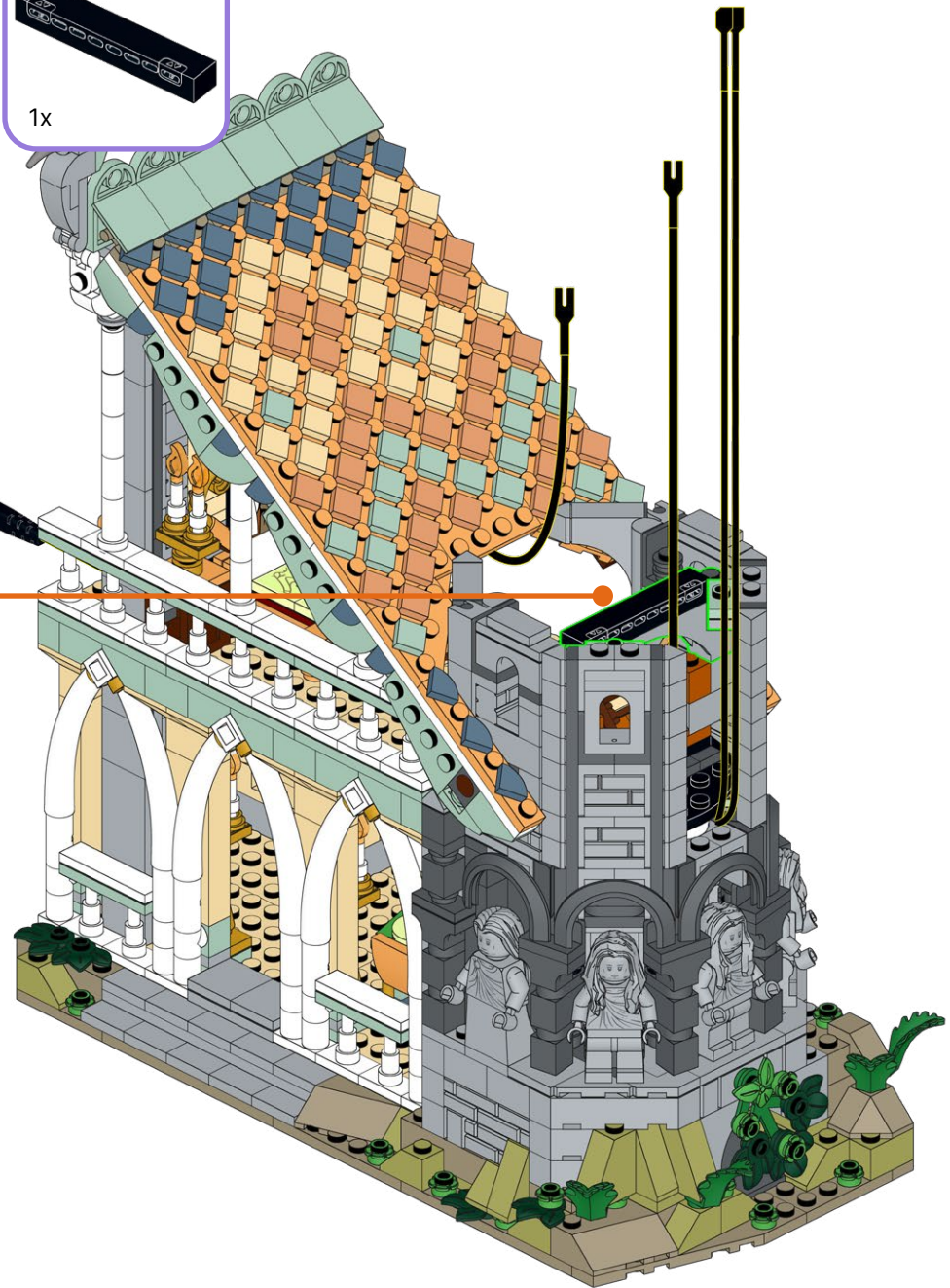
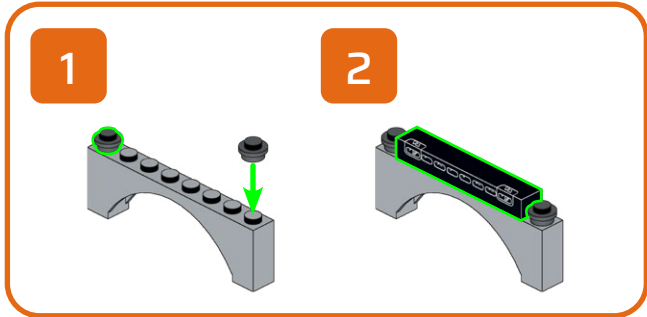
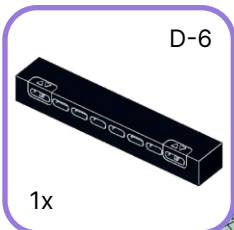
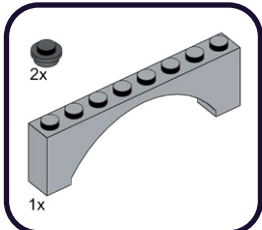

205

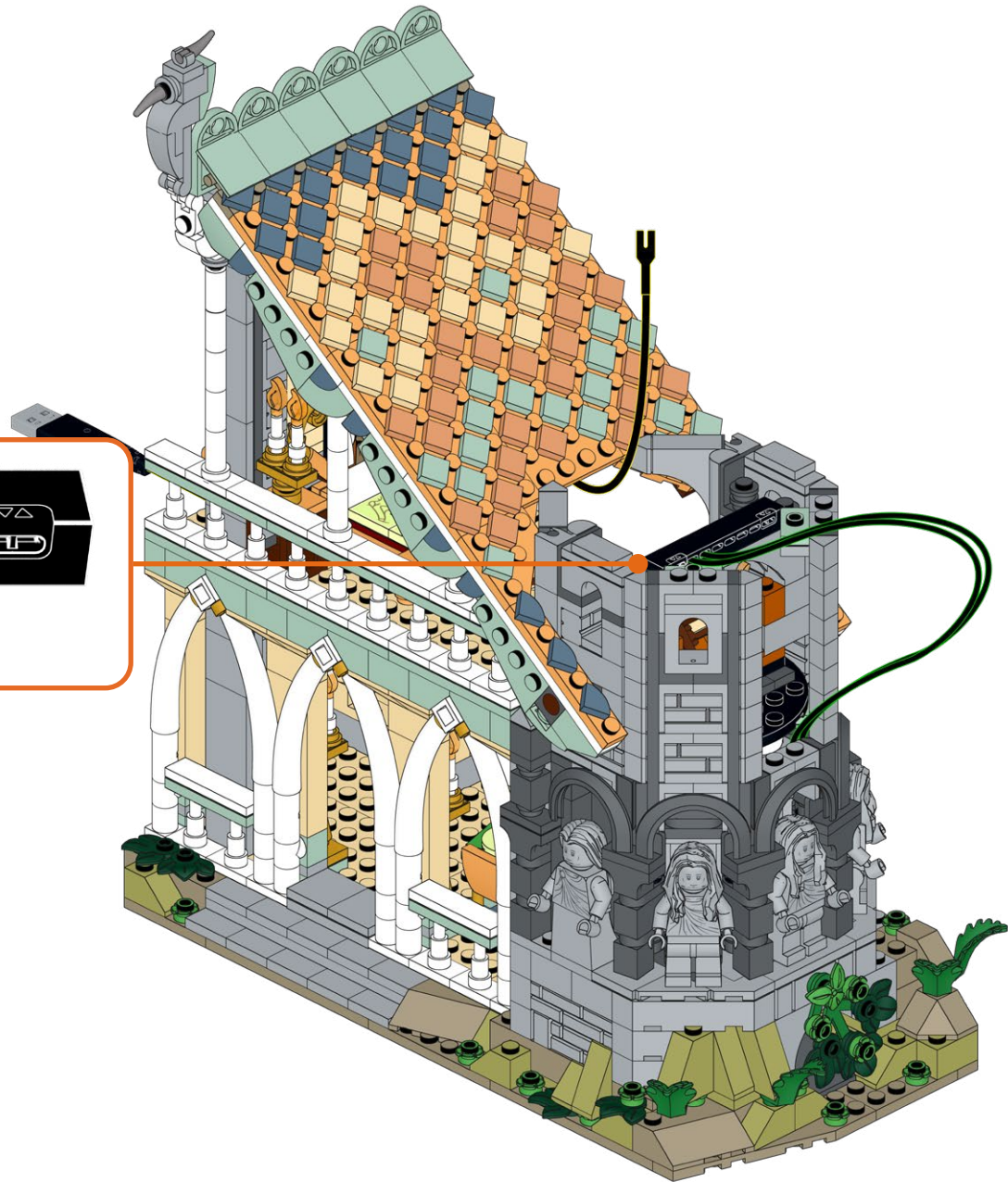
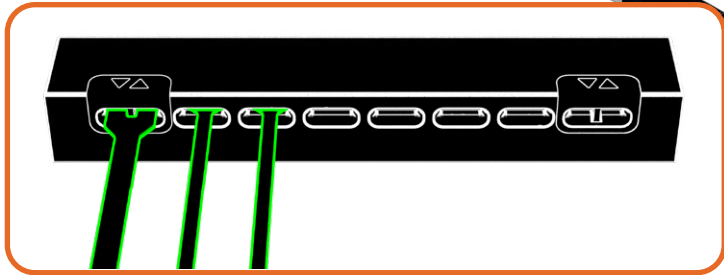

206

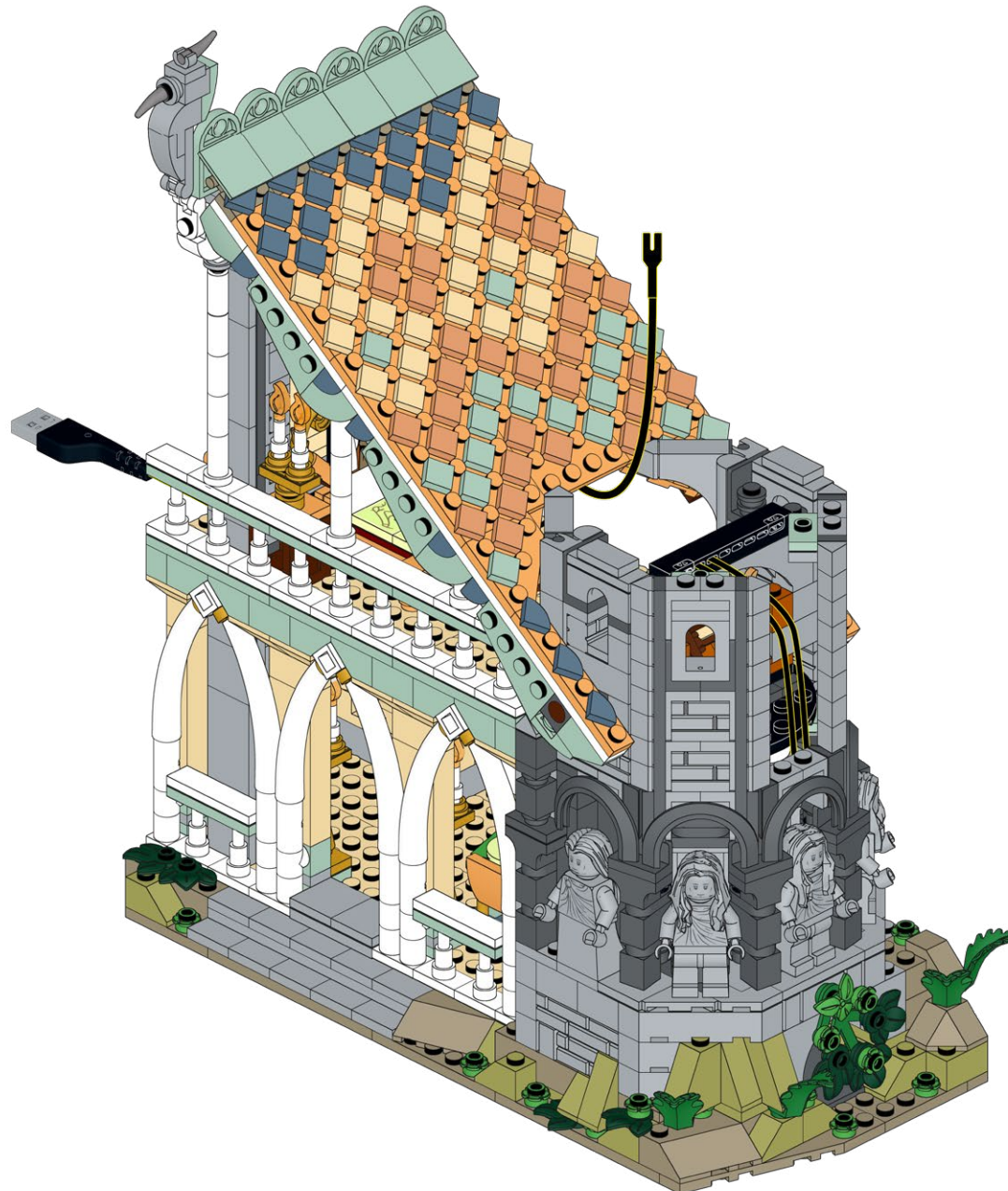

207

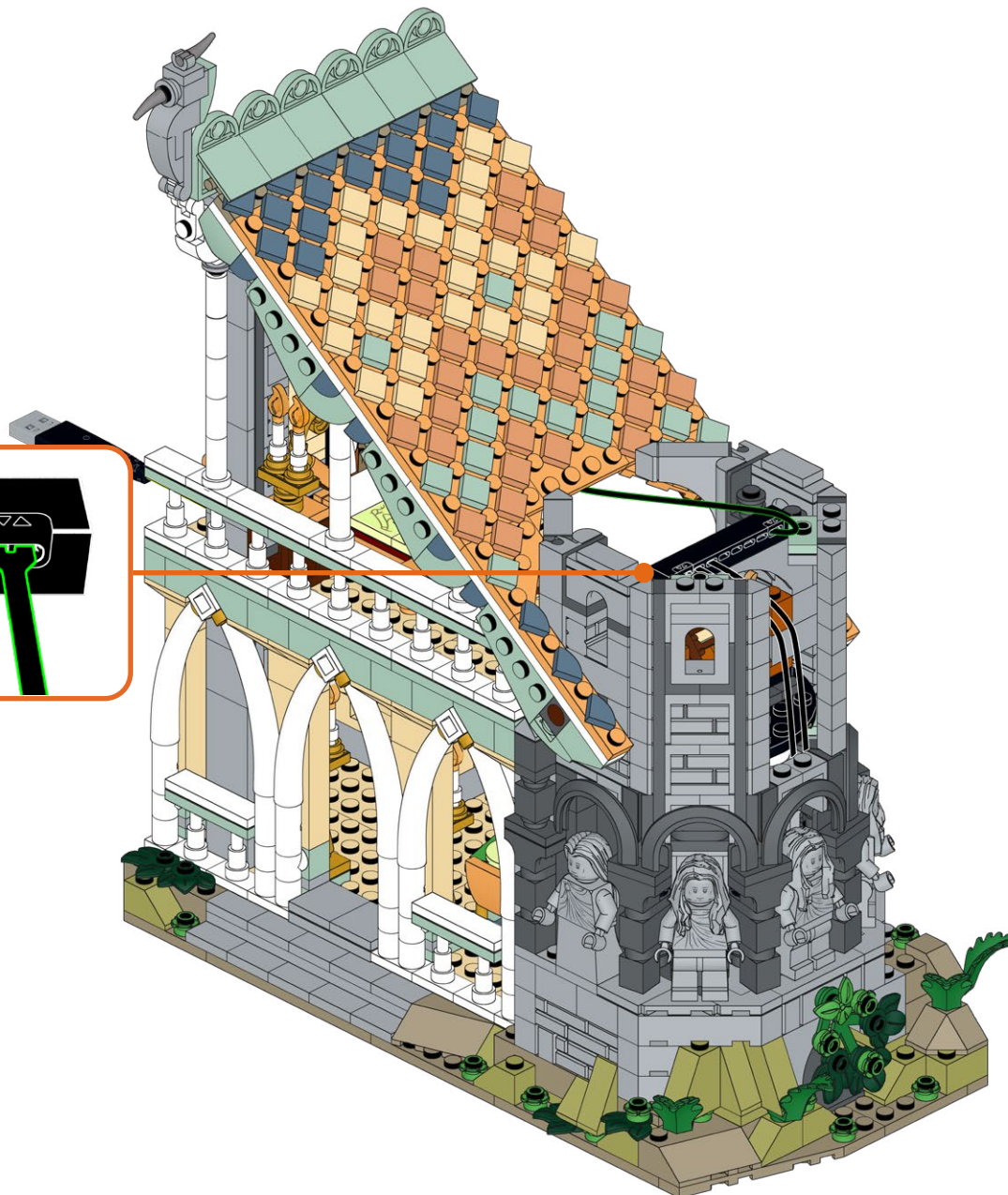
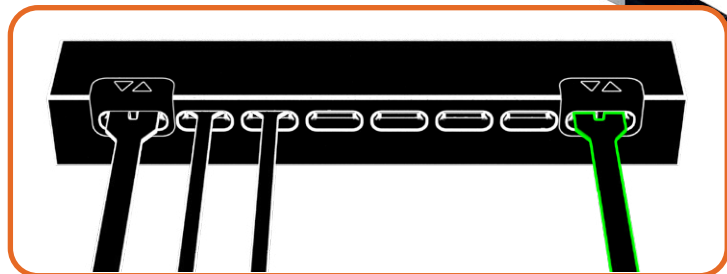

208

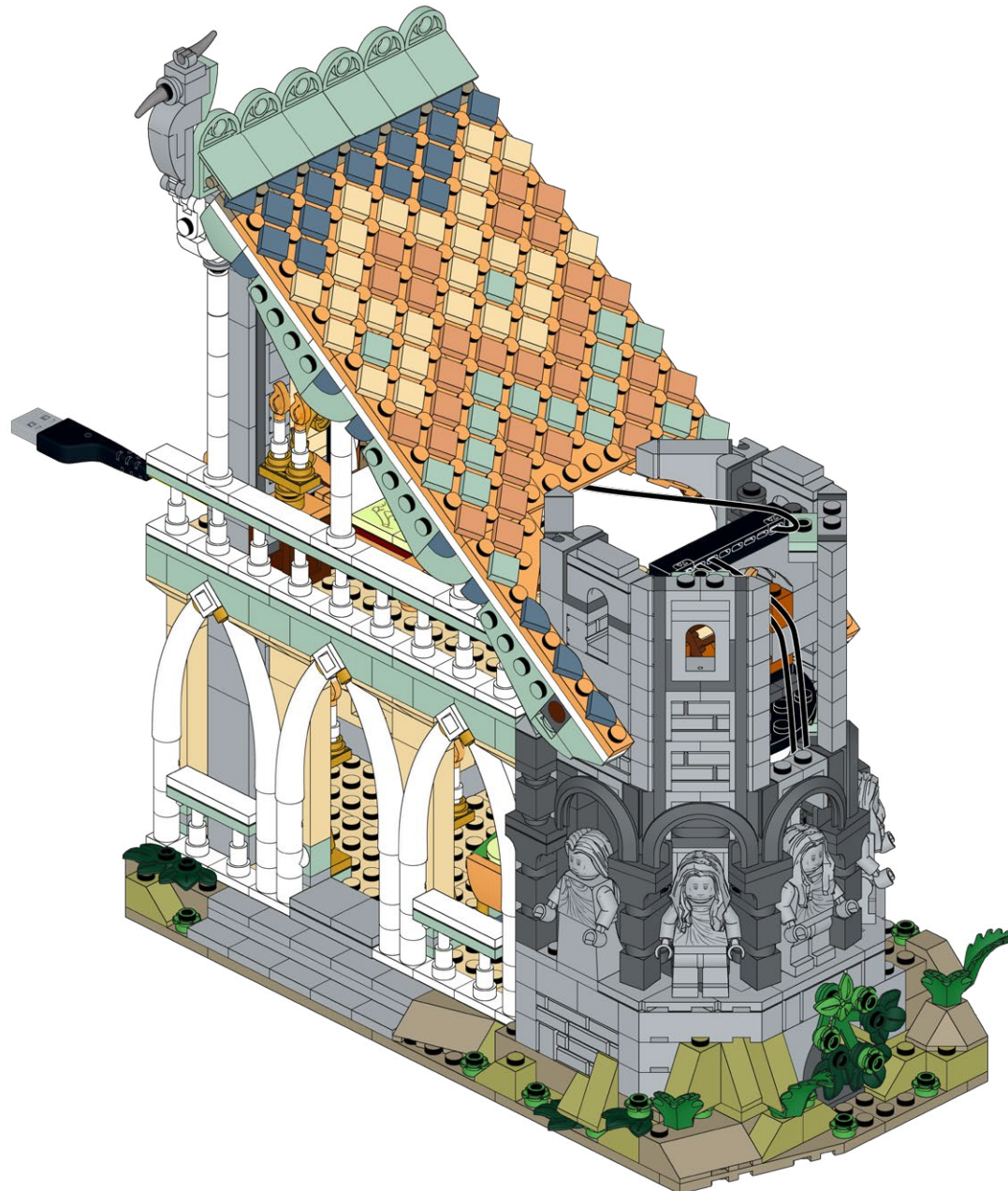

209

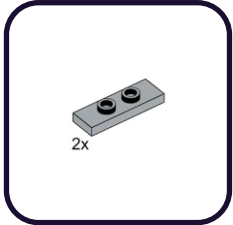

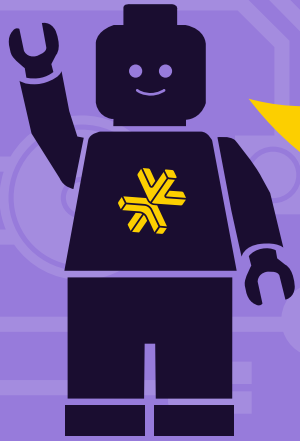
**HOLD UP!**

You might notice some bags aren't in order, as well as left over pieces, but that's ok! We're changing the way you build LEGO!

**ATTENDEZ!**

Vous remarquerez peut-être que certains sacs, ainsi que certaines pièces, ne sont pas dans le bon ordre. Mais pas de panique! Nous changeons simplement la façon avec laquelle vous construisez vos LEGO!

**ASPETTA!**

Potresti notare che alcuni sacchetti non sono in ordine, così come i pezzi avanzati, ma va bene così! Stiamo cambiando il modo in cui costruisci i LEGO!

**HALT!**

Sie werden möglicherweise bemerken, dass einige tüten durcheinander sind und teile übrig bleiben, aber das ist in Ordnung! Wir ändern die art und weise, wie Sie LEGO bauen!

**¡ESPERA!**

Es posible que notes que algunas bolsas están fuera de servicio, así como piezas sobrantes, ¡pero está bien! ¡Estamos cambiando la forma en que construyes LEGO!

**暫停!**

你可能会注意到一些袋子顺序错乱, 以及一些剩余的部件, 但没关系! 我们正在改变你搭建乐高的方式!

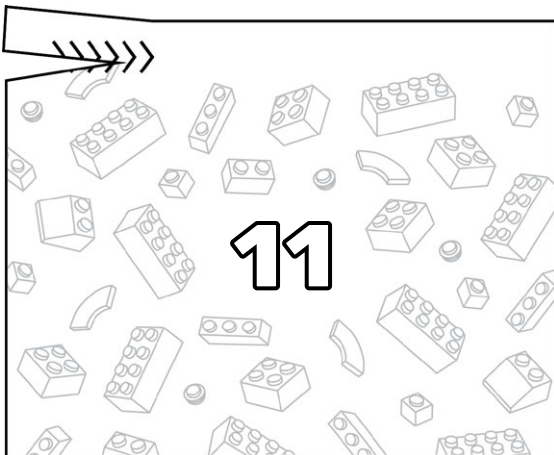
**Open LEGO® Bag 11**

210

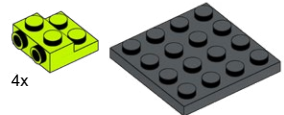

4x

1x

1

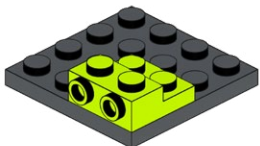

2

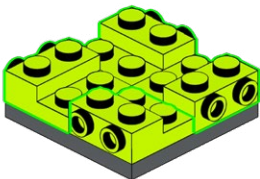

211

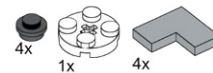

4x

1x

4x

1

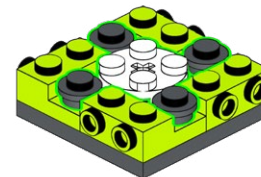

2

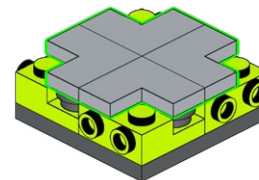



**212**

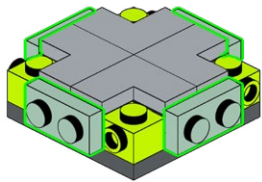
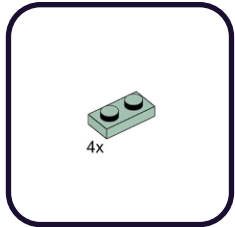

**213**

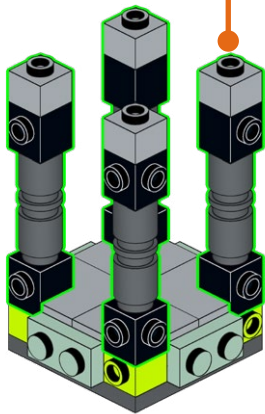
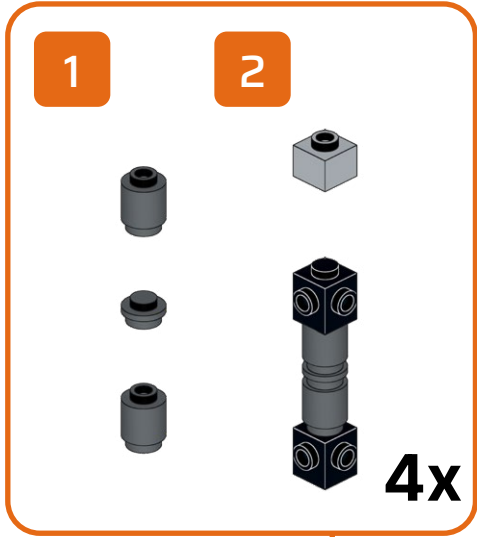
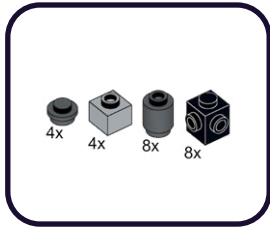

214

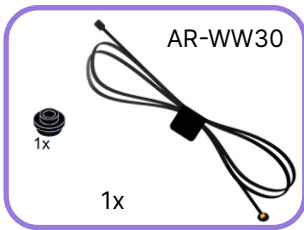
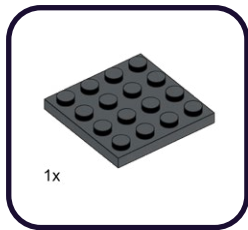

1

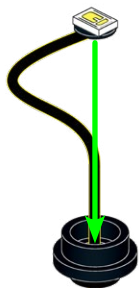

2



3

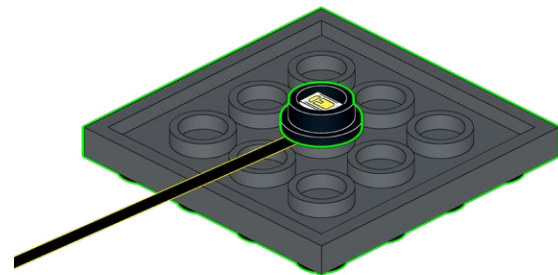

**215**

**216**

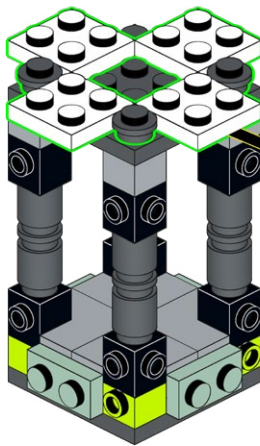
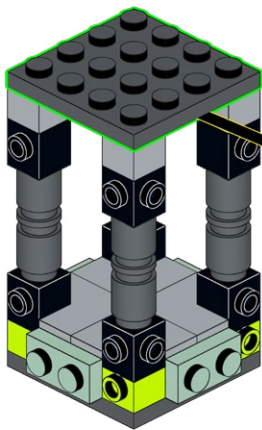
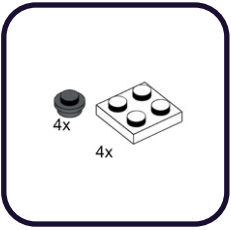

217

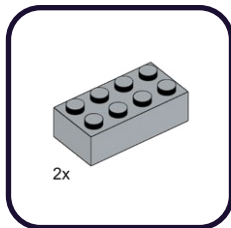

218

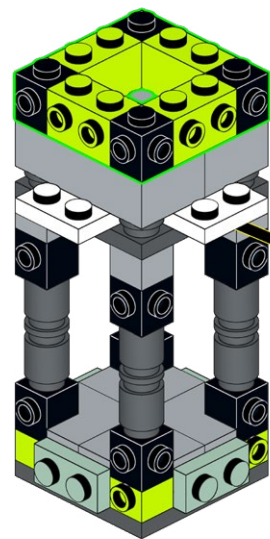
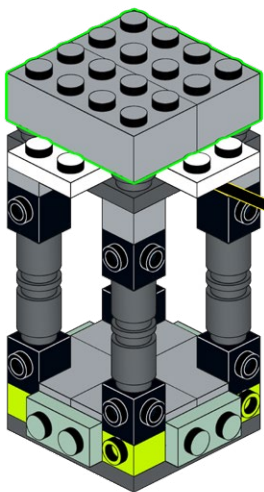
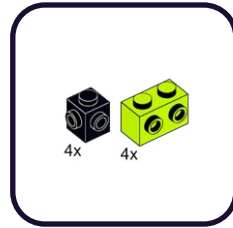

219

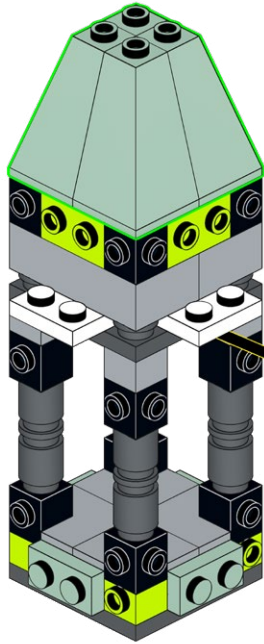
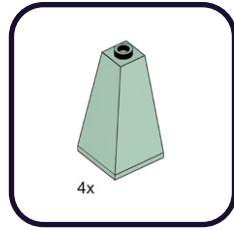

220

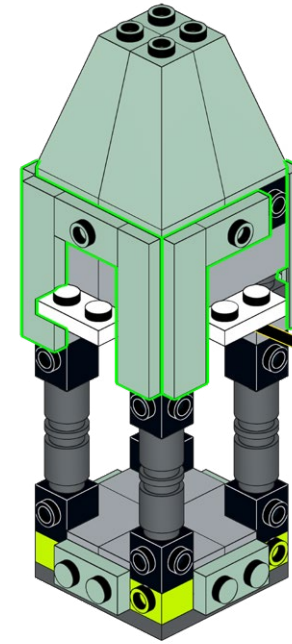
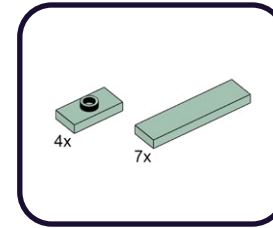

221

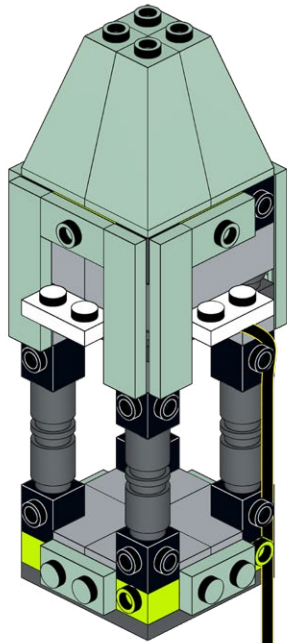

222

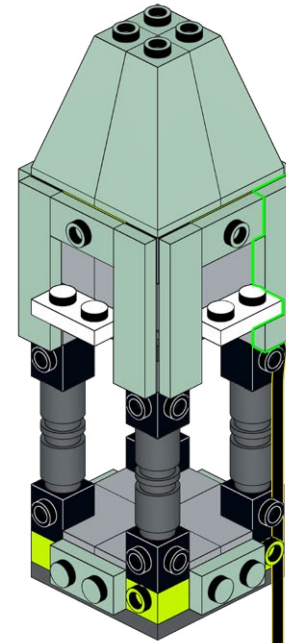
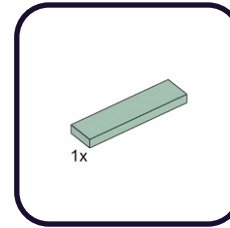

# 223

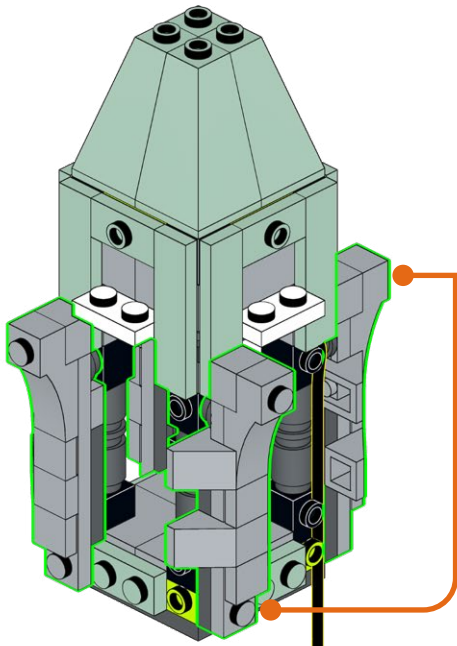
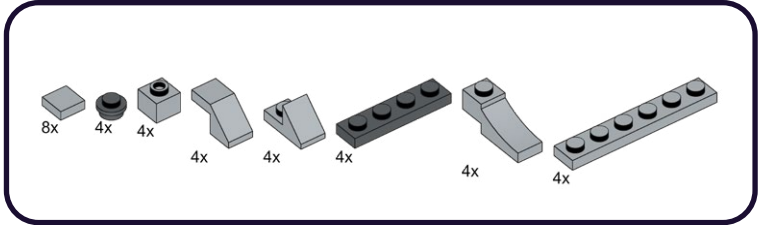

- 
- 
- 
-

224

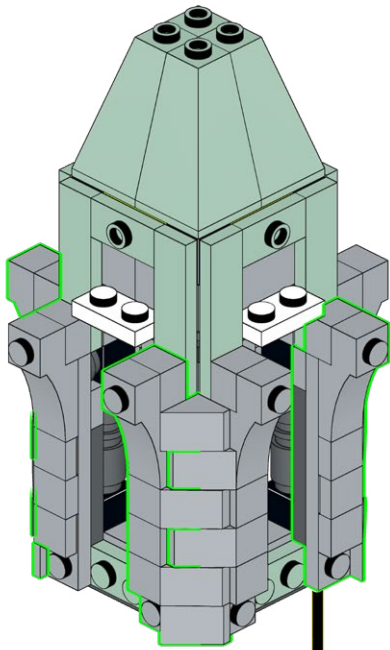
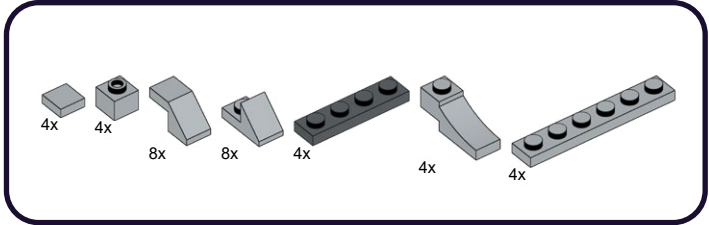

1

2

3

4

4x

A vertical list of four assembly steps, each with a numbered orange box and a corresponding diagram. Step 1 shows a 1x7 Technic brick being placed on top of a 1x5 Technic brick. Step 2 shows a 1x7 Technic brick with two 1x3 wedges attached to its ends. Step 3 shows a 1x7 Technic brick with four 1x3 wedges attached to its sides. Step 4 shows a 1x3 Technic brick with a 1x1 square being attached to its end. The number '4x' is written at the bottom right of the instructions.



225

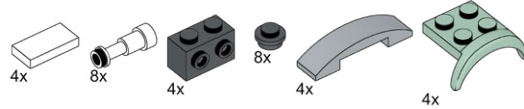

1

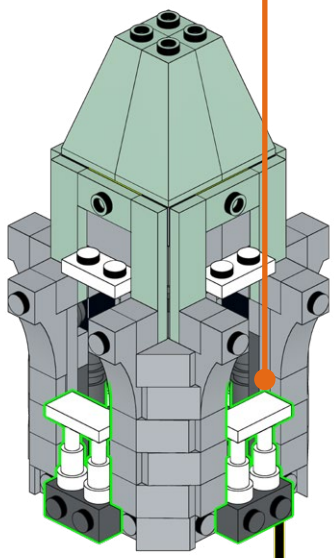
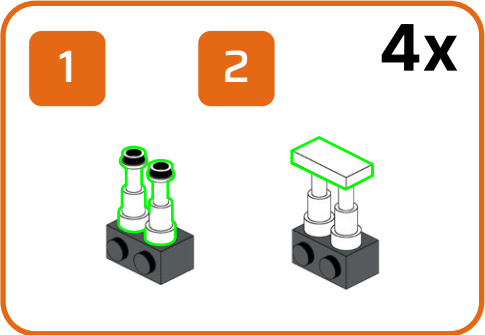

2

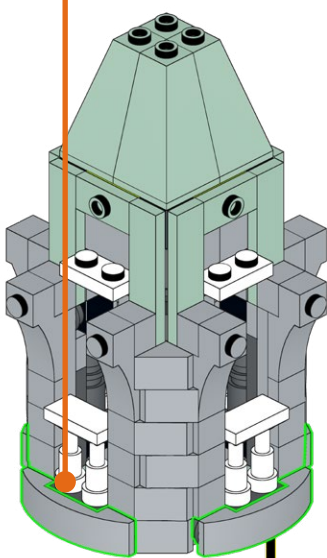
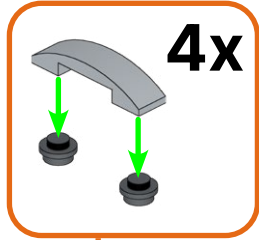

3

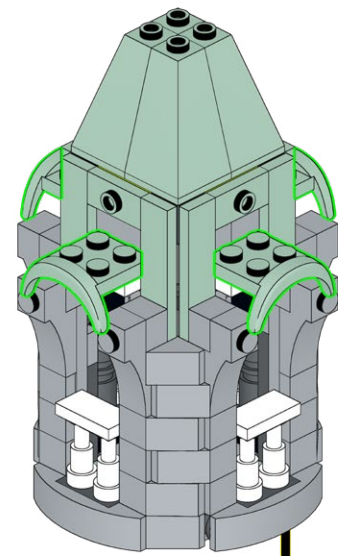

226

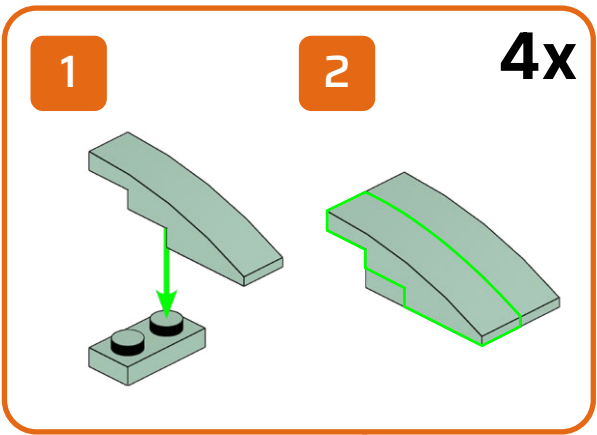
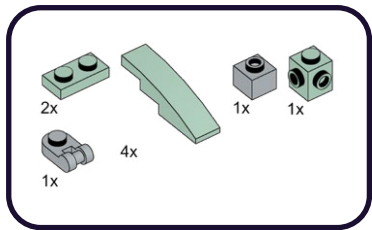

1

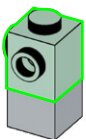

2

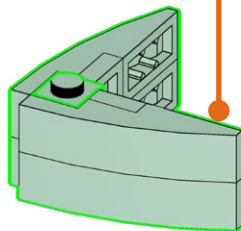

3

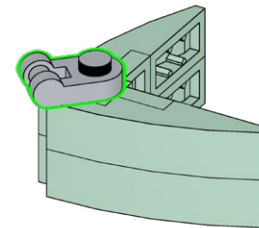

227

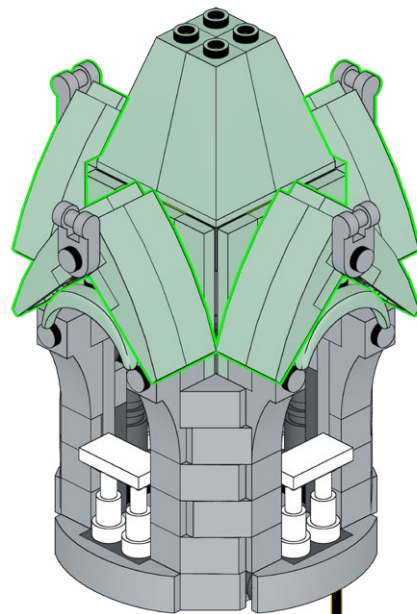

228

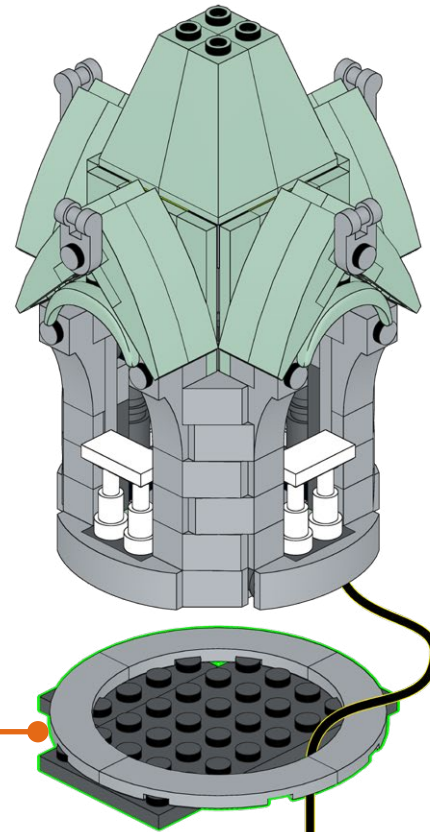
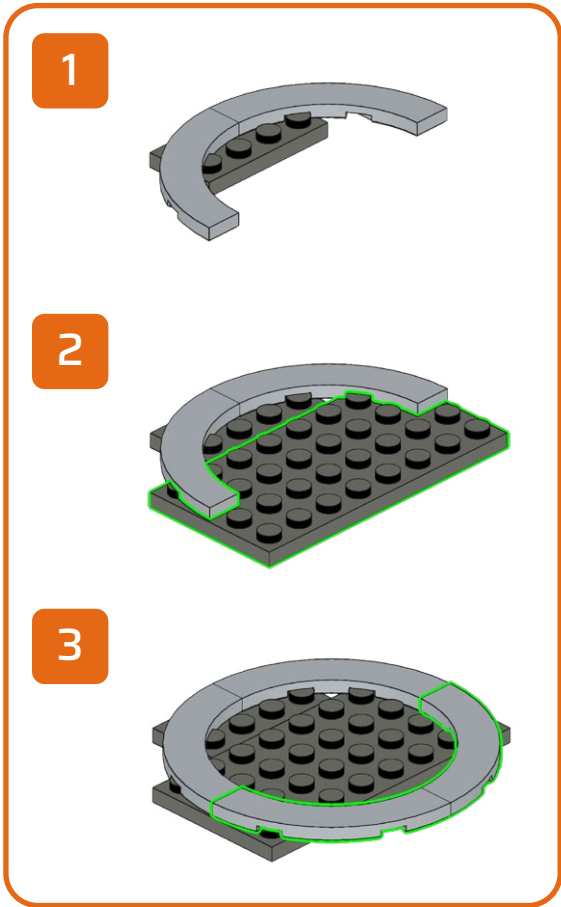
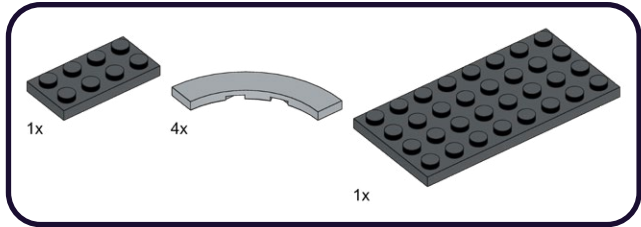

229

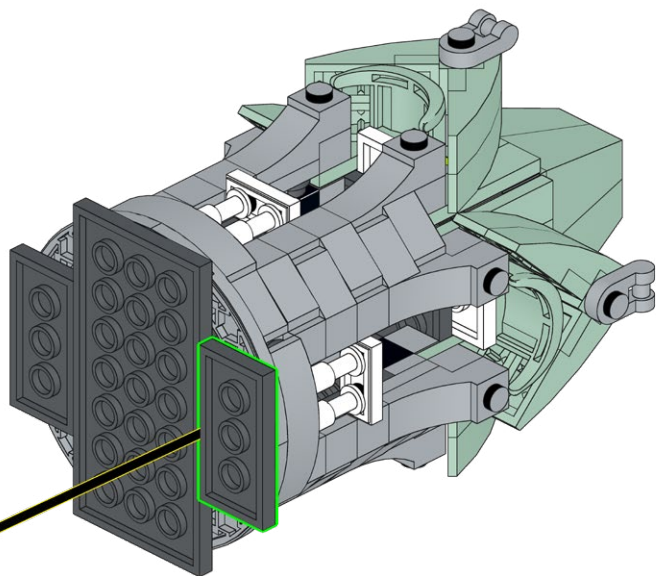

230

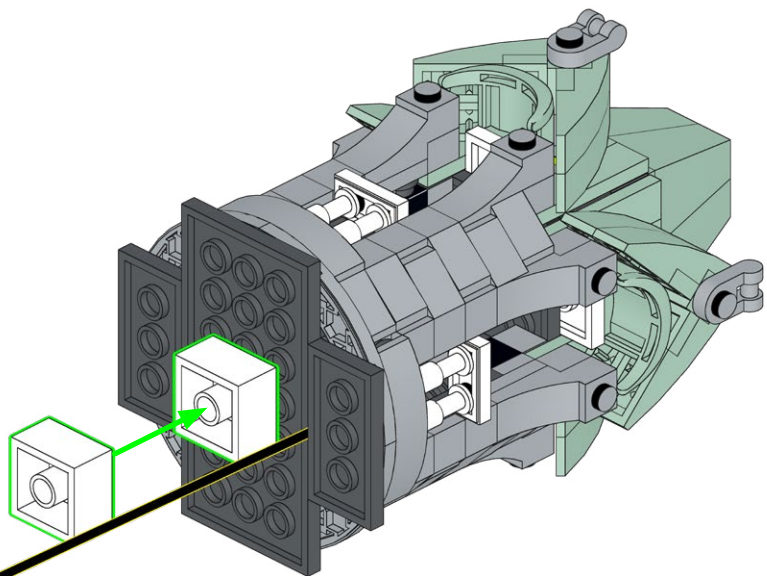
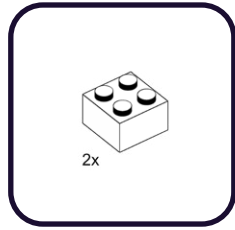

231

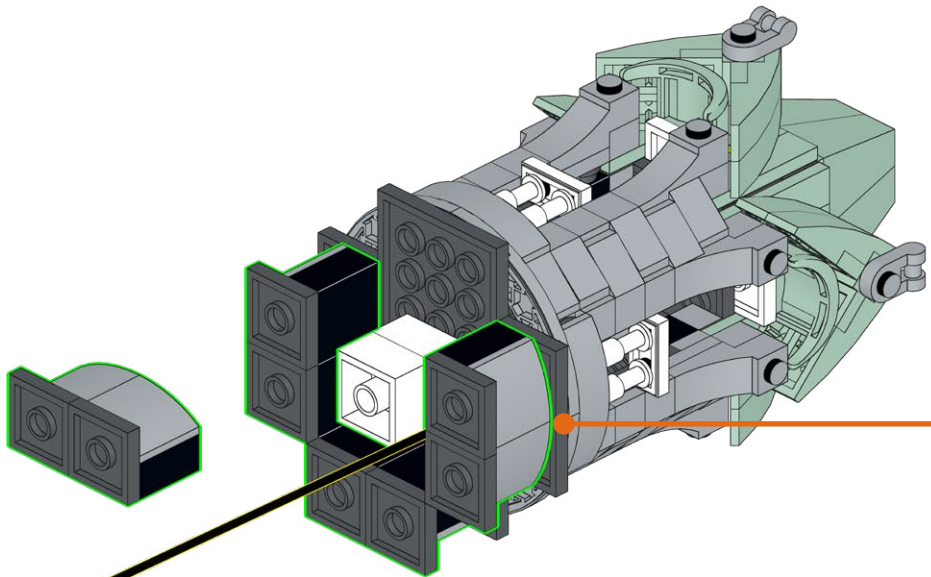
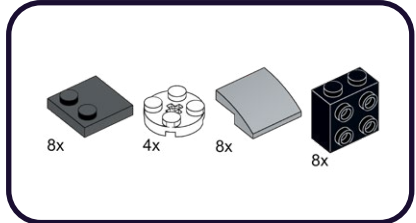

1

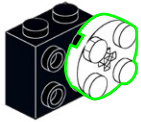

2

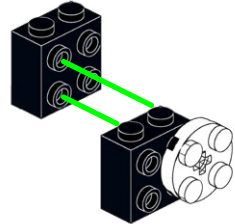

3

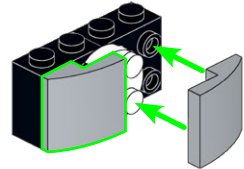

4

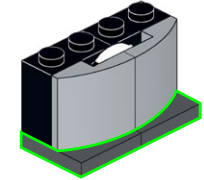

4x

232

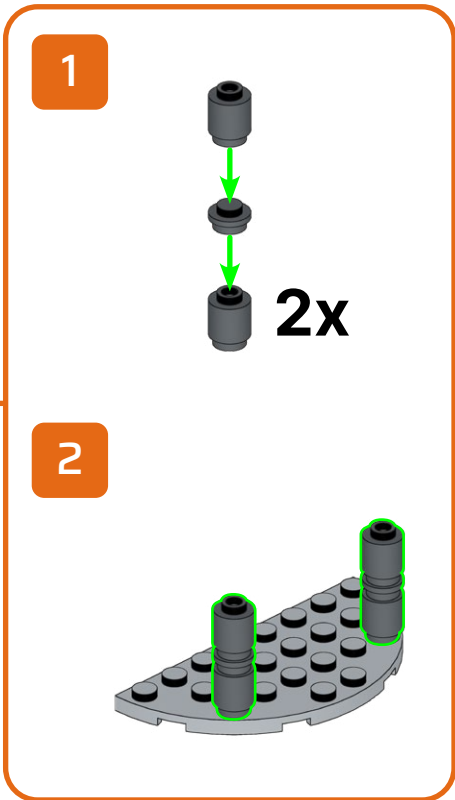
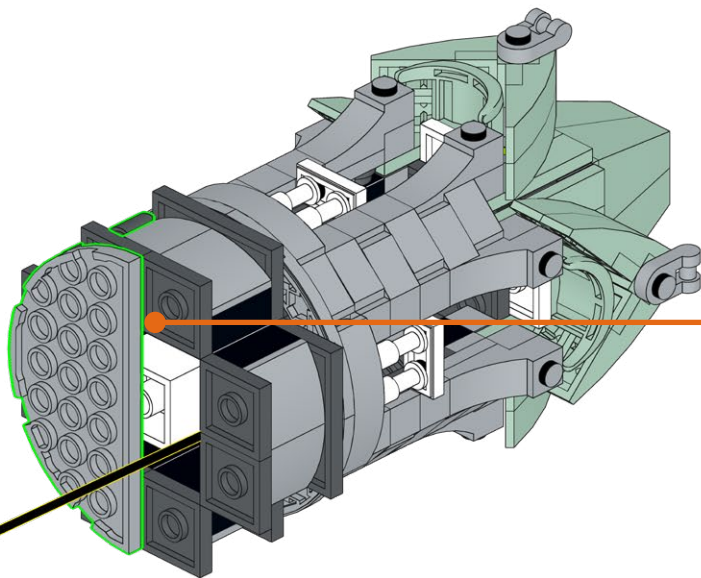
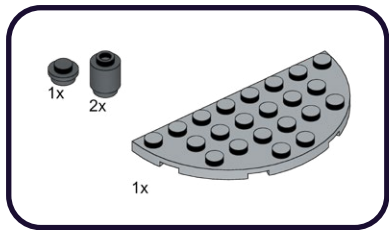

**233**

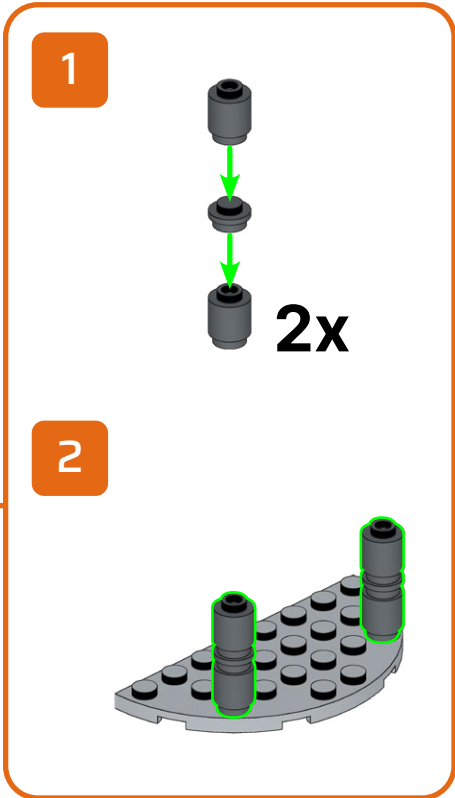
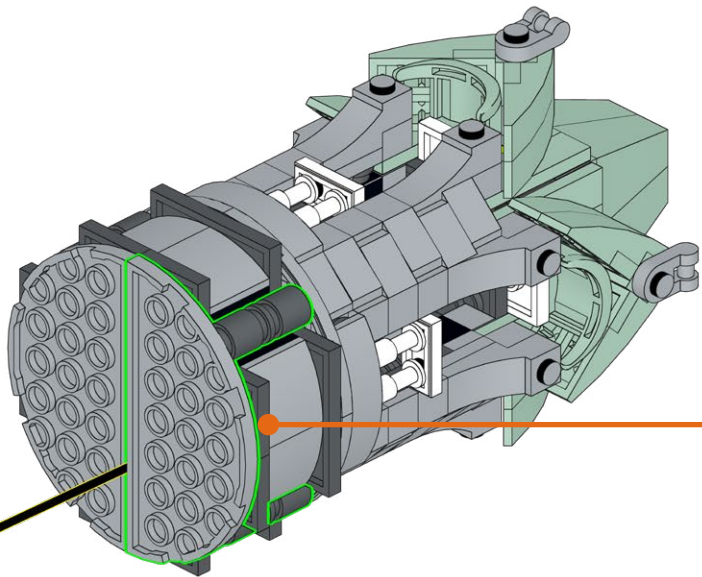
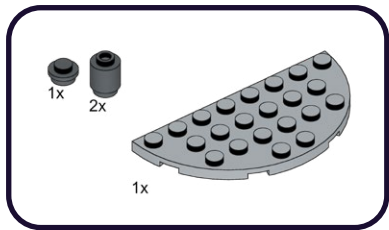



234

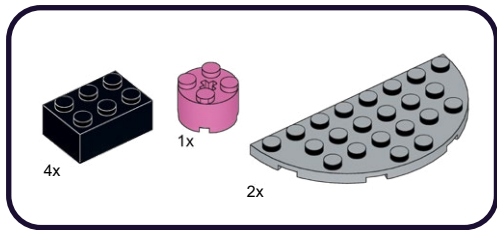

1

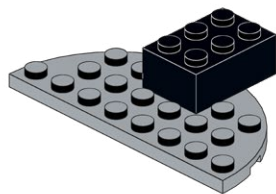

2

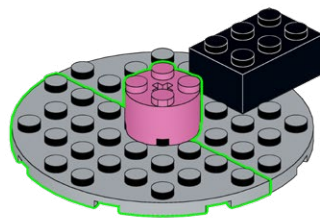

3

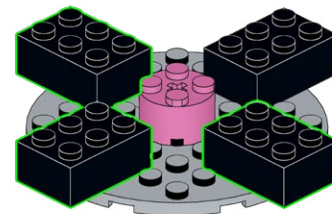

235

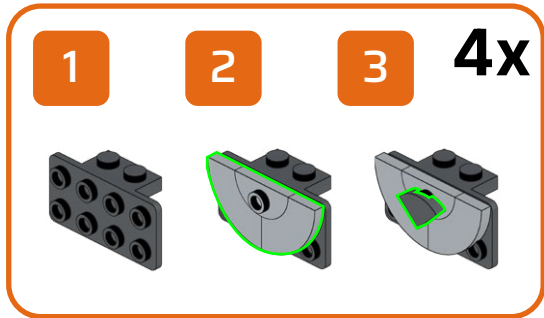
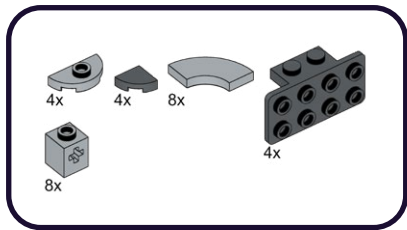

1

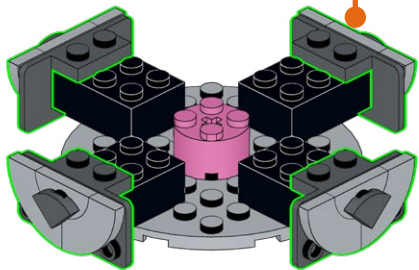

2

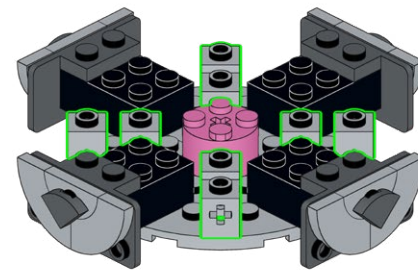

# 236

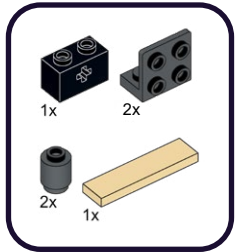

1

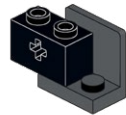

2

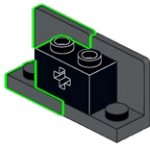

3

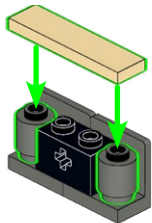

# 237

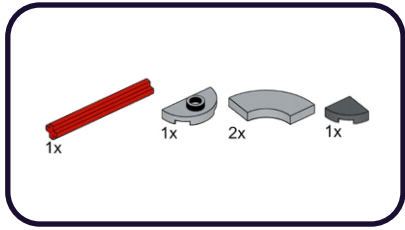

1

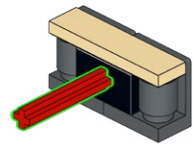

2

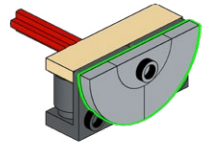

3

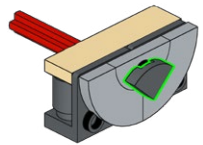

4x

238

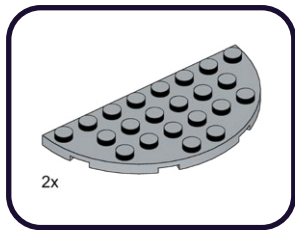

1

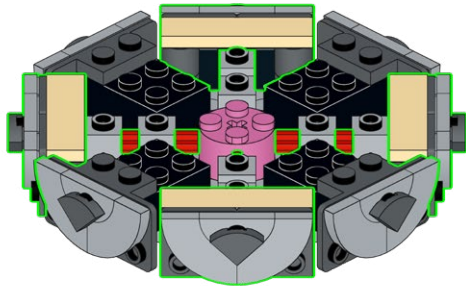

2

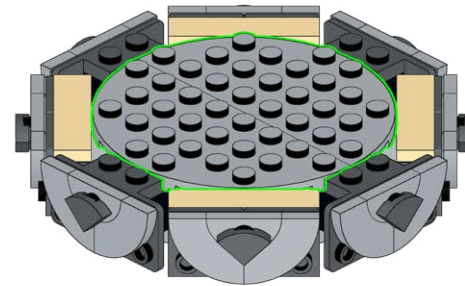

239

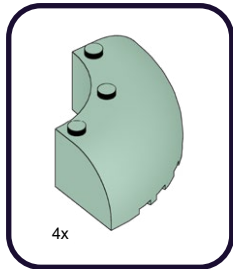

1

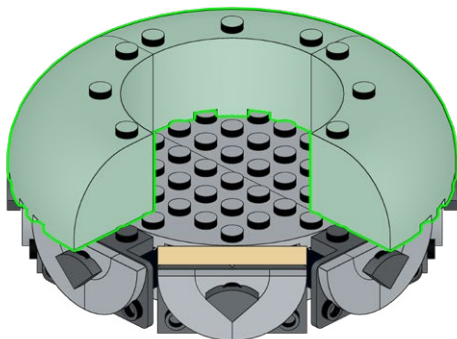

2

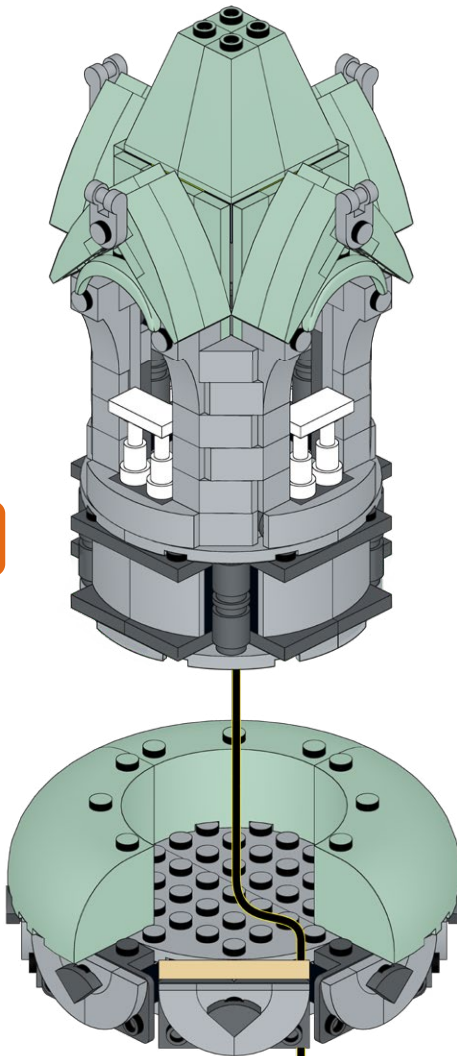

3

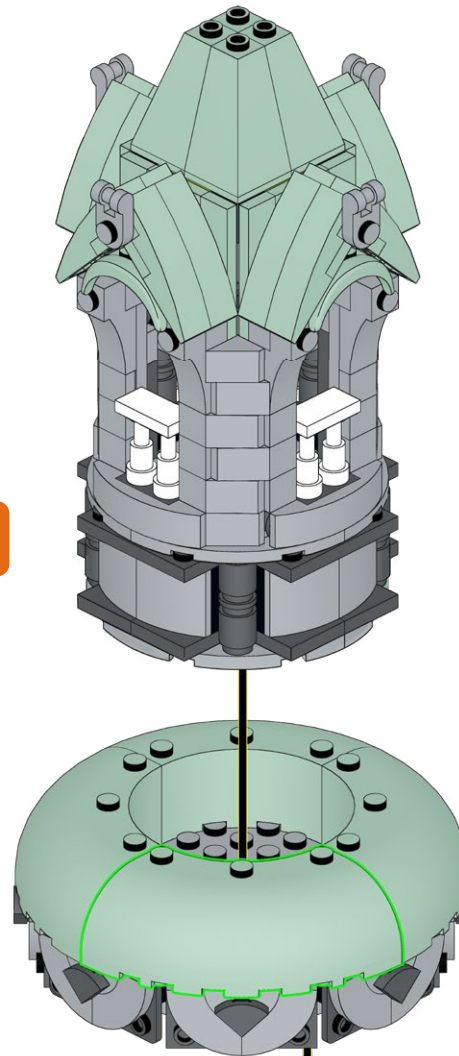

240

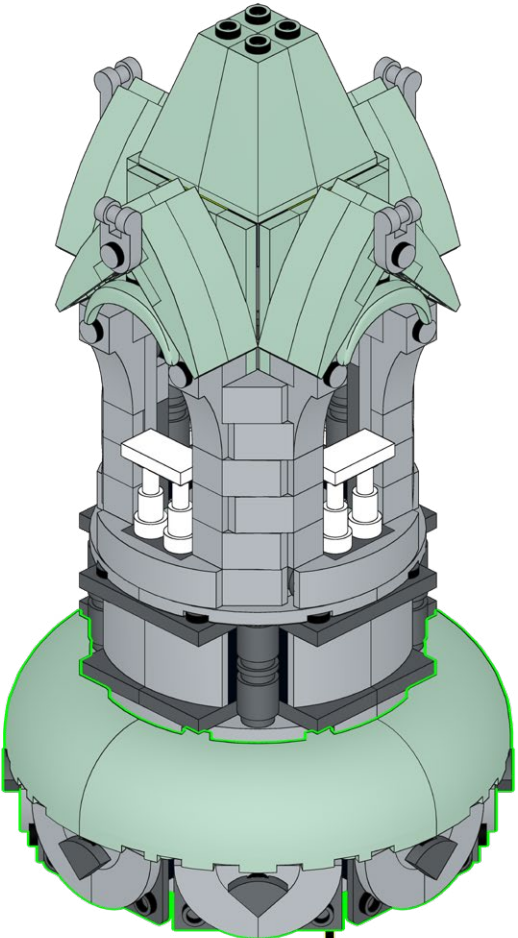

241

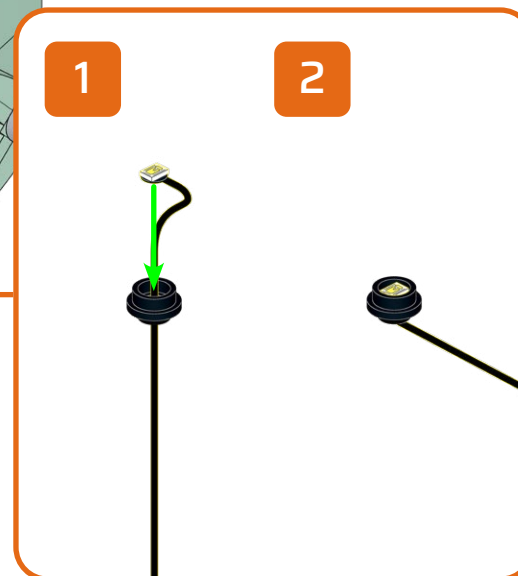
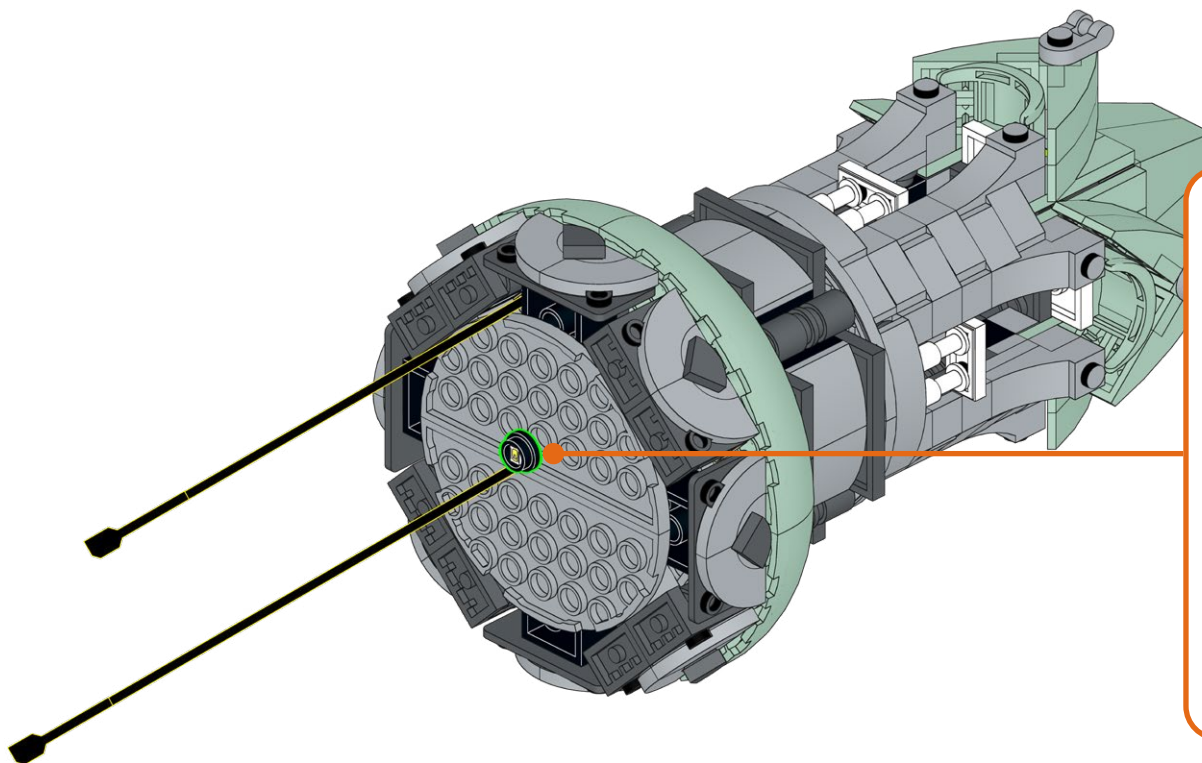
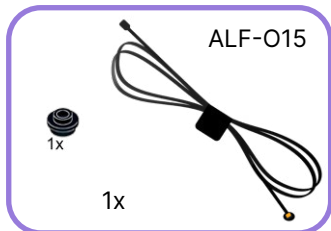

242

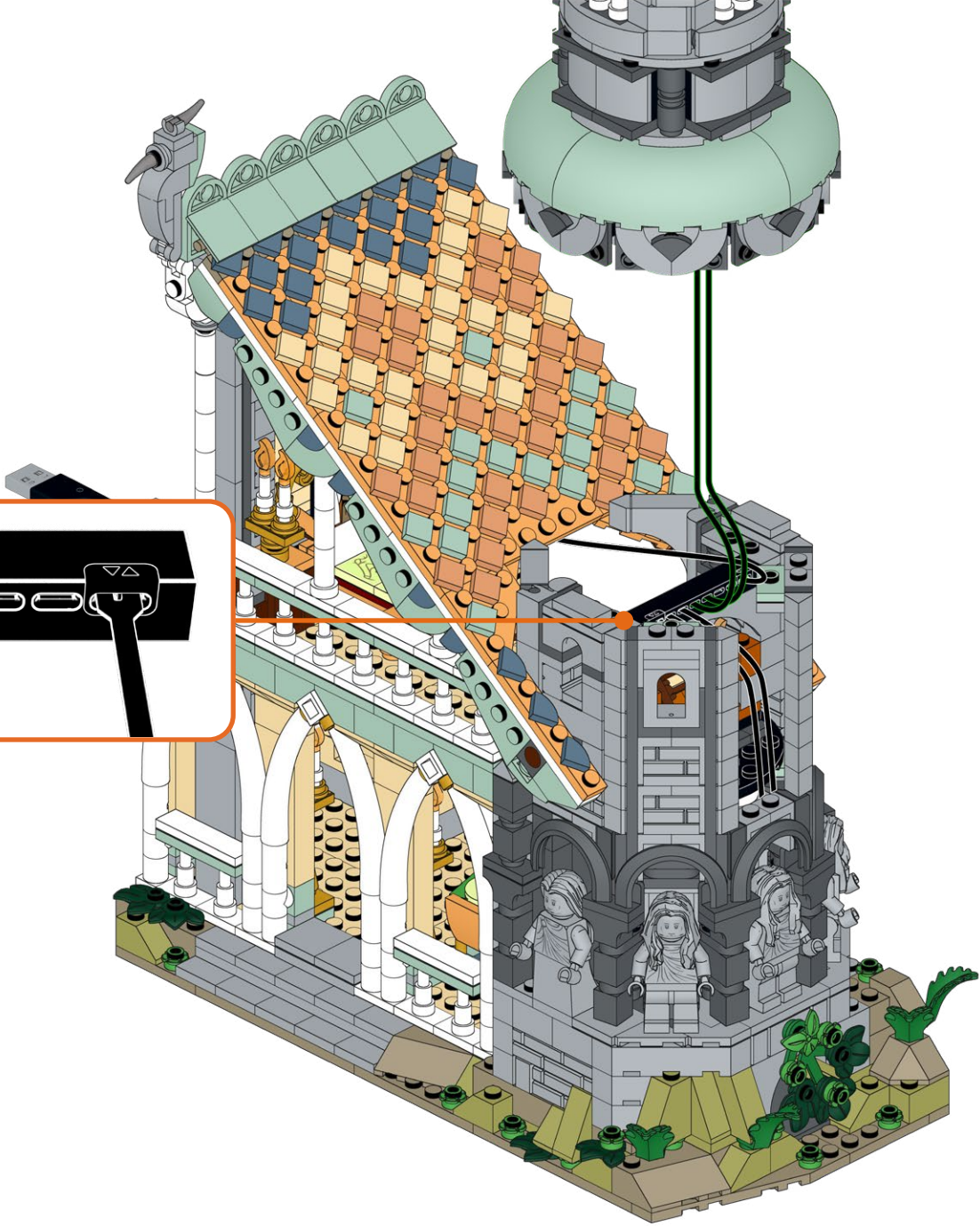
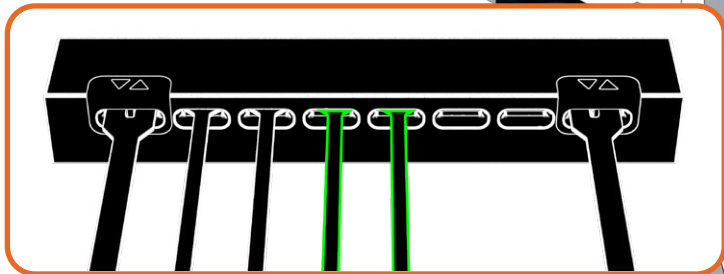



243

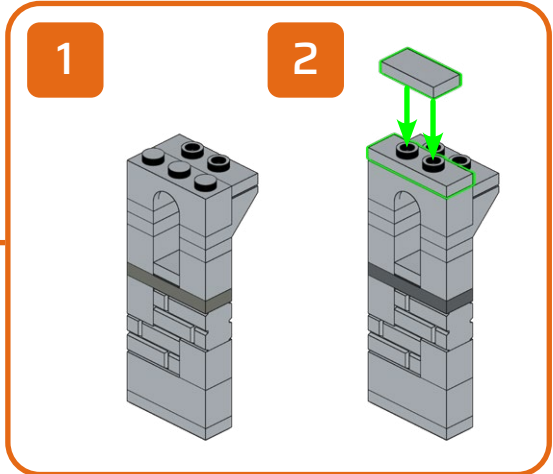
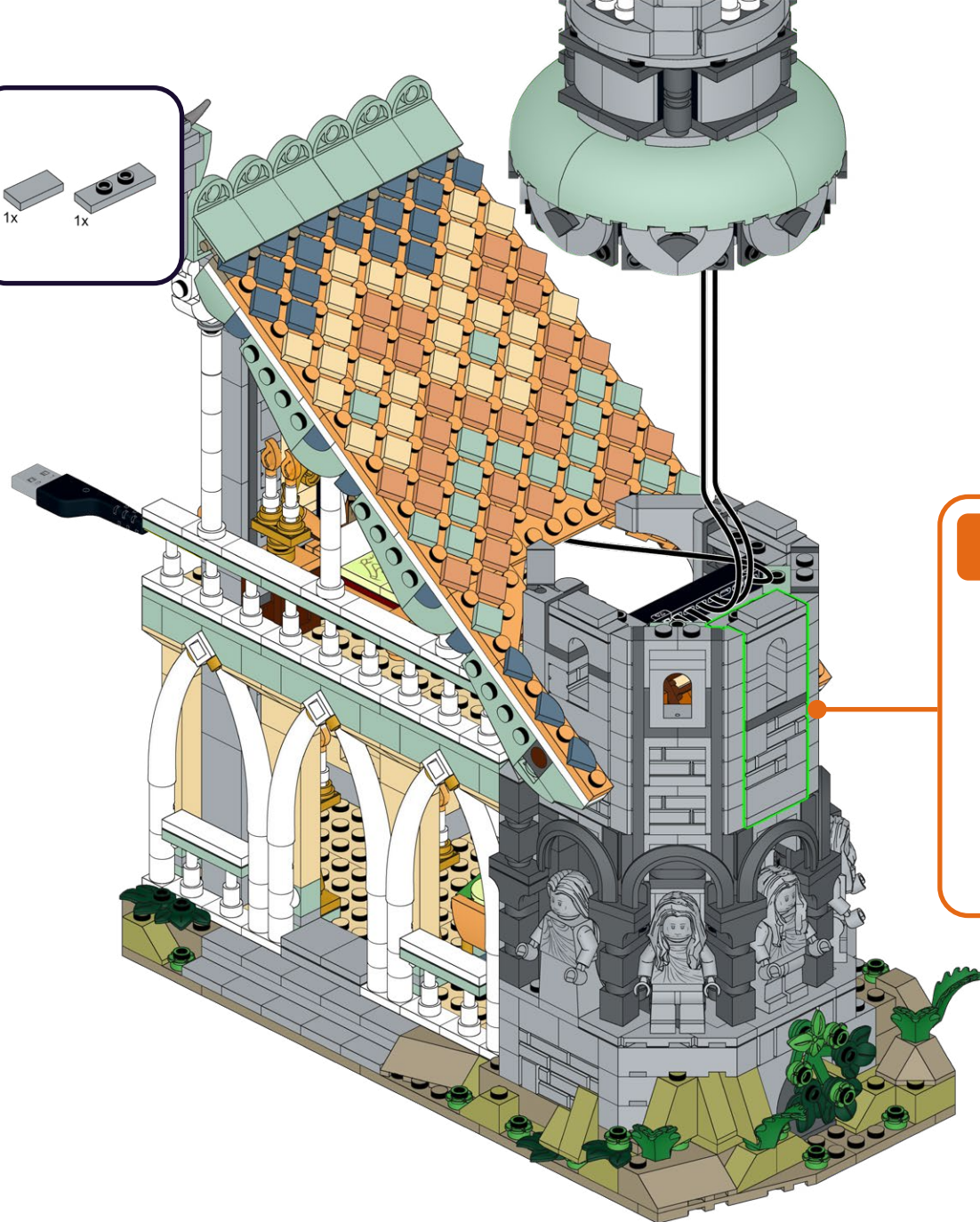
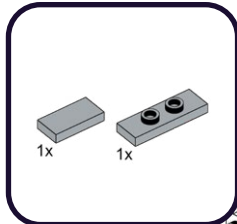

244

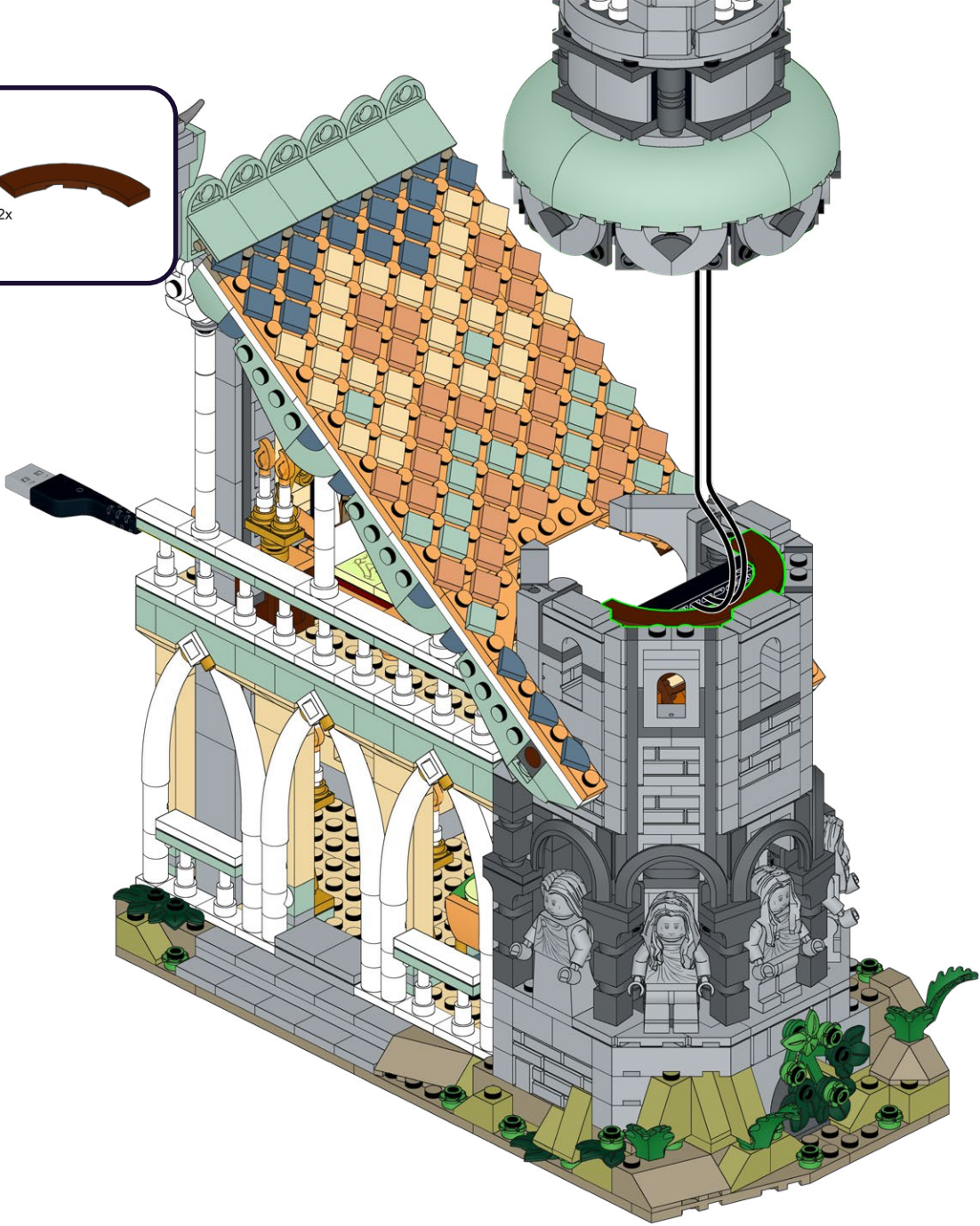

245



246

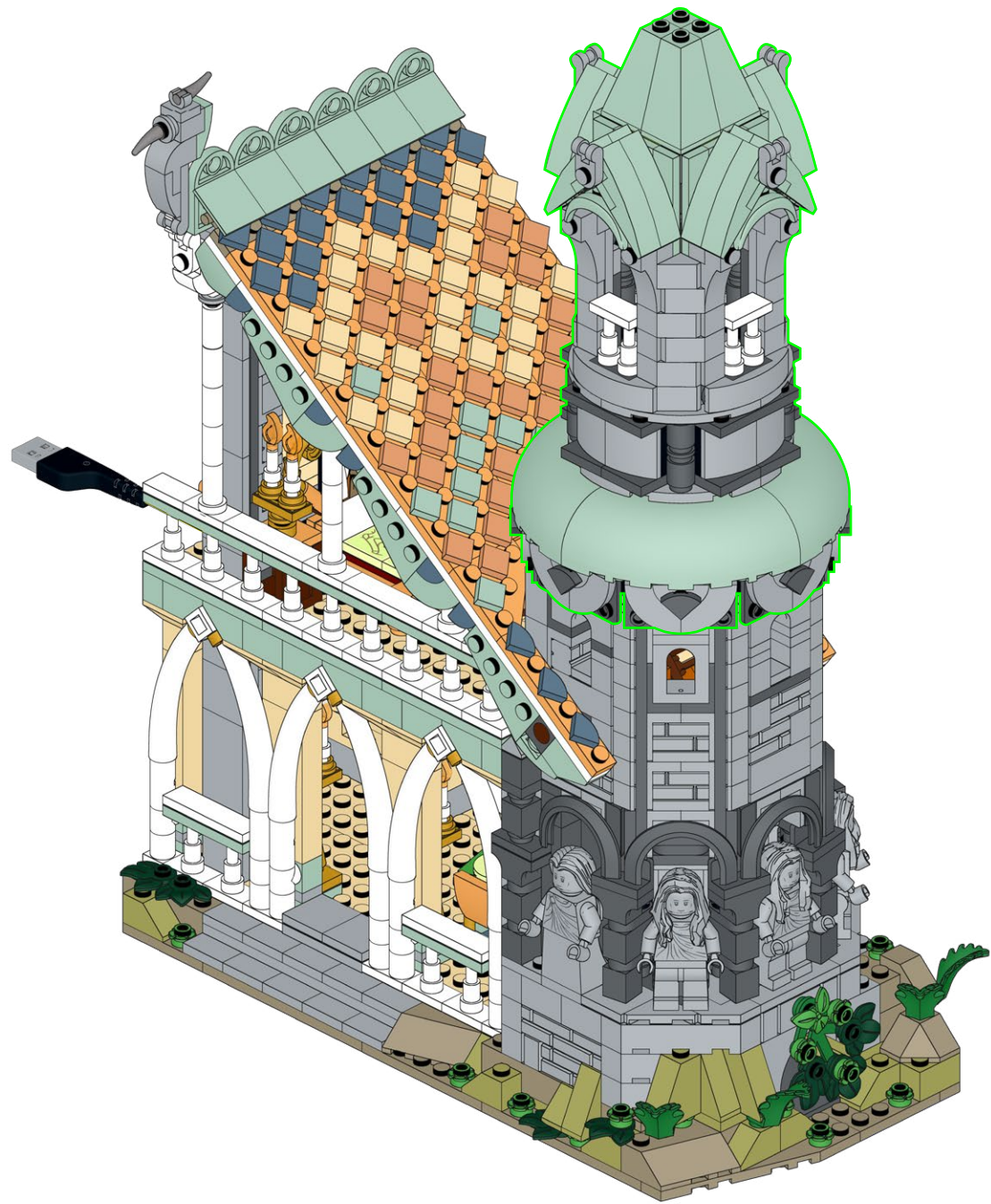

247



248

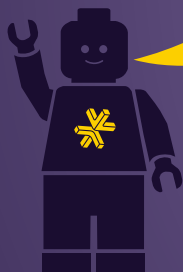

Power on Test  
Test de mise sous tension  
Test di Potenza  
Stromtest  
Prueba de Energía  
电源测试



# CONTACT US

Click below for customer support, or general inquiries.

Cliquez ci-dessous pour accéder au support client ou aux renseignements généraux.

Clicca qui sotto per l'assistenza clienti o per richieste generali.

Contact Us



Contactez-nous



Contattaci



Klicken sie unten für kundensupport oder allgemeine anfragen.

Haga clic a continuación para atención al cliente o consultas generales.

点击下方获取客户支持或一般咨询。

Kontaktieren sie uns



Contáctanos



联系我们



## TROUBLESHOOTING

If you're stuck, scan the QR code for troubleshooting.

Se sei bloccato, scansiona il codice QR per la risoluzione dei problemi.

Wenn Sie nicht weiterkommen, scannen Sie den QR-Code zur Fehlerbehebung.

Si vous êtes bloqué, scannez le code QR pour le dépannage

Si está atascado, escanee el código QR para solucionar el problema.

如果遇到问题, 请扫描二维码进行故障排除

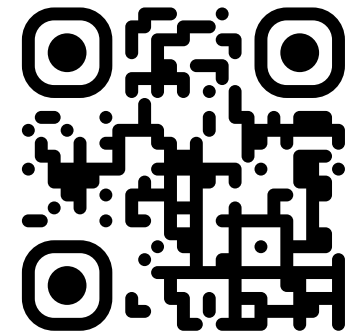



# LIGHTMYBRICKS

[lightmybricks.com](http://lightmybricks.com)



LEGO® is a trademark of the LEGO Group of companies, which does not sponsor, authorize or endorse this product. All LEGO® sets featured in images are sold separately. This is not a LEGO® product. The LEGO Group is not liable for any loss, injury or damage arising from the use or misuse of this product. ©2024 Light My Bricks Pty Ltd. All rights reserved. [www.lightmybricks.com](http://www.lightmybricks.com)

Our components are designed and packaged in Australia by Light My Bricks Pty Ltd. Components are manufactured in China. 3fl bldg C, Shuanghuan Quanxin Technology Information Industry Park Baolong Street, Longgang District, Shenzhen, China. Imported in Australia by Light My Bricks Pty Ltd, 5/26 Rushdale St, Knoxfield, VIC, 3180, Australia.

WARNING: CHOKING HAZARD - Small parts. Not for children under 3 years.

AVERTISSEMENT : RISQUE D'ÉTOUFFEMENT - Petites pièces. Ne convient pas aux enfants de moins de 3 ans.

ATTENZIONE: PERICOLO DI SOFFOCAMENTO - Piccole parti. Non adatto a bambini di età inferiore a 3 anni.

WARNUNG: ERSTICKUNGSGEFAHR - Kleine Teile. Nicht für Kinder unter 3 Jahren geeignet.

ADVERTENCIA: PELIGRO DE ASFIXIA - Piezas pequeñas. No son apto para niños menores de 3 años.

警告：窒息危险 - 小零件。不适合3岁以下儿童。