



**LIGHT^{MY}
BRICKS**



**LEGO[®] DUNGEONS & DRAGONS:
RED DRAGON'S TALE #21348
INSTALLATION GUIDE**

Light My Bricks



LEGO® DUNGEONS & DRAGONS: RED DRAGON'S TALE 21348 INSTALLATION GUIDE

Hi There!

We're here to help you get started on the LEGO®

Dungeons & Dragons: Red Dragon's Tale 21348 Light Kit.

This PDF details the instructions for the LED light kit only. If you are wishing to purchase this product, please [click here](#) to view the product page.

If you run into any issues, please refer to the troubleshooting section towards the end of this guide.

Have fun and enjoy!





PACKAGE CONTENTS:

Individual Bags



- 6 x Yellow 30cm Bit Light *
- 2 x Green 30cm Bit Light
- 2 x Pink 30cm Bit Light
- 1 x Light Blue 30cm Large Bit Light
- 1 x Red 30cm Large Bit Light
- 3 x Yellow 30cm Large Bit Light
- 1 x Orange 30cm Large Bit Light
- 3 x Wireless Power Connector set

Mixed Components 1



- 4 x 2-Port Expansion Board
- 5 x 6-Port Expansion Board
- 1 x Flicker Effects Board
- 6 x Adhesive Squares

Connecting Cables



- 1 x 5cm Connecting Cable
- 3 x 15cm Connecting Cable
- 1 x 30cm Connecting Cable
- 1 x 50cm Connecting Cable

USB Power Cable



- 1x USB Power Cable
(Power Source not Included)

Mixed Components 2



- 5 x Technic, Brick 1 x 1 with Hole - Black
- 1 x Brick 1x2 - Black
- 2 x Tile, Modified 1x1 with Open O Clip - Black
- 2 x Bracket 1 x 2 - 1 x 2 Inverted - Black
- 1 x Brick, Round 1x1 - Black

Mixed Components 3



- 5 x Plate 1x2 - Black
- 1 x Plate, Round 2 x 2 with Rounded Bottom (Boat Stud)
- 4 x Plate, Round 1x1 Open Stud - Trans Orange
- 2 x Plate, Round 1x1 Open Stud - Trans Clear
- 2 x Plate, Round 1x1 with Bar Handle - Black
- 7 x Plate, Round 1x1 Open Stud - Black
- 1 x Tile 1x2 - Light Bluish Grey

* Indicates components which include spares

Contents

Before You Begin	5
Blueprint	10
Instructions	11
Final Product	57
Troubleshooting	58
Contact	62

Before You Begin

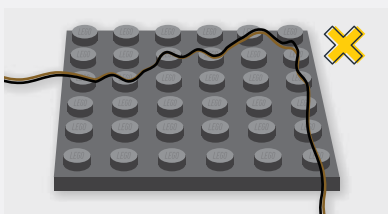
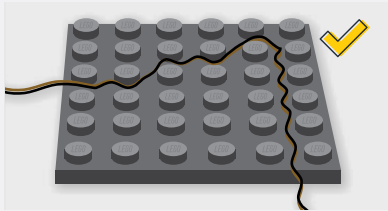

Laying cables in between and underneath bricks

Cables can fit in between and underneath LEGO® bricks, plates, and tiles providing they are laid correctly between the LEGO® studs. Do NOT forcefully join LEGO® together around cables; instead ensure they are laying comfortably in between each stud.

CAUTION: Forcing LEGO® to connect over a cable can result in damaging the cable and light.

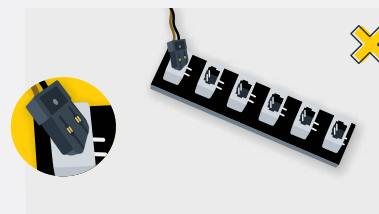
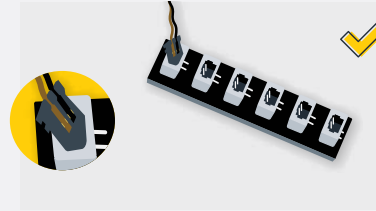

Connecting Cable Connectors To Expansion Boards

Take extra care when inserting connectors to ports of Expansion Boards. Connectors can be inserted only one way. With the expansion board facing up, look for the soldered “=” symbol on the left side of the port. The connector side with the wires exposed should be facing toward the soldered “=” symbol as you insert into the port. If a plug won't fit easily into a port connector, do not force it.

Incorrectly inserting the connector can result in bent pins inside the port or possible overheating of the expansion board when connected.

Before You Begin

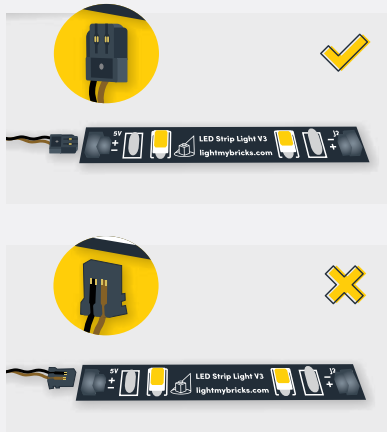

Connecting Cable Connectors To Strip Lights

Take extra care when inserting connectors to ports on the Strip Lights. Connectors can be inserted only one way. With the Strip Light facing up, ensure the side of the connector with the wires exposed is facing down. If a plug won't fit easily into a port connector, don't force it. Doing so will damage the plug and the connector.



Connecting Micro Cable Connectors To Micro Expansion Board Ports

Take extra care when inserting the micro connectors to micro ports of Micro Expansion Boards. Connecting Micro Bit Lights to Micro Expansion Boards is similar to connecting lights and cables to Strip Lights. With the expansion board facing up, ensure the side of the connector with the wires exposed is facing down. If a plug won't fit easily into a port connector, do not force it. Use your fingernail to push the plastic part of the connector to the micro port.

Before You Begin

Installing Bit Lights Under Lego® Bricks And Plates

When installing Bit Lights under LEGO® pieces, ensure they are placed the correct way up (Yellow LED component exposed). You can either place them directly on top of LEGO® studs or in between.

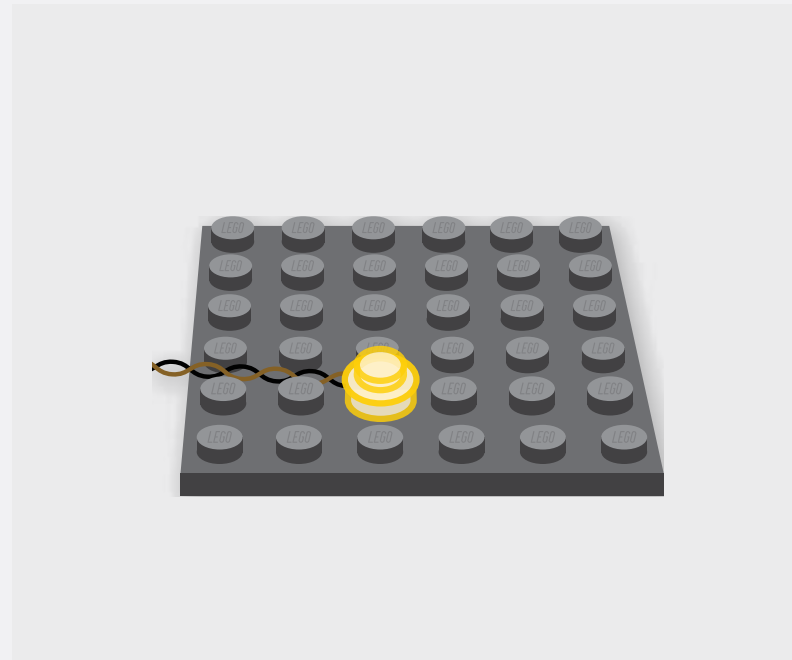

Before You Begin

The Symbols Used In This Guide

When going through the following guide you will come across symbols and formats that will assist with the installation of your light kit. Take notice of them as each has a specific purpose.

Light Kit Component

This is the most important image format as it indicates which part to use from the Light Kit. Make sure you pay close attention to which part is shown.

White 30cm Bit Light



Connect

Used when you need to connect a LEGO piece or LMB component.



Disconnect

Used when you need to remove a LEGO piece/ section or LMB component.



Directional

Used to show where to route cables, place components, or move them.



Bend/Pivot

Used when a component needs to be bent, or part folded or pivoted.



Turn/ Flip

Will be found in the top left corner when the set needs to be rotated or flipped.



Twist/ Braid

Seen when a set of cables need to be grouped and twisted together.



Power On Test

Found at the end of a major step to test the lights. Will be located in the top left corner.



Note

Notes will be found alongside the instruction photos and explain what to do.



Before You Begin

Repeat Step

Repeat the previous step eg. Make a spotlight, then make a second spotlight.

x2

Connect Focus

Used to highlight a hard to see area where a component is being connected.



Disconnect Focus

Used to highlight a hard to see area where a component is being disconnected.



General Focus

Used to highlight a hard to see area where a component needs to be acted on.



General Note

This is a sample note that is used anywhere in this guide. It will explain a difficult section where photos are hard to illustrate or easily confused.

Connect Note

The green coloured note is used when the topic focuses on a component being connected, like the shown Power Bank.

Disconnect Note

The red coloured note is used when the topic focuses on a component being disconnected or like here, the removed pieces.



NOTE

Take the 5cm Connecting Cable from the 4-Port Micro Expansion Board and route it into the "IN" port of the Flicker Effects Board

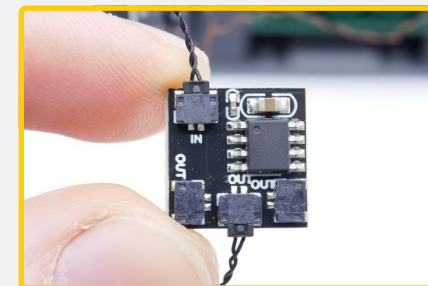

NOTE

Connect to a 5V USB Power Bank, 5V USB Wall Adaptor, or USB to AA Battery Pack (sold separately)



NOTE

You should have these parts left over that were removed from the LEGO set





BLUEPRINT

Steps 1-18

Steps 19-26

Steps 27-37

Steps 38-56

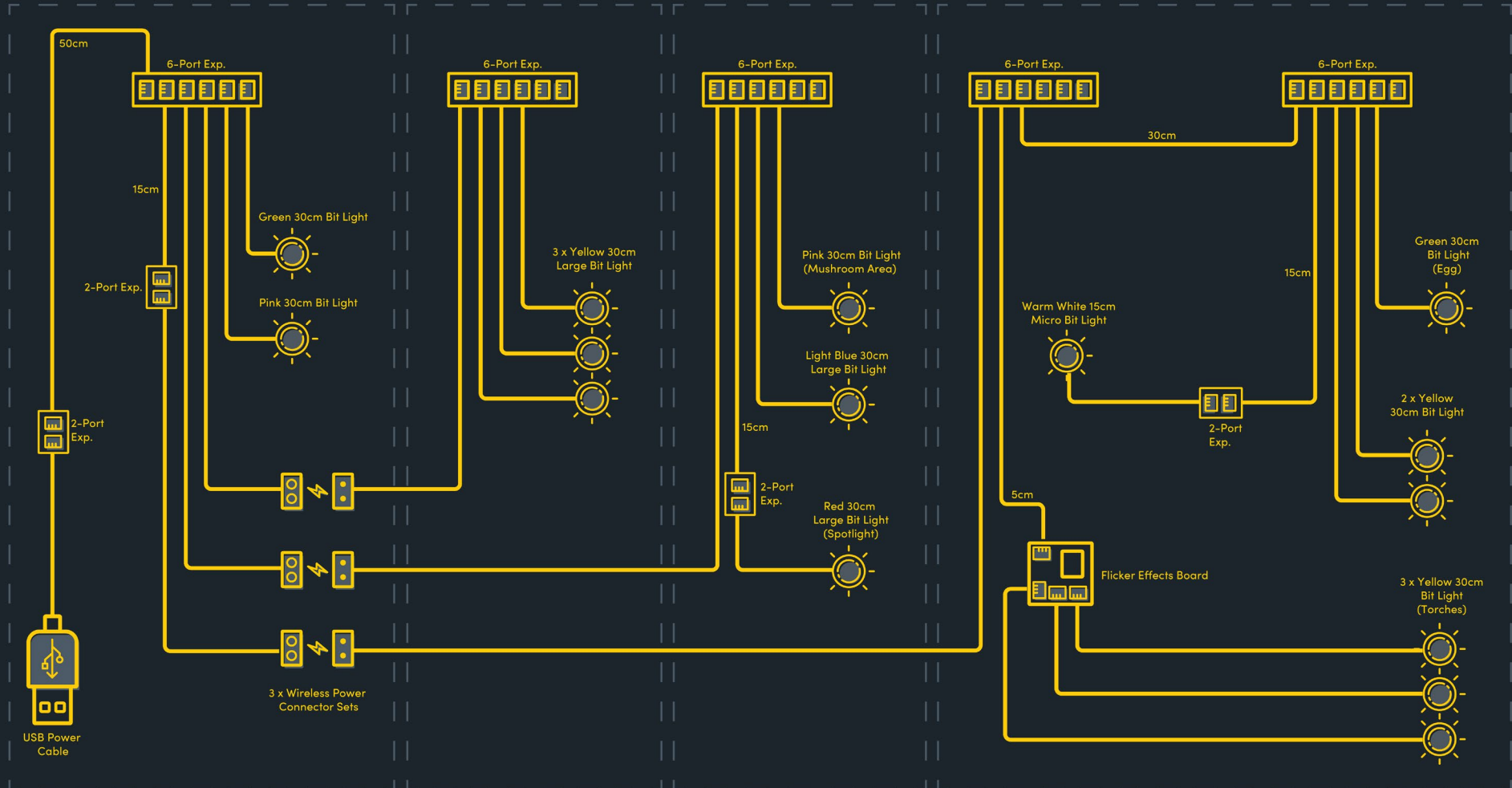



INSTRUCTIONS

To ensure a smooth installation of your light kit, please read and follow each step carefully. If you run into any issues, please refer to the online troubleshooting guide.

1

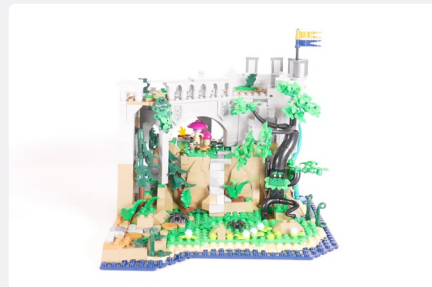

2

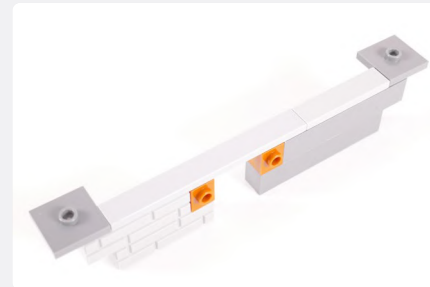

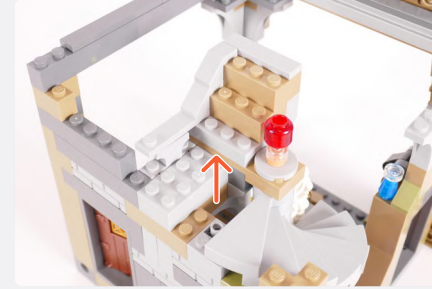
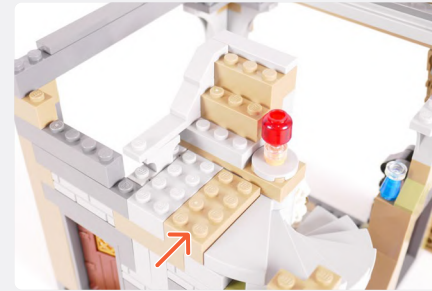
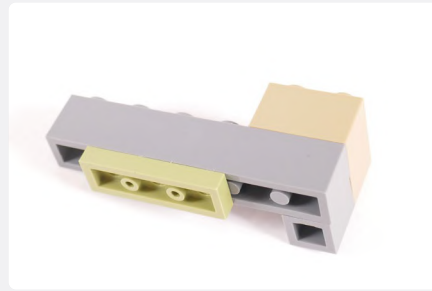
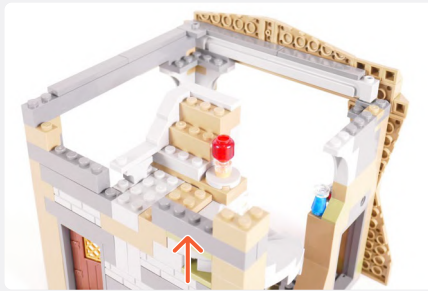

3

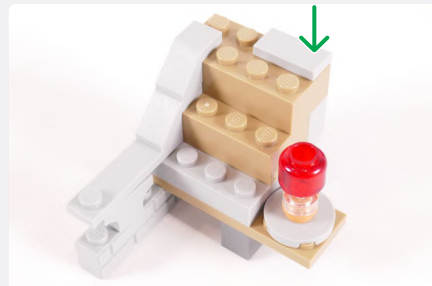
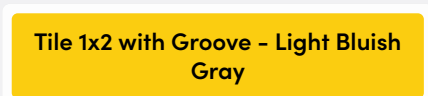

Wireless Power Connector Tile

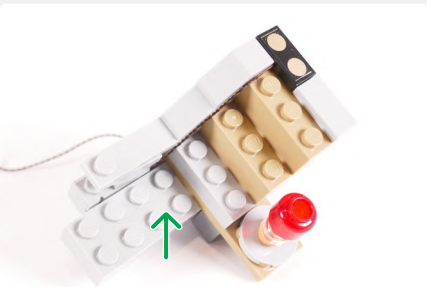
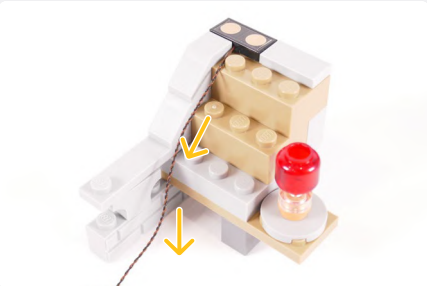
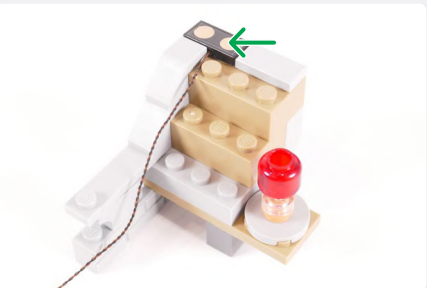

NOTE

Ensure the cable is routed through the indicated cavity

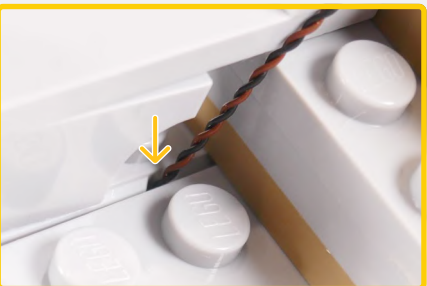

4

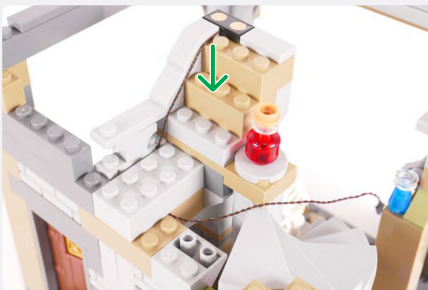
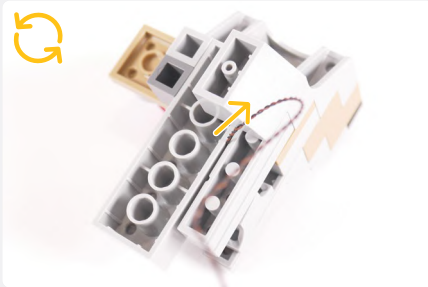

5



Pink 30cm Bit Light



Plate, Round 1x1 with Open Stud - Black

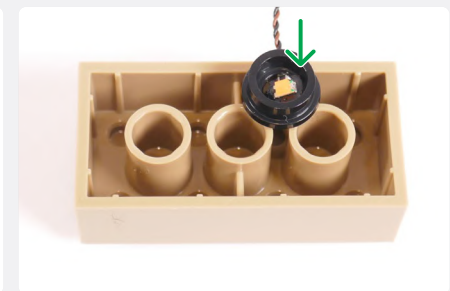
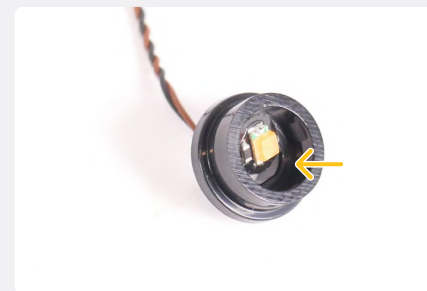

6

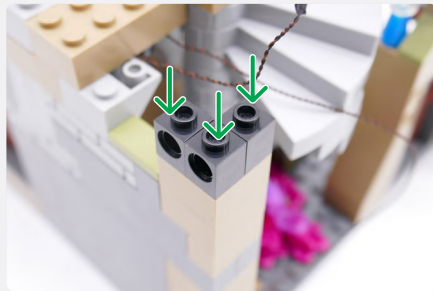
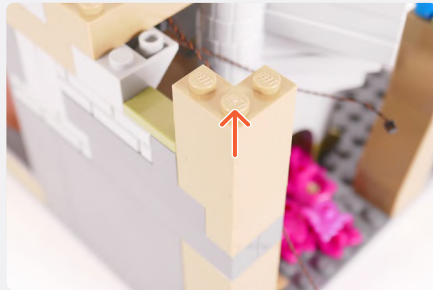
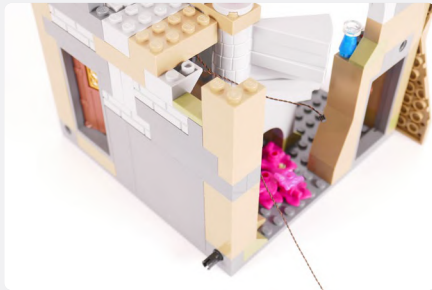
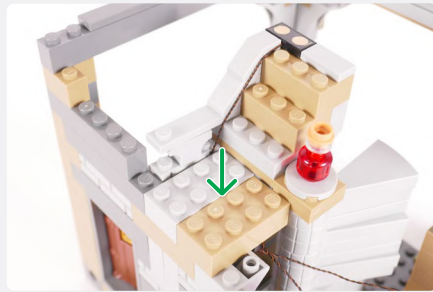
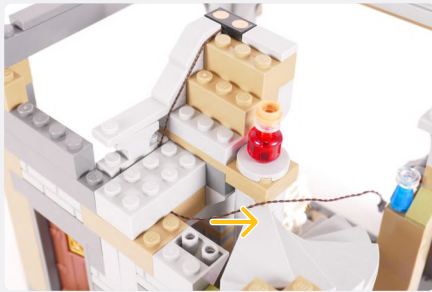

Wireless Power Connector Plate

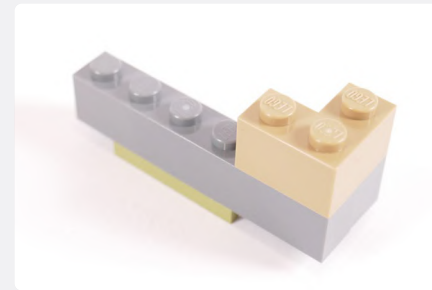
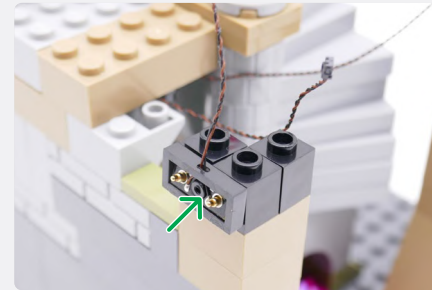

7

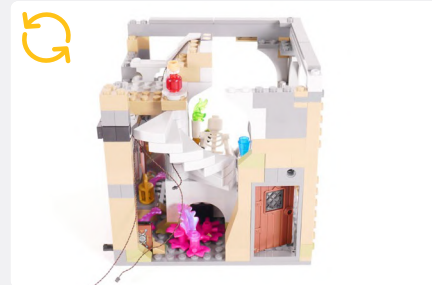

 **NOTE**

Slowly and carefully, partially disconnect the following section from the base

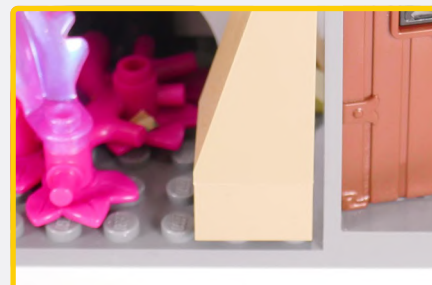

8



Brick 1x2 - Black



2 x Technic, Brick 1x1 with Hole - Black



Wireless Power Connector Plate

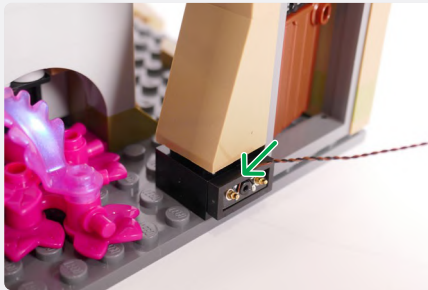

9

15cm Connecting Cable

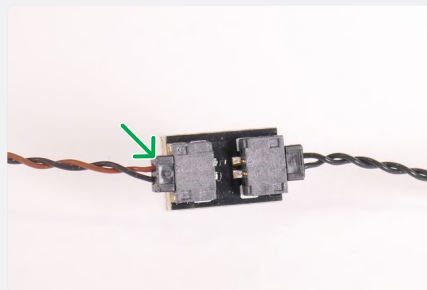
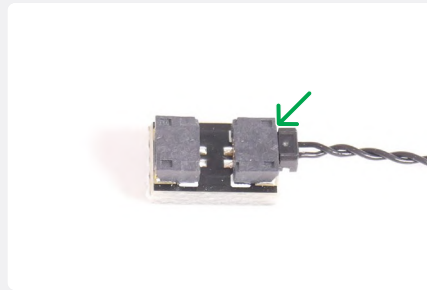

2-Port Expansion Board



10

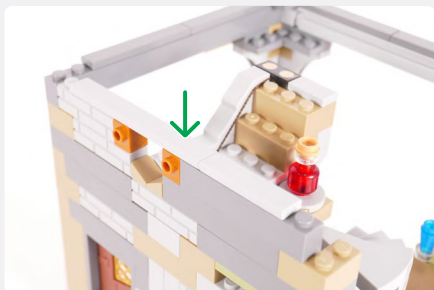
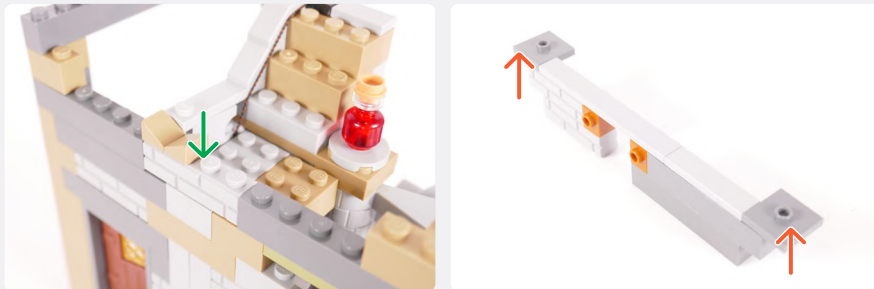
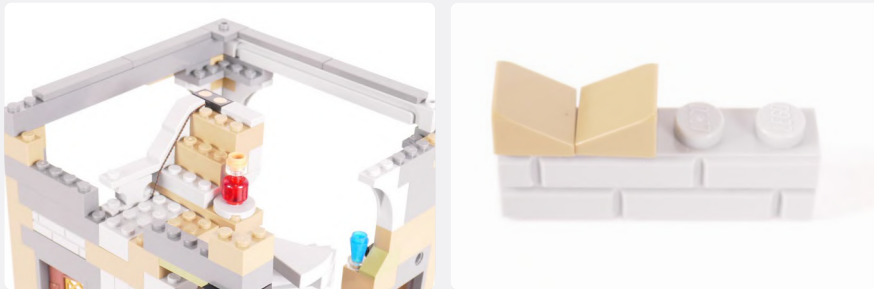

11

Green 30cm Bit Light



Plate, Round 1x1 with Open Stud - Black



Tile, Modified 1x1 with Open O Clip - Black



Plate, Round 1x1 with Bar Handle - Black



12

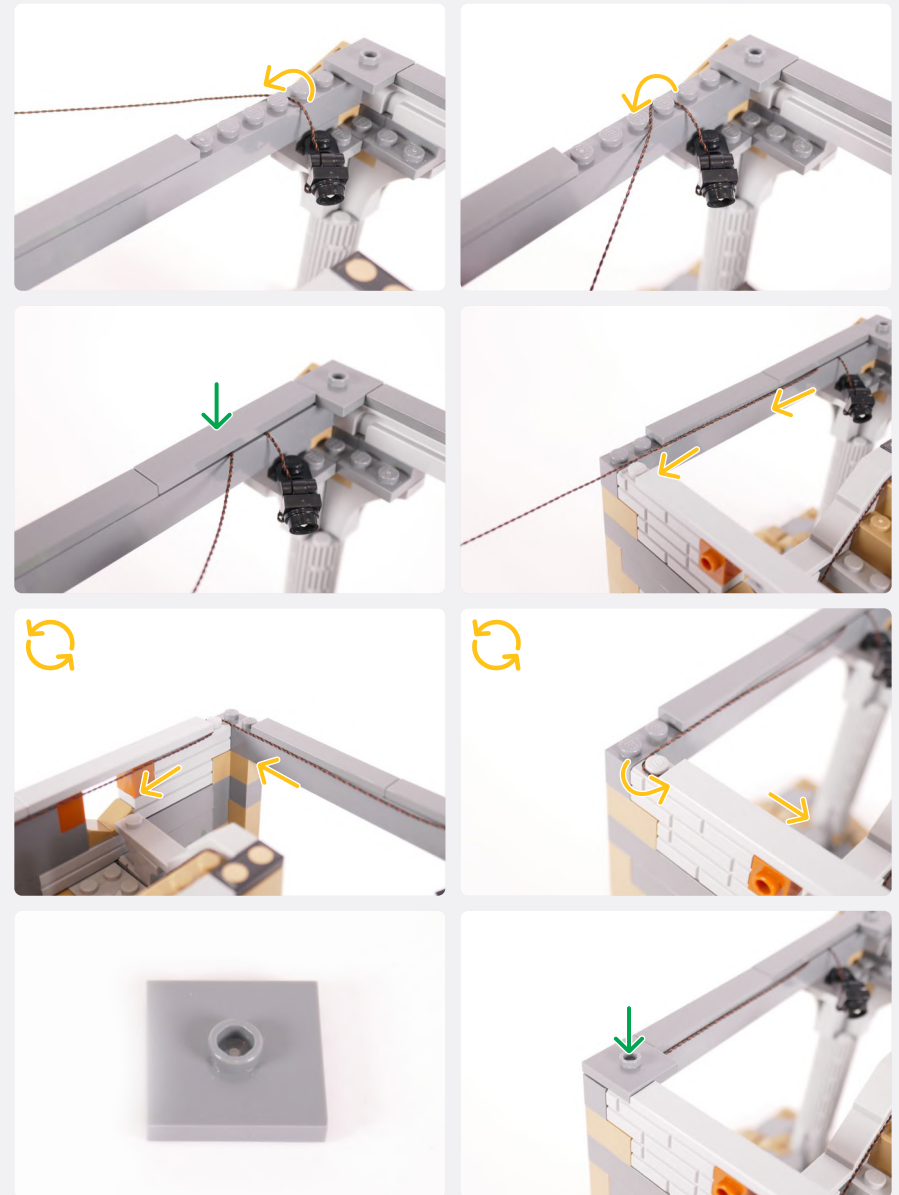
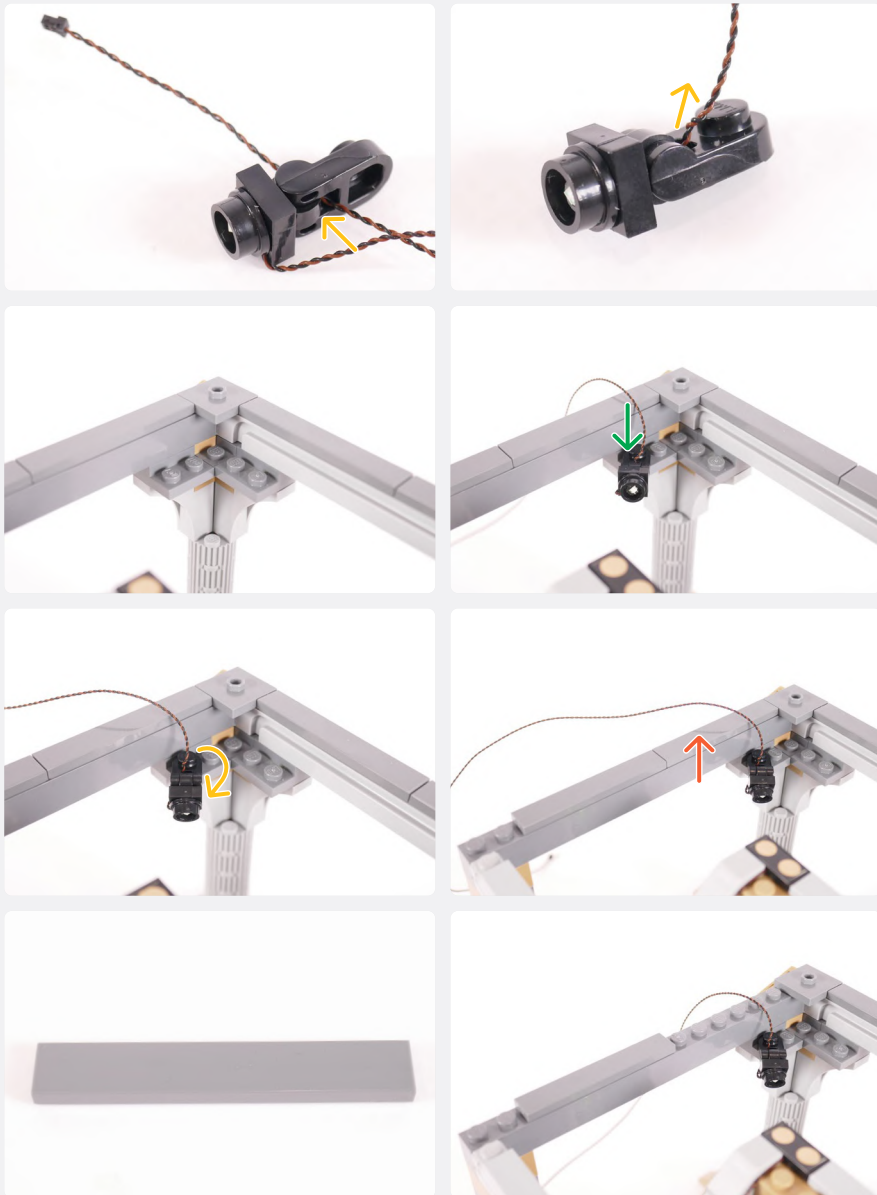

13

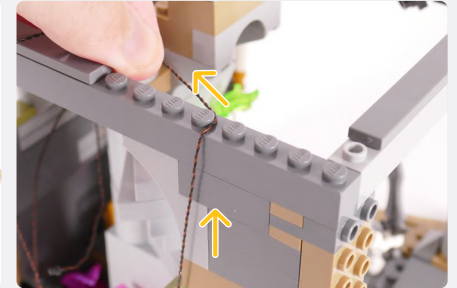
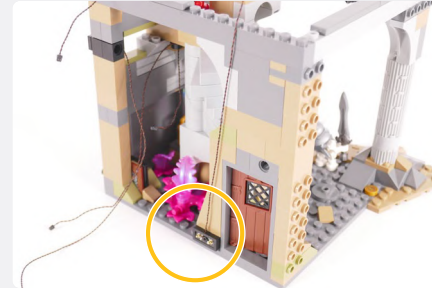
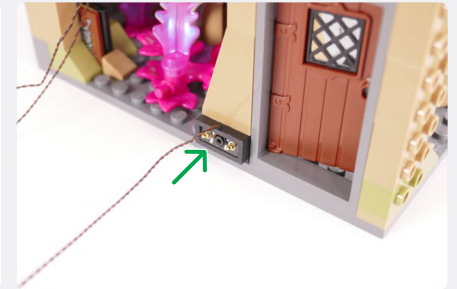
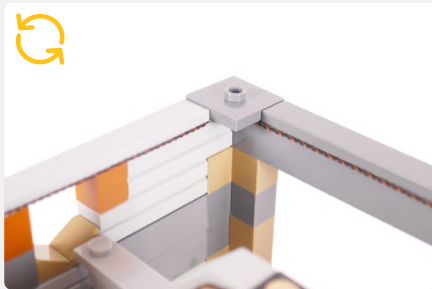

14

50cm Connecting Cable



2-Port Expansion Board

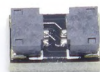

NOTE

Leave about 20cm of cable slack from the 2-Port Expansion Board to the base of the set

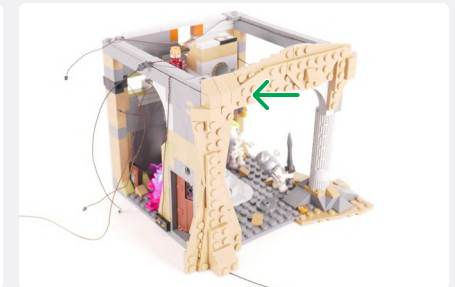
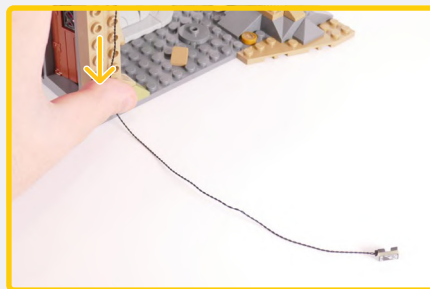

15



NOTE

Take the three cables from the top and route it as shown

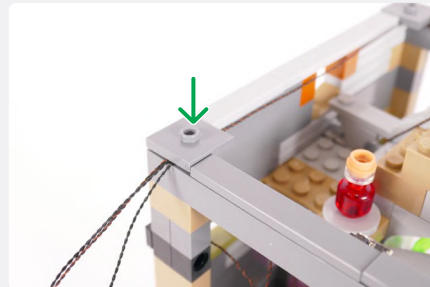
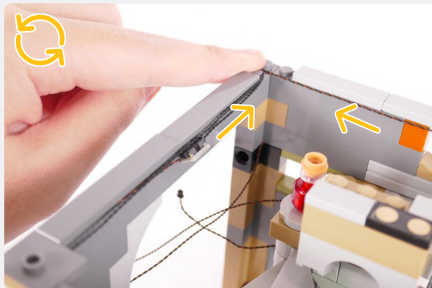
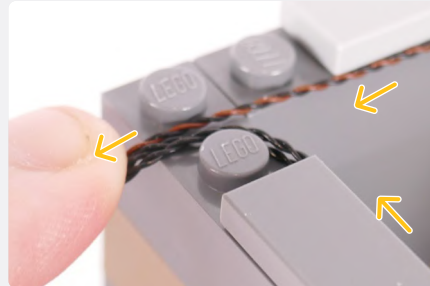
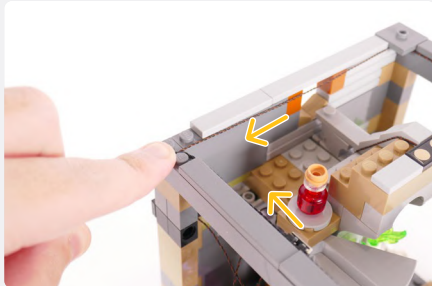
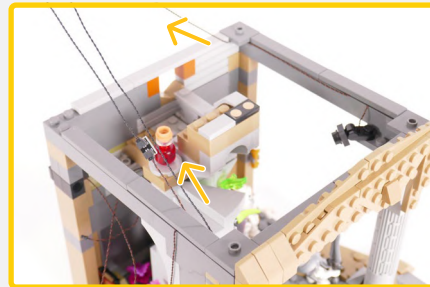

16



NOTE

Pull all the cables towards each other

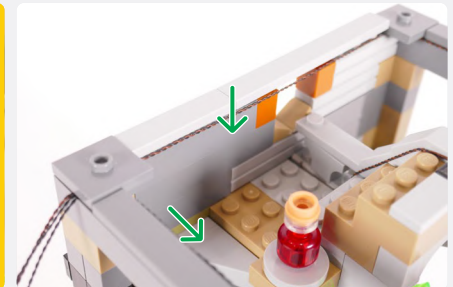
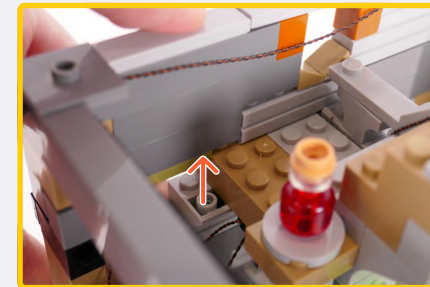
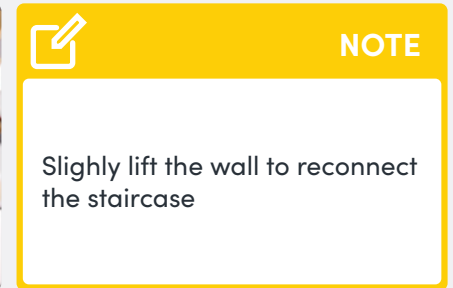

NOTE

Slightly lift the wall to reconnect the staircase

17

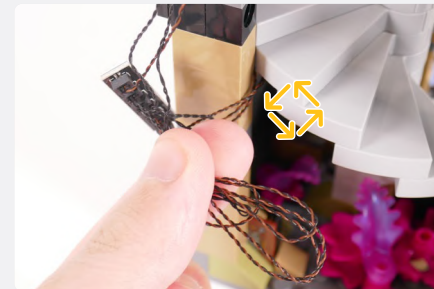
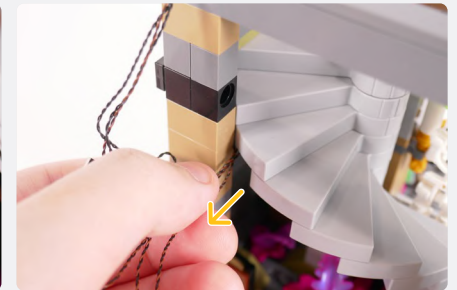
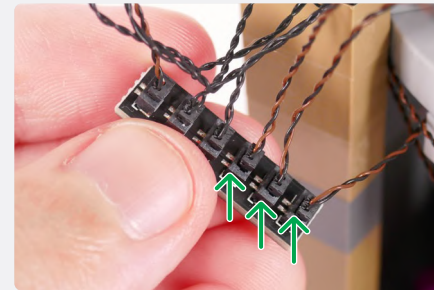
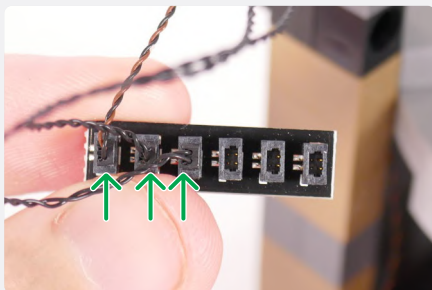
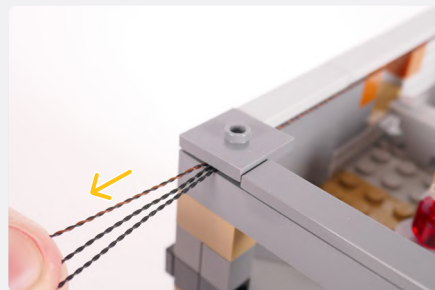

NOTE

Push the board against the wall until the Adhesive Squares flatten and the Board fits in between the stairs and wall

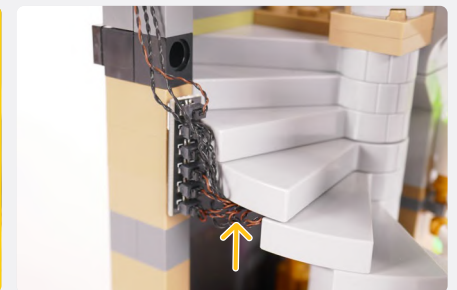
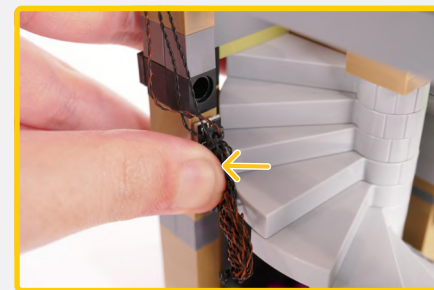

NOTE

Push the bunched up cables beneath the steps of the stairs



18



NOTE

Connect to a 5V USB Power Bank, 5V USB Wall Adaptor, or USB to AA Battery Pack (sold separately)

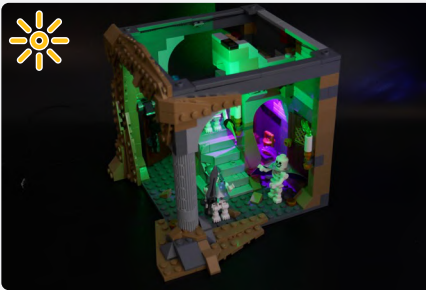

! If you experience any issues with the lights not working and suspect an issue with a component, please try a different port on the expansion board to verify where the fault lies (with the light or expansion board). To correct any issues with expansion board ports, please view the section addressing expansion board issues in our troubleshooting section. **i**



19



20



Bracket 1x2 - 1x2 Inverted - Black



Plate 1x2 - Black



Wireless Power Connector Tile

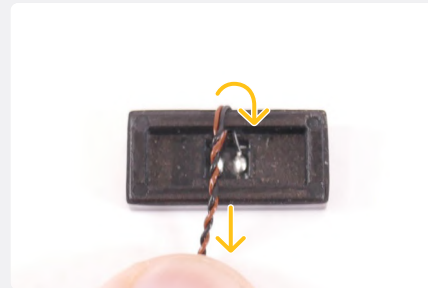

21

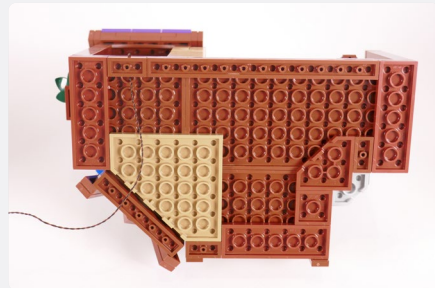
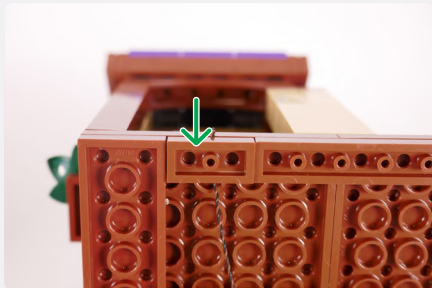
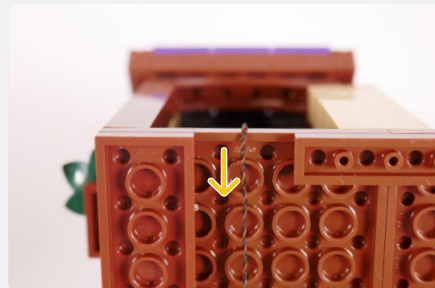
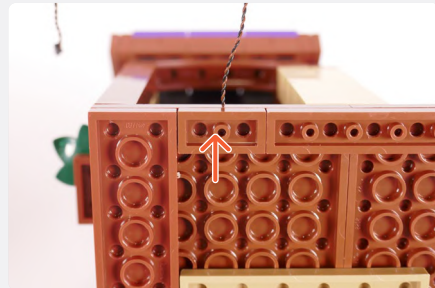
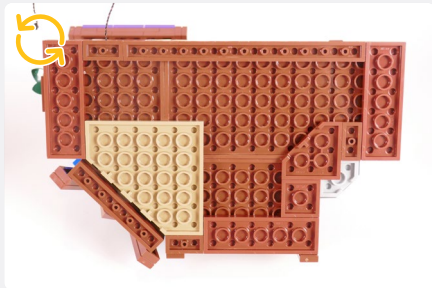

Yellow 30cm Large Bit Light

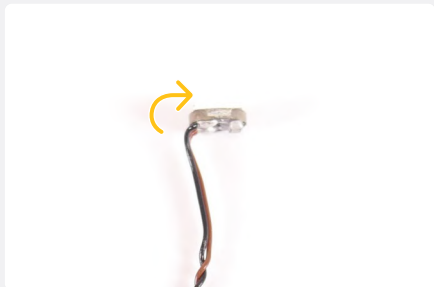

Plate, Round 1x1 with Open Stud - Black

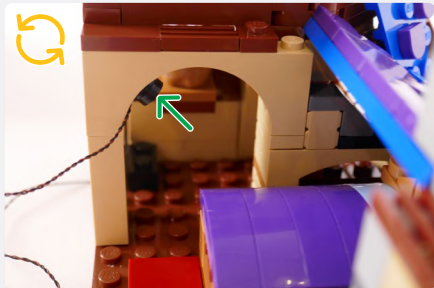
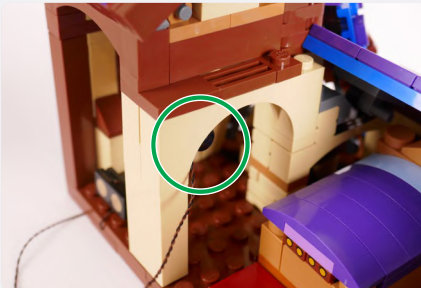
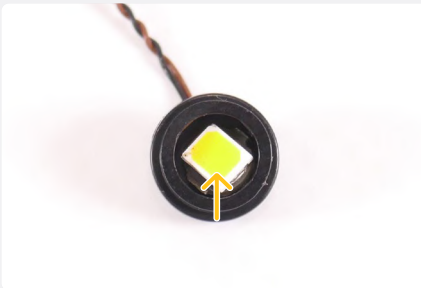

22

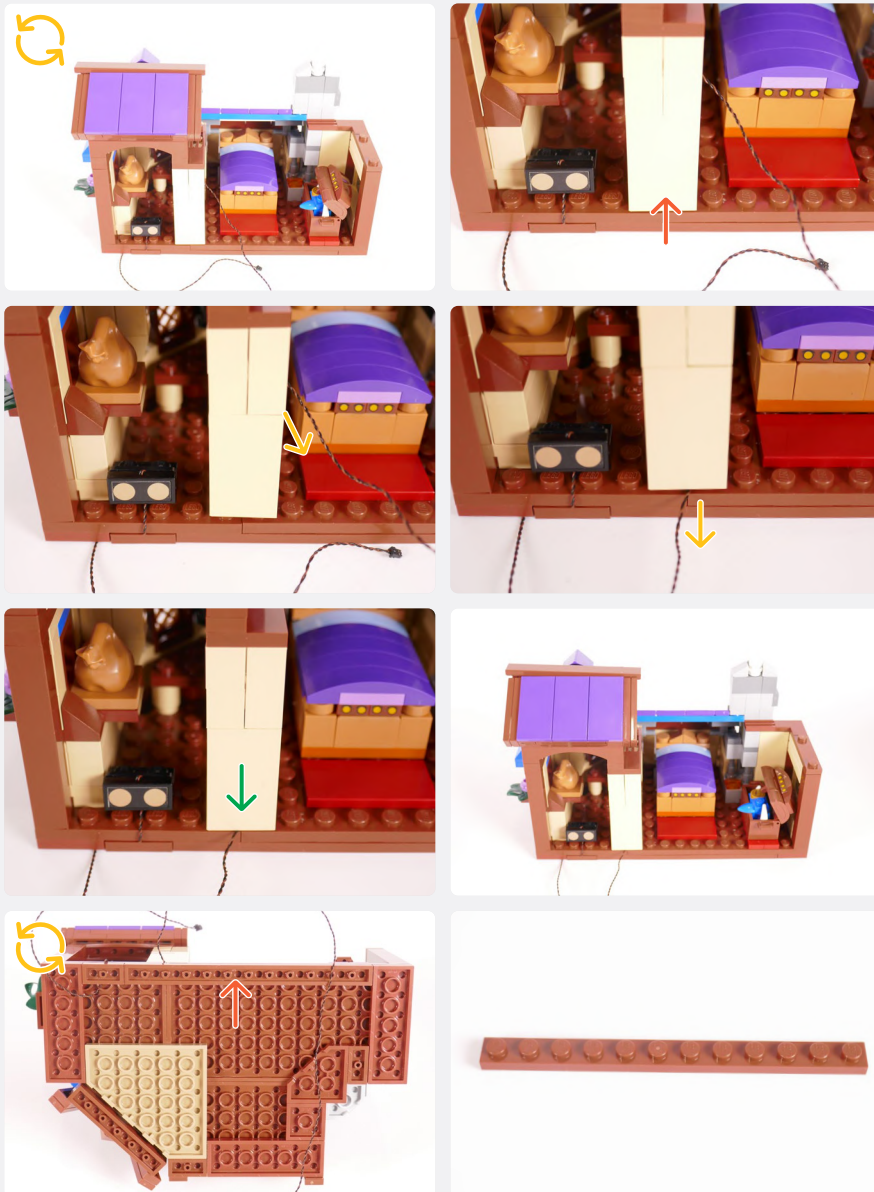

23

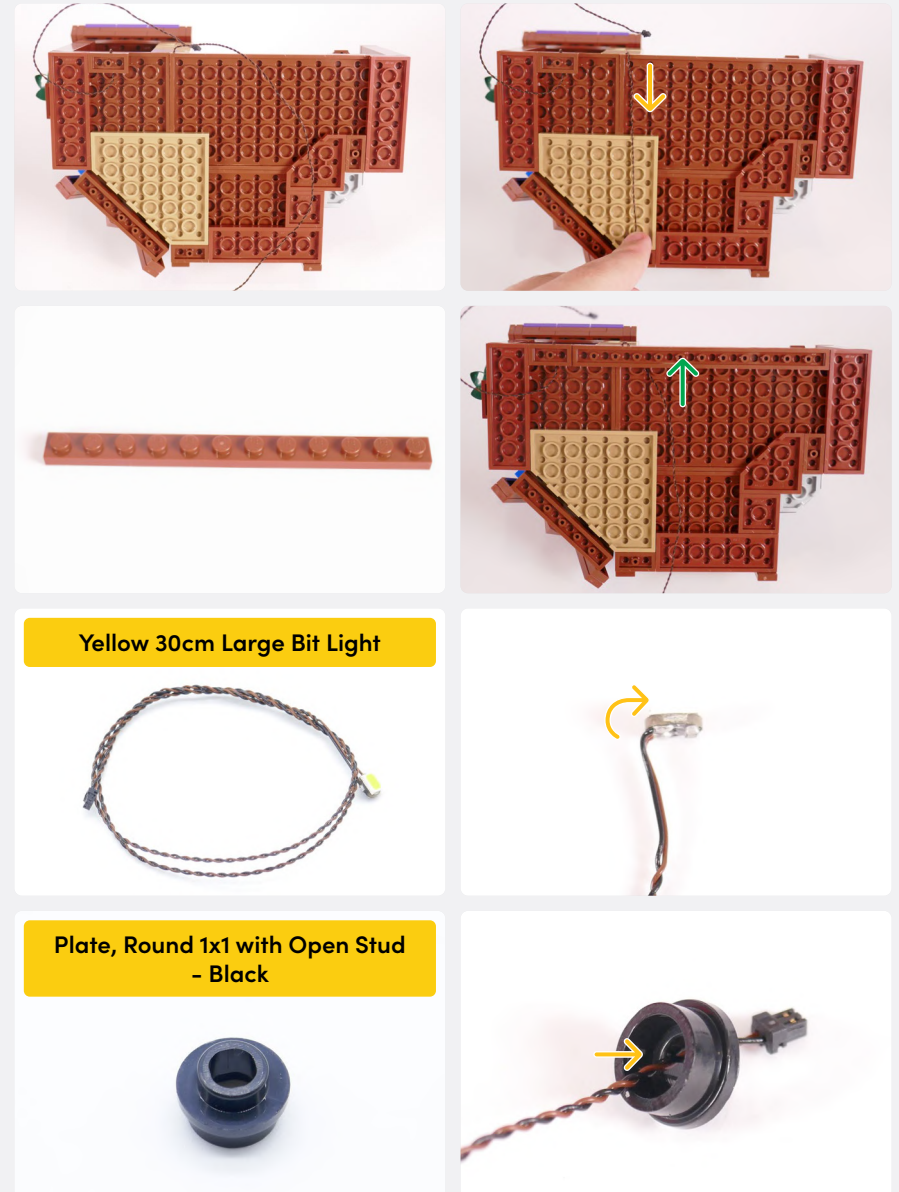

24

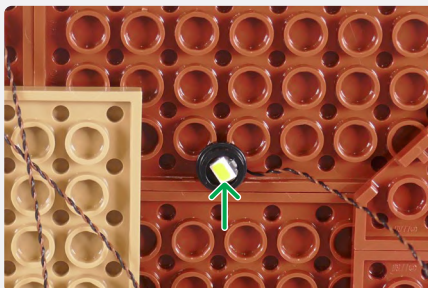
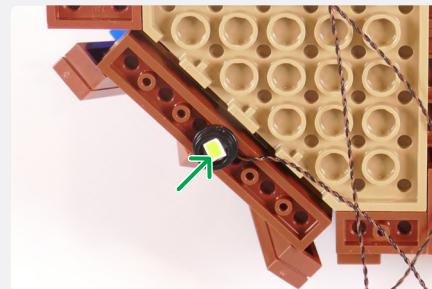
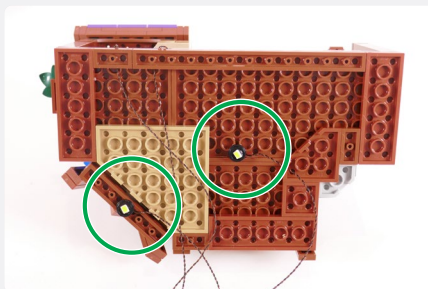
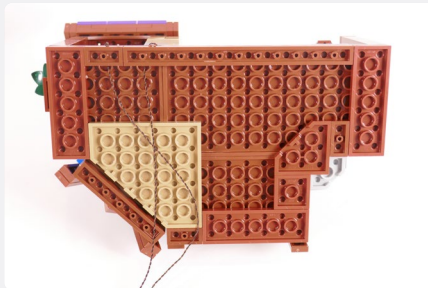
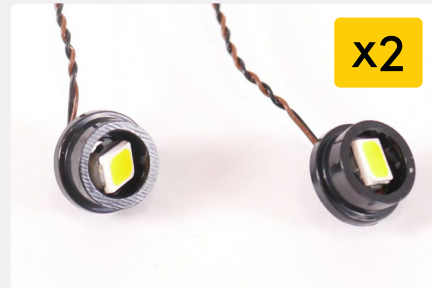
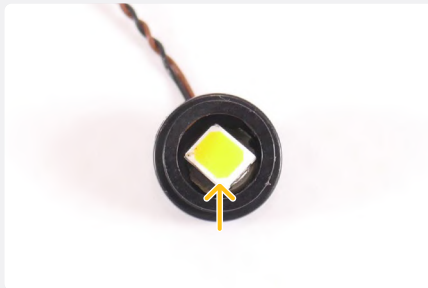
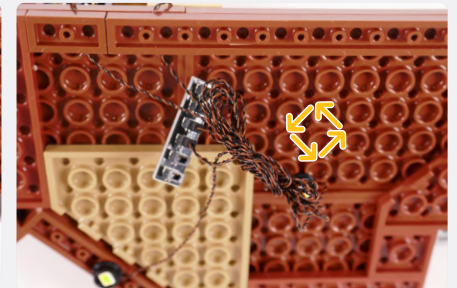
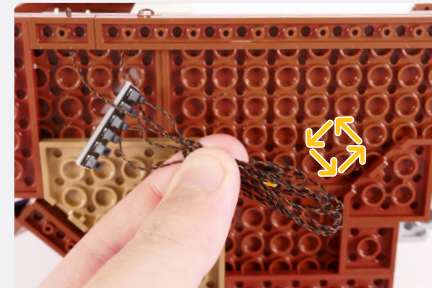
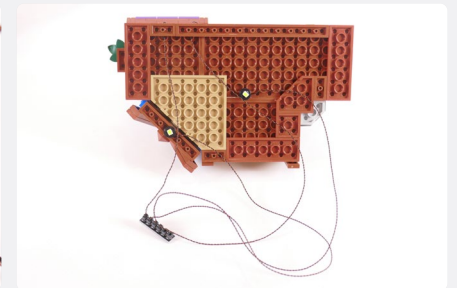
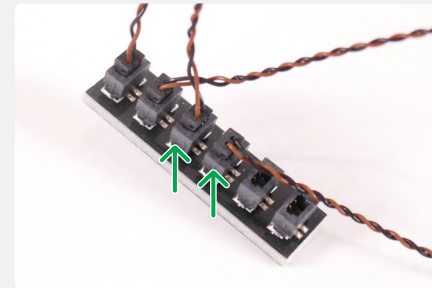
6-Port Expansion Board

 **NOTE**

Position the Expansion Board inbetween the tubes so that the board gets stuck. If you're having trouble, twist the cables very tight so the board is stuck in position instead.

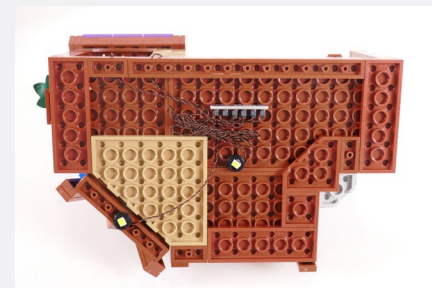
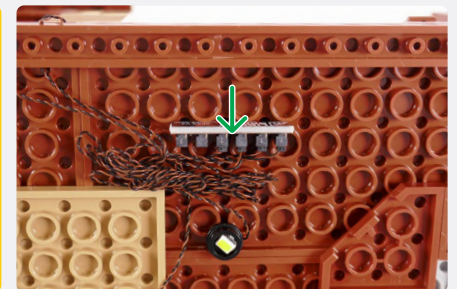



NOTE

When reconnecting the two sections back together, ensure the Wireless Power Connectors are aligned and touching

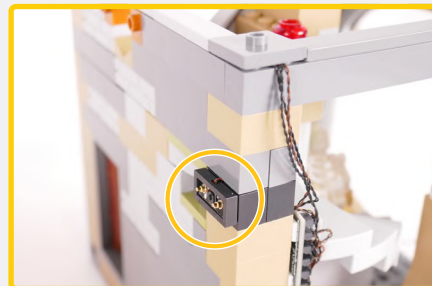
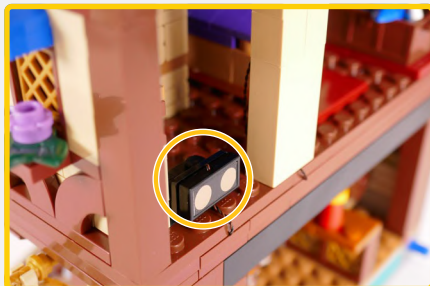
25
26

NOTE

Connect to a 5V USB Power Bank, 5V USB Wall Adaptor, or USB to AA Battery Pack (sold separately)



! If you experience any issues with the lights not working and suspect an issue with a component, please try a different port on the expansion board to verify where the fault lies (with the light or expansion board). To correct any issues with expansion board ports, please view the section addressing expansion board issues in our troubleshooting section. **i**



27



Red 30cm Large Bit Light



Brick, Round 1x1 Open Stud - Black



NOTE

We recommend positioning the LED around the center of the Round Brick. However, depending on brightness preference, the LED can be moved forwards or backwards



Plate, Round 1x1 with Bar Handle - Black



Tile, Modified 1x1 with Open O Clip - Black



28

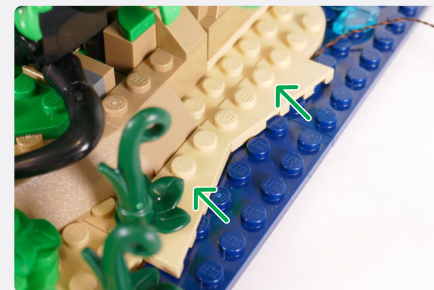
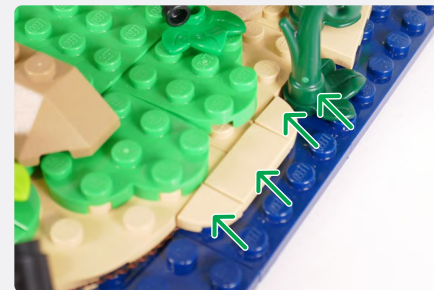
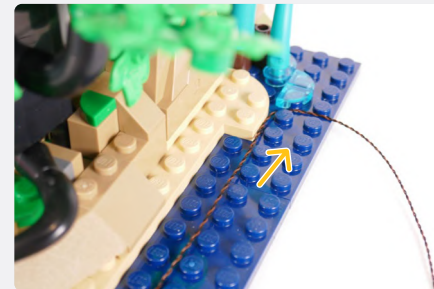
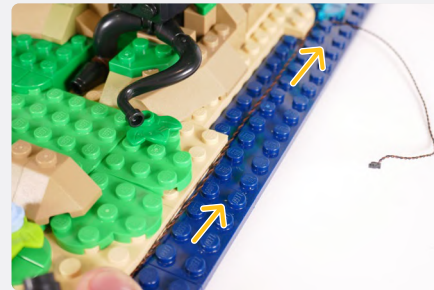
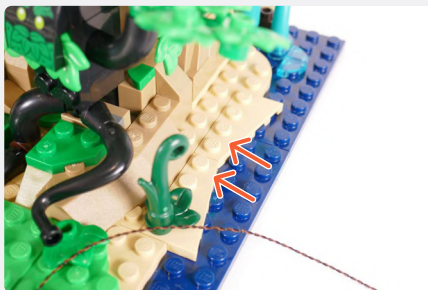
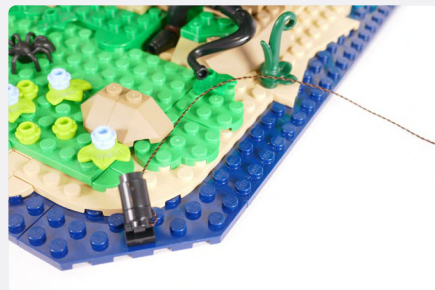
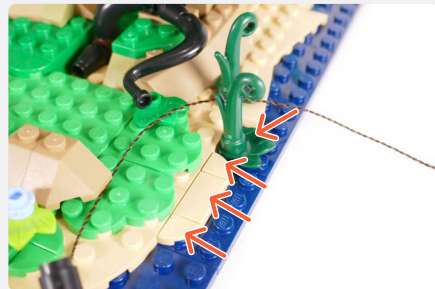
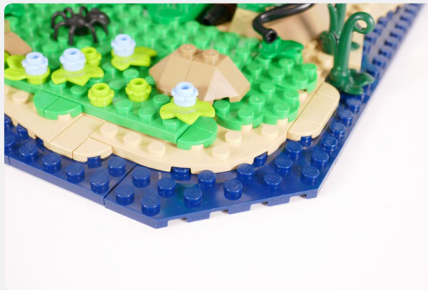

29

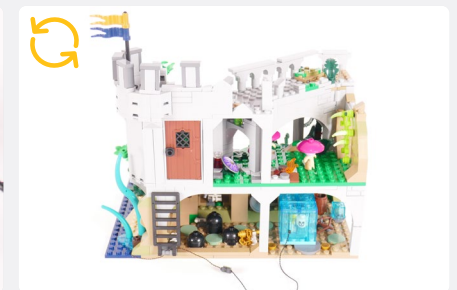
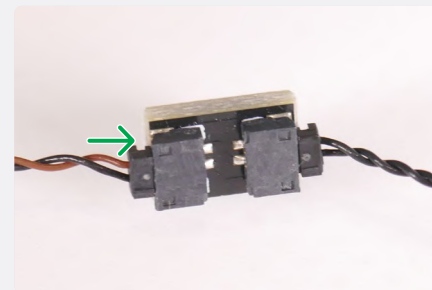
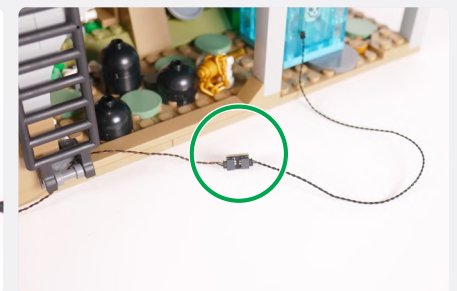
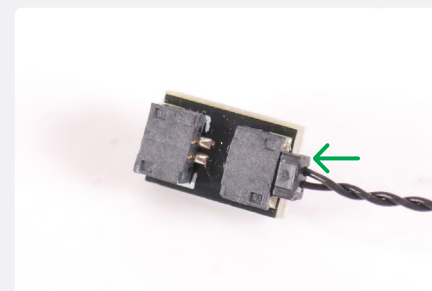
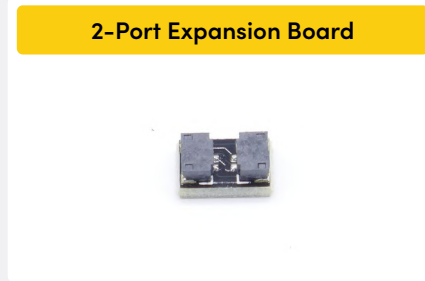
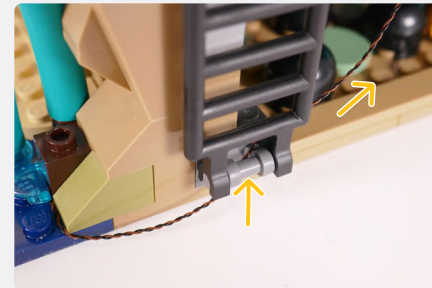
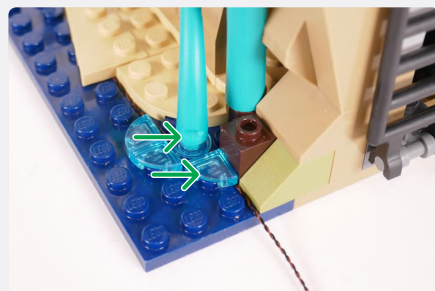
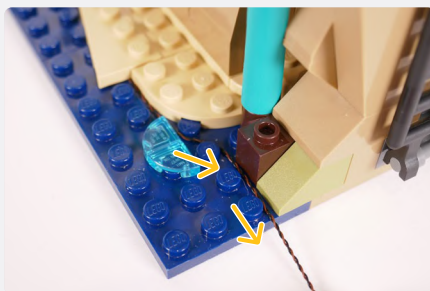
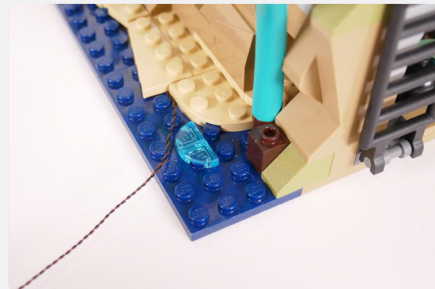
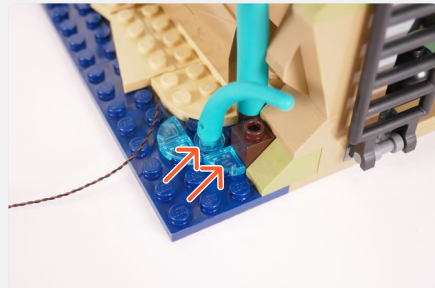

30

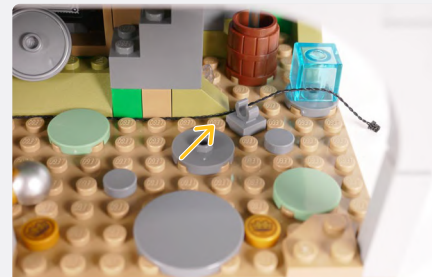
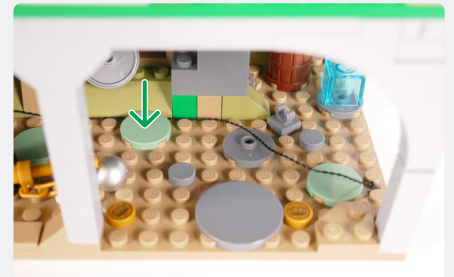
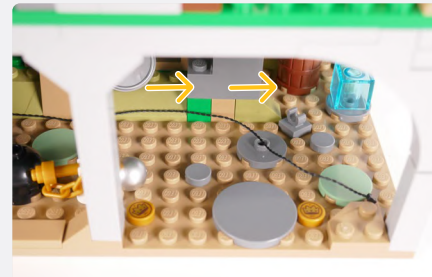
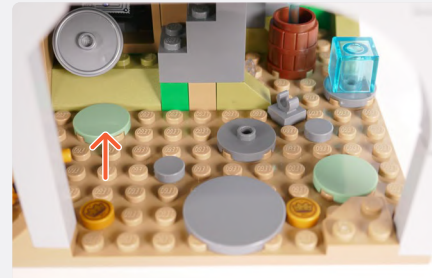
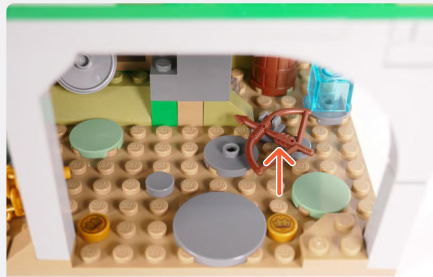
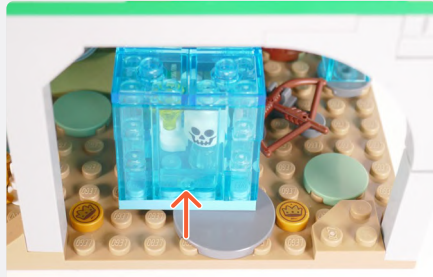

31

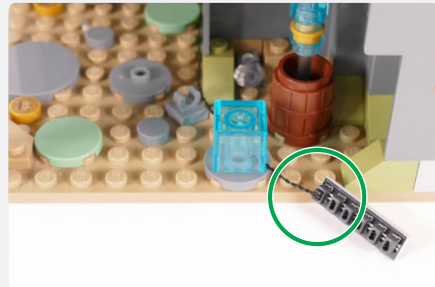

32

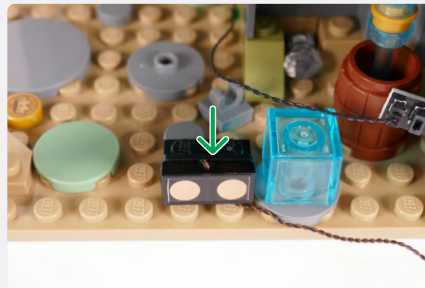
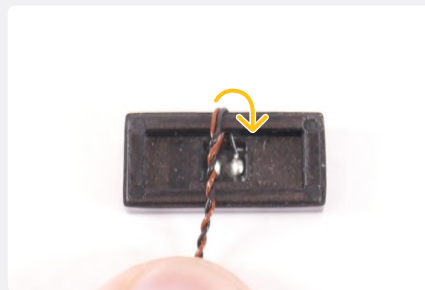

33

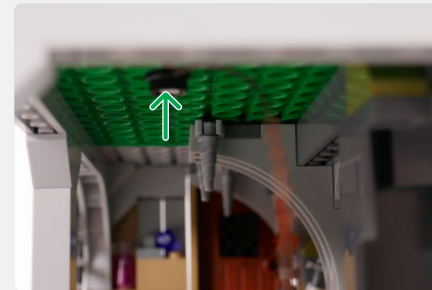
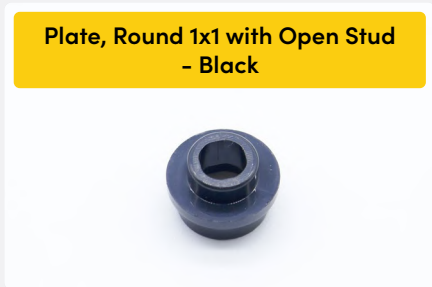
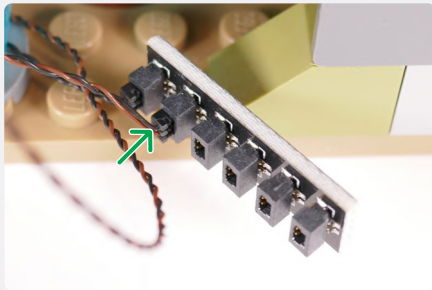

NOTE

The position of the LED does not have to be exact, anywhere in the vicinity is perfectly fine

NOTE

Slightly lift the following section to create a gap

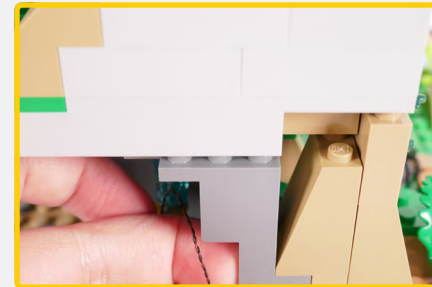
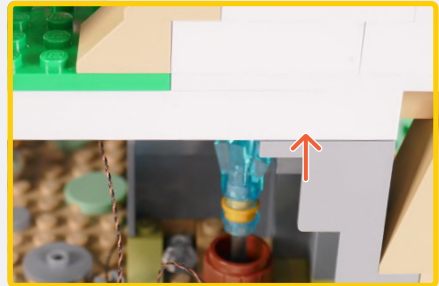

NOTE

Thread the Light Blue cable through the gap

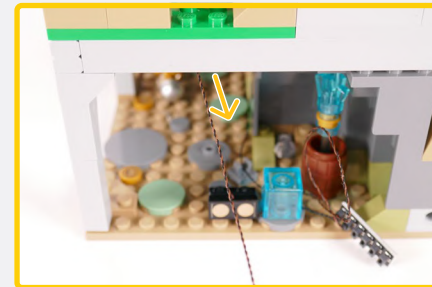

34

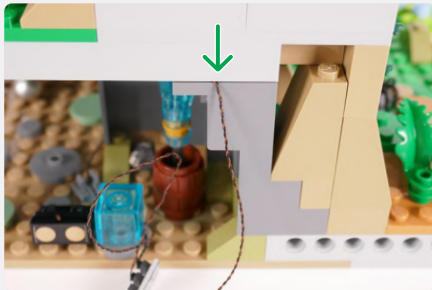

34

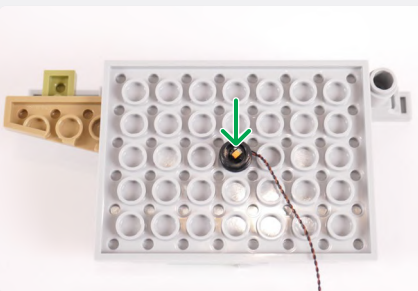

NOTE
If you're having trouble placing the open stud in position, place it off center, in between the tubes instead

35

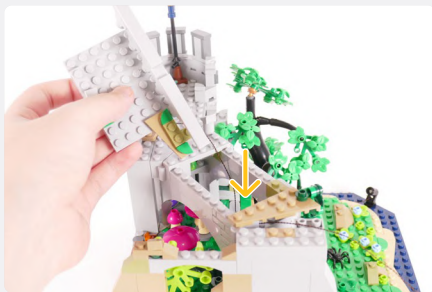
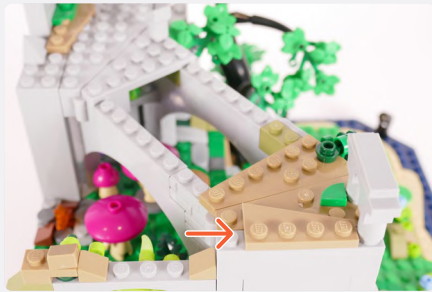
NOTE

Connect the Pink and Light Blue Bit Lights to the 6-Port Expansion Board

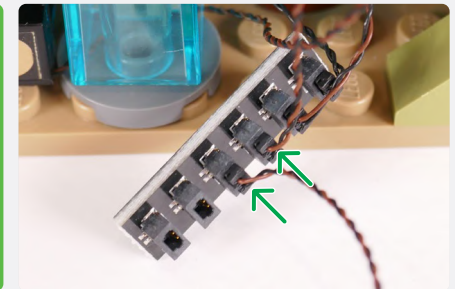

36

Plate 1x2 - Black



NOTE

Pin the Pink and Light Blue cables beneath the 1x2 Plate ensuring the cables are tight along the wall

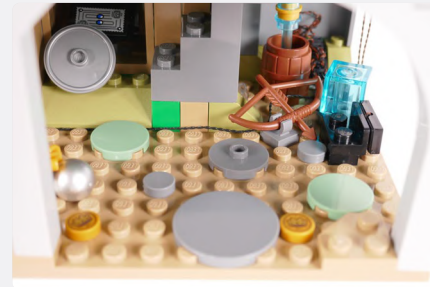
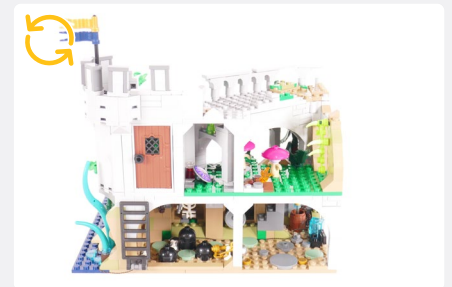
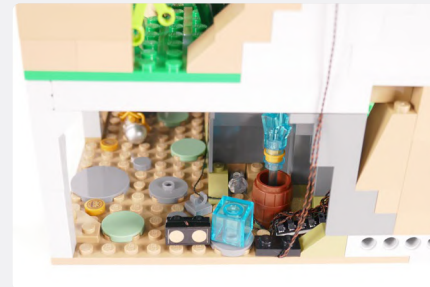
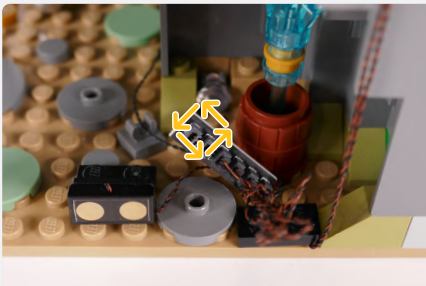
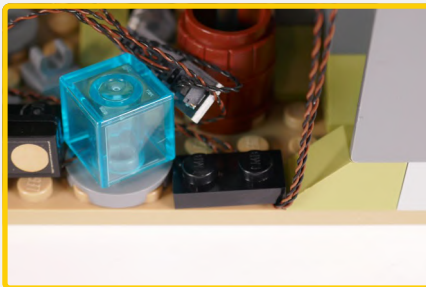
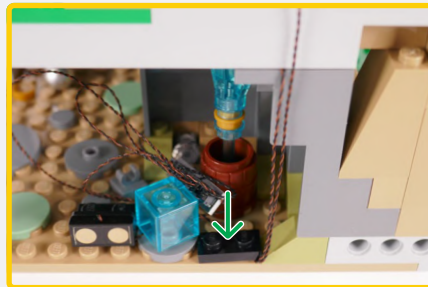

37

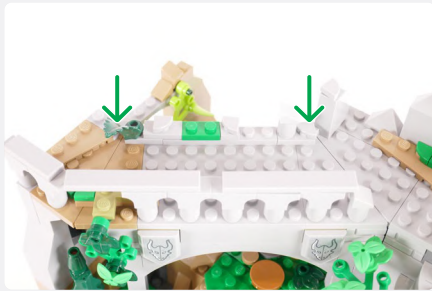

NOTE

Ensure the Wireless Power Connectors are touching and aligned when the sections reconnect



NOTE

Connect to a 5V USB Power Bank, 5V USB Wall Adaptor, or USB to AA Battery Pack (sold separately)



! If you experience any issues with the lights not working and suspect an issue with a component, please try a different port on the expansion board to verify where the fault lies (with the light or expansion board). To correct any issues with expansion board ports, please view the section addressing expansion board issues in our troubleshooting section. **i**



38



39



Yellow 30cm Bit Light



Plate, Round 1x1 with Open Stud - Trans-Orange

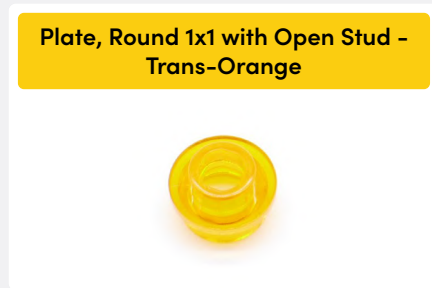

40

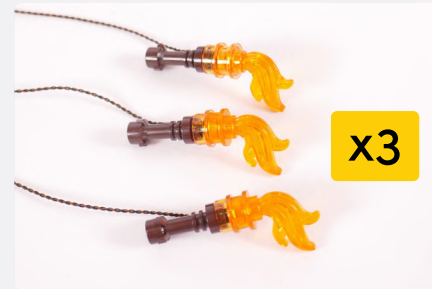

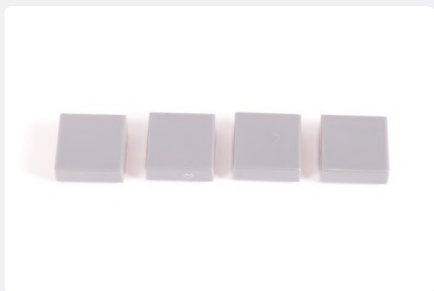
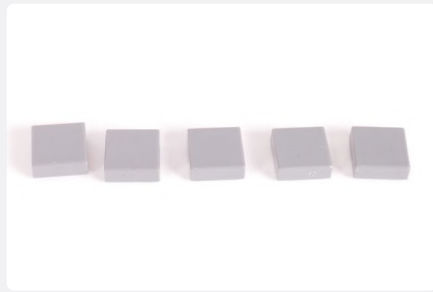
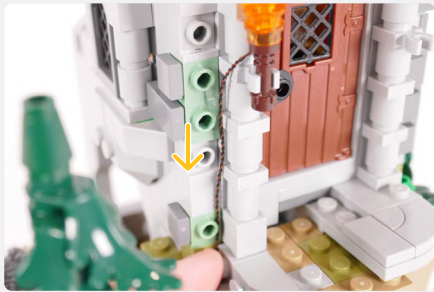

41

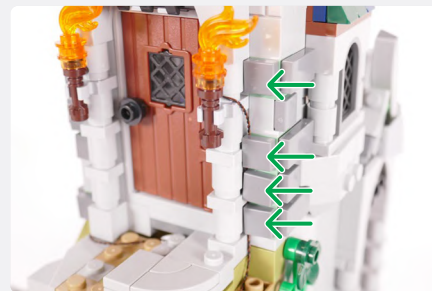

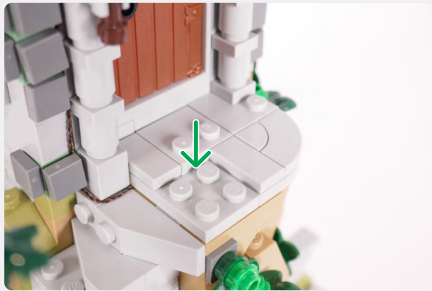
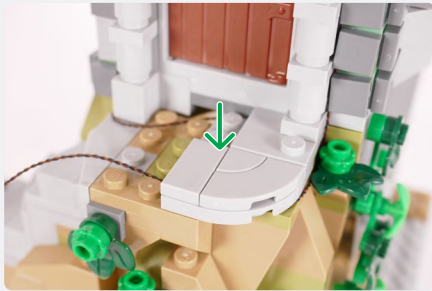
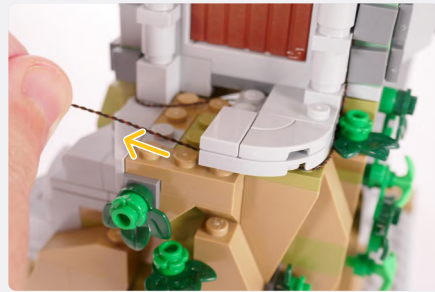
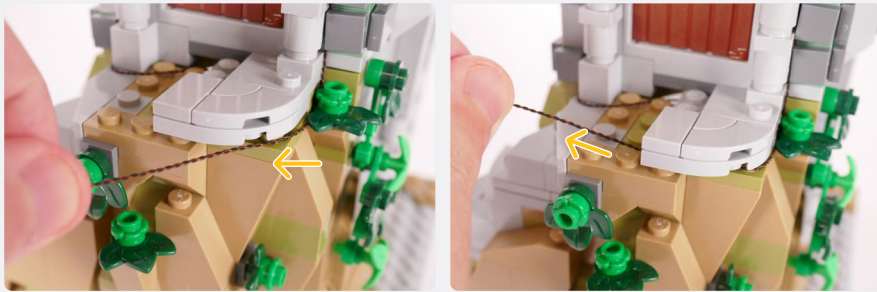

42

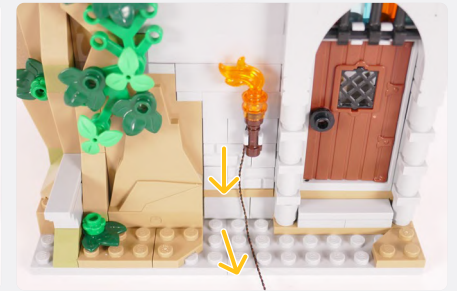

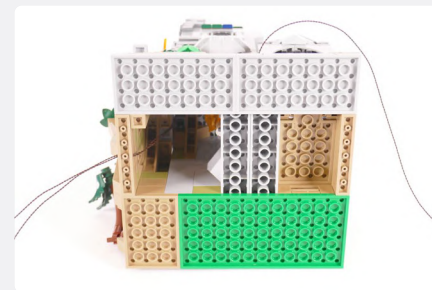
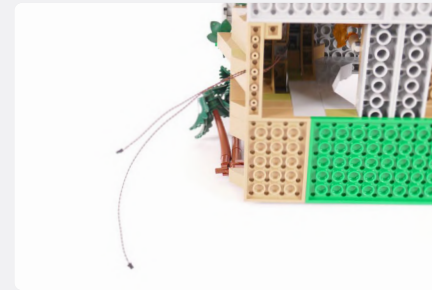
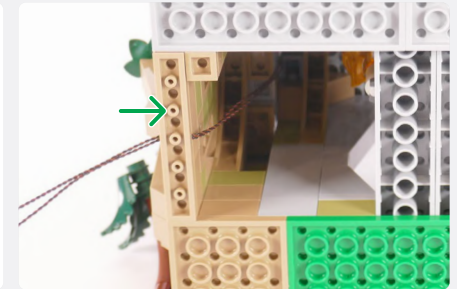
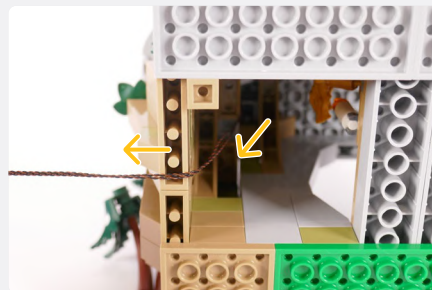
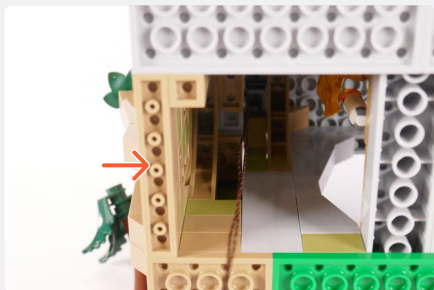
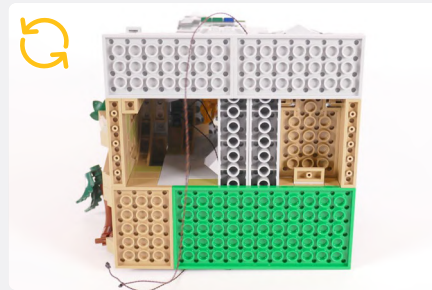
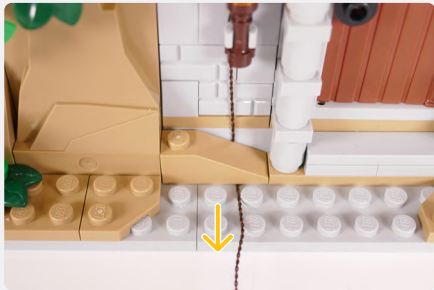

43

5cm Connecting Cable



Flicker Effects Board



NOTE

Connect the 5cm Connecting to the 'IN' port of the Flicker Effects Board

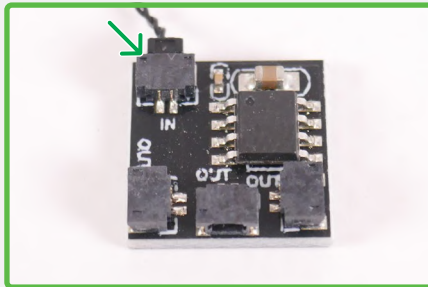

NOTE

Connect the three Yellow Bit Lights to the 'OUT' port of the Flicker Effects Board

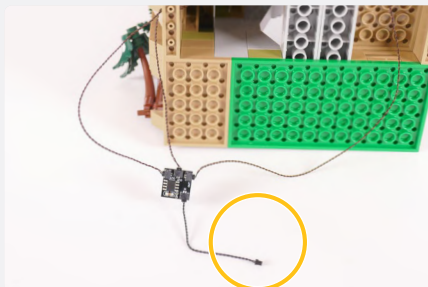
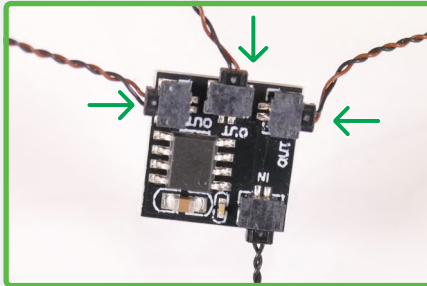
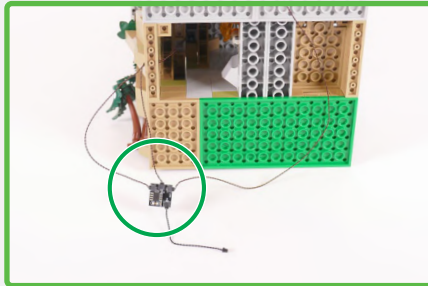

6-Port Expansion Board

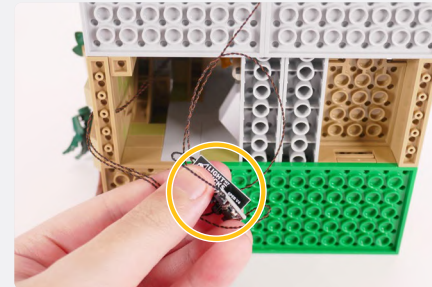
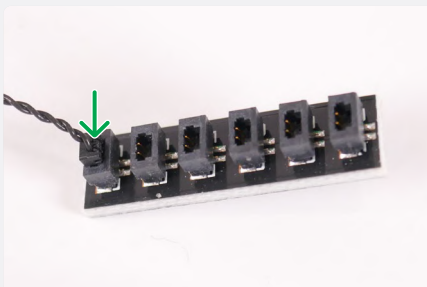
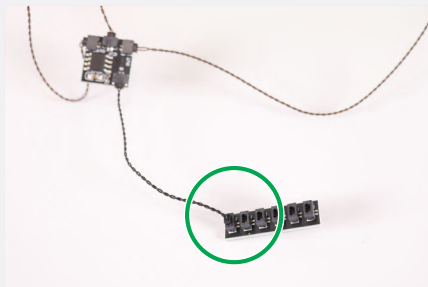

NOTE

Temporarily place the board and cables within the building

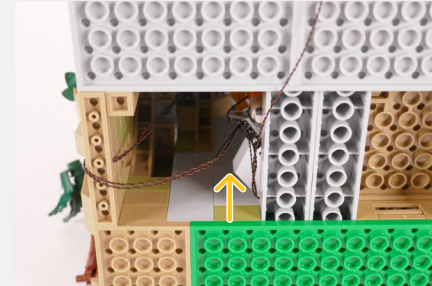

44



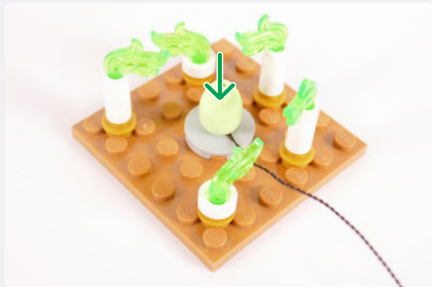
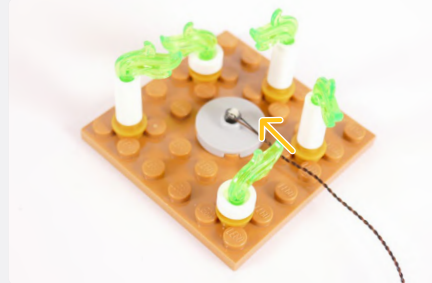

45

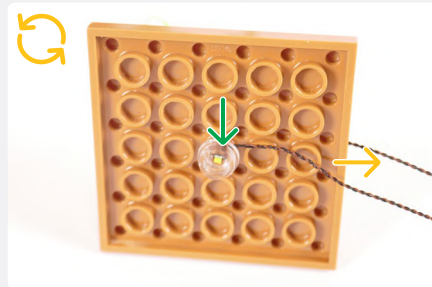

NOTE

If you're having trouble placing the open stud in position, place it off center, in between the tubes instead



46

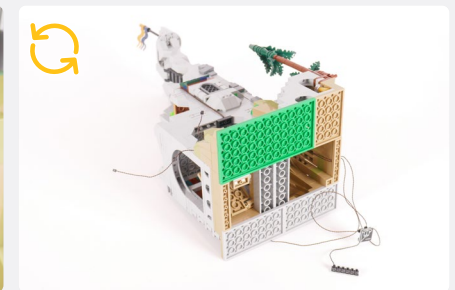
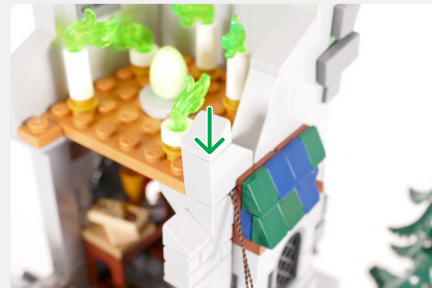
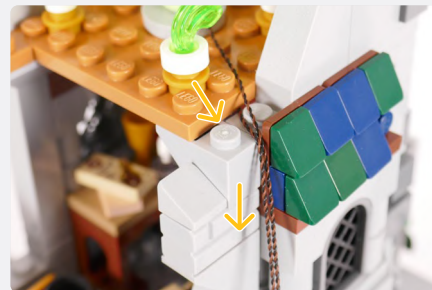

47

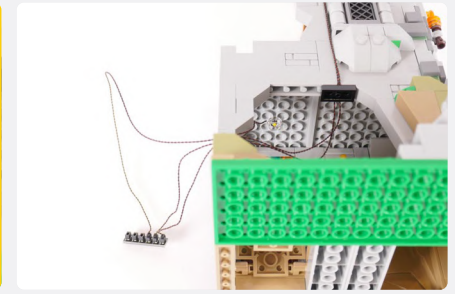
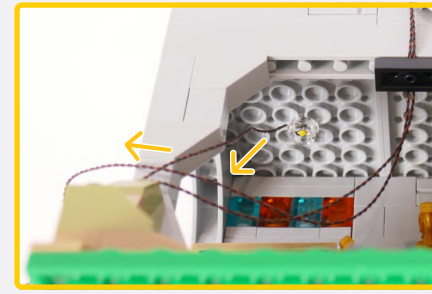
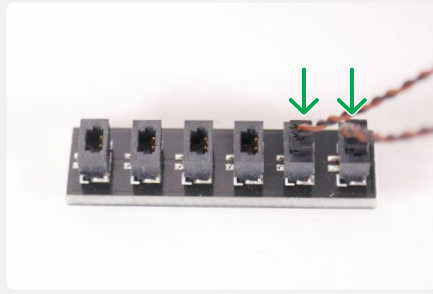

Yellow 30cm Bit Light

Plate, Round 1x1 with Open Stud - Trans Clear

15cm Connecting Cable

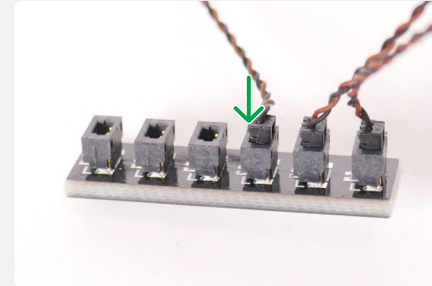
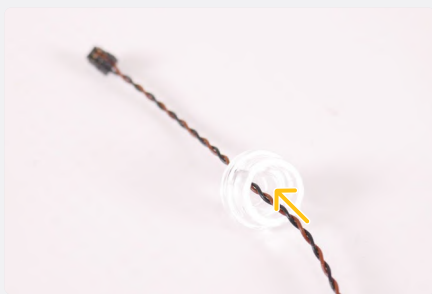

30cm Connecting Cable

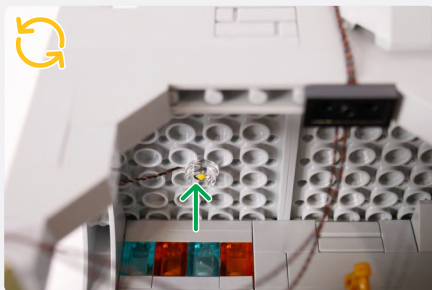

NOTE

Ensure the cables are running out through the same gap

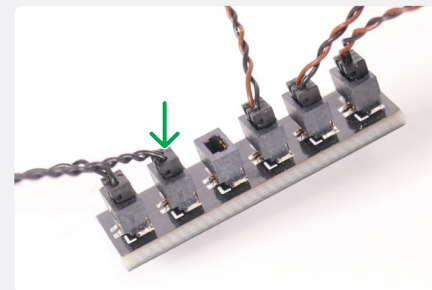
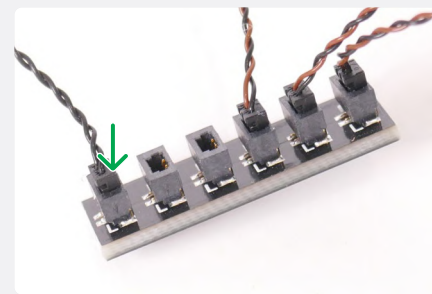

48



NOTE

Twist the cables together but exclude the 15cm and 30cm Connecting Cables

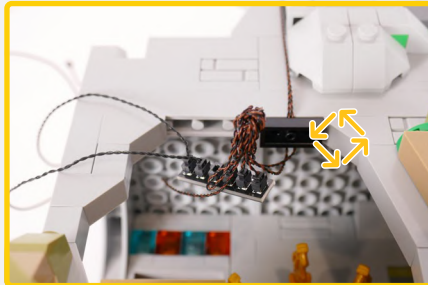

NOTE

Position the Expansion Board in between the tubes so that it gets stuck. If you're having trouble with this part, use a spare Plate 1x2 - Black to pin the cables and thus pin the board.

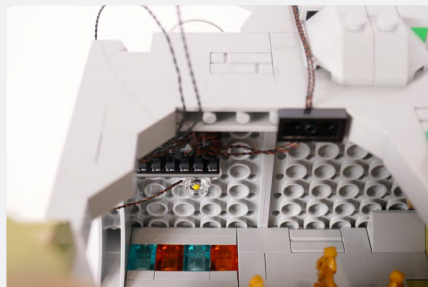
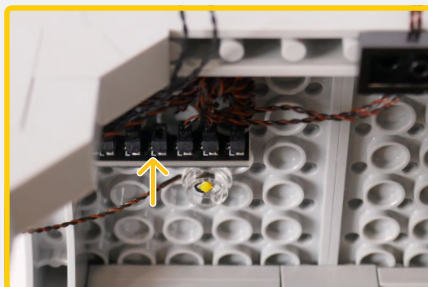

NOTE

Thread the 30cm Connecting Cable through the following gap to the bottom of the section

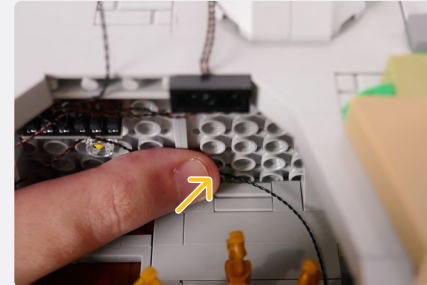
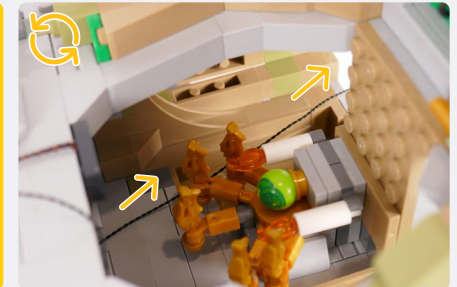
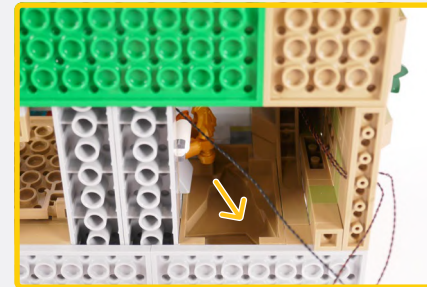
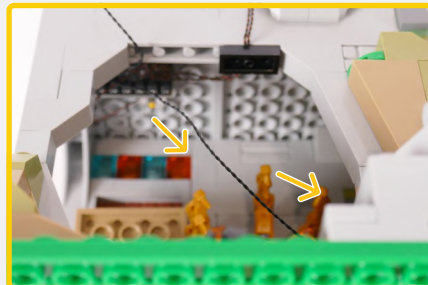

Plate, Round 2x2 with Rounded Bottom (Boat Stud) - Trans-Clear

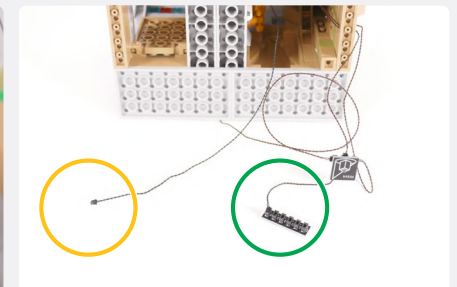
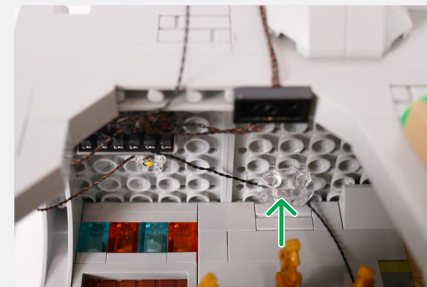

49

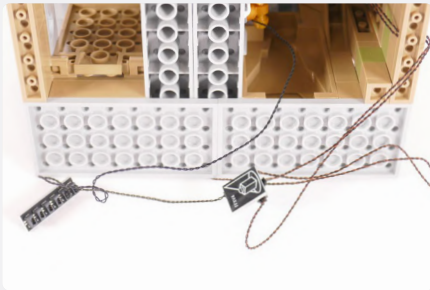

2x Adhesive Square

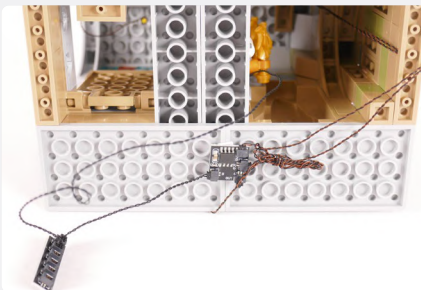
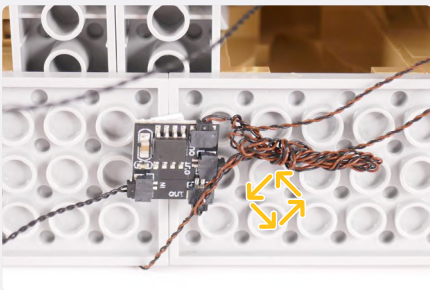
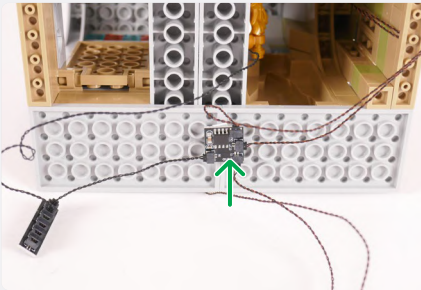

Wireless Power Connector Plate

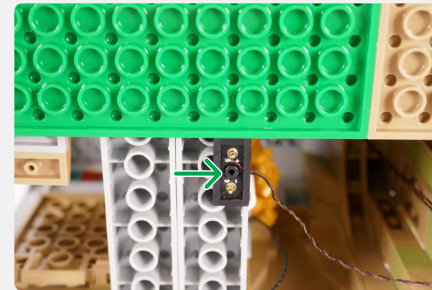
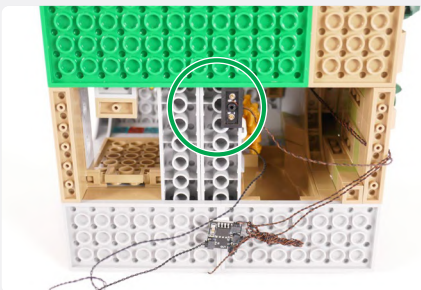

2x Adhesive Square

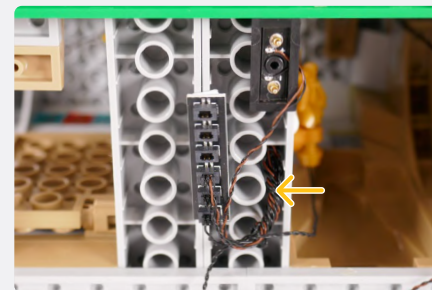
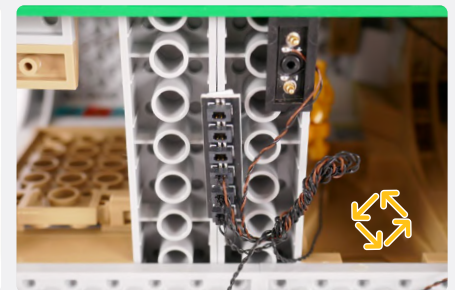
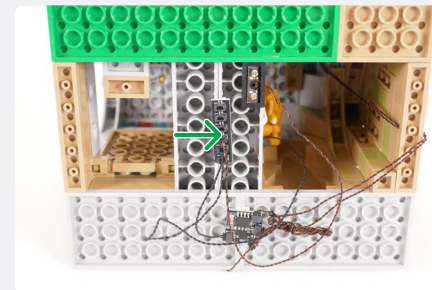
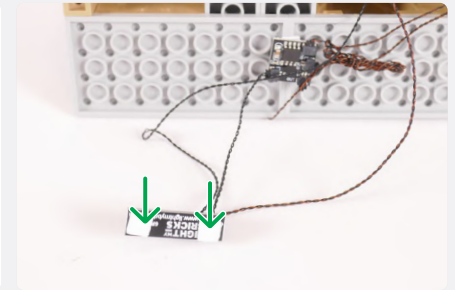
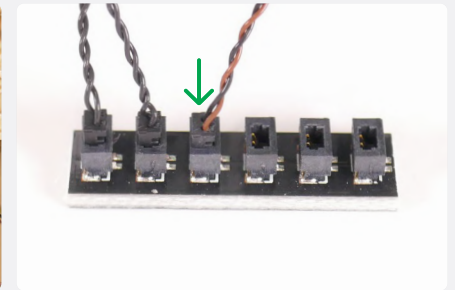
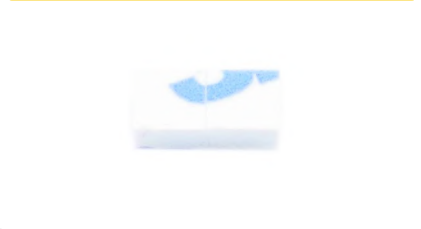

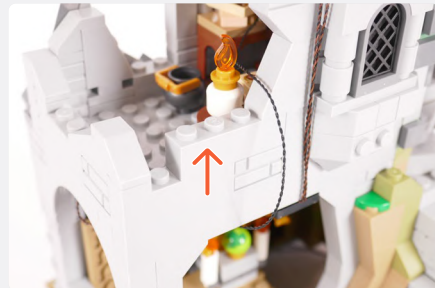
50

NOTE

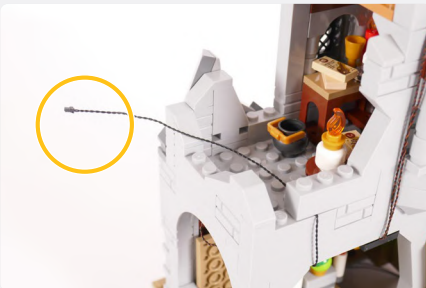
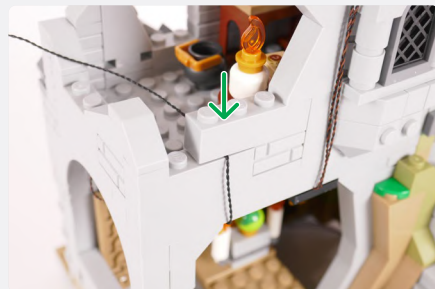
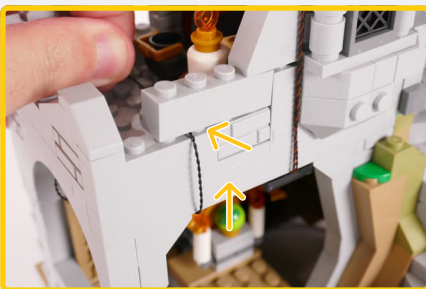
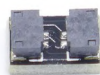
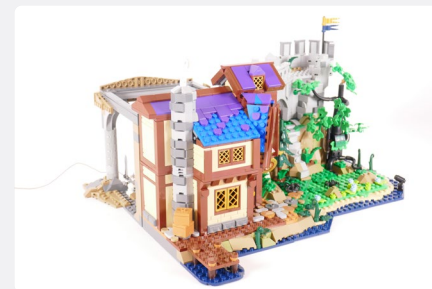
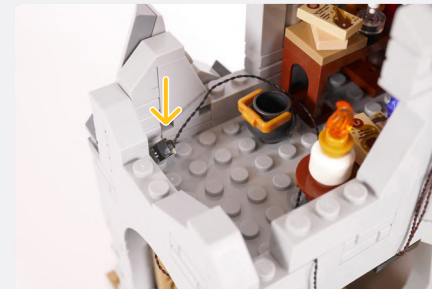
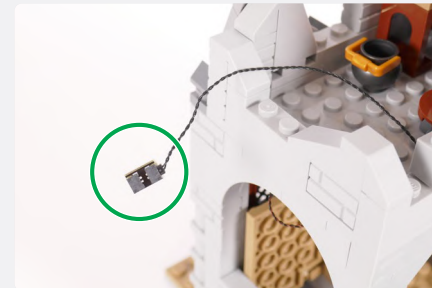
Thread the 15cm Connecting Cable in between the bricks as shown

2-Port Expansion Board

51

NOTE

Ensure the Wireless Power Connectors are touching and aligned when reconnecting the two sections





NOTE

Connect to a 5V USB Power Bank, 5V USB Wall Adaptor, or USB to AA Battery Pack (sold separately)

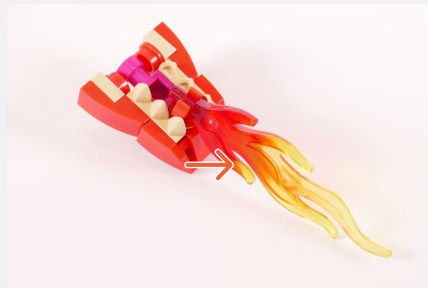

! If you experience any issues with the lights not working and suspect an issue with a component, please try a different port on the expansion board to verify where the fault lies (with the light or expansion board). To correct any issues with expansion board ports, please view the section addressing expansion board issues in our troubleshooting section. **i**

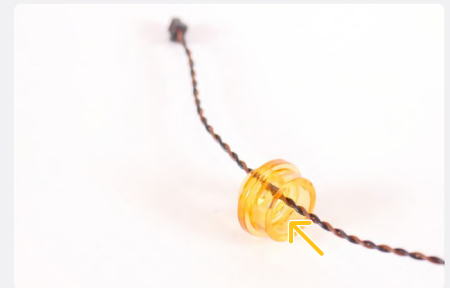
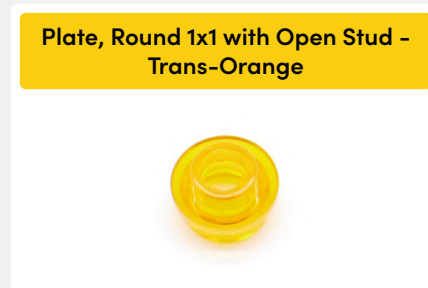
52

53
Orange 30cm Large Bit Light

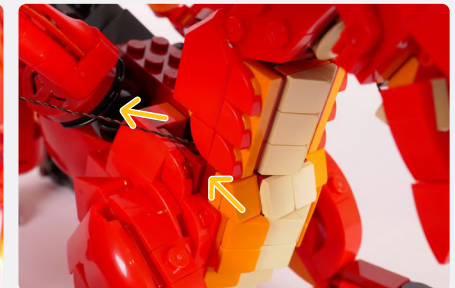
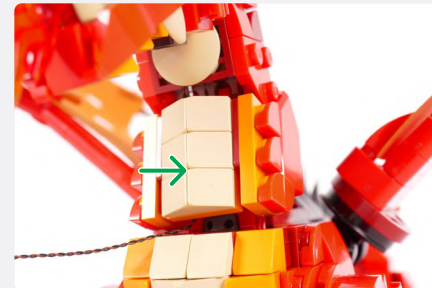
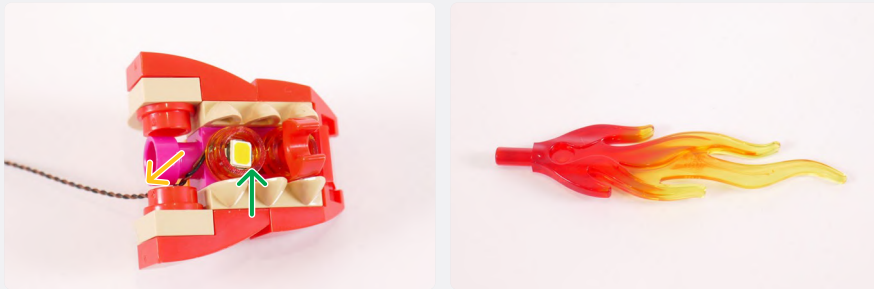
Plate, Round 1x1 with Open Stud - Trans-Orange

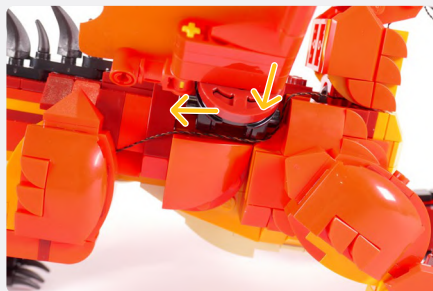
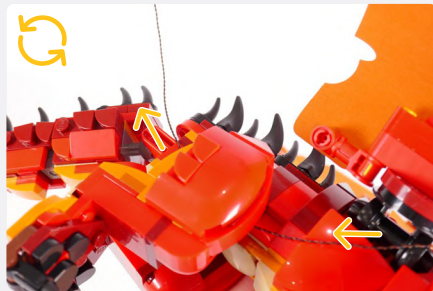

54



55

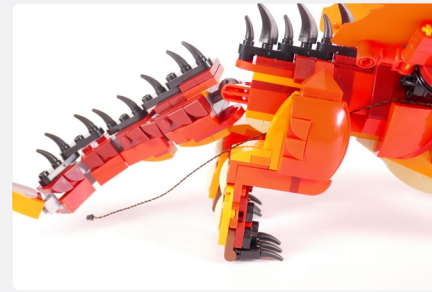

NOTE

Place the dragon in the following position by wedging its leg on the castle



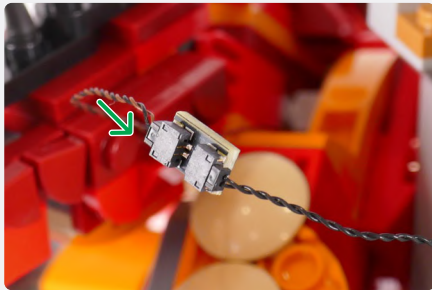
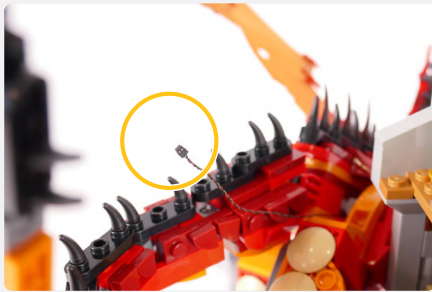

NOTE

Place excess cable in the castle

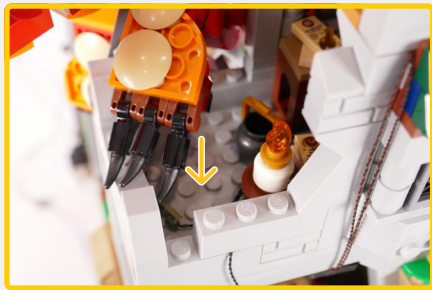

56

NOTE

Connect to a 5V USB Power Bank, 5V USB Wall Adaptor, or USB to AA Battery Pack (sold separately)



! If you experience any issues with the lights not working and suspect an issue with a component, please try a different port on the expansion board to verify where the fault lies (with the light or expansion board). To correct any issues with expansion board ports, please view the section addressing expansion board issues in our troubleshooting section. **i**

NOTE

You should have these parts left over that were removed from the LEGO set

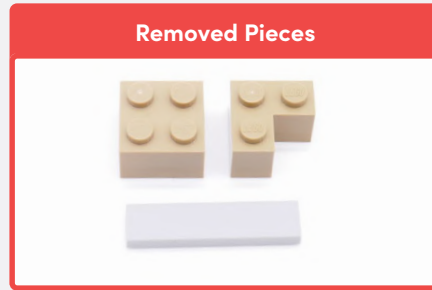

FINAL PRODUCT

This finally completes installation of the Light My Bricks

LEGO® Dungeons & Dragons: Red Dragon's Tale 21348





TROUBLESHOOTING

Light My Bricks lighting kits contain individual components that are very small and can be easily damaged if not handled correctly.

To prevent unnecessary damage to components, we highly recommend that the User Guide section, **“Important things to note”** is read carefully. Follow the handling procedures in the User Guide to help prevent faults and damages to your Light My Bricks components.

If you are experiencing issues with your Light My Bricks set, watch our troubleshooting video here or read on for a list of common causes to help you troubleshoot.

Troubleshooting

Firstly, ensure that the batteries have power using a battery charge gauge.

If the batteries have no power, replace the batteries.

If the batteries still have power, check to see if the batteries have been inserted correctly into the battery pack.

Check for AA batteries using the AA battery pack

Inside the battery pack are symbols indicating which direction the AA battery should be inserted. The flat side of the battery should be paired with the spring side of the battery pack.

If the batteries have been installed correctly and your kit still isn't operating correctly, the next step is to check the wiring.

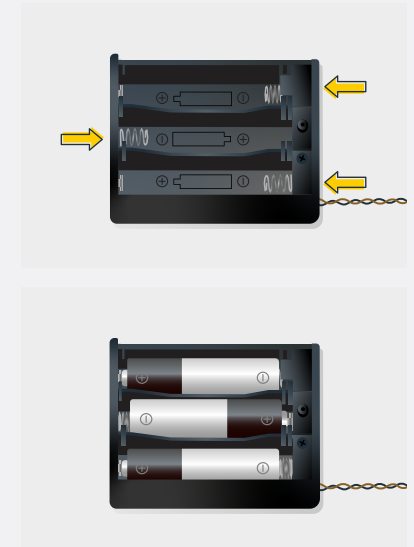

Troubleshooting

Check Your Wires

In order for Light My Bricks components to fit in between and underneath LEGO® bricks, the components need to be very small. Due to this nature, Light My Bricks components can be easily damaged when not handled correctly.

Be careful when removing unpacked components out of the packaging and ensure not to forcibly pull at the wires as this can damage the soldering that attach the wires to the LEDs.

If the wiring is detached from the LED itself, the light will not operate.

When connecting lights to your LEGO® set, check that there are no pinched wires underneath or in between bricks and plates. When the wires are pinched and the exposed wires are touching each other, this can cause a crosswire and the lights to not function correctly.

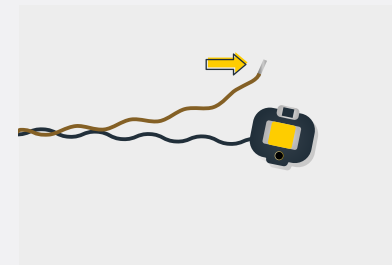
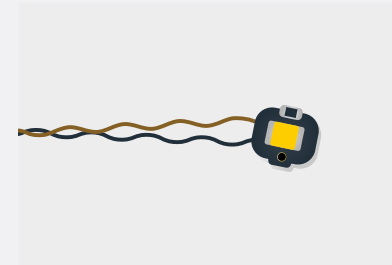

Troubleshooting

Check Your Expansion Board Ports/ Strip Light Ports / Effects Board Ports

It is important to note that connectors can only be inserted to the expansion board, strip light, or effects board ports in one direction.

Forcibly inserting connectors in the incorrect direction will result in damaging the pins inside each of the ports on your component board.

Not only will a light connected to the damaged port not work, but if the pins inside the port are bent to a point they are touching each other, this can result in all other lights in the system to stop working. This is a short circuit.

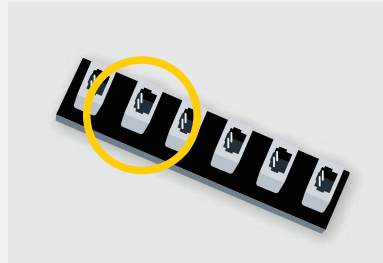
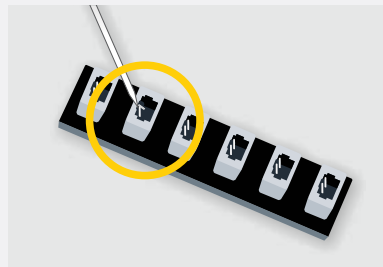

A short circuit can also result in overheating of the board, cable or batteries. If you suspect a short circuit, **DISCONNECT POWER IMMEDIATELY**. Batteries can fail, catch fire, or even explode if left connected to a short circuit for too long.

If you suspect you have a faulty component due to a bent pin, try the following steps:

If you look carefully inside each of the ports, each port contains 2 small pins that should be straight. You will be able to identify a faulty port if it has any bent pins.

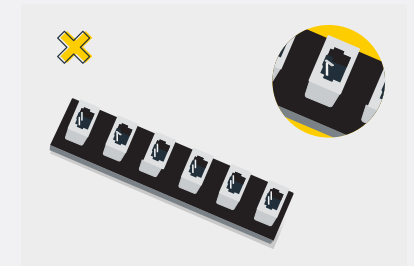
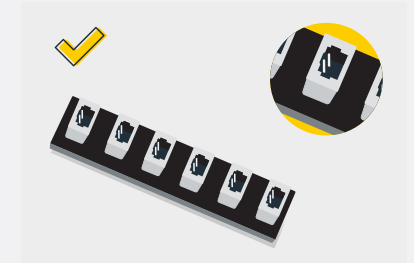
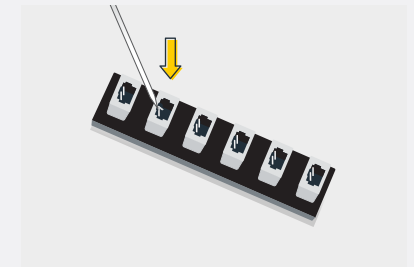



CONTACT US

If you have an enquiry regarding the online shop, our products or a general enquiry please refer to our Frequently Asked Questions webpage here.

Alternatively, you can contact our Customer Services team by visiting our online support portal here.

support.lightmybricks.com

We thank you for purchasing this product and hope you enjoy!



lightmybricks.com