

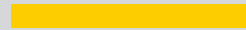

**LIGHT^{MY}
BRICKS**



**LEGO[®] STAR WARS VENATOR-CLASS
REPUBLIC ATTACK CRUISER #75367
INSTALLATION GUIDE**

Light My Bricks



LEGO® STAR WARS VENATOR-CLASS REPUBLIC ATTACK CRUISER 75367 INSTALLATION GUIDE

Hi There!

We're here to help you get started on the LEGO®

Star Wars Venator-Class Republic Attack Cruiser 75367 Light Kit.

This PDF details the instructions for the LED light kit only. If you are wishing to purchase this product, please [click here](#) to view the product page.

If you run into any issues, please refer to the troubleshooting section towards the end of this guide.

Have fun and enjoy!





PACKAGE CONTENTS:

Individual Bags



- 24 x Cool White 30cm Bit Light *
- 8 x Yellow 30cm Bit Light
- 6 x Light Blue 30cm Bit Light
- 2 x Cool White 30cm Large Bit Light
- 4 x Cool White 30cm Headlight

Connecting Cables



- 1 x 15cm Connecting Cable
- 4 x 30cm Connecting Cable
- 1 x 50cm Connecting Cable

USB Power Cable



- 1x USB Power Cable
(Power Source not Included)

Mixed Components 1



- 1 x 6-Port Expansion Board
- 1 x 8-Port Expansion Board
- 4 x 12-Port Expansion Board
- 1 x Dimmer Control Board

Mixed Components 2



- 4 x Dish 2x2 - Trans Dark Blue
- 2 x Technic Brick 1x2 - Light Grey
- 2 x Plate 1x2 - Black

* Indicates components which include spares

Contents

Before You Begin	5
Blueprint	10
Instructions	11
Final Product	71
Troubleshooting	72
Contact	76

Before You Begin

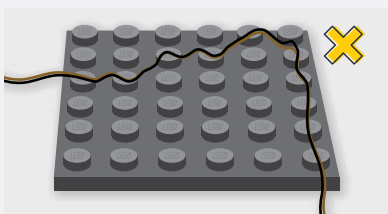
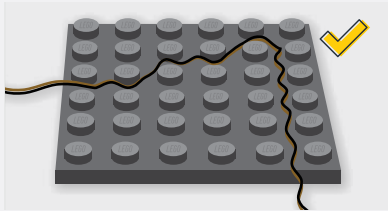

Laying cables in between and underneath bricks

Cables can fit in between and underneath LEGO® bricks, plates, and tiles providing they are laid correctly between the LEGO® studs. Do NOT forcefully join LEGO® together around cables; instead ensure they are laying comfortably in between each stud.

CAUTION: Forcing LEGO® to connect over a cable can result in damaging the cable and light.

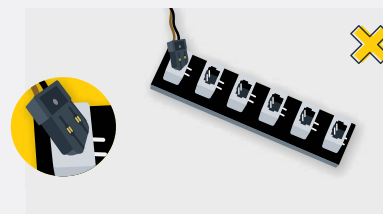
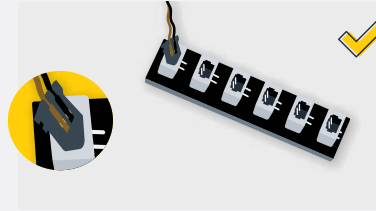

Connecting Cable Connectors To Expansion Boards

Take extra care when inserting connectors to ports of Expansion Boards. Connectors can be inserted only one way. With the expansion board facing up, look for the soldered “=” symbol on the left side of the port. The connector side with the wires exposed should be facing toward the soldered “=” symbol as you insert into the port. If a plug won’t fit easily into a port connector, do not force it.

Incorrectly inserting the connector can result in bent pins inside the port or possible overheating of the expansion board when connected.

Before You Begin

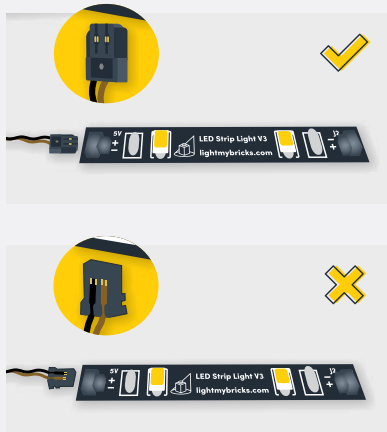

Connecting Cable Connectors To Strip Lights

Take extra care when inserting connectors to ports on the Strip Lights. Connectors can be inserted only one way. With the Strip Light facing up, ensure the side of the connector with the wires exposed is facing down. If a plug won't fit easily into a port connector, don't force it. Doing so will damage the plug and the connector.

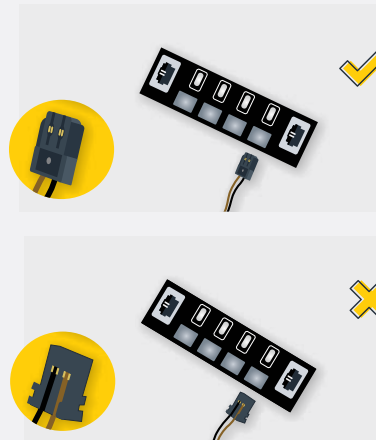

Connecting Micro Cable Connectors To Micro Expansion Board Ports

Take extra care when inserting the micro connectors to micro ports of Micro Expansion Boards. Connecting Micro Bit Lights to Micro Expansion Boards is similar to connecting lights and cables to Strip Lights. With the expansion board facing up, ensure the side of the connector with the wires exposed is facing down. If a plug won't fit easily into a port connector, do not force it. Use your fingernail to push the plastic part of the connector to the micro port.

Before You Begin

Installing Bit Lights Under Lego® Bricks And Plates

When installing Bit Lights under LEGO® pieces, ensure they are placed the correct way up (Yellow LED component exposed). You can either place them directly on top of LEGO® studs or in between.

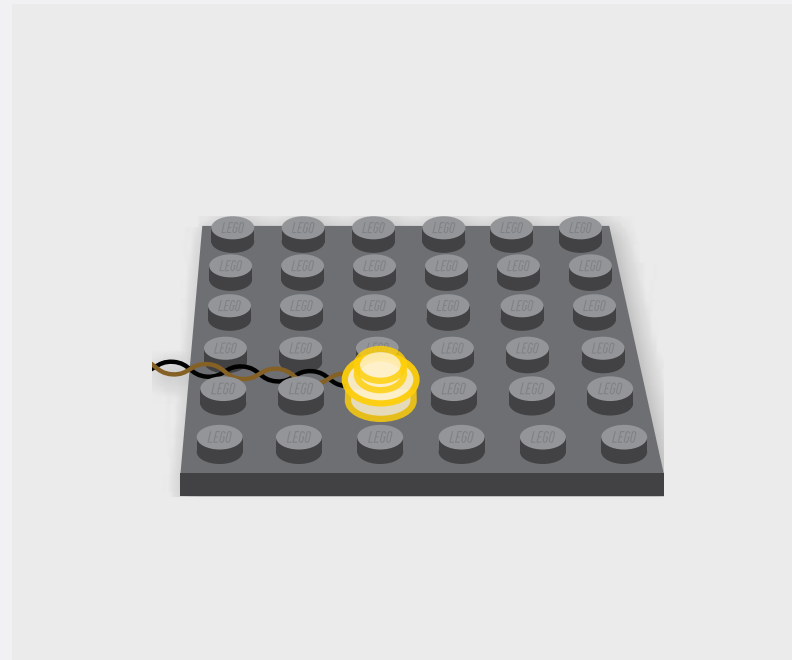

Before You Begin

The Symbols Used In This Guide

When going through the following guide you will come across symbols and formats that will assist with the installation of your light kit. Take notice of them as each has a specific purpose.

Light Kit Component

This is the most important image format as it indicates which part to use from the Light Kit. Make sure you pay close attention to which part is shown.

White 30cm Bit Light



Connect

Used when you need to connect a LEGO piece or LMB component.



Disconnect

Used when you need to remove a LEGO piece/ section or LMB component.



Directional

Used to show where to route cables, place components, or move them.



Bend/Pivot

Used when a component needs to be bent, or part folded or pivoted.



Turn/ Flip

Will be found in the top left corner when the set needs to be rotated or flipped.



Twist/ Braid

Seen when a set of cables need to be grouped and twisted together.



Power On Test

Found at the end of a major step to test the lights. Will be located in the top left corner.



Note

Notes will be found alongside the instruction photos and explain what to do.



Before You Begin

Repeat Step

Repeat the previous step eg. Make a spotlight, then make a second spotlight.

x2

Connect Focus

Used to highlight a hard to see area where a component is being connected.



Disconnect Focus

Used to highlight a hard to see area where a component is being disconnected.



General Focus

Used to highlight a hard to see area where a component needs to be acted on.



General Note

This is a sample note that is used anywhere in this guide. It will explain a difficult section where photos are hard to illustrate or easily confused.

Connect Note

The green coloured note is used when the topic focuses on a component being connected, like the shown Power Bank.

Disconnect Note

The red coloured note is used when the topic focuses on a component being disconnected or like here, the removed pieces.



NOTE

Take the 5cm Connecting Cable from the 4-Port Micro Expansion Board and route it into the "IN" port of the Flicker Effects Board

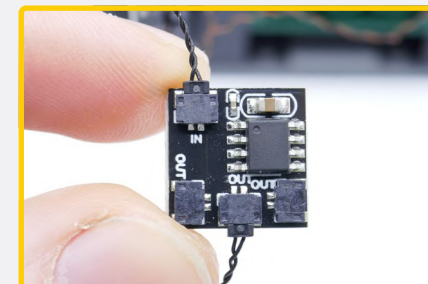

NOTE

Connect to a 5V USB Power Bank, 5V USB Wall Adaptor, or USB to AA Battery Pack (sold separately)



NOTE

You should have these parts left over that were removed from the LEGO set





BLUEPRINT

Star Wars Venator-Class Republic Attack Cruiser - 75367

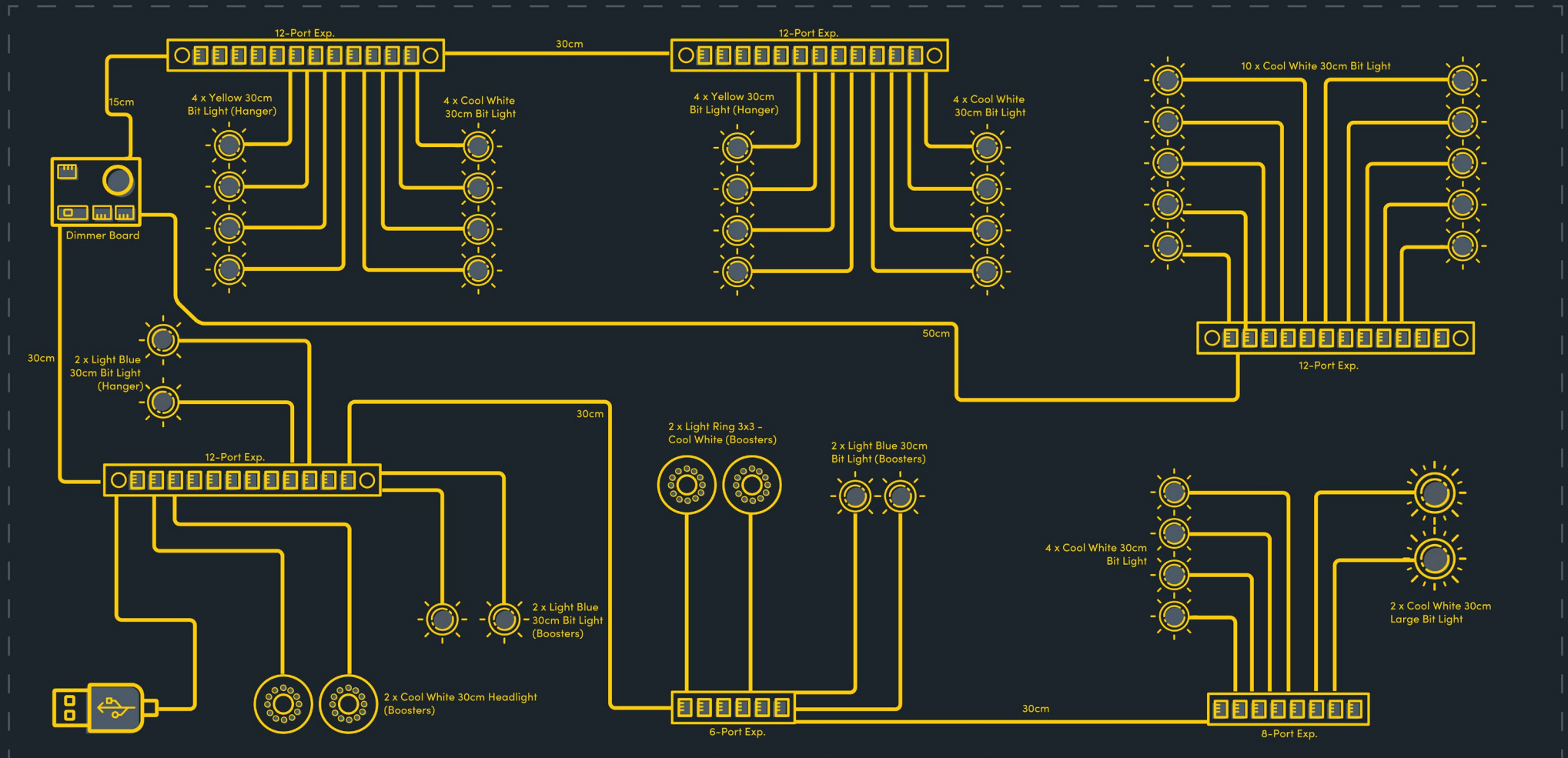



INSTRUCTIONS

To ensure a smooth installation of your light kit, please read and follow each step carefully. If you run into any issues, please refer to the online troubleshooting guide.

1

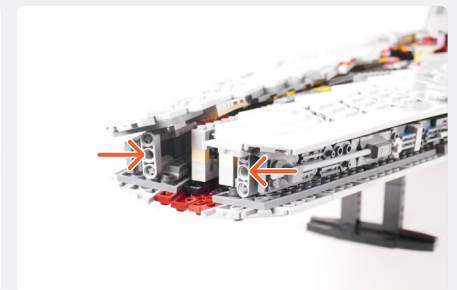
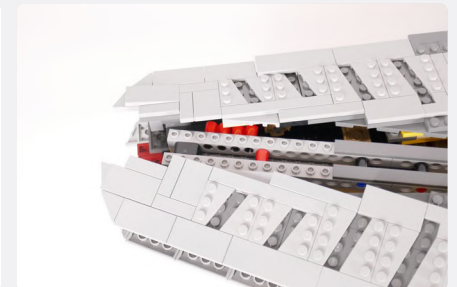
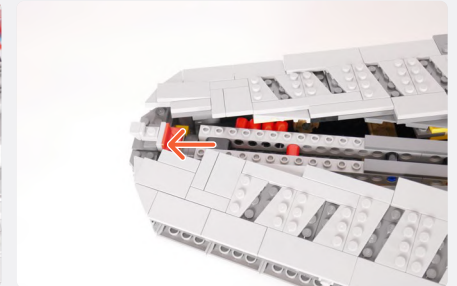
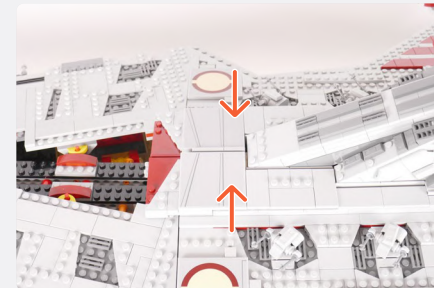
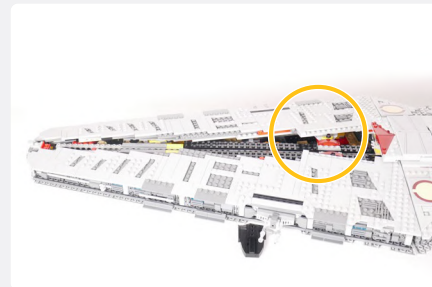
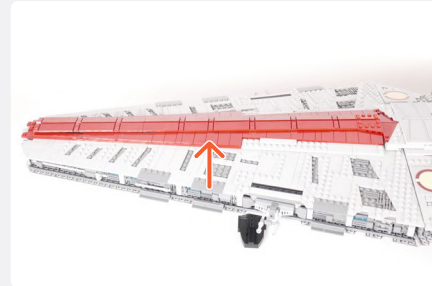

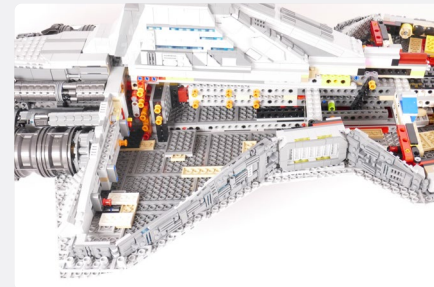
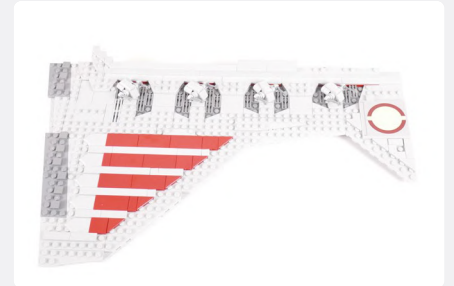
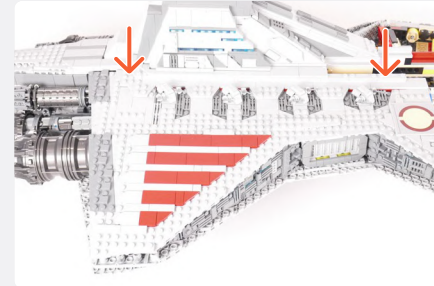
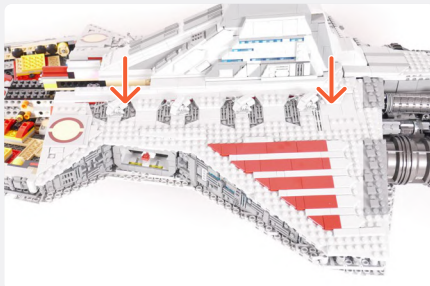
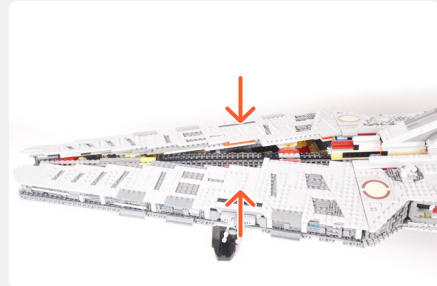

2

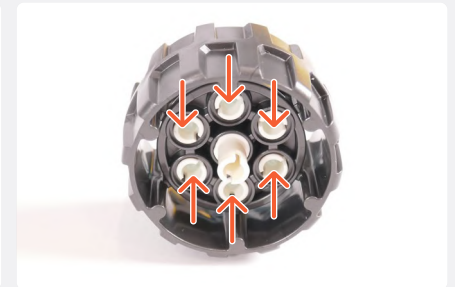
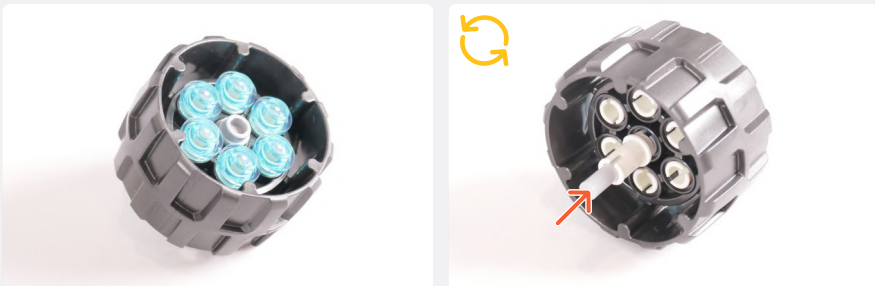
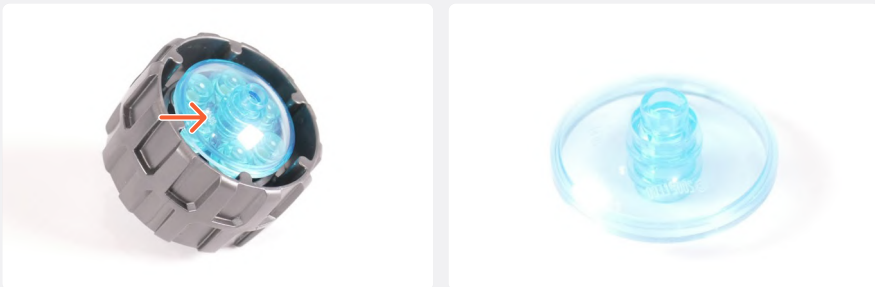
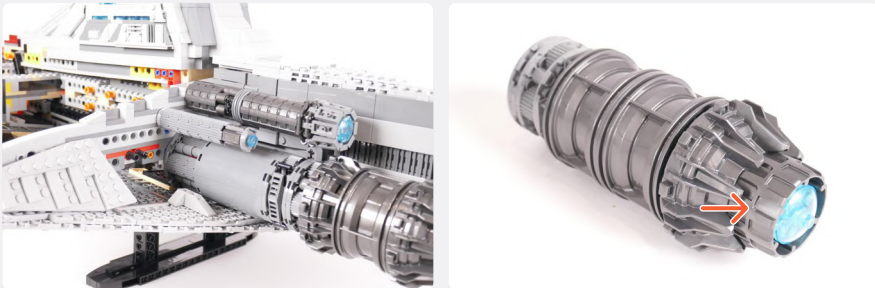
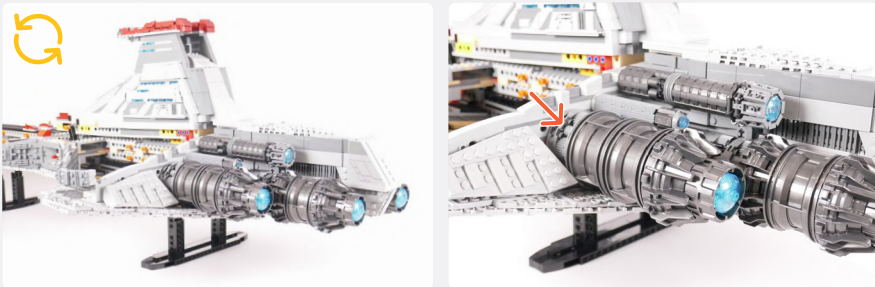

 **NOTE**

Use the following LEGO piece to assist in disconnecting all the Technic Pins.



3

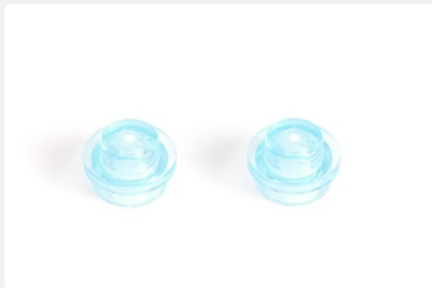
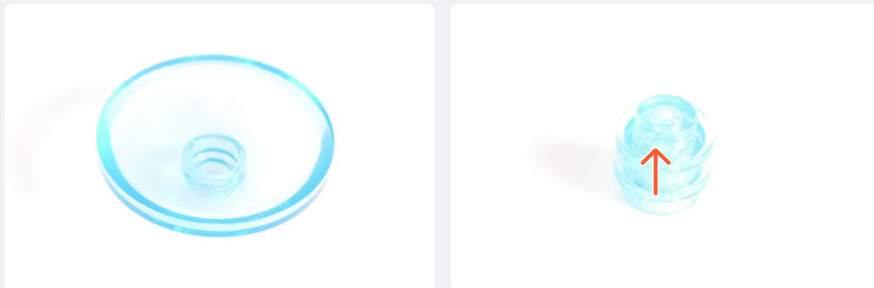
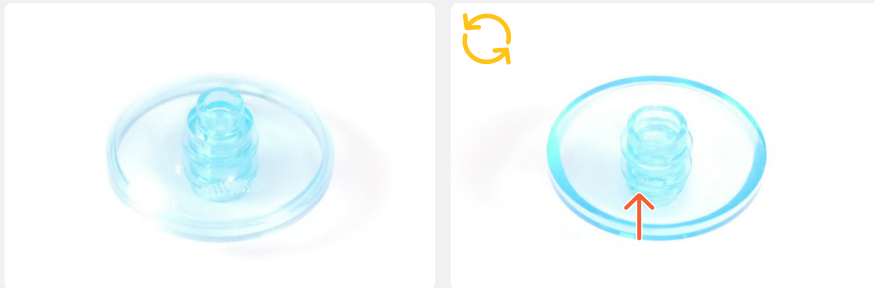

4

Cool White 30cm Headlight

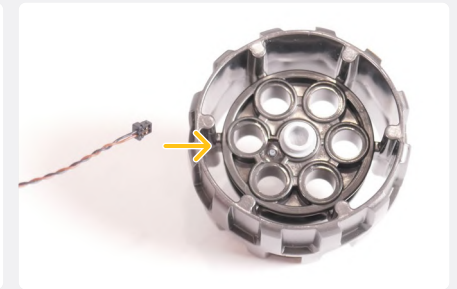

Dish 2x2 Inverted (Radar) - Trans Dark Blue



5

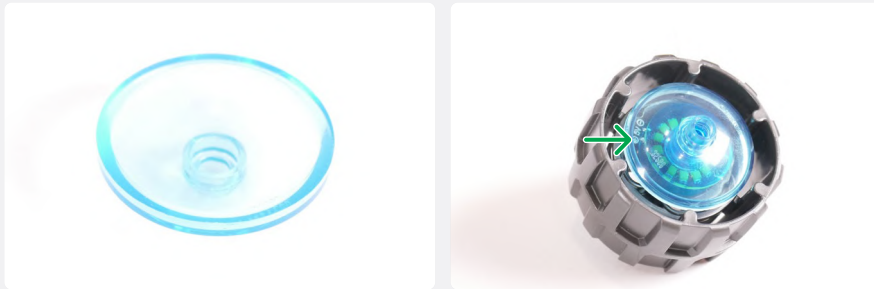

NOTE

If you are having trouble threading the cable through, separate the parts and thread through.



6

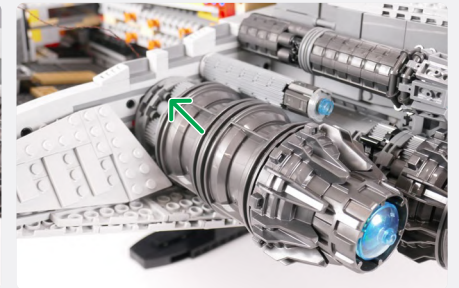
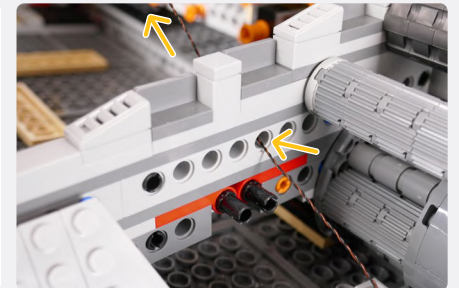

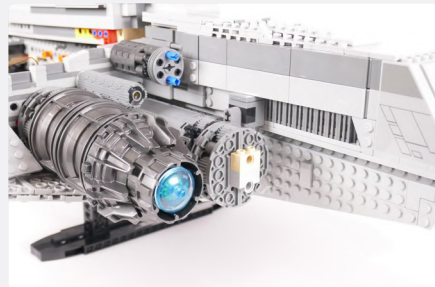
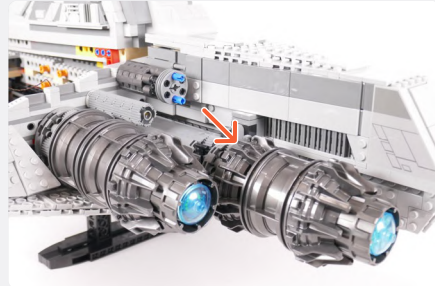
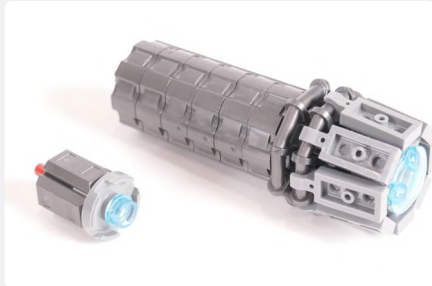
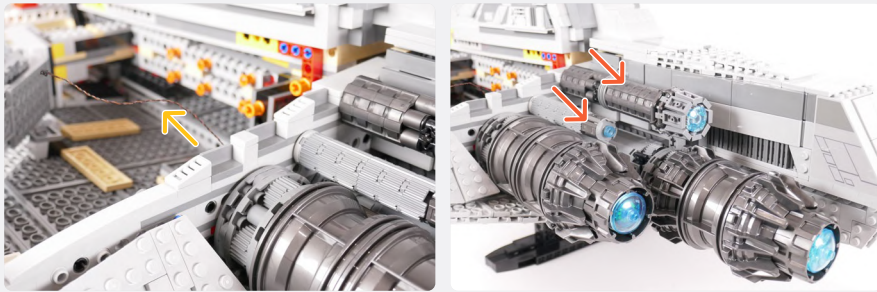

7



NOTE

Use the following LEGO piece to assist in disconnecting all the Technic Pins.



8



9

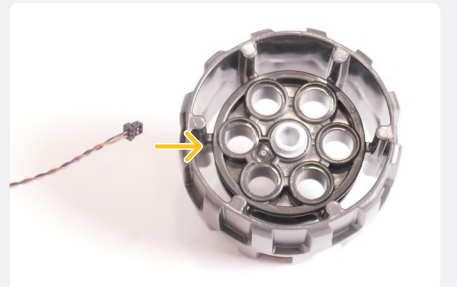

10



Dish 2x2 Inverted (Radar) - Trans Dark Blue



11

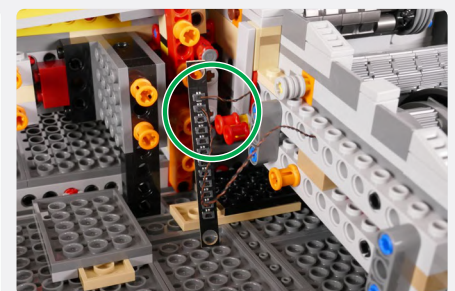
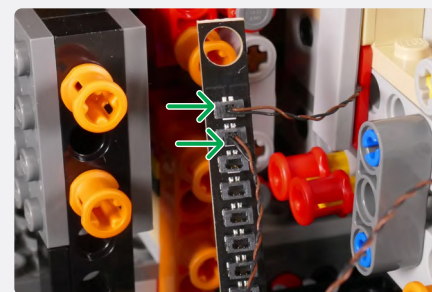
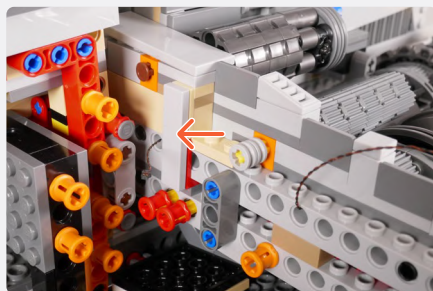
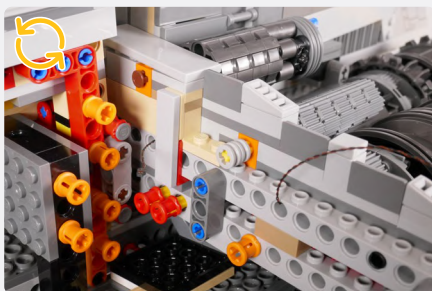
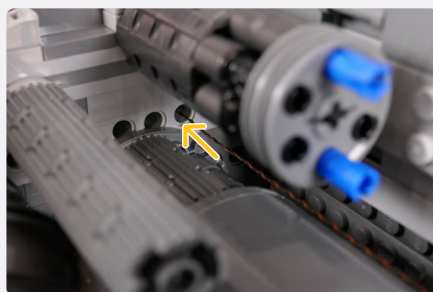
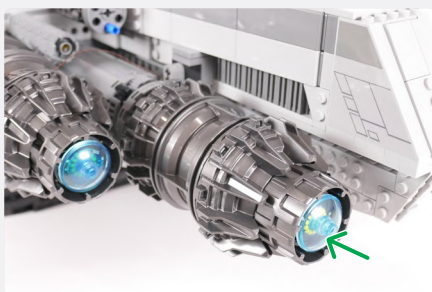
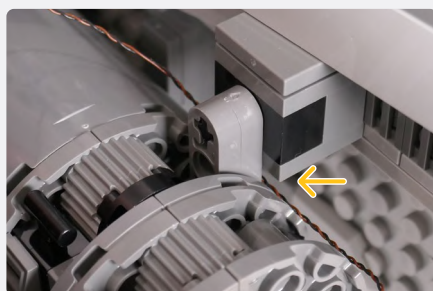
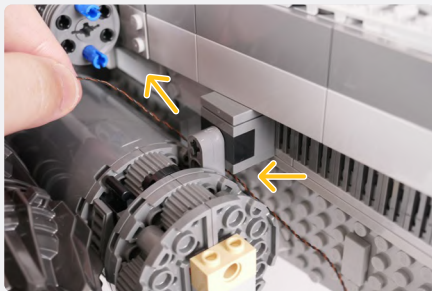
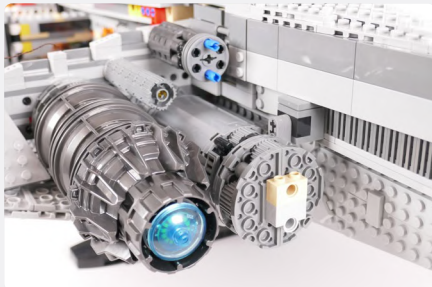

12

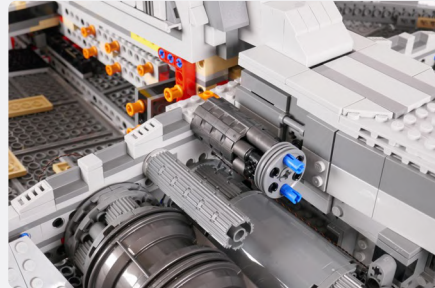
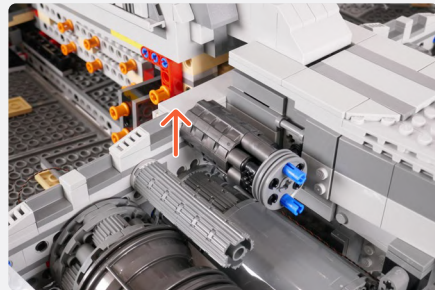
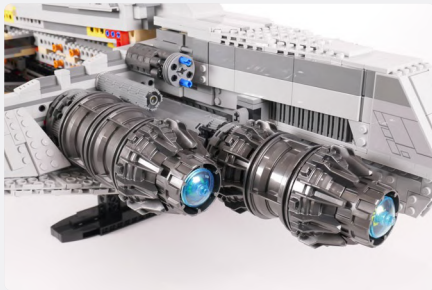

13



Light Blue 30cm Bit Light



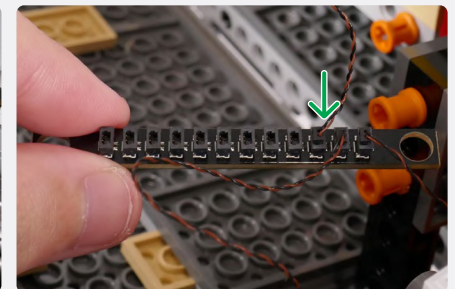
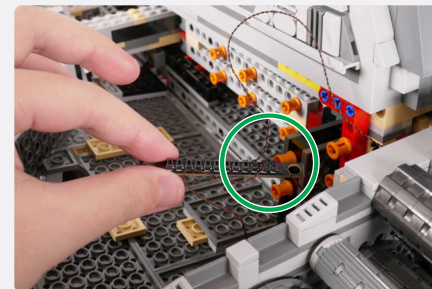
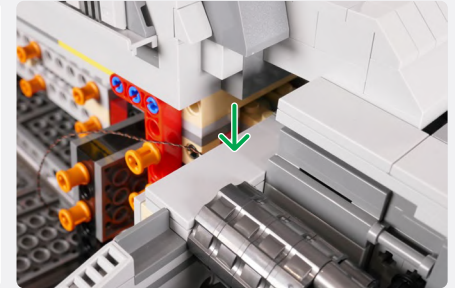
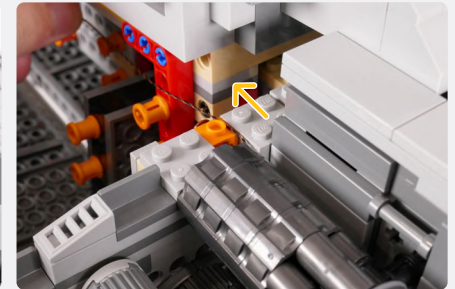
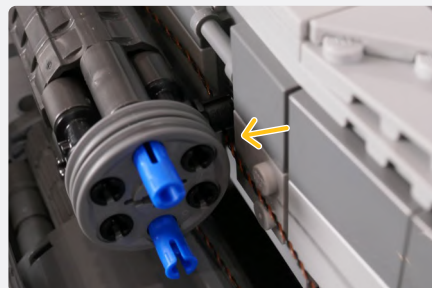
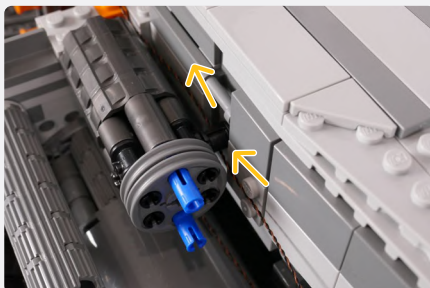
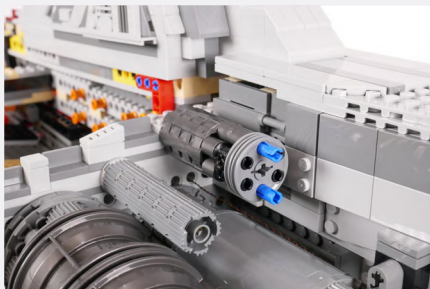

14

15

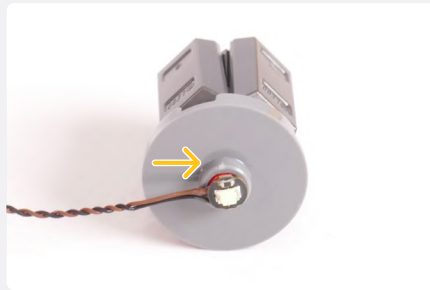
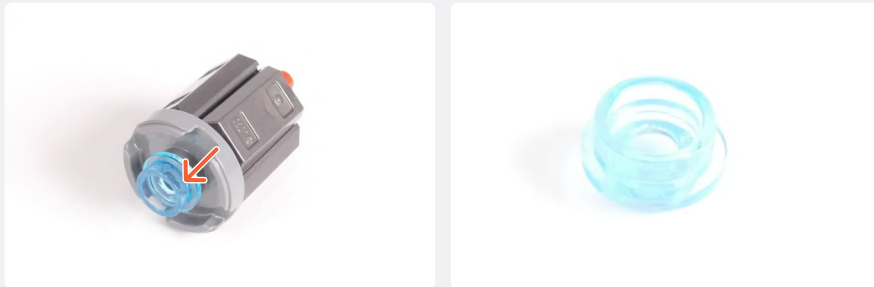

16

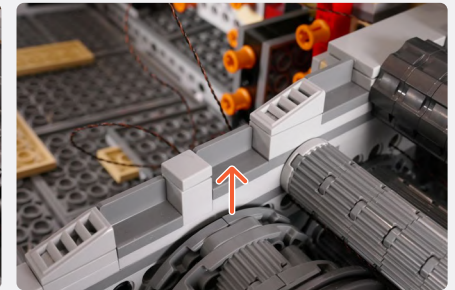
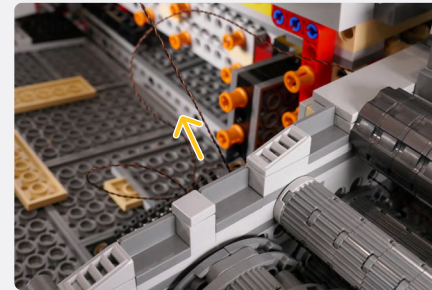
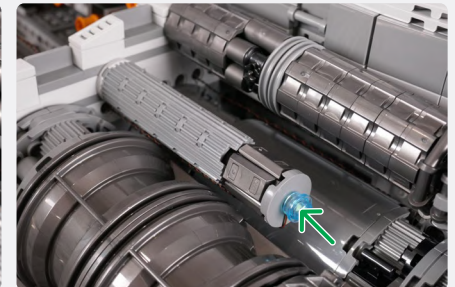
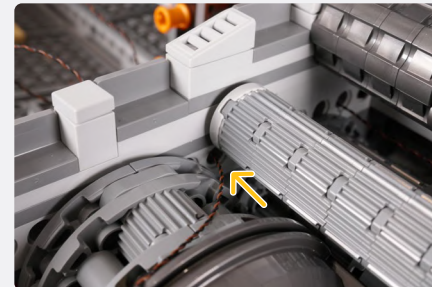
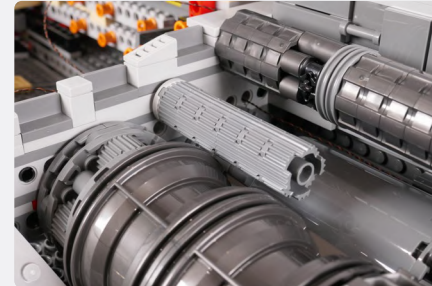

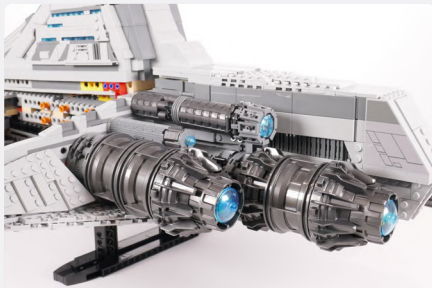
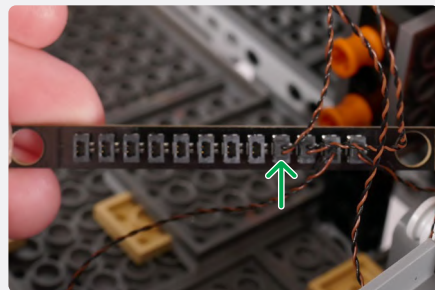
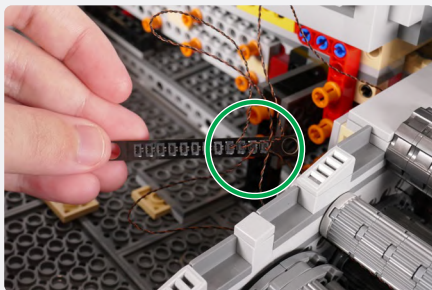
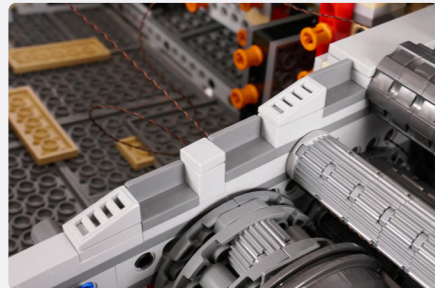
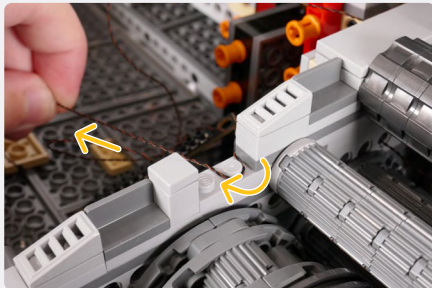
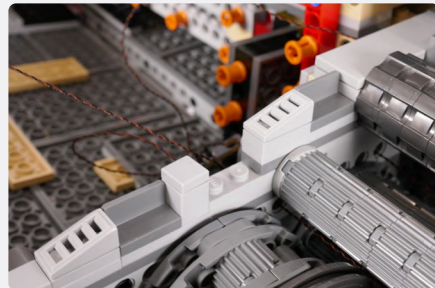

17

USB Power Cable



NOTE

Run the USB Power Cable from beneath the ship through the indicated gap

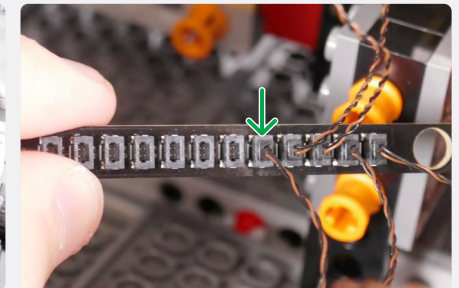
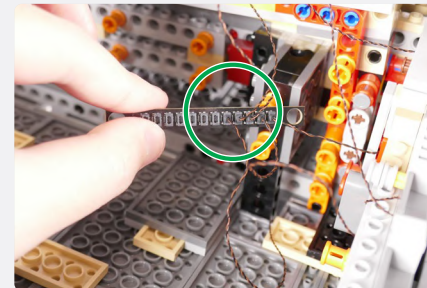
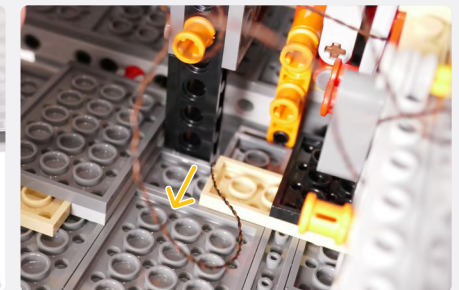
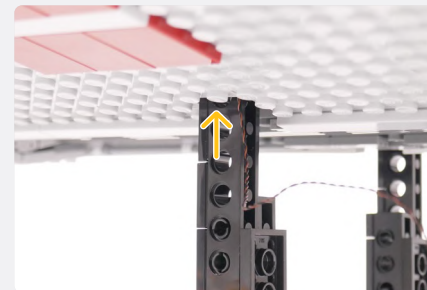
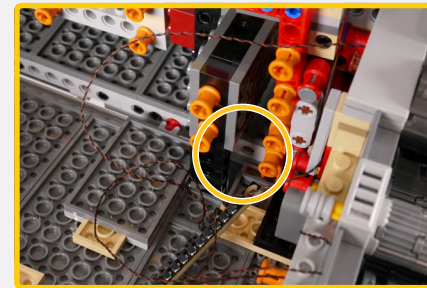

NOTE

Connect to a 5V USB Power Bank, 5V USB Wall Adaptor, or USB to AA Battery Pack (sold separately)





! If you experience any issues with the lights not working and suspect an issue with a component, please try a different port on the expansion board to verify where the fault lies (with the light or expansion board). To correct any issues with expansion board ports, please view the section addressing expansion board issues in our troubleshooting section. **i**

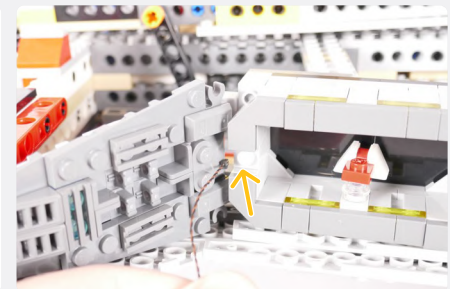
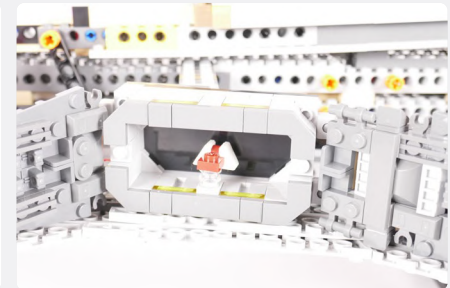
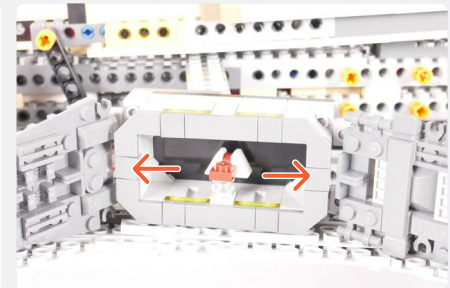
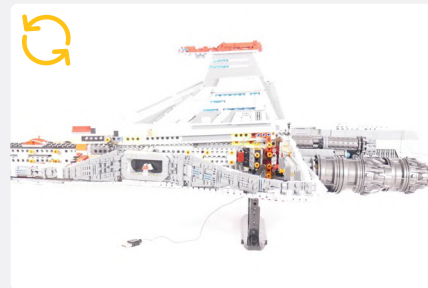

18

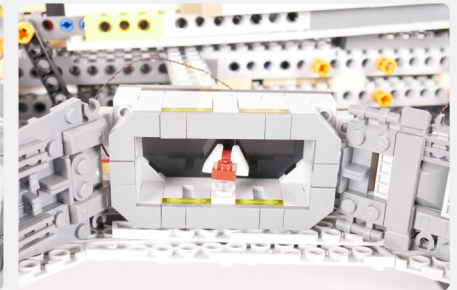
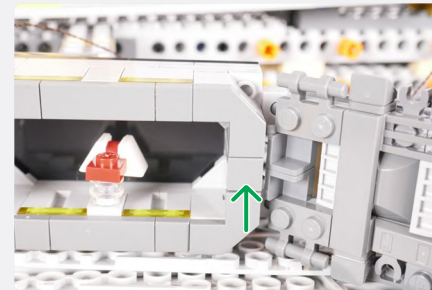
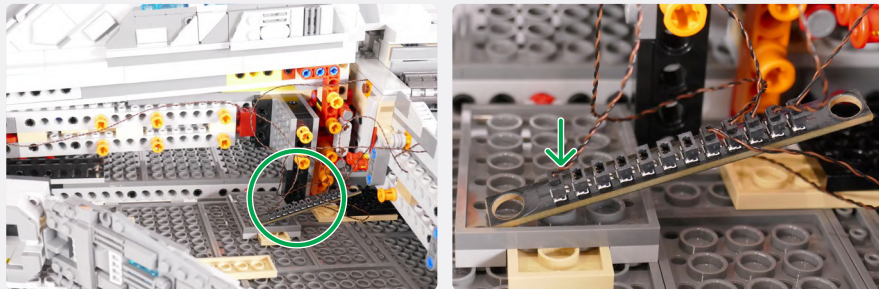



 **NOTE**

Connect the Light Blue 30cm Bit Light from this step to the 12-Port Expansion Board.

19

Light Blue 30cm Bit Light

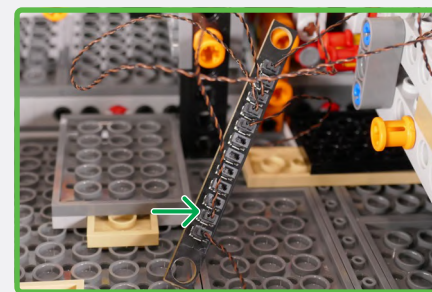
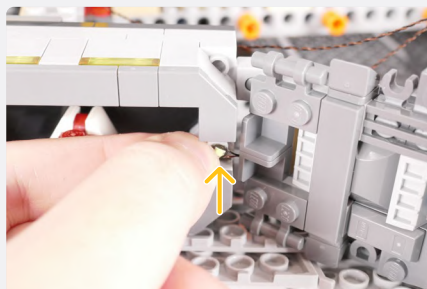
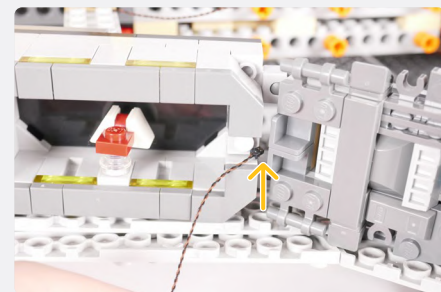

20

30cm Connecting Cable

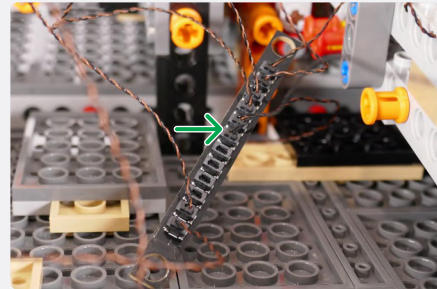

6-Port Expansion Board



NOTE

Connect the other end of the 30cm Connecting Cable to the 6-Port Expansion Board

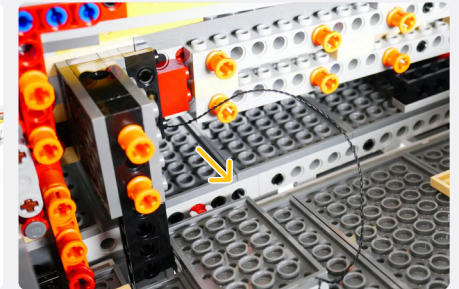
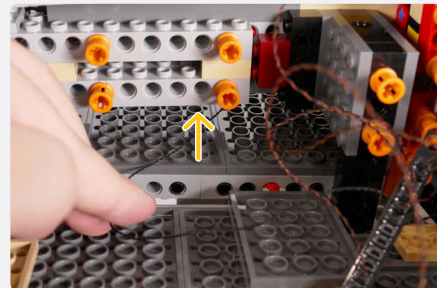
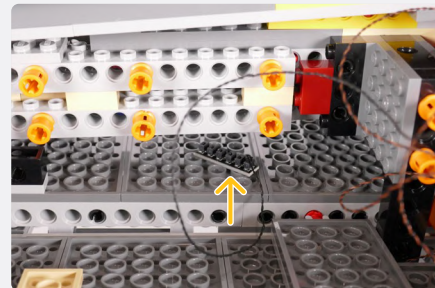
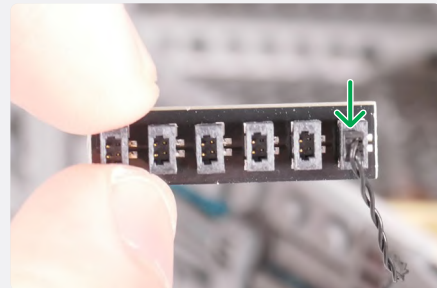
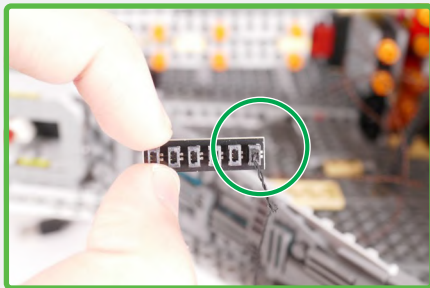

19

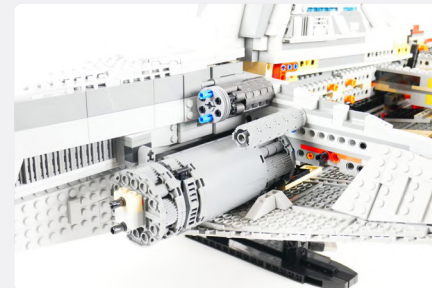
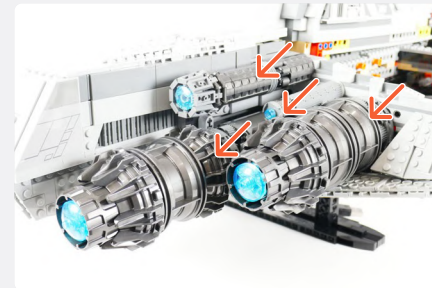

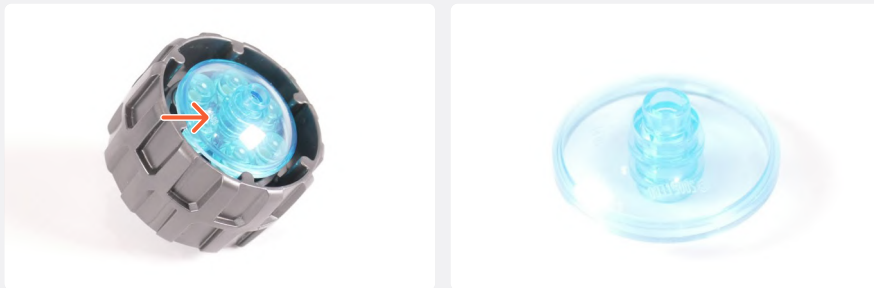

NOTE

Use the following LEGO piece to assist in disconnecting all the Technic Pins.



20

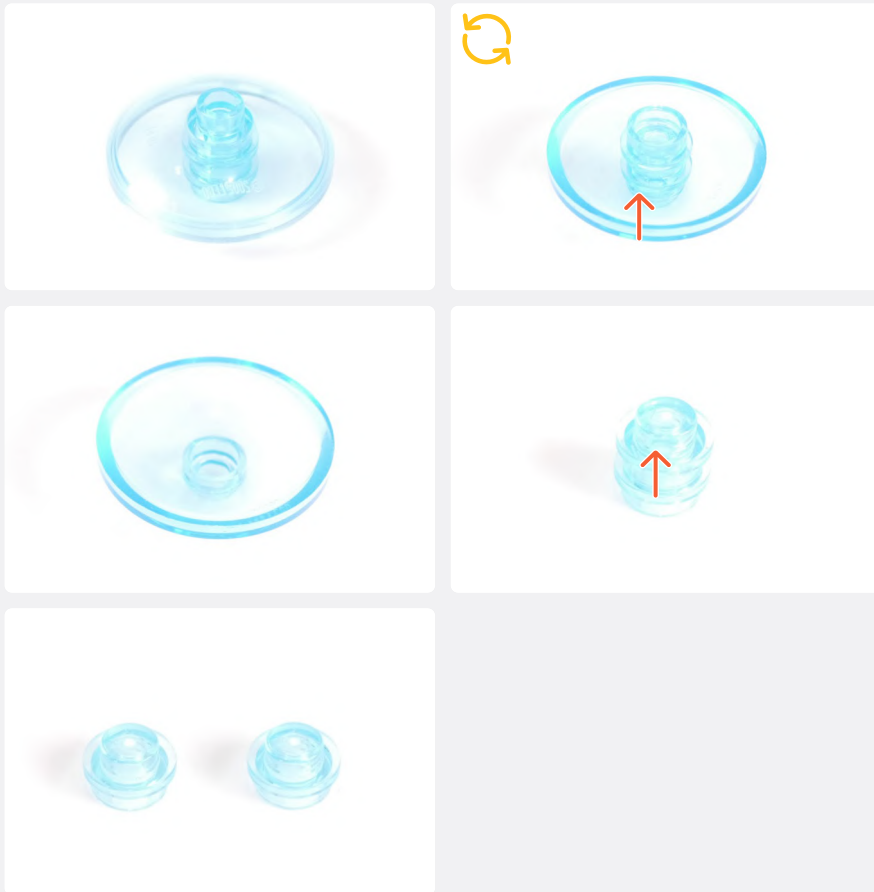

21

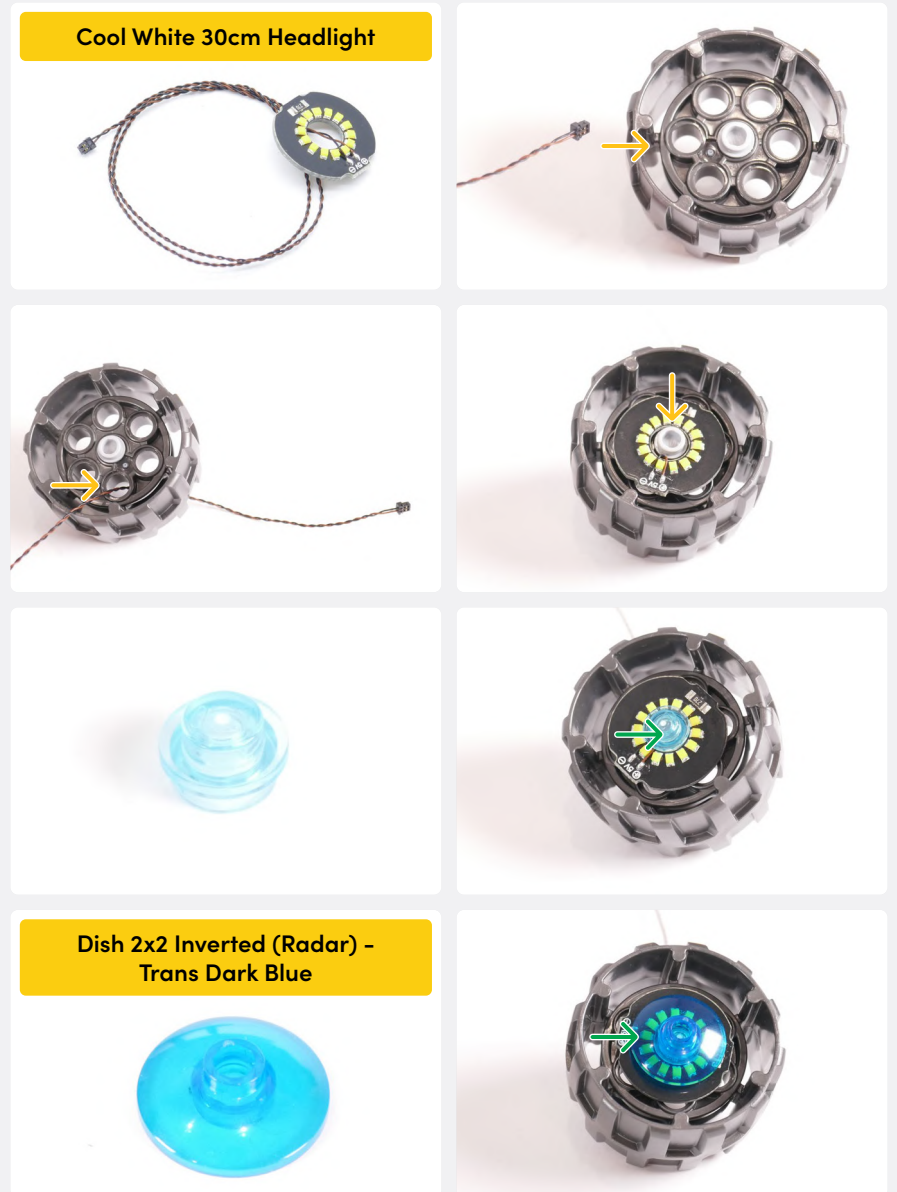

22



23

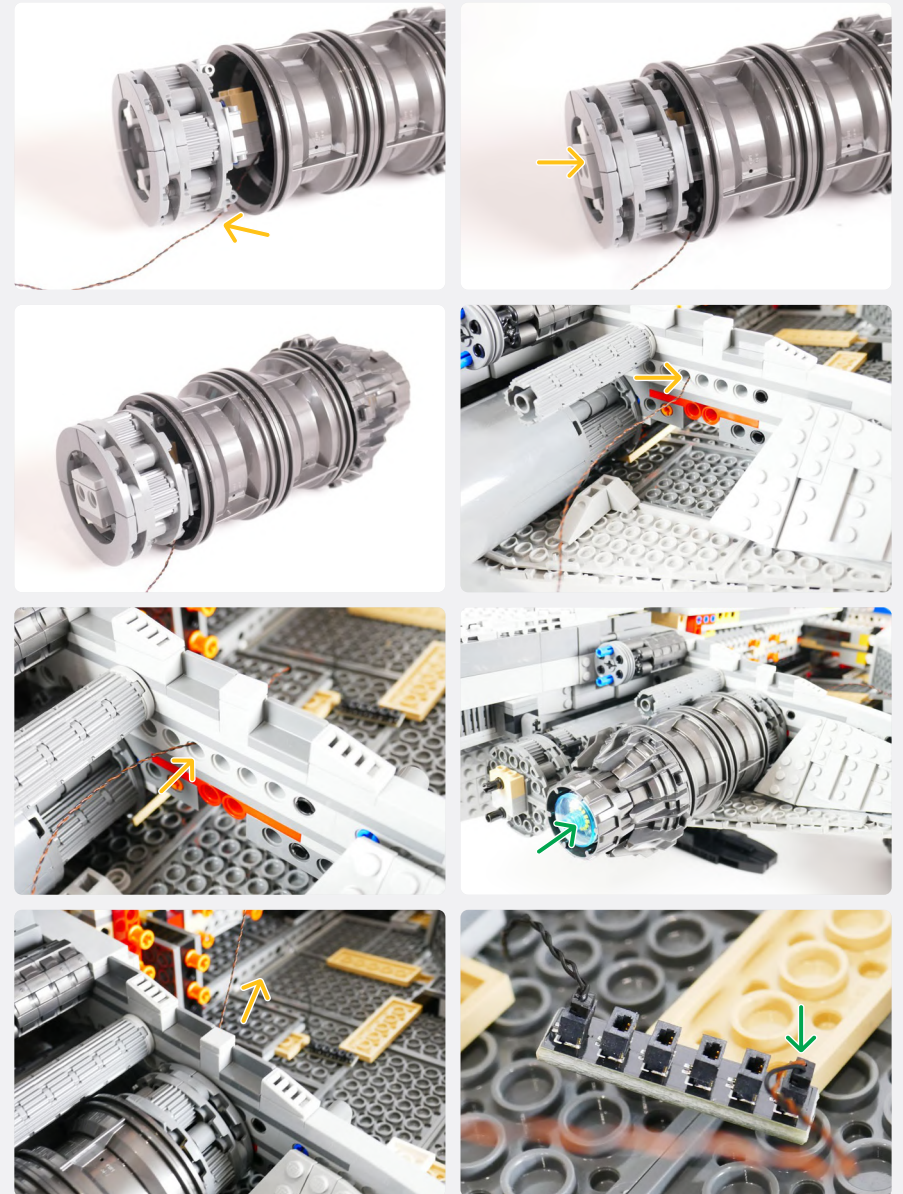

24

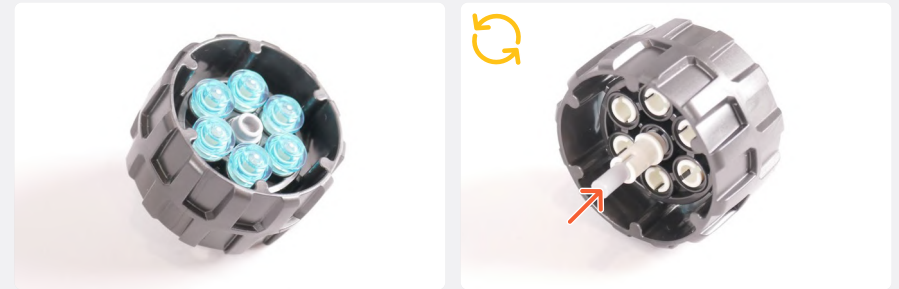

NOTE

Use the following LEGO piece to assist in disconnecting all the Technic Pins.

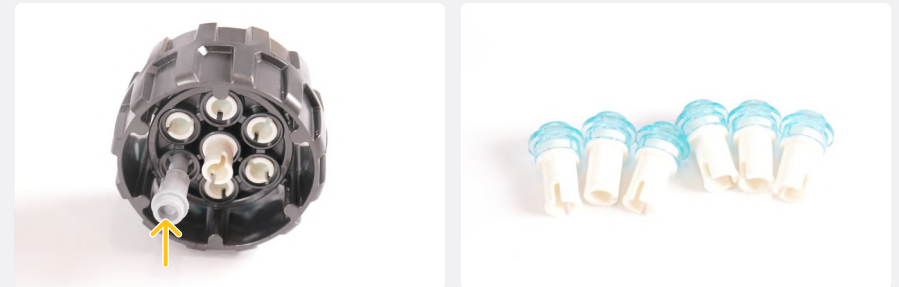



25

26



27



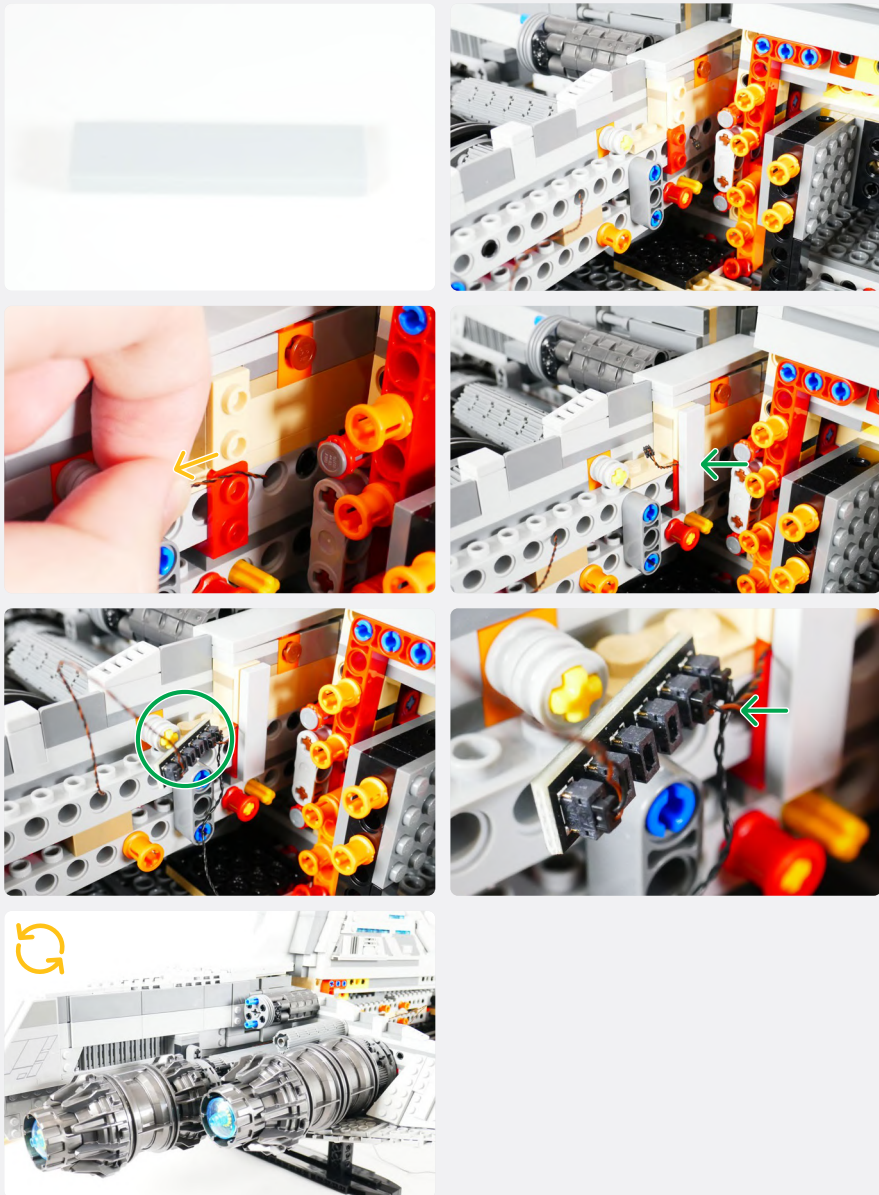

28

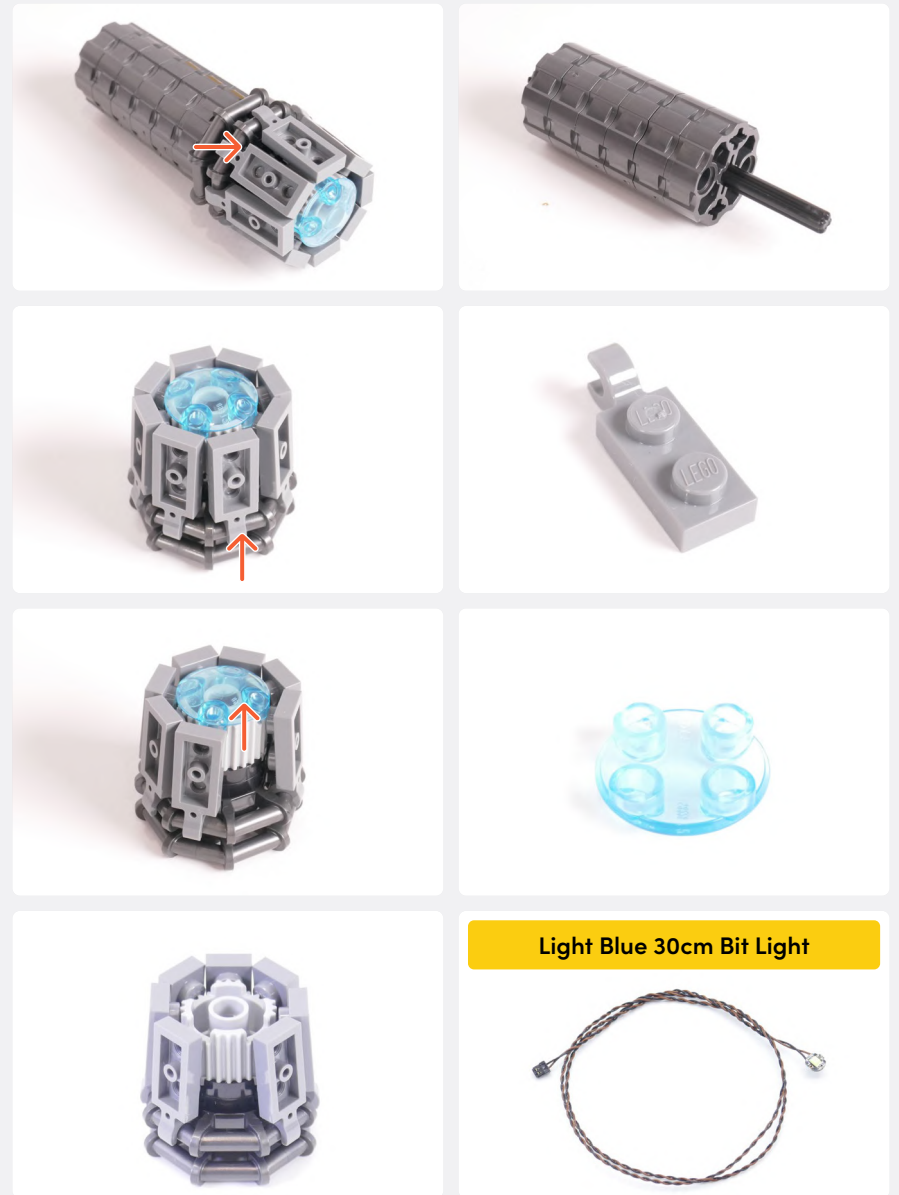

29

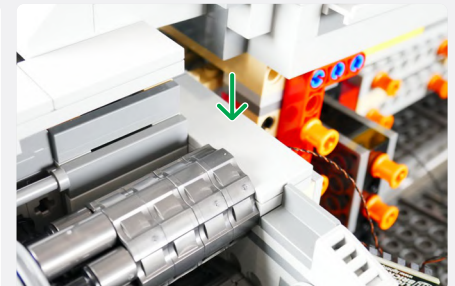
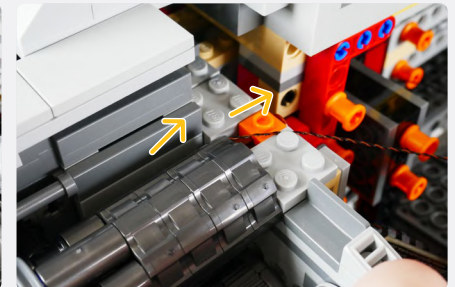
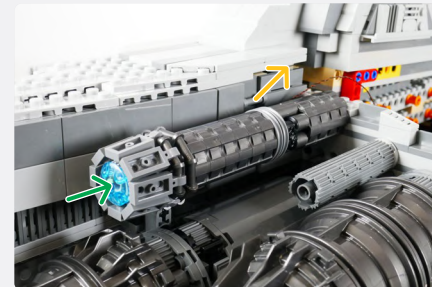
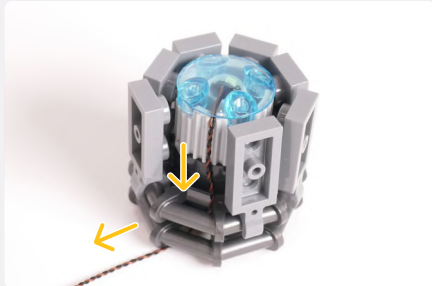
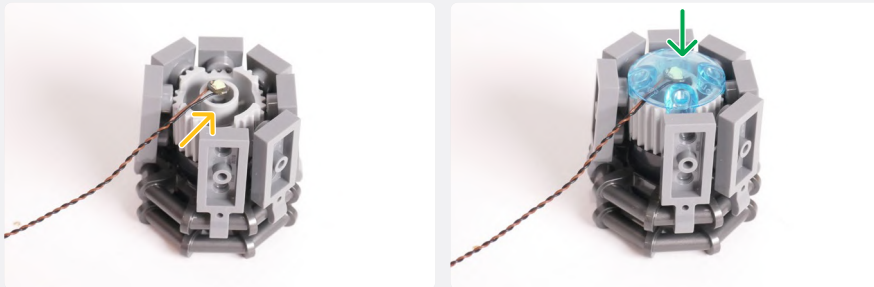

30

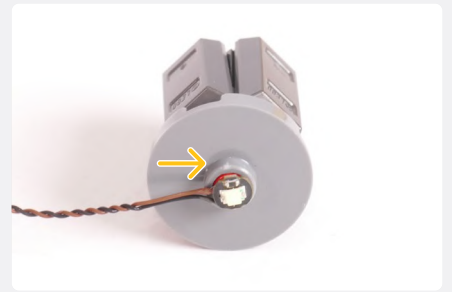
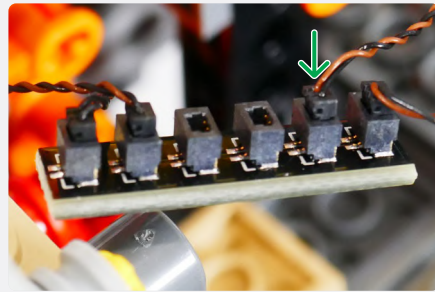
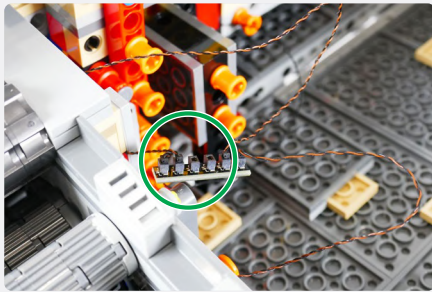

31



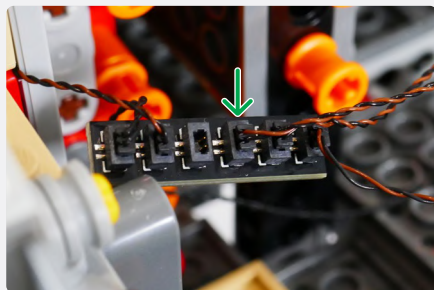
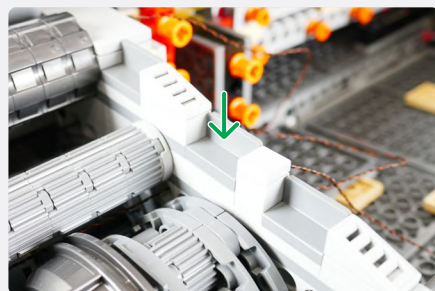
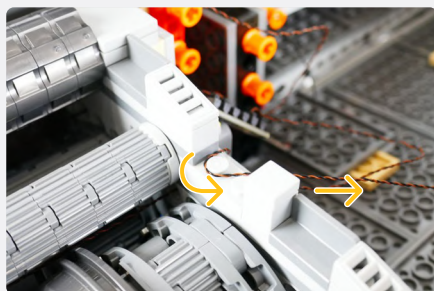
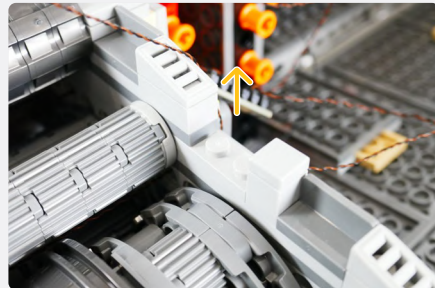
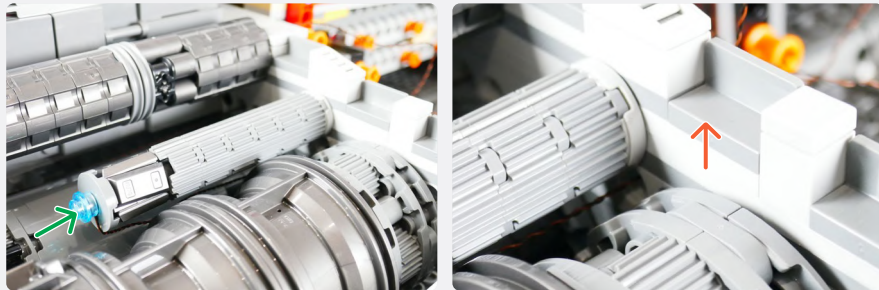

NOTE

Connect to a 5V USB Power Bank, 5V USB Wall Adaptor, or USB to AA Battery Pack (sold separately)



! If you experience any issues with the lights not working and suspect an issue with a component, please try a different port on the expansion board to verify where the fault lies (with the light or expansion board). To correct any issues with expansion board ports, please view the section addressing expansion board issues in our troubleshooting section. **i**

32

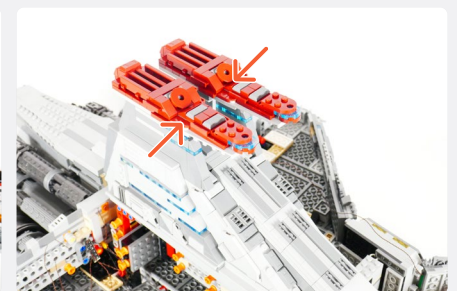

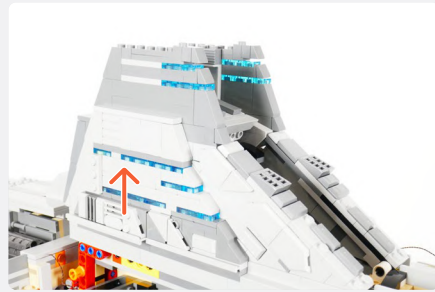

33

8-Port Expansion Board

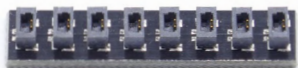

30cm Connecting Cable



NOTE

Connect the other end of the 30cm Connecting Cable to the 6-Port Expansion Board.

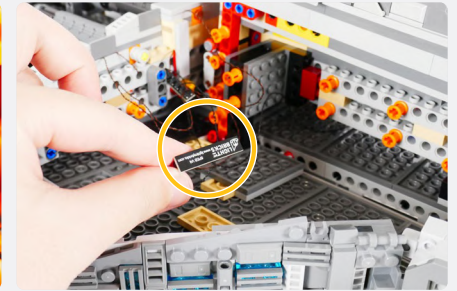
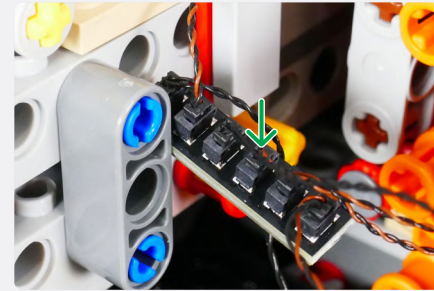

NOTE

Pull the 8-Port Expansion Board up

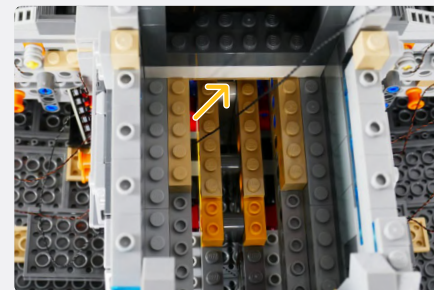

34

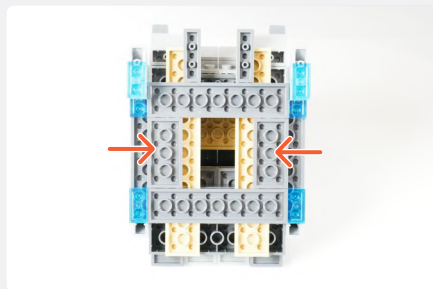
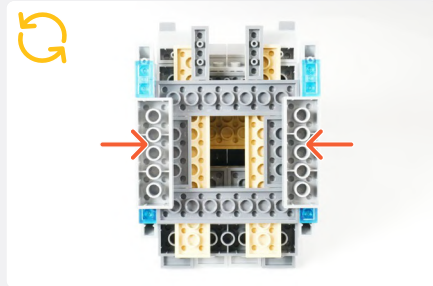
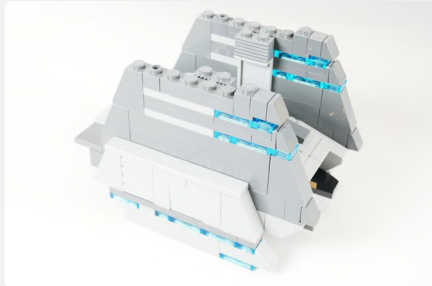
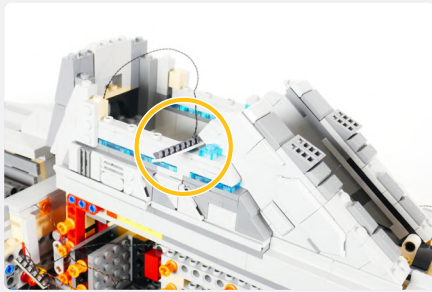

35

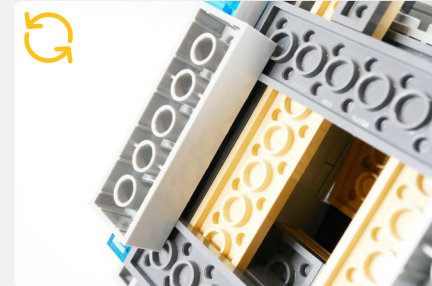
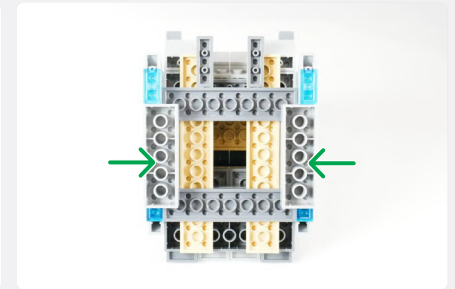

Cool White 30cm Large Bit Light



Plate 1x2 - Black

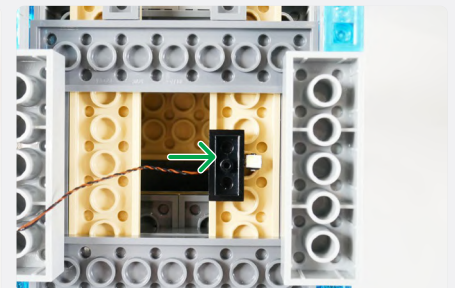
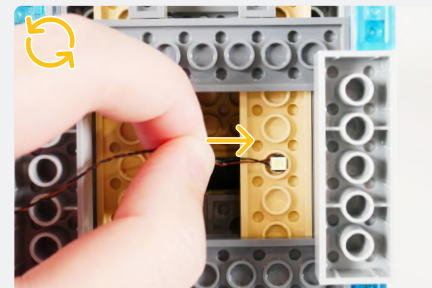

Cool White 30cm Large Bit Light

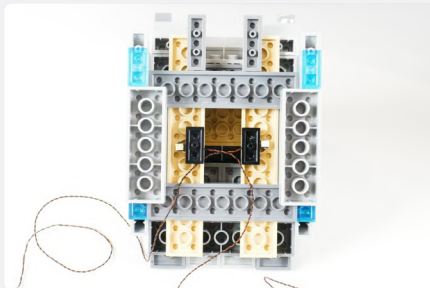
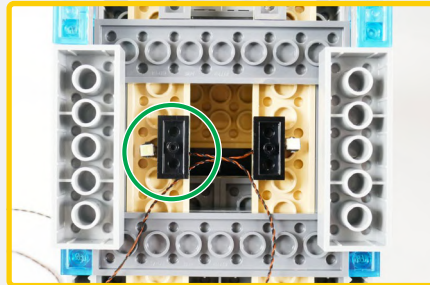

Plate 1x2 - Black



NOTE

Repeat the same process for the other side



36

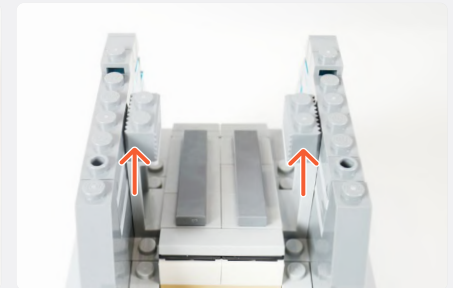
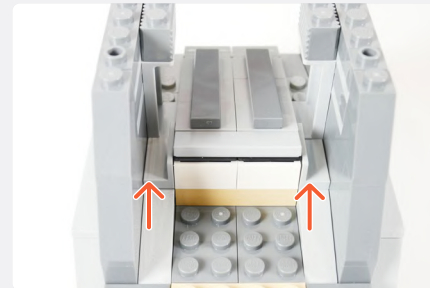
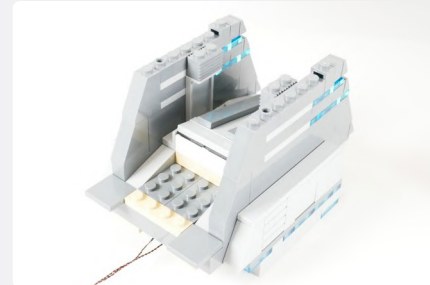
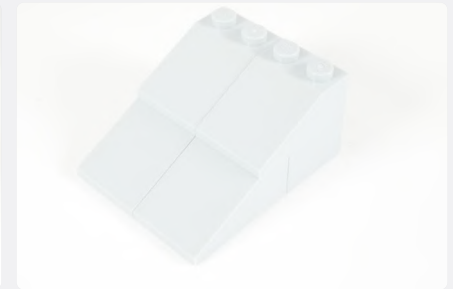
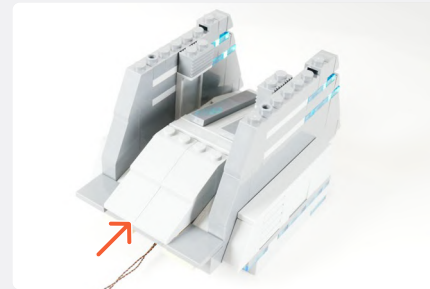

37

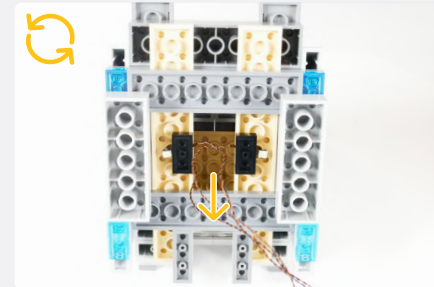
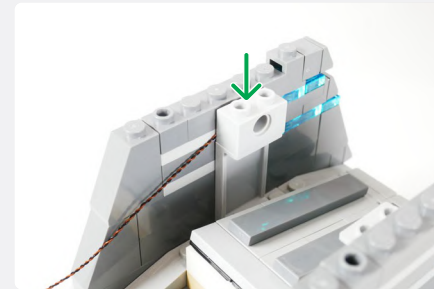
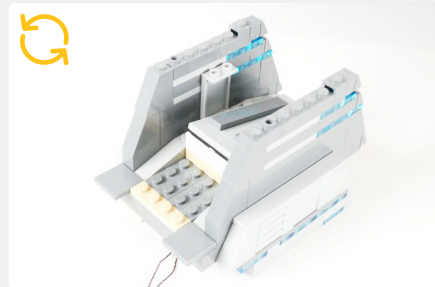
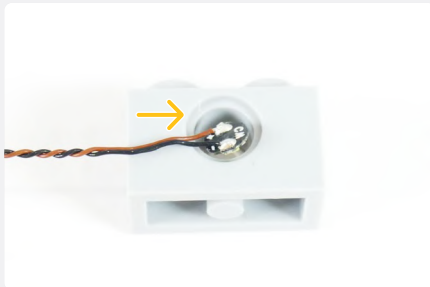
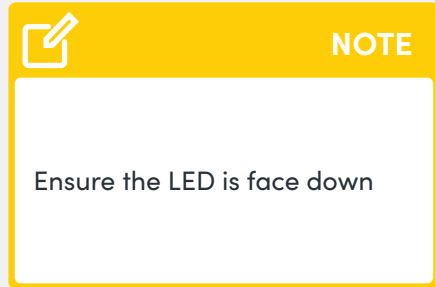

38

Technic, Brick 1x2 with Hole - Light Bluish Gray



Cool White 30cm Bit Light



NOTE

Ensure the LED is face down

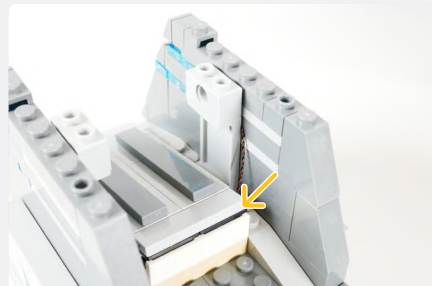
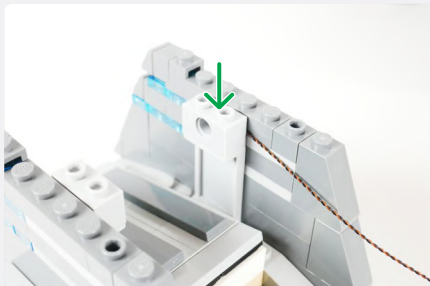
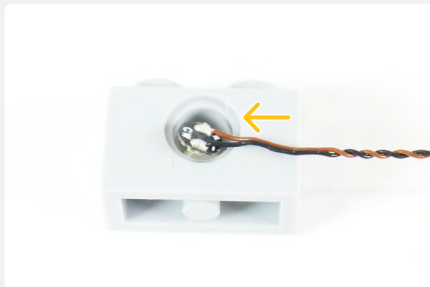

39

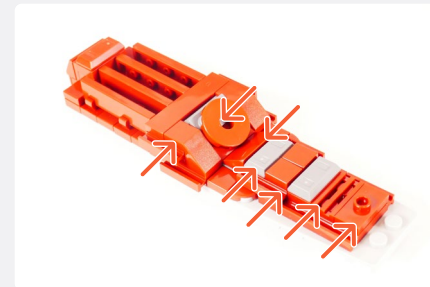
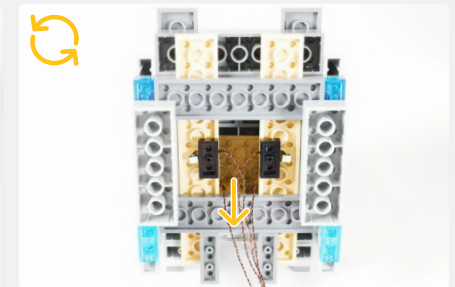

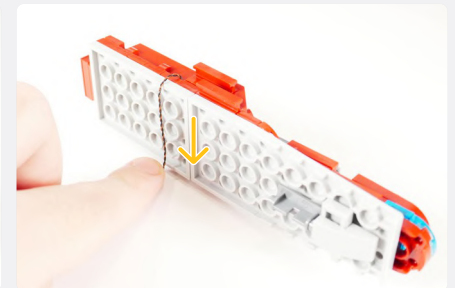
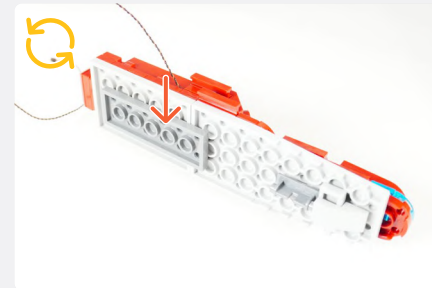
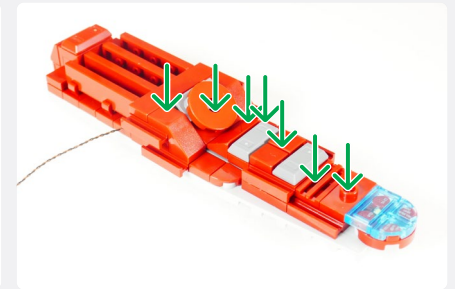
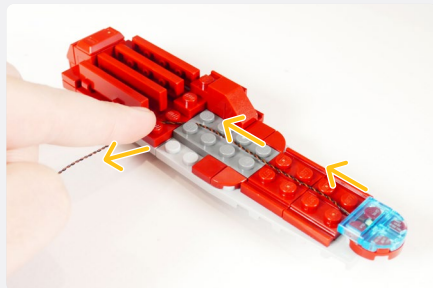
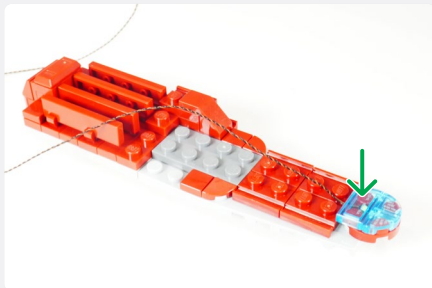
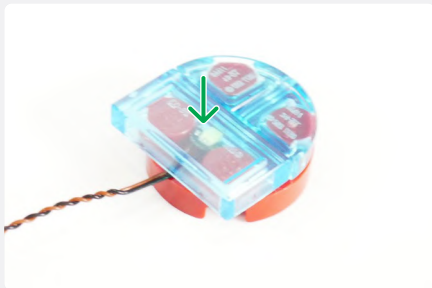
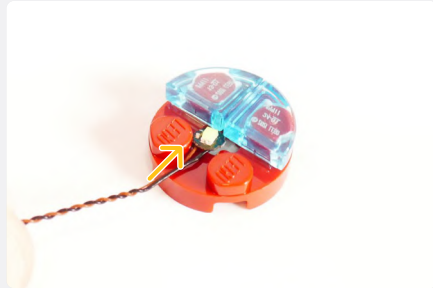

40

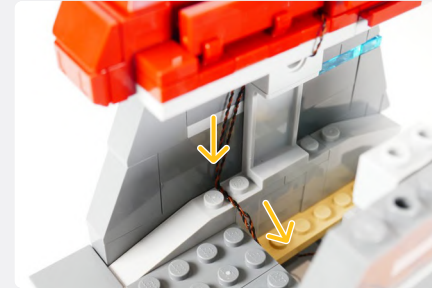
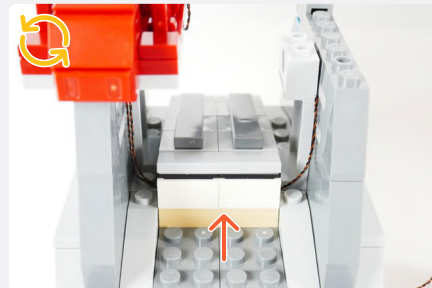
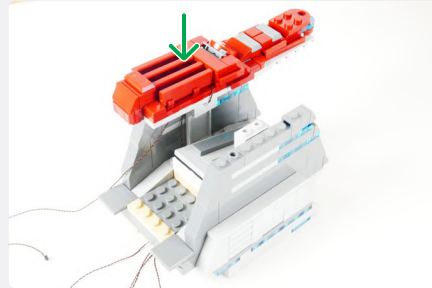
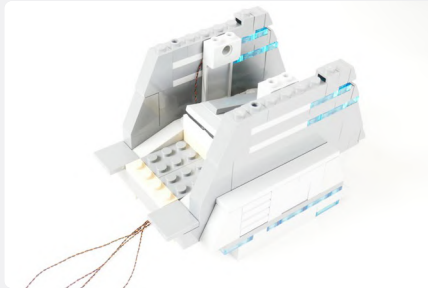
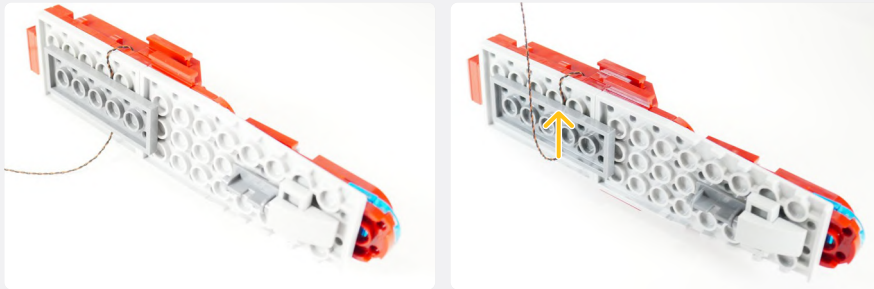

42

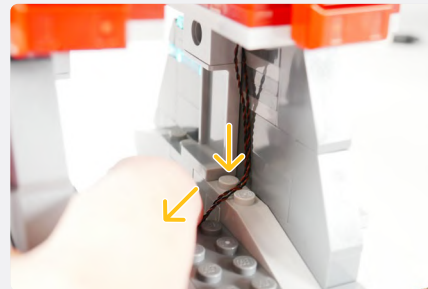
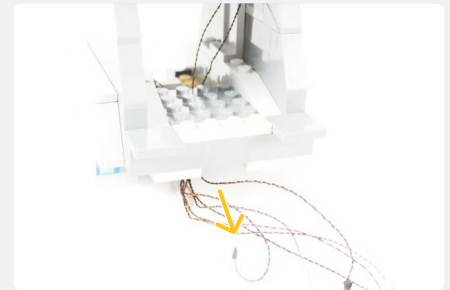
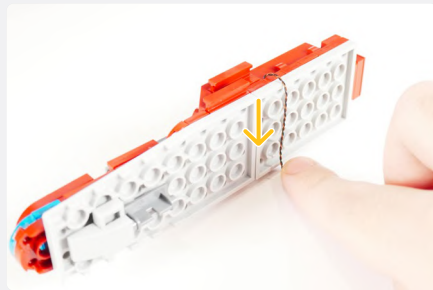
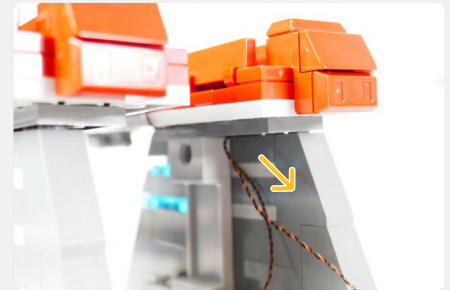
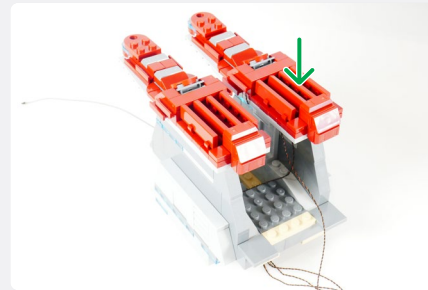
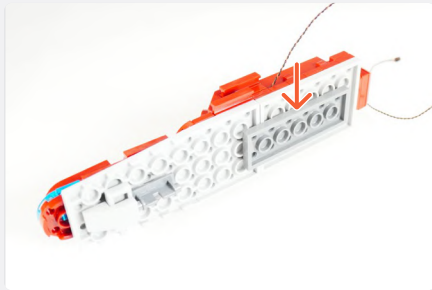
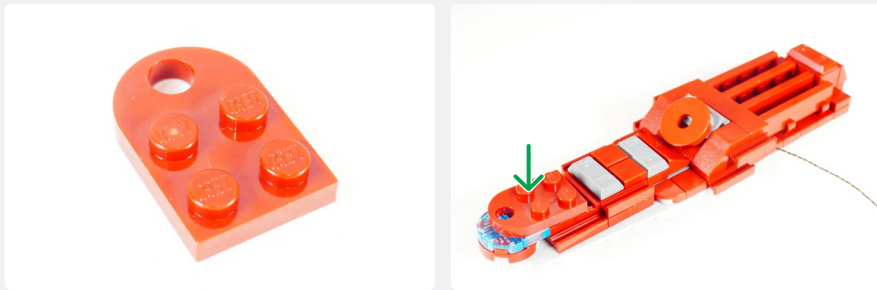

43

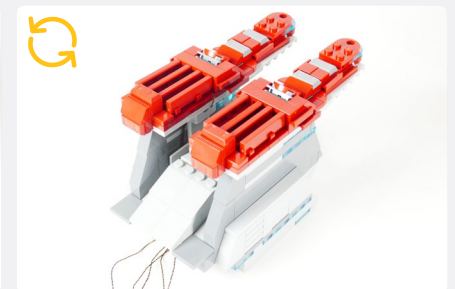
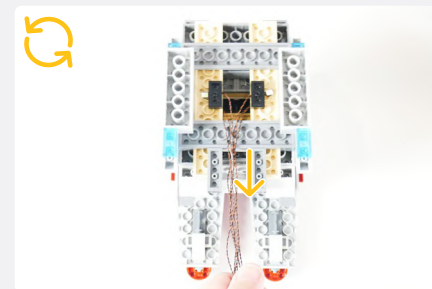
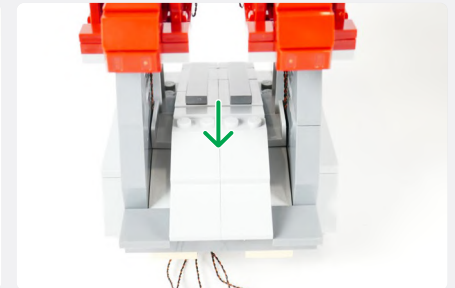
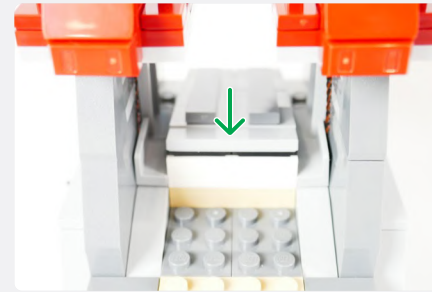
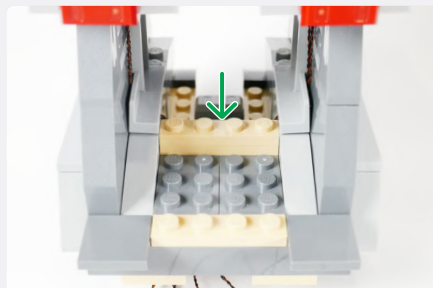
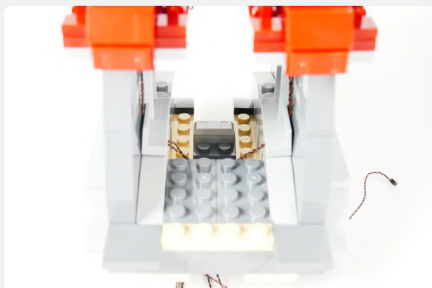
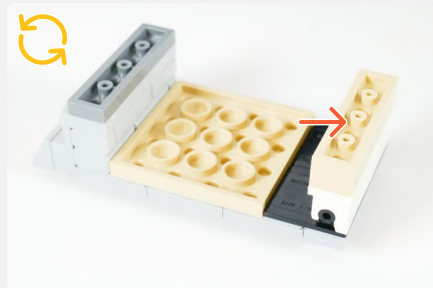
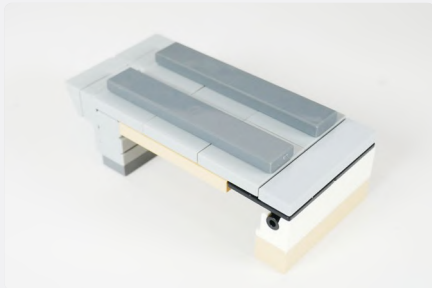
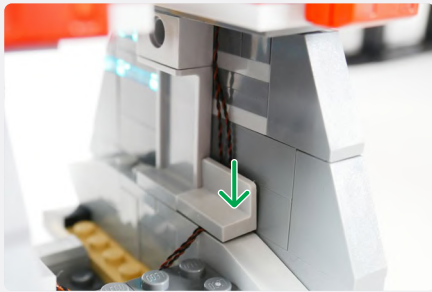

44

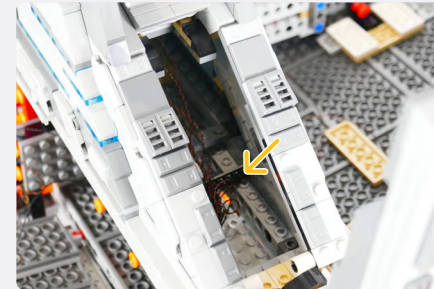
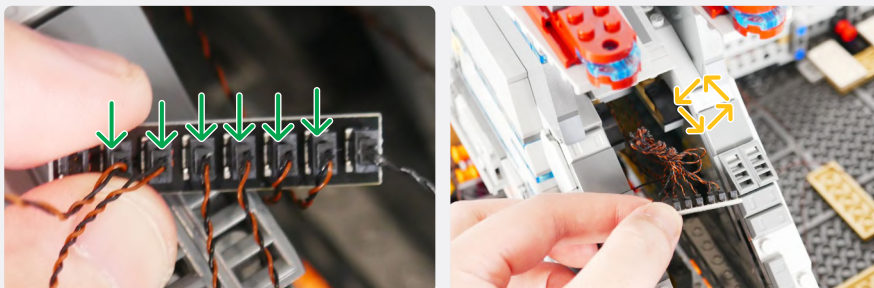
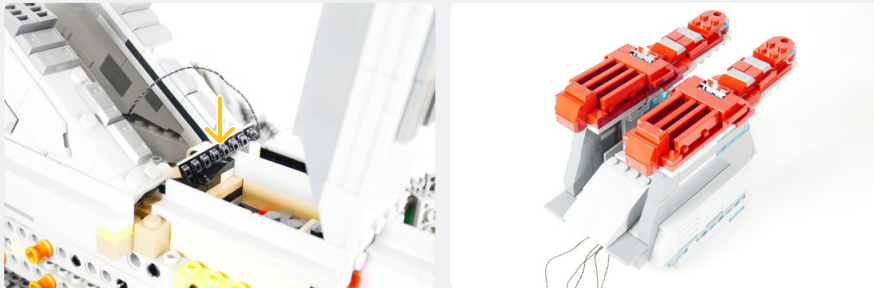

NOTE

Slightly lift the two ends

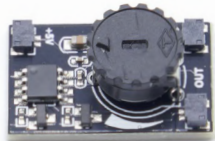

! If you experience any issues with the lights not working and suspect an issue with a component, please try a different port on the expansion board to verify where the fault lies (with the light or expansion board). To correct any issues with expansion board ports, please view the section addressing expansion board issues in our troubleshooting section.

45
Dimmer Control Board

30cm Connecting Cable

NOTE

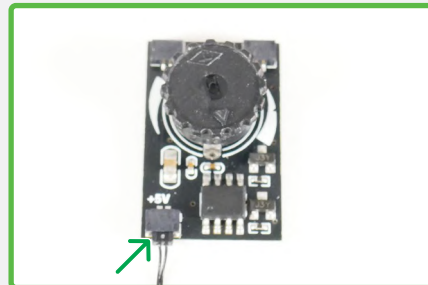
Connect the 30cm Connecting Cable to the '+5v' port of the Dimmer Control Board

NOTE

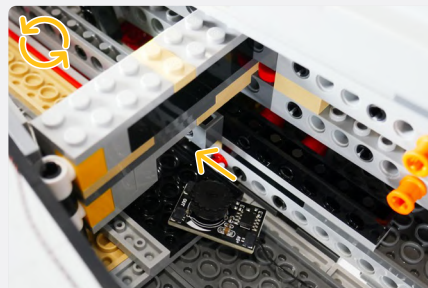
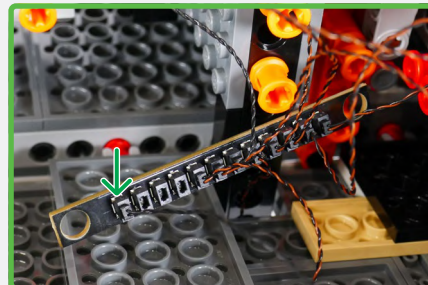
Connect the other end of the 30cm Connecting Cable to the 12-Port Expansion Board with the USB Power Cable connected

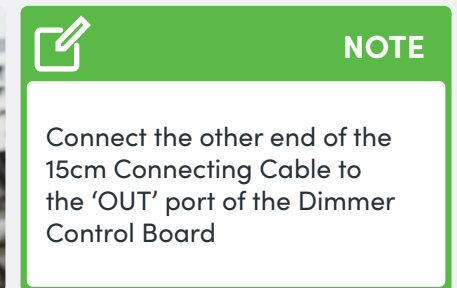
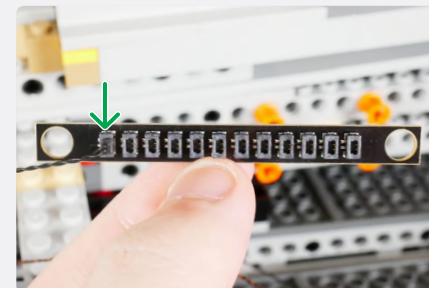
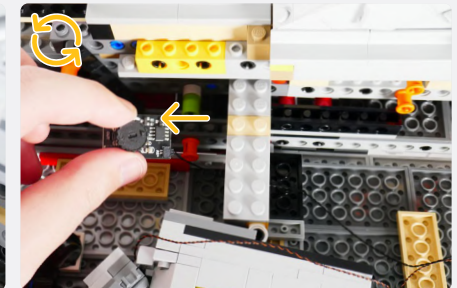

46
12-Port Expansion Board

15cm Connecting Cable

NOTE

Connect the other end of the 15cm Connecting Cable to the 'OUT' port of the Dimmer Control Board

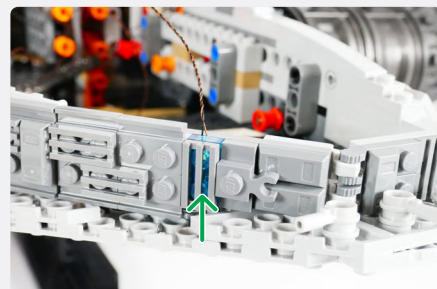
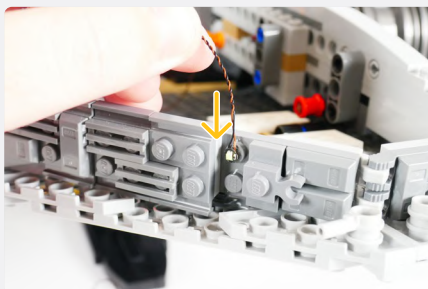
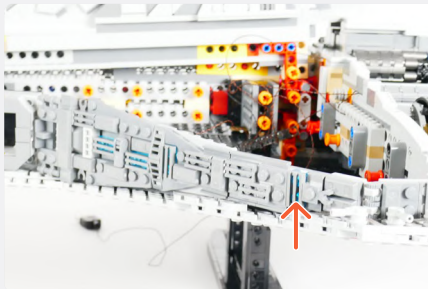
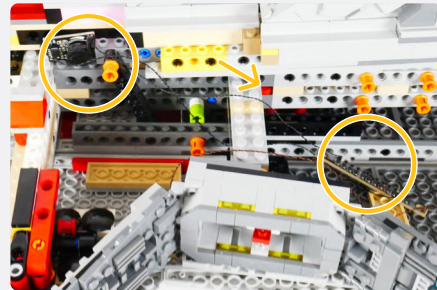
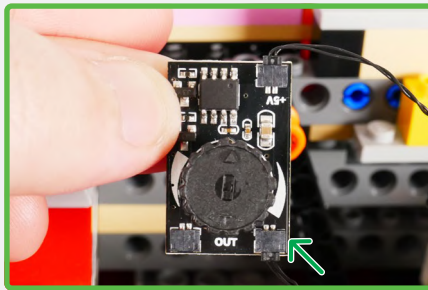

47



48

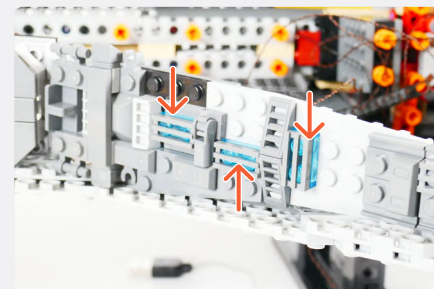
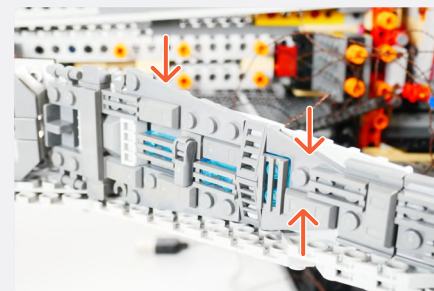
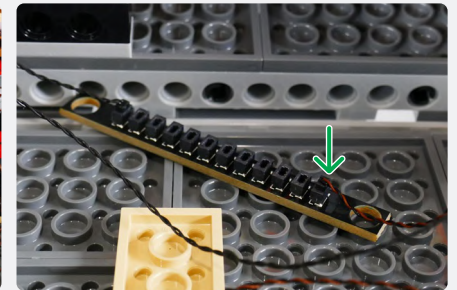
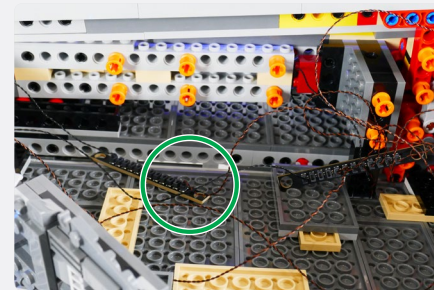



Cool White 30cm Bit Light

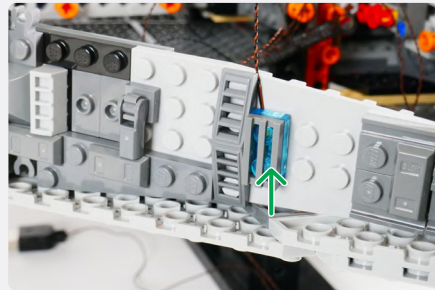
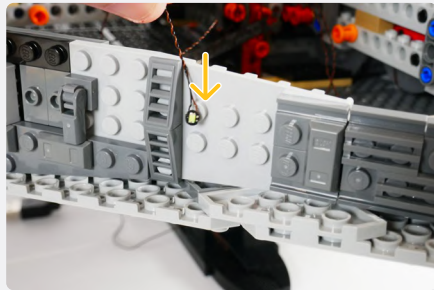

Cool White 30cm Bit Light

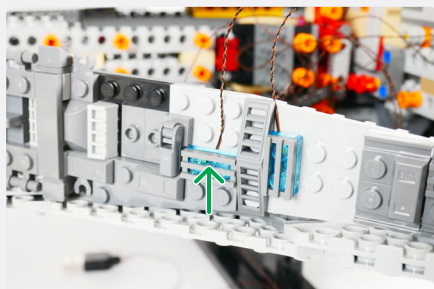

Cool White 30cm Bit Light

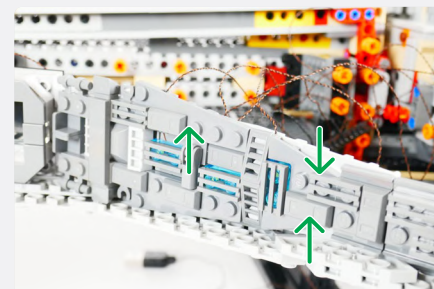
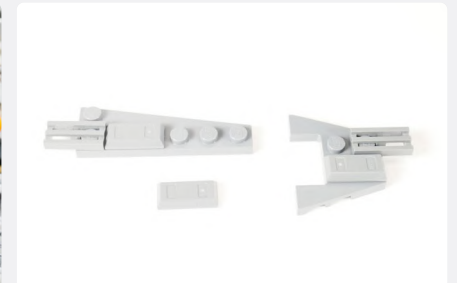
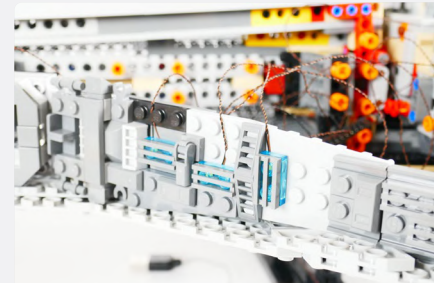
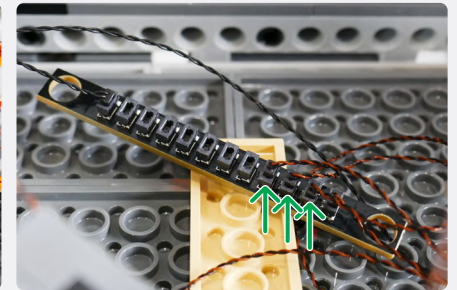
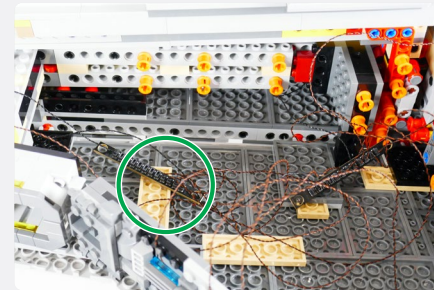
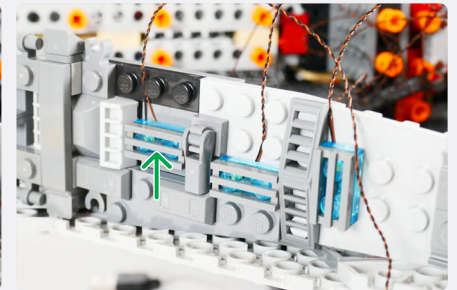
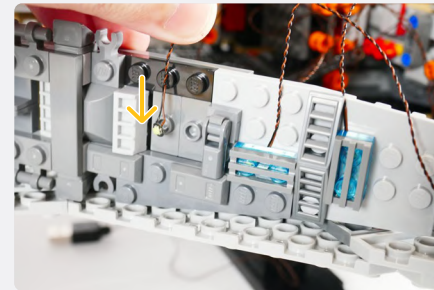

49

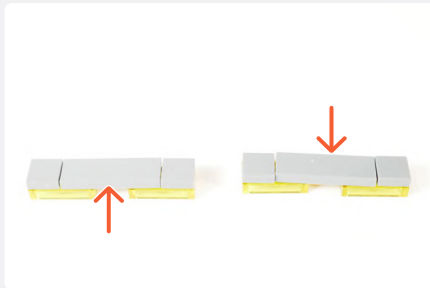

NOTE

Thread the cable from the connector head side first

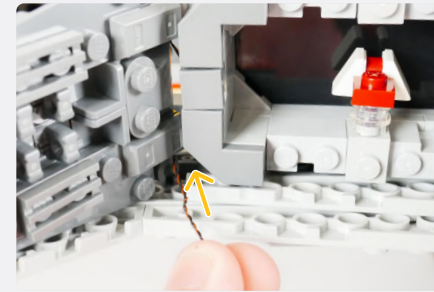

NOTE

Place the LED facing towards the Grey Tile

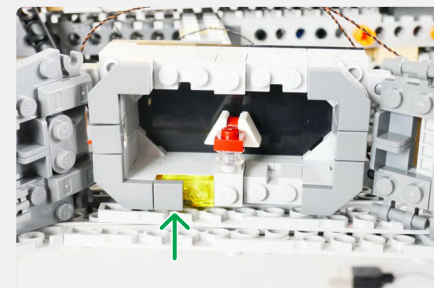
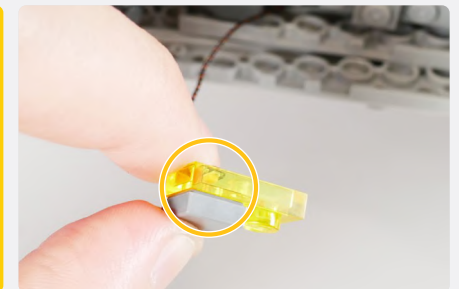
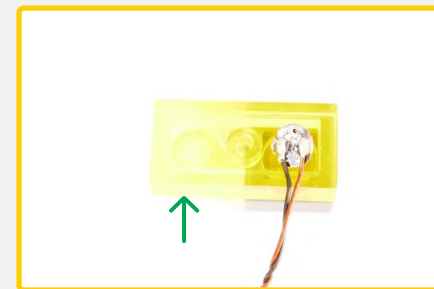

50

Yellow 30cm Bit Light

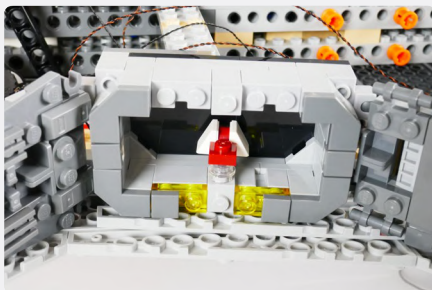
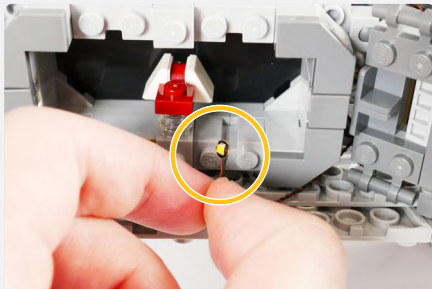
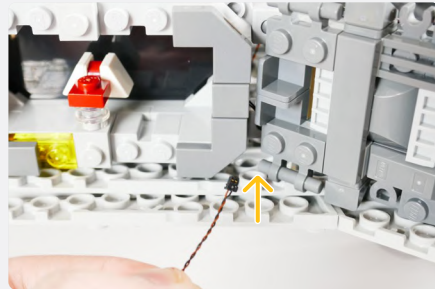

51

Yellow 30cm Bit Light

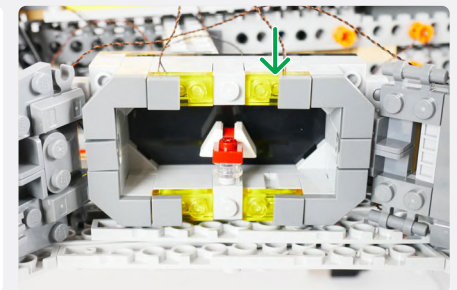
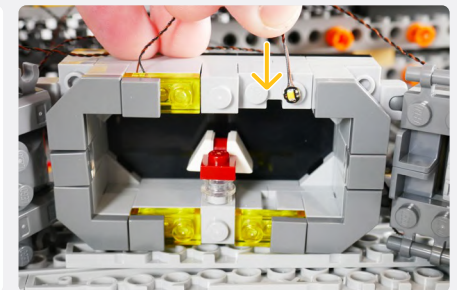
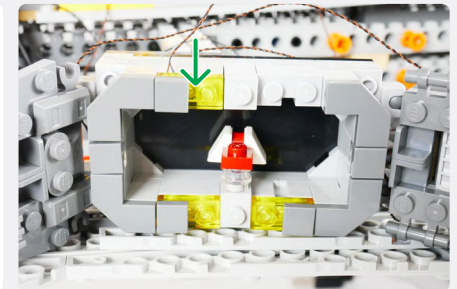
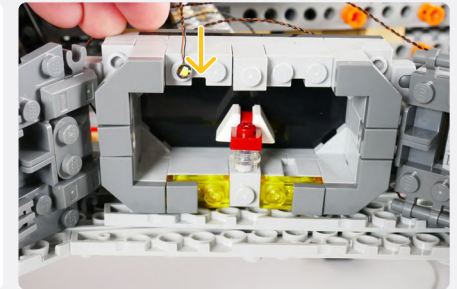

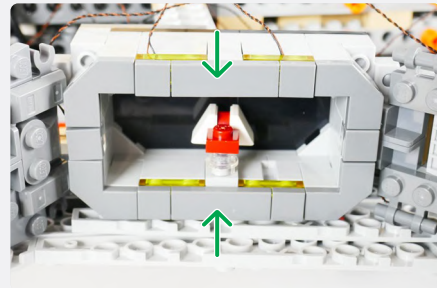

NOTE

Take all four Yellow 30cm Bit Lights from the hanger bay

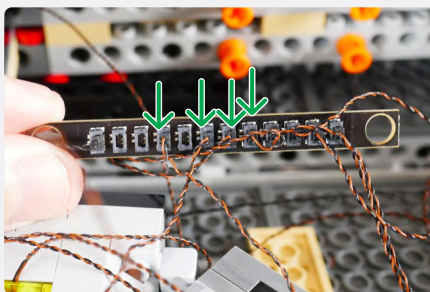
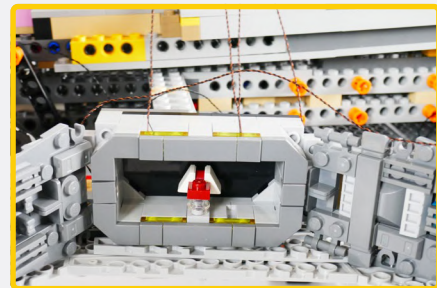

52

NOTE

Twist the cables from both 12-Port Expansion Boards but ensure the Dimmer Board stays in the same position

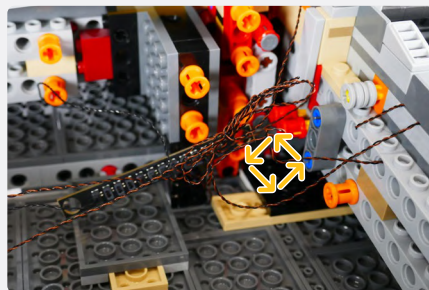
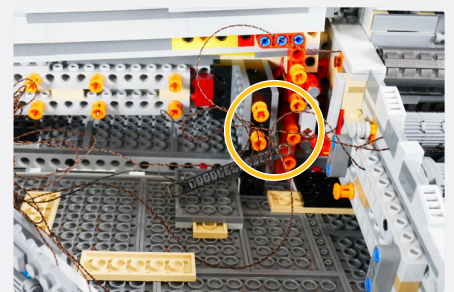
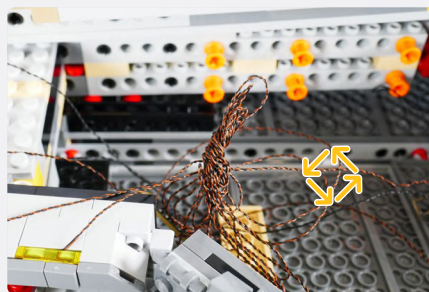
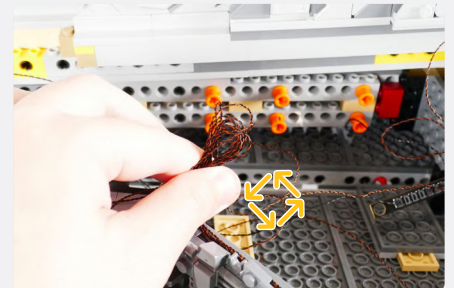
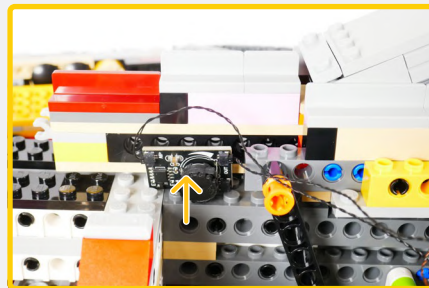
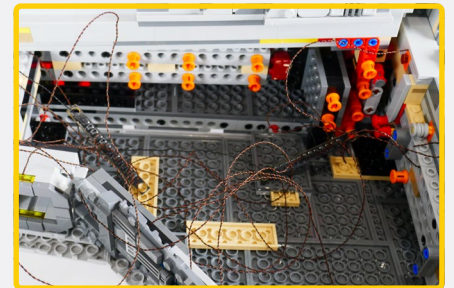

53

30cm Connecting Cable



12-Port Expansion Board

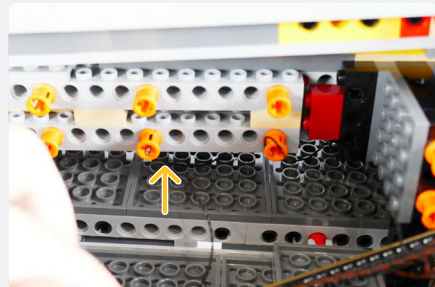
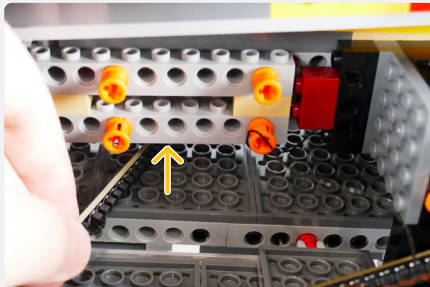
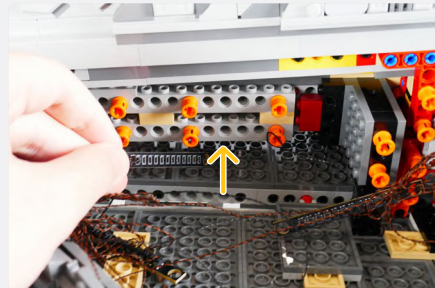
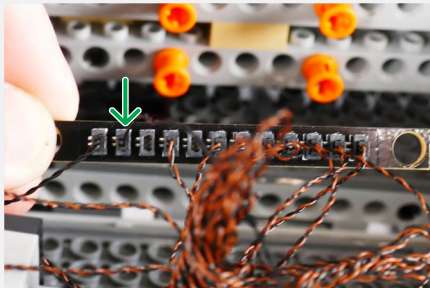
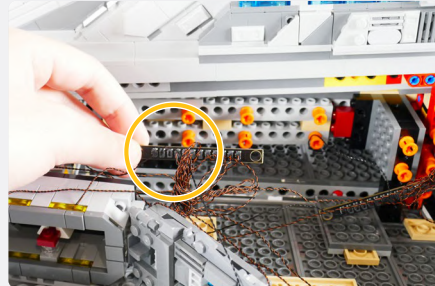
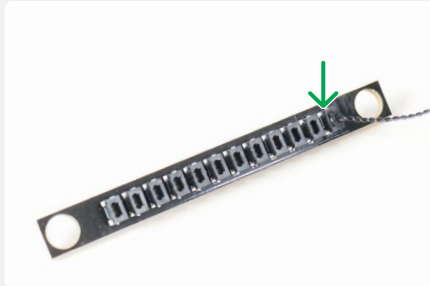

54

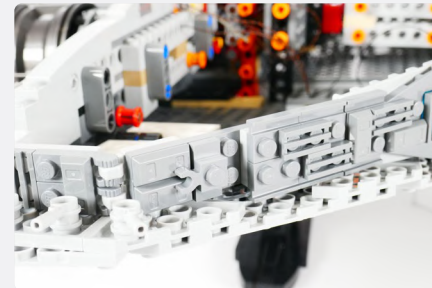
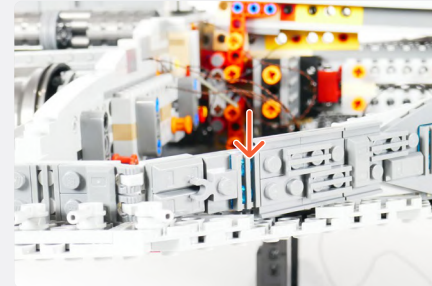
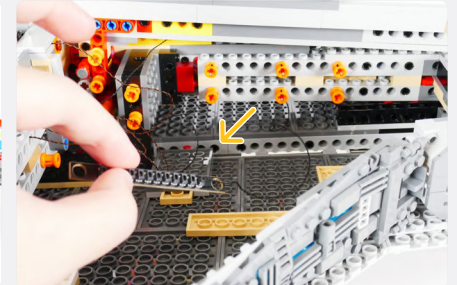

Cool White 30cm Bit Light

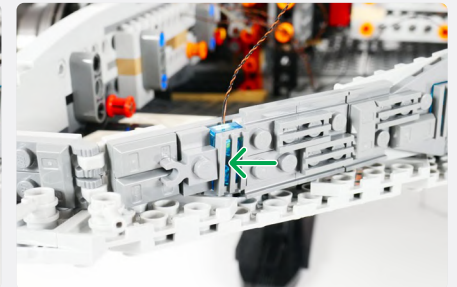
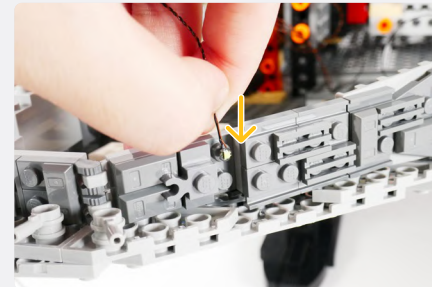

55

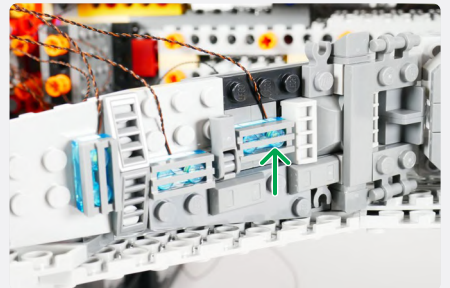
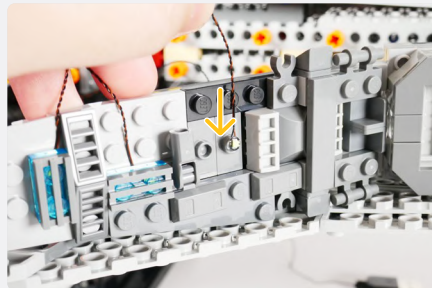
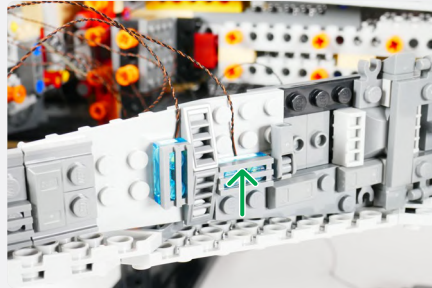
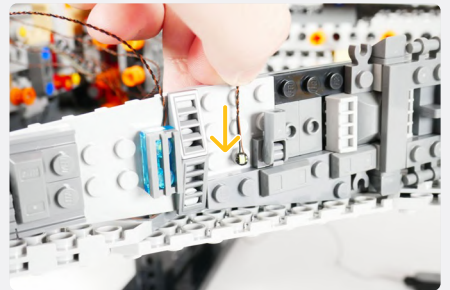
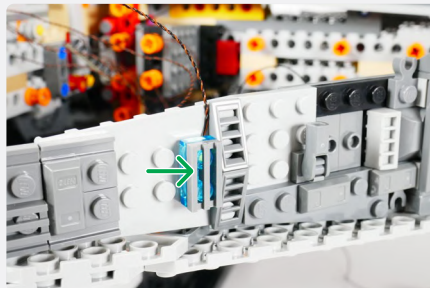
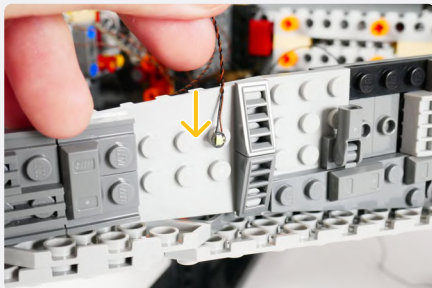
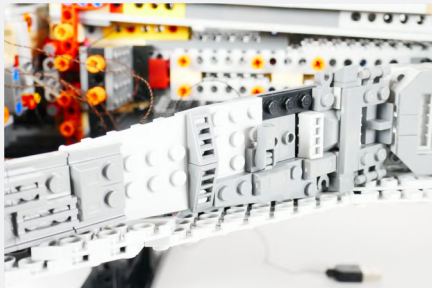
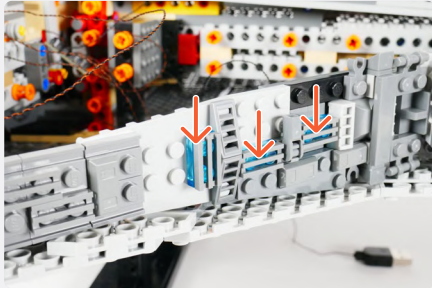
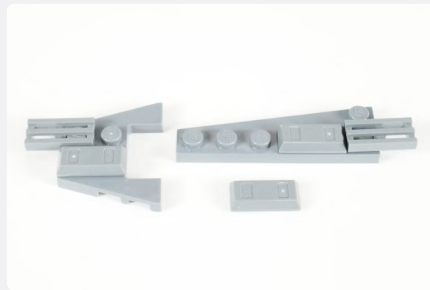
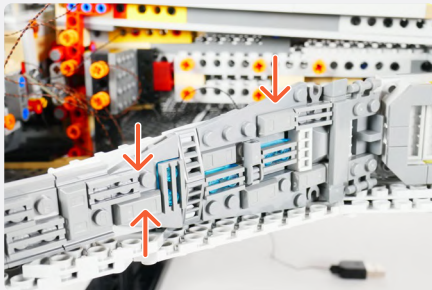

NOTE

Connect all four loose Cool White 30cm Bit Lights to the 12-Port Expansion Board

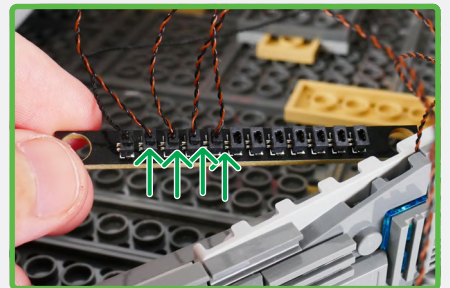

56

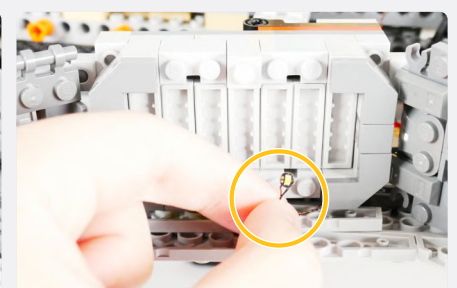
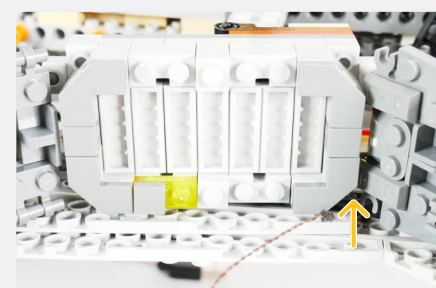
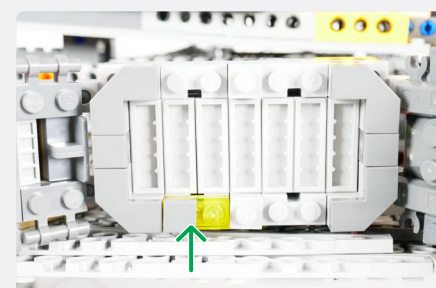
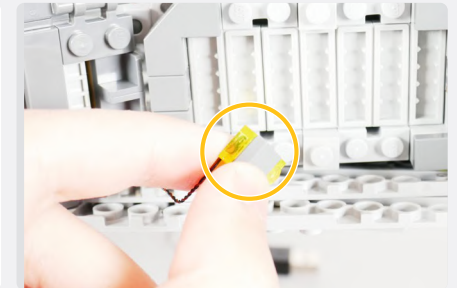
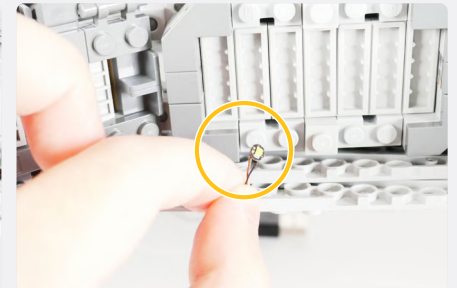
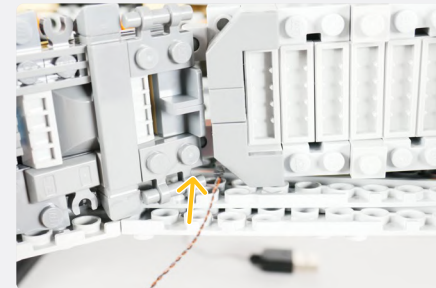
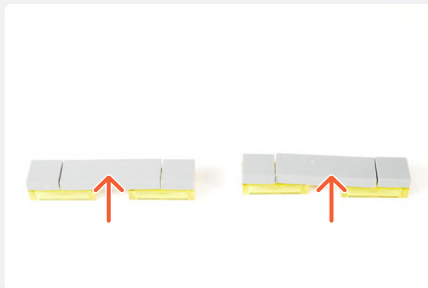
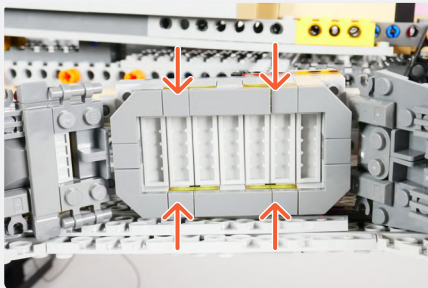
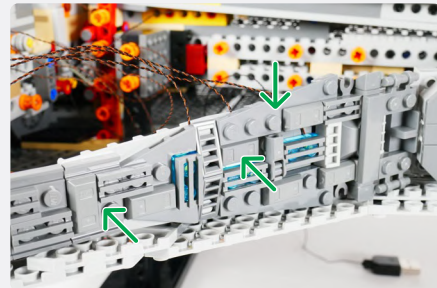
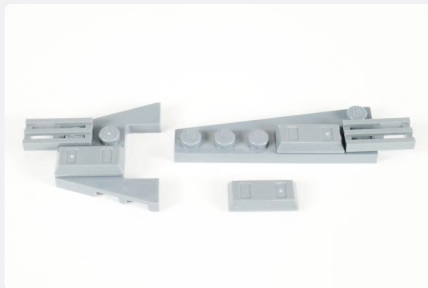

57

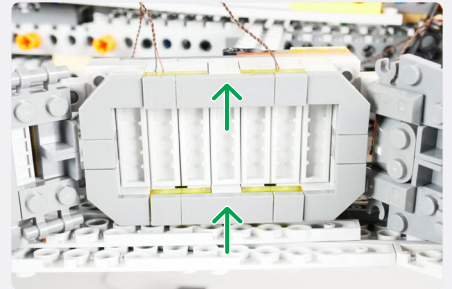
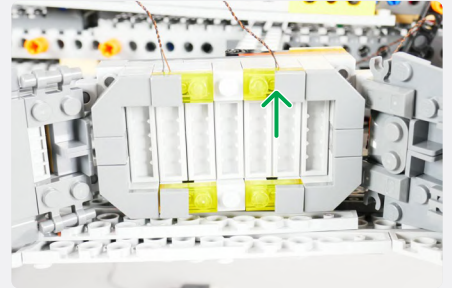
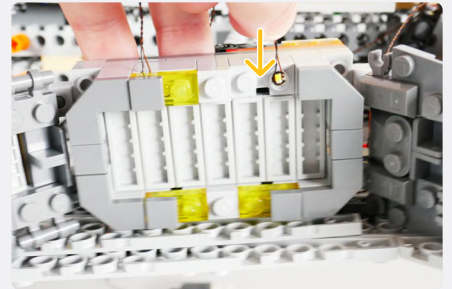
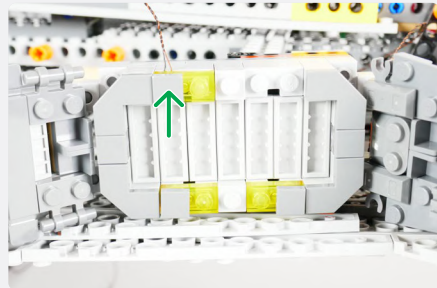
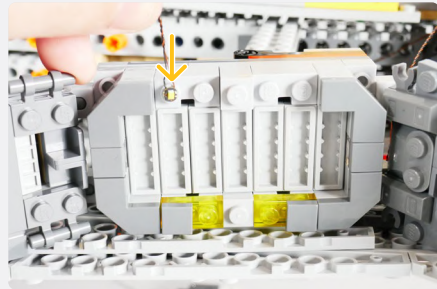
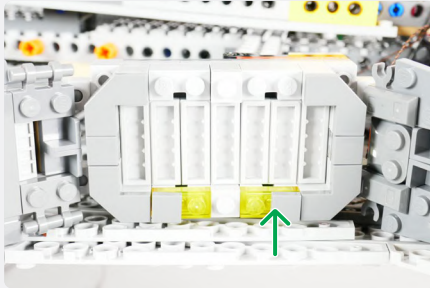
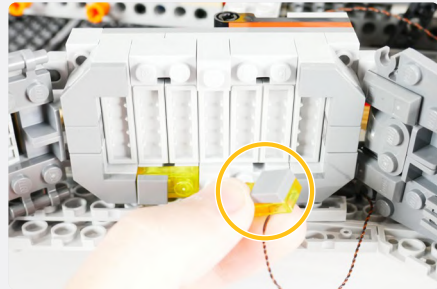

NOTE

Connect all four loose Yellow 30cm Bit Lights from the hanger bay to the 12-Port Expansion Board

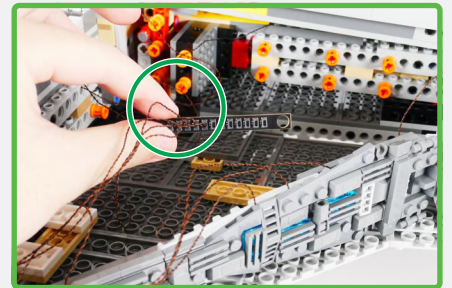

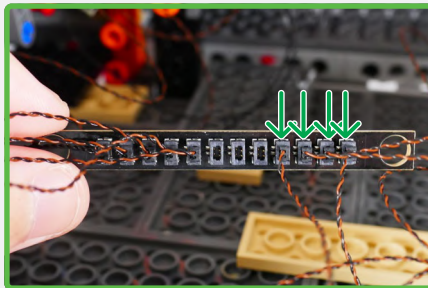

NOTE

Twist all the loose Bit Light cables to neaten up

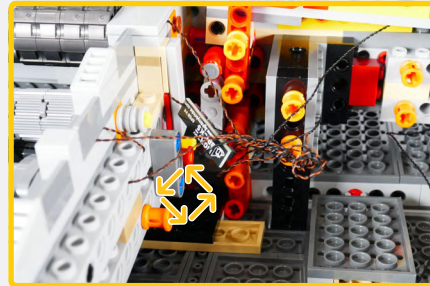
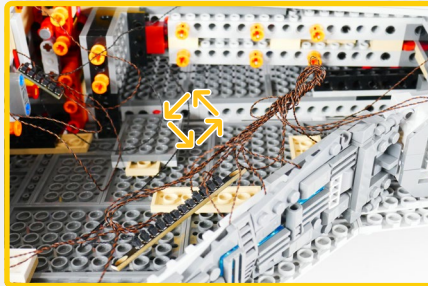

! If you experience any issues with the lights not working and suspect an issue with a component, please try a different port on the expansion board to verify where the fault lies (with the light or expansion board). To correct any issues with expansion board ports, please view the section addressing expansion board issues in our troubleshooting section. **i**

58



NOTE

Connect the other end of the 50cm Connecting Cable to the 'OUT' port of the Dimmer Control Board

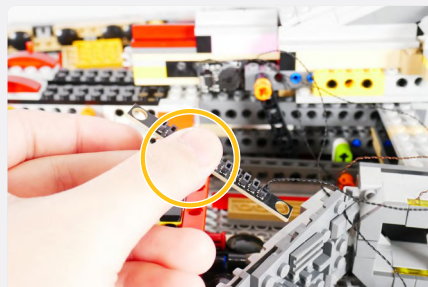
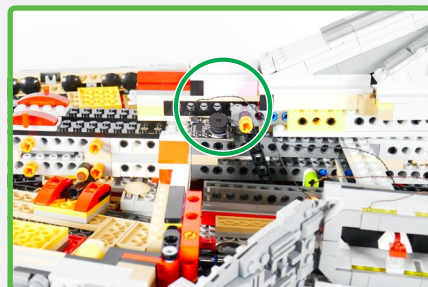
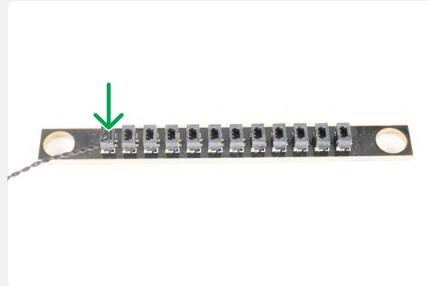
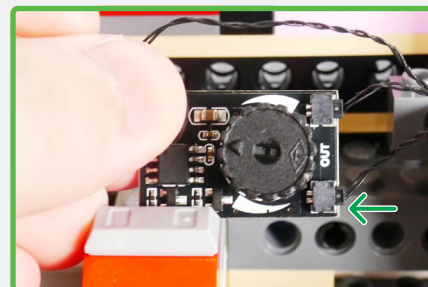

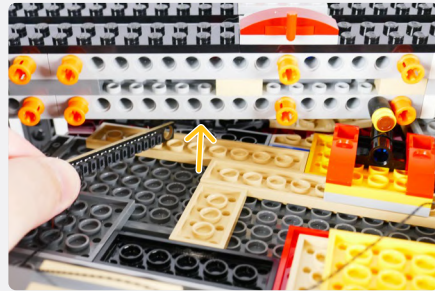
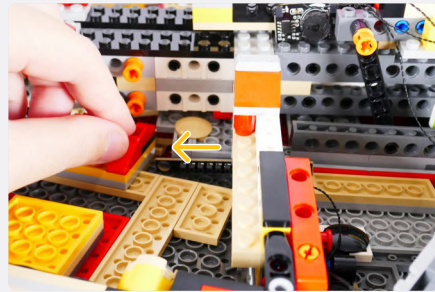
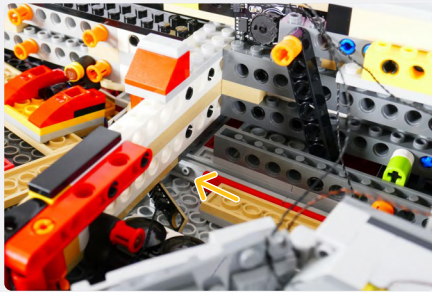

59

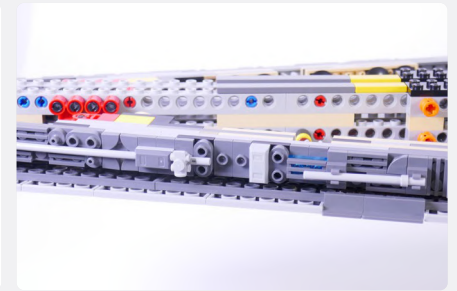
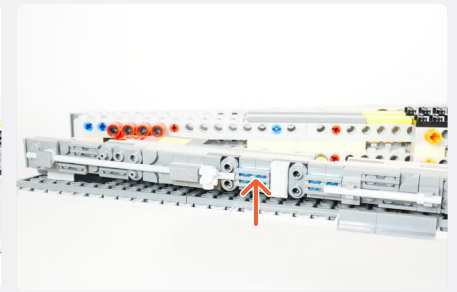

Cool White 30cm Bit Light

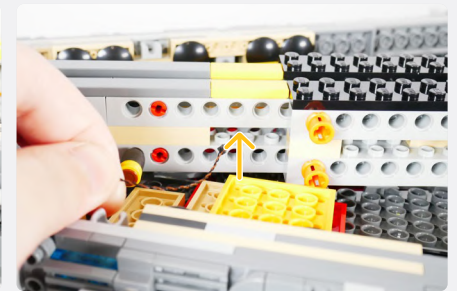
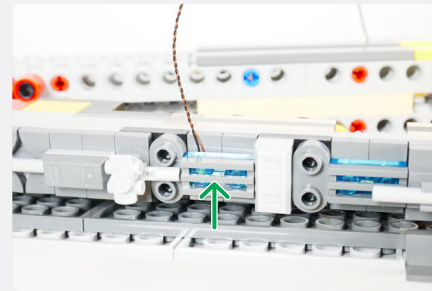

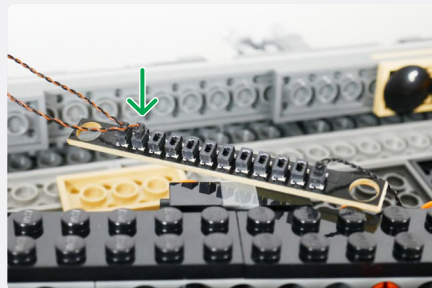
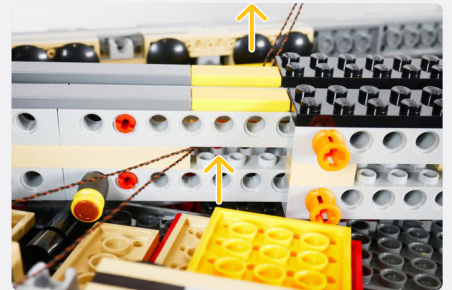
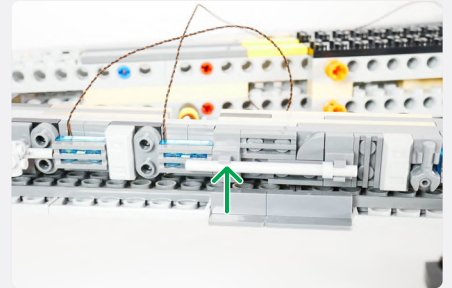
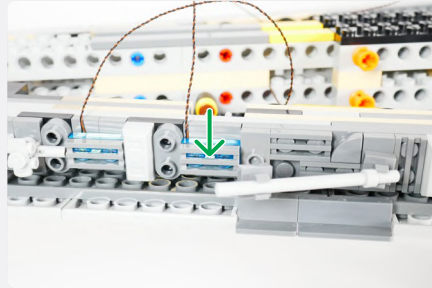
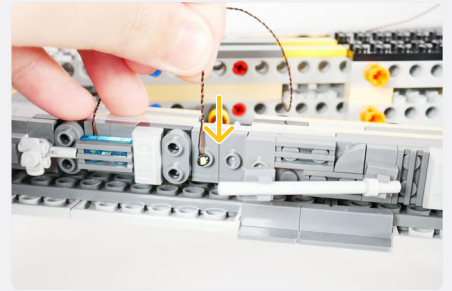
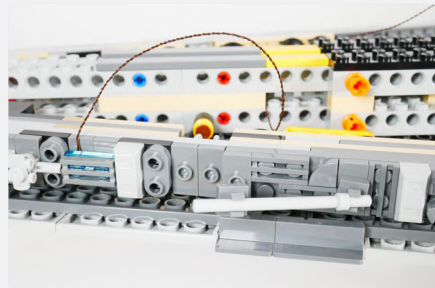
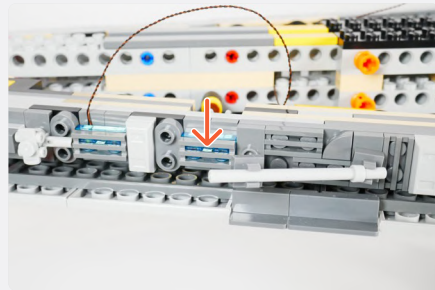
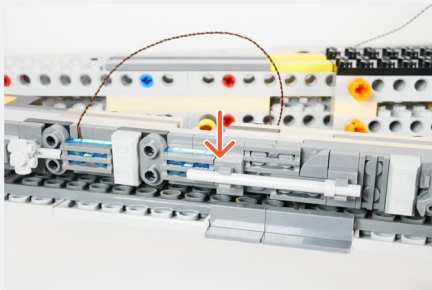
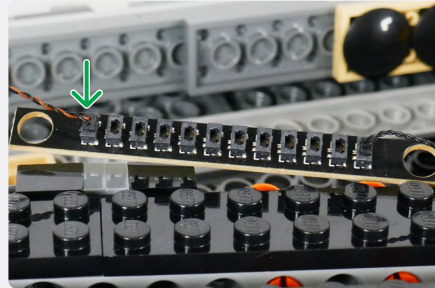
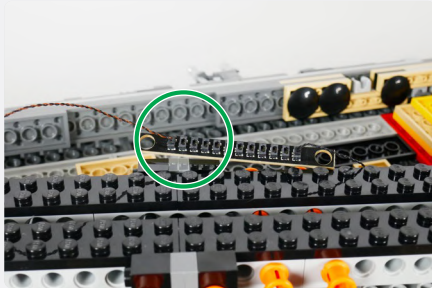
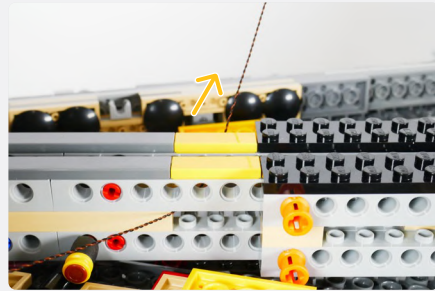
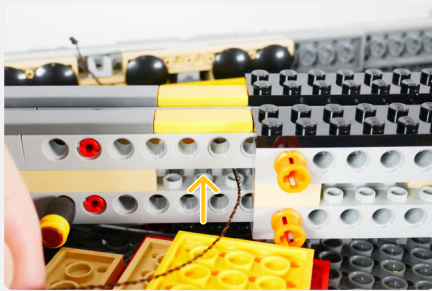

60

61

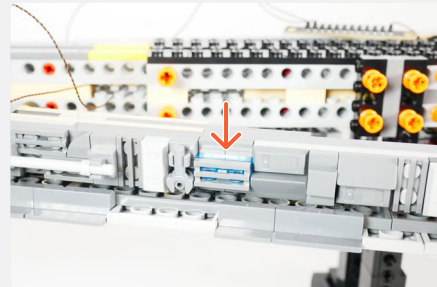

Cool White 30cm Bit Light

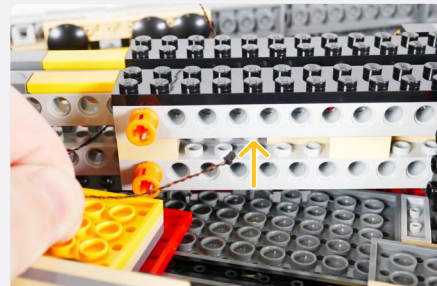
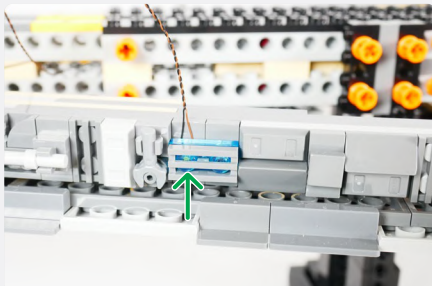
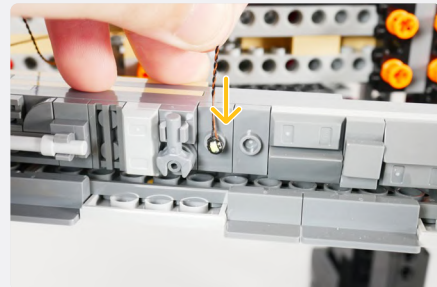

62

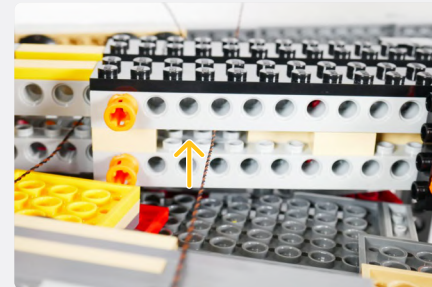

Cool White 30cm Bit Light

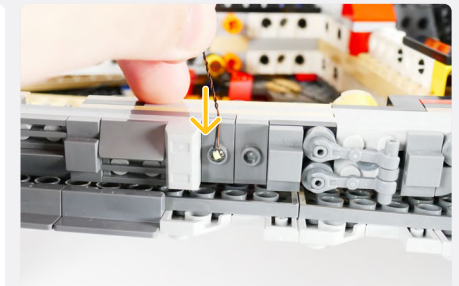

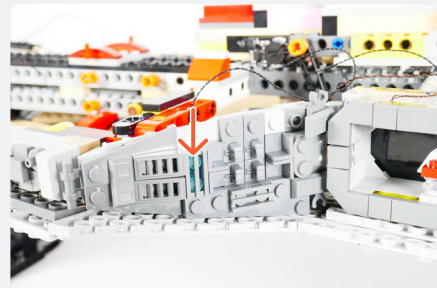
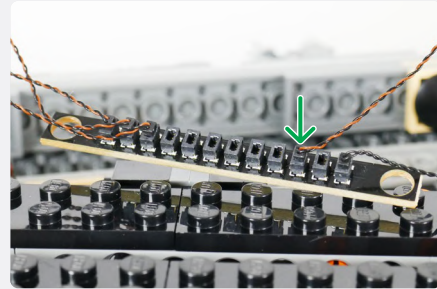
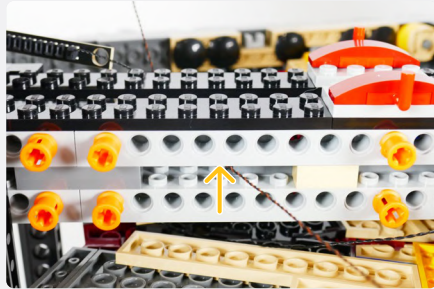
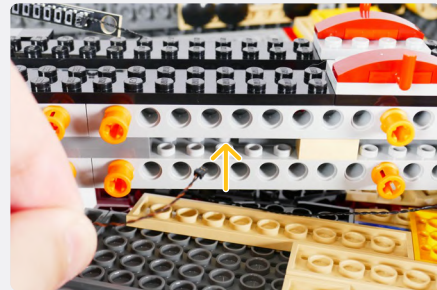
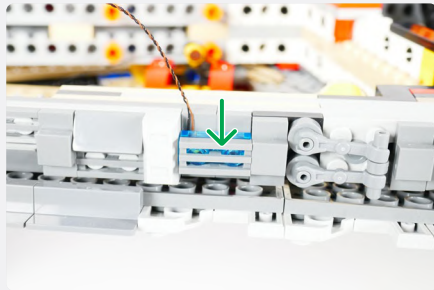

Cool White 30cm Bit Light

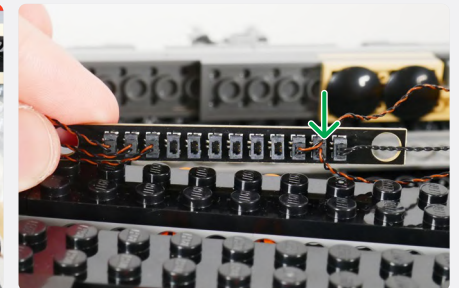
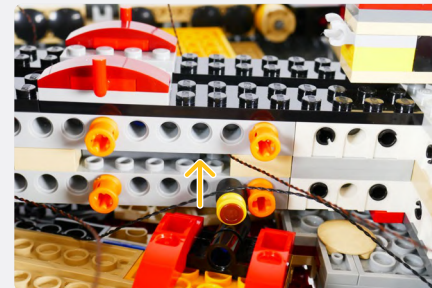
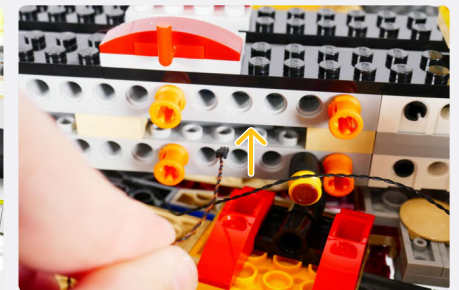
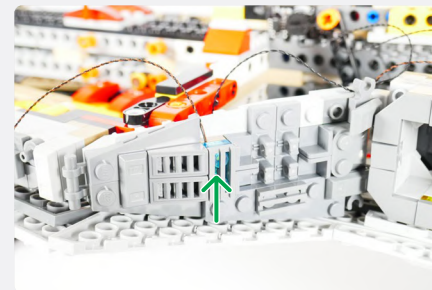
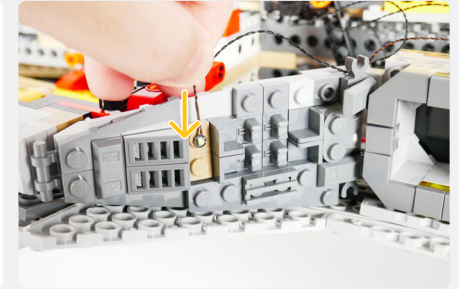

64

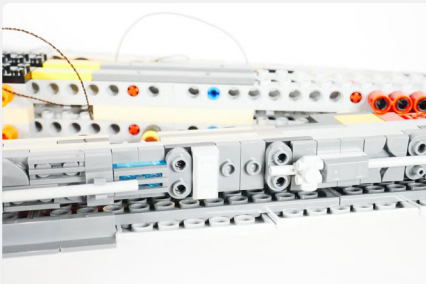
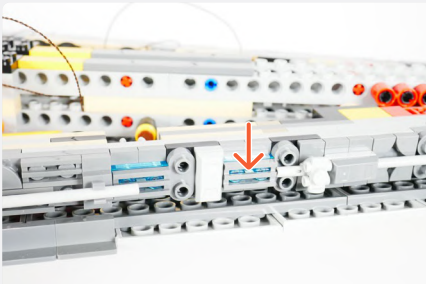
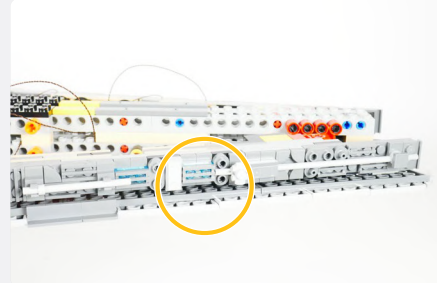

64

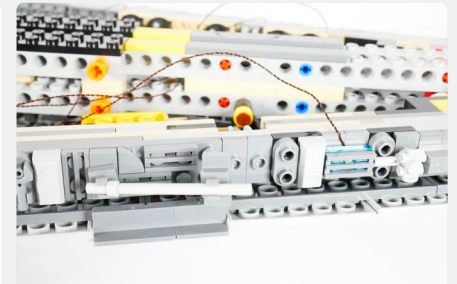
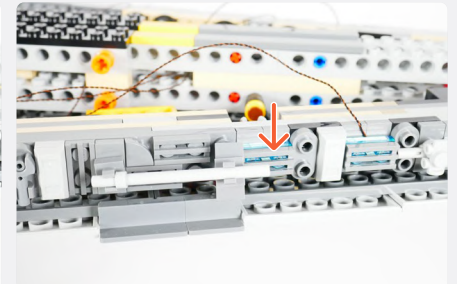
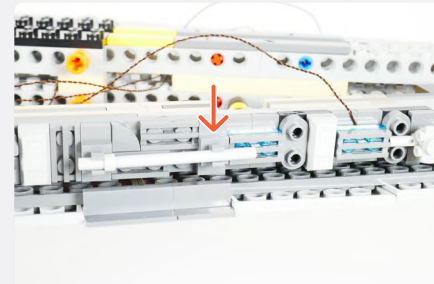
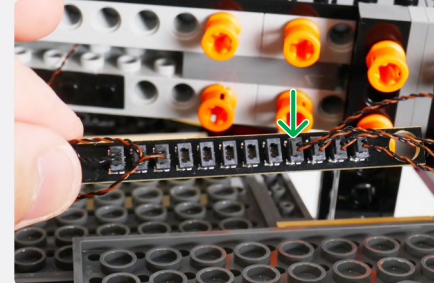
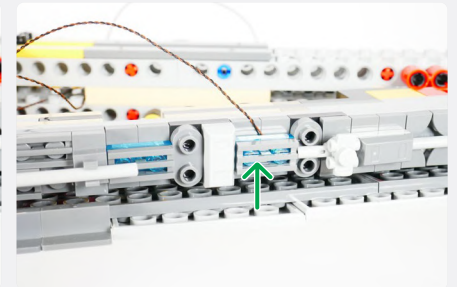
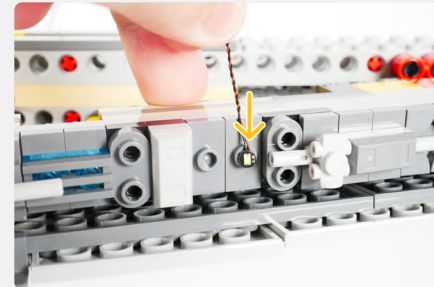

Cool White 30cm Bit Light

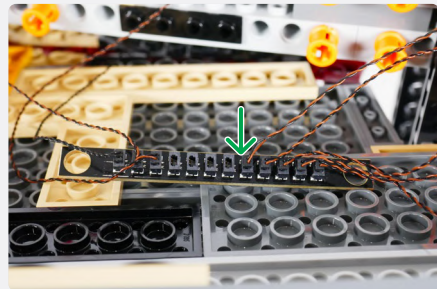
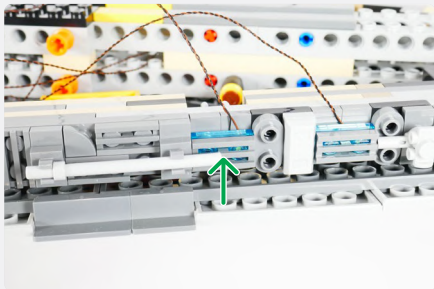
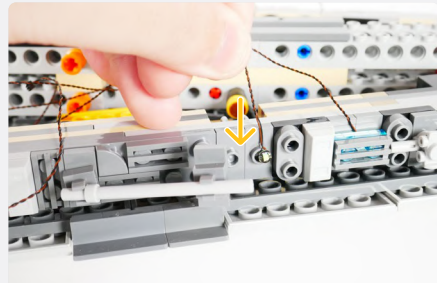

65

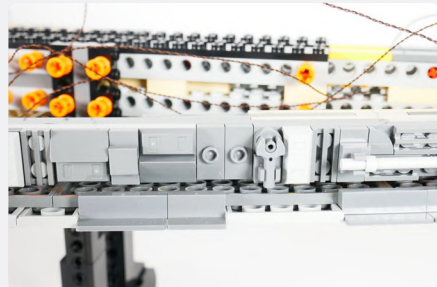
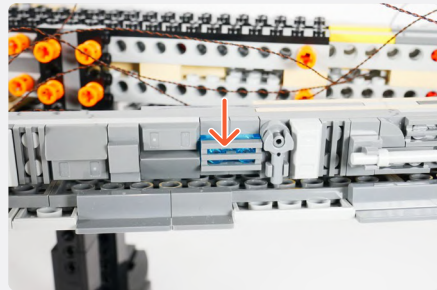
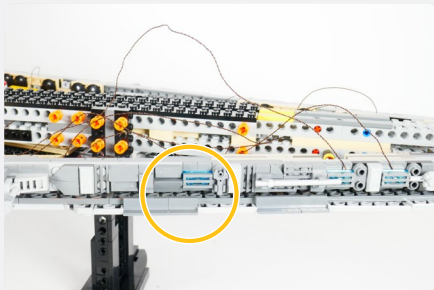

Cool White 30cm Bit Light

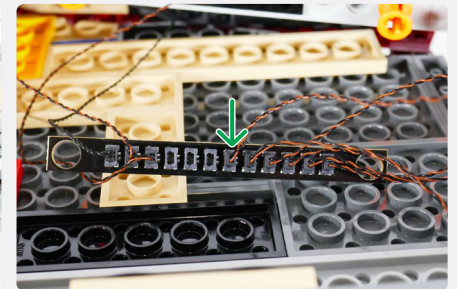
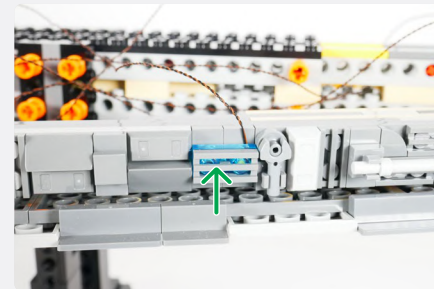
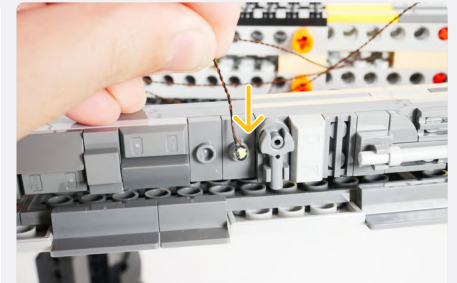

66

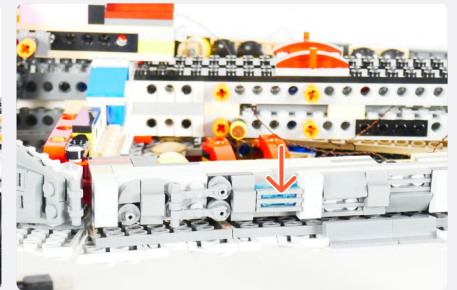
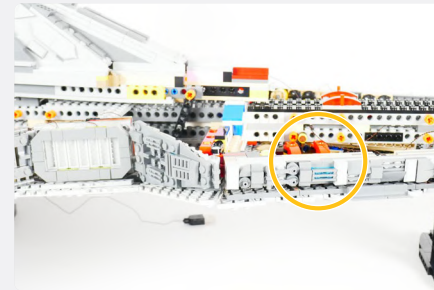

Cool White 30cm Bit Light

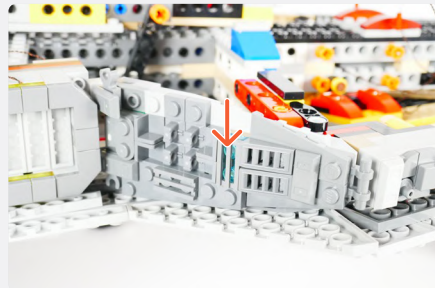
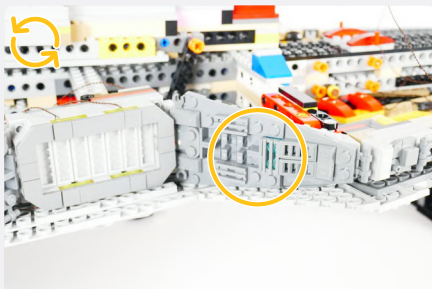
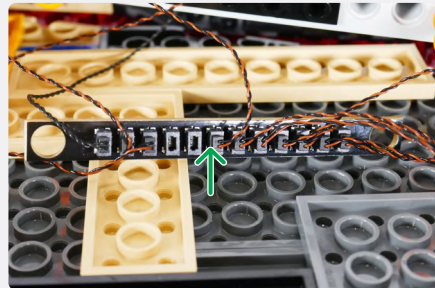
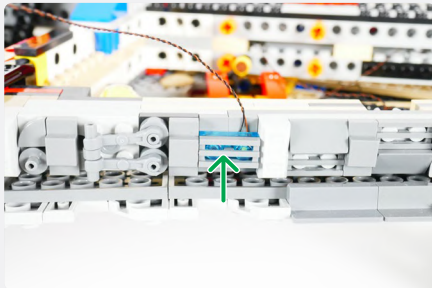
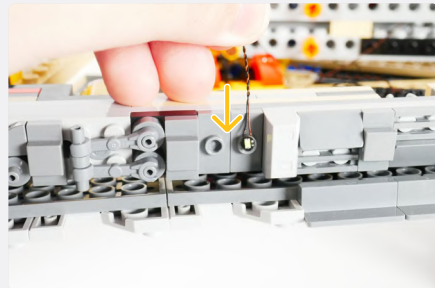

Cool White 30cm Bit Light

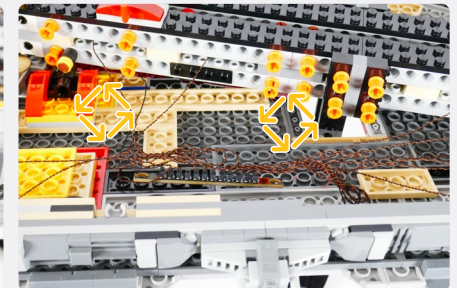
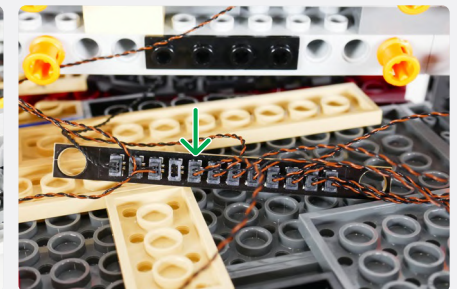
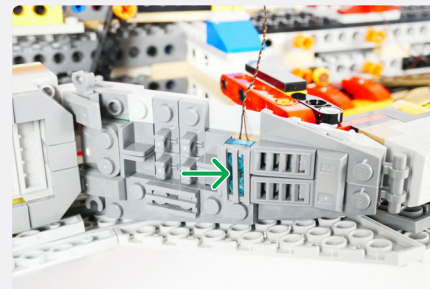

67

68

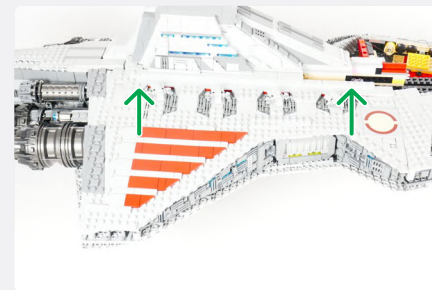
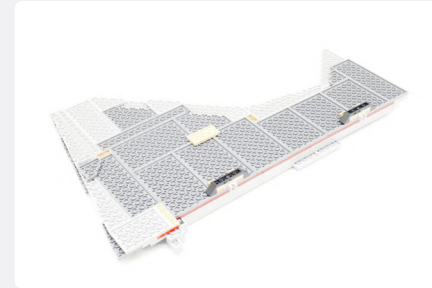
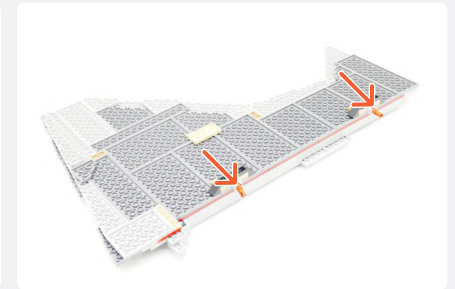
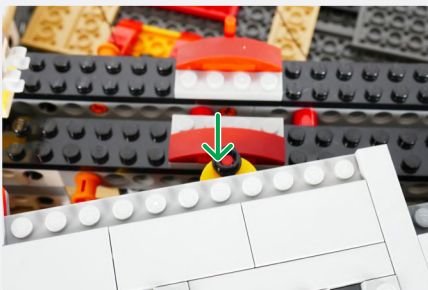

69

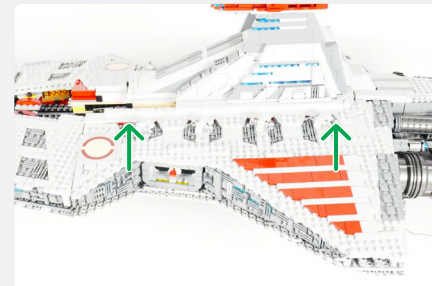
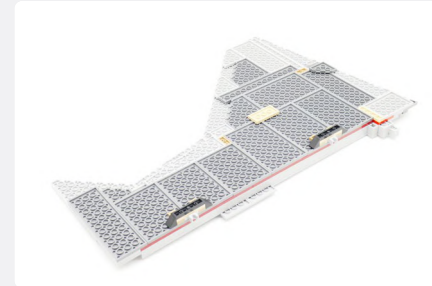
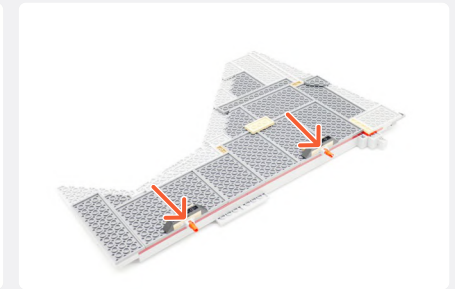
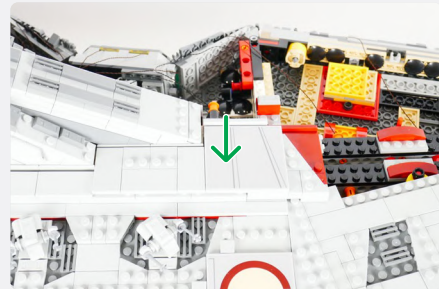

70

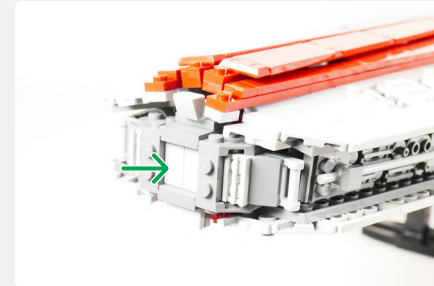
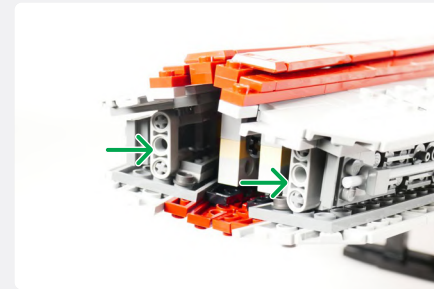
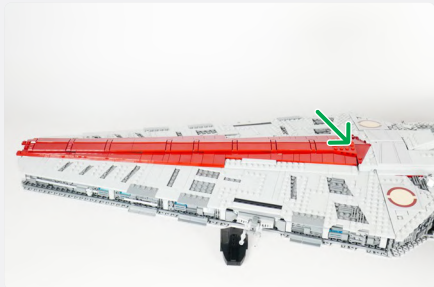

NOTE

Connect to a 5V USB Power Bank, 5V USB Wall Adaptor, or USB to AA Battery Pack (sold separately)



! If you experience any issues with the lights not working and suspect an issue with a component, please try a different port on the expansion board to verify where the fault lies (with the light or expansion board). To correct any issues with expansion board ports, please view the section addressing expansion board issues in our troubleshooting section. **i**



NOTE

You should have these parts left over that were removed from the LEGO set

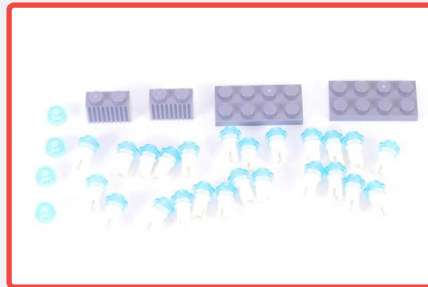

FINAL PRODUCT

This finally completes installation of the Light My Bricks

LEGO® Star Wars Venator-Class Republic Attack Cruiser 75367 Light Kit.





TROUBLESHOOTING

Light My Bricks lighting kits contain individual components that are very small and can be easily damaged if not handled correctly.

To prevent unnecessary damage to components, we highly recommend that the User Guide section, **“Important things to note”** is read carefully. Follow the handling procedures in the User Guide to help prevent faults and damages to your Light My Bricks components.

If you are experiencing issues with your Light My Bricks set, watch our troubleshooting video [here](#) or read on for a list of common causes to help you troubleshoot.

Troubleshooting

Firstly, ensure that the batteries have power using a battery charge gauge.

If the batteries have no power, replace the batteries.

If the batteries still have power, check to see if the batteries have been inserted correctly into the battery pack.

Check for AA batteries using the AA battery pack

Inside the battery pack are symbols indicating which direction the AA battery should be inserted. The flat side of the battery should be paired with the spring side of the battery pack.

If the batteries have been installed correctly and your kit still isn't operating correctly, the next step is to check the wiring.

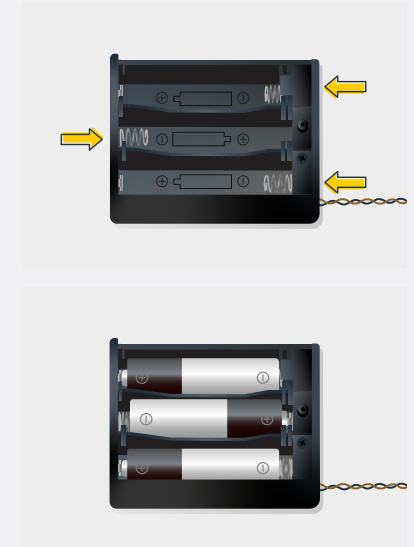

Troubleshooting

Check Your Wires

In order for Light My Bricks components to fit in between and underneath LEGO® bricks, the components need to be very small. Due to this nature, Light My Bricks components can be easily damaged when not handled correctly.

Be careful when removing unpacked components out of the packaging and ensure not to forcibly pull at the wires as this can damage the soldering that attach the wires to the LEDs.

If the wiring is detached from the LED itself, the light will not operate.

When connecting lights to your LEGO® set, check that there are no pinched wires underneath or in between bricks and plates.

When the wires are pinched and the exposed wires are touching each other, this can cause a crosswire and the lights to not function correctly.

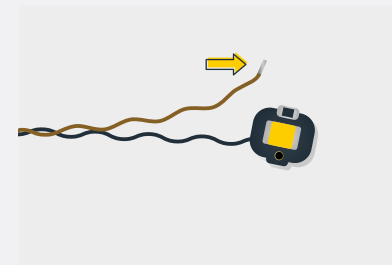
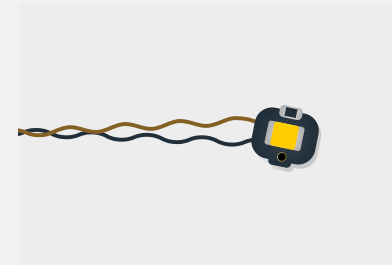

Troubleshooting

Check Your Expansion Board Ports / Strip Light Ports / Effects Board Ports

It is important to note that connectors can only be inserted to the expansion board, strip light, or effects board ports in one direction.

Forcibly inserting connectors in the incorrect direction will result in damaging the pins inside each of the ports on your component board.

Not only will a light connected to the damaged port not work, but if the pins inside the port are bent to a point they are touching each other, this can result in all other lights in the system to stop working. This is a short circuit.

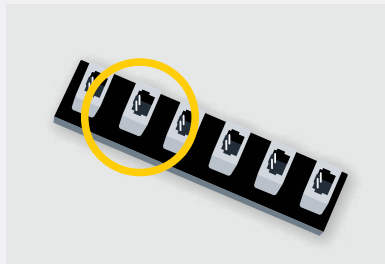

A short circuit can also result in overheating of the board, cable or batteries. If you suspect a short circuit, **DISCONNECT POWER IMMEDIATELY**. Batteries can fail, catch fire, or even explode if left connected to a short circuit for too long.

If you suspect you have a faulty component due to a bent pin, try the following steps:

If you look carefully inside each of the ports, each port contains 2 small pins that should be straight. You will be able to identify a faulty port if it has any bent pins.

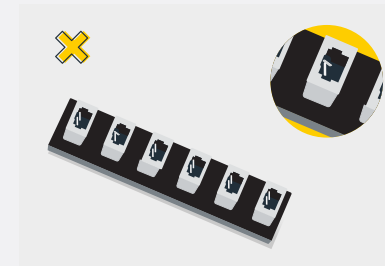
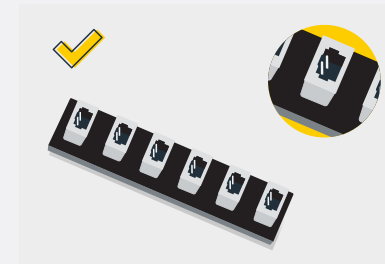
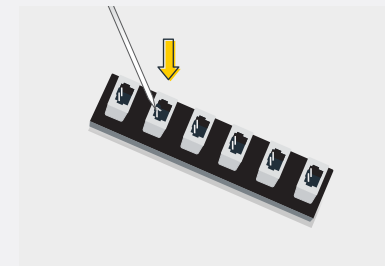



CONTACT US

If you have an enquiry regarding the online shop, our products or a general enquiry please refer to our Frequently Asked Questions webpage here.

Alternatively, you can contact our Customer Services team by visiting our online support portal here.

support.lightmybricks.com

We thank you for purchasing this product and hope you enjoy!



lightmybricks.com