



**LIGHT^{MY}
BRICKS**



LEGO[®] CHEVROLET CAMARO Z28

#10304 LIGHT KIT

INSTALLATION GUIDE

Light My Bricks



LEGO® CHEVROLET CAMARO Z28 10304 INSTALLATION GUIDE

Hi There!

We're here to help you get started on the LEGO®
Chevrolet Camaro Z28 10304 Light Kit.

This PDF details the instructions for the LED light kit only. If you are wishing to purchase this product, please [click here](#) to view the product page.

If you run into any issues, please refer to the troubleshooting section towards the end of this guide.

Have fun and enjoy!





PACKAGE CONTENTS:



5x White 30cm Bit Light *
 3x Warm White 30cm Large Bit Light
 7x Red 30cm Bit Light *



2x 8-Port Expansion Board
 1x N/C Push Board



1x 30cm Connecting Cable
 1x 5cm Connecting Cable



1x USB Power Cable
 (Power Source not Included)

+ 4x Adhesive Square

ASSORTED BRICKS:

- 2x Round Plate 1x1 - Trans Clear
- 1x Plate 2x2 w/ Rounded Bottom - Trans Clear
- 4x Plate 1x1 - Trans Red
- 2x Tile 1x2 - Trans Red

* Indicates components which include spares

Contents

Before You Begin	5
Blueprint	8
Instructions	9
Final Product	31
Troubleshooting	32
Contact	36

Before You Begin



Laying cables in between and underneath bricks

Cables can fit in between and underneath LEGO® bricks, plates, and tiles providing they are laid correctly between the LEGO® studs. Do NOT forcefully join LEGO® together around cables; instead ensure they are laying comfortably in between each stud.

CAUTION: Forcing LEGO® to connect over a cable can result in damaging the cable and light.

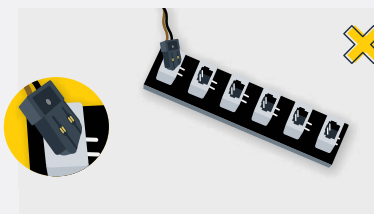

Connecting Cable Connectors To Expansion Boards

Take extra care when inserting connectors to ports of Expansion Boards. Connectors can be inserted only one way. With the expansion board facing up, look for the soldered “=” symbol on the left side of the port. The connector side with the wires exposed should be facing toward the soldered “=” symbol as you insert into the port. If a plug won’t fit easily into a port connector, do not force it.

Incorrectly inserting the connector can result in bent pins inside the port or possible overheating of the expansion board when connected.

Before You Begin



Connecting Cable Connectors To Strip Lights

Take extra care when inserting connectors to ports on the Strip Lights. Connectors can be inserted only one way. With the Strip Light facing up, ensure the side of the connector with the wires exposed is facing down. If a plug won't fit easily into a port connector, don't force it. Doing so will damage the plug and the connector.

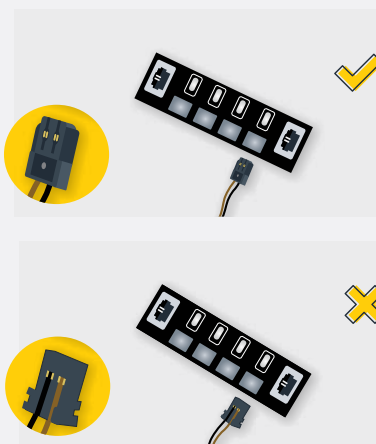

Connecting Micro Cable Connectors To Micro Expansion Board Ports

Take extra care when inserting the micro connectors to micro ports of Micro Expansion Boards. Connecting Micro Bit Lights to Micro Expansion Boards is similar to connecting lights and cables to Strip Lights. With the expansion board facing up, ensure the side of the connector with the wires exposed is facing down. If a plug won't fit easily into a port connector, do not force it. Use your fingernail to push the plastic part of the connector to the micro port.

Before You Begin

Installing Bit Lights Under Lego® Bricks And Plates

When installing Bit Lights under LEGO® pieces, ensure they are placed the correct way up (Yellow LED component exposed). You can either place them directly on top of LEGO® studs or in between.



BLUEPRINT

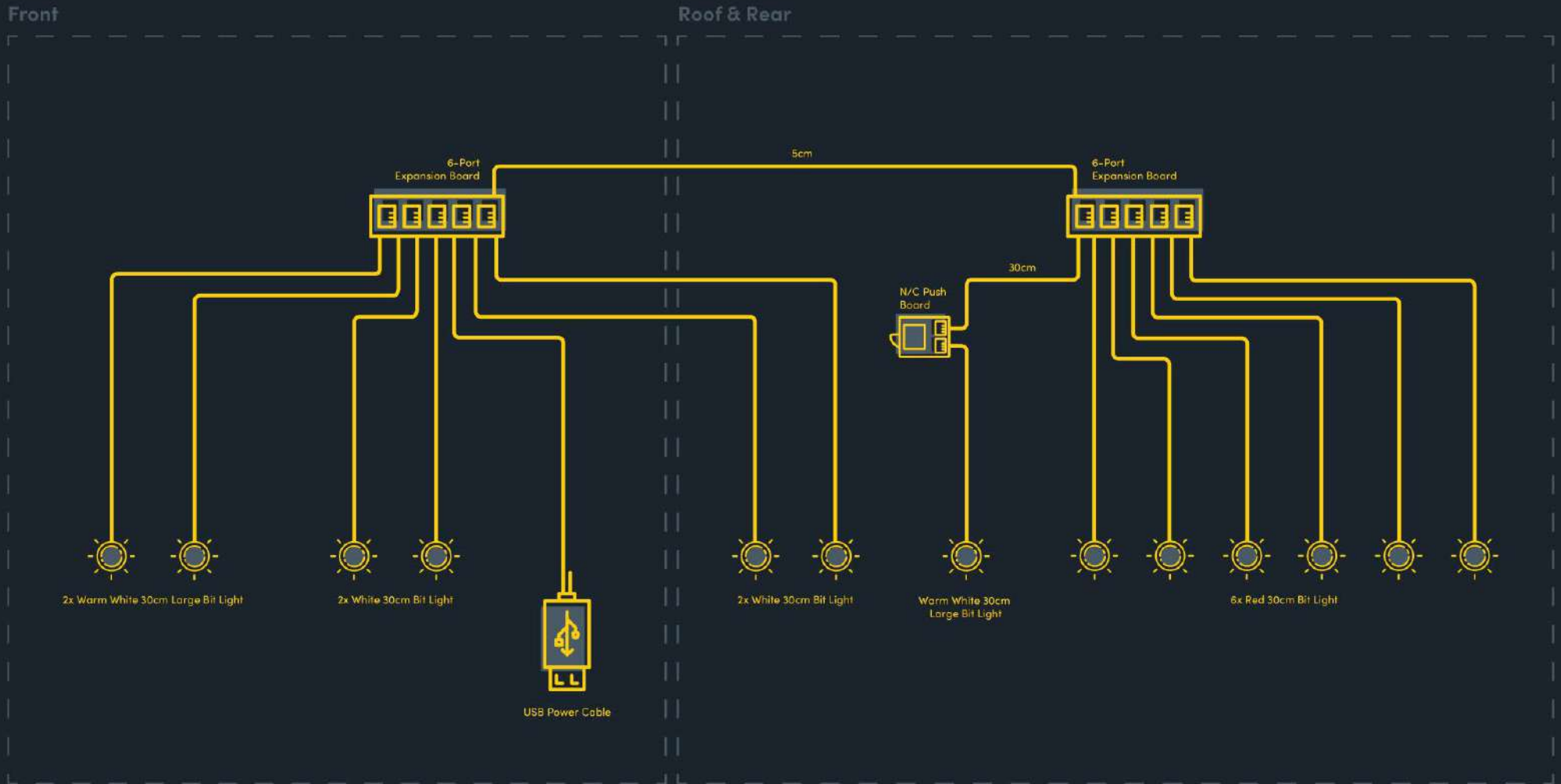



INSTRUCTIONS

To ensure a smooth installation of your light kit, please read and follow each step carefully. If you run into any issues, please refer to the online troubleshooting guide.

1



2



3



White 30cm Large Bit Light





NOTE

Use your finger to push the curved panel upwards from inside the wheel arch. Slightly disconnect but do not remove.

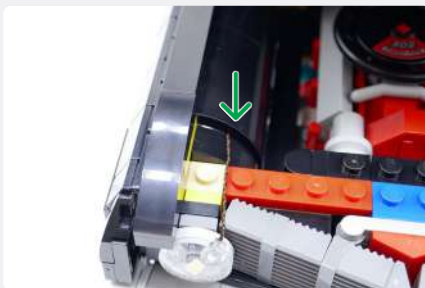

4



White 30cm Large Bit Light



5

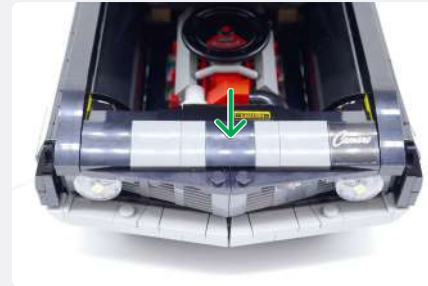
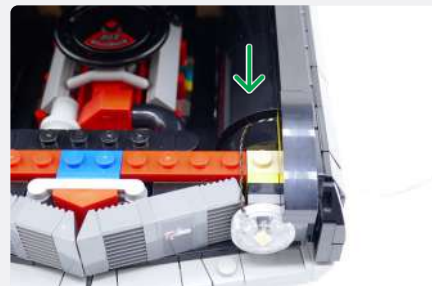
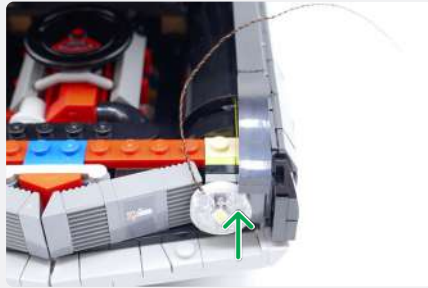

5



NOTE

Use the LEGO Brick Separator or similar to pry the section off



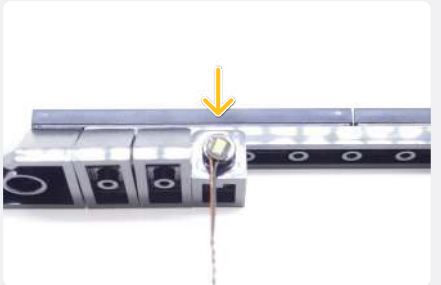
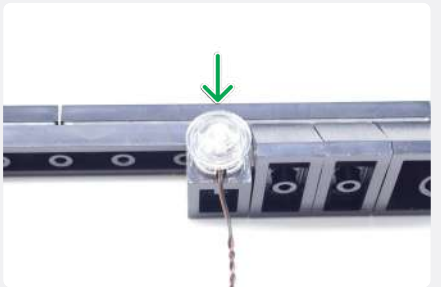
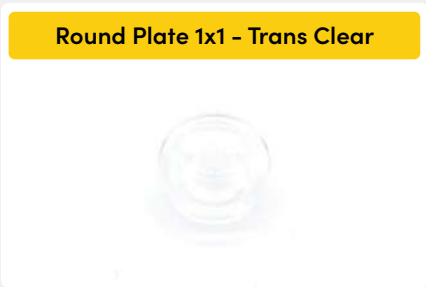
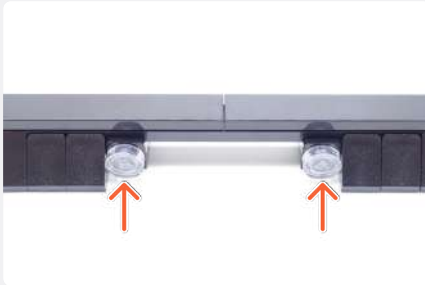

6

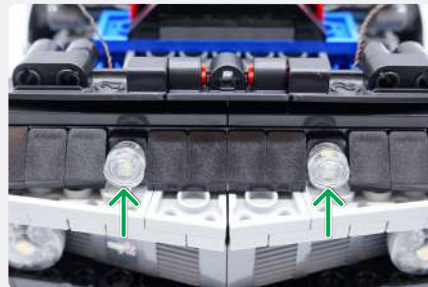
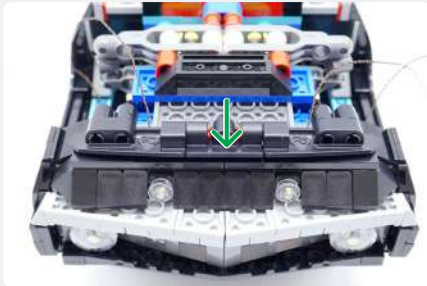
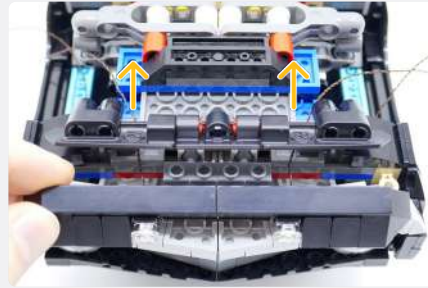
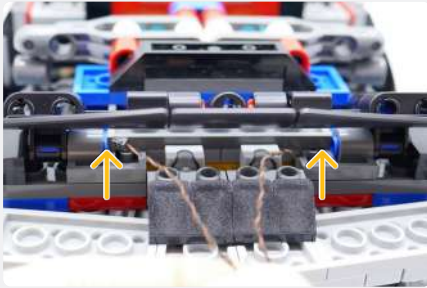

7



8



8-Port Expansion Board

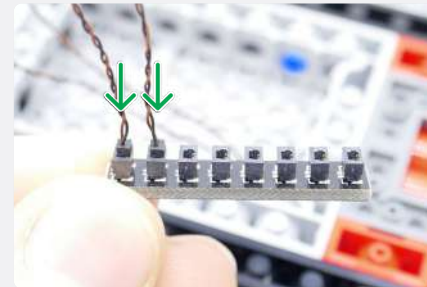

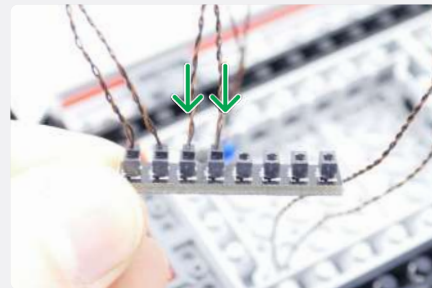
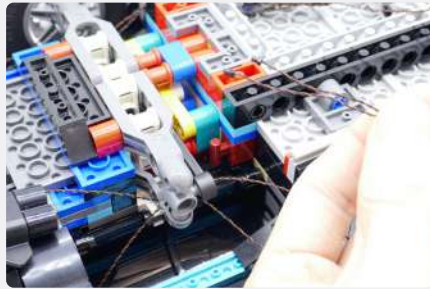

5cm Connecting Cable



8-Port Expansion Board

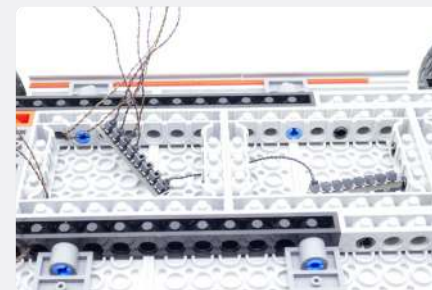

USB Power Cable

NOTE

The USB Power Cable can be routed through any of the holes underneath the car on either side depending on where you want to power it from

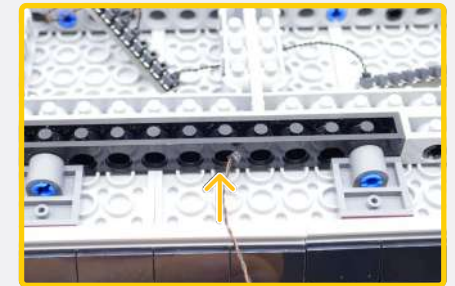

9

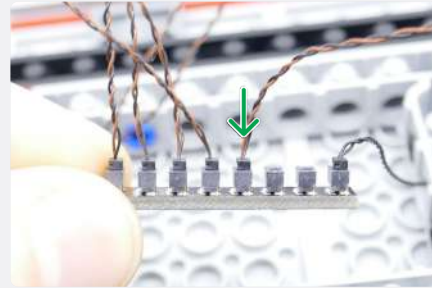
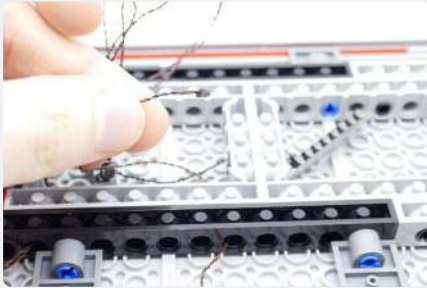

NOTE

Connect to a 5V USB Power Bank, 5V USB Wall Adaptor, or USB to AA Battery Pack (sold separately)



! If you experience any issues with the lights not working and suspect an issue with a component, please try a different port on the expansion board to verify where the fault lies (with the light or expansion board). To correct any issues with expansion board ports, please view the section addressing expansion board issues in our troubleshooting section. !

10

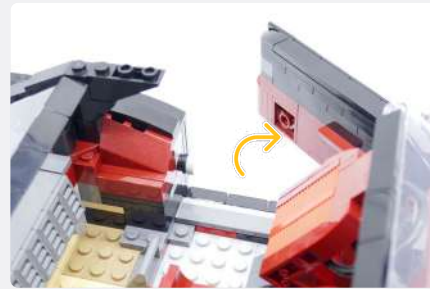

11

NOTE

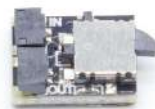
If you wish to display the car in convertible mode you choose whether to install the following parts. If so, you will need to locate the Bit Light elsewhere in the interior as it is placed on the roof.

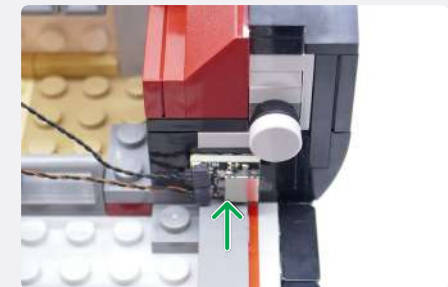
N/C Push Board

30cm Connecting Cable

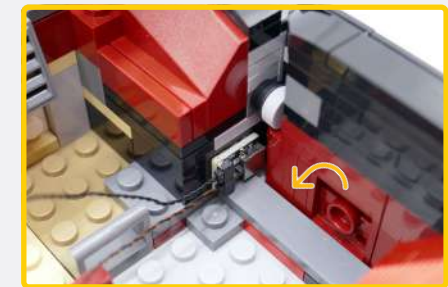
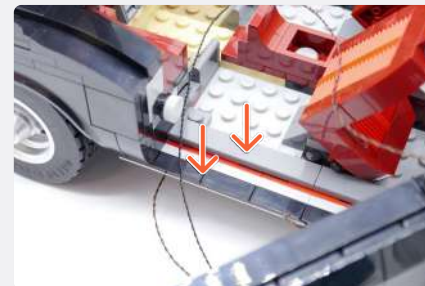
White 30cm Large Bit Light

NOTE

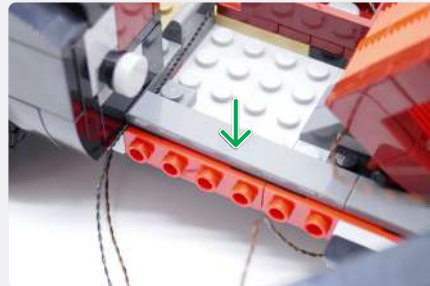
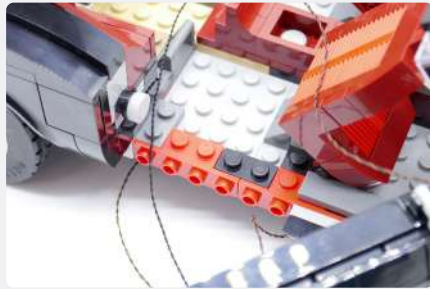
Ensure the door can shut completely while the trigger (on the NC Push Board) is pushed in.

12



13



NOTE

Use the Warm White 30cm Large Bit Light connected to the N/C Push Board.

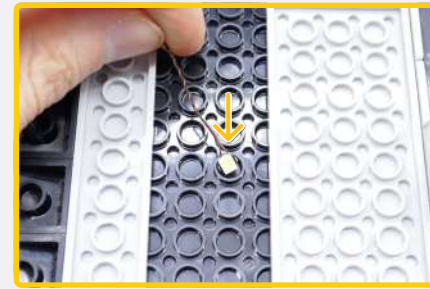
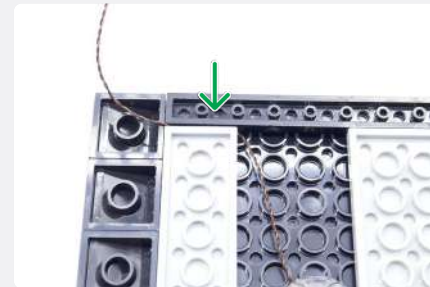
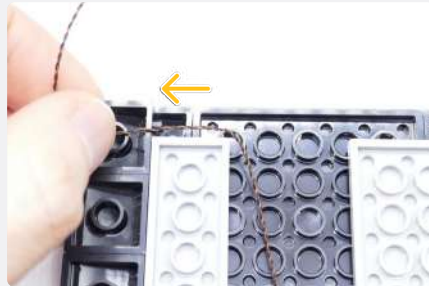
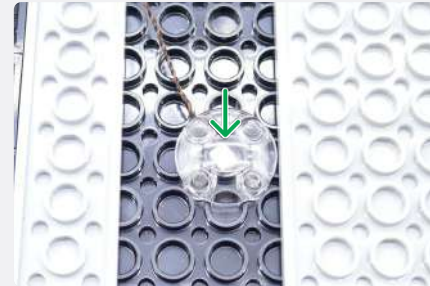
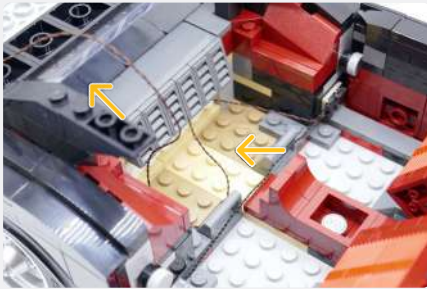

Plate 2x2 w/ Rounded Bottom - Trans Clear



14





NOTE

Bunch the loose cable behind the seat then reconnect it.

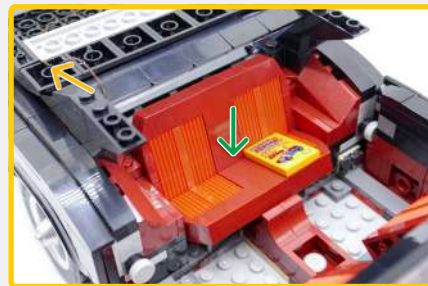

15

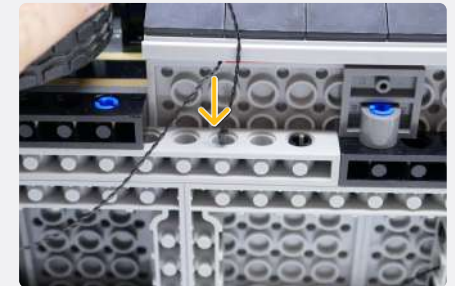
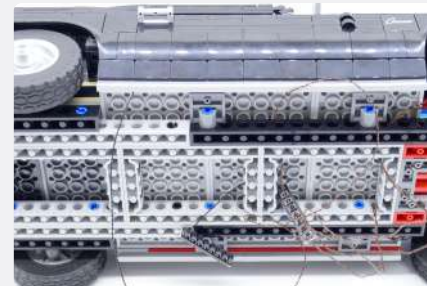
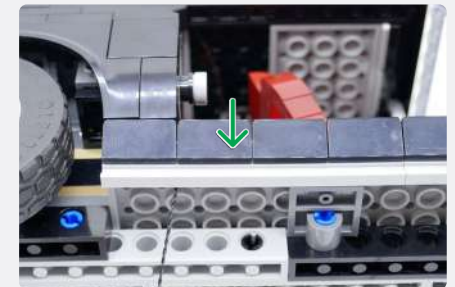
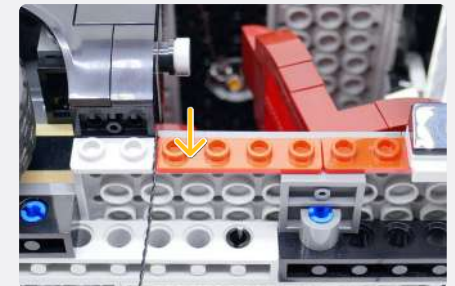
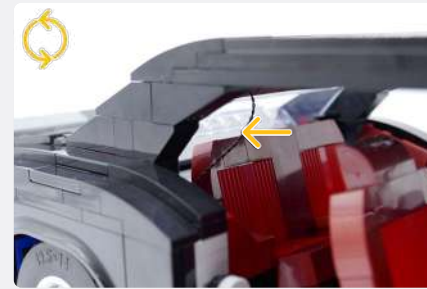

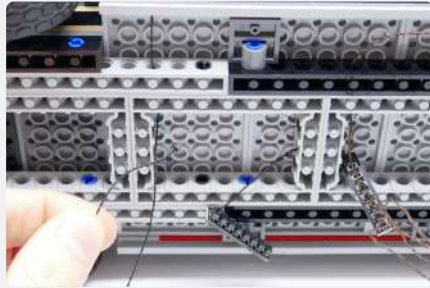

NOTE

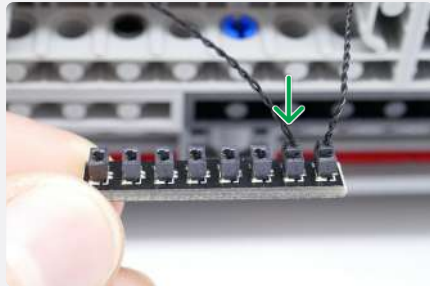
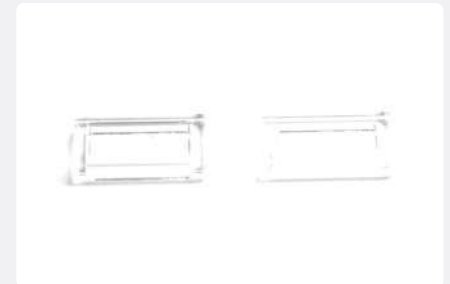
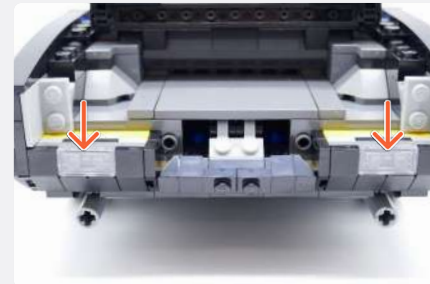
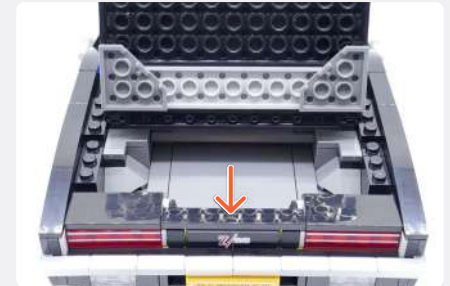
Plug the 30cm Connecting Cable from the N/C Push Board into the 6-Port Expansion Board with only one other cable plugged into it.

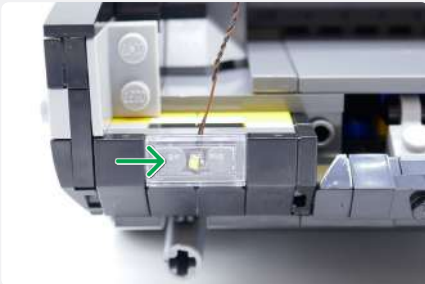
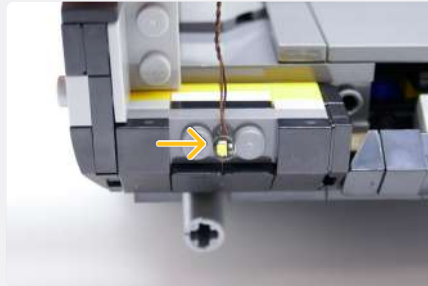

16

17

White 30cm Bit Light

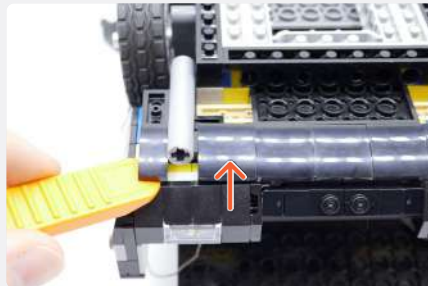
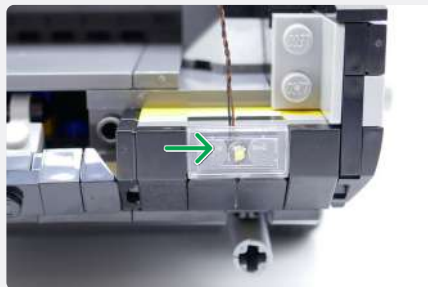
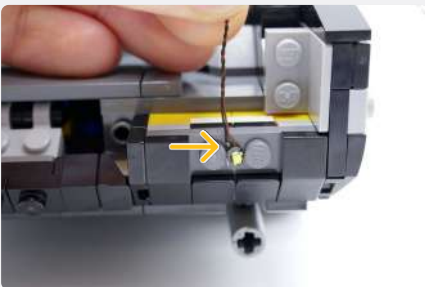

White 30cm Bit Light



18

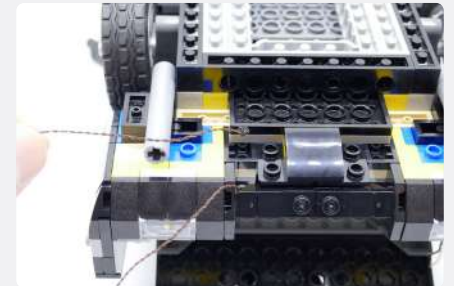
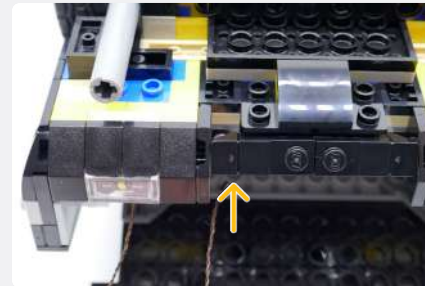
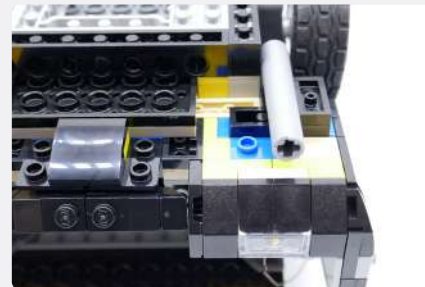
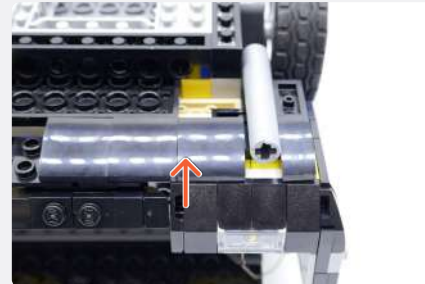
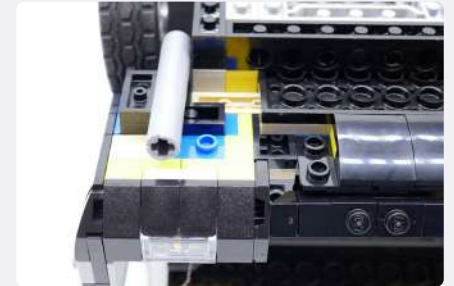

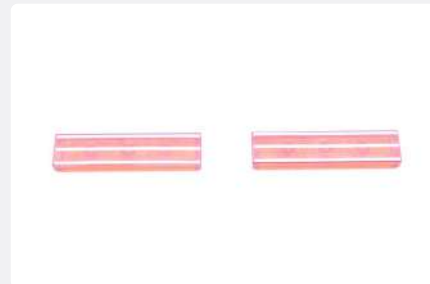
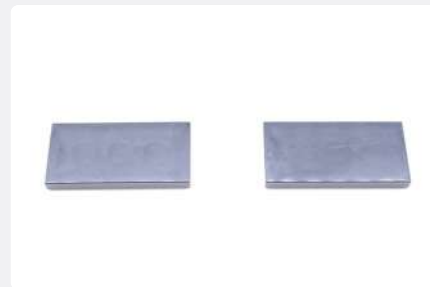
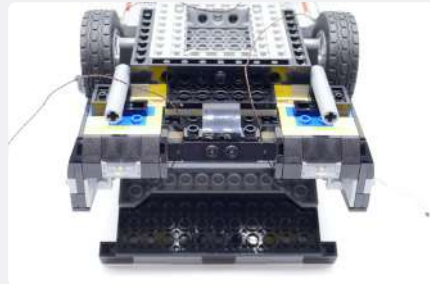
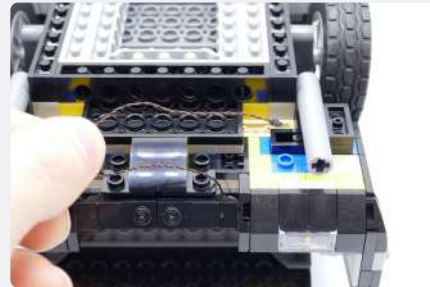
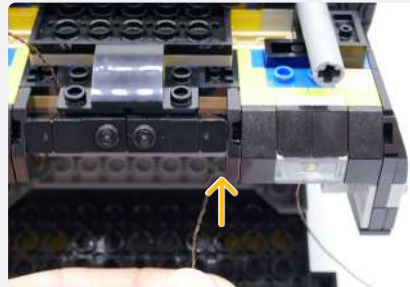

19

20

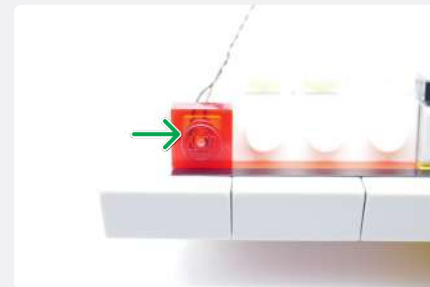
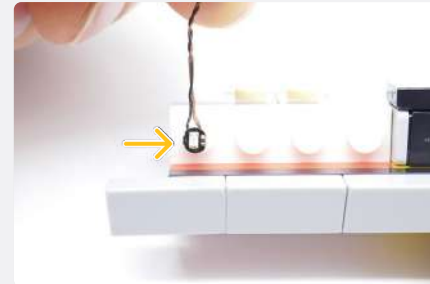

Red 30cm Bit Light

Plate 1x1 - Trans Red

Red 30cm Bit Light

Plate 1x1 - Trans Red

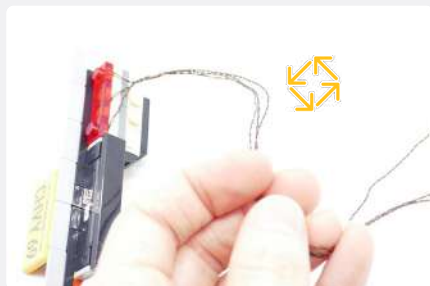
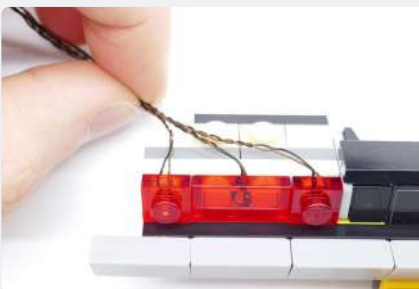
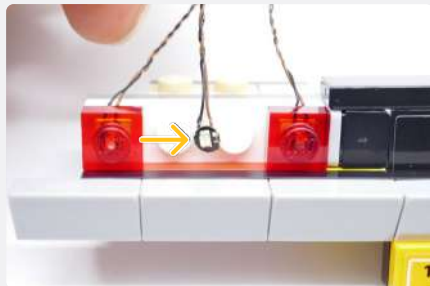
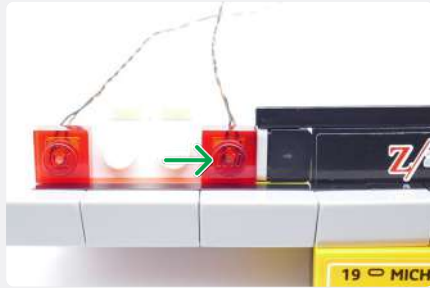

21

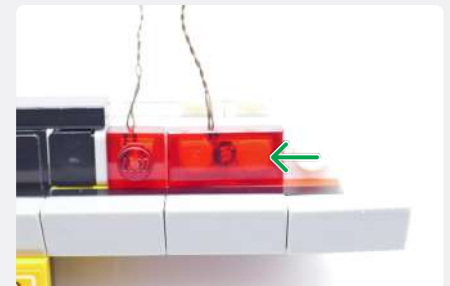
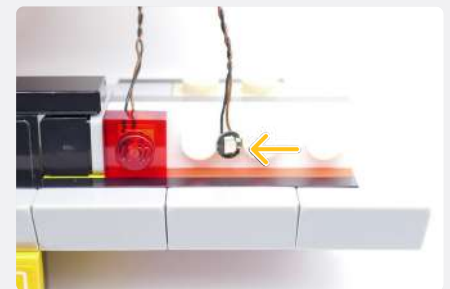
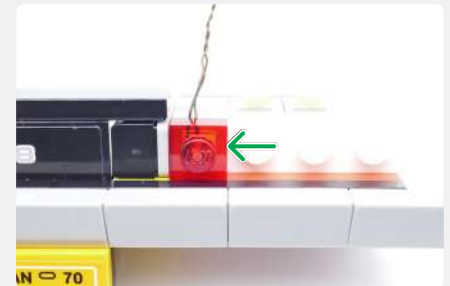
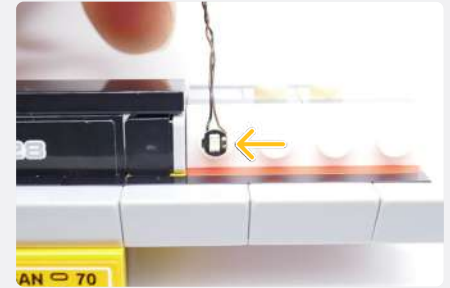

Red 30cm Bit Light

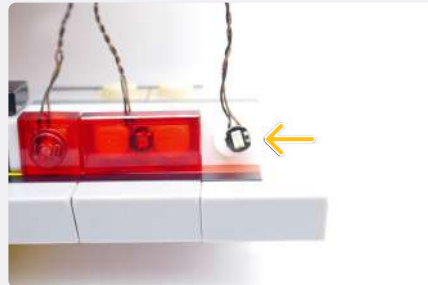

22

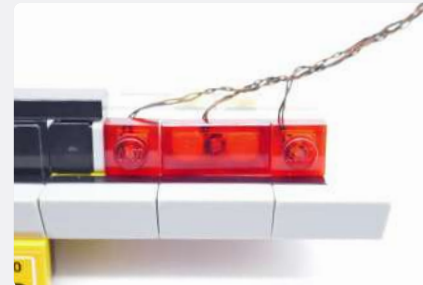
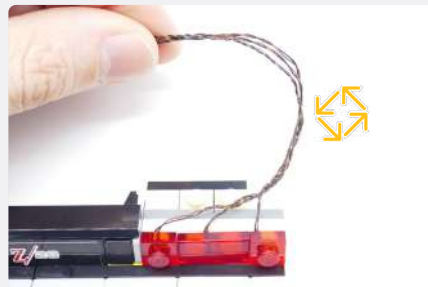
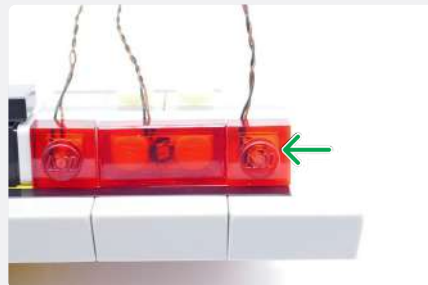
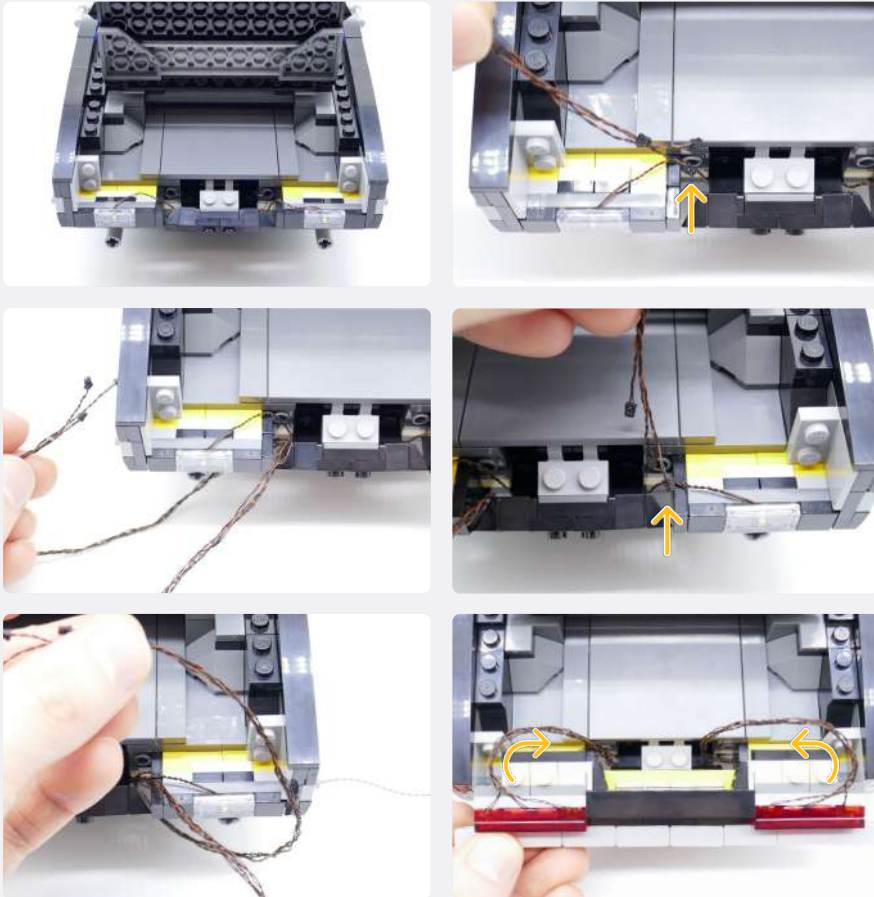



Plate 1x1 - Trans Red



23



 **NOTE**

Ensure the cables are running over the grey piece, then in between the black piece and black slope, then underneath the section and out.



24

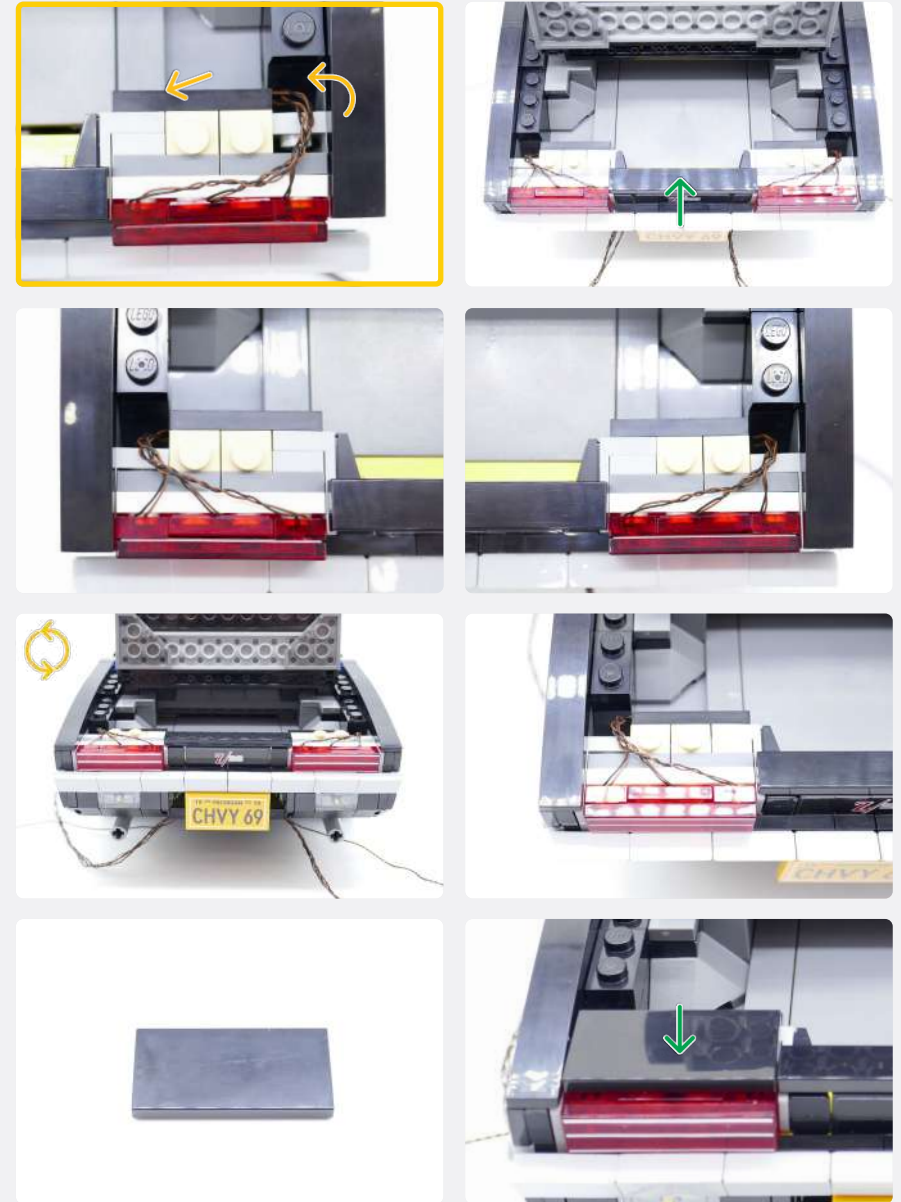

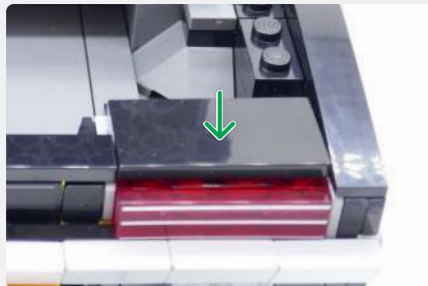
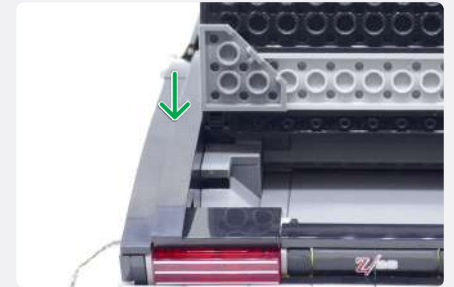
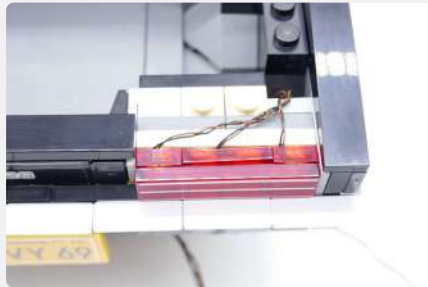

NOTE

Take the bundle of three cables on the left side and the single cable together. Line the plugs up as shown to better thread through the holes.

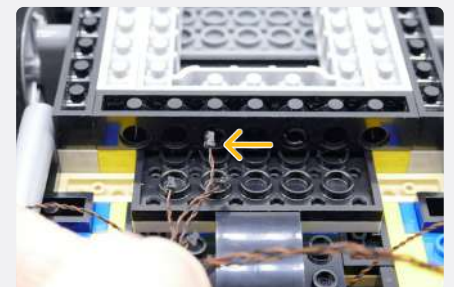
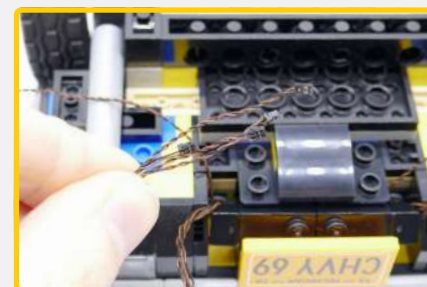
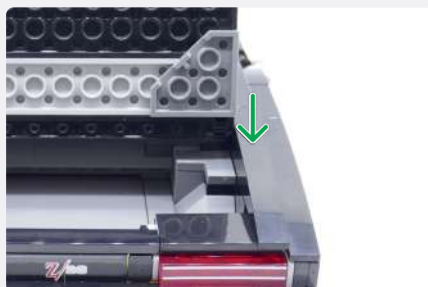

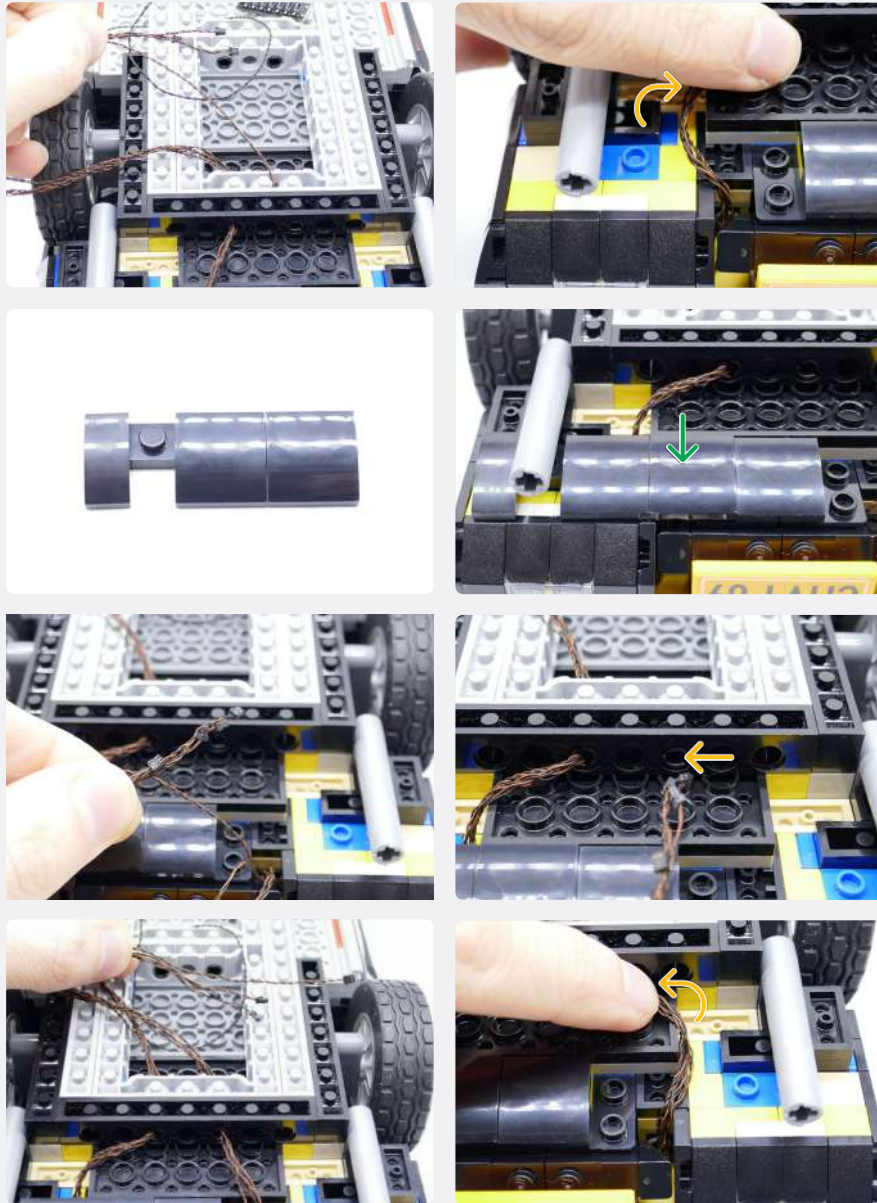

25



26

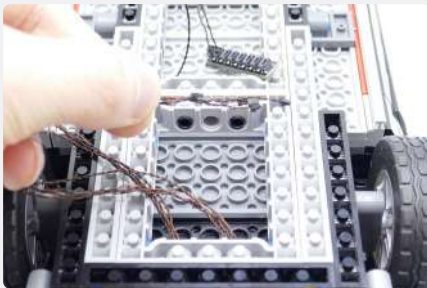

27

 **NOTE**

Take the longest cable from the ones you just threaded through. Thread it through the next hole.

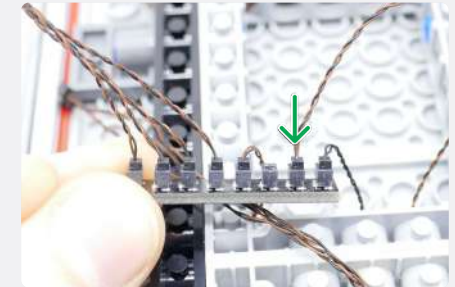
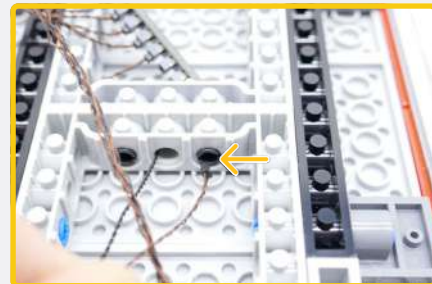

 **NOTE**

Take the other three bundled cables and plug them into the board shown.

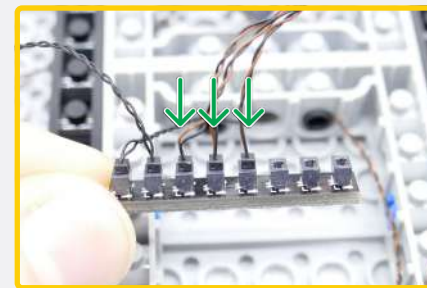
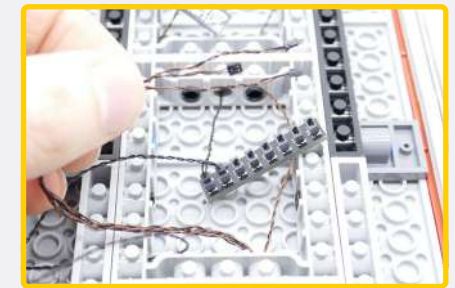
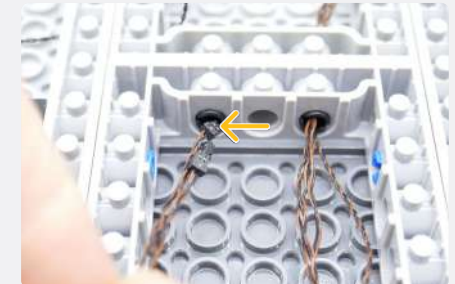
28

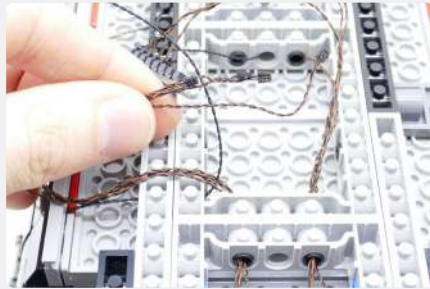

NOTE

Take the bundle of three cables from the left side and plug them in.

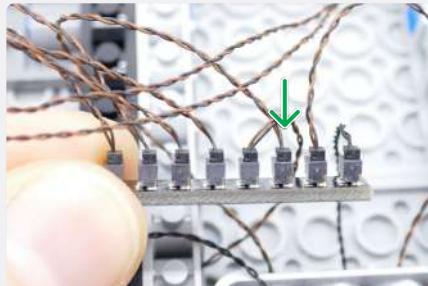
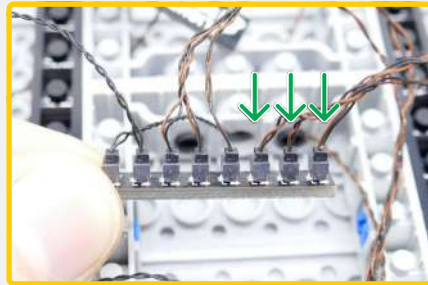
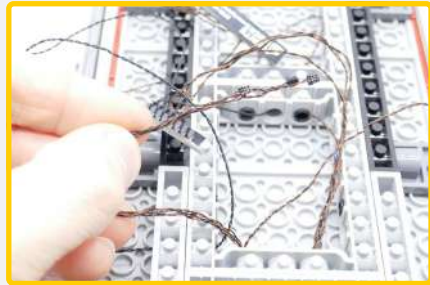

29

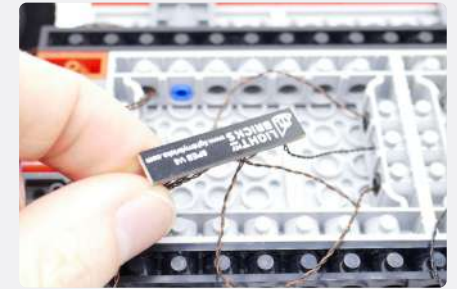
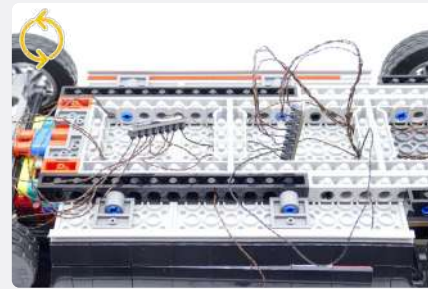

2x Adhesive Square

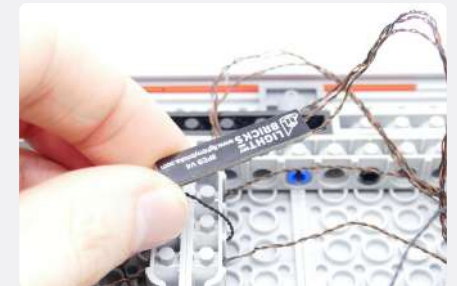
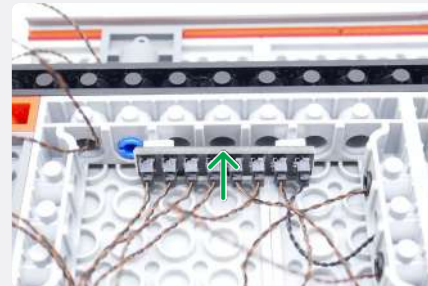
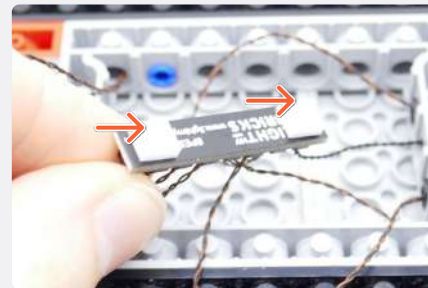
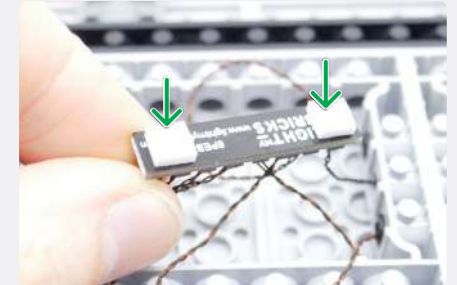

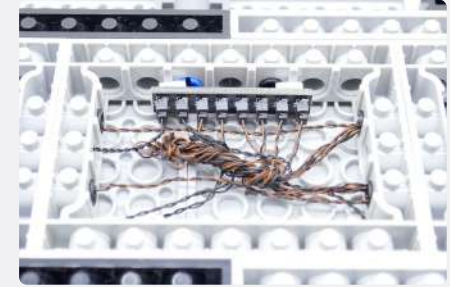
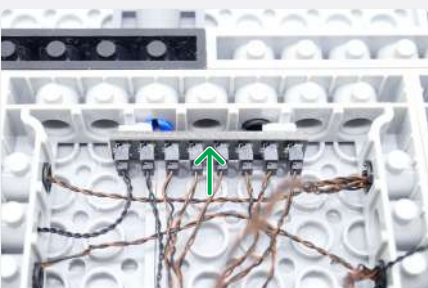
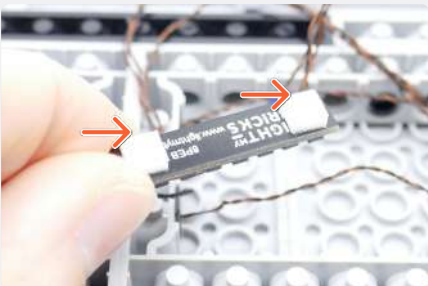
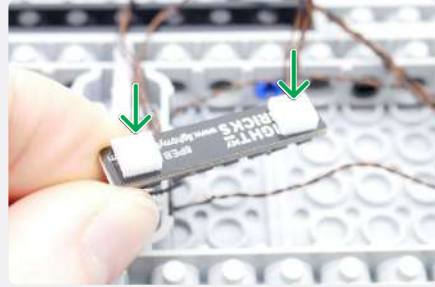

NOTE

Connect to a 5V USB Power Bank, 5V USB Wall Adaptor, or USB to AA Battery Pack (sold separately)



! If you experience any issues with the lights not working and suspect an issue with a component, please try a different port on the expansion board to verify where the fault lies (with the light or expansion board). To correct any issues with expansion board ports, please view the section addressing expansion board issues in our troubleshooting section. i

FINAL PRODUCT

This finally completes installation of the Light My Bricks

LEGO® Chevrolet Camaro Z28 10304 Light Kit.





TROUBLESHOOTING

Light My Bricks lighting kits contain individual components that are very small and can be easily damaged if not handled correctly.

To prevent unnecessary damage to components, we highly recommend that the User Guide section, **“Important things to note”** is read carefully. Follow the handling procedures in the User Guide to help prevent faults and damages to your Light My Bricks components.

If you are experiencing issues with your Light My Bricks set, watch our troubleshooting video [here](#) or read on for a list of common causes to help you troubleshoot.

Troubleshooting

Firstly, ensure that the batteries have power using a battery charge gauge.

If the batteries have no power, replace the batteries.

If the batteries still have power, check to see if the batteries have been inserted correctly into the battery pack.

Check for AA batteries using the AA battery pack

Inside the battery pack are symbols indicating which direction the AA battery should be inserted. The flat side of the battery should be paired with the spring side of the battery pack.

If the batteries have been installed correctly and your kit still isn't operating correctly, the next step is to check the wiring.

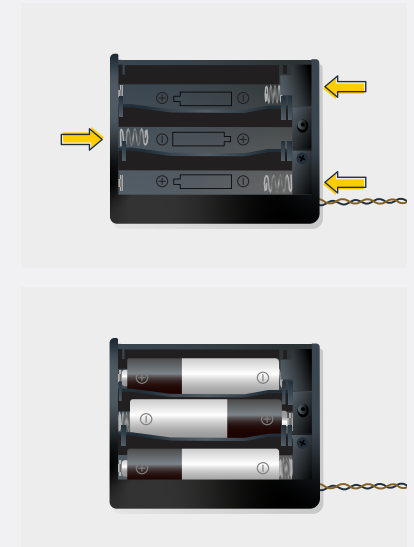

Troubleshooting

Check Your Wires

In order for Light My Bricks components to fit in between and underneath LEGO® bricks, the components need to be very small. Due to this nature, Light My Bricks components can be easily damaged when not handled correctly.

Be careful when removing unpacked components out of the packaging and ensure not to forcibly pull at the wires as this can damage the soldering that attach the wires to the LEDs.

If the wiring is detached from the LED itself, the light will not operate.

When connecting lights to your LEGO® set, check that there are no pinched wires underneath or in between bricks and plates.

When the wires are pinched and the exposed wires are touching each other, this can cause a crosswire and the lights to not function correctly.

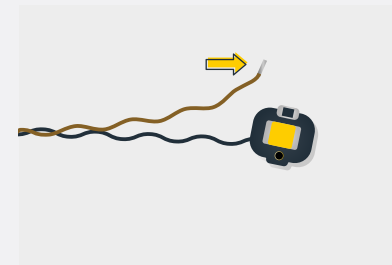
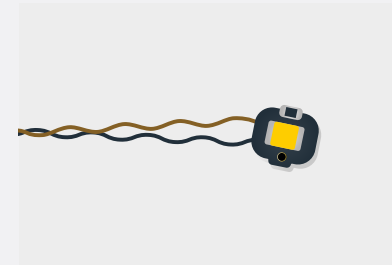

Troubleshooting

Check Your Expansion Board Ports/ Strip Light Ports / Effects Board Ports

It is important to note that connectors can only be inserted to the expansion board, strip light, or effects board ports in one direction.

Forcibly inserting connectors in the incorrect direction will result in damaging the pins inside each of the ports on your component board.

Not only will a light connected to the damaged port not work, but if the pins inside the port are bent to a point they are touching each other, this can result in all other lights in the system to stop working. This is a short circuit.

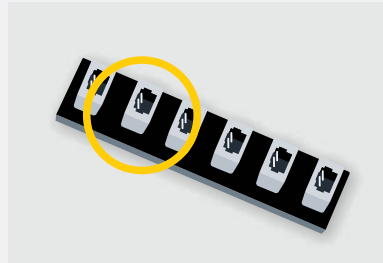
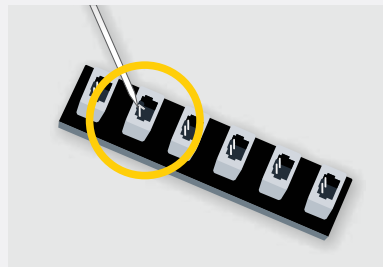

A short circuit can also result in overheating of the board, cable or batteries. If you suspect a short circuit, **DISCONNECT POWER IMMEDIATELY**. Batteries can fail, catch fire, or even explode if left connected to a short circuit for too long.

If you suspect you have a faulty component due to a bent pin, try the following steps:

If you look carefully inside each of the ports, each port contains 2 small pins that should be straight. You will be able to identify a faulty port if it has any bent pins.

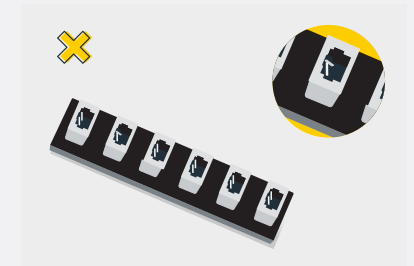
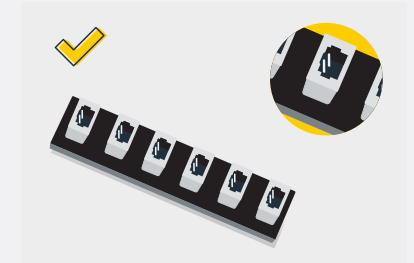
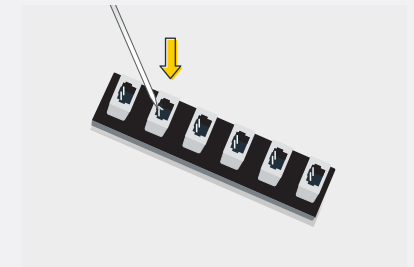



CONTACT US

If you have an enquiry regarding the online shop, our products or a general enquiry please refer to our Frequently Asked Questions webpage here.

Alternatively, you can contact our Customer Services team by visiting our online support portal here.

support.lightmybricks.com

We thank you for purchasing this product and hope you enjoy!



lightmybricks.com