



**LIGHT^{MY}
BRICKS**



**LEGO[®] DC BATCAVE SHADOW BOX 76252
LIGHT KIT
INSTALLATION GUIDE**

Light My Bricks



LEGO® DC BATCAVE SHADOW BOX 76252 INSTALLATION GUIDE

Hi There!

We're here to help you get started on the LEGO®

DC Batcave Shadow Box 76252 Light Kit.

This PDF details the instructions for the LED light kit only. If you are wishing to purchase this product, please [click here](#) to view the product page.

If you run into any issues, please refer to the troubleshooting section towards the end of this guide.

Have fun and enjoy!





PACKAGE CONTENTS:

Individual Bags



- 11 x White 30cm Bit Light *
- 24 x White 15cm Bit Light
- 5 x Cool White 15cm Bit Light
- 4 x Cool White 30cm Bit Light
- 1 x Flashing Red 30cm Bit Light
- 1 x Warm White 15cm Large Bit Light
- 1 x Cool White 30cm Large Bit Light
- 1 x Orange 30cm Large Bit Light
- 1 x Rotating 30cm Bit Light

Connecting Cables



- 6 x 5cm Connecting Cable
- 4 x 30cm Connecting Cable
- 5 x 50cm Connecting Cable *

USB Power Cable



- 1x USB Power Cable
(Power Source not Included)

Mixed Components 1



- 11 x 6-Port Expansion Board
- 2 x 8-Port Expansion Board

Mixed Components 2



- 1 x Flicker Effects Board
- 1 x Blink Effects Board
- 10 x Adhesive Squares

Mixed Components 3



- 11 x Round Plate 1x1 w/ Open Stud - Black
- 3 x Tile, Modified 1x1 with Open O Clip - Black
- 5 x Plate, Round 1x1 - Trans Red
- 1 x Brick, Round 1x1 - Trans Red
- 1 x Tile, Round 1x1 - Trans Red

Mixed Components 4



- 4 x Plate 1x2 - Black
- 2 x Plate 2x4 - Black
- 2 x Plate, Round 1x1 with Bar Handle - Black
- 1 x Plate, Modified 1x2 with 1 Stud with Groove and Bottom Stud Holder (Jumper) - Black

* Indicates components which include spares

Contents

| | |
|------------------|----|
| Before You Begin | 5 |
| Blueprint | 10 |
| Instructions | 12 |
| Final Product | 85 |
| Troubleshooting | 86 |
| Contact | 90 |

Before You Begin



Laying cables in between and underneath bricks

Cables can fit in between and underneath LEGO® bricks, plates, and tiles providing they are laid correctly between the LEGO® studs. Do NOT forcefully join LEGO® together around cables; instead ensure they are laying comfortably in between each stud.

CAUTION: Forcing LEGO® to connect over a cable can result in damaging the cable and light.



Connecting Cable Connectors To Expansion Boards

Take extra care when inserting connectors to ports of Expansion Boards. Connectors can be inserted only one way. With the expansion board facing up, look for the soldered “=” symbol on the left side of the port. The connector side with the wires exposed should be facing toward the soldered “=” symbol as you insert into the port. If a plug won’t fit easily into a port connector, do not force it.

Incorrectly inserting the connector can result in bent pins inside the port or possible overheating of the expansion board when connected.

Before You Begin



Connecting Cable Connectors To Strip Lights

Take extra care when inserting connectors to ports on the Strip Lights. Connectors can be inserted only one way. With the Strip Light facing up, ensure the side of the connector with the wires exposed is facing down. If a plug won't fit easily into a port connector, don't force it. Doing so will damage the plug and the connector.



Connecting Micro Cable Connectors To Micro Expansion Board Ports

Take extra care when inserting the micro connectors to micro ports of Micro Expansion Boards. Connecting Micro Bit Lights to Micro Expansion Boards is similar to connecting lights and cables to Strip Lights. With the expansion board facing up, ensure the side of the connector with the wires exposed is facing down. If a plug won't fit easily into a port connector, do not force it. Use your fingernail to push the plastic part of the connector to the micro port.

Before You Begin

Installing Bit Lights Under Lego® Bricks And Plates

When installing Bit Lights under LEGO® pieces, ensure they are placed the correct way up (Yellow LED component exposed). You can either place them directly on top of LEGO® studs or in between.



Before You Begin

The Symbols Used In This Guide

When going through the following guide you will come across symbols and formats that will assist with the installation of your light kit. Take notice of them as each has a specific purpose.

Light Kit Component

This is the most important image format as it indicates which part to use from the Light Kit. Make sure you pay close attention to which part is shown.

White 30cm Bit Light



Connect

Used when you need to connect a LEGO piece or LMB component.



Disconnect

Used when you need to remove a LEGO piece/ section or LMB component.



Directional

Used to show where to route cables, place components, or move them.



Bend/Pivot

Used when a component needs to be bent, or part folded or pivoted.



Turn/ Flip

Will be found in the top left corner when the set needs to be rotated or flipped.



Twist/ Braid

Seen when a set of cables need to be grouped and twisted together.



Power On Test

Found at the end of a major step to test the lights. Will be located in the top left corner.



Note

Notes will be found alongside the instruction photos and explain what to do.



Before You Begin

Repeat Step

Repeat the previous step eg. Make a spotlight, then make a second spotlight.



Connect Focus

Used to highlight a hard to see area where a component is being connected.



Disconnect Focus

Used to highlight a hard to see area where a component is being disconnected.



General Focus

Used to highlight a hard to see area where a component needs to be acted on.



General Note

This is a sample note that is used anywhere in this guide. It will explain a difficult section where photos are hard to illustrate or easily confused.

Connect Note

The green coloured note is used when the topic focuses on a component being connected, like the shown Power Bank.

Disconnect Note

The red coloured note is used when the topic focuses on a component being disconnected or like here, the removed pieces.



NOTE

Take the 5cm Connecting Cable from the 4-Port Micro Expansion Board and route it into the "IN" port of the Flicker Effects Board

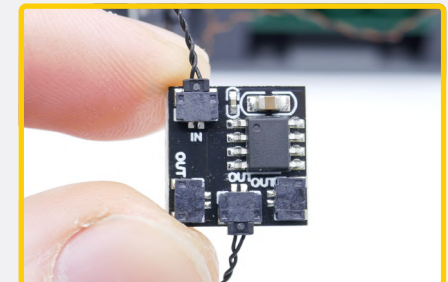



NOTE

Connect to a 5V USB Power Bank, 5V USB Wall Adaptor, or USB to AA Battery Pack (sold separately)





NOTE

You should have these parts left over that were removed from the LEGO set

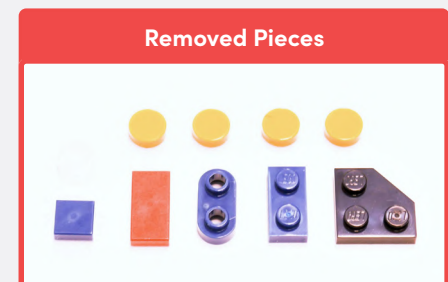



BLUEPRINT

Bottom & Left Section

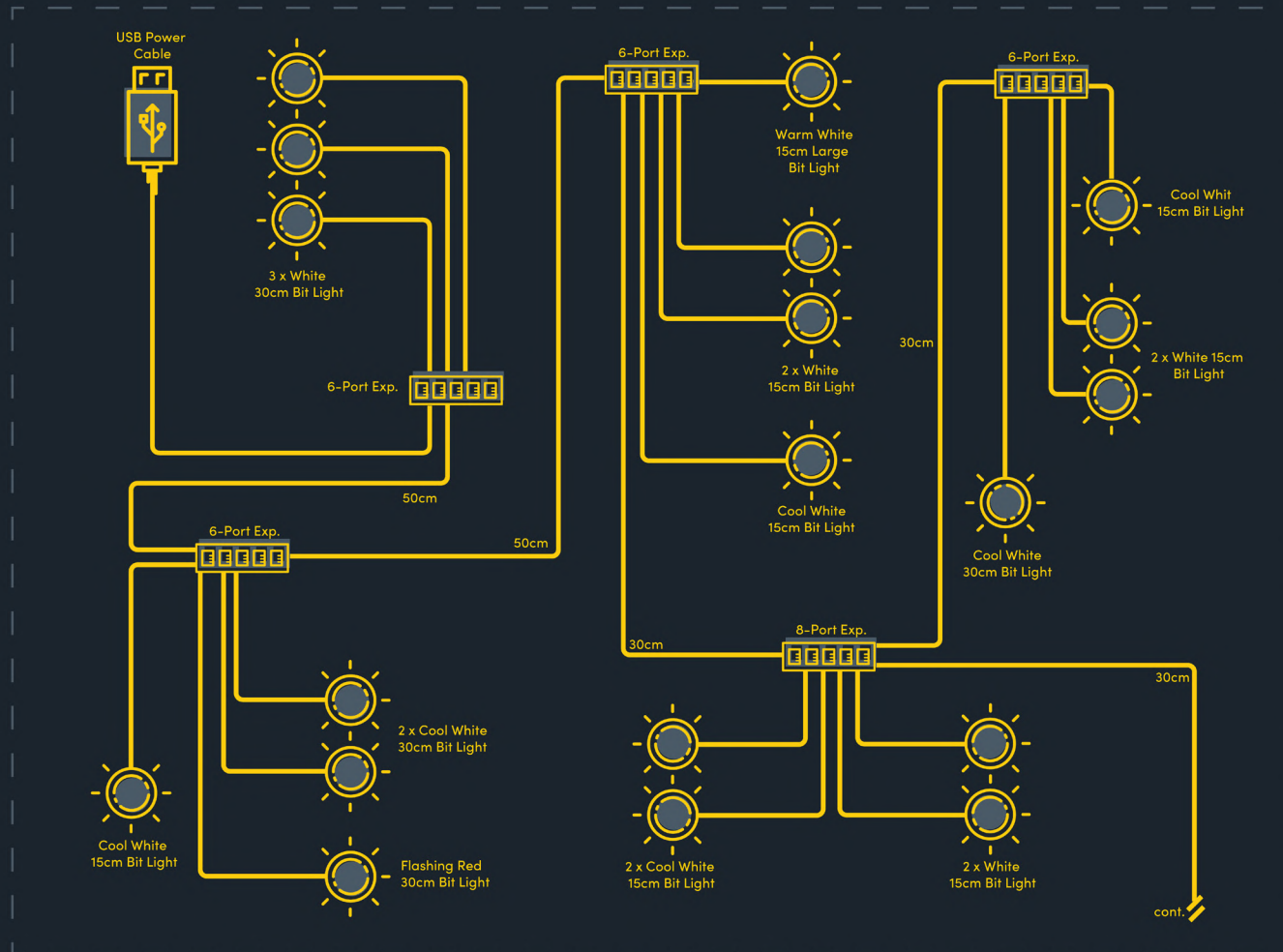



BLUEPRINT

Batmobile

Ramp/Garage & Right Section

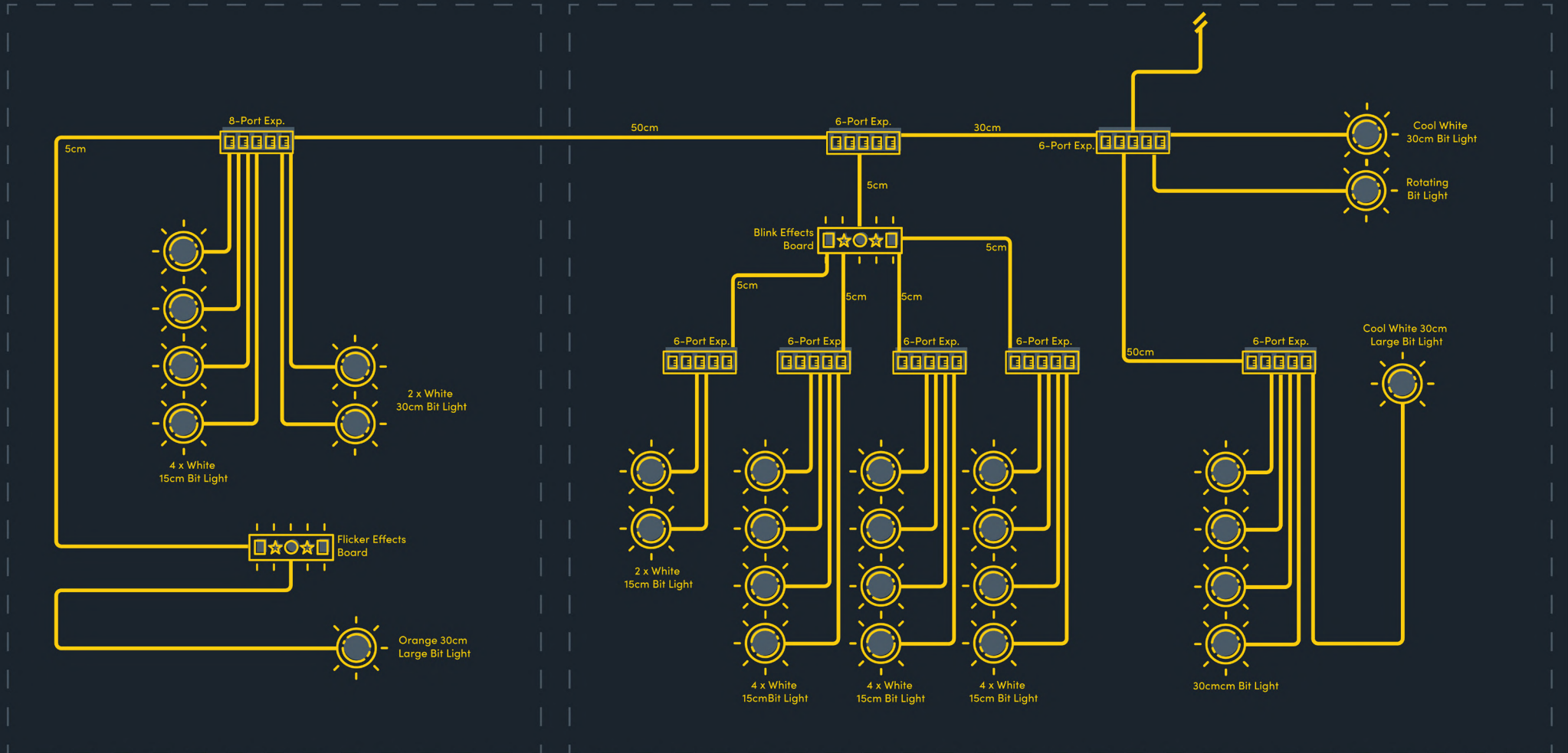



INSTRUCTIONS

To ensure a smooth installation of your light kit, please read and follow each step carefully. If you run into any issues, please refer to the online troubleshooting guide.

1

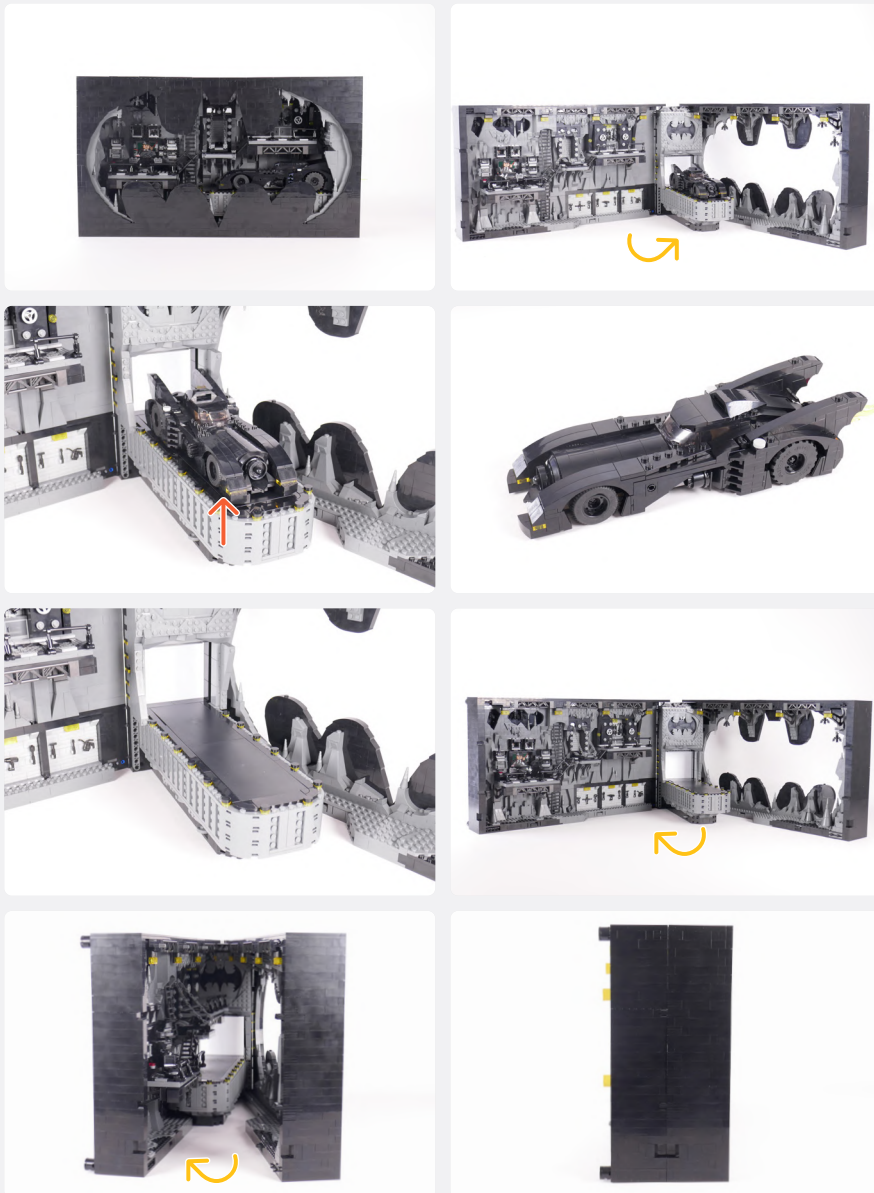

2

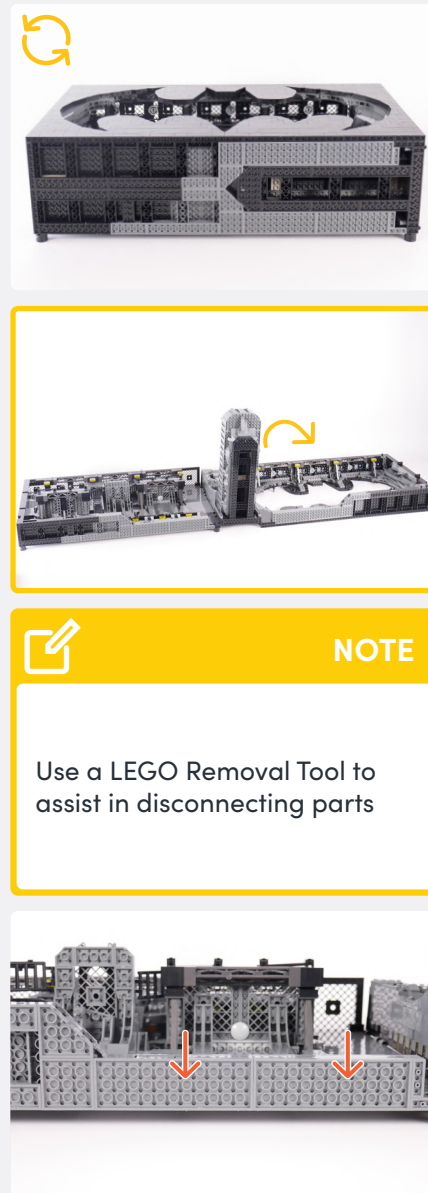

NOTE
Slowly and carefully open the set



NOTE
Use a LEGO Removal Tool to assist in disconnecting parts



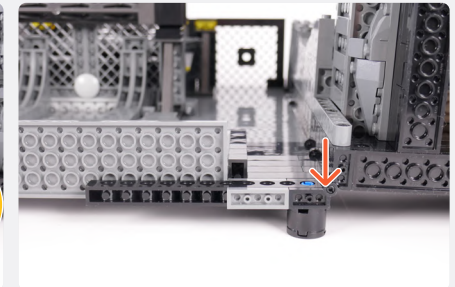
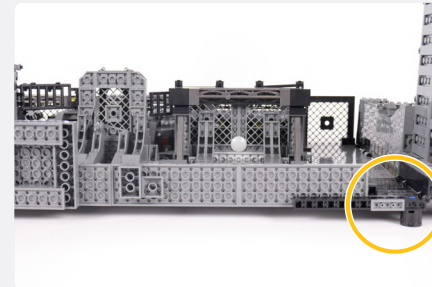
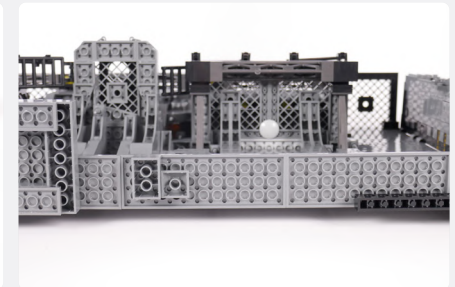
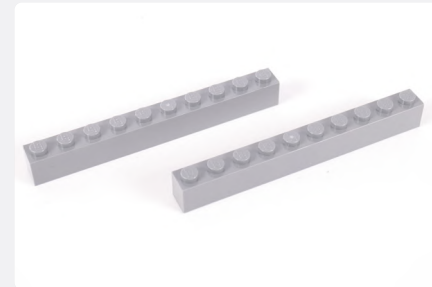
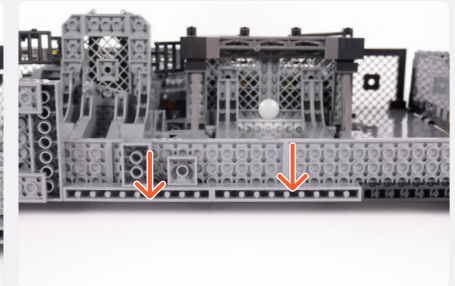
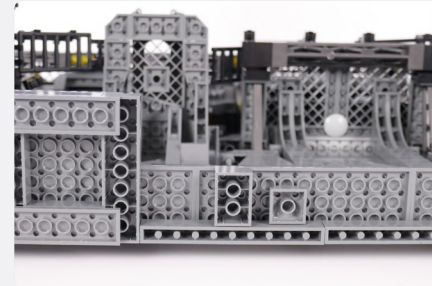
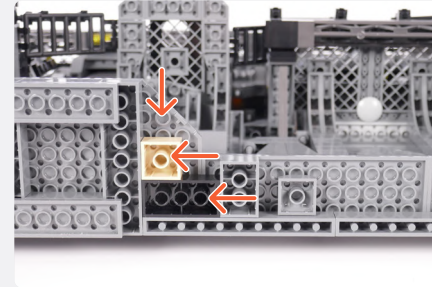
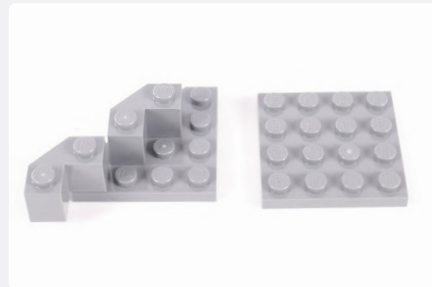
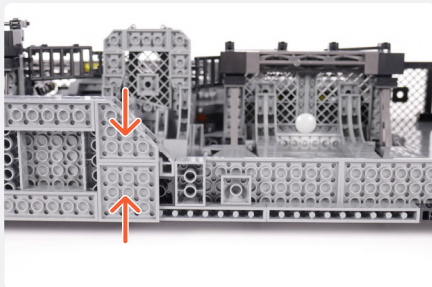
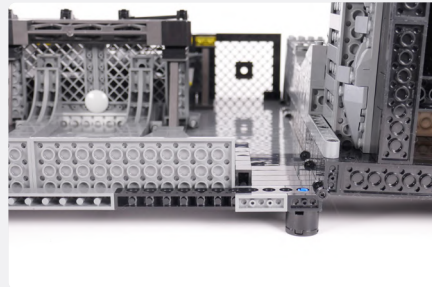
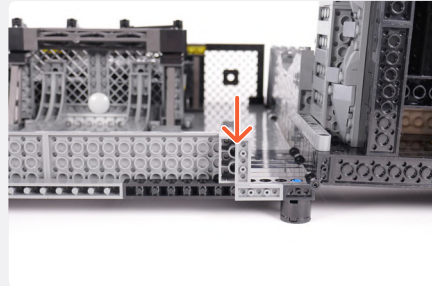
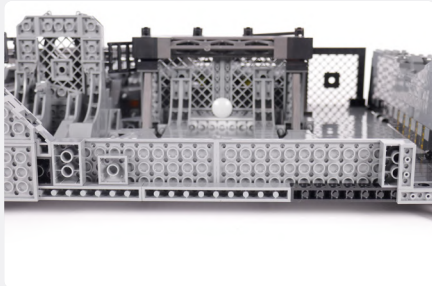
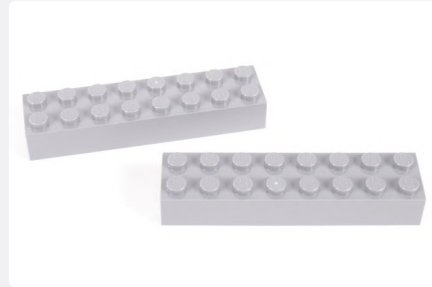
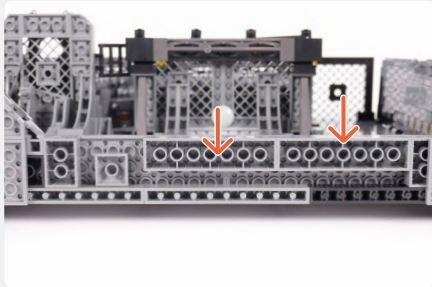

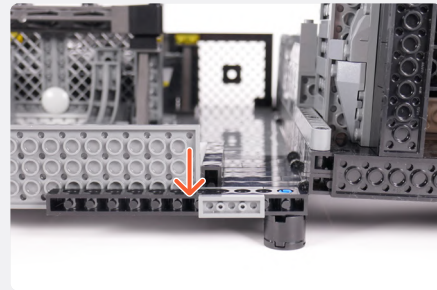

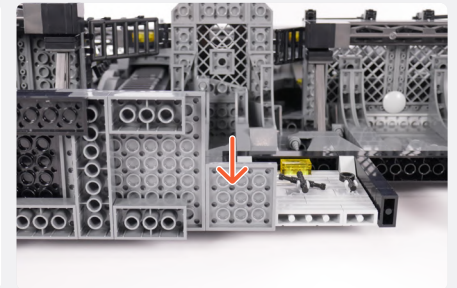
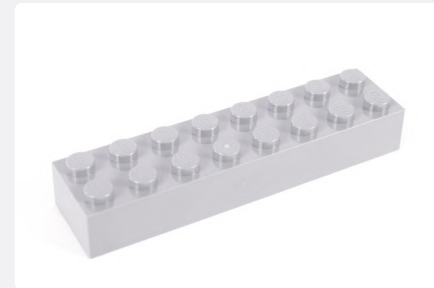
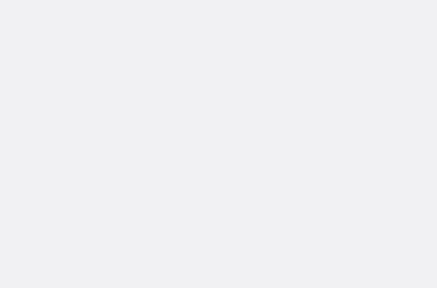
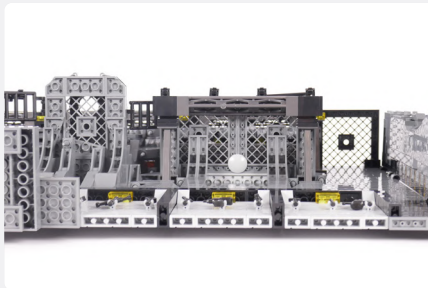
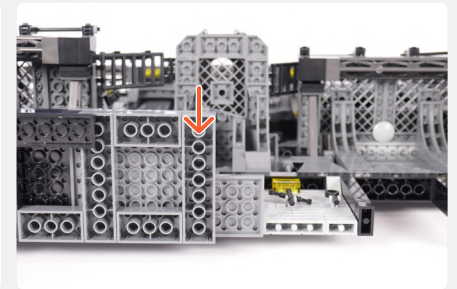
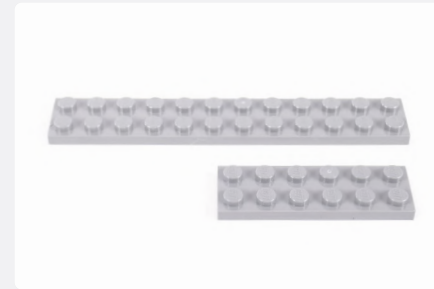
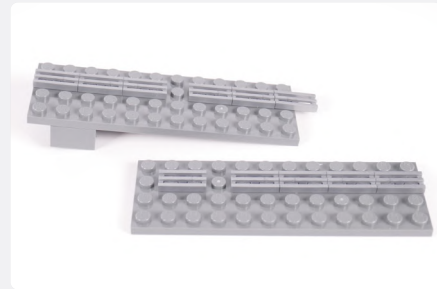
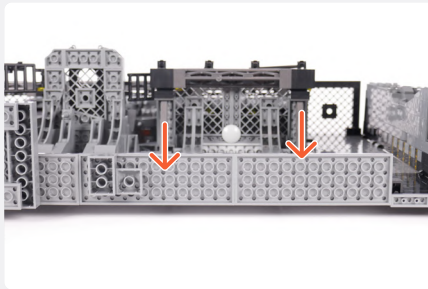
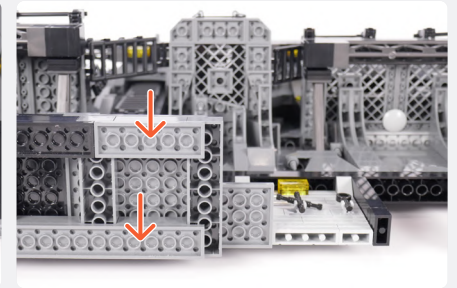
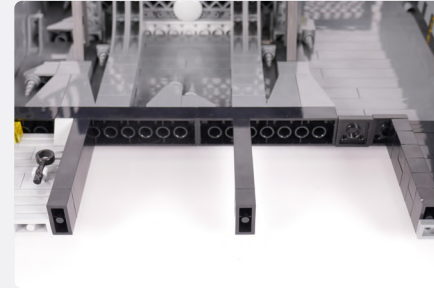
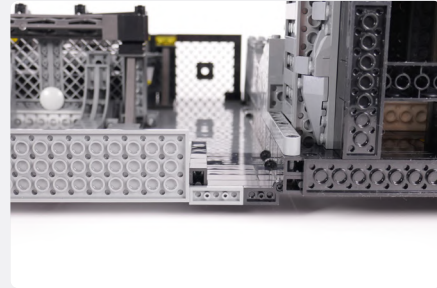
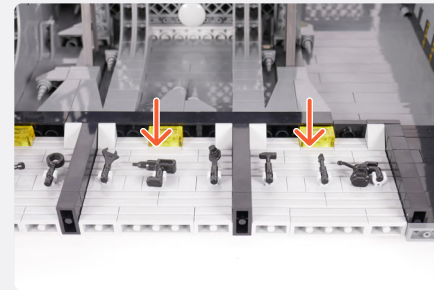

3

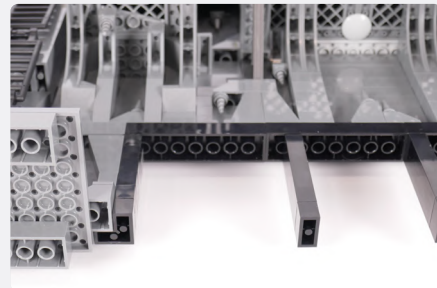
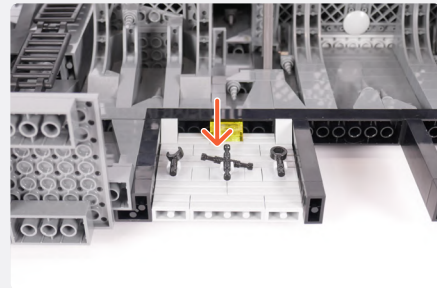

4



White 30cm Bit Light

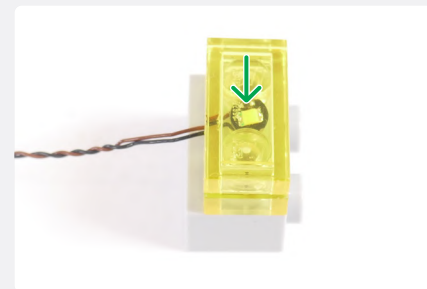
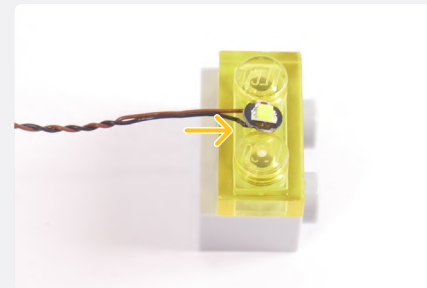

NOTE

Run the cable across the bottom exactly as shown

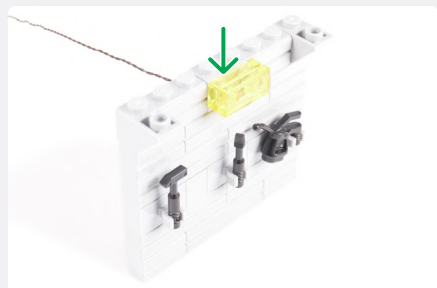
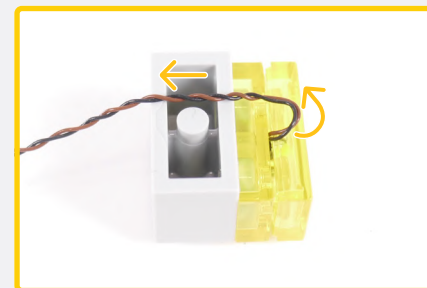

5

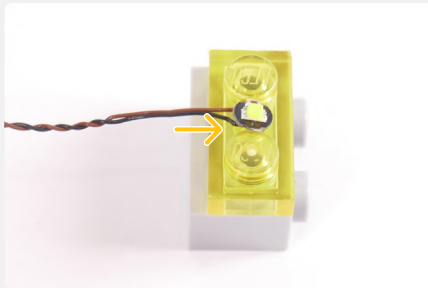

6

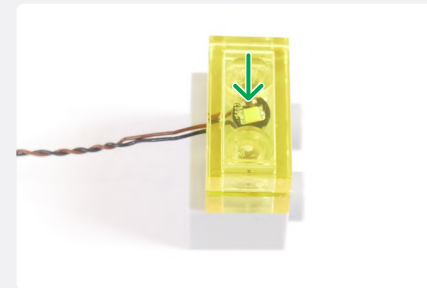

NOTE

Run the cable across the bottom exactly as shown

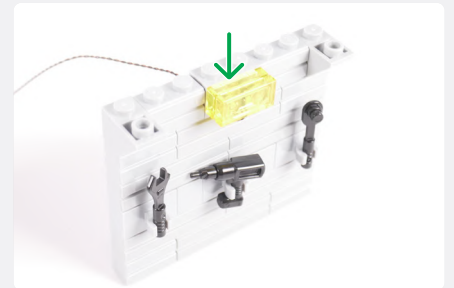
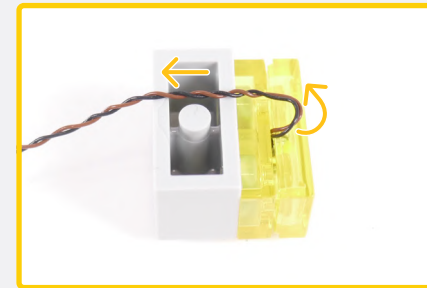



White 30cm Bit Light

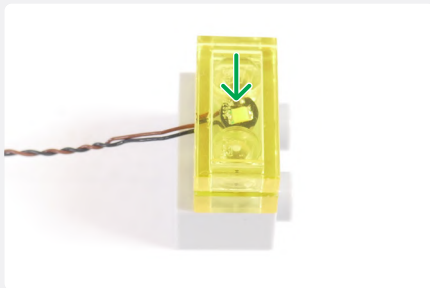
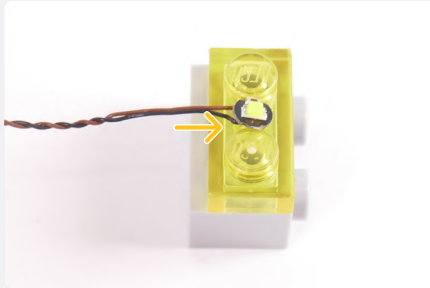

NOTE

Run the cable across the bottom exactly as shown

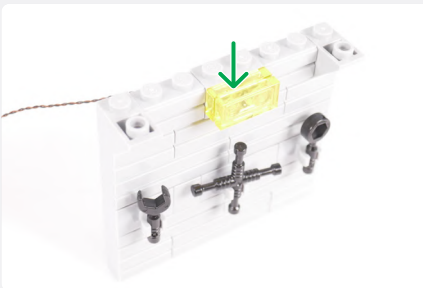
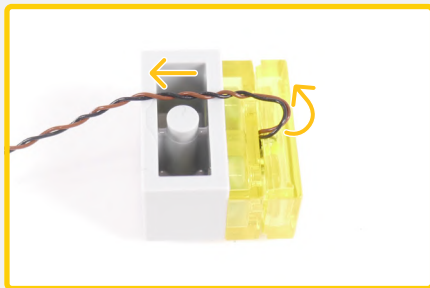

7

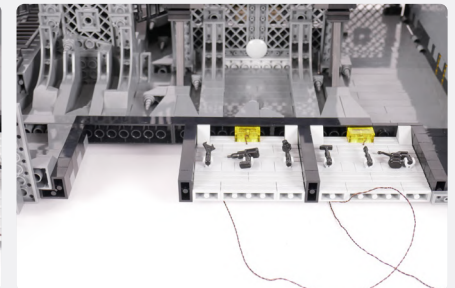
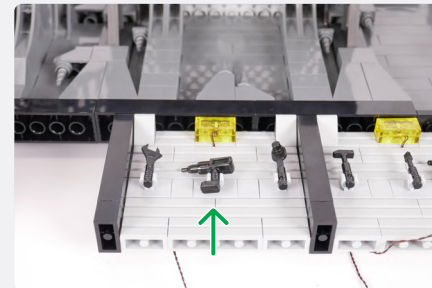
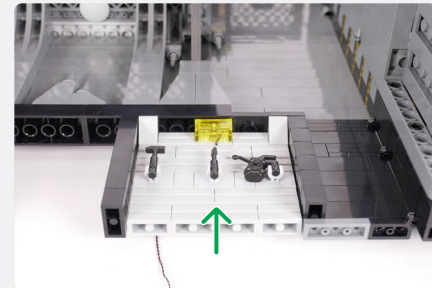
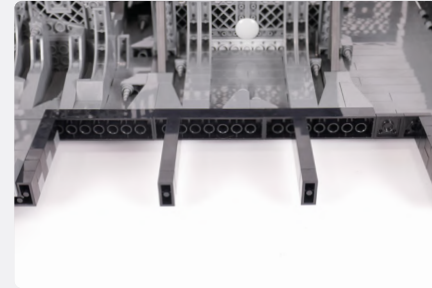

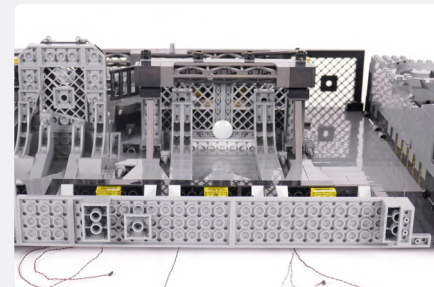
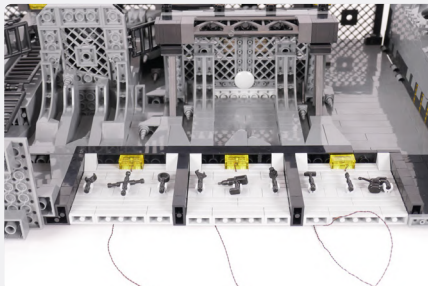
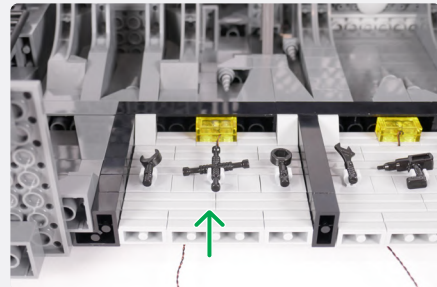
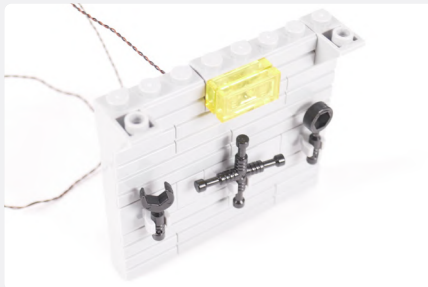

NOTE

Slightly lift the set from the left side as shown to reconnect the Technic Bar

8

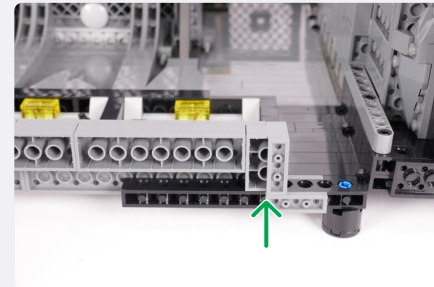
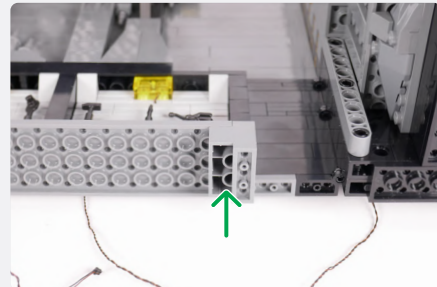
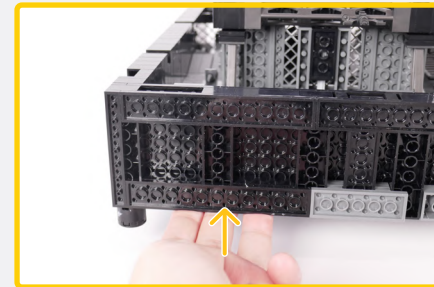
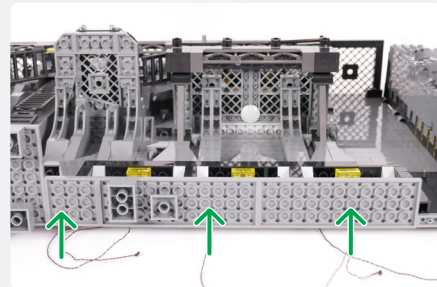

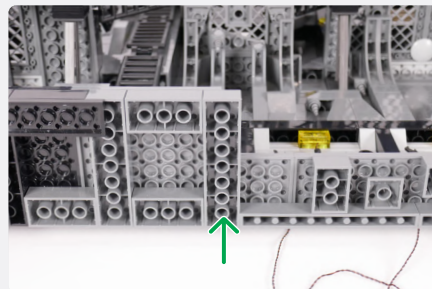
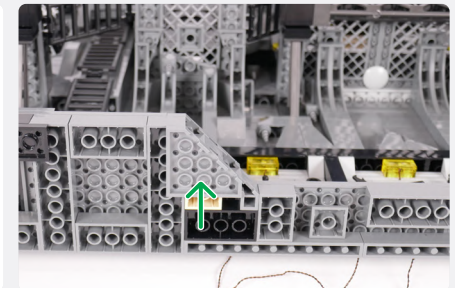
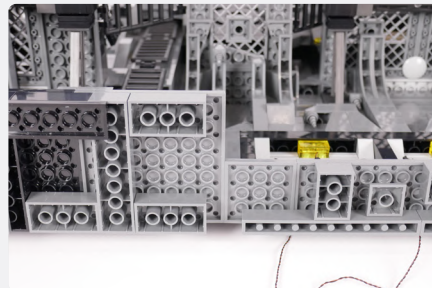
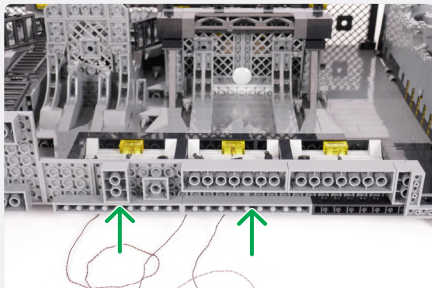
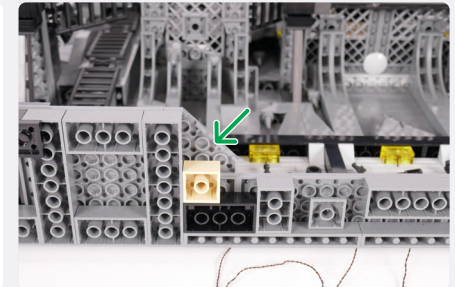
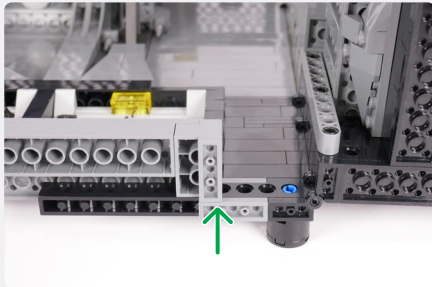

9

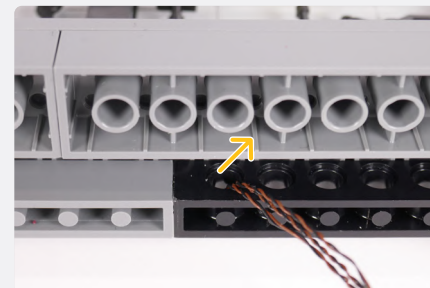
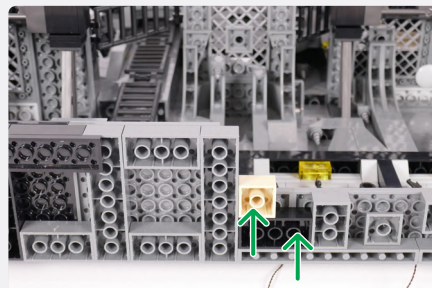
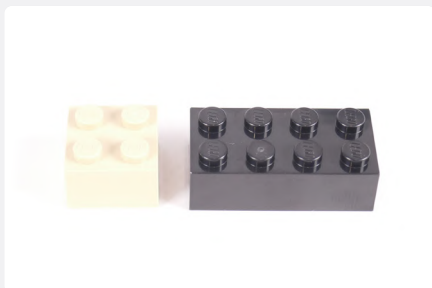
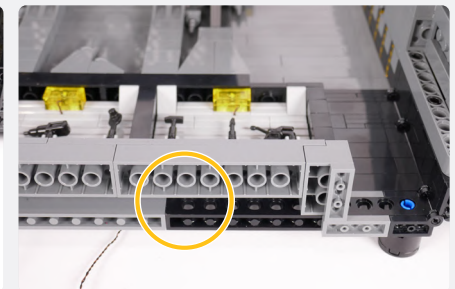
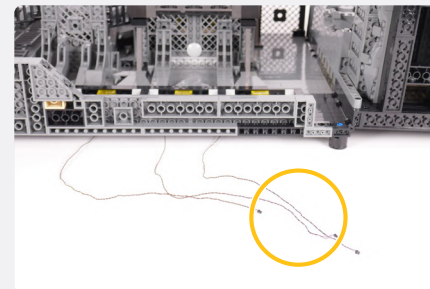

NOTE

If you are having trouble threading the cables through the Technic hole, temporarily disconnect the following Brick to allow for more space

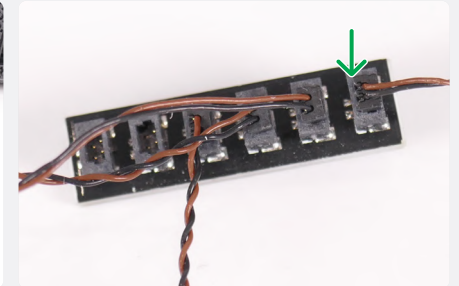
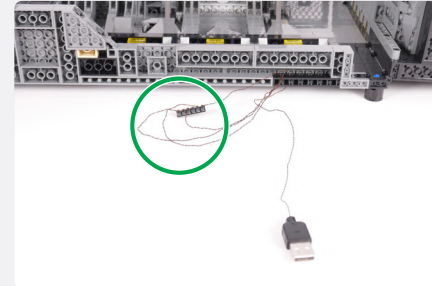
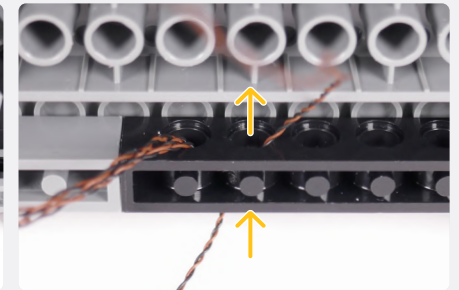
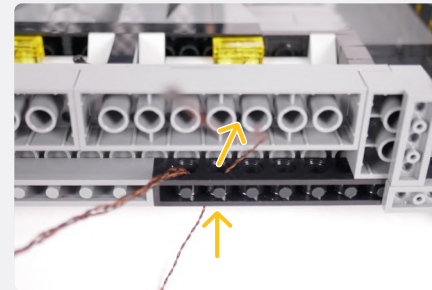
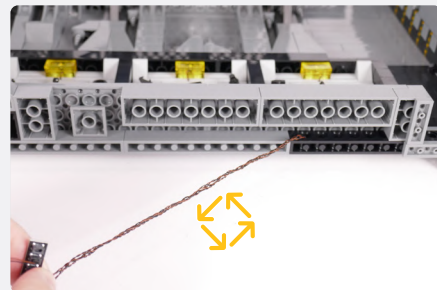
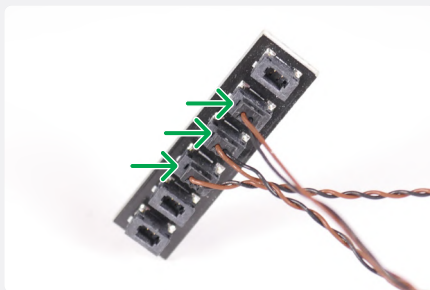
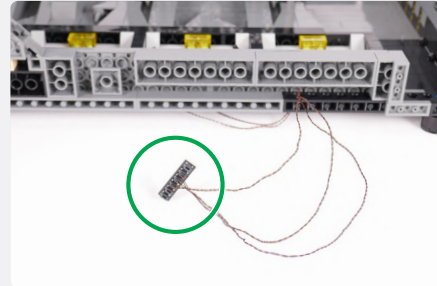
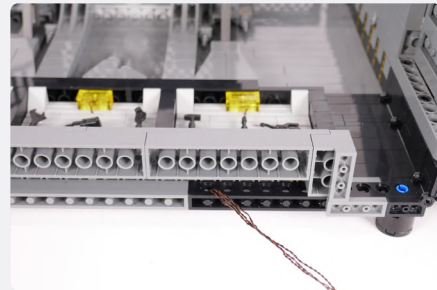
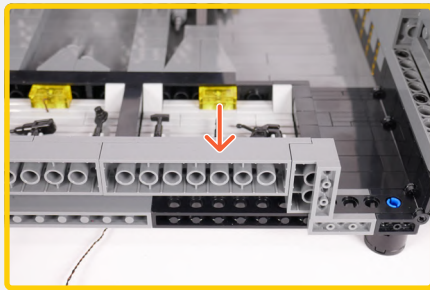

NOTE

Hold the Expansion Board in the following position before twisting the cables together (excluding the USB Power Cable)

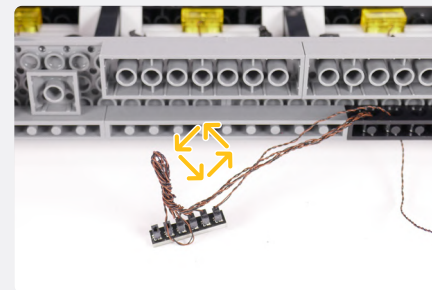
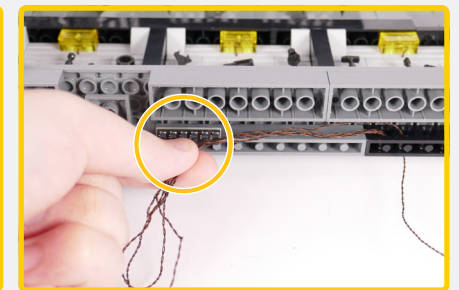

10

NOTE

Connect to a 5V USB Power Bank, 5V USB Wall Adaptor, or USB to AA Battery Pack (sold separately)

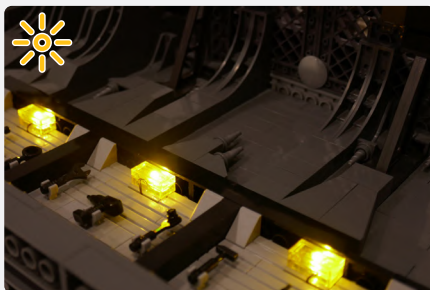

! If you experience any issues with the lights not working and suspect an issue with a component, please try a different port on the expansion board to verify where the fault lies (with the light or expansion board). To correct any issues with expansion board ports, please view the section addressing expansion board issues in our troubleshooting section.

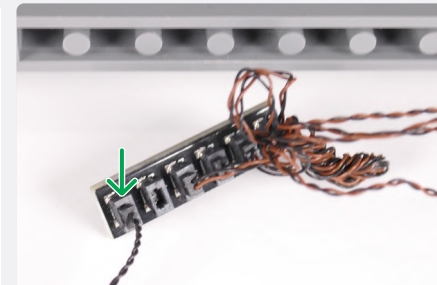
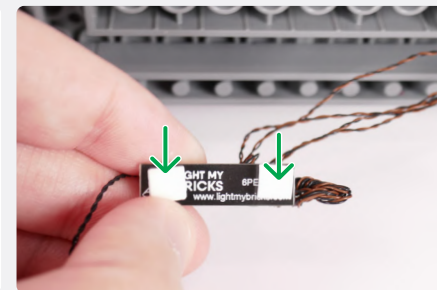
11
50cm Connecting Cable

2x Adhesive Square

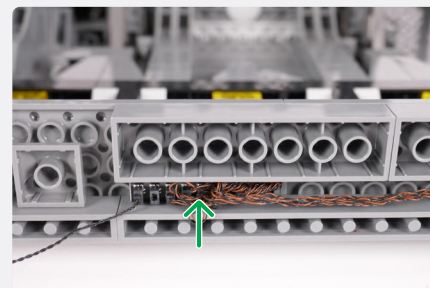
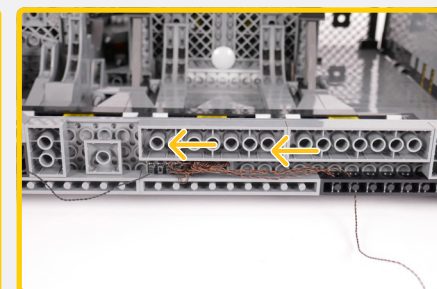
NOTE

Pull and twist the cables from the right to left

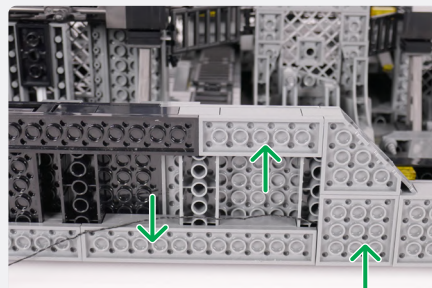
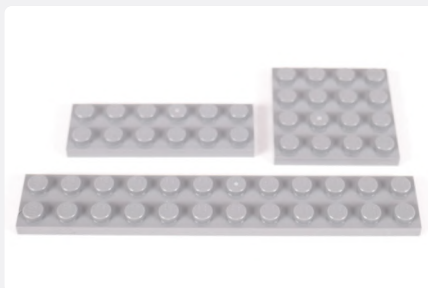
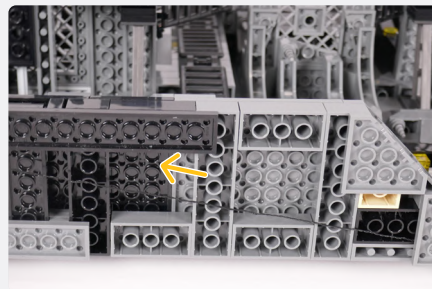
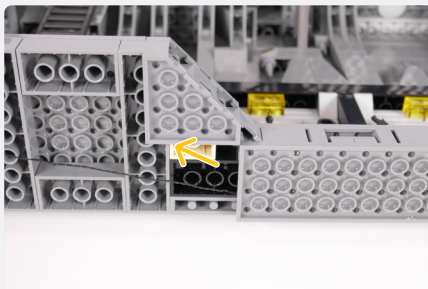
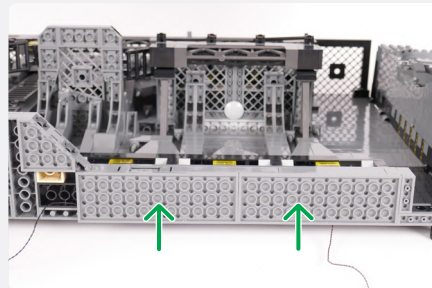
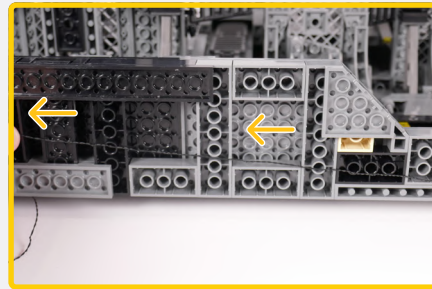
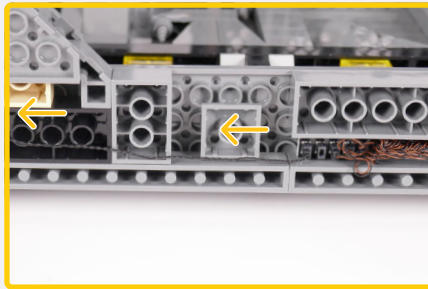

NOTE

Pull the 50cm Connecting Cable to the far left side

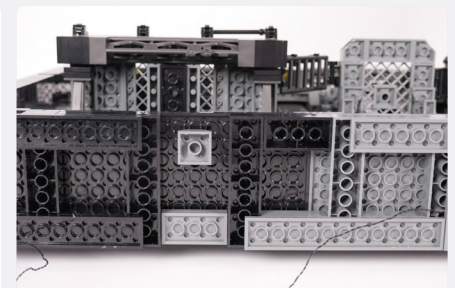
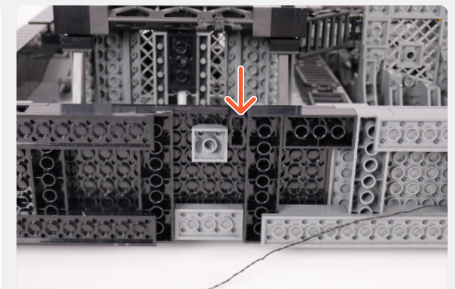
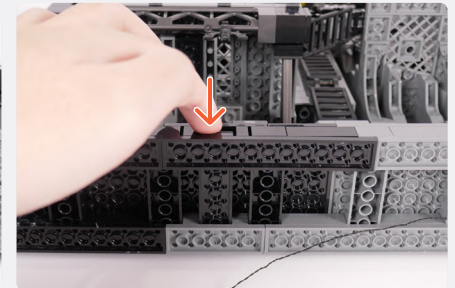
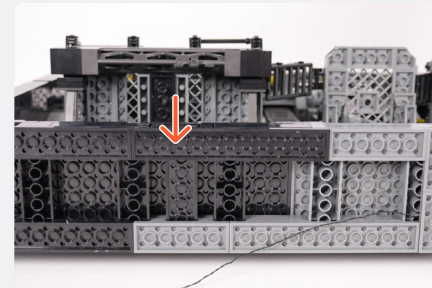
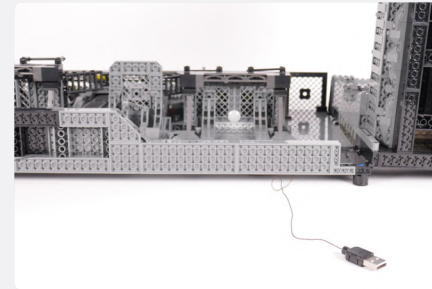

12

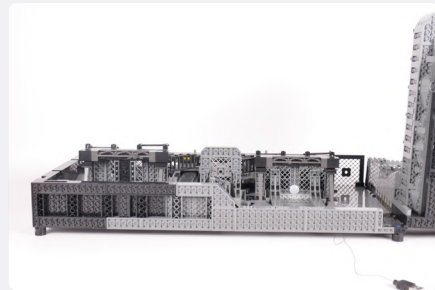
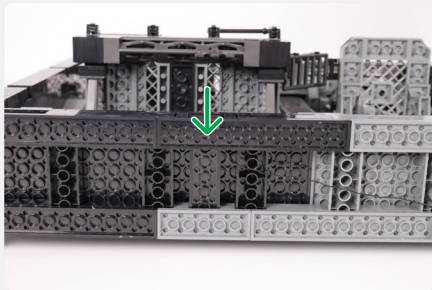
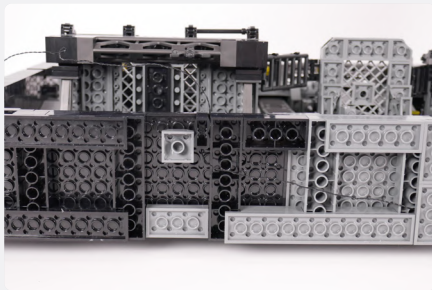
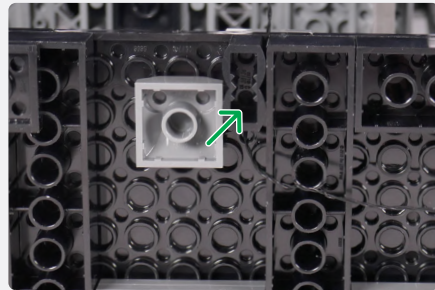
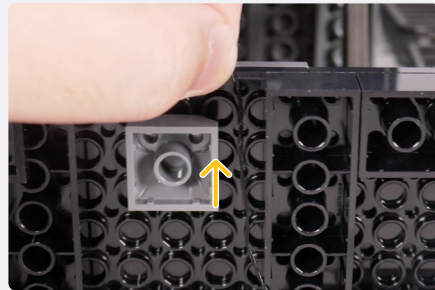
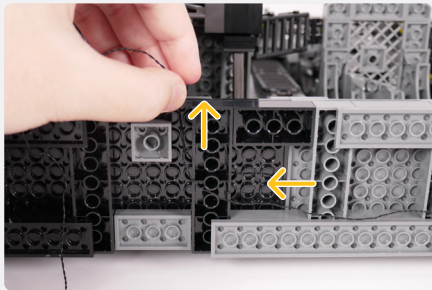



 **NOTE**

Slowly and carefully close the set

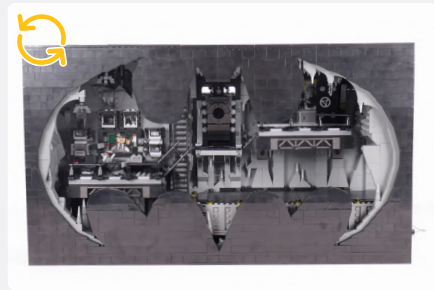
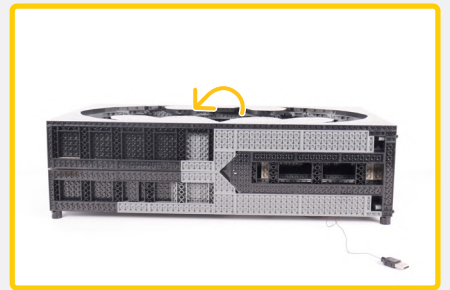

13

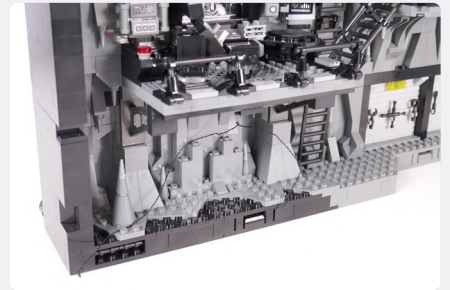
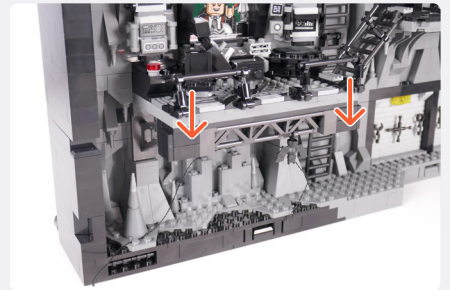
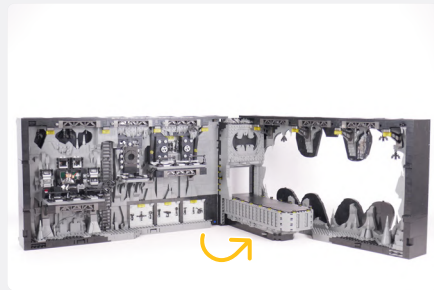

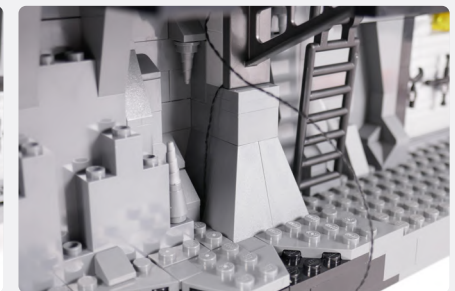
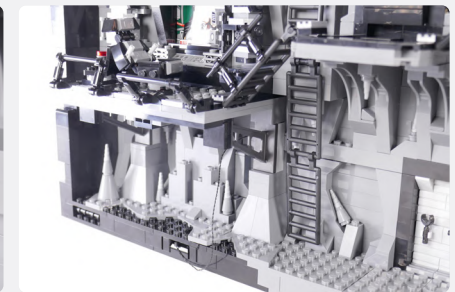
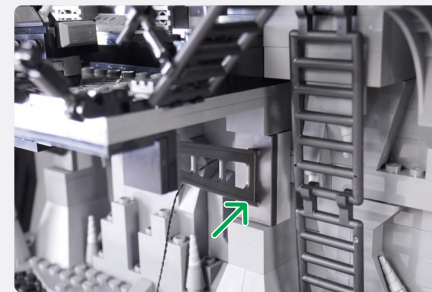
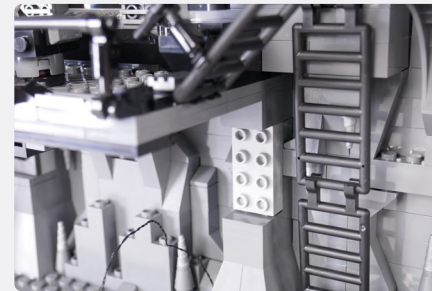
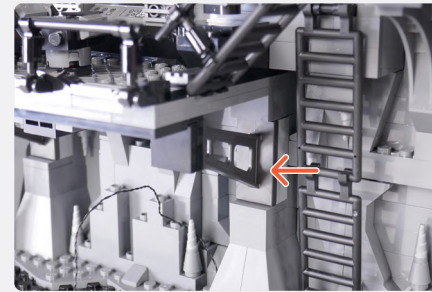
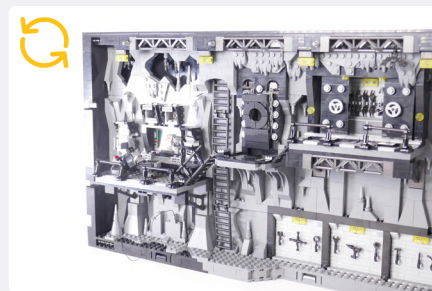
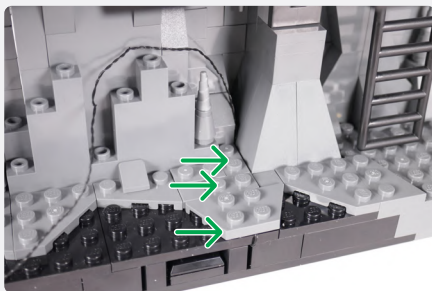
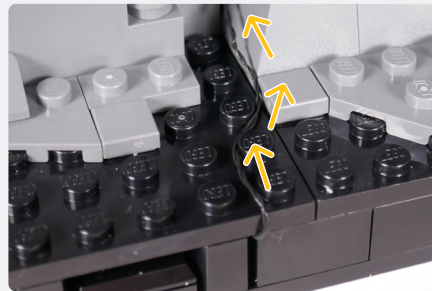
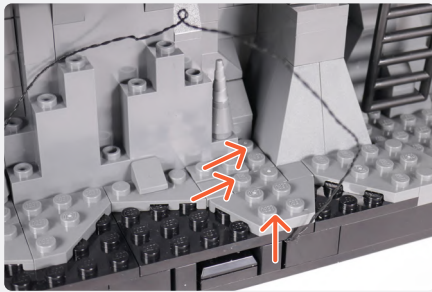

6-Port Expansion Board

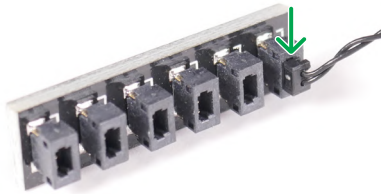
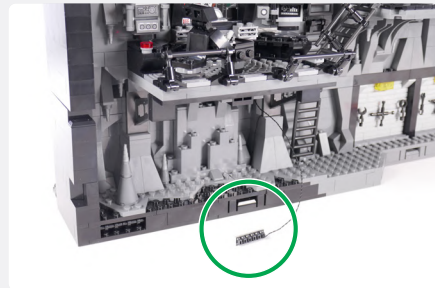

14

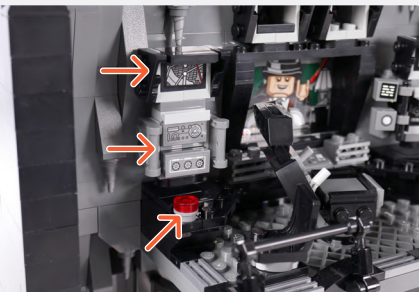

15

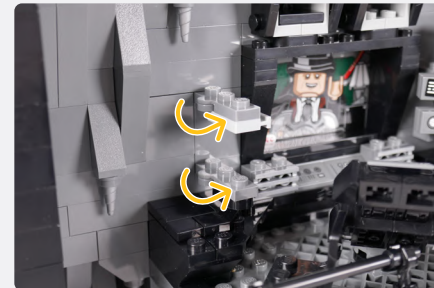

Flashing Red 30cm Bit Light



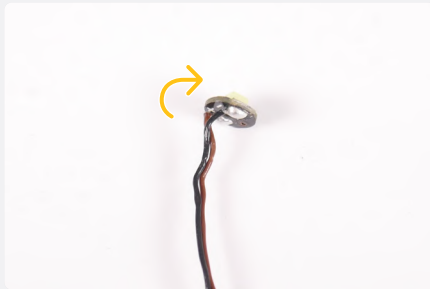

Plate, Round 1x1 - Trans-Red

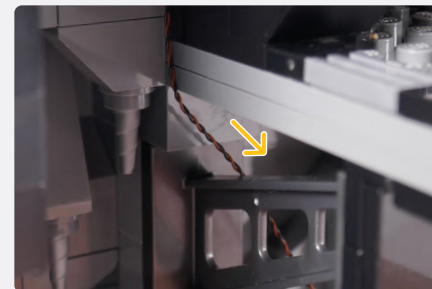
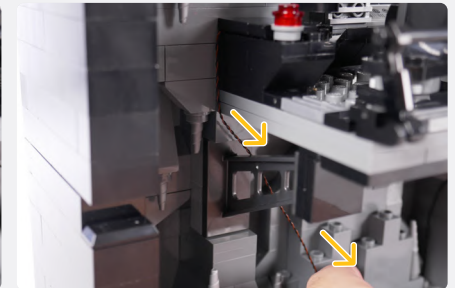
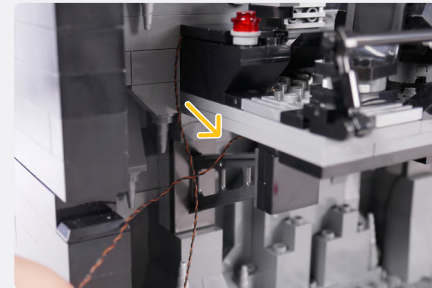
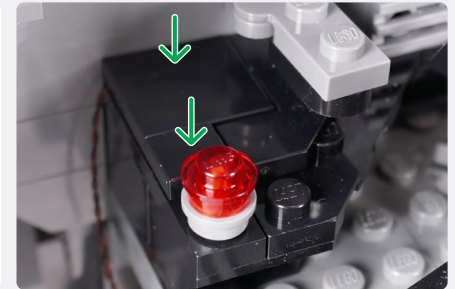
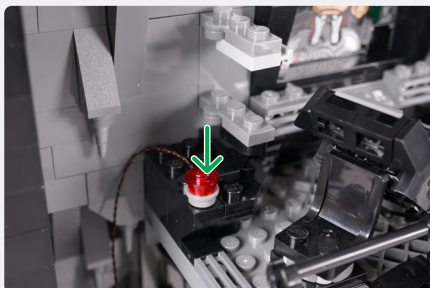
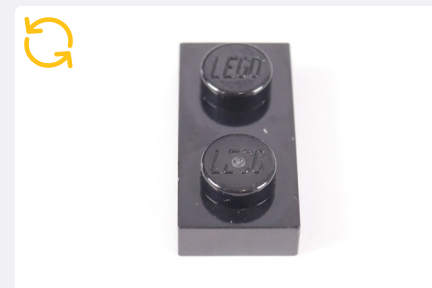
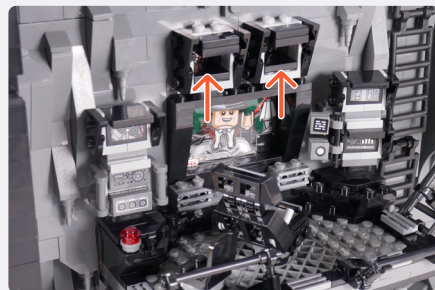
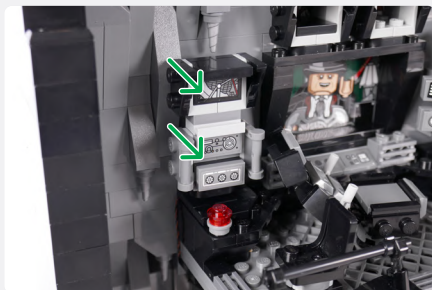
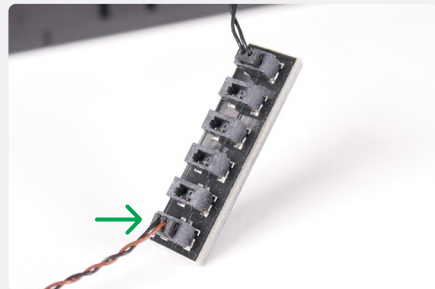
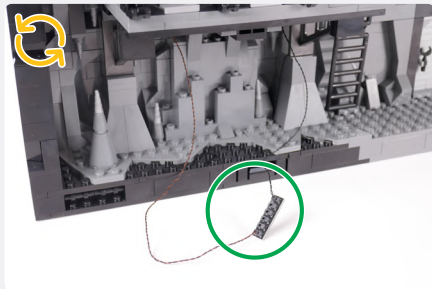
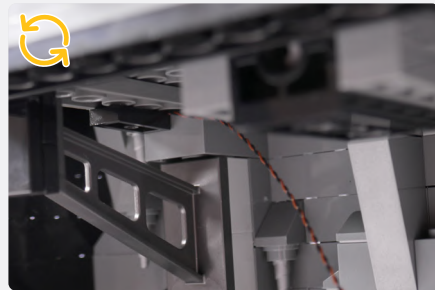
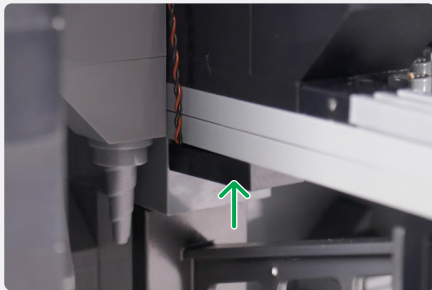

Plate 1x2 - Black





16

17

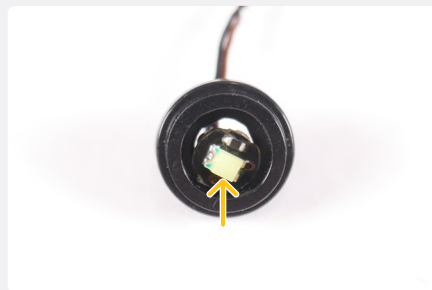
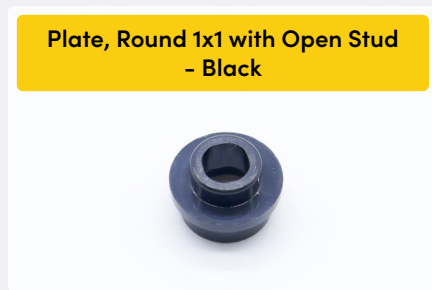
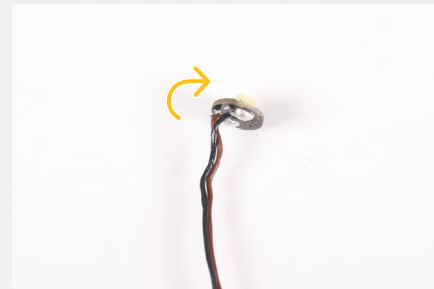

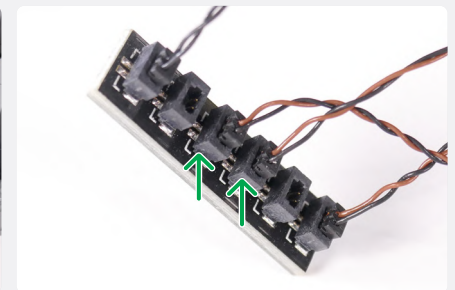
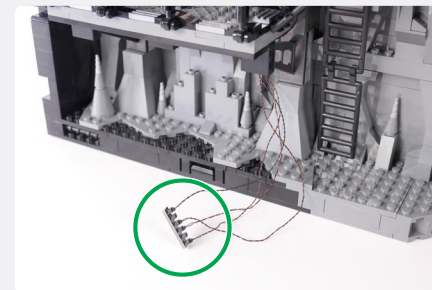
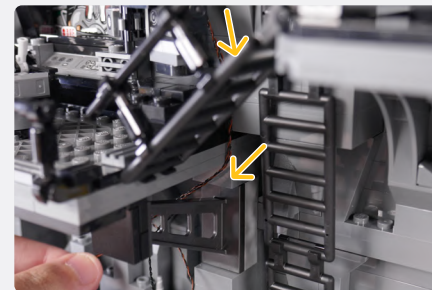
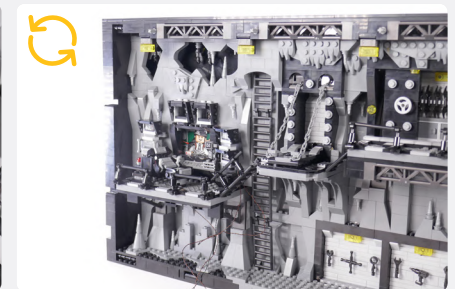
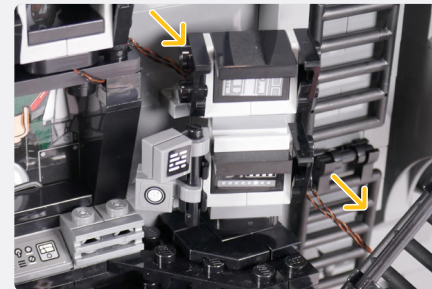
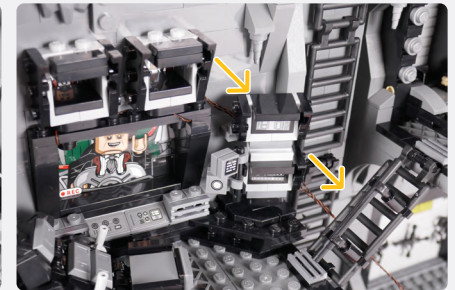
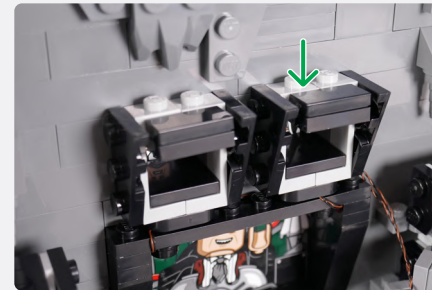
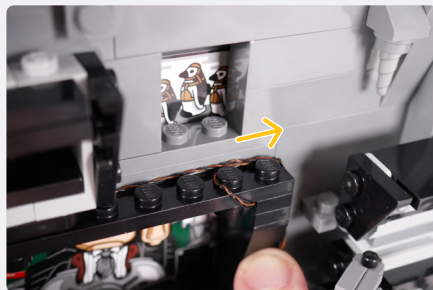
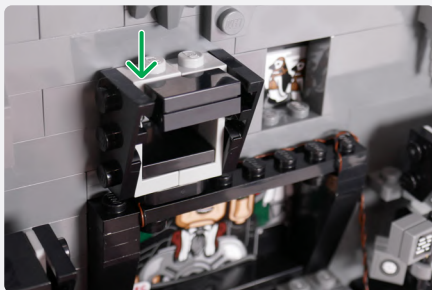
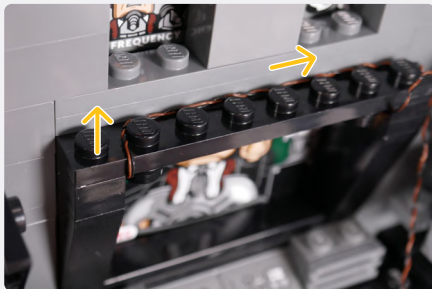
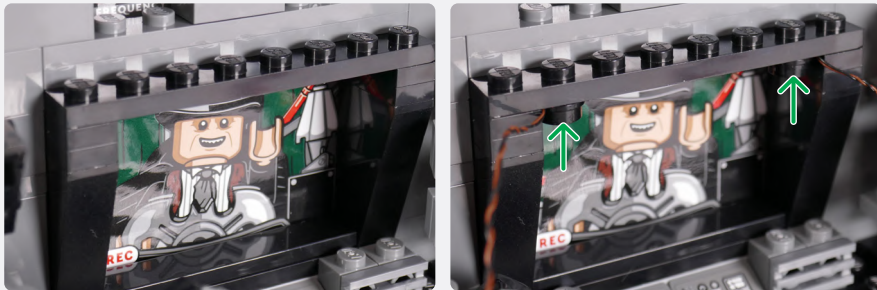

18

50cm Connecting Cable

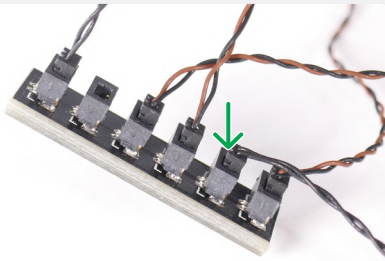
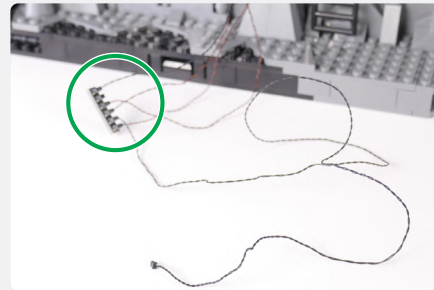

NOTE

Thread the 50cm Connecting Cable through the following gap

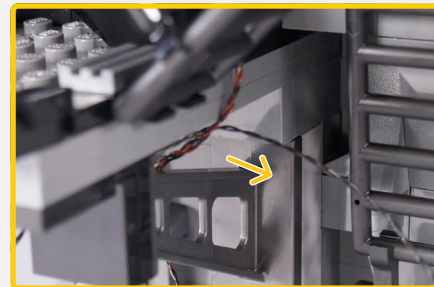
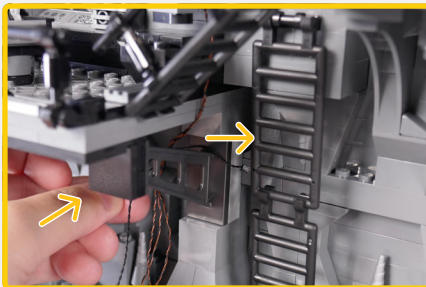

NOTE

Keep the Expansion Board in the following position as you thread the 50cm Connecting Cable

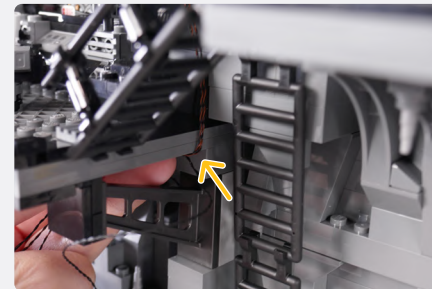
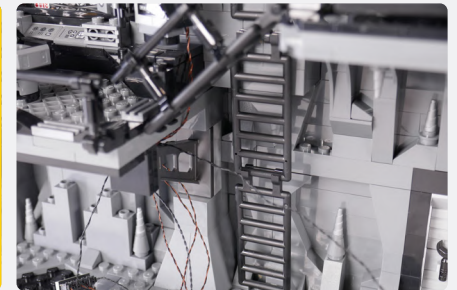
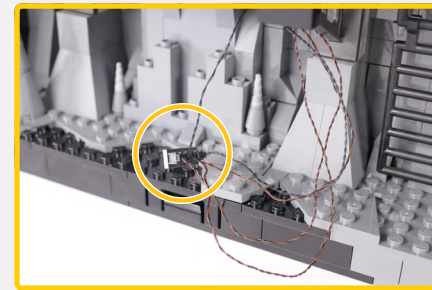
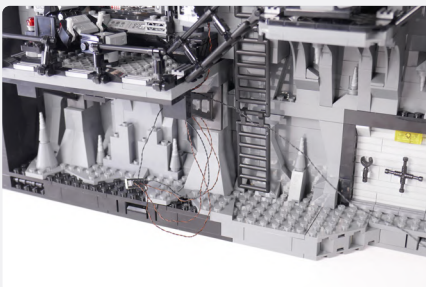
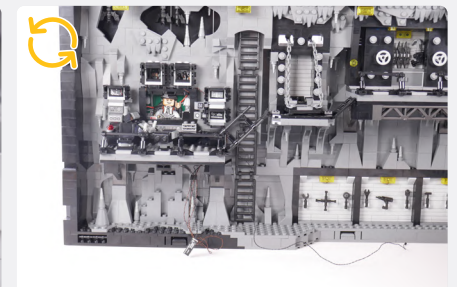
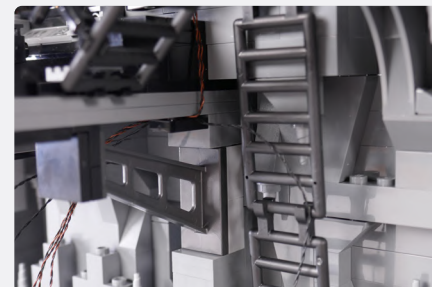
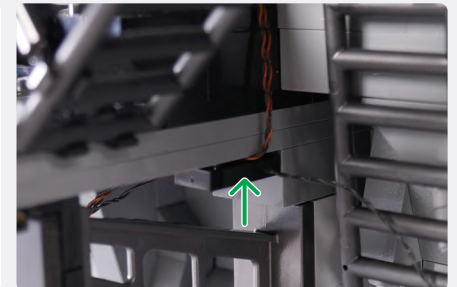

Plate 1x2 - Black



19

Cool White 15cm Bit Light



Plate, Round 1x1 with Open Stud - Black

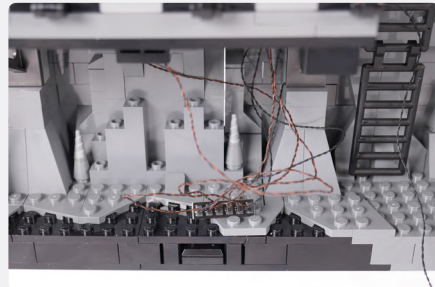
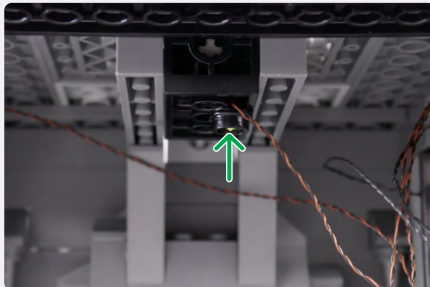
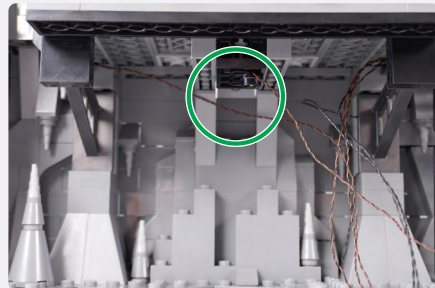
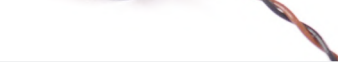

2x Adhesive Square

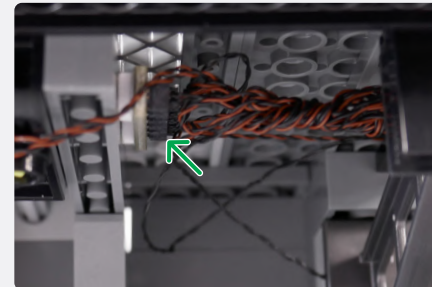
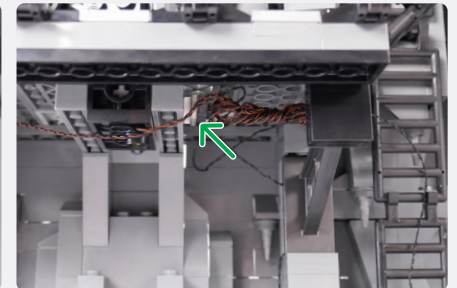
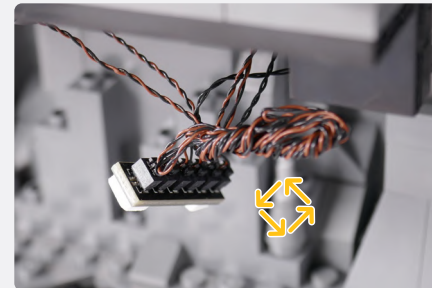
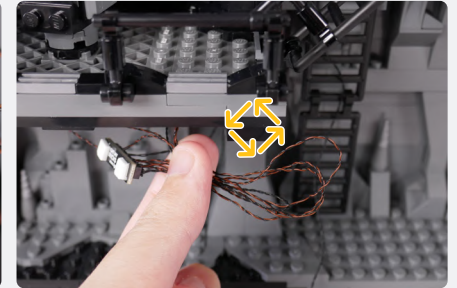
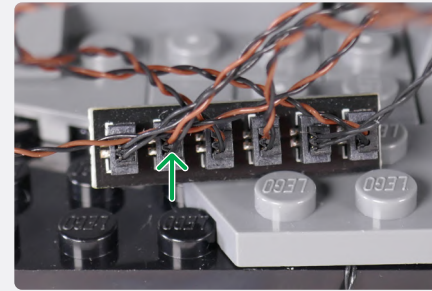

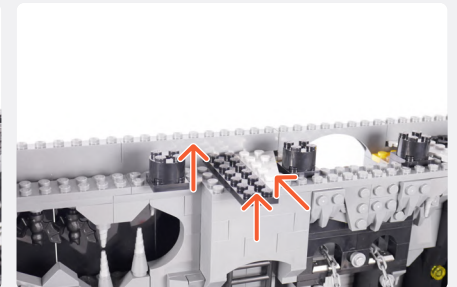
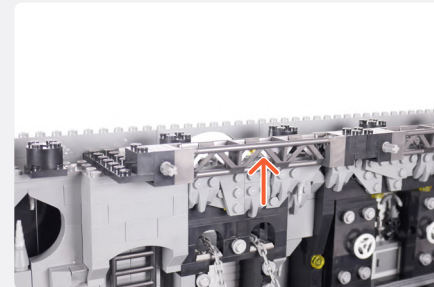
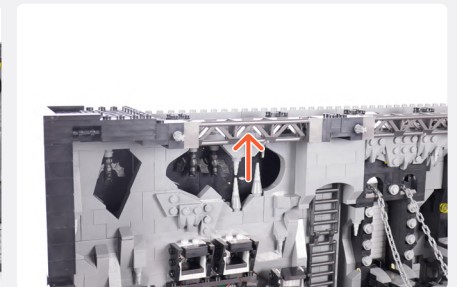
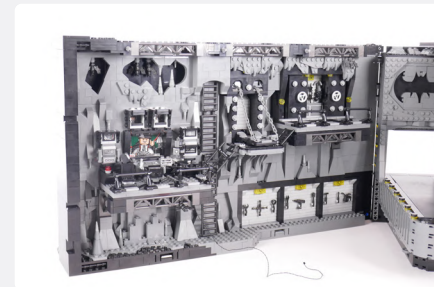
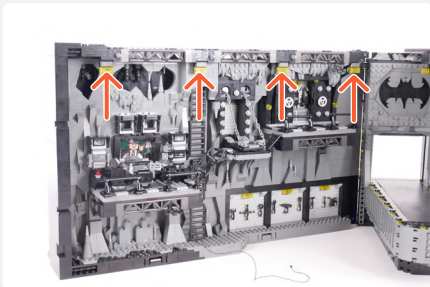
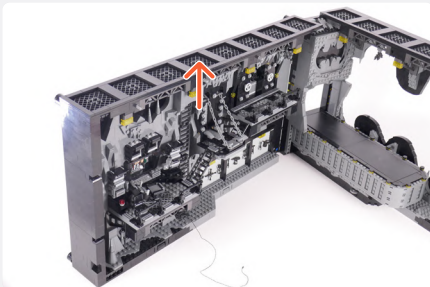
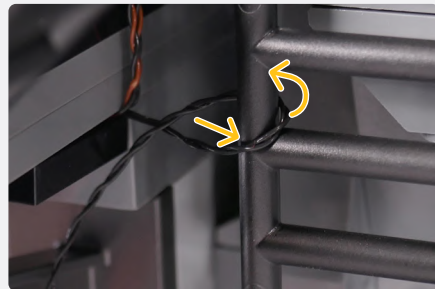
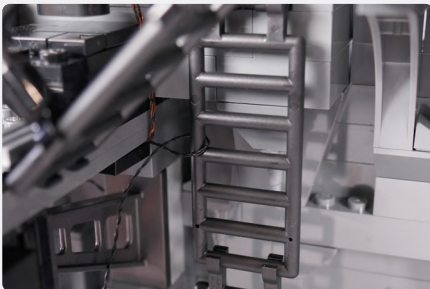
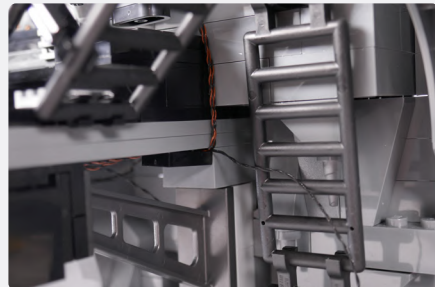
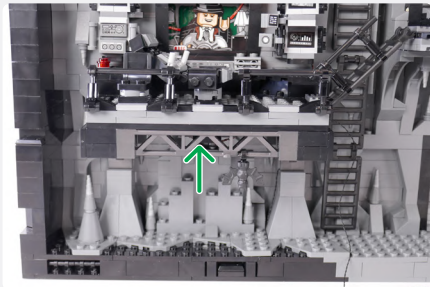

20

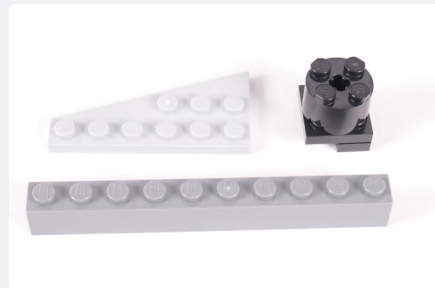
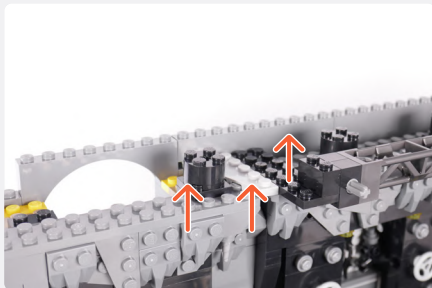
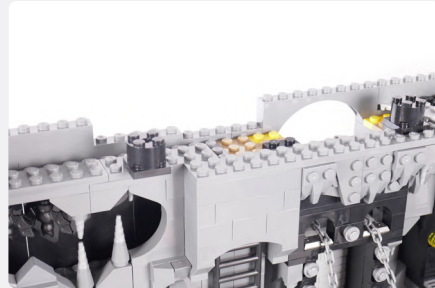
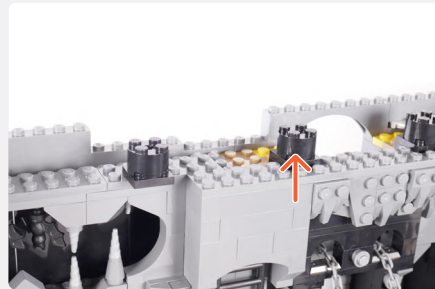

21

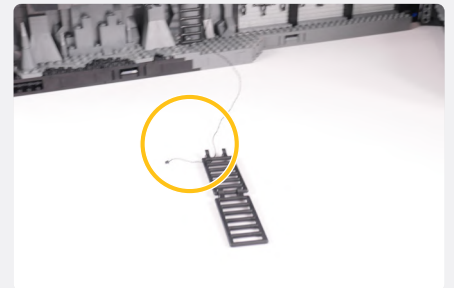
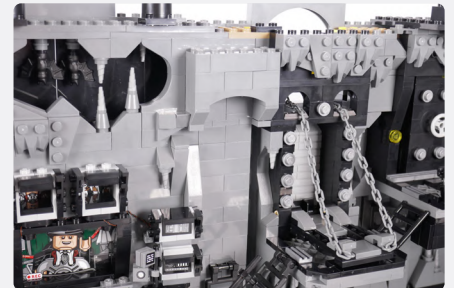
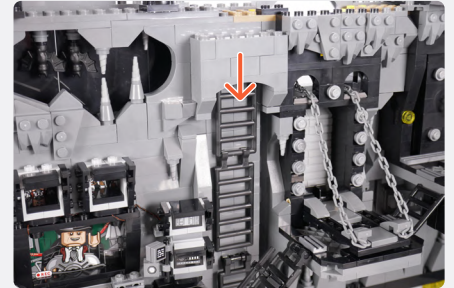
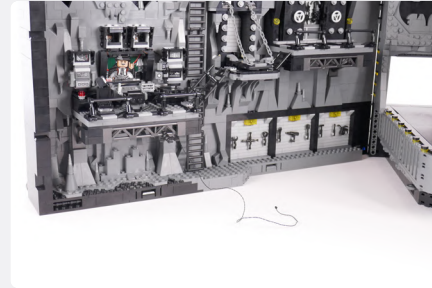

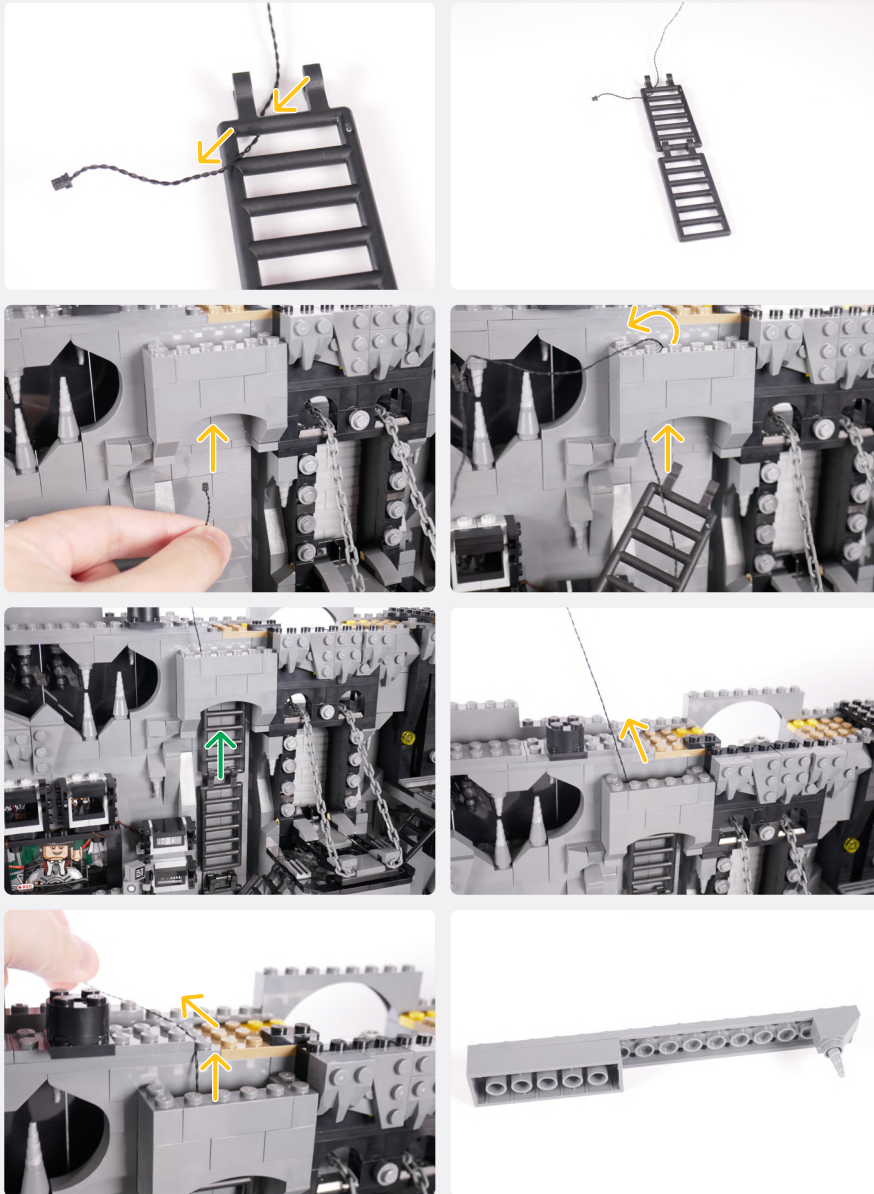

22

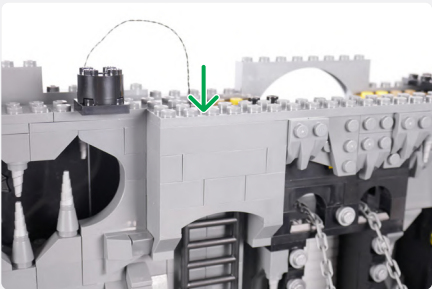

NOTE

Connect to a 5V USB Power Bank, 5V USB Wall Adaptor, or USB to AA Battery Pack (sold separately)



! If you experience any issues with the lights not working and suspect an issue with a component, please try a different port on the expansion board to verify where the fault lies (with the light or expansion board). To correct any issues with expansion board ports, please view the section addressing expansion board issues in our troubleshooting section.



6-Port Expansion Board

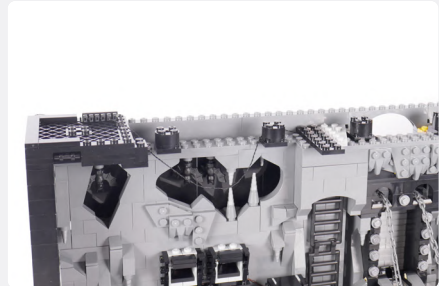
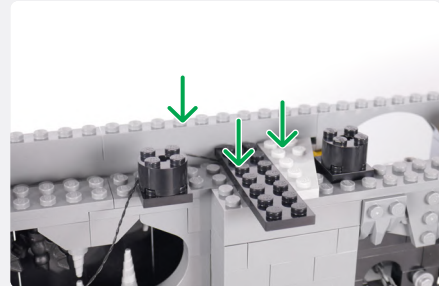
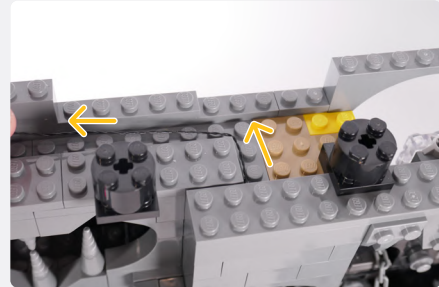
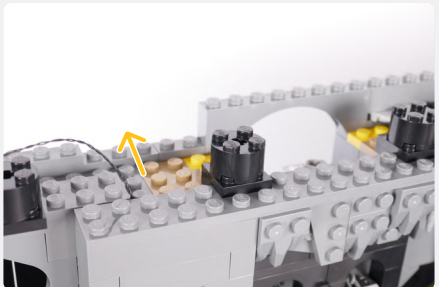
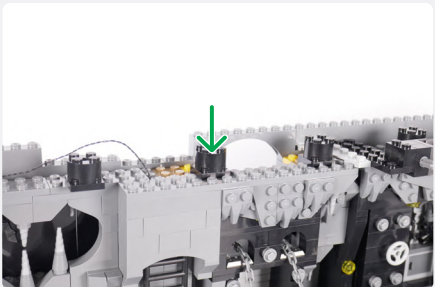
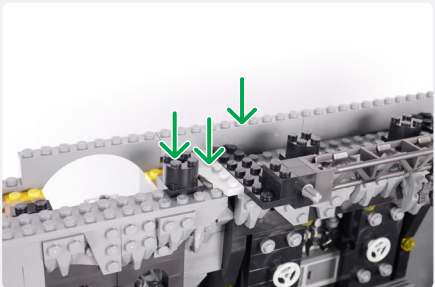
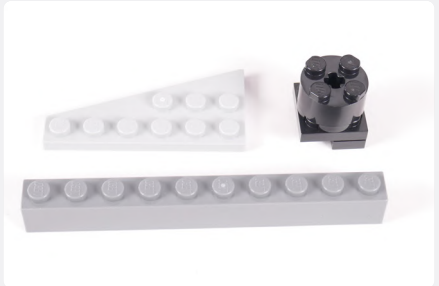
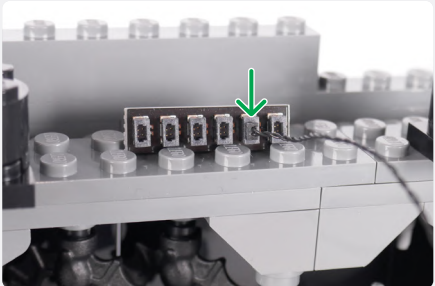
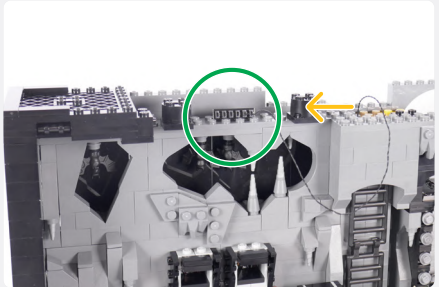
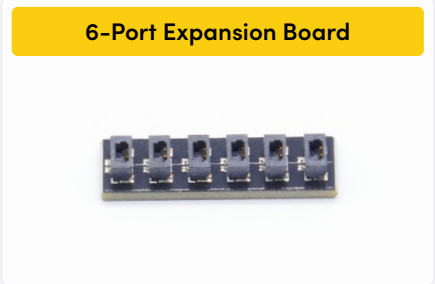

23



White 15cm Bit Light

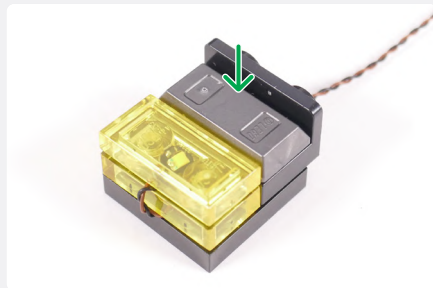
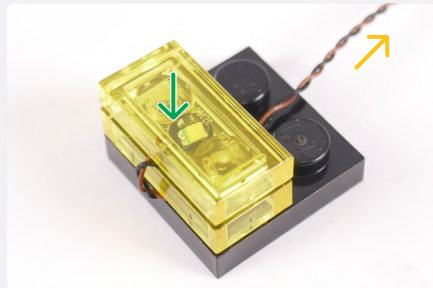
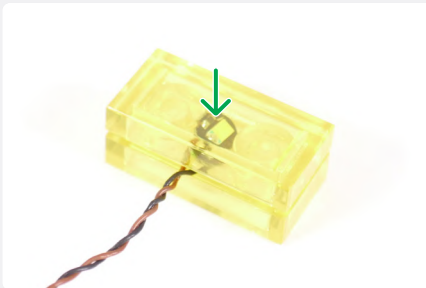

24

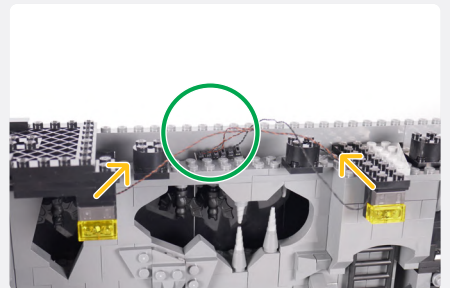
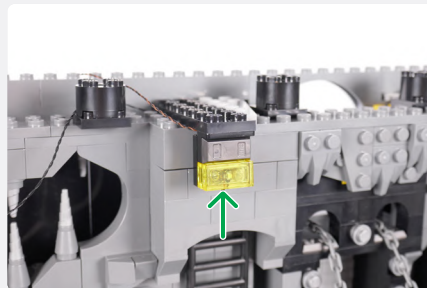
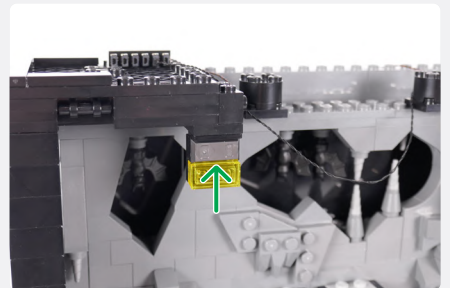
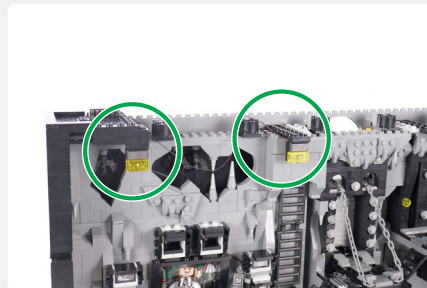
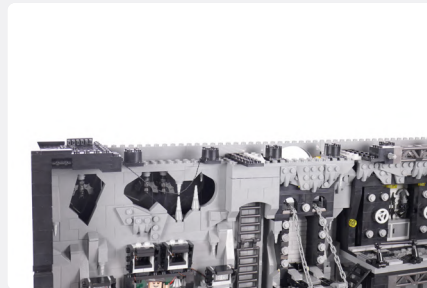

25

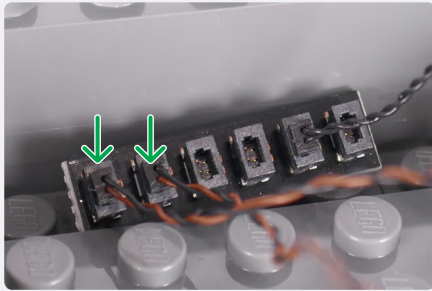

Cool White 15cm Bit Light



Plate, Round 1x1 with Open Stud - Black

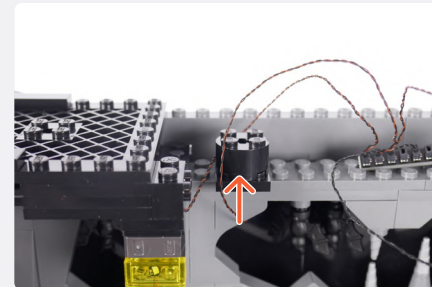
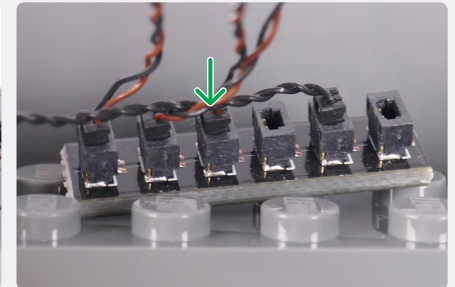
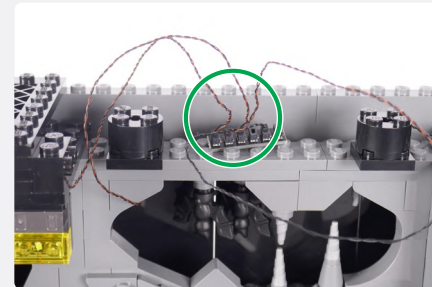
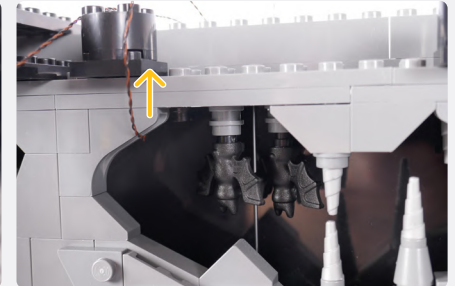
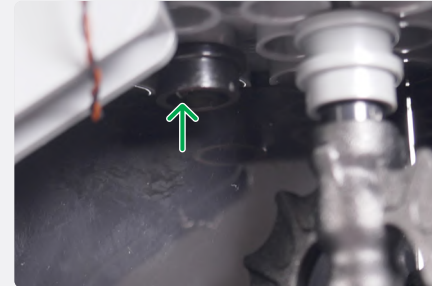
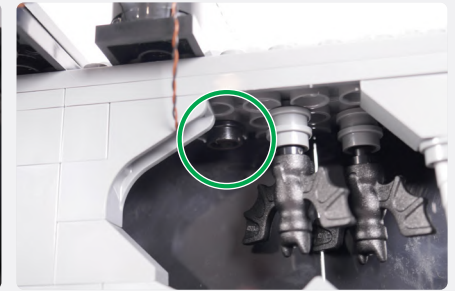
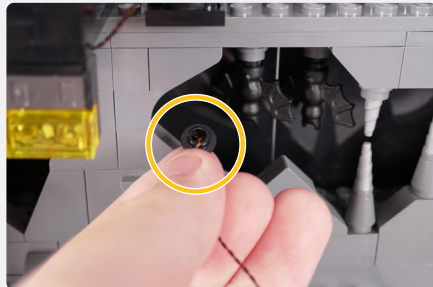
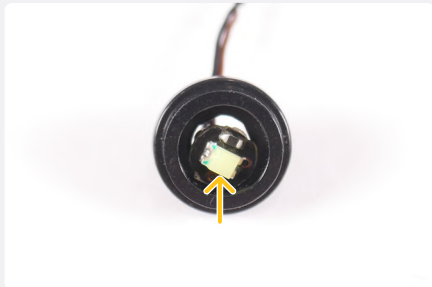

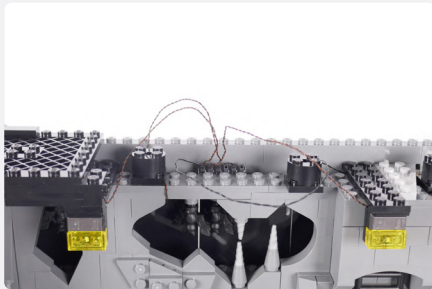
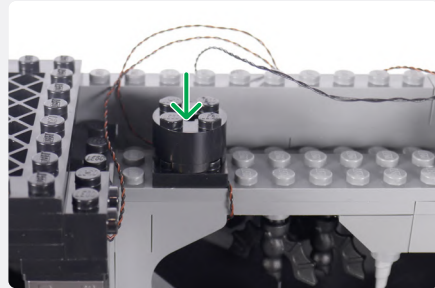
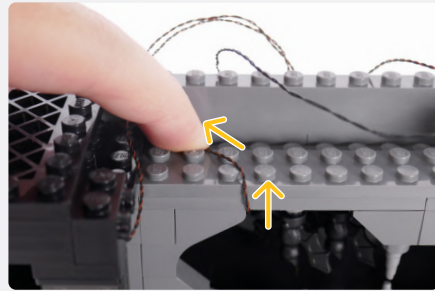
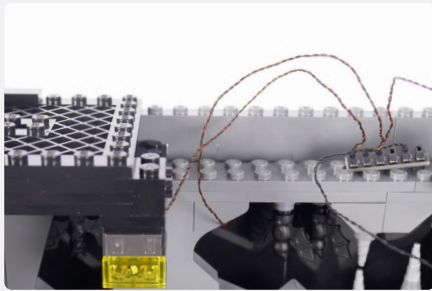

26

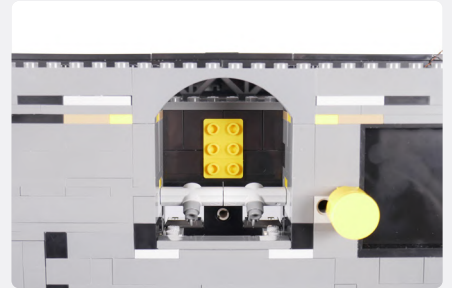
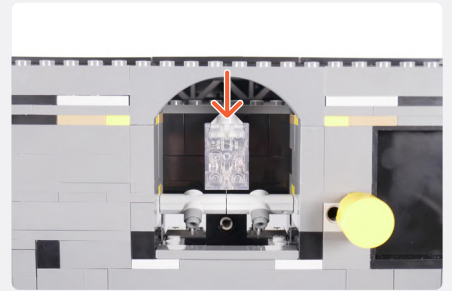
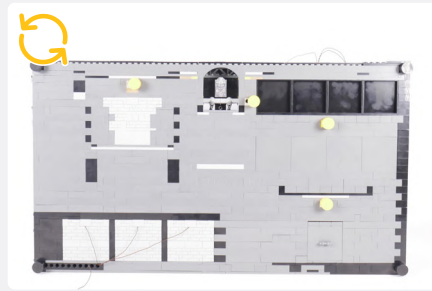

Warm White 15cm Large Bit Light

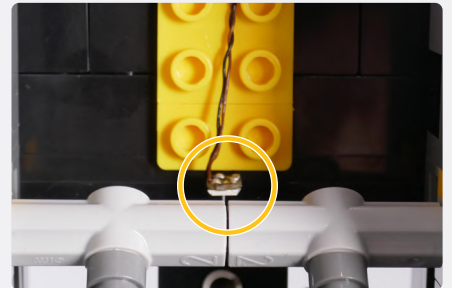
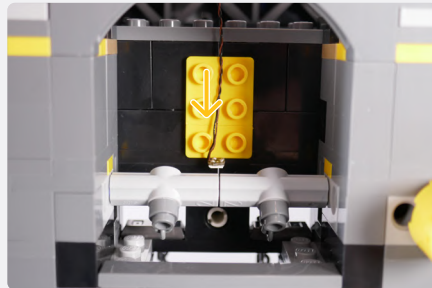
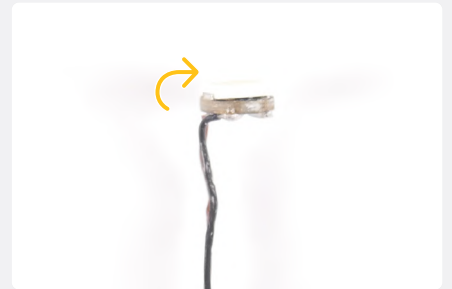

27

Plate 1x2 - Black

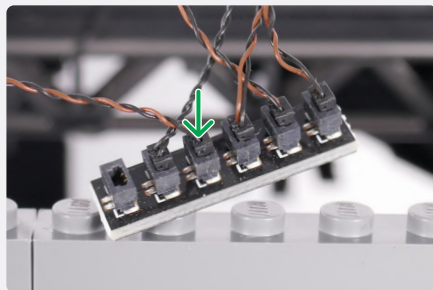
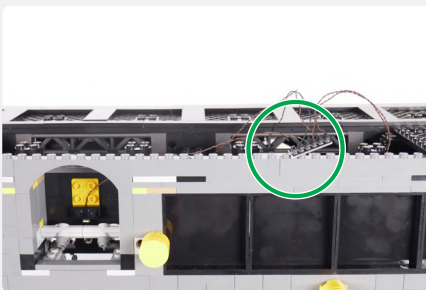
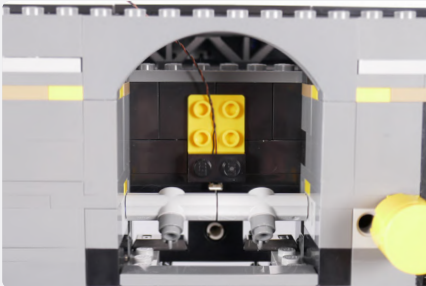
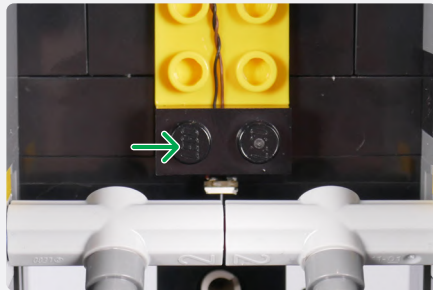

30cm Connecting Cable



8-Port Expansion Board



NOTE

Connect the other end of the 30cm Connecting Cable to the 6-Port Expansion Board

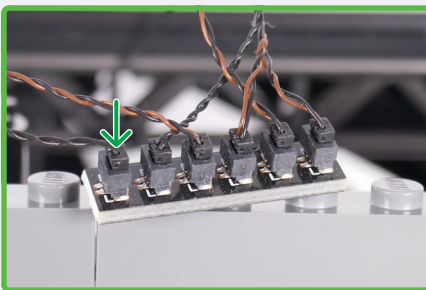

NOTE

Position the 8-Port Expansion Board on the other side

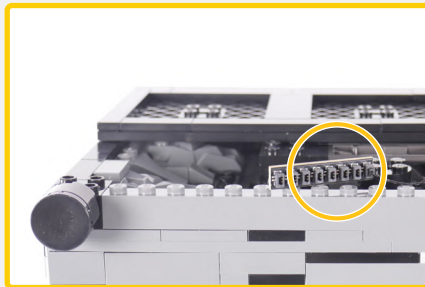
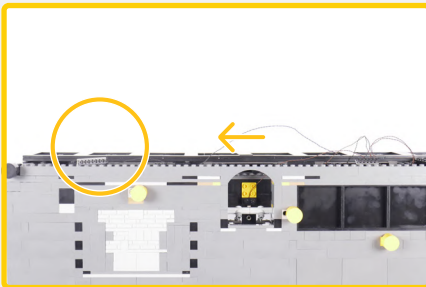

28

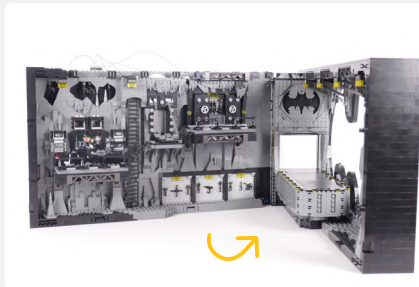
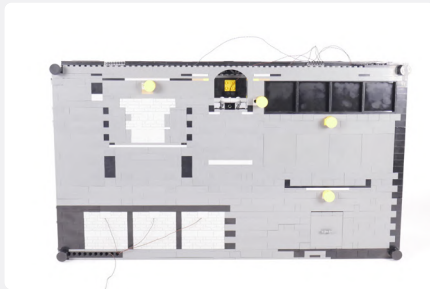

NOTE

Connect to a 5V USB Power Bank, 5V USB Wall Adaptor, or USB to AA Battery Pack (sold separately)

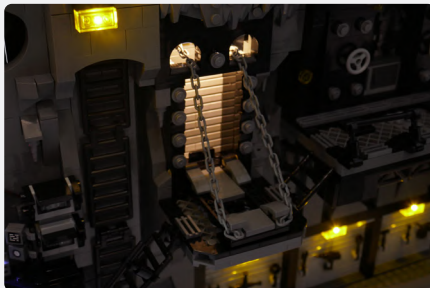

If you experience any issues with the lights not working and suspect an issue with a component, please try a different port on the expansion board to verify where the fault lies (with the light or expansion board). To correct any issues with expansion board ports, please view the section addressing expansion board issues in our troubleshooting section.

29

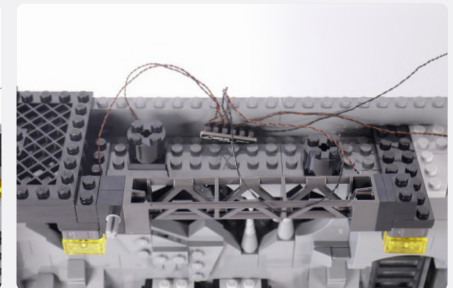
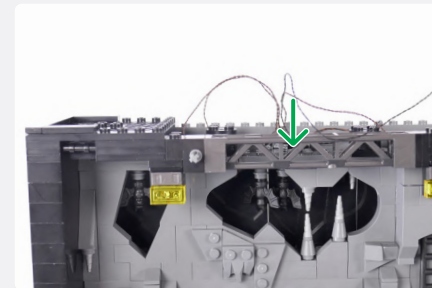
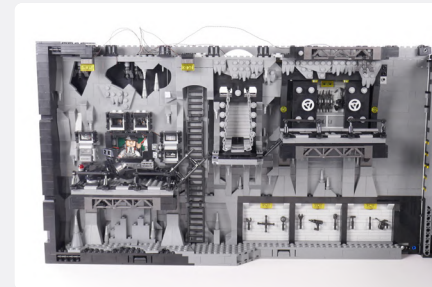

NOTE

Exclude the 30cm Connecting Cable from the twisting of cables

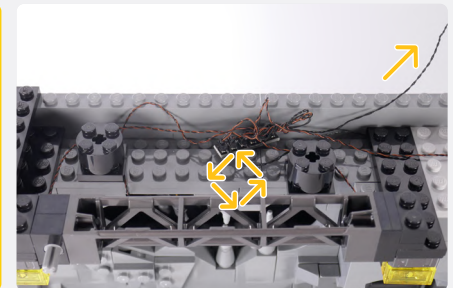

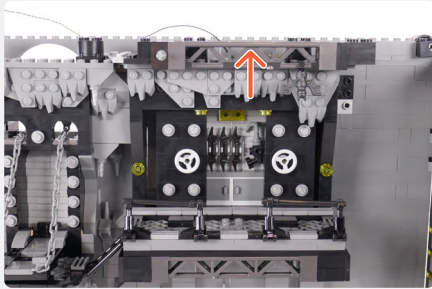

31

Cool White 15cm Bit Light

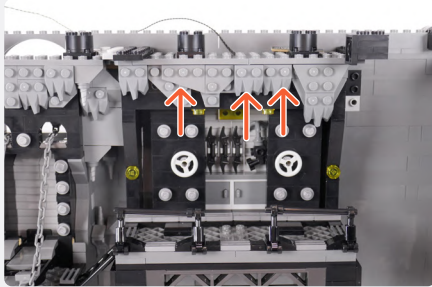

Plate, Round 1x1 with Open Stud - Black

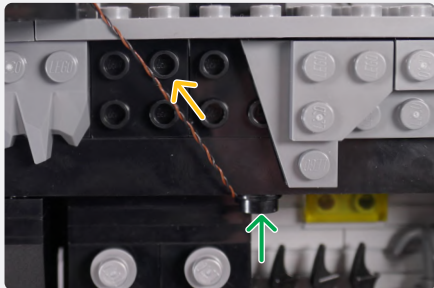
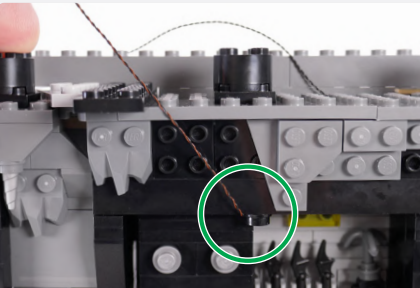
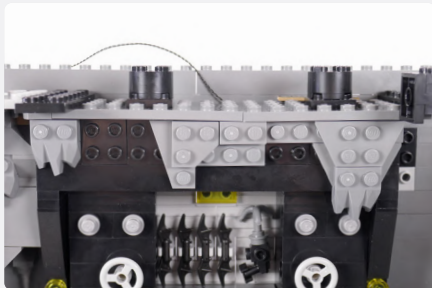
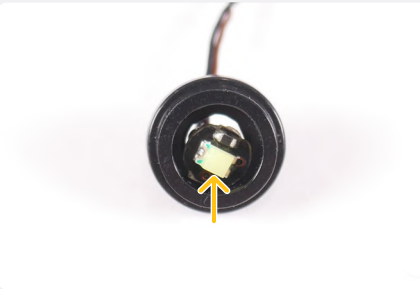
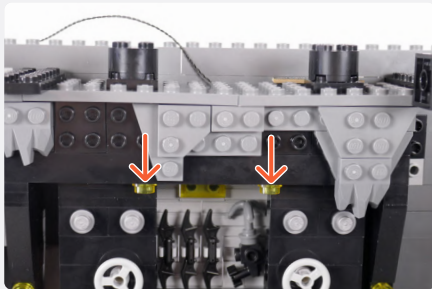

32

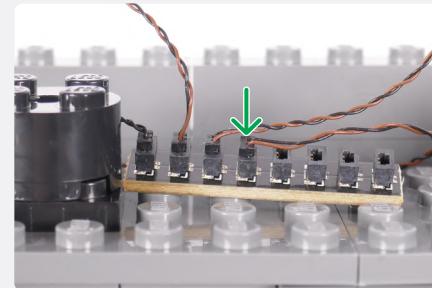
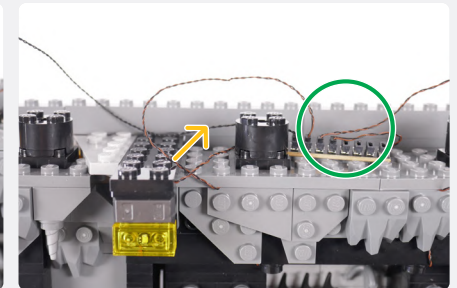
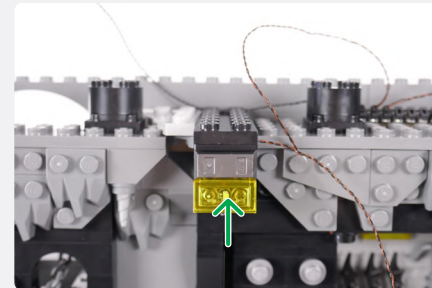
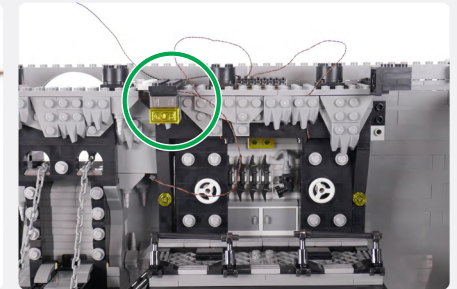
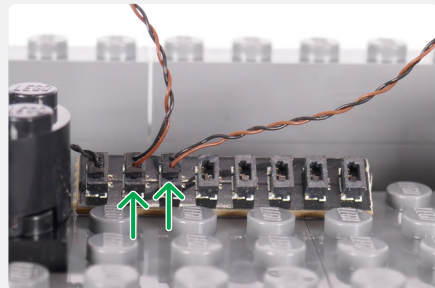
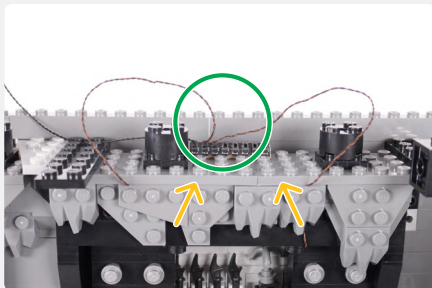
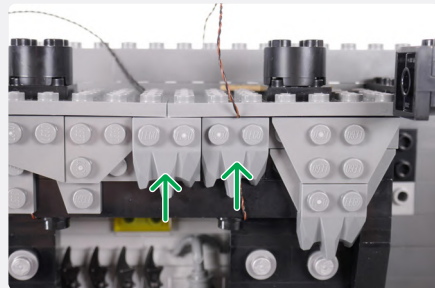
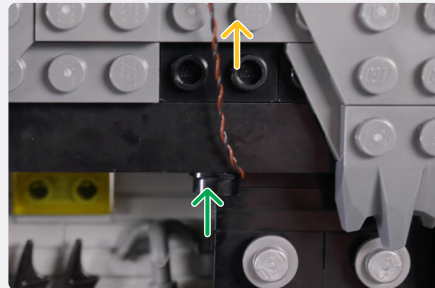
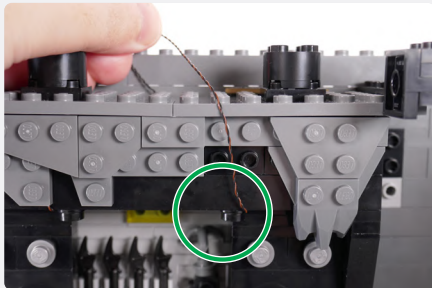
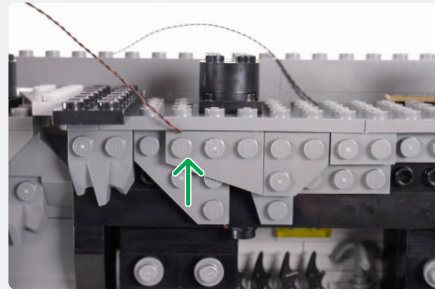

33

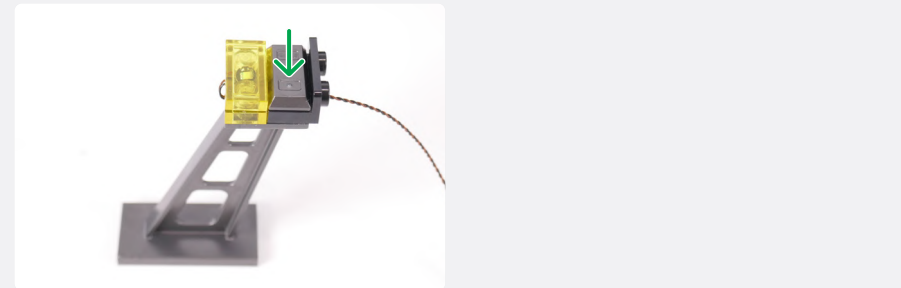
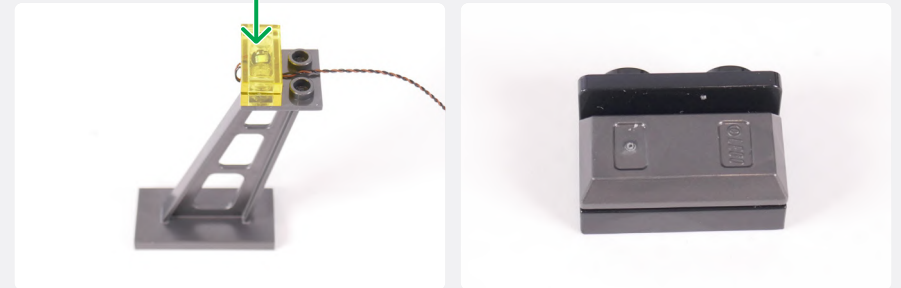
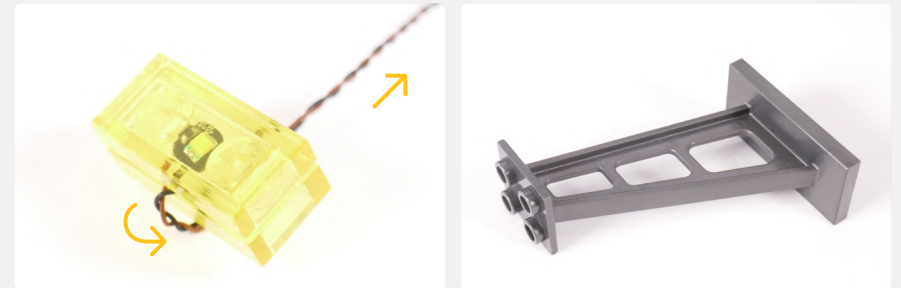
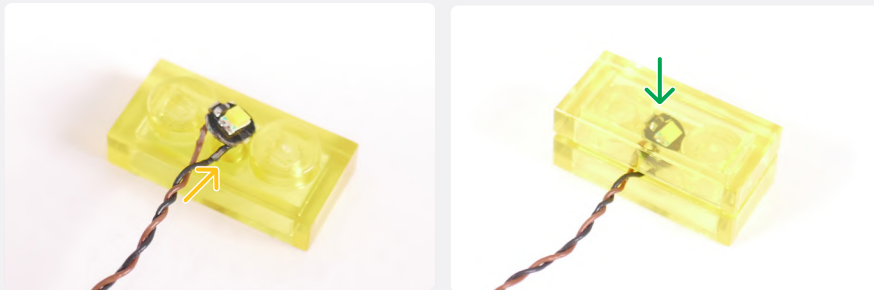
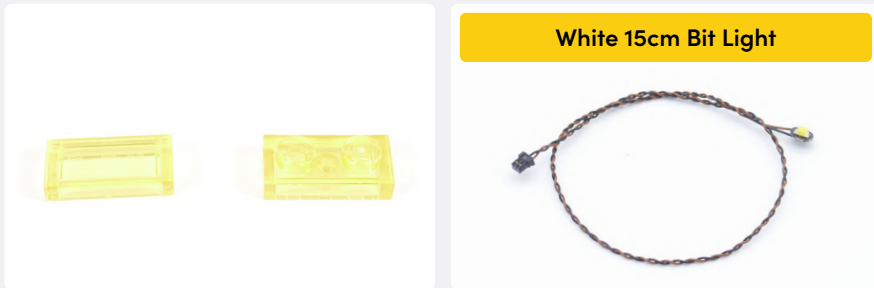
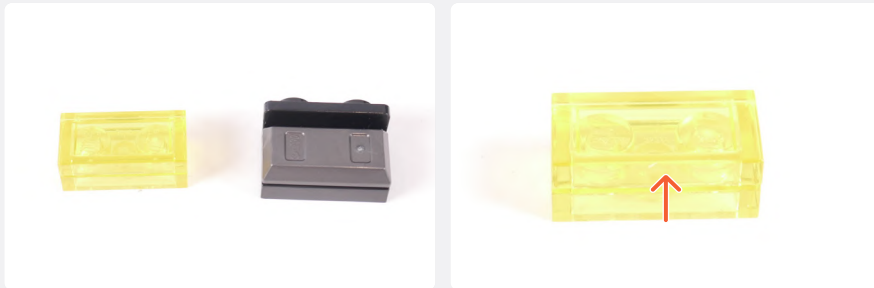
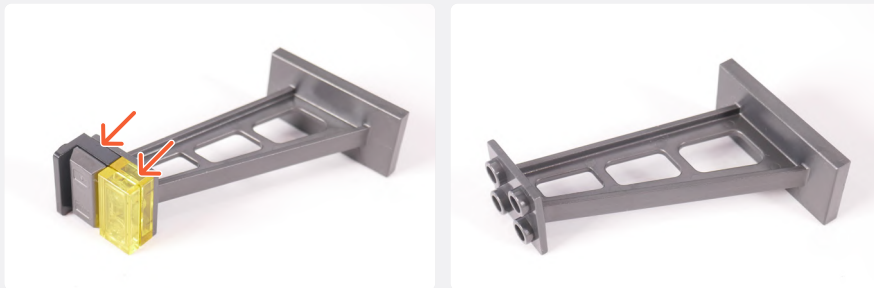

34

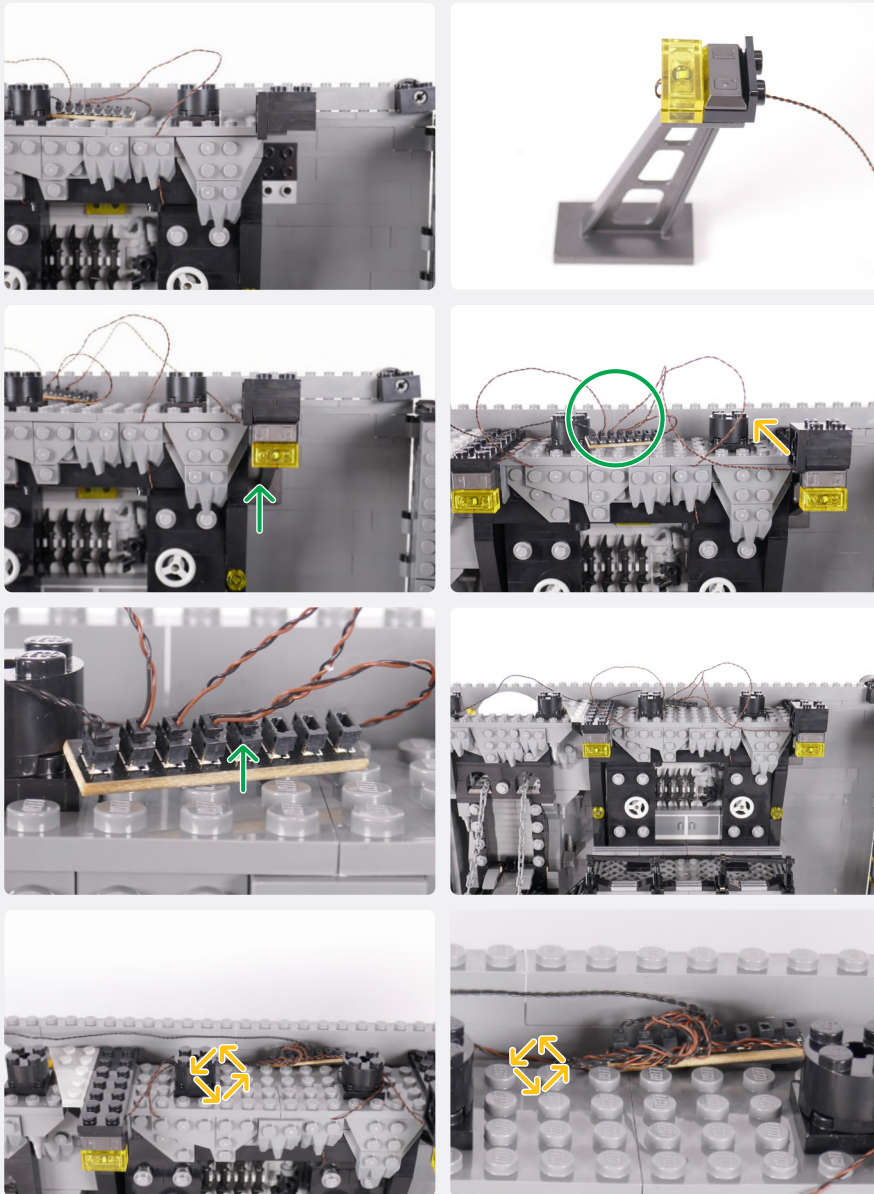

35

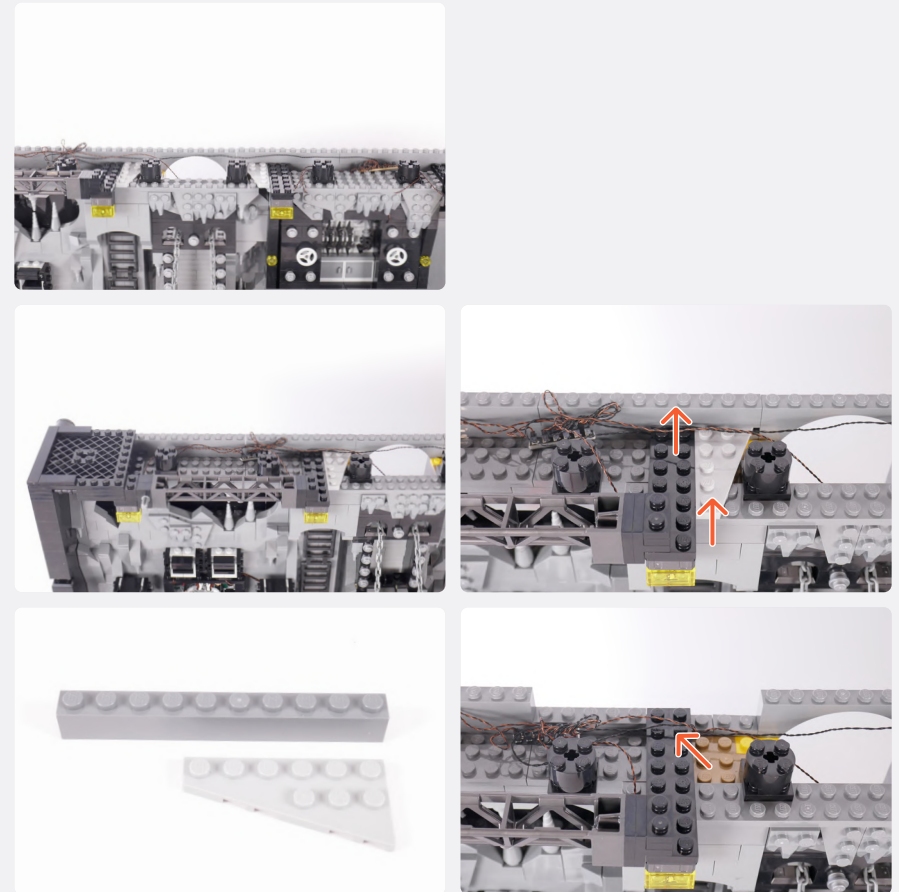

NOTE

Slightly lift the following Black Plate so the cables can be threaded underneath

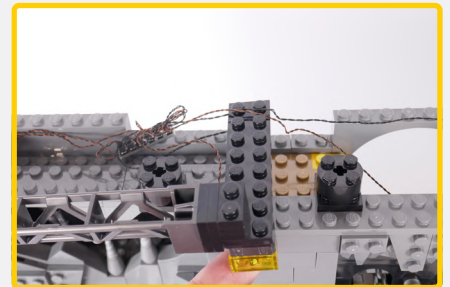

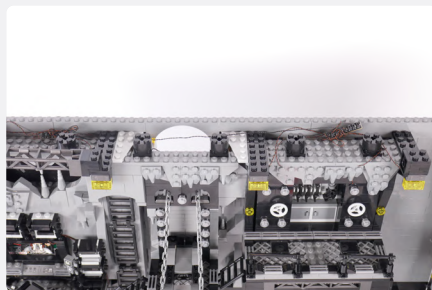
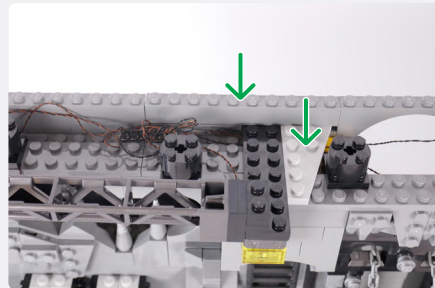
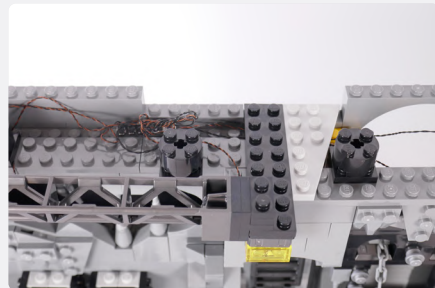
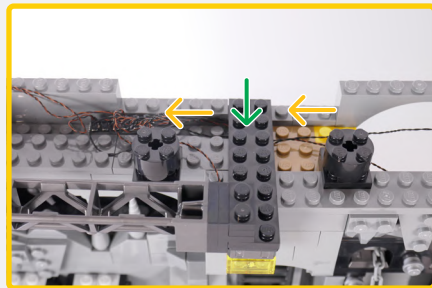

36

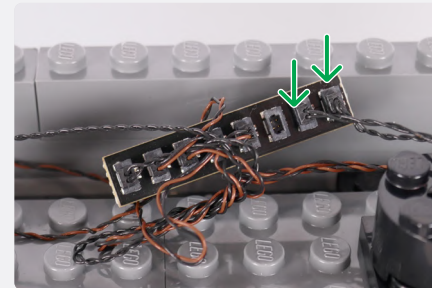
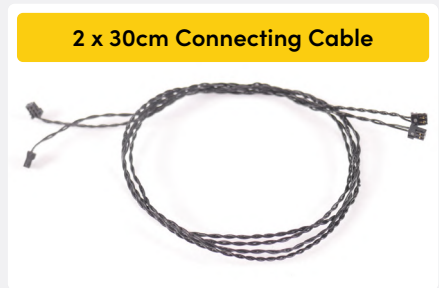
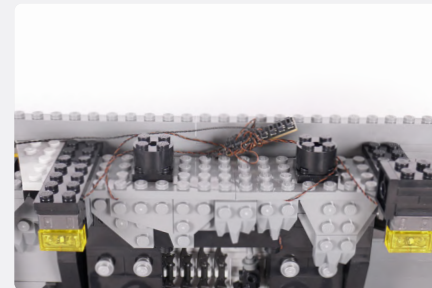

NOTE

Thread one of the 30cm Connecting Cables through the following gap

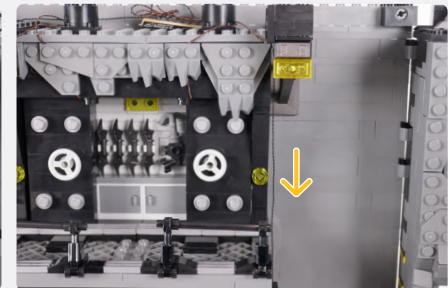
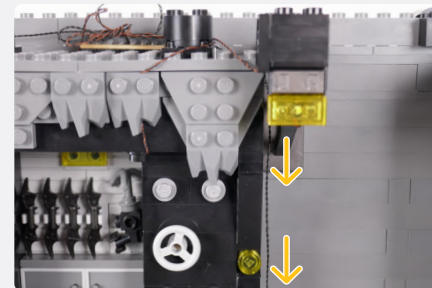
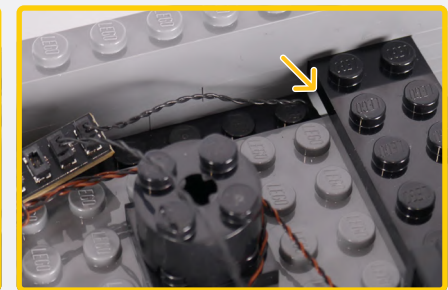
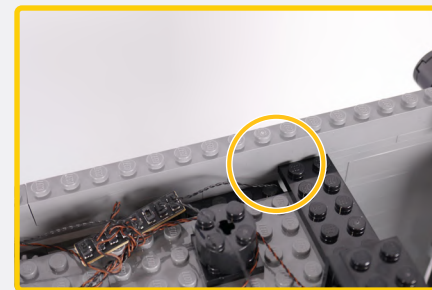

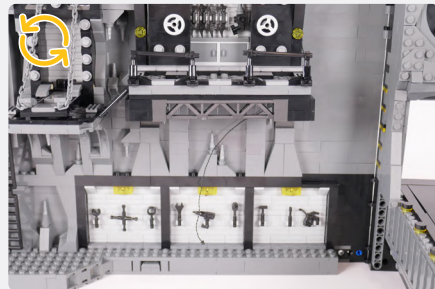
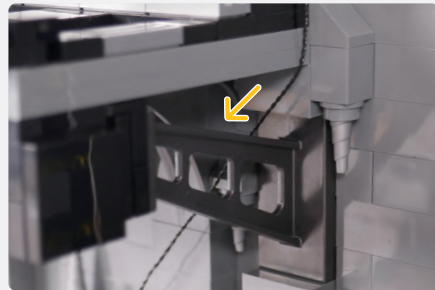

37

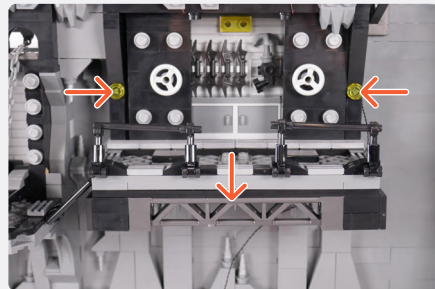
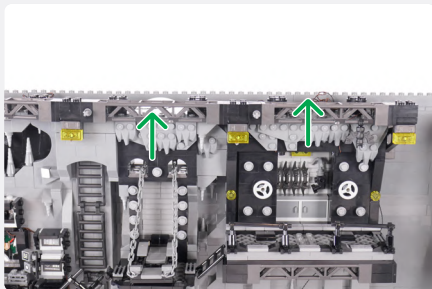
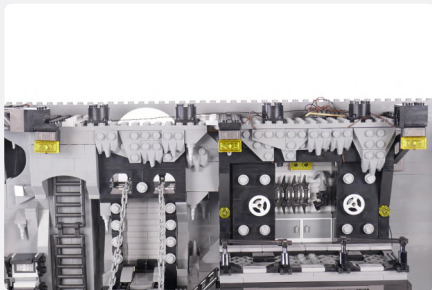

38

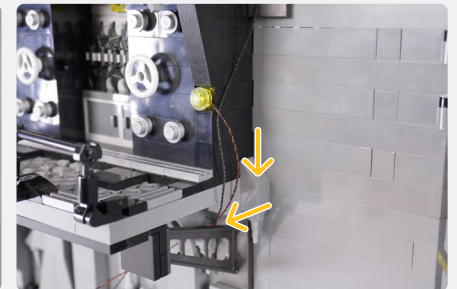
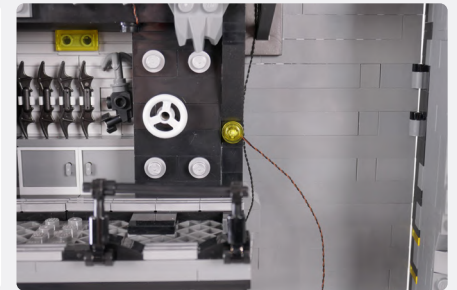
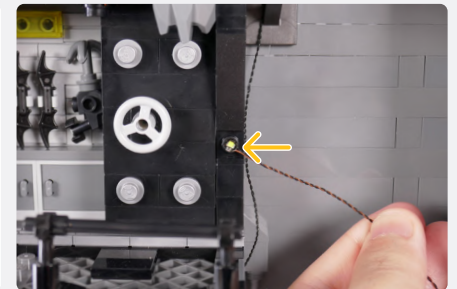
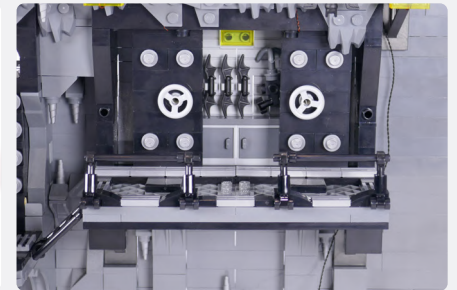
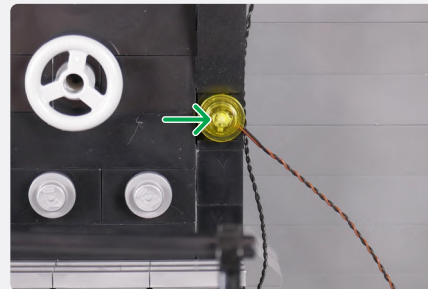

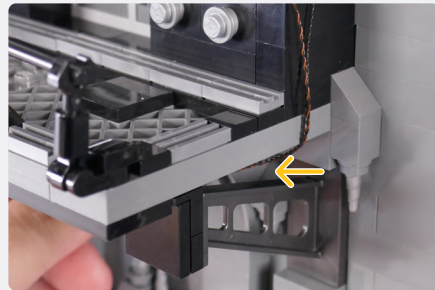
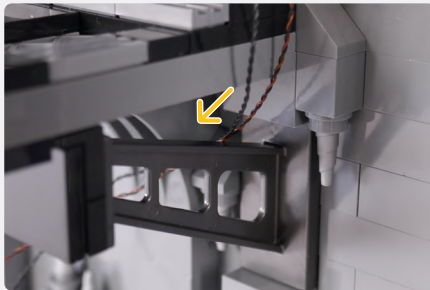
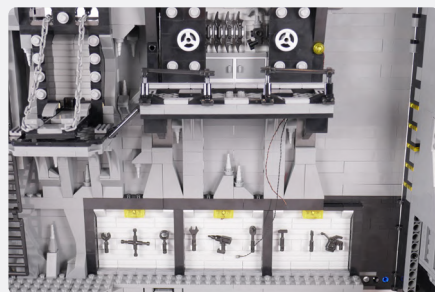
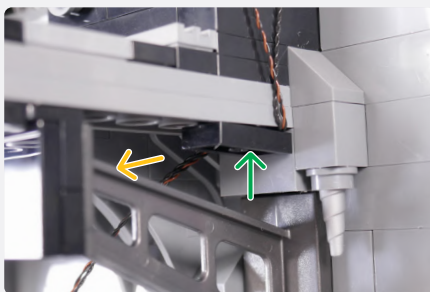
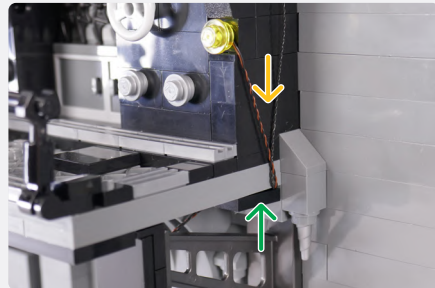
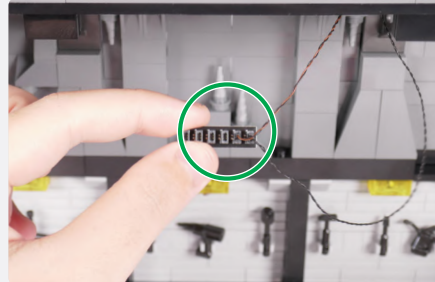

Plate 1x2 - Black



6-Port Expansion Board



39

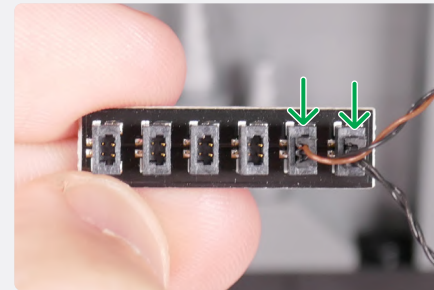

White 15cm Bit Light

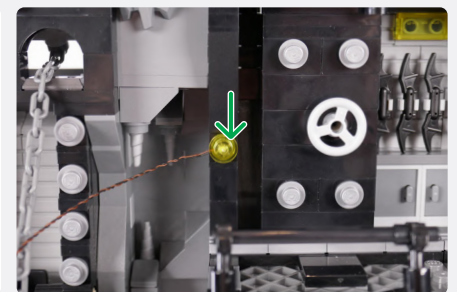
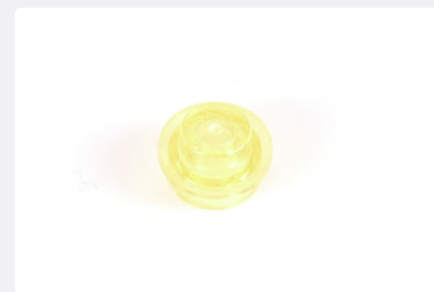

Plate, Round 1x1 with Open Stud - Black

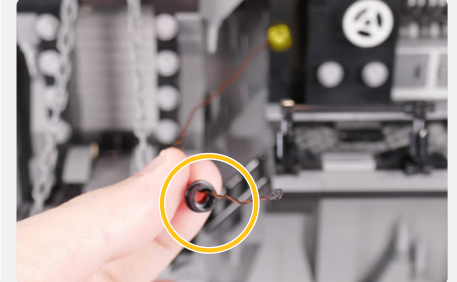

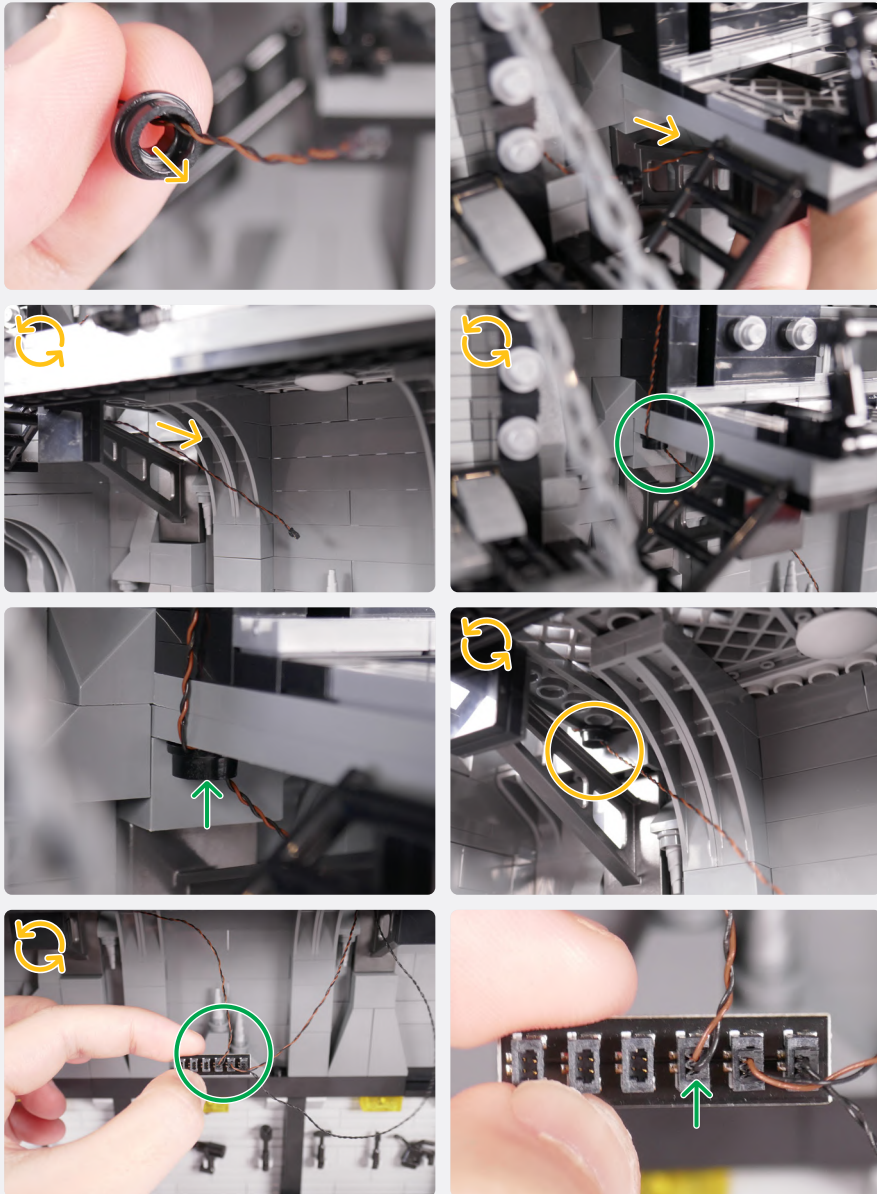

40

Cool White 30cm Bit Light



Plate, Round 1x1 with Open Stud - Black

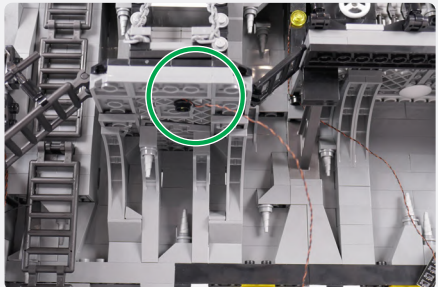
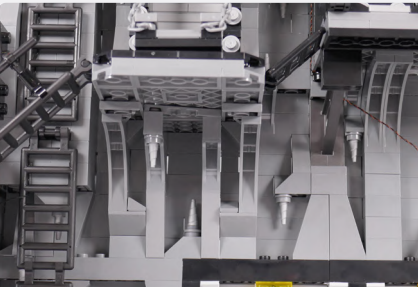
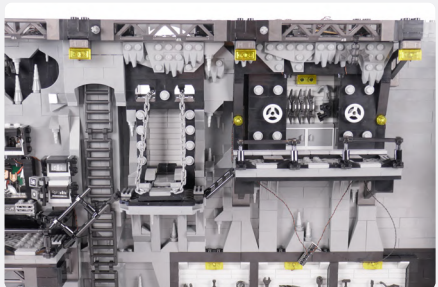
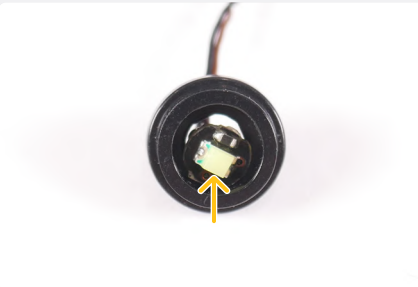

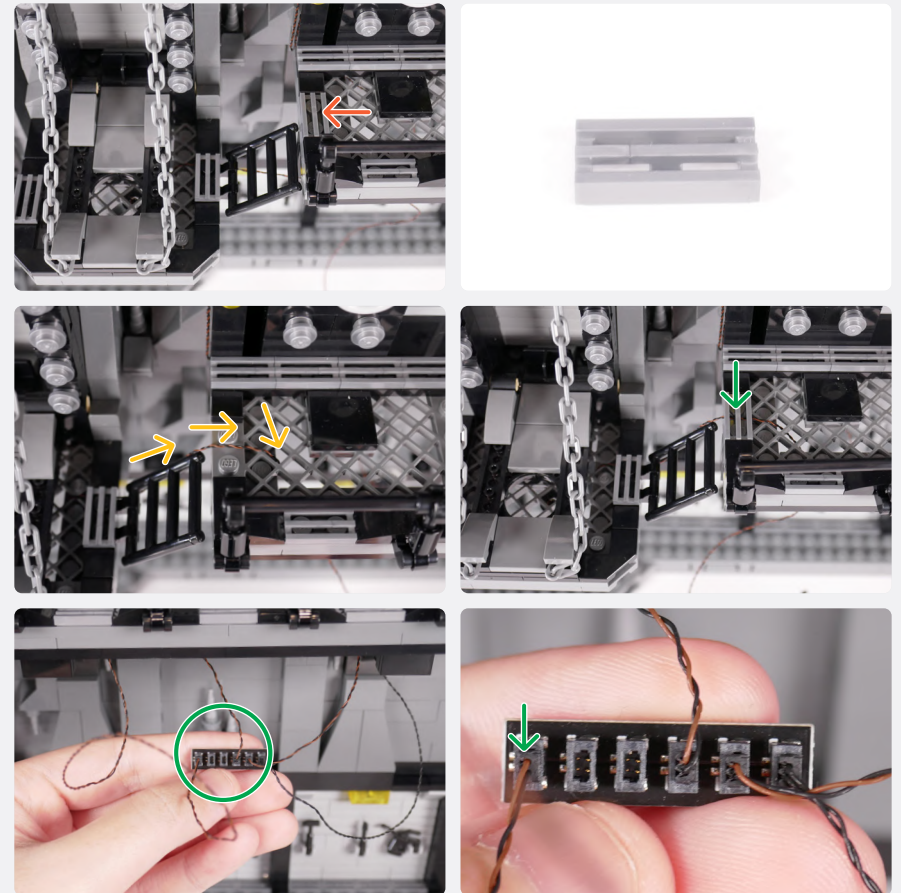
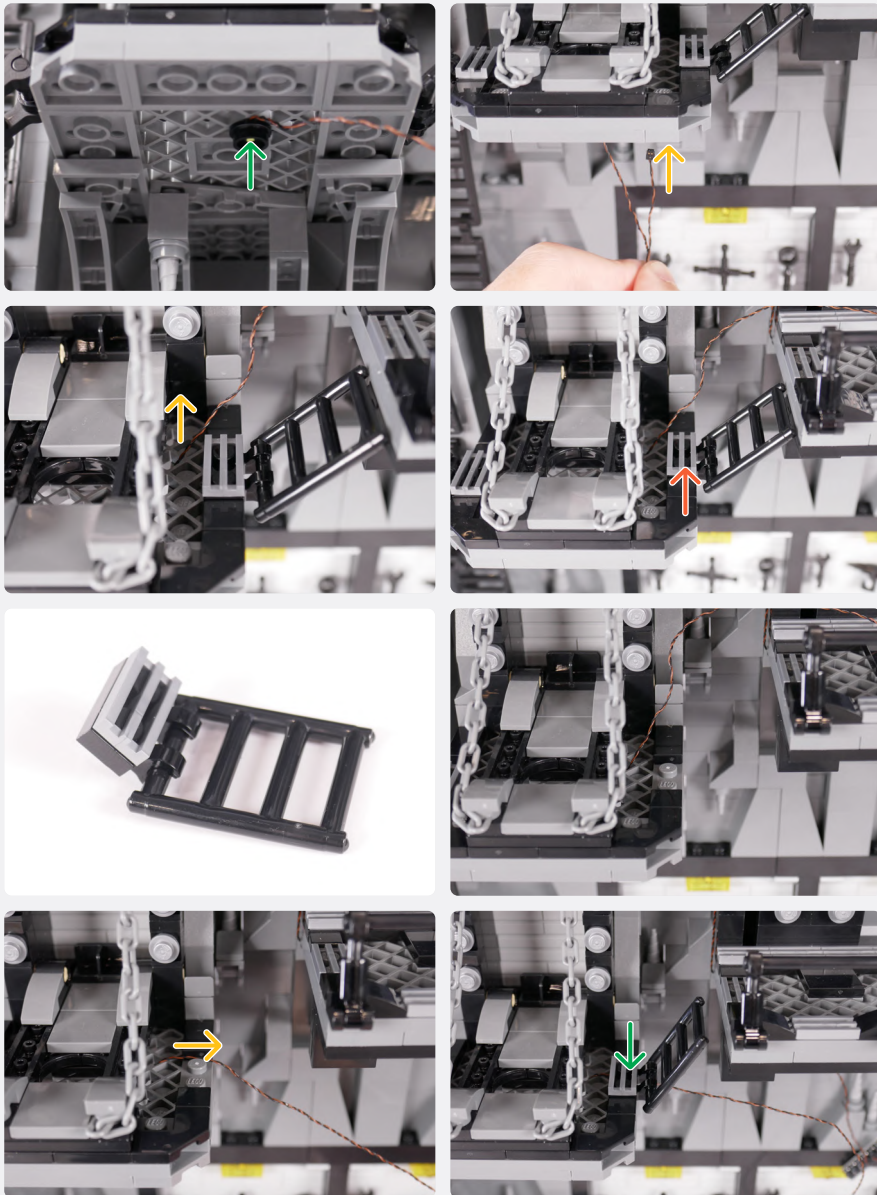

41

Cool White 15cm Bit Light



Plate, Round 1x1 with Open Stud - Black

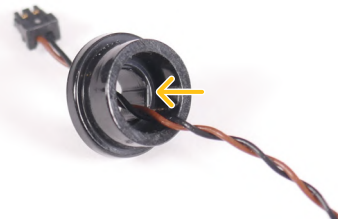

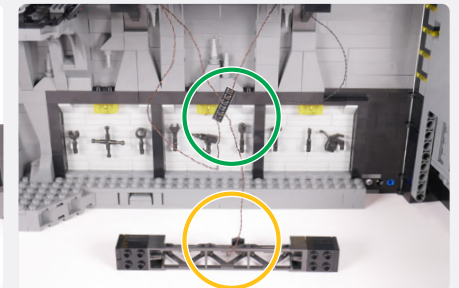
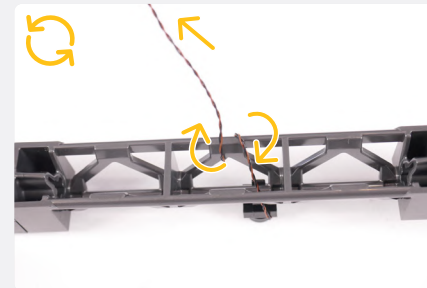
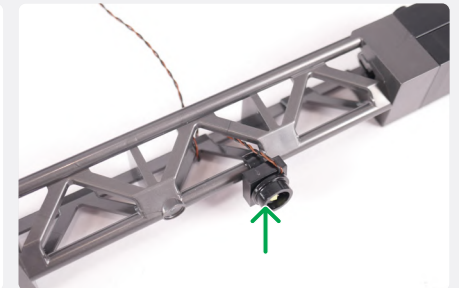
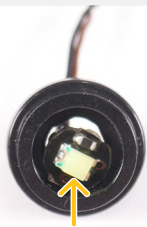

Tile, Modified 1x1 with Open O Clip - Black

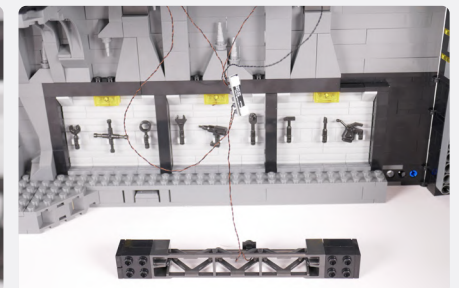
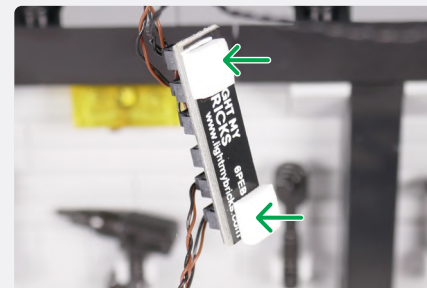
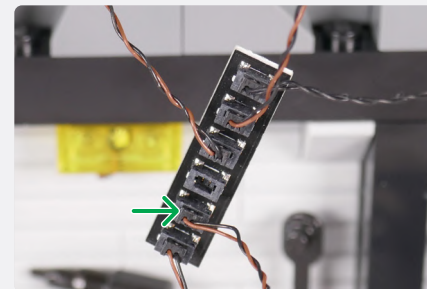

2x Adhesive Square

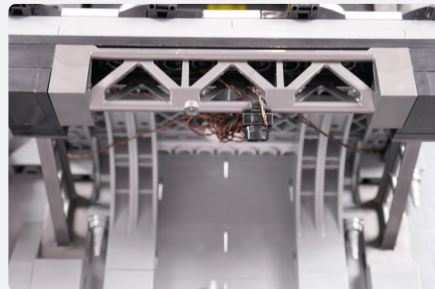
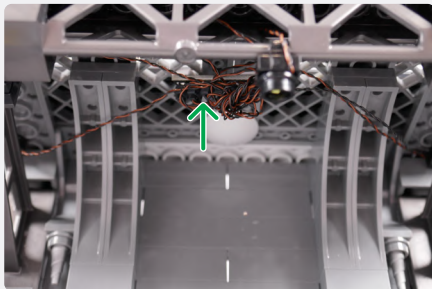
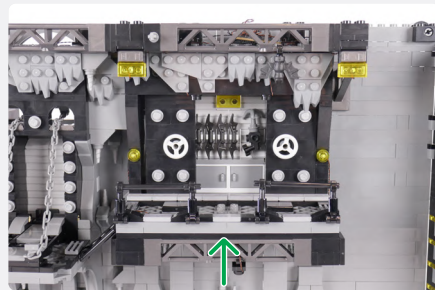
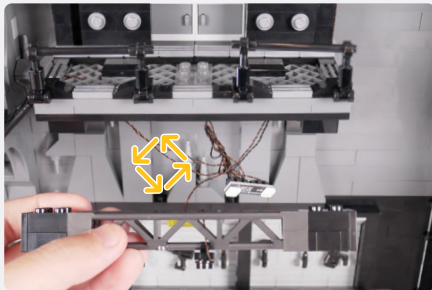



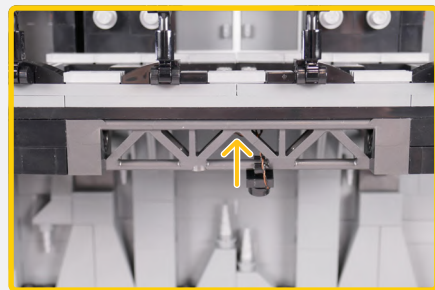

 **NOTE**

Ensure there are no visible dangling cables. Push the cables up to conceal them

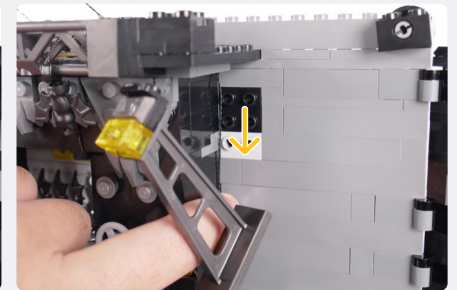
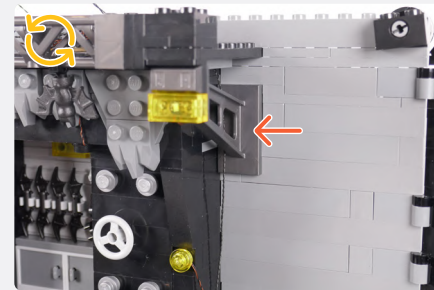

42



 **NOTE**

Run the 30cm Connecting Cable inbetween the wall and the studs

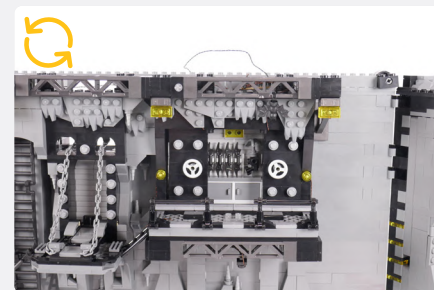
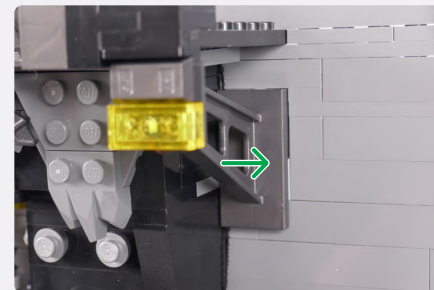
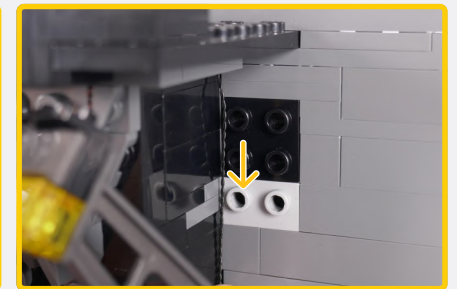

43

NOTE

Connect to a 5V USB Power Bank, 5V USB Wall Adaptor, or USB to AA Battery Pack (sold separately)

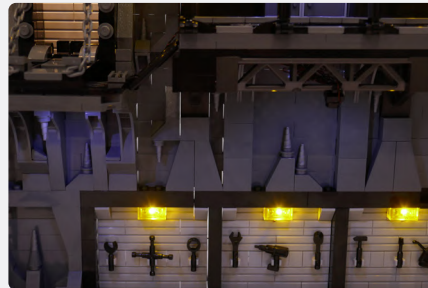
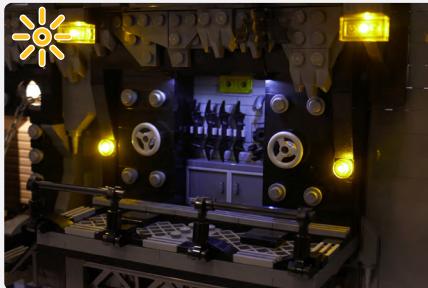

! If you experience any issues with the lights not working and suspect an issue with a component, please try a different port on the expansion board to verify where the fault lies (with the light or expansion board). To correct any issues with expansion board ports, please view the section addressing expansion board issues in our troubleshooting section. **i**



44

NOTE

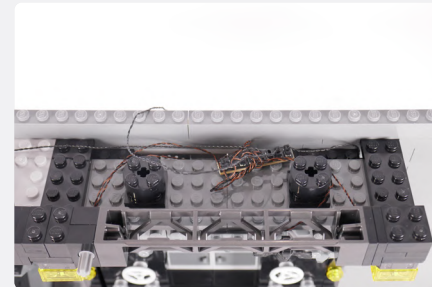
Thread the loose 30cm Connecting Cable at the top through the following gap

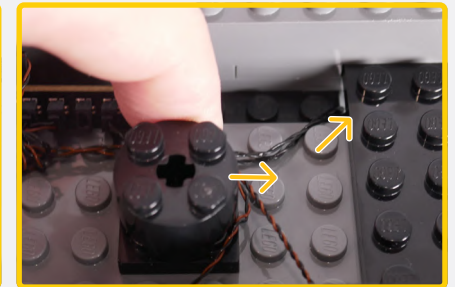
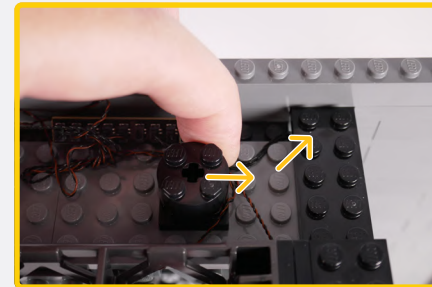
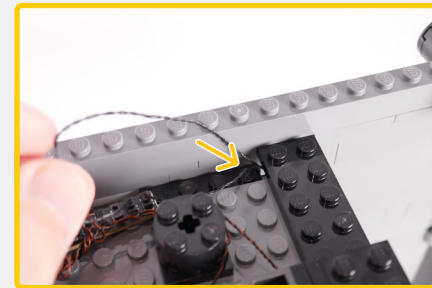
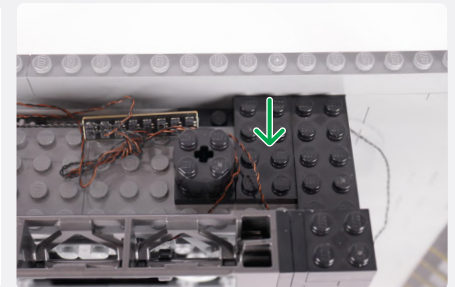

NOTE

Route both 30cm Connecting Cables going around the studs as shown.

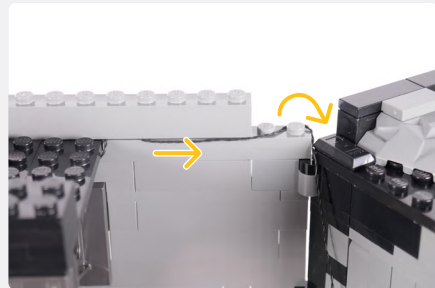
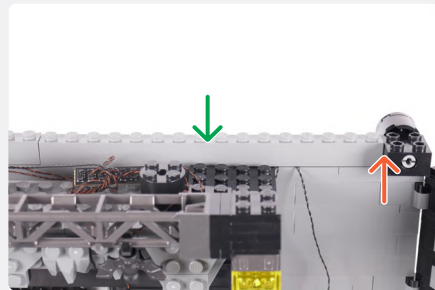
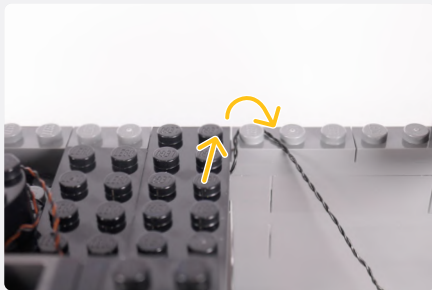
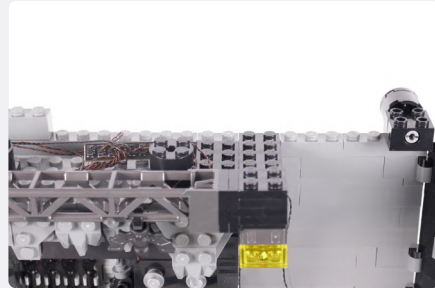
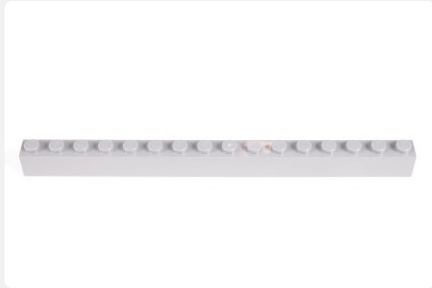
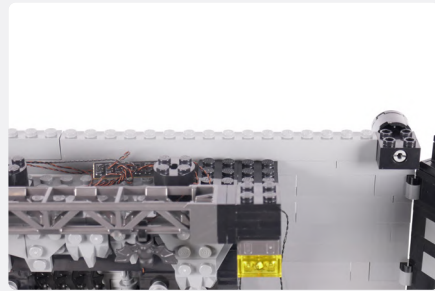
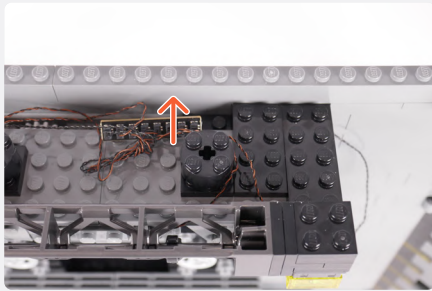
Plate 2x4 - Black

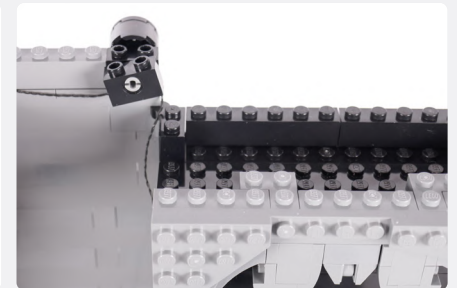
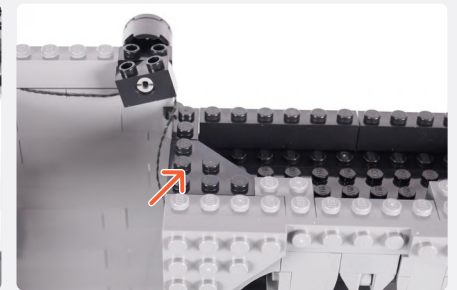
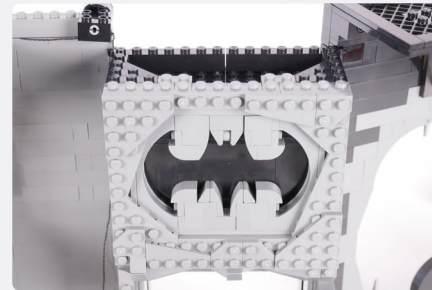
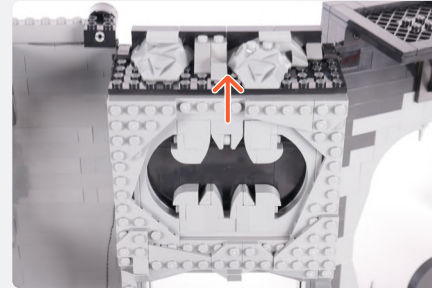
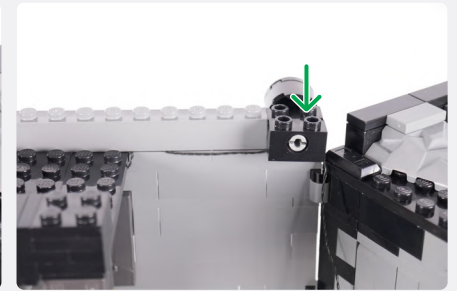

45



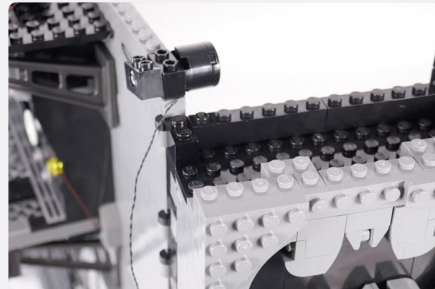
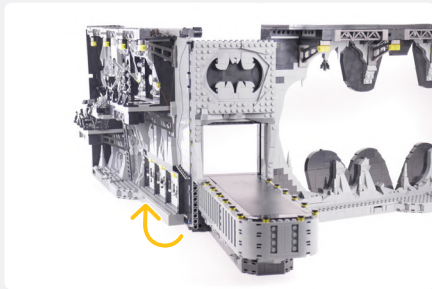

46

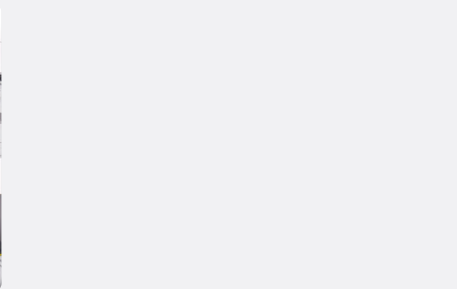
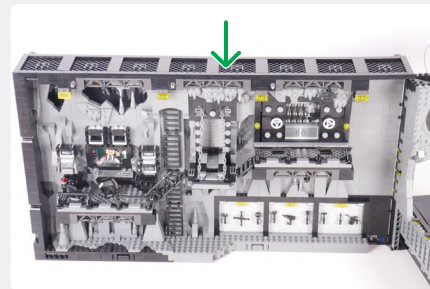
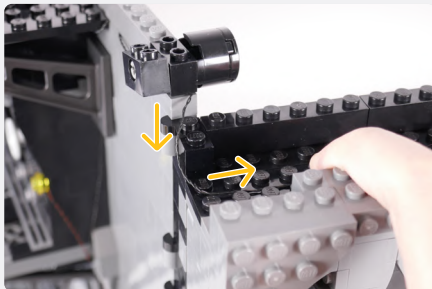
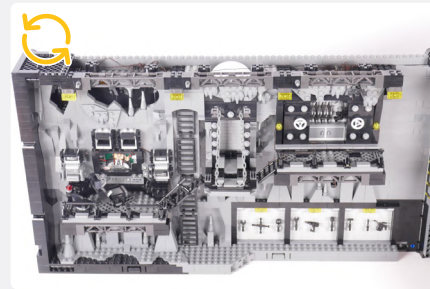

6-Port Expansion Board

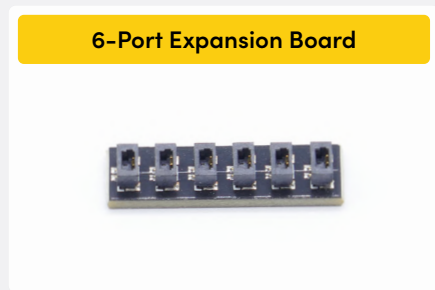

47

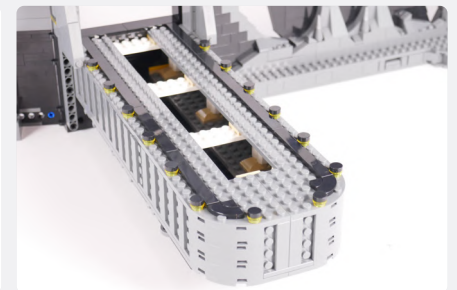
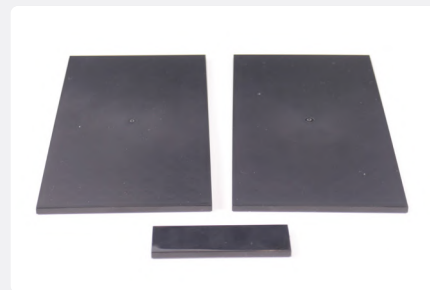
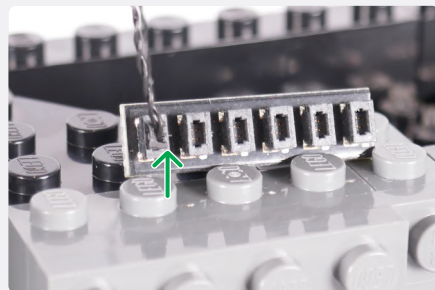
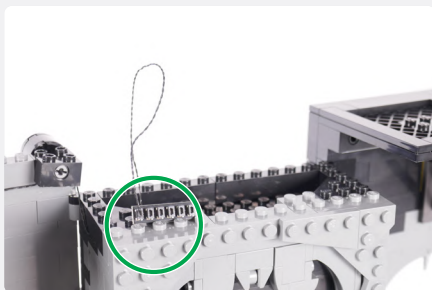
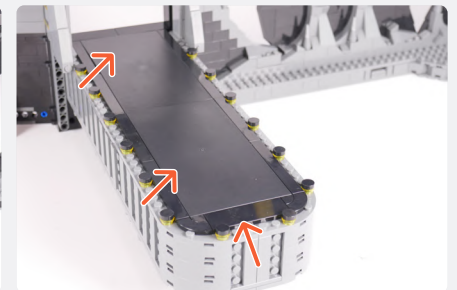
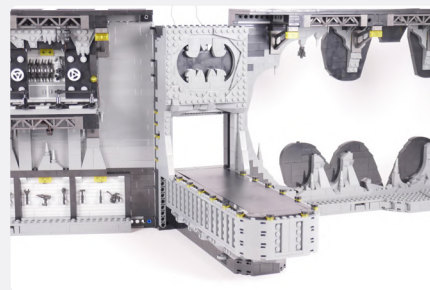

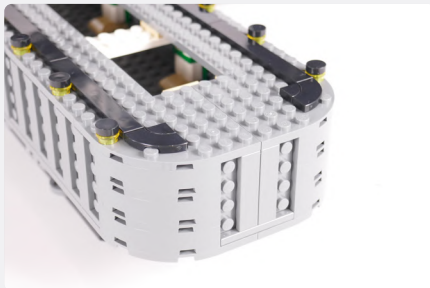
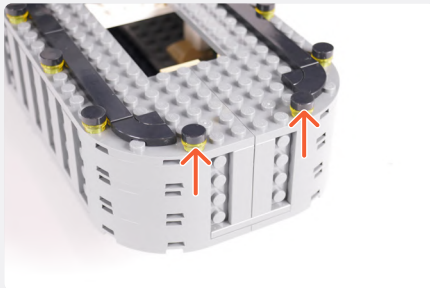

White 15cm Bit Light

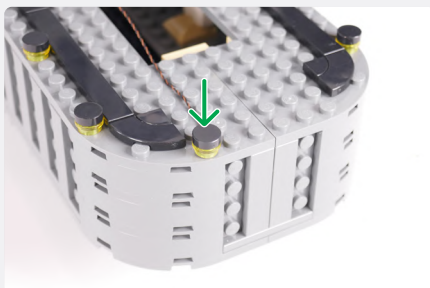
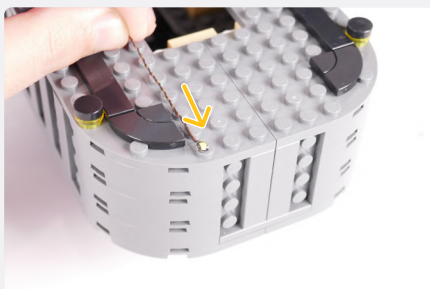

NOTE

Repeat the same process for the other light

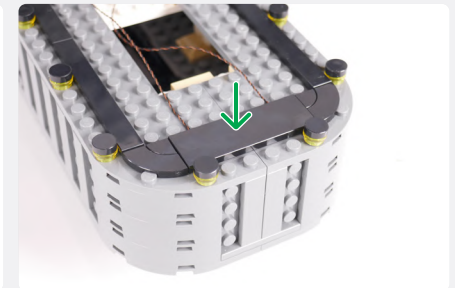
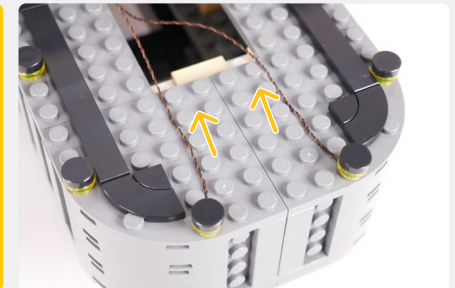
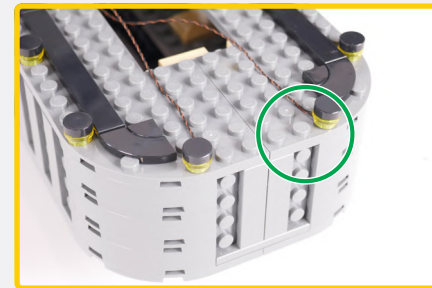

5cm Connecting Cable



6-Port Expansion Board

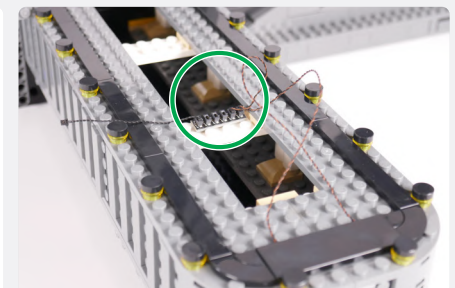
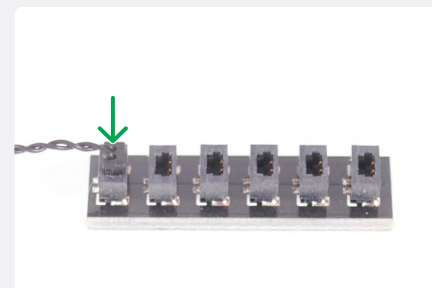
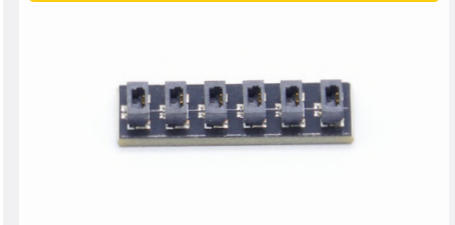

48

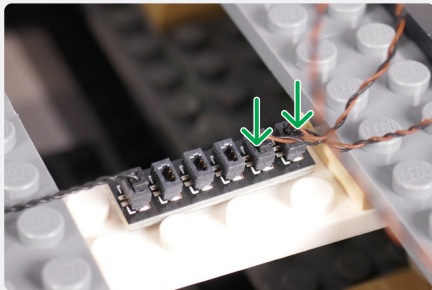

NOTE

Connect the other end of the 5cm Connecting Cable to the first port of the Blink Effects Board

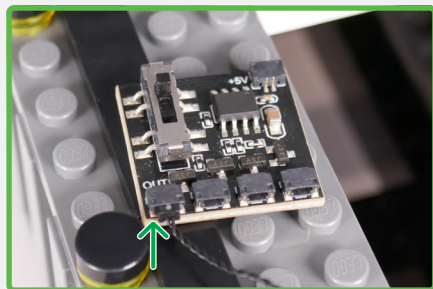
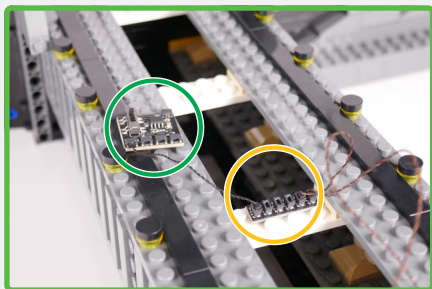

49

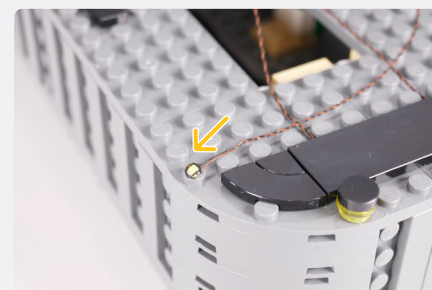
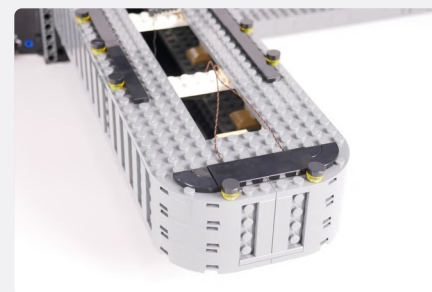
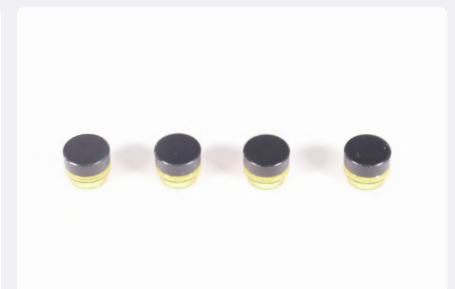
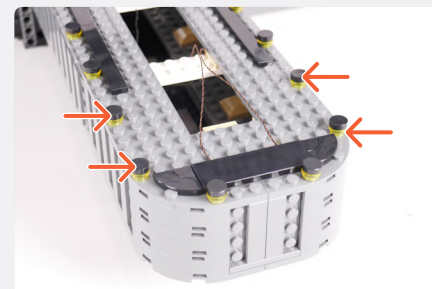
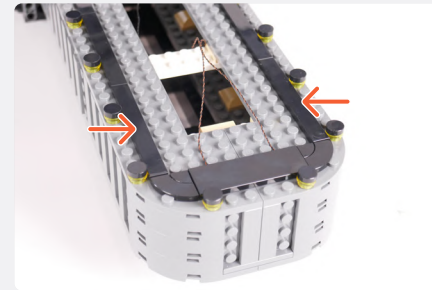

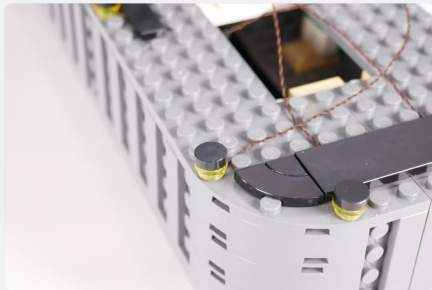

NOTE

Repeat the same process for the other three lights

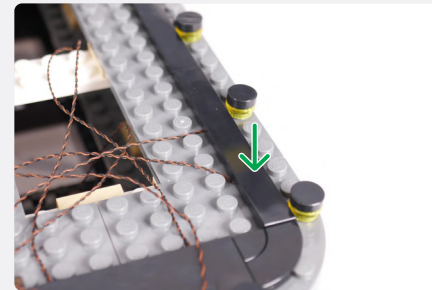
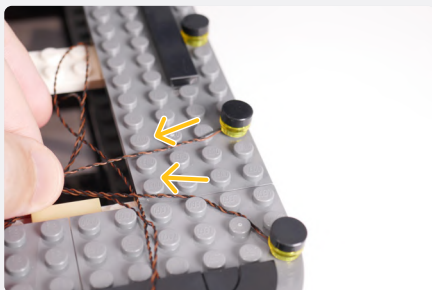
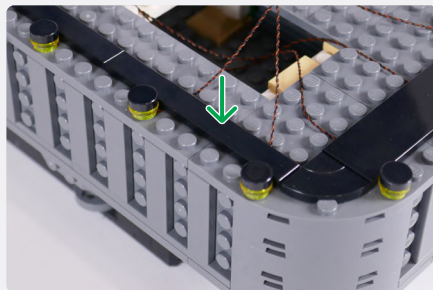
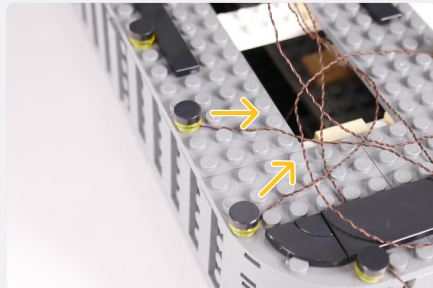
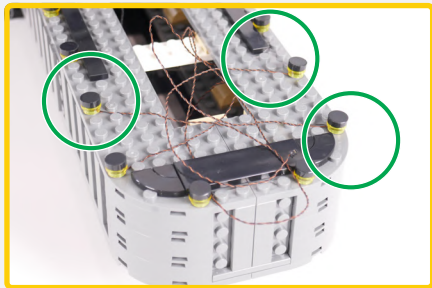

5cm Connecting Cable

6-Port Expansion Board

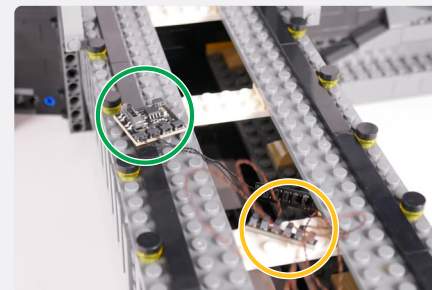
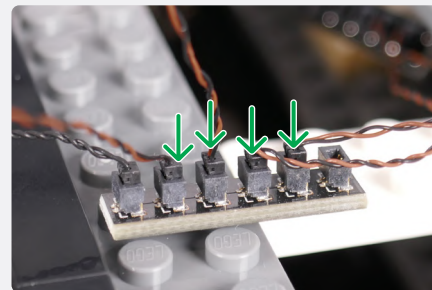
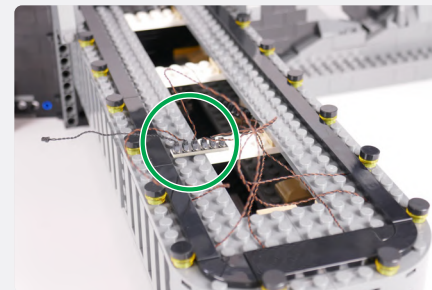
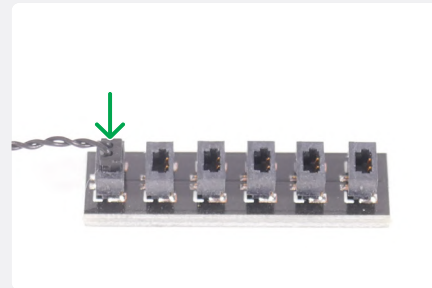

NOTE

Connect the other end of the 5cm Connecting Cable to the second port of the Blink Effects Board

50

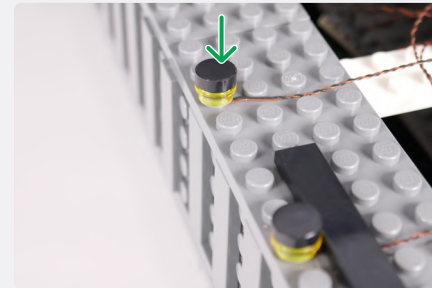
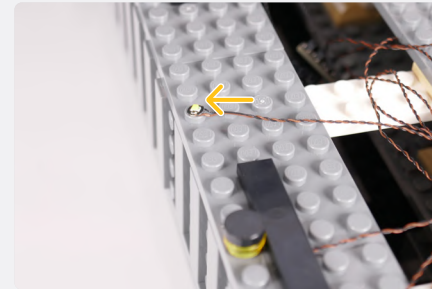
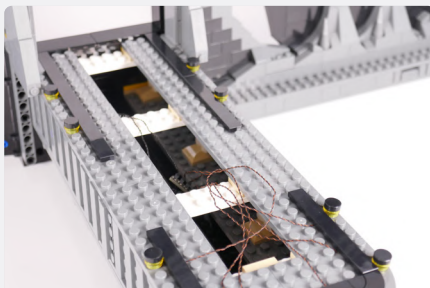
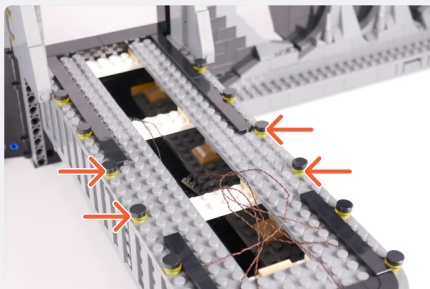
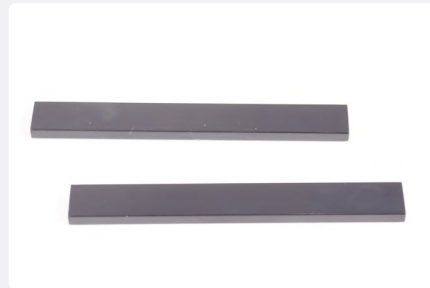
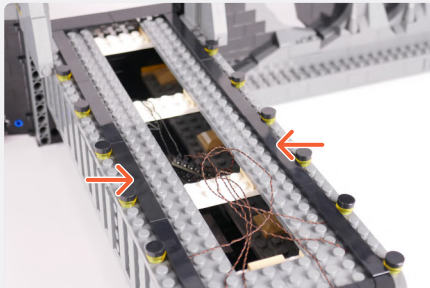
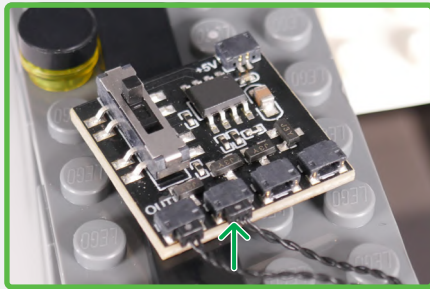

NOTE

Repeat the same process for the other three lights

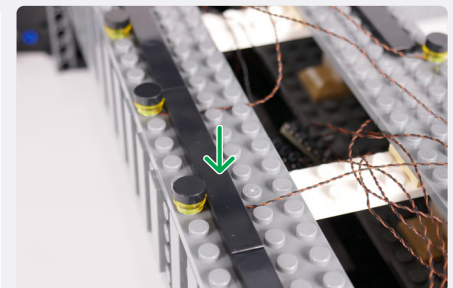
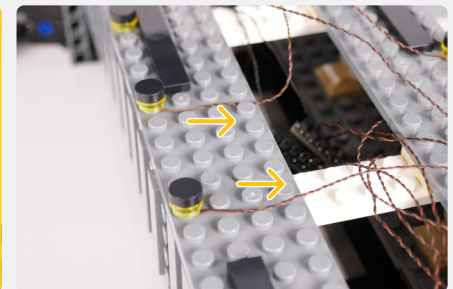
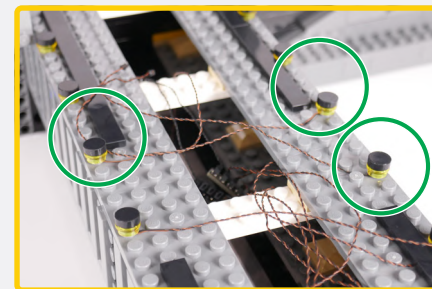

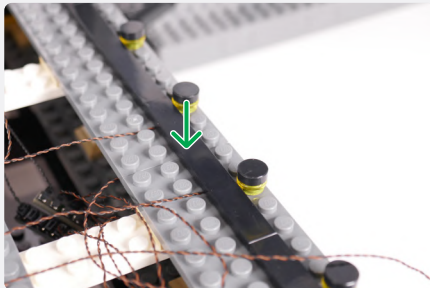
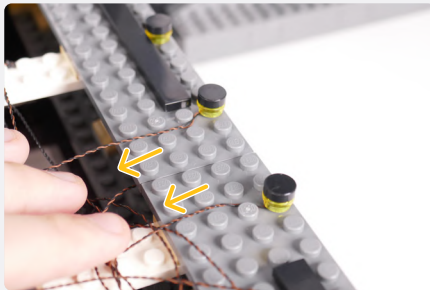

5cm Connecting Cable



6-Port Expansion Board

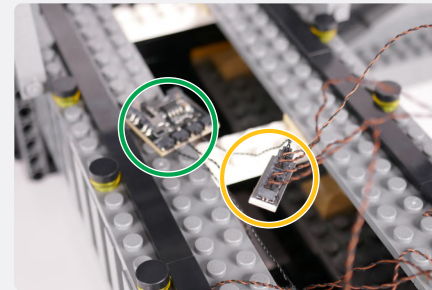
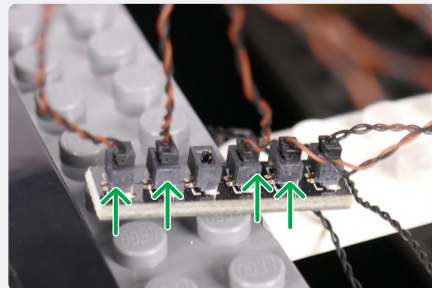
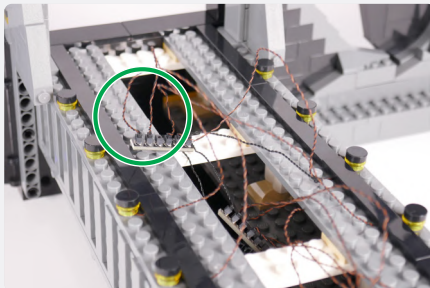
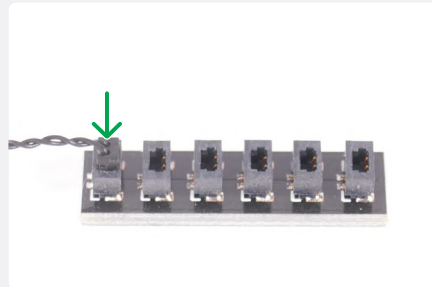
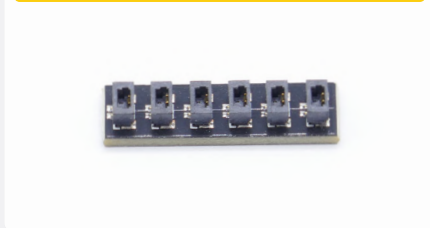

NOTE
Connect the other end of the 5cm Connecting Cable to the third port of the Blink Effects Board

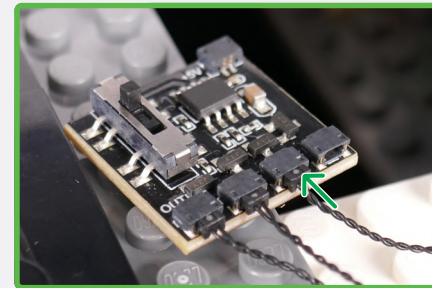

51

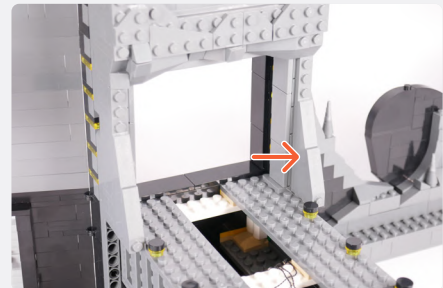
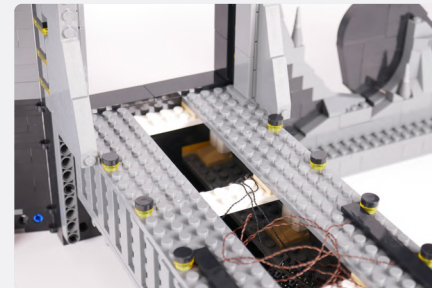
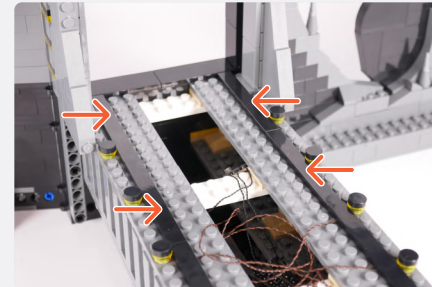

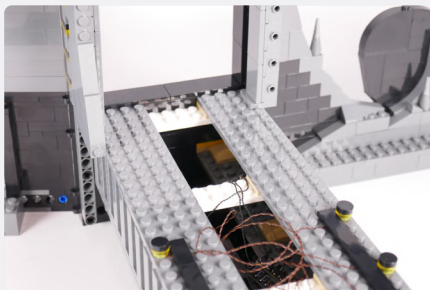
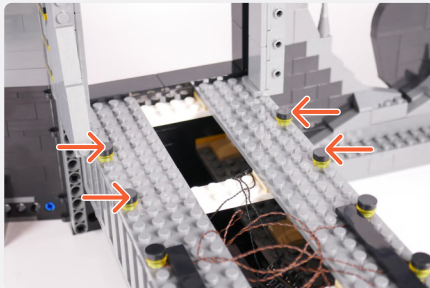
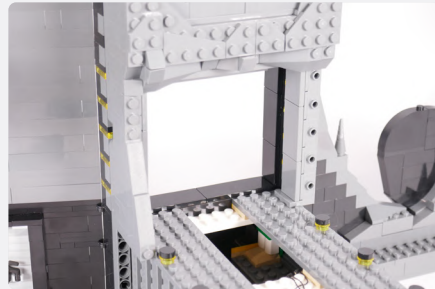
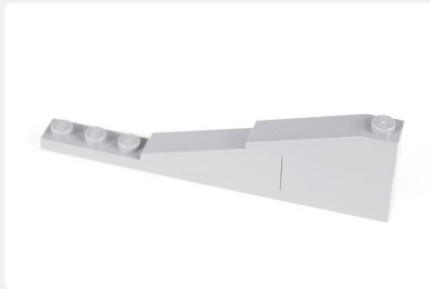

52

White 15cm Bit Light

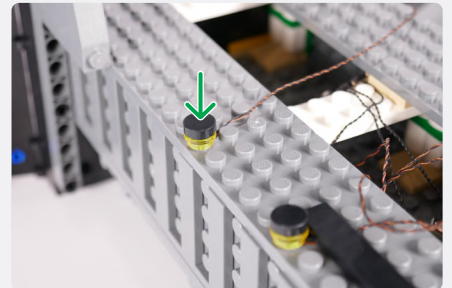
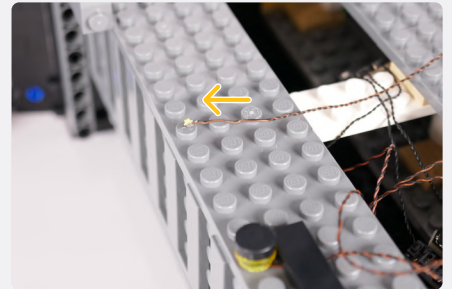

NOTE

Repeat the same process for the other three lights

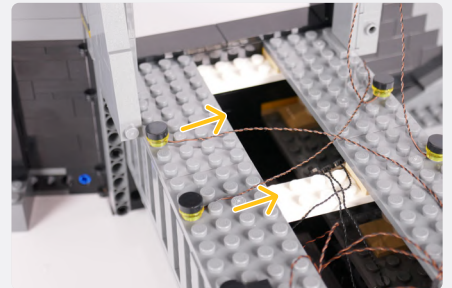
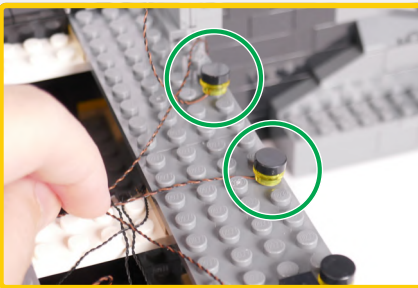
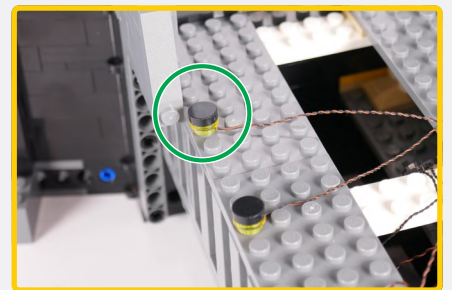

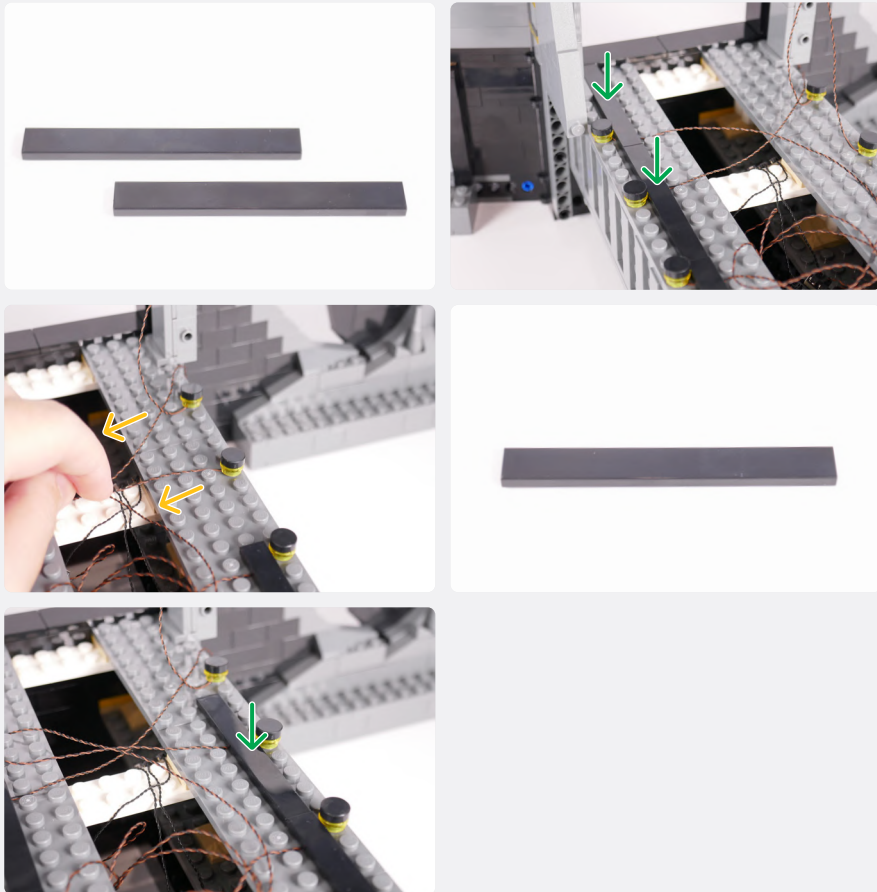

53

5cm Connecting Cable



6-Port Expansion Board

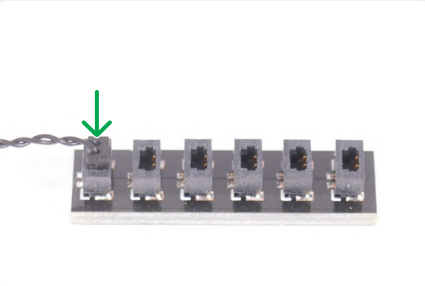

NOTE
Connect the four White 15cm Bit Lights from the previous step to the 6-Port Expansion Board

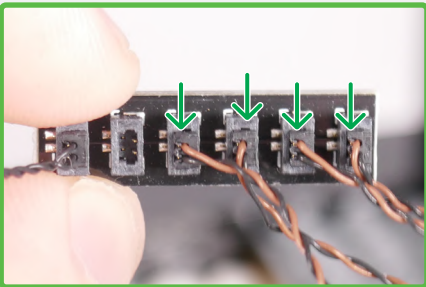
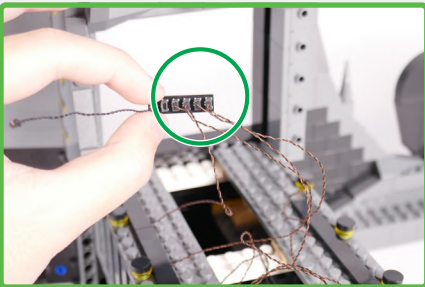

NOTE
Connect the other end to the fourth port of the Blink Effects Board

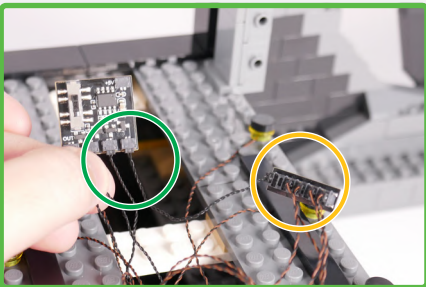

54

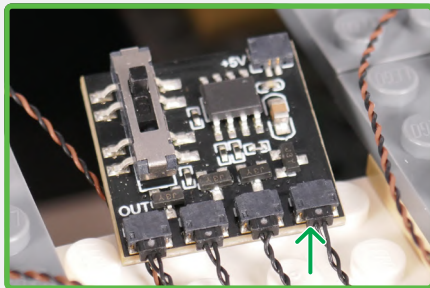

5cm Connecting Cable



6-Port Expansion Board

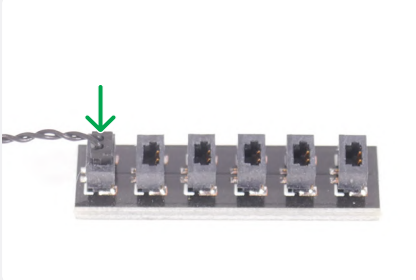
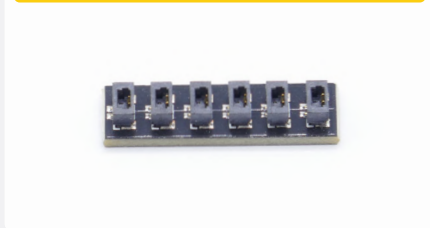

NOTE

Connect the other end of the 5cm Connecting Cable to the '+5V' port of the Blink Effects Board.

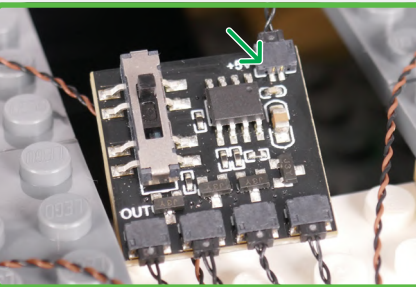

NOTE

Push the switch on the Board Upwards. This is the medium speed for the effect intervals. It can be changed later on.

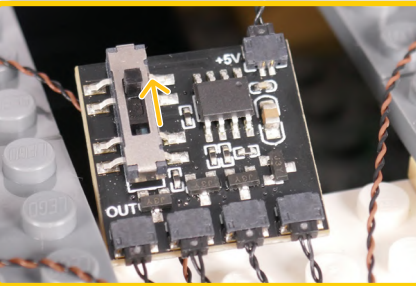

50cm Connecting Cable

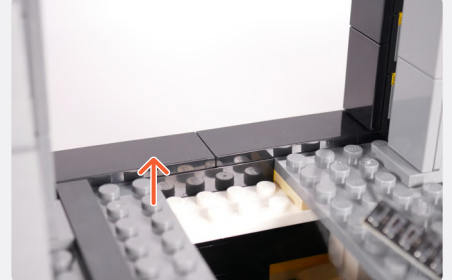
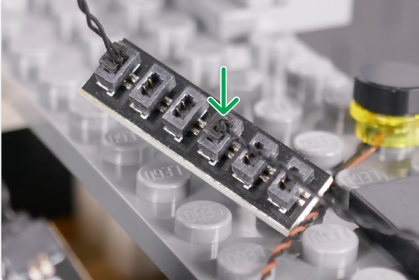
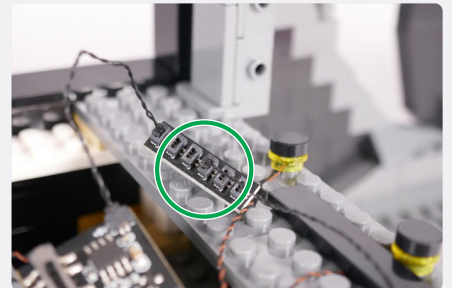

NOTE

Hold the most recent 6-Port Expansion Board in the following position before running the 50cm Connecting Cable beneath the tile.

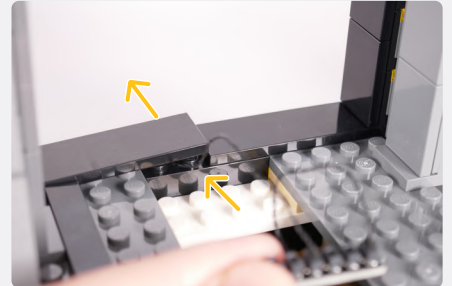
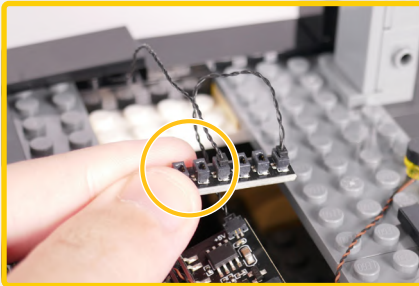

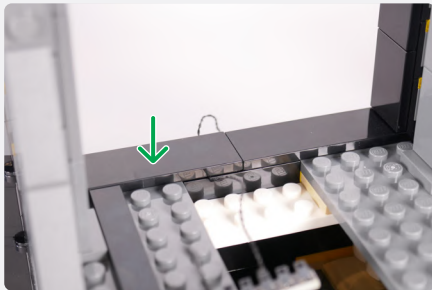

NOTE

Leave the 50cm Connecting Cable here for now. It will be connected to the Batmobile at the end of the guide

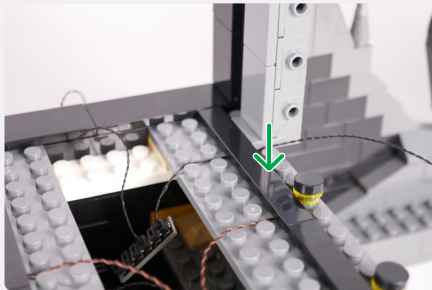
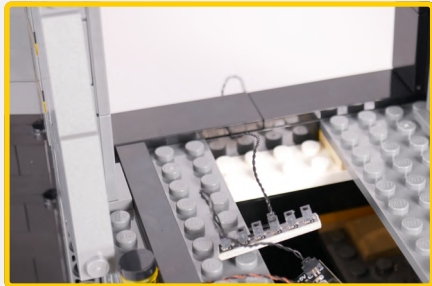

NOTE

Push all the cables and boards down into the cavity. In addition, ensure all the cables are run inbetween studs

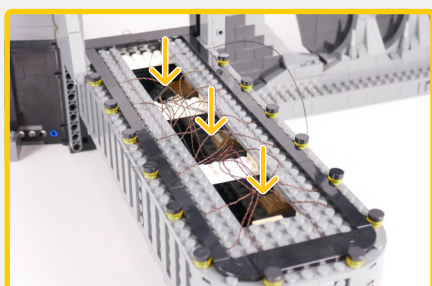

55

30cm Connecting Cable

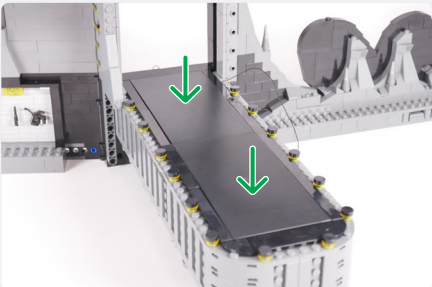
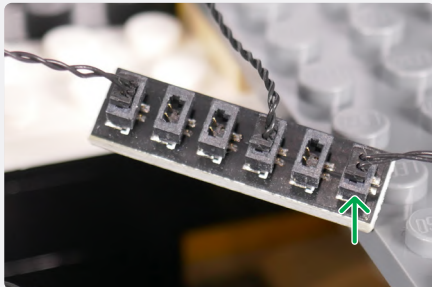
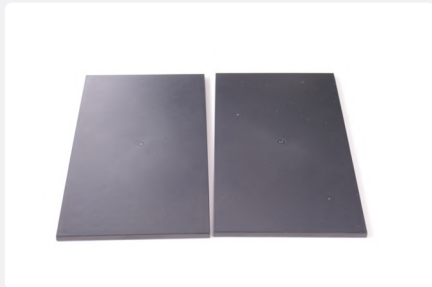
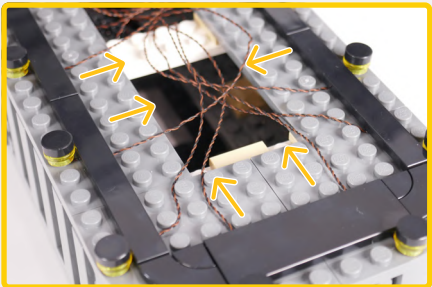
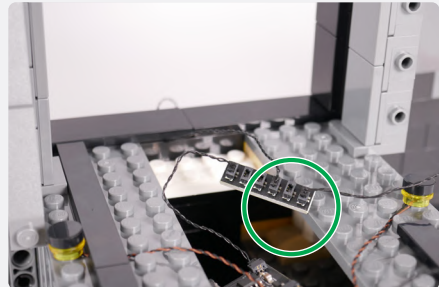

56

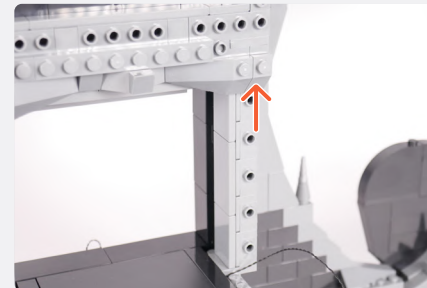
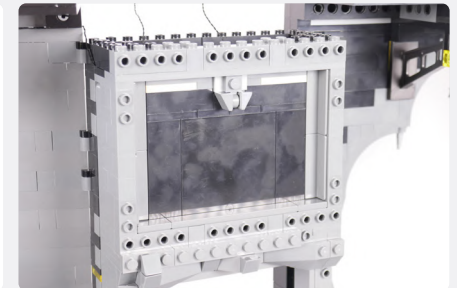
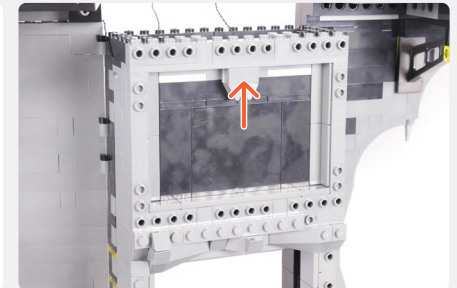
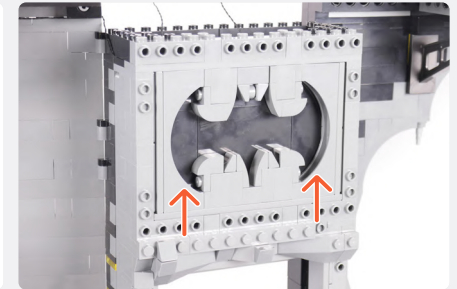
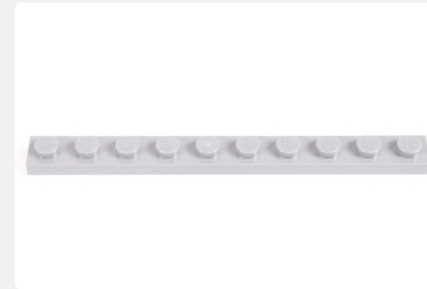
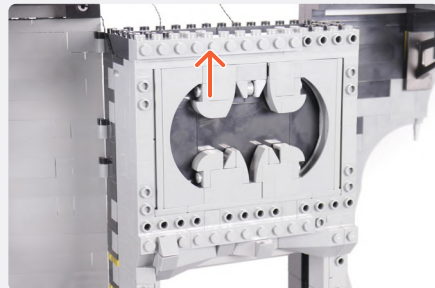
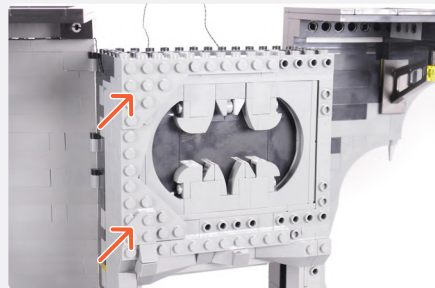
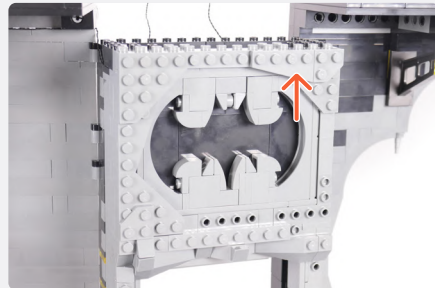
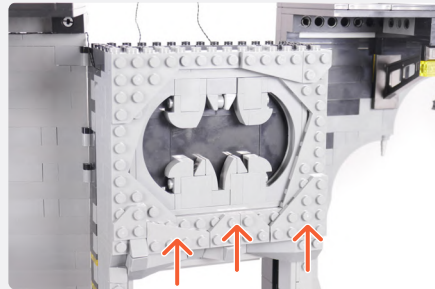
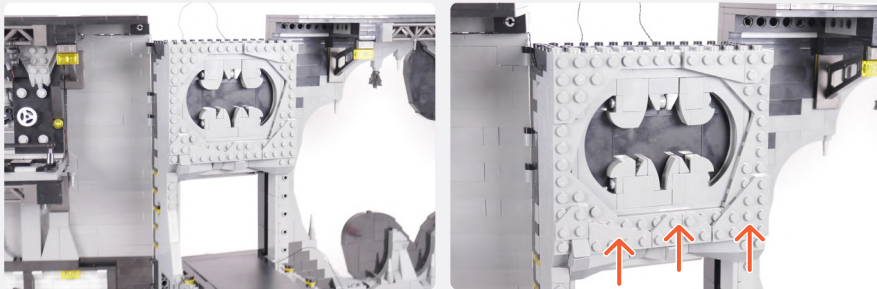

57

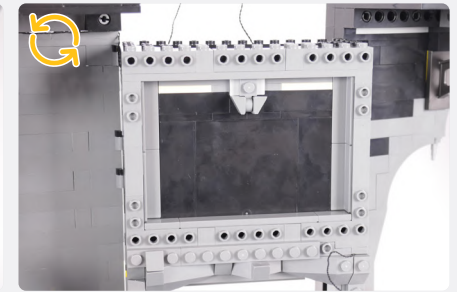
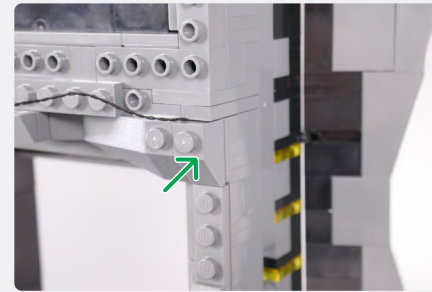
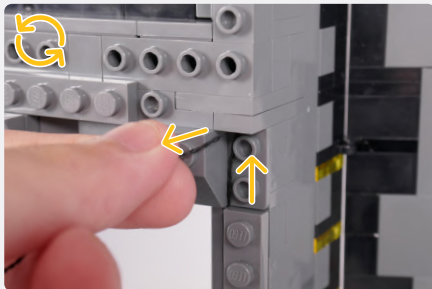
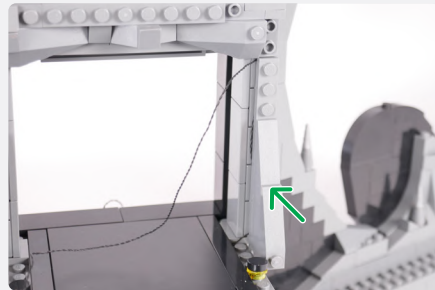
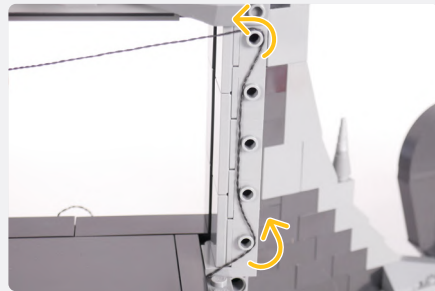
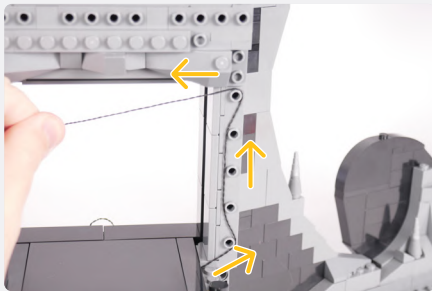
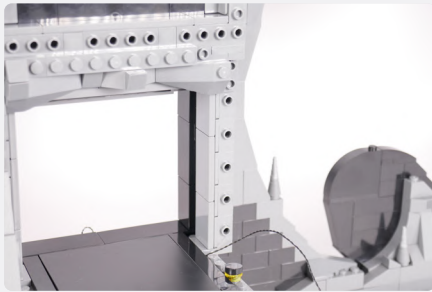

NOTE

Disconnect the following section but leave it resting on top

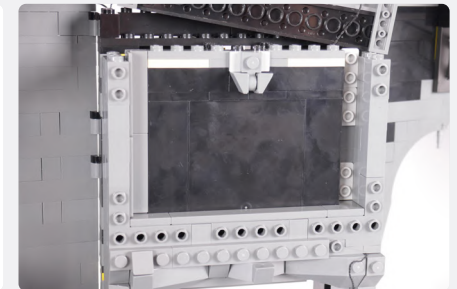
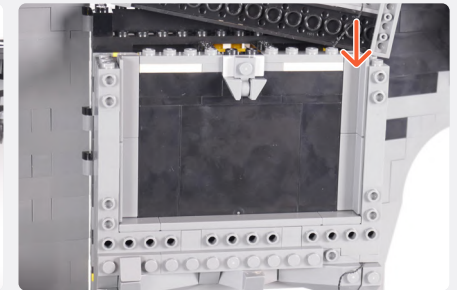
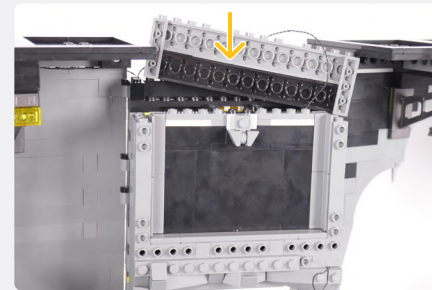
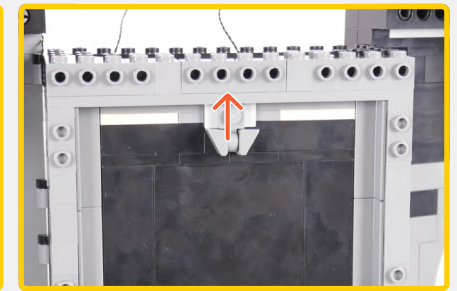

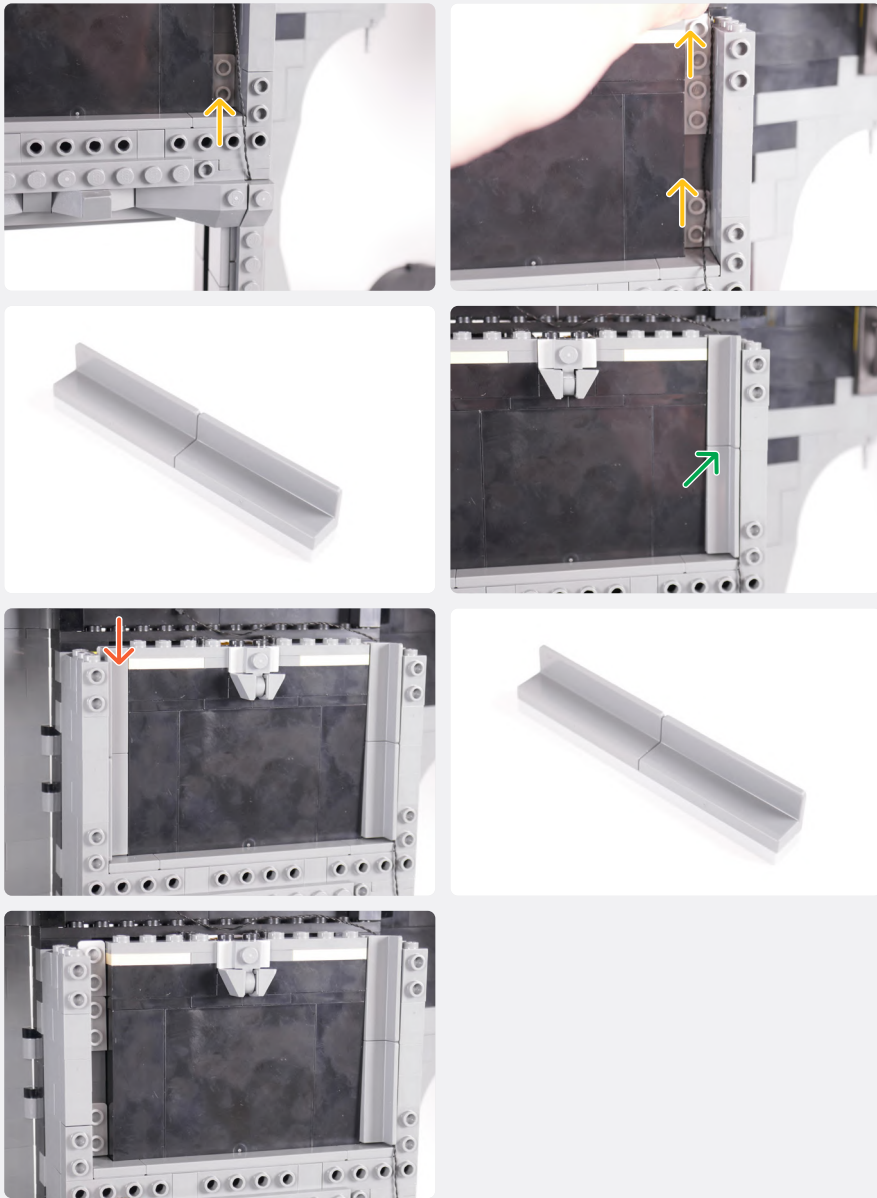

58

Brick, Round 1x1 Open Stud - Trans-Red



Tile, Round 1x1 - Trans-Red



Rotating Bit Light

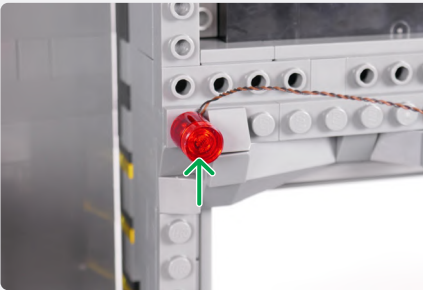
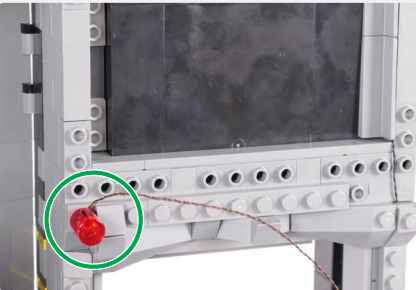
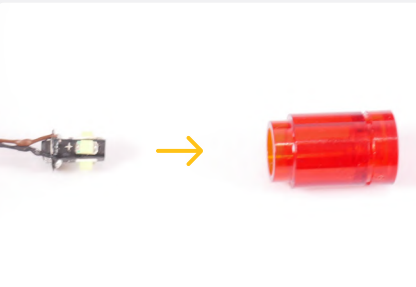

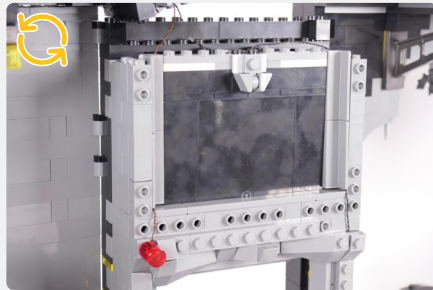
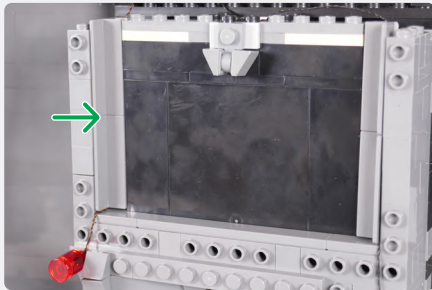
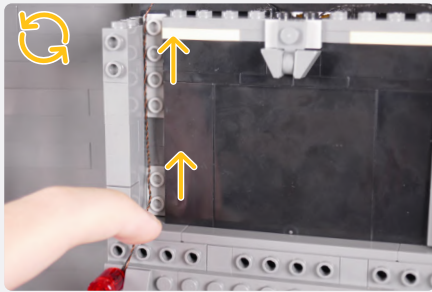

59

Cool White 30cm Bit Light



Plate, Round 1x1 with Open Stud - Black

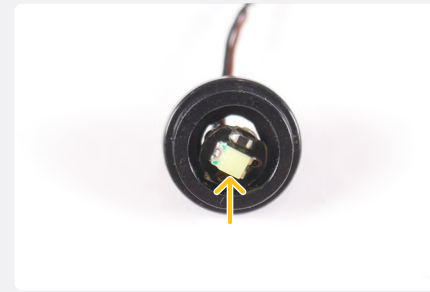
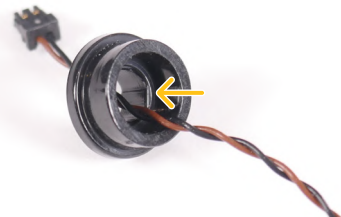

Tile, Modified 1x1 with Open O Clip - Black



Plate, Round 1x1 with Bar Handle - Black



Plate, Modified 1x2 with 1 Stud with Groove and Bottom Stud Holder (Jumper) - Black

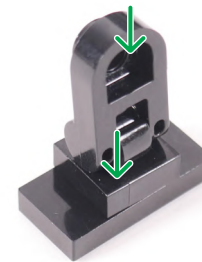

60

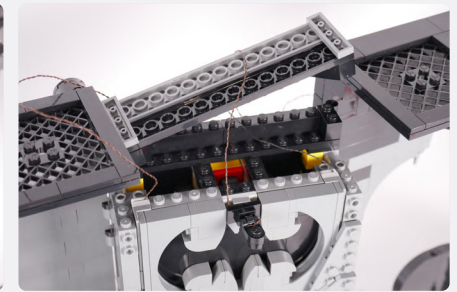
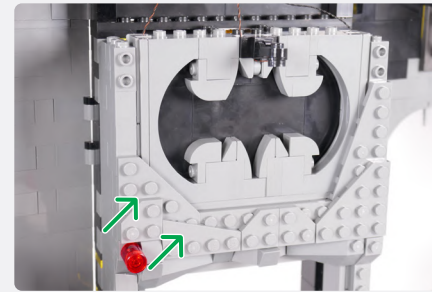
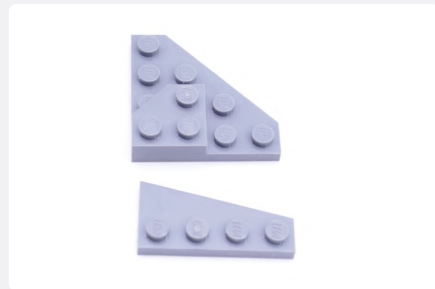
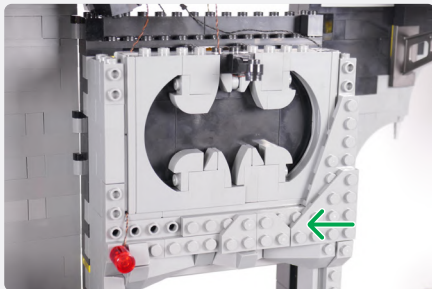
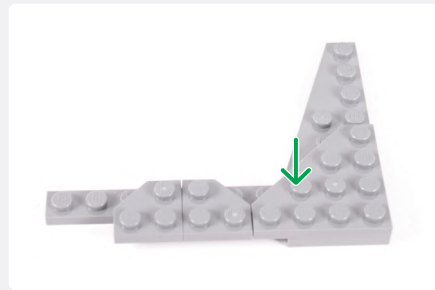
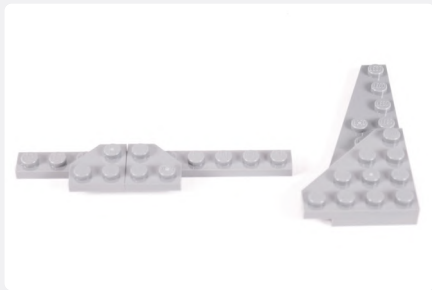
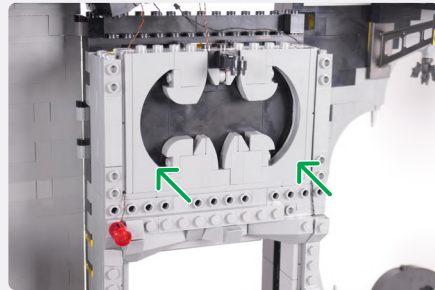
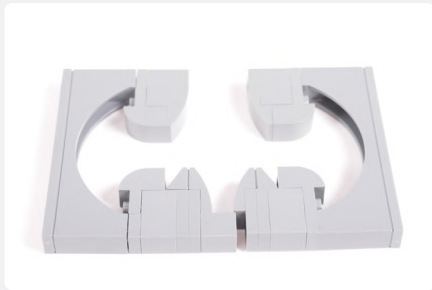
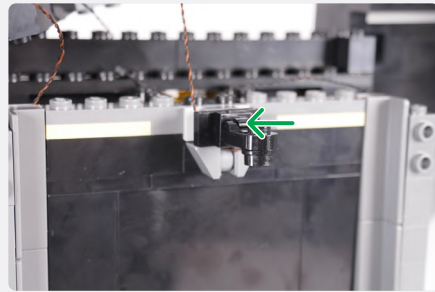
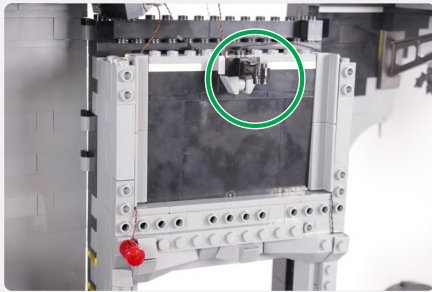

NOTE

Thread the three cables coming from the middle section through the following area before securing them into position

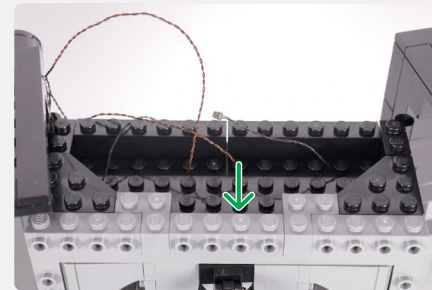
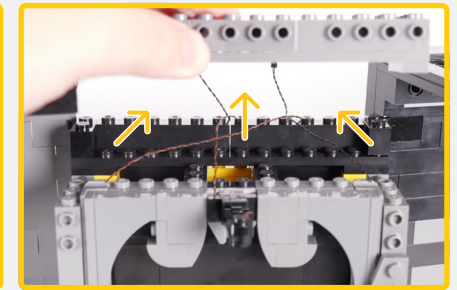

NOTE

Connect the three cables to the 6-Port Expansion Board from Step 45

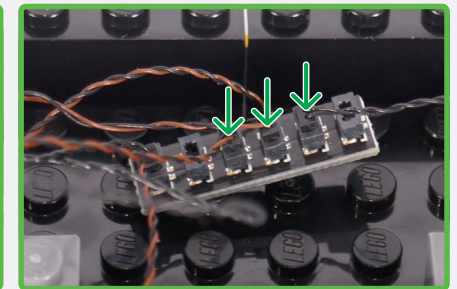
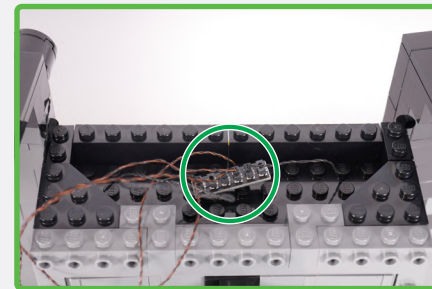

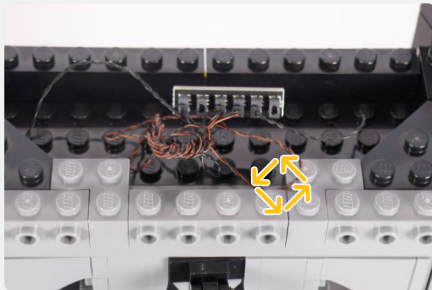
61

NOTE

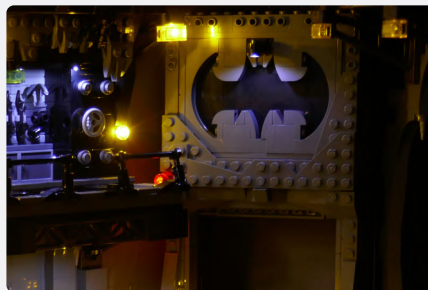
Connect to a 5V USB Power Bank, 5V USB Wall Adaptor, or USB to AA Battery Pack (sold separately)

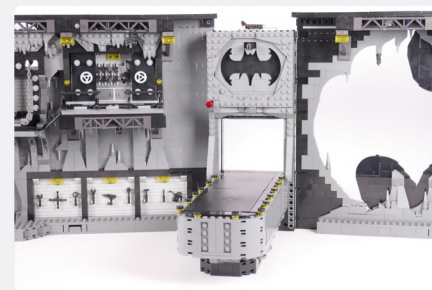
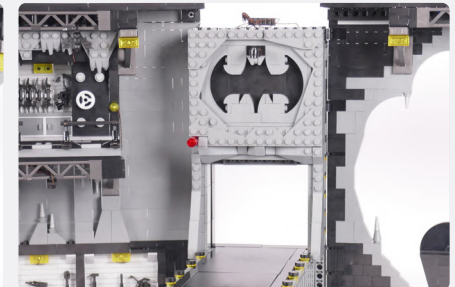
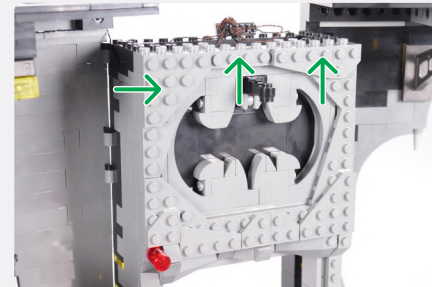
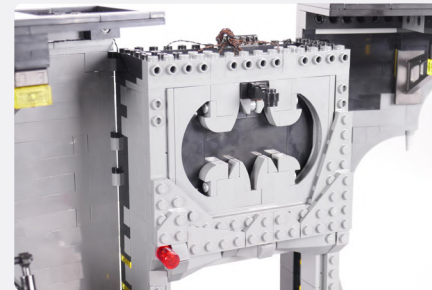

! If you experience any issues with the lights not working and suspect an issue with a component, please try a different port on the expansion board to verify where the fault lies (with the light or expansion board). To correct any issues with expansion board ports, please view the section addressing expansion board issues in our troubleshooting section. i

62

63

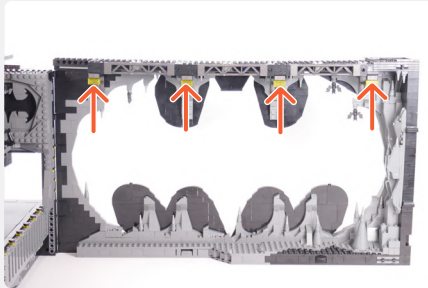
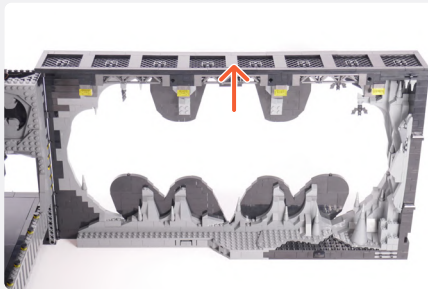

64

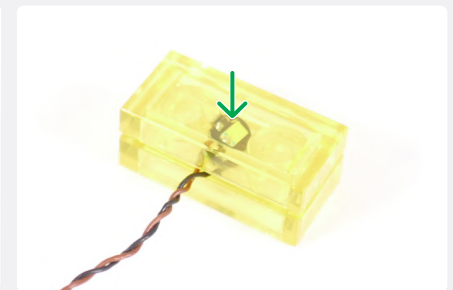
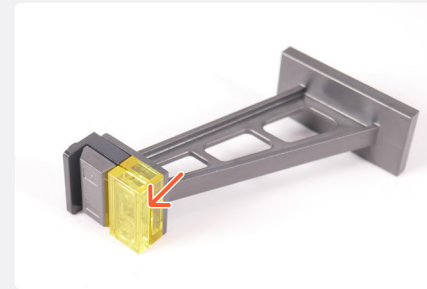

65

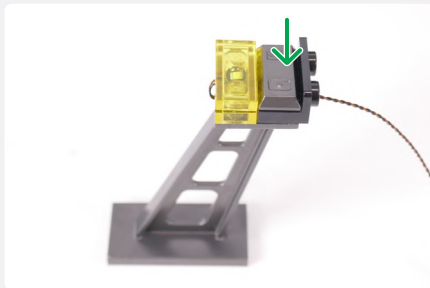
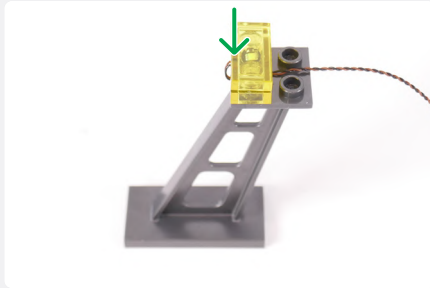
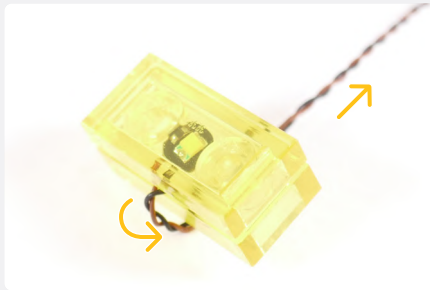

Cool White 30cm Large Bit Light



Plate, Round 1x1 with Open Stud - Black



Plate, Round 1x1 with Bar Handle - Black



Tile, Modified 1x1 with Open O Clip - Black



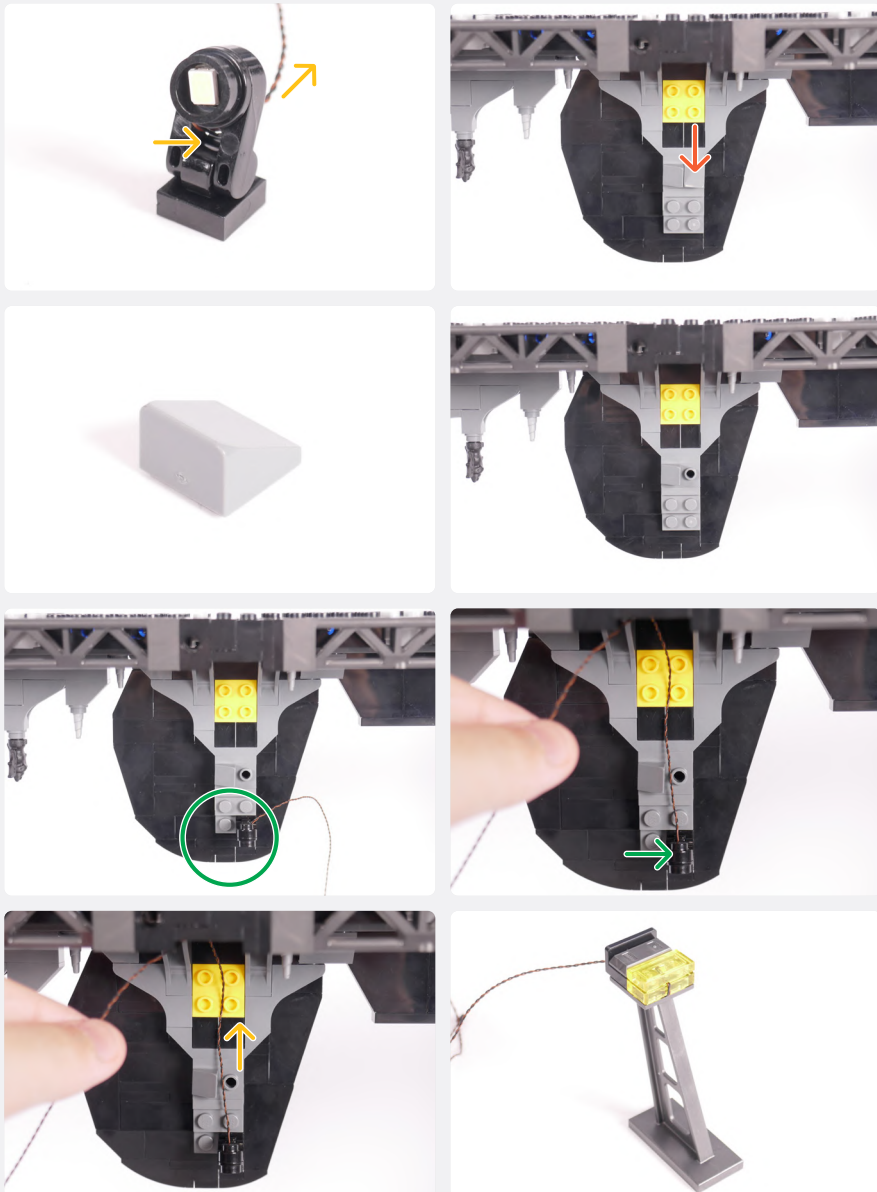

66

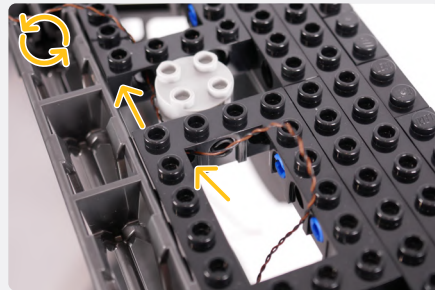
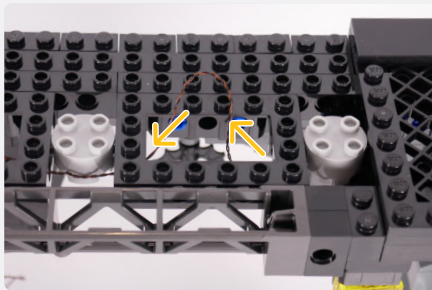

NOTE

Continue to thread through the technic holes until it reaches the indicated position

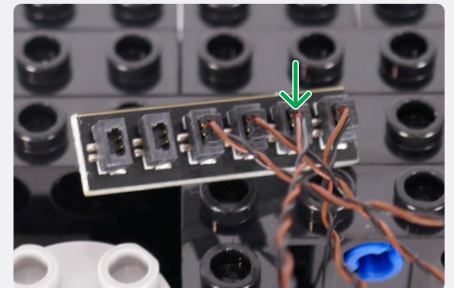
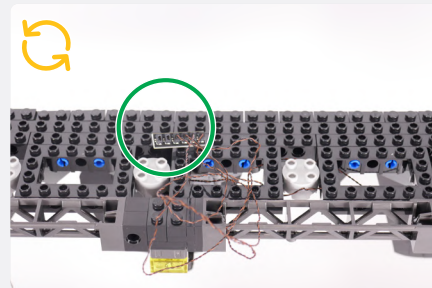
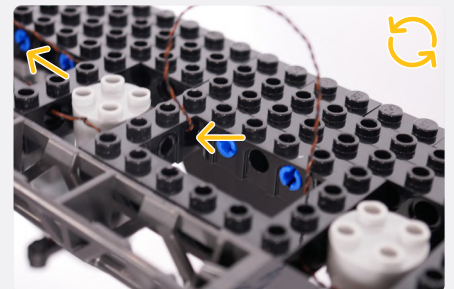
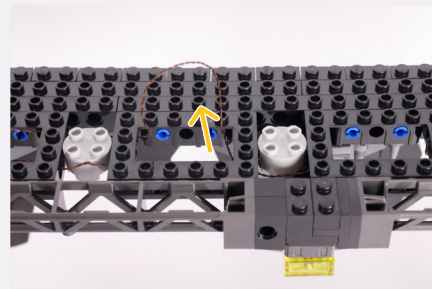
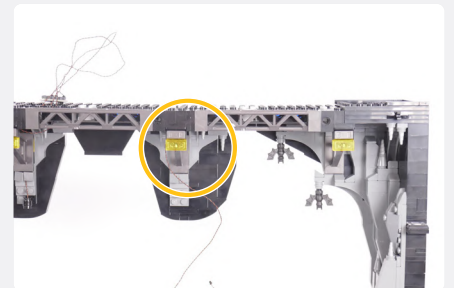
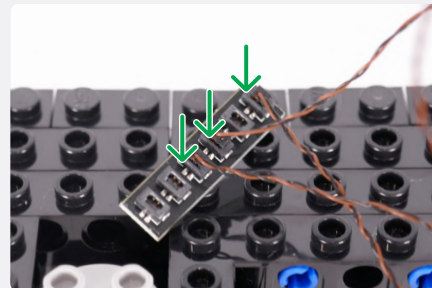
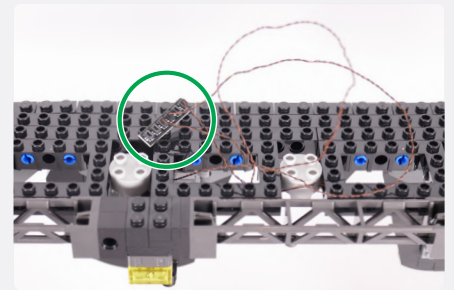
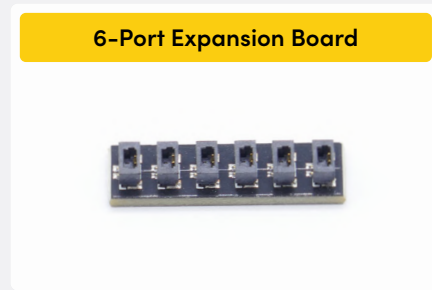
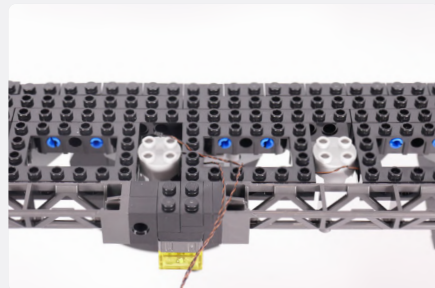
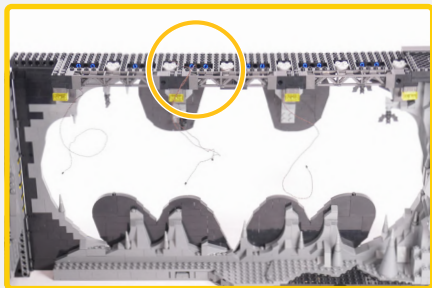
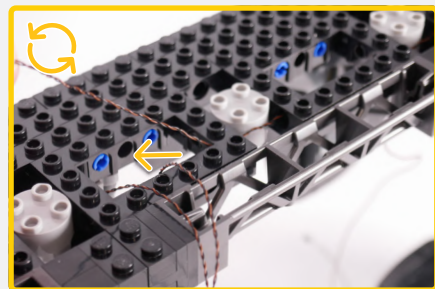
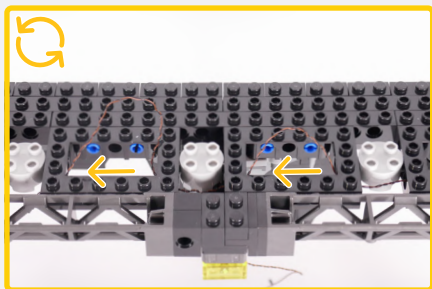
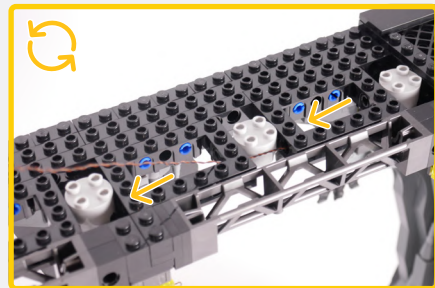

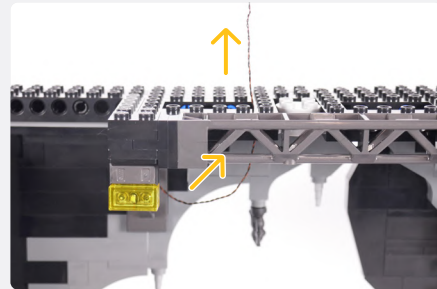
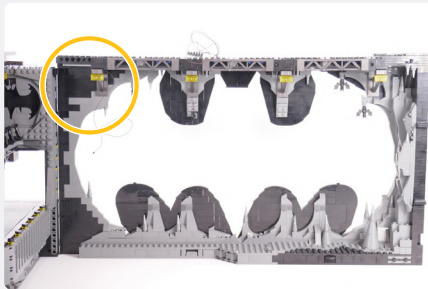

NOTE

Continue to thread through the technic holes until it reaches the indicated position

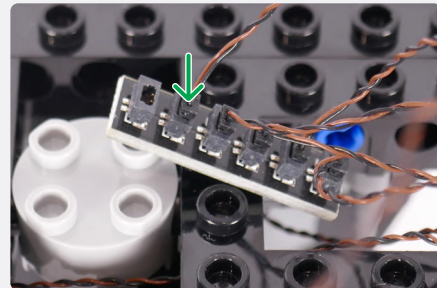
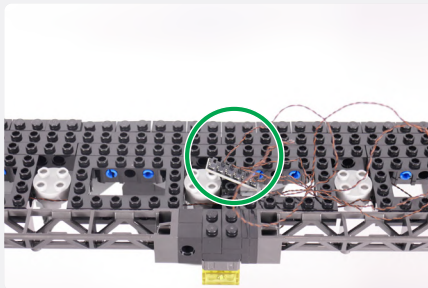
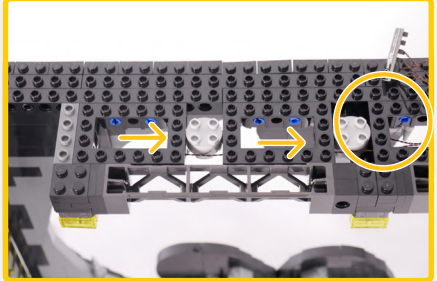

67

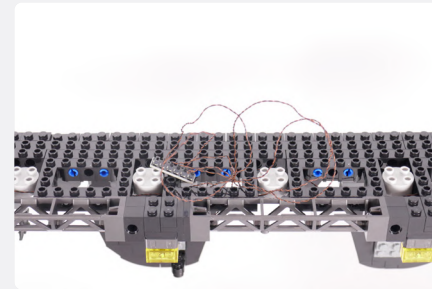

50cm Connecting Cable

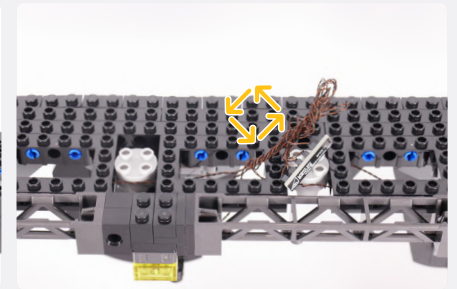

2x Adhesive Square

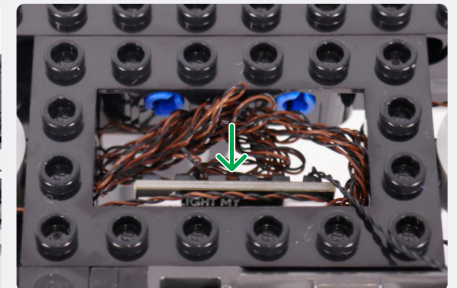
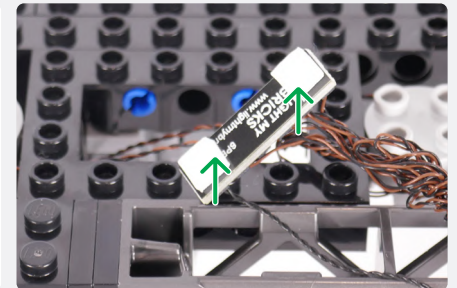
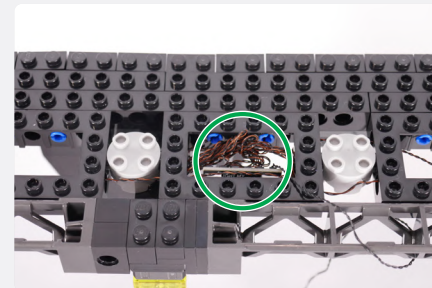
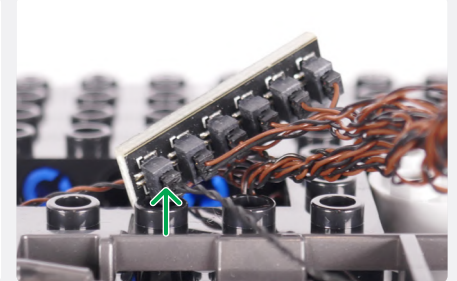

NOTE

Thread the 50cm Connecting Cable through the technic pins

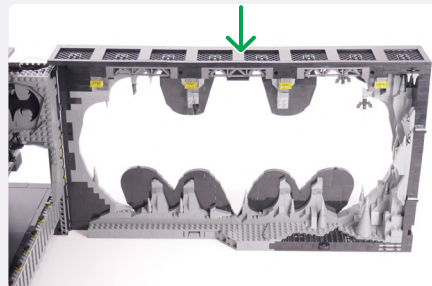
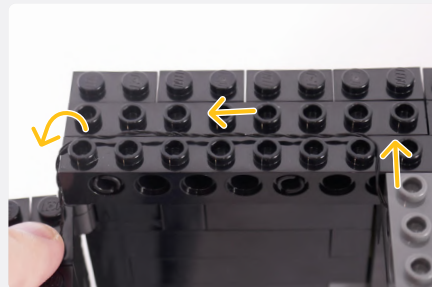
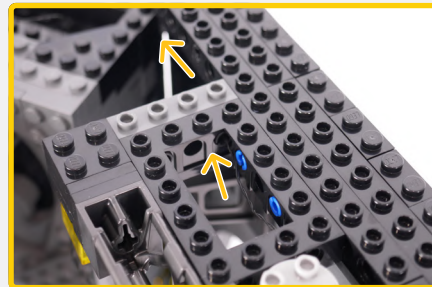
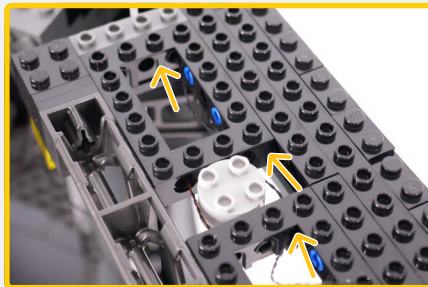
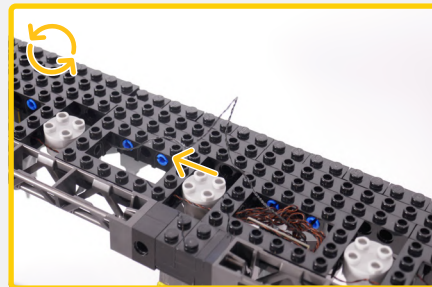

68

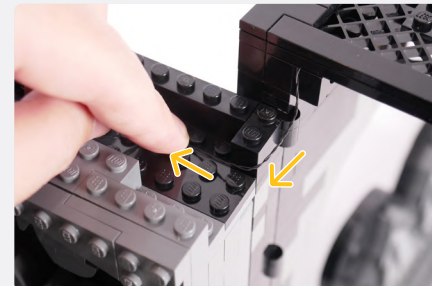
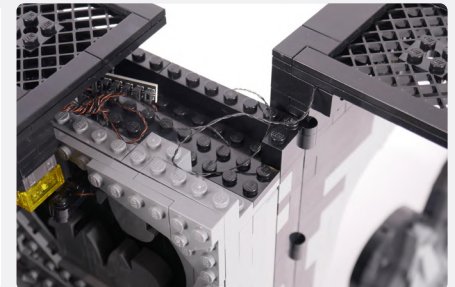
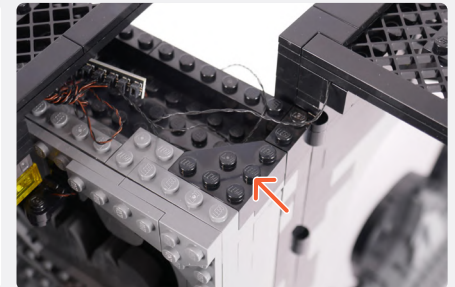
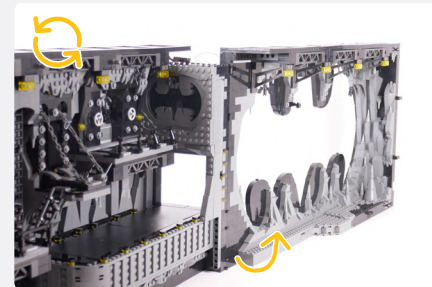
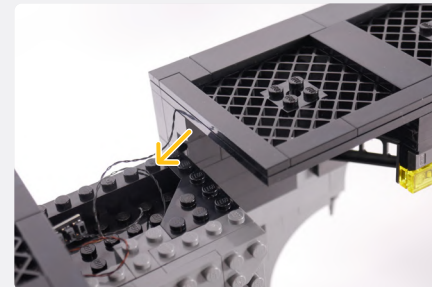

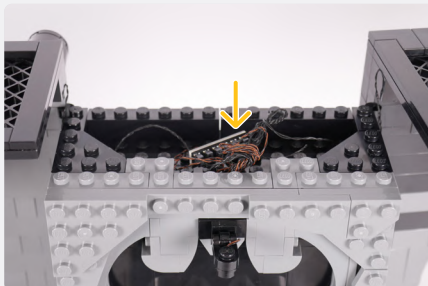
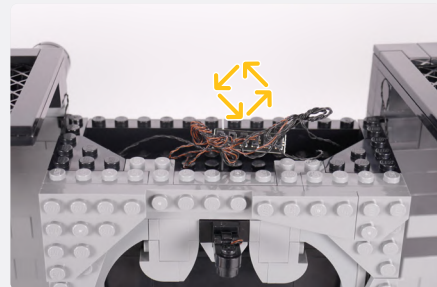
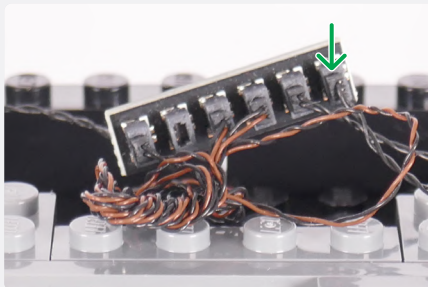
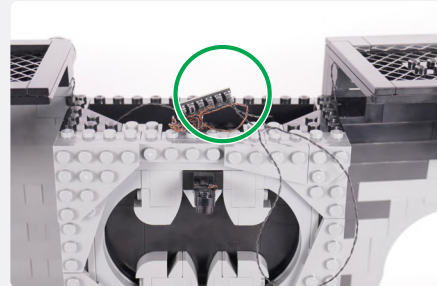
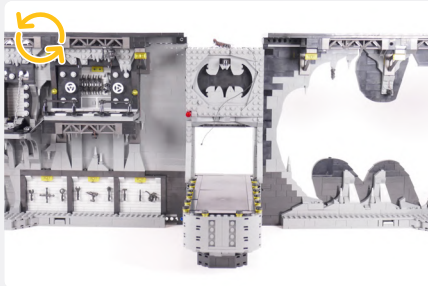
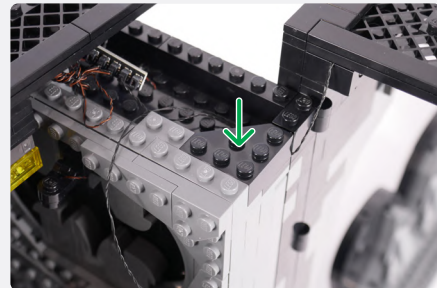

69

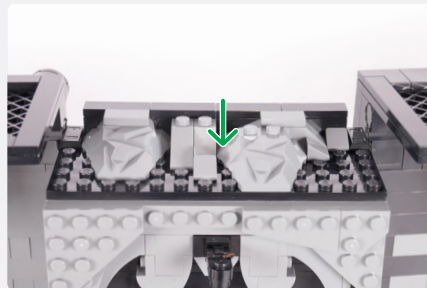

NOTE

Connect to a 5V USB Power Bank, 5V USB Wall Adaptor, or USB to AA Battery Pack (sold separately)

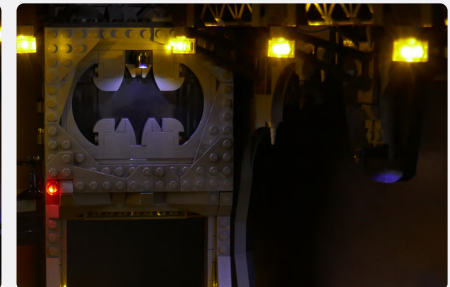

! If you experience any issues with the lights not working and suspect an issue with a component, please try a different port on the expansion board to verify where the fault lies (with the light or expansion board). To correct any issues with expansion board ports, please view the section addressing expansion board issues in our troubleshooting section. **i**



70

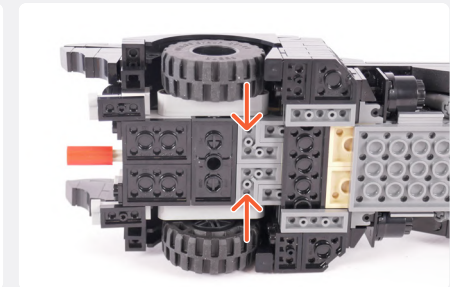
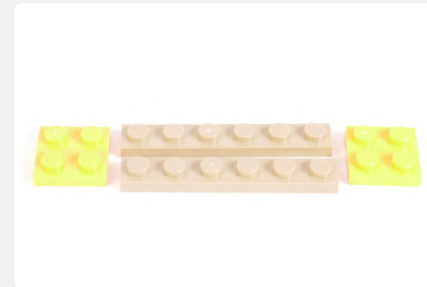
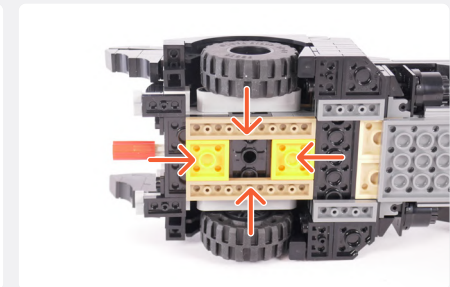
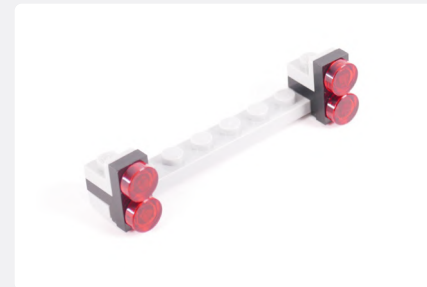
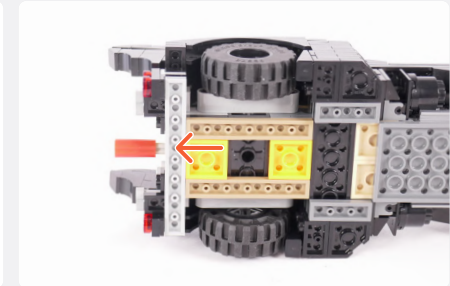
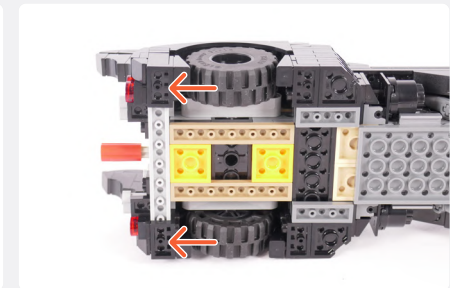
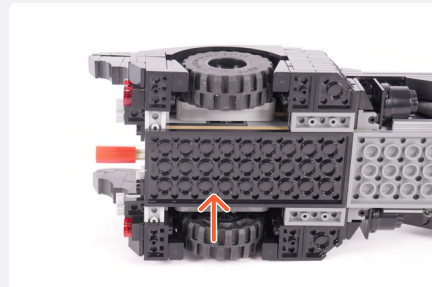
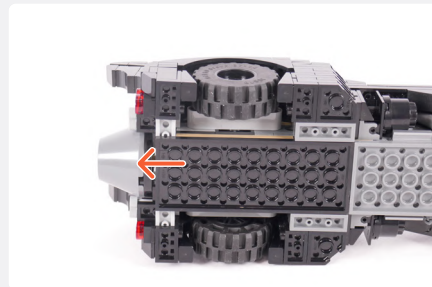
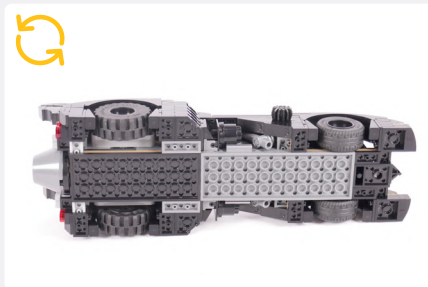
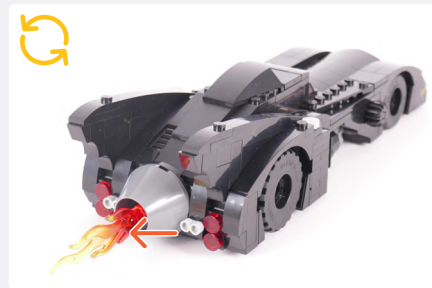

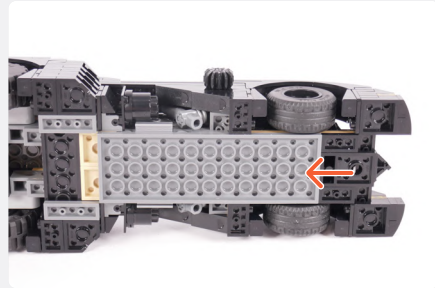
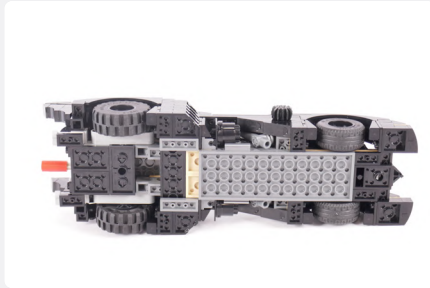
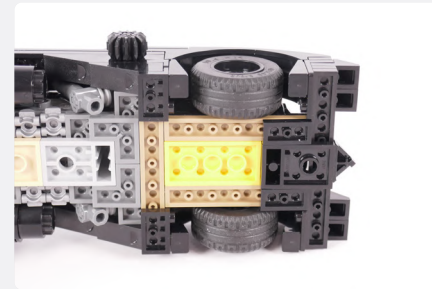
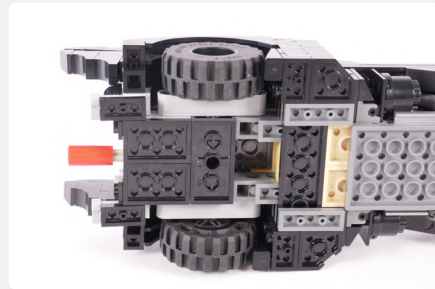
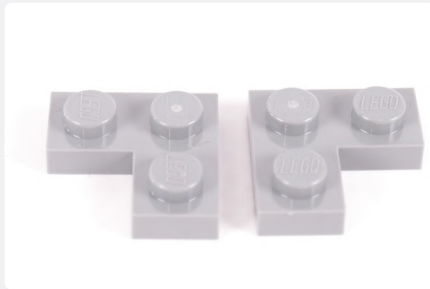

71

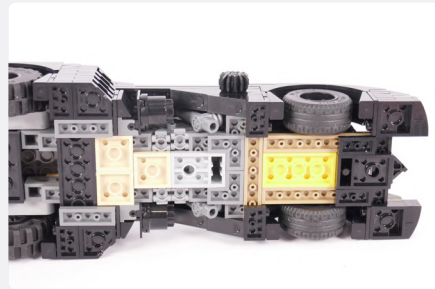

White 30cm Bit Light

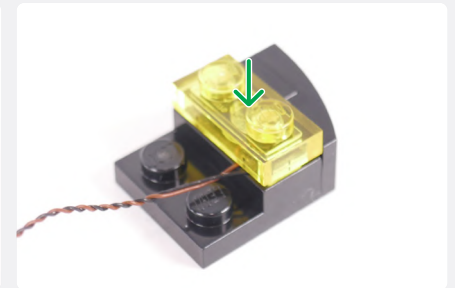
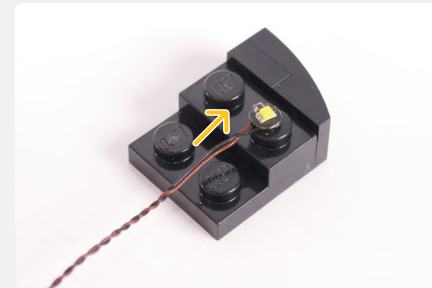
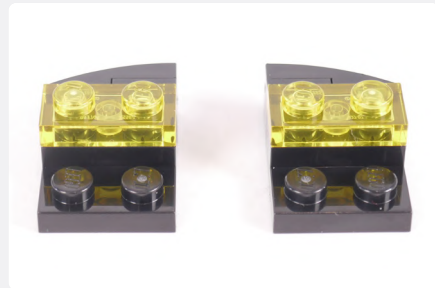
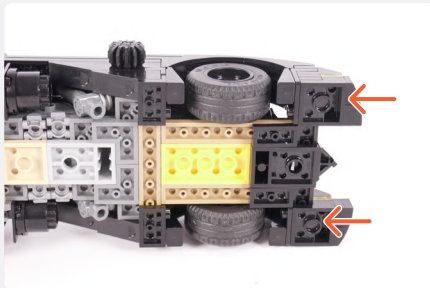

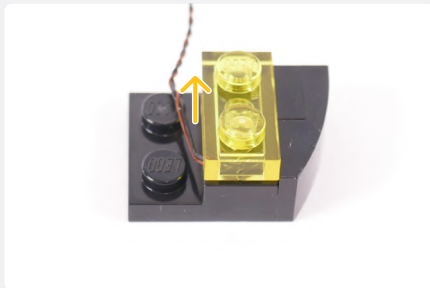

NOTE

Repeat this process for the other headlight

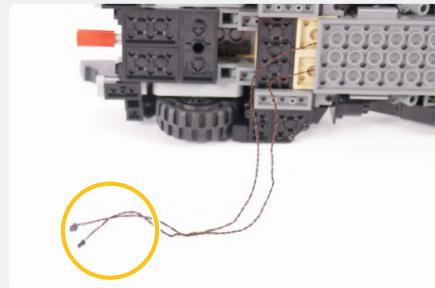
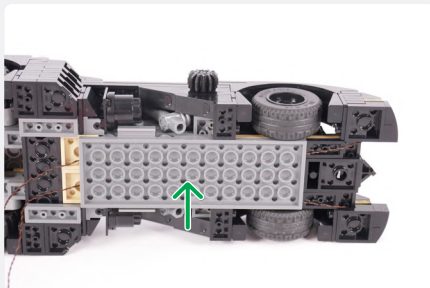
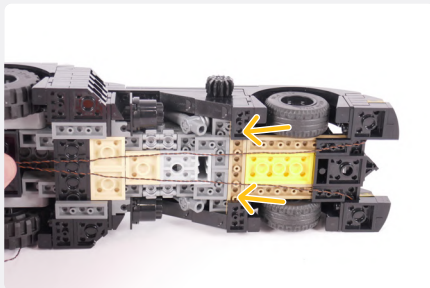
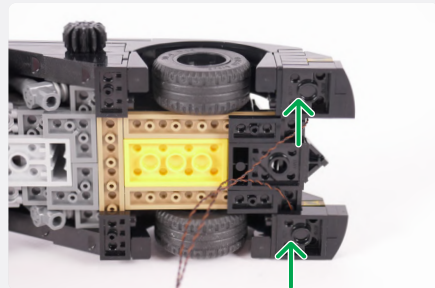
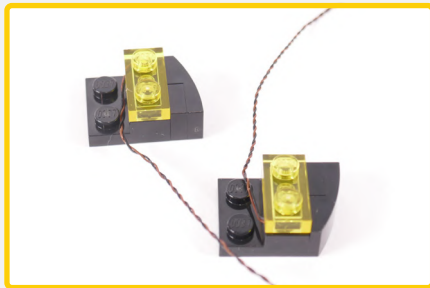

8-Port Expansion Board

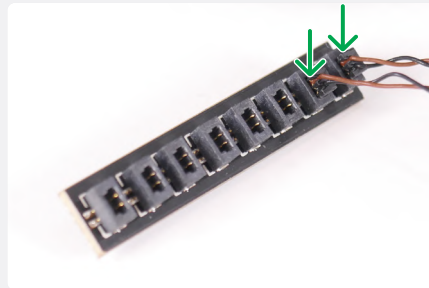
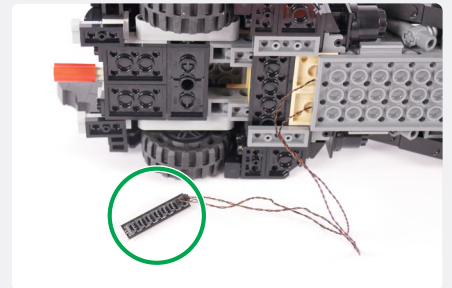

72



Orange 30cm Large Bit Light

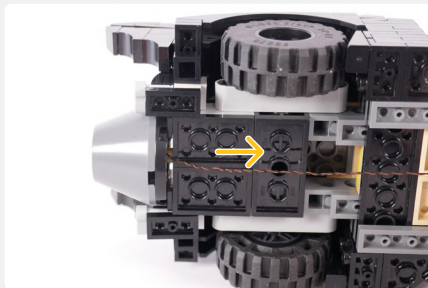
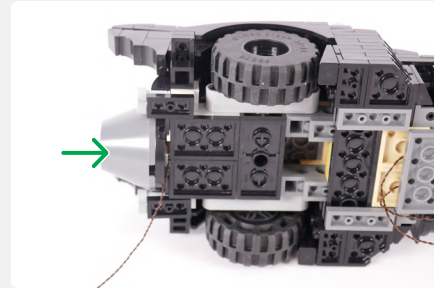
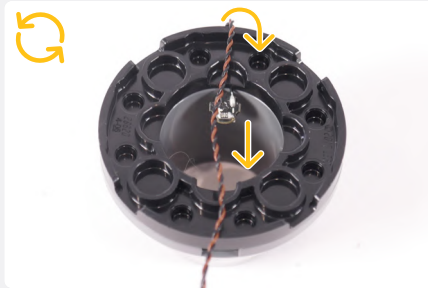

Flicker Effects Board

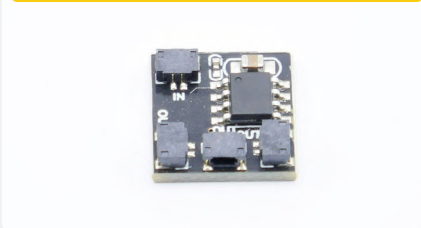

5cm Connecting Cable



NOTE

Connect the 5cm Connecting Cable to the 'IN' port on the Flicker Effects Board

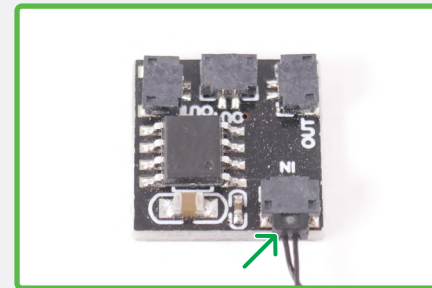

NOTE

Connect the Orange 30cm Large Bit Light to the 'OUT' port of the Flicker Effects Board

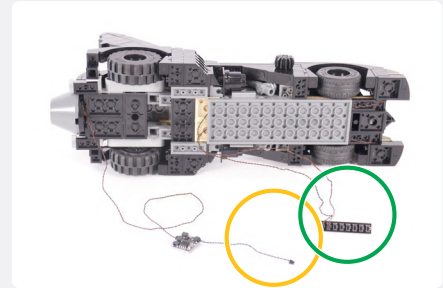
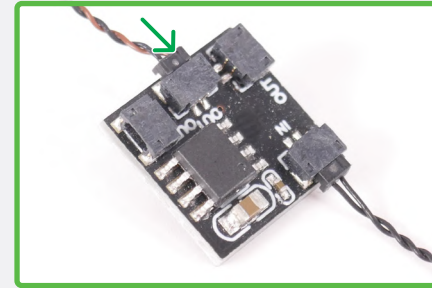

NOTE

Connect the other end of the 5cm Connecting Cable to the 8-Port Expansion Board

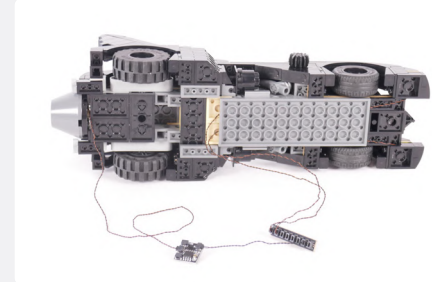
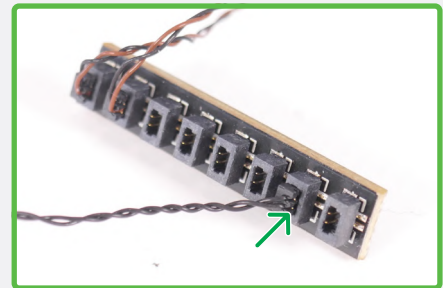

73

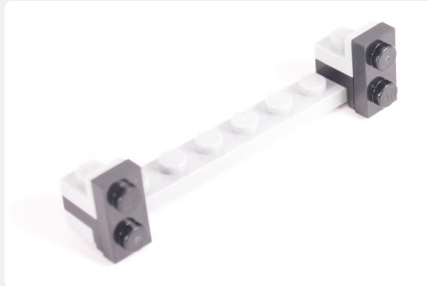
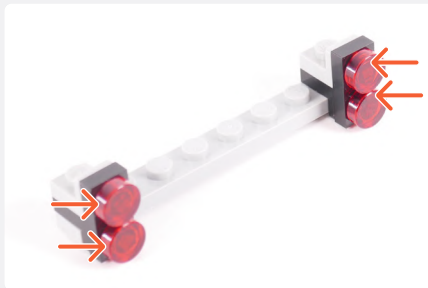

White 15cm Bit Light



Plate, Round 1x1 - Trans-Red

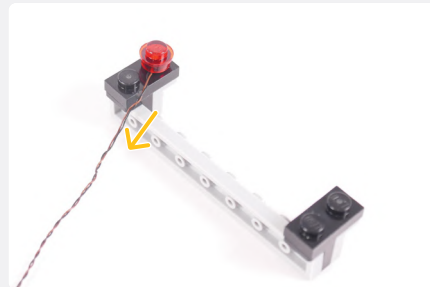
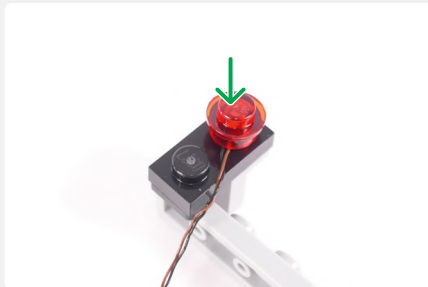

NOTE

Repeat the same process for the rear lights

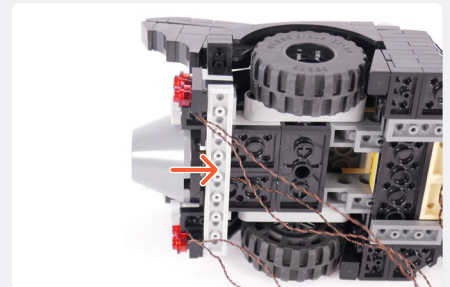
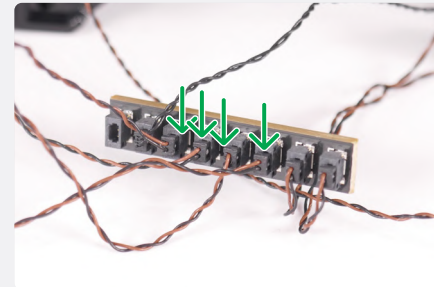
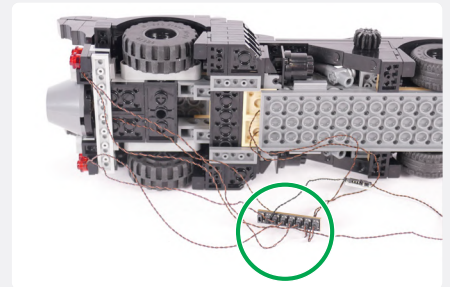
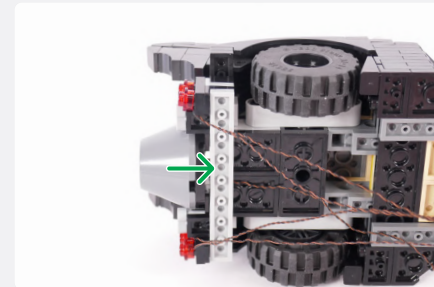
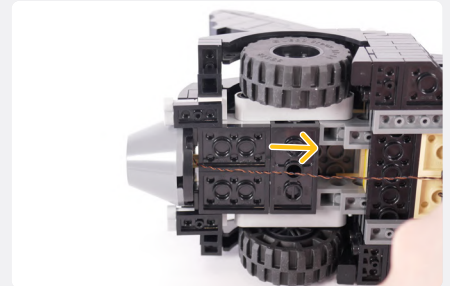
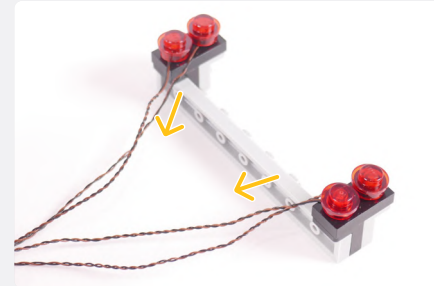
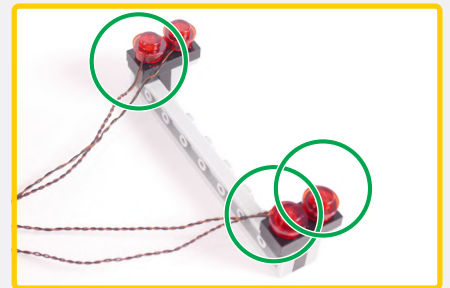

74

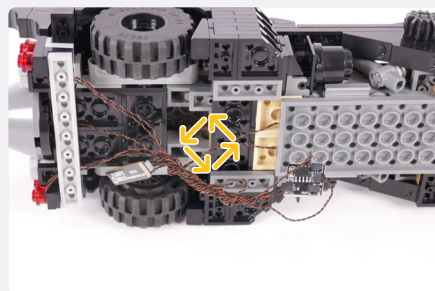
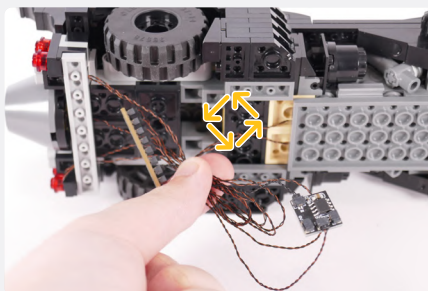
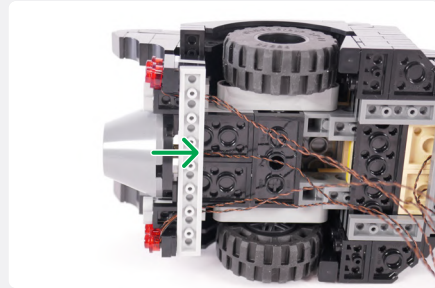
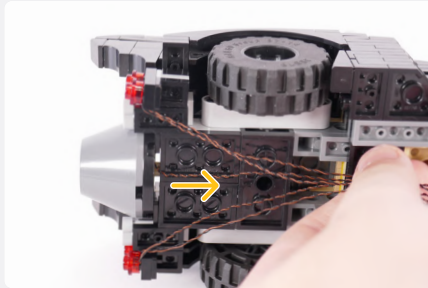
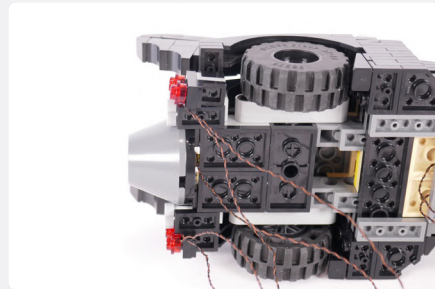

NOTE

Push all the cables and Flicker Effects Board into the cavity

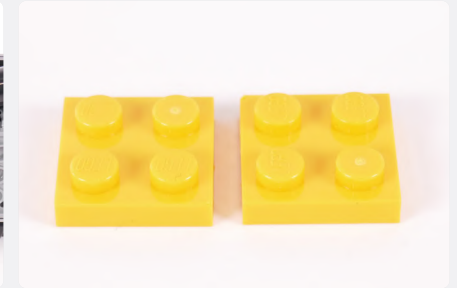
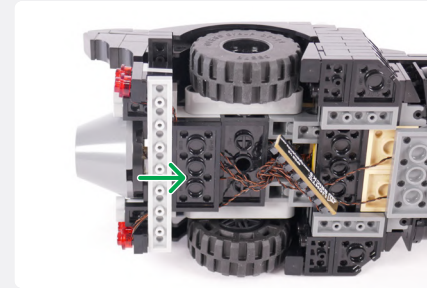
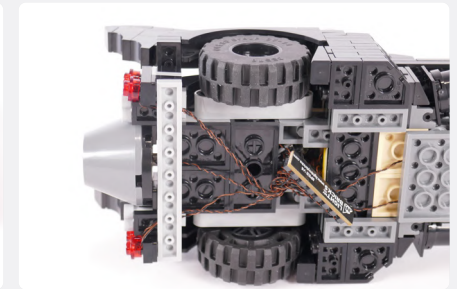
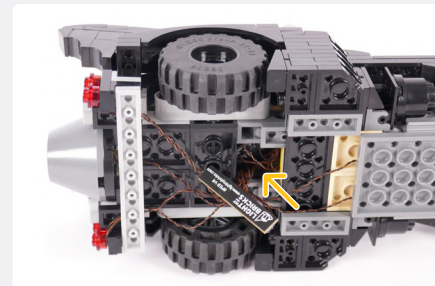

2x Adhesive Square

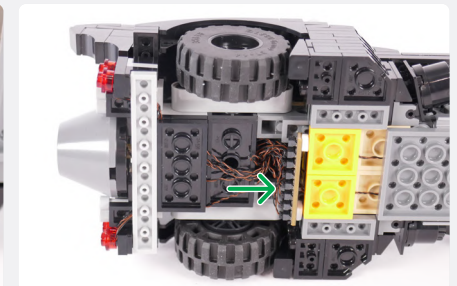
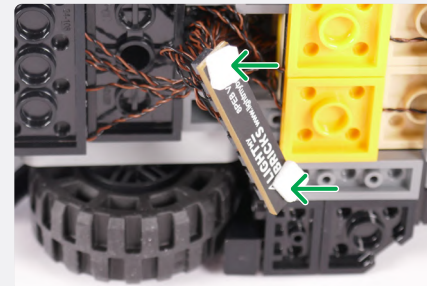
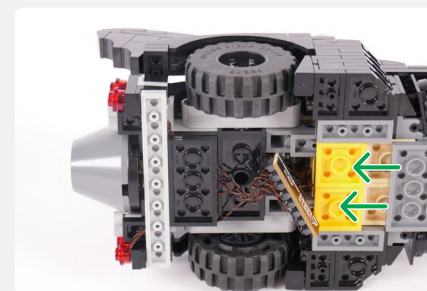

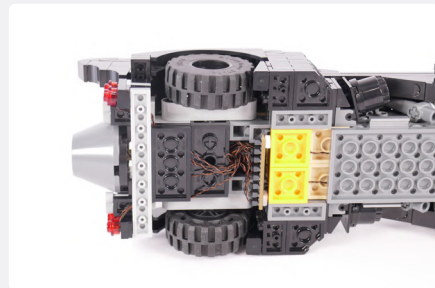

75

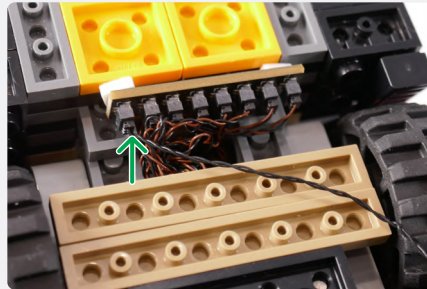
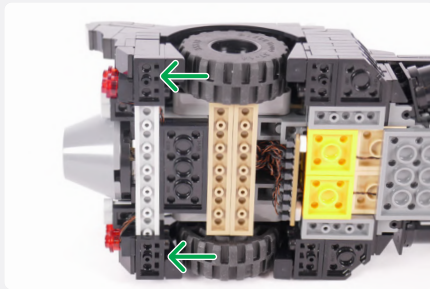
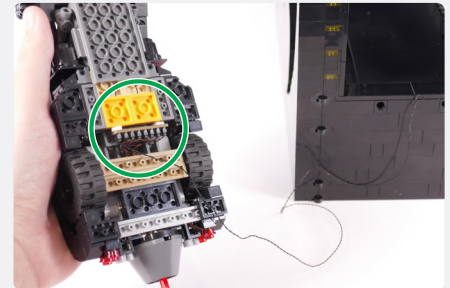
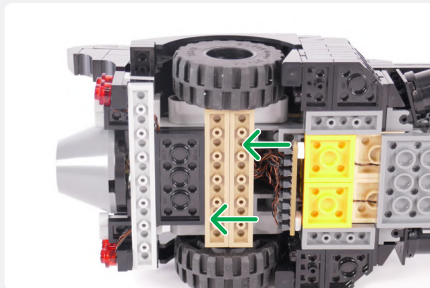

NOTE

If you are having trouble connect the 50cm Connecting Cable to the 8-Port Expansion Board, disconnect both 1x6 Plates first

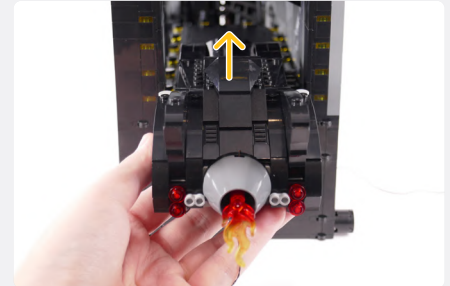
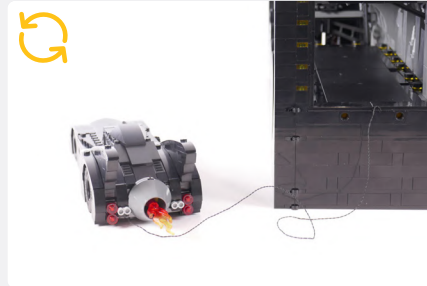
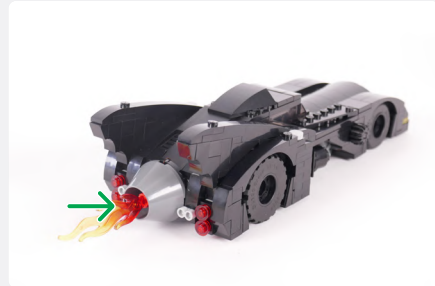

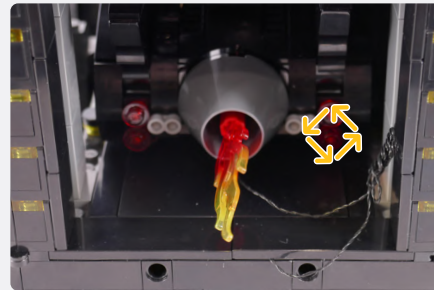
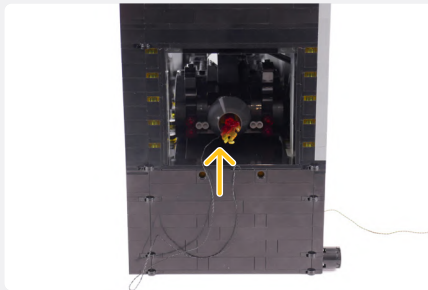

NOTE

Put the excess bundled cable beneath the Batmobile

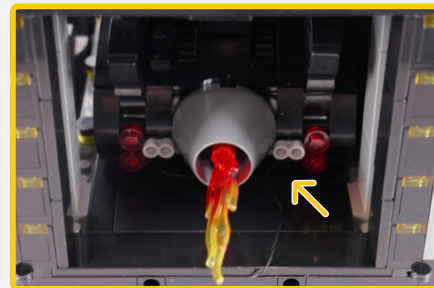

76

NOTE

Connect to a 5V USB Power Bank, 5V USB Wall Adaptor, or USB to AA Battery Pack (sold separately)



! If you experience any issues with the lights not working and suspect an issue with a component, please try a different port on the expansion board to verify where the fault lies (with the light or expansion board). To correct any issues with expansion board ports, please view the section addressing expansion board issues in our troubleshooting section. **i**

NOTE

You should have these parts left over that were removed from the LEGO set

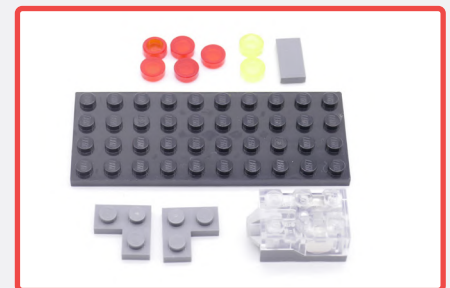

FINAL PRODUCT

This finally completes installation of the Light My Bricks

LEGO® DC Batcave Shadow Box 76252 Light Kit.

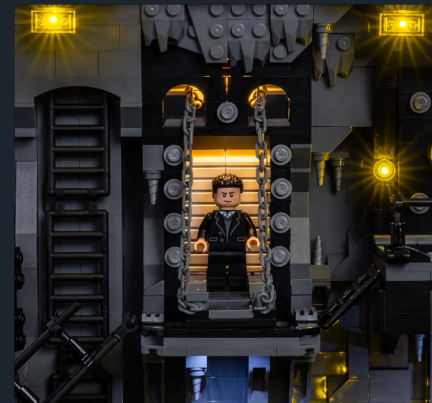



TROUBLESHOOTING

Light My Bricks lighting kits contain individual components that are very small and can be easily damaged if not handled correctly.

To prevent unnecessary damage to components, we highly recommend that the User Guide section, **“Important things to note”** is read carefully. Follow the handling procedures in the User Guide to help prevent faults and damages to your Light My Bricks components.

If you are experiencing issues with your Light My Bricks set, watch our troubleshooting video [here](#) or read on for a list of common causes to help you troubleshoot.

Troubleshooting

Firstly, ensure that the batteries have power using a battery charge gauge.

If the batteries have no power, replace the batteries.

If the batteries still have power, check to see if the batteries have been inserted correctly into the battery pack.

Check for AA batteries using the AA battery pack

Inside the battery pack are symbols indicating which direction the AA battery should be inserted. The flat side of the battery should be paired with the spring side of the battery pack.

If the batteries have been installed correctly and your kit still isn't operating correctly, the next step is to check the wiring.

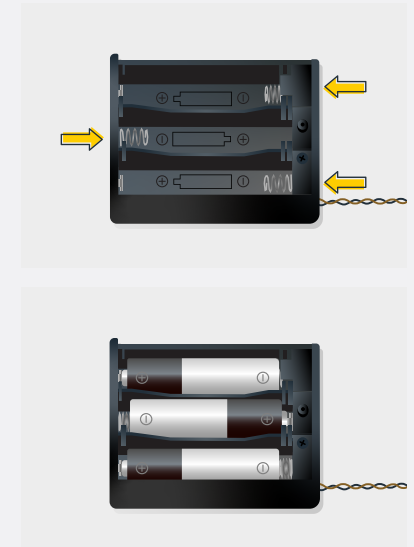

Troubleshooting

Check Your Wires

In order for Light My Bricks components to fit in between and underneath LEGO® bricks, the components need to be very small. Due to this nature, Light My Bricks components can be easily damaged when not handled correctly.

Be careful when removing unpacked components out of the packaging and ensure not to forcibly pull at the wires as this can damage the soldering that attach the wires to the LEDs.

If the wiring is detached from the LED itself, the light will not operate.

When connecting lights to your LEGO® set, check that there are no pinched wires underneath or in between bricks and plates.

When the wires are pinched and the exposed wires are touching each other, this can cause a crosswire and the lights to not function correctly.

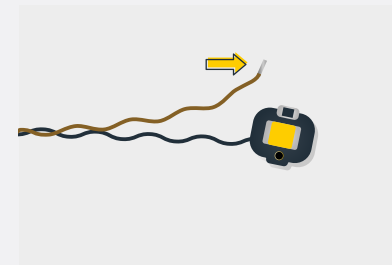
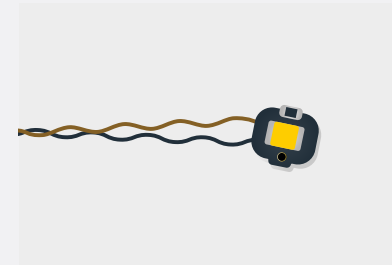

Troubleshooting

Check Your Expansion Board Ports/ Strip Light Ports / Effects Board Ports

It is important to note that connectors can only be inserted to the expansion board, strip light, or effects board ports in one direction.

Forcibly inserting connectors in the incorrect direction will result in damaging the pins inside each of the ports on your component board.

Not only will a light connected to the damaged port not work, but if the pins inside the port are bent to a point they are touching each other, this can result in all other lights in the system to stop working. This is a short circuit.

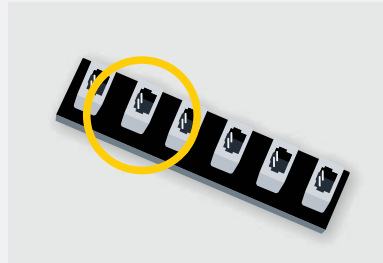

A short circuit can also result in overheating of the board, cable or batteries. If you suspect a short circuit, **DISCONNECT POWER IMMEDIATELY**. Batteries can fail, catch fire, or even explode if left connected to a short circuit for too long.

If you suspect you have a faulty component due to a bent pin, try the following steps:

If you look carefully inside each of the ports, each port contains 2 small pins that should be straight. You will be able to identify a faulty port if it has any bent pins.

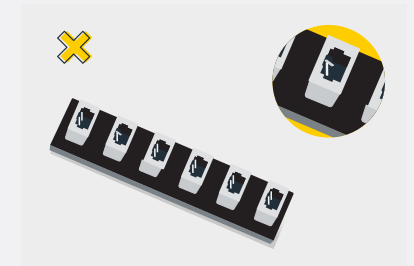
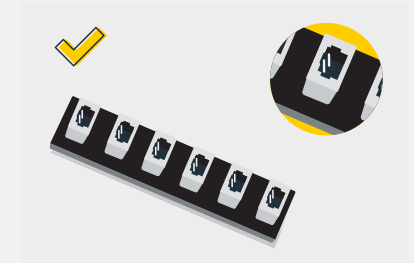
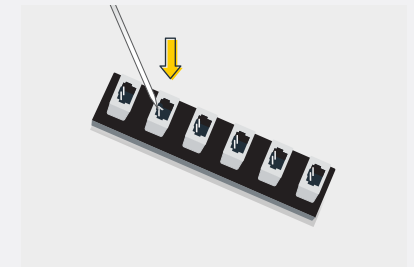



CONTACT US

If you have an enquiry regarding the online shop, our products or a general enquiry please refer to our Frequently Asked Questions webpage here.

Alternatively, you can contact our Customer Services team by visiting our online support portal here.

support.lightmybricks.com

We thank you for purchasing this product and hope you enjoy!



lightmybricks.com