



**LIGHT^{MY}
BRICKS**



LEGO[®] JAZZ CLUB #10312

LIGHT KIT

INSTALLATION GUIDE

Light My Bricks



LEGO® JAZZ CLUB 10312 INSTALLATION GUIDE

Hi There!

We're here to help you get started on the LEGO®
Jazz Club 10312 Light Kit.

This PDF details the instructions for the LED light kit only. If you are wishing to purchase this product, please [click here](#) to view the product page.

If you run into any issues, please refer to the troubleshooting section towards the end of this guide.

Have fun and enjoy!





PACKAGE CONTENTS:



- 1 x Multi-Colour Strip Light
- 6 x White Strip Light
- 8 x Flashing White 15cm Micro Bit Light*
- 14 x White 15cm Bit Light
- 4 x White 30cm Bit Light*
- 1 x Pink 30cm Bit Light
- 1 x Blue 30cm Bit Light
- 1 x Flashing Red 30cm Bit Light
- 1 x Orange 30cm Large Bit Light
- 1 x Lamp Post - White



- 1 x Micro 8-Port Expansion Board
- 3 x 6-Port Expansion Board
- 1 x 8-Port Expansion Board
- 1 x 12-Port Expansion Board
- 1 x Flicker Effects Board



- 2 x 5cm Connecting Cable
- 5 x 15cm Connecting Cable
- 2 x 30cm Connecting Cable
- 4 x Wireless Power Connectors



- 1x USB Power Cable
(Power Source not Included)

+ 10x Adhesive Square

ASSORTED BRICKS:

- 6 x Plate 1x6 (Any Colour)
- 6 x Round Plate 1x1 w/ Open Stud - Black
- 1 x Tile 1x1 W Clip Round Edges - Black
- 3 x Plate 1x1 Mod Rounded w Handle - Black
- 2 x Arm Skeleton, Bent with Clips (Horizontal Grip) - Black
- 6 x Round Plate 1x1 - Trans Yellow
- 1 x Round Plate 1x1 - Trans Clear
- 4 x Round Plate 1x1 w/ Open Stud - White
- 2 x Plate 1x2 - Light Grey
- 2 x Plate 1x2 - Black
- 2 x Tile 1x1 - Dark Grey
- 10 x Tile 1x2 - Dark Grey

* Indicates components which include spares

Contents

Before You Begin	5
Blueprint	10
Instructions	11
Final Product	56
Troubleshooting	57
Contact	61

Before You Begin



Laying cables in between and underneath bricks

Cables can fit in between and underneath LEGO® bricks, plates, and tiles providing they are laid correctly between the LEGO® studs. Do NOT forcefully join LEGO® together around cables; instead ensure they are laying comfortably in between each stud.

CAUTION: Forcing LEGO® to connect over a cable can result in damaging the cable and light.



Connecting Cable Connectors To Expansion Boards

Take extra care when inserting connectors to ports of Expansion Boards. Connectors can be inserted only one way. With the expansion board facing up, look for the soldered “=” symbol on the left side of the port. The connector side with the wires exposed should be facing toward the soldered “=” symbol as you insert into the port. If a plug won’t fit easily into a port connector, do not force it.

Incorrectly inserting the connector can result in bent pins inside the port or possible overheating of the expansion board when connected.

Before You Begin



Connecting Cable Connectors To Strip Lights

Take extra care when inserting connectors to ports on the Strip Lights. Connectors can be inserted only one way. With the Strip Light facing up, ensure the side of the connector with the wires exposed is facing down. If a plug won't fit easily into a port connector, don't force it. Doing so will damage the plug and the connector.



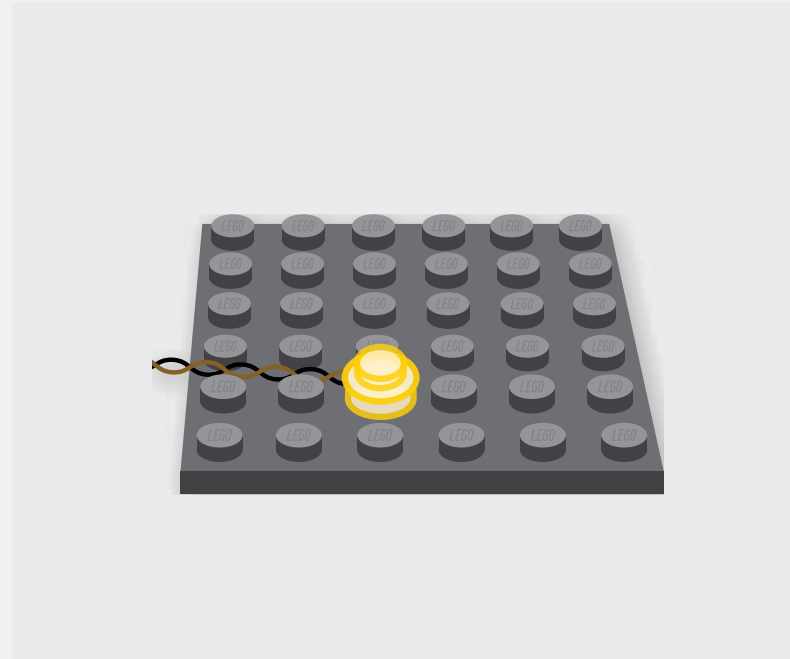
Connecting Micro Cable Connectors To Micro Expansion Board Ports

Take extra care when inserting the micro connectors to micro ports of Micro Expansion Boards. Connecting Micro Bit Lights to Micro Expansion Boards is similar to connecting lights and cables to Strip Lights. With the expansion board facing up, ensure the side of the connector with the wires exposed is facing down. If a plug won't fit easily into a port connector, do not force it. Use your fingernail to push the plastic part of the connector to the micro port.

Before You Begin

Installing Bit Lights Under Lego® Bricks And Plates

When installing Bit Lights under LEGO® pieces, ensure they are placed the correct way up (Yellow LED component exposed). You can either place them directly on top of LEGO® studs or in between.



Before You Begin

The Symbols Used In This Guide

When going through the following guide you will come across symbols and formats that will assist with the installation of your light kit. Take notice of them as each has a specific purpose.

Light Kit Component

This is the most important image format as it indicates which part to use from the Light Kit. Make sure you pay close attention to which part is shown.

White 30cm Bit Light



Connect

Used when you need to connect a LEGO piece or LMB component.



Disconnect

Used when you need to remove a LEGO piece/ section or LMB component.



Directional

Used to show where to route cables, place components, or move them.



Bend/Pivot

Used when a component needs to be bent, or part folded or pivoted.



Turn/ Flip

Will be found in the top left corner when the set needs to be rotated or flipped.



Twist/ Braid

Seen when a set of cables need to be grouped and twisted together.



Power On Test

Found at the end of a major step to test the lights. Will be located in the top left corner.



Note

Notes will be found alongside the instruction photos and explain what to do.



Before You Begin

Repeat Step

Repeat the previous step eg. Make a spotlight, then make a second spotlight.

x2

Connect Focus

Used to highlight a hard to see area where a component is being connected.



Disconnect Focus

Used to highlight a hard to see area where a component is being disconnected.



General Focus

Used to highlight a hard to see area where a component needs to be acted on.



General Note


This is a sample note that is used anywhere in this guide. It will explain a difficult section where photos are hard to illustrate or easily confused.

Connect Note

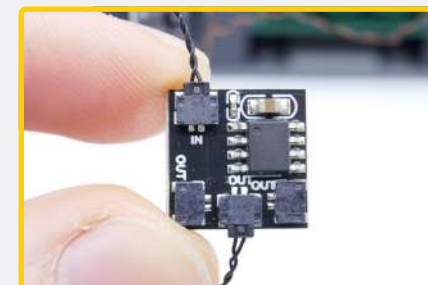
The green coloured note is used when the topic focuses on a component being connected, like the shown Power Bank.


Disconnect Note

The red coloured note is used when the topic focuses on a component being disconnected or like here, the removed pieces.


NOTE


Take the 5cm Connecting Cable from the 4-Port Micro Expansion Board and route it into the "IN" port of the Flicker Effects Board




NOTE

Connect to a 5V USB Power Bank, 5V USB Wall Adaptor, or USB to AA Battery Pack (sold separately)




NOTE

You should have these parts left over that were removed from the LEGO set

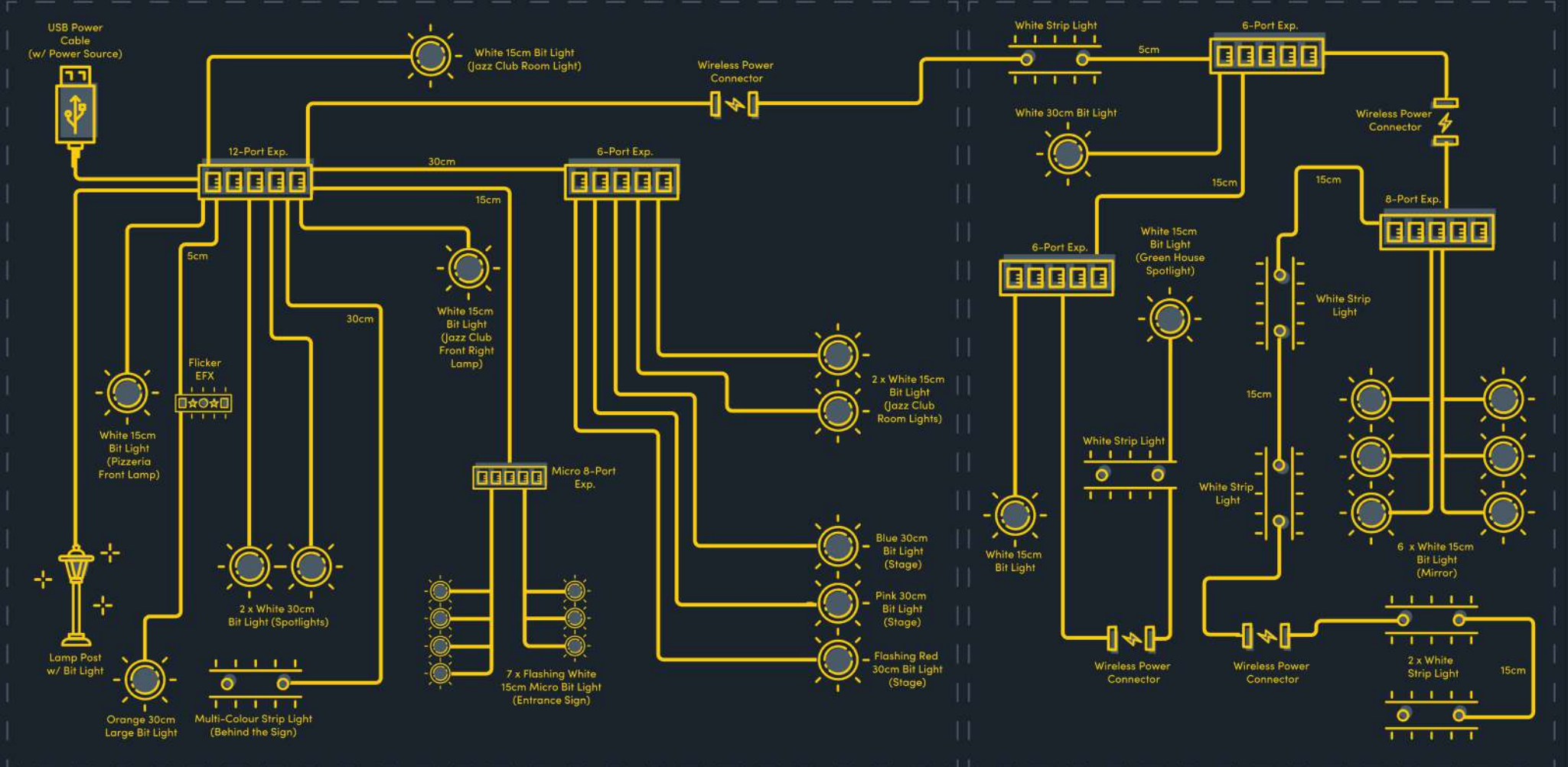




BLUEPRINT

Ground Floor & Sign

First & Second Floor

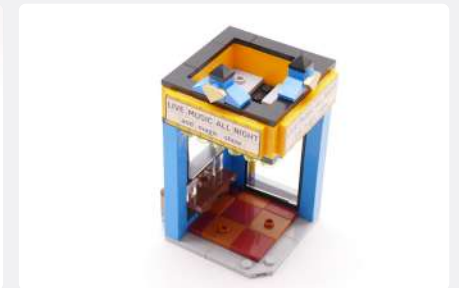
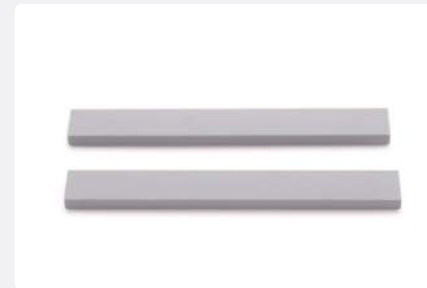




INSTRUCTIONS

To ensure a smooth installation of your light kit, please read and follow each step carefully. If you run into any issues, please refer to the online troubleshooting guide.

1

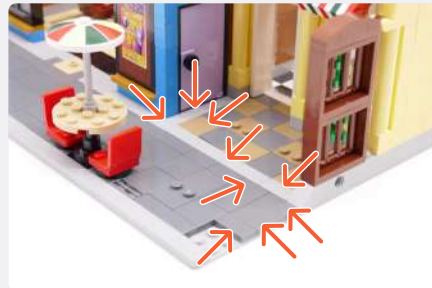


2

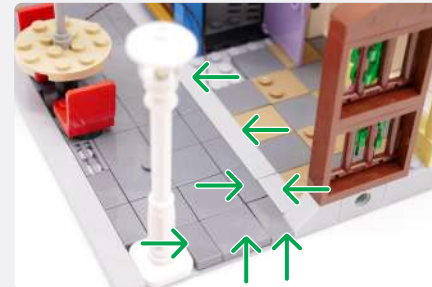


NOTE

Use the LEGO Removal Tool to assist in disconnecting parts

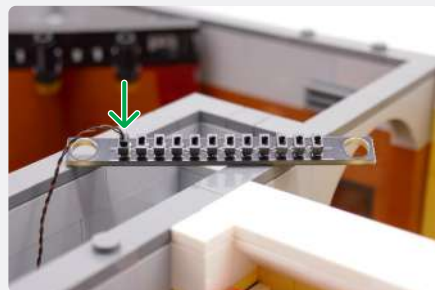


Lamp Post - White

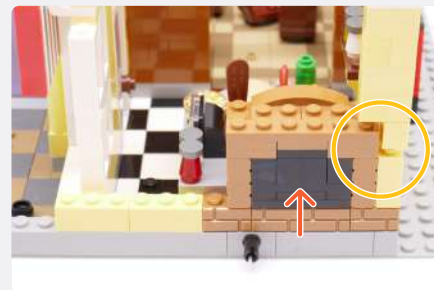
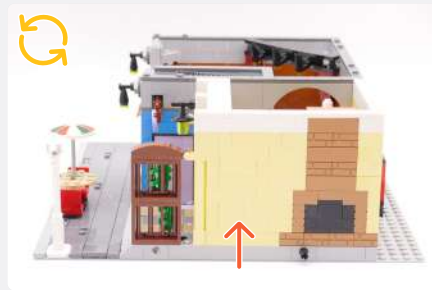


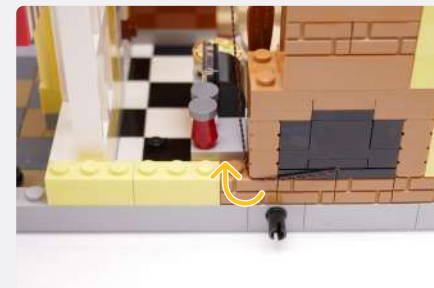
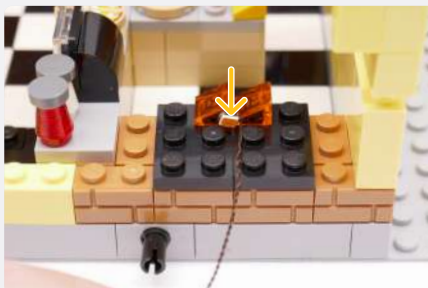
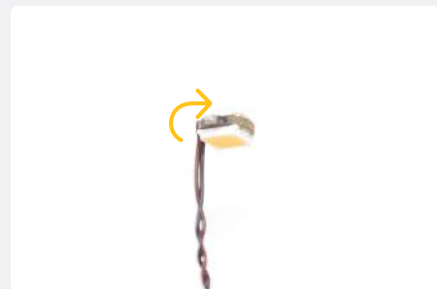
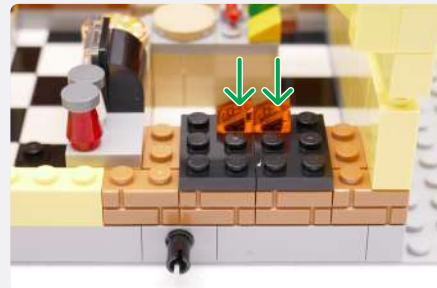
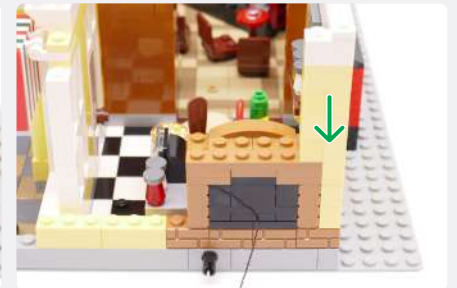
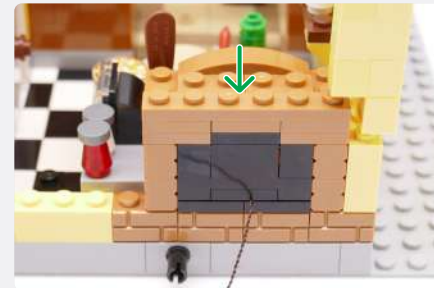
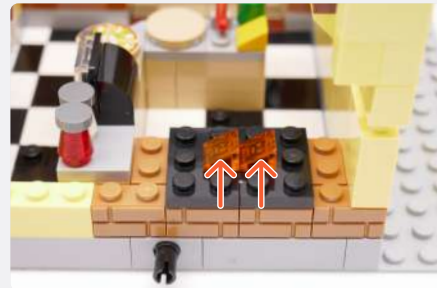


12-Port Expansion Board

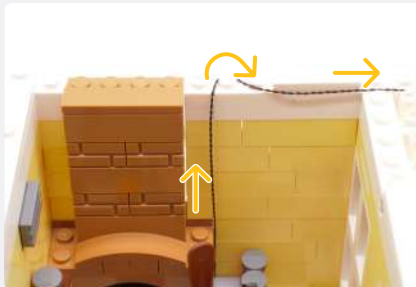
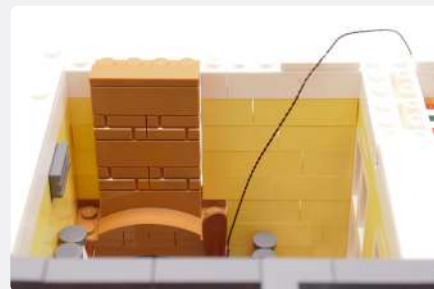
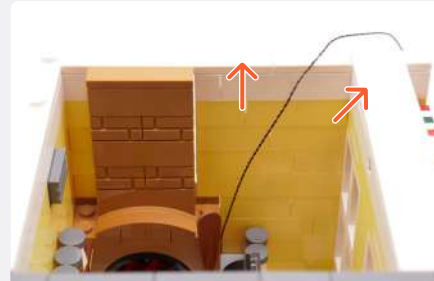


3



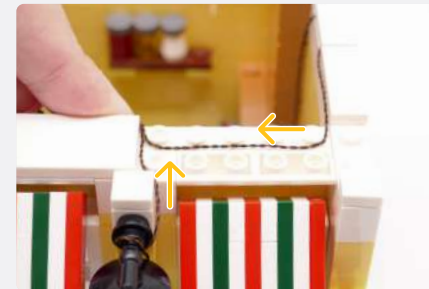
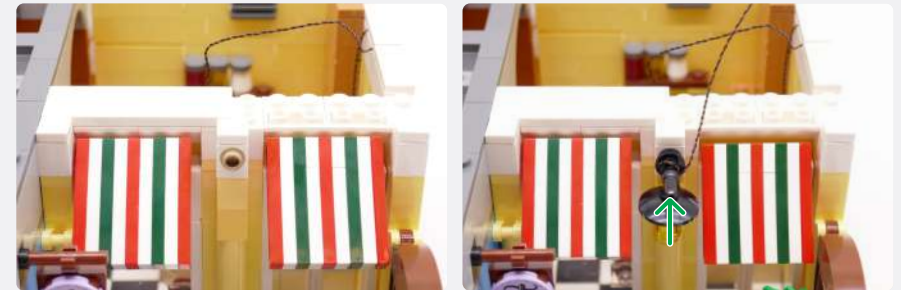


4



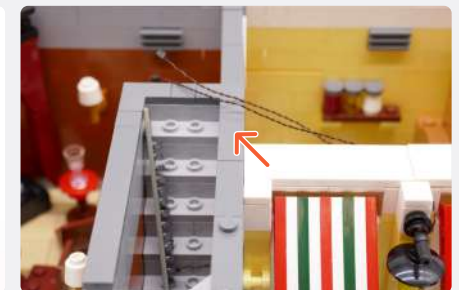
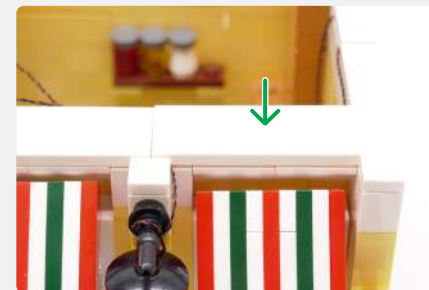
5

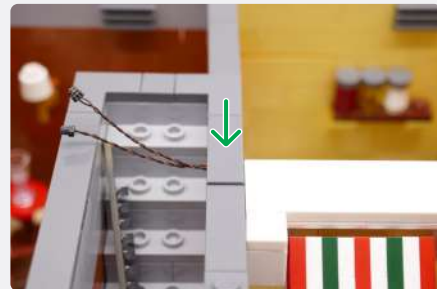
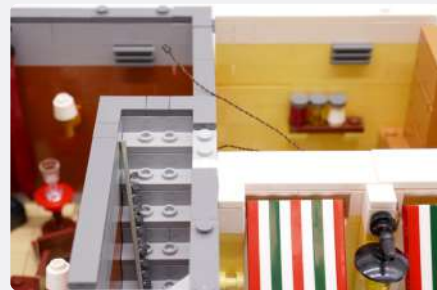
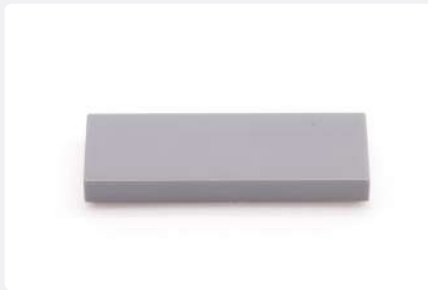




NOTE

Take note of which cable is the Orange Large Bit Light (from the oven)

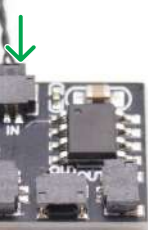



6
Flicker Effects Board

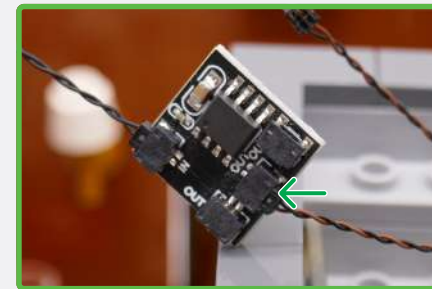
5cm Connecting Cable

NOTE

Connect the 5cm Connecting Cable into the "IN" port of the Flicker Effects Board

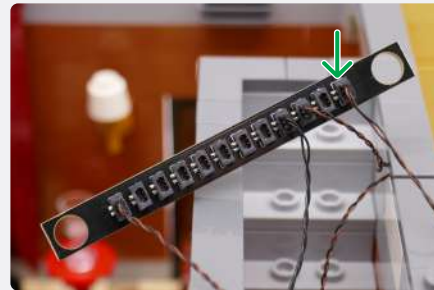

NOTE

Connect the Orange 30cm Large Bit Light into the 'OUT' port of the Flicker Effects Board


NOTE

Connect the 5cm Connecting Cable and White 15cm Bit Light to the 12-Port Expansion Board



7
USB Power Cable

NOTE

Connect to a 5V USB Power Bank, 5V USB Wall Adaptor, or USB to AA Battery Pack (sold separately)



! If you experience any issues with the lights not working and suspect an issue with a component, please try a different port on the expansion board to verify where the fault lies (with the light or expansion board). To correct any issues with expansion board ports, please view the section addressing expansion board issues in our troubleshooting section. i

8


White 15cm Bit Light



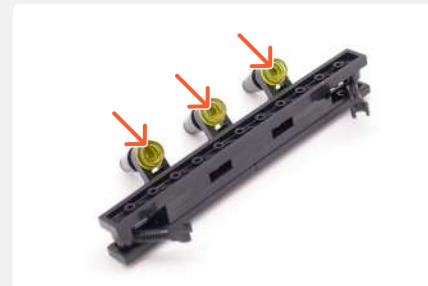
Round Plate 1x1 Open Stud - White



NOTE

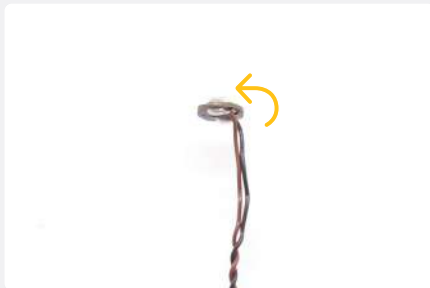
Do not push the pole too far up the Open Stud as this will break the LED. Only push until the two sections are secured as one.

9

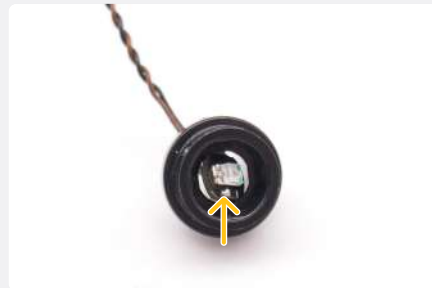




Blue 30cm Bit Light



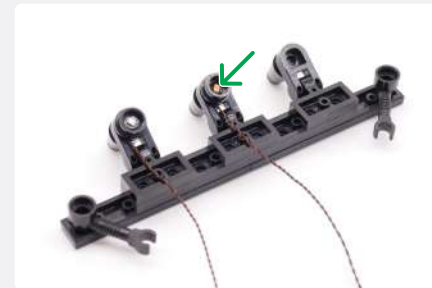
Round Plate 1x1 Open Stud - Black



Pink 30cm Bit Light



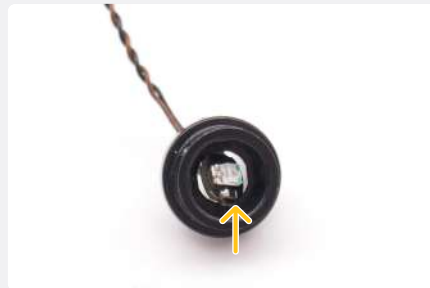
Round Plate 1x1 Open Stud - Black

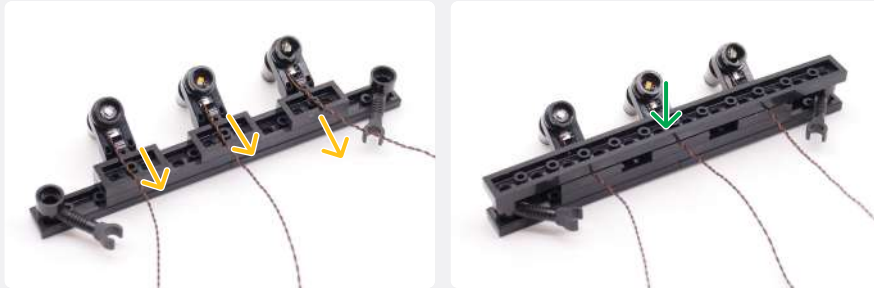
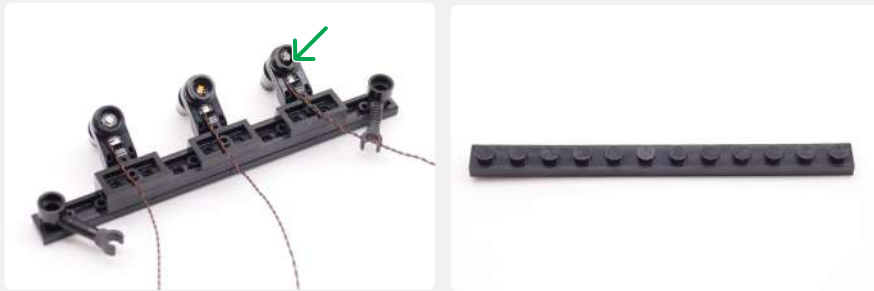


Flashing Red 30cm Bit Light



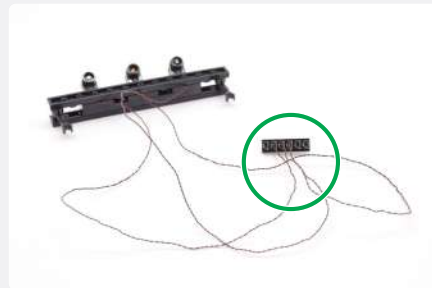
Round Plate 1x1 Open Stud - Black



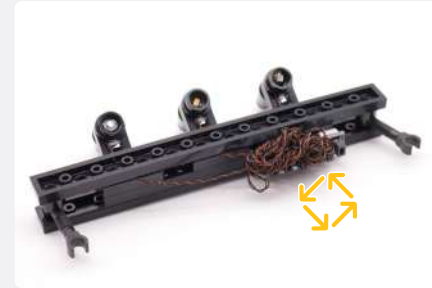
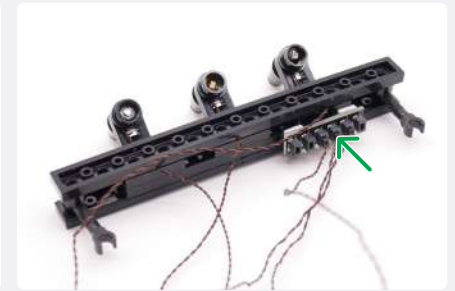
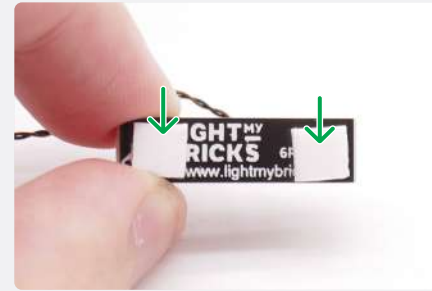
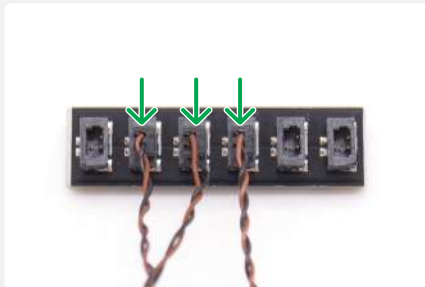


10

6-Port Expansion Board

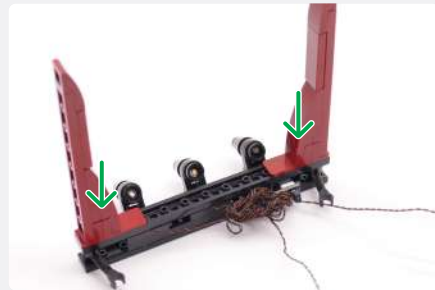


2x Adhesive Square

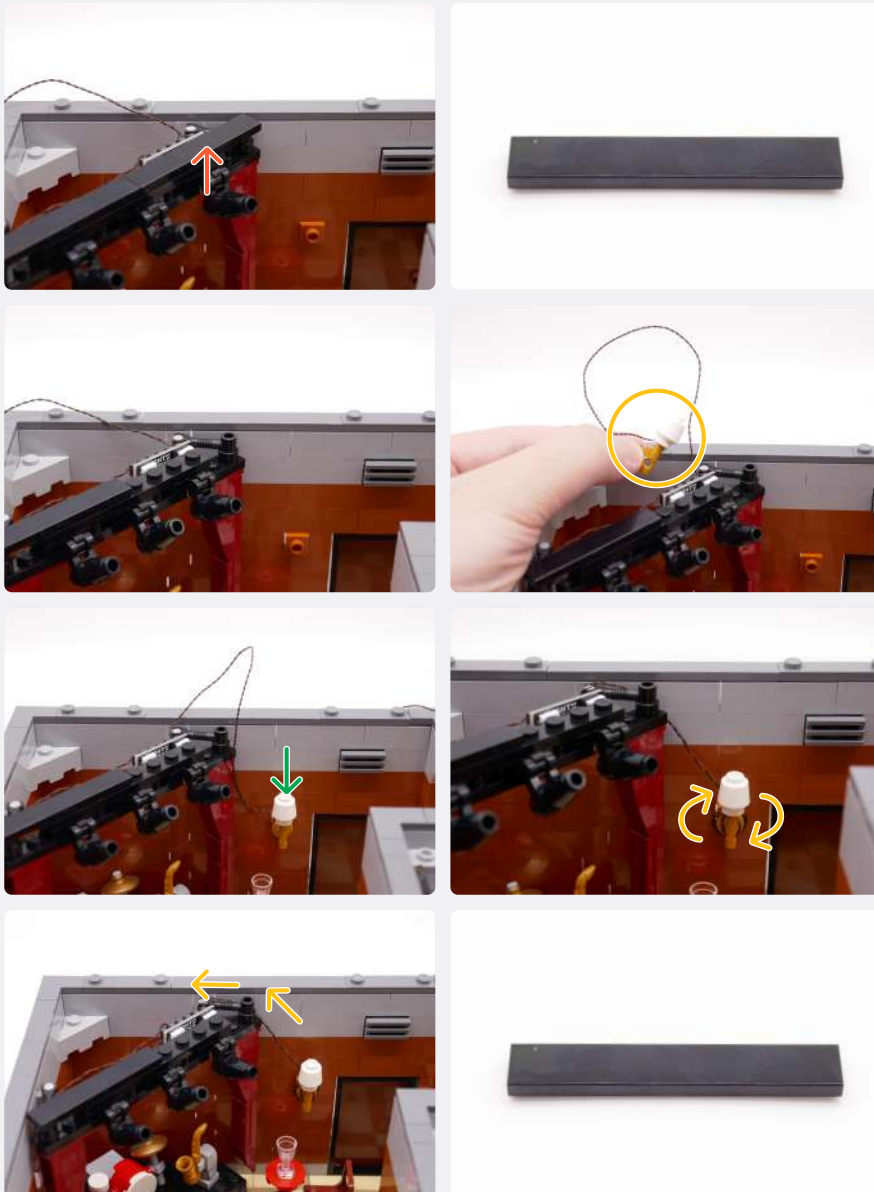


11

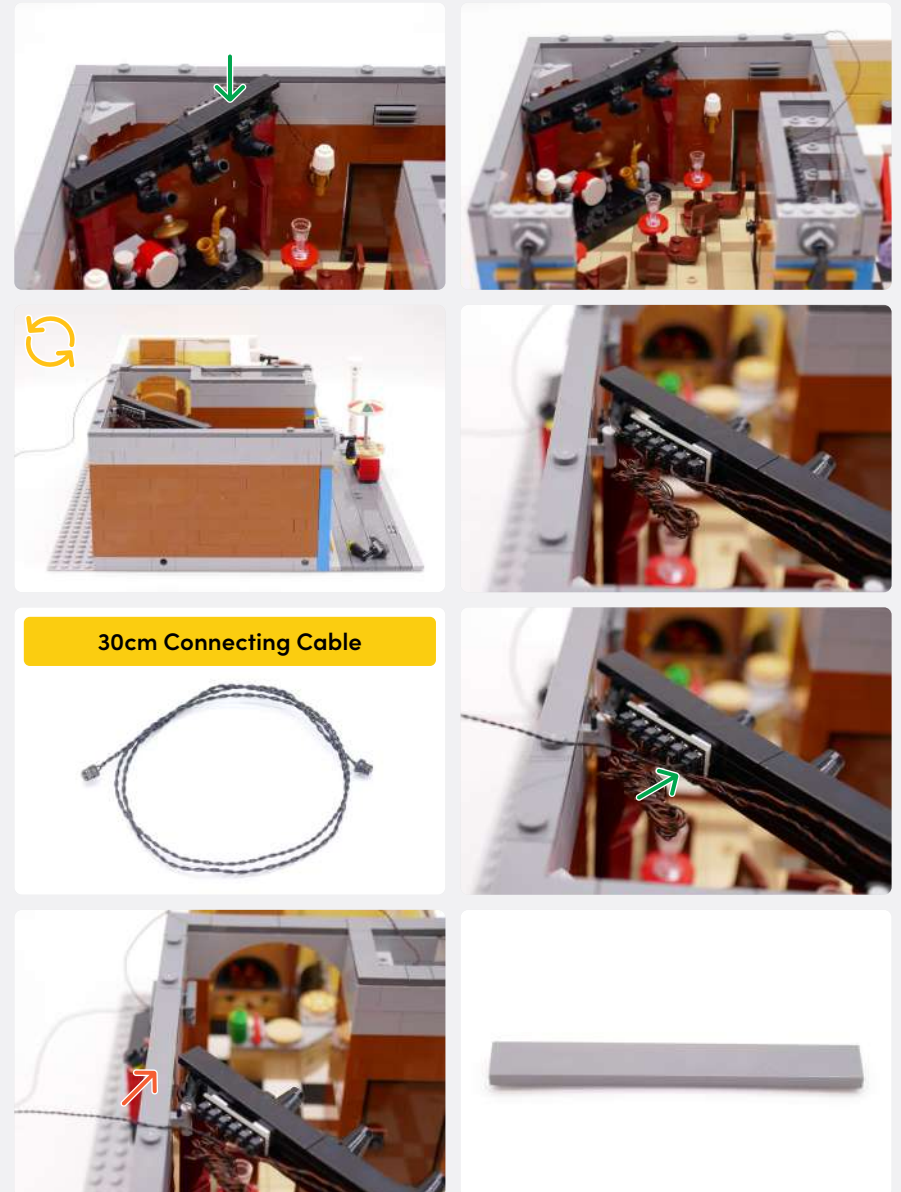


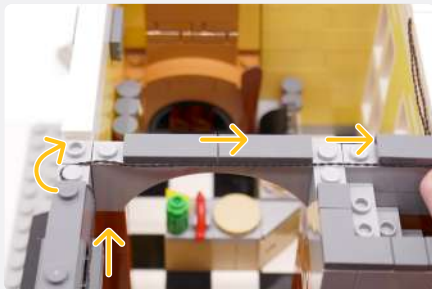
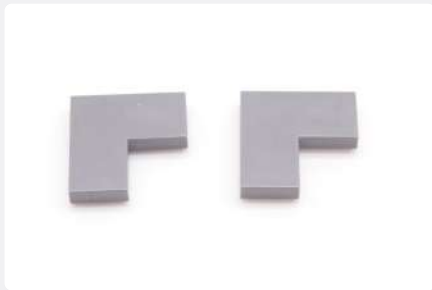
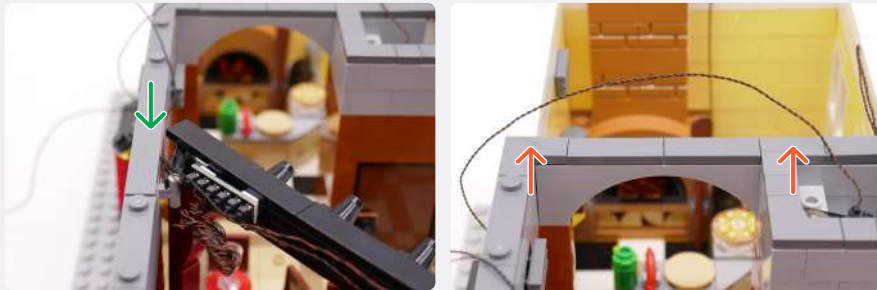
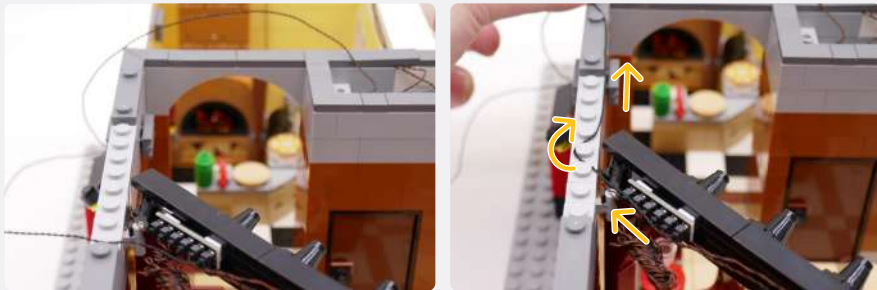


12



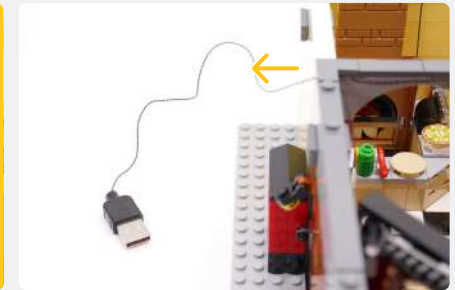
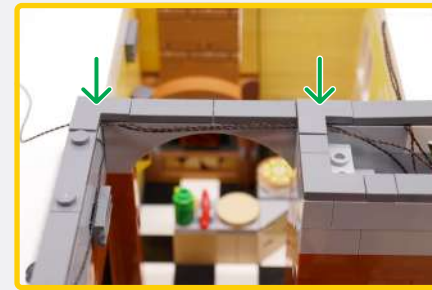
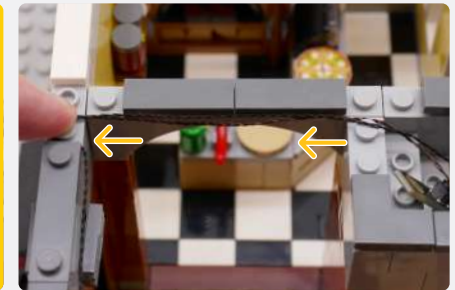
13



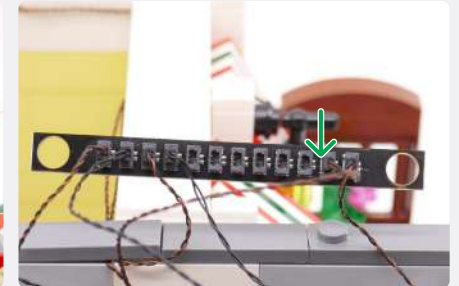
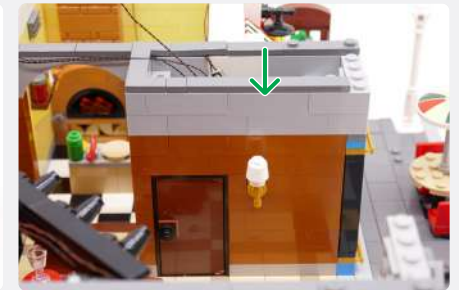
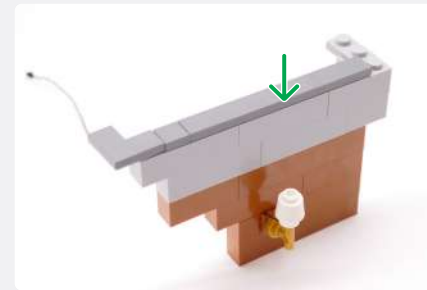
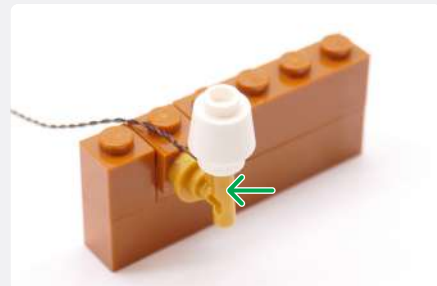
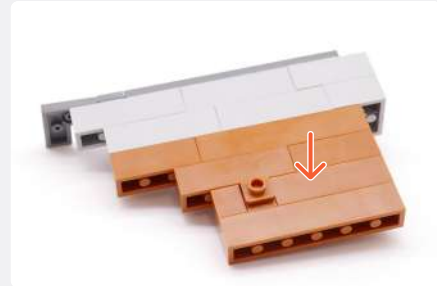


NOTE

Run the USB Power Cable inbetween the studs where the two 'L' plates were positioned



14



NOTE

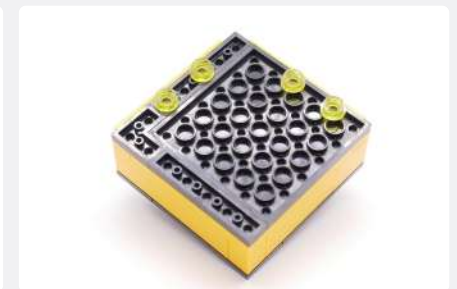
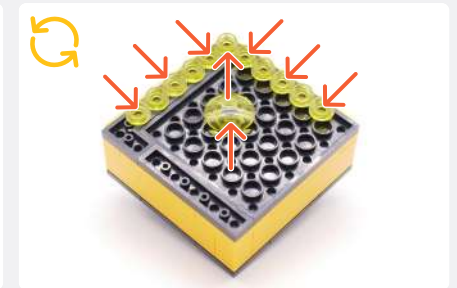
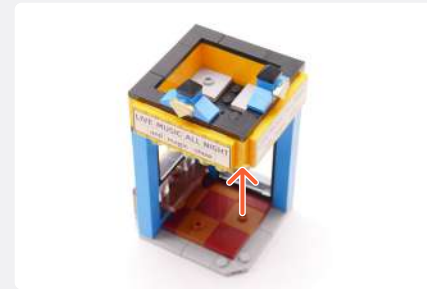
Connect to a 5V USB Power Bank, 5V USB Wall Adaptor, or USB to AA Battery Pack (sold separately)



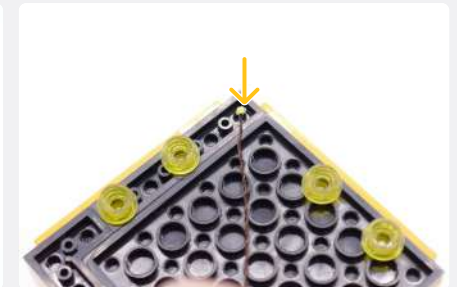
! If you experience any issues with the lights not working and suspect an issue with a component, please try a different port on the expansion board to verify where the fault lies (with the light or expansion board). To correct any issues with expansion board ports, please view the section addressing expansion board issues in our troubleshooting section. i

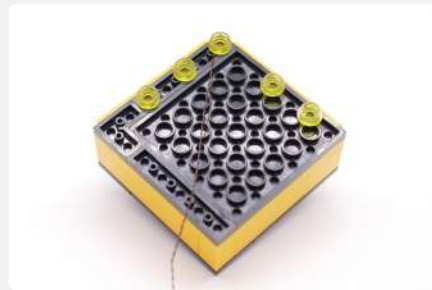
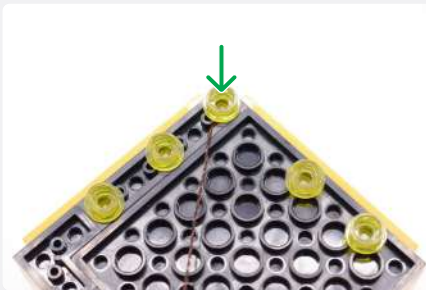


15



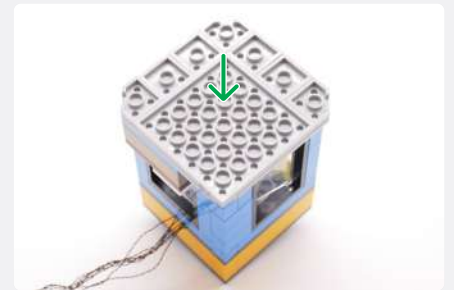
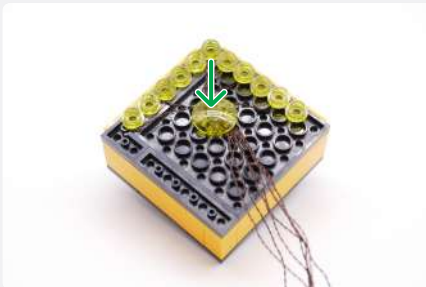
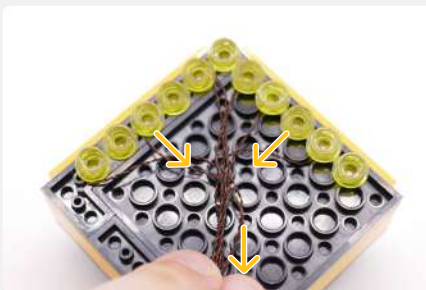
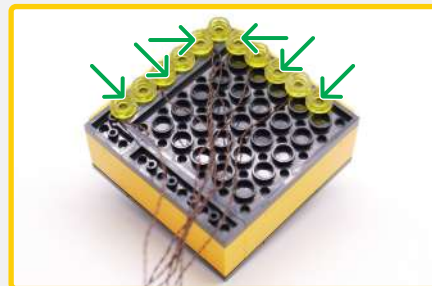
Flashing White 15cm Micro Bit Light





NOTE

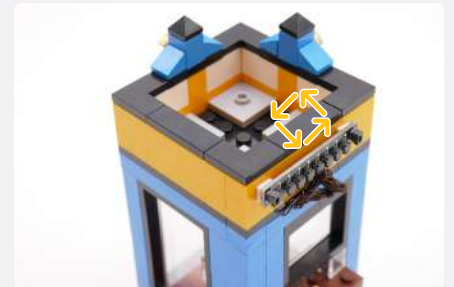
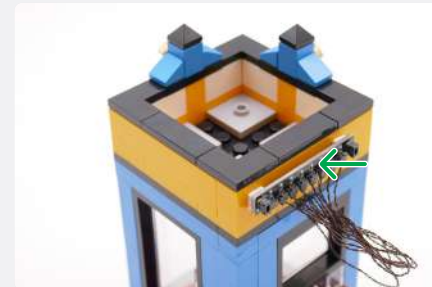
Repeat this process for the other 6 lights



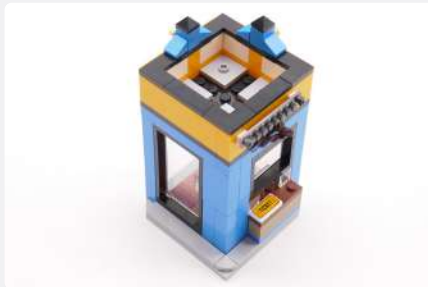
8-Port Micro Expansion Board



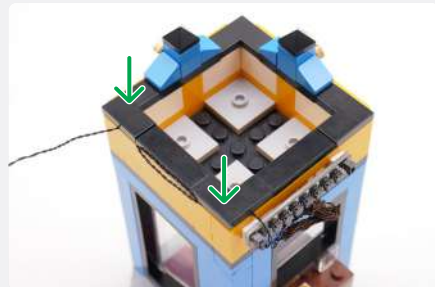
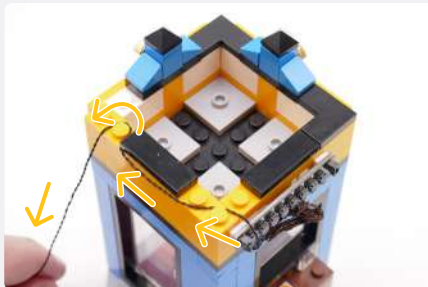
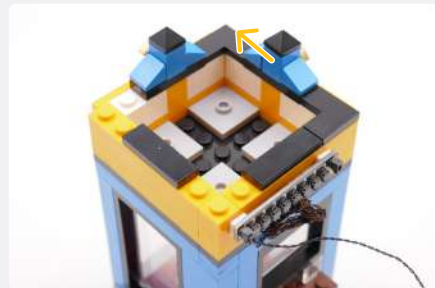
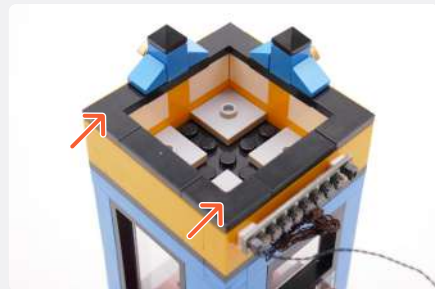
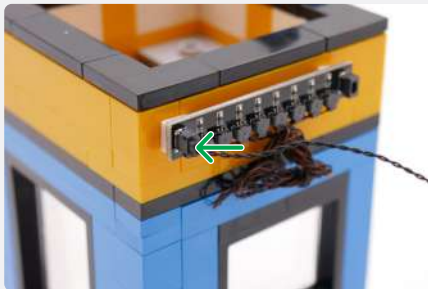
2x Adhesive Square



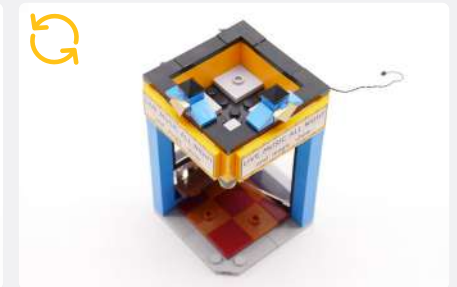
16



15cm Connecting Cable



17

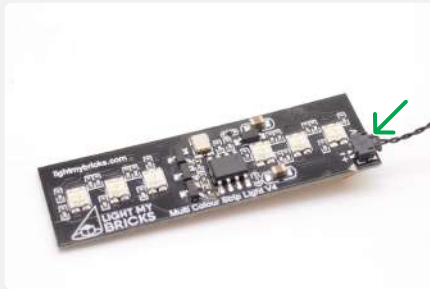


Multi Colour Strip Light

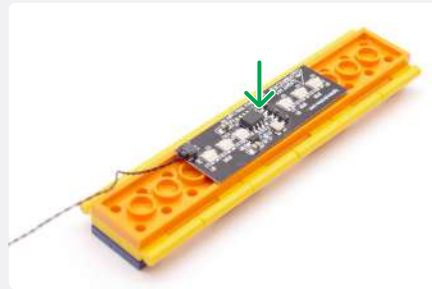
30cm Connecting Cable



18



White 30cm Bit Light



Round Plate 1x1 Open Stud - Black

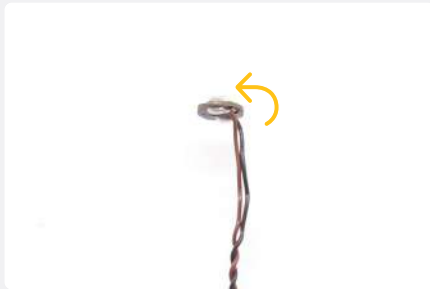
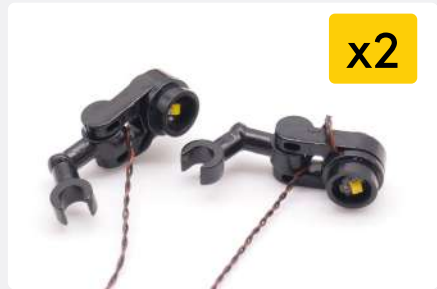


Plate 1x1 Mod Rounded W/ Handle - Black

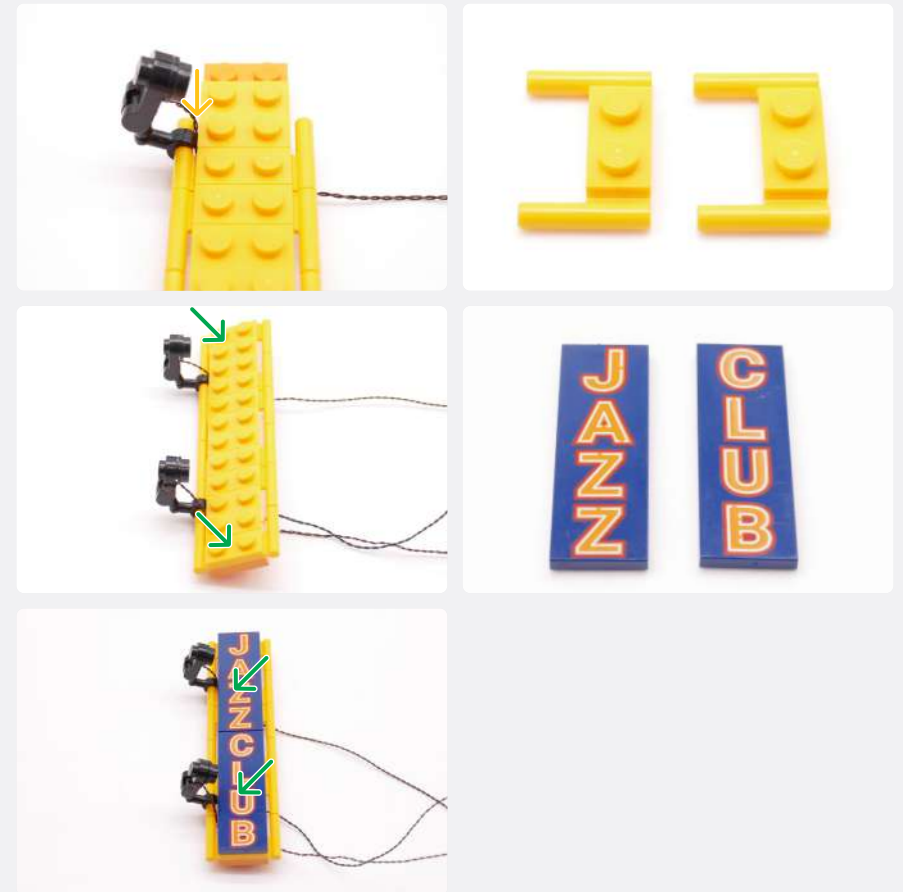
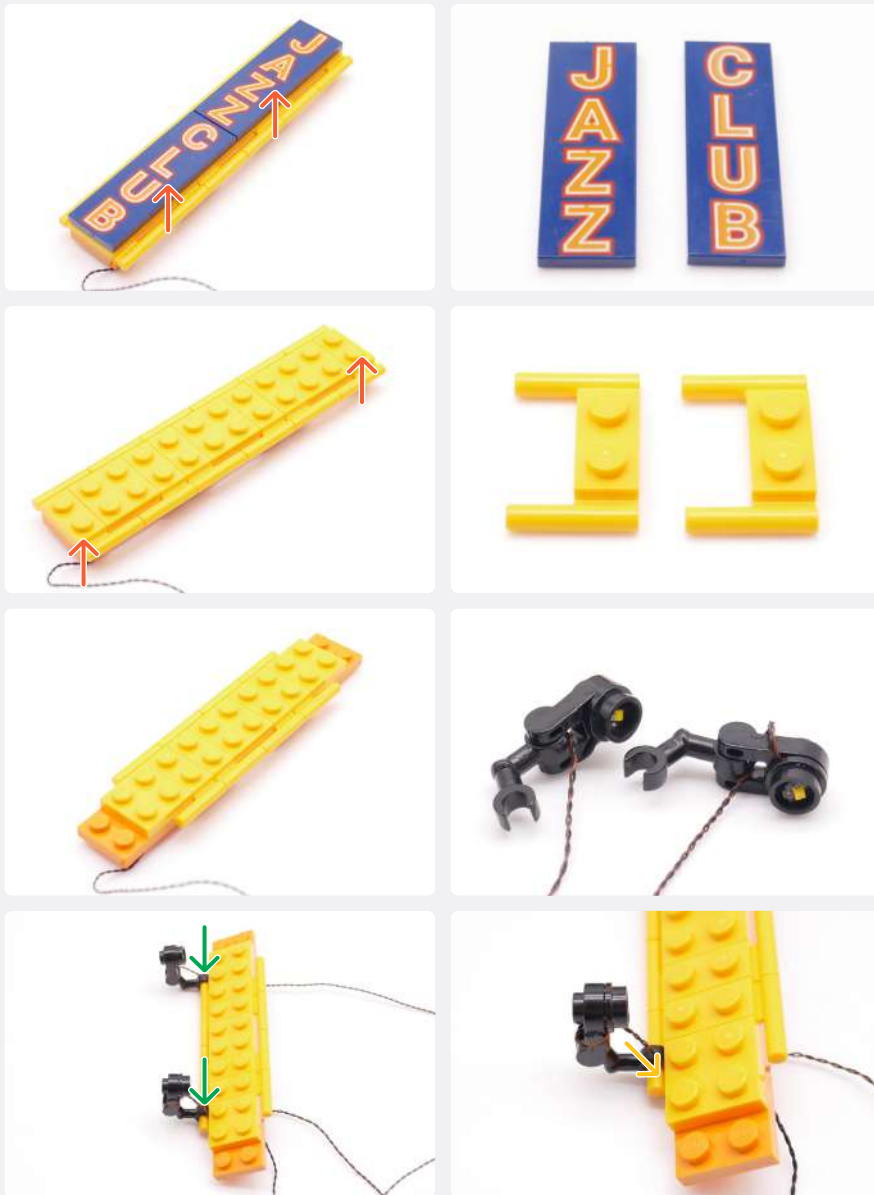


Arm Skeleton, Bent W/ Clips Horizontal Grip - Black



x2

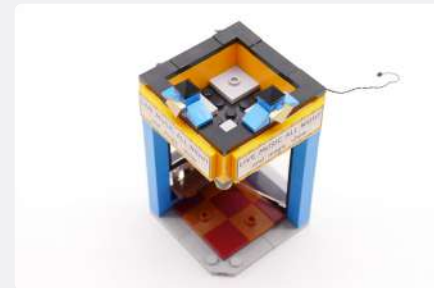
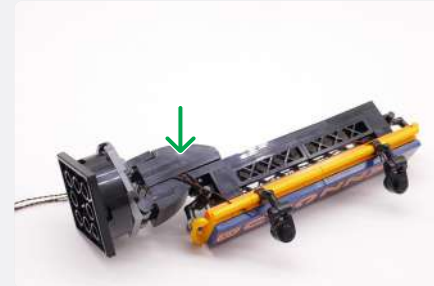
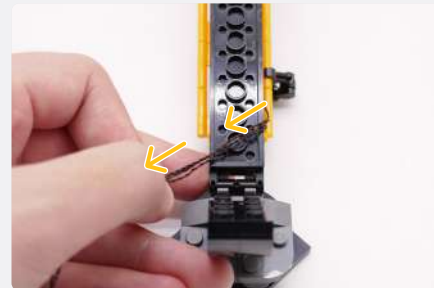
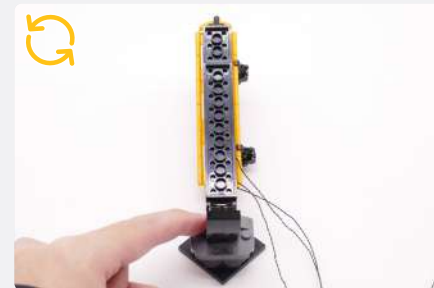
19



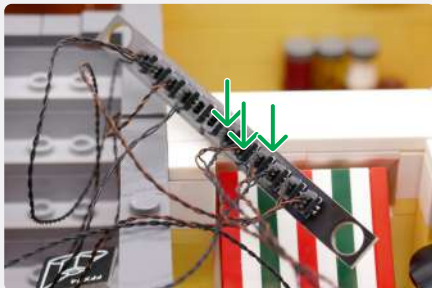
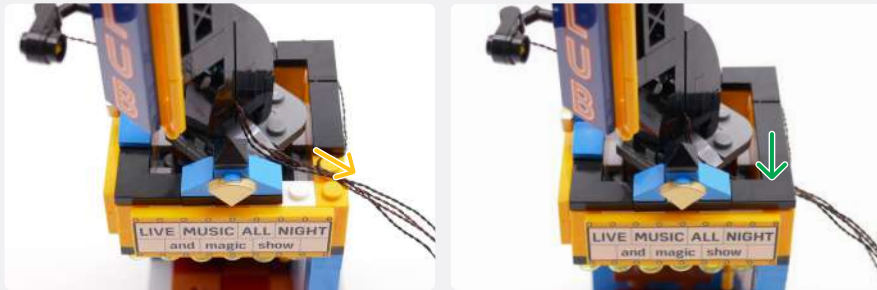
20



2 x Plate 1x2 - Black

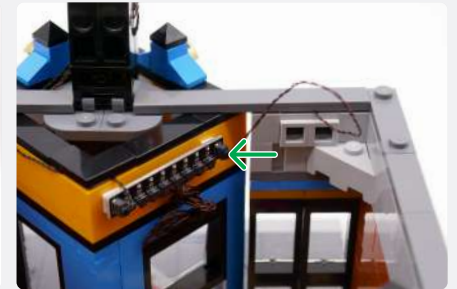
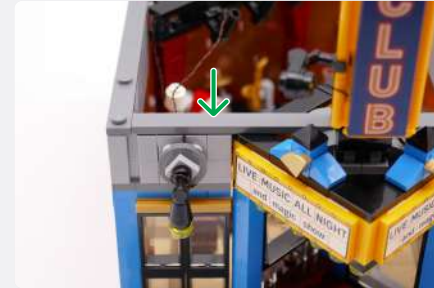
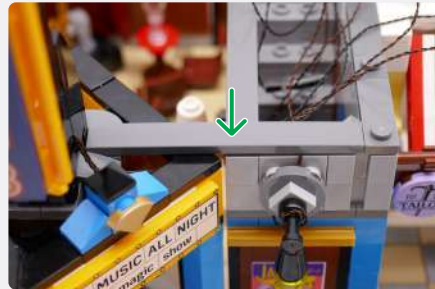
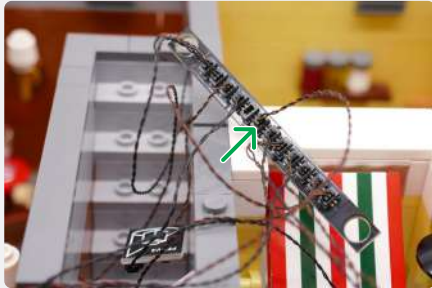


21

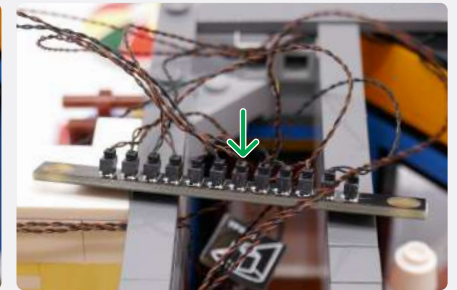
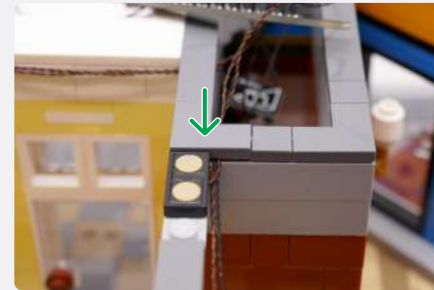
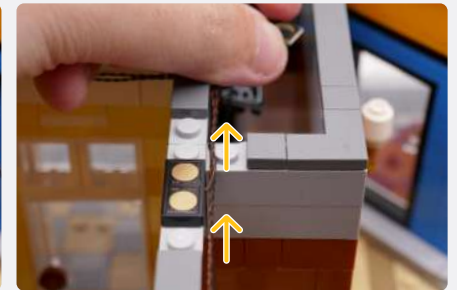
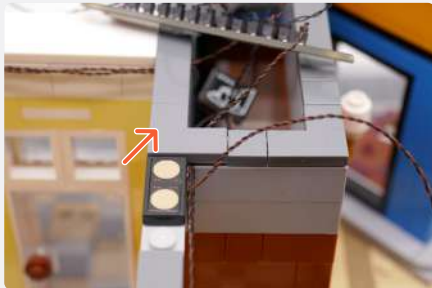
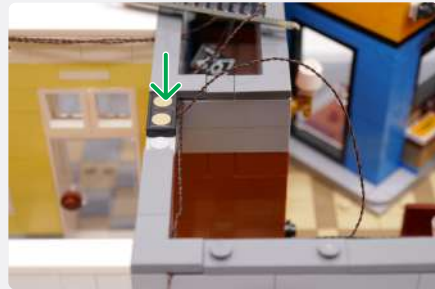


White 15cm Bit Light





22





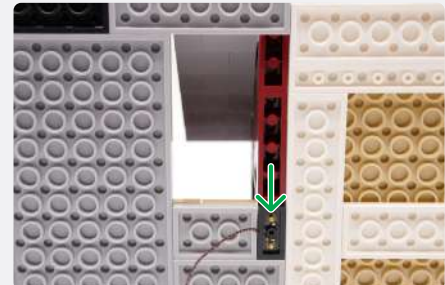
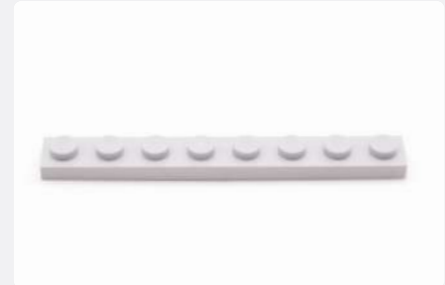
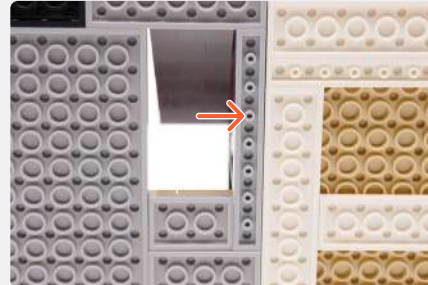
NOTE

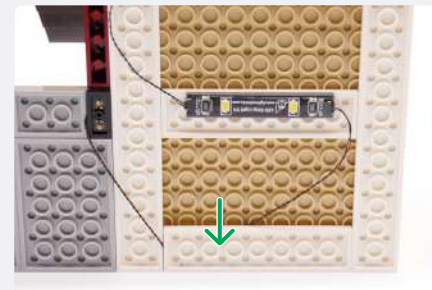
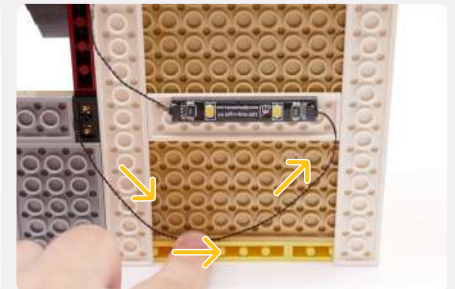
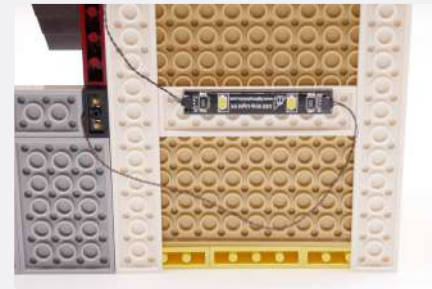
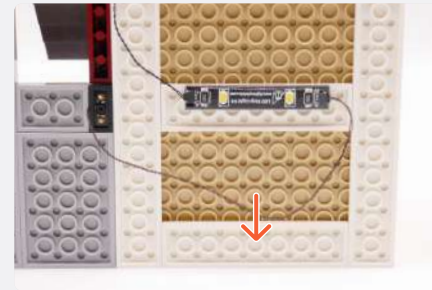
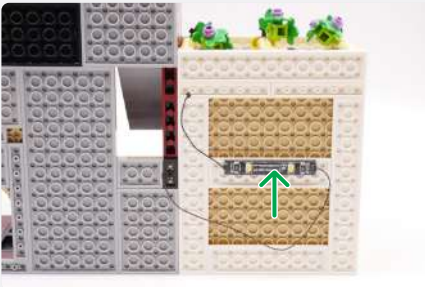
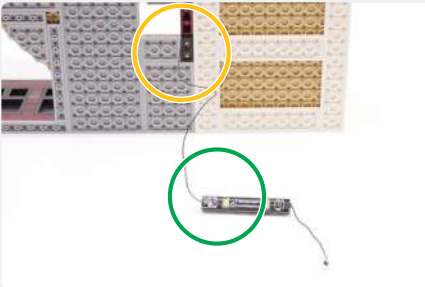
Connect to a 5V USB Power Bank, 5V USB Wall Adaptor, or USB to AA Battery Pack (sold separately)



! If you experience any issues with the lights not working and suspect an issue with a component, please try a different port on the expansion board to verify where the fault lies (with the light or expansion board). To correct any issues with expansion board ports, please view the section addressing expansion board issues in our troubleshooting section. i

23



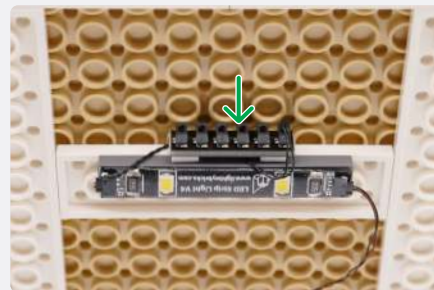
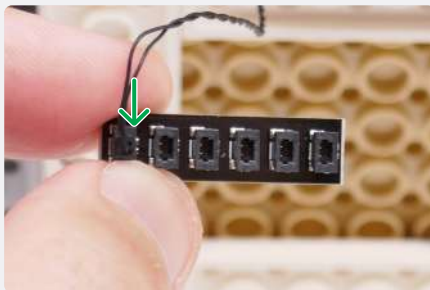
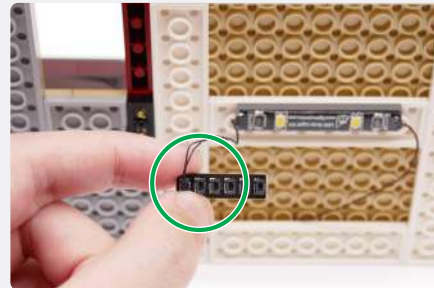


24

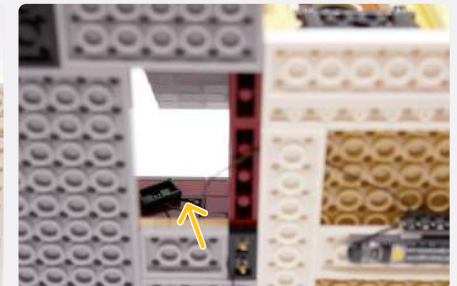
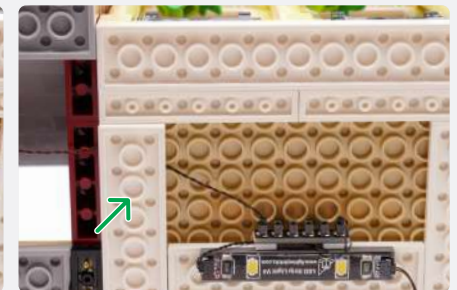
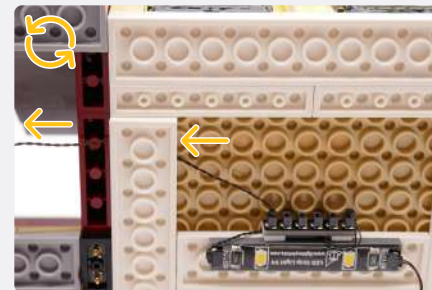
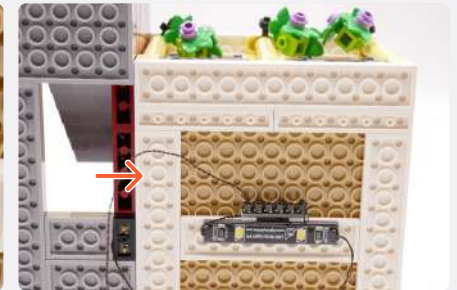
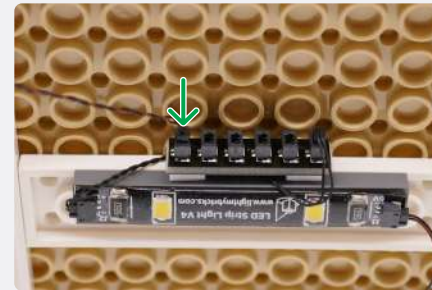
2x Adhesive Square

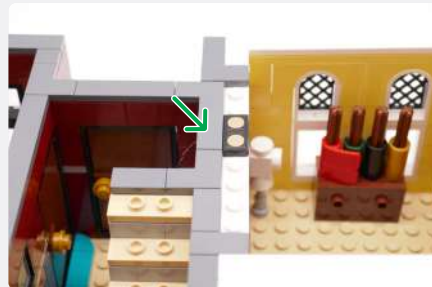
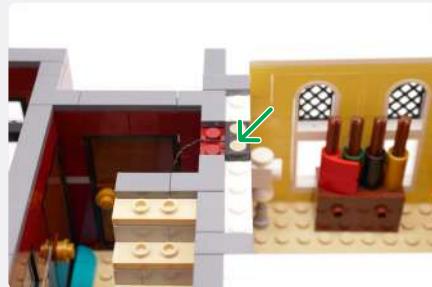
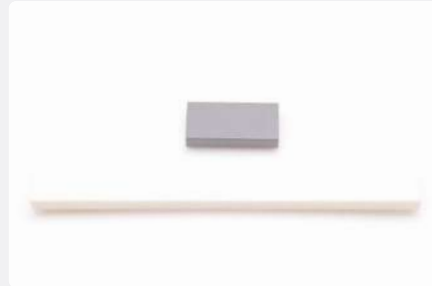
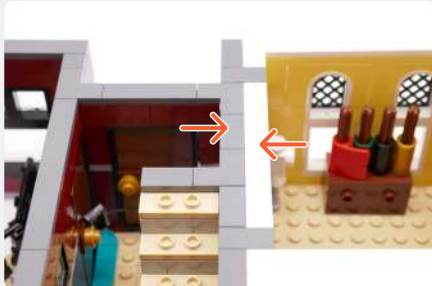


6-Port Expansion Board

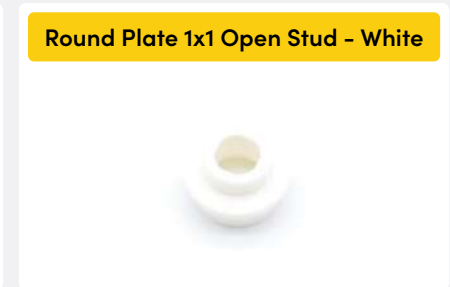
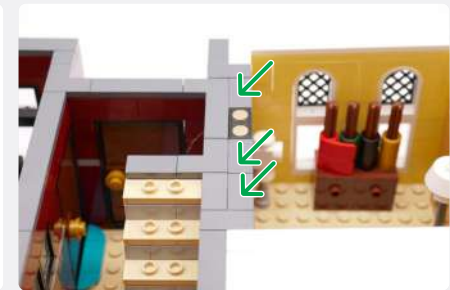


Wireless Power Connector Tile

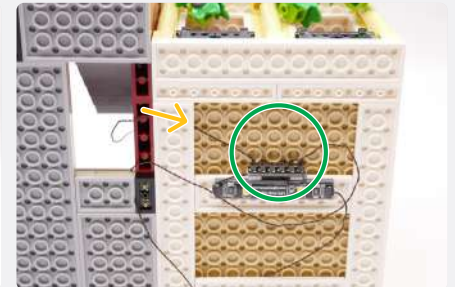
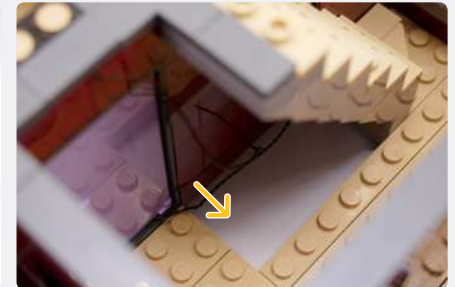
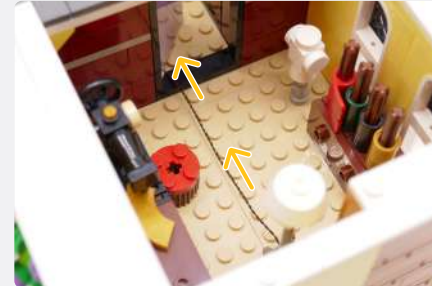
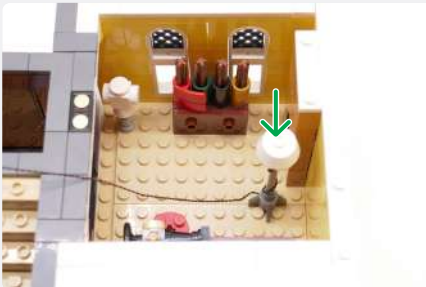
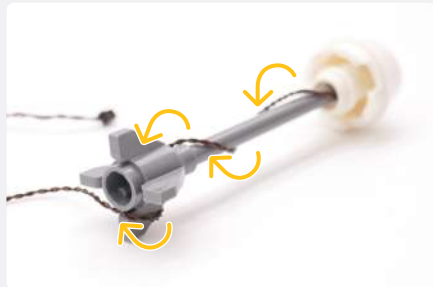
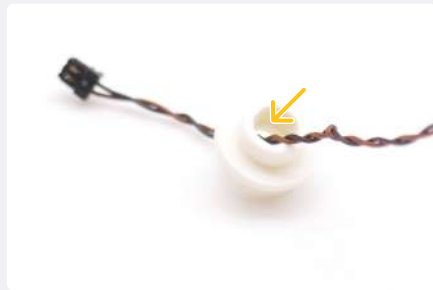


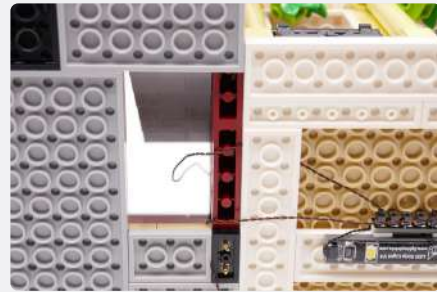
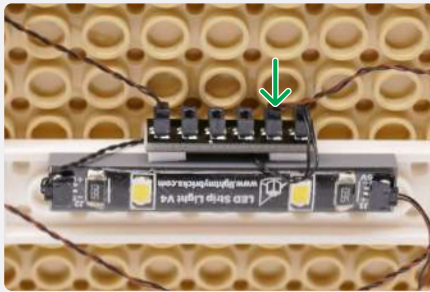


25



White 30cm Bit Light

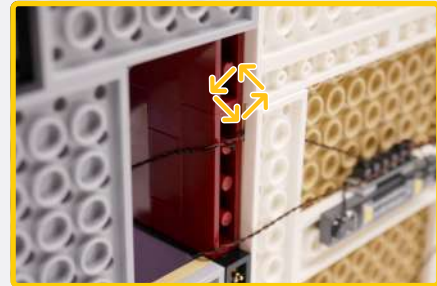




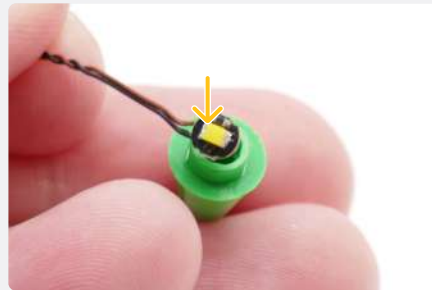
26

NOTE

Twist the Wireless Power Connector and Bit Light cable as much as you can to reduce slack



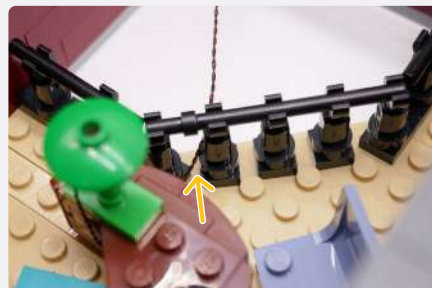
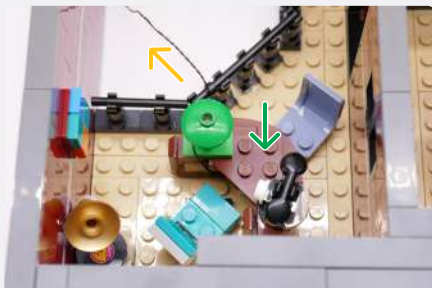
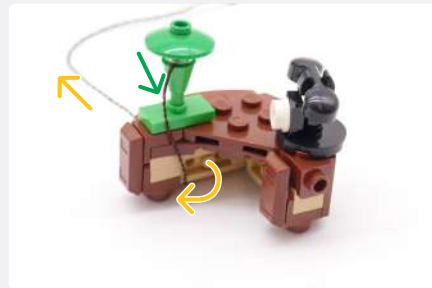
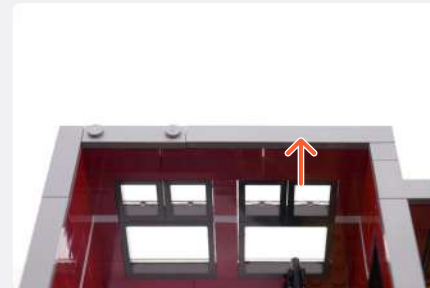
White 15cm Bit Light

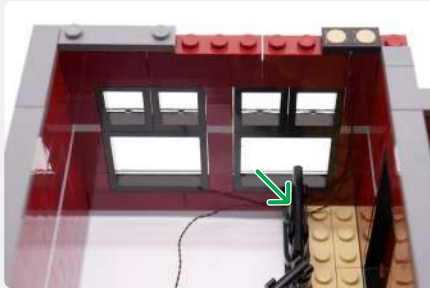
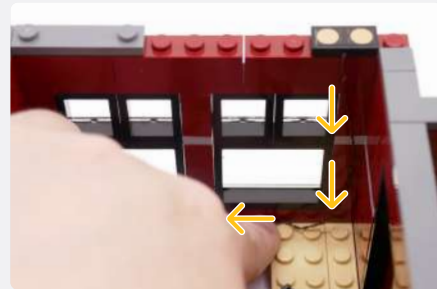


Round Plate 1x1 - Trans Clear

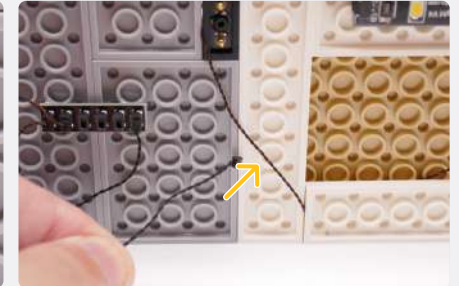
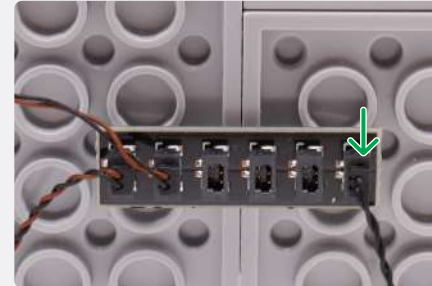
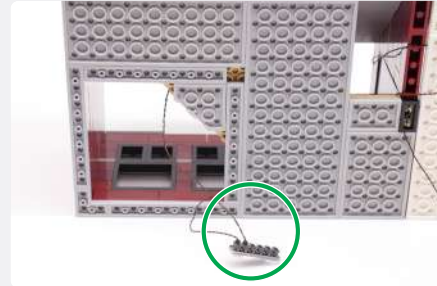
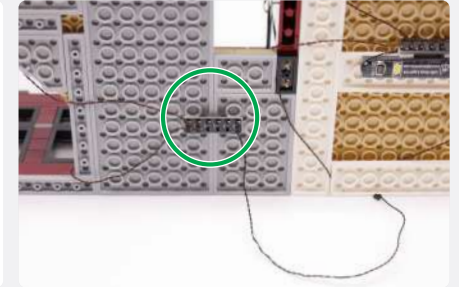
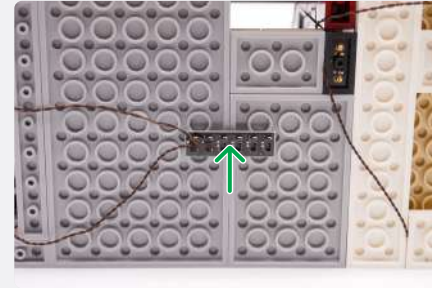
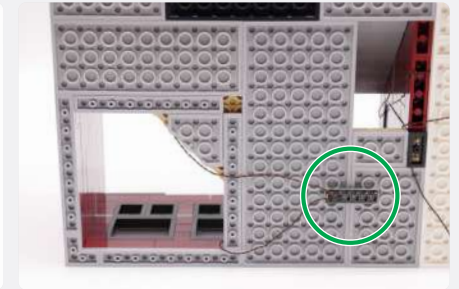
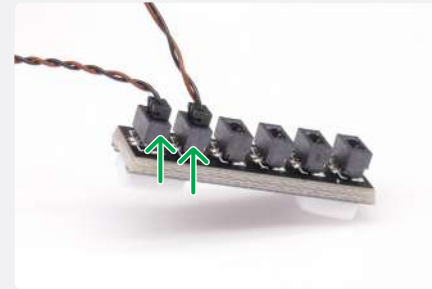


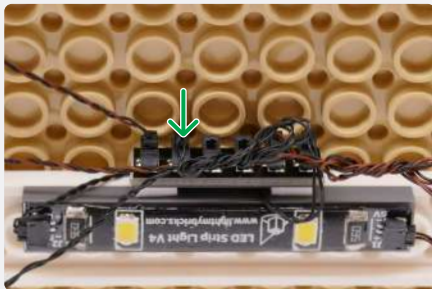
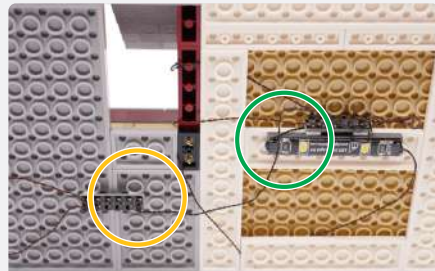
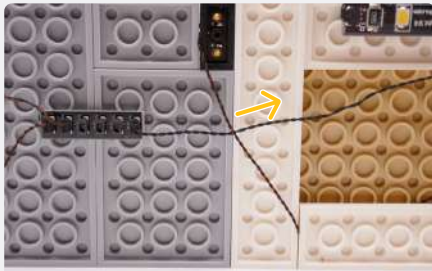
27






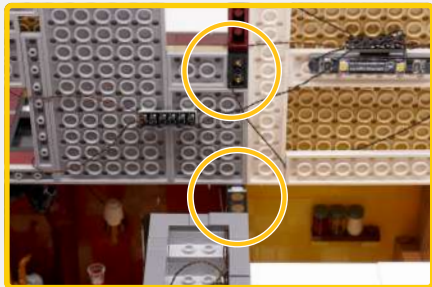
28






 **NOTE**

Ensure the Wireless Power Connectors are aligned when re-connecting the floors



 **NOTE**

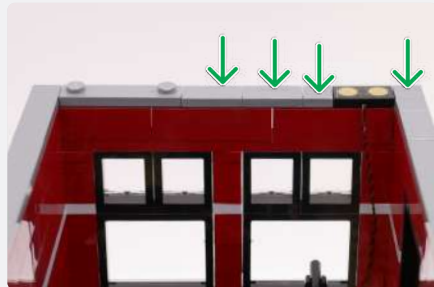
Connect to a 5V USB Power Bank, 5V USB Wall Adaptor, or USB to AA Battery Pack (sold separately)



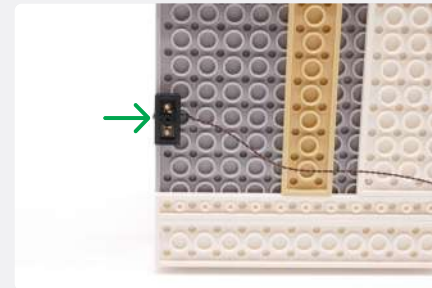
2 x Tile 1x1 - Dark Grey



2 x Tile 1x2 - Dark Grey

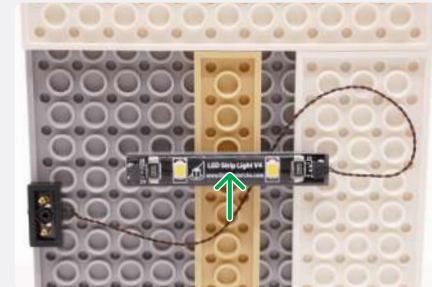
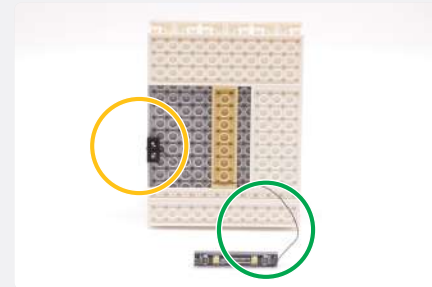
29



White Strip Light



Plate 1x6 - Dark Grey



30

White 15cm Bit Light



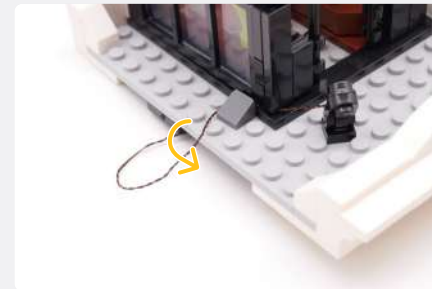
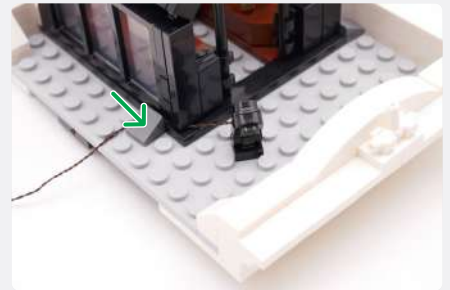
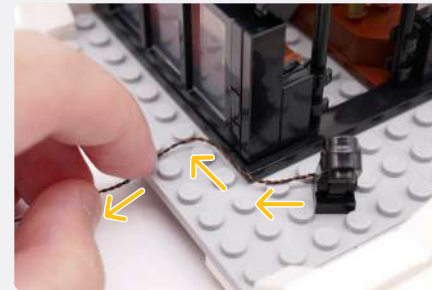
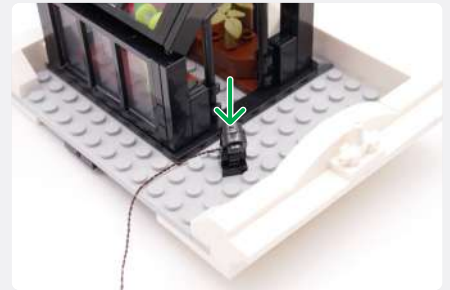
Round Plate 1x1 Open Stud - Black

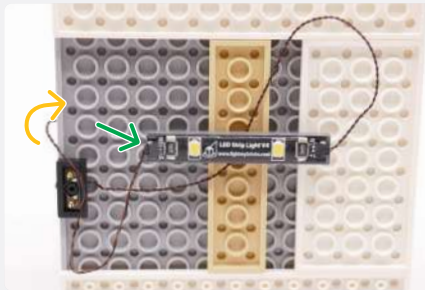


Tile 1x1 W/ Clip Round Edges - Black

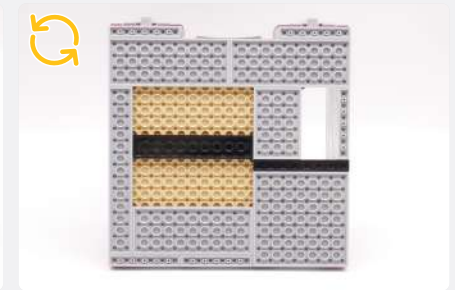


Plate 1x1 Mod Rounded W/ Handle - Black



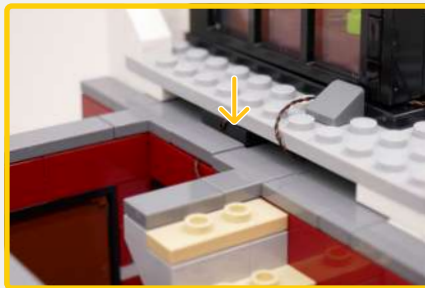
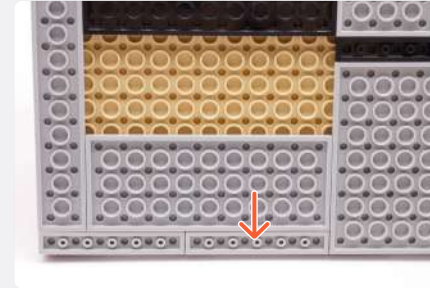


31



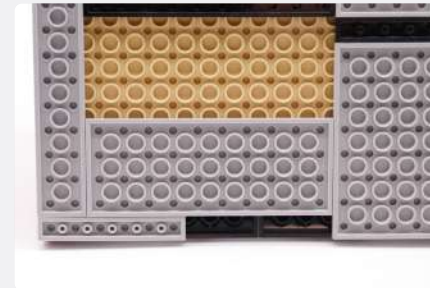
NOTE

Ensure the Wireless Power Connectors are aligned when re-connecting the floors

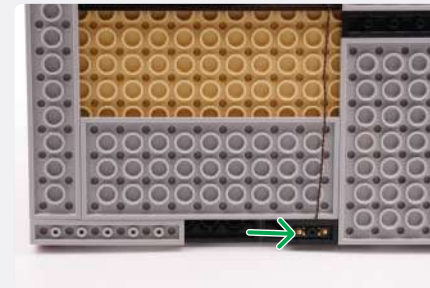
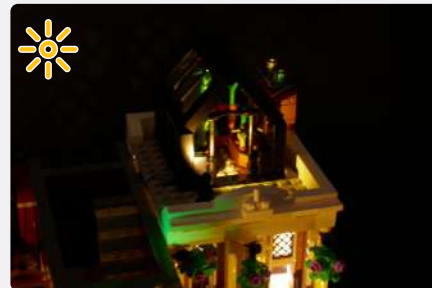


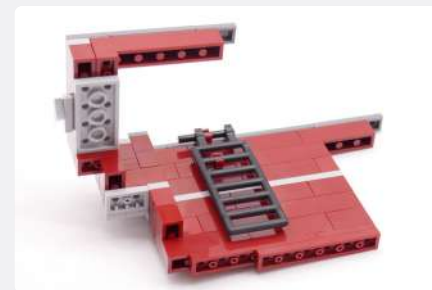
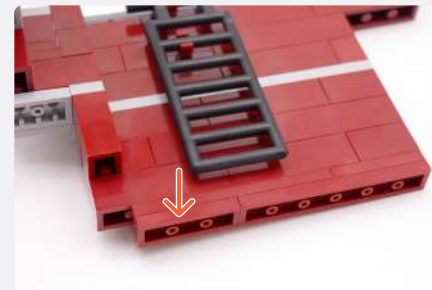
NOTE

Connect to a 5V USB Power Bank, 5V USB Wall Adaptor, or USB to AA Battery Pack (sold separately)

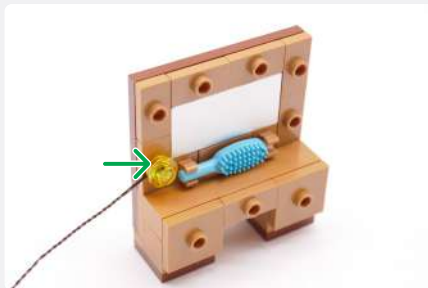
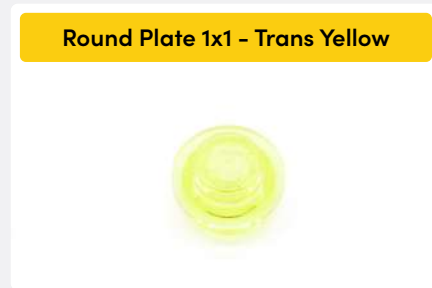
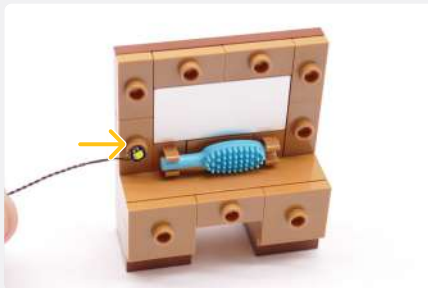
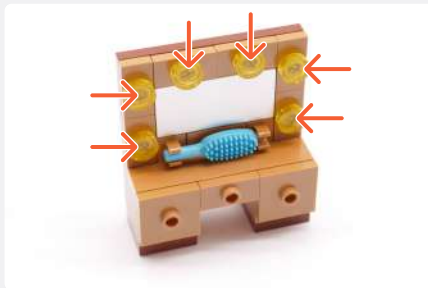


Wireless Power Connector Plate



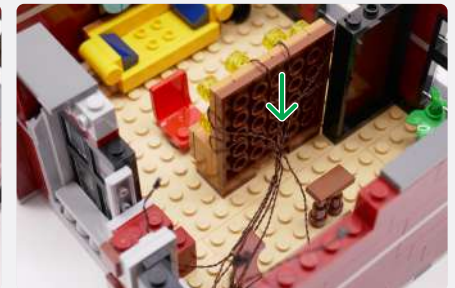
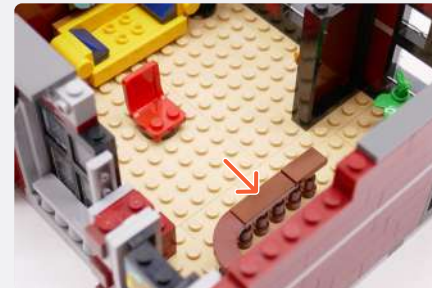
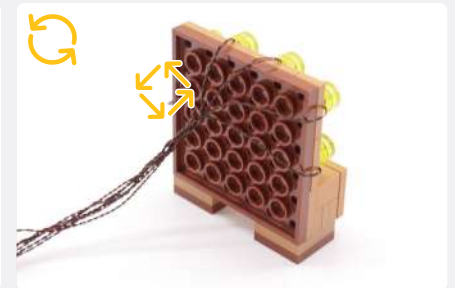
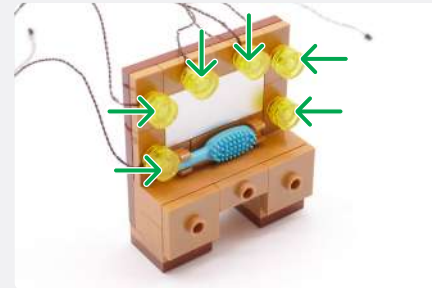
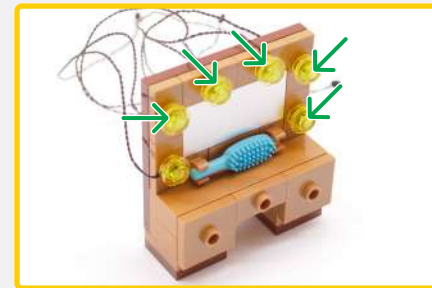


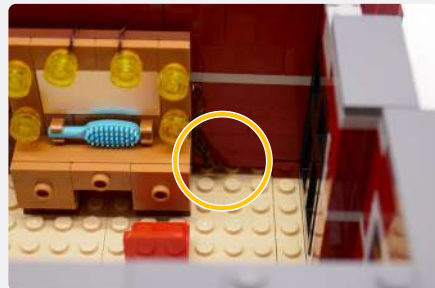
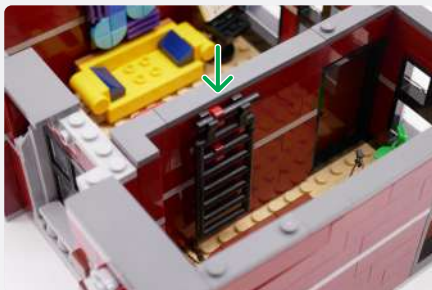
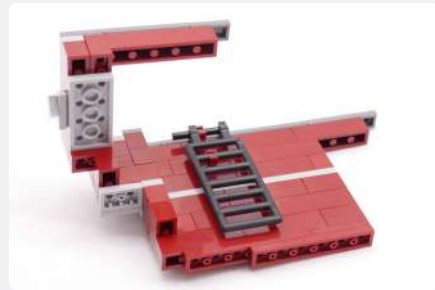
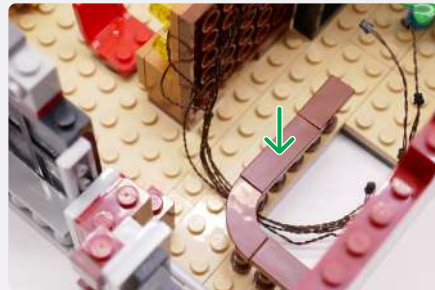
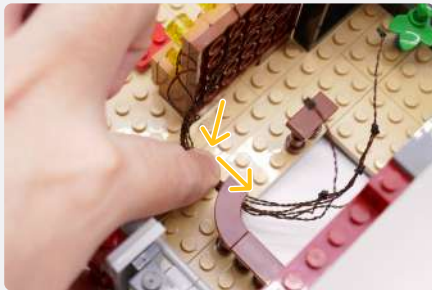
32



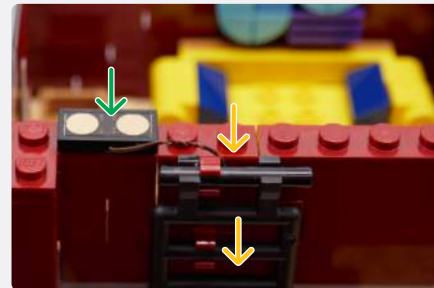
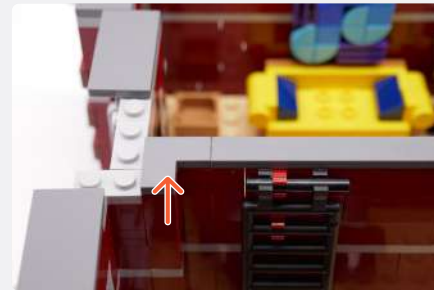
NOTE

Repeat this process for the other 5 lights

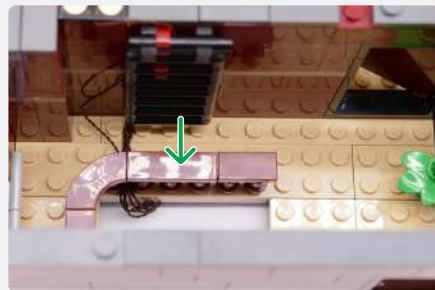
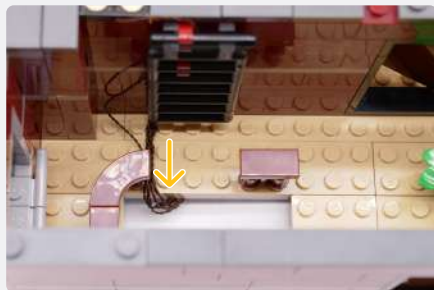
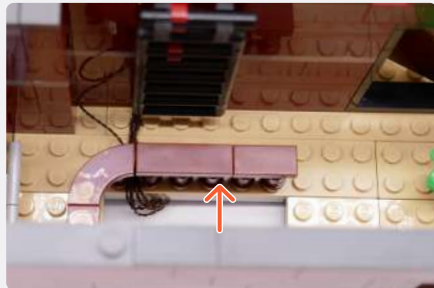
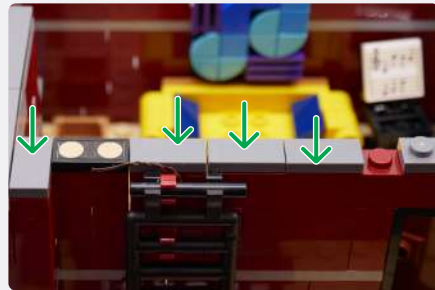




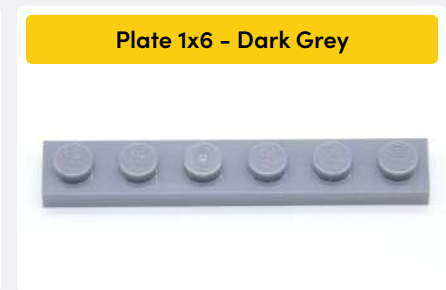
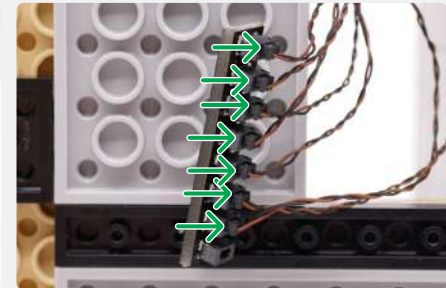
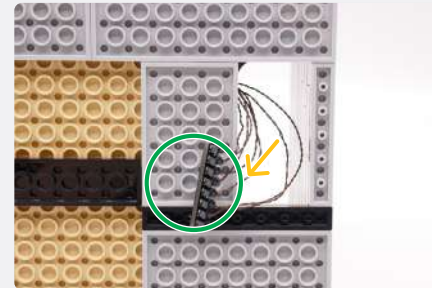
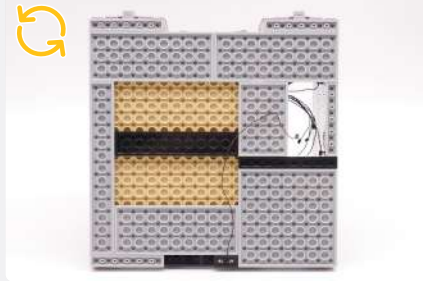
33

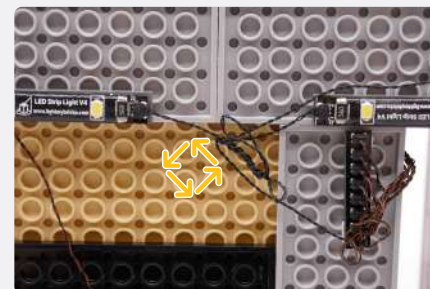
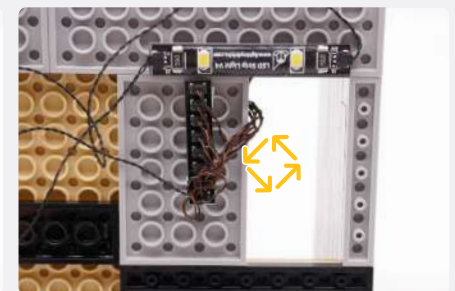
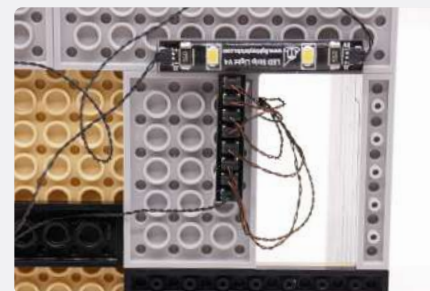
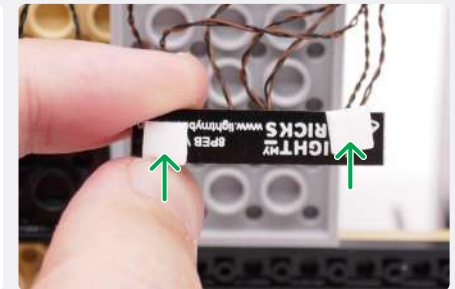
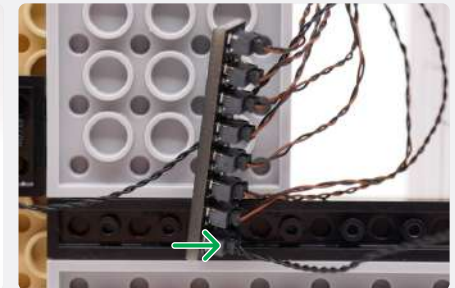
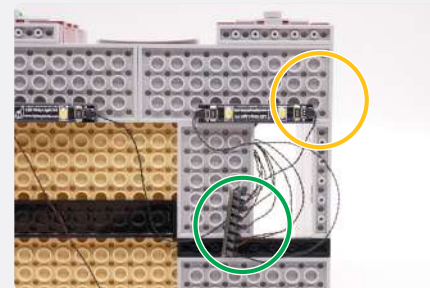
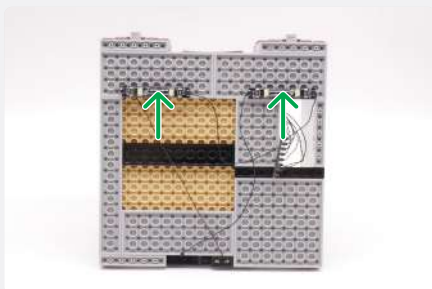
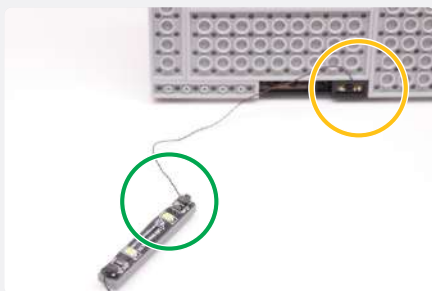
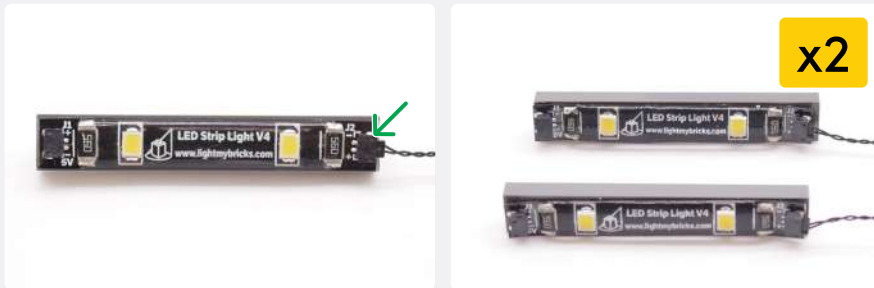


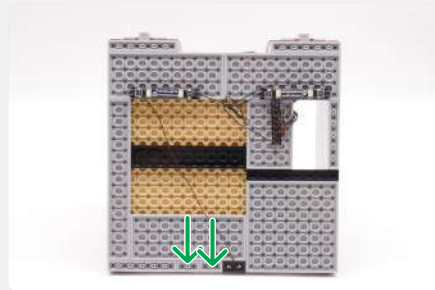
4 x Tile 1x2 - Dark Grey



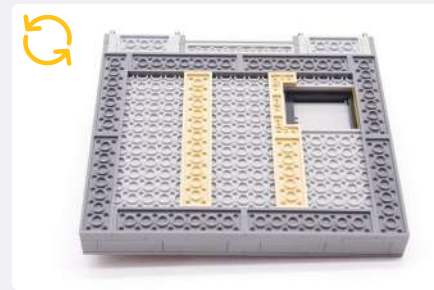
34





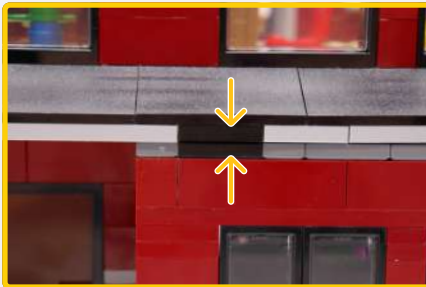
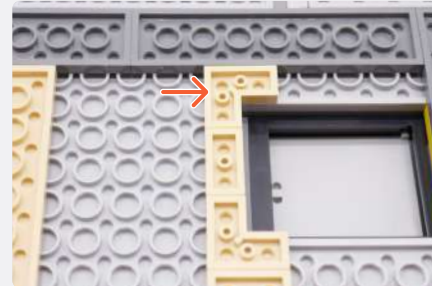


35



NOTE

Ensure the Wireless Power Connectors are aligned when re-connecting the floors

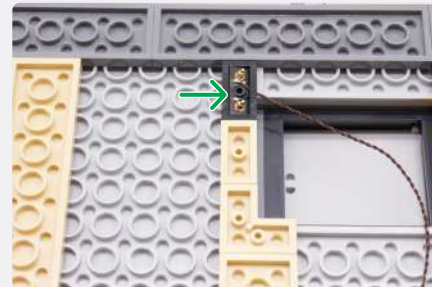


NOTE

Connect to a 5V USB Power Bank, 5V USB Wall Adaptor, or USB to AA Battery Pack (sold separately)



Wireless Power Connector Plate

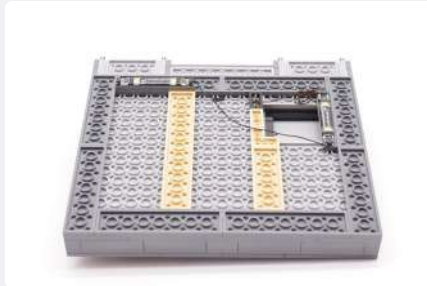
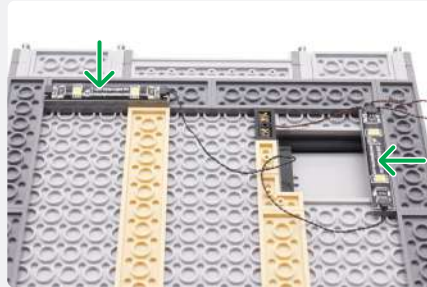
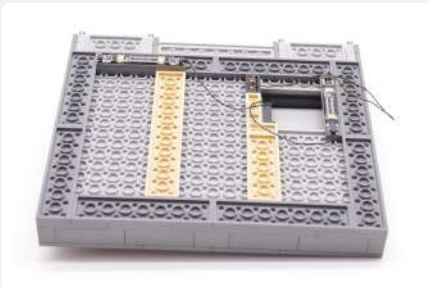
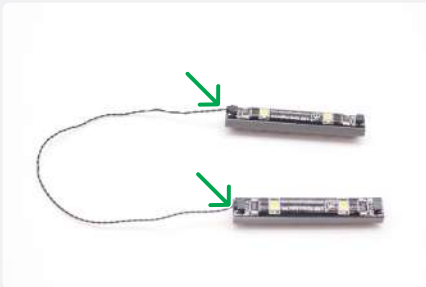


White Strip Light

Plate 1x6 - Dark Grey



15cm Connecting Cable



NOTE
Ensure the Wireless Power Connectors are aligned when re-connecting the floors



NOTE
Connect to a 5V USB Power Bank, 5V USB Wall Adaptor, or USB to AA Battery Pack (sold separately)



! If you experience any issues with the lights not working and suspect an issue with a component, please try a different port on the expansion board to verify where the fault lies (with the light or expansion board). To correct any issues with expansion board ports, please view the section addressing expansion board issues in our troubleshooting section. i

NOTE

You should have these parts left over that were removed from the LEGO set



FINAL PRODUCT

This finally completes installation of the Light My Bricks

LEGO® Jazz Club 10312 Light Kit.





TROUBLESHOOTING

Light My Bricks lighting kits contain individual components that are very small and can be easily damaged if not handled correctly.

To prevent unnecessary damage to components, we highly recommend that the User Guide section, **“Important things to note”** is read carefully. Follow the handling procedures in the User Guide to help prevent faults and damages to your Light My Bricks components.

If you are experiencing issues with your Light My Bricks set, watch our troubleshooting video [here](#) or read on for a list of common causes to help you troubleshoot.

Troubleshooting

Firstly, ensure that the batteries have power using a battery charge gauge.

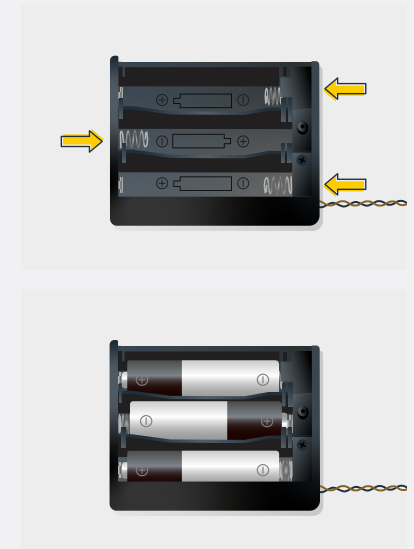
If the batteries have no power, replace the batteries.

If the batteries still have power, check to see if the batteries have been inserted correctly into the battery pack.

Check for AA batteries using the AA battery pack

Inside the battery pack are symbols indicating which direction the AA battery should be inserted. The flat side of the battery should be paired with the spring side of the battery pack.

If the batteries have been installed correctly and your kit still isn't operating correctly, the next step is to check the wiring.



Troubleshooting

Check Your Wires

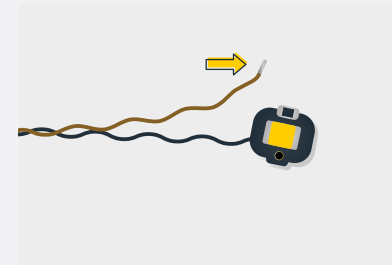
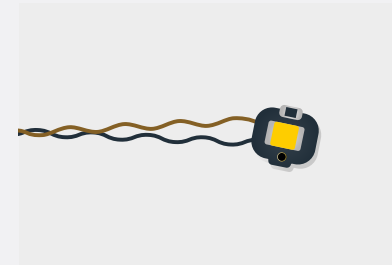
In order for Light My Bricks components to fit in between and underneath LEGO® bricks, the components need to be very small. Due to this nature, Light My Bricks components can be easily damaged when not handled correctly.

Be careful when removing unpacked components out of the packaging and ensure not to forcibly pull at the wires as this can damage the soldering that attach the wires to the LEDs.

If the wiring is detached from the LED itself, the light will not operate.

When connecting lights to your LEGO® set, check that there are no pinched wires underneath or in between bricks and plates.

When the wires are pinched and the exposed wires are touching each other, this can cause a crosswire and the lights to not function correctly.



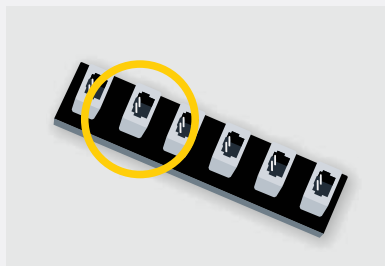
Troubleshooting

Check Your Expansion Board Ports / Strip Light Ports / Effects Board Ports

It is important to note that connectors can only be inserted to the expansion board, strip light, or effects board ports in one direction.

Forcibly inserting connectors in the incorrect direction will result in damaging the pins inside each of the ports on your component board.

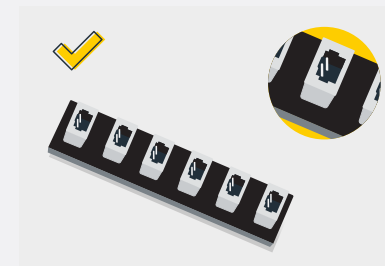
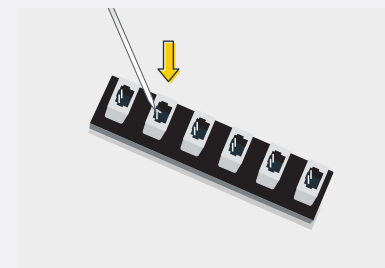
Not only will a light connected to the damaged port not work, but if the pins inside the port are bent to a point they are touching each other, this can result in all other lights in the system to stop working. This is a short circuit.



A short circuit can also result in overheating of the board, cable or batteries. If you suspect a short circuit, **DISCONNECT POWER IMMEDIATELY**. Batteries can fail, catch fire, or even explode if left connected to a short circuit for too long.

If you suspect you have a faulty component due to a bent pin, try the following steps:

If you look carefully inside each of the ports, each port contains 2 small pins that should be straight. You will be able to identify a faulty port if it has any bent pins.





CONTACT US

If you have an enquiry regarding the online shop, our products or a general enquiry please refer to our Frequently Asked Questions webpage here.

Alternatively, you can contact our Customer Services team by visiting our online support portal here.

support.lightmybricks.com

We thank you for purchasing this product and hope you enjoy!



lightmybricks.com