



**LIGHT^{MY}
BRICKS**



**LEGO® BACK TO THE FUTURE TIME
MACHINE
#10300 LIGHT KIT
INSTALLATION GUIDE**

Light My Bricks



LEGO® BACK TO THE FUTURE TIME MACHINE #10300 LIGHT KIT INSTALLATION GUIDE

Hi There!

We're here to help you get started on the LEGO®

Back to the Future Time Machine (10300) Light Kit.

This PDF details the instructions for the LED light kit only. If you are wishing to purchase this product, please [click here](#) to view the product page.

If you run into any issues, please refer to the troubleshooting section towards the end of this guide.

Have fun and enjoy!



PACKAGE CONTENTS:



- 5 x White 30cm Bit Light
- 19 x Cool White 30cm Bit Light*
- 9 x Warm White 30cm Micro Bit Light*
- 1 x Red to Blue 15cm Bit Light
- 1 x Green to Orange 15cm Bit Light
- 4 x Warm White 30cm Headlight



- 1 x 6-Port Expansion Board
- 1 x 8-Port Expansion Board
- 3 x 12-Port Expansion Board*
- 2 x 8-Port Micro Expansion Board*



- 1 x Pulse Effects Board
- 2 x NC Push Board
- 2 x Adhesive Square



- 3 x 5cm Connecting Cable
- 4 x 15cm Connecting Cable*
- 1 x 30cm Connecting Cable



- 1 x USB Power Cable
(Power Source not Included)

ASSORTED BRICKS:



- 4 x Plate 1x2 – Black
- 4 x Plate 1x2 – Trans Red
- 2 x Plate 1x2 – Trans Clear
- 1 x Round Plate 1x1 Open Stud – Black
- 1 x Slope 30 1x1x2/3 – Trans Orange
- 1 x Cone 1x1 W Top Groove – Trans Black
- 1 x Plate 2x2 W Rounded Bottom – Trans Clear

* Spares included

Contents

Before You Begin	5
Blueprint	8
Instructions	9
Final Product	46
Troubleshooting	47
Contact	52

Before You Begin



Laying cables in between and underneath bricks

Cables can fit in between and underneath LEGO® bricks, plates, and tiles providing they are laid correctly between the LEGO® studs. Do NOT forcefully join LEGO® together around cables; instead ensure they are laying comfortably in between each stud.

CAUTION: Forcing LEGO® to connect over a cable can result in damaging the cable and light.



Connecting Cable Connectors To Expansion Boards

Take extra care when inserting connectors to ports of Expansion Boards. Connectors can be inserted only one way. With the expansion board facing up, look for the soldered "=" symbol on the left side of the port. The connector side with the wires exposed should be facing toward the soldered "=" symbol as you insert into the port. If a plug won't fit easily into a port connector, do not force it.

Incorrectly inserting the connector can result in bent pins inside the port or possible overheating of the expansion board when connected.

Before You Begin

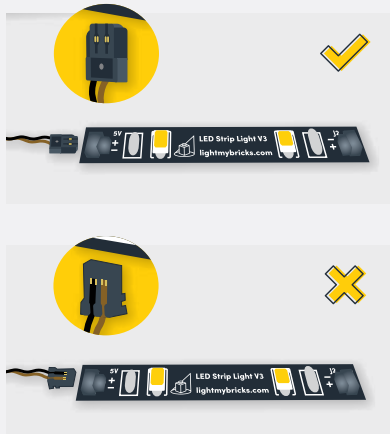

Connecting Cable Connectors To Strip Lights

Take extra care when inserting connectors to ports on the Strip Lights. Connectors can be inserted only one way. With the Strip Light facing up, ensure the side of the connector with the wires exposed is facing down. If a plug won't fit easily into a port connector, don't force it. Doing so will damage the plug and the connector.

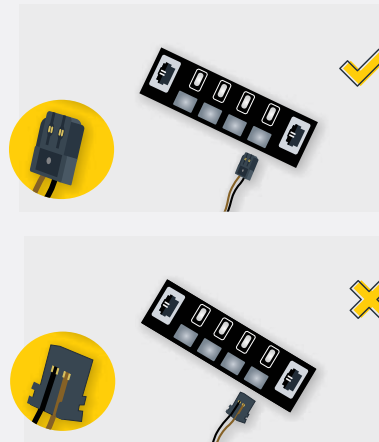

Connecting Micro Cable Connectors To Micro Expansion Board Ports

Take extra care when inserting the micro connectors to micro ports of Micro Expansion Boards. Connecting Micro Bit Lights to Micro Expansion Boards is similar to connecting lights and cables to Strip Lights. With the expansion board facing up, ensure the side of the connector with the wires exposed is facing down. If a plug won't fit easily into a port connector, do not force it. Use your fingernail to push the plastic part of the connector to the micro port.

Before You Begin

Installing Bit Lights Under Lego® Bricks And Plates

When installing Bit Lights under LEGO® pieces, ensure they are placed the correct way up (Yellow LED component exposed). You can either place them directly on top of LEGO® studs or in between.

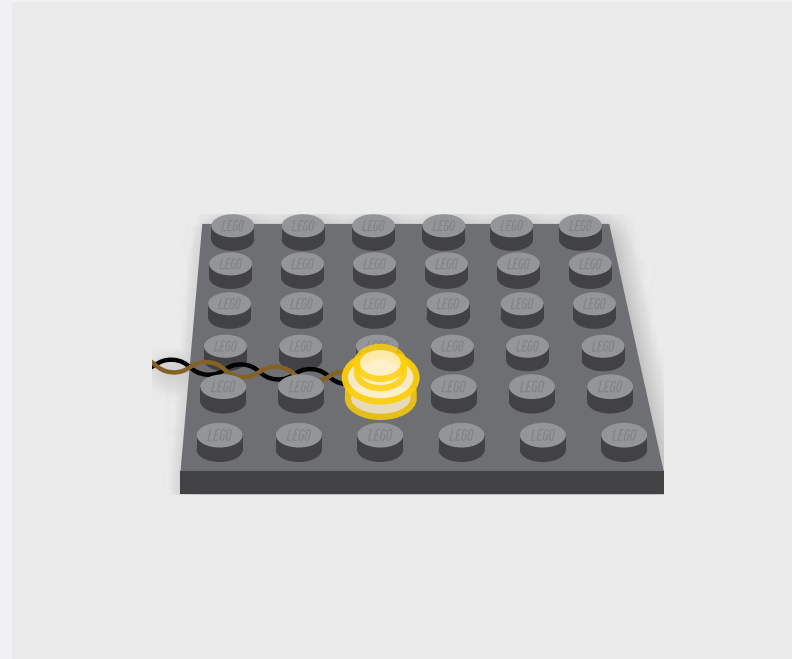

BLUEPRINT

Steps 1-11

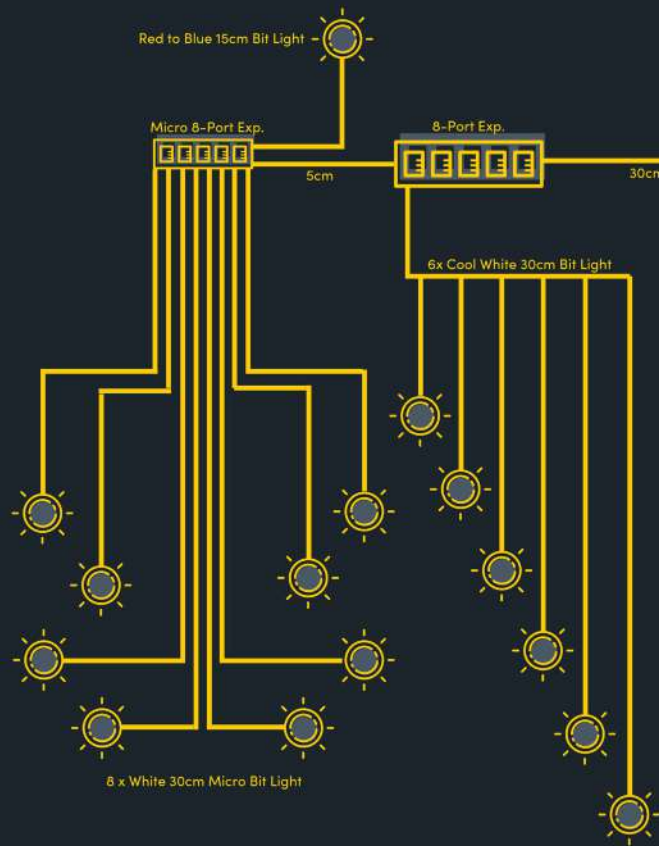

Steps 12-21

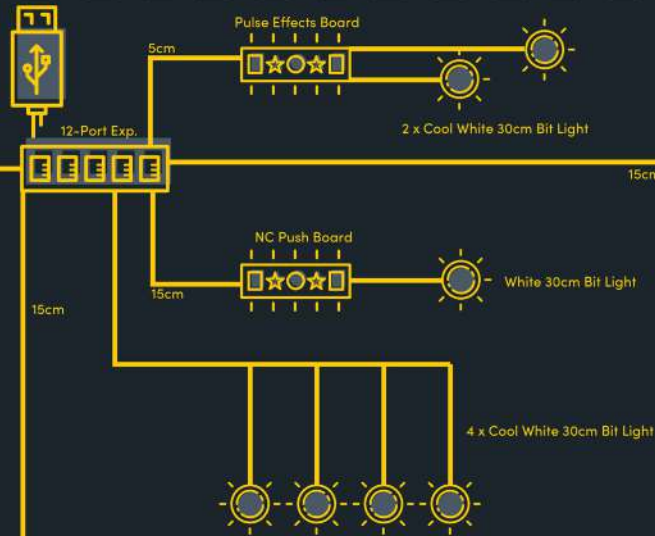

Steps 31- 37

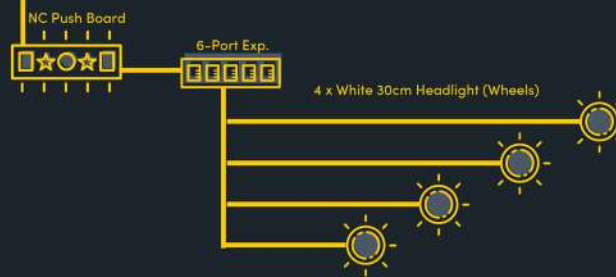

Steps 22-30

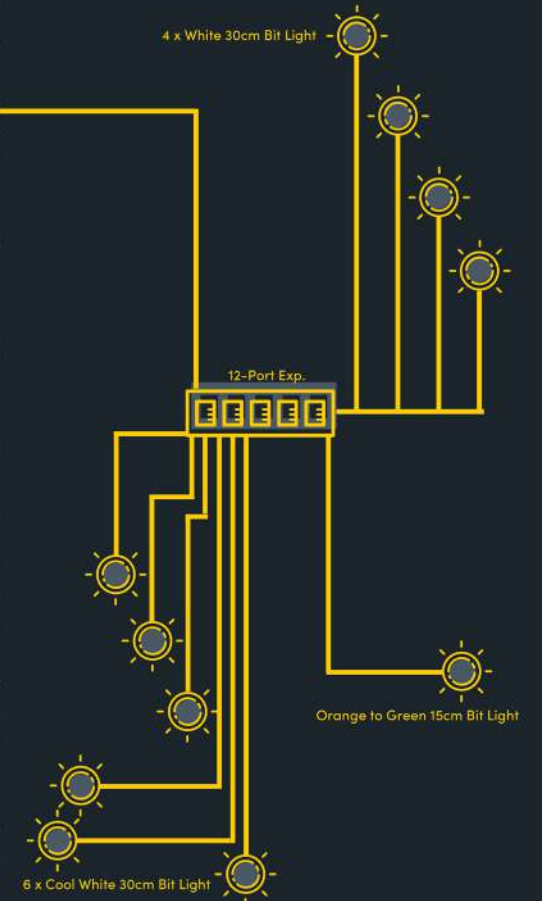



INSTRUCTIONS

To ensure a smooth installation of your light kit, please read and follow each step carefully. If you run into any issues, please refer to the online troubleshooting guide.

1

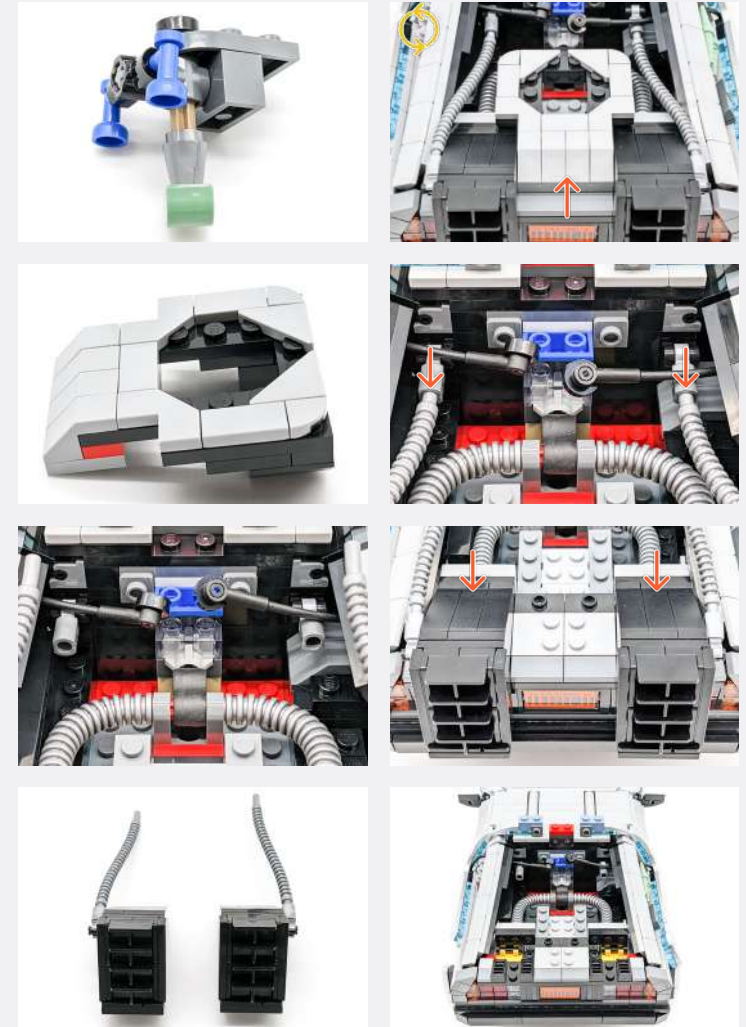

Legend

- DISCONNECT
- CONNECT / RECONNECT
- ↻ TURN / FLIP
- DIRECTIONAL
- ↻↻ TWIST / BRAID
- ✳ POWER ON TEST
- 📝 NOTE ICON

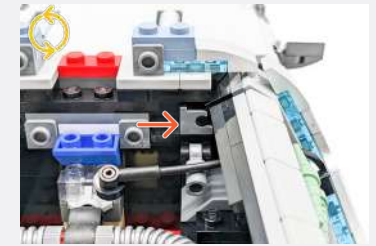

Carefully remove the side panel by disconnecting the hinge pieces.

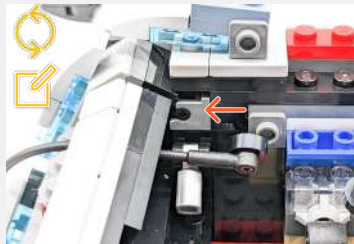

Legend DISCONNECT CONNECT / RECONNECT TURN / FLIP DIRECTIONAL TWIST / BRAID POWER ON TEST NOTE ICON

2

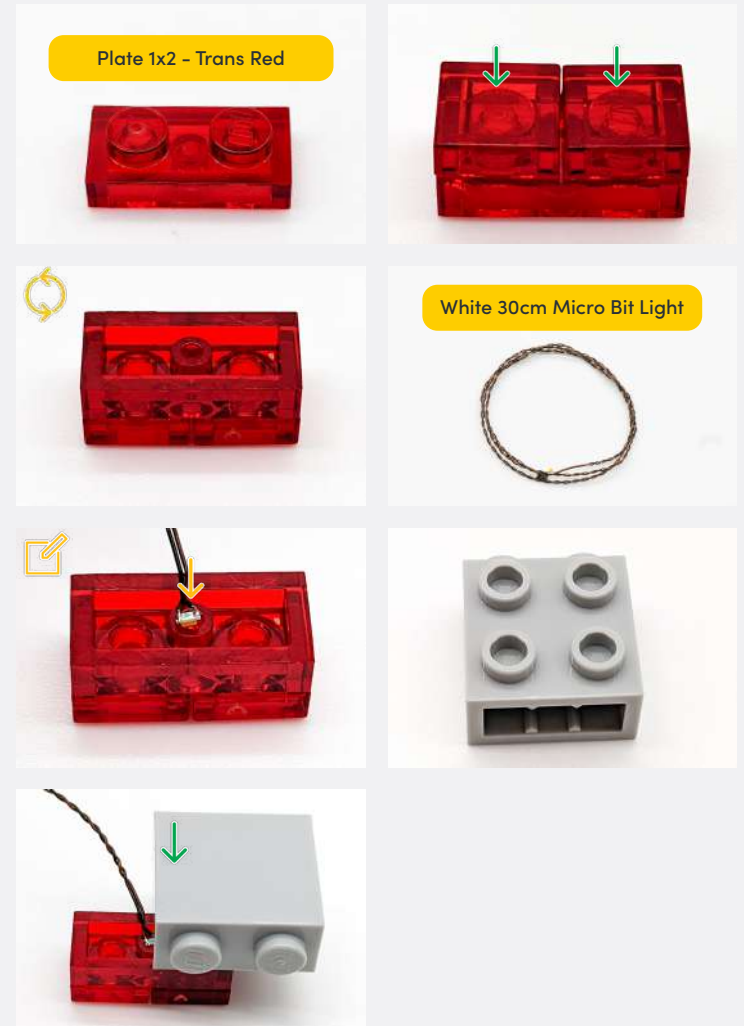

📌 Ensure the Micro Bit Light is facing down towards the plate.

Legend → DISCONNECT → CONNECT / RECONNECT ↻ TURN / FLIP → DIRECTIONAL ↻ TWIST / BRAID * POWER ON TEST 📌 NOTE ICON

3

<p>Plate 1x2 - Trans Red</p>	
	<p>White 30cm Micro Bit Light</p>
	<p>Plate 1x2 - Trans Clear</p>

Ensure the Micro Bit Light is facing down towards the plate.

Ensure the Micro Bit Light is facing down towards the plate.

	<p>White 30cm Micro Bit Light</p>
<p>White 30cm Micro Bit Light</p>	

Legend

- DISCONNECT
- CONNECT / RECONNECT
- TURN / FLIP
- DIRECTIONAL
- TWIST / BRAID
- POWER ON TEST
- NOTE ICON



4

We will now do the same for the right tail light.



Ensure the Micro Bit Light is facing down towards the plate.

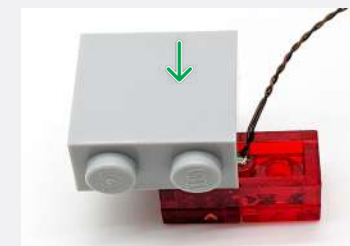
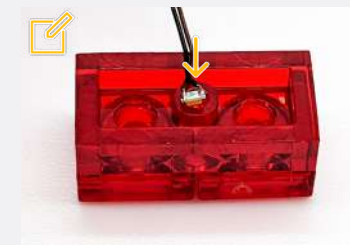

Legend DISCONNECT CONNECT / RECONNECT TURN / FLIP DIRECTIONAL TWIST / BRAID POWER ON TEST NOTE ICON



White 30cm Micro Bit Light



Ensure the Micro Bit Light is facing down towards the plate.

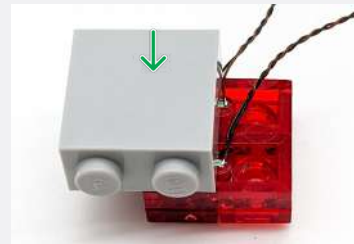
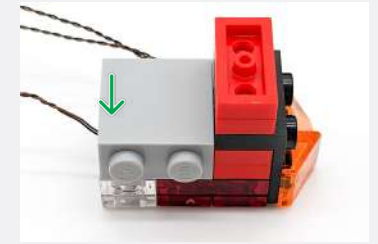
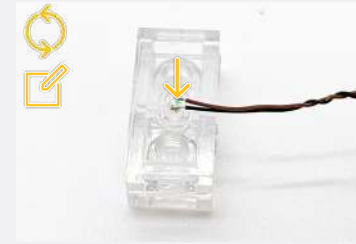
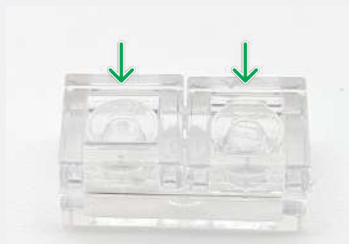

Plate 1x2 - Trans Clear



White 30cm Micro Bit Light



White 30cm Micro Bit Light

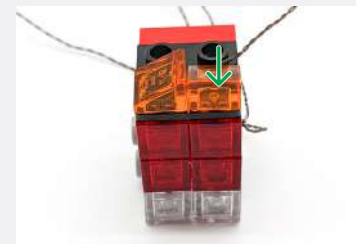

Legend

- DISCONNECT
- CONNECT / RECONNECT
- TURN / FLIP
- DIRECTIONAL
- TWIST / BRAID
- POWER ON TEST
- NOTE ICON

5

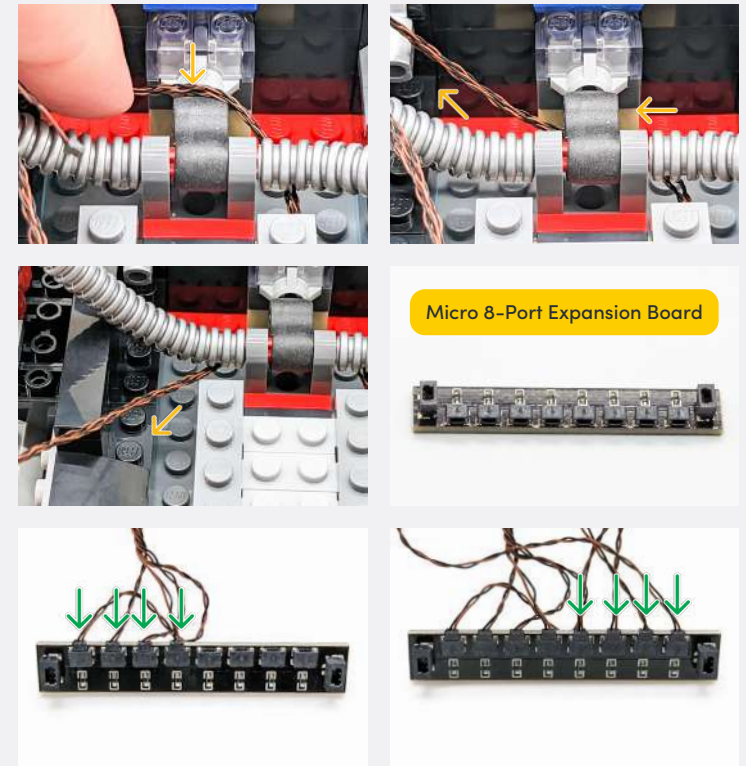
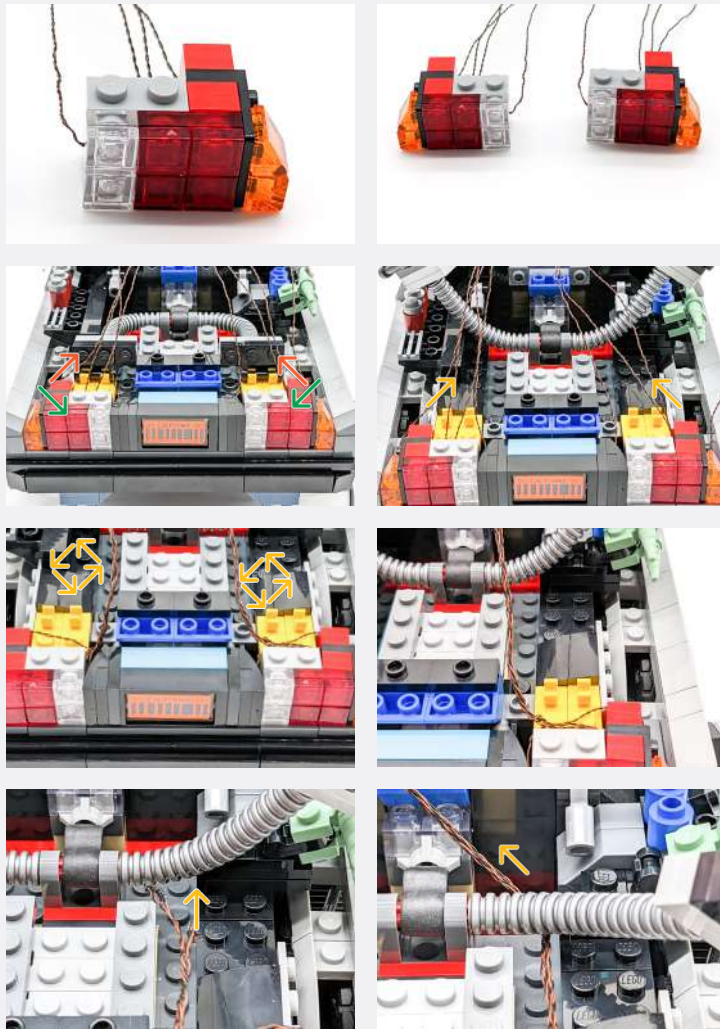

Micro 8-Port Expansion Board

Legend

- DISCONNECT
- CONNECT / RECONNECT
- TURN / FLIP
- DIRECTIONAL
- TWIST / BRAID
- POWER ON TEST
- NOTE ICON

6

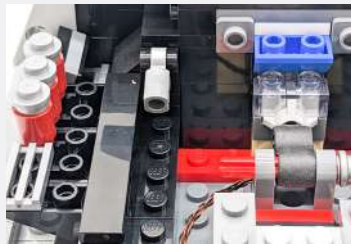
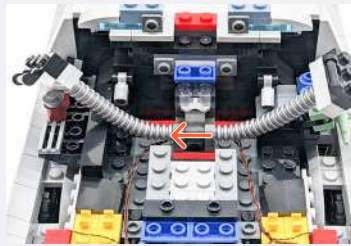

Red to Blue 15cm Bit Light



Cone 1x1 W Top Groove - Trans Black



When twisting the cables together, exclude the 5cm Connecting Cable.

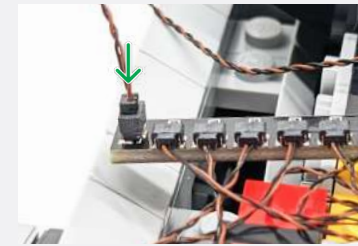

5cm Connecting Cable

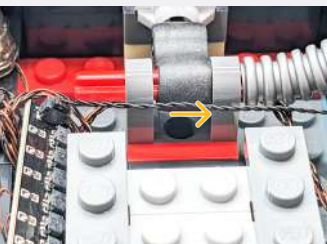
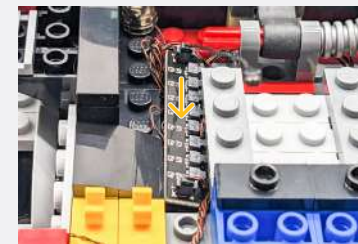
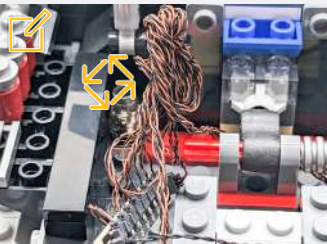
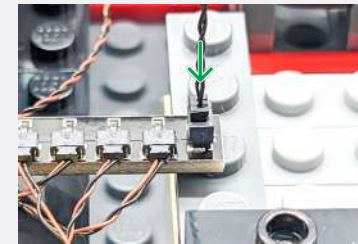

Legend → DISCONNECT → CONNECT / RECONNECT ↻ TURN / FLIP → DIRECTIONAL ↻ TWIST / BRAID * POWER ON TEST 📝 NOTE ICON

7

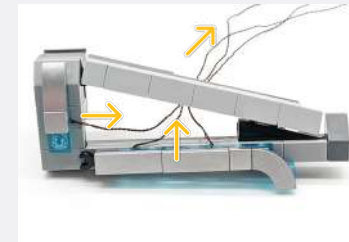
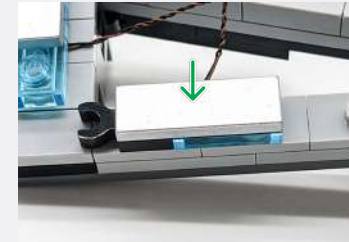
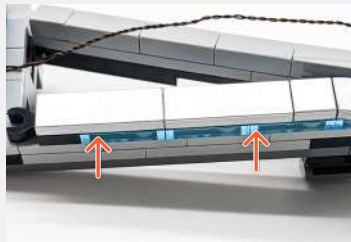
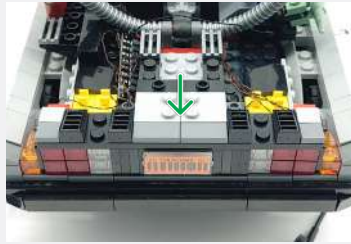

Legend → DISCONNECT → CONNECT / RECONNECT ↻ TURN / FLIP → DIRECTIONAL ↻ TWIST / BRAID * POWER ON TEST 📝 NOTE ICON

8

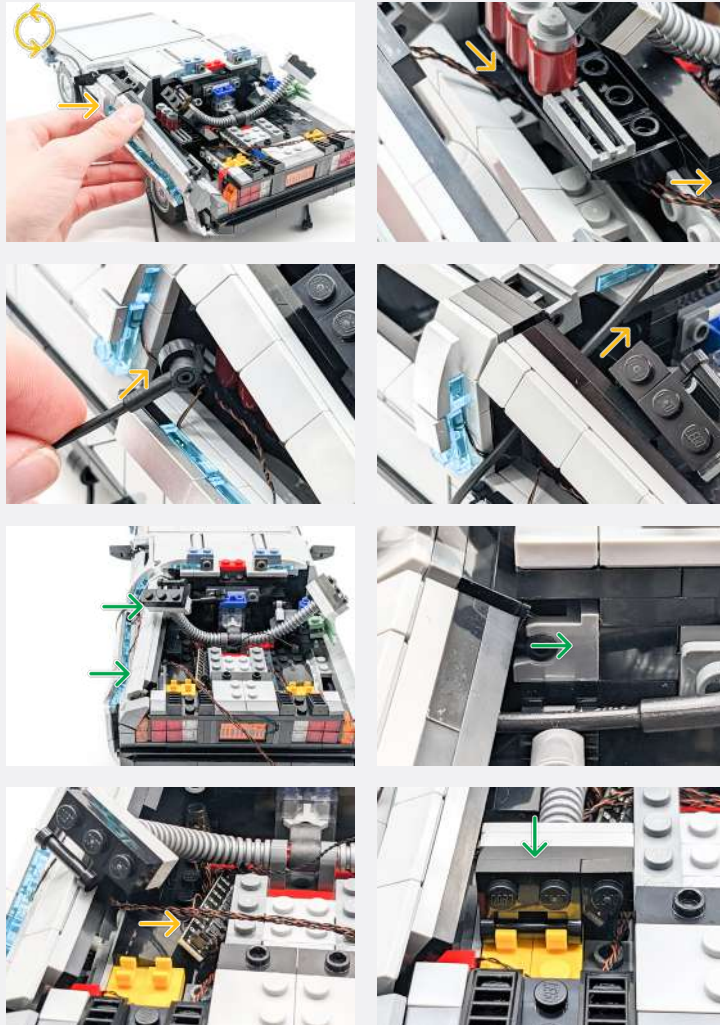

☑ Connect the three Cool White Bit Light cables as well as the 5cm Connecting Cable from step 6 to the 8-Port Expansion Board.

9

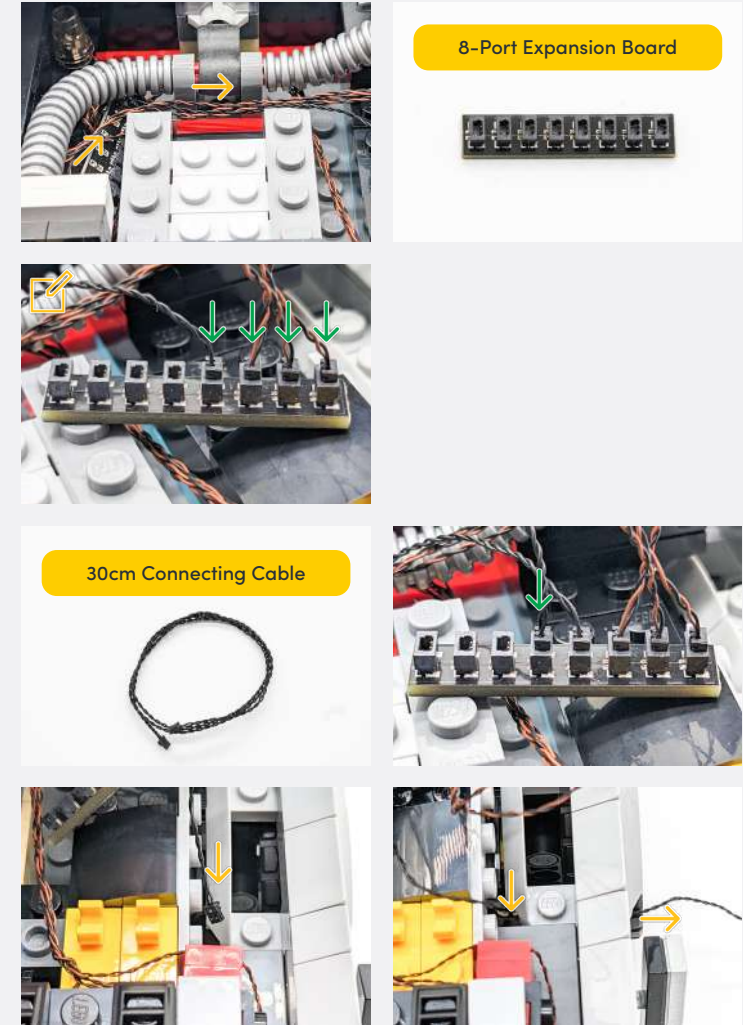

Legend → DISCONNECT → CONNECT / RECONNECT ↻ TURN / FLIP → DIRECTIONAL ↻ TWIST / BRAID * POWER ON TEST 📝 NOTE ICON

10

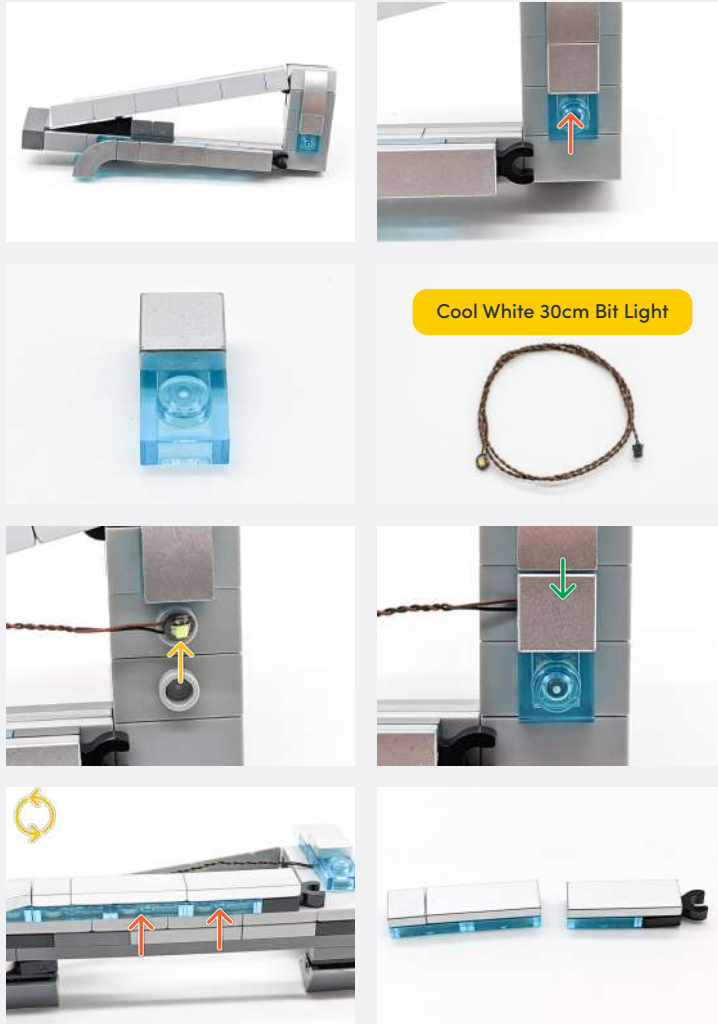

Legend → DISCONNECT → CONNECT / RECONNECT ↻ TURN / FLIP → DIRECTIONAL ↻ TWIST / BRAID ✨ POWER ON TEST 📝 NOTE ICON

11

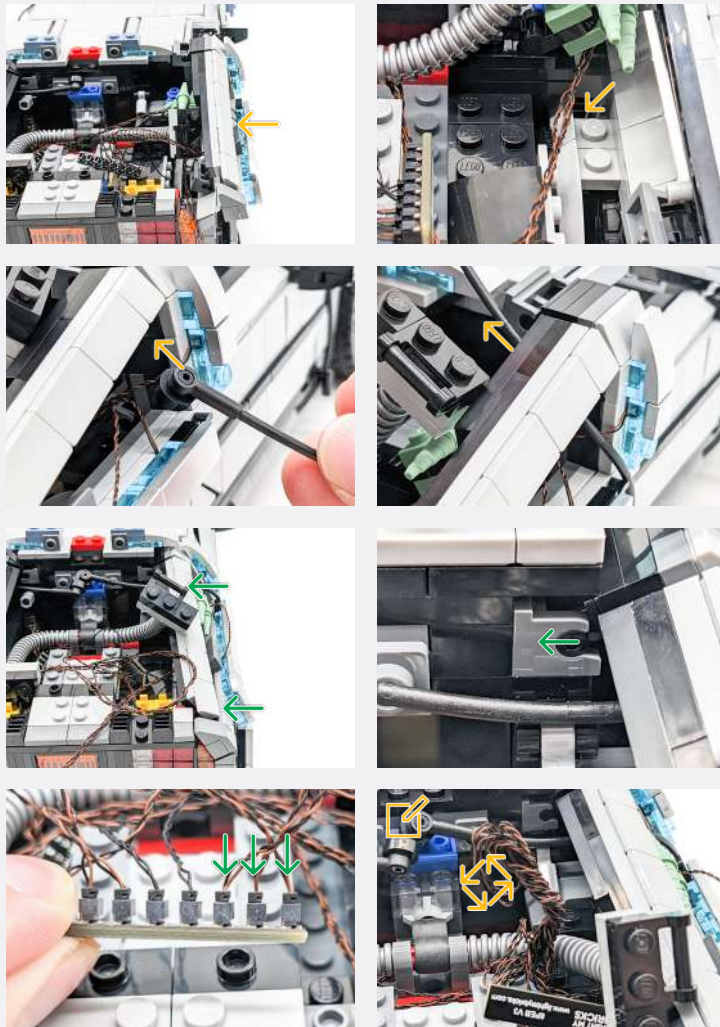

When twisting the cables together, exclude the 30cm Connecting Cable.



Legend

- DISCONNECT
- CONNECT / RECONNECT
- TURN / FLIP
- DIRECTIONAL
- TWIST / BRAID
- POWER ON TEST
- NOTE ICON

12

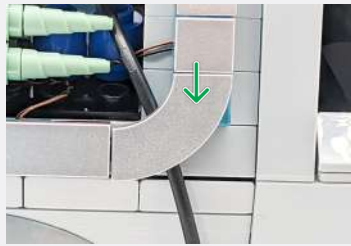

Grab the 30cm Connecting Cable from Step 9

13

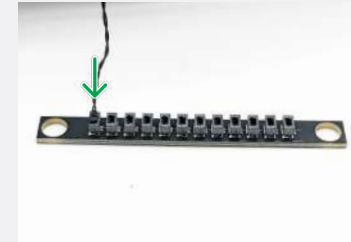
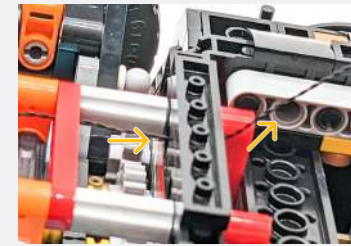

12-Port Expansion Board



Cool White 30cm Bit Light



Legend

- DISCONNECT
- CONNECT / RECONNECT
- ↻ TURN / FLIP
- DIRECTIONAL
- ↻↻ TWIST / BRAID
- ✳ POWER ON TEST
- 📝 NOTE ICON



Cool White 30cm Bit Light

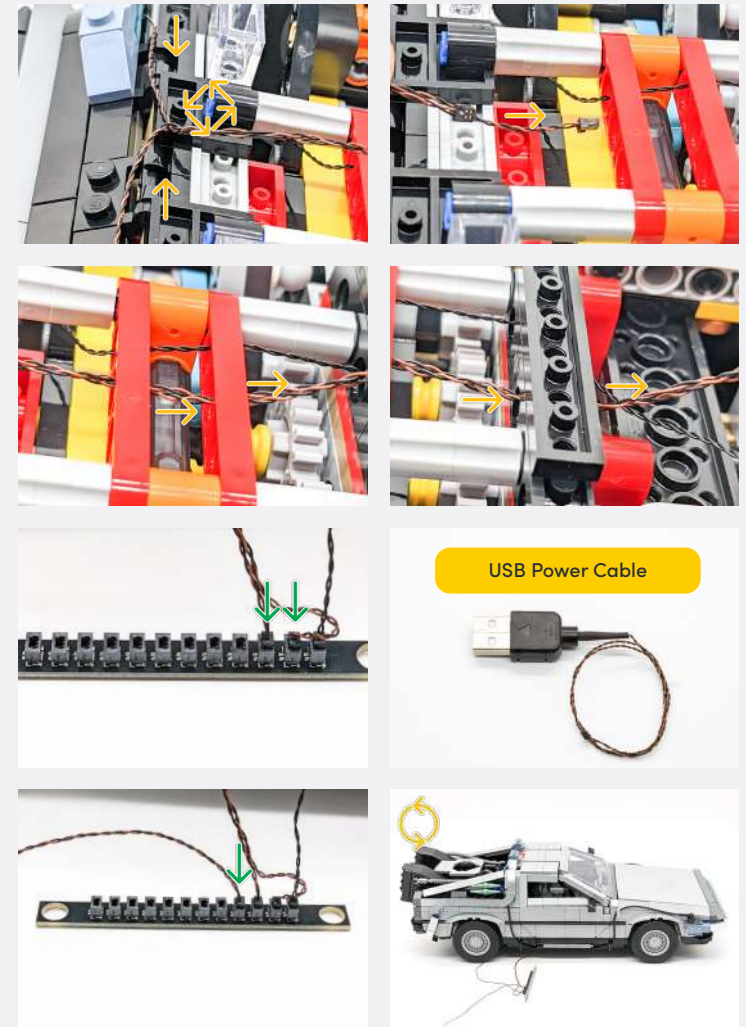

USB Power Cable

Legend → DISCONNECT → CONNECT / RECONNECT ↻ TURN / FLIP → DIRECTIONAL ↻ TWIST / BRAID ✨ POWER ON TEST 📝 NOTE ICON

📌 If you experience any issues with the lights not working and suspect an issue with a component, please try a different port on the expansion board to verify where the fault lies (with the light or expansion board). To correct any issues with expansion board ports, please view the section addressing expansion board issues in our troubleshooting section.

📌 Connect the other end to a 5V USB Power Bank, 5V USB Wall Adaptor, or USB to AA Battery Pack (sold separately)



14

📌 Remove the windshield by carefully disconnecting the ball joints at the top first.



Legend → DISCONNECT → CONNECT / RECONNECT ↻ TURN / FLIP → DIRECTIONAL ↻ TWIST / BRAID * POWER ON TEST 📌 NOTE ICON

15

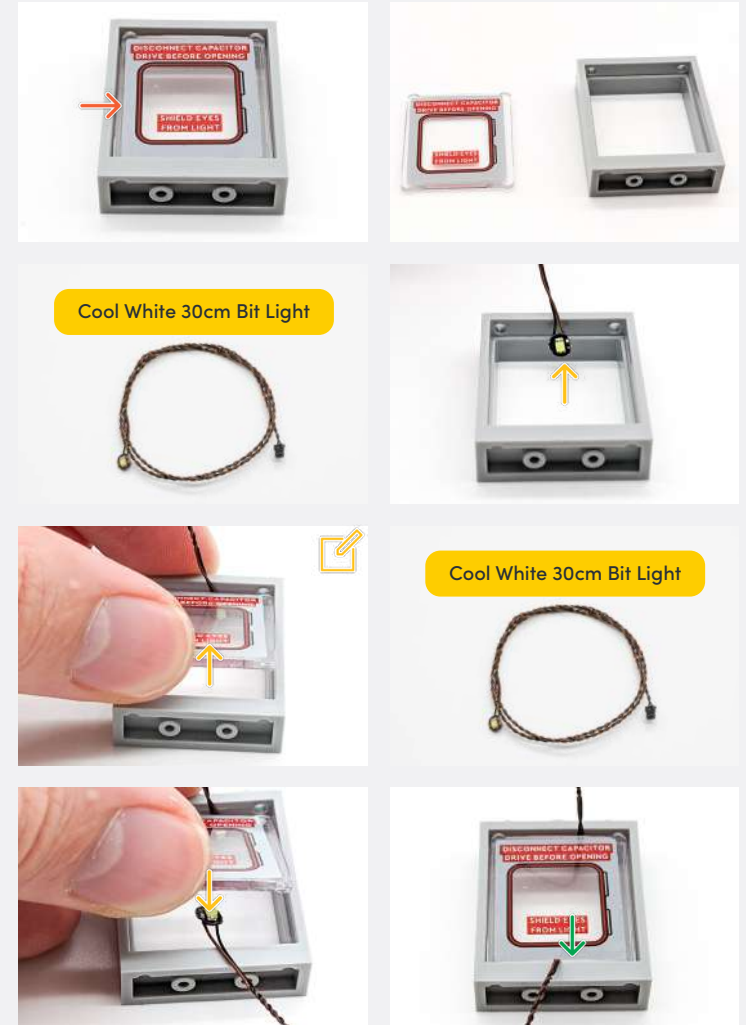
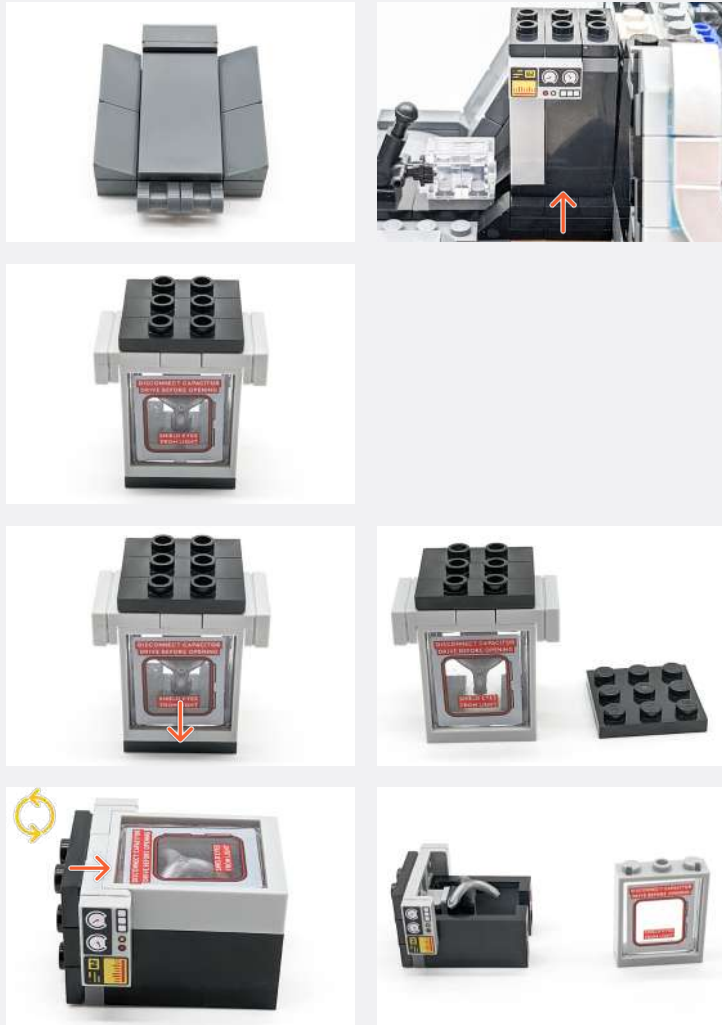

Hold the Trans-Clear panel on top of the Cool White Bit Light while placing the second Light

Legend

- DISCONNECT
- CONNECT / RECONNECT
- TURN / FLIP
- DIRECTIONAL
- TWIST / BRAID
- POWER ON TEST
- NOTE ICON



16

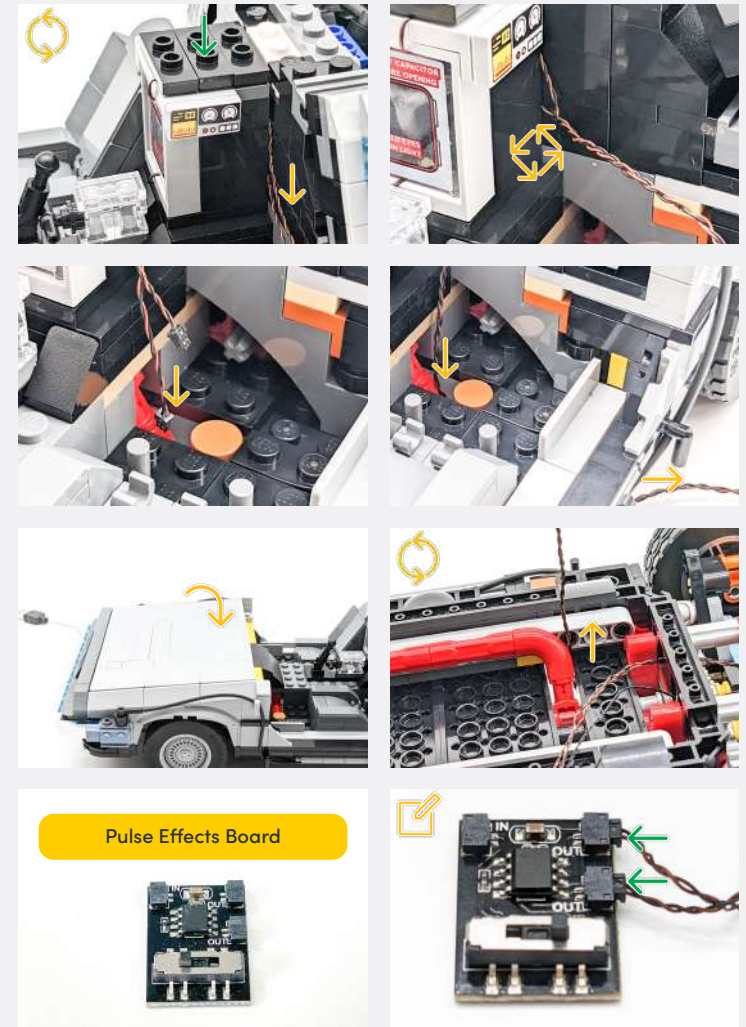

✂ Connect the two Bit Light cables to the "OUT" Ports on the Pulse Effects Board.

Pulse Effects Board

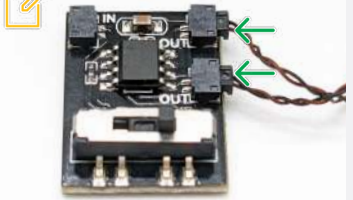

Legend → DISCONNECT → CONNECT / RECONNECT ↻ TURN / FLIP → DIRECTIONAL ↻ TWIST / BRAID * POWER ON TEST 📌 NOTE ICON

Connect the 5cm Connecting Cable to the "IN" Port of the Pulse Effects Board.

Push the switch all the way to the right. (You are able to change the speed of the pulse with the switch).

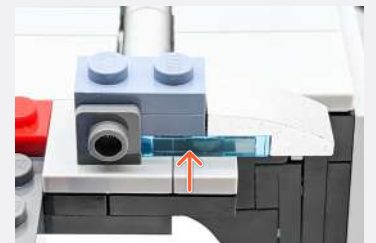
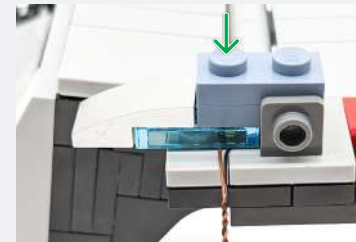
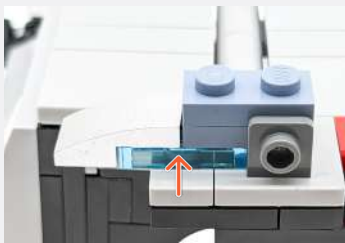
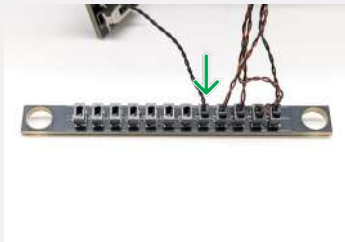
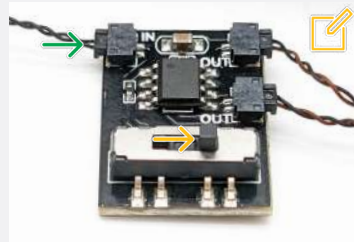

17

Legend

- DISCONNECT
- CONNECT / RECONNECT
- TURN / FLIP
- DIRECTIONAL
- TWIST / BRAID
- POWER ON TEST
- NOTE ICON

18



19

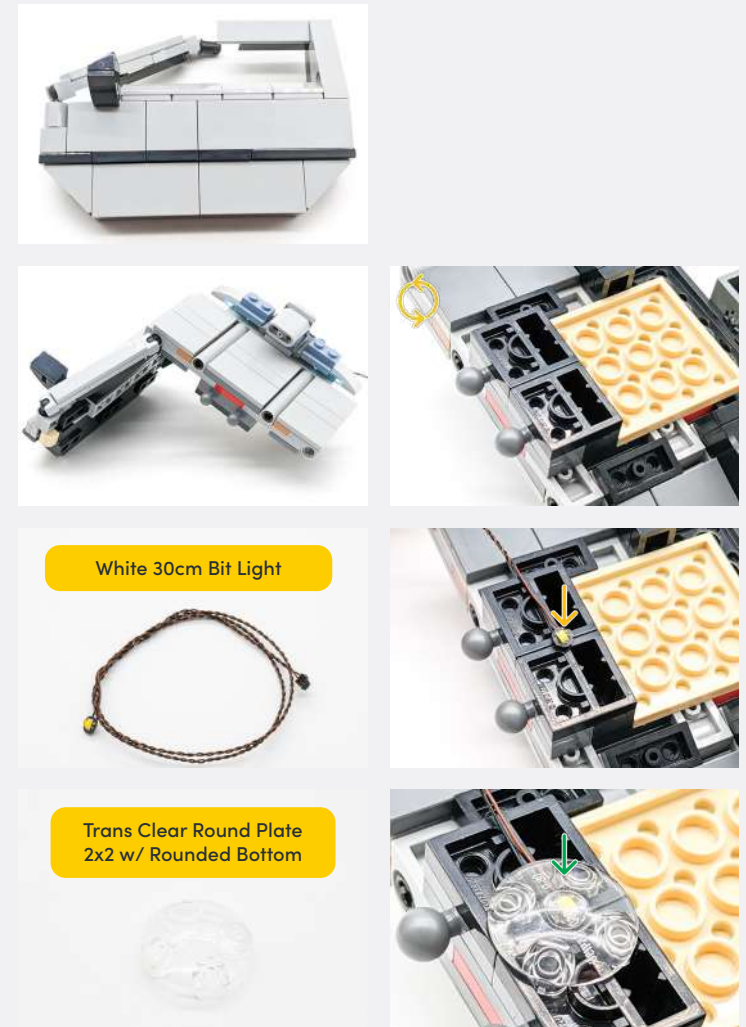

White 30cm Bit Light



Trans Clear Round Plate 2x2 w/ Rounded Bottom



Legend

- DISCONNECT
- CONNECT / RECONNECT
- TURN / FLIP
- DIRECTIONAL
- TWIST / BRAID
- POWER ON TEST
- NOTE ICON

✍ Thread the two Cool White Bit Light cables from the back of the roof through the gap underneath the side panel, leaving the White Bit Light cable free.



✍ Thread only the two Cool White Bit Light cables through the floor.



20



✍ Connect the White Bit Light to the "OUT" port of the NC Push Board.

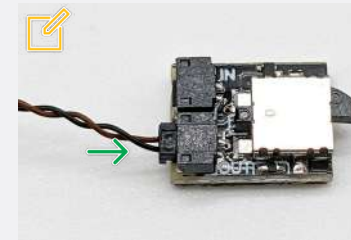

Legend

- DISCONNECT
- CONNECT / RECONNECT
- ↻ TURN / FLIP
- DIRECTIONAL
- ↻↻ TWIST / BRAID
- ✳ POWER ON TEST
- ✍ NOTE ICON

✍️ Connect the 15cm Connecting Cable to the "IN" port of the NC Push Board.

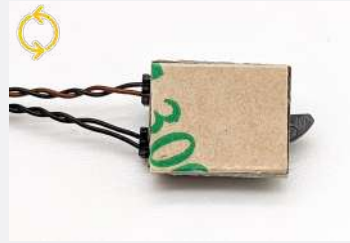
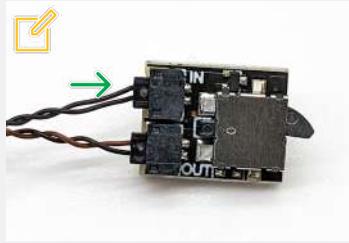

✍️ Ensure to place the NC Push Board in the exact position as shown in the vehicle.

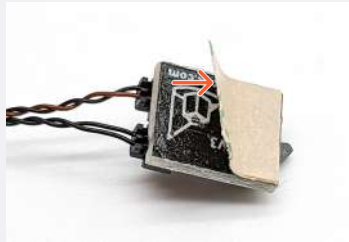

✍️ Thread the 15cm Connecting Cable through the floor.



21



Legend

- DISCONNECT
- CONNECT / RECONNECT
- TURN / FLIP
- DIRECTIONAL
- TWIST / BRAID
- POWER ON TEST
- NOTE ICON

If you experience any issues with the lights not working and suspect an issue with a component, please try a different port on the expansion board to verify where the fault lies (with the light or expansion board). To correct any issues with expansion board ports, please view the section addressing expansion board issues in our troubleshooting section.

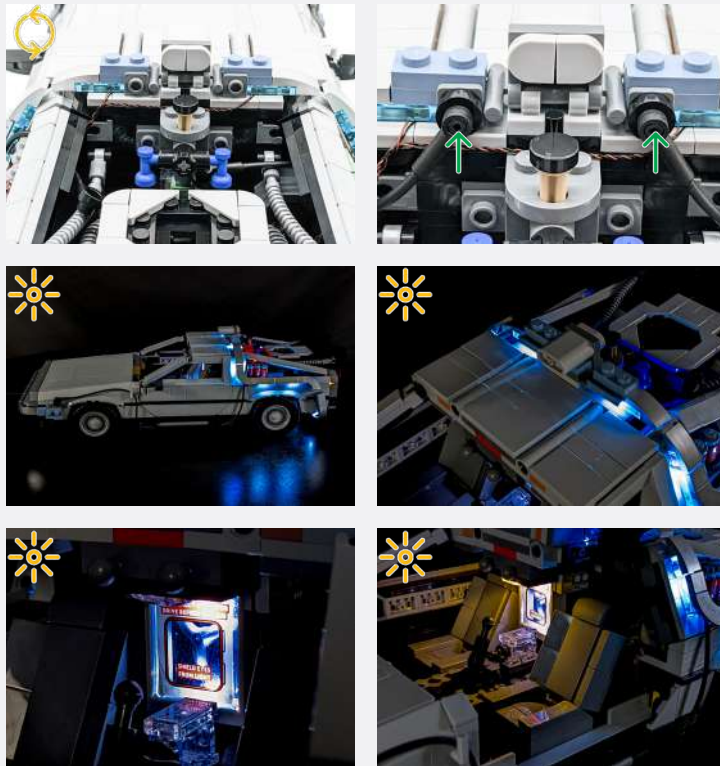

22

<p>Black Round Plate 1x1 w/ Open Stud</p>	<p>Green to Orange 15cm Bit Light</p>

Legend DISCONNECT CONNECT / RECONNECT TURN / FLIP DIRECTIONAL TWIST / BRAID POWER ON TEST NOTE ICON

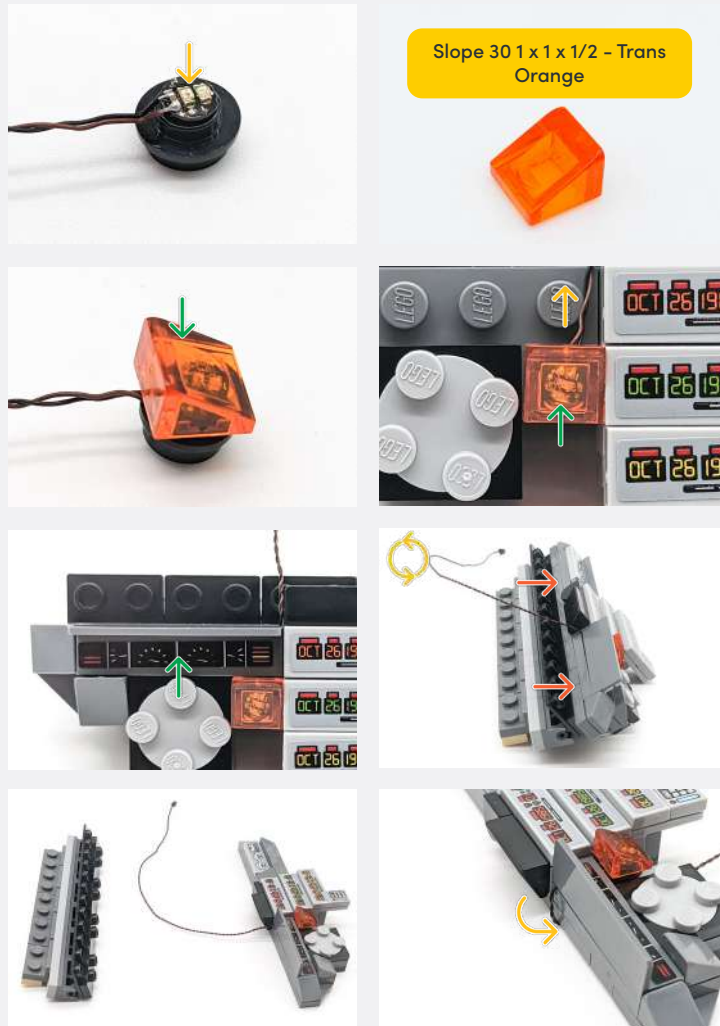

23

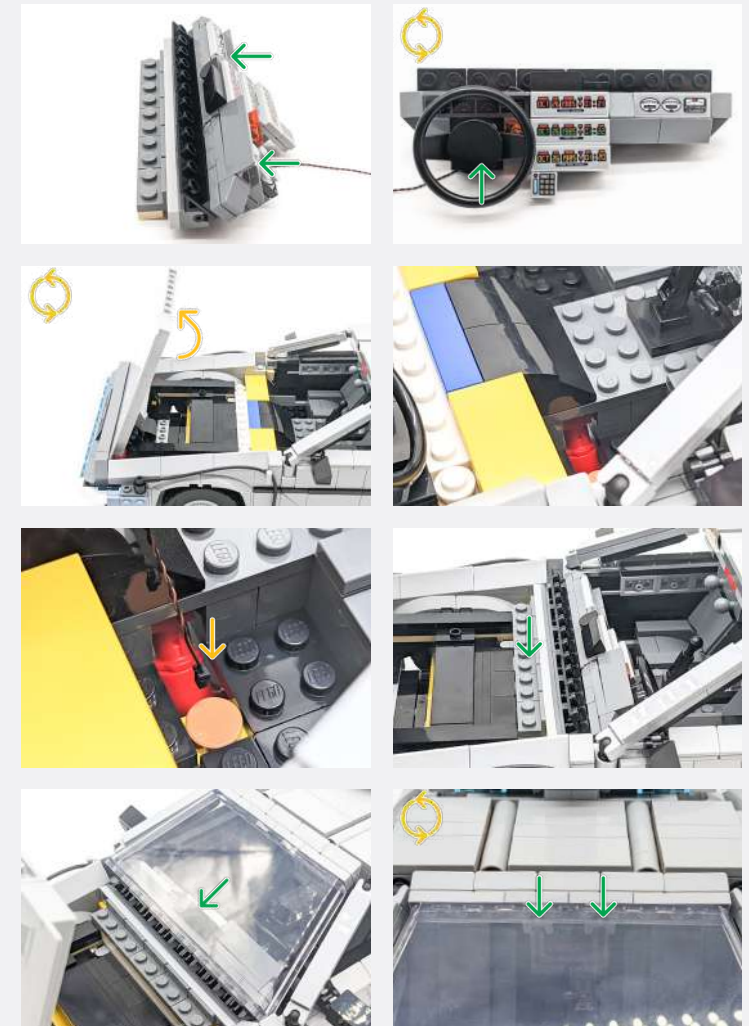

Legend → DISCONNECT → CONNECT / RECONNECT ↻ TURN / FLIP → DIRECTIONAL ↻ TWIST / BRAID ✨ POWER ON TEST 📝 NOTE ICON

24

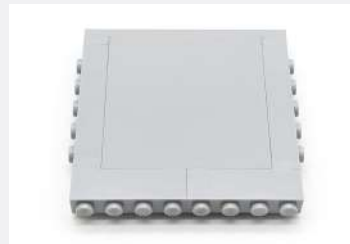
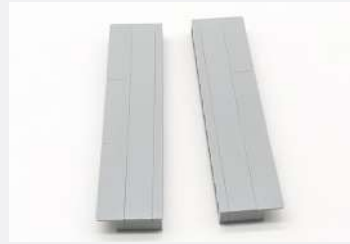
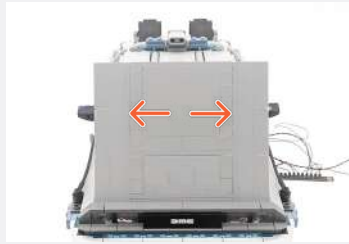

12-Port Expansion Board

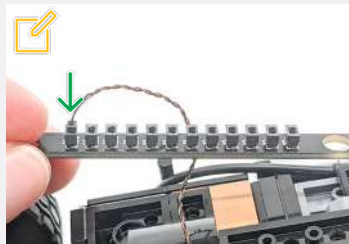

15cm Connecting Cable



Connect the cable from the Green to Orange 15cm Bit Light from Step 22

Connect the other end of the 15cm Connecting Cable to the other 12-Port Expansion Board from step 12, then twist the cables from it excluding the 15cm Connecting Cable.

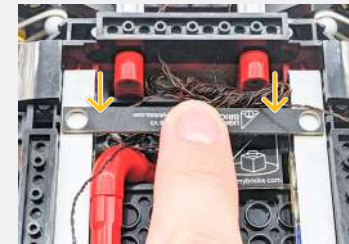
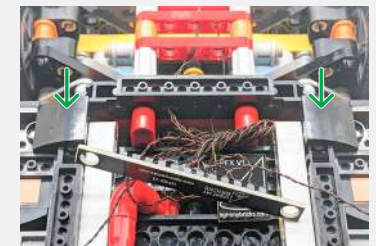
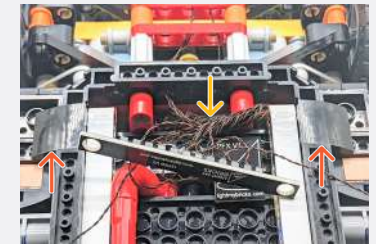
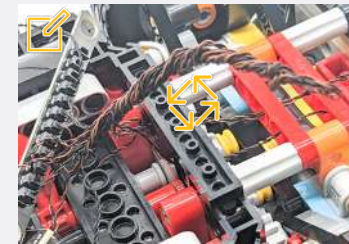
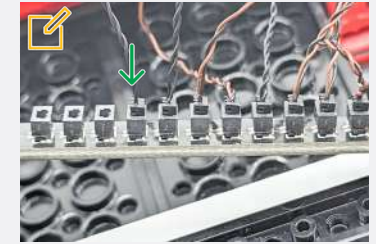
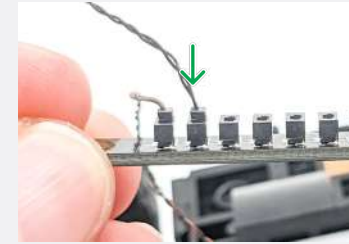

2x Plate 1x2 - Black



Legend

- DISCONNECT
- CONNECT / RECONNECT
- TURN / FLIP
- DIRECTIONAL
- TWIST / BRAID
- POWER ON TEST
- NOTE ICON

25

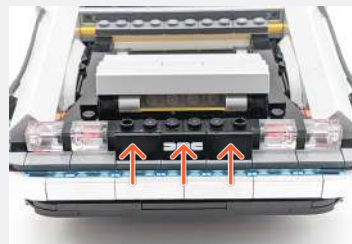

Cool White 30cm Bit Light



Legend

- DISCONNECT
- CONNECT / RECONNECT
- ↻ TURN / FLIP
- DIRECTIONAL
- ↻↻ TWIST / BRAID
- ✳ POWER ON TEST
- 📝 NOTE ICON

26



Cool White 30cm Bit Light



Cool White 30cm Bit Light

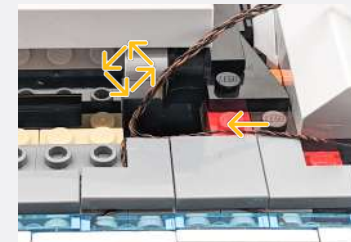
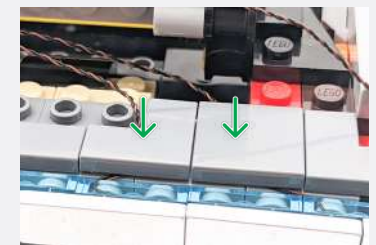
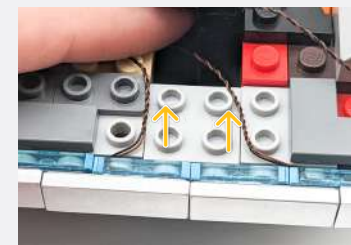
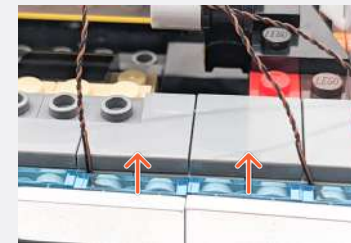
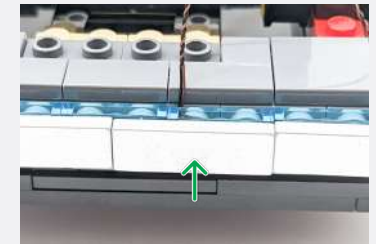

Legend



27



Cool White 30cm Bit Light

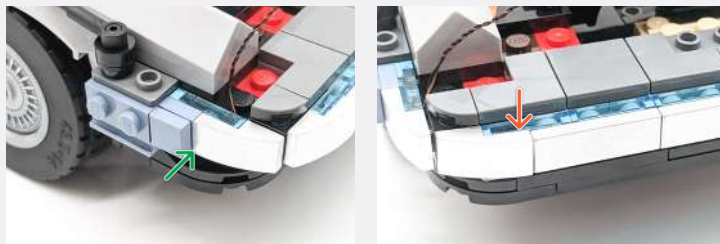

Cool White 30cm Bit Light



Cool White 30cm Bit Light

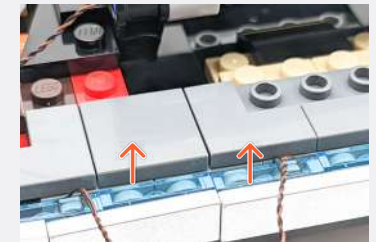
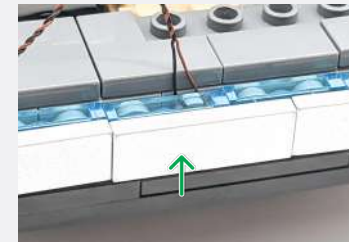

Legend

- DISCONNECT
- CONNECT / RECONNECT
- ↻ TURN / FLIP
- DIRECTIONAL
- ↻↻ TWIST / BRAID
- ✳ POWER ON TEST
- 📝 NOTE ICON

28

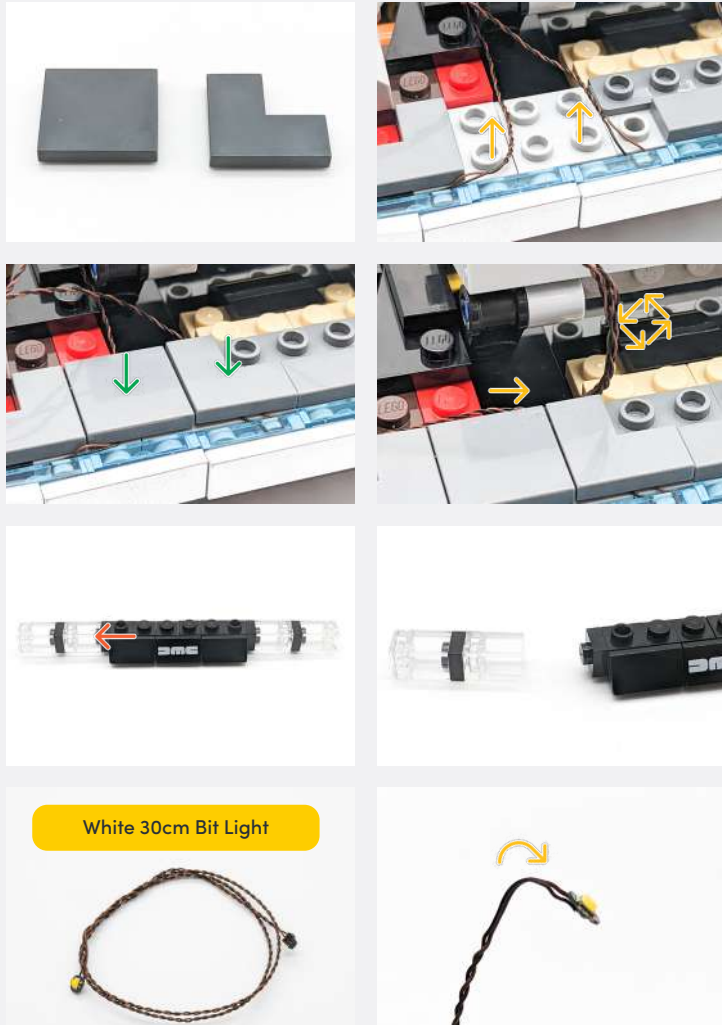

White 30cm Bit Light

White 30cm Bit Light

Legend → DISCONNECT → CONNECT / RECONNECT ↻ TURN / FLIP → DIRECTIONAL ↻ TWIST / BRAID ✨ POWER ON TEST 📝 NOTE ICON

Do the same for the other side.

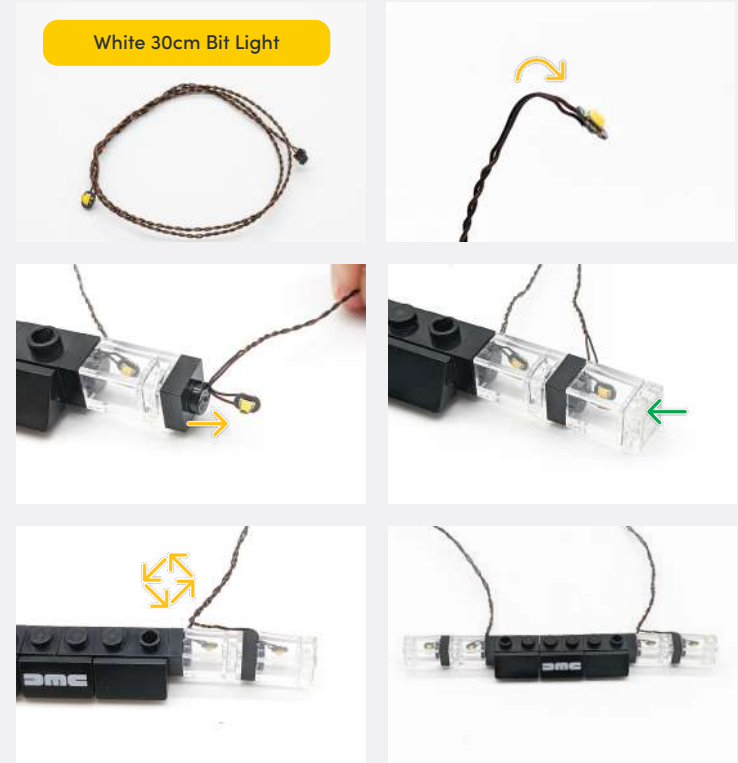

Legend → DISCONNECT → CONNECT / RECONNECT ↻ TURN / FLIP → DIRECTIONAL ↻ TWIST / BRAID ✨ POWER ON TEST 📝 NOTE ICON

29



 Split the cables into two sides, then thread each set of cables into the hole in the floor on their respective sides.

30



Legend

-  DISCONNECT
-  CONNECT / RECONNECT
-  TURN / FLIP
-  DIRECTIONAL
-  TWIST / BRAID
-  POWER ON TEST
-  NOTE ICON

If you experience any issues with the lights not working and suspect an issue with a component, please try a different port on the expansion board to verify where the fault lies (with the light or expansion board). To correct any issues with expansion board ports, please view the section addressing expansion board issues in our troubleshooting section.

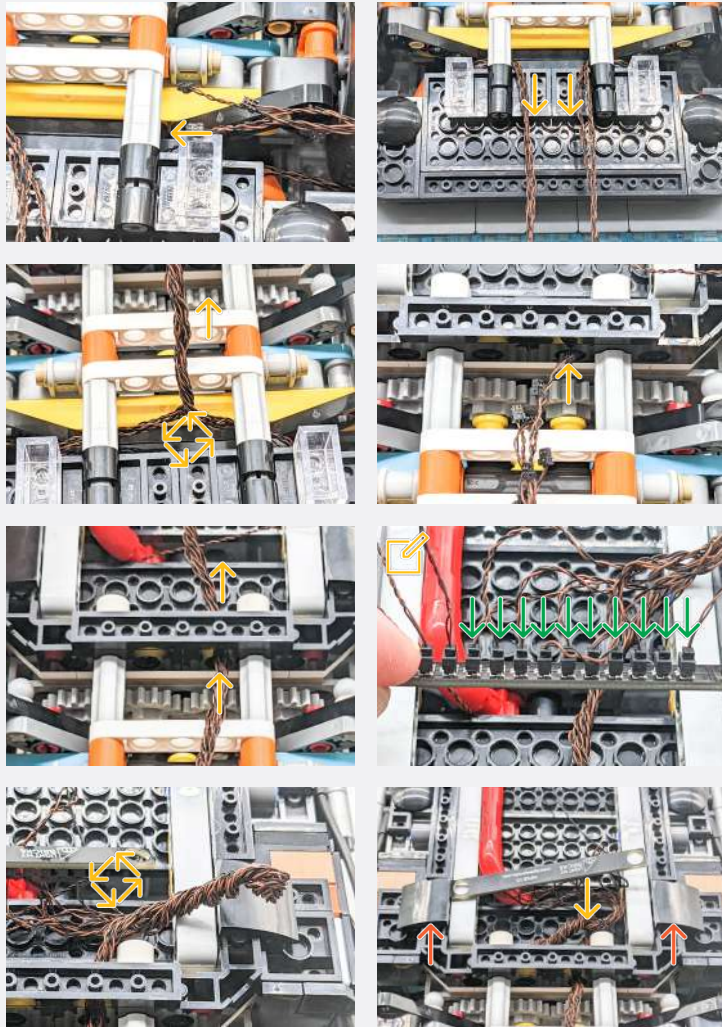

Connect all Bit Lights from steps 25-29 to the second Expansion Board.

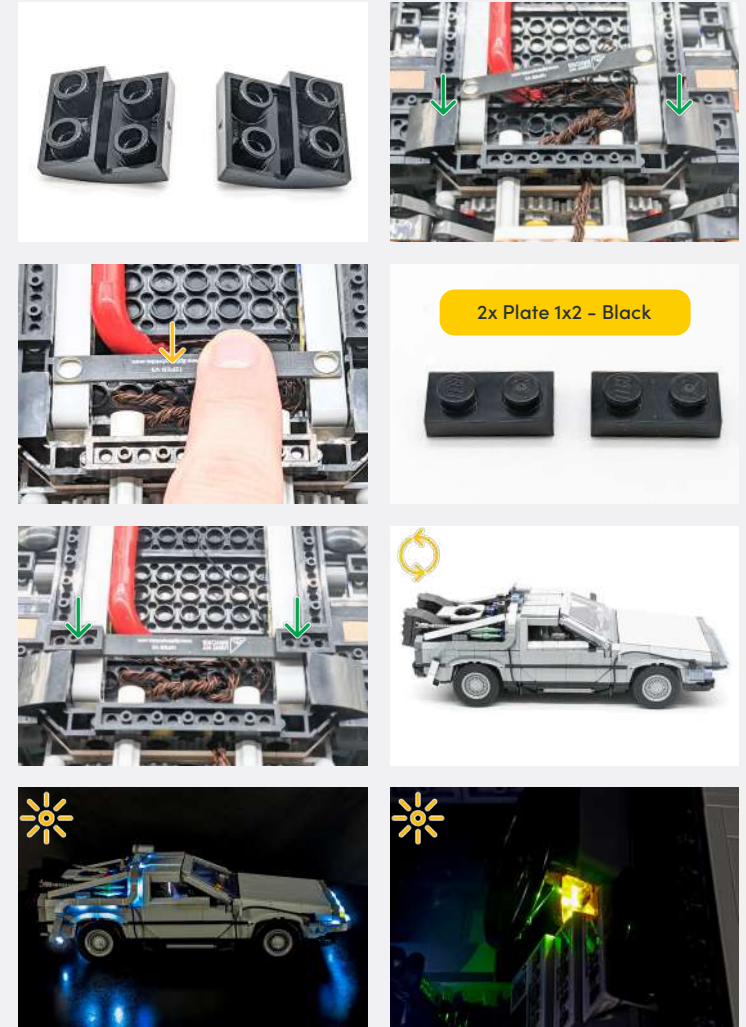

Legend

- DISCONNECT
- CONNECT / RECONNECT
- TURN / FLIP
- DIRECTIONAL
- TWIST / BRAID
- POWER ON TEST
- NOTE ICON

If you experience any issues with the lights not working and suspect an issue with a component, please try a different port on the expansion board to verify where the fault lies (with the light or expansion board). To correct any issues with expansion board ports, please view the section addressing expansion board issues in our troubleshooting section.

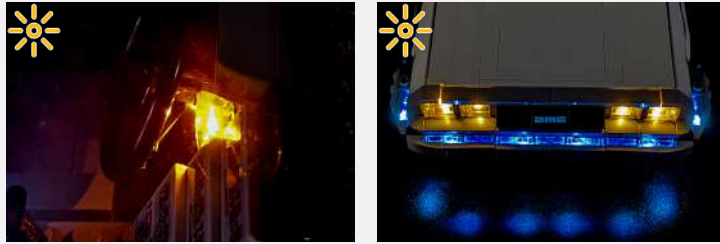

Continue onto Step 31 if you wish to light up the wheels for flying mode. These steps will remove the ability for the car to roll freely. If you don't wish to light up the wheels, please skip through to Step 37.

31

Only complete these steps if you wish to light up the wheels for flying mode. These steps will remove the ability for the car to roll freely. If you don't wish to light up the wheels, skip through to step 37.

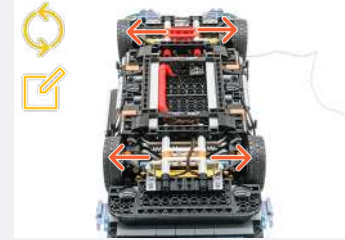

Warm White 30cm Headlight

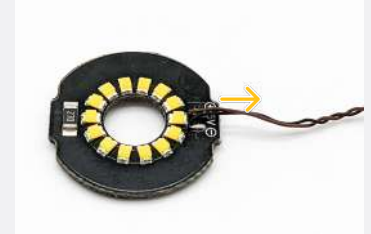

Legend

- DISCONNECT
- CONNECT / RECONNECT
- TURN / FLIP
- DIRECTIONAL
- TWIST / BRAID
- POWER ON TEST
- NOTE ICON

✍ Adhere the Headlight to the non-sticker side of the wheel.

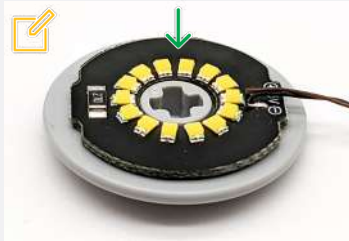

32

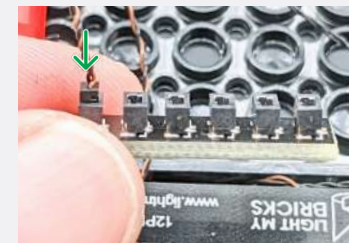
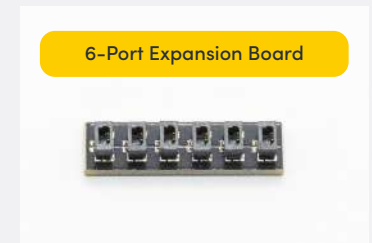

Legend

- DISCONNECT
- CONNECT / RECONNECT
- TURN / FLIP
- DIRECTIONAL
- TWIST / BRAID
- POWER ON TEST
- NOTE ICON

33



34

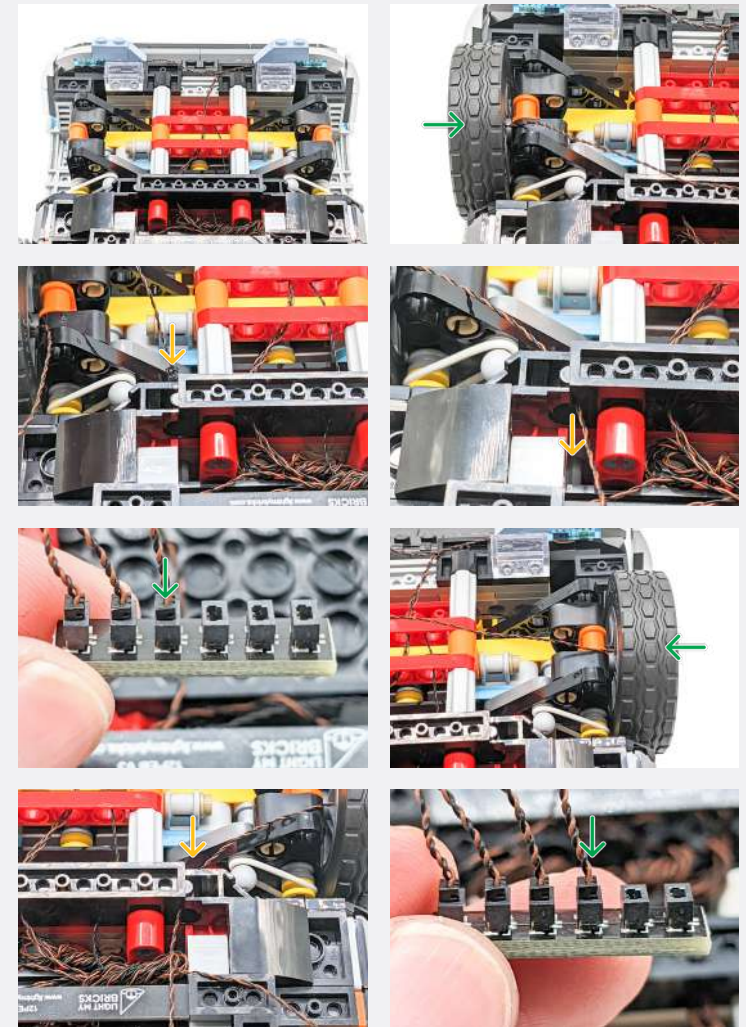

Legend

- DISCONNECT
- CONNECT / RECONNECT
- ↻ TURN / FLIP
- DIRECTIONAL
- ↻↻ TWIST / BRAID
- ✳ POWER ON TEST
- 📝 NOTE ICON

35

5cm Connecting Cable



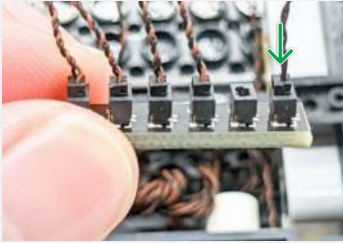



2x Adhesive Squares

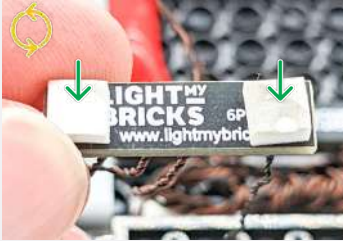













✎ Twist all the cables connected to the 6-Port Expansion Board except the 5cm Connecting Cable.

36

NC Push Board



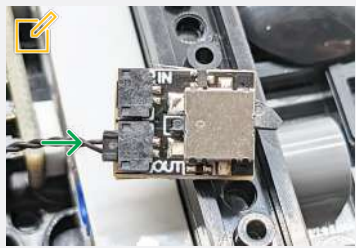

15cm Connecting Cable



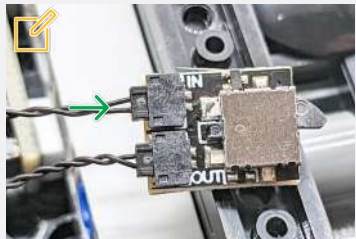

✎ Connect the other end of the 5cm Connecting Cable from step 35 to the "OUT" port on the NC Push Board.

Connect the 15cm Connecting Cable to the "IN" port on the NC Push Board.

Legend

- DISCONNECT
- CONNECT / RECONNECT
- TURN / FLIP
- DIRECTIONAL
- TWIST / BRAID
- POWER ON TEST
- NOTE ICON

📌 If you experience any issues with the lights not working and suspect an issue with a component, please try a different port on the expansion board to verify where the fault lies (with the light or expansion board). To correct any issues with expansion board ports, please view the section addressing expansion board issues in our troubleshooting section.

📌 Adhere the NC Push Board as shown, towards the back of the car.

Connect the other end of the 15cm Connecting Cable to the rear 12-Port Expansion Board from step 12.

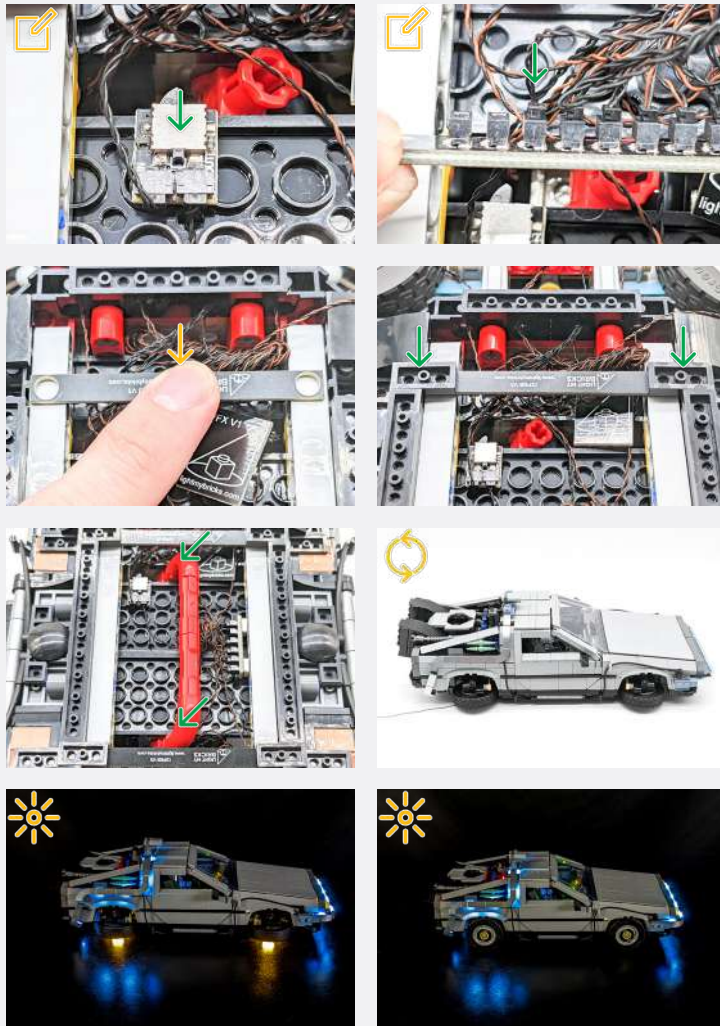

37



Legend → DISCONNECT → CONNECT / RECONNECT ↻ TURN / FLIP → DIRECTIONAL ↻ TWIST / BRAID ✨ POWER ON TEST 📌 NOTE ICON

FINAL PRODUCT

This finally completes installation of the Light My Bricks Back to the Future Time Machine 10300 Light Kit.





TROUBLESHOOTING

Light My Bricks lighting kits contain individual components that are very small and can be easily damaged if not handled correctly.

To prevent unnecessary damage to components, we highly recommend that the User Guide section, **“Important things to note”** is read carefully. Follow the handling procedures in the User Guide to help prevent faults and damages to your Light My Bricks components.

If you are experiencing issues with your Light My Bricks set, watch our troubleshooting video [here](#) or read on for a list of common causes to help you troubleshoot.

Troubleshooting

Firstly, ensure that the batteries have power using a battery charge gauge.

If the batteries have no power, replace the batteries.

If the batteries still have power, check to see if the batteries have been inserted correctly into the battery pack.

Check For CR2032 Batteries Using The Flat Battery Pack

Inside the battery pack is a symbol indicating which side the (round) CR2032 battery should be inserted. Check that the “+” side of the battery pack has the battery with the “+” symbol facing downwards.

On the opposite side, the “-” side of the battery pack should have the battery flipped upside down, that is the “+” symbol facing upwards.

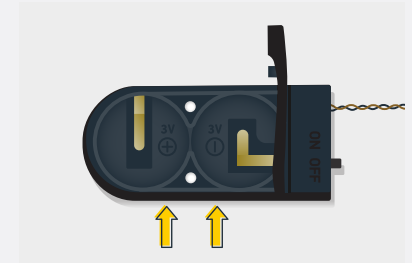

Troubleshooting

Check For Cr2032 Batteries Using The Round Battery Pack

Inside the battery pack is a symbol indicating which side the (round) CR2032 battery should be inserted. In this case, for the stacked battery pack, ensure that BOTH batteries have the “+” symbol facing upwards.

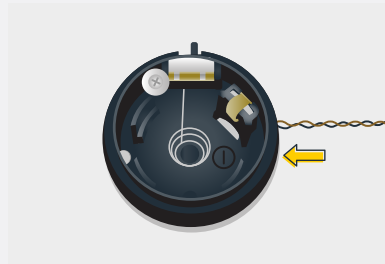

Check for AA batteries using the AA battery pack

Inside the battery pack are symbols indicating which direction the AA battery should be inserted. The flat side of the battery should be paired with the spring side of the battery pack.

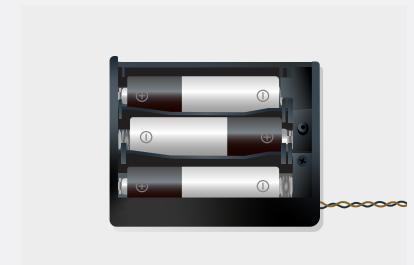
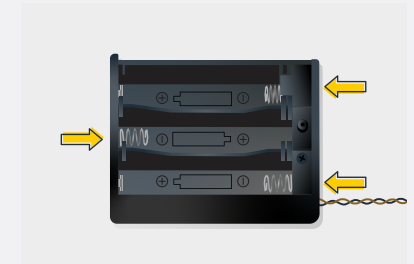

If the batteries have been installed correctly and your kit still isn't operating correctly, the next step is to check the wiring.

Troubleshooting

Check Your Wires

In order for Light My Bricks components to fit in between and underneath LEGO® bricks, the components need to be very small. Due to this nature, Light My Bricks components can be easily damaged when not handled correctly.

Be careful when removing unpacked components out of the packaging and ensure not to forcibly pull at the wires as this can damage the soldering that attach the wires to the LEDs.

If the wiring is detached from the LED itself, the light will not operate.

When connecting lights to your LEGO set, check that there are no pinched wires underneath or in between bricks and plates. When the wires are pinched and the exposed wires are touching each other, this can cause a crosswire and the lights to not function correctly.

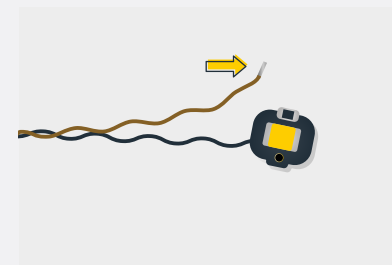
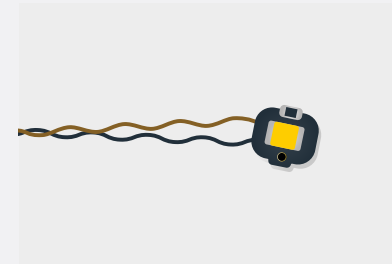

Troubleshooting

Check Your Expansion Board Ports/ Strip Light Ports / Effects Board Ports

It is important to note that connectors can only be inserted to the expansion board, strip light, or effects board ports in one direction.

Forcibly inserting connectors in the incorrect direction will result in damaging the pins inside each of the ports on your component board.

Not only will a light connected to the damaged port not work, but if the pins inside the port are bent to a point they are touching each other, this can result in all other lights in the system to stop working. This is a short circuit.

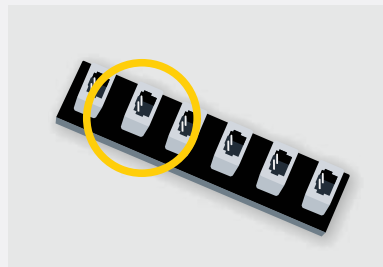

A short circuit can also result in overheating of the board, cable or batteries. If you suspect a short circuit, **DISCONNECT POWER IMMEDIATELY**. Batteries can fail, catch fire, or even explode if left connected to a short circuit for too long.

If you suspect you have a faulty component due to a bent pin, try the following steps:

If you look carefully inside each of the ports, each port contains 2 small pins that should be straight. You will be able to identify a faulty port if it has any bent pins.

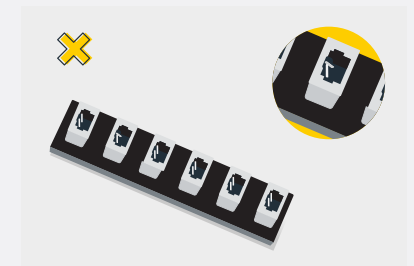
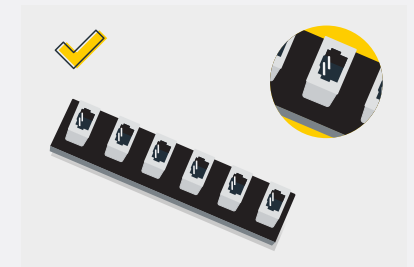
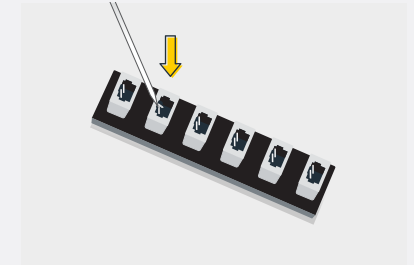



CONTACT US

If you have an enquiry regarding the online shop, our products or a general enquiry please refer to our Frequently Asked Questions webpage here.

Alternatively, you can contact our Customer Services team by visiting our online support portal here.

support.lightmybricks.com

We thank you for purchasing this product and hope you enjoy!



lightmybricks.com